

Resumo Executivo

O Presente Relatório tem como objetivo a incorporação de informações que sejam relevantes para que se possa fazer a devida associação aos dados contidos no corpo do documento objeto da classificação de Situação de Emergência caracterizada pelo Módulo 8 do Prodist, que tem como foco o impacto do evento sobre determinada rede geelétrica e cuja denominação é definida como CHI (Consumidor hora interrompido). O parâmetro para enquadramento nesta classificação de expurgo tem como premissa inicial o limite de Consumidor hora interrompido definido pela fórmula descrita no Módulo 01 do Prodist (Revisão - 9), acrescido de todos os outros informes e dados listados no Módulo 08 (Revisão 10) do Prodist. Este enquadramento se apresenta na maioria das vezes em condições climáticas adversas com severidade dos fatores inerentes a situação, caracterizado na maioria dos casos por fortes ventos e chuvas de grande intensidade e continuidade.

Entre o dia 01/11/2019 – sexta-feira – e a madrugada de 02/11/2019 – sábado- Houve a formação de nuvens de tempestade, do tipo Cumulonimbus, que avançaram sobre o continente e ajudaram a organizar áreas de instabilidade sobre as Regiões da Enel Distribuição Goiás.

Conforme informações do Climatempo Meteorologia, o Instituto Nacional de Meteorologia (INMET) detectou rajadas de vento acima de 50km/h durante o dia 01 de novembro. A máxima rajada registrada foi de 105,1km/h, sendo esse vento classificado como vento tempestade violenta pela escala Beaufort.

Entre as 10h20 do dia 01 e 03h do dia 02 de novembro de 2019 tivemos, em todo o Estado de Goiás, a incidências de 35.944 descargas atmosféricas (10.029 raios nuvem-solo e 25.915 descargas nuvem-nuvem) sobre a região, o que causou grande instabilidade na rede.

Chuva provoca estragos em Caldas Novas - Chuva e ventania duraram cerca de 30 minutos. Casas ficaram destelhadas. Acesso em: <<https://globoplay.globo.com/v/8039450/>>

Relatório de Ocorrências do período

Em todo o Estado de Goiás verificou-se também que a intensidade da chuva e dos ventos danificaram a rede de distribuição de energia elétrica em diversos pontos, registrando aproximadamente 130 mil clientes com interrupção no fornecimento de energia elétrica devido a eventos relacionados ao temporal.

Para otimizar o volume de atendimentos e reduzir os tempos de interrupção foram mobilizados os recursos extras da empresa que aumentou o contingente em relação a situação normal de operação. O acompanhamento da quantidade de equipes e o Tempo Médio de Atendimento podem ser consultados na Pág.02 do Relatório em anexo.

O impacto e severidade do evento estão relatados em artigos de mídia, como fotos e reportagens que demonstram os danos na Rede de Distribuição, oriundos dos eventos climáticos no período. Eventos estes que afetaram 129.991 consumidores com CHI de 762.912,92 superior ao de 482.391,86 estabelecido como limite para definição de Situação de Emergência, conforme resumo das informações obrigatórias.

Empresa	ENEL DISTRIBUIÇÃO GOIÁS		
Código do Relatório	CHI-018 - ENEL DISTRIBUIÇÃO GOIÁS		
Evento:	TEMPORAL NA AREA DE CONCESSÃO DA ENEL DISTRIBUIÇÃO GOIAS		
Código COBRADE:	1.3.2.1.2 e 1.3.2.1.5	Data Inicio	01/11/2019
			Hora início
			10h20
Código do Evento:	CHI-018-ENEL GO	Data Término	02/11/2019
			Hora Término
			08h59
Valor CHI (Limite e Real)	482.391,86	762.912,92	
Código do Decreto (Se Houver):			
Quantidade de Interrupções (Evento)	1315		
Início 1ª Incidência (Data e Hora)	01/11/2019 10:51:48	Subestações Atingidas	ABADIANIA / ACREUNA / ADELANDIA / AEROPORTO / AGUA LIMPA (MARZAGAO) / ALEXANIA / ALOANDIA / ALTO BURITI / AMORINOPOLIS / ANAPOLIS UNIVERSITARIA / ANHANGUERA / ANICUNS / ANTONIO DO VITTO / APARECIDA DO RIO DOCE / APORE / ARACU / ARAGARCAS / ARAGOIANIA / ARUANA / ATLANTICO / AURILANDIA / AVELINOPOLIS / BACURI (RIO VERDE) / BARRO ALTO / BELA VISTA (TRANSMISSAO) / BOA VISTA / BOM JARDIM / BOM JESUS DE GOIAS / BONFINOPOLIS / BONOPOLIS / BRAZABRANTES / BRITANIA / BURITI ALEGRE / BURITI DE GOIAS / CABRIUVA (RIO VERDE) / CACHOEIRA ALTA / CACHOEIRA DOURADA / CACHOEIRA NOVA / CACHOEIRINHA (ITARUMA) / CACU / CAIAPONIA / CALCILANDIA / CALDAS NOVAS / CAMPESTRE / CAMPINAS / CAMPINORTE / CAMPO ALEGRE DE GOIAS / CAMPO LIMPO DE GOIAS / CAMPO NOVO / CARAIBAS / CARAJAS / CASTELANDIA / CATALAO / CATURAI / CEBRASA FABRICA DA AMBEV / CEPAIGO / CEZARINA / COCALZINHO / CORUMBA / CRISTIANOPOLIS / CRIXAS / CROMINIA / DAIA - ANAPOLIS / DAMOLANDIA / DAVINOPOLIS / DIMIC / DOVERLANDIA / EDEALINA / EDEIA / ENERSUL / FAINA / FAZENDA CANADA / FERROVIARIO / FIRMINOPOLIS / FLORES DE GOIAS / FORMIGA / GOIANAPOLIS / GOIANDIRA / GOIANESIA / GOIANIA LESTE / GOIANIRA / GOIAS / GOIATUBA / GOUVERLANDIA / GOYA / GUAPU / HEITORAI / HIDROLANDIA / IACIARA / INACIOLANDIA / INDEPENDENCIA / INDIARA / INHUMAS / IPAMERI / IPEGUARI / IPORA / ITABERAI / ITAJA / ITAPACI (TRANSMISSAO) / ITAPIRAPUA / ITAPURANGA / ITAPURANGA (TRANSMISSAO) / ITARUMA / ITAUCU / ITIQUIRA (FORMOSA) / ITUMBIARA NOVA / ITUMBIARA VELHA / JACILANDIA / JANDAIA / JARAGUA / JARANAPOLIS / JATAI / JOVIANIA / JUNDIAI / JUSCELANDIA / JUSSARA / LAGOA DO BAUZINHO (RIO VERDE) / LEOPOLDO DE BULHOES / MAIRIPOTABA / MARA ROSA / MARIANOPOLIS / MATO GRANDE / MATRINCHA / MAURILANDIA / MEIA PONTE / MINACU / MINEIROS / MOIPORA / MONTE ALEGRE / MONTES CLAROS DE GOIAS / MONTIVIDIU T / MOSSAMEDES / MUTUNOPOLIS / NAVESLANDIA (JATAI) / NAZARIO / NEROPOLIS / NIQUELANDIA / NOVA AURORA / NOVA CRIXAS (TRANSMISSAO) / NOVA IGUACU / NOVA VENEZA / NOVO BRASIL / NOVO PLANALTO / OLOANA / ORIZONA / OUVIDOR / PALESTINA / PALMEIRAS DE GOIAS / PALMELO / PALMINOPOLIS / PANAMA / PARANAIBA / PARANAIGUARA / PARAUNA SE ALTA TENSAO / PARQUE DAS EMAS (MINEIROS) / PEROLANDIA / PETROLINA / PILAR / PIRACANJUBA / PIRANHAS T / PIRENOPOLIS / PIRES DO RIO / PLANALTINA / PLANALTINA (TRANSMISSAO) / PONTALINA / PORANGATU / PORTEIRAO / PORTELANDIA / PORTO SAO SIMAO / QUEBRA LINHA / QUIRINOPOLIS / REAL / RETIRO / GOIAS / RIO CLARO / JATAI MONTIVIDIU / RIO PRETO / RIO VERDE / RIVERLANDIA (RIO VERDE) / ROCHEDO (UEH) / RUBIATABA / SANCLERLANDIA / SANTA BARBARA / SANTA FE DE GOIAS / SANTA HELENA / SANTA RITA DO ARAGUAIA / SANTA ROSA DO MEIA PONTE / SANTA TEREZA DE GOIAS / SANTO ANTONIO DA BARRA / SANTO ANTONIO DO DESCOBERTO / SAO DOMINGOS / SAO JOAO D ALIANCA / SAO JOAO DA PARAUNA / SAO LUIZ DOS MONTES BELOS / SAO MIGUEL DO ARAGUAIA / SAO MIGUEL DO PASSA QUATRO / SENADOR CANEDO TRANSMISSAO / SERRA AZUL (JATAI) / SERRA DE CALDAS / SERRANOPOLIS / SUCURI / TAIOBA / TAQUARI / TEREZOPOLIS / TRES RANCHOS / TRINDADE / TURVANIA / URU / URUACU / URUTAI / VARJAO / VIANOPOLIS / VICENTINOPOLIS / VILA CORUMBA / VILA PROPICIO / XAVANTES
Início Ultima Incidência (Data e Hora)	02/11/2019 08:54:04		
Média de Duração das Incidências (h)	18,77		
Duração da Incidência mais longa (h)	168,79		
Total de Clientes afetados	129.992	Municípios Atingidos	ABADIA DE GOIAS / ABADIANIA / ACREUNA / AGUA FRIA DE GOIAS / AGUA LIMPA / ALEXANIA / ALOANDIA / ALTO HORIZONTE / ALTO PARAISO DE GOIAS / AMARALINA / AMORINOPOLIS / ANAPOLIS / ANICUNS / APARECIDA DE GOIANIA / APARECIDA DO RIO DOCE / APORE / ARACU / ARAGARCAS / ARAGOIANIA / ARUANA / AURILANDIA / AVELINOPOLIS / BALIZA / BARRO ALTO / BELA VISTA DE GOIAS / BOM JARDIM DE GOIAS / BOM JESUS DE GOIAS / BONFINOPOLIS / BONOPOLIS / BRAZABRANTES / BRITANIA / BURITI ALEGRE / BURITI DE GOIAS / CACHOEIRA ALTA / CACHOEIRA DOURADA / CACU / CAIAPONIA / CALDAS NOVAS / CALDAZINHA / CAMPESTRE DE GOIAS / CAMPINORTE / CAMPO ALEGRE DE GOIAS / CAMPO LIMPO / CASTELANDIA / CATALAO / CATURAI / CAVALCANTE / CEZARINA / COCALZINHO DE GOIAS / CORREGO DO OURO / CORUMBA DE GOIAS / CORUMBAIBA / CRISTIANOPOLIS / CRIXAS / CROMINIA / DAMOLANDIA / DAVINOPOLIS / DISTRITO FEDERAL / DIVINOPOLIS DE GOIAS / DOVERLANDIA / EDEALINA / EDEIA / FAINA / FIRMINOPOLIS / FLORES DE GOIAS / FORMOSA / GAMELEIRA DE GOIAS / GOIANAPOLIS / GOIANDIRA / GOIANESIA / GOIANIA / GOIANIRA / GOIAS / GOIATUBA / GOUVERLANDIA

		/ GUAPO / HEITORAI / HIDROLANDIA / HIDROLINA / IACIARA / INACIOLANDIA / INDIARA / INHUMAS / IPAMERI / IPORA / ITABERAI / ITAJA / ITAPIRAPUA / ITAPURANGA / ITARUMA / ITAUCU / ITUMBIARA / IVOLANDIA / JANDAIA / JARAGUA / JATAI / JOVIANIA / JUSSARA / LAGOA SANTA / LEOPOLDO DE BULHOES / LUZIANIA / MAIRIPOTABA / MAURILANDIA / MIMOSO DE GOIAS / MINACU / MINEIROS / MOIPORA / MONTE ALEGRE DE GOIAS / MONTES CLAROS DE GOIAS / MONTIVIDIU / MORRINHOS / MOSSAMEDES / MUTUNOPOLIS / NAZARIO / NEROPOLIS / NIQUELANDIA / NOVA AMERICA / NOVA AURORA / NOVA CRIXAS / NOVA VENEZA / NOVO BRASIL / NOVO PLANALTO / ORIZONA / OURO VERDE DE GOIAS / OUVIDOR / PADRE BERNARDO / PALESTINA DE GOIAS / PALMEIRAS DE GOIAS / PALMINOPOLIS / PANAMA / PARANAIGUARA / PARAUNA / PEROLANDIA / PETROLINA DE GOIAS / PILAR DE GOIAS / PIRACANJUBA / PIRANHAS / PIRENOPOLIS / PIRES DO RIO / PLANALTINA / PONTALINA / PORANGATU / PORTEIRAO / PORTELANDIA / PROFESSOR JAMIL SAFADY / QUIRINOPOLIS / RIO QUENTE / RIO VERDE / RUBIATABA / SANCLERLANDIA / SANTA BARBARA DE GOIAS / SANTA CRUZ DE GOIAS / SANTA FE DE GOIAS / SANTA HELENA DE GOIAS / SANTA RITA DO ARAGUAIA / SANTA RITA DO NOVO DESTINO / SANTA TEREZA DE GOIAS / SANTO ANTONIO DA BARRA / SANTO ANTONIO DO DESCOBERTO / SAO LUIS DE MONTES BELOS / SAO LUIZ DO NORTE / SAO MIGUEL DO ARAGUAIA / SAO MIGUEL DO PASSA QUATRO / SAO SIMAO / SENADOR CANEDO / SERRANOPOLIS / SILVANIA / TAQUARAL DE GOIAS / TERESINA DE GOIAS / TEREZOPOLIS DE GOIAS / TRES RANCHOS / TRINDADE / TURVANIA / TURVELANDIA / URUACU / URUTAI / VARJAO / VIANOPOLIS / VICENTINOPOLIS / VILA BOA / VILA PROPICIO
--	--	--

DANOS CAUSADOS			
Equipamentos Danificado	Importância para o Sistema	Local	Quantidade
Disjuntor/Religador Operado	Proteção do Alimentador	Área de Concessão	40
Chaves Fusíveis Operada	Proteção de Ramais de Alimentadores	Área de Concessão	356
Transformador Operado	Proteção do Transformador	Área de Concessão	365

Relato técnico sobre a Intervenção realizada em Goiânia e Região Metropolitana			
Informações sobre Equipes	01/11	02/11	
Quantidade Usual	530	530	turmas
Quantidade Adicional	6	0	turmas
Quantidade Total	536	440	turmas
Tempos Médios			
Preparação	16,97	15,10	Horas
Deslocamento	0,69	0,69	Horas
Execução	2,28	2,18	Horas
TMAE	19,93	17,96	Horas

Principais Dificuldades Encontradas:

Chuvas com ventos fortes provocaram muitos pontos de alagamento e enxurrada, trânsito impedido por vários semáforos desligados dificultando a chegada ao atendimento das ocorrências emergenciais. Em determinadas regiões, decorrente dos fortes ventos, houve o tombamento de árvores nas estruturas de alimentação de média tensão, danos em ramais de ligação dos clientes, impedimentos de acesso e atolamentos em estradas rurais.

Empresa	ENEL DISTRIBUIÇÃO GOIAS		
Valor CHI (Limite e Real)	482.391,86		762.912,92

DOC ORIGEM	MIUNICIPIO	EQP_ORIGEM	CONJUNTO	INI_OCORRENC	FIM_OCORRENC	DT_INI_EVENTO	DT_FIM_EVENTO	DURAÇ	UC INT	CHI	EXPURGO
20191186	JATAI	JT12184049	JATAI S1	01/11/2019 15:20	10/11/2019 09:23	01/11/2019 17:56	01/11/2019 18:07	0,18	56	10,17	CHI
20191186	JATAI	JT12184049	JATAI S1	01/11/2019 15:20	10/11/2019 09:23	01/11/2019 17:56	01/11/2019 18:07	0,18	39	7,09	CHI
20191186	SERRANOPOLIS	JT12184049	JATAI S1	01/11/2019 15:20	10/11/2019 09:23	01/11/2019 17:56	01/11/2019 18:07	0,18	10	1,82	CHI
20191186	JATAI	SX12264387	JATAI S1	01/11/2019 15:20	10/11/2019 09:23	01/11/2019 15:20	02/11/2019 22:36	31,26	7	218,84	CHI
20191186	SERRANOPOLIS	SX12264387	JATAI S1	01/11/2019 15:20	10/11/2019 09:23	01/11/2019 15:20	02/11/2019 22:36	31,26	22	687,78	CHI
20191186	JATAI	SX12264387	JATAI S1	01/11/2019 15:20	10/11/2019 09:23	02/11/2019 22:37	03/11/2019 16:15	17,64	7	123,47	CHI
20191186	SERRANOPOLIS	SX12264387	JATAI S1	01/11/2019 15:20	10/11/2019 09:23	02/11/2019 22:37	03/11/2019 16:15	17,64	3	52,91	CHI
20191186	SERRANOPOLIS	SX13337014	JATAI S1	01/11/2019 15:20	10/11/2019 09:23	02/11/2019 22:37	04/11/2019 11:09	36,53	7	255,74	CHI
20191186	JATAI	JT12184049	JATAI S1	01/11/2019 15:20	10/11/2019 09:23	05/11/2019 17:01	07/11/2019 01:26	32,41	5	162,07	CHI
20191186	JATAI	JT12184049	JATAI S1	01/11/2019 15:20	10/11/2019 09:23	06/11/2019 23:10	07/11/2019 01:26	2,26	1	2,26	CHI
20191186	JATAI	JT12184049	JATAI S1	01/11/2019 15:20	10/11/2019 09:23	05/11/2019 17:01	07/11/2019 12:16	43,25	2	86,50	CHI
20191186	JATAI	JT13337010	JATAI S1	01/11/2019 15:20	10/11/2019 09:23	06/11/2019 23:10	07/11/2019 12:16	13,10	1	13,10	CHI
20191186	JATAI	JT12184049	JATAI S1	01/11/2019 15:20	10/11/2019 09:23	05/11/2019 17:01	07/11/2019 21:56	52,93	14	740,97	CHI
20191186	JATAI	JT12184049	JATAI S1	01/11/2019 15:20	10/11/2019 09:23	06/11/2019 13:02	07/11/2019 21:56	32,90	4	131,59	CHI
20191186	JATAI	JT12184049	JATAI S1	01/11/2019 15:20	10/11/2019 09:23	05/11/2019 17:01	07/11/2019 23:30	54,48	12	653,77	CHI
20191186	JATAI	JT12184049	JATAI S1	01/11/2019 15:20	10/11/2019 09:23	06/11/2019 13:02	07/11/2019 23:30	34,45	2	68,90	CHI
20191186	JATAI	01030404	JATAI S1	01/11/2019 15:20	10/11/2019 09:23	07/11/2019 23:22	07/11/2019 23:30	0,13	340	43,44	CHI
20191186	PEROLANDIA	01030404	JATAI S1	01/11/2019 15:20	10/11/2019 09:23	07/11/2019 23:22	07/11/2019 23:30	0,13	3	0,38	CHI
20191186	SERRANOPOLIS	01030404	JATAI S1	01/11/2019 15:20	10/11/2019 09:23	07/11/2019 23:22	07/11/2019 23:30	0,13	6	0,77	CHI
20191186	JATAI	JT12184049	JATAI S1	01/11/2019 15:20	10/11/2019 09:23	05/11/2019 17:01	08/11/2019 01:16	56,25	4	225,00	CHI
20191186	JATAI	JT12184049	JATAI S1	01/11/2019 15:20	10/11/2019 09:23	06/11/2019 11:13	08/11/2019 01:16	38,04	4	152,16	CHI
20191186	JATAI	JT13264279	JATAI S1	01/11/2019 15:20	10/11/2019 09:23	06/11/2019 13:02	08/11/2019 01:16	36,22	1	36,22	CHI
20191186	JATAI	JT12184049	JATAI S1	01/11/2019 15:20	10/11/2019 09:23	08/11/2019 09:49	08/11/2019 10:09	0,33	36	11,88	CHI
20191186	JATAI	JT12184049	JATAI S1	01/11/2019 15:20	10/11/2019 09:23	08/11/2019 09:49	08/11/2019 10:09	0,33	14	4,62	CHI
20191186	JATAI	JT12184049	JATAI S1	01/11/2019 15:20	10/11/2019 09:23	08/11/2019 10:26	08/11/2019 11:00	0,57	13	7,47	CHI
20191186	JATAI	JT12184049	JATAI S1	01/11/2019 15:20	10/11/2019 09:23	08/11/2019 10:26	08/11/2019 11:00	0,57	14	8,05	CHI
20191186	JATAI	JT12184049	JATAI S1	01/11/2019 15:20	10/11/2019 09:23	08/11/2019 11:05	08/11/2019 11:59	0,89	13	11,57	CHI
20191186	JATAI	JT13264275	JATAI S1	01/11/2019 15:20	10/11/2019 09:23	08/11/2019 10:26	08/11/2019 12:30	2,07	23	47,50	CHI
20191186	JATAI	JT12184049	JATAI S1	01/11/2019 15:20	10/11/2019 09:23	05/11/2019 17:01	08/11/2019 13:40	68,65	12	823,82	CHI
20191186	SERRANOPOLIS	JT12184049	JATAI S1	01/11/2019 15:20	10/11/2019 09:23	05/11/2019 17:01	08/11/2019 13:40	68,65	1	68,65	CHI
20191186	JATAI	JT13241743	JATAI S1	01/11/2019 15:20	10/11/2019 09:23	06/11/2019 13:02	08/11/2019 13:40	48,62	2	97,24	CHI
20191186	SERRANOPOLIS	JT13274084	JATAI S1	01/11/2019 15:20	10/11/2019 09:23	02/11/2019 22:37	08/11/2019 19:14	140,62	12	1687,40	CHI

20191186	JATAI	JT12184049	JATAI S1	01/11/2019 15:20	10/11/2019 09:23	05/11/2019 17:01	08/11/2019 19:14	74,21	13	964,77	CHI
20191186	SERRANOPOLIS	JT12184049	JATAI S1	01/11/2019 15:20	10/11/2019 09:23	05/11/2019 17:01	08/11/2019 19:14	74,21	19	1410,05	CHI
20191186	JATAI	JT13274084	JATAI S1	01/11/2019 15:20	10/11/2019 09:23	06/11/2019 13:02	08/11/2019 19:14	54,18	1	54,18	CHI
20191186	JATAI	JT12184049	JATAI S1	01/11/2019 15:20	10/11/2019 09:23	05/11/2019 17:01	09/11/2019 00:23	79,37	8	634,99	CHI
20191186	JATAI	JT12184049	JATAI S1	01/11/2019 15:20	10/11/2019 09:23	06/11/2019 11:13	09/11/2019 00:23	61,16	17	1039,74	CHI
20191186	JATAI	JT12184049	JATAI S1	01/11/2019 15:20	10/11/2019 09:23	06/11/2019 13:02	09/11/2019 00:23	59,34	2	118,69	CHI
20191186	JATAI	JT13248376	JATAI S1	01/11/2019 15:20	10/11/2019 09:23	08/11/2019 11:05	10/11/2019 09:23	46,30	14	648,19	CHI
201911342	ITUMBIARA	IT12296778	ITUMBIARA VELHA S1	01/11/2019 16:59	04/11/2019 12:49	01/11/2019 16:59	04/11/2019 12:49	67,85	5	339,24	CHI
2019111642	SERRANOPOLIS	SX12166082	JATAI S1	01/11/2019 12:42	02/11/2019 09:44	01/11/2019 12:42	02/11/2019 09:44	21,03	19	399,57	CHI
2019111699	VILA BOA	FA21042057	ITUIQUIRA	01/11/2019 10:51	01/11/2019 11:52	01/11/2019 10:51	01/11/2019 11:52	1,00	1	1,00	CHI
2019111734	FAINA	GS12189948	GOIAS	01/11/2019 17:23	02/11/2019 22:09	01/11/2019 17:23	02/11/2019 22:09	28,75	11	316,27	CHI
2019111756	PANAMA	PX12102033	GOIATUBA S1	01/11/2019 17:23	02/11/2019 10:28	01/11/2019 17:23	02/11/2019 10:28	17,08	210	3586,04	CHI
2019111760	PIRACANJUBA	10020629352	PIRACANJUBA	01/11/2019 11:04	01/11/2019 16:56	01/11/2019 11:04	01/11/2019 16:56	5,87	1	5,87	CHI
2019111790	ITUMBIARA	10022152200	ITUMBIARA VELHA S1	01/11/2019 11:11	01/11/2019 13:32	01/11/2019 11:11	01/11/2019 13:32	2,34	1	2,34	CHI
2019111874	CAMPINORTE	CR21142235	CAMPINORTE	01/11/2019 14:40	01/11/2019 19:15	01/11/2019 14:40	01/11/2019 19:15	4,58	1	4,58	CHI
2019111876	CAMPINORTE	10003405387	CAMPINORTE	01/11/2019 15:23	01/11/2019 22:22	01/11/2019 15:23	01/11/2019 22:22	6,98	1	6,98	CHI
2019111888	APARECIDA DE GOIANIA	AP10402671	INDEPENDENCIA S2	01/11/2019 16:25	01/11/2019 18:05	01/11/2019 16:33	01/11/2019 17:55	1,36	1322	1794,25	CHI
2019111888	APARECIDA DE GOIANIA	AP12164415LD	INDEPENDENCIA S2	01/11/2019 16:25	01/11/2019 18:05	01/11/2019 16:33	01/11/2019 18:05	1,54	443	681,36	CHI
2019111890	CASTELANDIA	01560234	QUIRINOPOLIS	01/11/2019 16:48	02/11/2019 17:33	01/11/2019 16:48	01/11/2019 19:22	2,57	20	51,37	CHI
2019111890	GOUVELANDIA	01560234	QUIRINOPOLIS	01/11/2019 16:48	02/11/2019 17:33	01/11/2019 16:48	01/11/2019 19:22	2,57	2	5,14	CHI
2019111890	QUIRINOPOLIS	01560234	QUIRINOPOLIS	01/11/2019 16:48	02/11/2019 17:33	01/11/2019 16:48	01/11/2019 19:22	2,57	471	1209,69	CHI
2019111890	RIO VERDE	01560234	QUIRINOPOLIS	01/11/2019 16:48	02/11/2019 17:33	01/11/2019 16:48	01/11/2019 19:22	2,57	1	2,57	CHI
2019111890	GOUVELANDIA	01560234	QUIRINOPOLIS	01/11/2019 16:48	02/11/2019 17:33	01/11/2019 16:48	01/11/2019 20:36	3,81	215	818,31	CHI
2019111890	QUIRINOPOLIS	01560234	QUIRINOPOLIS	01/11/2019 16:48	02/11/2019 17:33	01/11/2019 16:48	01/11/2019 20:36	3,81	272	1035,26	CHI
2019111890	GOUVELANDIA	01560234	QUIRINOPOLIS	01/11/2019 16:48	02/11/2019 17:33	01/11/2019 16:48	01/11/2019 22:12	5,40	40	216,08	CHI
2019111890	QUIRINOPOLIS	01560234	QUIRINOPOLIS	01/11/2019 16:48	02/11/2019 17:33	01/11/2019 16:48	01/11/2019 22:12	5,40	13	70,23	CHI
2019111890	QUIRINOPOLIS	01560234	QUIRINOPOLIS	01/11/2019 16:48	02/11/2019 17:33	01/11/2019 16:48	01/11/2019 23:17	6,49	16	103,78	CHI
2019111890	CASTELANDIA	01560234	QUIRINOPOLIS	01/11/2019 16:48	02/11/2019 17:33	01/11/2019 22:52	01/11/2019 23:17	0,41	20	8,26	CHI
2019111890	GOUVELANDIA	01560234	QUIRINOPOLIS	01/11/2019 16:48	02/11/2019 17:33	01/11/2019 22:52	01/11/2019 23:17	0,41	257	106,16	CHI
2019111890	QUIRINOPOLIS	01560234	QUIRINOPOLIS	01/11/2019 16:48	02/11/2019 17:33	01/11/2019 22:52	01/11/2019 23:17	0,41	756	312,27	CHI
2019111890	RIO VERDE	01560234	QUIRINOPOLIS	01/11/2019 16:48	02/11/2019 17:33	01/11/2019 22:52	01/11/2019 23:17	0,41	1	0,41	CHI
2019111890	CASTELANDIA	01560234	QUIRINOPOLIS	01/11/2019 16:48	02/11/2019 17:33	02/11/2019 00:07	02/11/2019 01:13	1,11	20	22,22	CHI
2019111890	GOUVELANDIA	01560234	QUIRINOPOLIS	01/11/2019 16:48	02/11/2019 17:33	02/11/2019 00:07	02/11/2019 01:13	1,11	257	285,48	CHI

2019111890	QUIRINOPOLIS	01560234	QUIRINOPOLIS	01/11/2019 16:48	02/11/2019 17:33	02/11/2019 00:07	02/11/2019 01:13	1,11	773	858,67	CHI
2019111890	RIO VERDE	01560234	QUIRINOPOLIS	01/11/2019 16:48	02/11/2019 17:33	02/11/2019 00:07	02/11/2019 01:13	1,11	1	1,11	CHI
2019111890	GOUVELANDIA	01560234	QUIRINOPOLIS	01/11/2019 16:48	02/11/2019 17:33	01/11/2019 16:48	02/11/2019 16:27	23,65	9	212,85	CHI
2019111890	GOUVELANDIA	01560234	QUIRINOPOLIS	01/11/2019 16:48	02/11/2019 17:33	01/11/2019 16:48	02/11/2019 17:33	24,76	50	1237,94	CHI
2019111902	ITUMBIARA	690031221	ITUMBIARA VELHA S1	01/11/2019 11:13	01/11/2019 14:59	01/11/2019 11:13	01/11/2019 14:59	3,75	1	3,75	CHI
2019111920	MAIRIPOTABA	MI21244379	PONTALINA	01/11/2019 14:18	02/11/2019 17:30	01/11/2019 14:18	02/11/2019 17:30	27,20	1	27,20	CHI
2019111923	CAVALCANTE	CJ11380471	SAO DOMINGOS	01/11/2019 11:17	02/11/2019 11:09	01/11/2019 11:17	02/11/2019 11:09	23,85	1	23,85	CHI
2019111946	PIRES DO RIO	PR21195228	PIRES DO RIO S1	01/11/2019 11:22	02/11/2019 00:35	01/11/2019 11:22	02/11/2019 00:35	13,21	1	13,21	CHI
2019111953	FORMOSA	FA12245346	ITUIQUIRA	01/11/2019 11:19	01/11/2019 12:51	01/11/2019 11:19	01/11/2019 12:51	1,52	3	4,55	CHI
2019111979	FLORES DE GOIAS	IA12046295	IACIARA S2	01/11/2019 11:32	01/11/2019 13:39	01/11/2019 11:32	01/11/2019 13:39	2,10	1	2,10	CHI
2019111979	IACIARA	IA12046295	IACIARA S2	01/11/2019 11:32	01/11/2019 13:39	01/11/2019 11:32	01/11/2019 13:39	2,10	58	122,07	CHI
2019112013	CATALAO	CT12042362	CATALAO S1	01/11/2019 11:42	01/11/2019 16:19	01/11/2019 11:42	01/11/2019 16:19	4,61	1	4,61	CHI
2019112013	GOIANDIRA	CT12042362	CATALAO S1	01/11/2019 11:42	01/11/2019 16:19	01/11/2019 11:42	01/11/2019 16:19	4,61	1	4,61	CHI
2019112015	GOIAS	02270224	ITABERAI S1	01/11/2019 15:30	02/11/2019 12:47	01/11/2019 15:30	02/11/2019 10:18	18,78	44	826,48	CHI
2019112015	ITABERAI	02270224	ITABERAI S1	01/11/2019 15:30	02/11/2019 12:47	01/11/2019 15:30	02/11/2019 10:18	18,78	27	507,16	CHI
2019112015	GOIAS	02270224	ITABERAI S1	01/11/2019 15:30	02/11/2019 12:47	01/11/2019 15:30	02/11/2019 10:54	19,38	29	562,13	CHI
2019112015	GOIAS	02270224	ITABERAI S1	01/11/2019 15:30	02/11/2019 12:47	01/11/2019 15:30	02/11/2019 12:47	21,27	2	42,53	CHI
2019112058	CATALAO	CT12389880	CATALAO S1	01/11/2019 11:53	02/11/2019 11:56	01/11/2019 11:53	02/11/2019 11:56	24,04	2	48,09	CHI
2019112088	CATALAO	CT12266142RE	CATALAO S1	01/11/2019 19:15	02/11/2019 09:11	01/11/2019 19:15	02/11/2019 09:11	13,93	108	1504,44	CHI
2019112088	GOIANDIRA	CT12266142RE	CATALAO S1	01/11/2019 19:15	02/11/2019 09:11	01/11/2019 19:15	02/11/2019 09:11	13,93	43	598,99	CHI
2019112125	RUBIATABA	780050654	RUBIATABA	01/11/2019 12:03	01/11/2019 20:57	01/11/2019 12:03	01/11/2019 20:57	8,90	1	8,90	CHI
2019112129	PILAR DE GOIAS	GG12341619	URUACU	01/11/2019 12:03	02/11/2019 09:51	01/11/2019 12:03	02/11/2019 09:51	21,79	3	65,37	CHI
2019112136	GOIATUBA	00730214	GOIATUBA S2	01/11/2019 11:46	02/11/2019 19:18	01/11/2019 11:46	01/11/2019 11:49	0,05	5319	289,59	CHI
2019112136	MORRINHOS	00730214	GOIATUBA S2	01/11/2019 11:46	02/11/2019 19:18	01/11/2019 11:46	01/11/2019 11:49	0,05	57	3,10	CHI
2019112136	GOIATUBA	GT13000011	GOIATUBA S2	01/11/2019 11:46	02/11/2019 19:18	01/11/2019 11:53	01/11/2019 17:26	5,56	1830	10168,70	CHI
2019112136	GOIATUBA	00730214	GOIATUBA S2	01/11/2019 11:46	02/11/2019 19:18	01/11/2019 11:53	01/11/2019 18:03	6,18	462	2854,78	CHI
2019112136	GOIATUBA	GT13000010	GOIATUBA S2	01/11/2019 11:46	02/11/2019 19:18	01/11/2019 11:53	01/11/2019 19:15	7,37	1576	11608,99	CHI
2019112136	GOIATUBA	00730244	GOIATUBA S2	01/11/2019 11:46	02/11/2019 19:18	01/11/2019 11:49	01/11/2019 19:50	8,02	125	1003,09	CHI
2019112136	GOIATUBA	GT11000004	GOIATUBA S2	01/11/2019 11:46	02/11/2019 19:18	01/11/2019 11:53	01/11/2019 20:36	8,72	91	793,70	CHI
2019112136	GOIATUBA	GT13000006	GOIATUBA S2	01/11/2019 11:46	02/11/2019 19:18	01/11/2019 11:53	01/11/2019 21:23	9,51	1310	12453,73	CHI
2019112136	GOIATUBA	00730244	GOIATUBA S2	01/11/2019 11:46	02/11/2019 19:18	01/11/2019 21:43	01/11/2019 21:53	0,16	125	19,62	CHI
2019112136	GOIATUBA	GT10400352	GOIATUBA S2	01/11/2019 11:46	02/11/2019 19:18	01/11/2019 11:53	01/11/2019 23:10	11,30	19	214,67	CHI
2019112136	MORRINHOS	GT10400352	GOIATUBA S2	01/11/2019 11:46	02/11/2019 19:18	01/11/2019 11:53	01/11/2019 23:10	11,30	45	508,44	CHI

2019112136	GOIATUBA	00730244	GOIATUBA S2	01/11/2019 11:46	02/11/2019 19:18	01/11/2019 11:49	02/11/2019 17:34	29,76	14	416,62	CHI
2019112136	BURITI ALEGRE	00730244	GOIATUBA S2	01/11/2019 11:46	02/11/2019 19:18	01/11/2019 11:49	02/11/2019 17:52	30,05	29	871,56	CHI
2019112136	GOIATUBA	00730244	GOIATUBA S2	01/11/2019 11:46	02/11/2019 19:18	01/11/2019 11:49	02/11/2019 17:52	30,05	234	7032,61	CHI
2019112136	MORRINHOS	00730244	GOIATUBA S2	01/11/2019 11:46	02/11/2019 19:18	01/11/2019 11:49	02/11/2019 17:52	30,05	26	781,40	CHI
2019112136	GOIATUBA	00730244	GOIATUBA S2	01/11/2019 11:46	02/11/2019 19:18	01/11/2019 15:37	02/11/2019 17:52	26,25	5	131,24	CHI
2019112136	GOIATUBA	00730244	GOIATUBA S2	01/11/2019 11:46	02/11/2019 19:18	01/11/2019 11:49	02/11/2019 18:54	31,09	2	62,18	CHI
2019112136	MORRINHOS	8542358	GOIATUBA S2	01/11/2019 11:46	02/11/2019 19:18	01/11/2019 11:53	02/11/2019 19:18	31,42	1	31,42	CHI
2019112155	AMARALINA	LC12182428	MARA ROSA	01/11/2019 12:09	03/11/2019 16:36	01/11/2019 12:09	03/11/2019 16:17	52,12	3	156,37	CHI
2019112155	AMARALINA	LC21313411	MARA ROSA	01/11/2019 12:09	03/11/2019 16:36	01/11/2019 12:09	03/11/2019 16:36	52,45	1	52,45	CHI
2019112178	PALMEIRAS DE GOIAS	PL21000228	PALMEIRAS	01/11/2019 12:15	04/11/2019 14:02	01/11/2019 12:15	04/11/2019 14:02	73,79	1	73,79	CHI
2019112182	PORANGATU	PO12208614	PORANGATU	01/11/2019 12:16	01/11/2019 15:15	01/11/2019 12:16	01/11/2019 15:15	2,98	9	26,82	CHI
2019112190	CRIXAS	CX21102890	SERRA DO OURO	01/11/2019 12:17	03/11/2019 22:25	01/11/2019 12:17	03/11/2019 22:25	58,12	1	58,12	CHI
2019112196	URUACU	UR21118029	URUACU	01/11/2019 12:19	02/11/2019 18:11	01/11/2019 12:19	02/11/2019 18:11	29,86	1	29,86	CHI
2019112208	ITAJA	IJ12200688	ITAJA S2	01/11/2019 12:21	01/11/2019 16:46	01/11/2019 12:21	01/11/2019 16:46	4,40	4	17,61	CHI
2019112219	CATALAO	10010157539	CATALAO S2	01/11/2019 12:26	01/11/2019 16:03	01/11/2019 12:26	01/11/2019 16:03	3,62	1	3,62	CHI
2019112227	CAIAPONIA	CP12200873	PALESTINA	01/11/2019 12:28	03/11/2019 10:47	01/11/2019 12:28	03/11/2019 10:47	46,31	54	2500,53	CHI
2019112242	PALMINOPOLIS	PP21083697	PALMEIRAS	01/11/2019 12:30	01/11/2019 15:45	01/11/2019 12:30	01/11/2019 15:45	3,25	1	3,25	CHI
2019112276	RIO VERDE	RV11271697	RIO VERDE S1	01/11/2019 12:30	01/11/2019 16:20	01/11/2019 12:30	01/11/2019 16:20	3,83	122	467,43	CHI
2019112289	PARAUNA	PU12301174	ACREUNA	01/11/2019 12:43	02/11/2019 15:44	01/11/2019 12:43	02/11/2019 11:43	23,00	7	161,00	CHI
2019112289	PARAUNA	PU12301142LD	ACREUNA	01/11/2019 12:43	02/11/2019 15:44	01/11/2019 12:43	02/11/2019 15:44	27,01	6	162,09	CHI
2019112297	CALDAS NOVAS	10011775937	CALDAS NOVAS S1	01/11/2019 12:44	01/11/2019 15:55	01/11/2019 12:44	01/11/2019 15:55	3,18	1	3,18	CHI
2019112315	NOVA CRIXAS	NA21349185	NOVA CRIXAS	01/11/2019 12:49	03/11/2019 09:25	01/11/2019 12:49	03/11/2019 09:25	44,60	1	44,60	CHI
2019112349	RIO VERDE	RV11251852	RIO VERDE S1	01/11/2019 12:37	01/11/2019 16:11	01/11/2019 12:37	01/11/2019 16:11	3,56	114	405,90	CHI
2019112361	GOIANIA	10030386053	FERROVIARIO S3	01/11/2019 13:02	01/11/2019 14:08	01/11/2019 13:02	01/11/2019 14:08	1,10	1	1,10	CHI
2019112364	GOIANIA	GN11042134	ATLANTICO S3	01/11/2019 13:01	01/11/2019 14:00	01/11/2019 13:01	01/11/2019 14:00	0,97	120	116,43	CHI
2019112371	SAO MIGUEL DO ARAGUAIA	SM12000012	SAO MIGUEL DO ARAGUAIA	01/11/2019 13:05	02/11/2019 06:38	01/11/2019 13:05	02/11/2019 06:38	17,55	544	9549,01	CHI
2019112372	FORMOSA	FA21323058	ITUIQUIRA	01/11/2019 13:05	01/11/2019 16:39	01/11/2019 13:05	01/11/2019 16:39	3,56	1	3,56	CHI
2019112374	GOIANESIA	550031704	GOIANESIA S2	01/11/2019 13:06	02/11/2019 03:34	01/11/2019 13:06	02/11/2019 03:34	14,46	1	14,46	CHI
2019112387	JATAI	290207812	JATAI S2	01/11/2019 13:08	02/11/2019 13:42	01/11/2019 13:08	02/11/2019 13:42	24,56	1	24,56	CHI
2019112401	ALEXANIA	AX21190697	ALEXANIA	01/11/2019 13:12	01/11/2019 16:54	01/11/2019 13:12	01/11/2019 16:54	3,69	1	3,69	CHI
2019112404	GOIANIA	10014457	CAMPINAS S3	01/11/2019 13:12	01/11/2019 22:02	01/11/2019 13:12	01/11/2019 22:02	8,82	1	8,82	CHI
2019112412	BOM JESUS DE GOIAS	DM12153969	RIO DOS BOIS	01/11/2019 13:04	03/11/2019 18:00	01/11/2019 13:04	03/11/2019 16:57	51,88	1	51,88	CHI
2019112412	CASTELANDIA	DM12153969	RIO DOS BOIS	01/11/2019 13:04	03/11/2019 18:00	01/11/2019 13:04	03/11/2019 16:57	51,88	5	259,41	CHI

2019112412	QUIRINOPOLIS	DM12153969	RIO DOS BOIS	01/11/2019 13:04	03/11/2019 18:00	01/11/2019 13:04	03/11/2019 16:57	51,88	7	363,17	CHI
2019112412	QUIRINOPOLIS	DM12153969	RIO DOS BOIS	01/11/2019 13:04	03/11/2019 18:00	01/11/2019 13:04	03/11/2019 18:00	52,93	1	52,93	CHI
2019112414	AGUA LIMPA	AL21246559	VILA CORUMBA	01/11/2019 13:15	08/11/2019 09:59	01/11/2019 13:15	08/11/2019 09:59	164,73	1	164,73	CHI
2019112420	ANAPOLIS	AN12000585	ANAPOLIS UNIVERSITARIO S2	01/11/2019 13:16	01/11/2019 16:00	01/11/2019 13:16	01/11/2019 16:00	2,73	171	466,97	CHI
2019112422	JATAI	JT12337034	JATAI S2	01/11/2019 13:16	02/11/2019 19:23	01/11/2019 13:16	02/11/2019 14:41	25,42	1	25,42	CHI
2019112422	JATAI	JT12337034	JATAI S2	01/11/2019 13:16	02/11/2019 19:23	02/11/2019 14:50	02/11/2019 19:23	4,55	1	4,55	CHI
2019112433	AMARALINA	LC11270184	SAO MIGUEL DO ARAGUAIA	01/11/2019 13:20	03/11/2019 18:42	01/11/2019 13:20	03/11/2019 18:42	53,36	1	53,36	CHI
2019112434	GOIANIA	GN11000816	XAVANTES	01/11/2019 13:20	01/11/2019 19:58	01/11/2019 13:20	01/11/2019 19:58	6,63	83	549,94	CHI
2019112435	CASTELANDIA	DM21303642	RIO DOS BOIS	01/11/2019 13:20	02/11/2019 16:54	01/11/2019 13:20	02/11/2019 16:54	27,56	3	82,67	CHI
2019112436	ARAGARCAS	BM12316433	ARAGARCAS	01/11/2019 13:20	01/11/2019 17:54	01/11/2019 13:20	01/11/2019 17:54	4,56	47	214,18	CHI
2019112436	BOM JARDIM DE GOIAS	BM12316433	ARAGARCAS	01/11/2019 13:20	01/11/2019 17:54	01/11/2019 13:20	01/11/2019 17:54	4,56	2	9,11	CHI
2019112437	RIO VERDE	QI21116405	QUIRINOPOLIS	01/11/2019 13:20	01/11/2019 18:25	01/11/2019 13:20	01/11/2019 18:25	5,07	2	10,15	CHI
2019112444	PLANALTINA	2960013184	PLANALTINA	01/11/2019 13:22	01/11/2019 15:03	01/11/2019 13:22	01/11/2019 15:03	1,68	1	1,68	CHI
2019112452	JATAI	JT12184067	MONTIVIDIU T	01/11/2019 13:23	03/11/2019 18:10	01/11/2019 13:23	03/11/2019 18:10	52,78	3	158,33	CHI
2019112463	TEREZOPOLIS DE GOIAS	1370010749	DAIA S2	01/11/2019 13:25	01/11/2019 14:58	01/11/2019 13:25	01/11/2019 14:58	1,54	1	1,54	CHI
2019112472	BURITI ALEGRE	00260214	ITUMBIARA VELHA S2	01/11/2019 13:24	04/11/2019 14:36	01/11/2019 13:24	01/11/2019 22:15	8,85	28	247,70	CHI
2019112472	ITUMBIARA	00260214	ITUMBIARA VELHA S2	01/11/2019 13:24	04/11/2019 14:36	01/11/2019 13:24	01/11/2019 22:15	8,85	119	1052,72	CHI
2019112472	BURITI ALEGRE	BG13160440	ITUMBIARA VELHA S2	01/11/2019 13:24	04/11/2019 14:36	01/11/2019 13:24	02/11/2019 21:04	31,67	13	411,68	CHI
2019112472	ITUMBIARA	BG13160440	ITUMBIARA VELHA S2	01/11/2019 13:24	04/11/2019 14:36	01/11/2019 13:24	02/11/2019 21:04	31,67	16	506,68	CHI
2019112472	BURITI ALEGRE	BG12263568RE	ITUMBIARA VELHA S2	01/11/2019 13:24	04/11/2019 14:36	03/11/2019 10:42	04/11/2019 10:46	24,08	27	650,22	CHI
2019112472	ITUMBIARA	BG12263568RE	ITUMBIARA VELHA S2	01/11/2019 13:24	04/11/2019 14:36	03/11/2019 10:42	04/11/2019 10:46	24,08	119	2865,78	CHI
2019112472	BURITI ALEGRE	BG13000011	ITUMBIARA VELHA S2	01/11/2019 13:24	04/11/2019 14:36	01/11/2019 13:24	04/11/2019 14:36	73,19	43	3147,19	CHI
2019112472	GOIATUBA	BG13000011	ITUMBIARA VELHA S2	01/11/2019 13:24	04/11/2019 14:36	01/11/2019 13:24	04/11/2019 14:36	73,19	2	146,38	CHI
2019112472	ITUMBIARA	BG13000011	ITUMBIARA VELHA S2	01/11/2019 13:24	04/11/2019 14:36	01/11/2019 13:24	04/11/2019 14:36	73,19	102	7465,44	CHI
2019112477	ORIZONA	2060053888	PIRES DO RIO S2	01/11/2019 13:29	01/11/2019 17:20	01/11/2019 13:29	01/11/2019 17:20	3,85	1	3,85	CHI
2019112486	OUVIDOR	OU21250306	CATALAO S1	01/11/2019 13:30	02/11/2019 10:06	01/11/2019 13:30	02/11/2019 10:06	20,61	1	20,61	CHI
2019112487	ARAGARCAS	AG21188256	ARAGARCAS	01/11/2019 13:28	02/11/2019 07:35	01/11/2019 13:28	02/11/2019 07:35	18,12	1	18,12	CHI
2019112511	CAMPO ALEGRE DE GOIAS	CM21066305	CAMPO ALEGRE DE GOIAS	01/11/2019 13:31	02/11/2019 17:49	01/11/2019 13:31	02/11/2019 17:49	28,30	1	28,30	CHI
2019112530	SANTA HELENA DE GOIAS	SH12247775	SANTA HELENA S1	01/11/2019 13:37	04/11/2019 22:40	01/11/2019 13:37	04/11/2019 22:40	81,05	2	162,10	CHI
2019112531	RIO VERDE	RV21349547	CABRIUVA S1	01/11/2019 13:37	01/11/2019 16:50	01/11/2019 13:37	01/11/2019 16:50	3,21	1	3,21	CHI
2019112551	ITUMBIARA	IT11000061	PARANAIBA	01/11/2019 13:32	02/11/2019 12:20	01/11/2019 13:32	02/11/2019 12:20	22,79	129	2940,16	CHI
2019112555	ITABERAI	IB21281175	ITABERAI S2	01/11/2019 13:40	01/11/2019 18:29	01/11/2019 13:40	01/11/2019 18:29	4,81	1	4,81	CHI
2019112566	MONTIVIDIU	MV21075459	MONTIVIDIU T	01/11/2019 13:41	02/11/2019 20:40	01/11/2019 13:41	02/11/2019 20:40	30,97	2	61,93	CHI

2019112569	CACU	CC11247588	CACHOEIRA ALTA	01/11/2019 13:42	03/11/2019 20:34	01/11/2019 13:42	03/11/2019 20:34	54,86	1	54,86	CHI
2019112580	MINEIROS	MY21274160	PARQUE DAS EMAS	01/11/2019 13:43	02/11/2019 13:14	01/11/2019 13:43	02/11/2019 13:14	23,50	1	23,50	CHI
2019112582	COCALZINHO DE GOIAS	ZN12353427	COCALZINHO	01/11/2019 13:43	01/11/2019 18:21	01/11/2019 13:43	01/11/2019 18:21	4,62	6	27,71	CHI
2019112586	JATAI	JT10378104	JATAI S2	01/11/2019 13:43	01/11/2019 22:22	01/11/2019 13:43	01/11/2019 17:39	3,92	30	117,73	CHI
2019112586	JATAI	JT10378104	JATAI S2	01/11/2019 13:43	01/11/2019 22:22	01/11/2019 19:43	01/11/2019 19:57	0,22	30	6,67	CHI
2019112586	JATAI	JT13153987	JATAI S2	01/11/2019 13:43	01/11/2019 22:22	01/11/2019 13:43	01/11/2019 21:09	7,42	11	81,66	CHI
2019112586	JATAI	JT13153987	JATAI S2	01/11/2019 13:43	01/11/2019 22:22	01/11/2019 13:43	01/11/2019 21:59	8,26	13	107,34	CHI
2019112586	JATAI	JT13153987	JATAI S2	01/11/2019 13:43	01/11/2019 22:22	01/11/2019 13:43	01/11/2019 22:22	8,65	279	2413,35	CHI
2019112586	RIO VERDE	JT13153987	JATAI S2	01/11/2019 13:43	01/11/2019 22:22	01/11/2019 13:43	01/11/2019 22:22	8,65	31	268,15	CHI
2019112586	JATAI	JT10378104	JATAI S2	01/11/2019 13:43	01/11/2019 22:22	01/11/2019 22:13	01/11/2019 22:22	0,15	54	8,25	CHI
2019112592	CATALAO	10028213759	CATALAO S2	01/11/2019 13:45	01/11/2019 17:34	01/11/2019 13:45	01/11/2019 17:34	3,81	1	3,81	CHI
2019112597	MOSSAMEDES	MD11274186	FIRMINOPOLIS S2	01/11/2019 13:09	01/11/2019 19:28	01/11/2019 13:09	01/11/2019 19:28	6,31	54	340,92	CHI
2019112599	PARANAIGUARA	PC11000009	CACHOEIRA ALTA	01/11/2019 13:19	01/11/2019 16:41	01/11/2019 13:19	01/11/2019 16:41	3,35	152	509,45	CHI
2019112607	AMARALINA	LC12182475	SAO MIGUEL DO ARAGUAIA	01/11/2019 13:24	01/11/2019 23:07	01/11/2019 13:24	01/11/2019 20:23	6,99	37	258,69	CHI
2019112607	AMARALINA	LC12182475	SAO MIGUEL DO ARAGUAIA	01/11/2019 13:24	01/11/2019 23:07	01/11/2019 20:25	01/11/2019 22:37	2,21	37	81,62	CHI
2019112607	AMARALINA	LC13315123	SAO MIGUEL DO ARAGUAIA	01/11/2019 13:24	01/11/2019 23:07	01/11/2019 13:24	01/11/2019 23:07	9,72	40	388,62	CHI
2019112620	CALDAS NOVAS	CN21000079	CALDAS NOVAS S1	01/11/2019 13:52	02/11/2019 17:00	01/11/2019 13:52	02/11/2019 17:00	27,12	1	27,12	CHI
2019112626	AMARALINA	MQ21029580	SAO MIGUEL DO ARAGUAIA	01/11/2019 13:53	02/11/2019 01:47	01/11/2019 13:53	02/11/2019 01:47	11,89	13	154,52	CHI
2019112627	RIO VERDE	630261866	RIO VERDE S2	01/11/2019 13:54	03/11/2019 09:28	01/11/2019 13:54	03/11/2019 09:28	43,58	1	43,58	CHI
2019112630	CATALAO	1990017128	CATALAO S2	01/11/2019 13:54	01/11/2019 23:23	01/11/2019 13:54	01/11/2019 23:23	9,48	1	9,48	CHI
2019112636	CALDAS NOVAS	CN12213968	CALDAS NOVAS S1	01/11/2019 12:05	01/11/2019 15:57	01/11/2019 12:05	01/11/2019 15:57	3,86	145	559,34	CHI
2019112644	RIO VERDE	630083083	RIO VERDE S2	01/11/2019 13:57	01/11/2019 18:48	01/11/2019 13:57	01/11/2019 18:48	4,85	1	4,85	CHI
2019112650	NOVO PLANALTO	TA12192342	NOVO PLANALTO	01/11/2019 14:02	01/11/2019 16:29	01/11/2019 14:02	01/11/2019 16:29	2,44	1	2,44	CHI
2019112650	PORANGATU	TA12192342	NOVO PLANALTO	01/11/2019 14:02	01/11/2019 16:29	01/11/2019 14:02	01/11/2019 16:29	2,44	9	21,95	CHI
2019112657	GOIANIA	11737130	REAL S1	01/11/2019 13:59	01/11/2019 16:29	01/11/2019 13:59	01/11/2019 16:29	2,50	1	2,50	CHI
2019112658	FAINA	FC21217105	GOIAS	01/11/2019 13:59	02/11/2019 16:15	01/11/2019 13:59	02/11/2019 16:15	26,26	1	26,26	CHI
2019112674	APARECIDA DE GOIANIA	AP21137061	CEPAIGO S1	01/11/2019 14:02	02/11/2019 09:08	01/11/2019 14:02	02/11/2019 09:08	19,09	1	19,09	CHI
2019112676	PLANALTINA	PI21149439	PLANALTINA	01/11/2019 14:02	01/11/2019 19:46	01/11/2019 14:02	01/11/2019 19:46	5,72	1	5,72	CHI
2019112678	GOIANIA	10563052	REAL S2	01/11/2019 14:03	01/11/2019 21:45	01/11/2019 14:03	01/11/2019 21:45	7,71	1	7,71	CHI
2019112679	IPAMERI	IP12215693	URUTAI	01/11/2019 14:03	03/11/2019 19:23	01/11/2019 14:03	03/11/2019 19:23	53,33	4	213,33	CHI
2019112690	MONTIVIDIU	MV10400618	MONTIVIDIU T	01/11/2019 13:55	02/11/2019 14:45	01/11/2019 13:55	01/11/2019 18:37	4,70	16	75,22	CHI
2019112690	RIO VERDE	MV10400618	MONTIVIDIU T	01/11/2019 13:55	02/11/2019 14:45	01/11/2019 13:55	01/11/2019 18:37	4,70	75	352,58	CHI
2019112690	RIO VERDE	MV10400618	MONTIVIDIU T	01/11/2019 13:55	02/11/2019 14:45	01/11/2019 13:55	01/11/2019 20:31	6,61	18	118,98	CHI

2019112690	RIO VERDE	MV10400618	MONTIVIDIU T	01/11/2019 13:55	02/11/2019 14:45	01/11/2019 13:55	02/11/2019 12:51	22,94	29	665,40	CHI
2019112690	RIO VERDE	RV10406661	MONTIVIDIU T	01/11/2019 13:55	02/11/2019 14:45	01/11/2019 13:55	02/11/2019 12:51	22,94	1	22,94	CHI
2019112690	RIO VERDE	RV12106528	MONTIVIDIU T	01/11/2019 13:55	02/11/2019 14:45	02/11/2019 12:52	02/11/2019 14:45	1,87	4	7,48	CHI
2019112696	RIO VERDE	SH10394747	IPEGUARI	01/11/2019 14:04	01/11/2019 21:21	01/11/2019 14:04	01/11/2019 21:04	7,00	2	13,99	CHI
2019112696	SANTA HELENA DE GOIAS	SH10394747	IPEGUARI	01/11/2019 14:04	01/11/2019 21:21	01/11/2019 14:04	01/11/2019 21:04	7,00	582	4071,25	CHI
2019112696	SANTA HELENA DE GOIAS	SH11207101	IPEGUARI	01/11/2019 14:04	01/11/2019 21:21	01/11/2019 19:39	01/11/2019 21:21	1,70	37	62,99	CHI
2019112697	AGUA FRIA DE GOIAS	TL12264641	SAO JOAO D ALIANCA	01/11/2019 14:07	01/11/2019 18:17	01/11/2019 14:07	01/11/2019 18:17	4,16	12	49,87	CHI
2019112704	PIRENOPOLIS	PV21194531	CORUMBA	01/11/2019 14:08	01/11/2019 18:26	01/11/2019 14:08	01/11/2019 18:26	4,28	4	17,14	CHI
2019112709	CAVALCANTE	BF21264648	FLORES DE GOIAS	01/11/2019 14:09	01/11/2019 18:34	01/11/2019 14:09	01/11/2019 18:34	4,41	1	4,41	CHI
2019112715	ITABERAI	IB12364876	ITABERAI S2	01/11/2019 13:43	01/11/2019 22:00	01/11/2019 13:43	01/11/2019 22:00	8,27	2	16,53	CHI
2019112719	GOIATUBA	140089263	GOIATUBA S2	01/11/2019 14:12	03/11/2019 08:45	01/11/2019 14:12	03/11/2019 08:45	42,56	1	42,56	CHI
2019112730	BARRO ALTO	BA12382485	BARRO ALTO	01/11/2019 13:40	02/11/2019 00:13	01/11/2019 13:40	02/11/2019 00:13	10,54	9	94,85	CHI
2019112744	ITAPIRAPUA	IU21183154	MATRINCHA	01/11/2019 14:17	05/11/2019 09:27	01/11/2019 14:17	05/11/2019 09:27	91,16	1	91,16	CHI
2019112746	MINACU	IH12088797	MINACU	01/11/2019 14:16	01/11/2019 19:05	01/11/2019 14:16	01/11/2019 19:05	4,80	164	787,56	CHI
2019112753	SANTA TEREZA DE GOIAS	2430016261	MARA ROSA	01/11/2019 14:18	02/11/2019 00:03	01/11/2019 14:18	02/11/2019 00:03	9,75	1	9,75	CHI
2019112758	ALTO HORIZONTE	AJ21232403	SANTA TEREZINHA	01/11/2019 14:20	02/11/2019 11:25	01/11/2019 14:20	02/11/2019 11:25	21,09	1	21,09	CHI
2019112760	ITUMBIARA	10000084849	ITUMBIARA NOVA	01/11/2019 14:20	02/11/2019 10:10	01/11/2019 14:20	02/11/2019 10:10	19,82	1	19,82	CHI
2019112764	ITABERAI	IB12336527	ITABERAI S2	01/11/2019 14:06	01/11/2019 20:18	01/11/2019 14:06	01/11/2019 20:18	6,20	219	1358,65	CHI
2019112789	SANTA HELENA DE GOIAS	400135413	IPEGUARI	01/11/2019 14:25	02/11/2019 12:09	01/11/2019 14:25	02/11/2019 12:09	21,72	1	21,72	CHI
2019112792	BONOPOLIS	4350007132	SAO MIGUEL DO ARAGUAIA	01/11/2019 14:26	02/11/2019 18:39	01/11/2019 14:26	02/11/2019 18:39	28,22	1	28,22	CHI
2019112795	GOIANIA	GN11141933	GOIANIA LESTE S1	01/11/2019 14:17	01/11/2019 15:21	01/11/2019 14:17	01/11/2019 15:21	1,05	128	134,76	CHI
2019112798	IVOLANDIA	IV12165764	IPORA	01/11/2019 14:26	05/11/2019 09:24	01/11/2019 14:26	05/11/2019 09:24	90,95	5	454,77	CHI
2019112798	PARAUNA	IV12165764	IPORA	01/11/2019 14:26	05/11/2019 09:24	01/11/2019 14:26	05/11/2019 09:24	90,95	1	90,95	CHI
2019112806	MONTE ALEGRE DE GOIAS	1620001266	SAO DOMINGOS	01/11/2019 14:27	01/11/2019 18:05	01/11/2019 14:27	01/11/2019 18:05	3,62	1	3,62	CHI
2019112811	URUTAI	UT12075971RE	PIRES DO RIO S2	01/11/2019 13:56	02/11/2019 12:15	01/11/2019 13:56	02/11/2019 12:15	22,31	47	1048,50	CHI
2019112813	GAMELEIRA DE GOIAS	21231680	DAIA S1	01/11/2019 14:28	01/11/2019 17:02	01/11/2019 14:28	01/11/2019 17:02	2,56	1	2,56	CHI
2019112822	ANAPOLIS	20603319	JUNDIAI S1	01/11/2019 14:29	01/11/2019 17:36	01/11/2019 14:29	01/11/2019 17:36	3,10	1	3,10	CHI
2019112824	APARECIDA DE GOIANIA	200355296	ANHANGUERA	01/11/2019 14:30	01/11/2019 18:31	01/11/2019 14:30	01/11/2019 18:31	4,02	1	4,02	CHI
2019112828	ALTO PARAISO DE GOIAS	BF21208748	NIQUELANDIA SUBTRANSMISSAO	01/11/2019 14:30	01/11/2019 16:49	01/11/2019 14:30	01/11/2019 16:49	2,31	1	2,31	CHI
2019112834	CEZARINA	PL10404073	PALMEIRAS	01/11/2019 14:29	01/11/2019 18:14	01/11/2019 14:29	01/11/2019 18:14	3,76	4	15,04	CHI
2019112834	PALMEIRAS DE GOIAS	PL10404073	PALMEIRAS	01/11/2019 14:29	01/11/2019 18:14	01/11/2019 14:29	01/11/2019 18:14	3,76	198	744,43	CHI
2019112838	GOIANIA	GN12395299	REAL S2	01/11/2019 13:59	01/11/2019 15:29	01/11/2019 13:59	01/11/2019 15:29	1,48	332	492,65	CHI
2019112845	CALDAS NOVAS	760421791	SERRA DE CALDAS	01/11/2019 14:32	02/11/2019 08:15	01/11/2019 14:32	02/11/2019 08:15	17,71	1	17,71	CHI

2019112848	IPORA	IR12014557	IPORA	01/11/2019 14:17	01/11/2019 16:40	01/11/2019 14:17	01/11/2019 16:40	2,38	22	52,44	CHI
2019112857	BELA VISTA DE GOIAS	BV31000008	BELA VISTA S1	01/11/2019 14:34	02/11/2019 14:17	01/11/2019 14:34	02/11/2019 14:17	23,71	2	47,42	CHI
2019112873	GOIAS	GS21380082	GOIAS	01/11/2019 14:37	01/11/2019 17:22	01/11/2019 14:37	01/11/2019 17:22	2,74	1	2,74	CHI
2019112878	CALDAS NOVAS	10023913817	CALDAS NOVAS S2	01/11/2019 14:38	02/11/2019 15:30	01/11/2019 14:38	02/11/2019 15:30	24,86	1	24,86	CHI
2019112882	GOIANIA	10246708	CAMPINAS S3	01/11/2019 14:39	02/11/2019 11:42	01/11/2019 14:39	02/11/2019 11:42	21,05	1	21,05	CHI
2019112885	CALDAS NOVAS	CN12298642	CALDAS NOVAS S2	01/11/2019 14:39	02/11/2019 15:48	01/11/2019 14:39	02/11/2019 15:48	25,14	14	352,01	CHI
2019112897	FORMOSA	FA12394153	ITUIQUIRA	01/11/2019 14:39	01/11/2019 18:36	01/11/2019 14:39	01/11/2019 18:36	3,94	19	74,78	CHI
2019112901	FORMOSA	FA11139693	ITUIQUIRA	01/11/2019 14:42	01/11/2019 18:42	01/11/2019 14:42	01/11/2019 18:42	3,99	17	67,83	CHI
2019112904	CATALAO	1990164861	CATALAO S2	01/11/2019 14:42	02/11/2019 01:36	01/11/2019 14:42	02/11/2019 01:36	10,89	1	10,89	CHI
2019112908	CATALAO	GD12127538	CATALAO S1	01/11/2019 13:56	01/11/2019 16:38	01/11/2019 13:56	01/11/2019 16:38	2,69	5	13,47	CHI
2019112908	GOIANDIRA	GD12127538	CATALAO S1	01/11/2019 13:56	01/11/2019 16:38	01/11/2019 13:56	01/11/2019 16:38	2,69	13	35,03	CHI
2019112913	RIO VERDE	RV12051746	MONTIVIDIU T	01/11/2019 14:44	01/11/2019 18:10	01/11/2019 14:44	01/11/2019 18:10	3,42	76	259,73	CHI
2019112919	JARAGUA	JA21194257	JARAGUA	01/11/2019 14:46	01/11/2019 18:53	01/11/2019 14:46	01/11/2019 18:53	4,12	1	4,12	CHI
2019112932	JATAI	JT11219267	JATAI S2	01/11/2019 14:48	02/11/2019 11:12	01/11/2019 14:48	02/11/2019 11:12	20,40	31	632,44	CHI
2019112945	SANTA HELENA DE GOIAS	SH11000011	IPEGUARI	01/11/2019 14:28	01/11/2019 18:56	01/11/2019 14:28	01/11/2019 18:56	4,45	101	449,87	CHI
2019112972	CACHOEIRA ALTA	CA12196131	CACHOEIRA ALTA	01/11/2019 14:10	02/11/2019 18:50	01/11/2019 14:10	02/11/2019 18:50	28,65	12	343,84	CHI
2019112980	CORUMBA DE GOIAS	CB21089837	ALEXANIA	01/11/2019 14:55	02/11/2019 10:05	01/11/2019 14:55	02/11/2019 10:05	19,17	2	38,33	CHI
2019112981	HIDROLANDIA	10002417675	CEPAIGO S1	01/11/2019 14:55	04/11/2019 14:34	01/11/2019 14:55	04/11/2019 14:34	71,65	1	71,65	CHI
2019112982	AGUA LIMPA	RQ12257962	VILA CORUMBA	01/11/2019 13:17	01/11/2019 18:51	01/11/2019 13:17	01/11/2019 18:51	5,55	9	49,97	CHI
2019112982	MORRINHOS	RQ12257962	VILA CORUMBA	01/11/2019 13:17	01/11/2019 18:51	01/11/2019 13:17	01/11/2019 18:51	5,55	5	27,76	CHI
2019112982	RIO QUENTE	RQ12257962	VILA CORUMBA	01/11/2019 13:17	01/11/2019 18:51	01/11/2019 13:17	01/11/2019 18:51	5,55	55	305,39	CHI
2019112984	JATAI	JT12000167	JATAI S1	01/11/2019 14:16	04/11/2019 17:36	01/11/2019 14:16	02/11/2019 05:30	15,23	13	198,02	CHI
2019112984	JATAI	JT12303412	JATAI S1	01/11/2019 14:16	04/11/2019 17:36	01/11/2019 14:16	04/11/2019 14:03	71,77	11	789,50	CHI
2019112984	JATAI	JT12303412	JATAI S1	01/11/2019 14:16	04/11/2019 17:36	04/11/2019 14:04	04/11/2019 17:27	3,38	11	37,22	CHI
2019112984	JATAI	JT21138853	JATAI S1	01/11/2019 14:16	04/11/2019 17:36	01/11/2019 14:16	04/11/2019 17:36	75,32	1	75,32	CHI
2019112990	APARECIDA DE GOIANIA	AP11128008	ANHANGUERA	01/11/2019 13:38	01/11/2019 17:36	01/11/2019 13:38	01/11/2019 17:36	3,96	155	613,63	CHI
2019112994	PORANGATU	840037200	PORANGATU	01/11/2019 14:56	01/11/2019 17:50	01/11/2019 14:56	01/11/2019 17:50	2,90	1	2,90	CHI
2019112998	ITUMBIARA	IT12000208	ITUMBIARA NOVA	01/11/2019 14:57	05/11/2019 10:24	01/11/2019 14:57	05/11/2019 10:24	91,44	1	91,44	CHI
2019113003	RIO VERDE	630111844	RIO VERDE S1	01/11/2019 14:58	04/11/2019 10:20	01/11/2019 14:58	04/11/2019 10:20	67,38	1	67,38	CHI
2019113007	ANICUNS	AC12391421	ANICUNS	01/11/2019 14:22	01/11/2019 16:20	01/11/2019 14:22	01/11/2019 16:20	1,96	3	5,89	CHI
2019113013	ANAPOLIS	AN21291980	ANAPOLIS UNIVERSITARIO S1	01/11/2019 14:58	01/11/2019 17:09	01/11/2019 14:58	01/11/2019 17:09	2,17	1	2,17	CHI
2019113023	JATAI	04070214	JATAI S1	01/11/2019 14:02	01/11/2019 21:30	01/11/2019 14:02	01/11/2019 19:30	5,47	132	721,64	CHI
2019113023	JATAI	04070214	JATAI S1	01/11/2019 14:02	01/11/2019 21:30	01/11/2019 14:02	01/11/2019 20:40	6,63	62	411,28	CHI

2019113023	JATAI	04070214	JATAI S1	01/11/2019 14:02	01/11/2019 21:30	01/11/2019 14:02	01/11/2019 21:20	7,31	9	65,75	CHI
2019113023	APARECIDA DO RIO DOCE	04070214	JATAI S1	01/11/2019 14:02	01/11/2019 21:30	01/11/2019 14:02	01/11/2019 21:30	7,47	70	522,84	CHI
2019113023	JATAI	04070214	JATAI S1	01/11/2019 14:02	01/11/2019 21:30	01/11/2019 14:02	01/11/2019 21:30	7,47	92	687,16	CHI
2019113051	BELA VISTA DE GOIAS	BV12000027	BELA VISTA S1	01/11/2019 13:50	02/11/2019 12:32	01/11/2019 13:50	02/11/2019 09:54	20,06	11	220,66	CHI
2019113051	BELA VISTA DE GOIAS	BV12026628LD	BELA VISTA S1	01/11/2019 13:50	02/11/2019 12:32	01/11/2019 13:50	02/11/2019 12:32	22,69	4	90,77	CHI
2019113054	ORIZONA	OZ12022983	PIRES DO RIO S2	01/11/2019 14:30	02/11/2019 07:29	01/11/2019 14:30	02/11/2019 07:29	16,98	11	186,77	CHI
2019113056	CORREGO DO OURO	CO21321865	SAO LUIZ DOS MONTES BELOS	01/11/2019 15:04	03/11/2019 11:18	01/11/2019 15:04	03/11/2019 11:18	44,23	2	88,47	CHI
2019113058	PLANALTINA	PI11204769	PLANALTINA	01/11/2019 15:04	01/11/2019 17:54	01/11/2019 15:04	01/11/2019 17:54	2,83	18	50,93	CHI
2019113066	SERRANOPOLIS	SX21216641	JATAI S1	01/11/2019 15:04	02/11/2019 11:12	01/11/2019 15:04	02/11/2019 11:12	20,12	3	60,35	CHI
2019113072	DAVINOPOLIS	IO12085164	CATALAO S1	01/11/2019 13:42	02/11/2019 11:20	01/11/2019 13:42	02/11/2019 11:20	21,63	6	129,79	CHI
2019113072	OUVIDOR	IO12085164	CATALAO S1	01/11/2019 13:42	02/11/2019 11:20	01/11/2019 13:42	02/11/2019 11:20	21,63	5	108,16	CHI
2019113076	PORANGATU	PO12141124	NOVO PLANALTO	01/11/2019 14:09	03/11/2019 02:44	01/11/2019 14:09	02/11/2019 21:19	31,16	9	280,47	CHI
2019113076	PORANGATU	TA12187953LD	NOVO PLANALTO	01/11/2019 14:09	03/11/2019 02:44	01/11/2019 14:09	03/11/2019 02:44	36,57	11	402,32	CHI
2019113092	TURVANIA	TV12026469	FIRMINOPOLIS S1	01/11/2019 15:07	02/11/2019 12:48	01/11/2019 15:07	02/11/2019 12:48	21,67	5	108,34	CHI
2019113095	CACHOEIRA ALTA	CA11029083	CACHOEIRA ALTA	01/11/2019 14:39	01/11/2019 16:30	01/11/2019 14:39	01/11/2019 16:30	1,85	158	291,95	CHI
2019113108	TERESINA DE GOIAS	2650005367	FLORES DE GOIAS	01/11/2019 15:10	01/11/2019 16:30	01/11/2019 15:10	01/11/2019 16:30	1,33	1	1,33	CHI
2019113115	BONOPOLIS	TA10400556	NOVO PLANALTO	01/11/2019 14:52	01/11/2019 17:44	01/11/2019 14:52	01/11/2019 17:44	2,88	54	155,49	CHI
2019113115	PORANGATU	TA10400556	NOVO PLANALTO	01/11/2019 14:52	01/11/2019 17:44	01/11/2019 14:52	01/11/2019 17:44	2,88	145	417,52	CHI
2019113123	MONTIVIDIU	MV12267711	MONTIVIDIU T	01/11/2019 15:04	01/11/2019 17:35	01/11/2019 15:04	01/11/2019 17:35	2,51	29	72,73	CHI
2019113128	SANTA HELENA DE GOIAS	SH12296132	IPEGUARI	01/11/2019 13:05	02/11/2019 15:25	01/11/2019 13:05	02/11/2019 15:25	26,33	12	315,95	CHI
2019113129	JATAI	JT12196087	JATAI S1	01/11/2019 15:01	02/11/2019 09:26	01/11/2019 15:01	02/11/2019 09:26	18,42	4	73,67	CHI
2019113134	CAMPESTRE DE GOIAS	10007184580	TRINDADE	01/11/2019 15:14	02/11/2019 20:10	01/11/2019 15:14	02/11/2019 20:10	28,93	1	28,93	CHI
2019113146	GOIANIA	GN11001255	ATLANTICO S2	01/11/2019 14:35	01/11/2019 17:33	01/11/2019 14:35	01/11/2019 17:33	2,96	42	124,25	CHI
2019113162	URUACU	10011075510	URUACU	01/11/2019 15:17	02/11/2019 04:29	01/11/2019 15:17	02/11/2019 04:29	13,20	1	13,20	CHI
2019113164	ITAUCU	IB21304342	INHUMAS S1	01/11/2019 15:17	01/11/2019 15:50	01/11/2019 15:17	01/11/2019 15:50	0,55	1	0,55	CHI
2019113178	ACREUNA	EU12109113	ACREUNA	01/11/2019 15:18	04/11/2019 22:41	01/11/2019 15:18	04/11/2019 22:41	79,37	3	238,12	CHI
2019113178	PARAUNA	EU12109113	ACREUNA	01/11/2019 15:18	04/11/2019 22:41	01/11/2019 15:18	04/11/2019 22:41	79,37	1	79,37	CHI
2019113186	APARECIDA DE GOIANIA	200374898	INDEPENDENCIA S2	01/11/2019 15:19	02/11/2019 15:15	01/11/2019 15:19	02/11/2019 15:15	23,92	1	23,92	CHI
2019113194	CAIAPONIA	CP11334931	CAIAPONIA	01/11/2019 13:16	02/11/2019 00:08	01/11/2019 13:16	02/11/2019 00:08	10,86	120	1303,10	CHI
2019113203	ITAUCU	IX21110695	INHUMAS S1	01/11/2019 15:21	05/11/2019 11:06	01/11/2019 15:21	05/11/2019 11:06	91,74	2	183,49	CHI
2019113223	JATAI	JT12390597	JATAI S1	01/11/2019 13:57	01/11/2019 18:52	01/11/2019 13:57	01/11/2019 18:52	4,91	13	63,77	CHI
2019113223	PEROLANDIA	JT12390597	JATAI S1	01/11/2019 13:57	01/11/2019 18:52	01/11/2019 13:57	01/11/2019 18:52	4,91	6	29,43	CHI
2019113224	GOIAS	GS21068583	MATRINCHA	01/11/2019 15:22	02/11/2019 13:25	01/11/2019 15:22	02/11/2019 13:25	22,04	2	44,09	CHI

2019113235	CAMPINORTE	CR21094181	CAMPINORTE	01/11/2019 12:08	02/11/2019 14:36	01/11/2019 12:08	02/11/2019 14:36	26,45	1	26,45	CHI
2019113277	LUZIANIA	LZ21183536	VIANOPOLIS	01/11/2019 15:29	02/11/2019 10:06	01/11/2019 15:29	02/11/2019 10:06	18,60	1	18,60	CHI
2019113280	CATALAO	CT21215514	CATALAO S1	01/11/2019 15:29	02/11/2019 14:59	01/11/2019 15:29	02/11/2019 14:59	23,50	1	23,50	CHI
2019113290	NOVA VENEZA	10015757429	INHUMAS S1	01/11/2019 15:31	02/11/2019 08:32	01/11/2019 15:31	02/11/2019 08:32	17,02	1	17,02	CHI
2019113299	CACHOEIRA ALTA	AW10400643	CACHOEIRA ALTA	01/11/2019 14:37	02/11/2019 23:30	01/11/2019 14:37	01/11/2019 17:10	2,55	2	5,11	CHI
2019113299	RIO VERDE	AW10400643	CACHOEIRA ALTA	01/11/2019 14:37	02/11/2019 23:30	01/11/2019 14:37	01/11/2019 17:10	2,55	36	91,96	CHI
2019113299	APARECIDA DO RIO DOCE	AW13360617	CACHOEIRA ALTA	01/11/2019 14:37	02/11/2019 23:30	01/11/2019 14:37	01/11/2019 18:15	3,62	1	3,62	CHI
2019113299	JATAI	AW13360617	CACHOEIRA ALTA	01/11/2019 14:37	02/11/2019 23:30	01/11/2019 14:37	01/11/2019 18:15	3,62	1	3,62	CHI
2019113299	RIO VERDE	AW13360617	CACHOEIRA ALTA	01/11/2019 14:37	02/11/2019 23:30	01/11/2019 14:37	01/11/2019 18:15	3,62	20	72,43	CHI
2019113299	APARECIDA DO RIO DOCE	AW13360617	CACHOEIRA ALTA	01/11/2019 14:37	02/11/2019 23:30	01/11/2019 16:25	01/11/2019 18:15	1,83	4	7,33	CHI
2019113299	RIO VERDE	AW13360617	CACHOEIRA ALTA	01/11/2019 14:37	02/11/2019 23:30	01/11/2019 16:25	01/11/2019 18:15	1,83	5	9,17	CHI
2019113299	CACHOEIRA ALTA	RV12074671	CACHOEIRA ALTA	01/11/2019 14:37	02/11/2019 23:30	01/11/2019 14:37	02/11/2019 23:30	32,88	1	32,88	CHI
2019113299	RIO VERDE	RV12074671	CACHOEIRA ALTA	01/11/2019 14:37	02/11/2019 23:30	01/11/2019 14:37	02/11/2019 23:30	32,88	105	3452,75	CHI
2019113300	JOVIANIA	JV21349788	GOIATUBA S1	01/11/2019 15:32	08/11/2019 16:20	01/11/2019 15:32	08/11/2019 16:20	168,79	1	168,79	CHI
2019113302	ALTO PARAISO DE GOIAS	BF12264794	NIQUELANDIA SUBTRANSMISSAO	01/11/2019 15:32	01/11/2019 17:23	01/11/2019 15:32	01/11/2019 17:23	1,83	5	9,17	CHI
2019113310	RIO VERDE	4090003960	SANTA HELENA S1	01/11/2019 15:33	03/11/2019 16:03	01/11/2019 15:33	03/11/2019 16:03	48,51	1	48,51	CHI
2019113313	RIO VERDE	10029725613	RIO VERDE S1	01/11/2019 15:34	02/11/2019 21:05	01/11/2019 15:34	02/11/2019 21:05	29,51	1	29,51	CHI
2019113316	URUACU	640042144	URUACU	01/11/2019 15:34	01/11/2019 20:13	01/11/2019 15:34	01/11/2019 20:13	4,64	1	4,64	CHI
2019113331	SAO LUIZ DO NORTE	SZ21242772	ITAPACI	01/11/2019 15:36	04/11/2019 12:04	01/11/2019 15:36	04/11/2019 12:04	68,46	2	136,91	CHI
2019113335	GOIANIA	GN11249509	GOIANIA LESTE S3	01/11/2019 15:37	02/11/2019 09:43	01/11/2019 15:37	02/11/2019 09:43	18,09	126	2279,02	CHI
2019113339	BOM JESUS DE GOIAS	BJ12000202	CACHOEIRA DOURADA	01/11/2019 14:54	02/11/2019 11:45	01/11/2019 14:54	02/11/2019 11:45	20,84	23	479,38	CHI
2019113339	GOIATUBA	BJ12000202	CACHOEIRA DOURADA	01/11/2019 14:54	02/11/2019 11:45	01/11/2019 14:54	02/11/2019 11:45	20,84	7	145,90	CHI
2019113339	PANAMA	BJ12000202	CACHOEIRA DOURADA	01/11/2019 14:54	02/11/2019 11:45	01/11/2019 14:54	02/11/2019 11:45	20,84	2	41,69	CHI
2019113340	JUSSARA	JR21341175	BRITANIA	01/11/2019 15:38	01/11/2019 22:22	01/11/2019 15:38	01/11/2019 22:22	6,73	1	6,73	CHI
2019113359	EDEALINA	VI12212267RE	VICENTINOPOLIS	01/11/2019 15:39	04/11/2019 19:24	01/11/2019 15:39	04/11/2019 19:24	75,75	2	151,50	CHI
2019113360	PIRENOPOLIS	PV21286527	SAO FRANCISCO DE GOIAS	01/11/2019 15:39	01/11/2019 21:15	01/11/2019 15:39	01/11/2019 21:15	5,58	1	5,58	CHI
2019113361	SANCLERLANDIA	10015814538	FIRMINOPOLIS S2	01/11/2019 15:40	02/11/2019 11:06	01/11/2019 15:40	02/11/2019 11:06	19,43	1	19,43	CHI
2019113363	RIO VERDE	RV11018078	SANTA HELENA S1	01/11/2019 15:11	01/11/2019 23:20	01/11/2019 15:11	01/11/2019 23:20	8,14	125	1017,36	CHI
2019113364	NAZARIO	NZ12000021	ANICUNS	01/11/2019 15:27	03/11/2019 08:07	01/11/2019 15:27	03/11/2019 08:07	40,67	2	81,34	CHI
2019113364	PALMEIRAS DE GOIAS	NZ12000021	ANICUNS	01/11/2019 15:27	03/11/2019 08:07	01/11/2019 15:27	03/11/2019 08:07	40,67	15	610,07	CHI
2019113369	MINACU	IH11202451	MINACU	01/11/2019 15:17	01/11/2019 20:35	01/11/2019 15:17	01/11/2019 20:35	5,29	15	79,42	CHI
2019113371	CACHOEIRA DOURADA	CD11352677	CACHOEIRA DOURADA	01/11/2019 14:48	02/11/2019 10:10	01/11/2019 14:48	02/11/2019 10:10	19,36	108	2090,37	CHI
2019113374	RUBIATABA	RB11000024	RUBIATABA	01/11/2019 15:24	01/11/2019 18:53	01/11/2019 15:24	01/11/2019 18:53	3,48	93	323,25	CHI

2019113377	GOIAS	GS12070348	GOIAS	01/11/2019 15:41	04/11/2019 17:10	01/11/2019 15:41	04/11/2019 17:10	73,48	6	440,85	CHI
2019113425	GOIANIA	GN12289403	CARAJAS S2	01/11/2019 15:41	02/11/2019 10:20	01/11/2019 15:41	02/11/2019 09:53	18,21	503	9158,09	CHI
2019113425	GOIANIA	GN11287869	CARAJAS S2	01/11/2019 15:41	02/11/2019 10:20	01/11/2019 15:41	02/11/2019 10:20	18,65	62	1156,21	CHI
2019113433	APORE	AE13209675	ITAJA S1	01/11/2019 15:41	02/11/2019 11:37	01/11/2019 15:41	01/11/2019 21:03	5,36	83	444,67	CHI
2019113433	APORE	AE13209675	ITAJA S1	01/11/2019 15:41	02/11/2019 11:37	01/11/2019 15:41	01/11/2019 21:03	5,36	44	235,73	CHI
2019113433	SERRANOPOLIS	AE13209675	ITAJA S1	01/11/2019 15:41	02/11/2019 11:37	01/11/2019 15:41	01/11/2019 21:03	5,36	45	241,09	CHI
2019113433	APORE	00100414	ITAJA S1	01/11/2019 15:41	02/11/2019 11:37	01/11/2019 15:41	02/11/2019 09:58	18,29	5	91,45	CHI
2019113433	APORE	00100414	ITAJA S1	01/11/2019 15:41	02/11/2019 11:37	01/11/2019 15:41	02/11/2019 11:37	19,93	2	39,86	CHI
2019113434	URUACU	UR21156177	CAMPINORTE	01/11/2019 15:46	02/11/2019 09:09	01/11/2019 15:46	02/11/2019 09:09	17,38	7	121,67	CHI
2019113435	TRES RANCHOS	TH21021417	CATALAO S1	01/11/2019 15:46	02/11/2019 16:50	01/11/2019 15:46	02/11/2019 16:50	25,06	2	50,13	CHI
2019113437	BOM JESUS DE GOIAS	BJ11000008	BOM JESUS DE GOIAS	01/11/2019 13:30	01/11/2019 16:37	01/11/2019 13:30	01/11/2019 16:37	3,12	151	470,66	CHI
2019113440	APARECIDA DE GOIANIA	AP11383892	ATLANTICO S3	01/11/2019 15:36	02/11/2019 16:42	01/11/2019 15:36	02/11/2019 16:42	25,10	43	1079,14	CHI
2019113442	CACHOEIRA DOURADA	CD12000005	CACHOEIRA DOURADA	01/11/2019 14:49	02/11/2019 10:32	01/11/2019 14:49	02/11/2019 10:32	19,71	9	177,35	CHI
2019113442	ITUMBIARA	CD12000005	CACHOEIRA DOURADA	01/11/2019 14:49	02/11/2019 10:32	01/11/2019 14:49	02/11/2019 10:32	19,71	20	394,12	CHI
2019113448	SAO MIGUEL DO PASSA QUATRO	SV21137447	BELA VISTA S2	01/11/2019 15:47	01/11/2019 19:03	01/11/2019 15:47	01/11/2019 19:03	3,25	1	3,25	CHI
2019113466	CATALAO	1990215984	CATALAO S2	01/11/2019 15:50	01/11/2019 17:57	01/11/2019 15:50	01/11/2019 17:57	2,11	1	2,11	CHI
2019113489	QUIRINOPOLIS	QI21370172	QUIRINOPOLIS	01/11/2019 15:52	02/11/2019 11:57	01/11/2019 15:52	02/11/2019 11:57	20,08	1	20,08	CHI
2019113502	JATAI	JT11361760	JATAI S2	01/11/2019 15:53	03/11/2019 22:04	01/11/2019 15:53	03/11/2019 22:04	54,18	1	54,18	CHI
2019113510	GOIANIA	GN11166616	CARAJAS S2	01/11/2019 15:45	01/11/2019 18:16	01/11/2019 15:45	01/11/2019 18:16	2,51	174	436,40	CHI
2019113520	SANTA HELENA DE GOIAS	SH11189160	IPEGUARI	01/11/2019 14:42	03/11/2019 07:00	01/11/2019 14:42	03/11/2019 07:00	40,30	55	2216,35	CHI
2019113522	MUTUNOPOLIS	MU21220644	MARA ROSA	01/11/2019 15:55	03/11/2019 20:46	01/11/2019 15:55	03/11/2019 20:46	52,85	1	52,85	CHI
2019113528	JATAI	JT12219384RE	JATAI S3	01/11/2019 13:40	01/11/2019 16:50	01/11/2019 13:40	01/11/2019 16:50	3,16	77	243,13	CHI
2019113537	MINACU	IH12397473	MINACU	01/11/2019 15:39	01/11/2019 22:23	01/11/2019 15:39	01/11/2019 22:23	6,73	8	53,82	CHI
2019113551	GOIANIA	GN11002659	CARAJAS S2	01/11/2019 15:56	02/11/2019 18:15	01/11/2019 15:56	02/11/2019 18:15	26,32	156	4105,14	CHI
2019113563	SILVANIA	SV12070054	CEPAIGO S2	01/11/2019 15:57	05/11/2019 10:18	01/11/2019 15:57	05/11/2019 10:18	90,34	2	180,67	CHI
2019113569	RIO VERDE	RV21049064	RIO VERDE S1	01/11/2019 15:58	04/11/2019 15:28	01/11/2019 15:58	04/11/2019 15:28	71,50	2	143,00	CHI
2019113570	CAIAPONIA	CP21151173	CAIAPONIA	01/11/2019 15:58	06/11/2019 08:40	01/11/2019 15:58	06/11/2019 08:40	112,70	2	225,39	CHI
2019113572	GOIANIA	12968511	CARAJAS S1	01/11/2019 15:58	02/11/2019 09:56	01/11/2019 15:58	02/11/2019 09:56	17,96	1	17,96	CHI
2019113583	RIO VERDE	630309164	RIO VERDE S2	01/11/2019 15:59	01/11/2019 23:35	01/11/2019 15:59	01/11/2019 23:35	7,61	1	7,61	CHI
2019113584	APARECIDA DE GOIANIA	14582910	INDEPENDENCIA S2	01/11/2019 15:59	02/11/2019 20:40	01/11/2019 15:59	02/11/2019 20:40	28,68	1	28,68	CHI
2019113606	GOIANIA	GN11001476	ATLANTICO S2	01/11/2019 15:49	02/11/2019 08:23	01/11/2019 15:49	02/11/2019 08:23	16,57	224	3710,93	CHI
2019113616	INDIARA	IY12081489	EDEIA	01/11/2019 16:02	02/11/2019 11:23	01/11/2019 16:02	02/11/2019 11:23	19,35	52	1006,27	CHI
2019113616	PALMEIRAS DE GOIAS	IY12081489	EDEIA	01/11/2019 16:02	02/11/2019 11:23	01/11/2019 16:02	02/11/2019 11:23	19,35	1	19,35	CHI

2019113652	GOIANIA	GN21060099	GOIANIA LESTE S3	01/11/2019 16:05	01/11/2019 18:10	01/11/2019 16:05	01/11/2019 18:10	2,08	3	6,23	CHI
2019113653	CATALAO	CT21192727	CATALAO S2	01/11/2019 16:05	02/11/2019 09:28	01/11/2019 16:05	02/11/2019 09:28	17,37	1	17,37	CHI
2019113654	APARECIDA DE GOIANIA	AP11003030	INDEPENDENCIA S1	01/11/2019 15:49	01/11/2019 18:32	01/11/2019 15:49	01/11/2019 18:32	2,70	106	286,64	CHI
2019113657	GOIANIA	GN11002901	CARAJAS S1	01/11/2019 15:48	02/11/2019 13:22	01/11/2019 15:48	02/11/2019 13:22	21,57	90	1940,92	CHI
2019113667	CALDAS NOVAS	CN11075199	CALDAS NOVAS S2	01/11/2019 15:39	02/11/2019 10:50	01/11/2019 15:39	02/11/2019 10:50	19,19	124	2379,01	CHI
2019113669	GOIANIA	AP11062130	ATLANTICO S1	01/11/2019 16:01	02/11/2019 12:25	01/11/2019 16:01	02/11/2019 12:25	20,40	118	2407,69	CHI
2019113678	ITUMBIARA	IT12081100	ITUMBIARA VELHA S1	01/11/2019 15:12	01/11/2019 18:49	01/11/2019 15:12	01/11/2019 18:49	3,61	1853	6684,70	CHI
2019113679	GOIANIA	GN11287861	CARAJAS S1	01/11/2019 15:47	01/11/2019 22:33	01/11/2019 15:47	01/11/2019 22:33	6,76	101	683,24	CHI
2019113682	GOIANIA	GN11076701	CARAJAS S1	01/11/2019 15:42	02/11/2019 06:54	01/11/2019 15:42	02/11/2019 06:54	15,20	95	1443,82	CHI
2019113686	APARECIDA DE GOIANIA	AP11137105	INDEPENDENCIA S1	01/11/2019 16:08	02/11/2019 11:45	01/11/2019 16:08	02/11/2019 11:45	19,61	181	3549,61	CHI
2019113688	GOIANIA	17092929	XAVANTES	01/11/2019 16:08	02/11/2019 17:30	01/11/2019 16:08	02/11/2019 17:30	25,36	1	25,36	CHI
2019113691	GOIANIA	GN12127447	ATLANTICO S1	01/11/2019 15:42	01/11/2019 21:47	01/11/2019 15:42	01/11/2019 21:47	6,08	501	3046,36	CHI
2019113694	CATALAO	CT21042437	CATALAO S1	01/11/2019 16:09	05/11/2019 09:39	01/11/2019 16:09	05/11/2019 09:39	89,50	1	89,50	CHI
2019113697	CAIAPONIA	CP21381007	PALESTINA	01/11/2019 19:23	02/11/2019 09:48	01/11/2019 19:23	02/11/2019 09:48	14,40	1	14,40	CHI
2019113698	NIQUELANDIA	NQ12335416	BARRO ALTO	01/11/2019 13:30	01/11/2019 21:18	01/11/2019 13:30	01/11/2019 21:18	7,79	10	77,93	CHI
2019113703	GOIANIA	GN12246248	CARAJAS S1	01/11/2019 15:43	01/11/2019 23:13	01/11/2019 15:43	01/11/2019 23:13	7,51	1399	10501,44	CHI
2019113707	APARECIDA DE GOIANIA	AP11004882	ATLANTICO S3	01/11/2019 15:48	01/11/2019 18:35	01/11/2019 15:48	01/11/2019 18:35	2,77	168	465,78	CHI
2019113711	QUIRINOPOLIS	QI12100484	QUIRINOPOLIS	01/11/2019 16:08	02/11/2019 08:47	01/11/2019 16:08	02/11/2019 08:47	16,64	5	83,18	CHI
2019113724	GOIANIA	GN11167774	ATLANTICO S1	01/11/2019 15:52	02/11/2019 14:33	01/11/2019 15:52	02/11/2019 14:33	22,69	89	2019,29	CHI
2019113749	RIO VERDE	630060459	RIO VERDE S2	01/11/2019 16:15	01/11/2019 20:30	01/11/2019 16:15	01/11/2019 20:30	4,25	1	4,25	CHI
2019113750	RIO VERDE	RV21340920	RIO VERDE S2	01/11/2019 13:08	01/11/2019 21:45	01/11/2019 13:08	01/11/2019 21:45	8,61	1	8,61	CHI
2019113754	ITUMBIARA	690213335	ITUMBIARA NOVA	01/11/2019 16:16	02/11/2019 08:04	01/11/2019 16:16	02/11/2019 08:04	15,80	1	15,80	CHI
2019113763	GOIANIA	GN11191225	CARAJAS S1	01/11/2019 15:57	01/11/2019 23:50	01/11/2019 15:57	01/11/2019 23:50	7,89	119	939,31	CHI
2019113765	GOIANIA	GN11287862	CARAJAS S2	01/11/2019 15:53	02/11/2019 04:42	01/11/2019 15:53	02/11/2019 04:42	12,81	146	1870,95	CHI
2019113769	FORMOSA	FA12245453	ITUIQUIRA	01/11/2019 15:22	01/11/2019 19:59	01/11/2019 15:22	01/11/2019 19:59	4,61	3	13,82	CHI
2019113775	VILA PROPICIO	GE12247163	GOIANESIA S2	01/11/2019 16:16	01/11/2019 22:51	01/11/2019 16:16	01/11/2019 22:51	6,58	8	52,61	CHI
2019113787	JATAI	JT12134923	JATAI S1	01/11/2019 16:20	02/11/2019 19:39	01/11/2019 16:20	02/11/2019 19:39	27,31	11	300,38	CHI
2019113787	SERRANOPOLIS	JT12134923	JATAI S1	01/11/2019 16:20	02/11/2019 19:39	01/11/2019 16:20	02/11/2019 19:39	27,31	4	109,23	CHI
2019113790	GOIANIA	GN12226671	CARAJAS S1	01/11/2019 15:50	01/11/2019 20:00	01/11/2019 15:50	01/11/2019 20:00	4,17	534	2225,44	CHI
2019113793	RIO VERDE	RV21123222	RIO VERDE S1	01/11/2019 16:21	04/11/2019 10:45	01/11/2019 16:21	04/11/2019 10:45	66,39	2	132,77	CHI
2019113798	ACREUNA	EU11048342	ACREUNA	01/11/2019 16:13	02/11/2019 14:32	01/11/2019 16:13	02/11/2019 14:32	22,31	173	3860,06	CHI
2019113802	SANTA RITA DO ARAGUAIA	SU21142651	SANTA RITA DO ARAGUAIA	01/11/2019 16:23	02/11/2019 10:47	01/11/2019 16:23	02/11/2019 10:47	18,40	1	18,40	CHI
2019113804	GOIANAPOLIS	GP12357383	DAIA S2	01/11/2019 15:38	01/11/2019 18:10	01/11/2019 15:38	01/11/2019 18:10	2,53	15	37,92	CHI

2019113804	GOIANIA	GP12357383	DAIA S2	01/11/2019 15:38	01/11/2019 18:10	01/11/2019 15:38	01/11/2019 18:10	2,53	1	2,53	CHI
2019113807	GOIANIA	GN11277039	CARAJAS S2	01/11/2019 15:47	02/11/2019 01:37	01/11/2019 15:47	02/11/2019 01:37	9,82	40	392,70	CHI
2019113808	CATALAO	CT21266705	CATALAO S1	01/11/2019 16:24	02/11/2019 11:53	01/11/2019 16:24	02/11/2019 11:53	19,49	1	19,49	CHI
2019113809	GOIANIA	GN11001047	CARAJAS S1	01/11/2019 15:51	02/11/2019 09:26	01/11/2019 15:51	02/11/2019 09:26	17,57	60	1054,05	CHI
2019113818	CATALAO	CT12072921	CAMPO ALEGRE DE GOIAS	01/11/2019 16:25	02/11/2019 12:49	01/11/2019 16:25	02/11/2019 12:49	20,39	2	40,78	CHI
2019113825	BONOPOLIS	BX12316276	SAO MIGUEL DO ARAGUAIA	01/11/2019 15:18	03/11/2019 09:31	01/11/2019 15:18	03/11/2019 09:31	42,20	4	168,82	CHI
2019113828	GOIANIA	GN11209298	CARAJAS S1	01/11/2019 15:59	02/11/2019 04:40	01/11/2019 15:59	02/11/2019 04:40	12,68	85	1078,01	CHI
2019113830	GOIANIA	GN11337923	CARAJAS S1	01/11/2019 15:57	01/11/2019 22:44	01/11/2019 15:57	01/11/2019 22:44	6,77	119	805,63	CHI
2019113838	TRINDADE	TR12230638	TRINDADE	01/11/2019 15:42	01/11/2019 19:14	01/11/2019 15:42	01/11/2019 19:14	3,52	1397	4923,65	CHI
2019113843	RIO VERDE	RV12249024	SANTA HELENA S1	01/11/2019 15:14	02/11/2019 01:06	01/11/2019 15:14	02/11/2019 01:06	9,85	7	68,96	CHI
2019113847	EDEALINA	EA21078274	VICENTINOPOLIS	01/11/2019 16:29	04/11/2019 14:00	01/11/2019 16:29	04/11/2019 14:00	69,51	1	69,51	CHI
2019113850	APARECIDA DE GOIANIA	AP11051728	INDEPENDENCIA S2	01/11/2019 15:28	01/11/2019 21:03	01/11/2019 15:28	01/11/2019 21:03	5,57	222	1237,28	CHI
2019113856	APARECIDA DE GOIANIA	200388794	INDEPENDENCIA S2	01/11/2019 16:30	02/11/2019 08:59	01/11/2019 16:30	02/11/2019 08:59	16,48	1	16,48	CHI
2019113857	COCALZINHO DE GOIAS	ZN21168637	GOIANESIA S1	01/11/2019 16:30	02/11/2019 14:08	01/11/2019 16:30	02/11/2019 14:08	21,63	1	21,63	CHI
2019113858	DIVINOPOLIS DE GOIAS	GH12253952	SAO DOMINGOS	01/11/2019 16:30	01/11/2019 23:23	01/11/2019 16:30	01/11/2019 23:23	6,88	4	27,50	CHI
2019113872	GOIANIA	GN11001030	ATLANTICO S1	01/11/2019 15:56	01/11/2019 23:38	01/11/2019 15:56	01/11/2019 23:38	7,69	107	823,34	CHI
2019113880	ACREUNA	EU21296106	ACREUNA	01/11/2019 16:32	02/11/2019 15:12	01/11/2019 16:32	02/11/2019 15:12	22,67	1	22,67	CHI
2019113883	CACU	SO12303104	CACHOEIRA ALTA	01/11/2019 16:32	03/11/2019 14:20	01/11/2019 16:32	03/11/2019 14:20	45,80	1	45,80	CHI
2019113883	SAO SIMAO	SO12303104	CACHOEIRA ALTA	01/11/2019 16:32	03/11/2019 14:20	01/11/2019 16:32	03/11/2019 14:20	45,80	2	91,59	CHI
2019113885	RIO VERDE	630057989	RIO VERDE S1	01/11/2019 16:32	02/11/2019 18:40	01/11/2019 16:32	02/11/2019 18:40	26,13	1	26,13	CHI
2019113900	GOIANIA	GN12289391	CARAJAS S2	01/11/2019 15:47	01/11/2019 23:00	01/11/2019 15:47	01/11/2019 23:00	7,22	424	3059,40	CHI
2019113920	MINEIROS	1390083710	PARQUE DAS EMAS	01/11/2019 16:36	02/11/2019 04:57	01/11/2019 16:36	02/11/2019 04:57	12,34	1	12,34	CHI
2019113922	JATAI	JT12336942	JATAI S1	01/11/2019 16:37	02/11/2019 21:46	01/11/2019 16:37	02/11/2019 11:25	18,82	13	244,60	CHI
2019113922	PEROLANDIA	JT12336942	JATAI S1	01/11/2019 16:37	02/11/2019 21:46	01/11/2019 16:37	02/11/2019 11:25	18,82	3	56,45	CHI
2019113922	JATAI	JT12248490LD	JATAI S1	01/11/2019 16:37	02/11/2019 21:46	01/11/2019 16:37	02/11/2019 21:46	29,16	7	204,11	CHI
2019113922	JATAI	JT12336942	JATAI S1	01/11/2019 16:37	02/11/2019 21:46	02/11/2019 12:49	02/11/2019 21:46	8,94	13	116,25	CHI
2019113922	PEROLANDIA	JT12336942	JATAI S1	01/11/2019 16:37	02/11/2019 21:46	02/11/2019 12:49	02/11/2019 21:46	8,94	3	26,83	CHI
2019113927	MONTES CLAROS DE GOIAS	DI21072088	IPORA	01/11/2019 16:37	02/11/2019 10:50	01/11/2019 16:37	02/11/2019 10:50	18,22	1	18,22	CHI
2019113931	GOIANIA	GN11005004	CARAJAS S1	01/11/2019 15:44	02/11/2019 05:34	01/11/2019 15:44	02/11/2019 05:34	13,82	135	1865,70	CHI
2019113939	ANICUNS	AC12312600	ANICUNS	01/11/2019 16:33	01/11/2019 23:36	01/11/2019 16:33	01/11/2019 23:36	7,04	6	42,25	CHI
2019113945	CAVALCANTE	740015503	FLORES DE GOIAS	01/11/2019 16:39	01/11/2019 22:22	01/11/2019 16:39	01/11/2019 22:22	5,71	1	5,71	CHI
2019113948	SANTA FE DE GOIAS	7186292	BRITANIA	01/11/2019 16:40	05/11/2019 18:03	01/11/2019 16:40	05/11/2019 18:03	97,38	1	97,38	CHI
2019113948	SANTA FE DE GOIAS	7186292	BRITANIA	01/11/2019 16:40	05/11/2019 18:03	01/11/2019 16:40	05/11/2019 18:03	97,37	1	97,37	CHI

2019113949	GOIANIA	GN12077038	ATLANTICO S3	01/11/2019 15:32	02/11/2019 07:00	01/11/2019 15:32	02/11/2019 07:00	15,46	193	2983,83	CHI
2019113951	ITABERAÍ	HE21099453	ITABERAÍ S1	01/11/2019 16:40	02/11/2019 07:47	01/11/2019 16:40	02/11/2019 07:47	15,11	2	30,22	CHI
2019113953	GOIANIA	GN11162196	CARAJAS S1	01/11/2019 15:58	02/11/2019 02:52	01/11/2019 15:58	02/11/2019 02:52	10,89	97	1056,44	CHI
2019113968	GOIANIRA	390094936	MEIA PONTE	01/11/2019 16:42	04/11/2019 10:26	01/11/2019 16:42	04/11/2019 10:26	65,73	1	65,73	CHI
2019113979	ACREUNA	2440038642	ACREUNA	01/11/2019 16:42	02/11/2019 01:21	01/11/2019 16:42	02/11/2019 01:21	8,64	1	8,64	CHI
2019113982	CAIAPONIA	CP12207949	CAIAPONIA	01/11/2019 14:45	02/11/2019 12:27	01/11/2019 14:45	02/11/2019 12:27	21,70	59	1280,04	CHI
2019113988	GOIANIA	12089266	GOYA S1	01/11/2019 16:44	01/11/2019 17:46	01/11/2019 16:44	01/11/2019 17:46	1,03	1	1,03	CHI
2019113990	GOIANIA	GN11198447	CARAJAS S2	01/11/2019 15:51	02/11/2019 05:19	01/11/2019 15:51	02/11/2019 05:19	13,46	93	1251,34	CHI
2019113992	ARAGOIANIA	AO11251669	GUAPO S2	01/11/2019 16:44	01/11/2019 22:20	01/11/2019 16:44	01/11/2019 22:20	5,59	21	117,37	CHI
2019113998	GOIANIA	GN11001041	CARAJAS S1	01/11/2019 16:44	02/11/2019 14:10	01/11/2019 16:44	02/11/2019 14:10	21,42	111	2377,34	CHI
2019114003	GOIANIA	12587930	ATLANTICO S3	01/11/2019 16:45	02/11/2019 16:27	01/11/2019 16:45	02/11/2019 16:27	23,69	1	23,69	CHI
2019114030	APARECIDA DE GOIANIA	AP11077151	INDEPENDENCIA S2	01/11/2019 16:27	01/11/2019 19:45	01/11/2019 16:27	01/11/2019 19:45	3,29	191	628,71	CHI
2019114034	GOIANAPOLIS	GP11189610	DAIA S2	01/11/2019 16:47	01/11/2019 19:12	01/11/2019 16:47	01/11/2019 19:12	2,40	116	278,85	CHI
2019114035	GOIANIA	GN11161849	CARAJAS S1	01/11/2019 16:34	01/11/2019 19:10	01/11/2019 16:34	01/11/2019 19:10	2,60	123	319,63	CHI
2019114073	GOIATUBA	BJ11257225	RIO DOS BOIS	01/11/2019 16:34	02/11/2019 10:31	01/11/2019 16:34	02/11/2019 10:31	17,95	73	1310,65	CHI
2019114102	SENADOR CANEDO	SW11161111	SENADOR CANEDO	01/11/2019 16:42	01/11/2019 20:03	01/11/2019 16:42	01/11/2019 20:03	3,35	175	585,76	CHI
2019114109	GOIANIA	GN11051446	CARAJAS S1	01/11/2019 16:16	01/11/2019 18:54	01/11/2019 16:16	01/11/2019 18:54	2,62	173	453,45	CHI
2019114114	MONTIVIDIU	8313090	MONTIVIDIU T	01/11/2019 19:48	06/11/2019 23:01	01/11/2019 19:48	06/11/2019 23:01	123,21	1	123,21	CHI
2019114114	RIO VERDE	8313090	MONTIVIDIU T	01/11/2019 19:48	06/11/2019 23:01	01/11/2019 19:48	06/11/2019 23:01	123,21	2	246,42	CHI
2019114128	FORMOSA	610113331	ITUIQUIRA	01/11/2019 16:59	01/11/2019 18:53	01/11/2019 16:59	01/11/2019 18:53	1,89	1	1,89	CHI
2019114129	GOIANIA	GN21217425	ATLANTICO S1	01/11/2019 16:59	02/11/2019 12:59	01/11/2019 16:59	02/11/2019 12:59	19,99	5	99,93	CHI
2019114138	RIO VERDE	RV12260643	CABRIUVA S2	01/11/2019 14:27	01/11/2019 20:14	01/11/2019 14:27	01/11/2019 20:14	5,78	8	46,26	CHI
2019114143	AGUA FRIA DE GOIAS	TL12131760	SAO JOAO D ALIANCA	01/11/2019 15:47	01/11/2019 22:25	01/11/2019 15:47	01/11/2019 22:25	6,63	20	132,66	CHI
2019114143	FORMOSA	TL12131760	SAO JOAO D ALIANCA	01/11/2019 15:47	01/11/2019 22:25	01/11/2019 15:47	01/11/2019 22:25	6,63	2	13,27	CHI
2019114153	ACREUNA	EU11048339	ACREUNA	01/11/2019 15:58	02/11/2019 00:27	01/11/2019 23:33	02/11/2019 00:27	0,89	74	66,19	CHI
2019114157	QUIRINOPOLIS	80022418	QUIRINOPOLIS	01/11/2019 17:02	02/11/2019 09:14	01/11/2019 17:02	02/11/2019 09:14	16,20	1	16,20	CHI
2019114165	AURILANDIA	AI12377179	FIRMINOPOLIS S2	01/11/2019 17:03	02/11/2019 11:48	01/11/2019 17:03	02/11/2019 11:48	18,75	3	56,26	CHI
2019114166	EDEIA	EA12026646	EDEIA	01/11/2019 16:50	02/11/2019 13:25	01/11/2019 16:50	02/11/2019 13:25	20,58	9	185,21	CHI
2019114170	JANDAIA	PL12205904	PALMEIRAS	01/11/2019 15:32	03/11/2019 19:35	01/11/2019 15:32	03/11/2019 19:35	52,06	1	52,06	CHI
2019114170	PALMEIRAS DE GOIAS	PL12205904	PALMEIRAS	01/11/2019 15:32	03/11/2019 19:35	01/11/2019 15:32	03/11/2019 19:35	52,06	52	2707,09	CHI
2019114174	GOIANIA	GN11142929	CARAJAS S1	01/11/2019 18:50	02/11/2019 07:05	01/11/2019 18:50	02/11/2019 07:05	12,24	92	1126,16	CHI
2019114176	APARECIDA DE GOIANIA	16693218	INDEPENDENCIA S1	01/11/2019 17:04	01/11/2019 19:18	01/11/2019 17:04	01/11/2019 19:18	2,23	1	2,23	CHI
2019114190	APARECIDA DE GOIANIA	AP11003029	INDEPENDENCIA S1	01/11/2019 16:15	01/11/2019 18:52	01/11/2019 16:15	01/11/2019 18:52	2,61	133	346,76	CHI

2019114193	GOIANIA	GN12269050	CARAJAS S2	01/11/2019 20:09	01/11/2019 22:34	01/11/2019 20:09	01/11/2019 22:34	2,41	28	67,39	CHI
2019114194	BOM JESUS DE GOIAS	BJ12000131	BOM JESUS DE GOIAS	01/11/2019 17:06	07/11/2019 12:05	01/11/2019 17:06	07/11/2019 12:05	138,97	2	277,93	CHI
2019114196	GOIANIA	GN11000196	FERROVIARIO S3	01/11/2019 17:07	01/11/2019 19:38	01/11/2019 17:07	01/11/2019 19:38	2,51	23	57,74	CHI
2019114202	APARECIDA DE GOIANIA	AP11349641	INDEPENDENCIA S1	01/11/2019 16:32	02/11/2019 18:17	01/11/2019 16:32	02/11/2019 18:17	25,75	109	2806,45	CHI
2019114206	CACHOEIRA DOURADA	CD12000057RE	CACHOEIRA DOURADA	01/11/2019 14:56	02/11/2019 21:15	01/11/2019 14:56	02/11/2019 21:15	30,32	42	1273,41	CHI
2019114206	ITUMBIARA	CD12000057RE	CACHOEIRA DOURADA	01/11/2019 14:56	02/11/2019 21:15	01/11/2019 14:56	02/11/2019 21:15	30,32	15	454,79	CHI
2019114226	ITAPIRAPUA	IU11403047	MATRINCHA	01/11/2019 17:12	03/11/2019 12:45	03/11/2019 08:54	03/11/2019 12:45	3,85	48	184,95	CHI
2019114228	GOIANIA	GN11346268	CARAJAS S1	01/11/2019 15:51	02/11/2019 08:15	01/11/2019 15:51	02/11/2019 08:15	16,40	121	1983,80	CHI
2019114231	GOIANIA	GN11216849	ATLANTICO S1	01/11/2019 16:14	02/11/2019 05:22	01/11/2019 16:14	02/11/2019 05:22	13,12	71	931,36	CHI
2019114233	TRINDADE	TR12001811	GOYA S1	01/11/2019 13:29	02/11/2019 11:40	01/11/2019 13:29	02/11/2019 11:40	22,18	26	576,56	CHI
2019114237	PALMEIRAS DE GOIAS	PL21141719	PALMEIRAS	01/11/2019 17:13	04/11/2019 08:40	01/11/2019 17:13	04/11/2019 08:40	63,46	1	63,46	CHI
2019114241	SANTO ANTONIO DO DESCOBERTO	2210067280	ALEXANIA	01/11/2019 17:14	01/11/2019 19:42	01/11/2019 17:14	01/11/2019 19:42	2,46	1	2,46	CHI
2019114247	CATALAO	CT21318695	CATALAO S1	01/11/2019 17:14	02/11/2019 09:20	01/11/2019 17:14	02/11/2019 09:20	16,09	1	16,09	CHI
2019114252	ALEXANIA	AX12402045	ALEXANIA	01/11/2019 16:39	01/11/2019 19:29	01/11/2019 16:39	01/11/2019 19:29	2,83	174	492,71	CHI
2019114252	SANTO ANTONIO DO DESCOBERTO	AX12402045	ALEXANIA	01/11/2019 16:39	01/11/2019 19:29	01/11/2019 16:39	01/11/2019 19:29	2,83	1	2,83	CHI
2019114258	IPAMERI	IP12275536	CAMPO ALEGRE DE GOIAS	01/11/2019 16:46	03/11/2019 23:19	01/11/2019 16:46	03/11/2019 23:19	54,55	9	490,94	CHI
2019114259	GOIANESIA	GE12000150	GOIANESIA S1	01/11/2019 17:16	02/11/2019 15:11	01/11/2019 17:16	02/11/2019 15:11	21,92	3	65,75	CHI
2019114264	SANTA HELENA DE GOIAS	SH11160721	IPEGUARI	01/11/2019 15:58	01/11/2019 19:39	01/11/2019 15:58	01/11/2019 19:39	3,69	48	176,99	CHI
2019114280	BALIZA	BH12331303	CAIAPONIA	01/11/2019 16:46	05/11/2019 07:53	01/11/2019 16:46	05/11/2019 07:53	87,10	9	783,92	CHI
2019114282	BOM JESUS DE GOIAS	BJ12000149RE	BOM JESUS DE GOIAS	01/11/2019 17:17	02/11/2019 10:34	01/11/2019 17:17	02/11/2019 10:34	17,28	18	311,07	CHI
2019114296	ITUMBIARA	BJ12000002	BOM JESUS DE GOIAS	01/11/2019 17:48	01/11/2019 23:29	01/11/2019 17:48	01/11/2019 23:29	5,68	241	1367,74	CHI
2019114311	BOM JESUS DE GOIAS	BJ12312883	BOM JESUS DE GOIAS	01/11/2019 15:12	01/11/2019 21:38	01/11/2019 15:12	01/11/2019 21:38	6,43	773	4972,97	CHI
2019114312	AMORINOPOLIS	IV12165613	IPORA	01/11/2019 15:33	02/11/2019 10:55	01/11/2019 15:33	02/11/2019 10:55	19,36	5	96,82	CHI
2019114312	IVOLANDIA	IV12165613	IPORA	01/11/2019 15:33	02/11/2019 10:55	01/11/2019 15:33	02/11/2019 10:55	19,36	6	116,18	CHI
2019114319	GOIANIA	GN12102872	CARAJAS S1	01/11/2019 16:01	01/11/2019 21:45	01/11/2019 16:01	01/11/2019 21:45	5,72	240	1373,53	CHI
2019114324	PALMEIRAS DE GOIAS	PL12088499	PALMEIRAS	01/11/2019 17:13	02/11/2019 10:50	01/11/2019 17:13	02/11/2019 10:50	17,62	4	70,49	CHI
2019114326	TRINDADE	TR11110907	GOYA S2	01/11/2019 17:03	01/11/2019 22:19	01/11/2019 17:03	01/11/2019 22:19	5,25	166	871,55	CHI
2019114333	PEROLANDIA	DP12209680	JATAI S1	01/11/2019 17:25	02/11/2019 13:22	01/11/2019 17:25	02/11/2019 13:22	19,94	3	59,82	CHI
2019114345	RIO VERDE	SH12000198	IPEGUARI	01/11/2019 17:20	02/11/2019 18:49	01/11/2019 17:20	02/11/2019 18:49	25,47	3	76,40	CHI
2019114345	SANTA HELENA DE GOIAS	SH12000198	IPEGUARI	01/11/2019 17:20	02/11/2019 18:49	01/11/2019 17:20	02/11/2019 18:49	25,47	7	178,28	CHI
2019114353	MORRINHOS	MR21030230	MORRINHOS	01/11/2019 17:27	03/11/2019 08:17	01/11/2019 17:27	03/11/2019 08:17	38,82	1	38,82	CHI
2019114361	ANAPOLIS	LB12078506	DAIA S2	01/11/2019 17:10	02/11/2019 09:25	01/11/2019 17:10	02/11/2019 09:25	16,23	8	129,87	CHI
2019114361	LEOPOLDO DE BULHOES	LB12078506	DAIA S2	01/11/2019 17:10	02/11/2019 09:25	01/11/2019 17:10	02/11/2019 09:25	16,23	6	97,40	CHI

2019114375	PORTELANDIA	PW12374317	PARQUE DAS EMAS	01/11/2019 16:31	03/11/2019 16:24	01/11/2019 16:31	02/11/2019 11:42	19,17	5	95,87	CHI
2019114375	PORTELANDIA	PW12374317	PARQUE DAS EMAS	01/11/2019 16:31	03/11/2019 16:24	01/11/2019 16:31	02/11/2019 12:15	19,74	1	19,74	CHI
2019114375	CAIAPONIA	MY12301804LD	PARQUE DAS EMAS	01/11/2019 16:31	03/11/2019 16:24	01/11/2019 16:31	03/11/2019 16:24	47,88	1	47,88	CHI
2019114375	DOVERLANDIA	MY12301804LD	PARQUE DAS EMAS	01/11/2019 16:31	03/11/2019 16:24	01/11/2019 16:31	03/11/2019 16:24	47,88	4	191,50	CHI
2019114375	MINEIROS	MY12301804LD	PARQUE DAS EMAS	01/11/2019 16:31	03/11/2019 16:24	01/11/2019 16:31	03/11/2019 16:24	47,88	8	383,00	CHI
2019114375	MINEIROS	PW12374317	PARQUE DAS EMAS	01/11/2019 16:31	03/11/2019 16:24	01/11/2019 16:31	03/11/2019 16:24	47,88	8	383,00	CHI
2019114375	PEROLANDIA	PW12374317	PARQUE DAS EMAS	01/11/2019 16:31	03/11/2019 16:24	01/11/2019 16:31	03/11/2019 16:24	47,88	3	143,63	CHI
2019114375	PORTELANDIA	PW12374317	PARQUE DAS EMAS	01/11/2019 16:31	03/11/2019 16:24	01/11/2019 16:31	03/11/2019 16:24	47,88	1	47,88	CHI
2019114382	CATALAO	CT11231574	CATALAO S2	01/11/2019 17:10	01/11/2019 19:34	01/11/2019 17:10	01/11/2019 19:34	2,39	49	117,31	CHI
2019114386	OURO VERDE DE GOIAS	300029093	INHUMAS S1	01/11/2019 17:31	02/11/2019 23:00	01/11/2019 17:31	02/11/2019 23:00	29,49	1	29,49	CHI
2019114388	ITUMBIARA	IT12404026	ITUMBIARA VELHA S1	01/11/2019 18:15	02/11/2019 08:56	01/11/2019 18:15	02/11/2019 08:56	14,68	76	1115,34	CHI
2019114390	GOIANIA	11812679	REAL S2	01/11/2019 17:32	02/11/2019 10:25	01/11/2019 17:32	02/11/2019 10:25	16,88	1	16,88	CHI
2019114395	MINEIROS	10017158476	PARQUE DAS EMAS	01/11/2019 22:13	02/11/2019 13:55	01/11/2019 22:13	02/11/2019 13:55	15,71	1	15,71	CHI
2019114397	QUIRINOPOLIS	QI11091105	QUIRINOPOLIS	01/11/2019 17:27	01/11/2019 20:34	01/11/2019 17:27	01/11/2019 20:34	3,10	128	397,37	CHI
2019114398	MINEIROS	MY12248429	PARQUE DAS EMAS	01/11/2019 14:49	02/11/2019 02:37	01/11/2019 14:49	02/11/2019 02:37	11,80	18	212,35	CHI
2019114401	APARECIDA DE GOIANIA	10010087476	ANHANGUERA	01/11/2019 17:33	02/11/2019 07:42	01/11/2019 17:33	02/11/2019 07:42	14,14	1	14,14	CHI
2019114402	RIO VERDE	RV12054354	MONTIVIDIU T	01/11/2019 15:57	02/11/2019 12:05	01/11/2019 15:57	02/11/2019 12:05	20,14	2	40,28	CHI
2019114403	ANAPOLIS	AN31057524	ANAPOLIS UNIVERSITARIO S2	01/11/2019 17:34	01/11/2019 18:54	01/11/2019 17:34	01/11/2019 18:54	1,33	2	2,67	CHI
2019114406	TRINDADE	10022906655	GOYA S2	01/11/2019 17:19	01/11/2019 20:51	01/11/2019 17:19	01/11/2019 20:51	3,53	1	3,53	CHI
2019114415	GOUVELANDIA	GB11000041	QUIRINOPOLIS	01/11/2019 17:25	01/11/2019 22:56	01/11/2019 17:25	01/11/2019 22:56	5,51	80	440,64	CHI
2019114417	ARUANA	2380015709	ARUANA	01/11/2019 17:35	02/11/2019 08:30	01/11/2019 17:35	02/11/2019 08:30	14,92	1	14,92	CHI
2019114440	ITABERAI	IB12206929	ITABERAI S2	01/11/2019 15:40	03/11/2019 10:43	01/11/2019 15:40	03/11/2019 10:43	43,04	5	215,19	CHI
2019114443	TRINDADE	TR11158289	GOYA S2	01/11/2019 17:28	02/11/2019 00:10	01/11/2019 17:28	02/11/2019 00:10	6,70	70	468,88	CHI
2019114476	GOIANIA	15877978	GOIANIA LESTE S1	01/11/2019 17:41	02/11/2019 09:05	01/11/2019 17:41	02/11/2019 09:05	15,39	1	15,39	CHI
2019114478	APARECIDA DE GOIANIA	200135510	INDEPENDENCIA S1	01/11/2019 17:41	02/11/2019 11:10	01/11/2019 17:41	02/11/2019 11:10	17,47	1	17,47	CHI
2019114493	RUBIATABA	RB12194368	RUBIATABA	01/11/2019 16:00	01/11/2019 19:24	01/11/2019 16:00	01/11/2019 19:24	3,40	4	13,59	CHI
2019114494	JATAI	JT12092382	JATAI S1	01/11/2019 17:44	05/11/2019 10:54	01/11/2019 17:44	05/11/2019 10:54	89,17	4	356,68	CHI
2019114495	PALMEIRAS DE GOIAS	PL12331634	FIRMINOPOLIS S2	01/11/2019 16:57	01/11/2019 22:23	01/11/2019 16:57	01/11/2019 22:23	5,42	12	65,09	CHI
2019114506	APARECIDA DE GOIANIA	AP11095595	INDEPENDENCIA S1	01/11/2019 16:41	01/11/2019 20:57	01/11/2019 16:41	01/11/2019 20:57	4,26	118	502,78	CHI
2019114512	ITAPIRAPUA	IU12018834	MATRINCHA	01/11/2019 16:28	02/11/2019 15:52	01/11/2019 16:28	02/11/2019 15:52	23,39	9	210,55	CHI
2019114517	GOIANIA	GN11149605	CARAJAS S2	01/11/2019 16:06	01/11/2019 23:39	01/11/2019 16:06	01/11/2019 23:39	7,55	147	1109,69	CHI
2019114519	SANTA HELENA DE GOIAS	SH12301062	RIO DOS BOIS	01/11/2019 17:48	03/11/2019 13:53	01/11/2019 17:48	03/11/2019 13:53	44,07	3	132,21	CHI
2019114519	TURVELANDIA	SH12301062	RIO DOS BOIS	01/11/2019 17:48	03/11/2019 13:53	01/11/2019 17:48	03/11/2019 13:53	44,07	3	132,21	CHI

2019114524	RIO VERDE	RV21303477	MONTIVIDIU T	01/11/2019 17:49	05/11/2019 11:24	01/11/2019 17:49	05/11/2019 11:24	89,57	1	89,57	CHI
2019114531	GOIANIA	GN11001034	CARAJAS S1	01/11/2019 16:50	02/11/2019 04:26	01/11/2019 16:50	02/11/2019 04:26	11,60	68	789,06	CHI
2019114533	GOIANIA	GN12042924	FERROVIARIO S2	01/11/2019 17:29	01/11/2019 18:51	01/11/2019 17:29	01/11/2019 18:51	1,36	117	159,41	CHI
2019114535	ITARUMA	IM12041685	CACHOEIRA ALTA	01/11/2019 17:52	03/11/2019 09:57	01/11/2019 17:52	03/11/2019 09:57	40,08	5	200,41	CHI
2019114537	APARECIDA DE GOIANIA	AP11247988	INDEPENDENCIA S2	01/11/2019 17:42	01/11/2019 21:21	01/11/2019 17:42	01/11/2019 21:21	3,65	133	485,45	CHI
2019114553	GOIANIA	GN11170391	ATLANTICO S1	01/11/2019 16:11	02/11/2019 14:28	01/11/2019 16:11	02/11/2019 14:28	22,28	57	1269,87	CHI
2019114562	BOM JESUS DE GOIAS	BJ12000013	BOM JESUS DE GOIAS	01/11/2019 16:01	01/11/2019 22:12	01/11/2019 16:01	01/11/2019 22:12	6,18	166	1026,06	CHI
2019114562	GOIATUBA	BJ12000013	BOM JESUS DE GOIAS	01/11/2019 16:01	01/11/2019 22:12	01/11/2019 16:01	01/11/2019 22:12	6,18	5	30,91	CHI
2019114566	CAIAPONIA	CP12345397	CAIAPONIA	01/11/2019 14:29	07/11/2019 11:49	01/11/2019 14:29	07/11/2019 11:49	141,32	7	989,26	CHI
2019114571	ITUMBIARA	IT12296859	CACHOEIRA DOURADA	01/11/2019 17:54	04/11/2019 16:12	01/11/2019 17:54	04/11/2019 16:12	70,29	8	562,32	CHI
2019114575	GOIANIA	GN11210900	CARAJAS S2	01/11/2019 17:26	02/11/2019 00:43	01/11/2019 17:26	02/11/2019 00:43	7,28	134	975,82	CHI
2019114589	GOIANIA	10785668	CARAJAS S1	01/11/2019 17:57	02/11/2019 15:52	01/11/2019 17:57	02/11/2019 15:52	21,91	1	21,91	CHI
2019114606	ITUMBIARA	BJ11134667	BOM JESUS DE GOIAS	01/11/2019 17:38	02/11/2019 10:11	01/11/2019 17:38	02/11/2019 10:11	16,54	98	1621,33	CHI
2019114608	APARECIDA DE GOIANIA	AP12402133	INDEPENDENCIA S2	01/11/2019 17:18	01/11/2019 18:38	01/11/2019 17:18	01/11/2019 18:38	1,32	547	724,02	CHI
2019114609	GOUVELANDIA	GB21000352	QUIRINOPOLIS	01/11/2019 17:58	02/11/2019 22:49	01/11/2019 17:58	02/11/2019 22:49	28,83	1	28,83	CHI
2019114610	CASTELANDIA	ML12271556	RIO DOS BOIS	01/11/2019 17:09	02/11/2019 09:59	01/11/2019 17:09	02/11/2019 09:59	16,83	20	336,58	CHI
2019114610	MAURILANDIA	ML12271556	RIO DOS BOIS	01/11/2019 17:09	02/11/2019 09:59	01/11/2019 17:09	02/11/2019 09:59	16,83	9	151,46	CHI
2019114610	RIO VERDE	ML12271556	RIO DOS BOIS	01/11/2019 17:09	02/11/2019 09:59	01/11/2019 17:09	02/11/2019 09:59	16,83	20	336,58	CHI
2019114613	GOIANIA	10010731111	CARAJAS S2	01/11/2019 17:59	02/11/2019 13:03	01/11/2019 17:59	02/11/2019 13:03	19,06	1	19,06	CHI
2019114620	CAVALCANTE	CJ12310119	FLORES DE GOIAS	01/11/2019 16:43	01/11/2019 21:13	01/11/2019 16:43	01/11/2019 21:13	4,49	7	31,43	CHI
2019114623	CALDAS NOVAS	CN12298669RE	SERRA DE CALDAS	01/11/2019 15:12	01/11/2019 20:30	01/11/2019 15:12	01/11/2019 20:30	5,29	78	412,25	CHI
2019114625	PARAUNA	AI21008171	FIRMINOPOLIS S2	01/11/2019 18:00	04/11/2019 12:13	01/11/2019 18:00	04/11/2019 12:13	66,20	1	66,20	CHI
2019114629	PIRACANJUBA	CF12300660	CRISTIANOPOLIS	01/11/2019 17:30	02/11/2019 16:15	01/11/2019 17:30	02/11/2019 16:15	22,75	65	1478,59	CHI
2019114631	GOIANIA	GN11199197	ATLANTICO S1	01/11/2019 16:49	02/11/2019 03:18	01/11/2019 16:49	02/11/2019 03:18	10,48	92	964,16	CHI
2019114632	JATAI	JT12205194	JATAI S1	01/11/2019 18:02	01/11/2019 22:40	01/11/2019 18:02	01/11/2019 22:40	4,64	7	32,45	CHI
2019114646	TURVANIA	TV21005590	FIRMINOPOLIS S2	01/11/2019 18:03	02/11/2019 15:05	01/11/2019 18:03	02/11/2019 15:05	21,03	1	21,03	CHI
2019114654	CALDAS NOVAS	CN21190293	CALDAS NOVAS S2	01/11/2019 18:04	03/11/2019 11:59	01/11/2019 18:04	03/11/2019 11:59	41,92	1	41,92	CHI
2019114657	GOUVELANDIA	QI21271586	QUIRINOPOLIS	01/11/2019 18:04	02/11/2019 15:53	01/11/2019 18:04	02/11/2019 15:53	21,81	1	21,81	CHI
2019114659	MINEIROS	MY12274100	PARQUE DAS EMAS	01/11/2019 18:04	02/11/2019 10:38	01/11/2019 18:04	02/11/2019 10:38	16,56	16	264,99	CHI
2019114665	MINEIROS	MY12260337	PARQUE DAS EMAS	01/11/2019 17:35	01/11/2019 20:09	01/11/2019 17:35	01/11/2019 20:09	2,56	521	1332,02	CHI
2019114671	APARECIDA DE GOIANIA	AP11161817	ATLANTICO S3	01/11/2019 17:20	01/11/2019 21:36	01/11/2019 17:20	01/11/2019 21:36	4,27	92	392,51	CHI
2019114675	GOIANIA	GN11198747	CARAJAS S2	01/11/2019 18:05	02/11/2019 17:58	01/11/2019 18:05	02/11/2019 17:58	23,88	94	2244,67	CHI
2019114682	SANTA HELENA DE GOIAS	SH11091101	IPEGUARI	01/11/2019 16:51	02/11/2019 09:22	01/11/2019 16:51	02/11/2019 09:22	16,50	148	2442,16	CHI

2019114687	ANAPOLIS	21314536	ANAPOLIS UNIVERSITARIO S2	01/11/2019 18:06	01/11/2019 19:04	01/11/2019 18:06	01/11/2019 19:04	0,96	1	0,96	CHI
2019114690	GOIANIA	GN11127054	CARAJAS S1	01/11/2019 16:31	02/11/2019 04:56	01/11/2019 16:31	02/11/2019 04:56	12,40	102	1265,08	CHI
2019114694	NIQUELANDIA	NQ12140184	SAO JOAO D ALIANCA	01/11/2019 15:58	01/11/2019 21:03	01/11/2019 15:58	01/11/2019 21:03	5,08	60	304,52	CHI
2019114696	JATAI	JT11205170	JATAI S2	01/11/2019 16:40	02/11/2019 01:08	01/11/2019 16:40	02/11/2019 01:08	8,47	40	338,61	CHI
2019114697	GOIANIA	GN11003104	CARAJAS S1	01/11/2019 16:41	02/11/2019 04:18	01/11/2019 16:41	02/11/2019 04:18	11,60	262	3040,15	CHI
2019114698	TRINDADE	TR11121515	TRINDADE	01/11/2019 15:52	01/11/2019 22:50	01/11/2019 15:52	01/11/2019 22:50	6,96	60	417,83	CHI
2019114707	PALMINOPOLIS	PP11040342	FIRMINOPOLIS S2	01/11/2019 17:47	01/11/2019 20:07	01/11/2019 17:47	01/11/2019 20:07	2,33	35	81,56	CHI
2019114709	APARECIDA DE GOIANIA	200072640	INDEPENDENCIA S1	01/11/2019 18:09	01/11/2019 23:50	01/11/2019 18:09	01/11/2019 23:50	5,68	1	5,68	CHI
2019114710	ACREUNA	EU12257915	RIO DOS BOIS	01/11/2019 17:18	02/11/2019 12:15	01/11/2019 17:18	02/11/2019 12:15	18,93	5	94,67	CHI
2019114718	GOIANIA	GN11073423	ATLANTICO S1	01/11/2019 15:45	02/11/2019 10:35	01/11/2019 15:45	02/11/2019 10:35	18,83	50	941,26	CHI
2019114728	MINEIROS	MY21248378	PARQUE DAS EMAS	01/11/2019 18:12	03/11/2019 08:41	01/11/2019 18:12	03/11/2019 08:41	38,48	1	38,48	CHI
2019114730	CALDAS NOVAS	CN11164890	CALDAS NOVAS S1	01/11/2019 17:54	01/11/2019 21:17	01/11/2019 17:54	01/11/2019 21:17	3,38	72	243,24	CHI
2019114734	FIRMINOPOLIS	FR11056266	FIRMINOPOLIS S1	01/11/2019 18:04	01/11/2019 23:35	01/11/2019 18:04	01/11/2019 23:35	5,52	156	860,43	CHI
2019114740	SANTA FE DE GOIAS	RN12183391	BRITANIA	01/11/2019 18:14	01/11/2019 21:09	01/11/2019 18:14	01/11/2019 21:09	2,91	41	119,13	CHI
2019114748	CAIAPONIA	CP12207858	PALESTINA	01/11/2019 17:29	02/11/2019 09:45	01/11/2019 17:29	02/11/2019 09:45	16,26	18	292,66	CHI
2019114748	PALESTINA DE GOIAS	CP12207858	PALESTINA	01/11/2019 17:29	02/11/2019 09:45	01/11/2019 17:29	02/11/2019 09:45	16,26	1	16,26	CHI
2019114750	CORUMBAIBA	IP12242504	IPAMERI	01/11/2019 18:16	03/11/2019 09:52	01/11/2019 18:16	03/11/2019 09:52	39,59	1	39,59	CHI
2019114750	IPAMERI	IP12242504	IPAMERI	01/11/2019 18:16	03/11/2019 09:52	01/11/2019 18:16	03/11/2019 09:52	39,59	9	356,35	CHI
2019114754	GOIANIA	10833870	GOIANIA LESTE S1	01/11/2019 18:17	02/11/2019 09:57	01/11/2019 18:17	02/11/2019 09:57	15,66	1	15,66	CHI
2019114759	ITAPIRAPUA	IU21141422	MATRINCHA	01/11/2019 18:18	02/11/2019 17:25	01/11/2019 18:18	02/11/2019 17:25	23,12	1	23,12	CHI
2019114764	GOIANAPOLIS	GP12254184	DAIA S2	01/11/2019 18:18	02/11/2019 08:25	01/11/2019 18:18	02/11/2019 08:25	14,11	11	155,20	CHI
2019114765	ANAPOLIS	AN12201240	ANAPOLIS UNIVERSITARIO S2	01/11/2019 18:18	02/11/2019 11:35	01/11/2019 18:18	02/11/2019 11:35	17,28	9	155,48	CHI
2019114775	INDIARA	IY11215330	EDEIA	01/11/2019 18:06	01/11/2019 22:50	01/11/2019 18:06	01/11/2019 22:50	4,73	204	964,01	CHI
2019114776	JATAI	290323642	JATAI S2	01/11/2019 18:20	02/11/2019 12:40	01/11/2019 18:20	02/11/2019 12:40	18,32	1	18,32	CHI
2019114777	GOIANIA	GN11002073	AEROPORTO S2	01/11/2019 17:08	01/11/2019 19:28	01/11/2019 17:08	01/11/2019 19:28	2,32	34	78,89	CHI
2019114783	IPORA	730010399	IPORA	01/11/2019 18:21	01/11/2019 21:59	01/11/2019 18:21	01/11/2019 21:59	3,63	1	3,63	CHI
2019114785	ANAPOLIS	21366536	ANAPOLIS UNIVERSITARIO S2	01/11/2019 18:21	01/11/2019 20:20	01/11/2019 18:21	01/11/2019 20:20	1,97	1	1,97	CHI
2019114788	CALDAS NOVAS	CN12213917	CALDAS NOVAS S1	01/11/2019 16:14	01/11/2019 23:05	01/11/2019 16:14	01/11/2019 23:05	6,83	36	246,02	CHI
2019114795	GOIANIA	13242428	ATLANTICO S2	01/11/2019 18:23	02/11/2019 11:03	01/11/2019 18:23	02/11/2019 11:03	16,66	1	16,66	CHI
2019114796	PALMINOPOLIS	PP12000036	PALMEIRAS	01/11/2019 17:41	02/11/2019 13:19	01/11/2019 17:41	02/11/2019 02:44	9,05	8	72,43	CHI
2019114796	PALMEIRAS DE GOIAS	PP12007034LD	PALMEIRAS	01/11/2019 17:41	02/11/2019 13:19	01/11/2019 17:41	02/11/2019 09:35	15,90	17	270,35	CHI
2019114796	PALMINOPOLIS	PP12007034LD	PALMEIRAS	01/11/2019 17:41	02/11/2019 13:19	01/11/2019 17:41	02/11/2019 09:35	15,90	30	477,09	CHI
2019114796	PALMEIRAS DE GOIAS	PL12027206LD	PALMEIRAS	01/11/2019 17:41	02/11/2019 13:19	01/11/2019 17:41	02/11/2019 13:19	19,63	35	686,92	CHI

2019114805	SAO SIMAO	SO12191548	CACHOEIRA ALTA	01/11/2019 18:24	02/11/2019 15:14	01/11/2019 18:24	02/11/2019 15:14	20,82	4	83,29	CHI
2019114807	GOIANIA	11947962	GOYA S2	01/11/2019 18:25	02/11/2019 13:44	01/11/2019 18:25	02/11/2019 13:44	19,31	1	19,31	CHI
2019114810	MINEIROS	MY12070307	PARQUE DAS EMAS	01/11/2019 18:25	03/11/2019 21:53	01/11/2019 18:25	03/11/2019 21:53	51,46	1	51,46	CHI
2019114814	ORIZONA	OZ21160206	PIRES DO RIO S2	01/11/2019 18:26	02/11/2019 12:39	01/11/2019 18:26	02/11/2019 12:39	18,23	1	18,23	CHI
2019114816	SANTA RITA DO NOVO DESTINO	DF11200450	BARRO ALTO	01/11/2019 18:26	02/11/2019 17:25	01/11/2019 18:26	02/11/2019 17:25	22,98	1	22,98	CHI
2019114817	JUSSARA	1290043192	JUSSARA	01/11/2019 18:26	03/11/2019 16:50	01/11/2019 18:26	03/11/2019 16:50	46,40	1	46,40	CHI
2019114839	SAO LUIS DE MONTES BELOS	500016781	SAO LUIZ DOS MONTES BELOS	01/11/2019 18:27	01/11/2019 22:01	01/11/2019 18:27	01/11/2019 22:01	3,56	1	3,56	CHI
2019114870	FIRMINOPOLIS	FR21294731	FIRMINOPOLIS S1	01/11/2019 18:30	04/11/2019 14:49	01/11/2019 18:30	04/11/2019 14:49	68,31	1	68,31	CHI
2019114872	APARECIDA DE GOIANIA	AP11075389	INDEPENDENCIA S1	01/11/2019 17:59	01/11/2019 21:51	01/11/2019 17:59	01/11/2019 21:51	3,87	106	409,72	CHI
2019114883	CATALAO	CT12250392	CATALAO S2	01/11/2019 17:10	01/11/2019 19:04	01/11/2019 17:10	01/11/2019 19:04	1,89	518	981,18	CHI
2019114898	MINEIROS	MY12303394	PARQUE DAS EMAS	01/11/2019 16:59	02/11/2019 23:01	01/11/2019 16:59	02/11/2019 23:01	30,02	19	570,33	CHI
2019114909	APARECIDA DE GOIANIA	AP11160856	INDEPENDENCIA S1	01/11/2019 16:55	01/11/2019 20:15	01/11/2019 16:55	01/11/2019 20:15	3,33	215	714,99	CHI
2019114912	MINEIROS	PW12045348	PARQUE DAS EMAS	01/11/2019 17:28	04/11/2019 16:16	01/11/2019 17:28	04/11/2019 16:16	70,81	5	354,05	CHI
2019114912	PORTELANDIA	PW12045348	PARQUE DAS EMAS	01/11/2019 17:28	04/11/2019 16:16	01/11/2019 17:28	04/11/2019 16:16	70,81	12	849,73	CHI
2019114917	JATAI	290347440	JATAI S2	01/11/2019 18:34	01/11/2019 22:10	01/11/2019 18:34	01/11/2019 22:10	3,59	1	3,59	CHI
2019114922	APARECIDA DE GOIANIA	AP11072159	INDEPENDENCIA S1	01/11/2019 18:31	01/11/2019 23:34	01/11/2019 18:31	01/11/2019 23:34	5,05	154	777,06	CHI
2019114924	GOIANIRA	GR11073180	GOIANIRA	01/11/2019 18:27	02/11/2019 15:30	01/11/2019 18:27	02/11/2019 15:30	21,04	103	2167,52	CHI
2019114927	SANTA FE DE GOIAS	RN11183392	BRITANIA	01/11/2019 17:53	02/11/2019 00:49	01/11/2019 17:53	02/11/2019 00:01	6,12	48	293,83	CHI
2019114927	SANTA FE DE GOIAS	RN11183393	BRITANIA	01/11/2019 17:53	02/11/2019 00:49	01/11/2019 22:03	02/11/2019 00:49	2,78	41	113,87	CHI
2019114942	APARECIDA DE GOIANIA	10001016600	INDEPENDENCIA S2	01/11/2019 18:37	02/11/2019 14:10	01/11/2019 18:37	02/11/2019 14:10	19,54	1	19,54	CHI
2019114944	GOIANIA	GN11356163	CARAJAS S1	01/11/2019 15:42	01/11/2019 20:59	01/11/2019 15:42	01/11/2019 20:59	5,28	37	195,20	CHI
2019114954	ABADIA DE GOIAS	LG12365584	INDEPENDENCIA S2	01/11/2019 16:52	03/11/2019 09:12	01/11/2019 16:52	03/11/2019 09:12	40,33	5	201,63	CHI
2019114954	ARAGOIANIA	LG12365584	INDEPENDENCIA S2	01/11/2019 16:52	03/11/2019 09:12	01/11/2019 16:52	03/11/2019 09:12	40,33	34	1371,06	CHI
2019114963	GOIANIA	GN11275541	CARAJAS S2	01/11/2019 16:33	02/11/2019 03:17	01/11/2019 16:33	02/11/2019 03:17	10,73	100	1072,56	CHI
2019114968	GOIANIA	GN11161049	ATLANTICO S2	01/11/2019 15:53	02/11/2019 04:46	01/11/2019 15:53	02/11/2019 04:46	12,88	57	734,18	CHI
2019114971	PIRANHAS	PH12244935	PIRANHAS	01/11/2019 18:41	04/11/2019 18:52	01/11/2019 18:41	04/11/2019 18:52	72,19	1	72,19	CHI
2019114975	APARECIDA DE GOIANIA	200384790	ANHANGUERA	01/11/2019 18:41	02/11/2019 12:27	01/11/2019 18:41	02/11/2019 12:27	17,76	1	17,76	CHI
2019114980	BALIZA	BH12060671	BOM JARDIM	01/11/2019 18:41	04/11/2019 19:47	01/11/2019 18:41	04/11/2019 19:47	73,08	6	438,51	CHI
2019114984	PALMEIRAS DE GOIAS	PL11103216	PALMEIRAS	01/11/2019 14:29	01/11/2019 21:44	01/11/2019 14:29	01/11/2019 21:44	7,25	65	471,52	CHI
2019114989	GOIAS	90006628	GOIAS	01/11/2019 18:42	07/11/2019 16:19	01/11/2019 18:42	07/11/2019 16:19	141,61	1	141,61	CHI
2019114992	URUTAI	UT11203177	URUTAI	01/11/2019 18:26	01/11/2019 19:42	01/11/2019 18:26	01/11/2019 19:42	1,25	147	184,44	CHI
2019114994	GOIANIA	GN12383752	CARAJAS S2	01/11/2019 18:31	02/11/2019 00:21	01/11/2019 18:31	02/11/2019 00:21	5,83	174	1014,13	CHI
2019114997	SANTA FE DE GOIAS	RN12092017	BRITANIA	01/11/2019 18:43	02/11/2019 10:40	01/11/2019 18:43	02/11/2019 10:40	15,94	3	47,82	CHI

2019115002	CACHOEIRA ALTA	SO10394738	CACHOEIRA ALTA	01/11/2019 18:41	01/11/2019 22:05	01/11/2019 18:41	01/11/2019 21:24	2,72	6	16,31	CHI
2019115002	CACU	SO10394738	CACHOEIRA ALTA	01/11/2019 18:41	01/11/2019 22:05	01/11/2019 18:41	01/11/2019 21:24	2,72	89	241,93	CHI
2019115002	SAO SIMAO	SO10394738	CACHOEIRA ALTA	01/11/2019 18:41	01/11/2019 22:05	01/11/2019 18:41	01/11/2019 21:24	2,72	23	62,52	CHI
2019115002	CACU	CC13360544	CACHOEIRA ALTA	01/11/2019 18:41	01/11/2019 22:05	01/11/2019 18:41	01/11/2019 22:05	3,39	10	33,93	CHI
2019115003	BRAZABRANTES	00800214	INHUMAS S2	01/11/2019 18:53	02/11/2019 17:28	01/11/2019 21:29	01/11/2019 22:25	0,94	39	36,65	CHI
2019115003	CATURAI	00800214	INHUMAS S2	01/11/2019 18:53	02/11/2019 17:28	01/11/2019 21:29	01/11/2019 22:25	0,94	1	0,94	CHI
2019115003	GOIANIRA	00800214	INHUMAS S2	01/11/2019 18:53	02/11/2019 17:28	01/11/2019 21:29	01/11/2019 22:25	0,94	10	9,40	CHI
2019115003	INHUMAS	00800214	INHUMAS S2	01/11/2019 18:53	02/11/2019 17:28	01/11/2019 21:29	01/11/2019 22:25	0,94	3379	3175,32	CHI
2019115003	INHUMAS	00800214	INHUMAS S2	01/11/2019 18:53	02/11/2019 17:28	01/11/2019 21:29	02/11/2019 01:25	3,95	3153	12445,59	CHI
2019115003	INHUMAS	IN13000020	INHUMAS S2	01/11/2019 18:53	02/11/2019 17:28	01/11/2019 22:13	02/11/2019 01:25	3,21	550	1767,18	CHI
2019115003	INHUMAS	IN13000020	INHUMAS S2	01/11/2019 18:53	02/11/2019 17:28	02/11/2019 00:42	02/11/2019 01:25	0,72	296	212,87	CHI
2019115003	BRAZABRANTES	00800214	INHUMAS S2	01/11/2019 18:53	02/11/2019 17:28	02/11/2019 01:56	02/11/2019 02:12	0,25	39	9,80	CHI
2019115003	CATURAI	00800214	INHUMAS S2	01/11/2019 18:53	02/11/2019 17:28	02/11/2019 01:56	02/11/2019 02:12	0,25	1	0,25	CHI
2019115003	GOIANIRA	00800214	INHUMAS S2	01/11/2019 18:53	02/11/2019 17:28	02/11/2019 01:56	02/11/2019 02:12	0,25	10	2,51	CHI
2019115003	INHUMAS	00800214	INHUMAS S2	01/11/2019 18:53	02/11/2019 17:28	02/11/2019 01:56	02/11/2019 02:12	0,25	7378	1854,75	CHI
2019115003	INHUMAS	IN10403984	INHUMAS S2	01/11/2019 18:53	02/11/2019 17:28	02/11/2019 00:42	02/11/2019 10:01	9,32	452	4210,51	CHI
2019115003	INHUMAS	IN10403984	INHUMAS S2	01/11/2019 18:53	02/11/2019 17:28	02/11/2019 09:53	02/11/2019 10:01	0,14	458	62,47	CHI
2019115003	INHUMAS	IN10403984	INHUMAS S2	01/11/2019 18:53	02/11/2019 17:28	02/11/2019 10:02	02/11/2019 11:41	1,65	696	1148,59	CHI
2019115003	INHUMAS	IN11012239	INHUMAS S2	01/11/2019 18:53	02/11/2019 17:28	02/11/2019 10:02	02/11/2019 11:42	1,66	140	232,17	CHI
2019115003	INHUMAS	IN11397291	INHUMAS S2	01/11/2019 18:53	02/11/2019 17:28	02/11/2019 10:02	02/11/2019 11:42	1,66	68	112,77	CHI
2019115003	INHUMAS	IN12326219	INHUMAS S2	01/11/2019 18:53	02/11/2019 17:28	02/11/2019 10:02	02/11/2019 14:47	4,75	5	23,75	CHI
2019115003	INHUMAS	IN12326219	INHUMAS S2	01/11/2019 18:53	02/11/2019 17:28	02/11/2019 10:02	02/11/2019 17:28	7,43	1	7,43	CHI
2019115011	ITAJA	IJ10352433	ITAJA S2	01/11/2019 19:04	02/11/2019 16:00	02/11/2019 10:43	02/11/2019 11:59	1,27	5	6,34	CHI
2019115011	ITAJA	IJ13371231	ITAJA S2	01/11/2019 19:04	02/11/2019 16:00	01/11/2019 19:06	02/11/2019 16:00	20,90	10	209,02	CHI
2019115018	GOIANIRA	00550224	GOIANIRA	01/11/2019 19:43	01/11/2019 22:42	01/11/2019 19:43	01/11/2019 20:37	0,91	5427	4928,02	CHI
2019115018	TRINDADE	00550224	GOIANIRA	01/11/2019 19:43	01/11/2019 22:42	01/11/2019 19:43	01/11/2019 20:37	0,91	184	167,08	CHI
2019115018	GOIANIRA	GR12222868LD	GOIANIRA	01/11/2019 19:43	01/11/2019 22:42	01/11/2019 19:43	01/11/2019 22:42	2,99	650	1945,12	CHI
2019115028	TRINDADE	TR11378574	TRINDADE	01/11/2019 19:56	01/11/2019 22:24	01/11/2019 19:56	01/11/2019 22:24	2,46	21	51,71	CHI
2019115031	GOIANIA	GN11229368	CARAJAS S1	01/11/2019 17:37	02/11/2019 06:29	01/11/2019 17:37	02/11/2019 06:29	12,86	59	758,74	CHI
2019115045	CEZARINA	PJ13329051	PONTALINA	01/11/2019 22:17	02/11/2019 01:04	01/11/2019 22:17	02/11/2019 00:58	2,69	40	107,51	CHI
2019115045	CROMINIA	PJ13329051	PONTALINA	01/11/2019 22:17	02/11/2019 01:04	01/11/2019 22:17	02/11/2019 00:58	2,69	1775	4770,81	CHI
2019115045	CROMINIA	PJ13329051	PONTALINA	01/11/2019 22:17	02/11/2019 01:04	01/11/2019 22:17	02/11/2019 00:58	2,69	20	53,76	CHI
2019115045	CROMINIA	PJ13329051	PONTALINA	01/11/2019 22:17	02/11/2019 01:04	01/11/2019 22:17	02/11/2019 00:58	2,69	2	5,38	CHI

2019115045	CROMINIA	PJ13329051	PONTALINA	01/11/2019 22:17	02/11/2019 01:04	01/11/2019 22:17	02/11/2019 00:58	2,69	5	13,44	CHI
2019115045	CROMINIA	PJ13329051	PONTALINA	01/11/2019 22:17	02/11/2019 01:04	01/11/2019 22:17	02/11/2019 00:58	2,69	43	115,57	CHI
2019115045	CROMINIA	PJ13329051	PONTALINA	01/11/2019 22:17	02/11/2019 01:04	01/11/2019 22:17	02/11/2019 00:58	2,69	12	32,25	CHI
2019115045	CROMINIA	PJ13329051	PONTALINA	01/11/2019 22:17	02/11/2019 01:04	01/11/2019 22:17	02/11/2019 00:58	2,69	5	13,44	CHI
2019115045	HIDROLANDIA	PJ13329051	PONTALINA	01/11/2019 22:17	02/11/2019 01:04	01/11/2019 22:17	02/11/2019 00:58	2,69	182	489,18	CHI
2019115045	HIDROLANDIA	PJ13329051	PONTALINA	01/11/2019 22:17	02/11/2019 01:04	01/11/2019 22:17	02/11/2019 00:58	2,69	74	198,90	CHI
2019115045	HIDROLANDIA	PJ13329051	PONTALINA	01/11/2019 22:17	02/11/2019 01:04	01/11/2019 22:17	02/11/2019 00:58	2,69	3	8,06	CHI
2019115045	MAIRIPOTABA	PJ13329051	PONTALINA	01/11/2019 22:17	02/11/2019 01:04	01/11/2019 22:17	02/11/2019 00:58	2,69	64	172,02	CHI
2019115045	MAIRIPOTABA	PJ13329051	PONTALINA	01/11/2019 22:17	02/11/2019 01:04	01/11/2019 22:17	02/11/2019 00:58	2,69	625	1679,86	CHI
2019115045	MAIRIPOTABA	PJ13329051	PONTALINA	01/11/2019 22:17	02/11/2019 01:04	01/11/2019 22:17	02/11/2019 00:58	2,69	8	21,50	CHI
2019115045	MAIRIPOTABA	PJ13329051	PONTALINA	01/11/2019 22:17	02/11/2019 01:04	01/11/2019 22:17	02/11/2019 00:58	2,69	294	790,21	CHI
2019115045	MAIRIPOTABA	PJ13329051	PONTALINA	01/11/2019 22:17	02/11/2019 01:04	01/11/2019 22:17	02/11/2019 00:58	2,69	8	21,50	CHI
2019115045	MAIRIPOTABA	PJ13329051	PONTALINA	01/11/2019 22:17	02/11/2019 01:04	01/11/2019 22:17	02/11/2019 00:58	2,69	2	5,38	CHI
2019115045	MAIRIPOTABA	PJ13329051	PONTALINA	01/11/2019 22:17	02/11/2019 01:04	01/11/2019 22:17	02/11/2019 00:58	2,69	3	8,06	CHI
2019115045	PONTALINA	PJ13329051	PONTALINA	01/11/2019 22:17	02/11/2019 01:04	01/11/2019 22:17	02/11/2019 00:58	2,69	33	88,70	CHI
2019115045	PONTALINA	PJ13329051	PONTALINA	01/11/2019 22:17	02/11/2019 01:04	01/11/2019 22:17	02/11/2019 00:58	2,69	3	8,06	CHI
2019115045	PONTALINA	PJ13329051	PONTALINA	01/11/2019 22:17	02/11/2019 01:04	01/11/2019 22:17	02/11/2019 00:58	2,69	59	158,58	CHI
2019115045	PROFESSOR JAMIL SAFADY	PJ13329051	PONTALINA	01/11/2019 22:17	02/11/2019 01:04	01/11/2019 22:17	02/11/2019 00:58	2,69	14	37,63	CHI
2019115045	PROFESSOR JAMIL SAFADY	PJ13329051	PONTALINA	01/11/2019 22:17	02/11/2019 01:04	01/11/2019 22:17	02/11/2019 00:58	2,69	43	115,57	CHI
2019115045	VARJAO	PJ13329051	PONTALINA	01/11/2019 22:17	02/11/2019 01:04	01/11/2019 22:17	02/11/2019 00:58	2,69	1	2,69	CHI
2019115045	PIRACANJUBA	PJ13329051	ROCHEDO	01/11/2019 22:17	02/11/2019 01:04	01/11/2019 22:17	02/11/2019 01:04	2,79	1	2,79	CHI
2019115045	PROFESSOR JAMIL SAFADY	PJ13329051	ROCHEDO	01/11/2019 22:17	02/11/2019 01:04	01/11/2019 22:17	02/11/2019 01:04	2,79	5	13,93	CHI
2019115047	GOIANIRA	GR11035698	GOIANIRA	01/11/2019 20:04	02/11/2019 12:40	01/11/2019 20:04	02/11/2019 12:40	16,59	241	3999,33	CHI
2019115048	BARRO ALTO	00180434	BARRO ALTO	01/11/2019 21:54	01/11/2019 22:04	01/11/2019 21:54	01/11/2019 21:58	0,07	24	1,75	CHI
2019115048	BARRO ALTO	00180434	BARRO ALTO	01/11/2019 21:54	01/11/2019 22:04	01/11/2019 21:54	01/11/2019 21:58	0,07	2	0,15	CHI
2019115048	GOIANESIA	00180434	BARRO ALTO	01/11/2019 21:54	01/11/2019 22:04	01/11/2019 21:54	01/11/2019 21:58	0,07	4	0,29	CHI
2019115048	HIDROLINA	00180434	BARRO ALTO	01/11/2019 21:54	01/11/2019 22:04	01/11/2019 21:54	01/11/2019 21:58	0,07	1	0,07	CHI
2019115048	SANTA RITA DO NOVO DESTINO	00180434	BARRO ALTO	01/11/2019 21:54	01/11/2019 22:04	01/11/2019 21:54	01/11/2019 21:58	0,07	213	15,56	CHI
2019115048	SANTA RITA DO NOVO DESTINO	00180434	BARRO ALTO	01/11/2019 21:54	01/11/2019 22:04	01/11/2019 21:54	01/11/2019 21:58	0,07	7	0,51	CHI
2019115048	SAO LUIZ DO NORTE	00180434	BARRO ALTO	01/11/2019 21:54	01/11/2019 22:04	01/11/2019 21:54	01/11/2019 21:58	0,07	96	7,01	CHI
2019115048	SAO LUIZ DO NORTE	00180434	BARRO ALTO	01/11/2019 21:54	01/11/2019 22:04	01/11/2019 21:54	01/11/2019 21:58	0,07	14	1,02	CHI
2019115048	SAO LUIZ DO NORTE	00180434	BARRO ALTO	01/11/2019 21:54	01/11/2019 22:04	01/11/2019 21:54	01/11/2019 21:58	0,07	2	0,15	CHI
2019115048	MIMOSO DE GOIAS	00180434	BARRO ALTO	01/11/2019 21:54	01/11/2019 22:04	01/11/2019 21:54	01/11/2019 22:02	0,15	11	1,63	CHI

2019115048	MIMOSO DE GOIAS	00180434	BARRO ALTO	01/11/2019 21:54	01/11/2019 22:04	01/11/2019 21:54	01/11/2019 22:02	0,15	4	0,59	CHI
2019115048	NIQUELANDIA	00180434	BARRO ALTO	01/11/2019 21:54	01/11/2019 22:04	01/11/2019 21:54	01/11/2019 22:02	0,15	175	25,91	CHI
2019115048	NIQUELANDIA	00180434	BARRO ALTO	01/11/2019 21:54	01/11/2019 22:04	01/11/2019 21:54	01/11/2019 22:02	0,15	305	45,16	CHI
2019115048	VILA PROPICIO	00180434	BARRO ALTO	01/11/2019 21:54	01/11/2019 22:04	01/11/2019 21:54	01/11/2019 22:02	0,15	49	7,25	CHI
2019115048	VILA PROPICIO	00180434	BARRO ALTO	01/11/2019 21:54	01/11/2019 22:04	01/11/2019 21:54	01/11/2019 22:02	0,15	32	4,74	CHI
2019115048	VILA PROPICIO	BA10400442	BARRO ALTO	01/11/2019 21:54	01/11/2019 22:04	01/11/2019 21:54	01/11/2019 22:02	0,15	1	0,15	CHI
2019115048	NIQUELANDIA	00180434	BARRO ALTO	01/11/2019 21:54	01/11/2019 22:04	01/11/2019 21:57	01/11/2019 22:02	0,08	1	0,08	CHI
2019115048	NIQUELANDIA	00180434	BARRO ALTO	01/11/2019 21:54	01/11/2019 22:04	01/11/2019 21:54	01/11/2019 22:03	0,16	123	20,09	CHI
2019115048	NIQUELANDIA	00180434	BARRO ALTO	01/11/2019 21:54	01/11/2019 22:04	01/11/2019 21:54	01/11/2019 22:04	0,18	593	104,27	CHI
2019115051	GOIANIRA	GR11113284	GOIANIRA	01/11/2019 20:01	02/11/2019 16:03	01/11/2019 20:01	02/11/2019 16:03	20,02	211	4224,81	CHI
2019115052	INHUMAS	IN11040751	INHUMAS S2	01/11/2019 19:44	02/11/2019 10:48	01/11/2019 19:44	02/11/2019 10:48	15,05	92	1384,86	CHI
2019115068	BONOPOLIS	6656984	SAO MIGUEL DO ARAGUAIA	01/11/2019 14:13	02/11/2019 16:25	01/11/2019 14:13	02/11/2019 16:25	26,21	5	131,06	CHI
2019115111	CATALAO	GD12127538	CATALAO S1	01/11/2019 18:31	01/11/2019 23:02	01/11/2019 18:31	01/11/2019 23:02	4,52	5	22,58	CHI
2019115111	GOIANDIRA	GD12127538	CATALAO S1	01/11/2019 18:31	01/11/2019 23:02	01/11/2019 18:31	01/11/2019 23:02	4,52	13	58,71	CHI
2019115115	PALMEIRAS DE GOIAS	PL12049487	PALMEIRAS	01/11/2019 18:44	02/11/2019 14:37	01/11/2019 18:44	02/11/2019 14:37	19,89	17	338,05	CHI
2019115121	PEROLANDIA	JT21125867	JATAI S1	01/11/2019 18:46	03/11/2019 12:39	01/11/2019 18:46	03/11/2019 12:39	41,88	1	41,88	CHI
2019115125	MOSSAMEDES	ND12299618	ITABERAI S2	01/11/2019 15:36	02/11/2019 12:10	01/11/2019 15:36	01/11/2019 21:05	5,49	19	104,26	CHI
2019115125	MOSSAMEDES	ND12299618	ITABERAI S2	01/11/2019 15:36	02/11/2019 12:10	01/11/2019 21:39	01/11/2019 21:44	0,09	19	1,72	CHI
2019115125	MOSSAMEDES	MD12121027LD	ITABERAI S2	01/11/2019 15:36	02/11/2019 12:10	01/11/2019 21:45	01/11/2019 23:25	1,67	8	13,38	CHI
2019115125	MOSSAMEDES	MD12121027LD	ITABERAI S2	01/11/2019 15:36	02/11/2019 12:10	01/11/2019 21:45	02/11/2019 12:10	14,41	8	115,30	CHI
2019115125	MOSSAMEDES	MD12121027LD	ITABERAI S2	01/11/2019 15:36	02/11/2019 12:10	01/11/2019 23:26	02/11/2019 12:10	12,73	8	101,87	CHI
2019115128	OUVIDOR	2180024326	CATALAO S1	01/11/2019 18:47	02/11/2019 21:21	01/11/2019 18:47	02/11/2019 21:21	26,56	1	26,56	CHI
2019115150	IVOLANDIA	MO12165608	IPORA	01/11/2019 16:33	02/11/2019 09:55	01/11/2019 16:33	02/11/2019 09:55	17,37	17	295,24	CHI
2019115150	MOIPORA	MO12165608	IPORA	01/11/2019 16:33	02/11/2019 09:55	01/11/2019 16:33	02/11/2019 09:55	17,37	1	17,37	CHI
2019115151	MONTIVIDIU	MV21052170	MONTIVIDIU T	01/11/2019 18:49	02/11/2019 17:29	01/11/2019 18:49	02/11/2019 17:29	22,66	1	22,66	CHI
2019115157	RIO VERDE	RV21267680	CABRIUVA S1	01/11/2019 18:49	04/11/2019 15:46	01/11/2019 18:49	04/11/2019 15:46	68,94	1	68,94	CHI
2019115169	INDIARA	2710001762	EDEIA	01/11/2019 18:50	03/11/2019 15:56	01/11/2019 18:50	03/11/2019 15:56	45,10	1	45,10	CHI
2019115170	APARECIDA DE GOIANIA	200214329	INDEPENDENCIA S2	01/11/2019 18:51	02/11/2019 12:51	01/11/2019 18:51	02/11/2019 12:51	18,00	1	18,00	CHI
2019115172	BONFINOPOLIS	BO11045917	CEPAIGO S2	01/11/2019 18:44	01/11/2019 22:45	01/11/2019 18:44	01/11/2019 22:45	4,00	204	816,28	CHI
2019115181	GOIANIA	10030386053	FERROVIARIO S3	01/11/2019 18:51	02/11/2019 11:32	01/11/2019 18:51	02/11/2019 11:32	16,67	1	16,67	CHI
2019115184	GOIANIA	GN11058278	ATLANTICO S1	01/11/2019 15:58	02/11/2019 11:46	01/11/2019 15:58	02/11/2019 11:46	19,79	70	1385,42	CHI
2019115192	APARECIDA DE GOIANIA	AP12210390	ATLANTICO S3	01/11/2019 18:41	01/11/2019 19:58	01/11/2019 18:41	01/11/2019 19:58	1,28	443	565,69	CHI
2019115195	GOIANIA	15789240	MEIA PONTE	01/11/2019 18:52	02/11/2019 12:09	01/11/2019 18:52	02/11/2019 12:09	17,27	1	17,27	CHI

2019115201	BELA VISTA DE GOIAS	240056450	BELA VISTA S1	01/11/2019 18:53	02/11/2019 13:22	01/11/2019 18:53	02/11/2019 13:22	18,47	1	18,47	CHI
2019115204	PORTELANDIA	MY12358852	PARQUE DAS EMAS	01/11/2019 18:53	02/11/2019 10:20	01/11/2019 18:53	02/11/2019 10:20	15,44	2	30,89	CHI
2019115210	MONTES CLAROS DE GOIAS	ME12184484	IPORA	01/11/2019 17:32	02/11/2019 07:30	01/11/2019 17:32	02/11/2019 07:30	13,98	32	447,38	CHI
2019115217	LEOPOLDO DE BULHOES	10019262521	DAIA S2	01/11/2019 18:55	02/11/2019 14:40	01/11/2019 18:55	02/11/2019 14:40	19,74	1	19,74	CHI
2019115221	PORTEIRAO	CL11402455	RIO DOS BOIS	01/11/2019 17:16	02/11/2019 11:15	01/11/2019 17:16	02/11/2019 11:15	17,98	38	683,24	CHI
2019115226	HIDROLANDIA	HD12238211	ANHANGUERA	01/11/2019 15:22	01/11/2019 19:57	01/11/2019 15:22	01/11/2019 19:57	4,58	315	1443,40	CHI
2019115232	MORRINHOS	MR21302604	VILA CORUMBA	01/11/2019 18:56	03/11/2019 17:17	01/11/2019 18:56	03/11/2019 17:17	46,34	1	46,34	CHI
2019115234	CATALAO	CT21231656	CATALAO S1	01/11/2019 18:56	02/11/2019 11:50	01/11/2019 18:56	02/11/2019 11:50	16,89	1	16,89	CHI
2019115241	CAMPO LIMPO	AN12357368	NEROPOLIS S1	01/11/2019 18:48	02/11/2019 10:27	01/11/2019 18:48	02/11/2019 10:27	15,63	19	297,05	CHI
2019115242	GOIANIA	GN11001260	CAMPINAS S1	01/11/2019 18:57	02/11/2019 10:21	01/11/2019 18:57	02/11/2019 10:21	15,39	143	2200,69	CHI
2019115244	RIO VERDE	630304180	RIO VERDE S2	01/11/2019 18:57	04/11/2019 09:40	01/11/2019 18:57	04/11/2019 09:40	62,71	1	62,71	CHI
2019115245	CEZARINA	CZ11277739	GUAPU S2	01/11/2019 18:57	02/11/2019 01:00	01/11/2019 18:57	02/11/2019 01:00	6,04	14	84,50	CHI
2019115247	GOIANIA	GN11169350	CARAJAS S2	01/11/2019 18:05	02/11/2019 03:02	01/11/2019 18:05	02/11/2019 03:02	8,95	88	787,21	CHI
2019115262	CALDAS NOVAS	760089954	SERRA DE CALDAS	01/11/2019 19:00	02/11/2019 11:11	01/11/2019 19:00	02/11/2019 11:11	16,19	1	16,19	CHI
2019115271	IPAMERI	IP21232038	IPAMERI	01/11/2019 19:01	03/11/2019 12:09	01/11/2019 19:01	03/11/2019 12:09	41,13	1	41,13	CHI
2019115278	BARRO ALTO	BA21064549	BARRO ALTO	01/11/2019 19:02	02/11/2019 12:51	01/11/2019 19:02	02/11/2019 12:51	17,81	1	17,81	CHI
2019115286	TAQUARAL DE GOIAS	TQ12250778	INHUMAS S1	01/11/2019 13:27	02/11/2019 16:30	01/11/2019 13:27	02/11/2019 16:30	27,04	23	621,89	CHI
2019115296	ANICUNS	AC21020343	ANICUNS	01/11/2019 19:04	02/11/2019 16:00	01/11/2019 19:04	02/11/2019 16:00	20,93	1	20,93	CHI
2019115297	JATAI	JT11354940	JATAI S1	01/11/2019 19:06	01/11/2019 22:30	01/11/2019 19:06	01/11/2019 22:30	3,41	1	3,41	CHI
2019115306	GOIANIA	GN11002891	FERROVIARIO S2	01/11/2019 19:04	01/11/2019 21:31	01/11/2019 19:04	01/11/2019 21:31	2,43	13	31,65	CHI
2019115309	ORIZONA	2060012394	PIRES DO RIO S2	01/11/2019 19:05	01/11/2019 23:00	01/11/2019 19:05	01/11/2019 23:00	3,91	1	3,91	CHI
2019115311	GOIANIA	10492823	GOIANIA LESTE S3	01/11/2019 19:05	02/11/2019 12:28	01/11/2019 19:05	02/11/2019 12:28	17,38	1	17,38	CHI
2019115313	GOIANIRA	390062480	GOIANIRA	01/11/2019 19:05	03/11/2019 00:46	01/11/2019 19:05	03/11/2019 00:46	29,68	1	29,68	CHI
2019115323	CRISTIANOPOLIS	CF12000002RE	CRISTIANOPOLIS	01/11/2019 18:07	02/11/2019 14:39	01/11/2019 18:07	02/11/2019 10:25	16,30	19	309,66	CHI
2019115323	CRISTIANOPOLIS	CF12000002RE	CRISTIANOPOLIS	01/11/2019 18:07	02/11/2019 14:39	02/11/2019 09:00	02/11/2019 10:25	1,42	36	51,13	CHI
2019115323	CRISTIANOPOLIS	CF12000002RE	CRISTIANOPOLIS	01/11/2019 18:07	02/11/2019 14:39	01/11/2019 18:07	02/11/2019 14:39	20,53	1	20,53	CHI
2019115323	PIRACANJUBA	CF12000002RE	CRISTIANOPOLIS	01/11/2019 18:07	02/11/2019 14:39	01/11/2019 18:07	02/11/2019 14:39	20,53	29	595,39	CHI
2019115323	CRISTIANOPOLIS	CF12000002RE	CRISTIANOPOLIS	01/11/2019 18:07	02/11/2019 14:39	02/11/2019 09:00	02/11/2019 14:39	5,65	44	248,75	CHI
2019115323	PIRACANJUBA	CF12000002RE	CRISTIANOPOLIS	01/11/2019 18:07	02/11/2019 14:39	02/11/2019 09:00	02/11/2019 14:39	5,65	63	356,16	CHI
2019115323	CRISTIANOPOLIS	CF12000002RE	CRISTIANOPOLIS	01/11/2019 18:07	02/11/2019 14:39	02/11/2019 10:32	02/11/2019 14:39	4,11	55	226,19	CHI
2019115328	PIRENOPOLIS	PV13213664	CORUMBA	01/11/2019 19:07	02/11/2019 01:06	01/11/2019 19:09	01/11/2019 20:30	1,34	2937	3941,29	CHI
2019115328	PIRENOPOLIS	02040244	CORUMBA	01/11/2019 19:07	02/11/2019 01:06	01/11/2019 20:55	01/11/2019 21:04	0,16	430	68,08	CHI
2019115328	PIRENOPOLIS	02040244	CORUMBA	01/11/2019 19:07	02/11/2019 01:06	01/11/2019 20:55	01/11/2019 21:04	0,16	581	91,99	CHI

2019115328	ABADIANIA	PV10397557	CORUMBA	01/11/2019 19:07	02/11/2019 01:06	01/11/2019 20:55	01/11/2019 21:05	0,17	673	116,84	CHI
2019115328	CORUMBA DE GOIAS	PV10397557	CORUMBA	01/11/2019 19:07	02/11/2019 01:06	01/11/2019 20:55	01/11/2019 21:05	0,17	39	6,77	CHI
2019115328	PIRENOPOLIS	PV10397557	CORUMBA	01/11/2019 19:07	02/11/2019 01:06	01/11/2019 20:55	01/11/2019 21:05	0,17	14	2,43	CHI
2019115328	PIRENOPOLIS	02040244	CORUMBA	01/11/2019 19:07	02/11/2019 01:06	01/11/2019 20:55	01/11/2019 22:09	1,23	2833	3491,67	CHI
2019115328	PIRENOPOLIS	PV11000021	CORUMBA	01/11/2019 19:07	02/11/2019 01:06	01/11/2019 19:09	01/11/2019 22:46	3,62	155	560,54	CHI
2019115328	ITAUCU	PV10411453B	CORUMBA	01/11/2019 19:07	02/11/2019 01:06	01/11/2019 19:09	02/11/2019 01:06	5,96	1	5,96	CHI
2019115328	PIRENOPOLIS	PV10411453B	CORUMBA	01/11/2019 19:07	02/11/2019 01:06	01/11/2019 19:09	02/11/2019 01:06	5,96	710	4228,44	CHI
2019115362	INACIOLANDIA	ID32128215	QUIRINOPOLIS	01/11/2019 18:51	02/11/2019 19:22	01/11/2019 18:51	02/11/2019 19:22	24,51	6	147,04	CHI
2019115365	RIO VERDE	630463591	RIO VERDE S2	01/11/2019 19:12	02/11/2019 02:25	01/11/2019 19:12	02/11/2019 02:25	7,21	1	7,21	CHI
2019115366	MOSSAMEDES	MD12188041	ITABERAI S2	01/11/2019 19:13	02/11/2019 01:13	01/11/2019 19:13	02/11/2019 01:13	6,00	10	59,99	CHI
2019115372	VIANOPOLIS	OZ21339035	VIANOPOLIS	01/11/2019 19:13	02/11/2019 08:16	01/11/2019 19:13	02/11/2019 08:16	13,04	2	26,08	CHI
2019115388	DISTRITO FEDERAL	IJ21191581	ITAJA S2	01/11/2019 19:14	03/11/2019 11:58	01/11/2019 19:14	03/11/2019 11:58	40,72	1	40,72	CHI
2019115392	PIRENOPOLIS	PV12272925	CORUMBA	01/11/2019 16:38	02/11/2019 11:21	01/11/2019 16:38	02/11/2019 11:21	18,71	6	112,27	CHI
2019115400	CATURAI	00800424	INHUMAS S1	01/11/2019 19:15	01/11/2019 21:01	01/11/2019 19:15	01/11/2019 20:58	1,72	1602	2753,21	CHI
2019115400	CATURAI	00800424	INHUMAS S1	01/11/2019 19:15	01/11/2019 21:01	01/11/2019 19:15	01/11/2019 20:58	1,72	2	3,44	CHI
2019115400	CATURAI	00800424	INHUMAS S1	01/11/2019 19:15	01/11/2019 21:01	01/11/2019 19:15	01/11/2019 20:58	1,72	6	10,31	CHI
2019115400	GOIANIRA	00800424	INHUMAS S1	01/11/2019 19:15	01/11/2019 21:01	01/11/2019 19:15	01/11/2019 20:58	1,72	68	116,87	CHI
2019115400	INHUMAS	00800424	INHUMAS S1	01/11/2019 19:15	01/11/2019 21:01	01/11/2019 19:15	01/11/2019 20:58	1,72	2	3,44	CHI
2019115400	TRINDADE	00800424	INHUMAS S1	01/11/2019 19:15	01/11/2019 21:01	01/11/2019 19:15	01/11/2019 20:58	1,72	67	115,15	CHI
2019115400	CATURAI	CK13167718	INHUMAS S1	01/11/2019 19:15	01/11/2019 21:01	01/11/2019 19:15	01/11/2019 21:01	1,78	356	632,00	CHI
2019115400	INHUMAS	CK13167718	INHUMAS S1	01/11/2019 19:15	01/11/2019 21:01	01/11/2019 19:15	01/11/2019 21:01	1,78	42	74,56	CHI
2019115400	INHUMAS	CK13167718	INHUMAS S2	01/11/2019 19:15	01/11/2019 21:01	01/11/2019 19:15	01/11/2019 21:01	1,78	1151	2043,34	CHI
2019115423	PIRES DO RIO	10003735182	PIRES DO RIO S1	01/11/2019 19:19	02/11/2019 22:53	01/11/2019 19:19	02/11/2019 22:53	27,57	1	27,57	CHI
2019115427	BELA VISTA DE GOIAS	BV21027555	BELA VISTA S1	01/11/2019 19:19	02/11/2019 16:14	01/11/2019 19:19	02/11/2019 16:14	20,91	1	20,91	CHI
2019115431	GUAPO	710015902	GUAPO S1	01/11/2019 19:19	02/11/2019 16:41	01/11/2019 19:19	02/11/2019 16:41	21,35	1	21,35	CHI
2019115436	GOIANESIA	GE11386344	GOIANESIA S2	01/11/2019 18:42	01/11/2019 22:01	01/11/2019 18:42	01/11/2019 22:01	3,31	15	49,62	CHI
2019115450	SANTA CRUZ DE GOIAS	BC12012000	PIRES DO RIO S2	01/11/2019 19:18	02/11/2019 07:56	01/11/2019 19:18	02/11/2019 07:56	12,63	86	1086,39	CHI
2019115485	JANDAIA	JD12391440	PALMEIRAS	01/11/2019 19:28	02/11/2019 08:01	01/11/2019 19:28	02/11/2019 08:01	12,56	24	301,36	CHI
2019115491	GOIANIA	GN11164770	CARAJAS S1	01/11/2019 16:53	02/11/2019 07:48	01/11/2019 16:53	02/11/2019 07:48	14,91	163	2431,05	CHI
2019115495	GOIANIA	10000993881	ATLANTICO S1	01/11/2019 19:29	02/11/2019 13:20	01/11/2019 19:29	02/11/2019 13:20	17,85	1	17,85	CHI
2019115496	INDIARA	IY11393274	EDEIA	01/11/2019 17:04	01/11/2019 23:39	01/11/2019 17:04	01/11/2019 23:39	6,58	54	355,32	CHI
2019115505	GOIANESIA	550130408	GOIANESIA S2	01/11/2019 19:30	02/11/2019 04:32	01/11/2019 19:30	02/11/2019 04:32	9,03	1	9,03	CHI
2019115506	GOIAS	GS12220308	MATRINCHA	01/11/2019 19:30	04/11/2019 19:35	01/11/2019 19:30	04/11/2019 19:35	72,07	2	144,15	CHI

2019115508	MOIPORA	MO12223030	IPORA	01/11/2019 19:30	02/11/2019 10:50	01/11/2019 19:30	02/11/2019 10:50	15,32	4	61,28	CHI
2019115510	INDIARA	2710013302	EDEIA	01/11/2019 19:30	04/11/2019 10:53	01/11/2019 19:30	04/11/2019 10:53	63,38	1	63,38	CHI
2019115512	APARECIDA DE GOIANIA	10006303968	INDEPENDENCIA S2	01/11/2019 19:31	02/11/2019 18:48	01/11/2019 19:31	02/11/2019 18:48	23,28	1	23,28	CHI
2019115515	DOVERLANDIA	DV12138335	CAIAPONIA	01/11/2019 14:44	02/11/2019 09:57	01/11/2019 14:44	02/11/2019 09:57	19,22	37	711,16	CHI
2019115518	PALMEIRAS DE GOIAS	PL12205913	PALMEIRAS	01/11/2019 19:31	06/11/2019 16:45	01/11/2019 19:31	06/11/2019 16:45	117,23	4	468,93	CHI
2019115519	BRAZABRANTES	03920224	NEROPOLIS S1	01/11/2019 19:26	03/11/2019 12:25	01/11/2019 19:28	01/11/2019 21:45	2,28	371	846,19	CHI
2019115519	GOIANIRA	03920224	NEROPOLIS S1	01/11/2019 19:26	03/11/2019 12:25	01/11/2019 19:28	01/11/2019 21:45	2,28	7	15,97	CHI
2019115519	NOVA VENEZA	03920224	NEROPOLIS S1	01/11/2019 19:26	03/11/2019 12:25	01/11/2019 19:28	01/11/2019 21:45	2,28	3	6,84	CHI
2019115519	BRAZABRANTES	03920224	NEROPOLIS S1	01/11/2019 19:26	03/11/2019 12:25	02/11/2019 15:22	02/11/2019 16:42	1,34	371	497,76	CHI
2019115519	GOIANIRA	03920224	NEROPOLIS S1	01/11/2019 19:26	03/11/2019 12:25	02/11/2019 15:22	02/11/2019 16:42	1,34	7	9,39	CHI
2019115519	NOVA VENEZA	03920224	NEROPOLIS S1	01/11/2019 19:26	03/11/2019 12:25	02/11/2019 15:22	02/11/2019 16:42	1,34	3	4,03	CHI
2019115519	BRAZABRANTES	03920224	NEROPOLIS S1	01/11/2019 19:26	03/11/2019 12:25	01/11/2019 19:28	03/11/2019 12:25	40,94	4	163,77	CHI
2019115519	GOIANIRA	03920224	NEROPOLIS S1	01/11/2019 19:26	03/11/2019 12:25	01/11/2019 19:28	03/11/2019 12:25	40,94	23	941,68	CHI
2019115527	RIO VERDE	RV12360613	RIO VERDE S2	01/11/2019 19:08	01/11/2019 23:47	01/11/2019 19:08	01/11/2019 23:47	4,64	72	333,80	CHI
2019115541	INHUMAS	IN12047634	INHUMAS S2	01/11/2019 18:54	02/11/2019 13:53	01/11/2019 18:54	02/11/2019 13:53	18,98	170	3226,60	CHI
2019115546	INHUMAS	IN11000015	INHUMAS S2	01/11/2019 19:15	02/11/2019 17:46	01/11/2019 19:15	02/11/2019 17:46	22,51	72	1620,68	CHI
2019115557	OUVIDOR	OU12108315	CATALAO S1	01/11/2019 18:57	02/11/2019 17:56	01/11/2019 18:57	02/11/2019 17:56	22,98	2	45,95	CHI
2019115559	TEREZOPOLIS DE GOIAS	1370007453	DAIA S2	01/11/2019 19:36	02/11/2019 11:53	01/11/2019 19:36	02/11/2019 11:53	16,28	1	16,28	CHI
2019115584	ANAPOLIS	20026353	JUNDIAI S2	01/11/2019 19:38	02/11/2019 15:01	01/11/2019 19:38	02/11/2019 15:01	19,38	1	19,38	CHI
2019115596	TRINDADE	10026527390	GOYA S2	01/11/2019 17:34	01/11/2019 21:40	01/11/2019 17:34	01/11/2019 21:40	4,11	1	4,11	CHI
2019115606	GOIANIA	17428660	GOYA S1	01/11/2019 19:40	02/11/2019 17:40	01/11/2019 19:40	02/11/2019 17:40	22,00	1	22,00	CHI
2019115608	TRINDADE	TR11340465	TRINDADE	01/11/2019 19:32	01/11/2019 23:01	01/11/2019 19:32	01/11/2019 23:01	3,47	111	385,39	CHI
2019115622	APARECIDA DE GOIANIA	10028090401	INDEPENDENCIA S2	01/11/2019 19:41	03/11/2019 11:08	01/11/2019 19:41	03/11/2019 11:08	39,43	1	39,43	CHI
2019115623	ANAPOLIS	AN16407070	JUNDIAI S1	01/11/2019 19:32	01/11/2019 20:35	01/11/2019 19:40	01/11/2019 20:35	0,91	1059	963,69	CHI
2019115623	ANAPOLIS	02370244	JUNDIAI S1	01/11/2019 19:32	01/11/2019 20:35	01/11/2019 20:26	01/11/2019 20:35	0,14	2517	360,07	CHI
2019115626	GOIATUBA	BJ12088558	RIO DOS BOIS	01/11/2019 17:56	02/11/2019 11:20	01/11/2019 17:56	02/11/2019 11:20	17,41	1	17,41	CHI
2019115626	PORTEIRAO	BJ12088558	RIO DOS BOIS	01/11/2019 17:56	02/11/2019 11:20	01/11/2019 17:56	02/11/2019 11:20	17,41	2	34,81	CHI
2019115628	ITAJA	IM12016195	CACHOEIRA ALTA	01/11/2019 19:38	02/11/2019 20:07	02/11/2019 00:30	02/11/2019 20:07	19,63	19	372,98	CHI
2019115628	ITARUMA	IM12016195	CACHOEIRA ALTA	01/11/2019 19:38	02/11/2019 20:07	02/11/2019 00:30	02/11/2019 20:07	19,63	30	588,92	CHI
2019115635	INDIARA	IY10396906	EDEIA	01/11/2019 19:40	01/11/2019 21:48	01/11/2019 19:40	01/11/2019 21:32	1,86	32	59,57	CHI
2019115635	INDIARA	IY13299108	EDEIA	01/11/2019 19:40	01/11/2019 21:48	01/11/2019 19:40	01/11/2019 21:48	2,13	7	14,89	CHI
2019115652	APARECIDA DE GOIANIA	AP12165676	ATLANTICO S3	01/11/2019 19:33	02/11/2019 00:22	01/11/2019 19:33	02/11/2019 00:22	4,80	119	571,63	CHI
2019115655	GOIANIA	GN11001048	CARAJAS S1	01/11/2019 19:44	01/11/2019 23:06	01/11/2019 22:34	01/11/2019 23:06	0,53	129	67,90	CHI

2019115658	SANTO ANTONIO DA BARRA	BZ21303299	ACREUNA	01/11/2019 19:44	02/11/2019 13:10	01/11/2019 19:44	02/11/2019 13:10	17,42	2	34,84	CHI
2019115672	JATAI	JT11152222	JATAI S2	01/11/2019 17:04	02/11/2019 00:30	01/11/2019 17:04	02/11/2019 00:30	7,43	110	817,36	CHI
2019115681	GOIATUBA	GT12093513	GOIATUBA S2	01/11/2019 16:04	02/11/2019 10:41	01/11/2019 16:04	02/11/2019 10:41	18,61	195	3628,35	CHI
2019115684	GOIANIA	11311228	CAMPINAS S2	01/11/2019 19:48	01/11/2019 23:08	01/11/2019 19:48	01/11/2019 23:08	3,32	1	3,32	CHI
2019115692	INHUMAS	IN11395339	INHUMAS S2	01/11/2019 19:08	02/11/2019 18:07	01/11/2019 19:08	02/11/2019 18:07	22,98	13	298,69	CHI
2019115700	GOIANIA	GN11378663	CARAJAS S2	01/11/2019 15:47	02/11/2019 03:52	01/11/2019 15:47	02/11/2019 03:52	12,08	85	1026,99	CHI
2019115704	GOIANIA	GN12043915	GOIANIA LESTE S3	01/11/2019 19:43	01/11/2019 20:59	01/11/2019 19:43	01/11/2019 20:59	1,25	240	300,67	CHI
2019115711	CEZARINA	03320416	GUAPO S2	01/11/2019 17:30	02/11/2019 00:44	01/11/2019 17:30	02/11/2019 00:44	7,23	215	1554,21	CHI
2019115711	GUAPO	03320416	GUAPO S2	01/11/2019 17:30	02/11/2019 00:44	01/11/2019 17:30	02/11/2019 00:44	7,23	130	939,76	CHI
2019115711	INDIARA	03320416	GUAPO S2	01/11/2019 17:30	02/11/2019 00:44	01/11/2019 17:30	02/11/2019 00:44	7,23	1	7,23	CHI
2019115711	VARJAO	03320416	GUAPO S2	01/11/2019 17:30	02/11/2019 00:44	01/11/2019 17:30	02/11/2019 00:44	7,23	1674	12101,16	CHI
2019115711	VARJAO	03320416	GUAPO S2	01/11/2019 17:30	02/11/2019 00:44	01/11/2019 17:30	02/11/2019 00:44	7,23	200	1445,78	CHI
2019115720	ITAPIRAPUA	IU12020837	JUSSARA	01/11/2019 19:52	04/11/2019 12:11	01/11/2019 19:52	04/11/2019 12:11	64,31	10	643,07	CHI
2019115724	ITAPURANGA	IK11051549	ITAPURANGA	01/11/2019 19:48	02/11/2019 13:20	01/11/2019 19:48	02/11/2019 13:20	17,53	197	3452,53	CHI
2019115727	PARANAIGUARA	SO12000023	CACHOEIRA ALTA	01/11/2019 19:50	02/11/2019 00:15	01/11/2019 19:50	02/11/2019 00:15	4,41	62	273,39	CHI
2019115727	SAO SIMAO	SO12000023	CACHOEIRA ALTA	01/11/2019 19:50	02/11/2019 00:15	01/11/2019 19:50	02/11/2019 00:15	4,41	32	141,10	CHI
2019115745	JATAI	290338773	JATAI S2	01/11/2019 19:56	02/11/2019 09:58	01/11/2019 19:56	02/11/2019 09:58	14,03	1	14,03	CHI
2019115751	GOIANIA	14008567	MEIA PONTE	01/11/2019 19:57	02/11/2019 16:31	01/11/2019 19:57	02/11/2019 16:31	20,57	1	20,57	CHI
2019115754	ANAPOLIS	AN21062533	JUNDIAI S1	01/11/2019 19:57	02/11/2019 01:15	01/11/2019 19:57	02/11/2019 01:15	5,30	1	5,30	CHI
2019115758	PALESTINA DE GOIAS	PY21187413	PALESTINA	01/11/2019 19:57	05/11/2019 11:38	01/11/2019 19:57	05/11/2019 11:38	87,67	1	87,67	CHI
2019115765	IPAMERI	IP12231489	IPAMERI	01/11/2019 19:16	01/11/2019 22:33	01/11/2019 19:16	01/11/2019 22:33	3,28	67	219,46	CHI
2019115776	QUIRINOPOLIS	80039558	QUIRINOPOLIS	01/11/2019 19:59	02/11/2019 10:47	01/11/2019 19:59	02/11/2019 10:47	14,81	1	14,81	CHI
2019115777	INHUMAS	IN11051564	INHUMAS S2	01/11/2019 19:10	02/11/2019 13:51	01/11/2019 19:10	02/11/2019 13:51	18,68	71	1326,56	CHI
2019115787	SANTA BARBARA DE GOIAS	1030006985	TRINDADE	01/11/2019 19:59	04/11/2019 16:25	01/11/2019 19:59	04/11/2019 16:25	68,43	1	68,43	CHI
2019115790	CACU	CC12075913	CACHOEIRA ALTA	01/11/2019 16:52	02/11/2019 21:28	01/11/2019 16:52	02/11/2019 21:28	28,59	13	371,66	CHI
2019115790	ITARUMA	CC12075913	CACHOEIRA ALTA	01/11/2019 16:52	02/11/2019 21:28	01/11/2019 16:52	02/11/2019 21:28	28,59	31	886,27	CHI
2019115802	GOIAS	GS12162479	GOIAS	01/11/2019 18:07	03/11/2019 08:41	01/11/2019 18:07	03/11/2019 08:41	38,57	3	115,71	CHI
2019115839	CATALAO	10013145620	CATALAO S2	01/11/2019 20:05	02/11/2019 09:11	01/11/2019 20:05	02/11/2019 09:11	13,10	1	13,10	CHI
2019115840	GOIANIA	GN12169904	XAVANTES	01/11/2019 19:50	01/11/2019 22:33	01/11/2019 19:50	01/11/2019 22:33	2,71	28	75,86	CHI
2019115842	ANAPOLIS	AN11000499	JUNDIAI S1	01/11/2019 19:48	01/11/2019 22:43	01/11/2019 19:48	01/11/2019 22:43	2,91	149	434,13	CHI
2019115846	RIO VERDE	RV12340919	RIO VERDE S2	01/11/2019 16:15	01/11/2019 21:45	01/11/2019 16:15	01/11/2019 21:45	5,49	1	5,49	CHI
2019115847	APARECIDA DE GOIANIA	200442661	INDEPENDENCIA S2	01/11/2019 20:05	02/11/2019 13:14	01/11/2019 20:05	02/11/2019 13:14	17,13	1	17,13	CHI
2019115855	PALMEIRAS DE GOIAS	PL11215478	PALMEIRAS	01/11/2019 20:01	01/11/2019 23:01	01/11/2019 20:01	01/11/2019 23:01	3,00	137	410,58	CHI

2019115896	GOIANIRA	GR11209014	GOIANIRA	01/11/2019 20:09	02/11/2019 22:23	01/11/2019 20:09	02/11/2019 22:23	26,23	94	2465,85	CHI
2019115901	ARAGOIANIA	AO11040735	INDEPENDENCIA S2	01/11/2019 19:49	02/11/2019 04:06	01/11/2019 19:49	02/11/2019 04:06	8,28	43	355,94	CHI
2019115909	GOIANIRA	GR11232184	GOIANIRA	01/11/2019 20:05	02/11/2019 03:58	01/11/2019 20:05	02/11/2019 03:58	7,87	175	1377,64	CHI
2019115912	CATALAO	CT11166810	CATALAO S2	01/11/2019 20:03	02/11/2019 08:08	01/11/2019 20:03	02/11/2019 08:08	12,08	52	628,10	CHI
2019115921	GOIANIRA	GR11374036	GOIANIRA	01/11/2019 19:47	02/11/2019 18:08	01/11/2019 19:47	02/11/2019 18:08	22,33	84	1876,09	CHI
2019115933	ARAGOIANIA	AO32000019	GUAPO S2	01/11/2019 19:57	02/11/2019 18:28	01/11/2019 19:57	02/11/2019 18:28	22,52	15	337,73	CHI
2019115948	GOIANIA	GN11142945	CARAJAS S1	01/11/2019 15:44	01/11/2019 20:53	01/11/2019 15:44	01/11/2019 20:53	5,15	153	787,27	CHI
2019115951	GOIANIA	GN11158110	CARAJAS S1	01/11/2019 18:27	01/11/2019 22:15	01/11/2019 18:27	01/11/2019 22:15	3,79	102	386,33	CHI
2019115956	BURITI ALEGRE	BG12263620	ALTO BURITI	01/11/2019 20:20	06/11/2019 11:52	01/11/2019 20:20	06/11/2019 11:52	111,52	2	223,05	CHI
2019115959	GOIANIA	GN11313162	ATLANTICO S1	01/11/2019 18:30	02/11/2019 09:04	01/11/2019 18:30	02/11/2019 09:04	14,57	3	43,70	CHI
2019115961	GOIANIRA	GR11209013	GOIANIRA	01/11/2019 20:08	02/11/2019 21:02	01/11/2019 20:08	02/11/2019 21:02	24,91	104	2590,52	CHI
2019115980	GOIANIA	10074843	CAMPINAS S1	01/11/2019 20:23	02/11/2019 11:20	01/11/2019 20:23	02/11/2019 11:20	14,93	1	14,93	CHI
2019115986	GOIANESIA	JA12297398	GOIANESIA S2	01/11/2019 16:40	02/11/2019 02:03	01/11/2019 16:40	02/11/2019 02:03	9,37	2	18,74	CHI
2019115986	JARAGUA	JA12297398	GOIANESIA S2	01/11/2019 16:40	02/11/2019 02:03	01/11/2019 16:40	02/11/2019 02:03	9,37	12	112,42	CHI
2019115990	NEROPOLIS	160055957	NEROPOLIS S2	01/11/2019 20:25	01/11/2019 23:31	01/11/2019 20:25	01/11/2019 23:31	3,08	1	3,08	CHI
2019115993	GOIANIRA	GR11104380	GOIANIRA	01/11/2019 20:14	02/11/2019 10:45	01/11/2019 20:14	02/11/2019 10:45	14,52	195	2830,80	CHI
2019116007	APARECIDA DE GOIANIA	16043637	ATLANTICO S1	01/11/2019 20:28	01/11/2019 23:11	01/11/2019 20:28	01/11/2019 23:11	2,70	1	2,70	CHI
2019116012	GOIANIRA	10015829799	GOIANIRA	01/11/2019 20:29	03/11/2019 02:23	01/11/2019 20:29	03/11/2019 02:23	29,91	1	29,91	CHI
2019116016	GOIANIRA	GR12394658	GOIANIRA	01/11/2019 20:29	03/11/2019 18:10	01/11/2019 20:29	03/11/2019 18:10	45,67	1	45,67	CHI
2019116019	GOIANIRA	GR12217528	GOIANIRA	01/11/2019 20:08	02/11/2019 16:10	01/11/2019 20:08	02/11/2019 16:10	20,03	276	5529,12	CHI
2019116031	APARECIDA DE GOIANIA	AP11085125	ATLANTICO S1	01/11/2019 20:27	01/11/2019 21:56	01/11/2019 20:27	01/11/2019 21:56	1,48	89	131,70	CHI
2019116036	GOIANIRA	10010596389	GOIANIRA	01/11/2019 20:33	03/11/2019 11:13	01/11/2019 20:33	03/11/2019 11:13	38,66	1	38,66	CHI
2019116045	APARECIDA DE GOIANIA	AP11164450	INDEPENDENCIA S2	01/11/2019 18:27	02/11/2019 01:15	01/11/2019 18:27	02/11/2019 01:15	6,79	153	1038,95	CHI
2019116047	APARECIDA DE GOIANIA	AP11160856	INDEPENDENCIA S1	01/11/2019 20:36	02/11/2019 21:48	01/11/2019 20:36	02/11/2019 21:48	25,20	215	5417,94	CHI
2019116055	MINEIROS	MY12347881	PARQUE DAS EMAS	01/11/2019 18:10	01/11/2019 22:41	01/11/2019 18:10	01/11/2019 22:41	4,51	101	455,65	CHI
2019116065	AVELINOPOLIS	AV21282449	ANICUNS	01/11/2019 20:39	02/11/2019 08:41	01/11/2019 20:39	02/11/2019 08:41	12,02	1	12,02	CHI
2019116066	FIRMINOPOLIS	FR12312448	FIRMINOPOLIS S1	01/11/2019 20:39	03/11/2019 07:43	01/11/2019 20:39	03/11/2019 07:43	35,05	2	70,10	CHI
2019116067	GOIANIA	12661120	MEIA PONTE	01/11/2019 20:39	02/11/2019 01:15	01/11/2019 20:39	02/11/2019 01:15	4,59	1	4,59	CHI
2019116083	PIRACANJUBA	PJ13000022	PIRACANJUBA	01/11/2019 20:38	03/11/2019 11:56	01/11/2019 20:38	02/11/2019 10:26	13,79	90	1240,80	CHI
2019116083	PIRACANJUBA	PJ13000011	PIRACANJUBA	01/11/2019 20:38	03/11/2019 11:56	01/11/2019 20:38	02/11/2019 14:11	17,54	16	280,58	CHI
2019116083	PIRACANJUBA	PJ10394717	PIRACANJUBA	01/11/2019 20:38	03/11/2019 11:56	01/11/2019 20:38	03/11/2019 11:56	39,28	59	2317,77	CHI
2019116086	GOIANIRA	GR12016215	GOIANIRA	01/11/2019 20:42	03/11/2019 08:15	01/11/2019 20:42	03/11/2019 08:15	35,56	12	426,70	CHI
2019116086	TRINDADE	GR12016215	GOIANIRA	01/11/2019 20:42	03/11/2019 08:15	01/11/2019 20:42	03/11/2019 08:15	35,56	3	106,67	CHI

2019116086	GOIANIRA	GR12016215	GOIANIRA	01/11/2019 20:42	03/11/2019 08:15	03/11/2019 07:18	03/11/2019 08:15	0,95	2	1,90	CHI
2019116092	MINEIROS	MY12324399	PARQUE DAS EMAS	01/11/2019 20:20	03/11/2019 20:37	01/11/2019 20:20	03/11/2019 20:37	48,29	2	96,58	CHI
2019116100	SANTO ANTONIO DO DESCOBERTO	SN12168728	ALEXANIA	01/11/2019 20:45	02/11/2019 00:27	01/11/2019 20:45	01/11/2019 22:02	1,27	91	115,90	CHI
2019116100	SANTO ANTONIO DO DESCOBERTO	SN12168728	ALEXANIA	01/11/2019 20:45	02/11/2019 00:27	01/11/2019 20:45	02/11/2019 00:27	3,70	54	199,70	CHI
2019116104	SAO LUIS DE MONTES BELOS	SL32145768	SAO LUIZ DOS MONTES BELOS	01/11/2019 19:35	02/11/2019 08:28	01/11/2019 19:35	02/11/2019 08:28	12,87	30	386,11	CHI
2019116108	ITABERAÍ	IB11282419	ITABERAÍ S2	01/11/2019 20:46	02/11/2019 03:44	01/11/2019 20:46	02/11/2019 03:44	6,96	82	570,47	CHI
2019116118	TRINDADE	40223991	TRINDADE	01/11/2019 20:48	02/11/2019 19:00	01/11/2019 20:48	02/11/2019 19:00	22,19	1	22,19	CHI
2019116119	INHUMAS	30076766	INHUMAS S2	01/11/2019 20:48	02/11/2019 16:25	01/11/2019 20:48	02/11/2019 16:25	19,60	1	19,60	CHI
2019116120	SILVANIA	SV21120259	BELA VISTA S2	01/11/2019 20:49	03/11/2019 09:08	01/11/2019 20:49	03/11/2019 09:08	36,32	1	36,32	CHI
2019116129	GOIANIRA	GR12402798	GOIANIRA	01/11/2019 20:51	03/11/2019 16:15	01/11/2019 20:51	03/11/2019 16:15	43,40	1	43,40	CHI
2019116130	GOIANIA	15769197	CARAJAS S2	01/11/2019 20:51	02/11/2019 15:59	01/11/2019 20:51	02/11/2019 15:59	19,13	1	19,13	CHI
2019116134	LEOPOLDO DE BULHOES	LB21239288	DAIA S2	01/11/2019 20:51	03/11/2019 09:49	01/11/2019 20:51	03/11/2019 09:49	36,95	1	36,95	CHI
2019116137	JATAÍ	JT12062761	CACHOEIRA ALTA	01/11/2019 20:52	05/11/2019 11:17	01/11/2019 20:52	05/11/2019 11:17	86,41	3	259,24	CHI
2019116162	GOIANIA	GN11137211	XAVANTES	01/11/2019 20:38	01/11/2019 22:25	01/11/2019 20:38	01/11/2019 22:25	1,77	137	242,38	CHI
2019116175	GOIANIA	GN11162446	MEIA PONTE	01/11/2019 20:46	02/11/2019 14:45	01/11/2019 20:46	02/11/2019 14:45	17,99	93	1673,10	CHI
2019116178	GOIATUBA	GT12000129RE	GOIATUBA S2	01/11/2019 15:41	02/11/2019 15:28	01/11/2019 15:41	02/11/2019 15:28	23,77	24	570,52	CHI
2019116189	APARECIDA DE GOIANIA	200182717	INDEPENDENCIA S1	01/11/2019 21:00	02/11/2019 12:53	01/11/2019 21:00	02/11/2019 12:53	15,87	1	15,87	CHI
2019116199	CATURAI	IN21015354	INHUMAS S1	01/11/2019 21:02	03/11/2019 16:23	01/11/2019 21:02	03/11/2019 16:23	43,34	1	43,34	CHI
2019116202	GOIANIRA	GR11141254	GOIANIRA	01/11/2019 20:42	02/11/2019 02:15	01/11/2019 20:42	02/11/2019 02:15	5,54	223	1236,53	CHI
2019116203	GOIANIRA	GR11329385	GOIANIRA	01/11/2019 20:02	02/11/2019 15:40	01/11/2019 20:02	02/11/2019 15:40	19,63	159	3121,52	CHI
2019116204	INHUMAS	10014417772	INHUMAS S2	01/11/2019 21:03	03/11/2019 17:55	01/11/2019 21:03	03/11/2019 17:55	44,87	1	44,87	CHI
2019116206	SAO LUIS DE MONTES BELOS	SL12383600	SAO LUIZ DOS MONTES BELOS	01/11/2019 20:49	02/11/2019 09:11	01/11/2019 20:49	02/11/2019 09:11	12,36	9	111,20	CHI
2019116211	GOIANIA	GN12133365	MEIA PONTE	01/11/2019 20:55	01/11/2019 23:02	01/11/2019 20:55	01/11/2019 22:40	1,74	140	243,52	CHI
2019116211	GOIANIA	GN11002586	MEIA PONTE	01/11/2019 20:55	01/11/2019 23:02	01/11/2019 20:55	01/11/2019 23:02	2,11	142	299,15	CHI
2019116213	INHUMAS	IN12012244	INHUMAS S2	01/11/2019 21:05	04/11/2019 18:51	01/11/2019 21:05	04/11/2019 18:51	69,77	2	139,53	CHI
2019116214	SAO MIGUEL DO PASSA QUATRO	1490013470	CRISTIANOPOLIS	01/11/2019 21:05	02/11/2019 08:19	01/11/2019 21:05	02/11/2019 08:19	11,22	1	11,22	CHI
2019116222	INHUMAS	IN11168387	INHUMAS S2	01/11/2019 19:15	02/11/2019 20:50	01/11/2019 19:15	02/11/2019 20:50	25,58	39	997,46	CHI
2019116226	GOIANIA	GN11226674	CARAJAS S1	01/11/2019 20:40	02/11/2019 04:24	01/11/2019 20:40	02/11/2019 04:24	7,73	166	1282,53	CHI
2019116230	DOVERLANDIA	DV12207962	CAIAPONIA	01/11/2019 21:08	02/11/2019 15:31	01/11/2019 21:08	02/11/2019 15:31	18,37	7	128,60	CHI
2019116238	CAIAPONIA	MV12030666	MONTIVIDIU T	01/11/2019 21:10	03/11/2019 08:15	01/11/2019 21:10	03/11/2019 08:15	35,07	16	561,10	CHI
2019116238	MONTIVIDIU	MV12030666	MONTIVIDIU T	01/11/2019 21:10	03/11/2019 08:15	01/11/2019 21:10	03/11/2019 08:15	35,07	23	806,58	CHI
2019116243	APARECIDA DE GOIANIA	AP11137038	INDEPENDENCIA S2	01/11/2019 19:50	02/11/2019 02:11	01/11/2019 19:50	02/11/2019 02:11	6,35	104	659,97	CHI
2019116245	INHUMAS	30127099	INHUMAS S2	01/11/2019 21:11	03/11/2019 18:57	01/11/2019 21:11	03/11/2019 18:57	45,75	1	45,75	CHI

2019116248	ANAPOLIS	AN11196893	ANAPOLIS UNIVERSITARIO S2	01/11/2019 21:10	01/11/2019 22:36	01/11/2019 21:10	01/11/2019 22:36	1,43	154	219,96	CHI
2019116252	INHUMAS	IN11125340	INHUMAS S2	01/11/2019 19:39	02/11/2019 16:22	01/11/2019 19:39	02/11/2019 16:22	20,72	151	3128,13	CHI
2019116255	RIO VERDE	630164710	RIO VERDE S1	01/11/2019 21:13	03/11/2019 09:30	01/11/2019 21:13	03/11/2019 09:30	36,28	1	36,28	CHI
2019116257	QUIRINOPOLIS	QI21014940	QUIRINOPOLIS	01/11/2019 21:14	02/11/2019 11:58	01/11/2019 21:14	02/11/2019 11:58	14,73	1	14,73	CHI
2019116268	GUAPO	710044537	GUAPO S1	01/11/2019 21:16	04/11/2019 14:57	01/11/2019 21:16	04/11/2019 14:57	65,68	1	65,68	CHI
2019116272	ANAPOLIS	20614913	ANAPOLIS UNIVERSITARIO S1	01/11/2019 21:17	02/11/2019 09:20	01/11/2019 21:17	02/11/2019 09:20	12,05	1	12,05	CHI
2019116281	GOIANIA	GN11274972	CARAJAS S2	01/11/2019 15:53	02/11/2019 05:22	01/11/2019 15:53	02/11/2019 05:22	13,48	50	673,81	CHI
2019116282	GOIANIA	GN11269315	CARAJAS S2	01/11/2019 15:54	02/11/2019 01:16	01/11/2019 15:54	02/11/2019 01:16	9,36	266	2489,83	CHI
2019116291	JARAGUA	JA12382495RE	JARAGUA	01/11/2019 21:21	02/11/2019 09:14	01/11/2019 21:21	02/11/2019 09:14	11,87	132	1567,10	CHI
2019116291	PIRENOPOLIS	JA12382495RE	JARAGUA	01/11/2019 21:21	02/11/2019 09:14	01/11/2019 21:21	02/11/2019 09:14	11,87	97	1151,58	CHI
2019116299	JATAI	290143779	JATAI S3	01/11/2019 21:23	03/11/2019 11:35	01/11/2019 21:23	03/11/2019 11:35	38,19	1	38,19	CHI
2019116302	COCALZINHO DE GOIAS	6090007361	COCALZINHO	01/11/2019 21:23	02/11/2019 14:26	01/11/2019 21:23	02/11/2019 14:26	17,04	1	17,04	CHI
2019116304	GOIANIRA	GR11133812	GOIANIRA	01/11/2019 20:31	02/11/2019 16:03	01/11/2019 20:31	02/11/2019 16:03	19,54	134	2618,58	CHI
2019116305	SAO LUIS DE MONTES BELOS	SL12125616	FIRMINOPOLIS S1	01/11/2019 21:11	02/11/2019 12:44	01/11/2019 21:11	02/11/2019 12:44	15,55	10	155,48	CHI
2019116314	CALDAS NOVAS	10018736872	CALDAS NOVAS S1	01/11/2019 21:26	02/11/2019 10:50	01/11/2019 21:26	02/11/2019 10:50	13,40	1	13,40	CHI
2019116324	GOIANIA	10787732	CARAJAS S1	01/11/2019 21:29	02/11/2019 11:51	01/11/2019 21:29	02/11/2019 11:51	14,36	1	14,36	CHI
2019116329	CATALAO	1990298907	CATALAO S1	01/11/2019 21:32	02/11/2019 05:50	01/11/2019 21:32	02/11/2019 05:50	8,30	1	8,30	CHI
2019116330	ANAPOLIS	20816406	JUNDIAI S1	01/11/2019 21:32	02/11/2019 08:25	01/11/2019 21:32	02/11/2019 08:25	10,88	1	10,88	CHI
2019116332	IPAMERI	IP12300933	IPAMERI	01/11/2019 17:53	02/11/2019 22:25	01/11/2019 17:53	02/11/2019 11:16	17,38	50	868,96	CHI
2019116332	IPAMERI	IP21100322	IPAMERI	01/11/2019 17:53	02/11/2019 22:25	01/11/2019 17:53	02/11/2019 22:25	28,53	1	28,53	CHI
2019116334	NOVA AURORA	NE21000154	CATALAO S1	01/11/2019 21:33	02/11/2019 15:00	01/11/2019 21:33	02/11/2019 15:00	17,44	3	52,33	CHI
2019116351	INHUMAS	IN11000017	INHUMAS S2	01/11/2019 20:26	02/11/2019 12:20	01/11/2019 20:26	02/11/2019 12:20	15,88	96	1524,88	CHI
2019116358	BOM JARDIM DE GOIAS	BM12395481	BOM JARDIM	01/11/2019 21:00	02/11/2019 08:49	01/11/2019 21:00	02/11/2019 08:49	11,80	4	47,20	CHI
2019116359	INHUMAS	IN11012238	INHUMAS S2	01/11/2019 21:10	02/11/2019 15:48	01/11/2019 21:10	02/11/2019 15:04	17,90	113	2023,14	CHI
2019116359	INHUMAS	IN11012238	INHUMAS S2	01/11/2019 21:10	02/11/2019 15:48	02/11/2019 15:06	02/11/2019 15:48	0,70	113	78,91	CHI
2019116360	TRINDADE	10024906369	TRINDADE	01/11/2019 21:36	03/11/2019 12:53	01/11/2019 21:36	03/11/2019 12:53	39,28	1	39,28	CHI
2019116369	CATURAI	CK12326309	INHUMAS S1	01/11/2019 21:38	02/11/2019 16:57	01/11/2019 21:38	02/11/2019 16:57	19,31	26	502,01	CHI
2019116369	INHUMAS	CK12326309	INHUMAS S1	01/11/2019 21:38	02/11/2019 16:57	01/11/2019 21:38	02/11/2019 16:57	19,31	3	57,92	CHI
2019116371	SAO LUIS DE MONTES BELOS	500035982	SAO LUIZ DOS MONTES BELOS	01/11/2019 21:39	02/11/2019 00:26	01/11/2019 21:39	02/11/2019 00:26	2,79	1	2,79	CHI
2019116382	INHUMAS	IN11168393	INHUMAS S2	01/11/2019 19:38	02/11/2019 12:26	01/11/2019 19:38	02/11/2019 12:26	16,80	116	1949,35	CHI
2019116393	GOIANIA	GN11042208	CARAJAS S1	01/11/2019 19:11	02/11/2019 03:41	01/11/2019 19:11	02/11/2019 03:41	8,50	94	798,90	CHI
2019116395	QUIRINOPOLIS	QI12163448	SANTA HELENA S1	01/11/2019 21:42	02/11/2019 00:48	01/11/2019 21:42	02/11/2019 00:48	3,10	4	12,38	CHI
2019116395	RIO VERDE	QI12163448	SANTA HELENA S1	01/11/2019 21:42	02/11/2019 00:48	01/11/2019 21:42	02/11/2019 00:48	3,10	1	3,10	CHI

2019116398	MINACU	IH12348007	MINACU	01/11/2019 15:26	02/11/2019 14:20	01/11/2019 15:26	02/11/2019 14:20	22,89	25	572,31	CHI
2019116398	MINACU	IH12396740	MINACU	01/11/2019 15:26	02/11/2019 14:20	01/11/2019 15:26	02/11/2019 14:20	22,89	122	2792,82	CHI
2019116404	IPAMERI	IP12017034	IPAMERI	01/11/2019 18:30	03/11/2019 11:48	01/11/2019 18:30	01/11/2019 23:45	5,23	47	246,01	CHI
2019116404	IPAMERI	IP12017034	IPAMERI	01/11/2019 18:30	03/11/2019 11:48	01/11/2019 23:46	03/11/2019 11:48	36,03	47	1693,58	CHI
2019116418	GOIANIA	13133366	ATLANTICO S3	01/11/2019 21:48	02/11/2019 15:24	01/11/2019 21:48	02/11/2019 15:24	17,60	1	17,60	CHI
2019116424	PARANAIGUARA	PC12370045	CACHOEIRA ALTA	01/11/2019 21:51	02/11/2019 14:25	01/11/2019 21:51	02/11/2019 14:25	16,56	4	66,24	CHI
2019116425	TEREZOPOLIS DE GOIAS	TJ12080977	JUNDIAI S2	01/11/2019 21:51	02/11/2019 09:32	01/11/2019 21:51	02/11/2019 09:32	11,67	4	46,67	CHI
2019116430	CALDAS NOVAS	760017001	CALDAS NOVAS S1	01/11/2019 21:53	02/11/2019 08:34	01/11/2019 21:53	02/11/2019 08:34	10,68	1	10,68	CHI
2019116469	ITUMBIARA	690293306	PARANAIBA	01/11/2019 22:01	03/11/2019 15:42	01/11/2019 22:01	03/11/2019 15:42	41,67	1	41,67	CHI
2019116473	PIRACANJUBA	PJ12000102	CALDAS NOVAS S1	01/11/2019 22:02	02/11/2019 10:49	01/11/2019 22:02	02/11/2019 10:49	12,77	19	242,65	CHI
2019116476	GOIANIA	10012135176	CARAJAS S2	01/11/2019 22:03	02/11/2019 17:00	01/11/2019 22:03	02/11/2019 17:00	18,94	1	18,94	CHI
2019116478	ITABERAI	50016880	ITABERAI S2	01/11/2019 22:04	03/11/2019 17:16	01/11/2019 22:04	03/11/2019 17:16	43,19	1	43,19	CHI
2019116484	INHUMAS	10023684095	INHUMAS S2	01/11/2019 22:07	02/11/2019 22:55	01/11/2019 22:07	02/11/2019 22:55	24,81	1	24,81	CHI
2019116487	INHUMAS	IN11012220	INHUMAS S2	01/11/2019 19:22	02/11/2019 22:30	01/11/2019 19:22	02/11/2019 22:30	27,13	98	2658,74	CHI
2019116490	INHUMAS	30178174	INHUMAS S2	01/11/2019 21:43	02/11/2019 23:03	01/11/2019 21:43	02/11/2019 23:03	25,34	1	25,34	CHI
2019116500	ANAPOLIS	20853415	ANAPOLIS UNIVERSITARIO S2	01/11/2019 22:10	02/11/2019 10:25	01/11/2019 22:10	02/11/2019 10:25	12,26	1	12,26	CHI
2019116505	HIDROLANDIA	HD31216137	CEPAIGO S2	01/11/2019 22:11	04/11/2019 15:48	01/11/2019 22:11	04/11/2019 15:48	65,60	1	65,60	CHI
2019116524	CATALAO	CT21266984	CATALAO S1	01/11/2019 22:16	02/11/2019 09:20	01/11/2019 22:16	02/11/2019 09:20	11,05	2	22,11	CHI
2019116532	QUIRINOPOLIS	10026401094	QUIRINOPOLIS	01/11/2019 22:18	02/11/2019 09:17	01/11/2019 22:18	02/11/2019 09:17	10,98	1	10,98	CHI
2019116534	CALDAS NOVAS	CN21138154	SERRA DE CALDAS	01/11/2019 22:19	03/11/2019 14:29	01/11/2019 22:19	03/11/2019 14:29	40,17	1	40,17	CHI
2019116544	CATALAO	CT21278981	CATALAO S1	01/11/2019 22:21	02/11/2019 08:43	01/11/2019 22:21	02/11/2019 08:43	10,36	1	10,36	CHI
2019116552	TRINDADE	10023852826	GOYA S1	01/11/2019 22:25	02/11/2019 12:11	01/11/2019 22:25	02/11/2019 12:11	13,77	1	13,77	CHI
2019116564	GOIAS	GS21364877	ITABERAI S1	01/11/2019 22:28	04/11/2019 12:22	01/11/2019 22:28	04/11/2019 12:22	61,91	1	61,91	CHI
2019116633	AURILANDIA	SL12392710	SAO LUIZ DOS MONTES BELOS	01/11/2019 22:01	02/11/2019 10:47	02/11/2019 10:29	02/11/2019 10:45	0,26	32	8,43	CHI
2019116633	CORREGO DO OURO	SL12392710	SAO LUIZ DOS MONTES BELOS	01/11/2019 22:01	02/11/2019 10:47	02/11/2019 10:29	02/11/2019 10:45	0,26	325	85,58	CHI
2019116633	FIRMINOPOLIS	SL12392710	SAO LUIZ DOS MONTES BELOS	01/11/2019 22:01	02/11/2019 10:47	02/11/2019 10:29	02/11/2019 10:45	0,26	109	28,70	CHI
2019116633	MOIPIORA	SL12392710	SAO LUIZ DOS MONTES BELOS	01/11/2019 22:01	02/11/2019 10:47	02/11/2019 10:29	02/11/2019 10:45	0,26	28	7,37	CHI
2019116633	SANCLERLANDIA	SL12392710	SAO LUIZ DOS MONTES BELOS	01/11/2019 22:01	02/11/2019 10:47	02/11/2019 10:29	02/11/2019 10:45	0,26	33	8,69	CHI
2019116633	SAO LUIS DE MONTES BELOS	SL12392710	SAO LUIZ DOS MONTES BELOS	01/11/2019 22:01	02/11/2019 10:47	02/11/2019 10:29	02/11/2019 10:45	0,26	723	190,39	CHI
2019116633	SAO LUIS DE MONTES BELOS	SL11398632	SAO LUIZ DOS MONTES BELOS	01/11/2019 22:01	02/11/2019 10:47	01/11/2019 22:01	02/11/2019 10:47	12,78	15	191,66	CHI
2019116638	GOIANIRA	GR12020909	GOIANIRA	01/11/2019 20:14	02/11/2019 08:17	01/11/2019 20:14	02/11/2019 08:17	12,03	282	3393,87	CHI
2019116645	ITAJA	IJ11000008	ITAJA S2	01/11/2019 22:57	02/11/2019 08:52	01/11/2019 22:57	02/11/2019 08:52	9,90	88	871,30	CHI
2019116647	RIO VERDE	630488708	RIO VERDE S1	01/11/2019 23:00	03/11/2019 15:24	01/11/2019 23:00	03/11/2019 15:24	40,40	1	40,40	CHI

2019116658	GOIANIA	GN11002586	MEIA PONTE	01/11/2019 23:09	02/11/2019 13:18	01/11/2019 23:09	02/11/2019 13:18	14,14	142	2008,20	CHI
2019116659	SAO MIGUEL DO PASSA QUATRO	SQ11114717	CRISTIANOPOLIS	01/11/2019 21:12	02/11/2019 07:28	01/11/2019 21:12	02/11/2019 07:28	10,26	125	1282,40	CHI
2019116671	BARRO ALTO	BA11243484	BARRO ALTO	01/11/2019 23:15	02/11/2019 10:40	01/11/2019 23:15	02/11/2019 10:40	11,41	79	901,28	CHI
2019116679	LAGOA SANTA	IJ12200691	ITAJA S2	01/11/2019 23:20	03/11/2019 09:30	01/11/2019 23:20	03/11/2019 09:30	34,16	3	102,49	CHI
2019116680	SANTO ANTONIO DO DESCOBERTO	10006733458	ALEXANIA	01/11/2019 23:20	02/11/2019 07:16	01/11/2019 23:20	02/11/2019 07:16	7,93	1	7,93	CHI
2019116682	PALMEIRAS DE GOIAS	PP12314793	PALMEIRAS	02/11/2019 07:14	03/11/2019 15:08	02/11/2019 07:14	03/11/2019 11:32	28,29	2	56,57	CHI
2019116682	PALMINOPOLIS	PP12314793	PALMEIRAS	02/11/2019 07:14	03/11/2019 15:08	02/11/2019 07:14	03/11/2019 11:32	28,29	38	1074,92	CHI
2019116682	PALMEIRAS DE GOIAS	PP12314793	PALMEIRAS	02/11/2019 07:14	03/11/2019 15:08	03/11/2019 12:21	03/11/2019 15:08	2,78	2	5,56	CHI
2019116682	PALMINOPOLIS	PP12314793	PALMEIRAS	02/11/2019 07:14	03/11/2019 15:08	03/11/2019 12:21	03/11/2019 15:08	2,78	38	105,73	CHI
2019116694	PONTALINA	VI10400585	VICENTINOPOLIS	01/11/2019 22:39	02/11/2019 19:53	01/11/2019 22:52	02/11/2019 17:35	18,71	7	130,97	CHI
2019116694	VICENTINOPOLIS	VI10400585	VICENTINOPOLIS	01/11/2019 22:39	02/11/2019 19:53	01/11/2019 22:52	02/11/2019 17:35	18,71	2	37,42	CHI
2019116694	PONTALINA	VI13157335	VICENTINOPOLIS	01/11/2019 22:39	02/11/2019 19:53	01/11/2019 22:52	02/11/2019 18:52	20,00	8	159,98	CHI
2019116694	PONTALINA	VI10400585	VICENTINOPOLIS	01/11/2019 22:39	02/11/2019 19:53	01/11/2019 22:52	02/11/2019 19:17	20,42	166	3390,41	CHI
2019116694	PONTALINA	VI13157336	VICENTINOPOLIS	01/11/2019 22:39	02/11/2019 19:53	01/11/2019 22:52	02/11/2019 19:17	20,42	1	20,42	CHI
2019116694	VICENTINOPOLIS	VI10400585	VICENTINOPOLIS	01/11/2019 22:39	02/11/2019 19:53	01/11/2019 22:52	02/11/2019 19:17	20,42	13	265,51	CHI
2019116694	PONTALINA	VI10400585	VICENTINOPOLIS	01/11/2019 22:39	02/11/2019 19:53	02/11/2019 19:37	02/11/2019 19:52	0,25	165	41,75	CHI
2019116694	PONTALINA	VI10400585	VICENTINOPOLIS	01/11/2019 22:39	02/11/2019 19:53	02/11/2019 19:37	02/11/2019 19:52	0,25	16	4,05	CHI
2019116694	VICENTINOPOLIS	VI10400585	VICENTINOPOLIS	01/11/2019 22:39	02/11/2019 19:53	02/11/2019 19:37	02/11/2019 19:52	0,25	13	3,29	CHI
2019116694	VICENTINOPOLIS	VI10400585	VICENTINOPOLIS	01/11/2019 22:39	02/11/2019 19:53	02/11/2019 19:37	02/11/2019 19:52	0,25	2	0,51	CHI
2019116694	PONTALINA	PK12328924	VICENTINOPOLIS	01/11/2019 22:39	02/11/2019 19:53	01/11/2019 22:52	02/11/2019 19:53	21,02	1	21,02	CHI
2019116696	IPAMERI	IP11231496	IPAMERI	01/11/2019 19:16	02/11/2019 15:23	01/11/2019 19:16	02/11/2019 15:23	20,11	61	1226,66	CHI
2019116697	IPAMERI	IP12359101	IPAMERI	01/11/2019 23:27	02/11/2019 13:00	01/11/2019 23:27	02/11/2019 13:00	13,54	7	94,79	CHI
2019116699	CATALAO	CT11077615	CATALAO S1	01/11/2019 23:28	02/11/2019 19:58	01/11/2019 23:28	02/11/2019 19:58	20,49	55	1127,03	CHI
2019116703	GOIANIA	GN11287813	CARAJAS S2	01/11/2019 23:23	02/11/2019 02:54	01/11/2019 23:23	02/11/2019 02:54	3,51	298	1045,81	CHI
2019116708	ALOANDIA	650005934	GOIATUBA S1	01/11/2019 23:34	02/11/2019 11:15	01/11/2019 23:34	02/11/2019 11:15	11,67	1	11,67	CHI
2019116742	AMORINOPOLIS	AM11252385	IPORA	01/11/2019 22:17	02/11/2019 08:53	01/11/2019 22:17	02/11/2019 08:53	10,60	51	540,54	CHI
2019116745	GOIANIA	10815508	GOIANIA LESTE S1	02/11/2019 00:42	02/11/2019 10:27	02/11/2019 00:42	02/11/2019 10:27	9,74	1	9,74	CHI
2019116746	INDIARA	IY11215330	EDEIA	01/11/2019 23:56	02/11/2019 02:40	01/11/2019 23:56	02/11/2019 02:40	2,73	204	556,01	CHI
2019116757	GOIANIA	GN11001752	REAL S2	02/11/2019 00:44	02/11/2019 16:37	02/11/2019 00:44	02/11/2019 16:37	15,87	97	1539,55	CHI
2019116770	JARAGUA	JA12205814	JARAGUA	02/11/2019 01:55	02/11/2019 05:19	02/11/2019 01:55	02/11/2019 05:19	3,39	276	934,64	CHI
2019116778	JATAI	JT11379634	JATAI S2	02/11/2019 02:12	02/11/2019 19:57	02/11/2019 02:12	02/11/2019 19:57	17,75	4	71,00	CHI
2019116785	JATAI	JT21327032	MONTIVIDIU T	01/11/2019 22:09	04/11/2019 00:00	01/11/2019 22:09	04/11/2019 00:00	49,85	1	49,85	CHI
2019116797	GOIANIA	GN11251530	CARAJAS S1	02/11/2019 02:01	02/11/2019 04:41	02/11/2019 02:01	02/11/2019 04:41	2,67	133	354,48	CHI

2019116850	GOIANIA	10027358591	CARAJAS S1	02/11/2019 03:46	02/11/2019 12:11	02/11/2019 03:46	02/11/2019 12:11	8,41	1	8,41	CHI
2019116853	DAMOLANDIA	DL12384816	INHUMAS S1	02/11/2019 03:55	02/11/2019 11:05	02/11/2019 03:55	02/11/2019 11:05	7,16	16	114,59	CHI
2019116853	OURO VERDE DE GOIAS	DL12384816	INHUMAS S1	02/11/2019 03:55	02/11/2019 11:05	02/11/2019 03:55	02/11/2019 11:05	7,16	8	57,30	CHI
2019116853	PETROLINA DE GOIAS	DL12384816	INHUMAS S1	02/11/2019 03:55	02/11/2019 11:05	02/11/2019 03:55	02/11/2019 11:05	7,16	6	42,97	CHI
2019116864	BARRO ALTO	BA12156230	BARRO ALTO	02/11/2019 04:22	02/11/2019 16:29	02/11/2019 04:22	02/11/2019 16:29	12,10	2	24,21	CHI
2019116864	SANTA RITA DO NOVO DESTINO	BA12156230	BARRO ALTO	02/11/2019 04:22	02/11/2019 16:29	02/11/2019 04:22	02/11/2019 16:29	12,10	8	96,83	CHI
2019116883	JARAGUA	JA12273085	JARAGUA	02/11/2019 01:32	02/11/2019 07:34	02/11/2019 01:32	02/11/2019 07:34	6,02	8	48,16	CHI
2019116891	GOIANIRA	390028526	GOIANIRA	02/11/2019 04:48	03/11/2019 12:54	02/11/2019 04:48	03/11/2019 12:54	32,09	1	32,09	CHI
2019116892	NOVA AURORA	NE21239761	CATALAO S1	02/11/2019 04:51	02/11/2019 11:00	02/11/2019 04:51	02/11/2019 11:00	6,15	1	6,15	CHI
2019116894	CEZARINA	IY12089831	CEZARINA	02/11/2019 05:02	03/11/2019 09:00	02/11/2019 05:02	03/11/2019 09:00	27,97	6	167,82	CHI
2019116894	INDIARA	IY12089831	CEZARINA	02/11/2019 05:02	03/11/2019 09:00	02/11/2019 05:02	03/11/2019 09:00	27,97	2	55,94	CHI
2019116895	NOVA AURORA	NE21156363	CATALAO S1	02/11/2019 05:02	02/11/2019 11:18	02/11/2019 05:02	02/11/2019 11:18	6,26	1	6,26	CHI
2019116902	ABADIANIA	AA12285384	ANAPOLIS UNIVERSITARIO S1	02/11/2019 05:15	02/11/2019 11:19	02/11/2019 05:15	02/11/2019 11:19	6,05	3	18,16	CHI
2019116903	NOVA AURORA	NE21157524	CATALAO S1	02/11/2019 05:17	02/11/2019 10:32	02/11/2019 05:17	02/11/2019 10:32	5,25	1	5,25	CHI
2019116904	GOIANESIA	GE12402091	GOIANESIA S2	02/11/2019 05:18	02/11/2019 09:08	02/11/2019 05:18	02/11/2019 09:08	3,83	33	126,45	CHI
2019116917	INHUMAS	IN11086980	INHUMAS S2	01/11/2019 19:08	02/11/2019 19:45	01/11/2019 19:08	02/11/2019 19:45	24,60	83	2042,12	CHI
2019116918	INHUMAS	IN11086979	INHUMAS S2	01/11/2019 19:13	02/11/2019 17:00	01/11/2019 19:13	02/11/2019 17:00	21,78	94	2047,58	CHI
2019116923	GOIANESIA	550147421	GOIANESIA S2	02/11/2019 05:31	03/11/2019 07:15	02/11/2019 05:31	03/11/2019 07:15	25,72	1	25,72	CHI
2019116934	CAMPESTRE DE GOIAS	GC12277242	TRINDADE	01/11/2019 21:53	02/11/2019 09:45	01/11/2019 21:53	02/11/2019 09:45	11,87	95	1127,49	CHI
2019116937	GOIAS	NB12064413LD	MATRINCHA	02/11/2019 05:44	03/11/2019 21:46	02/11/2019 05:44	03/11/2019 21:46	40,02	1	40,02	CHI
2019116937	NOVO BRASIL	NB12064413LD	MATRINCHA	02/11/2019 05:44	03/11/2019 21:46	02/11/2019 05:44	03/11/2019 21:46	40,02	30	1200,68	CHI
2019116968	GOIANESIA	GE12353258	GOIANESIA S2	02/11/2019 04:32	02/11/2019 07:18	02/11/2019 04:32	02/11/2019 07:18	2,76	166	458,76	CHI
2019116968	VILA PROPICIO	GE12353258	GOIANESIA S2	02/11/2019 04:32	02/11/2019 07:18	02/11/2019 04:32	02/11/2019 07:18	2,76	18	49,75	CHI
2019116971	PIRACANJUBA	PJ21000175	PIRACANJUBA	02/11/2019 05:58	05/11/2019 10:44	02/11/2019 05:58	05/11/2019 10:44	76,75	1	76,75	CHI
2019116980	JARAGUA	JA12278876	JARAGUA	02/11/2019 06:02	02/11/2019 08:36	02/11/2019 06:02	02/11/2019 08:36	2,56	3	7,68	CHI
2019117012	INHUMAS	IN12012230	INHUMAS S2	02/11/2019 06:11	02/11/2019 09:11	02/11/2019 06:11	02/11/2019 09:11	3,00	362	1087,11	CHI
2019117022	GOIANESIA	GE12221555	GOIANESIA S2	02/11/2019 06:15	02/11/2019 08:25	02/11/2019 06:15	02/11/2019 08:25	2,15	723	1556,86	CHI
2019117033	ANAPOLIS	AN11196893	ANAPOLIS UNIVERSITARIO S2	02/11/2019 05:33	02/11/2019 08:59	02/11/2019 05:33	02/11/2019 08:59	3,43	154	528,35	CHI
2019117048	GOIANIA	GN11001763	AEROPORTO S3	02/11/2019 06:22	02/11/2019 16:41	02/11/2019 06:22	02/11/2019 16:41	10,31	14	144,36	CHI
2019117061	ABADIA DE GOIAS	TR12027281	TRINDADE	02/11/2019 06:26	03/11/2019 17:58	02/11/2019 06:26	03/11/2019 17:58	35,53	2	71,06	CHI
2019117061	TRINDADE	TR12027281	TRINDADE	02/11/2019 06:26	03/11/2019 17:58	02/11/2019 06:26	03/11/2019 17:58	35,53	1	35,53	CHI
2019117078	BARRO ALTO	1150000718	BARRO ALTO	02/11/2019 06:30	02/11/2019 11:21	02/11/2019 06:30	02/11/2019 11:21	4,85	1	4,85	CHI
2019117083	JATAI	JT1234478	JATAI S1	02/11/2019 06:31	02/11/2019 11:18	02/11/2019 06:31	02/11/2019 11:18	4,78	1	4,78	CHI

2019117085	CACHOEIRA ALTA	QI12191652	CACHOEIRA ALTA	02/11/2019 06:31	04/11/2019 12:55	02/11/2019 06:31	02/11/2019 17:28	10,94	3	32,81	CHI
2019117085	QUIRINOPOLIS	QI12191652	CACHOEIRA ALTA	02/11/2019 06:31	04/11/2019 12:55	02/11/2019 06:31	02/11/2019 17:28	10,94	9	98,44	CHI
2019117085	QUIRINOPOLIS	QI12191652	CACHOEIRA ALTA	02/11/2019 06:31	04/11/2019 12:55	02/11/2019 17:29	03/11/2019 17:44	24,25	7	169,78	CHI
2019117085	CACHOEIRA ALTA	QI12191652	CACHOEIRA ALTA	02/11/2019 06:31	04/11/2019 12:55	02/11/2019 17:29	04/11/2019 12:55	43,45	3	130,35	CHI
2019117085	QUIRINOPOLIS	QI12191652	CACHOEIRA ALTA	02/11/2019 06:31	04/11/2019 12:55	02/11/2019 17:29	04/11/2019 12:55	43,45	2	86,90	CHI
2019117086	ITAPURANGA	IK12220549	ITAPURANGA	02/11/2019 04:46	02/11/2019 18:40	02/11/2019 04:46	02/11/2019 18:40	13,89	90	1250,50	CHI
2019117087	GOIANIA	GN12043915	GOIANIA LESTE S3	02/11/2019 06:31	02/11/2019 08:43	02/11/2019 06:31	02/11/2019 08:43	2,19	240	525,00	CHI
2019117096	INHUMAS	10009907163	INHUMAS S2	02/11/2019 06:34	04/11/2019 12:30	02/11/2019 06:34	04/11/2019 12:30	53,93	1	53,93	CHI
2019117112	APORE	IJ12202625	ITAJA S2	02/11/2019 06:38	02/11/2019 09:37	02/11/2019 06:38	02/11/2019 09:37	2,98	4	11,91	CHI
2019117112	ITAJA	IJ12202625	ITAJA S2	02/11/2019 06:38	02/11/2019 09:37	02/11/2019 06:38	02/11/2019 09:37	2,98	18	53,59	CHI
2019117114	GOIANIA	GN11127054	CARAJAS S1	02/11/2019 06:22	02/11/2019 07:33	02/11/2019 06:22	02/11/2019 07:33	1,17	102	119,03	CHI
2019117118	ITARUMA	IJ12107422	ITAJA S2	02/11/2019 06:33	02/11/2019 20:53	02/11/2019 06:33	02/11/2019 20:53	14,32	41	587,01	CHI
2019117122	MONTES CLAROS DE GOIAS	ME12207822	IPORA	02/11/2019 06:16	02/11/2019 09:44	02/11/2019 06:16	02/11/2019 09:44	3,45	17	58,67	CHI
2019117129	HIDROLANDIA	HD12389419	CEPAIGO S2	02/11/2019 06:44	03/11/2019 15:14	02/11/2019 06:44	03/11/2019 15:14	32,50	3	97,49	CHI
2019117133	PIRENOPOLIS	PV12381257	CORUMBA	02/11/2019 06:16	02/11/2019 09:59	02/11/2019 06:16	02/11/2019 09:59	3,72	122	453,47	CHI
2019117135	IPAMERI	IP12112780	IPAMERI	02/11/2019 06:09	02/11/2019 13:46	02/11/2019 06:09	02/11/2019 13:46	7,61	9	68,48	CHI
2019117158	CEZARINA	CZ12405972	GUAPO S2	02/11/2019 07:01	03/11/2019 10:16	02/11/2019 07:01	03/11/2019 10:16	27,25	22	599,43	CHI
2019117160	PONTALINA	PK12109373	PONTALINA	01/11/2019 23:05	03/11/2019 18:20	01/11/2019 23:05	03/11/2019 18:20	43,24	5	216,22	CHI
2019117162	SANTA HELENA DE GOIAS	10027774307	IPEGUARI	02/11/2019 07:03	04/11/2019 12:10	02/11/2019 07:03	04/11/2019 12:10	53,13	1	53,13	CHI
2019117168	AMORINOPOLIS	IR12091436	IPORA	02/11/2019 04:12	02/11/2019 09:31	02/11/2019 04:12	02/11/2019 09:31	5,30	3	15,91	CHI
2019117168	IPORA	IR12091436	IPORA	02/11/2019 04:12	02/11/2019 09:31	02/11/2019 04:12	02/11/2019 09:31	5,30	15	79,55	CHI
2019117170	PALMEIRAS DE GOIAS	PL12299170	FIRMINOPOLIS S2	02/11/2019 07:04	04/11/2019 09:45	02/11/2019 07:04	04/11/2019 09:45	50,69	3	152,08	CHI
2019117173	GOIANIA	GN11002662	ATLANTICO S3	02/11/2019 07:03	02/11/2019 07:33	02/11/2019 07:03	02/11/2019 07:33	0,49	103	50,33	CHI
2019117174	PIRACANJUBA	PJ12049502	PONTALINA	02/11/2019 07:04	03/11/2019 18:40	02/11/2019 07:04	03/11/2019 18:40	35,60	1	35,60	CHI
2019117174	PROFESSOR JAMIL SAFADY	PJ12049502	PONTALINA	02/11/2019 07:04	03/11/2019 18:40	02/11/2019 07:04	03/11/2019 18:40	35,60	1	35,60	CHI
2019117177	SAO SIMAO	SO21000014	CACHOEIRA ALTA	02/11/2019 07:04	04/11/2019 07:52	02/11/2019 07:04	04/11/2019 07:52	48,79	1	48,79	CHI
2019117180	HIDROLANDIA	HD21333057	CEPAIGO S2	02/11/2019 07:06	04/11/2019 16:23	02/11/2019 07:06	04/11/2019 16:23	57,27	1	57,27	CHI
2019117185	ITAJA	IJ12184035	ITAJA S2	02/11/2019 07:07	03/11/2019 14:54	02/11/2019 07:07	03/11/2019 14:54	31,78	1	31,78	CHI
2019117191	GOIAS	HE12023221	ITAPURANGA	02/11/2019 01:58	02/11/2019 10:58	02/11/2019 01:58	02/11/2019 10:58	9,00	11	98,97	CHI
2019117191	HEITORAI	HE12023221	ITAPURANGA	02/11/2019 01:58	02/11/2019 10:58	02/11/2019 01:58	02/11/2019 10:58	9,00	20	179,94	CHI
2019117191	ITAPURANGA	HE12023221	ITAPURANGA	02/11/2019 01:58	02/11/2019 10:58	02/11/2019 01:58	02/11/2019 10:58	9,00	63	566,81	CHI
2019117192	APORE	AE21301901	ITAJA S1	02/11/2019 07:08	05/11/2019 09:52	02/11/2019 07:08	05/11/2019 09:52	74,73	1	74,73	CHI
2019117193	GOIANIA	GN11337923	CARAJAS S1	02/11/2019 07:00	02/11/2019 13:01	02/11/2019 07:00	02/11/2019 13:01	6,00	119	714,46	CHI

2019117203	BRITANIA	BT21255514	BRITANIA	02/11/2019 07:09	02/11/2019 09:10	02/11/2019 07:09	02/11/2019 09:10	2,01	1	2,01	CHI
2019117217	GOIANIA	GN11150420	XAVANTES	02/11/2019 04:33	02/11/2019 08:44	02/11/2019 04:33	02/11/2019 08:44	4,18	132	551,32	CHI
2019117228	INHUMAS	IN11144335	INHUMAS S2	01/11/2019 18:53	02/11/2019 18:48	01/11/2019 21:29	02/11/2019 18:48	21,32	124	2643,20	CHI
2019117232	SANTA FE DE GOIAS	RN21317898	BRITANIA	02/11/2019 07:15	02/11/2019 15:43	02/11/2019 07:15	02/11/2019 15:43	8,47	1	8,47	CHI
2019117241	RIO VERDE	RV12135973	CABRIUVA S2	02/11/2019 06:04	03/11/2019 01:23	02/11/2019 06:04	03/11/2019 01:23	19,30	11	212,33	CHI
2019117248	MONTIVIDIU	MV21365432	MONTIVIDIU T	02/11/2019 07:18	02/11/2019 11:37	02/11/2019 07:18	02/11/2019 11:37	4,30	1	4,30	CHI
2019117250	GOIANIA	GN12275554	CARAJAS S2	02/11/2019 06:18	02/11/2019 09:10	02/11/2019 06:18	02/11/2019 09:10	2,87	91	261,07	CHI
2019117251	JATAI	JT21241828	JATAI S2	02/11/2019 07:19	04/11/2019 13:58	02/11/2019 07:19	04/11/2019 13:58	54,65	1	54,65	CHI
2019117254	TURVANIA	TV12005544	FIRMINOPOLIS S2	02/11/2019 06:19	02/11/2019 11:30	02/11/2019 06:19	02/11/2019 11:30	5,18	159	823,53	CHI
2019117256	ITAJA	IJ12226574	ITAJA S2	02/11/2019 07:20	04/11/2019 10:00	02/11/2019 07:20	04/11/2019 08:22	49,04	4	196,16	CHI
2019117256	ITAJA	IJ12122658	ITAJA S2	02/11/2019 07:20	04/11/2019 10:00	02/11/2019 07:20	04/11/2019 10:00	50,67	4	202,67	CHI
2019117258	ANAPOLIS	AN12261182	JUNDIAI S1	02/11/2019 07:20	02/11/2019 09:42	02/11/2019 07:20	02/11/2019 09:42	2,36	145	342,48	CHI
2019117258	GOIANAPOLIS	AN12261182	JUNDIAI S1	02/11/2019 07:20	02/11/2019 09:42	02/11/2019 07:20	02/11/2019 09:42	2,36	5	11,81	CHI
2019117258	LEOPOLDO DE BULHOES	AN12261182	JUNDIAI S1	02/11/2019 07:20	02/11/2019 09:42	02/11/2019 07:20	02/11/2019 09:42	2,36	5	11,81	CHI
2019117267	INHUMAS	IN21014361	INHUMAS S1	02/11/2019 07:21	03/11/2019 17:04	02/11/2019 07:21	03/11/2019 17:04	33,70	2	67,41	CHI
2019117272	MINEIROS	MY12153058	PARQUE DAS EMAS	02/11/2019 07:11	02/11/2019 09:43	02/11/2019 07:11	02/11/2019 09:43	2,52	15	37,78	CHI
2019117272	SANTA RITA DO ARAGUAIA	MY12153058	PARQUE DAS EMAS	02/11/2019 07:11	02/11/2019 09:43	02/11/2019 07:11	02/11/2019 09:43	2,52	6	15,11	CHI
2019117286	PETROLINA DE GOIAS	PG12101850	PETROLINA	02/11/2019 06:26	02/11/2019 12:07	02/11/2019 06:26	02/11/2019 12:07	5,67	33	187,03	CHI
2019117295	BRITANIA	BT11284745	BRITANIA	02/11/2019 07:25	02/11/2019 11:28	02/11/2019 07:25	02/11/2019 11:28	4,04	59	238,47	CHI
2019117304	PARANAIGUARA	QI12276207	QUIRINOPOLIS	02/11/2019 07:20	02/11/2019 09:35	02/11/2019 07:20	02/11/2019 09:35	2,24	5	11,21	CHI
2019117304	QUIRINOPOLIS	QI12276207	QUIRINOPOLIS	02/11/2019 07:20	02/11/2019 09:35	02/11/2019 07:20	02/11/2019 09:35	2,24	51	114,30	CHI
2019117324	TRINDADE	TR11230641	TRINDADE	02/11/2019 06:55	02/11/2019 14:37	02/11/2019 06:55	02/11/2019 14:37	7,70	90	692,90	CHI
2019117326	APARECIDA DO RIO DOCE	04070214	JATAI S1	02/11/2019 02:55	02/11/2019 08:20	02/11/2019 02:55	02/11/2019 08:20	5,41	70	378,93	CHI
2019117326	JATAI	04070214	JATAI S1	02/11/2019 02:55	02/11/2019 08:20	02/11/2019 02:55	02/11/2019 08:20	5,41	295	1596,93	CHI
2019117332	GOIANIA	14014968	CARAJAS S2	02/11/2019 07:29	02/11/2019 23:34	02/11/2019 07:29	02/11/2019 23:34	16,07	1	16,07	CHI
2019117333	MINEIROS	PW10406624	PARQUE DAS EMAS	02/11/2019 06:31	02/11/2019 14:45	02/11/2019 06:31	02/11/2019 14:45	8,22	50	410,99	CHI
2019117333	PORTELANDIA	PW10406624	PARQUE DAS EMAS	02/11/2019 06:31	02/11/2019 14:45	02/11/2019 06:31	02/11/2019 14:45	8,22	2	16,44	CHI
2019117333	MINEIROS	PW10406624	PARQUE DAS EMAS	02/11/2019 06:31	02/11/2019 14:45	02/11/2019 14:26	02/11/2019 14:45	0,31	8	2,51	CHI
2019117338	JARAGUA	JA12353232	GOIANESIA S2	02/11/2019 05:05	02/11/2019 10:04	02/11/2019 05:05	02/11/2019 10:04	4,97	31	154,10	CHI
2019117361	ORIZONA	OZ11047553	PIRES DO RIO S2	02/11/2019 07:22	02/11/2019 08:43	02/11/2019 07:22	02/11/2019 08:43	1,33	151	201,42	CHI
2019117376	MORRINHOS	MR21171711	MORRINHOS	02/11/2019 07:36	03/11/2019 18:32	02/11/2019 07:36	03/11/2019 18:32	34,93	1	34,93	CHI
2019117388	CATURAI	CK21018952	INHUMAS S1	02/11/2019 07:37	03/11/2019 16:54	02/11/2019 07:37	03/11/2019 16:54	33,27	1	33,27	CHI
2019117401	MOSSAMEDES	MD12299595	ITABERAÍ S2	02/11/2019 06:03	02/11/2019 16:37	02/11/2019 06:03	02/11/2019 16:37	10,56	9	95,05	CHI

2019117404	SENADOR CANEDO	190041330	SENADOR CANEDO	02/11/2019 07:39	02/11/2019 09:54	02/11/2019 07:39	02/11/2019 09:54	2,24	1	2,24	CHI
2019117415	CACU	CC11242154	CACHOEIRA ALTA	02/11/2019 05:28	02/11/2019 12:02	02/11/2019 05:28	02/11/2019 12:02	6,55	116	760,38	CHI
2019117425	GOIANIA	GN11209298	CARAJAS S1	02/11/2019 07:15	02/11/2019 10:50	02/11/2019 07:15	02/11/2019 10:50	3,58	85	304,35	CHI
2019117427	VILA PROPICIO	PV21150316	GOIANESIA S1	02/11/2019 07:43	02/11/2019 16:50	02/11/2019 07:43	02/11/2019 16:50	9,11	1	9,11	CHI
2019117431	EDEALINA	ED12049300	PONTALINA	02/11/2019 07:44	03/11/2019 16:19	02/11/2019 07:44	03/11/2019 16:19	32,59	3	97,78	CHI
2019117438	SANTA CRUZ DE GOIAS	BC21012531	PIRES DO RIO S2	02/11/2019 07:45	04/11/2019 17:16	02/11/2019 07:45	04/11/2019 17:16	57,50	1	57,50	CHI
2019117439	JARAGUA	GE12000244	GOIANESIA S2	02/11/2019 07:46	02/11/2019 13:14	02/11/2019 07:46	02/11/2019 13:14	5,46	20	109,15	CHI
2019117443	APARECIDA DE GOIANIA	10009216047	INDEPENDENCIA S2	02/11/2019 07:47	02/11/2019 17:55	02/11/2019 07:47	02/11/2019 17:55	10,13	1	10,13	CHI
2019117446	PETROLINA DE GOIAS	PG12048641	PETROLINA	02/11/2019 07:04	02/11/2019 14:33	02/11/2019 07:04	02/11/2019 14:33	7,47	19	141,91	CHI
2019117449	ITARUMA	AE12216728	ITAJA S1	02/11/2019 07:48	03/11/2019 15:31	02/11/2019 07:48	03/11/2019 15:31	31,71	1	31,71	CHI
2019117456	IPAMERI	IP21315242	IPAMERI	02/11/2019 07:49	03/11/2019 16:13	02/11/2019 07:49	03/11/2019 16:13	32,39	1	32,39	CHI
2019117458	JATAI	JT21267533	JATAI S1	02/11/2019 07:50	03/11/2019 18:04	02/11/2019 07:50	03/11/2019 18:04	34,23	1	34,23	CHI
2019117459	BURITI ALEGRE	BG12222481	ALTO BURITI	02/11/2019 07:50	06/11/2019 11:52	02/11/2019 07:50	06/11/2019 11:52	100,03	16	1600,45	CHI
2019117462	PIRACANJUBA	PJ12000054	PIRACANJUBA	02/11/2019 05:57	02/11/2019 16:12	02/11/2019 05:57	02/11/2019 16:12	10,25	17	174,18	CHI
2019117468	GOIANESIA	GE12353391	GOIANESIA S2	02/11/2019 07:48	02/11/2019 11:19	02/11/2019 07:48	02/11/2019 11:19	3,51	1	3,51	CHI
2019117468	JARAGUA	GE12353391	GOIANESIA S2	02/11/2019 07:48	02/11/2019 11:19	02/11/2019 07:48	02/11/2019 11:19	3,51	8	28,06	CHI
2019117475	BARRO ALTO	10002311133	BARRO ALTO	02/11/2019 07:52	02/11/2019 10:12	02/11/2019 07:52	02/11/2019 10:12	2,32	1	2,32	CHI
2019117484	PIRACANJUBA	PJ12212150RE	PIRACANJUBA	02/11/2019 06:07	03/11/2019 13:10	02/11/2019 06:07	03/11/2019 13:10	31,05	66	2049,21	CHI
2019117485	JARAGUA	JA12273009	JARAGUA	02/11/2019 07:54	02/11/2019 11:06	02/11/2019 07:54	02/11/2019 11:06	3,20	12	38,36	CHI
2019117489	GUAPO	GA11048128	GUAPO S1	02/11/2019 07:27	02/11/2019 15:52	02/11/2019 07:27	02/11/2019 15:52	8,41	95	799,40	CHI
2019117494	ITAJA	2300002020	ITAJA S2	02/11/2019 07:56	03/11/2019 14:21	02/11/2019 07:56	03/11/2019 14:21	30,41	1	30,41	CHI
2019117500	CATALAO	10018083917	CATALAO S2	02/11/2019 07:57	02/11/2019 08:42	02/11/2019 07:57	02/11/2019 08:42	0,75	1	0,75	CHI
2019117503	ITAPIRAPUA	IU12087963	MATRINCHA	02/11/2019 06:20	04/11/2019 10:07	02/11/2019 06:20	04/11/2019 10:07	51,78	45	2330,11	CHI
2019117513	NOVA AMERICA	RB12320982	RUBIATABA	01/11/2019 14:49	02/11/2019 14:55	01/11/2019 14:49	02/11/2019 14:55	24,09	3	72,27	CHI
2019117513	RUBIATABA	RB12320982	RUBIATABA	01/11/2019 14:49	02/11/2019 14:55	01/11/2019 14:49	02/11/2019 14:55	24,09	23	554,04	CHI
2019117519	JARAGUA	JA12382429	JARAGUA	02/11/2019 06:17	02/11/2019 09:13	02/11/2019 06:17	02/11/2019 09:13	2,93	17	49,77	CHI
2019117533	GOIANESIA	GE12384160	GOIANESIA S2	02/11/2019 07:45	02/11/2019 09:46	02/11/2019 07:45	02/11/2019 09:46	2,01	13	26,18	CHI
2019117546	GOIANESIA	GE12321377	GOIANESIA S2	02/11/2019 07:33	02/11/2019 11:36	02/11/2019 07:33	02/11/2019 11:36	4,04	14	56,59	CHI
2019117546	VILA PROPICIO	GE12321377	GOIANESIA S2	02/11/2019 07:33	02/11/2019 11:36	02/11/2019 07:33	02/11/2019 11:36	4,04	9	36,38	CHI
2019117555	APARECIDA DE GOIANIA	13325577	INDEPENDENCIA S1	02/11/2019 08:04	02/11/2019 11:47	02/11/2019 08:04	02/11/2019 11:47	3,71	1	3,71	CHI
2019117558	INHUMAS	IX12016404	INHUMAS S1	02/11/2019 07:06	02/11/2019 13:00	02/11/2019 07:06	02/11/2019 13:00	5,89	1	5,89	CHI
2019117558	ITAUCU	IX12016404	INHUMAS S1	02/11/2019 07:06	02/11/2019 13:00	02/11/2019 07:06	02/11/2019 13:00	5,89	4	23,55	CHI
2019117569	ARACU	AR21000118	ARACU	02/11/2019 08:06	04/11/2019 17:06	02/11/2019 08:06	04/11/2019 17:06	57,00	1	57,00	CHI

2019117571	CATALAO	CT21266876	CATALAO S1	02/11/2019 08:06	02/11/2019 09:29	02/11/2019 08:06	02/11/2019 09:29	1,37	1	1,37	CHI
2019117576	CALDAZINHA	LB21217981	CEPAIGO S2	02/11/2019 08:08	04/11/2019 08:41	02/11/2019 08:08	04/11/2019 08:41	48,55	1	48,55	CHI
2019117577	INHUMAS	IN11378278	INHUMAS S2	01/11/2019 18:53	02/11/2019 21:40	01/11/2019 22:13	02/11/2019 21:40	23,45	69	1617,88	CHI
2019117593	JANDAIA	JD12029835	PALMEIRAS	02/11/2019 08:10	02/11/2019 10:58	02/11/2019 08:10	02/11/2019 10:58	2,79	3	8,38	CHI
2019117596	RIO VERDE	630321589	RIO VERDE S1	02/11/2019 08:11	02/11/2019 19:36	02/11/2019 08:11	02/11/2019 19:36	11,41	1	11,41	CHI
2019117618	HIDROLANDIA	HD31046382	PONTALINA	02/11/2019 08:15	04/11/2019 11:45	02/11/2019 08:15	04/11/2019 11:45	51,50	1	51,50	CHI
2019117629	PALESTINA DE GOIAS	PY12079592	PALESTINA	02/11/2019 05:20	02/11/2019 11:03	02/11/2019 05:20	02/11/2019 11:03	5,72	18	102,91	CHI
2019117640	ABADIA DE GOIAS	LG21245578	CARAJAS S1	02/11/2019 08:17	03/11/2019 12:44	02/11/2019 08:17	03/11/2019 12:44	28,44	2	56,88	CHI
2019117645	IPAMERI	8611904	IPAMERI	02/11/2019 05:55	03/11/2019 21:30	02/11/2019 05:55	03/11/2019 21:30	39,58	4	158,33	CHI
2019117655	SAO SIMAO	SO21224177	CACHOEIRA ALTA	02/11/2019 08:20	03/11/2019 18:39	02/11/2019 08:20	03/11/2019 18:39	34,31	1	34,31	CHI
2019117657	MINEIROS	MY21221992	PARQUE DAS EMAS	02/11/2019 08:20	02/11/2019 19:04	02/11/2019 08:20	02/11/2019 19:04	10,72	1	10,72	CHI
2019117665	CATALAO	CT21192524	CATALAO S1	02/11/2019 08:22	02/11/2019 11:31	02/11/2019 08:22	02/11/2019 11:31	3,14	2	6,29	CHI
2019117667	BRITANIA	BT21008714	BRITANIA	02/11/2019 08:22	06/11/2019 10:57	02/11/2019 08:22	06/11/2019 10:57	98,57	1	98,57	CHI
2019117668	SANTA HELENA DE GOIAS	SH12301400	ACREUNA	02/11/2019 08:23	08/11/2019 13:44	02/11/2019 08:23	03/11/2019 21:35	37,22	3	111,65	CHI
2019117668	SANTA HELENA DE GOIAS	6623372	ACREUNA	02/11/2019 08:23	08/11/2019 13:44	02/11/2019 08:23	08/11/2019 13:44	149,36	1	149,36	CHI
2019117674	CORUMBA DE GOIAS	CB11351483	CORUMBA	02/11/2019 08:23	02/11/2019 13:23	02/11/2019 08:23	02/11/2019 13:23	4,99	47	234,37	CHI
2019117676	GOIANAPOLIS	AN11011347	JUNDIAI S1	02/11/2019 08:24	02/11/2019 12:20	02/11/2019 08:24	02/11/2019 12:20	3,93	22	86,50	CHI
2019117678	GOIANIA	10008639009	CARAJAS S2	02/11/2019 08:24	02/11/2019 14:33	02/11/2019 08:24	02/11/2019 14:33	6,15	1	6,15	CHI
2019117691	ALEXANIA	AX21370423	ALEXANIA	02/11/2019 08:26	02/11/2019 16:00	02/11/2019 08:26	02/11/2019 16:00	7,56	2	15,12	CHI
2019117695	HIDROLANDIA	HD12120557	CEPAIGO S2	02/11/2019 07:03	03/11/2019 16:58	02/11/2019 07:03	03/11/2019 16:58	33,91	17	576,43	CHI
2019117700	MINEIROS	MY12360820	PARQUE DAS EMAS	02/11/2019 08:22	02/11/2019 10:19	02/11/2019 08:22	02/11/2019 10:19	1,94	9	17,44	CHI
2019117709	SERRANOPOLIS	SX12303000	JATAI S1	02/11/2019 07:10	02/11/2019 11:21	02/11/2019 07:10	02/11/2019 11:21	4,17	13	54,26	CHI
2019117742	GOIANIRA	GR13062069	GOIANIRA	01/11/2019 22:58	02/11/2019 23:17	01/11/2019 22:58	02/11/2019 15:41	16,72	3832	64088,07	CHI
2019117742	TRINDADE	GR13062069	GOIANIRA	01/11/2019 22:58	02/11/2019 23:17	01/11/2019 22:58	02/11/2019 15:41	16,72	184	3077,30	CHI
2019117742	GOIANIRA	GR13062069	GOIANIRA	01/11/2019 22:58	02/11/2019 23:17	02/11/2019 14:51	02/11/2019 15:41	0,84	55	46,31	CHI
2019117742	GOIANIRA	GR12133799LD	GOIANIRA	01/11/2019 22:58	02/11/2019 23:17	01/11/2019 22:58	02/11/2019 15:45	16,79	915	15363,61	CHI
2019117742	GOIANIRA	GR12272170	GOIANIRA	01/11/2019 22:58	02/11/2019 23:17	01/11/2019 22:58	02/11/2019 16:09	17,19	59	1014,36	CHI
2019117742	GOIANIRA	GR11128469	GOIANIRA	01/11/2019 22:58	02/11/2019 23:17	01/11/2019 22:58	02/11/2019 23:01	24,05	1	24,05	CHI
2019117742	GOIANIRA	GR16401509	GOIANIRA	01/11/2019 22:58	02/11/2019 23:17	01/11/2019 22:58	02/11/2019 23:01	24,05	649	15609,53	CHI
2019117742	GOIANIRA	GR11117121	GOIANIRA	01/11/2019 22:58	02/11/2019 23:17	01/11/2019 22:58	02/11/2019 23:17	24,32	158	3843,17	CHI
2019117746	BALIZA	BH21190371	BOM JARDIM	01/11/2019 18:46	05/11/2019 11:15	01/11/2019 18:46	05/11/2019 11:15	88,48	1	88,48	CHI
2019117804	RIO VERDE	RV12240425	CABRIUVA S2	02/11/2019 08:16	02/11/2019 10:26	02/11/2019 08:16	02/11/2019 10:26	2,16	3	6,49	CHI
2019117806	CALDAS NOVAS	760082960	SERRA DE CALDAS	02/11/2019 08:28	02/11/2019 11:38	02/11/2019 08:28	02/11/2019 11:38	3,17	1	3,17	CHI

2019117809	PALMEIRAS DE GOIAS	PL21287686	PALMEIRAS	02/11/2019 08:29	04/11/2019 12:00	02/11/2019 08:29	04/11/2019 12:00	51,53	2	103,05	CHI
2019117812	OUVIDOR	OU21308654	CATALAO S1	02/11/2019 08:29	02/11/2019 22:41	02/11/2019 08:29	02/11/2019 22:41	14,19	3	42,56	CHI
2019117815	CORUMBAIBA	NE12131080	CATALAO S1	02/11/2019 07:24	02/11/2019 10:30	02/11/2019 07:24	02/11/2019 10:30	3,09	15	46,39	CHI
2019117815	NOVA AURORA	NE12131080	CATALAO S1	02/11/2019 07:24	02/11/2019 10:30	02/11/2019 07:24	02/11/2019 10:30	3,09	15	46,39	CHI
2019117828	CALDAS NOVAS	760025988	SERRA DE CALDAS	02/11/2019 08:31	02/11/2019 17:42	02/11/2019 08:31	02/11/2019 17:42	9,18	1	9,18	CHI
2019117831	GOIANIA	11854601	GOYA S2	02/11/2019 08:32	02/11/2019 18:42	02/11/2019 08:32	02/11/2019 18:42	10,17	1	10,17	CHI
2019117836	GOIANIA	GN11216849	ATLANTICO S1	02/11/2019 08:26	02/11/2019 11:11	02/11/2019 08:26	02/11/2019 11:11	2,75	71	195,03	CHI
2019117838	JATAI	JT21138836	JATAI S1	02/11/2019 08:33	02/11/2019 12:16	02/11/2019 08:33	02/11/2019 12:16	3,71	1	3,71	CHI
2019117840	GOIANESIA	GE21382831	GOIANESIA S2	02/11/2019 08:33	03/11/2019 13:37	02/11/2019 08:33	03/11/2019 13:37	29,08	1	29,08	CHI
2019117841	PALMINOPOLIS	PP21197361	PALMEIRAS	02/11/2019 08:33	03/11/2019 18:50	02/11/2019 08:33	03/11/2019 18:50	34,28	2	68,55	CHI
2019117845	GOIANIRA	GR12131271	GOIANIRA	02/11/2019 07:23	02/11/2019 11:42	02/11/2019 07:23	02/11/2019 11:42	4,31	131	564,43	CHI
2019117848	APARECIDA DE GOIANIA	13060740	INDEPENDENCIA S1	02/11/2019 08:34	02/11/2019 16:07	02/11/2019 08:34	02/11/2019 16:07	7,55	1	7,55	CHI
2019117849	ORIZONA	OZ12000351RE	PIRES DO RIO S1	02/11/2019 08:06	02/11/2019 12:37	02/11/2019 08:06	02/11/2019 12:37	4,51	55	248,08	CHI
2019117849	PIRES DO RIO	OZ12000351RE	PIRES DO RIO S1	02/11/2019 08:06	02/11/2019 12:37	02/11/2019 08:06	02/11/2019 12:37	4,51	4	18,04	CHI
2019117856	JATAI	JT12234319	JATAI S3	02/11/2019 07:55	03/11/2019 21:27	02/11/2019 07:55	03/11/2019 21:27	37,54	3	112,62	CHI
2019117859	SENADOR CANEDO	SW11240477	CEPAIGO S1	02/11/2019 08:35	02/11/2019 11:21	02/11/2019 08:35	02/11/2019 11:21	2,76	21	57,88	CHI
2019117867	MONTES CLAROS DE GOIAS	ME12139989	IPORA	02/11/2019 07:27	02/11/2019 17:16	02/11/2019 07:27	02/11/2019 15:54	8,45	62	523,66	CHI
2019117867	MONTES CLAROS DE GOIAS	ME12139989	IPORA	02/11/2019 07:27	02/11/2019 17:16	02/11/2019 07:27	02/11/2019 17:16	9,81	2	19,62	CHI
2019117870	GOIANIA	12905306	CARAJAS S1	02/11/2019 08:38	02/11/2019 15:58	02/11/2019 08:38	02/11/2019 15:58	7,33	1	7,33	CHI
2019117875	APARECIDA DO RIO DOCE	JT13211437	JATAI S1	02/11/2019 08:39	03/11/2019 19:20	02/11/2019 08:39	03/11/2019 19:20	34,67	53	1837,75	CHI
2019117875	JATAI	JT13211437	JATAI S1	02/11/2019 08:39	03/11/2019 19:20	02/11/2019 08:39	03/11/2019 19:20	34,67	6	208,05	CHI
2019117877	TURVANIA	TV12259072	FIRMINOPOLIS S2	02/11/2019 08:39	02/11/2019 14:38	02/11/2019 08:39	02/11/2019 14:38	5,97	3	17,92	CHI
2019117882	ITAPURANGA	IK21206798	ITAPURANGA	02/11/2019 08:40	02/11/2019 11:28	02/11/2019 08:40	02/11/2019 11:28	2,81	1	2,81	CHI
2019117885	JARAGUA	70122805	JARAGUA	02/11/2019 08:40	02/11/2019 13:15	02/11/2019 08:40	02/11/2019 13:15	4,57	1	4,57	CHI
2019117887	SAO MIGUEL DO PASSA QUATRO	SQ12282719	VIANOPOLIS	02/11/2019 08:28	02/11/2019 15:58	02/11/2019 08:28	02/11/2019 15:58	7,49	20	149,78	CHI
2019117889	CAIAPONIA	CP12374978	PALESTINA	01/11/2019 12:03	06/11/2019 19:32	01/11/2019 12:03	06/11/2019 19:32	127,48	4	509,93	CHI
2019117891	PEROLANDIA	DP21197159	PARQUE DAS EMAS	02/11/2019 08:41	03/11/2019 12:01	02/11/2019 08:41	03/11/2019 12:01	27,33	1	27,33	CHI
2019117892	ABADIA DE GOIAS	LG11387526	INDEPENDENCIA S2	02/11/2019 08:14	02/11/2019 10:37	02/11/2019 08:14	02/11/2019 10:37	2,38	59	140,71	CHI
2019117893	JARAGUA	JA11219008	JARAGUA	02/11/2019 08:33	02/11/2019 10:06	02/11/2019 08:33	02/11/2019 10:06	1,53	135	207,04	CHI
2019117894	PIRANHAS	PH12204991	PIRANHAS	02/11/2019 04:30	02/11/2019 17:35	02/11/2019 04:30	02/11/2019 17:35	13,07	4	52,27	CHI
2019117895	CALDAS NOVAS	CN21060423	CALDAS NOVAS S2	02/11/2019 08:42	03/11/2019 12:55	02/11/2019 08:42	03/11/2019 12:55	28,21	1	28,21	CHI
2019117900	RIO VERDE	RV21279862	CABRIUVA S2	02/11/2019 08:42	04/11/2019 10:20	02/11/2019 08:42	04/11/2019 10:20	49,64	1	49,64	CHI
2019117901	GOIANESIA	GE12382838	GOIANESIA S2	02/11/2019 08:40	02/11/2019 11:00	02/11/2019 08:40	02/11/2019 11:00	2,32	2	4,64	CHI

2019117904	ALEXANIA	AX11388845	ALEXANIA	02/11/2019 08:43	02/11/2019 11:16	02/11/2019 08:43	02/11/2019 11:16	2,55	20	50,93	CHI
2019117918	ARAGOIANIA	HD12000186	CEPAIGO S2	02/11/2019 08:10	02/11/2019 13:29	02/11/2019 08:10	02/11/2019 13:29	5,31	13	69,02	CHI
2019117918	HIDROLANDIA	HD12000186	CEPAIGO S2	02/11/2019 08:10	02/11/2019 13:29	02/11/2019 08:10	02/11/2019 13:29	5,31	9	47,78	CHI
2019117926	IPAMERI	IP21107635	IPAMERI	02/11/2019 08:46	03/11/2019 15:04	02/11/2019 08:46	03/11/2019 15:04	30,30	2	60,59	CHI
2019117930	IPAMERI	IP11375978	IPAMERI	02/11/2019 06:18	03/11/2019 18:37	02/11/2019 06:18	03/11/2019 17:08	34,83	32	1114,44	CHI
2019117930	IPAMERI	IP12203216LD	IPAMERI	02/11/2019 06:18	03/11/2019 18:37	03/11/2019 17:08	03/11/2019 18:37	1,48	249	369,35	CHI
2019117936	ANICUNS	AC12391421	ANICUNS	02/11/2019 07:22	02/11/2019 10:57	02/11/2019 07:22	02/11/2019 10:57	3,58	3	10,75	CHI
2019117937	COCALZINHO DE GOIAS	ZN1221335	COCALZINHO	02/11/2019 08:48	02/11/2019 12:19	02/11/2019 08:48	02/11/2019 12:19	3,51	1	3,51	CHI
2019117940	CORUMBA DE GOIAS	CB12215013	CORUMBA	02/11/2019 08:48	02/11/2019 14:54	02/11/2019 08:48	02/11/2019 14:54	6,09	3	18,26	CHI
2019117941	GOIANESIA	GE11140947	GOIANESIA S2	02/11/2019 04:26	02/11/2019 09:50	02/11/2019 04:26	02/11/2019 09:50	5,40	114	615,63	CHI
2019117944	ACREUNA	2440076357	ACREUNA	02/11/2019 08:49	02/11/2019 22:10	02/11/2019 08:49	02/11/2019 22:10	13,35	1	13,35	CHI
2019117951	MINEIROS	MY12241805	PARQUE DAS EMAS	02/11/2019 08:24	02/11/2019 10:01	02/11/2019 08:24	02/11/2019 10:01	1,61	14	22,59	CHI
2019117966	PALMEIRAS DE GOIAS	PL21074055	PALMEIRAS	02/11/2019 08:53	02/11/2019 15:40	02/11/2019 08:53	02/11/2019 15:40	6,78	1	6,78	CHI
2019117973	ANAPOLIS	AN11394297	JUNDIAI S1	02/11/2019 08:52	02/11/2019 11:49	02/11/2019 08:52	02/11/2019 11:49	2,94	23	67,58	CHI
2019117974	COCALZINHO DE GOIAS	ZN12302398	COCALZINHO	02/11/2019 08:49	02/11/2019 15:33	02/11/2019 08:49	02/11/2019 15:33	6,73	11	73,99	CHI
2019118037	TRINDADE	TR11158284	GOYA S2	02/11/2019 08:15	02/11/2019 14:44	02/11/2019 08:15	02/11/2019 14:44	6,49	149	966,60	CHI
2019118041	ITAUCU	PV12271945	CORUMBA	02/11/2019 05:30	02/11/2019 13:25	02/11/2019 05:30	02/11/2019 13:25	7,91	1	7,91	CHI
2019118041	PIRENOPOLIS	PV12271945	CORUMBA	02/11/2019 05:30	02/11/2019 13:25	02/11/2019 05:30	02/11/2019 13:25	7,91	12	94,91	CHI
2019118050	CALDAS NOVAS	CN12257927	SERRA DE CALDAS	02/11/2019 06:26	02/11/2019 16:04	02/11/2019 06:26	02/11/2019 16:04	9,63	3	28,89	CHI
2019118059	ITABERAI	IB12310476	ITABERAI S2	02/11/2019 06:59	03/11/2019 09:57	02/11/2019 06:59	03/11/2019 09:57	26,97	3	80,90	CHI
2019118068	INHUMAS	IN12320360	INHUMAS S2	02/11/2019 05:45	02/11/2019 17:23	02/11/2019 05:45	02/11/2019 17:23	11,62	217	2521,78	CHI
2019118076	QUIRINOPOLIS	QJ32017987	QUIRINOPOLIS	02/11/2019 06:15	02/11/2019 11:17	02/11/2019 06:15	02/11/2019 11:17	5,03	9	45,25	CHI
2019118106	ITAPURANGA	IK12300233	ITAPURANGA	02/11/2019 07:51	02/11/2019 16:05	02/11/2019 07:51	02/11/2019 16:05	8,23	15	123,46	CHI
2019118123	RIO VERDE	RV11213406	CABRIUVA S1	02/11/2019 07:34	02/11/2019 15:56	02/11/2019 07:34	02/11/2019 15:56	8,35	105	877,07	CHI
2019118135	ABADIA DE GOIAS	LG12335567	CARAJAS S1	02/11/2019 07:33	03/11/2019 11:57	02/11/2019 07:33	03/11/2019 11:57	28,40	10	284,00	CHI
2019118161	HIDROLANDIA	HD12065751	PONTALINA	02/11/2019 07:44	02/11/2019 13:50	02/11/2019 07:44	02/11/2019 13:50	6,10	23	140,27	CHI
2019118224	INHUMAS	IN12092615	INHUMAS S2	02/11/2019 08:23	03/11/2019 16:30	02/11/2019 08:23	03/11/2019 16:30	32,12	13	417,59	CHI
2019118253	ANICUNS	AC12158912	FIRMINOPOLIS S2	02/11/2019 08:56	02/11/2019 11:53	02/11/2019 08:56	02/11/2019 11:53	2,95	59	174,20	CHI
2019118272	INDIARA	IY12266581	EDEIA	02/11/2019 07:53	02/11/2019 12:07	02/11/2019 07:53	02/11/2019 12:07	4,23	4	16,93	CHI
2019118299	COCALZINHO DE GOIAS	ZN12307706	COCALZINHO	02/11/2019 08:51	02/11/2019 15:49	02/11/2019 08:51	02/11/2019 15:49	6,96	14	97,42	CHI
2019118396	CAMPO ALEGRE DE GOIAS	CM12203138	CAMPO ALEGRE DE GOIAS	02/11/2019 07:35	03/11/2019 17:35	02/11/2019 07:35	03/11/2019 17:35	33,99	6	203,92	CHI
2019118412	GOIAS	GS12223995	GOIAS	02/11/2019 07:25	03/11/2019 11:45	02/11/2019 07:25	03/11/2019 11:45	28,33	4	113,32	CHI
2019118425	LEOPOLDO DE BULHOES	LB12382359	DAIA S2	02/11/2019 07:51	02/11/2019 14:40	02/11/2019 07:51	02/11/2019 14:40	6,81	31	211,14	CHI

2019118437	DAMOLANDIA	IN12272289	INHUMAS S1	02/11/2019 07:54	03/11/2019 11:56	02/11/2019 07:54	03/11/2019 11:56	28,03	3	84,10	CHI
2019118437	INHUMAS	IN12272289	INHUMAS S1	02/11/2019 07:54	03/11/2019 11:56	02/11/2019 07:54	03/11/2019 11:56	28,03	2	56,07	CHI
2019118437	PETROLINA DE GOIAS	IN12272289	INHUMAS S1	02/11/2019 07:54	03/11/2019 11:56	02/11/2019 07:54	03/11/2019 11:56	28,03	3	84,10	CHI
2019118483	JATAI	JT12306444	JATAI S3	02/11/2019 07:59	03/11/2019 16:47	02/11/2019 07:59	03/11/2019 16:47	32,79	6	196,74	CHI
2019118492	GOIANIA	GN12000055	CAMPINAS S1	02/11/2019 07:01	02/11/2019 12:49	02/11/2019 07:01	02/11/2019 12:49	5,79	122	706,35	CHI
2019118518	GOIANESIA	GE21000214	GOIANESIA S2	02/11/2019 07:28	02/11/2019 19:11	02/11/2019 07:28	02/11/2019 19:11	11,70	1	11,70	CHI
2019118962	PIRACANJUBA	PJ12233807	ROCHEDO	02/11/2019 05:58	02/11/2019 18:34	02/11/2019 05:58	02/11/2019 18:34	12,60	8	100,76	CHI
2019118969	HIDROLANDIA	HD11275659	CEPAIGO S2	01/11/2019 17:14	02/11/2019 18:00	01/11/2019 17:14	02/11/2019 18:00	24,75	5	123,76	CHI
2019118991	SANTA CRUZ DE GOIAS	BC12390406	PIRES DO RIO S2	02/11/2019 08:25	02/11/2019 22:32	02/11/2019 08:25	02/11/2019 22:32	14,11	4	56,45	CHI
2019119045	CATURAI	CK12014362	INHUMAS S1	02/11/2019 07:25	03/11/2019 13:57	02/11/2019 07:25	03/11/2019 13:57	30,52	1	30,52	CHI
2019119045	INHUMAS	CK12014362	INHUMAS S1	02/11/2019 07:25	03/11/2019 13:57	02/11/2019 07:25	03/11/2019 13:57	30,52	2	61,04	CHI
2019119240	FAINA	FC12299338	ITAPURANGA	02/11/2019 07:05	02/11/2019 14:43	02/11/2019 07:05	02/11/2019 14:43	7,62	53	404,12	CHI
2019119240	ITAPURANGA	FC12299338	ITAPURANGA	02/11/2019 07:05	02/11/2019 14:43	02/11/2019 07:05	02/11/2019 14:43	7,62	163	1242,87	CHI
2019119291	ITAPIRAPUA	IU12018777	JUSSARA	02/11/2019 05:01	02/11/2019 18:27	02/11/2019 05:01	02/11/2019 18:27	13,43	12	161,17	CHI
2019119305	EDEIA	EA12044042	EDEIA	01/11/2019 11:58	02/11/2019 16:20	01/11/2019 11:58	02/11/2019 16:20	28,36	3	85,08	CHI
2019119324	PONTALINA	PK12080060	PONTALINA	02/11/2019 05:54	03/11/2019 11:23	02/11/2019 05:54	03/11/2019 11:23	29,47	25	736,84	CHI
2019119358	TRINDADE	TR32033962	TRINDADE	02/11/2019 07:39	03/11/2019 13:00	02/11/2019 07:39	03/11/2019 13:00	29,34	10	293,41	CHI
2019119379	INHUMAS	IN11064378	INHUMAS S2	01/11/2019 18:53	02/11/2019 20:00	01/11/2019 21:29	02/11/2019 20:00	22,52	85	1913,78	CHI
2019119505	RIO VERDE	RV12260650	MONTIVIDIU T	01/11/2019 14:35	03/11/2019 23:30	01/11/2019 14:35	03/11/2019 23:30	56,92	5	284,62	CHI
2019119539	MINEIROS	MY12248429	PARQUE DAS EMAS	02/11/2019 07:10	02/11/2019 17:18	02/11/2019 07:10	02/11/2019 17:18	10,13	18	182,38	CHI
2019119698	INHUMAS	IN12383424	INHUMAS S2	02/11/2019 08:59	02/11/2019 17:28	02/11/2019 08:59	02/11/2019 17:28	8,48	85	720,68	CHI
2019119776	JANDAIA	PU12205943	PARAUNA	02/11/2019 06:36	02/11/2019 18:47	02/11/2019 06:36	02/11/2019 18:47	12,17	3	36,52	CHI
2019119776	PARAUNA	PU12205943	PARAUNA	02/11/2019 06:36	02/11/2019 18:47	02/11/2019 06:36	02/11/2019 18:47	12,17	27	328,67	CHI
20191110408	ITARUMA	IM10394710	CACHOEIRA ALTA	01/11/2019 22:12	04/11/2019 06:17	01/11/2019 22:13	02/11/2019 20:17	22,08	85	1876,71	CHI
20191110408	JATAI	IM10394710	CACHOEIRA ALTA	01/11/2019 22:12	04/11/2019 06:17	01/11/2019 22:13	02/11/2019 20:17	22,08	12	264,95	CHI
20191110408	ITARUMA	IM13248369	CACHOEIRA ALTA	01/11/2019 22:12	04/11/2019 06:17	01/11/2019 22:13	02/11/2019 21:40	23,46	9	211,18	CHI
20191110408	ITARUMA	IM13107436	CACHOEIRA ALTA	01/11/2019 22:12	04/11/2019 06:17	01/11/2019 22:13	04/11/2019 06:17	56,08	28	1570,30	CHI
20191110408	SERRANOPOLIS	IM13107436	CACHOEIRA ALTA	01/11/2019 22:12	04/11/2019 06:17	01/11/2019 22:13	04/11/2019 06:17	56,08	49	2748,03	CHI
20191110632	IPAMERI	10004658467	IPAMERI	02/11/2019 08:03	03/11/2019 22:06	02/11/2019 08:03	03/11/2019 22:06	38,04	1	38,04	CHI
20191110657	MINEIROS	MY12336395	PARQUE DAS EMAS	01/11/2019 17:53	03/11/2019 13:41	01/11/2019 17:53	03/11/2019 13:41	43,79	3	131,37	CHI
20191111335	GOIATUBA	GT10400352	GOIATUBA S2	01/11/2019 11:48	04/11/2019 01:39	01/11/2019 11:53	03/11/2019 16:08	52,26	30	1567,70	CHI
20191111335	MORRINHOS	GT10400352	GOIATUBA S2	01/11/2019 11:48	04/11/2019 01:39	01/11/2019 11:53	03/11/2019 16:08	52,26	12	627,08	CHI
20191111335	GOIATUBA	GT10400352	GOIATUBA S2	01/11/2019 11:48	04/11/2019 01:39	03/11/2019 16:01	03/11/2019 16:08	0,11	18	1,97	CHI

20191111335	MORRINHOS	GT10400352	GOIATUBA S2	01/11/2019 11:48	04/11/2019 01:39	03/11/2019 16:01	03/11/2019 16:08	0,11	45	4,94	CHI
20191111335	GOIATUBA	GT12000086LD	GOIATUBA S2	01/11/2019 11:48	04/11/2019 01:39	01/11/2019 11:49	03/11/2019 17:40	53,85	6	323,07	CHI
20191111335	GOIATUBA	GT12293098	GOIATUBA S2	01/11/2019 11:48	04/11/2019 01:39	01/11/2019 11:53	04/11/2019 01:39	61,77	1	61,77	CHI
20191112578	LAGOA SANTA	IJ12162693	ITAJA S2	02/11/2019 06:30	03/11/2019 07:35	02/11/2019 06:30	03/11/2019 07:35	25,07	2	50,15	CHI
201910789324	JUSSARA	10022017354	BRITANIA	01/11/2019 22:34	02/11/2019 10:22	01/11/2019 22:34	02/11/2019 10:22	11,80	1	11,80	CHI
201910793788	ITAPURANGA	IK12387485	ITAPURANGA	01/11/2019 14:27	04/11/2019 15:42	01/11/2019 14:27	04/11/2019 15:42	73,24	3	219,72	CHI
201910796295	AVELINOPOLIS	AV12272366	ANICUNS	01/11/2019 23:06	02/11/2019 12:05	01/11/2019 23:06	02/11/2019 12:05	12,98	5	64,92	CHI
201910796295	CATURAI	AV12272366	ANICUNS	01/11/2019 23:06	02/11/2019 12:05	01/11/2019 23:06	02/11/2019 12:05	12,98	8	103,88	CHI
201910797396	BALIZA	BH12358826	BOM JARDIM	01/11/2019 18:46	02/11/2019 11:57	01/11/2019 18:46	02/11/2019 11:57	17,18	2	34,36	CHI
201910798465	VICENTINOPOLIS	JV21228262	VICENTINOPOLIS	01/11/2019 16:58	03/11/2019 15:12	01/11/2019 16:58	03/11/2019 15:12	46,23	3	138,69	CHI
201910802272	AGUA LIMPA	RQ12050878	VILA CORUMBA	01/11/2019 17:53	02/11/2019 17:56	01/11/2019 17:53	02/11/2019 17:56	24,04	3	72,12	CHI
201911332349	GOIANIRA	GR11076552	GOIANIRA	01/11/2019 20:11	02/11/2019 22:30	01/11/2019 20:11	02/11/2019 22:30	26,31	222	5841,31	CHI
201911352366	BURITI DE GOIAS	BS12304459	FIRMINOPOLIS S2	02/11/2019 04:06	02/11/2019 08:12	02/11/2019 04:06	02/11/2019 08:12	4,09	10	40,87	CHI
201911352366	MOSSAMEDES	BS12304459	FIRMINOPOLIS S2	02/11/2019 04:06	02/11/2019 08:12	02/11/2019 04:06	02/11/2019 08:12	4,09	5	20,44	CHI
201911352366	SANCLERLANDIA	BS12304459	FIRMINOPOLIS S2	02/11/2019 04:06	02/11/2019 08:12	02/11/2019 04:06	02/11/2019 08:12	4,09	1	4,09	CHI
201911368141	ITAUCU	O20402204	CORUMBA	01/11/2019 18:43	01/11/2019 18:55	01/11/2019 18:43	01/11/2019 18:55	0,21	1	0,21	CHI
201911368141	PIRENOPOLIS	O20402204	CORUMBA	01/11/2019 18:43	01/11/2019 18:55	01/11/2019 18:43	01/11/2019 18:55	0,21	4142	854,86	CHI
201911368336	CACHOEIRA ALTA	00270444	CACHOEIRA ALTA	01/11/2019 20:43	02/11/2019 13:41	01/11/2019 20:44	02/11/2019 08:07	11,38	16	182,12	CHI
201911368336	CACU	00270444	CACHOEIRA ALTA	01/11/2019 20:43	02/11/2019 13:41	01/11/2019 20:44	02/11/2019 08:07	11,38	50	569,13	CHI
201911368336	CACU	00270444	CACHOEIRA ALTA	01/11/2019 20:43	02/11/2019 13:41	01/11/2019 20:44	02/11/2019 13:41	16,96	100	1696,03	CHI
201911368336	ITARUMA	00270444	CACHOEIRA ALTA	01/11/2019 20:43	02/11/2019 13:41	01/11/2019 20:44	02/11/2019 13:41	16,96	13	220,48	CHI
2019110100021	SERRANOPOLIS	O1670224	JATAI S1	01/11/2019 13:55	01/11/2019 13:58	01/11/2019 13:55	01/11/2019 13:58	0,05	83	4,15	CHI
2019110200031	COCALZINHO DE GOIAS	O5740224	COCALZINHO	02/11/2019 05:29	02/11/2019 08:20	02/11/2019 05:29	02/11/2019 08:20	2,84	1566	4440,04	CHI
2019110200031	CORUMBA DE GOIAS	O5740224	COCALZINHO	02/11/2019 05:29	02/11/2019 08:20	02/11/2019 05:29	02/11/2019 08:20	2,84	313	887,44	CHI
2019110200031	PADRE BERNARDO	O5740224	COCALZINHO	02/11/2019 05:29	02/11/2019 08:20	02/11/2019 05:29	02/11/2019 08:20	2,84	1	2,84	CHI
2019110200031	PIRENOPOLIS	O5740224	COCALZINHO	02/11/2019 05:29	02/11/2019 08:20	02/11/2019 05:29	02/11/2019 08:20	2,84	49	138,93	CHI
2019110200031	VILA PROPICIO	O5740224	COCALZINHO	02/11/2019 05:29	02/11/2019 08:20	02/11/2019 05:29	02/11/2019 08:20	2,84	1	2,84	CHI
2019110200031	COCALZINHO DE GOIAS	O5745114	COCALZINHO	02/11/2019 05:29	02/11/2019 08:20	02/11/2019 05:30	02/11/2019 08:20	2,83	3285	9308,41	CHI
2019110200031	PIRENOPOLIS	O5745114	COCALZINHO	02/11/2019 05:29	02/11/2019 08:20	02/11/2019 05:30	02/11/2019 08:20	2,83	20	56,67	CHI

Plotagem das Ocorrências conforme a Especialização das Chuvas

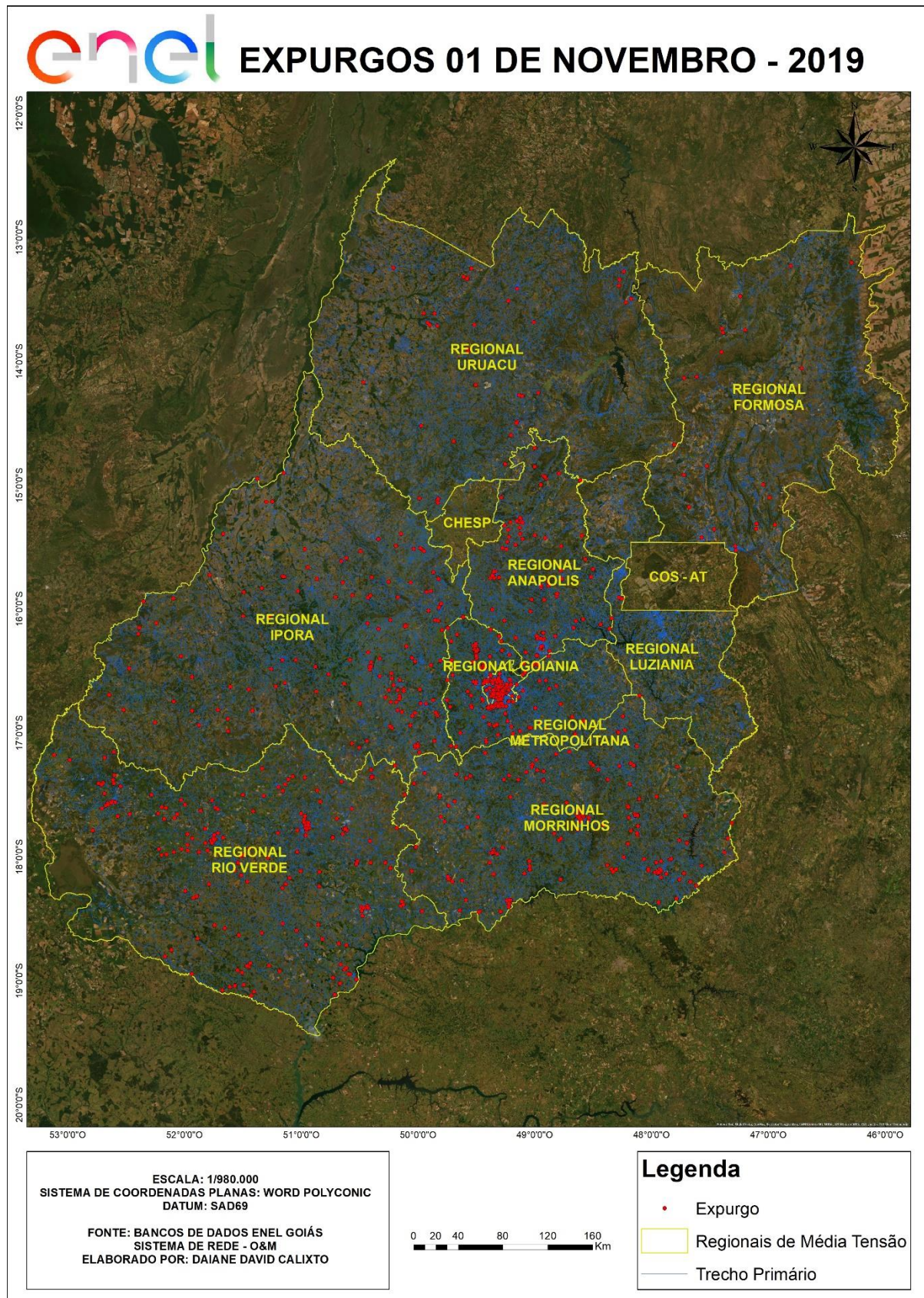

Diagramas Unifilares

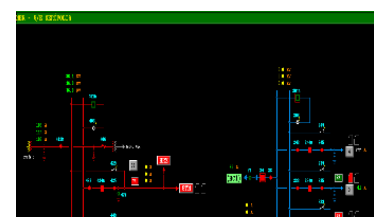
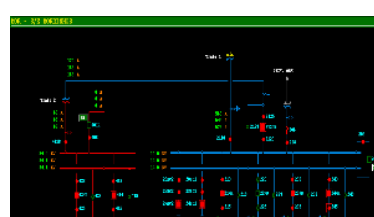
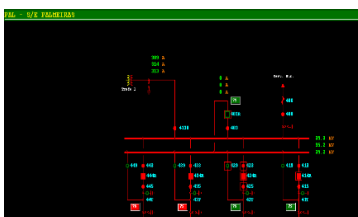
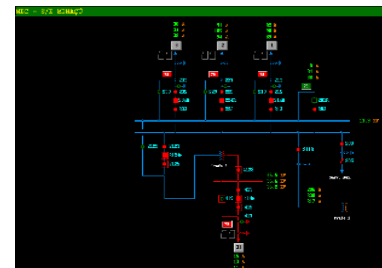
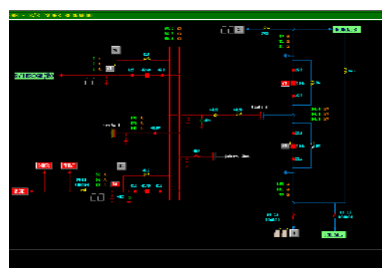
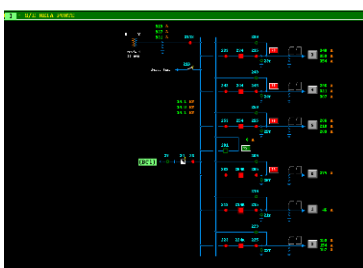
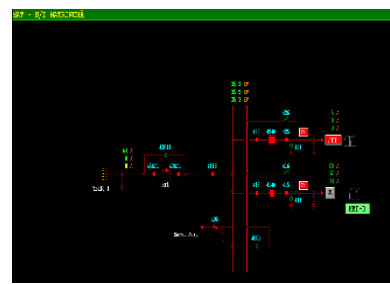
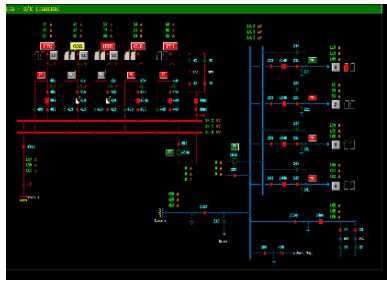
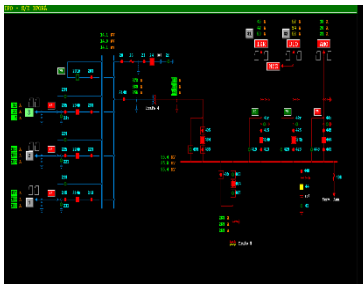
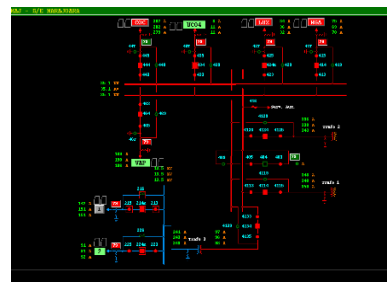
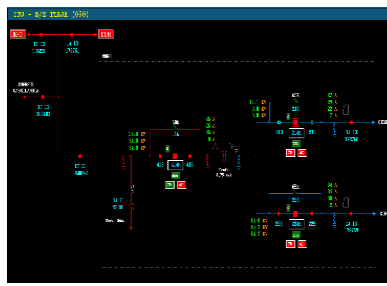
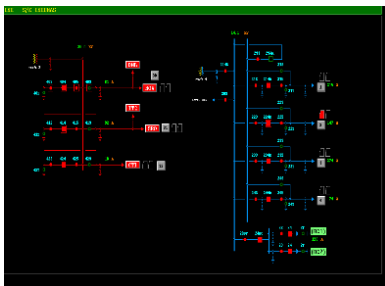
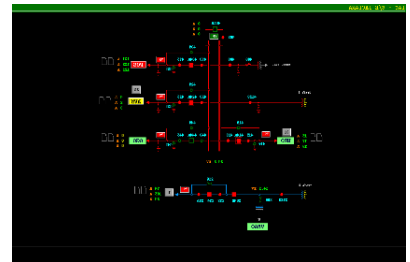
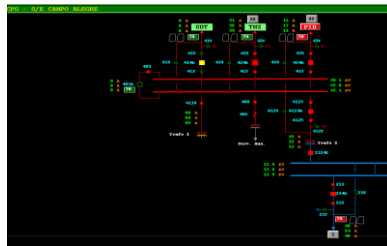
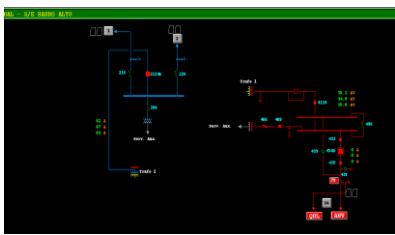
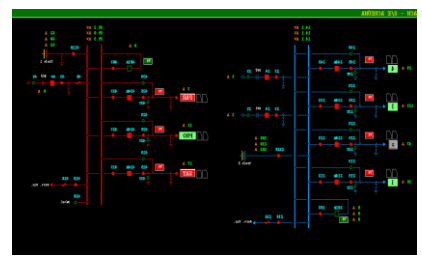
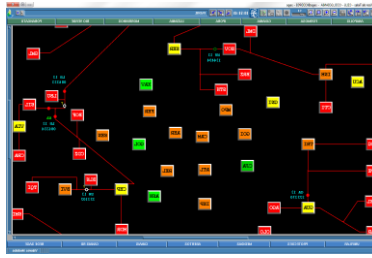
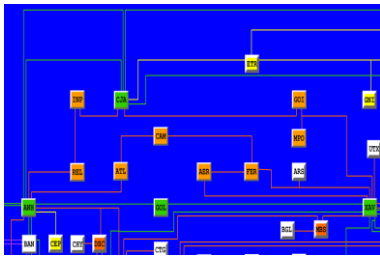

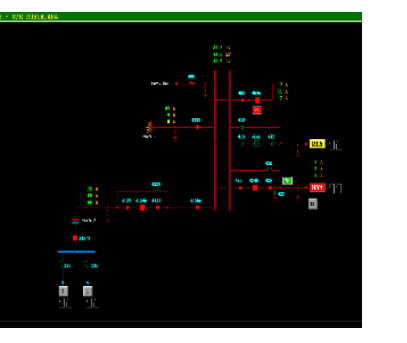
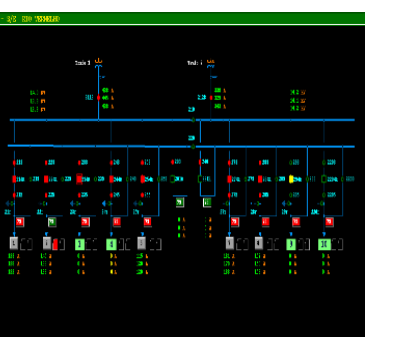
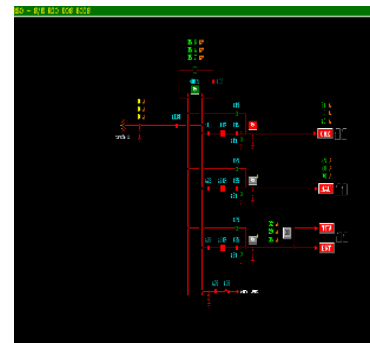
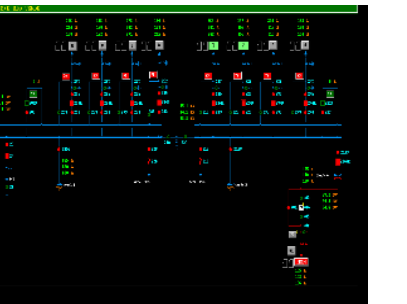
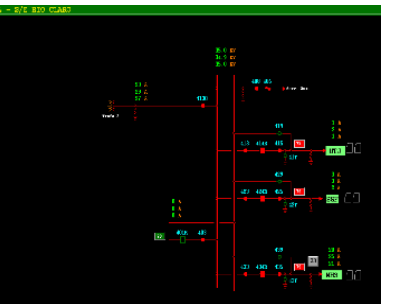
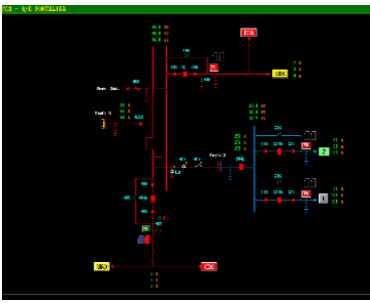
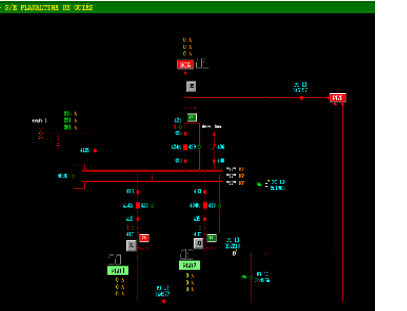
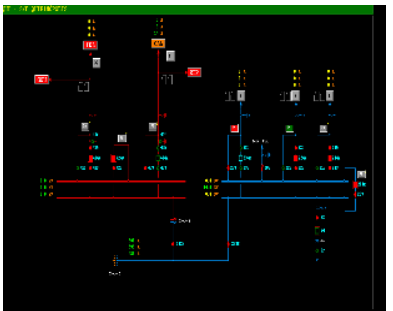
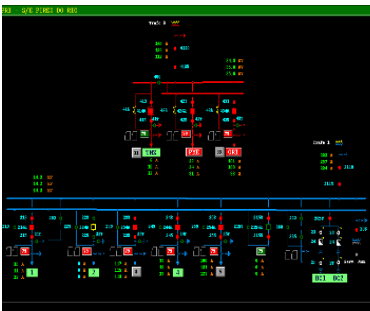
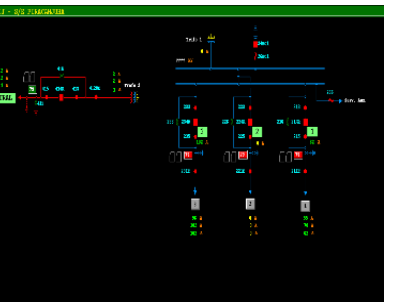
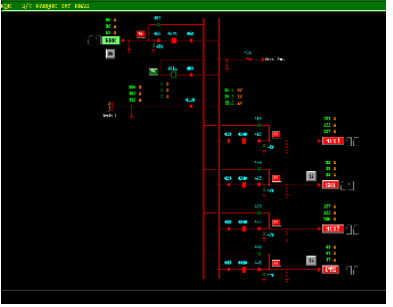
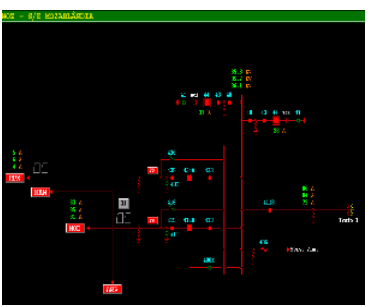
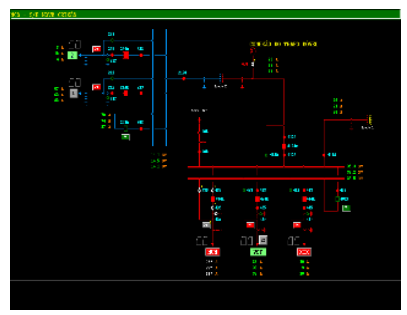

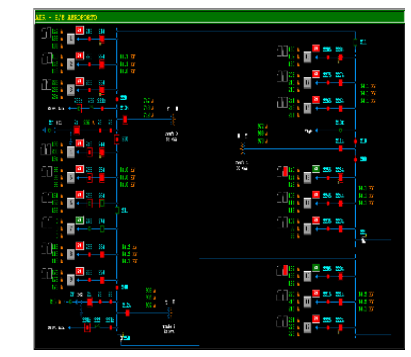
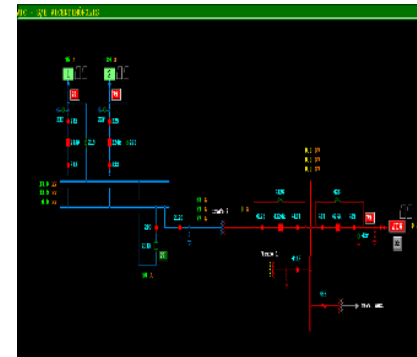
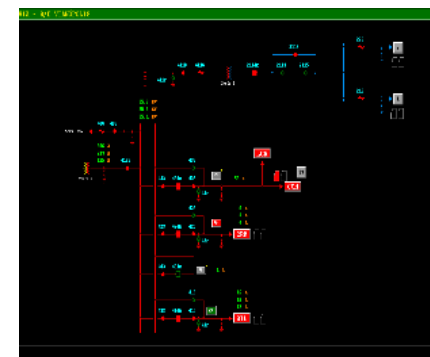
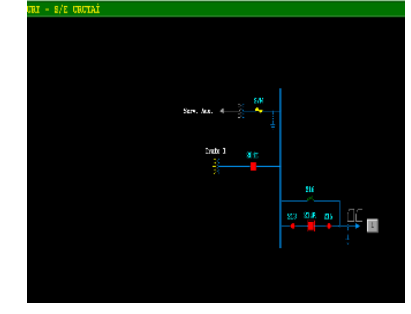
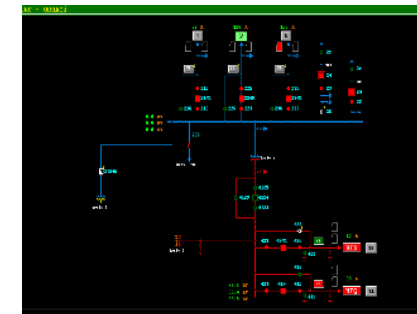
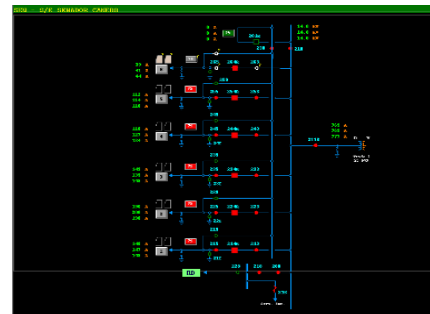
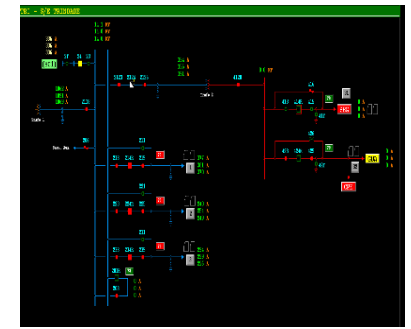
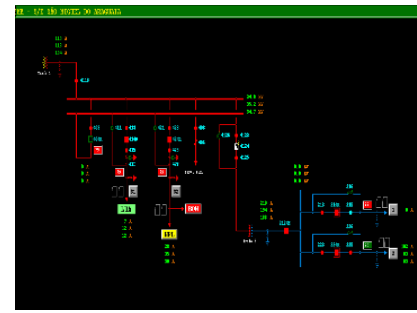
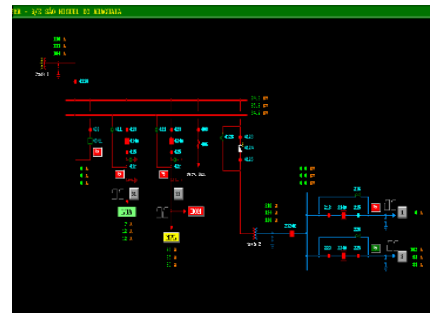
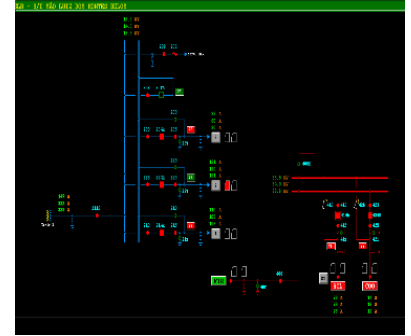
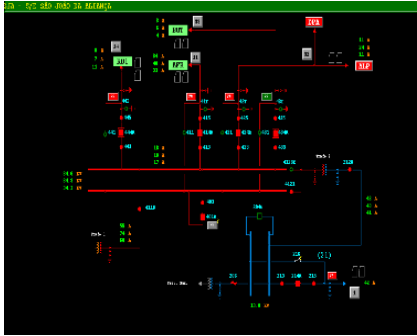
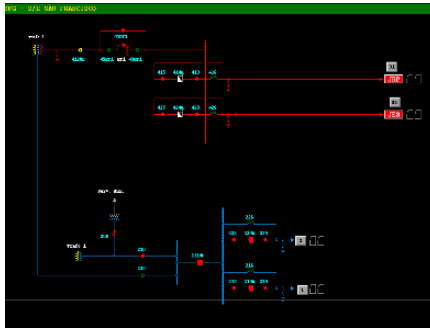
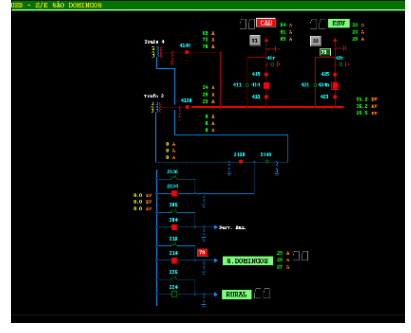
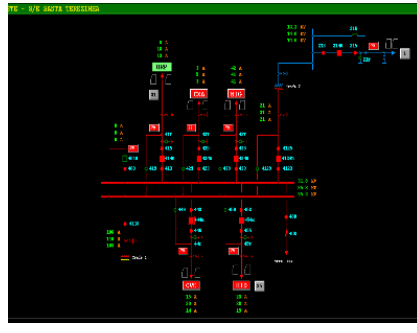
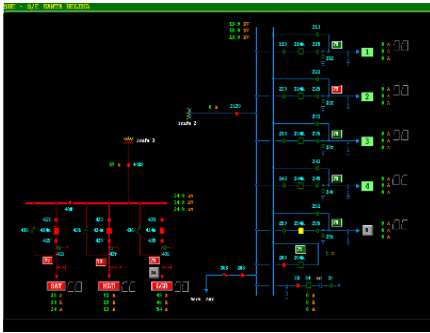

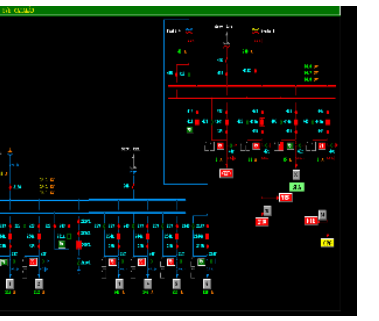
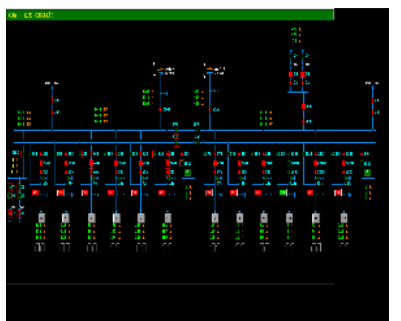
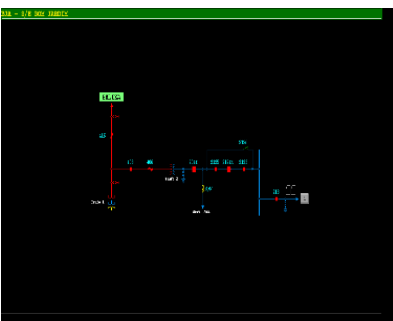
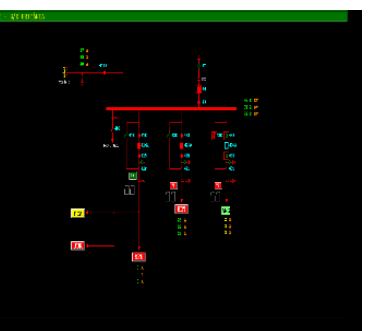
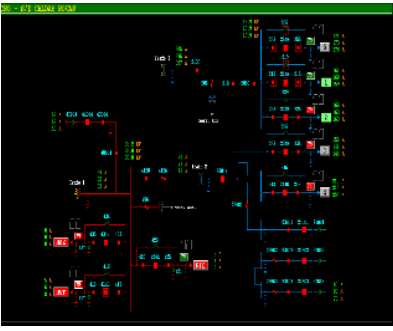
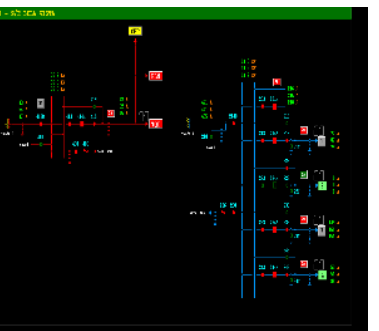
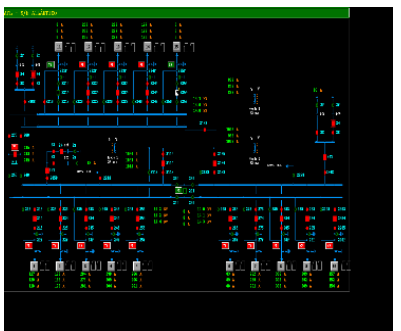
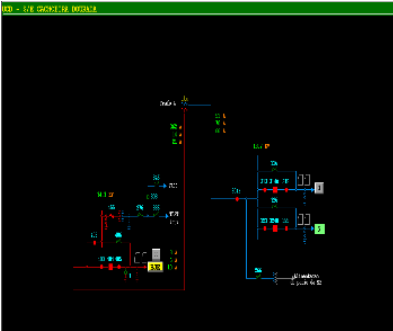
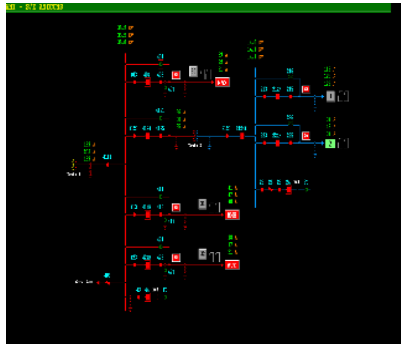
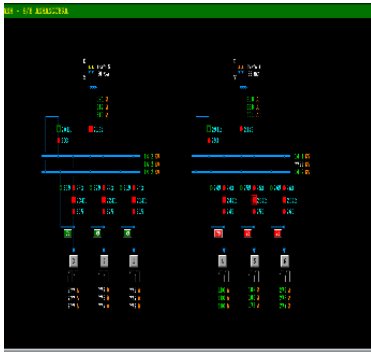
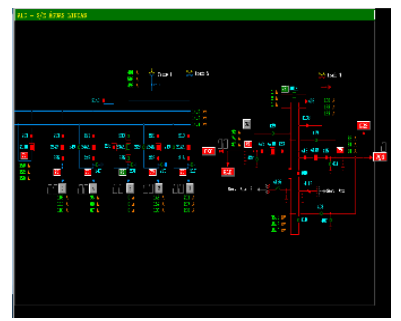
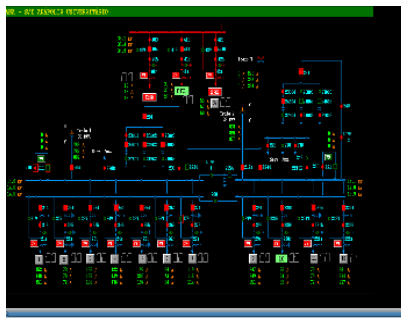
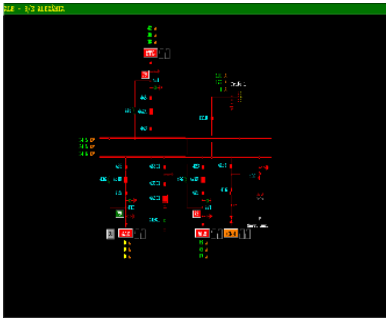

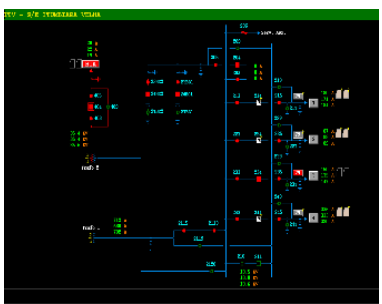
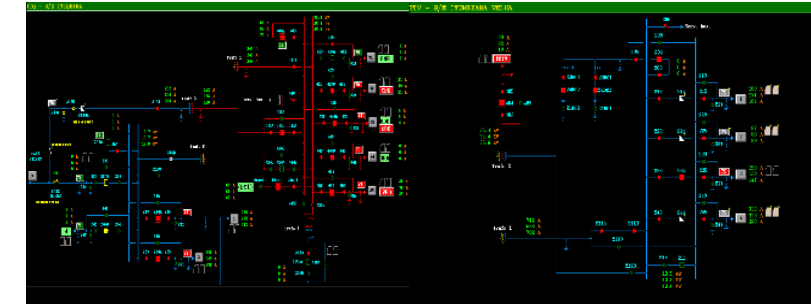
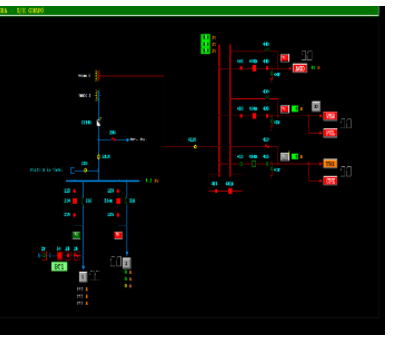
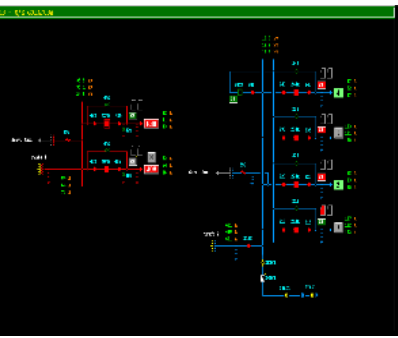
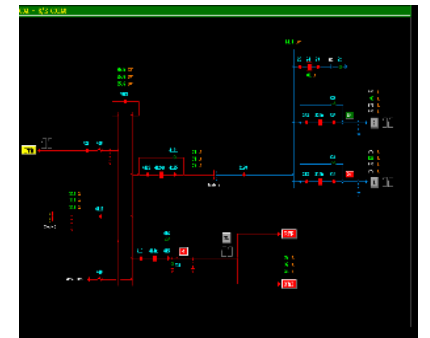
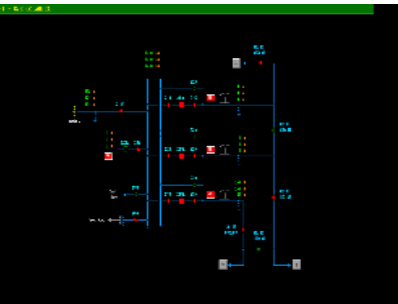
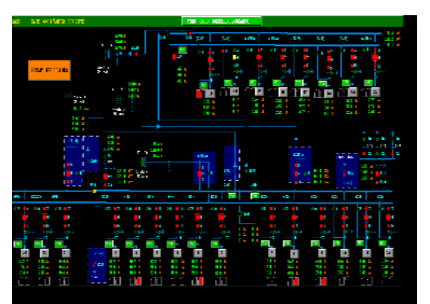
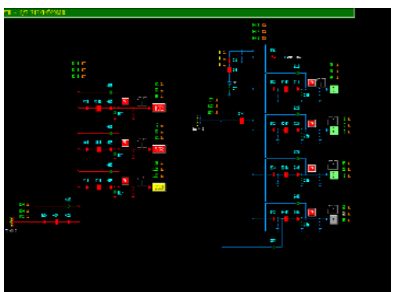
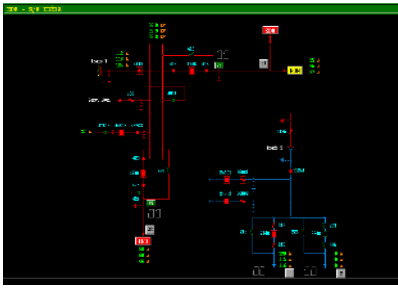
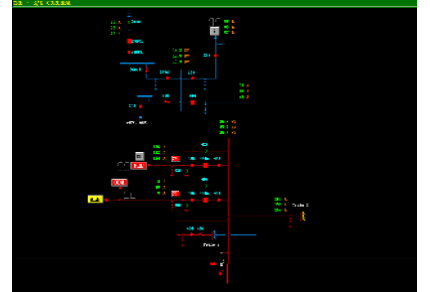
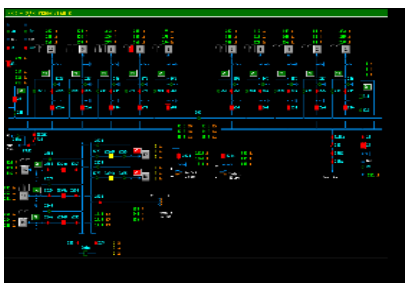
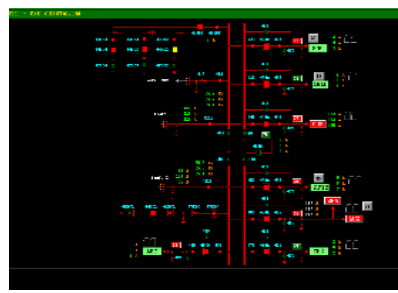
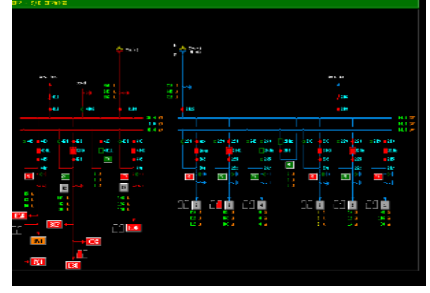
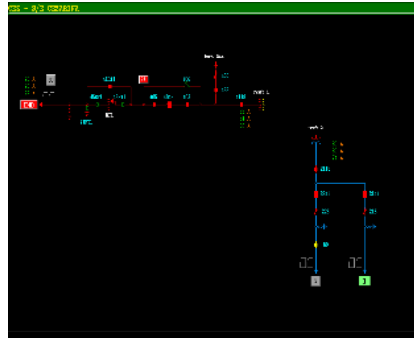
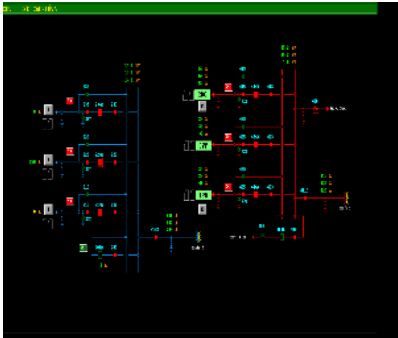
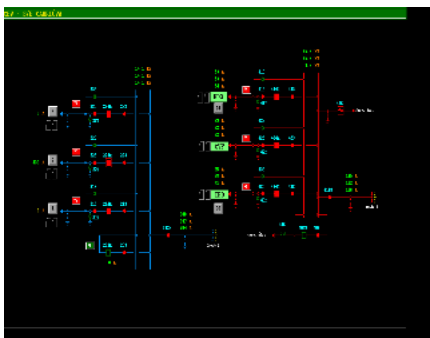

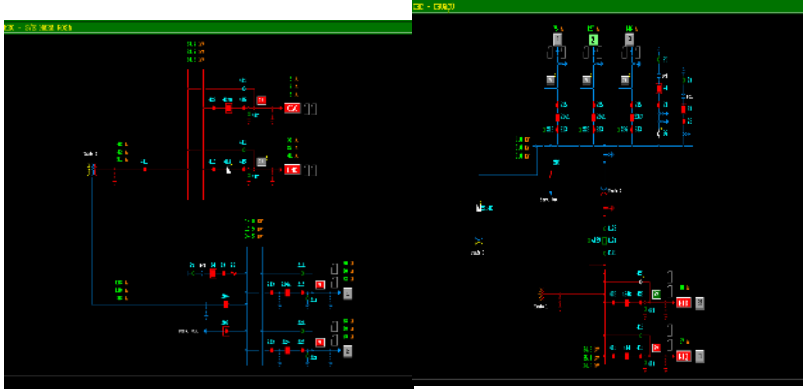
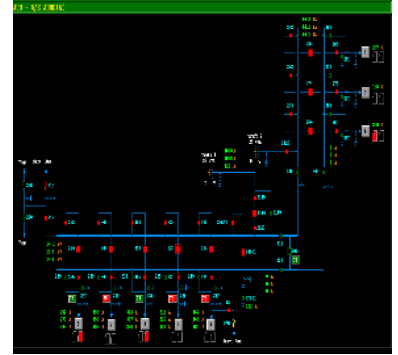
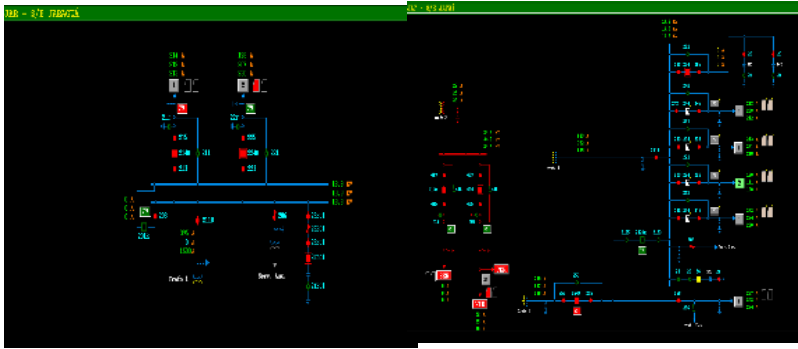

DEMAIS EVIDÊNCIAS

DADOS TÉCNICO - OPERACIONAIS ENEL GO

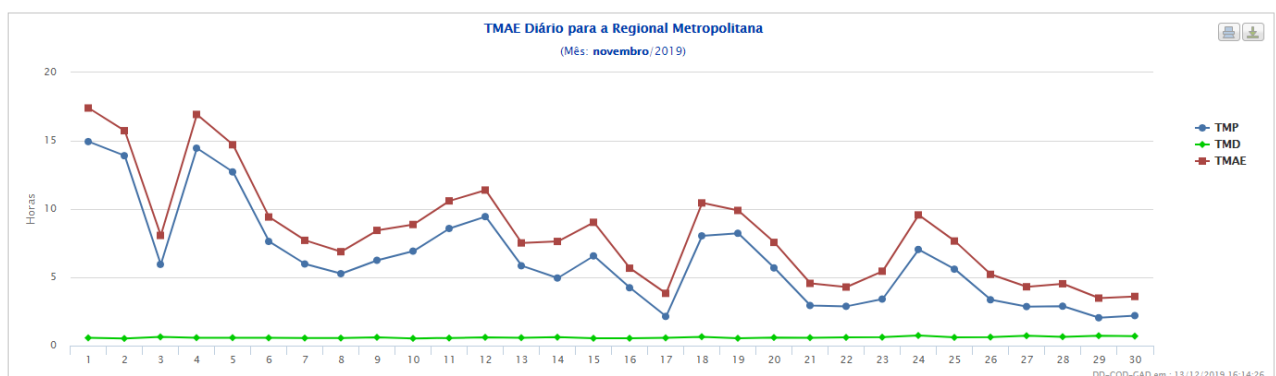
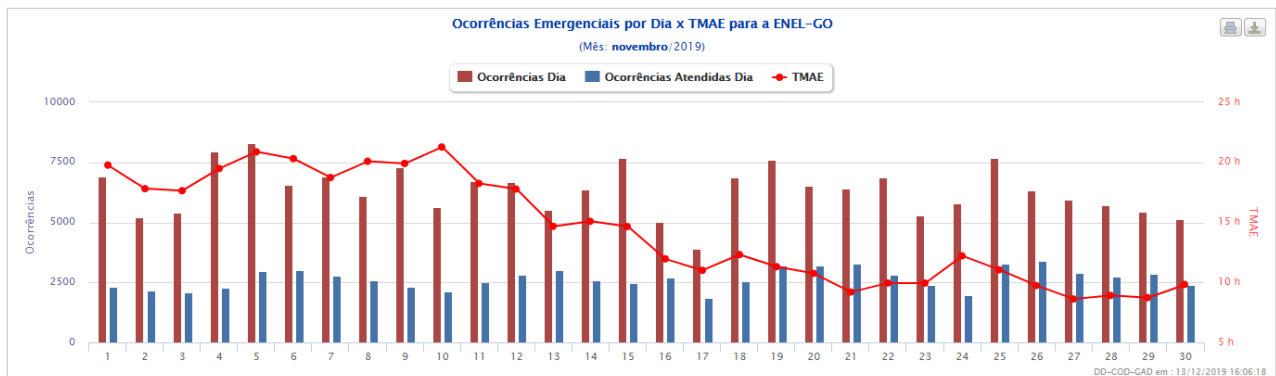
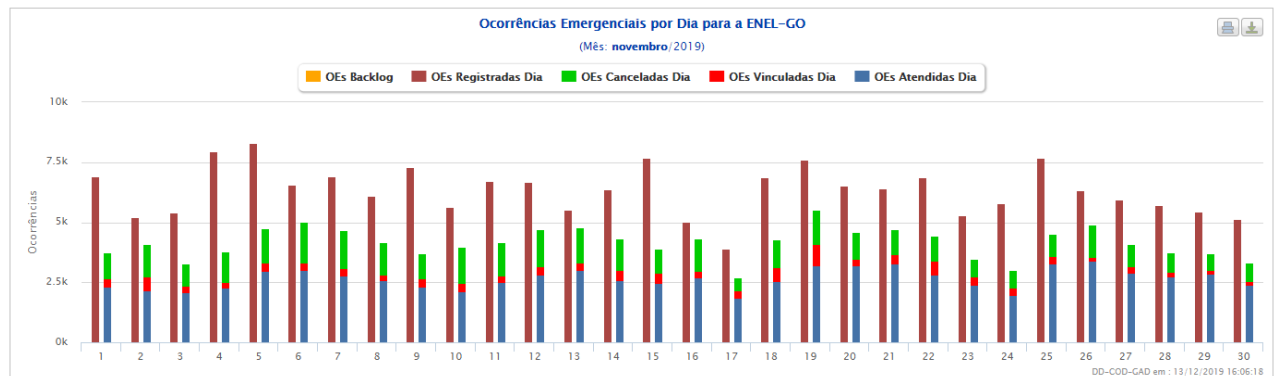
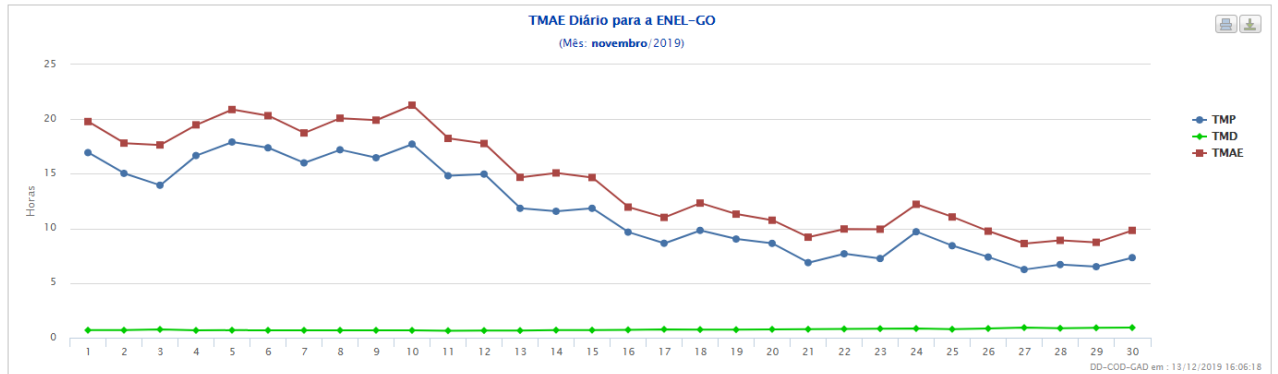

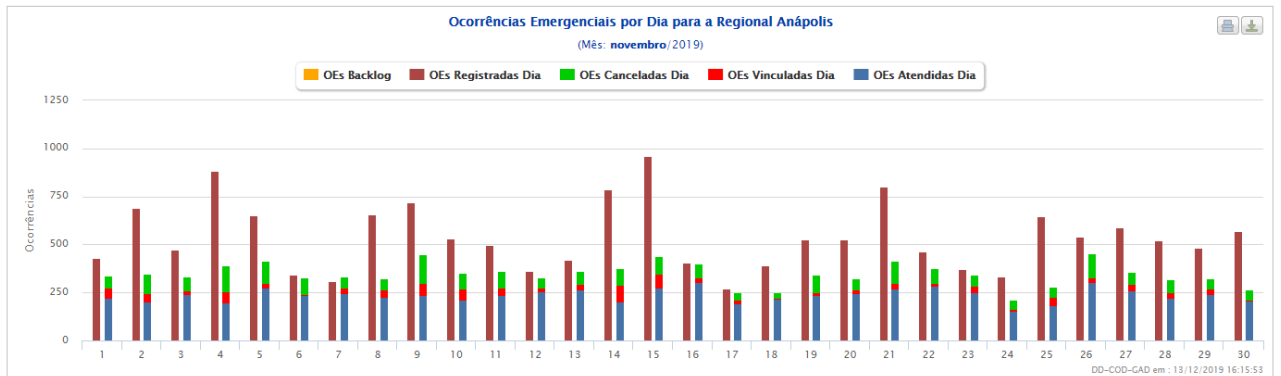
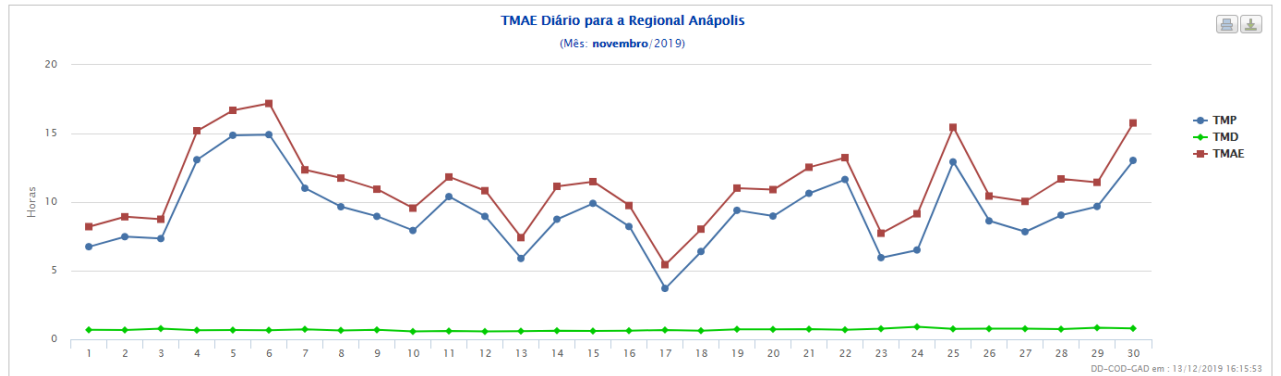
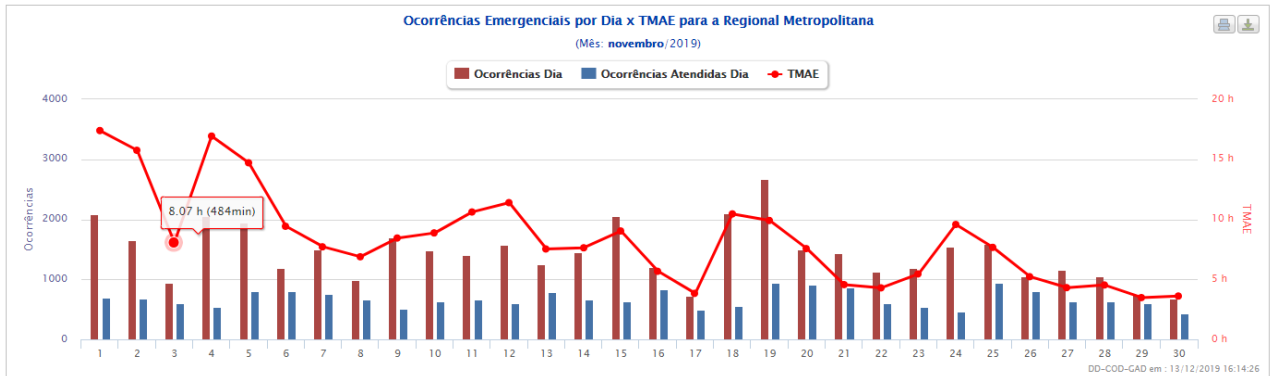
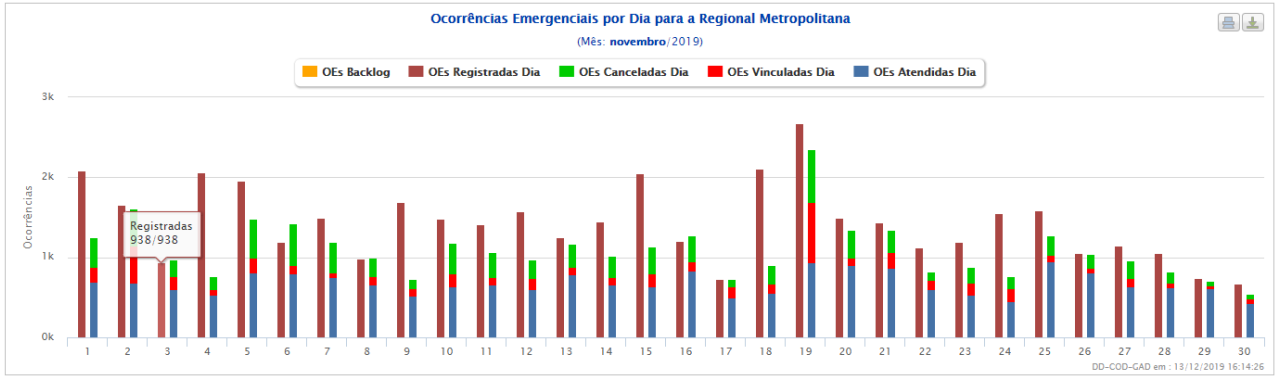

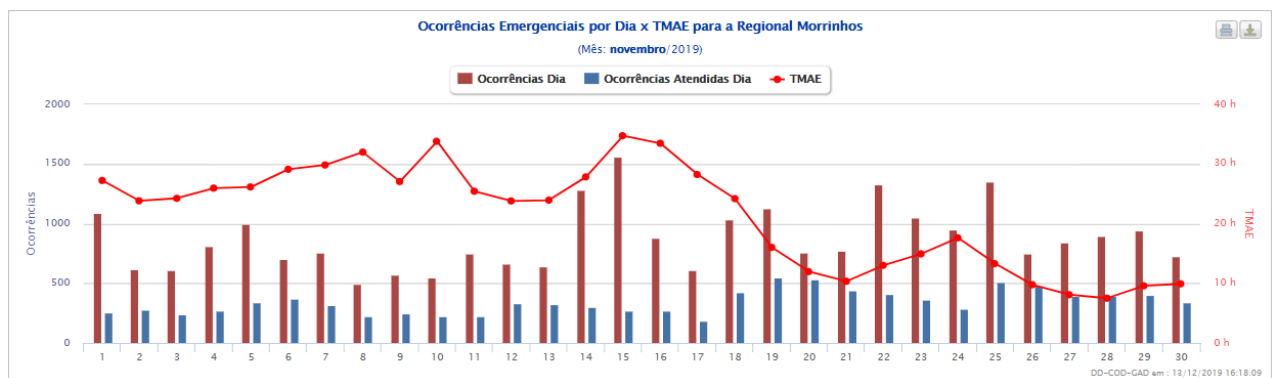
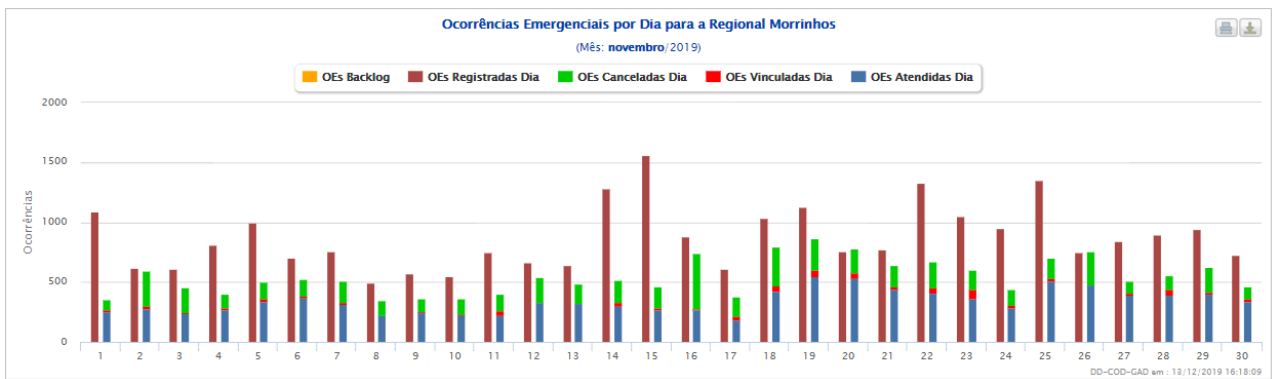
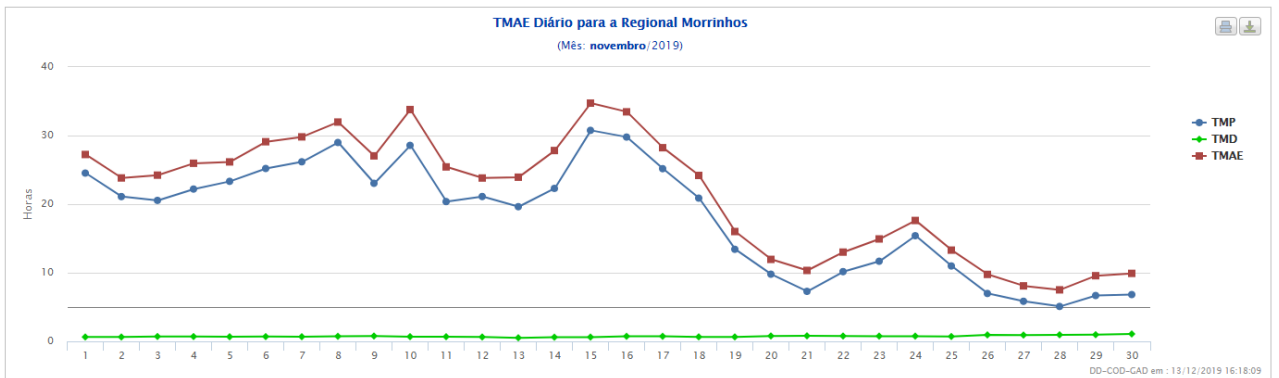
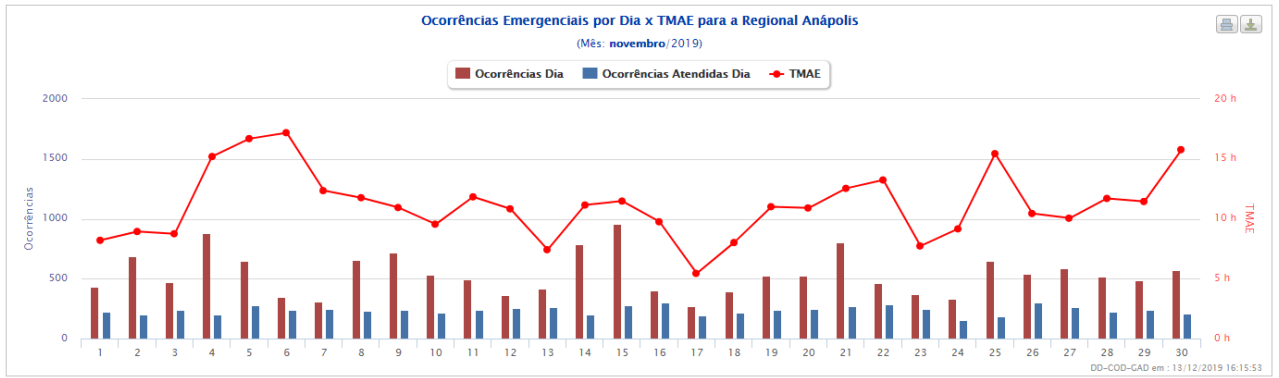

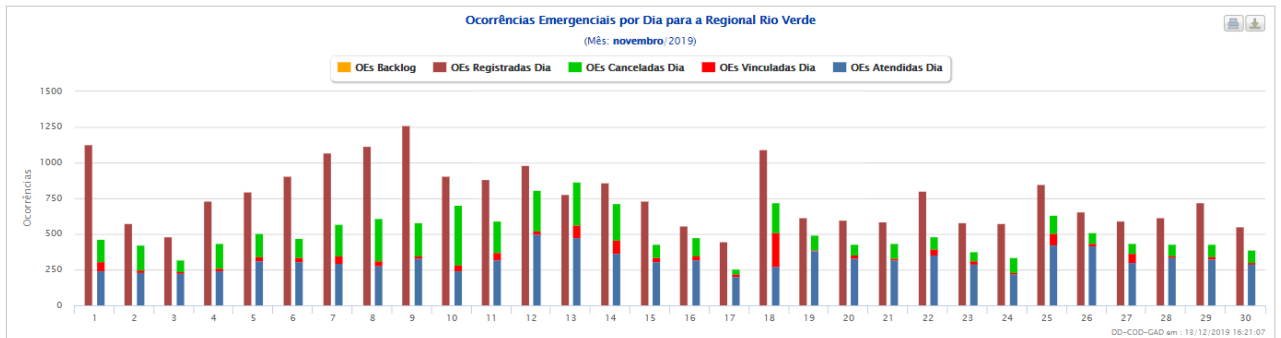
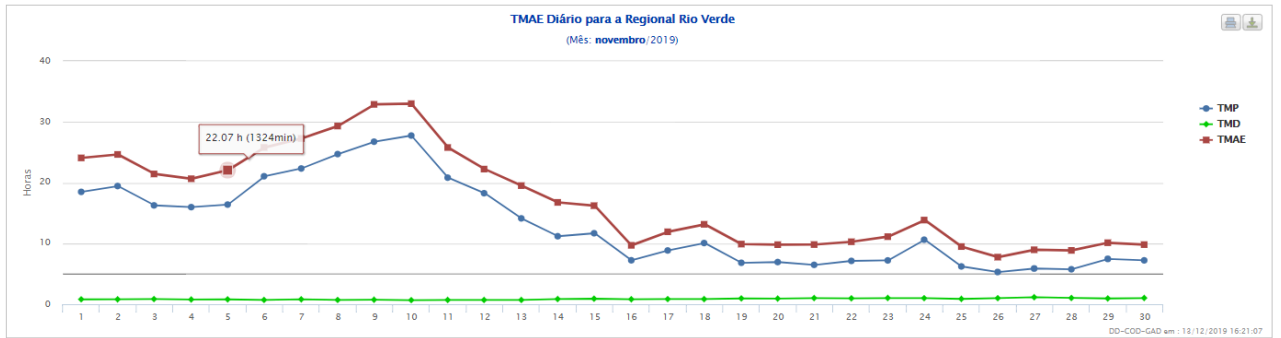
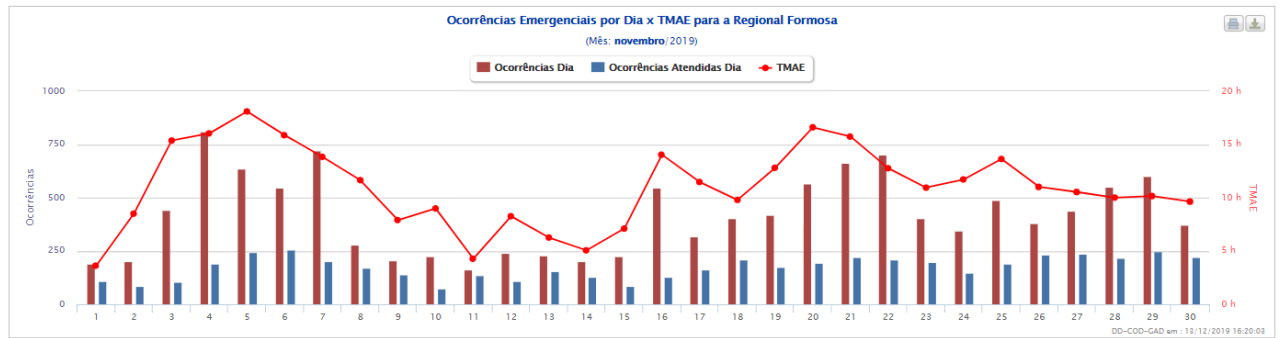
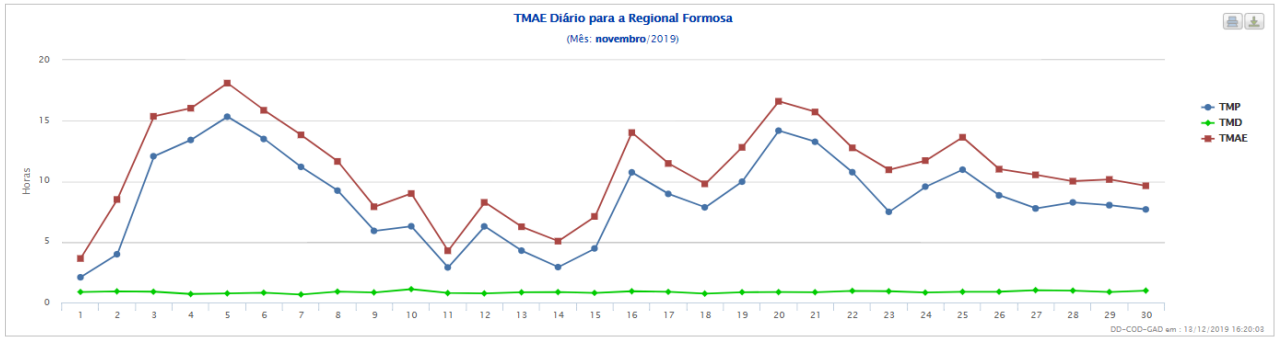

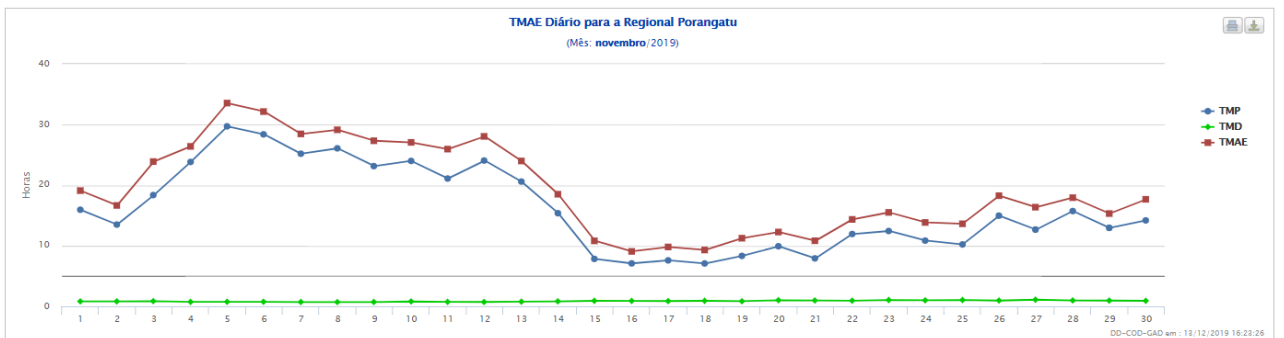
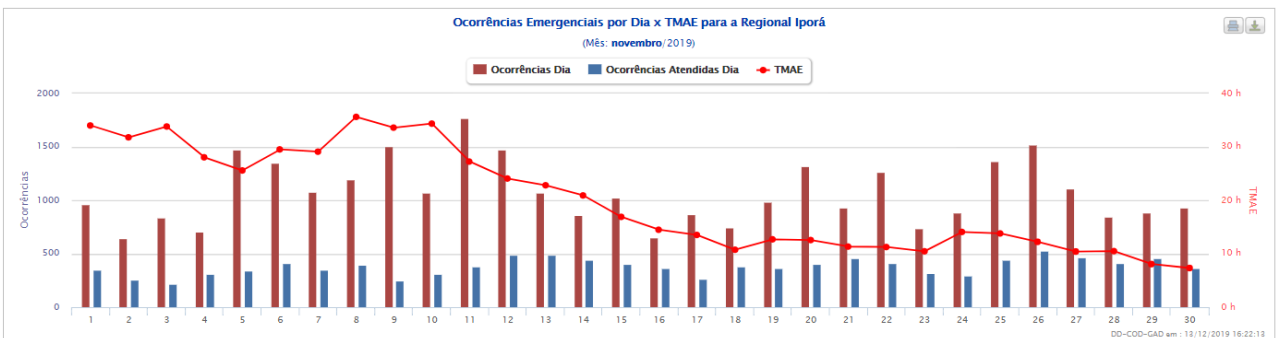
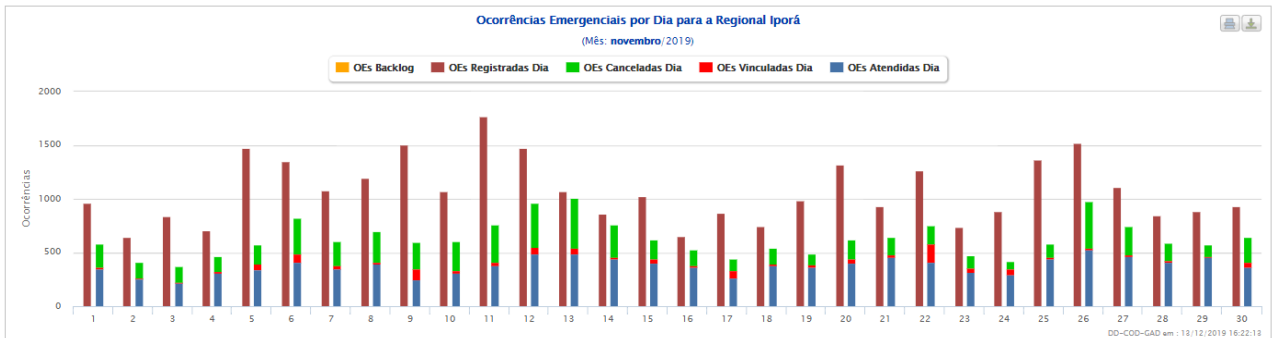
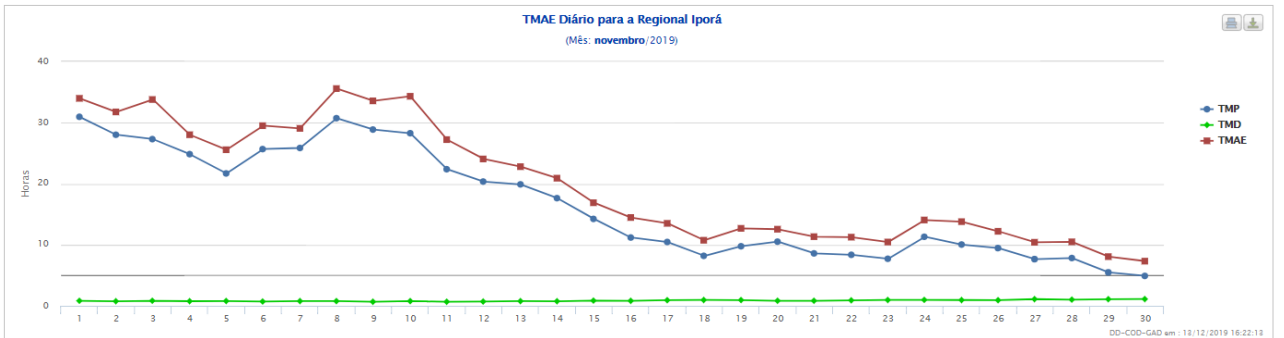
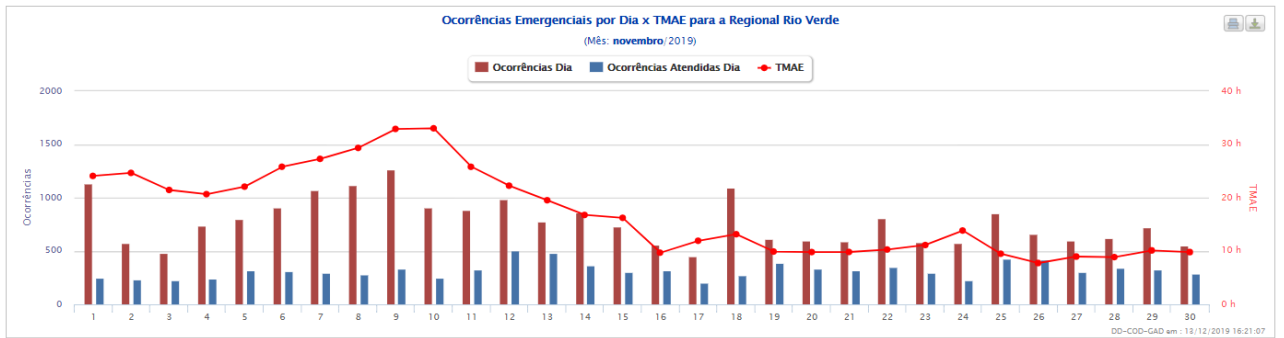

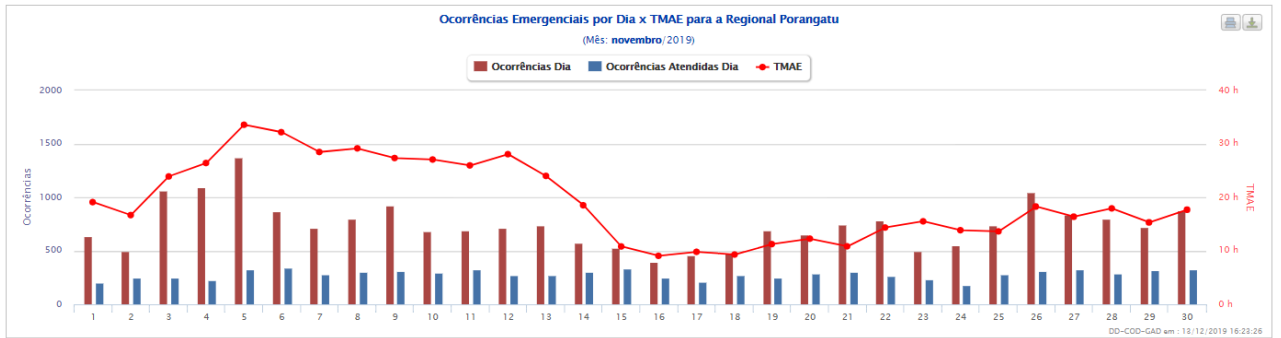

CLIMATEMPO

**Laudo Meteorológico de Evento Climático -
CELG Distribuição S.A. - 28 de outubro de
2019**

São Paulo, SP, Brasil Novembro de 2019

Sumário

1	ANÁLISE DE EVENTO METEOROLÓGICO	2
1.1	Descrição do Evento.....	2
1.2	Abrangência do Evento	4
2	CLASSIFICAÇÃO COBRADE	7
3	RESUMO DO EVENTO	8
4	REFERÊNCIAS.....	10

1 Análise de Evento Meteorológico

1.1 Descrição do Evento

Na figura a seguir é apresentada a área de concessão da CELG Distribuição, dividida em regiões, a serem analisadas neste relatório.



Figura 1 – Regiões de Goiás atendidas pela CELG Distribuição.

Nuvens de tempestade, do tipo Cumulonimbus, formadas pelo ar quente e úmido e pela presença de um sistema de baixa pressão sobre o continente, avançaram sobre o estado de Goiás entre o dia 27 de outubro e a madrugada do dia 28 de outubro de 2019.

Nas Figura 2 e 3 são apresentadas as descargas atmosféricas nuvem-solo (raios) e nuvem-nuvem detectadas pelo sistema Earth Networks. Entre as 12h00 do dia 27 e as 00h40 do dia 28 de outubro foram registrados 2855 raios nuvem-solo e 4541 descargas nuvem-nuvem sobre a área da CELG Distribuição em Goiás.

Segundo informações coletadas pelas estações automáticas o Instituto Nacional de Meteorologia (INMET) representativas da região de interesse, rajadas de vento de até 60,5 km/h foram registrados entre 17h00 e 18h00 eem Itumbiara. Segundo a escala Beaufort, ventos entre 50 e 61 km/h são classificados como vento forte

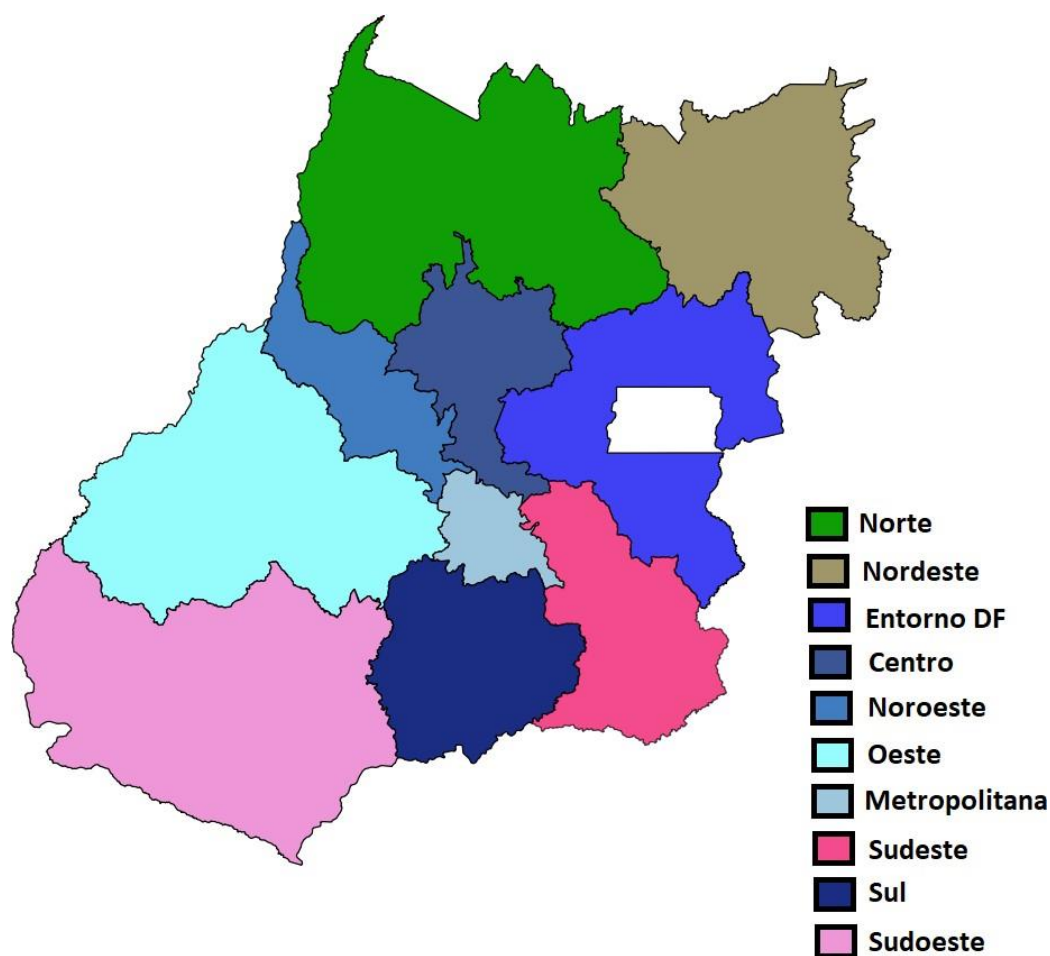
Figura 2 – Descargas atmosféricas nuvem-solo (em preto) e nuvem-nuvem (em vermelho)

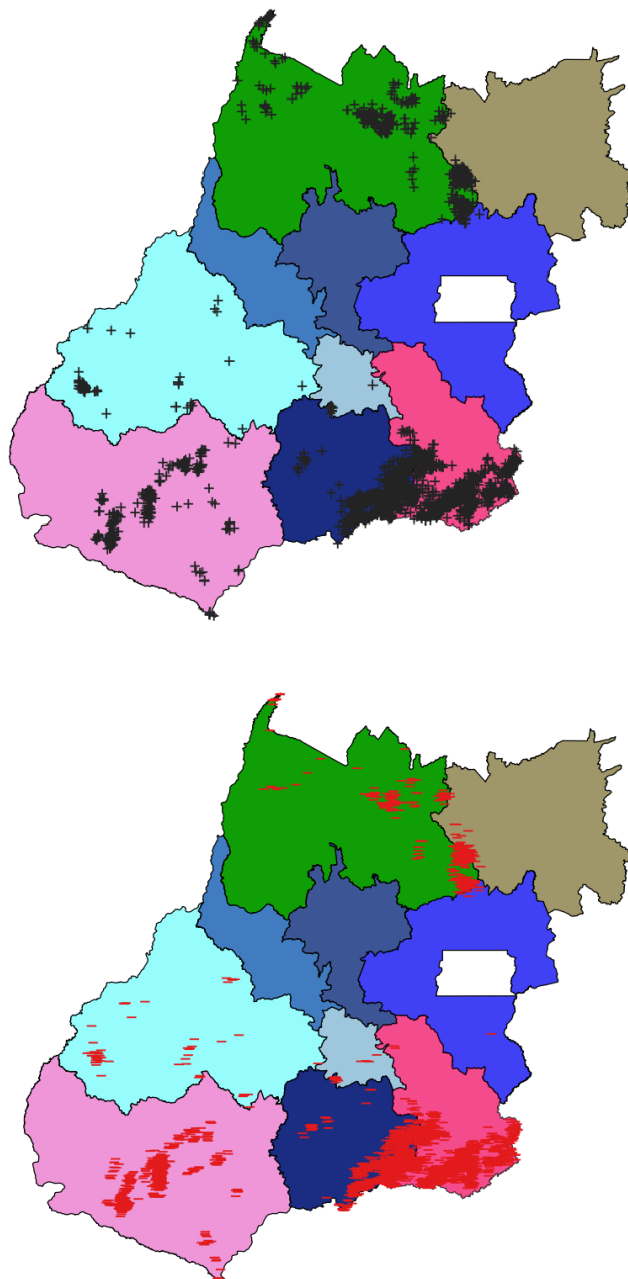

detectadas pelo sistema Earth Networks entre 12h00 do dia 27 e as 00h40 do dia 28 de outubro de 2019 sobre a área de concessão da CELG Distribuição.

Rua José Antônio Coelho, 567 - São Paulo / SP - TEL: 11 3736-4591.

© 2019 - Climatedempo Meteorologia. Todos os direitos reservados.

1.2 Abrangência do Evento

A seguir são apresentadas as imagens realçadas do satélite GOES-16 entre as 15h00 e 23h00 do dia 27 de outubro de 2019. Os tons em vermelho e preto indicam a presença de nuvens de grande desenvolvimento vertical, geralmente associadas à ocorrência de tempo severo.

Como é possível observar pela sequência de imagens, durante o período houve a formação e o deslocamento de nuvens de tempestade sobre as áreas do norte e sul do estado de Goiás.



Figura 3 –Imagens realçadas do satélite GOES-16 das 13h00 do dia 28 de outubro de 2019. FONTE: Cptec/INPE.

17h00 - 27 de outubro de 2019

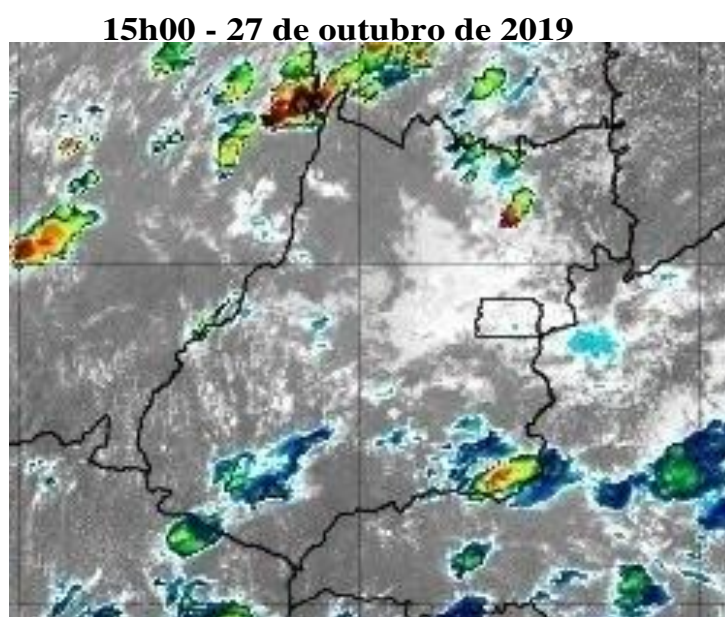

Figura 4 –Imagens realçadas do satélite GOES-16 das 17h00 do dia 27 de outubro de 2019. FONTE: Cptec/INPE.

19h00 - 27 de outubro de 2019



Figura 5 –Imagens realçadas do satélite GOES-16 das 19h00 do dia 27 de outubro de 2019. FONTE: Cptec/INPE.

Rua José Antônio Coelho, 567 - São Paulo / SP - TEL: 11 3736-4591.

© 2019 - Climatempo Meteorologia. Todos os direitos reservados.



Figura 6 –Imagens realçadas do satélite GOES-16 das 21h00 do dia 27 de outubro de 2019. FONTE: Cptec/INPE.



Figura 7 –Imagens realçadas do satélite GOES-16 das 23h00 do dia 27 de outubro de 2019. FONTE: Cptec/INPE.

2 Classificação COBRADE

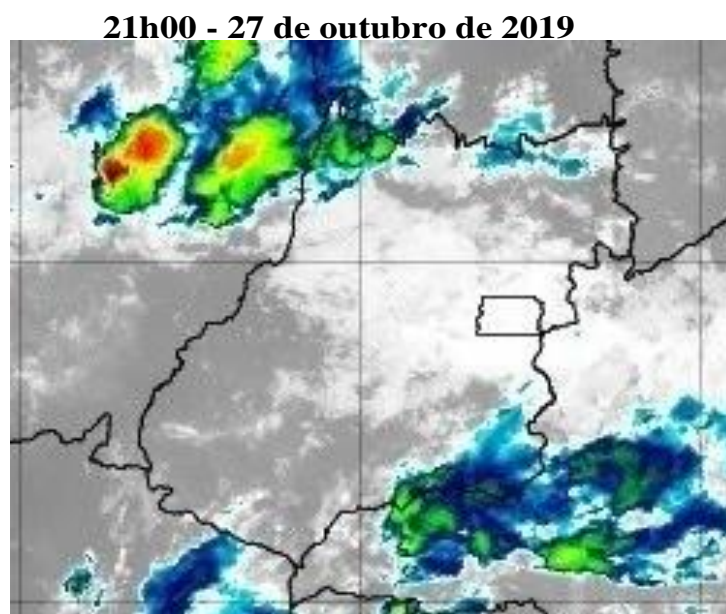
O COBRADE (Classificação e Codificação Brasileira de Desastres) foi criado com o intuito de adequar a classificação brasileira à classificação utilizada pela ONU na classificação de desastres e nivelar o país aos demais organismos de gestão de desastres do mundo.

Baseados nos dados analisados nos itens anteriores, podemos classificar o evento sobre a área de concessão da CELG Distribuição como Zona de Convergência (Código 1.3.1.2.0).

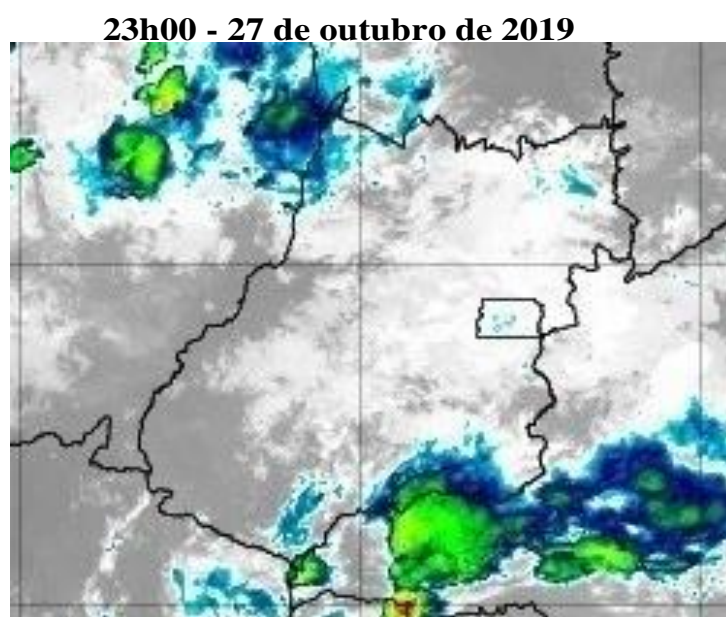
3 Resumo do Evento

O ar quente e úmido e a presença de um sistema de baixa pressão sobre o continente foram responsáveis pela formação de nuvens do tipo Cumulonimbus, que avançaram sobre o estado de Goiás, entre a tarde do dia 27 e a madrugada do dia 28 de outubro de 2019.

Entre as 12h00 do dia 27 e as 00h40 do dia 28 de outubro foram registrados 7396 descargas atmosféricas sobre a área de concessão da CELG Distribuição em Goiás, sendo 4541 nuvem-nuvem e 2855 nuvem-solo. Rajadas de vento forte, entre 50 e 61 km/h, foram registradas na estação de Itumbiara na tarde do dia 27 de outubro.

Tabela 1 – Resumo do evento Região Sudoeste

Número/Código do Evento	
Número/Código do Relatório	
Descrição	Região ligada à tempestade causada por uma zona de baixa pressão atmosférica, provocando forte deslocamento de massas de ar, vendavais, chuvas intensa e possível queda de granizo.
Código COBRADE	1.3.1.2.0 – Zona de Convergência
Hora início do evento	13h00 do dia 27 de outubro de 2019
Hora de fim do evento	23h30 do dia 27 de outubro de 2019
Abrangência	Região Sudoeste da CELG Distribuição S.A.

Tabela 2 – Resumo do evento Região Sul

Número/Código do Evento	
Número/Código do Relatório	
Descrição	Região ligada à tempestade causada por uma zona de baixa pressão atmosférica, provocando forte deslocamento de massas de ar, vendavais, chuvas intensa e possível queda de granizo.
Código COBRADE	1.3.1.2.0 – Zona de Convergência
Hora início do evento	12h30 do dia 27 de outubro de 2019
Hora de fim do evento	00h40 do dia 27 de outubro de 2019
Abrangência	Região Sul da CELG Distribuição S.A.

Tabela 3 – Resumo do evento Região Sudeste

Número/Código do Evento	
Número/Código do Relatório	
Descrição	Região ligada à tempestade causada por uma zona de baixa pressão atmosférica, provocando forte deslocamento de massas de ar, vendavais, chuvas intensa e possível queda de granizo.
Código COBRADE	1.3.1.2.0 – Zona de Convergência
Hora início do evento	12h30 do dia 27 de outubro de 2019
Hora de fim do evento	20h30 do dia 27 de outubro de 2019
Abrangência	Região Sudeste da CELG Distribuição S.A.

Tabela 4 – Resumo do evento Região Norte

Número/Código do Evento	
Número/Código do Relatório	
Descrição	Região ligada à tempestade causada por uma zona de baixa pressão atmosférica, provocando forte deslocamento de massas de ar, vendavais, chuvas intensa e possível queda de granizo.
Código COBRADE	1.3.1.2.0 – Zona de Convergência
Hora início do evento	13h40 do dia 27 de outubro de 2019
Hora de fim do evento	21h00 do dia 27 de outubro de 2019
Abrangência	Região Norte da CELG Distribuição S.A.

4 Referências

- RMets Royal Meteorological Society – Beaufort Scale - <https://www.rmets.org/weather-and-climate/observing/beaufort-scale>
- Instituto Nacional de Meteorologia (INMET) - <http://www.inmet.gov.br>
- Cptec/INPE- <https://www.cptec.inpe.br/>
- Centro de Hidrografia da Marinha do Brasil - <https://www.marinha.mil.br/chm/>

Anexos

A.1 Carta Sinótica da Marinha do Brasil



Figura A1 - Carta sinótica da Marinha do Brasil para as 1200Z do dia 27 de outubro de 2019 (09h00 do dia 27 de outubro de 2019, hora local).

A.2 Notícias relacionadas

Chuva provoca estragos em Caldas Novas - <https://globoplay.globo.com/v/8039450/>

Chuva forte e granizo causam estragos em Caldas Novas neste domingo (27) -

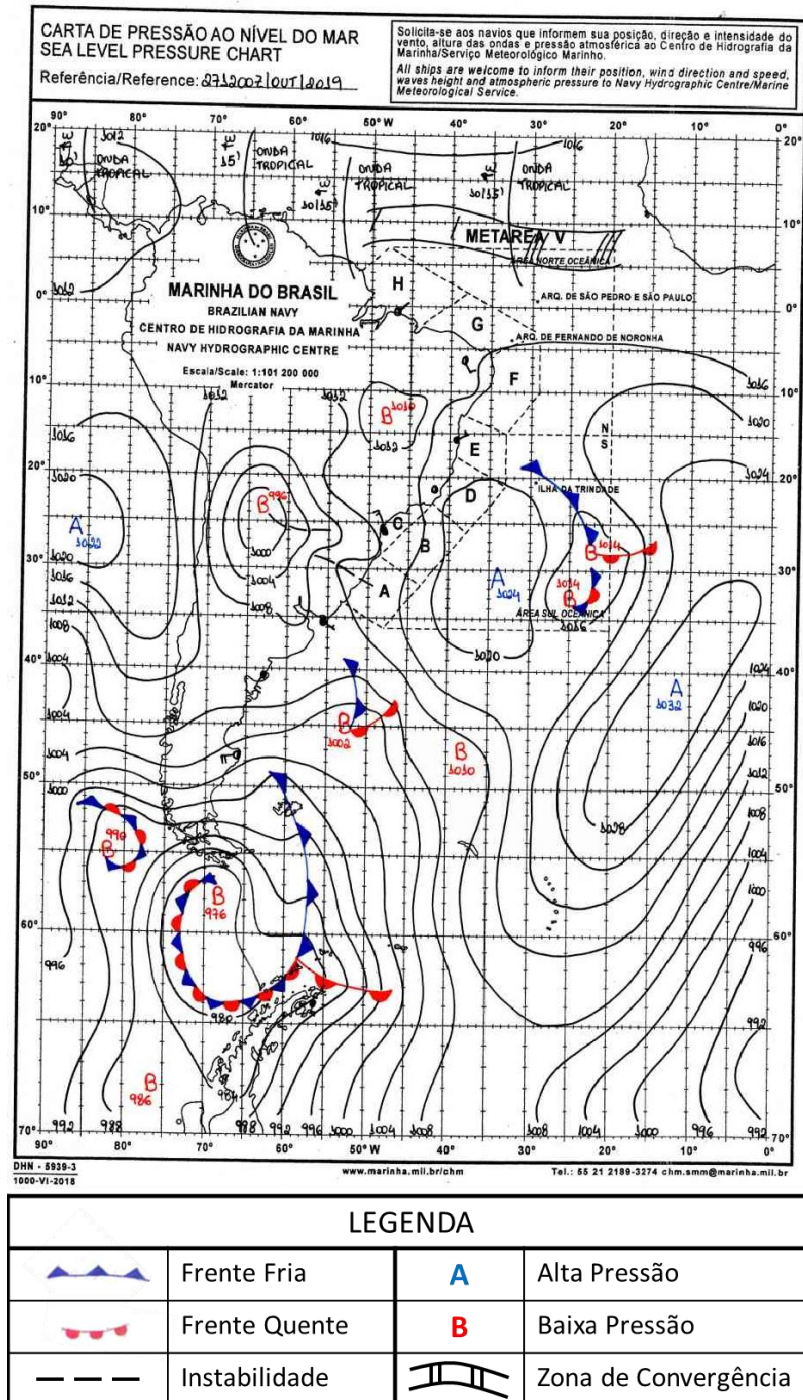
<https://www.emaisgoias.com.br/chuva-forte-e-granizo-causam-estragos-em-caldas-novas-neste-domingo-27/>

Vídeos: Chuva de granizo causam estragos Caldas Novas – GO -

<http://informatudodf.com.br/2019/10/29/videos-chuva-de-granizo-em-caldas-novas-go/>

Temporal causa estragos e deixa Caldas Novas sem energia - Jornal O Popular

- <https://www.opopular.com.br/noticias/cidades/temporal-causa-estragos-e-deixa-caldas-novas-sem-energia-1.1918698>

Bianca Lobo Silva

Meteorologista

CREA 5063840461

Instituto Nacional de Meteorologia - INMET

Umidade Relativa do Ar 00h UTC
Estação: ARAGARCAS (GO) - 11/2019

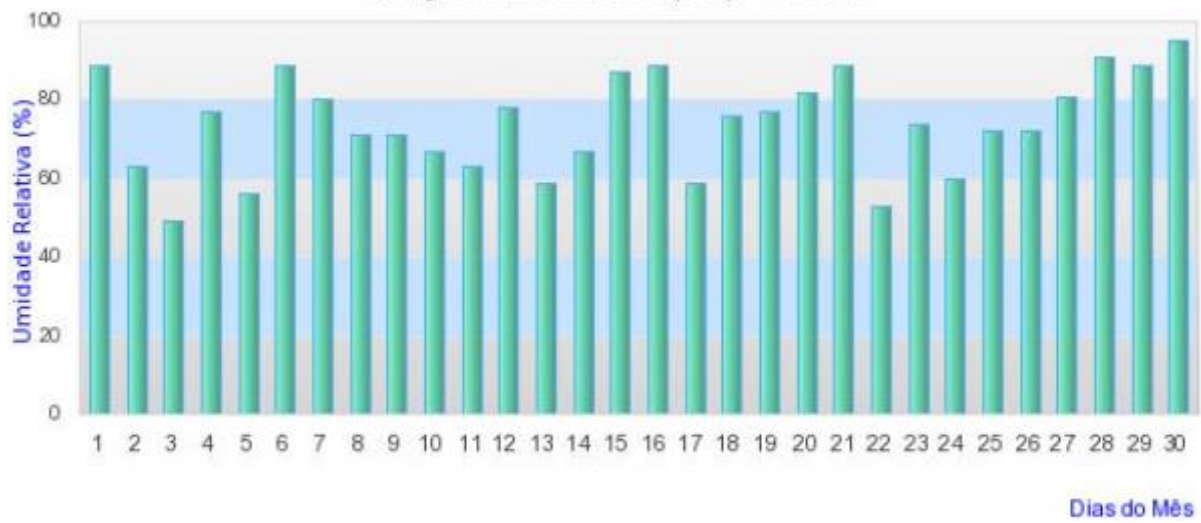

Instituto Nacional de Meteorologia - INMET

Chuva Acumulada 24h
Estação: ARAGARCAS - 11/2019

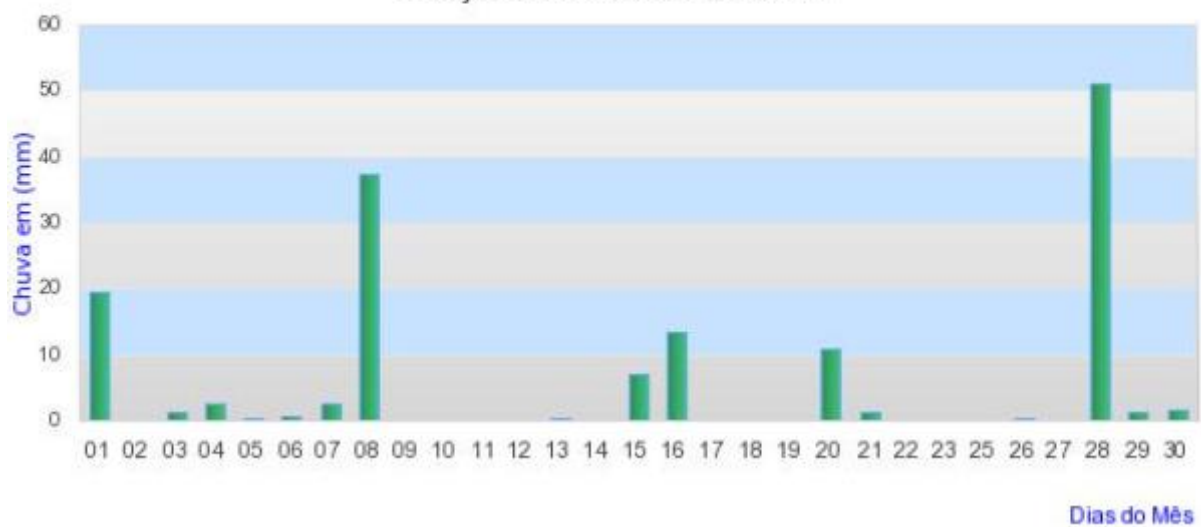

Instituto Nacional de Meteorologia - INMET

Umidade Relativa do Ar 00h UTC

Estação: IPAMERI (GO) - 11/2019

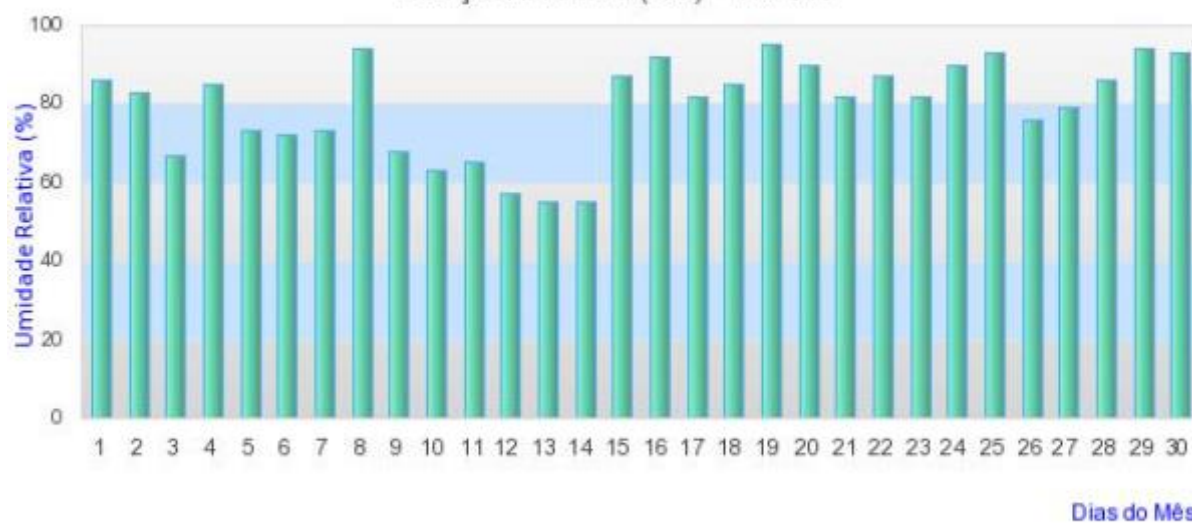

Instituto Nacional de Meteorologia - INMET

Chuva Acumulada 24h

Estação: IPAMERI - 11/2019

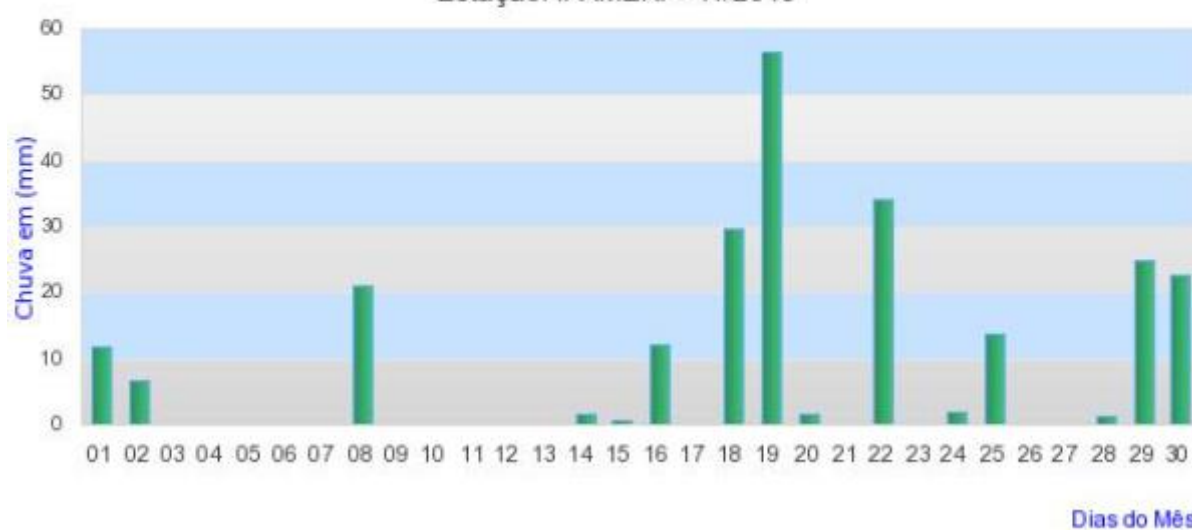

Instituto Nacional de Meteorologia - INMET

Umidade Relativa do Ar 00h UTC

Estação: JATAI (GO) - 11/2019

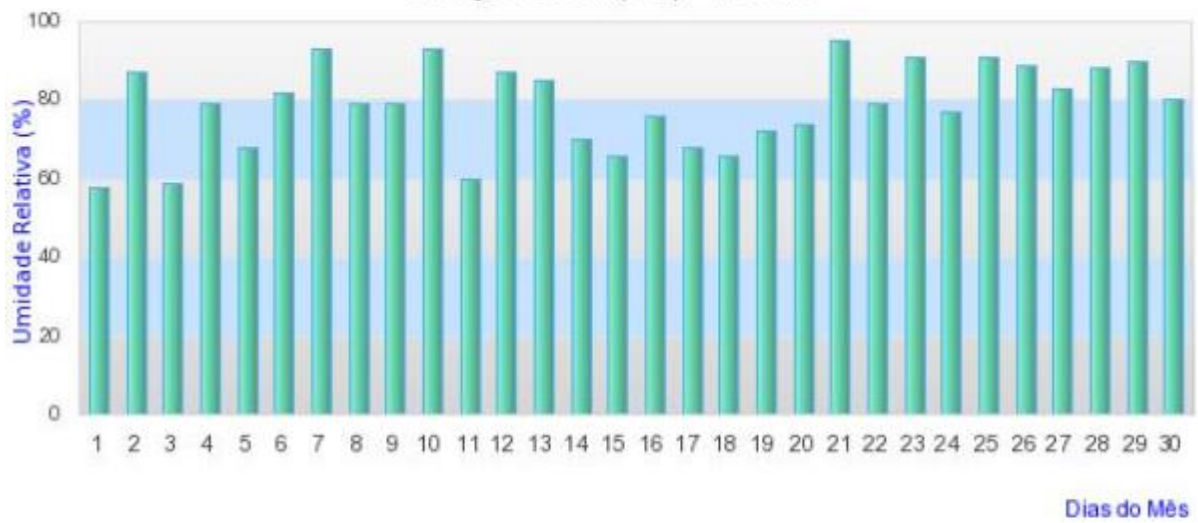

Instituto Nacional de Meteorologia - INMET

Chuva Acumulada 24h

Estação: JATAI - 11/2019



Instituto Nacional de Meteorologia - INMET

Umidade Relativa do Ar 00h UTC
Estação: RIO VERDE (GO) - 11/2019

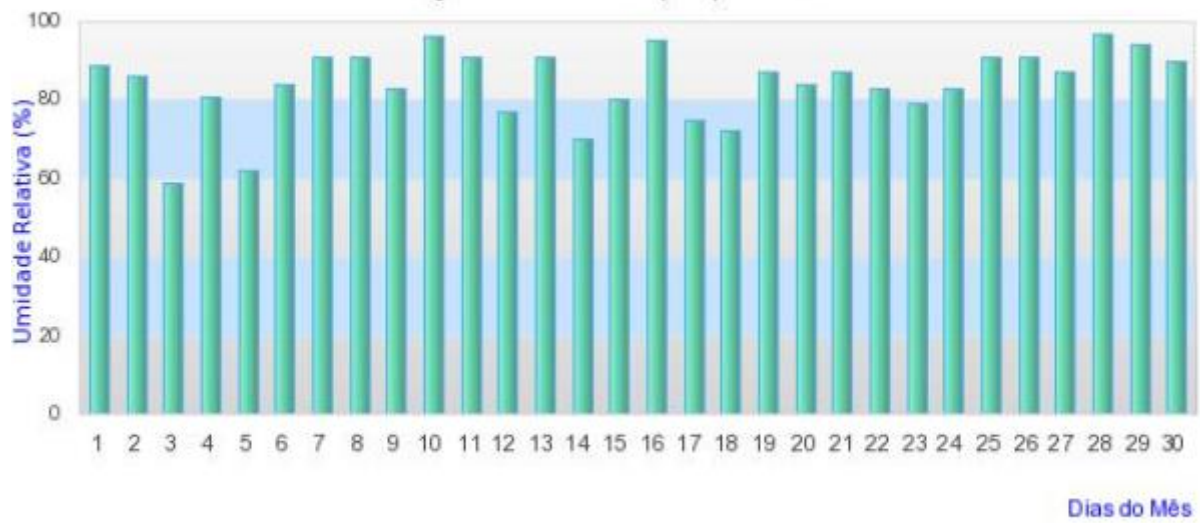

Instituto Nacional de Meteorologia - INMET

Chuva Acumulada 24h
Estação: RIO VERDE - 11/2019



Maurilândia - Estação Usina Vale do Verdão - Maurilândia - Novembro de 2019

Para ver os dados horários clique no dia desejado

Dia	Precip.	Prec.Acum.	Vel. Vent. (m/s)	Dir. Vent.	Umid. Relat. AR (Max) %	Umid. Relat. AR (Min) %	Umid. Relat. AR (Média)%	Temp. Max. °C Dia	Temp. Min. °C Dia	Temp. Med. °C do Ar	Temp. 09:00h	Temp. 21:00h	Ponto orvalho	Razao Mistura	Radiação Solar Diária MJ/m²
1	4.20	4.20	2.5	N	0.0	0.0	0	-10.0	-10.0	-10	-10	-10	-	-	14.9
2	0.20	4.40	1.9	SE	0.0	0.0	0	-10.0	-10.0	-10	-10	-10	-	-	18.9
3	0.00	4.40	2.8	O	0.0	0.0	0	-10.0	-10.0	-10	-10	-10	-	-	17.4
4	0.00	4.40	1.9	NO	0.0	0.0	0	-10.0	-10.0	-10	-10	-10	-	-	17
5	0.00	4.40	2.1	NO	0.0	0.0	0	-10.0	-10.0	-10	-10	-10	-	-	11.9
6	0.40	4.80	2.3	NO	0.0	0.0	0	-10.0	-10.0	-10	-10	-10	-	-	17.6
7	9.20	14.00	1.7	L	0.0	0.0	0	-10.0	-10.0	-10	-10	-10	-	-	16.9
8	1.80	15.80	2.0	SE	0.0	0.0	0	-10.0	-10.0	-10	-10	-10	-	-	7.2
9	14.20	30.00	2.0	SO	0.0	0.0	0	-10.0	-10.0	-10	-10	-10	-	-	15
10	0.60	30.60	1.8	L	0.0	0.0	0	-10.0	-10.0	-10	-10	-10	-	-	16.8
11	22.80	53.40	2.8	SE	0.0	0.0	0	-10.0	-10.0	-10	-10	-10	-	-	19.2
12	0.00	53.40	3.1	S	0.0	0.0	0	-10.0	-10.0	-10	-10	-10	-	-	10.6
13	0.00	53.40	3.0	S	0.0	0.0	0	-10.0	-10.0	-10	-10	-10	-	-	14.1
14	2.00	55.40	2.1	S	0.0	0.0	0	-10.0	-10.0	-10	-10	-10	-	-	13.5
15	14.00	69.40	1.5	S	0.0	0.0	0	-10.0	-10.0	-10	-10	-10	-	-	9.6
16	1.20	70.60	1.3	O	0.0	0.0	0	-10.0	-10.0	-10	-10	-10	-	-	13.5
17	0.00	70.60	2.0	NO	0.0	0.0	0	-10.0	-10.0	-10	-10	-10	-	-	17
18	5.00	75.60	2.6	NO	0.0	0.0	0	-10.0	-10.0	-10	-10	-10	-	-	14.6
19	0.00	75.60	1.5	NO	0.0	0.0	0	-10.0	-10.0	-10	-10	-10	-	-	12.9
20	0.00	75.60	1.8	NO	0.0	0.0	0	-10.0	-10.0	-10	-10	-10	-	-	14.3
21	18.80	94.40	2.0	L	0.0	0.0	0	-10.0	-10.0	-10	-10	-10	-	-	16
22	3.20	97.60	1.9	NO	1.0	0.0	0	-10.0	-10.0	-10	-10	-10	-	-	15.4
23	0.00	97.60	1.9	NO	4.0	0.0	0.5	-10.0	-10.0	-10	-10	-10	-	-	14.3
24	3.60	101.20	2.0	S	4.0	0.0	1.2	-10.0	-10.0	-10	-10	-10	-	-	7.8
25	0.40	101.60	1.6	NO	2.0	0.0	0.2	-10.0	-10.0	-10	-10	-10	-	-	11.4
26	2.20	103.80	1.6	NO	2.0	0.0	0.5	-10.0	-10.0	-10	-10	-10	-	-	13.1
27	56.20	160.00	2.5	N	1.0	0.0	0	-10.0	-10.0	-10	-10	-10	-	-	7.7
28	10.20	170.20	1.4	NO	4.0	0.0	2	-10.0	-10.0	-10	-10	-10	-	-	10.5
29	9.60	179.80	1.2	NO	4.0	0.0	1.5	-10.0	-10.0	-10	-10	-10	-	-	9.8
30	45.20	225.00	2.2	NO	5.0	0.0	1.7	-10.0	-10.0	-10	-10	-10	-	-	9.4

Santa Helena de Goiás - Estação Usina Santa Helena - Santa Helena - Novembro de 2019

Para ver os dados horários clique no dia desejado

Dia	Precip.	Prec.Acum.	Vel. Vent. (m/s)	Dir. Vent.	Umid. Relat. AR (Max) %	Umid. Relat. AR (Min) %	Umid. Relat. AR (Média)%	Temp. Max. °C Dia	Temp. Min. °C Dia	Temp. Med. °C do Ar	Temp. 09:00h	Temp. 21:00h	Ponto orvalho	Razao Mistura	Radiação Solar Diária MJ/m²
1	3.40	3.40	1.5	NO	89.0	36.0	67.7	34.6	22.3	27.28	30.3	24.6	-	-	11.8
2	0.20	3.60	1.3	L	99.0	27.0	57.7	36.0	20.6	27.26	26.9	26.4	-	-	18.4
3	6.80	10.40	1.9	N	96.0	46.0	83	31.6	23.4	26.88	29.8	24.8	-	-	12.6
4	0.00	10.40	1.3	N	100.0	32.0	47	34.7	21.9	28.58	29.1	28.6	-	-	14.3
5	1.80	12.20	1.8	NO	100.0	39.0	84.5	34.2	21.9	26.68	29.1	24.1	-	-	10.2
6	0.20	12.40	1.6	NO	100.0	45.0	75.7	33.6	23.0	26.54	26.9	24.6	-	-	15.6
7	0.00	12.40	1.4	O	100.0	39.0	62	34.8	21.9	27.62	27.6	26.9	-	-	16.9
8	20.80	33.20	1.5	SE	100.0	63.0	91	28.4	20.9	23.8	22.1	23.8	-	-	8.5
9	30.80	64.00	1.5	N	100.0	39.0	73.7	34.3	20.1	25.44	28.6	22.1	-	-	15.7
10	0.00	64.00	1.0	L	100.0	48.0	73.7	32.8	21.1	25.8	25.1	25	-	-	14.9
11	4.60	68.60	1.9	SE	100.0	34.0	69.7	35.1	22.1	26.36	29	22.8	-	-	18.2
12	1.00	69.60	1.4	O	98.0	63.0	83.7	30.1	22.0	25.66	24	26.1	-	-	6.1
13	0.00	69.60	1.7	N	95.0	36.0	57	34.2	23.9	28.48	29.1	27.6	-	-	16.5
14	0.00	69.60	1.1	SE	100.0	38.0	71.5	34.3	22.4	26.5	26.6	24.6	-	-	13.4
15	28.20	97.80	1.3	N	100.0	53.0	92	30.6	20.7	24.24	28.1	20.9	-	-	7.8
16	0.00	97.80	1.0	O	100.0	46.0	81	32.0	20.5	25.32	25.9	24.1	-	-	17.8
17	0.00	97.80	1.3	N	100.0	42.0	62.2	32.2	20.7	26.58	27.8	26.1	-	-	18.6
18	3.40	101.20	2.1	N	100.0	44.0	83	32.0	21.6	24.76	27	21.6	-	-	16.8
19	0.20	101.40	1.4	N	100.0	50.0	79.7	31.1	21.6	24.98	25.6	23.3	-	-	11
20	0.00	101.40	1.4	N	100.0	43.0	73.5	32.5	21.4	25.64	27.1	23.6	-	-	13.9
21	0.40	101.80	1.2	SE	100.0	37.0	67	33.6	20.5	25.64	27.3	23.4	-	-	17.1
22	0.00	101.80	1.5	N	100.0	43.0	74.5	32.2	20.4	25.3	25.3	24.3	-	-	16.1
23	2.60	104.40	1.2	NO	99.0	47.0	82.2	31.8	22.0	26.38	29.3	24.4	-	-	9.3
24	0.20	104.60	1.2	N	100.0	51.0	80.5	31.6	22.1	25.72	27.1	23.9	-	-	10.9
25	0.00	104.60	1.3	O	100.0	59.0	92.5	31.3	21.7	25.58	27.1	23.9	-	-	8.6
26	0.00	104.60	1.4	N	100.0	49.0	76.2	32.0	21.7	26.7	26.6	26.6	-	-	15.2
27	33.80	138.40	2.2	N	100.0	56.0	85	31.6	22.1	25.48	28.1	22.8	-	-	13.1
28	29.40	167.80	1.1	NO	100.0	67.0	100	29.8	21.7	24.06	23.6	22.6	-	-	7.9
29	0.60	168.40	1.2	N	100.0	64.0	92	29.1	22.3	25.22	24.1	25.3	-	-	12.7
30	8.00	176.40	1.7	N	100.0	52.0	89	32.5	21.8	24.88	25.3	22.4	-	-	9.9

Morrinhos - Estação Usina CEM - Morrinhos - Novembro de 2019

Para ver os dados horários clique no dia desejado

Dia	Precip.	Prec.Acum.	Vel. Vent. (m/s)	Dir. Vent.	Umid. Relat. AR (Max) %	Umid. Relat. AR (Min) %	Umid. Relat. AR (Média)%	Temp. Max. °C Dia	Temp. Min. °C Dia	Temp. Med. do Ar °C	Temp. 09:00h	Temp. 21:00h	Ponto orvalho	Razao Mistura	Radiação Solar Diária MJ/m²
1	9.40	9.40	3.2	L	94.0	43.0	65	31.3	20.2	24.96	28.3	22.5	-	-	14.4
2	0.00	9.40	2.1	L	89.0	43.0	61	31.6	19.3	25.26	24.8	25.3	-	-	20.7
3	0.80	10.20	4.1	L	91.0	50.0	75.2	30.1	20.8	24.1	25.4	22.1	-	-	20
4	0.00	10.20	2.7	N	94.0	49.0	66.7	30.5	20.7	25.3	28.3	23.5	-	-	14.4
5	0.00	10.20	3.1	N	91.0	41.0	71.5	32.5	21.0	25.36	26.3	23.5	-	-	18
6	0.00	10.20	2.5	N	100.0	54.0	77.5	30.9	21.0	24.84	26.1	23.1	-	-	19.4
7	0.00	10.20	2.6	L	100.0	40.0	61.7	32.5	20.0	25.66	26	24.9	-	-	18.6
8	0.00	10.20	2.9	S	100.0	53.0	69	30.5	19.9	24.2	22.6	24	-	-	15.6
9	13.20	23.40	3.2	L	100.0	37.0	64.7	33.1	20.2	24.86	27.6	21.7	-	-	17.7
10	6.80	30.20	2.2	S	100.0	55.0	85	30.9	19.4	23.46	24.6	21.2	-	-	16.6
11	17.60	47.80	2.6	S	93.0	39.0	63.2	33.1	19.8	25.44	25.1	24.6	-	-	18.7
12	1.00	48.80	2.5	S	96.0	42.0	61	33.3	21.0	26.68	24.9	27.1	-	-	22.8
13	0.00	48.80	4.3	L	77.0	37.0	48	32.3	21.6	27.32	26.1	28.3	-	-	20.1
14	4.20	53.00	2.1	S	100.0	55.0	86.2	29.8	20.4	24.06	27.1	21.5	-	-	14.3
15	18.60	71.60	2.1	O	100.0	61.0	92	27.9	19.5	22.24	23.8	20	-	-	11.9
16	0.00	71.60	2.3	L	100.0	74.0	85	26.4	19.3	22.86	22.6	23	-	-	13
17	0.60	72.20	2.5	N	100.0	47.0	75.2	31.1	19.6	24.42	26.6	22.4	-	-	17.8
18	11.40	83.60	4.1	N	100.0	69.0	94.2	25.8	19.8	21.76	22.6	20.3	-	-	11.4
19	3.00	86.60	2.8	L	100.0	59.0	90.5	28.3	19.0	21.66	22.6	19.2	-	-	14.1
20	0.00	86.60	3.1	L	100.0	55.0	79.2	29.3	18.8	22.98	24.8	21	-	-	20.5
21	0.00	86.60	2.6	L	100.0	51.0	69.5	29.8	19.1	24.32	24.5	24.1	-	-	18.7
22	33.00	119.60	4.1	L	100.0	63.0	89.7	28.0	17.5	22.8	23.3	22.6	-	-	16.9
23	3.00	122.60	3.1	N	100.0	64.0	83.5	27.5	20.3	23.64	25.4	22.5	-	-	14.9
24	0.00	122.60	3.3	N	100.0	59.0	84	28.5	19.6	23.1	24.4	21.5	-	-	14.3
25	23.20	145.80	2.6	N	100.0	57.0	86	30.1	19.4	23.78	26.4	21.5	-	-	16.1
26	0.40	146.20	3.0	L	100.0	63.0	87.7	28.6	20.2	24.18	24.9	23.6	-	-	16.9
27	4.80	151.00	3.7	N	100.0	79.0	100	26.6	20.2	22.32	22.4	21.2	-	-	10.1
28	0.80	151.80	3.0	N	100.0	72.0	91.7	28.1	20.3	23.16	23.6	21.9	-	-	15
29	2.00	153.80	2.6	L	100.0	78.0	94.5	27.1	21.1	23.26	23.3	22.4	-	-	12.6
30	1.20	155.00	3.5	N	100.0	65.0	92.7	28.4	20.4	23.12	22.8	22	-	-	11.2

Estacao : Palmeiras de Goiás
 Data : 1 de Novembro de 2019
 Municipio : Palmeiras de Goiás

Hora LOCAL	Precip.	Prec.Acum.	Vel. Vento (m/s)	Dir. Vento	Vel.Rajada Vento (m/s)	Dir.Rajada Vento	Umid. Relat. AR (%)	Temperatura do ar (C)	Ponto Orvalho	Razao Mistura	Radiacao Solar Acum. MJ/m²
00:00	0.00	0.00	0.0	SO	13.2	S	76.0	24.9			0.3
01:00	0.00	0.00	0.0	NE	6.8	NE	74.0	24.6			0.3
02:00	0.00	0.00	1.6	SO	8.6	S	80.0	23.7			0.3
03:00	0.00	0.00	2.7	O	17.7	S	87.0	22.6			0.4
04:00	0.00	0.00	0.0	S	12.6	S	84.0	22.9			0.7
05:00	0.00	0.00	0.0	NE	17.6	S	88.0	22.4			0.3
06:00	0.00	0.00	0.7	S	16.5	O	96.0	21.3			0.1
07:00	0.00	0.00	0.0	S	17.8	S	86.0	23.9			0.6
08:00	0.00	0.00	0.4	O	18.4	S	76.0	25.6			1.1
09:00	0.00	0.00	0.5	O	22.0	NE	62.0	27.7			1.5
10:00	0.00	0.00	1.0	SO	19.0	S	56.0	29.3			2
11:00	0.00	0.00	6.9	L	21.7	NE	52.0	30.2			2.1
12:00	0.00	0.00	2.5	S	49.2	NE	45.0	32.5			2.8
13:00	0.00	0.00	0.0	NE	49.6	N	40.0	34.4			2.8
14:00	0.00	0.00	0.0	NE	19.3	S	35.0	35.3			2.7
15:00	0.00	0.00	4.7	SE	16.4	S	38.0	33.3			2.4
16:00	0.00	0.00	4.2	SE	20.4	S	34.0	34.3			1.9
17:00	0.00	0.00	1.3	S	5.1	S	35.0	33.3			0.9
18:00	0.00	0.00	17.8	S	20.8	NE	57.0	27.2			0.3
19:00	0.00	0.00	6.8	NE	19.2	NE	67.0	26			0.3
20:00	0.00	0.00	4.7	S	18.0	NE	68.0	26			0.3
21:00	0.00	0.00	0.0	SO	6.8	NE	70.0	25.1			0.3
22:00	0.00	0.00	2.9	S	19.4	SO	67.0	24.4			0.1
23:00	0.00	0.00	1.4	S	21.9	SO	80.0	22.6			0.4

Palmeiras de Goiás - Estação Palmeiras de Goiás - Novembro de 2019

Para ver os dados horários clique no dia desejado

Dia	Precip.	Prec. Acum.	Vel. Vent. (m/s)	Dir. Vent.	Umid. Relat. AR (Max) %	Umid. Relat. AR (Min) %	Umid. Relat. AR (Média)%	Temp. Max. °C Dia	Temp. Min. °C Dia	Temp. Med. °C do Ar	Temp. 09:00h	Temp. 21:00h	Ponto orvalho	Razao Mistura	Radiação Solar Diária MJ/m²
1	0.00	0.00	2.5	S	96.0	34.0	60	35.3	21.3	26.9	27.7	25.1	-	-	21.8
2	0.00	0.00	2.9	SO	96.0	34.0	50.5	34.3	20.5	27.78	27.9	28.1	-	-	-
3	1.20	1.20	2.3	SO	90.0	48.0	69.7	30.1	22.0	25.66	26.8	24.7	-	-	-
4	0.00	1.20	3.0	S	90.0	32.0	57.2	34.6	22.8	27.72	29	26.1	-	-	-
5	14.80	16.00	2.4	SO	100.0	32.0	76.2	35.4	22.3	25.94	27.2	22.4	-	-	-
6	0.20	16.20	1.1	S	100.0	43.0	80.5	32.6	21.2	25.22	23.3	24.5	-	-	-
7	0.00	16.20	1.8	S	100.0	40.0	62.7	34.1	20.9	27.08	27	26.7	-	-	-
8	0.00	16.20	2.8	SO	100.0	48.0	63	32.6	21.6	26.48	24.4	26.9	-	-	-
9	39.60	55.80	1.8	S	100.0	35.0	74	34.7	19.8	24.94	29.6	20.3	-	-	-
10	0.20	56.00	2.3	S	100.0	39.0	66	33.9	19.8	26.32	24.9	26.5	-	-	-
11	18.00	74.00	2.2	S	100.0	31.0	75	35.9	22.2	26.22	28	22.5	-	-	-
12	1.40	75.40	1.8	SO	100.0	41.0	71.2	34.6	21.5	26.02	24.8	24.6	-	-	-
13	0.00	75.40	0.9	S	100.0	36.0	55	34.4	22.0	27.94	26.7	28.3	-	-	-
14	0.00	75.40	1.1	S	92.0	35.0	52.2	34.7	22.3	28.48	28.2	28.6	-	-	-
15	24.20	99.60	2.7	L	100.0	47.0	84.2	31.8	21.0	24.7	27.7	21.5	-	-	-
16	0.20	99.80	1.1	L	100.0	52.0	80.2	30.3	21.2	25.1	23.4	25.3	-	-	-
17	9.40	109.20	1.3	L	100.0	57.0	74.5	30.7	20.8	25.22	25.8	24.4	-	-	-
18	2.20	111.40	1.4	SO	100.0	54.0	92.5	30.1	21.4	24.12	25.7	21.7	-	-	-
19	0.20	111.60	0.6	O	100.0	56.0	90	29.5	20.6	23.84	24.5	22.3	-	-	-
20	1.80	113.40	1.1	SO	100.0	41.0	92	31.9	21.1	24.68	26.4	22	-	-	-
21	0.20	113.60	1.2	S	100.0	42.0	64.2	32.0	20.3	25.58	25.4	25.1	-	-	-
22	18.40	132.00	1.9	S	100.0	54.0	73.7	30.0	19.3	24.96	25.3	25.1	-	-	-
23	2.40	134.40	3.4	O	100.0	47.0	87	32.9	22.6	25.98	27.8	23.3	-	-	-
24	2.20	136.60	1.7	S	100.0	46.0	86	32.8	21.8	24.94	26.1	22	-	-	-
25	3.40	140.00	1.5	SO	100.0	59.0	88.7	31.0	20.0	24.36	25.4	22.7	-	-	-
26	0.00	140.00	0.8	O	100.0	59.0	72.5	30.8	21.1	25.76	26.5	25.2	-	-	-
27	5.80	145.80	1.3	L	100.0	77.0	93.5	27.7	21.8	24.7	26.2	23.9	-	-	-
28	9.80	155.60	0.9	S	100.0	58.0	81.5	29.2	20.6	24.92	25	24.9	-	-	-
29	2.40	158.00	1.9	O	100.0	63.0	89.7	30.8	22.0	24.96	24.6	23.7	-	-	-
30	1.40	159.40	0.7	L	100.0	76.0	98.5	28.4	22.6	24.52	26.2	22.7	-	-	-

Aparecida de Goiania - Estação CELG Estação Aparecida de Goiania - Novembro de 2019

Para ver os dados horários clique no dia desejado

Dia	Precip.	Prec. Acum.	Vel. Vent. (m/s)	Dir. Vent.	Umid. Relat. AR (Max) %	Umid. Relat. AR (Min) %	Umid. Relat. AR (Média)%	Temp. Max. °C Dia	Temp. Min. °C Dia	Temp. Med. °C do Ar	Temp. 09:00h	Temp. 21:00h	Ponto orvalho	Razao Mistura
1	6.40	6.40	1.0	S	84.0	33.0	62.2	33.5	20.6	24.72	27.9	20.8	17.03333	13.4514
2	0.00	6.40	1.1	S	85.0	37.0	53	32.5	20.1	26.46	25.7	27	17.22917	13.6736
3	0.00	6.40	1.4	N	71.0	45.0	60.2	30.4	21.7	25.46	25.6	24.8	17.47500	13.8194
4	1.80	8.20	1.3	N	79.0	33.0	59.2	34.0	22.2	26.44	27.8	24.1	17.80000	14.1736
5	0.20	8.40	1.0	N	82.0	36.0	62.7	33.8	21.1	25.84	27.3	23.5	18.37917	14.6597
6	0.00	8.40	1.0	NO	79.0	42.0	63.5	31.1	21.9	25.66	24.5	25.4	18.46250	14.6667
7	0.00	8.40	0.9	S	82.0	46.0	60.5	31.4	21.6	26.14	25.1	26.3	18.81250	15.1667
8	0.00	8.40	0.9	SE	85.0	60.0	70.7	28.7	21.2	24.9	22.6	26	19.22083	15.5694
9	0.20	8.60	1.5	L	78.0	30.0	53	34.9	22.9	27.1	28.3	24.7	17.51250	13.7639
10	0.00	8.60	0.9	S	83.0	35.0	56	33.5	20.7	26.26	25.5	25.8	17.59583	13.9583
11	2.60	11.20	0.9	S	76.0	36.0	56	34.0	21.9	26.7	28.6	24.5	17.75417	14.1250
12	2.60	13.80	0.9	S	81.0	30.0	50.5	34.8	21.3	27.76	27.3	27.7	17.34583	13.8333
13	0.00	13.80	2.1	N	76.0	27.0	37.5	33.8	21.3	28.86	28.6	30.3	15.21667	12.0764
14	0.00	13.80	1.0	N	75.0	39.0	59	33.6	22.5	26.7	28.4	24.5	17.94167	14.2847
15	4.40	18.20	0.8	NO	89.0	45.0	73.7	31.2	21.1	24.5	27.6	21.3	18.34583	14.7361
16	0.40	18.60	0.7	N	94.0	58.0	72.5	27.8	20.7	24.32	22.9	25.1	19.59583	15.9583
17	0.00	18.60	1.1	NO	85.0	50.0	65	30.8	21.3	25.62	25.4	25.3	19.14583	15.5417
18	20.60	39.20	1.5	SE	94.0	58.0	80.7	27.9	18.8	21.62	22	19.7	18.47500	14.7500
19	7.00	46.20	0.8	SO	95.0	57.0	85.7	29.2	19.8	22.94	24.3	20.7	19.39167	15.5000
20	0.00	46.20	1.2	N	93.0	49.0	79	29.8	20.0	23.7	25.3	21.7	18.91667	15.1667
21	0.00	46.20	1.4	L	91.0	47.0	63.5	29.6	19.3	24.18	24.2	23.9	18.05417	14.3819
22	3.00	49.20	1.5	S	93.0	51.0	70.7	29.2	19.0	23.72	23.6	23.4	18.49167	14.8264
23	6.00	55.20	0.7	N	85.0	49.0	74.7	29.8	22.2	24.76	27.2	22.3	18.88333	15.1597
24	9.80	65.00	1.1	NO	93.0	44.0	74.7	31.7	20.1	23.84	26.4	20.5	18.91667	15.0833
25	2.00	67.00	1.0	N	94.0	53.0	78.5	31.2	19.7	24.18	22.8	23.6	19.67500	15.9583
26	0.40	67.40	1.2	N	84.0	54.0	71.5	29.9	20.6	25.32	25.9	25.1	19.51667	15.9097
27	6.20	73.60	1.0	SE	94.0	74.0	83.7	25.6	20.6	23.56	24.2	23.7	20.60833	16.8264
28	13.20	86.80	1.1	N	94.0	71.0	90.2	26.8	21.2	22.9	23.7	21.4	20.51667	16.9167
29	3.20	90.00	1.1	NO	96.0	59.0	80	29.7	21.0	24.02	23.2	23.1	20.69583	17.0000
30	1.20	91.20	0.8	SE	95.0	79.0	85.5	26.5	21.2	23.7	24.6	23.1	20.87917	17.1319

Abadia de Goiás - Estação Abadia de Goiás - Novembro de 2019

Para ver os dados horários clique no dia desejado

Dia	Precip.	Prec. Acum.	Vel. Vent. (m/s)	Dir. Vent.	Umid. Relat. AR (Max) %	Umid. Relat. AR (Min) %	Umid. Relat. AR (Média)%	Temp. Max. °C Dia	Temp. Min. °C Dia	Temp. Med. °C do Ar	Temp. 09:00h	Temp. 21:00h	Ponto orvalho	Razao Mistura	Radiação Solar Diária MJ/m²
1	8.80	8.80	2.3	NO	87.0	31.0	53	32.5	19.6	25.64	28.3	23.9	-	-	18.5
2	0.00	8.80	2.5	SE	92.0	37.0	56.7	31.6	19.0	25.32	26.4	24.8	-	-	19.7
3	0.00	8.80	2.8	N	82.0	40.0	63.7	29.9	20.5	24.42	25.1	23.3	-	-	19.5
4	12.20	21.00	2.1	N	91.0	33.0	65.7	33.1	19.8	24.9	28.4	21.6	-	-	19.1
5	5.20	26.20	1.9	NO	90.0	41.0	68.7	31.6	20.0	25.28	28	23.4	-	-	14.1
6	0.00	26.20	2.0	NO	87.0	47.0	70.2	29.4	20.4	23.92	23.6	23.1	-	-	14.6
7	0.00	26.20	1.9	SE	95.0	44.0	63	31.6	19.6	24.76	25.6	23.5	-	-	16.5
8	0.00	26.20	2.6	SO	92.0	59.0	73.2	28.3	20.7	23.88	22.8	23.8	-	-	12.3
9	16.40	42.60	3.2	SE	90.0	31.0	66.2	34.6	20.1	24.6	28.1	20.1	-	-	19.1
10	0.00	42.60	1.8	SO	96.0	35.0	61.5	32.5	19.1	24.96	26	23.6	-	-	18.8
11	1.00	43.60	2.3	NO	84.0	38.0	60.7	33.1	20.9	25.32	28.4	22.1	-	-	18
12	0.00	43.60	2.5	O	88.0	32.0	52.2	33.3	20.6	26.52	26.1	26.3	-	-	18.1
13	0.00	43.60	2.3	N	87.0	29.0	43	33.2	19.7	27.14	27.6	27.6	-	-	18.9
14	0.00	43.60	1.7	NO	89.0	40.0	59.2	31.1	20.4	25.78	27.8	24.8	-	-	15.2
15	11.40	55.00	1.6	NO	96.0	47.0	79.5	30.1	19.8	23.72	27.9	20.4	-	-	12.8
16	0.20	55.20	1.2	N	98.0	57.0	75.7	28.3	20.0	23.12	22.3	22.5	-	-	12
17	0.20	55.40	2.0	NO	95.0	59.0	76.7	28.6	20.0	24.14	25.3	23.4	-	-	13.4
18	12.60	68.00	2.1	L	95.0	60.0	88	26.8	19.2	21.72	22.6	20	-	-	7.1
19	1.00	69.00	1.6	L	97.0	52.0	85	28.3	19.7	22.74	23.9	20.9	-	-	10.5
20	0.00	69.00	1.9	L	94.0	51.0	82	28.0	20.0	22.98	25.3	20.8	-	-	8.6
21	0.00	69.00	2.5	SE	97.0	44.0	64.5	29.0	19.1	23.52	24.9	22.3	-	-	18.2
22	0.00	69.00	2.9	L	97.0	46.0	64	29.1	18.3	23.78	24.3	23.6	-	-	15.8
23	4.40	73.40	2.1	NO	95.0	44.0	73	29.4	20.0	23.96	27	21.7	-	-	8.2
24	48.00	121.40	2.3	N	97.0	44.0	77.2	30.3	18.9	22.78	25.1	19.8	-	-	16.7
25	0.40	121.80	2.2	NO	97.0	52.0	75	29.0	19.6	23.74	24.1	23	-	-	15.9
26	0.00	121.80	1.9	L	91.0	52.0	69.7	29.8	19.4	24.58	26.5	23.6	-	-	18.3
27	7.60	129.40	1.9	L	97.0	69.0	82.2	26.3	20.1	23.14	25.1	22.1	-	-	10.2
28	15.60	145.00	1.9	NO	98.0	75.0	90.5	25.1	20.0	22.2	23.9	21	-	-	5.8
29	8.00	153.00	1.9	NO	97.0	67.0	89	27.1	20.0	22.74	22.6	22	-	-	12.1
30	9.80	162.80	1.5	L	97.0	67.0	80	26.5	20.7	23.06	25.9	21.1	-	-	7.6

NOTÍCIAS RELACIONADAS

<https://diaonline.com.br/video-on-demand/chuva-causa-estragos-em-caldas-novas/>



TV SERRA DOURADA 28 DE OUTUBRO DE 2019

CHUVA CAUSA ESTRAGOS EM CALDAS NOVAS

12:54:01

00:03 00:53

WhatsApp Facebook Twitter Email Link

<https://www.opopular.com.br/noticias/cidades/temporal-causa-estragos-e-deixa-caldas-novas-sem-energia-1.1918698>

Classi | Clube O Pop

O Popular 62 99995 2795 BUSCAR 3 ALEXANDRE x AM

CAPA POLÍTICA ECONOMIA MUNDO **CIDADES** ESPORTE MAGAZINE LUDOVICA OPINIÃO ESPECIAIS VÍDEOS INFOMERCIAL GUIAS



Pedro Nunes



Temporal causa estragos e deixa Caldas Novas sem energia

O telhado de uma drogaria chegou a cair com clientes dentro nesta tarde e árvores e postes também caíram. Enel informou que trabalha para tentar normalizar o serviço.

27/10/2019 - 23:04

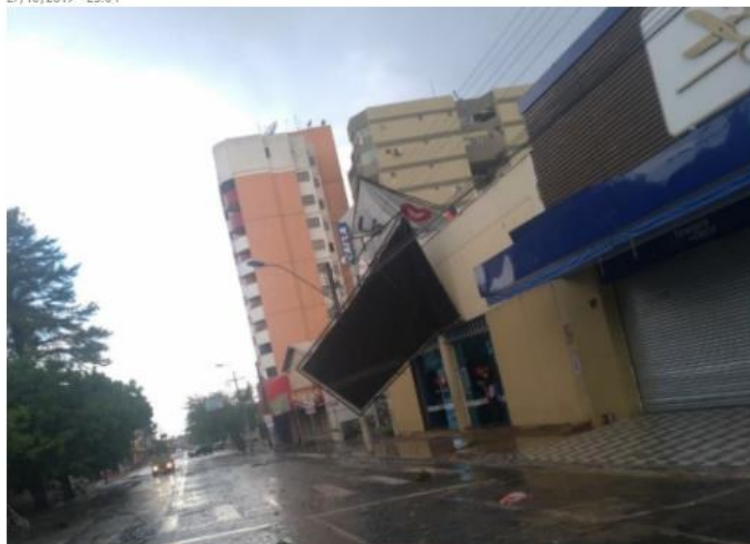

(Foto: Reprodução/ Twitter)

<https://www.cbngoiania.com.br/programas/cbn-goiania/cbn-goi%C3%A2nia-1.213644/temporal-causa-p%C3%A2nico-e-in%C3%BAmeros-estragos-na-cidade-de-caldas-novas-1.1918846>

CBN Goiânia

97,1 FM

CAPA PROGRAMAS ▾ BOLETINS ▾ COMENTARISTAS ▾ FALE CONOSCO EXPEDIENTE

CBN Goiânia

CHUVA | 28 de Outubro de 2019

Recomendar 0 Tweet

Temporal causa pânico e inúmeros estragos na cidade de Caldas Novas



A forte chuva que caiu na ontem à tarde em Caldas Novas, no sudeste goiano, deixou diversos estragos pela cidade. O temporal, que foi acompanhado de ventania e granizo, deixou parte do município sem energia elétrica.

Sobre o assunto, Luiz Geraldo e Mariani Ribeiro conversaram com Joyce Ferreira - chefe da defesa civil em Caldas Novas e Capitã do Corpo de Bombeiros. Acompanhe!



<https://www.emaisgoias.com.br/chuva-forte-e-granizo-causam-estragos-em-caldas-novas-neste-domingo-27/>



5 divirta-se brasil cidades esportes entretenimento economia tecnolo

Chuva forte e granizo causam estragos em Caldas Novas neste domingo (27)

Chuva e granizo deixaram vias alagadas e causou diversos estragos pelas ruas da cidade. Vento forte derrubou outdoors e fachadas de estabelecimentos

Da Redação
Do Mais Goiás | Em: 27/10/2019 às 18:30:33



<https://globoplay.globo.com/v/8039450/>

globoplay Agora na Globo Novelas Séries Cinema Infantil Mais ▾

#BomDiaGoias



GO 7:29 **TEMPORAL EM CALDAS** AO VIVO
Chuva durou 30 minutos e causou muitos estragos

Bom Dia GO >

Chuva provoca estragos em Caldas Novas

6 min Exibição em 28 Out 2019

globoplay Agora na Globo Novelas Séries Cinema Infantil Mais ▾

#BomDiaGoias



GO 7:30 **imagens**
01:35 / 05:30 **RAFAEL OLIVEIRA**

Bom Dia GO >

Chuva provoca estragos em Caldas Novas

6 min Exibição em 28 Out 2019



MUNICÍPIO DE CALDAS NOVAS

DECRETO Nº 1.774/2019

DE 31 DE OUTUBRO DE 2019.

**“DECLARA SITUAÇÃO DE EMERGÊNCIA EM
RAZÃO DO TEMPORAL (ANTICLONE), NAS
ÁREAS DO MUNICÍPIO DE CALDAS NOVAS,
AFETADAS PELAS CHUVAS”**

O PREFEITO DO MUNICÍPIO DE CALDAS NOVAS, Estado de Goiás, no uso da competência e das atribuições que lhe conferem as Constituições da República e do Estado de Goiás, bem como a Lei Orgânica Municipal, e

CONSIDERANDO o caos instalado no Município em razão das chuvas acompanhadas das fortíssimas correntes de ventos na tarde do dia 27 (vinte e sete) de outubro de 2019, mais precisamente por volta das 16h (dezesesseis horas);

CONSIDERANDO o registro de índice pluviométrico muito superior ao habitual, com fortíssimas correntes de ventos, causando inúmeros prejuízos humanos e materiais ao município, em residências, em estabelecimentos comerciais, prédios, equipamentos públicos e hospitais;

CONSIDERANDO que as intempéries acarretaram uma série de problemas e danos em diversas regiões rurais, com a ocorrência de grande número de queda de árvores nas redes elétricas; o que causou diversas perdas, partindo cabos elétricos;

CONSIDERANDO ainda, os danos causados na zona urbana do município, como danos às calçadas, destelhamento de residências, destruição de fachadas de prédios comerciais e públicos;

CONSIDERANDO por fim que, de acordo com os serviços de meteorologia a cidade de Caldas Novas foi atingida por um anticiclone, com chuva de granizo, com ventos de mais de 100km/h, causando danos em vários bairros e assustando toda a população e os turistas.

DECRETA:

Art. 1º. Fica Decretada situação de emergência e estado de calamidade pública no município entre os dias 27 de outubro de 2019 à 15 de novembro de 2019.

Art. 2º. Autoriza-se a mobilização de todos os órgãos municipais para atuarem sob a coordenação do Órgão Municipal de Proteção e Defesa Civil, nas ações de resposta aos danos e reabilitação do cenário e reconstrução.

Art. 3º. Este Decreto entrará em vigor na data de sua publicação, para que surta todos os seus jurídicos e legais efeitos.

Cumpra-se e Publique-se.

GABINETE DO PREFEITO DE CALDAS NOVAS-GO, aos trinta e um dias do mês de outubro de 2019.

EVANDO MAGAL ABADIA CORREIA SILVA
Prefeito de Caldas Novas/GO