

Resumo Executivo

O Presente Relatório tem como objetivo a incorporação de informações que sejam relevantes para que se possa fazer a devida associação aos dados contidos no corpo do documento objeto da classificação de Situação de Emergência caracterizada pelo Módulo 8 do Prodist, que tem como foco o impacto do evento sobre determinada rede geelétrica e cuja denominação é definida como CHI (Consumidor hora interrompido). O parâmetro para enquadramento nesta classificação de expurgo tem como premissa inicial o limite de Consumidor hora interrompido definido pela fórmula descrita no Módulo 01 do Prodist (Revisão - 9), acrescido de todos os outros informes e dados listados no Módulo 08 (Revisão 10) do Prodist. Este enquadramento se apresenta na maioria das vezes em condições climáticas adversas com severidade dos fatores inerentes a situação, caracterizado na maioria dos casos por fortes ventos e chuvas de grande intensidade e continuidade.

Entre o dia 05/11/2019 – terça-feira – e o dia 06/11/2019 – quarta-feira – O ar quente e úmido sobre a região central do Brasil favoreceu a formação de nuvens de tempestade, do tipo Cumulonimbus, avançaram sobre o continente e ajudaram a organizar áreas de instabilidade sobre as Regiões da Enel Distribuição Goiás.

Entre as 09h30 do dia 05 e 08h00 do dia 06 de novembro de 2019 tivemos, em todo o Estado de Goiás, a incidências de 28.372 descargas atmosféricas (15.896 raios nuvem-solo e 12.476 descargas nuvem-nuvem) sobre a região, o que causou grande instabilidade na rede.

Conforme informações do Climatempo Meteorologia, o Instituto Nacional de Meteorologia (INMET) detectou rajadas de vento acima de 50km/h durante o período. A máxima rajada registrada foi de 71,3km/h entre as 14h e 16h do dia 05 de novembro, sendo esse vento classificado como ventania pela escala Beaufort.

Queda de árvores e ventania provocam danos em bairros de Goiânia; veja vídeos - Jornal O Popular.

Entre os efeitos da chuva que caiu em algumas regiões da capital nessa terça-feira (5), está a interrupção do fornecimento de energia elétrica. Veja mais em:

<https://www.opopular.com.br/noticias/cidades/queda-de-%C3%A1rvores-e-ventania-provocam-danos-em-bairros-de-goi%C3%A2nia-veja-v%C3%ADdeos-1.1925552> -

Chuva forte derruba árvore em cima de poste em Goiânia – Moradores ficaram sem energia elétrica.

Acesso em: <<https://globoplay.globo.com/v/8062814/>>.

Outro poste é encontrado no chão após chuva na Grande Goiânia

.Acesso em: <http://g1.globo.com/goias/bom-dia-go/videos/t/edicoes/v/outro-poste-e-encontrado-no-chao-apos-chuva-na-grande-goiania/8064394/>

Seis postes de energia caem durante chuva no Setor Maysa- Por causa dos acidentes, várias casas ficaram sem energia. Acesso em: <<https://globoplay.globo.com/v/8061773/>>

Tempestade de poeira assusta moradores de Santa Helena de Goiás - Segundo o Cimehgo, vento de mais de 60Km/h sobre a terra arada 'sem cobertura vegetal' fez a poeira subir formando uma gigantesca nuvem que encobriu parte do município. Acesso em:

<https://g1.globo.com/go/goias/noticia/2019/11/05/tempestade-de-poeira-assusta-moradores-de-santa-helena-de-goias.ghtml>.

Relatório de Ocorrências do período

Em todo o Estado de Goiás verificou-se também que a intensidade da chuva e dos ventos danificaram a rede de distribuição de energia elétrica em diversos pontos, registrando aproximadamente 222 mil clientes com interrupção no fornecimento de energia elétrica devido a eventos relacionados ao temporal.

Para otimizar o volume de atendimentos e reduzir os tempos de interrupção foram mobilizados os recursos extras da empresa que aumentou o contingente em relação a situação normal de operação. O acompanhamento da quantidade de equipes e o Tempo Médio de Atendimento podem ser consultados na Pág.02 do Relatório em anexo.

O impacto e severidade do evento estão relatados em artigos de mídia, como fotos e reportagens que demonstram os danos na Rede de Distribuição, oriundos dos eventos climáticos no período. Eventos estes que afetaram 222.264 consumidores com CHI de 638.577,88 superior ao de 482.391,86 estabelecido como limite para definição de Situação de Emergência, conforme resumo das informações obrigatórias.

Empresa	ENEL DISTRIBUIÇÃO GOIÁS				
Código do Relatório	CHI-020 - ENEL DISTRIBUIÇÃO GOIÁS				
Evento:	TEMPORAL NA AREA DE CONCESSÃO DA ENEL DISTRIBUIÇÃO GOIAS				
Código COBRADE:	1.3.2.1.2, 1.3.2.1.4 e 1.3.2.1.5	Data Inicio	05/11/2019	Hora início	09h40
Código do Evento:	CHI-020-ENEL GO	Data Término	06/11/2019	Hora Término	08h59
Valor CHI (Limite e Real)	482.391,86	638.577,88	Subestações Atingidas CACHOEIRA ALTA / QUEBRA LINHA / GOIANIRA / CAMPOS VERDES / PROFESSOR JAMIL / NOVO PLANALTO / GOYA / PARQUE DAS EMAS (MINEIROS) / CALCILANDIA / ITIQUIRA (FORMOSA) / PLANALTINA (TRANSMISSAO) / IACIARA / POSSE / PLANALTINA / CABECEIRAS / MONTE ALEGRE / ITAPACI (TRANSMISSAO) / MARA ROSA / NIQUELANDIA / SAO MIGUEL DO ARAGUAIA / MINACU / SANTA TEREZINHA / PARQUE DAS NACOES / NOVA IGUACU / MORRINHOS / CALDAS NOVAS / DESTILARIA BRASIL CENTRAL / PACAEMBU (NOVO GAMA) / CUMARI / BONOPOLIS / VILA CORUMBA / APORE / PARAUNA SE ALTA TENSÃO / COLINACU / BACURI (RIO VERDE) / ARARAS / RIO VERMELHO / SAO DOMINGOS / CROMINIA / FLORES DE GOIAS / CABRIUVA (RIO VERDE) / INDIARA / JATAI / CAMPO NOVO / MATRINCHA / VALPARAISO / SANTA ROSA DO MEIA PONTE / SAO LUIZ DOS MONTES BELOS / MINEIROS / OUIDOR / AMERICANO (RIO VERDE) / RUBIATABA / PORANGATU / PADRE BERNARDO / MONTIVIDIU T / CAMPOS BELOS / SENADOR CANEDO TRANSMISSAO / ATLANTICO / CACHOEIRA NOVA / IPORA / COCALZINHO / MARAJOARA / PIRENOPOLIS / GOIANESIA / SAO JOAO D ALIANCA / PORTELANDIA / BOA VISTA / SERRA DE CALDAS / SANTA HELENA / INDEPENDENCIA / ALEXANIA / JUNDIAI / CEBRASA FABRICA DA AMBEV / CARAJAS / HIDROLANDIA / RIO VERDE / AGUAS LINDAS / JARANAPOLIS / CAIAPONIA / PIRES DO RIO / SERRANOPOLIS / SERRA AZUL (JATAI) / BELA VISTA (TRANSMISSAO) / JARAGUA / ITUMBIARA NOVA / FERROVIARIO / ANAPOLIS UNIVERSITARIA / MAMBAI / CATALAO / BURITI ALEGRE / GOIANIA LESTE / VIANOPOLIS / GAMELEIRA / JOVIANIA / ABADIANIA / ARAGUAZ / SAO FRANCISCO DE GOIAS / ACREUNA / GOIAS / APARECIDA DO RIO DOCE / QUIRINOPOLIS / CALDAZINHA / ENERSUL / REAL / CAMPINAS / SUCURI / IPAMERI / URUACU / SANTO ANTONIO DO DESCOBERTO / MEIA PONTE / BARRO ALTO / RIO PRETO / GOIANDIRA / TRES BARRAS / PALMELO / RIVERLANDIA (RIO VERDE) / FORMIGA / PONTALINA / NOVA CRIXAS (TRANSMISSAO) / PAMPLONA / ITARUMA / CAMPO ALEGRE DE GOIAS / CAMPINORTE / PALMEIRAS DE GOIAS / PILAR / HIDROLINA / NAZARIO / GOIATUBA / PORTEIRAO / FORMOSO / MAIRIPOTABA / OURO VERDE DE GOIAS / ITAPACI / IPEGUARI / ITAJA / PIRES BELO / PIRACANJUBA / ARAGOIANIA / PALMEIRAS / CACHOEIRA DOURADA / ORIZONA / JUSSARA / ISRAELANDIA / NOVO BRASIL / CORUMBAIBA / NOVA AMERICA / SAO SIMAO / ITUMBIARA VELHA / NOVO GAMA / TAQUARI / NOVA AURORA / VARJAO / LAGOA DO BAUZINHO (RIO VERDE) / CARAIBAS / ALEXANIA TRANSMISSAO / VICENTINOPOLIS / INHUMAS / TRINDADE / JANDAIA / NOVA PONTE / PARANA / SILVANIA / PALMINOPOLIS / RIO CLARO JATAI MONTIVIDIU / CIDADE OCIDENTAL / CORUMBA / ZELANDIA / INACIOLANDIA / MOZARLANDIA / BARCELONA / URUTAI / TEREZOPOLIS / BARREIRO (PORANGATU) / PARANAIGUARA / JACILANDIA / ITAPURANGA / ARAGARCAS / PIRANHAS T / ESTRELA DO NORTE / NOVA VENEZA / PALESTINA / JUSCELANDIA / ARACU / ITAUCU / ALMERINDONOPOLIS / CRISTALINA TRANSMISSAO / ITAGUARI / PORTO SAO SIMAO / SANTO ANTONIO DE GOIAS / ALOANDIA / FIRMINOPOLIS / BURITI DE GOIAS / GUAPO / ITABERAI / SANTA FE DE GOIAS / CEPALGO / DORCELINO PEIXOTO DE MORAES / HEITORAI / SANCLERLANDIA / TURVELANDIA / PETROLINA / MUTUNOPOLIS / CHAPADAO DO CEU / CRIXAS / LAGES / MONTES CLAROS DE GOIAS / ITAGUARU / DESFECHO / BONITO / DOVERLANDIA / GIRASSOL / ANHANGUERA / AMERICANO DO BRASIL / RIO DO PEIXE / PARANAIBA / MOSSAMEDES / SANTA ROSA DE GOIAS / SOUZALANDIA / ARENOPOLIS / CRISTIANOPOLIS / SANTA TEREZA DE GOIAS / ALPHAVILLE / BRITANIA / SAO JUDAS TADEU / CEMAT/BALIZA / MOZARLANDIA (TRANSMISSAO) / AGUA LIMPA (MARZAGAO) / FAINA / ITAPIRAPUA / AREIAS / AMORINOPOLIS / RETIRO / GOIAS / XIXA / TURVANIA / BOM JARDIM / ADELANDIA / ANICUNS / JAUPACI / AVELINOPOLIS / ALVORADA DO NORTE / SAO JOAO DA PARAUNA / SANTA ROSA / FAZENDA NOVA / PANAMA / SITIO DABADIA / ARUANA (TRANSMISSAO) / EDEALINA / BRITANIA (TRANSMISSAO) / CRISTALINA / URU / ROCHEDO (UEH) / AURILANDIA / GOIANAPOLIS / TERRA VERMELHA / MARIAPOLIS (PADRE BERNARDO) / EDEIA / VILA PROPICIO / BARBOSELANDIA / TRAJANOPOLIS (PADRE BERNARDO) / NAVESLANDIA (JATAI) / OLOANA / CAMPO LIMPO DE GOIAS / NEROPOLIS / ARUANA / TUCUNARE / FAZENDA CANADA / JURUMIRIM / MOIPORA / DIORAMA		
Código do Decreto (Se Houver):					
Quantidade de Interrupções (Evento)	1937				
Início 1ª Incidência (Data e Hora)	05/11/2019 09:40				
Início Ultima Incidência (Data e Hora)	06/11/2019 08:59				

Média de Duração das Incidências (h)	16,93		PLANALTO / PORANGATU / GOIANIA / MINEIROS / SERRANOPOLIS / ITABERAI / FORMOSA / PLANALTINA / GUARANI DE GOIAS / POSSE / CABECEIRAS / MONTE ALEGRE DE GOIAS / SAO LUIZ DO NORTE / MARA ROSA / ALTO PARAISO DE GOIAS / MINACU / AGUAS LINDAS DE GOIAS / ALTO HORIZONTE / MORRINHOS / CALDAS NOVAS / VALPARAISO DE GOIAS / CUMARI / BONOPOLIS / AGUA LIMPA / APORE / JANDAIA / PARAUNA / RIO VERDE / CAMPINACU / PEROLANDIA / RIO QUENTE / LUZIANIA / CAMPOS BELOS / CROMINIA / CAVALCANTE / INDIARA / JATAI / ITARUMA / MATRINCHA / ITUMBIARA / SAO LUIS DE MONTES BELOS / OUVIDOR / NOVA GLORIA / CAMPINORTE / PADRE BERNARDO / SAO MIGUEL DO ARAGUAIA / AMARALINA / MUTUNOPOLIS / SENADOR CANEDO / NOVO GAMA / IPORA / PIRENOPOLIS / JARAGUA / AGUA FRIA DE GOIAS / SAO JOAO D ALIANCA / SANTA HELENA DE GOIAS / APARECIDA DE GOIANIA / ALEXANIA / CORUMBA DE GOIAS / ANAPOLIS / HIDROLANDIA / MONTIVIDIU DO NORTE / TROMBAS / BALIZA / PIRES DO RIO / SILVANIA / DOVERLANDIA / BELA VISTA DE GOIAS / PANAMA / DAMIANOPOLIS / CATALAO / BURITI ALEGRE / ABADIANIA / GUARINOS / NOVA ROMA / GAMELEIRA DE GOIAS / JOVIANIA / ABADIA DE GOIAS / ARAGUAPAZ / ARUANA / MOZARLANDIA / SAO FRANCISCO DE GOIAS / ORIZONA / SANTO ANTONIO DA BARRA / URUACU / GOIAS / APARECIDA DO RIO DOCE / QUIRINOPOLIS / CALDAZINHA / ITAJA / PALMEIRAS DE GOIAS / IPAMERI / SANTO ANTONIO DO DESCOBERTO / GOIANDIRA / CRISTALINA / CACHOEIRA ALTA / EDEALINA / PONTALINA / VILA PROPICIO / IPIRANGA DE GOIAS / MUNDO NOVO DE GOIAS / HIDROLINA / ITAPACI / PILAR DE GOIAS / NAZARIO / PALMELO / GOIATUBA / EDEIA / TURVELANDIA / SANTA TEREZA DE GOIAS / MAIRIPOTABA / MONTIVIDIU / COCALZINHO DE GOIAS / GOIANESIA / UIRAPURU / ARAGOIANIA / CEZARINA / CACHOEIRA DOURADA / FORMOSO / FLORES DE GOIAS / FAZENDA NOVA / JUSSARA / NOVO BRASIL / CAIAPONIA / ISRAELANDIA / IACIARA / ACREUNA / PARANAIGUARA / CORUMBAIBA / CRIXAS / NOVA AMERICA / RUBIATABA / SAO SIMAO / SANTA CRUZ DE GOIAS / SAO MIGUEL DO PASSA QUATRO / ANHANGUERA / NOVA AURORA / GUAPO / VARJAO / VIANOPOLIS / VICENTINOPOLIS / INHUMAS / CATURAI / GOIANIRA / SANTA BARBARA DE GOIAS / PALMINOPOLIS / NOVA IGUACU DE GOIAS / CIDADE OCIDENTAL / INACIOLANDIA / NEROPOLIS / PORTELANDIA / ITAPIRAPUA / ITAPURANGA / ARAGARCAS / BOM JARDIM DE GOIAS / PIRANHAS / NOVA VENEZA / PALESTINA DE GOIAS / GOUVELANDIA / TEREZOPOLIS DE GOIAS / ARACU / ITAUUCU / ITAGUARI / TAQUARAL DE GOIAS / BARRO ALTO / SANTO ANTONIO DE GOIAS / FIRMINOPOLIS / SANCLERLANDIA / CAMPO ALEGRE DE GOIAS / ESTRELA DO NORTE / HEITORAI / MONTES CLAROS DE GOIAS / PETROLINA DE GOIAS / JESUPOLIS / BURITI DE GOIAS / CHAPADAO DO CEU / SANTA ROSA DE GOIAS / NOVA CRIXAS / SAO DOMINGOS / PROFESSOR JAMIL SAFADY / AMERICANO DO BRASIL / DIVINOPOLIS DE GOIAS / MOSSAMEDES / ARENOPOLIS / CRISTIANOPOLIS / TURVANIA / BRITANIA / ADELANDIA / ANICUNS / CARMO DO RIO VERDE / CERES / SAO PATRICIO / AMORINOPOLIS / AVELINOPOLIS / IVOLANDIA / ALVORADA DO NORTE / SIMOLANDIA / SITIO D ABADIA / VILA BOA / AURILANDIA / SAO JOAO DA PARAUNA / DISTRITO FEDERAL / MORRO AGUDO DE GOIAS / TERESINA DE GOIAS / URUTAI / FAINA / CACHOEIRA DE GOIAS / GOIANAPOLIS / LEOPOLDO DE BULHOES / MIMOSO DE GOIAS / DIORAMA / CAMPO LIMPO / OURO VERDE DE GOIAS / JAUPACI / SANTA FE DE GOIAS / MOIPORA
Duração da Incidência mais longa (h)	166,50		
Total de Clientes afetados	222.264		

DANOS CAUSADOS			
Equipamentos Danificado	Importância para o Sistema	Local	Quantidade
Disjuntor/Religador Operado	Proteção do Alimentador	Área de Concessão	97
Chaves Fusíveis Operada	Proteção de Ramais de Alimentadores	Área de Concessão	611
Transformador Operado	Proteção do Transformador	Área de Concessão	399

Relato técnico sobre a Intervenção realizada em Goiânia e Região Metropolitana			
Informações sobre Equipes	05/11	06/11	
Quantidade Usual	530	530	turmas
Quantidade Adicional	53	67	turmas
Quantidade Total	583	597	turmas
Tempos Médios			
Preparação	17,94	17,46	Horas
Deslocamento	0,69	0,68	Horas
Execução	2,28	2,34	Horas
TMAE	20,91	20,48	Horas

Principais Dificuldades Encontradas:

Chuvas com ventos fortes provocaram muitos pontos de alagamento e enxurrada, trânsito impedido por vários semáforos desligados dificultando a chegada ao atendimento das ocorrências emergenciais. Em determinadas regiões, decorrente dos fortes ventos, houve o tombamento de árvores nas estruturas de alimentação de média tensão, danos em ramais de ligação dos clientes, impedimentos de acesso e atolamentos em estradas rurais.

Empresa	ENEL DISTRIBUIÇÃO GOIAS		
Valor CHI (Limite e Real)	482.391,86		638.577,88

DOC ORIGEM	MIUNICIPIO	EQP_ORIGEM	CONJUNTO	INI_OCORRENC	FIM_OCORRENC	DT_INI_EVENTO	DT_FIM_EVENTO	DURAC	UC INT	CHI	EXPURGO
20191110297	CACU	CC12196048	CACHOEIRA ALTA	05/11/2019 16:30	05/11/2019 20:35	05/11/2019 16:30	05/11/2019 20:35	4,07	18	73,24	CHI
20191119496	NIQUELANDIA	NQ21310108	BARRO ALTO	05/11/2019 16:15	07/11/2019 08:25	05/11/2019 16:15	07/11/2019 08:25	40,16	4	160,62	CHI
20191120747	TRINDADE	TR12393570	GOIANIRA	05/11/2019 12:44	05/11/2019 14:40	05/11/2019 12:44	05/11/2019 14:40	1,93	12	23,14	CHI
20191128997	CAMPOS VERDES	VD12201660	SANTA TEREZINHA	05/11/2019 16:24	06/11/2019 00:09	05/11/2019 16:24	06/11/2019 00:09	7,74	21	162,59	CHI
20191128997	SANTA TEREZINHA DE GOIAS	VD12201660	SANTA TEREZINHA	05/11/2019 16:24	06/11/2019 00:09	05/11/2019 16:24	06/11/2019 00:09	7,74	45	348,41	CHI
20191129613	PIRACANJUBA	PJ12268166	ROCHEDO	05/11/2019 17:54	06/11/2019 15:19	05/11/2019 17:54	06/11/2019 15:19	21,42	157	3362,42	CHI
20191129613	PIRACANJUBA	PJ12268166	ROCHEDO	05/11/2019 17:54	06/11/2019 15:19	05/11/2019 20:07	06/11/2019 15:19	19,20	14	268,80	CHI
20191131049	NOVO PLANALTO	TA12139159	NOVO PLANALTO	05/11/2019 17:20	06/11/2019 20:51	05/11/2019 17:20	06/11/2019 20:51	27,50	12	330,04	CHI
20191131049	PORANGATU	TA12139159	NOVO PLANALTO	05/11/2019 17:20	06/11/2019 20:51	05/11/2019 17:20	06/11/2019 20:51	27,50	28	770,09	CHI
20191131242	GOIANIA	GN12001014	GOYA S2	05/11/2019 17:31	06/11/2019 15:14	05/11/2019 17:31	06/11/2019 15:14	21,71	5	108,54	CHI
20191133658	MINEIROS	MY10396070	PARQUE DAS EMAS	05/11/2019 14:52	06/11/2019 00:41	05/11/2019 14:52	06/11/2019 00:05	9,23	33	304,63	CHI
20191133658	MINEIROS	MY12341117LD	PARQUE DAS EMAS	05/11/2019 14:52	06/11/2019 00:41	05/11/2019 14:52	06/11/2019 00:41	9,83	89	874,72	CHI
20191133658	SERRANOPOLIS	MY12341117LD	PARQUE DAS EMAS	05/11/2019 14:52	06/11/2019 00:41	05/11/2019 14:52	06/11/2019 00:41	9,83	5	49,14	CHI
20191134500	ITABERAI	IB21093879	ITABERAI S1	05/11/2019 18:26	06/11/2019 18:00	05/11/2019 18:26	06/11/2019 18:00	23,55	1	23,55	CHI
20191134683	FORMOSA	FA21257561	ITUIQUIRA	05/11/2019 09:46	05/11/2019 14:43	05/11/2019 09:46	05/11/2019 14:43	4,94	1	4,94	CHI
20191134709	FORMOSA	FA12376671	ITUIQUIRA	05/11/2019 09:48	05/11/2019 13:31	05/11/2019 09:48	05/11/2019 13:31	3,70	34	125,92	CHI
20191134754	FORMOSA	PI12164599	PLANALTINA	05/11/2019 09:58	05/11/2019 15:27	05/11/2019 09:58	05/11/2019 15:27	5,48	1	5,48	CHI
20191134754	PLANALTINA	PI12164599	PLANALTINA	05/11/2019 09:58	05/11/2019 15:27	05/11/2019 09:58	05/11/2019 15:27	5,48	1	5,48	CHI
20191134806	PLANALTINA	2960087155	PLANALTINA	05/11/2019 10:09	06/11/2019 17:17	05/11/2019 10:09	06/11/2019 17:17	31,14	1	31,14	CHI
20191134828	GUARANI DE GOIAS	6244566	IACIARA S1	05/11/2019 10:12	05/11/2019 17:41	05/11/2019 10:12	05/11/2019 17:41	7,47	1	7,47	CHI
20191134842	POSSE	PS11329710	IACIARA S2	05/11/2019 10:14	05/11/2019 11:17	05/11/2019 10:14	05/11/2019 11:17	1,04	31	32,28	CHI
20191134853	PLANALTINA	2960249817	PLANALTINA	05/11/2019 10:16	05/11/2019 18:50	05/11/2019 10:16	05/11/2019 18:50	8,55	1	8,55	CHI
20191134925	CABECEIRAS	860018260	ITUIQUIRA	05/11/2019 10:29	05/11/2019 18:26	05/11/2019 10:29	05/11/2019 18:26	7,94	1	7,94	CHI
20191134993	MONTE ALEGRE DE GOIAS	MA21349964	SAO DOMINGOS	05/11/2019 10:41	06/11/2019 12:55	05/11/2019 10:41	06/11/2019 12:55	26,23	1	26,23	CHI
20191134995	SAO LUIZ DO NORTE	SZ21143543	ITAPACI	05/11/2019 10:41	06/11/2019 14:40	05/11/2019 10:41	06/11/2019 14:40	27,97	1	27,97	CHI
20191135030	MARA ROSA	2260023030	MARA ROSA	05/11/2019 10:48	08/11/2019 18:01	05/11/2019 10:48	08/11/2019 18:01	79,21	1	79,21	CHI
20191135036	NIQUELANDIA	NQ12290033	NIQUELANDIA SUBTRANSMISSAO	05/11/2019 10:49	06/11/2019 15:50	05/11/2019 10:49	06/11/2019 15:50	29,01	4	116,04	CHI
20191135049	ALTO PARAISO DE GOIAS	BF10400725	NIQUELANDIA SUBTRANSMISSAO	05/11/2019 10:39	06/11/2019 20:55	05/11/2019 10:39	05/11/2019 13:12	2,55	11	28,05	CHI
20191135049	ALTO PARAISO DE GOIAS	BF10400725	NIQUELANDIA SUBTRANSMISSAO	05/11/2019 10:39	06/11/2019 20:55	05/11/2019 10:39	05/11/2019 15:18	4,65	395	1835,87	CHI
20191135049	ALTO PARAISO DE GOIAS	BF10400725	NIQUELANDIA SUBTRANSMISSAO	05/11/2019 10:39	06/11/2019 20:55	05/11/2019 17:00	05/11/2019 17:33	0,55	406	224,77	CHI
20191135049	ALTO PARAISO DE GOIAS	BF10400725	NIQUELANDIA SUBTRANSMISSAO	05/11/2019 10:39	06/11/2019 20:55	05/11/2019 10:39	05/11/2019 18:40	8,00	2	16,00	CHI
20191135049	ALTO PARAISO DE GOIAS	BF10400725	NIQUELANDIA SUBTRANSMISSAO	05/11/2019 10:39	06/11/2019 20:55	05/11/2019 10:39	05/11/2019 19:37	8,95	7	62,66	CHI

20191135049	ALTO PARAISO DE GOIAS	BF13248796	NIQUELANDIA SUBTRANSMISSAO	05/11/2019 10:39	06/11/2019 20:55	06/11/2019 11:45	06/11/2019 16:05	4,33	377	1633,25	CHI
20191135049	ALTO PARAISO DE GOIAS	BF13120581	NIQUELANDIA SUBTRANSMISSAO	05/11/2019 10:39	06/11/2019 20:55	06/11/2019 11:45	06/11/2019 18:02	6,28	31	194,65	CHI
20191135049	ALTO PARAISO DE GOIAS	BF10400725	NIQUELANDIA SUBTRANSMISSAO	05/11/2019 10:39	06/11/2019 20:55	05/11/2019 10:39	06/11/2019 18:42	32,04	56	1794,22	CHI
20191135049	ALTO PARAISO DE GOIAS	BF12208746	NIQUELANDIA SUBTRANSMISSAO	05/11/2019 10:39	06/11/2019 20:55	05/11/2019 10:39	06/11/2019 19:47	33,12	25	828,01	CHI
20191135049	ALTO PARAISO DE GOIAS	BF12231960	NIQUELANDIA SUBTRANSMISSAO	05/11/2019 10:39	06/11/2019 20:55	05/11/2019 10:39	06/11/2019 20:16	33,60	20	672,10	CHI
20191135049	ALTO PARAISO DE GOIAS	BF13120567	NIQUELANDIA SUBTRANSMISSAO	05/11/2019 10:39	06/11/2019 20:55	06/11/2019 09:59	06/11/2019 20:55	10,95	7	76,62	CHI
20191135059	NOVO PLANALTO	TA11338236	SAO MIGUEL DO ARAGUAIA	05/11/2019 10:54	10/11/2019 11:27	05/11/2019 10:54	10/11/2019 11:27	120,54	2	241,08	CHI
20191135084	MINACU	IH21252306	MINACU	05/11/2019 10:59	06/11/2019 13:53	05/11/2019 10:59	06/11/2019 13:53	26,89	1	26,89	CHI
20191135088	SANTA TEREZINHA DE GOIAS	7870000047	SANTA TEREZINHA	05/11/2019 10:59	05/11/2019 15:26	05/11/2019 10:59	05/11/2019 15:26	4,44	1	4,44	CHI
20191135110	AGUAS LINDAS DE GOIAS	4830243108	AGUAS LINDAS DE GOIAS S2	05/11/2019 11:04	05/11/2019 12:09	05/11/2019 11:04	05/11/2019 12:09	1,08	1	1,08	CHI
20191135118	ALTO HORIZONTE	AJ21318476	SANTA TEREZINHA	05/11/2019 11:04	09/11/2019 09:14	05/11/2019 11:04	09/11/2019 09:14	94,15	2	188,30	CHI
20191135136	MORRINHOS	MR11182639	MORRINHOS	05/11/2019 11:08	05/11/2019 13:43	05/11/2019 11:08	05/11/2019 13:43	2,58	125	322,29	CHI
20191135145	CALDAS NOVAS	CN12142379	CALDAS NOVAS S2	05/11/2019 11:01	05/11/2019 14:38	05/11/2019 11:01	05/11/2019 14:38	3,62	410	1482,95	CHI
20191135145	CALDAS NOVAS	CN12142379	CALDAS NOVAS S2	05/11/2019 11:01	05/11/2019 14:38	05/11/2019 14:05	05/11/2019 14:38	0,54	444	240,75	CHI
20191135158	FORMOSA	FA12194802	ITUIQUIRA	05/11/2019 11:13	05/11/2019 20:10	05/11/2019 11:13	05/11/2019 20:10	8,95	12	107,37	CHI
20191135168	VALPARAISO DE GOIAS	10012696526	PACAEMBU S2	05/11/2019 11:14	05/11/2019 12:43	05/11/2019 11:14	05/11/2019 12:43	1,47	1	1,47	CHI
20191135175	CUMARI	CY21336731	CATALAO S1	05/11/2019 11:15	05/11/2019 11:53	05/11/2019 11:15	05/11/2019 11:53	0,65	1	0,65	CHI
20191135187	BONOPOLIS	BX12136924	SAO MIGUEL DO ARAGUAIA	05/11/2019 11:18	06/11/2019 22:28	05/11/2019 11:18	06/11/2019 22:28	35,16	5	175,78	CHI
20191135207	PLANALTINA	PI21155427	PLANALTINA	05/11/2019 11:24	07/11/2019 10:50	05/11/2019 11:24	07/11/2019 10:50	47,43	1	47,43	CHI
20191135240	AGUA LIMPA	AL21166420	VILA CORUMBA	05/11/2019 11:30	06/11/2019 18:00	05/11/2019 11:30	06/11/2019 18:00	30,48	1	30,48	CHI
20191135303	APORE	AE12234186	ITAJA S1	05/11/2019 11:51	06/11/2019 10:50	05/11/2019 11:51	06/11/2019 10:50	22,98	1	22,98	CHI
20191135309	JANDAIA	05760414	PARAUNA	05/11/2019 13:33	05/11/2019 13:49	05/11/2019 13:33	05/11/2019 13:49	0,26	3	0,78	CHI
20191135309	PARAUNA	05760414	PARAUNA	05/11/2019 13:33	05/11/2019 13:49	05/11/2019 13:33	05/11/2019 13:49	0,26	236	61,69	CHI
20191135309	RIO VERDE	05760414	PARAUNA	05/11/2019 13:33	05/11/2019 13:49	05/11/2019 13:33	05/11/2019 13:49	0,26	2	0,52	CHI
20191135410	CAMPINACU	UC11269645	MARA ROSA	05/11/2019 11:40	05/11/2019 14:51	05/11/2019 11:40	05/11/2019 14:51	3,17	1	3,17	CHI
20191135437	MINACU	IH21208313	MINACU	05/11/2019 11:41	06/11/2019 09:05	05/11/2019 11:41	06/11/2019 09:05	21,39	1	21,39	CHI
20191135443	NIQUELANDIA	NQ21403460	NIQUELANDIA SUBTRANSMISSAO	05/11/2019 11:43	06/11/2019 03:46	05/11/2019 11:43	06/11/2019 03:46	16,05	1	16,05	CHI
20191135454	MINEIROS	MY12149301	PARQUE DAS EMAS	05/11/2019 11:02	06/11/2019 15:39	05/11/2019 11:02	06/11/2019 15:39	28,60	17	486,21	CHI
20191135454	PEROLANDIA	MY12149301	PARQUE DAS EMAS	05/11/2019 11:02	06/11/2019 15:39	05/11/2019 11:02	06/11/2019 15:39	28,60	1	28,60	CHI
20191135461	RIO VERDE	RV12260739	CABRIUVA S2	05/11/2019 11:36	06/11/2019 16:38	05/11/2019 11:36	06/11/2019 16:38	29,03	6	174,16	CHI
20191135481	MORRINHOS	MR21212265	MORRINHOS	05/11/2019 11:49	06/11/2019 16:00	05/11/2019 11:49	05/11/2019 18:10	6,34	1	6,34	CHI
20191135481	CALDAS NOVAS	MR13086111	MORRINHOS	05/11/2019 11:49	06/11/2019 16:00	05/11/2019 18:06	06/11/2019 10:07	16,01	2	32,03	CHI
20191135481	MORRINHOS	MR13086111	MORRINHOS	05/11/2019 11:49	06/11/2019 16:00	05/11/2019 18:06	06/11/2019 10:07	16,01	144	2305,88	CHI

20191135481	RIO QUENTE	MR13086111	MORRINHOS	05/11/2019 11:49	06/11/2019 16:00	05/11/2019 18:06	06/11/2019 10:07	16,01	19	304,25	CHI
20191135481	MORRINHOS	MR13190251	MORRINHOS	05/11/2019 11:49	06/11/2019 16:00	05/11/2019 18:06	06/11/2019 16:00	21,88	8	175,07	CHI
20191135495	LUZIANIA	120233370	RIO VERMELHO	05/11/2019 11:51	05/11/2019 18:20	05/11/2019 11:51	05/11/2019 18:20	6,48	1	6,48	CHI
20191135505	CAMPOS BELOS	MA12261962	SAO DOMINGOS	05/11/2019 11:53	05/11/2019 15:49	05/11/2019 11:53	05/11/2019 15:49	3,92	3	11,76	CHI
20191135513	CROMINIA	CQ21009389	PONTALINA	05/11/2019 11:55	09/11/2019 15:20	05/11/2019 11:55	09/11/2019 15:20	99,40	1	99,40	CHI
20191135514	CAVALCANTE	CJ21208761	FLORES DE GOIAS	05/11/2019 11:56	06/11/2019 17:27	05/11/2019 11:56	06/11/2019 17:27	29,51	1	29,51	CHI
20191135517	RIO VERDE	RV10396180	CABRIUVA S2	05/11/2019 11:47	08/11/2019 07:25	05/11/2019 11:47	05/11/2019 17:19	5,53	19	105,06	CHI
20191135517	RIO VERDE	RV10396180	CABRIUVA S2	05/11/2019 11:47	08/11/2019 07:25	05/11/2019 11:47	05/11/2019 19:25	7,63	10	76,27	CHI
20191135517	RIO VERDE	RV10396180	CABRIUVA S2	05/11/2019 11:47	08/11/2019 07:25	05/11/2019 19:34	05/11/2019 20:12	0,63	19	12,05	CHI
20191135517	RIO VERDE	RV10396180	CABRIUVA S2	05/11/2019 11:47	08/11/2019 07:25	05/11/2019 11:47	06/11/2019 13:55	26,12	18	470,14	CHI
20191135517	RIO VERDE	RV13238313	CABRIUVA S2	05/11/2019 11:47	08/11/2019 07:25	05/11/2019 19:34	06/11/2019 13:55	18,34	7	128,35	CHI
20191135517	RIO VERDE	RV10396180	CABRIUVA S2	05/11/2019 11:47	08/11/2019 07:25	06/11/2019 13:57	06/11/2019 14:10	0,22	19	4,20	CHI
20191135517	RIO VERDE	RV13238313	CABRIUVA S2	05/11/2019 11:47	08/11/2019 07:25	06/11/2019 13:57	07/11/2019 11:57	22,00	7	154,01	CHI
20191135517	RIO VERDE	RV13383958	CABRIUVA S2	05/11/2019 11:47	08/11/2019 07:25	06/11/2019 13:57	07/11/2019 12:57	23,00	12	275,99	CHI
20191135517	RIO VERDE	RV12279477	CABRIUVA S2	05/11/2019 11:47	08/11/2019 07:25	06/11/2019 13:57	07/11/2019 13:30	23,55	6	141,33	CHI
20191135517	RIO VERDE	RV12280128	CABRIUVA S2	05/11/2019 11:47	08/11/2019 07:25	05/11/2019 19:34	08/11/2019 07:25	59,84	3	179,52	CHI
20191135518	RIO VERDE	630380880	CABRIUVA S1	05/11/2019 11:57	05/11/2019 14:55	05/11/2019 11:57	05/11/2019 14:55	2,96	1	2,96	CHI
20191135519	CAVALCANTE	CJ12047981	FLORES DE GOIAS	05/11/2019 09:40	05/11/2019 17:42	05/11/2019 09:40	05/11/2019 17:42	8,02	1141	9147,33	CHI
20191135522	INDIARA	10000360080	EDEIA	05/11/2019 11:57	06/11/2019 12:00	05/11/2019 11:57	06/11/2019 12:00	24,05	1	24,05	CHI
20191135527	JATAI	10009305040	JATAI S2	05/11/2019 11:58	06/11/2019 01:03	05/11/2019 11:58	06/11/2019 01:03	13,07	1	13,07	CHI
20191135529	APORE	AE10396071	ITAJA S1	05/11/2019 11:53	06/11/2019 16:27	05/11/2019 11:53	05/11/2019 14:55	3,03	181	548,33	CHI
20191135529	ITARUMA	AE10396071	ITAJA S1	05/11/2019 11:53	06/11/2019 16:27	05/11/2019 11:53	05/11/2019 14:55	3,03	1	3,03	CHI
20191135529	APORE	AE13254716	ITAJA S1	05/11/2019 11:53	06/11/2019 16:27	05/11/2019 11:53	05/11/2019 17:32	5,64	66	372,39	CHI
20191135529	SERRANOPOLIS	AE13254716	ITAJA S1	05/11/2019 11:53	06/11/2019 16:27	05/11/2019 11:53	05/11/2019 17:32	5,64	46	259,54	CHI
20191135529	APORE	AE13254717	ITAJA S1	05/11/2019 11:53	06/11/2019 16:27	05/11/2019 11:53	05/11/2019 17:34	5,68	51	289,81	CHI
20191135529	APORE	AE13254717	ITAJA S1	05/11/2019 11:53	06/11/2019 16:27	05/11/2019 14:40	05/11/2019 17:34	2,90	5	14,48	CHI
20191135529	APORE	04320214	ITAJA S1	05/11/2019 11:53	06/11/2019 16:27	06/11/2019 15:59	06/11/2019 16:02	0,05	66	3,30	CHI
20191135529	SERRANOPOLIS	04320214	ITAJA S1	05/11/2019 11:53	06/11/2019 16:27	06/11/2019 15:59	06/11/2019 16:02	0,05	46	2,30	CHI
20191135529	APORE	AE13365050	ITAJA S1	05/11/2019 11:53	06/11/2019 16:27	05/11/2019 11:53	06/11/2019 16:27	28,56	30	856,82	CHI
20191135531	PLANALTINA	2960242677	PLANALTINA	05/11/2019 11:59	06/11/2019 09:25	05/11/2019 11:59	06/11/2019 09:25	21,42	1	21,42	CHI
20191135564	MATRINCHA	MP21299727	MATRINCHA	05/11/2019 12:05	05/11/2019 15:41	05/11/2019 12:05	05/11/2019 15:41	3,60	1	3,60	CHI
20191135572	VALPARAISO DE GOIAS	LZ12000369	MARAJOARA	05/11/2019 12:08	05/11/2019 13:57	05/11/2019 12:08	05/11/2019 13:57	1,81	276	500,48	CHI
20191135573	ITUMBIARA	IT12273930	CACHOEIRA DOURADA	05/11/2019 11:59	05/11/2019 19:56	05/11/2019 11:59	05/11/2019 19:11	7,19	9	64,73	CHI

20191135573	ITUMBIARA	CD12000215	CACHOEIRA DOURADA	05/11/2019 11:59	05/11/2019 19:56	05/11/2019 11:59	05/11/2019 19:56	7,95	6	47,67	CHI
20191135594	INDIARA	IY11007825	EDEIA	05/11/2019 11:48	05/11/2019 14:54	05/11/2019 11:48	05/11/2019 14:54	3,09	155	479,21	CHI
20191135602	FORMOSA	FA12270556	ITUIQUIRA	05/11/2019 10:39	05/11/2019 16:54	05/11/2019 10:39	05/11/2019 16:54	6,24	15	93,66	CHI
20191135618	SAO LUIS DE MONTES BELOS	SL21072355	SAO LUIZ DOS MONTES BELOS	05/11/2019 12:16	07/11/2019 14:54	05/11/2019 12:16	07/11/2019 14:54	50,62	1	50,62	CHI
20191135638	MINEIROS	10014980019	PARQUE DAS EMAS	05/11/2019 12:20	05/11/2019 17:46	05/11/2019 12:20	05/11/2019 17:46	5,43	1	5,43	CHI
20191135649	NIQUELANDIA	NQ21256340	NIQUELANDIA SUBTRANSMISSAO	05/11/2019 12:22	07/11/2019 10:13	05/11/2019 12:22	07/11/2019 10:13	45,85	1	45,85	CHI
20191135654	OUVIDOR	OU21061242	CATALAO S1	05/11/2019 12:22	06/11/2019 11:40	05/11/2019 12:22	06/11/2019 11:40	23,29	1	23,29	CHI
20191135663	CAVALCANTE	CJ12329689	FLORES DE GOIAS	05/11/2019 12:24	06/11/2019 08:01	05/11/2019 12:24	06/11/2019 08:01	19,61	5	98,07	CHI
20191135665	MARA ROSA	2260037738	MARA ROSA	05/11/2019 12:24	09/11/2019 17:35	05/11/2019 12:24	09/11/2019 17:35	101,18	1	101,18	CHI
20191135669	RIO VERDE	RV13193803	MONTIVIDIU T	05/11/2019 20:53	06/11/2019 01:18	05/11/2019 20:53	06/11/2019 01:18	4,42	79	349,38	CHI
20191135679	NOVA GLORIA	NG12181340	RUBIATABA	05/11/2019 12:27	06/11/2019 08:28	05/11/2019 12:27	06/11/2019 08:28	20,01	4	80,05	CHI
20191135682	CAMPINORTE	MQ21083044	MARA ROSA	05/11/2019 12:27	07/11/2019 15:40	05/11/2019 12:27	07/11/2019 15:40	51,20	1	51,20	CHI
20191135683	PORANGATU	PO12286007	PORANGATU	05/11/2019 12:27	06/11/2019 18:43	05/11/2019 12:27	06/11/2019 18:43	30,25	8	242,01	CHI
20191135686	PADRE BERNARDO	PB21263219	PADRE BERNARDO	05/11/2019 12:28	05/11/2019 17:14	05/11/2019 12:28	05/11/2019 17:14	4,76	1	4,76	CHI
20191135688	PARAUNA	RV12306606	MONTIVIDIU T	05/11/2019 12:28	05/11/2019 18:12	05/11/2019 12:28	05/11/2019 18:12	5,72	54	308,97	CHI
20191135704	CAMPOS BELOS	CH12243118	SAO DOMINGOS	05/11/2019 12:44	05/11/2019 20:14	05/11/2019 12:44	05/11/2019 20:14	7,48	5	37,42	CHI
20191135704	MONTE ALEGRE DE GOIAS	CH12243118	SAO DOMINGOS	05/11/2019 12:44	05/11/2019 20:14	05/11/2019 12:44	05/11/2019 20:14	7,48	3	22,45	CHI
20191135722	MINEIROS	MY10401436	PARQUE DAS EMAS	05/11/2019 13:53	07/11/2019 14:14	05/11/2019 13:53	05/11/2019 13:59	0,11	36	3,96	CHI
20191135722	MINEIROS	MY10401436	PARQUE DAS EMAS	05/11/2019 13:53	07/11/2019 14:14	05/11/2019 14:00	05/11/2019 16:00	1,99	14	27,84	CHI
20191135722	MINEIROS	MY13341118	PARQUE DAS EMAS	05/11/2019 13:53	07/11/2019 14:14	05/11/2019 14:00	05/11/2019 20:26	6,43	3	19,29	CHI
20191135722	MINEIROS	MY13322110	PARQUE DAS EMAS	05/11/2019 13:53	07/11/2019 14:14	05/11/2019 14:00	05/11/2019 23:15	9,25	12	110,98	CHI
20191135722	MINEIROS	MY13324529	PARQUE DAS EMAS	05/11/2019 13:53	07/11/2019 14:14	05/11/2019 14:00	06/11/2019 11:36	21,59	2	43,18	CHI
20191135722	MINEIROS	MY10401436	PARQUE DAS EMAS	05/11/2019 13:53	07/11/2019 14:14	06/11/2019 12:20	06/11/2019 12:30	0,16	31	4,95	CHI
20191135722	MINEIROS	MY10401436	PARQUE DAS EMAS	05/11/2019 13:53	07/11/2019 14:14	06/11/2019 13:55	06/11/2019 14:13	0,31	31	9,48	CHI
20191135722	MINEIROS	MY13324530	PARQUE DAS EMAS	05/11/2019 13:53	07/11/2019 14:14	05/11/2019 14:00	07/11/2019 14:14	48,23	5	241,14	CHI
20191135723	SAO MIGUEL DO ARAGUAIA	SM10391487	SAO MIGUEL DO ARAGUAIA	05/11/2019 14:02	05/11/2019 19:33	05/11/2019 14:02	05/11/2019 19:33	5,52	57	314,43	CHI
20191135751	MARA ROSA	MQ10400666	MARA ROSA	05/11/2019 15:29	05/11/2019 23:01	05/11/2019 15:29	05/11/2019 17:03	1,56	18	28,08	CHI
20191135751	MARA ROSA	MQ10400666	MARA ROSA	05/11/2019 15:29	05/11/2019 23:01	05/11/2019 17:16	05/11/2019 17:29	0,23	18	4,08	CHI
20191135751	MARA ROSA	MQ10400666	MARA ROSA	05/11/2019 15:29	05/11/2019 23:01	05/11/2019 18:48	05/11/2019 19:08	0,33	18	5,96	CHI
20191135751	AMARALINA	MQ10400666	MARA ROSA	05/11/2019 15:29	05/11/2019 23:01	05/11/2019 15:29	05/11/2019 22:19	6,84	12	82,10	CHI
20191135751	MARA ROSA	MQ10400666	MARA ROSA	05/11/2019 15:29	05/11/2019 23:01	05/11/2019 15:29	05/11/2019 22:19	6,84	19	129,99	CHI
20191135751	MARA ROSA	MQ12086247	MARA ROSA	05/11/2019 15:29	05/11/2019 23:01	05/11/2019 15:29	05/11/2019 22:39	7,16	7	50,13	CHI
20191135751	AMARALINA	MQ10400666	MARA ROSA	05/11/2019 15:29	05/11/2019 23:01	05/11/2019 15:29	05/11/2019 23:01	7,54	731	5509,51	CHI

20191135751	MARA ROSA	MQ10400666	MARA ROSA	05/11/2019 15:29	05/11/2019 23:01	05/11/2019 15:29	05/11/2019 23:01	7,54	13	97,98	CHI
20191135751	MUTUNOPOLIS	MQ10400666	MARA ROSA	05/11/2019 15:29	05/11/2019 23:01	05/11/2019 15:29	05/11/2019 23:01	7,54	2	15,07	CHI
20191135754	GOIANIA	SW10395406	SENADOR CANEDO	05/11/2019 15:40	05/11/2019 23:18	05/11/2019 15:40	05/11/2019 23:18	7,64	8	61,12	CHI
20191135754	SENADOR CANEDO	SW10395406	SENADOR CANEDO	05/11/2019 15:40	05/11/2019 23:18	05/11/2019 15:40	05/11/2019 23:18	7,64	1599	12216,36	CHI
20191135766	JATAI	JT11036303	JATAI S2	05/11/2019 15:57	05/11/2019 18:00	05/11/2019 15:57	05/11/2019 18:00	2,05	90	184,25	CHI
20191135768	CAMPOS BELOS	CH21129979	SAO DOMINGOS	05/11/2019 16:11	05/11/2019 16:22	05/11/2019 16:11	05/11/2019 16:22	0,17	1	0,17	CHI
20191135779	GOIANIA	15972756	ATLANTICO S1	05/11/2019 16:27	05/11/2019 18:44	05/11/2019 16:27	05/11/2019 18:44	2,27	1	2,27	CHI
20191135788	CAMPOS BELOS	00760444	SAO DOMINGOS	05/11/2019 16:34	05/11/2019 19:55	05/11/2019 16:34	05/11/2019 17:55	1,35	134	180,38	CHI
20191135788	CAMPOS BELOS	CH13262244	SAO DOMINGOS	05/11/2019 16:34	05/11/2019 19:55	05/11/2019 16:34	05/11/2019 19:55	3,34	18	60,15	CHI
20191135800	LUZIANIA	LZ13192901	VIANOPOLIS	05/11/2019 17:39	05/11/2019 20:47	05/11/2019 17:39	05/11/2019 20:47	3,12	150	467,96	CHI
20191135806	NOVO GAMA	2460030028	PACAEMBU S1	05/11/2019 12:30	05/11/2019 18:35	05/11/2019 12:30	05/11/2019 18:35	6,07	1	6,07	CHI
20191135819	CAMPOS BELOS	MA12209854	SAO DOMINGOS	06/11/2019 07:09	06/11/2019 11:43	06/11/2019 07:09	06/11/2019 11:43	4,55	4	18,21	CHI
20191135819	MONTE ALEGRE DE GOIAS	MA12209854	SAO DOMINGOS	06/11/2019 07:09	06/11/2019 11:43	06/11/2019 07:09	06/11/2019 11:43	4,55	17	77,40	CHI
20191135822	IPORA	IR21070215	IPORA	05/11/2019 12:33	05/11/2019 18:41	05/11/2019 12:33	05/11/2019 18:41	6,13	1	6,13	CHI
20191135828	PIRENOPOLIS	ZN21345258	COCALZINHO	05/11/2019 12:34	07/11/2019 23:03	05/11/2019 12:34	07/11/2019 23:03	58,47	2	116,95	CHI
20191135833	LUZIANIA	10020374150	MARAJOARA	05/11/2019 12:35	05/11/2019 19:44	05/11/2019 12:35	05/11/2019 19:44	7,14	1	7,14	CHI
20191135834	SAO MIGUEL DO ARAGUAIA	SM11262694	SAO MIGUEL DO ARAGUAIA	05/11/2019 10:44	05/11/2019 15:33	05/11/2019 10:44	05/11/2019 15:33	4,80	97	465,82	CHI
20191135850	PLANALTINA	PI12344158	PLANALTINA	05/11/2019 10:41	05/11/2019 16:56	05/11/2019 10:41	05/11/2019 16:56	6,24	68	424,23	CHI
20191135856	PIRENOPOLIS	PV21241189	CORUMBA	05/11/2019 12:37	05/11/2019 15:37	05/11/2019 12:37	05/11/2019 15:37	2,98	1	2,98	CHI
20191135867	ALTO PARAISO DE GOIAS	BF21129911	FLORES DE GOIAS	05/11/2019 12:38	06/11/2019 22:14	05/11/2019 12:38	06/11/2019 22:14	33,58	1	33,58	CHI
20191135869	JARAGUA	JA21314075	GOIANESIA S2	05/11/2019 12:39	06/11/2019 19:44	05/11/2019 12:39	06/11/2019 19:44	31,07	1	31,07	CHI
20191135883	AGUA FRIA DE GOIAS	JL12262352	SAO JOAO D ALIANCA	05/11/2019 12:41	07/11/2019 18:52	06/11/2019 09:00	07/11/2019 18:52	33,87	6	203,20	CHI
20191135883	SAO JOAO D ALIANCA	JL12262352	SAO JOAO D ALIANCA	05/11/2019 12:41	07/11/2019 18:52	06/11/2019 09:00	07/11/2019 18:52	33,87	100	3386,69	CHI
20191135884	MINEIROS	MY21156805	PARQUE DAS EMAS	05/11/2019 12:41	08/11/2019 15:20	05/11/2019 12:41	08/11/2019 15:20	74,64	1	74,64	CHI
20191135889	PIRACANJUBA	PJ21076778	CALDAS NOVAS S1	05/11/2019 12:42	07/11/2019 16:57	05/11/2019 12:42	07/11/2019 16:57	52,24	1	52,24	CHI
20191135896	CALDAS NOVAS	760379026	SERRA DE CALDAS	05/11/2019 12:43	06/11/2019 11:02	05/11/2019 12:43	06/11/2019 11:02	22,32	1	22,32	CHI
20191135908	SANTA HELENA DE GOIAS	SH12316189	SANTA HELENA S1	05/11/2019 12:44	07/11/2019 11:08	05/11/2019 12:44	07/11/2019 11:08	46,40	1	46,40	CHI
20191135921	APARECIDA DE GOIANIA	10022103030	INDEPENDENCIA S1	05/11/2019 12:46	05/11/2019 16:44	05/11/2019 12:46	05/11/2019 16:44	3,97	1	3,97	CHI
20191135923	ALEXANIA	AX12374674	ALEXANIA	05/11/2019 12:46	06/11/2019 22:06	05/11/2019 12:46	06/11/2019 22:06	33,33	7	233,30	CHI
20191135923	CORUMBA DE GOIAS	AX12374674	ALEXANIA	05/11/2019 12:46	06/11/2019 22:06	05/11/2019 12:46	06/11/2019 22:06	33,33	2	66,66	CHI
20191135937	APARECIDA DE GOIANIA	10002253281	ATLANTICO S3	05/11/2019 12:48	05/11/2019 16:04	05/11/2019 12:48	05/11/2019 16:04	3,26	1	3,26	CHI
20191135939	GOIANIA	16155233	GOYA S1	05/11/2019 12:48	06/11/2019 13:34	05/11/2019 12:48	06/11/2019 13:34	24,76	1	24,76	CHI
20191135942	ANAPOLIS	10018142050	JUNDIAI S1	05/11/2019 12:48	05/11/2019 22:09	05/11/2019 12:48	05/11/2019 22:09	9,34	1	9,34	CHI

20191135953	ANAPOLIS	AN12096735	ANAPOLIS UNIVERSITARIO S1	05/11/2019 12:51	06/11/2019 14:05	05/11/2019 12:51	06/11/2019 14:05	25,23	11	277,58	CHI
20191135955	GOIANIA	16401554	CARAJAS S2	05/11/2019 12:51	06/11/2019 00:56	05/11/2019 12:51	06/11/2019 00:56	12,07	1	12,07	CHI
20191135957	HIDROLANDIA	HD12000305	CEPAIGO S2	05/11/2019 12:51	05/11/2019 16:13	05/11/2019 12:51	05/11/2019 16:13	3,35	22	73,75	CHI
20191135963	GOIANIA	10004548351	GOYA S1	05/11/2019 12:52	06/11/2019 10:34	05/11/2019 12:52	06/11/2019 10:34	21,69	1	21,69	CHI
20191135965	RIO VERDE	630558711	RIO VERDE S1	05/11/2019 12:53	05/11/2019 17:14	05/11/2019 12:53	05/11/2019 17:14	4,35	1	4,35	CHI
20191135968	MONTIVIDIU DO NORTE	MX10400351	PORANGATU	05/11/2019 12:53	06/11/2019 16:02	05/11/2019 13:25	05/11/2019 15:39	2,23	389	868,12	CHI
20191135968	TROMBAS	MX10400351	PORANGATU	05/11/2019 12:53	06/11/2019 16:02	05/11/2019 13:25	05/11/2019 15:39	2,23	23	51,33	CHI
20191135968	MONTIVIDIU DO NORTE	MX10400351	PORANGATU	05/11/2019 12:53	06/11/2019 16:02	05/11/2019 13:25	05/11/2019 23:51	10,43	180	1876,55	CHI
20191135968	MONTIVIDIU DO NORTE	MX11254830	PORANGATU	05/11/2019 12:53	06/11/2019 16:02	05/11/2019 12:53	06/11/2019 15:45	26,86	1	26,86	CHI
20191135968	MONTIVIDIU DO NORTE	MX12244258	PORANGATU	05/11/2019 12:53	06/11/2019 16:02	05/11/2019 13:25	06/11/2019 16:02	26,61	17	452,37	CHI
20191135979	AGUAS LINDAS DE GOIAS	10015069530	AGUAS LINDAS DE GOIAS S1	05/11/2019 12:56	05/11/2019 17:45	05/11/2019 12:56	05/11/2019 17:45	4,82	1	4,82	CHI
20191135984	PIRENOPOLIS	PV21093285	SAO FRANCISCO DE GOIAS	05/11/2019 12:56	07/11/2019 07:41	05/11/2019 12:56	07/11/2019 07:41	42,74	1	42,74	CHI
20191135992	BALIZA	DV21137080	CAIAPONIA	05/11/2019 12:59	11/11/2019 09:45	05/11/2019 12:59	11/11/2019 09:45	140,76	1	140,76	CHI
20191135993	GOIANIA	13227440	CARAJAS S1	05/11/2019 12:59	06/11/2019 11:22	05/11/2019 12:59	06/11/2019 11:22	22,37	1	22,37	CHI
20191136001	PIRES DO RIO	460084550	PIRES DO RIO S1	05/11/2019 13:00	05/11/2019 17:50	05/11/2019 13:00	05/11/2019 17:50	4,83	1	4,83	CHI
20191136002	SILVANIA	SV21157830	VIANOPOLIS	05/11/2019 13:00	06/11/2019 14:06	05/11/2019 13:00	06/11/2019 14:06	25,08	1	25,08	CHI
20191136007	DOVERLANDIA	DV21156562	CAIAPONIA	05/11/2019 13:01	07/11/2019 15:32	05/11/2019 13:01	07/11/2019 15:32	50,51	1	50,51	CHI
20191136014	JATAI	04800424	JATAI S1	05/11/2019 12:56	05/11/2019 20:30	05/11/2019 12:56	05/11/2019 15:20	2,40	11	26,45	CHI
20191136014	JATAI	JT13092338	JATAI S1	05/11/2019 12:56	05/11/2019 20:30	05/11/2019 12:56	05/11/2019 19:55	6,99	12	83,89	CHI
20191136014	APORE	04800424	JATAI S1	05/11/2019 12:56	05/11/2019 20:30	05/11/2019 12:56	05/11/2019 20:30	7,57	7	52,99	CHI
20191136014	ITARUMA	04800424	JATAI S1	05/11/2019 12:56	05/11/2019 20:30	05/11/2019 12:56	05/11/2019 20:30	7,57	1	7,57	CHI
20191136014	JATAI	04800424	JATAI S1	05/11/2019 12:56	05/11/2019 20:30	05/11/2019 12:56	05/11/2019 20:30	7,57	14	105,98	CHI
20191136014	JATAI	JT13324659	JATAI S1	05/11/2019 12:56	05/11/2019 20:30	05/11/2019 12:56	05/11/2019 20:30	7,57	231	1748,73	CHI
20191136014	SERRANOPOLIS	04800424	JATAI S1	05/11/2019 12:56	05/11/2019 20:30	05/11/2019 12:56	05/11/2019 20:30	7,57	3180	24073,48	CHI
20191136014	SERRANOPOLIS	04800424	JATAI S1	05/11/2019 12:56	05/11/2019 20:30	05/11/2019 12:56	05/11/2019 20:30	7,57	82	620,76	CHI
20191136014	SERRANOPOLIS	JT13324659	JATAI S1	05/11/2019 12:56	05/11/2019 20:30	05/11/2019 12:56	05/11/2019 20:30	7,57	107	810,02	CHI
20191136019	BELA VISTA DE GOIAS	BV21108615	BELA VISTA S1	05/11/2019 13:03	06/11/2019 10:26	05/11/2019 13:03	06/11/2019 10:26	21,38	1	21,38	CHI
20191136020	JARAGUA	JA21140692	JARAGUA	05/11/2019 13:03	06/11/2019 14:09	05/11/2019 13:03	06/11/2019 14:09	25,09	1	25,09	CHI
20191136029	CAMPOS BELOS	CH12384777	SAO DOMINGOS	05/11/2019 12:02	05/11/2019 20:26	05/11/2019 12:02	05/11/2019 20:26	8,39	13	109,08	CHI
20191136043	PANAMA	IT12252752	ITUMBIARA NOVA	05/11/2019 13:06	06/11/2019 16:57	05/11/2019 13:06	06/11/2019 16:57	27,85	2	55,70	CHI
20191136046	GOIANIA	15579610	FERROVIARIO S2	05/11/2019 13:06	05/11/2019 14:05	05/11/2019 13:06	05/11/2019 14:05	0,97	1	0,97	CHI
20191136047	ANAPOLIS	20018320	JUNDIAI S2	05/11/2019 13:06	05/11/2019 16:35	05/11/2019 13:06	05/11/2019 16:35	3,47	1	3,47	CHI
20191136049	PIRENOPOLIS	PV21196852	ANAPOLIS UNIVERSITARIO S2	05/11/2019 13:07	06/11/2019 14:22	05/11/2019 13:07	06/11/2019 14:22	25,25	1	25,25	CHI

20191136052	DAMIANOPOLIS	DA12262341	IACIARA S2	05/11/2019 13:07	05/11/2019 16:32	05/11/2019 13:07	05/11/2019 16:32	3,42	3	10,26	CHI
20191136056	CATALAO	CT21104206	CATALAO S1	05/11/2019 13:08	07/11/2019 17:47	05/11/2019 13:08	07/11/2019 17:47	52,65	1	52,65	CHI
20191136059	APARECIDA DE GOIANIA	AP12150275	INDEPENDENCIA S2	05/11/2019 13:08	05/11/2019 18:53	05/11/2019 13:08	05/11/2019 18:53	5,74	4	22,95	CHI
20191136065	RIO VERDE	630111832	RIO VERDE S1	05/11/2019 13:09	08/11/2019 18:02	05/11/2019 13:09	08/11/2019 18:02	76,89	1	76,89	CHI
20191136078	GOIANIA	GN11158450	CARAJAS S2	05/11/2019 13:10	06/11/2019 12:09	06/11/2019 09:58	06/11/2019 12:09	2,18	113	246,62	CHI
20191136086	BURITI ALEGRE	00260406	ITUMBIARA VELHA S2	05/11/2019 12:56	05/11/2019 19:21	05/11/2019 12:56	05/11/2019 19:21	6,42	14	89,84	CHI
20191136086	BURITI ALEGRE	00260406	ITUMBIARA VELHA S2	05/11/2019 12:56	05/11/2019 19:21	05/11/2019 12:56	05/11/2019 19:21	6,42	968	6211,60	CHI
20191136086	ITUMBIARA	00260406	ITUMBIARA VELHA S2	05/11/2019 12:56	05/11/2019 19:21	05/11/2019 12:56	05/11/2019 19:21	6,42	15	96,25	CHI
20191136096	JATAI	01030234	JATAI S2	05/11/2019 12:58	05/11/2019 13:11	05/11/2019 12:58	05/11/2019 13:05	0,12	6447	770,06	CHI
20191136096	JATAI	JT10378104	JATAI S2	05/11/2019 12:58	05/11/2019 13:11	05/11/2019 12:58	05/11/2019 13:05	0,13	302	38,59	CHI
20191136096	RIO VERDE	JT10378104	JATAI S2	05/11/2019 12:58	05/11/2019 13:11	05/11/2019 12:58	05/11/2019 13:05	0,13	31	3,96	CHI
20191136096	JATAI	JT16407803	JATAI S2	05/11/2019 12:58	05/11/2019 13:11	05/11/2019 12:58	05/11/2019 13:11	0,22	1100	243,22	CHI
20191136099	ABADIANIA	AA21062504	ANAPOLIS UNIVERSITARIO S1	05/11/2019 13:14	05/11/2019 15:42	05/11/2019 13:14	05/11/2019 15:42	2,46	1	2,46	CHI
20191136107	GOIANIA	10920237	GOIANIA LESTE S1	05/11/2019 13:15	05/11/2019 17:59	05/11/2019 13:15	05/11/2019 17:59	4,73	1	4,73	CHI
20191136110	LUZIANIA	LZ21320058	VIANOPOLIS	05/11/2019 13:15	05/11/2019 15:06	05/11/2019 13:15	05/11/2019 15:06	1,85	1	1,85	CHI
20191136115	GUARINOS	GF11072595	SANTA TEREZINHA	05/11/2019 13:05	05/11/2019 18:36	05/11/2019 13:05	05/11/2019 18:36	5,50	103	566,81	CHI
20191136120	LUZIANIA	LZ21319530	VIANOPOLIS	05/11/2019 13:16	05/11/2019 17:28	05/11/2019 13:16	05/11/2019 17:25	4,15	1	4,15	CHI
20191136120	LUZIANIA	03720214	VIANOPOLIS	05/11/2019 13:16	05/11/2019 17:28	05/11/2019 17:22	05/11/2019 17:28	0,09	367	33,13	CHI
20191136127	NOVA ROMA	ND12161820	IACIARA S2	05/11/2019 13:01	05/11/2019 16:37	05/11/2019 13:01	05/11/2019 16:37	3,59	54	194,10	CHI
20191136128	GAMELEIRA DE GOIAS	3820000432	DAIA S2	05/11/2019 13:18	05/11/2019 17:40	05/11/2019 13:18	05/11/2019 17:40	4,37	1	4,37	CHI
20191136129	INDIARA	IY21186405	EDEIA	05/11/2019 13:18	06/11/2019 10:07	05/11/2019 13:18	06/11/2019 10:07	20,82	1	20,82	CHI
20191136131	JOVIANIA	JV11293214	GOIATUBA S1	05/11/2019 12:54	05/11/2019 17:13	05/11/2019 12:54	05/11/2019 17:13	4,31	57	245,89	CHI
20191136154	ABADIA DE GOIAS	GN21057789	CARAJAS S1	05/11/2019 13:20	05/11/2019 21:39	05/11/2019 13:20	05/11/2019 21:39	8,31	1	8,31	CHI
20191136161	JATAI	01030234	JATAI S2	05/11/2019 14:25	05/11/2019 22:31	05/11/2019 14:25	05/11/2019 14:48	0,38	7761	2936,25	CHI
20191136161	RIO VERDE	01030234	JATAI S2	05/11/2019 14:25	05/11/2019 22:31	05/11/2019 14:25	05/11/2019 14:48	0,38	31	11,73	CHI
20191136161	JATAI	JT13000116	JATAI S2	05/11/2019 14:25	05/11/2019 22:31	05/11/2019 14:25	05/11/2019 22:31	8,09	41	331,69	CHI
20191136163	RIO VERDE	RV12355126	RIO VERDE S1	05/11/2019 13:21	06/11/2019 11:36	05/11/2019 13:21	06/11/2019 11:36	22,25	2	44,50	CHI
20191136170	ABADIANIA	10000982880	ANAPOLIS UNIVERSITARIO S1	05/11/2019 13:21	05/11/2019 15:00	05/11/2019 13:21	05/11/2019 15:00	1,64	1	1,64	CHI
20191136177	ARAGUAPAZ	01850406	MOZARLANDIA	05/11/2019 13:20	05/11/2019 16:40	05/11/2019 13:20	05/11/2019 16:40	3,32	2699	8965,93	CHI
20191136177	ARUANA	01850406	MOZARLANDIA	05/11/2019 13:20	05/11/2019 16:40	05/11/2019 13:20	05/11/2019 16:40	3,32	65	215,93	CHI
20191136177	MATRINCHA	01850406	MOZARLANDIA	05/11/2019 13:20	05/11/2019 16:40	05/11/2019 13:20	05/11/2019 16:40	3,32	17	56,47	CHI
20191136177	MOZARLANDIA	01850406	MOZARLANDIA	05/11/2019 13:20	05/11/2019 16:40	05/11/2019 13:20	05/11/2019 16:40	3,32	9	29,90	CHI
20191136181	GOIANIA	GN11002600	GOYA S1	05/11/2019 13:20	05/11/2019 14:48	05/11/2019 13:20	05/11/2019 14:48	1,45	145	210,89	CHI

20191136185	CABECEIRAS	CW21242914	ITUIQUIRA	05/11/2019 13:23	05/11/2019 21:29	05/11/2019 13:23	05/11/2019 21:29	8,09	1	8,09	CHI
20191136189	SAO FRANCISCO DE GOIAS	SF21112821	SAO FRANCISCO DE GOIAS	05/11/2019 13:23	05/11/2019 17:50	05/11/2019 13:23	05/11/2019 17:50	4,45	1	4,45	CHI
20191136190	ITUMBIARA	BG12257007	ITUMBIARA VELHA S2	06/11/2019 08:42	06/11/2019 13:54	06/11/2019 08:42	06/11/2019 13:54	5,19	4	20,75	CHI
20191136193	ORIZONA	OZ12036099	PIRES DO RIO S1	05/11/2019 13:23	07/11/2019 12:20	05/11/2019 13:23	07/11/2019 12:20	46,93	4	187,74	CHI
20191136198	SANTO ANTONIO DA BARRA	BZ12207396	ACREUNA	05/11/2019 13:24	06/11/2019 09:36	05/11/2019 13:24	06/11/2019 09:36	20,21	3	60,63	CHI
20191136200	GOIANIA	GN11213955	GOYA S1	05/11/2019 12:34	05/11/2019 18:04	05/11/2019 12:34	05/11/2019 18:04	5,49	110	603,44	CHI
20191136218	NIQUELANDIA	NQ11035685	BARRO ALTO	05/11/2019 13:26	05/11/2019 19:34	05/11/2019 13:26	05/11/2019 19:34	6,12	40	244,80	CHI
20191136228	BONOPOLIS	BX12168214	SAO MIGUEL DO ARAGUAIA	05/11/2019 13:29	06/11/2019 01:47	05/11/2019 13:29	06/11/2019 01:47	12,29	92	1130,27	CHI
20191136266	CAMPINORTE	UR12231336	MARA ROSA	05/11/2019 13:34	06/11/2019 15:40	05/11/2019 13:34	06/11/2019 15:40	26,09	2	52,18	CHI
20191136266	URUACU	UR12231336	MARA ROSA	05/11/2019 13:34	06/11/2019 15:40	05/11/2019 13:34	06/11/2019 15:40	26,09	22	573,99	CHI
20191136270	CALDAS NOVAS	760287302	CALDAS NOVAS S2	05/11/2019 13:35	08/11/2019 22:22	05/11/2019 13:35	08/11/2019 22:22	80,79	1	80,79	CHI
20191136271	GOIAS	GS12162482	GOIAS	05/11/2019 13:13	05/11/2019 19:00	05/11/2019 13:13	05/11/2019 19:00	5,77	7	40,41	CHI
20191136272	APARECIDA DO RIO DOCE	AW11163943	CACHOEIRA ALTA	05/11/2019 13:20	05/11/2019 21:29	05/11/2019 13:20	05/11/2019 21:29	8,15	133	1083,51	CHI
20191136287	NIQUELANDIA	10005836490	NIQUELANDIA SUBTRANSMISSAO	05/11/2019 13:37	06/11/2019 01:57	05/11/2019 13:37	06/11/2019 01:57	12,33	1	12,33	CHI
20191136291	MINEIROS	1390041521	PARQUE DAS EMAS	05/11/2019 13:38	07/11/2019 09:07	05/11/2019 13:38	07/11/2019 09:07	43,49	1	43,49	CHI
20191136301	QUIRINOPOLIS	QI21227707	QUIRINOPOLIS	05/11/2019 13:39	06/11/2019 10:16	05/11/2019 13:39	06/11/2019 10:16	20,62	2	41,23	CHI
20191136336	FORMOSA	FA12404381	ITUIQUIRA	05/11/2019 09:45	05/11/2019 18:25	05/11/2019 09:45	05/11/2019 18:25	8,66	4	34,62	CHI
20191136411	GOIANIA	10004994793	CARAJAS S1	05/11/2019 13:49	05/11/2019 19:51	05/11/2019 13:49	05/11/2019 19:51	6,03	1	6,03	CHI
20191136417	CALDAZINHA	DE12197382	CEPAIGO S2	05/11/2019 13:50	06/11/2019 11:26	05/11/2019 13:50	06/11/2019 11:26	21,59	2	43,19	CHI
20191136424	CATALAO	CT12399870	CATALAO S1	05/11/2019 13:50	06/11/2019 11:27	05/11/2019 13:50	06/11/2019 11:27	21,60	9	194,41	CHI
20191136454	AMARALINA	LC12270111	SAO MIGUEL DO ARAGUAIA	05/11/2019 13:07	07/11/2019 01:14	05/11/2019 13:07	07/11/2019 01:14	36,11	5	180,57	CHI
20191136456	AGUAS LINDAS DE GOIAS	SN21083393	AGUAS LINDAS DE GOIAS S2	05/11/2019 13:53	05/11/2019 15:52	05/11/2019 13:53	05/11/2019 15:52	1,98	1	1,98	CHI
20191136461	ITAJA	IJ12154152	ITAJA S2	05/11/2019 13:47	06/11/2019 15:18	05/11/2019 13:47	06/11/2019 15:18	25,51	2	51,02	CHI
20191136480	PORANGATU	PO12391930	PORANGATU	05/11/2019 11:04	06/11/2019 00:07	05/11/2019 11:04	06/11/2019 00:07	13,04	56	730,18	CHI
20191136480	PORANGATU	PO12265802	PORANGATU	05/11/2019 11:04	06/11/2019 00:07	05/11/2019 23:04	06/11/2019 00:07	1,04	57	59,04	CHI
20191136492	CAVALCANTE	CJ21131722	FLORES DE GOIAS	05/11/2019 13:46	06/11/2019 11:45	05/11/2019 13:46	06/11/2019 11:45	21,98	2	43,97	CHI
20191136498	GOIANIA	GN11093394	ATLANTICO S2	05/11/2019 13:24	05/11/2019 16:08	05/11/2019 13:24	05/11/2019 16:08	2,73	106	289,26	CHI
20191136500	CATALAO	CT21131062	CATALAO S1	05/11/2019 13:57	06/11/2019 12:12	05/11/2019 13:57	06/11/2019 12:12	22,25	1	22,25	CHI
20191136520	RIO VERDE	630153802	RIO VERDE S1	05/11/2019 13:58	08/11/2019 08:00	05/11/2019 13:58	08/11/2019 08:00	66,03	1	66,03	CHI
20191136528	APARECIDA DE GOIANIA	AP11004903	REAL S1	05/11/2019 13:55	05/11/2019 17:40	05/11/2019 13:55	05/11/2019 17:40	3,75	94	352,79	CHI
20191136530	ANAPOLIS	AN11382443	ANAPOLIS UNIVERSITARIO S2	05/11/2019 16:00	05/11/2019 17:09	05/11/2019 16:00	05/11/2019 17:09	1,14	50	56,85	CHI
20191136534	GOIANIA	11774605	CAMPINAS S2	05/11/2019 13:59	05/11/2019 22:25	05/11/2019 13:59	05/11/2019 22:25	8,43	1	8,43	CHI
20191136550	INDIARA	PL12376414	PALMEIRAS	05/11/2019 13:55	06/11/2019 08:00	05/11/2019 13:55	06/11/2019 08:00	18,09	3	54,26	CHI

20191136550	PALMEIRAS DE GOIAS	PL12376414	PALMEIRAS	05/11/2019 13:55	06/11/2019 08:00	05/11/2019 13:55	06/11/2019 08:00	18,09	47	850,09	CHI
20191136564	IPAMERI	IP12000032	IPAMERI	05/11/2019 14:02	05/11/2019 15:29	05/11/2019 14:02	05/11/2019 15:29	1,44	65	93,64	CHI
20191136567	NIQUELANDIA	NQ12375602	URUACU	05/11/2019 10:38	06/11/2019 08:18	05/11/2019 10:38	06/11/2019 08:18	21,67	34	736,67	CHI
20191136579	SANTO ANTONIO DO DESCOBERTO	2210152120	ALEXANIA	05/11/2019 14:03	05/11/2019 17:15	05/11/2019 14:03	05/11/2019 17:15	3,18	1	3,18	CHI
20191136601	GOIANIA	13972121	MEIA PONTE	05/11/2019 14:05	06/11/2019 13:11	05/11/2019 14:05	06/11/2019 13:11	23,09	1	23,09	CHI
20191136610	CATALAO	CT12104168	CATALAO S1	05/11/2019 14:06	05/11/2019 16:44	05/11/2019 14:06	05/11/2019 16:44	2,63	4	10,51	CHI
20191136616	ALTO PARAISO DE GOIAS	BF21196486	SAO JOAO D ALIANCA	05/11/2019 14:06	08/11/2019 11:32	05/11/2019 14:06	08/11/2019 11:32	69,42	1	69,42	CHI
20191136637	BONOPOLIS	01360214	NOVO PLANALTO	05/11/2019 14:08	05/11/2019 21:40	05/11/2019 14:08	05/11/2019 16:09	2,01	41	82,59	CHI
20191136637	NOVO PLANALTO	01360214	NOVO PLANALTO	05/11/2019 14:08	05/11/2019 21:40	05/11/2019 14:08	05/11/2019 16:09	2,01	94	189,36	CHI
20191136637	PORANGATU	01360214	NOVO PLANALTO	05/11/2019 14:08	05/11/2019 21:40	05/11/2019 14:08	05/11/2019 16:09	2,01	104	209,50	CHI
20191136637	NOVO PLANALTO	TA12038669LD	NOVO PLANALTO	05/11/2019 14:08	05/11/2019 21:40	05/11/2019 14:08	05/11/2019 21:40	7,53	406	3057,63	CHI
20191136652	NIQUELANDIA	BA12194392	BARRO ALTO	05/11/2019 14:08	07/11/2019 11:15	05/11/2019 14:08	07/11/2019 11:15	45,10	4	180,40	CHI
20191136678	QUIRINOPOLIS	QI10396885	QUIRINOPOLIS	05/11/2019 14:04	05/11/2019 18:39	05/11/2019 14:04	05/11/2019 14:40	0,60	2274	1371,98	CHI
20191136678	QUIRINOPOLIS	QI10395333	QUIRINOPOLIS	05/11/2019 14:04	05/11/2019 18:39	05/11/2019 14:04	05/11/2019 14:41	0,62	2565	1597,42	CHI
20191136678	QUIRINOPOLIS	QI10395333	QUIRINOPOLIS	05/11/2019 14:04	05/11/2019 18:39	05/11/2019 14:04	05/11/2019 14:41	0,62	103	64,15	CHI
20191136678	QUIRINOPOLIS	QI13000023	QUIRINOPOLIS	05/11/2019 14:04	05/11/2019 18:39	05/11/2019 14:04	05/11/2019 18:39	4,58	203	930,36	CHI
20191136686	APARECIDA DE GOIANIA	AP11127803	REAL S1	05/11/2019 13:39	05/11/2019 15:53	05/11/2019 13:39	05/11/2019 15:53	2,24	199	445,04	CHI
20191136691	RIO VERDE	630395998	RIO VERDE S1	05/11/2019 14:12	05/11/2019 16:00	05/11/2019 14:12	05/11/2019 16:00	1,79	1	1,79	CHI
20191136698	CATALAO	GD12127538	CATALAO S1	05/11/2019 12:54	05/11/2019 19:07	05/11/2019 12:54	05/11/2019 19:07	6,20	5	31,02	CHI
20191136698	GOIANDIRA	GD12127538	CATALAO S1	05/11/2019 12:54	05/11/2019 19:07	05/11/2019 12:54	05/11/2019 19:07	6,20	13	80,65	CHI
20191136718	CRISTALINA	KR11272771	CRISTALINA S2	05/11/2019 14:14	05/11/2019 16:09	05/11/2019 14:14	05/11/2019 16:09	1,91	1	1,91	CHI
20191136722	PIRES DO RIO	BC21060928	PIRES DO RIO S2	05/11/2019 14:15	07/11/2019 09:08	05/11/2019 14:15	07/11/2019 09:08	42,88	2	85,76	CHI
20191136723	RIO VERDE	RV12021392	SANTA HELENA S1	05/11/2019 13:59	06/11/2019 11:35	05/11/2019 13:59	06/11/2019 11:35	21,60	21	453,59	CHI
20191136727	CACHOEIRA ALTA	04860224	QUIRINOPOLIS	05/11/2019 13:33	05/11/2019 17:12	05/11/2019 13:33	05/11/2019 17:12	3,66	3	10,97	CHI
20191136727	QUIRINOPOLIS	04860224	QUIRINOPOLIS	05/11/2019 13:33	05/11/2019 17:12	05/11/2019 13:33	05/11/2019 17:12	3,66	182	665,41	CHI
20191136727	RIO VERDE	04860224	QUIRINOPOLIS	05/11/2019 13:33	05/11/2019 17:12	05/11/2019 13:33	05/11/2019 17:12	3,66	41	149,90	CHI
20191136740	MORRINHOS	PJ12076912	MORRINHOS	05/11/2019 14:15	07/11/2019 16:28	05/11/2019 14:15	07/11/2019 16:28	50,20	4	200,81	CHI
20191136749	JATAI	290348778	JATAI S2	05/11/2019 14:16	05/11/2019 22:46	05/11/2019 14:16	05/11/2019 22:46	8,50	1	8,50	CHI
20191136751	APORE	AE21274121	ITAJA S1	05/11/2019 14:16	05/11/2019 19:32	05/11/2019 14:16	05/11/2019 19:32	5,26	1	5,26	CHI
20191136753	EDEALINA	ED12223495	PONTALINA	05/11/2019 11:37	06/11/2019 10:56	05/11/2019 11:37	06/11/2019 10:56	23,31	4	93,22	CHI
20191136753	PONTALINA	ED12223495	PONTALINA	05/11/2019 11:37	06/11/2019 10:56	05/11/2019 11:37	06/11/2019 10:56	23,31	2	46,61	CHI
20191136755	HIDROLANDIA	HD21058883	INDEPENDENCIA S1	05/11/2019 14:17	05/11/2019 18:44	05/11/2019 14:17	05/11/2019 18:44	4,45	2	8,90	CHI
20191136763	VILA PROPICIO	NP21318172	GOIANESIA S2	05/11/2019 14:17	08/11/2019 08:02	05/11/2019 14:17	08/11/2019 08:02	65,74	1	65,74	CHI

20191136776	TRINDADE	TR11110907	GOYA S2	05/11/2019 13:34	05/11/2019 16:28	05/11/2019 13:34	05/11/2019 16:28	2,90	166	480,75	CHI
20191136784	IPIRANGA DE GOIAS	RB12194284	RUBIATABA	05/11/2019 14:07	05/11/2019 22:37	05/11/2019 14:07	05/11/2019 22:37	8,50	9	76,49	CHI
20191136799	QUIRINOPOLIS	QI12000016	QUIRINOPOLIS	05/11/2019 14:10	05/11/2019 16:26	05/11/2019 14:10	05/11/2019 16:26	2,26	239	539,68	CHI
20191136802	MUNDO NOVO DE GOIAS	MH12274702	NOVA CRIXAS	05/11/2019 13:33	06/11/2019 17:58	05/11/2019 13:33	06/11/2019 17:58	28,41	44	1250,22	CHI
20191136806	RIO VERDE	RV12106528	MONTIVIDIU T	05/11/2019 13:47	06/11/2019 09:12	05/11/2019 13:47	06/11/2019 09:12	19,42	4	77,66	CHI
20191136833	CRISTALINA	KR21132666	PAMPLONA	05/11/2019 14:23	05/11/2019 19:20	05/11/2019 14:23	05/11/2019 19:20	4,95	1	4,95	CHI
20191136841	ITARUMA	IM12338674	CACHOEIRA ALTA	05/11/2019 14:24	06/11/2019 12:22	05/11/2019 14:24	06/11/2019 12:22	21,96	1	21,96	CHI
20191136845	SAO LUIS DE MONTES BELOS	500052610	SAO LUIZ DOS MONTES BELOS	05/11/2019 14:24	06/11/2019 09:34	05/11/2019 14:24	06/11/2019 09:34	19,15	1	19,15	CHI
20191136847	AGUA FRIA DE GOIAS	TL21342449	SAO JOAO D ALIANCA	05/11/2019 14:25	09/11/2019 13:05	05/11/2019 14:25	09/11/2019 13:05	94,67	1	94,67	CHI
20191136852	IPAMERI	IP21137569	CAMPO ALEGRE DE GOIAS	05/11/2019 14:25	06/11/2019 10:48	05/11/2019 14:25	06/11/2019 10:48	20,38	1	20,38	CHI
20191136858	URUACU	UR12285343	CAMPINORTE	05/11/2019 14:26	06/11/2019 09:42	05/11/2019 14:26	06/11/2019 09:42	19,26	44	847,48	CHI
20191136865	PALMEIRAS DE GOIAS	10003631328	PALMEIRAS	05/11/2019 14:27	06/11/2019 15:44	05/11/2019 14:27	06/11/2019 15:44	25,29	1	25,29	CHI
20191136870	GOIANIA	14364670	CARAJAS S2	05/11/2019 14:27	06/11/2019 09:43	05/11/2019 14:27	06/11/2019 09:43	19,25	1	19,25	CHI
20191136882	GUARINOS	01800424	URUACU	05/11/2019 14:28	05/11/2019 16:03	05/11/2019 14:28	05/11/2019 16:03	1,57	11	17,28	CHI
20191136882	HIDROLINA	01800424	URUACU	05/11/2019 14:28	05/11/2019 16:03	05/11/2019 14:28	05/11/2019 16:03	1,57	1256	1972,97	CHI
20191136882	HIDROLINA	01800424	URUACU	05/11/2019 14:28	05/11/2019 16:03	05/11/2019 14:28	05/11/2019 16:03	1,57	25	39,27	CHI
20191136882	HIDROLINA	01800424	URUACU	05/11/2019 14:28	05/11/2019 16:03	05/11/2019 14:28	05/11/2019 16:03	1,57	191	300,03	CHI
20191136882	ITAPACI	01800424	URUACU	05/11/2019 14:28	05/11/2019 16:03	05/11/2019 14:28	05/11/2019 16:03	1,57	2	3,14	CHI
20191136882	PILAR DE GOIAS	01800424	URUACU	05/11/2019 14:28	05/11/2019 16:03	05/11/2019 14:28	05/11/2019 16:03	1,57	23	36,13	CHI
20191136882	PILAR DE GOIAS	01800424	URUACU	05/11/2019 14:28	05/11/2019 16:03	05/11/2019 14:28	05/11/2019 16:03	1,57	152	238,77	CHI
20191136882	PILAR DE GOIAS	01800424	URUACU	05/11/2019 14:28	05/11/2019 16:03	05/11/2019 14:28	05/11/2019 16:03	1,57	41	64,40	CHI
20191136882	PILAR DE GOIAS	01800424	URUACU	05/11/2019 14:28	05/11/2019 16:03	05/11/2019 14:28	05/11/2019 16:03	1,57	27	42,41	CHI
20191136882	SANTA TEREZINHA DE GOIAS	01800424	URUACU	05/11/2019 14:28	05/11/2019 16:03	05/11/2019 14:28	05/11/2019 16:03	1,57	4	6,28	CHI
20191136882	URUACU	01800424	URUACU	05/11/2019 14:28	05/11/2019 16:03	05/11/2019 14:28	05/11/2019 16:03	1,57	299	469,68	CHI
20191136884	APARECIDA DE GOIANIA	12256006	INDEPENDENCIA S2	05/11/2019 14:29	05/11/2019 16:28	05/11/2019 14:29	05/11/2019 16:28	1,98	1	1,98	CHI
20191136897	JARAGUA	70134480	JARAGUA	05/11/2019 14:29	06/11/2019 11:21	05/11/2019 14:29	06/11/2019 11:21	20,86	1	20,86	CHI
20191136901	NAZARIO	440012259	ANICUNS	05/11/2019 14:30	05/11/2019 21:51	05/11/2019 14:30	05/11/2019 21:51	7,35	1	7,35	CHI
20191136904	PALMELO	PR12000096RE	PIRES DO RIO S1	05/11/2019 14:03	05/11/2019 17:29	05/11/2019 14:03	05/11/2019 17:29	3,42	6	20,50	CHI
20191136904	PIRES DO RIO	PR12000096RE	PIRES DO RIO S1	05/11/2019 14:03	05/11/2019 17:29	05/11/2019 14:03	05/11/2019 17:29	3,42	22	75,18	CHI
20191136906	QUIRINOPOLIS	QI11171910	QUIRINOPOLIS	05/11/2019 14:21	05/11/2019 17:03	05/11/2019 14:21	05/11/2019 17:03	2,70	86	232,01	CHI
20191136911	FORMOSA	FA12233612	ITIQUEIRA	05/11/2019 14:31	05/11/2019 19:10	05/11/2019 14:31	05/11/2019 19:10	4,65	59	274,07	CHI
20191136912	GOIATUBA	140095718	GOIATUBA S2	05/11/2019 14:31	06/11/2019 10:10	05/11/2019 14:31	06/11/2019 10:10	19,66	1	19,66	CHI
20191136913	EDEIA	XX17045339	RIO DOS BOIS	05/11/2019 14:31	05/11/2019 21:00	05/11/2019 14:31	05/11/2019 21:00	6,47	1	6,47	CHI

20191136913	TURVELANDIA	XX17045339	RIO DOS BOIS	05/11/2019 14:31	05/11/2019 21:00	05/11/2019 14:31	05/11/2019 21:00	6,47	2	12,95	CHI
20191136917	SANTA TEREZA DE GOIAS	SE12262714	PORANGATU	05/11/2019 14:27	05/11/2019 22:50	05/11/2019 14:27	05/11/2019 22:50	8,37	15	125,53	CHI
20191136918	TRINDADE	10015927839	GOYA S2	05/11/2019 14:32	07/11/2019 10:21	05/11/2019 14:32	07/11/2019 10:21	43,81	1	43,81	CHI
20191136921	MAIRIPOTABA	MI21051002	PONTALINA	05/11/2019 14:32	09/11/2019 17:44	05/11/2019 14:32	09/11/2019 17:44	99,19	2	198,38	CHI
20191136936	ANAPOLIS	AN31114249	NEROPOLIS S1	05/11/2019 14:34	05/11/2019 19:49	05/11/2019 14:34	05/11/2019 19:49	5,24	2	10,49	CHI
20191136964	MINACU	IH21236267	MINACU	05/11/2019 14:36	05/11/2019 18:22	05/11/2019 14:36	05/11/2019 18:22	3,76	1	3,76	CHI
20191136970	GOIANIA	10781420	CARAJAS S1	05/11/2019 14:37	06/11/2019 02:38	05/11/2019 14:37	06/11/2019 02:38	12,02	1	12,02	CHI
20191136985	CRISTALINA	KR12162511	CRISTALINA S2	05/11/2019 14:38	05/11/2019 16:44	05/11/2019 14:38	05/11/2019 16:44	2,09	10	20,87	CHI
20191136991	ITAPACI	IW21379427	ITAPACI	05/11/2019 14:39	06/11/2019 00:05	05/11/2019 14:39	06/11/2019 00:05	9,43	1	9,43	CHI
20191137006	MONTIVIDIU	2840025043	MONTIVIDIU T	05/11/2019 14:40	05/11/2019 19:47	05/11/2019 14:40	05/11/2019 19:47	5,12	1	5,12	CHI
20191137008	SANTA HELENA DE GOIAS	SH12271563	IPEGUARI	05/11/2019 14:25	05/11/2019 22:59	05/11/2019 14:25	05/11/2019 22:59	8,56	28	239,56	CHI
20191137008	TURVELANDIA	SH12271563	IPEGUARI	05/11/2019 14:25	05/11/2019 22:59	05/11/2019 14:25	05/11/2019 22:59	8,56	12	102,67	CHI
20191137009	GOIANIA	GN12000541	CAMPINAS S3	05/11/2019 14:35	06/11/2019 00:16	05/11/2019 14:35	06/11/2019 00:16	9,67	103	995,81	CHI
20191137024	COCALZINHO DE GOIAS	ZN12297579	COCALZINHO	05/11/2019 13:23	06/11/2019 21:45	05/11/2019 13:23	06/11/2019 21:45	32,35	5	161,77	CHI
20191137057	GOIANIA	GN11238228	GOYA S1	05/11/2019 14:45	06/11/2019 16:19	05/11/2019 14:45	06/11/2019 16:19	25,55	7	178,88	CHI
20191137067	ABADIANIA	AA11374700	ANAPOLIS UNIVERSITARIO S1	05/11/2019 14:42	05/11/2019 18:52	05/11/2019 14:42	05/11/2019 18:52	4,16	20	83,28	CHI
20191137085	POSSE	IA12060874	IACIARA S2	05/11/2019 14:37	05/11/2019 20:00	05/11/2019 14:37	05/11/2019 20:00	5,38	42	226,05	CHI
20191137088	COCALZINHO DE GOIAS	CB12028344	COCALZINHO	05/11/2019 12:45	06/11/2019 09:20	05/11/2019 12:45	06/11/2019 09:20	20,58	4	82,32	CHI
20191137090	FORMOSA	610250206	ITIQUEIRA	05/11/2019 14:47	05/11/2019 17:48	05/11/2019 14:47	05/11/2019 17:48	3,00	1	3,00	CHI
20191137093	PILAR DE GOIAS	GG12171805	SANTA TEREZINHA	05/11/2019 13:35	07/11/2019 10:10	05/11/2019 13:35	05/11/2019 21:15	7,67	21	160,99	CHI
20191137093	PILAR DE GOIAS	GG12171805	SANTA TEREZINHA	05/11/2019 13:35	07/11/2019 10:10	05/11/2019 21:16	06/11/2019 08:44	11,48	19	218,06	CHI
20191137093	PILAR DE GOIAS	GG12171805	SANTA TEREZINHA	05/11/2019 13:35	07/11/2019 10:10	05/11/2019 13:35	07/11/2019 04:03	38,48	30	1154,46	CHI
20191137093	SANTA TEREZINHA DE GOIAS	GG12171805	SANTA TEREZINHA	05/11/2019 13:35	07/11/2019 10:10	05/11/2019 13:35	07/11/2019 04:03	38,48	44	1693,21	CHI
20191137093	PILAR DE GOIAS	GG12171805	SANTA TEREZINHA	05/11/2019 13:35	07/11/2019 10:10	05/11/2019 21:16	07/11/2019 04:03	30,80	2	61,60	CHI
20191137093	PILAR DE GOIAS	GG12171805	SANTA TEREZINHA	05/11/2019 13:35	07/11/2019 10:10	06/11/2019 08:45	07/11/2019 04:03	19,32	19	367,01	CHI
20191137093	PILAR DE GOIAS	GG12171805	SANTA TEREZINHA	05/11/2019 13:35	07/11/2019 10:10	05/11/2019 13:35	07/11/2019 09:33	43,98	6	263,85	CHI
20191137093	PILAR DE GOIAS	GG12171805	SANTA TEREZINHA	05/11/2019 13:35	07/11/2019 10:10	05/11/2019 13:35	07/11/2019 10:10	44,58	2	89,17	CHI
20191137109	GOIATUBA	GT21102747	GOIATUBA S2	05/11/2019 14:49	07/11/2019 16:34	05/11/2019 14:49	07/11/2019 16:34	49,74	1	49,74	CHI
20191137124	ITAJA	IJ12086739	ITAJA S2	05/11/2019 13:20	06/11/2019 16:25	05/11/2019 13:20	06/11/2019 16:25	27,08	2	54,16	CHI
20191137127	MONTIVIDIU DO NORTE	MX11209185	PORANGATU	05/11/2019 14:51	07/11/2019 02:20	05/11/2019 14:51	07/11/2019 02:20	35,48	54	1915,71	CHI
20191137132	CORUMBA DE GOIAS	CB12295657	ALEXANIA	05/11/2019 14:16	05/11/2019 16:24	05/11/2019 14:16	05/11/2019 16:24	2,12	19	40,33	CHI
20191137133	CATALAO	CT12215709RE	CATALAO S1	05/11/2019 09:55	08/11/2019 18:33	05/11/2019 09:55	08/11/2019 18:33	80,64	78	6289,70	CHI
20191137151	GOIANESIA	GE21342221	ITAPACI	05/11/2019 14:53	06/11/2019 11:00	05/11/2019 14:53	06/11/2019 11:00	20,11	1	20,11	CHI

20191137155	UIRAPURU	UP12181266	SANTA TEREZINHA	05/11/2019 14:53	06/11/2019 06:21	05/11/2019 14:53	06/11/2019 06:21	15,45	4	61,82	CHI
20191137162	GOIANESIA	GE12376588	GOIANESIA S2	05/11/2019 13:35	06/11/2019 02:40	05/11/2019 13:35	06/11/2019 02:40	13,08	8	104,60	CHI
20191137162	VILA PROPICIO	GE12376588	GOIANESIA S2	05/11/2019 13:35	06/11/2019 02:40	05/11/2019 13:35	06/11/2019 02:40	13,08	2	26,15	CHI
20191137173	GOIANIA	GN21169661	GOYA S1	05/11/2019 14:54	05/11/2019 19:29	05/11/2019 14:54	05/11/2019 19:29	4,57	2	9,15	CHI
20191137196	GUARANI DE GOIAS	GY21000003	IACIARA S1	05/11/2019 14:56	05/11/2019 20:59	05/11/2019 14:56	05/11/2019 20:59	6,04	1	6,04	CHI
20191137204	APARECIDA DE GOIANIA	10023053885	INDEPENDENCIA S1	05/11/2019 14:57	05/11/2019 18:09	05/11/2019 14:57	05/11/2019 18:09	3,19	1	3,19	CHI
20191137205	GOIANIA	GN12396183	GOYA S1	05/11/2019 14:57	06/11/2019 16:19	05/11/2019 14:57	06/11/2019 16:19	25,35	56	1419,85	CHI
20191137207	PIRACANJUBA	PJ12293360	PIRACANJUBA	06/11/2019 06:48	06/11/2019 18:20	06/11/2019 06:48	06/11/2019 18:20	11,52	10	115,18	CHI
20191137227	QUIRINOPOLIS	QI21241877	QUIRINOPOLIS	05/11/2019 14:58	07/11/2019 09:53	05/11/2019 14:58	07/11/2019 09:53	42,90	1	42,90	CHI
20191137231	ARAGOIANIA	AO12251688	GUAPO S2	05/11/2019 14:03	05/11/2019 16:00	05/11/2019 14:03	05/11/2019 16:00	1,94	100	193,89	CHI
20191137232	ITAPACI	100089070	ITAPACI	05/11/2019 14:59	07/11/2019 09:40	05/11/2019 14:59	07/11/2019 09:40	42,67	1	42,67	CHI
20191137233	PIRENOPOLIS	PV21134020	CORUMBA	05/11/2019 14:59	07/11/2019 11:53	05/11/2019 14:59	07/11/2019 11:53	44,89	1	44,89	CHI
20191137245	PALMEIRAS DE GOIAS	PL10404073	PALMEIRAS	05/11/2019 14:58	06/11/2019 18:42	05/11/2019 14:58	05/11/2019 19:01	4,05	167	675,93	CHI
20191137245	CEZARINA	PL10404073	PALMEIRAS	05/11/2019 14:58	06/11/2019 18:42	05/11/2019 14:58	06/11/2019 18:10	27,19	4	108,76	CHI
20191137245	PALMEIRAS DE GOIAS	PL10404073	PALMEIRAS	05/11/2019 14:58	06/11/2019 18:42	05/11/2019 14:58	06/11/2019 18:10	27,19	77	2093,63	CHI
20191137245	CEZARINA	PL12349283	PALMEIRAS	05/11/2019 14:58	06/11/2019 18:42	06/11/2019 10:20	06/11/2019 18:42	8,38	1	8,38	CHI
20191137253	MINEIROS	1390000075	PARQUE DAS EMAS	05/11/2019 15:00	06/11/2019 08:12	05/11/2019 15:00	06/11/2019 08:12	17,19	1	17,19	CHI
20191137265	NIQUELANDIA	NQ12135340	NIQUELANDIA SUBTRANSMISSAO	05/11/2019 13:34	05/11/2019 21:39	05/11/2019 13:34	05/11/2019 21:39	8,07	13	104,91	CHI
20191137281	CACHOEIRA DOURADA	130013559	CACHOEIRA DOURADA	05/11/2019 15:02	07/11/2019 17:20	05/11/2019 15:02	07/11/2019 17:20	50,30	1	50,30	CHI
20191137285	GOIANIA	GN11001283	CAMPINAS S2	05/11/2019 14:54	05/11/2019 17:04	05/11/2019 14:54	05/11/2019 17:04	2,16	122	263,89	CHI
20191137289	FORMOSO	FO12185315	PORANGATU	05/11/2019 15:03	10/11/2019 09:20	05/11/2019 15:03	10/11/2019 09:20	114,28	8	914,27	CHI
20191137316	ORIZONA	OZ12073391	PIRES DO RIO S2	05/11/2019 13:36	05/11/2019 16:51	05/11/2019 13:36	05/11/2019 16:51	3,24	10	32,38	CHI
20191137318	FLORES DE GOIAS	FB12248238	FLORES DE GOIAS	05/11/2019 15:06	05/11/2019 22:04	05/11/2019 15:06	05/11/2019 22:04	6,96	14	97,47	CHI
20191137318	SAO JOAO D ALIANCA	FB12248238	FLORES DE GOIAS	05/11/2019 15:06	05/11/2019 22:04	05/11/2019 15:06	05/11/2019 22:04	6,96	40	278,48	CHI
20191137320	GOIANIA	GN11097868	GOYA S1	05/11/2019 13:51	05/11/2019 20:25	05/11/2019 13:51	05/11/2019 20:25	6,56	46	301,67	CHI
20191137328	GOIANIA	10734983	CARAJAS S1	05/11/2019 15:06	06/11/2019 02:26	05/11/2019 15:06	06/11/2019 02:26	11,32	1	11,32	CHI
20191137331	FAZENDA NOVA	NB12020225	JUSSARA	05/11/2019 14:56	05/11/2019 22:50	05/11/2019 14:56	05/11/2019 22:50	7,91	38	300,39	CHI
20191137331	JUSSARA	NB12020225	JUSSARA	05/11/2019 14:56	05/11/2019 22:50	05/11/2019 14:56	05/11/2019 22:50	7,91	1	7,91	CHI
20191137331	NOVO BRASIL	NB12020225	JUSSARA	05/11/2019 14:56	05/11/2019 22:50	05/11/2019 14:56	05/11/2019 22:50	7,91	40	316,20	CHI
20191137340	MONTE ALEGRE DE GOIAS	MA12236686	SAO DOMINGOS	05/11/2019 15:07	06/11/2019 11:44	05/11/2019 15:07	06/11/2019 11:44	20,61	23	474,07	CHI
20191137348	CAIAPONIA	CP21312288	CAIAPONIA	05/11/2019 15:07	10/11/2019 12:22	05/11/2019 15:07	10/11/2019 12:22	117,23	1	117,23	CHI
20191137349	GOIAS	GS12206885	GOIAS	05/11/2019 13:17	05/11/2019 22:05	05/11/2019 13:17	05/11/2019 22:05	8,80	4	35,21	CHI
20191137355	FAZENDA NOVA	FN12223049	IPORA	05/11/2019 15:08	07/11/2019 10:35	05/11/2019 15:08	07/11/2019 10:35	43,45	8	347,58	CHI

20191137355	ISRAELANDIA	FN12223049	IPORA	05/11/2019 15:08	07/11/2019 10:35	05/11/2019 15:08	07/11/2019 10:35	43,45	2	86,89	CHI
20191137363	BONOPOLIS	BX12079317	SAO MIGUEL DO ARAGUAIA	05/11/2019 15:09	06/11/2019 20:25	05/11/2019 15:09	06/11/2019 20:25	29,25	37	1082,26	CHI
20191137364	IACIARA	IA12206170	IACIARA S1	06/11/2019 06:27	06/11/2019 09:10	06/11/2019 06:27	06/11/2019 09:10	2,71	80	216,64	CHI
20191137365	TRINDADE	TR12240929	GOYA S2	05/11/2019 15:03	05/11/2019 17:30	05/11/2019 15:03	05/11/2019 17:30	2,44	189	462,00	CHI
20191137367	MINEIROS	10019324250	PARQUE DAS EMAS	05/11/2019 15:10	06/11/2019 09:58	05/11/2019 15:10	06/11/2019 09:58	18,80	1	18,80	CHI
20191137373	GOIANIA	GN11001303	GOIANIA LESTE S3	05/11/2019 15:10	06/11/2019 14:30	05/11/2019 15:10	06/11/2019 14:30	23,32	51	1189,53	CHI
20191137375	GOIANIA	GN11031130	ATLANTICO S1	05/11/2019 14:55	05/11/2019 18:21	05/11/2019 14:55	05/11/2019 18:21	3,42	19	64,96	CHI
20191137384	ABADIANIA	AA12241539	ANAPOLIS UNIVERSITARIO S1	05/11/2019 13:54	05/11/2019 17:29	05/11/2019 13:54	05/11/2019 17:29	3,58	39	139,76	CHI
20191137384	CORUMBA DE GOIAS	AA12241539	ANAPOLIS UNIVERSITARIO S1	05/11/2019 13:54	05/11/2019 17:29	05/11/2019 13:54	05/11/2019 17:29	3,58	2	7,17	CHI
20191137390	MATRINCHA	4380004649	MATRINCHA	05/11/2019 15:11	05/11/2019 17:03	05/11/2019 15:11	05/11/2019 17:03	1,85	1	1,85	CHI
20191137395	MONTIVIDIU DO NORTE	MX12182380	PORANGATU	05/11/2019 15:11	07/11/2019 03:09	05/11/2019 15:11	07/11/2019 03:09	35,95	1	35,95	CHI
20191137399	ANAPOLIS	21011552	JUNDIAI S1	05/11/2019 15:13	06/11/2019 14:46	05/11/2019 15:13	06/11/2019 14:46	23,55	1	23,55	CHI
20191137419	MARA ROSA	MQ12291279	MARA ROSA	05/11/2019 11:46	09/11/2019 11:18	05/11/2019 11:46	09/11/2019 11:18	95,55	2	191,09	CHI
20191137422	NOVA ROMA	ND12229410	IACIARA S2	05/11/2019 15:14	05/11/2019 18:00	05/11/2019 15:14	05/11/2019 18:00	2,76	3	8,27	CHI
20191137432	CATALAO	1990076893	CATALAO S2	05/11/2019 15:14	05/11/2019 20:07	05/11/2019 15:14	05/11/2019 20:07	4,87	1	4,87	CHI
20191137435	GOIANIA	GN11001292	GOIANIA LESTE S1	05/11/2019 15:15	05/11/2019 17:38	05/11/2019 15:15	05/11/2019 16:13	0,96	171	163,87	CHI
20191137435	GOIANIA	GN11001292	GOIANIA LESTE S1	05/11/2019 15:15	05/11/2019 17:38	05/11/2019 16:21	05/11/2019 17:21	1,00	171	170,95	CHI
20191137435	GOIANIA	GN16407217	GOIANIA LESTE S1	05/11/2019 15:15	05/11/2019 17:38	05/11/2019 16:21	05/11/2019 17:38	1,27	191	242,36	CHI
20191137435	GOIANIA	GN16407217	GOIANIA LESTE S1	05/11/2019 15:15	05/11/2019 17:38	05/11/2019 17:25	05/11/2019 17:38	0,21	2021	415,43	CHI
20191137439	ACREUNA	SH12271266	SANTA HELENA S1	05/11/2019 15:15	06/11/2019 09:10	05/11/2019 15:15	06/11/2019 09:10	17,91	3	53,73	CHI
20191137439	SANTA HELENA DE GOIAS	SH12271266	SANTA HELENA S1	05/11/2019 15:15	06/11/2019 09:10	05/11/2019 15:15	06/11/2019 09:10	17,91	3	53,73	CHI
20191137440	UIRAPURU	UP12397484	NOVA CRIXAS	05/11/2019 15:15	06/11/2019 15:01	05/11/2019 15:15	06/11/2019 15:01	23,76	1	23,76	CHI
20191137451	PANAMA	IT21305343	CACHOEIRA DOURADA	05/11/2019 15:16	07/11/2019 10:37	05/11/2019 15:16	07/11/2019 10:37	43,35	1	43,35	CHI
20191137462	PARANAIGUARA	QI12101708	QUIRINOPOLIS	05/11/2019 14:58	06/11/2019 10:40	05/11/2019 14:58	06/11/2019 10:40	19,69	3	59,06	CHI
20191137462	QUIRINOPOLIS	QI12101708	QUIRINOPOLIS	05/11/2019 14:58	06/11/2019 10:40	05/11/2019 14:58	06/11/2019 10:40	19,69	9	177,18	CHI
20191137464	MINEIROS	10000503671	PARQUE DAS EMAS	05/11/2019 15:16	06/11/2019 12:06	05/11/2019 15:16	06/11/2019 12:06	20,82	1	20,82	CHI
20191137470	NOVO BRASIL	NB11093993	JUSSARA	05/11/2019 12:52	05/11/2019 20:25	05/11/2019 12:52	05/11/2019 19:25	6,55	54	353,64	CHI
20191137470	NOVO BRASIL	NB12198897	JUSSARA	05/11/2019 12:52	05/11/2019 20:25	05/11/2019 12:52	05/11/2019 20:25	7,55	58	437,84	CHI
20191137491	APARECIDA DE GOIANIA	10004953647	INDEPENDENCIA S1	05/11/2019 15:17	05/11/2019 17:25	05/11/2019 15:17	05/11/2019 17:25	2,12	1	2,12	CHI
20191137499	TRINDADE	TR11101120	GOYA S1	05/11/2019 14:55	05/11/2019 17:25	05/11/2019 14:55	05/11/2019 17:25	2,49	112	278,79	CHI
20191137516	SANTA HELENA DE GOIAS	SH21295842	IPEGUARI	05/11/2019 15:19	05/11/2019 20:09	05/11/2019 15:19	05/11/2019 20:09	4,82	1	4,82	CHI
20191137534	CORUMBAIBA	10011942698	VILA CORUMBA	05/11/2019 15:21	07/11/2019 17:49	05/11/2019 15:21	07/11/2019 17:49	50,48	1	50,48	CHI
20191137540	CRIXAS	NM12194294	RUBIATABA	05/11/2019 10:37	07/11/2019 22:59	07/11/2019 15:00	07/11/2019 22:59	7,98	1	7,98	CHI

20191137540	NOVA AMERICA	NM12194294	RUBIATABA	05/11/2019 10:37	07/11/2019 22:59	07/11/2019 15:00	07/11/2019 22:59	7,98	158	1261,37	CHI
20191137540	RUBIATABA	NM12194294	RUBIATABA	05/11/2019 10:37	07/11/2019 22:59	07/11/2019 15:00	07/11/2019 22:59	7,98	8	63,87	CHI
20191137545	ALTO PARAISO DE GOIAS	BF21163462	FLORES DE GOIAS	05/11/2019 15:21	07/11/2019 16:36	05/11/2019 15:21	07/11/2019 16:36	49,24	1	49,24	CHI
20191137555	SAO SIMAO	2240046140	CACHOEIRA ALTA	05/11/2019 15:22	06/11/2019 11:25	05/11/2019 15:22	06/11/2019 11:25	20,04	1	20,04	CHI
20191137558	GOIANIA	GN12043915	GOIANIA LESTE S3	05/11/2019 13:33	05/11/2019 17:20	05/11/2019 13:33	05/11/2019 17:20	3,78	240	907,93	CHI
20191137561	ABADIANIA	AA21115042	ANAPOLIS UNIVERSITARIO S1	05/11/2019 15:23	06/11/2019 08:31	05/11/2019 15:23	06/11/2019 08:31	17,12	1	17,12	CHI
20191137563	APARECIDA DE GOIANIA	10026556683	INDEPENDENCIA S2	05/11/2019 15:23	05/11/2019 19:00	05/11/2019 15:23	05/11/2019 19:00	3,60	1	3,60	CHI
20191137567	ITUMBIARA	690248891	ITUMBIARA VELHA S1	05/11/2019 15:24	06/11/2019 10:26	05/11/2019 15:24	06/11/2019 10:26	19,03	1	19,03	CHI
20191137571	ALEXANIA	AX11096633	ALEXANIA	05/11/2019 14:15	05/11/2019 17:24	05/11/2019 14:15	05/11/2019 17:24	3,14	131	410,98	CHI
20191137575	SAO MIGUEL DO ARAGUAIA	SM11242037	SAO MIGUEL DO ARAGUAIA	05/11/2019 14:28	06/11/2019 05:05	05/11/2019 14:28	06/11/2019 05:05	14,60	115	1679,51	CHI
20191137578	NIQUELANDIA	2750119322	NIQUELANDIA SUBTRANSMISSAO	05/11/2019 15:25	06/11/2019 23:48	05/11/2019 15:25	06/11/2019 23:48	32,38	1	32,38	CHI
20191137588	CORUMBA DE GOIAS	CB21185627	COCALZINHO	05/11/2019 15:25	06/11/2019 11:30	05/11/2019 15:25	06/11/2019 11:30	20,07	2	40,14	CHI
20191137592	SANTA CRUZ DE GOIAS	PR12051689	PIRES DO RIO S2	05/11/2019 15:26	07/11/2019 15:42	05/11/2019 15:26	07/11/2019 15:42	48,26	2	96,53	CHI
20191137599	GOIANIA	GN12166667	GOYA S1	05/11/2019 14:46	06/11/2019 09:09	05/11/2019 14:46	06/11/2019 09:09	18,39	148	2721,93	CHI
20191137603	INDIARA	IY11215330	EDEIA	05/11/2019 15:18	05/11/2019 16:52	05/11/2019 15:18	05/11/2019 16:52	1,55	204	316,54	CHI
20191137608	NOVO GAMA	4990085190	MARAJOARA	05/11/2019 15:27	05/11/2019 17:46	05/11/2019 15:27	05/11/2019 17:46	2,31	1	2,31	CHI
20191137611	BELA VISTA DE GOIAS	BV12272141	BELA VISTA S2	05/11/2019 14:46	05/11/2019 16:42	05/11/2019 14:46	05/11/2019 16:42	1,93	32	61,81	CHI
20191137611	SAO MIGUEL DO PASSA QUATRO	BV12272141	BELA VISTA S2	05/11/2019 14:46	05/11/2019 16:42	05/11/2019 14:46	05/11/2019 16:42	1,93	89	171,92	CHI
20191137623	CRIXAS	UP12171811	SANTA TEREZINHA	05/11/2019 14:20	06/11/2019 03:36	05/11/2019 14:20	06/11/2019 03:36	13,25	6	79,50	CHI
20191137623	UIRAPURU	UP12171811	SANTA TEREZINHA	05/11/2019 14:20	06/11/2019 03:36	05/11/2019 14:20	06/11/2019 03:36	13,25	31	410,78	CHI
20191137625	IPAMERI	IP12108218	IPAMERI	05/11/2019 13:58	05/11/2019 18:43	05/11/2019 13:58	05/11/2019 18:43	4,74	249	1179,85	CHI
20191137626	CRIXAS	CX21075608	RUBIATABA	05/11/2019 15:28	07/11/2019 19:21	05/11/2019 15:28	07/11/2019 19:21	51,88	2	103,77	CHI
20191137635	APARECIDA DO RIO DOCE	AW12296521	CACHOEIRA ALTA	05/11/2019 15:29	06/11/2019 20:38	05/11/2019 15:29	06/11/2019 20:38	29,14	4	116,58	CHI
20191137639	CALDAS NOVAS	CN16405748	CALDAS NOVAS S1	05/11/2019 13:48	06/11/2019 01:22	05/11/2019 13:48	06/11/2019 01:22	11,57	775	8969,12	CHI
20191137639	SANTA CRUZ DE GOIAS	CN16405748	CALDAS NOVAS S1	05/11/2019 13:48	06/11/2019 01:22	05/11/2019 13:48	06/11/2019 01:22	11,57	102	1180,45	CHI
20191137644	CATALAO	00340434	CATALAO S1	05/11/2019 15:30	06/11/2019 02:59	05/11/2019 15:30	05/11/2019 16:36	1,10	30	33,08	CHI
20191137644	GOIANDIRA	00340434	CATALAO S1	05/11/2019 15:30	06/11/2019 02:59	05/11/2019 15:30	05/11/2019 16:36	1,10	28	30,88	CHI
20191137644	CATALAO	00340434	CATALAO S1	05/11/2019 15:30	06/11/2019 02:59	05/11/2019 15:30	05/11/2019 16:37	1,12	35	39,08	CHI
20191137644	GOIANDIRA	00340434	CATALAO S1	05/11/2019 15:30	06/11/2019 02:59	05/11/2019 15:30	05/11/2019 16:37	1,12	1271	1419,28	CHI
20191137644	GOIANDIRA	00340434	CATALAO S1	05/11/2019 15:30	06/11/2019 02:59	05/11/2019 15:30	05/11/2019 16:37	1,12	543	606,35	CHI
20191137644	IPAMERI	00340434	CATALAO S1	05/11/2019 15:30	06/11/2019 02:59	05/11/2019 15:30	05/11/2019 16:37	1,12	7	7,82	CHI
20191137644	NOVA AURORA	00340434	CATALAO S1	05/11/2019 15:30	06/11/2019 02:59	05/11/2019 15:30	05/11/2019 16:37	1,12	15	16,75	CHI
20191137644	GOIANDIRA	00340434	CATALAO S1	05/11/2019 15:30	06/11/2019 02:59	05/11/2019 15:30	05/11/2019 16:40	1,16	886	1025,05	CHI

20191137644	CORUMBAIBA	00340434	CATALAO S1	05/11/2019 15:30	06/11/2019 02:59	05/11/2019 15:30	05/11/2019 16:45	1,24	136	168,22	CHI
20191137644	GOIANDIRA	00340434	CATALAO S1	05/11/2019 15:30	06/11/2019 02:59	05/11/2019 15:30	05/11/2019 16:45	1,24	7	8,66	CHI
20191137644	IPAMERI	00340434	CATALAO S1	05/11/2019 15:30	06/11/2019 02:59	05/11/2019 15:30	05/11/2019 16:45	1,24	15	18,55	CHI
20191137644	MORRINHOS	00340434	CATALAO S1	05/11/2019 15:30	06/11/2019 02:59	05/11/2019 15:30	05/11/2019 16:45	1,24	1	1,24	CHI
20191137644	NOVA AURORA	00340434	CATALAO S1	05/11/2019 15:30	06/11/2019 02:59	05/11/2019 15:30	05/11/2019 16:45	1,24	1112	1375,48	CHI
20191137644	NOVA AURORA	00340434	CATALAO S1	05/11/2019 15:30	06/11/2019 02:59	05/11/2019 15:30	05/11/2019 16:45	1,24	13	16,08	CHI
20191137644	NOVA AURORA	GD13147715	CATALAO S1	05/11/2019 15:30	06/11/2019 02:59	05/11/2019 15:30	05/11/2019 16:45	1,24	3	3,71	CHI
20191137644	GOIANDIRA	00340434	CATALAO S1	05/11/2019 15:30	06/11/2019 02:59	05/11/2019 15:30	05/11/2019 18:18	2,79	14	39,02	CHI
20191137644	CATALAO	00340434	CATALAO S1	05/11/2019 15:30	06/11/2019 02:59	05/11/2019 22:03	05/11/2019 22:06	0,06	39	2,34	CHI
20191137644	CATALAO	00340434	CATALAO S1	05/11/2019 15:30	06/11/2019 02:59	05/11/2019 22:03	05/11/2019 22:06	0,06	30	1,80	CHI
20191137644	CORUMBAIBA	00340434	CATALAO S1	05/11/2019 15:30	06/11/2019 02:59	05/11/2019 22:03	05/11/2019 22:06	0,06	136	8,16	CHI
20191137644	GOIANDIRA	00340434	CATALAO S1	05/11/2019 15:30	06/11/2019 02:59	05/11/2019 22:03	05/11/2019 22:06	0,06	2157	129,42	CHI
20191137644	GOIANDIRA	00340434	CATALAO S1	05/11/2019 15:30	06/11/2019 02:59	05/11/2019 22:03	05/11/2019 22:06	0,06	449	26,94	CHI
20191137644	GOIANDIRA	00340434	CATALAO S1	05/11/2019 15:30	06/11/2019 02:59	05/11/2019 22:03	05/11/2019 22:06	0,06	7	0,42	CHI
20191137644	GOIANDIRA	00340434	CATALAO S1	05/11/2019 15:30	06/11/2019 02:59	05/11/2019 22:03	05/11/2019 22:06	0,06	14	0,84	CHI
20191137644	GOIANDIRA	00340434	CATALAO S1	05/11/2019 15:30	06/11/2019 02:59	05/11/2019 22:03	05/11/2019 22:06	0,06	28	1,68	CHI
20191137644	IPAMERI	00340434	CATALAO S1	05/11/2019 15:30	06/11/2019 02:59	05/11/2019 22:03	05/11/2019 22:06	0,06	15	0,90	CHI
20191137644	IPAMERI	00340434	CATALAO S1	05/11/2019 15:30	06/11/2019 02:59	05/11/2019 22:03	05/11/2019 22:06	0,06	7	0,42	CHI
20191137644	MORRINHOS	00340434	CATALAO S1	05/11/2019 15:30	06/11/2019 02:59	05/11/2019 22:03	05/11/2019 22:06	0,06	1	0,06	CHI
20191137644	NOVA AURORA	00340434	CATALAO S1	05/11/2019 15:30	06/11/2019 02:59	05/11/2019 22:03	05/11/2019 22:06	0,06	1112	66,72	CHI
20191137644	NOVA AURORA	00340434	CATALAO S1	05/11/2019 15:30	06/11/2019 02:59	05/11/2019 22:03	05/11/2019 22:06	0,06	13	0,78	CHI
20191137644	NOVA AURORA	00340434	CATALAO S1	05/11/2019 15:30	06/11/2019 02:59	05/11/2019 22:03	05/11/2019 22:06	0,06	3	0,18	CHI
20191137644	GOIANDIRA	00340434	CATALAO S1	05/11/2019 15:30	06/11/2019 02:59	05/11/2019 15:30	06/11/2019 02:21	10,84	2	21,68	CHI
20191137644	ANHANGUERA	00340434	CATALAO S1	05/11/2019 15:30	06/11/2019 02:59	05/11/2019 15:30	06/11/2019 02:59	11,49	574	6592,55	CHI
20191137644	CORUMBAIBA	00340434	CATALAO S1	05/11/2019 15:30	06/11/2019 02:59	05/11/2019 15:30	06/11/2019 02:59	11,49	4	45,94	CHI
20191137644	CUMARI	00340434	CATALAO S1	05/11/2019 15:30	06/11/2019 02:59	05/11/2019 15:30	06/11/2019 02:59	11,49	1208	13874,22	CHI
20191137644	CUMARI	00340434	CATALAO S1	05/11/2019 15:30	06/11/2019 02:59	05/11/2019 15:30	06/11/2019 02:59	11,49	311	3571,92	CHI
20191137644	CUMARI	00340434	CATALAO S1	05/11/2019 15:30	06/11/2019 02:59	05/11/2019 15:30	06/11/2019 02:59	11,49	5	57,43	CHI
20191137644	GOIANDIRA	00340434	CATALAO S1	05/11/2019 15:30	06/11/2019 02:59	05/11/2019 15:30	06/11/2019 02:59	11,49	13	149,31	CHI
20191137644	GOIANDIRA	00340434	CATALAO S1	05/11/2019 15:30	06/11/2019 02:59	05/11/2019 15:30	06/11/2019 02:59	11,49	19	218,22	CHI
20191137644	NOVA AURORA	00340434	CATALAO S1	05/11/2019 15:30	06/11/2019 02:59	05/11/2019 15:30	06/11/2019 02:59	11,49	1	11,49	CHI
20191137649	GOIANIA	GN11050815	REAL S1	05/11/2019 15:26	05/11/2019 22:40	05/11/2019 15:26	05/11/2019 22:40	7,23	181	1309,03	CHI
20191137653	CABECEIRAS	CW21224216	ITUIQUIRA	05/11/2019 15:30	05/11/2019 21:00	05/11/2019 15:30	05/11/2019 21:00	5,50	1	5,50	CHI

20191137691	GOIANIA	13531220	REAL S1	05/11/2019 15:33	05/11/2019 17:11	05/11/2019 15:33	05/11/2019 17:11	1,63	1	1,63	CHI
20191137693	GUAPO	VJ13312879	GUAPO S2	05/11/2019 15:33	05/11/2019 20:27	05/11/2019 15:34	05/11/2019 19:34	3,99	3	11,96	CHI
20191137693	VARJAO	VJ13312879	GUAPO S2	05/11/2019 15:33	05/11/2019 20:27	05/11/2019 15:34	05/11/2019 19:34	3,99	97	386,60	CHI
20191137693	GUAPO	VJ13000011	GUAPO S2	05/11/2019 15:33	05/11/2019 20:27	05/11/2019 15:33	05/11/2019 20:27	4,89	75	366,90	CHI
20191137693	VARJAO	VJ13000011	GUAPO S2	05/11/2019 15:33	05/11/2019 20:27	05/11/2019 15:33	05/11/2019 20:27	4,89	22	107,62	CHI
20191137727	PONTALINA	PK11000009	PONTALINA	05/11/2019 14:39	06/11/2019 15:10	05/11/2019 14:39	06/11/2019 15:10	24,50	140	3430,66	CHI
20191137728	RIO VERDE	RV12249024	SANTA HELENA S1	05/11/2019 13:30	06/11/2019 15:21	05/11/2019 13:30	06/11/2019 15:21	25,84	6	155,06	CHI
20191137729	ORIZONA	OZ11022981	PIRES DO RIO S2	05/11/2019 15:26	06/11/2019 00:48	05/11/2019 15:26	06/11/2019 00:48	9,36	45	421,32	CHI
20191137734	ARAGOIANIA	AO21111908	GUAPO S2	05/11/2019 15:39	07/11/2019 17:30	05/11/2019 15:39	07/11/2019 17:30	49,84	2	99,68	CHI
20191137747	GOIANIA	GN12051593	GOIANIA LESTE S3	05/11/2019 15:36	05/11/2019 18:26	05/11/2019 15:36	05/11/2019 18:26	2,83	48	135,67	CHI
20191137770	VIANOPOLIS	VN12026007	VIANOPOLIS	05/11/2019 15:27	06/11/2019 18:27	05/11/2019 15:27	05/11/2019 19:43	4,27	30	128,13	CHI
20191137770	MORRINHOS	VN13237569	VIANOPOLIS	05/11/2019 15:27	06/11/2019 18:27	05/11/2019 15:27	06/11/2019 18:27	27,00	1	27,00	CHI
20191137770	ORIZONA	VN13237569	VIANOPOLIS	05/11/2019 15:27	06/11/2019 18:27	05/11/2019 15:27	06/11/2019 18:27	27,00	51	1377,01	CHI
20191137770	SILVANIA	VN13237569	VIANOPOLIS	05/11/2019 15:27	06/11/2019 18:27	05/11/2019 15:27	06/11/2019 18:27	27,00	5	135,00	CHI
20191137770	VIANOPOLIS	VN13237569	VIANOPOLIS	05/11/2019 15:27	06/11/2019 18:27	05/11/2019 15:27	06/11/2019 18:27	27,00	23	621,01	CHI
20191137773	SAO FRANCISCO DE GOIAS	SF21221174	SAO FRANCISCO DE GOIAS	05/11/2019 15:38	06/11/2019 15:25	05/11/2019 15:38	06/11/2019 15:25	23,77	2	47,55	CHI
20191137776	ALEXANIA	AX12157931	ALEXANIA	05/11/2019 15:39	06/11/2019 17:43	05/11/2019 15:39	06/11/2019 17:43	26,07	1	26,07	CHI
20191137778	TRINDADE	16000274	GOYA S2	05/11/2019 15:39	06/11/2019 00:35	05/11/2019 15:39	06/11/2019 00:35	8,94	1	8,94	CHI
20191137782	VICENTINOPOLIS	VI12047297	VICENTINOPOLIS	05/11/2019 15:39	10/11/2019 16:44	05/11/2019 15:39	10/11/2019 16:44	121,08	5	605,42	CHI
20191137796	BELA VISTA DE GOIAS	BV21215204	BELA VISTA S1	05/11/2019 15:39	06/11/2019 16:52	05/11/2019 15:39	06/11/2019 16:52	25,20	5	126,01	CHI
20191137797	FLORES DE GOIAS	FB12204157	FLORES DE GOIAS	05/11/2019 15:03	05/11/2019 22:55	05/11/2019 15:03	05/11/2019 22:55	7,87	13	102,27	CHI
20191137812	URUACU	10006649309	URUACU	05/11/2019 15:41	06/11/2019 01:43	05/11/2019 15:41	06/11/2019 01:43	10,03	1	10,03	CHI
20191137819	CAMPINACU	UC12269867	MARA ROSA	05/11/2019 15:42	05/11/2019 17:14	05/11/2019 15:42	05/11/2019 17:14	1,53	2	3,06	CHI
20191137823	SANTA HELENA DE GOIAS	SH12295845	IPEGUARI	05/11/2019 14:00	05/11/2019 18:56	05/11/2019 14:00	05/11/2019 18:56	4,93	9	44,38	CHI
20191137828	NOVO GAMA	4990114876	PACAEMBU S1	05/11/2019 15:42	05/11/2019 17:13	05/11/2019 15:42	05/11/2019 17:13	1,50	1	1,50	CHI
20191137830	ALEXANIA	480037929	ALEXANIA	05/11/2019 15:43	05/11/2019 20:10	05/11/2019 15:43	05/11/2019 20:10	4,45	1	4,45	CHI
20191137845	INHUMAS	30103666	INHUMAS S2	05/11/2019 15:44	07/11/2019 09:13	05/11/2019 15:44	07/11/2019 09:13	41,49	1	41,49	CHI
20191137850	JARAGUA	JA21098915	JARAGUA	05/11/2019 15:44	08/11/2019 02:20	05/11/2019 15:44	08/11/2019 02:20	58,59	1	58,59	CHI
20191137852	ALTO HORIZONTE	AJ12320992	SANTA TEREZINHA	05/11/2019 15:44	06/11/2019 00:25	05/11/2019 15:44	06/11/2019 00:25	8,67	46	398,87	CHI
20191137858	ABADIANIA	350041090	ANAPOLIS UNIVERSITARIO S1	05/11/2019 15:45	05/11/2019 18:18	05/11/2019 15:45	05/11/2019 18:18	2,55	1	2,55	CHI
20191137869	ITARUMA	IM21062394	CACHOEIRA ALTA	05/11/2019 15:46	06/11/2019 11:17	05/11/2019 15:46	06/11/2019 11:17	19,51	1	19,51	CHI
20191137871	MINEIROS	MY21209982	PARQUE DAS EMAS	05/11/2019 15:46	07/11/2019 15:05	05/11/2019 15:46	07/11/2019 15:05	47,31	1	47,31	CHI
20191137873	CATURAI	TR12277048	TRINDADE	05/11/2019 13:50	05/11/2019 23:05	05/11/2019 13:50	05/11/2019 23:05	9,25	9	83,22	CHI

20191137873	GOIANIRA	TR12277048	TRINDADE	05/11/2019 13:50	05/11/2019 23:05	05/11/2019 13:50	05/11/2019 23:05	9,25	26	240,42	CHI
20191137873	SANTA BARBARA DE GOIAS	TR12277048	TRINDADE	05/11/2019 13:50	05/11/2019 23:05	05/11/2019 13:50	05/11/2019 23:05	9,25	23	212,68	CHI
20191137873	TRINDADE	TR12277048	TRINDADE	05/11/2019 13:50	05/11/2019 23:05	05/11/2019 13:50	05/11/2019 23:05	9,25	17	157,20	CHI
20191137885	LUZIANIA	LZ12120026	VIANOPOLIS	05/11/2019 15:47	05/11/2019 21:17	05/11/2019 15:47	05/11/2019 21:17	5,49	2	10,98	CHI
20191137886	JANDAIA	1180004738	PALMEIRAS	05/11/2019 15:47	06/11/2019 07:55	05/11/2019 15:47	06/11/2019 07:55	16,14	1	16,14	CHI
20191137900	JANDAIA	JD12005438	PALMEIRAS	05/11/2019 15:17	05/11/2019 19:41	05/11/2019 15:17	05/11/2019 19:41	4,39	55	241,31	CHI
20191137900	PALMEIRAS DE GOIAS	JD12005438	PALMEIRAS	05/11/2019 15:17	05/11/2019 19:41	05/11/2019 15:17	05/11/2019 19:41	4,39	8	35,10	CHI
20191137900	PALMINOPOLIS	JD12005438	PALMEIRAS	05/11/2019 15:17	05/11/2019 19:41	05/11/2019 15:17	05/11/2019 19:41	4,39	14	61,43	CHI
20191137906	SANTO ANTONIO DO DESCOBERTO	10022004236	ALEXANIA	05/11/2019 15:49	05/11/2019 21:58	05/11/2019 15:49	05/11/2019 21:58	6,14	1	6,14	CHI
20191137919	NOVA IGUACU DE GOIAS	UR12210932	URUACU	05/11/2019 15:05	05/11/2019 21:29	05/11/2019 15:05	05/11/2019 21:29	6,40	12	76,80	CHI
20191137919	PILAR DE GOIAS	UR12210932	URUACU	05/11/2019 15:05	05/11/2019 21:29	05/11/2019 15:05	05/11/2019 21:29	6,40	1	6,40	CHI
20191137919	URUACU	UR12210932	URUACU	05/11/2019 15:05	05/11/2019 21:29	05/11/2019 15:05	05/11/2019 21:29	6,40	30	192,01	CHI
20191137937	ITAPACI	IW11003345	ITAPACI	05/11/2019 15:52	05/11/2019 22:54	05/11/2019 15:52	05/11/2019 22:54	7,03	61	428,56	CHI
20191137942	GOIANIA	GN12000364	GOIANIA LESTE S1	05/11/2019 15:32	06/11/2019 20:50	05/11/2019 15:32	05/11/2019 18:03	2,50	85	212,90	CHI
20191137942	GOIANIA	GN11000834	GOIANIA LESTE S1	05/11/2019 15:32	06/11/2019 20:50	05/11/2019 15:32	06/11/2019 20:50	29,28	92	2694,19	CHI
20191137943	CAMPOS VERDES	SG12318464	SANTA TEREZINHA	05/11/2019 14:04	05/11/2019 21:38	05/11/2019 14:04	05/11/2019 21:38	7,56	13	98,33	CHI
20191137943	SANTA TEREZINHA DE GOIAS	SG12318464	SANTA TEREZINHA	05/11/2019 14:04	05/11/2019 21:38	05/11/2019 14:04	05/11/2019 21:38	7,56	33	249,62	CHI
20191137943	UIRAPURU	SG12318464	SANTA TEREZINHA	05/11/2019 14:04	05/11/2019 21:38	05/11/2019 14:04	05/11/2019 21:38	7,56	12	90,77	CHI
20191137949	FLORES DE GOIAS	FB12255011	FLORES DE GOIAS	05/11/2019 15:37	05/11/2019 18:41	05/11/2019 15:37	05/11/2019 18:41	3,05	374	1141,64	CHI
20191137949	SAO JOAO D ALIANCA	FB12255011	FLORES DE GOIAS	05/11/2019 15:37	05/11/2019 18:41	05/11/2019 15:37	05/11/2019 18:41	3,05	7	21,37	CHI
20191137966	FORMOSA	FA32042714	SAO JOAO D ALIANCA	05/11/2019 15:54	05/11/2019 19:38	05/11/2019 15:54	05/11/2019 19:38	3,72	8	29,74	CHI
20191137969	IACIARA	6910000208	IACIARA S1	05/11/2019 15:55	05/11/2019 19:40	05/11/2019 15:55	05/11/2019 19:40	3,75	1	3,75	CHI
20191137977	TRINDADE	TR11158284	GOYA S2	05/11/2019 15:14	05/11/2019 21:50	05/11/2019 15:14	05/11/2019 21:50	6,59	149	982,20	CHI
20191137978	ITAJA	IJ12226576	ITAJA S2	05/11/2019 12:22	05/11/2019 21:20	05/11/2019 12:22	05/11/2019 21:20	8,98	6	53,85	CHI
20191137980	RIO VERDE	630420658	RIO VERDE S2	05/11/2019 15:56	06/11/2019 03:40	05/11/2019 15:56	06/11/2019 03:40	11,73	1	11,73	CHI
20191137988	SILVANIA	10026277067	VIANOPOLIS	05/11/2019 15:56	06/11/2019 16:49	05/11/2019 15:56	06/11/2019 16:49	24,87	1	24,87	CHI
20191137996	ALTO PARAISO DE GOIAS	ND12302635	IACIARA S2	05/11/2019 15:41	06/11/2019 05:09	05/11/2019 15:41	06/11/2019 05:09	13,46	18	242,36	CHI
20191137996	NOVA ROMA	ND12302635	IACIARA S2	05/11/2019 15:41	06/11/2019 05:09	05/11/2019 15:41	06/11/2019 05:09	13,46	121	1629,23	CHI
20191137996	SAO JOAO D ALIANCA	ND12302635	IACIARA S2	05/11/2019 15:41	06/11/2019 05:09	05/11/2019 15:41	06/11/2019 05:09	13,46	27	363,55	CHI
20191138002	CACU	CC12051359	CACHOEIRA ALTA	05/11/2019 15:57	06/11/2019 15:01	05/11/2019 15:57	06/11/2019 15:01	23,05	4	92,20	CHI
20191138014	ALTO PARAISO DE GOIAS	BF12302848	FLORES DE GOIAS	05/11/2019 13:14	05/11/2019 17:33	05/11/2019 13:14	05/11/2019 17:33	4,31	9	38,77	CHI
20191138018	MINACU	IH11202507	MINACU	05/11/2019 19:02	06/11/2019 02:20	05/11/2019 19:02	06/11/2019 02:20	7,31	11	80,40	CHI
20191138024	SAO JOAO D ALIANCA	JL31198426	SAO JOAO D ALIANCA	05/11/2019 15:59	06/11/2019 15:55	05/11/2019 15:59	06/11/2019 15:55	23,92	2	47,85	CHI

20191138042	CALDAS NOVAS	CN11363871	CALDAS NOVAS S1	05/11/2019 15:06	06/11/2019 15:44	05/11/2019 15:06	06/11/2019 15:44	24,62	78	1920,75	CHI
20191138045	JARAGUA	JA11022751	JARAGUA	05/11/2019 14:58	05/11/2019 18:49	05/11/2019 14:58	05/11/2019 18:49	3,85	154	592,39	CHI
20191138048	JANDAIA	JD21159011	PALMEIRAS	05/11/2019 16:02	06/11/2019 14:36	05/11/2019 16:02	06/11/2019 14:36	22,57	2	45,15	CHI
20191138054	INDIARA	2710012425	EDEIA	05/11/2019 16:02	06/11/2019 16:13	05/11/2019 16:02	06/11/2019 16:13	24,18	1	24,18	CHI
20191138056	IACIARA	IA12392240	FLORES DE GOIAS	05/11/2019 14:45	05/11/2019 17:38	05/11/2019 14:45	05/11/2019 17:38	2,88	7	20,17	CHI
20191138057	MINACU	IH12392286	MINACU	05/11/2019 16:03	05/11/2019 23:34	05/11/2019 16:03	05/11/2019 21:32	5,48	19	104,08	CHI
20191138057	MINACU	IH12392286	MINACU	05/11/2019 16:03	05/11/2019 23:34	05/11/2019 22:48	05/11/2019 23:34	0,76	19	14,45	CHI
20191138061	PIRENOPOLIS	PV12355915	CORUMBA	05/11/2019 15:43	05/11/2019 20:32	05/11/2019 15:43	05/11/2019 20:32	4,81	19	91,41	CHI
20191138074	GOIANIA	GN11161961	CAMPINAS S1	05/11/2019 15:37	05/11/2019 16:54	05/11/2019 15:37	05/11/2019 16:54	1,28	47	60,09	CHI
20191138083	RIO VERDE	RV12092821	MONTIVIDIU T	05/11/2019 16:05	06/11/2019 18:58	05/11/2019 16:05	06/11/2019 18:58	26,88	11	295,70	CHI
20191138100	SENADOR CANEDO	SW12002157	SENADOR CANEDO	05/11/2019 16:07	06/11/2019 19:55	05/11/2019 16:07	06/11/2019 19:55	27,80	5	138,99	CHI
20191138101	ANAPOLIS	10029086530	JUNDIAI S1	05/11/2019 16:07	05/11/2019 20:29	05/11/2019 16:07	05/11/2019 20:29	4,37	1	4,37	CHI
20191138104	LUZIANIA	LZ12000377	MARAJOARA	05/11/2019 16:07	05/11/2019 17:56	05/11/2019 16:07	05/11/2019 17:56	1,81	504	912,94	CHI
20191138106	LUZIANIA	LZ11000522	RIO VERMELHO	05/11/2019 16:07	05/11/2019 16:54	05/11/2019 16:07	05/11/2019 16:54	0,77	110	85,07	CHI
20191138119	SANTA TEREZINHA DE GOIAS	4130001580	SANTA TEREZINHA	05/11/2019 16:08	07/11/2019 18:49	05/11/2019 16:08	07/11/2019 18:49	50,70	1	50,70	CHI
20191138121	ITARUMA	IM21122620	CACHOEIRA ALTA	05/11/2019 16:08	05/11/2019 19:55	05/11/2019 16:08	05/11/2019 19:55	3,78	1	3,78	CHI
20191138151	GUARANI DE GOIAS	GY11262278	IACIARA S1	05/11/2019 16:11	05/11/2019 17:40	05/11/2019 16:11	05/11/2019 17:40	1,47	87	127,89	CHI
20191138154	CORUMBA DE GOIAS	CB12382193	CORUMBA	05/11/2019 16:12	05/11/2019 18:44	05/11/2019 16:12	05/11/2019 18:44	2,53	4	10,13	CHI
20191138160	GOIANIA	GN11000435	CAMPINAS S3	05/11/2019 15:27	05/11/2019 18:35	05/11/2019 15:27	05/11/2019 18:35	3,12	141	440,04	CHI
20191138161	PARAUNA	PU11216523	PARAUNA	05/11/2019 15:32	05/11/2019 21:25	05/11/2019 15:32	05/11/2019 21:25	5,88	152	893,25	CHI
20191138163	PORANGATU	PO12020946	PORANGATU	05/11/2019 16:13	06/11/2019 21:00	05/11/2019 16:13	06/11/2019 21:00	28,78	4	115,13	CHI
20191138164	DOVERLANDIA	DV12334951	PARQUE DAS EMAS	05/11/2019 16:13	08/11/2019 13:03	05/11/2019 16:13	08/11/2019 13:03	68,83	2	137,66	CHI
20191138166	ARAGOIANIA	AO31045557	GUAPO S2	05/11/2019 16:13	07/11/2019 12:34	05/11/2019 16:13	07/11/2019 12:34	44,36	1	44,36	CHI
20191138167	APARECIDA DO RIO DOCE	AW12189038	CACHOEIRA ALTA	05/11/2019 16:13	06/11/2019 22:07	05/11/2019 16:13	06/11/2019 22:07	29,90	4	119,59	CHI
20191138169	GOIANESIA	SZ12034200	ITAPACI	05/11/2019 16:13	06/11/2019 19:19	05/11/2019 16:13	06/11/2019 19:19	27,09	1	27,09	CHI
20191138169	SAO LUIZ DO NORTE	SZ12034200	ITAPACI	05/11/2019 16:13	06/11/2019 19:19	05/11/2019 16:13	06/11/2019 19:19	27,09	3	81,28	CHI
20191138178	CIDADE OCIDENTAL	LZ21070121	MARAJOARA	05/11/2019 16:14	06/11/2019 07:48	05/11/2019 16:14	06/11/2019 07:48	15,56	1	15,56	CHI
20191138185	INACIOLANDIA	CD12000349	QUIRINOPODIS	05/11/2019 16:15	06/11/2019 10:55	05/11/2019 16:15	06/11/2019 10:55	18,67	6	111,99	CHI
20191138188	URUACU	UR12050041	URUACU	05/11/2019 16:15	06/11/2019 19:06	05/11/2019 16:15	06/11/2019 19:06	26,85	8	214,77	CHI
20191138194	GOIATUBA	GT21208001	GOIATUBA S1	05/11/2019 16:16	05/11/2019 19:00	05/11/2019 16:16	05/11/2019 19:00	2,73	2	5,46	CHI
20191138195	MOZARLANDIA	10023431910	MOZARLANDIA	05/11/2019 16:16	10/11/2019 13:00	05/11/2019 16:16	10/11/2019 13:00	116,73	1	116,73	CHI
20191138216	BELA VISTA DE GOIAS	SW12203608	CEPAIGO S2	05/11/2019 17:49	06/11/2019 12:38	05/11/2019 17:49	06/11/2019 12:38	18,81	1	18,81	CHI
20191138216	SENADOR CANEDO	SW12203608	CEPAIGO S2	05/11/2019 17:49	06/11/2019 12:38	05/11/2019 17:49	06/11/2019 12:38	18,81	131	2463,67	CHI

20191138223	IPAMERI	IP12036044	URUTAI	05/11/2019 16:19	08/11/2019 09:38	05/11/2019 16:19	08/11/2019 09:38	65,31	8	522,48	CHI
20191138226	NEROPOLIS	NR21353483	DAIA S2	05/11/2019 16:19	06/11/2019 10:04	05/11/2019 16:19	06/11/2019 10:04	17,74	1	17,74	CHI
20191138234	PORANGATU	PO21139170	PORANGATU	05/11/2019 16:20	10/11/2019 11:07	05/11/2019 16:20	10/11/2019 11:07	114,78	1	114,78	CHI
20191138236	GOIANIRA	GR12402799	GOIANIRA	05/11/2019 16:10	06/11/2019 08:42	05/11/2019 16:10	06/11/2019 08:42	16,53	5	82,63	CHI
20191138242	PORTELANDIA	PW12151599	PARQUE DAS EMAS	05/11/2019 16:21	06/11/2019 11:27	05/11/2019 16:21	06/11/2019 11:27	19,10	4	76,39	CHI
20191138243	ITAPACI	10008842912	ITAPACI	05/11/2019 16:21	08/11/2019 12:50	05/11/2019 16:21	08/11/2019 12:50	68,49	1	68,49	CHI
20191138251	JATAI	JT11182182	JATAI S3	05/11/2019 16:22	05/11/2019 20:37	05/11/2019 16:22	05/11/2019 20:37	4,26	4	17,06	CHI
20191138252	SAO SIMAO	SO11000021	CACHOEIRA ALTA	05/11/2019 15:13	05/11/2019 22:07	05/11/2019 15:13	05/11/2019 22:07	6,89	89	612,99	CHI
20191138254	CAMPINACU	UC12244555	PORANGATU	05/11/2019 15:47	06/11/2019 16:03	05/11/2019 15:47	06/11/2019 16:03	24,25	17	412,31	CHI
20191138261	GOIANIA	GN11189604	ATLANTICO S1	05/11/2019 15:11	05/11/2019 17:56	05/11/2019 15:11	05/11/2019 17:56	2,75	77	211,39	CHI
20191138270	CAVALCANTE	TE21321616	FLORES DE GOIAS	05/11/2019 16:25	07/11/2019 15:49	05/11/2019 16:25	07/11/2019 15:49	47,40	1	47,40	CHI
20191138275	GOIANIA	GN11000335	GOIANIA LESTE S1	05/11/2019 16:25	05/11/2019 20:07	05/11/2019 16:25	05/11/2019 20:07	3,69	16	59,00	CHI
20191138280	ANAPOLIS	AN12009330	NEROPOLIS S1	05/11/2019 15:35	05/11/2019 18:39	05/11/2019 15:35	05/11/2019 18:39	3,06	25	76,48	CHI
20191138280	PIRENOPOLIS	AN12009330	NEROPOLIS S1	05/11/2019 15:35	05/11/2019 18:39	05/11/2019 15:35	05/11/2019 18:39	3,06	19	58,12	CHI
20191138283	ANAPOLIS	AN11351095	ANAPOLIS UNIVERSITARIO S2	05/11/2019 16:26	05/11/2019 19:02	05/11/2019 16:26	05/11/2019 19:02	2,59	77	199,09	CHI
20191138289	VILA PROPICIO	NP12196266	GOIANESIA S1	05/11/2019 15:43	06/11/2019 18:31	05/11/2019 15:43	06/11/2019 18:31	26,79	22	589,32	CHI
20191138293	APARECIDA DE GOIANIA	200131552	INDEPENDENCIA S2	05/11/2019 16:27	05/11/2019 17:28	05/11/2019 16:27	05/11/2019 17:28	1,00	1	1,00	CHI
20191138295	ITAPIRAPUA	IU12018834	MATRINCHA	05/11/2019 16:27	07/11/2019 10:54	05/11/2019 16:27	07/11/2019 10:54	42,44	1	42,44	CHI
20191138296	GOIANIA	GN11112717	MEIA PONTE	05/11/2019 16:27	06/11/2019 20:24	06/11/2019 18:42	06/11/2019 20:24	1,69	127	214,07	CHI
20191138297	BELA VISTA DE GOIAS	BV12000046	CEPAIGO S2	05/11/2019 16:24	05/11/2019 23:33	05/11/2019 16:24	05/11/2019 23:33	7,14	30	214,32	CHI
20191138308	ABADIANIA	AA12271855	ANAPOLIS UNIVERSITARIO S1	05/11/2019 14:07	05/11/2019 18:16	05/11/2019 14:07	05/11/2019 18:16	4,14	6	24,83	CHI
20191138316	GUARANI DE GOIAS	GY12267340	IACIARA S2	05/11/2019 15:44	05/11/2019 21:16	05/11/2019 15:44	05/11/2019 21:16	5,52	61	336,70	CHI
20191138324	FORMOSA	FA21334126	SAO JOAO D ALIANCA	05/11/2019 16:30	05/11/2019 20:31	05/11/2019 16:30	05/11/2019 20:31	4,00	1	4,00	CHI
20191138325	PIRACANJUBA	10005244372	PIRACANJUBA	05/11/2019 16:30	06/11/2019 16:11	05/11/2019 16:30	06/11/2019 16:11	23,68	1	23,68	CHI
20191138326	ITAPURANGA	IK12298410	ITAPURANGA	05/11/2019 14:13	05/11/2019 21:40	05/11/2019 14:13	05/11/2019 21:40	7,44	12	89,33	CHI
20191138327	CEZARINA	CZ12099664	GUAPO S2	05/11/2019 15:54	05/11/2019 17:35	05/11/2019 15:54	05/11/2019 17:35	1,67	78	130,15	CHI
20191138327	INDIARA	CZ12099664	GUAPO S2	05/11/2019 15:54	05/11/2019 17:35	05/11/2019 15:54	05/11/2019 17:35	1,67	1	1,67	CHI
20191138329	URUACU	UR21147166	URUACU	05/11/2019 16:30	06/11/2019 23:49	05/11/2019 16:30	06/11/2019 23:49	31,30	1	31,30	CHI
20191138330	RIO VERDE	RV21301760	RIO VERDE S2	05/11/2019 16:31	08/11/2019 10:10	05/11/2019 16:31	08/11/2019 10:10	65,65	1	65,65	CHI
20191138331	ARAGARCAS	AG10400712	ARAGARCAS	05/11/2019 16:28	06/11/2019 20:32	05/11/2019 16:28	06/11/2019 20:32	28,06	139	3900,80	CHI
20191138331	BOM JARDIM DE GOIAS	AG10400712	ARAGARCAS	05/11/2019 16:28	06/11/2019 20:32	05/11/2019 16:28	06/11/2019 20:32	28,06	54	1515,42	CHI
20191138333	PIRANHAS	PH11259348	PIRANHAS	05/11/2019 16:31	05/11/2019 19:25	05/11/2019 16:31	05/11/2019 19:25	2,90	20	57,93	CHI
20191138334	MARA ROSA	MQ12156002	MARA ROSA	05/11/2019 16:26	06/11/2019 14:00	05/11/2019 16:26	06/11/2019 14:00	21,55	20	431,01	CHI

20191138337	JARAGUA	JA21107590	GOIANESIA S2	05/11/2019 16:31	06/11/2019 20:41	05/11/2019 16:31	06/11/2019 20:41	28,16	1	28,16	CHI
20191138349	QUIRINOPOLIS	QI31052461	QUIRINOPOLIS	05/11/2019 16:33	06/11/2019 12:00	05/11/2019 16:33	06/11/2019 12:00	19,44	1	19,44	CHI
20191138350	ALEXANIA	AX12349389	ALEXANIA	05/11/2019 16:33	05/11/2019 22:29	05/11/2019 16:33	05/11/2019 22:29	5,93	55	326,03	CHI
20191138352	CACHOEIRA ALTA	CA1284289	CACHOEIRA ALTA	05/11/2019 14:22	13/11/2019 17:10	05/11/2019 14:22	06/11/2019 18:40	28,29	8	226,34	CHI
20191138352	CACHOEIRA ALTA	CA1284289	CACHOEIRA ALTA	05/11/2019 14:22	13/11/2019 17:10	06/11/2019 18:41	13/11/2019 17:10	166,50	8	1331,96	CHI
20191138355	LUZIANIA	LZ21109863	VIANOPOLIS	05/11/2019 16:33	06/11/2019 16:39	05/11/2019 16:33	06/11/2019 16:39	24,10	1	24,10	CHI
20191138358	TRINDADE	TR11074522	GOYA S2	05/11/2019 15:11	05/11/2019 23:42	05/11/2019 15:11	05/11/2019 23:42	8,50	161	1368,99	CHI
20191138360	NOVA VENEZA	NV11203572	INHUMAS S1	05/11/2019 16:34	05/11/2019 21:31	05/11/2019 16:34	05/11/2019 21:31	4,95	57	282,05	CHI
20191138364	ANAPOLIS	AN12327784	JUNDIAI S1	05/11/2019 16:34	05/11/2019 18:54	05/11/2019 16:34	05/11/2019 18:54	2,33	52	121,04	CHI
20191138375	ABADIANIA	AA12295550	ANAPOLIS UNIVERSITARIO S1	05/11/2019 16:15	06/11/2019 07:59	05/11/2019 16:15	06/11/2019 07:59	15,73	5	78,67	CHI
20191138377	TRINDADE	TR11207461	TRINDADE	05/11/2019 14:20	06/11/2019 05:30	05/11/2019 14:20	06/11/2019 05:30	15,15	43	651,65	CHI
20191138378	BELA VISTA DE GOIAS	BV21246637	BELA VISTA S1	05/11/2019 16:35	07/11/2019 12:17	05/11/2019 16:35	07/11/2019 12:17	43,69	1	43,69	CHI
20191138381	QUIRINOPOLIS	QI11000029	QUIRINOPOLIS	05/11/2019 16:36	06/11/2019 18:43	05/11/2019 16:36	06/11/2019 18:43	26,13	59	1541,74	CHI
20191138384	PORANGATU	PO12000010	PORANGATU	05/11/2019 15:55	06/11/2019 02:13	05/11/2019 15:55	06/11/2019 02:13	10,30	6	61,79	CHI
20191138388	PALESTINA DE GOIAS	PY12138375	PALESTINA	05/11/2019 16:36	06/11/2019 17:05	05/11/2019 16:36	06/11/2019 17:05	24,47	24	587,31	CHI
20191138398	QUIRINOPOLIS	QI21305146	QUIRINOPOLIS	05/11/2019 16:37	07/11/2019 13:04	05/11/2019 16:37	07/11/2019 13:04	44,44	1	44,44	CHI
20191138399	PLANALTINA	PI21149410	SAO JOAO D ALIANCA	05/11/2019 16:37	06/11/2019 13:30	05/11/2019 16:37	06/11/2019 13:30	20,87	1	20,87	CHI
20191138401	GOIANESIA	SZ12292609	GOIANESIA S1	05/11/2019 16:05	05/11/2019 20:44	05/11/2019 16:05	05/11/2019 20:44	4,63	8	37,07	CHI
20191138401	SAO LUIZ DO NORTE	SZ12292609	GOIANESIA S1	05/11/2019 16:05	05/11/2019 20:44	05/11/2019 16:05	05/11/2019 20:44	4,63	21	97,32	CHI
20191138406	PLANALTINA	PI12248193	PLANALTINA	05/11/2019 15:45	06/11/2019 09:53	05/11/2019 15:45	06/11/2019 09:53	18,13	4	72,51	CHI
20191138407	URUACU	UR12341322	URUACU	05/11/2019 16:38	06/11/2019 22:30	05/11/2019 16:38	06/11/2019 22:30	29,86	7	209,02	CHI
20191138410	JARAGUA	JA12297901	JARAGUA	05/11/2019 16:38	05/11/2019 20:45	05/11/2019 16:38	05/11/2019 20:45	4,11	18	73,92	CHI
20191138414	SAO LUIZ DO NORTE	SZ12348617	ITAPACI	05/11/2019 15:52	05/11/2019 17:59	05/11/2019 15:52	05/11/2019 17:59	2,12	5	10,58	CHI
20191138421	GOIANIA	GN11126716	ATLANTICO S1	05/11/2019 15:20	05/11/2019 21:36	05/11/2019 15:20	05/11/2019 21:36	6,25	61	381,27	CHI
20191138427	GOIANIA	14646225	INDEPENDENCIA S2	05/11/2019 16:40	06/11/2019 09:40	05/11/2019 16:40	06/11/2019 09:40	16,99	1	16,99	CHI
20191138428	PORANGATU	840122457	PORANGATU	05/11/2019 16:40	05/11/2019 18:41	05/11/2019 16:40	05/11/2019 18:41	2,01	1	2,01	CHI
20191138450	GOIANIA	GN11246352	GOYA S2	05/11/2019 15:30	05/11/2019 19:10	05/11/2019 15:30	05/11/2019 19:10	3,66	94	344,01	CHI
20191138452	PIRENOPOLIS	SF12017628	SAO FRANCISCO DE GOIAS	05/11/2019 16:17	05/11/2019 19:13	05/11/2019 16:17	05/11/2019 19:13	2,93	4	11,73	CHI
20191138452	SAO FRANCISCO DE GOIAS	SF12017628	SAO FRANCISCO DE GOIAS	05/11/2019 16:17	05/11/2019 19:13	05/11/2019 16:17	05/11/2019 19:13	2,93	8	23,46	CHI
20191138461	HIDROLINA	HL12190112	URUACU	05/11/2019 16:43	06/11/2019 22:05	05/11/2019 16:43	06/11/2019 22:05	29,37	5	146,84	CHI
20191138461	PILAR DE GOIAS	HL12190112	URUACU	05/11/2019 16:43	06/11/2019 22:05	05/11/2019 16:43	06/11/2019 22:05	29,37	1	29,37	CHI
20191138471	PARANAIGUARA	PC12100506LD	QUIRINOPOLIS	05/11/2019 16:43	08/11/2019 10:02	05/11/2019 16:43	08/11/2019 10:02	65,30	2	130,61	CHI
20191138471	QUIRINOPOLIS	PC12100506LD	QUIRINOPOLIS	05/11/2019 16:43	08/11/2019 10:02	05/11/2019 16:43	08/11/2019 10:02	65,30	8	522,42	CHI

20191138474	GOUVELANDIA	GB21271687	QUIRINOPOLIS	05/11/2019 16:44	06/11/2019 08:39	05/11/2019 16:44	06/11/2019 08:39	15,92	2	31,83	CHI
20191138482	ITAPIRAPUA	IU12018852	MATRINCHA	05/11/2019 16:44	06/11/2019 08:57	05/11/2019 16:44	06/11/2019 08:57	16,21	35	567,30	CHI
20191138485	TEREZOPOLIS DE GOIAS	AN21258448	JUNDIAI S2	05/11/2019 16:44	06/11/2019 13:40	05/11/2019 16:44	06/11/2019 13:40	20,93	1	20,93	CHI
20191138490	GOIANIRA	390110115	GOIANIRA	05/11/2019 16:44	06/11/2019 12:34	05/11/2019 16:44	06/11/2019 12:34	19,82	1	19,82	CHI
20191138493	APARECIDA DE GOIANIA	AP12004638	ATLANTICO S1	05/11/2019 16:20	05/11/2019 17:55	05/11/2019 16:20	05/11/2019 17:55	1,58	172	271,95	CHI
20191138493	GOIANIA	AP12004638	ATLANTICO S1	05/11/2019 16:20	05/11/2019 17:55	05/11/2019 16:20	05/11/2019 17:55	1,58	254	401,60	CHI
20191138495	MATRINCHA	MP12250742	MATRINCHA	05/11/2019 16:45	07/11/2019 11:39	05/11/2019 16:45	07/11/2019 11:39	42,89	1	42,89	CHI
20191138499	ARAGARCAS	AG12188251	ARAGARCAS	05/11/2019 16:35	09/11/2019 07:23	05/11/2019 16:35	07/11/2019 14:54	46,31	17	787,31	CHI
20191138499	ARAGARCAS	AG12188251	ARAGARCAS	05/11/2019 16:35	09/11/2019 07:23	05/11/2019 16:35	07/11/2019 16:05	47,50	4	190,02	CHI
20191138499	ARAGARCAS	AG12188251	ARAGARCAS	05/11/2019 16:35	09/11/2019 07:23	05/11/2019 16:35	07/11/2019 17:21	48,77	31	1511,91	CHI
20191138499	ARAGARCAS	AG12188251	ARAGARCAS	05/11/2019 16:35	09/11/2019 07:23	05/11/2019 16:35	09/11/2019 07:23	86,79	1	86,79	CHI
20191138500	CAMPINORTE	CR11243390	CAMPINORTE	05/11/2019 16:49	05/11/2019 20:25	05/11/2019 16:49	05/11/2019 20:25	3,59	63	225,94	CHI
20191138501	GOIANIRA	GR12336567	GOIANIRA	05/11/2019 16:44	05/11/2019 19:10	05/11/2019 16:44	05/11/2019 19:10	2,43	2	4,85	CHI
20191138503	ARAGUAPAZ	AZ21042943	MOZARLANDIA	05/11/2019 16:46	06/11/2019 14:33	05/11/2019 16:46	06/11/2019 14:33	21,78	1	21,78	CHI
20191138506	URUACU	CR12398061	CAMPINORTE	05/11/2019 16:46	06/11/2019 11:13	05/11/2019 16:46	06/11/2019 11:13	18,45	7	129,12	CHI
20191138510	ARACU	10009365476	ARACU	05/11/2019 16:47	07/11/2019 13:11	05/11/2019 16:47	07/11/2019 13:11	44,40	1	44,40	CHI
20191138511	MINACU	IH21288121	MINACU	05/11/2019 16:47	07/11/2019 10:19	05/11/2019 16:47	07/11/2019 10:19	41,55	2	83,09	CHI
20191138523	GOIANESIA	550038401	GOIANESIA S2	05/11/2019 16:47	07/11/2019 09:56	05/11/2019 16:47	07/11/2019 09:56	41,14	1	41,14	CHI
20191138527	ITABERAI	IX12016074	INHUMAS S1	05/11/2019 16:35	06/11/2019 13:30	05/11/2019 16:35	06/11/2019 13:30	20,91	18	376,46	CHI
20191138527	ITAUCU	IX12016074	INHUMAS S1	05/11/2019 16:35	06/11/2019 13:30	05/11/2019 16:35	06/11/2019 13:30	20,91	12	250,97	CHI
20191138540	RIO VERDE	BZ12211442	SANTA HELENA S1	05/11/2019 16:53	05/11/2019 23:28	05/11/2019 16:53	05/11/2019 23:28	6,57	4	26,29	CHI
20191138540	SANTO ANTONIO DA BARRA	BZ12211442	SANTA HELENA S1	05/11/2019 16:53	05/11/2019 23:28	05/11/2019 16:53	05/11/2019 23:28	6,57	20	131,47	CHI
20191138542	IACIARA	IA12164702	IACIARA S1	05/11/2019 14:00	05/11/2019 18:10	05/11/2019 14:00	05/11/2019 18:10	4,17	148	616,42	CHI
20191138544	PORANGATU	PO12291266	PORANGATU	05/11/2019 16:07	05/11/2019 22:12	05/11/2019 16:07	05/11/2019 22:12	6,07	7	42,49	CHI
20191138550	MINACU	IH12207742	MINACU	05/11/2019 16:50	05/11/2019 23:30	05/11/2019 16:50	05/11/2019 23:30	6,65	8	53,20	CHI
20191138557	ARACU	AR12019445	ARACU	05/11/2019 13:59	06/11/2019 08:55	05/11/2019 13:59	06/11/2019 08:55	18,92	14	264,92	CHI
20191138557	ITABERAI	AR12019445	ARACU	05/11/2019 13:59	06/11/2019 08:55	05/11/2019 13:59	06/11/2019 08:55	18,92	12	227,08	CHI
20191138561	BELA VISTA DE GOIAS	BV21035144	CEPAIGO S2	05/11/2019 16:52	06/11/2019 15:04	05/11/2019 16:52	06/11/2019 15:04	22,20	1	22,20	CHI
20191138564	APARECIDA DE GOIANIA	200102680	INDEPENDENCIA S2	05/11/2019 16:52	05/11/2019 18:18	05/11/2019 16:52	05/11/2019 18:18	1,42	1	1,42	CHI
20191138565	PORANGATU	PO12020580	PORANGATU	05/11/2019 16:08	05/11/2019 23:13	05/11/2019 16:08	05/11/2019 23:13	7,07	66	466,73	CHI
20191138571	ABADIA DE GOIAS	AO12000113	INDEPENDENCIA S2	05/11/2019 16:56	05/11/2019 18:15	05/11/2019 16:56	05/11/2019 18:15	1,31	1	1,31	CHI
20191138579	APARECIDA DE GOIANIA	14600110	INDEPENDENCIA S2	05/11/2019 16:53	05/11/2019 18:01	05/11/2019 16:53	05/11/2019 18:01	1,12	1	1,12	CHI
20191138595	SENADOR CANEDO	190028040	SENADOR CANEDO	05/11/2019 16:55	05/11/2019 18:01	05/11/2019 16:55	05/11/2019 18:01	1,10	1	1,10	CHI

20191138607	SAO JOAO D ALIANCA	JL12218396	SAO JOAO D ALIANCA	05/11/2019 14:30	05/11/2019 18:22	05/11/2019 14:30	05/11/2019 18:22	3,86	7	27,05	CHI
20191138610	SAO MIGUEL DO ARAGUAIA	SM21202536	SAO MIGUEL DO ARAGUAIA	05/11/2019 16:56	09/11/2019 15:54	05/11/2019 16:56	09/11/2019 15:54	94,96	1	94,96	CHI
20191138618	URUACU	640004179	URUACU	05/11/2019 16:56	05/11/2019 22:24	05/11/2019 16:56	05/11/2019 22:24	5,45	1	5,45	CHI
20191138619	ITUMBIARA	IT12264052	ITUMBIARA NOVA	05/11/2019 13:31	08/11/2019 11:13	05/11/2019 13:31	08/11/2019 11:13	69,69	2	139,39	CHI
20191138620	CACHOEIRA DOURADA	CD11166378	CACHOEIRA DOURADA	05/11/2019 16:19	07/11/2019 11:30	05/11/2019 16:19	07/11/2019 11:30	43,17	81	3497,17	CHI
20191138623	LUZIANIA	LZ12051365	CRISTALINA S2	05/11/2019 16:57	05/11/2019 21:00	05/11/2019 16:57	05/11/2019 21:00	4,04	2	8,09	CHI
20191138632	ITABERAI	II12217217	ITABERAI S1	05/11/2019 12:03	05/11/2019 18:41	05/11/2019 12:03	05/11/2019 18:41	6,63	15	99,46	CHI
20191138632	ITAGUARI	II12217217	ITABERAI S1	05/11/2019 12:03	05/11/2019 18:41	05/11/2019 12:03	05/11/2019 18:41	6,63	30	198,92	CHI
20191138632	TAQUARAL DE GOIAS	II12217217	ITABERAI S1	05/11/2019 12:03	05/11/2019 18:41	05/11/2019 12:03	05/11/2019 18:41	6,63	46	305,01	CHI
20191138639	TRINDADE	TR12388750	TRINDADE	05/11/2019 16:59	06/11/2019 13:35	05/11/2019 16:59	06/11/2019 13:35	20,59	1	20,59	CHI
20191138640	SAO SIMAO	SO21385770	CACHOEIRA ALTA	05/11/2019 16:59	07/11/2019 17:18	05/11/2019 16:59	07/11/2019 17:18	48,31	1	48,31	CHI
20191138644	CACHOEIRA ALTA	1090011481	CACHOEIRA ALTA	05/11/2019 17:00	06/11/2019 15:58	05/11/2019 17:00	06/11/2019 15:58	22,96	1	22,96	CHI
20191138649	BARRO ALTO	BA12000040	BARRO ALTO	05/11/2019 17:00	07/11/2019 17:37	05/11/2019 17:00	07/11/2019 17:37	48,61	5	243,07	CHI
20191138649	BARRO ALTO	BA21294079	BARRO ALTO	05/11/2019 17:00	07/11/2019 17:37	05/11/2019 17:00	07/11/2019 17:37	48,62	1	48,62	CHI
20191138653	SANTO ANTONIO DE GOIAS	GR21232090	NEROPOLIS S1	05/11/2019 17:01	06/11/2019 11:00	05/11/2019 17:01	06/11/2019 11:00	17,98	1	17,98	CHI
20191138656	PONTALINA	AD21108885	GOIATUBA S1	05/11/2019 17:01	07/11/2019 09:10	05/11/2019 17:01	07/11/2019 09:10	40,15	1	40,15	CHI
20191138671	FORMOSO	TB12372648	PORANGATU	05/11/2019 16:55	06/11/2019 00:51	05/11/2019 16:55	06/11/2019 00:51	7,93	1	7,93	CHI
20191138671	TROMBAS	TB12372648	PORANGATU	05/11/2019 16:55	06/11/2019 00:51	05/11/2019 16:55	06/11/2019 00:51	7,93	67	531,07	CHI
20191138681	CALDAS NOVAS	10017112719	SERRA DE CALDAS	05/11/2019 17:02	06/11/2019 07:54	05/11/2019 17:02	06/11/2019 07:54	14,85	1	14,85	CHI
20191138686	FIRMINOPOLIS	FR11076416	FIRMINOPOLIS S1	05/11/2019 16:44	05/11/2019 19:25	05/11/2019 16:44	05/11/2019 19:25	2,68	125	334,97	CHI
20191138693	NOVA ROMA	ND21348803	IACIARA S2	05/11/2019 17:03	05/11/2019 20:46	05/11/2019 17:03	05/11/2019 20:46	3,70	1	3,70	CHI
20191138703	ALTO PARAISO DE GOIAS	NQ12234731	NIQUELANDIA SUBTRANSMISSAO	05/11/2019 13:56	06/11/2019 12:46	05/11/2019 13:56	06/11/2019 12:46	22,83	12	273,92	CHI
20191138703	NIQUELANDIA	NQ12234731	NIQUELANDIA SUBTRANSMISSAO	05/11/2019 13:56	06/11/2019 12:46	05/11/2019 13:56	06/11/2019 12:46	22,83	14	319,57	CHI
20191138703	SAO JOAO D ALIANCA	NQ12234731	NIQUELANDIA SUBTRANSMISSAO	05/11/2019 13:56	06/11/2019 12:46	05/11/2019 13:56	06/11/2019 12:46	22,83	1	22,83	CHI
20191138704	ORIZONA	OZ21325248	PIRES DO RIO S2	05/11/2019 16:08	06/11/2019 09:49	05/11/2019 16:08	06/11/2019 09:49	17,69	1	17,69	CHI
20191138709	CRISTALINA	KR21170316	PAMPLONA	05/11/2019 17:05	05/11/2019 20:20	05/11/2019 17:05	05/11/2019 20:20	3,24	1	3,24	CHI
20191138711	AGUA FRIA DE GOIAS	TL12279981	SAO JOAO D ALIANCA	05/11/2019 17:05	05/11/2019 23:07	05/11/2019 17:05	05/11/2019 23:07	6,02	41	246,93	CHI
20191138716	GOIANIA	SW12395816	GOIANIA LESTE S1	05/11/2019 13:47	06/11/2019 01:04	05/11/2019 13:47	06/11/2019 01:04	11,27	3	33,82	CHI
20191138716	SENADOR CANEDO	SW12395816	GOIANIA LESTE S1	05/11/2019 13:47	06/11/2019 01:04	05/11/2019 13:47	06/11/2019 01:04	11,27	4	45,09	CHI
20191138717	ARAGUAPAZ	AZ11042964	MOZARLANDIA	05/11/2019 17:06	05/11/2019 18:00	05/11/2019 17:06	05/11/2019 18:00	0,91	84	76,51	CHI
20191138718	SANCLERLANDIA	SC21068244	FIRMINOPOLIS S2	05/11/2019 17:06	07/11/2019 08:39	05/11/2019 17:06	07/11/2019 08:39	39,55	1	39,55	CHI
20191138719	APARECIDA DE GOIANIA	11690926	REAL S1	05/11/2019 17:06	05/11/2019 18:28	05/11/2019 17:06	05/11/2019 18:28	1,36	1	1,36	CHI
20191138720	CATALAO	1990217373	CATALAO S2	05/11/2019 17:06	05/11/2019 18:43	05/11/2019 17:06	05/11/2019 18:43	1,61	1	1,61	CHI

20191138737	GUAPO	TR21000204	GUAPO S1	05/11/2019 17:08	08/11/2019 10:40	05/11/2019 17:08	08/11/2019 10:40	65,53	3	196,60	CHI
20191138752	FLORES DE GOIAS	FB11285975	FLORES DE GOIAS	05/11/2019 17:09	06/11/2019 01:27	05/11/2019 17:09	06/11/2019 01:27	8,29	8	66,33	CHI
20191138757	ITABERAÍ	IB12336527	ITABERAÍ S2	05/11/2019 15:39	05/11/2019 19:10	05/11/2019 15:39	05/11/2019 19:10	3,50	219	767,35	CHI
20191138761	TRINDADE	TR12095579LD	TRINDADE	05/11/2019 15:43	05/11/2019 19:10	05/11/2019 15:43	05/11/2019 19:10	3,43	535	1837,58	CHI
20191138764	BELA VISTA DE GOIAS	SW12091937LD	SENADOR CANEDO	05/11/2019 16:20	06/11/2019 09:40	05/11/2019 16:20	06/11/2019 09:40	17,32	11	190,56	CHI
20191138764	CALDAZINHA	SW12091937LD	SENADOR CANEDO	05/11/2019 16:20	06/11/2019 09:40	05/11/2019 16:20	06/11/2019 09:40	17,32	12	207,88	CHI
20191138764	SENADOR CANEDO	SW12091937LD	SENADOR CANEDO	05/11/2019 16:20	06/11/2019 09:40	05/11/2019 16:20	06/11/2019 09:40	17,32	10	173,24	CHI
20191138779	CATALAO	CT12013670	CATALAO S1	05/11/2019 17:12	07/11/2019 13:13	05/11/2019 17:12	07/11/2019 13:13	44,01	4	176,06	CHI
20191138781	URUACU	UR21066501	URUACU	05/11/2019 17:12	06/11/2019 01:58	05/11/2019 17:12	06/11/2019 01:58	8,76	2	17,52	CHI
20191138790	JOVIANIA	JV12244778	GOIATUBA S1	05/11/2019 15:54	07/11/2019 00:48	05/11/2019 15:54	07/11/2019 00:48	32,89	353	11609,97	CHI
20191138796	GOIANIA	GN11213735	GOYA S1	05/11/2019 15:55	05/11/2019 18:20	05/11/2019 15:55	05/11/2019 18:20	2,42	129	312,47	CHI
20191138801	CAMPO ALEGRE DE GOIAS	CM12215493	CAMPO ALEGRE DE GOIAS	06/11/2019 08:51	06/11/2019 14:05	06/11/2019 08:51	06/11/2019 14:05	5,22	4	20,89	CHI
20191138801	IPAMERI	CM12215493	CAMPO ALEGRE DE GOIAS	06/11/2019 08:51	06/11/2019 14:05	06/11/2019 08:51	06/11/2019 14:05	5,22	1	5,22	CHI
20191138813	JUSSARA	JR12093635	BRITANIA	05/11/2019 17:15	10/11/2019 08:11	05/11/2019 17:15	10/11/2019 08:11	110,92	3	332,76	CHI
20191138823	MINEIROS	MY12202613	PARQUE DAS EMAS	05/11/2019 17:16	05/11/2019 21:15	05/11/2019 17:16	05/11/2019 21:15	3,97	10	39,70	CHI
20191138824	MORRINHOS	MR12000214	MORRINHOS	06/11/2019 07:56	06/11/2019 12:05	06/11/2019 07:56	06/11/2019 12:05	4,13	4	16,54	CHI
20191138828	URUACU	UR11210918	URUACU	05/11/2019 17:09	05/11/2019 21:05	05/11/2019 17:09	05/11/2019 21:05	3,93	106	416,84	CHI
20191138834	URUACU	UR12202058	URUACU	05/11/2019 14:51	05/11/2019 23:06	05/11/2019 14:51	05/11/2019 23:06	8,25	11	90,71	CHI
20191138837	NOVA IGUACU DE GOIAS	NH21150759	CAMPINORTE	06/11/2019 07:55	08/11/2019 12:37	06/11/2019 07:55	08/11/2019 12:37	52,69	2	105,38	CHI
20191138844	CALDAZINHA	DE21128332	CEPAIGO S2	05/11/2019 17:19	06/11/2019 10:16	05/11/2019 17:19	06/11/2019 10:16	16,95	1	16,95	CHI
20191138850	MUNDO NOVO DE GOIAS	MH12362454	NOVA CRIXAS	05/11/2019 11:29	05/11/2019 18:27	05/11/2019 11:29	05/11/2019 18:27	6,96	125	869,48	CHI
20191138866	CAMPINORTE	CR11043329	MARA ROSA	05/11/2019 15:42	06/11/2019 00:03	05/11/2019 15:42	06/11/2019 00:03	8,35	81	676,01	CHI
20191138867	APARECIDA DE GOIANIA	10004764666	INDEPENDENCIA S2	05/11/2019 17:20	06/11/2019 00:06	05/11/2019 17:20	06/11/2019 00:06	6,75	1	6,75	CHI
20191138875	CAMPINORTE	CR12093167	CAMPINORTE	05/11/2019 17:21	05/11/2019 21:33	05/11/2019 17:21	05/11/2019 21:33	4,19	26	108,98	CHI
20191138875	NOVA IGUACU DE GOIAS	CR12093167	CAMPINORTE	05/11/2019 17:21	05/11/2019 21:33	05/11/2019 17:21	05/11/2019 21:33	4,19	4	16,77	CHI
20191138876	ABADIANIA	AA12130228	DAIA S2	05/11/2019 16:46	05/11/2019 22:23	05/11/2019 16:46	05/11/2019 22:23	5,61	30	168,41	CHI
20191138883	NOVA ROMA	ND11266531	IACIARA S2	05/11/2019 17:22	05/11/2019 20:01	05/11/2019 17:22	05/11/2019 20:01	2,65	6	15,90	CHI
20191138895	APARECIDA DE GOIANIA	200650348	INDEPENDENCIA S2	05/11/2019 17:23	05/11/2019 18:50	05/11/2019 17:23	05/11/2019 18:50	1,44	1	1,44	CHI
20191138901	URUACU	UR11353601	URUACU	05/11/2019 16:56	05/11/2019 22:36	05/11/2019 16:56	05/11/2019 22:36	5,66	97	548,75	CHI
20191138912	ESTRELA DO NORTE	ET12182462	MARA ROSA	05/11/2019 17:24	10/11/2019 11:19	05/11/2019 17:24	10/11/2019 11:19	113,90	3	341,71	CHI
20191138917	CATALAO	CT21215531	CATALAO S1	05/11/2019 17:25	06/11/2019 15:52	05/11/2019 17:25	06/11/2019 15:52	22,44	1	22,44	CHI
20191138918	HEITORAI	HE12300137	ITAPURANGA	05/11/2019 15:11	06/11/2019 10:20	05/11/2019 15:11	06/11/2019 10:20	19,15	15	287,29	CHI
20191138920	FAZENDA NOVA	NB12117282	JUSSARA	05/11/2019 16:58	06/11/2019 00:05	05/11/2019 16:58	06/11/2019 00:05	7,12	1	7,12	CHI

20191138920	JUSSARA	NB12117282	JUSSARA	05/11/2019 16:58	06/11/2019 00:05	05/11/2019 16:58	06/11/2019 00:05	7,12	1	7,12	CHI
20191138920	NOVO BRASIL	NB12117282	JUSSARA	05/11/2019 16:58	06/11/2019 00:05	05/11/2019 16:58	06/11/2019 00:05	7,12	12	85,42	CHI
20191138926	MAIRIPOTABA	MI11264008	PONTALINA	05/11/2019 16:52	05/11/2019 18:26	05/11/2019 16:52	05/11/2019 18:26	1,57	84	132,00	CHI
20191138935	NOVA VENEZA	NV11000018	INHUMAS S1	05/11/2019 16:52	05/11/2019 19:52	05/11/2019 16:52	05/11/2019 19:52	3,00	133	398,82	CHI
20191138937	CACHOEIRA ALTA	CA12196131	CACHOEIRA ALTA	05/11/2019 17:03	06/11/2019 12:29	05/11/2019 17:03	06/11/2019 12:29	19,43	12	233,17	CHI
20191138942	GOIANIA	13176780	INDEPENDENCIA S2	05/11/2019 17:28	06/11/2019 09:03	05/11/2019 17:28	06/11/2019 09:03	15,58	1	15,58	CHI
20191138949	CAMPINORTE	UR12243278	MARA ROSA	05/11/2019 12:29	06/11/2019 15:00	05/11/2019 12:29	06/11/2019 15:00	26,52	7	185,61	CHI
20191138949	URUACU	UR12243278	MARA ROSA	05/11/2019 12:29	06/11/2019 15:00	05/11/2019 12:29	06/11/2019 15:00	26,52	15	397,75	CHI
20191138957	APARECIDA DE GOIANIA	16799768	CARAJAS S1	05/11/2019 17:29	05/11/2019 20:57	05/11/2019 17:29	05/11/2019 20:57	3,46	1	3,46	CHI
20191138964	ANAPOLIS	AN12375930	ANAPOLIS UNIVERSITARIO S1	05/11/2019 15:43	05/11/2019 19:20	05/11/2019 15:43	05/11/2019 19:20	3,61	6	21,65	CHI
20191138966	SANCLERLANDIA	SC12004777	FIRMINOPOLIS S2	05/11/2019 17:30	07/11/2019 13:53	05/11/2019 17:30	07/11/2019 13:53	44,38	1	44,38	CHI
20191138967	TURVELANDIA	TD11170324	RIO DOS BOIS	05/11/2019 14:36	06/11/2019 08:15	05/11/2019 14:36	06/11/2019 08:15	17,65	106	1870,37	CHI
20191138972	MONTES CLAROS DE GOIAS	ME21223243	IPORA	05/11/2019 17:30	10/11/2019 13:40	05/11/2019 17:30	10/11/2019 13:40	116,16	1	116,16	CHI
20191138977	SAO MIGUEL DO ARAGUAIA	SM21291088	SAO MIGUEL DO ARAGUAIA	05/11/2019 17:30	08/11/2019 00:10	05/11/2019 17:30	08/11/2019 00:10	54,67	1	54,67	CHI
20191138981	PETROLINA DE GOIAS	PG12015788	PETROLINA	05/11/2019 16:58	06/11/2019 13:44	05/11/2019 16:58	06/11/2019 13:44	20,77	18	373,80	CHI
20191138981	JESUPOLIS	PG12015788	PETROLINA	05/11/2019 16:58	06/11/2019 13:44	06/11/2019 11:34	06/11/2019 13:44	2,17	1	2,17	CHI
20191138981	PETROLINA DE GOIAS	PG12015788	PETROLINA	05/11/2019 16:58	06/11/2019 13:44	06/11/2019 11:34	06/11/2019 13:44	2,17	58	125,91	CHI
20191138996	NOVO BRASIL	NB12396209	JUSSARA	05/11/2019 17:28	06/11/2019 22:39	05/11/2019 17:28	06/11/2019 22:39	29,18	2	58,36	CHI
20191138998	MUTUNOPOLIS	MU11003802	MARA ROSA	05/11/2019 14:37	05/11/2019 19:28	05/11/2019 14:37	05/11/2019 19:28	4,84	147	711,48	CHI
20191139005	CAMPINACU	UC12265668	PORANGATU	05/11/2019 17:34	07/11/2019 07:51	05/11/2019 17:34	07/11/2019 07:51	38,28	4	153,11	CHI
20191139007	CATALAO	CT12399861	CATALAO S1	05/11/2019 17:34	06/11/2019 09:08	05/11/2019 17:34	06/11/2019 09:08	15,56	4	62,24	CHI
20191139007	GOIANDIRA	CT12399861	CATALAO S1	05/11/2019 17:34	06/11/2019 09:08	05/11/2019 17:34	06/11/2019 09:08	15,56	4	62,24	CHI
20191139008	GOIANESIA	GE12372623	GOIANESIA S1	05/11/2019 16:08	06/11/2019 14:59	05/11/2019 16:08	06/11/2019 14:59	22,85	30	685,50	CHI
20191139011	URUACU	UR12342129	URUACU	05/11/2019 16:39	05/11/2019 23:11	05/11/2019 16:39	05/11/2019 23:11	6,52	176	1148,35	CHI
20191139012	BARRO ALTO	BA12286095	BARRO ALTO	05/11/2019 14:21	06/11/2019 08:05	05/11/2019 14:21	06/11/2019 08:05	17,72	176	3119,16	CHI
20191139019	BURITI DE GOIAS	BS12008822	FIRMINOPOLIS S2	05/11/2019 17:14	05/11/2019 19:42	05/11/2019 17:14	05/11/2019 19:42	2,46	28	68,80	CHI
20191139024	ITABERAI	19615666	ITABERAI S2	05/11/2019 17:36	06/11/2019 22:34	05/11/2019 17:36	06/11/2019 22:34	28,96	4	115,86	CHI
20191139025	CHAPADAO DO CEU	DJ12324666	CHAPADAO DO CEU	05/11/2019 15:37	06/11/2019 11:35	05/11/2019 15:37	06/11/2019 09:51	18,22	19	346,25	CHI
20191139025	CHAPADAO DO CEU	DJ12152817	CHAPADAO DO CEU	05/11/2019 15:37	06/11/2019 11:35	05/11/2019 15:37	06/11/2019 11:35	19,95	18	359,17	CHI
20191139033	GOIANDIRA	GD21323423	CATALAO S1	05/11/2019 17:37	06/11/2019 11:10	05/11/2019 17:37	06/11/2019 11:10	17,55	3	52,64	CHI
20191139035	SENADOR CANEDO	SW11074733	GOIANIA LESTE S2	05/11/2019 16:41	06/11/2019 03:24	05/11/2019 16:41	06/11/2019 03:24	10,71	166	1777,81	CHI
20191139048	SANTA TEREZINHA DE GOIAS	SG12197603	SANTA TEREZINHA	05/11/2019 17:38	07/11/2019 17:16	05/11/2019 17:38	07/11/2019 17:16	47,63	2	95,25	CHI
20191139049	INHUMAS	IN11064359	INHUMAS S2	05/11/2019 16:03	05/11/2019 22:30	05/11/2019 16:03	05/11/2019 22:30	6,44	64	412,23	CHI

20191139050	GUAPO	GA12099059	GUAPO S1	05/11/2019 17:38	06/11/2019 09:20	05/11/2019 17:38	06/11/2019 09:20	15,69	16	251,04	CHI
20191139056	RIO VERDE	10019540076	RIO VERDE S2	05/11/2019 16:27	05/11/2019 21:05	05/11/2019 16:27	05/11/2019 21:05	4,64	1	4,64	CHI
20191139060	CRIXAS	CX12200706	SERRA DO OURO	05/11/2019 17:38	07/11/2019 15:58	05/11/2019 17:38	07/11/2019 15:58	46,32	1	46,32	CHI
20191139063	SANTO ANTONIO DO DESCOBERTO	SN12078187	MARAJOARA	05/11/2019 17:01	05/11/2019 19:18	05/11/2019 17:01	05/11/2019 19:18	2,28	33	75,20	CHI
20191139067	AMARALINA	ET12000004	MARA ROSA	05/11/2019 17:33	07/11/2019 20:00	05/11/2019 17:33	07/11/2019 20:00	50,44	6	302,65	CHI
20191139067	MUTUNOPOLIS	ET12000004	MARA ROSA	05/11/2019 17:33	07/11/2019 20:00	05/11/2019 17:33	07/11/2019 20:00	50,44	3	151,32	CHI
20191139070	AGUAS LINDAS DE GOIAS	LA11164955	AGUAS LINDAS DE GOIAS S1	05/11/2019 17:39	05/11/2019 20:52	05/11/2019 17:39	05/11/2019 20:52	3,22	187	601,41	CHI
20191139078	CAMPINACU	UC12300538	PORANGATU	05/11/2019 17:40	06/11/2019 12:14	05/11/2019 17:40	06/11/2019 12:14	18,56	15	278,35	CHI
20191139088	CATALAO	CT12399850	CATALAO S1	05/11/2019 16:28	05/11/2019 18:43	05/11/2019 16:28	05/11/2019 18:43	2,24	52	116,58	CHI
20191139088	GOIANDIRA	CT12399850	CATALAO S1	05/11/2019 16:28	05/11/2019 18:43	05/11/2019 16:28	05/11/2019 18:43	2,24	41	91,92	CHI
20191139093	CAIAPONIA	00300204	CAIAPONIA	05/11/2019 17:32	05/11/2019 18:44	05/11/2019 17:32	05/11/2019 18:44	1,21	274	332,61	CHI
20191139093	CAIAPONIA	00300204	CAIAPONIA	05/11/2019 17:32	05/11/2019 18:44	05/11/2019 17:32	05/11/2019 18:44	1,21	6028	7317,32	CHI
20191139093	DOVERLANDIA	00300204	CAIAPONIA	05/11/2019 17:32	05/11/2019 18:44	05/11/2019 17:32	05/11/2019 18:44	1,21	3	3,64	CHI
20191139093	JATAI	00300204	CAIAPONIA	05/11/2019 17:32	05/11/2019 18:44	05/11/2019 17:32	05/11/2019 18:44	1,21	3	3,64	CHI
20191139093	RIO VERDE	00300204	CAIAPONIA	05/11/2019 17:32	05/11/2019 18:44	05/11/2019 17:32	05/11/2019 18:44	1,21	4	4,86	CHI
20191139094	INHUMAS	IN12282891	INHUMAS S2	05/11/2019 12:38	06/11/2019 09:15	05/11/2019 12:38	06/11/2019 09:15	20,61	134	2761,52	CHI
20191139094	ITAUCU	IN12282891	INHUMAS S2	05/11/2019 12:38	06/11/2019 09:15	05/11/2019 12:38	06/11/2019 09:15	20,61	64	1318,93	CHI
20191139094	PETROLINA DE GOIAS	IN12282891	INHUMAS S2	05/11/2019 12:38	06/11/2019 09:15	05/11/2019 12:38	06/11/2019 09:15	20,61	2	41,22	CHI
20191139094	SANTA ROSA DE GOIAS	IN12282891	INHUMAS S2	05/11/2019 12:38	06/11/2019 09:15	05/11/2019 12:38	06/11/2019 09:15	20,61	10	206,08	CHI
20191139095	ARAGOIANIA	680002145	GUAPO S2	05/11/2019 17:42	06/11/2019 15:36	05/11/2019 17:42	06/11/2019 15:36	21,90	1	21,90	CHI
20191139097	ARAGOIANIA	AO21100628	INDEPENDENCIA S2	05/11/2019 17:42	08/11/2019 13:41	05/11/2019 17:42	08/11/2019 13:41	67,99	4	271,95	CHI
20191139098	PARAUNA	PU11000001	PARAUNA	05/11/2019 15:36	05/11/2019 22:15	05/11/2019 15:36	05/11/2019 22:15	6,64	109	723,97	CHI
20191139101	NOVA CRIXAS	NA12057172	MOZARLANDIA	05/11/2019 17:42	08/11/2019 09:35	05/11/2019 17:42	08/11/2019 09:35	63,89	21	1341,66	CHI
20191139102	NIQUELANDIA	NQ12232332	NIQUELANDIA SUBTRANSMISSAO	05/11/2019 16:11	05/11/2019 19:10	05/11/2019 16:11	05/11/2019 19:10	2,98	81	241,29	CHI
20191139104	IPAMERI	IP21328818	IPAMERI	05/11/2019 17:42	08/11/2019 20:39	05/11/2019 17:42	08/11/2019 20:39	74,94	1	74,94	CHI
20191139107	MINACU	IH21135033	MINACU	05/11/2019 17:43	06/11/2019 08:18	05/11/2019 17:43	06/11/2019 08:18	14,58	1	14,58	CHI
20191139116	MONTES CLAROS DE GOIAS	ME11004036	IPORA	05/11/2019 16:43	06/11/2019 12:16	05/11/2019 16:43	06/11/2019 12:16	19,55	42	821,06	CHI
20191139126	ANAPOLIS	21309589	JUNDIAI S2	05/11/2019 17:44	05/11/2019 23:54	05/11/2019 17:44	05/11/2019 23:54	6,16	1	6,16	CHI
20191139128	URUACU	UR21339140	MARA ROSA	05/11/2019 17:44	08/11/2019 15:35	05/11/2019 17:44	08/11/2019 15:35	69,84	1	69,84	CHI
20191139131	JUSSARA	JR11119420	JUSSARA	05/11/2019 17:39	06/11/2019 13:27	05/11/2019 17:39	06/11/2019 13:27	19,79	165	3264,53	CHI
20191139133	URUACU	UR12082989	URUACU	05/11/2019 17:09	06/11/2019 08:53	05/11/2019 17:09	06/11/2019 08:53	15,73	3	47,18	CHI
20191139139	ANAPOLIS	AN21370468	ANAPOLIS UNIVERSITARIO S2	05/11/2019 17:45	05/11/2019 21:31	05/11/2019 17:45	05/11/2019 21:31	3,76	1	3,76	CHI
20191139143	GOIANIA	GN21082445	CAMPINAS S2	05/11/2019 17:45	06/11/2019 02:43	05/11/2019 17:45	06/11/2019 02:43	8,95	1	8,95	CHI

20191139149	GOIANIA	GN11001539	GOYA S2	05/11/2019 15:07	05/11/2019 19:23	05/11/2019 15:07	05/11/2019 19:23	4,27	121	516,13	CHI
20191139152	BELA VISTA DE GOIAS	BV12360000	BELA VISTA S2	05/11/2019 17:46	05/11/2019 23:15	05/11/2019 17:46	05/11/2019 23:15	5,47	3	16,41	CHI
20191139154	CACHOEIRA DOURADA	CD11000005	CACHOEIRA DOURADA	05/11/2019 16:42	06/11/2019 09:53	05/11/2019 16:42	06/11/2019 09:53	17,18	120	2061,93	CHI
20191139155	GOIANESIA	GE21285427	GOIANESIA S2	05/11/2019 17:47	08/11/2019 01:15	05/11/2019 17:47	08/11/2019 01:15	55,47	2	110,93	CHI
20191139166	CROMINIA	CQ11000026	PONTALINA	05/11/2019 16:08	06/11/2019 09:03	05/11/2019 16:08	06/11/2019 09:03	16,90	100	1690,39	CHI
20191139167	MINACU	IH21192473	MINACU	05/11/2019 17:47	06/11/2019 09:48	05/11/2019 17:47	06/11/2019 09:48	16,00	1	16,00	CHI
20191139169	CATALAO	10013656137	CATALAO S2	05/11/2019 17:48	06/11/2019 09:19	05/11/2019 17:48	06/11/2019 09:19	15,53	1	15,53	CHI
20191139171	ANAPOLIS	10003754063	JUNDIAI S1	05/11/2019 17:48	05/11/2019 23:16	05/11/2019 17:48	05/11/2019 23:16	5,46	1	5,46	CHI
20191139173	JARAGUA	JA21053462	ITABERAI S1	05/11/2019 17:48	06/11/2019 18:15	05/11/2019 17:48	06/11/2019 18:15	24,44	1	24,44	CHI
20191139175	LUZIANIA	LZ21192761	MARAJOARA	05/11/2019 17:48	06/11/2019 01:55	05/11/2019 17:48	06/11/2019 01:55	8,11	1	8,11	CHI
20191139183	MONTES CLAROS DE GOIAS	ME11023313	IPORA	05/11/2019 17:46	05/11/2019 18:59	05/11/2019 17:46	05/11/2019 18:59	1,21	113	136,64	CHI
20191139186	NIQUELANDIA	NQ12264564	BARRO ALTO	05/11/2019 13:26	06/11/2019 11:40	05/11/2019 13:26	06/11/2019 11:40	22,23	12	266,76	CHI
20191139189	PORANGATU	PO12020578	PORANGATU	05/11/2019 16:47	05/11/2019 22:52	05/11/2019 16:47	05/11/2019 22:52	6,07	23	139,70	CHI
20191139207	BARRO ALTO	BA21038190	BARRO ALTO	05/11/2019 17:51	07/11/2019 18:32	05/11/2019 17:51	07/11/2019 18:32	48,68	1	48,68	CHI
20191139209	EDEIA	EA21237741	VICENTINOPOLIS	05/11/2019 17:51	06/11/2019 14:50	05/11/2019 17:51	06/11/2019 14:50	20,98	1	20,98	CHI
20191139211	CAMPINORTE	CR12051895	MARA ROSA	05/11/2019 14:35	06/11/2019 09:22	05/11/2019 14:35	06/11/2019 09:22	18,77	17	319,05	CHI
20191139211	NOVA IGUACU DE GOIAS	CR12051895	MARA ROSA	05/11/2019 14:35	06/11/2019 09:22	05/11/2019 14:35	06/11/2019 09:22	18,77	15	281,52	CHI
20191139223	HIDROLINA	HL21201754	URUACU	05/11/2019 17:52	06/11/2019 01:47	05/11/2019 17:52	06/11/2019 01:47	7,92	1	7,92	CHI
20191139229	DOVERLANDIA	DV11139978	CAIAPONIA	05/11/2019 16:42	06/11/2019 11:04	05/11/2019 16:42	06/11/2019 11:04	18,36	145	2662,20	CHI
20191139243	VALPARAISO DE GOIAS	3350009023	PACAEMBU S2	05/11/2019 17:54	05/11/2019 22:29	05/11/2019 17:54	05/11/2019 22:29	4,58	1	4,58	CHI
20191139247	GOIANIA	11139134	CARAJAS S2	05/11/2019 17:54	06/11/2019 07:22	05/11/2019 17:54	06/11/2019 07:22	13,45	1	13,45	CHI
20191139249	CAMPO ALEGRE DE GOIAS	CM21102373	CAMPO ALEGRE DE GOIAS	05/11/2019 17:55	07/11/2019 16:55	05/11/2019 17:55	07/11/2019 16:55	47,00	1	47,00	CHI
20191139254	VALPARAISO DE GOIAS	VA21009671	PACAEMBU S1	05/11/2019 17:55	05/11/2019 20:47	05/11/2019 17:55	05/11/2019 20:47	2,86	1	2,86	CHI
20191139255	ITAPIRAPUA	IU12008889	MATRINCHA	05/11/2019 17:55	06/11/2019 11:46	05/11/2019 17:55	06/11/2019 11:46	17,85	9	160,61	CHI
20191139259	NOVO BRASIL	NB12109601	JUSSARA	05/11/2019 17:55	07/11/2019 15:51	05/11/2019 17:55	07/11/2019 15:51	45,92	10	459,23	CHI
20191139262	SENADOR CANEDO	SW12072659	SENADOR CANEDO	05/11/2019 16:10	05/11/2019 21:32	05/11/2019 16:10	05/11/2019 21:32	5,36	791	4243,06	CHI
20191139263	MONTIVIDIU DO NORTE	MX12143686	PORANGATU	05/11/2019 15:38	07/11/2019 08:41	05/11/2019 15:38	07/11/2019 08:41	41,03	103	4226,55	CHI
20191139280	SAO LUIZ DO NORTE	3090013081	ITAPACI	05/11/2019 17:57	05/11/2019 20:14	05/11/2019 17:57	05/11/2019 20:14	2,28	1	2,28	CHI
20191139287	SENADOR CANEDO	SW11291698	CEPAIGO S1	05/11/2019 16:47	06/11/2019 07:21	05/11/2019 16:47	06/11/2019 07:21	14,56	58	844,50	CHI
20191139293	COCALZINHO DE GOIAS	9970003476	AGUAS LINDAS DE GOIAS S2	05/11/2019 17:58	06/11/2019 07:56	05/11/2019 17:58	06/11/2019 07:56	13,96	1	13,96	CHI
20191139295	ITABERAI	IB12336526	ITABERAI S1	05/11/2019 16:30	05/11/2019 19:53	05/11/2019 16:30	05/11/2019 19:53	3,38	3	10,14	CHI
20191139296	MONTES CLAROS DE GOIAS	ME21353768	IPORA	05/11/2019 17:58	07/11/2019 00:14	05/11/2019 17:58	07/11/2019 00:14	30,25	1	30,25	CHI
20191139300	JUSSARA	JR12250810	JUSSARA	05/11/2019 16:55	07/11/2019 09:33	05/11/2019 16:55	07/11/2019 09:33	40,62	3	121,87	CHI

20191139389	SAO DOMINGOS	SD11388973	SAO DOMINGOS	06/11/2019 01:25	08/11/2019 21:36	06/11/2019 01:25	08/11/2019 21:36	68,18	1	68,18	CHI
20191139402	ABADIANIA	AA12295520	ANAPOLIS UNIVERSITARIO S1	05/11/2019 15:29	05/11/2019 19:15	05/11/2019 15:29	05/11/2019 19:15	3,75	6	22,53	CHI
20191139404	SAO LUIS DE MONTES BELOS	SL12007006	FIRMINOPOLIS S1	05/11/2019 17:46	06/11/2019 01:47	05/11/2019 17:46	06/11/2019 01:47	8,01	10	80,13	CHI
20191139427	URUACU	640109822	URUACU	05/11/2019 18:00	05/11/2019 20:10	05/11/2019 18:00	05/11/2019 20:10	2,16	1	2,16	CHI
20191139442	MOZARLANDIA	AZ12326098LD	MOZARLANDIA	05/11/2019 18:01	08/11/2019 15:54	05/11/2019 18:01	08/11/2019 15:54	69,87	1	69,87	CHI
20191139446	PROFESSOR JAMIL SAFADY	JS21025865	ROCHEDO	05/11/2019 18:01	07/11/2019 07:57	05/11/2019 18:01	07/11/2019 07:57	37,92	1	37,92	CHI
20191139449	GOIAS	GS12220495	ITABERAI S1	05/11/2019 17:14	07/11/2019 18:11	05/11/2019 17:14	07/11/2019 18:11	48,96	2	97,91	CHI
20191139451	NIQUELANDIA	NQ21207368	BARRO ALTO	05/11/2019 18:02	07/11/2019 11:26	05/11/2019 18:02	07/11/2019 11:26	41,40	1	41,40	CHI
20191139456	PONTALINA	PK21223282	PONTALINA	05/11/2019 18:02	06/11/2019 09:53	05/11/2019 18:02	06/11/2019 09:53	15,84	2	31,69	CHI
20191139457	APARECIDA DE GOIANIA	200660044	ANHANGUERA	05/11/2019 18:02	05/11/2019 19:21	05/11/2019 18:02	05/11/2019 19:21	1,31	1	1,31	CHI
20191139459	AMARALINA	MQ12391953	NOVA CRIXAS	05/11/2019 18:02	09/11/2019 15:00	05/11/2019 18:02	09/11/2019 15:00	92,96	8	743,67	CHI
20191139459	MARA ROSA	MQ12391953	NOVA CRIXAS	05/11/2019 18:02	09/11/2019 15:00	05/11/2019 18:02	09/11/2019 15:00	92,96	15	1394,38	CHI
20191139467	IACIARA	IA21232151	IACIARA S1	05/11/2019 18:03	06/11/2019 11:44	05/11/2019 18:03	06/11/2019 11:44	17,68	1	17,68	CHI
20191139468	MINACU	IH12236222	MINACU	05/11/2019 18:03	06/11/2019 13:48	05/11/2019 18:03	06/11/2019 13:48	19,76	19	375,47	CHI
20191139469	AMERICANO DO BRASIL	10025239048	ANICUNS	05/11/2019 18:03	06/11/2019 11:13	05/11/2019 18:03	06/11/2019 11:13	17,16	1	17,16	CHI
20191139475	SANCLERLANDIA	SC12005282	FIRMINOPOLIS S2	05/11/2019 18:03	07/11/2019 00:48	05/11/2019 18:03	07/11/2019 00:48	30,74	15	461,08	CHI
20191139477	ARAGUAPAZ	AZ11278270	MOZARLANDIA	05/11/2019 18:03	06/11/2019 07:10	05/11/2019 18:03	06/11/2019 07:10	13,10	119	1559,13	CHI
20191139484	TRINDADE	TR11202903	GOYA S2	05/11/2019 15:58	06/11/2019 01:40	05/11/2019 15:58	06/11/2019 01:40	9,69	28	271,41	CHI
20191139488	GOIANIA	12247273	FERROVIARIO S1	05/11/2019 18:05	06/11/2019 00:31	05/11/2019 18:05	06/11/2019 00:31	6,43	1	6,43	CHI
20191139494	CRIXAS	UP12233001	SANTA TEREZINHA	05/11/2019 17:11	06/11/2019 00:05	05/11/2019 17:11	06/11/2019 00:05	6,89	5	34,47	CHI
20191139494	UIRAPURU	UP12233001	SANTA TEREZINHA	05/11/2019 17:11	06/11/2019 00:05	05/11/2019 17:11	06/11/2019 00:05	6,89	44	303,34	CHI
20191139504	CAVALCANTE	CJ12208769	FLORES DE GOIAS	05/11/2019 17:50	05/11/2019 22:05	05/11/2019 17:50	05/11/2019 22:05	4,24	185	784,09	CHI
20191139511	ABADIANIA	AA12017723	ANAPOLIS UNIVERSITARIO S1	05/11/2019 16:52	05/11/2019 23:16	05/11/2019 16:52	05/11/2019 23:16	6,40	11	70,36	CHI
20191139515	PILAR DE GOIAS	GG21318436	URUACU	05/11/2019 18:06	07/11/2019 17:03	05/11/2019 18:06	07/11/2019 17:03	46,93	1	46,93	CHI
20191139517	SENADOR CANEDO	SW11215893	SENADOR CANEDO	05/11/2019 18:07	06/11/2019 11:30	05/11/2019 18:07	06/11/2019 11:30	17,38	210	3650,44	CHI
20191139522	ANAPOLIS	10001667252	JUNDIAI S1	05/11/2019 18:07	06/11/2019 01:09	05/11/2019 18:07	06/11/2019 01:09	7,03	1	7,03	CHI
20191139523	ARUANA	AK12307445	MOZARLANDIA	05/11/2019 17:04	07/11/2019 11:25	05/11/2019 17:04	07/11/2019 11:25	42,35	12	508,19	CHI
20191139531	MOZARLANDIA	MZ11206796	MOZARLANDIA	05/11/2019 17:43	06/11/2019 14:02	05/11/2019 17:43	06/11/2019 14:02	20,31	179	3635,44	CHI
20191139532	AGUA FRIA DE GOIAS	TL12164607	SAO JOAO D ALIANCA	05/11/2019 16:29	06/11/2019 08:32	05/11/2019 16:29	06/11/2019 08:32	16,03	16	256,54	CHI
20191139536	ANAPOLIS	20269614	JUNDIAI S2	05/11/2019 18:08	05/11/2019 22:26	05/11/2019 18:08	05/11/2019 22:26	4,29	1	4,29	CHI
20191139538	GOIANDIRA	GD12000007LD	CATALAO S1	05/11/2019 17:07	06/11/2019 08:07	05/11/2019 17:07	06/11/2019 08:07	14,99	104	1558,79	CHI
20191139538	NOVA AURORA	GD12000007LD	CATALAO S1	05/11/2019 17:07	06/11/2019 08:07	05/11/2019 17:07	06/11/2019 08:07	14,99	15	224,82	CHI
20191139540	IACIARA	IA21251095	IACIARA S2	05/11/2019 18:08	06/11/2019 12:27	05/11/2019 18:08	06/11/2019 12:27	18,30	1	18,30	CHI

20191139542	MOZARLANDIA	MZ12300434	MOZARLANDIA	05/11/2019 17:02	06/11/2019 14:45	05/11/2019 17:02	06/11/2019 14:45	21,72	219	4756,80	CHI
20191139544	APARECIDA DE GOIANIA	15945935	INDEPENDENCIA S2	05/11/2019 18:09	05/11/2019 19:59	05/11/2019 18:09	05/11/2019 19:59	1,83	1	1,83	CHI
20191139545	DIVINOPOLIS DE GOIAS	GH21092960	SAO DOMINGOS	05/11/2019 18:09	07/11/2019 22:49	05/11/2019 18:09	07/11/2019 22:49	52,67	2	105,33	CHI
20191139548	ITAPURANGA	IK12307331	ITAPURANGA	05/11/2019 15:16	05/11/2019 22:15	05/11/2019 15:16	05/11/2019 22:15	6,98	7	48,88	CHI
20191139555	CALDAZINHA	SW12091934	SENADOR CANEDO	05/11/2019 16:53	06/11/2019 21:48	05/11/2019 16:53	06/11/2019 12:35	19,69	4	78,77	CHI
20191139555	SENADOR CANEDO	SW12091934	SENADOR CANEDO	05/11/2019 16:53	06/11/2019 21:48	05/11/2019 16:53	06/11/2019 12:35	19,69	4	78,77	CHI
20191139555	CALDAZINHA	SW12091934	SENADOR CANEDO	05/11/2019 16:53	06/11/2019 21:48	05/11/2019 16:53	06/11/2019 21:48	28,91	2	57,82	CHI
20191139555	SENADOR CANEDO	SW12091934	SENADOR CANEDO	05/11/2019 16:53	06/11/2019 21:48	05/11/2019 16:53	06/11/2019 21:48	28,91	1	28,91	CHI
20191139560	ARAGOIANIA	AO32000298	GUAPO S2	05/11/2019 15:22	06/11/2019 09:06	05/11/2019 15:22	06/11/2019 09:06	17,72	6	106,35	CHI
20191139566	CRIXAS	CX12405291	SANTA TEREZINHA	05/11/2019 13:03	06/11/2019 14:37	05/11/2019 13:03	06/11/2019 14:37	25,57	90	2300,85	CHI
20191139567	BARRO ALTO	BA11055045	BARRO ALTO	05/11/2019 17:04	05/11/2019 20:24	05/11/2019 17:04	05/11/2019 20:24	3,32	164	544,66	CHI
20191139574	CRIXAS	CX21166535	SERRA DO OURO	05/11/2019 18:12	10/11/2019 10:53	05/11/2019 18:12	10/11/2019 10:53	112,68	1	112,68	CHI
20191139603	NIQUELANDIA	NQ21140865	NIQUELANDIA SUBTRANSMISSAO	05/11/2019 18:14	06/11/2019 02:54	05/11/2019 18:14	06/11/2019 02:54	8,66	2	17,32	CHI
20191139610	IPORA	IR12070185	IPORA	05/11/2019 18:14	06/11/2019 00:51	05/11/2019 18:14	05/11/2019 22:57	4,72	177	835,54	CHI
20191139610	IPORA	IR12091250LD	IPORA	05/11/2019 18:14	06/11/2019 00:51	05/11/2019 18:14	06/11/2019 00:51	6,61	38	251,22	CHI
20191139618	MONTE ALEGRE DE GOIAS	10020841483	SAO DOMINGOS	05/11/2019 18:15	07/11/2019 13:00	05/11/2019 18:15	07/11/2019 13:00	42,75	1	42,75	CHI
20191139626	VALPARAISO DE GOIAS	VA11067694	MARAJOARA	05/11/2019 17:43	05/11/2019 20:04	05/11/2019 17:43	05/11/2019 20:04	2,35	95	223,01	CHI
20191139633	PARANAIGUARA	PC11136003	CACHOEIRA ALTA	05/11/2019 15:47	06/11/2019 20:00	05/11/2019 15:47	06/11/2019 20:00	28,21	137	3864,88	CHI
20191139638	ITABERAI	IB12379749	ITABERAI S2	05/11/2019 16:39	06/11/2019 02:15	05/11/2019 16:39	06/11/2019 02:15	9,59	2	19,17	CHI
20191139639	MORRINHOS	MR11000010	MORRINHOS	05/11/2019 17:54	05/11/2019 22:15	05/11/2019 17:54	05/11/2019 22:15	4,34	81	351,70	CHI
20191139648	SENADOR CANEDO	SW11161111	SENADOR CANEDO	05/11/2019 18:02	06/11/2019 00:14	05/11/2019 18:02	06/11/2019 00:14	6,21	175	1086,07	CHI
20191139651	ABADIANIA	AA12377766	ANAPOLIS UNIVERSITARIO S1	05/11/2019 15:59	06/11/2019 07:40	05/11/2019 15:59	06/11/2019 07:40	15,68	9	141,11	CHI
20191139662	IACIARA	PS12257681	IACIARA S2	05/11/2019 18:18	05/11/2019 20:37	05/11/2019 18:18	05/11/2019 20:37	2,31	5	11,53	CHI
20191139662	POSSE	PS12257681	IACIARA S2	05/11/2019 18:18	05/11/2019 20:37	05/11/2019 18:18	05/11/2019 20:37	2,31	1	2,31	CHI
20191139663	ITUMBIARA	IT21309975	PARANAIBA	05/11/2019 18:19	06/11/2019 10:12	05/11/2019 18:19	06/11/2019 10:12	15,87	1	15,87	CHI
20191139664	ITUMBIARA	690239518	ITUMBIARA NOVA	05/11/2019 18:19	06/11/2019 10:09	05/11/2019 18:19	06/11/2019 10:09	15,82	1	15,82	CHI
20191139667	ITUMBIARA	IT11000132	PARANAIBA	05/11/2019 18:17	05/11/2019 21:59	05/11/2019 18:17	05/11/2019 21:59	3,69	29	107,11	CHI
20191139675	ITAPACI	10013973949	ITAPACI	05/11/2019 18:20	06/11/2019 00:40	05/11/2019 18:20	06/11/2019 00:40	6,32	1	6,32	CHI
20191139680	PILAR DE GOIAS	GG21241446	URUACU	05/11/2019 18:20	08/11/2019 17:22	05/11/2019 18:20	08/11/2019 17:22	71,02	1	71,02	CHI
20191139685	URUACU	UR21268550	URUACU	05/11/2019 18:21	06/11/2019 22:59	05/11/2019 18:21	06/11/2019 22:59	28,62	1	28,62	CHI
20191139693	PORANGATU	PO12253858	PORANGATU	05/11/2019 18:22	06/11/2019 14:23	05/11/2019 18:22	06/11/2019 14:23	20,02	3	60,05	CHI
20191139702	BALIZA	BH12331467	CAIAPONIA	05/11/2019 17:19	07/11/2019 16:58	05/11/2019 17:19	07/11/2019 16:58	47,65	14	667,07	CHI
20191139705	SAO LUIS DE MONTES BELOS	SL12154565	FIRMINOPOLIS S2	05/11/2019 18:23	06/11/2019 13:31	05/11/2019 18:23	06/11/2019 13:31	19,13	21	401,81	CHI

20191139714	MINACU	IH12212277	MINACU	05/11/2019 18:01	06/11/2019 04:24	05/11/2019 18:01	06/11/2019 04:24	10,38	32	332,16	CHI
20191139719	IPAMERI	IP12203233	IPAMERI	05/11/2019 17:29	05/11/2019 21:01	05/11/2019 17:29	05/11/2019 21:01	3,52	368	1295,16	CHI
20191139731	ABADIANA	AA12085971	ANAPOLIS UNIVERSITARIO S1	05/11/2019 18:14	05/11/2019 19:38	05/11/2019 18:14	05/11/2019 19:38	1,38	12	16,61	CHI
20191139733	CACHOEIRA DOURADA	CD11065964	CACHOEIRA DOURADA	05/11/2019 16:39	06/11/2019 10:38	05/11/2019 16:39	06/11/2019 10:38	17,97	100	1797,47	CHI
20191139734	CAIAPONIA	CP12238699	PALESTINA	05/11/2019 18:26	06/11/2019 11:24	05/11/2019 18:26	06/11/2019 11:24	16,96	8	135,68	CHI
20191139748	CAVALCANTE	CJ12329834	FLORES DE GOIAS	06/11/2019 07:55	06/11/2019 15:13	06/11/2019 07:55	06/11/2019 15:13	7,29	11	80,14	CHI
20191139758	DIVINOPOLIS DE GOIAS	GH12241928	SAO DOMINGOS	05/11/2019 17:56	05/11/2019 21:37	05/11/2019 17:56	05/11/2019 21:37	3,67	37	135,74	CHI
20191139758	MONTE ALEGRE DE GOIAS	GH12241928	SAO DOMINGOS	05/11/2019 17:56	05/11/2019 21:37	05/11/2019 17:56	05/11/2019 21:37	3,67	3	11,01	CHI
20191139758	SAO DOMINGOS	GH12241928	SAO DOMINGOS	05/11/2019 17:56	05/11/2019 21:37	05/11/2019 17:56	05/11/2019 21:37	3,67	12	44,02	CHI
20191139768	MOSSAMEDES	MD12057741	FIRMINOPOLIS S2	05/11/2019 18:00	06/11/2019 10:38	05/11/2019 18:00	06/11/2019 10:38	16,63	18	299,28	CHI
20191139768	SANCLERLANDIA	MD12057741	FIRMINOPOLIS S2	05/11/2019 18:00	06/11/2019 10:38	05/11/2019 18:00	06/11/2019 10:38	16,63	1	16,63	CHI
20191139771	FAZENDA NOVA	FN12354616LD	BRITANIA	05/11/2019 16:55	06/11/2019 19:50	05/11/2019 16:55	06/11/2019 19:50	26,91	43	1157,31	CHI
20191139771	JUSSARA	FN12354616LD	BRITANIA	05/11/2019 16:55	06/11/2019 19:50	05/11/2019 16:55	06/11/2019 19:50	26,91	11	296,06	CHI
20191139777	QUIRINOPOLIS	QI32050233	QUIRINOPOLIS	05/11/2019 13:45	06/11/2019 23:37	05/11/2019 13:45	06/11/2019 23:37	33,86	7	237,05	CHI
20191139790	FORMOSO	FO12151052	PORANGATU	05/11/2019 18:00	06/11/2019 10:27	05/11/2019 18:00	06/11/2019 10:27	16,44	6	98,62	CHI
20191139797	JUSSARA	JR12019314	JUSSARA	05/11/2019 17:50	06/11/2019 04:29	05/11/2019 17:50	06/11/2019 04:29	10,64	83	883,17	CHI
20191139801	MOZARLANDIA	MZ11000003	MOZARLANDIA	05/11/2019 18:01	06/11/2019 18:43	05/11/2019 18:01	06/11/2019 18:43	24,70	101	2494,50	CHI
20191139810	SANTA CRUZ DE GOIAS	BC21109686	PIRES DO RIO S2	05/11/2019 17:32	06/11/2019 09:14	05/11/2019 17:32	06/11/2019 09:14	15,69	1	15,69	CHI
20191139815	COCALZINHO DE GOIAS	ZN21297616	COCALZINHO	05/11/2019 18:32	07/11/2019 13:05	05/11/2019 18:32	07/11/2019 13:05	42,54	1	42,54	CHI
20191139819	AMERICANO DO BRASIL	1410001924	ANICUNS	05/11/2019 18:32	06/11/2019 10:56	05/11/2019 18:32	06/11/2019 10:56	16,39	1	16,39	CHI
20191139821	DIVINOPOLIS DE GOIAS	GH12285456	SAO DOMINGOS	05/11/2019 18:30	06/11/2019 11:04	05/11/2019 18:30	06/11/2019 11:04	16,56	2	33,11	CHI
20191139826	CAMPINORTE	10017763809	MARA ROSA	05/11/2019 18:33	08/11/2019 13:45	05/11/2019 18:33	08/11/2019 13:45	67,19	1	67,19	CHI
20191139829	PARAUNA	980030626	PARAUNA	05/11/2019 18:34	06/11/2019 06:52	05/11/2019 18:34	06/11/2019 06:52	12,31	1	12,31	CHI
20191139841	PIRENOPOLIS	PV12117852	CORUMBA	05/11/2019 13:10	06/11/2019 08:15	05/11/2019 13:10	06/11/2019 08:15	19,08	12	228,91	CHI
20191139842	CABECEIRAS	CW21184957	ITUIQUIRA	05/11/2019 18:35	05/11/2019 23:50	05/11/2019 18:35	05/11/2019 23:50	5,25	1	5,25	CHI
20191139856	SAO MIGUEL DO ARAGUAIA	SM11208580	SAO MIGUEL DO ARAGUAIA	05/11/2019 15:53	06/11/2019 06:10	05/11/2019 15:53	06/11/2019 06:10	14,27	87	1241,83	CHI
20191139863	SANTA ROSA DE GOIAS	SR12000047	INHUMAS S1	05/11/2019 17:43	06/11/2019 09:10	05/11/2019 17:43	06/11/2019 09:10	15,45	52	803,34	CHI
20191139865	ITUMBIARA	IT12000249	ITUMBIARA NOVA	05/11/2019 17:39	06/11/2019 08:49	05/11/2019 17:39	06/11/2019 08:49	15,15	4	60,61	CHI
20191139871	NOVO PLANALTO	TA11354449	NOVO PLANALTO	05/11/2019 18:38	07/11/2019 12:20	05/11/2019 18:38	07/11/2019 12:20	41,69	2	83,39	CHI
20191139898	MARA ROSA	MQ12146959	MARA ROSA	05/11/2019 18:41	06/11/2019 18:50	05/11/2019 18:41	06/11/2019 18:50	24,15	10	241,49	CHI
20191139898	NOVA IGUACU DE GOIAS	MQ12146959	MARA ROSA	05/11/2019 18:41	06/11/2019 18:50	05/11/2019 18:41	06/11/2019 18:50	24,15	11	265,64	CHI
20191139913	PLANALTINA	PI11202201	PLANALTINA	05/11/2019 17:56	05/11/2019 21:08	05/11/2019 17:56	05/11/2019 21:08	3,19	97	309,40	CHI
20191139914	CRIXAS	CX12319094	SERRA DO OURO	05/11/2019 18:42	07/11/2019 14:48	05/11/2019 18:42	07/11/2019 14:48	44,09	5	220,43	CHI

20191139916	ANAPOLIS	AN11000269	JUNDIAI S1	05/11/2019 18:23	05/11/2019 19:32	05/11/2019 18:23	05/11/2019 19:32	1,13	102	115,66	CHI
20191139924	CALDAS NOVAS	760294549	SERRA DE CALDAS	05/11/2019 18:43	06/11/2019 04:46	05/11/2019 18:43	06/11/2019 04:46	10,04	1	10,04	CHI
20191139930	PLANALTINA	PI11131815	PLANALTINA	05/11/2019 16:55	05/11/2019 21:00	05/11/2019 16:55	05/11/2019 21:00	4,07	193	786,37	CHI
20191139937	MATRINCHA	MP12321180	MATRINCHA	05/11/2019 18:00	07/11/2019 10:37	05/11/2019 18:00	07/11/2019 10:37	40,61	10	406,13	CHI
20191139938	SAO LUIS DE MONTES BELOS	SL21206336	FIRMINOPOLIS S2	05/11/2019 18:44	06/11/2019 09:40	05/11/2019 18:44	06/11/2019 09:40	14,94	1	14,94	CHI
20191139958	CATALAO	CT21215528	CATALAO S1	05/11/2019 17:34	06/11/2019 09:30	05/11/2019 17:34	06/11/2019 09:30	15,93	2	31,85	CHI
20191139978	GOIANESIA	GE12000233	GOIANESIA S2	05/11/2019 17:53	06/11/2019 08:56	05/11/2019 17:53	06/11/2019 08:56	15,04	23	346,01	CHI
20191139982	HIDROLINA	HL11269818	URUACU	05/11/2019 17:44	05/11/2019 21:19	05/11/2019 17:44	05/11/2019 21:19	3,58	79	282,82	CHI
20191139986	SAO LUIS DE MONTES BELOS	SL32145964	SAO LUIZ DOS MONTES BELOS	05/11/2019 18:04	05/11/2019 22:26	05/11/2019 18:04	05/11/2019 22:26	4,36	36	157,11	CHI
20191139997	BARRO ALTO	BA12382486	BARRO ALTO	05/11/2019 16:50	07/11/2019 09:55	05/11/2019 16:50	07/11/2019 09:55	41,08	6	246,48	CHI
20191140003	ITAPIRAPUA	IU12016406	MATRINCHA	05/11/2019 17:19	06/11/2019 10:29	05/11/2019 17:19	06/11/2019 10:29	17,15	12	205,86	CHI
20191140009	GOIANIA	GN11257210	GOYA S1	05/11/2019 14:41	05/11/2019 20:38	05/11/2019 14:41	05/11/2019 20:38	5,95	115	684,15	CHI
20191140022	GOIANESIA	BA12163310	GOIANESIA S1	05/11/2019 13:22	06/11/2019 22:07	05/11/2019 13:22	06/11/2019 22:07	32,74	3	98,23	CHI
20191140022	VILA PROPICIO	BA12163310	GOIANESIA S1	05/11/2019 13:22	06/11/2019 22:07	05/11/2019 13:22	06/11/2019 22:07	32,74	11	360,19	CHI
20191140023	URUACU	640140660	URUACU	05/11/2019 18:51	05/11/2019 19:50	05/11/2019 18:51	05/11/2019 19:50	0,98	1	0,98	CHI
20191140026	CRISTALINA	KR12219592	CRISTALINA S2	05/11/2019 18:51	05/11/2019 20:25	05/11/2019 18:51	05/11/2019 20:25	1,56	3	4,68	CHI
20191140035	MONTE ALEGRE DE GOIAS	MA12130277	SAO DOMINGOS	05/11/2019 18:52	07/11/2019 17:09	05/11/2019 18:52	06/11/2019 15:40	20,80	1	20,80	CHI
20191140035	MONTE ALEGRE DE GOIAS	20057305	SAO DOMINGOS	05/11/2019 18:52	07/11/2019 17:09	05/11/2019 18:52	06/11/2019 17:31	22,65	1	22,65	CHI
20191140035	MONTE ALEGRE DE GOIAS	MA12399010	SAO DOMINGOS	05/11/2019 18:52	07/11/2019 17:09	05/11/2019 18:52	07/11/2019 17:09	46,28	1	46,28	CHI
20191140046	ARENOPOLIS	AY12040872	ARENOPOLIS	05/11/2019 18:53	09/11/2019 15:29	05/11/2019 18:53	09/11/2019 15:29	92,60	13	1203,80	CHI
20191140052	CRISTIANOPOLIS	CF12000002RE	CRISTIANOPOLIS	05/11/2019 13:55	06/11/2019 03:49	05/11/2019 13:55	06/11/2019 03:49	13,89	47	652,62	CHI
20191140052	PIRACANJUBA	CF12000002RE	CRISTIANOPOLIS	05/11/2019 13:55	06/11/2019 03:49	05/11/2019 13:55	06/11/2019 03:49	13,89	7	97,20	CHI
20191140059	BURITI DE GOIAS	BS12304459	FIRMINOPOLIS S2	05/11/2019 18:54	06/11/2019 18:44	05/11/2019 18:54	06/11/2019 18:44	23,83	10	238,31	CHI
20191140059	MOSSAMEDES	BS12304459	FIRMINOPOLIS S2	05/11/2019 18:54	06/11/2019 18:44	05/11/2019 18:54	06/11/2019 18:44	23,83	5	119,16	CHI
20191140059	SANCLERLANDIA	BS12304459	FIRMINOPOLIS S2	05/11/2019 18:54	06/11/2019 18:44	05/11/2019 18:54	06/11/2019 18:44	23,83	1	23,83	CHI
20191140064	ABADIANIA	AA21399742	ANAPOLIS UNIVERSITARIO S1	05/11/2019 18:54	06/11/2019 08:50	05/11/2019 18:54	06/11/2019 08:50	13,92	2	27,83	CHI
20191140080	MOZARLANDIA	MZ11274178	MOZARLANDIA	05/11/2019 17:46	06/11/2019 11:56	05/11/2019 17:46	06/11/2019 11:56	18,17	88	1599,33	CHI
20191140081	PIRENOPOLIS	PV11264950	CORUMBA	05/11/2019 17:08	05/11/2019 22:50	05/11/2019 17:08	05/11/2019 22:50	5,70	35	199,33	CHI
20191140089	CALDAS NOVAS	CN12363765	CALDAS NOVAS S1	05/11/2019 14:06	06/11/2019 09:47	05/11/2019 14:06	06/11/2019 09:47	19,67	18	354,14	CHI
20191140092	SANCLERLANDIA	SC11093501	FIRMINOPOLIS S2	05/11/2019 17:29	06/11/2019 00:08	05/11/2019 17:29	06/11/2019 00:08	6,64	177	1176,12	CHI
20191140096	RIO VERDE	RV12029165	CABRIUVA S2	05/11/2019 13:46	06/11/2019 22:14	05/11/2019 13:46	06/11/2019 22:14	32,46	34	1103,66	CHI
20191140099	MATRINCHA	MP12299692	MATRINCHA	05/11/2019 18:57	10/11/2019 08:07	05/11/2019 18:57	10/11/2019 08:07	109,15	4	436,62	CHI
20191140103	PIRACANJUBA	PJ12212207	PIRACANJUBA	05/11/2019 18:58	08/11/2019 11:50	05/11/2019 18:58	08/11/2019 11:50	64,86	9	583,73	CHI

20191140106	ITABERAÍ	50081287	ITABERAÍ S2	05/11/2019 18:58	06/11/2019 19:10	05/11/2019 18:58	06/11/2019 19:10	24,19	1	24,19	CHI
20191140110	BURITI DE GOIAS	BS12252226	FIRMINOPOLIS S2	05/11/2019 18:59	05/11/2019 23:31	05/11/2019 18:59	05/11/2019 23:31	4,53	13	58,85	CHI
20191140117	ARUANA	AK12078438	MOZARLANDIA	05/11/2019 17:45	07/11/2019 16:04	05/11/2019 17:45	07/11/2019 16:04	46,32	80	3705,24	CHI
20191140144	SAO LUIS DE MONTES BELOS	SL12206033	SAO LUIZ DOS MONTES BELOS	05/11/2019 18:25	07/11/2019 01:59	05/11/2019 18:25	07/11/2019 01:59	31,56	13	410,22	CHI
20191140146	MOZARLANDIA	MZ11250764	MOZARLANDIA	05/11/2019 17:34	06/11/2019 19:20	05/11/2019 17:34	06/11/2019 19:20	25,76	82	2112,41	CHI
20191140148	MOZARLANDIA	MZ11092769	MOZARLANDIA	05/11/2019 17:47	06/11/2019 17:40	05/11/2019 17:47	06/11/2019 17:40	23,89	223	5326,42	CHI
20191140149	MOZARLANDIA	MZ11089966	MOZARLANDIA	05/11/2019 17:58	06/11/2019 16:45	05/11/2019 17:58	06/11/2019 16:45	22,78	161	3667,18	CHI
20191140160	PONTALINA	210020600	PONTALINA	05/11/2019 19:04	06/11/2019 19:42	05/11/2019 19:04	06/11/2019 19:42	24,63	1	24,63	CHI
20191140164	NIQUELANDIA	2750140025	NIQUELANDIA SUBTRANSMISSAO	05/11/2019 19:04	05/11/2019 20:42	05/11/2019 19:04	05/11/2019 20:42	1,63	1	1,63	CHI
20191140170	FIRMINOPOLIS	SL12125617	FIRMINOPOLIS S1	05/11/2019 18:23	06/11/2019 16:25	05/11/2019 18:23	06/11/2019 16:25	22,03	17	374,58	CHI
20191140170	SAO LUIS DE MONTES BELOS	SL12125617	FIRMINOPOLIS S1	05/11/2019 18:23	06/11/2019 16:25	05/11/2019 18:23	06/11/2019 16:25	22,03	52	1145,78	CHI
20191140170	TURVANIA	SL12125617	FIRMINOPOLIS S1	05/11/2019 18:23	06/11/2019 16:25	05/11/2019 18:23	06/11/2019 16:25	22,03	8	176,27	CHI
20191140176	SANTA TEREZA DE GOIAS	SE12390458	MARA ROSA	06/11/2019 07:56	07/11/2019 03:19	06/11/2019 07:56	07/11/2019 03:19	19,38	7	135,64	CHI
20191140186	PIRENOPOLIS	PV21318090	CORUMBA	05/11/2019 19:06	07/11/2019 15:45	05/11/2019 19:06	07/11/2019 15:45	44,64	1	44,64	CHI
20191140192	PIRENOPOLIS	PV21171312	CORUMBA	05/11/2019 19:07	06/11/2019 20:22	05/11/2019 19:07	06/11/2019 20:22	25,25	2	50,50	CHI
20191140193	SAO MIGUEL DO ARAGUAIA	SM12211095	SAO MIGUEL DO ARAGUAIA	05/11/2019 16:10	06/11/2019 10:20	05/11/2019 16:10	06/11/2019 10:20	18,15	131	2378,01	CHI
20191140206	CRISTALINA	KR11032618	PAMPLONA	05/11/2019 19:05	05/11/2019 22:14	05/11/2019 19:05	05/11/2019 22:14	3,14	65	204,32	CHI
20191140207	JARAGUA	JA12353232	GOIANESIA S2	05/11/2019 16:25	06/11/2019 00:58	05/11/2019 16:25	06/11/2019 00:58	8,55	31	264,92	CHI
20191140208	ARUANA	00250414	BRITANIA	05/11/2019 19:03	05/11/2019 19:07	05/11/2019 19:03	05/11/2019 19:07	0,07	38	2,65	CHI
20191140208	BRITANIA	00250414	BRITANIA	05/11/2019 19:03	05/11/2019 19:07	05/11/2019 19:03	05/11/2019 19:07	0,07	12	0,84	CHI
20191140208	BRITANIA	00250414	BRITANIA	05/11/2019 19:03	05/11/2019 19:07	05/11/2019 19:03	05/11/2019 19:07	0,07	18	1,26	CHI
20191140217	PALESTINA DE GOIAS	PY12040193	PALESTINA	05/11/2019 19:06	06/11/2019 00:52	05/11/2019 19:06	06/11/2019 00:52	5,76	81	466,45	CHI
20191140239	ITAPIRAPUA	JR13267249	JUSSARA	05/11/2019 14:26	06/11/2019 04:24	05/11/2019 14:26	06/11/2019 04:24	13,95	146	2037,35	CHI
20191140239	JUSSARA	JR13267249	JUSSARA	05/11/2019 14:26	06/11/2019 04:24	05/11/2019 14:26	06/11/2019 04:24	13,95	1265	17652,37	CHI
20191140239	NOVO BRASIL	JR13267249	JUSSARA	05/11/2019 14:26	06/11/2019 04:24	05/11/2019 14:26	06/11/2019 04:24	13,95	12	167,45	CHI
20191140239	JUSSARA	JR13267249	JUSSARA	05/11/2019 14:26	06/11/2019 04:24	05/11/2019 23:54	06/11/2019 04:24	4,49	1	4,49	CHI
20191140248	PLANALTINA	PI21211503	PLANALTINA	05/11/2019 19:11	07/11/2019 09:26	05/11/2019 19:11	07/11/2019 09:26	38,25	1	38,25	CHI
20191140249	BONOPOLIS	SM10396890	SAO MIGUEL DO ARAGUAIA	05/11/2019 14:00	06/11/2019 00:41	05/11/2019 14:00	06/11/2019 00:40	10,68	103	1100,01	CHI
20191140249	SAO MIGUEL DO ARAGUAIA	SM10396890	SAO MIGUEL DO ARAGUAIA	05/11/2019 14:00	06/11/2019 00:41	05/11/2019 14:00	06/11/2019 00:40	10,68	50	533,99	CHI
20191140249	SAO MIGUEL DO ARAGUAIA	6641955	SAO MIGUEL DO ARAGUAIA	05/11/2019 14:00	06/11/2019 00:41	05/11/2019 14:00	06/11/2019 00:41	10,68	1	10,68	CHI
20191140258	URUACU	UR21135639	URUACU	05/11/2019 19:12	07/11/2019 08:42	05/11/2019 19:12	07/11/2019 08:42	37,49	1	37,49	CHI
20191140261	MORRINHOS	MR12035104	GOIATUBA S1	05/11/2019 19:12	06/11/2019 18:13	05/11/2019 19:12	06/11/2019 18:13	23,01	4	92,04	CHI
20191140262	IPORA	IR12060703	IPORA	05/11/2019 18:46	06/11/2019 10:40	05/11/2019 18:46	06/11/2019 10:40	15,89	6	95,37	CHI

20191140263	AGUA FRIA DE GOIAS	JL12342443	SAO JOAO D ALIANCA	05/11/2019 17:27	07/11/2019 13:39	05/11/2019 17:27	07/11/2019 13:39	44,20	4	176,80	CHI
20191140263	NIQUELANDIA	JL12342443	SAO JOAO D ALIANCA	05/11/2019 17:27	07/11/2019 13:39	05/11/2019 17:27	07/11/2019 13:39	44,20	2	88,40	CHI
20191140263	SAO JOAO D ALIANCA	JL12342443	SAO JOAO D ALIANCA	05/11/2019 17:27	07/11/2019 13:39	05/11/2019 17:27	07/11/2019 13:39	44,20	3	132,60	CHI
20191140272	CATALAO	CT12358401	CATALAO S1	05/11/2019 19:14	06/11/2019 11:49	05/11/2019 19:14	06/11/2019 11:49	16,58	5	82,90	CHI
20191140279	URUACU	UR21314180	URUACU	05/11/2019 19:15	07/11/2019 15:36	05/11/2019 19:15	07/11/2019 15:36	44,35	1	44,35	CHI
20191140281	IPAMERI	GD21100333	IPAMERI	05/11/2019 19:15	06/11/2019 23:19	05/11/2019 19:15	06/11/2019 23:19	28,06	1	28,06	CHI
20191140284	NIQUELANDIA	NQ21035677	NIQUELANDIA SUBTRANSMISSAO	05/11/2019 19:15	07/11/2019 10:51	05/11/2019 19:15	07/11/2019 10:51	39,59	1	39,59	CHI
20191140288	BURITI DE GOIAS	BS11045643	FIRMINOPOLIS S2	05/11/2019 19:16	05/11/2019 20:44	05/11/2019 19:16	05/11/2019 20:44	1,47	96	140,64	CHI
20191140294	MINACU	IH12207740	MINACU	05/11/2019 14:53	05/11/2019 21:14	05/11/2019 14:53	05/11/2019 21:14	6,35	98	622,30	CHI
20191140295	URUACU	10002502710	URUACU	05/11/2019 18:45	05/11/2019 20:18	05/11/2019 18:45	05/11/2019 20:18	1,55	1	1,55	CHI
20191140297	FORMOSA	FA11180591	ITUIQUIRA	05/11/2019 19:14	05/11/2019 21:12	05/11/2019 19:14	05/11/2019 21:12	1,96	199	389,32	CHI
20191140298	PONTALINA	PK21000038	PONTALINA	05/11/2019 19:17	06/11/2019 11:26	05/11/2019 19:17	06/11/2019 11:26	16,15	1	16,15	CHI
20191140300	PLANALTINA	2960145878	PLANALTINA	05/11/2019 19:17	06/11/2019 16:40	05/11/2019 19:17	06/11/2019 16:40	21,39	1	21,39	CHI
20191140301	CAIAPONIA	CP21259323	CAIAPONIA	05/11/2019 19:17	06/11/2019 19:47	05/11/2019 19:17	06/11/2019 19:47	24,49	1	24,49	CHI
20191140302	ITAPIRAPUA	IU12018840	MATRINCHA	05/11/2019 18:52	07/11/2019 10:46	05/11/2019 18:52	07/11/2019 10:46	39,89	18	718,00	CHI
20191140303	NIQUELANDIA	NQ12265966	NIQUELANDIA SUBTRANSMISSAO	05/11/2019 17:15	05/11/2019 22:30	05/11/2019 17:15	05/11/2019 22:30	5,24	24	125,68	CHI
20191140311	FORMOSA	FA13233568	SAO JOAO D ALIANCA	05/11/2019 19:17	06/11/2019 13:20	06/11/2019 02:06	06/11/2019 06:49	4,70	157	738,55	CHI
20191140311	FORMOSA	FA12233644	SAO JOAO D ALIANCA	05/11/2019 19:17	06/11/2019 13:20	05/11/2019 19:17	06/11/2019 13:20	18,04	22	396,78	CHI
20191140318	UIRAPURU	UP12067411	SANTA TEREZINHA	05/11/2019 17:01	05/11/2019 22:03	05/11/2019 17:01	05/11/2019 22:03	5,02	89	446,63	CHI
20191140324	VILA PROPICIO	BA12210735	GOIANESIA S1	05/11/2019 19:05	07/11/2019 02:05	05/11/2019 19:05	07/11/2019 02:05	30,99	27	836,68	CHI
20191140332	MONTIVIDIU DO NORTE	MX12065532	PORANGATU	05/11/2019 19:21	08/11/2019 13:45	05/11/2019 19:21	08/11/2019 13:45	66,40	3	199,19	CHI
20191140343	BALIZA	BH11188437	BOM JARDIM	05/11/2019 16:53	05/11/2019 23:19	05/11/2019 16:53	05/11/2019 23:19	6,42	74	475,26	CHI
20191140350	ARAGUAPAZ	AZ12188220	MOZARLANDIA	05/11/2019 17:11	06/11/2019 14:35	05/11/2019 17:11	06/11/2019 09:05	15,89	23	365,56	CHI
20191140350	ARAGUAPAZ	AZ12042907LD	MOZARLANDIA	05/11/2019 17:11	06/11/2019 14:35	05/11/2019 17:11	06/11/2019 10:08	16,94	10	169,40	CHI
20191140350	MOZARLANDIA	AZ12042907LD	MOZARLANDIA	05/11/2019 17:11	06/11/2019 14:35	05/11/2019 17:11	06/11/2019 10:08	16,94	2	33,88	CHI
20191140350	ARAGUAPAZ	AZ13188218	MOZARLANDIA	05/11/2019 17:11	06/11/2019 14:35	05/11/2019 17:11	06/11/2019 14:35	21,40	2	42,80	CHI
20191140350	MOZARLANDIA	AZ13188218	MOZARLANDIA	05/11/2019 17:11	06/11/2019 14:35	05/11/2019 17:11	06/11/2019 14:35	21,40	5	107,01	CHI
20191140353	MOZARLANDIA	MZ12264150	MOZARLANDIA	05/11/2019 17:48	06/11/2019 19:38	05/11/2019 17:48	06/11/2019 19:38	25,83	39	1007,22	CHI
20191140354	SAO JOAO D ALIANCA	JL12314646	FLORES DE GOIAS	05/11/2019 18:52	06/11/2019 09:36	05/11/2019 18:52	06/11/2019 09:36	14,72	9	132,51	CHI
20191140373	FORMOSA	610302565	ITUIQUIRA	05/11/2019 19:26	05/11/2019 21:52	05/11/2019 19:26	05/11/2019 21:52	2,42	1	2,42	CHI
20191140375	TAQUARAL DE GOIAS	TQ21037884	ITABERAI S1	05/11/2019 19:26	10/11/2019 10:48	05/11/2019 19:26	10/11/2019 10:48	111,36	1	111,36	CHI
20191140394	MARA ROSA	MQ12263046	MARA ROSA	05/11/2019 19:29	08/11/2019 14:44	05/11/2019 19:29	08/11/2019 14:44	67,26	7	470,82	CHI
20191140396	CAMPOS BELOS	CH12218811	SAO DOMINGOS	05/11/2019 14:06	06/11/2019 02:00	05/11/2019 14:06	06/11/2019 02:00	11,89	12	142,66	CHI

20191140404	ITAGUARI	II12025632	ITABERAÍ S1	05/11/2019 16:42	06/11/2019 11:15	05/11/2019 16:42	06/11/2019 09:54	17,21	14	240,87	CHI
20191140404	JARAGUA	II12025632	ITABERAÍ S1	05/11/2019 16:42	06/11/2019 11:15	05/11/2019 16:42	06/11/2019 09:54	17,21	2	34,41	CHI
20191140404	ITAGUARI	II12025632	ITABERAÍ S1	05/11/2019 16:42	06/11/2019 11:15	06/11/2019 09:55	06/11/2019 11:15	1,34	14	18,74	CHI
20191140404	JARAGUA	II12025632	ITABERAÍ S1	05/11/2019 16:42	06/11/2019 11:15	06/11/2019 09:55	06/11/2019 11:15	1,34	2	2,68	CHI
20191140405	URUACU	UR21136432	MARA ROSA	05/11/2019 19:30	08/11/2019 17:20	05/11/2019 19:30	08/11/2019 17:20	69,83	1	69,83	CHI
20191140409	SAO FRANCISCO DE GOIAS	SF31048284	SAO FRANCISCO DE GOIAS	05/11/2019 19:30	06/11/2019 10:10	05/11/2019 19:30	06/11/2019 10:10	14,66	1	14,66	CHI
20191140411	NIQUELANDIA	6316015	NIQUELANDIA SUBTRANSMISSAO	05/11/2019 19:28	06/11/2019 00:32	05/11/2019 19:28	06/11/2019 00:32	5,05	41	207,23	CHI
20191140435	PIRANHAS	1930005341	PIRANHAS	05/11/2019 19:34	08/11/2019 11:20	05/11/2019 19:34	08/11/2019 11:20	63,77	1	63,77	CHI
20191140450	MAIRIPOTABA	PK12390276	PONTALINA	05/11/2019 19:36	07/11/2019 16:25	05/11/2019 19:36	07/11/2019 16:25	44,81	57	2554,22	CHI
20191140451	BURITI DE GOIAS	BS11375304	FIRMINOPOLIS S2	05/11/2019 19:36	05/11/2019 22:53	05/11/2019 19:36	05/11/2019 22:53	3,27	20	65,47	CHI
20191140457	SAO MIGUEL DO ARAGUAIA	SM12332466	SAO MIGUEL DO ARAGUAIA	05/11/2019 19:06	08/11/2019 16:10	05/11/2019 19:06	08/11/2019 16:10	69,06	16	1104,96	CHI
20191140461	ITUMBIARA	690206185	ITUMBIARA NOVA	05/11/2019 19:37	06/11/2019 16:14	05/11/2019 19:37	06/11/2019 16:14	20,61	1	20,61	CHI
20191140468	MOZARLANDIA	MZ11234817	MOZARLANDIA	05/11/2019 18:36	06/11/2019 12:14	05/11/2019 18:36	06/11/2019 12:14	17,64	30	529,07	CHI
20191140472	LUZIANIA	120261261	RIO VERMELHO	05/11/2019 19:39	05/11/2019 23:51	05/11/2019 19:39	05/11/2019 23:51	4,18	1	4,18	CHI
20191140485	PLANALTINA	PI12211502	PLANALTINA	05/11/2019 18:07	05/11/2019 22:28	05/11/2019 18:07	05/11/2019 22:28	4,34	171	742,57	CHI
20191140489	CALDAS NOVAS	CN11103220	SERRA DE CALDAS	05/11/2019 19:32	05/11/2019 21:51	05/11/2019 19:32	05/11/2019 21:51	2,30	102	234,97	CHI
20191140494	SAO FRANCISCO DE GOIAS	SF12008975	SAO FRANCISCO DE GOIAS	05/11/2019 19:43	06/11/2019 09:32	05/11/2019 19:43	06/11/2019 09:32	13,80	15	207,01	CHI
20191140501	HEITORAI	HE21158799	ITAPURANGA	05/11/2019 19:45	08/11/2019 15:00	05/11/2019 19:45	08/11/2019 15:00	67,24	1	67,24	CHI
20191140516	PLANALTINA	PI11361427	PLANALTINA	05/11/2019 18:55	05/11/2019 23:34	05/11/2019 18:55	05/11/2019 23:34	4,65	138	641,43	CHI
20191140517	COCALZINHO DE GOIAS	ZN12381281	COCALZINHO	05/11/2019 13:04	05/11/2019 20:14	05/11/2019 13:04	05/11/2019 20:14	7,16	308	2206,82	CHI
20191140517	PIRENOPOLIS	ZN12381281	COCALZINHO	05/11/2019 13:04	05/11/2019 20:14	05/11/2019 13:04	05/11/2019 20:14	7,16	20	143,30	CHI
20191140518	SANTO ANTONIO DO DESCOBERTO	2210079828	AGUAS LINDAS DE GOIAS S2	05/11/2019 19:47	05/11/2019 23:50	05/11/2019 19:47	05/11/2019 23:50	4,04	1	4,04	CHI
20191140523	AGUA LIMPA	AL21263207	VILA CORUMBA	05/11/2019 19:48	08/11/2019 09:34	05/11/2019 19:48	08/11/2019 09:34	61,76	1	61,76	CHI
20191140524	IPAMERI	580065893	IPAMERI	05/11/2019 19:48	07/11/2019 11:11	05/11/2019 19:48	07/11/2019 11:11	39,38	1	39,38	CHI
20191140535	ANAPOLIS	10022002063	JUNDIAI S1	05/11/2019 19:49	06/11/2019 01:50	05/11/2019 19:49	06/11/2019 01:50	6,01	1	6,01	CHI
20191140537	SANTO ANTONIO DO DESCOBERTO	SN12345967	AGUAS LINDAS DE GOIAS S2	05/11/2019 19:49	05/11/2019 21:42	05/11/2019 19:49	05/11/2019 21:42	1,88	1	1,88	CHI
20191140538	ARAGUAPAZ	AZ12274481	GOIAS	05/11/2019 19:49	08/11/2019 11:50	05/11/2019 19:49	08/11/2019 11:50	64,01	1	64,01	CHI
20191140539	CAMPINORTE	CR12070384	CAMPINORTE	05/11/2019 18:31	06/11/2019 10:55	05/11/2019 18:31	06/11/2019 10:55	16,40	6	98,40	CHI
20191140539	NOVA IGUAÇU DE GOIAS	CR12070384	CAMPINORTE	05/11/2019 18:31	06/11/2019 10:55	05/11/2019 18:31	06/11/2019 10:55	16,40	21	344,39	CHI
20191140561	GOIAS	NB12092962	MATRINCHA	05/11/2019 19:50	08/11/2019 17:20	05/11/2019 19:50	08/11/2019 17:20	69,50	3	208,50	CHI
20191140561	ITAPIRAPUA	NB12092962	MATRINCHA	05/11/2019 19:50	08/11/2019 17:20	05/11/2019 19:50	08/11/2019 17:20	69,50	1	69,50	CHI
20191140561	NOVO BRASIL	NB12092962	MATRINCHA	05/11/2019 19:50	08/11/2019 17:20	05/11/2019 19:50	08/11/2019 17:20	69,50	5	347,50	CHI
20191140566	ARENOPOLIS	AY12381016	IPORA	05/11/2019 17:35	06/11/2019 08:35	05/11/2019 17:35	06/11/2019 08:35	14,99	40	599,68	CHI

20191140569	PILAR DE GOIAS	GG12318427	URUACU	05/11/2019 19:52	07/11/2019 17:54	05/11/2019 19:52	07/11/2019 17:54	46,03	9	414,28	CHI
20191140575	MARA ROSA	MQ12244393	MARA ROSA	05/11/2019 17:18	06/11/2019 11:52	05/11/2019 17:18	06/11/2019 11:52	18,56	10	185,58	CHI
20191140587	MORRINHOS	MR12000077RE	MORRINHOS	05/11/2019 19:27	06/11/2019 07:52	05/11/2019 19:27	06/11/2019 07:52	12,40	101	1252,54	CHI
20191140597	SAO LUIS DE MONTES BELOS	SL12146020	SAO LUIZ DOS MONTES BELOS	05/11/2019 19:37	06/11/2019 02:39	05/11/2019 19:37	06/11/2019 02:39	7,03	5	35,14	CHI
20191140600	SAO SIMAO	SO12191548	CACHOEIRA ALTA	05/11/2019 16:52	07/11/2019 16:31	05/11/2019 16:52	07/11/2019 16:31	47,65	5	238,23	CHI
20191140613	MINACU	CR12265815	PORANGATU	05/11/2019 17:43	09/11/2019 00:12	05/11/2019 17:43	09/11/2019 00:12	78,48	4	313,91	CHI
20191140619	PLANALTINA	10008152401	PLANALTINA	05/11/2019 19:58	06/11/2019 20:30	05/11/2019 19:58	06/11/2019 20:30	24,52	1	24,52	CHI
20191140620	MONTES CLAROS DE GOIAS	ME12138697	IPORA	05/11/2019 17:01	07/11/2019 15:00	05/11/2019 17:01	07/11/2019 15:00	45,99	2	91,98	CHI
20191140621	MAIRIPOTABA	MI21293019	PONTALINA	05/11/2019 19:59	07/11/2019 10:06	05/11/2019 19:59	07/11/2019 10:06	38,11	1	38,11	CHI
20191140624	SAO LUIS DE MONTES BELOS	SL12145927	SAO LUIZ DOS MONTES BELOS	05/11/2019 18:28	06/11/2019 04:02	05/11/2019 18:28	06/11/2019 04:02	9,57	20	191,32	CHI
20191140637	ITABERAI	IB12310600	ITABERAI S2	05/11/2019 20:02	06/11/2019 09:30	05/11/2019 20:02	06/11/2019 09:30	13,46	77	1036,38	CHI
20191140660	IPORA	AM12402911	IPORA	05/11/2019 19:57	06/11/2019 07:48	05/11/2019 19:57	06/11/2019 07:48	11,84	45	532,64	CHI
20191140668	GOIAS	GS12035930	GOIAS	05/11/2019 19:34	06/11/2019 15:35	05/11/2019 19:34	06/11/2019 15:35	20,03	40	801,19	CHI
20191140668	HEITORAI	GS12035930	GOIAS	05/11/2019 19:34	06/11/2019 15:35	05/11/2019 19:34	06/11/2019 15:35	20,03	29	580,86	CHI
20191140668	ITABERAI	GS12035930	GOIAS	05/11/2019 19:34	06/11/2019 15:35	05/11/2019 19:34	06/11/2019 15:35	20,03	2	40,06	CHI
20191140668	ITAPURANGA	GS12035930	GOIAS	05/11/2019 19:34	06/11/2019 15:35	05/11/2019 19:34	06/11/2019 15:35	20,03	3	60,09	CHI
20191140683	NIQUELANDIA	NQ12135523	URUACU	05/11/2019 18:50	07/11/2019 17:46	05/11/2019 18:50	07/11/2019 17:46	46,94	2	93,88	CHI
20191140686	NIQUELANDIA	NQ12095916	URUACU	05/11/2019 19:37	06/11/2019 02:52	05/11/2019 19:37	06/11/2019 02:52	7,24	2	14,47	CHI
20191140696	CATALAO	CT21192574	CATALAO S1	05/11/2019 20:08	06/11/2019 15:48	05/11/2019 20:08	06/11/2019 15:48	19,66	2	39,33	CHI
20191140699	GOIAS	GS12259614	GOIAS	05/11/2019 19:24	07/11/2019 19:19	05/11/2019 19:24	06/11/2019 17:30	22,11	9	198,98	CHI
20191140699	GOIAS	GS12259614	GOIAS	05/11/2019 19:24	07/11/2019 19:19	05/11/2019 19:24	07/11/2019 19:19	47,92	4	191,67	CHI
20191140699	GOIAS	GS12259614	GOIAS	05/11/2019 19:24	07/11/2019 19:19	07/11/2019 19:00	07/11/2019 19:19	0,32	9	2,88	CHI
20191140710	MOZARLANDIA	MZ10400707	MOZARLANDIA	05/11/2019 18:23	10/11/2019 11:07	05/11/2019 18:23	06/11/2019 08:41	14,31	35	500,72	CHI
20191140710	NOVA CRIXAS	MZ10400707	MOZARLANDIA	05/11/2019 18:23	10/11/2019 11:07	05/11/2019 18:23	06/11/2019 08:41	14,31	9	128,76	CHI
20191140710	CRIXAS	MZ13240474	MOZARLANDIA	05/11/2019 18:23	10/11/2019 11:07	05/11/2019 18:23	06/11/2019 09:45	15,36	92	1413,22	CHI
20191140710	MOZARLANDIA	MZ13240474	MOZARLANDIA	05/11/2019 18:23	10/11/2019 11:07	05/11/2019 18:23	06/11/2019 09:45	15,36	247	3794,19	CHI
20191140710	NOVA CRIXAS	MZ13240474	MOZARLANDIA	05/11/2019 18:23	10/11/2019 11:07	05/11/2019 18:23	06/11/2019 09:45	15,36	27	414,75	CHI
20191140710	MOZARLANDIA	MZ13240474	MOZARLANDIA	05/11/2019 18:23	10/11/2019 11:07	06/11/2019 09:30	06/11/2019 09:45	0,25	11	2,75	CHI
20191140710	NOVA CRIXAS	MZ10400707	MOZARLANDIA	05/11/2019 18:23	10/11/2019 11:07	05/11/2019 18:23	06/11/2019 10:34	16,19	7	113,32	CHI
20191140710	MOZARLANDIA	MZ10400707	MOZARLANDIA	05/11/2019 18:23	10/11/2019 11:07	06/11/2019 09:13	06/11/2019 10:34	1,35	35	47,31	CHI
20191140710	NOVA CRIXAS	MZ10400707	MOZARLANDIA	05/11/2019 18:23	10/11/2019 11:07	06/11/2019 09:13	06/11/2019 10:34	1,35	9	12,17	CHI
20191140710	NOVA CRIXAS	MZ10400707	MOZARLANDIA	05/11/2019 18:23	10/11/2019 11:07	05/11/2019 18:23	06/11/2019 12:44	18,36	20	367,22	CHI
20191140710	CRIXAS	MZ10400707	MOZARLANDIA	05/11/2019 18:23	10/11/2019 11:07	06/11/2019 12:46	06/11/2019 12:51	0,09	2	0,19	CHI

20191140710	MOZARLANDIA	MZ10400707	MOZARLANDIA	05/11/2019 18:23	10/11/2019 11:07	06/11/2019 12:46	06/11/2019 12:51	0,09	35	3,32	CHI
20191140710	NOVA CRIXAS	MZ10400707	MOZARLANDIA	05/11/2019 18:23	10/11/2019 11:07	06/11/2019 12:46	06/11/2019 12:51	0,09	90	8,52	CHI
20191140710	CRIXAS	MZ10400707	MOZARLANDIA	05/11/2019 18:23	10/11/2019 11:07	06/11/2019 12:52	06/11/2019 13:05	0,23	2	0,45	CHI
20191140710	MOZARLANDIA	MZ10400707	MOZARLANDIA	05/11/2019 18:23	10/11/2019 11:07	06/11/2019 12:52	06/11/2019 13:05	0,23	35	7,88	CHI
20191140710	NOVA CRIXAS	MZ10400707	MOZARLANDIA	05/11/2019 18:23	10/11/2019 11:07	06/11/2019 12:52	06/11/2019 13:05	0,23	70	15,77	CHI
20191140710	NOVA CRIXAS	NA13259652	MOZARLANDIA	05/11/2019 18:23	10/11/2019 11:07	06/11/2019 12:52	06/11/2019 14:53	2,03	9	18,24	CHI
20191140710	CRIXAS	MZ10400707	MOZARLANDIA	05/11/2019 18:23	10/11/2019 11:07	06/11/2019 14:54	06/11/2019 15:14	0,33	2	0,65	CHI
20191140710	MOZARLANDIA	MZ10400707	MOZARLANDIA	05/11/2019 18:23	10/11/2019 11:07	06/11/2019 14:54	06/11/2019 15:14	0,33	35	11,43	CHI
20191140710	NOVA CRIXAS	MZ10400707	MOZARLANDIA	05/11/2019 18:23	10/11/2019 11:07	06/11/2019 14:54	06/11/2019 15:14	0,33	70	22,87	CHI
20191140710	NOVA CRIXAS	NA13259652	MOZARLANDIA	05/11/2019 18:23	10/11/2019 11:07	06/11/2019 14:54	07/11/2019 15:30	24,59	3	73,77	CHI
20191140710	CRIXAS	NA12057420LD	MOZARLANDIA	05/11/2019 18:23	10/11/2019 11:07	05/11/2019 18:23	07/11/2019 16:00	45,61	1	45,61	CHI
20191140710	NOVA CRIXAS	NA12057420LD	MOZARLANDIA	05/11/2019 18:23	10/11/2019 11:07	05/11/2019 18:23	07/11/2019 16:00	45,61	38	1733,23	CHI
20191140710	NOVA CRIXAS	NA12057420LD	NOVA CRIXAS	05/11/2019 18:23	10/11/2019 11:07	05/11/2019 18:23	07/11/2019 16:00	45,61	1	45,61	CHI
20191140710	NOVA CRIXAS	NA12321769	MOZARLANDIA	05/11/2019 18:23	10/11/2019 11:07	06/11/2019 12:52	07/11/2019 16:10	27,30	11	300,27	CHI
20191140710	CRIXAS	MZ10400707	MOZARLANDIA	05/11/2019 18:23	10/11/2019 11:07	07/11/2019 16:29	07/11/2019 17:47	1,30	2	2,60	CHI
20191140710	MOZARLANDIA	MZ10400707	MOZARLANDIA	05/11/2019 18:23	10/11/2019 11:07	07/11/2019 16:29	07/11/2019 17:47	1,30	35	45,45	CHI
20191140710	NOVA CRIXAS	MZ10400707	MOZARLANDIA	05/11/2019 18:23	10/11/2019 11:07	07/11/2019 16:29	07/11/2019 17:47	1,30	70	90,90	CHI
20191140710	CRIXAS	MZ10400707	MOZARLANDIA	05/11/2019 18:23	10/11/2019 11:07	07/11/2019 16:29	07/11/2019 19:15	2,76	1	2,76	CHI
20191140710	NOVA CRIXAS	MZ10400707	MOZARLANDIA	05/11/2019 18:23	10/11/2019 11:07	07/11/2019 16:29	07/11/2019 19:15	2,76	52	143,69	CHI
20191140710	NOVA CRIXAS	MZ10400707	NOVA CRIXAS	05/11/2019 18:23	10/11/2019 11:07	07/11/2019 16:29	07/11/2019 19:15	2,76	1	2,76	CHI
20191140710	NOVA CRIXAS	NA12084405	MOZARLANDIA	05/11/2019 18:23	10/11/2019 11:07	06/11/2019 14:54	08/11/2019 10:20	43,42	1	43,42	CHI
20191140710	NOVA CRIXAS	NA12057203	MOZARLANDIA	05/11/2019 18:23	10/11/2019 11:07	06/11/2019 14:54	08/11/2019 10:40	43,76	1	43,76	CHI
20191140710	NOVA CRIXAS	NA12300460	MOZARLANDIA	05/11/2019 18:23	10/11/2019 11:07	06/11/2019 14:54	08/11/2019 11:10	44,26	1	44,26	CHI
20191140710	NOVA CRIXAS	NA12057206	MOZARLANDIA	05/11/2019 18:23	10/11/2019 11:07	06/11/2019 14:54	08/11/2019 11:40	44,76	1	44,76	CHI
20191140710	NOVA CRIXAS	NA12220517	MOZARLANDIA	05/11/2019 18:23	10/11/2019 11:07	06/11/2019 14:54	10/11/2019 11:07	92,21	2	184,42	CHI
20191140737	CAMPINORTE	CR12109072	MARA ROSA	05/11/2019 20:02	06/11/2019 13:08	05/11/2019 20:02	06/11/2019 13:08	17,08	2	34,17	CHI
20191140738	PETROLINA DE GOIAS	PG21297854	PETROLINA	05/11/2019 20:16	07/11/2019 10:25	05/11/2019 20:16	07/11/2019 10:25	38,14	2	76,29	CHI
20191140740	SAO LUIS DE MONTES BELOS	SL12323580	SAO LUIZ DOS MONTES BELOS	05/11/2019 17:54	06/11/2019 03:06	05/11/2019 17:54	06/11/2019 03:06	9,20	55	505,97	CHI
20191140742	VALPARAISO DE GOIAS	2860058911	PACAEMBU S2	05/11/2019 20:16	05/11/2019 23:37	05/11/2019 20:16	05/11/2019 23:37	3,34	1	3,34	CHI
20191140750	ITUMBIARA	IT12000182	ITUMBIARA NOVA	05/11/2019 20:18	06/11/2019 16:28	05/11/2019 20:18	06/11/2019 16:28	20,17	3	60,50	CHI
20191140751	ALTO HORIZONTE	AJ21100995	SANTA TEREZINHA	05/11/2019 20:18	07/11/2019 16:42	05/11/2019 20:18	07/11/2019 16:42	44,40	1	44,40	CHI
20191140765	PALMINOPOLIS	TV12005542	FIRMINOPOLIS S2	05/11/2019 17:37	06/11/2019 10:13	05/11/2019 17:37	06/11/2019 10:13	16,59	19	315,17	CHI
20191140765	TURVANIA	TV12005542	FIRMINOPOLIS S2	05/11/2019 17:37	06/11/2019 10:13	05/11/2019 17:37	06/11/2019 10:13	16,59	51	845,99	CHI

20191140776	BONOPOLIS	BX12079321	SAO MIGUEL DO ARAGUAIA	05/11/2019 13:09	06/11/2019 07:16	05/11/2019 13:09	06/11/2019 07:16	18,11	55	996,03	CHI
20191140778	VALPARAISO DE GOIAS	3350030401	PACAEMBU S1	05/11/2019 20:23	05/11/2019 22:01	05/11/2019 20:23	05/11/2019 22:01	1,62	1	1,62	CHI
20191140785	ANAPOLIS	AN21273186	JUNDIAI S2	05/11/2019 20:24	06/11/2019 14:40	05/11/2019 20:24	06/11/2019 14:40	18,26	2	36,51	CHI
20191140791	MONTE ALEGRE DE GOIAS	MA12209950	SAO DOMINGOS	05/11/2019 20:26	06/11/2019 16:27	05/11/2019 20:26	06/11/2019 16:27	20,01	1	20,01	CHI
20191140848	SAO DOMINGOS	SD12218642	SAO DOMINGOS	05/11/2019 20:11	05/11/2019 23:39	05/11/2019 20:11	05/11/2019 23:39	3,46	80	276,71	CHI
20191140859	ITAPACI	10002936427	ITAPACI	05/11/2019 20:39	06/11/2019 01:28	05/11/2019 20:39	06/11/2019 01:28	4,81	1	4,81	CHI
20191140867	PIRES DO RIO	PR12075745	PIRES DO RIO S1	05/11/2019 16:39	06/11/2019 09:28	05/11/2019 16:39	06/11/2019 09:28	16,80	18	302,44	CHI
20191140874	BRITANIA	IU12025071	MATRINCHA	05/11/2019 19:50	06/11/2019 14:29	05/11/2019 19:50	06/11/2019 14:29	18,64	6	111,86	CHI
20191140874	ITAPIRAPUA	IU12025071	MATRINCHA	05/11/2019 19:50	06/11/2019 14:29	05/11/2019 19:50	06/11/2019 14:29	18,64	8	149,14	CHI
20191140879	MONTE ALEGRE DE GOIAS	MA12236748	SAO DOMINGOS	05/11/2019 20:41	06/11/2019 18:13	05/11/2019 20:41	06/11/2019 18:13	21,52	2	43,04	CHI
20191140879	NOVA ROMA	MA12236748	SAO DOMINGOS	05/11/2019 20:41	06/11/2019 18:13	05/11/2019 20:41	06/11/2019 18:13	21,52	55	1183,57	CHI
20191140890	JANDAIA	JD12005438	PALMEIRAS	06/11/2019 04:20	06/11/2019 09:05	06/11/2019 04:20	06/11/2019 09:05	4,74	55	260,91	CHI
20191140890	PALMEIRAS DE GOIAS	JD12005438	PALMEIRAS	06/11/2019 04:20	06/11/2019 09:05	06/11/2019 04:20	06/11/2019 09:05	4,74	8	37,95	CHI
20191140890	PALMINOPOLIS	JD12005438	PALMEIRAS	06/11/2019 04:20	06/11/2019 09:05	06/11/2019 04:20	06/11/2019 09:05	4,74	14	66,41	CHI
20191140897	CEZARINA	VJ12405985	GUAPU S2	05/11/2019 16:56	06/11/2019 10:30	05/11/2019 16:56	06/11/2019 10:30	17,56	38	667,34	CHI
20191140897	VARJAO	VJ12405985	GUAPU S2	05/11/2019 16:56	06/11/2019 10:30	05/11/2019 16:56	06/11/2019 10:30	17,56	2	35,12	CHI
20191140901	PALESTINA DE GOIAS	PY21023467	PALESTINA	05/11/2019 20:43	06/11/2019 10:35	05/11/2019 20:43	06/11/2019 10:35	13,87	1	13,87	CHI
20191140902	ARENOPOLIS	4170000755	IPORA	05/11/2019 20:46	06/11/2019 09:36	05/11/2019 20:46	06/11/2019 09:36	12,83	1	12,83	CHI
20191140919	LUZIANIA	3200108135	MARAJOARA	05/11/2019 20:48	05/11/2019 23:16	05/11/2019 20:48	05/11/2019 23:16	2,46	1	2,46	CHI
20191140931	PIRANHAS	PH12100283	PIRANHAS	05/11/2019 20:49	06/11/2019 14:53	05/11/2019 20:49	06/11/2019 14:53	18,07	61	1102,08	CHI
20191140933	PALMEIRAS DE GOIAS	PL12349319	PALMEIRAS	05/11/2019 20:49	06/11/2019 16:43	05/11/2019 20:49	06/11/2019 16:43	19,91	2	39,81	CHI
20191140934	ANAPOLIS	20665222	JUNDIAI S1	05/11/2019 20:49	06/11/2019 03:23	05/11/2019 20:49	06/11/2019 03:23	6,56	1	6,56	CHI
20191140944	ARAGARCAS	BM12155759	BOM JARDIM	05/11/2019 18:02	06/11/2019 16:26	05/11/2019 18:02	06/11/2019 16:26	22,40	7	156,78	CHI
20191140944	BOM JARDIM DE GOIAS	BM12155759	BOM JARDIM	05/11/2019 18:02	06/11/2019 16:26	05/11/2019 18:02	06/11/2019 16:26	22,40	20	447,96	CHI
20191140954	IPORA	IR12097730	IPORA	05/11/2019 20:53	06/11/2019 14:49	05/11/2019 20:53	06/11/2019 14:49	17,94	11	197,31	CHI
20191140965	MINACU	IH12397473	MINACU	05/11/2019 16:45	05/11/2019 22:51	05/11/2019 16:45	05/11/2019 22:51	6,10	8	48,80	CHI
20191140974	MONTE ALEGRE DE GOIAS	MA12209853	SAO DOMINGOS	05/11/2019 20:58	06/11/2019 18:07	05/11/2019 20:58	06/11/2019 18:07	21,15	1	21,15	CHI
20191140978	ADELANDIA	DN12277724	FIRMINOPOLIS S2	06/11/2019 06:15	06/11/2019 12:36	06/11/2019 06:15	06/11/2019 12:36	6,33	50	316,74	CHI
20191140978	MOSSAMEDES	DN12277724	FIRMINOPOLIS S2	06/11/2019 06:15	06/11/2019 12:36	06/11/2019 06:15	06/11/2019 12:36	6,33	5	31,67	CHI
20191140978	SANCLERLANDIA	DN12277724	FIRMINOPOLIS S2	06/11/2019 06:15	06/11/2019 12:36	06/11/2019 06:15	06/11/2019 12:36	6,33	30	190,04	CHI
20191140978	SAO LUIS DE MONTES BELOS	DN12277724	FIRMINOPOLIS S2	06/11/2019 06:15	06/11/2019 12:36	06/11/2019 06:15	06/11/2019 12:36	6,33	49	310,40	CHI
20191140978	ADELANDIA	DN12277724	FIRMINOPOLIS S2	06/11/2019 06:15	06/11/2019 12:36	06/11/2019 09:25	06/11/2019 12:36	3,18	9	28,60	CHI
20191140978	SAO LUIS DE MONTES BELOS	DN12277724	FIRMINOPOLIS S2	06/11/2019 06:15	06/11/2019 12:36	06/11/2019 09:25	06/11/2019 12:36	3,18	17	54,03	CHI

20191140992	IACIARA	IA21232133	IACIARA S1	05/11/2019 21:02	06/11/2019 12:00	05/11/2019 21:02	06/11/2019 12:00	14,97	1	14,97	CHI
20191140993	JUSSARA	JR12341198	JUSSARA	05/11/2019 19:11	09/11/2019 23:03	05/11/2019 19:11	09/11/2019 13:52	90,68	6	544,08	CHI
20191140993	JUSSARA	JR12341198	JUSSARA	05/11/2019 19:11	09/11/2019 23:03	05/11/2019 19:11	09/11/2019 23:03	99,85	1	99,85	CHI
20191140994	FIRMINOPOLIS	TV12005563	FIRMINOPOLIS S1	05/11/2019 20:17	06/11/2019 08:57	05/11/2019 20:17	06/11/2019 08:57	12,66	62	785,02	CHI
20191140994	TURVANIA	TV12005563	FIRMINOPOLIS S1	05/11/2019 20:17	06/11/2019 08:57	05/11/2019 20:17	06/11/2019 08:57	12,66	12	151,94	CHI
20191141008	NIQUELANDIA	NQ21139049	NIQUELANDIA SUBTRANSMISSAO	05/11/2019 21:06	06/11/2019 08:46	05/11/2019 21:06	06/11/2019 08:46	11,65	1	11,65	CHI
20191141010	ANICUNS	AC12000082	ANICUNS	05/11/2019 18:26	06/11/2019 02:15	05/11/2019 18:26	06/11/2019 02:15	7,81	52	406,24	CHI
20191141013	PIRENOPOLIS	PV21350844	CORUMBA	05/11/2019 21:08	07/11/2019 13:40	05/11/2019 21:08	07/11/2019 13:40	40,53	2	81,05	CHI
20191141045	FORMOSA	10014994303	ITIQUEIRA	05/11/2019 21:19	05/11/2019 23:19	05/11/2019 21:19	05/11/2019 23:19	1,99	1	1,99	CHI
20191141059	FAZENDA NOVA	10008027496	IPORA	05/11/2019 21:25	07/11/2019 19:49	05/11/2019 21:25	07/11/2019 19:49	46,41	1	46,41	CHI
20191141072	HIDROLINA	HL21140490	URUACU	05/11/2019 21:30	06/11/2019 20:23	05/11/2019 21:30	06/11/2019 20:23	22,87	1	22,87	CHI
20191141076	CARMO DO RIO VERDE	RB12034149	RUBIATABA	05/11/2019 14:22	05/11/2019 23:26	05/11/2019 14:22	05/11/2019 23:26	9,06	3	27,19	CHI
20191141076	CERES	RB12034149	RUBIATABA	05/11/2019 14:22	05/11/2019 23:26	05/11/2019 14:22	05/11/2019 23:26	9,06	2	18,13	CHI
20191141076	SAO PATRICIO	RB12034149	RUBIATABA	05/11/2019 14:22	05/11/2019 23:26	05/11/2019 14:22	05/11/2019 23:26	9,06	5	45,32	CHI
20191141084	SAO LUIS DE MONTES BELOS	SL32144895	SAO LUIZ DOS MONTES BELOS	05/11/2019 18:23	06/11/2019 12:48	05/11/2019 18:23	06/11/2019 12:48	18,42	5	92,11	CHI
20191141088	LUZIANIA	10024666350	RIO VERMELHO	05/11/2019 21:38	06/11/2019 01:50	05/11/2019 21:38	06/11/2019 01:50	4,19	1	4,19	CHI
20191141094	CATALAO	CT21134413	CATALAO S1	05/11/2019 21:41	06/11/2019 15:16	05/11/2019 21:41	06/11/2019 15:16	17,58	1	17,58	CHI
20191141109	ABADIANIA	AX12000165	ALEXANIA	05/11/2019 20:33	05/11/2019 23:53	05/11/2019 20:33	05/11/2019 23:53	3,33	4	13,31	CHI
20191141109	ALEXANIA	AX12000165	ALEXANIA	05/11/2019 20:33	05/11/2019 23:53	05/11/2019 20:33	05/11/2019 23:53	3,33	1	3,33	CHI
20191141109	CORUMBA DE GOIAS	AX12000165	ALEXANIA	05/11/2019 20:33	05/11/2019 23:53	05/11/2019 20:33	05/11/2019 23:53	3,33	64	212,98	CHI
20191141118	ALTO PARAISO DE GOIAS	BF12105395	SAO JOAO D ALIANCA	05/11/2019 14:46	06/11/2019 17:57	05/11/2019 14:46	06/11/2019 17:57	27,18	14	380,56	CHI
20191141158	GOIANIA	GN11001258	ATLANTICO S3	05/11/2019 16:30	06/11/2019 00:41	05/11/2019 16:30	06/11/2019 00:41	8,18	85	695,35	CHI
20191141172	FIRMINOPOLIS	10017813202	FIRMINOPOLIS S1	05/11/2019 22:08	06/11/2019 09:25	05/11/2019 22:08	06/11/2019 09:25	11,28	1	11,28	CHI
20191141174	COCALZINHO DE GOIAS	10007774840	AGUAS LINDAS DE GOIAS S2	05/11/2019 22:09	06/11/2019 10:34	05/11/2019 22:09	06/11/2019 10:34	12,42	1	12,42	CHI
20191141176	SANTA TEREZINHA DE GOIAS	SG12237481	SANTA TEREZINHA	05/11/2019 19:56	06/11/2019 16:48	05/11/2019 19:56	06/11/2019 16:48	20,85	13	271,10	CHI
20191141179	PIRES DO RIO	OZ21300567	PIRES DO RIO S2	05/11/2019 22:10	06/11/2019 11:50	05/11/2019 22:10	06/11/2019 11:50	13,66	3	40,99	CHI
20191141202	ANAPOLIS	10003692572	JUNDIAI S1	05/11/2019 22:18	06/11/2019 19:10	05/11/2019 22:18	06/11/2019 19:10	20,85	1	20,85	CHI
20191141219	SAO JOAO D ALIANCA	JL11057473	SAO JOAO D ALIANCA	05/11/2019 22:23	06/11/2019 00:38	05/11/2019 22:23	06/11/2019 00:38	2,24	133	297,85	CHI
20191141221	AMORINOPOLIS	IR21139465	IPORA	05/11/2019 22:24	06/11/2019 16:58	05/11/2019 22:24	06/11/2019 16:58	18,57	1	18,57	CHI
20191141235	PORANGATU	840155189	PORANGATU	05/11/2019 22:30	06/11/2019 08:09	05/11/2019 22:30	06/11/2019 08:09	9,64	1	9,64	CHI
20191141239	SANTO ANTONIO DO DESCOBERTO	10011007514	ALEXANIA	05/11/2019 22:32	06/11/2019 10:46	05/11/2019 22:32	06/11/2019 10:46	12,23	1	12,23	CHI
20191141243	NAZARIO	01280214	ANICUNS	05/11/2019 22:28	05/11/2019 23:49	05/11/2019 22:28	05/11/2019 23:18	0,82	2399	1967,85	CHI
20191141243	ANICUNS	01280214	ANICUNS	05/11/2019 22:28	05/11/2019 23:49	05/11/2019 22:28	05/11/2019 23:49	1,33	145	193,37	CHI

20191141243	NAZARIO	01280214	ANICUNS	05/11/2019 22:28	05/11/2019 23:49	05/11/2019 22:28	05/11/2019 23:49	1,33	872	1162,91	CHI
20191141243	PALMEIRAS DE GOIAS	01280214	ANICUNS	05/11/2019 22:28	05/11/2019 23:49	05/11/2019 22:28	05/11/2019 23:49	1,33	78	104,02	CHI
20191141243	TURVANIA	01280214	ANICUNS	05/11/2019 22:28	05/11/2019 23:49	05/11/2019 22:28	05/11/2019 23:49	1,33	47	62,68	CHI
20191141243	NAZARIO	01280214	ANICUNS	05/11/2019 22:28	05/11/2019 23:49	05/11/2019 22:30	05/11/2019 23:49	1,32	1	1,32	CHI
20191141254	MONTES CLAROS DE GOIAS	10010624390	IPORA	05/11/2019 22:40	06/11/2019 07:53	05/11/2019 22:40	06/11/2019 07:53	9,21	1	9,21	CHI
20191141266	SÃO LUIZ DO NORTE	SZ21344747	ITAPACI	05/11/2019 22:45	07/11/2019 18:36	05/11/2019 22:45	07/11/2019 18:36	43,85	1	43,85	CHI
20191141267	VALPARAISO DE GOIAS	VA11169029	PACAEMBU S2	05/11/2019 22:38	06/11/2019 00:17	05/11/2019 22:38	06/11/2019 00:17	1,64	273	448,40	CHI
20191141269	AVELINOPOLIS	10023746597	ANICUNS	05/11/2019 22:45	06/11/2019 09:22	05/11/2019 22:45	06/11/2019 09:22	10,61	1	10,61	CHI
20191141278	SÃO FRANCISCO DE GOIAS	PV21216698	SÃO FRANCISCO DE GOIAS	05/11/2019 22:48	07/11/2019 13:07	05/11/2019 22:48	07/11/2019 13:07	38,30	1	38,30	CHI
20191141282	ITUMBIARA	IT11000158	ITUMBIARA NOVA	05/11/2019 22:46	06/11/2019 00:05	05/11/2019 22:46	06/11/2019 00:05	1,31	165	216,70	CHI
20191141293	MORRINHOS	150076666	MORRINHOS	05/11/2019 22:58	06/11/2019 02:50	05/11/2019 22:58	06/11/2019 02:50	3,86	1	3,86	CHI
20191141302	NAZARIO	440017440	ANICUNS	05/11/2019 23:06	06/11/2019 00:23	05/11/2019 23:06	06/11/2019 00:23	1,27	1	1,27	CHI
20191141307	ITUMBIARA	IT11273862	ITUMBIARA NOVA	05/11/2019 22:49	06/11/2019 00:57	05/11/2019 22:49	06/11/2019 00:57	2,13	92	195,86	CHI
20191141313	ITUMBIARA	IT11315501	ITUMBIARA NOVA	05/11/2019 22:44	06/11/2019 00:22	05/11/2019 22:44	06/11/2019 00:22	1,62	110	178,38	CHI
20191141316	CAIAPONIA	CP21301815	CAIAPONIA	05/11/2019 23:14	06/11/2019 14:55	05/11/2019 23:14	06/11/2019 14:55	15,68	1	15,68	CHI
20191141318	IVOLANDIA	IV21133555	IPORA	05/11/2019 23:10	07/11/2019 09:01	05/11/2019 23:10	07/11/2019 09:01	33,84	2	67,68	CHI
20191141323	ALVORADA DO NORTE	VB13261994	IACIARA S2	05/11/2019 22:54	06/11/2019 16:51	05/11/2019 22:54	06/11/2019 02:17	3,38	143	482,70	CHI
20191141323	SIMOLANDIA	VB13261994	IACIARA S2	05/11/2019 22:54	06/11/2019 16:51	05/11/2019 22:54	06/11/2019 02:17	3,38	1	3,38	CHI
20191141323	ALVORADA DO NORTE	AQ13082123	IACIARA S2	05/11/2019 22:54	06/11/2019 16:51	05/11/2019 22:54	06/11/2019 03:18	4,39	145	636,11	CHI
20191141323	FLORES DE GOIAS	AQ13082123	IACIARA S2	05/11/2019 22:54	06/11/2019 16:51	05/11/2019 22:54	06/11/2019 03:18	4,39	40	175,48	CHI
20191141323	SITIO D ABADIA	AQ13082123	IACIARA S2	05/11/2019 22:54	06/11/2019 16:51	05/11/2019 22:54	06/11/2019 03:18	4,39	26	114,06	CHI
20191141323	FLORES DE GOIAS	VB13261994	IACIARA S2	05/11/2019 22:54	06/11/2019 16:51	05/11/2019 22:54	06/11/2019 03:42	4,80	510	2447,72	CHI
20191141323	FORMOSA	VB13261994	IACIARA S2	05/11/2019 22:54	06/11/2019 16:51	05/11/2019 22:54	06/11/2019 03:42	4,80	1	4,80	CHI
20191141323	VILA BOA	VB13261994	IACIARA S2	05/11/2019 22:54	06/11/2019 16:51	05/11/2019 22:54	06/11/2019 03:42	4,80	64	307,16	CHI
20191141323	ALVORADA DO NORTE	00010414	IACIARA S2	05/11/2019 22:54	06/11/2019 16:51	06/11/2019 09:31	06/11/2019 10:04	0,54	288	156,56	CHI
20191141323	FLORES DE GOIAS	00010414	IACIARA S2	05/11/2019 22:54	06/11/2019 16:51	06/11/2019 09:31	06/11/2019 10:04	0,54	40	21,74	CHI
20191141323	IACIARA	00010414	IACIARA S2	05/11/2019 22:54	06/11/2019 16:51	06/11/2019 09:31	06/11/2019 10:04	0,54	1	0,54	CHI
20191141323	SIMOLANDIA	00010414	IACIARA S2	05/11/2019 22:54	06/11/2019 16:51	06/11/2019 09:31	06/11/2019 10:04	0,54	1	0,54	CHI
20191141323	SITIO D ABADIA	00010414	IACIARA S2	05/11/2019 22:54	06/11/2019 16:51	06/11/2019 09:31	06/11/2019 10:04	0,54	26	14,13	CHI
20191141323	FLORES DE GOIAS	FB13344347	IACIARA S2	05/11/2019 22:54	06/11/2019 16:51	05/11/2019 22:54	06/11/2019 16:45	17,85	331	5907,71	CHI
20191141323	FLORES DE GOIAS	FB12044985LD	IACIARA S2	05/11/2019 22:54	06/11/2019 16:51	05/11/2019 22:54	06/11/2019 16:51	17,95	76	1364,28	CHI
20191141323	SITIO D ABADIA	FB12044985LD	IACIARA S2	05/11/2019 22:54	06/11/2019 16:51	05/11/2019 22:54	06/11/2019 16:51	17,95	114	2046,43	CHI
20191141331	AMARALINA	LC12170975	MARA ROSA	06/11/2019 08:24	06/11/2019 19:10	06/11/2019 08:24	06/11/2019 19:10	10,76	11	118,41	CHI

20191141344	IACIARA	IA12211563	IACIARA S1	05/11/2019 23:40	06/11/2019 07:45	05/11/2019 23:40	06/11/2019 07:45	8,07	7	56,50	CHI
20191141346	PROFESSOR JAMIL SAFADY	PJ21084959	ROCHEDO	05/11/2019 23:43	08/11/2019 10:38	05/11/2019 23:43	08/11/2019 10:38	58,91	3	176,73	CHI
20191141406	IPORA	IR12074019	IPORA	05/11/2019 22:26	06/11/2019 03:02	05/11/2019 22:26	06/11/2019 03:02	4,59	15	68,85	CHI
20191141426	AGUA FRIA DE GOIAS	TL11279968	SAO JOAO D ALIANCA	06/11/2019 01:12	09/11/2019 16:35	06/11/2019 01:12	09/11/2019 16:35	87,38	1	87,38	CHI
20191141427	SAO MIGUEL DO ARAGUAIA	6641955	SAO MIGUEL DO ARAGUAIA	06/11/2019 01:00	11/11/2019 06:56	06/11/2019 01:00	11/11/2019 06:56	125,94	1	125,94	CHI
20191141441	AURILANDIA	RP12076381	FIRMINOPOLIS S2	05/11/2019 15:29	06/11/2019 08:55	05/11/2019 15:29	06/11/2019 08:55	17,45	4	69,79	CHI
20191141441	SAO JOAO DA PARAUNA	RP12076381	FIRMINOPOLIS S2	05/11/2019 15:29	06/11/2019 08:55	05/11/2019 15:29	06/11/2019 08:55	17,45	33	575,79	CHI
20191141455	PORANGATU	PO12349237	MARA ROSA	05/11/2019 14:28	06/11/2019 10:25	05/11/2019 14:28	06/11/2019 10:25	19,94	18	359,00	CHI
20191141460	MUTUNOPOLIS	MU12086730	MARA ROSA	05/11/2019 16:00	07/11/2019 20:42	05/11/2019 16:00	07/11/2019 20:42	52,70	31	1633,67	CHI
20191141466	PORANGATU	MU21086725	MARA ROSA	05/11/2019 15:11	07/11/2019 20:13	05/11/2019 15:11	07/11/2019 19:05	51,90	1	51,90	CHI
20191141466	AMARALINA	MU12394938	MARA ROSA	05/11/2019 15:11	07/11/2019 20:13	05/11/2019 15:11	07/11/2019 20:13	53,04	2	106,08	CHI
20191141466	BONOPOLIS	MU12394938	MARA ROSA	05/11/2019 15:11	07/11/2019 20:13	05/11/2019 15:11	07/11/2019 20:13	53,04	2	106,08	CHI
20191141466	MUTUNOPOLIS	MU12394938	MARA ROSA	05/11/2019 15:11	07/11/2019 20:13	05/11/2019 15:11	07/11/2019 20:13	53,04	3	159,11	CHI
20191141466	PORANGATU	MU12394938	MARA ROSA	05/11/2019 15:11	07/11/2019 20:13	05/11/2019 15:11	07/11/2019 20:13	53,04	74	3924,78	CHI
20191141479	GOIANESIA	GE12352312	GOIANESIA S2	06/11/2019 03:43	07/11/2019 12:46	06/11/2019 03:43	07/11/2019 12:46	33,04	20	660,88	CHI
20191141485	ITABERAI	IB12300320	ITABERAI S2	05/11/2019 20:16	06/11/2019 14:21	05/11/2019 20:16	06/11/2019 14:21	18,08	21	379,69	CHI
20191141488	FIRMINOPOLIS	FR21033013	FIRMINOPOLIS S2	06/11/2019 04:14	06/11/2019 10:30	06/11/2019 04:14	06/11/2019 10:30	6,26	1	6,26	CHI
20191141489	CROMINIA	JS12091717	ROCHEDO	05/11/2019 21:27	06/11/2019 20:39	05/11/2019 21:27	06/11/2019 20:39	23,20	2	46,39	CHI
20191141489	PROFESSOR JAMIL SAFADY	JS12091717	ROCHEDO	05/11/2019 21:27	06/11/2019 20:39	05/11/2019 21:27	06/11/2019 20:39	23,20	29	672,70	CHI
20191141493	PORANGATU	PO12038745	PORANGATU	06/11/2019 04:27	07/11/2019 10:59	06/11/2019 04:27	07/11/2019 10:59	30,52	2	61,03	CHI
20191141498	DISTRITO FEDERAL	FA12383392	ITIQUEIRA	06/11/2019 04:50	06/11/2019 07:59	06/11/2019 04:50	06/11/2019 07:59	3,14	2	6,28	CHI
20191141503	FORMOSA	FA12262305	ITIQUEIRA	06/11/2019 04:56	06/11/2019 09:31	06/11/2019 04:56	06/11/2019 09:31	4,58	639	2928,39	CHI
20191141512	MORRINHOS	MR12092964	MORRINHOS	06/11/2019 05:11	06/11/2019 11:14	06/11/2019 05:11	06/11/2019 11:14	6,03	3	18,10	CHI
20191141517	BALIZA	DV12133496	CAIAPONIA	06/11/2019 05:14	07/11/2019 14:54	06/11/2019 05:14	07/11/2019 14:54	33,66	48	1615,63	CHI
20191141517	DOVERLANDIA	DV12133496	CAIAPONIA	06/11/2019 05:14	07/11/2019 14:54	06/11/2019 05:14	07/11/2019 14:54	33,66	1	33,66	CHI
20191141520	PROFESSOR JAMIL SAFADY	JS21296764	ROCHEDO	06/11/2019 05:18	08/11/2019 11:09	06/11/2019 05:18	08/11/2019 11:09	53,83	1	53,83	CHI
20191141529	CRISTALINA	KR12349171	PAMPLONA	06/11/2019 05:23	06/11/2019 10:07	06/11/2019 05:23	06/11/2019 10:07	4,73	1	4,73	CHI
20191141529	LUZIANIA	KR12349171	PAMPLONA	06/11/2019 05:23	06/11/2019 10:07	06/11/2019 05:23	06/11/2019 10:07	4,73	30	141,98	CHI
20191141530	GUARANI DE GOIAS	GY12195884	IACIARA S1	06/11/2019 05:23	06/11/2019 09:33	06/11/2019 05:23	06/11/2019 09:33	4,16	9	37,42	CHI
20191141531	CUMARI	GD21042333	CATALAO S1	06/11/2019 05:24	06/11/2019 13:49	06/11/2019 05:24	06/11/2019 13:49	8,42	1	8,42	CHI
20191141535	ITAPIRAPUA	IU12020177	JUSSARA	06/11/2019 05:26	06/11/2019 13:47	06/11/2019 05:26	06/11/2019 13:16	7,84	13	101,91	CHI
20191141535	ITAPIRAPUA	IU12015133LD	JUSSARA	06/11/2019 05:26	06/11/2019 13:47	06/11/2019 05:26	06/11/2019 13:47	8,35	81	676,71	CHI
20191141538	ITAPACI	IW12275237	ITAPACI	06/11/2019 05:28	06/11/2019 11:09	06/11/2019 05:28	06/11/2019 09:18	3,82	1	3,82	CHI

20191141538	ITAPACI	IW12275237	ITAPACI	06/11/2019 05:28	06/11/2019 11:09	06/11/2019 05:28	06/11/2019 11:09	5,68	2	11,35	CHI
20191141541	ITAPACI	IW21248096	ITAPACI	06/11/2019 05:30	07/11/2019 11:44	06/11/2019 05:30	07/11/2019 11:44	30,22	1	30,22	CHI
20191141544	FORMOSA	FA12278155	ITUIQUIRA	06/11/2019 05:32	06/11/2019 08:38	06/11/2019 05:32	06/11/2019 08:38	3,10	32	99,17	CHI
20191141544	VILA BOA	FA12278155	ITUIQUIRA	06/11/2019 05:32	06/11/2019 08:38	06/11/2019 05:32	06/11/2019 08:38	3,10	4	12,40	CHI
20191141547	FORMOSA	7681194	ITUIQUIRA	06/11/2019 05:32	06/11/2019 12:29	06/11/2019 05:32	06/11/2019 12:29	6,94	3	20,82	CHI
20191141551	GOIAS	GS12073642	MATRINCHA	06/11/2019 05:35	07/11/2019 08:40	06/11/2019 05:35	07/11/2019 08:40	27,07	26	703,84	CHI
20191141572	SAO LUIS DE MONTES BELOS	SL32145768	SAO LUIZ DOS MONTES BELOS	06/11/2019 04:53	06/11/2019 10:14	06/11/2019 04:53	06/11/2019 10:14	5,34	30	160,20	CHI
20191141579	GOIANESIA	GE12352313	GOIANESIA S1	06/11/2019 05:04	06/11/2019 10:25	06/11/2019 05:04	06/11/2019 10:25	5,34	24	128,15	CHI
20191141579	SAO LUIZ DO NORTE	GE12352313	GOIANESIA S1	06/11/2019 05:04	06/11/2019 10:25	06/11/2019 05:04	06/11/2019 10:25	5,34	21	112,13	CHI
20191141584	FAZENDA NOVA	FN21039998	JUSSARA	06/11/2019 05:52	07/11/2019 19:15	06/11/2019 05:52	07/11/2019 19:15	37,38	1	37,38	CHI
20191141587	ITABERAI	IB12206934	ITABERAI S2	06/11/2019 05:36	06/11/2019 09:22	06/11/2019 05:36	06/11/2019 09:22	3,75	17	63,77	CHI
20191141590	MORRINHOS	MR21120859	MORRINHOS	06/11/2019 05:53	06/11/2019 10:27	06/11/2019 05:53	06/11/2019 10:27	4,56	1	4,56	CHI
20191141595	FORMOSA	FA11342526	ITUIQUIRA	06/11/2019 05:54	06/11/2019 06:53	06/11/2019 05:54	06/11/2019 06:53	0,98	72	70,60	CHI
20191141603	IACIARA	IA12394108	IACIARA S1	06/11/2019 05:56	06/11/2019 09:29	06/11/2019 05:56	06/11/2019 09:29	3,53	7	24,74	CHI
20191141612	IPORA	IR12105167	IPORA	06/11/2019 05:59	06/11/2019 16:17	06/11/2019 05:59	06/11/2019 16:17	10,29	9	92,62	CHI
20191141615	PANAMA	GT12000259	GOIATUBA S1	06/11/2019 06:00	06/11/2019 12:37	06/11/2019 06:00	06/11/2019 12:37	6,61	3	19,84	CHI
20191141617	SAO LUIS DE MONTES BELOS	SL21151317	SAO LUIZ DOS MONTES BELOS	06/11/2019 06:00	06/11/2019 15:45	06/11/2019 06:00	06/11/2019 15:45	9,74	2	19,47	CHI
20191141618	FORMOSO	FO12088777	MARA ROSA	05/11/2019 23:25	08/11/2019 00:33	05/11/2019 23:25	08/11/2019 00:33	49,13	35	1719,50	CHI
20191141619	FAZENDA NOVA	FN12100373	JUSSARA	06/11/2019 06:01	06/11/2019 08:13	06/11/2019 06:01	06/11/2019 08:13	2,19	6	13,11	CHI
20191141636	PALESTINA DE GOIAS	10028399275	PALESTINA	06/11/2019 06:07	06/11/2019 14:20	06/11/2019 06:07	06/11/2019 14:20	8,22	1	8,22	CHI
20191141638	FORMOSA	FA12270001	ITUIQUIRA	06/11/2019 06:07	06/11/2019 08:50	06/11/2019 06:07	06/11/2019 08:50	2,71	5	13,53	CHI
20191141642	MORRO AGUDO DE GOIAS	RB12156092	RUBIATABA	06/11/2019 02:55	06/11/2019 19:38	06/11/2019 02:55	06/11/2019 19:38	16,72	10	167,15	CHI
20191141644	LUZIANIA	LZ11000110	RIO VERMELHO	06/11/2019 06:09	06/11/2019 07:56	06/11/2019 06:09	06/11/2019 07:56	1,77	184	325,17	CHI
20191141646	LUZIANIA	LZ21332733	RIO VERMELHO	06/11/2019 06:11	06/11/2019 07:51	06/11/2019 06:11	06/11/2019 07:51	1,66	1	1,66	CHI
20191141673	SITIO D ABADIA	PS12236912	IACIARA S2	06/11/2019 06:16	06/11/2019 09:49	06/11/2019 06:16	06/11/2019 09:49	3,54	2	7,08	CHI
20191141676	SANCLERLANDIA	10001758584	FIRMINOPOLIS S2	06/11/2019 06:17	06/11/2019 08:51	06/11/2019 06:17	06/11/2019 08:51	2,56	1	2,56	CHI
20191141703	UIRAPURU	UP12328087	SANTA TEREZINHA	06/11/2019 06:22	09/11/2019 14:29	06/11/2019 06:22	09/11/2019 14:29	80,11	3	240,34	CHI
20191141705	PIRENOPOLIS	PV12360292	CORUMBA	06/11/2019 06:14	06/11/2019 12:14	06/11/2019 06:14	06/11/2019 12:14	6,00	11	65,98	CHI
20191141706	CAMPOS BELOS	MA12240205	SAO DOMINGOS	06/11/2019 06:23	06/11/2019 18:33	06/11/2019 06:23	06/11/2019 18:33	12,16	1	12,16	CHI
20191141706	MONTE ALEGRE DE GOIAS	MA12240205	SAO DOMINGOS	06/11/2019 06:23	06/11/2019 18:33	06/11/2019 06:23	06/11/2019 18:33	12,16	9	109,46	CHI
20191141719	NOVA ROMA	10002108230	IACIARA S2	06/11/2019 06:25	06/11/2019 12:44	06/11/2019 06:25	06/11/2019 12:44	6,31	1	6,31	CHI
20191141727	CAVALCANTE	CJ12262441	FLORES DE GOIAS	06/11/2019 02:44	06/11/2019 17:27	06/11/2019 02:44	06/11/2019 17:27	14,70	18	264,64	CHI
20191141727	TERESINA DE GOIAS	CJ12262441	FLORES DE GOIAS	06/11/2019 02:44	06/11/2019 17:27	06/11/2019 02:44	06/11/2019 17:27	14,70	2	29,40	CHI

20191141737	IPAMERI	IP12017029	IPAMERI	06/11/2019 00:10	06/11/2019 17:36	06/11/2019 00:10	06/11/2019 17:36	17,43	14	243,98	CHI
20191141743	PONTALINA	PK12257244	PONTALINA	06/11/2019 05:54	06/11/2019 08:40	06/11/2019 05:54	06/11/2019 08:40	2,75	15	41,26	CHI
20191141744	PADRE BERNARDO	PB12360023	PADRE BERNARDO	06/11/2019 06:33	06/11/2019 10:35	06/11/2019 06:33	06/11/2019 10:35	4,03	3	12,08	CHI
20191141747	URUACU	UR11353601	URUACU	06/11/2019 06:34	06/11/2019 12:51	06/11/2019 06:34	06/11/2019 12:51	6,28	97	608,84	CHI
20191141759	GUARANI DE GOIAS	SD12161811	SAO DOMINGOS	06/11/2019 05:29	06/11/2019 08:32	06/11/2019 05:29	06/11/2019 08:32	3,05	5	15,23	CHI
20191141759	SAO DOMINGOS	SD12161811	SAO DOMINGOS	06/11/2019 05:29	06/11/2019 08:32	06/11/2019 05:29	06/11/2019 08:32	3,05	41	124,88	CHI
20191141763	FAZENDA NOVA	10003414211	JUSSARA	06/11/2019 06:37	07/11/2019 20:43	06/11/2019 06:37	07/11/2019 20:43	38,10	1	38,10	CHI
20191141772	MONTE ALEGRE DE GOIAS	MA12233174	SAO DOMINGOS	06/11/2019 05:39	06/11/2019 09:21	06/11/2019 05:39	06/11/2019 09:21	3,69	17	62,70	CHI
20191141774	LUZIANIA	LZ12000220	RIO VERMELHO	06/11/2019 06:40	06/11/2019 11:08	06/11/2019 06:40	06/11/2019 11:08	4,47	13	58,05	CHI
20191141774	LUZIANIA	LZ11000075	RIO VERMELHO	06/11/2019 06:40	06/11/2019 11:08	06/11/2019 06:40	06/11/2019 11:08	4,47	57	254,65	CHI
20191141776	MONTE ALEGRE DE GOIAS	SD12322677	SAO DOMINGOS	06/11/2019 06:42	06/11/2019 10:52	06/11/2019 06:42	06/11/2019 10:52	4,17	2	8,33	CHI
20191141776	NOVA ROMA	SD12322677	SAO DOMINGOS	06/11/2019 06:42	06/11/2019 10:52	06/11/2019 06:42	06/11/2019 10:52	4,17	3	12,50	CHI
20191141776	SAO DOMINGOS	SD12322677	SAO DOMINGOS	06/11/2019 06:42	06/11/2019 10:52	06/11/2019 06:42	06/11/2019 10:52	4,17	35	145,79	CHI
20191141778	NIQUELANDIA	NQ21197594	NIQUELANDIA SUBTRANSMISSAO	06/11/2019 06:42	08/11/2019 09:44	06/11/2019 06:42	08/11/2019 09:44	51,03	1	51,03	CHI
20191141782	COCALZINHO DE GOIAS	ZN12330505	AGUAS LINDAS DE GOIAS S2	06/11/2019 05:55	06/11/2019 09:11	06/11/2019 05:55	06/11/2019 09:11	3,27	28	91,45	CHI
20191141782	PADRE BERNARDO	ZN12330505	AGUAS LINDAS DE GOIAS S2	06/11/2019 05:55	06/11/2019 09:11	06/11/2019 05:55	06/11/2019 09:11	3,27	4	13,06	CHI
20191141825	ALTO PARAISO DE GOIAS	O2830434	FLORES DE GOIAS	06/11/2019 08:35	06/11/2019 19:02	06/11/2019 17:59	06/11/2019 19:02	1,04	16	16,64	CHI
20191141825	CAVALCANTE	O2830434	FLORES DE GOIAS	06/11/2019 08:35	06/11/2019 19:02	06/11/2019 17:59	06/11/2019 19:02	1,04	2545	2646,09	CHI
20191141825	FLORES DE GOIAS	O2830434	FLORES DE GOIAS	06/11/2019 08:35	06/11/2019 19:02	06/11/2019 17:59	06/11/2019 19:02	1,04	1	1,04	CHI
20191141825	NOVA ROMA	O2830434	FLORES DE GOIAS	06/11/2019 08:35	06/11/2019 19:02	06/11/2019 17:59	06/11/2019 19:02	1,04	6	6,24	CHI
20191141825	SAO JOAO D ALIANCA	O2830434	FLORES DE GOIAS	06/11/2019 08:35	06/11/2019 19:02	06/11/2019 17:59	06/11/2019 19:02	1,04	7	7,28	CHI
20191141825	TERESINA DE GOIAS	O2830434	FLORES DE GOIAS	06/11/2019 08:35	06/11/2019 19:02	06/11/2019 17:59	06/11/2019 19:02	1,04	990	1029,32	CHI
20191141901	LUZIANIA	LZ11061746	RIO VERMELHO	06/11/2019 06:48	06/11/2019 09:05	06/11/2019 06:48	06/11/2019 09:05	2,28	33	75,28	CHI
20191141914	CATALAO	CT21287029	CATALAO S1	06/11/2019 06:50	07/11/2019 10:51	06/11/2019 06:50	07/11/2019 10:51	28,01	1	28,01	CHI
20191141919	SAO MIGUEL DO ARAGUAIA	SM21013247	SAO MIGUEL DO ARAGUAIA	06/11/2019 06:51	07/11/2019 21:40	06/11/2019 06:51	07/11/2019 21:40	38,83	1	38,83	CHI
20191141928	DIVINOPOLIS DE GOIAS	GH21290048	SAO DOMINGOS	06/11/2019 06:53	08/11/2019 11:55	06/11/2019 06:53	08/11/2019 11:55	53,03	1	53,03	CHI
20191141938	PIRACANJUBA	PJ12363983	CRISTIANOPOLIS	06/11/2019 06:54	06/11/2019 11:20	06/11/2019 06:54	06/11/2019 11:20	4,42	3	13,26	CHI
20191141948	IPAMERI	IP21328816	IPAMERI	06/11/2019 06:57	09/11/2019 07:48	06/11/2019 06:57	09/11/2019 07:48	72,85	1	72,85	CHI
20191141953	COCALZINHO DE GOIAS	ZN21201262	COCALZINHO	06/11/2019 06:57	06/11/2019 17:24	06/11/2019 06:57	06/11/2019 17:24	10,44	1	10,44	CHI
20191141954	PROFESSOR JAMIL SAFADY	JS21109203	ROCHEDO	06/11/2019 06:58	07/11/2019 16:45	06/11/2019 06:58	07/11/2019 16:45	33,78	1	33,78	CHI
20191141955	NOVA CRIXAS	NA12034763	NOVA CRIXAS	06/11/2019 05:37	06/11/2019 14:29	06/11/2019 05:37	06/11/2019 14:29	8,86	6	53,14	CHI
20191141958	ARENOPOLIS	AY12000021	ARENOPOLIS	06/11/2019 06:59	06/11/2019 19:32	06/11/2019 06:59	06/11/2019 19:32	12,54	19	238,31	CHI
20191141964	FORMOSA	FA12404381	ITIQUEIRA	06/11/2019 07:00	06/11/2019 10:46	06/11/2019 07:00	06/11/2019 10:46	3,76	4	15,04	CHI

20191141965	ARUANA	AK12184500	ARUANA	06/11/2019 07:00	09/11/2019 14:26	06/11/2019 07:00	09/11/2019 14:26	79,42	2	158,85	CHI
20191141967	PALESTINA DE GOIAS	PY12140029	IPORA	06/11/2019 06:14	06/11/2019 11:18	06/11/2019 06:14	06/11/2019 11:18	5,06	6	30,36	CHI
20191141969	PLANALTINA	PI12379178	PLANALTINA	06/11/2019 07:01	08/11/2019 08:49	06/11/2019 07:01	08/11/2019 08:49	49,79	1	49,79	CHI
20191141970	NOVA GLORIA	8700511	ITAPACI	06/11/2019 07:01	07/11/2019 09:58	06/11/2019 07:01	07/11/2019 09:58	26,95	5	134,77	CHI
20191141973	MONTE ALEGRE DE GOIAS	MA12114728	SAO DOMINGOS	06/11/2019 06:36	06/11/2019 08:25	06/11/2019 06:36	06/11/2019 08:25	1,81	32	57,82	CHI
20191141987	AGUA FRIA DE GOIAS	NQ12334497	SAO JOAO D ALIANCA	06/11/2019 07:05	10/11/2019 10:09	06/11/2019 07:05	10/11/2019 10:09	99,07	3	297,20	CHI
20191141987	NIQUELANDIA	NQ12334497	SAO JOAO D ALIANCA	06/11/2019 07:05	10/11/2019 10:09	06/11/2019 07:05	10/11/2019 10:09	99,07	2	198,13	CHI
20191141990	BURITI ALEGRE	BG21134663	ITUMBIARA VELHA S2	06/11/2019 07:05	10/11/2019 10:20	06/11/2019 07:05	10/11/2019 10:20	99,24	1	99,24	CHI
20191141995	SAO FRANCISCO DE GOIAS	SF21008926	SAO FRANCISCO DE GOIAS	06/11/2019 07:06	06/11/2019 08:07	06/11/2019 07:06	06/11/2019 08:07	1,01	1	1,01	CHI
20191141998	PIRES DO RIO	PR11013682	PIRES DO RIO S1	06/11/2019 07:07	06/11/2019 16:30	06/11/2019 07:07	06/11/2019 16:30	9,39	89	836,03	CHI
20191142002	ARAGUAPAZ	AZ12329923	MOZARLANDIA	06/11/2019 07:07	06/11/2019 18:23	06/11/2019 07:07	06/11/2019 18:23	11,25	3	33,75	CHI
20191142015	CRIXAS	CX21070405	SERRA DO OURO	06/11/2019 07:09	06/11/2019 12:15	06/11/2019 07:09	06/11/2019 12:15	5,08	1	5,08	CHI
20191142036	NOVO GAMA	LZ12040416	PACAEMBU S1	06/11/2019 07:13	06/11/2019 08:23	06/11/2019 07:13	06/11/2019 08:23	1,16	18	20,85	CHI
20191142043	AGUA FRIA DE GOIAS	JL21102176	SAO JOAO D ALIANCA	06/11/2019 07:14	07/11/2019 21:41	06/11/2019 07:14	07/11/2019 21:41	38,45	1	38,45	CHI
20191142049	AMARALINA	LC12291118	MARA ROSA	06/11/2019 07:15	09/11/2019 17:17	06/11/2019 07:15	09/11/2019 17:17	82,02	1	82,02	CHI
20191142051	SANTA TEREZA DE GOIAS	SE12143626	PORANGATU	06/11/2019 07:16	08/11/2019 14:43	06/11/2019 07:16	08/11/2019 14:43	55,45	5	277,27	CHI
20191142054	ARUANA	AK21183128	MOZARLANDIA	06/11/2019 07:16	07/11/2019 16:29	06/11/2019 07:16	07/11/2019 16:29	33,21	1	33,21	CHI
20191142057	PORANGATU	PO12363572	PORANGATU	06/11/2019 07:08	07/11/2019 02:30	06/11/2019 07:08	07/11/2019 02:30	19,36	9	174,21	CHI
20191142075	LUZIANIA	NJ12376266LD	PACAEMBU S1	06/11/2019 07:18	06/11/2019 10:12	06/11/2019 07:18	06/11/2019 10:12	2,90	29	83,97	CHI
20191142075	NOVO GAMA	NJ12376266LD	PACAEMBU S1	06/11/2019 07:18	06/11/2019 10:12	06/11/2019 07:18	06/11/2019 10:12	2,90	3	8,69	CHI
20191142079	MARA ROSA	MQ12208528	MARA ROSA	06/11/2019 07:19	09/11/2019 15:36	06/11/2019 07:19	09/11/2019 15:36	80,28	1	80,28	CHI
20191142084	CRISTALINA	KR12097123	CRISTALINA S2	06/11/2019 07:19	06/11/2019 09:39	06/11/2019 07:19	06/11/2019 09:39	2,32	3	6,95	CHI
20191142088	FORMOSA	FA12395906	FLORES DE GOIAS	06/11/2019 07:20	06/11/2019 14:33	06/11/2019 07:20	06/11/2019 14:33	7,20	27	194,50	CHI
20191142090	VALPARAISO DE GOIAS	VA12199572	MARAJOARA	06/11/2019 07:21	06/11/2019 10:05	06/11/2019 07:21	06/11/2019 10:05	2,73	359	980,47	CHI
20191142091	PETROLINA DE GOIAS	PG21273223	PETROLINA	06/11/2019 07:21	07/11/2019 15:00	06/11/2019 07:21	07/11/2019 15:00	31,66	1	31,66	CHI
20191142097	CAMPINACU	UC12265672	PORANGATU	06/11/2019 07:21	07/11/2019 09:30	06/11/2019 07:21	07/11/2019 09:30	26,13	7	182,94	CHI
20191142103	FORMOSA	FA11130048	ITUIQUIRA	06/11/2019 05:26	06/11/2019 09:01	06/11/2019 05:26	06/11/2019 09:01	3,58	139	497,77	CHI
20191142107	BOM JARDIM DE GOIAS	10007386913	BOM JARDIM	06/11/2019 07:23	07/11/2019 01:20	06/11/2019 07:23	07/11/2019 01:20	17,95	1	17,95	CHI
20191142137	SAO FRANCISCO DE GOIAS	PV21273314	SAO FRANCISCO DE GOIAS	06/11/2019 07:28	07/11/2019 08:41	06/11/2019 07:28	07/11/2019 08:41	25,21	1	25,21	CHI
20191142138	MINACU	IH12341446	MINACU	06/11/2019 07:28	06/11/2019 20:23	06/11/2019 07:28	06/11/2019 20:23	12,90	36	464,49	CHI
20191142142	CATALAO	CT12077524	CATALAO S1	06/11/2019 07:29	06/11/2019 14:06	06/11/2019 07:29	06/11/2019 14:06	6,62	7	46,33	CHI
20191142144	CRIXAS	CX12221599	SANTA TEREZINHA	06/11/2019 06:35	06/11/2019 17:59	06/11/2019 06:35	06/11/2019 17:59	11,39	19	216,47	CHI
20191142144	SANTA TEREZINHA DE GOIAS	CX12221599	SANTA TEREZINHA	06/11/2019 06:35	06/11/2019 17:59	06/11/2019 06:35	06/11/2019 17:59	11,39	1	11,39	CHI

20191142148	SILVANIA	SV12317633	DAIA S2	06/11/2019 07:30	06/11/2019 16:38	06/11/2019 07:30	06/11/2019 16:38	9,13	7	63,90	CHI
20191142149	AMARALINA	LC12215796	MARA ROSA	06/11/2019 02:41	09/11/2019 19:45	06/11/2019 02:41	09/11/2019 19:45	89,05	13	1157,71	CHI
20191142156	CAMPINORTE	CR21168839	MARA ROSA	06/11/2019 07:31	11/11/2019 12:29	06/11/2019 07:31	11/11/2019 12:29	124,96	1	124,96	CHI
20191142159	EDEALINA	ED12293192	PONTALINA	06/11/2019 07:31	08/11/2019 16:50	06/11/2019 07:31	08/11/2019 16:50	57,31	17	974,19	CHI
20191142159	INDIARA	ED12293192	PONTALINA	06/11/2019 07:31	08/11/2019 16:50	06/11/2019 07:31	08/11/2019 16:50	57,31	2	114,61	CHI
20191142169	VILA PROPICIO	NP21307143	BARRO ALTO	06/11/2019 07:34	09/11/2019 15:50	06/11/2019 07:34	09/11/2019 15:50	80,27	1	80,27	CHI
20191142177	PROFESSOR JAMIL SAFADY	JS12000039	PONTALINA	06/11/2019 05:03	07/11/2019 10:00	06/11/2019 05:03	07/11/2019 10:00	28,94	35	1012,86	CHI
20191142178	FIRMINOPOLIS	SL12079926	FIRMINOPOLIS S1	06/11/2019 06:31	06/11/2019 12:03	06/11/2019 06:31	06/11/2019 12:03	5,52	1	5,52	CHI
20191142178	SAO LUIS DE MONTES BELOS	SL12079926	FIRMINOPOLIS S1	06/11/2019 06:31	06/11/2019 12:03	06/11/2019 06:31	06/11/2019 12:03	5,52	6	33,13	CHI
20191142186	NAZARIO	NZ21037857	ANICUNS	06/11/2019 07:35	06/11/2019 09:52	06/11/2019 07:35	06/11/2019 09:52	2,28	1	2,28	CHI
20191142196	LUZIANIA	LZ12349110	MARAJOARA	06/11/2019 05:55	06/11/2019 08:43	06/11/2019 05:55	06/11/2019 08:43	2,80	16	44,80	CHI
20191142198	PALESTINA DE GOIAS	PY12342606	PALESTINA	06/11/2019 05:55	06/11/2019 15:41	06/11/2019 05:55	06/11/2019 15:41	9,77	6	58,61	CHI
20191142202	CAIAPONIA	CP12235316	PIRANHAS	06/11/2019 07:37	09/11/2019 11:22	06/11/2019 07:37	09/11/2019 11:22	75,74	5	378,71	CHI
20191142206	LUZIANIA	LZ11163772	RIO VERMELHO	06/11/2019 07:38	06/11/2019 09:50	06/11/2019 07:38	06/11/2019 09:50	2,19	137	300,45	CHI
20191142209	NIQUELANDIA	NQ12378040	NIQUELANDIA SUBTRANSMISSAO	06/11/2019 06:11	06/11/2019 09:30	06/11/2019 06:11	06/11/2019 09:30	3,31	24	79,47	CHI
20191142211	GOIAS	GS12054690	GOIAS	06/11/2019 06:36	06/11/2019 18:00	06/11/2019 06:36	06/11/2019 18:00	11,40	14	159,56	CHI
20191142221	PIRES DO RIO	PR12000079RE	PIRES DO RIO S1	06/11/2019 05:12	07/11/2019 09:12	06/11/2019 05:12	07/11/2019 09:12	28,00	16	448,01	CHI
20191142236	PIRANHAS	PH12259448RE	PIRANHAS	06/11/2019 06:24	06/11/2019 12:42	06/11/2019 06:24	06/11/2019 12:09	5,73	33	189,21	CHI
20191142236	PIRANHAS	PH21038109	PIRANHAS	06/11/2019 06:24	06/11/2019 12:42	06/11/2019 06:25	06/11/2019 12:42	6,29	1	6,29	CHI
20191142242	URUTAI	UT21139670	PIRES DO RIO S2	06/11/2019 07:43	07/11/2019 17:56	06/11/2019 07:43	07/11/2019 17:56	34,23	5	171,14	CHI
20191142257	PLANALTINA	PI12344131	PLANALTINA	06/11/2019 07:45	07/11/2019 11:42	06/11/2019 07:45	07/11/2019 11:42	27,95	1	27,95	CHI
20191142260	MUNDO NOVO DE GOIAS	MH12321428	NOVA CRIXAS	06/11/2019 07:45	10/11/2019 12:10	06/11/2019 07:45	10/11/2019 12:10	100,41	4	401,66	CHI
20191142263	IPIRANGA DE GOIAS	RB21114317	RUBIATABA	06/11/2019 07:46	07/11/2019 20:21	06/11/2019 07:46	07/11/2019 20:21	36,58	2	73,16	CHI
20191142279	LUZIANIA	LZ21376206	RIO VERMELHO	06/11/2019 07:48	06/11/2019 08:59	06/11/2019 07:48	06/11/2019 08:59	1,17	1	1,17	CHI
20191142282	IPAMERI	IP21036049	URUTAI	05/11/2019 16:19	08/11/2019 10:30	05/11/2019 16:19	08/11/2019 10:30	66,18	1	66,18	CHI
20191142285	CATALAO	1990327701	CATALAO S2	06/11/2019 07:50	06/11/2019 10:34	06/11/2019 07:50	06/11/2019 10:34	2,75	1	2,75	CHI
20191142292	CRISTALINA	1060087148	PAMPLONA	06/11/2019 07:50	06/11/2019 13:24	06/11/2019 07:50	06/11/2019 13:24	5,56	1	5,56	CHI
20191142293	PORANGATU	10030026936	PORANGATU	06/11/2019 07:51	06/11/2019 09:29	06/11/2019 07:51	06/11/2019 09:29	1,63	1	1,63	CHI
20191142294	ANAPOLIS	10000750784	ANAPOLIS UNIVERSITARIO S1	06/11/2019 07:51	06/11/2019 12:36	06/11/2019 07:51	06/11/2019 12:36	4,74	1	4,74	CHI
20191142296	COCALZINHO DE GOIAS	ZN21259004	COCALZINHO	06/11/2019 07:51	07/11/2019 17:23	06/11/2019 07:51	07/11/2019 17:23	33,53	1	33,53	CHI
20191142304	LUZIANIA	LZ12041476	RIO VERMELHO	06/11/2019 07:52	06/11/2019 11:57	06/11/2019 07:52	06/11/2019 11:57	4,07	21	85,46	CHI
20191142310	IACIARA	PS21106654	IACIARA S1	06/11/2019 07:53	06/11/2019 14:55	06/11/2019 07:53	06/11/2019 14:55	7,03	1	7,03	CHI
20191142318	PALMEIRAS DE GOIAS	PL12349324	PALMEIRAS	06/11/2019 07:14	06/11/2019 09:15	06/11/2019 07:14	06/11/2019 09:15	2,02	164	331,64	CHI

20191142319	ALTO PARAISO DE GOIAS	BF21274590	FLORES DE GOIAS	06/11/2019 07:54	06/11/2019 12:51	06/11/2019 07:54	06/11/2019 12:51	4,94	1	4,94	CHI
20191142333	NIQUELANDIA	NQ12280531	NIQUELANDIA SUBTRANSMISSAO	06/11/2019 07:56	06/11/2019 14:39	06/11/2019 07:56	06/11/2019 14:39	6,71	4	26,84	CHI
20191142366	AMARALINA	LC12308828	MARA ROSA	06/11/2019 08:00	08/11/2019 18:29	06/11/2019 08:00	08/11/2019 18:29	58,48	2	116,96	CHI
20191142366	MARA ROSA	LC12308828	MARA ROSA	06/11/2019 08:00	08/11/2019 18:29	06/11/2019 08:00	08/11/2019 18:29	58,48	1	58,48	CHI
20191142382	CIDADE OCIDENTAL	DH11261140	MARAJOARA	06/11/2019 08:00	06/11/2019 11:41	06/11/2019 08:00	06/11/2019 11:41	3,67	13	47,72	CHI
20191142383	CRIXAS	CX12276750	SERRA DO OURO	06/11/2019 08:00	06/11/2019 20:19	06/11/2019 08:00	06/11/2019 20:19	12,30	9	110,71	CHI
20191142385	CIDADE OCIDENTAL	DH21136676	MARAJOARA	06/11/2019 08:00	06/11/2019 10:12	06/11/2019 08:00	06/11/2019 10:12	2,18	1	2,18	CHI
20191142388	URUACU	UR21213187	URUACU	06/11/2019 08:01	07/11/2019 12:40	06/11/2019 08:01	07/11/2019 12:40	28,64	1	28,64	CHI
20191142390	SAO DOMINGOS	SD21290036	SAO DOMINGOS	06/11/2019 08:01	09/11/2019 11:04	06/11/2019 08:01	09/11/2019 11:04	75,03	2	150,07	CHI
20191142392	MORRINHOS	MR12039380	MORRINHOS	06/11/2019 07:30	06/11/2019 09:35	06/11/2019 07:30	06/11/2019 09:35	2,08	13	27,03	CHI
20191142394	CAMPOS BELOS	MA12218640	SAO DOMINGOS	06/11/2019 08:02	06/11/2019 17:02	06/11/2019 08:02	06/11/2019 17:02	8,99	2	17,99	CHI
20191142394	MONTE ALEGRE DE GOIAS	MA12218640	SAO DOMINGOS	06/11/2019 08:02	06/11/2019 17:02	06/11/2019 08:02	06/11/2019 17:02	8,99	6	53,96	CHI
20191142397	ABADIANIA	AA12085971	ANAPOLIS UNIVERSITARIO S1	06/11/2019 06:18	06/11/2019 10:07	06/11/2019 06:18	06/11/2019 10:07	3,81	12	45,75	CHI
20191142406	JUSSARA	JR12105382	BRITANIA	06/11/2019 08:02	07/11/2019 07:42	06/11/2019 08:02	07/11/2019 07:42	23,66	2	47,33	CHI
20191142408	FAINA	FC21252453	GOIAS	06/11/2019 08:03	11/11/2019 10:56	06/11/2019 08:03	11/11/2019 10:56	122,87	1	122,87	CHI
20191142409	PORANGATU	PO12348863	PORANGATU	06/11/2019 07:35	07/11/2019 09:19	06/11/2019 07:35	07/11/2019 09:19	25,72	9	231,47	CHI
20191142411	GOIANESIA	GE21234248	GOIANESIA S1	06/11/2019 08:04	06/11/2019 10:34	06/11/2019 08:04	06/11/2019 10:34	2,49	1	2,49	CHI
20191142419	INDIARA	2710011019	EDEIA	06/11/2019 08:05	06/11/2019 18:03	06/11/2019 08:05	06/11/2019 18:03	9,96	1	9,96	CHI
20191142420	MARA ROSA	MQ12051065	MARA ROSA	06/11/2019 08:05	10/11/2019 02:16	06/11/2019 08:05	10/11/2019 00:31	88,42	10	884,24	CHI
20191142420	MARA ROSA	MQ12240071LD	MARA ROSA	06/11/2019 08:05	10/11/2019 02:16	06/11/2019 08:05	10/11/2019 01:51	89,75	9	807,78	CHI
20191142420	MARA ROSA	MQ12240071LD	MARA ROSA	06/11/2019 08:05	10/11/2019 02:16	10/11/2019 02:06	10/11/2019 02:16	0,17	11	1,85	CHI
20191142424	UIRAPURU	UP12190106	SANTA TEREZINHA	06/11/2019 05:59	06/11/2019 12:05	06/11/2019 05:59	06/11/2019 12:05	6,10	10	60,96	CHI
20191142501	IPAMERI	IP12284386	IPAMERI	06/11/2019 07:32	06/11/2019 09:40	06/11/2019 07:32	06/11/2019 09:40	2,12	3	6,36	CHI
20191142503	CALDAS NOVAS	760287983	SERRA DE CALDAS	06/11/2019 08:06	06/11/2019 10:05	06/11/2019 08:06	06/11/2019 10:05	1,97	1	1,97	CHI
20191142515	CALDAS NOVAS	CN12000047	CALDAS NOVAS S2	06/11/2019 08:08	06/11/2019 10:49	06/11/2019 08:08	06/11/2019 10:49	2,68	6	16,07	CHI
20191142516	SANTO ANTONIO DO DESCOBERTO	SN12219810	MARAJOARA	06/11/2019 08:08	06/11/2019 12:02	06/11/2019 08:08	06/11/2019 12:02	3,89	3	11,68	CHI
20191142517	CRISTALINA	1060076916	CRISTALINA S1	06/11/2019 08:08	06/11/2019 09:15	06/11/2019 08:08	06/11/2019 09:15	1,11	1	1,11	CHI
20191142519	ALTO HORIZONTE	AJ12143571	MARA ROSA	06/11/2019 05:31	06/11/2019 14:16	06/11/2019 05:31	06/11/2019 14:16	8,76	37	324,16	CHI
20191142519	MARA ROSA	AJ12143571	MARA ROSA	06/11/2019 05:31	06/11/2019 14:16	06/11/2019 05:31	06/11/2019 14:16	8,76	5	43,81	CHI
20191142519	NOVA IGUACU DE GOIAS	AJ12143571	MARA ROSA	06/11/2019 05:31	06/11/2019 14:16	06/11/2019 05:31	06/11/2019 14:16	8,76	11	96,37	CHI
20191142523	NIQUELANDIA	NQ12237324	URUACU	06/11/2019 06:30	06/11/2019 11:12	06/11/2019 06:30	06/11/2019 11:12	4,70	44	206,71	CHI
20191142524	PIRACANJUBA	PJ12095462	PIRACANJUBA	06/11/2019 08:09	09/11/2019 16:02	06/11/2019 08:09	09/11/2019 16:02	79,88	1	79,88	CHI
20191142534	JARAGUA	10000794498	JARAGUA	06/11/2019 08:10	06/11/2019 21:01	06/11/2019 08:10	06/11/2019 21:01	12,85	1	12,85	CHI

20191142537	MONTE ALEGRE DE GOIAS	MA12211500	SAO DOMINGOS	06/11/2019 08:10	06/11/2019 11:41	06/11/2019 08:10	06/11/2019 11:41	3,51	2	7,02	CHI
20191142540	JARAGUA	JA12247701	GOIANESIA S2	06/11/2019 06:37	06/11/2019 10:34	06/11/2019 06:37	06/11/2019 10:34	3,94	6	23,64	CHI
20191142543	DOVERLANDIA	DV12217564	CAIAPONIA	06/11/2019 06:57	08/11/2019 16:35	06/11/2019 06:57	08/11/2019 16:35	57,64	7	403,47	CHI
20191142544	DIVINOPOLIS DE GOIAS	GH21255349	SAO DOMINGOS	06/11/2019 08:11	08/11/2019 12:30	06/11/2019 08:11	08/11/2019 12:30	52,32	1	52,32	CHI
20191142549	ITUMBIARA	IT11091648	ITUMBIARA NOVA	06/11/2019 06:27	06/11/2019 12:41	06/11/2019 06:27	06/11/2019 12:41	6,23	175	1089,67	CHI
20191142555	GOIAS	IB12300139	ITABERAI S1	06/11/2019 08:11	07/11/2019 14:17	06/11/2019 08:11	07/11/2019 14:17	30,09	6	180,54	CHI
20191142555	HEITORAI	IB12300139	ITABERAI S1	06/11/2019 08:11	07/11/2019 14:17	06/11/2019 08:11	07/11/2019 14:17	30,09	2	60,18	CHI
20191142555	ITABERAI	IB12300139	ITABERAI S1	06/11/2019 08:11	07/11/2019 14:17	06/11/2019 08:11	07/11/2019 14:17	30,09	54	1624,86	CHI
20191142563	PIRENOPOLIS	PV21185507	CORUMBA	06/11/2019 06:03	06/11/2019 11:04	06/11/2019 06:03	06/11/2019 11:04	5,01	1	5,01	CHI
20191142573	ANICUNS	910079330	ANICUNS	06/11/2019 08:14	06/11/2019 15:07	06/11/2019 08:14	06/11/2019 15:07	6,88	1	6,88	CHI
20191142587	ANAPOLIS	20726259	JUNDIAI S2	06/11/2019 08:15	06/11/2019 13:18	06/11/2019 08:15	06/11/2019 13:18	5,04	1	5,04	CHI
20191142588	AGUA FRIA DE GOIAS	TL12320625	SAO JOAO D ALIANCA	06/11/2019 08:15	09/11/2019 18:30	06/11/2019 08:15	09/11/2019 18:30	82,25	1	82,25	CHI
20191142599	URUACU	UR12353573	URUACU	06/11/2019 04:59	06/11/2019 16:40	06/11/2019 04:59	06/11/2019 16:40	11,67	10	116,70	CHI
20191142600	BONOPOLIS	BX12364615	SAO MIGUEL DO ARAGUAIA	06/11/2019 05:12	06/11/2019 19:22	06/11/2019 05:12	06/11/2019 19:22	14,15	19	268,87	CHI
20191142612	CRISTALINA	KR21313578	CRISTALINA S2	06/11/2019 08:18	06/11/2019 19:31	06/11/2019 08:18	06/11/2019 19:31	11,21	1	11,21	CHI
20191142617	LUZIANIA	LZ12000080	RIO VERMELHO	06/11/2019 07:18	06/11/2019 09:05	06/11/2019 07:18	06/11/2019 09:05	1,78	81	143,98	CHI
20191142705	SAO MIGUEL DO ARAGUAIA	SM12342059	SAO MIGUEL DO ARAGUAIA	05/11/2019 21:05	08/11/2019 21:48	05/11/2019 21:05	08/11/2019 21:48	72,71	8	581,67	CHI
20191142708	ITABERAI	IB12387008	ITABERAI S1	06/11/2019 08:19	07/11/2019 10:58	06/11/2019 08:19	07/11/2019 10:58	26,64	1	26,64	CHI
20191142710	GOIANESIA	GE11406316	GOIANESIA S2	06/11/2019 08:19	11/11/2019 11:55	06/11/2019 08:19	07/11/2019 11:41	27,37	2	54,73	CHI
20191142710	GOIANESIA	GE11406316	GOIANESIA S2	06/11/2019 08:19	11/11/2019 11:55	10/11/2019 11:41	11/11/2019 11:55	24,23	2	48,46	CHI
20191142711	ALTO PARAISO DE GOIAS	BF12224071	SAO JOAO D ALIANCA	06/11/2019 08:19	07/11/2019 11:09	06/11/2019 08:19	07/11/2019 11:09	26,82	3	80,46	CHI
20191142717	SAO PATRICIO	RB21254182	RUBIATABA	06/11/2019 08:20	06/11/2019 21:21	06/11/2019 08:20	06/11/2019 21:21	13,02	1	13,02	CHI
20191142732	AMARALINA	3590000798	MARA ROSA	06/11/2019 08:21	07/11/2019 00:02	06/11/2019 08:21	07/11/2019 00:02	15,68	1	15,68	CHI
20191142734	MINACU	4020051873	MINACU	06/11/2019 08:21	06/11/2019 11:16	06/11/2019 08:21	06/11/2019 11:16	2,91	1	2,91	CHI
20191142740	CATALAO	CT21042323	CATALAO S1	06/11/2019 08:22	07/11/2019 18:19	06/11/2019 08:22	07/11/2019 18:19	33,95	1	33,95	CHI
20191142745	CAMPOS BELOS	820006257	SAO DOMINGOS	06/11/2019 08:22	06/11/2019 16:20	06/11/2019 08:22	06/11/2019 16:20	7,97	1	7,97	CHI
20191142747	NIQUELANDIA	10011923987	NIQUELANDIA SUBTRANSMISSAO	06/11/2019 08:22	06/11/2019 10:46	06/11/2019 08:22	06/11/2019 10:46	2,39	1	2,39	CHI
20191142748	PIRACANJUBA	PJ21205551	PIRACANJUBA	06/11/2019 08:22	11/11/2019 10:19	06/11/2019 08:22	11/11/2019 10:19	121,94	1	121,94	CHI
20191142754	AMARALINA	LC12182362	MARA ROSA	06/11/2019 05:21	06/11/2019 14:35	06/11/2019 05:21	06/11/2019 14:35	9,23	105	968,74	CHI
20191142754	MARA ROSA	LC12182362	MARA ROSA	06/11/2019 05:21	06/11/2019 14:35	06/11/2019 05:21	06/11/2019 14:35	9,23	8	73,81	CHI
20191142754	MUTUNOPOLIS	LC12182362	MARA ROSA	06/11/2019 05:21	06/11/2019 14:35	06/11/2019 05:21	06/11/2019 14:35	9,23	2	18,45	CHI
20191142761	PORANGATU	PO12208558	PORANGATU	06/11/2019 07:18	06/11/2019 10:56	06/11/2019 07:18	06/11/2019 10:56	3,63	14	50,81	CHI
20191142764	FAINA	FC12199793	GOIAS	06/11/2019 08:23	08/11/2019 15:00	06/11/2019 08:23	08/11/2019 15:00	54,61	16	873,72	CHI

20191142770	PIRACANJUBA	PJ12223255	ROCHEDO	06/11/2019 05:40	07/11/2019 16:55	06/11/2019 05:40	07/11/2019 16:55	35,24	23	810,47	CHI
20191142778	AGUAS LINDAS DE GOIAS	4830416003	AGUAS LINDAS DE GOIAS S1	06/11/2019 08:24	06/11/2019 14:56	06/11/2019 08:24	06/11/2019 14:56	6,52	1	6,52	CHI
20191142783	IACIARA	IA21194774	IACIARA S2	06/11/2019 08:28	06/11/2019 08:59	06/11/2019 08:28	06/11/2019 08:59	0,51	1	0,51	CHI
20191142786	SAO DOMINGOS	SD12245178	SAO DOMINGOS	06/11/2019 07:11	06/11/2019 13:45	06/11/2019 07:11	06/11/2019 13:45	6,56	6	39,37	CHI
20191142790	CATALAO	CT21215810	CATALAO S1	05/11/2019 17:12	07/11/2019 18:49	05/11/2019 17:12	07/11/2019 18:49	49,61	1	49,61	CHI
20191142792	PETROLINA DE GOIAS	PG12011518	PETROLINA	06/11/2019 07:45	06/11/2019 18:42	06/11/2019 07:45	06/11/2019 18:42	10,95	10	109,50	CHI
20191142799	ABADIANIA	AA21247609	ANAPOLIS UNIVERSITARIO S1	06/11/2019 08:26	07/11/2019 09:55	06/11/2019 08:26	07/11/2019 09:55	25,47	1	25,47	CHI
20191142801	ISRAELANDIA	IS12138487	IPORA	06/11/2019 08:26	07/11/2019 18:55	06/11/2019 08:26	07/11/2019 18:55	34,48	1	34,48	CHI
20191142805	MORRINHOS	MR21000268	MORRINHOS	06/11/2019 08:27	07/11/2019 09:43	06/11/2019 08:27	07/11/2019 09:43	25,26	2	50,52	CHI
20191142809	CRIXAS	CX12318471	SERRA DO OURO	06/11/2019 08:27	07/11/2019 19:27	06/11/2019 08:27	07/11/2019 19:27	34,99	12	419,87	CHI
20191142823	URUACU	UR12342129	URUACU	06/11/2019 05:33	09/11/2019 01:44	06/11/2019 05:33	06/11/2019 11:28	5,93	176	1044,02	CHI
20191142823	URUACU	UR12342129	URUACU	06/11/2019 05:33	09/11/2019 01:44	06/11/2019 11:29	06/11/2019 14:52	3,38	40	135,38	CHI
20191142823	URUACU	UR12342129	URUACU	06/11/2019 05:33	09/11/2019 01:44	06/11/2019 14:53	06/11/2019 20:52	5,99	2	11,97	CHI
20191142823	URUACU	UR12364063	URUACU	06/11/2019 05:33	09/11/2019 01:44	06/11/2019 14:53	06/11/2019 21:11	6,30	32	201,63	CHI
20191142823	URUACU	UR12342129	URUACU	06/11/2019 05:33	09/11/2019 01:44	06/11/2019 22:20	06/11/2019 23:16	0,94	34	31,99	CHI
20191142823	URUACU	UR12342129	URUACU	06/11/2019 05:33	09/11/2019 01:44	06/11/2019 14:53	08/11/2019 15:40	48,78	4	195,13	CHI
20191142823	URUACU	UR12374576LD	URUACU	06/11/2019 05:33	09/11/2019 01:44	06/11/2019 11:29	08/11/2019 15:53	52,40	136	7126,44	CHI
20191142823	URUACU	UR12342129	URUACU	06/11/2019 05:33	09/11/2019 01:44	06/11/2019 14:53	08/11/2019 16:13	49,34	1	49,34	CHI
20191142823	URUACU	UR12342129	URUACU	06/11/2019 05:33	09/11/2019 01:44	06/11/2019 14:53	09/11/2019 01:44	58,86	1	58,86	CHI
20191142833	CACHOEIRA DE GOIAS	1260002771	FIRMINOPOLIS S2	06/11/2019 08:29	07/11/2019 14:04	06/11/2019 08:29	07/11/2019 14:04	29,57	1	29,57	CHI
20191143001	CAMPINORTE	CR12243572	CAMPINORTE	06/11/2019 06:39	06/11/2019 11:20	06/11/2019 06:39	06/11/2019 11:20	4,68	10	46,78	CHI
20191143103	MINACU	IH12339103	MINACU	06/11/2019 08:30	07/11/2019 02:11	06/11/2019 08:30	07/11/2019 02:11	17,67	29	512,41	CHI
20191143117	PARAUNA	10002315805	PARAUNA	06/11/2019 08:32	06/11/2019 11:38	06/11/2019 08:32	06/11/2019 11:38	3,10	1	3,10	CHI
20191143118	GUARANI DE GOIAS	GY12262082	IACIARA S1	06/11/2019 08:32	06/11/2019 15:04	06/11/2019 08:32	06/11/2019 15:04	6,53	1	6,53	CHI
20191143124	GOIAS	GS21059821	ITABERAI S1	06/11/2019 08:32	08/11/2019 09:26	06/11/2019 08:32	08/11/2019 09:26	48,88	1	48,88	CHI
20191143135	BARRO ALTO	BA21181768	BARRO ALTO	06/11/2019 08:33	06/11/2019 19:43	06/11/2019 08:33	06/11/2019 19:43	11,15	3	33,46	CHI
20191143138	SAO DOMINGOS	SD12344106	SAO DOMINGOS	06/11/2019 08:21	06/11/2019 12:59	06/11/2019 08:21	06/11/2019 12:59	4,62	6	27,75	CHI
20191143140	LUZIANIA	LZ11000048	RIO VERMELHO	06/11/2019 08:27	06/11/2019 09:20	06/11/2019 08:27	06/11/2019 09:20	0,88	140	122,58	CHI
20191143148	GOIANAPOLIS	950004492	DAIA S2	06/11/2019 08:34	07/11/2019 08:19	06/11/2019 08:34	07/11/2019 08:19	23,74	1	23,74	CHI
20191143152	AGUAS LINDAS DE GOIAS	4830424528	AGUAS LINDAS DE GOIAS S1	06/11/2019 08:35	06/11/2019 09:52	06/11/2019 08:35	06/11/2019 09:52	1,28	1	1,28	CHI
20191143155	FORMOSA	FA11342527	ITIQUIRA	06/11/2019 08:35	06/11/2019 16:09	06/11/2019 08:35	06/11/2019 16:09	7,57	90	681,35	CHI
20191143168	LUZIANIA	LZ21214910	PAMPLONA	06/11/2019 08:36	06/11/2019 11:06	06/11/2019 08:36	06/11/2019 11:06	2,49	2	4,97	CHI
20191143170	ITAPIRAPUA	MP12070343	MATRINCHA	06/11/2019 06:52	07/11/2019 08:48	06/11/2019 06:52	07/11/2019 08:48	25,93	33	855,75	CHI

20191143170	MATRINCHA	MP12070343	MATRINCHA	06/11/2019 06:52	07/11/2019 08:48	06/11/2019 06:52	07/11/2019 08:48	25,93	2	51,86	CHI
20191143171	LEOPOLDO DE BULHOES	LB21024179	DAIA S2	06/11/2019 08:36	06/11/2019 19:46	06/11/2019 08:36	06/11/2019 19:46	11,15	1	11,15	CHI
20191143178	FAZENDA NOVA	NB12117290	JUSSARA	06/11/2019 05:59	06/11/2019 21:18	06/11/2019 05:59	06/11/2019 21:18	15,31	4	61,24	CHI
20191143178	NOVO BRASIL	NB12117290	JUSSARA	06/11/2019 05:59	06/11/2019 21:18	06/11/2019 05:59	06/11/2019 21:18	15,31	5	76,55	CHI
20191143184	GAMELEIRA DE GOIAS	SV21045758	DAIA S2	06/11/2019 08:38	08/11/2019 14:06	06/11/2019 08:38	08/11/2019 14:06	53,46	1	53,46	CHI
20191143187	CALDAS NOVAS	760140753	SERRA DE CALDAS	06/11/2019 08:38	06/11/2019 10:01	06/11/2019 08:38	06/11/2019 10:01	1,37	1	1,37	CHI
20191143188	CACHOEIRA DOURADA	130031150	CACHOEIRA DOURADA	06/11/2019 08:38	07/11/2019 16:35	06/11/2019 08:38	07/11/2019 16:35	31,95	1	31,95	CHI
20191143193	PLANALTINA	PI11355374	PADRE BERNARDO	06/11/2019 08:39	08/11/2019 17:59	06/11/2019 08:39	08/11/2019 17:59	57,34	2	114,67	CHI
20191143195	BARRO ALTO	1150002570	BARRO ALTO	06/11/2019 08:39	07/11/2019 12:53	06/11/2019 08:39	07/11/2019 12:53	28,23	1	28,23	CHI
20191143200	AURILANDIA	1010005203	FIRMINOPOLIS S2	06/11/2019 08:39	06/11/2019 15:36	06/11/2019 08:39	06/11/2019 15:36	6,94	1	6,94	CHI
20191143204	URUACU	UR21117946	URUACU	06/11/2019 08:40	07/11/2019 09:03	06/11/2019 08:40	07/11/2019 09:03	24,38	1	24,38	CHI
20191143205	DISTRITO FEDERAL	PI12131789	PLANALTINA	06/11/2019 06:44	06/11/2019 12:57	06/11/2019 06:44	06/11/2019 12:57	6,21	5	31,03	CHI
20191143205	PLANALTINA	PI12131789	PLANALTINA	06/11/2019 06:44	06/11/2019 12:57	06/11/2019 06:44	06/11/2019 12:57	6,21	23	142,73	CHI
20191143208	FORMOSO	FO12200403	MARA ROSA	06/11/2019 08:40	09/11/2019 19:22	06/11/2019 08:40	09/11/2019 19:22	82,69	1	82,69	CHI
20191143212	ABADIANIA	AA12017723	ANAPOLIS UNIVERSITARIO S1	06/11/2019 07:41	06/11/2019 11:10	06/11/2019 07:41	06/11/2019 11:10	3,48	11	38,28	CHI
20191143216	UIRAPURU	UP12297241	SANTA TEREZINHA	06/11/2019 05:33	07/11/2019 16:16	06/11/2019 05:33	07/11/2019 16:16	34,71	3	104,12	CHI
20191143221	FAINA	FC12268647	ITAPURANGA	06/11/2019 08:42	11/11/2019 18:41	06/11/2019 08:42	11/11/2019 18:41	129,98	3	389,93	CHI
20191143222	FAZENDA NOVA	FN12096201	JUSSARA	06/11/2019 08:33	06/11/2019 17:25	06/11/2019 08:33	06/11/2019 17:25	8,88	4	35,51	CHI
20191143244	NIQUELANDIA	NQ12280978	URUACU	06/11/2019 08:42	06/11/2019 15:11	06/11/2019 08:42	06/11/2019 15:11	6,47	85	549,93	CHI
20191143246	MAIRIPOTABA	MI12011393	PONTALINA	06/11/2019 05:13	06/11/2019 10:48	06/11/2019 05:13	06/11/2019 10:48	5,57	29	161,55	CHI
20191143247	MOSSAMEDES	MD21343916	FIRMINOPOLIS S2	06/11/2019 08:42	06/11/2019 09:56	06/11/2019 08:42	06/11/2019 09:56	1,22	1	1,22	CHI
20191143250	PIRENOPOLIS	PV12353230	CORUMBA	06/11/2019 08:43	07/11/2019 21:41	06/11/2019 08:43	07/11/2019 21:41	36,96	9	332,67	CHI
20191143258	PADRE BERNARDO	PB12376722	PADRE BERNARDO	06/11/2019 08:43	07/11/2019 13:59	06/11/2019 08:43	07/11/2019 13:59	29,25	7	204,77	CHI
20191143260	NIQUELANDIA	NQ21257264	URUACU	06/11/2019 08:44	08/11/2019 12:00	06/11/2019 08:44	08/11/2019 12:00	51,26	2	102,52	CHI
20191143266	MIMOSO DE GOIAS	MJ21246181	PADRE BERNARDO	06/11/2019 08:45	07/11/2019 20:19	06/11/2019 08:45	07/11/2019 20:19	35,56	1	35,56	CHI
20191143274	DAMIANOPOLIS	DA21309347	IACIARA S2	06/11/2019 08:46	06/11/2019 13:18	06/11/2019 08:46	06/11/2019 13:18	4,53	1	4,53	CHI
20191143281	PIRES DO RIO	460032800	PIRES DO RIO S1	06/11/2019 08:46	07/11/2019 11:59	06/11/2019 08:46	07/11/2019 11:59	27,22	1	27,22	CHI
20191143294	ESTRELA DO NORTE	ET12012488	MARA ROSA	06/11/2019 07:50	06/11/2019 13:07	06/11/2019 07:50	06/11/2019 13:07	5,28	18	95,04	CHI
20191143298	AGUA FRIA DE GOIAS	PI12049169	SAO JOAO D ALIANCA	06/11/2019 08:47	07/11/2019 21:26	06/11/2019 08:47	07/11/2019 21:26	36,64	1	36,64	CHI
20191143307	AMARALINA	MH12362454	NOVA CRIXAS	06/11/2019 05:32	06/11/2019 11:22	06/11/2019 05:32	06/11/2019 11:22	5,83	1	5,83	CHI
20191143307	MUNDO NOVO DE GOIAS	MH12362454	NOVA CRIXAS	06/11/2019 05:32	06/11/2019 11:22	06/11/2019 05:32	06/11/2019 11:22	5,83	136	792,58	CHI
20191143314	CAMPINORTE	CR12053035	MARA ROSA	06/11/2019 08:49	07/11/2019 17:27	06/11/2019 08:49	07/11/2019 17:27	32,63	3	97,90	CHI
20191143327	LEOPOLDO DE BULHOES	LB21353171	DAIA S2	06/11/2019 08:50	06/11/2019 23:01	06/11/2019 08:50	06/11/2019 23:01	14,17	2	28,35	CHI

20191143329	PORANGATU	PO21115474	PORANGATU	06/11/2019 08:50	08/11/2019 08:22	06/11/2019 08:50	08/11/2019 08:22	47,52	1	47,52	CHI
20191143330	JUSSARA	JR12103806	JUSSARA	06/11/2019 06:46	06/11/2019 16:51	06/11/2019 06:46	06/11/2019 16:51	10,07	122	1229,12	CHI
20191143337	CALDAS NOVAS	760172602	SERRA DE CALDAS	06/11/2019 08:51	07/11/2019 08:10	06/11/2019 08:51	07/11/2019 08:10	23,32	1	23,32	CHI
20191143346	EDEIA	EA12000044	EDEIA	06/11/2019 08:53	10/11/2019 14:35	06/11/2019 08:53	10/11/2019 14:35	101,70	3	305,09	CHI
20191143351	MIMOSO DE GOIAS	MJ12333273	PADRE BERNARDO	06/11/2019 05:36	07/11/2019 11:39	06/11/2019 05:36	07/11/2019 11:39	30,04	5	150,21	CHI
20191143370	MOZARLANDIA	10008191741	MOZARLANDIA	06/11/2019 08:56	08/11/2019 13:45	06/11/2019 08:56	08/11/2019 13:45	52,80	1	52,80	CHI
20191143373	JUSSARA	3150000243	IPORA	06/11/2019 08:56	07/11/2019 16:58	06/11/2019 08:56	07/11/2019 16:58	32,02	1	32,02	CHI
20191143382	AGUAS LINDAS DE GOIAS	10007738542	AGUAS LINDAS DE GOIAS S1	06/11/2019 08:58	06/11/2019 10:44	06/11/2019 08:58	06/11/2019 10:44	1,77	1	1,77	CHI
20191143385	CRIXAS	CX21243630	SERRA DO OURO	06/11/2019 08:58	07/11/2019 16:18	06/11/2019 08:58	07/11/2019 16:18	31,33	1	31,33	CHI
20191143409	FORMOSA	FA32042714	SAO JOAO D ALIANCA	06/11/2019 05:19	06/11/2019 12:55	06/11/2019 05:19	06/11/2019 12:55	7,60	7	53,17	CHI
20191143421	PIRES DO RIO	PR12051695	PIRES DO RIO S2	06/11/2019 06:34	08/11/2019 15:08	06/11/2019 06:34	08/11/2019 15:08	56,55	9	508,98	CHI
20191144007	URUACU	UR21210905	URUACU	06/11/2019 07:39	06/11/2019 12:03	06/11/2019 07:39	06/11/2019 12:03	4,39	1	4,39	CHI
20191144021	PALMEIRAS DE GOIAS	PL12000240	PALMEIRAS	06/11/2019 08:16	06/11/2019 12:40	06/11/2019 08:16	06/11/2019 12:40	4,40	5	22,01	CHI
20191144031	FAINA	FC12299792	GOIAS	06/11/2019 07:10	06/11/2019 15:07	06/11/2019 07:10	06/11/2019 15:07	7,94	48	381,35	CHI
20191144217	COCALZINHO DE GOIAS	ZN12188781	GOIANESIA S1	06/11/2019 08:47	06/11/2019 17:46	06/11/2019 08:47	06/11/2019 17:46	8,98	57	511,84	CHI
20191144219	POSSE	PS11071345	IACIARA S2	06/11/2019 08:57	06/11/2019 10:18	06/11/2019 08:57	06/11/2019 10:18	1,34	158	210,93	CHI
20191144401	ITABERAI	IB12078567	ITABERAI S1	06/11/2019 04:03	06/11/2019 13:57	06/11/2019 04:03	06/11/2019 13:57	9,91	17	168,45	CHI
20191144401	ITAUCU	IB12078567	ITABERAI S1	06/11/2019 04:03	06/11/2019 13:57	06/11/2019 04:03	06/11/2019 13:57	9,91	2	19,82	CHI
20191144414	LUZIANIA	LZ12396837	MARAOARA	06/11/2019 08:46	06/11/2019 11:05	06/11/2019 08:46	06/11/2019 11:05	2,30	12	27,61	CHI
20191144427	AMORINOPOLIS	AM12212987	IPORA	06/11/2019 06:36	07/11/2019 09:01	06/11/2019 06:36	06/11/2019 13:20	6,72	25	168,06	CHI
20191144427	IVOLANDIA	AM12212987	IPORA	06/11/2019 06:36	07/11/2019 09:01	06/11/2019 06:36	06/11/2019 13:20	6,72	9	60,50	CHI
20191144427	AMORINOPOLIS	AM12212987	IPORA	06/11/2019 06:36	07/11/2019 09:01	06/11/2019 06:36	07/11/2019 09:01	26,41	1	26,41	CHI
20191144472	PIRENOPOLIS	PV12377430	GOIANESIA S1	06/11/2019 06:21	07/11/2019 09:40	06/11/2019 06:21	07/11/2019 09:40	27,31	10	273,07	CHI
20191144485	CALDAS NOVAS	CN12246589	SERRA DE CALDAS	06/11/2019 06:31	06/11/2019 15:49	06/11/2019 06:31	06/11/2019 15:49	9,29	54	501,87	CHI
20191144495	PORANGATU	PO12202569	PORANGATU	06/11/2019 06:55	08/11/2019 12:29	06/11/2019 06:55	08/11/2019 12:29	53,55	6	321,33	CHI
20191144518	FORMOSO	FO12390372	PORANGATU	06/11/2019 06:05	06/11/2019 21:10	06/11/2019 06:05	06/11/2019 21:10	15,07	6	90,41	CHI
20191144519	DIVINOPOLIS DE GOIAS	GH12151252	SAO DOMINGOS	06/11/2019 06:06	06/11/2019 20:21	06/11/2019 06:06	06/11/2019 20:21	14,25	6	85,50	CHI
20191144525	MUTUNOPOLIS	PO12038770	PORANGATU	06/11/2019 07:30	06/11/2019 10:21	06/11/2019 07:30	06/11/2019 10:21	2,85	4	11,40	CHI
20191144525	PORANGATU	PO12038770	PORANGATU	06/11/2019 07:30	06/11/2019 10:21	06/11/2019 07:30	06/11/2019 10:21	2,85	17	48,45	CHI
20191144580	ALTO HORIZONTE	AJ12384910	MARA ROSA	06/11/2019 04:52	06/11/2019 16:20	06/11/2019 04:52	06/11/2019 16:20	11,45	34	389,40	CHI
20191144580	MARA ROSA	AJ12384910	MARA ROSA	06/11/2019 04:52	06/11/2019 16:20	06/11/2019 04:52	06/11/2019 16:20	11,45	5	57,27	CHI
20191144669	NIQUELANDIA	NQ12375602	URUACU	06/11/2019 08:35	06/11/2019 11:31	06/11/2019 08:35	06/11/2019 11:31	2,92	34	99,44	CHI
20191144671	PORANGATU	PO12104373	PORANGATU	06/11/2019 08:34	06/11/2019 15:28	06/11/2019 08:34	06/11/2019 15:28	6,88	32	220,32	CHI

20191144704	MOZARLANDIA	MZ12181412LD	MOZARLANDIA	06/11/2019 05:54	06/11/2019 15:46	06/11/2019 05:54	06/11/2019 15:46	9,86	73	719,62	CHI
20191144733	ARENOPOLIS	AY12123896	ARENOPOLIS	06/11/2019 07:53	06/11/2019 16:17	06/11/2019 07:53	06/11/2019 16:17	8,39	14	117,49	CHI
20191144733	DIORAMA	AY12123896	ARENOPOLIS	06/11/2019 07:53	06/11/2019 16:17	06/11/2019 07:53	06/11/2019 16:17	8,39	15	125,88	CHI
20191144735	DOVERLANDIA	DV11201858	CAIAPONIA	06/11/2019 08:46	06/11/2019 12:03	06/11/2019 08:46	06/11/2019 12:03	3,28	53	173,87	CHI
20191144762	MOSSAMEDES	MD12037744	FIRMINOPOLIS S2	06/11/2019 07:28	07/11/2019 17:15	06/11/2019 07:28	07/11/2019 17:15	33,78	9	304,01	CHI
20191144770	FAINA	FC12228838	GOIAS	06/11/2019 05:58	07/11/2019 18:15	06/11/2019 05:58	07/11/2019 18:15	36,30	5	181,49	CHI
20191144771	FLORES DE GOIAS	FB12255011	FLORES DE GOIAS	06/11/2019 07:21	06/11/2019 11:53	06/11/2019 07:21	06/11/2019 11:53	4,52	417	1884,03	CHI
20191144771	NOVA ROMA	FB12255011	FLORES DE GOIAS	06/11/2019 07:21	06/11/2019 11:53	06/11/2019 07:21	06/11/2019 11:53	4,52	2	9,04	CHI
20191144771	SAO JOAO D ALIANCA	FB12255011	FLORES DE GOIAS	06/11/2019 07:21	06/11/2019 11:53	06/11/2019 07:21	06/11/2019 11:53	4,52	48	216,87	CHI
20191144806	PANAMA	IT12000120	PARANAIBA	06/11/2019 06:45	09/11/2019 12:49	06/11/2019 06:45	09/11/2019 12:49	78,06	2	156,12	CHI
20191144811	JUSSARA	JR12054018	JUSSARA	06/11/2019 08:08	06/11/2019 20:33	06/11/2019 08:08	06/11/2019 20:33	12,42	2	24,83	CHI
20191144811	NOVO BRASIL	JR12054018	JUSSARA	06/11/2019 08:08	06/11/2019 20:33	06/11/2019 08:08	06/11/2019 20:33	12,42	3	37,25	CHI
20191144822	AGUA FRIA DE GOIAS	TL12381390	SAO JOAO D ALIANCA	06/11/2019 08:29	06/11/2019 15:56	06/11/2019 08:29	06/11/2019 15:56	7,45	3	22,34	CHI
20191144822	PLANALTINA	TL12381390	SAO JOAO D ALIANCA	06/11/2019 08:29	06/11/2019 15:56	06/11/2019 08:29	06/11/2019 15:56	7,45	20	148,93	CHI
20191144887	PIRACANJUBA	PJ12233807	ROCHEDO	06/11/2019 06:12	06/11/2019 17:00	06/11/2019 06:12	06/11/2019 17:00	10,79	7	75,54	CHI
20191144917	PLANALTINA	PI12302825	SAO JOAO D ALIANCA	06/11/2019 07:44	06/11/2019 14:03	06/11/2019 07:44	06/11/2019 14:03	6,31	7	44,18	CHI
20191145006	POSSE	PS12132043	IACIARA S2	06/11/2019 07:12	07/11/2019 12:03	06/11/2019 07:12	06/11/2019 15:32	8,34	9	75,03	CHI
20191145006	POSSE	PS12132044LD	IACIARA S2	06/11/2019 07:12	07/11/2019 12:03	06/11/2019 07:12	06/11/2019 18:31	11,31	16	180,90	CHI
20191145006	POSSE	PS12133570	IACIARA S2	06/11/2019 07:12	07/11/2019 12:03	06/11/2019 07:12	06/11/2019 19:35	12,38	7	86,69	CHI
20191145006	POSSE	PS12133570	IACIARA S2	06/11/2019 07:12	07/11/2019 12:03	06/11/2019 19:36	07/11/2019 10:52	15,27	7	106,88	CHI
20191145006	POSSE	PS12211246LD	IACIARA S2	06/11/2019 07:12	07/11/2019 12:03	06/11/2019 07:12	07/11/2019 12:03	28,84	5	144,22	CHI
20191145020	FORMOSA	FA12404514	SAO JOAO D ALIANCA	06/11/2019 07:31	06/11/2019 13:20	06/11/2019 07:31	06/11/2019 13:20	5,81	165	958,37	CHI
20191145092	MONTES CLAROS DE GOIAS	ME12380869	IPORA	06/11/2019 08:46	07/11/2019 16:17	06/11/2019 08:46	07/11/2019 16:17	31,51	4	126,03	CHI
20191145242	AMORINOPOLIS	IR12188430	IPORA	06/11/2019 06:43	07/11/2019 09:01	06/11/2019 06:43	07/11/2019 09:01	26,29	43	1130,55	CHI
20191145242	IPORA	IR12188430	IPORA	06/11/2019 06:43	07/11/2019 09:01	06/11/2019 06:43	07/11/2019 09:01	26,29	22	578,42	CHI
20191145242	IVOLANDIA	IR12188430	IPORA	06/11/2019 06:43	07/11/2019 09:01	06/11/2019 06:43	07/11/2019 09:01	26,29	102	2681,78	CHI
20191145242	PALESTINA DE GOIAS	IR12188430	IPORA	06/11/2019 06:43	07/11/2019 09:01	06/11/2019 06:43	07/11/2019 09:01	26,29	11	289,21	CHI
20191145247	PILAR DE GOIAS	GG12262855	ITAPACI	06/11/2019 08:11	06/11/2019 15:10	06/11/2019 08:11	06/11/2019 15:10	6,98	5	34,92	CHI
20191145280	CAMPINORTE	MQ12286000	MARA ROSA	06/11/2019 08:02	06/11/2019 18:21	06/11/2019 08:02	06/11/2019 18:21	10,30	7	72,10	CHI
20191145280	ESTRELA DO NORTE	MQ12286000	MARA ROSA	06/11/2019 08:02	06/11/2019 18:21	06/11/2019 08:02	06/11/2019 18:21	10,30	3	30,90	CHI
20191145280	MARA ROSA	MQ12286000	MARA ROSA	06/11/2019 08:02	06/11/2019 18:21	06/11/2019 08:02	06/11/2019 18:21	10,30	134	1380,24	CHI
20191145287	LEOPOLDO DE BULHOES	LB12353164	DAIA S2	06/11/2019 08:52	06/11/2019 20:35	06/11/2019 08:52	06/11/2019 20:35	11,72	8	93,73	CHI
20191145321	GOIANESIA	PV21155077	GOIANESIA S2	06/11/2019 08:39	06/11/2019 16:30	06/11/2019 08:39	06/11/2019 16:30	7,85	1	7,85	CHI

20191145355	PORANGATU	PO12022073	PORANGATU	06/11/2019 03:34	06/11/2019 15:21	06/11/2019 03:34	06/11/2019 15:21	11,78	44	518,33	CHI
20191145465	GOIATUBA	PX12029611	GOIATUBA S1	06/11/2019 06:22	07/11/2019 10:01	06/11/2019 06:22	07/11/2019 10:01	27,65	10	276,48	CHI
20191145479	DIVINOPOLIS DE GOIAS	GH12389051	SAO DOMINGOS	06/11/2019 08:20	06/11/2019 16:11	06/11/2019 08:20	06/11/2019 16:11	7,83	22	172,36	CHI
20191145485	GOIAS	GS12362366	MATRINCHA	06/11/2019 06:50	10/11/2019 22:51	06/11/2019 06:50	10/11/2019 22:51	112,01	3	336,02	CHI
20191145570	ALTO PARAISO DE GOIAS	BF12105397	SAO JOAO D ALIANCA	06/11/2019 06:03	07/11/2019 03:15	06/11/2019 06:03	07/11/2019 03:15	21,20	185	3922,21	CHI
20191145610	CALDAS NOVAS	CN12180278	CALDAS NOVAS S1	06/11/2019 08:11	06/11/2019 15:42	06/11/2019 08:11	06/11/2019 15:42	7,51	6	45,05	CHI
20191145610	SANTA CRUZ DE GOIAS	CN12180278	CALDAS NOVAS S1	06/11/2019 08:11	06/11/2019 15:42	06/11/2019 08:11	06/11/2019 15:42	7,51	4	30,03	CHI
20191145634	SAO LUIZ DO NORTE	SZ12315247	ITAPACI	06/11/2019 08:08	06/11/2019 15:35	06/11/2019 08:08	06/11/2019 15:35	7,44	3	22,31	CHI
20191145666	BOM JARDIM DE GOIAS	BM12205305	BOM JARDIM	06/11/2019 07:26	07/11/2019 10:48	06/11/2019 07:26	07/11/2019 10:48	27,35	7	191,48	CHI
20191145752	PADRE BERNARDO	PB12333235	PADRE BERNARDO	06/11/2019 07:48	07/11/2019 12:18	06/11/2019 07:48	07/11/2019 12:18	28,49	25	712,21	CHI
20191145867	CALDAS NOVAS	IP12195205	IPAMERI	06/11/2019 06:43	07/11/2019 10:35	06/11/2019 06:43	07/11/2019 10:35	27,86	7	195,03	CHI
20191145867	CORUMBAIBA	IP12195205	IPAMERI	06/11/2019 06:43	07/11/2019 10:35	06/11/2019 06:43	07/11/2019 10:35	27,86	2	55,72	CHI
20191145867	IPAMERI	IP12195205	IPAMERI	06/11/2019 06:43	07/11/2019 10:35	06/11/2019 06:43	07/11/2019 10:35	27,86	67	1866,69	CHI
20191145919	URUACU	UR12232397	URUACU	06/11/2019 07:34	06/11/2019 17:41	06/11/2019 07:34	06/11/2019 17:41	10,11	16	161,69	CHI
20191145941	BARRO ALTO	BA12064534	BARRO ALTO	06/11/2019 08:56	06/11/2019 20:59	06/11/2019 08:56	06/11/2019 20:59	12,03	7	84,24	CHI
20191145952	FAINA	FC11378217	GOIAS	06/11/2019 07:10	10/11/2019 09:20	06/11/2019 07:10	10/11/2019 09:20	98,16	1	98,16	CHI
20191145988	ARAGUAPAZ	AZ12253439	RUBIATABA	06/11/2019 06:46	08/11/2019 09:46	06/11/2019 06:46	08/11/2019 09:46	51,00	9	459,00	CHI
20191147318	NIQUELANDIA	NQ21218308	URUACU	06/11/2019 07:10	06/11/2019 23:08	06/11/2019 14:57	06/11/2019 23:08	8,18	1	8,18	CHI
20191147380	CAMPINORTE	MQ12390470	MARA ROSA	05/11/2019 18:59	09/11/2019 11:25	05/11/2019 18:59	09/11/2019 11:25	88,45	1	88,45	CHI
20191147380	MARA ROSA	MQ12390470	MARA ROSA	05/11/2019 18:59	09/11/2019 11:25	05/11/2019 18:59	09/11/2019 11:25	88,45	3	265,34	CHI
20191147556	PIRACANJUBA	MR12000241	MORRINHOS	06/11/2019 07:39	06/11/2019 18:29	06/11/2019 07:39	06/11/2019 18:29	10,82	6	64,91	CHI
20191148118	MINACU	IH12181712	MINACU	06/11/2019 08:59	06/11/2019 20:23	06/11/2019 08:59	06/11/2019 20:23	11,39	38	432,70	CHI
20191148840	PILAR DE GOIAS	GG21171785	URUACU	05/11/2019 19:52	08/11/2019 15:57	05/11/2019 19:52	08/11/2019 15:57	68,08	1	68,08	CHI
20191150399	UIRAPURU	UP12391847	SANTA TEREZINHA	06/11/2019 07:32	07/11/2019 12:50	06/11/2019 07:32	07/11/2019 12:50	29,29	7	205,03	CHI
20191151037	SANTA TEREZA DE GOIAS	SE12332803	MARA ROSA	05/11/2019 19:54	11/11/2019 10:49	05/11/2019 19:54	11/11/2019 10:49	134,91	4	539,64	CHI
20191153771	ALTO PARAISO DE GOIAS	BF11365392	SAO JOAO D ALIANCA	06/11/2019 06:03	08/11/2019 13:59	06/11/2019 06:03	08/11/2019 13:59	55,92	1	55,92	CHI
20191155071	PLANALTINA	3890001619	PLANALTINA	05/11/2019 15:12	08/11/2019 09:43	05/11/2019 15:12	08/11/2019 09:43	66,52	1	66,52	CHI
20191155841	IPAMERI	IP21036051	URUTAI	05/11/2019 16:19	08/11/2019 11:21	05/11/2019 16:19	08/11/2019 11:21	67,03	1	67,03	CHI
20191156369	CRIXAS	CX21147037	SANTA TEREZINHA	05/11/2019 17:16	09/11/2019 13:18	05/11/2019 17:16	09/11/2019 13:18	92,02	1	92,02	CHI
20191157432	CRIXAS	IW12031351	RUBIATABA	05/11/2019 15:28	09/11/2019 02:30	05/11/2019 15:28	09/11/2019 02:30	83,02	5	415,11	CHI
20191157432	ITAPACI	IW12031351	RUBIATABA	05/11/2019 15:28	09/11/2019 02:30	05/11/2019 15:28	09/11/2019 02:30	83,02	1	83,02	CHI
20191162969	SAO JOAO D ALIANCA	JL12324133	SAO JOAO D ALIANCA	05/11/2019 16:14	09/11/2019 11:21	05/11/2019 16:14	09/11/2019 11:21	91,11	5	455,53	CHI
201911331555	MONTIVIDIU DO NORTE	PO12391673	PORANGATU	05/11/2019 15:01	06/11/2019 11:41	05/11/2019 15:01	06/11/2019 11:41	20,66	1	20,66	CHI

201911331555	PORANGATU	PO12391673	PORANGATU	05/11/2019 15:01	06/11/2019 11:41	05/11/2019 15:01	06/11/2019 11:41	20,66	10	206,57	CHI
201911331970	MONTIVIDIU	MV12267623	MONTIVIDIU T	05/11/2019 15:32	08/11/2019 18:30	05/11/2019 15:32	05/11/2019 23:25	7,88	12	94,60	CHI
201911331970	MONTIVIDIU	MV12267634	MONTIVIDIU T	05/11/2019 15:32	08/11/2019 18:30	05/11/2019 15:32	08/11/2019 18:30	74,96	17	1274,32	CHI
201911339099	GOIANIA	10002542720	CARAJAS S2	05/11/2019 13:10	06/11/2019 09:58	05/11/2019 13:10	06/11/2019 09:58	20,79	1	20,79	CHI
201911350054	CAIAPONIA	CP12269004	CAIAPONIA	05/11/2019 17:17	05/11/2019 18:44	05/11/2019 17:17	05/11/2019 18:44	1,44	4	5,74	CHI
201911352586	JATAI	JT12334216	JATAI S1	05/11/2019 12:56	07/11/2019 07:00	05/11/2019 12:56	07/11/2019 07:00	42,07	3	126,20	CHI
201911352721	PLANALTINA	PI12394160	SAO JOAO D ALIANCA	05/11/2019 12:59	06/11/2019 15:33	05/11/2019 12:59	06/11/2019 15:33	26,56	8	212,44	CHI
201911352847	ABADIANIA	AA12085971	ANAPOLIS UNIVERSITARIO S1	05/11/2019 14:16	05/11/2019 17:29	05/11/2019 14:16	05/11/2019 17:29	3,22	12	38,68	CHI
201911352931	ALTO PARAISO DE GOIAS	BF12129943	FLORES DE GOIAS	05/11/2019 15:01	07/11/2019 18:29	05/11/2019 15:01	07/11/2019 18:29	51,46	1	51,46	CHI
201911353062	ANAPOLIS	AN12080965	ANAPOLIS UNIVERSITARIO S1	05/11/2019 15:38	05/11/2019 19:20	05/11/2019 15:38	05/11/2019 19:20	3,69	14	51,72	CHI
201911353141	COCALZINHO DE GOIAS	ZN12273061	COCALZINHO	05/11/2019 13:09	05/11/2019 20:14	05/11/2019 13:09	05/11/2019 20:14	7,07	26	183,91	CHI
201911353296	ORIZONA	OZ12017062	PIRES DO RIO S2	05/11/2019 16:08	06/11/2019 08:48	05/11/2019 16:08	06/11/2019 08:48	16,66	9	149,94	CHI
201911353296	PIRES DO RIO	OZ12017062	PIRES DO RIO S2	05/11/2019 16:08	06/11/2019 08:48	05/11/2019 16:08	06/11/2019 08:48	16,66	2	33,32	CHI
201911356002	CACHOEIRA DOURADA	CD12000291	CACHOEIRA DOURADA	05/11/2019 18:06	06/11/2019 16:07	05/11/2019 18:06	06/11/2019 16:07	22,01	8	176,11	CHI
201911356193	NOVA ROMA	TE12284926	FLORES DE GOIAS	05/11/2019 12:53	06/11/2019 18:35	05/11/2019 12:53	06/11/2019 18:35	29,69	23	682,97	CHI
201911356193	TERESINA DE GOIAS	TE12284926	FLORES DE GOIAS	05/11/2019 12:53	06/11/2019 18:35	05/11/2019 12:53	06/11/2019 18:35	29,69	11	326,64	CHI
201911356282	CACHOEIRA DOURADA	CD12000085	CACHOEIRA DOURADA	05/11/2019 17:05	09/11/2019 12:04	05/11/2019 17:05	09/11/2019 12:04	90,97	14	1273,55	CHI
201911356544	CAVALCANTE	CJ12047979	FLORES DE GOIAS	06/11/2019 07:23	06/11/2019 17:27	06/11/2019 07:23	06/11/2019 17:27	10,06	5	50,31	CHI
201911368160	PALESTINA DE GOIAS	3370012386	IPORA	05/11/2019 12:21	06/11/2019 18:49	05/11/2019 12:21	06/11/2019 18:49	30,47	1	30,47	CHI
201911368208	SAO JOAO D ALIANCA	10007122681	SAO JOAO D ALIANCA	05/11/2019 12:41	06/11/2019 09:00	05/11/2019 12:41	06/11/2019 09:00	20,31	1	20,31	CHI
201911368230	NOVA CRIXAS	8580002890	NOVA CRIXAS	05/11/2019 16:02	07/11/2019 07:50	05/11/2019 16:02	07/11/2019 07:50	39,81	1	39,81	CHI
201911368243	NOVA AMERICA	2160010206	RUBIATABA	05/11/2019 10:37	07/11/2019 15:00	05/11/2019 10:37	07/11/2019 15:00	52,38	1	52,38	CHI
201911368330	HIDROLINA	01800234	URUACU	06/11/2019 07:34	06/11/2019 07:42	06/11/2019 07:34	06/11/2019 07:42	0,15	13	1,91	CHI
201911368330	URUACU	01800234	URUACU	06/11/2019 07:34	06/11/2019 07:42	06/11/2019 07:34	06/11/2019 07:42	0,15	290	42,61	CHI
201911368330	URUACU	01800234	URUACU	06/11/2019 07:34	06/11/2019 07:42	06/11/2019 07:34	06/11/2019 07:42	0,15	7601	1116,92	CHI
2019110500006	JATAI	04800424	JATAI S1	05/11/2019 12:56	05/11/2019 15:20	05/11/2019 12:56	05/11/2019 15:20	2,40	49	117,60	CHI
2019110500006	SERRANOPOLIS	01670404	JATAI S1	05/11/2019 12:56	05/11/2019 15:20	05/11/2019 12:56	05/11/2019 15:20	2,40	10	24,00	CHI
2019110500006	SERRANOPOLIS	16701	JATAI S1	05/11/2019 12:56	05/11/2019 15:20	05/11/2019 12:56	05/11/2019 15:20	2,40	6	14,40	CHI
2019110500006	SERRANOPOLIS	01670404	JATAI S1	05/11/2019 12:56	05/11/2019 15:20	05/11/2019 12:56	05/11/2019 15:20	2,40	1	2,40	CHI
2019110500033	CEZARINA	01620404	PONTALINA	05/11/2019 17:54	05/11/2019 21:05	05/11/2019 17:54	05/11/2019 18:26	0,54	39	21,15	CHI
2019110500033	CROMINIA	01620404	PONTALINA	05/11/2019 17:54	05/11/2019 21:05	05/11/2019 17:54	05/11/2019 18:26	0,54	1669	904,97	CHI
2019110500033	CROMINIA	01620404	PONTALINA	05/11/2019 17:54	05/11/2019 21:05	05/11/2019 17:54	05/11/2019 18:26	0,54	18	9,76	CHI
2019110500033	CROMINIA	01620404	PONTALINA	05/11/2019 17:54	05/11/2019 21:05	05/11/2019 17:54	05/11/2019 18:26	0,54	1	0,54	CHI

2019110500033	CROMINIA	01620404	PONTALINA	05/11/2019 17:54	05/11/2019 21:05	05/11/2019 17:54	05/11/2019 18:26	0,54	17	9,22	CHI
2019110500033	CROMINIA	PJ10401415	PONTALINA	05/11/2019 17:54	05/11/2019 21:05	05/11/2019 17:54	05/11/2019 18:26	0,54	40	21,69	CHI
2019110500033	CROMINIA	01620404	PONTALINA	05/11/2019 17:54	05/11/2019 21:05	05/11/2019 17:54	05/11/2019 18:26	0,54	12	6,51	CHI
2019110500033	CROMINIA	01620404	PONTALINA	05/11/2019 17:54	05/11/2019 21:05	05/11/2019 17:54	05/11/2019 18:26	0,54	9	4,88	CHI
2019110500033	HIDROLANDIA	01620404	PONTALINA	05/11/2019 17:54	05/11/2019 21:05	05/11/2019 17:54	05/11/2019 18:26	0,54	182	98,68	CHI
2019110500033	HIDROLANDIA	01620404	PONTALINA	05/11/2019 17:54	05/11/2019 21:05	05/11/2019 17:54	05/11/2019 18:26	0,54	75	40,67	CHI
2019110500033	HIDROLANDIA	01620404	PONTALINA	05/11/2019 17:54	05/11/2019 21:05	05/11/2019 17:54	05/11/2019 18:26	0,54	3	1,63	CHI
2019110500033	MAIRIPOTABA	01620404	PONTALINA	05/11/2019 17:54	05/11/2019 21:05	05/11/2019 17:54	05/11/2019 18:26	0,54	60	32,53	CHI
2019110500033	MAIRIPOTABA	01620404	PONTALINA	05/11/2019 17:54	05/11/2019 21:05	05/11/2019 17:54	05/11/2019 18:26	0,54	775	420,22	CHI
2019110500033	MAIRIPOTABA	01620404	PONTALINA	05/11/2019 17:54	05/11/2019 21:05	05/11/2019 17:54	05/11/2019 18:26	0,54	8	4,34	CHI
2019110500033	MAIRIPOTABA	01620404	PONTALINA	05/11/2019 17:54	05/11/2019 21:05	05/11/2019 17:54	05/11/2019 18:26	0,54	267	144,77	CHI
2019110500033	MAIRIPOTABA	PJ10401415	PONTALINA	05/11/2019 17:54	05/11/2019 21:05	05/11/2019 17:54	05/11/2019 18:26	0,54	5	2,71	CHI
2019110500033	MAIRIPOTABA	01620404	PONTALINA	05/11/2019 17:54	05/11/2019 21:05	05/11/2019 17:54	05/11/2019 18:26	0,54	2	1,08	CHI
2019110500033	MAIRIPOTABA	01620404	PONTALINA	05/11/2019 17:54	05/11/2019 21:05	05/11/2019 17:54	05/11/2019 18:26	0,54	3	1,63	CHI
2019110500033	PONTALINA	01620404	PONTALINA	05/11/2019 17:54	05/11/2019 21:05	05/11/2019 17:54	05/11/2019 18:26	0,54	35	18,98	CHI
2019110500033	PONTALINA	01620404	PONTALINA	05/11/2019 17:54	05/11/2019 21:05	05/11/2019 17:54	05/11/2019 18:26	0,54	3	1,63	CHI
2019110500033	PONTALINA	01620404	PONTALINA	05/11/2019 17:54	05/11/2019 21:05	05/11/2019 17:54	05/11/2019 18:26	0,54	55	29,82	CHI
2019110500033	PROFESSOR JAMIL SAFADY	01620404	PONTALINA	05/11/2019 17:54	05/11/2019 21:05	05/11/2019 17:54	05/11/2019 18:26	0,54	13	7,05	CHI
2019110500033	PROFESSOR JAMIL SAFADY	PJ10401415	PONTALINA	05/11/2019 17:54	05/11/2019 21:05	05/11/2019 17:54	05/11/2019 18:26	0,54	43	23,32	CHI
2019110500033	VARJAO	01620404	PONTALINA	05/11/2019 17:54	05/11/2019 21:05	05/11/2019 17:54	05/11/2019 18:26	0,54	1	0,54	CHI
2019110500033	PIRACANJUBA	01620204	ROCHEDO	05/11/2019 17:54	05/11/2019 21:05	05/11/2019 17:54	05/11/2019 18:43	0,82	48	39,20	CHI
2019110500033	PIRACANJUBA	01620204	ROCHEDO	05/11/2019 17:54	05/11/2019 21:05	05/11/2019 17:54	05/11/2019 18:43	0,82	262	213,97	CHI
2019110500033	PROFESSOR JAMIL SAFADY	01620204	ROCHEDO	05/11/2019 17:54	05/11/2019 21:05	05/11/2019 17:54	05/11/2019 18:43	0,82	25	20,42	CHI
2019110500033	CROMINIA	01620424	ROCHEDO	05/11/2019 17:54	05/11/2019 21:05	05/11/2019 17:54	05/11/2019 21:05	3,19	41	130,85	CHI
2019110500033	CROMINIA	01620424	ROCHEDO	05/11/2019 17:54	05/11/2019 21:05	05/11/2019 17:54	05/11/2019 21:05	3,19	2	6,38	CHI
2019110500033	HIDROLANDIA	01620424	ROCHEDO	05/11/2019 17:54	05/11/2019 21:05	05/11/2019 17:54	05/11/2019 21:05	3,19	9	28,72	CHI
2019110500033	PIRACANJUBA	01620424	ROCHEDO	05/11/2019 17:54	05/11/2019 21:05	05/11/2019 17:54	05/11/2019 21:05	3,19	110	351,05	CHI
2019110500033	PIRACANJUBA	PJ10401415	ROCHEDO	05/11/2019 17:54	05/11/2019 21:05	05/11/2019 17:54	05/11/2019 21:05	3,19	1	3,19	CHI
2019110500033	PROFESSOR JAMIL SAFADY	01620424	ROCHEDO	05/11/2019 17:54	05/11/2019 21:05	05/11/2019 17:54	05/11/2019 21:05	3,19	827	2639,28	CHI
2019110500033	PROFESSOR JAMIL SAFADY	01620424	ROCHEDO	05/11/2019 17:54	05/11/2019 21:05	05/11/2019 17:54	05/11/2019 21:05	3,19	639	2039,30	CHI
2019110500033	PROFESSOR JAMIL SAFADY	PJ10401415	ROCHEDO	05/11/2019 17:54	05/11/2019 21:05	05/11/2019 17:54	05/11/2019 21:05	3,19	5	15,96	CHI
2019110500033	CEZARINA	PJ10401415	PONTALINA	05/11/2019 17:54	05/11/2019 21:05	05/11/2019 20:53	05/11/2019 21:05	0,19	39	7,49	CHI
2019110500033	CROMINIA	PJ10401415	PONTALINA	05/11/2019 17:54	05/11/2019 21:05	05/11/2019 20:53	05/11/2019 21:05	0,19	1673	321,12	CHI

2019110500033	CROMINIA	PJ10401415	PONTALINA	05/11/2019 17:54	05/11/2019 21:05	05/11/2019 20:53	05/11/2019 21:05	0,19	20	3,84	CHI
2019110500033	CROMINIA	PJ10401415	PONTALINA	05/11/2019 17:54	05/11/2019 21:05	05/11/2019 20:53	05/11/2019 21:05	0,19	1	0,19	CHI
2019110500033	CROMINIA	PJ10401415	PONTALINA	05/11/2019 17:54	05/11/2019 21:05	05/11/2019 20:53	05/11/2019 21:05	0,19	17	3,26	CHI
2019110500033	CROMINIA	PJ10401415	PONTALINA	05/11/2019 17:54	05/11/2019 21:05	05/11/2019 20:53	05/11/2019 21:05	0,19	42	8,06	CHI
2019110500033	CROMINIA	PJ10401415	PONTALINA	05/11/2019 17:54	05/11/2019 21:05	05/11/2019 20:53	05/11/2019 21:05	0,19	12	2,30	CHI
2019110500033	CROMINIA	PJ10401415	PONTALINA	05/11/2019 17:54	05/11/2019 21:05	05/11/2019 20:53	05/11/2019 21:05	0,19	9	1,73	CHI
2019110500033	HIDROLANDIA	PJ10401415	PONTALINA	05/11/2019 17:54	05/11/2019 21:05	05/11/2019 20:53	05/11/2019 21:05	0,19	182	34,93	CHI
2019110500033	HIDROLANDIA	PJ10401415	PONTALINA	05/11/2019 17:54	05/11/2019 21:05	05/11/2019 20:53	05/11/2019 21:05	0,19	75	14,40	CHI
2019110500033	HIDROLANDIA	PJ10401415	PONTALINA	05/11/2019 17:54	05/11/2019 21:05	05/11/2019 20:53	05/11/2019 21:05	0,19	3	0,58	CHI
2019110500033	MAIRIPOTABA	PJ10401415	PONTALINA	05/11/2019 17:54	05/11/2019 21:05	05/11/2019 20:53	05/11/2019 21:05	0,19	65	12,48	CHI
2019110500033	MAIRIPOTABA	PJ10401415	PONTALINA	05/11/2019 17:54	05/11/2019 21:05	05/11/2019 20:53	05/11/2019 21:05	0,19	776	148,95	CHI
2019110500033	MAIRIPOTABA	PJ10401415	PONTALINA	05/11/2019 17:54	05/11/2019 21:05	05/11/2019 20:53	05/11/2019 21:05	0,19	9	1,73	CHI
2019110500033	MAIRIPOTABA	PJ10401415	PONTALINA	05/11/2019 17:54	05/11/2019 21:05	05/11/2019 20:53	05/11/2019 21:05	0,19	355	68,14	CHI
2019110500033	MAIRIPOTABA	PJ10401415	PONTALINA	05/11/2019 17:54	05/11/2019 21:05	05/11/2019 20:53	05/11/2019 21:05	0,19	8	1,54	CHI
2019110500033	MAIRIPOTABA	PJ10401415	PONTALINA	05/11/2019 17:54	05/11/2019 21:05	05/11/2019 20:53	05/11/2019 21:05	0,19	2	0,38	CHI
2019110500033	MAIRIPOTABA	PJ10401415	PONTALINA	05/11/2019 17:54	05/11/2019 21:05	05/11/2019 20:53	05/11/2019 21:05	0,19	3	0,58	CHI
2019110500033	PONTALINA	PJ10401415	PONTALINA	05/11/2019 17:54	05/11/2019 21:05	05/11/2019 20:53	05/11/2019 21:05	0,19	35	6,72	CHI
2019110500033	PONTALINA	PJ10401415	PONTALINA	05/11/2019 17:54	05/11/2019 21:05	05/11/2019 20:53	05/11/2019 21:05	0,19	3	0,58	CHI
2019110500033	PONTALINA	PJ10401415	PONTALINA	05/11/2019 17:54	05/11/2019 21:05	05/11/2019 20:53	05/11/2019 21:05	0,19	57	10,94	CHI
2019110500033	PROFESSOR JAMIL SAFADY	PJ10401415	PONTALINA	05/11/2019 17:54	05/11/2019 21:05	05/11/2019 20:53	05/11/2019 21:05	0,19	13	2,50	CHI
2019110500033	PROFESSOR JAMIL SAFADY	PJ10401415	PONTALINA	05/11/2019 17:54	05/11/2019 21:05	05/11/2019 20:53	05/11/2019 21:05	0,19	44	8,45	CHI
2019110500033	VARJAO	PJ10401415	PONTALINA	05/11/2019 17:54	05/11/2019 21:05	05/11/2019 20:53	05/11/2019 21:05	0,19	1	0,19	CHI
2019110500063	ANAPOLIS	31201	NEROPOLIS S1	05/11/2019 14:29	05/11/2019 14:32	05/11/2019 14:29	05/11/2019 14:32	0,05	192	9,60	CHI
2019110500063	ANAPOLIS	39302	NEROPOLIS S1	05/11/2019 14:29	05/11/2019 14:32	05/11/2019 14:29	05/11/2019 14:32	0,05	441	22,05	CHI
2019110500063	CAMPO LIMPO	31201	NEROPOLIS S1	05/11/2019 14:29	05/11/2019 14:32	05/11/2019 14:29	05/11/2019 14:32	0,05	16	0,80	CHI
2019110500063	CAMPO LIMPO	39301	NEROPOLIS S1	05/11/2019 14:29	05/11/2019 14:32	05/11/2019 14:29	05/11/2019 14:32	0,05	874	43,70	CHI
2019110500063	CAMPO LIMPO	39302	NEROPOLIS S1	05/11/2019 14:29	05/11/2019 14:32	05/11/2019 14:29	05/11/2019 14:32	0,05	1705	85,25	CHI
2019110500063	CAMPO LIMPO	01320444	NEROPOLIS S1	05/11/2019 14:29	05/11/2019 14:32	05/11/2019 14:29	05/11/2019 14:32	0,05	5	0,25	CHI
2019110500063	NEROPOLIS	39302	NEROPOLIS S1	05/11/2019 14:29	05/11/2019 14:32	05/11/2019 14:29	05/11/2019 14:32	0,05	1	0,05	CHI
2019110500063	OURO VERDE DE GOIAS	31201	NEROPOLIS S1	05/11/2019 14:29	05/11/2019 14:32	05/11/2019 14:29	05/11/2019 14:32	0,05	1428	71,40	CHI
2019110500063	OURO VERDE DE GOIAS	39301	NEROPOLIS S1	05/11/2019 14:29	05/11/2019 14:32	05/11/2019 14:29	05/11/2019 14:32	0,05	1	0,05	CHI
2019110500063	OURO VERDE DE GOIAS	01320444	NEROPOLIS S1	05/11/2019 14:29	05/11/2019 14:32	05/11/2019 14:29	05/11/2019 14:32	0,05	13	0,65	CHI
2019110500063	PETROLINA DE GOIAS	31201	NEROPOLIS S1	05/11/2019 14:29	05/11/2019 14:32	05/11/2019 14:29	05/11/2019 14:32	0,05	13	0,65	CHI

2019110500063	PIRENOPOLIS	31201	NEROPOLIS S1	05/11/2019 14:29	05/11/2019 14:32	05/11/2019 14:29	05/11/2019 14:32	0,05	49	2,45	CHI
2019110500063	TEREZOPOLIS DE GOIAS	39302	NEROPOLIS S1	05/11/2019 14:29	05/11/2019 14:32	05/11/2019 14:29	05/11/2019 14:32	0,05	10	0,50	CHI
2019110500074	CAIAPONIA	00300224	CAIAPONIA	05/11/2019 17:32	05/11/2019 18:44	05/11/2019 17:32	05/11/2019 18:44	1,20	1	1,20	CHI
2019110500083	ARUANA	01401	ARUANA	05/11/2019 20:43	05/11/2019 20:47	05/11/2019 20:43	05/11/2019 20:47	0,07	2623	174,87	CHI
2019110500083	ARUANA	49401	ARUANA	05/11/2019 20:43	05/11/2019 20:47	05/11/2019 20:43	05/11/2019 20:47	0,07	60	4,00	CHI
2019110500083	ARUANA	01402	ARUANA	05/11/2019 20:43	05/11/2019 20:47	05/11/2019 20:43	05/11/2019 20:47	0,07	733	48,87	CHI
2019110500083	ARUANA	03205114	ARUANA	05/11/2019 20:43	05/11/2019 20:47	05/11/2019 20:43	05/11/2019 20:47	0,07	810	54,00	CHI
2019110500083	ARUANA	03205114	ARUANA	05/11/2019 20:43	05/11/2019 20:47	05/11/2019 20:43	05/11/2019 20:47	0,07	8	0,53	CHI
2019110500083	ARUANA	03205114	ARUANA	05/11/2019 20:43	05/11/2019 20:47	05/11/2019 20:43	05/11/2019 20:47	0,07	233	15,53	CHI
2019110500083	ARUANA	02502	BRITANIA	05/11/2019 20:43	05/11/2019 20:47	05/11/2019 20:43	05/11/2019 20:47	0,07	25	1,67	CHI
2019110500083	ARUANA	02531	BRITANIA	05/11/2019 20:43	05/11/2019 20:47	05/11/2019 20:43	05/11/2019 20:47	0,07	38	2,53	CHI
2019110500083	BRITANIA	02501	BRITANIA	05/11/2019 20:43	05/11/2019 20:47	05/11/2019 20:43	05/11/2019 20:47	0,07	1312	87,47	CHI
2019110500083	BRITANIA	40501	BRITANIA	05/11/2019 20:43	05/11/2019 20:47	05/11/2019 20:43	05/11/2019 20:47	0,07	12	0,80	CHI
2019110500083	BRITANIA	02502	BRITANIA	05/11/2019 20:43	05/11/2019 20:47	05/11/2019 20:43	05/11/2019 20:47	0,07	1905	127,00	CHI
2019110500083	BRITANIA	02531	BRITANIA	05/11/2019 20:43	05/11/2019 20:47	05/11/2019 20:43	05/11/2019 20:47	0,07	19	1,27	CHI
2019110500083	BRITANIA	02705114	BRITANIA	05/11/2019 20:43	05/11/2019 20:47	05/11/2019 20:43	05/11/2019 20:47	0,07	7	0,47	CHI
2019110500083	BRITANIA	03215114	BRITANIA	05/11/2019 20:43	05/11/2019 20:47	05/11/2019 20:43	05/11/2019 20:47	0,07	50	3,33	CHI
2019110500083	BRITANIA	03215114	BRITANIA	05/11/2019 20:43	05/11/2019 20:47	05/11/2019 20:43	05/11/2019 20:47	0,07	11	0,73	CHI
2019110500083	FAZENDA NOVA	16501	BRITANIA	05/11/2019 20:43	05/11/2019 20:47	05/11/2019 20:43	05/11/2019 20:47	0,07	165	11,00	CHI
2019110500083	ITAPIRAPUA	02502	BRITANIA	05/11/2019 20:43	05/11/2019 20:47	05/11/2019 20:43	05/11/2019 20:47	0,07	2	0,13	CHI
2019110500083	ITAPIRAPUA	02705114	BRITANIA	05/11/2019 20:43	05/11/2019 20:47	05/11/2019 20:43	05/11/2019 20:47	0,07	2	0,13	CHI
2019110500083	JAUPACI	16501	BRITANIA	05/11/2019 20:43	05/11/2019 20:47	05/11/2019 20:43	05/11/2019 20:47	0,07	2	0,13	CHI
2019110500083	JUSSARA	02501	BRITANIA	05/11/2019 20:43	05/11/2019 20:47	05/11/2019 20:43	05/11/2019 20:47	0,07	12	0,80	CHI
2019110500083	JUSSARA	16501	BRITANIA	05/11/2019 20:43	05/11/2019 20:47	05/11/2019 20:43	05/11/2019 20:47	0,07	333	22,20	CHI
2019110500083	JUSSARA	38701	BRITANIA	05/11/2019 20:43	05/11/2019 20:47	05/11/2019 20:43	05/11/2019 20:47	0,07	122	8,13	CHI
2019110500083	JUSSARA	02502	BRITANIA	05/11/2019 20:43	05/11/2019 20:47	05/11/2019 20:43	05/11/2019 20:47	0,07	24	1,60	CHI
2019110500083	JUSSARA	16502	BRITANIA	05/11/2019 20:43	05/11/2019 20:47	05/11/2019 20:43	05/11/2019 20:47	0,07	12	0,80	CHI
2019110500083	JUSSARA	02705114	BRITANIA	05/11/2019 20:43	05/11/2019 20:47	05/11/2019 20:43	05/11/2019 20:47	0,07	10	0,67	CHI
2019110500083	JUSSARA	02705114	BRITANIA	05/11/2019 20:43	05/11/2019 20:47	05/11/2019 20:43	05/11/2019 20:47	0,07	11	0,73	CHI
2019110500083	JUSSARA	02705114	BRITANIA	05/11/2019 20:43	05/11/2019 20:47	05/11/2019 20:43	05/11/2019 20:47	0,07	118	7,87	CHI
2019110500083	JUSSARA	03215114	BRITANIA	05/11/2019 20:43	05/11/2019 20:47	05/11/2019 20:43	05/11/2019 20:47	0,07	0	0,00	CHI
2019110500083	MONTES CLAROS DE GOIAS	38701	BRITANIA	05/11/2019 20:43	05/11/2019 20:47	05/11/2019 20:43	05/11/2019 20:47	0,07	366	24,40	CHI
2019110500083	SANTA FE DE GOIAS	16501	BRITANIA	05/11/2019 20:43	05/11/2019 20:47	05/11/2019 20:43	05/11/2019 20:47	0,07	414	27,60	CHI

2019110500083	FAZENDA NOVA	08732	IPORA	05/11/2019 20:43	05/11/2019 20:47	05/11/2019 20:43	05/11/2019 20:47	0,07	14	0,93	CHI
2019110500083	IPORA	00850614	IPORA	05/11/2019 20:43	05/11/2019 20:47	05/11/2019 20:43	05/11/2019 20:47	0,07	8717	581,13	CHI
2019110500083	IPORA	08701	IPORA	05/11/2019 20:43	05/11/2019 20:47	05/11/2019 20:43	05/11/2019 20:47	0,07	43	2,87	CHI
2019110500083	IPORA	20001	IPORA	05/11/2019 20:43	05/11/2019 20:47	05/11/2019 20:43	05/11/2019 20:47	0,07	17	1,13	CHI
2019110500083	IPORA	00850614	IPORA	05/11/2019 20:43	05/11/2019 20:47	05/11/2019 20:43	05/11/2019 20:47	0,07	6314	420,93	CHI
2019110500083	IPORA	36102	IPORA	05/11/2019 20:43	05/11/2019 20:47	05/11/2019 20:43	05/11/2019 20:47	0,07	1001	66,73	CHI
2019110500083	IPORA	36102	IPORA	05/11/2019 20:43	05/11/2019 20:47	05/11/2019 20:43	05/11/2019 20:47	0,07	91	6,07	CHI
2019110500083	IPORA	00850614	IPORA	05/11/2019 20:43	05/11/2019 20:47	05/11/2019 20:43	05/11/2019 20:47	0,07	324	21,60	CHI
2019110500083	IPORA	00850614	IPORA	05/11/2019 20:43	05/11/2019 20:47	05/11/2019 20:43	05/11/2019 20:47	0,07	102	6,80	CHI
2019110500083	IPORA	00850614	IPORA	05/11/2019 20:43	05/11/2019 20:47	05/11/2019 20:43	05/11/2019 20:47	0,07	80	5,33	CHI
2019110500083	IPORA	00850614	IPORA	05/11/2019 20:43	05/11/2019 20:47	05/11/2019 20:43	05/11/2019 20:47	0,07	1	0,07	CHI
2019110500083	ISRAELANDIA	08701	IPORA	05/11/2019 20:43	05/11/2019 20:47	05/11/2019 20:43	05/11/2019 20:47	0,07	975	65,00	CHI
2019110500083	ISRAELANDIA	37101	IPORA	05/11/2019 20:43	05/11/2019 20:47	05/11/2019 20:43	05/11/2019 20:47	0,07	15	1,00	CHI
2019110500083	ISRAELANDIA	08702	IPORA	05/11/2019 20:43	05/11/2019 20:47	05/11/2019 20:43	05/11/2019 20:47	0,07	26	1,73	CHI
2019110500083	ISRAELANDIA	30902	IPORA	05/11/2019 20:43	05/11/2019 20:47	05/11/2019 20:43	05/11/2019 20:47	0,07	12	0,80	CHI
2019110500083	ISRAELANDIA	37102	IPORA	05/11/2019 20:43	05/11/2019 20:47	05/11/2019 20:43	05/11/2019 20:47	0,07	4	0,27	CHI
2019110500083	ISRAELANDIA	00850614	IPORA	05/11/2019 20:43	05/11/2019 20:47	05/11/2019 20:43	05/11/2019 20:47	0,07	25	1,67	CHI
2019110500083	ISRAELANDIA	08730	IPORA	05/11/2019 20:43	05/11/2019 20:47	05/11/2019 20:43	05/11/2019 20:47	0,07	131	8,73	CHI
2019110500083	ISRAELANDIA	00850614	IPORA	05/11/2019 20:43	05/11/2019 20:47	05/11/2019 20:43	05/11/2019 20:47	0,07	68	4,53	CHI
2019110500083	ISRAELANDIA	00850614	IPORA	05/11/2019 20:43	05/11/2019 20:47	05/11/2019 20:43	05/11/2019 20:47	0,07	3	0,20	CHI
2019110500083	ISRAELANDIA	08732	IPORA	05/11/2019 20:43	05/11/2019 20:47	05/11/2019 20:43	05/11/2019 20:47	0,07	70	4,67	CHI
2019110500083	IVOLANDIA	00850614	IPORA	05/11/2019 20:43	05/11/2019 20:47	05/11/2019 20:43	05/11/2019 20:47	0,07	14	0,93	CHI
2019110500083	IVOLANDIA	36101	IPORA	05/11/2019 20:43	05/11/2019 20:47	05/11/2019 20:43	05/11/2019 20:47	0,07	89	5,93	CHI
2019110500083	IVOLANDIA	36102	IPORA	05/11/2019 20:43	05/11/2019 20:47	05/11/2019 20:43	05/11/2019 20:47	0,07	68	4,53	CHI
2019110500083	IVOLANDIA	37102	IPORA	05/11/2019 20:43	05/11/2019 20:47	05/11/2019 20:43	05/11/2019 20:47	0,07	1004	66,93	CHI
2019110500083	IVOLANDIA	00850614	IPORA	05/11/2019 20:43	05/11/2019 20:47	05/11/2019 20:43	05/11/2019 20:47	0,07	62	4,13	CHI
2019110500083	JAUPACI	12101	IPORA	05/11/2019 20:43	05/11/2019 20:47	05/11/2019 20:43	05/11/2019 20:47	0,07	7	0,47	CHI
2019110500083	JAUPACI	30901	IPORA	05/11/2019 20:43	05/11/2019 20:47	05/11/2019 20:43	05/11/2019 20:47	0,07	1385	92,33	CHI
2019110500083	JAUPACI	08702	IPORA	05/11/2019 20:43	05/11/2019 20:47	05/11/2019 20:43	05/11/2019 20:47	0,07	51	3,40	CHI
2019110500083	JAUPACI	08730	IPORA	05/11/2019 20:43	05/11/2019 20:47	05/11/2019 20:43	05/11/2019 20:47	0,07	4	0,27	CHI
2019110500083	JAUPACI	00850614	IPORA	05/11/2019 20:43	05/11/2019 20:47	05/11/2019 20:43	05/11/2019 20:47	0,07	3	0,20	CHI
2019110500083	JAUPACI	00850614	IPORA	05/11/2019 20:43	05/11/2019 20:47	05/11/2019 20:43	05/11/2019 20:47	0,07	25	1,67	CHI
2019110500083	JUSSARA	12101	IPORA	05/11/2019 20:43	05/11/2019 20:47	05/11/2019 20:43	05/11/2019 20:47	0,07	406	27,07	CHI

2019110500083	MOIPORA	37101	IPORA	05/11/2019 20:43	05/11/2019 20:47	05/11/2019 20:43	05/11/2019 20:47	0,07	230	15,33	CHI
2019110500083	MOIPORA	37102	IPORA	05/11/2019 20:43	05/11/2019 20:47	05/11/2019 20:43	05/11/2019 20:47	0,07	214	14,27	CHI
2019110500083	MOIPORA	00850614	IPORA	05/11/2019 20:43	05/11/2019 20:47	05/11/2019 20:43	05/11/2019 20:47	0,07	94	6,27	CHI
2019110500083	MOIPORA	37103	IPORA	05/11/2019 20:43	05/11/2019 20:47	05/11/2019 20:43	05/11/2019 20:47	0,07	331	22,07	CHI
2019110500083	MOIPORA	08732	IPORA	05/11/2019 20:43	05/11/2019 20:47	05/11/2019 20:43	05/11/2019 20:47	0,07	12	0,80	CHI
2019110500083	MONTE ALEGRE DE GOIAS	12101	IPORA	05/11/2019 20:43	05/11/2019 20:47	05/11/2019 20:43	05/11/2019 20:47	0,07	2	0,13	CHI
2019110500083	MONTES CLAROS DE GOIAS	12101	IPORA	05/11/2019 20:43	05/11/2019 20:47	05/11/2019 20:43	05/11/2019 20:47	0,07	3198	213,20	CHI
2019110500083	MONTES CLAROS DE GOIAS	38301	IPORA	05/11/2019 20:43	05/11/2019 20:47	05/11/2019 20:43	05/11/2019 20:47	0,07	82	5,47	CHI
2019110500083	MONTES CLAROS DE GOIAS	00850614	IPORA	05/11/2019 20:43	05/11/2019 20:47	05/11/2019 20:43	05/11/2019 20:47	0,07	1017	67,80	CHI
2019110500083	ORIZONA	12101	IPORA	05/11/2019 20:43	05/11/2019 20:47	05/11/2019 20:43	05/11/2019 20:47	0,07	39	2,60	CHI
2019110500083	PARAUNA	37102	IPORA	05/11/2019 20:43	05/11/2019 20:47	05/11/2019 20:43	05/11/2019 20:47	0,07	7	0,47	CHI
2019110500083	PIRANHAS	38301	IPORA	05/11/2019 20:43	05/11/2019 20:47	05/11/2019 20:43	05/11/2019 20:47	0,07	2	0,13	CHI
2019110500083	FAZENDA NOVA	04801	JUSSARA	05/11/2019 20:43	05/11/2019 20:47	05/11/2019 20:43	05/11/2019 20:47	0,07	1409	93,93	CHI
2019110500083	FAZENDA NOVA	13401	JUSSARA	05/11/2019 20:43	05/11/2019 20:47	05/11/2019 20:43	05/11/2019 20:47	0,07	100	6,67	CHI
2019110500083	FAZENDA NOVA	04802	JUSSARA	05/11/2019 20:43	05/11/2019 20:47	05/11/2019 20:43	05/11/2019 20:47	0,07	800	53,33	CHI
2019110500083	FAZENDA NOVA	13430	JUSSARA	05/11/2019 20:43	05/11/2019 20:47	05/11/2019 20:43	05/11/2019 20:47	0,07	47	3,13	CHI
2019110500083	FAZENDA NOVA	01055114	JUSSARA	05/11/2019 20:43	05/11/2019 20:47	05/11/2019 20:43	05/11/2019 20:47	0,07	6	0,40	CHI
2019110500083	FAZENDA NOVA	01055114	JUSSARA	05/11/2019 20:43	05/11/2019 20:47	05/11/2019 20:43	05/11/2019 20:47	0,07	0	0,00	CHI
2019110500083	ITAPIRAPUA	13401	JUSSARA	05/11/2019 20:43	05/11/2019 20:47	05/11/2019 20:43	05/11/2019 20:47	0,07	55	3,67	CHI
2019110500083	ITAPIRAPUA	01055114	JUSSARA	05/11/2019 20:43	05/11/2019 20:47	05/11/2019 20:43	05/11/2019 20:47	0,07	23	1,53	CHI
2019110500083	ITAPIRAPUA	13431	JUSSARA	05/11/2019 20:43	05/11/2019 20:47	05/11/2019 20:43	05/11/2019 20:47	0,07	27	1,80	CHI
2019110500083	JUSSARA	01055114	JUSSARA	05/11/2019 20:43	05/11/2019 20:47	05/11/2019 20:43	05/11/2019 20:47	0,07	5748	383,20	CHI
2019110500083	JUSSARA	01055114	JUSSARA	05/11/2019 20:43	05/11/2019 20:47	05/11/2019 20:43	05/11/2019 20:47	0,07	1077	71,80	CHI
2019110500083	JUSSARA	01055114	JUSSARA	05/11/2019 20:43	05/11/2019 20:47	05/11/2019 20:43	05/11/2019 20:47	0,07	171	11,40	CHI
2019110500083	JUSSARA	01055114	JUSSARA	05/11/2019 20:43	05/11/2019 20:47	05/11/2019 20:43	05/11/2019 20:47	0,07	100	6,67	CHI
2019110500083	NOVO BRASIL	13401	JUSSARA	05/11/2019 20:43	05/11/2019 20:47	05/11/2019 20:43	05/11/2019 20:47	0,07	494	32,93	CHI
2019110500083	NOVO BRASIL	13402	JUSSARA	05/11/2019 20:43	05/11/2019 20:47	05/11/2019 20:43	05/11/2019 20:47	0,07	1196	79,73	CHI
2019110500083	NOVO BRASIL	13430	JUSSARA	05/11/2019 20:43	05/11/2019 20:47	05/11/2019 20:43	05/11/2019 20:47	0,07	50	3,33	CHI
2019110500083	NOVO BRASIL	13431	JUSSARA	05/11/2019 20:43	05/11/2019 20:47	05/11/2019 20:43	05/11/2019 20:47	0,07	16	1,07	CHI
2019110500083	NOVO BRASIL	01055114	JUSSARA	05/11/2019 20:43	05/11/2019 20:47	05/11/2019 20:43	05/11/2019 20:47	0,07	69	4,60	CHI
2019110500083	SANTA FE DE GOIAS	01055114	JUSSARA	05/11/2019 20:43	05/11/2019 20:47	05/11/2019 20:43	05/11/2019 20:47	0,07	28	1,87	CHI
2019110500083	ARUANA	03295114	MATRINCHA	05/11/2019 20:43	05/11/2019 20:47	05/11/2019 20:43	05/11/2019 20:47	0,07	6	0,40	CHI
2019110500083	FAINA	03295114	MATRINCHA	05/11/2019 20:43	05/11/2019 20:47	05/11/2019 20:43	05/11/2019 20:47	0,07	44	2,93	CHI

2019110500083	GOIAS	09201	MATRINCHA	05/11/2019 20:43	05/11/2019 20:47	05/11/2019 20:43	05/11/2019 20:47	0,07	563	37,53	CHI
2019110500083	GOIAS	03295114	MATRINCHA	05/11/2019 20:43	05/11/2019 20:47	05/11/2019 20:43	05/11/2019 20:47	0,07	425	28,33	CHI
2019110500083	ITAPIRAPUA	09201	MATRINCHA	05/11/2019 20:43	05/11/2019 20:47	05/11/2019 20:43	05/11/2019 20:47	0,07	1654	110,27	CHI
2019110500083	ITAPIRAPUA	47501	MATRINCHA	05/11/2019 20:43	05/11/2019 20:47	05/11/2019 20:43	05/11/2019 20:47	0,07	369	24,60	CHI
2019110500083	ITAPIRAPUA	09202	MATRINCHA	05/11/2019 20:43	05/11/2019 20:47	05/11/2019 20:43	05/11/2019 20:47	0,07	1390	92,67	CHI
2019110500083	ITAPIRAPUA	47502	MATRINCHA	05/11/2019 20:43	05/11/2019 20:47	05/11/2019 20:43	05/11/2019 20:47	0,07	63	4,20	CHI
2019110500083	ITAPIRAPUA	03295114	MATRINCHA	05/11/2019 20:43	05/11/2019 20:47	05/11/2019 20:43	05/11/2019 20:47	0,07	150	10,00	CHI
2019110500083	ITAPIRAPUA	03295114	MATRINCHA	05/11/2019 20:43	05/11/2019 20:47	05/11/2019 20:43	05/11/2019 20:47	0,07	1	0,07	CHI
2019110500083	JUSSARA	47501	MATRINCHA	05/11/2019 20:43	05/11/2019 20:47	05/11/2019 20:43	05/11/2019 20:47	0,07	4	0,27	CHI
2019110500083	MATRINCHA	03295114	MATRINCHA	05/11/2019 20:43	05/11/2019 20:47	05/11/2019 20:43	05/11/2019 20:47	0,07	2045	136,33	CHI
2019110500083	MATRINCHA	03295114	MATRINCHA	05/11/2019 20:43	05/11/2019 20:47	05/11/2019 20:43	05/11/2019 20:47	0,07	19	1,27	CHI
2019110500083	NOVO BRASIL	09201	MATRINCHA	05/11/2019 20:43	05/11/2019 20:47	05/11/2019 20:43	05/11/2019 20:47	0,07	31	2,07	CHI
2019110500083	SANTA FE DE GOIAS	47501	MATRINCHA	05/11/2019 20:43	05/11/2019 20:47	05/11/2019 20:43	05/11/2019 20:47	0,07	12	0,80	CHI
2019110500083	CAIAPONIA	03800506	PALESTINA	05/11/2019 20:43	05/11/2019 20:47	05/11/2019 20:43	05/11/2019 20:47	0,07	49	3,27	CHI
2019110500083	CAIAPONIA	03800506	PALESTINA	05/11/2019 20:43	05/11/2019 20:47	05/11/2019 20:43	05/11/2019 20:47	0,07	361	24,07	CHI
2019110500083	PALESTINA DE GOIAS	03800506	PALESTINA	05/11/2019 20:43	05/11/2019 20:47	05/11/2019 20:43	05/11/2019 20:47	0,07	1152	76,80	CHI
2019110500083	PALESTINA DE GOIAS	03800506	PALESTINA	05/11/2019 20:43	05/11/2019 20:47	05/11/2019 20:43	05/11/2019 20:47	0,07	242	16,13	CHI
2019110500083	CAIAPONIA	00305114	PIRANHAS	05/11/2019 20:43	05/11/2019 20:47	05/11/2019 20:43	05/11/2019 20:47	0,07	85	5,67	CHI
2019110500083	PIRANHAS	00305114	PIRANHAS	05/11/2019 20:43	05/11/2019 20:47	05/11/2019 20:43	05/11/2019 20:47	0,07	9	0,60	CHI
2019110500084	ARENOPOLIS	00160503	ARENOPOLIS	05/11/2019 20:43	05/11/2019 20:48	05/11/2019 20:43	05/11/2019 20:48	0,08	1309	109,08	CHI
2019110500084	ARENOPOLIS	00160503	ARENOPOLIS	05/11/2019 20:43	05/11/2019 20:48	05/11/2019 20:43	05/11/2019 20:48	0,08	233	19,42	CHI
2019110500084	ARENOPOLIS	00160503	ARENOPOLIS	05/11/2019 20:43	05/11/2019 20:48	05/11/2019 20:43	05/11/2019 20:48	0,08	19	1,58	CHI
2019110500084	DIORAMA	00160503	ARENOPOLIS	05/11/2019 20:43	05/11/2019 20:48	05/11/2019 20:43	05/11/2019 20:48	0,08	169	14,08	CHI
2019110500084	DIORAMA	00160503	ARENOPOLIS	05/11/2019 20:43	05/11/2019 20:48	05/11/2019 20:43	05/11/2019 20:48	0,08	12	1,00	CHI
2019110500084	IPORA	00160503	ARENOPOLIS	05/11/2019 20:43	05/11/2019 20:48	05/11/2019 20:43	05/11/2019 20:48	0,08	157	13,08	CHI
2019110500084	IVOLANDIA	00160503	ARENOPOLIS	05/11/2019 20:43	05/11/2019 20:48	05/11/2019 20:43	05/11/2019 20:48	0,08	83	6,92	CHI
2019110500084	MONTES CLAROS DE GOIAS	00160503	ARENOPOLIS	05/11/2019 20:43	05/11/2019 20:48	05/11/2019 20:43	05/11/2019 20:48	0,08	40	3,33	CHI
2019110500084	MONTES CLAROS DE GOIAS	00160503	ARENOPOLIS	05/11/2019 20:43	05/11/2019 20:48	05/11/2019 20:43	05/11/2019 20:48	0,08	25	2,08	CHI
2019110500084	PALESTINA DE GOIAS	00160503	ARENOPOLIS	05/11/2019 20:43	05/11/2019 20:48	05/11/2019 20:43	05/11/2019 20:48	0,08	50	4,17	CHI
2019110500084	PALESTINA DE GOIAS	00160503	ARENOPOLIS	05/11/2019 20:43	05/11/2019 20:48	05/11/2019 20:43	05/11/2019 20:48	0,08	3	0,25	CHI
2019110500084	PALESTINA DE GOIAS	00160503	ARENOPOLIS	05/11/2019 20:43	05/11/2019 20:48	05/11/2019 20:43	05/11/2019 20:48	0,08	7	0,58	CHI
2019110500084	PIRANHAS	00160503	ARENOPOLIS	05/11/2019 20:43	05/11/2019 20:48	05/11/2019 20:43	05/11/2019 20:48	0,08	25	2,08	CHI
2019110500084	PIRANHAS	00160503	ARENOPOLIS	05/11/2019 20:43	05/11/2019 20:48	05/11/2019 20:43	05/11/2019 20:48	0,08	43	3,58	CHI

2019110500085	ARAGARCAS	00110504	ARAGARCAS	05/11/2019 20:43	05/11/2019 20:48	05/11/2019 20:43	05/11/2019 20:48	0,08	4522	376,83	CHI
2019110500085	ARAGARCAS	00110504	ARAGARCAS	05/11/2019 20:43	05/11/2019 20:48	05/11/2019 20:43	05/11/2019 20:48	0,08	3096	258,00	CHI
2019110500085	PIRANHAS	05560524	ARENOPOLIS	05/11/2019 20:43	05/11/2019 20:48	05/11/2019 20:43	05/11/2019 20:48	0,08	24	2,00	CHI
2019110500085	ARAGARCAS	00240406	BOM JARDIM	05/11/2019 20:43	05/11/2019 20:48	05/11/2019 20:43	05/11/2019 20:48	0,08	53	4,42	CHI
2019110500085	ARAGARCAS	00240518	BOM JARDIM	05/11/2019 20:43	05/11/2019 20:48	05/11/2019 20:43	05/11/2019 20:48	0,08	55	4,58	CHI
2019110500085	BALIZA	00240406	BOM JARDIM	05/11/2019 20:43	05/11/2019 20:48	05/11/2019 20:43	05/11/2019 20:48	0,08	148	12,33	CHI
2019110500085	BALIZA	00240518	BOM JARDIM	05/11/2019 20:43	05/11/2019 20:48	05/11/2019 20:43	05/11/2019 20:48	0,08	129	10,75	CHI
2019110500085	BOM JARDIM DE GOIAS	00240406	BOM JARDIM	05/11/2019 20:43	05/11/2019 20:48	05/11/2019 20:43	05/11/2019 20:48	0,08	1658	138,17	CHI
2019110500085	BOM JARDIM DE GOIAS	00240518	BOM JARDIM	05/11/2019 20:43	05/11/2019 20:48	05/11/2019 20:43	05/11/2019 20:48	0,08	2229	185,75	CHI
2019110500085	PIRANHAS	00240406	BOM JARDIM	05/11/2019 20:43	05/11/2019 20:48	05/11/2019 20:43	05/11/2019 20:48	0,08	19	1,58	CHI
2019110500085	PIRANHAS	00240518	BOM JARDIM	05/11/2019 20:43	05/11/2019 20:48	05/11/2019 20:43	05/11/2019 20:48	0,08	23	1,92	CHI
2019110500085	ARENOPOLIS	05560524	PIRANHAS	05/11/2019 20:43	05/11/2019 20:48	05/11/2019 20:43	05/11/2019 20:48	0,08	11	0,92	CHI
2019110500085	BOM JARDIM DE GOIAS	05560524	PIRANHAS	05/11/2019 20:43	05/11/2019 20:48	05/11/2019 20:43	05/11/2019 20:48	0,08	18	1,50	CHI
2019110500085	CAIAPONIA	05560524	PIRANHAS	05/11/2019 20:43	05/11/2019 20:48	05/11/2019 20:43	05/11/2019 20:48	0,08	1	0,08	CHI
2019110500085	PIRANHAS	05560524	PIRANHAS	05/11/2019 20:43	05/11/2019 20:48	05/11/2019 20:43	05/11/2019 20:48	0,08	2137	178,08	CHI
2019110500085	PIRANHAS	05560524	PIRANHAS	05/11/2019 20:43	05/11/2019 20:48	05/11/2019 20:43	05/11/2019 20:48	0,08	3132	261,00	CHI
2019110500085	PIRANHAS	05560524	PIRANHAS	05/11/2019 20:43	05/11/2019 20:48	05/11/2019 20:43	05/11/2019 20:48	0,08	24	2,00	CHI
2019110500085	PIRANHAS	05560524	PIRANHAS	05/11/2019 20:43	05/11/2019 20:48	05/11/2019 20:43	05/11/2019 20:48	0,08	2	0,17	CHI
2019110500119	ARUANA	43001	MOZARLANDIA	05/11/2019 17:06	05/11/2019 17:13	05/11/2019 17:06	05/11/2019 17:13	0,12	8	0,93	CHI
2019110500119	ARUANA	43002	MOZARLANDIA	05/11/2019 17:06	05/11/2019 17:13	05/11/2019 17:06	05/11/2019 17:13	0,12	113	13,18	CHI
2019110500119	MOZARLANDIA	43001	MOZARLANDIA	05/11/2019 17:06	05/11/2019 17:13	05/11/2019 17:06	05/11/2019 17:13	0,12	81	9,45	CHI
2019110500119	MOZARLANDIA	43002	MOZARLANDIA	05/11/2019 17:06	05/11/2019 17:13	05/11/2019 17:06	05/11/2019 17:13	0,12	13	1,52	CHI
2019110500119	MOZARLANDIA	03370434	MOZARLANDIA	05/11/2019 17:06	05/11/2019 17:13	05/11/2019 17:06	05/11/2019 17:13	0,12	4	0,47	CHI
2019110500119	NOVA CRIXAS	43001	MOZARLANDIA	05/11/2019 17:06	05/11/2019 17:13	05/11/2019 17:06	05/11/2019 17:13	0,12	1	0,12	CHI

Plotagem das Ocorrências conforme a Especialização das Chuvas

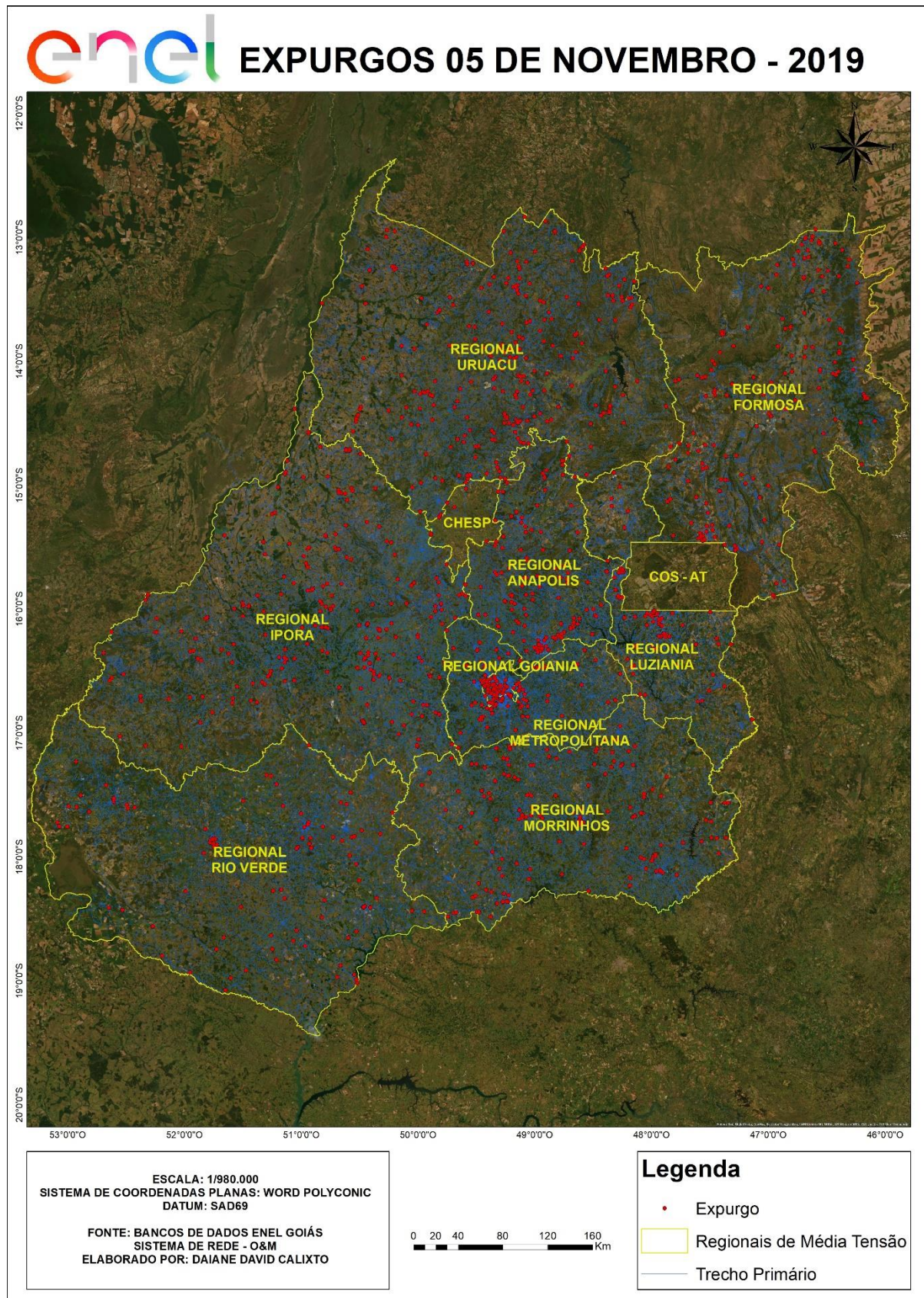

Diagramas Unifilares

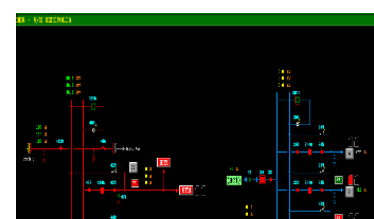
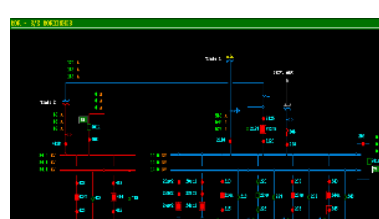
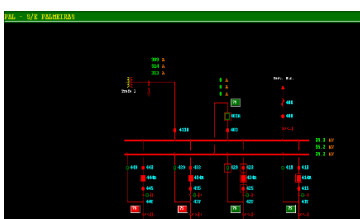
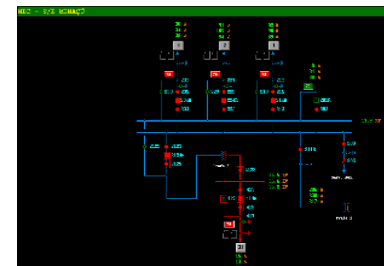
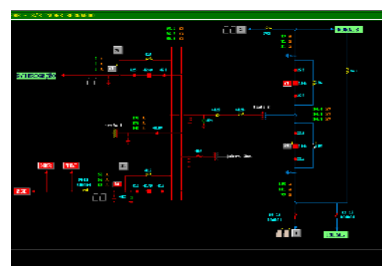
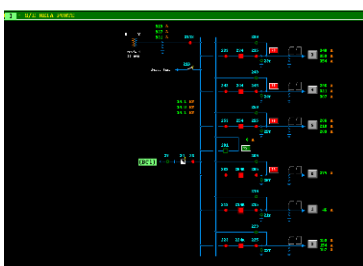
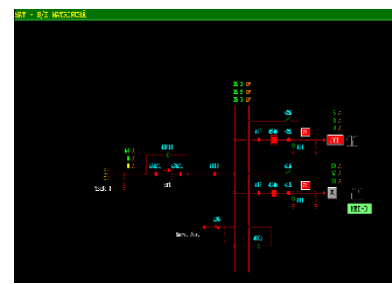
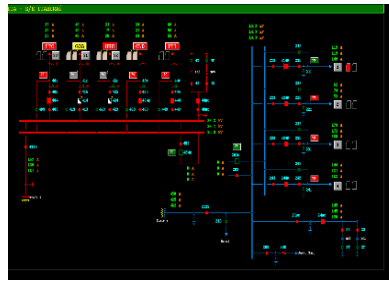
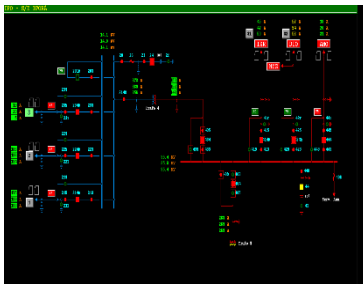
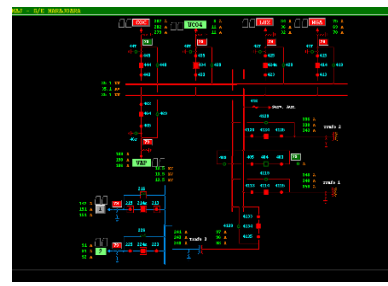
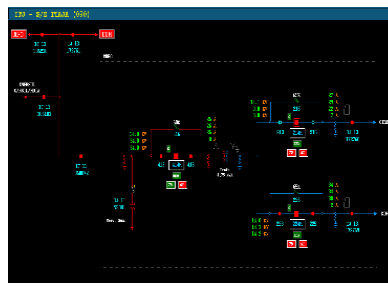
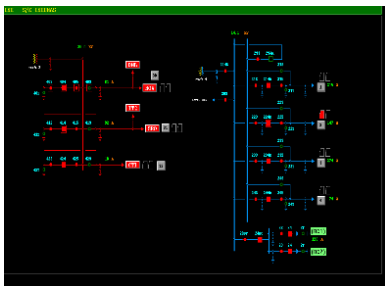
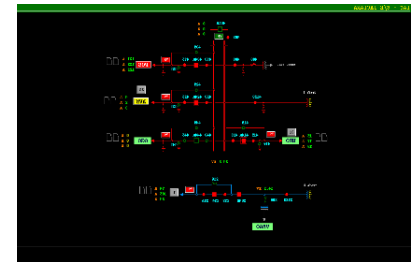
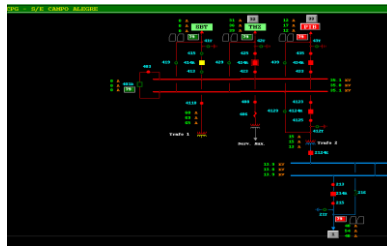
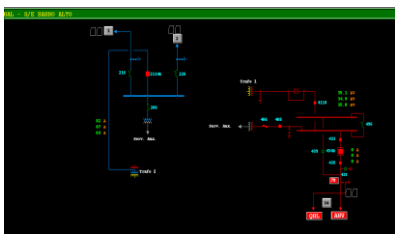
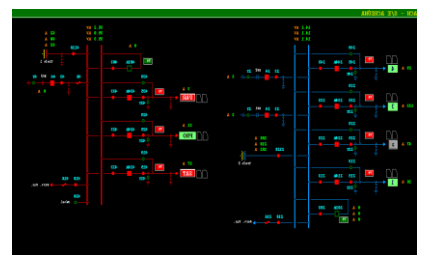
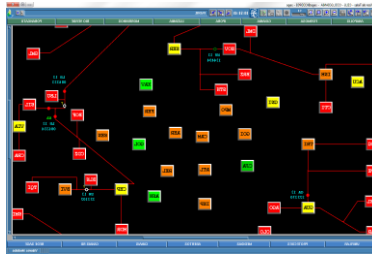
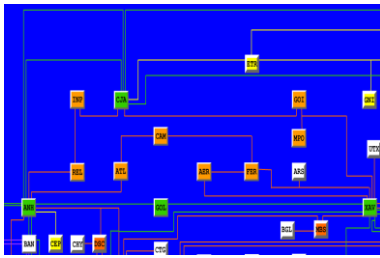

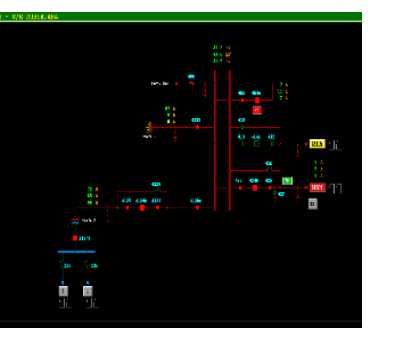
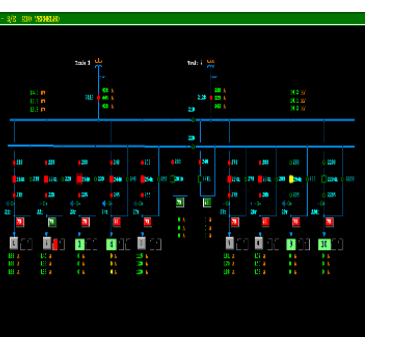
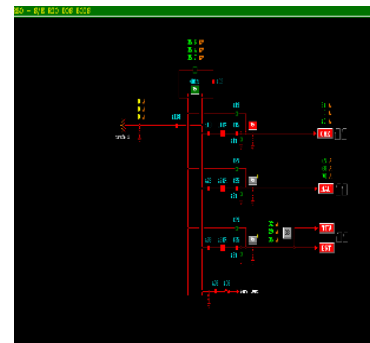
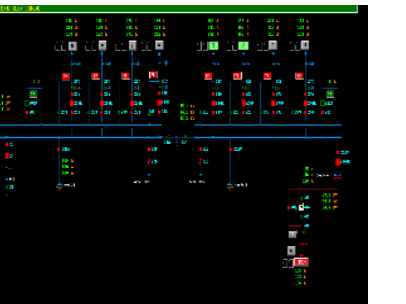
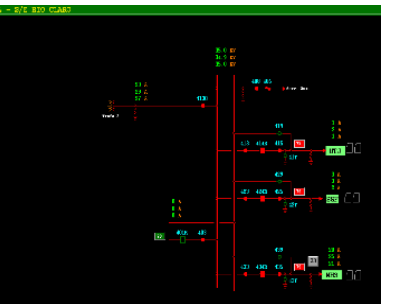
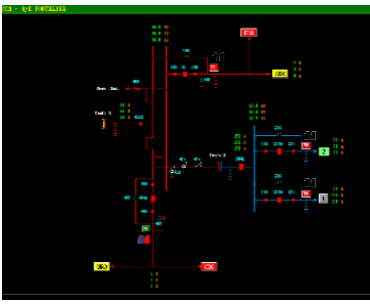
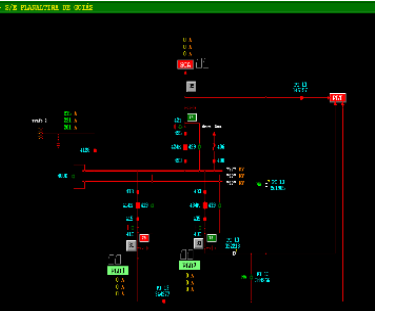
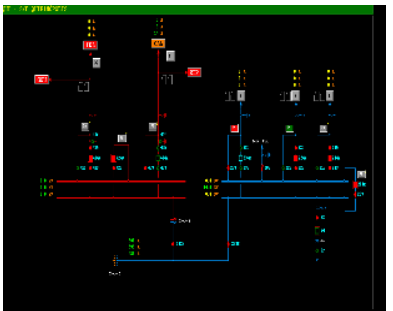
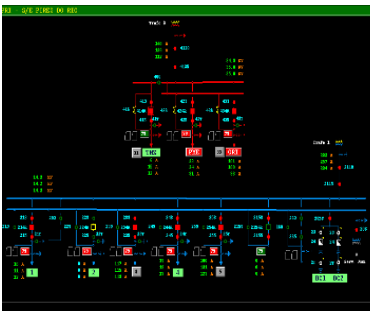
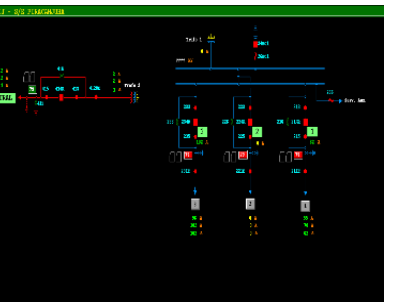
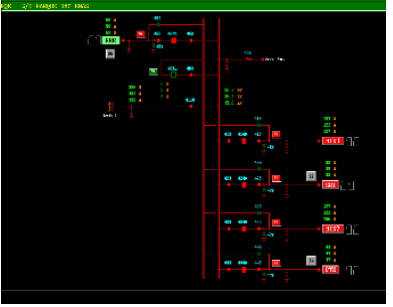
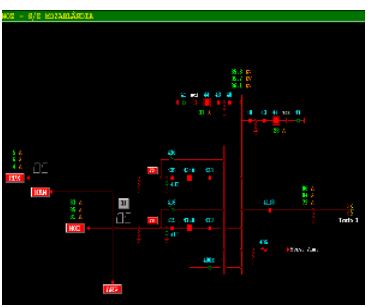
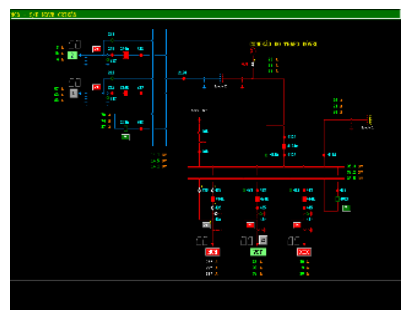

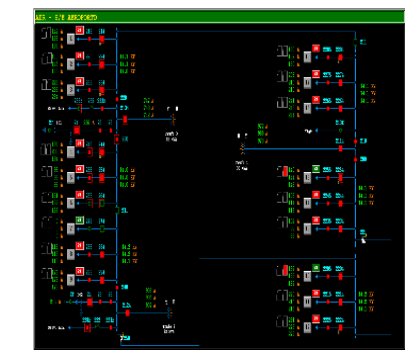
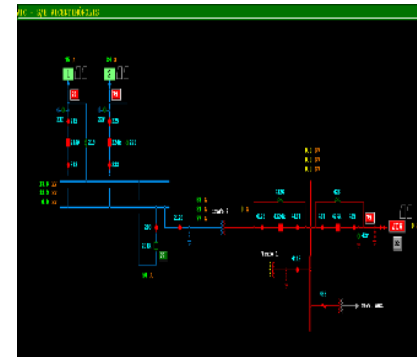
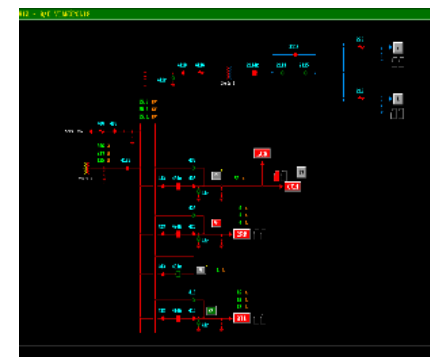
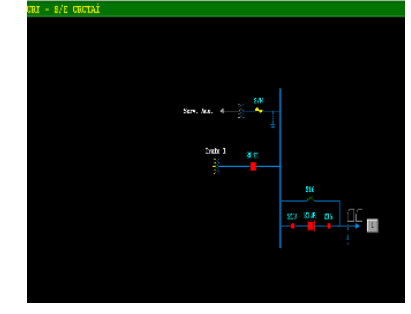
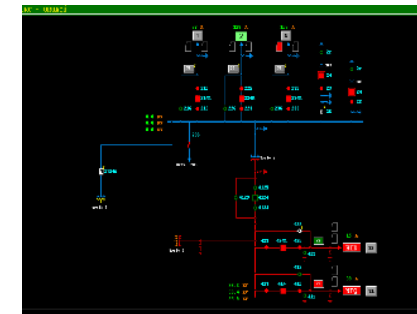
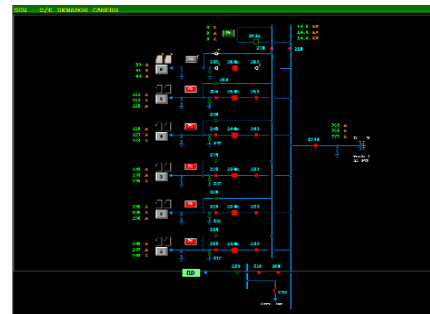
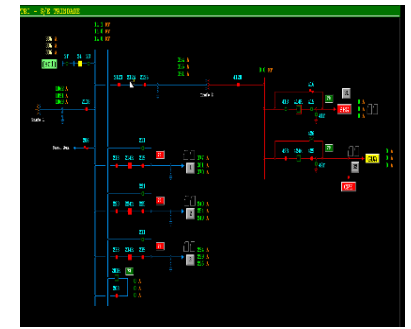
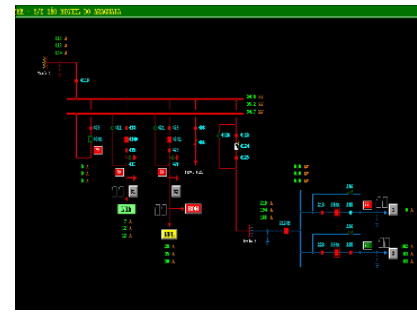
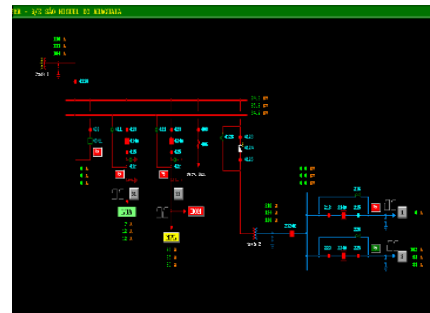
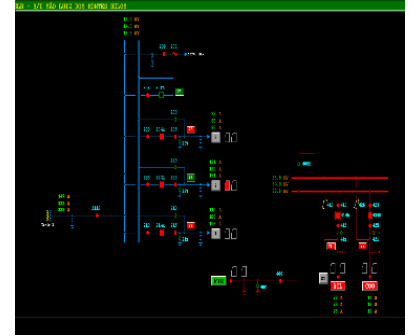
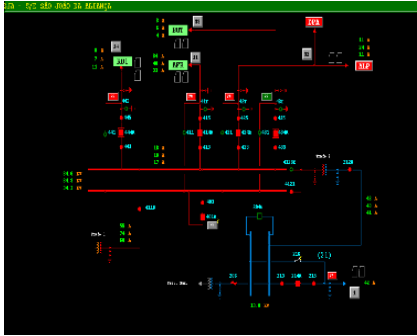
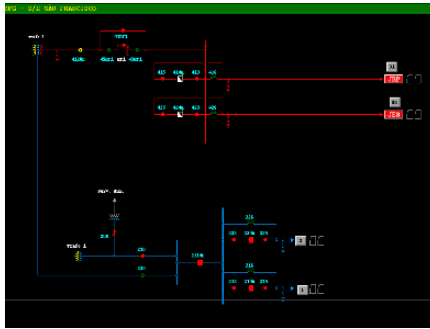
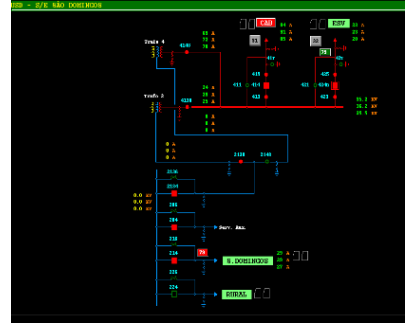
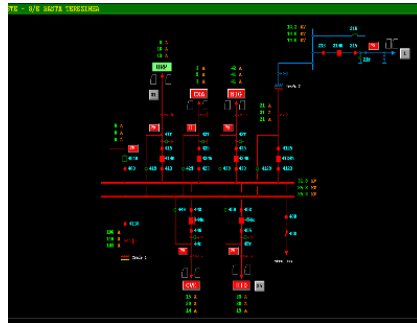
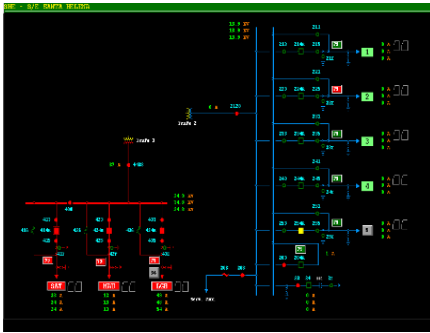

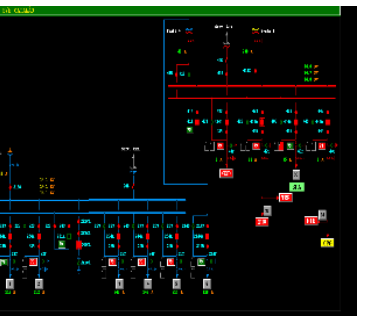
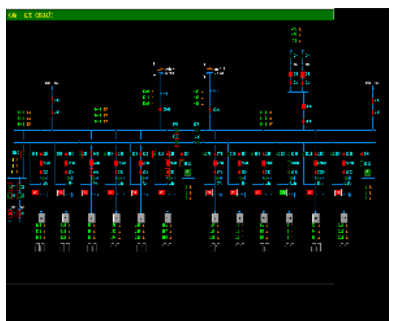
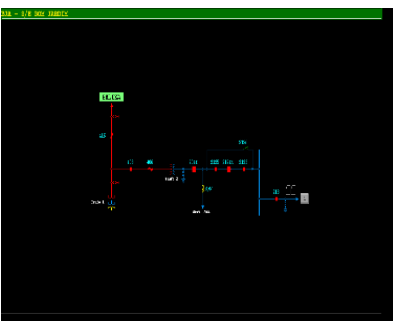
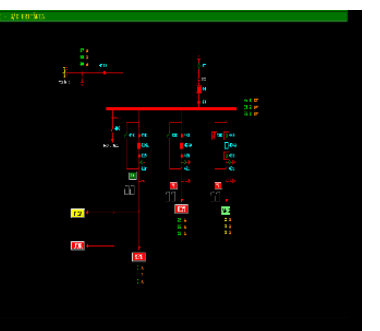
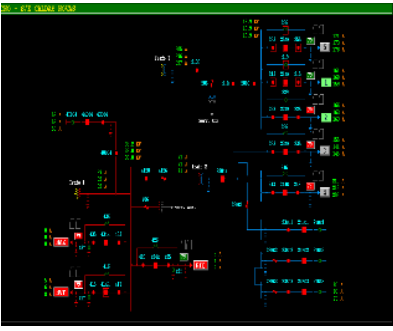
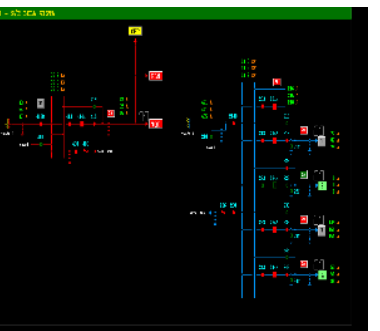
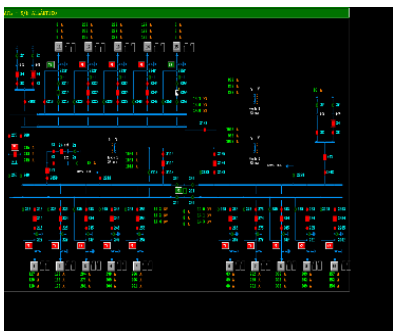
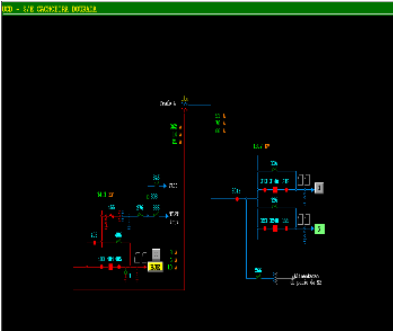
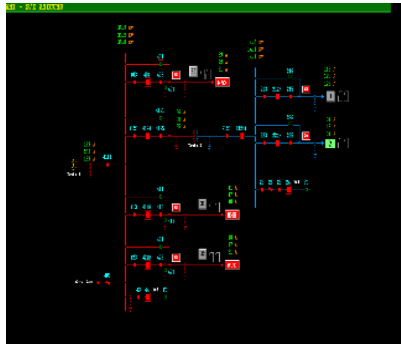
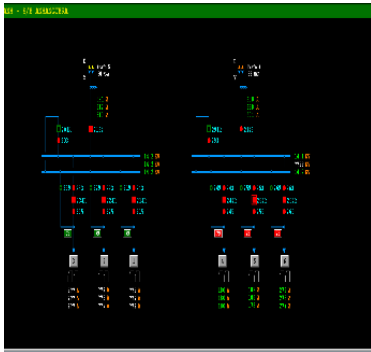
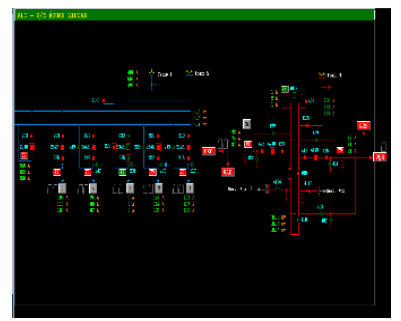
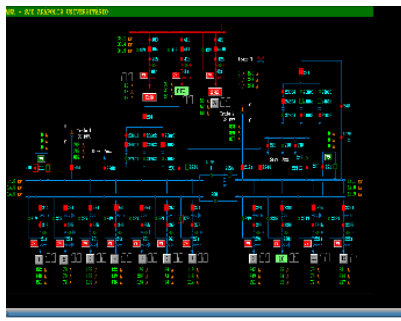
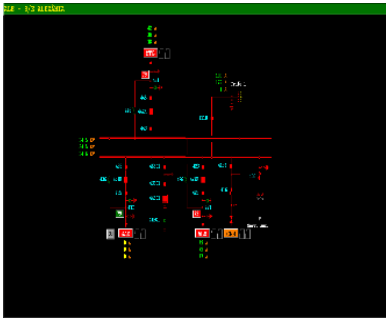

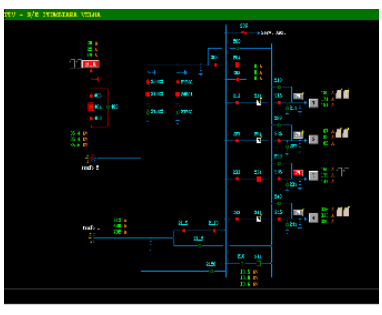
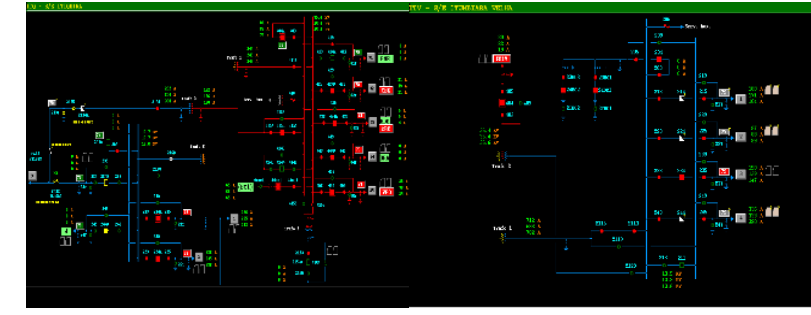
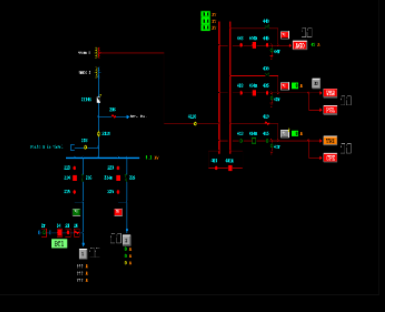
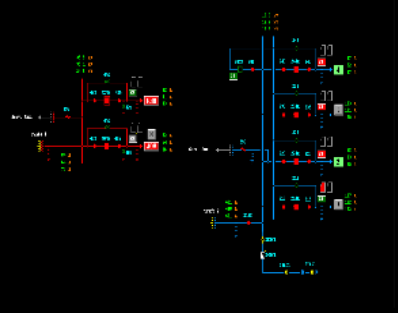
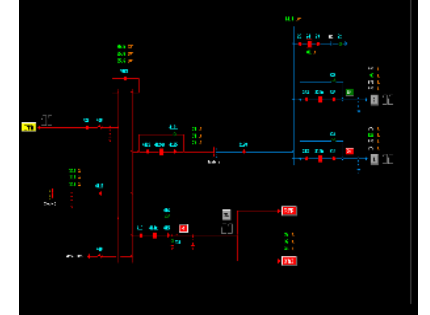
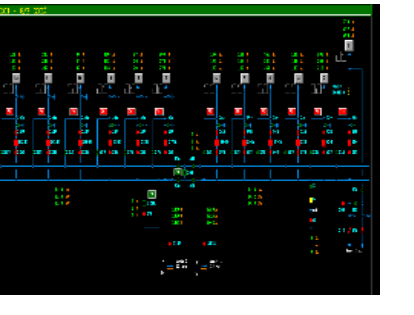
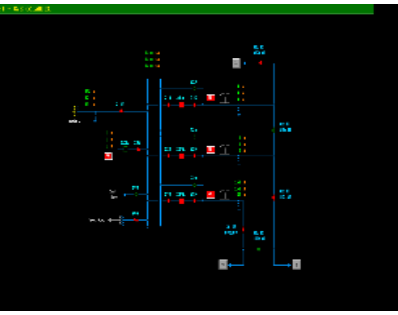
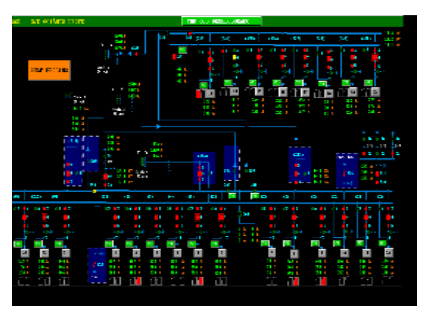
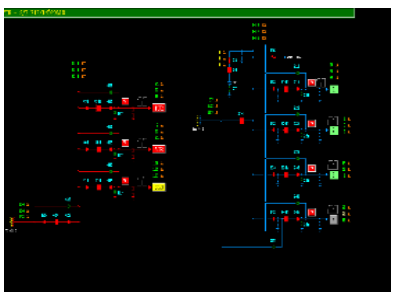
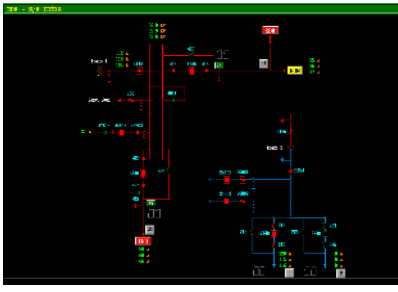
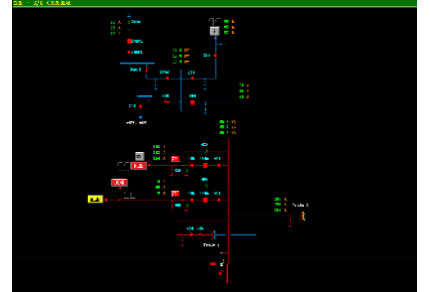
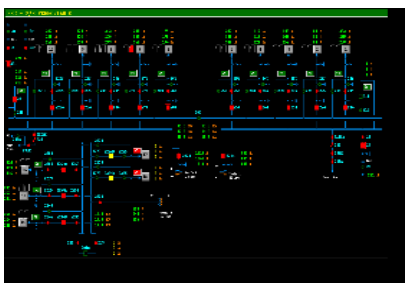
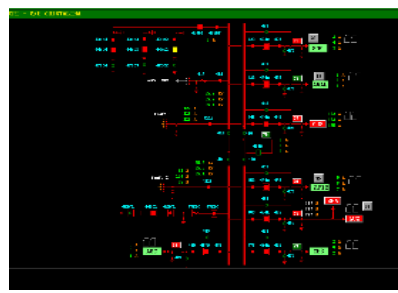
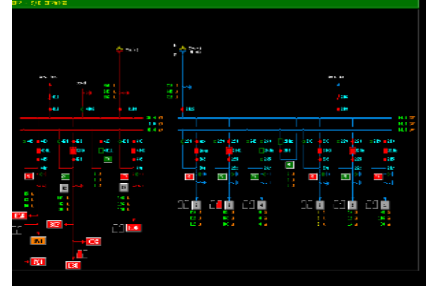
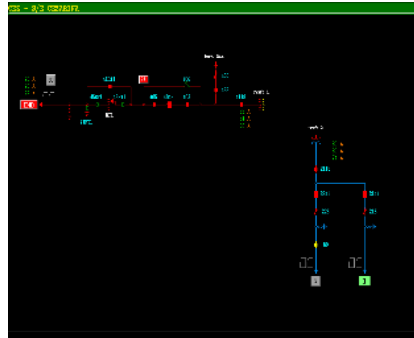
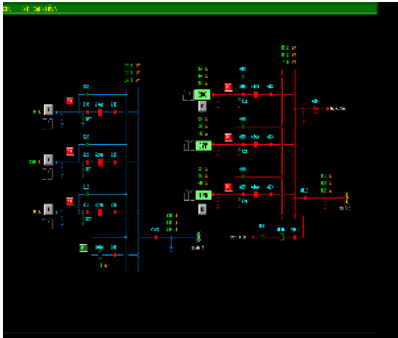
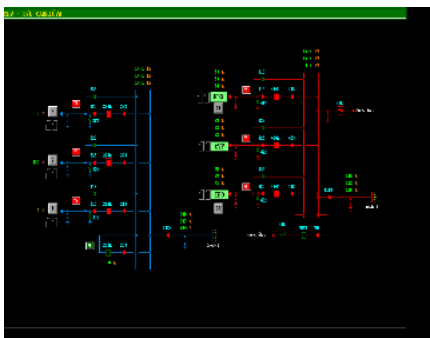

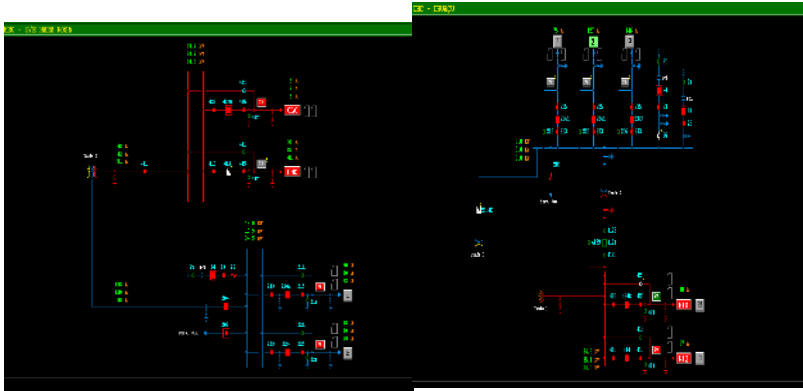
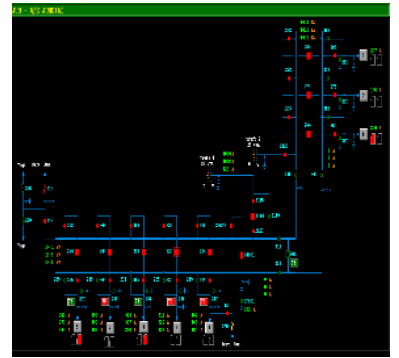
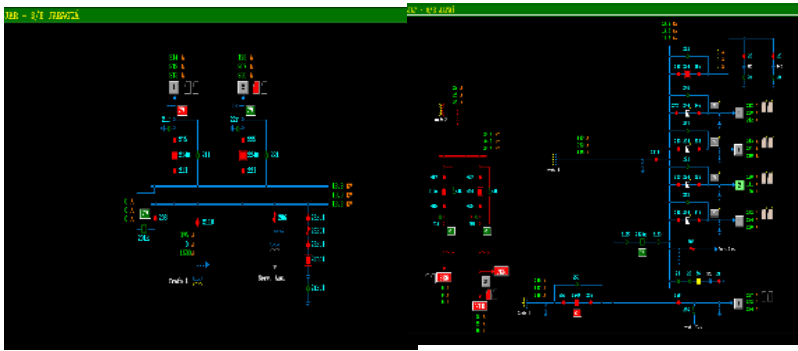

DEMAIS EVIDÊNCIAS

DADOS TÉCNICO - OPERACIONAIS ENEL GO

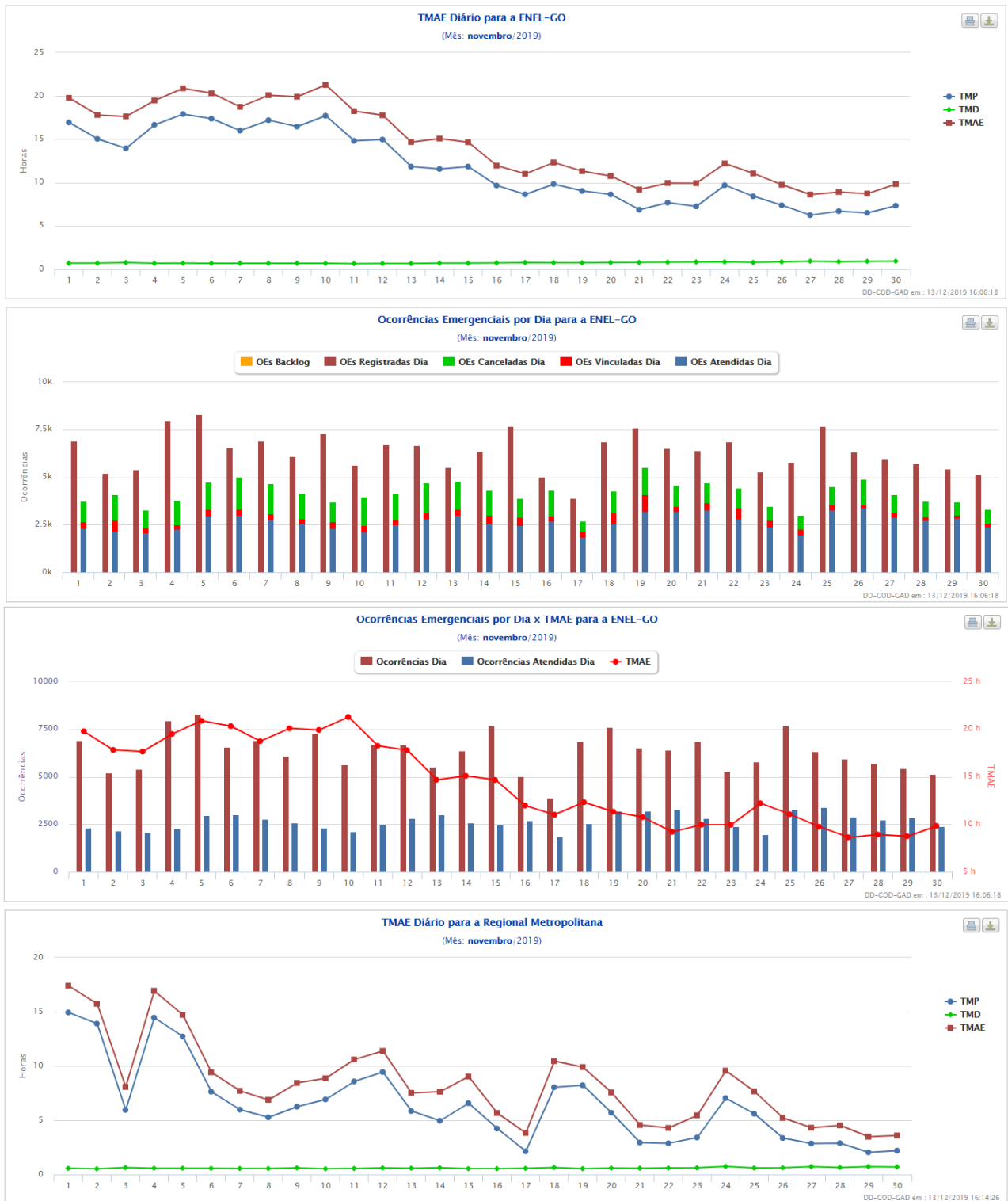

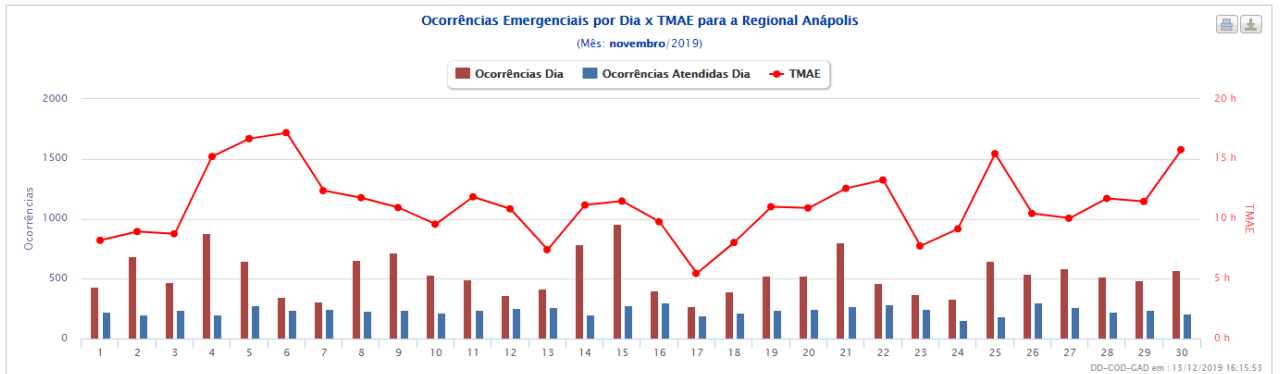
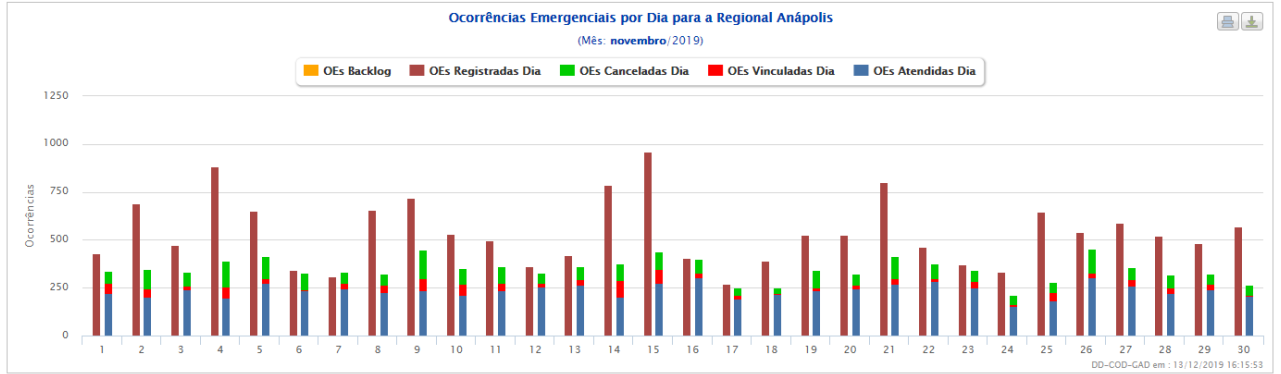
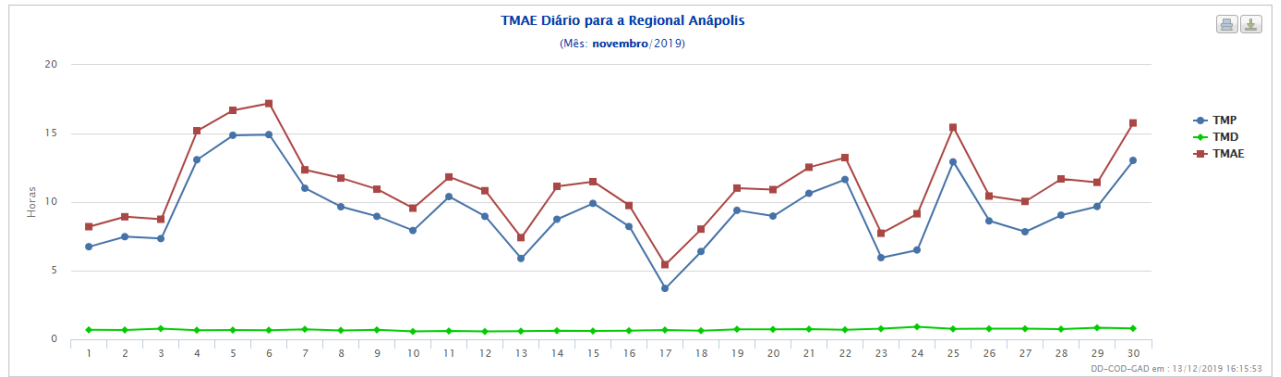
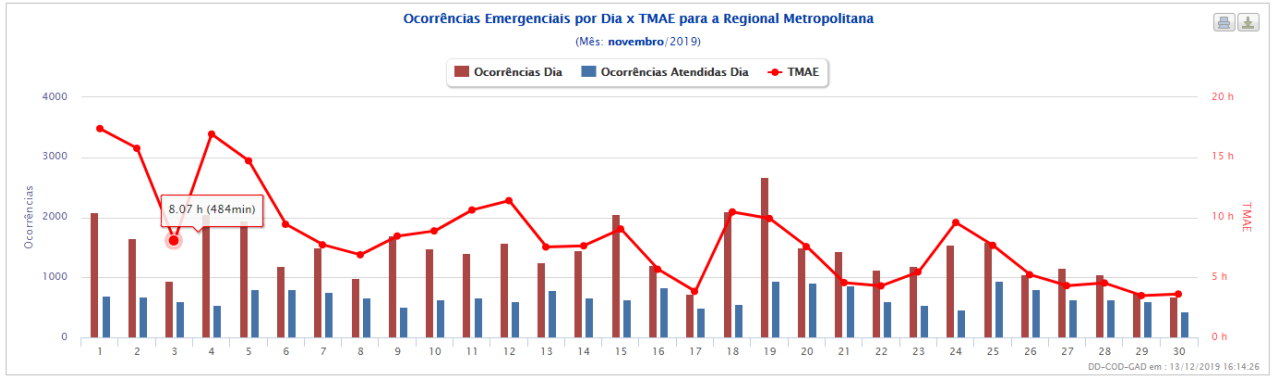
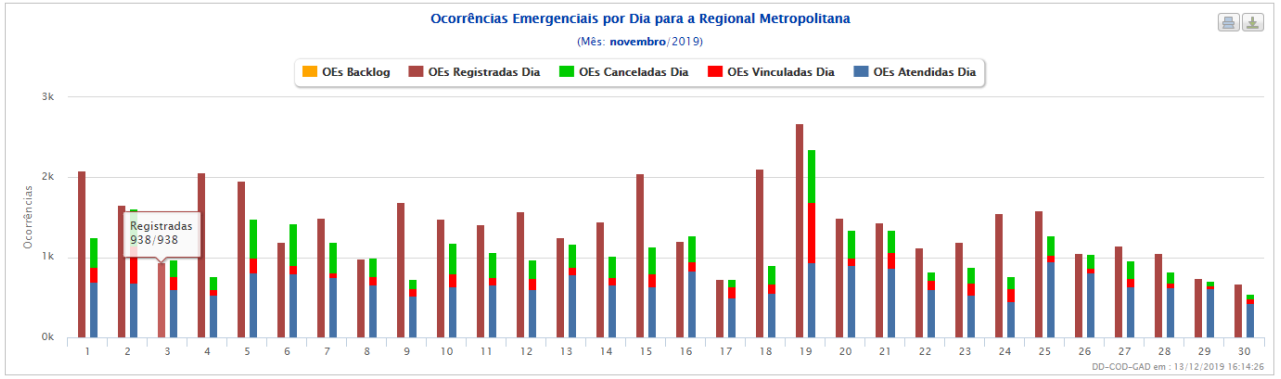

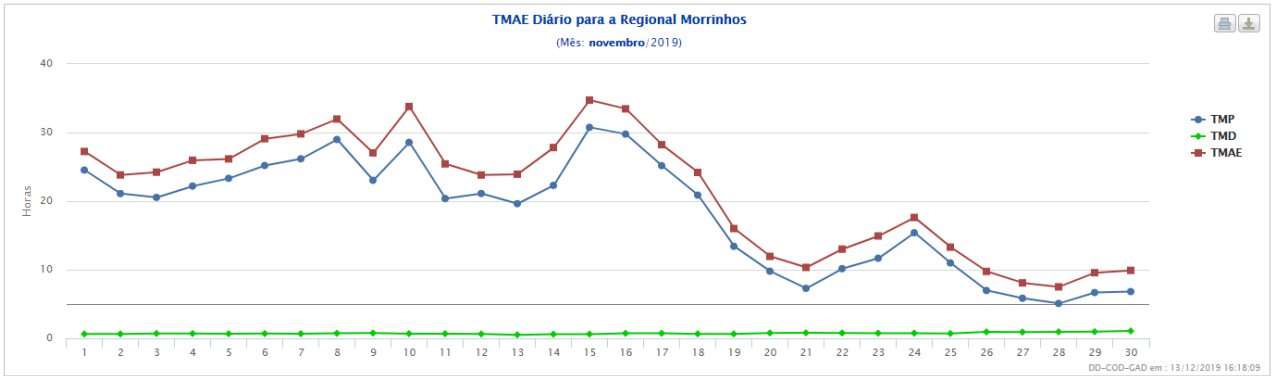
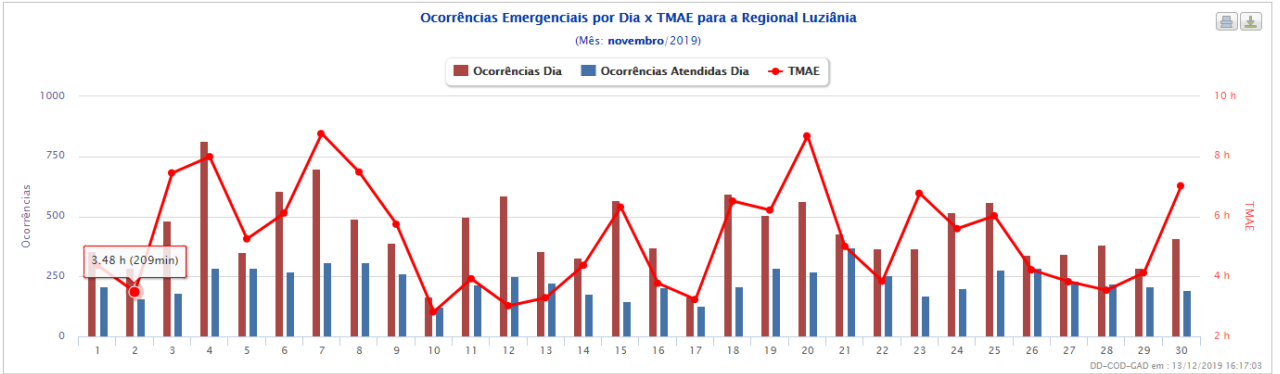
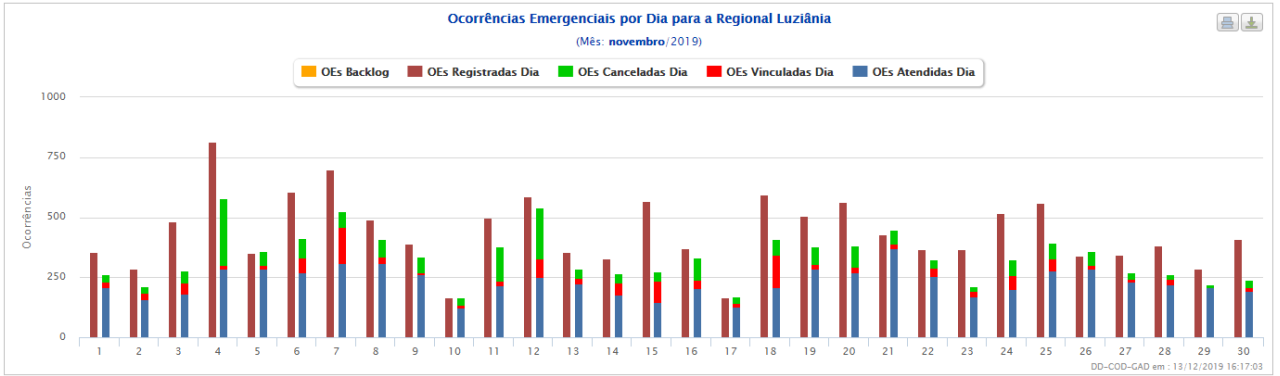
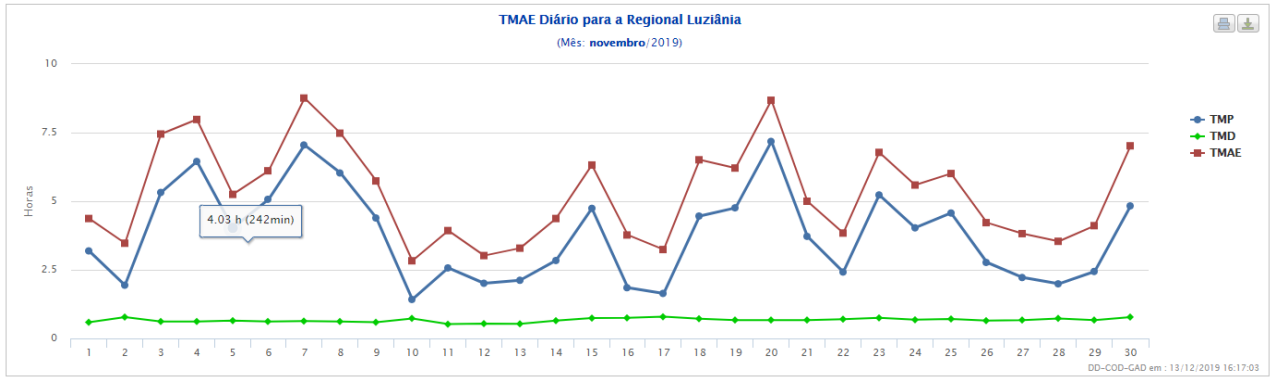

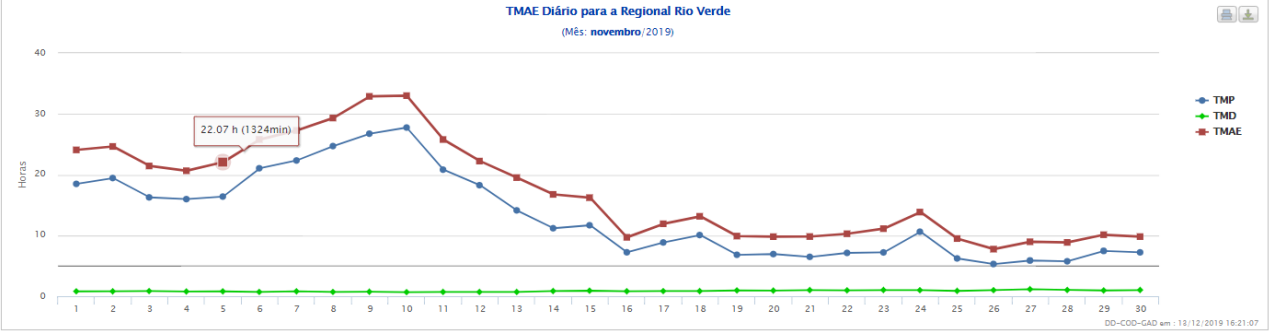
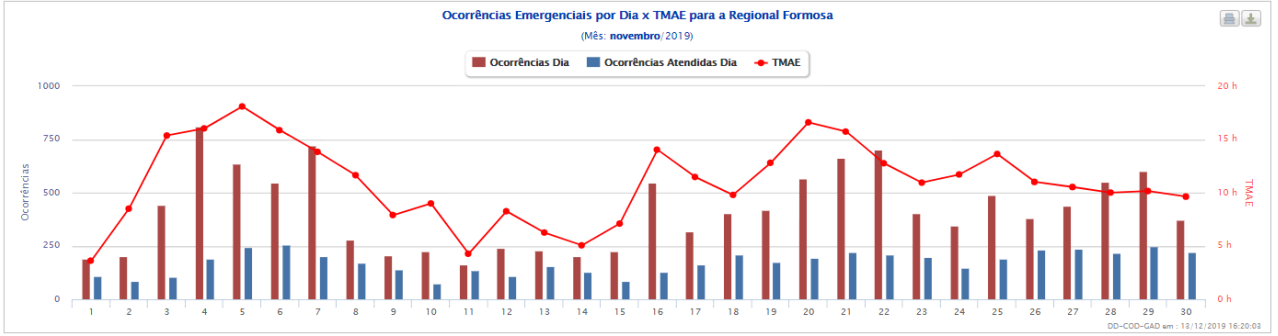
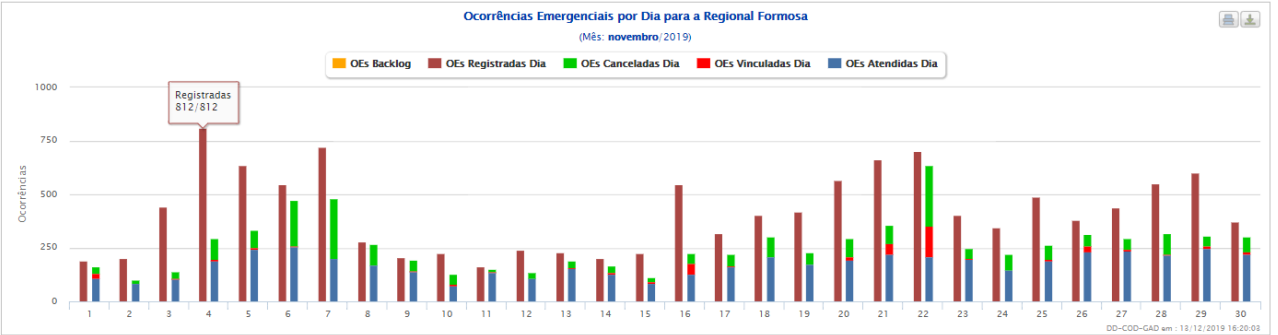
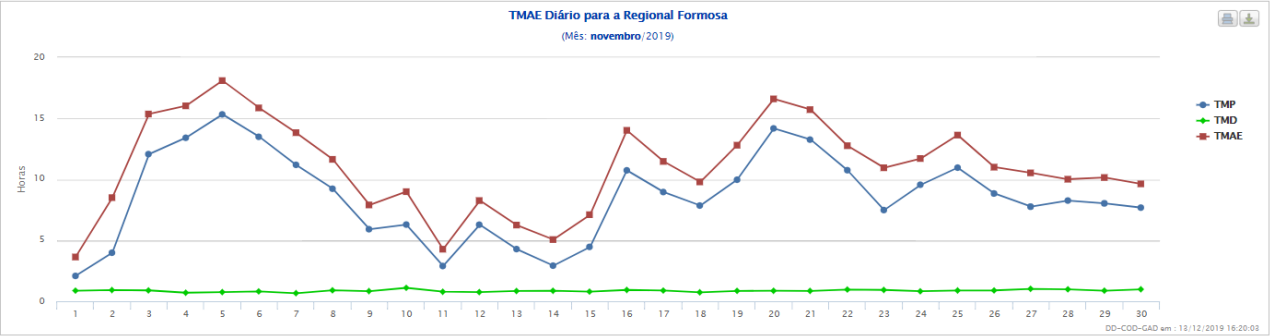
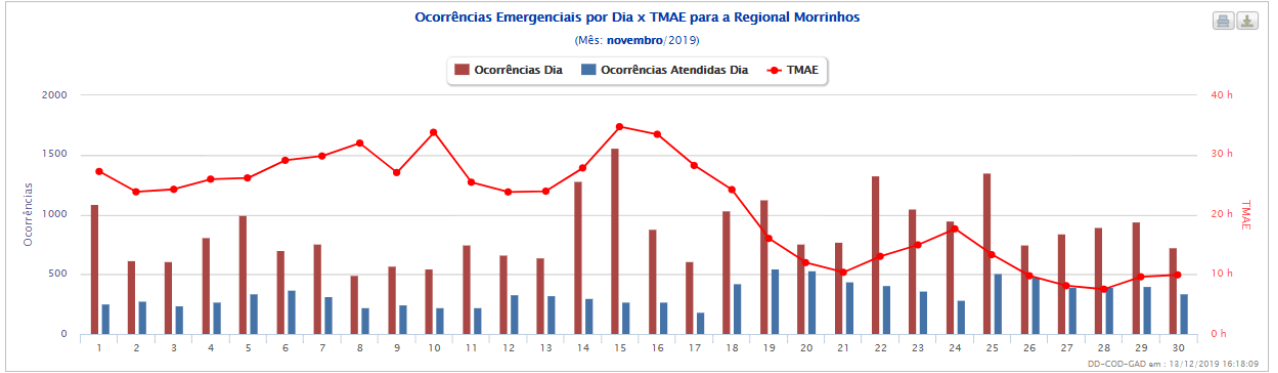

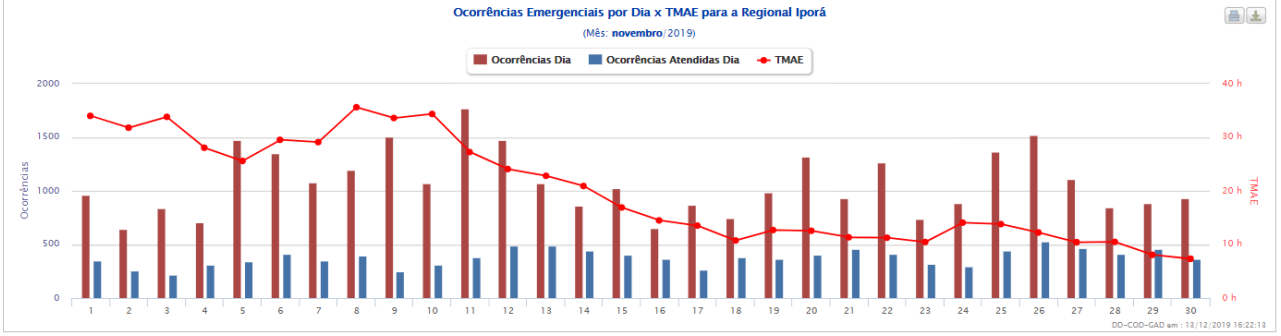
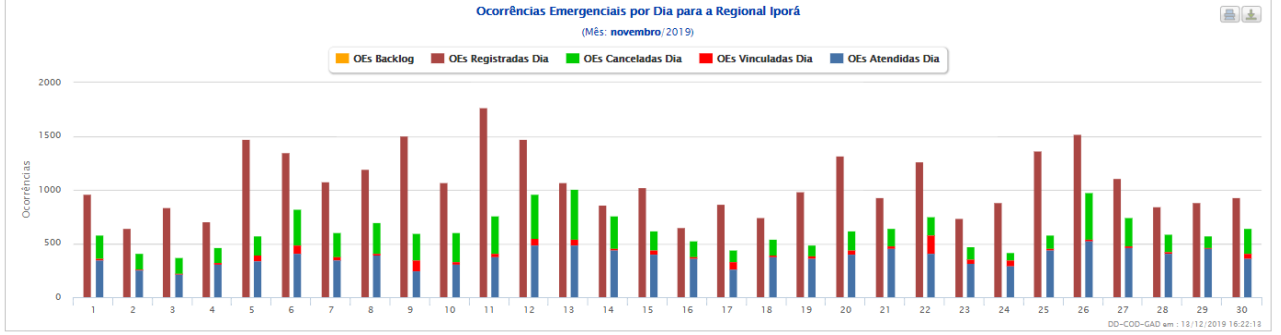
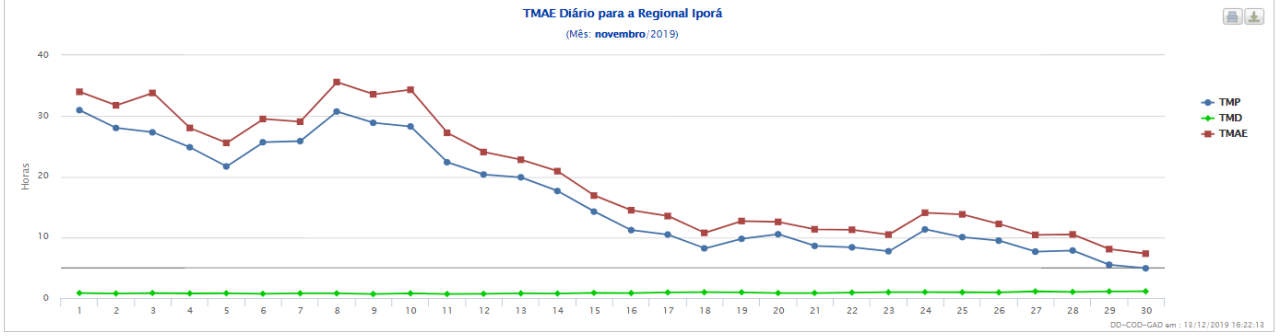
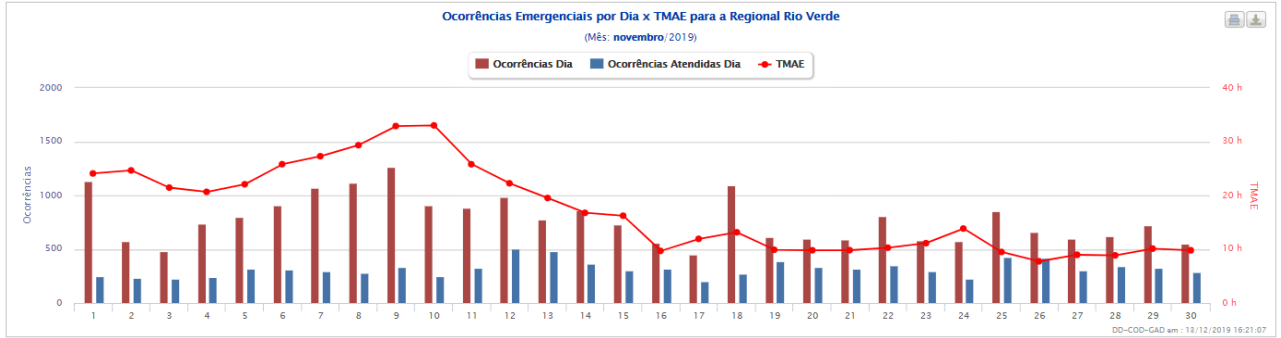
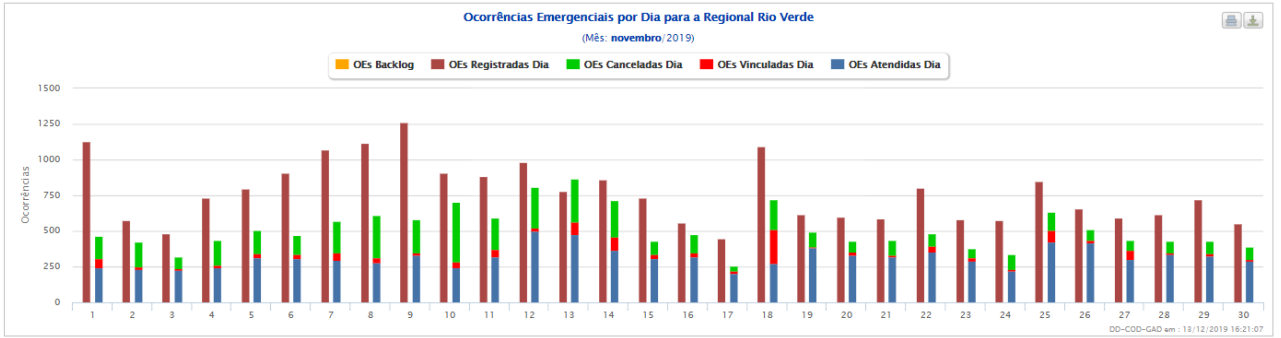

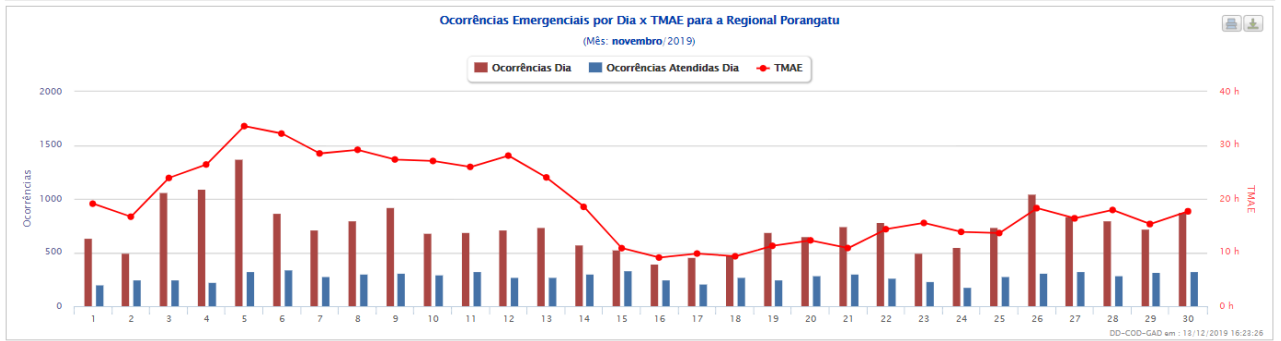
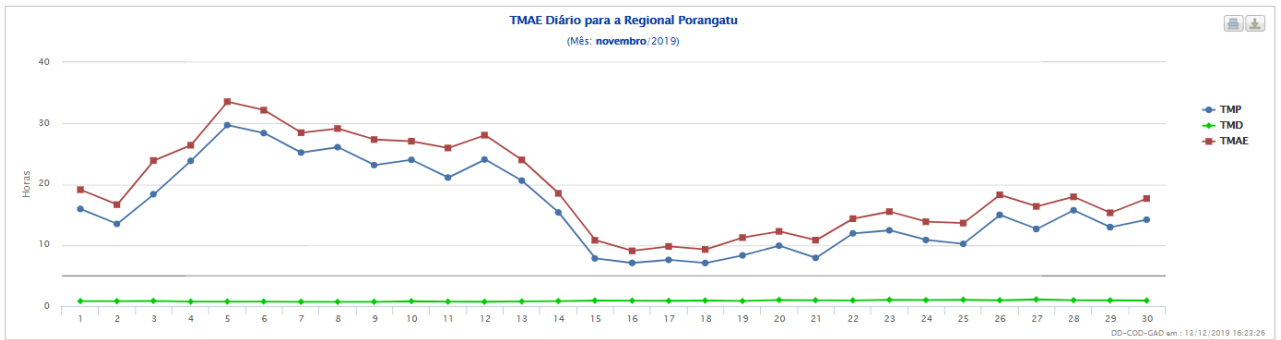

CLIMATEMPO

**Laudo Meteorológico de Evento Climático -
CELG Distribuição S.A. - 05 de novembro de
2019**

São Paulo, SP, Brasil Novembro de 2019

Sumário

1	ANÁLISE DE EVENTO METEOROLÓGICO	2
1.1	Descrição do Evento.....	2
1.2	Abrangência do Evento	4
2	CLASSIFICAÇÃO COBRADE	9
3	RESUMO DO EVENTO	10
4	REFERÊNCIAS.....	16

1 Análise de Evento Meteorológico

1.1 Descrição do Evento

Na figura a seguir é apresentada a área de concessão da CELG Distribuição, dividida em regiões, a serem analisadas neste relatório.



Figura 1 – Regiões de Goiás atendidas pela CELG Distribuição.

O ar quente e úmido sobre a região central do Brasil favoreceu a formação de nuvens de tempestade, do tipo Cumulonimbus, que avançaram sobre o estado de Goiás entre os dias 05 e 06 de novembro de 2019.

Nas Figura 2 são apresentadas as descargas atmosféricas nuvem-solo (raios) e nuvem-nuvem detectadas pelo sistema Earth Networks. Entre as 09h30 do dia 05 e as 08h00 do dia 06 de novembro foram registrados 15896 raios nuvem-solo e 12476 descargas nuvem-nuvem sobre a área da CELG Distribuição em Goiás.

Na tabela 1 são apresentados os valores de rajada de vento iguais ou maiores a 50 km/h registradas nas estações meteorológicas do Instituto Nacional de Meteorologia (INMET) representativas da região de interesse. O maior valor de rajada registrado foi de 71,3 km/h na estação de São Simão entre as 14h e 16h do dia 05 de novembro.

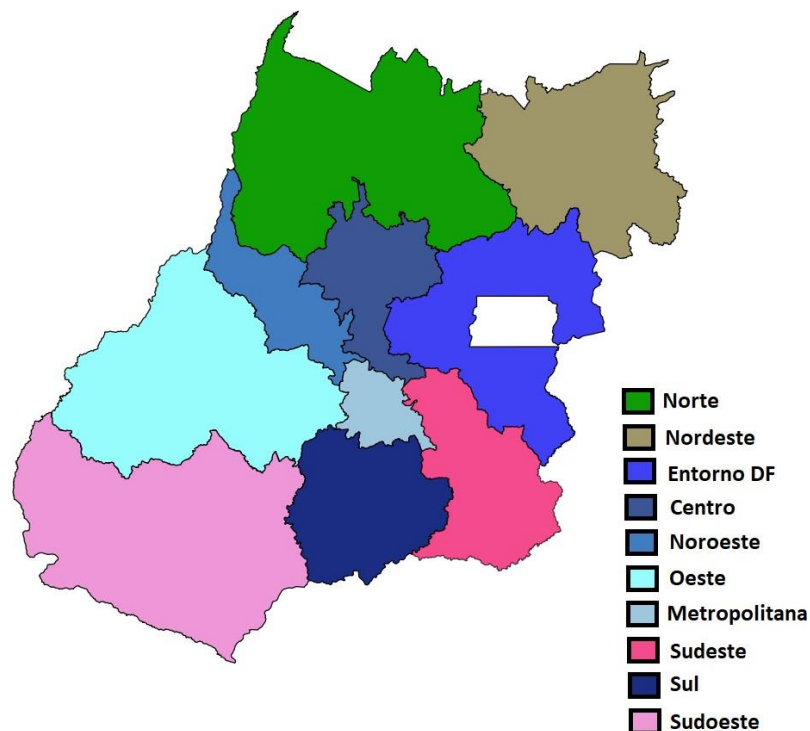
Tabela 1 – Rajadas de vento maiores ou iguais a 50 km/h registradas pelo INMET entre os dias 04 e 05 de novembro de 2019. Segundo a escala Beaufort, ventos entre 50 e 61 km/h são classificados como vento forte e entre 62 e 74 km/h como ventania.

Estação	Horário	Rajada (km/h)
Luziânia	Entre 5h e 6h do dia 6/11/2019	52.2
Rio Verde	Entre 12h e 13h do dia 5/11/2019	53.6
São Simão	Entre 14h e 15h do dia 5/11/2019	71.3
São Simão	Entre 15h e 16h do dia 5/11/2019	71.3



Figura 2 – Descargas atmosféricas nuvem-solo (em preto) e nuvem-nuvem (em vermelho) detectadas pelo sistema Earth Networks entre 09h30 do dia 05 e 08h00 do dia 06 de novembro de 2019 sobre a área de concessão da CELG Distribuição.

1.2 Abrangência do Evento

A seguir são apresentadas as imagens realçadas do satélite GOES-16 entre as 13h00 do dia 05 e 05h00 do dia 06 de novembro de 2019. Os tons em vermelho e preto indicam a presença de nuvens de grande desenvolvimento vertical, geralmente associadas à ocorrência de tempo severo.

Nestas imagens é possível observar o desenvolvimento e o deslocamento das instabilidades sobre o estado de Goiás entre os dias 05 e 06 de novembro.

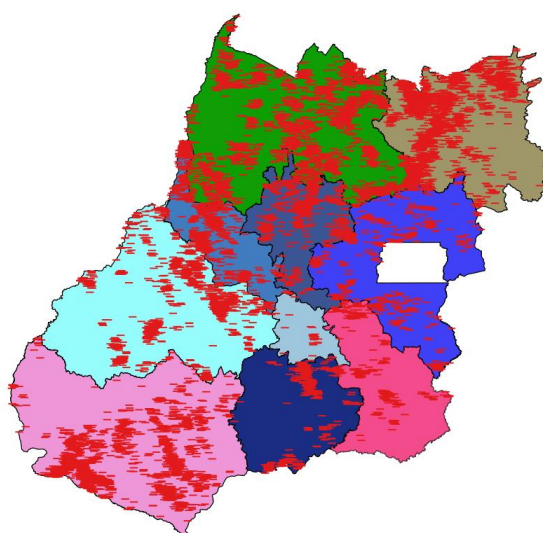
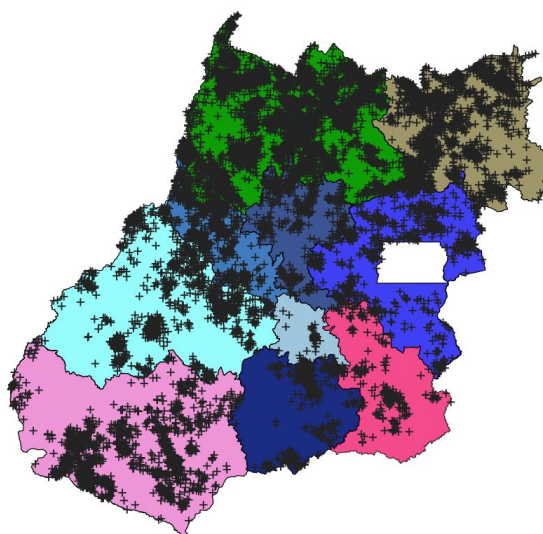
13h00 - 05 de novembro de 2019



Figura 3 –Imagens realçadas do satélite GOES-16 das 13h00 do dia 05 de novembro de 2019. FONTE: Cptec/INPE.

15h00 - 05 de novembro de 2019

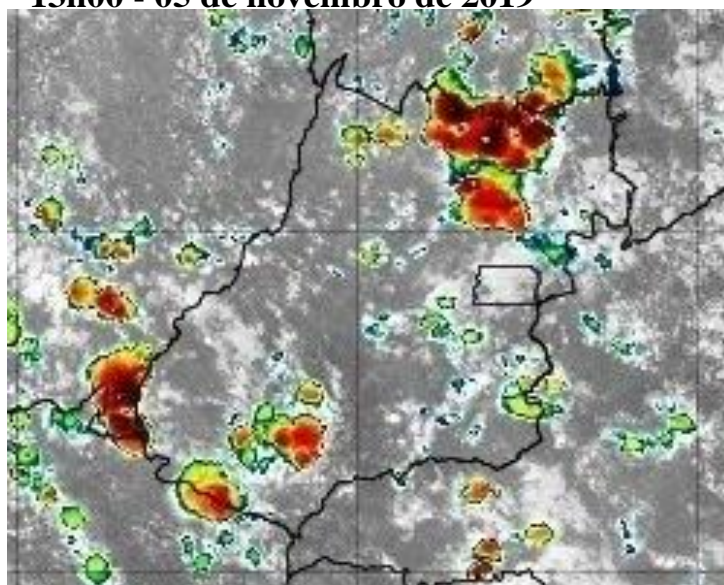

Figura 4 –Imagens realçadas do satélite GOES-16 das 15h00 do dia 05 de novembro de 2019. FONTE: Cptec/INPE.

17h00 - 05 de novembro de 2019

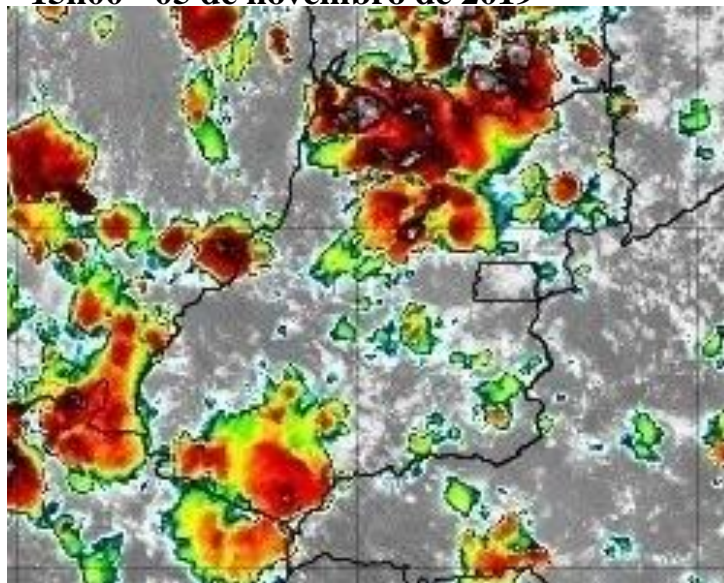

Figura 5 –Imagens realçadas do satélite GOES-16 das 17h00 do dia 05 de novembro de 2019. FONTE: Cptec/INPE.

19h00 - 05 de novembro de 2019

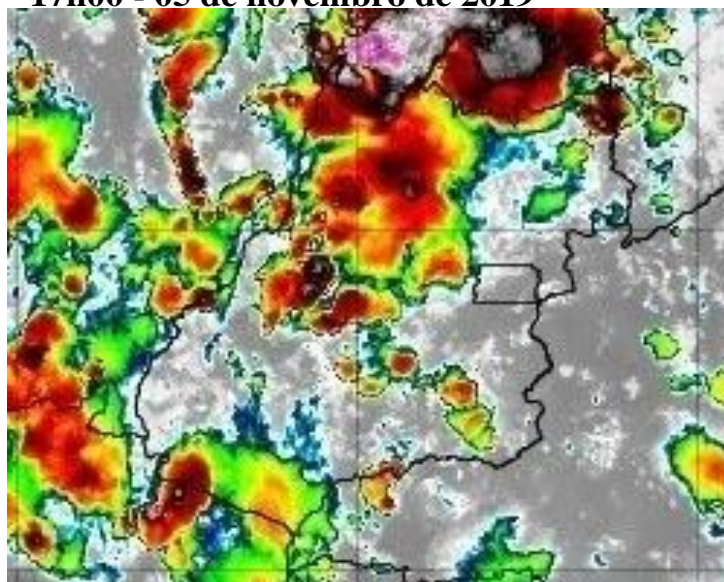

Figura 6 –Imagens realçadas do satélite GOES-16 das 19h00 do dia 05 de novembro de 2019. FONTE: Cptec/INPE.

21h00 - 05 de novembro de 2019

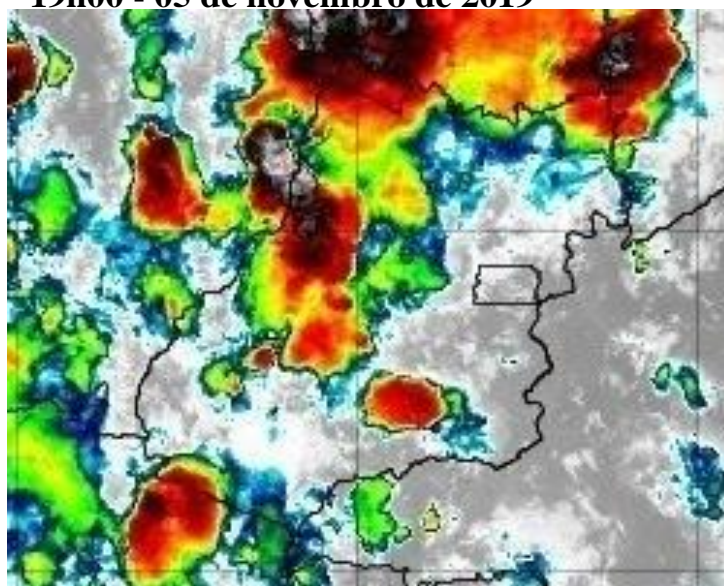

Figura 7 –Imagens realçadas do satélite GOES-16 das 21h00 do dia 05 de novembro de 2019. FONTE: Cptec/INPE.

23h00 - 05 de novembro de 2019

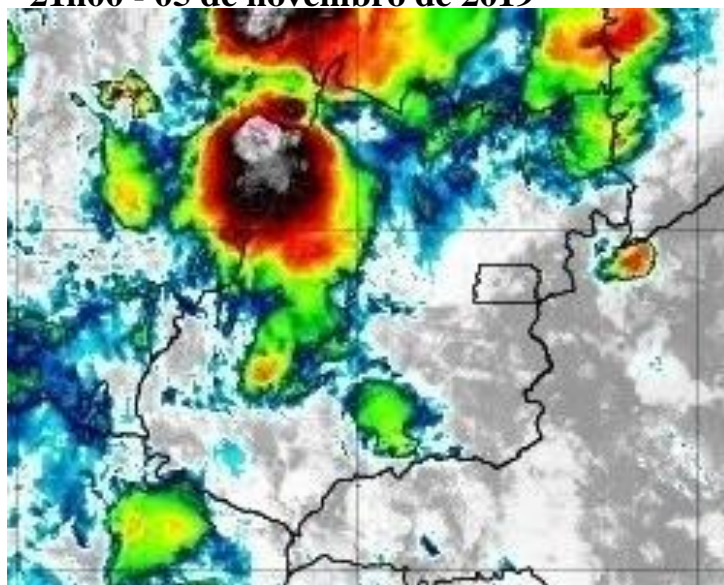

Figura 8 –Imagens realçadas do satélite GOES-16 das 23h00 do dia 05 de novembro de 2019. FONTE: Cptec/INPE.

01h00 - 06 de novembro de 2019

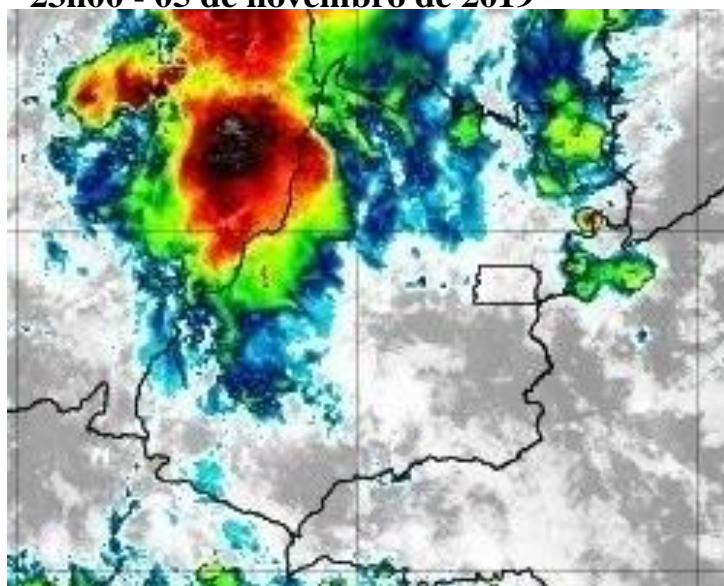

Figura 9 –Imagens realçadas do satélite GOES-16 das 01h00 do dia 06 de novembro de 2019. FONTE: Cptec/INPE.

03h00 - 06 de novembro de 2019

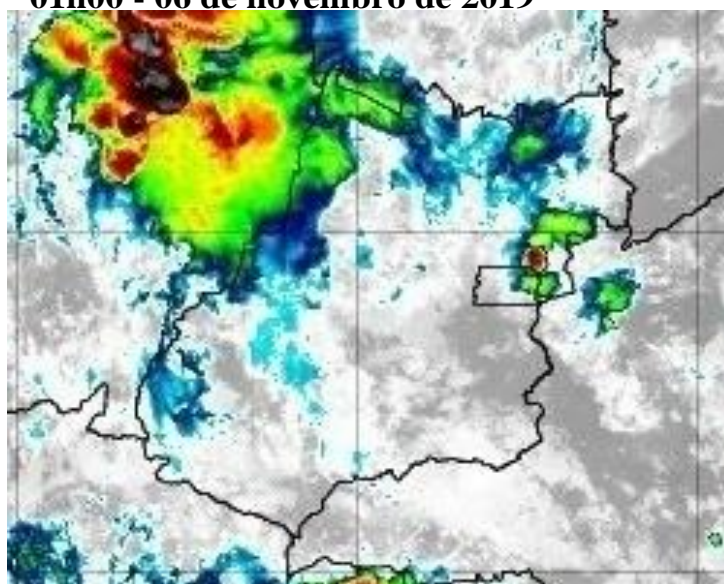

Figura 10 –Imagens realçadas do satélite GOES-16 das 03h00 do dia 06 de novembro de 2019. FONTE: Cptec/INPE.

05h00 - 06 de novembro de 2019

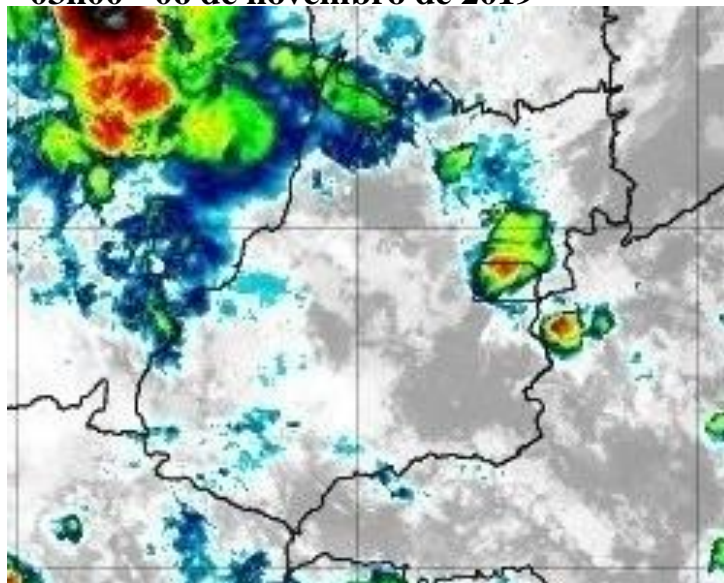

Figura 11 –Imagens realçadas do satélite GOES-16 das 05h00 do dia 06 de novembro de 2019. FONTE: Cptec/INPE.

2 Classificação COBRADE

O COBRADE (Classificação e Codificação Brasileira de Desastres) foi criado com o intuito de adequar a classificação brasileira à classificação utilizada pela ONU na classificação de desastres e nivelar o país aos demais organismos de gestão de desastres do mundo.

Baseados nos dados analisados nos itens anteriores, podemos classificar o evento ocorrido na CELG Distribuição como Tempestades - Vendaval (Código 1.3.2.1.5), Tempestade de raios Código (1.3.2.1.2) e Chuvas intensas (Código 1.3.2.1.4).

3 Resumo do Evento

Entre os dias 05 e 06 de novembro de 2019 áreas de instabilidade associadas ao ar quente e úmido sobre a região favoreceram a formação de nuvens de tempestade que avançaram sobre o estado de Goiás, provocando chuva, raios e rajadas de ventos sobre a área de concessão da CELG Distribuição.

Vento forte e ventania foram registrados por estações do INMET representativas da região de interesse. Na estação de São Simão as rajadas chegaram a até 71,3 km/h entre 14h e 16h do dia 05 de novembro.

O sistema de detecção EarthNetworks registrou 28372 descargas atmosféricas sobre a área de concessão da CELG Distribuição Goiás entre as 09h30 do dia 05 e 08h00 do dia 06 de novembro.

Tabela 2 – Resumo do evento Região Sudoeste

Número/Código do Evento	
Número/Código do Relatório	
Descrição	Forte deslocamento de uma massa de ar em uma região. Tempestade com intensa atividade elétrica no interior das nuvens, com grande desenvolvimento vertical. Chuvas com acumulados significativos.
Código COBRADE	1.3.2.1.5 - Tempestades, Vendaval e 1.3.2.1.2 - Tempestade de raios e 1.3.2.1.4 - Chuvas intensas
Hora início do evento	11h00 do dia 05 de novembro de 2019
Hora de fim do evento	17h30 do dia 05 de novembro de 2019
Abrangência	Região Sudoeste da CELG Distribuição S.A.

Tabela 3 – Resumo do evento Região Sul

Número/Código do Evento	
Número/Código do Relatório	
Descrição	Forte deslocamento de uma massa de ar em uma região. Tempestade com intensa atividade elétrica no interior das nuvens, com grande desenvolvimento vertical. Chuvas com acumulados significativos.
Código COBRADE	1.3.2.1.5 - Tempestades, Vendaval e 1.3.2.1.2 - Tempestade de raios e 1.3.2.1.4 - Chuvas intensas
Hora início do evento	11h30 do dia 05 de novembro de 2019
Hora de fim do evento	21h30 do dia 05 de novembro de 2019
Abrangência	Região Sul da CELG Distribuição S.A.

Tabela 4 – Resumo do evento Região Sudeste

Número/Código do Evento	
Número/Código do Relatório	
Descrição	Forte deslocamento de uma massa de ar em uma região. Tempestade com intensa atividade elétrica no interior das nuvens, com grande desenvolvimento vertical. Chuvas com acumulados significativos.
Código COBRADE	1.3.2.1.5 - Tempestades, Vendaval e 1.3.2.1.2 - Tempestade de raios e 1.3.2.1.4 - Chuvas intensas
Hora início do evento	11h00 do dia 05 de novembro de 2019
Hora de fim do evento	08h00 do dia 06 de novembro de 2019
Abrangência	Região Sudeste da CELG Distribuição S.A.

Tabela 5 – Resumo do evento Região Metropolitana

Número/Código do Evento	
Número/Código do Relatório	
Descrição	Forte deslocamento de uma massa de ar em uma região. Tempestade com intensa atividade elétrica no interior das nuvens, com grande desenvolvimento vertical. Chuvas com acumulados significativos.
Código COBRADE	1.3.2.1.5 - Tempestades, Vendaval e 1.3.2.1.2 - Tempestade de raios e 1.3.2.1.4 - Chuvas intensas
Hora início do evento	12h30 do dia 05 de novembro de 2019
Hora de fim do evento	18h10 do dia 05 de novembro de 2019
Abrangência	Região Metropolitana da CELG Distribuição S.A.

Tabela 6 – Resumo do evento Região Oeste

Número/Código do Evento	
Número/Código do Relatório	
Descrição	Forte deslocamento de uma massa de ar em uma região. Tempestade com intensa atividade elétrica no interior das nuvens, com grande desenvolvimento vertical. Chuvas com acumulados significativos.
Código COBRADE	1.3.2.1.5 - Tempestades, Vendaval e 1.3.2.1.2 - Tempestade de raios e 1.3.2.1.4 - Chuvas intensas
Hora início do evento	11h40 do dia 05 de novembro de 2019
Hora de fim do evento	00h00 do dia 06 de novembro de 2019
Abrangência	Região Oeste da CELG Distribuição S.A.

Tabela 7 – Resumo do evento Região Entorno DF

Número/Código do Evento	
Número/Código do Relatório	
Descrição	Forte deslocamento de uma massa de ar em uma região. Tempestade com intensa atividade elétrica no interior das nuvens, com grande desenvolvimento vertical. Chuvas com acumulados significativos.
Código COBRADE	1.3.2.1.5 - Tempestades, Vendaval e 1.3.2.1.2 - Tempestade de raios e 1.3.2.1.4 - Chuvas intensas
Hora início do evento	11h00 do dia 05 de novembro de 2019
Hora de fim do evento	07h05 do dia 06 de novembro de 2019
Abrangência	Região Entorno DF da CELG Distribuição S.A.

Tabela 8 – Resumo do evento Região Centro

Número/Código do Evento	
Número/Código do Relatório	
Descrição	Forte deslocamento de uma massa de ar em uma região. Tempestade com intensa atividade elétrica no interior das nuvens, com grande desenvolvimento vertical. Chuvas com acumulados significativos.
Código COBRADE	1.3.2.1.5 - Tempestades, Vendaval e 1.3.2.1.2 - Tempestade de raios e 1.3.2.1.4 - Chuvas intensas
Hora início do evento	12h20 do dia 05 de novembro de 2019
Hora de fim do evento	05h20 do dia 06 de novembro de 2019
Abrangência	Região Centro da CELG Distribuição S.A.

Tabela 9 – Resumo do evento Região Noroeste

Número/Código do Evento	
Número/Código do Relatório	
Descrição	Forte deslocamento de uma massa de ar em uma região. Tempestade com intensa atividade elétrica no interior das nuvens, com grande desenvolvimento vertical. Chuvas com acumulados significativos.
Código COBRADE	1.3.2.1.5 - Tempestades, Vendaval e 1.3.2.1.2 - Tempestade de raios e 1.3.2.1.4 - Chuvas intensas
Hora início do evento	12h40 do dia 05 de novembro de 2019
Hora de fim do evento	23h00 do dia 05 de novembro de 2019
Abrangência	Região Noroeste da CELG Distribuição S.A.

Tabela 10 – Resumo do evento Região Nordeste

Número/Código do Evento	
Número/Código do Relatório	
Descrição	Forte deslocamento de uma massa de ar em uma região. Tempestade com intensa atividade elétrica no interior das nuvens, com grande desenvolvimento vertical. Chuvas com acumulados significativos.
Código COBRADE	1.3.2.1.5 - Tempestades, Vendaval e 1.3.2.1.2 - Tempestade de raios e 1.3.2.1.4 - Chuvas intensas
Hora início do evento	09h30 do dia 05 de novembro de 2019
Hora de fim do evento	02h00 do dia 06 de novembro de 2019
Abrangência	Região Nordeste da CELG Distribuição S.A.

Tabela 11 – Resumo do evento Região Norte

Número/Código do Evento	
Número/Código do Relatório	
Descrição	Forte deslocamento de uma massa de ar em uma região. Tempestade com intensa atividade elétrica no interior das nuvens, com grande desenvolvimento vertical. Chuvas com acumulados significativos.
Código COBRADE	1.3.2.1.5 - Tempestades, Vendaval e 1.3.2.1.2 - Tempestade de raios e 1.3.2.1.4 - Chuvas intensas
Hora início do evento	10h30 do dia 05 de novembro de 2019
Hora de fim do evento	04h00 do dia 06 de novembro de 2019
Abrangência	Região Norte da CELG Distribuição S.A.

4 Referências

- RMets Royal Meteorological Society – Beaufort Scale - <https://www.rmets.org/weather-and-climate/observing/beaufort-scale>
- Instituto Nacional de Meteorologia (INMET) - <http://www.inmet.gov.br>
- Cptec/INPE- <https://www.cptec.inpe.br/>
- Centro de Hidrografia da Marinha do Brasil - <https://www.marinha.mil.br/chm/>
- Meteorology Glossary - American Meteorological Society - <http://glossary.ametsoc.org/>

Anexos

A.1 Carta Sinótica da Marinha do Brasil



Figura A1 - Carta sinótica da Marinha do Brasil para as 1200Z do dia 05 de novembro de 2019 (09h00 do dia 05 de novembro de 2019, hora local).

A.2 Notícias relacionadas

Queda de árvores e ventania provocam danos em bairros de Goiânia -

<https://www.opopular.com.br/noticias/cidades/queda-de-%C3%A1rvores-e-ventania-provocam-danos-em-bairros-de-goi%C3%A2nia-veja-%C3%ADdeos-1.1925552>

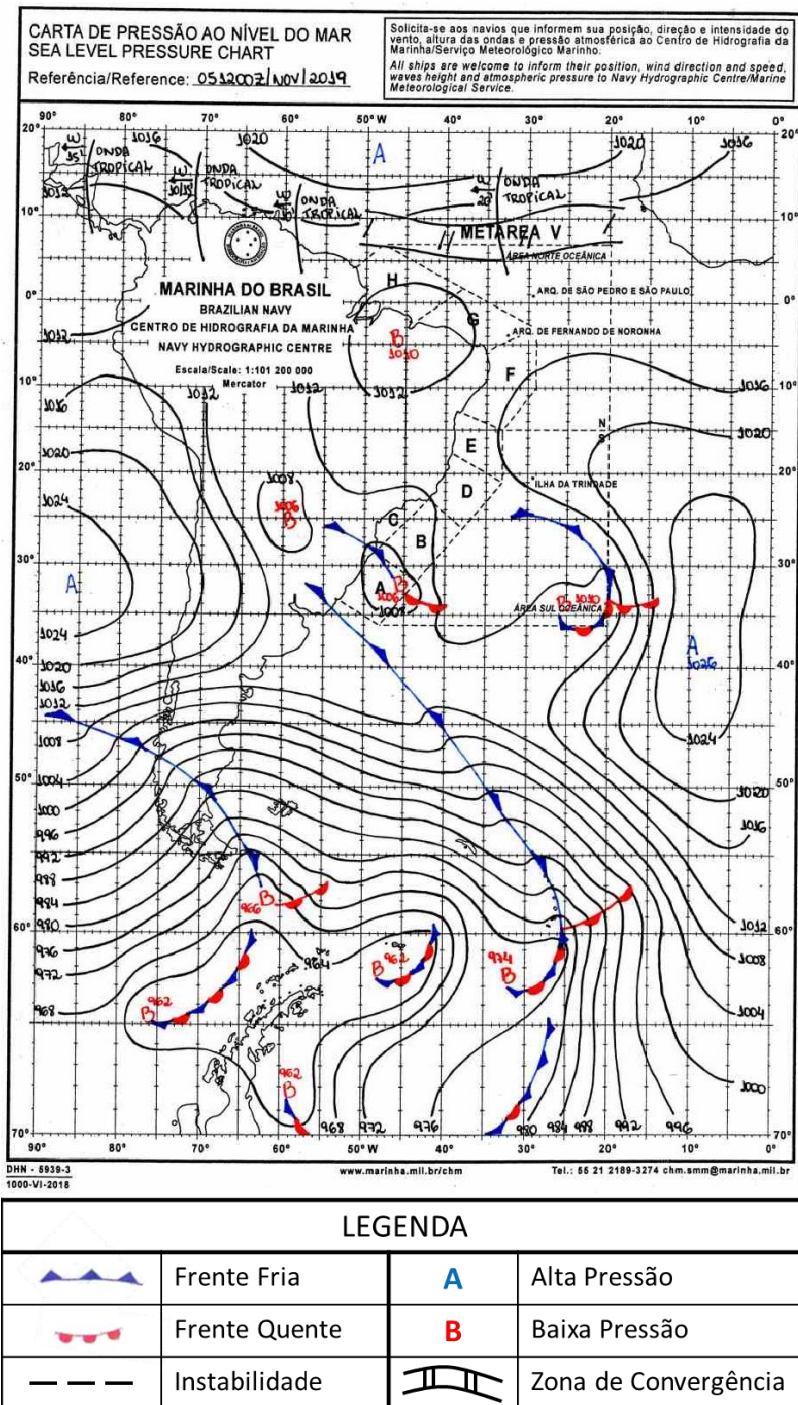
Outro poste é encontrado no chão após chuva na Grande Goiânia -

<http://g1.globo.com/goias/bom-dia-go/videos/t/edicoes/v/outro-poste-e-encontrado-no-chao-apos-chuva-na-grande-goiania/8064394/>

Tempestade de poeira assusta moradores de Santa Helena de Goiás -

<https://g1.globo.com/go/goias/noticia/2019/11/05/tempestade-de-poeira-assusta-moradores-de-santa-helena-de-goias.ghtml>

Bianca Lobo Silva Meteorologista CREA 5063840461

Instituto Nacional de Meteorologia - INMET

Umidade Relativa do Ar 00h UTC
Estação: PIRENOPOLIS (GO) - 11/2019

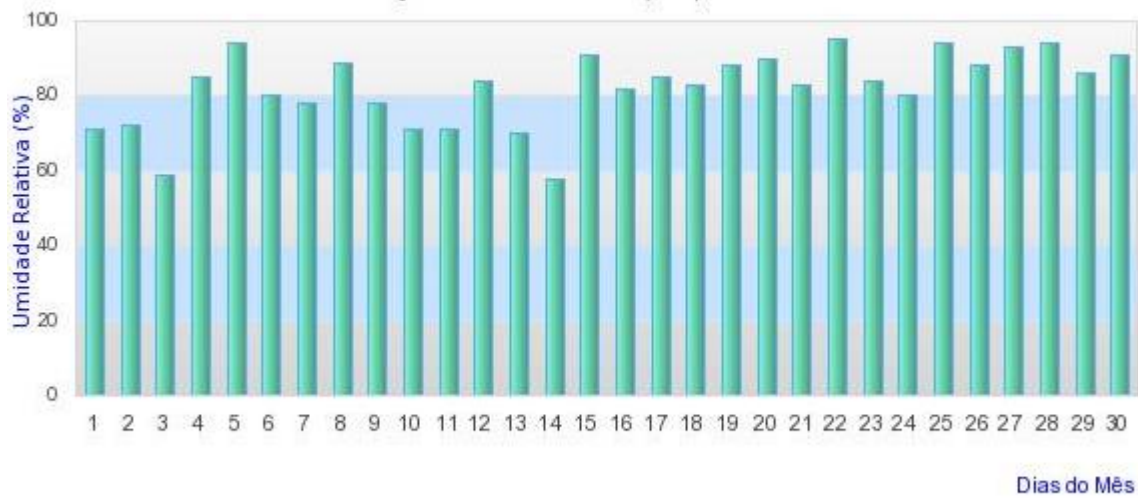

Instituto Nacional de Meteorologia - INMET

Chuva Acumulada 24h
Estação: PIRENOPOLIS - 11/2019

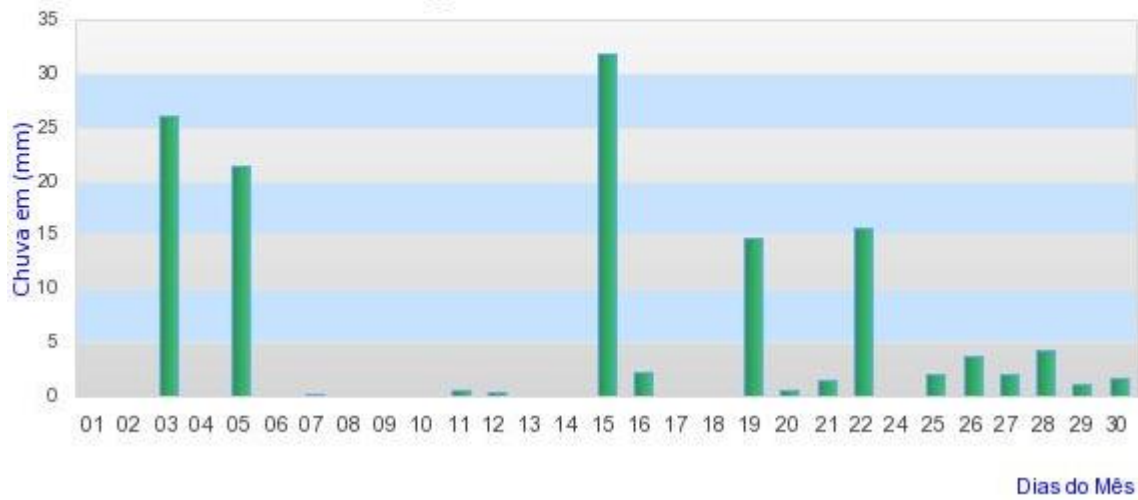

Instituto Nacional de Meteorologia - INMET

Umidade Relativa do Ar 00h UTC

Estação: POSSE (GO) - 11/2019

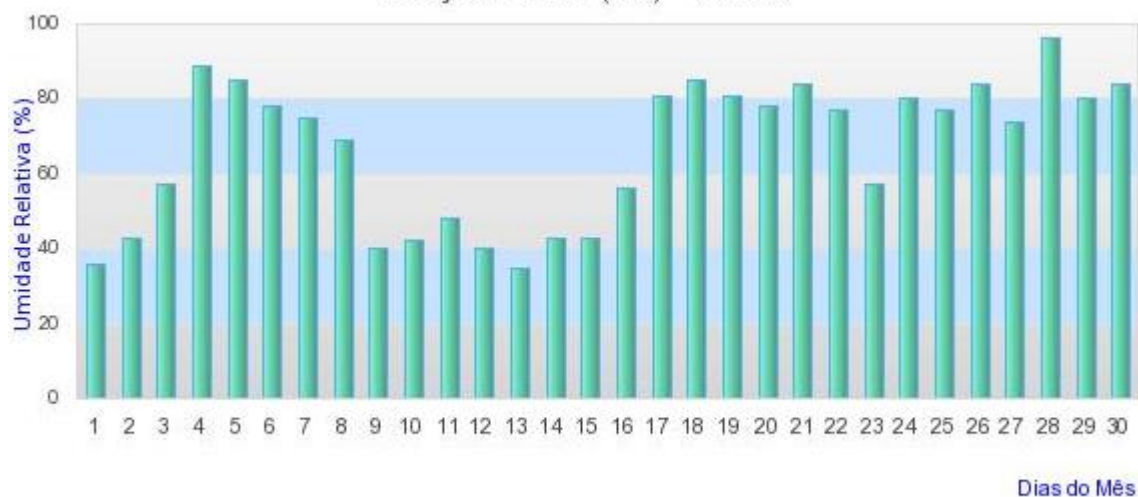

Instituto Nacional de Meteorologia - INMET

Chuva Acumulada 24h

Estação: POSSE - 11/2019



Instituto Nacional de Meteorologia - INMET

Umidade Relativa do Ar 00h UTC

Estação: JATAI (GO) - 11/2019

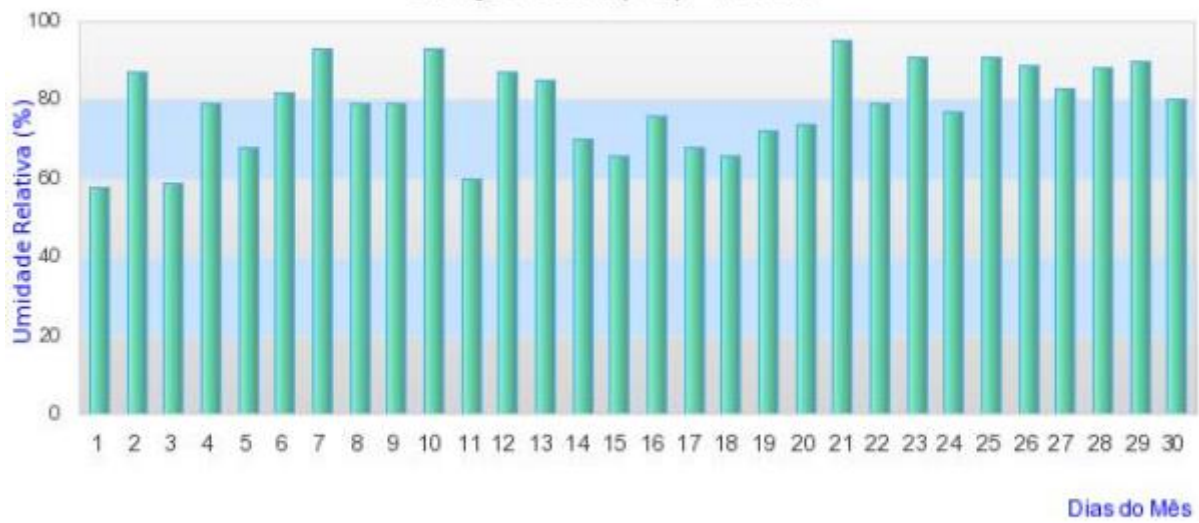

Instituto Nacional de Meteorologia - INMET

Chuva Acumulada 24h

Estação: JATAI - 11/2019



Instituto Nacional de Meteorologia - INMET

Umidade Relativa do Ar 00h UTC
Estação: RIO VERDE (GO) - 11/2019

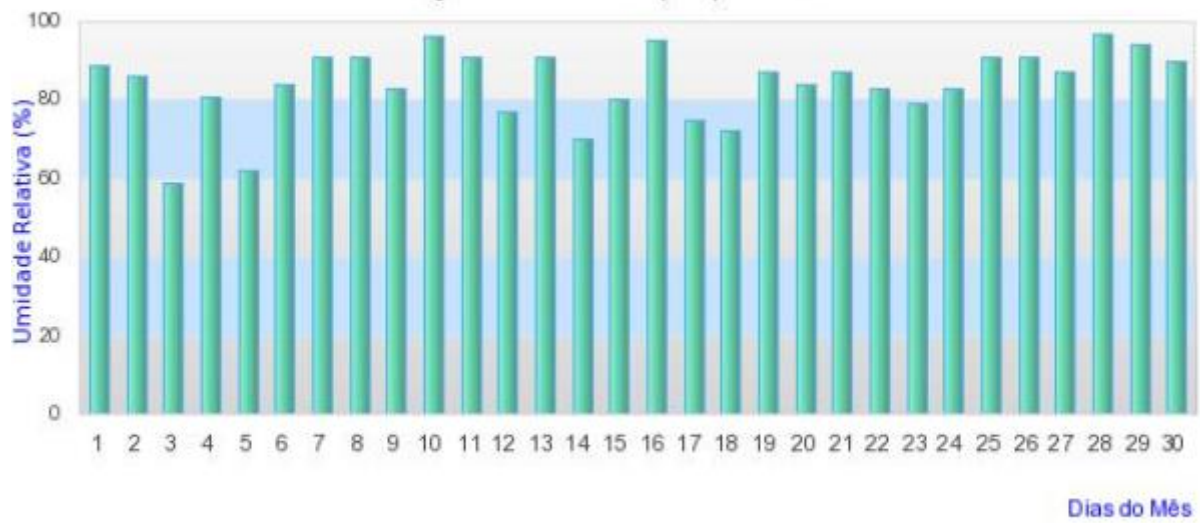

Instituto Nacional de Meteorologia - INMET

Chuva Acumulada 24h
Estação: RIO VERDE - 11/2019



Instituto Nacional de Meteorologia - INMET

Umidade Relativa do Ar 00h UTC
Estação: FORMOSA (GO) - 11/2019

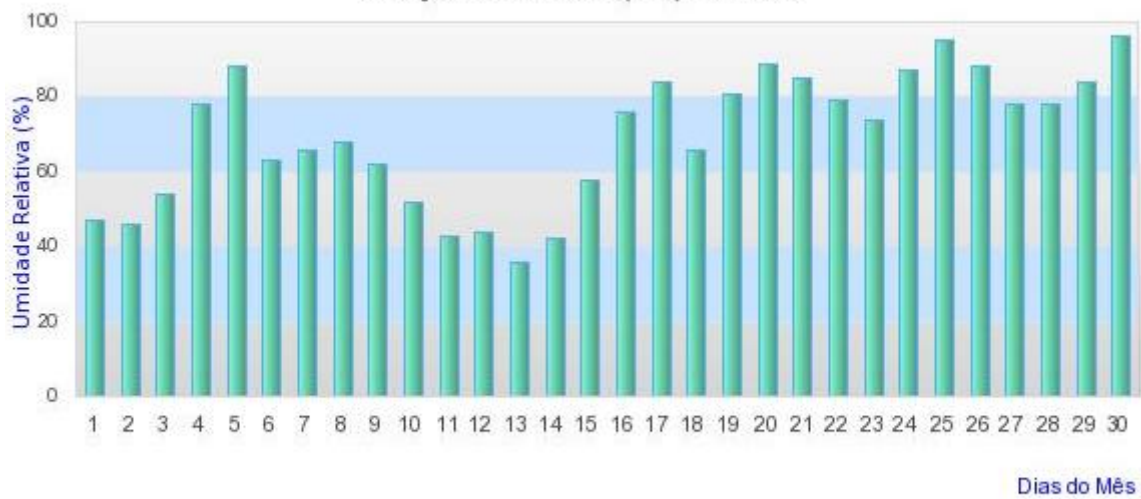

Instituto Nacional de Meteorologia - INMET

Chuva Acumulada 24h
Estação: FORMOSA - 11/2019



Instituto Nacional de Meteorologia - INMET

Umidade Relativa do Ar 00h UTC

Estação: GOIANIA (GO) - 11/2019

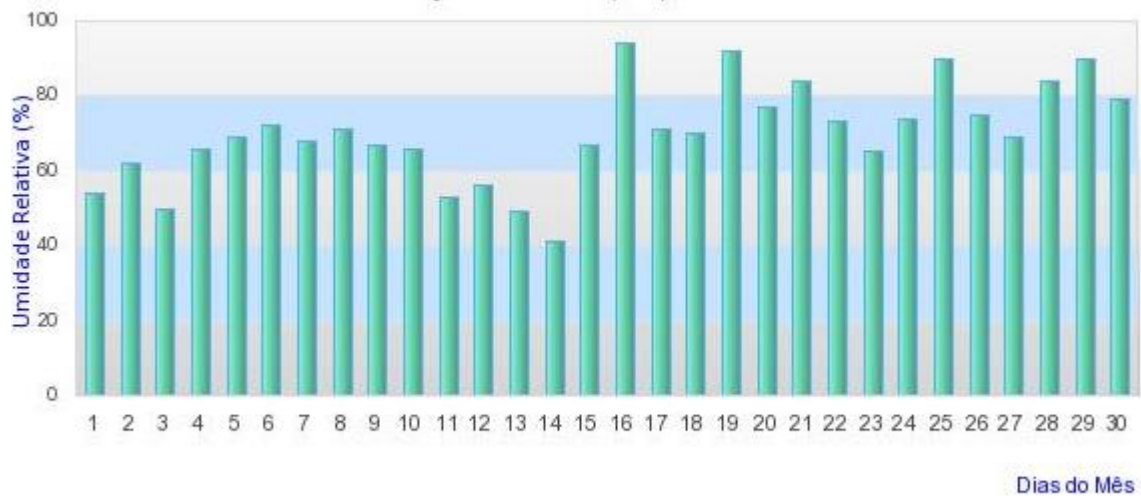

Instituto Nacional de Meteorologia - INMET

Chuva Acumulada 24h

Estação: GOIANIA - 11/2019

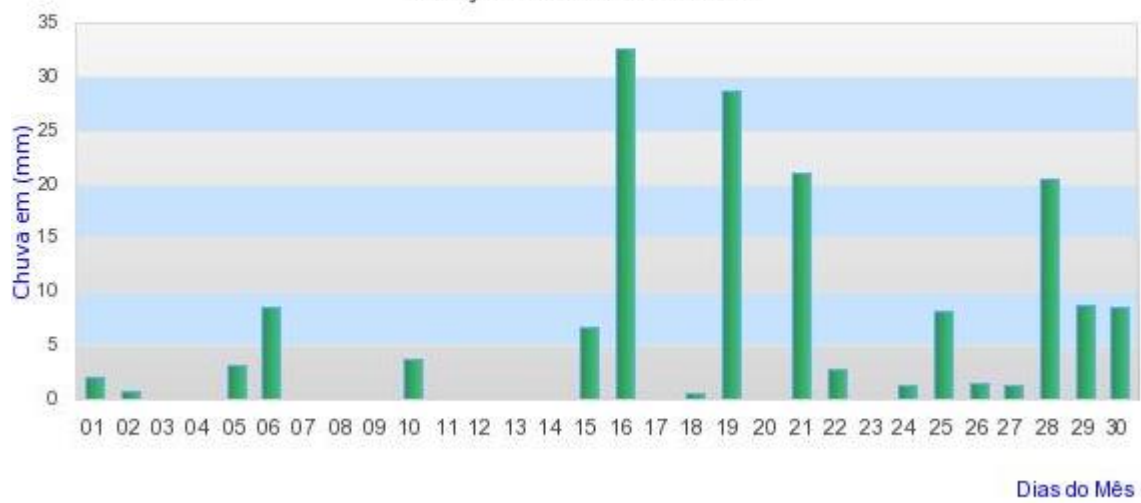

Abadia de Goiás - Estação Abadia de Goiás - Novembro de 2019

Para ver os dados horários clique no dia desejado

Dia	Precip.	Prec. Acum.	Vel. Vent. (m/s)	Dir. Vent.	Umid. Relat. AR (Max) %	Umid. Relat. AR (Min) %	Umid. Relat. AR (Média) %	Temp. Max. °C Dia	Temp. Min. °C Dia	Temp. Med. °C do Ar	Temp. 09:00h	Temp. 21:00h	Ponto orvalho	Razao Mistura	Radiação Solar Diária MJ/m²
1	8.80	8.80	2.3	NO	87.0	31.0	53	32.5	19.6	25.64	28.3	23.9	-	-	18.5
2	0.00	8.80	2.5	SE	92.0	37.0	56.7	31.6	19.0	25.32	26.4	24.8	-	-	19.7
3	0.00	8.80	2.8	N	82.0	40.0	63.7	29.9	20.5	24.42	25.1	23.3	-	-	19.5
4	12.20	21.00	2.1	N	91.0	33.0	65.7	33.1	19.8	24.9	28.4	21.6	-	-	19.1
5	5.20	26.20	1.9	NO	90.0	41.0	68.7	31.6	20.0	25.28	28	23.4	-	-	14.1
6	0.00	26.20	2.0	NO	87.0	47.0	70.2	29.4	20.4	23.92	23.6	23.1	-	-	14.6
7	0.00	26.20	1.9	SE	95.0	44.0	63	31.6	19.6	24.76	25.6	23.5	-	-	16.5
8	0.00	26.20	2.6	SO	92.0	59.0	73.2	28.3	20.7	23.88	22.8	23.8	-	-	12.3
9	16.40	42.60	3.2	SE	90.0	31.0	66.2	34.6	20.1	24.6	28.1	20.1	-	-	19.1
10	0.00	42.60	1.8	SO	96.0	35.0	61.5	32.5	19.1	24.96	26	23.6	-	-	18.8
11	1.00	43.60	2.3	NO	84.0	38.0	60.7	33.1	20.9	25.32	28.4	22.1	-	-	18
12	0.00	43.60	2.5	O	88.0	32.0	52.2	33.3	20.6	26.52	26.1	26.3	-	-	18.1
13	0.00	43.60	2.3	N	87.0	29.0	43	33.2	19.7	27.14	27.6	27.6	-	-	18.9
14	0.00	43.60	1.7	NO	89.0	40.0	59.2	31.1	20.4	25.78	27.8	24.8	-	-	15.2
15	11.40	55.00	1.6	NO	96.0	47.0	79.5	30.1	19.8	23.72	27.9	20.4	-	-	12.8
16	0.20	55.20	1.2	N	98.0	57.0	75.7	28.3	20.0	23.12	22.3	22.5	-	-	12
17	0.20	55.40	2.0	NO	95.0	59.0	76.7	28.6	20.0	24.14	25.3	23.4	-	-	13.4
18	12.60	68.00	2.1	L	95.0	60.0	88	26.8	19.2	21.72	22.6	20	-	-	7.1
19	1.00	69.00	1.6	L	97.0	52.0	85	28.3	19.7	22.74	23.9	20.9	-	-	10.5
20	0.00	69.00	1.9	L	94.0	51.0	82	28.0	20.0	22.98	25.3	20.8	-	-	8.6
21	0.00	69.00	2.5	SE	97.0	44.0	64.5	29.0	19.1	23.52	24.9	22.3	-	-	18.2
22	0.00	69.00	2.9	L	97.0	46.0	64	29.1	18.3	23.78	24.3	23.6	-	-	15.8
23	4.40	73.40	2.1	NO	95.0	44.0	73	29.4	20.0	23.96	27	21.7	-	-	8.2
24	48.00	121.40	2.3	N	97.0	44.0	77.2	30.3	18.9	22.78	25.1	19.8	-	-	16.7
25	0.40	121.80	2.2	NO	97.0	52.0	75	29.0	19.6	23.74	24.1	23	-	-	15.9
26	0.00	121.80	1.9	L	91.0	52.0	69.7	29.8	19.4	24.58	26.5	23.6	-	-	18.3
27	7.60	129.40	1.9	L	97.0	69.0	82.2	26.3	20.1	23.14	25.1	22.1	-	-	10.2
28	15.60	145.00	1.9	NO	98.0	75.0	90.5	25.1	20.0	22.2	23.9	21	-	-	5.8
29	8.00	153.00	1.9	NO	97.0	67.0	89	27.1	20.0	22.74	22.6	22	-	-	12.1
30	9.80	162.80	1.5	L	97.0	67.0	80	26.5	20.7	23.06	25.9	21.1	-	-	7.6

Aruanã - Estação Estação Hidro Aruanã - GO - ANA - Novembro de 2019

Para ver os dados horários clique no dia desejado

Dia	Precip.	Prec. Acum.	Sensor Pressão min	Sensor Pressão max	Sensor Pressão media	Nível Régua	CodifEixo	Vazão min (m3/s)	Vazão max (m3/s)	Vazão media (m3/s)
1	0.00	0.00	1.49	1.53	1.5	1.53	0.97	0.00	0.00	0.00
2	0.00	0.00	1.47	1.49	1.5	1.49	0.97	0.00	0.00	0.00
3	0.20	0.20	1.47	1.51	1.5	1.51	0.97	0.00	0.00	0.00
4	0.00	0.20	1.5	1.55	1.5	1.55	0.97	0.00	0.00	0.00
5	14.20	14.40	1.55	1.6	1.6	1.6	0.97	0.00	0.00	0.00
6	0.60	15.00	1.6	1.65	1.6	1.65	0.97	0.00	0.00	0.00
7	0.00	15.00	1.61	1.65	1.6	1.65	0.97	0.00	0.00	0.00
8	0.00	15.00	0	1.61	1.6	1.61	0.97	0.00	0.00	0.00
9	-85.40	-70.40	1.55	1.57	1.6	1.57	0.97	0.00	0.00	0.00
10	0.00	-70.40	1.55	1.55	1.5	1.55	0.97	0.00	0.00	0.00
11	4.60	-65.80	1.55	1.57	1.6	1.57	0.97	0.00	0.00	0.00
12	0.20	-65.60	1.56	1.59	1.6	1.59	0.97	0.00	0.00	0.00
13	11.60	-54.00	1.58	1.65	1.6	1.65	0.97	0.00	0.00	0.00
14	0.00	-54.00	1.66	1.8	1.7	1.8	0.97	0.00	0.00	0.00
15	0.00	-54.00	1.8	1.84	1.8	1.84	0.97	0.00	0.00	0.00
16	0.00	-54.00	1.8	1.83	1.8	1.83	0.97	0.00	0.00	0.00
17	3.40	-50.60	1.76	1.8	1.8	1.8	0.97	0.00	0.00	0.00
18	0.00	-50.60	1.75	1.76	1.8	1.76	0.97	0.00	0.00	0.00
19	0.00	-50.60	1.67	1.75	1.7	1.75	0.97	0.00	0.00	0.00
20	6.80	-43.80	1.65	1.67	1.7	1.67	0.97	0.00	0.00	0.00
21	0.00	-43.80	1.66	1.75	1.7	1.75	0.97	0.00	0.00	0.00
22	3.20	-40.60	1.76	1.86	1.8	1.86	0.97	0.00	0.00	0.00
23	14.60	-26.00	1.82	1.86	1.8	1.86	0.97	0.00	0.00	0.00
24	1.00	-25.00	1.81	1.85	1.8	1.85	0.97	0.00	0.00	0.00
25	3.40	-21.60	1.85	1.91	1.9	1.91	0.97	0.00	0.00	0.00
26	0.00	-21.60	1.88	1.91	1.9	1.91	0.97	0.00	0.00	0.00
27	1.80	-19.80	1.86	1.88	1.9	1.88	0.97	0.00	0.00	0.00
28	110.00	90.20	1.83	1.95	1.9	1.95	0.97	0.00	0.00	0.00
29	1.00	91.20	1.82	1.89	1.8	1.89	0.97	0.00	0.00	0.00
30	0.00	91.20	1.89	2.18	2.0	2.18	0.97	0.00	0.00	0.00

Cidade de Goiás - Estação Estação Hidro Cid. Goiás Montante - GO - ANA - Novembro de 2019

Para ver os dados horários clique no dia desejado

Dia	Precip.	Prec.Acum.	Sensor Pressão min	Sensor Pressão max	Sensor Pressão media	Nível Régua	CodifEixo	Vazão min (m3/s)	Vazão max (m3/s)	Vazão media (m3/s)
1	0.00	0.00	0.2	0.21	0.2	0.21	-0.17	0.00	0.00	0.00
2	2.20	2.20	0.19	0.2	0.2	0.2	-0.17	0.00	0.00	0.00
3	0.20	2.40	0.19	0.21	0.2	0.21	-0.17	0.00	0.00	0.00
4	0.00	2.40	0.19	0.2	0.2	0.2	-0.17	0.00	0.00	0.00
5	5.20	7.60	0.19	0.75	0.2	0.75	-0.17	0.00	0.00	0.00
6	0.00	7.60	0.23	0.58	0.3	0.58	-0.17	0.00	0.00	0.00
7	0.00	7.60	0	0.23	0.2	0.23	-0.17	0.00	0.00	0.00
8	-145.40	-137.80	0.19	0.21	0.2	0.21	-0.17	0.00	0.00	0.00
9	7.40	-130.40	0.19	0.2	0.2	0.2	-0.17	0.00	0.00	0.00
10	0.00	-130.40	0.18	0.19	0.2	0.19	-0.17	0.00	0.00	0.00
11	1.80	-128.60	0.18	0.2	0.2	0.2	-0.17	0.00	0.00	0.00
12	1.00	-127.60	0.19	0.2	0.2	0.2	-0.17	0.00	0.00	0.00
13	0.20	-127.40	0.18	0.19	0.2	0.19	-0.17	0.00	0.00	0.00
14	0.00	-127.40	0.17	0.18	0.2	0.18	-0.17	0.00	0.00	0.00
15	7.80	-119.60	0.17	0.18	0.2	0.18	-0.17	0.00	0.00	0.00
16	0.00	-119.60	0.17	0.18	0.2	0.18	-0.17	0.00	0.00	0.00
17	3.20	-116.40	0.17	0.18	0.2	0.18	-0.17	0.00	0.00	0.00
18	0.00	-116.40	0.18	0.18	0.2	0.18	-0.17	0.00	0.00	0.00
19	0.20	-116.20	0.18	0.18	0.2	0.18	-0.17	0.00	0.00	0.00
20	1.80	-114.40	0.18	0.19	0.2	0.19	-0.17	0.00	0.00	0.00
21	0.00	-114.40	0.19	0.19	0.2	0.19	-0.17	0.00	0.00	0.00
22	0.80	-113.60	0.19	0.19	0.2	0.19	-0.17	0.00	0.00	0.00
23	0.00	-113.60	0.19	0.21	0.2	0.21	-0.17	0.00	0.00	0.00
24	2.80	-110.80	0.18	0.22	0.2	0.22	-0.17	0.00	0.00	0.00
25	7.20	-103.60	0.22	0.91	0.3	0.91	-0.17	0.00	0.00	0.00
26	0.00	-103.60	0.26	0.69	0.4	0.69	-0.17	0.00	0.00	0.00
27	9.20	-94.40	0.25	0.97	0.4	0.97	-0.17	0.00	0.00	0.00
28	11.80	-82.60	0.27	0.44	0.3	0.44	-0.17	0.00	0.00	0.00
29	0.20	-82.40	0.24	0.27	0.3	0.27	-0.17	0.00	0.00	0.00
30	0.00	-82.40	0.22	0.24	0.2	0.24	-0.17	0.00	0.00	0.00

Goiania - Estação Heliponto Goiania - Novembro de 2019

Para ver os dados horários clique no dia desejado

Dia	Precip.	Prec.Acum.	Vel. Vent. (m/s)	Dir. Vent.	Umid. Relat. AR (Max) %	Umid. Relat. AR (Min) %	Umid. Relat. AR (Média) %	Temp. Max. °C Dia	Temp. Min. °C Dia	Temp. Med. °C do Ar	Temp. 09:00h	Temp. 21:00h	Ponto orvalho	Razao Mistura	Radiação Solar Diária MJ/m²
1	0.00	0.00	1.9	SE	81.0	30.0	54	33.1	21.9	26.22	28.9	23.6	-	-	15.6
2	0.00	0.00	1.8	SE	85.0	32.0	47.2	33.3	21.1	27.54	26.5	28.4	-	-	20.3
3	0.00	0.00	1.5	N	76.0	39.0	60.2	29.5	22.4	25.76	25.3	25.8	-	-	15.2
4	0.60	0.60	1.4	L	81.0	28.0	56.5	33.8	23.0	26.68	28.8	23.9	-	-	19.3
5	8.80	9.40	1.4	NO	82.0	36.0	62.5	32.3	22.0	26.12	27.3	24.5	-	-	14.8
6	0.00	9.40	1.7	NO	89.0	38.0	63.7	31.1	21.5	25.62	24.5	25.5	-	-	15.7
7	0.00	9.40	1.4	SE	88.0	43.0	63.7	31.9	22.4	25.94	26.4	24.5	-	-	15.8
8	0.00	9.40	2.0	SE	90.0	60.0	70.2	28.4	21.9	25.2	22.9	26.4	-	-	9.9
9	0.00	9.40	2.4	SE	74.0	25.0	53.5	35.6	23.6	26.94	28.3	23.6	-	-	20.2
10	0.00	9.40	1.7	SE	85.0	32.0	48.7	32.8	21.7	26.84	26.1	26.8	-	-	21
11	0.00	9.40	2.0	NO	80.0	28.0	50	34.1	22.5	27.12	27.8	25.6	-	-	18.4
12	0.00	9.40	1.7	S	78.0	24.0	44.7	34.8	22.8	28.06	27.1	27.8	-	-	17.6
13	0.00	9.40	1.5	N	72.0	23.0	36	33.6	23.1	28.5	28	28.9	-	-	20.2
14	3.80	13.20	1.7	NO	74.0	36.0	59.5	32.3	23.6	27.1	29.8	24.9	-	-	17.7
15	31.00	44.20	1.6	SE	99.0	43.0	76.5	30.3	20.7	24.28	28.6	20.9	-	-	13.9
16	0.60	44.80	0.8	L	99.0	53.0	73	29.3	20.8	24.62	22.8	25.1	-	-	9.1
17	0.00	44.80	1.5	N	95.0	47.0	70.7	30.4	21.6	25.22	24.9	24.6	-	-	16.4
18	17.60	62.40	1.8	SE	100.0	57.0	87.2	27.5	19.6	22.24	23.3	20.4	-	-	12.5
19	0.20	62.60	1.4	SE	97.0	58.0	80.7	28.0	20.8	23.6	25.6	21.8	-	-	10.7
20	23.00	85.60	1.4	SE	96.0	51.0	85.5	29.1	20.6	23.72	25.9	21.5	-	-	9.8
21	0.00	85.60	1.5	SE	100.0	43.0	66.2	30.4	19.7	24.26	24.4	23.4	-	-	19.3
22	3.60	89.20	1.7	L	99.0	44.0	64.7	29.1	19.5	24.64	24	25.3	-	-	16.4
23	0.60	89.80	1.3	NO	88.0	46.0	70.2	29.5	22.5	25.26	27.3	23.5	-	-	12.5
24	5.60	95.40	1.8	NO	99.0	36.0	76.5	30.9	20.4	23.92	25.1	21.6	-	-	19.1
25	2.00	97.40	1.4	SE	99.0	55.0	78.5	28.8	20.3	24.24	24.9	23.6	-	-	14.1
26	0.00	97.40	1.4	L	89.0	52.0	69	29.4	21.1	25.16	26.1	24.6	-	-	15.7
27	16.00	113.40	1.4	SE	98.0	71.0	85.5	27.1	21.6	24.2	25.1	23.6	-	-	10.2
28	10.20	123.60	1.8	NO	99.0	62.0	91	27.8	20.7	23.26	24.8	21.5	-	-	9.1
29	7.00	130.60	1.4	NO	100.0	60.0	86.2	28.4	21.1	24.02	22.4	24.1	-	-	13.6
30	1.60	132.20	1.6	SE	99.0	68.0	79.5	27.6	22.1	24.52	27.1	22.9	-	-	12.1

Matrinchã - Estação Estação Hidro Matrinchã - GO - ANA - Novembro de 2019

[Para ver os dados horários clique no dia desejado](#)

Dia	Precip.	Prec.Acum.	Sensor Pressão min	Sensor Pressão max	Sensor Pressão media	Nível Régua	CodifEixo	Vazão min (m3/s)	Vazão max (m3/s)	Vazão media (m3/s)
1	0.00	0.00	0.17	0.22	0.2	0.22	6.74	0.00	0.00	0.00
2	0.00	0.00	0.18	0.21	0.2	0.21	6.74	0.00	0.00	0.00
3	0.00	0.00	0.15	0.18	0.2	0.18	6.74	0.00	0.00	0.00
4	0.00	0.00	0.12	0.15	0.1	0.15	6.74	0.00	0.00	0.00
5	29.60	29.60	0.1	0.15	0.1	0.15	6.74	0.00	0.00	0.00
6	0.00	29.60	0	0.14	0.1	0.14	6.74	0.00	0.00	0.00
7	-134.40	-104.80	0.06	0.09	0.1	0.09	6.74	0.00	0.00	0.00
8	0.00	-104.80	0.06	0.1	0.1	0.1	6.74	0.00	0.00	0.00
9	0.00	-104.80	0.1	0.17	0.1	0.17	6.74	0.00	0.00	0.00
10	0.00	-104.80	0.09	0.14	0.1	0.14	6.74	0.00	0.00	0.00
11	0.00	-104.80	0.07	0.1	0.1	0.1	6.74	0.00	0.00	0.00
12	0.00	-104.80	0.07	0.09	0.1	0.09	6.74	0.00	0.00	0.00
13	2.60	-102.20	0.09	0.17	0.1	0.17	6.74	0.00	0.00	0.00
14	0.00	-102.20	0.13	0.16	0.1	0.16	6.74	0.00	0.00	0.00
15	0.00	-102.20	0.1	0.13	0.1	0.13	6.74	0.00	0.00	0.00
16	0.00	-102.20	0.09	0.16	0.1	0.16	6.74	0.00	0.00	0.00
17	4.40	-97.80	0.13	0.16	0.1	0.16	6.74	0.00	0.00	0.00
18	0.00	-97.80	0.1	0.13	0.1	0.13	6.74	0.00	0.00	0.00
19	0.00	-97.80	0.08	0.1	0.1	0.1	6.74	0.00	0.00	0.00
20	1.20	-96.60	0.08	0.09	0.1	0.09	6.74	0.00	0.00	0.00
21	0.00	-96.60	0.09	0.1	0.1	0.1	6.74	0.00	0.00	0.00
22	22.80	-73.80	0.09	0.12	0.1	0.12	6.74	0.00	0.00	0.00
23	0.00	-73.80	0.12	0.21	0.2	0.21	6.74	0.00	0.00	0.00
24	0.40	-73.40	0.17	0.21	0.2	0.21	6.74	0.00	0.00	0.00
25	8.80	-64.60	0.15	0.18	0.2	0.18	6.74	0.00	0.00	0.00
26	4.20	-60.40	0.15	0.21	0.2	0.21	6.74	0.00	0.00	0.00
27	20.20	-40.20	0.19	0.35	0.2	0.35	6.74	0.00	0.00	0.00
28	25.00	-15.20	0.33	0.37	0.4	0.37	6.74	0.00	0.00	0.00
29	0.40	-14.80	0.32	0.39	0.4	0.39	6.74	0.00	0.00	0.00
30	0.00	-14.80	0.31	0.41	0.4	0.41	6.74	0.00	0.00	0.00

Nova Crixas - Estação Estação Hidro Bandeirantes - GO - ANA - Novembro de 2019

[Para ver os dados horários clique no dia desejado](#)

Dia	Precip.	Prec.Acum.	Sensor Pressão min	Sensor Pressão max	Sensor Pressão media	Nível Régua	CodifEixo	Vazão min (m3/s)	Vazão max (m3/s)	Vazão media (m3/s)
1	0.00	0.00	3.84	3.87	3.9	3.87	2.78	0.00	0.00	0.00
2	0.00	0.00	3.8	3.84	3.8	3.84	2.78	0.00	0.00	0.00
3	46.60	46.60	3.8	3.82	3.8	3.82	2.78	0.00	0.00	0.00
4	0.00	46.60	3.76	3.81	3.8	3.81	2.78	0.00	0.00	0.00
5	49.60	96.20	3.74	3.83	3.8	3.83	2.78	0.00	0.00	0.00
6	21.00	117.20	3.81	3.85	3.8	3.85	2.78	0.00	0.00	0.00
7	0.00	117.20	0	3.83	3.7	3.83	2.78	0.00	0.00	0.00
8	-226.80	-109.60	3.83	3.87	3.8	3.87	2.78	0.00	0.00	0.00
9	1.00	-108.60	3.86	3.88	3.9	3.88	2.78	0.00	0.00	0.00
10	0.00	-108.60	3.83	3.86	3.8	3.86	2.78	0.00	0.00	0.00
11	0.00	-108.60	3.81	3.83	3.8	3.83	2.78	0.00	0.00	0.00
12	10.60	-98.00	3.79	3.81	3.8	3.81	2.78	0.00	0.00	0.00
13	21.00	-77.00	3.79	3.85	3.8	3.85	2.78	0.00	0.00	0.00
14	0.00	-77.00	3.84	3.85	3.8	3.85	2.78	0.00	0.00	0.00
15	6.40	-70.60	3.84	3.87	3.8	3.87	2.78	0.00	0.00	0.00
16	0.00	-70.60	3.87	3.93	3.9	3.93	2.78	0.00	0.00	0.00
17	6.80	-63.80	3.92	4	4.0	4	2.78	0.00	0.00	0.00
18	0.20	-63.60	4	4.02	4.0	4.02	2.78	0.00	0.00	0.00
19	0.00	-63.60	3.99	4.02	4.0	4.02	2.78	0.00	0.00	0.00
20	0.00	-63.60	3.98	4	4.0	4	2.78	0.00	0.00	0.00
21	0.00	-63.60	3.95	3.98	4.0	3.98	2.78	0.00	0.00	0.00
22	0.00	-63.60	3.91	3.95	3.9	3.95	2.78	0.00	0.00	0.00
23	0.00	-63.60	3.9	3.93	3.9	3.93	2.78	0.00	0.00	0.00
24	1.00	-62.60	3.93	4	4.0	4	2.78	0.00	0.00	0.00
25	73.80	11.20	4	4.1	4.0	4.1	2.78	0.00	0.00	0.00
26	4.40	15.60	4.04	4.1	4.1	4.1	2.78	0.00	0.00	0.00
27	33.60	49.20	4.03	4.1	4.1	4.1	2.78	0.00	0.00	0.00
28	37.40	86.60	4.09	4.16	4.1	4.16	2.78	0.00	0.00	0.00
29	0.00	86.60	4.13	4.16	4.1	4.16	2.78	0.00	0.00	0.00
30	19.60	106.20	4.12	4.14	4.1	4.14	2.78	0.00	0.00	0.00

Palmeiras de Goiás - Estação Palmeiras de Goiás - Novembro de 2019

[Para ver os dados horários clique no dia desejado](#)

Dia	Precip.	Prec. Acum.	Vel. Vent. (m/s)	Dir. Vent.	Umid. Relat. AR (Max) %	Umid. Relat. AR (Min) %	Umid. Relat. AR (Média)%	Temp. Max. °C Dia	Temp. Min. °C Dia	Temp. Med. °C do Ar	Temp. 09:00h	Temp. 21:00h	Ponto orvalho	Razao Mistura	Radiação Solar Diária MJ/m²
1	0.00	0.00	2.5	S	96.0	34.0	60	35.3	21.3	26.9	27.7	25.1	-	-	21.8
2	0.00	0.00	2.9	SO	96.0	34.0	50.5	34.3	20.5	27.78	27.9	28.1	-	-	-
3	1.20	1.20	2.3	SO	90.0	48.0	69.7	30.1	22.0	25.66	26.8	24.7	-	-	-
4	0.00	1.20	3.0	S	90.0	32.0	57.2	34.6	22.8	27.72	29	26.1	-	-	-
5	14.80	16.00	2.4	SO	100.0	32.0	76.2	35.4	22.3	25.94	27.2	22.4	-	-	-
6	0.20	16.20	1.1	S	100.0	43.0	80.5	32.6	21.2	25.22	23.3	24.5	-	-	-
7	0.00	16.20	1.8	S	100.0	40.0	62.7	34.1	20.9	27.08	27	26.7	-	-	-
8	0.00	16.20	2.8	SO	100.0	48.0	63	32.6	21.6	26.48	24.4	26.9	-	-	-
9	39.60	55.80	1.8	S	100.0	35.0	74	34.7	19.8	24.94	29.6	20.3	-	-	-
10	0.20	56.00	2.3	S	100.0	39.0	66	33.9	19.8	26.32	24.9	26.5	-	-	-
11	18.00	74.00	2.2	S	100.0	31.0	75	35.9	22.2	26.22	28	22.5	-	-	-
12	1.40	75.40	1.8	SO	100.0	41.0	71.2	34.6	21.5	26.02	24.8	24.6	-	-	-
13	0.00	75.40	0.9	S	100.0	36.0	55	34.4	22.0	27.94	26.7	28.3	-	-	-
14	0.00	75.40	1.1	S	92.0	35.0	52.2	34.7	22.3	28.48	28.2	28.6	-	-	-
15	24.20	99.60	2.7	L	100.0	47.0	84.2	31.8	21.0	24.7	27.7	21.5	-	-	-
16	0.20	99.80	1.1	L	100.0	52.0	80.2	30.3	21.2	25.1	23.4	25.3	-	-	-
17	9.40	109.20	1.3	L	100.0	57.0	74.5	30.7	20.8	25.22	25.8	24.4	-	-	-
18	2.20	111.40	1.4	SO	100.0	54.0	92.5	30.1	21.4	24.12	25.7	21.7	-	-	-
19	0.20	111.60	0.6	O	100.0	56.0	90	29.5	20.6	23.84	24.5	22.3	-	-	-
20	1.80	113.40	1.1	SO	100.0	41.0	92	31.9	21.1	24.68	26.4	22	-	-	-
21	0.20	113.60	1.2	S	100.0	42.0	64.2	32.0	20.3	25.58	25.4	25.1	-	-	-
22	18.40	132.00	1.9	S	100.0	54.0	73.7	30.0	19.3	24.96	25.3	25.1	-	-	-
23	2.40	134.40	3.4	O	100.0	47.0	87	32.9	22.6	25.98	27.8	23.3	-	-	-
24	2.20	136.60	1.7	S	100.0	46.0	86	32.8	21.8	24.94	26.1	22	-	-	-
25	3.40	140.00	1.5	SO	100.0	59.0	88.7	31.0	20.0	24.36	25.4	22.7	-	-	-
26	0.00	140.00	0.8	O	100.0	59.0	72.5	30.8	21.1	25.76	26.5	25.2	-	-	-
27	5.80	145.80	1.3	L	100.0	77.0	93.5	27.7	21.8	24.7	26.2	23.9	-	-	-
28	9.80	155.60	0.9	S	100.0	58.0	81.5	29.2	20.6	24.92	25	24.9	-	-	-
29	2.40	158.00	1.9	O	100.0	63.0	89.7	30.8	22.0	24.96	24.6	23.7	-	-	-
30	1.40	159.40	0.7	L	100.0	76.0	98.5	28.4	22.6	24.52	26.2	22.7	-	-	-

Parauna - Estação Estação Hidro Ponte Rodagem - GO - ANA - Novembro de 2019

[Para ver os dados horários clique no dia desejado](#)

Dia	Precip.	Prec. Acum.	Sensor Pressão min	Sensor Pressão max	Sensor Pressão media	Nível Régua	CodifEixo	Vazão min (m3/s)	Vazão max (m3/s)	Vazão media (m3/s)
1	0.00	0.00	0.57	1.17	0.8	1.17	42.69	0.00	0.00	0.00
2	0.00	0.00	0.6	1.01	0.7	1.01	42.69	0.00	0.00	0.00
3	0.00	0.00	0.59	1.06	0.7	1.06	42.69	0.00	0.00	0.00
4	0.00	0.00	0.61	1.2	0.8	1.2	42.69	0.00	0.00	0.00
5	1.80	1.80	0.65	1.15	0.8	1.15	42.69	0.00	0.00	0.00
6	9.40	11.20	0.66	1.07	0.8	1.07	42.69	0.00	0.00	0.00
7	0.40	11.60	0.63	1.12	0.8	1.12	42.69	0.00	0.00	0.00
8	6.60	18.20	0.71	1.34	0.8	1.34	42.69	0.00	0.00	0.00
9	13.20	31.40	0.68	1.26	0.8	1.26	42.69	0.00	0.00	0.00
10	0.20	31.60	0.65	1.28	0.8	1.28	42.69	0.00	0.00	0.00
11	8.60	40.20	0.7	1.33	0.8	1.33	42.69	0.00	0.00	0.00
12	0.20	40.40	0.68	1.23	0.8	1.23	42.69	0.00	0.00	0.00
13	0.00	40.40	0.68	1.17	0.8	1.17	42.69	0.00	0.00	0.00
14	3.00	43.40	0.66	1.09	0.8	1.09	42.69	0.00	0.00	0.00
15	2.00	45.40	0	1.18	0.8	1.18	42.99	0.00	0.00	0.00
16	-89.20	-43.80	0.89	1.33	1.1	1.33	42.99	0.00	0.00	0.00
17	4.40	-39.40	0.92	1.36	1.1	1.36	42.99	0.00	0.00	0.00
18	49.80	10.40	0.92	1.26	1.1	1.26	42.99	0.00	0.00	0.00
19	3.80	14.20	0.91	1.41	1.1	1.41	42.99	0.00	0.00	0.00
20	0.20	14.40	0.9	1.55	1.1	1.55	42.99	0.00	0.00	0.00
21	0.00	14.40	0.93	1.46	1.1	1.46	42.99	0.00	0.00	0.00
22	0.00	14.40	0.91	1.29	1.1	1.29	42.99	0.00	0.00	0.00
23	4.40	18.80	0.95	1.53	1.1	1.53	42.99	0.00	0.00	0.00
24	12.40	31.20	1	1.58	1.1	1.58	42.99	0.00	0.00	0.00
25	8.40	39.60	1	1.49	1.1	1.49	42.99	0.00	0.00	0.00
26	0.20	39.80	1	1.56	1.2	1.56	42.99	0.00	0.00	0.00
27	9.00	48.80	1.03	1.45	1.2	1.45	42.99	0.00	0.00	0.00
28	6.40	55.20	1.04	1.47	1.2	1.47	42.99	0.00	0.00	0.00
29	7.60	62.80	1.06	1.65	1.2	1.65	42.99	0.00	0.00	0.00
30	1.20	64.00	1.06	1.56	1.2	1.56	42.99	0.00	0.00	0.00

Santa Isabel - Estação Usina Codora - Santa Isabel - Novembro de 2019

Para ver os dados horários clique no dia desejado

Dia	Precip.	Prec.Acum.	Vel. Vent. (m/s)	Dir. Vent.	Umid. Relat. AR (Max) %	Umid. Relat. AR (Min) %	Umid. Relat. AR (Média)%	Temp. Max. °C Dia	Temp. Min. °C Dia	Temp. Med. °C do Ar	Temp. 09:00h	Temp. 21:00h	Ponto orvalho	Razao Mistura	Radiação Solar Diária MJ/m²
1	0.00	0.00	2.0	SO	77.0	26.0	47.7	35.8	21.0	27.42	29.1	25.6	-	-	17.4
2	0.00	0.00	2.7	SO	73.0	33.0	48	34.7	22.9	28.3	29.3	27.3	-	-	16.7
3	12.40	12.40	2.5	L	98.0	41.0	61.7	31.1	20.2	25.16	24.5	25	-	-	17
4	9.40	21.80	2.7	SO	97.0	37.0	79.2	33.7	20.2	25.14	28.6	21.6	-	-	17.6
5	21.80	43.60	1.8	S	100.0	35.0	80.2	34.5	20.6	25.28	26.5	22.4	-	-	16.7
6	0.00	43.60	1.9	L	100.0	38.0	67.5	33.3	21.0	25.66	23	25.5	-	-	16.1
7	0.00	43.60	2.3	SO	90.0	47.0	68.7	32.2	22.0	26.48	28.6	24.8	-	-	16.4
8	0.00	43.60	3.2	SO	93.0	43.0	57.5	32.8	21.8	27.4	26.8	27.8	-	-	19.7
9	0.00	43.60	2.9	S	88.0	34.0	56.2	35.6	20.3	26.62	30	23.6	-	-	20
10	0.00	43.60	2.0	SO	92.0	38.0	65	34.0	20.7	26.36	29.5	23.8	-	-	17.3
11	0.00	43.60	2.4	SO	77.0	31.0	53.7	35.6	22.3	27.56	29.3	25.3	-	-	16.5
12	0.00	43.60	2.2	SO	82.0	26.0	-	36.2	22.4	29.4	30.6	28.9	-	-	17.9
13	0.00	43.60	2.7	SO	81.0	32.0	-	33.7	23.1	28.12	30.6	26.6	-	-	21
14	37.80	81.40	2.5	SO	100.0	32.0	59.2	35.3	19.8	26.76	29.5	24.6	-	-	21.8
15	0.00	81.40	2.3	NO	88.0	36.0	55.5	34.8	22.4	27.9	29.1	26.6	-	-	20.8
16	0.00	81.40	1.4	SO	94.0	44.0	57.5	31.6	21.5	26.82	27.4	26.8	-	-	14.5
17	29.00	110.40	2.0	L	100.0	60.0	76	28.3	21.0	24.2	22.1	24.8	-	-	8.9
18	0.80	111.20	2.2	S	98.0	48.0	67.7	30.9	20.6	25.04	23.1	25.3	-	-	16.9
19	0.20	111.40	1.9	SO	90.0	45.0	70.7	32.2	22.4	25.94	28.1	23.5	-	-	14.8
20	0.00	111.40	1.9	N	96.0	49.0	64.7	30.0	20.9	24.9	25.6	24	-	-	10
21	0.00	111.40	2.3	SE	87.0	36.0	62.7	32.0	21.7	25.68	27.1	23.8	-	-	19.3
22	0.00	111.40	1.7	SO	99.0	45.0	63	31.0	21.0	25.4	24.8	25.1	-	-	14.8
23	0.00	111.40	1.5	SO	88.0	45.0	61.7	31.3	22.4	26.58	26	26.6	-	-	9.6
24	0.00	111.40	1.8	S	89.0	50.0	75.7	30.5	22.3	25.38	26.9	23.6	-	-	11.2
25	2.40	113.80	2.0	SO	97.0	43.0	74.2	32.8	20.4	24.58	26.9	21.4	-	-	15.8
26	12.60	126.40	1.8	L	100.0	47.0	86.7	31.5	20.4	24.78	25.8	23.1	-	-	14.7
27	4.00	130.40	2.4	L	100.0	56.0	84.2	28.6	20.3	23.52	22.1	23.3	-	-	14.8
28	9.40	139.80	2.4	L	100.0	74.0	88.5	25.9	20.9	23.14	22.3	23.3	-	-	8.9
29	3.00	142.80	1.9	NO	100.0	51.0	73.7	32.1	20.7	25.7	25.5	25.1	-	-	21.9
30	0.00	142.80	2.1	L	98.0	46.0	80.7	33.0	21.9	25.8	27.9	23.1	-	-	15.5

Estacao : Palmeiras de Goiás
Data : 5 de Novembro de 2019
Município : Palmeiras de Goiás

Hora LOCAL	Precip.	Prec.Acum.	Vel. Vento (m/s)	Dir. Vento	Vel.Rajada Vento (m/s)	Dir.Rajada Vento	Umid. Relat. AR (%)	Temperatura do ar (C)	Ponto Orvalho	Razao Mistura	Radiação Solar Acum. MJ/m²
00:00	0.00	0.00	0.0	SO	15.8	SO	75.0	24			-
01:00	0.00	0.00	0.7	SO	15.6	SO	79.0	23.6			-
02:00	0.00	0.00	2.9	SO	12.6	S	85.0	22.3			-
03:00	0.00	0.00	2.8	SO	17.2	O	85.0	22.6			-
04:00	0.00	0.00	11.5	S	11.5	S	83.0	22.8			-
05:00	0.00	0.00	0.0	NE	16.9	SO	86.0	22.4			-
06:00	0.00	0.00	2.8	O	16.6	SO	85.0	22.7			-
07:00	0.00	0.00	0.0	O	2.6	O	81.0	23.7			-
08:00	0.00	0.00	2.5	SO	17.0	SO	74.0	25.1			-
09:00	0.00	0.00	0.0	NE	7.6	NE	68.0	27.2			-
10:00	0.00	0.00	1.4	S	22.1	NE	53.0	30.8			-
11:00	0.00	0.00	12.6	L	21.3	NE	44.0	32.7			-
12:00	0.00	0.00	0.4	O	49.3	NE	39.0	34			-
13:00	0.00	0.00	0.0	NE	19.8	S	32.0	35.4			-
14:00	0.00	0.00	15.5	NE	19.2	S	33.0	35.2			-
15:00	0.00	0.00	0.0	NE	52.5	N	39.0	33.9			-
16:00	9.60	9.60	2.8	SO	40.1	SE	64.0	27.1			-
17:00	0.60	10.20	2.8	SO	-	-	91.0	23.9			-
18:00	0.00	10.20	0.0	NE	17.5	SO	85.0	25.8			-
19:00	3.00	13.20	0.0	NE	15.8	S	88.0	24.4			-
20:00	0.00	13.20	0.0	NE	81.8	N	88.0	24			-
21:00	0.40	13.60	0.0	NE	115.8	N	100.0	22.4			-
22:00	1.00	14.60	0.0	NE	16.5	O	100.0	22.4			-
23:00	0.20	14.80	0.0	NE	6.7	NE	100.0	22.5			-

NOTÍCIAS RELACIONADAS

<https://globoplay.globo.com/v/8062814/>

globoplay Agora na Globo Novelas Séries Cinema Infantil Mais ▾



ANHANGUERA NOTÍCIAS 17:22 AO VIVO

Anhanguera Notícias >

Chuva forte derruba árvore em cima de poste em Goiânia

2 min Exibição em 5 Nov 2019

Moradores ficaram sem energia elétrica.

<https://globoplay.globo.com/v/8061773/>

globoplay Agora na Globo Novelas Séries Cinema Infantil Mais ▾



Jornal Manhã 12:00 AO VIVO

JA 1ª Edição >

Seis postes de energia caem durante chuva no Setor Maysa

5 min Exibição em 5 Nov 2019

Por causa dos acidentes, várias casas ficaram sem energia.

<https://globoplay.globo.com/v/8063244/>

globoplay Agora na Globo Novelas Séries Cinema Infantil Mais ▾

#JornalAnhanguera



JA

JA 2ª Edição >

Com chuva, motoristas atolam veículos no GO-454 em Goiás

1 min Exibição em 5 Nov 2019

Problema ocorre em trecho entre Mozarlândia e Cocalinho.

<https://www.opopular.com.br/noticias/cidades/queda-de-%C3%A1rvores-e-ventania-provocam-danos-em-bairros-de-goi%C3%A2nia-veja-v%C3%ADdeos-1.1925552>

O Popular 62 99995 2795 BUSCAR 4 ALEXANDRE x

CAPA POLÍTICA ECONOMIA MUNDO CIDADES ESPORTE MAGAZINE LUDOVICA OPINIÃO ESPECIAIS VÍDEOS INFOMERCIAL GUI

 **CIDADES**

Queda de árvores e ventania provocam danos em bairros de Goiânia; veja vídeos

Entre os efeitos da chuva que caiu em algumas regiões da capital nesta terça-feira (5), está a interrupção do fornecimento de energia elétrica

05/11/2019 - 16:59



Atualizado às 17h24

A chuva que atingiu alguns bairros de Goiânia causou estragos na tarde desta terça-feira (5). Uma árvore caiu na Rua 228, no Setor Leste Vila Nova, na Região Central da capital, e provocou o rompimento da fiação de eletricidade. Por isso, parte da região ficou sem energia. Segundo informações da *CBN Goiânia*, um

<https://www.instagram.com/p/B4fIB1JF45J/>

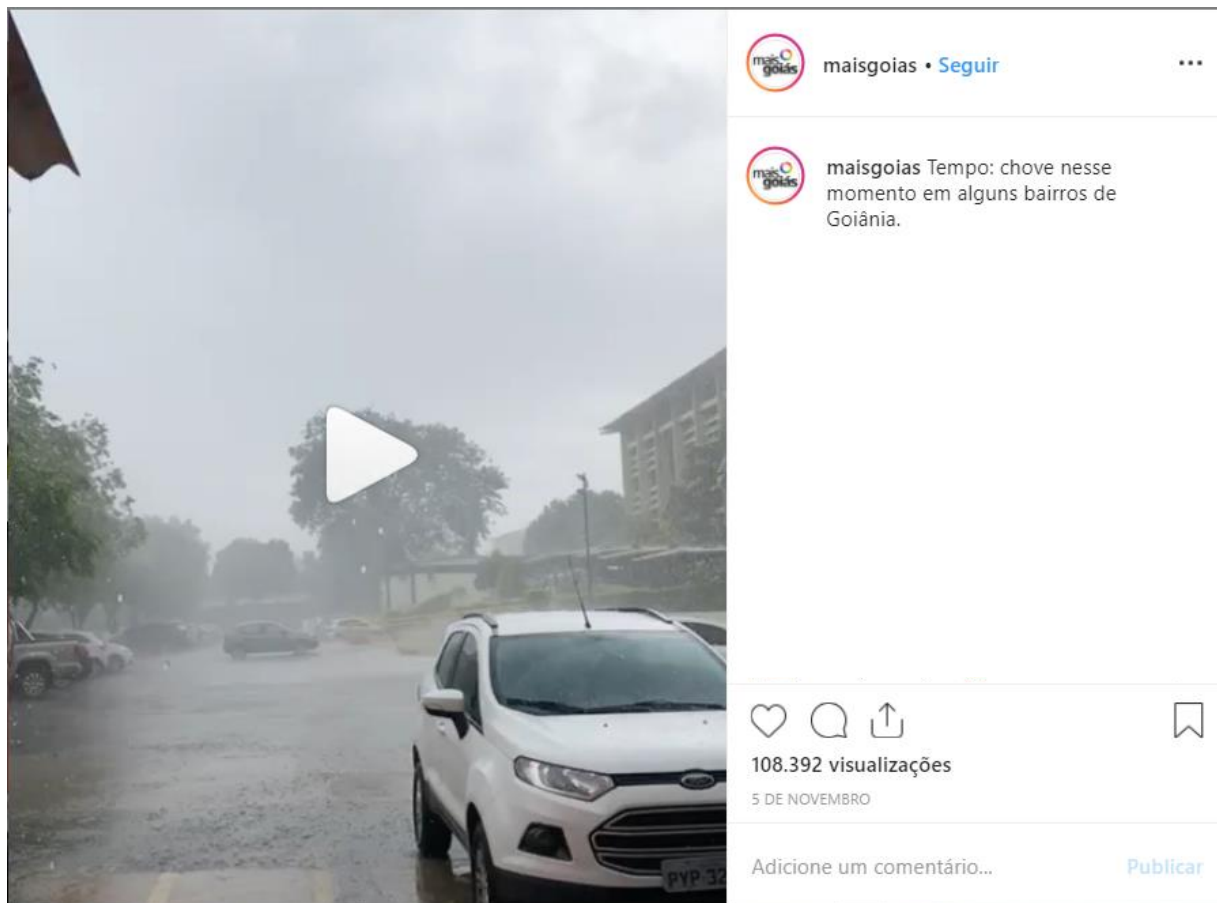

<https://g1.globo.com/go/goias/noticia/2019/11/05/tempestade-de-poeira-assusta-moradores-de-santa-helena-de-goias.ghtml>

G1 **GOIÁS**

Tempestade de poeira assusta moradores de Santa Helena de Goiás

Segundo o Cimehgo, vento de mais de 60Km/h sobre a terra arada 'sem cobertura vegetal' fez a poeira subir formando uma gigantesca nuvem que encobriu parte do município.

Por **Rodrigo Gonçalves, G1 GO**
05/11/2019 20h26 - Atualizado há um mês



Nuvem de poeira encobre Santa Helena de Goiás

<http://g1.globo.com/goias/bom-dia-go/videos/t/edicoes/v/outro-poste-e-encontrado-no-chao-apos-chuva-na-grande-goiania/8064394/>

[globo.com](#) | [g1](#) | [globoesporte](#) | [gshow](#) | [videos](#)

[ASSINE JÁ](#) | [MINHA CONTA](#) | [E-M](#)

MENU



GOIÁS



Q BUS



Outro poste é encontrado no chão após chuva na Grande Goiânia

MAIS INFORMAÇÕES |

[Tweeter](#) [Curtir 0](#)





MUNICÍPIO DE CALDAS NOVAS

DECRETO Nº 1.774/2019

DE 31 DE OUTUBRO DE 2019.

**“DECLARA SITUAÇÃO DE EMERGÊNCIA EM
RAZÃO DO TEMPORAL (ANTICLONE), NAS
ÁREAS DO MUNICÍPIO DE CALDAS NOVAS,
AFETADAS PELAS CHUVAS”**

O PREFEITO DO MUNICÍPIO DE CALDAS NOVAS, Estado de Goiás, no uso da competência e das atribuições que lhe conferem as Constituições da República e do Estado de Goiás, bem como a Lei Orgânica Municipal, e

CONSIDERANDO o caos instalado no Município em razão das chuvas acompanhadas das fortíssimas correntes de ventos na tarde do dia 27 (vinte e sete) de outubro de 2019, mais precisamente por volta das 16h (dezesseis horas);

CONSIDERANDO o registro de índice pluviométrico muito superior ao habitual, com fortíssimas correntes de ventos, causando inúmeros prejuízos humanos e materiais ao município, em residências, em estabelecimentos comerciais, prédios, equipamentos públicos e hospitais;

CONSIDERANDO que as intempéries acarretaram uma série de problemas e danos em diversas regiões rurais, com a ocorrência de grande número de queda de árvores nas redes elétricas; o que causou diversas perdas, partindo cabos elétricos;

CONSIDERANDO ainda, os danos causados na zona urbana do município, como danos às calçadas, destelhamento de residências, destruição de fachadas de prédios comerciais e públicos;

CONSIDERANDO por fim que, de acordo com os serviços de meteorologia a cidade de Caldas Novas foi atingida por um anticiclone, com chuva de granizo, com ventos de mais de 100km/h, causando danos em vários bairros e assustando toda a população e os turistas.

DECRETA:

Art. 1º. Fica Decretada situação de emergência e estado de calamidade pública no município entre os dias 27 de outubro de 2019 à 15 de novembro de 2019.

Art. 2º. Autoriza-se a mobilização de todos os órgãos municipais para atuarem sob a coordenação do Órgão Municipal de Proteção e Defesa Civil, nas ações de resposta aos danos e reabilitação do cenário e reconstrução.

Art. 3º. Este Decreto entrará em vigor na data de sua publicação, para que surta todos os seus jurídicos e legais efeitos.

Cumpra-se e Publique-se.

GABINETE DO PREFEITO DE CALDAS NOVAS-GO, aos trinta e um dias do mês de outubro de 2019.

EVANDO MAGAL ABADIA CORREIA SILVA
Prefeito de Caldas Novas/GO