

Resumo Executivo

O Presente Relatório tem como objetivo a incorporação de informações que sejam relevantes para que se possa fazer a devida associação aos dados contidos no corpo do documento objeto da classificação de Situação de Emergência caracterizada pelo Módulo 8 do Prodist, que tem como foco o impacto do evento sobre determinada rede geelétrica e cuja denominação é definida como CHI (Consumidor hora interrompido). O parâmetro para enquadramento nesta classificação de expurgo tem como premissa inicial o limite de Consumidor hora interrompido definido pela fórmula descrita no Módulo 01 do Prodist (Revisão - 9), acrescido de todos os outros informes e dados listados no Módulo 08 (Revisão 10) do Prodist. Este enquadramento se apresenta na maioria das vezes em condições climáticas adversas com severidade dos fatores inerentes a situação, caracterizado na maioria dos casos por fortes ventos e chuvas de grande intensidade e continuidade.

Entre o dia 06/11/2019 – quarta-feira – e o dia 09/11/2019 – sábado – O ar quente e úmido, reforçados pela passagem de uma frente fria pela costa do Brasil favoreceu a formação áreas de instabilidade sobre as Regiões da Enel Distribuição Goiás.

Entre as 10h00 do dia 06 e 05h00 do dia 09 de novembro de 2019 tivemos, em todo o Estado de Goiás, a incidências de 105.416 descargas atmosféricas (34.693 raios nuvem-solo e 70.723 descargas nuvem-nuvem) sobre a região, o que causou grande instabilidade na rede.

Conforme informações do Climatempo Meteorologia, o Instituto Nacional de Meteorologia (INMET) detectou rajadas de vento acima de 50km/h durante o período. A máxima rajada registrada foi de 65,9km/h entre as 14h e 15h do dia 07 de novembro, sendo esse vento classificado como ventania pela escala Beaufort.

Os maiores acumulados de chuva foram registrados pelo INMET entre as 09h do dia 07 e as 09h do dia 08 de novembro. Durante o período a estação de Iporá registrou 50,0 mm de chuva e em Aragarças foram acumulados 37,2 mm. A chuva registrada em Iporá equivale a aproximadamente 25% da média climatológica de precipitação para o mês de novembro na região.

Forte chuva deixou estragos em Rio Verde. Acesso em: <http://g1.globo.com/goias/videos/t/todos-os-videos/v/forte-chuva-deixou-estragos-em-rio-verde/8070763/>

Chuva de granizo surpreende rio-verdenses - Na tarde desta quarta-feira (06), os moradores de alguns bairros de Rio Verde foram surpreendidos com chuva de granizo. Acesso em: <http://jornalsomos.com.br/rio-verde/detalhe/chuva-de-granizo-surpreende-rio-verdenses>.

Rio Verde tem 2º dia de chuva com granizo e vento provoca estragos

.Acesso em: <http://jornalsomos.com.br/rio-verde/detalhe/rio-verde-tem-2o-dia-de-chuva-com-granizo-e-vento-provoca-estragos>

Granizos gigantes são registrados em Goiás - Em menos de 40 minutos, chuva destruiu carros e plantações. Acesso em: <http://correiodoar.com.br/noticia/granizos-gigantes-sao-registrados-em-goias/47122/>

Relatório de Ocorrências do período

Em todo o Estado de Goiás verificou-se também que a intensidade da chuva e dos ventos danificaram a rede de distribuição de energia elétrica em diversos pontos, registrando aproximadamente 314 mil clientes com interrupção no fornecimento de energia elétrica devido a eventos relacionados ao temporal.

Para otimizar o volume de atendimentos e reduzir os tempos de interrupção foram mobilizados os recursos extras da empresa que aumentou o contingente em relação a situação normal de operação. O acompanhamento da quantidade de equipes e o Tempo Médio de Atendimento podem ser consultados na Pág.02 do Relatório em anexo.

O impacto e severidade do evento estão relatados em artigos de mídia, como fotos e reportagens que demonstram os danos na Rede de Distribuição, oriundos dos eventos climáticos no período. Eventos estes que afetaram 314.226 consumidores com CHI de 1.546.075,12 superior ao de 482.391,86 estabelecido como limite para definição de Situação de Emergência, conforme resumo das informações obrigatórias.

Empresa	ENEL DISTRIBUIÇÃO GOIÁS					
Código do Relatório	CHI-021 - ENEL DISTRIBUIÇÃO GOIÁS					
Evento:	TEMPORAL NA AREA DE CONCESSÃO DA ENEL DISTRIBUIÇÃO GOIAS					
Código COBRADE:	1.3.2.1.2, 1.3.2.1.4 e 1.3.2.1.5	Data Início	06/11/2019	Hora início	10h	
Código do Evento:	CHI-021-ENEL GO	Data Término	09/11/2019	Hora Término	08h59	
Valor CHI (Limite e Real)	482.391,86		1.546.075,12			
Código do Decreto (Se Houver):						
Quantidade de Interrupções (Evento)	4273					
Início 1ª Incidência (Data e Hora)	06/11/2019 10:06	Subestações Atingidas	ABADIANA / ABC / ACREUNA / ADELANDIA / AEROPORTO / AGUA LIMPA (MARZAGAO) / AGUAS LINDAS / ALEXANIA / ALMERINDONOPOLIS / ALOANDIA / ALPHAVILLE / ALTO BURITI / ALTO PARAISO DE GOIAS / ALVORADA DO NORTE / AMERICANO (RIO VERDE) / AMERICANO DO BRASIL / AMORINOPOLIS / ANAPOLIS UNIVERSITARIA / ANHANGUERA / ANICUNS / ANTONIO DO VITTO / APORE / ARACU / ARAGARCAS / ARAGOIANIA / ARAGUAPAZ / ARARAS / AREIAS / ARENOPOLIS / ARUANA / ASA BRANCA / ATLANTICO / AURILANDIA / AVELINOPOLIS / BACURI (RIO VERDE) / BARBOSELANDIA / BARCELONA / BARREIRO (PORANGATU) / BARRO ALTO / BELA VISTA (TRANSMISSAO) / BOM JARDIM / BOM JESUS DE GOIAS / BONFINOPOLIS / BONITO / BONOPOLIS / BONSUCESSO (RIO VERDE) / BRAZABRANTES / BRITANIA / BRITANIA (TRANSMISSAO) / BURITI ALEGRE / BURITI DE GOIAS / CABECEIRAS / CABRIUVA (RIO VERDE) / CACHOEIRA ALTA / CACHOEIRA DOURADA / CACHOEIRA NOVA / CACHOEIRINHA (ITARUMA) / CACU / CAIAPONIA / CALCILANDIA / CALDAS NOVAS / CALDAZINHA / CAMPESTRE / CAMPINAS / CAMPINORTE / CAMPO ALEGRE DE GOIAS / CAMPO NOVO / CAMPOS BELOS / CAMPOS VERDES / CARAIBAS / CARAJAS / CATALAO / CEBRASA FABRICA DA AMBEV / CEPALGO / CEZARINA / CHAPADAO DO CEU / CIDADE ECLETICA / CIDADE OCIDENTAL / COCALZINHO / COLINACU / CORREGO DO OURO / CORUMBA / CORUMBAIBA / CRISTALINA / CRISTALINA TRANSMISSAO / CRISTIANOPOLIS / CRIXAS / CROMINIA / CUMARI / DAIA - ANAPOLIS / DAMOLANDIA / DAVINOPOLIS / DESFECHO / DESTILARIA BRASIL CENTRAL / DIMIC / DORCELINO PEIXOTO DE MORAES / DOVERLANDIA / EDEIA / ENERSUL / ESTANIFERA / ESTRELA DO NORTE / FAINA / FAZENDA CANADA / FAZENDA NOVA / FERROVIARIO / FIRMINOPOLIS / FLORES DE GOIAS / FORMIGA / FORMOSO / FRONTEIRA / GAMELEIRA / GIRASSOL / GOIANAPOLIS / GOIANDIRA / GOIANESIA / GOIANIA LESTE / GOIANIRA / GOIAS / GOIATUBA / GOUVERLANDIA / GOYA / GUAPO / HEITORAI / HIDROLANDIA / HIDROLINA / IACIARA / INACIOLANDIA / INDEPENDENCIA / INDIARA / INHUMAS / IPAMERI / IPEGUARI / IPORA / ISRAELANDIA / ITABERAI / ITAGUARI / ITAGUARU / ITAJA / ITAPACI / ITAPACI (TRANSMISSAO) / ITAPIRAPUA / ITAPURANGA / ITAPURANGA (TRANSMISSAO) / ITARUMA / ITAUCU / ITIQUIRA (FORMOSA) / ITUMBIARA NOVA / ITUMBIARA VELHA / JACILANDIA / JANDAIA / JARAGUA / JARANAPOLIS / JATAI / JAUPACI / JESUPOLIS / JOVIANIA / JUNDIAI / JURUMIRIM / JUSCELANDIA / JUSSARA / LAGES / LAGOA / LAGOA DA SERRA / LAGOA DO BAUZINHO (RIO VERDE) / LEOPOLDO DE BULHOES / LUZIANIA / MAMBAI / MARA ROSA / MARAJOARA / MARIAPOLIS (PADRE BERNARDO) / MARZAGAO / MATO GRANDE / MATRINCHA / MAURILANDIA / MEIA PONTE / MINACU / MINEIROS / MOIPORA / MONTE ALEGRE / MONTES CLAROS DE GOIAS / MONTIVIDIU T / MORRINHOS / MORRO AGUDO / MOSSAMEDES / MOZARLANDIA / MOZARLANDIA (TRANSMISSAO) / MUNDO NOVO DE GOIAS / MUTUNOPOLIS / NAVESLANDIA (JATAI) / NAZARIO / NEROPOLIS / NIQUELANDIA / NOVA AMERICA / NOVA AURORA / NOVA CRIXAS (TRANSMISSAO) / NOVA IGUAQU / NOVA PONTE / NOVA VENEZA / NOVO BRASIL / NOVO GAMA / NOVO PLANALTO / ORIZONA / OUVIDOR / PACAEMBU (NOVO GAMA) / PADRE BERNARDO / PALESTINA / PALMEIRAS / PALMEIRAS DE GOIAS / PALMELO / PALMINOPOLIS / PAMPLONA / PANAMA / PARANA / PARANAIBA / PARANAIGUARA / PARAUNA SE ALTA TENSAO / PARQUE DAS EMAS (MINEIROS) / PARQUE DAS NACOES / PEROLANDIA / PETROLINA / PILAR / PILOANDIA / PIRACANJUBA / PIRANHAS T / PIRENOPOLIS / PIRES BELO / PIRES DO RIO / PLANALTINA / PLANALTINA (TRANSMISSAO) / PLANALTO / PONTALINA / PORANGATU / PORTEIRAO / PORTELANDIA / PORTO SAO SIMAO / POSSE / POSSELANDIA / PROFESSOR JAMIL / QUEBRA LINHA / QUIRINOPOLIS / REAL / RIO CLARO / JATAI MONTIVIDIU / RIO DO PEIXE / RIO DOS BOIS (MAURILANDIA) / RIO PRETO / RIO QUENTE / RIO VERDE / RIO VERMELHO / RIVERLANDIA (RIO VERDE) / ROCHEDO (UEH) / RUBIATABA / SANCLERLANDIA / SANTA FE DE GOIAS / SANTA HELENA / SANTA RITA DO ARAGUAIA / SANTA ROSA / SANTA ROSA DE GOIAS / SANTA ROSA DO MEIA PONTE / SANTA TEREZA DE GOIAS / SANTA TEREZINHA / SANTO ANTONIO DA BARRA / SANTO ANTONIO DE GOIAS / SANTO ANTONIO DO DESCOBERTO / SAO BARTOLOMEU / SAO DOMINGOS / SAO FRANCISCO DE GOIAS / SAO GABRIEL DE GOIAS / SAO JOAO D ALIANCA / SAO JOAO DA PARAUNA / SAO LUIZ DOS MONTES BELOS / SAO MIGUEL DO ARAGUAIA / SAO MIGUEL DO PASSA QUATRO / SAO SIMAO / SENADOR CANEDO TRANSMISSAO / SERRA AZUL (JATAI) / SERRA DE CALDAS / SERRANOPOLIS / SILVANIA / SOUZALANDIA / SUCURI / TAIOBA / TEREZOPOLIS / TRES BARRAS / TRES RANCHOS / TRINDADE / TUCUNARE / TURVANIA / TURVELANDIA / URUACU / URUTAI / USINA DE ACUCAR DE GOIANESIA / VALPARAISO / VARJAO / VIANOPOLIS / VICENTINOPOLIS / VILA BOA / VILA CORUMBA / VILA PROPICIO / XAVANTES / XIXA			
Início Última Incidência (Data e Hora)	09/11/2019 08:57		Municípios Atingidos	ABADIA DE GOIAS / ABADIANA / ACREUNA / ADELANDIA / AGUA FRIA DE GOIAS / AGUA LIMPA / AGUAS LINDAS DE GOIAS / ALEXANIA / ALOANDIA / ALTO HORIZONTE / ALTO PARAISO DE GOIAS / ALVORADA DO NORTE / AMARALINA / AMERICANO DO BRASIL / AMORINOPOLIS / ANAPOLIS / ANHANGUERA / ANICUNS / APARECIDA DE GOIANIA / APARECIDA DO RIO DOCE / APORE / ARAGARCAS / ARAGOIANIA / ARAGUAPAZ / ARENOPOLIS / ARUANA / AURILANDIA / AVELINOPOLIS / BALIZA / BARRO ALTO / BELA VISTA DE GOIAS / BOM JARDIM DE GOIAS / BOM JESUS DE GOIAS / BONFINOPOLIS / BONOPOLIS / BRAZABRANTES / BRITANIA / BURITI ALEGRE / BURITI DE GOIAS / BURITINOPOLIS / CABECEIRAS / CACHOEIRA ALTA / CACHOEIRA DE GOIAS / CACHOEIRA DOURADA / CACU / CAIAPONIA / CALDAS NOVAS / CALDAZINHA / CAMPESTRE DE GOIAS / CAMPINACU / CAMPINORTE / CAMPO ALEGRE DE GOIAS / CAMPOS BELOS / CAMPOS VERDES / CARMO DO RIO VERDE / CASTELANDIA / CATALAO / CATURAI / CAVALCANTE / CERES / CEZARINA / CHAPADAO DO CEU / CIDADE OCIDENTAL / COCALZINHO DE GOIAS		
Média de Duração das Incidências (h)	20,27					
Duração da Incidência mais longa (h)	217,41					
Total de Clientes afetados	314.226					

			COLINAS DO SUL / CORREGO DO OURO / CORUMBA DE GOIAS / CORUMBAIBA / CRISTALINA / CRISTIANOPOLIS / CRIXAS / CROMINIA / CUMARI / DAMOLANDIA / DAVINOPOLIS / DIORAMA / DISTRITO FEDERAL / DIVINOPOLIS DE GOIAS / DOVERLANDIA / EDEALINA / EDEIA / ESTRELA DO NORTE / FAINA / FAZENDA NOVA / FIRMINOPOLIS / FLORES DE GOIAS / FORMOSA / FORMOSO / GAMELEIRA DE GOIAS / GOIANAPOLIS / GOIANDIRA / GOIANESIA / GOIANIA / GOIANIRA / GOIAS / GOIATUBA / GOUVELANDIA / GUAPO / GUARAITA / GUARANI DE GOIAS / GUARINOS / HEITORAI / HIDROLANDIA / HIDROLINA / IACIARA / INACIOLANDIA / INDIARA / INHUMAS / IPAMERI / IPIRANGA DE GOIAS / IPORA / ISRAELANDIA / ITABERAI / ITAGUARI / ITAGUARU / ITAJA / ITAPACI / ITAPIRAPUA / ITAPURANGA / ITARUMA / ITAUCU / ITUMBIARA / IVOLANDIA / JANDAIA / JARAGUA / JATAI / JAUPACI / JESUPOLIS / JOVIANIA / JUSSARA / LAGOA SANTA / LEOPOLDO DE BULHOES / LUZIANIA / MAIRIPOTABA / MAMBAI / MARA ROSA / MARZAGAO / MATRINCHA / MAURILANDIA / MIMOSO DE GOIAS / MINACU / MINEIROS / MOIPORA / MONTE ALEGRE DE GOIAS / MONTES CLAROS DE GOIAS / MONTIVIDIU / MONTIVIDIU DO NORTE / MORRINHOS / MORRO AGUDO DE GOIAS / MOSSAMEDES / MOZARLANDIA / MUNDO NOVO DE GOIAS / MUTUNOPOLIS / NAZARIO / NEROPOLIS / NIQUELANDIA / NOVA AMERICA / NOVA AURORA / NOVA CRIXAS / NOVA GLORIA / NOVA IGUACU DE GOIAS / NOVA ROMA / NOVA VENEZA / NOVO BRASIL / NOVO GAMA / NOVO PLANALTO / ORIZONA / OURO VERDE DE GOIAS / OUVIDOR / PADRE BERNARDO / PALESTINA DE GOIAS / PALMEIRAS DE GOIAS / PALMELO / PALMINOPOLIS / PANAMA / PARANAIGUARA / PARAUNA / PEROLANDIA / PETROLINA DE GOIAS / PILAR DE GOIAS / PIRACANJUBA / PIRANHAS / PIRENOPOLIS / PIRES DO RIO / PLANALTINA / PONTALINA / PORANGATU / PORTEIRAO / PORTELANDIA / POSSE / PROFESSOR JAMIL SAFADY / QUIRINOPOLIS / RIO QUENTE / RIO VERDE / RUBIATABA / SANCLERLANDIA / SANTA BARBARA DE GOIAS / SANTA CRUZ DE GOIAS / SANTA FE DE GOIAS / SANTA HELENA DE GOIAS / SANTA ISABEL / SANTA RITA DO ARAGUAIA / SANTA RITA DO NOVO DESTINO / SANTA ROSA DE GOIAS / SANTA TEREZA DE GOIAS / SANTA TEREZINHA DE GOIAS / SANTO ANTONIO DA BARRA / SANTO ANTONIO DE GOIAS / SANTO ANTONIO DO DESCOBERTO / SAO DOMINGOS / SAO FRANCISCO DE GOIAS / SAO JOAO D ALIANCA / SAO JOAO DA PARAUNA / SAO LUIS DE MONTES BELOS / SAO LUIZ DO NORTE / SAO MIGUEL DO ARAGUAIA / SAO MIGUEL DO PASSA QUATRO / SAO PATRICIO / SAO SIMAO / SENADOR CANEDO / SERRANOPOLIS / SILVANIA / SIMOLANDIA / SITIO D ABADIA / TAQUARAL DE GOIAS / TERESINA DE GOIAS / TRES RANCHOS / TRINDADE / TROMBAS / TURVANIA / TURVELANDIA / UIRAPURU / URUACU / URUTAI / VALPARAISO DE GOIAS / VARJAO / VIANOPOLIS / VICENTINOPOLIS / VILA BOA / VILA PROPICIO
--	--	--	----------------------------------------------------------------------------------------------------------------------------------------------------------------------------------------------------------------------------------------------------------------------------------------------------------------------------------------------------------------------------------------------------------------------------------------------------------------------------------------------------------------------------------------------------------------------------------------------------------------------------------------------------------------------------------------------------------------------------------------------------------------------------------------------------------------------------------------------------------------------------------------------------------------------------------------------------------------------------------------------------------------------------------------------------------------------------------------------------------------------------------------------------------------------------------------------------------------------------------------------------------------------------------------------------------------------------------------------------------------------------------------------------------------------------------------------------------------------------------------------------------------------------------------------------------------------------------------------------------------------------------------------------------------------------------------------------------------------------------------------------------------------------------------------------------------------------------------------------------------------------------------------------------------------------------------------------------------------------------------------------------------------------------------------------------------------------------------------------------------------------------------------------------------------------------------------------------------------------------------------------------------------------------------------------------------------------------------------------------------------------------------------------------------------------------------------------------------------------------------------------------------------------------------------------------------------------------------------------------------------------------------------------------------------------------------------------

DANOS CAUSADOS			
Equipamentos Danificado	Importância para o Sistema	Local	Quantidade
Disjuntor/Religador Operado	Proteção do Alimentador	Área de Concessão	116
Chaves Fusíveis Operada	Proteção de Ramais de Alimentadores	Área de Concessão	1297
Transformador Operado	Proteção do Transformador	Área de Concessão	1064

Informações sobre Equipes	06/11	07/11	08/11	09/11	
Quantidade Usual	530	530	530	467	turmas
Quantidade Adicional	67	56	39	41	turmas
Quantidade Total	597	586	569	508	turmas
Tempos Médios					
Preparação	17,46	16,09	17,20	16,58	Horas
Deslocamento	0,68	0,68	0,68	0,68	Horas
Execução	2,34	2,11	2,26	2,81	Horas
TMAE	20,48	18,88	20,13	20,07	Horas

Principais Dificuldades Encontradas:

Chuvas com ventos fortes provocaram muitos pontos de alagamento e enxurrada, trânsito impedido por vários semáforos desligados dificultando a chegada ao atendimento das ocorrências emergenciais. Em determinadas regiões, decorrente dos fortes ventos, houve o tombamento de árvores nas estruturas de alimentação de média tensão, danos em ramais de ligação dos clientes, impedimentos de acesso e atolamentos em estradas rurais.

Empresa	ENEL DISTRIBUIÇÃO GOIAS		
Valor CHI (Limite e Real)	482.391,86		1.546.075,12

DOC ORIGEM	MIUNICIPIO	EQP_ORIGEM	CONJUNTO	INI_OCORRENC	FIM_OCORRENC	DT_INI_EVENTO	DT_FIM_EVENTO	DURAÇ	UC INT	CHI	EXPURGO
2019119361	CACHOEIRA DOURADA	CD12222448	CACHOEIRA DOURADA	06/11/2019 14:44	08/11/2019 13:40	06/11/2019 14:44	08/11/2019 13:40	46,93	9	422,37	CHI
2019119361	ITUMBIARA	CD12222448	CACHOEIRA DOURADA	06/11/2019 14:44	08/11/2019 13:40	06/11/2019 14:44	08/11/2019 13:40	46,93	23	1079,40	CHI
20191115439	TROMBAS	TB11271999	PORANGATU	06/11/2019 14:50	10/11/2019 18:16	06/11/2019 14:50	10/11/2019 18:16	99,44	4	397,76	CHI
20191117206	MONTIVIDIU DO NORTE	MX12226413	PORANGATU	06/11/2019 18:42	07/11/2019 00:47	06/11/2019 18:42	07/11/2019 00:47	6,08	40	243,30	CHI
20191120538	AURILANDIA	CG12391407	FIRMINOPOLIS S2	07/11/2019 14:38	07/11/2019 15:26	07/11/2019 14:38	07/11/2019 15:26	0,80	2	1,59	CHI
20191120538	CACHOEIRA DE GOIAS	CG12391407	FIRMINOPOLIS S2	07/11/2019 14:38	07/11/2019 15:26	07/11/2019 14:38	07/11/2019 15:26	0,80	66	52,53	CHI
20191120538	PARAUNA	CG12391407	FIRMINOPOLIS S2	07/11/2019 14:38	07/11/2019 15:26	07/11/2019 14:38	07/11/2019 15:26	0,80	32	25,47	CHI
20191129554	CAIAPONIA	CP12374978	PALESTINA	07/11/2019 09:08	07/11/2019 17:19	07/11/2019 09:08	07/11/2019 17:19	8,17	4	32,70	CHI
20191133426	JOVIANIA	VI12208231RE	VICENTINOPOLIS	06/11/2019 19:04	08/11/2019 10:16	06/11/2019 19:04	08/11/2019 10:16	39,19	13	509,50	CHI
20191133426	PONTALINA	VI12208231RE	VICENTINOPOLIS	06/11/2019 19:04	08/11/2019 10:16	06/11/2019 19:04	08/11/2019 10:16	39,19	25	979,81	CHI
20191133426	VICENTINOPOLIS	VI12208231RE	VICENTINOPOLIS	06/11/2019 19:04	08/11/2019 10:16	06/11/2019 19:04	08/11/2019 10:16	39,19	27	1058,19	CHI
20191134129	CORUMBAIBA	CI21105561	VILA CORUMBA	07/11/2019 07:18	07/11/2019 15:33	07/11/2019 07:18	07/11/2019 15:33	8,24	1	8,24	CHI
20191134204	CRIXAS	CX12390328	SANTA TEREZINHA	07/11/2019 09:13	09/11/2019 04:01	07/11/2019 09:13	09/11/2019 04:01	42,79	30	1283,57	CHI
20191135615	ABADIA DE GOIAS	LG12343065	INDEPENDENCIA S2	07/11/2019 07:37	07/11/2019 16:20	07/11/2019 07:37	07/11/2019 16:20	8,70	18	156,67	CHI
20191140515	JATAI	JT12374237	JATAI S1	07/11/2019 08:41	07/11/2019 17:25	07/11/2019 08:41	07/11/2019 17:25	8,72	19	165,69	CHI
20191140777	ARAGUAPAZ	AZ12253302	RUBIATABA	07/11/2019 19:49	08/11/2019 11:05	07/11/2019 19:49	08/11/2019 11:05	15,27	21	320,59	CHI
20191143137	MONTES CLAROS DE GOIAS	ME21139480	BRITANIA	08/11/2019 11:38	09/11/2019 13:10	08/11/2019 11:38	09/11/2019 13:10	25,52	54	1378,29	CHI
20191144755	SANCLERLANDIA	10027337829	FIRMINOPOLIS S2	06/11/2019 10:06	06/11/2019 20:28	06/11/2019 10:06	06/11/2019 20:28	10,36	1	10,36	CHI
20191144792	MOZARLANDIA	MZ11250926	MOZARLANDIA	06/11/2019 10:10	06/11/2019 18:50	06/11/2019 10:10	06/11/2019 18:50	8,67	40	346,64	CHI
20191144846	JUSSARA	1290069648	JUSSARA	06/11/2019 10:19	07/11/2019 08:05	06/11/2019 10:19	07/11/2019 08:05	21,76	1	21,76	CHI
20191144865	FAINA	FC12205455	GOIAS	06/11/2019 10:21	06/11/2019 16:15	06/11/2019 10:21	06/11/2019 16:15	5,89	1	5,89	CHI
20191144934	IVOLANDIA	AM12244949	IPORA	06/11/2019 10:32	06/11/2019 14:52	06/11/2019 10:32	06/11/2019 14:52	4,32	1	4,32	CHI
20191144953	ITAPIRAPUA	IU12095446	MATRINCHA	06/11/2019 14:57	07/11/2019 12:12	06/11/2019 14:57	07/11/2019 12:12	21,24	9	191,14	CHI
20191144966	PEROLANDIA	DP21182215	JATAI S1	06/11/2019 10:37	08/11/2019 16:05	06/11/2019 10:37	08/11/2019 16:05	53,45	1	53,45	CHI
20191144995	CEZARINA	CZ21349317	CEZARINA	06/11/2019 10:42	06/11/2019 16:25	06/11/2019 10:42	06/11/2019 16:25	5,72	3	17,17	CHI
20191145007	PARAUNA	PU12361641	MONTIVIDIU T	06/11/2019 10:45	07/11/2019 14:54	06/11/2019 10:45	07/11/2019 14:54	28,15	36	1013,56	CHI
20191145025	SANTA HELENA DE GOIAS	400105822	IPEGUARI	06/11/2019 10:48	07/11/2019 00:10	06/11/2019 10:48	07/11/2019 00:10	13,38	1	13,38	CHI
20191145049	ARAGUAPAZ	AZ21242471	MOZARLANDIA	06/11/2019 10:52	06/11/2019 20:14	06/11/2019 10:52	06/11/2019 20:14	9,36	1	9,36	CHI
20191145067	MINEIROS	PW12000116	PARQUE DAS EMAS	06/11/2019 10:55	07/11/2019 16:21	06/11/2019 10:55	07/11/2019 16:21	29,42	4	117,67	CHI
20191145067	PORTELANDIA	PW12000116	PARQUE DAS EMAS	06/11/2019 10:55	07/11/2019 16:21	06/11/2019 10:55	07/11/2019 16:21	29,42	4	117,67	CHI
20191145082	SANTA FE DE GOIAS	RN11375837	BRITANIA	06/11/2019 10:59	08/11/2019 03:15	06/11/2019 10:59	08/11/2019 01:40	38,68	1	38,68	CHI
20191145082	SANTA FE DE GOIAS	RN12167540	BRITANIA	06/11/2019 10:59	08/11/2019 03:15	06/11/2019 10:59	08/11/2019 03:15	40,27	1	40,27	CHI

20191145162	AGUA FRIA DE GOIAS	01370214	PADRE BERNARDO	06/11/2019 14:55	06/11/2019 23:25	06/11/2019 14:55	06/11/2019 15:10	0,25	10	2,52	CHI
20191145162	MIMOSO DE GOIAS	01370214	PADRE BERNARDO	06/11/2019 14:55	06/11/2019 23:25	06/11/2019 14:55	06/11/2019 15:10	0,25	652	164,09	CHI
20191145162	PADRE BERNARDO	01370214	PADRE BERNARDO	06/11/2019 14:55	06/11/2019 23:25	06/11/2019 14:55	06/11/2019 15:10	0,25	4249	1069,33	CHI
20191145162	PADRE BERNARDO	01370214	PADRE BERNARDO	06/11/2019 14:55	06/11/2019 23:25	06/11/2019 15:11	06/11/2019 17:15	2,06	3142	6478,63	CHI
20191145162	PADRE BERNARDO	PB13219599	PADRE BERNARDO	06/11/2019 14:55	06/11/2019 23:25	06/11/2019 15:11	06/11/2019 18:02	2,85	1102	3135,50	CHI
20191145162	PADRE BERNARDO	01370214	PADRE BERNARDO	06/11/2019 14:55	06/11/2019 23:25	06/11/2019 20:04	06/11/2019 20:09	0,09	4244	366,63	CHI
20191145162	PADRE BERNARDO	PB12219602LD	PADRE BERNARDO	06/11/2019 14:55	06/11/2019 23:25	06/11/2019 14:55	06/11/2019 23:22	8,45	108	913,05	CHI
20191145162	PLANALTINA	PB12219602LD	PADRE BERNARDO	06/11/2019 14:55	06/11/2019 23:25	06/11/2019 14:55	06/11/2019 23:22	8,45	11	93,00	CHI
20191145162	AGUA FRIA DE GOIAS	PB12219602LD	PADRE BERNARDO	06/11/2019 14:55	06/11/2019 23:25	06/11/2019 15:11	06/11/2019 23:22	8,19	10	81,90	CHI
20191145162	MIMOSO DE GOIAS	PB12219602LD	PADRE BERNARDO	06/11/2019 14:55	06/11/2019 23:25	06/11/2019 15:11	06/11/2019 23:22	8,19	652	5339,88	CHI
20191145162	PADRE BERNARDO	PB12219602LD	PADRE BERNARDO	06/11/2019 14:55	06/11/2019 23:25	06/11/2019 15:11	06/11/2019 23:22	8,19	5	40,95	CHI
20191145162	MIMOSO DE GOIAS	PB10396066	PADRE BERNARDO	06/11/2019 14:55	06/11/2019 23:25	06/11/2019 14:55	06/11/2019 23:25	8,51	379	3223,71	CHI
20191145162	NIQUELANDIA	PB10396066	PADRE BERNARDO	06/11/2019 14:55	06/11/2019 23:25	06/11/2019 14:55	06/11/2019 23:25	8,51	1	8,51	CHI
20191145170	ALVORADA DO NORTE	FB10401475	FLORES DE GOIAS	06/11/2019 14:40	07/11/2019 17:43	06/11/2019 14:40	07/11/2019 17:43	27,05	53	1433,71	CHI
20191145170	FLORES DE GOIAS	FB10401475	FLORES DE GOIAS	06/11/2019 14:40	07/11/2019 17:43	06/11/2019 14:40	07/11/2019 17:43	27,05	38	1027,94	CHI
20191145170	IACIARA	FB10401475	FLORES DE GOIAS	06/11/2019 14:40	07/11/2019 17:43	06/11/2019 14:40	07/11/2019 17:43	27,05	16	432,82	CHI
20191145170	POSSE	FB10401475	FLORES DE GOIAS	06/11/2019 14:40	07/11/2019 17:43	06/11/2019 14:40	07/11/2019 17:43	27,05	2	54,10	CHI
20191145172	ITAPIRAPUA	IU21131397	MATRINCHA	06/11/2019 12:21	08/11/2019 20:05	06/11/2019 12:21	08/11/2019 19:51	55,49	1	55,49	CHI
20191145172	ITAPIRAPUA	IU12206870	MATRINCHA	06/11/2019 12:21	08/11/2019 20:05	08/11/2019 14:42	08/11/2019 20:05	5,38	7	37,64	CHI
20191145240	CRISTALINA	KR11032674	CRISTALINA S1	06/11/2019 11:11	06/11/2019 16:00	06/11/2019 11:11	06/11/2019 16:00	4,82	63	303,38	CHI
20191145265	PARAUNA	PU12010292	FIRMINOPOLIS S2	06/11/2019 10:14	08/11/2019 00:17	06/11/2019 10:14	08/11/2019 00:17	38,06	8	304,45	CHI
20191145265	PARAUNA	PU12010292	FIRMINOPOLIS S2	06/11/2019 10:14	08/11/2019 00:17	06/11/2019 16:25	08/11/2019 00:17	31,86	19	605,41	CHI
20191145298	PALMEIRAS DE GOIAS	590071427	PALMEIRAS	06/11/2019 11:18	06/11/2019 16:22	06/11/2019 11:18	06/11/2019 16:22	5,05	1	5,05	CHI
20191145299	CEZARINA	7604847	CEZARINA	06/11/2019 11:18	07/11/2019 18:10	06/11/2019 11:18	07/11/2019 18:10	30,85	6	185,10	CHI
20191145307	LUZIANIA	LZ11000022	RIO VERMELHO	06/11/2019 11:20	06/11/2019 18:13	06/11/2019 11:20	06/11/2019 18:13	6,88	21	144,46	CHI
20191145359	CACU	CC11000011	CACHOEIRA ALTA	06/11/2019 11:10	06/11/2019 18:08	06/11/2019 11:10	06/11/2019 18:08	6,97	71	494,55	CHI
20191145361	MOSSAMEDES	SC21155834	FIRMINOPOLIS S2	06/11/2019 11:28	06/11/2019 15:19	06/11/2019 11:28	06/11/2019 15:19	3,84	1	3,84	CHI
20191145367	MOSSAMEDES	MD21204382	FIRMINOPOLIS S2	06/11/2019 11:29	07/11/2019 19:59	06/11/2019 11:29	07/11/2019 19:59	32,50	1	32,50	CHI
20191145404	MINEIROS	MY21278383	PARQUE DAS EMAS	06/11/2019 11:36	09/11/2019 12:18	06/11/2019 11:36	09/11/2019 12:18	72,70	1	72,70	CHI
20191145411	CAVALCANTE	CJ11390350	SAO DOMINGOS	06/11/2019 11:37	09/11/2019 15:54	06/11/2019 11:37	09/11/2019 15:54	76,28	1	76,28	CHI
20191145425	AGUAS LINDAS DE GOIAS	LA21347937	AGUAS LINDAS DE GOIAS S1	06/11/2019 11:40	06/11/2019 12:28	06/11/2019 11:40	06/11/2019 12:28	0,80	1	0,80	CHI
20191145444	GOIAS	90036013	GOIAS	06/11/2019 11:44	06/11/2019 16:41	06/11/2019 11:44	06/11/2019 16:41	4,95	1	4,95	CHI
20191145448	AGUA FRIA DE GOIAS	10009585310	SAO JOAO D ALIANCA	06/11/2019 11:45	10/11/2019 20:23	06/11/2019 11:45	10/11/2019 20:23	104,64	1	104,64	CHI

20191145450	LUZIANIA	10027281033	RIO VERMELHO	06/11/2019 11:45	06/11/2019 20:25	06/11/2019 11:45	06/11/2019 20:25	8,66	1	8,66	CHI
20191145461	ANICUNS	10023193172	ANICUNS	06/11/2019 11:46	06/11/2019 15:07	06/11/2019 11:46	06/11/2019 15:07	3,34	1	3,34	CHI
20191145470	CIDADE OCIDENTAL	10010531007	MARAJOARA	06/11/2019 11:47	06/11/2019 14:08	06/11/2019 11:47	06/11/2019 14:08	2,35	1	2,35	CHI
20191145495	LUZIANIA	LZ11000075	RIO VERMELHO	06/11/2019 11:50	06/11/2019 14:24	06/11/2019 11:50	06/11/2019 14:24	2,55	57	145,57	CHI
20191145498	AMERICANO DO BRASIL	1410009224	ANICUNS	06/11/2019 11:52	06/11/2019 14:51	06/11/2019 11:52	06/11/2019 14:51	2,98	1	2,98	CHI
20191145578	LUZIANIA	3200196723	MARAJOARA	06/11/2019 12:12	06/11/2019 17:30	06/11/2019 12:12	06/11/2019 17:30	5,29	1	5,29	CHI
20191145589	LUZIANIA	3200027044	MARAJOARA	06/11/2019 12:15	06/11/2019 18:18	06/11/2019 12:15	06/11/2019 18:18	6,04	1	6,04	CHI
20191145591	PALMEIRAS DE GOIAS	PL21097326	PALMEIRAS	06/11/2019 12:16	07/11/2019 18:48	06/11/2019 12:16	07/11/2019 18:48	30,53	1	30,53	CHI
20191145602	NOVA ROMA	ND21206208	IACIARA S2	06/11/2019 12:18	06/11/2019 14:40	06/11/2019 12:18	06/11/2019 14:40	2,35	1	2,35	CHI
20191145606	URUACU	CR12271956	MARA ROSA	06/11/2019 12:20	07/11/2019 15:32	06/11/2019 12:20	07/11/2019 15:32	27,19	2	54,39	CHI
20191145608	HIDROLINA	1020000676	URUACU	06/11/2019 12:20	08/11/2019 08:25	06/11/2019 12:20	08/11/2019 08:25	44,07	1	44,07	CHI
20191145617	GUAPO	GA12196690	GUAPO S1	06/11/2019 15:29	06/11/2019 21:37	06/11/2019 15:29	06/11/2019 21:37	6,12	85	520,53	CHI
20191145640	INDIARA	IY12158916	CEZARINA	06/11/2019 12:27	07/11/2019 16:16	06/11/2019 12:27	07/11/2019 16:16	27,81	3	83,44	CHI
20191145650	PALMEIRAS DE GOIAS	10019745999	PALMEIRAS	06/11/2019 12:29	07/11/2019 12:45	06/11/2019 12:29	07/11/2019 12:45	24,27	1	24,27	CHI
20191145651	UIRAPURU	UP21190103	SANTA TEREZINHA	06/11/2019 12:29	07/11/2019 13:54	06/11/2019 12:29	07/11/2019 13:54	25,41	1	25,41	CHI
20191145656	CAVALCANTE	CJ12384725	SAO DOMINGOS	06/11/2019 12:29	09/11/2019 16:50	06/11/2019 12:29	09/11/2019 16:50	76,33	5	381,67	CHI
20191145660	TURVANIA	TV21005592	FIRMINOPOLIS S2	06/11/2019 12:31	07/11/2019 07:50	06/11/2019 12:31	07/11/2019 07:50	19,32	2	38,64	CHI
20191145661	CATALAO	CT21363959	CATALAO S1	06/11/2019 12:31	07/11/2019 12:04	06/11/2019 12:31	07/11/2019 12:04	23,55	1	23,55	CHI
20191145665	ITAPURANGA	170079168	ITAPURANGA	06/11/2019 12:32	08/11/2019 15:57	06/11/2019 12:32	08/11/2019 15:57	51,42	1	51,42	CHI
20191145667	MONTE ALEGRE DE GOIAS	8563532	SAO DOMINGOS	06/11/2019 12:32	06/11/2019 19:12	06/11/2019 12:32	06/11/2019 19:12	6,65	1	6,65	CHI
20191145680	ITAPURANGA	IK12274272	ITAPURANGA	06/11/2019 12:35	07/11/2019 11:40	06/11/2019 12:35	07/11/2019 11:40	23,09	1	23,09	CHI
20191145684	CABECEIRAS	CW12204613	ITIQUEIRA	06/11/2019 12:36	06/11/2019 16:12	06/11/2019 12:36	06/11/2019 16:12	3,60	1	3,60	CHI
20191145687	GOIAS	GS21055016	MATRINCHA	06/11/2019 12:36	11/11/2019 00:23	06/11/2019 12:36	11/11/2019 00:23	107,77	1	107,77	CHI
20191145699	RIO VERDE	RV21029162	SANTA HELENA S1	06/11/2019 12:38	08/11/2019 14:00	06/11/2019 12:38	08/11/2019 14:00	49,36	1	49,36	CHI
20191145708	SANTA HELENA DE GOIAS	10010596800	IPEGUARI	06/11/2019 12:40	07/11/2019 11:37	06/11/2019 12:40	07/11/2019 11:37	22,96	1	22,96	CHI
20191145710	CALDAS NOVAS	10015312931	SERRA DE CALDAS	06/11/2019 12:40	07/11/2019 08:40	06/11/2019 12:40	07/11/2019 08:40	20,00	1	20,00	CHI
20191145721	ADELANDIA	MD12304614	ANICUNS	06/11/2019 12:42	07/11/2019 19:45	06/11/2019 12:42	07/11/2019 19:45	31,04	2	62,08	CHI
20191145721	MOSSAMEDES	MD12304614	ANICUNS	06/11/2019 12:42	07/11/2019 19:45	06/11/2019 12:42	07/11/2019 19:45	31,04	7	217,29	CHI
20191145728	PORANGATU	840062461	PORANGATU	06/11/2019 12:43	06/11/2019 23:27	06/11/2019 12:43	06/11/2019 23:27	10,72	1	10,72	CHI
20191145732	PIRES DO RIO	PR21083236	PIRES DO RIO S1	06/11/2019 12:45	07/11/2019 10:14	06/11/2019 12:45	07/11/2019 10:14	21,49	1	21,49	CHI
20191145737	CALDAS NOVAS	CN12298658	CALDAS NOVAS S1	06/11/2019 12:46	07/11/2019 09:05	06/11/2019 12:46	07/11/2019 09:05	20,30	1	20,30	CHI
20191145742	CAIAPONIA	CP12338830	CAIAPONIA	06/11/2019 12:48	07/11/2019 13:38	06/11/2019 12:48	07/11/2019 13:38	24,83	11	273,10	CHI
20191145750	CRIXAS	CX12208559	SERRA DO OURO	06/11/2019 12:50	06/11/2019 23:16	06/11/2019 12:50	06/11/2019 23:16	10,43	4	41,73	CHI

20191145751	JATAI	RV12000142	CABRIUVA S1	06/11/2019 12:02	06/11/2019 17:02	06/11/2019 12:02	06/11/2019 17:02	5,00	6	30,00	CHI
20191145751	RIO VERDE	RV12000142	CABRIUVA S1	06/11/2019 12:02	06/11/2019 17:02	06/11/2019 12:02	06/11/2019 17:02	5,00	78	389,98	CHI
20191145769	FORMOSO	TB12185306	PORANGATU	06/11/2019 12:55	06/11/2019 19:33	06/11/2019 12:55	06/11/2019 19:33	6,63	1	6,63	CHI
20191145769	TROMBAS	TB12185306	PORANGATU	06/11/2019 12:55	06/11/2019 19:33	06/11/2019 12:55	06/11/2019 19:33	6,63	10	66,33	CHI
20191145772	BONOPOLIS	4350006220	SAO MIGUEL DO ARAGUAIA	06/11/2019 12:55	08/11/2019 07:22	06/11/2019 12:55	08/11/2019 07:22	42,44	1	42,44	CHI
20191145781	CAMPOS BELOS	MA12209854	SAO DOMINGOS	06/11/2019 12:45	06/11/2019 17:51	06/11/2019 12:45	06/11/2019 17:51	5,10	4	20,38	CHI
20191145781	MONTE ALEGRE DE GOIAS	MA12209854	SAO DOMINGOS	06/11/2019 12:45	06/11/2019 17:51	06/11/2019 12:45	06/11/2019 17:51	5,10	18	91,73	CHI
20191145785	FORMOSA	610180344	ITUIQUIRA	06/11/2019 12:58	06/11/2019 15:02	06/11/2019 12:58	06/11/2019 15:02	2,06	1	2,06	CHI
20191145787	PALMEIRAS DE GOIAS	PL12085247	PALMEIRAS	06/11/2019 12:59	06/11/2019 21:25	06/11/2019 12:59	06/11/2019 21:25	8,44	8	67,49	CHI
20191145796	LUZIANIA	KR12304893	PAMPLONA	06/11/2019 13:01	06/11/2019 23:17	06/11/2019 13:01	06/11/2019 23:17	10,25	1	10,25	CHI
20191145799	ITUMBIARA	10012925967	ITUMBIARA NOVA	06/11/2019 12:48	06/11/2019 16:21	06/11/2019 12:48	06/11/2019 16:21	3,54	1	3,54	CHI
20191145812	SANTO ANTONIO DO DESCOBERTO	LZ21000421	AGUAS LINDAS DE GOIAS S2	06/11/2019 13:04	06/11/2019 17:22	06/11/2019 13:04	06/11/2019 17:22	4,28	1	4,28	CHI
20191145828	RIO VERDE	RV21000150	MONTIVIDIU T	06/11/2019 13:07	06/11/2019 16:49	06/11/2019 13:07	06/11/2019 16:49	3,70	1	3,70	CHI
20191145834	CAMPOS BELOS	CH12384777	SAO DOMINGOS	06/11/2019 12:49	06/11/2019 14:07	06/11/2019 12:49	06/11/2019 14:07	1,29	13	16,76	CHI
20191145842	MORRINHOS	MR21021168	MORRINHOS	06/11/2019 13:11	06/11/2019 15:00	06/11/2019 13:11	06/11/2019 15:00	1,81	1	1,81	CHI
20191145848	MONTIVIDIU	MV10398076	MONTIVIDIU T	06/11/2019 13:01	09/11/2019 07:10	06/11/2019 13:01	06/11/2019 13:33	0,53	22	11,71	CHI
20191145848	RIO VERDE	MV10398076	MONTIVIDIU T	06/11/2019 13:01	09/11/2019 07:10	06/11/2019 13:01	06/11/2019 13:33	0,53	28	14,91	CHI
20191145848	RIO VERDE	MV10398076	MONTIVIDIU T	06/11/2019 13:01	09/11/2019 07:10	06/11/2019 13:01	06/11/2019 13:33	0,53	88	46,86	CHI
20191145848	RIO VERDE	MV10398076	MONTIVIDIU T	06/11/2019 13:01	09/11/2019 07:10	06/11/2019 13:01	06/11/2019 13:33	0,53	41	21,83	CHI
20191145848	RIO VERDE	MV10398076	CABRIUVA S2	06/11/2019 13:01	09/11/2019 07:10	06/11/2019 13:01	06/11/2019 16:11	3,17	106	335,61	CHI
20191145848	RIO VERDE	MV10398076	CABRIUVA S2	06/11/2019 13:01	09/11/2019 07:10	07/11/2019 14:33	07/11/2019 14:37	0,07	106	7,07	CHI
20191145848	MONTIVIDIU	MV10398076	MONTIVIDIU T	06/11/2019 13:01	09/11/2019 07:10	07/11/2019 14:33	07/11/2019 14:37	0,07	22	1,47	CHI
20191145848	RIO VERDE	MV10398076	MONTIVIDIU T	06/11/2019 13:01	09/11/2019 07:10	07/11/2019 14:33	07/11/2019 14:37	0,07	28	1,87	CHI
20191145848	RIO VERDE	MV10398076	MONTIVIDIU T	06/11/2019 13:01	09/11/2019 07:10	07/11/2019 14:33	07/11/2019 14:37	0,07	97	6,47	CHI
20191145848	RIO VERDE	MV10398076	MONTIVIDIU T	06/11/2019 13:01	09/11/2019 07:10	07/11/2019 14:33	07/11/2019 14:37	0,07	41	2,73	CHI
20191145848	MONTIVIDIU	MV10398076	MONTIVIDIU T	06/11/2019 13:01	09/11/2019 07:10	07/11/2019 14:38	07/11/2019 16:47	2,16	10	21,55	CHI
20191145848	MONTIVIDIU	MV13213455	MONTIVIDIU T	06/11/2019 13:01	09/11/2019 07:10	07/11/2019 14:38	07/11/2019 18:50	4,20	12	50,35	CHI
20191145848	RIO VERDE	MV13213455	MONTIVIDIU T	06/11/2019 13:01	09/11/2019 07:10	07/11/2019 14:38	07/11/2019 18:50	4,20	29	121,69	CHI
20191145848	RIO VERDE	RV13322228	MONTIVIDIU T	06/11/2019 13:01	09/11/2019 07:10	07/11/2019 14:38	07/11/2019 20:36	5,96	7	41,74	CHI
20191145848	MONTIVIDIU	MV10398076	MONTIVIDIU T	06/11/2019 13:01	09/11/2019 07:10	07/11/2019 20:57	07/11/2019 21:27	0,50	22	11,07	CHI
20191145848	RIO VERDE	MV10398076	MONTIVIDIU T	06/11/2019 13:01	09/11/2019 07:10	07/11/2019 20:57	07/11/2019 21:27	0,50	36	18,12	CHI
20191145848	MONTIVIDIU	MV10398076	MONTIVIDIU T	06/11/2019 13:01	09/11/2019 07:10	08/11/2019 03:56	08/11/2019 08:25	4,49	10	44,88	CHI
20191145848	RIO VERDE	MV10398076	MONTIVIDIU T	06/11/2019 13:01	09/11/2019 07:10	07/11/2019 14:38	08/11/2019 12:30	21,87	97	2121,39	CHI

20191145848	MONTIVIDIU	MV13213455	MONTIVIDIU T	06/11/2019 13:01	09/11/2019 07:10	08/11/2019 03:56	08/11/2019 13:29	9,56	12	114,75	CHI
20191145848	RIO VERDE	MV13213455	MONTIVIDIU T	06/11/2019 13:01	09/11/2019 07:10	08/11/2019 03:56	08/11/2019 13:29	9,56	36	344,25	CHI
20191145848	RIO VERDE	MV10398076	MONTIVIDIU T	06/11/2019 13:01	09/11/2019 07:10	07/11/2019 14:38	08/11/2019 14:30	23,88	28	668,57	CHI
20191145848	RIO VERDE	MV10398076	CABRIUVA S2	06/11/2019 13:01	09/11/2019 07:10	06/11/2019 13:01	08/11/2019 17:20	52,31	6	313,88	CHI
20191145848	RIO VERDE	RV13322229	CABRIUVA S2	06/11/2019 13:01	09/11/2019 07:10	07/11/2019 14:38	08/11/2019 17:20	26,71	96	2564,00	CHI
20191145848	RIO VERDE	RV10406663	CABRIUVA S2	06/11/2019 13:01	09/11/2019 07:10	08/11/2019 17:13	08/11/2019 17:20	0,12	11	1,30	CHI
20191145848	RIO VERDE	RV12260653	CABRIUVA S2	06/11/2019 13:01	09/11/2019 07:10	07/11/2019 14:38	08/11/2019 17:42	27,06	10	270,63	CHI
20191145848	RIO VERDE	RV13322229	MONTIVIDIU T	06/11/2019 13:01	09/11/2019 07:10	07/11/2019 14:38	09/11/2019 07:10	40,53	5	202,65	CHI
20191145864	FORMOSA	FA12376699	ITIQUEIRA	06/11/2019 12:41	06/11/2019 14:39	06/11/2019 12:41	06/11/2019 14:39	1,95	34	66,34	CHI
20191145865	AGUAS LINDAS DE GOIAS	10019064800	AGUAS LINDAS DE GOIAS S1	06/11/2019 13:16	06/11/2019 14:37	06/11/2019 13:16	06/11/2019 14:37	1,34	1	1,34	CHI
20191145869	CABECEIRAS	FA12302845	ITIQUEIRA	06/11/2019 13:16	06/11/2019 15:21	06/11/2019 13:16	06/11/2019 15:21	2,07	17	35,14	CHI
20191145869	FORMOSA	FA12302845	ITIQUEIRA	06/11/2019 13:16	06/11/2019 15:21	06/11/2019 13:16	06/11/2019 15:21	2,07	19	39,28	CHI
20191145892	FIRMINOPOLIS	900023764	FIRMINOPOLIS S1	06/11/2019 13:20	06/11/2019 17:55	06/11/2019 13:20	06/11/2019 17:55	4,58	1	4,58	CHI
20191145896	JATAI	JT10400617	JATAI S1	06/11/2019 13:16	09/11/2019 16:37	06/11/2019 13:16	06/11/2019 15:36	2,33	42	97,94	CHI
20191145896	JATAI	JT10400238	JATAI S1	06/11/2019 13:16	09/11/2019 16:37	06/11/2019 13:16	06/11/2019 16:22	3,10	34	105,36	CHI
20191145896	SERRANOPOLIS	JT10400238	JATAI S1	06/11/2019 13:16	09/11/2019 16:37	06/11/2019 13:16	06/11/2019 16:22	3,10	6	18,59	CHI
20191145896	JATAI	JT10400617	JATAI S1	06/11/2019 13:16	09/11/2019 16:37	08/11/2019 22:11	08/11/2019 23:14	1,04	76	79,36	CHI
20191145896	SERRANOPOLIS	JT10400617	JATAI S1	06/11/2019 13:16	09/11/2019 16:37	08/11/2019 22:11	08/11/2019 23:14	1,04	6	6,26	CHI
20191145896	JATAI	JT13402474	JATAI S1	06/11/2019 13:16	09/11/2019 16:37	06/11/2019 13:16	09/11/2019 16:37	75,36	4	301,45	CHI
20191145910	URUACU	UR12341440	URUACU	06/11/2019 13:23	06/11/2019 23:25	06/11/2019 13:23	06/11/2019 23:25	10,02	5	50,11	CHI
20191145916	RIO VERDE	RV12279877	CABRIUVA S1	06/11/2019 13:24	06/11/2019 17:02	06/11/2019 13:24	06/11/2019 17:02	3,62	107	387,13	CHI
20191145921	PORANGATU	PO21357400	PORANGATU	06/11/2019 13:25	10/11/2019 18:15	06/11/2019 13:25	10/11/2019 18:15	100,83	1	100,83	CHI
20191145922	CALDAS NOVAS	CN16404599	CALDAS NOVAS S1	06/11/2019 13:17	06/11/2019 13:23	06/11/2019 13:17	06/11/2019 13:21	0,05	1240	67,51	CHI
20191145922	CALDAS NOVAS	CN16405748	CALDAS NOVAS S1	06/11/2019 13:17	06/11/2019 13:23	06/11/2019 13:17	06/11/2019 13:22	0,07	1251	85,48	CHI
20191145922	CALDAS NOVAS	CN10408437	CALDAS NOVAS S1	06/11/2019 13:17	06/11/2019 13:23	06/11/2019 13:17	06/11/2019 13:23	0,10	172	16,77	CHI
20191145922	SANTA CRUZ DE GOIAS	CN10408437	CALDAS NOVAS S1	06/11/2019 13:17	06/11/2019 13:23	06/11/2019 13:17	06/11/2019 13:23	0,10	98	9,55	CHI
20191145934	RIO VERDE	10006747343	RIO VERDE S1	06/11/2019 13:29	07/11/2019 10:19	06/11/2019 13:29	07/11/2019 10:19	20,84	1	20,84	CHI
20191145936	PILAR DE GOIAS	GG21202104	SANTA TEREZINHA	06/11/2019 13:29	08/11/2019 12:27	06/11/2019 13:29	08/11/2019 12:27	46,97	1	46,97	CHI
20191145944	GOIATUBA	JV12208118	GOIATUBA S1	06/11/2019 12:41	07/11/2019 01:05	06/11/2019 12:41	07/11/2019 01:05	12,40	4	49,59	CHI
20191145944	JOVIANIA	JV12208118	GOIATUBA S1	06/11/2019 12:41	07/11/2019 01:05	06/11/2019 12:41	07/11/2019 01:05	12,40	15	185,96	CHI
20191145951	AGUAS LINDAS DE GOIAS	4830346580	AGUAS LINDAS DE GOIAS S1	06/11/2019 13:32	06/11/2019 15:25	06/11/2019 13:32	06/11/2019 15:25	1,88	1	1,88	CHI
20191145970	MOZARLANDIA	NA12084403	MOZARLANDIA	06/11/2019 11:22	08/11/2019 11:59	06/11/2019 11:22	08/11/2019 11:59	48,60	2	97,21	CHI
20191145970	NOVA CRIXAS	NA12084403	MOZARLANDIA	06/11/2019 11:22	08/11/2019 11:59	06/11/2019 11:22	08/11/2019 11:59	48,60	5	243,02	CHI

20191145982	CEZARINA	1650001657	CEZARINA	06/11/2019 13:34	07/11/2019 09:55	06/11/2019 13:34	07/11/2019 09:55	20,35	1	20,35	CHI
20191145983	CACHOEIRA ALTA	CA12000077	CACHOEIRA ALTA	06/11/2019 11:14	06/11/2019 18:03	06/11/2019 11:14	06/11/2019 18:03	6,82	44	299,93	CHI
20191145991	SAO DOMINGOS	SD21149339	SAO DOMINGOS	06/11/2019 13:35	06/11/2019 19:05	06/11/2019 13:35	06/11/2019 19:05	5,49	1	5,49	CHI
20191145996	PALMEIRAS DE GOIAS	PL12205903	PALMEIRAS	06/11/2019 12:09	07/11/2019 08:07	06/11/2019 12:09	07/11/2019 08:07	19,96	4	79,83	CHI
20191145999	IPAMERI	IP21152023	PIRES DO RIO S2	06/11/2019 13:37	07/11/2019 17:23	06/11/2019 13:37	07/11/2019 17:23	27,76	3	83,28	CHI
20191146002	URUACU	UR12341275	URUACU	06/11/2019 13:37	06/11/2019 21:27	06/11/2019 13:37	06/11/2019 21:27	7,82	5	39,09	CHI
20191146009	CALDAS NOVAS	10030137991	SERRA DE CALDAS	06/11/2019 13:39	06/11/2019 18:30	06/11/2019 13:39	06/11/2019 18:30	4,85	1	4,85	CHI
20191146044	AGUA FRIA DE GOIAS	TL21169883	SAO JOAO D ALIANCA	06/11/2019 13:45	09/11/2019 13:30	06/11/2019 13:45	09/11/2019 13:30	71,74	1	71,74	CHI
20191146051	TERESINA DE GOIAS	TE21092976	FLORES DE GOIAS	06/11/2019 13:47	07/11/2019 19:55	06/11/2019 13:47	07/11/2019 19:55	30,13	1	30,13	CHI
20191146056	ALTO PARAISO DE GOIAS	BF21382816	FLORES DE GOIAS	06/11/2019 13:49	08/11/2019 13:35	06/11/2019 13:49	08/11/2019 13:35	47,77	2	95,53	CHI
20191146058	INDIARA	2710010246	EDEIA	06/11/2019 13:50	07/11/2019 11:57	06/11/2019 13:50	07/11/2019 11:57	22,12	1	22,12	CHI
20191146061	MARA ROSA	MQ21088766	MARA ROSA	06/11/2019 13:50	08/11/2019 18:30	06/11/2019 13:50	08/11/2019 18:30	52,67	1	52,67	CHI
20191146066	POSSE	8190001828	IACIARA S1	06/11/2019 13:51	08/11/2019 11:19	06/11/2019 13:51	08/11/2019 11:19	45,45	1	45,45	CHI
20191146071	NIQUELANDIA	NQ21139055	NIQUELANDIA SUBTRANSMISSAO	06/11/2019 13:52	06/11/2019 19:08	06/11/2019 13:52	06/11/2019 19:08	5,27	1	5,27	CHI
20191146075	RIO VERDE	RV11136195	RIO VERDE S2	06/11/2019 13:19	06/11/2019 22:30	06/11/2019 13:19	06/11/2019 22:30	9,17	121	1110,14	CHI
20191146085	RIO VERDE	RV11000060	RIO VERDE S2	06/11/2019 13:43	06/11/2019 15:10	06/11/2019 13:43	06/11/2019 15:10	1,45	135	195,34	CHI
20191146090	MORRINHOS	MR21404837	MORRINHOS	06/11/2019 13:57	06/11/2019 18:05	06/11/2019 13:57	06/11/2019 18:05	4,14	1	4,14	CHI
20191146093	RIO VERDE	RV12260178	RIO VERDE S2	06/11/2019 13:05	09/11/2019 15:08	06/11/2019 13:05	09/11/2019 15:08	74,06	10	740,61	CHI
20191146101	NOVO GAMA	LZ12040416	PACAEMBU S1	06/11/2019 13:18	06/11/2019 18:03	06/11/2019 13:18	06/11/2019 18:03	4,73	18	85,20	CHI
20191146206	CALDAS NOVAS	10011336119	CALDAS NOVAS S2	06/11/2019 13:59	07/11/2019 10:08	06/11/2019 13:59	07/11/2019 10:08	20,14	0	0,00	CHI
20191146211	FLORES DE GOIAS	FB11286857	FLORES DE GOIAS	06/11/2019 14:00	09/11/2019 18:40	06/11/2019 14:00	09/11/2019 18:40	76,66	1	76,66	CHI
20191146219	BALIZA	BH12331469	CAIAPONIA	06/11/2019 11:59	07/11/2019 16:30	06/11/2019 11:59	07/11/2019 16:30	28,50	20	570,06	CHI
20191146233	NOVA CRIXAS	NA21203624	NOVA CRIXAS	06/11/2019 14:05	10/11/2019 13:05	06/11/2019 14:05	10/11/2019 13:05	95,00	1	95,00	CHI
20191146236	RIO VERDE	RV21260751	RIO VERDE S1	06/11/2019 14:05	07/11/2019 11:10	06/11/2019 14:05	07/11/2019 11:10	21,07	2	42,14	CHI
20191146254	MONTIVIDIU	MV12303520	MONTIVIDIU T	06/11/2019 13:35	07/11/2019 11:28	06/11/2019 13:35	07/11/2019 11:28	21,87	3	65,61	CHI
20191146254	RIO VERDE	MV12303520	MONTIVIDIU T	06/11/2019 13:35	07/11/2019 11:28	06/11/2019 13:35	07/11/2019 11:28	21,87	1	21,87	CHI
20191146401	NOVA ROMA	ND21159882	IACIARA S2	06/11/2019 14:10	07/11/2019 15:17	06/11/2019 14:10	07/11/2019 15:17	25,11	1	25,11	CHI
20191146603	AGUAS LINDAS DE GOIAS	LA12313875	AGUAS LINDAS DE GOIAS S1	06/11/2019 13:57	06/11/2019 19:42	06/11/2019 13:57	06/11/2019 16:35	2,63	63	165,50	CHI
20191146603	SANTO ANTONIO DO DESCOBERTO	LA12313875	AGUAS LINDAS DE GOIAS S1	06/11/2019 13:57	06/11/2019 19:42	06/11/2019 13:57	06/11/2019 16:35	2,63	18	47,28	CHI
20191146603	AGUAS LINDAS DE GOIAS	LA12382257LD	AGUAS LINDAS DE GOIAS S1	06/11/2019 13:57	06/11/2019 19:42	06/11/2019 13:57	06/11/2019 19:42	5,75	32	183,89	CHI
20191146603	COCALZINHO DE GOIAS	LA12382257LD	AGUAS LINDAS DE GOIAS S1	06/11/2019 13:57	06/11/2019 19:42	06/11/2019 13:57	06/11/2019 19:42	5,75	1	5,75	CHI
20191146607	IPAMERI	CM21235348	CAMPO ALEGRE DE GOIAS	06/11/2019 14:11	06/11/2019 16:56	06/11/2019 14:11	06/11/2019 16:56	2,74	1	2,74	CHI
20191146608	JUSSARA	JR12349229	BRITANIA	06/11/2019 14:11	07/11/2019 12:12	06/11/2019 14:11	07/11/2019 12:12	22,01	2	44,02	CHI

20191146711	NOVO GAMA	2460019239	PACAEMBU S1	06/11/2019 14:13	06/11/2019 19:07	06/11/2019 14:13	06/11/2019 19:07	4,90	1	4,90	CHI
20191147001	RIO VERDE	RV11136220	RIO VERDE S2	06/11/2019 14:13	07/11/2019 10:50	06/11/2019 14:13	07/11/2019 10:50	20,61	122	2514,05	CHI
20191147005	SANTA ROSA DE GOIAS	SR21029652	INHUMAS S1	06/11/2019 14:11	06/11/2019 16:51	06/11/2019 14:11	06/11/2019 16:51	2,66	2	5,32	CHI
20191147006	ANICUNS	910003737	ANICUNS	06/11/2019 14:14	06/11/2019 16:28	06/11/2019 14:14	06/11/2019 16:28	2,24	1	2,24	CHI
20191147007	CACHOEIRA ALTA	SO10394738	CACHOEIRA ALTA	06/11/2019 14:09	06/11/2019 20:23	06/11/2019 14:09	06/11/2019 17:10	3,02	6	18,13	CHI
20191147007	CACU	SO10394738	CACHOEIRA ALTA	06/11/2019 14:09	06/11/2019 20:23	06/11/2019 14:09	06/11/2019 17:10	3,02	100	302,22	CHI
20191147007	SAO SIMAO	SO10394738	CACHOEIRA ALTA	06/11/2019 14:09	06/11/2019 20:23	06/11/2019 14:09	06/11/2019 17:10	3,02	18	54,40	CHI
20191147007	SAO SIMAO	SO10394738	CACHOEIRA ALTA	06/11/2019 14:09	06/11/2019 20:23	06/11/2019 14:09	06/11/2019 20:23	6,25	5	31,23	CHI
20191147025	SANTA HELENA DE GOIAS	400030615	IPEGUARI	06/11/2019 14:17	07/11/2019 14:00	06/11/2019 14:17	07/11/2019 14:00	23,73	1	23,73	CHI
20191147037	GOIANIA	10006983217	CARAJAS S1	06/11/2019 14:19	07/11/2019 03:35	06/11/2019 14:19	07/11/2019 03:35	13,27	1	13,27	CHI
20191147040	PLANALTINA	2960197570	PLANALTINA	06/11/2019 14:19	07/11/2019 01:33	06/11/2019 14:19	07/11/2019 01:33	11,22	1	11,22	CHI
20191147063	JATAI	01030214	JATAI S2	06/11/2019 14:21	06/11/2019 18:37	06/11/2019 14:26	06/11/2019 16:48	2,38	4519	10736,39	CHI
20191147063	JATAI	01030224	JATAI S2	06/11/2019 14:21	06/11/2019 18:37	06/11/2019 16:37	06/11/2019 16:48	0,18	3165	559,15	CHI
20191147063	JATAI	01030214	JATAI S2	06/11/2019 14:21	06/11/2019 18:37	06/11/2019 14:26	06/11/2019 18:16	3,84	408	1567,29	CHI
20191147063	JATAI	01030224	JATAI S2	06/11/2019 14:21	06/11/2019 18:37	06/11/2019 16:49	06/11/2019 18:16	1,45	4519	6541,25	CHI
20191147063	JATAI	JT10400368	JATAI S2	06/11/2019 14:21	06/11/2019 18:37	06/11/2019 14:21	06/11/2019 18:28	4,13	2246	9267,25	CHI
20191147063	JATAI	JT12000047	JATAI S2	06/11/2019 14:21	06/11/2019 18:37	06/11/2019 14:26	06/11/2019 18:37	4,20	732	3073,59	CHI
20191147066	ACREUNA	EU12045539	ACREUNA	06/11/2019 14:26	07/11/2019 12:00	06/11/2019 14:26	07/11/2019 12:00	21,58	1	21,58	CHI
20191147068	INDIARA	PL12376414	PALMEIRAS	06/11/2019 14:22	07/11/2019 15:26	06/11/2019 14:22	07/11/2019 15:26	25,06	3	75,18	CHI
20191147068	PALMEIRAS DE GOIAS	PL12376414	PALMEIRAS	06/11/2019 14:22	07/11/2019 15:26	06/11/2019 14:22	07/11/2019 15:26	25,06	47	1177,77	CHI
20191147071	RIO VERDE	RV12062719	CABRIUVA S2	06/11/2019 14:26	11/11/2019 13:21	06/11/2019 14:26	11/11/2019 13:21	118,91	7	832,38	CHI
20191147075	ITAPIRAPUA	IU12015133LD	JUSSARA	06/11/2019 13:59	07/11/2019 18:58	06/11/2019 13:59	07/11/2019 00:27	10,47	80	837,71	CHI
20191147075	ITAPIRAPUA	6164162	JUSSARA	06/11/2019 13:59	07/11/2019 18:58	06/11/2019 13:59	07/11/2019 18:58	28,98	1	28,98	CHI
20191147089	GOIANIRA	GR11365525	GOIANIRA	06/11/2019 14:29	06/11/2019 16:06	06/11/2019 14:29	06/11/2019 16:06	1,61	87	140,17	CHI
20191147108	IPAMERI	IP12231369	URUTAI	06/11/2019 14:29	09/11/2019 10:55	06/11/2019 14:29	09/11/2019 10:55	68,43	3	205,28	CHI
20191147110	ORIZONA	OZ12084915RE	PIRES DO RIO S2	06/11/2019 13:11	06/11/2019 19:35	06/11/2019 13:11	06/11/2019 19:35	6,39	3	19,18	CHI
20191147110	VIANOPOLIS	OZ12084915RE	PIRES DO RIO S2	06/11/2019 13:11	06/11/2019 19:35	06/11/2019 13:11	06/11/2019 19:35	6,39	35	223,82	CHI
20191147116	SANTA RITA DO NOVO DESTINO	BA21286935	BARRO ALTO	06/11/2019 14:32	08/11/2019 00:00	06/11/2019 14:32	08/11/2019 00:00	33,47	1	33,47	CHI
20191147117	GOIATUBA	GT12349795	GOIATUBA S2	06/11/2019 13:54	06/11/2019 23:02	06/11/2019 13:54	06/11/2019 23:02	9,12	146	1332,17	CHI
20191147120	GUAPO	10006733156	GUAPO S2	06/11/2019 14:33	07/11/2019 10:25	06/11/2019 14:33	07/11/2019 10:25	19,87	1	19,87	CHI
20191147126	QUIRINOPOLIS	QI11171910	QUIRINOPOLIS	06/11/2019 15:09	06/11/2019 16:17	06/11/2019 15:09	06/11/2019 16:17	1,13	86	97,47	CHI
20191147130	TRINDADE	13407326	GOYA S2	06/11/2019 14:34	07/11/2019 11:57	06/11/2019 14:34	07/11/2019 11:57	21,38	1	21,38	CHI
20191147148	GOIANIA	12069905	GOYA S1	06/11/2019 14:36	07/11/2019 00:43	06/11/2019 14:36	07/11/2019 00:43	10,12	1	10,12	CHI

20191147152	NIQUELANDIA	NQ12095766	NIQUELANDIA SUBTRANSMISSAO	06/11/2019 14:15	06/11/2019 16:43	06/11/2019 14:15	06/11/2019 16:43	2,47	71	175,03	CHI
20191147152	URUACU	NQ12095766	NIQUELANDIA SUBTRANSMISSAO	06/11/2019 14:15	06/11/2019 16:43	06/11/2019 14:15	06/11/2019 16:43	2,47	3	7,40	CHI
20191147209	CATALAO	CT21077523	CATALAO S1	06/11/2019 14:39	06/11/2019 16:06	06/11/2019 14:39	06/11/2019 16:06	1,44	1	1,44	CHI
20191147214	JATAI	290223556	JATAI S2	06/11/2019 14:40	07/11/2019 05:30	06/11/2019 14:40	07/11/2019 05:30	14,83	1	14,83	CHI
20191147217	JATAI	290178344	JATAI S2	06/11/2019 14:41	07/11/2019 10:20	06/11/2019 14:41	07/11/2019 10:20	19,66	1	19,66	CHI
20191147224	JATAI	04800434	JATAI S1	06/11/2019 14:40	07/11/2019 17:56	06/11/2019 14:40	06/11/2019 15:47	1,13	2	2,25	CHI
20191147224	JATAI	04800434	JATAI S1	06/11/2019 14:40	07/11/2019 17:56	06/11/2019 14:40	06/11/2019 16:25	1,76	47	82,77	CHI
20191147224	JATAI	04800434	JATAI S1	06/11/2019 14:40	07/11/2019 17:56	06/11/2019 15:48	06/11/2019 16:25	0,63	2	1,26	CHI
20191147224	JATAI	04800434	JATAI S1	06/11/2019 14:40	07/11/2019 17:56	06/11/2019 14:40	06/11/2019 17:19	2,66	3	7,99	CHI
20191147224	JATAI	04800434	JATAI S1	06/11/2019 14:40	07/11/2019 17:56	06/11/2019 16:31	06/11/2019 17:19	0,81	49	39,85	CHI
20191147224	JATAI	04800434	JATAI S1	06/11/2019 14:40	07/11/2019 17:56	06/11/2019 17:21	06/11/2019 19:40	2,32	52	120,60	CHI
20191147224	JATAI	JT12306448	JATAI S1	06/11/2019 14:40	07/11/2019 17:56	06/11/2019 14:40	06/11/2019 20:26	5,78	16	92,47	CHI
20191147224	JATAI	JT13212561	JATAI S1	06/11/2019 14:40	07/11/2019 17:56	06/11/2019 14:40	07/11/2019 17:56	27,27	2	54,54	CHI
20191147224	APARECIDA DO RIO DOCE	JT13212561	JATAI S1	06/11/2019 14:40	07/11/2019 17:56	07/11/2019 07:17	07/11/2019 17:56	10,64	70	744,78	CHI
20191147224	JATAI	JT13212561	JATAI S1	06/11/2019 14:40	07/11/2019 17:56	07/11/2019 07:17	07/11/2019 17:56	10,64	292	3106,80	CHI
20191147233	NOVO GAMA	4990064101	PACAEMBU S1	06/11/2019 14:43	06/11/2019 20:34	06/11/2019 14:43	06/11/2019 20:34	5,83	1	5,83	CHI
20191147239	CAMPO ALEGRE DE GOIAS	CM12276003	CAMPO ALEGRE DE GOIAS	06/11/2019 14:23	06/11/2019 15:53	06/11/2019 14:23	06/11/2019 15:53	1,49	4	5,95	CHI
20191147245	TRINDADE	40252899	TRINDADE	06/11/2019 14:45	07/11/2019 10:50	06/11/2019 14:45	07/11/2019 10:50	20,07	1	20,07	CHI
20191147250	LUZIANIA	LZ12059742	CRISTALINA S2	06/11/2019 11:38	06/11/2019 19:55	06/11/2019 11:38	06/11/2019 19:55	8,28	5	41,40	CHI
20191147261	PIRACANJUBA	PJ21092778	CRISTIANOPOLIS	06/11/2019 14:47	08/11/2019 09:17	06/11/2019 14:47	08/11/2019 09:17	42,49	1	42,49	CHI
20191147266	CEZARINA	1650019030	CEZARINA	06/11/2019 14:48	07/11/2019 10:49	06/11/2019 14:48	07/11/2019 10:49	20,02	1	20,02	CHI
20191147270	DOVERLANDIA	DV10395384	CAIAPONIA	06/11/2019 14:48	09/11/2019 19:53	06/11/2019 14:48	06/11/2019 20:59	6,19	45	278,40	CHI
20191147270	DOVERLANDIA	DV10395384	CAIAPONIA	06/11/2019 14:48	09/11/2019 19:53	06/11/2019 23:19	06/11/2019 23:43	0,41	45	18,40	CHI
20191147270	DOVERLANDIA	DV10395384	CAIAPONIA	06/11/2019 14:48	09/11/2019 19:53	07/11/2019 10:06	07/11/2019 10:25	0,32	45	14,46	CHI
20191147270	DOVERLANDIA	DV10395384	CAIAPONIA	06/11/2019 14:48	09/11/2019 19:53	07/11/2019 11:32	07/11/2019 11:49	0,29	45	13,14	CHI
20191147270	DOVERLANDIA	DV10395384	CAIAPONIA	06/11/2019 14:48	09/11/2019 19:53	07/11/2019 13:18	07/11/2019 13:37	0,32	45	14,20	CHI
20191147270	DOVERLANDIA	DV10395384	CAIAPONIA	06/11/2019 14:48	09/11/2019 19:53	06/11/2019 14:48	09/11/2019 12:45	69,95	16	1119,19	CHI
20191147270	DOVERLANDIA	DV12217563	CAIAPONIA	06/11/2019 14:48	09/11/2019 19:53	06/11/2019 14:48	09/11/2019 13:17	70,48	90	6343,05	CHI
20191147270	DOVERLANDIA	DV12217563	CAIAPONIA	06/11/2019 14:48	09/11/2019 19:53	06/11/2019 23:19	09/11/2019 13:17	61,97	37	2292,89	CHI
20191147270	DOVERLANDIA	DV12217563	CAIAPONIA	06/11/2019 14:48	09/11/2019 19:53	07/11/2019 10:06	09/11/2019 13:17	51,18	1	51,18	CHI
20191147270	DOVERLANDIA	DV12138334	CAIAPONIA	06/11/2019 14:48	09/11/2019 19:53	06/11/2019 14:48	09/11/2019 13:47	70,98	15	1064,75	CHI
20191147270	CAIAPONIA	DV12357445LD	CAIAPONIA	06/11/2019 14:48	09/11/2019 19:53	06/11/2019 14:48	09/11/2019 19:53	77,09	20	1541,70	CHI
20191147271	HIDROLANDIA	HD21399749	GUAPO S2	06/11/2019 14:49	06/11/2019 21:38	06/11/2019 14:49	06/11/2019 21:38	6,81	1	6,81	CHI

20191147272	SILVANIA	SV12053522	VIANOPOLIS	06/11/2019 14:49	06/11/2019 19:37	06/11/2019 14:49	06/11/2019 19:37	4,79	42	201,02	CHI
20191147273	APARECIDA DE GOIANIA	AP12317436	CEPAIGO S1	08/11/2019 10:59	08/11/2019 16:27	08/11/2019 10:59	08/11/2019 16:27	5,48	3	16,45	CHI
20191147289	AGUA FRIA DE GOIAS	TL12164607	SAO JOAO D ALIANCA	06/11/2019 14:52	10/11/2019 14:58	06/11/2019 14:52	10/11/2019 14:58	96,09	16	1537,40	CHI
20191147292	SAO DOMINGOS	SD21144402	SAO DOMINGOS	06/11/2019 14:53	07/11/2019 10:45	06/11/2019 14:53	07/11/2019 10:45	19,87	1	19,87	CHI
20191147296	PIRENOPOLIS	PV21403284	SAO FRANCISCO DE GOIAS	06/11/2019 14:54	07/11/2019 09:11	06/11/2019 14:54	07/11/2019 09:11	18,28	2	36,56	CHI
20191147311	BOM JARDIM DE GOIAS	BM21123549	BOM JARDIM	06/11/2019 14:56	07/11/2019 09:09	06/11/2019 14:56	07/11/2019 09:09	18,21	1	18,21	CHI
20191147321	NOVO GAMA	NJ11097136	PACAEMBU S1	06/11/2019 14:45	06/11/2019 16:54	06/11/2019 14:45	06/11/2019 16:54	2,14	250	534,79	CHI
20191147329	JOVIANIA	JV12089985	GOIATUBA S1	06/11/2019 14:58	07/11/2019 17:08	06/11/2019 14:58	07/11/2019 17:08	26,15	1	26,15	CHI
20191147330	TRINDADE	TR11101119	GOYA S2	06/11/2019 14:47	06/11/2019 17:29	06/11/2019 14:47	06/11/2019 17:29	2,68	219	587,83	CHI
20191147333	BELA VISTA DE GOIAS	XX03592455	CEPAIGO S2	06/11/2019 14:57	07/11/2019 12:10	06/11/2019 14:57	07/11/2019 12:10	21,21	1	21,21	CHI
20191147334	MINEIROS	SU12184123	SANTA RITA DO ARAGUAIA	06/11/2019 14:01	06/11/2019 20:18	06/11/2019 14:01	06/11/2019 20:18	6,27	15	94,05	CHI
20191147334	SANTA RITA DO ARAGUAIA	SU12184123	SANTA RITA DO ARAGUAIA	06/11/2019 14:01	06/11/2019 20:18	06/11/2019 14:01	06/11/2019 20:18	6,27	6	37,62	CHI
20191147341	ITUMBIARA	IT11000133	ITUMBIARA NOVA	06/11/2019 14:39	06/11/2019 22:55	06/11/2019 14:39	06/11/2019 22:55	8,26	58	479,05	CHI
20191147343	RIO VERDE	RV21322331	CABRIUVA S2	06/11/2019 15:00	08/11/2019 20:20	06/11/2019 15:00	08/11/2019 12:30	45,49	1	45,49	CHI
20191147343	RIO VERDE	RV12322328	CABRIUVA S2	06/11/2019 15:00	08/11/2019 20:20	08/11/2019 12:31	08/11/2019 18:04	5,56	4	22,23	CHI
20191147343	RIO VERDE	RV21322331	CABRIUVA S2	06/11/2019 15:00	08/11/2019 20:20	08/11/2019 18:05	08/11/2019 19:13	1,14	1	1,14	CHI
20191147343	RIO VERDE	RV12322328	CABRIUVA S2	06/11/2019 15:00	08/11/2019 20:20	08/11/2019 18:05	08/11/2019 19:35	1,51	3	4,52	CHI
20191147343	RIO VERDE	RV12172877	CABRIUVA S2	06/11/2019 15:00	08/11/2019 20:20	08/11/2019 19:36	08/11/2019 20:20	0,73	11	8,02	CHI
20191147347	GOIANIA	16796147	CARAJAS S1	06/11/2019 15:02	07/11/2019 01:24	06/11/2019 15:02	07/11/2019 01:24	10,35	1	10,35	CHI
20191147353	RIO VERDE	RV12306400	CABRIUVA S2	06/11/2019 14:16	07/11/2019 10:00	06/11/2019 14:16	07/11/2019 10:00	19,72	5	98,60	CHI
20191147360	SAO LUIS DE MONTES BELOS	500093477	SAO LUIZ DOS MONTES BELOS	06/11/2019 15:04	07/11/2019 14:41	06/11/2019 15:04	07/11/2019 14:41	23,61	1	23,61	CHI
20191147364	MOZARLANDIA	MZ11035605	MOZARLANDIA	06/11/2019 16:03	06/11/2019 16:22	06/11/2019 16:03	06/11/2019 16:22	0,31	103	32,02	CHI
20191147365	ITUMBIARA	IT21048572	ITUMBIARA NOVA	06/11/2019 15:05	08/11/2019 09:19	06/11/2019 15:05	08/11/2019 09:19	42,22	1	42,22	CHI
20191147376	FLORES DE GOIAS	FB12302762	FLORES DE GOIAS	06/11/2019 15:07	06/11/2019 18:19	06/11/2019 15:07	06/11/2019 18:19	3,20	7	22,39	CHI
20191147404	VALPARAISO DE GOIAS	3350049604	PACAEMBU S2	06/11/2019 15:10	06/11/2019 21:53	06/11/2019 15:10	06/11/2019 21:53	6,71	1	6,71	CHI
20191147411	PETROLINA DE GOIAS	PG21201323	PETROLINA	06/11/2019 15:11	06/11/2019 18:16	06/11/2019 15:11	06/11/2019 18:16	3,08	2	6,16	CHI
20191147417	CORUMBA DE GOIAS	CB21267353	CORUMBA	06/11/2019 15:12	06/11/2019 16:52	06/11/2019 15:12	06/11/2019 16:52	1,66	1	1,66	CHI
20191147424	BALIZA	BH12331164	CAIAPONIA	06/11/2019 14:35	09/11/2019 11:00	06/11/2019 14:35	09/11/2019 11:00	68,41	9	615,66	CHI
20191147428	GOIANIA	10302268	CAMPINAS S2	06/11/2019 15:14	06/11/2019 21:20	06/11/2019 15:14	06/11/2019 21:20	6,09	1	6,09	CHI
20191147442	FORMOSO	2410012389	PORANGATU	06/11/2019 15:15	09/11/2019 09:22	06/11/2019 15:15	09/11/2019 09:22	66,11	1	66,11	CHI
20191147450	ITAUCU	IX12335562	INHUMAS S1	06/11/2019 15:15	08/11/2019 09:52	06/11/2019 15:15	08/11/2019 09:52	42,60	2	85,20	CHI
20191147451	ITUMBIARA	IT12009500	PARANAIBA	06/11/2019 15:15	07/11/2019 09:28	06/11/2019 15:15	07/11/2019 09:28	18,21	3	54,64	CHI
20191147457	COCALZINHO DE GOIAS	ZN12084617	AGUAS LINDAS DE GOIAS S2	06/11/2019 15:16	06/11/2019 18:03	06/11/2019 15:16	06/11/2019 18:03	2,77	27	74,78	CHI

20191147462	TRINDADE	TR12390003	GOYA S2	06/11/2019 14:50	06/11/2019 17:25	06/11/2019 14:50	06/11/2019 17:25	2,57	225	578,19	CHI
20191147466	ACREUNA	SH12271266	SANTA HELENA S1	06/11/2019 15:17	09/11/2019 14:20	06/11/2019 15:17	09/11/2019 14:20	71,05	3	213,14	CHI
20191147466	SANTA HELENA DE GOIAS	SH12271266	SANTA HELENA S1	06/11/2019 15:17	09/11/2019 14:20	06/11/2019 15:17	09/11/2019 14:20	71,05	3	213,14	CHI
20191147469	GOIANIA	16834926	MEIA PONTE	06/11/2019 15:17	06/11/2019 17:41	06/11/2019 15:17	06/11/2019 17:41	2,39	1	2,39	CHI
20191147471	INHUMAS	IN12311187	INHUMAS S2	06/11/2019 15:06	06/11/2019 16:22	06/11/2019 15:06	06/11/2019 16:22	1,26	5	6,29	CHI
20191147477	MONTIVIDIU	MV21200063	MONTIVIDIU T	06/11/2019 15:18	08/11/2019 17:50	06/11/2019 15:18	08/11/2019 17:50	50,53	1	50,53	CHI
20191147478	CAMPOS VERDES	3790025389	SANTA TEREZINHA	06/11/2019 15:18	06/11/2019 17:55	06/11/2019 15:18	06/11/2019 17:55	2,61	1	2,61	CHI
20191147480	CABECEIRAS	CW12211604	ITIQUEIRA	06/11/2019 15:16	06/11/2019 19:40	06/11/2019 15:16	06/11/2019 19:40	4,40	25	109,92	CHI
20191147495	CABECEIRAS	CW21218534	ITIQUEIRA	06/11/2019 15:20	06/11/2019 21:18	06/11/2019 15:20	06/11/2019 21:18	5,95	1	5,95	CHI
20191147498	RIO VERDE	JT21189214	JATAI S3	06/11/2019 15:21	09/11/2019 18:11	06/11/2019 15:21	09/11/2019 18:11	74,83	1	74,83	CHI
20191147499	MORRINHOS	MR12412117	MORRINHOS	06/11/2019 14:59	06/11/2019 16:56	06/11/2019 14:59	06/11/2019 16:56	1,95	6	11,69	CHI
20191147507	RIO QUENTE	RQ21153375	VILA CORUMBA	06/11/2019 15:22	06/11/2019 18:35	06/11/2019 15:22	06/11/2019 18:35	3,20	1	3,20	CHI
20191147519	GOIANESIA	550169556	GOIANESIA S2	06/11/2019 15:24	08/11/2019 13:50	06/11/2019 15:24	08/11/2019 13:50	46,43	1	46,43	CHI
20191147524	CATALAO	CT21278960	CATALAO S1	06/11/2019 15:25	07/11/2019 16:25	06/11/2019 15:25	07/11/2019 16:25	25,00	2	50,00	CHI
20191147526	INHUMAS	30161060	INHUMAS S2	06/11/2019 15:25	06/11/2019 17:10	06/11/2019 15:25	06/11/2019 17:10	1,76	0	0,00	CHI
20191147529	ACREUNA	EU12026740	RIO DOS BOIS	06/11/2019 15:25	07/11/2019 23:59	06/11/2019 15:25	07/11/2019 23:59	32,55	2	65,11	CHI
20191147540	INHUMAS	IX12016404	INHUMAS S1	06/11/2019 15:17	07/11/2019 15:37	06/11/2019 15:17	07/11/2019 15:37	24,32	1	24,32	CHI
20191147540	ITAUCU	IX12016404	INHUMAS S1	06/11/2019 15:17	07/11/2019 15:37	06/11/2019 15:17	07/11/2019 15:37	24,32	4	97,28	CHI
20191147557	ORIZONA	OZ21216082	PIRES DO RIO S2	06/11/2019 15:29	07/11/2019 09:57	06/11/2019 15:29	07/11/2019 09:57	18,47	1	18,47	CHI
20191147560	OUVIDOR	IO21156381	CATALAO S1	06/11/2019 15:29	07/11/2019 16:40	06/11/2019 15:29	07/11/2019 16:40	25,17	1	25,17	CHI
20191147563	MONTE ALEGRE DE GOIAS	MA21315158	SAO DOMINGOS	06/11/2019 15:30	07/11/2019 00:15	06/11/2019 15:30	07/11/2019 00:15	8,74	1	8,74	CHI
20191147567	PORANGATU	PO11349565	MARA ROSA	06/11/2019 15:31	10/11/2019 12:49	06/11/2019 15:31	10/11/2019 12:49	93,28	1	93,28	CHI
20191147571	LEOPOLDO DE BULHOES	LB21338896	DAIA S2	06/11/2019 15:33	06/11/2019 22:15	06/11/2019 15:33	06/11/2019 22:15	6,70	2	13,40	CHI
20191147576	DOVERLANDIA	DV12221021	CAIAPONIA	06/11/2019 15:25	08/11/2019 16:03	06/11/2019 15:25	08/11/2019 16:03	48,63	22	1069,86	CHI
20191147577	GOIANIA	GN11002053	FERROVIARIO S3	06/11/2019 15:27	06/11/2019 21:14	06/11/2019 15:27	06/11/2019 21:14	5,78	96	554,99	CHI
20191147580	IPORA	IR21079599	IPORA	06/11/2019 15:30	06/11/2019 17:47	06/11/2019 15:30	06/11/2019 17:47	2,29	1	2,29	CHI
20191147583	PARAUNA	PU13233408	MONTIVIDIU T	06/11/2019 15:31	07/11/2019 19:31	06/11/2019 15:32	07/11/2019 14:54	23,38	3	70,13	CHI
20191147583	PARAUNA	PU12110565	MONTIVIDIU T	06/11/2019 15:31	07/11/2019 19:31	06/11/2019 15:31	07/11/2019 19:31	28,00	4	112,01	CHI
20191147586	SAO MIGUEL DO ARAGUAIA	SM12371084	SAO MIGUEL DO ARAGUAIA	06/11/2019 13:59	08/11/2019 02:05	06/11/2019 13:59	08/11/2019 02:05	36,08	3	108,25	CHI
20191147609	ITABERAI	00880244	ITABERAI S2	06/11/2019 15:36	06/11/2019 19:07	06/11/2019 15:36	06/11/2019 16:10	0,57	4135	2368,44	CHI
20191147609	ITABERAI	IB13082116	ITABERAI S2	06/11/2019 15:36	06/11/2019 19:07	06/11/2019 15:36	06/11/2019 19:07	3,52	531	1868,38	CHI
20191147609	ITAPURANGA	IB13082116	ITABERAI S2	06/11/2019 15:36	06/11/2019 19:07	06/11/2019 15:36	06/11/2019 19:07	3,52	1	3,52	CHI
20191147609	TAQUARAL DE GOIAS	IB13082116	ITABERAI S2	06/11/2019 15:36	06/11/2019 19:07	06/11/2019 15:36	06/11/2019 19:07	3,52	16	56,30	CHI

20191147613	MAMBAI	MB13291535	IACIARA S2	06/11/2019 14:46	06/11/2019 20:23	06/11/2019 14:46	06/11/2019 19:12	4,43	647	2864,05	CHI
20191147613	MAMBAI	MB12046224LD	IACIARA S2	06/11/2019 14:46	06/11/2019 20:23	06/11/2019 14:46	06/11/2019 19:50	5,06	1727	8744,38	CHI
20191147613	SITIO D ABADIA	MB12046224LD	IACIARA S2	06/11/2019 14:46	06/11/2019 20:23	06/11/2019 14:46	06/11/2019 19:50	5,06	1	5,06	CHI
20191147613	BURITINOPOLIS	MB12325576LD	IACIARA S2	06/11/2019 14:46	06/11/2019 20:23	06/11/2019 14:46	06/11/2019 20:23	5,61	441	2475,97	CHI
20191147613	MAMBAI	MB12325576LD	IACIARA S2	06/11/2019 14:46	06/11/2019 20:23	06/11/2019 14:46	06/11/2019 20:23	5,61	487	2734,23	CHI
20191147616	ANAPOLIS	AN11000243	JUNDIAI S2	06/11/2019 16:18	06/11/2019 17:09	06/11/2019 16:18	06/11/2019 17:09	0,84	15	12,57	CHI
20191147622	ARAGUAPAZ	MP12355886	MATRINCHA	06/11/2019 16:50	08/11/2019 19:09	06/11/2019 16:50	07/11/2019 01:00	8,16	1	8,16	CHI
20191147622	FAINA	MP12355886	MATRINCHA	06/11/2019 16:50	08/11/2019 19:09	06/11/2019 16:50	07/11/2019 01:00	8,16	2	16,31	CHI
20191147622	FAINA	MP12355886	MATRINCHA	06/11/2019 16:50	08/11/2019 19:09	07/11/2019 03:33	07/11/2019 19:24	15,86	2	31,72	CHI
20191147622	FAINA	FC12307520	GOIAS	06/11/2019 16:50	08/11/2019 19:09	08/11/2019 09:47	08/11/2019 15:31	5,74	5	28,69	CHI
20191147622	ARAGUAPAZ	MP12299732	MATRINCHA	06/11/2019 16:50	08/11/2019 19:09	07/11/2019 03:33	08/11/2019 19:09	39,60	1	39,60	CHI
20191147622	FAINA	MP12299732	MATRINCHA	06/11/2019 16:50	08/11/2019 19:09	07/11/2019 19:25	08/11/2019 19:09	23,73	2	47,47	CHI
20191147622	FAINA	MP12299732	MATRINCHA	06/11/2019 16:50	08/11/2019 19:09	08/11/2019 09:03	08/11/2019 19:09	10,09	19	191,76	CHI
20191147622	MATRINCHA	MP12299732	MATRINCHA	06/11/2019 16:50	08/11/2019 19:09	08/11/2019 09:03	08/11/2019 19:09	10,09	57	575,29	CHI
20191147685	URUACU	UR12314212	URUACU	06/11/2019 20:27	07/11/2019 04:40	06/11/2019 20:27	07/11/2019 04:40	8,20	1	8,20	CHI
20191147697	ALTO PARAISO DE GOIAS	BF21204702	FLORES DE GOIAS	06/11/2019 12:18	08/11/2019 10:10	06/11/2019 12:18	08/11/2019 10:10	45,85	1	45,85	CHI
20191147703	PIRENOPOLIS	PV21122853	CORUMBA	06/11/2019 15:41	08/11/2019 01:04	06/11/2019 15:41	08/11/2019 01:04	33,38	1	33,38	CHI
20191147705	QUIRINOPOLIS	80029930	QUIRINOPOLIS	06/11/2019 15:41	07/11/2019 14:03	06/11/2019 15:41	07/11/2019 14:03	22,36	1	22,36	CHI
20191147802	JATAI	JT12354963	JATAI S1	06/11/2019 14:56	07/11/2019 12:46	06/11/2019 14:56	07/11/2019 12:46	21,83	8	174,65	CHI
20191148005	IPAMERI	CM21235352	CAMPO ALEGRE DE GOIAS	06/11/2019 15:44	08/11/2019 10:30	06/11/2019 15:44	08/11/2019 10:30	42,76	1	42,76	CHI
20191148029	IACIARA	IA21218827	IACIARA S2	06/11/2019 15:48	06/11/2019 21:22	06/11/2019 15:48	06/11/2019 21:22	5,55	1	5,55	CHI
20191148035	LUZIANIA	120302100	RIO VERMELHO	06/11/2019 15:50	06/11/2019 23:12	06/11/2019 15:50	06/11/2019 23:12	7,36	1	7,36	CHI
20191148043	TRINDADE	10005801417	TRINDADE	06/11/2019 15:51	06/11/2019 22:29	06/11/2019 15:51	06/11/2019 22:29	6,62	1	6,62	CHI
20191148044	ABADIANIA	AA21180471	ANAPOLIS UNIVERSITARIO S1	06/11/2019 15:51	06/11/2019 19:59	06/11/2019 15:51	06/11/2019 19:59	4,12	1	4,12	CHI
20191148052	CRIXAS	CX21276695	SANTA TEREZINHA	06/11/2019 15:53	08/11/2019 11:59	06/11/2019 15:53	08/11/2019 11:59	44,09	2	88,18	CHI
20191148055	GOIANIA	GN11001064	GOIANIA LESTE S1	06/11/2019 15:52	06/11/2019 19:07	06/11/2019 15:52	06/11/2019 19:07	3,24	34	110,33	CHI
20191148062	GOIANIA	GN12167388	FERROVIARIO S2	06/11/2019 15:43	06/11/2019 20:52	06/11/2019 15:43	06/11/2019 20:17	4,56	43	196,09	CHI
20191148062	GOIANIA	GN11167387	FERROVIARIO S2	06/11/2019 15:43	06/11/2019 20:52	06/11/2019 15:43	06/11/2019 20:52	5,14	49	251,64	CHI
20191148067	JATAI	JT121274177	JATAI S1	06/11/2019 15:56	09/11/2019 15:56	06/11/2019 15:56	09/11/2019 15:56	71,99	1	71,99	CHI
20191148068	ITUMBIARA	CD21000212	CACHOEIRA DOURADA	06/11/2019 15:56	06/11/2019 18:02	06/11/2019 15:56	06/11/2019 18:02	2,09	1	2,09	CHI
20191148071	PARANAIGUARA	PC12100483	QUIRINOPOLIS	06/11/2019 15:51	08/11/2019 11:13	06/11/2019 15:51	08/11/2019 11:13	43,35	10	433,55	CHI
20191148071	QUIRINOPOLIS	PC12100483	QUIRINOPOLIS	06/11/2019 15:51	08/11/2019 11:13	06/11/2019 15:51	08/11/2019 11:13	43,35	1	43,35	CHI
20191148080	SANTA HELENA DE GOIAS	SH21213263	IPEGUARI	06/11/2019 15:58	06/11/2019 20:13	06/11/2019 15:58	06/11/2019 20:13	4,25	1	4,25	CHI

20191148091	SANTO ANTONIO DA BARRA	BZ12000001	ACREUNA	06/11/2019 15:19	06/11/2019 18:38	06/11/2019 15:19	06/11/2019 18:38	3,32	1211	4015,81	CHI
20191148092	ARAGUAPAZ	AZ12404526	MOZARLANDIA	06/11/2019 16:00	06/11/2019 23:24	06/11/2019 16:00	06/11/2019 23:24	7,39	1	7,39	CHI
20191148093	INACIOLANDIA	ID12306349	CACHOEIRA DOURADA	06/11/2019 15:13	06/11/2019 17:29	06/11/2019 15:13	06/11/2019 17:29	2,26	40	90,51	CHI
20191148099	NOVA VENEZA	NV12323108	NEROPOLIS S1	06/11/2019 16:01	06/11/2019 17:30	06/11/2019 16:01	06/11/2019 17:30	1,48	4	5,92	CHI
20191148104	ITAPIRAPUA	IU12020837	JUSSARA	06/11/2019 16:02	12/11/2019 07:37	06/11/2019 16:02	12/11/2019 07:37	135,58	11	1491,33	CHI
20191148108	GOIANIA	GN12383189	GOYA S2	06/11/2019 14:15	06/11/2019 17:32	06/11/2019 14:15	06/11/2019 17:32	3,28	85	278,54	CHI
20191148110	LUZIANIA	LZ21388445	CRISTALINA S2	06/11/2019 16:03	06/11/2019 21:36	06/11/2019 16:03	06/11/2019 21:36	5,54	1	5,54	CHI
20191148121	CACHOEIRA ALTA	CA21202754	CACHOEIRA ALTA	06/11/2019 16:05	07/11/2019 20:55	06/11/2019 16:05	07/11/2019 20:55	28,84	2	57,67	CHI
20191148133	NIQUELANDIA	NQ21341304	URUACU	06/11/2019 16:06	07/11/2019 17:26	06/11/2019 16:06	07/11/2019 17:26	25,32	2	50,65	CHI
20191148147	PONTALINA	10003539855	PONTALINA	06/11/2019 16:09	06/11/2019 18:40	06/11/2019 16:09	06/11/2019 18:40	2,50	1	2,50	CHI
20191148149	GOIANIA	GN11374091	CARAJAS S2	06/11/2019 16:03	06/11/2019 17:04	06/11/2019 16:03	06/11/2019 17:04	1,01	13	13,11	CHI
20191148156	DOVERLANDIA	DV12380883	CAIAPONIA	06/11/2019 15:44	11/11/2019 08:32	06/11/2019 15:44	09/11/2019 07:45	64,03	3	192,08	CHI
20191148156	DOVERLANDIA	DV12342550LD	CAIAPONIA	06/11/2019 15:44	11/11/2019 08:32	06/11/2019 15:44	11/11/2019 08:32	112,81	4	451,26	CHI
20191148158	GOUVELANDIA	QI12326803	QUIRINOPOLIS	06/11/2019 16:10	06/11/2019 20:49	06/11/2019 16:10	06/11/2019 20:49	4,64	2	9,27	CHI
20191148301	VALPARAISO DE GOIAS	VA12290897	MARAJOARA	06/11/2019 16:12	06/11/2019 17:47	06/11/2019 16:12	06/11/2019 17:47	1,58	28	44,31	CHI
20191148408	AGUA FRIA DE GOIAS	JL21270091	SAO JOAO D ALIANCA	06/11/2019 16:13	07/11/2019 19:30	06/11/2019 16:13	07/11/2019 19:30	27,29	1	27,29	CHI
20191148412	MINEIROS	10022687058	PARQUE DAS EMAS	06/11/2019 16:14	07/11/2019 01:22	06/11/2019 16:14	07/11/2019 01:22	9,13	1	9,13	CHI
20191148418	PALMINOPOLIS	PP21299142	FIRMINOPOLIS S2	06/11/2019 16:14	06/11/2019 21:52	06/11/2019 16:14	06/11/2019 21:52	5,63	1	5,63	CHI
20191148427	ITABERAI	19615773	ITABERAI S2	06/11/2019 16:07	06/11/2019 21:04	06/11/2019 16:07	06/11/2019 21:04	4,94	250	1235,28	CHI
20191148430	QUIRINOPOLIS	10008933152	QUIRINOPOLIS	06/11/2019 16:15	06/11/2019 18:51	06/11/2019 16:15	06/11/2019 18:51	2,59	1	2,59	CHI
20191148444	IPORA	IR12231286	IPORA	06/11/2019 16:10	06/11/2019 17:55	06/11/2019 16:10	06/11/2019 17:55	1,74	36	62,61	CHI
20191148445	ALEXANIA	8204658	MARAJOARA	06/11/2019 16:18	07/11/2019 02:09	06/11/2019 16:18	07/11/2019 02:09	9,85	4	39,38	CHI
20191148445	SANTO ANTONIO DO DESCOBERTO	8204658	MARAJOARA	06/11/2019 16:18	07/11/2019 02:09	06/11/2019 16:18	07/11/2019 02:09	9,85	23	226,45	CHI
20191148449	AMORINOPOLIS	AM12193408	IPORA	08/11/2019 00:19	08/11/2019 16:29	08/11/2019 00:19	08/11/2019 16:29	16,16	57	921,07	CHI
20191148449	IPORA	AM12193408	IPORA	08/11/2019 00:19	08/11/2019 16:29	08/11/2019 00:19	08/11/2019 16:29	16,16	67	1082,66	CHI
20191148452	JATAI	JT12184065	JATAI S2	06/11/2019 15:14	08/11/2019 18:21	06/11/2019 15:14	08/11/2019 18:21	51,11	13	664,49	CHI
20191148458	AMARALINA	LC12168855	MARA ROSA	06/11/2019 14:55	06/11/2019 22:01	06/11/2019 14:55	06/11/2019 22:01	7,09	35	248,24	CHI
20191148458	MARA ROSA	LC12168855	MARA ROSA	06/11/2019 14:55	06/11/2019 22:01	06/11/2019 14:55	06/11/2019 22:01	7,09	8	56,74	CHI
20191148459	GOIANIA	10001271685	CARAJAS S1	06/11/2019 16:20	06/11/2019 19:16	06/11/2019 16:20	06/11/2019 19:16	2,93	1	2,93	CHI
20191148468	GOIATUBA	GT12052882	GOIATUBA S1	06/11/2019 14:09	07/11/2019 18:25	06/11/2019 14:09	07/11/2019 18:25	28,27	26	734,90	CHI
20191148469	FORMOSA	610268107	ITIQUEIRA	06/11/2019 16:15	06/11/2019 18:56	06/11/2019 16:15	06/11/2019 18:56	2,68	1	2,68	CHI
20191148479	AMARALINA	LC12227062	MARA ROSA	06/11/2019 16:13	06/11/2019 22:44	06/11/2019 16:13	06/11/2019 22:44	6,50	3	19,50	CHI
20191148484	SAO LUIS DE MONTES BELOS	SL11000025	SAO LUIZ DOS MONTES BELOS	07/11/2019 09:16	07/11/2019 10:32	07/11/2019 09:16	07/11/2019 10:32	1,26	164	207,10	CHI

20191148486	ESTRELA DO NORTE	ET21256554	MARA ROSA	06/11/2019 16:25	11/11/2019 09:01	06/11/2019 16:25	11/11/2019 09:01	112,60	1	112,60	CHI
20191148488	ALEXANIA	AX12384864	ALEXANIA	06/11/2019 16:23	06/11/2019 20:00	06/11/2019 16:23	06/11/2019 20:00	3,61	74	267,35	CHI
20191148490	CALDAS NOVAS	CN11040988	SERRA DE CALDAS	06/11/2019 16:20	07/11/2019 07:36	06/11/2019 16:20	07/11/2019 07:36	15,26	93	1418,97	CHI
20191148495	QUIRINOPOLIS	80048560	QUIRINOPOLIS	06/11/2019 16:26	07/11/2019 09:14	06/11/2019 16:26	07/11/2019 09:14	16,80	1	16,80	CHI
20191148498	GOIANIRA	GR11340372	GOIANIRA	06/11/2019 16:26	06/11/2019 18:40	06/11/2019 16:26	06/11/2019 18:40	2,22	130	289,03	CHI
20191148508	GOIANIA	13509457	ATLANTICO S1	06/11/2019 16:28	06/11/2019 21:24	06/11/2019 16:28	06/11/2019 21:24	4,93	1	4,93	CHI
20191148509	ABADIANIA	00200214	ANAPOLIS UNIVERSITARIO S1	06/11/2019 16:12	06/11/2019 19:15	06/11/2019 16:12	06/11/2019 16:16	0,07	1483	109,17	CHI
20191148509	CORUMBA DE GOIAS	00200214	ANAPOLIS UNIVERSITARIO S1	06/11/2019 16:12	06/11/2019 19:15	06/11/2019 16:12	06/11/2019 16:16	0,07	60	4,42	CHI
20191148509	ABADIANIA	00200214	ANAPOLIS UNIVERSITARIO S1	06/11/2019 16:12	06/11/2019 19:15	06/11/2019 16:18	06/11/2019 17:12	0,91	1186	1083,21	CHI
20191148509	CORUMBA DE GOIAS	00200214	ANAPOLIS UNIVERSITARIO S1	06/11/2019 16:12	06/11/2019 19:15	06/11/2019 16:18	06/11/2019 17:12	0,91	60	54,80	CHI
20191148509	ABADIANIA	AA13402088	ANAPOLIS UNIVERSITARIO S1	06/11/2019 16:12	06/11/2019 19:15	06/11/2019 16:18	06/11/2019 18:01	1,72	284	487,77	CHI
20191148509	ABADIANIA	AA12265134	ANAPOLIS UNIVERSITARIO S1	06/11/2019 16:12	06/11/2019 19:15	06/11/2019 16:18	06/11/2019 18:54	2,61	7	18,29	CHI
20191148509	ABADIANIA	AA12101784	ANAPOLIS UNIVERSITARIO S1	06/11/2019 16:12	06/11/2019 19:15	06/11/2019 16:18	06/11/2019 19:15	2,95	6	17,71	CHI
20191148513	APARECIDA DE GOIANIA	AP21238693	CEPAIGO S1	06/11/2019 16:29	06/11/2019 18:10	06/11/2019 16:29	06/11/2019 18:10	1,67	1	1,67	CHI
20191148514	PALMEIRAS DE GOIAS	PL21000076	PALMEIRAS	06/11/2019 16:29	08/11/2019 16:05	06/11/2019 16:29	08/11/2019 16:05	47,60	1	47,60	CHI
20191148516	CAMPINORTE	2040020725	CAMPINORTE	06/11/2019 16:29	08/11/2019 09:14	06/11/2019 16:29	08/11/2019 09:14	40,74	1	40,74	CHI
20191148522	GOIANIRA	390041518	GOIANIRA	06/11/2019 16:30	07/11/2019 12:45	06/11/2019 16:30	07/11/2019 12:45	20,24	1	20,24	CHI
20191148537	TRINDADE	40073658	GOYA S1	06/11/2019 16:30	07/11/2019 09:19	06/11/2019 16:30	07/11/2019 09:19	16,80	1	16,80	CHI
20191148547	CORREGO DO OURO	CO11004033	SAO LUIZ DOS MONTES BELOS	06/11/2019 14:28	07/11/2019 00:40	06/11/2019 14:28	07/11/2019 00:40	10,19	35	356,73	CHI
20191148552	CAMPOS BELOS	CH21144731	SAO DOMINGOS	06/11/2019 16:15	06/11/2019 20:08	06/11/2019 16:15	06/11/2019 20:08	3,88	1	3,88	CHI
20191148554	MINEIROS	MY12043894	PARQUE DAS EMAS	06/11/2019 16:33	07/11/2019 16:09	06/11/2019 16:33	07/11/2019 16:09	23,60	101	2383,63	CHI
20191148562	LUZIANIA	LZ12247959	CRISTALINA S2	06/11/2019 16:35	07/11/2019 00:08	06/11/2019 16:35	07/11/2019 00:08	7,55	2	15,11	CHI
20191148581	MINEIROS	MY21336471	PARQUE DAS EMAS	06/11/2019 16:37	11/11/2019 13:06	06/11/2019 16:37	11/11/2019 13:06	116,47	1	116,47	CHI
20191148582	PADRE BERNARDO	PI12099216	PLANALTINA	06/11/2019 16:14	06/11/2019 20:22	06/11/2019 16:14	06/11/2019 20:22	4,13	14	57,76	CHI
20191148582	PLANALTINA	PI12099216	PLANALTINA	06/11/2019 16:14	06/11/2019 20:22	06/11/2019 16:14	06/11/2019 20:22	4,13	154	635,34	CHI
20191148588	ADELANDIA	DN21016333	FIRMINOPOLIS S2	06/11/2019 16:38	07/11/2019 07:33	06/11/2019 16:38	07/11/2019 07:33	14,91	2	29,81	CHI
20191148590	GOIANIA	GN11043052	AEROPORTO S2	06/11/2019 15:52	07/11/2019 02:37	06/11/2019 15:52	07/11/2019 02:37	10,73	41	440,12	CHI
20191148592	APARECIDA DE GOIANIA	AP11077147	INDEPENDENCIA S2	06/11/2019 16:03	06/11/2019 21:10	06/11/2019 16:03	06/11/2019 21:10	5,11	138	704,91	CHI
20191148613	LUZIANIA	LZ21244629	CRISTALINA S2	06/11/2019 16:40	07/11/2019 17:35	06/11/2019 16:40	07/11/2019 17:35	24,90	1	24,90	CHI
20191148631	QUIRINOPOLIS	QI21350054	QUIRINOPOLIS	06/11/2019 16:43	08/11/2019 14:47	06/11/2019 16:43	08/11/2019 14:47	46,06	1	46,06	CHI
20191148635	SAO MIGUEL DO ARAGUAIA	SM12020625	SAO MIGUEL DO ARAGUAIA	06/11/2019 16:43	07/11/2019 17:30	06/11/2019 16:43	07/11/2019 17:30	24,77	3	74,31	CHI
20191148637	ITAJA	IJ12154152	ITAJA S2	06/11/2019 16:43	08/11/2019 14:28	06/11/2019 16:43	08/11/2019 14:28	45,74	1	45,74	CHI
20191148641	QUIRINOPOLIS	QI21326585	QUIRINOPOLIS	06/11/2019 16:44	07/11/2019 11:39	06/11/2019 16:44	07/11/2019 11:39	18,91	1	18,91	CHI

20191148644	ANAPOLIS	20677390	JUNDIAI S1	06/11/2019 16:44	07/11/2019 00:48	06/11/2019 16:44	07/11/2019 00:48	8,05	1	8,05	CHI
20191148649	CHAPADAO DO CEU	DJ12303887	CHAPADAO DO CEU	06/11/2019 16:05	06/11/2019 19:23	06/11/2019 16:05	06/11/2019 19:23	3,28	72	236,44	CHI
20191148649	MINEIROS	DJ12303887	CHAPADAO DO CEU	06/11/2019 16:05	06/11/2019 19:23	06/11/2019 16:05	06/11/2019 19:23	3,28	5	16,42	CHI
20191148655	GOIANIA	13938009	MEIA PONTE	06/11/2019 16:46	07/11/2019 08:38	06/11/2019 16:46	07/11/2019 08:38	15,86	1	15,86	CHI
20191148656	INHUMAS	IN11392708	INHUMAS S2	06/11/2019 14:57	07/11/2019 01:09	06/11/2019 14:57	07/11/2019 01:09	10,20	58	591,63	CHI
20191148659	GOIANIA	GN12000541	CAMPINAS S3	06/11/2019 16:01	06/11/2019 19:15	06/11/2019 16:01	06/11/2019 19:15	3,23	103	332,18	CHI
20191148662	AGUAS LINDAS DE GOIAS	LA21192798	AGUAS LINDAS DE GOIAS S2	06/11/2019 16:48	06/11/2019 19:41	06/11/2019 16:48	06/11/2019 19:41	2,88	1	2,88	CHI
20191148679	CRISTALINA	KR21237836	PAMPLONA	06/11/2019 16:49	06/11/2019 18:07	06/11/2019 16:49	06/11/2019 18:07	1,30	1	1,30	CHI
20191148692	NIQUELANDIA	NQ12281633	BARRO ALTO	06/11/2019 16:50	09/11/2019 08:26	06/11/2019 16:50	09/11/2019 08:26	63,59	4	254,35	CHI
20191148699	ALTO PARAISO DE GOIAS	02830434	FLORES DE GOIAS	06/11/2019 16:21	06/11/2019 17:27	06/11/2019 16:21	06/11/2019 16:24	0,06	28	1,67	CHI
20191148699	CAVALCANTE	02830434	FLORES DE GOIAS	06/11/2019 16:21	06/11/2019 17:27	06/11/2019 16:21	06/11/2019 16:24	0,06	2688	160,53	CHI
20191148699	FLORES DE GOIAS	02830434	FLORES DE GOIAS	06/11/2019 16:21	06/11/2019 17:27	06/11/2019 16:21	06/11/2019 16:24	0,06	3	0,18	CHI
20191148699	NOVA ROMA	02830434	FLORES DE GOIAS	06/11/2019 16:21	06/11/2019 17:27	06/11/2019 16:21	06/11/2019 16:24	0,06	5	0,30	CHI
20191148699	SAO JOAO D ALIANCA	02830434	FLORES DE GOIAS	06/11/2019 16:21	06/11/2019 17:27	06/11/2019 16:21	06/11/2019 16:24	0,06	9	0,54	CHI
20191148699	TERESINA DE GOIAS	02830434	FLORES DE GOIAS	06/11/2019 16:21	06/11/2019 17:27	06/11/2019 16:21	06/11/2019 16:24	0,06	1054	62,95	CHI
20191148699	ALTO PARAISO DE GOIAS	02830434	FLORES DE GOIAS	06/11/2019 16:21	06/11/2019 17:27	06/11/2019 16:36	06/11/2019 17:00	0,40	12	4,79	CHI
20191148699	FLORES DE GOIAS	02830434	FLORES DE GOIAS	06/11/2019 16:21	06/11/2019 17:27	06/11/2019 16:36	06/11/2019 17:00	0,40	3	1,20	CHI
20191148699	SAO JOAO D ALIANCA	02830434	FLORES DE GOIAS	06/11/2019 16:21	06/11/2019 17:27	06/11/2019 16:36	06/11/2019 17:00	0,40	9	3,59	CHI
20191148699	ALTO PARAISO DE GOIAS	BF10400374	FLORES DE GOIAS	06/11/2019 16:21	06/11/2019 17:27	06/11/2019 16:36	06/11/2019 17:05	0,49	1	0,49	CHI
20191148699	ALTO PARAISO DE GOIAS	BF10214595	FLORES DE GOIAS	06/11/2019 16:21	06/11/2019 17:27	06/11/2019 16:36	06/11/2019 17:27	0,84	15	12,66	CHI
20191148699	CAVALCANTE	BF10214595	FLORES DE GOIAS	06/11/2019 16:21	06/11/2019 17:27	06/11/2019 16:36	06/11/2019 17:27	0,84	2688	2268,37	CHI
20191148699	NOVA ROMA	BF10214595	FLORES DE GOIAS	06/11/2019 16:21	06/11/2019 17:27	06/11/2019 16:36	06/11/2019 17:27	0,84	5	4,22	CHI
20191148699	TERESINA DE GOIAS	BF10214595	FLORES DE GOIAS	06/11/2019 16:21	06/11/2019 17:27	06/11/2019 16:36	06/11/2019 17:27	0,84	1054	889,46	CHI
20191148703	FORMOSA	FA21072541	ITIQUEIRA	06/11/2019 16:52	07/11/2019 18:50	06/11/2019 16:52	07/11/2019 18:50	25,97	1	25,97	CHI
20191148703	FORMOSA	FA12404388	ITIQUEIRA	06/11/2019 16:52	07/11/2019 18:50	07/11/2019 16:56	07/11/2019 18:50	1,90	15	28,43	CHI
20191148704	SANTA ROSA DE GOIAS	SR21053362	INHUMAS S1	06/11/2019 16:52	07/11/2019 10:21	06/11/2019 16:52	07/11/2019 10:21	17,48	1	17,48	CHI
20191148708	NOVO BRASIL	JR21171754	JUSSARA	06/11/2019 16:52	10/11/2019 23:22	06/11/2019 16:52	10/11/2019 23:22	102,48	1	102,48	CHI
20191148713	MOIPIORA	1450004602	IPORA	06/11/2019 16:53	07/11/2019 14:29	06/11/2019 16:53	07/11/2019 14:29	21,61	1	21,61	CHI
20191148714	LUZIANIA	LZ21000088	PACAEMBU S1	06/11/2019 16:53	08/11/2019 11:27	06/11/2019 16:53	08/11/2019 11:27	42,56	1	42,56	CHI
20191148720	NIQUELANDIA	NQ12391782	NIQUELANDIA SUBTRANSMISSAO	06/11/2019 16:53	07/11/2019 02:50	06/11/2019 16:53	07/11/2019 02:50	9,93	74	735,09	CHI
20191148728	FLORES DE GOIAS	FB21302751	FLORES DE GOIAS	06/11/2019 16:54	08/11/2019 00:22	06/11/2019 16:54	08/11/2019 00:22	31,45	2	62,90	CHI
20191148733	MINACU	IH21128799	MINACU	06/11/2019 16:55	07/11/2019 00:10	06/11/2019 16:55	07/11/2019 00:10	7,24	2	14,49	CHI
20191148734	CATALAO	CT21192641	CATALAO S1	06/11/2019 16:55	07/11/2019 15:21	06/11/2019 16:55	07/11/2019 15:21	22,43	1	22,43	CHI

20191148735	GOIANIA	13074258	GOYA S1	06/11/2019 16:55	07/11/2019 11:05	06/11/2019 16:55	07/11/2019 11:05	18,16	1	18,16	CHI
20191148741	IPAMERI	IP21000034	IPAMERI	06/11/2019 16:56	07/11/2019 15:00	06/11/2019 16:56	07/11/2019 15:00	22,06	1	22,06	CHI
20191148752	PIRES DO RIO	PR21207688	PIRES DO RIO S1	06/11/2019 16:57	09/11/2019 11:56	06/11/2019 16:57	09/11/2019 11:56	66,98	2	133,97	CHI
20191148754	TRES RANCHOS	TH21061080	CATALAO S1	06/11/2019 16:57	06/11/2019 19:31	06/11/2019 16:57	06/11/2019 19:31	2,55	2	5,10	CHI
20191148758	NIQUELANDIA	NQ12265966	NIQUELANDIA SUBTRANSMISSAO	06/11/2019 15:18	06/11/2019 17:50	06/11/2019 15:18	06/11/2019 17:50	2,53	24	60,79	CHI
20191148761	IPORA	IR12070185	IPORA	06/11/2019 16:58	06/11/2019 19:01	06/11/2019 16:58	06/11/2019 19:01	2,04	215	438,18	CHI
20191148762	QUIRINOPOLIS	10018795127	QUIRINOPOLIS	06/11/2019 16:58	07/11/2019 09:05	06/11/2019 16:58	07/11/2019 09:05	16,10	1	16,10	CHI
20191148766	CUMARI	CY21092266	CATALAO S1	06/11/2019 16:59	07/11/2019 09:35	06/11/2019 16:59	07/11/2019 09:35	16,59	1	16,59	CHI
20191148775	ITAUCU	10013590438	INHUMAS S1	06/11/2019 16:59	07/11/2019 17:45	06/11/2019 16:59	07/11/2019 17:45	24,75	1	24,75	CHI
20191148777	NAZARIO	NZ12233489	ANICUNS	06/11/2019 16:43	06/11/2019 22:30	06/11/2019 16:43	06/11/2019 22:30	5,78	40	231,27	CHI
20191148777	PALMEIRAS DE GOIAS	NZ12233489	ANICUNS	06/11/2019 16:43	06/11/2019 22:30	06/11/2019 16:43	06/11/2019 22:30	5,78	3	17,34	CHI
20191148778	CORUMBA DE GOIAS	CB11215164	CORUMBA	06/11/2019 17:00	06/11/2019 18:43	06/11/2019 17:00	06/11/2019 18:43	1,71	152	260,55	CHI
20191148785	FLORES DE GOIAS	FB21321150	IACIARA S2	06/11/2019 17:01	08/11/2019 01:46	06/11/2019 17:01	08/11/2019 01:46	32,75	1	32,75	CHI
20191148807	SANTA TEREZINHA DE GOIAS	SG21321968	SANTA TEREZINHA	06/11/2019 17:03	07/11/2019 15:43	06/11/2019 17:03	07/11/2019 15:43	22,65	1	22,65	CHI
20191148817	CAIAPONIA	MY12329880	PARQUE DAS EMAS	06/11/2019 13:04	08/11/2019 16:58	06/11/2019 13:04	08/11/2019 16:58	51,90	1	51,90	CHI
20191148817	DOVERLANDIA	MY12329880	PARQUE DAS EMAS	06/11/2019 13:04	08/11/2019 16:58	06/11/2019 13:04	08/11/2019 16:58	51,90	4	207,59	CHI
20191148817	MINEIROS	MY12329880	PARQUE DAS EMAS	06/11/2019 13:04	08/11/2019 16:58	06/11/2019 13:04	08/11/2019 16:58	51,90	7	363,29	CHI
20191148819	TRINDADE	40264865	GOYA S1	06/11/2019 17:04	07/11/2019 08:08	06/11/2019 17:04	07/11/2019 08:08	15,05	1	15,05	CHI
20191148832	IVOLANDIA	1560004499	IPORA	06/11/2019 17:07	07/11/2019 15:17	06/11/2019 17:07	07/11/2019 15:17	22,18	1	22,18	CHI
20191148837	SANTA HELENA DE GOIAS	SH11000027	IPEGUARI	06/11/2019 16:41	06/11/2019 18:30	06/11/2019 16:41	06/11/2019 18:30	1,80	135	243,23	CHI
20191148838	CATALAO	IP12281428	IPAMERI	06/11/2019 17:07	06/11/2019 17:28	06/11/2019 17:07	06/11/2019 17:28	0,34	4	1,36	CHI
20191148841	ALEXANIA	AX12221351	ALEXANIA	06/11/2019 16:49	06/11/2019 19:23	06/11/2019 16:49	06/11/2019 19:23	2,55	144	367,76	CHI
20191148849	RIO VERDE	RV11136155	RIO VERDE S1	06/11/2019 16:50	06/11/2019 20:57	06/11/2019 16:50	06/11/2019 20:57	4,12	101	415,78	CHI
20191148855	SERRANOPOLIS	SX21166086	JATAI S1	06/11/2019 17:10	08/11/2019 17:42	06/11/2019 17:10	08/11/2019 17:42	48,53	1	48,53	CHI
20191148873	GOIANIA	GN12000977	GOYA S1	06/11/2019 17:30	06/11/2019 18:24	06/11/2019 17:30	06/11/2019 18:24	0,91	2	1,82	CHI
20191148876	SERRANOPOLIS	SX12260526	JATAI S1	06/11/2019 16:25	07/11/2019 18:46	06/11/2019 16:25	07/11/2019 18:46	26,34	10	263,36	CHI
20191148892	NOVO GAMA	SN12290826	PACAEMBU S1	06/11/2019 16:59	06/11/2019 19:25	06/11/2019 16:59	06/11/2019 19:25	2,42	3	7,26	CHI
20191148892	SANTO ANTONIO DO DESCOBERTO	SN12290826	PACAEMBU S1	06/11/2019 16:59	06/11/2019 19:25	06/11/2019 16:59	06/11/2019 19:25	2,42	15	36,28	CHI
20191148905	JARAGUA	SF12343923	JARAGUA	06/11/2019 17:18	07/11/2019 10:58	06/11/2019 17:18	07/11/2019 10:58	17,66	2	35,32	CHI
20191148906	MARA ROSA	MQ21338227	MARA ROSA	06/11/2019 17:18	09/11/2019 10:05	06/11/2019 17:18	09/11/2019 10:05	64,78	1	64,78	CHI
20191148910	ITUMBIARA	690316318	ITUMBIARA VELHA S1	06/11/2019 17:18	07/11/2019 01:46	06/11/2019 17:18	07/11/2019 01:46	8,46	1	8,46	CHI
20191148915	ADELANDIA	DN12145856	FIRMINOPOLIS S2	06/11/2019 17:02	06/11/2019 18:56	06/11/2019 17:02	06/11/2019 18:56	1,90	20	38,04	CHI
20191148916	CATALAO	CT21192574	CATALAO S1	06/11/2019 17:19	07/11/2019 10:00	06/11/2019 17:19	07/11/2019 10:00	16,67	2	33,35	CHI

20191148918	NIQUELANDIA	NQ21082993	URUACU	06/11/2019 17:19	07/11/2019 23:05	06/11/2019 17:19	07/11/2019 23:05	29,75	2	59,51	CHI
20191148929	FORMOSO	FO12200415	MARA ROSA	06/11/2019 17:20	08/11/2019 03:01	06/11/2019 17:20	08/11/2019 03:01	33,67	18	606,00	CHI
20191148931	SAO MIGUEL DO ARAGUAIA	SM21059982	SAO MIGUEL DO ARAGUAIA	06/11/2019 17:21	07/11/2019 18:35	06/11/2019 17:21	07/11/2019 18:35	25,23	1	25,23	CHI
20191148937	SERRANOPOLIS	SX12324832	JATAI S1	06/11/2019 11:26	10/11/2019 11:09	06/11/2019 11:26	10/11/2019 11:09	95,70	13	1244,16	CHI
20191148948	GOIANIA	GN11131444	GOYA S2	06/11/2019 16:30	06/11/2019 20:38	06/11/2019 16:30	06/11/2019 20:38	4,15	104	431,31	CHI
20191148962	SAO MIGUEL DO ARAGUAIA	SM12262623	SAO MIGUEL DO ARAGUAIA	06/11/2019 17:17	09/11/2019 22:10	06/11/2019 17:17	09/11/2019 22:10	76,88	2	153,76	CHI
20191148968	GOIANIA	GN11002659	CARAJAS S2	06/11/2019 17:24	06/11/2019 23:22	06/11/2019 17:24	06/11/2019 23:22	5,95	156	928,55	CHI
20191148969	GOIANIA	10770008	ATLANTICO S1	06/11/2019 17:24	07/11/2019 08:07	06/11/2019 17:24	07/11/2019 08:07	14,70	1	14,70	CHI
20191148970	ANAPOLIS	AN21339363	ANAPOLIS UNIVERSITARIO S1	06/11/2019 17:25	07/11/2019 14:58	06/11/2019 17:25	07/11/2019 14:58	21,54	1	21,54	CHI
20191148978	SANTO ANTONIO DO DESCOBERTO	SN12314001	MARAJOARA	06/11/2019 17:26	06/11/2019 21:21	06/11/2019 17:26	06/11/2019 21:21	3,90	132	514,87	CHI
20191148984	GUARAITA	GK12299763	ITAPURANGA	06/11/2019 17:27	07/11/2019 15:25	06/11/2019 17:27	07/11/2019 15:25	21,96	1	21,96	CHI
20191148988	SANTA ROSA DE GOIAS	SR12019025	INHUMAS S1	06/11/2019 16:14	07/11/2019 13:31	06/11/2019 16:14	07/11/2019 13:31	21,28	17	361,71	CHI
20191148994	SILVANIA	SV21152366	DAIA S2	06/11/2019 17:28	07/11/2019 16:23	06/11/2019 17:28	07/11/2019 16:23	22,90	1	22,90	CHI
20191148997	CAMPINORTE	01120214	MARA ROSA	06/11/2019 16:31	06/11/2019 18:21	06/11/2019 16:31	06/11/2019 18:21	1,82	25	45,56	CHI
20191148997	MARA ROSA	01120214	MARA ROSA	06/11/2019 16:31	06/11/2019 18:21	06/11/2019 16:31	06/11/2019 18:21	1,82	3791	6908,04	CHI
20191148999	JARAGUA	JA21296998	JARAGUA	06/11/2019 17:29	07/11/2019 09:30	06/11/2019 17:29	07/11/2019 09:30	16,02	2	32,03	CHI
20191149004	BURITI ALEGRE	00260214	ITUMBIARA VELHA S2	06/11/2019 17:16	07/11/2019 16:20	06/11/2019 17:16	06/11/2019 23:44	6,47	41	265,29	CHI
20191149004	ITUMBIARA	00260214	ITUMBIARA VELHA S2	06/11/2019 17:16	07/11/2019 16:20	06/11/2019 17:16	06/11/2019 23:44	6,47	131	847,64	CHI
20191149004	BURITI ALEGRE	BG13000011	ITUMBIARA VELHA S2	06/11/2019 17:16	07/11/2019 16:20	06/11/2019 17:16	07/11/2019 09:45	16,49	24	395,67	CHI
20191149004	ITUMBIARA	BG13000011	ITUMBIARA VELHA S2	06/11/2019 17:16	07/11/2019 16:20	06/11/2019 17:16	07/11/2019 09:45	16,49	41	675,94	CHI
20191149004	BURITI ALEGRE	00260214	ITUMBIARA VELHA S2	06/11/2019 17:16	07/11/2019 16:20	07/11/2019 12:41	07/11/2019 12:50	0,15	41	6,26	CHI
20191149004	ITUMBIARA	00260214	ITUMBIARA VELHA S2	06/11/2019 17:16	07/11/2019 16:20	07/11/2019 12:41	07/11/2019 12:50	0,15	133	20,32	CHI
20191149004	BURITI ALEGRE	BG13000011	ITUMBIARA VELHA S2	06/11/2019 17:16	07/11/2019 16:20	06/11/2019 17:16	07/11/2019 16:20	23,06	3	69,17	CHI
20191149004	ITUMBIARA	BG13000011	ITUMBIARA VELHA S2	06/11/2019 17:16	07/11/2019 16:20	06/11/2019 17:16	07/11/2019 16:20	23,06	57	1314,26	CHI
20191149004	ITUMBIARA	BG13000011	ITUMBIARA VELHA S2	06/11/2019 17:16	07/11/2019 16:20	07/11/2019 09:46	07/11/2019 16:20	6,56	20	131,22	CHI
20191149007	ALVORADA DO NORTE	AQ12184985	IACIARA S2	06/11/2019 17:29	06/11/2019 20:12	06/11/2019 17:29	06/11/2019 20:12	2,71	43	116,42	CHI
20191149015	NIQUELANDIA	NQ12375652	URUACU	06/11/2019 15:10	06/11/2019 20:05	06/11/2019 15:10	06/11/2019 20:05	4,91	208	1021,28	CHI
20191149026	CABECEIRAS	860015567	ITUIQUIRA	06/11/2019 17:31	06/11/2019 22:47	06/11/2019 17:31	06/11/2019 22:47	5,26	1	5,26	CHI
20191149034	ITARUMA	IM12086334	ITAJA S2	06/11/2019 17:33	07/11/2019 08:50	06/11/2019 17:33	07/11/2019 08:50	15,28	1	15,28	CHI
20191149035	PIRENOPOLIS	PV21135426	CORUMBA	06/11/2019 17:33	07/11/2019 17:43	06/11/2019 17:33	07/11/2019 17:43	24,16	1	24,16	CHI
20191149036	BALIZA	BH12331310	CAIAPONIA	06/11/2019 17:33	07/11/2019 18:45	06/11/2019 17:33	07/11/2019 18:45	25,20	3	75,59	CHI
20191149037	CAIAPONIA	10024633532	CAIAPONIA	06/11/2019 17:33	07/11/2019 15:35	06/11/2019 17:33	07/11/2019 15:35	22,03	1	22,03	CHI
20191149038	INDIARA	IY12391438	EDEIA	06/11/2019 17:33	07/11/2019 09:20	06/11/2019 17:33	07/11/2019 09:20	15,79	15	236,79	CHI

20191149038	PALMEIRAS DE GOIAS	IY12391438	EDEIA	06/11/2019 17:33	07/11/2019 09:20	06/11/2019 17:33	07/11/2019 09:20	15,79	1	15,79	CHI
20191149039	ITARUMA	2310000523	CACHOEIRA ALTA	06/11/2019 17:33	07/11/2019 07:51	06/11/2019 17:33	07/11/2019 07:51	14,29	1	14,29	CHI
20191149041	CATALAO	CT12390635	CATALAO S2	06/11/2019 17:34	06/11/2019 22:09	06/11/2019 17:34	06/11/2019 22:09	4,58	3	13,74	CHI
20191149043	NOVO PLANALTO	TA12391925	SAO MIGUEL DO ARAGUAIA	06/11/2019 17:34	06/11/2019 20:00	06/11/2019 17:34	06/11/2019 20:00	2,43	8	19,43	CHI
20191149048	RIO VERDE	RV21191777	MONTIVIDIU T	06/11/2019 17:34	10/11/2019 16:26	06/11/2019 17:34	10/11/2019 16:16	94,69	1	94,69	CHI
20191149048	JATAI	03280424	MONTIVIDIU T	06/11/2019 17:34	10/11/2019 16:26	10/11/2019 15:24	10/11/2019 16:26	1,03	3	3,08	CHI
20191149048	RIO VERDE	03280424	MONTIVIDIU T	06/11/2019 17:34	10/11/2019 16:26	10/11/2019 15:24	10/11/2019 16:26	1,03	7	7,18	CHI
20191149050	BOM JESUS DE GOIAS	BJ12000143	BOM JESUS DE GOIAS	06/11/2019 16:21	09/11/2019 18:30	06/11/2019 16:21	09/11/2019 18:30	74,14	6	444,81	CHI
20191149058	QUIRINOPOLIS	10002434740	QUIRINOPOLIS	06/11/2019 17:36	07/11/2019 07:52	06/11/2019 17:36	07/11/2019 07:52	14,27	1	14,27	CHI
20191149067	IPORA	730092914	IPORA	06/11/2019 17:37	07/11/2019 09:50	06/11/2019 17:37	07/11/2019 09:50	16,22	1	16,22	CHI
20191149070	PARAUNA	PU12163951	PARAUNA	06/11/2019 17:35	08/11/2019 19:02	06/11/2019 17:35	08/11/2019 19:02	49,44	3	148,31	CHI
20191149075	GOIAS	GS11188122	GOIAS	06/11/2019 17:38	08/11/2019 15:58	06/11/2019 17:38	08/11/2019 15:58	46,33	2	92,66	CHI
20191149085	IPORA	730021040	IPORA	06/11/2019 17:39	07/11/2019 01:24	06/11/2019 17:39	07/11/2019 01:24	7,74	1	7,74	CHI
20191149091	SAO LUIS DE MONTES BELOS	500058659	SAO LUIZ DOS MONTES BELOS	06/11/2019 17:40	06/11/2019 22:32	06/11/2019 17:40	06/11/2019 22:32	4,86	1	4,86	CHI
20191149097	FIRMINOPOLIS	TV12005554	FIRMINOPOLIS S1	06/11/2019 17:40	06/11/2019 19:00	06/11/2019 17:40	06/11/2019 19:00	1,33	2	2,67	CHI
20191149097	TURVANIA	TV12005554	FIRMINOPOLIS S1	06/11/2019 17:40	06/11/2019 19:00	06/11/2019 17:40	06/11/2019 19:00	1,33	46	61,32	CHI
20191149099	CATURAI	CK12032824	ARACU	06/11/2019 15:45	07/11/2019 14:49	06/11/2019 15:45	07/11/2019 14:49	23,07	12	276,80	CHI
20191149105	PIRES DO RIO	PR12319028	PIRES DO RIO S1	06/11/2019 17:09	06/11/2019 19:17	06/11/2019 17:09	06/11/2019 19:17	2,13	8	17,02	CHI
20191149112	GOIANIA	10021317737	GOYA S2	06/11/2019 17:42	07/11/2019 09:52	06/11/2019 17:42	07/11/2019 09:52	16,15	1	16,15	CHI
20191149116	ALTO PARAISO DE GOIAS	BF21196476	SAO JOAO D ALIANCA	06/11/2019 16:10	08/11/2019 11:59	06/11/2019 16:10	08/11/2019 11:59	43,82	1	43,82	CHI
20191149125	SANTO ANTONIO DO DESCOBERTO	SN12305157	MARAJOARA	06/11/2019 17:58	06/11/2019 23:59	06/11/2019 17:58	06/11/2019 23:59	6,02	13	78,31	CHI
20191149125	SANTO ANTONIO DO DESCOBERTO	SN12037170	MARAJOARA	06/11/2019 17:58	06/11/2019 23:59	06/11/2019 23:19	06/11/2019 23:59	0,68	20	13,54	CHI
20191149136	FAINA	MP21299721	MATRINCHA	06/11/2019 17:44	06/11/2019 19:59	06/11/2019 17:44	06/11/2019 19:59	2,23	1	2,23	CHI
20191149137	VALPARAISO DE GOIAS	2860139819	PACAEMBU S1	06/11/2019 17:44	06/11/2019 20:59	06/11/2019 17:44	06/11/2019 20:59	3,23	1	3,23	CHI
20191149140	DIORAMA	DI12065688	IPORA	06/11/2019 17:45	07/11/2019 13:59	06/11/2019 17:45	07/11/2019 13:59	20,23	2	40,46	CHI
20191149146	SANCLERLANDIA	SC12005400	FIRMINOPOLIS S2	06/11/2019 13:18	07/11/2019 00:48	06/11/2019 13:18	07/11/2019 00:48	11,49	27	310,15	CHI
20191149146	SAO LUIS DE MONTES BELOS	SC12005400	FIRMINOPOLIS S2	06/11/2019 13:18	07/11/2019 00:48	06/11/2019 13:18	07/11/2019 00:48	11,49	2	22,97	CHI
20191149160	RIO VERDE	RV11279878	CABRIUVA S1	06/11/2019 17:37	07/11/2019 00:32	06/11/2019 17:37	07/11/2019 00:32	6,91	42	290,06	CHI
20191149162	ACREUNA	EU11226258	ACREUNA	06/11/2019 15:05	06/11/2019 19:54	06/11/2019 15:05	06/11/2019 19:54	4,81	107	514,34	CHI
20191149163	GOIAS	GS11170846	GOIAS	06/11/2019 17:48	09/11/2019 08:58	06/11/2019 17:48	09/11/2019 08:58	63,18	1	63,18	CHI
20191149167	CORUMBA DE GOIAS	260005575	CORUMBA	06/11/2019 17:48	07/11/2019 09:14	06/11/2019 17:48	07/11/2019 09:14	15,42	1	15,42	CHI
20191149173	GOIANIA	10011526082	AEROPORTO S2	06/11/2019 17:49	06/11/2019 22:13	06/11/2019 17:49	06/11/2019 22:13	4,40	1	4,40	CHI
20191149176	JANDAIA	JD12005438	PALMEIRAS	06/11/2019 17:35	07/11/2019 10:20	06/11/2019 17:35	06/11/2019 23:17	5,70	55	313,61	CHI

20191149176	PALMEIRAS DE GOIAS	JD12005438	PALMEIRAS	06/11/2019 17:35	07/11/2019 10:20	06/11/2019 17:35	06/11/2019 23:17	5,70	8	45,62	CHI
20191149176	PALMINOPOLIS	JD12005438	PALMEIRAS	06/11/2019 17:35	07/11/2019 10:20	06/11/2019 17:35	06/11/2019 23:17	5,70	14	79,83	CHI
20191149176	JANDAIA	JD12005438	PALMEIRAS	06/11/2019 17:35	07/11/2019 10:20	06/11/2019 23:48	07/11/2019 10:20	10,53	55	579,04	CHI
20191149176	PALMEIRAS DE GOIAS	JD12005438	PALMEIRAS	06/11/2019 17:35	07/11/2019 10:20	06/11/2019 23:48	07/11/2019 10:20	10,53	8	84,22	CHI
20191149176	PALMINOPOLIS	JD12005438	PALMEIRAS	06/11/2019 17:35	07/11/2019 10:20	06/11/2019 23:48	07/11/2019 10:20	10,53	14	147,39	CHI
20191149179	GOIANIA	TR12001806	TRINDADE	06/11/2019 17:49	07/11/2019 12:14	06/11/2019 17:49	07/11/2019 12:14	18,41	3	55,23	CHI
20191149187	NEROPOLIS	NR12029257	NEROPOLIS S2	06/11/2019 16:14	07/11/2019 00:50	06/11/2019 16:14	07/11/2019 00:50	8,61	9	77,47	CHI
20191149188	INACIOLANDIA	CD21000099	CACHOEIRA DOURADA	06/11/2019 15:13	07/11/2019 16:31	06/11/2019 15:13	07/11/2019 16:31	25,30	1	25,30	CHI
20191149190	JARAGUA	JA21144526	JARAGUA	06/11/2019 17:51	07/11/2019 10:13	06/11/2019 17:51	07/11/2019 10:13	16,37	1	16,37	CHI
20191149195	BRITANIA	BT12060643	BRITANIA	06/11/2019 16:58	06/11/2019 22:00	06/11/2019 16:58	06/11/2019 22:00	5,03	12	60,37	CHI
20191149200	INACIOLANDIA	ID21000098	CACHOEIRA DOURADA	06/11/2019 15:13	07/11/2019 16:15	06/11/2019 15:13	07/11/2019 16:15	25,03	1	25,03	CHI
20191149211	GUAPO	GA32098714	GUAPO S2	06/11/2019 17:53	07/11/2019 17:00	06/11/2019 17:53	07/11/2019 17:00	23,11	6	138,66	CHI
20191149215	APARECIDA DE GOIANIA	200072640	INDEPENDENCIA S1	06/11/2019 17:53	07/11/2019 09:41	06/11/2019 17:53	07/11/2019 09:41	15,79	1	15,79	CHI
20191149221	FAINA	FC12238752	GOIAS	06/11/2019 17:38	07/11/2019 09:40	06/11/2019 17:38	07/11/2019 09:40	16,02	5	80,12	CHI
20191149229	ABADIANIA	587000020	DAIA S2	06/11/2019 17:55	07/11/2019 12:07	06/11/2019 17:55	07/11/2019 12:07	18,19	1	18,19	CHI
20191149231	APARECIDA DE GOIANIA	200268181	INDEPENDENCIA S1	06/11/2019 17:56	07/11/2019 08:55	06/11/2019 17:56	07/11/2019 08:55	15,00	1	15,00	CHI
20191149233	ACREUNA	SH12246720	ACREUNA	06/11/2019 15:59	06/11/2019 19:00	06/11/2019 15:59	06/11/2019 19:00	3,02	5	15,10	CHI
20191149233	SANTA HELENA DE GOIAS	SH12246720	ACREUNA	06/11/2019 15:59	06/11/2019 19:00	06/11/2019 15:59	06/11/2019 19:00	3,02	73	220,40	CHI
20191149233	SANTO ANTONIO DA BARRA	SH12246720	ACREUNA	06/11/2019 15:59	06/11/2019 19:00	06/11/2019 15:59	06/11/2019 19:00	3,02	16	48,31	CHI
20191149238	IPORA	IR11207786	IPORA	06/11/2019 17:10	06/11/2019 19:44	06/11/2019 17:10	06/11/2019 19:44	2,56	113	288,97	CHI
20191149240	IPORA	IR12079742	IPORA	06/11/2019 16:58	07/11/2019 03:06	06/11/2019 16:58	07/11/2019 03:06	10,13	38	384,93	CHI
20191149240	IVOLANDIA	IR12079742	IPORA	06/11/2019 16:58	07/11/2019 03:06	06/11/2019 16:58	07/11/2019 03:06	10,13	12	121,56	CHI
20191149246	COCALZINHO DE GOIAS	ZN21201356	COCALZINHO	06/11/2019 17:57	08/11/2019 18:08	06/11/2019 17:57	08/11/2019 18:08	48,17	1	48,17	CHI
20191149254	RIO VERDE	RV12260123	CABRIUVA S1	06/11/2019 17:09	07/11/2019 04:00	06/11/2019 17:09	07/11/2019 04:00	10,85	17	184,37	CHI
20191149258	SANTO ANTONIO DO DESCOBERTO	SN12330527	MARAJOARA	06/11/2019 17:58	07/11/2019 16:16	06/11/2019 17:58	07/11/2019 16:16	22,29	12	267,50	CHI
20191149268	GOIAS	GS12250875	GOIAS	06/11/2019 17:59	08/11/2019 19:09	06/11/2019 17:59	08/11/2019 19:09	49,17	3	147,51	CHI
20191149271	PLANALTINA	10006667358	PLANALTINA	06/11/2019 17:59	07/11/2019 03:22	06/11/2019 17:59	07/11/2019 03:22	9,37	1	9,37	CHI
20191149273	GOUVELANDIA	GB12261016	QUIRINOPOLIS	06/11/2019 17:59	06/11/2019 22:03	06/11/2019 17:59	06/11/2019 22:03	4,05	4	16,21	CHI
20191149280	PALMEIRAS DE GOIAS	PL12391390	PALMEIRAS	06/11/2019 18:00	06/11/2019 20:19	06/11/2019 18:00	06/11/2019 20:19	2,32	1	2,32	CHI
20191149292	PILAR DE GOIAS	GG21244232	URUACU	06/11/2019 18:02	09/11/2019 12:00	06/11/2019 18:02	09/11/2019 12:00	65,97	1	65,97	CHI
20191149302	QUIRINOPOLIS	QI31014252	QUIRINOPOLIS	06/11/2019 18:03	07/11/2019 11:20	06/11/2019 18:03	07/11/2019 11:20	17,27	2	34,55	CHI
20191149401	VICENTINOPOLIS	VI21028477	VICENTINOPOLIS	06/11/2019 18:03	09/11/2019 17:44	06/11/2019 18:03	09/11/2019 17:44	71,67	2	143,35	CHI
20191149501	GOIANIA	11868156	CAMPINAS S2	06/11/2019 18:04	07/11/2019 03:00	06/11/2019 18:04	07/11/2019 03:00	8,93	1	8,93	CHI

20191149502	IPORA	IR11107563	IPORA	06/11/2019 17:35	06/11/2019 21:35	06/11/2019 17:35	06/11/2019 21:35	3,99	89	355,36	CHI
20191149509	URUACU	CR21221635	MARA ROSA	06/11/2019 18:04	07/11/2019 16:34	06/11/2019 18:04	07/11/2019 16:34	22,49	1	22,49	CHI
20191149518	SAO DOMINGOS	SD11046276	SAO DOMINGOS	06/11/2019 18:05	06/11/2019 19:32	06/11/2019 18:05	06/11/2019 19:32	1,43	28	40,14	CHI
20191149520	ITAUCU	IX12016756	INHUMAS S1	06/11/2019 17:00	07/11/2019 09:30	06/11/2019 17:00	07/11/2019 09:30	16,49	7	115,41	CHI
20191149529	JATAI	JT12205194	JATAI S1	06/11/2019 13:04	08/11/2019 19:41	06/11/2019 13:04	08/11/2019 19:41	54,61	7	382,24	CHI
20191149537	INDIARA	2710005470	EDEIA	06/11/2019 18:08	07/11/2019 07:57	06/11/2019 18:08	07/11/2019 07:57	13,82	1	13,82	CHI
20191149549	COCALZINHO DE GOIAS	ZN12000096	COCALZINHO	06/11/2019 16:56	06/11/2019 21:50	06/11/2019 16:56	06/11/2019 21:50	4,88	24	117,21	CHI
20191149553	ABADIA DE GOIAS	5580014770	INDEPENDENCIA S2	06/11/2019 18:10	07/11/2019 11:44	06/11/2019 18:10	07/11/2019 11:44	17,57	1	17,57	CHI
20191149562	SANTO ANTONIO DO DESCOBERTO	SN12382244	AGUAS LINDAS DE GOIAS S2	06/11/2019 17:34	06/11/2019 20:07	06/11/2019 17:34	06/11/2019 20:07	2,54	14	35,52	CHI
20191149567	CORUMBA DE GOIAS	CB12000010	CORUMBA	06/11/2019 17:02	06/11/2019 19:22	06/11/2019 17:02	06/11/2019 19:22	2,32	8	18,54	CHI
20191149581	PIRENOPOLIS	PV21318583	CORUMBA	06/11/2019 18:13	08/11/2019 09:09	06/11/2019 18:13	08/11/2019 09:09	38,93	1	38,93	CHI
20191149586	PIRACANJUBA	PJ12043107	ROCHEDO	06/11/2019 17:29	07/11/2019 15:24	06/11/2019 17:29	07/11/2019 15:24	21,91	2	43,82	CHI
20191149586	PROFESSOR JAMIL SAFADY	PJ12043107	ROCHEDO	06/11/2019 17:29	07/11/2019 15:24	06/11/2019 17:29	07/11/2019 15:24	21,91	1	21,91	CHI
20191149588	COLINAS DO SUL	TI21197198	NIQUELANDIA SUBTRANSMISSAO	06/11/2019 18:13	06/11/2019 19:57	06/11/2019 18:13	06/11/2019 19:57	1,72	1	1,72	CHI
20191149590	PARAUNA	980012181	PARAUNA	06/11/2019 18:14	08/11/2019 10:10	06/11/2019 18:14	08/11/2019 10:10	39,93	1	39,93	CHI
20191149593	MOSSAMEDES	MD12057741	FIRMINOPOLIS S2	06/11/2019 17:51	06/11/2019 23:11	06/11/2019 17:51	06/11/2019 23:11	5,33	18	95,88	CHI
20191149593	SANCLERLANDIA	MD12057741	FIRMINOPOLIS S2	06/11/2019 17:51	06/11/2019 23:11	06/11/2019 17:51	06/11/2019 23:11	5,33	1	5,33	CHI
20191149615	ITAPURANGA	IK21310830	ITAPURANGA	06/11/2019 18:16	09/11/2019 09:05	06/11/2019 18:16	09/11/2019 09:05	62,81	2	125,62	CHI
20191149621	IPORA	730063112	IPORA	06/11/2019 18:16	07/11/2019 12:11	06/11/2019 18:16	07/11/2019 12:11	17,92	1	17,92	CHI
20191149626	IPORA	IR10403937	IPORA	06/11/2019 17:00	06/11/2019 19:15	06/11/2019 17:00	06/11/2019 19:15	2,24	2317	5181,71	CHI
20191149626	IVOLANDIA	IR10403937	IPORA	06/11/2019 17:00	06/11/2019 19:15	06/11/2019 17:00	06/11/2019 19:15	2,24	2	4,47	CHI
20191149632	BRAZABRANTES	380009535	NEROPOLIS S1	06/11/2019 18:17	07/11/2019 20:11	06/11/2019 18:17	07/11/2019 20:11	25,89	1	25,89	CHI
20191149638	DAMOLANDIA	7402352	INHUMAS S1	06/11/2019 18:18	06/11/2019 19:40	06/11/2019 18:18	06/11/2019 19:40	1,36	15	20,44	CHI
20191149638	OURO VERDE DE GOIAS	7402352	INHUMAS S1	06/11/2019 18:18	06/11/2019 19:40	06/11/2019 18:18	06/11/2019 19:40	1,36	8	10,90	CHI
20191149638	PETROLINA DE GOIAS	7402352	INHUMAS S1	06/11/2019 18:18	06/11/2019 19:40	06/11/2019 18:18	06/11/2019 19:40	1,36	6	8,18	CHI
20191149639	COCALZINHO DE GOIAS	ZN12394288	COCALZINHO	06/11/2019 17:06	06/11/2019 20:08	06/11/2019 17:06	06/11/2019 20:08	3,02	2	6,05	CHI
20191149639	CORUMBA DE GOIAS	ZN12394288	COCALZINHO	06/11/2019 17:06	06/11/2019 20:08	06/11/2019 17:06	06/11/2019 20:08	3,02	11	33,26	CHI
20191149644	ITAJA	IM12303219	CACHOEIRA ALTA	07/11/2019 16:49	10/11/2019 14:40	07/11/2019 16:49	10/11/2019 14:40	69,83	6	419,00	CHI
20191149644	ITARUMA	IM12303219	CACHOEIRA ALTA	07/11/2019 16:49	10/11/2019 14:40	07/11/2019 16:49	10/11/2019 14:40	69,83	2	139,67	CHI
20191149647	ITAJA	IJ12200688	ITAJA S2	06/11/2019 18:19	08/11/2019 22:52	06/11/2019 18:19	08/11/2019 22:52	52,55	3	157,65	CHI
20191149648	FORMOSA	610222843	ITIQUEIRA	06/11/2019 18:19	06/11/2019 20:02	06/11/2019 18:19	06/11/2019 20:02	1,72	1	1,72	CHI
20191149673	PORANGATU	PO12102902	PORANGATU	06/11/2019 17:43	08/11/2019 09:34	06/11/2019 17:43	08/11/2019 09:34	39,84	8	318,70	CHI
20191149674	CATALAO	CT21152868	IPAMERI	06/11/2019 18:22	07/11/2019 09:15	06/11/2019 18:22	07/11/2019 09:15	14,87	1	14,87	CHI

20191149676	PONTALINA	PK21161668	PONTALINA	06/11/2019 17:20	10/11/2019 09:47	06/11/2019 17:20	10/11/2019 09:47	88,44	1	88,44	CHI
20191149679	ITAJA	IJ21092217	CACHOEIRA ALTA	06/11/2019 18:19	11/11/2019 09:17	06/11/2019 18:19	11/11/2019 09:17	110,95	1	110,95	CHI
20191149682	SANTA BARBARA DE GOIAS	TR12048114	TRINDADE	06/11/2019 18:22	06/11/2019 21:32	06/11/2019 18:22	06/11/2019 21:32	3,17	142	450,26	CHI
20191149682	TRINDADE	TR12048114	TRINDADE	06/11/2019 18:22	06/11/2019 21:32	06/11/2019 18:22	06/11/2019 21:32	3,17	28	88,78	CHI
20191149688	MONTIVIDIU	2840003291	MONTIVIDIU T	06/11/2019 18:23	07/11/2019 01:04	06/11/2019 18:23	07/11/2019 01:04	6,68	1	6,68	CHI
20191149689	EDEIA	ED12000041	EDEIA	06/11/2019 18:05	07/11/2019 20:06	06/11/2019 18:05	07/11/2019 20:06	26,01	25	650,22	CHI
20191149694	FIRMINOPOLIS	FR12391442	FIRMINOPOLIS S2	06/11/2019 18:20	06/11/2019 23:19	06/11/2019 18:20	06/11/2019 23:19	4,99	65	324,15	CHI
20191149694	SAO JOAO DA PARAUNA	FR12391442	FIRMINOPOLIS S2	06/11/2019 18:20	06/11/2019 23:19	06/11/2019 18:20	06/11/2019 23:19	4,99	71	354,07	CHI
20191149697	SANCLERLANDIA	SC12068212	FIRMINOPOLIS S2	06/11/2019 18:04	07/11/2019 00:11	06/11/2019 18:04	07/11/2019 00:11	6,11	12	73,37	CHI
20191149704	ITAJA	IJ2214312	ITAJA S2	06/11/2019 18:00	08/11/2019 09:53	06/11/2019 18:00	08/11/2019 09:53	39,87	5	199,34	CHI
20191149707	GOIANIA	13745300	MEIA PONTE	06/11/2019 18:24	07/11/2019 10:43	06/11/2019 18:24	07/11/2019 10:43	16,30	1	16,30	CHI
20191149713	JANDAIA	JD12095918	PALMEIRAS	06/11/2019 18:17	07/11/2019 11:50	06/11/2019 18:17	07/11/2019 11:50	17,56	14	245,77	CHI
20191149713	PALMEIRAS DE GOIAS	JD12095918	PALMEIRAS	06/11/2019 18:17	07/11/2019 11:50	06/11/2019 18:17	07/11/2019 11:50	17,56	1	17,56	CHI
20191149722	TURVANIA	TV12259072	FIRMINOPOLIS S2	06/11/2019 18:27	06/11/2019 19:32	06/11/2019 18:27	06/11/2019 19:32	1,09	3	3,26	CHI
20191149723	BRITANIA	04750224	MATRINCHA	06/11/2019 16:05	06/11/2019 22:20	06/11/2019 16:05	06/11/2019 22:20	6,24	6	37,42	CHI
20191149723	ITAPIRAPUA	04750224	MATRINCHA	06/11/2019 16:05	06/11/2019 22:20	06/11/2019 16:05	06/11/2019 22:20	6,24	80	498,91	CHI
20191149728	CALDAS NOVAS	CN12363790	SERRA DE CALDAS	06/11/2019 17:53	07/11/2019 03:37	06/11/2019 17:53	07/11/2019 03:37	9,73	72	700,46	CHI
20191149732	CAMPESTRE DE GOIAS	GC11193206	TRINDADE	06/11/2019 16:01	06/11/2019 20:20	06/11/2019 16:01	06/11/2019 20:20	4,32	177	765,03	CHI
20191149735	EDEIA	EA12378410	EDEIA	06/11/2019 16:38	09/11/2019 12:03	06/11/2019 16:38	09/11/2019 12:03	67,42	5	337,08	CHI
20191149746	IPORA	IR21073254	IPORA	06/11/2019 18:30	08/11/2019 08:50	06/11/2019 18:30	08/11/2019 08:50	38,34	2	76,67	CHI
20191149751	URUACU	UR12243259	MARAJOARA	06/11/2019 18:21	07/11/2019 10:43	06/11/2019 18:21	07/11/2019 10:43	16,36	7	114,55	CHI
20191149754	CIDADE OCIDENTAL	DH11149723	MARAJOARA	06/11/2019 18:09	06/11/2019 19:54	06/11/2019 18:09	06/11/2019 19:54	1,75	81	141,59	CHI
20191149758	JANDAIA	JD12134334	PALMEIRAS	06/11/2019 18:09	07/11/2019 00:34	06/11/2019 18:09	07/11/2019 00:34	6,41	21	134,51	CHI
20191149761	GOIANIA	GN21092300	XAVANTES	06/11/2019 18:32	07/11/2019 18:10	06/11/2019 18:32	07/11/2019 18:10	23,62	1	23,62	CHI
20191149762	SANTA RITA DO ARAGUAIA	SU21157174	SANTA RITA DO ARAGUAIA	06/11/2019 18:32	07/11/2019 14:29	06/11/2019 18:32	07/11/2019 14:29	19,94	3	59,82	CHI
20191149775	GOIAS	GS12222226	GOIAS	06/11/2019 18:33	07/11/2019 14:58	06/11/2019 18:33	07/11/2019 14:58	20,41	3	61,23	CHI
20191149780	GOIANIA	15266564	GOYA S1	06/11/2019 18:33	07/11/2019 12:09	06/11/2019 18:33	07/11/2019 12:09	17,58	1	17,58	CHI
20191149788	LAGOA SANTA	IJ12089382	ITAJA S2	07/11/2019 06:59	07/11/2019 18:37	07/11/2019 06:59	07/11/2019 18:37	11,62	8	92,94	CHI
20191149791	FIRMINOPOLIS	FR12096828	FIRMINOPOLIS S1	06/11/2019 17:53	07/11/2019 07:10	06/11/2019 17:53	07/11/2019 07:10	13,27	8	106,19	CHI
20191149802	DISTRITO FEDERAL	NJ12290513	MARAJOARA	06/11/2019 17:09	06/11/2019 19:58	06/11/2019 17:09	06/11/2019 19:58	2,80	10	28,02	CHI
20191149811	CACU	CC12051359	CACHOEIRA ALTA	06/11/2019 16:27	09/11/2019 10:30	06/11/2019 16:27	09/11/2019 10:30	66,04	4	264,14	CHI
20191149814	IPAMERI	IP21112278	IPAMERI	06/11/2019 18:36	09/11/2019 09:34	06/11/2019 18:36	09/11/2019 09:34	62,95	1	62,95	CHI
20191149823	INHUMAS	IN11253149	INHUMAS S2	06/11/2019 15:40	06/11/2019 22:20	06/11/2019 15:40	06/11/2019 22:20	6,65	104	691,77	CHI

20191149824	COCALZINHO DE GOIAS	ZN11215169	COCALZINHO	06/11/2019 18:37	07/11/2019 19:15	06/11/2019 18:37	07/11/2019 19:15	24,63	6	147,75	CHI
20191149826	INHUMAS	30129138	INHUMAS S2	06/11/2019 18:37	07/11/2019 11:57	06/11/2019 18:37	07/11/2019 11:57	17,33	1	17,33	CHI
20191149832	CAIAPONIA	DV12023480	CAIAPONIA	06/11/2019 14:18	06/11/2019 21:37	06/11/2019 14:18	06/11/2019 21:37	7,31	19	138,85	CHI
20191149832	DOVERLANDIA	DV12023480	CAIAPONIA	06/11/2019 14:18	06/11/2019 21:37	06/11/2019 14:18	06/11/2019 21:37	7,31	6	43,85	CHI
20191149832	PIRANHAS	DV12023480	CAIAPONIA	06/11/2019 14:18	06/11/2019 21:37	06/11/2019 14:18	06/11/2019 21:37	7,31	7	51,16	CHI
20191149851	SANCLERLANDIA	SC11194201	FIRMINOPOLIS S2	06/11/2019 17:32	06/11/2019 21:53	06/11/2019 17:32	06/11/2019 21:53	4,35	163	708,96	CHI
20191149852	ANAPOLIS	AN12000585	ANAPOLIS UNIVERSITARIO S2	06/11/2019 17:46	06/11/2019 20:10	06/11/2019 17:46	06/11/2019 20:10	2,39	163	388,94	CHI
20191149859	ABADIANIA	AA21412445	ANAPOLIS UNIVERSITARIO S1	06/11/2019 18:40	07/11/2019 13:53	06/11/2019 18:40	07/11/2019 13:53	19,20	1	19,20	CHI
20191149861	LUZIANIA	LZ12169056	VIANOPOLIS	06/11/2019 18:41	06/11/2019 22:29	06/11/2019 18:41	06/11/2019 22:29	3,80	9	34,19	CHI
20191149867	COCALZINHO DE GOIAS	ZN12084622	AGUAS LINDAS DE GOIAS S2	06/11/2019 18:40	06/11/2019 20:37	06/11/2019 18:40	06/11/2019 20:37	1,94	2	3,88	CHI
20191149871	SANCLERLANDIA	SC11180176	FIRMINOPOLIS S2	06/11/2019 17:40	06/11/2019 22:35	06/11/2019 17:40	06/11/2019 22:35	4,91	61	299,70	CHI
20191149881	CACHOEIRA DE GOIAS	CG12206081	FIRMINOPOLIS S2	06/11/2019 16:15	07/11/2019 12:59	06/11/2019 16:15	07/11/2019 12:59	20,73	8	165,86	CHI
20191149887	BALIZA	BH12331423	CAIAPONIA	06/11/2019 14:35	07/11/2019 18:27	06/11/2019 14:35	07/11/2019 18:27	27,85	15	417,76	CHI
20191149889	INDIARA	IY21312568	EDEIA	06/11/2019 18:42	07/11/2019 10:42	06/11/2019 18:42	07/11/2019 10:42	16,00	1	16,00	CHI
20191149891	SILVANIA	SV12190403	DAIA S2	06/11/2019 17:49	07/11/2019 01:37	06/11/2019 17:49	07/11/2019 01:37	7,78	58	451,48	CHI
20191149900	FIRMINOPOLIS	FR21096842	FIRMINOPOLIS S1	06/11/2019 18:45	07/11/2019 07:54	06/11/2019 18:45	07/11/2019 07:54	13,15	1	13,15	CHI
20191149901	ADELANDIA	2330002252	FIRMINOPOLIS S2	06/11/2019 18:45	07/11/2019 00:30	06/11/2019 18:45	07/11/2019 00:30	5,75	1	5,75	CHI
20191149903	RIO VERDE	RV12303875	ACREUNA	08/11/2019 06:02	08/11/2019 09:42	08/11/2019 06:02	08/11/2019 09:42	3,66	40	146,52	CHI
20191149906	ITARUMA	IM21244059	CACHOEIRA ALTA	06/11/2019 18:46	08/11/2019 14:56	06/11/2019 18:46	08/11/2019 14:56	44,16	1	44,16	CHI
20191149907	IACIARA	IA21232133	IACIARA S1	06/11/2019 18:46	07/11/2019 07:29	06/11/2019 18:46	07/11/2019 07:29	12,71	1	12,71	CHI
20191149909	AMARALINA	MQ12390465	MARA ROSA	06/11/2019 18:46	10/11/2019 19:43	06/11/2019 18:46	07/11/2019 20:48	26,03	279	7262,14	CHI
20191149909	MARA ROSA	MQ12390465	MARA ROSA	06/11/2019 18:46	10/11/2019 19:43	06/11/2019 18:46	07/11/2019 20:48	26,03	86	2238,51	CHI
20191149909	AMARALINA	MQ12390465	MARA ROSA	06/11/2019 18:46	10/11/2019 19:43	07/11/2019 21:01	07/11/2019 22:44	1,71	7	11,98	CHI
20191149909	MARA ROSA	MQ12390465	MARA ROSA	06/11/2019 18:46	10/11/2019 19:43	07/11/2019 21:01	07/11/2019 22:44	1,71	26	44,50	CHI
20191149909	AMARALINA	MQ13263049	MARA ROSA	06/11/2019 18:46	10/11/2019 19:43	07/11/2019 21:01	08/11/2019 00:17	3,27	272	889,14	CHI
20191149909	MARA ROSA	MQ13263049	MARA ROSA	06/11/2019 18:46	10/11/2019 19:43	07/11/2019 21:01	08/11/2019 00:17	3,27	36	117,68	CHI
20191149909	MARA ROSA	MQ13132661	MARA ROSA	06/11/2019 18:46	10/11/2019 19:43	07/11/2019 21:01	08/11/2019 02:04	5,05	19	95,95	CHI
20191149909	MARA ROSA	MQ12380712LD	MARA ROSA	06/11/2019 18:46	10/11/2019 19:43	07/11/2019 21:01	10/11/2019 01:03	52,03	1	52,03	CHI
20191149909	MARA ROSA	MQ13342066	MARA ROSA	06/11/2019 18:46	10/11/2019 19:43	07/11/2019 21:01	10/11/2019 19:43	70,69	4	282,76	CHI
20191149910	SAO LUIS DE MONTES BELOS	SL21156471	FIRMINOPOLIS S1	06/11/2019 18:46	07/11/2019 10:52	06/11/2019 18:46	07/11/2019 10:52	16,09	1	16,09	CHI
20191149915	GOIAS	GS21021592	GOIAS	06/11/2019 18:47	08/11/2019 15:01	06/11/2019 18:47	08/11/2019 15:01	44,23	2	88,46	CHI
20191149916	PIRES DO RIO	PR11186720	PIRES DO RIO S1	06/11/2019 18:34	06/11/2019 20:23	06/11/2019 18:34	06/11/2019 20:23	1,80	59	106,30	CHI
20191149920	CIDADE OCIDENTAL	10004231960	MARAJOARA	06/11/2019 18:47	06/11/2019 22:13	06/11/2019 18:47	06/11/2019 22:13	3,42	1	3,42	CHI

20191149921	AGUA LIMPA	AL21251314	VILA CORUMBA	06/11/2019 18:48	08/11/2019 11:12	06/11/2019 18:48	08/11/2019 11:12	40,39	1	40,39	CHI
20191149923	MOSSAMEDES	MD12364733	FIRMINOPOLIS S2	06/11/2019 18:29	07/11/2019 08:20	06/11/2019 18:29	07/11/2019 08:20	13,84	18	249,07	CHI
20191149928	NAZARIO	NZ11158908	ANICUNS	06/11/2019 16:40	06/11/2019 21:20	06/11/2019 16:40	06/11/2019 21:20	4,66	124	577,56	CHI
20191149937	GAMELEIRA DE GOIAS	SV12056396	DAIA S2	06/11/2019 18:08	06/11/2019 21:17	06/11/2019 18:08	06/11/2019 21:17	3,14	102	320,17	CHI
20191149937	SILVANIA	SV12056396	DAIA S2	06/11/2019 18:08	06/11/2019 21:17	06/11/2019 18:08	06/11/2019 21:17	3,14	1	3,14	CHI
20191149941	ANAPOLIS	AN11000227	JUNDIAI S2	06/11/2019 17:49	06/11/2019 20:02	06/11/2019 17:49	06/11/2019 20:02	2,21	67	148,27	CHI
20191149947	ABADIANIA	AA12326382	CORUMBA	06/11/2019 17:10	06/11/2019 22:57	06/11/2019 17:10	06/11/2019 22:57	5,78	5	28,90	CHI
20191149947	CORUMBA DE GOIAS	AA12326382	CORUMBA	06/11/2019 17:10	06/11/2019 22:57	06/11/2019 17:10	06/11/2019 22:57	5,78	2	11,56	CHI
20191149951	CATALAO	1990059743	CATALAO S2	06/11/2019 18:53	06/11/2019 19:32	06/11/2019 18:53	06/11/2019 19:32	0,64	1	0,64	CHI
20191149952	CAIAPONIA	MV12340904	MONTIVIDIU T	06/11/2019 17:49	07/11/2019 09:58	06/11/2019 17:49	07/11/2019 09:58	16,14	1	16,14	CHI
20191149952	MONTIVIDIU	MV12340904	MONTIVIDIU T	06/11/2019 17:49	07/11/2019 09:58	06/11/2019 17:49	07/11/2019 09:58	16,14	18	290,48	CHI
20191149953	DISTRITO FEDERAL	IJ12200690	ITAJA S2	06/11/2019 17:57	07/11/2019 19:59	06/11/2019 17:57	07/11/2019 19:59	26,02	3	78,07	CHI
20191149953	ITAJA	IJ12200690	ITAJA S2	06/11/2019 17:57	07/11/2019 19:59	06/11/2019 17:57	07/11/2019 19:59	26,02	6	156,14	CHI
20191149960	MINACU	4020074745	MINACU	06/11/2019 18:54	07/11/2019 00:02	06/11/2019 18:54	07/11/2019 00:02	5,14	1	5,14	CHI
20191149962	BURITINOPOLIS	PS12189370	IACIARA S2	06/11/2019 14:40	06/11/2019 23:58	06/11/2019 14:40	06/11/2019 23:58	9,29	2	18,59	CHI
20191149962	MAMBAI	PS12189370	IACIARA S2	06/11/2019 14:40	06/11/2019 23:58	06/11/2019 14:40	06/11/2019 23:58	9,29	25	232,31	CHI
20191149962	POSSE	PS12189370	IACIARA S2	06/11/2019 14:40	06/11/2019 23:58	06/11/2019 14:40	06/11/2019 23:58	9,29	4	37,17	CHI
20191149968	APARECIDA DE GOIANIA	AP11165683	INDEPENDENCIA S2	06/11/2019 18:39	06/11/2019 22:07	06/11/2019 18:39	06/11/2019 22:07	3,47	92	318,78	CHI
20191149969	CRISTALINA	KR11032618	PAMPLONA	06/11/2019 18:52	06/11/2019 20:13	06/11/2019 18:52	06/11/2019 20:13	1,34	65	86,97	CHI
20191149979	PLANALTINA	2960132227	PLANALTINA	06/11/2019 18:55	06/11/2019 23:47	06/11/2019 18:55	06/11/2019 23:47	4,85	1	4,85	CHI
20191149990	ALEXANIA	AX21190695	ALEXANIA	06/11/2019 18:56	07/11/2019 16:19	06/11/2019 18:56	07/11/2019 16:19	21,38	2	42,75	CHI
20191149992	FIRMINOPOLIS	TV12105311	FIRMINOPOLIS S1	06/11/2019 18:56	06/11/2019 20:36	06/11/2019 18:56	06/11/2019 20:36	1,67	6	9,99	CHI
20191150009	RIO QUENTE	RQ21263090	VILA CORUMBA	06/11/2019 18:58	06/11/2019 19:29	06/11/2019 18:58	06/11/2019 19:29	0,51	1	0,51	CHI
20191150012	CALDAS NOVAS	CN12000057	CALDAS NOVAS S2	06/11/2019 18:03	07/11/2019 09:04	06/11/2019 18:03	07/11/2019 09:04	15,00	39	585,17	CHI
20191150017	FORMOSA	610113768	ITUIQUIRA	06/11/2019 19:00	06/11/2019 20:43	06/11/2019 19:00	06/11/2019 20:43	1,71	1	1,71	CHI
20191150024	VILA PROPICIO	PV21095422	GOIANESIA S1	06/11/2019 19:01	08/11/2019 19:48	06/11/2019 19:01	08/11/2019 19:48	48,78	1	48,78	CHI
20191150026	MINEIROS	10016411313	PARQUE DAS EMAS	06/11/2019 19:01	08/11/2019 11:25	06/11/2019 19:01	08/11/2019 11:25	40,41	1	40,41	CHI
20191150028	MAIRIPOTABA	PK12046051RE	PONTALINA	06/11/2019 17:20	07/11/2019 07:56	06/11/2019 17:20	07/11/2019 07:56	14,59	8	116,75	CHI
20191150028	PONTALINA	PK12046051RE	PONTALINA	06/11/2019 17:20	07/11/2019 07:56	06/11/2019 17:20	07/11/2019 07:56	14,59	205	2991,80	CHI
20191150032	RIO VERDE	630544049	RIO VERDE S2	06/11/2019 19:01	07/11/2019 11:40	06/11/2019 19:01	07/11/2019 11:40	16,64	1	16,64	CHI
20191150034	JANDAIA	JD12005421	PALMEIRAS	06/11/2019 18:32	07/11/2019 07:50	06/11/2019 18:32	07/11/2019 07:50	13,29	4	53,15	CHI
20191150036	NOVO GAMA	NJ11290862	PACAEMBU S1	06/11/2019 19:02	07/11/2019 01:08	06/11/2019 19:02	07/11/2019 01:08	6,10	18	109,73	CHI
20191150039	URUACU	UR21243243	MARA ROSA	06/11/2019 19:02	09/11/2019 13:36	06/11/2019 19:02	09/11/2019 13:36	66,55	1	66,55	CHI

20191150042	INHUMAS	30092097	INHUMAS S2	06/11/2019 19:02	07/11/2019 23:59	06/11/2019 19:02	07/11/2019 23:59	28,95	1	28,95	CHI
20191150047	PLANALTINA	10004586148	PLANALTINA	06/11/2019 19:03	07/11/2019 02:28	06/11/2019 19:03	07/11/2019 02:28	7,41	1	7,41	CHI
20191150054	SERRANOPOLIS	SX12205266	JATAI S1	06/11/2019 19:04	07/11/2019 16:49	06/11/2019 19:04	07/11/2019 16:49	21,74	2	43,49	CHI
20191150055	ABADIA DE GOIAS	AO12032892	INDEPENDENCIA S2	06/11/2019 16:14	07/11/2019 15:01	06/11/2019 16:14	07/11/2019 15:01	22,77	21	478,17	CHI
20191150069	MINEIROS	1390030559	PARQUE DAS EMAS	06/11/2019 19:06	07/11/2019 03:53	06/11/2019 19:06	07/11/2019 03:53	8,78	1	8,78	CHI
20191150070	CAMPINORTE	MQ21050722	MARA ROSA	06/11/2019 19:06	07/11/2019 11:41	06/11/2019 19:06	07/11/2019 11:41	16,58	1	16,58	CHI
20191150075	ITAJA	IJ12063067	ITAJA S2	06/11/2019 17:57	08/11/2019 20:16	06/11/2019 17:57	08/11/2019 20:16	50,32	3	150,95	CHI
20191150075	LAGOA SANTA	IJ12063067	ITAJA S2	06/11/2019 17:57	08/11/2019 20:16	06/11/2019 17:57	08/11/2019 20:16	50,32	13	654,10	CHI
20191150084	CAMPOS VERDES	VD21332089	SANTA TEREZINHA	06/11/2019 19:08	08/11/2019 09:27	06/11/2019 19:08	08/11/2019 09:27	38,32	1	38,32	CHI
20191150091	ITABERAI	IB12300044	ITABERAI S1	06/11/2019 15:44	07/11/2019 17:10	06/11/2019 15:44	07/11/2019 17:10	25,42	9	228,81	CHI
20191150094	GOIANIA	12253121	CAMPINAS S1	06/11/2019 19:09	06/11/2019 22:00	06/11/2019 19:09	06/11/2019 22:00	2,83	1	2,83	CHI
20191150095	MINEIROS	10000655048	PARQUE DAS EMAS	06/11/2019 19:10	07/11/2019 04:50	06/11/2019 19:10	07/11/2019 04:50	9,67	1	9,67	CHI
20191150101	PARAUNA	PU12081329	PARAUNA	06/11/2019 15:34	09/11/2019 16:45	06/11/2019 15:34	09/11/2019 16:45	73,18	16	1170,84	CHI
20191150101	PARAUNA	PU12081329	PARAUNA	06/11/2019 15:34	09/11/2019 16:45	08/11/2019 13:20	09/11/2019 16:45	27,42	5	137,08	CHI
20191150106	INDIARA	IY21022078	EDEIA	06/11/2019 19:12	07/11/2019 18:06	06/11/2019 19:12	07/11/2019 18:06	22,90	1	22,90	CHI
20191150107	CAMPOS VERDES	3790030270	SANTA TEREZINHA	06/11/2019 19:13	07/11/2019 16:40	06/11/2019 19:13	07/11/2019 16:40	21,46	1	21,46	CHI
20191150119	AGUA LIMPA	AL12309321	VILA CORUMBA	06/11/2019 18:51	07/11/2019 12:08	06/11/2019 18:51	07/11/2019 12:08	17,28	3	51,84	CHI
20191150126	AGUAS LINDAS DE GOIAS	LA12350436	AGUAS LINDAS DE GOIAS S1	06/11/2019 17:56	06/11/2019 20:57	06/11/2019 17:56	06/11/2019 20:57	3,01	4	12,02	CHI
20191150126	COCALZINHO DE GOIAS	LA12350436	AGUAS LINDAS DE GOIAS S1	06/11/2019 17:56	06/11/2019 20:57	06/11/2019 17:56	06/11/2019 20:57	3,01	2	6,01	CHI
20191150136	BALIZA	BH12331415	CAIAPONIA	06/11/2019 18:36	09/11/2019 11:20	06/11/2019 18:36	09/11/2019 11:20	64,72	9	582,49	CHI
20191150140	MORRINHOS	150056059	MORRINHOS	06/11/2019 19:17	08/11/2019 11:52	06/11/2019 19:17	08/11/2019 11:52	40,58	1	40,58	CHI
20191150143	CAIAPONIA	CP11279328	CAIAPONIA	06/11/2019 15:56	07/11/2019 05:43	06/11/2019 15:56	07/11/2019 05:43	13,78	42	578,92	CHI
20191150144	CAMPINORTE	2040018226	CAMPINORTE	06/11/2019 19:18	07/11/2019 05:24	06/11/2019 19:18	07/11/2019 05:24	10,10	1	10,10	CHI
20191150149	MOSSAMEDES	MD120666158	FIRMINOPOLIS S2	06/11/2019 18:34	07/11/2019 07:41	06/11/2019 18:34	07/11/2019 07:41	13,11	21	275,25	CHI
20191150151	ALVORADA DO NORTE	AQ12085499	IACIARA S2	06/11/2019 19:19	08/11/2019 11:05	06/11/2019 19:19	08/11/2019 11:05	39,76	3	119,27	CHI
20191150151	FLORES DE GOIAS	AQ12085499	IACIARA S2	06/11/2019 19:19	08/11/2019 11:05	06/11/2019 19:19	08/11/2019 11:05	39,76	2	79,52	CHI
20191150154	BELA VISTA DE GOIAS	BV21029566	CEPAIGO S2	06/11/2019 19:19	07/11/2019 10:29	06/11/2019 19:19	07/11/2019 10:29	15,16	1	15,16	CHI
20191150159	SENADOR CANEDO	16658140	GOIANIA LESTE S1	06/11/2019 19:20	07/11/2019 02:30	06/11/2019 19:20	07/11/2019 02:30	7,16	1	7,16	CHI
20191150160	APARECIDA DE GOIANIA	12835602	INDEPENDENCIA S2	06/11/2019 19:20	07/11/2019 02:32	06/11/2019 19:20	07/11/2019 02:32	7,19	1	7,19	CHI
20191150161	CHAPADAO DO CEU	DJ11303891	CHAPADAO DO CEU	06/11/2019 16:36	06/11/2019 19:58	06/11/2019 16:36	06/11/2019 19:58	3,35	152	509,75	CHI
20191150169	JANDAIA	PL12189969	PALMEIRAS	06/11/2019 19:01	07/11/2019 20:16	06/11/2019 19:01	07/11/2019 20:16	25,24	5	126,22	CHI
20191150176	ABADIANIA	AA12302116	ANAPOLIS UNIVERSITARIO S1	06/11/2019 19:14	07/11/2019 00:10	06/11/2019 19:14	07/11/2019 00:10	4,92	17	83,68	CHI
20191150176	CORUMBA DE GOIAS	AA12302116	ANAPOLIS UNIVERSITARIO S1	06/11/2019 19:14	07/11/2019 00:10	06/11/2019 19:14	07/11/2019 00:10	4,92	1	4,92	CHI

20191150177	CEZARINA	CZ21314873	CEZARINA	06/11/2019 19:24	07/11/2019 19:39	06/11/2019 19:24	07/11/2019 19:39	24,25	2	48,49	CHI
20191150178	ANAPOLIS	20078626	ANAPOLIS UNIVERSITARIO S2	06/11/2019 19:24	07/11/2019 04:21	06/11/2019 19:24	07/11/2019 04:21	8,94	1	8,94	CHI
20191150184	JATAI	290156476	JATAI S3	06/11/2019 19:25	08/11/2019 20:09	06/11/2019 19:25	08/11/2019 20:09	48,73	1	48,73	CHI
20191150191	MARA ROSA	MQ12220617	MARA ROSA	06/11/2019 19:26	08/11/2019 15:34	06/11/2019 19:26	08/11/2019 15:34	44,13	7	308,92	CHI
20191150199	SILVANIA	SV21254604	VIANOPOLIS	06/11/2019 19:26	07/11/2019 14:49	06/11/2019 19:26	07/11/2019 14:49	19,37	1	19,37	CHI
20191150203	GOIANIA	10761366	ATLANTICO S1	06/11/2019 19:27	07/11/2019 07:23	06/11/2019 19:27	07/11/2019 07:23	11,93	1	11,93	CHI
20191150205	ITAPACI	IW11074945	ITAPACI	06/11/2019 19:25	06/11/2019 23:47	06/11/2019 19:25	06/11/2019 23:47	4,36	132	575,15	CHI
20191150209	MINACU	IH21220734	MINACU	06/11/2019 19:28	06/11/2019 22:40	06/11/2019 19:28	06/11/2019 22:40	3,20	2	6,40	CHI
20191150211	JATAI	JT11166024	JATAI S2	06/11/2019 18:40	06/11/2019 20:30	06/11/2019 18:40	06/11/2019 20:30	1,84	129	237,65	CHI
20191150213	NOVO GAMA	NJ11214852	PACAEMBU S1	06/11/2019 19:28	06/11/2019 21:06	06/11/2019 19:28	06/11/2019 21:06	1,62	14	22,65	CHI
20191150220	ABADIANIA	AA12084806	CORUMBA	06/11/2019 19:29	06/11/2019 23:43	06/11/2019 19:29	06/11/2019 23:43	4,22	2	8,44	CHI
20191150224	NOVA CRIXAS	NA12262740	NOVA CRIXAS	06/11/2019 16:25	07/11/2019 08:20	06/11/2019 16:25	07/11/2019 08:20	15,90	100	1590,22	CHI
20191150226	ITUMBIARA	IT12399537	PARANAIBA	06/11/2019 19:31	07/11/2019 09:01	06/11/2019 19:31	07/11/2019 09:01	13,50	5	67,49	CHI
20191150238	APARECIDA DE GOIANIA	AP11000052	INDEPENDENCIA S1	06/11/2019 19:19	06/11/2019 21:02	06/11/2019 19:19	06/11/2019 21:02	1,71	208	354,81	CHI
20191150239	CATALAO	CT12399870	CATALAO S1	06/11/2019 19:32	07/11/2019 16:50	06/11/2019 19:32	07/11/2019 16:50	21,29	12	255,43	CHI
20191150241	ABADIANIA	CB12272931	CORUMBA	06/11/2019 16:51	06/11/2019 21:50	06/11/2019 16:51	06/11/2019 21:50	4,98	1	4,98	CHI
20191150241	CORUMBA DE GOIAS	CB12272931	CORUMBA	06/11/2019 16:51	06/11/2019 21:50	06/11/2019 16:51	06/11/2019 21:50	4,98	49	244,01	CHI
20191150245	CAIAPONIA	CP11374940	CAIAPONIA	06/11/2019 18:57	06/11/2019 22:19	06/11/2019 18:57	06/11/2019 22:19	3,36	26	87,25	CHI
20191150246	CIDADE OCIDENTAL	DH11209580	MARAJOARA	06/11/2019 16:59	06/11/2019 20:59	06/11/2019 16:59	06/11/2019 20:59	3,99	67	267,52	CHI
20191150247	JATAI	JT21348480	JATAI S1	06/11/2019 19:34	06/11/2019 22:14	06/11/2019 19:34	06/11/2019 22:14	2,67	1	2,67	CHI
20191150253	JATAI	290125996	JATAI S2	06/11/2019 19:35	06/11/2019 21:50	06/11/2019 19:35	06/11/2019 21:50	2,24	1	2,24	CHI
20191150254	IPORA	730022924	IPORA	06/11/2019 19:35	06/11/2019 22:36	06/11/2019 19:35	06/11/2019 22:36	3,00	1	3,00	CHI
20191150262	SENADOR CANEDO	SW11322857	SENADOR CANEDO	06/11/2019 19:37	06/11/2019 21:27	06/11/2019 19:37	06/11/2019 21:27	1,83	119	218,10	CHI
20191150266	GOIANIA	13890451	GOYA S1	06/11/2019 19:37	07/11/2019 02:00	06/11/2019 19:37	07/11/2019 02:00	6,37	1	6,37	CHI
20191150269	ALTO PARAISO DE GOIAS	BF12048008LD	SAO JOAO D ALIANCA	06/11/2019 19:38	08/11/2019 18:46	06/11/2019 19:38	08/11/2019 18:46	47,13	2	94,26	CHI
20191150290	CRIXAS	CX12230555	MOZARLANDIA	07/11/2019 07:56	10/11/2019 09:30	07/11/2019 07:56	10/11/2019 09:30	73,56	12	882,74	CHI
20191150322	PARANAIGUARA	PC12306052	QUIRINOPOLIS	06/11/2019 19:44	08/11/2019 11:53	06/11/2019 19:44	08/11/2019 11:53	40,14	6	240,84	CHI
20191150322	QUIRINOPOLIS	PC12306052	QUIRINOPOLIS	06/11/2019 19:44	08/11/2019 11:53	06/11/2019 19:44	08/11/2019 11:53	40,14	3	120,42	CHI
20191150325	CRISTIANOPOLIS	CF21112061	CRISTIANOPOLIS	06/11/2019 19:45	08/11/2019 10:20	06/11/2019 19:45	08/11/2019 10:20	38,58	1	38,58	CHI
20191150326	URUACU	UR12088762	CAMPINORTE	06/11/2019 19:46	07/11/2019 09:17	06/11/2019 19:46	07/11/2019 09:17	13,52	2	27,03	CHI
20191150329	GOIANIA	17026040	CARAJAS S2	06/11/2019 19:46	07/11/2019 09:42	06/11/2019 19:46	07/11/2019 09:42	13,92	1	13,92	CHI
20191150341	SANTA HELENA DE GOIAS	400128779	IPEGUARI	06/11/2019 19:49	07/11/2019 12:56	06/11/2019 19:49	07/11/2019 12:56	17,11	1	17,11	CHI
20191150344	MORRO AGUDO DE GOIAS	RB12156092	RUBIATABA	06/11/2019 19:49	09/11/2019 22:32	06/11/2019 19:49	09/11/2019 22:32	74,70	10	747,01	CHI

20191150356	MOIPORA	MO21060546	IPORA	06/11/2019 19:51	08/11/2019 15:40	06/11/2019 19:51	08/11/2019 15:40	43,81	1	43,81	CHI
20191150370	FIRMINOPOLIS	FR11076442	FIRMINOPOLIS S1	06/11/2019 18:44	06/11/2019 22:18	06/11/2019 18:44	06/11/2019 22:18	3,56	141	502,63	CHI
20191150372	CAMPINORTE	MQ12099868	MARA ROSA	06/11/2019 19:55	08/11/2019 09:25	06/11/2019 19:55	07/11/2019 14:26	18,51	3	55,54	CHI
20191150372	MARA ROSA	MQ12099868	MARA ROSA	06/11/2019 19:55	08/11/2019 09:25	06/11/2019 19:55	07/11/2019 14:26	18,51	9	166,61	CHI
20191150372	MARA ROSA	MQ12099868	MARA ROSA	06/11/2019 19:55	08/11/2019 09:25	06/11/2019 19:55	08/11/2019 09:25	37,51	2	75,01	CHI
20191150373	CAVALCANTE	BF21255796	FLORES DE GOIAS	06/11/2019 19:55	07/11/2019 19:11	06/11/2019 19:55	07/11/2019 19:11	23,26	1	23,26	CHI
20191150375	FAZENDA NOVA	FN12383522	FIRMINOPOLIS S2	06/11/2019 14:15	09/11/2019 10:35	06/11/2019 14:15	09/11/2019 09:31	67,26	9	605,32	CHI
20191150375	BURITI DE GOIAS	CO12000058	FIRMINOPOLIS S2	06/11/2019 14:15	09/11/2019 10:35	09/11/2019 10:29	09/11/2019 10:35	0,10	31	3,03	CHI
20191150375	CORREGO DO OURO	CO12000058	FIRMINOPOLIS S2	06/11/2019 14:15	09/11/2019 10:35	09/11/2019 10:29	09/11/2019 10:35	0,10	141	13,79	CHI
20191150375	FAZENDA NOVA	CO12000058	FIRMINOPOLIS S2	06/11/2019 14:15	09/11/2019 10:35	09/11/2019 10:29	09/11/2019 10:35	0,10	38	3,72	CHI
20191150376	PLANALTINA	PI12291523	PLANALTINA	06/11/2019 19:56	06/11/2019 21:45	06/11/2019 19:56	06/11/2019 21:45	1,81	10	18,14	CHI
20191150379	INHUMAS	30015947	INHUMAS S2	06/11/2019 19:56	07/11/2019 12:52	06/11/2019 19:56	07/11/2019 12:52	16,93	1	16,93	CHI
20191150397	ALEXANIA	480045057	ALEXANIA	06/11/2019 20:00	06/11/2019 22:48	06/11/2019 20:00	06/11/2019 22:48	2,79	1	2,79	CHI
20191150401	URUACU	UR12317135	URUACU	06/11/2019 20:01	06/11/2019 22:13	06/11/2019 20:01	06/11/2019 22:13	2,19	11	24,13	CHI
20191150406	DAMOLANDIA	DL31058348	INHUMAS S1	06/11/2019 20:02	07/11/2019 15:35	06/11/2019 20:02	07/11/2019 15:35	19,56	1	19,56	CHI
20191150414	CORUMBA DE GOIAS	CB21382196	CORUMBA	06/11/2019 20:04	07/11/2019 10:24	06/11/2019 20:04	07/11/2019 10:24	14,33	1	14,33	CHI
20191150423	FAZENDA NOVA	FN21183151	JUSSARA	06/11/2019 18:25	09/11/2019 10:09	06/11/2019 18:25	09/11/2019 10:09	63,72	1	63,72	CHI
20191150429	APARECIDA DE GOIANIA	AP21238693	CEPAIGO S1	06/11/2019 20:08	07/11/2019 07:23	06/11/2019 20:08	07/11/2019 07:23	11,24	1	11,24	CHI
20191150433	CRISTALINA	KR11032621	PAMPLONA	06/11/2019 19:13	06/11/2019 21:06	06/11/2019 19:13	06/11/2019 21:06	1,89	77	145,44	CHI
20191150441	NOVA CRIXAS	NA12034763	NOVA CRIXAS	06/11/2019 14:57	07/11/2019 15:00	06/11/2019 14:57	07/11/2019 15:00	24,05	6	144,30	CHI
20191150452	GOIANIA	GN11216340	CAMPINAS S2	06/11/2019 20:13	06/11/2019 23:38	06/11/2019 20:13	06/11/2019 23:38	3,40	88	299,47	CHI
20191150456	CALDAS NOVAS	10008361841	SERRA DE CALDAS	06/11/2019 20:16	07/11/2019 10:29	06/11/2019 20:16	07/11/2019 10:29	14,22	1	14,22	CHI
20191150457	ITAPURANGA	IK12307340	ITAPURANGA	06/11/2019 20:05	07/11/2019 02:13	06/11/2019 20:05	07/11/2019 02:13	6,13	197	1207,83	CHI
20191150462	IPORA	IR12065090	IPORA	06/11/2019 19:57	07/11/2019 04:29	06/11/2019 19:57	07/11/2019 04:29	8,53	29	247,27	CHI
20191150473	APORE	AE12000052	ITAJA S1	06/11/2019 20:19	07/11/2019 19:26	06/11/2019 20:19	07/11/2019 19:26	23,11	13	300,46	CHI
20191150474	SAO FRANCISCO DE GOIAS	SF12211814	SAO FRANCISCO DE GOIAS	06/11/2019 20:19	06/11/2019 23:43	06/11/2019 20:19	06/11/2019 23:43	3,39	14	47,50	CHI
20191150478	GOIATUBA	GT12044851	GOIATUBA S2	06/11/2019 20:13	11/11/2019 01:40	06/11/2019 20:13	11/11/2019 01:40	101,45	8	811,60	CHI
20191150480	MOSSAMEDES	MD21299585	ITABERAI S2	06/11/2019 20:20	08/11/2019 09:24	06/11/2019 20:20	08/11/2019 09:24	37,06	1	37,06	CHI
20191150485	ITABERAI	IB11000022	ITABERAI S2	06/11/2019 20:16	06/11/2019 23:30	06/11/2019 20:16	06/11/2019 23:30	3,23	241	778,76	CHI
20191150492	CATALAO	CT21152903	CATALAO S1	06/11/2019 20:24	08/11/2019 11:06	06/11/2019 20:24	08/11/2019 11:06	38,70	2	77,39	CHI
20191150494	JUSSARA	JR12019332	JUSSARA	06/11/2019 20:10	07/11/2019 11:58	06/11/2019 20:10	07/11/2019 11:58	15,80	13	205,39	CHI
20191150499	PADRE BERNARDO	PB21313838	PADRE BERNARDO	06/11/2019 20:25	07/11/2019 12:01	06/11/2019 20:25	07/11/2019 12:01	15,60	1	15,60	CHI
20191150500	FORMOSA	FA11129972	ITUIQUIRA	06/11/2019 19:44	06/11/2019 21:22	06/11/2019 19:44	06/11/2019 21:22	1,62	110	178,54	CHI

20191150509	ITAPACI	SZ12243712	ITAPACI	06/11/2019 20:27	07/11/2019 09:21	06/11/2019 20:27	07/11/2019 09:21	12,90	3	38,69	CHI
20191150509	SAO LUIZ DO NORTE	SZ12243712	ITAPACI	06/11/2019 20:27	07/11/2019 09:21	06/11/2019 20:27	07/11/2019 09:21	12,90	12	154,76	CHI
20191150510	LUZIANIA	10021626586	RIO VERMELHO	06/11/2019 20:28	06/11/2019 22:06	06/11/2019 20:28	06/11/2019 22:06	1,64	1	1,64	CHI
20191150512	SAO LUIS DE MONTES BELOS	500017414	SAO LUIZ DOS MONTES BELOS	06/11/2019 20:28	07/11/2019 17:10	06/11/2019 20:28	07/11/2019 17:10	20,71	1	20,71	CHI
20191150521	ACREUNA	EA12263394	RIO DOS BOIS	06/11/2019 20:20	09/11/2019 17:25	06/11/2019 20:20	09/11/2019 17:25	69,08	13	898,07	CHI
20191150521	EDEIA	EA12263394	RIO DOS BOIS	06/11/2019 20:20	09/11/2019 17:25	06/11/2019 20:20	09/11/2019 17:25	69,08	13	898,07	CHI
20191150523	MOSSAMEDES	1310012791	FIRMINOPOLIS S2	06/11/2019 20:31	07/11/2019 22:33	06/11/2019 20:31	07/11/2019 22:33	26,02	1	26,02	CHI
20191150524	ORIZONA	OZ21207569	VIANOPOLIS	06/11/2019 20:32	08/11/2019 22:36	06/11/2019 20:32	08/11/2019 22:36	50,06	1	50,06	CHI
20191150531	MORRO AGUDO DE GOIAS	MS12335823	ITAPURANGA	06/11/2019 20:34	09/11/2019 11:50	06/11/2019 20:34	09/11/2019 11:50	63,28	2	126,55	CHI
20191150532	LUZIANIA	3200072402	MARAJOARA	06/11/2019 20:35	07/11/2019 00:30	06/11/2019 20:35	07/11/2019 00:30	3,90	1	3,90	CHI
20191150534	PARANAIGUARA	SO12000023	CACHOEIRA ALTA	06/11/2019 15:34	10/11/2019 14:07	06/11/2019 15:34	07/11/2019 11:10	19,59	40	783,68	CHI
20191150534	SAO SIMAO	SO12000023	CACHOEIRA ALTA	06/11/2019 15:34	10/11/2019 14:07	06/11/2019 15:34	07/11/2019 11:10	19,59	6	117,55	CHI
20191150534	PARANAIGUARA	SO12000023	CACHOEIRA ALTA	06/11/2019 15:34	10/11/2019 14:07	06/11/2019 15:34	07/11/2019 13:08	21,56	22	474,41	CHI
20191150534	SAO SIMAO	SO12000023	CACHOEIRA ALTA	06/11/2019 15:34	10/11/2019 14:07	06/11/2019 15:34	07/11/2019 13:08	21,56	2	43,13	CHI
20191150534	PARANAIGUARA	SO12000023	CACHOEIRA ALTA	06/11/2019 15:34	10/11/2019 14:07	09/11/2019 17:30	09/11/2019 18:05	0,58	62	35,79	CHI
20191150534	SAO SIMAO	SO12000023	CACHOEIRA ALTA	06/11/2019 15:34	10/11/2019 14:07	09/11/2019 17:30	09/11/2019 18:05	0,58	8	4,62	CHI
20191150534	SAO SIMAO	SO12000023	CACHOEIRA ALTA	06/11/2019 15:34	10/11/2019 14:07	06/11/2019 15:34	10/11/2019 14:07	94,56	24	2269,33	CHI
20191150538	GOIANIA	GN11001064	GOIANIA LESTE S1	06/11/2019 20:37	06/11/2019 22:46	06/11/2019 20:37	06/11/2019 22:46	2,15	34	72,94	CHI
20191150540	JATAI	10006900583	JATAI S2	06/11/2019 20:38	07/11/2019 09:23	06/11/2019 20:38	07/11/2019 09:23	12,75	1	12,75	CHI
20191150542	APARECIDA DE GOIANIA	AP11153538	ATLANTICO S2	06/11/2019 20:24	07/11/2019 00:30	06/11/2019 20:24	07/11/2019 00:30	4,09	72	294,24	CHI
20191150543	RIO VERDE	630207185	CABRIUVA S1	06/11/2019 20:40	07/11/2019 10:00	06/11/2019 20:40	07/11/2019 10:00	13,34	1	13,34	CHI
20191150549	CATALAO	CT21215650	CATALAO S1	06/11/2019 20:42	07/11/2019 13:02	06/11/2019 20:42	07/11/2019 13:02	16,32	1	16,32	CHI
20191150551	VARJAO	VJ12402746	GUAPU S2	06/11/2019 17:07	07/11/2019 04:58	06/11/2019 17:07	07/11/2019 04:58	11,84	39	461,92	CHI
20191150552	FORMOSA	FA12383276	ITUIQUIRA	06/11/2019 16:27	06/11/2019 22:39	06/11/2019 16:27	06/11/2019 22:39	6,20	22	136,33	CHI
20191150553	CATALAO	IP12281428	IPAMERI	06/11/2019 20:45	07/11/2019 10:10	06/11/2019 20:45	07/11/2019 10:10	13,42	4	53,66	CHI
20191150559	EDEIA	1120004382	EDEIA	06/11/2019 20:47	07/11/2019 16:53	06/11/2019 20:47	07/11/2019 16:53	20,08	1	20,08	CHI
20191150560	CHAPADAO DO CEU	DJ12160236	CHAPADAO DO CEU	06/11/2019 20:48	07/11/2019 13:58	06/11/2019 20:48	07/11/2019 13:58	17,18	7	120,23	CHI
20191150563	CORUMBA DE GOIAS	260006105	CORUMBA	06/11/2019 20:48	07/11/2019 08:09	06/11/2019 20:48	07/11/2019 08:09	11,34	1	11,34	CHI
20191150569	PIRENOPOLIS	PV21273272	COCALZINHO	06/11/2019 20:50	07/11/2019 23:23	06/11/2019 20:50	07/11/2019 23:23	26,54	1	26,54	CHI
20191150572	FORMOSA	FA12376699	ITUIQUIRA	06/11/2019 20:51	07/11/2019 11:21	06/11/2019 20:51	07/11/2019 11:21	14,49	33	478,10	CHI
20191150573	NIQUELANDIA	NQ21341305	URUACU	06/11/2019 16:36	07/11/2019 17:00	06/11/2019 16:36	07/11/2019 17:00	24,40	8	195,20	CHI
20191150576	JARAGUA	JA11000005	JARAGUA	06/11/2019 20:19	06/11/2019 22:14	06/11/2019 20:19	06/11/2019 22:14	1,91	94	179,91	CHI
20191150578	CATALAO	CT21250363	CATALAO S1	06/11/2019 20:53	07/11/2019 18:55	06/11/2019 20:53	07/11/2019 18:55	22,03	1	22,03	CHI

20191150582	GOIANESIA	10020449800	GOIANESIA S2	06/11/2019 20:53	08/11/2019 15:09	06/11/2019 20:53	08/11/2019 15:09	42,26	1	42,26	CHI
20191150583	APARECIDA DE GOIANIA	200602275	INDEPENDENCIA S1	06/11/2019 20:53	07/11/2019 10:17	06/11/2019 20:53	07/11/2019 10:17	13,39	1	13,39	CHI
20191150587	PIRACANJUBA	PJ21142470	PIRACANJUBA	06/11/2019 20:56	08/11/2019 18:47	06/11/2019 20:56	08/11/2019 18:47	45,85	2	91,69	CHI
20191150600	PARAUNA	PU12194227	PARAUNA	06/11/2019 17:54	08/11/2019 04:45	06/11/2019 17:54	07/11/2019 11:32	17,62	14	246,68	CHI
20191150600	SAO JOAO DA PARAUNA	PU12194227	PARAUNA	06/11/2019 17:54	08/11/2019 04:45	06/11/2019 17:54	07/11/2019 11:32	17,62	26	458,11	CHI
20191150600	SAO JOAO DA PARAUNA	PU12194227	PARAUNA	06/11/2019 17:54	08/11/2019 04:45	06/11/2019 17:54	07/11/2019 14:25	20,50	10	205,03	CHI
20191150600	SAO JOAO DA PARAUNA	PU12194227	PARAUNA	06/11/2019 17:54	08/11/2019 04:45	06/11/2019 17:54	07/11/2019 14:50	20,92	12	251,04	CHI
20191150600	FIRMINOPOLIS	RP13205951	FIRMINOPOLIS S1	06/11/2019 17:54	08/11/2019 04:45	07/11/2019 14:00	08/11/2019 04:45	14,75	3	44,26	CHI
20191150600	SAO JOAO DA PARAUNA	RP13205951	FIRMINOPOLIS S1	06/11/2019 17:54	08/11/2019 04:45	07/11/2019 14:00	08/11/2019 04:45	14,75	4	59,01	CHI
20191150604	PLANALTINA	PI12085567	PLANALTINA	06/11/2019 21:02	07/11/2019 07:33	06/11/2019 21:02	07/11/2019 07:33	10,51	4	42,06	CHI
20191150607	BURITI DE GOIAS	CO12048391	FIRMINOPOLIS S2	06/11/2019 21:02	08/11/2019 09:20	06/11/2019 21:02	08/11/2019 09:20	36,29	27	979,81	CHI
20191150619	DISTRITO FEDERAL	NJ21209509	MARAJOARA	06/11/2019 21:08	06/11/2019 23:32	06/11/2019 21:08	06/11/2019 23:32	2,40	3	7,20	CHI
20191150625	DISTRITO FEDERAL	SN12383067	MARAJOARA	06/11/2019 17:23	07/11/2019 07:36	06/11/2019 17:23	07/11/2019 07:36	14,22	2	28,43	CHI
20191150625	SANTO ANTONIO DO DESCOBERTO	SN12383067	MARAJOARA	06/11/2019 17:23	07/11/2019 07:36	06/11/2019 17:23	07/11/2019 07:36	14,22	5	71,08	CHI
20191150626	SENADOR CANEDO	13379471	GOIANIA LESTE S2	06/11/2019 21:09	07/11/2019 12:23	06/11/2019 21:09	07/11/2019 12:23	15,24	1	15,24	CHI
20191150641	AGUAS LINDAS DE GOIAS	10018298620	AGUAS LINDAS DE GOIAS S1	06/11/2019 21:13	07/11/2019 00:09	06/11/2019 21:13	07/11/2019 00:09	2,92	1	2,92	CHI
20191150644	LUZIANIA	LZ21149931	VIANOPOLIS	06/11/2019 21:15	06/11/2019 22:58	06/11/2019 21:15	06/11/2019 22:58	1,71	1	1,71	CHI
20191150651	ITARUMA	IM12370175	ITAJA S2	06/11/2019 19:05	10/11/2019 13:31	06/11/2019 19:05	10/11/2019 13:31	90,42	5	452,10	CHI
20191150658	ALTO PARAISO DE GOIAS	BF11329726	FLORES DE GOIAS	06/11/2019 20:07	07/11/2019 09:54	06/11/2019 20:07	07/11/2019 09:54	13,77	29	399,30	CHI
20191150665	NEROPOLIS	160011905	NEROPOLIS S2	06/11/2019 21:31	06/11/2019 23:26	06/11/2019 21:31	06/11/2019 23:26	1,91	1	1,91	CHI
20191150681	ALTO PARAISO DE GOIAS	BF21125267	SAO JOAO D ALIANCA	06/11/2019 20:45	08/11/2019 11:21	06/11/2019 20:45	08/11/2019 11:21	38,59	1	38,59	CHI
20191150686	GOIANIA	12723083	GOIANIA LESTE S1	06/11/2019 21:39	07/11/2019 10:51	06/11/2019 21:39	07/11/2019 10:51	13,19	1	13,19	CHI
20191150689	GOIATUBA	GT12000127	GOIATUBA S2	06/11/2019 16:55	10/11/2019 21:00	06/11/2019 16:55	10/11/2019 21:00	100,08	34	3402,88	CHI
20191150693	GOIANESIA	GE12342219	ITAPACI	06/11/2019 21:42	08/11/2019 15:02	06/11/2019 21:42	08/11/2019 15:02	41,33	1	41,33	CHI
20191150700	TRINDADE	40109770	MEIA PONTE	06/11/2019 21:47	07/11/2019 22:24	06/11/2019 21:47	07/11/2019 22:24	24,62	1	24,62	CHI
20191150702	NEROPOLIS	10000787670	NEROPOLIS S2	06/11/2019 21:48	06/11/2019 22:48	06/11/2019 21:48	06/11/2019 22:48	0,99	1	0,99	CHI
20191150704	NAZARIO	NZ21306849	ANICUNS	06/11/2019 21:49	08/11/2019 08:00	06/11/2019 21:49	08/11/2019 08:00	34,18	2	68,36	CHI
20191150706	GOIANDIRA	GD12237105	CATALAO S1	06/11/2019 21:51	07/11/2019 07:47	06/11/2019 21:51	07/11/2019 07:47	9,92	2	19,84	CHI
20191150717	AGUAS LINDAS DE GOIAS	LA11305234	AGUAS LINDAS DE GOIAS S2	06/11/2019 21:48	06/11/2019 23:08	06/11/2019 21:48	06/11/2019 23:08	1,33	209	277,22	CHI
20191150718	FLORES DE GOIAS	FB12250123	FLORES DE GOIAS	06/11/2019 16:20	06/11/2019 22:55	06/11/2019 16:20	06/11/2019 22:55	6,57	81	532,03	CHI
20191150718	SAO JOAO D ALIANCA	FB12250123	FLORES DE GOIAS	06/11/2019 16:20	06/11/2019 22:55	06/11/2019 16:20	06/11/2019 22:55	6,57	20	131,37	CHI
20191150719	CORUMBA DE GOIAS	ZN21388222	COCALZINHO	06/11/2019 21:58	08/11/2019 16:25	06/11/2019 21:58	08/11/2019 16:25	42,45	1	42,45	CHI
20191150725	INACIOLANDIA	ID11304144	CACHOEIRA DOURADA	06/11/2019 22:01	09/11/2019 15:14	06/11/2019 22:01	09/11/2019 15:14	65,21	2	130,41	CHI

20191150730	ORIZONA	OZ11231747	PIRES DO RIO S2	06/11/2019 21:55	07/11/2019 02:31	06/11/2019 21:55	07/11/2019 02:31	4,60	156	716,86	CHI
20191150733	QUIRINOPOLIS	80128968	QUIRINOPOLIS	06/11/2019 22:05	07/11/2019 10:42	06/11/2019 22:05	07/11/2019 10:42	12,61	1	12,61	CHI
20191150735	PARANAIGUARA	QI21306053	QUIRINOPOLIS	06/11/2019 20:35	10/11/2019 17:12	06/11/2019 20:35	10/11/2019 17:12	92,62	2	185,23	CHI
20191150741	ABADIANIA	AA21393146	ANAPOLIS UNIVERSITARIO S1	06/11/2019 22:09	07/11/2019 14:13	06/11/2019 22:09	07/11/2019 14:13	16,06	2	32,11	CHI
20191150742	CIDADE OCIDENTAL	DH11209580	MARAJOARA	06/11/2019 22:10	06/11/2019 23:26	06/11/2019 22:10	06/11/2019 23:26	1,27	67	84,79	CHI
20191150756	ANAPOLIS	20879301	JUNDIAI S1	06/11/2019 22:17	07/11/2019 03:15	06/11/2019 22:17	07/11/2019 03:15	4,96	1	4,96	CHI
20191150799	CRISTALINA	KR21320148	PAMPLONA	06/11/2019 22:34	07/11/2019 01:12	06/11/2019 22:34	07/11/2019 01:12	2,62	1	2,62	CHI
20191150803	MINEIROS	SX13337101	PARQUE DAS EMAS	06/11/2019 22:08	07/11/2019 15:39	06/11/2019 22:08	07/11/2019 15:39	17,51	1	17,51	CHI
20191150803	SERRANOPOLIS	SX13337101	PARQUE DAS EMAS	06/11/2019 22:08	07/11/2019 15:39	06/11/2019 22:08	07/11/2019 15:39	17,51	2	35,02	CHI
20191150818	CAIAPONIA	CP12076264	MONTIVIDIU T	06/11/2019 16:30	07/11/2019 17:15	06/11/2019 16:30	07/11/2019 17:15	24,76	77	1906,26	CHI
20191150818	JATAI	CP12076264	MONTIVIDIU T	06/11/2019 16:30	07/11/2019 17:15	06/11/2019 16:30	07/11/2019 17:15	24,76	7	173,30	CHI
20191150818	MONTIVIDIU	CP12076264	MONTIVIDIU T	06/11/2019 16:30	07/11/2019 17:15	06/11/2019 16:30	07/11/2019 17:15	24,76	2	49,51	CHI
20191150818	RIO VERDE	CP12076264	MONTIVIDIU T	06/11/2019 16:30	07/11/2019 17:15	06/11/2019 16:30	07/11/2019 17:15	24,76	12	297,08	CHI
20191150823	MINACU	IH12392286	MINACU	06/11/2019 17:47	07/11/2019 22:21	06/11/2019 17:47	07/11/2019 22:21	28,58	19	542,99	CHI
20191150910	RIO VERDE	630483875	RIO VERDE S2	06/11/2019 22:42	07/11/2019 11:52	06/11/2019 22:42	07/11/2019 11:52	13,17	1	13,17	CHI
20191150920	NOVO PLANALTO	TA11248589	NOVO PLANALTO	06/11/2019 22:34	07/11/2019 01:40	06/11/2019 22:34	07/11/2019 01:40	3,10	266	823,94	CHI
20191150922	ITAJA	IJ21154088	CACHOEIRA ALTA	06/11/2019 22:57	10/11/2019 16:36	06/11/2019 22:57	10/11/2019 16:36	89,64	1	89,64	CHI
20191150925	CRISTALINA	1060128734	CRISTALINA S1	06/11/2019 23:00	06/11/2019 23:50	06/11/2019 23:00	06/11/2019 23:50	0,83	1	0,83	CHI
20191150929	SANTO ANTONIO DO DESCOBERTO	SN21214800	ALEXANIA	06/11/2019 23:03	07/11/2019 18:52	06/11/2019 23:03	07/11/2019 18:52	19,81	2	39,62	CHI
20191150936	MINACU	IH12245140	MINACU	06/11/2019 23:10	07/11/2019 04:20	06/11/2019 23:10	07/11/2019 04:20	5,16	5	25,81	CHI
20191150939	AGUAS LINDAS DE GOIAS	4830328941	AGUAS LINDAS DE GOIAS S2	06/11/2019 23:16	07/11/2019 01:26	06/11/2019 23:16	07/11/2019 01:26	2,16	1	2,16	CHI
20191150943	GOUVELANDIA	GB11303200	QUIRINOPOLIS	06/11/2019 23:17	07/11/2019 11:04	06/11/2019 23:17	07/11/2019 11:04	11,77	52	611,95	CHI
20191150947	SITIO D ABADIA	AQ12344369	IACIARA S2	06/11/2019 23:28	07/11/2019 13:47	06/11/2019 23:28	07/11/2019 13:47	14,31	15	214,58	CHI
20191150948	SENADOR CANEDO	10010987671	SENADOR CANEDO	06/11/2019 23:30	07/11/2019 00:56	06/11/2019 23:30	07/11/2019 00:56	1,42	1	1,42	CHI
20191150950	PALMEIRAS DE GOIAS	PL21194166	ANICUNS	06/11/2019 23:31	08/11/2019 16:06	06/11/2019 23:31	08/11/2019 16:06	40,58	1	40,58	CHI
20191150958	GOIANIA	10027843694	FERROVIARIO S2	06/11/2019 23:40	07/11/2019 00:36	06/11/2019 23:40	07/11/2019 00:36	0,92	1	0,92	CHI
20191151001	LUZIANIA	LZ12025119	RIO VERMELHO	07/11/2019 00:01	07/11/2019 01:28	07/11/2019 00:01	07/11/2019 01:28	1,44	23	33,16	CHI
20191151010	BRITANIA	BT12131110	BRITANIA	07/11/2019 00:06	08/11/2019 21:42	07/11/2019 00:06	08/11/2019 21:42	45,59	30	1367,75	CHI
20191151015	ITAPIRAPUA	IU11070527	MATRINCHA	07/11/2019 00:31	07/11/2019 10:03	07/11/2019 00:31	07/11/2019 10:03	9,53	121	1152,56	CHI
20191151021	MINEIROS	MY10396069	PARQUE DAS EMAS	07/11/2019 00:30	07/11/2019 07:50	07/11/2019 00:30	07/11/2019 07:50	7,34	8	58,70	CHI
20191151021	PEROLANDIA	MY10396069	PARQUE DAS EMAS	07/11/2019 00:30	07/11/2019 07:50	07/11/2019 00:30	07/11/2019 07:50	7,34	17	124,75	CHI
20191151039	JATAI	RV12074258	CABRIUVA S1	07/11/2019 06:09	07/11/2019 14:40	07/11/2019 06:09	07/11/2019 14:40	8,51	4	34,04	CHI
20191151039	RIO VERDE	RV12074258	CABRIUVA S1	07/11/2019 06:09	07/11/2019 14:40	07/11/2019 06:09	07/11/2019 14:40	8,51	17	144,65	CHI

20191151044	IPORA	IR12013991	IPORA	06/11/2019 19:32	07/11/2019 08:28	06/11/2019 19:32	07/11/2019 08:09	12,61	34	428,91	CHI
20191151044	IPORA	IR12039575	IPORA	06/11/2019 19:32	07/11/2019 08:28	06/11/2019 19:32	07/11/2019 08:28	12,94	11	142,31	CHI
20191151056	ABADIA DE GOIAS	LG11392700	INDEPENDENCIA S2	07/11/2019 04:14	07/11/2019 12:30	07/11/2019 04:14	07/11/2019 12:30	8,26	9	74,38	CHI
20191151058	ITABERAI	IB21250712	ITABERAI S1	07/11/2019 04:22	07/11/2019 09:06	07/11/2019 04:22	07/11/2019 09:06	4,72	1	4,72	CHI
20191151059	FORMOSA	FA12404372	ITIQUEIRA	07/11/2019 04:30	09/11/2019 01:38	07/11/2019 04:30	07/11/2019 12:33	8,06	93	749,30	CHI
20191151059	FORMOSA	FA12404372	ITIQUEIRA	07/11/2019 04:30	09/11/2019 01:38	07/11/2019 12:45	07/11/2019 14:08	1,38	20	27,57	CHI
20191151059	FORMOSA	FA12404372	ITIQUEIRA	07/11/2019 04:30	09/11/2019 01:38	07/11/2019 14:09	07/11/2019 17:37	3,46	20	69,30	CHI
20191151059	FORMOSA	FA12404372	ITIQUEIRA	07/11/2019 04:30	09/11/2019 01:38	07/11/2019 12:45	08/11/2019 23:13	34,47	73	2516,05	CHI
20191151059	FORMOSA	FA12404372	ITIQUEIRA	07/11/2019 04:30	09/11/2019 01:38	08/11/2019 21:00	08/11/2019 23:13	2,22	20	44,38	CHI
20191151059	FORMOSA	FA12269924LD	ITIQUEIRA	07/11/2019 04:30	09/11/2019 01:38	07/11/2019 04:30	08/11/2019 23:48	43,29	60	2597,67	CHI
20191151059	FORMOSA	FA12278186	ITIQUEIRA	07/11/2019 04:30	09/11/2019 01:38	07/11/2019 04:30	09/11/2019 01:38	45,13	14	631,83	CHI
20191151060	SAO FRANCISCO DE GOIAS	SF21211920	SAO FRANCISCO DE GOIAS	07/11/2019 04:34	07/11/2019 11:14	07/11/2019 04:34	07/11/2019 11:14	6,66	1	6,66	CHI
20191151062	MORRINHOS	MR12160429RE	MORRINHOS	07/11/2019 02:19	07/11/2019 08:38	07/11/2019 02:19	07/11/2019 08:38	6,31	100	631,03	CHI
20191151064	ITAPACI	IW12170008	ITAPACI	07/11/2019 04:49	07/11/2019 23:25	07/11/2019 04:49	07/11/2019 23:25	18,59	5	92,95	CHI
20191151064	PILAR DE GOIAS	IW12170008	ITAPACI	07/11/2019 04:49	07/11/2019 23:25	07/11/2019 04:49	07/11/2019 23:25	18,59	3	55,77	CHI
20191151068	NOVA CRIXAS	NA12334349	NOVA CRIXAS	07/11/2019 05:02	07/11/2019 14:00	07/11/2019 05:02	07/11/2019 14:00	8,97	86	770,99	CHI
20191151073	SANCLERLANDIA	SC21164002	FIRMINOPOLIS S2	07/11/2019 05:05	07/11/2019 11:51	07/11/2019 05:05	07/11/2019 11:51	6,75	1	6,75	CHI
20191151077	CRISTALINA	03940214	CRISTALINA S2	07/11/2019 05:09	07/11/2019 08:42	07/11/2019 05:09	07/11/2019 08:42	3,54	284	1004,57	CHI
20191151084	DISTRITO FEDERAL	FA12383392	ITIQUEIRA	07/11/2019 05:19	07/11/2019 13:19	07/11/2019 05:19	07/11/2019 13:19	8,00	2	16,00	CHI
20191151084	FORMOSA	FA12383392	ITIQUEIRA	07/11/2019 05:19	07/11/2019 13:19	07/11/2019 05:19	07/11/2019 13:19	8,00	1	8,00	CHI
20191151091	FLORES DE GOIAS	FB12071376	FLORES DE GOIAS	07/11/2019 05:26	07/11/2019 19:18	07/11/2019 05:26	07/11/2019 19:18	13,85	140	1939,51	CHI
20191151092	MIMOSO DE GOIAS	MJ12304747	PADRE BERNARDO	07/11/2019 05:27	07/11/2019 08:42	07/11/2019 05:27	07/11/2019 08:42	3,24	7	22,69	CHI
20191151100	HIDROLANDIA	HD12000290	CEPAIGO S1	07/11/2019 05:32	07/11/2019 08:08	07/11/2019 05:32	07/11/2019 08:08	2,59	3	7,76	CHI
20191151203	ADELANDIA	DN21021819	FIRMINOPOLIS S2	07/11/2019 05:36	07/11/2019 08:56	07/11/2019 05:36	07/11/2019 08:56	3,33	2	6,67	CHI
20191151210	CRISTALINA	KR13203452	CRISTALINA S2	07/11/2019 05:39	08/11/2019 17:04	07/11/2019 13:40	07/11/2019 15:41	2,01	251	504,86	CHI
20191151210	CRISTALINA	KR13203452	CRISTALINA S2	07/11/2019 05:39	08/11/2019 17:04	07/11/2019 13:40	07/11/2019 15:41	2,01	607	1220,91	CHI
20191151210	CRISTALINA	KR13203452	CRISTALINA S2	07/11/2019 05:39	08/11/2019 17:04	07/11/2019 13:40	07/11/2019 15:41	2,01	14	28,16	CHI
20191151210	CRISTALINA	03470484	CRISTALINA S2	07/11/2019 05:39	08/11/2019 17:04	08/11/2019 16:18	08/11/2019 16:44	0,43	284	123,22	CHI
20191151210	CRISTALINA	03470484	CRISTALINA S2	07/11/2019 05:39	08/11/2019 17:04	08/11/2019 16:18	08/11/2019 16:44	0,43	627	272,05	CHI
20191151210	CRISTALINA	03470484	CRISTALINA S2	07/11/2019 05:39	08/11/2019 17:04	08/11/2019 16:18	08/11/2019 16:44	0,43	17	7,38	CHI
20191151210	CRISTALINA	KR12248743	CRISTALINA S2	07/11/2019 05:39	08/11/2019 17:04	07/11/2019 05:39	08/11/2019 17:04	35,43	8	283,43	CHI
20191151222	DISTRITO FEDERAL	NJ21209509	MARAJOARA	07/11/2019 05:47	07/11/2019 08:22	07/11/2019 05:47	07/11/2019 08:22	2,57	3	7,70	CHI
20191151231	FLORES DE GOIAS	FB21321132	IACIARA S2	07/11/2019 05:50	08/11/2019 00:05	07/11/2019 05:50	08/11/2019 00:05	18,25	1	18,25	CHI

20191151232	QUIRINOPOLIS	QI31021135	QUIRINOPOLIS	07/11/2019 05:51	07/11/2019 10:37	07/11/2019 05:51	07/11/2019 10:37	4,76	1	4,76	CHI
20191151233	BELA VISTA DE GOIAS	BV21244198	BELA VISTA S1	07/11/2019 05:52	07/11/2019 13:17	07/11/2019 05:52	07/11/2019 13:17	7,40	1	7,40	CHI
20191151234	VALPARAISO DE GOIAS	VA12165009	PACAEMBU S1	07/11/2019 05:54	07/11/2019 07:25	07/11/2019 05:54	07/11/2019 07:25	1,52	118	178,84	CHI
20191151235	MORRINHOS	PK12095164RE	PONTALINA	07/11/2019 05:54	08/11/2019 13:35	07/11/2019 05:54	08/11/2019 13:35	31,68	4	126,72	CHI
20191151235	PONTALINA	PK12095164RE	PONTALINA	07/11/2019 05:54	08/11/2019 13:35	07/11/2019 05:54	08/11/2019 13:35	31,68	13	411,84	CHI
20191151238	GUAPO	GA21000081	GUAPO S2	07/11/2019 05:55	08/11/2019 17:02	07/11/2019 05:55	08/11/2019 17:02	35,13	1	35,13	CHI
20191151242	VILA PROPICIO	PV21144561	GOIANESIA S1	07/11/2019 05:56	08/11/2019 14:13	07/11/2019 05:56	08/11/2019 14:13	32,28	1	32,28	CHI
20191151246	FORMOSA	610068829	ITUIQUIRA	07/11/2019 05:57	07/11/2019 17:53	07/11/2019 05:57	07/11/2019 17:53	11,94	1	11,94	CHI
20191151252	FIRMINOPOLIS	FR12096990	FIRMINOPOLIS S1	07/11/2019 05:46	07/11/2019 08:30	07/11/2019 05:46	07/11/2019 08:30	2,73	5	13,67	CHI
20191151254	SANTA ROSA DE GOIAS	SR12000047	INHUMAS S1	07/11/2019 05:07	07/11/2019 08:21	07/11/2019 05:07	07/11/2019 08:21	3,22	50	160,92	CHI
20191151255	SANCLERLANDIA	SC12006150	FIRMINOPOLIS S2	07/11/2019 05:04	07/11/2019 11:25	07/11/2019 05:04	07/11/2019 11:25	6,34	32	202,73	CHI
20191151259	CACHOEIRA ALTA	CA12080005	CACHOEIRA ALTA	07/11/2019 05:57	07/11/2019 19:12	07/11/2019 05:57	07/11/2019 19:12	13,26	6	79,57	CHI
20191151269	CRISTALINA	KR12163740	CRISTALINA S2	07/11/2019 06:06	07/11/2019 07:38	07/11/2019 06:06	07/11/2019 07:38	1,52	8	12,17	CHI
20191151273	ITABERAI	IB10404109	ITABERAI S2	07/11/2019 03:39	07/11/2019 09:09	07/11/2019 03:39	07/11/2019 09:09	5,49	132	725,16	CHI
20191151276	CALDAS NOVAS	CN12363790	SERRA DE CALDAS	07/11/2019 05:57	07/11/2019 10:28	07/11/2019 05:57	07/11/2019 10:28	4,50	72	324,16	CHI
20191151286	QUIRINOPOLIS	QI12000344	QUIRINOPOLIS	07/11/2019 06:10	07/11/2019 18:27	07/11/2019 06:10	07/11/2019 18:27	12,29	7	86,01	CHI
20191151288	ITAJA	IJ12194908	ITAJA S2	07/11/2019 06:10	08/11/2019 10:05	07/11/2019 06:10	08/11/2019 10:05	27,90	8	223,21	CHI
20191151289	ITARUMA	IJ12107422	ITAJA S2	07/11/2019 06:11	07/11/2019 11:30	07/11/2019 06:11	07/11/2019 11:30	5,32	40	212,71	CHI
20191151290	URUACU	UR21268550	URUACU	07/11/2019 06:11	07/11/2019 15:02	07/11/2019 06:11	07/11/2019 15:02	8,84	1	8,84	CHI
20191151291	MONTIVIDIU DO NORTE	MX12240734	PORANGATU	07/11/2019 05:37	10/11/2019 22:30	07/11/2019 05:37	10/11/2019 22:30	88,87	7	622,07	CHI
20191151291	TROMBAS	MX12240734	PORANGATU	07/11/2019 05:37	10/11/2019 22:30	07/11/2019 05:37	10/11/2019 22:30	88,87	1	88,87	CHI
20191151295	MARA ROSA	MQ12286000	MARA ROSA	07/11/2019 06:12	08/11/2019 15:01	07/11/2019 06:12	08/11/2019 09:25	27,22	108	2939,46	CHI
20191151295	CAMPINORTE	MQ12286000	MARA ROSA	07/11/2019 06:12	08/11/2019 15:01	08/11/2019 09:26	08/11/2019 15:01	5,59	8	44,73	CHI
20191151295	ESTRELA DO NORTE	MQ12286000	MARA ROSA	07/11/2019 06:12	08/11/2019 15:01	08/11/2019 09:26	08/11/2019 15:01	5,59	3	16,77	CHI
20191151295	MARA ROSA	MQ12286000	MARA ROSA	07/11/2019 06:12	08/11/2019 15:01	08/11/2019 09:26	08/11/2019 15:01	5,59	148	827,44	CHI
20191151405	LUZIANIA	LZ12025119	RIO VERMELHO	07/11/2019 06:15	07/11/2019 12:01	07/11/2019 06:15	07/11/2019 12:01	5,76	23	132,59	CHI
20191151406	SAO DOMINGOS	SD12218814	SAO DOMINGOS	07/11/2019 06:15	07/11/2019 09:48	07/11/2019 06:15	07/11/2019 09:48	3,54	7	24,75	CHI
20191151408	ALTO PARAISO DE GOIAS	BF21223257	FLORES DE GOIAS	07/11/2019 06:16	08/11/2019 08:47	07/11/2019 06:16	08/11/2019 08:47	26,51	1	26,51	CHI
20191151409	PORTELANDIA	PW12302930	PARQUE DAS EMAS	07/11/2019 06:03	09/11/2019 09:23	07/11/2019 06:03	09/11/2019 09:23	51,33	14	718,63	CHI
20191151410	QUIRINOPOLIS	QI32296599	QUIRINOPOLIS	07/11/2019 06:16	07/11/2019 15:56	07/11/2019 06:16	07/11/2019 15:56	9,67	7	67,66	CHI
20191151419	VILA PROPICIO	NP21312780	GOIANESIA S1	07/11/2019 06:18	09/11/2019 14:34	07/11/2019 06:18	09/11/2019 14:34	56,26	1	56,26	CHI
20191151424	TERESINA DE GOIAS	TE21328341	FLORES DE GOIAS	07/11/2019 06:19	07/11/2019 21:53	07/11/2019 06:19	07/11/2019 21:53	15,55	1	15,55	CHI
20191151427	PLANALTINA	PI21218368	PLANALTINA	07/11/2019 06:20	07/11/2019 11:25	07/11/2019 06:20	07/11/2019 11:25	5,08	1	5,08	CHI

20191151432	CACHOEIRA ALTA	CA21022142	CACHOEIRA ALTA	07/11/2019 06:21	07/11/2019 22:09	07/11/2019 06:21	07/11/2019 22:09	15,80	2	31,60	CHI
20191151435	RUBIATABA	RB11045809	RUBIATABA	07/11/2019 14:15	07/11/2019 16:05	07/11/2019 14:15	07/11/2019 16:05	1,84	155	285,03	CHI
20191151437	ITUMBIARA	IT12257023RE	ITUMBIARA NOVA	07/11/2019 06:21	07/11/2019 18:03	07/11/2019 06:21	07/11/2019 18:03	11,69	63	736,68	CHI
20191151439	PARAUNA	980031722	PARAUNA	07/11/2019 06:22	08/11/2019 11:12	07/11/2019 06:22	08/11/2019 11:12	28,84	1	28,84	CHI
20191151448	SANTA CRUZ DE GOIAS	BC11012004	PIRES DO RIO S2	07/11/2019 04:20	07/11/2019 11:40	07/11/2019 04:20	07/11/2019 11:40	7,32	70	512,67	CHI
20191151449	CAMPINACU	UC12236229	PORANGATU	07/11/2019 06:25	07/11/2019 21:40	07/11/2019 06:25	07/11/2019 17:10	10,75	1	10,75	CHI
20191151449	CAMPINACU	UC12236229	PORANGATU	07/11/2019 06:25	07/11/2019 21:40	07/11/2019 14:47	07/11/2019 17:10	2,38	1	2,38	CHI
20191151449	CAMPINACU	UC12236229	PORANGATU	07/11/2019 06:25	07/11/2019 21:40	07/11/2019 06:25	07/11/2019 19:53	13,46	21	282,72	CHI
20191151449	CAMPINACU	UC12286716LD	PORANGATU	07/11/2019 06:25	07/11/2019 21:40	07/11/2019 14:47	07/11/2019 19:53	5,09	2	10,18	CHI
20191151449	CAMPINACU	UC12286744LD	PORANGATU	07/11/2019 06:25	07/11/2019 21:40	07/11/2019 06:25	07/11/2019 21:26	15,02	1	15,02	CHI
20191151449	CAMPINACU	UC12236229	PORANGATU	07/11/2019 06:25	07/11/2019 21:40	07/11/2019 06:25	07/11/2019 21:40	15,24	1	15,24	CHI
20191151463	GOIANIA	15104084	GOYA S2	07/11/2019 06:31	07/11/2019 11:20	07/11/2019 06:31	07/11/2019 11:20	4,81	1	4,81	CHI
20191151476	CRISTALINA	KR12228876	CRISTALINA S2	07/11/2019 02:37	07/11/2019 09:42	07/11/2019 02:37	07/11/2019 09:42	7,08	10	70,79	CHI
20191151486	NOVO PLANALTO	TA12192346	SAO MIGUEL DO ARAGUAIA	06/11/2019 21:40	07/11/2019 11:30	06/11/2019 21:40	07/11/2019 11:30	13,83	101	1396,49	CHI
20191151491	CRIXAS	UP12391834	SANTA TEREZINHA	06/11/2019 18:33	07/11/2019 16:56	06/11/2019 18:33	07/11/2019 16:56	22,38	10	223,79	CHI
20191151491	UIRAPURU	UP12391834	SANTA TEREZINHA	06/11/2019 18:33	07/11/2019 16:56	06/11/2019 18:33	07/11/2019 16:56	22,38	1	22,38	CHI
20191151500	BONOPOLIS	BX12079315	SAO MIGUEL DO ARAGUAIA	07/11/2019 06:41	09/11/2019 07:21	07/11/2019 06:41	09/11/2019 07:21	48,66	1	48,66	CHI
20191151504	SAO LUIS DE MONTES BELOS	6855993	SAO LUIZ DOS MONTES BELOS	07/11/2019 05:48	07/11/2019 21:52	07/11/2019 05:48	07/11/2019 21:52	16,05	3	48,16	CHI
20191151510	JUSSARA	BT12396220	BRITANIA	07/11/2019 06:47	09/11/2019 10:00	07/11/2019 06:47	09/11/2019 10:00	51,20	3	153,60	CHI
20191151513	PADRE BERNARDO	8523719	PADRE BERNARDO	07/11/2019 08:34	07/11/2019 16:05	07/11/2019 08:34	07/11/2019 16:05	7,52	4	30,06	CHI
20191151518	GOIANIA	10028654500	MEIA PONTE	07/11/2019 06:52	07/11/2019 08:02	07/11/2019 06:52	07/11/2019 08:02	1,16	1	1,16	CHI
20191151527	JOVIANIA	JV12222565RE	VICENTINOPOLIS	07/11/2019 06:53	09/11/2019 14:55	07/11/2019 06:53	07/11/2019 11:30	4,61	4	18,45	CHI
20191151527	GOIATUBA	JV13222509	VICENTINOPOLIS	07/11/2019 06:53	09/11/2019 14:55	07/11/2019 06:53	07/11/2019 13:29	6,60	13	85,80	CHI
20191151527	JOVIANIA	JV13222509	VICENTINOPOLIS	07/11/2019 06:53	09/11/2019 14:55	07/11/2019 06:53	07/11/2019 13:29	6,60	1	6,60	CHI
20191151527	VICENTINOPOLIS	JV13222509	VICENTINOPOLIS	07/11/2019 06:53	09/11/2019 14:55	07/11/2019 06:53	07/11/2019 13:29	6,60	2	13,20	CHI
20191151527	BOM JESUS DE GOIAS	GT13218125	VICENTINOPOLIS	07/11/2019 06:53	09/11/2019 14:55	07/11/2019 06:53	07/11/2019 14:25	7,54	3	22,61	CHI
20191151527	GOIATUBA	GT13218125	VICENTINOPOLIS	07/11/2019 06:53	09/11/2019 14:55	07/11/2019 06:53	07/11/2019 14:25	7,54	2	15,07	CHI
20191151527	GOIATUBA	JV12222565RE	VICENTINOPOLIS	07/11/2019 06:53	09/11/2019 14:55	07/11/2019 14:26	07/11/2019 18:01	3,59	13	46,65	CHI
20191151527	JOVIANIA	JV12222565RE	VICENTINOPOLIS	07/11/2019 06:53	09/11/2019 14:55	07/11/2019 14:26	07/11/2019 18:01	3,59	5	17,94	CHI
20191151527	VICENTINOPOLIS	JV12222565RE	VICENTINOPOLIS	07/11/2019 06:53	09/11/2019 14:55	07/11/2019 14:26	07/11/2019 18:01	3,59	2	7,18	CHI
20191151527	GOIATUBA	JV10400589	VICENTINOPOLIS	07/11/2019 06:53	09/11/2019 14:55	08/11/2019 00:06	08/11/2019 01:31	1,41	13	18,35	CHI
20191151527	JOVIANIA	JV10400589	VICENTINOPOLIS	07/11/2019 06:53	09/11/2019 14:55	08/11/2019 00:06	08/11/2019 01:31	1,41	16	22,58	CHI
20191151527	VICENTINOPOLIS	JV10400589	VICENTINOPOLIS	07/11/2019 06:53	09/11/2019 14:55	08/11/2019 00:06	08/11/2019 01:31	1,41	4	5,65	CHI

20191151527	VICENTINOPOLIS	VI10400587	VICENTINOPOLIS	07/11/2019 06:53	09/11/2019 14:55	08/11/2019 00:06	08/11/2019 15:24	15,31	4	61,23	CHI
20191151527	BOM JESUS DE GOIAS	GT13218125	VICENTINOPOLIS	07/11/2019 06:53	09/11/2019 14:55	07/11/2019 14:26	09/11/2019 14:55	48,49	3	145,48	CHI
20191151527	GOIATUBA	GT13218125	VICENTINOPOLIS	07/11/2019 06:53	09/11/2019 14:55	07/11/2019 14:26	09/11/2019 14:55	48,49	2	96,99	CHI
20191151528	PORANGATU	PO12192252	PORANGATU	07/11/2019 06:54	07/11/2019 11:52	07/11/2019 06:54	07/11/2019 11:52	4,96	23	114,13	CHI
20191151543	BELA VISTA DE GOIAS	BV12082045RE	CRISTIANOPOLIS	07/11/2019 05:30	07/11/2019 09:03	07/11/2019 05:30	07/11/2019 09:03	3,55	4	14,19	CHI
20191151543	CRISTIANOPOLIS	BV12082045RE	CRISTIANOPOLIS	07/11/2019 05:30	07/11/2019 09:03	07/11/2019 05:30	07/11/2019 09:03	3,55	19	67,40	CHI
20191151544	RIO VERDE	RV12305720	RIO VERDE S1	07/11/2019 06:58	09/11/2019 10:00	07/11/2019 06:58	09/11/2019 10:00	51,05	4	204,19	CHI
20191151549	ITAPIRAPUA	IU21016407	MATRINCHA	07/11/2019 06:59	13/11/2019 07:50	07/11/2019 06:59	13/11/2019 07:50	144,86	1	144,86	CHI
20191151550	GOIANIA	10007082876	XAVANTES	07/11/2019 06:59	07/11/2019 08:00	07/11/2019 06:59	07/11/2019 08:00	1,01	1	1,01	CHI
20191151557	MINACU	IH12337408LD	MINACU	07/11/2019 07:01	07/11/2019 13:49	07/11/2019 07:01	07/11/2019 13:49	6,79	35	237,61	CHI
20191151564	INHUMAS	30088215	INHUMAS S1	07/11/2019 07:03	07/11/2019 11:44	07/11/2019 07:03	07/11/2019 11:44	4,68	1	4,68	CHI
20191151567	CRISTALINA	KR11206726	PAMPLONA	07/11/2019 06:47	07/11/2019 10:55	07/11/2019 06:47	07/11/2019 10:55	4,13	133	549,84	CHI
20191151570	CRISTALINA	KR21320148	PAMPLONA	07/11/2019 07:04	07/11/2019 09:47	07/11/2019 07:04	07/11/2019 09:47	2,70	1	2,70	CHI
20191151572	MORRINHOS	MR12044910	GOIATUBA S2	07/11/2019 07:04	12/11/2019 09:00	07/11/2019 07:04	12/11/2019 09:00	121,93	3	365,79	CHI
20191151575	TRINDADE	40245123	TRINDADE	07/11/2019 07:05	07/11/2019 15:57	07/11/2019 07:05	07/11/2019 15:57	8,87	1	8,87	CHI
20191151577	IPORA	730043964	IPORA	07/11/2019 07:05	07/11/2019 12:38	07/11/2019 07:05	07/11/2019 12:38	5,55	1	5,55	CHI
20191151579	BURITINOPOLIS	MB12314303	IACIARA S2	07/11/2019 06:39	07/11/2019 09:02	07/11/2019 06:39	07/11/2019 09:02	2,38	2	4,76	CHI
20191151579	MAMBAI	MB12314303	IACIARA S2	07/11/2019 06:39	07/11/2019 09:02	07/11/2019 06:39	07/11/2019 09:02	2,38	3	7,14	CHI
20191151592	PALMEIRAS DE GOIAS	PL12000031	PALMEIRAS	07/11/2019 05:55	07/11/2019 07:45	07/11/2019 05:55	07/11/2019 07:45	1,83	23	42,00	CHI
20191151593	DOVERLANDIA	DV11253415	CAIAPONIA	07/11/2019 07:08	07/11/2019 13:35	07/11/2019 07:08	07/11/2019 13:35	6,45	1	6,45	CHI
20191151609	LUZIANIA	LZ10404056	RIO VERMELHO	07/11/2019 07:32	07/11/2019 09:39	07/11/2019 07:32	07/11/2019 08:06	0,57	1857	1061,59	CHI
20191151609	LUZIANIA	LZ12351426LD	RIO VERMELHO	07/11/2019 07:32	07/11/2019 09:39	07/11/2019 07:32	07/11/2019 09:31	1,99	1654	3292,84	CHI
20191151609	LUZIANIA	LZ12000468LD	RIO VERMELHO	07/11/2019 07:32	07/11/2019 09:39	07/11/2019 07:32	07/11/2019 09:39	2,12	1170	2478,13	CHI
20191151619	RIO VERDE	RV11402377	RIO VERDE S2	07/11/2019 09:37	07/11/2019 10:00	07/11/2019 09:37	07/11/2019 10:00	0,38	5	1,92	CHI
20191151629	RIO VERDE	RV21237115	CABRIUVA S2	07/11/2019 08:55	07/11/2019 10:18	07/11/2019 08:55	07/11/2019 10:18	1,38	1	1,38	CHI
20191151653	JATAI	JT12390597	JATAI S1	06/11/2019 14:07	08/11/2019 18:17	06/11/2019 14:07	08/11/2019 18:17	52,16	13	678,04	CHI
20191151653	PEROLANDIA	JT12390597	JATAI S1	06/11/2019 14:07	08/11/2019 18:17	06/11/2019 14:07	08/11/2019 18:17	52,16	6	312,94	CHI
20191151704	CAIAPONIA	CP12054805	CAIAPONIA	07/11/2019 05:45	07/11/2019 12:20	07/11/2019 05:45	07/11/2019 12:20	6,57	32	210,21	CHI
20191151704	PIRANHAS	CP12054805	CAIAPONIA	07/11/2019 05:45	07/11/2019 12:20	07/11/2019 05:45	07/11/2019 12:20	6,57	76	499,26	CHI
20191151730	ITABERAI	IB12099038	ITABERAI S2	07/11/2019 06:24	07/11/2019 10:05	07/11/2019 06:24	07/11/2019 10:05	3,68	14	51,55	CHI
20191151732	PEROLANDIA	DP12182220	JATAI S1	07/11/2019 07:16	08/11/2019 11:55	07/11/2019 07:16	08/11/2019 11:55	28,65	7	200,57	CHI
20191151741	FORMOSA	FA31071332	ITIQUEIRA	07/11/2019 07:05	07/11/2019 10:47	07/11/2019 07:05	07/11/2019 10:47	3,69	1	3,69	CHI
20191151745	ANAPOLIS	AN12000605	DAIA S1	07/11/2019 07:17	07/11/2019 09:24	07/11/2019 07:17	07/11/2019 09:24	2,11	3	6,33	CHI

20191151752	DAMOLANDIA	DL12027176	INHUMAS S1	07/11/2019 07:19	07/11/2019 16:29	07/11/2019 07:19	07/11/2019 16:29	9,17	1	9,17	CHI
20191151756	PIRANHAS	PH12343619	PIRANHAS	07/11/2019 07:19	08/11/2019 10:00	07/11/2019 07:19	08/11/2019 10:00	26,67	1	26,67	CHI
20191151757	LUZIANIA	LZ21058462	CRISTALINA S2	07/11/2019 07:19	09/11/2019 08:24	07/11/2019 07:19	09/11/2019 08:24	49,07	1	49,07	CHI
20191151762	ESTRELA DO NORTE	ET12136395	MARA ROSA	07/11/2019 07:20	08/11/2019 18:53	07/11/2019 07:20	08/11/2019 18:53	35,54	10	355,39	CHI
20191151762	MARA ROSA	ET12136395	MARA ROSA	07/11/2019 07:20	08/11/2019 18:53	07/11/2019 07:20	08/11/2019 18:53	35,54	8	284,31	CHI
20191151765	BRITANIA	BT12073348	BRITANIA	07/11/2019 07:20	09/11/2019 23:32	07/11/2019 07:20	09/11/2019 23:32	64,19	1	64,19	CHI
20191151765	BRITANIA	BT12073348	BRITANIA	07/11/2019 07:20	09/11/2019 23:32	09/11/2019 17:57	09/11/2019 23:32	5,58	47	262,19	CHI
20191151769	IPAMERI	580037265	IPAMERI	07/11/2019 07:21	08/11/2019 16:53	07/11/2019 07:21	08/11/2019 16:53	33,53	1	33,53	CHI
20191151772	HIDROLANDIA	HD12045729LD	INDEPENDENCIA S1	07/11/2019 07:22	07/11/2019 10:04	07/11/2019 07:22	07/11/2019 10:04	2,70	21	56,61	CHI
20191151779	MUTUNOPOLIS	SE12352924	MARA ROSA	07/11/2019 07:23	08/11/2019 18:40	07/11/2019 07:23	08/11/2019 18:40	35,28	6	211,69	CHI
20191151779	SANTA TEREZA DE GOIAS	SE12352924	MARA ROSA	07/11/2019 07:23	08/11/2019 18:40	07/11/2019 07:23	08/11/2019 18:40	35,28	1	35,28	CHI
20191151789	FLORES DE GOIAS	FB21321149	IACIARA S2	07/11/2019 07:25	08/11/2019 01:49	07/11/2019 07:25	08/11/2019 01:49	18,39	1	18,39	CHI
20191151792	ITAGUARI	IC12219941	ITABERAI S1	07/11/2019 04:38	08/11/2019 20:38	07/11/2019 04:38	08/11/2019 20:38	40,00	31	1240,05	CHI
20191151792	ITAGUARU	IC12219941	ITABERAI S1	07/11/2019 04:38	08/11/2019 20:38	07/11/2019 04:38	08/11/2019 20:38	40,00	21	840,03	CHI
20191151793	ALTO PARAISO DE GOIAS	BF11262439	SAO JOAO D ALIANCA	07/11/2019 07:25	07/11/2019 12:36	07/11/2019 07:25	07/11/2019 12:36	5,17	29	149,91	CHI
20191151797	URUACU	UR11065511	URUACU	07/11/2019 07:26	07/11/2019 11:06	07/11/2019 07:26	07/11/2019 11:06	3,66	18	65,96	CHI
20191151805	RIO VERDE	RV12106528	MONTIVIDIU T	07/11/2019 07:28	07/11/2019 17:19	07/11/2019 07:28	07/11/2019 17:19	9,85	4	39,40	CHI
20191151811	INACIOLANDIA	ID21279510	QUIRINOPOLIS	07/11/2019 07:30	07/11/2019 11:54	07/11/2019 07:30	07/11/2019 11:54	4,40	1	4,40	CHI
20191151819	FAZENDA NOVA	FN12237035	JUSSARA	07/11/2019 07:23	07/11/2019 17:55	07/11/2019 07:23	07/11/2019 17:55	10,52	7	73,66	CHI
20191151826	SAO LUIS DE MONTES BELOS	SL32111610	FIRMINOPOLIS S1	07/11/2019 02:56	07/11/2019 15:15	07/11/2019 02:56	07/11/2019 15:15	12,31	30	369,33	CHI
20191151828	LEOPOLDO DE BULHOES	LB21353171	DAIA S2	07/11/2019 07:32	09/11/2019 13:23	07/11/2019 07:32	09/11/2019 13:23	53,85	2	107,70	CHI
20191151833	NIQUELANDIA	NQ11280420	NIQUELANDIA SUBTRANSMISSAO	07/11/2019 07:34	07/11/2019 18:03	07/11/2019 07:34	07/11/2019 18:03	10,48	1	10,48	CHI
20191151840	PALMEIRAS DE GOIAS	PL12349319	PALMEIRAS	07/11/2019 07:35	07/11/2019 14:41	07/11/2019 07:35	07/11/2019 14:41	7,11	2	14,21	CHI
20191151850	ORIZONA	OZ12115280	VIANOPOLIS	07/11/2019 07:35	07/11/2019 16:49	07/11/2019 07:35	07/11/2019 16:49	9,23	7	64,64	CHI
20191151852	SAO JOAO D ALIANCA	JL31198426	SAO JOAO D ALIANCA	07/11/2019 07:36	07/11/2019 17:12	07/11/2019 07:36	07/11/2019 17:12	9,60	2	19,20	CHI
20191151854	JATAI	JT12234494	JATAI S3	06/11/2019 11:36	07/11/2019 12:20	06/11/2019 11:36	07/11/2019 12:20	24,72	4	98,88	CHI
20191151857	CORUMBA DE GOIAS	CB12155979	CORUMBA	07/11/2019 06:37	07/11/2019 12:34	07/11/2019 06:37	07/11/2019 12:34	5,95	13	77,35	CHI
20191151860	ABADIA DE GOIAS	LG12387523	INDEPENDENCIA S2	07/11/2019 06:20	07/11/2019 12:12	07/11/2019 06:20	07/11/2019 12:12	5,87	59	346,10	CHI
20191151864	MINEIROS	SU12184123	SANTA RITA DO ARAGUAIA	07/11/2019 07:38	07/11/2019 22:41	07/11/2019 07:38	07/11/2019 22:41	15,05	15	225,72	CHI
20191151864	SANTA RITA DO ARAGUAIA	SU12184123	SANTA RITA DO ARAGUAIA	07/11/2019 07:38	07/11/2019 22:41	07/11/2019 07:38	07/11/2019 22:41	15,05	6	90,29	CHI
20191151865	SAO FRANCISCO DE GOIAS	SF12000177	SAO FRANCISCO DE GOIAS	07/11/2019 07:23	07/11/2019 10:29	07/11/2019 07:23	07/11/2019 10:29	3,09	4	12,36	CHI
20191151867	GOIANIRA	390055098	GOIANIRA	07/11/2019 07:38	07/11/2019 11:22	07/11/2019 07:38	07/11/2019 11:22	3,73	1	3,73	CHI
20191151869	PONTALINA	VI10400585	VICENTINOPOLIS	07/11/2019 07:36	07/11/2019 17:50	07/11/2019 07:36	07/11/2019 10:12	2,59	7	18,16	CHI

20191151869	VICENTINOPOLIS	VI10400585	VICENTINOPOLIS	07/11/2019 07:36	07/11/2019 17:50	07/11/2019 07:36	07/11/2019 10:12	2,59	2	5,19	CHI
20191151869	PONTALINA	VI10400585	VICENTINOPOLIS	07/11/2019 07:36	07/11/2019 17:50	07/11/2019 07:36	07/11/2019 10:17	2,67	175	467,15	CHI
20191151869	PONTALINA	VI13157335	VICENTINOPOLIS	07/11/2019 07:36	07/11/2019 17:50	07/11/2019 07:36	07/11/2019 10:17	2,67	9	24,02	CHI
20191151869	VICENTINOPOLIS	VI10400585	VICENTINOPOLIS	07/11/2019 07:36	07/11/2019 17:50	07/11/2019 07:36	07/11/2019 10:17	2,67	13	34,70	CHI
20191151869	PONTALINA	PK12328924	VICENTINOPOLIS	07/11/2019 07:36	07/11/2019 17:50	07/11/2019 07:36	07/11/2019 17:50	10,23	1	10,23	CHI
20191151880	APORE	SX12264283	ITAJA S1	07/11/2019 07:41	09/11/2019 11:21	07/11/2019 07:41	09/11/2019 11:21	51,67	1	51,67	CHI
20191151880	SERRANOPOLIS	SX12264283	ITAJA S1	07/11/2019 07:41	09/11/2019 11:21	07/11/2019 07:41	09/11/2019 11:21	51,67	38	1963,28	CHI
20191151882	CRISTALINA	KR21244613	CRISTALINA S2	07/11/2019 07:41	07/11/2019 19:25	07/11/2019 07:41	07/11/2019 19:25	11,73	1	11,73	CHI
20191151890	ITAPACI	IW21335724	ITAPACI	07/11/2019 07:42	07/11/2019 10:24	07/11/2019 07:42	07/11/2019 10:24	2,68	1	2,68	CHI
20191151903	ANAPOLIS	AN11059829	JUNDIAI S1	07/11/2019 06:54	07/11/2019 10:18	07/11/2019 06:54	07/11/2019 10:18	3,39	80	271,47	CHI
20191151906	GOIANIA	GN11000754	GOIANIA LESTE S1	07/11/2019 07:45	07/11/2019 09:41	07/11/2019 07:45	07/11/2019 09:41	1,93	10	19,33	CHI
20191151911	SANTO ANTONIO DA BARRA	2270004006	ACREUNA	07/11/2019 07:45	07/11/2019 15:21	07/11/2019 07:45	07/11/2019 15:21	7,59	1	7,59	CHI
20191151921	PALMEIRAS DE GOIAS	PL11314943	PALMEIRAS	07/11/2019 06:48	07/11/2019 10:40	07/11/2019 06:48	07/11/2019 10:40	3,85	27	104,02	CHI
20191151923	SERRANOPOLIS	SX12390596	JATAI S1	06/11/2019 19:19	08/11/2019 19:37	06/11/2019 19:19	08/11/2019 19:37	48,29	33	1593,48	CHI
20191151926	EDEIA	EA12160410	VICENTINOPOLIS	07/11/2019 13:41	09/11/2019 08:53	07/11/2019 13:41	09/11/2019 08:53	43,19	22	950,08	CHI
20191151928	MONTIVIDIU DO NORTE	MX12203423	PORANGATU	07/11/2019 07:12	07/11/2019 13:18	07/11/2019 07:12	07/11/2019 13:18	6,10	16	97,55	CHI
20191151933	AGUA FRIA DE GOIAS	MJ12183873	PADRE BERNARDO	07/11/2019 02:53	07/11/2019 09:19	07/11/2019 02:53	07/11/2019 09:19	6,43	11	70,69	CHI
20191151933	MIMOSO DE GOIAS	MJ12183873	PADRE BERNARDO	07/11/2019 02:53	07/11/2019 09:19	07/11/2019 02:53	07/11/2019 09:19	6,43	23	147,81	CHI
20191151934	BONOPOLIS	BX12321724	SAO MIGUEL DO ARAGUAIA	07/11/2019 07:44	07/11/2019 12:29	07/11/2019 07:44	07/11/2019 12:29	4,75	4	19,00	CHI
20191151944	CATALAO	CT21358301	CATALAO S1	07/11/2019 07:51	07/11/2019 16:10	07/11/2019 07:51	07/11/2019 16:10	8,31	1	8,31	CHI
20191151948	LUZIANIA	120362880	RIO VERMELHO	07/11/2019 07:53	07/11/2019 13:12	07/11/2019 07:53	07/11/2019 13:12	5,31	1	5,31	CHI
20191151956	ITAUCU	IX12000017	INHUMAS S1	07/11/2019 06:55	07/11/2019 09:49	07/11/2019 06:55	07/11/2019 09:49	2,89	8	23,14	CHI
20191151957	ARENOPOLIS	AY12000004	ARENOPOLIS	07/11/2019 06:27	08/11/2019 01:04	07/11/2019 06:27	08/11/2019 01:04	18,61	6	111,64	CHI
20191151960	MOSSAMEDES	MD12161970	FIRMINOPOLIS S2	07/11/2019 06:09	07/11/2019 12:51	07/11/2019 06:09	07/11/2019 12:51	6,68	11	73,53	CHI
20191151963	ANAPOLIS	AN12003541	JUNDIAI S1	07/11/2019 07:55	07/11/2019 10:36	07/11/2019 07:55	07/11/2019 10:36	2,68	380	1019,03	CHI
20191151969	BURITI DE GOIAS	BS12041419	FIRMINOPOLIS S2	07/11/2019 05:35	07/11/2019 20:51	07/11/2019 05:35	07/11/2019 20:51	15,26	4	61,02	CHI
20191151974	POSSE	PS12218734	IACIARA S2	07/11/2019 07:56	07/11/2019 15:49	07/11/2019 07:56	07/11/2019 15:49	7,87	1	7,87	CHI
20191151978	PORANGATU	PO21189536	PORANGATU	07/11/2019 07:57	10/11/2019 10:36	07/11/2019 07:57	10/11/2019 10:36	74,64	1	74,64	CHI
20191151984	JARAGUA	SR21172662	INHUMAS S1	07/11/2019 07:58	11/11/2019 12:11	07/11/2019 07:58	11/11/2019 12:11	100,21	1	100,21	CHI
20191151985	COCALZINHO DE GOIAS	6368414	PADRE BERNARDO	07/11/2019 13:17	07/11/2019 21:36	07/11/2019 13:17	07/11/2019 21:36	8,32	7	58,21	CHI
20191151987	RIO VERDE	RV12327013	CABRIUVA S1	07/11/2019 07:58	08/11/2019 22:00	07/11/2019 07:58	08/11/2019 22:00	38,02	10	380,22	CHI
20191151988	GOIANIA	16276929	GOYA S1	07/11/2019 07:59	07/11/2019 10:11	07/11/2019 07:59	07/11/2019 10:11	2,20	1	2,20	CHI
20191151993	MIMOSO DE GOIAS	MJ12305277	PADRE BERNARDO	07/11/2019 05:05	07/11/2019 16:49	07/11/2019 05:05	07/11/2019 16:49	11,72	16	187,54	CHI

20191152001	INHUMAS	IN21172571	INHUMAS S2	07/11/2019 08:00	08/11/2019 13:19	07/11/2019 08:00	08/11/2019 13:19	29,31	1	29,31	CHI
20191152003	SANTA TEREZA DE GOIAS	SE12390458	MARA ROSA	07/11/2019 08:01	10/11/2019 12:24	07/11/2019 08:01	10/11/2019 12:24	76,38	7	534,68	CHI
20191152009	GUAPO	GA21098788	GUAPO S1	07/11/2019 08:01	08/11/2019 09:58	07/11/2019 08:01	08/11/2019 09:58	25,95	2	51,90	CHI
20191152010	JATAI	JT12226497	PARQUE DAS EMAS	07/11/2019 07:32	08/11/2019 19:29	07/11/2019 07:32	08/11/2019 19:29	35,95	20	718,97	CHI
20191152010	PEROLANDIA	JT12226497	PARQUE DAS EMAS	07/11/2019 07:32	08/11/2019 19:29	07/11/2019 07:32	08/11/2019 19:29	35,95	7	251,64	CHI
20191152011	MOZARLANDIA	MZ21063725	MOZARLANDIA	07/11/2019 08:02	12/11/2019 08:25	07/11/2019 08:02	12/11/2019 08:25	120,38	1	120,38	CHI
20191152013	MONTE ALEGRE DE GOIAS	MA21283737	SAO DOMINGOS	07/11/2019 08:02	07/11/2019 16:19	07/11/2019 08:02	07/11/2019 16:19	8,27	2	16,53	CHI
20191152022	SAO SIMAO	SO12152201	CACHOEIRA ALTA	07/11/2019 07:54	07/11/2019 20:01	07/11/2019 07:54	07/11/2019 20:01	12,11	5	60,53	CHI
20191152023	AGUA LIMPA	AL21075703	VILA CORUMBA	07/11/2019 08:04	08/11/2019 12:01	07/11/2019 08:04	08/11/2019 12:01	27,94	1	27,94	CHI
20191152025	URUACU	640134270	URUACU	07/11/2019 08:04	07/11/2019 12:14	07/11/2019 08:04	07/11/2019 12:14	4,15	1	4,15	CHI
20191152029	FORMOSO	ET12143681	MARA ROSA	07/11/2019 06:24	07/11/2019 22:52	07/11/2019 06:24	07/11/2019 22:52	16,46	13	213,96	CHI
20191152036	VIANOPOLIS	VN21151143	VIANOPOLIS	07/11/2019 08:05	07/11/2019 17:58	07/11/2019 08:05	07/11/2019 17:58	9,87	5	49,37	CHI
20191152043	URUACU	10030479744	URUACU	07/11/2019 08:06	07/11/2019 09:57	07/11/2019 08:06	07/11/2019 09:57	1,85	1	1,85	CHI
20191152045	LUZIANIA	LZ12245498	MARAJOARA	07/11/2019 08:06	08/11/2019 10:01	07/11/2019 08:06	08/11/2019 10:01	25,91	4	103,65	CHI
20191152047	GOIANIA	10297765	CAMPINAS S2	07/11/2019 08:06	07/11/2019 12:30	07/11/2019 08:06	07/11/2019 12:30	4,39	1	4,39	CHI
20191152049	IPORA	10016865845	IPORA	07/11/2019 08:06	07/11/2019 13:01	07/11/2019 08:06	07/11/2019 13:01	4,90	1	4,90	CHI
20191152051	PARAUNA	RV12206011	ACREUNA	07/11/2019 07:54	08/11/2019 01:36	07/11/2019 07:54	08/11/2019 01:36	17,70	109	1929,36	CHI
20191152051	RIO VERDE	RV12206011	ACREUNA	07/11/2019 07:54	08/11/2019 01:36	07/11/2019 07:54	08/11/2019 01:36	17,70	1	17,70	CHI
20191152053	DOVERLANDIA	DV12324390	PARQUE DAS EMAS	07/11/2019 05:50	08/11/2019 21:05	07/11/2019 05:50	08/11/2019 21:05	39,24	11	431,62	CHI
20191152060	GOIANIA	13583610	ATLANTICO S1	07/11/2019 08:08	07/11/2019 12:24	07/11/2019 08:08	07/11/2019 12:24	4,26	1	4,26	CHI
20191152064	BOM JESUS DE GOIAS	ID12128151	QUIRINOPOLIS	07/11/2019 05:20	07/11/2019 11:26	07/11/2019 05:20	07/11/2019 11:26	6,09	69	420,02	CHI
20191152064	INACIOLANDIA	ID12128151	QUIRINOPOLIS	07/11/2019 05:20	07/11/2019 11:26	07/11/2019 05:20	07/11/2019 11:26	6,09	41	249,58	CHI
20191152064	ITUMBIARA	ID12128151	QUIRINOPOLIS	07/11/2019 05:20	07/11/2019 11:26	07/11/2019 05:20	07/11/2019 11:26	6,09	4	24,35	CHI
20191152065	DIVINOPOLIS DE GOIAS	GH21160024	SAO DOMINGOS	07/11/2019 08:09	08/11/2019 18:08	07/11/2019 08:09	08/11/2019 18:08	33,98	1	33,98	CHI
20191152072	GOIAS	GS12073686	MATRINCHA	07/11/2019 07:29	08/11/2019 10:52	07/11/2019 07:29	08/11/2019 10:52	27,38	5	136,90	CHI
20191152073	CATALAO	CT21072377	CATALAO S1	07/11/2019 08:09	07/11/2019 17:40	07/11/2019 08:09	07/11/2019 17:40	9,51	1	9,51	CHI
20191152075	PILAR DE GOIAS	GG21288830	ITAPACI	07/11/2019 08:09	08/11/2019 12:46	07/11/2019 08:09	08/11/2019 12:46	28,60	2	57,20	CHI
20191152076	JUSSARA	JR12016651	BRITANIA	07/11/2019 05:47	11/11/2019 11:43	07/11/2019 05:47	11/11/2019 11:43	101,94	6	611,63	CHI
20191152079	SAO LUIS DE MONTES BELOS	SL21145981	FIRMINOPOLIS S2	06/11/2019 13:55	07/11/2019 10:10	06/11/2019 13:55	07/11/2019 10:10	20,25	1	20,25	CHI
20191152080	ALTO PARAISO DE GOIAS	BF21072308	SAO JOAO D ALIANCA	06/11/2019 23:11	08/11/2019 12:10	06/11/2019 23:11	08/11/2019 12:10	36,98	1	36,98	CHI
20191152086	ITABERAI	50065002	ITABERAI S2	07/11/2019 08:10	08/11/2019 12:22	07/11/2019 08:10	08/11/2019 12:22	28,20	1	28,20	CHI
20191152091	GOIANIA	11864175	CAMPINAS S2	07/11/2019 08:10	07/11/2019 09:28	07/11/2019 08:10	07/11/2019 09:28	1,28	1	1,28	CHI
20191152105	MORRINHOS	10006949922	MORRINHOS	07/11/2019 08:13	07/11/2019 12:10	07/11/2019 08:13	07/11/2019 12:10	3,94	1	3,94	CHI

20191152106	PIRES DO RIO	PR21099981	PIRES DO RIO S1	07/11/2019 08:13	09/11/2019 12:02	07/11/2019 08:13	09/11/2019 12:02	51,81	1	51,81	CHI
20191152107	GOIANESIA	GE12000108	GOIANESIA S1	07/11/2019 05:47	07/11/2019 12:40	07/11/2019 05:47	07/11/2019 12:40	6,88	1	6,88	CHI
20191152107	SANTA RITA DO NOVO DESTINO	GE12000108	GOIANESIA S1	07/11/2019 05:47	07/11/2019 12:40	07/11/2019 05:47	07/11/2019 12:40	6,88	1	6,88	CHI
20191152110	IPAMERI	580012025	IPAMERI	07/11/2019 08:14	07/11/2019 11:43	07/11/2019 08:14	07/11/2019 11:43	3,48	1	3,48	CHI
20191152115	GOIANIA	10005192763	ATLANTICO S2	07/11/2019 08:14	07/11/2019 12:21	07/11/2019 08:14	07/11/2019 12:21	4,13	1	4,13	CHI
20191152120	ITAPURANGA	IK12299350	ITAPURANGA	07/11/2019 05:54	08/11/2019 08:30	07/11/2019 05:54	08/11/2019 08:30	26,59	12	319,12	CHI
20191152124	CRISTALINA	KR12344657	PAMPLONA	07/11/2019 08:15	07/11/2019 12:29	07/11/2019 08:15	07/11/2019 12:29	4,22	2	8,45	CHI
20191152129	PADRE BERNARDO	PB12275401	PADRE BERNARDO	07/11/2019 07:21	07/11/2019 10:56	07/11/2019 07:21	07/11/2019 10:56	3,57	27	96,34	CHI
20191152132	LUZIANIA	LZ12349111	MARAJOARA	07/11/2019 08:03	07/11/2019 09:48	07/11/2019 08:03	07/11/2019 09:48	1,75	155	270,99	CHI
20191152133	NOVO GAMA	4990091177	PACAEMBU S1	07/11/2019 08:16	07/11/2019 17:12	07/11/2019 08:16	07/11/2019 17:12	8,93	1	8,93	CHI
20191152134	GOIANIA	14638484	CARAJAS S1	07/11/2019 08:16	07/11/2019 10:36	07/11/2019 08:16	07/11/2019 10:36	2,33	1	2,33	CHI
20191152135	MORRINHOS	MR12292980	MORRINHOS	07/11/2019 06:20	07/11/2019 12:36	07/11/2019 06:20	07/11/2019 12:36	6,26	4	25,02	CHI
20191152139	IACIARA	1550011641	IACIARA S1	07/11/2019 08:16	07/11/2019 11:21	07/11/2019 08:16	07/11/2019 11:21	3,08	1	3,08	CHI
20191152141	FORMOSO	FO11220872	PORANGATU	07/11/2019 08:17	07/11/2019 08:48	07/11/2019 08:17	07/11/2019 08:48	0,51	90	45,87	CHI
20191152146	CACHOEIRA ALTA	CA12084291	CACHOEIRA ALTA	07/11/2019 07:53	08/11/2019 15:42	07/11/2019 07:53	08/11/2019 15:42	31,82	5	159,08	CHI
20191152149	CRISTALINA	1060131551	CRISTALINA S1	07/11/2019 08:17	07/11/2019 10:31	07/11/2019 08:17	07/11/2019 10:31	2,23	1	2,23	CHI
20191152153	NIQUELANDIA	NQ12359847	NIQUELANDIA SUBTRANSMISSAO	07/11/2019 08:18	07/11/2019 15:00	07/11/2019 08:18	07/11/2019 15:00	6,70	43	288,09	CHI
20191152160	JARAGUA	JA21070671	JARAGUA	07/11/2019 08:18	07/11/2019 10:56	07/11/2019 08:18	07/11/2019 10:56	2,62	1	2,62	CHI
20191152168	CACU	CC12280370	CACHOEIRA ALTA	07/11/2019 08:15	09/11/2019 09:39	07/11/2019 08:15	09/11/2019 09:39	49,39	9	444,49	CHI
20191152169	ARAGUAPAZ	AZ21143376	MOZARLANDIA	07/11/2019 08:20	08/11/2019 13:06	07/11/2019 08:20	08/11/2019 13:06	28,76	1	28,76	CHI
20191152173	SANTA RITA DO NOVO DESTINO	DF21258517	GOIANESIA S1	07/11/2019 08:20	08/11/2019 23:39	07/11/2019 08:20	08/11/2019 23:39	39,30	1	39,30	CHI
20191152180	DAMOLANDIA	DL21014184	INHUMAS S1	07/11/2019 08:22	07/11/2019 17:15	07/11/2019 08:22	07/11/2019 17:15	8,88	1	8,88	CHI
20191152182	SAO MIGUEL DO ARAGUAIA	SM12372634	SAO MIGUEL DO ARAGUAIA	07/11/2019 08:14	07/11/2019 15:00	07/11/2019 08:14	07/11/2019 15:00	6,76	23	155,56	CHI
20191152187	GOIANIA	13877161	CARAJAS S1	07/11/2019 08:22	07/11/2019 16:12	07/11/2019 08:22	07/11/2019 16:12	7,83	1	7,83	CHI
20191152190	SANTO ANTONIO DO DESCOBERTO	SN21255404	AGUAS LINDAS DE GOIAS S2	07/11/2019 08:22	07/11/2019 09:39	07/11/2019 08:22	07/11/2019 09:39	1,27	1	1,27	CHI
20191152197	GOIANIA	10463276	AEROPORTO S2	07/11/2019 08:24	07/11/2019 11:49	07/11/2019 08:24	07/11/2019 11:49	3,41	1	3,41	CHI
20191152199	BELA VISTA DE GOIAS	BV21009119	BELA VISTA S1	07/11/2019 08:24	07/11/2019 12:48	07/11/2019 08:24	07/11/2019 12:48	4,39	1	4,39	CHI
20191152209	GOIANIA	10504011	GOIANIA LESTE S1	07/11/2019 08:26	07/11/2019 10:47	07/11/2019 08:26	07/11/2019 10:47	2,35	1	2,35	CHI
20191152210	TRINDADE	40264865	GOYA S1	07/11/2019 08:26	07/11/2019 13:57	07/11/2019 08:26	07/11/2019 13:57	5,51	1	5,51	CHI
20191152214	RIO VERDE	630137298	RIO VERDE S1	07/11/2019 08:27	07/11/2019 09:30	07/11/2019 08:27	07/11/2019 09:30	1,04	1	1,04	CHI
20191152215	QUIRINOPOLIS	QI12303038	QUIRINOPOLIS	07/11/2019 07:03	07/11/2019 16:43	07/11/2019 07:03	07/11/2019 16:43	9,66	38	367,07	CHI
20191152216	NOVA VENEZA	GR21000389	NEROPOLIS S1	07/11/2019 08:27	07/11/2019 12:19	07/11/2019 08:27	07/11/2019 12:19	3,86	1	3,86	CHI
20191152220	MORRINHOS	PJ12105736	MORRINHOS	07/11/2019 07:59	07/11/2019 13:46	07/11/2019 07:59	07/11/2019 13:46	5,78	1	5,78	CHI

20191152220	PIRACANJUBA	PJ12105736	MORRINHOS	07/11/2019 07:59	07/11/2019 13:46	07/11/2019 07:59	07/11/2019 13:46	5,78	3	17,34	CHI
20191152224	SANTA ROSA DE GOIAS	SR21079765	INHUMAS S1	07/11/2019 08:28	07/11/2019 11:48	07/11/2019 08:28	07/11/2019 11:48	3,32	2	6,64	CHI
20191152226	GOIANIA	11191867	GOYA S2	07/11/2019 08:29	07/11/2019 13:25	07/11/2019 08:29	07/11/2019 13:25	4,93	1	4,93	CHI
20191152230	LUZIANIA	LZ21330648	PACAEMBU S1	07/11/2019 08:29	07/11/2019 12:00	07/11/2019 08:29	07/11/2019 12:00	3,51	1	3,51	CHI
20191152232	PIRENOPOLIS	PV21086670	CORUMBA	07/11/2019 08:29	07/11/2019 14:42	07/11/2019 08:29	07/11/2019 14:42	6,21	1	6,21	CHI
20191152237	JUSSARA	JR21206873	BRITANIA	07/11/2019 08:30	07/11/2019 20:24	07/11/2019 08:30	07/11/2019 20:24	11,89	1	11,89	CHI
20191152240	CATALAO	1990085559	CATALAO S2	07/11/2019 08:30	07/11/2019 18:16	07/11/2019 08:30	07/11/2019 18:16	9,75	1	9,75	CHI
20191152248	ALTO PARAISO DE GOIAS	BF12365282	SAO JOAO D ALIANCA	07/11/2019 07:15	08/11/2019 10:21	07/11/2019 07:15	07/11/2019 22:37	15,37	5	76,85	CHI
20191152248	ALTO PARAISO DE GOIAS	BF13345774	SAO JOAO D ALIANCA	07/11/2019 07:15	08/11/2019 10:21	07/11/2019 07:15	08/11/2019 10:21	27,10	41	1111,17	CHI
20191152252	CALDAZINHA	2340002467	CEPAIGO S2	07/11/2019 08:31	07/11/2019 11:48	07/11/2019 08:31	07/11/2019 11:48	3,27	1	3,27	CHI
20191152253	SAO MIGUEL DO ARAGUAIA	SM11276057	SAO MIGUEL DO ARAGUAIA	07/11/2019 08:31	10/11/2019 17:59	07/11/2019 08:31	10/11/2019 17:59	81,46	1	81,46	CHI
20191152260	MINEIROS	DP12210131	PARQUE DAS EMAS	07/11/2019 07:06	09/11/2019 11:18	07/11/2019 07:06	09/11/2019 11:18	52,19	13	678,44	CHI
20191152260	PEROLANDIA	DP12210131	PARQUE DAS EMAS	07/11/2019 07:06	09/11/2019 11:18	07/11/2019 07:06	09/11/2019 11:18	52,19	5	260,94	CHI
20191152260	PORTELANDIA	DP12210131	PARQUE DAS EMAS	07/11/2019 07:06	09/11/2019 11:18	07/11/2019 07:06	09/11/2019 11:18	52,19	1	52,19	CHI
20191152261	ALVORADA DO NORTE	AQ11347085	IACIARA S2	07/11/2019 08:33	08/11/2019 16:40	07/11/2019 08:33	08/11/2019 16:40	32,12	4	128,47	CHI
20191152263	FAINA	GS12042217	GOIAS	07/11/2019 05:39	07/11/2019 10:17	07/11/2019 05:39	07/11/2019 10:17	4,63	72	333,26	CHI
20191152278	PORTELANDIA	PW21209697	PARQUE DAS EMAS	07/11/2019 08:34	09/11/2019 09:51	07/11/2019 08:34	09/11/2019 09:51	49,27	1	49,27	CHI
20191152280	SANTO ANTONIO DO DESCOBERTO	SN12401712	ALEXANIA	07/11/2019 07:16	07/11/2019 17:25	07/11/2019 07:16	07/11/2019 17:25	10,14	5	50,69	CHI
20191152284	GOIANIA	10837541	GOIANIA LESTE S1	07/11/2019 08:35	07/11/2019 10:51	07/11/2019 08:35	07/11/2019 10:51	2,27	1	2,27	CHI
20191152287	MINEIROS	1390103629	PARQUE DAS EMAS	07/11/2019 08:35	08/11/2019 12:17	07/11/2019 08:35	08/11/2019 12:17	27,69	1	27,69	CHI
20191152294	CACHOEIRA ALTA	CA21357917	CACHOEIRA ALTA	07/11/2019 08:36	10/11/2019 15:11	07/11/2019 08:36	10/11/2019 15:11	78,57	1	78,57	CHI
20191152297	PADRE BERNARDO	PB12389557	PADRE BERNARDO	07/11/2019 08:36	07/11/2019 18:54	07/11/2019 08:36	07/11/2019 18:54	10,28	8	82,28	CHI
20191152298	CEZARINA	PL13260014	PALMEIRAS	07/11/2019 08:36	07/11/2019 15:26	07/11/2019 08:36	07/11/2019 15:26	6,82	1	6,82	CHI
20191152298	PALMEIRAS DE GOIAS	PL13260014	PALMEIRAS	07/11/2019 08:36	07/11/2019 15:26	07/11/2019 08:36	07/11/2019 15:26	6,82	50	340,88	CHI
20191152298	CEZARINA	PL13260014	PALMEIRAS	07/11/2019 08:36	07/11/2019 15:26	07/11/2019 11:38	07/11/2019 15:26	3,80	4	15,20	CHI
20191152298	PALMEIRAS DE GOIAS	PL13260014	PALMEIRAS	07/11/2019 08:36	07/11/2019 15:26	07/11/2019 11:38	07/11/2019 15:26	3,80	285	1083,00	CHI
20191152298	PALMEIRAS DE GOIAS	PL13260014	PALMEIRAS	07/11/2019 08:36	07/11/2019 15:26	07/11/2019 13:30	07/11/2019 15:26	1,92	16	30,70	CHI
20191152300	IPORA	IR21207944	IPORA	07/11/2019 08:37	07/11/2019 10:15	07/11/2019 08:37	07/11/2019 10:15	1,62	1	1,62	CHI
20191152302	MINACU	IH21150735	MINACU	07/11/2019 08:37	07/11/2019 19:32	07/11/2019 08:37	07/11/2019 19:32	10,90	1	10,90	CHI
20191152307	ALTO HORIZONTE	AJ12384910	MARA ROSA	07/11/2019 05:24	07/11/2019 15:18	07/11/2019 05:24	07/11/2019 15:18	9,90	34	336,52	CHI
20191152307	MARA ROSA	AJ12384910	MARA ROSA	07/11/2019 05:24	07/11/2019 15:18	07/11/2019 05:24	07/11/2019 15:18	9,90	5	49,49	CHI
20191152309	GOIANIA	16407167	GOIANIA LESTE S2	07/11/2019 08:38	07/11/2019 11:52	07/11/2019 08:38	07/11/2019 11:52	3,22	1	3,22	CHI
20191152313	MOSSAMEDES	MD21406301	ITABERAÍ S2	07/11/2019 08:39	08/11/2019 19:31	07/11/2019 08:39	08/11/2019 19:31	34,87	1	34,87	CHI

20191152317	NIQUELANDIA	NQ21239294	NIQUELANDIA SUBTRANSMISSAO	07/11/2019 08:39	08/11/2019 12:11	07/11/2019 08:39	08/11/2019 12:11	27,53	1	27,53	CHI
20191152320	ANAPOLIS	20692845	JUNDIAI S1	07/11/2019 08:39	07/11/2019 15:01	07/11/2019 08:39	07/11/2019 15:01	6,36	1	6,36	CHI
20191152330	CABECEIRAS	CW21090893	ITUIQUIRA	07/11/2019 08:40	07/11/2019 11:36	07/11/2019 08:40	07/11/2019 11:36	2,92	1	2,92	CHI
20191152336	PETROLINA DE GOIAS	PG12048641	PETROLINA	07/11/2019 08:14	07/11/2019 11:29	07/11/2019 08:14	07/11/2019 11:29	3,25	19	61,73	CHI
20191152345	MORRINHOS	MR21000184	MORRINHOS	07/11/2019 08:42	07/11/2019 15:19	07/11/2019 08:42	07/11/2019 15:19	6,61	1	6,61	CHI
20191152346	CATALAO	CT21231547	CATALAO S1	07/11/2019 08:42	07/11/2019 16:08	07/11/2019 08:42	07/11/2019 16:08	7,43	2	14,86	CHI
20191152347	NIQUELANDIA	NQ21232336	NIQUELANDIA SUBTRANSMISSAO	07/11/2019 08:42	07/11/2019 11:51	07/11/2019 08:42	07/11/2019 11:51	3,15	1	3,15	CHI
20191152352	ALOANDIA	650004887	GOIATUBA S1	07/11/2019 08:42	10/11/2019 13:32	07/11/2019 08:42	10/11/2019 13:32	76,84	1	76,84	CHI
20191152362	LUZIANIA	LZ12305050	CRISTALINA S2	07/11/2019 07:18	08/11/2019 23:40	07/11/2019 15:14	08/11/2019 17:18	26,07	3	78,21	CHI
20191152362	LUZIANIA	LZ12305050	CRISTALINA S2	07/11/2019 07:18	08/11/2019 23:40	07/11/2019 07:18	08/11/2019 22:10	38,87	2	77,73	CHI
20191152362	LUZIANIA	LZ12305050	CRISTALINA S2	07/11/2019 07:18	08/11/2019 23:40	07/11/2019 15:14	08/11/2019 22:10	30,94	8	247,52	CHI
20191152362	LUZIANIA	LZ12305050	CRISTALINA S2	07/11/2019 07:18	08/11/2019 23:40	08/11/2019 19:40	08/11/2019 22:10	2,50	3	7,49	CHI
20191152362	LUZIANIA	LZ12305050	CRISTALINA S2	07/11/2019 07:18	08/11/2019 23:40	07/11/2019 07:18	08/11/2019 23:10	39,86	1	39,86	CHI
20191152362	LUZIANIA	LZ12167451	CRISTALINA S2	07/11/2019 07:18	08/11/2019 23:40	07/11/2019 15:14	08/11/2019 23:10	31,93	3	95,80	CHI
20191152362	LUZIANIA	LZ12164807	CRISTALINA S2	07/11/2019 07:18	08/11/2019 23:40	07/11/2019 07:18	08/11/2019 23:40	40,37	2	80,73	CHI
20191152363	SAO PATRICIO	RB21152831	RUBIATABA	07/11/2019 08:43	11/11/2019 02:28	07/11/2019 08:43	11/11/2019 02:28	89,74	1	89,74	CHI
20191152369	CABECEIRAS	CW11287241	ITUIQUIRA	07/11/2019 08:43	07/11/2019 12:12	07/11/2019 08:43	07/11/2019 12:12	3,47	1	3,47	CHI
20191152374	PALMEIRAS DE GOIAS	PL21147511	PALMEIRAS	07/11/2019 08:44	08/11/2019 15:10	07/11/2019 08:44	08/11/2019 15:10	30,43	1	30,43	CHI
20191152379	GOIATUBA	JV12208115RE	GOIATUBA S1	07/11/2019 07:46	08/11/2019 10:50	07/11/2019 07:46	08/11/2019 10:50	27,06	26	703,53	CHI
20191152379	JOVIANIA	JV12208115RE	GOIATUBA S1	07/11/2019 07:46	08/11/2019 10:50	07/11/2019 07:46	08/11/2019 10:50	27,06	36	974,12	CHI
20191152379	VICENTINOPOLIS	JV12208115RE	GOIATUBA S1	07/11/2019 07:46	08/11/2019 10:50	07/11/2019 07:46	08/11/2019 10:50	27,06	35	947,06	CHI
20191152387	PALESTINA DE GOIAS	CP21020924	PALESTINA	07/11/2019 08:45	07/11/2019 20:23	07/11/2019 08:45	07/11/2019 20:23	11,63	1	11,63	CHI
20191152390	BARRO ALTO	BA12132080	GOIANESIA S1	07/11/2019 07:35	07/11/2019 11:34	07/11/2019 07:35	07/11/2019 11:34	3,98	6	23,90	CHI
20191152391	NOVO GAMA	LZ12040416	PACAEMBU S1	07/11/2019 04:06	07/11/2019 16:00	07/11/2019 04:06	07/11/2019 16:00	11,90	18	214,17	CHI
20191152392	ABADIANIA	AA21123835	ANAPOLIS UNIVERSITARIO S1	07/11/2019 08:45	07/11/2019 14:54	07/11/2019 08:45	07/11/2019 14:54	6,14	1	6,14	CHI
20191152395	IACIARA	IA12206170	IACIARA S1	07/11/2019 06:18	07/11/2019 10:36	07/11/2019 06:18	07/11/2019 10:36	4,29	79	338,89	CHI
20191152405	SENADOR CANEDO	SW21094028	CEPAIGO S2	07/11/2019 08:46	07/11/2019 12:59	07/11/2019 08:46	07/11/2019 12:59	4,21	1	4,21	CHI
20191152406	CATALAO	10003225168	CATALAO S2	07/11/2019 08:46	07/11/2019 16:48	07/11/2019 08:46	07/11/2019 16:48	8,02	1	8,02	CHI
20191152411	PIRACANJUBA	PJ21233838	PIRACANJUBA	07/11/2019 08:47	10/11/2019 14:54	07/11/2019 08:47	10/11/2019 14:54	78,12	1	78,12	CHI
20191152445	RIO VERDE	RV12245473	CABRIUVA S2	07/11/2019 07:10	08/11/2019 12:39	07/11/2019 07:10	08/11/2019 12:39	29,48	10	294,81	CHI
20191152451	NIQUELANDIA	NQ12140184	SAO JOAO D ALIANCA	07/11/2019 08:25	07/11/2019 15:18	07/11/2019 08:25	07/11/2019 15:18	6,88	53	364,42	CHI
20191152452	SANTO ANTONIO DO DESCOBERTO	SN21219866	MARAJOARA	07/11/2019 07:00	07/11/2019 18:47	07/11/2019 07:00	07/11/2019 18:47	11,78	1	11,78	CHI
20191152483	IPAMERI	IP21199367	IPAMERI	07/11/2019 08:52	10/11/2019 18:36	07/11/2019 08:52	10/11/2019 18:36	81,73	1	81,73	CHI

20191152494	AMERICANO DO BRASIL	KB12000070	ANICUNS	07/11/2019 08:31	07/11/2019 11:54	07/11/2019 08:31	07/11/2019 11:54	3,37	350	1179,40	CHI
20191152494	MOSSAMEDES	KB12000070	ANICUNS	07/11/2019 08:31	07/11/2019 11:54	07/11/2019 08:31	07/11/2019 11:54	3,37	24	80,87	CHI
20191152507	SAO JOAO D ALIANCA	JL12325052	FLORES DE GOIAS	07/11/2019 08:16	09/11/2019 08:51	07/11/2019 08:16	09/11/2019 08:51	48,58	3	145,73	CHI
20191152508	PLANALTINA	PI11043444	PLANALTINA	07/11/2019 08:41	07/11/2019 12:55	07/11/2019 08:41	07/11/2019 12:55	4,23	207	876,01	CHI
20191152524	GOIATUBA	GT21142254	GOIATUBA S1	07/11/2019 08:54	11/11/2019 14:23	07/11/2019 08:54	11/11/2019 14:23	101,48	2	202,96	CHI
20191152544	CAMPO ALEGRE DE GOIAS	04760226	CATALAO S1	07/11/2019 04:59	07/11/2019 13:10	07/11/2019 04:59	07/11/2019 13:10	8,18	2	16,35	CHI
20191152544	CATALAO	04760226	CATALAO S1	07/11/2019 04:59	07/11/2019 13:10	07/11/2019 04:59	07/11/2019 13:10	8,18	514	4202,38	CHI
20191152574	URUACU	01800424	URUACU	07/11/2019 08:49	07/11/2019 14:25	07/11/2019 08:49	07/11/2019 10:36	1,78	211	376,34	CHI
20191152574	GUARINOS	01800424	URUACU	07/11/2019 08:49	07/11/2019 14:25	07/11/2019 08:49	07/11/2019 11:40	2,85	11	31,35	CHI
20191152574	HIDROLINA	01800424	URUACU	07/11/2019 08:49	07/11/2019 14:25	07/11/2019 08:49	07/11/2019 11:40	2,85	1256	3579,95	CHI
20191152574	HIDROLINA	01800424	URUACU	07/11/2019 08:49	07/11/2019 14:25	07/11/2019 08:49	07/11/2019 11:40	2,85	110	313,53	CHI
20191152574	ITAPACI	01800424	URUACU	07/11/2019 08:49	07/11/2019 14:25	07/11/2019 08:49	07/11/2019 11:40	2,85	2	5,70	CHI
20191152574	PILAR DE GOIAS	01800424	URUACU	07/11/2019 08:49	07/11/2019 14:25	07/11/2019 08:49	07/11/2019 11:40	2,85	54	153,92	CHI
20191152574	PILAR DE GOIAS	01800424	URUACU	07/11/2019 08:49	07/11/2019 14:25	07/11/2019 08:49	07/11/2019 11:40	2,85	682	1943,89	CHI
20191152574	PILAR DE GOIAS	01800424	URUACU	07/11/2019 08:49	07/11/2019 14:25	07/11/2019 08:49	07/11/2019 11:40	2,85	41	116,86	CHI
20191152574	SANTA TEREZINHA DE GOIAS	01800424	URUACU	07/11/2019 08:49	07/11/2019 14:25	07/11/2019 08:49	07/11/2019 11:40	2,85	5	14,25	CHI
20191152574	HIDROLINA	HL13317149	URUACU	07/11/2019 08:49	07/11/2019 14:25	07/11/2019 08:49	07/11/2019 12:35	3,77	186	700,60	CHI
20191152574	PILAR DE GOIAS	HL13317149	URUACU	07/11/2019 08:49	07/11/2019 14:25	07/11/2019 08:49	07/11/2019 12:35	3,77	27	101,70	CHI
20191152574	URUACU	HL13317149	URUACU	07/11/2019 08:49	07/11/2019 14:25	07/11/2019 08:49	07/11/2019 12:35	3,77	98	369,13	CHI
20191152574	URUACU	UR13382011	URUACU	07/11/2019 08:49	07/11/2019 14:25	07/11/2019 08:49	07/11/2019 13:54	5,10	4	20,40	CHI
20191152574	HIDROLINA	UR13292491	URUACU	07/11/2019 08:49	07/11/2019 14:25	07/11/2019 14:17	07/11/2019 14:25	0,13	176	23,71	CHI
20191152574	PILAR DE GOIAS	UR13292491	URUACU	07/11/2019 08:49	07/11/2019 14:25	07/11/2019 14:17	07/11/2019 14:25	0,13	27	3,64	CHI
20191152574	URUACU	UR13292491	URUACU	07/11/2019 08:49	07/11/2019 14:25	07/11/2019 14:17	07/11/2019 14:25	0,13	122	16,44	CHI
20191152578	TERESINA DE GOIAS	10027755663	FLORES DE GOIAS	07/11/2019 08:57	07/11/2019 20:12	07/11/2019 08:57	07/11/2019 20:12	11,25	1	11,25	CHI
20191152602	GOIANIA	10788633	CARAJAS S1	07/11/2019 08:58	07/11/2019 12:44	07/11/2019 08:58	07/11/2019 12:44	3,76	1	3,76	CHI
20191152603	ITABERAÍ	10009235408	ITABERAÍ S2	07/11/2019 08:58	07/11/2019 11:52	07/11/2019 08:58	07/11/2019 11:52	2,89	1	2,89	CHI
20191152604	BELA VISTA DE GOIAS	SV12389414	DAIA S2	07/11/2019 07:11	08/11/2019 09:46	07/11/2019 07:11	08/11/2019 09:46	26,58	1	26,58	CHI
20191152604	SILVANIA	SV12389414	DAIA S2	07/11/2019 07:11	08/11/2019 09:46	07/11/2019 07:11	08/11/2019 09:46	26,58	12	319,00	CHI
20191152606	BURITI ALEGRE	BG12254415	ITUMBIARA VELHA S2	07/11/2019 08:58	09/11/2019 20:20	07/11/2019 08:58	09/11/2019 20:20	59,36	2	118,73	CHI
20191152609	NIQUELANDIA	NQ12088704	URUACU	07/11/2019 08:59	07/11/2019 15:46	07/11/2019 08:59	07/11/2019 15:46	6,78	6	40,69	CHI
20191152624	PIRANHAS	PH12349758	PIRANHAS	07/11/2019 08:59	09/11/2019 19:49	07/11/2019 08:59	09/11/2019 19:49	58,82	1	58,82	CHI
20191152647	RIO VERDE	630029143	RIO VERDE S2	07/11/2019 09:01	07/11/2019 19:39	07/11/2019 09:01	07/11/2019 19:39	10,63	1	10,63	CHI
20191152653	CAMPINORTE	CR12378298	MARA ROSA	07/11/2019 09:01	09/11/2019 11:34	07/11/2019 09:01	09/11/2019 11:34	50,56	4	202,24	CHI

20191152653	FORMOSO	CR12378298	MARA ROSA	07/11/2019 09:01	09/11/2019 11:34	07/11/2019 09:01	09/11/2019 11:34	50,56	3	151,68	CHI
20191152659	MAIRIPOTABA	PK12046051RE	PONTALINA	07/11/2019 08:13	08/11/2019 19:08	07/11/2019 08:13	08/11/2019 19:08	34,91	8	279,27	CHI
20191152659	PONTALINA	PK12046051RE	PONTALINA	07/11/2019 08:13	08/11/2019 19:08	07/11/2019 08:13	08/11/2019 19:08	34,91	211	7365,78	CHI
20191152661	LAGOA SANTA	LS12394496	CACHOEIRA ALTA	07/11/2019 07:09	09/11/2019 15:40	07/11/2019 07:09	09/11/2019 15:40	56,53	17	960,93	CHI
20191152668	IACIARA	IA21264663	IACIARA S2	07/11/2019 08:36	07/11/2019 13:28	07/11/2019 08:36	07/11/2019 13:28	4,87	1	4,87	CHI
20191152671	AMARALINA	LC12168855	MARA ROSA	07/11/2019 07:38	07/11/2019 20:33	07/11/2019 07:38	07/11/2019 20:33	12,91	35	451,90	CHI
20191152671	MARA ROSA	LC12168855	MARA ROSA	07/11/2019 07:38	07/11/2019 20:33	07/11/2019 07:38	07/11/2019 20:33	12,91	8	103,29	CHI
20191152681	GUARANI DE GOIAS	GY12160070	IACIARA S1	08/11/2019 07:44	08/11/2019 16:47	08/11/2019 07:44	08/11/2019 16:47	9,04	3	27,12	CHI
20191152681	IACIARA	GY12160070	IACIARA S1	08/11/2019 07:44	08/11/2019 16:47	08/11/2019 07:44	08/11/2019 16:47	9,04	2	18,08	CHI
20191152681	SAO DOMINGOS	GY12160070	IACIARA S1	08/11/2019 07:44	08/11/2019 16:47	08/11/2019 07:44	08/11/2019 16:47	9,04	1	9,04	CHI
20191152691	MINEIROS	MY12324512	PARQUE DAS EMAS	07/11/2019 09:03	08/11/2019 18:25	07/11/2019 09:03	08/11/2019 18:25	33,36	1	33,36	CHI
20191152698	SAO MIGUEL DO ARAGUAIA	SM12032000	SAO MIGUEL DO ARAGUAIA	07/11/2019 08:24	07/11/2019 20:00	07/11/2019 08:24	07/11/2019 20:00	11,59	4	46,35	CHI
20191152699	CORUMBA DE GOIAS	CB21171461	CORUMBA	07/11/2019 09:04	07/11/2019 11:55	07/11/2019 09:04	07/11/2019 11:55	2,84	2	5,69	CHI
20191152705	GOIANDIRA	GD21042553	CATALAO S1	07/11/2019 09:05	08/11/2019 10:00	07/11/2019 09:05	08/11/2019 10:00	24,92	1	24,92	CHI
20191152718	ANICUNS	KB21031447	ANICUNS	07/11/2019 09:06	07/11/2019 22:50	07/11/2019 09:06	07/11/2019 22:50	13,73	1	13,73	CHI
20191152725	ABADIANIA	AA12017723	ANAPOLIS UNIVERSITARIO S1	07/11/2019 07:35	07/11/2019 11:10	07/11/2019 07:35	07/11/2019 11:10	3,58	11	39,37	CHI
20191152742	ANAPOLIS	21299470	JUNDIAI S2	07/11/2019 09:08	07/11/2019 11:31	07/11/2019 09:08	07/11/2019 11:31	2,39	1	2,39	CHI
20191152757	ITARUMA	IM21148588	CACHOEIRA ALTA	07/11/2019 07:44	14/11/2019 06:57	07/11/2019 07:44	14/11/2019 06:57	167,21	1	167,21	CHI
20191152764	SAO MIGUEL DO ARAGUAIA	SM12276195	SAO MIGUEL DO ARAGUAIA	07/11/2019 08:33	07/11/2019 14:53	07/11/2019 08:33	07/11/2019 14:53	6,33	8	50,60	CHI
20191152775	ALEXANIA	AX11398943	ALEXANIA	07/11/2019 09:11	07/11/2019 12:36	07/11/2019 09:11	07/11/2019 12:36	3,40	8	27,24	CHI
20191152777	FIRMINOPOLIS	FR11205954	FIRMINOPOLIS S1	07/11/2019 07:44	07/11/2019 11:53	07/11/2019 07:44	07/11/2019 11:53	4,16	68	282,86	CHI
20191152778	GOIAS	GS12021038	GOIAS	07/11/2019 09:11	11/11/2019 09:07	07/11/2019 09:11	11/11/2019 09:07	95,92	2	191,84	CHI
20191152782	IPORA	730061656	IPORA	07/11/2019 09:12	07/11/2019 15:39	07/11/2019 09:12	07/11/2019 15:39	6,44	1	6,44	CHI
20191152784	INDIARA	IY11169763	EDEIA	07/11/2019 09:12	07/11/2019 16:56	07/11/2019 09:12	07/11/2019 16:56	7,72	78	602,25	CHI
20191152792	NEROPOLIS	NR21009275	NEROPOLIS S2	07/11/2019 09:13	07/11/2019 11:18	07/11/2019 09:13	07/11/2019 11:18	2,08	2	4,15	CHI
20191152794	COCALZINHO DE GOIAS	ZN12084617	AGUAS LINDAS DE GOIAS S2	07/11/2019 07:48	07/11/2019 16:04	07/11/2019 07:48	07/11/2019 16:04	8,26	26	214,75	CHI
20191152804	GOIANIA	12369871	CAMPINAS S2	07/11/2019 09:14	07/11/2019 10:52	07/11/2019 09:14	07/11/2019 10:52	1,62	1	1,62	CHI
20191152814	PEROLANDIA	DP21325321	JATAI S1	07/11/2019 09:15	08/11/2019 18:20	07/11/2019 09:15	08/11/2019 18:20	33,07	1	33,07	CHI
20191152815	CALDAS NOVAS	CN21103259	CALDAS NOVAS S2	07/11/2019 09:15	07/11/2019 12:23	07/11/2019 09:15	07/11/2019 12:23	3,12	1	3,12	CHI
20191152816	CRISTALINA	KR12171525	PAMPLONA	07/11/2019 07:50	07/11/2019 11:13	07/11/2019 07:50	07/11/2019 11:13	3,38	17	57,46	CHI
20191152818	IPORA	IR12222977	IPORA	07/11/2019 04:07	08/11/2019 15:40	07/11/2019 04:07	08/11/2019 15:40	35,55	15	533,25	CHI
20191152818	ISRAELANDIA	IR12222977	IPORA	07/11/2019 04:07	08/11/2019 15:40	07/11/2019 04:07	08/11/2019 15:40	35,55	25	888,74	CHI
20191152818	MOIPORA	IR12222977	IPORA	07/11/2019 04:07	08/11/2019 15:40	07/11/2019 04:07	08/11/2019 15:40	35,55	57	2026,33	CHI

20191152826	FAINA	GS21250564	GOIAS	07/11/2019 09:16	08/11/2019 15:55	07/11/2019 09:16	08/11/2019 15:55	30,65	1	30,65	CHI
20191152833	GOIANIA	10001481639	FERROVIARIO S2	07/11/2019 09:17	07/11/2019 10:57	07/11/2019 09:17	07/11/2019 10:57	1,66	1	1,66	CHI
20191152839	ANAPOLIS	AN11135757	ANAPOLIS UNIVERSITARIO S2	07/11/2019 08:40	07/11/2019 11:25	07/11/2019 08:40	07/11/2019 11:25	2,74	96	263,09	CHI
20191152859	EDEALINA	EA12105005	VICENTINOPOLIS	08/11/2019 11:13	09/11/2019 08:36	08/11/2019 11:13	09/11/2019 08:36	21,37	3	64,11	CHI
20191152859	EDEIA	EA12105005	VICENTINOPOLIS	08/11/2019 11:13	09/11/2019 08:36	08/11/2019 11:13	09/11/2019 08:36	21,37	4	85,48	CHI
20191152864	APARECIDA DE GOIANIA	200371216	INDEPENDENCIA S1	07/11/2019 09:20	07/11/2019 12:06	07/11/2019 09:20	07/11/2019 12:06	2,76	1	2,76	CHI
20191152866	NIQUELANDIA	NQ12292649	NIQUELANDIA SUBTRANSMISSAO	07/11/2019 09:21	07/11/2019 16:38	07/11/2019 09:21	07/11/2019 16:38	7,28	2	14,56	CHI
20191152867	UIRAPURU	UP12352423	SANTA TEREZINHA	07/11/2019 09:21	07/11/2019 15:46	07/11/2019 09:21	07/11/2019 15:46	6,41	4	25,64	CHI
20191152868	SAO JOAO D ALIANCA	JL21202259	SAO JOAO D ALIANCA	07/11/2019 08:36	09/11/2019 12:08	07/11/2019 08:36	09/11/2019 12:08	51,53	3	154,60	CHI
20191152872	IACIARA	IA21190565	IACIARA S2	07/11/2019 08:36	07/11/2019 16:14	07/11/2019 08:36	07/11/2019 16:14	7,63	1	7,63	CHI
20191152873	GOIANIA	10021704277	MEIA PONTE	07/11/2019 09:22	07/11/2019 12:33	07/11/2019 09:22	07/11/2019 12:33	3,18	1	3,18	CHI
20191152878	CAIAPONIA	CP12349641	CAIAPONIA	07/11/2019 09:23	07/11/2019 17:50	07/11/2019 09:23	07/11/2019 17:50	8,44	2	16,89	CHI
20191152897	GOIANIA	12382073	CARAJAS S1	07/11/2019 09:25	07/11/2019 12:26	07/11/2019 09:25	07/11/2019 12:26	3,01	1	3,01	CHI
20191152905	SANTA HELENA DE GOIAS	SH16404334	IPEGUARI	07/11/2019 18:25	07/11/2019 18:29	07/11/2019 18:25	07/11/2019 18:29	0,07	1919	131,66	CHI
20191152912	SANCLERLANDIA	SC21164053	FIRMINOPOLIS S2	07/11/2019 09:27	08/11/2019 01:13	07/11/2019 09:27	08/11/2019 01:13	15,75	1	15,75	CHI
20191152915	FAZENDA NOVA	FN21278052	IPORA	07/11/2019 09:28	07/11/2019 20:31	07/11/2019 09:28	07/11/2019 20:31	11,05	1	11,05	CHI
20191152932	ARUANA	AK11216524	ARUANA	07/11/2019 07:53	08/11/2019 09:18	07/11/2019 07:53	08/11/2019 09:18	25,40	28	711,33	CHI
20191152933	SENADOR CANEDO	10016231021	SENADOR CANEDO	07/11/2019 09:30	07/11/2019 15:44	07/11/2019 09:30	07/11/2019 15:44	6,22	1	6,22	CHI
20191152936	PALMINOPOLIS	RP12156223	FIRMINOPOLIS S2	07/11/2019 05:30	07/11/2019 11:47	07/11/2019 05:30	07/11/2019 11:47	6,28	2	12,56	CHI
20191152936	SAO JOAO DA PARAUNA	RP12156223	FIRMINOPOLIS S2	07/11/2019 05:30	07/11/2019 11:47	07/11/2019 05:30	07/11/2019 11:47	6,28	26	163,32	CHI
20191152939	NOVO GAMA	2460039469	PACAEMBU S1	07/11/2019 09:32	07/11/2019 12:16	07/11/2019 09:32	07/11/2019 12:16	2,73	1	2,73	CHI
20191152943	PALMEIRAS DE GOIAS	590074453	PALMEIRAS	07/11/2019 09:33	09/11/2019 14:41	07/11/2019 09:33	09/11/2019 14:41	53,13	1	53,13	CHI
20191152949	NOVA ROMA	ND12216998	IACIARA S2	07/11/2019 08:00	07/11/2019 14:04	07/11/2019 08:00	07/11/2019 14:04	6,06	23	139,28	CHI
20191152952	FAINA	MS12220561	ITAPURANGA	07/11/2019 09:34	09/11/2019 11:13	07/11/2019 09:34	09/11/2019 11:13	49,66	7	347,62	CHI
20191152953	IACIARA	IA21134185	IACIARA S2	07/11/2019 09:34	07/11/2019 17:42	07/11/2019 09:34	07/11/2019 17:42	8,13	1	8,13	CHI
20191152963	AMORINOPOLIS	IR12188430	IPORA	08/11/2019 13:24	08/11/2019 22:30	08/11/2019 13:24	08/11/2019 22:30	9,10	84	764,33	CHI
20191152963	IPORA	IR12188430	IPORA	08/11/2019 13:24	08/11/2019 22:30	08/11/2019 13:24	08/11/2019 22:30	9,10	116	1055,50	CHI
20191152963	IVOLANDIA	IR12188430	IPORA	08/11/2019 13:24	08/11/2019 22:30	08/11/2019 13:24	08/11/2019 22:30	9,10	139	1264,78	CHI
20191152963	PALESTINA DE GOIAS	IR12188430	IPORA	08/11/2019 13:24	08/11/2019 22:30	08/11/2019 13:24	08/11/2019 22:30	9,10	44	400,36	CHI
20191152964	GOIANIA	13793780	FERROVIARIO S3	07/11/2019 09:36	07/11/2019 11:14	07/11/2019 09:36	07/11/2019 11:14	1,62	1	1,62	CHI
20191152968	POSSE	SA21265482	IACIARA S2	07/11/2019 09:38	08/11/2019 11:19	07/11/2019 09:38	08/11/2019 11:19	25,67	1	25,67	CHI
20191152996	ITAPACI	10012303125	ITAPACI	07/11/2019 09:42	08/11/2019 18:29	07/11/2019 09:42	08/11/2019 18:29	32,78	1	32,78	CHI
20191152999	SENADOR CANEDO	SW21084085	CEPAIGO S1	07/11/2019 09:43	07/11/2019 12:45	07/11/2019 09:43	07/11/2019 12:45	3,03	1	3,03	CHI

20191153000	BONOPOLIS	BX12246493	SAO MIGUEL DO ARAGUAIA	07/11/2019 09:43	09/11/2019 13:11	07/11/2019 09:43	09/11/2019 13:11	51,46	4	205,85	CHI
20191153003	FIRMINOPOLIS	FR21215261	FIRMINOPOLIS S1	07/11/2019 09:43	08/11/2019 08:50	07/11/2019 09:43	08/11/2019 08:50	23,12	1	23,12	CHI
20191153014	PADRE BERNARDO	9980031493	PADRE BERNARDO	07/11/2019 09:45	07/11/2019 14:42	07/11/2019 09:45	07/11/2019 14:42	4,95	1	4,95	CHI
20191153015	APARECIDA DE GOIANIA	200025170	ANHANGUERA	07/11/2019 09:45	07/11/2019 11:07	07/11/2019 09:45	07/11/2019 11:07	1,36	1	1,36	CHI
20191153019	ITARUMA	CC12202746	CACHOEIRA ALTA	07/11/2019 09:45	09/11/2019 17:50	07/11/2019 09:45	09/11/2019 17:50	56,07	2	112,15	CHI
20191153037	NOVA GLORIA	NG12181404	RUBIATABA	07/11/2019 09:49	07/11/2019 11:54	07/11/2019 09:49	07/11/2019 11:54	2,08	2	4,15	CHI
20191153043	CIDADE OCIDENTAL	DH21136676	MARAJOARA	07/11/2019 09:51	07/11/2019 23:17	07/11/2019 09:51	07/11/2019 23:17	13,43	1	13,43	CHI
20191153063	IPAMERI	IP21306742	IPAMERI	07/11/2019 09:54	09/11/2019 12:11	07/11/2019 09:54	09/11/2019 12:11	50,27	1	50,27	CHI
20191153067	GOUVELANDIA	QI12402335	QUIRINOPOLIS	07/11/2019 08:00	07/11/2019 23:15	07/11/2019 08:00	07/11/2019 14:45	6,75	1	6,75	CHI
20191153067	GOUVELANDIA	QI12402335	QUIRINOPOLIS	07/11/2019 08:00	07/11/2019 23:15	07/11/2019 08:00	07/11/2019 23:15	15,25	8	121,96	CHI
20191153069	PADRE BERNARDO	10003352712	PADRE BERNARDO	07/11/2019 09:55	07/11/2019 15:27	07/11/2019 09:55	07/11/2019 15:27	5,52	1	5,52	CHI
20191153071	VALPARAISO DE GOIAS	VA12060574	MARAJOARA	07/11/2019 09:14	07/11/2019 14:54	07/11/2019 09:14	07/11/2019 14:54	5,67	455	2579,98	CHI
20191153072	CHAPADAO DO CEU	9880016720	CHAPADAO DO CEU	07/11/2019 09:56	07/11/2019 15:59	07/11/2019 09:56	07/11/2019 15:59	6,05	1	6,05	CHI
20191153074	NOVO GAMA	2900070060	MARAJOARA	07/11/2019 09:56	08/11/2019 10:20	07/11/2019 09:56	08/11/2019 10:20	24,39	1	24,39	CHI
20191153075	QUIRINOPOLIS	80164031	QUIRINOPOLIS	07/11/2019 09:56	07/11/2019 15:03	07/11/2019 09:56	07/11/2019 15:03	5,10	1	5,10	CHI
20191153077	GOIAS	GS11082082	GOIAS	07/11/2019 09:57	09/11/2019 09:35	07/11/2019 09:57	09/11/2019 09:35	47,63	2	95,26	CHI
20191153079	TRINDADE	TR12393097	TRINDADE	07/11/2019 09:57	07/11/2019 16:31	07/11/2019 09:57	07/11/2019 16:31	6,56	8	52,46	CHI
20191153080	GOIANIA	16918903	MEIA PONTE	07/11/2019 09:58	07/11/2019 16:19	07/11/2019 09:58	07/11/2019 16:19	6,34	1	6,34	CHI
20191153083	ADELANDIA	2330005228	FIRMINOPOLIS S2	07/11/2019 09:58	08/11/2019 00:55	07/11/2019 09:58	08/11/2019 00:55	14,95	1	14,95	CHI
20191153084	JATAI	JT12031876	JATAI S1	08/11/2019 13:57	09/11/2019 08:51	08/11/2019 13:57	09/11/2019 08:51	18,89	12	226,74	CHI
20191153094	SAO MIGUEL DO ARAGUAIA	10005446641	SAO MIGUEL DO ARAGUAIA	07/11/2019 10:00	10/11/2019 22:09	07/11/2019 10:00	10/11/2019 22:09	84,16	1	84,16	CHI
20191153095	ARAGARCAS	1820035028	ARAGARCAS	07/11/2019 10:00	07/11/2019 16:25	07/11/2019 10:00	07/11/2019 16:25	6,42	1	6,42	CHI
20191153096	SENADOR CANEDO	190104442	SENADOR CANEDO	07/11/2019 10:00	07/11/2019 14:36	07/11/2019 10:00	07/11/2019 14:36	4,60	1	4,60	CHI
20191153100	PADRE BERNARDO	PB12261686	PADRE BERNARDO	07/11/2019 07:34	07/11/2019 16:44	07/11/2019 07:34	07/11/2019 16:44	9,16	9	82,46	CHI
20191153108	PADRE BERNARDO	PB12313848	PADRE BERNARDO	07/11/2019 10:00	07/11/2019 19:48	07/11/2019 10:00	07/11/2019 19:48	9,79	2	19,58	CHI
20191153110	GOUVELANDIA	QI12301516	QUIRINOPOLIS	07/11/2019 10:01	07/11/2019 13:43	07/11/2019 10:01	07/11/2019 13:43	3,68	8	29,48	CHI
20191153112	MINACU	IH21230526	MINACU	07/11/2019 10:02	08/11/2019 11:03	07/11/2019 10:02	08/11/2019 11:03	25,01	1	25,01	CHI
20191153115	SANTO ANTONIO DO DESCOBERTO	SN21338450	AGUAS LINDAS DE GOIAS S2	07/11/2019 10:02	07/11/2019 10:12	07/11/2019 10:02	07/11/2019 10:12	0,16	2	0,32	CHI
20191153118	AMERICANO DO BRASIL	AC12391519	ANICUNS	07/11/2019 10:02	07/11/2019 16:49	07/11/2019 10:02	07/11/2019 16:49	6,78	1	6,78	CHI
20191153118	ANICUNS	AC12391519	ANICUNS	07/11/2019 10:02	07/11/2019 16:49	07/11/2019 10:02	07/11/2019 16:49	6,78	14	94,97	CHI
20191153123	DISTRITO FEDERAL	SN12305177	MARAJOARA	07/11/2019 09:53	07/11/2019 20:08	07/11/2019 09:53	07/11/2019 14:47	4,89	23	112,52	CHI
20191153123	SANTO ANTONIO DO DESCOBERTO	SN12053556	MARAJOARA	07/11/2019 09:53	07/11/2019 20:08	07/11/2019 16:00	07/11/2019 16:05	0,08	9	0,75	CHI
20191153123	DISTRITO FEDERAL	SN12305177	MARAJOARA	07/11/2019 09:53	07/11/2019 20:08	07/11/2019 15:08	07/11/2019 16:07	0,99	23	22,77	CHI

20191153123	DISTRITO FEDERAL	SN11351421	MARAJOARA	07/11/2019 09:53	07/11/2019 20:08	07/11/2019 09:53	07/11/2019 20:08	10,24	25	255,91	CHI
20191153125	NOVO GAMA	2900010373	MARAJOARA	07/11/2019 10:04	07/11/2019 23:23	07/11/2019 10:04	07/11/2019 23:23	13,31	1	13,31	CHI
20191153130	SANCLERLANDIA	SC21163974	FIRMINOPOLIS S2	07/11/2019 10:05	07/11/2019 21:35	07/11/2019 10:05	07/11/2019 21:35	11,50	2	22,99	CHI
20191153134	CATALAO	1990094690	CATALAO S2	07/11/2019 10:06	07/11/2019 14:48	07/11/2019 10:06	07/11/2019 14:48	4,70	1	4,70	CHI
20191153139	MORRINHOS	MR21399301	MORRINHOS	07/11/2019 10:06	10/11/2019 12:47	07/11/2019 10:06	10/11/2019 12:47	74,67	2	149,34	CHI
20191153144	ABADIA DE GOIAS	5584382168	CARAJAS S1	07/11/2019 10:08	08/11/2019 17:21	07/11/2019 10:08	08/11/2019 17:21	31,22	1	31,22	CHI
20191153146	JATAI	RV12189232	CABRIUVA S1	07/11/2019 08:57	09/11/2019 11:58	07/11/2019 08:57	09/11/2019 11:58	51,02	1	51,02	CHI
20191153146	RIO VERDE	RV12189232	CABRIUVA S1	07/11/2019 08:57	09/11/2019 11:58	07/11/2019 08:57	09/11/2019 11:58	51,02	8	408,13	CHI
20191153149	NAZARIO	440021376	ANICUNS	07/11/2019 10:09	08/11/2019 11:52	07/11/2019 10:09	08/11/2019 11:52	25,70	1	25,70	CHI
20191153154	CATALAO	10025981267	CATALAO S2	07/11/2019 10:12	07/11/2019 14:35	07/11/2019 10:12	07/11/2019 14:35	4,38	1	4,38	CHI
20191153155	AVELINOPOLIS	AV21346900	ANICUNS	07/11/2019 10:12	08/11/2019 08:35	07/11/2019 10:12	08/11/2019 08:35	22,38	1	22,38	CHI
20191153158	MARA ROSA	MQ21244396	MARA ROSA	07/11/2019 10:13	11/11/2019 13:19	07/11/2019 10:13	11/11/2019 13:19	99,09	1	99,09	CHI
20191153162	GOIAS	GS12274255	ITABERAÍ S1	07/11/2019 10:14	09/11/2019 09:29	07/11/2019 10:14	09/11/2019 09:29	47,25	2	94,50	CHI
20191153168	GOIANIA	10023289072	GOYA S1	07/11/2019 10:14	08/11/2019 08:57	07/11/2019 10:14	08/11/2019 08:57	22,70	1	22,70	CHI
20191153171	HIDROLANDIA	180040364	CEPAIGO S2	07/11/2019 10:15	07/11/2019 14:29	07/11/2019 10:15	07/11/2019 14:29	4,23	1	4,23	CHI
20191153174	NOVO PLANALTO	SM12020677	SAO MIGUEL DO ARAGUAIA	07/11/2019 07:22	07/11/2019 15:49	07/11/2019 07:22	07/11/2019 15:49	8,44	7	59,10	CHI
20191153174	SAO MIGUEL DO ARAGUAIA	SM12020677	SAO MIGUEL DO ARAGUAIA	07/11/2019 07:22	07/11/2019 15:49	07/11/2019 07:22	07/11/2019 15:49	8,44	37	312,38	CHI
20191153176	SILVANIA	SV12205354	DAIA S2	07/11/2019 10:15	07/11/2019 11:45	07/11/2019 10:15	07/11/2019 11:45	1,49	37	55,00	CHI
20191153179	GOIANIA	11897065	FERROVIARIO S1	07/11/2019 10:15	07/11/2019 12:31	07/11/2019 10:15	07/11/2019 12:31	2,25	1	2,25	CHI
20191153183	CATALAO	CT12104183	CATALAO S1	07/11/2019 10:16	07/11/2019 17:00	07/11/2019 10:16	07/11/2019 17:00	6,72	4	26,88	CHI
20191153186	ITUMBIARA	IT21057908	ITUMBIARA NOVA	07/11/2019 10:18	07/11/2019 18:51	07/11/2019 10:18	07/11/2019 18:51	8,54	1	8,54	CHI
20191153189	PIRENOPOLIS	PV21347844	CORUMBA	07/11/2019 10:19	07/11/2019 13:06	07/11/2019 10:19	07/11/2019 13:06	2,77	2	5,54	CHI
20191153193	MARA ROSA	MQ12246483	MARA ROSA	06/11/2019 14:39	09/11/2019 11:06	06/11/2019 14:39	09/11/2019 11:06	68,45	2	136,89	CHI
20191153193	MARA ROSA	MQ12246483	MARA ROSA	06/11/2019 14:39	09/11/2019 11:06	06/11/2019 14:39	09/11/2019 11:06	68,44	2	136,89	CHI
20191153198	CALDAS NOVAS	760185827	CALDAS NOVAS S2	07/11/2019 10:22	09/11/2019 00:01	07/11/2019 10:22	09/11/2019 00:01	37,65	1	37,65	CHI
20191153201	BONOPOLIS	BX12391937	SAO MIGUEL DO ARAGUAIA	07/11/2019 10:25	10/11/2019 09:49	07/11/2019 10:25	10/11/2019 09:49	71,39	2	142,77	CHI
20191153212	GOUVELANDIA	QI12402335	QUIRINOPOLIS	07/11/2019 10:30	07/11/2019 23:15	07/11/2019 10:30	07/11/2019 23:15	12,74	2	25,47	CHI
20191153218	LUZIANIA	10013929303	RIO VERMELHO	07/11/2019 10:32	07/11/2019 13:20	07/11/2019 10:32	07/11/2019 13:20	2,79	1	2,79	CHI
20191153220	VIANOPOLIS	VN12105256	VIANOPOLIS	07/11/2019 10:32	07/11/2019 12:37	07/11/2019 10:32	07/11/2019 12:37	2,07	2	4,14	CHI
20191153228	GOIANIA	10155521	FERROVIARIO S3	07/11/2019 10:35	07/11/2019 12:25	07/11/2019 10:35	07/11/2019 12:25	1,82	1	1,82	CHI
20191153234	VIANOPOLIS	VN21278865	VIANOPOLIS	07/11/2019 10:36	08/11/2019 11:31	07/11/2019 10:36	08/11/2019 11:31	24,91	1	24,91	CHI
20191153235	FLORES DE GOIAS	FB21211654	IACIARA S2	07/11/2019 10:36	07/11/2019 11:13	07/11/2019 10:36	07/11/2019 11:13	0,61	1	0,61	CHI
20191153240	SANTA ROSA DE GOIAS	SR21079754	INHUMAS S1	07/11/2019 10:39	07/11/2019 12:09	07/11/2019 10:39	07/11/2019 12:09	1,50	1	1,50	CHI

20191153250	CATALAO	10015696110	CATALAO S2	07/11/2019 10:42	07/11/2019 20:38	07/11/2019 10:42	07/11/2019 20:38	9,92	1	9,92	CHI
20191153260	PIRES DO RIO	460008389	PIRES DO RIO S1	07/11/2019 10:45	07/11/2019 15:50	07/11/2019 10:45	07/11/2019 15:50	5,08	1	5,08	CHI
20191153261	BURITI ALEGRE	BG21297010	ITUMBIARA VELHA S2	07/11/2019 10:46	09/11/2019 18:05	07/11/2019 10:46	09/11/2019 18:05	55,32	1	55,32	CHI
20191153263	SAO SIMAO	SO12216668	CACHOEIRA ALTA	07/11/2019 06:09	07/11/2019 18:47	07/11/2019 06:09	07/11/2019 18:47	12,62	12	151,46	CHI
20191153275	CIDADE OCIDENTAL	2680187691	MARAJOARA	07/11/2019 10:49	07/11/2019 12:46	07/11/2019 10:49	07/11/2019 12:46	1,94	1	1,94	CHI
20191153279	HEITORAI	HE21300123	ITAPURANGA	07/11/2019 10:51	13/11/2019 10:40	07/11/2019 10:51	13/11/2019 10:40	143,81	2	287,61	CHI
20191153289	GUARANI DE GOIAS	GY12344197	IACIARA S1	07/11/2019 10:55	08/11/2019 13:03	07/11/2019 10:55	08/11/2019 13:03	26,12	48	1253,95	CHI
20191153289	IACIARA	GY12344197	IACIARA S1	07/11/2019 10:55	08/11/2019 13:03	07/11/2019 10:55	08/11/2019 13:03	26,12	2	52,25	CHI
20191153298	CRISTALINA	KR21261540	PAMPLONA	07/11/2019 10:56	08/11/2019 14:52	07/11/2019 10:56	08/11/2019 14:52	27,93	1	27,93	CHI
20191153402	ITAGUARU	JA12328472	JARAGUA	07/11/2019 08:48	09/11/2019 16:51	07/11/2019 08:48	09/11/2019 16:51	56,05	17	952,82	CHI
20191153402	JARAGUA	JA12328472	JARAGUA	07/11/2019 08:48	09/11/2019 16:51	07/11/2019 08:48	09/11/2019 16:51	56,05	1	56,05	CHI
20191153404	GOIANIA	GN21044108	GOYA S1	07/11/2019 10:57	07/11/2019 13:20	07/11/2019 10:57	07/11/2019 13:20	2,38	1	2,38	CHI
20191153411	LUZIANIA	3200088574	MARAJOARA	07/11/2019 10:58	07/11/2019 21:37	07/11/2019 10:58	07/11/2019 21:37	10,65	1	10,65	CHI
20191153416	CRISTIANOPOLIS	PJ12212176RE	PIRACANJUBA	07/11/2019 09:52	07/11/2019 18:47	07/11/2019 09:52	07/11/2019 18:47	8,91	4	35,64	CHI
20191153416	PIRACANJUBA	PJ12212176RE	PIRACANJUBA	07/11/2019 09:52	07/11/2019 18:47	07/11/2019 09:52	07/11/2019 18:47	8,91	14	124,74	CHI
20191153416	SANTA CRUZ DE GOIAS	PJ12212176RE	PIRACANJUBA	07/11/2019 09:52	07/11/2019 18:47	07/11/2019 09:52	07/11/2019 18:47	8,91	73	650,45	CHI
20191153417	SANTO ANTONIO DO DESCOBERTO	SN12388639	ALEXANIA	07/11/2019 10:59	08/11/2019 15:40	07/11/2019 10:59	08/11/2019 09:33	22,58	4	90,30	CHI
20191153417	SANTO ANTONIO DO DESCOBERTO	SN12092298	ALEXANIA	07/11/2019 10:59	08/11/2019 15:40	08/11/2019 10:20	08/11/2019 15:40	5,33	12	63,92	CHI
20191153424	TRINDADE	40060184	TRINDADE	07/11/2019 11:00	07/11/2019 13:08	07/11/2019 11:00	07/11/2019 13:08	2,12	1	2,12	CHI
20191153425	PONTALINA	PK12060875	PONTALINA	07/11/2019 10:47	07/11/2019 11:55	07/11/2019 10:47	07/11/2019 11:55	1,13	7	7,92	CHI
20191153427	JANDAIA	JD12003211	PALMEIRAS	07/11/2019 10:57	07/11/2019 13:11	07/11/2019 10:57	07/11/2019 13:11	2,22	11	24,44	CHI
20191153427	PALMEIRAS DE GOIAS	JD12003211	PALMEIRAS	07/11/2019 10:57	07/11/2019 13:11	07/11/2019 10:57	07/11/2019 13:11	2,22	4	8,89	CHI
20191153427	PALMINOPOLIS	JD12003211	PALMEIRAS	07/11/2019 10:57	07/11/2019 13:11	07/11/2019 10:57	07/11/2019 13:11	2,22	14	31,11	CHI
20191153428	GOIANIA	10000314186	REAL S1	07/11/2019 11:01	07/11/2019 12:36	07/11/2019 11:01	07/11/2019 12:36	1,58	1	1,58	CHI
20191153433	APARECIDA DE GOIANIA	15002925	REAL S1	07/11/2019 11:01	07/11/2019 15:16	07/11/2019 11:01	07/11/2019 15:16	4,24	1	4,24	CHI
20191153436	ITABERAI	IB12404552	ITABERAI S1	07/11/2019 08:56	07/11/2019 15:15	07/11/2019 08:56	07/11/2019 15:15	6,31	8	50,46	CHI
20191153452	GOIANIA	GN11001268	CAMPINAS S3	07/11/2019 10:32	07/11/2019 12:49	07/11/2019 10:32	07/11/2019 12:49	2,28	164	373,69	CHI
20191153454	OUVIDOR	OU11161393	CATALAO S1	07/11/2019 11:04	08/11/2019 11:35	07/11/2019 11:04	08/11/2019 11:35	24,52	6	147,11	CHI
20191153455	PORTEIRAO	CL21260969	RIO DOS BOIS	07/11/2019 11:05	09/11/2019 19:00	07/11/2019 11:05	09/11/2019 19:00	55,91	1	55,91	CHI
20191153471	SAO MIGUEL DO ARAGUAIA	SM12328565	SAO MIGUEL DO ARAGUAIA	07/11/2019 13:12	08/11/2019 20:28	07/11/2019 13:12	08/11/2019 20:28	31,27	1	31,27	CHI
20191153477	GOIANIRA	10015682461	MEIA PONTE	07/11/2019 11:08	07/11/2019 13:20	07/11/2019 11:08	07/11/2019 13:20	2,20	1	2,20	CHI
20191153486	ITABERAI	IB21018288	ITABERAI S2	07/11/2019 11:09	07/11/2019 16:32	07/11/2019 11:09	07/11/2019 16:32	5,38	2	10,76	CHI
20191153498	URUACU	UR21003450	CAMPINORTE	07/11/2019 11:11	07/11/2019 14:54	07/11/2019 11:11	07/11/2019 14:54	3,70	1	3,70	CHI

20191153500	MOSSAMEDES	MD12060620	ITABERAÍ S2	07/11/2019 09:48	07/11/2019 19:04	07/11/2019 09:48	07/11/2019 19:04	9,26	9	83,31	CHI
20191153505	VALPARAISO DE GOIAS	VA11183701	PACAEMBU S1	07/11/2019 11:13	07/11/2019 13:37	07/11/2019 11:13	07/11/2019 13:37	2,39	45	107,69	CHI
20191153506	ITAPURANGA	IK11108192	ITAPURANGA	07/11/2019 15:56	07/11/2019 16:10	07/11/2019 15:56	07/11/2019 16:10	0,23	125	29,24	CHI
20191153530	CACHOEIRA ALTA	CA21000055	CACHOEIRA ALTA	07/11/2019 11:18	10/11/2019 16:29	07/11/2019 11:18	10/11/2019 16:29	77,18	2	154,35	CHI
20191153532	CHAPADAO DO CEU	9880015416	CHAPADAO DO CEU	07/11/2019 11:18	07/11/2019 17:38	07/11/2019 11:18	07/11/2019 17:38	6,32	1	6,32	CHI
20191153534	SANTO ANTONIO DO DESCOBERTO	SN12000463	AGUAS LINDAS DE GOIAS S2	07/11/2019 11:19	07/11/2019 16:10	07/11/2019 11:19	07/11/2019 16:10	4,85	73	353,75	CHI
20191153535	SENADOR CANEDO	19761856	CEPAIGO S1	07/11/2019 11:19	10/11/2019 17:52	07/11/2019 11:19	10/11/2019 17:52	78,55	2	157,09	CHI
20191153538	ARAGOIANA	AO31000370	GUAPU S2	07/11/2019 11:20	08/11/2019 14:51	07/11/2019 11:20	08/11/2019 14:51	27,51	1	27,51	CHI
20191153544	MONTE ALEGRE DE GOIAS	MA12208683	SAO DOMINGOS	07/11/2019 07:35	08/11/2019 16:06	07/11/2019 07:35	07/11/2019 14:55	7,33	93	681,43	CHI
20191153544	MONTE ALEGRE DE GOIAS	MA13236685	SAO DOMINGOS	07/11/2019 07:35	08/11/2019 16:06	07/11/2019 07:35	07/11/2019 16:22	8,78	129	1132,91	CHI
20191153544	NOVA ROMA	MA13236685	SAO DOMINGOS	07/11/2019 07:35	08/11/2019 16:06	07/11/2019 07:35	07/11/2019 16:22	8,78	55	483,02	CHI
20191153544	MONTE ALEGRE DE GOIAS	MA12236749LD	SAO DOMINGOS	07/11/2019 07:35	08/11/2019 16:06	07/11/2019 07:35	07/11/2019 18:39	11,07	46	509,21	CHI
20191153544	MONTE ALEGRE DE GOIAS	MA12280212LD	SAO DOMINGOS	07/11/2019 07:35	08/11/2019 16:06	07/11/2019 07:35	08/11/2019 12:23	28,81	65	1872,56	CHI
20191153544	MONTE ALEGRE DE GOIAS	MA13280157	SAO DOMINGOS	07/11/2019 07:35	08/11/2019 16:06	07/11/2019 07:35	08/11/2019 15:34	31,98	90	2878,45	CHI
20191153544	CAVALCANTE	MA12280267	SAO DOMINGOS	07/11/2019 07:35	08/11/2019 16:06	07/11/2019 07:35	08/11/2019 16:06	32,52	163	5301,30	CHI
20191153544	MONTE ALEGRE DE GOIAS	MA12280267	SAO DOMINGOS	07/11/2019 07:35	08/11/2019 16:06	07/11/2019 07:35	08/11/2019 16:06	32,52	12	390,28	CHI
20191153546	VIANOPOLIS	OZ21157752	PIRES DO RIO S2	07/11/2019 11:21	08/11/2019 09:45	07/11/2019 11:21	08/11/2019 09:45	22,39	1	22,39	CHI
20191153548	ARAGARCAS	AG11231065	ARAGARCAS	07/11/2019 11:02	07/11/2019 14:35	07/11/2019 11:02	07/11/2019 14:35	3,54	81	287,14	CHI
20191153549	BURITINOPOLIS	MB21128060	IACIARA S2	07/11/2019 11:22	07/11/2019 15:36	07/11/2019 11:22	07/11/2019 15:36	4,23	3	12,70	CHI
20191153557	FIRMINOPOLIS	FR21149424	FIRMINOPOLIS S1	07/11/2019 11:22	08/11/2019 09:45	07/11/2019 11:22	08/11/2019 09:45	22,38	1	22,38	CHI
20191153558	PARAUNA	980051125	PARAUNA	07/11/2019 11:23	08/11/2019 16:31	07/11/2019 11:23	08/11/2019 16:31	29,13	1	29,13	CHI
20191153562	ITAUCU	IX21016757	INHUMAS S1	07/11/2019 11:23	08/11/2019 11:08	07/11/2019 11:23	08/11/2019 11:08	23,73	3	71,20	CHI
20191153570	JATAI	JT21036306	JATAI S2	07/11/2019 11:23	07/11/2019 18:15	07/11/2019 11:23	07/11/2019 18:15	6,86	1	6,86	CHI
20191153574	APARECIDA DE GOIANIA	200056396	INDEPENDENCIA S2	07/11/2019 11:27	07/11/2019 13:13	07/11/2019 11:27	07/11/2019 13:13	1,76	1	1,76	CHI
20191153575	ANAPOLIS	AN11279065	JUNDIAI S1	07/11/2019 11:11	07/11/2019 14:15	07/11/2019 11:11	07/11/2019 14:15	3,05	6	18,32	CHI
20191153577	SAO FRANCISCO DE GOIAS	SF21112823	SAO FRANCISCO DE GOIAS	07/11/2019 11:27	07/11/2019 18:29	07/11/2019 11:27	07/11/2019 18:29	7,02	1	7,02	CHI
20191153580	VALPARAISO DE GOIAS	VA11330581	PACAEMBU S1	07/11/2019 10:19	07/11/2019 16:11	07/11/2019 10:19	07/11/2019 16:11	5,86	57	334,05	CHI
20191153581	PONTALINA	PK21047336	VICENTINOPOLIS	07/11/2019 11:28	11/11/2019 08:18	07/11/2019 11:28	11/11/2019 08:18	92,83	1	92,83	CHI
20191153587	RIO VERDE	RV12303286	CABRIUVA S2	07/11/2019 11:28	08/11/2019 15:01	07/11/2019 11:28	08/11/2019 15:00	27,54	7	192,76	CHI
20191153587	RIO VERDE	RV21322240	CABRIUVA S2	07/11/2019 11:28	08/11/2019 15:01	07/11/2019 11:28	08/11/2019 15:01	27,54	1	27,54	CHI
20191153589	SANTA TEREZINHA DE GOIAS	SG12201785	SANTA TEREZINHA	07/11/2019 11:18	08/11/2019 00:28	07/11/2019 11:18	08/11/2019 00:28	13,16	44	578,99	CHI
20191153591	QUIRINOPOLIS	10017251247	QUIRINOPOLIS	07/11/2019 11:30	07/11/2019 18:00	07/11/2019 11:30	07/11/2019 18:00	6,49	1	6,49	CHI
20191153596	AGUAS LINDAS DE GOIAS	10029195347	AGUAS LINDAS DE GOIAS S2	07/11/2019 11:31	07/11/2019 13:11	07/11/2019 11:31	07/11/2019 13:11	1,67	1	1,67	CHI

20191153597	ALEXANIA	AX21319860	ALEXANIA	07/11/2019 11:31	07/11/2019 20:42	07/11/2019 11:31	07/11/2019 20:42	9,18	1	9,18	CHI
20191153599	JUSSARA	JR21292788	JUSSARA	07/11/2019 11:31	14/11/2019 19:00	07/11/2019 11:31	14/11/2019 19:00	175,48	1	175,48	CHI
20191153600	CRISTALINA	KR12304816	CRISTALINA S2	07/11/2019 10:12	07/11/2019 15:28	07/11/2019 10:12	07/11/2019 15:28	5,25	15	78,81	CHI
20191153601	GOIANIA	12080688	GOYA S1	07/11/2019 11:31	07/11/2019 15:40	07/11/2019 11:31	07/11/2019 15:40	4,14	1	4,14	CHI
20191153608	MINACU	IH12245160	MINACU	07/11/2019 11:33	08/11/2019 13:10	07/11/2019 11:33	08/11/2019 13:10	25,62	1	25,62	CHI
20191153615	LAGOA SANTA	10014759746	ITAJA S2	07/11/2019 11:33	07/11/2019 17:37	07/11/2019 11:33	07/11/2019 17:37	6,05	1	6,05	CHI
20191153623	ALEXANIA	AX11048165	ALEXANIA	07/11/2019 09:53	07/11/2019 13:35	07/11/2019 09:53	07/11/2019 13:35	3,69	91	335,36	CHI
20191153626	IPORA	730056727	IPORA	07/11/2019 11:35	07/11/2019 14:20	07/11/2019 11:35	07/11/2019 14:20	2,74	1	2,74	CHI
20191153629	BONOPOLIS	BX12165447	SAO MIGUEL DO ARAGUAIA	07/11/2019 11:36	08/11/2019 08:20	07/11/2019 11:36	08/11/2019 08:20	20,72	3	62,17	CHI
20191153634	GOIAS	GS12408674	MATRINCHA	07/11/2019 08:41	09/11/2019 21:30	07/11/2019 08:41	09/11/2019 21:30	60,82	18	1094,69	CHI
20191153635	APARECIDA DE GOIANIA	16723636	INDEPENDENCIA S1	07/11/2019 11:37	07/11/2019 15:57	07/11/2019 11:37	07/11/2019 15:57	4,33	1	4,33	CHI
20191153641	CAIAPONIA	CP12097751	CAIAPONIA	07/11/2019 11:32	07/11/2019 14:26	07/11/2019 11:32	07/11/2019 14:26	2,90	103	298,41	CHI
20191153649	APARECIDA DE GOIANIA	17311100	INDEPENDENCIA S2	07/11/2019 11:40	07/11/2019 13:10	07/11/2019 11:40	07/11/2019 13:10	1,50	1	1,50	CHI
20191153655	CORUMBA DE GOIAS	CB21121718	CORUMBA	07/11/2019 11:40	07/11/2019 19:33	07/11/2019 11:40	07/11/2019 19:33	7,87	1	7,87	CHI
20191153664	POSSE	IA12060874	IACIARA S2	07/11/2019 11:43	08/11/2019 19:51	07/11/2019 11:43	08/11/2019 19:51	32,13	42	1349,51	CHI
20191153669	CAMPINORTE	CR21068066	MARA ROSA	07/11/2019 11:44	08/11/2019 11:50	07/11/2019 11:44	08/11/2019 11:50	24,09	1	24,09	CHI
20191153687	MONTES CLAROS DE GOIAS	ME12207822	IPORA	07/11/2019 09:55	08/11/2019 12:02	07/11/2019 09:55	08/11/2019 12:02	26,10	16	417,65	CHI
20191153697	MONTE ALEGRE DE GOIAS	MA21214773	SAO DOMINGOS	07/11/2019 11:50	07/11/2019 16:24	07/11/2019 11:50	07/11/2019 16:24	4,55	1	4,55	CHI
20191153721	CRISTALINA	03470454	CRISTALINA S2	07/11/2019 12:09	07/11/2019 20:37	07/11/2019 12:09	07/11/2019 13:06	0,95	14	13,34	CHI
20191153721	CRISTALINA	KR13401323	CRISTALINA S2	07/11/2019 12:09	07/11/2019 20:37	07/11/2019 12:09	07/11/2019 14:56	2,79	102	284,52	CHI
20191153721	IPAMERI	KR13401323	CRISTALINA S2	07/11/2019 12:09	07/11/2019 20:37	07/11/2019 12:09	07/11/2019 14:56	2,79	110	306,84	CHI
20191153721	CRISTALINA	03470454	CRISTALINA S2	07/11/2019 12:09	07/11/2019 20:37	07/11/2019 14:57	07/11/2019 15:05	0,13	14	1,86	CHI
20191153721	CRISTALINA	KR13401323	CRISTALINA S2	07/11/2019 12:09	07/11/2019 20:37	07/11/2019 14:57	07/11/2019 16:02	1,08	101	109,50	CHI
20191153721	IPAMERI	KR13401323	CRISTALINA S2	07/11/2019 12:09	07/11/2019 20:37	07/11/2019 14:57	07/11/2019 16:02	1,08	110	119,26	CHI
20191153721	CRISTALINA	KR12209473	CRISTALINA S2	07/11/2019 12:09	07/11/2019 20:37	07/11/2019 16:24	07/11/2019 16:37	0,22	8	1,76	CHI
20191153721	CRISTALINA	KR21313605	CRISTALINA S2	07/11/2019 12:09	07/11/2019 20:37	07/11/2019 14:57	07/11/2019 20:37	5,68	1	5,68	CHI
20191153731	PALMEIRAS DE GOIAS	PL21287700	PALMEIRAS	07/11/2019 08:36	08/11/2019 15:50	07/11/2019 08:36	08/11/2019 15:50	31,22	1	31,22	CHI
20191153764	ITAPACI	00910434	ITAPACI	07/11/2019 14:14	08/11/2019 04:54	07/11/2019 14:14	07/11/2019 16:10	1,93	7	13,50	CHI
20191153764	NOVA GLORIA	00910434	ITAPACI	07/11/2019 14:14	08/11/2019 04:54	07/11/2019 14:14	07/11/2019 16:10	1,93	13	25,08	CHI
20191153764	CERES	RA13241557	RUBIATABA	07/11/2019 14:14	08/11/2019 04:54	07/11/2019 14:14	07/11/2019 19:28	5,23	1	5,23	CHI
20191153764	IPIRANGA DE GOIAS	RA13241557	RUBIATABA	07/11/2019 14:14	08/11/2019 04:54	07/11/2019 14:14	07/11/2019 19:28	5,23	2	10,46	CHI
20191153764	NOVA GLORIA	RA13241557	RUBIATABA	07/11/2019 14:14	08/11/2019 04:54	07/11/2019 14:14	07/11/2019 19:28	5,23	27	141,21	CHI
20191153764	RUBIATABA	RA13241557	RUBIATABA	07/11/2019 14:14	08/11/2019 04:54	07/11/2019 14:14	07/11/2019 19:28	5,23	2	10,46	CHI

20191153764	GUARINOS	00910434	ITAPACI	07/11/2019 14:14	08/11/2019 04:54	07/11/2019 14:14	08/11/2019 04:54	14,65	20	293,09	CHI
20191153764	ITAPACI	00910434	ITAPACI	07/11/2019 14:14	08/11/2019 04:54	07/11/2019 14:14	08/11/2019 04:54	14,65	177	2593,89	CHI
20191153764	NOVA GLORIA	00910434	ITAPACI	07/11/2019 14:14	08/11/2019 04:54	07/11/2019 14:14	08/11/2019 04:54	14,65	1	14,65	CHI
20191153764	NOVA GLORIA	NG13315104	RUBIATABA	07/11/2019 14:14	08/11/2019 04:54	07/11/2019 14:14	08/11/2019 04:54	14,65	49	718,08	CHI
20191153776	GUARANI DE GOIAS	SD10401447	SAO DOMINGOS	07/11/2019 14:45	08/11/2019 16:55	07/11/2019 14:45	07/11/2019 16:12	1,46	3	4,38	CHI
20191153776	SAO DOMINGOS	SD10401447	SAO DOMINGOS	07/11/2019 14:45	08/11/2019 16:55	07/11/2019 14:45	07/11/2019 16:12	1,46	340	496,40	CHI
20191153776	MONTE ALEGRE DE GOIAS	SD12115759LD	SAO DOMINGOS	07/11/2019 14:45	08/11/2019 16:55	07/11/2019 14:45	07/11/2019 16:22	1,62	2	3,24	CHI
20191153776	NOVA ROMA	SD12115759LD	SAO DOMINGOS	07/11/2019 14:45	08/11/2019 16:55	07/11/2019 14:45	07/11/2019 16:22	1,62	3	4,87	CHI
20191153776	SAO DOMINGOS	SD12115759LD	SAO DOMINGOS	07/11/2019 14:45	08/11/2019 16:55	07/11/2019 14:45	07/11/2019 16:22	1,62	178	288,71	CHI
20191153776	GUARANI DE GOIAS	SD12104101LD	SAO DOMINGOS	07/11/2019 14:45	08/11/2019 16:55	07/11/2019 14:45	07/11/2019 17:25	2,68	5	13,41	CHI
20191153776	SAO DOMINGOS	SD12104101LD	SAO DOMINGOS	07/11/2019 14:45	08/11/2019 16:55	07/11/2019 14:45	07/11/2019 17:25	2,68	115	308,33	CHI
20191153776	SAO DOMINGOS	SD12134706LD	SAO DOMINGOS	07/11/2019 14:45	08/11/2019 16:55	07/11/2019 14:45	07/11/2019 20:18	5,56	6	33,34	CHI
20191153776	GUARANI DE GOIAS	SD12261971LD	SAO DOMINGOS	07/11/2019 14:45	08/11/2019 16:55	07/11/2019 14:45	07/11/2019 22:00	7,26	1	7,26	CHI
20191153776	GUARANI DE GOIAS	SD10401447	SAO DOMINGOS	07/11/2019 14:45	08/11/2019 16:55	07/11/2019 22:52	07/11/2019 23:09	0,28	9	2,49	CHI
20191153776	MONTE ALEGRE DE GOIAS	SD10401447	SAO DOMINGOS	07/11/2019 14:45	08/11/2019 16:55	07/11/2019 22:52	07/11/2019 23:09	0,28	2	0,55	CHI
20191153776	NOVA ROMA	SD10401447	SAO DOMINGOS	07/11/2019 14:45	08/11/2019 16:55	07/11/2019 22:52	07/11/2019 23:09	0,28	3	0,83	CHI
20191153776	SAO DOMINGOS	SD10401447	SAO DOMINGOS	07/11/2019 14:45	08/11/2019 16:55	07/11/2019 22:52	07/11/2019 23:09	0,28	640	177,07	CHI
20191153776	GUARANI DE GOIAS	GY13248791	SAO DOMINGOS	07/11/2019 14:45	08/11/2019 16:55	07/11/2019 14:45	08/11/2019 12:29	21,74	18	391,32	CHI
20191153776	GUARANI DE GOIAS	GY12211248	SAO DOMINGOS	07/11/2019 14:45	08/11/2019 16:55	07/11/2019 14:45	08/11/2019 13:06	22,35	115	2570,76	CHI
20191153776	SAO DOMINGOS	GY12211248	SAO DOMINGOS	07/11/2019 14:45	08/11/2019 16:55	07/11/2019 14:45	08/11/2019 13:06	22,35	13	290,61	CHI
20191153776	GUARANI DE GOIAS	SD10401447	SAO DOMINGOS	07/11/2019 14:45	08/11/2019 16:55	08/11/2019 13:53	08/11/2019 14:02	0,14	142	20,31	CHI
20191153776	MONTE ALEGRE DE GOIAS	SD10401447	SAO DOMINGOS	07/11/2019 14:45	08/11/2019 16:55	08/11/2019 13:53	08/11/2019 14:02	0,14	2	0,29	CHI
20191153776	NOVA ROMA	SD10401447	SAO DOMINGOS	07/11/2019 14:45	08/11/2019 16:55	08/11/2019 13:53	08/11/2019 14:02	0,14	3	0,43	CHI
20191153776	SAO DOMINGOS	SD10401447	SAO DOMINGOS	07/11/2019 14:45	08/11/2019 16:55	08/11/2019 13:53	08/11/2019 14:02	0,14	653	93,42	CHI
20191153776	GUARANI DE GOIAS	GY13248791	SAO DOMINGOS	07/11/2019 14:45	08/11/2019 16:55	07/11/2019 14:45	08/11/2019 16:35	25,83	2	51,67	CHI
20191153776	SAO DOMINGOS	GY13248791	SAO DOMINGOS	07/11/2019 14:45	08/11/2019 16:55	07/11/2019 14:45	08/11/2019 16:35	25,83	1	25,83	CHI
20191153776	GUARANI DE GOIAS	GY13248791	SAO DOMINGOS	07/11/2019 14:45	08/11/2019 16:55	07/11/2019 14:45	08/11/2019 16:55	26,17	2	52,34	CHI
20191153776	GUARANI DE GOIAS	GY13256731	SAO DOMINGOS	07/11/2019 14:45	08/11/2019 16:55	07/11/2019 14:45	08/11/2019 16:55	26,17	1	26,17	CHI
20191153810	BOM JESUS DE GOIAS	BJ21296949	BOM JESUS DE GOIAS	07/11/2019 07:57	14/11/2019 07:59	07/11/2019 07:57	14/11/2019 07:59	168,03	1	168,03	CHI
20191153811	SENADOR CANEDO	SW12002156	SENADOR CANEDO	07/11/2019 11:53	07/11/2019 16:51	07/11/2019 11:53	07/11/2019 16:51	4,96	4	19,86	CHI
20191153819	CIDADE OCIDENTAL	DH12370611	MARAJOARA	07/11/2019 11:54	08/11/2019 11:44	07/11/2019 11:54	08/11/2019 11:44	23,83	5	119,13	CHI
20191153821	ITABERAI	IB21336510	ITABERAI S2	07/11/2019 11:54	07/11/2019 17:08	07/11/2019 11:54	07/11/2019 17:08	5,22	1	5,22	CHI
20191153826	GOIANIA	GN11197455	GOIANIA LESTE S1	07/11/2019 11:55	07/11/2019 14:24	07/11/2019 11:55	07/11/2019 14:24	2,47	19	47,01	CHI

20191153827	FIRMINOPOLIS	FR12323491	FIRMINOPOLIS S2	07/11/2019 10:13	08/11/2019 22:32	07/11/2019 10:13	08/11/2019 22:32	36,32	3	108,95	CHI
20191153838	LUZIANIA	LZ21155606	MARAJOARA	07/11/2019 11:57	08/11/2019 16:25	07/11/2019 11:57	08/11/2019 16:25	28,47	1	28,47	CHI
20191153848	NIQUELANDIA	NQ12265966	NIQUELANDIA SUBTRANSMISSAO	07/11/2019 11:47	07/11/2019 16:48	07/11/2019 11:47	07/11/2019 16:48	5,00	24	120,11	CHI
20191153855	ORIZONA	OZ12084926	PIRES DO RIO S2	07/11/2019 08:30	07/11/2019 17:14	07/11/2019 08:30	07/11/2019 17:14	8,73	1	8,73	CHI
20191153855	VIANOPOLIS	OZ12084926	PIRES DO RIO S2	07/11/2019 08:30	07/11/2019 17:14	07/11/2019 08:30	07/11/2019 17:14	8,73	7	61,10	CHI
20191153857	GAMELEIRA DE GOIAS	SV12056333	DAIA S2	07/11/2019 11:52	08/11/2019 04:27	07/11/2019 11:52	08/11/2019 04:27	16,58	36	596,74	CHI
20191153857	SILVANIA	SV12056333	DAIA S2	07/11/2019 11:52	08/11/2019 04:27	07/11/2019 11:52	08/11/2019 04:27	16,58	1	16,58	CHI
20191153860	SANTA CRUZ DE GOIAS	BC21027018	PIRES DO RIO S2	07/11/2019 12:00	07/11/2019 23:35	07/11/2019 12:00	07/11/2019 23:35	11,58	1	11,58	CHI
20191153864	RIO VERDE	RV12240063	CABRIUVA S2	07/11/2019 12:01	12/11/2019 15:20	07/11/2019 12:01	12/11/2019 15:20	123,32	5	616,62	CHI
20191153871	PALMEIRAS DE GOIAS	10020086308	PALMEIRAS	07/11/2019 12:03	08/11/2019 01:38	07/11/2019 12:03	08/11/2019 01:38	13,58	1	13,58	CHI
20191153872	LEOPOLDO DE BULHOES	LB11191068	DAIA S2	07/11/2019 12:03	07/11/2019 17:52	07/11/2019 12:03	07/11/2019 17:52	5,80	79	458,27	CHI
20191153873	ANAPOLIS	20445090	JUNDIAI S2	07/11/2019 12:04	07/11/2019 17:12	07/11/2019 12:04	07/11/2019 17:12	5,13	1	5,13	CHI
20191153875	IPORA	IR21354600	IPORA	07/11/2019 12:04	09/11/2019 11:50	07/11/2019 12:04	09/11/2019 11:50	47,75	1	47,75	CHI
20191153883	IPAMERI	IP12107655	URUTAI	07/11/2019 12:05	11/11/2019 05:56	07/11/2019 12:05	11/11/2019 05:56	89,84	2	179,68	CHI
20191153891	HIDROLANDIA	HD31142632	GUAPU S2	07/11/2019 12:07	07/11/2019 20:48	07/11/2019 12:07	07/11/2019 20:48	8,68	1	8,68	CHI
20191153897	LUZIANIA	LZ21059747	PAMPLONA	07/11/2019 12:08	08/11/2019 15:35	07/11/2019 12:08	08/11/2019 15:35	27,45	1	27,45	CHI
20191153904	LUZIANIA	LZ12051365	CRISTALINA S2	07/11/2019 12:10	08/11/2019 01:54	07/11/2019 12:10	08/11/2019 01:54	13,73	1	13,73	CHI
20191153906	CIDADE OCIDENTAL	DH11248731	MARAJOARA	07/11/2019 12:10	07/11/2019 14:27	07/11/2019 12:10	07/11/2019 14:27	2,27	35	79,58	CHI
20191153909	CRISTALINA	KR21332494	CRISTALINA S2	07/11/2019 12:10	07/11/2019 13:58	07/11/2019 12:10	07/11/2019 13:58	1,79	1	1,79	CHI
20191153919	TRINDADE	40209520	GOYA S1	07/11/2019 12:13	07/11/2019 16:55	07/11/2019 12:13	07/11/2019 16:55	4,70	1	4,70	CHI
20191153923	ITABERAI	IB21158871	ITABERAI S2	07/11/2019 12:13	09/11/2019 16:30	07/11/2019 12:13	09/11/2019 16:30	52,27	1	52,27	CHI
20191153925	LUZIANIA	LZ11136535	PACAEMBU S1	07/11/2019 11:40	07/11/2019 15:50	07/11/2019 11:40	07/11/2019 15:50	4,16	16	66,52	CHI
20191153933	PLANALTINA	2960244807	PLANALTINA	07/11/2019 12:16	07/11/2019 15:29	07/11/2019 12:16	07/11/2019 15:29	3,21	1	3,21	CHI
20191153939	CIDADE OCIDENTAL	LZ12031093	RIO VERMELHO	07/11/2019 10:59	07/11/2019 14:43	07/11/2019 10:59	07/11/2019 14:43	3,73	7	26,08	CHI
20191153939	LUZIANIA	LZ12031093	RIO VERMELHO	07/11/2019 10:59	07/11/2019 14:43	07/11/2019 10:59	07/11/2019 14:43	3,73	41	152,78	CHI
20191153947	PLANALTINA	PI12324319	SAO JOAO D ALIANCA	07/11/2019 06:03	07/11/2019 20:37	07/11/2019 06:03	07/11/2019 20:37	14,57	6	87,40	CHI
20191153950	CRISTALINA	KR12210364	CRISTALINA S2	07/11/2019 12:09	07/11/2019 16:25	07/11/2019 12:09	07/11/2019 16:25	4,26	2	8,52	CHI
20191153956	SAO SIMAO	2240005690	CACHOEIRA ALTA	07/11/2019 12:20	11/11/2019 08:27	07/11/2019 12:20	11/11/2019 08:27	92,13	1	92,13	CHI
20191153961	GAMELEIRA DE GOIAS	SV12017866	DAIA S2	07/11/2019 12:13	08/11/2019 11:12	07/11/2019 12:13	08/11/2019 11:12	22,98	13	298,69	CHI
20191153962	ANAPOLIS	AN11270459	ANAPOLIS UNIVERSITARIO S2	07/11/2019 12:14	07/11/2019 13:40	07/11/2019 12:14	07/11/2019 13:40	1,42	78	111,08	CHI
20191153963	CORUMBA DE GOIAS	260006105	CORUMBA	07/11/2019 12:21	07/11/2019 15:59	07/11/2019 12:21	07/11/2019 15:59	3,63	1	3,63	CHI
20191153971	CAMPOS BELOS	CH12384777	SAO DOMINGOS	07/11/2019 11:52	07/11/2019 17:43	07/11/2019 11:52	07/11/2019 17:43	5,85	13	76,08	CHI
20191153978	CAMPO ALEGRE DE GOIAS	CM21231667	CAMPO ALEGRE DE GOIAS	07/11/2019 12:23	07/11/2019 18:05	07/11/2019 12:23	07/11/2019 18:05	5,69	1	5,69	CHI

20191153987	RIO VERDE	630303083	RIO VERDE S1	07/11/2019 12:25	07/11/2019 17:55	07/11/2019 12:25	07/11/2019 17:55	5,50	1	5,50	CHI
20191153991	VALPARAISO DE GOIAS	VA11353978	PACAEMBU S1	07/11/2019 11:34	07/11/2019 17:22	07/11/2019 11:34	07/11/2019 17:22	5,79	102	590,86	CHI
20191153992	FORMOSA	610333756	ITUIQUIRA	07/11/2019 12:26	07/11/2019 15:03	07/11/2019 12:26	07/11/2019 15:03	2,62	1	2,62	CHI
20191153999	MINEIROS	MY12324396	PARQUE DAS EMAS	07/11/2019 12:17	07/11/2019 22:59	07/11/2019 12:17	07/11/2019 22:59	10,69	18	192,36	CHI
20191154000	ALTO PARAISO DE GOIAS	BF21336774	FLORES DE GOIAS	07/11/2019 12:27	08/11/2019 08:16	07/11/2019 12:27	08/11/2019 08:16	19,81	1	19,81	CHI
20191154002	GOIANIA	14126400	CARAJAS S1	07/11/2019 12:27	07/11/2019 17:05	07/11/2019 12:27	07/11/2019 17:05	4,62	1	4,62	CHI
20191154005	AGUAS LINDAS DE GOIAS	ZN12148419	AGUAS LINDAS DE GOIAS S2	07/11/2019 11:33	07/11/2019 18:30	07/11/2019 11:33	07/11/2019 18:30	6,95	3	20,85	CHI
20191154005	COCALZINHO DE GOIAS	ZN12148419	AGUAS LINDAS DE GOIAS S2	07/11/2019 11:33	07/11/2019 18:30	07/11/2019 11:33	07/11/2019 18:30	6,95	1	6,95	CHI
20191154013	CRISTALINA	LZ12261748	CRISTALINA S2	07/11/2019 10:24	09/11/2019 09:13	07/11/2019 10:24	09/11/2019 09:13	46,81	1	46,81	CHI
20191154013	LUZIANIA	LZ12261748	CRISTALINA S2	07/11/2019 10:24	09/11/2019 09:13	07/11/2019 10:24	09/11/2019 09:13	46,81	2	93,61	CHI
20191154018	ALTO PARAISO DE GOIAS	BF21146144	FLORES DE GOIAS	07/11/2019 12:30	08/11/2019 10:25	07/11/2019 12:30	08/11/2019 10:25	21,91	1	21,91	CHI
20191154020	MINACU	IH21182356	MINACU	07/11/2019 12:30	08/11/2019 13:43	07/11/2019 12:30	08/11/2019 13:43	25,20	1	25,20	CHI
20191154027	FORMOSA	610084458	ITUIQUIRA	07/11/2019 12:33	07/11/2019 17:15	07/11/2019 12:33	07/11/2019 17:15	4,69	1	4,69	CHI
20191154028	PADRE BERNARDO	PB12313902	PADRE BERNARDO	07/11/2019 12:33	08/11/2019 11:34	07/11/2019 12:33	08/11/2019 11:34	23,00	1	23,00	CHI
20191154030	AMARALINA	LC12270122	SAO MIGUEL DO ARAGUAIA	07/11/2019 10:15	07/11/2019 16:45	07/11/2019 10:15	07/11/2019 16:45	6,48	11	71,33	CHI
20191154031	CALDAS NOVAS	CN11257961	SERRA DE CALDAS	07/11/2019 11:53	07/11/2019 13:39	07/11/2019 11:53	07/11/2019 13:39	1,76	118	207,75	CHI
20191154033	VILA BOA	VB21235785	IACIARA S2	07/11/2019 12:35	08/11/2019 01:53	07/11/2019 12:35	08/11/2019 01:53	13,30	1	13,30	CHI
20191154034	RIO VERDE	RV12260739	CABRIUVA S2	07/11/2019 12:18	08/11/2019 17:20	07/11/2019 12:18	08/11/2019 17:20	29,02	6	174,14	CHI
20191154038	PLANALTINA	PI12302825	SAO JOAO D ALIANCA	07/11/2019 08:36	07/11/2019 21:18	07/11/2019 08:36	07/11/2019 21:18	12,70	7	88,90	CHI
20191154042	JOVIANIA	JV21123826	GOIATUBA S1	07/11/2019 12:36	09/11/2019 19:08	07/11/2019 12:36	09/11/2019 19:08	54,53	1	54,53	CHI
20191154051	GOIANIA	10162926	FERROVIARIO S1	07/11/2019 12:38	07/11/2019 14:41	07/11/2019 12:38	07/11/2019 14:41	2,04	1	2,04	CHI
20191154052	URUACU	UR12147019	URUACU	07/11/2019 12:38	07/11/2019 19:04	07/11/2019 12:38	07/11/2019 19:04	6,43	5	32,13	CHI
20191154053	GOIANESIA	GE21140624	GOIANESIA S2	07/11/2019 12:38	08/11/2019 20:40	07/11/2019 12:38	08/11/2019 20:40	32,02	1	32,02	CHI
20191154055	GOIANIA	GN11002519	CAMPINAS S2	07/11/2019 12:23	07/11/2019 14:47	07/11/2019 12:23	07/11/2019 14:47	2,40	94	225,39	CHI
20191154064	LUZIANIA	LZ21161311	MARAJOARA	07/11/2019 12:41	08/11/2019 16:17	07/11/2019 12:41	08/11/2019 16:17	27,59	1	27,59	CHI
20191154067	ITAPACI	100042740	ITAPACI	07/11/2019 12:42	08/11/2019 13:10	07/11/2019 12:42	08/11/2019 13:10	24,46	1	24,46	CHI
20191154069	QUIRINOPOLIS	QI11000016	QUIRINOPOLIS	07/11/2019 15:55	07/11/2019 20:03	07/11/2019 15:55	07/11/2019 20:03	4,12	134	552,49	CHI
20191154074	COCALZINHO DE GOIAS	4930000969	AGUAS LINDAS DE GOIAS S1	07/11/2019 12:43	07/11/2019 17:05	07/11/2019 12:43	07/11/2019 17:05	4,36	1	4,36	CHI
20191154082	MIMOSO DE GOIAS	MJ12071970	PADRE BERNARDO	07/11/2019 05:43	07/11/2019 15:34	07/11/2019 05:43	07/11/2019 15:34	9,85	23	226,47	CHI
20191154085	JATAI	JT12303380	JATAI S1	07/11/2019 12:24	07/11/2019 18:42	07/11/2019 12:24	07/11/2019 18:42	6,30	25	157,46	CHI
20191154090	ANAPOLIS	10025185940	DAIA S1	07/11/2019 12:46	07/11/2019 19:52	07/11/2019 12:46	07/11/2019 19:52	7,09	1	7,09	CHI
20191154100	JATAI	JT21187740	JATAI S3	07/11/2019 12:48	07/11/2019 15:25	07/11/2019 12:48	07/11/2019 15:25	2,62	1	2,62	CHI
20191154103	COCALZINHO DE GOIAS	ZN12185681	COCALZINHO	07/11/2019 07:51	07/11/2019 22:19	07/11/2019 07:51	07/11/2019 22:19	14,46	6	86,78	CHI

20191154103	PIRENOPOLIS	ZN12185681	COCALZINHO	07/11/2019 07:51	07/11/2019 22:19	07/11/2019 07:51	07/11/2019 22:19	14,46	5	72,31	CHI
20191154115	DAMOLANDIA	IN12022237	INHUMAS S1	07/11/2019 08:33	07/11/2019 17:12	07/11/2019 08:33	07/11/2019 17:12	8,64	8	69,15	CHI
20191154115	INHUMAS	IN12022237	INHUMAS S1	07/11/2019 08:33	07/11/2019 17:12	07/11/2019 08:33	07/11/2019 17:12	8,64	15	129,66	CHI
20191154115	PETROLINA DE GOIAS	IN12022237	INHUMAS S1	07/11/2019 08:33	07/11/2019 17:12	07/11/2019 08:33	07/11/2019 17:12	8,64	3	25,93	CHI
20191154116	PLANALTINA	PI12262312	PLANALTINA	07/11/2019 12:52	07/11/2019 17:23	07/11/2019 12:52	07/11/2019 17:23	4,51	9	40,62	CHI
20191154118	RIO VERDE	RV21260981	RIO VERDE S1	07/11/2019 12:53	11/11/2019 15:46	07/11/2019 12:53	11/11/2019 15:46	98,87	1	98,87	CHI
20191154120	PIRES DO RIO	PR21300841	PIRES DO RIO S1	07/11/2019 12:54	08/11/2019 12:06	07/11/2019 12:54	08/11/2019 12:06	23,19	1	23,19	CHI
20191154122	SAO JOAO D ALIANCA	3840026918	SAO JOAO D ALIANCA	07/11/2019 16:57	09/11/2019 15:09	07/11/2019 16:57	09/11/2019 15:09	46,20	1	46,20	CHI
20191154124	RUBIATABA	780052640	RUBIATABA	07/11/2019 12:56	08/11/2019 06:24	07/11/2019 12:56	08/11/2019 06:24	17,46	1	17,46	CHI
20191154125	NOVO PLANALTO	TA12293686	SAO MIGUEL DO ARAGUAIA	07/11/2019 12:12	07/11/2019 16:57	07/11/2019 12:12	07/11/2019 16:57	4,74	2	9,47	CHI
20191154126	LUZIANIA	120295726	RIO VERMELHO	07/11/2019 12:56	07/11/2019 21:08	07/11/2019 12:56	07/11/2019 21:08	8,20	1	8,20	CHI
20191154128	JANDAIA	1180026618	PALMEIRAS	07/11/2019 12:57	07/11/2019 15:46	07/11/2019 12:57	07/11/2019 15:46	2,83	1	2,83	CHI
20191154134	GOIATUBA	GT12263957	BOM JESUS DE GOIAS	07/11/2019 11:20	15/11/2019 23:00	07/11/2019 11:20	13/11/2019 13:40	146,33	3	438,98	CHI
20191154134	GOIATUBA	GT12263957	BOM JESUS DE GOIAS	07/11/2019 11:20	15/11/2019 23:00	15/11/2019 16:26	15/11/2019 19:21	2,92	3	8,77	CHI
20191154134	GOIATUBA	6956981	BOM JESUS DE GOIAS	07/11/2019 11:20	15/11/2019 23:00	07/11/2019 11:20	15/11/2019 19:22	200,03	2	400,05	CHI
20191154134	GOIATUBA	GT12263957	BOM JESUS DE GOIAS	07/11/2019 11:20	15/11/2019 23:00	15/11/2019 19:23	15/11/2019 23:00	3,62	5	18,08	CHI
20191154139	SAO LUIS DE MONTES BELOS	SL12259053	SAO LUIZ DOS MONTES BELOS	07/11/2019 08:29	07/11/2019 23:01	07/11/2019 08:29	07/11/2019 23:01	14,53	3	43,60	CHI
20191154145	APORE	AE12340774	ITAJA S2	07/11/2019 13:02	11/11/2019 10:25	07/11/2019 13:02	11/11/2019 10:25	93,38	1	93,38	CHI
20191154146	ANAPOLIS	20500737	JUNDIAI S1	07/11/2019 13:02	07/11/2019 16:00	07/11/2019 13:02	07/11/2019 16:00	2,97	1	2,97	CHI
20191154151	RIO VERDE	630397569	RIO VERDE S2	07/11/2019 13:04	11/11/2019 11:37	07/11/2019 13:04	11/11/2019 11:37	94,54	1	94,54	CHI
20191154154	FIRMINOPOLIS	FR12105325LD	FIRMINOPOLIS S1	07/11/2019 10:46	07/11/2019 19:18	07/11/2019 10:46	07/11/2019 19:18	8,53	6	51,20	CHI
20191154154	SAO LUIS DE MONTES BELOS	FR12105325LD	FIRMINOPOLIS S1	07/11/2019 10:46	07/11/2019 19:18	07/11/2019 10:46	07/11/2019 19:18	8,53	2	17,07	CHI
20191154154	TURVANIA	FR12105325LD	FIRMINOPOLIS S1	07/11/2019 10:46	07/11/2019 19:18	07/11/2019 10:46	07/11/2019 19:18	8,53	2	17,07	CHI
20191154156	PALMELO	BC21166926	PIRES DO RIO S2	07/11/2019 13:05	08/11/2019 17:24	07/11/2019 13:05	08/11/2019 17:24	28,32	1	28,32	CHI
20191154157	SANTA HELENA DE GOIAS	400066002	IPEGUARI	07/11/2019 13:05	08/11/2019 10:02	07/11/2019 13:05	08/11/2019 10:02	20,95	1	20,95	CHI
20191154160	TRINDADE	TR21388219	GOYA S1	07/11/2019 13:06	08/11/2019 11:24	07/11/2019 13:06	08/11/2019 11:24	22,30	2	44,59	CHI
20191154169	ANAPOLIS	AN21390327	ANAPOLIS UNIVERSITARIO S2	07/11/2019 13:07	08/11/2019 13:16	07/11/2019 13:07	08/11/2019 13:16	24,15	1	24,15	CHI
20191154175	CHAPADAO DO CEU	DJ12162540	CHAPADAO DO CEU	07/11/2019 13:09	07/11/2019 18:42	07/11/2019 13:09	07/11/2019 18:42	5,54	4	22,16	CHI
20191154175	MINEIROS	DJ12162540	CHAPADAO DO CEU	07/11/2019 13:09	07/11/2019 18:42	07/11/2019 13:09	07/11/2019 18:42	5,54	2	11,08	CHI
20191154181	SAO JOAO D ALIANCA	JL12146134	SAO JOAO D ALIANCA	07/11/2019 13:10	08/11/2019 17:55	07/11/2019 13:10	08/11/2019 17:55	28,75	1	28,75	CHI
20191154182	GOIATUBA	GT21000068	GOIATUBA S2	07/11/2019 13:10	07/11/2019 14:20	07/11/2019 13:10	07/11/2019 14:20	1,15	2	2,30	CHI
20191154185	GOIANIA	10004088679	CARAJAS S2	07/11/2019 13:11	07/11/2019 16:00	07/11/2019 13:11	07/11/2019 16:00	2,81	1	2,81	CHI
20191154190	GOIANIA	13314154	CAMPINAS S1	07/11/2019 13:11	07/11/2019 19:26	07/11/2019 13:11	07/11/2019 19:26	6,23	1	6,23	CHI

20191154196	GOIANESIA	GE21297307	GOIANESIA S2	07/11/2019 13:12	09/11/2019 12:50	07/11/2019 13:12	09/11/2019 12:50	47,62	1	47,62	CHI
20191154198	MARA ROSA	MQ21182266	MARA ROSA	07/11/2019 13:13	09/11/2019 09:44	07/11/2019 13:13	09/11/2019 09:44	44,52	1	44,52	CHI
20191154207	PIRES DO RIO	460071506	PIRES DO RIO S1	07/11/2019 13:16	07/11/2019 16:15	07/11/2019 13:16	07/11/2019 16:15	2,97	1	2,97	CHI
20191154213	FLORES DE GOIAS	FB12243096	FLORES DE GOIAS	07/11/2019 05:55	07/11/2019 17:54	07/11/2019 05:55	07/11/2019 17:54	11,97	5	59,84	CHI
20191154220	GOIANIA	GN11097445	CAMPINAS S1	07/11/2019 13:19	07/11/2019 16:49	07/11/2019 13:19	07/11/2019 16:49	3,49	100	349,17	CHI
20191154242	GOIANIA	12386844	CAMPINAS S1	07/11/2019 13:24	08/11/2019 11:19	07/11/2019 13:24	08/11/2019 11:19	21,92	1	21,92	CHI
20191154247	GOIANIA	GN11001268	CAMPINAS S3	07/11/2019 13:21	07/11/2019 14:17	07/11/2019 13:21	07/11/2019 14:17	0,93	164	152,16	CHI
20191154248	PORANGATU	PO11349891	MARA ROSA	07/11/2019 13:25	10/11/2019 12:03	07/11/2019 13:25	10/11/2019 12:03	70,63	1	70,63	CHI
20191154249	NOVO PLANALTO	TA12293712	SAO MIGUEL DO ARAGUAIA	07/11/2019 13:25	11/11/2019 14:17	07/11/2019 13:25	11/11/2019 14:17	96,86	10	968,59	CHI
20191154255	GOIANIA	14990301	FERROVIARIO S2	07/11/2019 13:26	07/11/2019 16:25	07/11/2019 13:26	07/11/2019 16:25	2,97	1	2,97	CHI
20191154258	CRISTALINA	KR21245510	PAMPLONA	07/11/2019 13:27	08/11/2019 08:05	07/11/2019 13:27	08/11/2019 08:05	18,63	1	18,63	CHI
20191154272	MAIRIPOTABA	MI21011396	PONTALINA	07/11/2019 13:28	08/11/2019 08:30	07/11/2019 13:28	08/11/2019 08:30	19,02	1	19,02	CHI
20191154273	RIO VERDE	630417155	RIO VERDE S2	07/11/2019 13:29	08/11/2019 10:52	07/11/2019 13:29	08/11/2019 10:52	21,38	1	21,38	CHI
20191154276	SANTA ROSA DE GOIAS	SR21079765	INHUMAS S1	07/11/2019 13:29	07/11/2019 14:10	07/11/2019 13:29	07/11/2019 14:10	0,68	2	1,35	CHI
20191154289	SANTO ANTONIO DO DESCOBERTO	O3560406	AGUAS LINDAS DE GOIAS S2	07/11/2019 13:31	07/11/2019 16:10	07/11/2019 13:31	07/11/2019 16:10	2,64	183	482,26	CHI
20191154295	JANDAIA	JD12377181LD	PALMEIRAS	07/11/2019 12:09	07/11/2019 17:50	07/11/2019 12:09	07/11/2019 17:50	5,67	26	147,41	CHI
20191154295	PALESTINA DE GOIAS	JD12377181LD	PALMEIRAS	07/11/2019 12:09	07/11/2019 17:50	07/11/2019 12:09	07/11/2019 17:50	5,67	1	5,67	CHI
20191154295	PALMEIRAS DE GOIAS	JD12377181LD	PALMEIRAS	07/11/2019 12:09	07/11/2019 17:50	07/11/2019 12:09	07/11/2019 17:50	5,67	34	192,76	CHI
20191154296	BELA VISTA DE GOIAS	SQ12338141	CRISTIANOPOLIS	07/11/2019 13:27	07/11/2019 15:43	07/11/2019 13:27	07/11/2019 15:43	2,26	3	6,77	CHI
20191154296	SAO MIGUEL DO PASSA QUATRO	SQ12338141	CRISTIANOPOLIS	07/11/2019 13:27	07/11/2019 15:43	07/11/2019 13:27	07/11/2019 15:43	2,26	164	369,87	CHI
20191154304	NAZARIO	NZ12004798	ANICUNS	07/11/2019 05:57	07/11/2019 16:10	07/11/2019 05:57	07/11/2019 16:10	10,20	12	122,43	CHI
20191154312	GOIANIA	10000861055	TRINDADE	07/11/2019 16:07	07/11/2019 16:58	07/11/2019 16:07	07/11/2019 16:58	0,85	1	0,85	CHI
20191154317	LUZIANIA	LZ12382235	MARAJOARA	07/11/2019 13:35	08/11/2019 15:01	07/11/2019 13:35	08/11/2019 15:01	25,42	7	177,95	CHI
20191154319	ITABERAI	IB21183135	ITABERAI S1	07/11/2019 13:35	07/11/2019 18:45	07/11/2019 13:35	07/11/2019 18:45	5,16	1	5,16	CHI
20191154321	FAINA	FC12211270	GOIAS	07/11/2019 11:43	10/11/2019 17:57	07/11/2019 11:43	10/11/2019 17:57	78,23	8	625,84	CHI
20191154326	SAO DOMINGOS	SD11046276	SAO DOMINGOS	07/11/2019 13:38	07/11/2019 15:00	07/11/2019 13:38	07/11/2019 15:00	1,36	28	38,03	CHI
20191154334	TRINDADE	13548852	GOYA S2	07/11/2019 13:39	07/11/2019 15:03	07/11/2019 13:39	07/11/2019 15:03	1,39	1	1,39	CHI
20191154340	VICENTINOPOLIS	VI12208243	VICENTINOPOLIS	07/11/2019 07:26	09/11/2019 12:51	07/11/2019 07:26	09/11/2019 12:51	53,41	12	640,86	CHI
20191154347	LUZIANIA	120141401	RIO VERMELHO	07/11/2019 13:41	07/11/2019 16:29	07/11/2019 13:41	07/11/2019 16:29	2,80	1	2,80	CHI
20191154350	COLINAS DO SUL	TI12355513	NIQUELANDIA SUBTRANSMISSAO	07/11/2019 13:42	08/11/2019 08:07	07/11/2019 13:42	07/11/2019 18:48	5,10	10	50,97	CHI
20191154350	COLINAS DO SUL	TI12355513	NIQUELANDIA SUBTRANSMISSAO	07/11/2019 13:42	08/11/2019 08:07	07/11/2019 13:42	08/11/2019 08:07	18,41	1	18,41	CHI
20191154359	GOIANIA	10226140	CAMPINAS S3	07/11/2019 13:43	08/11/2019 13:51	07/11/2019 13:43	08/11/2019 13:51	24,12	1	24,12	CHI
20191154362	PIRENOPOLIS	PV11264950	CORUMBA	07/11/2019 11:18	07/11/2019 15:56	07/11/2019 11:18	07/11/2019 15:56	4,63	35	162,13	CHI

20191154368	LUZIANIA	120430680	RIO VERMELHO	07/11/2019 13:44	07/11/2019 15:46	07/11/2019 13:44	07/11/2019 15:46	2,03	1	2,03	CHI
20191154370	ARAGOIANIA	AO21219129	GUAPO S2	07/11/2019 13:45	07/11/2019 17:30	07/11/2019 13:45	07/11/2019 17:30	3,76	1	3,76	CHI
20191154377	GOIANIA	14830577	CARAJAS S1	07/11/2019 13:46	08/11/2019 12:18	07/11/2019 13:46	08/11/2019 12:18	22,53	1	22,53	CHI
20191154381	MORRINHOS	RQ12063040	RIO QUENTE	07/11/2019 13:47	07/11/2019 23:09	07/11/2019 13:47	07/11/2019 23:09	9,36	10	93,60	CHI
20191154381	RIO QUENTE	RQ12063040	RIO QUENTE	07/11/2019 13:47	07/11/2019 23:09	07/11/2019 13:47	07/11/2019 23:09	9,36	1	9,36	CHI
20191154384	GOIAS	HE12061062	ITAPURANGA	07/11/2019 13:48	14/11/2019 00:20	13/11/2019 21:20	14/11/2019 00:20	3,00	10	30,00	CHI
20191154387	LAGOA SANTA	LS11326831	ITAJA S2	07/11/2019 11:12	07/11/2019 16:14	07/11/2019 11:12	07/11/2019 16:14	5,02	90	452,10	CHI
20191154400	GOIANESIA	GE21000282	GOIANESIA S1	07/11/2019 13:51	09/11/2019 13:18	07/11/2019 13:51	09/11/2019 13:18	47,45	1	47,45	CHI
20191154405	VALPARAISO DE GOIAS	VA11320164	MARAJOARA	07/11/2019 12:02	07/11/2019 20:39	07/11/2019 12:02	07/11/2019 20:39	8,61	6	51,66	CHI
20191154406	GOIANIA	16582111	MEIA PONTE	07/11/2019 13:52	08/11/2019 09:30	07/11/2019 13:52	08/11/2019 09:30	19,63	1	19,63	CHI
20191154408	APARECIDA DE GOIANIA	15223930	ATLANTICO S2	07/11/2019 13:52	07/11/2019 21:26	07/11/2019 13:52	07/11/2019 21:26	7,56	1	7,56	CHI
20191154421	QUIRINOPOLIS	QI12191652	CACHOEIRA ALTA	07/11/2019 13:18	09/11/2019 12:44	07/11/2019 13:18	09/11/2019 12:44	47,43	6	284,59	CHI
20191154426	FLORES DE GOIAS	FB11255063	FLORES DE GOIAS	07/11/2019 13:55	07/11/2019 19:37	07/11/2019 13:55	07/11/2019 19:37	5,69	18	102,44	CHI
20191154435	VIANOPOLIS	VN12105256	VIANOPOLIS	07/11/2019 13:57	07/11/2019 17:04	07/11/2019 13:57	07/11/2019 17:04	3,11	2	6,21	CHI
20191154443	GOIANIA	10539633	REAL S2	07/11/2019 13:59	07/11/2019 15:38	07/11/2019 13:59	07/11/2019 15:38	1,64	1	1,64	CHI
20191154447	APARECIDA DE GOIANIA	11735673	ATLANTICO S1	07/11/2019 13:59	07/11/2019 20:17	07/11/2019 13:59	07/11/2019 20:17	6,29	1	6,29	CHI
20191154451	CALDAS NOVAS	760185591	CALDAS NOVAS S2	07/11/2019 14:00	08/11/2019 07:38	07/11/2019 14:00	08/11/2019 07:38	17,62	1	17,62	CHI
20191154453	PLANALTINA	PI11355699	PLANALTINA	07/11/2019 14:01	08/11/2019 21:34	07/11/2019 14:01	08/11/2019 21:34	31,55	1	31,55	CHI
20191154459	PIRACANJUBA	PJ11000008	PIRACANJUBA	07/11/2019 13:18	07/11/2019 16:03	07/11/2019 13:18	07/11/2019 16:03	2,74	99	271,56	CHI
20191154461	GUAPO	10030480963	GUAPO S2	07/11/2019 14:02	08/11/2019 16:28	07/11/2019 14:02	08/11/2019 16:28	26,42	1	26,42	CHI
20191154464	CRISTALINA	KR21212026	PAMPLONA	07/11/2019 14:03	08/11/2019 12:44	07/11/2019 14:03	08/11/2019 12:44	22,68	2	45,36	CHI
20191154466	PLANALTINA	PI21200107	PADRE BERNARDO	07/11/2019 14:03	09/11/2019 12:25	07/11/2019 14:03	09/11/2019 12:25	46,36	1	46,36	CHI
20191154474	ANICUNS	910055269	ANICUNS	07/11/2019 14:04	07/11/2019 19:34	07/11/2019 14:04	07/11/2019 19:34	5,50	1	5,50	CHI
20191154478	AMARALINA	LC12270117	SAO MIGUEL DO ARAGUAIA	07/11/2019 08:36	07/11/2019 17:50	07/11/2019 08:36	07/11/2019 17:50	9,22	8	73,76	CHI
20191154484	OURO VERDE DE GOIAS	OV21227025	INHUMAS S1	07/11/2019 14:05	08/11/2019 12:23	07/11/2019 14:05	08/11/2019 12:23	22,30	1	22,30	CHI
20191154504	NAZARIO	1170002204	ANICUNS	07/11/2019 14:07	08/11/2019 11:41	07/11/2019 14:07	08/11/2019 11:41	21,56	1	21,56	CHI
20191154517	RIO VERDE	RV11214210	CABRIUVA S1	07/11/2019 12:46	07/11/2019 15:29	07/11/2019 12:46	07/11/2019 15:29	2,71	266	721,45	CHI
20191154518	CALDAS NOVAS	CN12391202	CALDAS NOVAS S1	07/11/2019 14:10	07/11/2019 17:01	07/11/2019 14:10	07/11/2019 17:01	2,85	4	11,39	CHI
20191154531	CAMPOS BELOS	MA12209854	SAO DOMINGOS	07/11/2019 10:06	07/11/2019 16:17	07/11/2019 10:06	07/11/2019 16:17	6,17	4	24,69	CHI
20191154531	MONTE ALEGRE DE GOIAS	MA12209854	SAO DOMINGOS	07/11/2019 10:06	07/11/2019 16:17	07/11/2019 10:06	07/11/2019 16:17	6,17	18	111,11	CHI
20191154533	URUACU	UR21181143	URUACU	07/11/2019 14:12	07/11/2019 16:26	07/11/2019 14:12	07/11/2019 16:26	2,22	1	2,22	CHI
20191154537	CARMO DO RIO VERDE	IK12025227	ITAPURANGA	07/11/2019 07:01	08/11/2019 14:18	07/11/2019 07:01	08/11/2019 14:18	31,28	8	250,26	CHI
20191154541	SITIO D ABADIA	AQ21146061	IACIARA S2	07/11/2019 14:13	08/11/2019 12:20	07/11/2019 14:13	08/11/2019 12:20	22,10	1	22,10	CHI

20191154544	GOIANIA	10003087008	GOYA S1	07/11/2019 14:14	08/11/2019 03:59	07/11/2019 14:14	08/11/2019 03:59	13,74	1	13,74	CHI
20191154568	INHUMAS	IN21131939	INHUMAS S2	07/11/2019 14:18	09/11/2019 01:12	07/11/2019 14:18	09/11/2019 01:12	34,90	1	34,90	CHI
20191154569	SERRANOPOLIS	SX21209930	JATAI S1	07/11/2019 14:19	08/11/2019 20:54	07/11/2019 14:19	08/11/2019 20:54	30,58	1	30,58	CHI
20191154580	LUZIANIA	LZ12330887	RIO VERMELHO	07/11/2019 10:59	07/11/2019 16:46	07/11/2019 10:59	07/11/2019 16:46	5,77	124	716,07	CHI
20191154593	FAINA	FC11169232	GOIAS	07/11/2019 14:22	07/11/2019 17:09	07/11/2019 14:22	07/11/2019 17:09	2,78	169	469,26	CHI
20191154597	CAMPINORTE	10004297847	CAMPINORTE	07/11/2019 14:23	08/11/2019 03:59	07/11/2019 14:23	08/11/2019 03:59	13,60	1	13,60	CHI
20191154600	MINEIROS	MY12202613	PARQUE DAS EMAS	07/11/2019 14:23	09/11/2019 15:14	07/11/2019 14:23	09/11/2019 15:14	48,85	10	488,46	CHI
20191154602	BURITI ALEGRE	BG12000067RE	ITUMBIARA VELHA S2	07/11/2019 09:46	09/11/2019 11:36	07/11/2019 09:46	09/11/2019 11:36	49,83	26	1295,51	CHI
20191154602	ITUMBIARA	BG12000067RE	ITUMBIARA VELHA S2	07/11/2019 09:46	09/11/2019 11:36	07/11/2019 09:46	09/11/2019 11:36	49,83	22	1096,20	CHI
20191154602	BURITI ALEGRE	BG12000067RE	ITUMBIARA VELHA S2	07/11/2019 09:46	09/11/2019 11:36	07/11/2019 14:16	09/11/2019 11:36	45,32	13	589,22	CHI
20191154602	GOIATUBA	BG12000067RE	ITUMBIARA VELHA S2	07/11/2019 09:46	09/11/2019 11:36	07/11/2019 14:16	09/11/2019 11:36	45,32	2	90,65	CHI
20191154605	PLANALTINA	PI11061286	PLANALTINA	07/11/2019 14:24	09/11/2019 10:03	07/11/2019 14:24	09/11/2019 10:03	43,65	9	392,83	CHI
20191154610	MONTIVIDIU	MV12303520	MONTIVIDIU T	07/11/2019 14:25	09/11/2019 08:15	07/11/2019 14:25	09/11/2019 08:15	41,84	3	125,52	CHI
20191154610	RIO VERDE	MV12303520	MONTIVIDIU T	07/11/2019 14:25	09/11/2019 08:15	07/11/2019 14:25	09/11/2019 08:15	41,84	1	41,84	CHI
20191154611	CAMPINORTE	CR21320979	MARA ROSA	07/11/2019 14:25	08/11/2019 11:05	07/11/2019 14:25	08/11/2019 11:05	20,66	2	41,32	CHI
20191154613	QUIRINOPOLIS	QI21005187	QUIRINOPOLIS	07/11/2019 14:25	09/11/2019 09:56	07/11/2019 14:25	09/11/2019 09:56	43,51	1	43,51	CHI
20191154614	CIDADE OCIDENTAL	DH11128796	MARAJOARA	07/11/2019 10:58	07/11/2019 18:17	07/11/2019 10:58	07/11/2019 18:17	7,31	91	665,44	CHI
20191154616	PORANGATU	PO12022073	PORANGATU	07/11/2019 07:39	08/11/2019 11:30	07/11/2019 07:39	08/11/2019 11:30	27,84	36	1002,34	CHI
20191154622	APARECIDA DE GOIANIA	AP11043245	INDEPENDENCIA S1	07/11/2019 14:14	07/11/2019 16:52	07/11/2019 14:14	07/11/2019 16:52	2,62	76	199,01	CHI
20191154623	ITAPACI	10012391539	ITAPACI	07/11/2019 14:26	08/11/2019 18:32	07/11/2019 14:26	08/11/2019 18:32	28,09	1	28,09	CHI
20191154626	AMARALINA	MQ21029580	SAO MIGUEL DO ARAGUAIA	07/11/2019 14:27	07/11/2019 19:48	07/11/2019 14:27	07/11/2019 19:48	5,35	13	69,55	CHI
20191154627	CACHOEIRA DOURADA	CD21222434	CACHOEIRA DOURADA	07/11/2019 14:27	09/11/2019 14:57	07/11/2019 14:27	09/11/2019 14:57	48,50	1	48,50	CHI
20191154628	PADRE BERNARDO	PB12376789	PADRE BERNARDO	07/11/2019 08:05	07/11/2019 18:08	07/11/2019 08:05	07/11/2019 18:08	10,04	7	70,26	CHI
20191154629	PORANGATU	PO12286007	PORANGATU	07/11/2019 14:27	08/11/2019 09:45	07/11/2019 14:27	08/11/2019 09:45	19,29	8	154,30	CHI
20191154630	ITAUCU	IX21330181	INHUMAS S1	07/11/2019 14:27	08/11/2019 12:03	07/11/2019 14:27	08/11/2019 12:03	21,58	1	21,58	CHI
20191154637	DISTRITO FEDERAL	FA12383392	ITUIQUIRA	07/11/2019 14:28	07/11/2019 21:57	07/11/2019 14:28	07/11/2019 21:57	7,47	2	14,94	CHI
20191154637	FORMOSA	FA12383392	ITUIQUIRA	07/11/2019 14:28	07/11/2019 21:57	07/11/2019 14:28	07/11/2019 21:57	7,47	1	7,47	CHI
20191154641	MORRINHOS	MR11399808	MORRINHOS	07/11/2019 14:29	07/11/2019 17:15	07/11/2019 14:29	07/11/2019 17:15	2,76	5	13,78	CHI
20191154658	MARA ROSA	MQ21325193	MARA ROSA	07/11/2019 14:32	09/11/2019 20:38	07/11/2019 14:32	09/11/2019 20:38	54,09	1	54,09	CHI
20191154660	ORIZONA	OZ12311604	PIRES DO RIO S2	07/11/2019 14:32	08/11/2019 08:27	07/11/2019 14:32	08/11/2019 08:27	17,90	1	17,90	CHI
20191154666	PIRENOPOLIS	3100002300	SAO FRANCISCO DE GOIAS	07/11/2019 14:33	07/11/2019 22:26	07/11/2019 14:33	07/11/2019 22:26	7,87	1	7,87	CHI
20191154668	GOIATUBA	PX12029611	GOIATUBA S1	07/11/2019 13:28	09/11/2019 15:15	07/11/2019 13:28	09/11/2019 15:15	49,78	10	497,80	CHI
20191154672	BONOPOLIS	BX21254002	NOVO PLANALTO	07/11/2019 14:34	09/11/2019 20:39	07/11/2019 14:34	09/11/2019 20:39	54,08	1	54,08	CHI

20191154685	JUSSARA	ME12204887	BRITANIA	07/11/2019 09:09	10/11/2019 15:38	07/11/2019 09:09	10/11/2019 15:38	78,47	2	156,94	CHI
20191154685	MONTES CLAROS DE GOIAS	ME12204887	BRITANIA	07/11/2019 09:09	10/11/2019 15:38	07/11/2019 09:09	10/11/2019 15:38	78,47	109	8553,23	CHI
20191154700	NOVA CRIXAS	10000890136	NOVA CRIXAS	07/11/2019 14:40	08/11/2019 01:55	07/11/2019 14:40	08/11/2019 01:55	11,26	1	11,26	CHI
20191154707	MONTIVIDIU	MV12230886	MONTIVIDIU T	07/11/2019 14:32	08/11/2019 07:45	07/11/2019 14:32	08/11/2019 07:45	17,22	9	154,94	CHI
20191154707	RIO VERDE	MV12230886	MONTIVIDIU T	07/11/2019 14:32	08/11/2019 07:45	07/11/2019 14:32	08/11/2019 07:45	17,22	39	671,41	CHI
20191154716	GOIANIA	10000249805	ATLANTICO S3	07/11/2019 14:42	07/11/2019 16:44	07/11/2019 14:42	07/11/2019 16:44	2,03	1	2,03	CHI
20191154725	GOIANIRA	IN21015199	GOIANIRA	07/11/2019 14:43	08/11/2019 20:30	07/11/2019 14:43	08/11/2019 20:30	29,77	2	59,55	CHI
20191154726	CAMPINORTE	FO12182459	PORANGATU	07/11/2019 12:18	08/11/2019 09:31	07/11/2019 12:18	08/11/2019 09:31	21,21	68	1442,07	CHI
20191154726	MINACU	FO12182459	PORANGATU	07/11/2019 12:18	08/11/2019 09:31	07/11/2019 12:18	08/11/2019 09:31	21,21	38	805,86	CHI
20191154727	LEOPOLDO DE BULHOES	LB12353164	DAIA S2	07/11/2019 14:30	07/11/2019 19:10	07/11/2019 14:30	07/11/2019 19:10	4,66	8	37,28	CHI
20191154731	BONOPOLIS	BX21172405	SAO MIGUEL DO ARAGUAIA	07/11/2019 14:44	07/11/2019 23:16	07/11/2019 14:44	07/11/2019 23:16	8,52	1	8,52	CHI
20191154733	MARA ROSA	MQ12146959	MARA ROSA	07/11/2019 09:26	07/11/2019 22:06	07/11/2019 09:26	07/11/2019 22:06	12,65	10	126,53	CHI
20191154733	NOVA IGUACU DE GOIAS	MQ12146959	MARA ROSA	07/11/2019 09:26	07/11/2019 22:06	07/11/2019 09:26	07/11/2019 22:06	12,65	11	139,18	CHI
20191154744	AGUAS LINDAS DE GOIAS	4830296125	AGUAS LINDAS DE GOIAS S1	07/11/2019 14:47	07/11/2019 16:22	07/11/2019 14:47	07/11/2019 16:22	1,57	1	1,57	CHI
20191154748	ACREUNA	2440060830	ACREUNA	07/11/2019 14:48	07/11/2019 18:50	07/11/2019 14:48	07/11/2019 18:50	4,04	1	4,04	CHI
20191154761	NAZARIO	10018654078	ANICUNS	07/11/2019 14:50	08/11/2019 12:52	07/11/2019 14:50	08/11/2019 12:52	22,03	1	22,03	CHI
20191154765	CALDAS NOVAS	CN11000026	SERRA DE CALDAS	07/11/2019 14:21	07/11/2019 16:22	07/11/2019 14:21	07/11/2019 16:22	2,01	60	120,78	CHI
20191154766	SILVANIA	SV12384976	DAIA S2	07/11/2019 14:50	07/11/2019 23:05	07/11/2019 14:50	07/11/2019 23:05	8,24	5	41,22	CHI
20191154780	GOIANIA	13256520	GOIANIA LESTE S1	07/11/2019 14:52	07/11/2019 16:59	07/11/2019 14:52	07/11/2019 16:59	2,10	1	2,10	CHI
20191154784	MINEIROS	1390169689	PARQUE DAS EMAS	07/11/2019 14:52	07/11/2019 17:01	07/11/2019 14:52	07/11/2019 17:01	2,15	1	2,15	CHI
20191154785	PLANALTINA	PI21092401	PLANALTINA	07/11/2019 14:53	09/11/2019 07:57	07/11/2019 14:53	09/11/2019 07:57	41,06	1	41,06	CHI
20191154787	CACU	CC12260993	CACHOEIRA ALTA	07/11/2019 07:27	08/11/2019 17:30	07/11/2019 07:27	08/11/2019 17:30	34,05	6	204,29	CHI
20191154790	ITAPACI	IW11136320	ITAPACI	07/11/2019 12:29	07/11/2019 16:05	07/11/2019 12:29	07/11/2019 16:05	3,59	130	466,63	CHI
20191154792	MONTIVIDIU	MV10400563	MONTIVIDIU T	07/11/2019 14:39	07/11/2019 22:07	07/11/2019 14:39	07/11/2019 21:12	6,54	10	65,39	CHI
20191154792	RIO VERDE	MV10400563	MONTIVIDIU T	07/11/2019 14:39	07/11/2019 22:07	07/11/2019 14:39	07/11/2019 21:12	6,54	2	13,08	CHI
20191154792	RIO VERDE	RV12051746	MONTIVIDIU T	07/11/2019 14:39	07/11/2019 22:07	07/11/2019 14:39	07/11/2019 21:40	7,01	76	533,03	CHI
20191154792	RIO VERDE	RV12338538	MONTIVIDIU T	07/11/2019 14:39	07/11/2019 22:07	07/11/2019 14:39	07/11/2019 22:07	7,46	12	89,47	CHI
20191154799	RIO VERDE	RV12322325	MONTIVIDIU T	07/11/2019 14:55	08/11/2019 10:30	07/11/2019 14:55	08/11/2019 10:30	19,57	1	19,57	CHI
20191154801	SAO JOAO D ALIANCA	JL12321181	SAO JOAO D ALIANCA	07/11/2019 14:56	09/11/2019 13:31	07/11/2019 14:56	09/11/2019 13:31	46,59	10	465,94	CHI
20191154801	SAO JOAO D ALIANCA	JL12218373	SAO JOAO D ALIANCA	07/11/2019 14:56	09/11/2019 13:31	09/11/2019 11:03	09/11/2019 13:31	2,47	96	237,33	CHI
20191154804	IPAMERI	IP11186737	IPAMERI	07/11/2019 13:35	07/11/2019 17:19	07/11/2019 13:35	07/11/2019 17:19	3,72	37	137,67	CHI
20191154808	SIMOLANDIA	1940010060	IACIARA S2	07/11/2019 14:56	07/11/2019 18:50	07/11/2019 14:56	07/11/2019 18:50	3,89	1	3,89	CHI
20191154815	LUZIANIA	LZ12041473	RIO VERMELHO	07/11/2019 14:01	07/11/2019 17:40	07/11/2019 14:01	07/11/2019 17:40	3,64	83	302,42	CHI

20191154819	PETROLINA DE GOIAS	PG12017759	PETROLINA	07/11/2019 14:14	07/11/2019 16:42	07/11/2019 14:14	07/11/2019 16:42	2,45	15	36,81	CHI
20191154826	BARRO ALTO	BA12066363	BARRO ALTO	07/11/2019 07:20	07/11/2019 17:20	07/11/2019 07:20	07/11/2019 17:20	9,99	7	69,90	CHI
20191154828	ORIZONA	10006314803	PIRES DO RIO S2	07/11/2019 14:59	07/11/2019 21:57	07/11/2019 14:59	07/11/2019 21:57	6,96	1	6,96	CHI
20191154838	BALIZA	BH12207583	BOM JARDIM	07/11/2019 15:00	08/11/2019 15:46	07/11/2019 15:00	08/11/2019 15:46	24,76	11	272,31	CHI
20191154841	VALPARAISO DE GOIAS	VA11049595	MARAJOARA	07/11/2019 14:51	07/11/2019 19:09	07/11/2019 14:51	07/11/2019 19:09	4,29	136	583,10	CHI
20191154854	ITAGUARU	IC11159958	ITABERAI S1	07/11/2019 15:03	08/11/2019 18:46	07/11/2019 15:03	08/11/2019 18:46	27,72	43	1191,77	CHI
20191154865	GOIANIA	GN11168593	FERROVIARIO S2	07/11/2019 15:03	07/11/2019 17:30	07/11/2019 15:03	07/11/2019 17:30	2,45	59	144,48	CHI
20191154866	ARENOPOLIS	AY12000008B	ARENOPOLIS	07/11/2019 09:08	07/11/2019 19:31	07/11/2019 09:08	07/11/2019 19:31	10,38	172	1784,60	CHI
20191154866	DIORAMA	AY12000008B	ARENOPOLIS	07/11/2019 09:08	07/11/2019 19:31	07/11/2019 09:08	07/11/2019 19:31	10,38	127	1317,70	CHI
20191154866	IPORA	AY12000008B	ARENOPOLIS	07/11/2019 09:08	07/11/2019 19:31	07/11/2019 09:08	07/11/2019 19:31	10,38	112	1162,06	CHI
20191154866	IVOLANDIA	AY12000008B	ARENOPOLIS	07/11/2019 09:08	07/11/2019 19:31	07/11/2019 09:08	07/11/2019 19:31	10,38	53	549,90	CHI
20191154866	MONTES CLAROS DE GOIAS	AY12000008B	ARENOPOLIS	07/11/2019 09:08	07/11/2019 19:31	07/11/2019 09:08	07/11/2019 19:31	10,38	39	404,65	CHI
20191154866	PALESTINA DE GOIAS	AY12000008B	ARENOPOLIS	07/11/2019 09:08	07/11/2019 19:31	07/11/2019 09:08	07/11/2019 19:31	10,38	46	477,28	CHI
20191154870	JATAI	JT12184194	JATAI S1	07/11/2019 14:46	08/11/2019 21:13	07/11/2019 14:46	08/11/2019 21:13	30,45	11	334,94	CHI
20191154873	ALTO PARAISO DE GOIAS	BF11365244	SAO JOAO D ALIANCA	07/11/2019 15:05	08/11/2019 13:01	07/11/2019 15:05	08/11/2019 13:01	21,92	1	21,92	CHI
20191154875	LEOPOLDO DE BULHOES	GP12039292	DAIA S2	07/11/2019 12:45	07/11/2019 17:56	07/11/2019 12:45	07/11/2019 17:56	5,18	9	46,63	CHI
20191154880	RIO VERDE	RV11136195	RIO VERDE S2	07/11/2019 14:49	07/11/2019 16:25	07/11/2019 14:49	07/11/2019 16:25	1,59	121	192,29	CHI
20191154881	JARAGUA	JA12194403	JARAGUA	07/11/2019 14:41	08/11/2019 02:19	07/11/2019 14:41	08/11/2019 02:19	11,63	29	337,31	CHI
20191154888	APARECIDA DE GOIANIA	AP11216350	REAL S1	07/11/2019 14:48	07/11/2019 16:45	07/11/2019 14:48	07/11/2019 16:45	1,95	49	95,39	CHI
20191154894	CORUMBAIBA	CI21110131	VILA CORUMBA	07/11/2019 15:07	08/11/2019 11:11	07/11/2019 15:07	08/11/2019 11:11	20,05	1	20,05	CHI
20191154901	PADRE BERNARDO	PB12313952	PADRE BERNARDO	07/11/2019 15:09	07/11/2019 16:37	07/11/2019 15:09	07/11/2019 16:37	1,46	2	2,92	CHI
20191154911	AGUAS LINDAS DE GOIAS	4830198413	AGUAS LINDAS DE GOIAS S1	07/11/2019 15:10	07/11/2019 16:48	07/11/2019 15:10	07/11/2019 16:48	1,63	1	1,63	CHI
20191154917	APARECIDA DE GOIANIA	AP11210857	ATLANTICO S1	07/11/2019 14:41	07/11/2019 17:16	07/11/2019 14:41	07/11/2019 17:16	2,60	143	371,72	CHI
20191154919	JARAGUA	JA12038328	JARAGUA	07/11/2019 15:10	08/11/2019 10:04	07/11/2019 15:10	08/11/2019 10:04	18,89	7	132,20	CHI
20191154922	CALDAS NOVAS	CN11213986	SERRA DE CALDAS	07/11/2019 14:49	07/11/2019 15:58	07/11/2019 14:49	07/11/2019 15:58	1,14	101	115,17	CHI
20191154930	CACHOEIRA ALTA	04860224	QUIRINOPOLIS	07/11/2019 14:52	10/11/2019 21:15	07/11/2019 14:52	08/11/2019 17:30	26,62	3	79,87	CHI
20191154930	QUIRINOPOLIS	04860224	QUIRINOPOLIS	07/11/2019 14:52	10/11/2019 21:15	07/11/2019 14:52	08/11/2019 17:30	26,62	87	2316,33	CHI
20191154930	RIO VERDE	04860224	QUIRINOPOLIS	07/11/2019 14:52	10/11/2019 21:15	07/11/2019 14:52	08/11/2019 17:30	26,62	42	1118,23	CHI
20191154930	RIO VERDE	QI10400627	QUIRINOPOLIS	07/11/2019 14:52	10/11/2019 21:15	07/11/2019 19:40	08/11/2019 17:30	21,83	1	21,83	CHI
20191154930	CACHOEIRA ALTA	04860224	QUIRINOPOLIS	07/11/2019 14:52	10/11/2019 21:15	08/11/2019 17:31	08/11/2019 17:45	0,23	3	0,68	CHI
20191154930	QUIRINOPOLIS	04860224	QUIRINOPOLIS	07/11/2019 14:52	10/11/2019 21:15	08/11/2019 17:31	08/11/2019 17:45	0,23	8	1,82	CHI
20191154930	QUIRINOPOLIS	04860224	QUIRINOPOLIS	07/11/2019 14:52	10/11/2019 21:15	07/11/2019 14:52	08/11/2019 23:23	32,51	96	3121,23	CHI
20191154930	QUIRINOPOLIS	QI13301521	QUIRINOPOLIS	07/11/2019 14:52	10/11/2019 21:15	08/11/2019 17:31	08/11/2019 23:23	5,87	79	463,86	CHI

20191154930	RIO VERDE	QI13301521	QUIRINOPOLIS	07/11/2019 14:52	10/11/2019 21:15	08/11/2019 17:31	08/11/2019 23:23	5,87	43	252,48	CHI
20191154930	CACHOEIRA ALTA	QI13251538	QUIRINOPOLIS	07/11/2019 14:52	10/11/2019 21:15	08/11/2019 17:46	10/11/2019 21:15	51,49	3	154,46	CHI
20191154930	QUIRINOPOLIS	QI13251538	QUIRINOPOLIS	07/11/2019 14:52	10/11/2019 21:15	08/11/2019 17:46	10/11/2019 21:15	51,49	8	411,90	CHI
20191154942	LUZIANIA	120205282	RIO VERMELHO	07/11/2019 15:14	07/11/2019 17:00	07/11/2019 15:14	07/11/2019 17:00	1,78	1	1,78	CHI
20191154943	NOVA AURORA	NE12384411	CATALAO S1	07/11/2019 14:41	07/11/2019 19:51	07/11/2019 14:41	07/11/2019 19:50	5,14	94	483,24	CHI
20191154943	CORUMBAIBA	NE10397343	CATALAO S1	07/11/2019 14:41	07/11/2019 19:51	07/11/2019 14:41	07/11/2019 19:51	5,16	17	87,74	CHI
20191154943	IPAMERI	NE10397343	CATALAO S1	07/11/2019 14:41	07/11/2019 19:51	07/11/2019 14:41	07/11/2019 19:51	5,16	4	20,65	CHI
20191154943	NOVA AURORA	NE10397343	CATALAO S1	07/11/2019 14:41	07/11/2019 19:51	07/11/2019 14:41	07/11/2019 19:51	5,16	19	98,07	CHI
20191154944	LUZIANIA	120322110	RIO VERMELHO	07/11/2019 15:14	07/11/2019 17:18	07/11/2019 15:14	07/11/2019 17:18	2,06	1	2,06	CHI
20191154947	MINEIROS	10006458279	PARQUE DAS EMAS	07/11/2019 15:15	07/11/2019 18:30	07/11/2019 15:15	07/11/2019 18:30	3,26	1	3,26	CHI
20191154948	CALDAS NOVAS	CN12139720	SERRA DE CALDAS	07/11/2019 15:15	07/11/2019 22:14	07/11/2019 15:15	07/11/2019 22:14	6,98	67	467,83	CHI
20191154951	IPAMERI	IP21266939	IPAMERI	07/11/2019 15:12	08/11/2019 09:59	07/11/2019 15:12	08/11/2019 09:59	18,78	1	18,78	CHI
20191154953	MORRINHOS	MR12035910	MORRINHOS	07/11/2019 14:36	07/11/2019 17:45	07/11/2019 14:36	07/11/2019 17:45	3,16	6	18,94	CHI
20191154978	CATALAO	CT12042393	CATALAO S1	07/11/2019 11:30	08/11/2019 11:32	07/11/2019 11:30	08/11/2019 11:32	24,02	11	264,25	CHI
20191154983	DIORAMA	IR12091410	IPORA	07/11/2019 15:20	09/11/2019 15:12	07/11/2019 15:20	09/11/2019 15:12	47,87	10	478,65	CHI
20191154983	IPORA	IR12091410	IPORA	07/11/2019 15:20	09/11/2019 15:12	07/11/2019 15:20	09/11/2019 15:12	47,87	7	335,06	CHI
20191154983	JAUPACI	IR12091410	IPORA	07/11/2019 15:20	09/11/2019 15:12	07/11/2019 15:20	09/11/2019 15:12	47,87	5	239,33	CHI
20191154986	MONTE ALEGRE DE GOIAS	MA12129802	SAO DOMINGOS	07/11/2019 15:20	08/11/2019 16:30	07/11/2019 15:20	08/11/2019 16:30	25,16	2	50,32	CHI
20191154989	NIQUELANDIA	NQ12255073	NIQUELANDIA SUBTRANSMISSAO	07/11/2019 15:20	08/11/2019 11:36	07/11/2019 15:20	08/11/2019 11:36	20,25	2	40,51	CHI
20191155004	JATAI	JT11036309	JATAI S2	07/11/2019 15:02	07/11/2019 21:45	07/11/2019 15:02	07/11/2019 21:45	6,71	153	1026,76	CHI
20191155016	AGUAS LINDAS DE GOIAS	6830002651	AGUAS LINDAS DE GOIAS S2	07/11/2019 15:23	07/11/2019 16:17	07/11/2019 15:23	07/11/2019 16:17	0,89	1	0,89	CHI
20191155017	RIO VERDE	RV21200745	MONTIVIDIU T	07/11/2019 15:23	08/11/2019 20:45	07/11/2019 15:23	08/11/2019 20:45	29,36	1	29,36	CHI
20191155026	RIO VERDE	RV12305862LD	RIO VERDE S2	07/11/2019 15:23	08/11/2019 10:40	07/11/2019 15:23	08/11/2019 10:40	19,28	9	173,49	CHI
20191155028	BALIZA	BH12207585	BOM JARDIM	07/11/2019 15:24	07/11/2019 17:05	07/11/2019 15:24	07/11/2019 17:05	1,68	6	10,06	CHI
20191155028	BOM JARDIM DE GOIAS	BH12207585	BOM JARDIM	07/11/2019 15:24	07/11/2019 17:05	07/11/2019 15:24	07/11/2019 17:05	1,68	1	1,68	CHI
20191155039	RIO VERDE	RV12000136	RIO VERDE S2	07/11/2019 14:38	07/11/2019 17:00	07/11/2019 14:38	07/11/2019 17:00	2,35	145	341,31	CHI
20191155055	APARECIDA DE GOIANIA	AP12356818	INDEPENDENCIA S2	07/11/2019 15:09	07/11/2019 19:35	07/11/2019 15:09	07/11/2019 19:26	4,28	506	2163,29	CHI
20191155055	APARECIDA DE GOIANIA	AP11078368	INDEPENDENCIA S2	07/11/2019 15:09	07/11/2019 19:35	07/11/2019 15:10	07/11/2019 19:35	4,42	194	856,83	CHI
20191155058	PETROLINA DE GOIAS	PG12216919	PETROLINA	07/11/2019 14:25	08/11/2019 13:33	07/11/2019 14:25	07/11/2019 19:31	5,10	6	30,58	CHI
20191155058	PETROLINA DE GOIAS	PG12216919	PETROLINA	07/11/2019 14:25	08/11/2019 13:33	08/11/2019 12:59	08/11/2019 13:33	0,57	6	3,41	CHI
20191155058	PETROLINA DE GOIAS	6411244	PETROLINA	07/11/2019 14:25	08/11/2019 13:33	07/11/2019 14:25	08/11/2019 13:33	23,14	2	46,28	CHI
20191155058	SAO FRANCISCO DE GOIAS	6411244	PETROLINA	07/11/2019 14:25	08/11/2019 13:33	07/11/2019 14:25	08/11/2019 13:33	23,14	1	23,14	CHI
20191155059	CRIXAS	GF12146937	SANTA TEREZINHA	07/11/2019 14:04	08/11/2019 20:24	07/11/2019 14:04	08/11/2019 20:24	30,33	206	6248,38	CHI

20191155059	GUARINOS	GF12146937	SANTA TEREZINHA	07/11/2019 14:04	08/11/2019 20:24	07/11/2019 14:04	08/11/2019 20:24	30,33	12	363,98	CHI
20191155059	CRIXAS	GF12146937	SANTA TEREZINHA	07/11/2019 14:04	08/11/2019 20:24	07/11/2019 23:02	08/11/2019 20:24	21,36	1	21,36	CHI
20191155065	LUZIANIA	LZ12376142	MARAJOARA	07/11/2019 15:23	07/11/2019 21:56	07/11/2019 15:23	07/11/2019 21:56	6,54	17	111,12	CHI
20191155073	MORRO AGUDO DE GOIAS	MS11270411	ITAPURANGA	07/11/2019 15:10	10/11/2019 14:40	07/11/2019 15:10	10/11/2019 14:40	71,50	182	13012,39	CHI
20191155076	ARAGARCAS	AG21152405	ARAGARCAS	07/11/2019 15:29	09/11/2019 10:20	07/11/2019 15:29	09/11/2019 10:20	42,84	1	42,84	CHI
20191155077	GOIANIA	10413157	GOIANIA LESTE S2	07/11/2019 15:29	07/11/2019 16:40	07/11/2019 15:29	07/11/2019 16:40	1,17	1	1,17	CHI
20191155078	CATALAO	CT12390635	CATALAO S2	07/11/2019 15:29	07/11/2019 22:46	07/11/2019 15:29	07/11/2019 22:46	7,27	3	21,81	CHI
20191155081	EDEIA	EA12000050	EDEIA	07/11/2019 11:24	09/11/2019 14:52	07/11/2019 11:24	09/11/2019 14:52	51,46	4	205,84	CHI
20191155088	CATALAO	CT21042484	CATALAO S1	07/11/2019 15:30	07/11/2019 22:12	07/11/2019 15:30	07/11/2019 22:12	6,68	1	6,68	CHI
20191155090	CIDADE OCIDENTAL	DH11156961	MARAJOARA	07/11/2019 11:06	07/11/2019 17:22	07/11/2019 11:06	07/11/2019 17:22	6,27	75	469,96	CHI
20191155099	ITAGUARU	IC11089314	ITABERAI S1	07/11/2019 14:57	07/11/2019 22:11	07/11/2019 14:57	07/11/2019 22:11	7,23	75	542,25	CHI
20191155101	NOVA CRIXAS	05630414	NOVA CRIXAS	07/11/2019 15:18	08/11/2019 13:10	07/11/2019 15:18	07/11/2019 18:19	3,02	4	12,07	CHI
20191155101	NOVA CRIXAS	05630414	NOVA CRIXAS	07/11/2019 15:18	08/11/2019 13:10	07/11/2019 15:18	07/11/2019 19:00	3,71	2	7,42	CHI
20191155101	ARUANA	05630414	NOVA CRIXAS	07/11/2019 15:18	08/11/2019 13:10	07/11/2019 15:18	07/11/2019 19:15	3,96	22	87,02	CHI
20191155101	NOVA CRIXAS	05630414	NOVA CRIXAS	07/11/2019 15:18	08/11/2019 13:10	07/11/2019 15:18	07/11/2019 19:15	3,96	83	328,31	CHI
20191155101	NOVA CRIXAS	05630414	NOVA CRIXAS	07/11/2019 15:18	08/11/2019 13:10	07/11/2019 15:18	07/11/2019 19:15	3,96	1124	4446,04	CHI
20191155101	NOVA CRIXAS	05630414	NOVA CRIXAS	07/11/2019 15:18	08/11/2019 13:10	07/11/2019 15:18	07/11/2019 19:15	3,96	9	35,60	CHI
20191155101	NOVA CRIXAS	05630414	NOVA CRIXAS	07/11/2019 15:18	08/11/2019 13:10	07/11/2019 15:18	08/11/2019 11:59	20,68	1	20,68	CHI
20191155101	NOVA CRIXAS	05630414	NOVA CRIXAS	07/11/2019 15:18	08/11/2019 13:10	07/11/2019 15:18	08/11/2019 13:10	21,88	5	109,39	CHI
20191155102	SANTO ANTONIO DE GOIAS	BW10401401	NEROPOLIS S1	07/11/2019 15:21	07/11/2019 18:28	07/11/2019 15:21	07/11/2019 18:28	3,12	1	3,12	CHI
20191155115	ORIZONA	2060024116	PIRES DO RIO S2	07/11/2019 16:19	07/11/2019 17:29	07/11/2019 16:19	07/11/2019 17:29	1,17	1	1,17	CHI
20191155135	NOVA CRIXAS	MH10400727	NOVA CRIXAS	07/11/2019 16:54	07/11/2019 22:45	07/11/2019 16:54	07/11/2019 20:27	3,56	217	772,04	CHI
20191155135	NOVA CRIXAS	MH10400727	NOVA CRIXAS	07/11/2019 16:54	07/11/2019 22:45	07/11/2019 16:56	07/11/2019 20:27	3,52	1	3,52	CHI
20191155135	NOVA CRIXAS	MH10400727	NOVA CRIXAS	07/11/2019 16:54	07/11/2019 22:45	07/11/2019 16:54	07/11/2019 21:59	5,09	844	4294,32	CHI
20191155135	NOVA CRIXAS	NA12328070	NOVA CRIXAS	07/11/2019 16:54	07/11/2019 22:45	07/11/2019 16:54	07/11/2019 22:45	5,85	113	661,24	CHI
20191155203	BONOPOLIS	BX12266016	SAO MIGUEL DO ARAGUAIA	07/11/2019 10:56	07/11/2019 21:03	07/11/2019 10:56	07/11/2019 21:03	10,11	8	80,89	CHI
20191155204	MORRINHOS	MR12292980	MORRINHOS	07/11/2019 15:32	07/11/2019 18:00	07/11/2019 15:32	07/11/2019 18:00	2,46	4	9,84	CHI
20191155209	NOVO GAMA	2460189637	PACAEMBU S1	07/11/2019 15:32	08/11/2019 07:16	07/11/2019 15:32	08/11/2019 07:16	15,72	1	15,72	CHI
20191155223	RIO VERDE	RV12365438	MONTIVIDIU T	07/11/2019 15:35	10/11/2019 12:23	07/11/2019 15:35	10/11/2019 12:23	68,81	2	137,63	CHI
20191155225	JARAGUA	JA12353260	GOIANESIA S2	07/11/2019 13:53	07/11/2019 18:17	07/11/2019 13:53	07/11/2019 18:17	4,39	179	785,46	CHI
20191155228	NOVO PLANALTO	SM12328903	SAO MIGUEL DO ARAGUAIA	07/11/2019 14:35	08/11/2019 23:55	07/11/2019 14:35	08/11/2019 23:55	33,32	9	299,86	CHI
20191155234	CAMPOS VERDES	SG12203146	SANTA TEREZINHA	07/11/2019 15:36	09/11/2019 08:09	07/11/2019 15:36	09/11/2019 08:09	40,54	8	324,33	CHI
20191155234	SANTA TEREZINHA DE GOIAS	SG12203146	SANTA TEREZINHA	07/11/2019 15:36	09/11/2019 08:09	07/11/2019 15:36	09/11/2019 08:09	40,54	8	324,33	CHI

20191155239	RIO VERDE	RV12029165	CABRIUVA S2	07/11/2019 15:20	08/11/2019 17:40	07/11/2019 15:20	08/11/2019 17:40	26,33	34	895,12	CHI
20191155242	MINACU	IH21292242	MINACU	07/11/2019 15:37	07/11/2019 21:46	07/11/2019 15:37	07/11/2019 21:46	6,14	1	6,14	CHI
20191155245	SAO MIGUEL DO ARAGUAIA	830072688	SAO MIGUEL DO ARAGUAIA	07/11/2019 15:38	08/11/2019 17:47	07/11/2019 15:38	08/11/2019 17:47	26,14	1	26,14	CHI
20191155247	IPAMERI	IP21279400	IPAMERI	07/11/2019 15:38	09/11/2019 17:22	07/11/2019 15:38	09/11/2019 17:22	49,72	1	49,72	CHI
20191155248	IVOLANDIA	IV12037918	IPORA	07/11/2019 15:38	10/11/2019 23:52	07/11/2019 15:38	10/11/2019 23:52	80,22	10	802,17	CHI
20191155266	CUMARI	CY12000318	CATALAO S1	07/11/2019 15:40	08/11/2019 18:00	07/11/2019 15:40	08/11/2019 18:00	26,32	2	52,63	CHI
20191155286	CACHOEIRA ALTA	CA12000077	CACHOEIRA ALTA	07/11/2019 14:04	08/11/2019 16:19	07/11/2019 14:04	08/11/2019 16:19	26,25	45	1181,14	CHI
20191155303	SENADOR CANEDO	190098363	SENADOR CANEDO	07/11/2019 15:45	07/11/2019 18:43	07/11/2019 15:45	07/11/2019 18:43	2,96	1	2,96	CHI
20191155307	RIO VERDE	RV21152076	CABRIUVA S2	07/11/2019 15:45	09/11/2019 18:05	07/11/2019 15:45	09/11/2019 18:05	50,33	1	50,33	CHI
20191155308	MORRO AGUDO DE GOIAS	MS21185126	ITAPURANGA	07/11/2019 15:45	09/11/2019 10:15	07/11/2019 15:45	09/11/2019 10:15	42,49	1	42,49	CHI
20191155309	BOM JESUS DE GOIAS	BJ12305342	BOM JESUS DE GOIAS	07/11/2019 15:20	16/11/2019 19:34	07/11/2019 15:20	15/11/2019 19:31	196,19	1	196,19	CHI
20191155309	GOIATUBA	BJ12305342	BOM JESUS DE GOIAS	07/11/2019 15:20	16/11/2019 19:34	07/11/2019 15:20	15/11/2019 19:31	196,19	3	588,57	CHI
20191155309	BOM JESUS DE GOIAS	BJ12305342	BOM JESUS DE GOIAS	07/11/2019 15:20	16/11/2019 19:34	15/11/2019 19:32	16/11/2019 19:34	24,05	1	24,05	CHI
20191155309	GOIATUBA	BJ12305342	BOM JESUS DE GOIAS	07/11/2019 15:20	16/11/2019 19:34	15/11/2019 19:32	16/11/2019 19:34	24,05	3	72,14	CHI
20191155313	ALTO PARAISO DE GOIAS	NQ12234731	NIQUELANDIA SUBTRANSMISSAO	07/11/2019 09:59	08/11/2019 15:51	07/11/2019 09:59	08/11/2019 15:51	29,87	12	358,48	CHI
20191155313	NIQUELANDIA	NQ12234731	NIQUELANDIA SUBTRANSMISSAO	07/11/2019 09:59	08/11/2019 15:51	07/11/2019 09:59	08/11/2019 15:51	29,87	14	418,23	CHI
20191155313	SAO JOAO D ALIANCA	NQ12234731	NIQUELANDIA SUBTRANSMISSAO	07/11/2019 09:59	08/11/2019 15:51	07/11/2019 09:59	08/11/2019 15:51	29,87	1	29,87	CHI
20191155314	IPAMERI	IP12108218	IPAMERI	07/11/2019 15:18	08/11/2019 01:15	07/11/2019 15:18	08/11/2019 01:15	9,93	249	2473,54	CHI
20191155327	DAMOLANDIA	NV13319338	INHUMAS S1	07/11/2019 15:42	07/11/2019 23:04	07/11/2019 15:42	07/11/2019 23:04	7,36	3	22,09	CHI
20191155327	NEROPOLIS	NV13319338	INHUMAS S1	07/11/2019 15:42	07/11/2019 23:04	07/11/2019 15:42	07/11/2019 23:04	7,36	2	14,73	CHI
20191155327	NOVA VENEZA	NV13319338	INHUMAS S1	07/11/2019 15:42	07/11/2019 23:04	07/11/2019 15:42	07/11/2019 23:04	7,36	304	2238,71	CHI
20191155327	OURO VERDE DE GOIAS	NV13319338	INHUMAS S1	07/11/2019 15:42	07/11/2019 23:04	07/11/2019 15:42	07/11/2019 23:04	7,36	47	346,12	CHI
20191155327	SANTO ANTONIO DE GOIAS	NV13319338	INHUMAS S1	07/11/2019 15:42	07/11/2019 23:04	07/11/2019 15:42	07/11/2019 23:04	7,36	1	7,36	CHI
20191155327	NEROPOLIS	NV13319338	INHUMAS S1	07/11/2019 15:42	07/11/2019 23:04	07/11/2019 22:57	07/11/2019 23:04	0,12	8	0,99	CHI
20191155327	NOVA VENEZA	NV13319338	INHUMAS S1	07/11/2019 15:42	07/11/2019 23:04	07/11/2019 22:57	07/11/2019 23:04	0,12	1488	184,35	CHI
20191155337	CATALAO	CT21333403	CATALAO S1	07/11/2019 15:47	08/11/2019 08:58	07/11/2019 15:47	08/11/2019 08:58	17,18	1	17,18	CHI
20191155339	IACIARA	IA11242858	IACIARA S1	07/11/2019 14:44	07/11/2019 16:49	07/11/2019 14:44	07/11/2019 16:49	2,08	19	39,55	CHI
20191155351	JARAGUA	JA21000180	JARAGUA	07/11/2019 15:47	08/11/2019 09:25	07/11/2019 15:47	08/11/2019 09:25	17,62	2	35,23	CHI
20191155365	CRISTALINA	KR12171525	PAMPLONA	07/11/2019 15:48	08/11/2019 11:20	07/11/2019 15:48	08/11/2019 11:20	19,52	17	331,85	CHI
20191155373	NIQUELANDIA	10007951343	NIQUELANDIA SUBTRANSMISSAO	07/11/2019 15:49	08/11/2019 00:23	07/11/2019 15:49	08/11/2019 00:23	8,56	1	8,56	CHI
20191155375	GOIANIA	GN11166709	REAL S2	07/11/2019 15:49	07/11/2019 18:34	07/11/2019 15:49	07/11/2019 18:34	2,74	86	235,88	CHI
20191155378	CATALAO	CT21333406	CATALAO S1	07/11/2019 15:49	10/11/2019 09:54	07/11/2019 15:49	10/11/2019 09:54	66,07	1	66,07	CHI
20191155383	ITAGUARU	IC11154617	ITABERAÍ S1	07/11/2019 15:17	07/11/2019 22:41	07/11/2019 15:17	07/11/2019 22:41	7,39	155	1145,49	CHI

20191155395	RIO VERDE	RV12260127	CABRIUVA S1	07/11/2019 15:07	09/11/2019 10:15	07/11/2019 15:07	09/11/2019 10:15	43,14	2	86,27	CHI
20191155398	NOVA VENEZA	NV21211025	INHUMAS S1	07/11/2019 15:42	08/11/2019 12:41	07/11/2019 15:42	08/11/2019 12:41	20,97	2	41,95	CHI
20191155404	CRISTALINA	KR21304958	CRISTALINA S2	07/11/2019 15:52	08/11/2019 02:30	07/11/2019 15:52	08/11/2019 02:30	10,63	1	10,63	CHI
20191155406	JARAGUA	JA12097017	GOIANESIA S2	07/11/2019 15:52	07/11/2019 19:18	07/11/2019 15:52	07/11/2019 19:18	3,42	7	23,96	CHI
20191155410	LUZIANIA	120071629	RIO VERMELHO	07/11/2019 15:53	07/11/2019 17:36	07/11/2019 15:53	07/11/2019 17:36	1,72	1	1,72	CHI
20191155421	BRITANIA	BT11171782	BRITANIA	07/11/2019 15:54	08/11/2019 08:26	07/11/2019 15:54	08/11/2019 08:26	16,53	96	1587,04	CHI
20191155425	INHUMAS	IN12205503	INHUMAS S2	07/11/2019 15:42	07/11/2019 16:50	07/11/2019 15:42	07/11/2019 16:50	1,13	457	516,79	CHI
20191155427	TRINDADE	TR11222155	TRINDADE	07/11/2019 15:54	07/11/2019 17:33	07/11/2019 15:54	07/11/2019 17:33	1,64	25	41,08	CHI
20191155431	IPORA	IR12233159	IPORA	07/11/2019 15:17	07/11/2019 17:11	07/11/2019 15:17	07/11/2019 17:11	1,89	371	700,88	CHI
20191155438	GOIANIA	GN11001949	CAMPINAS S3	07/11/2019 15:47	07/11/2019 18:47	07/11/2019 15:47	07/11/2019 18:47	2,99	86	256,88	CHI
20191155440	INHUMAS	30150577	INHUMAS S2	07/11/2019 15:55	08/11/2019 03:13	07/11/2019 15:55	08/11/2019 03:13	11,30	1	11,30	CHI
20191155442	JESUPOLIS	SF12066036	SAO FRANCISCO DE GOIAS	07/11/2019 15:44	07/11/2019 17:38	07/11/2019 15:44	07/11/2019 17:38	1,88	16	30,15	CHI
20191155443	GOIANIA	GN11000196	FERROVIARIO S3	07/11/2019 15:55	07/11/2019 20:11	07/11/2019 15:55	07/11/2019 20:11	4,26	23	97,87	CHI
20191155448	RIO VERDE	RV11213463	RIO VERDE S2	07/11/2019 15:22	07/11/2019 17:20	07/11/2019 15:22	07/11/2019 17:20	1,95	136	265,54	CHI
20191155456	ITAPACI	IW11044776	ITAPACI	07/11/2019 14:05	07/11/2019 16:58	07/11/2019 14:05	07/11/2019 16:58	2,87	164	471,36	CHI
20191155459	TRINDADE	TR12323750	TRINDADE	07/11/2019 15:56	07/11/2019 18:00	07/11/2019 15:56	07/11/2019 18:00	2,06	2	4,12	CHI
20191155466	CRISTALINA	KR12184956	CRISTALINA S2	07/11/2019 15:56	08/11/2019 01:35	07/11/2019 15:56	08/11/2019 01:35	9,63	48	462,45	CHI
20191155468	CALDAS NOVAS	CN21000082	CALDAS NOVAS S2	07/11/2019 15:57	09/11/2019 16:34	07/11/2019 15:57	09/11/2019 16:34	48,62	1	48,62	CHI
20191155480	GOIANIA	GN11167774	ATLANTICO S1	07/11/2019 15:53	07/11/2019 20:32	07/11/2019 15:53	07/11/2019 20:32	4,63	89	412,49	CHI
20191155489	CACU	CC12226513	CACHOEIRA ALTA	07/11/2019 07:34	07/11/2019 17:34	07/11/2019 07:34	07/11/2019 17:34	10,00	3	30,00	CHI
20191155493	NOVA VENEZA	NV11229800	INHUMAS S1	07/11/2019 15:42	08/11/2019 02:35	07/11/2019 15:42	08/11/2019 02:35	10,87	92	1000,35	CHI
20191155504	JARAGUA	JA21339792	GOIANESIA S2	07/11/2019 15:59	07/11/2019 19:35	07/11/2019 15:59	07/11/2019 19:35	3,59	4	14,36	CHI
20191155516	FAINA	FC12228930	GOIAS	07/11/2019 16:00	08/11/2019 16:21	07/11/2019 16:00	08/11/2019 16:21	24,36	10	243,58	CHI
20191155517	GOIANIA	GN12001527	GOYA S1	07/11/2019 15:58	07/11/2019 17:56	07/11/2019 15:58	07/11/2019 17:56	1,95	60	117,12	CHI
20191155523	ARUANA	AK12066611	ARUANA	07/11/2019 16:00	09/11/2019 11:09	07/11/2019 16:00	09/11/2019 11:09	43,14	13	560,81	CHI
20191155526	RUBIATABA	RB21291690	RUBIATABA	07/11/2019 16:00	07/11/2019 18:56	07/11/2019 16:00	07/11/2019 18:56	2,92	1	2,92	CHI
20191155530	NIQUELANDIA	NQ12397520	URUACU	07/11/2019 16:01	09/11/2019 11:00	07/11/2019 16:01	09/11/2019 11:00	42,98	3	128,95	CHI
20191155534	ARENOPOLIS	AY12358539	ARENOPOLIS	07/11/2019 16:01	12/11/2019 21:33	07/11/2019 16:01	12/11/2019 21:33	125,53	1	125,53	CHI
20191155534	PALESTINA DE GOIAS	AY12358539	ARENOPOLIS	07/11/2019 16:01	12/11/2019 21:33	07/11/2019 16:01	12/11/2019 21:33	125,53	7	878,69	CHI
20191155536	APARECIDA DE GOIANIA	AP11085125	ATLANTICO S1	07/11/2019 15:06	07/11/2019 19:20	07/11/2019 15:06	07/11/2019 19:20	4,23	89	376,32	CHI
20191155541	INACIOLANDIA	ID31128232	QUIRINOPOLIS	07/11/2019 16:01	08/11/2019 17:01	07/11/2019 16:01	08/11/2019 17:01	24,99	1	24,99	CHI
20191155548	MARA ROSA	AJ12089925	MARA ROSA	07/11/2019 16:02	09/11/2019 21:13	07/11/2019 16:02	09/11/2019 21:13	53,18	2	106,36	CHI
20191155560	GOIANIA	GN11199222	MEIA PONTE	07/11/2019 15:48	07/11/2019 17:23	07/11/2019 15:48	07/11/2019 17:23	1,57	98	154,16	CHI

20191155561	GOIANIA	GN10394640	XAVANTES	07/11/2019 15:45	07/11/2019 22:51	07/11/2019 15:45	07/11/2019 18:37	2,87	637	1825,36	CHI
20191155561	SANTO ANTONIO DE GOIAS	GN10394640	XAVANTES	07/11/2019 15:45	07/11/2019 22:51	07/11/2019 15:45	07/11/2019 18:37	2,87	14	40,12	CHI
20191155561	GOIANIA	GN12002287	XAVANTES	07/11/2019 15:45	07/11/2019 22:51	07/11/2019 15:45	07/11/2019 19:22	3,63	32	116,05	CHI
20191155561	GOIANIA	GN13000437	XAVANTES	07/11/2019 15:45	07/11/2019 22:51	07/11/2019 15:45	07/11/2019 20:06	4,36	628	2739,30	CHI
20191155561	GOIANIA	GN12054911	XAVANTES	07/11/2019 15:45	07/11/2019 22:51	07/11/2019 15:45	07/11/2019 20:30	4,75	3	14,25	CHI
20191155561	GOIANIA	GN12159195	XAVANTES	07/11/2019 15:45	07/11/2019 22:51	07/11/2019 15:45	07/11/2019 21:10	5,42	5	27,08	CHI
20191155561	GOIANIA	GN11159197	XAVANTES	07/11/2019 15:45	07/11/2019 22:51	07/11/2019 15:45	07/11/2019 22:50	7,10	25	177,47	CHI
20191155561	GOIANIA	GN11355975	XAVANTES	07/11/2019 15:45	07/11/2019 22:51	07/11/2019 15:45	07/11/2019 22:51	7,11	40	284,59	CHI
20191155562	GOIANIA	10002246790	MEIA PONTE	07/11/2019 16:03	07/11/2019 18:09	07/11/2019 16:03	07/11/2019 18:09	2,09	0	0,00	CHI
20191155565	ITAGUARI	II12025632	ITABERAI S1	07/11/2019 14:14	08/11/2019 16:08	07/11/2019 14:14	08/11/2019 16:08	25,89	14	362,49	CHI
20191155565	JARAGUA	II12025632	ITABERAI S1	07/11/2019 14:14	08/11/2019 16:08	07/11/2019 14:14	08/11/2019 16:08	25,89	2	51,78	CHI
20191155566	RIO VERDE	RV11240310	RIO VERDE S1	07/11/2019 14:46	07/11/2019 17:00	07/11/2019 14:46	07/11/2019 17:00	2,22	117	259,77	CHI
20191155571	APARECIDA DE GOIANIA	AP11003038	REAL S2	07/11/2019 16:00	07/11/2019 17:46	07/11/2019 16:00	07/11/2019 17:46	1,75	218	382,11	CHI
20191155575	NOVA IGUAQU DE GOIAS	CR21038702	CAMPINORTE	07/11/2019 16:05	08/11/2019 16:43	07/11/2019 16:05	08/11/2019 16:43	24,62	1	24,62	CHI
20191155576	CRISTALINA	KR21147562	CRISTALINA S2	07/11/2019 16:05	07/11/2019 18:43	07/11/2019 16:05	07/11/2019 18:43	2,62	1	2,62	CHI
20191155594	RIO VERDE	RV11000020	RIO VERDE S2	07/11/2019 15:47	08/11/2019 03:30	07/11/2019 15:47	08/11/2019 03:30	11,71	92	1077,29	CHI
20191155609	GOIANIA	GN11001852	CAMPINAS S3	07/11/2019 15:50	07/11/2019 19:04	07/11/2019 15:50	07/11/2019 19:04	3,23	113	364,52	CHI
20191155613	ARUANA	AK21220023	BRITANIA	07/11/2019 16:08	09/11/2019 09:37	07/11/2019 16:08	09/11/2019 09:37	41,48	1	41,48	CHI
20191155617	NOVO PLANALTO	SM12020677	SAO MIGUEL DO ARAGUAIA	07/11/2019 16:08	09/11/2019 10:42	07/11/2019 16:08	09/11/2019 10:42	42,56	7	297,95	CHI
20191155617	SAO MIGUEL DO ARAGUAIA	SM12020677	SAO MIGUEL DO ARAGUAIA	07/11/2019 16:08	09/11/2019 10:42	07/11/2019 16:08	09/11/2019 10:42	42,56	37	1574,86	CHI
20191155620	CALDAS NOVAS	10030308788	SERRA DE CALDAS	07/11/2019 16:08	07/11/2019 18:06	07/11/2019 16:08	07/11/2019 18:06	1,95	1	1,95	CHI
20191155623	MINEIROS	MY12043892	PARQUE DAS EMAS	07/11/2019 14:46	09/11/2019 02:50	07/11/2019 14:46	09/11/2019 02:50	36,05	14	504,76	CHI
20191155625	IPORA	IR11060654	IPORA	07/11/2019 15:44	08/11/2019 02:57	07/11/2019 15:44	08/11/2019 00:35	8,85	148	1309,96	CHI
20191155625	IPORA	IR12060650	IPORA	07/11/2019 15:44	08/11/2019 02:57	08/11/2019 00:40	08/11/2019 01:00	0,33	148	49,29	CHI
20191155625	IPORA	IR11402916	IPORA	07/11/2019 15:44	08/11/2019 02:57	07/11/2019 15:44	08/11/2019 02:57	11,21	97	1087,48	CHI
20191155645	SAO FRANCISCO DE GOIAS	SF21017615	SAO FRANCISCO DE GOIAS	07/11/2019 16:11	07/11/2019 19:20	07/11/2019 16:11	07/11/2019 19:20	3,14	1	3,14	CHI
20191155654	MONTIVIDIU	MV12295830	MONTIVIDIU T	07/11/2019 08:32	09/11/2019 09:27	07/11/2019 08:32	09/11/2019 09:27	48,91	19	929,30	CHI
20191155657	BELA VISTA DE GOIAS	BV21299255	BELA VISTA S1	07/11/2019 16:12	07/11/2019 19:28	07/11/2019 16:12	07/11/2019 19:28	3,25	1	3,25	CHI
20191155662	GOIANIA	GN11150241	GOYA S2	07/11/2019 16:12	08/11/2019 07:00	07/11/2019 16:12	08/11/2019 07:00	14,79	182	2691,38	CHI
20191155664	SANTA ISABEL	GE12000139	GOIANESIA S1	07/11/2019 13:55	07/11/2019 18:55	07/11/2019 13:55	07/11/2019 18:55	4,99	14	69,89	CHI
20191155675	GOIANIA	GN11198747	CARAJAS S2	07/11/2019 15:56	07/11/2019 17:30	07/11/2019 15:56	07/11/2019 17:30	1,57	94	147,14	CHI
20191155690	URUACU	UR21237442	URUACU	07/11/2019 16:15	08/11/2019 09:35	07/11/2019 16:15	08/11/2019 09:35	17,33	1	17,33	CHI
20191155691	GOIANIA	GN12234819	GOYA S1	07/11/2019 15:52	07/11/2019 18:56	07/11/2019 15:52	07/11/2019 18:56	3,07	111	340,46	CHI

20191155700	GAMELEIRA DE GOIAS	SV12115579	VIANOPOLIS	07/11/2019 16:11	08/11/2019 13:13	07/11/2019 16:11	08/11/2019 13:13	21,03	6	126,16	CHI
20191155702	SILVANIA	SV21094737	DAIA S2	07/11/2019 16:16	08/11/2019 17:54	07/11/2019 16:16	08/11/2019 17:54	25,63	1	25,63	CHI
20191155704	INHUMAS	IN12047634	INHUMAS S2	07/11/2019 15:46	07/11/2019 17:50	07/11/2019 15:46	07/11/2019 17:50	2,06	170	350,58	CHI
20191155706	TRINDADE	14856190	GOYA S2	06/11/2019 17:03	07/11/2019 09:44	06/11/2019 17:03	07/11/2019 09:44	16,67	1	16,67	CHI
20191155707	CATALAO	CT12130960RE	CATALAO S2	07/11/2019 10:02	07/11/2019 17:19	07/11/2019 10:02	07/11/2019 17:19	7,27	34	247,31	CHI
20191155707	CUMARI	CT12130960RE	CATALAO S2	07/11/2019 10:02	07/11/2019 17:19	07/11/2019 10:02	07/11/2019 17:19	7,27	162	1178,37	CHI
20191155707	GOIANDIRA	CT12130960RE	CATALAO S2	07/11/2019 10:02	07/11/2019 17:19	07/11/2019 10:02	07/11/2019 17:19	7,27	3	21,82	CHI
20191155709	LUZIANIA	LZ11192883	RIO VERMELHO	07/11/2019 16:16	07/11/2019 17:45	07/11/2019 16:16	07/11/2019 17:45	1,47	56	82,54	CHI
20191155710	APARECIDA DE GOIANIA	AP11164431	REAL S1	07/11/2019 16:08	07/11/2019 18:51	07/11/2019 16:08	07/11/2019 18:51	2,70	127	343,36	CHI
20191155711	GOIANIA	02330264	MEIA PONTE	07/11/2019 16:10	07/11/2019 18:20	07/11/2019 16:10	07/11/2019 16:13	0,05	1664	87,82	CHI
20191155711	GOIANIA	GN16405763	MEIA PONTE	07/11/2019 16:10	07/11/2019 18:20	07/11/2019 16:10	07/11/2019 16:15	0,08	1384	117,64	CHI
20191155711	GOIANIA	GN16405763	XAVANTES	07/11/2019 16:10	07/11/2019 18:20	07/11/2019 16:10	07/11/2019 16:15	0,08	5260	447,10	CHI
20191155711	GOIANIA	GN10384933	MEIA PONTE	07/11/2019 16:10	07/11/2019 18:20	07/11/2019 16:10	07/11/2019 18:20	2,17	4089	8857,23	CHI
20191155722	NOVA AURORA	NE12127530	CATALAO S1	07/11/2019 16:06	07/11/2019 20:38	07/11/2019 16:06	07/11/2019 20:38	4,52	178	804,71	CHI
20191155723	NOVA VENEZA	NV12200061	INHUMAS S1	07/11/2019 15:21	07/11/2019 18:10	07/11/2019 15:21	07/11/2019 18:10	2,80	269	753,27	CHI
20191155728	CRISTALINA	KR11170459	CRISTALINA S2	07/11/2019 16:18	08/11/2019 02:01	07/11/2019 16:18	08/11/2019 02:01	9,71	1	9,71	CHI
20191155729	SANTO ANTONIO DO DESCOBERTO	SN12163756	AGUAS LINDAS DE GOIAS S2	07/11/2019 16:18	07/11/2019 20:50	07/11/2019 16:18	07/11/2019 20:50	4,53	4	18,12	CHI
20191155733	SANCLERLANDIA	SC21006134	FIRMINOPOLIS S2	07/11/2019 16:18	08/11/2019 08:40	07/11/2019 16:18	08/11/2019 08:40	16,38	2	32,75	CHI
20191155738	BRAZABRANTES	BR11199248	INHUMAS S2	07/11/2019 15:48	07/11/2019 18:51	07/11/2019 15:48	07/11/2019 18:51	3,04	58	176,26	CHI
20191155772	FLORES DE GOIAS	FB12270839	IACIARA S2	07/11/2019 14:40	07/11/2019 22:39	07/11/2019 14:40	07/11/2019 22:39	7,97	23	183,34	CHI
20191155772	FORMOSA	FB12270839	IACIARA S2	07/11/2019 14:40	07/11/2019 22:39	07/11/2019 14:40	07/11/2019 22:39	7,97	1	7,97	CHI
20191155772	VILA BOA	FB12270839	IACIARA S2	07/11/2019 14:40	07/11/2019 22:39	07/11/2019 14:40	07/11/2019 22:39	7,97	4	31,89	CHI
20191155776	NOVA CRIXAS	NA12040307	NOVA CRIXAS	07/11/2019 16:19	08/11/2019 15:20	07/11/2019 16:19	08/11/2019 15:20	23,02	5	115,10	CHI
20191155794	FORMOSA	FA12245453	ITIQUEIRA	07/11/2019 13:51	08/11/2019 11:07	07/11/2019 13:51	08/11/2019 11:07	21,26	3	63,77	CHI
20191155797	ARENOPOLIS	AY12040870	ARENOPOLIS	07/11/2019 16:24	08/11/2019 09:59	07/11/2019 16:24	08/11/2019 09:59	17,58	24	421,87	CHI
20191155801	VILA PROPICIO	NP12384850	GOIANESIA S1	07/11/2019 16:25	07/11/2019 18:50	07/11/2019 16:25	07/11/2019 18:50	2,41	5	12,07	CHI
20191155806	RUBIATABA	RB12197854	RUBIATABA	07/11/2019 16:06	08/11/2019 01:12	07/11/2019 16:06	08/11/2019 01:12	9,09	10	90,95	CHI
20191155819	CAVALCANTE	TI12162624	NIQUELANDIA SUBTRANSMISSAO	07/11/2019 16:14	08/11/2019 08:07	07/11/2019 16:14	08/11/2019 08:07	15,87	1	15,87	CHI
20191155819	COLINAS DO SUL	TI12162624	NIQUELANDIA SUBTRANSMISSAO	07/11/2019 16:14	08/11/2019 08:07	07/11/2019 16:14	08/11/2019 08:07	15,87	5	79,36	CHI
20191155820	SAO LUIS DE MONTES BELOS	SL21132260	SAO LUIZ DOS MONTES BELOS	07/11/2019 16:26	08/11/2019 08:25	07/11/2019 16:26	08/11/2019 08:25	15,97	3	47,92	CHI
20191155822	PALMEIRAS DE GOIAS	PL21382606	PALMEIRAS	07/11/2019 16:26	08/11/2019 15:02	07/11/2019 16:26	08/11/2019 15:02	22,59	1	22,59	CHI
20191155829	GOIANIA	GN11167695	ATLANTICO S3	07/11/2019 15:56	07/11/2019 17:43	07/11/2019 15:56	07/11/2019 17:43	1,77	109	193,05	CHI
20191155834	GOUVELANDIA	GB21296588	QUIRINOPOLIS	07/11/2019 16:27	09/11/2019 12:40	07/11/2019 16:27	09/11/2019 12:40	44,20	1	44,20	CHI

20191155840	LUZIANIA	120421628	RIO VERMELHO	07/11/2019 16:28	08/11/2019 09:34	07/11/2019 16:28	08/11/2019 09:34	17,09	1	17,09	CHI
20191155842	NOVA CRIXAS	NA12181597	NOVA CRIXAS	07/11/2019 16:28	11/11/2019 12:08	07/11/2019 16:28	11/11/2019 12:08	91,66	3	274,99	CHI
20191155843	SAO MIGUEL DO ARAGUAIA	SM12089293	SAO MIGUEL DO ARAGUAIA	07/11/2019 15:22	08/11/2019 21:20	07/11/2019 15:22	08/11/2019 21:20	29,96	18	539,28	CHI
20191155844	ITABERAI	IB12336526	ITABERAI S1	07/11/2019 16:27	07/11/2019 23:25	07/11/2019 16:27	07/11/2019 23:25	6,96	3	20,89	CHI
20191155846	IPORA	IR11323879	IPORA	07/11/2019 15:53	08/11/2019 05:51	07/11/2019 15:53	08/11/2019 05:51	13,96	119	1661,54	CHI
20191155849	NOVA VENEZA	NV12323108	NEROPOLIS S1	07/11/2019 15:50	07/11/2019 18:41	07/11/2019 15:50	07/11/2019 18:41	2,84	4	11,37	CHI
20191155858	PALMINOPOLIS	RP12259184	FIRMINOPOLIS S2	07/11/2019 14:02	08/11/2019 10:06	07/11/2019 14:02	08/11/2019 10:06	20,06	2	40,11	CHI
20191155858	SAO JOAO DA PARAUNA	RP12259184	FIRMINOPOLIS S2	07/11/2019 14:02	08/11/2019 10:06	07/11/2019 14:02	08/11/2019 10:06	20,06	6	120,34	CHI
20191155864	ITAPACI	IW12201633	ITAPACI	07/11/2019 16:27	08/11/2019 00:40	07/11/2019 16:27	08/11/2019 00:40	8,20	11	90,22	CHI
20191155874	GOIANIA	GN11187576	REAL S2	07/11/2019 16:05	07/11/2019 21:33	07/11/2019 16:05	07/11/2019 21:33	5,46	29	158,28	CHI
20191155876	ABADIANIA	350035258	ANAPOLIS UNIVERSITARIO S1	07/11/2019 16:32	07/11/2019 22:06	07/11/2019 16:32	07/11/2019 22:06	5,56	1	5,56	CHI
20191155884	GOIANIA	GN11042202	GOYA S2	07/11/2019 15:46	07/11/2019 17:47	07/11/2019 15:46	07/11/2019 17:47	2,00	166	332,41	CHI
20191155891	INHUMAS	IN11168387	INHUMAS S2	07/11/2019 15:53	07/11/2019 22:00	07/11/2019 15:53	07/11/2019 22:00	6,11	39	238,33	CHI
20191155898	MONTES CLAROS DE GOIAS	ME11091486	IPORA	07/11/2019 16:34	08/11/2019 17:49	07/11/2019 16:34	08/11/2019 17:49	25,25	74	1868,52	CHI
20191155906	CORUMBAIBA	IP12199861	IPAMERI	07/11/2019 15:33	08/11/2019 10:53	07/11/2019 15:33	08/11/2019 10:53	19,33	2	38,66	CHI
20191155906	IPAMERI	IP12199861	IPAMERI	07/11/2019 15:33	08/11/2019 10:53	07/11/2019 15:33	08/11/2019 10:53	19,33	2	38,66	CHI
20191155908	ITAPACI	IW12201725	ITAPACI	07/11/2019 14:13	07/11/2019 17:44	07/11/2019 14:13	07/11/2019 17:44	3,50	663	2322,16	CHI
20191155912	NIQUELANDIA	NQ12266021	NIQUELANDIA SUBTRANSMISSAO	07/11/2019 14:04	08/11/2019 08:10	07/11/2019 14:04	08/11/2019 08:10	18,10	3	54,29	CHI
20191155930	RIO VERDE	RV21279573	CABRIUVA S1	07/11/2019 16:36	08/11/2019 22:25	07/11/2019 16:36	08/11/2019 22:25	29,81	1	29,81	CHI
20191155936	GOIANIA	GN11090175	MEIA PONTE	07/11/2019 16:18	07/11/2019 21:02	07/11/2019 16:18	07/11/2019 21:02	4,72	188	888,14	CHI
20191155937	SENADOR CANEDO	10015993009	SENADOR CANEDO	07/11/2019 16:36	07/11/2019 18:09	07/11/2019 16:36	07/11/2019 18:09	1,54	1	1,54	CHI
20191155941	ANAPOLIS	AN11000402	JUNDIAI S2	07/11/2019 16:38	07/11/2019 18:10	07/11/2019 16:38	07/11/2019 18:10	1,53	95	145,56	CHI
20191155942	PALESTINA DE GOIAS	3370000979	PALESTINA	07/11/2019 16:37	08/11/2019 12:30	07/11/2019 16:37	08/11/2019 12:30	19,89	1	19,89	CHI
20191155948	CAMPESTRE DE GOIAS	GC11193206	TRINDADE	07/11/2019 16:24	07/11/2019 18:38	07/11/2019 16:24	07/11/2019 18:38	2,23	177	394,51	CHI
20191155949	ALTO PARAISO DE GOIAS	3870000397	FLORES DE GOIAS	07/11/2019 16:38	08/11/2019 12:07	07/11/2019 16:38	08/11/2019 12:07	19,48	1	19,48	CHI
20191155950	GOIANIA	GN12001853	FERROVIARIO S3	07/11/2019 15:58	07/11/2019 20:10	07/11/2019 15:58	07/11/2019 20:10	4,19	139	582,83	CHI
20191155954	BELA VISTA DE GOIAS	BV21108625	BELA VISTA S1	07/11/2019 16:38	07/11/2019 21:30	07/11/2019 16:38	07/11/2019 21:30	4,85	1	4,85	CHI
20191155957	GOIANIA	GN12050431	GOIANIA LESTE S2	07/11/2019 16:18	07/11/2019 18:01	07/11/2019 16:18	07/11/2019 18:01	1,71	325	556,83	CHI
20191155958	APARECIDA DE GOIANIA	200046238	INDEPENDENCIA S2	07/11/2019 16:39	07/11/2019 18:02	07/11/2019 16:39	07/11/2019 18:02	1,38	1	1,38	CHI
20191155961	NAZARIO	10009817105	ANICUNS	06/11/2019 18:03	07/11/2019 01:00	06/11/2019 18:03	07/11/2019 01:00	6,94	1	6,94	CHI
20191155962	BRAZABRANTES	BR21193097	NEROPOLIS S1	07/11/2019 16:39	08/11/2019 13:05	07/11/2019 16:39	08/11/2019 13:05	20,42	1	20,42	CHI
20191155967	BRAZABRANTES	BR11101109	NEROPOLIS S1	07/11/2019 16:23	07/11/2019 20:30	07/11/2019 16:23	07/11/2019 20:30	4,10	60	246,07	CHI
20191155969	CRISTALINA	KR12313552	CRISTALINA S2	07/11/2019 16:23	07/11/2019 17:48	07/11/2019 16:23	07/11/2019 17:48	1,41	28	39,45	CHI

20191155974	AMERICANO DO BRASIL	KB12000001	ANICUNS	07/11/2019 16:41	08/11/2019 11:00	07/11/2019 16:41	08/11/2019 11:00	18,32	7	128,21	CHI
20191155986	INDIARA	IY21124604	EDEIA	07/11/2019 16:42	07/11/2019 20:03	07/11/2019 16:42	07/11/2019 20:03	3,36	1	3,36	CHI
20191155993	APARECIDA DE GOIANIA	AP11003030	INDEPENDENCIA S1	07/11/2019 16:29	07/11/2019 17:52	07/11/2019 16:29	07/11/2019 17:52	1,37	106	145,51	CHI
20191155996	GOIANIA	GN12151986	MEIA PONTE	07/11/2019 15:59	07/11/2019 21:16	07/11/2019 15:59	07/11/2019 21:16	5,28	542	2861,61	CHI
20191156008	FORMOSA	FA12404370	SAO JOAO D ALIANCA	07/11/2019 16:44	08/11/2019 05:49	07/11/2019 16:44	08/11/2019 05:49	13,08	6	78,47	CHI
20191156014	GOIANIA	GN11257210	GOYA S1	08/11/2019 01:50	08/11/2019 12:27	08/11/2019 01:50	08/11/2019 12:27	10,60	115	1219,26	CHI
20191156015	GOIANIA	GN11002224	CAMPINAS S3	07/11/2019 16:14	07/11/2019 18:48	07/11/2019 16:14	07/11/2019 18:48	2,55	62	158,19	CHI
20191156021	IPAMERI	IP12404720	IPAMERI	07/11/2019 16:40	09/11/2019 11:45	07/11/2019 16:40	09/11/2019 11:45	43,08	7	301,56	CHI
20191156031	SAO JOAO D ALIANCA	JL12314488	SAO JOAO D ALIANCA	07/11/2019 16:09	08/11/2019 15:20	07/11/2019 16:09	08/11/2019 15:20	23,17	8	185,40	CHI
20191156032	ITABERAI	50056815	ITABERAI S2	07/11/2019 16:47	08/11/2019 13:40	07/11/2019 16:47	08/11/2019 13:40	20,88	1	20,88	CHI
20191156035	APARECIDA DE GOIANIA	AP11077147	INDEPENDENCIA S2	07/11/2019 16:25	07/11/2019 20:27	07/11/2019 16:25	07/11/2019 20:27	4,03	138	556,33	CHI
20191156041	GOIANIRA	10013863434	MEIA PONTE	07/11/2019 16:48	08/11/2019 15:30	07/11/2019 16:48	08/11/2019 15:30	22,70	1	22,70	CHI
20191156044	ITABERAI	IB12336527	ITABERAI S2	07/11/2019 15:54	08/11/2019 00:48	07/11/2019 15:54	08/11/2019 00:48	8,90	219	1948,37	CHI
20191156045	JOVIANIA	JV21375785	GOIATUBA S1	07/11/2019 16:49	10/11/2019 16:21	07/11/2019 16:49	10/11/2019 16:21	71,53	1	71,53	CHI
20191156046	FORMOSA	FA21042751	SAO JOAO D ALIANCA	07/11/2019 16:49	07/11/2019 18:43	07/11/2019 16:49	07/11/2019 18:43	1,89	1	1,89	CHI
20191156052	TRINDADE	TR11187594	GOYA S1	07/11/2019 16:50	07/11/2019 18:20	07/11/2019 16:50	07/11/2019 18:20	1,50	98	147,08	CHI
20191156054	NOVA AMERICA	RB12251987	RUBIATABA	07/11/2019 16:50	08/11/2019 12:53	07/11/2019 16:50	08/11/2019 12:53	20,04	3	60,12	CHI
20191156054	RUBIATABA	RB12251987	RUBIATABA	07/11/2019 16:50	08/11/2019 12:53	07/11/2019 16:50	08/11/2019 12:53	20,04	6	120,25	CHI
20191156056	CACHOEIRA DOURADA	CD13000012	CACHOEIRA DOURADA	07/11/2019 16:40	09/11/2019 11:42	07/11/2019 16:40	08/11/2019 20:20	27,66	685	18947,86	CHI
20191156056	CACHOEIRA DOURADA	00280404	CACHOEIRA DOURADA	07/11/2019 16:40	09/11/2019 11:42	07/11/2019 16:40	09/11/2019 01:06	32,44	6	194,62	CHI
20191156056	ITUMBIARA	00280404	CACHOEIRA DOURADA	07/11/2019 16:40	09/11/2019 11:42	07/11/2019 16:40	09/11/2019 01:06	32,44	3	97,31	CHI
20191156056	CACHOEIRA DOURADA	00280404	CACHOEIRA DOURADA	07/11/2019 16:40	09/11/2019 11:42	07/11/2019 16:40	09/11/2019 08:57	40,29	4	161,16	CHI
20191156056	CACHOEIRA DOURADA	CD13000012	CACHOEIRA DOURADA	07/11/2019 16:40	09/11/2019 11:42	09/11/2019 09:34	09/11/2019 09:48	0,22	685	151,65	CHI
20191156056	CACHOEIRA DOURADA	CD12000067	CACHOEIRA DOURADA	07/11/2019 16:40	09/11/2019 11:42	07/11/2019 16:40	09/11/2019 10:00	41,34	23	950,85	CHI
20191156056	INACIOLANDIA	CD12000067	CACHOEIRA DOURADA	07/11/2019 16:40	09/11/2019 11:42	07/11/2019 16:40	09/11/2019 10:00	41,34	98	4051,46	CHI
20191156056	ITUMBIARA	CD12000067	CACHOEIRA DOURADA	07/11/2019 16:40	09/11/2019 11:42	07/11/2019 16:40	09/11/2019 10:00	41,34	13	537,44	CHI
20191156056	CACHOEIRA DOURADA	CD11088530	CACHOEIRA DOURADA	07/11/2019 16:40	09/11/2019 11:42	09/11/2019 10:09	09/11/2019 10:29	0,34	47	15,86	CHI
20191156056	CACHOEIRA DOURADA	CD21190998	CACHOEIRA DOURADA	07/11/2019 16:40	09/11/2019 11:42	09/11/2019 10:56	09/11/2019 11:02	0,11	1	0,11	CHI
20191156056	ITUMBIARA	00280404	CACHOEIRA DOURADA	07/11/2019 16:40	09/11/2019 11:42	07/11/2019 16:40	09/11/2019 11:42	43,04	9	387,35	CHI
20191156061	CATALAO	CT21160936	CATALAO S1	07/11/2019 16:51	09/11/2019 13:51	07/11/2019 16:51	09/11/2019 13:51	45,00	1	45,00	CHI
20191156065	FAINA	FC12274422	GOIAS	07/11/2019 16:51	08/11/2019 15:00	07/11/2019 16:51	08/11/2019 15:00	22,15	38	841,52	CHI
20191156066	CIDADE OCIDENTAL	2680128893	MARAJOARA	07/11/2019 16:51	08/11/2019 14:10	07/11/2019 16:51	08/11/2019 14:10	21,31	1	21,31	CHI
20191156071	IPAMERI	IP12056197	IPAMERI	07/11/2019 16:51	09/11/2019 10:10	07/11/2019 16:51	09/11/2019 10:10	41,30	3	123,91	CHI

20191156072	RIO VERDE	RV11131627	RIO VERDE S1	07/11/2019 15:41	09/11/2019 11:25	07/11/2019 15:41	09/11/2019 11:25	43,73	155	6778,49	CHI
20191156073	GOIANIA	GN11127468	MEIA PONTE	07/11/2019 16:20	07/11/2019 22:59	07/11/2019 16:20	07/11/2019 22:59	6,64	140	928,94	CHI
20191156075	CACHOEIRA DE GOIAS	IV12253637	IPORA	07/11/2019 16:52	11/11/2019 02:02	07/11/2019 16:52	11/11/2019 02:02	81,17	5	405,83	CHI
20191156075	IVOLANDIA	IV12253637	IPORA	07/11/2019 16:52	11/11/2019 02:02	07/11/2019 16:52	11/11/2019 02:02	81,17	21	1704,49	CHI
20191156075	PARAUNA	IV12253637	IPORA	07/11/2019 16:52	11/11/2019 02:02	07/11/2019 16:52	11/11/2019 02:02	81,17	6	487,00	CHI
20191156077	GOIANIRA	GR11131273	GOIANIRA	07/11/2019 16:32	08/11/2019 03:42	07/11/2019 16:32	08/11/2019 03:42	11,15	131	1460,80	CHI
20191156080	VALPARAISO DE GOIAS	VA11162821	MARAJOARA	07/11/2019 14:51	07/11/2019 18:20	07/11/2019 14:51	07/11/2019 18:20	3,47	19	65,88	CHI
20191156082	JARAGUA	JA12009229	JARAGUA	07/11/2019 16:52	08/11/2019 11:23	07/11/2019 16:52	08/11/2019 11:23	18,51	3	55,52	CHI
20191156087	PONTALINA	PK21076916	GOIATUBA S1	07/11/2019 16:53	10/11/2019 20:48	07/11/2019 16:53	10/11/2019 20:48	75,92	1	75,92	CHI
20191156091	GOIANIRA	10017854960	GOIANIRA	07/11/2019 16:53	08/11/2019 04:36	07/11/2019 16:53	08/11/2019 04:36	11,72	1	11,72	CHI
20191156094	ITABERAI	AC21323618	ANICUNS	07/11/2019 16:53	08/11/2019 15:41	07/11/2019 16:53	08/11/2019 15:41	22,79	2	45,59	CHI
20191156095	ITABERAI	10010043070	ITABERAI S2	07/11/2019 16:53	08/11/2019 08:11	07/11/2019 16:53	08/11/2019 08:11	15,30	1	15,30	CHI
20191156097	AGUAS LINDAS DE GOIAS	10009620450	AGUAS LINDAS DE GOIAS S1	07/11/2019 16:53	07/11/2019 17:33	07/11/2019 16:53	07/11/2019 17:33	0,65	1	0,65	CHI
20191156098	RIO VERDE	630283930	CABRIUVA S1	07/11/2019 16:53	08/11/2019 10:48	07/11/2019 16:53	08/11/2019 10:48	17,91	1	17,91	CHI
20191156106	SANTA CRUZ DE GOIAS	BC11286287	PIRES DO RIO S2	07/11/2019 16:55	09/11/2019 11:49	07/11/2019 16:55	09/11/2019 11:49	42,91	2	85,81	CHI
20191156111	APARECIDA DE GOIANIA	14324325	ATLANTICO S2	07/11/2019 16:55	07/11/2019 20:28	07/11/2019 16:55	07/11/2019 20:28	3,54	1	3,54	CHI
20191156118	GOIANIA	GN11322419	XAVANTES	07/11/2019 16:30	07/11/2019 20:54	07/11/2019 16:30	07/11/2019 20:54	4,41	86	379,00	CHI
20191156125	IPORA	IR12014497	IPORA	07/11/2019 14:40	08/11/2019 02:00	07/11/2019 14:40	08/11/2019 02:00	11,33	209	2368,14	CHI
20191156147	CRIXAS	2490014967	SERRA DO OURO	07/11/2019 16:59	09/11/2019 17:14	07/11/2019 16:59	09/11/2019 17:14	48,24	1	48,24	CHI
20191156151	IPORA	IR12107566	IPORA	07/11/2019 16:08	08/11/2019 04:26	07/11/2019 16:08	08/11/2019 04:26	12,28	89	1093,27	CHI
20191156152	APARECIDA DE GOIANIA	14685980	INDEPENDENCIA S1	07/11/2019 17:00	07/11/2019 20:18	07/11/2019 17:00	07/11/2019 20:18	3,29	1	3,29	CHI
20191156164	AMARALINA	MH12362454	NOVA CRIXAS	07/11/2019 15:27	08/11/2019 09:34	07/11/2019 15:27	08/11/2019 09:34	18,10	1	18,10	CHI
20191156164	MUNDO NOVO DE GOIAS	MH12362454	NOVA CRIXAS	07/11/2019 15:27	08/11/2019 09:34	07/11/2019 15:27	08/11/2019 09:34	18,10	234	4236,05	CHI
20191156165	FAINA	GS12220409	GOIAS	07/11/2019 12:23	08/11/2019 10:25	07/11/2019 12:23	08/11/2019 10:25	22,03	1	22,03	CHI
20191156165	GOIAS	GS12220409	GOIAS	07/11/2019 12:23	08/11/2019 10:25	07/11/2019 12:23	08/11/2019 10:25	22,03	78	1717,97	CHI
20191156171	CALDAS NOVAS	CN12075111	SERRA DE CALDAS	07/11/2019 15:24	08/11/2019 07:56	07/11/2019 15:24	08/11/2019 07:56	16,52	21	346,98	CHI
20191156181	GOIANIA	GN11189327	GOYA S2	07/11/2019 16:26	07/11/2019 19:09	07/11/2019 16:26	07/11/2019 19:09	2,71	84	227,34	CHI
20191156183	NIQUELANDIA	10014515405	NIQUELANDIA SUBTRANSMISSAO	07/11/2019 17:03	08/11/2019 04:49	07/11/2019 17:03	08/11/2019 04:49	11,76	1	11,76	CHI
20191156188	VALPARAISO DE GOIAS	VA12183504	PACAEMBU S1	07/11/2019 14:59	07/11/2019 19:41	07/11/2019 14:59	07/11/2019 19:41	4,69	83	388,92	CHI
20191156189	GOIANIA	GN11002081	CAMPINAS S2	07/11/2019 15:59	07/11/2019 20:18	07/11/2019 15:59	07/11/2019 20:18	4,32	123	530,92	CHI
20191156192	FIRMINOPOLIS	FR21073022	FIRMINOPOLIS S1	07/11/2019 17:04	08/11/2019 18:54	07/11/2019 17:04	08/11/2019 18:54	25,83	1	25,83	CHI
20191156196	RIO VERDE	RV11241410	RIO VERDE S2	07/11/2019 16:04	07/11/2019 19:55	07/11/2019 16:04	07/11/2019 19:55	3,86	167	644,11	CHI
20191156219	EDEIA	EA11160414	EDEIA	07/11/2019 16:51	07/11/2019 23:23	07/11/2019 16:51	07/11/2019 23:23	6,53	203	1325,53	CHI

20191156226	JATAI	JT12000077	JATAI S3	07/11/2019 15:33	08/11/2019 14:06	07/11/2019 15:33	08/11/2019 14:06	22,55	116	2616,22	CHI
20191156240	GOIANDIRA	GD12250481	CATALAO S1	07/11/2019 15:31	07/11/2019 22:51	07/11/2019 15:31	07/11/2019 22:51	7,32	54	395,23	CHI
20191156241	MINACU	IH11207707	MINACU	07/11/2019 17:08	08/11/2019 08:40	07/11/2019 17:08	08/11/2019 08:40	15,52	1	15,52	CHI
20191156244	INHUMAS	IN11086376	INHUMAS S2	07/11/2019 15:46	07/11/2019 21:40	07/11/2019 15:46	07/11/2019 21:40	5,89	50	294,43	CHI
20191156248	CRIXAS	CX11398104	SERRA DO OURO	07/11/2019 17:09	11/11/2019 05:22	07/11/2019 17:09	11/11/2019 05:22	84,21	1	84,21	CHI
20191156249	BURITI ALEGRE	430008223	ITUMBIARA VELHA S2	06/11/2019 19:31	07/11/2019 13:43	06/11/2019 19:31	07/11/2019 13:43	18,19	1	18,19	CHI
20191156251	SAO LUIZ DO NORTE	SZ21353894	ITAPACI	07/11/2019 17:09	07/11/2019 20:19	07/11/2019 17:09	07/11/2019 20:19	3,15	1	3,15	CHI
20191156256	IPAMERI	IP12000058	IPAMERI	07/11/2019 14:59	08/11/2019 10:11	07/11/2019 14:59	08/11/2019 10:11	19,19	164	3146,70	CHI
20191156285	RIO VERDE	RV21260755	RIO VERDE S2	07/11/2019 17:13	08/11/2019 11:28	07/11/2019 17:13	08/11/2019 11:28	18,24	2	36,48	CHI
20191156291	CRISTALINA	KR21304968	CRISTALINA S2	07/11/2019 17:13	08/11/2019 03:07	07/11/2019 17:13	08/11/2019 03:07	9,88	1	9,88	CHI
20191156300	GUARINOS	GF12164878	SANTA TEREZINHA	07/11/2019 15:48	08/11/2019 00:57	07/11/2019 15:48	08/11/2019 00:57	9,15	57	521,38	CHI
20191156319	CIDADE OCIDENTAL	DH10403925	MARAJOARA	07/11/2019 19:18	07/11/2019 22:39	07/11/2019 19:18	07/11/2019 20:21	1,04	1152	1201,28	CHI
20191156319	CIDADE OCIDENTAL	DH12170120LD	MARAJOARA	07/11/2019 19:18	07/11/2019 22:39	07/11/2019 19:18	07/11/2019 22:39	3,34	579	1934,66	CHI
20191156320	RIO VERDE	RV21355033	CABRIUVA S2	07/11/2019 13:55	08/11/2019 10:45	07/11/2019 13:55	08/11/2019 10:45	20,82	1	20,82	CHI
20191156349	CACHOEIRA ALTA	CA12200636	CACHOEIRA ALTA	07/11/2019 08:11	08/11/2019 01:09	07/11/2019 08:11	08/11/2019 01:09	16,96	4	67,85	CHI
20191156350	IACIARA	O1230424	IACIARA S2	07/11/2019 20:41	08/11/2019 16:22	07/11/2019 20:41	07/11/2019 22:09	1,48	12	17,70	CHI
20191156350	POSSE	O1230424	IACIARA S2	07/11/2019 20:41	08/11/2019 16:22	07/11/2019 20:41	07/11/2019 22:09	1,48	111	163,73	CHI
20191156350	ALVORADA DO NORTE	AQ13302881	IACIARA S2	07/11/2019 20:41	08/11/2019 16:22	07/11/2019 20:41	07/11/2019 23:21	2,66	3	7,99	CHI
20191156350	POSSE	AQ13302881	IACIARA S2	07/11/2019 20:41	08/11/2019 16:22	07/11/2019 20:41	07/11/2019 23:21	2,66	80	213,04	CHI
20191156350	SIMOLANDIA	AQ13302881	IACIARA S2	07/11/2019 20:41	08/11/2019 16:22	07/11/2019 20:41	07/11/2019 23:21	2,66	247	657,77	CHI
20191156350	POSSE	AQ13082125	IACIARA S2	07/11/2019 20:41	08/11/2019 16:22	07/11/2019 20:41	08/11/2019 01:49	5,13	10	51,34	CHI
20191156350	POSSE	PS13375593	IACIARA S2	07/11/2019 20:41	08/11/2019 16:22	07/11/2019 20:41	08/11/2019 14:09	17,47	3	52,42	CHI
20191156350	POSSE	PS12180788	IACIARA S2	07/11/2019 20:41	08/11/2019 16:22	07/11/2019 20:41	08/11/2019 15:03	18,37	39	716,56	CHI
20191156350	POSSE	PS12180838RE	IACIARA S2	07/11/2019 20:41	08/11/2019 16:22	07/11/2019 20:41	08/11/2019 16:22	19,68	72	1416,64	CHI
20191156356	NIQUELANDIA	NQ12371149	SAO JOAO D ALIANCA	07/11/2019 16:47	12/11/2019 21:39	07/11/2019 16:47	09/11/2019 14:55	46,13	4	184,53	CHI
20191156356	NIQUELANDIA	NQ13371151	SAO JOAO D ALIANCA	07/11/2019 16:47	12/11/2019 21:39	07/11/2019 16:47	09/11/2019 16:12	47,42	4	189,69	CHI
20191156356	NIQUELANDIA	NQ12371149	SAO JOAO D ALIANCA	07/11/2019 16:47	12/11/2019 21:39	09/11/2019 16:21	09/11/2019 18:07	1,77	5	8,83	CHI
20191156356	NIQUELANDIA	NQ13371151	SAO JOAO D ALIANCA	07/11/2019 16:47	12/11/2019 21:39	09/11/2019 16:21	11/11/2019 22:22	54,01	1	54,01	CHI
20191156356	NIQUELANDIA	NQ12371150	SAO JOAO D ALIANCA	07/11/2019 16:47	12/11/2019 21:39	07/11/2019 16:47	11/11/2019 22:36	101,81	26	2647,04	CHI
20191156356	NIQUELANDIA	6919620	SAO JOAO D ALIANCA	07/11/2019 16:47	12/11/2019 21:39	09/11/2019 16:21	12/11/2019 21:39	77,30	3	231,90	CHI
20191156358	GOIANIA	GN11040692	FERROVIARIO S2	07/11/2019 16:05	07/11/2019 23:11	07/11/2019 16:05	07/11/2019 23:11	7,10	76	539,28	CHI
20191156366	ITABERAI	IB11206916	ITABERAI S2	07/11/2019 19:31	07/11/2019 23:06	07/11/2019 19:31	07/11/2019 23:06	3,58	157	561,41	CHI
20191156407	CAVALCANTE	740001401	FLORES DE GOIAS	07/11/2019 17:15	08/11/2019 16:01	07/11/2019 17:15	08/11/2019 16:01	22,75	1	22,75	CHI

20191156409	ARENOPOLIS	AY11193258	ARENOPOLIS	07/11/2019 15:14	08/11/2019 12:05	07/11/2019 15:14	08/11/2019 12:05	20,84	56	1166,99	CHI
20191156419	ITAPIRAPUA	IU12378860	MATRINCHA	07/11/2019 16:28	09/11/2019 03:37	07/11/2019 16:28	09/11/2019 00:57	32,48	28	909,55	CHI
20191156419	ITAPIRAPUA	IU12378860	MATRINCHA	07/11/2019 16:28	09/11/2019 03:37	07/11/2019 16:28	09/11/2019 01:55	33,45	11	367,94	CHI
20191156419	ITAPIRAPUA	IU12378860	MATRINCHA	07/11/2019 16:28	09/11/2019 03:37	07/11/2019 16:28	09/11/2019 02:42	34,24	2	68,48	CHI
20191156419	ITAPIRAPUA	IU12018810	MATRINCHA	07/11/2019 16:28	09/11/2019 03:37	07/11/2019 16:28	09/11/2019 03:37	35,16	27	949,36	CHI
20191156422	ACREUNA	SH12301267	ACREUNA	07/11/2019 15:07	09/11/2019 07:54	07/11/2019 15:07	09/11/2019 07:54	40,78	5	203,90	CHI
20191156422	SANTA HELENA DE GOIAS	SH12301267	ACREUNA	07/11/2019 15:07	09/11/2019 07:54	07/11/2019 15:07	09/11/2019 07:54	40,78	1	40,78	CHI
20191156422	SANTO ANTONIO DA BARRA	SH12301267	ACREUNA	07/11/2019 15:07	09/11/2019 07:54	07/11/2019 15:07	09/11/2019 07:54	40,78	16	652,47	CHI
20191156427	COLINAS DO SUL	TI21138256	MINACU	07/11/2019 17:18	07/11/2019 22:39	07/11/2019 17:18	07/11/2019 22:39	5,34	1	5,34	CHI
20191156434	BONFINOPOLIS	BO12200287	CEPAIGO S2	07/11/2019 16:51	07/11/2019 20:23	07/11/2019 16:51	07/11/2019 20:23	3,53	149	525,47	CHI
20191156436	SANTO ANTONIO DE GOIAS	BW12402879	NEROPOLIS S1	07/11/2019 14:52	08/11/2019 14:05	07/11/2019 14:52	08/11/2019 14:05	23,21	6	139,25	CHI
20191156437	SANTO ANTONIO DO DESCOBERTO	SN11321885	ALEXANIA	07/11/2019 17:19	07/11/2019 19:10	07/11/2019 17:19	07/11/2019 19:10	1,83	36	66,02	CHI
20191156444	CRISTALINA	KR12320036	CRISTALINA S2	07/11/2019 16:59	07/11/2019 19:51	07/11/2019 16:59	07/11/2019 19:51	2,85	11	31,38	CHI
20191156450	NOVA AMERICA	CX21290236	RUBIATABA	07/11/2019 17:21	08/11/2019 02:13	07/11/2019 17:21	08/11/2019 02:13	8,85	1	8,85	CHI
20191156452	JUSSARA	JR12101970RE	BRITANIA	07/11/2019 17:22	10/11/2019 22:15	07/11/2019 17:22	10/11/2019 22:15	76,88	11	845,69	CHI
20191156453	GOIANIA	GN12038754	AEROPORTO S3	07/11/2019 16:40	07/11/2019 21:19	07/11/2019 16:40	07/11/2019 21:19	4,64	103	477,52	CHI
20191156458	CRISTALINA	KR21170526	CRISTALINA S2	07/11/2019 17:22	08/11/2019 02:51	07/11/2019 17:22	08/11/2019 02:51	9,47	1	9,47	CHI
20191156459	GOIANIA	GN11194305	FERROVIARIO S2	07/11/2019 16:38	07/11/2019 19:36	07/11/2019 16:38	07/11/2019 19:36	2,96	48	142,29	CHI
20191156465	ALEXANIA	10007482840	ALEXANIA	07/11/2019 17:23	08/11/2019 09:21	07/11/2019 17:23	08/11/2019 09:21	15,96	1	15,96	CHI
20191156469	MUNDO NOVO DE GOIAS	MH12274849	NOVA CRIXAS	07/11/2019 16:22	08/11/2019 10:05	07/11/2019 16:22	08/11/2019 10:05	17,71	16	283,36	CHI
20191156487	GOIANIA	GN11374103	FERROVIARIO S3	07/11/2019 13:26	07/11/2019 20:44	07/11/2019 13:26	07/11/2019 20:44	7,29	50	364,69	CHI
20191156489	ITUMBIARA	690307019	ITUMBIARA NOVA	07/11/2019 17:25	16/11/2019 18:50	07/11/2019 17:25	16/11/2019 18:50	217,41	1	217,41	CHI
20191156493	INHUMAS	IN12162096	INHUMAS S2	07/11/2019 16:06	07/11/2019 20:12	07/11/2019 16:06	07/11/2019 20:12	4,10	962	3943,93	CHI
20191156497	CORUMBAIBA	CI12000451	VILA CORUMBA	07/11/2019 17:27	08/11/2019 11:04	07/11/2019 17:27	08/11/2019 11:04	17,61	7	123,30	CHI
20191156497	NOVA AURORA	CI12000451	VILA CORUMBA	07/11/2019 17:27	08/11/2019 11:04	07/11/2019 17:27	08/11/2019 11:04	17,61	7	123,30	CHI
20191156499	GOIANIA	GN11282963	GOYA S1	07/11/2019 16:27	07/11/2019 20:54	07/11/2019 16:27	07/11/2019 20:54	4,44	89	395,21	CHI
20191156504	CATALAO	GD12127624RE	CATALAO S1	07/11/2019 14:39	08/11/2019 10:09	07/11/2019 14:39	08/11/2019 10:09	19,50	14	272,99	CHI
20191156504	GOIANDIRA	GD12127624RE	CATALAO S1	07/11/2019 14:39	08/11/2019 10:09	07/11/2019 14:39	08/11/2019 10:09	19,50	17	331,49	CHI
20191156504	IPAMERI	GD12127624RE	CATALAO S1	07/11/2019 14:39	08/11/2019 10:09	07/11/2019 14:39	08/11/2019 10:09	19,50	7	136,49	CHI
20191156509	GOIAS	GS12124703	GOIAS	07/11/2019 16:52	08/11/2019 08:35	07/11/2019 16:52	08/11/2019 08:35	15,72	177	2781,95	CHI
20191156520	SANTO ANTONIO DE GOIAS	BW11383840	NEROPOLIS S1	07/11/2019 16:15	08/11/2019 02:00	07/11/2019 16:15	08/11/2019 02:00	9,74	70	681,70	CHI
20191156527	SANTA RITA DO NOVO DESTINO	SZ12242779	BARRO ALTO	07/11/2019 13:09	07/11/2019 23:20	07/11/2019 13:09	07/11/2019 23:20	10,17	1	10,17	CHI
20191156527	SAO LUIZ DO NORTE	SZ12242779	BARRO ALTO	07/11/2019 13:09	07/11/2019 23:20	07/11/2019 13:09	07/11/2019 23:20	10,17	6	61,01	CHI

20191156530	CRIXAS	NA12078447	NOVA CRIXAS	07/11/2019 16:13	07/11/2019 21:45	07/11/2019 16:13	07/11/2019 21:45	5,53	18	99,51	CHI
20191156530	NOVA CRIXAS	NA12078447	NOVA CRIXAS	07/11/2019 16:13	07/11/2019 21:45	07/11/2019 16:13	07/11/2019 21:45	5,53	19	105,04	CHI
20191156547	IPORA	IR11349750	IPORA	07/11/2019 16:25	08/11/2019 07:16	07/11/2019 16:25	08/11/2019 07:16	14,84	113	1676,54	CHI
20191156551	UIRAPURU	UP12391846	SANTA TEREZINHA	07/11/2019 16:41	08/11/2019 13:30	07/11/2019 16:41	08/11/2019 13:30	20,82	7	145,76	CHI
20191156554	NOVA CRIXAS	NA12334349	NOVA CRIXAS	07/11/2019 15:39	09/11/2019 00:25	07/11/2019 15:39	09/11/2019 00:25	32,76	86	2817,12	CHI
20191156556	JARAGUA	JA12297982	SAO FRANCISCO DE GOIAS	07/11/2019 17:20	08/11/2019 04:11	07/11/2019 17:20	08/11/2019 04:11	10,84	25	270,89	CHI
20191156556	JESUPOLIS	JA12297982	SAO FRANCISCO DE GOIAS	07/11/2019 17:20	08/11/2019 04:11	07/11/2019 17:20	08/11/2019 04:11	10,84	5	54,18	CHI
20191156561	AMARALINA	MH12037774	NOVA CRIXAS	07/11/2019 17:03	08/11/2019 14:50	07/11/2019 17:03	08/11/2019 14:50	21,78	34	740,47	CHI
20191156561	MARA ROSA	MH12037774	NOVA CRIXAS	07/11/2019 17:03	08/11/2019 14:50	07/11/2019 17:03	08/11/2019 14:50	21,78	8	174,23	CHI
20191156561	MUNDO NOVO DE GOIAS	MH12037774	NOVA CRIXAS	07/11/2019 17:03	08/11/2019 14:50	07/11/2019 17:03	08/11/2019 14:50	21,78	2	43,56	CHI
20191156561	UIRAPURU	MH12037774	NOVA CRIXAS	07/11/2019 17:03	08/11/2019 14:50	07/11/2019 17:03	08/11/2019 14:50	21,78	48	1045,37	CHI
20191156567	CALDAS NOVAS	CN11000004	CALDAS NOVAS S2	07/11/2019 16:24	07/11/2019 21:49	07/11/2019 16:24	07/11/2019 21:49	5,40	97	523,91	CHI
20191156586	CRISTALINA	KR21349075	PAMPLONA	07/11/2019 17:35	08/11/2019 15:33	07/11/2019 17:35	08/11/2019 15:33	21,95	1	21,95	CHI
20191156592	ITUMBIARA	690316318	ITUMBIARA VELHA S1	07/11/2019 17:36	08/11/2019 19:52	07/11/2019 17:36	08/11/2019 19:52	26,27	1	26,27	CHI
20191156597	CAIAPONIA	CP12354340	CAIAPONIA	07/11/2019 17:07	08/11/2019 15:35	07/11/2019 17:07	08/11/2019 15:35	22,46	12	269,58	CHI
20191156598	ABADIANIA	AA12130228	ANAPOLIS UNIVERSITARIO S1	07/11/2019 15:33	07/11/2019 20:22	07/11/2019 15:33	07/11/2019 20:22	4,81	11	52,89	CHI
20191156598	ABADIANIA	AA12130228	DAIA S2	07/11/2019 15:33	07/11/2019 20:22	07/11/2019 15:33	07/11/2019 20:22	4,81	30	144,24	CHI
20191156605	CALDAS NOVAS	10006342084	SERRA DE CALDAS	06/11/2019 16:19	09/11/2019 09:45	06/11/2019 16:19	09/11/2019 09:45	65,44	1	65,44	CHI
20191156616	LUZIANIA	10012660203	MARAJOARA	07/11/2019 17:38	07/11/2019 23:14	07/11/2019 17:38	07/11/2019 23:14	5,59	1	5,59	CHI
20191156625	GOIANIRA	GR11340372	GOIANIRA	07/11/2019 16:40	07/11/2019 18:53	07/11/2019 16:40	07/11/2019 18:53	2,21	130	287,08	CHI
20191156627	PETROLINA DE GOIAS	PG21201537	PETROLINA	07/11/2019 17:39	08/11/2019 15:19	07/11/2019 17:39	08/11/2019 15:19	21,67	1	21,67	CHI
20191156644	PLANALTINA	10016729631	PLANALTINA	07/11/2019 17:39	08/11/2019 01:19	07/11/2019 17:39	08/11/2019 01:19	7,66	1	7,66	CHI
20191156645	CATALAO	CT21287013	CATALAO S1	07/11/2019 17:39	09/11/2019 13:07	07/11/2019 17:39	09/11/2019 13:07	43,45	1	43,45	CHI
20191156657	CRISTALINA	KR12162511	CRISTALINA S2	07/11/2019 15:21	07/11/2019 19:41	07/11/2019 15:21	07/11/2019 19:41	4,33	10	43,28	CHI
20191156659	GOIANIA	GN11097702	GOYA S2	07/11/2019 16:34	08/11/2019 00:56	07/11/2019 16:34	08/11/2019 00:56	8,35	168	1403,31	CHI
20191156661	MONTES CLAROS DE GOIAS	1440013280	IPORA	07/11/2019 17:41	08/11/2019 10:23	07/11/2019 17:41	08/11/2019 10:23	16,70	1	16,70	CHI
20191156663	BARRO ALTO	1150013350	BARRO ALTO	07/11/2019 17:41	10/11/2019 11:50	07/11/2019 17:41	10/11/2019 11:50	66,14	1	66,14	CHI
20191156669	MIMOSO DE GOIAS	MJ12305118	PADRE BERNARDO	07/11/2019 17:42	07/11/2019 23:31	07/11/2019 17:42	07/11/2019 23:31	5,80	2	11,61	CHI
20191156670	FORMOSA	610186747	ITIQUEIRA	07/11/2019 17:42	07/11/2019 21:07	07/11/2019 17:42	07/11/2019 21:07	3,40	1	3,40	CHI
20191156678	GUARAITA	IK12250511	ITAPURANGA	07/11/2019 15:10	08/11/2019 09:30	07/11/2019 15:10	08/11/2019 09:30	18,32	7	128,24	CHI
20191156678	ITAPURANGA	IK12250511	ITAPURANGA	07/11/2019 15:10	08/11/2019 09:30	07/11/2019 15:10	08/11/2019 09:30	18,32	37	677,83	CHI
20191156681	CATALAO	CT11250249	CATALAO S2	07/11/2019 15:01	07/11/2019 19:56	07/11/2019 15:01	07/11/2019 19:56	4,91	23	113,01	CHI
20191156682	ANICUNS	AC21102337	ANICUNS	07/11/2019 17:44	08/11/2019 09:00	07/11/2019 17:44	08/11/2019 09:00	15,25	2	30,50	CHI

20191156685	ABADIANIA	AA21239982	ANAPOLIS UNIVERSITARIO S1	07/11/2019 17:45	08/11/2019 11:25	07/11/2019 17:45	08/11/2019 11:25	17,67	1	17,67	CHI
20191156691	BRITANIA	BT12210599	BRITANIA	07/11/2019 15:13	07/11/2019 20:24	07/11/2019 15:13	07/11/2019 20:24	5,17	594	3070,98	CHI
20191156691	JUSSARA	BT12210599	BRITANIA	07/11/2019 15:13	07/11/2019 20:24	07/11/2019 15:13	07/11/2019 20:24	5,17	29	149,93	CHI
20191156692	AGUAS LINDAS DE GOIAS	4830403768	AGUAS LINDAS DE GOIAS S2	07/11/2019 17:45	07/11/2019 18:39	07/11/2019 17:45	07/11/2019 18:39	0,89	1	0,89	CHI
20191156699	NOVA CRIXAS	NA11282179	NOVA CRIXAS	07/11/2019 22:42	08/11/2019 00:20	07/11/2019 22:42	08/11/2019 00:20	1,63	107	174,53	CHI
20191156704	GOIANIA	GN11162001	FERROVIARIO S3	07/11/2019 16:08	07/11/2019 22:08	07/11/2019 16:08	07/11/2019 22:08	5,99	25	149,85	CHI
20191156705	GOIANDIRA	GD12281470	CATALAO S1	07/11/2019 16:56	07/11/2019 21:55	07/11/2019 16:56	07/11/2019 21:55	4,97	5	24,85	CHI
20191156714	IPAMERI	IP12000071	IPAMERI	07/11/2019 14:55	08/11/2019 11:50	07/11/2019 14:55	08/11/2019 11:50	20,91	5	104,56	CHI
20191156717	QUIRINOPOLIS	QI11289366	QUIRINOPOLIS	07/11/2019 17:49	08/11/2019 13:04	07/11/2019 17:49	08/11/2019 13:04	19,24	25	480,93	CHI
20191156722	LUZIANIA	LZ21216259	CRISTALINA S2	07/11/2019 12:10	08/11/2019 02:42	07/11/2019 12:10	08/11/2019 02:42	14,53	1	14,53	CHI
20191156732	BOM JARDIM DE GOIAS	BM12184273	BOM JARDIM	07/11/2019 17:51	08/11/2019 14:20	07/11/2019 17:51	08/11/2019 14:20	20,47	3	61,41	CHI
20191156734	AGUA FRIA DE GOIAS	TL21205636	SAO JOAO D ALIANCA	07/11/2019 17:52	10/11/2019 18:00	07/11/2019 17:52	10/11/2019 18:00	72,13	1	72,13	CHI
20191156737	RIO VERDE	RV11136195	RIO VERDE S2	07/11/2019 16:30	08/11/2019 00:40	07/11/2019 16:30	08/11/2019 00:40	8,16	121	986,92	CHI
20191156740	GOIANESIA	10023188845	GOIANESIA S2	07/11/2019 17:52	08/11/2019 18:39	07/11/2019 17:52	08/11/2019 18:39	24,77	1	24,77	CHI
20191156752	ITAGUARU	IC12068828	ITABERAI S1	07/11/2019 17:54	10/11/2019 14:00	07/11/2019 17:54	10/11/2019 14:00	68,09	3	204,27	CHI
20191156754	CRIXAS	CX12391769	RUBIATABA	07/11/2019 17:10	10/11/2019 10:00	07/11/2019 17:10	10/11/2019 10:00	64,82	4	259,29	CHI
20191156756	CRIXAS	CX12239577	SANTA TEREZINHA	07/11/2019 17:07	08/11/2019 07:33	07/11/2019 17:07	08/11/2019 07:33	14,42	16	230,79	CHI
20191156765	URUACU	640103194	URUACU	07/11/2019 17:56	07/11/2019 19:38	07/11/2019 17:56	07/11/2019 19:38	1,70	1	1,70	CHI
20191156772	ITAGUARU	IC11089315	ITABERAI S1	07/11/2019 15:34	08/11/2019 17:41	07/11/2019 15:34	08/11/2019 17:41	26,11	88	2297,26	CHI
20191156786	LUZIANIA	LZ21065580	CRISTALINA S2	07/11/2019 12:10	08/11/2019 03:22	07/11/2019 12:10	08/11/2019 03:22	15,19	1	15,19	CHI
20191156788	ARAGARCAS	AG12154718	ARAGARCAS	07/11/2019 16:44	09/11/2019 11:30	07/11/2019 16:44	09/11/2019 11:30	42,76	20	855,23	CHI
20191156790	MONTES CLAROS DE GOIAS	ME12091493	IPORA	07/11/2019 11:36	09/11/2019 00:32	07/11/2019 11:36	09/11/2019 00:32	36,92	89	3286,30	CHI
20191156793	BRAZABRANTES	BR12026094	INHUMAS S2	07/11/2019 16:37	08/11/2019 08:37	07/11/2019 16:37	08/11/2019 08:37	16,00	6	95,98	CHI
20191156799	PLANALTINA	PI12322789	PLANALTINA	07/11/2019 16:18	07/11/2019 22:42	07/11/2019 16:18	07/11/2019 22:42	6,40	38	243,12	CHI
20191156804	MORRO AGUDO DE GOIAS	RB12292120	RUBIATABA	07/11/2019 15:37	07/11/2019 20:02	07/11/2019 15:37	07/11/2019 20:02	4,42	4	17,66	CHI
20191156804	RUBIATABA	RB12292120	RUBIATABA	07/11/2019 15:37	07/11/2019 20:02	07/11/2019 15:37	07/11/2019 20:02	4,42	4	17,66	CHI
20191156807	IPAMERI	IP21231428	IPAMERI	07/11/2019 18:00	09/11/2019 16:33	07/11/2019 18:00	09/11/2019 16:33	46,54	1	46,54	CHI
20191156809	PALMEIRAS DE GOIAS	590061914	PALMEIRAS	07/11/2019 18:00	08/11/2019 11:30	07/11/2019 18:00	08/11/2019 11:30	17,49	1	17,49	CHI
20191156813	NOVA VENEZA	NV12219022	NEROPOLIS S1	07/11/2019 15:36	08/11/2019 11:35	07/11/2019 15:36	08/11/2019 11:35	19,98	26	519,57	CHI
20191156828	CAIAPONIA	CP11020865	CAIAPONIA	07/11/2019 17:35	08/11/2019 11:22	07/11/2019 17:35	08/11/2019 11:22	17,77	114	2025,84	CHI
20191156833	MOSSAMEDES	KB21000068	ANICUNS	07/11/2019 18:03	08/11/2019 14:57	07/11/2019 18:03	08/11/2019 14:57	20,89	1	20,89	CHI
20191156836	CUMARI	CY12000301	CATALAO S1	07/11/2019 16:15	08/11/2019 15:36	07/11/2019 16:15	08/11/2019 15:36	23,35	4	93,40	CHI
20191156838	CRIXAS	CX11108002	SERRA DO OURO	07/11/2019 17:05	07/11/2019 23:13	07/11/2019 17:05	07/11/2019 23:13	6,13	186	1139,92	CHI

20191156859	LUZIANIA	LZ21244624	MARAJOARA	07/11/2019 18:22	08/11/2019 20:00	07/11/2019 18:22	08/11/2019 20:00	25,62	13	333,02	CHI
20191156860	RIO VERDE	RV11213463	RIO VERDE S2	07/11/2019 17:28	07/11/2019 20:52	07/11/2019 17:28	07/11/2019 20:52	3,40	136	461,87	CHI
20191156861	JATAI	04070406	JATAI S1	07/11/2019 18:22	08/11/2019 15:14	07/11/2019 18:22	07/11/2019 22:05	3,71	79	292,91	CHI
20191156861	APARECIDA DO RIO DOCE	04070406	JATAI S1	07/11/2019 18:22	08/11/2019 15:14	07/11/2019 18:22	08/11/2019 00:00	5,63	70	393,75	CHI
20191156861	JATAI	04070406	JATAI S1	07/11/2019 18:22	08/11/2019 15:14	07/11/2019 18:22	08/11/2019 00:00	5,63	233	1310,63	CHI
20191156861	JATAI	04070406	JATAI S1	07/11/2019 18:22	08/11/2019 15:14	08/11/2019 00:01	08/11/2019 07:37	7,61	79	600,90	CHI
20191156861	JATAI	04800434	JATAI S1	07/11/2019 18:22	08/11/2019 15:14	08/11/2019 07:22	08/11/2019 07:37	0,25	70	17,62	CHI
20191156861	JATAI	04070406	JATAI S1	07/11/2019 18:22	08/11/2019 15:14	08/11/2019 00:01	08/11/2019 10:07	10,11	89	899,37	CHI
20191156861	APARECIDA DO RIO DOCE	JT13214393	JATAI S1	07/11/2019 18:22	08/11/2019 15:14	08/11/2019 00:01	08/11/2019 13:27	13,44	70	940,74	CHI
20191156861	JATAI	JT13214393	JATAI S1	07/11/2019 18:22	08/11/2019 15:14	08/11/2019 00:01	08/11/2019 13:27	13,44	144	1935,24	CHI
20191156861	JATAI	JT13214415	JATAI S1	07/11/2019 18:22	08/11/2019 15:14	08/11/2019 10:04	08/11/2019 13:47	3,73	428	1596,08	CHI
20191156861	SERRANOPOLIS	JT13214415	JATAI S1	07/11/2019 18:22	08/11/2019 15:14	08/11/2019 10:04	08/11/2019 13:47	3,73	65	242,40	CHI
20191156861	JATAI	JT11155600	JATAI S1	07/11/2019 18:22	08/11/2019 15:14	07/11/2019 18:22	08/11/2019 15:14	20,86	62	1293,20	CHI
20191156865	ALEXANIA	AX11096651	ALEXANIA	07/11/2019 15:38	07/11/2019 20:37	07/11/2019 15:38	07/11/2019 20:37	4,98	25	124,50	CHI
20191156867	CATALAO	CT12266100	CATALAO S1	07/11/2019 16:59	07/11/2019 21:49	07/11/2019 16:59	07/11/2019 21:49	4,82	20	96,38	CHI
20191156872	URUACU	640025225	URUACU	07/11/2019 18:08	07/11/2019 20:06	07/11/2019 18:08	07/11/2019 20:06	1,95	1	1,95	CHI
20191156881	NIQUELANDIA	NQ12235223	NIQUELANDIA SUBTRANSMISSAO	07/11/2019 18:09	08/11/2019 03:37	07/11/2019 18:09	08/11/2019 03:37	9,46	27	255,29	CHI
20191156885	JATAI	290277383	JATAI S2	07/11/2019 18:10	07/11/2019 23:46	07/11/2019 18:10	07/11/2019 23:46	5,60	1	5,60	CHI
20191156887	CATALAO	10002751982	CATALAO S2	07/11/2019 18:10	07/11/2019 20:20	07/11/2019 18:10	07/11/2019 20:20	2,16	1	2,16	CHI
20191156893	PIRACANJUBA	PJ21004965	ROCHEDO	07/11/2019 18:11	09/11/2019 03:20	07/11/2019 18:11	09/11/2019 03:20	33,14	1	33,14	CHI
20191156899	CALDAS NOVAS	7169686	VILA CORUMBA	07/11/2019 18:11	09/11/2019 15:48	07/11/2019 18:11	09/11/2019 15:48	45,60	1	45,60	CHI
20191156899	MARZAGAO	7169686	VILA CORUMBA	07/11/2019 18:11	09/11/2019 15:48	07/11/2019 18:11	09/11/2019 15:48	45,60	1	45,60	CHI
20191156900	BRITANIA	BT12009771	BRITANIA	07/11/2019 17:00	08/11/2019 17:24	07/11/2019 17:00	08/11/2019 11:15	18,24	9	164,13	CHI
20191156900	BRITANIA	BT12009771	BRITANIA	07/11/2019 17:00	08/11/2019 17:24	08/11/2019 11:25	08/11/2019 17:24	6,00	18	107,94	CHI
20191156907	NIQUELANDIA	NQ12088704	URUACU	07/11/2019 18:13	07/11/2019 22:41	07/11/2019 18:13	07/11/2019 22:41	4,47	21	93,78	CHI
20191156918	BRITANIA	BT11252614	BRITANIA	07/11/2019 17:23	07/11/2019 22:25	07/11/2019 17:23	07/11/2019 22:25	5,03	220	1106,72	CHI
20191156920	MOZARLANDIA	MZ12063703	MOZARLANDIA	07/11/2019 17:59	08/11/2019 08:50	07/11/2019 17:59	08/11/2019 08:50	14,84	10	148,42	CHI
20191156925	DIVINOPOLIS DE GOIAS	GH12272677	SAO DOMINGOS	07/11/2019 16:01	07/11/2019 21:31	07/11/2019 16:01	07/11/2019 21:31	5,50	15	82,49	CHI
20191156935	BOM JARDIM DE GOIAS	BM21155709	BOM JARDIM	07/11/2019 18:16	08/11/2019 00:44	07/11/2019 18:16	08/11/2019 00:44	6,47	1	6,47	CHI
20191156938	JARAGUA	JA12064321	JARAGUA	07/11/2019 18:16	08/11/2019 13:22	07/11/2019 18:16	08/11/2019 13:22	19,10	4	76,39	CHI
20191156939	BARRO ALTO	10021548119	BARRO ALTO	07/11/2019 18:16	09/11/2019 13:11	07/11/2019 18:16	09/11/2019 13:11	42,91	1	42,91	CHI
20191156944	JATAI	290250699	JATAI S2	07/11/2019 18:17	08/11/2019 17:32	07/11/2019 18:17	08/11/2019 17:32	23,25	1	23,25	CHI
20191156948	RIO VERDE	RV11365422	RIO VERDE S1	07/11/2019 16:41	08/11/2019 06:20	07/11/2019 16:41	08/11/2019 06:20	13,63	78	1063,49	CHI

20191156952	UIRAPURU	UP12190106	SANTA TEREZINHA	07/11/2019 17:08	08/11/2019 01:51	07/11/2019 17:08	08/11/2019 01:51	8,72	10	87,15	CHI
20191156960	ALTO PARAISO DE GOIAS	BF12274597	FLORES DE GOIAS	07/11/2019 18:19	08/11/2019 20:46	07/11/2019 18:19	08/11/2019 20:46	26,44	1	26,44	CHI
20191156963	GOIAS	GS12206865	MATRINCHA	07/11/2019 17:20	08/11/2019 10:52	07/11/2019 17:20	08/11/2019 10:52	17,52	63	1104,02	CHI
20191156964	FORMOSA	610175282	ITIQUEIRA	07/11/2019 18:19	07/11/2019 20:03	07/11/2019 18:19	07/11/2019 20:03	1,72	1	1,72	CHI
20191156967	IACIARA	PS12262172	IACIARA S2	07/11/2019 18:20	08/11/2019 08:28	07/11/2019 18:20	08/11/2019 08:28	14,12	1	14,12	CHI
20191156974	JATAI	JT12219384RE	JATAI S3	07/11/2019 17:52	08/11/2019 15:27	07/11/2019 17:52	08/11/2019 15:27	21,57	77	1660,85	CHI
20191156975	PORANGATU	PO12139177	PORANGATU	07/11/2019 17:19	07/11/2019 22:41	07/11/2019 17:19	07/11/2019 22:41	5,37	242	1298,80	CHI
20191156979	CABECEIRAS	CW21184957	ITIQUEIRA	07/11/2019 18:21	07/11/2019 20:01	07/11/2019 18:21	07/11/2019 20:01	1,65	1	1,65	CHI
20191156982	PIRACANJUBA	PJ21027575	PIRACANJUBA	07/11/2019 18:22	08/11/2019 16:58	07/11/2019 18:22	08/11/2019 16:58	22,60	1	22,60	CHI
20191157002	FORMOSA	FA12040565	ITIQUEIRA	08/11/2019 11:01	09/11/2019 07:47	08/11/2019 22:25	09/11/2019 01:30	3,08	92	283,10	CHI
20191157002	FORMOSA	FA12140791LD	ITIQUEIRA	08/11/2019 11:01	09/11/2019 07:47	08/11/2019 11:01	09/11/2019 07:47	20,77	4	83,07	CHI
20191157019	ORIZONA	OZ11130690	PIRES DO RIO S2	07/11/2019 17:22	07/11/2019 21:07	07/11/2019 17:22	07/11/2019 21:07	3,75	37	138,62	CHI
20191157025	FORMOSA	610002351	ITIQUEIRA	07/11/2019 18:26	07/11/2019 19:46	07/11/2019 18:26	07/11/2019 19:46	1,32	1	1,32	CHI
20191157031	VICENTINOPOLIS	VI21314396	VICENTINOPOLIS	07/11/2019 18:27	08/11/2019 11:58	07/11/2019 18:27	08/11/2019 11:58	17,51	1	17,51	CHI
20191157040	CRIXAS	UP12171811	SANTA TEREZINHA	07/11/2019 17:45	08/11/2019 00:53	07/11/2019 17:45	08/11/2019 00:53	7,13	6	42,79	CHI
20191157040	UIRAPURU	UP12171811	SANTA TEREZINHA	07/11/2019 17:45	08/11/2019 00:53	07/11/2019 17:45	08/11/2019 00:53	7,13	31	221,09	CHI
20191157044	ACREUNA	EU12026747	RIO DOS BOIS	07/11/2019 17:49	08/11/2019 13:07	07/11/2019 17:49	08/11/2019 13:07	19,29	11	212,15	CHI
20191157044	TURVELANDIA	EU12026747	RIO DOS BOIS	07/11/2019 17:49	08/11/2019 13:07	07/11/2019 17:49	08/11/2019 13:07	19,29	15	289,30	CHI
20191157044	ACREUNA	EU12026734	RIO DOS BOIS	07/11/2019 17:49	08/11/2019 13:07	08/11/2019 10:22	08/11/2019 13:07	2,73	7	19,14	CHI
20191157044	TURVELANDIA	EU12026734	RIO DOS BOIS	07/11/2019 17:49	08/11/2019 13:07	08/11/2019 10:22	08/11/2019 13:07	2,73	4	10,94	CHI
20191157045	GOIAS	GS12310416	ITABERAI S1	07/11/2019 15:27	09/11/2019 07:47	07/11/2019 15:27	09/11/2019 07:47	40,33	18	726,00	CHI
20191157061	INHUMAS	IN12012230	INHUMAS S2	07/11/2019 14:13	07/11/2019 20:45	07/11/2019 14:13	07/11/2019 20:45	6,52	362	2360,14	CHI
20191157064	BONOPOLIS	BX12364615	SAO MIGUEL DO ARAGUAIA	07/11/2019 17:18	07/11/2019 22:38	07/11/2019 17:18	07/11/2019 22:38	5,32	19	101,09	CHI
20191157071	FORMOSA	610084458	ITIQUEIRA	07/11/2019 18:31	07/11/2019 23:32	07/11/2019 18:31	07/11/2019 23:32	5,01	1	5,01	CHI
20191157078	ARUANA	MP12183061	MOZARLANDIA	07/11/2019 07:12	09/11/2019 12:55	07/11/2019 07:12	09/11/2019 12:55	53,71	8	429,66	CHI
20191157078	MATRINCHA	MP12183061	MOZARLANDIA	07/11/2019 07:12	09/11/2019 12:55	07/11/2019 07:12	09/11/2019 12:55	53,71	27	1450,09	CHI
20191157079	NIQUELANDIA	10019358944	BARRO ALTO	07/11/2019 18:32	08/11/2019 20:52	07/11/2019 18:32	08/11/2019 20:52	26,32	1	26,32	CHI
20191157097	ABADIANIA	AA21302221	DAIA S2	07/11/2019 18:36	08/11/2019 10:14	07/11/2019 18:36	08/11/2019 10:14	15,63	2	31,26	CHI
20191157110	MUTUNOPOLIS	MU12391986	MARA ROSA	07/11/2019 07:30	12/11/2019 18:57	10/11/2019 01:03	11/11/2019 10:37	33,57	14	469,92	CHI
20191157110	MUTUNOPOLIS	MU12391658	MARA ROSA	07/11/2019 07:30	12/11/2019 18:57	07/11/2019 07:30	11/11/2019 10:37	99,12	34	3370,01	CHI
20191157110	ESTRELA DO NORTE	MU12076698	MARA ROSA	07/11/2019 07:30	12/11/2019 18:57	10/11/2019 01:03	11/11/2019 14:16	37,22	1	37,22	CHI
20191157110	MUTUNOPOLIS	MU12076698	MARA ROSA	07/11/2019 07:30	12/11/2019 18:57	10/11/2019 01:03	11/11/2019 14:16	37,22	16	595,56	CHI
20191157110	MUTUNOPOLIS	MU12391986	MARA ROSA	07/11/2019 07:30	12/11/2019 18:57	11/11/2019 12:59	11/11/2019 14:16	1,28	48	61,57	CHI

20191157110	MUTUNOPOLIS	MU12076698	MARA ROSA	07/11/2019 07:30	12/11/2019 18:57	12/11/2019 09:11	12/11/2019 17:35	8,40	7	58,82	CHI
20191157110	ESTRELA DO NORTE	MU12076698	MARA ROSA	07/11/2019 07:30	12/11/2019 18:57	12/11/2019 09:11	12/11/2019 17:58	8,77	1	8,77	CHI
20191157110	MUTUNOPOLIS	MU12076698	MARA ROSA	07/11/2019 07:30	12/11/2019 18:57	12/11/2019 09:11	12/11/2019 17:58	8,77	9	78,96	CHI
20191157110	MUTUNOPOLIS	MU13341437	MARA ROSA	07/11/2019 07:30	12/11/2019 18:57	10/11/2019 01:03	12/11/2019 18:57	65,91	16	1054,60	CHI
20191157115	MORRINHOS	150098250	MORRINHOS	07/11/2019 18:36	08/11/2019 09:45	07/11/2019 18:36	08/11/2019 09:45	15,15	1	15,15	CHI
20191157129	NAZARIO	NZ12004798	ANICUNS	07/11/2019 18:33	08/11/2019 09:05	07/11/2019 18:33	08/11/2019 09:05	14,53	12	174,35	CHI
20191157140	GOIANIRA	GR11234818	GOIANIRA	07/11/2019 16:41	07/11/2019 21:45	07/11/2019 16:41	07/11/2019 21:45	5,06	31	156,85	CHI
20191157158	FLORES DE GOIAS	FB21252146	FLORES DE GOIAS	07/11/2019 18:42	07/11/2019 22:05	07/11/2019 18:42	07/11/2019 22:05	3,38	2	6,76	CHI
20191157165	CIDADE OCIDENTAL	DH11248725	MARAJOARA	07/11/2019 17:14	08/11/2019 02:09	07/11/2019 17:14	08/11/2019 02:09	8,92	19	169,41	CHI
20191157170	MINACU	IH13240765	MINACU	07/11/2019 18:43	09/11/2019 14:14	09/11/2019 09:33	09/11/2019 14:14	4,68	41	191,68	CHI
20191157170	MINACU	IH21242185	MINACU	07/11/2019 18:43	09/11/2019 14:14	07/11/2019 18:43	09/11/2019 14:14	43,51	2	87,02	CHI
20191157175	JARAGUA	JA21140547	GOIANESIA S2	07/11/2019 18:44	08/11/2019 13:58	07/11/2019 18:44	08/11/2019 13:58	19,23	1	19,23	CHI
20191157182	CATALAO	GD12127538	CATALAO S1	07/11/2019 15:28	08/11/2019 17:55	07/11/2019 15:28	08/11/2019 09:09	17,69	3	53,07	CHI
20191157182	GOIANDIRA	GD12127538	CATALAO S1	07/11/2019 15:28	08/11/2019 17:55	07/11/2019 15:28	08/11/2019 09:09	17,69	13	229,99	CHI
20191157182	CATALAO	GD12323404	CATALAO S1	07/11/2019 15:28	08/11/2019 17:55	07/11/2019 15:28	08/11/2019 17:55	26,45	2	52,89	CHI
20191157183	SAO FRANCISCO DE GOIAS	490023551	SAO FRANCISCO DE GOIAS	07/11/2019 18:45	08/11/2019 11:06	07/11/2019 18:45	08/11/2019 11:06	16,34	1	16,34	CHI
20191157192	NIQUELANDIA	NQ12197539	NIQUELANDIA SUBTRANSMISSAO	07/11/2019 16:29	07/11/2019 22:56	07/11/2019 16:29	07/11/2019 22:56	6,45	5	32,24	CHI
20191157196	JUSSARA	JR12076133	BRITANIA	07/11/2019 18:09	09/11/2019 11:20	07/11/2019 18:09	09/11/2019 11:20	41,17	3	123,52	CHI
20191157218	ARUANA	AK12404527	MOZARLANDIA	07/11/2019 16:50	08/11/2019 14:25	07/11/2019 16:50	08/11/2019 14:25	21,57	33	711,72	CHI
20191157220	PARANAIGUARA	PC12070705	QUIRINOPOLIS	07/11/2019 16:47	08/11/2019 14:20	07/11/2019 16:47	08/11/2019 14:20	21,55	34	732,67	CHI
20191157221	JATAI	10006398209	JATAI S2	07/11/2019 18:49	08/11/2019 11:30	07/11/2019 18:49	08/11/2019 11:30	16,68	1	16,68	CHI
20191157225	CRISTALINA	KR12168488	CRISTALINA S1	07/11/2019 18:49	07/11/2019 21:06	07/11/2019 18:49	07/11/2019 21:06	2,27	32	72,69	CHI
20191157225	LUZIANIA	KR12168488	CRISTALINA S1	07/11/2019 18:49	07/11/2019 21:06	07/11/2019 18:49	07/11/2019 21:06	2,27	1	2,27	CHI
20191157226	SERRANOPOLIS	SX12226581	JATAI S1	07/11/2019 17:13	09/11/2019 13:10	07/11/2019 17:13	09/11/2019 13:10	43,95	8	351,60	CHI
20191157234	NIQUELANDIA	NQ12271070	BARRO ALTO	07/11/2019 08:09	07/11/2019 22:01	07/11/2019 08:09	07/11/2019 22:01	13,85	9	124,66	CHI
20191157240	ITARUMA	IM21296702	ITAJA S2	07/11/2019 18:51	10/11/2019 15:08	07/11/2019 18:51	10/11/2019 15:08	68,28	1	68,28	CHI
20191157243	CRIXAS	CX12380748	SERRA DO OURO	07/11/2019 16:11	08/11/2019 14:42	07/11/2019 16:11	08/11/2019 14:42	22,50	18	405,08	CHI
20191157245	JATAI	JT12182140	JATAI S1	08/11/2019 08:00	09/11/2019 09:26	08/11/2019 08:00	09/11/2019 09:26	25,43	9	228,84	CHI
20191157245	SERRANOPOLIS	JT12182140	JATAI S1	08/11/2019 08:00	09/11/2019 09:26	08/11/2019 08:00	09/11/2019 09:26	25,43	2	50,85	CHI
20191157265	ITABERAI	IB12404552	ITABERAI S1	07/11/2019 16:51	08/11/2019 07:40	07/11/2019 16:51	08/11/2019 07:40	14,81	8	118,50	CHI
20191157266	SANTA FE DE GOIAS	RN11183393	BRITANIA	07/11/2019 17:28	08/11/2019 05:17	07/11/2019 17:28	08/11/2019 05:17	11,81	41	484,14	CHI
20191157286	CATALAO	CT12270789	CATALAO S2	07/11/2019 18:29	09/11/2019 08:50	07/11/2019 18:29	09/11/2019 08:50	38,34	3	115,02	CHI
20191157286	CUMARI	CT12270789	CATALAO S2	07/11/2019 18:29	09/11/2019 08:50	07/11/2019 18:29	09/11/2019 08:50	38,34	8	306,73	CHI

20191157292	MINACU	IH21292259	MINACU	07/11/2019 19:00	08/11/2019 02:01	07/11/2019 19:00	08/11/2019 02:01	7,02	4	28,07	CHI
20191157293	SANTA TEREZINHA DE GOIAS	SG21190175	URUACU	07/11/2019 19:00	09/11/2019 09:23	07/11/2019 19:00	09/11/2019 09:23	38,40	1	38,40	CHI
20191157308	ALEXANIA	AX12295610	ALEXANIA	07/11/2019 18:58	08/11/2019 07:54	07/11/2019 18:58	08/11/2019 07:54	12,93	22	284,48	CHI
20191157309	BOM JARDIM DE GOIAS	BM12259514	BOM JARDIM	07/11/2019 18:18	08/11/2019 06:58	07/11/2019 18:18	08/11/2019 06:58	12,65	11	139,15	CHI
20191157313	JATAI	JT12274074	JATAI S2	07/11/2019 18:57	07/11/2019 23:55	07/11/2019 18:57	07/11/2019 23:55	4,96	695	3450,48	CHI
20191157316	BALIZA	BH12356956	BOM JARDIM	07/11/2019 19:02	08/11/2019 10:11	07/11/2019 19:02	08/11/2019 10:11	15,14	2	30,28	CHI
20191157317	RIO VERDE	RV12031389	RIO VERDE S1	07/11/2019 15:10	08/11/2019 16:20	07/11/2019 15:10	08/11/2019 16:20	25,16	16	402,60	CHI
20191157326	POSSE	PS11150809	IACIARA S2	07/11/2019 16:28	07/11/2019 19:53	07/11/2019 16:28	07/11/2019 19:53	3,40	100	340,33	CHI
20191157330	IPORA	IR12062881	IPORA	07/11/2019 08:59	09/11/2019 11:30	07/11/2019 08:59	09/11/2019 11:30	50,51	4	202,06	CHI
20191157336	EDEIA	EA12223418	EDEIA	07/11/2019 16:32	07/11/2019 21:25	07/11/2019 16:32	07/11/2019 21:25	4,88	142	692,68	CHI
20191157348	VILA BOA	FA21042044	IACIARA S2	07/11/2019 19:06	08/11/2019 02:03	07/11/2019 19:06	08/11/2019 02:03	6,94	1	6,94	CHI
20191157370	GOIANIA	GN11271872	GOYA S1	07/11/2019 16:45	08/11/2019 05:10	07/11/2019 16:45	08/11/2019 05:10	12,41	11	136,50	CHI
20191157388	LUZIANIA	LZ12112942	PAMPLONA	07/11/2019 16:59	07/11/2019 21:22	07/11/2019 16:59	07/11/2019 21:22	4,37	10	43,68	CHI
20191157389	RIO VERDE	630112861	RIO VERDE S2	07/11/2019 19:13	09/11/2019 10:38	07/11/2019 19:13	09/11/2019 10:38	39,42	1	39,42	CHI
20191157398	AGUAS LINDAS DE GOIAS	10019809849	AGUAS LINDAS DE GOIAS S1	07/11/2019 19:14	07/11/2019 23:52	07/11/2019 19:14	07/11/2019 23:52	4,62	1	4,62	CHI
20191157403	CRIXAS	CX11000015	SERRA DO OURO	07/11/2019 18:39	07/11/2019 23:53	07/11/2019 18:39	07/11/2019 23:53	5,22	62	323,61	CHI
20191157408	SANTA FE DE GOIAS	RN11250640	BRITANIA	07/11/2019 17:56	07/11/2019 22:43	07/11/2019 17:56	07/11/2019 22:43	4,77	75	357,83	CHI
20191157409	BOM JARDIM DE GOIAS	ME12251375	IPORA	07/11/2019 17:08	11/11/2019 16:32	07/11/2019 17:08	11/11/2019 16:32	95,40	18	1717,13	CHI
20191157409	MONTES CLAROS DE GOIAS	ME12251375	IPORA	07/11/2019 17:08	11/11/2019 16:32	07/11/2019 17:08	11/11/2019 16:32	95,40	7	667,77	CHI
20191157414	NOVA CRIXAS	NA12201789	NOVA CRIXAS	07/11/2019 19:16	08/11/2019 17:30	07/11/2019 19:16	08/11/2019 17:30	22,23	26	577,91	CHI
20191157425	JATAI	JT12000118	JATAI S2	07/11/2019 16:56	09/11/2019 05:30	07/11/2019 16:56	08/11/2019 10:55	17,99	38	683,62	CHI
20191157425	JATAI	JT12000118	JATAI S2	07/11/2019 16:56	09/11/2019 05:30	07/11/2019 16:56	09/11/2019 05:30	36,57	35	1279,83	CHI
20191157430	PIRENOPOLIS	PV21298820	GOIANESIA S1	07/11/2019 19:18	08/11/2019 23:24	07/11/2019 19:18	08/11/2019 23:24	28,09	2	56,18	CHI
20191157436	TAQUARAL DE GOIAS	TQ12074928	ITABERAI S1	07/11/2019 13:30	08/11/2019 10:53	07/11/2019 13:30	08/11/2019 10:53	21,38	27	577,21	CHI
20191157437	MOIPIORA	1430000548	IPORA	07/11/2019 19:18	08/11/2019 17:44	07/11/2019 19:18	08/11/2019 17:44	22,43	1	22,43	CHI
20191157443	CACHOEIRA ALTA	CA12196160	CACHOEIRA ALTA	07/11/2019 18:35	09/11/2019 11:07	07/11/2019 18:35	09/11/2019 11:07	40,53	14	567,40	CHI
20191157451	SILVANIA	SV12281886	VIANOPOLIS	07/11/2019 15:54	08/11/2019 02:28	07/11/2019 15:54	08/11/2019 02:28	10,56	114	1204,22	CHI
20191157453	SANTA FE DE GOIAS	RN12220397	BRITANIA	07/11/2019 17:29	08/11/2019 15:29	07/11/2019 17:29	08/11/2019 15:29	22,00	21	461,94	CHI
20191157458	GOIANESIA	10009408043	GOIANESIA S1	07/11/2019 19:23	08/11/2019 05:00	07/11/2019 19:23	08/11/2019 05:00	9,61	1	9,61	CHI
20191157462	ITABERAI	50067588	ITABERAI S2	07/11/2019 19:23	08/11/2019 05:32	07/11/2019 19:23	08/11/2019 05:32	10,15	1	10,15	CHI
20191157473	CACHOEIRA ALTA	SO12000002	CACHOEIRA ALTA	07/11/2019 19:24	07/11/2019 22:15	07/11/2019 19:24	07/11/2019 22:15	2,85	5	14,25	CHI
20191157473	CACU	SO12000002	CACHOEIRA ALTA	07/11/2019 19:24	07/11/2019 22:15	07/11/2019 19:24	07/11/2019 22:15	2,85	34	96,93	CHI
20191157473	SAO SIMAO	SO12000002	CACHOEIRA ALTA	07/11/2019 19:24	07/11/2019 22:15	07/11/2019 19:24	07/11/2019 22:15	2,85	388	1106,12	CHI

20191157490	EDEIA	CL12230806	RIO DOS BOIS	07/11/2019 15:07	09/11/2019 18:00	07/11/2019 15:07	09/11/2019 18:00	50,87	2	101,75	CHI
20191157490	PORTEIRAO	CL12230806	RIO DOS BOIS	07/11/2019 15:07	09/11/2019 18:00	07/11/2019 15:07	09/11/2019 18:00	50,87	4	203,49	CHI
20191157490	VICENTINOPOLIS	CL12230806	RIO DOS BOIS	07/11/2019 15:07	09/11/2019 18:00	07/11/2019 15:07	09/11/2019 18:00	50,87	4	203,49	CHI
20191157492	PIRES DO RIO	10027242488	PIRES DO RIO S1	07/11/2019 19:26	08/11/2019 11:13	07/11/2019 19:26	08/11/2019 11:13	15,78	1	15,78	CHI
20191157495	CRIXAS	CX12254975	SERRA DO OURO	07/11/2019 18:15	08/11/2019 00:34	07/11/2019 18:15	08/11/2019 00:34	6,30	60	378,03	CHI
20191157508	RIO VERDE	RV11213405	RIO VERDE S1	07/11/2019 19:15	07/11/2019 22:00	07/11/2019 19:15	07/11/2019 22:00	2,74	319	872,91	CHI
20191157509	BRITANIA	2110003516	BRITANIA	07/11/2019 19:28	08/11/2019 00:31	07/11/2019 19:28	08/11/2019 00:31	5,04	1	5,04	CHI
20191157512	ANAPOLIS	AN12214711	JUNDIAI S1	07/11/2019 19:22	07/11/2019 21:16	07/11/2019 19:22	07/11/2019 21:16	1,89	240	454,47	CHI
20191157516	SAO MIGUEL DO ARAGUAIA	SM12083960	SAO MIGUEL DO ARAGUAIA	07/11/2019 19:28	10/11/2019 11:25	07/11/2019 19:28	10/11/2019 11:25	63,95	5	319,73	CHI
20191157529	LEOPOLDO DE BULHOES	LB12353164	DAIA S2	07/11/2019 19:29	08/11/2019 10:04	07/11/2019 19:29	08/11/2019 10:04	14,58	8	116,62	CHI
20191157533	PLANALTINA	PI11361427	PLANALTINA	07/11/2019 19:25	07/11/2019 22:17	07/11/2019 19:25	07/11/2019 22:17	2,87	138	395,45	CHI
20191157544	GUAPO	GC12000274	GUAPO S1	07/11/2019 16:49	08/11/2019 09:04	07/11/2019 16:49	08/11/2019 09:04	16,24	38	617,03	CHI
20191157544	TRINDADE	GC12000274	GUAPO S1	07/11/2019 16:49	08/11/2019 09:04	07/11/2019 16:49	08/11/2019 09:04	16,24	38	617,03	CHI
20191157560	AGUAS LINDAS DE GOIAS	LA11113295	AGUAS LINDAS DE GOIAS S2	07/11/2019 19:22	07/11/2019 20:20	07/11/2019 19:22	07/11/2019 20:20	0,96	234	225,16	CHI
20191157561	ITAPIRAPUA	IU12067919	MATRINCHA	07/11/2019 15:30	08/11/2019 10:06	07/11/2019 15:30	08/11/2019 10:06	18,59	8	148,68	CHI
20191157563	CRISTALINA	KR21307458	CRISTALINA S2	07/11/2019 19:35	08/11/2019 10:05	07/11/2019 19:35	08/11/2019 10:05	14,49	1	14,49	CHI
20191157564	ITAPIRAPUA	IU12072503	JUSSARA	07/11/2019 19:35	10/11/2019 11:37	07/11/2019 19:35	10/11/2019 11:37	64,02	11	704,25	CHI
20191157588	CAMPINACU	IH12250126	MINACU	07/11/2019 13:31	08/11/2019 01:05	07/11/2019 13:31	08/11/2019 01:05	11,55	9	103,97	CHI
20191157603	ITUMBIARA	IT12257023RE	ITUMBIARA NOVA	07/11/2019 18:38	08/11/2019 08:42	07/11/2019 18:38	08/11/2019 08:42	14,05	63	885,32	CHI
20191157608	CACHOEIRA ALTA	CA21190372	CACHOEIRA ALTA	07/11/2019 19:44	10/11/2019 14:58	07/11/2019 19:44	10/11/2019 14:58	67,23	2	134,46	CHI
20191157614	RIO VERDE	630288690	RIO VERDE S1	07/11/2019 19:45	09/11/2019 17:39	07/11/2019 19:45	09/11/2019 17:39	45,90	1	45,90	CHI
20191157617	CACU	CC12244141	CACHOEIRA ALTA	07/11/2019 19:45	14/11/2019 17:48	07/11/2019 19:45	14/11/2019 17:48	166,04	1	166,04	CHI
20191157621	RIO VERDE	RV12054354	MONTIVIDIU T	07/11/2019 18:47	11/11/2019 09:10	07/11/2019 18:47	11/11/2019 09:10	86,38	2	172,76	CHI
20191157629	ALVORADA DO NORTE	5260000242	IACIARA S2	07/11/2019 19:48	08/11/2019 15:59	07/11/2019 19:48	08/11/2019 15:59	20,18	1	20,18	CHI
20191157630	CORUMBA DE GOIAS	CB12061922	ANAPOLIS UNIVERSITARIO S1	07/11/2019 18:12	08/11/2019 11:49	07/11/2019 18:12	08/11/2019 11:49	17,60	11	193,61	CHI
20191157632	ITAPIRAPUA	IU11070527	MATRINCHA	07/11/2019 19:47	08/11/2019 09:45	07/11/2019 19:47	08/11/2019 09:45	13,96	121	1688,66	CHI
20191157640	CRISTALINA	KR21230268	CRISTALINA S2	07/11/2019 19:50	08/11/2019 07:17	07/11/2019 19:50	08/11/2019 07:17	11,44	1	11,44	CHI
20191157644	GAMELEIRA DE GOIAS	SV21026791	DAIA S2	07/11/2019 19:50	09/11/2019 11:32	07/11/2019 19:50	09/11/2019 11:32	39,69	1	39,69	CHI
20191157647	GAMELEIRA DE GOIAS	SV21241541	DAIA S2	07/11/2019 19:51	08/11/2019 12:01	07/11/2019 19:51	08/11/2019 12:01	16,16	2	32,31	CHI
20191157651	LUZIANIA	LZ12388659	MARAJOARA	07/11/2019 18:48	07/11/2019 22:56	07/11/2019 18:48	07/11/2019 22:56	4,12	8	32,96	CHI
20191157651	VALPARAISO DE GOIAS	LZ12388659	MARAJOARA	07/11/2019 18:48	07/11/2019 22:56	07/11/2019 18:48	07/11/2019 22:56	4,12	28	115,38	CHI
20191157652	JATAI	290337203	JATAI S2	07/11/2019 19:53	08/11/2019 10:04	07/11/2019 19:53	08/11/2019 10:04	14,18	1	14,18	CHI
20191157655	JATAI	290326102	JATAI S2	07/11/2019 19:54	08/11/2019 10:18	07/11/2019 19:54	08/11/2019 10:18	14,40	1	14,40	CHI

20191157661	JATAI	290216862	JATAI S2	07/11/2019 19:54	08/11/2019 17:26	07/11/2019 19:54	08/11/2019 17:26	21,52	1	21,52	CHI
20191157663	AGUAS LINDAS DE GOIAS	4830215526	AGUAS LINDAS DE GOIAS S2	07/11/2019 19:54	07/11/2019 22:26	07/11/2019 19:54	07/11/2019 22:26	2,52	1	2,52	CHI
20191157667	PADRE BERNARDO	PB12052000	PADRE BERNARDO	07/11/2019 19:55	08/11/2019 02:07	07/11/2019 19:55	08/11/2019 02:07	6,19	4	24,77	CHI
20191157669	BALIZA	BH12343730	BOM JARDIM	07/11/2019 19:56	08/11/2019 19:57	07/11/2019 19:56	08/11/2019 19:57	24,02	8	192,13	CHI
20191157670	NOVO GAMA	4990084963	MARAJOARA	07/11/2019 19:56	08/11/2019 11:49	07/11/2019 19:56	08/11/2019 11:49	15,88	1	15,88	CHI
20191157673	RIO VERDE	RV11018077	SANTA HELENA S1	07/11/2019 18:53	09/11/2019 10:10	07/11/2019 18:53	09/11/2019 10:10	39,27	94	3691,46	CHI
20191157681	JANDAIA	JD12345689	PALMEIRAS	07/11/2019 08:18	08/11/2019 00:00	07/11/2019 08:18	08/11/2019 00:00	15,69	2	31,37	CHI
20191157694	CRISTALINA	3490002499	PAMPLONA	07/11/2019 20:02	07/11/2019 22:44	07/11/2019 20:02	07/11/2019 22:44	2,71	1	2,71	CHI
20191157696	ITAJA	IJ21188982	ITAJA S2	07/11/2019 20:02	08/11/2019 15:51	07/11/2019 20:02	08/11/2019 15:51	19,81	2	39,61	CHI
20191157697	ITARUMA	O3700234	CACHOEIRA ALTA	07/11/2019 20:02	07/11/2019 21:47	07/11/2019 20:02	07/11/2019 21:47	1,74	71	123,86	CHI
20191157698	MINEIROS	MY12209687	PARQUE DAS EMAS	07/11/2019 20:02	09/11/2019 09:05	07/11/2019 20:02	09/11/2019 09:05	37,04	9	333,32	CHI
20191157700	ITABERAI	IB11220150	ITABERAI S2	07/11/2019 17:34	08/11/2019 01:16	07/11/2019 17:34	08/11/2019 01:16	7,70	87	669,90	CHI
20191157720	CRISTALINA	1060057120	CRISTALINA S1	07/11/2019 20:07	08/11/2019 04:13	07/11/2019 20:07	08/11/2019 04:13	8,09	1	8,09	CHI
20191157722	SANCLERLANDIA	SC21005432	FIRMINOPOLIS S2	07/11/2019 20:08	08/11/2019 12:12	07/11/2019 20:08	08/11/2019 12:12	16,06	1	16,06	CHI
20191157729	JUSSARA	JR11259688	JUSSARA	07/11/2019 20:10	09/11/2019 20:05	07/11/2019 20:10	09/11/2019 20:05	47,91	79	3785,04	CHI
20191157751	FORMOSA	FA10404994	ITUIQUIRA	07/11/2019 20:08	07/11/2019 20:16	07/11/2019 20:08	07/11/2019 20:16	0,13	17	2,20	CHI
20191157755	SANTO ANTONIO DO DESCOBERTO	2210120014	AGUAS LINDAS DE GOIAS S2	07/11/2019 20:16	07/11/2019 21:51	07/11/2019 20:16	07/11/2019 21:51	1,57	1	1,57	CHI
20191157757	PEROLANDIA	DP11055739	JATAI S1	07/11/2019 20:17	08/11/2019 10:22	07/11/2019 20:17	08/11/2019 10:22	14,08	107	1506,71	CHI
20191157760	NOVA AURORA	NE12127548	CATALAO S1	07/11/2019 20:17	09/11/2019 12:32	07/11/2019 20:17	09/11/2019 12:32	40,25	39	1569,64	CHI
20191157773	SANTA TEREZA DE GOIAS	2430019274	MARA ROSA	07/11/2019 20:20	09/11/2019 11:59	07/11/2019 20:20	09/11/2019 11:59	39,66	1	39,66	CHI
20191157797	MINEIROS	1390033081	PARQUE DAS EMAS	07/11/2019 20:24	07/11/2019 22:48	07/11/2019 20:24	07/11/2019 22:48	2,39	1	2,39	CHI
20191157801	EDEIA	EA11264946	EDEIA	07/11/2019 20:25	08/11/2019 07:39	07/11/2019 20:25	08/11/2019 07:39	11,22	82	920,29	CHI
20191157807	PLANALTINA	PI12361252	PLANALTINA	08/11/2019 09:38	08/11/2019 16:45	08/11/2019 09:38	08/11/2019 16:45	7,11	33	234,68	CHI
20191157813	GOIANESIA	550056385	GOIANESIA S2	07/11/2019 20:27	09/11/2019 12:16	07/11/2019 20:27	09/11/2019 12:16	39,81	1	39,81	CHI
20191157825	MORRINHOS	MR21249857	MORRINHOS	07/11/2019 20:29	10/11/2019 16:35	07/11/2019 20:29	10/11/2019 16:35	68,09	1	68,09	CHI
20191157826	ABADIANIA	AN12261177	ANAPOLIS UNIVERSITARIO S2	07/11/2019 20:30	08/11/2019 20:13	07/11/2019 20:30	08/11/2019 20:13	23,71	62	1470,26	CHI
20191157830	CRISTALINA	KR11128712	CRISTALINA S1	07/11/2019 20:23	07/11/2019 21:37	07/11/2019 20:23	07/11/2019 21:37	1,23	256	314,38	CHI
20191157833	SANTA FE DE GOIAS	RN11245675	BRITANIA	07/11/2019 18:38	07/11/2019 23:41	07/11/2019 18:38	07/11/2019 23:41	5,04	84	423,22	CHI
20191157852	CATALAO	CT11333573	CATALAO S2	07/11/2019 20:13	07/11/2019 21:26	07/11/2019 20:13	07/11/2019 21:26	1,21	93	112,81	CHI
20191157856	LUZIANIA	120054486	RIO VERMELHO	07/11/2019 20:35	07/11/2019 21:55	07/11/2019 20:35	07/11/2019 21:55	1,33	1	1,33	CHI
20191157857	EDEALINA	VI12381142	VICENTINOPOLIS	07/11/2019 13:52	09/11/2019 16:54	07/11/2019 13:52	09/11/2019 16:54	51,03	10	510,30	CHI
20191157861	BARRO ALTO	BA12169965	BARRO ALTO	07/11/2019 20:36	09/11/2019 17:01	07/11/2019 20:36	09/11/2019 17:01	44,41	1	44,41	CHI
20191157866	ANAPOLIS	AN11135720	ANAPOLIS UNIVERSITARIO S1	07/11/2019 20:26	07/11/2019 23:36	07/11/2019 20:26	07/11/2019 23:36	3,16	105	331,83	CHI

20191157867	NOVA AURORA	2220001228	CATALAO S1	07/11/2019 20:37	07/11/2019 23:07	07/11/2019 20:37	07/11/2019 23:07	2,50	1	2,50	CHI
20191157889	EDEIA	EA21159156	EDEIA	07/11/2019 20:45	08/11/2019 10:52	07/11/2019 20:45	08/11/2019 10:52	14,10	1	14,10	CHI
20191157909	PLANALTINA	PI11361426	PLANALTINA	07/11/2019 20:46	08/11/2019 00:47	07/11/2019 20:46	08/11/2019 00:47	4,01	182	729,77	CHI
20191157916	FORMOSA	610179093	ITIQUEIRA	07/11/2019 20:51	07/11/2019 23:28	07/11/2019 20:51	07/11/2019 23:28	2,61	1	2,61	CHI
20191157921	JANDAIA	JD12003211	PALMEIRAS	07/11/2019 20:43	08/11/2019 12:23	07/11/2019 20:43	08/11/2019 09:12	12,48	10	124,77	CHI
20191157921	JANDAIA	JD12003211	PALMEIRAS	07/11/2019 20:43	08/11/2019 12:23	07/11/2019 20:43	08/11/2019 12:23	15,67	1	15,67	CHI
20191157921	PALMEIRAS DE GOIAS	JD12003211	PALMEIRAS	07/11/2019 20:43	08/11/2019 12:23	07/11/2019 20:43	08/11/2019 12:23	15,67	4	62,67	CHI
20191157921	PALMINOPOLIS	JD12003211	PALMEIRAS	07/11/2019 20:43	08/11/2019 12:23	07/11/2019 20:43	08/11/2019 12:23	15,67	14	219,35	CHI
20191157921	JANDAIA	JD12003211	PALMEIRAS	07/11/2019 20:43	08/11/2019 12:23	08/11/2019 11:40	08/11/2019 12:23	0,73	10	7,27	CHI
20191157939	GOUVELANDIA	GB21261020	QUIRINOPOLIS	07/11/2019 20:57	09/11/2019 08:45	07/11/2019 20:57	09/11/2019 08:45	35,79	1	35,79	CHI
20191157949	CORUMBA DE GOIAS	ZN11319613	COCALZINHO	07/11/2019 21:00	08/11/2019 16:48	07/11/2019 21:00	08/11/2019 16:48	19,80	11	217,76	CHI
20191157950	IPORA	730143387	IPORA	07/11/2019 21:00	08/11/2019 10:22	07/11/2019 21:00	08/11/2019 10:22	13,36	1	13,36	CHI
20191157956	MAURILANDIA	ML21147890	SANTA HELENA S1	07/11/2019 21:01	11/11/2019 17:15	07/11/2019 21:01	11/11/2019 17:15	92,23	1	92,23	CHI
20191157985	CACHOEIRA DOURADA	CD21296852	CACHOEIRA DOURADA	07/11/2019 21:10	10/11/2019 09:57	07/11/2019 21:10	10/11/2019 09:57	60,78	1	60,78	CHI
20191158019	VILA BOA	2880001852	IACIARA S2	07/11/2019 21:22	07/11/2019 23:40	07/11/2019 21:22	07/11/2019 23:40	2,30	1	2,30	CHI
20191158028	CHAPADAO DO CEU	02430414	CHAPADAO DO CEU	07/11/2019 21:16	08/11/2019 17:44	07/11/2019 21:16	08/11/2019 09:31	12,25	11	134,78	CHI
20191158028	SERRANOPOLIS	02430414	CHAPADAO DO CEU	07/11/2019 21:16	08/11/2019 17:44	07/11/2019 21:16	08/11/2019 09:31	12,25	11	134,78	CHI
20191158028	MINEIROS	DJ13164076	CHAPADAO DO CEU	07/11/2019 21:16	08/11/2019 17:44	07/11/2019 21:16	08/11/2019 11:11	13,92	5	69,59	CHI
20191158028	SERRANOPOLIS	DJ13164076	CHAPADAO DO CEU	07/11/2019 21:16	08/11/2019 17:44	07/11/2019 21:16	08/11/2019 11:11	13,92	23	320,12	CHI
20191158028	SERRANOPOLIS	DJ13164068	CHAPADAO DO CEU	07/11/2019 21:16	08/11/2019 17:44	07/11/2019 21:16	08/11/2019 12:38	15,37	4	61,47	CHI
20191158028	MINEIROS	SX10400642	CHAPADAO DO CEU	07/11/2019 21:16	08/11/2019 17:44	07/11/2019 21:16	08/11/2019 14:08	16,88	20	337,54	CHI
20191158028	SERRANOPOLIS	SX10400642	CHAPADAO DO CEU	07/11/2019 21:16	08/11/2019 17:44	07/11/2019 21:16	08/11/2019 14:08	16,88	33	556,95	CHI
20191158028	SERRANOPOLIS	DJ13340837	CHAPADAO DO CEU	07/11/2019 21:16	08/11/2019 17:44	07/11/2019 21:16	08/11/2019 17:10	19,91	4	79,63	CHI
20191158028	MINEIROS	DJ13164066	CHAPADAO DO CEU	07/11/2019 21:16	08/11/2019 17:44	08/11/2019 17:34	08/11/2019 17:44	0,16	20	3,27	CHI
20191158028	SERRANOPOLIS	DJ13164066	CHAPADAO DO CEU	07/11/2019 21:16	08/11/2019 17:44	08/11/2019 17:34	08/11/2019 17:44	0,16	37	6,05	CHI
20191158033	CRISTALINA	KR11128713	CRISTALINA S1	07/11/2019 20:49	07/11/2019 22:34	07/11/2019 20:49	07/11/2019 22:34	1,74	123	213,95	CHI
20191158034	CUMARI	CY21000318	CATALAO S1	07/11/2019 21:25	08/11/2019 19:33	07/11/2019 21:25	08/11/2019 19:33	22,13	2	44,25	CHI
20191158041	EDEIA	EA11263276	EDEIA	07/11/2019 16:32	07/11/2019 22:16	07/11/2019 16:32	07/11/2019 22:16	5,73	71	406,67	CHI
20191158044	JATAI	10001330690	JATAI S1	07/11/2019 21:30	08/11/2019 17:01	07/11/2019 21:30	08/11/2019 17:01	19,52	1	19,52	CHI
20191158050	MAIRIPOTABA	MI12223493	PONTALINA	07/11/2019 21:32	09/11/2019 08:28	07/11/2019 21:32	09/11/2019 08:28	34,92	2	69,85	CHI
20191158069	DOVERLANDIA	DV10354680	CAIAPONIA	07/11/2019 21:35	08/11/2019 16:07	07/11/2019 21:35	08/11/2019 01:05	3,51	51	178,91	CHI
20191158069	DOVERLANDIA	DV10354680	CAIAPONIA	07/11/2019 21:35	08/11/2019 16:07	08/11/2019 09:52	08/11/2019 10:12	0,33	51	17,03	CHI
20191158069	BALIZA	DV10354680	CAIAPONIA	07/11/2019 21:35	08/11/2019 16:07	07/11/2019 21:35	08/11/2019 14:27	16,88	1	16,88	CHI

20191158069	DOVERLANDIA	DV10354680	CAIAPONIA	07/11/2019 21:35	08/11/2019 16:07	07/11/2019 21:35	08/11/2019 14:27	16,88	38	641,41	CHI
20191158069	BALIZA	DV13133316	CAIAPONIA	07/11/2019 21:35	08/11/2019 16:07	07/11/2019 21:35	08/11/2019 16:07	18,54	603	11182,47	CHI
20191158069	DOVERLANDIA	DV10354680	CAIAPONIA	07/11/2019 21:35	08/11/2019 16:07	07/11/2019 21:35	08/11/2019 16:07	18,54	19	352,35	CHI
20191158069	DOVERLANDIA	DV13133316	CAIAPONIA	07/11/2019 21:35	08/11/2019 16:07	07/11/2019 21:35	08/11/2019 16:07	18,54	340	6305,21	CHI
20191158075	ANAPOLIS	AN11198710	ANAPOLIS UNIVERSITARIO S2	07/11/2019 21:36	07/11/2019 22:41	07/11/2019 21:36	07/11/2019 22:41	1,07	101	108,10	CHI
20191158082	CHAPADAO DO CEU	9880000036	CHAPADAO DO CEU	07/11/2019 21:44	08/11/2019 12:14	07/11/2019 21:44	08/11/2019 12:14	14,50	1	14,50	CHI
20191158091	PIRES DO RIO	PR21128979	PIRES DO RIO S2	07/11/2019 21:48	08/11/2019 17:40	07/11/2019 21:48	08/11/2019 17:40	19,87	1	19,87	CHI
20191158095	MOSSAMEDES	MD12049596	FIRMINOPOLIS S2	07/11/2019 19:34	07/11/2019 23:51	07/11/2019 19:34	07/11/2019 23:51	4,27	2	8,55	CHI
20191158099	PALESTINA DE GOIAS	PY11231069	PALESTINA	07/11/2019 20:19	08/11/2019 11:30	07/11/2019 20:19	08/11/2019 11:30	15,18	116	1760,43	CHI
20191158103	ITAPURANGA	IK11051549	ITAPURANGA	07/11/2019 21:47	08/11/2019 02:36	07/11/2019 21:47	08/11/2019 02:36	4,82	197	948,83	CHI
20191158113	APORE	AE13311577	ITAJA S1	07/11/2019 21:15	10/11/2019 16:20	07/11/2019 21:15	08/11/2019 16:19	19,08	5	95,38	CHI
20191158113	APORE	AE13209675	ITAJA S1	07/11/2019 21:15	10/11/2019 16:20	07/11/2019 21:15	08/11/2019 16:54	19,64	92	1807,24	CHI
20191158113	APORE	AE13209675	ITAJA S1	07/11/2019 21:15	10/11/2019 16:20	07/11/2019 21:15	08/11/2019 16:54	19,64	48	942,91	CHI
20191158113	SERRANOPOLIS	AE13209675	ITAJA S1	07/11/2019 21:15	10/11/2019 16:20	07/11/2019 21:15	08/11/2019 16:54	19,64	7	137,51	CHI
20191158113	APORE	AE13311583	ITAJA S1	07/11/2019 21:15	10/11/2019 16:20	07/11/2019 21:15	08/11/2019 20:15	23,00	2	45,99	CHI
20191158113	APORE	00100414	ITAJA S1	07/11/2019 21:15	10/11/2019 16:20	08/11/2019 20:16	08/11/2019 20:32	0,27	5	1,34	CHI
20191158113	APORE	AE13311583	ITAJA S1	07/11/2019 21:15	10/11/2019 16:20	08/11/2019 20:16	08/11/2019 21:11	0,91	2	1,81	CHI
20191158113	APORE	00100414	ITAJA S1	07/11/2019 21:15	10/11/2019 16:20	09/11/2019 16:07	09/11/2019 16:41	0,56	7	3,90	CHI
20191158113	APORE	AE13254716	ITAJA S1	07/11/2019 21:15	10/11/2019 16:20	10/11/2019 16:06	10/11/2019 16:20	0,23	94	21,41	CHI
20191158113	SERRANOPOLIS	AE13254716	ITAJA S1	07/11/2019 21:15	10/11/2019 16:20	10/11/2019 16:06	10/11/2019 16:20	0,23	45	10,25	CHI
20191158114	CACU	CC21322279	CACHOEIRA ALTA	07/11/2019 21:56	11/11/2019 23:59	07/11/2019 21:56	11/11/2019 23:59	98,05	1	98,05	CHI
20191158118	LUZIANIA	LZ11000522	RIO VERMELHO	07/11/2019 21:25	07/11/2019 22:52	07/11/2019 21:25	07/11/2019 22:52	1,44	110	158,46	CHI
20191158121	ANAPOLIS	21228759	JUNDIAI S1	07/11/2019 21:59	08/11/2019 03:23	07/11/2019 21:59	08/11/2019 03:23	5,40	1	5,40	CHI
20191158135	PARANAIGUARA	PC12000074	CACHOEIRA ALTA	07/11/2019 19:42	08/11/2019 23:34	07/11/2019 19:42	08/11/2019 23:34	27,86	3	83,58	CHI
20191158144	FIRMINOPOLIS	FR12096973	FIRMINOPOLIS S1	07/11/2019 22:05	08/11/2019 10:45	07/11/2019 22:05	08/11/2019 10:45	12,67	9	114,01	CHI
20191158159	CRIXAS	NA21257892	SANTA TEREZINHA	07/11/2019 22:15	11/11/2019 15:37	07/11/2019 22:15	11/11/2019 15:37	89,35	1	89,35	CHI
20191158160	NIQUELANDIA	NQ12039296	BARRO ALTO	07/11/2019 22:15	08/11/2019 01:15	07/11/2019 22:15	08/11/2019 01:15	2,99	91	271,91	CHI
20191158164	JATAI	290179270	JATAI S2	08/11/2019 09:41	09/11/2019 10:30	08/11/2019 09:41	09/11/2019 10:30	24,81	1	24,81	CHI
20191158177	RIO VERDE	SH12296215	IPEGUARI	07/11/2019 22:22	09/11/2019 11:24	07/11/2019 22:22	08/11/2019 07:41	9,31	3	27,94	CHI
20191158177	SANTA HELENA DE GOIAS	SH12296215	IPEGUARI	07/11/2019 22:22	09/11/2019 11:24	07/11/2019 22:22	08/11/2019 07:41	9,31	39	363,24	CHI
20191158177	SANTA HELENA DE GOIAS	SH12296215	IPEGUARI	07/11/2019 22:22	09/11/2019 11:24	08/11/2019 07:42	08/11/2019 08:58	1,26	2	2,53	CHI
20191158177	RIO VERDE	SH13214071	IPEGUARI	07/11/2019 22:22	09/11/2019 11:24	08/11/2019 07:42	08/11/2019 10:25	2,72	3	8,15	CHI
20191158177	SANTA HELENA DE GOIAS	SH13214071	IPEGUARI	07/11/2019 22:22	09/11/2019 11:24	08/11/2019 07:42	08/11/2019 10:25	2,72	28	76,04	CHI

20191158177	SANTA HELENA DE GOIAS	SH12301641LD	IPEGUARI	07/11/2019 22:22	09/11/2019 11:24	08/11/2019 07:42	08/11/2019 10:50	3,14	9	28,22	CHI
20191158177	SANTA HELENA DE GOIAS	SH12010246	IPEGUARI	07/11/2019 22:22	09/11/2019 11:24	08/11/2019 10:26	08/11/2019 18:15	7,82	19	148,50	CHI
20191158177	RIO VERDE	SH12000198	IPEGUARI	07/11/2019 22:22	09/11/2019 11:24	08/11/2019 10:31	09/11/2019 11:24	24,88	3	74,64	CHI
20191158177	SANTA HELENA DE GOIAS	SH12000198	IPEGUARI	07/11/2019 22:22	09/11/2019 11:24	08/11/2019 10:31	09/11/2019 11:24	24,88	7	174,16	CHI
20191158201	MUNDO NOVO DE GOIAS	MH11275557	NOVA CRIXAS	07/11/2019 22:31	09/11/2019 09:31	07/11/2019 22:31	09/11/2019 09:31	34,99	1	34,99	CHI
20191158206	ANAPOLIS	10001893139	ANAPOLIS UNIVERSITARIO S2	07/11/2019 22:34	08/11/2019 01:44	07/11/2019 22:34	08/11/2019 01:44	3,16	1	3,16	CHI
20191158214	AMORINOPOLIS	AM10374984	IPORA	07/11/2019 22:31	09/11/2019 11:18	07/11/2019 22:31	07/11/2019 22:35	0,06	104	6,21	CHI
20191158214	CAIAPONIA	AM10374984	IPORA	07/11/2019 22:31	09/11/2019 11:18	07/11/2019 22:31	07/11/2019 22:35	0,06	59	3,52	CHI
20191158214	IVOLANDIA	AM10374984	IPORA	07/11/2019 22:31	09/11/2019 11:18	07/11/2019 22:31	07/11/2019 22:35	0,06	89	5,32	CHI
20191158214	AMORINOPOLIS	AM10374984	IPORA	07/11/2019 22:31	09/11/2019 11:18	07/11/2019 22:36	08/11/2019 09:56	11,33	104	1178,72	CHI
20191158214	IVOLANDIA	AM10374984	IPORA	07/11/2019 22:31	09/11/2019 11:18	07/11/2019 22:36	08/11/2019 09:56	11,33	49	555,36	CHI
20191158214	CAIAPONIA	AM10374984	IPORA	07/11/2019 22:31	09/11/2019 11:18	07/11/2019 22:36	09/11/2019 11:18	36,69	59	2164,81	CHI
20191158214	IVOLANDIA	AM10374984	IPORA	07/11/2019 22:31	09/11/2019 11:18	07/11/2019 22:36	09/11/2019 11:18	36,69	40	1467,67	CHI
20191158223	CIDADE OCIDENTAL	DH11169050	MARAJOARA	07/11/2019 19:18	08/11/2019 01:27	07/11/2019 19:18	08/11/2019 01:27	6,14	201	1234,31	CHI
20191158231	SAO JOAO D ALIANCA	JL12404385	SAO JOAO D ALIANCA	08/11/2019 07:33	09/11/2019 09:25	08/11/2019 07:33	09/11/2019 09:25	25,86	55	1422,54	CHI
20191158233	VALPARAISO DE GOIAS	LZ21183871	PACAEMBU S1	07/11/2019 22:46	08/11/2019 01:02	07/11/2019 22:46	08/11/2019 01:02	2,27	1	2,27	CHI
20191158235	JATAI	290161320	JATAI S3	07/11/2019 22:47	08/11/2019 19:46	07/11/2019 22:47	08/11/2019 19:46	20,97	1	20,97	CHI
20191158248	ANAPOLIS	AN11198710	ANAPOLIS UNIVERSITARIO S2	07/11/2019 22:55	08/11/2019 00:42	07/11/2019 22:55	08/11/2019 00:42	1,77	101	178,63	CHI
20191158249	SANTA RITA DO ARAGUAIA	SU10400564	SANTA RITA DO ARAGUAIA	07/11/2019 22:54	08/11/2019 10:44	07/11/2019 22:54	08/11/2019 08:32	9,64	55	530,06	CHI
20191158249	MINEIROS	SU10400564	SANTA RITA DO ARAGUAIA	07/11/2019 22:54	08/11/2019 10:44	07/11/2019 22:54	08/11/2019 10:04	11,17	15	167,50	CHI
20191158249	SANTA RITA DO ARAGUAIA	SU10400564	SANTA RITA DO ARAGUAIA	07/11/2019 22:54	08/11/2019 10:44	07/11/2019 22:54	08/11/2019 10:04	11,17	8	89,33	CHI
20191158249	MINEIROS	SU12184123	SANTA RITA DO ARAGUAIA	07/11/2019 22:54	08/11/2019 10:44	07/11/2019 22:54	08/11/2019 10:44	11,85	15	177,72	CHI
20191158249	SANTA RITA DO ARAGUAIA	SU12184123	SANTA RITA DO ARAGUAIA	07/11/2019 22:54	08/11/2019 10:44	07/11/2019 22:54	08/11/2019 10:44	11,85	6	71,09	CHI
20191158272	SANTA HELENA DE GOIAS	SH12279869	IPEGUARI	07/11/2019 18:39	08/11/2019 08:57	07/11/2019 18:39	08/11/2019 08:57	14,30	168	2402,03	CHI
20191158287	SANTO ANTONIO DE GOIAS	GR12048879	NEROPOLIS S1	07/11/2019 15:46	08/11/2019 09:12	07/11/2019 15:46	08/11/2019 09:12	17,43	15	261,50	CHI
20191158290	PIRANHAS	PH21204987	PIRANHAS	07/11/2019 23:20	08/11/2019 12:36	07/11/2019 23:20	08/11/2019 12:36	13,25	1	13,25	CHI
20191158295	SANTA FE DE GOIAS	RN11167544	BRITANIA	07/11/2019 22:27	08/11/2019 00:15	07/11/2019 22:27	08/11/2019 00:15	1,80	121	217,60	CHI
20191158314	RIO VERDE	630270478	RIO VERDE S1	07/11/2019 23:40	10/11/2019 17:47	07/11/2019 23:40	10/11/2019 17:47	66,11	1	66,11	CHI
20191158340	CACHOEIRA ALTA	1090025844	CACHOEIRA ALTA	08/11/2019 00:26	09/11/2019 17:15	08/11/2019 00:26	09/11/2019 17:15	40,81	1	40,81	CHI
20191158342	BRITANIA	BT11252614	BRITANIA	07/11/2019 22:40	08/11/2019 07:20	07/11/2019 22:40	08/11/2019 07:20	8,66	220	1904,47	CHI
20191158350	ARENOPOLIS	AY12070195	ARENOPOLIS	08/11/2019 00:43	11/11/2019 11:17	08/11/2019 00:43	11/11/2019 11:17	82,56	10	825,59	CHI
20191158350	DIORAMA	AY12070195	ARENOPOLIS	08/11/2019 00:43	11/11/2019 11:17	08/11/2019 00:43	11/11/2019 11:17	82,56	3	247,68	CHI
20191158350	MONTES CLAROS DE GOIAS	AY12070195	ARENOPOLIS	08/11/2019 00:43	11/11/2019 11:17	08/11/2019 00:43	11/11/2019 11:17	82,56	25	2063,98	CHI

20191158356	SAO LUIS DE MONTES BELOS	SL21226440	FIRMINOPOLIS S2	08/11/2019 01:07	08/11/2019 09:20	08/11/2019 01:07	08/11/2019 09:20	8,23	1	8,23	CHI
20191158373	RIO VERDE	RV10212406	CABRIUVA S2	08/11/2019 00:06	08/11/2019 09:42	08/11/2019 00:06	08/11/2019 00:24	0,30	60	18,02	CHI
20191158373	RIO VERDE	RV10212406	CABRIUVA S2	08/11/2019 00:06	08/11/2019 09:42	08/11/2019 00:27	08/11/2019 09:37	9,15	34	311,18	CHI
20191158373	RIO VERDE	RV12207053LD	CABRIUVA S2	08/11/2019 00:06	08/11/2019 09:42	08/11/2019 00:27	08/11/2019 09:42	9,25	26	240,47	CHI
20191158374	IPORA	00850414	IPORA	08/11/2019 01:27	08/11/2019 16:32	08/11/2019 01:27	08/11/2019 07:42	6,25	100	625,08	CHI
20191158374	ISRAELANDIA	00850414	IPORA	08/11/2019 01:27	08/11/2019 16:32	08/11/2019 01:27	08/11/2019 07:42	6,25	47	293,79	CHI
20191158374	JAUPACI	00850414	IPORA	08/11/2019 01:27	08/11/2019 16:32	08/11/2019 01:27	08/11/2019 07:42	6,25	3	18,75	CHI
20191158374	FAZENDA NOVA	00850414	JUSSARA	08/11/2019 01:27	08/11/2019 16:32	08/11/2019 01:27	08/11/2019 07:53	6,44	1408	9065,56	CHI
20191158374	FAZENDA NOVA	00850414	JUSSARA	08/11/2019 01:27	08/11/2019 16:32	08/11/2019 01:27	08/11/2019 07:53	6,44	800	5150,89	CHI
20191158374	DIORAMA	00850414	IPORA	08/11/2019 01:27	08/11/2019 16:32	08/11/2019 01:27	08/11/2019 08:05	6,63	12	79,61	CHI
20191158374	FAZENDA NOVA	00850414	IPORA	08/11/2019 01:27	08/11/2019 16:32	08/11/2019 01:27	08/11/2019 08:05	6,63	22	145,96	CHI
20191158374	FAZENDA NOVA	00850414	IPORA	08/11/2019 01:27	08/11/2019 16:32	08/11/2019 01:27	08/11/2019 08:05	6,63	468	3104,92	CHI
20191158374	FAZENDA NOVA	00850414	IPORA	08/11/2019 01:27	08/11/2019 16:32	08/11/2019 01:27	08/11/2019 08:05	6,63	66	437,87	CHI
20191158374	ISRAELANDIA	00850414	IPORA	08/11/2019 01:27	08/11/2019 16:32	08/11/2019 01:27	08/11/2019 08:05	6,63	12	79,61	CHI
20191158374	ISRAELANDIA	00850414	IPORA	08/11/2019 01:27	08/11/2019 16:32	08/11/2019 01:27	08/11/2019 08:05	6,63	131	869,11	CHI
20191158374	JAUPACI	00850414	IPORA	08/11/2019 01:27	08/11/2019 16:32	08/11/2019 01:27	08/11/2019 08:05	6,63	1384	9182,07	CHI
20191158374	JAUPACI	00850414	IPORA	08/11/2019 01:27	08/11/2019 16:32	08/11/2019 01:27	08/11/2019 08:05	6,63	4	26,54	CHI
20191158374	DIORAMA	FN10400396	IPORA	08/11/2019 01:27	08/11/2019 16:32	08/11/2019 08:06	08/11/2019 08:26	0,33	12	4,00	CHI
20191158374	FAZENDA NOVA	FN10400396	IPORA	08/11/2019 01:27	08/11/2019 16:32	08/11/2019 08:06	08/11/2019 08:26	0,33	22	7,34	CHI
20191158374	FAZENDA NOVA	FN10400396	IPORA	08/11/2019 01:27	08/11/2019 16:32	08/11/2019 08:06	08/11/2019 08:26	0,33	468	156,13	CHI
20191158374	FAZENDA NOVA	FN10401420	IPORA	08/11/2019 01:27	08/11/2019 16:32	08/11/2019 08:06	08/11/2019 08:26	0,33	66	22,02	CHI
20191158374	ISRAELANDIA	FN10400396	IPORA	08/11/2019 01:27	08/11/2019 16:32	08/11/2019 08:06	08/11/2019 08:26	0,33	12	4,00	CHI
20191158374	ISRAELANDIA	FN10401420	IPORA	08/11/2019 01:27	08/11/2019 16:32	08/11/2019 08:06	08/11/2019 08:26	0,33	131	43,70	CHI
20191158374	JAUPACI	FN10400396	IPORA	08/11/2019 01:27	08/11/2019 16:32	08/11/2019 08:06	08/11/2019 08:26	0,33	1384	461,72	CHI
20191158374	JAUPACI	FN10401420	IPORA	08/11/2019 01:27	08/11/2019 16:32	08/11/2019 08:06	08/11/2019 08:26	0,33	4	1,33	CHI
20191158374	CORREGO DO OURO	00850414	IPORA	08/11/2019 01:27	08/11/2019 16:32	08/11/2019 01:27	08/11/2019 08:34	7,12	3	21,35	CHI
20191158374	FAZENDA NOVA	00850414	IPORA	08/11/2019 01:27	08/11/2019 16:32	08/11/2019 01:27	08/11/2019 08:34	7,12	202	1437,62	CHI
20191158374	FAZENDA NOVA	00850414	IPORA	08/11/2019 01:27	08/11/2019 16:32	08/11/2019 01:27	08/11/2019 08:34	7,12	9	64,05	CHI
20191158374	ISRAELANDIA	00850414	IPORA	08/11/2019 01:27	08/11/2019 16:32	08/11/2019 01:27	08/11/2019 08:34	7,12	105	747,28	CHI
20191158374	ISRAELANDIA	00850414	IPORA	08/11/2019 01:27	08/11/2019 16:32	08/11/2019 01:27	08/11/2019 08:34	7,12	60	427,02	CHI
20191158374	IPORA	00850414	IPORA	08/11/2019 01:27	08/11/2019 16:32	08/11/2019 01:27	08/11/2019 08:34	7,13	43	306,69	CHI
20191158374	ISRAELANDIA	00850414	IPORA	08/11/2019 01:27	08/11/2019 16:32	08/11/2019 01:27	08/11/2019 08:34	7,13	974	6946,78	CHI
20191158374	FAZENDA NOVA	IS10400385	IPORA	08/11/2019 01:27	08/11/2019 16:32	08/11/2019 01:27	08/11/2019 08:37	7,17	13	93,25	CHI

20191158374	ISRAELANDIA	00850414	IPORA	08/11/2019 01:27	08/11/2019 16:32	08/11/2019 01:27	08/11/2019 08:37	7,17	4	28,69	CHI
20191158374	ISRAELANDIA	IS10400385	IPORA	08/11/2019 01:27	08/11/2019 16:32	08/11/2019 01:27	08/11/2019 08:37	7,17	12	86,07	CHI
20191158374	IVOLANDIA	00850414	IPORA	08/11/2019 01:27	08/11/2019 16:32	08/11/2019 01:27	08/11/2019 08:37	7,17	973	6979,11	CHI
20191158374	MOIPIORA	00850414	IPORA	08/11/2019 01:27	08/11/2019 16:32	08/11/2019 01:27	08/11/2019 08:37	7,17	214	1534,97	CHI
20191158374	MOIPIORA	00850414	IPORA	08/11/2019 01:27	08/11/2019 16:32	08/11/2019 01:27	08/11/2019 08:37	7,17	331	2374,19	CHI
20191158374	MOIPIORA	IS10400385	IPORA	08/11/2019 01:27	08/11/2019 16:32	08/11/2019 01:27	08/11/2019 08:37	7,17	12	86,07	CHI
20191158374	PARAUNA	00850414	IPORA	08/11/2019 01:27	08/11/2019 16:32	08/11/2019 01:27	08/11/2019 08:37	7,17	1	7,17	CHI
20191158374	ISRAELANDIA	00850414	IPORA	08/11/2019 01:27	08/11/2019 16:32	08/11/2019 01:27	08/11/2019 09:24	7,96	15	119,35	CHI
20191158374	MOIPIORA	00850414	IPORA	08/11/2019 01:27	08/11/2019 16:32	08/11/2019 01:27	08/11/2019 09:24	7,96	230	1830,10	CHI
20191158374	IPORA	00850414	IPORA	08/11/2019 01:27	08/11/2019 16:32	08/11/2019 09:58	08/11/2019 10:17	0,32	100	31,56	CHI
20191158374	ISRAELANDIA	00850414	IPORA	08/11/2019 01:27	08/11/2019 16:32	08/11/2019 09:58	08/11/2019 10:17	0,32	47	14,83	CHI
20191158374	JAUPACI	00850414	IPORA	08/11/2019 01:27	08/11/2019 16:32	08/11/2019 09:58	08/11/2019 10:17	0,32	3	0,95	CHI
20191158374	ISRAELANDIA	00850414	IPORA	08/11/2019 01:27	08/11/2019 16:32	08/11/2019 01:27	08/11/2019 15:26	13,99	10	139,91	CHI
20191158374	ISRAELANDIA	00850414	IPORA	08/11/2019 01:27	08/11/2019 16:32	08/11/2019 01:27	08/11/2019 15:52	14,43	11	158,72	CHI
20191158374	ISRAELANDIA	IS12018686	IPORA	08/11/2019 01:27	08/11/2019 16:32	08/11/2019 01:27	08/11/2019 16:32	15,09	26	392,34	CHI
20191158374	JAUPACI	IS12018686	IPORA	08/11/2019 01:27	08/11/2019 16:32	08/11/2019 01:27	08/11/2019 16:32	15,09	51	769,59	CHI
20191158386	INDIARA	IY21194217	CEZARINA	08/11/2019 02:51	08/11/2019 12:27	08/11/2019 02:51	08/11/2019 12:27	9,60	1	9,60	CHI
20191158501	IPORA	IR12033222	IPORA	08/11/2019 02:03	08/11/2019 03:25	08/11/2019 02:03	08/11/2019 03:25	1,35	4	5,42	CHI
20191158601	AMARALINA	LC12189854	MARA ROSA	08/11/2019 03:41	08/11/2019 19:21	08/11/2019 03:41	08/11/2019 19:21	15,66	7	109,65	CHI
20191158601	MARA ROSA	LC12189854	MARA ROSA	08/11/2019 03:41	08/11/2019 19:21	08/11/2019 03:41	08/11/2019 19:21	15,66	2	31,33	CHI
20191158618	PILAR DE GOIAS	SG12149672LD	SANTA TEREZINHA	08/11/2019 04:22	09/11/2019 10:55	08/11/2019 04:22	09/11/2019 10:55	30,54	13	397,08	CHI
20191158618	SANTA TEREZINHA DE GOIAS	SG12149672LD	SANTA TEREZINHA	08/11/2019 04:22	09/11/2019 10:55	08/11/2019 04:22	09/11/2019 10:55	30,54	24	733,07	CHI
20191158628	ANAPOLIS	AN12096781	ANAPOLIS UNIVERSITARIO S2	08/11/2019 04:38	08/11/2019 09:13	08/11/2019 04:38	08/11/2019 09:13	4,57	5	22,87	CHI
20191158633	NOVA IGUACU DE GOIAS	NH10400425	SANTA TEREZINHA	08/11/2019 04:31	08/11/2019 09:10	08/11/2019 04:31	08/11/2019 09:10	4,66	26	121,17	CHI
20191158633	PILAR DE GOIAS	NH10400425	SANTA TEREZINHA	08/11/2019 04:31	08/11/2019 09:10	08/11/2019 04:31	08/11/2019 09:10	4,66	139	647,82	CHI
20191158633	SANTA TEREZINHA DE GOIAS	NH10400425	SANTA TEREZINHA	08/11/2019 04:31	08/11/2019 09:10	08/11/2019 04:31	08/11/2019 09:10	4,66	15	69,91	CHI
20191158635	QUIRINOPOLIS	QI21306040	QUIRINOPOLIS	08/11/2019 04:48	08/11/2019 08:30	08/11/2019 04:48	08/11/2019 08:30	3,70	1	3,70	CHI
20191158639	ALTO HORIZONTE	VD12056599	SANTA TEREZINHA	07/11/2019 20:22	08/11/2019 08:42	07/11/2019 20:22	08/11/2019 08:42	12,32	9	110,87	CHI
20191158639	CAMPOS VERDES	VD12056599	SANTA TEREZINHA	07/11/2019 20:22	08/11/2019 08:42	07/11/2019 20:22	08/11/2019 08:42	12,32	96	1182,56	CHI
20191158639	MARA ROSA	VD12056599	SANTA TEREZINHA	07/11/2019 20:22	08/11/2019 08:42	07/11/2019 20:22	08/11/2019 08:42	12,32	67	825,33	CHI
20191158643	QUIRINOPOLIS	QI21107397	QUIRINOPOLIS	08/11/2019 04:56	08/11/2019 11:00	08/11/2019 04:56	08/11/2019 11:00	6,06	5	30,28	CHI
20191158656	ABADIANIA	AA21101468	ANAPOLIS UNIVERSITARIO S1	08/11/2019 05:08	08/11/2019 13:01	08/11/2019 05:08	08/11/2019 13:01	7,88	1	7,88	CHI
20191158657	PALESTINA DE GOIAS	PY10406618	PALESTINA	08/11/2019 05:05	10/11/2019 08:35	08/11/2019 05:05	09/11/2019 10:30	29,43	22	647,38	CHI

20191158657	CAIAPONIA	PY10406618	PALESTINA	08/11/2019 05:05	10/11/2019 08:35	08/11/2019 05:05	09/11/2019 19:25	38,34	154	5903,93	CHI
20191158657	PALESTINA DE GOIAS	PY10406618	PALESTINA	08/11/2019 05:05	10/11/2019 08:35	08/11/2019 05:05	09/11/2019 19:25	38,34	24	920,09	CHI
20191158657	PALESTINA DE GOIAS	PY10406618	PALESTINA	08/11/2019 05:05	10/11/2019 08:35	09/11/2019 10:31	09/11/2019 19:25	8,91	22	195,95	CHI
20191158657	CAIAPONIA	PY12040163	PALESTINA	08/11/2019 05:05	10/11/2019 08:35	08/11/2019 21:06	10/11/2019 08:10	35,06	41	1437,29	CHI
20191158657	PALESTINA DE GOIAS	PY12040163	PALESTINA	08/11/2019 05:05	10/11/2019 08:35	08/11/2019 21:06	10/11/2019 08:10	35,06	102	3575,70	CHI
20191158657	PALESTINA DE GOIAS	PY12223011	PALESTINA	08/11/2019 05:05	10/11/2019 08:35	08/11/2019 05:05	10/11/2019 08:35	51,50	113	5818,97	CHI
20191158657	PALESTINA DE GOIAS	PY12223011	PALESTINA	08/11/2019 05:05	10/11/2019 08:35	08/11/2019 16:15	10/11/2019 08:35	40,33	2	80,66	CHI
20191158687	RIO VERDE	RV12303551	SANTA HELENA S1	08/11/2019 05:31	09/11/2019 15:00	08/11/2019 05:31	09/11/2019 15:00	33,48	3	100,44	CHI
20191158693	MINEIROS	MY12197174	PARQUE DAS EMAS	08/11/2019 05:33	08/11/2019 20:48	08/11/2019 05:33	08/11/2019 20:48	15,26	1	15,26	CHI
20191158696	CRISTALINA	KR12389576	CRISTALINA S2	08/11/2019 05:34	08/11/2019 11:53	08/11/2019 05:34	08/11/2019 11:53	6,31	42	265,06	CHI
20191158705	AMERICANO DO BRASIL	KB21065174	ANICUNS	08/11/2019 05:37	08/11/2019 09:58	08/11/2019 05:37	08/11/2019 09:58	4,34	1	4,34	CHI
20191158710	IACIARA	IA12000014	IACIARA S1	08/11/2019 05:40	08/11/2019 09:24	08/11/2019 05:40	08/11/2019 09:24	3,73	5	18,64	CHI
20191158716	QUIRINOPOLIS	QI12370150	QUIRINOPOLIS	08/11/2019 05:30	09/11/2019 09:53	08/11/2019 05:30	08/11/2019 15:06	9,60	29	278,50	CHI
20191158716	CASTELANDIA	QI12370150	QUIRINOPOLIS	08/11/2019 05:30	09/11/2019 09:53	08/11/2019 05:30	09/11/2019 09:53	28,38	4	113,53	CHI
20191158716	QUIRINOPOLIS	QI12370150	QUIRINOPOLIS	08/11/2019 05:30	09/11/2019 09:53	08/11/2019 05:30	09/11/2019 09:53	28,38	20	567,63	CHI
20191158716	RIO VERDE	QI12370150	QUIRINOPOLIS	08/11/2019 05:30	09/11/2019 09:53	08/11/2019 05:30	09/11/2019 09:53	28,38	1	28,38	CHI
20191158725	IPORA	10002410409	IPORA	08/11/2019 05:47	11/11/2019 08:59	08/11/2019 05:47	11/11/2019 08:59	75,21	1	75,21	CHI
20191158729	CRISTALINA	KR12244310	CRISTALINA S2	08/11/2019 05:47	08/11/2019 09:35	08/11/2019 05:47	08/11/2019 09:35	3,79	4	15,16	CHI
20191158743	CACHOEIRA ALTA	CA12040332	CACHOEIRA ALTA	08/11/2019 05:50	08/11/2019 20:59	08/11/2019 05:50	08/11/2019 20:59	15,15	10	151,45	CHI
20191158748	SAO LUIS DE MONTES BELOS	SL12391408	FIRMINOPOLIS S2	08/11/2019 05:52	08/11/2019 19:24	08/11/2019 05:52	08/11/2019 19:24	13,53	2	27,06	CHI
20191158755	AMARALINA	MQ12050047	MARA ROSA	08/11/2019 05:54	08/11/2019 17:38	08/11/2019 05:54	08/11/2019 17:38	11,73	229	2685,09	CHI
20191158767	QUIRINOPOLIS	QI32058080	QUIRINOPOLIS	08/11/2019 05:56	08/11/2019 17:59	08/11/2019 05:56	08/11/2019 17:59	12,04	9	108,32	CHI
20191158768	NIQUELANDIA	NQ12400337	URUACU	08/11/2019 05:56	08/11/2019 11:11	08/11/2019 05:56	08/11/2019 11:11	5,23	17	88,99	CHI
20191158769	SERRANOPOLIS	SX12165995	CHAPADAO DO CEU	07/11/2019 21:16	09/11/2019 12:45	07/11/2019 21:16	09/11/2019 12:45	39,48	2	78,96	CHI
20191158769	SERRANOPOLIS	SX12165995	CHAPADAO DO CEU	07/11/2019 21:16	09/11/2019 12:45	08/11/2019 05:57	09/11/2019 12:45	30,80	2	61,60	CHI
20191158773	ANAPOLIS	20003500	JUNDIAI S2	08/11/2019 05:58	08/11/2019 07:39	08/11/2019 05:58	08/11/2019 07:39	1,68	1	1,68	CHI
20191158790	CUMARI	CY12071522	CATALAO S1	07/11/2019 18:36	08/11/2019 09:31	07/11/2019 18:36	08/11/2019 09:31	14,91	6	89,43	CHI
20191158790	GOIANDIRA	CY12071522	CATALAO S1	07/11/2019 18:36	08/11/2019 09:31	07/11/2019 18:36	08/11/2019 09:31	14,91	8	119,24	CHI
20191158797	GOIANDIRA	GD12131091	CATALAO S1	07/11/2019 21:21	08/11/2019 10:57	07/11/2019 21:21	08/11/2019 10:57	13,60	5	67,99	CHI
20191158825	NEROPOLIS	GR12133315	NEROPOLIS S1	07/11/2019 16:29	08/11/2019 17:16	07/11/2019 16:29	08/11/2019 17:16	24,78	16	396,55	CHI
20191158825	SANTO ANTONIO DE GOIAS	GR12133315	NEROPOLIS S1	07/11/2019 16:29	08/11/2019 17:16	07/11/2019 16:29	08/11/2019 17:16	24,78	5	123,92	CHI
20191158856	LUZIANIA	LZ12290703	RIO VERMELHO	08/11/2019 08:05	08/11/2019 11:00	08/11/2019 08:05	08/11/2019 11:00	2,91	9	26,20	CHI
20191158858	CAMPOS BELOS	CH12392371	SAO DOMINGOS	08/11/2019 08:55	08/11/2019 11:46	08/11/2019 08:55	08/11/2019 11:46	2,85	1	2,85	CHI

20191158866	JATAI	JT12378171	MONTIVIDIU T	08/11/2019 09:15	09/11/2019 12:00	08/11/2019 09:15	09/11/2019 12:00	26,74	5	133,71	CHI
20191158867	JARAGUA	JA11025638	ITABERAI S1	08/11/2019 09:15	08/11/2019 12:10	08/11/2019 09:15	08/11/2019 12:10	2,91	26	75,62	CHI
20191158901	PANAMA	IT12316775	ITUMBIARA NOVA	07/11/2019 18:12	09/11/2019 22:33	07/11/2019 18:12	09/11/2019 22:33	52,33	5	261,67	CHI
20191158920	FAINA	MP12096007	MATRINCHA	07/11/2019 22:32	12/11/2019 17:49	07/11/2019 22:32	12/11/2019 17:49	115,28	8	922,22	CHI
20191158937	SANTA TEREZINHA DE GOIAS	7870000047	SANTA TEREZINHA	08/11/2019 06:11	08/11/2019 08:28	08/11/2019 06:11	08/11/2019 08:28	2,27	1	2,27	CHI
20191158939	CACHOEIRA ALTA	CA12200638	CACHOEIRA ALTA	07/11/2019 19:26	08/11/2019 12:42	07/11/2019 19:26	08/11/2019 12:42	17,26	9	155,32	CHI
20191158939	CACU	CA12200638	CACHOEIRA ALTA	07/11/2019 19:26	08/11/2019 12:42	07/11/2019 19:26	08/11/2019 12:42	17,26	6	103,55	CHI
20191158947	QUIRINOPOLIS	QI10394707	QUIRINOPOLIS	08/11/2019 05:56	08/11/2019 13:59	08/11/2019 05:56	08/11/2019 09:56	4,00	137	547,62	CHI
20191158947	QUIRINOPOLIS	QI10394707	QUIRINOPOLIS	08/11/2019 05:56	08/11/2019 13:59	08/11/2019 05:56	08/11/2019 12:47	6,85	62	424,89	CHI
20191158947	CACHOEIRA ALTA	QI10394707	CACHOEIRA ALTA	08/11/2019 05:56	08/11/2019 13:59	08/11/2019 05:56	08/11/2019 13:09	7,22	19	137,11	CHI
20191158947	QUIRINOPOLIS	QI10394707	CACHOEIRA ALTA	08/11/2019 05:56	08/11/2019 13:59	08/11/2019 05:56	08/11/2019 13:09	7,22	37	267,01	CHI
20191158947	CACHOEIRA ALTA	QI10394707	QUIRINOPOLIS	08/11/2019 05:56	08/11/2019 13:59	08/11/2019 05:56	08/11/2019 13:09	7,22	37	267,01	CHI
20191158947	QUIRINOPOLIS	QI10394707	QUIRINOPOLIS	08/11/2019 05:56	08/11/2019 13:59	08/11/2019 05:56	08/11/2019 13:09	7,22	79	570,09	CHI
20191158947	QUIRINOPOLIS	QI10394707	QUIRINOPOLIS	08/11/2019 05:56	08/11/2019 13:59	08/11/2019 05:56	08/11/2019 13:09	7,22	68	490,71	CHI
20191158947	RIO VERDE	QI10394707	QUIRINOPOLIS	08/11/2019 05:56	08/11/2019 13:59	08/11/2019 05:56	08/11/2019 13:09	7,22	113	815,45	CHI
20191158947	QUIRINOPOLIS	QI10394707	QUIRINOPOLIS	08/11/2019 05:56	08/11/2019 13:59	08/11/2019 05:56	08/11/2019 13:59	8,06	12	96,68	CHI
20191158953	ARAGUAPAZ	MS12113246	ITAPURANGA	08/11/2019 07:35	09/11/2019 11:20	08/11/2019 07:35	09/11/2019 11:20	27,75	1	27,75	CHI
20191158953	FAINA	MS12113246	ITAPURANGA	08/11/2019 07:35	09/11/2019 11:20	08/11/2019 07:35	09/11/2019 11:20	27,75	7	194,27	CHI
20191158953	MORRO AGUDO DE GOIAS	MS12113246	ITAPURANGA	08/11/2019 07:35	09/11/2019 11:20	08/11/2019 07:35	09/11/2019 11:20	27,75	7	194,27	CHI
20191158954	ITAGUARU	JA12027826	JARAGUA	08/11/2019 04:51	08/11/2019 09:09	08/11/2019 04:51	08/11/2019 09:09	4,29	9	38,58	CHI
20191158954	JARAGUA	JA12027826	JARAGUA	08/11/2019 04:51	08/11/2019 09:09	08/11/2019 04:51	08/11/2019 09:09	4,29	18	77,16	CHI
20191158962	IPORA	IR12037853	IPORA	08/11/2019 06:15	09/11/2019 12:36	08/11/2019 06:15	09/11/2019 12:36	30,34	7	212,37	CHI
20191158964	SAO DOMINGOS	SD11046278	SAO DOMINGOS	08/11/2019 06:02	08/11/2019 14:14	08/11/2019 06:02	08/11/2019 14:14	8,20	87	713,16	CHI
20191158968	NOVA AMERICA	NM12199860	RUBIATABA	08/11/2019 06:15	08/11/2019 11:49	08/11/2019 06:15	08/11/2019 11:49	5,56	11	61,19	CHI
20191158985	PARANAIGUARA	QI12047567	QUIRINOPOLIS	08/11/2019 04:55	08/11/2019 16:59	08/11/2019 04:55	08/11/2019 16:59	12,05	11	132,57	CHI
20191158985	QUIRINOPOLIS	QI12047567	QUIRINOPOLIS	08/11/2019 04:55	08/11/2019 16:59	08/11/2019 04:55	08/11/2019 16:59	12,05	38	457,95	CHI
20191158991	QUIRINOPOLIS	QI21094273	QUIRINOPOLIS	08/11/2019 06:21	08/11/2019 09:40	08/11/2019 06:21	08/11/2019 09:40	3,31	1	3,31	CHI
20191158994	NOVO GAMA	LZ12040416	PACAEMBU S1	08/11/2019 06:21	08/11/2019 08:15	08/11/2019 06:21	08/11/2019 08:15	1,89	18	33,93	CHI
20191158999	BONOPOLIS	BX12202593	SAO MIGUEL DO ARAGUAIA	08/11/2019 05:14	08/11/2019 19:17	08/11/2019 05:14	08/11/2019 19:17	14,04	4	56,16	CHI
20191159003	ARENOPOLIS	AY12000008B	ARENOPOLIS	08/11/2019 03:53	08/11/2019 11:13	08/11/2019 03:53	08/11/2019 11:13	7,33	90	659,55	CHI
20191159003	DIORAMA	AY12000008B	ARENOPOLIS	08/11/2019 03:53	08/11/2019 11:13	08/11/2019 03:53	08/11/2019 11:13	7,33	85	622,91	CHI
20191159003	IPORA	AY12000008B	ARENOPOLIS	08/11/2019 03:53	08/11/2019 11:13	08/11/2019 03:53	08/11/2019 11:13	7,33	57	417,72	CHI
20191159003	IVOLANDIA	AY12000008B	ARENOPOLIS	08/11/2019 03:53	08/11/2019 11:13	08/11/2019 03:53	08/11/2019 11:13	7,33	43	315,12	CHI

20191159003	MONTES CLAROS DE GOIAS	AY12000008B	ARENOPOLIS	08/11/2019 03:53	08/11/2019 11:13	08/11/2019 03:53	08/11/2019 11:13	7,33	23	168,55	CHI
20191159003	PALESTINA DE GOIAS	AY12000008B	ARENOPOLIS	08/11/2019 03:53	08/11/2019 11:13	08/11/2019 03:53	08/11/2019 11:13	7,33	33	241,84	CHI
20191159012	CUMARI	CY12203044	CATALAO S1	08/11/2019 06:25	09/11/2019 16:42	08/11/2019 06:25	09/11/2019 16:16	33,86	2	67,72	CHI
20191159012	CUMARI	CY12203044	CATALAO S1	08/11/2019 06:25	09/11/2019 16:42	09/11/2019 16:17	09/11/2019 16:42	0,43	2	0,85	CHI
20191159018	MONTES CLAROS DE GOIAS	ME12204921	IPORA	08/11/2019 05:35	10/11/2019 09:58	08/11/2019 05:35	10/11/2019 09:58	52,38	47	2461,81	CHI
20191159035	ARAGARCAS	BM12354693	BOM JARDIM	08/11/2019 04:39	08/11/2019 07:29	08/11/2019 04:39	08/11/2019 07:29	2,83	7	19,79	CHI
20191159035	BOM JARDIM DE GOIAS	BM12354693	BOM JARDIM	08/11/2019 04:39	08/11/2019 07:29	08/11/2019 04:39	08/11/2019 07:29	2,83	37	104,60	CHI
20191159039	IPORA	IR21014048	IPORA	08/11/2019 06:29	10/11/2019 20:30	08/11/2019 06:29	10/11/2019 20:30	62,01	1	62,01	CHI
20191159040	RIO VERDE	RV12296155	SANTA HELENA S1	08/11/2019 05:25	08/11/2019 12:17	08/11/2019 05:25	08/11/2019 12:17	6,87	69	474,18	CHI
20191159040	SANTA HELENA DE GOIAS	RV12296155	SANTA HELENA S1	08/11/2019 05:25	08/11/2019 12:17	08/11/2019 05:25	08/11/2019 12:17	6,87	1	6,87	CHI
20191159047	FIRMINOPOLIS	FR12391442	FIRMINOPOLIS S2	08/11/2019 05:29	08/11/2019 11:25	08/11/2019 05:29	08/11/2019 11:25	5,93	58	343,79	CHI
20191159047	SAO JOAO DA PARAUNA	FR12391442	FIRMINOPOLIS S2	08/11/2019 05:29	08/11/2019 11:25	08/11/2019 05:29	08/11/2019 11:25	5,93	30	177,82	CHI
20191159049	AMORINOPOLIS	AM21138512	IPORA	08/11/2019 06:31	12/11/2019 08:50	08/11/2019 06:31	12/11/2019 08:50	98,30	3	294,91	CHI
20191159053	ABADIANIA	AA12130228	ANAPOLIS UNIVERSITARIO S1	07/11/2019 20:32	08/11/2019 09:16	07/11/2019 20:32	08/11/2019 09:16	12,72	11	139,91	CHI
20191159053	ABADIANIA	AA12130228	DAIA S2	07/11/2019 20:32	08/11/2019 09:16	07/11/2019 20:32	08/11/2019 09:16	12,72	30	381,57	CHI
20191159055	URUACU	UR21070575	URUACU	08/11/2019 06:32	08/11/2019 08:34	08/11/2019 06:32	08/11/2019 08:34	2,02	2	4,05	CHI
20191159070	ARUANA	MP12041292	MOZARLANDIA	08/11/2019 06:04	08/11/2019 11:34	08/11/2019 06:04	08/11/2019 11:34	5,49	3	16,48	CHI
20191159070	MATRINCHA	MP12041292	MOZARLANDIA	08/11/2019 06:04	08/11/2019 11:34	08/11/2019 06:04	08/11/2019 11:34	5,49	1	5,49	CHI
20191159085	ANAPOLIS	AN11385788	ANAPOLIS UNIVERSITARIO S1	08/11/2019 09:20	08/11/2019 13:48	08/11/2019 09:20	08/11/2019 13:48	4,47	26	116,11	CHI
20191159089	RIO VERDE	630555199	RIO VERDE S2	08/11/2019 06:40	08/11/2019 16:15	08/11/2019 06:40	08/11/2019 16:15	9,58	1	9,58	CHI
20191159096	NIQUELANDIA	NQ12262815	NIQUELANDIA SUBTRANSMISSAO	08/11/2019 06:18	08/11/2019 08:18	08/11/2019 06:18	08/11/2019 08:18	2,00	11	21,99	CHI
20191159108	ANAPOLIS	10027084734	JUNDIAI S1	08/11/2019 06:44	08/11/2019 08:57	08/11/2019 06:44	08/11/2019 08:57	2,21	1	2,21	CHI
20191159109	RIO VERDE	RV12322152	RIO VERDE S1	08/11/2019 06:31	08/11/2019 20:20	08/11/2019 06:31	08/11/2019 20:20	13,82	28	387,01	CHI
20191159126	IPORA	IR11107563	IPORA	08/11/2019 05:00	08/11/2019 13:36	08/11/2019 05:00	08/11/2019 13:36	8,59	89	764,53	CHI
20191159128	JARAGUA	JA21328465	JARAGUA	08/11/2019 06:49	08/11/2019 15:43	08/11/2019 06:49	08/11/2019 15:43	8,89	1	8,89	CHI
20191159134	MONTIVIDIU	MV12214243	MONTIVIDIU T	08/11/2019 06:51	08/11/2019 12:01	08/11/2019 06:51	08/11/2019 12:01	5,17	2	10,33	CHI
20191159139	URUACU	UR21292655	MARA ROSA	08/11/2019 06:53	09/11/2019 14:11	08/11/2019 06:53	09/11/2019 14:11	31,29	1	31,29	CHI
20191159147	FORMOSA	10004966153	ITUIQUIRA	08/11/2019 06:55	08/11/2019 18:45	08/11/2019 06:55	08/11/2019 18:45	11,83	1	11,83	CHI
20191159148	QUIRINOPOLIS	QI21014969	QUIRINOPOLIS	08/11/2019 06:55	11/11/2019 09:49	08/11/2019 06:55	11/11/2019 09:49	74,89	1	74,89	CHI
20191159152	IPORA	IR12187287	IPORA	08/11/2019 06:56	08/11/2019 16:30	08/11/2019 06:56	08/11/2019 16:30	9,56	16	152,94	CHI
20191159157	NOVA ROMA	TE12398396	FLORES DE GOIAS	08/11/2019 06:34	08/11/2019 11:33	08/11/2019 06:34	08/11/2019 11:33	4,97	9	44,75	CHI
20191159157	TERESINA DE GOIAS	TE12398396	FLORES DE GOIAS	08/11/2019 06:34	08/11/2019 11:33	08/11/2019 06:34	08/11/2019 11:33	4,97	118	586,79	CHI
20191159162	PIRES DO RIO	PR12000071	PIRES DO RIO S1	08/11/2019 06:28	08/11/2019 08:24	08/11/2019 06:28	08/11/2019 08:24	1,92	21	40,38	CHI

20191159168	SERRANOPOLIS	SX13248486	JATAI S1	08/11/2019 06:59	11/11/2019 12:40	08/11/2019 06:59	11/11/2019 12:40	77,69	5	388,45	CHI
20191159168	SERRANOPOLIS	SX13248486	JATAI S1	08/11/2019 06:59	11/11/2019 12:40	11/11/2019 09:39	11/11/2019 12:40	3,03	1	3,03	CHI
20191159172	CACHOEIRA ALTA	CA12384078	CACHOEIRA ALTA	08/11/2019 05:54	10/11/2019 16:27	08/11/2019 05:54	10/11/2019 16:27	58,54	8	468,30	CHI
20191159172	CACU	CA12384078	CACHOEIRA ALTA	08/11/2019 05:54	10/11/2019 16:27	08/11/2019 05:54	10/11/2019 16:27	58,54	1	58,54	CHI
20191159178	NIQUELANDIA	NQ21213207	URUACU	08/11/2019 07:03	08/11/2019 12:01	08/11/2019 07:03	08/11/2019 12:01	4,97	1	4,97	CHI
20191159180	SANTA HELENA DE GOIAS	SH12271563	IPEGUARI	08/11/2019 03:06	09/11/2019 11:35	08/11/2019 03:06	09/11/2019 11:35	32,47	1	32,47	CHI
20191159186	SAO FRANCISCO DE GOIAS	SF21391339	SAO FRANCISCO DE GOIAS	08/11/2019 07:04	08/11/2019 19:14	08/11/2019 07:04	08/11/2019 19:14	12,16	1	12,16	CHI
20191159187	PONTALINA	PK32047343	VICENTINOPOLIS	07/11/2019 19:06	09/11/2019 17:57	07/11/2019 19:06	08/11/2019 11:45	16,65	30	499,53	CHI
20191159187	PONTALINA	PK32047343	VICENTINOPOLIS	07/11/2019 19:06	09/11/2019 17:57	07/11/2019 19:06	09/11/2019 17:57	46,84	2	93,69	CHI
20191159214	JUSSARA	JR12396094	JUSSARA	08/11/2019 04:58	08/11/2019 10:04	08/11/2019 04:58	08/11/2019 10:04	5,09	26	132,43	CHI
20191159220	PALMEIRAS DE GOIAS	PL12143287	PALMEIRAS	08/11/2019 07:10	11/11/2019 20:55	08/11/2019 07:10	09/11/2019 07:10	24,00	18	432,01	CHI
20191159220	PALMEIRAS DE GOIAS	PL12143287	PALMEIRAS	08/11/2019 07:10	11/11/2019 20:55	08/11/2019 07:10	11/11/2019 20:55	85,74	21	1800,59	CHI
20191159220	PALMEIRAS DE GOIAS	PL12143287	PALMEIRAS	08/11/2019 07:10	11/11/2019 20:55	11/11/2019 09:52	11/11/2019 20:55	11,04	18	198,66	CHI
20191159223	ABADIANIA	AA21370376	ANAPOLIS UNIVERSITARIO S1	08/11/2019 07:11	08/11/2019 13:30	08/11/2019 07:11	08/11/2019 13:30	6,32	1	6,32	CHI
20191159228	ITABERAI	II12217217	ITABERAI S1	08/11/2019 07:11	08/11/2019 15:13	08/11/2019 07:11	08/11/2019 15:13	8,03	22	176,64	CHI
20191159228	ITAGUARI	II12217217	ITABERAI S1	08/11/2019 07:11	08/11/2019 15:13	08/11/2019 07:11	08/11/2019 15:13	8,03	42	337,22	CHI
20191159228	TAQUARAL DE GOIAS	II12217217	ITABERAI S1	08/11/2019 07:11	08/11/2019 15:13	08/11/2019 07:11	08/11/2019 15:13	8,03	45	361,31	CHI
20191159237	ARAGARCAS	BM12204856	BOM JARDIM	07/11/2019 22:20	08/11/2019 08:43	07/11/2019 22:20	08/11/2019 08:43	10,37	23	238,59	CHI
20191159237	BALIZA	BM12204856	BOM JARDIM	07/11/2019 22:20	08/11/2019 08:43	07/11/2019 22:20	08/11/2019 08:43	10,37	49	508,29	CHI
20191159238	LEOPOLDO DE BULHOES	LB12382365	DAIA S2	08/11/2019 06:42	08/11/2019 15:09	08/11/2019 06:42	08/11/2019 15:09	8,43	17	143,38	CHI
20191159241	IPORA	IR12315044	IPORA	08/11/2019 06:23	08/11/2019 11:31	08/11/2019 06:23	08/11/2019 11:31	5,12	415	2126,53	CHI
20191159242	CACHOEIRA ALTA	CA12402274	CACHOEIRA ALTA	08/11/2019 02:10	08/11/2019 12:11	08/11/2019 02:10	08/11/2019 12:11	10,01	83	830,83	CHI
20191159242	CACU	CA12402274	CACHOEIRA ALTA	08/11/2019 02:10	08/11/2019 12:11	08/11/2019 02:10	08/11/2019 12:11	10,01	8	80,08	CHI
20191159242	ITARUMA	CA12402274	CACHOEIRA ALTA	08/11/2019 02:10	08/11/2019 12:11	08/11/2019 02:10	08/11/2019 12:11	10,01	3	30,03	CHI
20191159248	RIO VERDE	RV21230877	SANTA HELENA S1	08/11/2019 07:15	12/11/2019 09:30	08/11/2019 07:15	12/11/2019 09:30	98,26	2	196,52	CHI
20191159249	CARMO DO RIO VERDE	IK12298505	ITAPURANGA	08/11/2019 06:04	08/11/2019 14:29	08/11/2019 06:04	08/11/2019 14:29	8,41	30	252,28	CHI
20191159249	ITAPURANGA	IK12298505	ITAPURANGA	08/11/2019 06:04	08/11/2019 14:29	08/11/2019 06:04	08/11/2019 14:29	8,41	8	67,27	CHI
20191159250	JATAI	JT12274032	JATAI S2	08/11/2019 07:09	09/11/2019 10:15	08/11/2019 07:09	09/11/2019 10:15	27,09	10	270,90	CHI
20191159252	RIO VERDE	RV21246824	CABRIUVA S2	08/11/2019 07:15	09/11/2019 12:23	08/11/2019 07:15	09/11/2019 12:23	29,12	1	29,12	CHI
20191159254	RIO VERDE	RV11365422	RIO VERDE S1	08/11/2019 06:45	08/11/2019 09:12	08/11/2019 06:45	08/11/2019 09:12	2,44	78	190,34	CHI
20191159255	ACREUNA	EU12207083	ACREUNA	08/11/2019 05:34	08/11/2019 08:06	08/11/2019 05:34	08/11/2019 08:06	2,52	611	1540,23	CHI
20191159272	IPORA	IR12021275	IPORA	08/11/2019 07:19	13/11/2019 09:06	08/11/2019 07:19	13/11/2019 09:06	121,77	1	121,77	CHI
20191159277	CATALAO	CT13050601	CATALAO S2	07/11/2019 17:31	08/11/2019 20:56	08/11/2019 17:14	08/11/2019 17:32	0,30	7	2,07	CHI

20191159277	CATALAO	CT13050601	CATALAO S2	07/11/2019 17:31	08/11/2019 20:56	07/11/2019 17:31	08/11/2019 20:56	27,42	83	2275,65	CHI
20191159277	CUMARI	CT13050601	CATALAO S2	07/11/2019 17:31	08/11/2019 20:56	07/11/2019 17:31	08/11/2019 20:56	27,42	194	5319,00	CHI
20191159277	GOIANDIRA	CT13050601	CATALAO S2	07/11/2019 17:31	08/11/2019 20:56	07/11/2019 17:31	08/11/2019 20:56	27,42	6	164,51	CHI
20191159277	CATALAO	CT13050601	CATALAO S2	07/11/2019 17:31	08/11/2019 20:56	08/11/2019 18:24	08/11/2019 20:56	2,53	7	17,72	CHI
20191159287	IPORA	IR21070228	IPORA	08/11/2019 07:22	09/11/2019 08:35	08/11/2019 07:22	09/11/2019 08:35	25,21	2	50,41	CHI
20191159305	SAO SIMAO	2910003523	CACHOEIRA ALTA	08/11/2019 07:26	11/11/2019 12:10	08/11/2019 07:26	11/11/2019 12:10	76,73	1	76,73	CHI
20191159309	RIO VERDE	RV21384688	CABRIUVA S2	08/11/2019 07:27	09/11/2019 13:00	08/11/2019 17:32	09/11/2019 12:10	18,63	1	18,63	CHI
20191159309	RIO VERDE	RV12280128	CABRIUVA S2	08/11/2019 07:27	09/11/2019 13:00	08/11/2019 07:27	09/11/2019 12:40	29,22	1	29,22	CHI
20191159309	RIO VERDE	RV12280128	CABRIUVA S2	08/11/2019 07:27	09/11/2019 13:00	08/11/2019 07:27	09/11/2019 13:00	29,56	1	29,56	CHI
20191159311	JATAI	JT21313311	JATAI S2	08/11/2019 07:28	08/11/2019 16:26	08/11/2019 07:28	08/11/2019 16:26	8,96	2	17,92	CHI
20191159312	JOVIANIA	JV12218116	GOIATUBA S1	07/11/2019 20:46	08/11/2019 15:10	07/11/2019 20:46	08/11/2019 15:10	18,40	9	165,58	CHI
20191159315	PADRE BERNARDO	PB12163217	PADRE BERNARDO	08/11/2019 07:28	08/11/2019 09:51	08/11/2019 07:28	08/11/2019 09:51	2,37	20	47,36	CHI
20191159341	SERRANOPOLIS	SX12216620	JATAI S1	07/11/2019 21:02	11/11/2019 12:40	07/11/2019 21:02	11/11/2019 12:40	87,64	5	438,22	CHI
20191159345	QUIRINOPOLIS	QI12000060	QUIRINOPOLIS	08/11/2019 07:33	09/11/2019 09:38	08/11/2019 07:33	09/11/2019 09:38	26,08	8	208,64	CHI
20191159355	MINEIROS	MY12324341	PARQUE DAS EMAS	08/11/2019 07:34	09/11/2019 12:58	08/11/2019 07:34	09/11/2019 12:58	29,39	23	676,00	CHI
20191159358	MORRINHOS	MR12263657	GOIATUBA S1	08/11/2019 06:29	08/11/2019 17:57	08/11/2019 06:29	08/11/2019 17:57	11,47	12	137,67	CHI
20191159362	NOVA CRIXAS	NA21203625	NOVA CRIXAS	08/11/2019 07:35	10/11/2019 13:45	08/11/2019 07:35	10/11/2019 13:45	54,16	1	54,16	CHI
20191159368	GOUVELANDIA	GB12000207	QUIRINOPOLIS	08/11/2019 07:36	08/11/2019 15:48	08/11/2019 07:36	08/11/2019 15:48	8,19	4	32,75	CHI
20191159395	IACIARA	IA12206170	IACIARA S1	08/11/2019 05:49	08/11/2019 08:30	08/11/2019 05:49	08/11/2019 08:30	2,68	80	214,47	CHI
20191159396	ORIZONA	OZ11272878	PIRES DO RIO S2	08/11/2019 07:11	08/11/2019 08:45	08/11/2019 07:11	08/11/2019 08:45	1,57	89	139,85	CHI
20191159405	QUIRINOPOLIS	QI21306041	QUIRINOPOLIS	08/11/2019 07:41	08/11/2019 12:55	08/11/2019 07:41	08/11/2019 12:55	5,22	1	5,22	CHI
20191159407	ANAPOLIS	LB12078506	DAIA S2	08/11/2019 07:38	08/11/2019 19:59	08/11/2019 07:38	08/11/2019 19:59	12,34	8	98,73	CHI
20191159407	LEOPOLDO DE BULHOES	LB12078506	DAIA S2	08/11/2019 07:38	08/11/2019 19:59	08/11/2019 07:38	08/11/2019 19:59	12,34	6	74,05	CHI
20191159411	CRIXAS	CX11083039	SERRA DO OURO	08/11/2019 07:42	10/11/2019 16:07	08/11/2019 07:42	10/11/2019 16:07	56,41	4	225,63	CHI
20191159413	GUARINOS	GG21393412	URUACU	08/11/2019 07:42	09/11/2019 13:50	08/11/2019 07:42	09/11/2019 13:50	30,13	1	30,13	CHI
20191159418	AGUAS LINDAS DE GOIAS	4830013565	AGUAS LINDAS DE GOIAS S1	08/11/2019 07:43	09/11/2019 10:27	08/11/2019 07:43	09/11/2019 10:27	26,72	1	26,72	CHI
20191159420	CIDADE OCIDENTAL	DH12376123	MARAJOARA	08/11/2019 07:44	08/11/2019 10:50	08/11/2019 07:44	08/11/2019 10:50	3,11	6	18,63	CHI
20191159423	PORANGATU	PO12282160	PORANGATU	08/11/2019 05:56	08/11/2019 16:09	08/11/2019 05:56	08/11/2019 16:09	10,21	11	112,29	CHI
20191159426	COCALZINHO DE GOIAS	ZN12069171	COCALZINHO	08/11/2019 07:44	09/11/2019 10:44	08/11/2019 07:44	09/11/2019 10:44	26,98	2	53,97	CHI
20191159426	PIRENOPOLIS	ZN12069171	COCALZINHO	08/11/2019 07:44	09/11/2019 10:44	08/11/2019 07:44	09/11/2019 10:44	26,98	5	134,92	CHI
20191159433	CHAPADAO DO CEU	DJ12365007	CHAPADAO DO CEU	08/11/2019 07:45	09/11/2019 11:35	08/11/2019 07:45	09/11/2019 11:35	27,82	7	194,76	CHI
20191159433	MINEIROS	DJ12365007	CHAPADAO DO CEU	08/11/2019 07:45	09/11/2019 11:35	08/11/2019 07:45	09/11/2019 11:35	27,82	3	83,47	CHI
20191159434	RUBIATABA	RB21114345	RUBIATABA	09/11/2019 07:06	10/11/2019 21:42	09/11/2019 07:06	10/11/2019 21:42	38,59	2	77,19	CHI

20191159435	QUIRINOPOLIS	QI31014252	QUIRINOPOLIS	08/11/2019 07:45	08/11/2019 17:02	08/11/2019 07:45	08/11/2019 17:02	9,27	2	18,54	CHI
20191159439	JATAI	RV12038514	CABRIUVA S1	08/11/2019 07:08	09/11/2019 18:38	08/11/2019 07:08	08/11/2019 14:30	7,37	6	44,23	CHI
20191159439	RIO VERDE	RV12038514	CABRIUVA S1	08/11/2019 07:08	09/11/2019 18:38	08/11/2019 07:08	08/11/2019 14:30	7,37	73	538,15	CHI
20191159439	JATAI	RV12000142	CABRIUVA S1	08/11/2019 07:08	09/11/2019 18:38	08/11/2019 14:31	08/11/2019 21:35	7,08	6	42,50	CHI
20191159439	RIO VERDE	RV12000142	CABRIUVA S1	08/11/2019 07:08	09/11/2019 18:38	08/11/2019 14:31	08/11/2019 21:35	7,08	75	531,19	CHI
20191159439	RIO VERDE	RV12260596	CABRIUVA S2	08/11/2019 07:08	09/11/2019 18:38	08/11/2019 22:58	09/11/2019 18:38	19,66	1	19,66	CHI
20191159444	CATALAO	CT12266108	CATALAO S1	08/11/2019 07:46	08/11/2019 09:56	08/11/2019 07:46	08/11/2019 09:56	2,17	8	17,32	CHI
20191159445	ALTO HORIZONTE	AJ12384910	MARA ROSA	08/11/2019 05:17	08/11/2019 13:23	08/11/2019 05:17	08/11/2019 13:23	8,10	34	275,35	CHI
20191159445	MARA ROSA	AJ12384910	MARA ROSA	08/11/2019 05:17	08/11/2019 13:23	08/11/2019 05:17	08/11/2019 13:23	8,10	3	24,30	CHI
20191159453	PORANGATU	PO12104373	PORANGATU	08/11/2019 04:46	08/11/2019 14:06	08/11/2019 04:46	08/11/2019 14:06	9,33	32	298,52	CHI
20191159459	CALDAS NOVAS	10030308788	SERRA DE CALDAS	08/11/2019 07:52	08/11/2019 11:55	08/11/2019 07:52	08/11/2019 11:55	4,06	1	4,06	CHI
20191159466	CALDAS NOVAS	CN21292955	CALDAS NOVAS S2	08/11/2019 07:54	09/11/2019 10:26	08/11/2019 07:54	09/11/2019 10:26	26,53	1	26,53	CHI
20191159473	BONOPOLIS	TA12247490	NOVO PLANALTO	08/11/2019 03:08	10/11/2019 18:35	08/11/2019 03:08	09/11/2019 09:57	30,81	3	92,44	CHI
20191159473	BONOPOLIS	TA12247490	NOVO PLANALTO	08/11/2019 03:08	10/11/2019 18:35	08/11/2019 03:08	10/11/2019 18:35	63,44	9	570,99	CHI
20191159473	PORANGATU	TA12247490	NOVO PLANALTO	08/11/2019 03:08	10/11/2019 18:35	08/11/2019 03:08	10/11/2019 18:35	63,44	2	126,89	CHI
20191159479	ARAGARCAS	AG12334918	ARAGARCAS	08/11/2019 07:56	13/11/2019 14:42	08/11/2019 07:56	13/11/2019 14:42	126,76	3	380,28	CHI
20191159485	BRITANIA	IU12020119	MATRINCHA	08/11/2019 05:20	08/11/2019 11:24	08/11/2019 05:20	08/11/2019 11:24	6,06	3	18,19	CHI
20191159485	ITAPIRAPUA	IU12020119	MATRINCHA	08/11/2019 05:20	08/11/2019 11:24	08/11/2019 05:20	08/11/2019 11:24	6,06	10	60,62	CHI
20191159487	APORE	AE11136071	ITAJA S1	08/11/2019 07:19	08/11/2019 13:30	08/11/2019 07:19	08/11/2019 12:00	4,67	81	378,38	CHI
20191159487	APORE	AE11348875	ITAJA S1	08/11/2019 07:19	08/11/2019 13:30	08/11/2019 11:14	08/11/2019 13:30	2,26	72	162,38	CHI
20191159489	QUIRINOPOLIS	QI21067495	QUIRINOPOLIS	08/11/2019 07:58	08/11/2019 12:00	08/11/2019 07:58	08/11/2019 12:00	4,03	1	4,03	CHI
20191159498	ANHANGUERA	CY12071523RE	CATALAO S1	08/11/2019 06:03	08/11/2019 14:15	08/11/2019 06:03	08/11/2019 14:15	8,20	5	41,00	CHI
20191159498	CORUMBAIBA	CY12071523RE	CATALAO S1	08/11/2019 06:03	08/11/2019 14:15	08/11/2019 06:03	08/11/2019 14:15	8,20	4	32,80	CHI
20191159498	CUMARI	CY12071523RE	CATALAO S1	08/11/2019 06:03	08/11/2019 14:15	08/11/2019 06:03	08/11/2019 14:15	8,20	20	164,02	CHI
20191159498	NOVA AURORA	CY12071523RE	CATALAO S1	08/11/2019 06:03	08/11/2019 14:15	08/11/2019 06:03	08/11/2019 14:15	8,20	1	8,20	CHI
20191159502	ARUANA	AK21072178	ARUANA	08/11/2019 07:59	08/11/2019 18:00	08/11/2019 07:59	08/11/2019 18:00	10,01	1	10,01	CHI
20191159509	NIQUELANDIA	6306776	NIQUELANDIA SUBTRANSMISSAO	08/11/2019 05:29	08/11/2019 09:18	08/11/2019 05:29	08/11/2019 09:18	3,81	50	190,29	CHI
20191159509	URUACU	6306776	NIQUELANDIA SUBTRANSMISSAO	08/11/2019 05:29	08/11/2019 09:18	08/11/2019 05:29	08/11/2019 09:18	3,81	2	7,61	CHI
20191159514	ANAPOLIS	10030491817	ANAPOLIS UNIVERSITARIO S2	08/11/2019 08:00	08/11/2019 11:45	08/11/2019 08:00	08/11/2019 11:45	3,75	1	3,75	CHI
20191159518	IPAMERI	IP12071024	IPAMERI	08/11/2019 08:00	09/11/2019 08:01	08/11/2019 08:00	09/11/2019 08:01	24,01	7	168,04	CHI
20191159524	CALDAS NOVAS	CN21082159	CALDAS NOVAS S2	08/11/2019 08:01	09/11/2019 12:12	08/11/2019 08:01	09/11/2019 12:12	28,17	1	28,17	CHI
20191159527	CRISTALINA	KR21170316	PAMPLONA	08/11/2019 08:02	08/11/2019 13:58	08/11/2019 08:02	08/11/2019 13:58	5,92	1	5,92	CHI
20191159528	GOIANESIA	SZ12292609	GOIANESIA S1	08/11/2019 07:58	08/11/2019 17:15	08/11/2019 07:58	08/11/2019 17:15	9,27	7	64,90	CHI

20191159528	SAO LUIZ DO NORTE	SZ12292609	GOIANESIA S1	08/11/2019 07:58	08/11/2019 17:15	08/11/2019 07:58	08/11/2019 17:15	9,27	21	194,69	CHI
20191159530	ARUANA	AK21140336	MOZARLANDIA	08/11/2019 08:02	11/11/2019 09:46	08/11/2019 08:02	11/11/2019 09:46	73,72	1	73,72	CHI
20191159545	RIO VERDE	RV12123226	RIO VERDE S1	08/11/2019 06:23	09/11/2019 10:39	08/11/2019 06:23	09/11/2019 10:39	28,26	61	1723,66	CHI
20191159555	CAIAPONIA	CP12244222	CAIAPONIA	08/11/2019 08:05	09/11/2019 19:07	08/11/2019 08:05	09/11/2019 19:07	35,03	5	175,14	CHI
20191159568	URUACU	UR21082990	URUACU	08/11/2019 08:06	09/11/2019 10:41	08/11/2019 08:06	09/11/2019 10:41	26,58	1	26,58	CHI
20191159569	URUACU	640078886	URUACU	08/11/2019 08:06	08/11/2019 09:26	08/11/2019 08:06	08/11/2019 09:26	1,32	1	1,32	CHI
20191159573	ANAPOLIS	AN12344562	ANAPOLIS UNIVERSITARIO S1	08/11/2019 06:40	08/11/2019 18:40	08/11/2019 06:40	08/11/2019 18:40	12,00	2	23,99	CHI
20191159576	LUZIANIA	120448518	RIO VERMELHO	08/11/2019 08:07	08/11/2019 12:57	08/11/2019 08:07	08/11/2019 12:57	4,83	1	4,83	CHI
20191159588	ITABERAI	IB21336848	ITABERAI S2	08/11/2019 08:08	10/11/2019 09:38	08/11/2019 08:08	10/11/2019 09:38	49,49	1	49,49	CHI
20191159594	FAINA	GS12189948	GOIAS	07/11/2019 21:59	15/11/2019 17:00	07/11/2019 21:59	15/11/2019 17:00	187,00	11	2057,03	CHI
20191159595	GOUVELANDIA	GB12402360	QUIRINOPOLIS	08/11/2019 08:09	09/11/2019 08:16	08/11/2019 08:09	09/11/2019 08:16	24,11	8	192,87	CHI
20191159595	QUIRINOPOLIS	GB12402360	QUIRINOPOLIS	08/11/2019 08:09	09/11/2019 08:16	08/11/2019 08:09	09/11/2019 08:16	24,11	4	96,43	CHI
20191159600	ITAJA	IJ21264407	CACHOEIRA ALTA	08/11/2019 08:09	10/11/2019 16:10	08/11/2019 08:09	10/11/2019 16:10	56,00	2	112,01	CHI
20191159601	CACHOEIRA DOURADA	CD21000044	CACHOEIRA DOURADA	08/11/2019 08:09	10/11/2019 11:48	08/11/2019 08:09	10/11/2019 11:48	51,64	1	51,64	CHI
20191159617	ALEXANIA	AX21094731	ALEXANIA	08/11/2019 08:11	09/11/2019 09:36	08/11/2019 08:11	09/11/2019 09:36	25,40	1	25,40	CHI
20191159622	RIO VERDE	RV12154027	MONTIVIDIU T	08/11/2019 08:12	15/11/2019 07:50	08/11/2019 08:12	15/11/2019 07:50	167,63	2	335,27	CHI
20191159627	BRITANIA	BT21009938	BRITANIA	08/11/2019 08:12	13/11/2019 09:07	08/11/2019 08:12	13/11/2019 09:07	120,90	1	120,90	CHI
20191159634	CALDAS NOVAS	CN21100582	CALDAS NOVAS S2	08/11/2019 08:13	09/11/2019 15:17	08/11/2019 08:13	09/11/2019 15:17	31,06	1	31,06	CHI
20191159636	JARAGUA	JA21266572	JARAGUA	08/11/2019 08:13	08/11/2019 13:53	08/11/2019 08:13	08/11/2019 13:53	5,66	1	5,66	CHI
20191159638	JATAI	290103368	JATAI S2	08/11/2019 08:13	08/11/2019 17:34	08/11/2019 08:13	08/11/2019 17:34	9,35	1	9,35	CHI
20191159640	VALPARAISO DE GOIAS	10003103933	PACAEMBU S1	08/11/2019 08:14	08/11/2019 10:58	08/11/2019 08:14	08/11/2019 10:58	2,73	1	2,73	CHI
20191159643	MUTUNOPOLIS	MU12297027	MARA ROSA	08/11/2019 05:21	12/11/2019 13:50	08/11/2019 05:21	12/11/2019 13:50	104,47	3	313,41	CHI
20191159644	JARAGUA	JA21114606	JARAGUA	08/11/2019 08:14	08/11/2019 19:07	08/11/2019 08:14	08/11/2019 19:07	10,87	1	10,87	CHI
20191159650	SANTO ANTONIO DA BARRA	BZ12207396	ACREUNA	08/11/2019 08:15	08/11/2019 16:32	08/11/2019 08:15	08/11/2019 16:32	8,28	3	24,84	CHI
20191159652	SILVANIA	SV21166952	DAIA S2	08/11/2019 08:15	08/11/2019 16:48	08/11/2019 08:15	08/11/2019 16:48	8,55	1	8,55	CHI
20191159658	SAO LUIS DE MONTES BELOS	SL32145926	SAO LUIZ DOS MONTES BELOS	08/11/2019 08:16	08/11/2019 12:10	08/11/2019 08:16	08/11/2019 12:10	3,91	2	7,83	CHI
20191159659	NOVO GAMA	NJ11172226	PACAEMBU S1	08/11/2019 08:16	09/11/2019 08:36	08/11/2019 08:16	09/11/2019 08:36	24,33	83	2019,62	CHI
20191159661	SAO MIGUEL DO ARAGUAIA	4650001214	SAO MIGUEL DO ARAGUAIA	08/11/2019 08:16	10/11/2019 23:47	08/11/2019 08:16	10/11/2019 23:47	63,52	1	63,52	CHI
20191159663	PARANAIGUARA	PC12209794	QUIRINOPOLIS	08/11/2019 08:16	09/11/2019 11:28	08/11/2019 08:16	09/11/2019 11:28	27,20	6	163,18	CHI
20191159665	VICENTINOPOLIS	VI12166491	VICENTINOPOLIS	08/11/2019 08:16	08/11/2019 13:40	08/11/2019 08:16	08/11/2019 13:40	5,39	25	134,81	CHI
20191159666	MINEIROS	MY21332643	PARQUE DAS EMAS	08/11/2019 08:16	08/11/2019 12:40	08/11/2019 08:16	08/11/2019 12:40	4,40	1	4,40	CHI
20191159669	JUSSARA	BT21167547	BRITANIA	08/11/2019 08:17	09/11/2019 12:42	08/11/2019 08:17	09/11/2019 12:42	28,41	1	28,41	CHI
20191159670	FLORES DE GOIAS	04920406	SAO JOAO D ALIANCA	08/11/2019 05:57	08/11/2019 16:05	08/11/2019 05:57	08/11/2019 16:05	10,12	6	60,71	CHI

20191159670	FORMOSA	04920406	SAO JOAO D ALIANCA	08/11/2019 05:57	08/11/2019 16:05	08/11/2019 05:57	08/11/2019 16:05	10,12	428	4330,88	CHI
20191159670	FORMOSA	04920406	SAO JOAO D ALIANCA	08/11/2019 05:57	08/11/2019 16:05	08/11/2019 05:57	08/11/2019 16:05	10,12	399	4037,44	CHI
20191159670	SAO JOAO D ALIANCA	04920406	SAO JOAO D ALIANCA	08/11/2019 05:57	08/11/2019 16:05	08/11/2019 05:57	08/11/2019 16:05	10,12	52	526,18	CHI
20191159683	ITUMBIARA	IT12000185	ITUMBIARA NOVA	08/11/2019 08:19	09/11/2019 16:35	08/11/2019 08:19	09/11/2019 16:35	32,26	1	32,26	CHI
20191159684	ANAPOLIS	AN12201240	ANAPOLIS UNIVERSITARIO S2	08/11/2019 08:19	08/11/2019 10:32	08/11/2019 08:19	08/11/2019 10:32	2,21	9	19,93	CHI
20191159694	CASTELANDIA	RV12026916	RIO DOS BOIS	08/11/2019 05:34	08/11/2019 15:20	08/11/2019 05:34	08/11/2019 15:20	9,77	12	117,25	CHI
20191159694	RIO VERDE	RV12026916	RIO DOS BOIS	08/11/2019 05:34	08/11/2019 15:20	08/11/2019 05:34	08/11/2019 15:20	9,77	2	19,54	CHI
20191159696	VALPARAISO DE GOIAS	10004426426	PACAEMBU S2	08/11/2019 08:19	08/11/2019 12:19	08/11/2019 08:19	08/11/2019 12:19	3,99	1	3,99	CHI
20191159698	AGUAS LINDAS DE GOIAS	10005496649	AGUAS LINDAS DE GOIAS S1	08/11/2019 08:19	08/11/2019 10:03	08/11/2019 08:19	08/11/2019 10:03	1,72	1	1,72	CHI
20191159720	IPORA	IR11323879	IPORA	08/11/2019 07:15	08/11/2019 10:35	08/11/2019 07:15	08/11/2019 10:35	3,33	119	395,91	CHI
20191159730	GOIAS	GS12021057	GOIAS	08/11/2019 08:23	10/11/2019 16:40	08/11/2019 08:23	10/11/2019 16:40	56,28	3	168,84	CHI
20191159731	DIORAMA	IR12014524	IPORA	08/11/2019 08:23	11/11/2019 10:45	08/11/2019 08:23	11/11/2019 10:45	74,36	2	148,71	CHI
20191159731	IPORA	IR12014524	IPORA	08/11/2019 08:23	11/11/2019 10:45	08/11/2019 08:23	11/11/2019 10:45	74,36	1	74,36	CHI
20191159733	CALDAS NOVAS	CN21298661	CALDAS NOVAS S2	08/11/2019 08:23	09/11/2019 15:34	08/11/2019 08:23	09/11/2019 15:34	31,17	1	31,17	CHI
20191159747	DIVINOPOLIS DE GOIAS	GH21321273	SAO DOMINGOS	08/11/2019 08:25	08/11/2019 15:10	08/11/2019 08:25	08/11/2019 15:10	6,75	1	6,75	CHI
20191159758	DOVERLANDIA	DV12204324	CAIAPONIA	08/11/2019 06:15	09/11/2019 13:52	08/11/2019 06:15	09/11/2019 13:52	31,60	11	347,64	CHI
20191159763	POSSE	1480081386	IACIARA S2	08/11/2019 08:26	08/11/2019 10:49	08/11/2019 08:26	08/11/2019 10:49	2,37	1	2,37	CHI
20191159766	PALMEIRAS DE GOIAS	PL11312588	PALMEIRAS	08/11/2019 07:35	08/11/2019 08:50	08/11/2019 07:35	08/11/2019 08:50	1,24	332	411,13	CHI
20191159770	PARAUNA	PU21040942	FIRMINOPOLIS S2	08/11/2019 08:27	09/11/2019 12:14	08/11/2019 08:27	09/11/2019 12:14	27,78	1	27,78	CHI
20191159774	IPAMERI	580002494	IPAMERI	08/11/2019 08:27	08/11/2019 14:47	08/11/2019 08:27	08/11/2019 14:47	6,32	1	6,32	CHI
20191159779	INDIARA	IY21016771	PALMEIRAS	08/11/2019 08:28	09/11/2019 09:25	08/11/2019 08:28	09/11/2019 09:25	24,95	1	24,95	CHI
20191159785	CATALAO	CT12399850	CATALAO S1	08/11/2019 05:19	08/11/2019 09:35	08/11/2019 05:19	08/11/2019 09:35	4,26	52	221,39	CHI
20191159785	GOIANDIRA	CT12399850	CATALAO S1	08/11/2019 05:19	08/11/2019 09:35	08/11/2019 05:19	08/11/2019 09:35	4,26	41	174,56	CHI
20191159786	CASTELANDIA	QI12296614	QUIRINOPOLIS	08/11/2019 08:29	08/11/2019 16:45	08/11/2019 08:29	08/11/2019 16:45	8,26	1	8,26	CHI
20191159786	QUIRINOPOLIS	QI12296614	QUIRINOPOLIS	08/11/2019 08:29	08/11/2019 16:45	08/11/2019 08:29	08/11/2019 16:45	8,26	10	82,61	CHI
20191159787	SANTO ANTONIO DO DESCOBERTO	SN21219796	MARAJOARA	08/11/2019 08:29	08/11/2019 12:16	08/11/2019 08:29	08/11/2019 12:16	3,77	2	7,55	CHI
20191159792	IPORA	IR21014078	IPORA	08/11/2019 08:30	09/11/2019 09:20	08/11/2019 08:30	09/11/2019 09:20	24,83	1	24,83	CHI
20191159804	RIO VERDE	RV12340876	MONTIVIDIU T	08/11/2019 07:39	08/11/2019 09:58	08/11/2019 07:39	08/11/2019 09:58	2,33	5	11,64	CHI
20191159817	ITABERAI	IB12000032	ITABERAI S2	08/11/2019 08:32	09/11/2019 07:28	08/11/2019 08:32	09/11/2019 07:28	22,92	2	45,85	CHI
20191159821	BOM JARDIM DE GOIAS	BM12074235	PIRANHAS	08/11/2019 07:28	08/11/2019 12:57	08/11/2019 07:28	08/11/2019 12:57	5,47	12	65,65	CHI
20191159823	MOSSAMEDES	MD12049596	FIRMINOPOLIS S2	08/11/2019 05:37	08/11/2019 11:29	08/11/2019 05:37	08/11/2019 11:29	5,86	2	11,72	CHI
20191159828	IPORA	IR12187483	IPORA	08/11/2019 06:10	08/11/2019 11:20	08/11/2019 06:10	08/11/2019 11:20	5,16	97	500,82	CHI
20191159830	INDIARA	IY11215330	EDEIA	08/11/2019 08:12	08/11/2019 15:05	08/11/2019 08:12	08/11/2019 15:05	6,87	204	1402,33	CHI

20191159849	RIO VERDE	630397922	RIO VERDE S1	08/11/2019 08:35	08/11/2019 12:32	08/11/2019 08:35	08/11/2019 12:32	3,95	1	3,95	CHI
20191159854	ANAPOLIS	AN11135851	ANAPOLIS UNIVERSITARIO S1	08/11/2019 07:33	08/11/2019 11:03	08/11/2019 07:33	08/11/2019 11:03	3,49	125	436,08	CHI
20191159855	IPORA	IR11060708	IPORA	08/11/2019 10:28	08/11/2019 14:10	08/11/2019 10:28	08/11/2019 14:10	3,69	119	439,01	CHI
20191159856	ITAGUARU	IC11089314	ITABERAI S1	08/11/2019 03:37	08/11/2019 18:40	08/11/2019 03:37	08/11/2019 18:40	15,04	75	1127,90	CHI
20191159857	IPORA	IR11040214	IPORA	08/11/2019 06:41	08/11/2019 14:45	08/11/2019 06:41	08/11/2019 14:45	8,05	147	1184,00	CHI
20191159863	ALTO PARAISO DE GOIAS	BF11365387	SAO JOAO D ALIANCA	08/11/2019 08:37	08/11/2019 14:15	08/11/2019 08:37	08/11/2019 14:15	5,63	1	5,63	CHI
20191159865	IPORA	IR12014557	IPORA	08/11/2019 07:18	09/11/2019 11:20	08/11/2019 07:18	09/11/2019 09:37	26,31	18	473,59	CHI
20191159865	IPORA	IR12014557	IPORA	08/11/2019 07:18	09/11/2019 11:20	08/11/2019 07:18	09/11/2019 11:20	28,02	4	112,09	CHI
20191159877	CRIXAS	CX12295212	SERRA DO OURO	08/11/2019 08:10	08/11/2019 11:15	08/11/2019 08:10	08/11/2019 11:15	3,07	28	85,94	CHI
20191159882	TRES RANCHOS	TH21149199	CATALAO S1	08/11/2019 08:39	10/11/2019 17:15	08/11/2019 08:39	08/11/2019 16:54	8,25	1	8,25	CHI
20191159882	TRES RANCHOS	TH12057692	CATALAO S1	08/11/2019 08:39	10/11/2019 17:15	08/11/2019 14:34	10/11/2019 17:15	50,69	2	101,37	CHI
20191159888	SANTA CRUZ DE GOIAS	3570003058	PIRES DO RIO S2	08/11/2019 08:39	09/11/2019 20:16	08/11/2019 08:39	09/11/2019 20:16	35,60	1	35,60	CHI
20191159900	DOVERLANDIA	DV12139919	CAIAPONIA	08/11/2019 08:25	09/11/2019 14:59	08/11/2019 08:25	09/11/2019 14:59	30,56	49	1497,47	CHI
20191159906	LUZIANIA	3200006983	MARAJOARA	08/11/2019 08:42	08/11/2019 11:50	08/11/2019 08:42	08/11/2019 11:50	3,13	1	3,13	CHI
20191159919	RIO VERDE	RV12355126	RIO VERDE S1	08/11/2019 08:44	09/11/2019 12:04	08/11/2019 08:44	09/11/2019 12:04	27,34	2	54,68	CHI
20191159932	ITAPACI	100008161	ITAPACI	08/11/2019 08:47	08/11/2019 13:50	08/11/2019 08:47	08/11/2019 13:50	5,06	1	5,06	CHI
20191159941	MINEIROS	MY12043894	PARQUE DAS EMAS	07/11/2019 22:33	08/11/2019 14:00	07/11/2019 22:33	08/11/2019 14:00	15,45	99	1529,50	CHI
20191159946	PADRE BERNARDO	9980018038	PADRE BERNARDO	08/11/2019 08:48	08/11/2019 14:56	08/11/2019 08:48	08/11/2019 14:56	6,12	1	6,12	CHI
20191159949	JATAI	10023781040	JATAI S3	08/11/2019 08:49	09/11/2019 11:18	08/11/2019 08:49	09/11/2019 11:18	26,49	1	26,49	CHI
20191159952	JUSSARA	IU12087423	MATRINCHA	08/11/2019 08:29	08/11/2019 17:19	08/11/2019 08:29	08/11/2019 17:19	8,84	4	35,35	CHI
20191159960	AURILANDIA	AI21194098	FIRMINOPOLIS S2	08/11/2019 08:50	08/11/2019 16:13	08/11/2019 08:50	08/11/2019 16:13	7,38	1	7,38	CHI
20191159965	MINEIROS	10015367493	PARQUE DAS EMAS	08/11/2019 08:48	09/11/2019 00:50	08/11/2019 08:48	09/11/2019 00:50	16,04	1	16,04	CHI
20191159971	CHAPADAO DO CEU	DJ12164750	CHAPADAO DO CEU	08/11/2019 08:51	09/11/2019 09:30	08/11/2019 08:51	09/11/2019 09:30	24,65	38	936,56	CHI
20191159988	NIQUELANDIA	NQ11262777	URUACU	08/11/2019 08:54	08/11/2019 13:35	08/11/2019 08:54	08/11/2019 13:35	4,67	10	46,74	CHI
20191159992	ITAGUARU	IC12230735	ITABERAI S1	07/11/2019 23:13	10/11/2019 12:53	07/11/2019 23:13	10/11/2019 12:53	61,68	5	308,38	CHI
20191160003	MORRINHOS	MR21263628	MORRINHOS	08/11/2019 08:56	09/11/2019 08:23	08/11/2019 08:56	09/11/2019 08:23	23,43	1	23,43	CHI
20191160004	ITAPURANGA	IK11051549	ITAPURANGA	08/11/2019 08:38	08/11/2019 10:55	08/11/2019 08:38	08/11/2019 10:55	2,28	197	449,21	CHI
20191160008	AGUAS LINDAS DE GOIAS	4830080232	AGUAS LINDAS DE GOIAS S1	08/11/2019 08:57	08/11/2019 10:36	08/11/2019 08:57	08/11/2019 10:36	1,64	1	1,64	CHI
20191160009	RIO VERDE	RV11234184	MONTIVIDIU T	08/11/2019 08:57	08/11/2019 19:40	08/11/2019 08:57	08/11/2019 19:40	10,71	1	10,71	CHI
20191160018	TURVANIA	1220018147	FIRMINOPOLIS S2	08/11/2019 08:58	08/11/2019 14:44	08/11/2019 08:58	08/11/2019 14:44	5,76	1	5,76	CHI
20191160032	ARUANA	AK21187332	MOZARLANDIA	08/11/2019 09:00	11/11/2019 12:58	08/11/2019 09:00	11/11/2019 12:58	75,97	1	75,97	CHI
20191160035	RIO VERDE	RV12018095	SANTA HELENA S1	08/11/2019 09:00	16/11/2019 21:53	08/11/2019 09:00	09/11/2019 17:11	32,17	5	160,85	CHI
20191160035	RIO VERDE	RV12018095	SANTA HELENA S1	08/11/2019 09:00	16/11/2019 21:53	08/11/2019 09:00	16/11/2019 21:26	204,43	1	204,43	CHI

20191160035	RIO VERDE	RV12018095	SANTA HELENA S1	08/11/2019 09:00	16/11/2019 21:53	08/11/2019 09:00	16/11/2019 21:27	204,44	1	204,44	CHI
20191160035	RIO VERDE	RV12018095	SANTA HELENA S1	08/11/2019 09:00	16/11/2019 21:53	08/11/2019 09:00	16/11/2019 21:53	204,87	2	409,74	CHI
20191160035	RIO VERDE	RV12018095	SANTA HELENA S1	08/11/2019 09:00	16/11/2019 21:53	16/11/2019 19:40	16/11/2019 21:53	2,21	5	11,04	CHI
20191160040	IPAMERI	IP21080884	URUTAI	08/11/2019 09:01	09/11/2019 09:01	08/11/2019 09:01	09/11/2019 09:01	23,99	1	23,99	CHI
20191160048	ARAGARCAS	1820035016	ARAGARCAS	08/11/2019 09:02	10/11/2019 17:06	08/11/2019 09:02	10/11/2019 17:06	56,06	1	56,06	CHI
20191160054	SANTA TEREZA DE GOIAS	TB12170075	PORANGATU	08/11/2019 09:02	12/11/2019 13:45	08/11/2019 09:02	12/11/2019 13:45	100,70	3	302,10	CHI
20191160068	PLANALTINA	10004758739	PLANALTINA	08/11/2019 09:04	08/11/2019 13:58	08/11/2019 09:04	08/11/2019 13:58	4,89	1	4,89	CHI
20191160070	ITABERAI	IB11000024	ITABERAI S2	08/11/2019 09:04	11/11/2019 17:49	08/11/2019 09:04	11/11/2019 17:49	80,75	127	10255,07	CHI
20191160076	MUNDO NOVO DE GOIAS	MH11274907	NOVA CRIXAS	07/11/2019 15:27	11/11/2019 15:31	07/11/2019 15:27	11/11/2019 15:31	96,06	1	96,06	CHI
20191160077	LUZIANIA	3200017476	MARAJOARA	08/11/2019 09:06	08/11/2019 13:00	08/11/2019 09:06	08/11/2019 13:00	3,90	1	3,90	CHI
20191160078	INDIARA	IY12186294	EDEIA	08/11/2019 09:06	09/11/2019 12:00	08/11/2019 09:06	09/11/2019 12:00	26,91	3	80,73	CHI
20191160085	CATALAO	CT21192680	CATALAO S1	08/11/2019 09:07	08/11/2019 13:56	08/11/2019 09:07	08/11/2019 13:56	4,81	1	4,81	CHI
20191160086	ISRAELANDIA	1270002445	IPORA	08/11/2019 09:07	11/11/2019 16:26	08/11/2019 09:07	11/11/2019 16:26	79,31	1	79,31	CHI
20191160095	ITUMBIARA	690373892	ITUMBIARA NOVA	08/11/2019 09:08	10/11/2019 08:30	08/11/2019 09:08	10/11/2019 08:30	47,37	1	47,37	CHI
20191160101	ACREUNA	2440038253	ACREUNA	08/11/2019 09:09	08/11/2019 19:10	08/11/2019 09:09	08/11/2019 19:10	10,02	1	10,02	CHI
20191160112	VILA PROPICIO	NP12384850	GOIANESIA S1	08/11/2019 09:11	10/11/2019 17:44	08/11/2019 09:11	10/11/2019 17:44	56,54	5	282,72	CHI
20191160122	PETROLINA DE GOIAS	PG21011519	PETROLINA	08/11/2019 09:12	08/11/2019 10:33	08/11/2019 09:12	08/11/2019 10:33	1,34	2	2,69	CHI
20191160128	ANAPOLIS	20445090	JUNDIAI S2	08/11/2019 09:13	08/11/2019 10:35	08/11/2019 09:13	08/11/2019 10:35	1,36	1	1,36	CHI
20191160129	NOVA CRIXAS	NA12229610	NOVA CRIXAS	08/11/2019 08:07	09/11/2019 18:18	08/11/2019 08:07	09/11/2019 18:18	34,17	8	273,36	CHI
20191160134	CACHOEIRA ALTA	CA21041661	CACHOEIRA ALTA	08/11/2019 09:14	10/11/2019 13:10	08/11/2019 09:14	10/11/2019 13:10	51,93	1	51,93	CHI
20191160137	ACREUNA	8578389	ACREUNA	08/11/2019 09:14	11/11/2019 09:15	08/11/2019 09:14	11/11/2019 09:15	72,01	1	72,01	CHI
20191160139	ARENOPOLIS	AY11056272	IPORA	08/11/2019 08:47	08/11/2019 22:30	08/11/2019 08:47	08/11/2019 22:30	13,70	112	1534,56	CHI
20191160140	CIDADE OCIDENTAL	DH11170172	MARAJOARA	08/11/2019 07:33	08/11/2019 10:34	08/11/2019 07:33	08/11/2019 10:34	3,01	121	364,75	CHI
20191160147	ITABERAI	IB12379741	ITABERAI S2	08/11/2019 05:46	08/11/2019 10:54	08/11/2019 05:46	08/11/2019 10:54	5,13	41	210,38	CHI
20191160149	SANTA HELENA DE GOIAS	SH11371496	IPEGUARI	08/11/2019 08:28	09/11/2019 07:56	08/11/2019 08:28	09/11/2019 07:56	23,47	67	1572,71	CHI
20191160150	PIRANHAS	PH21343556	CAIAPONIA	08/11/2019 09:16	12/11/2019 20:09	08/11/2019 09:16	12/11/2019 20:09	106,87	1	106,87	CHI
20191160155	GOIATUBA	JV12208118	GOIATUBA S1	08/11/2019 06:11	08/11/2019 16:00	08/11/2019 06:11	08/11/2019 16:00	9,81	4	39,25	CHI
20191160155	JOVIANIA	JV12208118	GOIATUBA S1	08/11/2019 06:11	08/11/2019 16:00	08/11/2019 06:11	08/11/2019 16:00	9,81	11	107,95	CHI
20191160158	GOIANESIA	GE12258467	GOIANESIA S1	08/11/2019 05:01	08/11/2019 19:26	08/11/2019 05:01	08/11/2019 19:26	14,41	11	158,49	CHI
20191160158	SANTA RITA DO NOVO DESTINO	GE12258467	GOIANESIA S1	08/11/2019 05:01	08/11/2019 19:26	08/11/2019 05:01	08/11/2019 19:26	14,41	16	230,53	CHI
20191160159	DAVINOPOLIS	IO21127837	CATALAO S1	08/11/2019 09:18	09/11/2019 11:42	08/11/2019 09:18	09/11/2019 11:42	26,40	1	26,40	CHI
20191160165	SAO LUIZ DO NORTE	GE13339958	ITAPACI	08/11/2019 16:01	08/11/2019 18:46	08/11/2019 16:01	08/11/2019 18:46	2,75	3	8,26	CHI
20191160170	RIO VERDE	RV12085773	MONTIVIDIU T	08/11/2019 09:20	12/11/2019 14:15	08/11/2019 09:20	12/11/2019 14:15	100,90	2	201,80	CHI

20191160173	ANAPOLIS	20466560	ANAPOLIS UNIVERSITARIO S1	08/11/2019 09:21	08/11/2019 12:55	08/11/2019 09:21	08/11/2019 12:55	3,56	1	3,56	CHI
20191160174	GOIANDIRA	GD21131085	CATALAO S1	08/11/2019 09:21	10/11/2019 09:30	08/11/2019 09:21	10/11/2019 09:30	48,15	1	48,15	CHI
20191160178	ARAGARCAS	BH12162960	BOM JARDIM	08/11/2019 08:57	08/11/2019 12:42	08/11/2019 08:57	08/11/2019 12:42	3,74	12	44,93	CHI
20191160178	BALIZA	BH12162960	BOM JARDIM	08/11/2019 08:57	08/11/2019 12:42	08/11/2019 08:57	08/11/2019 12:42	3,74	15	56,16	CHI
20191160179	CALDAS NOVAS	760098049	SERRA DE CALDAS	08/11/2019 09:22	09/11/2019 09:00	08/11/2019 09:22	09/11/2019 09:00	23,64	1	23,64	CHI
20191160206	CEZARINA	CZ21205977	GUAPO S2	06/11/2019 14:45	08/11/2019 17:58	06/11/2019 14:45	08/11/2019 17:58	51,21	1	51,21	CHI
20191160307	RIO VERDE	630224845	RIO VERDE S2	08/11/2019 09:23	09/11/2019 13:10	08/11/2019 09:23	09/11/2019 13:10	27,78	1	27,78	CHI
20191160308	MINACU	4020009042	MINACU	08/11/2019 09:24	08/11/2019 17:40	08/11/2019 09:24	08/11/2019 17:40	8,28	1	8,28	CHI
20191160316	PORANGATU	PO12333231	PORANGATU	08/11/2019 09:25	10/11/2019 10:06	08/11/2019 09:25	10/11/2019 10:06	48,67	1	48,67	CHI
20191160318	HEITORAI	HE12310813	ITAPURANGA	08/11/2019 05:31	10/11/2019 09:20	08/11/2019 05:31	10/11/2019 09:20	51,81	54	2797,59	CHI
20191160327	MINEIROS	MY12048095	PARQUE DAS EMAS	08/11/2019 06:23	08/11/2019 20:59	08/11/2019 06:23	08/11/2019 20:59	14,58	21	306,27	CHI
20191160332	PORTELANDIA	PW12302000	PARQUE DAS EMAS	08/11/2019 07:24	08/11/2019 17:18	08/11/2019 07:24	08/11/2019 17:18	9,89	3	29,67	CHI
20191160337	DIORAMA	DI12184430	IPORA	08/11/2019 09:27	11/11/2019 11:16	08/11/2019 09:27	11/11/2019 11:16	73,81	1	73,81	CHI
20191160337	IPORA	DI12184430	IPORA	08/11/2019 09:27	11/11/2019 11:16	08/11/2019 09:27	11/11/2019 11:16	73,81	1	73,81	CHI
20191160339	GOIANESIA	550140270	GOIANESIA S2	08/11/2019 09:27	09/11/2019 12:25	08/11/2019 09:27	09/11/2019 12:25	26,96	1	26,96	CHI
20191160347	DOVERLANDIA	DV12207830	CAIAPONIA	08/11/2019 08:16	09/11/2019 19:54	08/11/2019 08:16	09/11/2019 19:54	35,63	5	178,16	CHI
20191160348	NIQUELANDIA	NQ21372009	URUACU	08/11/2019 09:27	08/11/2019 15:11	08/11/2019 09:27	08/11/2019 15:11	5,72	1	5,72	CHI
20191160349	JATAI	JT11348485	JATAI S2	08/11/2019 08:53	08/11/2019 20:27	08/11/2019 08:53	08/11/2019 20:27	11,58	103	1192,25	CHI
20191160353	PLANALTINA	PI21372162	PLANALTINA	08/11/2019 09:28	09/11/2019 17:58	08/11/2019 09:28	09/11/2019 17:58	32,50	1	32,50	CHI
20191160359	QUIRINOPOLIS	QI21012365	QUIRINOPOLIS	08/11/2019 09:28	09/11/2019 18:24	08/11/2019 09:28	09/11/2019 18:24	32,92	1	32,92	CHI
20191160364	JANDAIA	JD12008602	PALMEIRAS	08/11/2019 05:02	08/11/2019 14:50	08/11/2019 05:02	08/11/2019 14:50	9,78	9	88,06	CHI
20191160365	IPORA	IR12091549	IPORA	08/11/2019 06:17	09/11/2019 02:16	08/11/2019 06:17	09/11/2019 02:16	19,97	15	299,58	CHI
20191160376	CROMINIA	CQ12344595	PONTALINA	08/11/2019 09:30	09/11/2019 12:40	08/11/2019 09:30	09/11/2019 12:40	27,17	2	54,33	CHI
20191160377	CRISTALINA	KR12244611	CRISTALINA S2	08/11/2019 09:30	08/11/2019 12:49	08/11/2019 09:30	08/11/2019 12:49	3,31	3	9,94	CHI
20191160386	ANAPOLIS	21350875	JUNDIAI S1	08/11/2019 09:31	08/11/2019 12:21	08/11/2019 09:31	08/11/2019 12:21	2,83	1	2,83	CHI
20191160391	ITAPIRAPUA	IU12018846	MATRINCHA	08/11/2019 08:00	08/11/2019 15:08	08/11/2019 08:00	08/11/2019 15:08	7,13	4	28,53	CHI
20191160401	QUIRINOPOLIS	QI32053199	QUIRINOPOLIS	08/11/2019 09:26	08/11/2019 11:28	08/11/2019 09:26	08/11/2019 11:28	2,03	2	4,06	CHI
20191160408	BARRO ALTO	BA11265651	BARRO ALTO	08/11/2019 09:33	09/11/2019 19:40	08/11/2019 09:33	09/11/2019 19:40	34,10	124	4228,88	CHI
20191160415	QUIRINOPOLIS	QI21204289	QUIRINOPOLIS	08/11/2019 09:35	08/11/2019 14:00	08/11/2019 09:35	08/11/2019 14:00	4,42	2	8,83	CHI
20191160418	JATAI	JT11037070	JATAI S2	08/11/2019 06:32	08/11/2019 13:18	08/11/2019 06:32	08/11/2019 13:18	6,76	175	1183,39	CHI
20191160422	BARRO ALTO	BA12342220	GOIANESIA S1	08/11/2019 09:35	08/11/2019 12:45	08/11/2019 09:35	08/11/2019 12:45	3,15	1	3,15	CHI
20191160502	SAO JOAO DA PARAUNA	RP21252505	FIRMINOPOLIS S2	08/11/2019 09:36	08/11/2019 23:47	08/11/2019 09:36	08/11/2019 23:47	14,18	1	14,18	CHI
20191160505	GOIANAPOLIS	950006830	DAIA S2	08/11/2019 09:37	08/11/2019 16:22	08/11/2019 09:37	08/11/2019 16:22	6,76	1	6,76	CHI

20191160517	HEITORAI	HE11223984	ITAPURANGA	08/11/2019 09:39	08/11/2019 21:59	08/11/2019 09:39	08/11/2019 21:59	12,35	2	24,69	CHI
20191160518	EDEIA	EA12237745	EDEIA	08/11/2019 07:09	09/11/2019 15:25	08/11/2019 07:09	09/11/2019 15:25	32,26	9	290,36	CHI
20191160526	RUBIATABA	RB21359301	RUBIATABA	08/11/2019 09:40	11/11/2019 00:38	08/11/2019 09:40	11/11/2019 00:38	62,97	1	62,97	CHI
20191160545	JUSSARA	JR11259698	JUSSARA	08/11/2019 09:22	08/11/2019 12:16	08/11/2019 09:22	08/11/2019 12:16	2,89	131	379,06	CHI
20191160550	PARANAIGUARA	QI12279808	QUIRINOPOLIS	08/11/2019 04:21	08/11/2019 12:31	08/11/2019 04:21	08/11/2019 12:31	8,16	10	81,59	CHI
20191160550	QUIRINOPOLIS	QI12279808	QUIRINOPOLIS	08/11/2019 04:21	08/11/2019 12:31	08/11/2019 04:21	08/11/2019 12:31	8,16	61	497,71	CHI
20191160553	GOIANDIRA	GD21287053	CATALAO S1	08/11/2019 09:43	09/11/2019 07:13	08/11/2019 09:43	09/11/2019 07:13	21,49	1	21,49	CHI
20191160565	PARANAIGUARA	PC12060518	QUIRINOPOLIS	07/11/2019 07:31	08/11/2019 11:16	07/11/2019 07:31	08/11/2019 11:16	27,74	5	138,68	CHI
20191160570	CAMPO ALEGRE DE GOIAS	CM21165304	CAMPO ALEGRE DE GOIAS	08/11/2019 09:45	08/11/2019 15:04	08/11/2019 09:45	08/11/2019 15:04	5,31	1	5,31	CHI
20191160575	NIQUELANDIA	NQ21055097	NIQUELANDIA SUBTRANSMISSAO	08/11/2019 09:46	08/11/2019 14:17	08/11/2019 09:46	08/11/2019 14:17	4,51	1	4,51	CHI
20191160577	LUZIANIA	3200027901	MARAJOARA	08/11/2019 09:46	08/11/2019 11:02	08/11/2019 09:46	08/11/2019 11:02	1,25	1	1,25	CHI
20191160585	JARAGUA	JA12116881	JARAGUA	08/11/2019 09:40	08/11/2019 14:38	08/11/2019 09:40	08/11/2019 14:38	4,96	12	59,47	CHI
20191160597	ALEXANIA	AX12402045	ALEXANIA	08/11/2019 09:29	08/11/2019 11:39	08/11/2019 09:29	08/11/2019 11:39	2,15	190	409,19	CHI
20191160597	SANTO ANTONIO DO DESCOBERTO	AX12402045	ALEXANIA	08/11/2019 09:29	08/11/2019 11:39	08/11/2019 09:29	08/11/2019 11:39	2,15	1	2,15	CHI
20191160615	VICENTINOPOLIS	VI12097452	VICENTINOPOLIS	08/11/2019 13:40	09/11/2019 16:01	08/11/2019 13:40	09/11/2019 16:01	26,34	11	289,76	CHI
20191160651	JARAGUA	JA12059976	JARAGUA	08/11/2019 08:36	08/11/2019 12:34	08/11/2019 08:36	08/11/2019 12:34	3,95	2	7,90	CHI
20191160651	PIRENOPOLIS	JA12059976	JARAGUA	08/11/2019 08:36	08/11/2019 12:34	08/11/2019 08:36	08/11/2019 12:34	3,95	97	383,26	CHI
20191160652	CAMPINORTE	CR21147059	MARA ROSA	08/11/2019 09:55	08/11/2019 12:05	08/11/2019 09:55	08/11/2019 12:05	2,16	1	2,16	CHI
20191160657	MONTIVIDIU	MV12065978	MONTIVIDIU T	08/11/2019 07:39	08/11/2019 22:50	08/11/2019 07:39	08/11/2019 22:50	15,17	22	333,83	CHI
20191160671	ITAJA	IJ12200627	CACHOEIRA ALTA	08/11/2019 07:27	10/11/2019 15:14	08/11/2019 07:27	10/11/2019 15:14	55,78	22	1227,18	CHI
20191160671	ITARUMA	IJ12200627	CACHOEIRA ALTA	08/11/2019 07:27	10/11/2019 15:14	08/11/2019 07:27	10/11/2019 15:14	55,78	1	55,78	CHI
20191160671	LAGOA SANTA	IJ12200627	CACHOEIRA ALTA	08/11/2019 07:27	10/11/2019 15:14	08/11/2019 07:27	10/11/2019 15:14	55,78	4	223,12	CHI
20191160803	FORMOSA	FA12041983	ITUIQUIRA	08/11/2019 09:59	09/11/2019 08:30	08/11/2019 09:59	09/11/2019 08:30	22,50	1	22,50	CHI
20191160805	AGUA FRIA DE GOIAS	NQ12270128RE	SAO JOAO D ALIANCA	08/11/2019 19:17	09/11/2019 09:47	08/11/2019 19:17	09/11/2019 09:47	14,50	70	1014,75	CHI
20191160805	NIQUELANDIA	NQ12270128RE	SAO JOAO D ALIANCA	08/11/2019 19:17	09/11/2019 09:47	08/11/2019 19:17	09/11/2019 09:47	14,50	18	260,93	CHI
20191160812	CAMPOS VERDES	VD12201664	SANTA TEREZINHA	08/11/2019 09:17	08/11/2019 11:29	08/11/2019 09:17	08/11/2019 11:29	2,19	105	229,66	CHI
20191160815	QUIRINOPOLIS	QI32035343	QUIRINOPOLIS	08/11/2019 08:48	09/11/2019 10:22	08/11/2019 08:48	09/11/2019 10:22	25,56	17	434,58	CHI
20191161111	NIQUELANDIA	NQ21235473	NIQUELANDIA SUBTRANSMISSAO	08/11/2019 10:05	08/11/2019 23:41	08/11/2019 10:05	08/11/2019 23:41	13,59	1	13,59	CHI
20191161128	MONTIVIDIU DO NORTE	MX12088676	PORANGATU	08/11/2019 10:08	11/11/2019 10:48	08/11/2019 10:08	11/11/2019 10:48	72,66	1	72,66	CHI
20191161147	NOVA CRIXAS	9320002453	NOVA CRIXAS	08/11/2019 10:10	09/11/2019 10:30	08/11/2019 10:10	09/11/2019 10:30	24,33	1	24,33	CHI
20191161148	SANTA HELENA DE GOIAS	400037464	IPEGUARI	08/11/2019 10:11	09/11/2019 07:20	08/11/2019 10:11	09/11/2019 07:20	21,16	1	21,16	CHI
20191161304	CRISTALINA	KR21055332	CRISTALINA S1	08/11/2019 10:12	08/11/2019 16:42	08/11/2019 10:12	08/11/2019 16:42	6,50	1	6,50	CHI
20191161308	SILVANIA	SV21163697	DAIA S2	08/11/2019 10:12	10/11/2019 13:49	08/11/2019 10:12	10/11/2019 13:49	51,61	1	51,61	CHI

20191161310	FORMOSA	FA11131871	ITIQUEIRA	08/11/2019 09:53	08/11/2019 12:13	08/11/2019 09:53	08/11/2019 12:13	2,33	177	412,16	CHI
20191161319	PIRENOPOLIS	ZN12273387	COCALZINHO	08/11/2019 06:07	08/11/2019 18:55	08/11/2019 06:07	08/11/2019 18:55	12,79	14	179,03	CHI
20191161325	CALDAS NOVAS	10022752895	CALDAS NOVAS S2	08/11/2019 10:14	09/11/2019 16:52	08/11/2019 10:14	09/11/2019 16:52	30,62	1	30,62	CHI
20191161330	CRISTALINA	KR12171519	CRISTALINA S1	08/11/2019 10:15	08/11/2019 17:35	08/11/2019 10:15	08/11/2019 17:35	7,33	12	87,95	CHI
20191161341	CAIAPONIA	930046110	CAIAPONIA	08/11/2019 10:18	08/11/2019 17:50	08/11/2019 10:18	08/11/2019 17:50	7,53	1	7,53	CHI
20191161347	CRISTALINA	KR11000017	CRISTALINA S1	08/11/2019 10:19	08/11/2019 12:22	08/11/2019 10:19	08/11/2019 12:22	2,05	55	112,75	CHI
20191161348	CATALAO	CT21190486	CATALAO S2	08/11/2019 10:19	08/11/2019 12:43	08/11/2019 10:19	08/11/2019 12:43	2,40	1	2,40	CHI
20191161349	SAO LUIS DE MONTES BELOS	SL21132260	SAO LUIZ DOS MONTES BELOS	08/11/2019 10:19	08/11/2019 21:21	08/11/2019 10:19	08/11/2019 21:21	11,03	3	33,10	CHI
20191161350	CAMPINORTE	CR21104712	MARA ROSA	08/11/2019 10:19	09/11/2019 11:35	08/11/2019 10:19	09/11/2019 11:35	25,26	2	50,52	CHI
20191161361	PARAUNA	PU12210283	PARAUNA	08/11/2019 10:21	09/11/2019 11:24	08/11/2019 10:21	09/11/2019 11:24	25,06	1	25,06	CHI
20191161366	PLANALTINA	PI12365327	PLANALTINA	08/11/2019 10:21	09/11/2019 08:47	08/11/2019 10:21	09/11/2019 08:47	22,42	2	44,84	CHI
20191161373	FORMOSA	FA12235151	ITIQUEIRA	08/11/2019 08:55	08/11/2019 19:47	08/11/2019 08:55	08/11/2019 19:47	10,85	3	32,56	CHI
20191161376	SILVANIA	SV21093383	DAIA S2	08/11/2019 10:22	08/11/2019 19:20	08/11/2019 10:22	08/11/2019 19:20	8,95	2	17,90	CHI
20191161379	ALEXANIA	AX21049755	ALEXANIA	08/11/2019 09:29	08/11/2019 12:25	08/11/2019 09:29	08/11/2019 12:25	2,92	1	2,92	CHI
20191161383	FLORES DE GOIAS	FB12252147	FLORES DE GOIAS	08/11/2019 10:23	11/11/2019 15:10	08/11/2019 10:23	11/11/2019 15:10	76,79	1	76,79	CHI
20191161387	MATRINCHA	MP12250740	MATRINCHA	08/11/2019 08:06	09/11/2019 08:39	08/11/2019 08:06	09/11/2019 08:39	24,55	7	171,83	CHI
20191161388	PETROLINA DE GOIAS	PG21146752	PETROLINA	08/11/2019 10:24	08/11/2019 16:55	08/11/2019 10:24	08/11/2019 16:55	6,51	1	6,51	CHI
20191161389	MINACU	IH21220754	MINACU	08/11/2019 10:24	09/11/2019 00:40	08/11/2019 10:24	09/11/2019 00:40	14,28	1	14,28	CHI
20191161391	MORRINHOS	MR12092964	MORRINHOS	08/11/2019 10:24	08/11/2019 16:02	08/11/2019 10:24	08/11/2019 16:02	5,62	3	16,86	CHI
20191161397	NIQUELANDIA	NQ21035677	NIQUELANDIA SUBTRANSMISSAO	08/11/2019 10:25	08/11/2019 14:43	08/11/2019 10:25	08/11/2019 14:43	4,29	1	4,29	CHI
20191161398	PLANALTINA	PI21324296	SAO JOAO D ALIANCA	08/11/2019 10:25	09/11/2019 11:45	08/11/2019 10:25	09/11/2019 11:45	25,32	1	25,32	CHI
20191161430	NOVA CRIXAS	MH10400727	NOVA CRIXAS	08/11/2019 11:20	09/11/2019 14:49	08/11/2019 11:20	08/11/2019 17:37	6,29	175	1101,58	CHI
20191161430	NOVA CRIXAS	MH10400727	NOVA CRIXAS	08/11/2019 11:20	09/11/2019 14:49	08/11/2019 18:15	08/11/2019 18:51	0,61	175	106,36	CHI
20191161430	MUNDO NOVO DE GOIAS	MH10364963	NOVA CRIXAS	08/11/2019 11:20	09/11/2019 14:49	08/11/2019 21:36	08/11/2019 23:18	1,69	25	42,34	CHI
20191161430	NOVA CRIXAS	MH10364963	NOVA CRIXAS	08/11/2019 11:20	09/11/2019 14:49	08/11/2019 21:36	08/11/2019 23:18	1,69	243	411,55	CHI
20191161430	NOVA CRIXAS	MH10400727	NOVA CRIXAS	08/11/2019 11:20	09/11/2019 14:49	08/11/2019 11:20	09/11/2019 01:16	13,95	28	390,50	CHI
20191161430	NOVA CRIXAS	MH10400727	NOVA CRIXAS	08/11/2019 11:20	09/11/2019 14:49	08/11/2019 11:20	09/11/2019 12:00	24,68	848	20926,28	CHI
20191161430	NOVA CRIXAS	NA12328070	NOVA CRIXAS	08/11/2019 11:20	09/11/2019 14:49	08/11/2019 11:20	09/11/2019 12:23	25,05	112	2805,54	CHI
20191161430	MUNDO NOVO DE GOIAS	SM10401470	NOVA CRIXAS	08/11/2019 11:20	09/11/2019 14:49	08/11/2019 21:36	09/11/2019 13:18	15,70	99	1554,05	CHI
20191161430	SAO MIGUEL DO ARAGUAIA	SM10401470	NOVA CRIXAS	08/11/2019 11:20	09/11/2019 14:49	08/11/2019 21:36	09/11/2019 14:49	17,22	20	344,40	CHI
20191161433	MINEIROS	SU12157162	SANTA RITA DO ARAGUAIA	08/11/2019 10:53	08/11/2019 13:04	08/11/2019 10:53	08/11/2019 13:04	2,18	6	13,07	CHI
20191161506	PADRE BERNARDO	PB21305250	PADRE BERNARDO	08/11/2019 10:27	08/11/2019 16:36	08/11/2019 10:27	08/11/2019 16:36	6,14	1	6,14	CHI
20191161508	GOIANDIRA	GD21127540	CATALAO S1	08/11/2019 10:27	08/11/2019 11:55	08/11/2019 10:27	08/11/2019 11:55	1,45	2	2,90	CHI

20191161509	ITAGUARU	IC11000011	ITABERAI S1	08/11/2019 09:56	08/11/2019 21:24	08/11/2019 09:56	08/11/2019 21:24	11,47	66	756,76	CHI
20191161523	TURVELANDIA	TD12025727	RIO DOS BOIS	08/11/2019 08:07	10/11/2019 11:40	08/11/2019 08:07	10/11/2019 11:40	51,54	6	309,23	CHI
20191161523	TURVELANDIA	TD12025727	RIO DOS BOIS	08/11/2019 08:07	10/11/2019 11:40	10/11/2019 09:40	10/11/2019 11:40	2,00	7	13,98	CHI
20191161525	PADRE BERNARDO	PB12305130	PADRE BERNARDO	08/11/2019 10:30	09/11/2019 12:21	08/11/2019 10:30	09/11/2019 12:21	25,84	1	25,84	CHI
20191161530	JATAI	JT12000156	JATAI S2	08/11/2019 09:42	09/11/2019 13:45	08/11/2019 09:42	09/11/2019 13:45	28,05	5	140,24	CHI
20191161531	IPORA	IR12398638	IPORA	08/11/2019 10:07	10/11/2019 01:40	08/11/2019 10:07	10/11/2019 01:40	39,54	7	276,76	CHI
20191161532	CRIXAS	NA12078447	NOVA CRIXAS	08/11/2019 08:11	09/11/2019 07:20	08/11/2019 08:11	09/11/2019 07:20	23,14	18	416,47	CHI
20191161532	NOVA CRIXAS	NA12078447	NOVA CRIXAS	08/11/2019 08:11	09/11/2019 07:20	08/11/2019 08:11	09/11/2019 07:20	23,14	19	439,60	CHI
20191161544	MORRINHOS	MR12000116	MORRINHOS	08/11/2019 10:33	10/11/2019 10:12	08/11/2019 10:33	10/11/2019 10:12	47,64	2	95,28	CHI
20191161545	ANAPOLIS	20266900	JUNDIAI S2	08/11/2019 10:33	08/11/2019 14:30	08/11/2019 10:33	08/11/2019 14:30	3,94	1	3,94	CHI
20191161552	SANTA HELENA DE GOIAS	SH12340820	SANTA HELENA S1	08/11/2019 10:34	09/11/2019 13:20	08/11/2019 10:34	09/11/2019 13:20	26,76	2	53,53	CHI
20191161569	MINACU	IH12242050	MINACU	08/11/2019 09:27	08/11/2019 22:04	08/11/2019 09:27	08/11/2019 22:04	12,61	6	75,65	CHI
20191161579	ABADIANIA	AA12130228	ANAPOLIS UNIVERSITARIO S1	08/11/2019 09:36	08/11/2019 13:53	08/11/2019 09:36	08/11/2019 13:53	4,28	11	47,07	CHI
20191161579	ABADIANIA	AA12130228	DAIA S2	08/11/2019 09:36	08/11/2019 13:53	08/11/2019 09:36	08/11/2019 13:53	4,28	30	128,37	CHI
20191161583	PLANALTINA	PI12325380	SAO JOAO D ALIANCA	08/11/2019 10:41	08/11/2019 13:17	08/11/2019 10:41	08/11/2019 13:17	2,59	6	15,52	CHI
20191161584	BRITANIA	BT11005983	BRITANIA	08/11/2019 10:34	08/11/2019 19:34	08/11/2019 10:34	08/11/2019 19:34	8,99	98	881,26	CHI
20191161589	RIO VERDE	RV12135950	CABRIUVA S2	08/11/2019 09:04	11/11/2019 10:39	08/11/2019 09:04	11/11/2019 10:39	73,58	20	1471,63	CHI
20191161591	CAMPO ALEGRE DE GOIAS	CM21086095	CAMPO ALEGRE DE GOIAS	08/11/2019 10:42	08/11/2019 13:50	08/11/2019 10:42	08/11/2019 13:50	3,12	1	3,12	CHI
20191161593	GAMELEIRA DE GOIAS	SV21088024	DAIA S2	08/11/2019 10:43	09/11/2019 12:19	08/11/2019 10:43	09/11/2019 12:19	25,60	1	25,60	CHI
20191161608	IPORA	730057161	IPORA	08/11/2019 10:45	11/11/2019 18:38	08/11/2019 10:45	11/11/2019 18:38	79,87	1	79,87	CHI
20191161619	RIO VERDE	10004434526	CABRIUVA S2	08/11/2019 10:48	14/11/2019 16:00	08/11/2019 10:48	14/11/2019 16:00	149,19	1	149,19	CHI
20191161620	QUIRINOPOLIS	QI11402259	QUIRINOPOLIS	08/11/2019 09:03	09/11/2019 13:27	08/11/2019 09:03	09/11/2019 13:27	28,39	57	1618,06	CHI
20191161623	GOUVELANDIA	QI12303121	QUIRINOPOLIS	08/11/2019 07:24	08/11/2019 19:45	08/11/2019 07:24	08/11/2019 19:45	12,35	3	37,05	CHI
20191161625	ITABERAI	AC21080508	ANICUNS	08/11/2019 10:49	12/11/2019 10:43	08/11/2019 10:49	12/11/2019 10:43	95,89	1	95,89	CHI
20191161633	JATAI	JT12196245	JATAI S1	08/11/2019 06:18	09/11/2019 13:05	08/11/2019 06:18	09/11/2019 13:05	30,78	4	123,13	CHI
20191161648	ITAJA	IJ21191590	ITAJA S2	08/11/2019 10:53	08/11/2019 17:25	08/11/2019 10:53	08/11/2019 17:25	6,53	1	6,53	CHI
20191161660	CACHOEIRA ALTA	10007577387	CACHOEIRA ALTA	08/11/2019 10:55	08/11/2019 22:15	08/11/2019 10:55	08/11/2019 22:15	11,32	1	11,32	CHI
20191161681	URUACU	UR21237442	URUACU	08/11/2019 11:00	08/11/2019 16:08	08/11/2019 11:00	08/11/2019 16:08	5,12	1	5,12	CHI
20191161689	SERRANOPOLIS	SX12296510	JATAI S1	08/11/2019 11:03	09/11/2019 19:08	08/11/2019 11:03	09/11/2019 19:08	32,08	3	96,25	CHI
20191161693	IPORA	730096348	IPORA	08/11/2019 11:03	08/11/2019 17:03	08/11/2019 11:03	08/11/2019 17:03	6,01	1	6,01	CHI
20191161700	ESTRELA DO NORTE	ET12094692	MARA ROSA	08/11/2019 07:14	10/11/2019 02:53	08/11/2019 07:14	10/11/2019 02:53	43,64	13	567,36	CHI
20191161700	SANTA TEREZA DE GOIAS	ET12094692	MARA ROSA	08/11/2019 07:14	10/11/2019 02:53	08/11/2019 07:14	10/11/2019 02:53	43,64	4	174,57	CHI
20191161702	FORMOSA	FA12204761	ITUIQUIRA	08/11/2019 11:04	09/11/2019 08:14	08/11/2019 11:04	09/11/2019 08:14	21,16	49	1036,91	CHI

20191161712	CAIAPONIA	CP21099549	CAIAPONIA	08/11/2019 11:05	09/11/2019 17:21	08/11/2019 11:05	09/11/2019 17:21	30,27	2	60,54	CHI
20191161723	LUZIANIA	10028146679	MARAJOARA	08/11/2019 11:07	08/11/2019 13:49	08/11/2019 11:07	08/11/2019 13:49	2,69	1	2,69	CHI
20191161725	RIO VERDE	RV12301039	CABRIUVA S2	08/11/2019 11:07	11/11/2019 10:30	08/11/2019 11:07	11/11/2019 10:30	71,38	1	71,38	CHI
20191161732	NOVO GAMA	10005762390	MARAJOARA	08/11/2019 11:08	08/11/2019 13:46	08/11/2019 11:08	08/11/2019 13:46	2,63	0	0,00	CHI
20191161733	CATALAO	IP21264520	IPAMERI	08/11/2019 11:08	10/11/2019 20:23	08/11/2019 11:08	10/11/2019 20:23	57,24	1	57,24	CHI
20191161734	CAMPINORTE	UR21295231	MARA ROSA	08/11/2019 11:08	13/11/2019 19:44	08/11/2019 11:08	13/11/2019 19:44	128,60	1	128,60	CHI
20191161736	ITAJA	04400214	CACHOEIRA ALTA	08/11/2019 05:22	09/11/2019 14:10	08/11/2019 05:22	08/11/2019 21:50	16,47	22	362,26	CHI
20191161736	ITARUMA	04400214	CACHOEIRA ALTA	08/11/2019 05:22	09/11/2019 14:10	08/11/2019 05:22	08/11/2019 21:50	16,47	54	889,19	CHI
20191161736	CACU	IM13326953	CACHOEIRA ALTA	08/11/2019 05:22	09/11/2019 14:10	08/11/2019 05:22	09/11/2019 14:10	32,80	4	131,19	CHI
20191161736	ITARUMA	IM13326953	CACHOEIRA ALTA	08/11/2019 05:22	09/11/2019 14:10	08/11/2019 05:22	09/11/2019 14:10	32,80	75	2459,83	CHI
20191161745	CAIAPONIA	CP12207858	PALESTINA	08/11/2019 05:48	12/11/2019 06:55	08/11/2019 05:48	12/11/2019 06:55	97,12	18	1748,13	CHI
20191161745	PALESTINA DE GOIAS	CP12207858	PALESTINA	08/11/2019 05:48	12/11/2019 06:55	08/11/2019 05:48	12/11/2019 06:55	97,12	1	97,12	CHI
20191161752	QUIRINOPOLIS	QI21152346	QUIRINOPOLIS	08/11/2019 11:11	10/11/2019 18:31	08/11/2019 11:11	10/11/2019 18:31	55,33	1	55,33	CHI
20191161764	JUSSARA	JR12009940	JUSSARA	08/11/2019 05:47	10/11/2019 14:00	08/11/2019 05:47	10/11/2019 14:00	56,21	4	224,85	CHI
20191161771	SAO JOAO DA PARAUNA	RP12206100	FIRMINOPOLIS S2	08/11/2019 11:13	08/11/2019 22:32	08/11/2019 11:13	08/11/2019 22:32	11,30	3	33,90	CHI
20191161776	ARAGARCAS	1820007847	ARAGARCAS	08/11/2019 11:14	12/11/2019 14:40	08/11/2019 11:14	12/11/2019 14:40	99,42	1	99,42	CHI
20191161788	SANTO ANTONIO DO DESCOBERTO	SN12401717	ALEXANIA	08/11/2019 06:50	08/11/2019 20:31	08/11/2019 06:50	08/11/2019 20:31	13,67	5	68,37	CHI
20191161796	CAMPINORTE	CR12234938	PORANGATU	08/11/2019 09:41	08/11/2019 22:10	08/11/2019 09:41	08/11/2019 22:10	12,48	19	237,03	CHI
20191161796	MINACU	CR12234938	PORANGATU	08/11/2019 09:41	08/11/2019 22:10	08/11/2019 09:41	08/11/2019 22:10	12,48	38	474,06	CHI
20191161797	ITAJA	IJ12301775	CACHOEIRA ALTA	08/11/2019 11:19	09/11/2019 15:41	08/11/2019 11:19	09/11/2019 15:41	28,35	14	396,91	CHI
20191161797	LAGOA SANTA	IJ12301775	CACHOEIRA ALTA	08/11/2019 11:19	09/11/2019 15:41	08/11/2019 11:19	09/11/2019 15:41	28,35	8	226,80	CHI
20191161798	ITUMBIARA	IT21304225	ITUMBIARA NOVA	08/11/2019 11:20	09/11/2019 11:20	08/11/2019 11:20	09/11/2019 11:20	23,99	1	23,99	CHI
20191161810	CRISTALINA	10004543988	CRISTALINA S1	08/11/2019 11:23	08/11/2019 15:18	08/11/2019 11:23	08/11/2019 15:18	3,92	1	3,92	CHI
20191161812	IPORA	IR12233159	IPORA	08/11/2019 09:24	08/11/2019 14:45	08/11/2019 09:24	08/11/2019 14:45	5,34	79	421,68	CHI
20191161822	JATAI	290183558	JATAI S3	08/11/2019 11:24	10/11/2019 17:46	08/11/2019 11:24	10/11/2019 17:46	54,36	1	54,36	CHI
20191161825	JATAI	290283498	JATAI S2	08/11/2019 11:25	09/11/2019 09:34	08/11/2019 11:25	09/11/2019 09:34	22,14	1	22,14	CHI
20191161830	AGUAS LINDAS DE GOIAS	4830146814	AGUAS LINDAS DE GOIAS S1	08/11/2019 11:27	08/11/2019 16:06	08/11/2019 11:27	08/11/2019 16:06	4,65	1	4,65	CHI
20191161833	PORANGATU	PO12088782	PORANGATU	08/11/2019 11:27	08/11/2019 23:07	08/11/2019 11:27	08/11/2019 23:07	11,66	5	58,31	CHI
20191161835	ITAPIRAPUA	IU11070527	MATRINCHA	08/11/2019 17:11	08/11/2019 19:58	08/11/2019 17:11	08/11/2019 19:58	2,77	121	335,27	CHI
20191161838	AGUA FRIA DE GOIAS	TL21337511	SAO JOAO D ALIANCA	08/11/2019 11:27	09/11/2019 15:55	08/11/2019 11:27	09/11/2019 15:55	28,47	1	28,47	CHI
20191161847	JATAI	JT12000160	JATAI S2	08/11/2019 07:38	09/11/2019 05:30	08/11/2019 07:38	09/11/2019 05:30	21,86	2	43,72	CHI
20191161860	PARANAIGUARA	PC12306104	QUIRINOPOLIS	08/11/2019 07:49	09/11/2019 12:11	08/11/2019 07:49	09/11/2019 12:11	28,35	3	85,05	CHI
20191161860	QUIRINOPOLIS	PC12306104	QUIRINOPOLIS	08/11/2019 07:49	09/11/2019 12:11	08/11/2019 07:49	09/11/2019 12:11	28,35	3	85,05	CHI

20191161868	MINEIROS	MY12393226	PARQUE DAS EMAS	08/11/2019 11:34	09/11/2019 13:25	08/11/2019 11:34	09/11/2019 13:25	25,84	4	103,36	CHI
20191161868	PORTELANDIA	MY12393226	PARQUE DAS EMAS	08/11/2019 11:34	09/11/2019 13:25	08/11/2019 11:34	09/11/2019 13:25	25,84	2	51,68	CHI
20191161874	ALTO HORIZONTE	AJ21137906	SANTA TEREZINHA	07/11/2019 15:22	09/11/2019 14:40	07/11/2019 15:22	09/11/2019 14:40	47,31	1	47,31	CHI
20191161887	NOVA AURORA	NE12127536	CATALAO S1	08/11/2019 06:23	08/11/2019 15:55	08/11/2019 06:23	08/11/2019 15:55	9,52	9	85,66	CHI
20191161889	URUACU	UR21232401	URUACU	08/11/2019 11:37	08/11/2019 15:03	08/11/2019 11:37	08/11/2019 15:03	3,43	10	34,31	CHI
20191161890	MINEIROS	MY21324517	PARQUE DAS EMAS	08/11/2019 11:37	09/11/2019 10:53	08/11/2019 11:37	09/11/2019 10:53	23,26	1	23,26	CHI
20191161897	ALTO HORIZONTE	01120224	MARA ROSA	08/11/2019 11:18	08/11/2019 11:23	08/11/2019 11:18	08/11/2019 11:23	0,08	3	0,25	CHI
20191161897	AMARALINA	01120224	MARA ROSA	08/11/2019 11:18	08/11/2019 11:23	08/11/2019 11:18	08/11/2019 11:23	0,08	804	67,00	CHI
20191161897	CAMPINORTE	01120224	MARA ROSA	08/11/2019 11:18	08/11/2019 11:23	08/11/2019 11:18	08/11/2019 11:23	0,08	11	0,92	CHI
20191161897	MARA ROSA	01120224	MARA ROSA	08/11/2019 11:18	08/11/2019 11:23	08/11/2019 11:18	08/11/2019 11:23	0,08	339	28,25	CHI
20191161897	MUTUNOPOLIS	01120224	MARA ROSA	08/11/2019 11:18	08/11/2019 11:23	08/11/2019 11:18	08/11/2019 11:23	0,08	2	0,17	CHI
20191161908	ITABERAI	50032987	ITABERAI S2	08/11/2019 11:40	08/11/2019 15:50	08/11/2019 11:40	08/11/2019 15:50	4,16	1	4,16	CHI
20191161910	CIDADE OCIDENTAL	10009086518	MARAJOARA	08/11/2019 11:40	08/11/2019 19:05	08/11/2019 11:40	08/11/2019 19:05	7,40	1	7,40	CHI
20191161913	MIMOSO DE GOIAS	NQ12207364	BARRO ALTO	08/11/2019 10:07	09/11/2019 10:11	08/11/2019 10:07	09/11/2019 10:11	24,06	4	96,26	CHI
20191161913	NIQUELANDIA	NQ12207364	BARRO ALTO	08/11/2019 10:07	09/11/2019 10:11	08/11/2019 10:07	09/11/2019 10:11	24,06	27	649,73	CHI
20191161915	CIDADE OCIDENTAL	2680025071	MARAJOARA	08/11/2019 11:40	08/11/2019 18:25	08/11/2019 11:40	08/11/2019 18:25	6,73	1	6,73	CHI
20191161917	CRISTALINA	KR11060230	PAMPLONA	08/11/2019 11:36	08/11/2019 12:59	08/11/2019 11:36	08/11/2019 12:59	1,38	187	258,32	CHI
20191161918	CALDAS NOVAS	10004436839	CALDAS NOVAS S1	08/11/2019 11:41	08/11/2019 15:13	08/11/2019 11:41	08/11/2019 15:13	3,53	1	3,53	CHI
20191161924	VALPARAISO DE GOIAS	VA12199531LD	PACAEMBU S1	08/11/2019 11:44	08/11/2019 15:48	08/11/2019 11:44	08/11/2019 15:48	4,07	34	138,28	CHI
20191161927	UIRAPURU	UP12297241	SANTA TEREZINHA	08/11/2019 06:46	08/11/2019 15:52	08/11/2019 06:46	08/11/2019 15:52	9,09	3	27,26	CHI
20191161937	PIRENOPOLIS	220034187	CORUMBA	08/11/2019 11:46	08/11/2019 19:20	08/11/2019 11:46	08/11/2019 19:20	7,56	1	7,56	CHI
20191161946	CALDAS NOVAS	760074100	SERRA DE CALDAS	08/11/2019 11:47	08/11/2019 16:16	08/11/2019 11:47	08/11/2019 16:16	4,48	1	4,48	CHI
20191161950	NIQUELANDIA	NQ12227348	URUACU	08/11/2019 07:03	08/11/2019 13:55	08/11/2019 07:03	08/11/2019 13:55	6,86	45	308,55	CHI
20191161952	PIRENOPOLIS	ZN21244905	COCALZINHO	08/11/2019 11:49	08/11/2019 22:21	08/11/2019 11:49	08/11/2019 22:21	10,53	1	10,53	CHI
20191161959	CACHOEIRA DOURADA	CD12000044	CACHOEIRA DOURADA	08/11/2019 09:11	09/11/2019 18:55	08/11/2019 09:11	09/11/2019 18:55	33,72	7	236,06	CHI
20191161962	GOIAS	GS12234111	GOIAS	08/11/2019 08:06	08/11/2019 14:50	08/11/2019 08:06	08/11/2019 14:50	6,73	47	316,17	CHI
20191161963	BRITANIA	2110023990	BRITANIA	08/11/2019 11:51	09/11/2019 00:41	08/11/2019 11:51	09/11/2019 00:41	12,83	1	12,83	CHI
20191161971	MORRINHOS	MR21196299	VILA CORUMBA	08/11/2019 11:53	10/11/2019 14:59	08/11/2019 11:53	10/11/2019 14:59	51,10	1	51,10	CHI
20191161981	CAIAPONIA	CP12160847	PALESTINA	08/11/2019 05:22	08/11/2019 15:30	08/11/2019 05:22	08/11/2019 15:30	10,13	26	263,48	CHI
20191161987	BRITANIA	2110013819	BRITANIA	08/11/2019 11:56	09/11/2019 08:03	08/11/2019 11:56	09/11/2019 08:03	20,10	1	20,10	CHI
20191162017	MINEIROS	MY12195578	PARQUE DAS EMAS	08/11/2019 13:48	08/11/2019 14:17	08/11/2019 13:48	08/11/2019 14:17	0,47	9	4,26	CHI
20191162020	PARANAIGUARA	PC12119224	QUIRINOPOLIS	08/11/2019 14:36	13/11/2019 13:06	08/11/2019 14:36	13/11/2019 09:24	114,81	19	2181,47	CHI
20191162020	PARANAIGUARA	PC12119224	QUIRINOPOLIS	08/11/2019 14:36	13/11/2019 13:06	08/11/2019 14:36	13/11/2019 13:06	118,52	1	118,52	CHI

20191162021	SAO MIGUEL DO ARAGUAIA	SM10391487	SAO MIGUEL DO ARAGUAIA	08/11/2019 14:26	08/11/2019 17:03	08/11/2019 14:26	08/11/2019 17:03	2,60	57	148,33	CHI
20191162101	BURITI DE GOIAS	1680003449	FIRMINOPOLIS S2	08/11/2019 12:00	08/11/2019 17:15	08/11/2019 12:00	08/11/2019 17:15	5,25	1	5,25	CHI
20191162115	RIO VERDE	7599337	SANTA HELENA S1	08/11/2019 10:47	08/11/2019 14:52	08/11/2019 10:47	08/11/2019 14:52	4,10	9	36,88	CHI
20191162121	FAINA	GS12042217	GOIAS	08/11/2019 11:41	09/11/2019 14:40	08/11/2019 11:41	09/11/2019 14:40	26,99	64	1727,08	CHI
20191162122	RIO VERDE	RV12271473	RIO VERDE S2	08/11/2019 12:05	11/11/2019 12:07	08/11/2019 12:05	11/11/2019 12:07	72,02	2	144,04	CHI
20191162122	SANTA HELENA DE GOIAS	RV12271473	RIO VERDE S2	08/11/2019 12:05	11/11/2019 12:07	08/11/2019 12:05	11/11/2019 12:07	72,02	1	72,02	CHI
20191162201	GOIANDIRA	GD21215576	CATALAO S1	08/11/2019 12:07	08/11/2019 13:23	08/11/2019 12:07	08/11/2019 13:23	1,26	1	1,26	CHI
20191162202	CALDAS NOVAS	CN11163532	SERRA DE CALDAS	08/11/2019 09:47	08/11/2019 14:10	08/11/2019 09:47	08/11/2019 14:10	4,37	11	48,05	CHI
20191162206	CATALAO	GD21295487	CATALAO S1	08/11/2019 12:08	09/11/2019 09:55	08/11/2019 12:08	09/11/2019 09:55	21,77	1	21,77	CHI
20191162215	NOVO GAMA	4990098949	MARAJOARA	08/11/2019 12:10	08/11/2019 17:14	08/11/2019 12:10	08/11/2019 17:14	5,05	1	5,05	CHI
20191162217	MARA ROSA	MQ21187853	MARA ROSA	08/11/2019 12:11	09/11/2019 16:06	08/11/2019 12:11	09/11/2019 16:06	27,91	1	27,91	CHI
20191162222	AGUAS LINDAS DE GOIAS	4830339987	AGUAS LINDAS DE GOIAS S1	08/11/2019 12:12	08/11/2019 17:53	08/11/2019 12:12	08/11/2019 17:53	5,69	1	5,69	CHI
20191162225	IPAMERI	IP12071433	IPAMERI	08/11/2019 09:32	09/11/2019 09:21	08/11/2019 09:32	09/11/2019 09:21	23,80	4	95,21	CHI
20191162230	NOVO GAMA	2460048549	PACAEMBU S1	08/11/2019 12:15	08/11/2019 19:58	08/11/2019 12:15	08/11/2019 19:58	7,71	1	7,71	CHI
20191162232	CRISTALINA	KR21244337	CRISTALINA S2	08/11/2019 12:16	09/11/2019 11:44	08/11/2019 12:16	09/11/2019 11:44	23,46	2	46,91	CHI
20191162238	RIO VERDE	RV12207235	RIO VERDE S2	08/11/2019 07:30	09/11/2019 10:49	08/11/2019 07:30	09/11/2019 10:49	27,32	9	245,90	CHI
20191162245	ALVORADA DO NORTE	AQ21231844	IACIARA S2	08/11/2019 12:19	08/11/2019 14:30	08/11/2019 12:19	08/11/2019 14:30	2,18	1	2,18	CHI
20191162246	FLORES DE GOIAS	3480013920	FLORES DE GOIAS	08/11/2019 12:19	08/11/2019 20:58	08/11/2019 12:19	08/11/2019 20:58	8,65	1	8,65	CHI
20191162248	NOVA CRIXAS	NA12038063	MOZARLANDIA	08/11/2019 12:19	10/11/2019 16:55	08/11/2019 12:19	10/11/2019 16:55	52,60	8	420,76	CHI
20191162251	JATAI	290099766	JATAI S2	08/11/2019 12:20	09/11/2019 11:48	08/11/2019 12:20	09/11/2019 11:48	23,45	1	23,45	CHI
20191162252	SANTA HELENA DE GOIAS	SH12279533	IPEGUARI	08/11/2019 12:20	12/11/2019 21:19	08/11/2019 12:20	12/11/2019 21:19	104,97	32	3359,11	CHI
20191162259	ANAPOLIS	AN11115005	ANAPOLIS UNIVERSITARIO S2	08/11/2019 12:22	08/11/2019 13:43	08/11/2019 12:22	08/11/2019 13:43	1,34	113	151,14	CHI
20191162260	ITAGUARU	IC11154617	ITABERAI S1	08/11/2019 07:59	08/11/2019 21:11	08/11/2019 07:59	08/11/2019 21:11	13,20	155	2045,35	CHI
20191162261	DOVERLANDIA	DV12259466	CAIAPONIA	08/11/2019 12:23	09/11/2019 12:53	08/11/2019 12:23	09/11/2019 12:53	24,50	1	24,50	CHI
20191162278	ABADIANIA	AA21291814	ANAPOLIS UNIVERSITARIO S1	08/11/2019 12:28	08/11/2019 16:19	08/11/2019 12:28	08/11/2019 16:19	3,84	1	3,84	CHI
20191162284	CRISTALINA	KR12352836	CRISTALINA S1	08/11/2019 09:45	08/11/2019 16:46	08/11/2019 09:45	08/11/2019 16:46	7,01	62	434,45	CHI
20191162288	ANAPOLIS	21222976	ANAPOLIS UNIVERSITARIO S1	08/11/2019 12:31	08/11/2019 14:54	08/11/2019 12:31	08/11/2019 14:54	2,37	1	2,37	CHI
20191162291	URUACU	UR21131404	MARA ROSA	08/11/2019 12:32	09/11/2019 13:33	08/11/2019 12:32	09/11/2019 13:33	25,01	1	25,01	CHI
20191162292	CEZARINA	1650017460	CEZARINA	08/11/2019 12:32	09/11/2019 16:43	08/11/2019 12:32	09/11/2019 16:43	28,18	1	28,18	CHI
20191162293	SANTA TEREZA DE GOIAS	SE21242579	PORANGATU	08/11/2019 12:32	12/11/2019 14:50	08/11/2019 12:32	12/11/2019 14:50	98,29	1	98,29	CHI
20191162302	PIRES DO RIO	460034790	PIRES DO RIO S1	08/11/2019 12:34	08/11/2019 19:28	08/11/2019 12:34	08/11/2019 19:28	6,89	1	6,89	CHI
20191162306	FAZENDA NOVA	FN12390152	IPORA	08/11/2019 10:05	09/11/2019 08:48	08/11/2019 10:05	09/11/2019 08:48	22,70	12	272,46	CHI
20191162306	ISRAELANDIA	FN12390152	IPORA	08/11/2019 10:05	09/11/2019 08:48	08/11/2019 10:05	09/11/2019 08:48	22,70	2	45,41	CHI

20191162308	ALTO HORIZONTE	AJ12204148	SANTA TEREZINHA	08/11/2019 07:29	08/11/2019 16:22	08/11/2019 07:29	08/11/2019 16:22	8,88	14	124,25	CHI
20191162312	ITAJA	IM12279901	CACHOEIRA ALTA	07/11/2019 07:44	09/11/2019 08:07	07/11/2019 07:44	09/11/2019 08:07	48,37	11	532,11	CHI
20191162312	ITARUMA	IM12279901	CACHOEIRA ALTA	07/11/2019 07:44	09/11/2019 08:07	07/11/2019 07:44	09/11/2019 08:07	48,37	18	870,73	CHI
20191162314	CATALAO	CT21078192	CAMPO ALEGRE DE GOIAS	08/11/2019 12:37	10/11/2019 08:16	08/11/2019 12:37	10/11/2019 08:16	43,65	1	43,65	CHI
20191162318	BOM JARDIM DE GOIAS	BM12065611	BOM JARDIM	08/11/2019 12:38	08/11/2019 16:35	08/11/2019 12:38	08/11/2019 16:35	3,94	4	15,77	CHI
20191162322	NIQUELANDIA	NQ21156623	URUACU	08/11/2019 12:39	09/11/2019 11:56	08/11/2019 12:39	09/11/2019 11:56	23,28	1	23,28	CHI
20191162323	GOUVELANDIA	GB21296575	QUIRINOPOLIS	08/11/2019 12:39	09/11/2019 09:23	08/11/2019 12:39	09/11/2019 09:23	20,73	2	41,45	CHI
20191162325	AMERICANO DO BRASIL	10029049928	ANICUNS	08/11/2019 12:39	08/11/2019 15:10	08/11/2019 12:39	08/11/2019 15:10	2,50	1	2,50	CHI
20191162332	JARAGUA	70036299	JARAGUA	08/11/2019 12:42	08/11/2019 16:27	08/11/2019 12:42	08/11/2019 16:27	3,74	1	3,74	CHI
20191162340	PIRACANJUBA	PJ21223407	ROCHEDO	08/11/2019 12:44	11/11/2019 12:35	08/11/2019 12:44	11/11/2019 12:35	71,84	2	143,69	CHI
20191162352	ISRAELANDIA	IV12011798	IPORA	08/11/2019 11:18	11/11/2019 03:13	08/11/2019 11:18	11/11/2019 03:13	63,92	4	255,66	CHI
20191162352	IVOLANDIA	IV12011798	IPORA	08/11/2019 11:18	11/11/2019 03:13	08/11/2019 11:18	11/11/2019 03:13	63,92	22	1406,14	CHI
20191162352	MOIPORA	IV12011798	IPORA	08/11/2019 11:18	11/11/2019 03:13	08/11/2019 11:18	11/11/2019 03:13	63,92	21	1342,23	CHI
20191162359	NIQUELANDIA	6311666	NIQUELANDIA SUBTRANSMISSAO	09/11/2019 08:40	09/11/2019 11:50	09/11/2019 08:40	09/11/2019 11:50	3,16	1	3,16	CHI
20191162360	IACIARA	IA11359006	IACIARA S1	08/11/2019 12:48	08/11/2019 15:19	08/11/2019 12:48	08/11/2019 15:19	2,51	16	40,12	CHI
20191162362	GOUVELANDIA	GB12116524	QUIRINOPOLIS	08/11/2019 12:44	08/11/2019 20:28	08/11/2019 12:44	08/11/2019 20:28	7,73	4	30,90	CHI
20191162362	QUIRINOPOLIS	GB12116524	QUIRINOPOLIS	08/11/2019 12:44	08/11/2019 20:28	08/11/2019 12:44	08/11/2019 20:28	7,73	7	54,08	CHI
20191162371	MORRINHOS	MR21119789	MORRINHOS	08/11/2019 12:50	10/11/2019 11:37	08/11/2019 12:50	10/11/2019 11:37	46,77	1	46,77	CHI
20191162381	VALPARAISO DE GOIAS	VA11162791	PACAEMBU S2	08/11/2019 12:45	08/11/2019 15:07	08/11/2019 12:45	08/11/2019 15:07	2,36	64	151,34	CHI
20191162385	ITAJA	IJ21068443	ITAJA S2	08/11/2019 12:53	08/11/2019 16:55	08/11/2019 12:53	08/11/2019 16:55	4,02	1	4,02	CHI
20191162386	PIRENOPOLIS	PV21230742	JARAGUA	08/11/2019 12:54	08/11/2019 17:06	08/11/2019 12:54	08/11/2019 17:06	4,20	1	4,20	CHI
20191162388	LUZIANIA	10022478130	MARAJOARA	08/11/2019 12:54	09/11/2019 01:20	08/11/2019 12:54	09/11/2019 01:20	12,43	1	12,43	CHI
20191162391	CATALAO	10029692286	CATALAO S2	08/11/2019 12:54	08/11/2019 13:50	08/11/2019 12:54	08/11/2019 13:50	0,92	1	0,92	CHI
20191162397	CAIAPONIA	CP12097751	CAIAPONIA	08/11/2019 12:55	08/11/2019 22:01	08/11/2019 12:55	08/11/2019 22:01	9,10	100	909,92	CHI
20191162402	CACHOEIRA DE GOIAS	PU12093868	FIRMINOPOLIS S2	08/11/2019 09:46	12/11/2019 11:05	08/11/2019 09:46	12/11/2019 11:05	97,31	3	291,94	CHI
20191162402	PARAUNA	PU12093868	FIRMINOPOLIS S2	08/11/2019 09:46	12/11/2019 11:05	08/11/2019 09:46	12/11/2019 11:05	97,31	5	486,57	CHI
20191162410	IPORA	IR12380966	IPORA	08/11/2019 09:12	09/11/2019 19:10	08/11/2019 09:12	09/11/2019 19:10	33,98	5	169,88	CHI
20191162411	AGUAS LINDAS DE GOIAS	LA11352075	AGUAS LINDAS DE GOIAS S1	08/11/2019 12:57	08/11/2019 17:20	08/11/2019 12:57	08/11/2019 17:20	4,38	124	542,67	CHI
20191162432	PORANGATU	PO21374542	PORANGATU	08/11/2019 13:02	09/11/2019 10:29	08/11/2019 13:02	09/11/2019 10:29	21,44	1	21,44	CHI
20191162439	SANTA TEREZINHA DE GOIAS	GG21168832	SANTA TEREZINHA	08/11/2019 13:04	10/11/2019 08:24	08/11/2019 13:04	10/11/2019 08:24	43,33	1	43,33	CHI
20191162440	GOIAS	IU21060545	MATRINCHA	08/11/2019 10:11	10/11/2019 21:36	08/11/2019 10:11	10/11/2019 21:36	59,40	1	59,40	CHI
20191162444	AGUA FRIA DE GOIAS	TL12194272	SAO JOAO D ALIANCA	08/11/2019 13:05	10/11/2019 18:05	08/11/2019 13:05	10/11/2019 18:05	52,99	5	264,97	CHI
20191162447	ALTO PARAISO DE GOIAS	BF12159157	NIQUELANDIA SUBTRANSMISSAO	08/11/2019 12:55	08/11/2019 14:51	08/11/2019 12:55	08/11/2019 14:51	1,93	16	30,91	CHI

20191162448	PIRENOPOLIS	220064301	CORUMBA	08/11/2019 13:06	08/11/2019 17:38	08/11/2019 13:06	08/11/2019 17:38	4,53	1	4,53	CHI
20191162459	URUACU	CR21051929	MARA ROSA	08/11/2019 13:08	09/11/2019 13:57	08/11/2019 13:08	09/11/2019 13:57	24,82	1	24,82	CHI
20191162466	VILA PROPICIO	PV21147432	GOIANESIA S1	08/11/2019 13:09	10/11/2019 15:59	08/11/2019 13:09	10/11/2019 15:59	50,83	1	50,83	CHI
20191162473	CATALAO	CT21278983	CATALAO S1	08/11/2019 13:11	09/11/2019 12:20	08/11/2019 13:11	09/11/2019 12:20	23,15	1	23,15	CHI
20191162476	BURITI ALEGRE	BG12000023	ALTO BURITI	08/11/2019 08:37	08/11/2019 20:04	08/11/2019 08:37	08/11/2019 20:04	11,44	27	309,00	CHI
20191162476	ITUMBIARA	BG12000023	ALTO BURITI	08/11/2019 08:37	08/11/2019 20:04	08/11/2019 08:37	08/11/2019 20:04	11,44	11	125,89	CHI
20191162477	JATAI	JT21214324	JATAI S2	08/11/2019 13:11	11/11/2019 15:59	08/11/2019 13:11	11/11/2019 15:59	74,79	1	74,79	CHI
20191162480	PLANALTINA	2960008036	PLANALTINA	08/11/2019 13:12	09/11/2019 00:49	08/11/2019 13:12	09/11/2019 00:49	11,60	1	11,60	CHI
20191162483	SANTA TEREZINHA DE GOIAS	SG12201785	SANTA TEREZINHA	08/11/2019 13:13	08/11/2019 15:16	08/11/2019 13:13	08/11/2019 15:16	2,05	44	90,00	CHI
20191162487	GOUVELANDIA	GB12000204	QUIRINOPOLIS	08/11/2019 12:52	08/11/2019 15:08	08/11/2019 12:52	08/11/2019 15:08	2,26	2	4,52	CHI
20191162490	ITARUMA	IM12068691	CACHOEIRA ALTA	08/11/2019 13:15	08/11/2019 19:31	08/11/2019 13:15	08/11/2019 19:31	6,27	1	6,27	CHI
20191162495	PORANGATU	PO11342072	PORANGATU	08/11/2019 13:15	08/11/2019 19:12	08/11/2019 13:15	08/11/2019 19:12	5,93	4	23,74	CHI
20191162505	QUIRINOPOLIS	QI21370296	QUIRINOPOLIS	08/11/2019 13:19	09/11/2019 17:45	08/11/2019 13:19	09/11/2019 17:45	28,43	1	28,43	CHI
20191162508	IVOLANDIA	IV12259453	IPORA	08/11/2019 13:20	11/11/2019 09:47	08/11/2019 13:20	11/11/2019 09:47	68,45	9	616,01	CHI
20191162518	PORANGATU	PO11000038	PORANGATU	08/11/2019 12:33	08/11/2019 18:03	08/11/2019 12:33	08/11/2019 18:03	5,49	83	455,79	CHI
20191162525	JATAI	290142192	JATAI S3	08/11/2019 13:24	09/11/2019 13:33	08/11/2019 13:24	09/11/2019 13:33	24,14	1	24,14	CHI
20191162530	IPORA	730080869	IPORA	08/11/2019 13:25	08/11/2019 18:13	08/11/2019 13:25	08/11/2019 18:13	4,80	1	4,80	CHI
20191162540	JATAI	290043992	JATAI S2	08/11/2019 13:28	10/11/2019 15:26	08/11/2019 13:28	10/11/2019 15:26	49,95	1	49,95	CHI
20191162548	NIQUELANDIA	NQ21139052	URUACU	08/11/2019 13:27	09/11/2019 13:18	08/11/2019 13:27	09/11/2019 13:18	23,85	1	23,85	CHI
20191162556	BARRO ALTO	BA11000004	BARRO ALTO	08/11/2019 13:24	08/11/2019 19:05	08/11/2019 13:24	08/11/2019 19:05	5,68	130	738,11	CHI
20191162557	RIO VERDE	RV21191752	CABRIUVA S2	08/11/2019 13:31	12/11/2019 09:00	08/11/2019 13:31	12/11/2019 09:00	91,47	1	91,47	CHI
20191162564	MOZARLANDIA	10000216346	MOZARLANDIA	08/11/2019 13:32	11/11/2019 11:18	08/11/2019 13:32	11/11/2019 11:18	69,75	1	69,75	CHI
20191162565	BELA VISTA DE GOIAS	CF21115370	CRISTIANOPOLIS	08/11/2019 13:33	12/11/2019 11:30	08/11/2019 13:33	12/11/2019 11:30	93,95	1	93,95	CHI
20191162571	CALDAS NOVAS	CN21000061	CALDAS NOVAS S2	08/11/2019 13:34	09/11/2019 11:40	08/11/2019 13:34	09/11/2019 11:40	22,10	1	22,10	CHI
20191162589	URUACU	UR21363345	URUACU	08/11/2019 13:36	08/11/2019 18:08	08/11/2019 13:36	08/11/2019 18:08	4,52	2	9,04	CHI
20191162593	NIQUELANDIA	NQ21235472	NIQUELANDIA SUBTRANSMISSAO	08/11/2019 13:38	08/11/2019 21:27	08/11/2019 13:38	08/11/2019 21:27	7,81	2	15,63	CHI
20191162595	ALEXANIA	10019270559	ALEXANIA	08/11/2019 13:38	08/11/2019 18:23	08/11/2019 13:38	08/11/2019 18:23	4,75	1	4,75	CHI
20191162604	QUIRINOPOLIS	QI32295718	QUIRINOPOLIS	08/11/2019 07:21	11/11/2019 19:21	08/11/2019 07:21	11/11/2019 19:21	84,00	1	84,00	CHI
20191162703	ITUMBIARA	BJ12000194	CACHOEIRA DOURADA	08/11/2019 07:09	09/11/2019 12:38	08/11/2019 07:09	09/11/2019 12:38	29,48	6	176,87	CHI
20191162704	PARAUNA	PU12301174	ACREUNA	08/11/2019 12:52	09/11/2019 00:12	08/11/2019 12:52	08/11/2019 20:55	8,05	13	104,62	CHI
20191162704	PARAUNA	PU12301174	ACREUNA	08/11/2019 12:52	09/11/2019 00:12	08/11/2019 20:59	08/11/2019 23:38	2,64	7	18,51	CHI
20191162704	PARAUNA	PU12301142LD	ACREUNA	08/11/2019 12:52	09/11/2019 00:12	08/11/2019 20:59	09/11/2019 00:12	3,21	6	19,24	CHI
20191162711	NOVA AMERICA	NM21188994	RUBIATABA	08/11/2019 13:42	12/11/2019 10:46	08/11/2019 13:42	12/11/2019 10:46	93,06	2	186,11	CHI

20191162712	CAIAPONIA	05700434	MONTIVIDIU T	08/11/2019 13:37	09/11/2019 07:07	08/11/2019 13:37	08/11/2019 21:30	7,88	279	2198,98	CHI
20191162712	CAIAPONIA	05700434	MONTIVIDIU T	08/11/2019 13:37	09/11/2019 07:07	08/11/2019 13:37	08/11/2019 21:30	7,88	37	291,62	CHI
20191162712	JATAI	05700434	MONTIVIDIU T	08/11/2019 13:37	09/11/2019 07:07	08/11/2019 13:37	08/11/2019 21:30	7,88	2	15,76	CHI
20191162712	MONTIVIDIU	05700434	MONTIVIDIU T	08/11/2019 13:37	09/11/2019 07:07	08/11/2019 13:37	08/11/2019 21:30	7,88	6	47,29	CHI
20191162712	MONTIVIDIU	05700434	MONTIVIDIU T	08/11/2019 13:37	09/11/2019 07:07	08/11/2019 13:37	08/11/2019 21:30	7,88	172	1355,65	CHI
20191162712	RIO VERDE	05700434	MONTIVIDIU T	08/11/2019 13:37	09/11/2019 07:07	08/11/2019 13:37	08/11/2019 21:30	7,88	18	141,87	CHI
20191162712	RIO VERDE	05700434	MONTIVIDIU T	08/11/2019 13:37	09/11/2019 07:07	08/11/2019 13:37	08/11/2019 21:30	7,88	3	23,64	CHI
20191162712	RIO VERDE	RV10400629	MONTIVIDIU T	08/11/2019 13:37	09/11/2019 07:07	08/11/2019 13:37	09/11/2019 00:11	10,58	12	126,98	CHI
20191162712	RIO VERDE	RV10400629	MONTIVIDIU T	08/11/2019 13:37	09/11/2019 07:07	08/11/2019 13:37	09/11/2019 07:07	17,50	46	804,92	CHI
20191162712	RIO VERDE	RV12213283LD	MONTIVIDIU T	08/11/2019 13:37	09/11/2019 07:07	08/11/2019 19:55	09/11/2019 07:07	11,19	4	44,75	CHI
20191162721	PORANGATU	PO12102901	PORANGATU	08/11/2019 13:44	08/11/2019 23:55	08/11/2019 13:44	08/11/2019 23:55	10,18	3	30,53	CHI
20191162725	TROMBAS	TB12137675	PORANGATU	08/11/2019 11:10	08/11/2019 20:54	08/11/2019 11:10	08/11/2019 20:54	9,72	8	77,77	CHI
20191162730	ALTO PARAISO DE GOIAS	BF12218456	NIQUELANDIA SUBTRANSMISSAO	08/11/2019 12:49	08/11/2019 15:21	08/11/2019 12:49	08/11/2019 15:21	2,52	5	12,59	CHI
20191162731	BARRO ALTO	BA21196854	BARRO ALTO	08/11/2019 13:47	10/11/2019 19:55	08/11/2019 13:47	10/11/2019 19:55	54,13	7	378,92	CHI
20191162735	JUSSARA	JR12292912	JUSSARA	08/11/2019 12:26	11/11/2019 04:17	08/11/2019 12:26	11/11/2019 04:17	63,85	3	191,54	CHI
20191162745	URUACU	10010936970	URUACU	08/11/2019 13:51	08/11/2019 16:37	08/11/2019 13:51	08/11/2019 16:37	2,77	1	2,77	CHI
20191162758	SAO MIGUEL DO ARAGUAIA	10001676111	SAO MIGUEL DO ARAGUAIA	08/11/2019 13:55	10/11/2019 19:44	08/11/2019 13:55	10/11/2019 19:44	53,83	1	53,83	CHI
20191162769	GOIANESIA	550071337	GOIANESIA S2	08/11/2019 13:56	08/11/2019 15:45	08/11/2019 13:56	08/11/2019 15:45	1,81	1	1,81	CHI
20191162773	SANTO ANTONIO DA BARRA	EU12207513	ACREUNA	08/11/2019 13:56	08/11/2019 16:32	08/11/2019 13:56	08/11/2019 16:32	2,58	2	5,17	CHI
20191162779	AMERICANO DO BRASIL	10026911424	ANICUNS	08/11/2019 13:57	08/11/2019 15:50	08/11/2019 13:57	08/11/2019 15:50	1,87	1	1,87	CHI
20191162780	COLINAS DO SUL	9700007450	NIQUELANDIA SUBTRANSMISSAO	08/11/2019 13:57	08/11/2019 20:00	08/11/2019 13:57	08/11/2019 20:00	6,04	1	6,04	CHI
20191162782	GOIATUBA	GT21102747	GOIATUBA S2	08/11/2019 13:58	10/11/2019 15:43	08/11/2019 13:58	10/11/2019 15:43	49,74	1	49,74	CHI
20191162783	BOM JESUS DE GOIAS	IT12033089LD	CACHOEIRA DOURADA	08/11/2019 05:27	09/11/2019 08:29	08/11/2019 05:27	09/11/2019 08:29	27,03	30	810,84	CHI
20191162783	GOIATUBA	IT12033089LD	CACHOEIRA DOURADA	08/11/2019 05:27	09/11/2019 08:29	08/11/2019 05:27	09/11/2019 08:29	27,03	7	189,20	CHI
20191162783	ITUMBIARA	IT12033089LD	CACHOEIRA DOURADA	08/11/2019 05:27	09/11/2019 08:29	08/11/2019 05:27	09/11/2019 08:29	27,03	102	2756,86	CHI
20191162783	PANAMA	IT12033089LD	CACHOEIRA DOURADA	08/11/2019 05:27	09/11/2019 08:29	08/11/2019 05:27	09/11/2019 08:29	27,03	18	486,50	CHI
20191162784	NIQUELANDIA	NQ12088704	URUACU	08/11/2019 13:59	08/11/2019 17:40	08/11/2019 13:59	08/11/2019 17:40	3,68	21	77,31	CHI
20191162787	IVOLANDIA	IV12201972	IPORA	08/11/2019 14:00	11/11/2019 11:57	08/11/2019 14:00	11/11/2019 11:57	69,95	2	139,90	CHI
20191162787	MOIPORA	IV12201972	IPORA	08/11/2019 14:00	11/11/2019 11:57	08/11/2019 14:00	11/11/2019 11:57	69,95	5	349,75	CHI
20191162791	PADRE BERNARDO	PB12336085	PADRE BERNARDO	08/11/2019 14:00	09/11/2019 10:58	08/11/2019 14:00	09/11/2019 10:58	20,95	12	251,45	CHI
20191162799	URUACU	UR21213044	URUACU	08/11/2019 14:02	08/11/2019 16:58	08/11/2019 14:02	08/11/2019 16:58	2,93	1	2,93	CHI
20191162801	SANCLERLANDIA	SC12299153	FIRMINOPOLIS S2	08/11/2019 13:19	08/11/2019 23:29	08/11/2019 13:19	08/11/2019 23:29	10,16	4	40,64	CHI
20191162811	SAO MIGUEL DO ARAGUAIA	830015322	SAO MIGUEL DO ARAGUAIA	08/11/2019 14:05	10/11/2019 11:29	08/11/2019 14:05	10/11/2019 11:29	45,41	1	45,41	CHI

20191162820	OUVIDOR	CT12075554LD	CATALAO S1	08/11/2019 14:05	09/11/2019 10:30	08/11/2019 14:05	09/11/2019 10:30	20,40	1	20,40	CHI
20191162821	AGUAS LINDAS DE GOIAS	LA12151531	AGUAS LINDAS DE GOIAS S2	08/11/2019 14:06	08/11/2019 18:41	08/11/2019 14:06	08/11/2019 18:41	4,58	18	82,39	CHI
20191162823	SANTO ANTONIO DA BARRA	BZ21301382	ACREUNA	08/11/2019 14:06	10/11/2019 15:58	08/11/2019 14:06	10/11/2019 15:58	49,86	1	49,86	CHI
20191162827	IPORA	730084425	IPORA	08/11/2019 14:07	11/11/2019 11:00	08/11/2019 14:07	11/11/2019 11:00	68,88	1	68,88	CHI
20191162830	NOVA CRIXAS	NA21057264	MOZARLANDIA	08/11/2019 14:08	15/11/2019 17:15	08/11/2019 14:08	15/11/2019 17:15	171,11	1	171,11	CHI
20191162834	ALTO PARAISO DE GOIAS	BF21249281	NIQUELANDIA SUBTRANSMISSAO	08/11/2019 14:08	08/11/2019 15:55	08/11/2019 14:08	08/11/2019 15:55	1,77	2	3,54	CHI
20191162839	PARAUNA	PU12109627	PARAUNA	08/11/2019 14:09	09/11/2019 15:31	08/11/2019 14:09	09/11/2019 15:31	25,36	16	405,79	CHI
20191162843	OUVIDOR	OU21166888	CATALAO S1	08/11/2019 14:09	11/11/2019 08:21	08/11/2019 14:09	11/11/2019 08:21	66,18	1	66,18	CHI
20191162844	JATAI	290149721	JATAI S2	08/11/2019 14:09	09/11/2019 10:40	08/11/2019 14:09	09/11/2019 10:40	20,50	1	20,50	CHI
20191162855	JUSSARA	JR21259692	JUSSARA	08/11/2019 14:11	14/11/2019 01:07	08/11/2019 14:11	13/11/2019 14:11	120,00	1	120,00	CHI
20191162855	JUSSARA	JR12259693	JUSSARA	08/11/2019 14:11	14/11/2019 01:07	13/11/2019 19:25	14/11/2019 01:07	5,71	2	11,42	CHI
20191162859	CRISTALINA	KR11060230	PAMPLONA	08/11/2019 14:00	08/11/2019 14:32	08/11/2019 14:00	08/11/2019 14:32	0,53	187	99,37	CHI
20191162860	ITUMBIARA	IT12304170	ITUMBIARA NOVA	08/11/2019 08:12	09/11/2019 09:24	08/11/2019 08:12	09/11/2019 09:24	25,20	6	151,18	CHI
20191162864	ITUMBIARA	IT12000182	ITUMBIARA NOVA	08/11/2019 10:12	09/11/2019 16:00	08/11/2019 10:12	09/11/2019 16:00	29,79	3	89,37	CHI
20191162867	BARRO ALTO	00180214	BARRO ALTO	08/11/2019 14:09	09/11/2019 04:33	08/11/2019 14:09	08/11/2019 15:06	0,95	1082	1022,79	CHI
20191162867	NIQUELANDIA	00180214	BARRO ALTO	08/11/2019 14:09	09/11/2019 04:33	08/11/2019 14:09	08/11/2019 15:06	0,95	118	111,54	CHI
20191162867	BARRO ALTO	00180214	BARRO ALTO	08/11/2019 14:09	09/11/2019 04:33	08/11/2019 14:09	08/11/2019 18:10	4,01	29	116,40	CHI
20191162867	SANTA RITA DO NOVO DESTINO	00180214	BARRO ALTO	08/11/2019 14:09	09/11/2019 04:33	08/11/2019 14:09	08/11/2019 18:10	4,01	14	56,19	CHI
20191162867	BARRO ALTO	00180214	BARRO ALTO	08/11/2019 14:09	09/11/2019 04:33	08/11/2019 14:09	09/11/2019 04:33	14,39	61	877,72	CHI
20191162867	HIDROLINA	00180214	BARRO ALTO	08/11/2019 14:09	09/11/2019 04:33	08/11/2019 14:09	09/11/2019 04:33	14,39	1	14,39	CHI
20191162867	SANTA RITA DO NOVO DESTINO	00180214	BARRO ALTO	08/11/2019 14:09	09/11/2019 04:33	08/11/2019 14:09	09/11/2019 04:33	14,39	477	6863,50	CHI
20191162867	SAO LUIZ DO NORTE	00180214	BARRO ALTO	08/11/2019 14:09	09/11/2019 04:33	08/11/2019 14:09	09/11/2019 04:33	14,39	34	489,22	CHI
20191162867	SANTA RITA DO NOVO DESTINO	BA13101179	BARRO ALTO	08/11/2019 14:09	09/11/2019 04:33	08/11/2019 14:24	09/11/2019 04:33	14,15	1	14,15	CHI
20191162880	ITABERAI	IB12000056	ITABERAI S2	08/11/2019 12:45	08/11/2019 21:46	08/11/2019 12:45	08/11/2019 21:46	9,00	10	90,03	CHI
20191162884	ARENOPOLIS	AY12087192	ARENOPOLIS	08/11/2019 14:16	10/11/2019 14:14	08/11/2019 14:16	10/11/2019 14:14	47,96	12	575,50	CHI
20191162887	FAINA	FC21228848	GOIAS	08/11/2019 14:17	14/11/2019 17:11	08/11/2019 14:17	14/11/2019 17:11	146,89	1	146,89	CHI
20191162902	JATAI	290250250	JATAI S3	08/11/2019 14:19	09/11/2019 11:20	08/11/2019 14:19	09/11/2019 11:20	21,02	1	21,02	CHI
20191162907	JAUPACI	JP21021463	IPORA	08/11/2019 14:21	11/11/2019 11:28	08/11/2019 14:21	11/11/2019 11:28	69,12	1	69,12	CHI
20191162908	PADRE BERNARDO	10011685580	PADRE BERNARDO	08/11/2019 14:21	08/11/2019 18:44	08/11/2019 14:21	08/11/2019 18:44	4,38	1	4,38	CHI
20191162909	SERRANOPOLIS	SX12226484	JATAI S1	08/11/2019 09:26	09/11/2019 14:08	08/11/2019 09:26	09/11/2019 14:08	28,69	14	401,60	CHI
20191162920	CIDADE OCIDENTAL	DH11169047	MARAJOARA	08/11/2019 14:17	08/11/2019 19:15	08/11/2019 14:17	08/11/2019 19:15	4,97	202	1004,45	CHI
20191162921	IPORA	10027231095	IPORA	08/11/2019 14:22	11/11/2019 10:29	08/11/2019 14:22	11/11/2019 10:29	68,12	1	68,12	CHI
20191162927	ARENOPOLIS	AY12139436	ARENOPOLIS	08/11/2019 13:45	11/11/2019 08:50	08/11/2019 13:45	11/11/2019 08:50	67,07	16	1073,19	CHI

20191162927	IPORA	AY12139436	ARENOPOLIS	08/11/2019 13:45	11/11/2019 08:50	08/11/2019 13:45	11/11/2019 08:50	67,07	10	670,74	CHI
20191162934	SANTA CRUZ DE GOIAS	BC12027030	PIRES DO RIO S2	08/11/2019 05:22	08/11/2019 15:56	08/11/2019 05:22	08/11/2019 15:56	10,56	24	253,52	CHI
20191162935	ACREUNA	2440050587	ACREUNA	08/11/2019 14:24	09/11/2019 08:56	08/11/2019 14:24	09/11/2019 08:56	18,54	1	18,54	CHI
20191162936	ITUMBIARA	10002727461	PARANAIBA	08/11/2019 14:24	13/11/2019 14:08	08/11/2019 14:24	13/11/2019 14:08	119,74	1	119,74	CHI
20191162946	INACIOLANDIA	ID32128258	QUIRINOPOLIS	08/11/2019 04:56	08/11/2019 18:37	08/11/2019 04:56	08/11/2019 18:37	13,67	6	82,04	CHI
20191162949	PADRE BERNARDO	9980031493	PADRE BERNARDO	08/11/2019 14:26	08/11/2019 17:37	08/11/2019 14:26	08/11/2019 17:37	3,17	1	3,17	CHI
20191162963	PONTALINA	PK12033342	VICENTINOPOLIS	08/11/2019 10:36	09/11/2019 13:10	08/11/2019 10:36	09/11/2019 13:10	26,56	24	637,33	CHI
20191162988	URUACU	UR21212326	URUACU	08/11/2019 14:32	08/11/2019 22:36	08/11/2019 14:32	08/11/2019 22:36	8,05	1	8,05	CHI
20191162989	ACREUNA	EU11000008	ACREUNA	08/11/2019 14:14	08/11/2019 16:10	08/11/2019 14:14	08/11/2019 16:10	1,92	37	71,04	CHI
20191162993	QUIRINOPOLIS	QI12054727	QUIRINOPOLIS	08/11/2019 14:33	11/11/2019 15:07	08/11/2019 14:33	11/11/2019 15:07	72,58	12	870,91	CHI
20191162995	MINEIROS	MY12210139	PARQUE DAS EMAS	08/11/2019 14:34	09/11/2019 10:19	08/11/2019 14:34	09/11/2019 10:19	19,75	2	39,49	CHI
20191163002	ITAPURANGA	170106354	ITAPURANGA	08/11/2019 14:35	08/11/2019 19:32	08/11/2019 14:35	08/11/2019 19:32	4,95	1	4,95	CHI
20191163006	CRISTALINA	KR21261275	CRISTALINA S2	08/11/2019 14:35	09/11/2019 11:32	08/11/2019 14:35	09/11/2019 11:32	20,94	1	20,94	CHI
20191163009	ALTO PARAISO DE GOIAS	BF21385536	NIQUELANDIA SUBTRANSMISSAO	08/11/2019 14:36	08/11/2019 15:33	08/11/2019 14:36	08/11/2019 15:33	0,94	2	1,89	CHI
20191163015	ARUANA	AK21274209	MOZARLANDIA	08/11/2019 14:37	11/11/2019 11:04	08/11/2019 14:37	11/11/2019 11:04	68,45	1	68,45	CHI
20191163016	CRIXAS	CX12342303	SERRA DO OURO	08/11/2019 14:37	10/11/2019 17:17	08/11/2019 14:37	10/11/2019 17:17	50,66	2	101,32	CHI
20191163020	JATAI	JT21209808	JATAI S2	08/11/2019 14:38	08/11/2019 18:59	08/11/2019 14:38	08/11/2019 18:59	4,35	1	4,35	CHI
20191163029	JATAI	JT21361512	JATAI S1	08/11/2019 14:39	09/11/2019 12:00	08/11/2019 14:39	09/11/2019 12:00	21,34	1	21,34	CHI
20191163038	FORMOSO	FO12185309	MARA ROSA	09/11/2019 05:48	09/11/2019 22:57	09/11/2019 05:48	09/11/2019 22:57	17,13	8	137,08	CHI
20191163041	QUIRINOPOLIS	QI21070707	QUIRINOPOLIS	08/11/2019 14:41	09/11/2019 15:07	08/11/2019 14:41	09/11/2019 15:07	24,42	1	24,42	CHI
20191163043	CORUMBA DE GOIAS	260037424	CORUMBA	08/11/2019 14:42	09/11/2019 08:54	08/11/2019 14:42	09/11/2019 08:54	18,20	1	18,20	CHI
20191163053	MUNDO NOVO DE GOIAS	MH12391946	NOVA CRIXAS	08/11/2019 08:17	09/11/2019 22:20	08/11/2019 08:17	09/11/2019 22:20	38,04	7	266,30	CHI
20191163055	ALEXANIA	480016951	ALEXANIA	08/11/2019 14:43	08/11/2019 16:06	08/11/2019 14:43	08/11/2019 16:06	1,37	1	1,37	CHI
20191163059	JATAI	290313211	JATAI S2	08/11/2019 14:44	09/11/2019 10:41	08/11/2019 14:44	09/11/2019 10:41	19,96	1	19,96	CHI
20191163073	ANAPOLIS	AN11279065	JUNDIAI S1	08/11/2019 14:19	08/11/2019 17:22	08/11/2019 14:19	08/11/2019 17:22	3,04	6	18,23	CHI
20191163074	ITUMBIARA	IT12033699	CACHOEIRA DOURADA	08/11/2019 06:06	09/11/2019 10:13	08/11/2019 06:06	09/11/2019 10:13	28,10	10	281,04	CHI
20191163075	URUACU	UR12384347	URUACU	08/11/2019 14:46	08/11/2019 22:17	08/11/2019 14:46	08/11/2019 22:17	7,50	24	180,01	CHI
20191163096	JATAI	JT21127291	JATAI S3	08/11/2019 14:49	09/11/2019 16:45	08/11/2019 14:49	09/11/2019 16:45	25,92	1	25,92	CHI
20191163097	NIQUELANDIA	NQ12359847	NIQUELANDIA SUBTRANSMISSAO	08/11/2019 10:28	09/11/2019 10:19	08/11/2019 10:28	09/11/2019 10:19	23,85	41	978,00	CHI
20191163102	CABECEIRAS	CW21042575	ITUIQUIRA	08/11/2019 14:51	08/11/2019 22:17	08/11/2019 14:51	08/11/2019 22:17	7,43	1	7,43	CHI
20191163106	FORMOSO	FO12072579	PORANGATU	08/11/2019 14:51	09/11/2019 02:16	08/11/2019 14:51	09/11/2019 02:16	11,40	5	57,02	CHI
20191163107	LUZIANIA	LZ21133544	MARAJOARA	08/11/2019 14:51	09/11/2019 11:22	08/11/2019 14:51	09/11/2019 11:22	20,50	1	20,50	CHI
20191163108	INDIARA	IY21010931	PALMEIRAS	08/11/2019 14:51	09/11/2019 10:26	08/11/2019 14:51	09/11/2019 10:26	19,57	1	19,57	CHI

20191163113	PARANAIGUARA	CA12081277	CACHOEIRA ALTA	08/11/2019 11:33	09/11/2019 15:15	08/11/2019 11:33	09/11/2019 15:15	27,70	2	55,39	CHI
20191163118	ITAPACI	100081680	ITAPACI	08/11/2019 14:53	08/11/2019 23:57	08/11/2019 14:53	08/11/2019 23:57	9,05	1	9,05	CHI
20191163119	BOM JARDIM DE GOIAS	BM12231130	BOM JARDIM	08/11/2019 12:08	08/11/2019 17:01	08/11/2019 12:08	08/11/2019 17:01	4,87	8	38,98	CHI
20191163122	SAO SIMAO	SO12303104	CACHOEIRA ALTA	08/11/2019 14:55	09/11/2019 10:40	08/11/2019 14:55	09/11/2019 10:40	19,74	2	39,49	CHI
20191163127	ALTO PARAISO DE GOIAS	10018468045	FLORES DE GOIAS	08/11/2019 14:56	08/11/2019 16:45	08/11/2019 14:56	08/11/2019 16:45	1,81	1	1,81	CHI
20191163131	IPAMERI	OZ12137542RE	PIRES DO RIO S2	08/11/2019 06:56	08/11/2019 20:43	08/11/2019 06:56	08/11/2019 20:43	13,77	7	96,40	CHI
20191163314	JATAI	JT11061460	JATAI S3	08/11/2019 13:37	08/11/2019 16:22	08/11/2019 13:37	08/11/2019 16:22	2,75	91	250,40	CHI
20191163627	SAO MIGUEL DO ARAGUAIA	SM21013235	SAO MIGUEL DO ARAGUAIA	08/11/2019 15:06	09/11/2019 15:56	08/11/2019 15:06	09/11/2019 15:56	24,83	1	24,83	CHI
20191163628	QUIRINOPOLIS	QI12240330	QUIRINOPOLIS	08/11/2019 13:54	08/11/2019 18:14	08/11/2019 13:54	08/11/2019 18:14	4,33	251	1086,20	CHI
20191163629	PARANAIGUARA	QI12306077	QUIRINOPOLIS	08/11/2019 13:20	09/11/2019 09:42	08/11/2019 13:20	09/11/2019 09:42	20,36	3	61,09	CHI
20191163629	QUIRINOPOLIS	QI12306077	QUIRINOPOLIS	08/11/2019 13:20	09/11/2019 09:42	08/11/2019 13:20	09/11/2019 09:42	20,36	20	407,23	CHI
20191163634	QUIRINOPOLIS	QI21227769	QUIRINOPOLIS	08/11/2019 15:08	09/11/2019 15:09	08/11/2019 15:08	09/11/2019 15:09	24,01	1	24,01	CHI
20191163636	GOIATUBA	GT21033072	BOM JESUS DE GOIAS	08/11/2019 15:08	13/11/2019 16:27	08/11/2019 15:08	13/11/2019 16:27	121,31	1	121,31	CHI
20191163639	AGUAS LINDAS DE GOIAS	LA12219645	AGUAS LINDAS DE GOIAS S2	08/11/2019 15:08	08/11/2019 20:00	08/11/2019 15:08	08/11/2019 20:00	4,86	31	150,51	CHI
20191163642	LEOPOLDO DE BULHOES	LB21277389	DAIA S2	08/11/2019 15:09	09/11/2019 17:41	08/11/2019 15:09	09/11/2019 17:41	26,53	2	53,06	CHI
20191163647	INDIARA	IY12010960	EDEIA	08/11/2019 14:49	09/11/2019 10:20	08/11/2019 14:49	09/11/2019 10:20	19,52	19	370,85	CHI
20191163650	QUIRINOPOLIS	QI21091041	QUIRINOPOLIS	08/11/2019 15:11	09/11/2019 15:12	08/11/2019 15:11	09/11/2019 15:12	24,00	1	24,00	CHI
20191163659	CRISTALINA	KR21096915	PAMPLONA	08/11/2019 15:12	08/11/2019 19:32	08/11/2019 15:12	08/11/2019 19:32	4,33	3	13,00	CHI
20191163667	MOZARLANDIA	MZ21055663	MOZARLANDIA	08/11/2019 15:13	10/11/2019 11:05	08/11/2019 15:13	10/11/2019 11:05	43,86	1	43,86	CHI
20191163668	HIDROLINA	UR21257514	URUACU	08/11/2019 15:13	11/11/2019 16:17	08/11/2019 15:13	11/11/2019 16:17	73,06	1	73,06	CHI
20191163676	IPORA	10013820867	IPORA	08/11/2019 15:14	08/11/2019 17:21	08/11/2019 15:14	08/11/2019 17:21	2,12	1	2,12	CHI
20191163701	SERRANOPOLIS	SX21216695	JATAI S1	08/11/2019 15:14	10/11/2019 12:52	08/11/2019 15:14	10/11/2019 12:52	45,63	2	91,26	CHI
20191163804	JATAI	JT11155600	JATAI S1	08/11/2019 15:15	09/11/2019 22:30	08/11/2019 15:15	09/11/2019 22:30	31,25	62	1937,48	CHI
20191163805	IACIARA	IA12264175	IACIARA S2	08/11/2019 15:15	08/11/2019 16:48	08/11/2019 15:15	08/11/2019 16:48	1,54	5	7,69	CHI
20191163806	FORMOSO	FO12208550	PORANGATU	08/11/2019 15:15	09/11/2019 03:16	08/11/2019 15:15	09/11/2019 03:16	12,00	3	36,01	CHI
20191163807	QUIRINOPOLIS	80096530	QUIRINOPOLIS	08/11/2019 15:15	10/11/2019 09:27	08/11/2019 15:15	10/11/2019 09:27	42,19	1	42,19	CHI
20191163814	CIDADE OCIDENTAL	10020694693	MARAJOARA	08/11/2019 15:17	08/11/2019 19:55	08/11/2019 15:17	08/11/2019 19:55	4,63	1	4,63	CHI
20191163824	ANHANGUERA	CY12071523RE	CATALAO S1	08/11/2019 14:39	09/11/2019 19:05	08/11/2019 14:39	09/11/2019 01:48	11,16	3	33,47	CHI
20191163824	CUMARI	CY12071523RE	CATALAO S1	08/11/2019 14:39	09/11/2019 19:05	08/11/2019 14:39	09/11/2019 01:48	11,16	8	89,24	CHI
20191163824	ANHANGUERA	CY12071523RE	CATALAO S1	08/11/2019 14:39	09/11/2019 19:05	08/11/2019 14:39	09/11/2019 19:05	28,45	2	56,90	CHI
20191163824	CORUMBAIBA	CY12071523RE	CATALAO S1	08/11/2019 14:39	09/11/2019 19:05	08/11/2019 14:39	09/11/2019 19:05	28,45	4	113,79	CHI
20191163824	CUMARI	CY12071523RE	CATALAO S1	08/11/2019 14:39	09/11/2019 19:05	08/11/2019 14:39	09/11/2019 19:05	28,45	12	341,38	CHI
20191163824	NOVA AURORA	CY12071523RE	CATALAO S1	08/11/2019 14:39	09/11/2019 19:05	08/11/2019 14:39	09/11/2019 19:05	28,45	1	28,45	CHI

20191163830	IPAMERI	IP21112276	IPAMERI	08/11/2019 15:18	09/11/2019 10:45	08/11/2019 15:18	09/11/2019 10:45	19,44	1	19,44	CHI
20191163836	ALTO HORIZONTE	9640004588	SANTA TEREZINHA	08/11/2019 15:19	08/11/2019 17:53	08/11/2019 15:19	08/11/2019 17:53	2,56	1	2,56	CHI
20191163839	MORRINHOS	MR21182963	MORRINHOS	08/11/2019 15:20	14/11/2019 13:24	08/11/2019 15:20	14/11/2019 13:24	142,05	1	142,05	CHI
20191163847	ALEXANIA	AX12402045	ALEXANIA	08/11/2019 15:22	09/11/2019 18:05	09/11/2019 16:17	09/11/2019 18:05	1,79	191	342,16	CHI
20191163847	SANTO ANTONIO DO DESCOBERTO	AX12402045	ALEXANIA	08/11/2019 15:22	09/11/2019 18:05	09/11/2019 16:17	09/11/2019 18:05	1,79	1	1,79	CHI
20191163852	ITAPACI	IW21248354	ITAPACI	08/11/2019 15:23	09/11/2019 11:45	08/11/2019 15:23	09/11/2019 11:45	20,36	1	20,36	CHI
20191163856	QUIRINOPOLIS	QI12295719	QUIRINOPOLIS	08/11/2019 15:03	09/11/2019 11:12	08/11/2019 15:03	09/11/2019 11:12	20,14	4	80,56	CHI
20191163876	ISRAELANDIA	IS12139430	IPORA	08/11/2019 09:12	11/11/2019 12:07	08/11/2019 09:12	11/11/2019 12:07	74,91	20	1498,21	CHI
20191163886	SAO FRANCISCO DE GOIAS	PG21152970	PETROLINA	08/11/2019 15:28	08/11/2019 17:15	08/11/2019 15:28	08/11/2019 17:15	1,77	1	1,77	CHI
20191163889	CRIXAS	NA12057181	MOZARLANDIA	08/11/2019 15:13	10/11/2019 08:15	08/11/2019 15:13	10/11/2019 08:15	41,03	2	82,06	CHI
20191163889	NOVA CRIXAS	NA12057181	MOZARLANDIA	08/11/2019 15:13	10/11/2019 08:15	08/11/2019 15:13	10/11/2019 08:15	41,03	54	2215,56	CHI
20191163894	SAO FRANCISCO DE GOIAS	10013900399	SAO FRANCISCO DE GOIAS	08/11/2019 15:29	08/11/2019 23:13	08/11/2019 15:29	08/11/2019 23:13	7,72	1	7,72	CHI
20191163923	CRISTALINA	KR10400710	PAMPLONA	08/11/2019 16:55	09/11/2019 20:30	08/11/2019 16:55	08/11/2019 20:19	3,41	49	166,99	CHI
20191163923	CRISTALINA	KR12261518LD	PAMPLONA	08/11/2019 16:55	09/11/2019 20:30	08/11/2019 16:55	09/11/2019 20:30	27,59	17	468,96	CHI
20191164011	ABADIANIA	AA12017723	ANAPOLIS UNIVERSITARIO S1	08/11/2019 14:43	08/11/2019 17:59	08/11/2019 14:43	08/11/2019 17:59	3,26	11	35,82	CHI
20191164022	JATAI	JT21260391	JATAI S3	08/11/2019 15:34	11/11/2019 13:14	08/11/2019 15:34	11/11/2019 13:14	69,66	1	69,66	CHI
20191164033	NOVO PLANALTO	2500012093	NOVO PLANALTO	08/11/2019 15:35	09/11/2019 12:38	08/11/2019 15:35	09/11/2019 12:38	21,05	1	21,05	CHI
20191164035	QUIRINOPOLIS	QI21150628	QUIRINOPOLIS	08/11/2019 15:35	09/11/2019 11:17	08/11/2019 15:35	09/11/2019 11:17	19,69	1	19,69	CHI
20191164040	MIMOSO DE GOIAS	MJ12071970	PADRE BERNARDO	08/11/2019 10:04	08/11/2019 22:17	08/11/2019 10:04	08/11/2019 22:17	12,20	23	280,63	CHI
20191164043	MORRINHOS	MR12092107	MORRINHOS	08/11/2019 15:36	09/11/2019 22:01	08/11/2019 15:36	09/11/2019 22:01	30,41	2	60,82	CHI
20191164044	ANAPOLIS	AN11357109	JUNDIAI S1	08/11/2019 15:36	08/11/2019 17:19	08/11/2019 15:36	08/11/2019 17:19	1,71	49	83,74	CHI
20191164055	CRISTALINA	10000998727	CRISTALINA S1	08/11/2019 15:39	08/11/2019 17:49	08/11/2019 15:39	08/11/2019 17:49	2,16	1	2,16	CHI
20191164061	VALPARAISO DE GOIAS	10004913742	PACAEMBU S1	08/11/2019 15:40	08/11/2019 18:32	08/11/2019 15:40	08/11/2019 18:32	2,86	1	2,86	CHI
20191164066	PALMEIRAS DE GOIAS	PL21147511	PALMEIRAS	08/11/2019 15:40	09/11/2019 00:14	08/11/2019 15:40	09/11/2019 00:14	8,55	1	8,55	CHI
20191164067	ITAGUARI	II12036420	ITABERAI S1	08/11/2019 15:40	08/11/2019 19:07	08/11/2019 15:40	08/11/2019 19:07	3,44	11	37,88	CHI
20191164082	CACHOEIRA DOURADA	3290001785	CACHOEIRA DOURADA	08/11/2019 15:44	12/11/2019 12:22	08/11/2019 15:44	12/11/2019 12:22	92,62	1	92,62	CHI
20191164083	JUSSARA	JR12220059	JUSSARA	08/11/2019 06:21	10/11/2019 09:25	08/11/2019 06:21	10/11/2019 09:25	51,05	11	561,57	CHI
20191164086	NAZARIO	440007422	ANICUNS	08/11/2019 15:46	09/11/2019 01:20	08/11/2019 15:46	09/11/2019 01:20	9,57	1	9,57	CHI
20191164124	ANAPOLIS	20553341	ANAPOLIS UNIVERSITARIO S2	08/11/2019 15:50	08/11/2019 18:37	08/11/2019 15:50	08/11/2019 18:37	2,78	1	2,78	CHI
20191164129	BONOPOLIS	BX21286697	SAO MIGUEL DO ARAGUAIA	08/11/2019 15:48	10/11/2019 00:52	08/11/2019 15:48	10/11/2019 00:52	33,05	1	33,05	CHI
20191164144	ITAGUARU	IC11219945	ITABERAI S1	08/11/2019 13:08	08/11/2019 19:00	08/11/2019 13:08	08/11/2019 19:00	5,85	56	327,69	CHI
20191164145	INACIOLANDIA	ID12088534	QUIRINOPOLIS	08/11/2019 15:53	08/11/2019 17:18	08/11/2019 15:53	08/11/2019 17:18	1,41	5	7,03	CHI
20191164146	MINEIROS	MY21322539	PARQUE DAS EMAS	08/11/2019 15:53	09/11/2019 10:14	08/11/2019 15:53	09/11/2019 10:14	18,34	1	18,34	CHI

20191164163	CAMPO ALEGRE DE GOIAS	02250424	CAMPO ALEGRE DE GOIAS	08/11/2019 15:48	09/11/2019 03:22	08/11/2019 15:51	08/11/2019 17:31	1,67	102	170,48	CHI
20191164163	IPAMERI	02250424	CAMPO ALEGRE DE GOIAS	08/11/2019 15:48	09/11/2019 03:22	08/11/2019 15:51	08/11/2019 17:31	1,67	38	63,51	CHI
20191164163	CAMPO ALEGRE DE GOIAS	CM13266893	CAMPO ALEGRE DE GOIAS	08/11/2019 15:48	09/11/2019 03:22	08/11/2019 15:48	08/11/2019 18:54	3,09	132	407,62	CHI
20191164163	CATALAO	CM13266893	CAMPO ALEGRE DE GOIAS	08/11/2019 15:48	09/11/2019 03:22	08/11/2019 15:48	08/11/2019 18:54	3,09	21	64,85	CHI
20191164163	DISTRITO FEDERAL	CM13266893	CAMPO ALEGRE DE GOIAS	08/11/2019 15:48	09/11/2019 03:22	08/11/2019 15:48	08/11/2019 18:54	3,09	1	3,09	CHI
20191164163	IPAMERI	CM13266893	CAMPO ALEGRE DE GOIAS	08/11/2019 15:48	09/11/2019 03:22	08/11/2019 15:48	08/11/2019 18:54	3,09	12	37,06	CHI
20191164163	CAMPO ALEGRE DE GOIAS	CM13266893	CAMPO ALEGRE DE GOIAS	08/11/2019 15:48	09/11/2019 03:22	08/11/2019 15:51	08/11/2019 18:54	3,05	41	125,13	CHI
20191164163	CAMPO ALEGRE DE GOIAS	IP13231410	CAMPO ALEGRE DE GOIAS	08/11/2019 15:48	09/11/2019 03:22	08/11/2019 15:51	09/11/2019 00:56	9,08	5	45,42	CHI
20191164163	IPAMERI	IP13231410	CAMPO ALEGRE DE GOIAS	08/11/2019 15:48	09/11/2019 03:22	08/11/2019 15:51	09/11/2019 00:56	9,08	62	563,24	CHI
20191164163	CAMPO ALEGRE DE GOIAS	IP13337223	CAMPO ALEGRE DE GOIAS	08/11/2019 15:48	09/11/2019 03:22	08/11/2019 15:51	09/11/2019 03:22	11,53	33	380,50	CHI
20191164164	SANTA TEREZINHA DE GOIAS	SG11030741	SANTA TEREZINHA	08/11/2019 14:56	08/11/2019 20:52	08/11/2019 14:56	08/11/2019 20:52	5,92	113	669,02	CHI
20191164166	ARAGARCAS	AG12188251	ARAGARCAS	08/11/2019 11:56	09/11/2019 07:23	08/11/2019 11:56	09/11/2019 07:23	19,44	52	1010,69	CHI
20191164167	CRIXAS	CX12072149	SERRA DO OURO	08/11/2019 15:58	09/11/2019 15:58	08/11/2019 15:58	09/11/2019 15:58	23,98	7	167,89	CHI
20191164168	ARAGARCAS	BM12316433	ARAGARCAS	08/11/2019 15:47	09/11/2019 11:30	08/11/2019 15:47	09/11/2019 11:30	19,70	27	531,94	CHI
20191164168	BOM JARDIM DE GOIAS	BM12316433	ARAGARCAS	08/11/2019 15:47	09/11/2019 11:30	08/11/2019 15:47	09/11/2019 11:30	19,70	2	39,40	CHI
20191164174	MINEIROS	MY21340079	PARQUE DAS EMAS	08/11/2019 15:59	09/11/2019 14:07	08/11/2019 15:59	09/11/2019 14:07	22,13	1	22,13	CHI
20191164178	PADRE BERNARDO	PB11167405	PADRE BERNARDO	08/11/2019 16:00	08/11/2019 19:41	08/11/2019 16:00	08/11/2019 19:41	3,67	104	381,85	CHI
20191164180	COCALZINHO DE GOIAS	ZN21130861	COCALZINHO	08/11/2019 16:01	09/11/2019 09:55	08/11/2019 16:01	09/11/2019 09:55	17,89	1	17,89	CHI
20191164186	CAIAPONIA	930057594	CAIAPONIA	08/11/2019 16:03	10/11/2019 00:18	08/11/2019 16:03	10/11/2019 00:18	32,26	1	32,26	CHI
20191164187	ORIZONA	2060007945	PIRES DO RIO S2	08/11/2019 16:03	08/11/2019 23:51	08/11/2019 16:03	08/11/2019 23:51	7,80	1	7,80	CHI
20191164191	MINEIROS	MY12036636	PARQUE DAS EMAS	08/11/2019 06:39	08/11/2019 22:08	08/11/2019 06:39	08/11/2019 22:08	15,48	8	123,82	CHI
20191164196	CRIXAS	CX21318431	MOZARLANDIA	08/11/2019 16:04	10/11/2019 10:20	08/11/2019 16:04	10/11/2019 10:20	42,26	1	42,26	CHI
20191164305	PADRE BERNARDO	2760007309	PADRE BERNARDO	08/11/2019 16:07	08/11/2019 20:22	08/11/2019 16:07	08/11/2019 20:22	4,25	1	4,25	CHI
20191164306	PORANGATU	PO12253874	PORANGATU	08/11/2019 16:07	09/11/2019 12:22	08/11/2019 16:07	09/11/2019 12:22	20,26	5	101,30	CHI
20191164311	MONTIVIDIU DO NORTE	MX12270910	PORANGATU	08/11/2019 16:07	11/11/2019 00:04	08/11/2019 16:07	11/11/2019 00:04	55,94	7	391,56	CHI
20191164312	LUZIANIA	10000633761	RIO VERMELHO	08/11/2019 16:07	09/11/2019 00:54	08/11/2019 16:07	09/11/2019 00:54	8,77	1	8,77	CHI
20191164313	JATAI	290269842	JATAI S2	08/11/2019 16:07	09/11/2019 11:52	08/11/2019 16:07	09/11/2019 11:52	19,75	1	19,75	CHI
20191164314	RUBIATABA	RB12194746	RUBIATABA	08/11/2019 08:07	10/11/2019 12:05	08/11/2019 08:07	10/11/2019 12:05	51,95	5	259,76	CHI
20191164317	CIDADE OCIDENTAL	DH11169050	MARAJOARA	08/11/2019 16:21	08/11/2019 17:06	08/11/2019 16:21	08/11/2019 17:06	0,74	201	149,19	CHI
20191164318	SANTA TEREZA DE GOIAS	SE12143626	PORANGATU	08/11/2019 16:11	10/11/2019 15:13	08/11/2019 16:11	10/11/2019 15:13	47,03	2	94,06	CHI
20191164336	MONTIVIDIU DO NORTE	MX12226413	PORANGATU	08/11/2019 16:12	09/11/2019 00:08	08/11/2019 16:12	09/11/2019 00:08	7,92	40	316,70	CHI
20191164342	JATAI	290177728	JATAI S3	08/11/2019 16:14	08/11/2019 17:54	08/11/2019 16:14	08/11/2019 17:54	1,67	1	1,67	CHI
20191164343	JATAI	JT1036783	JATAI S2	08/11/2019 16:15	08/11/2019 17:44	08/11/2019 16:15	08/11/2019 17:44	1,48	1	1,48	CHI

20191164344	BOM JARDIM DE GOIAS	BM21184277	BOM JARDIM	08/11/2019 16:15	09/11/2019 17:43	08/11/2019 16:15	09/11/2019 17:43	25,47	1	25,47	CHI
20191164348	PADRE BERNARDO	PB21068693	PADRE BERNARDO	08/11/2019 16:15	09/11/2019 05:06	08/11/2019 16:15	09/11/2019 05:06	12,84	1	12,84	CHI
20191164354	JATAI	JT21086129	JATAI S2	08/11/2019 16:17	08/11/2019 18:31	08/11/2019 16:17	08/11/2019 18:31	2,22	1	2,22	CHI
20191164361	SAO SIMAO	SO12191548	CACHOEIRA ALTA	08/11/2019 13:28	09/11/2019 21:20	08/11/2019 13:28	09/11/2019 21:20	31,86	5	159,31	CHI
20191164368	SANTA HELENA DE GOIAS	SH13400670B	IPEGUARI	08/11/2019 13:43	08/11/2019 20:50	08/11/2019 13:43	08/11/2019 20:50	7,11	22	156,51	CHI
20191164372	NIQUELANDIA	NQ12398036	NIQUELANDIA SUBTRANSMISSAO	08/11/2019 15:09	09/11/2019 12:21	08/11/2019 15:09	09/11/2019 12:21	21,19	3	63,57	CHI
20191164373	JATAI	04070214	JATAI S1	08/11/2019 16:20	09/11/2019 07:34	08/11/2019 16:20	08/11/2019 18:50	2,49	141	351,44	CHI
20191164373	JATAI	04070214	JATAI S1	08/11/2019 16:20	09/11/2019 07:34	08/11/2019 21:04	08/11/2019 22:15	1,18	70	82,31	CHI
20191164373	JATAI	04070214	JATAI S1	08/11/2019 16:20	09/11/2019 07:34	08/11/2019 21:04	08/11/2019 23:00	1,92	6	11,54	CHI
20191164373	JATAI	JT13214393	JATAI S1	08/11/2019 16:20	09/11/2019 07:34	08/11/2019 21:04	08/11/2019 23:30	2,42	52	125,90	CHI
20191164373	APARECIDA DO RIO DOCE	JT13365070	JATAI S1	08/11/2019 16:20	09/11/2019 07:34	08/11/2019 16:20	08/11/2019 23:50	7,50	70	525,21	CHI
20191164373	JATAI	JT13365070	JATAI S1	08/11/2019 16:20	09/11/2019 07:34	08/11/2019 16:20	08/11/2019 23:50	7,50	53	397,66	CHI
20191164373	JATAI	JT13219247	JATAI S1	08/11/2019 16:20	09/11/2019 07:34	08/11/2019 16:20	09/11/2019 00:30	8,16	39	318,15	CHI
20191164373	JATAI	04070214	JATAI S1	08/11/2019 16:20	09/11/2019 07:34	08/11/2019 21:04	09/11/2019 07:34	10,50	13	136,45	CHI
20191164377	QUIRINOPOLIS	QI32053165	QUIRINOPOLIS	08/11/2019 16:20	08/11/2019 23:21	08/11/2019 16:20	08/11/2019 23:21	7,01	8	56,04	CHI
20191164385	ALTO PARAISO DE GOIAS	BF21274593	FLORES DE GOIAS	08/11/2019 16:21	08/11/2019 21:11	08/11/2019 16:21	08/11/2019 21:11	4,82	1	4,82	CHI
20191164404	MINEIROS	MY12219457	PARQUE DAS EMAS	08/11/2019 15:59	09/11/2019 00:15	08/11/2019 15:59	09/11/2019 00:15	8,26	21	173,44	CHI
20191164408	IPORA	IR12259868	ARENOPOLIS	08/11/2019 13:00	10/11/2019 18:45	08/11/2019 13:00	10/11/2019 18:45	53,75	15	806,32	CHI
20191164417	JATAI	JT12109029	JATAI S1	08/11/2019 15:51	09/11/2019 09:25	08/11/2019 15:51	09/11/2019 09:25	17,56	28	491,76	CHI
20191164433	ARENOPOLIS	AY12390169	ARENOPOLIS	08/11/2019 13:03	09/11/2019 17:27	08/11/2019 13:03	09/11/2019 17:27	28,39	24	681,35	CHI
20191164433	DIORAMA	AY12390169	ARENOPOLIS	08/11/2019 13:03	09/11/2019 17:27	08/11/2019 13:03	09/11/2019 17:27	28,39	3	85,17	CHI
20191164447	AMARALINA	MU12384317	MARA ROSA	08/11/2019 11:36	11/11/2019 22:50	08/11/2019 11:36	11/11/2019 22:50	83,23	4	332,92	CHI
20191164447	MUTUNOPOLIS	MU12384317	MARA ROSA	08/11/2019 11:36	11/11/2019 22:50	08/11/2019 11:36	11/11/2019 22:50	83,23	20	1664,61	CHI
20191164449	PORANGATU	PO12297141	PORANGATU	08/11/2019 16:15	08/11/2019 21:58	08/11/2019 16:15	08/11/2019 21:58	5,71	12	68,55	CHI
20191164461	PADRE BERNARDO	PB11390439	PADRE BERNARDO	08/11/2019 16:13	09/11/2019 00:48	08/11/2019 16:13	09/11/2019 00:48	8,57	82	702,72	CHI
20191164469	PLANALTINA	PI12015859	PLANALTINA	08/11/2019 15:03	08/11/2019 19:49	08/11/2019 15:03	08/11/2019 19:49	4,76	150	714,17	CHI
20191164470	FORMOSA	FA12394153	ITUIQUIRA	08/11/2019 13:07	09/11/2019 09:02	08/11/2019 13:07	09/11/2019 09:02	19,91	19	378,22	CHI
20191164488	PORTELANDIA	PW21103061	PARQUE DAS EMAS	08/11/2019 16:40	09/11/2019 14:16	08/11/2019 16:40	09/11/2019 14:16	21,59	1	21,59	CHI
20191164489	MONTES CLAROS DE GOIAS	ME12201974	IPORA	08/11/2019 16:40	11/11/2019 11:16	08/11/2019 16:40	11/11/2019 11:16	66,60	5	332,99	CHI
20191164491	NIQUELANDIA	NQ12262808	BARRO ALTO	08/11/2019 15:35	08/11/2019 23:28	08/11/2019 15:35	08/11/2019 23:28	7,88	26	204,78	CHI
20191164496	JATAI	JT12331838	JATAI S2	06/11/2019 14:35	09/11/2019 15:20	09/11/2019 11:27	09/11/2019 15:20	3,89	5	19,44	CHI
20191164508	QUIRINOPOLIS	QI21301487	QUIRINOPOLIS	08/11/2019 07:10	10/11/2019 09:22	08/11/2019 07:10	10/11/2019 09:22	50,19	4	200,76	CHI
20191164518	AGUAS LINDAS DE GOIAS	4830026717	AGUAS LINDAS DE GOIAS S1	08/11/2019 16:47	08/11/2019 19:09	08/11/2019 16:47	08/11/2019 19:09	2,36	1	2,36	CHI

20191164520	CRISTALINA	KR11040633	CRISTALINA S1	08/11/2019 15:53	08/11/2019 18:29	08/11/2019 15:53	08/11/2019 18:29	2,59	63	162,91	CHI
20191164524	CORUMBAIBA	CI21247842	CATALAO S1	08/11/2019 10:55	09/11/2019 10:57	08/11/2019 10:55	09/11/2019 10:57	24,03	1	24,03	CHI
20191164529	NIQUELANDIA	NQ12375652	URUACU	08/11/2019 16:50	09/11/2019 09:31	08/11/2019 16:50	09/11/2019 09:31	16,68	210	3502,10	CHI
20191164534	PALMEIRAS DE GOIAS	PL10404075	PALMEIRAS	08/11/2019 07:59	10/11/2019 11:56	08/11/2019 07:59	08/11/2019 23:41	15,71	36	565,52	CHI
20191164534	PALMEIRAS DE GOIAS	PL13181987	PALMEIRAS	08/11/2019 07:59	10/11/2019 11:56	08/11/2019 07:59	09/11/2019 13:06	29,11	35	1018,86	CHI
20191164534	PALMEIRAS DE GOIAS	PL10404075	PALMEIRAS	08/11/2019 07:59	10/11/2019 11:56	09/11/2019 13:07	09/11/2019 13:31	0,41	44	18,20	CHI
20191164534	PALMEIRAS DE GOIAS	PL13259259	PALMEIRAS	08/11/2019 07:59	10/11/2019 11:56	09/11/2019 13:07	09/11/2019 21:10	8,05	27	217,39	CHI
20191164534	PALMEIRAS DE GOIAS	PL12000114	PALMEIRAS	08/11/2019 07:59	10/11/2019 11:56	08/11/2019 07:59	10/11/2019 11:10	51,19	40	2047,58	CHI
20191164534	NAZARIO	PL12000118	PALMEIRAS	08/11/2019 07:59	10/11/2019 11:56	08/11/2019 07:59	10/11/2019 11:56	51,94	3	155,83	CHI
20191164534	PALMEIRAS DE GOIAS	PL12000118	PALMEIRAS	08/11/2019 07:59	10/11/2019 11:56	08/11/2019 07:59	10/11/2019 11:56	51,94	24	1246,67	CHI
20191164550	QUIRINOPOLIS	QI11346763	QUIRINOPOLIS	08/11/2019 16:54	11/11/2019 17:37	08/11/2019 16:54	11/11/2019 17:37	72,70	10	727,01	CHI
20191164551	CACHOEIRA ALTA	CA21371277	CACHOEIRA ALTA	08/11/2019 16:55	10/11/2019 12:35	08/11/2019 16:55	10/11/2019 12:35	43,66	1	43,66	CHI
20191164552	CRISTALINA	KR11315558	CRISTALINA S1	08/11/2019 16:55	09/11/2019 13:53	08/11/2019 16:55	09/11/2019 13:53	20,96	2	41,92	CHI
20191164565	MARA ROSA	2260031815	MARA ROSA	08/11/2019 16:56	11/11/2019 15:21	08/11/2019 16:56	11/11/2019 15:21	70,40	1	70,40	CHI
20191164573	ABADIANIA	AA12295520	ANAPOLIS UNIVERSITARIO S1	08/11/2019 11:58	08/11/2019 19:07	08/11/2019 11:58	08/11/2019 19:07	7,15	6	42,90	CHI
20191164576	PARAUNA	PU21301155	ACREUNA	08/11/2019 16:59	09/11/2019 11:45	08/11/2019 16:59	09/11/2019 11:45	18,77	1	18,77	CHI
20191164584	CATALAO	CT21266254	CATALAO S2	07/11/2019 17:31	09/11/2019 09:22	07/11/2019 17:31	09/11/2019 09:22	39,85	2	79,70	CHI
20191164590	PADRE BERNARDO	PB11206720	PADRE BERNARDO	08/11/2019 16:40	09/11/2019 00:39	08/11/2019 16:40	09/11/2019 00:39	7,98	112	893,95	CHI
20191164611	IPORA	IR12204950	IPORA	08/11/2019 18:28	09/11/2019 04:38	08/11/2019 18:28	09/11/2019 04:38	10,15	70	710,64	CHI
20191164623	NIQUELANDIA	NQ12274796	BARRO ALTO	08/11/2019 17:08	09/11/2019 12:37	08/11/2019 17:08	09/11/2019 12:37	19,47	1	19,47	CHI
20191164626	AMORINOPOLIS	AM12007749	IPORA	08/11/2019 17:08	12/11/2019 09:50	08/11/2019 17:08	12/11/2019 09:50	88,69	3	266,08	CHI
20191164630	NIQUELANDIA	NQ11243529	BARRO ALTO	08/11/2019 17:03	08/11/2019 20:03	08/11/2019 17:03	08/11/2019 20:03	2,99	126	377,19	CHI
20191164632	EDEIA	EA21182671	EDEIA	08/11/2019 17:09	11/11/2019 15:47	08/11/2019 17:09	11/11/2019 15:47	70,62	1	70,62	CHI
20191164636	CRISTALINA	KR12133610	CRISTALINA S2	08/11/2019 17:10	09/11/2019 08:40	08/11/2019 17:10	09/11/2019 08:40	15,50	12	185,96	CHI
20191164649	BALIZA	DV10400398	CAIAPONIA	08/11/2019 17:13	11/11/2019 19:41	10/11/2019 05:05	10/11/2019 07:02	1,97	526	1034,32	CHI
20191164649	BALIZA	DV10400398	CAIAPONIA	08/11/2019 17:13	11/11/2019 19:41	10/11/2019 07:03	10/11/2019 10:57	3,91	154	601,67	CHI
20191164649	DOVERLANDIA	DV10354680	CAIAPONIA	08/11/2019 17:13	11/11/2019 19:41	10/11/2019 14:46	10/11/2019 20:31	5,75	13	74,70	CHI
20191164649	BALIZA	DV13259779	CAIAPONIA	08/11/2019 17:13	11/11/2019 19:41	10/11/2019 07:03	10/11/2019 21:32	14,49	372	5390,28	CHI
20191164649	BALIZA	DV10354680	CAIAPONIA	08/11/2019 17:13	11/11/2019 19:41	10/11/2019 14:46	10/11/2019 21:32	6,77	1	6,77	CHI
20191164649	BALIZA	DV13259779	CAIAPONIA	08/11/2019 17:13	11/11/2019 19:41	10/11/2019 14:46	10/11/2019 21:32	6,77	202	1367,43	CHI
20191164649	DOVERLANDIA	DV10354680	CAIAPONIA	08/11/2019 17:13	11/11/2019 19:41	10/11/2019 14:46	10/11/2019 21:32	6,77	83	561,86	CHI
20191164649	DOVERLANDIA	DV13259779	CAIAPONIA	08/11/2019 17:13	11/11/2019 19:41	10/11/2019 14:46	10/11/2019 21:32	6,77	344	2328,69	CHI
20191164649	DOVERLANDIA	DV10354680	CAIAPONIA	08/11/2019 17:13	11/11/2019 19:41	10/11/2019 14:46	11/11/2019 19:40	28,90	10	288,96	CHI

20191164649	BALIZA	BH12331423	CAIAPONIA	08/11/2019 17:13	11/11/2019 19:41	08/11/2019 17:13	11/11/2019 19:41	74,46	15	1116,84	CHI
20191164656	URUTAI	UT21337258	URUTAI	08/11/2019 17:15	09/11/2019 11:06	08/11/2019 17:15	09/11/2019 11:06	17,86	1	17,86	CHI
20191164660	ARUANA	AK21088216	BRITANIA	08/11/2019 17:16	10/11/2019 17:15	08/11/2019 17:16	10/11/2019 17:15	47,97	1	47,97	CHI
20191164664	RIO VERDE	630129812	RIO VERDE S2	08/11/2019 17:17	09/11/2019 12:20	08/11/2019 17:17	09/11/2019 12:20	19,04	1	19,04	CHI
20191164667	NIQUELANDIA	NQ12358188	URUACU	08/11/2019 17:02	09/11/2019 19:15	08/11/2019 17:02	08/11/2019 22:40	5,64	82	462,69	CHI
20191164667	NIQUELANDIA	NQ12400321	URUACU	08/11/2019 17:02	09/11/2019 19:15	08/11/2019 17:02	09/11/2019 04:18	11,27	192	2164,43	CHI
20191164667	NIQUELANDIA	NQ12400321	URUACU	08/11/2019 17:02	09/11/2019 19:15	09/11/2019 04:40	09/11/2019 19:15	14,58	192	2799,68	CHI
20191164671	GOIATUBA	GT12000228	GOIATUBA S2	08/11/2019 16:51	08/11/2019 22:25	08/11/2019 16:51	08/11/2019 22:25	5,56	138	767,86	CHI
20191164675	ANICUNS	AC12259103	FIRMINOPOLIS S2	08/11/2019 16:27	08/11/2019 19:18	08/11/2019 16:27	08/11/2019 19:18	2,85	19	54,20	CHI
20191164678	ORIZONA	IP12217837	PIRES DO RIO S2	08/11/2019 17:20	09/11/2019 11:42	08/11/2019 17:20	09/11/2019 11:42	18,35	1	18,35	CHI
20191164681	PORANGATU	PO12286007	PORANGATU	08/11/2019 12:55	09/11/2019 19:45	08/11/2019 12:55	09/11/2019 19:45	30,83	8	246,65	CHI
20191164685	PORTELANDIA	PW12209812	PARQUE DAS EMAS	08/11/2019 18:24	09/11/2019 08:22	08/11/2019 18:24	09/11/2019 08:22	13,96	84	1172,27	CHI
20191164689	URUACU	UR12231321	MARA ROSA	08/11/2019 17:23	09/11/2019 01:41	08/11/2019 17:23	09/11/2019 01:41	8,29	4	33,15	CHI
20191164690	ARENOPOLIS	AY12381016	IPORA	08/11/2019 07:21	08/11/2019 23:28	08/11/2019 07:21	08/11/2019 23:28	16,10	20	322,03	CHI
20191164700	FAZENDA NOVA	NB12250852	JUSSARA	08/11/2019 17:02	09/11/2019 07:39	08/11/2019 17:02	09/11/2019 07:39	14,61	4	58,45	CHI
20191164700	NOVO BRASIL	NB12250852	JUSSARA	08/11/2019 17:02	09/11/2019 07:39	08/11/2019 17:02	09/11/2019 07:39	14,61	2	29,23	CHI
20191164714	BALIZA	BH12402901	CAIAPONIA	08/11/2019 17:28	11/11/2019 10:47	08/11/2019 17:28	11/11/2019 10:47	65,31	13	849,02	CHI
20191164724	SAO JOAO D ALIANCA	10000525462	SAO JOAO D ALIANCA	07/11/2019 21:05	09/11/2019 14:26	07/11/2019 21:05	09/11/2019 14:26	41,34	1	41,34	CHI
20191164727	PORANGATU	PO12363572	PORANGATU	08/11/2019 15:23	10/11/2019 17:14	08/11/2019 15:23	10/11/2019 17:14	49,84	9	448,55	CHI
20191164730	MUNDO NOVO DE GOIAS	MH21037798	NOVA CRIXAS	08/11/2019 11:47	12/11/2019 16:27	08/11/2019 11:47	12/11/2019 16:27	100,66	1	100,66	CHI
20191164742	RIO VERDE	RV12332189	CABRIUVA S2	08/11/2019 08:59	11/11/2019 10:34	08/11/2019 08:59	11/11/2019 10:34	73,59	5	367,94	CHI
20191164747	MINEIROS	MY21240274	PARQUE DAS EMAS	08/11/2019 17:34	09/11/2019 12:17	08/11/2019 17:34	09/11/2019 12:17	18,70	1	18,70	CHI
20191164757	CRIXAS	CX12239577	SANTA TEREZINHA	08/11/2019 12:48	09/11/2019 00:57	08/11/2019 12:48	09/11/2019 00:57	12,14	16	194,20	CHI
20191164763	URUACU	UR12000037	URUACU	08/11/2019 16:13	08/11/2019 21:48	08/11/2019 16:13	08/11/2019 21:48	5,57	68	379,01	CHI
20191164774	ITARUMA	IM21239520	ITAJA S2	08/11/2019 17:39	10/11/2019 17:20	08/11/2019 17:39	10/11/2019 17:20	47,67	1	47,67	CHI
20191164778	PORANGATU	PO12371059	PORANGATU	08/11/2019 17:40	08/11/2019 20:20	08/11/2019 17:40	08/11/2019 20:20	2,66	44	116,83	CHI
20191164784	ORIZONA	10017150491	PIRES DO RIO S2	08/11/2019 17:41	08/11/2019 22:41	08/11/2019 17:41	08/11/2019 22:41	4,98	1	4,98	CHI
20191164788	LUZIANIA	120025887	RIO VERMELHO	08/11/2019 17:42	08/11/2019 23:05	08/11/2019 17:42	08/11/2019 23:05	5,37	1	5,37	CHI
20191164792	PADRE BERNARDO	PB11277160	PADRE BERNARDO	08/11/2019 15:02	08/11/2019 23:14	08/11/2019 15:02	08/11/2019 23:14	8,19	23	188,41	CHI
20191164809	GOIANESIA	GE10394586	GOIANESIA S2	08/11/2019 18:47	08/11/2019 19:01	08/11/2019 18:47	08/11/2019 19:01	0,24	80	19,58	CHI
20191164809	VILA PROPICIO	GE10394586	GOIANESIA S2	08/11/2019 18:47	08/11/2019 19:01	08/11/2019 18:47	08/11/2019 19:01	0,24	37	9,05	CHI
20191164818	MUTUNOPOLIS	03520224	MARA ROSA	08/11/2019 19:12	09/11/2019 16:15	08/11/2019 19:12	08/11/2019 23:26	4,23	410	1735,67	CHI
20191164818	MUTUNOPOLIS	MU11003802	MARA ROSA	08/11/2019 19:12	09/11/2019 16:15	08/11/2019 19:12	08/11/2019 23:59	4,77	147	701,35	CHI

20191164818	MUTUNOPOLIS	03520224	MARA ROSA	08/11/2019 19:12	09/11/2019 16:15	08/11/2019 23:46	09/11/2019 00:42	0,94	410	383,81	CHI
20191164818	MUTUNOPOLIS	03520224	MARA ROSA	08/11/2019 19:12	09/11/2019 16:15	08/11/2019 19:12	09/11/2019 01:07	5,91	353	2085,35	CHI
20191164818	MUTUNOPOLIS	03520224	MARA ROSA	08/11/2019 19:12	09/11/2019 16:15	09/11/2019 02:17	09/11/2019 02:45	0,45	910	413,80	CHI
20191164818	MUTUNOPOLIS	03520224	MARA ROSA	08/11/2019 19:12	09/11/2019 16:15	09/11/2019 08:51	09/11/2019 10:00	1,14	557	633,43	CHI
20191164818	MUTUNOPOLIS	03520224	MARA ROSA	08/11/2019 19:12	09/11/2019 16:15	09/11/2019 08:51	09/11/2019 11:17	2,42	99	240,02	CHI
20191164818	MUTUNOPOLIS	03520224	MARA ROSA	08/11/2019 19:12	09/11/2019 16:15	09/11/2019 08:51	09/11/2019 12:16	3,40	254	864,31	CHI
20191164818	MUTUNOPOLIS	03520224	MARA ROSA	08/11/2019 19:12	09/11/2019 16:15	08/11/2019 19:12	09/11/2019 13:08	17,93	179	3210,02	CHI
20191164818	MUTUNOPOLIS	03520224	MARA ROSA	08/11/2019 19:12	09/11/2019 16:15	08/11/2019 19:12	09/11/2019 14:20	19,12	37	707,52	CHI
20191164818	ESTRELA DO NORTE	MU12037357LD	MARA ROSA	08/11/2019 19:12	09/11/2019 16:15	08/11/2019 21:55	09/11/2019 14:20	16,41	1	16,41	CHI
20191164818	MUTUNOPOLIS	MU12037357LD	MARA ROSA	08/11/2019 19:12	09/11/2019 16:15	08/11/2019 21:55	09/11/2019 14:20	16,41	32	524,97	CHI
20191164818	MUTUNOPOLIS	03520224	MARA ROSA	08/11/2019 19:12	09/11/2019 16:15	08/11/2019 19:12	09/11/2019 15:18	20,09	212	4258,73	CHI
20191164818	AMARALINA	03520224	MARA ROSA	08/11/2019 19:12	09/11/2019 16:15	08/11/2019 19:12	09/11/2019 16:15	21,05	127	2673,70	CHI
20191164818	MUTUNOPOLIS	03520224	MARA ROSA	08/11/2019 19:12	09/11/2019 16:15	08/11/2019 19:12	09/11/2019 16:15	21,05	21	442,11	CHI
20191164822	PARAUNA	PU21357965	ACREUNA	08/11/2019 19:48	08/11/2019 20:05	08/11/2019 19:48	08/11/2019 20:05	0,28	1	0,28	CHI
20191164834	GOIANESIA	GE11215219	GOIANESIA S2	08/11/2019 19:09	08/11/2019 22:03	08/11/2019 19:09	08/11/2019 22:03	2,89	75	217,04	CHI
20191164856	GOIANESIA	GE11334997	GOIANESIA S2	08/11/2019 19:30	09/11/2019 13:45	08/11/2019 19:30	09/11/2019 13:45	18,24	74	1349,51	CHI
20191164859	CAIAPONIA	CP12345397	CAIAPONIA	07/11/2019 13:04	09/11/2019 16:38	07/11/2019 13:04	09/11/2019 16:38	51,56	7	360,92	CHI
20191164861	CAIAPONIA	CP12354285	CAIAPONIA	07/11/2019 13:42	09/11/2019 18:11	07/11/2019 13:42	09/11/2019 18:11	52,48	12	629,76	CHI
20191164867	JATAI	JT13184167	JATAI S1	08/11/2019 14:41	09/11/2019 13:00	08/11/2019 14:41	09/11/2019 13:00	22,30	61	1360,45	CHI
20191164867	JATAI	JT13184167	JATAI S1	08/11/2019 14:41	09/11/2019 13:00	09/11/2019 07:59	09/11/2019 13:00	5,02	95	476,79	CHI
20191164867	JATAI	JT13184167	JATAI S1	08/11/2019 14:41	09/11/2019 13:00	09/11/2019 08:00	09/11/2019 13:00	5,00	207	1035,46	CHI
20191164867	SERRANOPOLIS	JT13184167	JATAI S1	08/11/2019 14:41	09/11/2019 13:00	09/11/2019 08:00	09/11/2019 13:00	5,00	65	325,14	CHI
20191164867	JATAI	JT13184167	JATAI S1	08/11/2019 14:41	09/11/2019 13:00	09/11/2019 12:00	09/11/2019 13:00	1,00	25	25,06	CHI
20191164878	GOIANESIA	GE11140955	GOIANESIA S2	08/11/2019 19:44	09/11/2019 16:55	08/11/2019 19:44	09/11/2019 16:55	21,17	135	2857,76	CHI
20191164913	APORE	AE12209682	ITAJA S2	08/11/2019 06:33	10/11/2019 20:48	08/11/2019 06:33	10/11/2019 20:48	62,25	10	622,49	CHI
20191164914	PORANGATU	TA12114216	NOVO PLANALTO	07/11/2019 09:16	09/11/2019 15:40	07/11/2019 09:16	09/11/2019 15:40	54,39	6	326,36	CHI
20191164918	AMARALINA	UP12294696	NOVA CRIXAS	08/11/2019 16:23	09/11/2019 11:23	08/11/2019 16:23	09/11/2019 11:23	18,99	31	588,61	CHI
20191164918	MARA ROSA	UP12294696	NOVA CRIXAS	08/11/2019 16:23	09/11/2019 11:23	08/11/2019 16:23	09/11/2019 11:23	18,99	27	512,66	CHI
20191164918	SANTA TEREZINHA DE GOIAS	UP12294696	NOVA CRIXAS	08/11/2019 16:23	09/11/2019 11:23	08/11/2019 16:23	09/11/2019 11:23	18,99	1	18,99	CHI
20191164918	UIRAPURU	UP12294696	NOVA CRIXAS	08/11/2019 16:23	09/11/2019 11:23	08/11/2019 16:23	09/11/2019 11:23	18,99	4	75,95	CHI
20191164928	PADRE BERNARDO	PB11275349	PADRE BERNARDO	08/11/2019 17:49	09/11/2019 13:05	08/11/2019 17:49	09/11/2019 13:05	19,25	1	19,25	CHI
20191164929	MONTIVIDIU DO NORTE	MX12203429	PORANGATU	08/11/2019 17:49	12/11/2019 21:35	08/11/2019 17:49	11/11/2019 13:22	67,54	23	1553,38	CHI
20191164929	MONTIVIDIU DO NORTE	MX12203429	PORANGATU	08/11/2019 17:49	12/11/2019 21:35	08/11/2019 17:49	12/11/2019 21:35	99,75	1	99,75	CHI

20191164930	MARZAGAO	MG11160492	VILA CORUMBA	08/11/2019 17:43	08/11/2019 23:01	08/11/2019 17:43	08/11/2019 23:01	5,30	85	450,17	CHI
20191164932	CRISTALINA	KR21246098	CRISTALINA S1	08/11/2019 17:50	09/11/2019 17:02	08/11/2019 17:50	09/11/2019 17:02	23,19	2	46,38	CHI
20191164944	FAZENDA NOVA	FN12292864	JUSSARA	08/11/2019 17:52	13/11/2019 08:00	08/11/2019 17:52	13/11/2019 08:00	110,13	2	220,26	CHI
20191164953	SANTA RITA DO NOVO DESTINO	BA21286935	BARRO ALTO	08/11/2019 17:53	11/11/2019 10:27	08/11/2019 17:53	11/11/2019 10:27	64,56	1	64,56	CHI
20191164957	MARA ROSA	MQ21080934	MARA ROSA	08/11/2019 17:54	08/11/2019 19:40	08/11/2019 17:54	08/11/2019 19:40	1,76	1	1,76	CHI
20191164958	TROMBAS	TB12202556	PORANGATU	08/11/2019 17:54	11/11/2019 10:49	08/11/2019 17:54	11/11/2019 10:49	64,91	2	129,81	CHI
20191164970	RIO VERDE	RV12111052	CABRIUVA S2	08/11/2019 17:55	09/11/2019 10:00	08/11/2019 17:55	08/11/2019 23:11	5,27	21	110,58	CHI
20191164970	RIO VERDE	RV12237206	CABRIUVA S2	08/11/2019 17:55	09/11/2019 10:00	08/11/2019 17:55	09/11/2019 10:00	16,08	4	64,31	CHI
20191164983	PADRE BERNARDO	PB12219600	PADRE BERNARDO	08/11/2019 16:27	08/11/2019 20:03	08/11/2019 16:27	08/11/2019 20:03	3,59	242	868,11	CHI
20191164997	CRISTALINA	KR12389576	CRISTALINA S2	08/11/2019 18:00	09/11/2019 09:44	08/11/2019 18:00	09/11/2019 09:44	15,73	5	78,65	CHI
20191165001	ALEXANIA	AX12302101	ALEXANIA	08/11/2019 17:59	08/11/2019 21:18	08/11/2019 17:59	08/11/2019 21:18	3,31	15	49,72	CHI
20191165004	PEROLANDIA	2370003863	JATAI S1	08/11/2019 18:01	09/11/2019 09:30	08/11/2019 18:01	09/11/2019 09:30	15,49	1	15,49	CHI
20191165009	CATALAO	1990159476	CATALAO S2	08/11/2019 18:02	09/11/2019 09:19	08/11/2019 18:02	09/11/2019 09:19	15,28	1	15,28	CHI
20191165011	PADRE BERNARDO	10006744816	PADRE BERNARDO	08/11/2019 18:02	08/11/2019 20:13	08/11/2019 18:02	08/11/2019 20:13	2,17	1	2,17	CHI
20191165020	RIO QUENTE	RQ21130672	VILA CORUMBA	08/11/2019 18:05	10/11/2019 17:05	08/11/2019 18:05	10/11/2019 17:05	47,00	1	47,00	CHI
20191165066	PADRE BERNARDO	10021563088	PADRE BERNARDO	08/11/2019 18:13	08/11/2019 21:05	08/11/2019 18:13	08/11/2019 21:05	2,86	1	2,86	CHI
20191165068	MINACU	IH11052601	MINACU	08/11/2019 17:45	08/11/2019 20:50	08/11/2019 17:45	08/11/2019 20:50	3,10	108	334,29	CHI
20191165087	LUZIANIA	LZ11128828	RIO VERMELHO	08/11/2019 18:17	09/11/2019 13:20	08/11/2019 18:17	09/11/2019 13:20	19,04	119	2265,20	CHI
20191165089	ANAPOLIS	10012113202	JUNDIAI S1	08/11/2019 18:17	08/11/2019 19:24	08/11/2019 18:17	08/11/2019 19:24	1,10	1	1,10	CHI
20191165096	QUIRINOPOLIS	QI12306209	QUIRINOPOLIS	08/11/2019 18:18	09/11/2019 11:09	08/11/2019 18:18	09/11/2019 11:09	16,84	1	16,84	CHI
20191165098	CRISTALINA	KR21168492	PAMPLONA	08/11/2019 18:18	09/11/2019 18:29	08/11/2019 18:18	09/11/2019 18:29	24,17	1	24,17	CHI
20191165106	CRISTALINA	KR12304869	CRISTALINA S2	08/11/2019 18:03	09/11/2019 09:47	08/11/2019 18:03	09/11/2019 09:47	15,73	15	235,95	CHI
20191165108	GOIANESIA	BA12163310	GOIANESIA S1	08/11/2019 18:02	09/11/2019 16:29	08/11/2019 18:02	09/11/2019 16:29	22,44	3	67,33	CHI
20191165108	VILA PROPICIO	BA12163310	GOIANESIA S1	08/11/2019 18:02	09/11/2019 16:29	08/11/2019 18:02	09/11/2019 16:29	22,44	11	246,88	CHI
20191165117	MAURILANDIA	ML12064391	RIO DOS BOIS	08/11/2019 18:21	12/11/2019 11:30	08/11/2019 18:21	12/11/2019 11:30	89,15	3	267,45	CHI
20191165120	ITAPIRAPUA	IU12209220	MATRINCHA	08/11/2019 15:50	12/11/2019 12:00	08/11/2019 15:50	12/11/2019 12:00	92,17	6	553,02	CHI
20191165121	RIO VERDE	RV12029165	CABRIUVA S2	08/11/2019 18:21	09/11/2019 18:10	08/11/2019 18:21	09/11/2019 15:24	21,04	34	715,28	CHI
20191165121	RIO VERDE	RV12029165	CABRIUVA S2	08/11/2019 18:21	09/11/2019 18:10	09/11/2019 16:52	09/11/2019 18:10	1,29	34	43,86	CHI
20191165135	GOIANAPOLIS	950006415	DAIA S2	08/11/2019 18:24	09/11/2019 11:37	08/11/2019 18:24	09/11/2019 11:37	17,23	1	17,23	CHI
20191165137	SAO MIGUEL DO ARAGUAIA	SM12099032	SAO MIGUEL DO ARAGUAIA	07/11/2019 11:06	07/11/2019 12:58	07/11/2019 11:06	07/11/2019 12:58	1,86	26	48,28	CHI
20191165139	CRISTALINA	KR11170148	CRISTALINA S1	08/11/2019 18:14	08/11/2019 19:46	08/11/2019 18:14	08/11/2019 19:46	1,53	135	206,29	CHI
20191165149	PADRE BERNARDO	PB12261500	PADRE BERNARDO	08/11/2019 16:31	09/11/2019 01:31	08/11/2019 16:31	09/11/2019 01:31	9,00	77	692,74	CHI
20191165155	PLANALTINA	PI12344175	SAO JOAO D ALIANCA	08/11/2019 16:47	09/11/2019 11:34	08/11/2019 16:47	09/11/2019 11:34	18,78	23	431,90	CHI

20191165162	BARRO ALTO	BA12381273LD	BARRO ALTO	08/11/2019 18:04	08/11/2019 20:46	08/11/2019 18:04	08/11/2019 20:46	2,71	113	306,10	CHI
20191165162	BARRO ALTO	BA12381273LD	BARRO ALTO	08/11/2019 18:04	08/11/2019 20:46	08/11/2019 19:23	08/11/2019 20:46	1,39	490	680,42	CHI
20191165170	NOVO BRASIL	FN12220513	JUSSARA	08/11/2019 18:31	13/11/2019 20:21	08/11/2019 18:31	13/11/2019 20:21	121,84	2	243,67	CHI
20191165171	CRISTALINA	KR12400532LD	CRISTALINA S1	08/11/2019 18:31	10/11/2019 19:00	08/11/2019 18:31	10/11/2019 19:00	48,47	1	48,47	CHI
20191165178	JARAGUA	70000773	JARAGUA	08/11/2019 18:32	08/11/2019 21:41	08/11/2019 18:32	08/11/2019 21:41	3,14	1	3,14	CHI
20191165182	ITUMBIARA	IT21190571	BOM JESUS DE GOIAS	07/11/2019 09:38	08/11/2019 22:18	07/11/2019 09:38	08/11/2019 22:18	36,65	1	36,65	CHI
20191165186	PADRE BERNARDO	PB12219601	PADRE BERNARDO	08/11/2019 16:31	08/11/2019 19:05	08/11/2019 16:31	08/11/2019 19:05	2,56	372	952,11	CHI
20191165187	CACHOEIRA ALTA	CA12338672	CACHOEIRA ALTA	08/11/2019 17:37	10/11/2019 14:26	08/11/2019 17:37	10/11/2019 14:26	44,81	5	224,03	CHI
20191165189	CATALAO	GD12127624RE	CATALAO S1	08/11/2019 12:21	09/11/2019 09:55	08/11/2019 12:21	09/11/2019 09:55	21,56	13	280,29	CHI
20191165189	GOIANDIRA	GD12127624RE	CATALAO S1	08/11/2019 12:21	09/11/2019 09:55	08/11/2019 12:21	09/11/2019 09:55	21,56	17	366,54	CHI
20191165189	IPAMERI	GD12127624RE	CATALAO S1	08/11/2019 12:21	09/11/2019 09:55	08/11/2019 12:21	09/11/2019 09:55	21,56	7	150,93	CHI
20191165193	SAO MIGUEL DO ARAGUAIA	SM12328098	SAO MIGUEL DO ARAGUAIA	08/11/2019 18:34	14/11/2019 02:40	08/11/2019 18:34	14/11/2019 02:40	128,09	1	128,09	CHI
20191165200	GUARAITA	GK21234053	ITAPURANGA	08/11/2019 18:36	11/11/2019 17:45	08/11/2019 18:36	11/11/2019 17:45	71,15	1	71,15	CHI
20191165201	ALEXANIA	AX12211853	ALEXANIA	08/11/2019 17:41	08/11/2019 19:37	08/11/2019 17:41	08/11/2019 19:37	1,92	85	163,39	CHI
20191165201	CORUMBA DE GOIAS	AX12211853	ALEXANIA	08/11/2019 17:41	08/11/2019 19:37	08/11/2019 17:41	08/11/2019 19:37	1,92	2	3,84	CHI
20191165201	SANTO ANTONIO DO DESCOBERTO	AX12211853	ALEXANIA	08/11/2019 17:41	08/11/2019 19:37	08/11/2019 17:41	08/11/2019 19:37	1,92	4	7,69	CHI
20191165205	ITARUMA	03700234	CACHOEIRA ALTA	08/11/2019 16:38	10/11/2019 14:40	08/11/2019 16:38	10/11/2019 10:47	42,14	40	1685,60	CHI
20191165205	ITARUMA	IM13303145	CACHOEIRA ALTA	08/11/2019 16:38	10/11/2019 14:40	08/11/2019 16:38	10/11/2019 13:33	44,91	27	1212,65	CHI
20191165205	ITAJA	IM12000105	CACHOEIRA ALTA	08/11/2019 16:38	10/11/2019 14:40	08/11/2019 16:38	10/11/2019 14:40	46,02	2	92,05	CHI
20191165205	ITARUMA	IM12000105	CACHOEIRA ALTA	08/11/2019 16:38	10/11/2019 14:40	08/11/2019 16:38	10/11/2019 14:40	46,02	4	184,09	CHI
20191165215	ANICUNS	AC21019290	ANICUNS	08/11/2019 18:38	08/11/2019 22:00	08/11/2019 18:38	08/11/2019 22:00	3,37	2	6,74	CHI
20191165221	CIDADE OCIDENTAL	2680166134	MARAJOARA	08/11/2019 18:39	08/11/2019 22:24	08/11/2019 18:39	08/11/2019 22:24	3,74	1	3,74	CHI
20191165224	URUACU	UR10400664	URUACU	08/11/2019 16:37	09/11/2019 01:44	08/11/2019 16:37	09/11/2019 01:44	9,11	213	1940,78	CHI
20191165231	VALPARAISO DE GOIAS	10004788646	PACAEMBU S2	08/11/2019 18:40	08/11/2019 21:35	08/11/2019 18:40	08/11/2019 21:35	2,91	1	2,91	CHI
20191165234	IPORA	IR12102605	IPORA	08/11/2019 18:41	09/11/2019 18:08	08/11/2019 18:41	09/11/2019 18:08	23,45	4	93,79	CHI
20191165238	ANAPOLIS	AN21341981	JUNDIAI S1	08/11/2019 18:42	08/11/2019 21:55	08/11/2019 18:42	08/11/2019 21:55	3,22	2	6,43	CHI
20191165241	AMARALINA	MH12362454	NOVA CRIXAS	08/11/2019 11:47	09/11/2019 08:47	08/11/2019 11:47	09/11/2019 08:47	20,99	1	20,99	CHI
20191165241	MUNDO NOVO DE GOIAS	MH12362454	NOVA CRIXAS	08/11/2019 11:47	09/11/2019 08:47	08/11/2019 11:47	09/11/2019 08:47	20,99	135	2834,03	CHI
20191165243	JATAI	JT21241733	JATAI S2	08/11/2019 18:34	09/11/2019 10:05	08/11/2019 18:34	09/11/2019 10:05	15,52	1	15,52	CHI
20191165253	CRISTALINA	KR11000017	CRISTALINA S1	08/11/2019 16:39	08/11/2019 20:02	08/11/2019 16:39	08/11/2019 20:02	3,37	55	185,23	CHI
20191165255	ESTRELA DO NORTE	SE12053814	MARA ROSA	08/11/2019 18:44	09/11/2019 13:12	08/11/2019 18:44	09/11/2019 13:12	18,46	3	55,37	CHI
20191165255	SANTA TEREZA DE GOIAS	SE12053814	MARA ROSA	08/11/2019 18:44	09/11/2019 13:12	08/11/2019 18:44	09/11/2019 13:12	18,46	5	92,29	CHI
20191165276	BALIZA	BH12331370	CAIAPONIA	08/11/2019 16:25	09/11/2019 10:45	08/11/2019 16:25	09/11/2019 10:45	18,32	13	238,21	CHI

20191165277	MINEIROS	MY12166286	CHAPADAO DO CEU	08/11/2019 18:46	09/11/2019 11:53	08/11/2019 18:46	09/11/2019 11:53	17,11	5	85,55	CHI
20191165277	SERRANOPOLIS	MY12166286	CHAPADAO DO CEU	08/11/2019 18:46	09/11/2019 11:53	08/11/2019 18:46	09/11/2019 11:53	17,11	10	171,11	CHI
20191165282	CRISTALINA	1060112532	CRISTALINA S1	08/11/2019 18:46	09/11/2019 05:17	08/11/2019 18:46	09/11/2019 05:17	10,50	1	10,50	CHI
20191165292	AMARALINA	LC21245302	MARA ROSA	08/11/2019 15:27	09/11/2019 09:46	08/11/2019 15:27	09/11/2019 09:46	18,31	1	18,31	CHI
20191165296	ITUMBIARA	BG12384546	ITUMBIARA VELHA S2	08/11/2019 18:37	09/11/2019 13:10	08/11/2019 18:37	09/11/2019 13:10	18,55	11	204,00	CHI
20191165297	QUIRINOPOLIS	80105865	QUIRINOPOLIS	08/11/2019 18:48	10/11/2019 12:47	08/11/2019 18:48	10/11/2019 12:47	41,97	1	41,97	CHI
20191165300	SANTO ANTONIO DA BARRA	BZ12301710	ACREUNA	08/11/2019 10:24	09/11/2019 09:55	08/11/2019 10:24	09/11/2019 09:55	23,51	5	117,54	CHI
20191165302	QUIRINOPOLIS	QI21360847	QUIRINOPOLIS	08/11/2019 18:49	09/11/2019 18:56	08/11/2019 18:49	09/11/2019 18:56	24,11	1	24,11	CHI
20191165303	CAMPOS VERDES	SG12202098	SANTA TEREZINHA	08/11/2019 17:33	08/11/2019 21:50	08/11/2019 17:33	08/11/2019 21:50	4,27	32	136,57	CHI
20191165303	SANTA TEREZINHA DE GOIAS	SG12202098	SANTA TEREZINHA	08/11/2019 17:33	08/11/2019 21:50	08/11/2019 17:33	08/11/2019 21:50	4,27	125	533,47	CHI
20191165303	UIRAPURU	SG12202098	SANTA TEREZINHA	08/11/2019 17:33	08/11/2019 21:50	08/11/2019 17:33	08/11/2019 21:50	4,27	56	239,00	CHI
20191165307	SANTO ANTONIO DO DESCOBERTO	SN11049933	ALEXANIA	08/11/2019 18:19	08/11/2019 20:54	08/11/2019 18:19	08/11/2019 20:54	2,57	217	557,03	CHI
20191165320	ANAPOLIS	20887413	JUNDIAI S1	08/11/2019 18:52	08/11/2019 20:27	08/11/2019 18:52	08/11/2019 20:27	1,58	1	1,58	CHI
20191165346	CEZARINA	CZ21358207	CEZARINA	08/11/2019 18:55	10/11/2019 11:05	08/11/2019 18:55	10/11/2019 11:05	40,17	2	80,34	CHI
20191165352	CRISTALINA	KR12101526	CRISTALINA S1	08/11/2019 18:56	10/11/2019 19:26	08/11/2019 18:56	09/11/2019 13:01	18,10	27	488,60	CHI
20191165352	LUZIANIA	KR12101526	CRISTALINA S1	08/11/2019 18:56	10/11/2019 19:26	08/11/2019 18:56	09/11/2019 13:01	18,10	1	18,10	CHI
20191165352	CRISTALINA	KR12168481	CRISTALINA S1	08/11/2019 18:56	10/11/2019 19:26	08/11/2019 18:56	10/11/2019 19:26	48,50	4	194,00	CHI
20191165354	LUZIANIA	10000197490	RIO VERMELHO	08/11/2019 18:56	08/11/2019 21:14	08/11/2019 18:56	08/11/2019 21:14	2,29	1	2,29	CHI
20191165358	SAO SIMAO	SO21360879	CACHOEIRA ALTA	08/11/2019 18:56	11/11/2019 11:22	08/11/2019 18:56	11/11/2019 11:22	64,42	1	64,42	CHI
20191165363	PADRE BERNARDO	PB11206722	PADRE BERNARDO	08/11/2019 18:43	09/11/2019 02:00	08/11/2019 18:43	09/11/2019 02:00	7,27	44	319,90	CHI
20191165373	ACREUNA	EU12271441	ACREUNA	08/11/2019 16:43	08/11/2019 20:27	08/11/2019 16:43	08/11/2019 20:27	3,72	266	989,82	CHI
20191165381	MONTIVIDIU DO NORTE	MX13334382	PORANGATU	08/11/2019 17:37	10/11/2019 02:30	09/11/2019 22:17	10/11/2019 02:02	3,76	112	420,72	CHI
20191165381	MONTIVIDIU DO NORTE	MX12192270	PORANGATU	08/11/2019 17:37	10/11/2019 02:30	08/11/2019 17:37	10/11/2019 02:30	32,88	104	3419,69	CHI
20191165386	JATAI	JT11036867	JATAI S2	08/11/2019 18:43	09/11/2019 02:23	08/11/2019 18:43	09/11/2019 02:23	7,66	83	635,50	CHI
20191165389	CAMPINORTE	10008598086	MARA ROSA	08/11/2019 19:01	09/11/2019 09:31	08/11/2019 19:01	09/11/2019 09:31	14,50	1	14,50	CHI
20191165409	JATAI	290004706	JATAI S2	08/11/2019 19:05	09/11/2019 11:34	08/11/2019 19:05	09/11/2019 11:34	16,48	1	16,48	CHI
20191165410	SAO MIGUEL DO ARAGUAIA	830050309	SAO MIGUEL DO ARAGUAIA	08/11/2019 19:05	10/11/2019 11:56	08/11/2019 19:05	10/11/2019 11:56	40,84	1	40,84	CHI
20191165412	ITUMBIARA	10010539997	ITUMBIARA NOVA	08/11/2019 19:06	10/11/2019 09:20	08/11/2019 19:06	10/11/2019 09:20	38,24	1	38,24	CHI
20191165413	URUACU	UR21190082	URUACU	08/11/2019 19:06	09/11/2019 11:19	08/11/2019 19:06	09/11/2019 11:19	16,22	1	16,22	CHI
20191165415	AGUAS LINDAS DE GOIAS	LA12379439	AGUAS LINDAS DE GOIAS S2	08/11/2019 19:06	08/11/2019 21:06	08/11/2019 19:06	08/11/2019 21:06	2,00	3	6,01	CHI
20191165419	CAMPINORTE	UR12243278	MARA ROSA	08/11/2019 17:42	09/11/2019 00:08	08/11/2019 17:42	09/11/2019 00:08	6,42	7	44,95	CHI
20191165419	URUACU	UR12243278	MARA ROSA	08/11/2019 17:42	09/11/2019 00:08	08/11/2019 17:42	09/11/2019 00:08	6,42	15	96,32	CHI
20191165424	SANTA HELENA DE GOIAS	SH11000018	IPEGUARI	09/11/2019 08:54	09/11/2019 10:15	09/11/2019 08:54	09/11/2019 10:15	1,35	101	136,38	CHI

20191165433	QUIRINOPOLIS	QI12370080	QUIRINOPOLIS	08/11/2019 13:57	09/11/2019 10:35	08/11/2019 13:57	09/11/2019 10:35	20,63	2	41,25	CHI
20191165436	SAO LUIS DE MONTES BELOS	SL12003948	SAO LUIZ DOS MONTES BELOS	08/11/2019 19:03	08/11/2019 20:33	08/11/2019 19:03	08/11/2019 20:33	1,51	588	885,59	CHI
20191165438	CIDADE OCIDENTAL	DH11169044	MARAJOARA	08/11/2019 18:47	08/11/2019 20:50	08/11/2019 18:47	08/11/2019 20:50	2,05	205	419,45	CHI
20191165451	ITABERAI	IB12250751	ITABERAI S1	08/11/2019 19:12	09/11/2019 09:23	08/11/2019 19:12	09/11/2019 09:23	14,18	8	113,41	CHI
20191165456	RIO VERDE	630576944	RIO VERDE S2	08/11/2019 19:13	09/11/2019 16:01	08/11/2019 19:13	09/11/2019 16:01	20,79	1	20,79	CHI
20191165470	CIDADE OCIDENTAL	DH11199627	MARAJOARA	08/11/2019 18:45	08/11/2019 20:38	08/11/2019 18:45	08/11/2019 20:38	1,87	11	20,60	CHI
20191165491	PORANGATU	PO12320999	PORANGATU	09/11/2019 07:06	09/11/2019 18:38	09/11/2019 07:06	09/11/2019 18:38	11,53	6	69,20	CHI
20191165502	CAMPINACU	UC12265668	PORANGATU	08/11/2019 15:13	09/11/2019 11:51	08/11/2019 15:13	09/11/2019 11:51	20,63	4	82,53	CHI
20191165508	MARA ROSA	2260023582	MARA ROSA	08/11/2019 13:21	09/11/2019 09:57	08/11/2019 13:21	09/11/2019 09:57	20,59	1	20,59	CHI
20191165524	SILVANIA	SV21138870	DAIA S2	08/11/2019 19:24	09/11/2019 16:02	08/11/2019 19:24	09/11/2019 16:02	20,63	2	41,26	CHI
20191165527	GOIANESIA	GE21366648	GOIANESIA S1	08/11/2019 19:24	09/11/2019 03:45	08/11/2019 19:24	09/11/2019 03:45	8,34	1	8,34	CHI
20191165530	FORMOSO	FO11222829	PORANGATU	08/11/2019 17:24	08/11/2019 21:04	08/11/2019 17:24	08/11/2019 21:04	3,65	93	339,81	CHI
20191165533	MARA ROSA	MQ12117969	MARA ROSA	08/11/2019 18:56	09/11/2019 18:30	08/11/2019 18:56	09/11/2019 18:30	23,55	31	730,16	CHI
20191165535	GOIANESIA	GE11098869	GOIANESIA S2	08/11/2019 19:10	09/11/2019 04:28	08/11/2019 19:10	09/11/2019 04:28	9,29	129	1198,16	CHI
20191165538	GOIANESIA	GE11064344	GOIANESIA S2	08/11/2019 19:25	09/11/2019 15:50	08/11/2019 19:25	09/11/2019 15:50	20,41	6	122,47	CHI
20191165540	PONTALINA	PK21109367	PONTALINA	08/11/2019 19:25	11/11/2019 17:08	08/11/2019 19:25	11/11/2019 17:08	69,71	1	69,71	CHI
20191165541	CRISTALINA	1060085991	CRISTALINA S1	08/11/2019 19:25	08/11/2019 20:32	08/11/2019 19:25	08/11/2019 20:32	1,11	1	1,11	CHI
20191165543	GOIATUBA	GT21000218	GOIATUBA S2	08/11/2019 19:25	12/11/2019 10:26	08/11/2019 19:25	12/11/2019 10:26	87,01	1	87,01	CHI
20191165577	QUIRINOPOLIS	QI21036056	QUIRINOPOLIS	08/11/2019 19:30	09/11/2019 10:47	08/11/2019 19:30	09/11/2019 10:47	15,28	1	15,28	CHI
20191165584	GOIANESIA	GE11032114	GOIANESIA S2	08/11/2019 19:20	09/11/2019 23:13	08/11/2019 19:20	09/11/2019 23:13	27,88	167	4655,26	CHI
20191165595	SAO MIGUEL DO ARAGUAIA	SM10391487	SAO MIGUEL DO ARAGUAIA	08/11/2019 18:54	09/11/2019 04:09	08/11/2019 18:54	09/11/2019 04:09	9,24	57	526,84	CHI
20191165598	PORANGATU	PO12052521	PORANGATU	08/11/2019 19:34	09/11/2019 14:07	08/11/2019 19:34	09/11/2019 14:07	18,55	4	74,22	CHI
20191165605	GOIANESIA	GE11000004	GOIANESIA S2	08/11/2019 18:55	10/11/2019 11:54	08/11/2019 18:55	10/11/2019 11:54	40,98	166	6802,40	CHI
20191165609	PORANGATU	PO12056115	PORANGATU	08/11/2019 15:12	09/11/2019 03:43	08/11/2019 15:12	09/11/2019 03:43	12,51	15	187,58	CHI
20191165610	GOIANESIA	GE12000030	GOIANESIA S2	08/11/2019 19:13	10/11/2019 09:22	08/11/2019 19:13	10/11/2019 09:22	38,15	13	495,94	CHI
20191165617	RIO VERDE	630489956	RIO VERDE S2	08/11/2019 19:36	09/11/2019 15:15	08/11/2019 19:36	09/11/2019 15:15	19,65	1	19,65	CHI
20191165630	JANDAIA	EU12000110	ACREUNA	08/11/2019 13:38	08/11/2019 21:47	08/11/2019 13:38	08/11/2019 21:47	8,15	1	8,15	CHI
20191165630	PARAUNA	EU12000110	ACREUNA	08/11/2019 13:38	08/11/2019 21:47	08/11/2019 13:38	08/11/2019 21:47	8,15	11	89,62	CHI
20191165647	LUZIANIA	120225890	RIO VERMELHO	08/11/2019 19:40	08/11/2019 21:49	08/11/2019 19:40	08/11/2019 21:49	2,15	1	2,15	CHI
20191165649	NOVA CRIXAS	NA21057232	MOZARLANDIA	08/11/2019 19:40	11/11/2019 18:45	08/11/2019 19:40	11/11/2019 18:45	71,08	1	71,08	CHI
20191165666	SAO MIGUEL DO ARAGUAIA	830039843	SAO MIGUEL DO ARAGUAIA	08/11/2019 19:42	10/11/2019 11:03	08/11/2019 19:42	10/11/2019 11:03	39,34	1	39,34	CHI
20191165677	ABADIANIA	8336574	ANAPOLIS UNIVERSITARIO S1	08/11/2019 19:37	09/11/2019 16:59	08/11/2019 19:37	09/11/2019 11:51	16,24	11	178,62	CHI
20191165677	ABADIANIA	AA12258351	DAIA S2	08/11/2019 19:37	09/11/2019 16:59	08/11/2019 19:37	09/11/2019 16:59	21,35	23	491,06	CHI

20191165679	GOIANESIA	GE11132573	GOIANESIA S2	08/11/2019 19:27	10/11/2019 08:46	08/11/2019 19:27	10/11/2019 08:46	37,30	65	2424,81	CHI
20191165686	GOIANESIA	GE12297424	GOIANESIA S1	08/11/2019 19:46	09/11/2019 17:07	08/11/2019 19:46	09/11/2019 17:07	21,34	1	21,34	CHI
20191165697	CUMARI	CY21165169	CATALAO S1	08/11/2019 19:48	10/11/2019 17:04	08/11/2019 19:48	10/11/2019 17:04	45,26	1	45,26	CHI
20191165699	GOIANESIA	GE12381275	GOIANESIA S2	08/11/2019 19:48	09/11/2019 08:34	08/11/2019 19:48	09/11/2019 08:34	12,77	173	2208,35	CHI
20191165711	LUZIANIA	3200048837	RIO VERMELHO	08/11/2019 19:50	08/11/2019 22:32	08/11/2019 19:50	08/11/2019 22:32	2,69	1	2,69	CHI
20191165727	CACU	CC12196048	CACHOEIRA ALTA	08/11/2019 19:53	14/11/2019 12:40	08/11/2019 19:53	11/11/2019 11:08	63,26	19	1201,91	CHI
20191165727	CACU	CC12196048	CACHOEIRA ALTA	08/11/2019 19:53	14/11/2019 12:40	11/11/2019 11:09	13/11/2019 14:13	51,08	12	612,99	CHI
20191165727	CACU	CC12260993	CACHOEIRA ALTA	08/11/2019 19:53	14/11/2019 12:40	11/11/2019 11:09	14/11/2019 12:40	73,52	7	514,62	CHI
20191165728	CIDADE OCIDENTAL	DH12261352	MARAJOARA	08/11/2019 18:48	08/11/2019 22:12	08/11/2019 18:48	08/11/2019 22:12	3,40	18	61,14	CHI
20191165736	ANAPOLIS	20500117	ANAPOLIS UNIVERSITARIO S2	08/11/2019 18:47	09/11/2019 08:00	08/11/2019 18:47	09/11/2019 08:00	13,21	1	13,21	CHI
20191165738	GOIANESIA	550179800	GOIANESIA S2	08/11/2019 19:54	09/11/2019 15:12	08/11/2019 19:54	09/11/2019 15:12	19,30	1	19,30	CHI
20191165759	CIDADE OCIDENTAL	10004806733	MARAJOARA	08/11/2019 19:56	09/11/2019 04:11	08/11/2019 19:56	09/11/2019 04:11	8,23	1	8,23	CHI
20191165774	BRITANIA	BT12183232	BRITANIA	08/11/2019 19:59	14/11/2019 07:25	08/11/2019 19:59	14/11/2019 07:25	131,42	5	657,11	CHI
20191165790	CACHOEIRA ALTA	CA12338614	CACHOEIRA ALTA	08/11/2019 17:38	10/11/2019 14:55	08/11/2019 17:38	10/11/2019 14:55	45,27	5	226,35	CHI
20191165793	CIDADE OCIDENTAL	DH12370609	MARAJOARA	08/11/2019 20:02	09/11/2019 12:27	08/11/2019 20:02	09/11/2019 00:46	4,73	22	104,01	CHI
20191165793	CIDADE OCIDENTAL	DH12370609	MARAJOARA	08/11/2019 20:02	09/11/2019 12:27	09/11/2019 01:16	09/11/2019 12:27	11,18	22	245,87	CHI
20191165794	INACIOLANDIA	ID31128268	QUIRINOPOLIS	08/11/2019 20:02	10/11/2019 14:29	08/11/2019 20:02	10/11/2019 14:29	42,44	2	84,88	CHI
20191165795	MORRINHOS	MR12153783	MORRINHOS	08/11/2019 17:36	08/11/2019 21:30	08/11/2019 17:36	08/11/2019 21:30	3,88	7	27,19	CHI
20191165796	RIO VERDE	630039604	RIO VERDE S1	08/11/2019 20:02	09/11/2019 09:50	08/11/2019 20:02	09/11/2019 09:50	13,79	1	13,79	CHI
20191165803	GOIANESIA	GE11000066	GOIANESIA S2	08/11/2019 20:03	09/11/2019 05:11	08/11/2019 20:03	09/11/2019 05:11	9,13	48	438,07	CHI
20191165805	GOIANESIA	GE12258295	GOIANESIA S2	08/11/2019 19:07	08/11/2019 22:41	08/11/2019 19:07	08/11/2019 22:41	3,56	345	1229,45	CHI
20191165806	GOIANESIA	GE11000002	GOIANESIA S2	08/11/2019 19:36	09/11/2019 02:41	08/11/2019 19:36	09/11/2019 02:41	7,07	127	898,38	CHI
20191165813	GOIANESIA	GE11055053	GOIANESIA S2	08/11/2019 19:41	09/11/2019 12:03	08/11/2019 19:41	09/11/2019 12:03	16,35	67	1095,62	CHI
20191165847	GOIANESIA	GE11091173	GOIANESIA S2	08/11/2019 20:00	09/11/2019 03:10	08/11/2019 20:00	09/11/2019 03:10	7,15	176	1258,74	CHI
20191165869	ITABERAI	50038734	ITABERAI S2	08/11/2019 20:15	09/11/2019 08:28	08/11/2019 20:15	09/11/2019 08:28	12,21	1	12,21	CHI
20191165871	GOIANESIA	550073760	GOIANESIA S2	08/11/2019 20:17	09/11/2019 16:14	08/11/2019 20:17	09/11/2019 16:14	19,95	1	19,95	CHI
20191165876	CATALAO	CT12394021	CATALAO S1	08/11/2019 10:16	09/11/2019 09:37	08/11/2019 10:16	09/11/2019 09:37	23,34	6	140,04	CHI
20191165876	DAVINOPOLIS	CT12394021	CATALAO S1	08/11/2019 10:16	09/11/2019 09:37	08/11/2019 10:16	09/11/2019 09:37	23,34	4	93,36	CHI
20191165888	ANICUNIS	AC21304595	FIRMINOPOLIS S2	08/11/2019 20:20	09/11/2019 08:15	08/11/2019 20:20	09/11/2019 08:15	11,92	1	11,92	CHI
20191165891	CACHOEIRA ALTA	1090025832	CACHOEIRA ALTA	08/11/2019 20:20	13/11/2019 09:57	08/11/2019 20:20	13/11/2019 09:57	109,60	1	109,60	CHI
20191165893	PEROLANDIA	2370003097	JATAI S1	08/11/2019 20:21	09/11/2019 09:57	08/11/2019 20:21	09/11/2019 09:57	13,60	1	13,60	CHI
20191165902	CRIXAS	RB12039306	RUBIATABA	08/11/2019 20:22	13/11/2019 11:11	08/11/2019 20:22	13/11/2019 11:11	110,80	1	110,80	CHI
20191165906	JATAI	10024502969	JATAI S3	08/11/2019 20:23	09/11/2019 11:15	08/11/2019 20:23	09/11/2019 11:15	14,87	1	14,87	CHI

20191165914	GOIANESIA	GE11140938	GOIANESIA S2	08/11/2019 19:58	09/11/2019 04:20	08/11/2019 19:58	09/11/2019 04:20	8,37	135	1129,46	CHI
20191165936	GOIANESIA	GE11215140	GOIANESIA S2	08/11/2019 19:49	09/11/2019 08:56	08/11/2019 19:49	09/11/2019 08:56	13,11	111	1454,75	CHI
20191165946	IPORA	IR12062914	IPORA	08/11/2019 20:29	10/11/2019 19:35	08/11/2019 20:29	10/11/2019 19:35	47,09	2	94,18	CHI
20191165948	GOIANESIA	GE13401970	GOIANESIA S2	09/11/2019 07:35	09/11/2019 15:05	09/11/2019 07:35	09/11/2019 15:05	7,51	501	3763,62	CHI
20191165948	GOIANESIA	GE13401970	GOIANESIA S2	09/11/2019 07:35	09/11/2019 15:05	09/11/2019 14:47	09/11/2019 15:05	0,31	152	46,99	CHI
20191165966	URUACU	640058450	URUACU	08/11/2019 20:34	09/11/2019 02:07	08/11/2019 20:34	09/11/2019 02:07	5,55	1	5,55	CHI
20191165971	ITAPIRAPUA	IU11070527	MATRINCHA	08/11/2019 20:23	09/11/2019 19:57	08/11/2019 20:23	09/11/2019 19:57	23,57	121	2851,57	CHI
20191165973	GOIANESIA	GE11040928	GOIANESIA S2	08/11/2019 19:13	09/11/2019 09:25	08/11/2019 19:13	09/11/2019 09:25	14,19	107	1517,88	CHI
20191165979	GOIANESIA	GE11000009	GOIANESIA S2	08/11/2019 19:29	09/11/2019 11:00	08/11/2019 19:29	09/11/2019 11:00	15,52	107	1660,28	CHI
20191165987	RIO VERDE	RV12306400	CABRIUVA S2	08/11/2019 20:23	09/11/2019 11:24	08/11/2019 20:23	09/11/2019 11:24	15,01	6	90,07	CHI
20191165992	LUZIANIA	LZ12376133	MARAJOARA	08/11/2019 19:55	08/11/2019 23:39	08/11/2019 19:55	08/11/2019 23:39	3,72	437	1625,88	CHI
20191165996	JATAI	JT21104678	JATAI S1	08/11/2019 20:43	09/11/2019 10:21	08/11/2019 20:43	09/11/2019 10:21	13,63	1	13,63	CHI
20191165997	CIDADE OCIDENTAL	DH11128795	MARAJOARA	08/11/2019 20:11	08/11/2019 22:22	08/11/2019 20:11	08/11/2019 22:22	2,18	92	200,33	CHI
20191166008	ANAPOLIS	20932819	JUNDIAI S1	08/11/2019 20:45	08/11/2019 23:55	08/11/2019 20:45	08/11/2019 23:55	3,16	1	3,16	CHI
20191166021	JATAI	JT21348480	JATAI S1	08/11/2019 20:51	09/11/2019 06:45	08/11/2019 20:51	09/11/2019 06:45	9,90	1	9,90	CHI
20191166031	GOIANESIA	550138596	GOIANESIA S2	08/11/2019 20:53	09/11/2019 05:10	08/11/2019 20:53	09/11/2019 05:10	8,28	1	8,28	CHI
20191166034	SERRANOPOLIS	SX12166103	JATAI S1	08/11/2019 20:53	11/11/2019 17:06	08/11/2019 20:53	11/11/2019 17:06	68,20	5	341,02	CHI
20191166042	PALMINOPOLIS	PP12307033	PALMEIRAS	08/11/2019 20:56	09/11/2019 01:43	08/11/2019 20:56	09/11/2019 01:43	4,78	2	9,57	CHI
20191166047	VALPARAISO DE GOIAS	VA11169029	PACAEMBU S2	08/11/2019 20:55	08/11/2019 22:09	08/11/2019 20:55	08/11/2019 22:09	1,23	273	335,64	CHI
20191166050	RIO VERDE	RV21403309	CABRIUVA S2	08/11/2019 20:58	09/11/2019 17:59	08/11/2019 20:58	09/11/2019 17:59	21,01	1	21,01	CHI
20191166056	GOIANESIA	550024347	GOIANESIA S2	08/11/2019 20:59	09/11/2019 14:33	08/11/2019 20:59	09/11/2019 14:33	17,56	1	17,56	CHI
20191166068	CAMPO ALEGRE DE GOIAS	CM21155543	CAMPO ALEGRE DE GOIAS	08/11/2019 21:03	09/11/2019 13:37	08/11/2019 21:03	09/11/2019 13:37	16,56	1	16,56	CHI
20191166070	RIO VERDE	630209236	RIO VERDE S1	08/11/2019 21:03	09/11/2019 18:30	08/11/2019 21:03	09/11/2019 18:30	21,45	1	21,45	CHI
20191166079	PORANGATU	PO11349927	MARA ROSA	08/11/2019 21:06	12/11/2019 02:03	08/11/2019 21:06	12/11/2019 02:03	76,94	1	76,94	CHI
20191166084	CIDADE OCIDENTAL	DH21255590	MARAJOARA	08/11/2019 20:02	09/11/2019 18:26	08/11/2019 20:02	09/11/2019 18:26	22,40	1	22,40	CHI
20191166115	MINACU	IH21134483	MINACU	08/11/2019 13:04	09/11/2019 03:53	08/11/2019 13:04	09/11/2019 03:53	14,81	1	14,81	CHI
20191166130	SAO MIGUEL DO ARAGUAIA	830021991	SAO MIGUEL DO ARAGUAIA	08/11/2019 21:22	10/11/2019 11:06	08/11/2019 21:22	10/11/2019 11:06	37,74	1	37,74	CHI
20191166137	CAVALCANTE	CJ12308272	MINACU	08/11/2019 17:06	09/11/2019 14:18	08/11/2019 17:06	09/11/2019 14:18	21,19	12	254,22	CHI
20191166140	CATALAO	CT11333375	CATALAO S2	08/11/2019 21:19	09/11/2019 03:23	08/11/2019 21:19	09/11/2019 03:23	6,06	118	714,88	CHI
20191166155	CACHOEIRA ALTA	CA12200649	CACHOEIRA ALTA	08/11/2019 14:45	10/11/2019 15:23	08/11/2019 14:45	10/11/2019 15:23	48,63	2	97,26	CHI
20191166175	GOIANESIA	GE11058404	GOIANESIA S2	08/11/2019 19:33	09/11/2019 07:22	08/11/2019 19:33	09/11/2019 07:22	11,80	158	1864,75	CHI
20191166187	GOIANESIA	GE12273355	GOIANESIA S2	08/11/2019 19:24	09/11/2019 02:21	08/11/2019 19:24	09/11/2019 02:21	6,94	183	1269,72	CHI
20191166205	VALPARAISO DE GOIAS	10007224190	PACAEMBU S1	08/11/2019 21:52	08/11/2019 23:18	08/11/2019 21:52	08/11/2019 23:18	1,43	1	1,43	CHI

20191166208	CIDADE OCIDENTAL	2680064362	MARAJOARA	08/11/2019 21:54	09/11/2019 03:41	08/11/2019 21:54	09/11/2019 03:41	5,78	1	5,78	CHI
20191166209	MINEIROS	SU12184133	SANTA RITA DO ARAGUAIA	08/11/2019 21:54	12/11/2019 04:08	08/11/2019 21:54	10/11/2019 13:06	39,21	3	117,62	CHI
20191166209	SANTA RITA DO ARAGUAIA	SU12184133	SANTA RITA DO ARAGUAIA	08/11/2019 21:54	12/11/2019 04:08	08/11/2019 21:54	10/11/2019 13:06	39,21	2	78,41	CHI
20191166209	MINEIROS	SU12184133	SANTA RITA DO ARAGUAIA	08/11/2019 21:54	12/11/2019 04:08	11/11/2019 00:14	11/11/2019 01:17	1,04	3	3,11	CHI
20191166209	SANTA RITA DO ARAGUAIA	SU12184133	SANTA RITA DO ARAGUAIA	08/11/2019 21:54	12/11/2019 04:08	11/11/2019 00:14	11/11/2019 01:17	1,04	2	2,07	CHI
20191166209	MINEIROS	MY13336957	SANTA RITA DO ARAGUAIA	08/11/2019 21:54	12/11/2019 04:08	08/11/2019 21:54	11/11/2019 12:59	63,08	2	126,17	CHI
20191166209	MINEIROS	MY13336957	SANTA RITA DO ARAGUAIA	08/11/2019 21:54	12/11/2019 04:08	08/11/2019 21:54	12/11/2019 04:08	78,24	6	469,42	CHI
20191166209	SANTA RITA DO ARAGUAIA	MY13336957	SANTA RITA DO ARAGUAIA	08/11/2019 21:54	12/11/2019 04:08	08/11/2019 21:54	12/11/2019 04:08	78,24	21	1642,96	CHI
20191166209	MINEIROS	MY13336957	SANTA RITA DO ARAGUAIA	08/11/2019 21:54	12/11/2019 04:08	12/11/2019 02:28	12/11/2019 04:08	1,68	2	3,35	CHI
20191166210	GOIANESIA	GE13382802	GOIANESIA S2	08/11/2019 19:09	09/11/2019 01:33	08/11/2019 19:09	09/11/2019 01:33	6,40	2178	13935,57	CHI
20191166218	MONTIVIDIU DO NORTE	MX12192265	PORANGATU	08/11/2019 17:06	09/11/2019 01:45	08/11/2019 17:06	09/11/2019 01:45	8,65	63	544,85	CHI
20191166225	SAO MIGUEL DO ARAGUAIA	SM11038964	SAO MIGUEL DO ARAGUAIA	08/11/2019 19:16	09/11/2019 10:30	08/11/2019 19:16	09/11/2019 10:30	15,23	179	2725,28	CHI
20191166233	MINEIROS	PW12219564	PARQUE DAS EMAS	08/11/2019 20:26	09/11/2019 10:53	08/11/2019 20:26	09/11/2019 10:53	14,44	7	101,10	CHI
20191166233	PORTELANDIA	PW12219564	PARQUE DAS EMAS	08/11/2019 20:26	09/11/2019 10:53	08/11/2019 20:26	09/11/2019 10:53	14,44	12	173,31	CHI
20191166238	GOIANESIA	GE11171631	GOIANESIA S2	08/11/2019 20:11	09/11/2019 10:56	08/11/2019 20:11	09/11/2019 10:56	14,75	53	781,72	CHI
20191166242	CATALAO	CT11306738	CATALAO S2	08/11/2019 20:42	09/11/2019 05:04	08/11/2019 20:42	09/11/2019 05:04	8,37	53	443,36	CHI
20191166248	PARAUNA	PU12007910	PARAUNA	08/11/2019 22:10	09/11/2019 08:50	08/11/2019 22:10	09/11/2019 08:50	10,67	3	32,01	CHI
20191166262	CATALAO	CT12077318	CATALAO S2	08/11/2019 21:42	09/11/2019 03:59	08/11/2019 21:42	09/11/2019 03:59	6,28	164	1029,28	CHI
20191166269	CATALAO	10008270455	CATALAO S2	08/11/2019 22:23	09/11/2019 10:03	08/11/2019 22:23	09/11/2019 10:03	11,67	1	11,67	CHI
20191166287	GOIANESIA	GE11185433	GOIANESIA S2	08/11/2019 20:25	09/11/2019 08:30	08/11/2019 20:25	09/11/2019 08:30	12,08	130	1570,33	CHI
20191166288	GOIANESIA	GE11040823	GOIANESIA S2	08/11/2019 20:01	09/11/2019 08:59	08/11/2019 20:01	09/11/2019 08:59	12,95	152	1969,03	CHI
20191166292	GOIANESIA	GE11171628	GOIANESIA S2	08/11/2019 19:44	09/11/2019 13:45	08/11/2019 19:44	09/11/2019 13:45	18,01	74	1332,64	CHI
20191166298	ALEXANIA	AX11129330	ALEXANIA	08/11/2019 22:26	09/11/2019 07:19	08/11/2019 22:26	09/11/2019 07:19	8,87	89	789,43	CHI
20191166321	MORRINHOS	MR21066314	MORRINHOS	08/11/2019 22:47	10/11/2019 09:39	08/11/2019 22:47	10/11/2019 09:39	34,86	1	34,86	CHI
20191166326	RUBIATABA	RB12246313	RUBIATABA	08/11/2019 22:34	09/11/2019 02:15	08/11/2019 22:34	09/11/2019 02:15	3,67	427	1568,63	CHI
20191166333	CALDAS NOVAS	760112241	CALDAS NOVAS S1	08/11/2019 22:55	09/11/2019 11:50	08/11/2019 22:55	09/11/2019 11:50	12,92	1	12,92	CHI
20191166336	GOIANESIA	GE11000012	GOIANESIA S2	08/11/2019 21:36	09/11/2019 09:48	08/11/2019 21:36	09/11/2019 09:48	12,20	64	780,80	CHI
20191166339	GOIANESIA	GE11211800	GOIANESIA S2	08/11/2019 20:06	09/11/2019 02:11	08/11/2019 20:06	09/11/2019 02:11	6,07	70	425,23	CHI
20191166363	MOZARLANDIA	MZ11273493	MOZARLANDIA	08/11/2019 22:46	09/11/2019 18:59	08/11/2019 22:46	09/11/2019 18:59	20,21	179	3617,24	CHI
20191166397	SAO MIGUEL DO ARAGUAIA	SM11217904	SAO MIGUEL DO ARAGUAIA	08/11/2019 21:14	09/11/2019 08:04	08/11/2019 21:14	09/11/2019 08:04	10,82	166	1796,77	CHI
20191166399	SAO MIGUEL DO ARAGUAIA	SM11292376	SAO MIGUEL DO ARAGUAIA	08/11/2019 21:38	09/11/2019 09:52	08/11/2019 21:38	09/11/2019 09:52	12,22	40	488,78	CHI
20191166404	GOIANESIA	GE11259018	GOIANESIA S2	08/11/2019 23:40	09/11/2019 20:57	08/11/2019 23:40	09/11/2019 20:57	21,28	41	872,58	CHI
20191166405	GOIANESIA	GE11000027	GOIANESIA S2	08/11/2019 19:11	09/11/2019 11:21	08/11/2019 19:11	09/11/2019 11:21	16,16	71	1147,04	CHI

20191166408	CATALAO	CT21164155	CATALAO S2	08/11/2019 23:43	09/11/2019 10:32	08/11/2019 23:43	09/11/2019 10:32	10,80	1	10,80	CHI
20191166412	GOIANESIA	10015902860	GOIANESIA S2	08/11/2019 23:52	10/11/2019 14:41	08/11/2019 23:52	10/11/2019 14:41	38,82	1	38,82	CHI
20191166413	NOVA GLORIA	NG21221737	ITAPACI	08/11/2019 23:56	11/11/2019 08:49	08/11/2019 23:56	11/11/2019 08:49	56,87	1	56,87	CHI
20191166425	MINACU	IH21242181	MINACU	08/11/2019 07:33	09/11/2019 01:53	08/11/2019 07:33	09/11/2019 01:53	18,32	1	18,32	CHI
20191166433	NOVA CRIXAS	NA12057214	MOZARLANDIA	09/11/2019 00:35	10/11/2019 09:45	09/11/2019 00:35	10/11/2019 09:45	33,16	5	165,78	CHI
20191166434	RUBIATABA	RB12070858	RUBIATABA	09/11/2019 00:36	09/11/2019 22:40	09/11/2019 00:36	09/11/2019 22:40	22,06	37	816,14	CHI
20191166438	ARAGARCAS	AG12138460	ARAGARCAS	08/11/2019 06:12	09/11/2019 08:32	08/11/2019 06:12	09/11/2019 08:32	26,33	13	342,25	CHI
20191166468	GOIANESIA	GE11272012	GOIANESIA S2	08/11/2019 22:45	09/11/2019 10:06	08/11/2019 22:45	09/11/2019 10:06	11,34	43	487,45	CHI
20191166488	GOIANESIA	GE11184432	GOIANESIA S2	08/11/2019 20:05	09/11/2019 03:42	08/11/2019 20:05	09/11/2019 03:42	7,61	165	1255,51	CHI
20191166491	CORREGO DO OURO	1070009389	FIRMINOPOLIS S2	09/11/2019 03:17	09/11/2019 15:33	09/11/2019 03:17	09/11/2019 15:33	12,26	1	12,26	CHI
20191166497	JANDAIA	PL13000002	PALMEIRAS	09/11/2019 03:21	09/11/2019 10:38	09/11/2019 03:21	09/11/2019 10:38	7,29	1	7,29	CHI
20191166497	PALMEIRAS DE GOIAS	PL13000002	PALMEIRAS	09/11/2019 03:21	09/11/2019 10:38	09/11/2019 03:21	09/11/2019 10:38	7,29	4949	36076,84	CHI
20191166497	PALMEIRAS DE GOIAS	PL13000002	PALMEIRAS	09/11/2019 03:21	09/11/2019 10:38	09/11/2019 10:17	09/11/2019 10:38	0,36	80	28,62	CHI
20191166512	PORANGATU	PO12139169	PORANGATU	09/11/2019 03:44	09/11/2019 09:44	09/11/2019 03:44	09/11/2019 09:44	6,00	103	617,57	CHI
20191166537	GOIANDIRA	GD21077532	CATALAO S2	09/11/2019 04:19	09/11/2019 10:50	09/11/2019 04:19	09/11/2019 10:50	6,50	1	6,50	CHI
20191166542	AMERICANO DO BRASIL	AC12314939	ANICUNS	09/11/2019 04:35	09/11/2019 08:57	09/11/2019 04:35	09/11/2019 08:57	4,35	6	26,12	CHI
20191166542	ANICUNS	AC12314939	ANICUNS	09/11/2019 04:35	09/11/2019 08:57	09/11/2019 04:35	09/11/2019 08:57	4,35	120	522,40	CHI
20191166542	ITABERAÍ	AC12314939	ANICUNS	09/11/2019 04:35	09/11/2019 08:57	09/11/2019 04:35	09/11/2019 08:57	4,35	2	8,71	CHI
20191166554	PETROLINA DE GOIAS	PG12216919	PETROLINA	09/11/2019 03:53	09/11/2019 10:12	09/11/2019 03:53	09/11/2019 10:12	6,32	8	50,55	CHI
20191166554	SAO FRANCISCO DE GOIAS	PG12216919	PETROLINA	09/11/2019 03:53	09/11/2019 10:12	09/11/2019 03:53	09/11/2019 10:12	6,32	1	6,32	CHI
20191166557	PIRENOPOLIS	ZN12273387	COCALZINHO	08/11/2019 20:10	09/11/2019 08:29	08/11/2019 20:10	09/11/2019 08:29	12,31	14	172,37	CHI
20191166562	MOSSAMEDES	MD21004826	FIRMINOPOLIS S2	09/11/2019 05:10	09/11/2019 16:29	09/11/2019 05:10	09/11/2019 16:29	11,31	1	11,31	CHI
20191166564	RUBIATABA	RB12003316	RUBIATABA	09/11/2019 05:11	11/11/2019 12:26	09/11/2019 05:11	09/11/2019 17:09	11,96	30	358,79	CHI
20191166564	RUBIATABA	RB12054137LD	RUBIATABA	09/11/2019 05:11	11/11/2019 12:26	09/11/2019 05:11	11/11/2019 11:54	54,71	11	601,84	CHI
20191166564	RUBIATABA	RB12194748LD	RUBIATABA	09/11/2019 05:11	11/11/2019 12:26	09/11/2019 05:11	11/11/2019 12:26	55,25	4	221,02	CHI
20191166573	ANICUNS	AC21016442	ANICUNS	09/11/2019 04:35	09/11/2019 09:42	09/11/2019 04:35	09/11/2019 09:42	5,10	2	10,21	CHI
20191166576	INACIOLANDIA	ID31122271	CACHOEIRA DOURADA	07/11/2019 16:40	09/11/2019 15:31	07/11/2019 16:40	09/11/2019 15:31	46,84	1	46,84	CHI
20191166580	AMERICANO DO BRASIL	IB21398751	ANICUNS	09/11/2019 04:35	09/11/2019 10:03	09/11/2019 04:35	09/11/2019 10:03	5,45	1	5,45	CHI
20191166581	CORUMBAIBA	CI12363786	VILA CORUMBA	08/11/2019 21:41	09/11/2019 11:23	08/11/2019 21:41	09/11/2019 11:23	13,69	18	246,41	CHI
20191166585	PIRENOPOLIS	PV12000006	CORUMBA	09/11/2019 05:34	09/11/2019 13:44	09/11/2019 05:34	09/11/2019 13:44	8,16	7	57,11	CHI
20191166586	RUBIATABA	RB12003205	RUBIATABA	09/11/2019 05:34	10/11/2019 00:06	09/11/2019 05:34	10/11/2019 00:06	18,53	6	111,16	CHI
20191166593	BALIZA	BH12356956	BOM JARDIM	09/11/2019 05:39	09/11/2019 08:06	09/11/2019 05:39	09/11/2019 08:06	2,45	2	4,90	CHI
20191166598	ITAPACI	IW12282269	ITAPACI	08/11/2019 22:10	10/11/2019 09:23	08/11/2019 22:10	10/11/2019 09:23	35,21	7	246,44	CHI

20191166601	COCALZINHO DE GOIAS	ZN12251184	COCALZINHO	09/11/2019 05:43	09/11/2019 13:43	09/11/2019 05:43	09/11/2019 13:43	7,98	3	23,95	CHI
20191166609	MOSSAMEDES	MD12005317	FIRMINOPOLIS S2	09/11/2019 05:49	09/11/2019 10:39	09/11/2019 05:49	09/11/2019 10:39	4,83	15	72,47	CHI
20191166624	GOIANAPOLIS	GP12285356	DAIA S2	09/11/2019 05:56	09/11/2019 10:40	09/11/2019 05:56	09/11/2019 10:40	4,74	8	37,95	CHI
20191166627	NOVA CRIXAS	NA12027812	NOVA CRIXAS	09/11/2019 05:59	10/11/2019 12:40	09/11/2019 05:59	10/11/2019 12:40	30,69	4	122,77	CHI
20191166655	NOVA GLORIA	NG12181404	RUBIATABA	09/11/2019 06:10	10/11/2019 10:53	09/11/2019 06:10	10/11/2019 10:53	28,71	2	57,43	CHI
20191166663	MORRO AGUDO DE GOIAS	MS12086902	ITAPURANGA	09/11/2019 06:12	11/11/2019 07:20	09/11/2019 06:12	11/11/2019 07:20	49,13	3	147,38	CHI
20191166680	SAO MIGUEL DO ARAGUAIA	SM12016662	SAO MIGUEL DO ARAGUAIA	09/11/2019 06:17	11/11/2019 13:00	09/11/2019 06:17	11/11/2019 13:00	54,71	2	109,42	CHI
20191166681	SAO MIGUEL DO ARAGUAIA	SM12128351	SAO MIGUEL DO ARAGUAIA	09/11/2019 06:20	10/11/2019 09:27	09/11/2019 06:20	10/11/2019 09:27	27,12	19	515,35	CHI
20191166691	BARRO ALTO	GE12000092	GOIANESIA S1	09/11/2019 06:17	09/11/2019 14:14	09/11/2019 06:17	09/11/2019 14:14	7,95	2	15,89	CHI
20191166691	GOIANESIA	GE12000092	GOIANESIA S1	09/11/2019 06:17	09/11/2019 14:14	09/11/2019 06:17	09/11/2019 14:14	7,95	18	143,02	CHI
20191166692	MINACU	IH12182309	MINACU	09/11/2019 06:26	10/11/2019 02:56	09/11/2019 06:26	10/11/2019 02:56	20,49	17	348,28	CHI
20191166699	RIO QUENTE	RQ21063129	RIO QUENTE	09/11/2019 06:28	10/11/2019 10:45	09/11/2019 06:28	10/11/2019 10:45	28,27	1	28,27	CHI
20191166741	BOM JESUS DE GOIAS	IT12034458RE	CACHOEIRA DOURADA	09/11/2019 08:45	09/11/2019 11:36	09/11/2019 08:45	09/11/2019 11:36	2,84	3	8,52	CHI
20191166741	ITUMBIRA	IT12034458RE	CACHOEIRA DOURADA	09/11/2019 08:45	09/11/2019 11:36	09/11/2019 08:45	09/11/2019 11:36	2,84	62	176,03	CHI
20191166741	PANAMA	IT12034458RE	CACHOEIRA DOURADA	09/11/2019 08:45	09/11/2019 11:36	09/11/2019 08:45	09/11/2019 11:36	2,84	13	36,91	CHI
20191166759	MOSSAMEDES	MD21198266	FIRMINOPOLIS S2	09/11/2019 07:01	09/11/2019 13:00	09/11/2019 07:01	09/11/2019 13:00	5,97	2	11,95	CHI
20191166809	GOIANESIA	10002573766	GOIANESIA S2	09/11/2019 06:31	10/11/2019 15:29	09/11/2019 06:31	10/11/2019 15:29	32,97	1	32,97	CHI
20191166815	NOVO PLANALTO	SM11247029	SAO MIGUEL DO ARAGUAIA	09/11/2019 06:32	09/11/2019 15:34	09/11/2019 06:32	09/11/2019 15:34	9,02	1	9,02	CHI
20191166817	FORMOSO	FO12115548	MARA ROSA	09/11/2019 04:01	09/11/2019 17:24	09/11/2019 04:01	09/11/2019 17:24	13,37	52	695,10	CHI
20191166817	MARA ROSA	FO12115548	MARA ROSA	09/11/2019 04:01	09/11/2019 17:24	09/11/2019 04:01	09/11/2019 17:24	13,37	23	307,45	CHI
20191166819	CATALAO	CT11000041	CATALAO S2	09/11/2019 06:34	09/11/2019 07:42	09/11/2019 06:34	09/11/2019 07:42	1,13	31	34,88	CHI
20191166832	PORANGATU	PO21100772	PORANGATU	09/11/2019 06:37	12/11/2019 15:12	09/11/2019 06:37	12/11/2019 15:12	80,57	1	80,57	CHI
20191166844	FIRMINOPOLIS	FR12076427	FIRMINOPOLIS S1	09/11/2019 06:52	09/11/2019 08:14	09/11/2019 06:52	09/11/2019 08:14	1,37	10	13,70	CHI
20191166848	CAMPOS VERDES	VD12264097	SANTA TEREZINHA	09/11/2019 06:53	09/11/2019 22:59	09/11/2019 06:53	09/11/2019 22:59	16,10	6	96,60	CHI
20191166866	SANCLERLANDIA	SL12019284	SAO LUIZ DOS MONTES BELOS	09/11/2019 06:57	09/11/2019 10:06	09/11/2019 06:57	09/11/2019 10:06	3,16	28	88,57	CHI
20191166866	SAO LUIS DE MONTES BELOS	SL12019284	SAO LUIZ DOS MONTES BELOS	09/11/2019 06:57	09/11/2019 10:06	09/11/2019 06:57	09/11/2019 10:06	3,16	56	177,15	CHI
20191166882	ORIZONA	10029255668	PIRES DO RIO S2	09/11/2019 06:59	09/11/2019 10:43	09/11/2019 06:59	09/11/2019 10:43	3,72	1	3,72	CHI
20191166884	GOIAS	GS12087523	GOIAS	09/11/2019 07:34	09/11/2019 15:25	09/11/2019 07:34	09/11/2019 15:25	7,86	67	526,55	CHI
20191166887	PORANGATU	PO12391665	PORANGATU	09/11/2019 07:01	12/11/2019 15:56	09/11/2019 07:01	12/11/2019 15:56	80,91	19	1537,22	CHI
20191166892	FIRMINOPOLIS	FR21339975	FIRMINOPOLIS S2	09/11/2019 07:01	09/11/2019 08:16	09/11/2019 07:01	09/11/2019 08:16	1,23	1	1,23	CHI
20191166896	BARRO ALTO	BA18000051FS	BARRO ALTO	09/11/2019 05:27	09/11/2019 10:38	09/11/2019 05:27	09/11/2019 10:38	5,17	131	677,12	CHI
20191166896	NIQUELANDIA	BA18000051FS	BARRO ALTO	09/11/2019 05:27	09/11/2019 10:38	09/11/2019 05:27	09/11/2019 10:38	5,17	118	609,93	CHI
20191166900	GOIANESIA	GE12291463LD	GOIANESIA S2	09/11/2019 05:21	09/11/2019 07:42	09/11/2019 05:21	09/11/2019 07:42	2,35	356	836,40	CHI

20191166902	ALEXANIA	AX21066465	ALEXANIA	09/11/2019 07:04	09/11/2019 19:13	09/11/2019 07:04	09/11/2019 19:13	12,15	1	12,15	CHI
20191166903	RUBIATABA	RB12156088	RUBIATABA	09/11/2019 07:04	09/11/2019 23:01	09/11/2019 07:04	09/11/2019 23:01	15,94	12	191,26	CHI
20191166904	GOIANESIA	550118524	GOIANESIA S2	09/11/2019 07:04	09/11/2019 10:45	09/11/2019 07:04	09/11/2019 10:45	3,68	1	3,68	CHI
20191166926	RIO VERDE	RV12213283LD	MONTIVIDIU T	08/11/2019 13:37	09/11/2019 18:00	08/11/2019 13:37	09/11/2019 18:00	28,38	1	28,38	CHI
20191166934	SILVANIA	SV21236996	DAIA S2	09/11/2019 07:10	09/11/2019 18:25	09/11/2019 07:10	09/11/2019 18:25	11,24	1	11,24	CHI
20191166937	JARAGUA	JA12278881	JARAGUA	09/11/2019 07:11	09/11/2019 10:56	09/11/2019 07:11	09/11/2019 10:56	3,75	12	44,95	CHI
20191166949	PORANGATU	PO12349234	MARA ROSA	08/11/2019 21:46	10/11/2019 09:54	08/11/2019 21:46	10/11/2019 09:54	36,13	15	541,95	CHI
20191166952	NAZARIO	NZ21027651	ANICUNS	09/11/2019 07:15	09/11/2019 11:11	09/11/2019 07:15	09/11/2019 11:11	3,94	1	3,94	CHI
20191166954	ALEXANIA	AX21342869	ALEXANIA	09/11/2019 07:15	09/11/2019 18:07	09/11/2019 07:15	09/11/2019 18:07	10,86	1	10,86	CHI
20191166976	SAO MIGUEL DO ARAGUAIA	SM10396890	SAO MIGUEL DO ARAGUAIA	08/11/2019 23:37	15/11/2019 12:35	08/11/2019 23:37	09/11/2019 15:42	16,08	46	739,68	CHI
20191166976	SAO MIGUEL DO ARAGUAIA	SM12013034LD	SAO MIGUEL DO ARAGUAIA	08/11/2019 23:37	15/11/2019 12:35	08/11/2019 23:37	09/11/2019 16:15	16,63	18	299,32	CHI
20191166976	SAO MIGUEL DO ARAGUAIA	SM10396890	SAO MIGUEL DO ARAGUAIA	08/11/2019 23:37	15/11/2019 12:35	09/11/2019 23:48	10/11/2019 00:36	0,81	64	51,89	CHI
20191166976	SAO MIGUEL DO ARAGUAIA	SM13182483	SAO MIGUEL DO ARAGUAIA	08/11/2019 23:37	15/11/2019 12:35	08/11/2019 23:37	10/11/2019 08:46	33,15	13	430,90	CHI
20191166976	SAO MIGUEL DO ARAGUAIA	SM13182483	SAO MIGUEL DO ARAGUAIA	08/11/2019 23:37	15/11/2019 12:35	10/11/2019 00:00	10/11/2019 08:46	8,77	22	192,87	CHI
20191166976	SAO MIGUEL DO ARAGUAIA	SM10396890	SAO MIGUEL DO ARAGUAIA	08/11/2019 23:37	15/11/2019 12:35	10/11/2019 10:45	10/11/2019 11:55	1,16	99	114,57	CHI
20191166976	SAO MIGUEL DO ARAGUAIA	SM10396890	SAO MIGUEL DO ARAGUAIA	08/11/2019 23:37	15/11/2019 12:35	10/11/2019 12:40	10/11/2019 13:05	0,42	99	41,52	CHI
20191166976	SAO MIGUEL DO ARAGUAIA	SM10396890	SAO MIGUEL DO ARAGUAIA	08/11/2019 23:37	15/11/2019 12:35	10/11/2019 12:56	10/11/2019 13:05	0,16	2	0,32	CHI
20191166976	SAO MIGUEL DO ARAGUAIA	SM10396890	SAO MIGUEL DO ARAGUAIA	08/11/2019 23:37	15/11/2019 12:35	10/11/2019 17:10	10/11/2019 17:34	0,39	99	38,86	CHI
20191166976	BONOPOLIS	SM13282213	SAO MIGUEL DO ARAGUAIA	08/11/2019 23:37	15/11/2019 12:35	08/11/2019 23:37	10/11/2019 19:01	43,41	3	130,23	CHI
20191166976	SAO MIGUEL DO ARAGUAIA	SM13282213	SAO MIGUEL DO ARAGUAIA	08/11/2019 23:37	15/11/2019 12:35	08/11/2019 23:37	10/11/2019 19:01	43,41	3	130,23	CHI
20191166976	BONOPOLIS	SM10396890	SAO MIGUEL DO ARAGUAIA	08/11/2019 23:37	15/11/2019 12:35	10/11/2019 20:14	10/11/2019 22:31	2,28	3	6,85	CHI
20191166976	SAO MIGUEL DO ARAGUAIA	SM10396890	SAO MIGUEL DO ARAGUAIA	08/11/2019 23:37	15/11/2019 12:35	10/11/2019 20:14	10/11/2019 22:31	2,28	105	239,72	CHI
20191166976	SAO MIGUEL DO ARAGUAIA	SM12013046LD	SAO MIGUEL DO ARAGUAIA	08/11/2019 23:37	15/11/2019 12:35	08/11/2019 23:37	11/11/2019 11:21	59,73	5	298,67	CHI
20191166976	BONOPOLIS	BX12262764	SAO MIGUEL DO ARAGUAIA	08/11/2019 23:37	15/11/2019 12:35	08/11/2019 23:37	11/11/2019 13:37	62,00	1	62,00	CHI
20191166976	SAO MIGUEL DO ARAGUAIA	BX12262764	SAO MIGUEL DO ARAGUAIA	08/11/2019 23:37	15/11/2019 12:35	08/11/2019 23:37	11/11/2019 13:37	62,00	1	62,00	CHI
20191166976	BONOPOLIS	BX12377680LD	SAO MIGUEL DO ARAGUAIA	08/11/2019 23:37	15/11/2019 12:35	08/11/2019 23:37	11/11/2019 17:16	65,65	51	3348,38	CHI
20191166976	BONOPOLIS	BX12377680LD	SAO MIGUEL DO ARAGUAIA	08/11/2019 23:37	15/11/2019 12:35	10/11/2019 12:56	11/11/2019 17:16	28,34	26	736,85	CHI
20191166976	SAO MIGUEL DO ARAGUAIA	BX12377680LD	SAO MIGUEL DO ARAGUAIA	08/11/2019 23:37	15/11/2019 12:35	10/11/2019 12:56	11/11/2019 17:16	28,34	0	0,00	CHI
20191166976	BONOPOLIS	SM10396890	SAO MIGUEL DO ARAGUAIA	08/11/2019 23:37	15/11/2019 12:35	12/11/2019 10:41	12/11/2019 14:31	3,83	81	310,50	CHI
20191166976	SAO MIGUEL DO ARAGUAIA	SM10396890	SAO MIGUEL DO ARAGUAIA	08/11/2019 23:37	15/11/2019 12:35	12/11/2019 10:41	12/11/2019 14:31	3,83	105	402,50	CHI
20191166976	SAO MIGUEL DO ARAGUAIA	SM10396890	SAO MIGUEL DO ARAGUAIA	08/11/2019 23:37	15/11/2019 12:35	12/11/2019 14:35	12/11/2019 16:15	1,67	46	76,65	CHI
20191166976	SAO MIGUEL DO ARAGUAIA	SM12013034LD	SAO MIGUEL DO ARAGUAIA	08/11/2019 23:37	15/11/2019 12:35	12/11/2019 14:35	12/11/2019 17:20	2,75	13	35,75	CHI
20191166976	SAO MIGUEL DO ARAGUAIA	SM10396890	SAO MIGUEL DO ARAGUAIA	08/11/2019 23:37	15/11/2019 12:35	12/11/2019 18:26	12/11/2019 18:46	0,33	59	19,63	CHI

20191166976	SAO MIGUEL DO ARAGUAIA	SM13182483	SAO MIGUEL DO ARAGUAIA	08/11/2019 23:37	15/11/2019 12:35	12/11/2019 14:35	12/11/2019 22:55	8,35	10	83,46	CHI
20191166976	SAO MIGUEL DO ARAGUAIA	SM13182483	SAO MIGUEL DO ARAGUAIA	08/11/2019 23:37	15/11/2019 12:35	12/11/2019 14:35	13/11/2019 08:34	17,99	10	179,87	CHI
20191166976	SAO MIGUEL DO ARAGUAIA	SM10396890	SAO MIGUEL DO ARAGUAIA	08/11/2019 23:37	15/11/2019 12:35	13/11/2019 09:35	13/11/2019 11:40	2,10	69	144,56	CHI
20191166976	SAO MIGUEL DO ARAGUAIA	SM13182482	SAO MIGUEL DO ARAGUAIA	08/11/2019 23:37	15/11/2019 12:35	13/11/2019 09:35	13/11/2019 19:39	10,07	10	100,67	CHI
20191166976	SAO MIGUEL DO ARAGUAIA	SM13182483	SAO MIGUEL DO ARAGUAIA	08/11/2019 23:37	15/11/2019 12:35	12/11/2019 14:35	13/11/2019 21:47	31,20	17	530,40	CHI
20191166976	SAO MIGUEL DO ARAGUAIA	SM10396890	SAO MIGUEL DO ARAGUAIA	08/11/2019 23:37	15/11/2019 12:35	13/11/2019 20:17	13/11/2019 21:47	1,50	79	118,46	CHI
20191166976	SAO MIGUEL DO ARAGUAIA	SM12013055	SAO MIGUEL DO ARAGUAIA	08/11/2019 23:37	15/11/2019 12:35	11/11/2019 12:10	13/11/2019 21:47	57,61	4	230,43	CHI
20191166976	BONOPOLIS	SM13282213	SAO MIGUEL DO ARAGUAIA	08/11/2019 23:37	15/11/2019 12:35	12/11/2019 14:35	14/11/2019 11:05	44,50	4	178,00	CHI
20191166976	SAO MIGUEL DO ARAGUAIA	SM13282213	SAO MIGUEL DO ARAGUAIA	08/11/2019 23:37	15/11/2019 12:35	12/11/2019 14:35	14/11/2019 11:05	44,50	9	400,50	CHI
20191166976	SAO MIGUEL DO ARAGUAIA	SM12282216	SAO MIGUEL DO ARAGUAIA	08/11/2019 23:37	15/11/2019 12:35	11/11/2019 12:10	15/11/2019 12:35	96,42	2	192,83	CHI
20191166989	PALMEIRAS DE GOIAS	PL12349319	PALMEIRAS	09/11/2019 07:20	09/11/2019 12:10	09/11/2019 07:20	09/11/2019 12:10	4,83	2	9,65	CHI
20191167000	MAIRIPIOTABA	PK12046051RE	PONTALINA	09/11/2019 07:23	09/11/2019 09:49	09/11/2019 07:23	09/11/2019 09:49	2,42	8	19,34	CHI
20191167000	PONTALINA	PK12046051RE	PONTALINA	09/11/2019 07:23	09/11/2019 09:49	09/11/2019 07:23	09/11/2019 09:49	2,42	202	488,34	CHI
20191167002	GOIANESIA	GE12000211	GOIANESIA S2	08/11/2019 19:54	09/11/2019 10:40	08/11/2019 19:54	09/11/2019 10:40	14,76	5	73,82	CHI
20191167018	CEZARINA	CZ12323632	CEZARINA	09/11/2019 07:27	10/11/2019 11:50	09/11/2019 07:27	10/11/2019 11:50	28,38	4	113,52	CHI
20191167018	INDIARA	CZ12323632	CEZARINA	09/11/2019 07:27	10/11/2019 11:50	09/11/2019 07:27	10/11/2019 11:50	28,38	3	85,14	CHI
20191167019	CAIAPONIA	CP21334737	CAIAPONIA	09/11/2019 07:27	12/11/2019 13:20	09/11/2019 07:27	12/11/2019 13:20	77,88	1	77,88	CHI
20191167020	URUACU	UR11210918	URUACU	09/11/2019 07:03	09/11/2019 10:46	09/11/2019 07:03	09/11/2019 10:46	3,71	106	392,73	CHI
20191167041	PORANGATU	PO12328829	PORANGATU	09/11/2019 07:30	09/11/2019 18:10	09/11/2019 07:30	09/11/2019 18:10	10,66	5	53,28	CHI
20191167046	GOIANESIA	10003092303	GOIANESIA S2	09/11/2019 05:26	09/11/2019 10:11	09/11/2019 05:26	09/11/2019 10:11	4,75	1	4,75	CHI
20191167053	NOVO PLANALTO	SM21127354	SAO MIGUEL DO ARAGUAIA	09/11/2019 07:32	10/11/2019 16:10	09/11/2019 07:32	10/11/2019 16:10	32,63	1	32,63	CHI
20191167069	SAO MIGUEL DO ARAGUAIA	830060406	SAO MIGUEL DO ARAGUAIA	09/11/2019 07:35	10/11/2019 11:04	09/11/2019 07:35	10/11/2019 11:04	27,49	1	27,49	CHI
20191167072	PROFESSOR JAMIL SAFADY	850006880	ROCHEDO	09/11/2019 07:35	09/11/2019 22:39	09/11/2019 07:35	09/11/2019 22:39	15,06	1	15,06	CHI
20191167074	GOIANESIA	550096346	GOIANESIA S2	09/11/2019 07:36	09/11/2019 15:41	09/11/2019 07:36	09/11/2019 15:41	8,08	1	8,08	CHI
20191167077	IPORA	IR12354607	IPORA	09/11/2019 07:36	13/11/2019 18:59	09/11/2019 07:36	13/11/2019 18:59	107,38	1	107,38	CHI
20191167078	MARA ROSA	MQ12146959	MARA ROSA	09/11/2019 05:18	10/11/2019 23:51	09/11/2019 05:18	10/11/2019 23:51	42,55	9	382,94	CHI
20191167078	NOVA IGUACU DE GOIAS	MQ12146959	MARA ROSA	09/11/2019 05:18	10/11/2019 23:51	09/11/2019 05:18	10/11/2019 23:51	42,55	12	510,59	CHI
20191167083	RIO VERDE	RV12303875	ACREUNA	08/11/2019 10:33	09/11/2019 13:25	08/11/2019 10:33	09/11/2019 13:25	26,86	31	832,57	CHI
20191167088	GOIATUBA	GT12000228	GOIATUBA S2	09/11/2019 06:58	09/11/2019 10:15	09/11/2019 06:58	09/11/2019 10:15	3,27	138	451,45	CHI
20191167115	IPORA	IR12091402	IPORA	09/11/2019 07:43	09/11/2019 16:13	09/11/2019 07:43	09/11/2019 16:13	8,50	3	25,50	CHI
20191167122	PIRENOPOLIS	PV12382304	SAO FRANCISCO DE GOIAS	09/11/2019 07:43	09/11/2019 18:37	09/11/2019 07:43	09/11/2019 18:37	10,88	7	76,19	CHI
20191167130	GOIANESIA	550010543	GOIANESIA S2	09/11/2019 07:44	09/11/2019 15:41	09/11/2019 07:44	09/11/2019 15:41	7,94	1	7,94	CHI
20191167135	CAMPINORTE	2040028177	CAMPINORTE	09/11/2019 07:46	09/11/2019 11:48	09/11/2019 07:46	09/11/2019 11:48	4,03	1	4,03	CHI

20191167140	NIQUELANDIA	NQ21213018	NIQUELANDIA SUBTRANSMISSAO	08/11/2019 15:31	09/11/2019 17:50	08/11/2019 15:31	09/11/2019 17:50	26,31	1	26,31	CHI
20191167155	SANTA RITA DO NOVO DESTINO	DF21258517	GOIANESIA S1	09/11/2019 07:48	10/11/2019 16:20	09/11/2019 07:48	10/11/2019 16:20	32,52	1	32,52	CHI
20191167164	IPORA	IR12069062	IPORA	08/11/2019 20:01	10/11/2019 17:43	08/11/2019 20:01	10/11/2019 17:43	45,69	12	548,32	CHI
20191167167	MOSSAMEDES	MD12188234	FIRMINOPOLIS S2	09/11/2019 06:09	09/11/2019 11:28	09/11/2019 06:09	09/11/2019 11:28	5,32	34	180,75	CHI
20191167169	GOIANESIA	GE11126173	GOIANESIA S2	09/11/2019 07:12	09/11/2019 09:09	09/11/2019 07:12	09/11/2019 09:09	1,94	157	305,36	CHI
20191167176	URUACU	UR10400664	URUACU	09/11/2019 05:11	10/11/2019 11:47	09/11/2019 05:11	09/11/2019 13:12	8,03	67	537,97	CHI
20191167176	URUACU	UR13364065	URUACU	09/11/2019 05:11	10/11/2019 11:47	09/11/2019 05:11	09/11/2019 14:11	9,00	5	45,02	CHI
20191167176	HIDROLINA	UR10374582	URUACU	09/11/2019 05:11	10/11/2019 11:47	09/11/2019 16:22	09/11/2019 16:26	0,06	14	0,84	CHI
20191167176	URUACU	UR10374582	URUACU	09/11/2019 05:11	10/11/2019 11:47	09/11/2019 16:22	09/11/2019 16:26	0,06	266	15,89	CHI
20191167176	URUACU	UR10374582	URUACU	09/11/2019 05:11	10/11/2019 11:47	09/11/2019 16:29	09/11/2019 18:28	1,99	15	29,91	CHI
20191167176	URUACU	UR13308221	URUACU	09/11/2019 05:11	10/11/2019 11:47	09/11/2019 16:29	09/11/2019 21:27	4,97	133	660,75	CHI
20191167176	URUACU	UR13341323	URUACU	09/11/2019 05:11	10/11/2019 11:47	09/11/2019 16:29	09/11/2019 22:42	6,23	21	130,80	CHI
20191167176	URUACU	UR13300980	URUACU	09/11/2019 05:11	10/11/2019 11:47	09/11/2019 16:29	09/11/2019 23:55	7,45	60	446,78	CHI
20191167176	HIDROLINA	UR12048650	URUACU	09/11/2019 05:11	10/11/2019 11:47	09/11/2019 16:29	10/11/2019 01:24	8,92	1	8,92	CHI
20191167176	URUACU	UR12048650	URUACU	09/11/2019 05:11	10/11/2019 11:47	09/11/2019 16:29	10/11/2019 01:24	8,92	17	151,59	CHI
20191167176	HIDROLINA	UR13374715	URUACU	09/11/2019 05:11	10/11/2019 11:47	09/11/2019 16:29	10/11/2019 02:20	9,85	13	128,01	CHI
20191167176	URUACU	UR13374715	URUACU	09/11/2019 05:11	10/11/2019 11:47	09/11/2019 16:29	10/11/2019 02:20	9,85	17	167,40	CHI
20191167176	URUACU	UR12291057LD	URUACU	09/11/2019 05:11	10/11/2019 11:47	09/11/2019 16:29	10/11/2019 03:09	10,67	3	32,02	CHI
20191167176	URUACU	UR10400664	URUACU	09/11/2019 05:11	10/11/2019 11:47	10/11/2019 09:06	10/11/2019 11:07	2,02	72	145,34	CHI
20191167176	URUACU	UR10400664	URUACU	09/11/2019 05:11	10/11/2019 11:47	09/11/2019 05:11	10/11/2019 11:46	30,59	141	4313,74	CHI
20191167176	URUACU	20121079	URUACU	09/11/2019 05:11	10/11/2019 11:47	09/11/2019 05:11	10/11/2019 11:47	30,60	1	30,60	CHI
20191167179	CATALAO	CT21165188	CATALAO S1	09/11/2019 07:52	10/11/2019 09:22	09/11/2019 07:52	10/11/2019 09:22	25,49	1	25,49	CHI
20191167204	MINACU	IH12236222	MINACU	09/11/2019 07:57	09/11/2019 15:20	09/11/2019 07:57	09/11/2019 15:20	7,38	19	140,27	CHI
20191167218	GOIANESIA	GE12064345	GOIANESIA S2	09/11/2019 07:59	09/11/2019 15:50	09/11/2019 07:59	09/11/2019 15:50	7,85	1	7,85	CHI
20191167225	GOIANESIA	GE11258301	GOIANESIA S2	09/11/2019 03:59	09/11/2019 11:39	09/11/2019 03:59	09/11/2019 11:39	7,66	122	934,96	CHI
20191167226	NIQUELANDIA	NQ12236707	NIQUELANDIA SUBTRANSMISSAO	09/11/2019 08:00	09/11/2019 14:43	09/11/2019 08:00	09/11/2019 14:43	6,71	6	40,29	CHI
20191167233	NIQUELANDIA	NQ21213207	URUACU	09/11/2019 08:01	09/11/2019 13:04	09/11/2019 08:01	09/11/2019 13:04	5,04	1	5,04	CHI
20191167252	BALIZA	BH11331344	CAIAPONIA	09/11/2019 08:04	13/11/2019 20:20	09/11/2019 08:04	13/11/2019 20:20	108,25	1	108,25	CHI
20191167254	MONTES CLAROS DE GOIAS	ME12088948	IPORA	09/11/2019 06:33	10/11/2019 11:54	09/11/2019 06:33	10/11/2019 11:54	29,34	3	88,02	CHI
20191167259	NOVA CRIXAS	MZ12055676	MOZARLANDIA	09/11/2019 05:18	10/11/2019 12:35	09/11/2019 05:18	10/11/2019 12:35	31,27	10	312,75	CHI
20191167266	MUTUNOPOLIS	MU12068522	MARA ROSA	09/11/2019 07:21	11/11/2019 17:35	09/11/2019 07:21	11/11/2019 00:36	41,25	18	742,48	CHI
20191167266	PORANGATU	MU12068522	MARA ROSA	09/11/2019 07:21	11/11/2019 17:35	09/11/2019 07:21	11/11/2019 00:36	41,25	19	783,73	CHI
20191167266	MUTUNOPOLIS	MU12068522	MARA ROSA	09/11/2019 07:21	11/11/2019 17:35	11/11/2019 00:39	11/11/2019 16:46	16,12	18	290,12	CHI

20191167266	PORANGATU	MU12068522	MARA ROSA	09/11/2019 07:21	11/11/2019 17:35	11/11/2019 00:39	11/11/2019 16:46	16,12	19	306,24	CHI
20191167266	MUTUNOPOLIS	MU12068522	MARA ROSA	09/11/2019 07:21	11/11/2019 17:35	09/11/2019 07:21	11/11/2019 17:35	58,22	42	2445,43	CHI
20191167266	MUTUNOPOLIS	MU12068529	MARA ROSA	09/11/2019 07:21	11/11/2019 17:35	10/11/2019 23:10	11/11/2019 17:35	18,42	2	36,83	CHI
20191167266	PORANGATU	MU12068529	MARA ROSA	09/11/2019 07:21	11/11/2019 17:35	10/11/2019 23:10	11/11/2019 17:35	18,42	11	202,59	CHI
20191167283	CAMPINACU	IH12360453	MINACU	09/11/2019 05:20	09/11/2019 13:56	09/11/2019 05:20	09/11/2019 13:56	8,60	5	43,00	CHI
20191167283	MINACU	IH12360453	MINACU	09/11/2019 05:20	09/11/2019 13:56	09/11/2019 05:20	09/11/2019 13:56	8,60	72	619,14	CHI
20191167292	MOIPIORA	MO12015679	IPIORA	09/11/2019 06:00	09/11/2019 10:58	09/11/2019 06:00	09/11/2019 10:58	4,96	5	24,80	CHI
20191167296	SANTA TEREZA DE GOIAS	SE12039889	MARA ROSA	09/11/2019 07:15	09/11/2019 10:25	09/11/2019 07:15	09/11/2019 10:25	3,15	22	69,32	CHI
20191167301	JATAI	JT12182073	JATAI S1	07/11/2019 09:59	09/11/2019 10:48	07/11/2019 09:59	09/11/2019 10:48	48,82	2	97,63	CHI
20191167308	CATALAO	1990188919	CATALAO S2	09/11/2019 08:13	09/11/2019 13:00	09/11/2019 08:13	09/11/2019 13:00	4,78	1	4,78	CHI
20191167312	CUMARI	CY21318868	CATALAO S2	09/11/2019 08:13	10/11/2019 18:39	09/11/2019 08:13	10/11/2019 18:39	34,42	1	34,42	CHI
20191167315	MUNDO NOVO DE GOIAS	MH11255523	NOVA CRIXAS	09/11/2019 07:05	09/11/2019 11:03	09/11/2019 07:05	09/11/2019 11:03	3,96	61	241,85	CHI
20191167318	SAO MIGUEL DO ARAGUAIA	SM12291100	SAO MIGUEL DO ARAGUAIA	09/11/2019 08:14	10/11/2019 16:59	09/11/2019 08:14	10/11/2019 16:59	32,74	2	65,49	CHI
20191167336	MOZARLANDIA	MZ12055646	MOZARLANDIA	09/11/2019 08:17	10/11/2019 19:25	09/11/2019 08:17	10/11/2019 19:25	35,14	3	105,42	CHI
20191167346	INDIARA	2710010246	EDEIA	09/11/2019 08:18	09/11/2019 14:22	09/11/2019 08:18	09/11/2019 14:22	6,07	1	6,07	CHI
20191167351	CRIXAS	CX12248300	SERRA DO OURO	09/11/2019 08:19	11/11/2019 17:10	09/11/2019 08:19	11/11/2019 17:10	56,85	5	284,24	CHI
20191167362	MUNDO NOVO DE GOIAS	MH11253835	NOVA CRIXAS	09/11/2019 07:30	09/11/2019 11:44	09/11/2019 07:30	09/11/2019 11:44	4,23	67	283,65	CHI
20191167367	RUBIATABA	RB11350031	RUBIATABA	09/11/2019 07:40	10/11/2019 08:19	09/11/2019 07:40	10/11/2019 08:19	24,64	28	689,78	CHI
20191167372	ORIZONA	OZ21125059	PIRES DO RIO S2	09/11/2019 08:22	09/11/2019 11:06	09/11/2019 08:22	09/11/2019 11:06	2,72	1	2,72	CHI
20191167376	PORANGATU	PO12079746	PORANGATU	09/11/2019 06:27	11/11/2019 12:07	09/11/2019 06:27	11/11/2019 12:07	53,67	3	161,00	CHI
20191167390	SAO MIGUEL DO ARAGUAIA	SM12000065	SAO MIGUEL DO ARAGUAIA	09/11/2019 05:45	10/11/2019 11:38	09/11/2019 05:45	10/11/2019 11:38	29,89	24	717,29	CHI
20191167400	RUBIATABA	RB11000004	RUBIATABA	09/11/2019 06:30	09/11/2019 13:11	09/11/2019 06:30	09/11/2019 13:11	6,68	104	694,92	CHI
20191167403	ANAPOLIS	AN12261182	JUNDIAI S1	09/11/2019 07:54	09/11/2019 09:30	09/11/2019 07:54	09/11/2019 09:30	1,59	148	234,91	CHI
20191167403	GOIANAPOLIS	AN12261182	JUNDIAI S1	09/11/2019 07:54	09/11/2019 09:30	09/11/2019 07:54	09/11/2019 09:30	1,59	9	14,29	CHI
20191167403	LEOPOLDO DE BULHOES	AN12261182	JUNDIAI S1	09/11/2019 07:54	09/11/2019 09:30	09/11/2019 07:54	09/11/2019 09:30	1,59	5	7,94	CHI
20191167413	CAMPOS VERDES	VD12056599	SANTA TEREZINHA	09/11/2019 06:50	10/11/2019 19:21	09/11/2019 06:50	09/11/2019 16:35	9,76	96	936,72	CHI
20191167413	MARA ROSA	VD12056599	SANTA TEREZINHA	09/11/2019 06:50	10/11/2019 19:21	09/11/2019 06:50	09/11/2019 16:35	9,76	3	29,27	CHI
20191167413	CAMPOS VERDES	VD12056599	SANTA TEREZINHA	09/11/2019 06:50	10/11/2019 19:21	09/11/2019 16:36	10/11/2019 14:28	21,88	12	262,52	CHI
20191167413	CAMPOS VERDES	VD12056599	SANTA TEREZINHA	09/11/2019 06:50	10/11/2019 19:21	09/11/2019 16:36	10/11/2019 14:47	22,18	20	443,68	CHI
20191167413	CAMPOS VERDES	VD13330122	SANTA TEREZINHA	09/11/2019 06:50	10/11/2019 19:21	09/11/2019 16:36	10/11/2019 15:02	22,44	55	1234,43	CHI
20191167413	MARA ROSA	VD13330122	SANTA TEREZINHA	09/11/2019 06:50	10/11/2019 19:21	09/11/2019 16:36	10/11/2019 15:02	22,44	3	67,33	CHI
20191167413	CAMPOS VERDES	VD12056599	SANTA TEREZINHA	09/11/2019 06:50	10/11/2019 19:21	09/11/2019 16:36	10/11/2019 15:18	22,71	9	204,40	CHI
20191167413	ALTO HORIZONTE	MQ13330160	SANTA TEREZINHA	09/11/2019 06:50	10/11/2019 19:21	09/11/2019 06:50	10/11/2019 19:21	36,51	9	328,60	CHI

20191167413	MARA ROSA	MQ13330160	SANTA TEREZINHA	09/11/2019 06:50	10/11/2019 19:21	09/11/2019 06:50	10/11/2019 19:21	36,51	25	912,78	CHI
20191167413	MARA ROSA	MQ13330160	SANTA TEREZINHA	09/11/2019 06:50	10/11/2019 19:21	10/11/2019 14:28	10/11/2019 19:21	4,88	39	190,22	CHI
20191167414	MORRINHOS	MR12056688	MORRINHOS	08/11/2019 20:33	09/11/2019 10:49	08/11/2019 20:33	09/11/2019 10:49	14,26	8	114,05	CHI
20191167420	ANAPOLIS	AN21325305	ANAPOLIS UNIVERSITARIO S1	09/11/2019 08:29	09/11/2019 16:27	09/11/2019 08:29	09/11/2019 16:27	7,95	1	7,95	CHI
20191167431	PARAUNA	PU21198712	FIRMINOPOLIS S2	08/11/2019 10:30	09/11/2019 10:48	08/11/2019 10:30	09/11/2019 10:48	24,31	1	24,31	CHI
20191167440	GOIANESIA	GE12213695	GOIANESIA S1	09/11/2019 08:32	09/11/2019 17:47	09/11/2019 08:32	09/11/2019 17:47	9,24	5	46,19	CHI
20191167448	BONOPOLIS	BX12202542	SAO MIGUEL DO ARAGUAIA	09/11/2019 05:54	09/11/2019 19:11	09/11/2019 05:54	09/11/2019 19:11	13,28	53	703,81	CHI
20191167448	PORANGATU	BX12202542	SAO MIGUEL DO ARAGUAIA	09/11/2019 05:54	09/11/2019 19:11	09/11/2019 05:54	09/11/2019 19:11	13,28	1	13,28	CHI
20191167449	CATALAO	CT12078822	CATALAO S1	09/11/2019 07:47	10/11/2019 07:20	09/11/2019 07:47	10/11/2019 07:20	23,55	5	117,74	CHI
20191167455	ABADIANA	AA11156848	ANAPOLIS UNIVERSITARIO S1	09/11/2019 08:34	09/11/2019 12:46	09/11/2019 10:10	09/11/2019 12:46	2,59	157	406,59	CHI
20191167464	ANAPOLIS	AN12000193RE	ANAPOLIS UNIVERSITARIO S2	09/11/2019 07:13	09/11/2019 10:28	09/11/2019 07:13	09/11/2019 10:28	3,25	4	13,00	CHI
20191167467	CORUMBAIBA	CI12392072	VILA CORUMBA	09/11/2019 08:37	09/11/2019 13:51	09/11/2019 08:37	09/11/2019 13:51	5,23	6	31,39	CHI
20191167470	SAO MIGUEL DO ARAGUAIA	SM12208506	SAO MIGUEL DO ARAGUAIA	09/11/2019 07:35	09/11/2019 08:37	09/11/2019 07:35	09/11/2019 08:37	1,04	9	9,38	CHI
20191167477	DOVERLANDIA	DV12138337	CAIAPONIA	09/11/2019 08:38	13/11/2019 11:20	09/11/2019 08:38	13/11/2019 11:20	98,69	3	296,06	CHI
20191167482	PONTALINA	PK11000019	PONTALINA	09/11/2019 08:13	09/11/2019 10:43	09/11/2019 08:13	09/11/2019 10:43	2,50	165	411,77	CHI
20191167483	GOIANESIA	GE21115124	GOIANESIA S2	09/11/2019 08:39	09/11/2019 18:15	09/11/2019 08:39	09/11/2019 18:15	9,59	1	9,59	CHI
20191167489	PIRENOPOLIS	PV12370305	CORUMBA	09/11/2019 08:03	09/11/2019 14:35	09/11/2019 08:03	09/11/2019 14:35	6,52	16	104,28	CHI
20191167500	PIRANHAS	PH12380878	PIRANHAS	09/11/2019 04:32	09/11/2019 17:10	09/11/2019 04:32	09/11/2019 17:10	12,63	11	138,90	CHI
20191167503	PORANGATU	PO12391930	PORANGATU	09/11/2019 05:41	09/11/2019 22:22	09/11/2019 05:41	09/11/2019 22:22	16,67	44	733,38	CHI
20191167504	UIRAPURU	UP21244473	NOVA CRIXAS	09/11/2019 08:42	12/11/2019 01:15	09/11/2019 08:42	12/11/2019 01:15	64,54	1	64,54	CHI
20191167510	SAO LUIS DE MONTES BELOS	SL12007695	SAO LUIZ DOS MONTES BELOS	09/11/2019 08:23	09/11/2019 09:57	09/11/2019 08:23	09/11/2019 09:57	1,57	9	14,09	CHI
20191167529	FAINA	FC12274382	GOIAS	09/11/2019 08:46	10/11/2019 09:56	09/11/2019 08:46	10/11/2019 09:56	25,16	4	100,62	CHI
20191167532	ANAPOLIS	10009024237	JUNDIAI S1	09/11/2019 08:47	09/11/2019 10:43	09/11/2019 08:47	09/11/2019 10:43	1,93	1	1,93	CHI
20191167539	BALIZA	BH12343730	BOM JARDIM	09/11/2019 08:48	11/11/2019 11:54	09/11/2019 08:48	11/11/2019 11:54	51,08	8	408,68	CHI
20191167544	CATALAO	CT21077614	CATALAO S1	09/11/2019 08:49	09/11/2019 14:59	09/11/2019 08:49	09/11/2019 14:59	6,15	1	6,15	CHI
20191167551	CAMPINORTE	CR12221640	MARA ROSA	08/11/2019 14:38	09/11/2019 15:10	08/11/2019 14:38	09/11/2019 15:10	24,53	1	24,53	CHI
20191167551	URUACU	CR12221640	MARA ROSA	08/11/2019 14:38	09/11/2019 15:10	08/11/2019 14:38	09/11/2019 15:10	24,53	28	686,75	CHI
20191167552	PARAUNA	PU12273594	PARAUNA	09/11/2019 08:51	09/11/2019 14:29	09/11/2019 08:51	09/11/2019 14:29	5,64	8	45,11	CHI
20191167561	FAZENDA NOVA	FN12042812	JUSSARA	09/11/2019 07:43	09/11/2019 15:05	09/11/2019 07:43	09/11/2019 15:05	7,35	10	73,54	CHI
20191167563	RUBIATABA	RB11185022	RUBIATABA	09/11/2019 06:27	09/11/2019 12:37	09/11/2019 06:27	09/11/2019 12:37	6,15	66	406,10	CHI
20191167572	BALIZA	10001992919	CAIAPONIA	09/11/2019 08:53	11/11/2019 14:49	09/11/2019 08:53	11/11/2019 14:49	53,92	1	53,92	CHI
20191167577	NIQUELANDIA	NQ12264564	BARRO ALTO	09/11/2019 06:11	09/11/2019 11:49	09/11/2019 06:11	09/11/2019 11:49	5,62	12	67,41	CHI
20191167583	JUSSARA	JR12022269	BRITANIA	09/11/2019 08:19	18/11/2019 16:52	11/11/2019 15:01	13/11/2019 10:41	43,66	8	349,29	CHI

20191167583	JUSSARA	JR12022269	BRITANIA	09/11/2019 08:19	18/11/2019 16:52	11/11/2019 15:01	13/11/2019 13:53	46,87	5	234,34	CHI
20191167583	JUSSARA	JR13024142	BRITANIA	09/11/2019 08:19	18/11/2019 16:52	11/11/2019 15:01	13/11/2019 14:43	47,69	12	572,29	CHI
20191167583	MONTES CLAROS DE GOIAS	JR13024142	BRITANIA	09/11/2019 08:19	18/11/2019 16:52	11/11/2019 15:01	13/11/2019 14:43	47,69	256	12208,92	CHI
20191167583	MONTES CLAROS DE GOIAS	JR13024142	BRITANIA	09/11/2019 08:19	18/11/2019 16:52	12/11/2019 21:53	13/11/2019 14:43	16,83	1	16,83	CHI
20191167583	JUSSARA	JR12022269	BRITANIA	09/11/2019 08:19	18/11/2019 16:52	11/11/2019 15:01	18/11/2019 16:32	169,52	3	508,57	CHI
20191167583	JUSSARA	JR12022269	BRITANIA	09/11/2019 08:19	18/11/2019 16:52	11/11/2019 15:01	18/11/2019 16:52	169,86	2	339,71	CHI
20191167584	MONTES CLAROS DE GOIAS	ME11334946	BRITANIA	07/11/2019 13:57	09/11/2019 14:11	07/11/2019 13:57	09/11/2019 14:11	48,22	7	337,53	CHI
20191167585	MONTES CLAROS DE GOIAS	ME21186370	BRITANIA	08/11/2019 07:59	09/11/2019 15:23	08/11/2019 07:59	09/11/2019 15:23	31,39	71	2228,89	CHI
20191167604	GOIANESIA	GE21273413	GOIANESIA S2	09/11/2019 08:57	09/11/2019 15:00	09/11/2019 08:57	09/11/2019 15:00	6,05	1	6,05	CHI
20191167608	BALIZA	BH21207599	BOM JARDIM	09/11/2019 08:57	11/11/2019 11:02	09/11/2019 08:57	11/11/2019 11:02	50,07	1	50,07	CHI
20191167626	GOIANESIA	GE12000299	GOIANESIA S2	09/11/2019 06:00	10/11/2019 08:58	09/11/2019 06:00	10/11/2019 08:58	26,95	17	458,17	CHI
20191167626	VILA PROPICIO	GE12000299	GOIANESIA S2	09/11/2019 06:00	10/11/2019 08:58	09/11/2019 06:00	10/11/2019 08:58	26,95	6	161,71	CHI
20191167707	ARAGARCAS	ME12095835	IPORA	09/11/2019 05:56	11/11/2019 10:58	09/11/2019 05:56	11/11/2019 10:58	53,03	49	2598,43	CHI
20191167707	BOM JARDIM DE GOIAS	ME12095835	IPORA	09/11/2019 05:56	11/11/2019 10:58	09/11/2019 05:56	11/11/2019 10:58	53,03	2	106,06	CHI
20191167707	MONTES CLAROS DE GOIAS	ME12095835	IPORA	09/11/2019 05:56	11/11/2019 10:58	09/11/2019 05:56	11/11/2019 10:58	53,03	8	424,23	CHI
20191167775	MOZARLANDIA	MZ11089966	MOZARLANDIA	09/11/2019 08:39	09/11/2019 22:44	09/11/2019 08:39	09/11/2019 22:44	14,08	161	2266,30	CHI
20191167798	ARAGARCAS	AG12138460	ARAGARCAS	09/11/2019 08:50	09/11/2019 13:29	09/11/2019 08:50	09/11/2019 13:29	4,65	13	60,40	CHI
20191167803	RIO VERDE	RV21000189	RIO VERDE S1	07/11/2019 11:32	09/11/2019 10:24	07/11/2019 11:32	09/11/2019 10:24	46,86	1	46,86	CHI
20191167805	GOIANAPOLIS	GP11195686	JUNDIAI S1	09/11/2019 08:34	09/11/2019 13:35	09/11/2019 08:34	09/11/2019 13:35	5,02	15	75,29	CHI
20191167840	SANTO ANTONIO DA BARRA	BZ21361033	ACREUNA	08/11/2019 16:56	09/11/2019 10:34	08/11/2019 16:56	09/11/2019 10:34	17,62	1	17,62	CHI
20191167859	NOVO PLANALTO	SM12074646	SAO MIGUEL DO ARAGUAIA	08/11/2019 23:56	09/11/2019 14:40	08/11/2019 23:56	09/11/2019 14:40	14,74	6	88,43	CHI
20191167859	SAO MIGUEL DO ARAGUAIA	SM12074646	SAO MIGUEL DO ARAGUAIA	08/11/2019 23:56	09/11/2019 14:40	08/11/2019 23:56	09/11/2019 14:40	14,74	296	4362,46	CHI
20191167866	RUBIATABA	RB12187182	RUBIATABA	08/11/2019 22:18	10/11/2019 04:37	08/11/2019 22:18	10/11/2019 04:37	30,31	11	333,46	CHI
20191167868	ESTRELA DO NORTE	ET12391908	MARA ROSA	09/11/2019 06:00	12/11/2019 02:54	09/11/2019 06:00	12/11/2019 02:54	68,90	1	68,90	CHI
20191167868	MARA ROSA	ET12391908	MARA ROSA	09/11/2019 06:00	12/11/2019 02:54	09/11/2019 06:00	12/11/2019 02:54	68,90	1	68,90	CHI
20191167983	PORANGATU	PO12020578	PORANGATU	09/11/2019 05:41	09/11/2019 11:33	09/11/2019 05:41	09/11/2019 11:33	5,86	23	134,89	CHI
20191167985	FORMOSO	FO12145406	PORANGATU	09/11/2019 05:03	09/11/2019 15:56	09/11/2019 05:03	09/11/2019 15:56	10,88	70	761,60	CHI
20191168173	NOVA CRIXAS	05630224	NOVA CRIXAS	09/11/2019 07:32	12/11/2019 12:41	09/11/2019 15:42	09/11/2019 15:58	0,26	27	7,09	CHI
20191168173	NOVA CRIXAS	NA13294704	NOVA CRIXAS	09/11/2019 07:32	12/11/2019 12:41	09/11/2019 15:42	12/11/2019 12:25	68,72	21	1443,15	CHI
20191168173	CRIXAS	NA12126913	NOVA CRIXAS	09/11/2019 07:32	12/11/2019 12:41	09/11/2019 07:32	12/11/2019 12:41	77,14	3	231,41	CHI
20191168173	NOVA CRIXAS	NA12126913	NOVA CRIXAS	09/11/2019 07:32	12/11/2019 12:41	09/11/2019 07:32	12/11/2019 12:41	77,14	5	385,69	CHI
20191168255	CRIXAS	CX12054992	SANTA TEREZINHA	09/11/2019 07:56	09/11/2019 18:01	09/11/2019 07:56	09/11/2019 18:01	10,09	97	978,46	CHI
20191168258	GUARAITA	IK12250511	ITAPURANGA	09/11/2019 05:48	10/11/2019 07:40	09/11/2019 05:48	10/11/2019 07:40	25,86	7	181,03	CHI

20191168258	ITAPURANGA	IK12250511	ITAPURANGA	09/11/2019 05:48	10/11/2019 07:40	09/11/2019 05:48	10/11/2019 07:40	25,86	37	956,87	CHI
20191168330	MORRINHOS	MR12033194	MORRINHOS	09/11/2019 07:32	09/11/2019 18:16	09/11/2019 07:32	09/11/2019 18:16	10,72	14	150,12	CHI
20191168331	ARUANA	AK11183275	ARUANA	09/11/2019 08:54	09/11/2019 17:00	09/11/2019 08:54	09/11/2019 17:00	8,08	91	735,66	CHI
20191168459	CRIXAS	CX12330137	RUBIATABA	09/11/2019 08:40	10/11/2019 12:54	09/11/2019 08:40	10/11/2019 12:54	28,23	37	1044,47	CHI
20191168603	NIQUELANDIA	NQ12264207	NIQUELANDIA SUBTRANSMISSAO	09/11/2019 08:40	10/11/2019 13:49	09/11/2019 08:40	10/11/2019 13:49	29,13	13	378,75	CHI
20191168613	GOIANESIA	GE11273402	GOIANESIA S2	08/11/2019 19:34	10/11/2019 06:41	08/11/2019 19:34	10/11/2019 06:41	35,11	103	3615,96	CHI
20191168636	NOVO PLANALTO	SM12099146	SAO MIGUEL DO ARAGUAIA	08/11/2019 20:10	11/11/2019 14:25	08/11/2019 20:10	10/11/2019 12:24	40,23	0	0,00	CHI
20191168636	SAO MIGUEL DO ARAGUAIA	SM12099146	SAO MIGUEL DO ARAGUAIA	08/11/2019 20:10	11/11/2019 14:25	08/11/2019 20:10	10/11/2019 12:24	40,23	29	1166,65	CHI
20191168636	SAO MIGUEL DO ARAGUAIA	SM13371096	SAO MIGUEL DO ARAGUAIA	08/11/2019 20:10	11/11/2019 14:25	08/11/2019 20:10	10/11/2019 15:57	43,78	22	963,17	CHI
20191168636	SAO MIGUEL DO ARAGUAIA	SM12253878LD	SAO MIGUEL DO ARAGUAIA	08/11/2019 20:10	11/11/2019 14:25	08/11/2019 20:10	11/11/2019 14:25	66,25	1	66,25	CHI
20191168651	SAO MIGUEL DO ARAGUAIA	SM12096089	SAO MIGUEL DO ARAGUAIA	07/11/2019 07:13	09/11/2019 18:14	07/11/2019 07:13	09/11/2019 18:14	59,02	27	1593,43	CHI
20191168728	MINACU	IH12230480	MINACU	09/11/2019 08:52	09/11/2019 14:48	09/11/2019 08:52	09/11/2019 14:48	5,92	17	100,72	CHI
20191168887	ARUANA	AK12250804	ARUANA	09/11/2019 04:01	09/11/2019 14:53	09/11/2019 04:01	09/11/2019 14:53	10,86	31	336,69	CHI
20191168946	NOVA CRIXAS	NA12328072	NOVA CRIXAS	08/11/2019 11:20	11/11/2019 18:25	08/11/2019 11:20	11/11/2019 18:25	79,09	1	79,09	CHI
20191169283	RUBIATABA	RB12070011	RUBIATABA	08/11/2019 23:05	09/11/2019 14:56	08/11/2019 23:05	09/11/2019 14:56	15,84	3	47,52	CHI
20191169284	CERES	RB12392307	RUBIATABA	09/11/2019 08:14	10/11/2019 02:39	09/11/2019 08:14	10/11/2019 02:39	18,41	25	460,19	CHI
20191169284	RUBIATABA	RB12392307	RUBIATABA	09/11/2019 08:14	10/11/2019 02:39	09/11/2019 08:14	10/11/2019 02:39	18,41	22	404,97	CHI
20191169450	GOIANESIA	GE12360291	GOIANESIA S2	09/11/2019 07:32	09/11/2019 17:37	09/11/2019 07:32	09/11/2019 17:37	10,08	8	80,60	CHI
20191169891	MORRINHOS	MR32056716	MORRINHOS	09/11/2019 06:17	09/11/2019 19:19	09/11/2019 06:17	09/11/2019 19:19	13,03	13	169,39	CHI
20191169991	MORRO AGUDO DE GOIAS	RB12070852	RUBIATABA	09/11/2019 06:57	10/11/2019 00:18	09/11/2019 06:57	10/11/2019 00:18	17,34	4	69,35	CHI
20191169991	RUBIATABA	RB12070852	RUBIATABA	09/11/2019 06:57	10/11/2019 00:18	09/11/2019 06:57	10/11/2019 00:18	17,34	75	1300,31	CHI
20191170609	JATAI	JT21104654	JATAI S1	08/11/2019 17:29	10/11/2019 20:21	08/11/2019 17:29	10/11/2019 20:21	50,85	1	50,85	CHI
20191170894	PANAMA	PX12000451	GOIATUBA S1	09/11/2019 07:44	11/11/2019 16:00	09/11/2019 07:44	11/11/2019 16:00	56,27	21	1181,65	CHI
20191170908	SERRANOPOLIS	SX12216725	JATAI S1	08/11/2019 08:22	11/11/2019 15:54	08/11/2019 08:22	11/11/2019 15:54	79,52	19	1510,87	CHI
20191171500	JUSSARA	JR12250547	JUSSARA	09/11/2019 07:07	10/11/2019 11:16	09/11/2019 07:07	10/11/2019 10:55	27,80	3	83,39	CHI
20191171500	JUSSARA	JR12090187	JUSSARA	09/11/2019 07:07	10/11/2019 11:16	09/11/2019 07:07	10/11/2019 11:16	28,15	3	84,45	CHI
20191173248	IVOLANDIA	IV12358531	IPORA	09/11/2019 08:57	11/11/2019 11:07	09/11/2019 08:57	11/11/2019 11:07	50,16	16	802,49	CHI
20191173595	FORMOSO	FO12170963	MARA ROSA	09/11/2019 08:43	09/11/2019 22:15	09/11/2019 08:43	09/11/2019 22:15	13,52	11	148,77	CHI
20191173980	MATRINCHA	MP12221185	MATRINCHA	08/11/2019 13:09	10/11/2019 09:02	08/11/2019 13:09	10/11/2019 09:02	43,87	56	2456,78	CHI
20191174210	JUSSARA	10001093310	IPORA	07/11/2019 15:08	11/11/2019 14:38	07/11/2019 15:08	11/11/2019 14:38	95,48	1	95,48	CHI
20191178568	SERRANOPOLIS	SX12267586	JATAI S1	08/11/2019 12:43	11/11/2019 14:54	08/11/2019 12:43	11/11/2019 14:54	74,17	7	519,22	CHI
20191179233	CAMPINORTE	CR21252004	MARA ROSA	08/11/2019 17:43	13/11/2019 11:57	08/11/2019 17:43	13/11/2019 11:57	114,23	1	114,23	CHI
20191179234	CAMPINORTE	CR21168807	MARA ROSA	08/11/2019 20:22	11/11/2019 13:25	08/11/2019 20:22	11/11/2019 13:25	65,05	3	195,14	CHI

20191180653	SANTA HELENA DE GOIAS	SH12271563	IPEGUARI	07/11/2019 23:04	11/11/2019 11:45	07/11/2019 23:04	11/11/2019 11:45	84,68	27	2286,32	CHI
20191180653	TURVELANDIA	SH12271563	IPEGUARI	07/11/2019 23:04	11/11/2019 11:45	07/11/2019 23:04	11/11/2019 11:45	84,68	12	1016,14	CHI
20191182013	SANTA HELENA DE GOIAS	SH12295822	IPEGUARI	07/11/2019 23:04	13/11/2019 19:10	07/11/2019 23:04	12/11/2019 10:53	107,81	13	1401,56	CHI
20191182013	SANTA HELENA DE GOIAS	SH12295822	IPEGUARI	07/11/2019 23:04	13/11/2019 19:10	07/11/2019 23:04	12/11/2019 11:25	108,35	17	1841,87	CHI
20191182013	SANTA HELENA DE GOIAS	SH12295822	IPEGUARI	07/11/2019 23:04	13/11/2019 19:10	07/11/2019 23:04	12/11/2019 12:59	109,91	25	2747,79	CHI
20191182013	SANTA HELENA DE GOIAS	SH12295822	IPEGUARI	07/11/2019 23:04	13/11/2019 19:10	07/11/2019 23:04	13/11/2019 19:10	140,10	40	5604,04	CHI
20191199582	CACHOEIRA ALTA	CC12084267	CACHOEIRA ALTA	08/11/2019 09:02	13/11/2019 21:46	08/11/2019 09:02	13/11/2019 21:46	132,74	6	796,42	CHI
201911137536	BONOPOLIS	BX12377680LD	SAO MIGUEL DO ARAGUAIA	08/11/2019 23:37	15/11/2019 10:47	12/11/2019 14:35	14/11/2019 13:04	46,50	77	3580,44	CHI
201911137536	SAO MIGUEL DO ARAGUAIA	BX12377680LD	SAO MIGUEL DO ARAGUAIA	08/11/2019 23:37	15/11/2019 10:47	12/11/2019 14:35	14/11/2019 13:04	46,50	0	0,00	CHI
201911137536	BONOPOLIS	SM10396890	SAO MIGUEL DO ARAGUAIA	08/11/2019 23:37	15/11/2019 10:47	14/11/2019 16:54	14/11/2019 17:25	0,52	81	41,83	CHI
201911137536	SAO MIGUEL DO ARAGUAIA	SM10396890	SAO MIGUEL DO ARAGUAIA	08/11/2019 23:37	15/11/2019 10:47	14/11/2019 16:54	14/11/2019 17:25	0,52	108	55,77	CHI
201911137536	BONOPOLIS	BX12045611LD	SAO MIGUEL DO ARAGUAIA	08/11/2019 23:37	15/11/2019 10:47	08/11/2019 23:37	14/11/2019 20:10	140,55	7	983,82	CHI
201911137536	BONOPOLIS	BX12045611LD	SAO MIGUEL DO ARAGUAIA	08/11/2019 23:37	15/11/2019 10:47	08/11/2019 23:37	15/11/2019 08:12	152,58	5	762,90	CHI
201911137536	BONOPOLIS	BX12045611LD	SAO MIGUEL DO ARAGUAIA	08/11/2019 23:37	15/11/2019 10:47	10/11/2019 00:00	15/11/2019 08:12	128,20	2	256,40	CHI
201911137536	BONOPOLIS	BX12045611LD	SAO MIGUEL DO ARAGUAIA	08/11/2019 23:37	15/11/2019 10:47	08/11/2019 23:37	15/11/2019 09:41	154,06	5	770,31	CHI
201911137536	BONOPOLIS	BX12045611LD	SAO MIGUEL DO ARAGUAIA	08/11/2019 23:37	15/11/2019 10:47	08/11/2019 23:37	15/11/2019 10:12	154,58	3	463,74	CHI
201911137536	BONOPOLIS	BX12045611LD	SAO MIGUEL DO ARAGUAIA	08/11/2019 23:37	15/11/2019 10:47	08/11/2019 23:37	15/11/2019 10:47	155,16	1	155,16	CHI
201911337564	FAINA	FC12084191	GOIAS	07/11/2019 18:55	10/11/2019 11:23	07/11/2019 18:55	10/11/2019 11:23	64,46	3	193,38	CHI
201911343410	CAIAPONIA	PY12040163	PALESTINA	07/11/2019 16:21	08/11/2019 20:25	07/11/2019 16:21	08/11/2019 20:25	28,05	43	1206,26	CHI
201911343410	PALESTINA DE GOIAS	PY12040163	PALESTINA	07/11/2019 16:21	08/11/2019 20:25	07/11/2019 16:21	08/11/2019 20:25	28,05	102	2861,35	CHI
201911343510	JAUPACI	JP12235888	IPORA	08/11/2019 13:43	11/11/2019 17:28	11/11/2019 13:43	11/11/2019 17:28	3,74	3	11,22	CHI
201911356729	AMERICANO DO BRASIL	IB12000062	ITABERAI S2	06/11/2019 10:24	06/11/2019 21:04	06/11/2019 10:24	06/11/2019 21:04	10,66	11	117,24	CHI
201911356729	ITABERAI	IB12000062	ITABERAI S2	06/11/2019 10:24	06/11/2019 21:04	06/11/2019 10:24	06/11/2019 21:04	10,66	18	191,84	CHI
201911356822	MOSSAMEDES	MD12119449	ANICUNS	06/11/2019 10:34	07/11/2019 17:55	06/11/2019 10:34	07/11/2019 17:55	31,35	16	501,58	CHI
201911357249	QUIRINOPOLIS	QI32255720	QUIRINOPOLIS	06/11/2019 15:15	07/11/2019 11:54	06/11/2019 15:15	07/11/2019 11:54	20,65	1	20,65	CHI
201911357389	RIO VERDE	RV12213283LD	MONTIVIDIU T	06/11/2019 12:51	07/11/2019 22:10	06/11/2019 12:51	07/11/2019 22:10	33,31	51	1698,90	CHI
201911357436	GUAPO	GA12000053	GUAPO S2	06/11/2019 17:04	08/11/2019 12:58	06/11/2019 17:04	08/11/2019 12:58	43,90	1	43,90	CHI
201911357455	FAINA	GS12061648	MATRINCHA	06/11/2019 15:36	08/11/2019 19:09	06/11/2019 15:36	08/11/2019 19:09	51,54	38	1958,41	CHI
201911357455	MATRINCHA	GS12061648	MATRINCHA	06/11/2019 15:36	08/11/2019 19:09	06/11/2019 15:36	08/11/2019 19:09	51,54	5	257,69	CHI
201911357562	FLORES DE GOIAS	FB12211536	IACIARA S2	07/11/2019 06:26	07/11/2019 10:09	07/11/2019 06:26	07/11/2019 10:09	3,71	14	51,98	CHI
201911357602	SAO LUIS DE MONTES BELOS	SL12011302	FIRMINOPOLIS S2	06/11/2019 13:55	07/11/2019 10:00	06/11/2019 13:55	07/11/2019 10:00	20,08	10	200,78	CHI
201911357708	NOVA IGUAQU DE GOIAS	MQ12057535	CAMPINORTE	07/11/2019 08:21	08/11/2019 16:27	07/11/2019 08:21	08/11/2019 16:27	32,08	3	96,25	CHI
201911357858	MUNDO NOVO DE GOIAS	MH11274642	NOVA CRIXAS	07/11/2019 08:35	07/11/2019 11:04	07/11/2019 08:35	07/11/2019 10:49	2,23	1	2,23	CHI

201911357858	MUNDO NOVO DE GOIAS	8276217	NOVA CRIXAS	07/11/2019 08:35	07/11/2019 11:04	07/11/2019 10:48	07/11/2019 11:04	0,27	1	0,27	CHI
201911368059	PIRENOPOLIS	PV12014768	SAO FRANCISCO DE GOIAS	07/11/2019 14:03	08/11/2019 00:23	07/11/2019 14:03	08/11/2019 00:23	10,32	7	72,24	CHI
201911368061	ITUMBIARA	BJ12000196	CACHOEIRA DOURADA	07/11/2019 18:31	09/11/2019 14:56	07/11/2019 18:31	09/11/2019 14:56	44,41	2	88,82	CHI
201911368063	APORE	00100214	ITAJA S1	07/11/2019 19:30	08/11/2019 00:00	07/11/2019 19:30	08/11/2019 00:00	4,49	1590	7137,78	CHI
201911368063	DISTRITO FEDERAL	00100214	ITAJA S1	07/11/2019 19:30	08/11/2019 00:00	07/11/2019 19:30	08/11/2019 00:00	4,49	2	8,98	CHI
201911368063	ITARUMA	00100214	ITAJA S1	07/11/2019 19:30	08/11/2019 00:00	07/11/2019 19:30	08/11/2019 00:00	4,49	1	4,49	CHI
201911368063	JATAI	00100214	ITAJA S1	07/11/2019 19:30	08/11/2019 00:00	07/11/2019 19:30	08/11/2019 00:00	4,49	1	4,49	CHI
201911368065	SANTA HELENA DE GOIAS	SH12279533	IPEGUARI	07/11/2019 22:41	08/11/2019 10:37	07/11/2019 22:41	08/11/2019 10:37	11,93	32	381,73	CHI
201911368067	CACHOEIRA ALTA	CA12200648	CACHOEIRA ALTA	08/11/2019 08:59	11/11/2019 16:00	08/11/2019 08:59	11/11/2019 16:00	79,01	2	158,02	CHI
201911368068	CRISTALINA	03940214	CRISTALINA S2	08/11/2019 16:52	08/11/2019 18:34	08/11/2019 16:52	08/11/2019 18:34	1,69	284	479,33	CHI
201911368069	RIO VERDE	RV12249116	CABRIUVA S2	08/11/2019 18:39	09/11/2019 13:50	08/11/2019 18:39	09/11/2019 13:50	19,18	3	57,54	CHI
201911368071	CAMPINACU	UC12400308	MARA ROSA	08/11/2019 19:50	11/11/2019 11:08	08/11/2019 19:50	11/11/2019 11:08	63,29	20	1265,73	CHI
201911368174	MONTES CLAROS DE GOIAS	1440019839	BRITANIA	09/11/2019 08:18	11/11/2019 15:01	09/11/2019 08:18	11/11/2019 15:01	54,71	1	54,71	CHI
201911368181	ITAGUARU	JA21062953	ITABERAI S1	08/11/2019 13:15	13/11/2019 09:37	08/11/2019 13:15	13/11/2019 09:37	116,36	1	116,36	CHI
201911368214	ALEXANIA	10018825107	ALEXANIA	08/11/2019 15:22	09/11/2019 16:27	08/11/2019 15:22	09/11/2019 16:27	25,09	1	25,09	CHI
201911368217	NIQUELANDIA	10009123049	SAO JOAO D ALIANCA	08/11/2019 13:44	09/11/2019 17:11	08/11/2019 13:44	09/11/2019 17:11	27,46	1	27,46	CHI
201911368247	PALMEIRAS DE GOIAS	590016015	PALMEIRAS	06/11/2019 14:43	07/11/2019 12:10	06/11/2019 14:43	07/11/2019 12:10	21,43	1	21,43	CHI
201911368318	MAURILANDIA	SH13271227	SANTA HELENA S1	08/11/2019 15:42	09/11/2019 10:22	08/11/2019 15:42	08/11/2019 17:47	2,08	28	58,30	CHI
201911368318	MAURILANDIA	SH13271227	SANTA HELENA S1	08/11/2019 15:42	09/11/2019 10:22	08/11/2019 15:42	08/11/2019 17:47	2,08	6	12,49	CHI
201911368318	QUIRINOPOLIS	SH13271227	SANTA HELENA S1	08/11/2019 15:42	09/11/2019 10:22	08/11/2019 15:42	08/11/2019 17:47	2,08	42	87,45	CHI
201911368318	QUIRINOPOLIS	SH13271227	SANTA HELENA S1	08/11/2019 15:42	09/11/2019 10:22	08/11/2019 15:42	08/11/2019 17:47	2,08	11	22,90	CHI
201911368318	RIO VERDE	SH13271227	SANTA HELENA S1	08/11/2019 15:42	09/11/2019 10:22	08/11/2019 15:42	08/11/2019 17:47	2,08	625	1301,39	CHI
201911368318	RIO VERDE	SH13271227	SANTA HELENA S1	08/11/2019 15:42	09/11/2019 10:22	08/11/2019 15:42	08/11/2019 17:47	2,08	292	608,01	CHI
201911368318	RIO VERDE	SH13271227	SANTA HELENA S1	08/11/2019 15:42	09/11/2019 10:22	08/11/2019 15:42	08/11/2019 17:47	2,08	640	1332,62	CHI
201911368318	RIO VERDE	SH13271227	SANTA HELENA S1	08/11/2019 15:42	09/11/2019 10:22	08/11/2019 15:42	08/11/2019 17:47	2,08	26	54,14	CHI
201911368318	RIO VERDE	SH13271228	SANTA HELENA S1	08/11/2019 15:42	09/11/2019 10:22	08/11/2019 15:42	08/11/2019 17:47	2,08	1	2,08	CHI
201911368318	SANTA HELENA DE GOIAS	SH13271227	SANTA HELENA S1	08/11/2019 15:42	09/11/2019 10:22	08/11/2019 15:42	08/11/2019 17:47	2,08	53	110,36	CHI
201911368318	SANTA HELENA DE GOIAS	SH13271227	SANTA HELENA S1	08/11/2019 15:42	09/11/2019 10:22	08/11/2019 15:42	08/11/2019 17:47	2,08	1	2,08	CHI
201911368318	SANTA HELENA DE GOIAS	SH13271228	SANTA HELENA S1	08/11/2019 15:42	09/11/2019 10:22	08/11/2019 15:42	08/11/2019 17:47	2,08	2	4,16	CHI
201911368318	MAURILANDIA	SH13271228	SANTA HELENA S1	08/11/2019 15:42	09/11/2019 10:22	08/11/2019 17:44	08/11/2019 17:47	0,06	4	0,23	CHI
201911368318	SANTA HELENA DE GOIAS	SH13271228	SANTA HELENA S1	08/11/2019 15:42	09/11/2019 10:22	08/11/2019 17:44	08/11/2019 17:47	0,06	16	0,91	CHI
201911368318	TURVELANDIA	SH13271228	SANTA HELENA S1	08/11/2019 15:42	09/11/2019 10:22	08/11/2019 17:44	08/11/2019 17:47	0,06	5	0,28	CHI
201911368318	SANTA HELENA DE GOIAS	SH13271227	SANTA HELENA S1	08/11/2019 15:42	09/11/2019 10:22	08/11/2019 15:42	08/11/2019 22:43	7,01	7	49,06	CHI

201911368318	SANTA HELENA DE GOIAS	SH13271227	SANTA HELENA S1	08/11/2019 15:42	09/11/2019 10:22	08/11/2019 15:42	08/11/2019 23:00	7,29	2	14,58	CHI
201911368318	MAURILANDIA	SH13191770	SANTA HELENA S1	08/11/2019 15:42	09/11/2019 10:22	08/11/2019 15:42	08/11/2019 23:46	8,06	4	32,23	CHI
201911368318	SANTA HELENA DE GOIAS	SH13191770	SANTA HELENA S1	08/11/2019 15:42	09/11/2019 10:22	08/11/2019 15:42	08/11/2019 23:46	8,06	8	64,47	CHI
201911368318	SANTA HELENA DE GOIAS	SH13271227	SANTA HELENA S1	08/11/2019 15:42	09/11/2019 10:22	08/11/2019 15:42	09/11/2019 10:22	18,67	2	37,34	CHI
201911368337	MONTIVIDIU	MV12030666	MONTIVIDIU T	08/11/2019 21:49	14/11/2019 16:10	08/11/2019 21:49	14/11/2019 08:31	130,69	21	2744,45	CHI
201911368337	CAIAPONIA	MV12030666	MONTIVIDIU T	08/11/2019 21:49	14/11/2019 16:10	08/11/2019 21:49	14/11/2019 16:10	138,35	16	2213,60	CHI
201911368337	MONTIVIDIU	MV12030666	MONTIVIDIU T	08/11/2019 21:49	14/11/2019 16:10	08/11/2019 21:49	14/11/2019 16:10	138,35	2	276,70	CHI
2019110700095	GUARANI DE GOIAS	01230214	IACIARA S1	07/11/2019 08:36	07/11/2019 09:00	07/11/2019 08:36	07/11/2019 09:00	0,40	1281	512,40	CHI
2019110700095	IACIARA	01230214	IACIARA S1	07/11/2019 08:36	07/11/2019 09:00	07/11/2019 08:36	07/11/2019 09:00	0,40	4168	1667,20	CHI
2019110700095	POSSE	01230214	IACIARA S1	07/11/2019 08:36	07/11/2019 09:00	07/11/2019 08:36	07/11/2019 09:00	0,40	170	68,00	CHI
2019110700095	SAO DOMINGOS	01230214	IACIARA S1	07/11/2019 08:36	07/11/2019 09:00	07/11/2019 08:36	07/11/2019 09:00	0,40	1	0,40	CHI
2019110700114	FORMOSA	03740214	ITIQUEIRA	07/11/2019 12:23	07/11/2019 12:26	07/11/2019 12:23	07/11/2019 12:26	0,05	12285	614,25	CHI
2019110700117	CAMPOS BELOS	07601	SAO DOMINGOS	07/11/2019 14:25	07/11/2019 14:28	07/11/2019 14:25	07/11/2019 14:28	0,05	4600	230,00	CHI
2019110700117	CAMPOS BELOS	07602	SAO DOMINGOS	07/11/2019 14:25	07/11/2019 14:28	07/11/2019 14:25	07/11/2019 14:28	0,05	2768	138,40	CHI
2019110700117	CAMPOS BELOS	02090504	SAO DOMINGOS	07/11/2019 14:25	07/11/2019 14:28	07/11/2019 14:25	07/11/2019 14:28	0,05	84	4,20	CHI
2019110700117	CAMPOS BELOS	07632	SAO DOMINGOS	07/11/2019 14:25	07/11/2019 14:28	07/11/2019 14:25	07/11/2019 14:28	0,05	153	7,65	CHI
2019110700117	CAMPOS BELOS	07633	SAO DOMINGOS	07/11/2019 14:25	07/11/2019 14:28	07/11/2019 14:25	07/11/2019 14:28	0,05	362	18,10	CHI
2019110700117	DIVINOPOLIS DE GOIAS	02090504	SAO DOMINGOS	07/11/2019 14:25	07/11/2019 14:28	07/11/2019 14:25	07/11/2019 14:28	0,05	2210	110,50	CHI
2019110700117	DIVINOPOLIS DE GOIAS	07633	SAO DOMINGOS	07/11/2019 14:25	07/11/2019 14:28	07/11/2019 14:25	07/11/2019 14:28	0,05	3	0,15	CHI
2019110700117	GUARANI DE GOIAS	02090504	SAO DOMINGOS	07/11/2019 14:25	07/11/2019 14:28	07/11/2019 14:25	07/11/2019 14:28	0,05	149	7,45	CHI
2019110700117	MONTE ALEGRE DE GOIAS	07601	SAO DOMINGOS	07/11/2019 14:25	07/11/2019 14:28	07/11/2019 14:25	07/11/2019 14:28	0,05	51	2,55	CHI
2019110700117	MONTE ALEGRE DE GOIAS	34301	SAO DOMINGOS	07/11/2019 14:25	07/11/2019 14:28	07/11/2019 14:25	07/11/2019 14:28	0,05	1444	72,20	CHI
2019110700117	MONTE ALEGRE DE GOIAS	02090504	SAO DOMINGOS	07/11/2019 14:25	07/11/2019 14:28	07/11/2019 14:25	07/11/2019 14:28	0,05	137	6,85	CHI
2019110700117	MONTE ALEGRE DE GOIAS	02090504	SAO DOMINGOS	07/11/2019 14:25	07/11/2019 14:28	07/11/2019 14:25	07/11/2019 14:28	0,05	2	0,10	CHI
2019110700117	MONTE ALEGRE DE GOIAS	07633	SAO DOMINGOS	07/11/2019 14:25	07/11/2019 14:28	07/11/2019 14:25	07/11/2019 14:28	0,05	729	36,45	CHI
2019110700117	NOVA ROMA	02090504	SAO DOMINGOS	07/11/2019 14:25	07/11/2019 14:28	07/11/2019 14:25	07/11/2019 14:28	0,05	3	0,15	CHI
2019110700117	SAO DOMINGOS	02090504	SAO DOMINGOS	07/11/2019 14:25	07/11/2019 14:28	07/11/2019 14:25	07/11/2019 14:28	0,05	2340	117,00	CHI
2019110700117	SAO DOMINGOS	02090504	SAO DOMINGOS	07/11/2019 14:25	07/11/2019 14:28	07/11/2019 14:25	07/11/2019 14:28	0,05	392	19,60	CHI
2019110700117	SAO DOMINGOS	02090504	SAO DOMINGOS	07/11/2019 14:25	07/11/2019 14:28	07/11/2019 14:25	07/11/2019 14:28	0,05	1151	57,55	CHI
2019110700117	SAO DOMINGOS	07633	SAO DOMINGOS	07/11/2019 14:25	07/11/2019 14:28	07/11/2019 14:25	07/11/2019 14:28	0,05	281	14,05	CHI
2019110800029	BOM JESUS DE GOIAS	00235114	BOM JESUS DE GOIAS	08/11/2019 14:42	08/11/2019 14:45	08/11/2019 14:42	08/11/2019 14:45	0,05	1779	88,95	CHI
2019110800029	BOM JESUS DE GOIAS	00235114	BOM JESUS DE GOIAS	08/11/2019 14:42	08/11/2019 14:45	08/11/2019 14:42	08/11/2019 14:45	0,05	6993	349,65	CHI
2019110800029	BOM JESUS DE GOIAS	00235114	BOM JESUS DE GOIAS	08/11/2019 14:42	08/11/2019 14:45	08/11/2019 14:42	08/11/2019 14:45	0,05	22	1,10	CHI

2019110800029	GOIATUBA	00235114	BOM JESUS DE GOIAS	08/11/2019 14:42	08/11/2019 14:45	08/11/2019 14:42	08/11/2019 14:45	0,05	105	5,25	CHI
2019110800029	GOIATUBA	00235114	BOM JESUS DE GOIAS	08/11/2019 14:42	08/11/2019 14:45	08/11/2019 14:42	08/11/2019 14:45	0,05	22	1,10	CHI
2019110800029	ITUMBIARA	00235114	BOM JESUS DE GOIAS	08/11/2019 14:42	08/11/2019 14:45	08/11/2019 14:42	08/11/2019 14:45	0,05	397	19,85	CHI
2019110800029	ITUMBIARA	00235114	BOM JESUS DE GOIAS	08/11/2019 14:42	08/11/2019 14:45	08/11/2019 14:42	08/11/2019 14:45	0,05	391	19,55	CHI
2019110800029	ITUMBIARA	00235114	BOM JESUS DE GOIAS	08/11/2019 14:42	08/11/2019 14:45	08/11/2019 14:42	08/11/2019 14:45	0,05	3	0,15	CHI
2019110800029	ITUMBIARA	00235114	BOM JESUS DE GOIAS	08/11/2019 14:42	08/11/2019 14:45	08/11/2019 14:42	08/11/2019 14:45	0,05	4	0,20	CHI
2019110800029	QUIRINOPOLIS	00235114	BOM JESUS DE GOIAS	08/11/2019 14:42	08/11/2019 14:45	08/11/2019 14:42	08/11/2019 14:45	0,05	6	0,30	CHI
2019110800029	BOM JESUS DE GOIAS	00235114	CACHOEIRA DOURADA	08/11/2019 14:42	08/11/2019 14:45	08/11/2019 14:42	08/11/2019 14:45	0,05	4	0,20	CHI
2019110800029	CACHOEIRA DOURADA	00280314	CACHOEIRA DOURADA	08/11/2019 14:42	08/11/2019 14:45	08/11/2019 14:42	08/11/2019 14:45	0,05	468	23,40	CHI
2019110800029	CACHOEIRA DOURADA	00280324	CACHOEIRA DOURADA	08/11/2019 14:42	08/11/2019 14:45	08/11/2019 14:42	08/11/2019 14:45	0,05	2844	142,20	CHI
2019110800029	DISTRITO FEDERAL	00280314	CACHOEIRA DOURADA	08/11/2019 14:42	08/11/2019 14:45	08/11/2019 14:42	08/11/2019 14:45	0,05	1	0,05	CHI
2019110800029	ITUMBIARA	00280314	CACHOEIRA DOURADA	08/11/2019 14:42	08/11/2019 14:45	08/11/2019 14:42	08/11/2019 14:45	0,05	38	1,90	CHI
2019110800029	ITUMBIARA	00280324	CACHOEIRA DOURADA	08/11/2019 14:42	08/11/2019 14:45	08/11/2019 14:42	08/11/2019 14:45	0,05	67	3,35	CHI
2019110800041	CHAPADAO DO CEU	02430524	CHAPADAO DO CEU	08/11/2019 20:19	08/11/2019 20:22	08/11/2019 20:19	08/11/2019 20:22	0,05	1983	99,15	CHI
2019110800041	CHAPADAO DO CEU	02430524	CHAPADAO DO CEU	08/11/2019 20:19	08/11/2019 20:22	08/11/2019 20:19	08/11/2019 20:22	0,05	2317	115,85	CHI
2019110800041	CHAPADAO DO CEU	02430524	CHAPADAO DO CEU	08/11/2019 20:19	08/11/2019 20:22	08/11/2019 20:19	08/11/2019 20:22	0,05	11	0,55	CHI
2019110800041	CHAPADAO DO CEU	02430524	CHAPADAO DO CEU	08/11/2019 20:19	08/11/2019 20:22	08/11/2019 20:19	08/11/2019 20:22	0,05	45	2,25	CHI
2019110800041	MINEIROS	02430524	CHAPADAO DO CEU	08/11/2019 20:19	08/11/2019 20:22	08/11/2019 20:19	08/11/2019 20:22	0,05	7	0,35	CHI
2019110800041	MINEIROS	02430524	CHAPADAO DO CEU	08/11/2019 20:19	08/11/2019 20:22	08/11/2019 20:19	08/11/2019 20:22	0,05	20	1,00	CHI
2019110800041	SERRANOPOLIS	02430524	CHAPADAO DO CEU	08/11/2019 20:19	08/11/2019 20:22	08/11/2019 20:19	08/11/2019 20:22	0,05	68	3,40	CHI
2019110800054	EDEALINA	49702	VICENTINOPOLIS	08/11/2019 00:00	08/11/2019 00:06	08/11/2019 00:00	08/11/2019 00:06	0,10	15	1,50	CHI
2019110800054	EDEIA	49701	VICENTINOPOLIS	08/11/2019 00:00	08/11/2019 00:06	08/11/2019 00:00	08/11/2019 00:06	0,10	11	1,10	CHI
2019110800054	EDEIA	49702	VICENTINOPOLIS	08/11/2019 00:00	08/11/2019 00:06	08/11/2019 00:00	08/11/2019 00:06	0,10	10	1,00	CHI
2019110800054	PONTALINA	31301	VICENTINOPOLIS	08/11/2019 00:00	08/11/2019 00:06	08/11/2019 00:00	08/11/2019 00:06	0,10	143	14,30	CHI
2019110800054	PONTALINA	49702	VICENTINOPOLIS	08/11/2019 00:00	08/11/2019 00:06	08/11/2019 00:00	08/11/2019 00:06	0,10	1	0,10	CHI
2019110800054	VICENTINOPOLIS	31301	VICENTINOPOLIS	08/11/2019 00:00	08/11/2019 00:06	08/11/2019 00:00	08/11/2019 00:06	0,10	13	1,30	CHI
2019110800054	VICENTINOPOLIS	49701	VICENTINOPOLIS	08/11/2019 00:00	08/11/2019 00:06	08/11/2019 00:00	08/11/2019 00:06	0,10	1	0,10	CHI
2019110800054	VICENTINOPOLIS	56601	VICENTINOPOLIS	08/11/2019 00:00	08/11/2019 00:06	08/11/2019 00:00	08/11/2019 00:06	0,10	1	0,10	CHI
2019110800054	VICENTINOPOLIS	49702	VICENTINOPOLIS	08/11/2019 00:00	08/11/2019 00:06	08/11/2019 00:00	08/11/2019 00:06	0,10	2	0,20	CHI
2019110800102	BARRO ALTO	00180518	BARRO ALTO	08/11/2019 13:31	08/11/2019 13:35	08/11/2019 13:31	08/11/2019 13:35	0,07	1186	79,07	CHI
2019110800102	BARRO ALTO	00180518	BARRO ALTO	08/11/2019 13:31	08/11/2019 13:35	08/11/2019 13:31	08/11/2019 13:35	0,07	2015	134,33	CHI
2019110800102	BARRO ALTO	56102	BARRO ALTO	08/11/2019 13:31	08/11/2019 13:35	08/11/2019 13:31	08/11/2019 13:35	0,07	24	1,60	CHI
2019110800102	BARRO ALTO	00180518	BARRO ALTO	08/11/2019 13:31	08/11/2019 13:35	08/11/2019 13:31	08/11/2019 13:35	0,07	2	0,13	CHI

2019110800102	GOIANESIA	56102	BARRO ALTO	08/11/2019 13:31	08/11/2019 13:35	08/11/2019 13:31	08/11/2019 13:35	0,07	4	0,27	CHI
2019110800102	HIDROLINA	00180518	BARRO ALTO	08/11/2019 13:31	08/11/2019 13:35	08/11/2019 13:31	08/11/2019 13:35	0,07	1	0,07	CHI
2019110800102	HIDROLINA	56101	BARRO ALTO	08/11/2019 13:31	08/11/2019 13:35	08/11/2019 13:31	08/11/2019 13:35	0,07	1	0,07	CHI
2019110800102	MIMOSO DE GOIAS	45601	BARRO ALTO	08/11/2019 13:31	08/11/2019 13:35	08/11/2019 13:31	08/11/2019 13:35	0,07	11	0,73	CHI
2019110800102	NIQUELANDIA	00180518	BARRO ALTO	08/11/2019 13:31	08/11/2019 13:35	08/11/2019 13:31	08/11/2019 13:35	0,07	118	7,87	CHI
2019110800102	NIQUELANDIA	45601	BARRO ALTO	08/11/2019 13:31	08/11/2019 13:35	08/11/2019 13:31	08/11/2019 13:35	0,07	175	11,67	CHI
2019110800102	NIQUELANDIA	00180518	BARRO ALTO	08/11/2019 13:31	08/11/2019 13:35	08/11/2019 13:31	08/11/2019 13:35	0,07	4	0,27	CHI
2019110800102	NIQUELANDIA	45602	BARRO ALTO	08/11/2019 13:31	08/11/2019 13:35	08/11/2019 13:31	08/11/2019 13:35	0,07	993	66,20	CHI
2019110800102	SANTA RITA DO NOVO DESTINO	00180518	BARRO ALTO	08/11/2019 13:31	08/11/2019 13:35	08/11/2019 13:31	08/11/2019 13:35	0,07	494	32,93	CHI
2019110800102	SANTA RITA DO NOVO DESTINO	56102	BARRO ALTO	08/11/2019 13:31	08/11/2019 13:35	08/11/2019 13:31	08/11/2019 13:35	0,07	213	14,20	CHI
2019110800102	SANTA RITA DO NOVO DESTINO	00180518	BARRO ALTO	08/11/2019 13:31	08/11/2019 13:35	08/11/2019 13:31	08/11/2019 13:35	0,07	7	0,47	CHI
2019110800102	SAO LUIZ DO NORTE	00180518	BARRO ALTO	08/11/2019 13:31	08/11/2019 13:35	08/11/2019 13:31	08/11/2019 13:35	0,07	34	2,27	CHI
2019110800102	SAO LUIZ DO NORTE	56101	BARRO ALTO	08/11/2019 13:31	08/11/2019 13:35	08/11/2019 13:31	08/11/2019 13:35	0,07	96	6,40	CHI
2019110800102	SAO LUIZ DO NORTE	56102	BARRO ALTO	08/11/2019 13:31	08/11/2019 13:35	08/11/2019 13:31	08/11/2019 13:35	0,07	14	0,93	CHI
2019110800102	SAO LUIZ DO NORTE	00180518	BARRO ALTO	08/11/2019 13:31	08/11/2019 13:35	08/11/2019 13:31	08/11/2019 13:35	0,07	2	0,13	CHI
2019110800102	VILA PROPICIO	45601	BARRO ALTO	08/11/2019 13:31	08/11/2019 13:35	08/11/2019 13:31	08/11/2019 13:35	0,07	49	3,27	CHI
2019110800102	VILA PROPICIO	00180518	BARRO ALTO	08/11/2019 13:31	08/11/2019 13:35	08/11/2019 13:31	08/11/2019 13:35	0,07	23	1,53	CHI
2019110800102	VILA PROPICIO	45602	BARRO ALTO	08/11/2019 13:31	08/11/2019 13:35	08/11/2019 13:31	08/11/2019 13:35	0,07	32	2,13	CHI
2019110800102	VILA PROPICIO	00180518	BARRO ALTO	08/11/2019 13:31	08/11/2019 13:35	08/11/2019 13:31	08/11/2019 13:35	0,07	1	0,07	CHI
2019110800102	CAMPINORTE	01800503	CAMPINORTE	08/11/2019 13:31	08/11/2019 13:35	08/11/2019 13:31	08/11/2019 13:35	0,07	10	0,67	CHI
2019110800102	NOVA IGUACU DE GOIAS	01800503	CAMPINORTE	08/11/2019 13:31	08/11/2019 13:35	08/11/2019 13:31	08/11/2019 13:35	0,07	15	1,00	CHI
2019110800102	URUACU	01800503	CAMPINORTE	08/11/2019 13:31	08/11/2019 13:35	08/11/2019 13:31	08/11/2019 13:35	0,07	102	6,80	CHI
2019110800102	BARRO ALTO	01800503	URUACU	08/11/2019 13:31	08/11/2019 13:35	08/11/2019 13:31	08/11/2019 13:35	0,07	1	0,07	CHI
2019110800102	CAMPINORTE	01800503	URUACU	08/11/2019 13:31	08/11/2019 13:35	08/11/2019 13:31	08/11/2019 13:35	0,07	14	0,93	CHI
2019110800102	CAMPINORTE	01805114	URUACU	08/11/2019 13:31	08/11/2019 13:35	08/11/2019 13:31	08/11/2019 13:35	0,07	9	0,60	CHI
2019110800102	GUARINOS	14902	URUACU	08/11/2019 13:31	08/11/2019 13:35	08/11/2019 13:31	08/11/2019 13:35	0,07	10	0,67	CHI
2019110800102	HIDROLINA	07901	URUACU	08/11/2019 13:31	08/11/2019 13:35	08/11/2019 13:31	08/11/2019 13:35	0,07	1256	83,73	CHI
2019110800102	HIDROLINA	01800503	URUACU	08/11/2019 13:31	08/11/2019 13:35	08/11/2019 13:31	08/11/2019 13:35	0,07	15	1,00	CHI
2019110800102	HIDROLINA	07931	URUACU	08/11/2019 13:31	08/11/2019 13:35	08/11/2019 13:31	08/11/2019 13:35	0,07	110	7,33	CHI
2019110800102	HIDROLINA	01800503	URUACU	08/11/2019 13:31	08/11/2019 13:35	08/11/2019 13:31	08/11/2019 13:35	0,07	103	6,87	CHI
2019110800102	HIDROLINA	01805114	URUACU	08/11/2019 13:31	08/11/2019 13:35	08/11/2019 13:31	08/11/2019 13:35	0,07	89	5,93	CHI
2019110800102	ITAPACI	14902	URUACU	08/11/2019 13:31	08/11/2019 13:35	08/11/2019 13:31	08/11/2019 13:35	0,07	2	0,13	CHI
2019110800102	MARA ROSA	01800503	URUACU	08/11/2019 13:31	08/11/2019 13:35	08/11/2019 13:31	08/11/2019 13:35	0,07	1	0,07	CHI

2019110800102	NIQUELANDIA	01800503	URUACU	08/11/2019 13:31	08/11/2019 13:35	08/11/2019 13:31	08/11/2019 13:35	0,07	1030	68,67	CHI
2019110800102	NIQUELANDIA	01805114	URUACU	08/11/2019 13:31	08/11/2019 13:35	08/11/2019 13:31	08/11/2019 13:35	0,07	1104	73,60	CHI
2019110800102	NOVA IGUACU DE GOIAS	01800503	URUACU	08/11/2019 13:31	08/11/2019 13:35	08/11/2019 13:31	08/11/2019 13:35	0,07	20	1,33	CHI
2019110800102	PILAR DE GOIAS	14901	URUACU	08/11/2019 13:31	08/11/2019 13:35	08/11/2019 13:31	08/11/2019 13:35	0,07	55	3,67	CHI
2019110800102	PILAR DE GOIAS	14902	URUACU	08/11/2019 13:31	08/11/2019 13:35	08/11/2019 13:31	08/11/2019 13:35	0,07	692	46,13	CHI
2019110800102	PILAR DE GOIAS	01800503	URUACU	08/11/2019 13:31	08/11/2019 13:35	08/11/2019 13:31	08/11/2019 13:35	0,07	1	0,07	CHI
2019110800102	PILAR DE GOIAS	07931	URUACU	08/11/2019 13:31	08/11/2019 13:35	08/11/2019 13:31	08/11/2019 13:35	0,07	42	2,80	CHI
2019110800102	PILAR DE GOIAS	01800503	URUACU	08/11/2019 13:31	08/11/2019 13:35	08/11/2019 13:31	08/11/2019 13:35	0,07	15	1,00	CHI
2019110800102	PILAR DE GOIAS	01805114	URUACU	08/11/2019 13:31	08/11/2019 13:35	08/11/2019 13:31	08/11/2019 13:35	0,07	13	0,87	CHI
2019110800102	SANTA TEREZINHA DE GOIAS	14902	URUACU	08/11/2019 13:31	08/11/2019 13:35	08/11/2019 13:31	08/11/2019 13:35	0,07	4	0,27	CHI
2019110800102	URUACU	01800503	URUACU	08/11/2019 13:31	08/11/2019 13:35	08/11/2019 13:31	08/11/2019 13:35	0,07	1782	118,80	CHI
2019110800102	URUACU	01800503	URUACU	08/11/2019 13:31	08/11/2019 13:35	08/11/2019 13:31	08/11/2019 13:35	0,07	7633	508,87	CHI
2019110800102	URUACU	01800503	URUACU	08/11/2019 13:31	08/11/2019 13:35	08/11/2019 13:31	08/11/2019 13:35	0,07	7675	511,67	CHI
2019110800102	URUACU	01800503	URUACU	08/11/2019 13:31	08/11/2019 13:35	08/11/2019 13:31	08/11/2019 13:35	0,07	267	17,80	CHI
2019110800102	URUACU	01805114	URUACU	08/11/2019 13:31	08/11/2019 13:35	08/11/2019 13:31	08/11/2019 13:35	0,07	323	21,53	CHI
2019110800102	URUACU	01800503	URUACU	08/11/2019 13:31	08/11/2019 13:35	08/11/2019 13:31	08/11/2019 13:35	0,07	132	8,80	CHI
2019110800102	URUACU	01805114	URUACU	08/11/2019 13:31	08/11/2019 13:35	08/11/2019 13:31	08/11/2019 13:35	0,07	208	13,87	CHI

Plotagem das Ocorrências conforme a Especialização das Chuvas

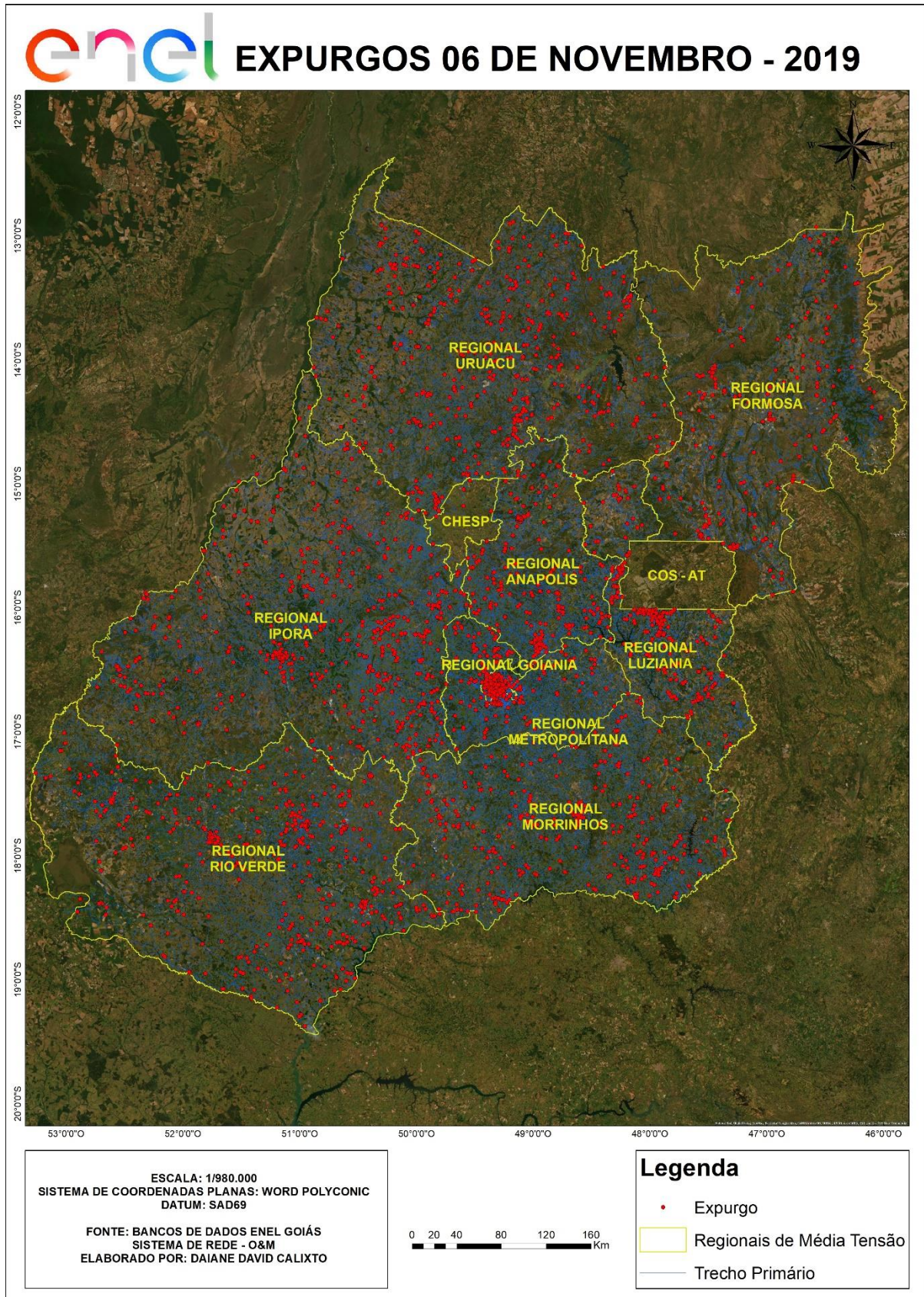

Diagramas Unifilares

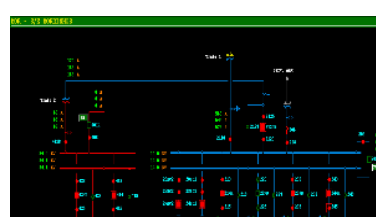
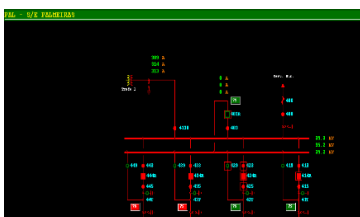
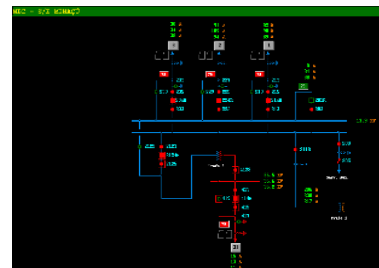
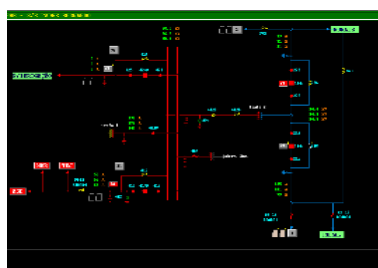
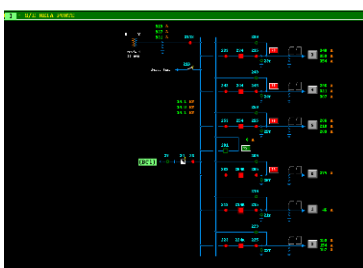
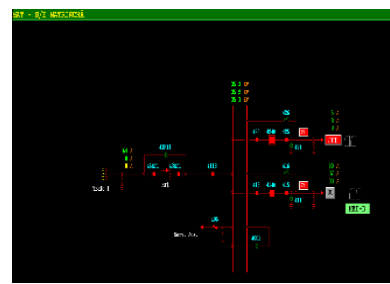
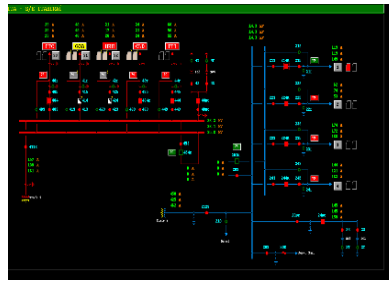
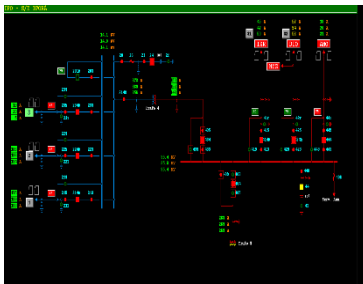
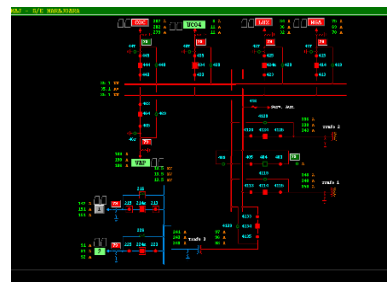
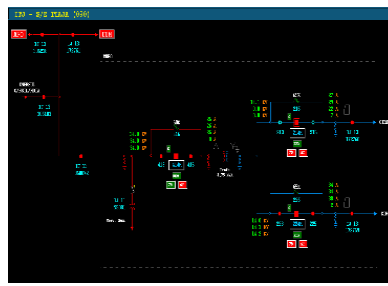
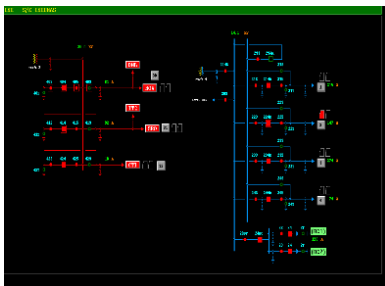
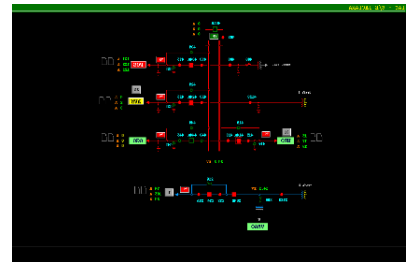
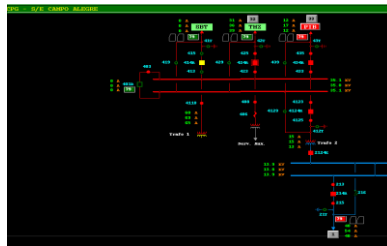
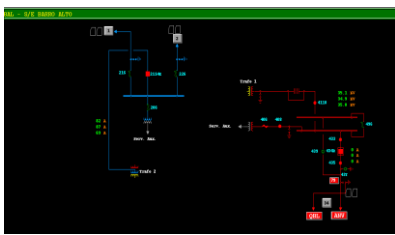
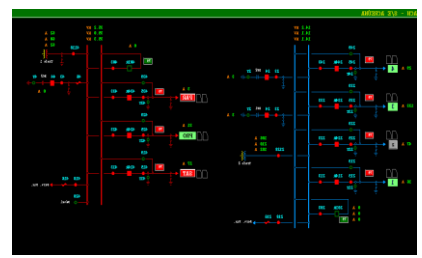
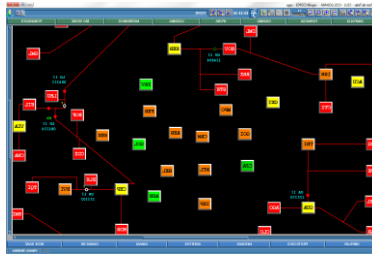
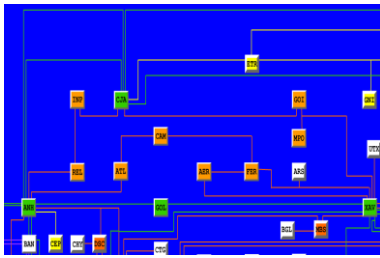

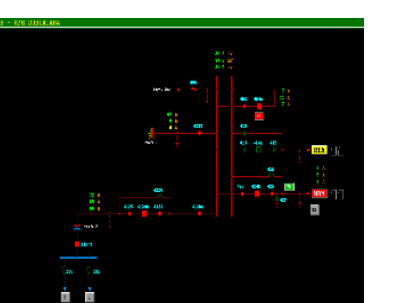
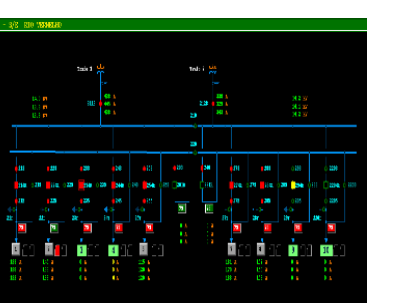
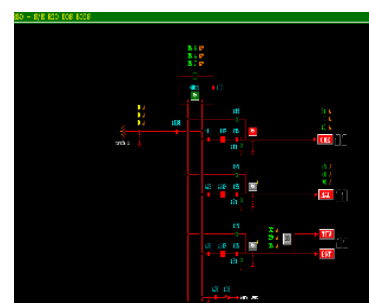
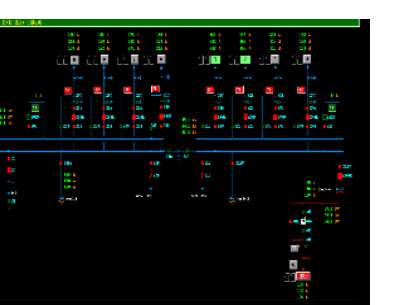
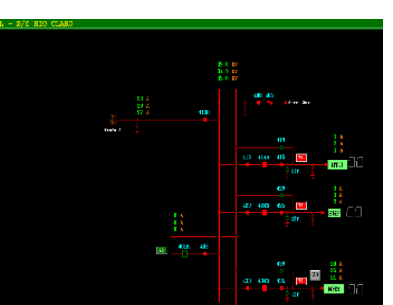
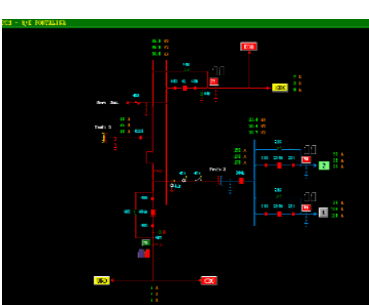
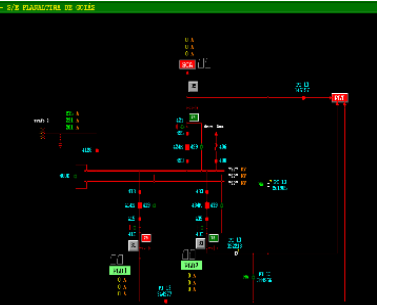
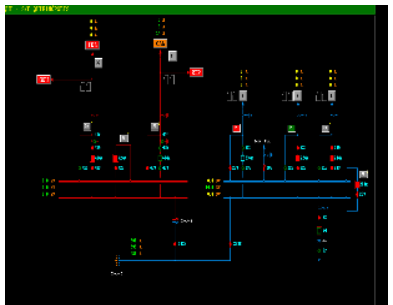
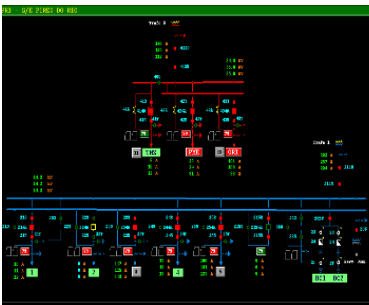
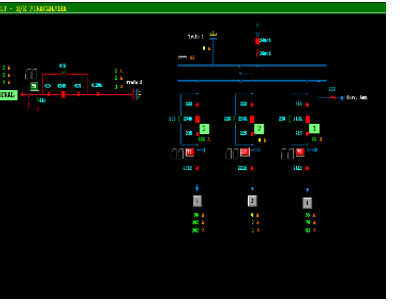
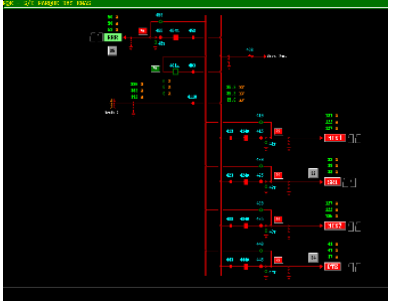
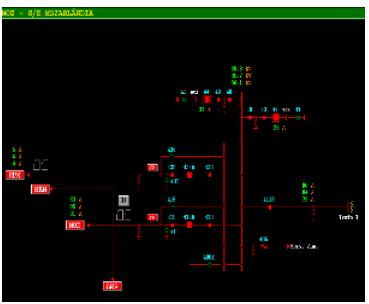
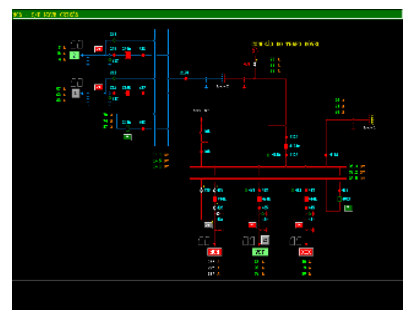

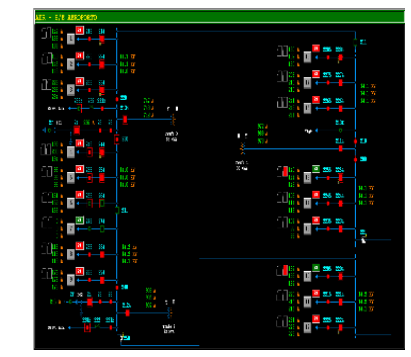
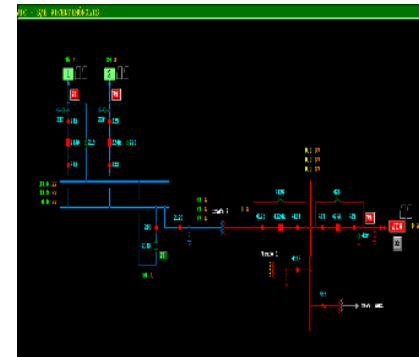
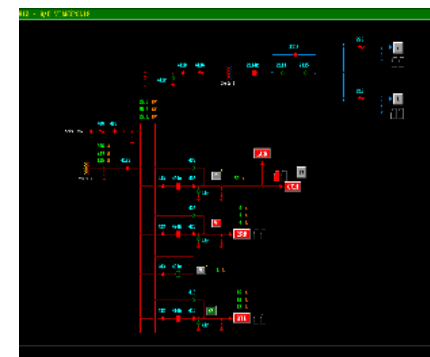
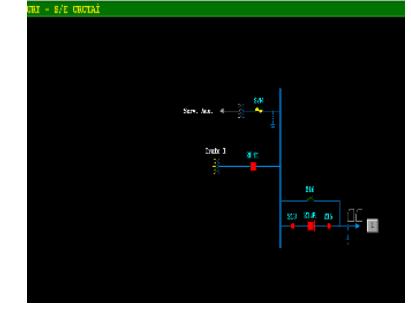
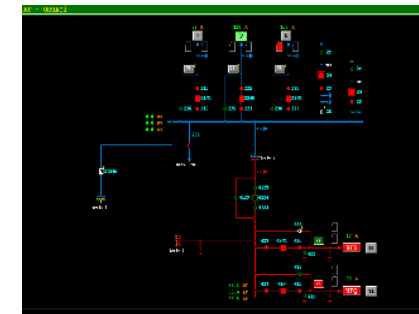
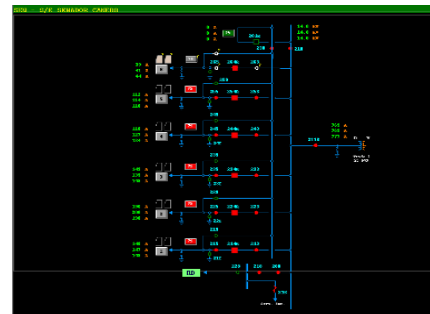
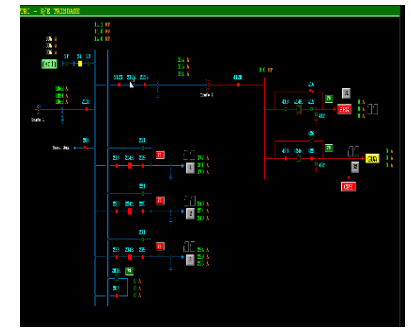
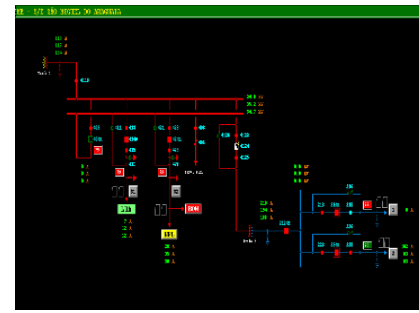
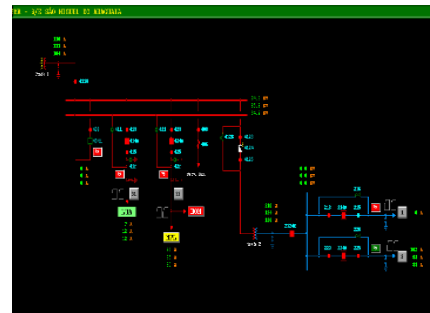
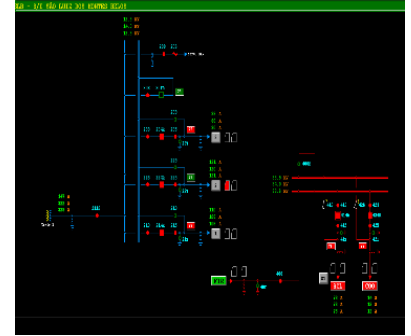
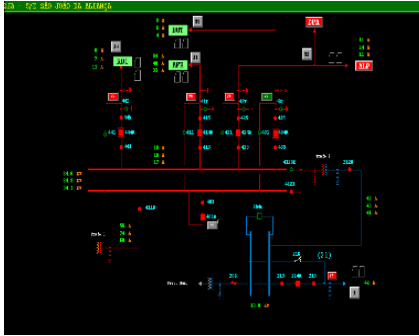
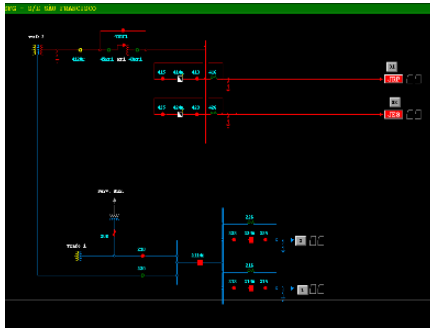
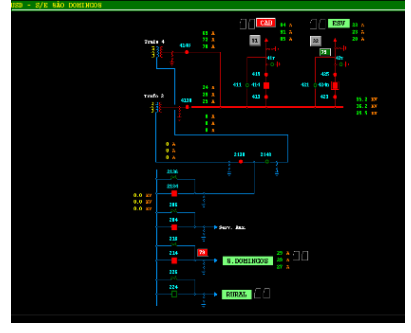
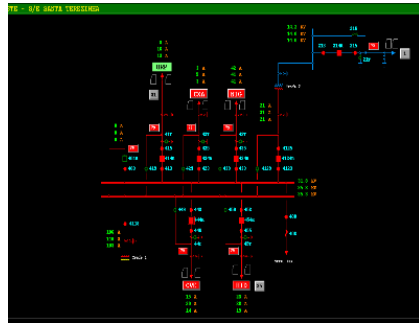
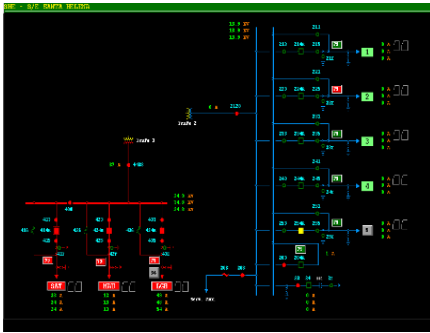

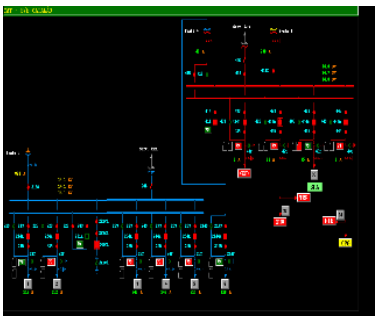
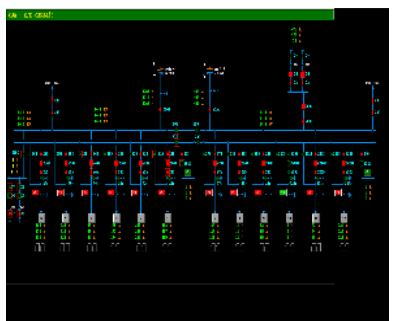
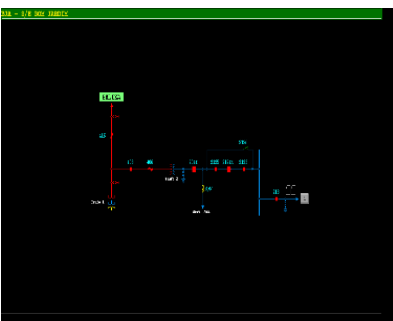
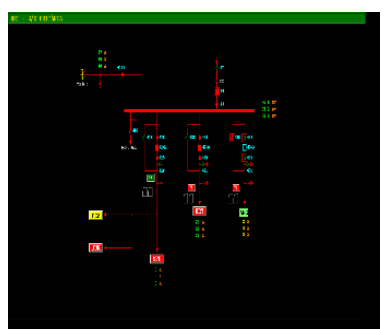
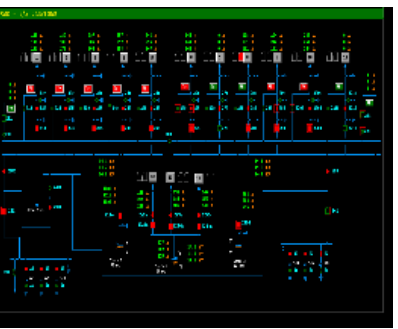
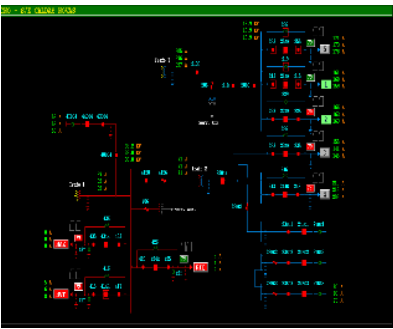
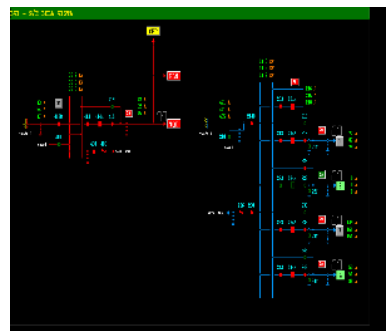
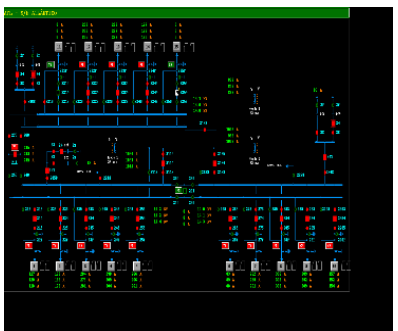
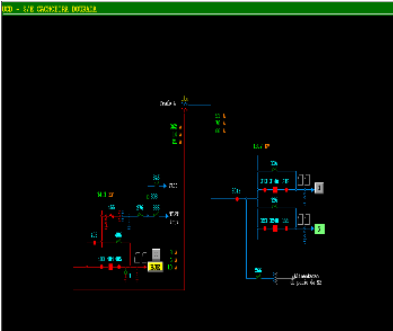
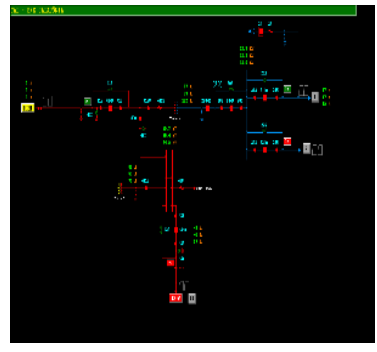
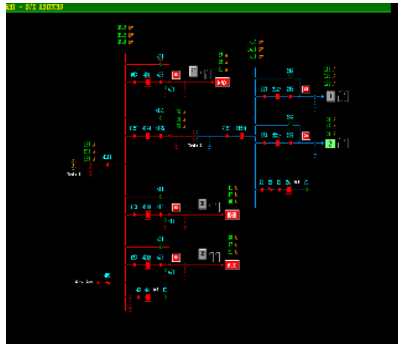
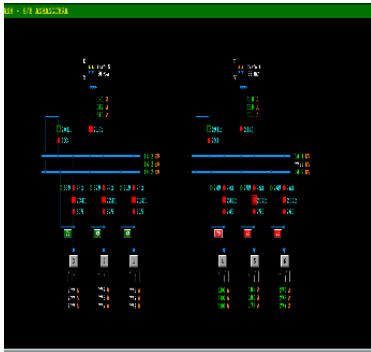
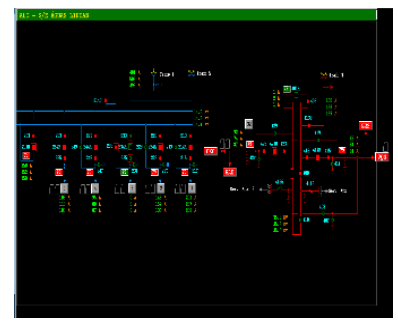
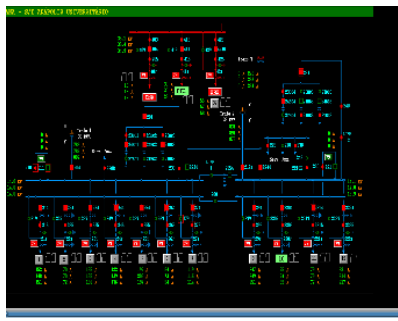
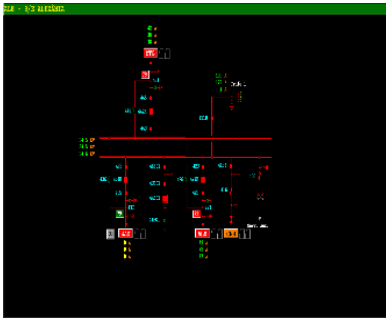

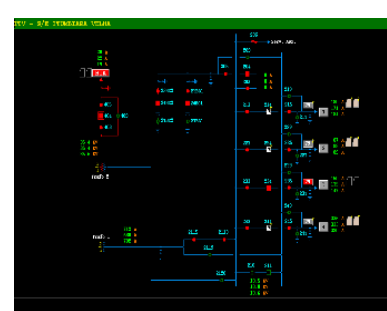
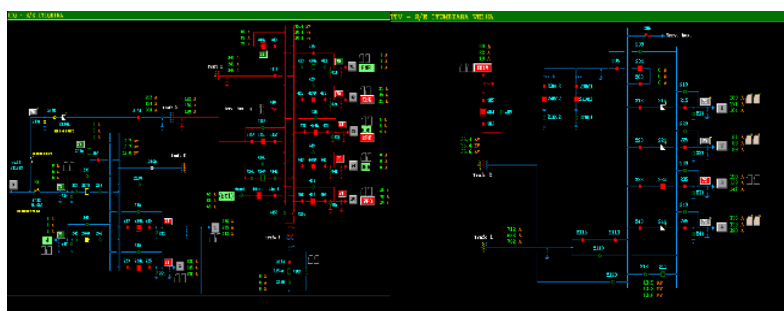
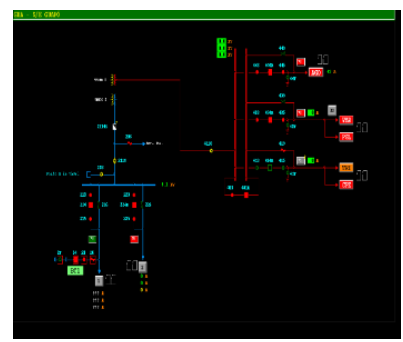
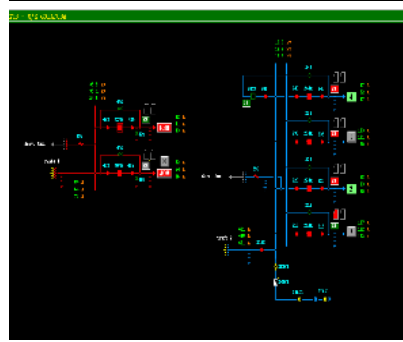
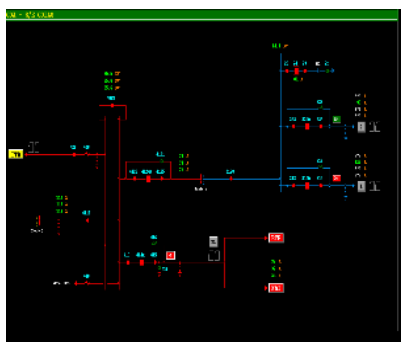
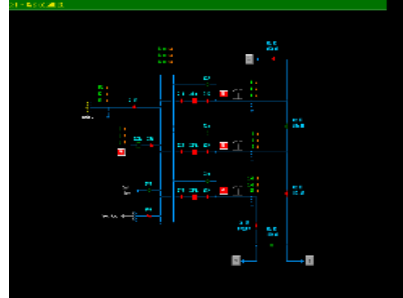
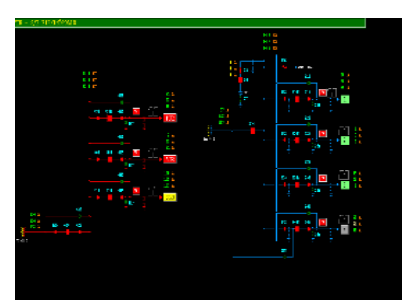
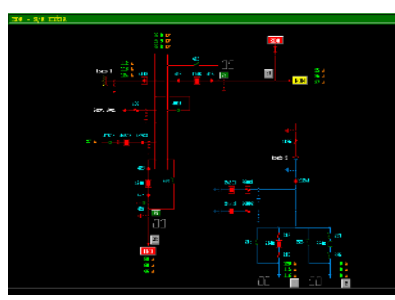
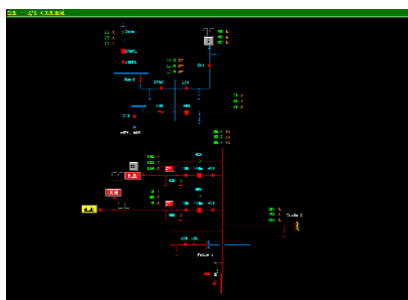
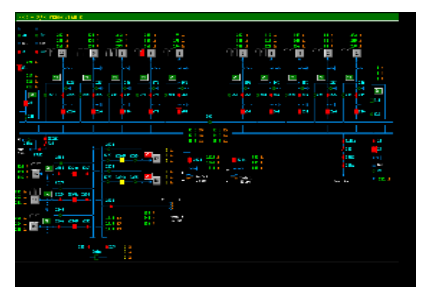
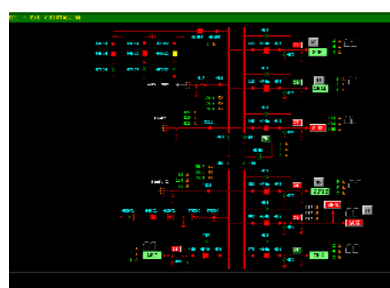
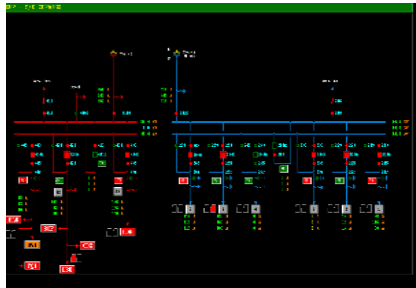
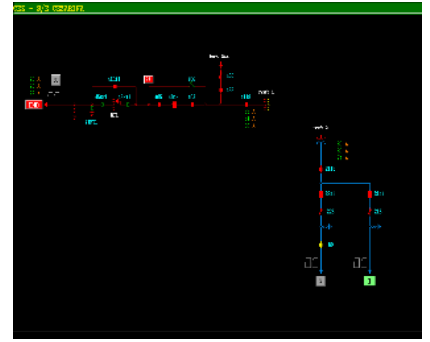
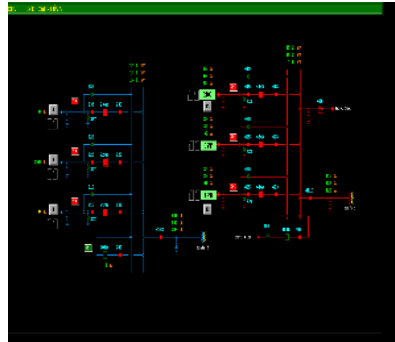
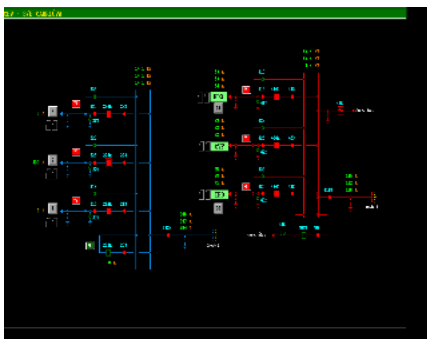

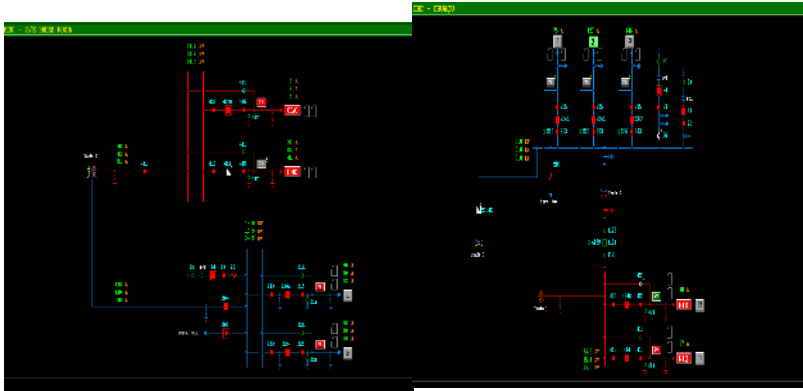
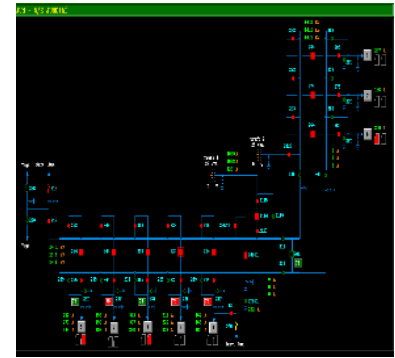
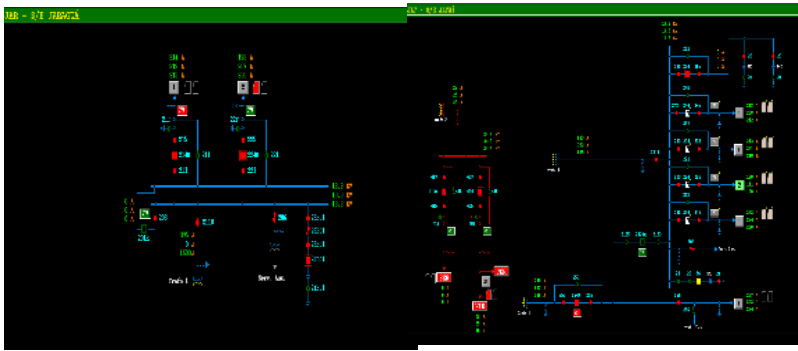

DEMAIS EVIDÊNCIAS

DADOS TÉCNICO - OPERACIONAIS ENEL GO

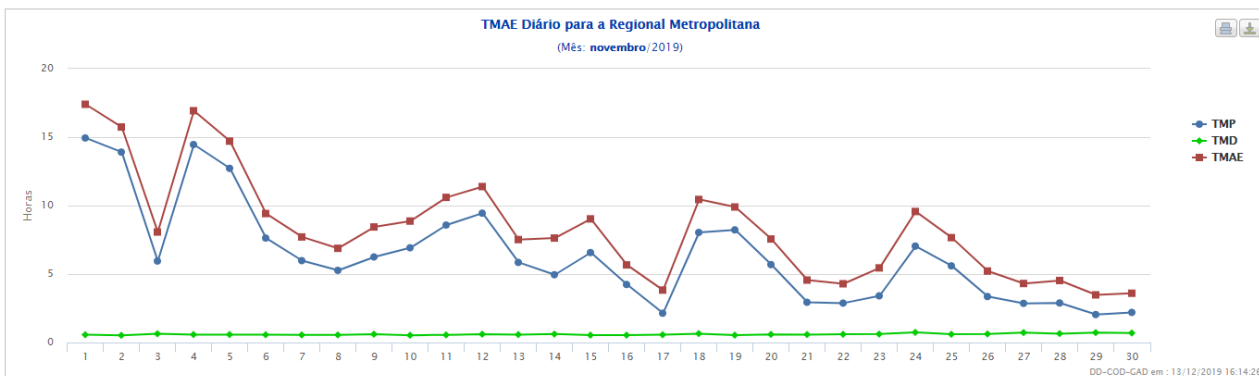
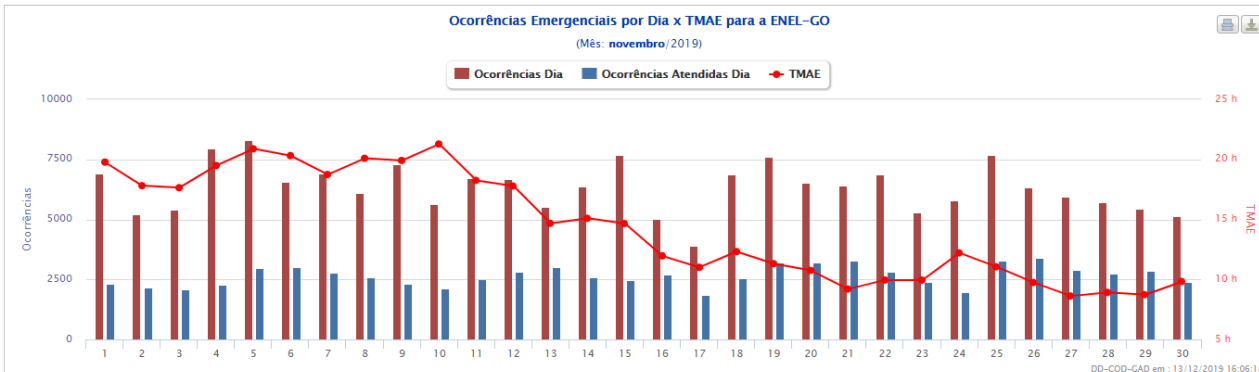
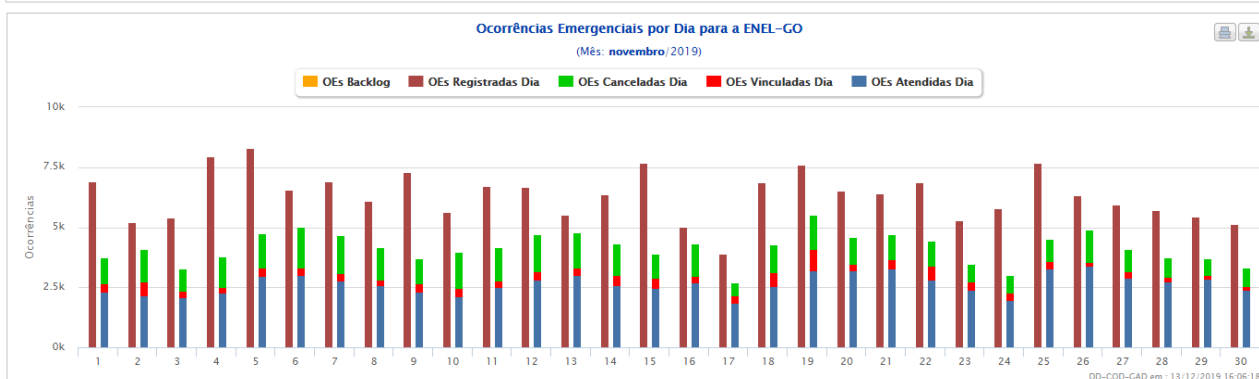
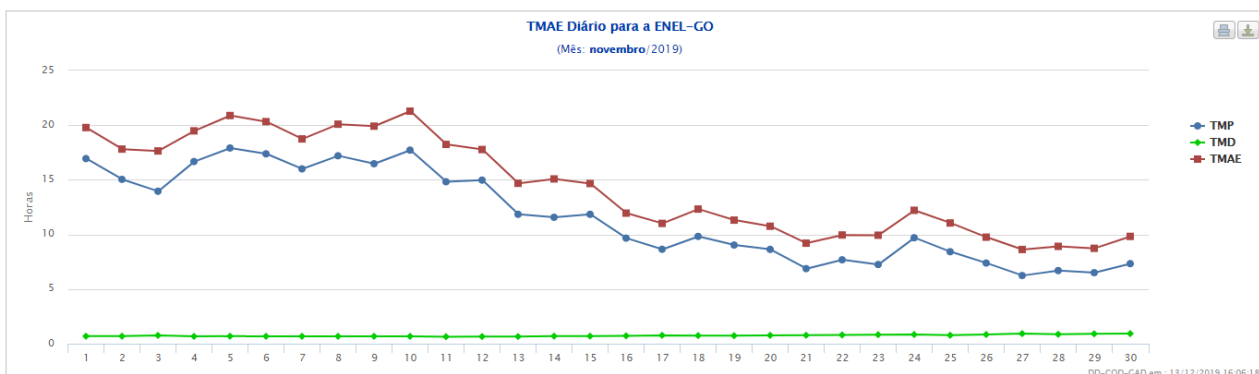

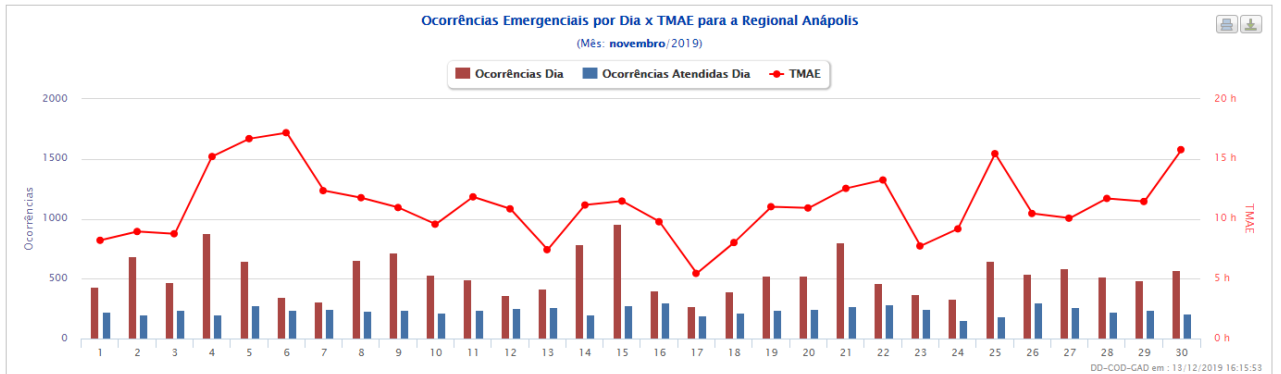
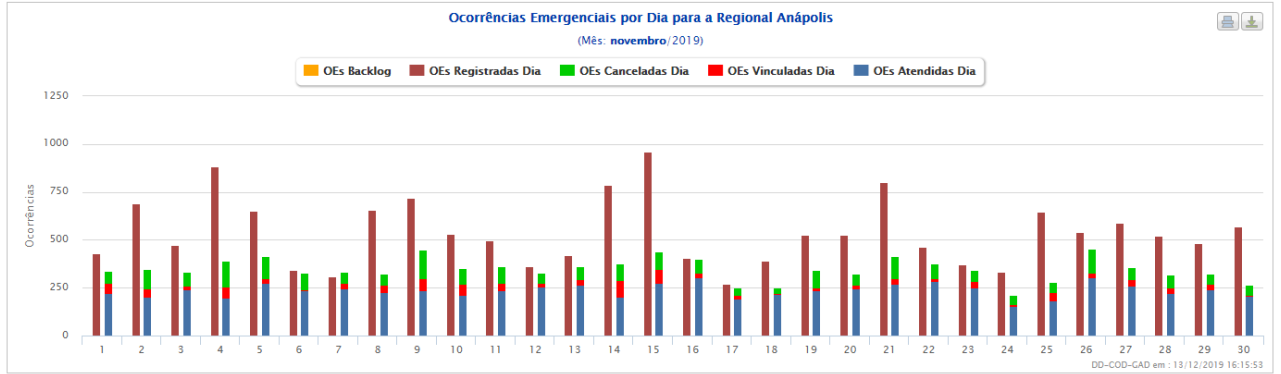
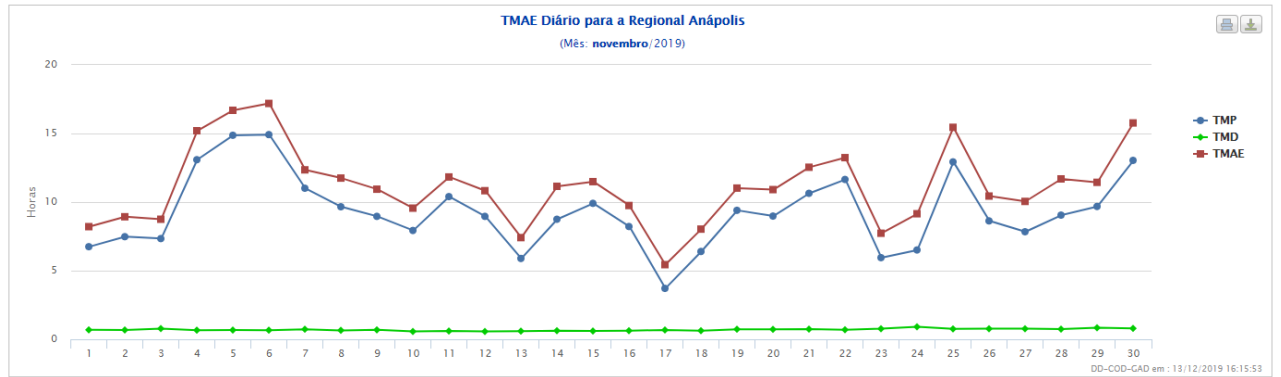
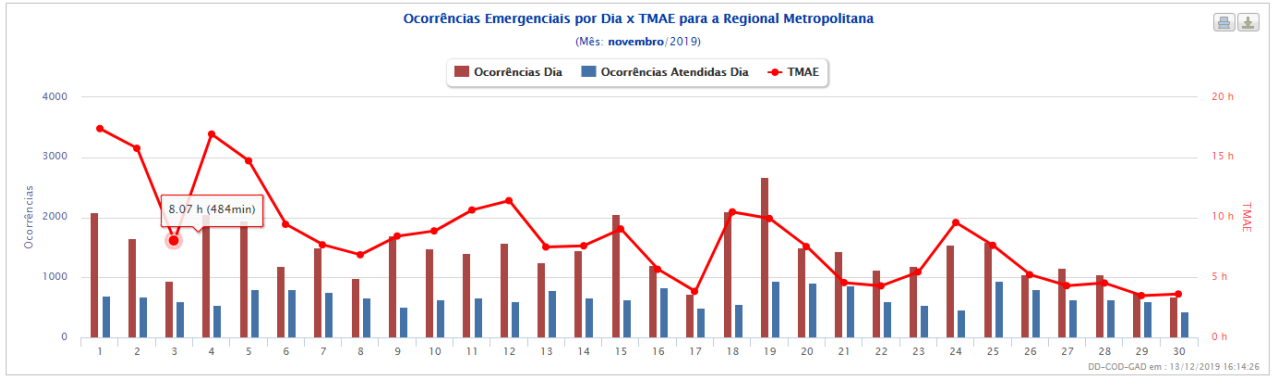
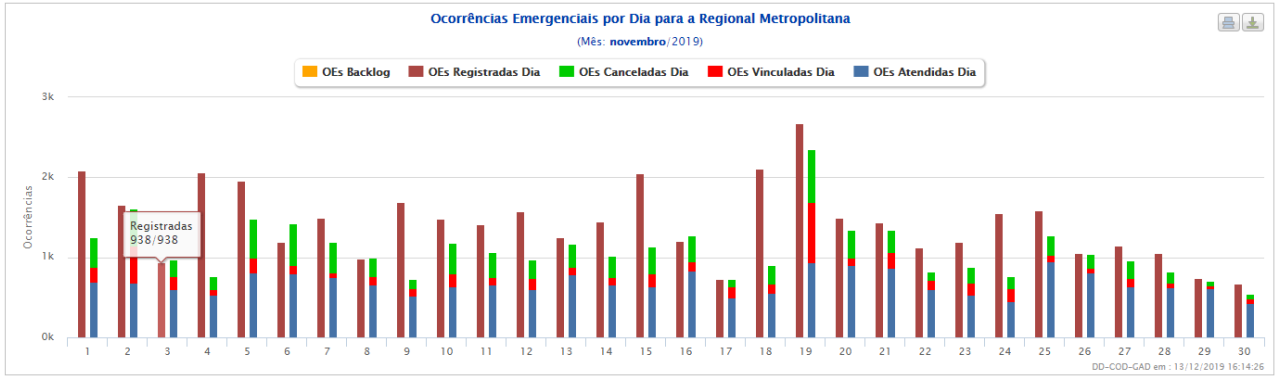

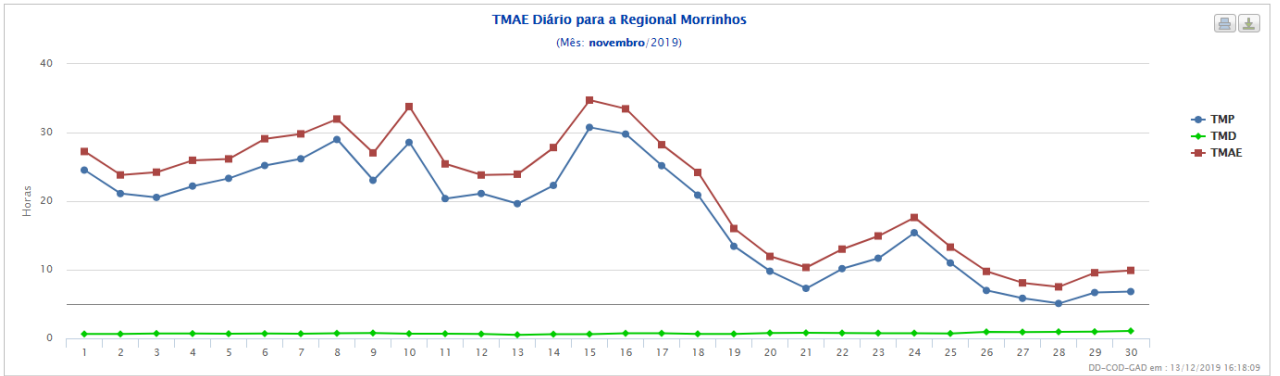
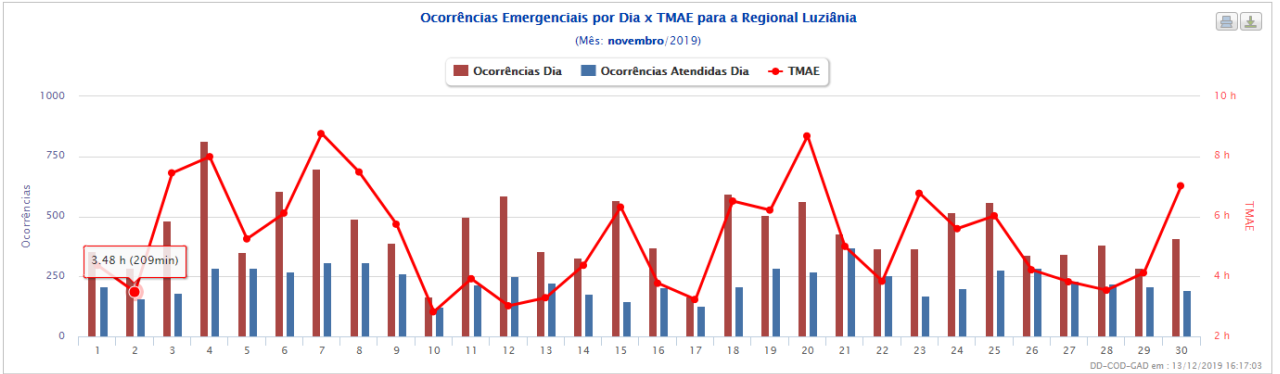
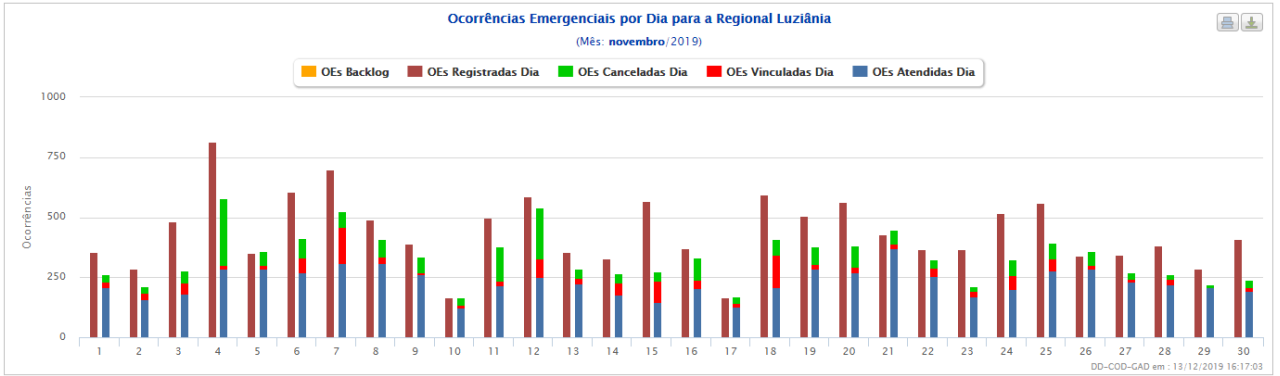
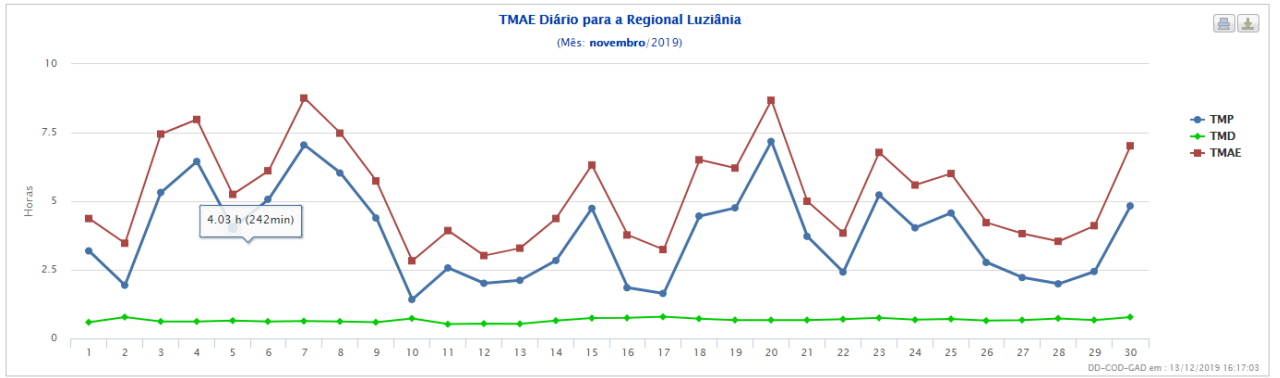

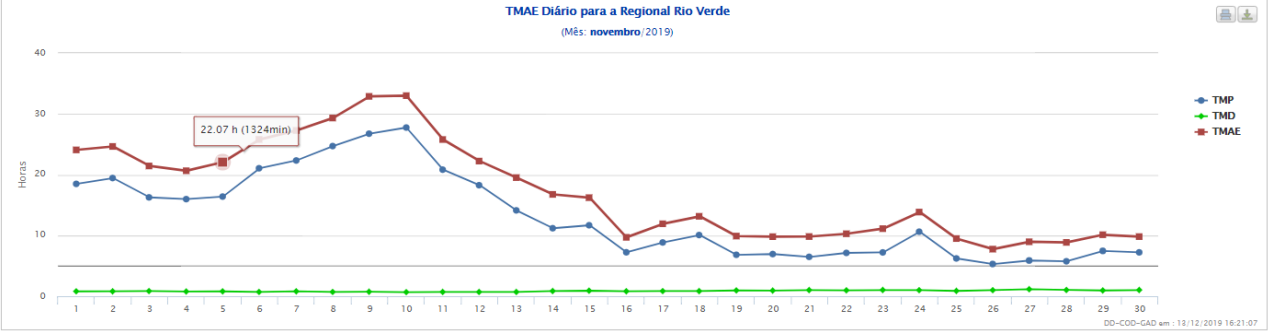
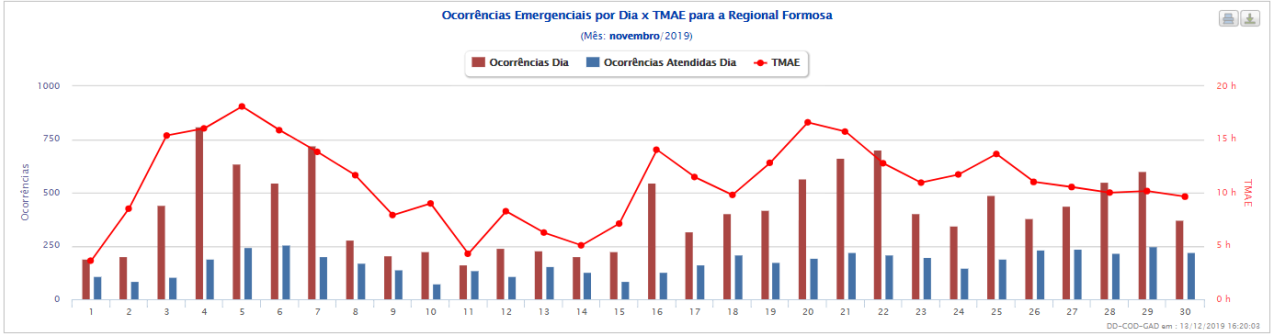
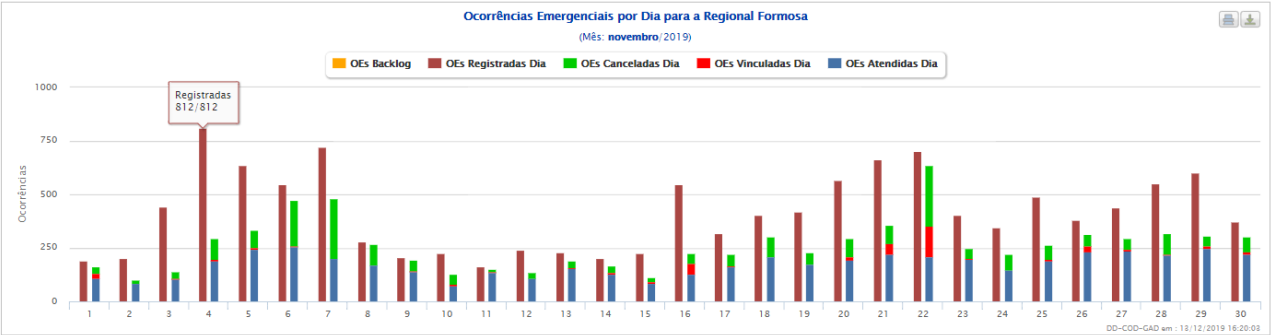
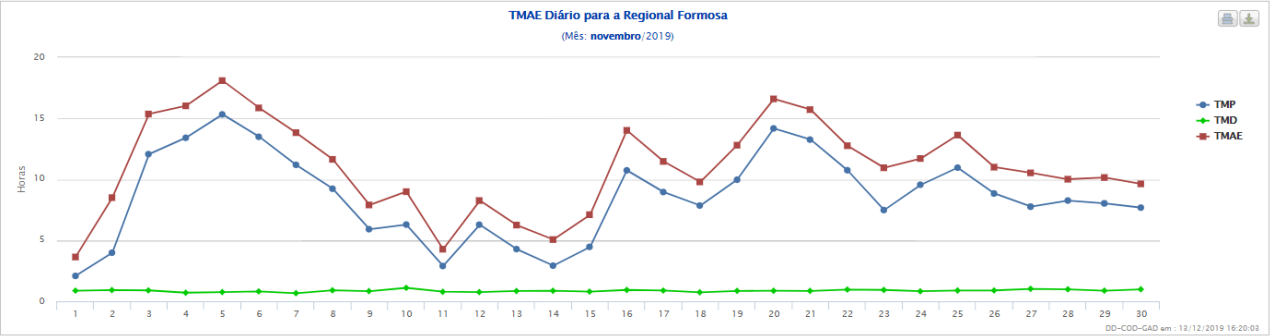
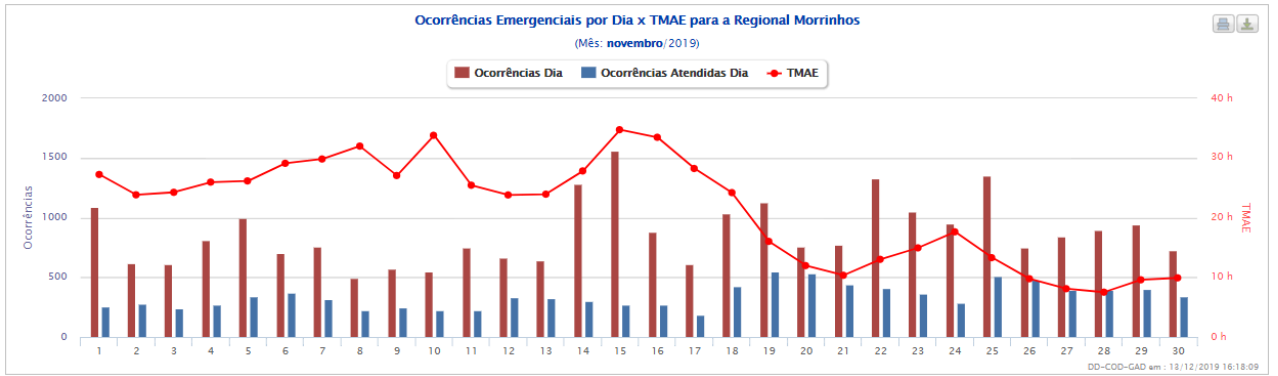

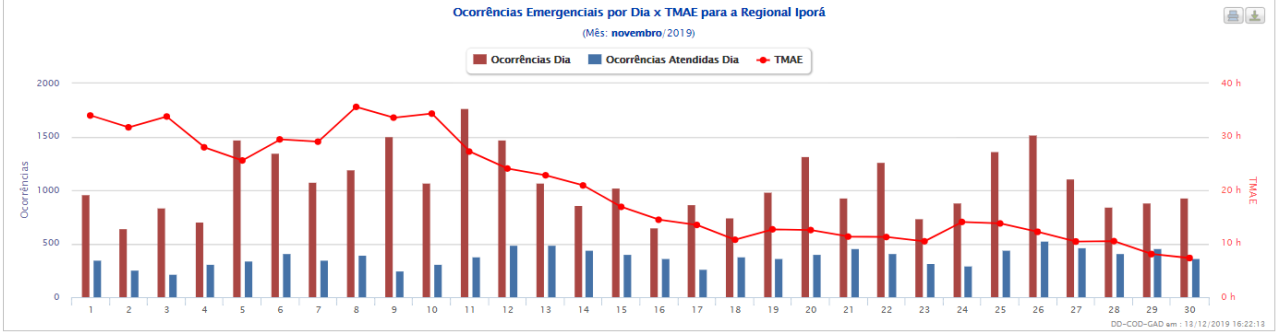
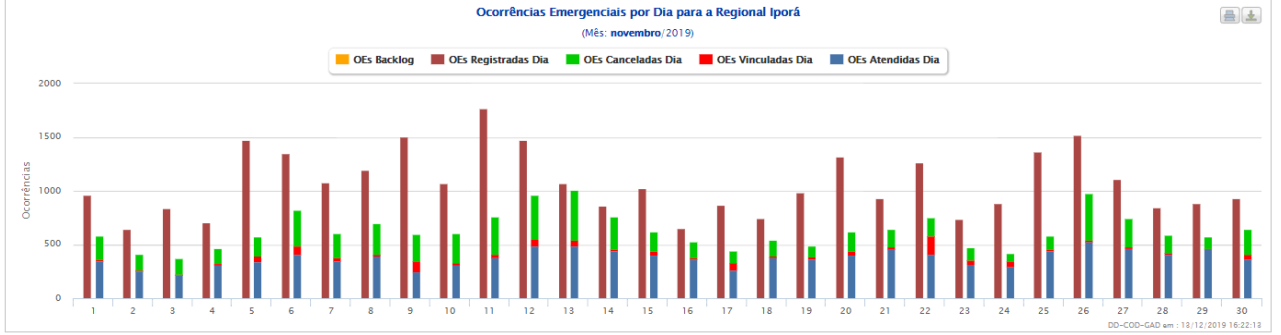
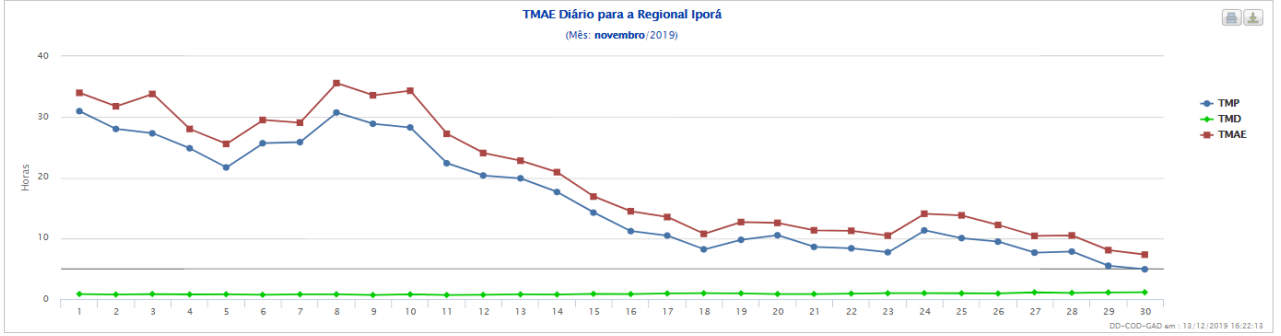
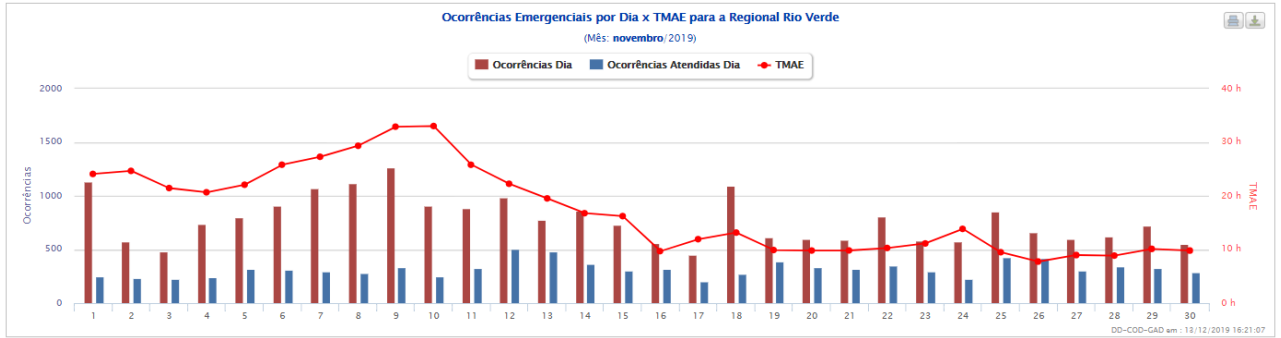
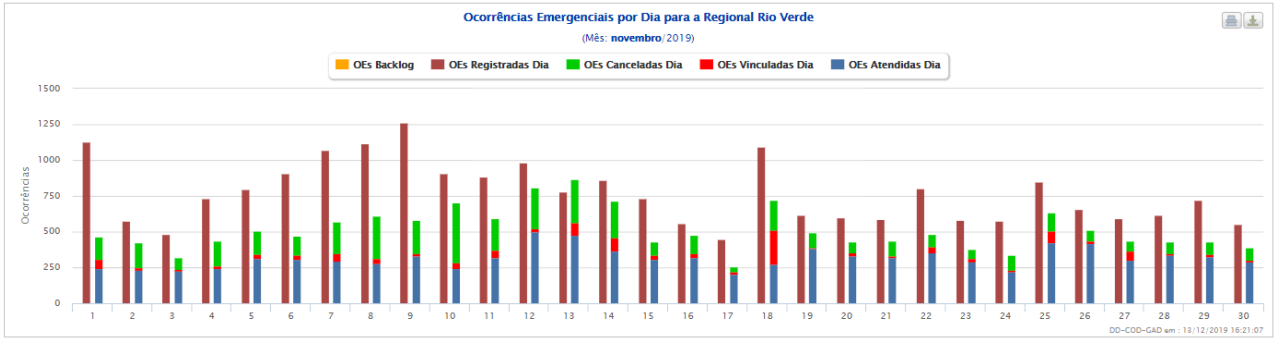

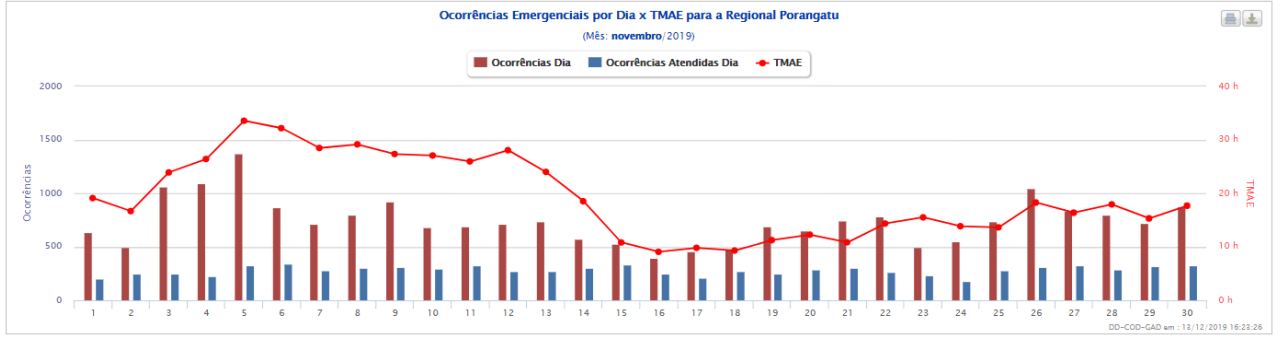
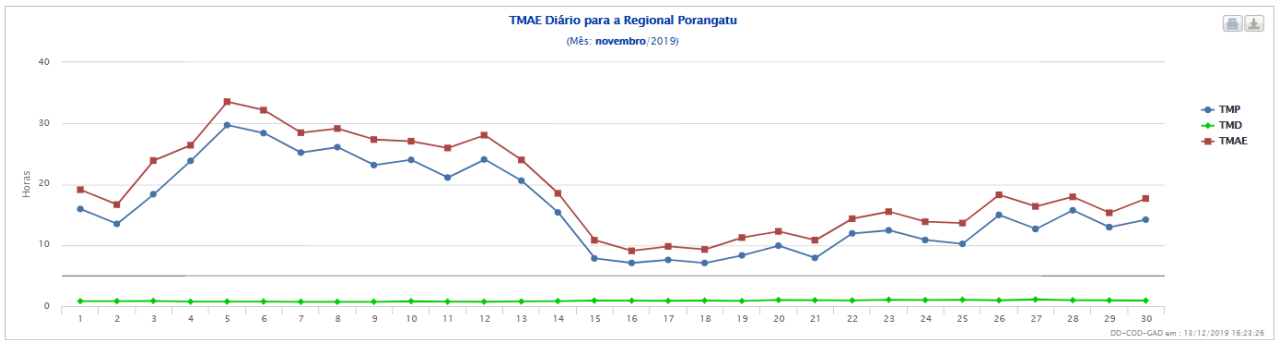

CLIMATEMPO

**Laudo Meteorológico de Evento Climático -
CELG Distribuição S.A. - 06 a 09 de novembro
de 2019**

São Paulo, SP, Brasil

Novembro de 2019

Sumário

1	ANÁLISE DE EVENTO METEOROLÓGICO	2
1.1	Descrição do Evento.....	2
1.2	Abrangência do Evento	5
2	CLASSIFICAÇÃO COBRADE	22
3	RESUMO DO EVENTO	23
4	REFERÊNCIAS.....	29

1 Análise de Evento Meteorológico

1.1 Descrição do Evento

Na figura a seguir é apresentada a área de concessão da CELG Distribuição, dividida em regiões, a serem analisadas neste relatório.



Figura 1 – Regiões de Goiás atendidas pela CELG Distribuição.

Áreas de instabilidade associadas ao ar quente e úmido e reforçadas pela passagem de uma frente fria pela costa do Brasil atuaram sobre o estado de Goiás entre os dias 06 e 09 de novembro de 2019.

Nas Figura 2 são apresentadas as descargas atmosféricas nuvem-solo (raios) e nuvem-nuvem detectadas pelo sistema Earth Networks. Entre as 10h00 do dia 06 e as 05h00 do dia 09 de novembro foram registrados 34693 raios nuvem-solo e 70723 descargas nuvem-nuvem sobre a área da CELG Distribuição em Goiás.

Na tabela 1 são apresentados os valores de rajada de vento iguais ou maiores a 50 km/h registradas nas estações meteorológicas do Instituto Nacional de Meteorologia (INMET) representativas da região de interesse. O maior valor de rajada registrado foi de 65,9 km/h, classificado como ventania pela escala Beaufort, na estação de Rio Verde entre as 14h e 15h do dia 07 de novembro.

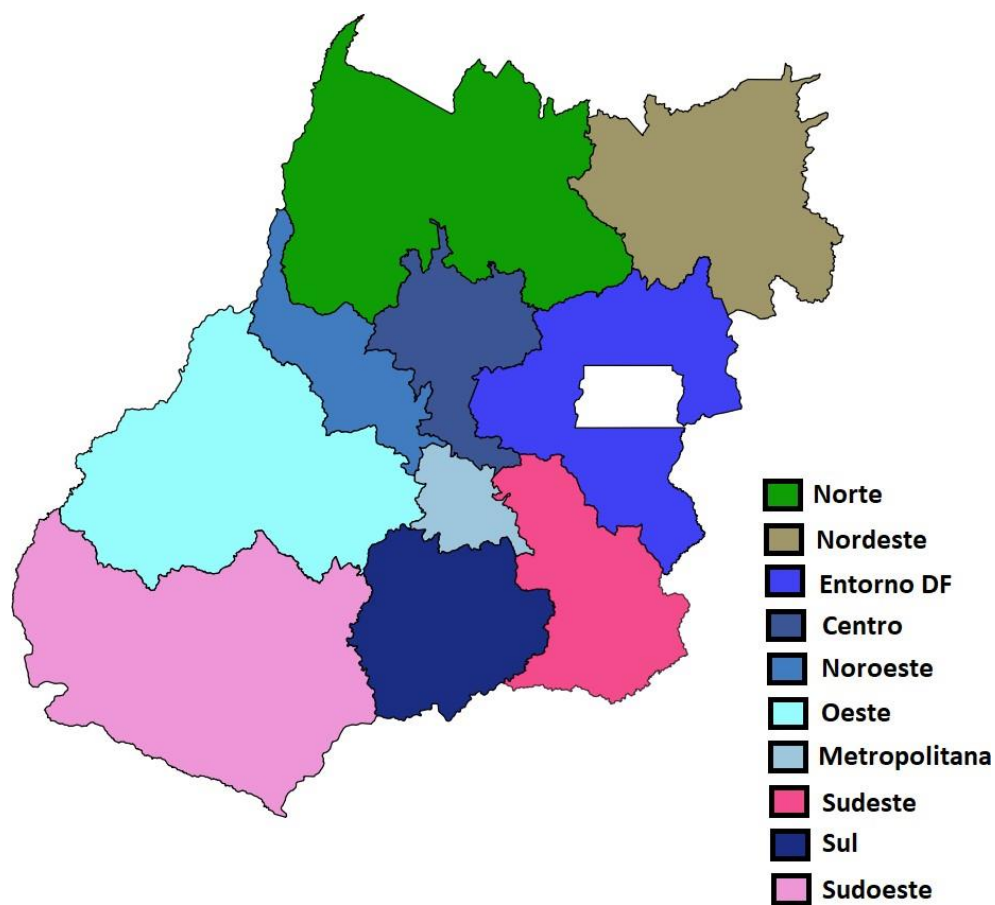
Os maiores acumulados de chuva foram registrados pelo INMET entre as 09h do dia 07 e as 09h do dia 08 de novembro. Durante o período a estação de Iporá registrou 50,0 mm de chuva e em Aragarças foram acumulados 37,2 mm. A chuva registrada em Iporá equivale a aproximadamente 25% da média climatológica de precipitação para o mês de novembro na região.

Tabela 1 –Rajadas de vento maiores ou iguais a 50 km/h registradas pelo INMET entre os dias 06 e 08 de novembro de 2019. Segundo a escala Beaufort, ventos entre 50 e 61 km/h são classificados como vento forte e entre 62 e 74 km/h como ventania.

Estação	Horário	Rajada (km/h)
Aragarças	Entre 22h e 23h do dia 7/11/2019	50.0
Caiapônia	Entre 17h e 18h do dia 7/11/2019	61.2
Iporá	Entre 16h e 17h do dia 6/11/2019	58.7
Luziânia	Entre 9h e 10h do dia 7/11/2019	52.6
Luziânia	Entre 10h e 11h do dia 7/11/2019	52.6
Rio Verde	Entre 14h e 15h do dia 7/11/2019	65.9



Figura 2 –Descargas atmosféricas nuvem-solo (em preto) e nuvem-nuvem (em vermelho) detectadas pelo sistema Earth Networks entre 10h00 do dia 06 e 05h00 do dia 09 de novembro de 2019 sobre a área de concessão da CELG Distribuição.

1.2 Abrangência do Evento

A seguir são apresentadas as imagens realçadas do satélite GOES-16 entre as 13h00 do dia 06 e 07h00 do dia 09 de novembro de 2019. Os tons em vermelho e preto indicam a presença de nuvens de grande desenvolvimento vertical, geralmente associadas à ocorrência de tempo severo. Nestas imagens é possível observar o desenvolvimento e o deslocamento das instabilidades sobre o estado de Goiás entre os dias 06 e 09 de novembro.

13h00 - 06 de novembro de 2019

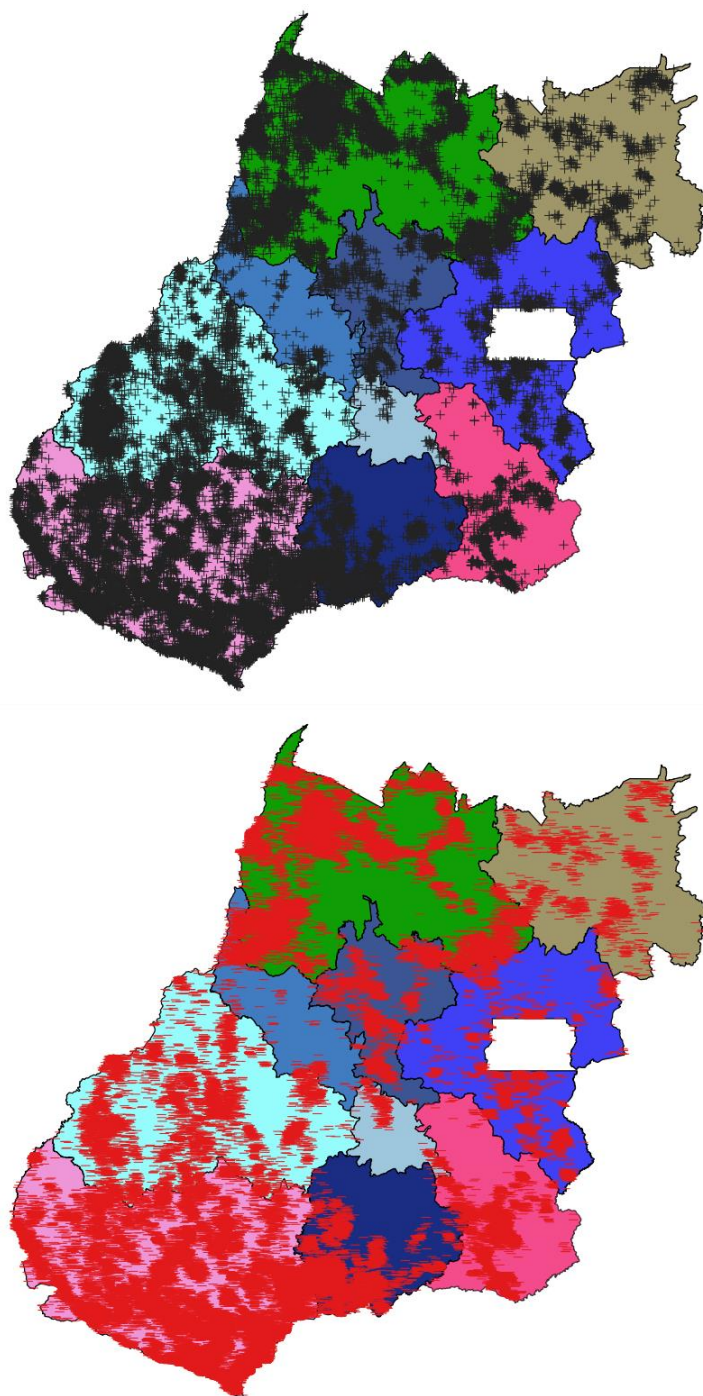

Figura 3 –Imagens realçadas do satélite GOES-16 das 13h00 do dia 06 de novembro de 2019. FONTE: Cptec/INPE.

15h00 - 06 de novembro de 2019

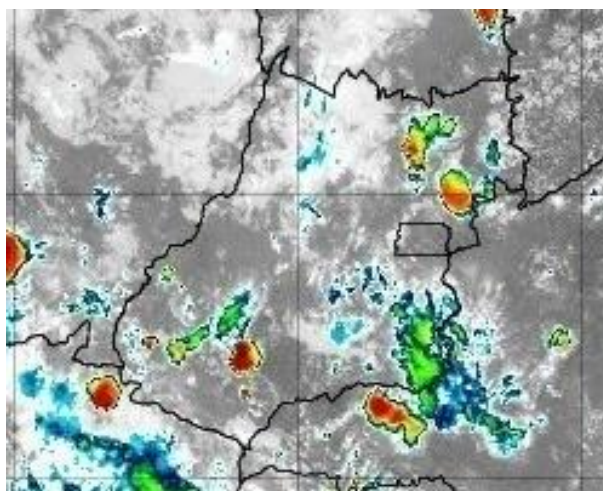

Figura 4 –Imagens realçadas do satélite GOES-16 das 15h00 do dia 06 de novembro de 2019. FONTE: Cptec/INPE.

17h00 - 06 de novembro de 2019



Figura 5 –Imagens realçadas do satélite GOES-16 das 17h00 do dia 06 de novembro de 2019. FONTE: Cptec/INPE.

19h00 - 06 de novembro de 2019

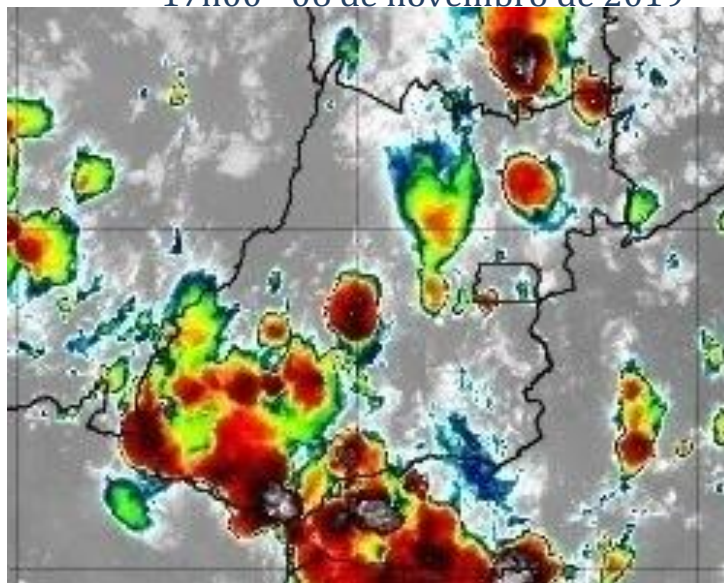

Figura 6 –Imagens realçadas do satélite GOES-16 das 19h00 do dia 06 de novembro de 2019. FONTE: Cptec/INPE.

21h00 - 06 de novembro de 2019

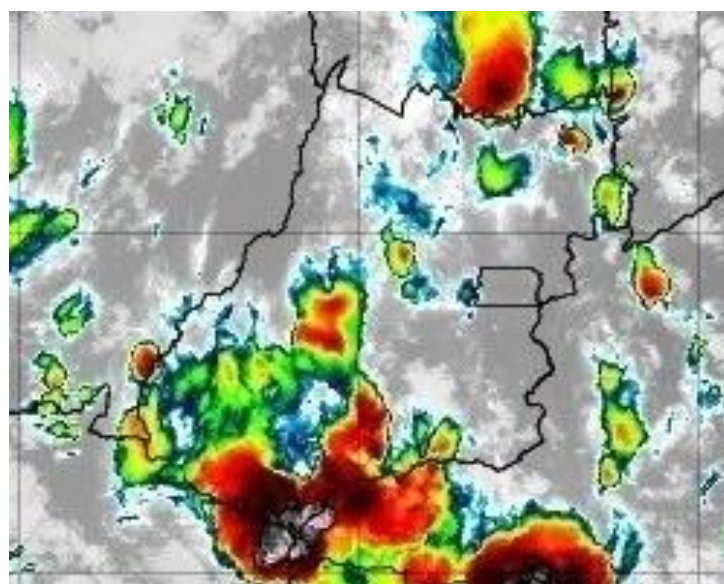

Figura 7 –Imagens realçadas do satélite GOES-16 das 21h00 do dia 06 de novembro de 2019. FONTE: Cptec/INPE.

23h00 - 06 de novembro de 2019

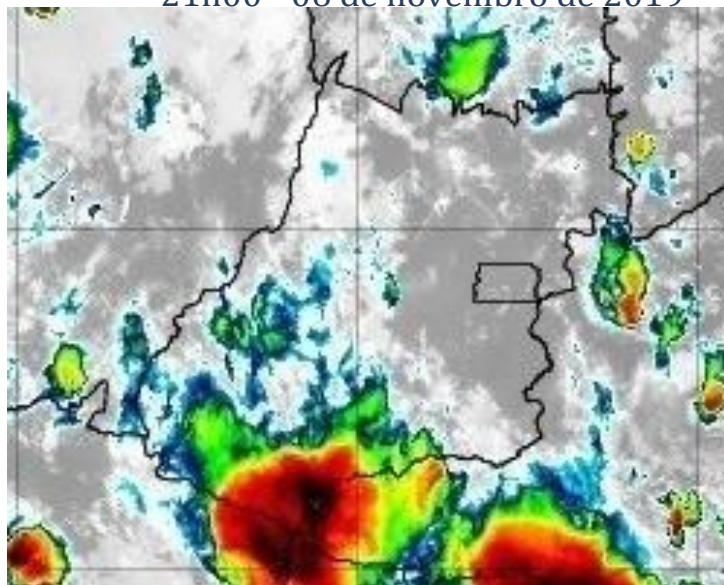

Figura 8 –Imagens realçadas do satélite GOES-16 das 23h00 do dia 06 de novembro de 2019. FONTE: Cptec/INPE.

01h00 - 07 de novembro de 2019

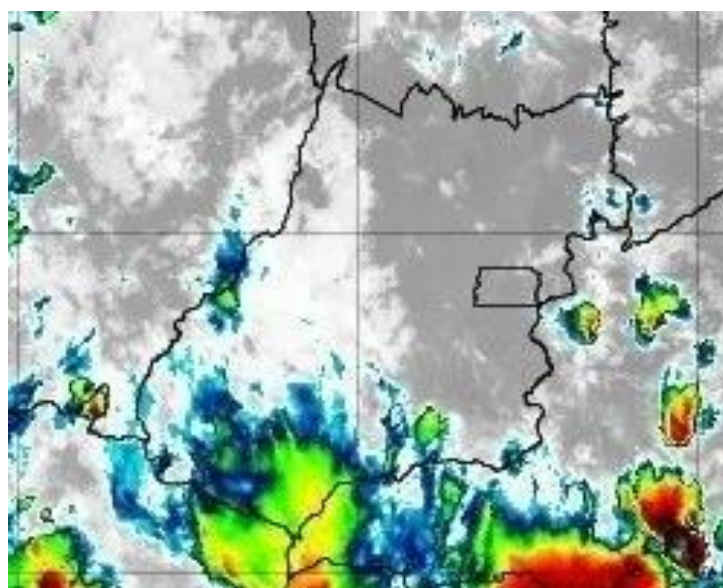

Figura 9 –Imagens realçadas do satélite GOES-16 das 01h00 do dia 07 de novembro de 2019. FONTE: Cptec/INPE.

03h00 - 07 de novembro de 2019

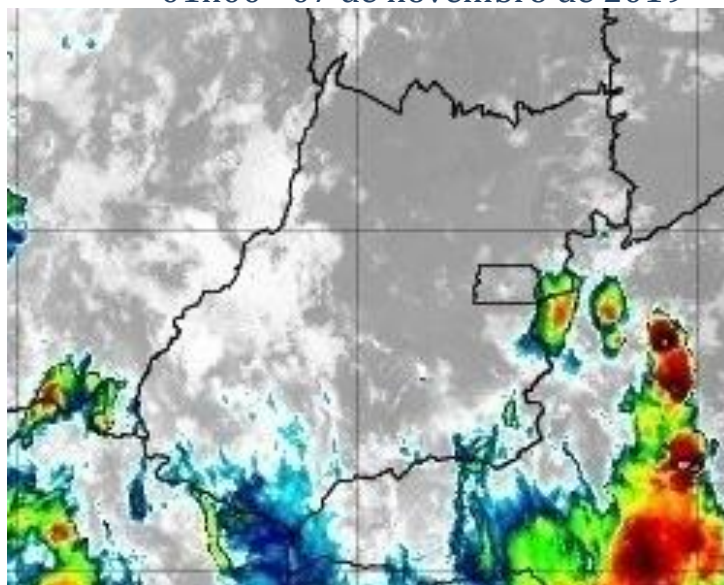

Figura 10 –Imagens realçadas do satélite GOES-16 das 03h00 do dia 07 de novembro de 2019. FONTE: Cptec/INPE.

05h00 - 07 de novembro de 2019

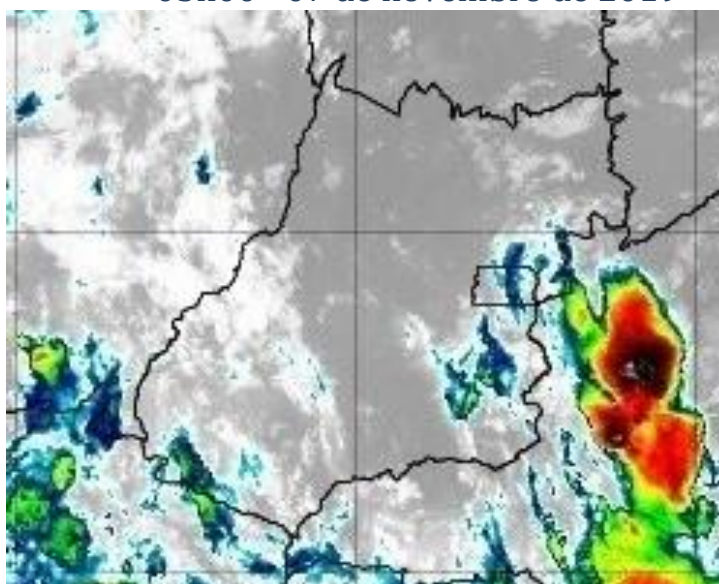

Figura 11 –Imagens realçadas do satélite GOES-16 das 05h00 do dia 07 de novembro de 2019. FONTE: Cptec/INPE.

07h00 - 07 de novembro de 2019



Figura 12 –Imagens realçadas do satélite GOES-16 das 07h00 do dia 07 de novembro de 2019. FONTE: Cptec/INPE.

09h00 - 07 de novembro de 2019

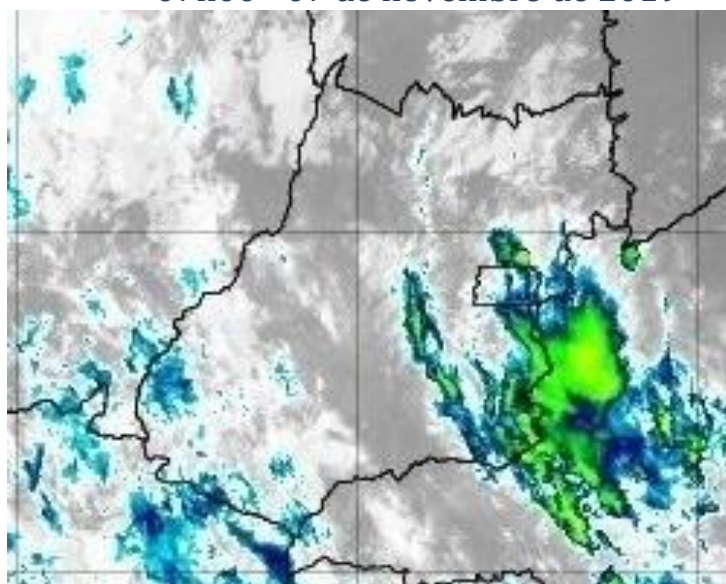

Figura 13 –Imagens realçadas do satélite GOES-16 das 09h00 do dia 07 de novembro de 2019. FONTE: Cptec/INPE.

11h00 - 07 de novembro de 2019



Figura 14 –Imagens realçadas do satélite GOES-16 das 11h00 do dia 07 de novembro de 2019. FONTE: Cptec/INPE.

13h00 - 07 de novembro de 2019

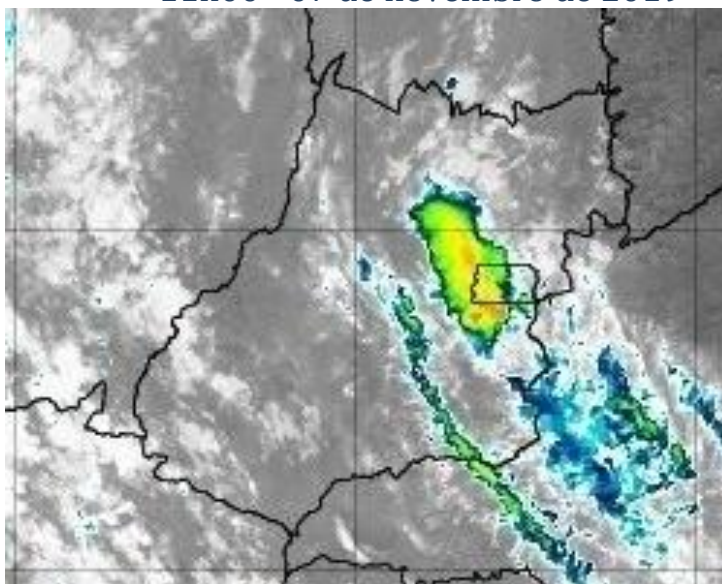

Figura 15 –Imagens realçadas do satélite GOES-16 das 13h00 do dia 07 de novembro de 2019.
FONTE: Cptec/INPE.

15h00 - 07 de novembro de 2019

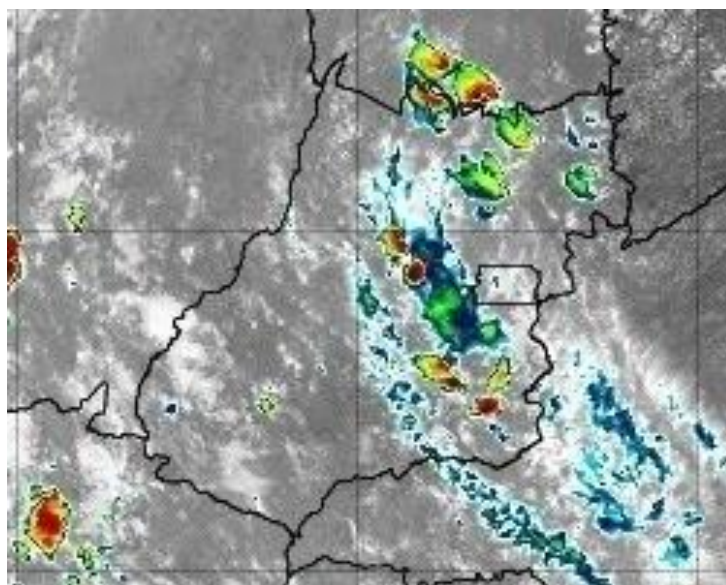

Figura 16 –Imagens realçadas do satélite GOES-16 das 15h00 do dia 07 de novembro de 2019.
FONTE: Cptec/INPE.

17h00 - 07 de novembro de 2019

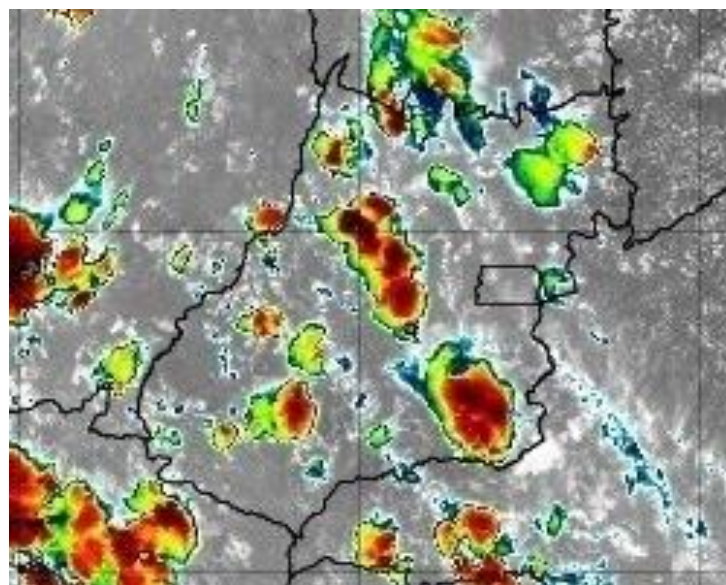

Figura 17 –Imagens realçadas do satélite GOES-16 das 17h00 do dia 07 de novembro de 2019.
FONTE: Cptec/INPE.

19h00 - 07 de novembro de 2019

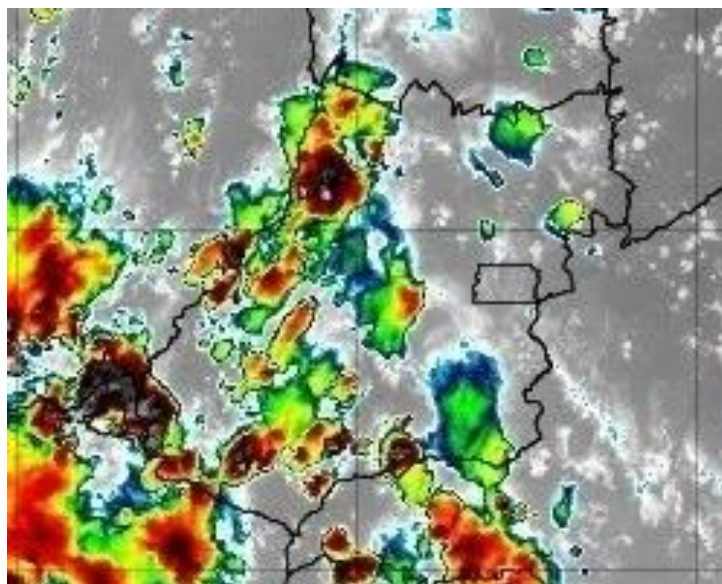

Figura 18 –Imagens realçadas do satélite GOES-16 das 19h00 do dia 07 de novembro de 2019. FONTE:
Cptec/INPE.

21h00 - 07 de novembro de 2019

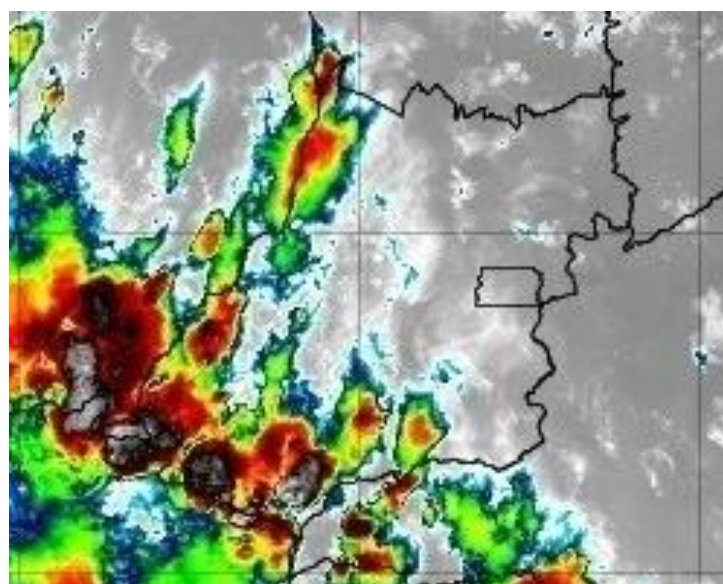

Figura 19 –Imagens realçadas do satélite GOES-16 das 21h00 do dia 07 de novembro de 2019. FONTE: Cptec/INPE.

23h00 - 07 de novembro de 2019

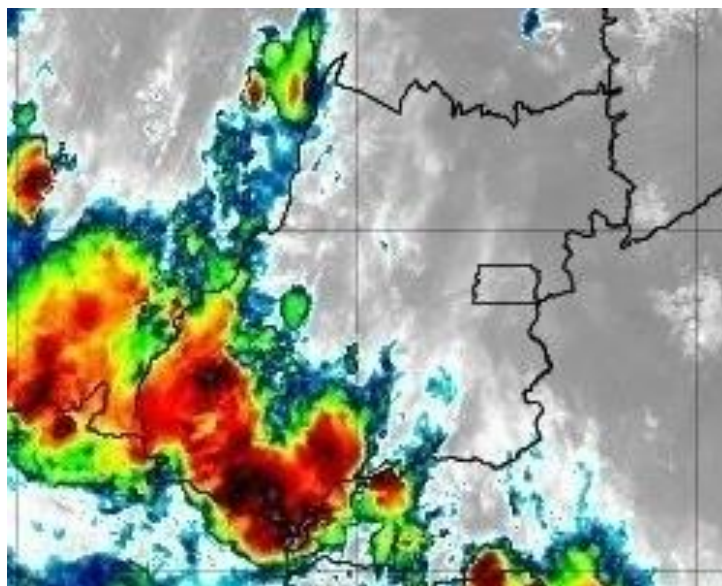

Figura 20 –Imagens realçadas do satélite GOES-16 das 23h00 do dia 07 de novembro de 2019. FONTE: Cptec/INPE.

01h00 - 08 de novembro de 2019

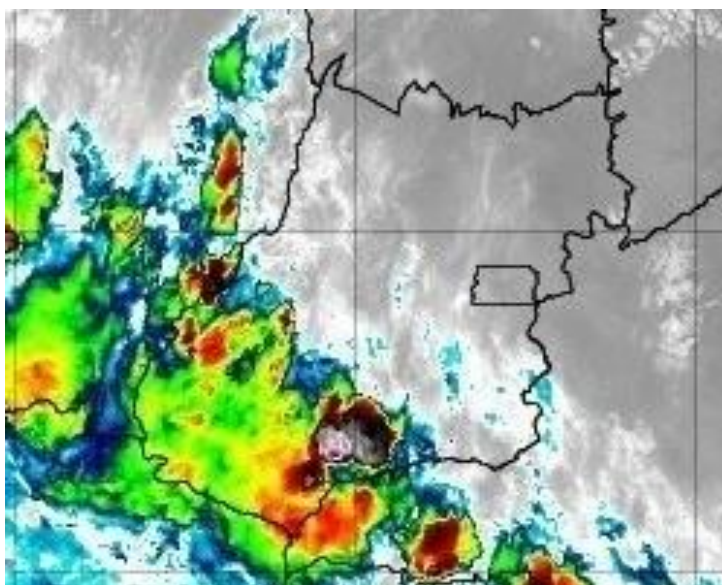

Figura 21 –Imagens realçadas do satélite GOES-16 das 01h00 do dia 08 de novembro de 2019. FONTE: Cptec/INPE.

03h00 - 08 de novembro de 2019

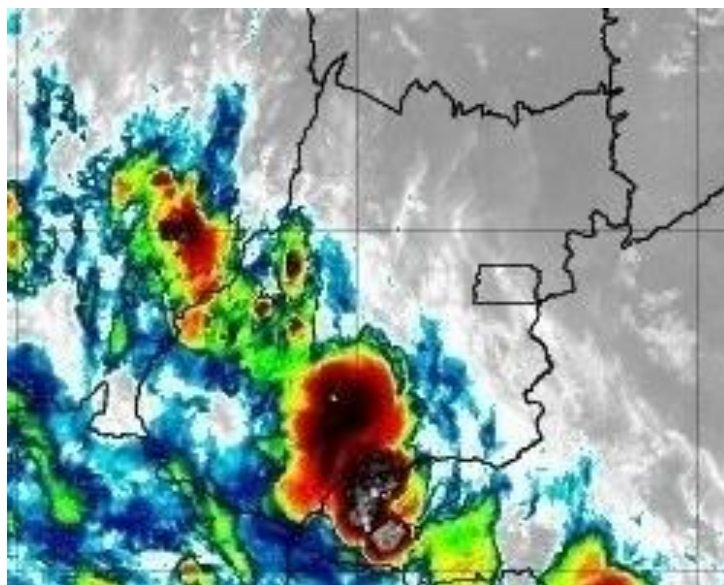

Figura 22 –Imagens realçadas do satélite GOES-16 das 03h00 do dia 08 de novembro de 2019. FONTE: Cptec/INPE.

05h00 - 08 de novembro de 2019

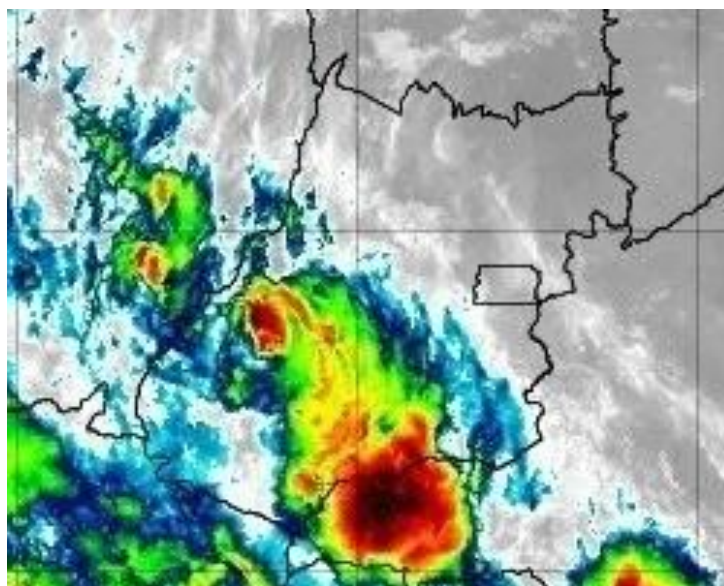

Figura 23 –Imagens realçadas do satélite GOES-16 das 05h00 do dia 08 de novembro de 2019. FONTE: Cptec/INPE.

07h00 - 08 de novembro de 2019

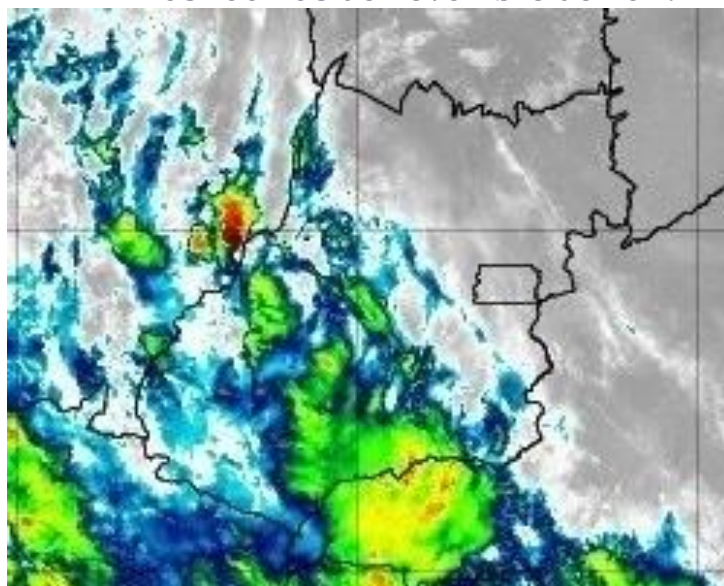

Figura 24 –Imagens realçadas do satélite GOES-16 das 07h00 do dia 08 de novembro de 2019. FONTE: Cptec/INPE.

09h00 - 08 de novembro de 2019

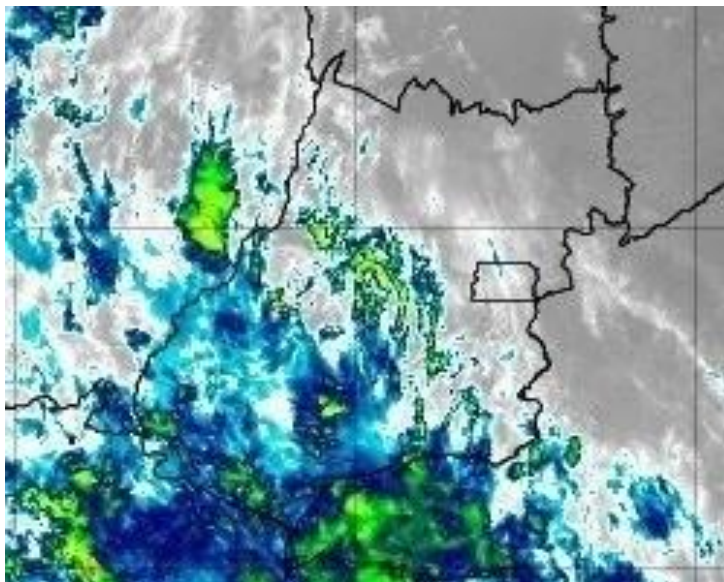

Figura 25 –Imagens realçadas do satélite GOES-16 das 09h00 do dia 08 de novembro de 2019. FONTE: Cptec/INPE.

11h00 - 08 de novembro de 2019

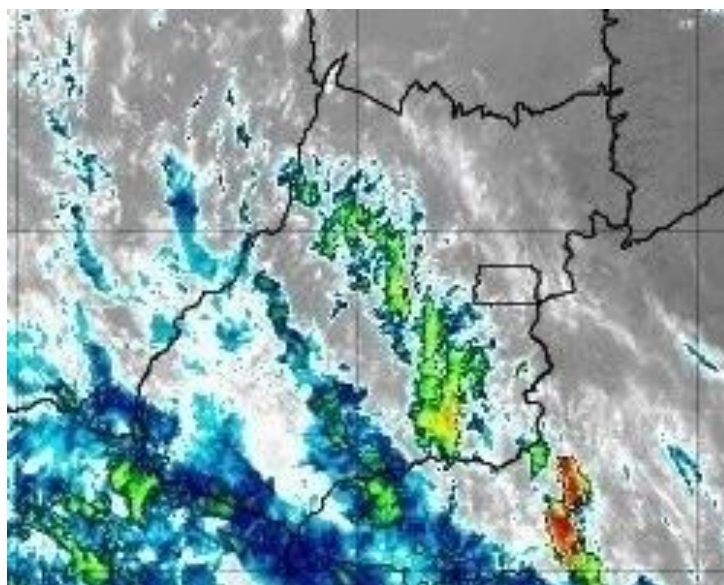

Figura 26 –Imagens realçadas do satélite GOES-16 das 11h00 do dia 08 de novembro de 2019. FONTE: Cptec/INPE.

13h00 - 08 de novembro de 2019

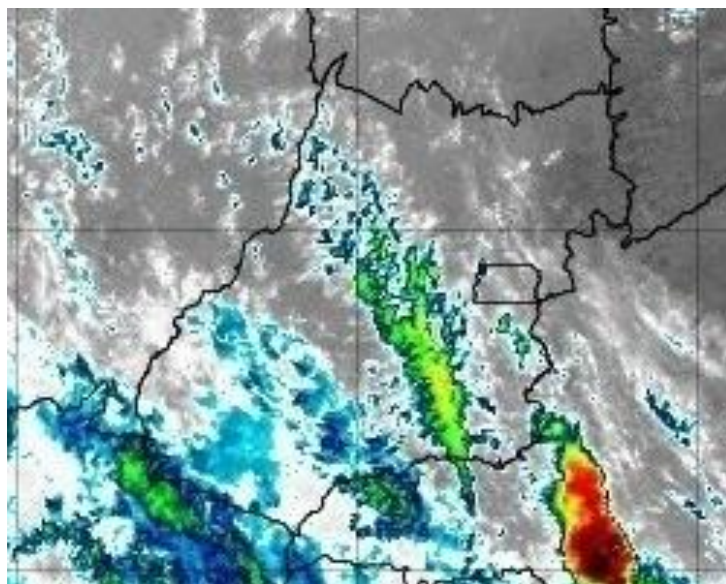

Figura 27 –Imagens realçadas do satélite GOES-16 das 13h00 do dia 08 de novembro de 2019. FONTE: Cptec/INPE.

15h00 - 08 de novembro de 2019

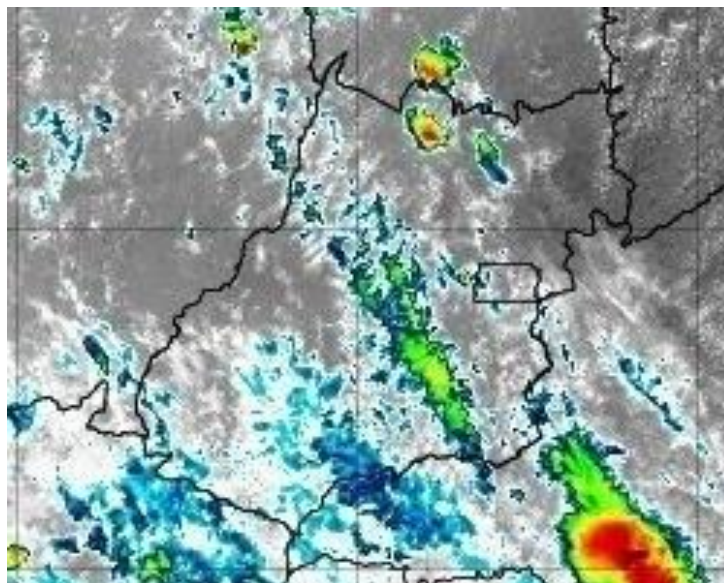

Figura 28 –Imagens realçadas do satélite GOES-16 das 15h00 do dia 08 de novembro de 2019. FONTE: Cptec/INPE.

17h00 - 08 de novembro de 2019



Figura 29 –Imagens realçadas do satélite GOES-16 das 17h00 do dia 08 de novembro de 2019. FONTE: Cptec/INPE.

19h00 - 08 de novembro de 2019

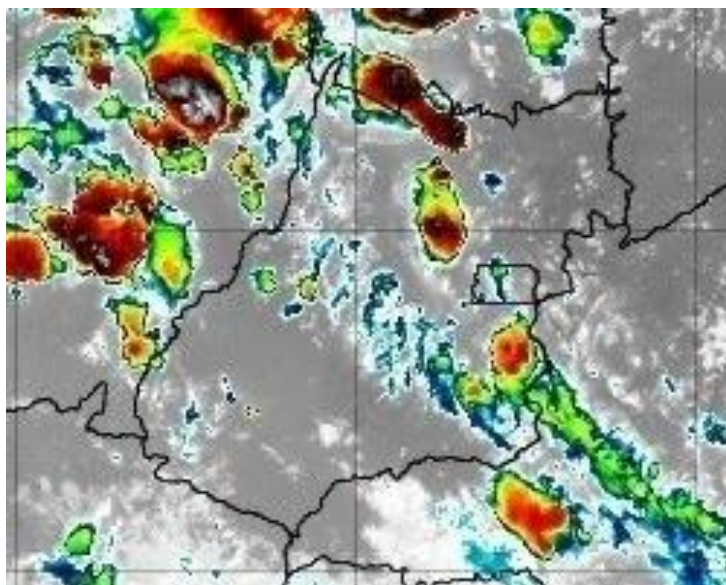

Figura 30 –Imagens realçadas do satélite GOES-16 das 19h00 do dia 08 de novembro de 2019. FONTE: Cptec/INPE.

21h00 - 08 de novembro de 2019

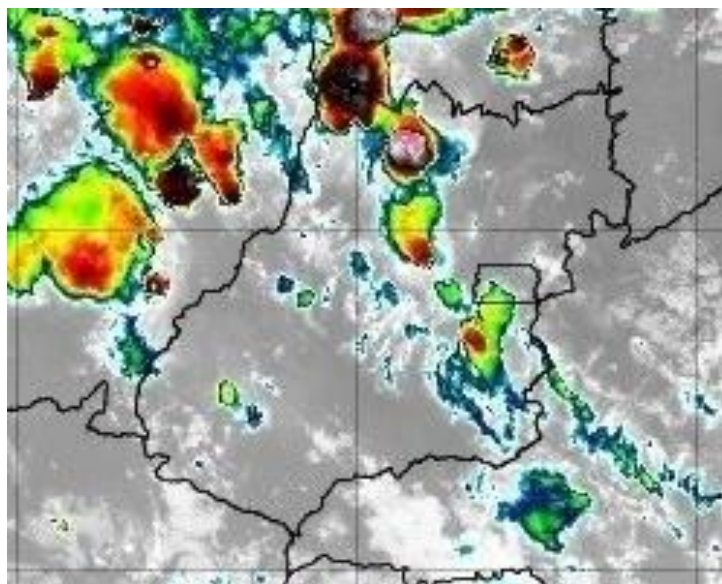

Figura 31 –Imagens realçadas do satélite GOES-16 das 21h00 do dia 08 de novembro de 2019. FONTE: Cptec/INPE.

23h00 - 08 de novembro de 2019



Figura 32 –Imagens realçadas do satélite GOES-16 das 23h00 do dia 08 de novembro de 2019. FONTE: Cptec/INPE.

01h00 - 09 de novembro de 2019

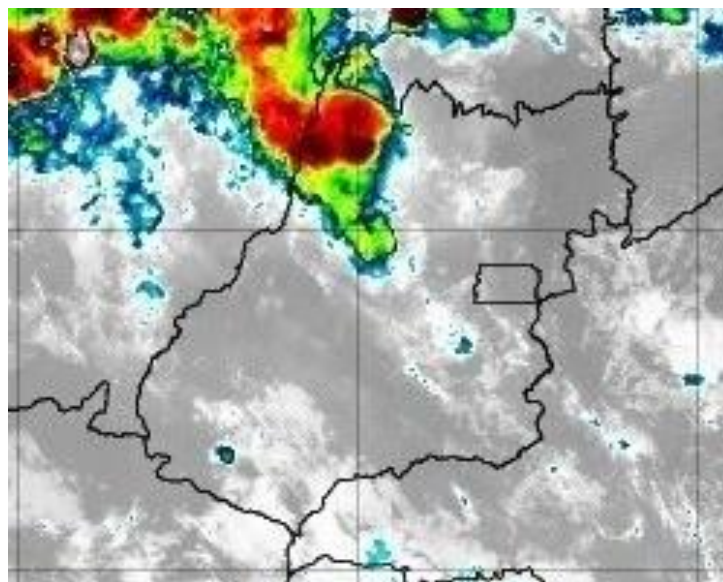

Figura 33 –Imagens realçadas do satélite GOES-16 das 01h00 do dia 09 de novembro de 2019. FONTE: Cptec/INPE.

03h00 - 09 de novembro de 2019

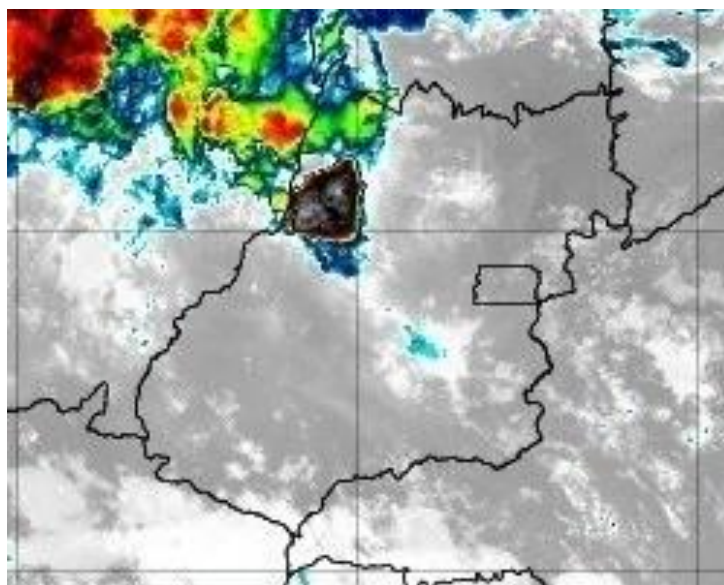

Figura 34 –Imagens realçadas do satélite GOES-16 das 03h00 do dia 09 de novembro de 2019. FONTE: Cptec/INPE.

05h00 - 09 de novembro de 2019

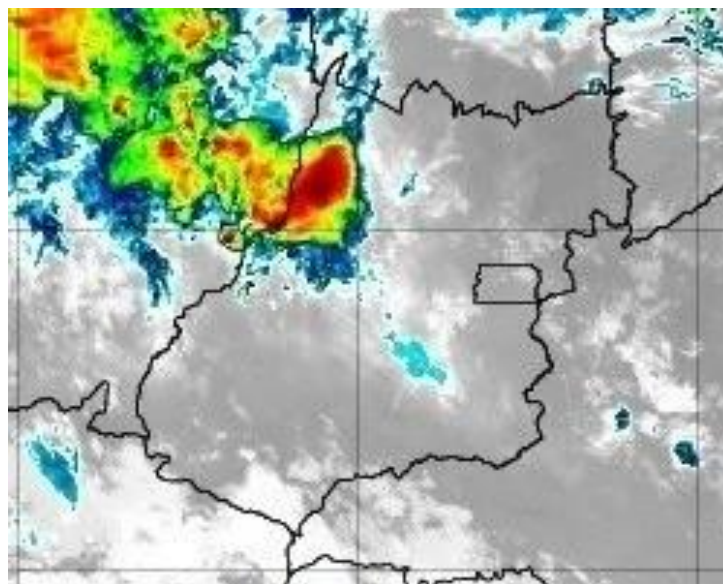

Figura 35 –Imagens realçadas do satélite GOES-16 das 05h00 do dia 09 de novembro de 2019. FONTE: Cptec/INPE.

07h00 - 09 de novembro de 2019

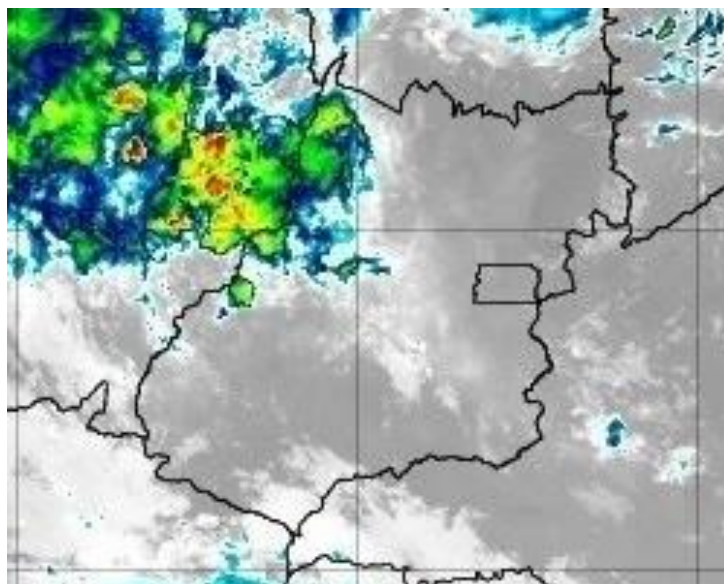

Figura 36 –Imagens realçadas do satélite GOES-16 das 07h00 do dia 09 de novembro de 2019. FONTE: Cptec/INPE.

2 Classificação COBRADE

O COBRADE (Classificação e Codificação Brasileira de Desastres) foi criado com o intuito de adequar a classificação brasileira à classificação utilizada pela ONU na classificação de desastres e nivelar o país aos demais organismos de gestão de desastres do mundo.

Baseados nos dados analisados nos itens anteriores, podemos classificar o evento ocorrido na CELG Distribuição como Tempestades - Vendaval (Código 1.3.2.1.5), Tempestade de raios Código (1.3.2.1.2) e Chuvas intensas (Código 1.3.2.1.4).

3 Resumo do Evento

Nuvens de tempestade, do tipo Cumulonimbus, formadas por áreas de instabilidade associadas ao tempo abafado e reforçadas pela presença de uma frente fria no mar, foram responsáveis pela ocorrência de chuva, raios e rajadas de vento sobre a área de concessão da CELG Distribuição em Goiás entre os dias 06 e 09 de novembro de 2019.

O sistema de detecção EarthNetworks registrou 105416 descargas atmosféricas sobre a área de concessão da CELG Distribuição Goiás entre as 10h00 do dia 06 e 05h00 do dia 09 de novembro.

Vento forte e ventania foram registrados por estações do INMET representativas da região de interesse. Na estação de Rio Verde as rajadas chegaram a até 65,9 km/h entre 14h e 15h do dia 07 de novembro.

Tabela 2 – Resumo do evento Região Sudoeste

Número/Código do Evento	
Número/Código do Relatório	
Descrição	Forte deslocamento de uma massa de ar em uma região. Tempestade com intensa atividade elétrica no interior das nuvens, com grande desenvolvimento vertical. Chuvas com acumulados significativos.
Código COBRADE	1.3.2.1.5 - Tempestades, Vendaval e 1.3.2.1.2 - Tempestade de raios e 1.3.2.1.4 - Chuvas intensas
Hora início do evento	10h30 do dia 06 de novembro de 2019
Hora de fim do evento	22h00 do dia 08 de novembro de 2019
Abrangência	Região Sudoeste da CELG Distribuição S.A.

Tabela 3 – Resumo do evento Região Sul

Número/Código do Evento	
Número/Código do Relatório	
Descrição	Forte deslocamento de uma massa de ar em uma região. Tempestade com intensa atividade elétrica no interior das nuvens, com grande desenvolvimento vertical. Chuvas com acumulados significativos.
Código COBRADE	1.3.2.1.5 - Tempestades, Vendaval e 1.3.2.1.2 - Tempestade de raios e 1.3.2.1.4 - Chuvas intensas
Hora início do evento	12h30 do dia 06 de novembro de 2019
Hora de fim do evento	05h40 do dia 08 de novembro de 2019
Abrangência	Região Sul da CELG Distribuição S.A.

Tabela 4 – Resumo do evento Região Sudeste

Número/Código do Evento	
Número/Código do Relatório	
Descrição	Forte deslocamento de uma massa de ar em uma região. Tempestade com intensa atividade elétrica no interior das nuvens, com grande desenvolvimento vertical. Chuvas com acumulados significativos.
Código COBRADE	1.3.2.1.5 - Tempestades, Vendaval e 1.3.2.1.2 - Tempestade de raios e 1.3.2.1.4 - Chuvas intensas
Hora início do evento	12h30 do dia 06 de novembro de 2019
Hora de fim do evento	00h00 do dia 09 de novembro de 2019
Abrangência	Região Sudeste da CELG Distribuição S.A.

Tabela 5 – Resumo do evento Região Metropolitana

Número/Código do Evento	
Número/Código do Relatório	
Descrição	Forte deslocamento de uma massa de ar em uma região. Tempestade com intensa atividade elétrica no interior das nuvens, com grande desenvolvimento vertical. Chuvas com acumulados significativos.
Código COBRADE	1.3.2.1.5 - Tempestades, Vendaval e 1.3.2.1.2 - Tempestade de raios e 1.3.2.1.4 - Chuvas intensas
Hora início do evento	14h00 do dia 06 de novembro de 2019
Hora de fim do evento	17h00 do dia 07 de novembro de 2019
Abrangência	Região Metropolitana da CELG Distribuição S.A.

Tabela 6 – Resumo do evento Região Oeste

Número/Código do Evento	
Número/Código do Relatório	
Descrição	Forte deslocamento de uma massa de ar em uma região. Tempestade com intensa atividade elétrica no interior das nuvens, com grande desenvolvimento vertical. Chuvas com acumulados significativos.
Código COBRADE	1.3.2.1.5 - Tempestades, Vendaval e 1.3.2.1.2 - Tempestade de raios e 1.3.2.1.4 - Chuvas intensas
Hora início do evento	10h00 do dia 06 de novembro de 2019
Hora de fim do evento	05h00 do dia 09 de novembro de 2019
Abrangência	Região Oeste da CELG Distribuição S.A.

Tabela 7 – Resumo do evento Região Entorno DF

Número/Código do Evento	
Número/Código do Relatório	
Descrição	Forte deslocamento de uma massa de ar em uma região. Tempestade com intensa atividade elétrica no interior das nuvens, com grande desenvolvimento vertical. Chuvas com acumulados significativos.
Código COBRADE	1.3.2.1.5 - Tempestades, Vendaval e 1.3.2.1.2 - Tempestade de raios e 1.3.2.1.4 - Chuvas intensas
Hora início do evento	11h00 do dia 06 de novembro de 2019
Hora de fim do evento	22h00 do dia 08 de novembro de 2019
Abrangência	Região Entorno DF da CELG Distribuição S.A.

Tabela 8 – Resumo do evento Região Centro

Número/Código do Evento	
Número/Código do Relatório	
Descrição	Forte deslocamento de uma massa de ar em uma região. Tempestade com intensa atividade elétrica no interior das nuvens, com grande desenvolvimento vertical. Chuvas com acumulados significativos.
Código COBRADE	1.3.2.1.5 - Tempestades, Vendaval e 1.3.2.1.2 - Tempestade de raios e 1.3.2.1.4 - Chuvas intensas
Hora início do evento	14h20 do dia 06 de novembro de 2019
Hora de fim do evento	00h00 do dia 09 de novembro de 2019
Abrangência	Região Centro da CELG Distribuição S.A.

Tabela 9 – Resumo do evento Região Noroeste

Número/Código do Evento	
Número/Código do Relatório	
Descrição	Forte deslocamento de uma massa de ar em uma região. Tempestade com intensa atividade elétrica no interior das nuvens, com grande desenvolvimento vertical. Chuvas com acumulados significativos.
Código COBRADE	1.3.2.1.5 - Tempestades, Vendaval e 1.3.2.1.2 - Tempestade de raios e 1.3.2.1.4 - Chuvas intensas
Hora início do evento	13h20 do dia 06 de novembro de 2019
Hora de fim do evento	03h00 do dia 09 de novembro de 2019
Abrangência	Região Noroeste da CELG Distribuição S.A.

Tabela 10 – Resumo do evento Região Nordeste

Número/Código do Evento	
Número/Código do Relatório	
Descrição	Forte deslocamento de uma massa de ar em uma região. Tempestade com intensa atividade elétrica no interior das nuvens, com grande desenvolvimento vertical. Chuvas com acumulados significativos.
Código COBRADE	1.3.2.1.5 - Tempestades, Vendaval e 1.3.2.1.2 - Tempestade de raios e 1.3.2.1.4 - Chuvas intensas
Hora início do evento	11h30 do dia 06 de novembro de 2019
Hora de fim do evento	17h00 do dia 08 de novembro de 2019
Abrangência	Região Nordeste da CELG Distribuição S.A.

Tabela 11 – Resumo do evento Região Norte

Número/Código do Evento	
Número/Código do Relatório	
Descrição	Forte deslocamento de uma massa de ar em uma região. Tempestade com intensa atividade elétrica no interior das nuvens, com grande desenvolvimento vertical. Chuvas com acumulados significativos.
Código COBRADE	1.3.2.1.5 - Tempestades, Vendaval e 1.3.2.1.2 - Tempestade de raios e 1.3.2.1.4 - Chuvas intensas
Hora início do evento	12h20 do dia 06 de novembro de 2019
Hora de fim do evento	03h00 do dia 09 de novembro de 2019
Abrangência	Região Norte da CELG Distribuição S.A.

4 Referências

- RMetS Royal Meteorological Society – Beaufort Scale - <https://www.rmets.org/weather-and-climate/observing/beaufort-scale>
- Instituto Nacional de Meteorologia (INMET) - <http://www.inmet.gov.br>
- Cptec/INPE- <https://www.cptec.inpe.br/>
- Centro de Hidrografia da Marinha do Brasil - <https://www.marinha.mil.br/chm/>
- Meteorology Glossary - American Meteorological Society - <http://glossary.ametsoc.org/>

Anexos

A.1 Carta Sinótica da Marinha do Brasil



Figura A1 - Carta sinótica da Marinha do Brasil para as 1200Z do dia 06 de novembro de 2019 (09h00 do dia 06 de novembro de 2019, hora local).



Figura A2 - Carta sinótica da Marinha do Brasil para as 1200Z do dia 07 de novembro de 2019 (09h00 do dia 07 de novembro de 2019, hora local).

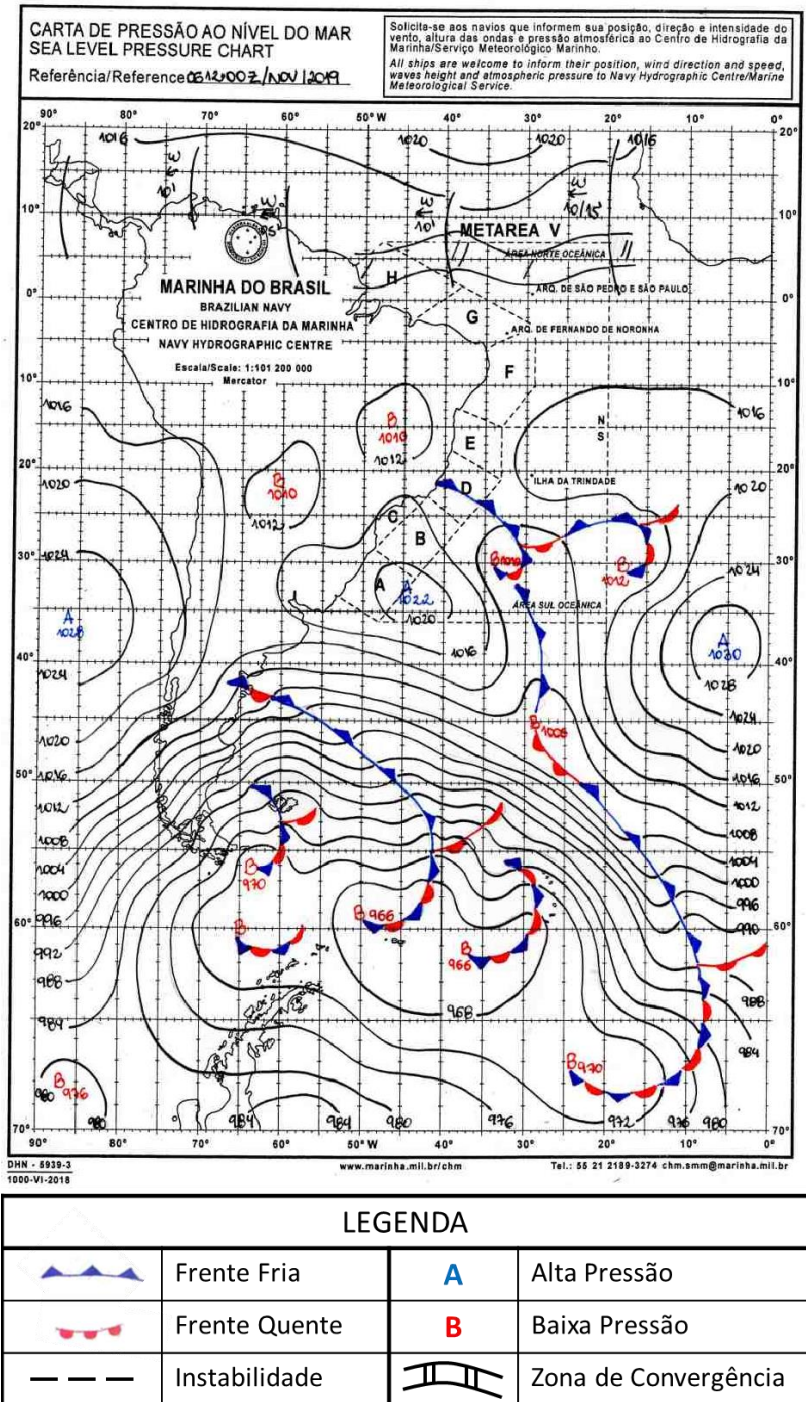

Figura A3 - Carta sinótica da Marinha do Brasil para as 1200Z do dia 08 de novembro de 2019 (09h00 do dia 08 de novembro de 2019, hora local).

A.2 Notícias relacionadas

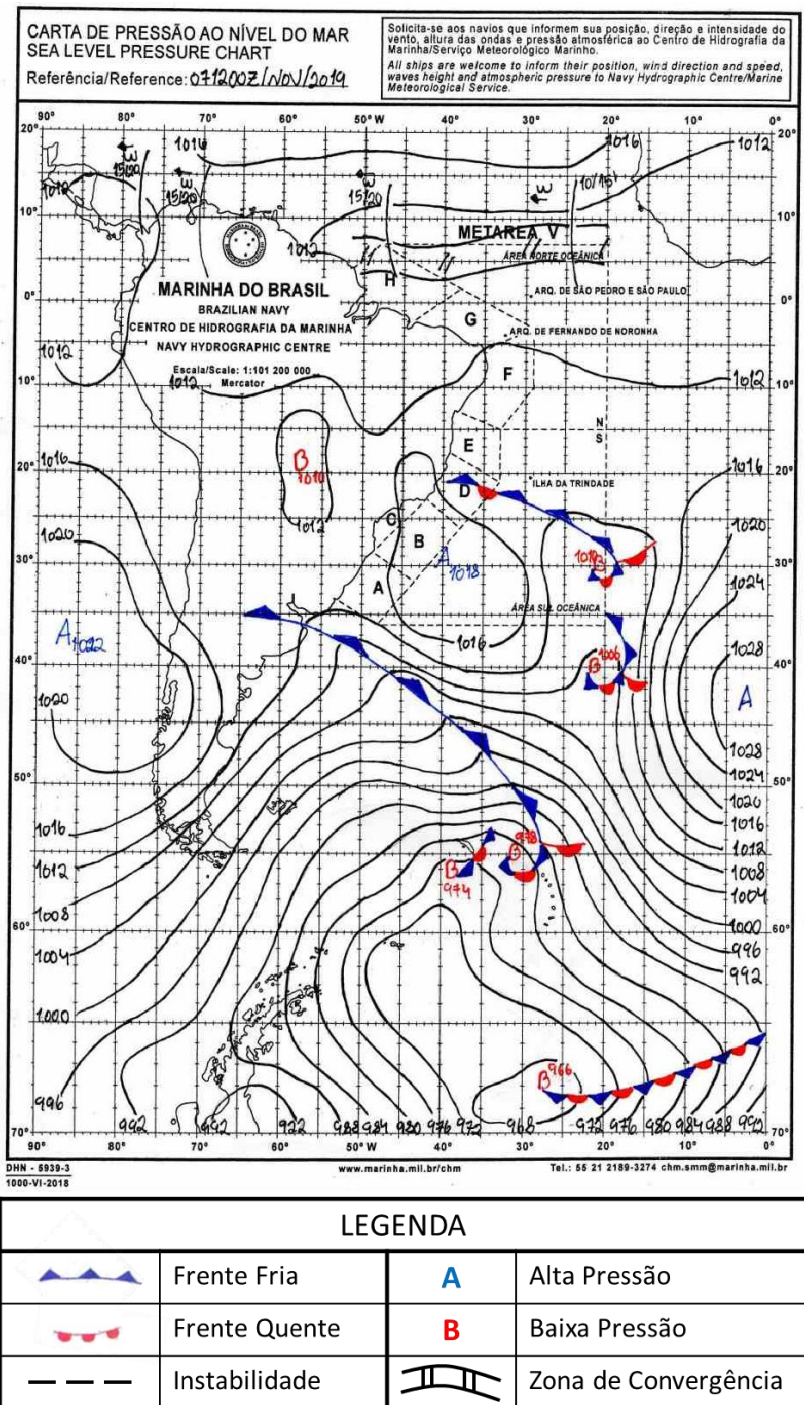
Forte chuva deixou estragos em Rio Verde - <http://g1.globo.com/goias/videos/t/todos-os-videos/v/forte-chuva-deixou-estragos-em-rio-verde/8070763/>

Chuva de granizo surpreende rio-verdenses -

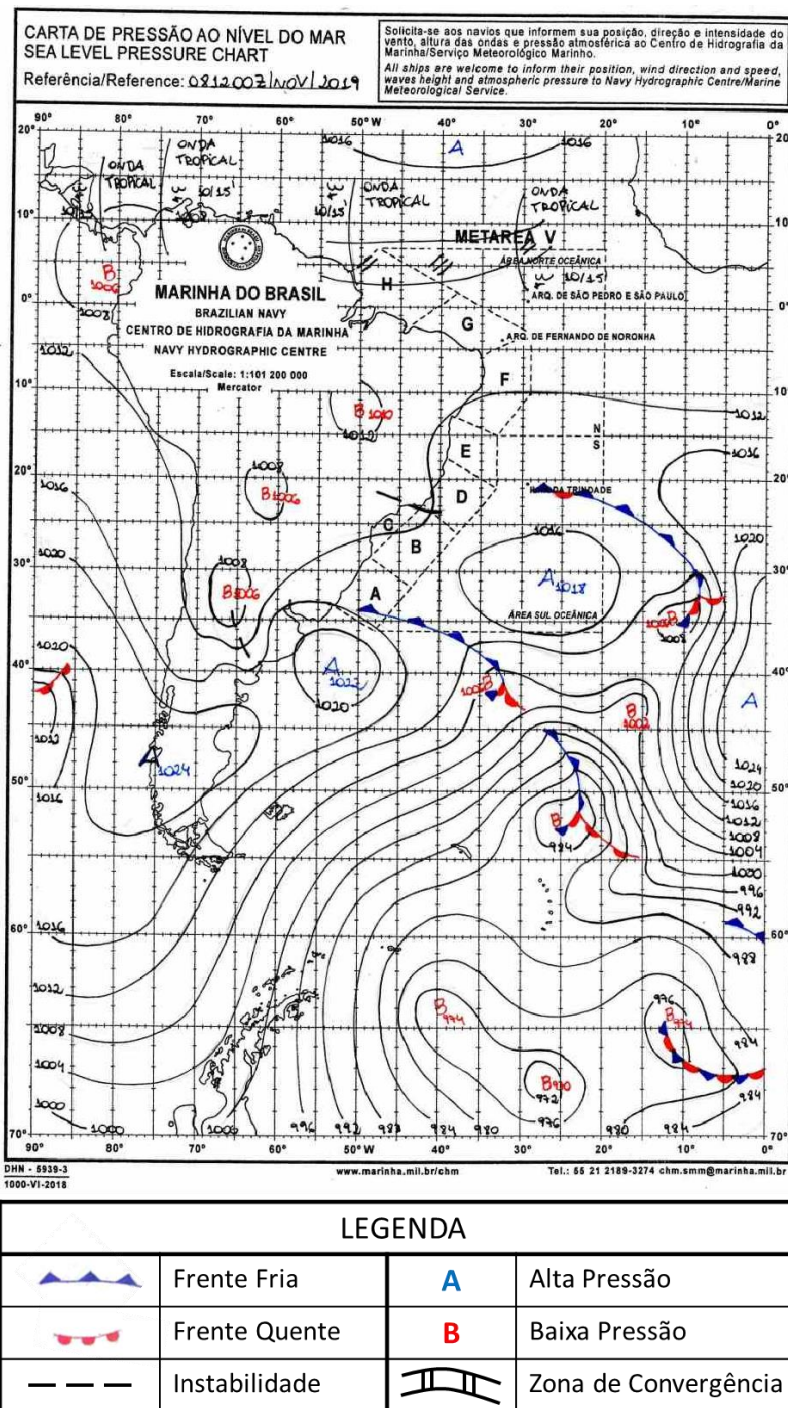
<http://jornalsomos.com.br/rio-verde/detalhe/chuva-de-granizo-surpreende-rio-verdenses> Rio Verde tem 2º dia de chuva com granizo e vento provoca estragos - [http://jornalsomos.com.br/rio-verde/detalhe/rio-verde-tem-](http://jornalsomos.com.br/rio-verde/detalhe/rio-verde-tem-2o-dia-de-chuva-com-granizo-e-vento-provoca-estragos)

[2o-dia-de-chuva-com-granizo-e-vento-provoca-estragos](http://jornalsomos.com.br/rio-verde/detalhe/rio-verde-tem-2o-dia-de-chuva-com-granizo-e-vento-provoca-estragos)

Granizos gigantes são registrados em Goiás - <http://correiodoar.com.br/noticia/granizos-gigantes-sao-registrados-em-goias/47122/>

Bianca Lobo Silva

Meteorologista

CREA 5063840461

Instituto Nacional de Meteorologia - INMET

Umidade Relativa do Ar 00h UTC

Estação: POSSE (GO) - 11/2019

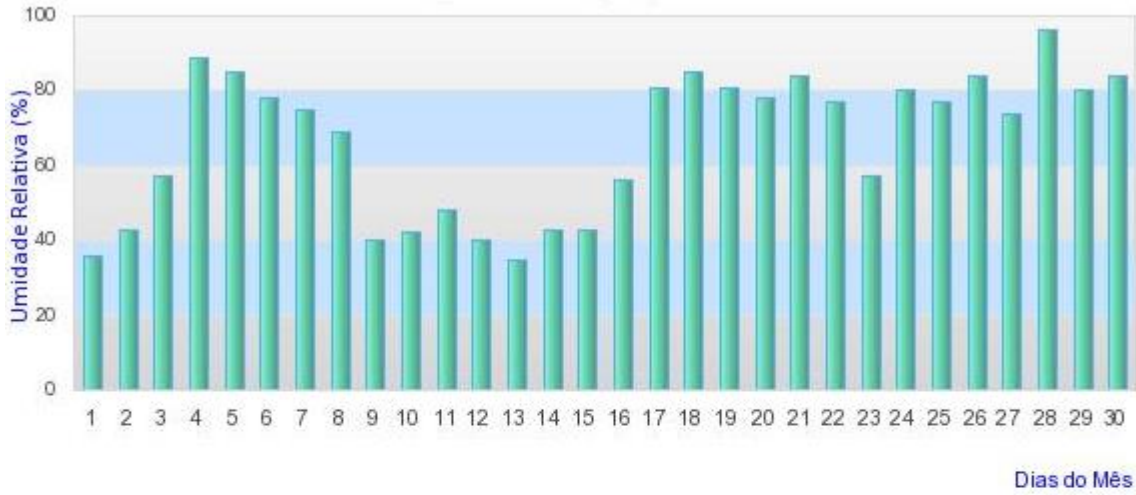

Instituto Nacional de Meteorologia - INMET

Chuva Acumulada 24h

Estação: POSSE - 11/2019



Instituto Nacional de Meteorologia - INMET

Umidade Relativa do Ar 00h UTC

Estação: JATAI (GO) - 11/2019

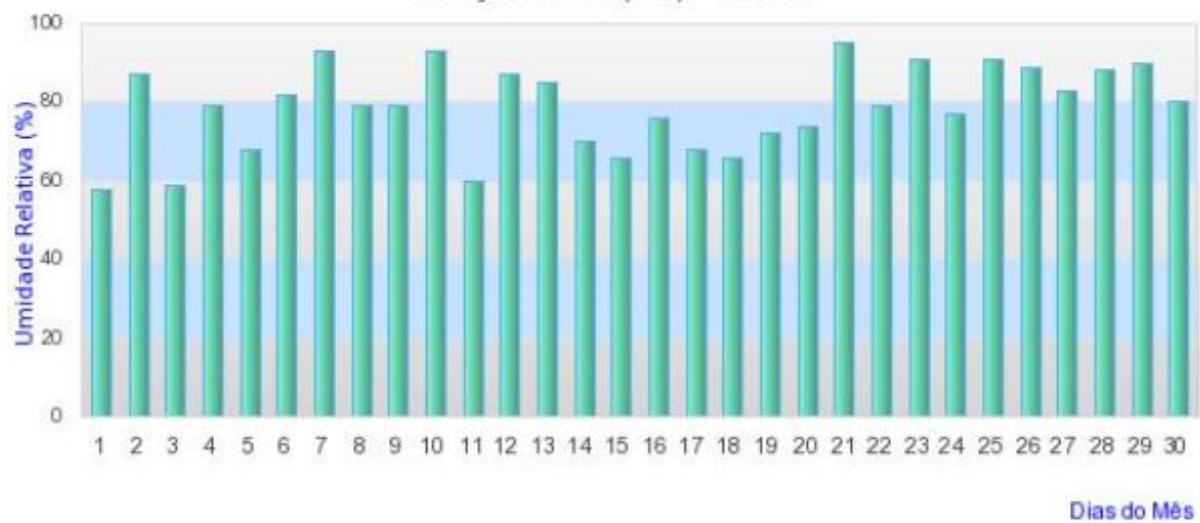

Instituto Nacional de Meteorologia - INMET

Chuva Acumulada 24h

Estação: JATAI - 11/2019



Instituto Nacional de Meteorologia - INMET

Umidade Relativa do Ar 00h UTC
Estação: RIO VERDE (GO) - 11/2019

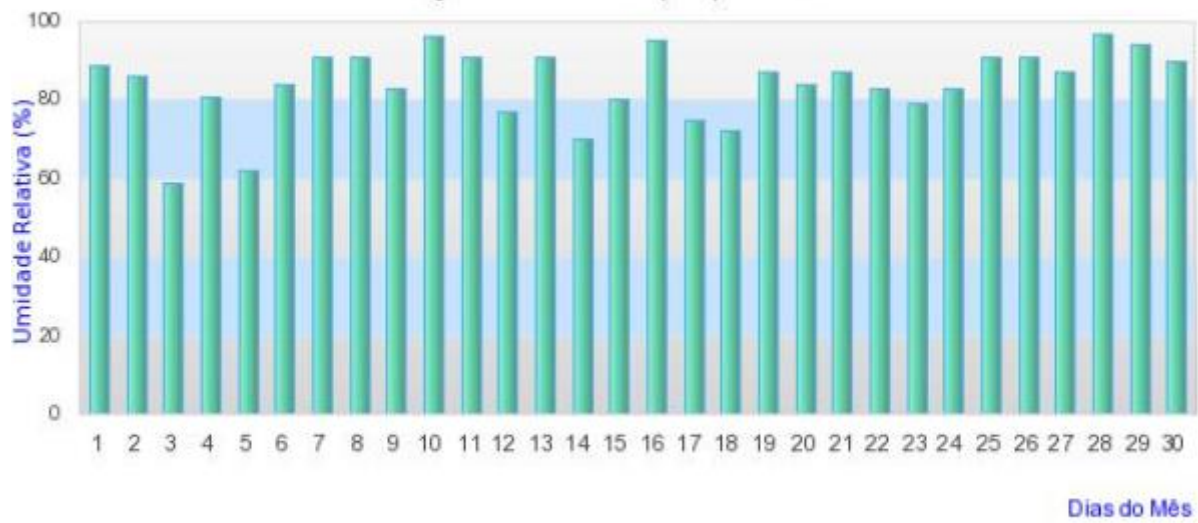

Instituto Nacional de Meteorologia - INMET

Chuva Acumulada 24h
Estação: RIO VERDE - 11/2019



Umidade Relativa do Ar 00h UTC
Estação: FORMOSA (GO) - 11/2019

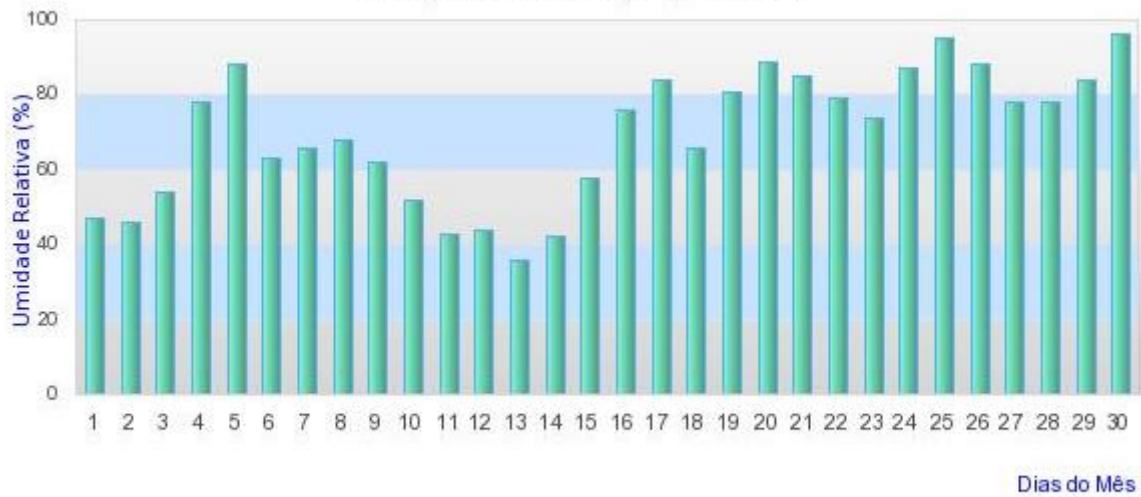

Instituto Nacional de Meteorologia - INMET

Chuva Acumulada 24h
Estação: FORMOSA - 11/2019



Instituto Nacional de Meteorologia - INMET

Umidade Relativa do Ar 00h UTC
Estação: GOIANIA (GO) - 11/2019

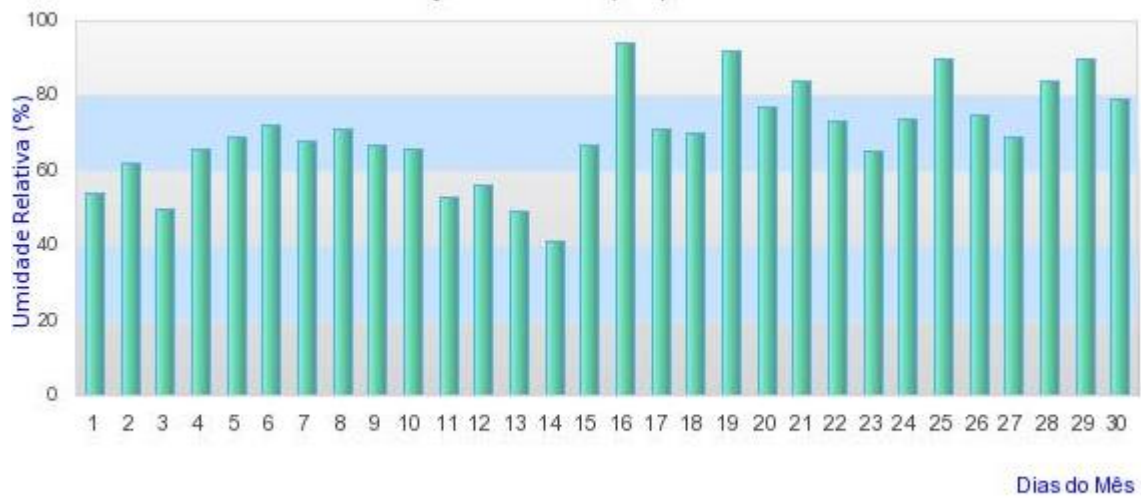

Instituto Nacional de Meteorologia - INMET

Chuva Acumulada 24h
Estação: GOIANIA - 11/2019

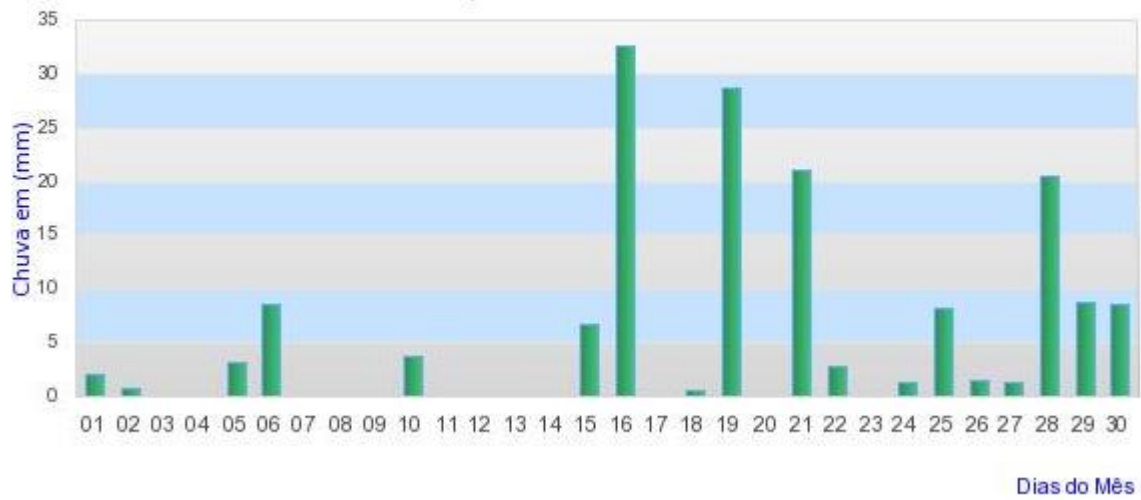

Aragarças - Estação Estação Hidro Aragarças - GO - ANA - Novembro de 2019

Para ver os dados horários clique no dia desejado

Dia	Precip.	Prec.Acum.	Sensor Pressão min	Sensor Pressão max	Sensor Pressão media	Nível Régua	CodifEixo	Vazão min (m3/s)	Vazão max (m3/s)	Vazão media (m3/s)
1	0.00	0.00	0.95	0.99	1.0	0.99	0.45	0.00	0.00	0.00
2	0.00	0.00	0.99	1.06	1.0	1.06	0.45	0.00	0.00	0.00
3	3.80	3.80	1.06	1.09	1.1	1.09	0.45	0.00	0.00	0.00
4	0.00	3.80	1.09	1.11	1.1	1.11	0.45	0.00	0.00	0.00
5	0.00	3.80	1.06	1.09	1.1	1.09	0.45	0.00	0.00	0.00
6	3.20	7.00	1.06	1.07	1.1	1.07	0.45	0.00	0.00	0.00
7	44.00	51.00	1.04	1.06	1.1	1.06	0.45	0.00	0.00	0.00
8	9.20	60.20	1.05	1.06	1.1	1.06	0.45	0.00	0.00	0.00
9	0.00	60.20	1.06	1.08	1.1	1.08	0.45	0.00	0.00	0.00
10	7.20	67.40	1.08	1.1	1.1	1.1	0.45	0.00	0.00	0.00
11	0.20	67.60	1.09	1.1	1.1	1.1	0.45	0.00	0.00	0.00
12	0.00	67.60	0	1.2	1.1	1.2	0.49	0.00	0.00	0.00
13	-122.80	-55.20	1.19	1.22	1.2	1.22	0.49	0.00	0.00	0.00
14	0.00	-55.20	1.18	1.19	1.2	1.19	0.49	0.00	0.00	0.00
15	8.20	-47.00	1.18	1.19	1.2	1.19	0.49	0.00	0.00	0.00
16	0.20	-46.80	1.16	1.18	1.2	1.18	0.49	0.00	0.00	0.00
17	0.00	-46.80	1.13	1.16	1.1	1.16	0.49	0.00	0.00	0.00
18	0.00	-46.80	1.13	1.14	1.1	1.14	0.49	0.00	0.00	0.00
19	16.40	-30.40	1.14	1.21	1.2	1.21	0.49	0.00	0.00	0.00
20	2.60	-27.80	1.21	1.24	1.2	1.24	0.49	0.00	0.00	0.00
21	0.20	-27.60	1.23	1.26	1.2	1.26	0.49	0.00	0.00	0.00
22	0.00	-27.60	1.26	1.32	1.3	1.32	0.49	0.00	0.00	0.00
23	0.00	-27.60	1.27	1.29	1.3	1.29	0.49	0.00	0.00	0.00
24	0.00	-27.60	1.29	1.32	1.3	1.32	0.49	0.00	0.00	0.00
25	0.00	-27.60	1.26	1.33	1.3	1.33	0.49	0.00	0.00	0.00
26	0.00	-27.60	1.2	1.27	1.2	1.27	0.49	0.00	0.00	0.00
27	34.00	6.40	1.21	1.77	1.4	1.77	0.49	0.00	0.00	0.00
28	0.80	7.20	1.73	1.77	1.8	1.77	0.49	0.00	0.00	0.00
29	0.00	7.20	1.73	1.84	1.8	1.84	0.49	0.00	0.00	0.00
30	0.20	7.40	1.82	2.06	1.9	2.06	0.49	0.00	0.00	0.00

Goiania - Estação CELG Estação Aerodromo Goiania - Novembro de 2019

Para ver os dados horários clique no dia desejado

Dia	Precip.	Prec.Acum.	Vel. Vent. (m/s)	Dir. Vent.	Umid. Relat. AR (Max) %	Umid. Relat. AR (Min) %	Umid. Relat. AR (Média) %	Temp. Max. °C Dia	Temp. Min. °C Dia	Temp. Med. °C do Ar	Temp. 09:00h	Temp. 21:00h	Ponto orvalho	Razao Mistura
1	1.00	1.00	1.9	SO	85.0	32.0	57.7	33.7	20.8	26.02	28	23.8	17.57083	-
2	0.40	1.40	2.4	SE	86.0	35.0	50.7	33.2	20.5	27.08	26.1	27.8	17.27917	-
3	0.00	1.40	2.8	NO	79.0	48.0	61.5	29.3	21.6	25.42	24.8	25.7	17.73333	-
4	16.40	17.80	1.7	N	89.0	34.0	63	33.4	20.9	25.54	27.8	22.8	18.19167	-
5	0.00	17.80	1.7	NO	90.0	46.0	64.2	31.4	20.4	25.56	26.8	24.6	18.91667	-
6	0.00	17.80	1.8	N	92.0	43.0	67	30.6	20.4	24.68	24	24.2	19.10833	-
7	17.00	34.80	1.6	SE	91.0	43.0	68	33.0	20.2	24.84	25	23	19.25833	-
8	0.00	34.80	2.2	S	93.0	63.0	72	28.4	21.4	24.96	23.2	25.9	19.88750	-
9	9.80	44.60	2.4	SE	84.0	34.0	63	33.8	21.7	25.62	28.4	22.1	18.47083	-
10	0.00	44.60	1.7	SO	89.0	37.0	56	32.6	20.6	25.9	25.3	25.5	18.18750	-
11	0.00	44.60	2.1	S	81.0	32.0	58.2	33.9	21.1	26.02	27.7	23.7	17.78750	-
12	0.00	44.60	2.4	SO	80.0	32.0	51.2	33.8	22.1	27.3	27	26.8	17.65417	-
13	0.00	44.60	2.2	N	77.0	30.0	46.2	33.2	21.8	27.74	26.7	28.5	16.36667	-
14	0.00	44.60	1.8	SO	76.0	43.0	61.2	32.1	22.9	26.66	26.9	25.7	18.30833	-
15	25.00	69.60	1.6	S	99.0	48.0	78.5	30.5	20.7	24.04	27.6	20.7	18.84167	-
16	0.40	70.00	0.9	N	100.0	60.0	74	27.6	20.4	23.82	22.5	24.3	19.75000	-
17	6.60	76.60	1.9	N	93.0	58.0	75.5	29.1	20.6	24.44	24.9	23.8	19.77083	-
18	69.80	146.40	2.2	N	100.0	63.0	91	26.8	19.2	21.68	23.2	19.6	19.32917	-
19	1.00	147.40	1.3	L	97.0	60.0	76	27.8	20.2	23.82	25.5	22.8	19.87083	-
20	5.20	152.60	1.5	L	92.0	57.0	86.5	28.2	20.9	23.62	25.4	21.8	19.57500	-
21	0.00	152.60	2.0	SE	98.0	53.0	68.7	29.5	19.6	23.76	23.9	22.9	18.60417	-
22	0.00	152.60	2.7	N	96.0	49.0	64	28.6	19.9	24.78	24.4	25.5	18.40833	-
23	0.60	153.20	2.0	NO	87.0	43.0	75	30.3	21.6	24.68	26.9	22.3	18.99583	-
24	12.80	166.00	2.7	NO	99.0	46.0	78.2	30.4	20.2	23.76	26.4	20.9	19.27917	-
25	1.40	167.40	1.8	N	98.0	56.0	76.5	28.9	20.2	24.1	25	23.2	19.84583	-
26	3.80	171.20	1.9	N	89.0	59.0	74.5	28.8	20.5	24.68	25.3	24.4	19.52917	-
27	6.80	178.00	2.1	N	98.0	61.0	73.5	28.5	21.0	24.56	25.5	23.9	20.38750	-
28	5.60	183.60	2.5	N	100.0	67.0	90.2	27.6	20.4	23.02	24.1	21.5	20.93333	-
29	0.00	183.60	1.8	NO	100.0	63.0	78.7	29.2	20.6	24.28	22.8	24.4	20.95000	-
30	0.00	183.60	2.1	N	95.0	66.0	81	28.0	21.9	24.26	26.2	22.6	21.03333	-

Goiania - Estação CELG Estação Goiania 2 - Novembro de 2019

Para ver os dados horários clique no dia desejado

Dia	Precip.	Prec.Acum.	Vel. Vent. (m/s)	Dir. Vent.	Umid. Relat. AR (Max) %	Umid. Relat. AR (Min) %	Umid. Relat. AR (Média)%	Temp. Max. °C Dia	Temp. Min. °C Dia	Temp. Med. °C do Ar	Temp. 09:00h	Temp. 21:00h	Ponto orvalho	Razao Mistura
1	0.00	0.00	0.5	NO	98.0	31.0	57.7	34.8	19.0	26.04	29	23.7	18.03750	14.2847
2	0.60	0.60	0.7	SE	97.0	39.0	56.2	34.0	19.7	26.56	28.1	25.5	18.25417	14.2500
3	0.00	0.60	0.7	N	81.0	41.0	65.7	30.9	21.7	25.56	26	24.6	18.49583	14.4514
4	1.80	2.40	0.5	NO	95.0	33.0	60.5	34.9	20.7	26.5	29.5	23.7	18.94583	15.0417
5	2.60	5.00	0.5	NO	99.0	39.0	68.5	33.6	19.4	25.7	28.7	23.4	19.69583	15.6667
6	0.00	5.00	0.6	NO	96.0	43.0	69.5	32.0	20.5	25.32	25.5	24.3	19.92500	15.9931
7	0.00	5.00	0.6	SE	98.0	44.0	73.5	33.2	20.5	24.96	28.3	21.4	19.97083	15.9306
8	0.00	5.00	0.7	SE	94.0	61.0	76.5	29.4	20.5	24.26	23.8	23.8	20.37083	16.5278
9	8.60	13.60	0.9	SE	93.0	30.0	63.7	36.0	20.8	26.02	30.5	21.4	18.98333	15.0903
10	0.60	14.20	0.5	NO	100.0	35.0	62.7	34.1	19.9	25.66	26.9	23.7	18.85833	14.8750
11	0.00	14.20	0.8	NO	98.0	33.0	59.5	35.6	19.5	26.28	28.3	24	18.67083	14.7222
12	0.00	14.20	0.7	SE	82.0	29.0	56.7	35.7	22.3	27.34	27.7	25.5	18.29583	14.5347
13	0.00	14.20	0.9	NO	95.0	28.0	-	34.2	19.4	-	29.5	-	16.57391	13.0000
14	4.60	18.80	0.7	NO	91.0	40.0	63.7	33.7	21.0	26.42	28.8	24.3	19.51667	15.6181
15	14.40	33.20	0.6	O	100.0	48.0	85	30.9	20.1	24.02	28.1	20.5	20.11667	16.1944
16	0.40	33.60	0.3	NO	100.0	55.0	84	29.2	20.4	23.3	21.9	22.5	20.64167	16.7917
17	0.00	33.60	0.7	NO	100.0	46.0	76.2	31.0	19.7	24.84	26.3	23.6	20.46667	16.5417
18	29.80	63.40	0.7	SE	100.0	62.0	89.7	28.0	19.2	22.32	24.6	19.9	20.01667	16.0486
19	0.60	64.00	0.4	L	100.0	66.0	83	28.3	19.6	23.56	25.7	22.1	20.70000	16.7083
20	15.80	79.80	0.4	NO	100.0	57.0	93.5	29.3	19.5	23.32	26.4	20.7	20.42500	16.3333
21	0.00	79.80	0.7	SE	100.0	52.0	77.5	30.2	19.2	23.38	24.7	21.4	19.60417	15.6250
22	6.20	86.00	0.8	NO	100.0	51.0	72.2	29.9	19.4	24.08	25.7	22.7	19.60417	15.6597
23	0.00	86.00	0.5	NO	99.0	47.0	78.5	31.2	20.6	24.68	28.2	21.7	20.11250	16.0000
24	6.40	92.40	0.8	NO	100.0	39.0	78.2	32.2	19.3	24.04	27.3	20.7	19.73333	15.7500
25	0.60	93.00	0.4	NO	100.0	61.0	76.7	29.1	19.6	24.28	25.9	23.4	20.53750	16.6736
26	0.00	93.00	0.6	NO	99.0	55.0	76	30.6	19.5	25	26.7	24.1	20.37917	16.4028
27	17.20	110.20	0.4	SE	100.0	71.0	90	27.9	20.9	23.74	26.1	21.9	21.55000	17.7014
28	11.20	121.40	0.7	NO	100.0	62.0	91.5	29.2	20.5	23.38	25.8	20.7	21.32083	17.4236
29	2.60	124.00	0.5	NO	100.0	61.0	92.5	29.5	20.3	23.94	23.7	23.1	21.51250	17.6597
30	0.00	124.00	0.7	O	100.0	65.0	82	29.6	21.5	24.72	27.3	22.6	21.72917	17.8403

Goiania - Estação Estação Hidro Goiânia Montante - GO - ANA - Novembro de 2019

Para ver os dados horários clique no dia desejado

Dia	Precip.	Prec.Acum.	Sensor Pressão min	Sensor Pressão max	Sensor Pressão media	Nível Régua	CodifEixo	Vazão min (m3/s)	Vazão max (m3/s)	Vazão media (m3/s)
1	2.40	2.40	1.1	1.48	1.3	1.48	6.71	0.00	0.00	0.00
2	1.40	3.80	1.18	1.62	1.3	1.62	6.71	0.00	0.00	0.00
3	0.00	3.80	1.06	1.49	1.3	1.49	6.71	0.00	0.00	0.00
4	2.80	6.60	0.95	1.52	1.4	1.52	6.71	0.00	0.00	0.00
5	0.20	6.80	0.91	1.51	1.3	1.51	6.71	0.00	0.00	0.00
6	0.00	6.80	1.01	1.45	1.3	1.45	6.71	0.00	0.00	0.00
7	7.60	14.40	0.91	1.46	1.3	1.46	6.71	0.00	0.00	0.00
8	0.00	14.40	0.9	1.47	1.3	1.47	6.71	0.00	0.00	0.00
9	14.60	29.00	0.93	1.43	1.2	1.43	6.71	0.00	0.00	0.00
10	0.00	29.00	0.92	1.42	1.2	1.42	6.71	0.00	0.00	0.00
11	0.00	29.00	0.91	1.35	1.2	1.35	6.71	0.00	0.00	0.00
12	0.00	29.00	1.06	1.33	1.2	1.33	6.71	0.00	0.00	0.00
13	0.00	29.00	0.98	1.43	1.2	1.43	6.71	0.00	0.00	0.00
14	0.00	29.00	0.98	1.4	1.2	1.4	6.71	0.00	0.00	0.00
15	23.20	52.20	1.03	2.07	1.3	2.07	6.71	0.00	0.00	0.00
16	0.60	52.80	1.03	1.5	1.3	1.5	6.71	0.00	0.00	0.00
17	0.00	52.80	1.09	1.53	1.3	1.53	6.71	0.00	0.00	0.00
18	37.00	89.80	1.1	2.45	1.5	2.45	6.71	0.00	0.00	0.00
19	2.60	92.40	0.94	1.38	1.1	1.38	6.71	0.00	0.00	0.00
20	11.20	103.60	1	1.39	1.1	1.39	6.71	0.00	0.00	0.00
21	0.00	103.60	0	1.63	1.4	1.63	7.17	0.00	0.00	0.00
22	-152.20	-48.60	1.4	1.55	1.5	1.55	7.17	0.00	0.00	0.00
23	0.00	-48.60	1.33	1.45	1.4	1.45	7.17	0.00	0.00	0.00
24	4.20	-44.40	1.33	1.51	1.4	1.51	7.17	0.00	0.00	0.00
25	0.00	-44.40	1.38	1.5	1.4	1.5	7.17	0.00	0.00	0.00
26	0.00	-44.40	1.46	1.58	1.5	1.58	7.17	0.00	0.00	0.00
27	6.80	-37.60	1.54	1.69	1.6	1.69	7.17	0.00	0.00	0.00
28	24.00	-13.60	1.49	1.74	1.6	1.74	7.17	0.00	0.00	0.00
29	1.40	-12.20	1.44	1.59	1.5	1.59	7.17	0.00	0.00	0.00
30	0.00	-12.20	1.42	1.56	1.5	1.56	7.17	0.00	0.00	0.00

Nova Crixas - Estação Estação Hidro Bandeirantes - GO - ANA - Novembro de 2019

Para ver os dados horários clique no dia desejado

Dia	Precip.	Prec.Acum.	Sensor Pressão min	Sensor Pressão max	Sensor Pressão media	Nível Régua	CodifEixo	Vazão min (m3/s)	Vazão max (m3/s)	Vazão media (m3/s)
1	0.00	0.00	3.84	3.87	3.9	3.87	2.78	0.00	0.00	0.00
2	0.00	0.00	3.8	3.84	3.8	3.84	2.78	0.00	0.00	0.00
3	46.60	46.60	3.8	3.82	3.8	3.82	2.78	0.00	0.00	0.00
4	0.00	46.60	3.76	3.81	3.8	3.81	2.78	0.00	0.00	0.00
5	49.60	96.20	3.74	3.83	3.8	3.83	2.78	0.00	0.00	0.00
6	21.00	117.20	3.81	3.85	3.8	3.85	2.78	0.00	0.00	0.00
7	0.00	117.20	0	3.83	3.7	3.83	2.78	0.00	0.00	0.00
8	-226.80	-109.60	3.83	3.87	3.8	3.87	2.78	0.00	0.00	0.00
9	1.00	-108.60	3.86	3.88	3.9	3.88	2.78	0.00	0.00	0.00
10	0.00	-108.60	3.83	3.86	3.8	3.86	2.78	0.00	0.00	0.00
11	0.00	-108.60	3.81	3.83	3.8	3.83	2.78	0.00	0.00	0.00
12	10.60	-98.00	3.79	3.81	3.8	3.81	2.78	0.00	0.00	0.00
13	21.00	-77.00	3.79	3.85	3.8	3.85	2.78	0.00	0.00	0.00
14	0.00	-77.00	3.84	3.85	3.8	3.85	2.78	0.00	0.00	0.00
15	6.40	-70.60	3.84	3.87	3.8	3.87	2.78	0.00	0.00	0.00
16	0.00	-70.60	3.87	3.93	3.9	3.93	2.78	0.00	0.00	0.00
17	6.80	-63.80	3.92	4	4.0	4	2.78	0.00	0.00	0.00
18	0.20	-63.60	4	4.02	4.0	4.02	2.78	0.00	0.00	0.00
19	0.00	-63.60	3.99	4.02	4.0	4.02	2.78	0.00	0.00	0.00
20	0.00	-63.60	3.98	4	4.0	4	2.78	0.00	0.00	0.00
21	0.00	-63.60	3.95	3.98	4.0	3.98	2.78	0.00	0.00	0.00
22	0.00	-63.60	3.91	3.95	3.9	3.95	2.78	0.00	0.00	0.00
23	0.00	-63.60	3.9	3.93	3.9	3.93	2.78	0.00	0.00	0.00
24	1.00	-62.60	3.93	4	4.0	4	2.78	0.00	0.00	0.00
25	73.80	11.20	4	4.1	4.0	4.1	2.78	0.00	0.00	0.00
26	4.40	15.60	4.04	4.1	4.1	4.1	2.78	0.00	0.00	0.00
27	33.60	49.20	4.03	4.1	4.1	4.1	2.78	0.00	0.00	0.00
28	37.40	86.60	4.09	4.16	4.1	4.16	2.78	0.00	0.00	0.00
29	0.00	86.60	4.13	4.16	4.1	4.16	2.78	0.00	0.00	0.00
30	19.60	106.20	4.12	4.14	4.1	4.14	2.78	0.00	0.00	0.00

Palmeiras de Goiás - Estação Palmeiras de Goiás - Novembro de 2019

Para ver os dados horários clique no dia desejado

Dia	Precip.	Prec.Acum.	Vel. Vent. (m/s)	Dir. Vent.	Umid. Relat. AR (Max) %	Umid. Relat. AR (Min) %	Umid. Relat. AR (Média) %	Temp. Max. °C Dia	Temp. Min. °C Dia	Temp. Med. °C do Ar	Temp. 09:00h	Temp. 21:00h	Ponto orvalho	Razao Mistura	Radiação Solar Diária MJ/m²
1	0.00	0.00	2.5	S	96.0	34.0	60	35.3	21.3	26.9	27.7	25.1	-	-	21.8
2	0.00	0.00	2.9	SO	96.0	34.0	50.5	34.3	20.5	27.78	27.9	28.1	-	-	-
3	1.20	1.20	2.3	SO	90.0	48.0	69.7	30.1	22.0	25.66	26.8	24.7	-	-	-
4	0.00	1.20	3.0	S	90.0	32.0	57.2	34.6	22.8	27.72	29	26.1	-	-	-
5	14.80	16.00	2.4	SO	100.0	32.0	76.2	35.4	22.3	25.94	27.2	22.4	-	-	-
6	0.20	16.20	1.1	S	100.0	43.0	80.5	32.6	21.2	25.22	23.3	24.5	-	-	-
7	0.00	16.20	1.8	S	100.0	40.0	62.7	34.1	20.9	27.08	27	26.7	-	-	-
8	0.00	16.20	2.8	SO	100.0	48.0	63	32.6	21.6	26.48	24.4	26.9	-	-	-
9	39.60	55.80	1.8	S	100.0	35.0	74	34.7	19.8	24.94	29.6	20.3	-	-	-
10	0.20	56.00	2.3	S	100.0	39.0	66	33.9	19.8	26.32	24.9	26.5	-	-	-
11	18.00	74.00	2.2	S	100.0	31.0	75	35.9	22.2	26.22	28	22.5	-	-	-
12	1.40	75.40	1.8	SO	100.0	41.0	71.2	34.6	21.5	26.02	24.8	24.6	-	-	-
13	0.00	75.40	0.9	S	100.0	36.0	55	34.4	22.0	27.94	26.7	28.3	-	-	-
14	0.00	75.40	1.1	S	92.0	35.0	52.2	34.7	22.3	28.48	28.2	28.6	-	-	-
15	24.20	99.60	2.7	L	100.0	47.0	84.2	31.8	21.0	24.7	27.7	21.5	-	-	-
16	0.20	99.80	1.1	L	100.0	52.0	80.2	30.3	21.2	25.1	23.4	25.3	-	-	-
17	9.40	109.20	1.3	L	100.0	57.0	74.5	30.7	20.8	25.22	25.8	24.4	-	-	-
18	2.20	111.40	1.4	SO	100.0	54.0	92.5	30.1	21.4	24.12	25.7	21.7	-	-	-
19	0.20	111.60	0.6	O	100.0	56.0	90	29.5	20.6	23.84	24.5	22.3	-	-	-
20	1.80	113.40	1.1	SO	100.0	41.0	92	31.9	21.1	24.68	26.4	22	-	-	-
21	0.20	113.60	1.2	S	100.0	42.0	64.2	32.0	20.3	25.58	25.4	25.1	-	-	-
22	18.40	132.00	1.9	S	100.0	54.0	73.7	30.0	19.3	24.96	25.3	25.1	-	-	-
23	2.40	134.40	3.4	O	100.0	47.0	87	32.9	22.6	25.98	27.8	23.3	-	-	-
24	2.20	136.60	1.7	S	100.0	46.0	86	32.8	21.8	24.94	26.1	22	-	-	-
25	3.40	140.00	1.5	SO	100.0	59.0	88.7	31.0	20.0	24.36	25.4	22.7	-	-	-
26	0.00	140.00	0.8	O	100.0	59.0	72.5	30.8	21.1	25.76	26.5	25.2	-	-	-
27	5.80	145.80	1.3	L	100.0	77.0	93.5	27.7	21.8	24.7	26.2	23.9	-	-	-
28	9.80	155.60	0.9	S	100.0	58.0	81.5	29.2	20.6	24.92	25	24.9	-	-	-
29	2.40	158.00	1.9	O	100.0	63.0	89.7	30.8	22.0	24.96	24.6	23.7	-	-	-
30	1.40	159.40	0.7	L	100.0	76.0	98.5	28.4	22.6	24.52	26.2	22.7	-	-	-

Parauna - Estação Estação Hidro Ponte Rodagem - GO - ANA - Novembro de 2019

[Para ver os dados horários clique no dia desejado](#)

Dia	Precip.	Prec. Acum.	Sensor Pressão min	Sensor Pressão max	Sensor Pressão média	Nível Régua	CodifEixo	Vazão min (m3/s)	Vazão max (m3/s)	Vazão média (m3/s)
1	0.00	0.00	0.57	1.17	0.8	1.17	42.69	0.00	0.00	0.00
2	0.00	0.00	0.6	1.01	0.7	1.01	42.69	0.00	0.00	0.00
3	0.00	0.00	0.59	1.06	0.7	1.06	42.69	0.00	0.00	0.00
4	0.00	0.00	0.61	1.2	0.8	1.2	42.69	0.00	0.00	0.00
5	1.80	1.80	0.65	1.15	0.8	1.15	42.69	0.00	0.00	0.00
6	9.40	11.20	0.66	1.07	0.8	1.07	42.69	0.00	0.00	0.00
7	0.40	11.60	0.63	1.12	0.8	1.12	42.69	0.00	0.00	0.00
8	6.60	18.20	0.71	1.34	0.8	1.34	42.69	0.00	0.00	0.00
9	13.20	31.40	0.68	1.26	0.8	1.26	42.69	0.00	0.00	0.00
10	0.20	31.60	0.65	1.28	0.8	1.28	42.69	0.00	0.00	0.00
11	8.60	40.20	0.7	1.33	0.8	1.33	42.69	0.00	0.00	0.00
12	0.20	40.40	0.68	1.23	0.8	1.23	42.69	0.00	0.00	0.00
13	0.00	40.40	0.68	1.17	0.8	1.17	42.69	0.00	0.00	0.00
14	3.00	43.40	0.66	1.09	0.8	1.09	42.69	0.00	0.00	0.00
15	2.00	45.40	0	1.18	0.8	1.18	42.99	0.00	0.00	0.00
16	-89.20	-43.80	0.89	1.33	1.1	1.33	42.99	0.00	0.00	0.00
17	4.40	-39.40	0.92	1.36	1.1	1.36	42.99	0.00	0.00	0.00
18	49.80	10.40	0.92	1.26	1.1	1.26	42.99	0.00	0.00	0.00
19	3.80	14.20	0.91	1.41	1.1	1.41	42.99	0.00	0.00	0.00
20	0.20	14.40	0.9	1.55	1.1	1.55	42.99	0.00	0.00	0.00
21	0.00	14.40	0.93	1.46	1.1	1.46	42.99	0.00	0.00	0.00
22	0.00	14.40	0.91	1.29	1.1	1.29	42.99	0.00	0.00	0.00
23	4.40	18.80	0.95	1.53	1.1	1.53	42.99	0.00	0.00	0.00
24	12.40	31.20	1	1.58	1.1	1.58	42.99	0.00	0.00	0.00
25	8.40	39.60	1	1.49	1.1	1.49	42.99	0.00	0.00	0.00
26	0.20	39.80	1	1.56	1.2	1.56	42.99	0.00	0.00	0.00
27	9.00	48.80	1.03	1.45	1.2	1.45	42.99	0.00	0.00	0.00
28	6.40	55.20	1.04	1.47	1.2	1.47	42.99	0.00	0.00	0.00
29	7.60	62.80	1.06	1.65	1.2	1.65	42.99	0.00	0.00	0.00
30	1.20	64.00	1.06	1.56	1.2	1.56	42.99	0.00	0.00	0.00

Anapolis - Estação Estação Hidro Ribeirão Antas - GO - ANA - Novembro de 2019

[Para ver os dados horários clique no dia desejado](#)

Dia	Precip.	Prec. Acum.	Sensor Pressão min	Sensor Pressão max	Sensor Pressão média	Nível Régua	CodifEixo	Vazão min (m3/s)	Vazão max (m3/s)	Vazão média (m3/s)
1	0.00	0.00	0.29	0.31	0.3	-	-	0.00	0.00	0.00
2	0.40	0.40	0.29	0.71	0.3	-	-	0.00	0.00	0.00
3	0.20	0.60	0.29	0.35	0.3	-	-	0.00	0.00	0.00
4	3.00	3.60	0.29	1.07	0.4	-	-	0.00	0.00	0.00
5	0.20	3.80	0.3	0.38	0.3	-	-	0.00	0.00	0.00
6	0.00	3.80	0.29	0.31	0.3	-	-	0.00	0.00	0.00
7	0.00	3.80	0.29	0.31	0.3	-	-	0.00	0.00	0.00
8	0.00	3.80	0.29	0.31	0.3	-	-	0.00	0.00	0.00
9	0.00	3.80	0.29	0.31	0.3	-	-	0.00	0.00	0.00
10	14.60	18.40	0.29	1.27	0.4	-	-	0.00	0.00	0.00
11	0.00	18.40	0.29	0.32	0.3	-	-	0.00	0.00	0.00
12	0.00	18.40	0.29	0.31	0.3	-	-	0.00	0.00	0.00
13	0.00	18.40	0.29	0.31	0.3	-	-	0.00	0.00	0.00
14	58.40	76.80	0.28	1.47	0.5	-	-	0.00	0.00	0.00
15	5.20	82.00	0.31	0.9	0.4	-	-	0.00	0.00	0.00
16	0.40	82.40	0.3	0.39	0.3	-	-	0.00	0.00	0.00
17	1.20	83.60	0.3	0.33	0.3	-	-	0.00	0.00	0.00
18	13.00	96.60	0.3	0.56	0.3	-	-	0.00	0.00	0.00
19	3.40	100.00	0.31	0.34	0.3	-	-	0.00	0.00	0.00
20	31.60	131.60	0.3	1	0.3	-	-	0.00	0.00	0.00
21	3.20	134.80	0.3	0.69	0.3	-	-	0.00	0.00	0.00
22	0.20	135.00	0.3	0.32	0.3	-	-	0.00	0.00	0.00
23	4.60	139.60	0.3	0.43	0.3	-	-	0.00	0.00	0.00
24	2.60	142.20	0.3	0.41	0.3	-	-	0.00	0.00	0.00
25	1.60	143.80	0.31	0.98	0.4	-	-	0.00	0.00	0.00
26	27.40	171.20	0.31	1.41	0.4	-	-	0.00	0.00	0.00
27	11.20	182.40	0.32	0.85	0.4	-	-	0.00	0.00	0.00
28	0.00	182.40	0.31	0.33	0.3	-	-	0.00	0.00	0.00
29	3.20	185.60	0.31	0.39	0.3	-	-	0.00	0.00	0.00
30	8.20	193.80	0.31	0.94	0.4	-	-	0.00	0.00	0.00

Morrinhos - Estação Usina CEM - Morrinhos - Novembro de 2019

Para ver os dados horários clique no dia desejado

Dia	Precip.	Prec.Acum.	Vel. Vent. (m/s)	Dir. Vent.	Umid. Relat. AR (Max) %	Umid. Relat. AR (Min) %	Umid. Relat. AR (Média)%	Temp. Max. °C Dia	Temp. Min. °C Dia	Temp. Med. °C do Ar	Temp. 09:00h	Temp. 21:00h	Ponto orvalho	Razao Mistura	Radiação Solar Diária MJ/m²
1	9.40	9.40	3.2	L	94.0	43.0	65	31.3	20.2	24.96	28.3	22.5	-	-	14.4
2	0.00	9.40	2.1	L	89.0	43.0	61	31.6	19.3	25.26	24.8	25.3	-	-	20.7
3	0.80	10.20	4.1	L	91.0	50.0	75.2	30.1	20.8	24.1	25.4	22.1	-	-	20
4	0.00	10.20	2.7	N	94.0	49.0	66.7	30.5	20.7	25.3	28.3	23.5	-	-	14.4
5	0.00	10.20	3.1	N	91.0	41.0	71.5	32.5	21.0	25.36	26.3	23.5	-	-	18
6	0.00	10.20	2.5	N	100.0	54.0	77.5	30.9	21.0	24.84	26.1	23.1	-	-	19.4
7	0.00	10.20	2.6	L	100.0	40.0	61.7	32.5	20.0	25.66	26	24.9	-	-	18.6
8	0.00	10.20	2.9	S	100.0	53.0	69	30.5	19.9	24.2	22.6	24	-	-	15.6
9	13.20	23.40	3.2	L	100.0	37.0	64.7	33.1	20.2	24.86	27.6	21.7	-	-	17.7
10	6.80	30.20	2.2	S	100.0	55.0	85	30.9	19.4	23.46	24.6	21.2	-	-	16.6
11	17.60	47.80	2.6	S	93.0	39.0	63.2	33.1	19.8	25.44	25.1	24.6	-	-	18.7
12	1.00	48.80	2.5	S	96.0	42.0	61	33.3	21.0	26.68	24.9	27.1	-	-	22.8
13	0.00	48.80	4.3	L	77.0	37.0	48	32.3	21.6	27.32	26.1	28.3	-	-	20.1
14	4.20	53.00	2.1	S	100.0	55.0	86.2	29.8	20.4	24.06	27.1	21.5	-	-	14.3
15	18.60	71.60	2.1	O	100.0	61.0	92	27.9	19.5	22.24	23.8	20	-	-	11.9
16	0.00	71.60	2.3	L	100.0	74.0	85	26.4	19.3	22.86	22.6	23	-	-	13
17	0.60	72.20	2.5	N	100.0	47.0	75.2	31.1	19.6	24.42	26.6	22.4	-	-	17.8
18	11.40	83.60	4.1	N	100.0	69.0	94.2	25.8	19.8	21.76	22.6	20.3	-	-	11.4
19	3.00	86.60	2.8	L	100.0	59.0	90.5	28.3	19.0	21.66	22.6	19.2	-	-	14.1
20	0.00	86.60	3.1	L	100.0	55.0	79.2	29.3	18.8	22.98	24.8	21	-	-	20.5
21	0.00	86.60	2.6	L	100.0	51.0	69.5	29.8	19.1	24.32	24.5	24.1	-	-	18.7
22	33.00	119.60	4.1	L	100.0	63.0	89.7	28.0	17.5	22.8	23.3	22.6	-	-	16.9
23	3.00	122.60	3.1	N	100.0	64.0	83.5	27.5	20.3	23.64	25.4	22.5	-	-	14.9
24	0.00	122.60	3.3	N	100.0	59.0	84	28.5	19.6	23.1	24.4	21.5	-	-	14.3
25	23.20	145.80	2.6	N	100.0	57.0	86	30.1	19.4	23.78	26.4	21.5	-	-	16.1
26	0.40	146.20	3.0	L	100.0	63.0	87.7	28.6	20.2	24.18	24.9	23.6	-	-	16.9
27	4.80	151.00	3.7	N	100.0	79.0	100	26.6	20.2	22.32	22.4	21.2	-	-	10.1
28	0.80	151.80	3.0	N	100.0	72.0	91.7	28.1	20.3	23.16	23.6	21.9	-	-	15
29	2.00	153.80	2.6	L	100.0	78.0	94.5	27.1	21.1	23.26	23.3	22.4	-	-	12.6
30	1.20	155.00	3.5	N	100.0	65.0	92.7	28.4	20.4	23.12	22.8	22	-	-	11.2

Bom Jesus de Goiás - Estação Usina Goiás - Bom Jesus de Goiás - Novembro de 2019

Para ver os dados horários clique no dia desejado

Dia	Precip.	Prec.Acum.	Vel. Vent. (m/s)	Dir. Vent.	Umid. Relat. AR (Max) %	Umid. Relat. AR (Min) %	Umid. Relat. AR (Média)%	Temp. Max. °C Dia	Temp. Min. °C Dia	Temp. Med. °C do Ar	Temp. 09:00h	Temp. 21:00h	Ponto orvalho	Razao Mistura	Radiação Solar Diária MJ/m²
1	0.00	0.00	3.4	L	78.0	35.0	61.7	33.1	21.9	25.92	29	22.8	-	-	14.9
2	0.00	0.00	2.7	L	90.0	30.0	50.2	33.8	19.8	26.76	25.6	27.3	-	-	19.9
3	11.00	11.00	4.8	L	100.0	39.0	66.2	31.5	18.9	24.44	28	21.9	-	-	16.8
4	0.00	11.00	2.8	L	84.0	40.0	63.2	32.7	22.1	26.28	26.4	25.1	-	-	19.5
5	0.00	11.00	3.1	L	82.0	35.0	59	33.6	21.8	26.76	28.6	24.9	-	-	17.3
6	0.20	11.20	3.0	S	90.0	50.0	73	31.1	21.8	24.82	26.6	22.3	-	-	17.5
7	0.20	11.40	2.7	S	100.0	35.0	63.5	33.8	20.5	26.12	27.1	24.6	-	-	17.2
8	0.00	11.40	3.2	S	100.0	42.0	66.7	29.9	19.5	23.62	21.7	23.5	-	-	13.2
9	8.20	19.60	3.8	SE	97.0	37.0	73.7	33.0	21.1	25.42	28	22.5	-	-	13.1
10	1.80	21.40	3.0	S	100.0	41.0	64.5	32.1	19.7	25.06	24.3	24.6	-	-	18.2
11	0.00	21.40	3.4	S	89.0	31.0	56.7	34.0	21.3	26.48	26.1	25.5	-	-	15.8
12	0.00	21.40	3.5	SO	93.0	36.0	54	33.1	21.6	27.58	26	28.6	-	-	19.5
13	2.00	21.40	5.1	SE	71.0	33.0	49.7	33.2	24.6	27.82	29.1	26.1	-	-	17.4
14	0.60	24.00	3.3	S	94.0	39.0	74	32.3	21.7	24.76	25.6	22.1	-	-	15.2
15	7.80	31.80	2.3	O	100.0	53.0	91	29.1	19.8	22.8	25.5	19.8	-	-	10.2
16	0.20	32.00	2.0	NO	100.0	45.0	69.7	30.9	19.6	24.16	23.1	23.6	-	-	16.8
17	0.00	32.00	2.4	L	92.0	41.0	60.7	31.9	20.6	26.24	27.5	25.6	-	-	20
18	5.00	37.00	3.4	N	95.0	60.0	83.2	27.8	20.9	23.18	24.6	21.3	-	-	12.4
19	10.20	47.20	3.0	L	97.0	53.0	84.7	29.5	19.3	22.2	23.6	19.3	-	-	11.6
20	0.00	47.20	2.8	L	91.0	45.0	67.5	30.4	19.5	24.12	26.1	22.3	-	-	16.9
21	1.00	48.20	3.4	L	92.0	40.0	66.2	31.6	20.2	24.12	25.6	21.6	-	-	18.5
22	10.60	58.80	4.5	L	98.0	57.0	78	28.6	17.1	23	24.1	22.6	-	-	17.2
23	2.00	60.80	2.2	NO	86.0	48.0	71.7	30.4	21.9	25.56	26.9	24.3	-	-	15.3
24	2.20	63.00	3.3	SO	99.0	56.0	75.7	29.1	20.8	23.42	23.6	21.8	-	-	11.9
25	11.60	74.60	2.5	L	100.0	50.0	87.7	30.9	20.0	24.02	25.6	21.8	-	-	16
26	0.00	74.60	2.8	L	100.0	53.0	77	29.9	21.0	24.72	25.1	23.8	-	-	14.3
27	13.60	88.20	3.2	L	100.0	73.0	97.7	27.3	19.9	22.8	23.4	21.7	-	-	8.7
28	30.60	118.80	2.3	NO	100.0	63.0	94	28.3	20.3	22.92	22.8	21.6	-	-	11.8
29	21.00	139.80	1.8	NO	100.0	71.0	98.2	26.3	20.7	23.14	21.5	23.6	-	-	5.3
30	0.60	140.40	2.6	N	100.0	69.0	85.7	26.8	20.4	23.06	24.1	22	-	-	10.9

Santa Helena de Goiás - Estação Usina Santa Helena - Santa Helena - Novembro de 2019

Para ver os dados horários clique no dia desejado

Dia	Precip.	Prec.Acum.	Vel. Vent. (m/s)	Dir. Vent.	Umid. Relat. AR (Max) %	Umid. Relat. AR (Min) %	Umid. Relat. AR (Média)%	Temp. Max. °C Dia	Temp. Min. °C Dia	Temp. Med. °C do Ar	Temp. 09:00h	Temp. 21:00h	Ponto orvalho	Razao Mistura	Radiação Solar Diária MJ/m²
1	3.40	3.40	1.5	NO	89.0	36.0	67.7	34.6	22.3	27.28	30.3	24.6	-	-	11.8
2	0.20	3.60	1.3	L	99.0	27.0	57.7	36.0	20.6	27.26	26.9	26.4	-	-	18.4
3	6.80	10.40	1.9	N	96.0	46.0	83	31.6	23.4	26.88	29.8	24.8	-	-	12.6
4	0.00	10.40	1.3	N	100.0	32.0	47	34.7	21.9	28.58	29.1	28.6	-	-	14.3
5	1.80	12.20	1.8	NO	100.0	39.0	84.5	34.2	21.9	26.68	29.1	24.1	-	-	10.2
6	0.20	12.40	1.6	NO	100.0	45.0	75.7	33.6	23.0	26.54	26.9	24.6	-	-	15.6
7	0.00	12.40	1.4	O	100.0	39.0	62	34.8	21.9	27.62	27.6	26.9	-	-	16.9
8	20.80	33.20	1.5	SE	100.0	63.0	91	28.4	20.9	23.8	22.1	23.8	-	-	8.5
9	30.80	64.00	1.5	N	100.0	39.0	73.7	34.3	20.1	25.44	28.6	22.1	-	-	15.7
10	0.00	64.00	1.0	L	100.0	48.0	73.7	32.8	21.1	25.8	25.1	25	-	-	14.9
11	4.60	68.60	1.9	SE	100.0	34.0	69.7	35.1	22.1	26.36	29	22.8	-	-	18.2
12	1.00	69.60	1.4	O	98.0	63.0	83.7	30.1	22.0	25.66	24	26.1	-	-	6.1
13	0.00	69.60	1.7	N	95.0	36.0	57	34.2	23.9	28.48	29.1	27.6	-	-	16.5
14	0.00	69.60	1.1	SE	100.0	38.0	71.5	34.3	22.4	26.5	26.6	24.6	-	-	13.4
15	28.20	97.80	1.3	N	100.0	53.0	92	30.6	20.7	24.24	28.1	20.9	-	-	7.8
16	0.00	97.80	1.0	O	100.0	46.0	81	32.0	20.5	25.32	25.9	24.1	-	-	17.8
17	0.00	97.80	1.3	N	100.0	42.0	62.2	32.2	20.7	26.58	27.8	26.1	-	-	18.6
18	3.40	101.20	2.1	N	100.0	44.0	83	32.0	21.6	24.76	27	21.6	-	-	16.8
19	0.20	101.40	1.4	N	100.0	50.0	79.7	31.1	21.6	24.98	25.6	23.3	-	-	11
20	0.00	101.40	1.4	N	100.0	43.0	73.5	32.5	21.4	25.64	27.1	23.6	-	-	13.9
21	0.40	101.80	1.2	SE	100.0	37.0	67	33.6	20.5	25.64	27.3	23.4	-	-	17.1
22	0.00	101.80	1.5	N	100.0	43.0	74.5	32.2	20.4	25.3	25.3	24.3	-	-	16.1
23	2.60	104.40	1.2	NO	99.0	47.0	82.2	31.8	22.0	26.38	29.3	24.4	-	-	9.3
24	0.20	104.60	1.2	N	100.0	51.0	80.5	31.6	22.1	25.72	27.1	23.9	-	-	10.9
25	0.00	104.60	1.3	O	100.0	59.0	92.5	31.3	21.7	25.58	27.1	23.9	-	-	8.6
26	0.00	104.60	1.4	N	100.0	49.0	76.2	32.0	21.7	26.7	26.6	26.6	-	-	15.2
27	33.80	138.40	2.2	N	100.0	56.0	85	31.6	22.1	25.48	28.1	22.8	-	-	13.1
28	29.40	167.80	1.1	NO	100.0	67.0	100	29.8	21.7	24.06	23.6	22.6	-	-	7.9
29	0.60	168.40	1.2	N	100.0	64.0	92	29.1	22.3	25.22	24.1	25.3	-	-	12.7
30	8.00	176.40	1.7	N	100.0	52.0	89	32.5	21.8	24.88	25.3	22.4	-	-	9.9

Maurilândia - Estação Usina Vale do Verdão - Maurilândia - Novembro de 2019

Para ver os dados horários clique no dia desejado

Dia	Precip.	Prec.Acum.	Vel. Vent. (m/s)	Dir. Vent.	Umid. Relat. AR (Max) %	Umid. Relat. AR (Min) %	Umid. Relat. AR (Média)%	Temp. Max. °C Dia	Temp. Min. °C Dia	Temp. Med. °C do Ar	Temp. 09:00h	Temp. 21:00h	Ponto orvalho	Razao Mistura	Radiação Solar Diária MJ/m²
1	4.20	4.20	2.5	N	0.0	0.0	0	-10.0	-10.0	-10	-10	-10	-	-	14.9
2	0.20	4.40	1.9	SE	0.0	0.0	0	-10.0	-10.0	-10	-10	-10	-	-	18.9
3	0.00	4.40	2.8	O	0.0	0.0	0	-10.0	-10.0	-10	-10	-10	-	-	17.4
4	0.00	4.40	1.9	NO	0.0	0.0	0	-10.0	-10.0	-10	-10	-10	-	-	17
5	0.00	4.40	2.1	NO	0.0	0.0	0	-10.0	-10.0	-10	-10	-10	-	-	11.9
6	0.40	4.80	2.3	NO	0.0	0.0	0	-10.0	-10.0	-10	-10	-10	-	-	17.6
7	9.20	14.00	1.7	L	0.0	0.0	0	-10.0	-10.0	-10	-10	-10	-	-	16.9
8	1.80	15.80	2.0	SE	0.0	0.0	0	-10.0	-10.0	-10	-10	-10	-	-	7.2
9	14.20	30.00	2.0	SO	0.0	0.0	0	-10.0	-10.0	-10	-10	-10	-	-	15
10	0.60	30.60	1.8	L	0.0	0.0	0	-10.0	-10.0	-10	-10	-10	-	-	16.8
11	22.80	53.40	2.8	SE	0.0	0.0	0	-10.0	-10.0	-10	-10	-10	-	-	19.2
12	0.00	53.40	3.1	S	0.0	0.0	0	-10.0	-10.0	-10	-10	-10	-	-	10.6
13	0.00	53.40	3.0	S	0.0	0.0	0	-10.0	-10.0	-10	-10	-10	-	-	14.1
14	2.00	55.40	2.1	S	0.0	0.0	0	-10.0	-10.0	-10	-10	-10	-	-	13.5
15	14.00	69.40	1.5	S	0.0	0.0	0	-10.0	-10.0	-10	-10	-10	-	-	9.6
16	1.20	70.60	1.3	O	0.0	0.0	0	-10.0	-10.0	-10	-10	-10	-	-	13.5
17	0.00	70.60	2.0	NO	0.0	0.0	0	-10.0	-10.0	-10	-10	-10	-	-	17
18	5.00	75.60	2.6	NO	0.0	0.0	0	-10.0	-10.0	-10	-10	-10	-	-	14.6
19	0.00	75.60	1.5	NO	0.0	0.0	0	-10.0	-10.0	-10	-10	-10	-	-	12.9
20	0.00	75.60	1.8	NO	0.0	0.0	0	-10.0	-10.0	-10	-10	-10	-	-	14.3
21	18.80	94.40	2.0	L	0.0	0.0	0	-10.0	-10.0	-10	-10	-10	-	-	16
22	3.20	97.60	1.9	NO	1.0	0.0	0	-10.0	-10.0	-10	-10	-10	-	-	15.4
23	0.00	97.60	1.9	NO	4.0	0.0	0.5	-10.0	-10.0	-10	-10	-10	-	-	14.3
24	3.60	101.20	2.0	S	4.0	0.0	1.2	-10.0	-10.0	-10	-10	-10	-	-	7.8
25	0.40	101.60	1.6	NO	2.0	0.0	0.2	-10.0	-10.0	-10	-10	-10	-	-	11.4
26	2.20	103.80	1.6	NO	2.0	0.0	0.5	-10.0	-10.0	-10	-10	-10	-	-	13.1
27	56.20	160.00	2.5	N	1.0	0.0	0	-10.0	-10.0	-10	-10	-10	-	-	7.7
28	10.20	170.20	1.4	NO	4.0	0.0	2	-10.0	-10.0	-10	-10	-10	-	-	10.5
29	9.60	179.80	1.2	NO	4.0	0.0	1.5	-10.0	-10.0	-10	-10	-10	-	-	9.8
30	45.20	225.00	2.2	NO	5.0	0.0	1.7	-10.0	-10.0	-10	-10	-10	-	-	9.4

NOTÍCIAS RELACIONADAS

<http://g1.globo.com/goias/videos/t/todos-os-videos/v/forte-chuva-deixou-estragos-em-rio-verde/8070763/>

Forte chuva deixou estragos em Rio Verde

MAIS INFORMAÇÕES |

[Tweeter](#) [Curtir 0](#)



<http://jornalsomos.com.br/rio-verde/detalhe/chuva-de-granizo-surpreende-rio-verdenses>



[jornal somos](#) / [rio verde](#) / [Chuva de granizo surpreende rio-verdenses](#)

Chuva de granizo surpreende rio-verdenses

POR JORNAL SOMOS | 06/11/2019



<http://jornalsomos.com.br/rio-verde/detalhe/rio-verde-tem-2o-dia-de-chuva-com-granizo-e-vento-provoca-estragos>



Jornal somos / rio verde / Rio Verde tem 2º dia de chuva com granizo e vento

Rio Verde tem 2º dia de chuva com granizo e vento provoca estragos

POR JORNAL SOMOS | 07/11/2019



<http://correiodoar.com.br/noticia/granizos-gigantes-sao-registrados-em-goias/47122/>

Quinta-feira, 07 de Novembro de 2019

Granizos gigantes são registrados em Goiás

Em menos de 40 minutos, chuva destruiu carros e plantações

A- A+

A cena é impressionante.

Nas imagens é possível ver o momento em que a chuva de granizo chega até o interior de Goiás, e causa destruição. O fato ocorreu na tarde de quarta-feira (6), e rapidamente o dia virou noite.



A chuva durou cerca de 40 minutos, e destruiu casas e plantações.

Em um estacionamento, os para-brisas dos carros ficaram destruídos, devido o tamanho e intensidade dos granizos.

De acordo com o Instituto Nacional de Meteorologia, não é comum chuvas como estas serem registradas, porém, devido ao intenso calor, podem ocorrer.

Redação Catve.com



<https://www.opopular.com.br/noticias/cidades/defesa-civil-emite-alerta-para-fortes-chuvas-com-possibilidade-de-alagamento-nesta-sexta-em-goi%C3%A2nia-1.1926953>

O Popular 62 99995 2795 BUSCAR 4 ALEXANDRE AN

CAPA POLÍTICA ECONOMIA MUNDO CIDADES ESPORTE MAGAZINE LUDOVICA OPINIÃO ESPECIAIS VÍDEOS INFOMERCIAL GUIAS

CIDADES

 Juan Meloni

Defesa Civil emite alerta para fortes chuvas com possibilidade de alagamento nesta sexta em Goiânia

Confira ainda a previsão do tempo para o fim de semana

07/11/2019 - 09:59



(Foto: Ricardo Rafael)

Atenção, moradores de Goiânia! A Defesa Civil emitiu nesta quinta-feira (7) um alerta de chuvas intensas e vendavais com risco para raios para sexta-feira (8) na capital. É recomendado evitar situações de risco e qualquer problema ligar para o Corpo de Bombeiros no 193.

O Instituto Nacional de Meteorologia (Inmet) afirma que a previsão para hoje (7) é de 21°C a 34°C, com céu nublado, pancadas de chuva e trovoadas. Já a sexta-feira (8), o clima deve variar entre 25°C e 32°C, com tempo encoberto, muitas nuvens e ventos fracos.

<https://www.instagram.com/p/B4qRk7Ylq71/?igshid=903atwtq4yj6>

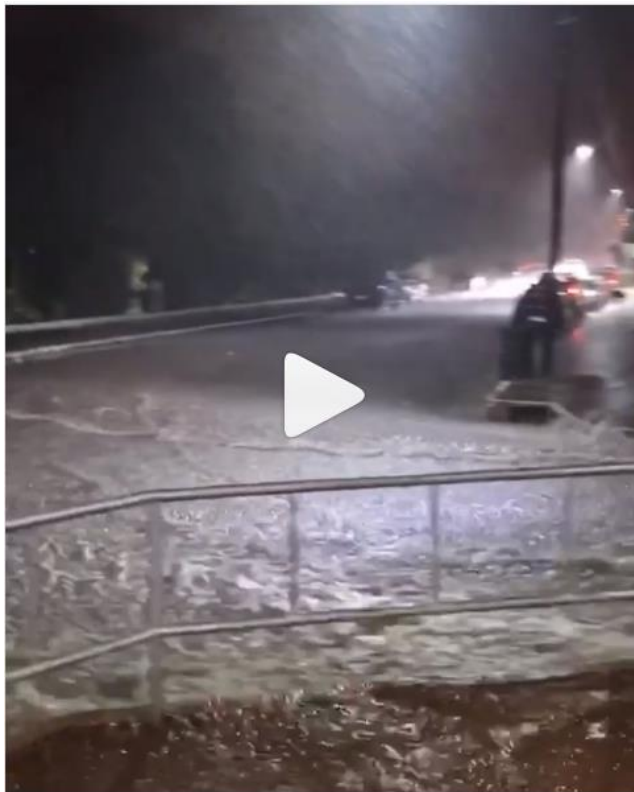

maisgoias • Seguir

141.380 visualizações

9 DE NOVEMBRO

Adicione um comentário... [Publicar](#)

https://www.instagram.com/p/B4k-AkIF_5k/?igshid=x2m4hqm4vk3s

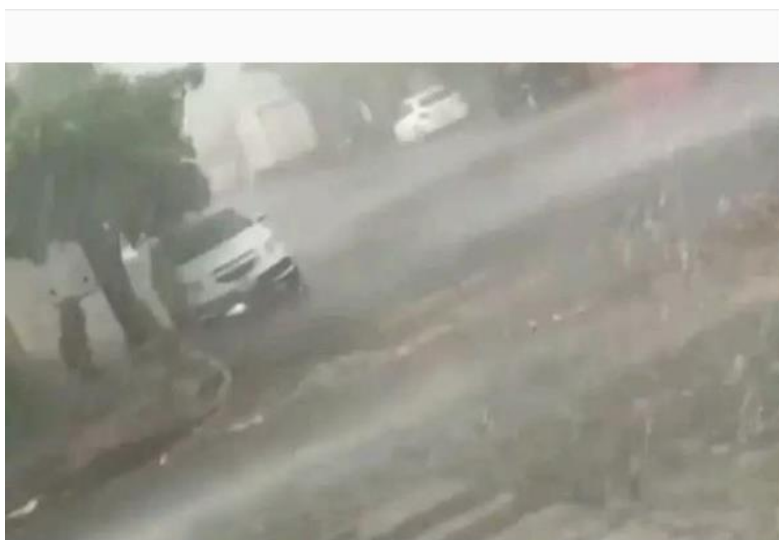

maisgoias • Seguir

Curtido por geraldjuniorimoveis e outras 2.476 pessoas

7 DE NOVEMBRO

<https://www.instagram.com/p/B4k20jXls9v/?igshid=1mvqcs8ccxm1x>



maisgoias • Seguir

maisgoias Tempo agora: chove forte na GO-060, na saída para Trindade.

6 sem

19.783 visualizações

7 DE NOVEMBRO

This Instagram post features a video of a highway exit during heavy rain. The video shows a wet road surface, streetlights, and a guardrail. A large white play button is centered over the video. The post is from the account 'maisgoias' and includes a caption in Portuguese: 'Tempo agora: chove forte na GO-060, na saída para Trindade.' It also shows 6 comments, 19,783 views, and is dated November 7th.

<https://www.instagram.com/p/B4kysWClkXO/?igshid=ximkauc5zi5f>



maisgoias • Seguir

maisgoias Tempo: chove em alguns bairros de Goiânia. Imagens registradas há pouco no Setor Recanto do Bosque pela leitora

27.483 visualizações

7 DE NOVEMBRO

Adicione um comentário... [Publicar](#)

This Instagram post features a video of a street scene during rain. The video shows a wet road, trees, and a utility pole. A large white play button is centered over the video. The post is from the account 'maisgoias' and includes a caption in Portuguese: 'Tempo: chove em alguns bairros de Goiânia. Imagens registradas há pouco no Setor Recanto do Bosque pela leitora.' It shows 27,483 views and is dated November 7th. At the bottom, there is a text input field for comments and a 'Publicar' button.



MUNICÍPIO DE CALDAS NOVAS

DECRETO Nº 1.774/2019

DE 31 DE OUTUBRO DE 2019.

**“DECLARA SITUAÇÃO DE EMERGÊNCIA EM
RAZÃO DO TEMPORAL (ANTICLONE), NAS
ÁREAS DO MUNICÍPIO DE CALDAS NOVAS,
AFETADAS PELAS CHUVAS”**

O PREFEITO DO MUNICÍPIO DE CALDAS NOVAS, Estado de Goiás, no uso da competência e das atribuições que lhe conferem as Constituições da República e do Estado de Goiás, bem como a Lei Orgânica Municipal, e

CONSIDERANDO o caos instalado no Município em razão das chuvas acompanhadas das fortíssimas correntes de ventos na tarde do dia 27 (vinte e sete) de outubro de 2019, mais precisamente por volta das 16h (dezesesseis horas);

CONSIDERANDO o registro de índice pluviométrico muito superior ao habitual, com fortíssimas correntes de ventos, causando inúmeros prejuízos humanos e materiais ao município, em residências, em estabelecimentos comerciais, prédios, equipamentos públicos e hospitais;

CONSIDERANDO que as intempéries acarretaram uma série de problemas e danos em diversas regiões rurais, com a ocorrência de grande número de queda de árvores nas redes elétricas; o que causou diversas perdas, partindo cabos elétricos;

CONSIDERANDO ainda, os danos causados na zona urbana do município, como danos às calçadas, destelhamento de residências, destruição de fachadas de prédios comerciais e públicos;

CONSIDERANDO por fim que, de acordo com os serviços de meteorologia a cidade de Caldas Novas foi atingida por um anticiclone, com chuva de granizo, com ventos de mais de 100km/h, causando danos em vários bairros e assustando toda a população e os turistas.

DECRETA:

Art. 1º. Fica Decretada situação de emergência e estado de calamidade pública no município entre os dias 27 de outubro de 2019 à 15 de novembro de 2019.

Art. 2º. Autoriza-se a mobilização de todos os órgãos municipais para atuarem sob a coordenação do Órgão Municipal de Proteção e Defesa Civil, nas ações de resposta aos danos e reabilitação do cenário e reconstrução.

Art. 3º. Este Decreto entrará em vigor na data de sua publicação, para que surta todos os seus jurídicos e legais efeitos.

Cumpra-se e Publique-se.

GABINETE DO PREFEITO DE CALDAS NOVAS-GO, aos trinta e um dias do mês de outubro de 2019.

EVANDO MAGAL ABADIA CORREIA SILVA
Prefeito de Caldas Novas/GO