

## Resumo Executivo

O Presente Relatório tem como objetivo a incorporação de informações que sejam relevantes para que se possa fazer a devida associação aos dados contidos no corpo do documento objeto da classificação de Situação de Emergência caracterizada pelo Módulo 8 do Prodist, que tem como foco o impacto do evento sobre determinada rede geelétrica e cuja denominação é definida como CHI (Consumidor hora interrompido). O parâmetro para enquadramento nesta classificação de expurgo tem como premissa inicial o limite de Consumidor hora interrompido definido pela fórmula descrita no Módulo 01 do Prodist (Revisão - 9), acrescido de todos os outros informes e dados listados no Módulo 08 (Revisão 10) do Prodist. Este enquadramento se apresenta na maioria das vezes em condições climáticas adversas com severidade dos fatores inerentes a situação, caracterizado na maioria dos casos por fortes ventos e chuvas de grande intensidade e continuidade.

A partir do fim da manhã do dia 09/11/2019 – sábado – O ar quente e úmido favoreceu a formação áreas de instabilidade sobre as Regiões da Enel Distribuição Goiás.

Entre as 11h00 do dia 09 e 01h00 do dia 10 de novembro de 2019 tivemos, em todo o Estado de Goiás, a incidências de 41.997 descargas atmosféricas (10.560 raios nuvem-solo e 31.437 descargas nuvem-nuvem) sobre a região, o que causou grande instabilidade na rede.

Conforme informações do Climatempo Meteorologia, o Instituto Nacional de Meteorologia (INMET) detectou rajadas de vento acima de 50km/h durante o período. As estações de Iporá e Mineiros registraram rajadas de vento superiores a 90km/h, classificados como tempestade pela escala Beaufort. Ventos com essa intensidade podem arrancar árvores e provocar danos em construções.

**Após mais de 24 horas, energia é restabelecida em Goiânia** - Após mais de 24 horas, energia é restabelecida em Goiânia. Acesso em : <https://www.opopular.com.br/noticias/cidades/ap%C3%B3s-mais-de-24-horas-energia-%C3%A9-restabelecida-em-goi%C3%A2nia-1.1929801>

**Temporal derruba postes da rede elétrica e árvores, e deixa bairros de Goiânia sem energia** - Temporal derruba postes da rede elétrica e árvores, e deixa bairros de Goiânia sem energia. Acesso em: <https://g1.globo.com/go/goias/transito/noticia/2019/11/10/piloto-morre-e-garupa-fica-ferido-apos-moto-bater-em-arvore-caida-em-goiania.ghtml>

**Piloto morre e garupa fica ferido após moto bater em galho de árvore caído, em Goiânia** - Investigações apontam que queda ocorreu durante chuva na Vila Jardim São Judas Tadeu. Acesso em: <http://jornalsomos.com.br/rio-verde/detalhe/rio-verde-tem-2o-dia-de-chuva-com-granizo-e-vento-provoca-estragos>

## Relatório de Ocorrências do período

Em todo o Estado de Goiás verificou-se também que a intensidade da chuva e dos ventos danificaram a rede de distribuição de energia elétrica em diversos pontos, registrando aproximadamente 198 mil clientes com interrupção no fornecimento de energia elétrica devido a eventos relacionados ao temporal.

Para otimizar o volume de atendimentos e reduzir os tempos de interrupção foram mobilizados os recursos extras da empresa que aumentou o contingente em relação a situação normal de operação. O acompanhamento da quantidade de equipes e o Tempo Médio de Atendimento podem ser consultados na Pág.02 do Relatório em anexo.

O impacto e severidade do evento estão relatados em artigos de mídia, como fotos e reportagens que demonstram os danos na Rede de Distribuição, oriundos dos eventos climáticos no período. Eventos estes que afetaram 198.061 consumidores com CHI de 963.045,81 superior ao de 482.391,86 estabelecido como limite para definição de Situação de Emergência, conforme resumo das informações obrigatórias.

<b>Empresa</b>	ENEL DISTRIBUIÇÃO GOIÁS				
<b>Código do Relatório</b>	CHI-022 - ENEL DISTRIBUIÇÃO GOIÁS				
<b>Evento:</b>	TEMPORAL NA AREA DE CONCESSÃO DA ENEL DISTRIBUIÇÃO GOIAS				
<b>Código COBRADE:</b>	1.3.2.1.5 e 1.3.2.1.2	<b>Data Inicio</b>	09/11/2019	<b>Hora início</b>	11h
<b>Código do Evento:</b>	CHI-022-ENEL GO	<b>Data Término</b>	10/11/2019	<b>Hora Término</b>	08h59
<b>Valor CHI (Limite e Real)</b>	482.391,86	963.045,81	<b>Subestações Atingidas</b> ACREUNA / ADELANDIA / AEROPORTO / ALEXANIA / ALMERINDONOPOLIS / ALVORADA DO NORTE / AMERICANO DO BRASIL / AMORINOPOLIS / ANAPOLIS UNIVERSITARIA / ANICUNS / APARECIDA DO RIO DOCE / ARAGOIANIA / ARAGUAPAZ / ARARAS / AREIAS / ARUANA / ATLANTICO / AURILANDIA / BARCELONA / BARREIRO (PORANGATU) / BARRO ALTO / BELA VISTA (TRANSMISSAO) / BOM JARDIM / BOM JESUS DE GOIAS / BONOPOLIS / BRITANIA / BURITI DE GOIAS / CABRIUVA (RIO VERDE) / CACHOEIRA ALTA / CACHOEIRA DOURADA / CACHOEIRA NOVA / CACHOEIRINHA (ITARUMA) / CACU / CAIAPONIA / CALCILANDIA / CALDAS NOVAS / CAMPESTRE / CAMPINAS / CAMPINORTE / CAMPO ALEGRE DE GOIAS / CAMPOS VERDES / CARAIBAS / CARAJAS / CASTELANDIA / CATALAO / CATURAI / CEMAT/BALIZA / CHAPADAO DO CEU / COCALZINHO / CORREGO DO OURO / CORUMBAIBA / CRISTIANOPOLIS / DAIA - ANAPOLIS / DIMIC / DIORAMA / DOVERLANDIA / EDEALINA / EDEIA / ENERSUL / FAINA / FAZENDA CANADA / FAZENDA NOVA / FERROVIARIO / FIRMINOPOLIS / FLORES DE GOIAS / FORMIGA / FORMOSO / FRONTEIRA / GAMELEIRA / GOIANAPOLIS / GOIANDIRA / GOIANESIA / GOIANIA LESTE / GOIANIRA / GOIAS / GOIATUBA / GOYA / GUAPO / HIDROLANDIA / HIDROLINA / IACIARA / INACIOLANDIA / INDEPENDENCIA / INDIARA / INHUMAS / IPAMERI / IPEGUARI / IPORA / ISRAELANDIA / ITABERAI / ITAGUARI / ITAGUARU / ITAJA / ITAPACI / ITAPACI (TRANSMISSAO) / ITAPIRAPUA / ITAPURANGA (TRANSMISSAO) / ITARUMA / ITAUCU / ITIQUIRA (FORMOSA) / ITUMBIARA NOVA / JACILANDIA / JANDAIA / JARAGUA / JARANAPOLIS / JATAI / JOVIANIA / JUSSARA / LAGOA DA SERRA / LAGOA DO BAUZINHO (RIO VERDE) / MAMBAI / MARA ROSA / MARCIANOPOLIS / MATRINCHA / MEIA PONTE / MINACU / MINEIROS / MOIPORA / MONTES CLAROS DE GOIAS / MONTIVIDIU T / MORRINHOS / MOSSAMEDES / MOZARLANDIA / MUTUNOPOLIS / NAVESLANDIA (JATAI) / NAZARIO / NEROPOLIS / NIQUELANDIA / NOVA AURORA / NOVA CRIXAS (TRANSMISSAO) / NOVA VENEZA / NOVO BRASIL / ORIZONA / OUVIDOR / PALESTINA / PALMEIRAS / PALMEIRAS DE GOIAS / PALMELO / PALMINOPOLIS / PARANA / PARAUNA SE ALTA TENSÃO / PARQUE DAS EMAS (MINEIROS) / PEROLANDIA (PILOANDIA) / PIRACANJUBA / PIRANHAS T / PIRENOPOLIS / PIRES BELO / PIRES DO RIO / PLANALTIMA (TRANSMISSAO) / PONTALINA / PORANGATU / PORTELANDIA / QUEBRA LINHA / QUIRINOPOLIS / REAL / RETIRO / GOIAS / RIO CLARO JATAI MONTIVIDIU / RIO PRETO / RIO QUENTE / RIO VERDE / RIVERLANDIA (RIO VERDE) / RUBIATABA / SANCLERLANDIA / SANTA HELENA / SANTA RITA DO ARAGUAIA / SANTA ROSA DO MEIA PONTE / SANTA TEREZINHA / SANTO ANTONIO DA BARRA / SANTO ANTONIO DE GOIAS / SANTO ANTONIO DO DESCOBERTO / SAO DOMINGOS / SAO FRANCISCO DE GOIAS / SAO JOAO D ALIANCA / SAO LUIZ DOS MONTES BELOS / SAO MIGUEL DO ARAGUAIA / SAO SIMAO / SENADOR CANEDO TRANSMISSAO / SERRA AZUL (JATAI) / SERRA DE CALDAS / SERRANOPOLIS / SILVANIA / SUCURI / TAQUARI / TEREZOPOLIS / TRES RANCHOS / TRINDADE / TURVANIA / TURVELANDIA / URUACU / VARJAO / VENDA SECA / VIANOPOLIS / VICENTINOPOLIS / VILA CORUMBA / VILA PROPICIO / XAVANTES		
<b>Código do Decreto (Se Houver):</b>					
<b>Quantidade de Interrupções (Evento)</b>	1459				
<b>Início 1ª Incidência (Data e Hora)</b>	09/11/2019 11:12				
<b>Início Ultima Incidência (Data e Hora)</b>	10/11/2019 08:57				
<b>Média de Duração das Incidências (h)</b>	19,46				
<b>Duração da Incidência mais longa (h)</b>	241,03				
<b>Total de Clientes afetados</b>	198.061		<b>Municípios Atingidos</b> ABADIA DE GOIAS / ACREUNA / ADELANDIA / ALTO PARAISO DE GOIAS / ALVORADA DO NORTE / AMARALINA / AMERICANO DO BRASIL / AMORINOPOLIS / ANAPOLIS / ANICUNS / APARECIDA DE GOIANIA / APARECIDA DO RIO DOCE / ARAGARCAS / ARAGOIANIA / ARAGUAPAZ / ARENOPOLIS / ARUANA / AURILANDIA / BALIZA / BARRO ALTO / BELA VISTA DE GOIAS / BOM JARDIM DE GOIAS / BOM JESUS DE GOIAS / BONFINOPOLIS / BONOPOLIS / BRITANIA / BURITI DE GOIAS / BURITINOPOLIS / CACHOEIRA ALTA / CACHOEIRA DE GOIAS / CACHOEIRA DOURADA / CACU / CAIAPONIA / CALDAS NOVAS / CAMPESTRE DE GOIAS / CAMPINACU / CAMPINORTE / CAMPO ALEGRE DE GOIAS / CAMPOS VERDES / CASTELANDIA / CATALAO / CATURAI / CAVALCANTE / CHAPADAO DO CEU / COLINAS DO SUL / CORREGO DO OURO / CORUMBA DE GOIAS / CORUMBAIBA / CRISTIANOPOLIS / CRIXAS / CUMARI / DIORAMA / DISTRITO FEDERAL / DOVERLANDIA / EDEALINA / EDEIA / FAINA / FAZENDA NOVA / FIRMINOPOLIS / FLORES DE GOIAS / FORMOSA / FORMOSO / GOIANAPOLIS / GOIANDIRA / GOIANESIA / GOIANIA / GOIANIRA / GOIAS / GOIATUBA / GOUVELANDIA / GUAPO / GUARANI DE GOIAS / GUARINOS / HIDROLANDIA / HIDROLINA / INACIOLANDIA / INDIARA / INHUMAS / IPAMERI / IPORA / ISRAELANDIA / ITABERAI / ITAGUARI / ITAGUARU / ITAJA / ITAPACI / ITAPIRAPUA / ITAPURANGA / ITARUMA / ITAUCU / ITUMBIARA / IVOLANDIA / JANDAIA / JARAGUA / JATAI / JAUPACI / JOVIANIA / JUSSARA / LAGOA SANTA / LEOPOLDO DE BULHOES / LUZIANIA / MAIRIPOTABA /		

			MARA ROSA / MARZAGAO / MATRINCHA / MAURILANDIA / MINACU / MINEIROS / MOIPORA / MONTE ALEGRE DE GOIAS / MONTES CLAROS DE GOIAS / MONTIVIDIU / MONTIVIDIU DO NORTE / MORRINHOS / MOSSAMEDES / MOZARLANDIA / MUNDO NOVO DE GOIAS / MUTUNOPOLIS / NAZARIO / NEROPOLIS / NIQUELANDIA / NOVA AURORA / NOVA CRIXAS / NOVA GLORIA / NOVA VENEZA / NOVO BRASIL / ORIZONA / OUIDOR / PALESTINA DE GOIAS / PALMEIRAS DE GOIAS / PALMELO / PALMINOPOLIS / PANAMA / PARANAIGUARA / PARAUNA / PEROLANDIA / PETROLINA DE GOIAS / PILAR DE GOIAS / PIRACANJUBA / PIRANHAS / PIRENOPOLIS / PIRES DO RIO / PLANALTINA / PONTALINA / PORANGATU / PORTELANDIA / POSSE / QUIRINOPOLIS / RIO QUENTE / RIO VERDE / RUBIATABA / SANCLERLANDIA / SANTA BARBARA DE GOIAS / SANTA CRUZ DE GOIAS / SANTA FE DE GOIAS / SANTA HELENA DE GOIAS / SANTA ISABEL / SANTA RITA DO ARAGUAIA / SANTA RITA DO NOVO DESTINO / SANTO ANTONIO DA BARRA / SANTO ANTONIO DE GOIAS / SANTO ANTONIO DO DESCOBERTO / SAO DOMINGOS / SAO FRANCISCO DE GOIAS / SAO JOAO D ALIANCA / SAO JOAO DA PARAUNA / SAO LUIS DE MONTES BELOS / SAO LUIZ DO NORTE / SAO MIGUEL DO ARAGUAIA / SAO MIGUEL DO PASSA QUATRO / SAO SIMAO / SENADOR CANEDO / SERRANOPOLIS / SILVANIA / SIMOLANDIA / TAQUARAL DE GOIAS / TEREZOPOLIS DE GOIAS / TRES RANCHOS / TRINDADE / TROMBAS / TURVANIA / TURVELANDIA / UIRAPURU / URUACU / URUTAI / VARJAO / VIANOPOLIS / VICENTINOPOLIS / VILA PROPICIO
--	--	--	---

<b>DANOS CAUSADOS</b>			
<b>Equipamentos Danificado</b>	<b>Importância para o Sistema</b>	<b>Local</b>	<b>Quantidade</b>
Disjuntor/Religador Operado	Proteção do Alimentador	Área de Concessão	64
Chaves Fusíveis Operada	Proteção de Ramais de Alimentadores	Área de Concessão	376
Transformador Operado	Proteção do Transformador	Área de Concessão	401

<b>Relato técnico sobre a Intervenção realizada em Goiânia e Região Metropolitana</b>			
<b>Informações sobre Equipes</b>	09/11	10/11	
<b>Quantidade Usual</b>	467	419	turmas
<b>Quantidade Adicional</b>	41	0	turmas
<b>Quantidade Total</b>	508	419	turmas
<b>Tempos Médios</b>			
<b>Preparação</b>	16,58	17,78	Horas
<b>Deslocamento</b>	0,68	0,68	Horas
<b>Execução</b>	2,81	2,99	Horas
<b>TMAE</b>	20,07	21,44	Horas

### **Principais Dificuldades Encontradas:**

Chuvas com ventos fortes provocaram muitos pontos de alagamento e enxurrada, trânsito impedido por vários semáforos desligados dificultando a chegada ao atendimento das ocorrências emergenciais. Em determinadas regiões, decorrente dos fortes ventos, houve o tombamento de árvores nas estruturas de alimentação de média tensão, danos em ramais de ligação dos clientes, impedimentos de acesso e atolamentos em estradas rurais.

<b>Empresa</b>	ENEL DISTRIBUIÇÃO GOIAS		
<b>Valor CHI (Limite e Real)</b>	<b>482.391,86</b>		<b>963.045,81</b>

DOC ORIGEM	MIUNICIPIO	EQP_ORIGEM	CONJUNTO	INI_OCORRENC	FIM_OCORRENC	DT_INI_EVENTO	DT_FIM_EVENTO	DURAÇ	UC INT	CHI	EXPURGO
2019118452	PIRACANJUBA	PJ11171408	PIRACANJUBA	09/11/2019 14:24	10/11/2019 13:56	09/11/2019 14:24	10/11/2019 13:26	23,04	1	23,04	CHI
2019118452	PIRACANJUBA	PJ12171368	PIRACANJUBA	09/11/2019 14:24	10/11/2019 13:56	09/11/2019 14:24	10/11/2019 13:56	23,52	9	211,71	CHI
20191143133	MATRINCHA	MP12321180	MATRINCHA	09/11/2019 17:06	12/11/2019 13:51	09/11/2019 17:06	12/11/2019 09:02	63,95	5	319,73	CHI
20191143133	MATRINCHA	MP12274451	MATRINCHA	09/11/2019 17:06	12/11/2019 13:51	09/11/2019 17:06	12/11/2019 13:51	68,75	5	343,75	CHI
20191157244	CAIAPONIA	PY12011439	PALESTINA	10/11/2019 08:23	12/11/2019 07:55	10/11/2019 08:23	12/11/2019 07:55	47,53	91	4324,88	CHI
20191157244	PALESTINA DE GOIAS	PY12011439	PALESTINA	10/11/2019 08:23	12/11/2019 07:55	10/11/2019 08:23	12/11/2019 07:55	47,53	24	1140,63	CHI
20191161817	CACU	CC21063051	CACHOEIRA ALTA	09/11/2019 17:57	14/11/2019 10:42	09/11/2019 17:57	14/11/2019 10:42	112,74	1	112,74	CHI
20191167394	CALDAS NOVAS	CN12363780LD	CALDAS NOVAS S1	09/11/2019 13:30	10/11/2019 10:13	09/11/2019 13:30	10/11/2019 10:13	20,70	97	2008,12	CHI
20191168374	MINEIROS	1390062676	PARQUE DAS EMAS	09/11/2019 11:12	11/11/2019 11:12	09/11/2019 11:12	11/11/2019 11:12	47,99	1	47,99	CHI
20191168421	MINEIROS	MY21156634	PARQUE DAS EMAS	09/11/2019 11:20	12/11/2019 10:40	09/11/2019 11:20	12/11/2019 10:40	71,33	1	71,33	CHI
20191168464	RIO VERDE	SH12000198	IPEGUARI	09/11/2019 11:30	11/11/2019 11:59	09/11/2019 11:30	11/11/2019 11:59	48,49	3	145,46	CHI
20191168464	SANTA HELENA DE GOIAS	SH12000198	IPEGUARI	09/11/2019 11:30	11/11/2019 11:59	09/11/2019 11:30	11/11/2019 11:59	48,49	7	339,40	CHI
20191168492	QUIRINOPOLIS	QI21350063	QUIRINOPOLIS	09/11/2019 11:34	09/11/2019 16:44	09/11/2019 11:34	09/11/2019 16:44	5,16	1	5,16	CHI
20191168498	CACHOEIRA ALTA	10010409120	CACHOEIRA ALTA	09/11/2019 11:35	09/11/2019 18:09	09/11/2019 11:35	09/11/2019 18:09	6,56	1	6,56	CHI
20191168561	ITARUMA	IM21214258	CACHOEIRA ALTA	09/11/2019 11:49	11/11/2019 19:14	09/11/2019 11:49	11/11/2019 19:14	55,41	1	55,41	CHI
20191168620	GUARINOS	02600414	ITAPACI	09/11/2019 13:19	09/11/2019 19:56	09/11/2019 13:20	09/11/2019 14:07	0,78	7	5,47	CHI
20191168620	ITAPACI	02600414	ITAPACI	09/11/2019 13:19	09/11/2019 19:56	09/11/2019 13:20	09/11/2019 14:07	0,78	5323	4160,81	CHI
20191168620	ITAPACI	02600414	ITAPACI	09/11/2019 13:19	09/11/2019 19:56	09/11/2019 13:20	09/11/2019 14:07	0,78	3169	2477,10	CHI
20191168620	ITAPACI	02600414	ITAPACI	09/11/2019 13:19	09/11/2019 19:56	09/11/2019 13:20	09/11/2019 14:07	0,78	3	2,34	CHI
20191168620	NOVA GLORIA	02600414	ITAPACI	09/11/2019 13:19	09/11/2019 19:56	09/11/2019 13:20	09/11/2019 14:07	0,78	26	20,32	CHI
20191168620	NOVA GLORIA	02600414	ITAPACI	09/11/2019 13:19	09/11/2019 19:56	09/11/2019 13:20	09/11/2019 14:07	0,78	4	3,13	CHI
20191168620	PILAR DE GOIAS	02600414	ITAPACI	09/11/2019 13:19	09/11/2019 19:56	09/11/2019 13:20	09/11/2019 14:07	0,78	37	28,92	CHI
20191168620	PILAR DE GOIAS	02600414	ITAPACI	09/11/2019 13:19	09/11/2019 19:56	09/11/2019 13:20	09/11/2019 14:07	0,78	1	0,78	CHI
20191168620	ITAPACI	00910434	ITAPACI	09/11/2019 13:19	09/11/2019 19:56	09/11/2019 13:19	09/11/2019 19:56	6,62	8	52,97	CHI
20191168620	NOVA GLORIA	00910434	ITAPACI	09/11/2019 13:19	09/11/2019 19:56	09/11/2019 13:19	09/11/2019 19:56	6,62	13	86,07	CHI
20191168626	DOVERLANDIA	DV12207926	CAIAPONIA	09/11/2019 14:50	09/11/2019 15:51	09/11/2019 14:50	09/11/2019 15:51	1,02	58	58,89	CHI
20191168654	MONTIVIDIU	MV12279840	MONTIVIDIU T	09/11/2019 15:37	09/11/2019 16:07	09/11/2019 15:37	09/11/2019 16:07	0,50	1	0,50	CHI
20191168676	MINEIROS	MY12413136LD	PARQUE DAS EMAS	09/11/2019 15:58	11/11/2019 13:20	09/11/2019 15:58	11/11/2019 13:20	45,37	1	45,37	CHI
20191168761	APARECIDA DO RIO DOCE	04070214	JATAI S1	09/11/2019 11:16	09/11/2019 18:25	09/11/2019 11:16	09/11/2019 17:50	6,56	70	459,24	CHI
20191168761	JATAI	04070214	JATAI S1	09/11/2019 11:16	09/11/2019 18:25	09/11/2019 11:16	09/11/2019 17:50	6,56	219	1436,76	CHI
20191168761	APARECIDA DO RIO DOCE	04070214	JATAI S1	09/11/2019 11:16	09/11/2019 18:25	09/11/2019 17:51	09/11/2019 18:25	0,58	70	40,43	CHI
20191168761	JATAI	04070214	JATAI S1	09/11/2019 11:16	09/11/2019 18:25	09/11/2019 17:51	09/11/2019 18:25	0,58	220	127,05	CHI

20191168778	SERRANOPOLIS	SX21184001	CHAPADAO DO CEU	09/11/2019 12:05	13/11/2019 08:57	09/11/2019 12:05	13/11/2019 08:57	92,85	1	92,85	CHI
20191168790	CHAPADAO DO CEU	DJ11274036	CHAPADAO DO CEU	09/11/2019 12:07	09/11/2019 16:18	09/11/2019 12:07	09/11/2019 16:18	4,17	38	158,54	CHI
20191168794	CAMPOS VERDES	3790026953	SANTA TEREZINHA	09/11/2019 12:09	10/11/2019 14:25	09/11/2019 12:09	10/11/2019 14:25	26,26	1	26,26	CHI
20191168872	ITARUMA	IM21216662	CACHOEIRA ALTA	09/11/2019 12:21	11/11/2019 18:44	09/11/2019 12:21	11/11/2019 18:44	54,37	1	54,37	CHI
20191168899	QUIRINOPOLIS	QI31052804	QUIRINOPOLIS	09/11/2019 12:26	09/11/2019 17:20	09/11/2019 12:26	09/11/2019 17:20	4,89	1	4,89	CHI
20191168935	SAO JOAO D ALIANCA	JL21325743	SAO JOAO D ALIANCA	09/11/2019 12:31	09/11/2019 14:32	09/11/2019 12:31	09/11/2019 14:32	2,00	1	2,00	CHI
20191168973	SAO DOMINGOS	SD21262243	SAO DOMINGOS	09/11/2019 12:39	09/11/2019 17:05	09/11/2019 12:39	09/11/2019 17:05	4,43	1	4,43	CHI
20191168993	INACIOLANDIA	CD21000107	CACHOEIRA DOURADA	09/11/2019 12:44	10/11/2019 16:03	09/11/2019 12:44	10/11/2019 16:03	27,30	1	27,30	CHI
20191168996	MORRINHOS	MR21265892	RIO QUENTE	09/11/2019 12:44	12/11/2019 11:41	09/11/2019 12:44	12/11/2019 11:41	70,94	1	70,94	CHI
20191168999	MORRINHOS	MR12024156	MORRINHOS	09/11/2019 12:45	10/11/2019 09:21	09/11/2019 12:45	10/11/2019 09:21	20,60	5	103,00	CHI
20191169004	MINEIROS	MY21274159	PARQUE DAS EMAS	09/11/2019 12:46	12/11/2019 09:55	09/11/2019 12:46	12/11/2019 09:55	69,14	1	69,14	CHI
20191169016	PILAR DE GOIAS	GG21309332	SANTA TEREZINHA	09/11/2019 12:49	12/11/2019 19:15	09/11/2019 12:49	12/11/2019 19:15	78,42	1	78,42	CHI
20191169031	CORUMBAIBA	NE21035389	CATALAO S1	09/11/2019 12:54	10/11/2019 20:31	09/11/2019 12:54	10/11/2019 20:31	31,61	1	31,61	CHI
20191169035	CUMARI	CT21195458	CATALAO S2	09/11/2019 12:55	10/11/2019 19:49	09/11/2019 12:55	10/11/2019 19:49	30,90	1	30,90	CHI
20191169037	CHAPADAO DO CEU	DJ12160236	CHAPADAO DO CEU	09/11/2019 12:55	11/11/2019 08:53	09/11/2019 12:55	11/11/2019 08:53	43,97	11	483,63	CHI
20191169039	ALVORADA DO NORTE	AQ11347021	IACIARA S2	09/11/2019 12:55	09/11/2019 21:40	09/11/2019 12:55	09/11/2019 21:40	8,75	1	8,75	CHI
20191169039	ALVORADA DO NORTE	AQ12043481RE	IACIARA S2	09/11/2019 12:55	09/11/2019 21:40	09/11/2019 17:45	09/11/2019 21:40	3,91	43	168,29	CHI
20191169039	SIMOLANDIA	AQ12043481RE	IACIARA S2	09/11/2019 12:55	09/11/2019 21:40	09/11/2019 17:45	09/11/2019 21:40	3,91	1	3,91	CHI
20191169042	MARA ROSA	MQ21051922	MARA ROSA	09/11/2019 12:56	09/11/2019 16:19	09/11/2019 12:56	09/11/2019 16:19	3,37	1	3,37	CHI
20191169047	FORMOSA	FA21391108	SAO JOAO D ALIANCA	09/11/2019 12:58	09/11/2019 21:06	09/11/2019 12:58	09/11/2019 21:06	8,12	2	16,24	CHI
20191169055	ITUMBIARA	CD12378958	CACHOEIRA DOURADA	09/11/2019 13:00	10/11/2019 21:27	09/11/2019 13:00	10/11/2019 21:27	32,45	1	32,45	CHI
20191169067	SILVANIA	SV12247192	VIANOPOLIS	09/11/2019 13:04	10/11/2019 09:27	09/11/2019 13:04	10/11/2019 09:27	20,38	9	183,40	CHI
20191169090	CAMPINORTE	CR11374771	CAMPINORTE	09/11/2019 13:10	09/11/2019 16:27	09/11/2019 13:10	09/11/2019 16:27	3,28	93	305,32	CHI
20191169092	CAIAPONIA	JT10400621	JATAI S1	09/11/2019 13:10	11/11/2019 04:14	10/11/2019 18:43	10/11/2019 18:46	0,06	20	1,11	CHI
20191169092	CAIAPONIA	JT10400621	JATAI S1	09/11/2019 13:10	11/11/2019 04:14	10/11/2019 18:43	10/11/2019 18:46	0,06	16	0,89	CHI
20191169092	JATAI	JT10400621	JATAI S1	09/11/2019 13:10	11/11/2019 04:14	10/11/2019 18:43	10/11/2019 18:46	0,06	299	16,61	CHI
20191169092	JATAI	JT10400565	JATAI S1	09/11/2019 13:10	11/11/2019 04:14	10/11/2019 18:43	10/11/2019 18:46	0,06	12	0,67	CHI
20191169092	MINEIROS	JT10400621	JATAI S1	09/11/2019 13:10	11/11/2019 04:14	10/11/2019 18:43	10/11/2019 18:46	0,06	3	0,17	CHI
20191169092	PEROLANDIA	JT10400621	JATAI S1	09/11/2019 13:10	11/11/2019 04:14	10/11/2019 18:43	10/11/2019 18:46	0,06	1031	57,28	CHI
20191169092	PEROLANDIA	JT10400621	JATAI S1	09/11/2019 13:10	11/11/2019 04:14	10/11/2019 18:43	10/11/2019 18:46	0,06	41	2,28	CHI
20191169092	PEROLANDIA	JT10400621	JATAI S1	09/11/2019 13:10	11/11/2019 04:14	10/11/2019 18:43	10/11/2019 18:46	0,06	133	7,39	CHI
20191169092	PEROLANDIA	JT10400565	JATAI S1	09/11/2019 13:10	11/11/2019 04:14	10/11/2019 18:43	10/11/2019 18:46	0,06	24	1,33	CHI
20191169092	JATAI	JT13296603	JATAI S1	09/11/2019 13:10	11/11/2019 04:14	10/11/2019 18:08	11/11/2019 04:12	10,07	3	30,20	CHI

20191169092	JATAI	JT12184049	JATAI S1	09/11/2019 13:10	11/11/2019 04:14	09/11/2019 13:10	11/11/2019 04:14	39,07	44	1719,07	CHI
20191169092	SERRANOPOLIS	JT12184049	JATAI S1	09/11/2019 13:10	11/11/2019 04:14	09/11/2019 13:10	11/11/2019 04:14	39,07	5	195,35	CHI
20191169092	SERRANOPOLIS	JT12184049	JATAI S1	09/11/2019 13:10	11/11/2019 04:14	10/11/2019 18:08	11/11/2019 04:14	10,09	12	121,14	CHI
20191169099	RIO VERDE	RV12301763	CABRIUVA S2	09/11/2019 13:10	11/11/2019 13:59	09/11/2019 13:10	11/11/2019 13:59	48,81	4	195,23	CHI
20191169104	PIRENOPOLIS	220079626	SAO FRANCISCO DE GOIAS	09/11/2019 13:12	09/11/2019 19:41	09/11/2019 13:12	09/11/2019 19:41	6,47	1	6,47	CHI
20191169105	SENADOR CANEDO	14894695	GOIANIA LESTE S1	09/11/2019 13:12	09/11/2019 17:10	09/11/2019 13:12	09/11/2019 17:10	3,95	1	3,95	CHI
20191169108	MONTES CLAROS DE GOIAS	ME21193382	IPORA	09/11/2019 13:14	13/11/2019 10:54	09/11/2019 13:14	13/11/2019 10:54	93,65	1	93,65	CHI
20191169113	NOVA AURORA	2220003493	CATALAO S1	09/11/2019 13:17	09/11/2019 22:34	09/11/2019 13:17	09/11/2019 22:34	9,27	1	9,27	CHI
20191169115	FORMOSA	FA12394153	ITUIQUIRA	09/11/2019 13:08	09/11/2019 18:17	09/11/2019 13:08	09/11/2019 18:17	5,14	19	97,59	CHI
20191169116	JARAGUA	70095425	JARAGUA	09/11/2019 13:17	09/11/2019 19:58	09/11/2019 13:17	09/11/2019 19:58	6,67	1	6,67	CHI
20191169118	GOIANESIA	550156290	GOIANESIA S2	09/11/2019 13:18	09/11/2019 17:23	09/11/2019 13:18	09/11/2019 17:23	4,08	1	4,08	CHI
20191169119	BELA VISTA DE GOIAS	XX01020720	BELA VISTA S2	09/11/2019 13:18	09/11/2019 16:25	09/11/2019 13:18	09/11/2019 16:25	3,11	6	18,66	CHI
20191169123	ITUMBIARA	IT11091648	ITUMBIARA NOVA	09/11/2019 12:43	10/11/2019 10:50	09/11/2019 12:43	10/11/2019 10:50	22,10	175	3867,94	CHI
20191169131	GOIANIA	16478812	CAMPINAS S2	09/11/2019 13:21	09/11/2019 15:04	09/11/2019 13:21	09/11/2019 15:04	1,71	1	1,71	CHI
20191169134	QUIRINOPOLIS	QI21150595	QUIRINOPOLIS	09/11/2019 13:22	10/11/2019 19:50	09/11/2019 13:22	10/11/2019 19:50	30,46	1	30,46	CHI
20191169137	RIO VERDE	RV11271600	RIO VERDE S1	09/11/2019 11:59	09/11/2019 18:00	09/11/2019 11:59	09/11/2019 18:00	6,01	103	618,94	CHI
20191169144	NIQUELANDIA	NQ12088704	URUACU	09/11/2019 13:25	11/11/2019 01:42	09/11/2019 13:25	11/11/2019 01:42	36,29	9	326,61	CHI
20191169147	CRIXAS	GF12135520	SANTA TEREZINHA	09/11/2019 12:32	10/11/2019 12:40	09/11/2019 12:32	10/11/2019 12:40	24,13	3	72,39	CHI
20191169147	GUARINOS	GF12135520	SANTA TEREZINHA	09/11/2019 12:32	10/11/2019 12:40	09/11/2019 12:32	10/11/2019 12:40	24,13	5	120,65	CHI
20191169148	BONOPOLIS	BX21246488	SAO MIGUEL DO ARAGUAIA	09/11/2019 13:25	09/11/2019 13:48	09/11/2019 13:25	09/11/2019 13:48	0,37	1	0,37	CHI
20191169155	IPORA	730061656	IPORA	09/11/2019 13:26	11/11/2019 10:10	09/11/2019 13:26	11/11/2019 10:10	44,72	1	44,72	CHI
20191169161	RUBIATABA	780048398	RUBIATABA	09/11/2019 13:27	11/11/2019 02:48	09/11/2019 13:27	11/11/2019 02:48	37,36	1	37,36	CHI
20191169169	FLORES DE GOIAS	FB21312364	IACIARA S2	09/11/2019 13:29	10/11/2019 07:43	09/11/2019 13:29	10/11/2019 07:43	18,23	1	18,23	CHI
20191169172	BOM JESUS DE GOIAS	BJ10406695	BOM JESUS DE GOIAS	09/11/2019 12:40	12/11/2019 23:27	09/11/2019 12:40	12/11/2019 23:27	82,79	24	1986,86	CHI
20191169172	ITUMBIARA	BJ10406695	BOM JESUS DE GOIAS	09/11/2019 12:40	12/11/2019 23:27	09/11/2019 12:40	12/11/2019 23:27	82,79	19	1572,93	CHI
20191169175	MINEIROS	SU12184123	SANTA RITA DO ARAGUAIA	09/11/2019 13:11	09/11/2019 18:13	09/11/2019 13:11	09/11/2019 18:13	5,03	15	75,50	CHI
20191169175	SANTA RITA DO ARAGUAIA	SU12184123	SANTA RITA DO ARAGUAIA	09/11/2019 13:11	09/11/2019 18:13	09/11/2019 13:11	09/11/2019 18:13	5,03	5	25,17	CHI
20191169188	GOIATUBA	GT12052882	GOIATUBA S1	09/11/2019 13:32	12/11/2019 13:58	09/11/2019 13:32	12/11/2019 13:58	72,43	26	1883,18	CHI
20191169193	ITABERAI	IB21022004	ITABERAI S2	09/11/2019 13:33	09/11/2019 18:52	09/11/2019 13:33	09/11/2019 18:52	5,32	1	5,32	CHI
20191169196	SILVANIA	SV12087255	DAIA S2	09/11/2019 13:33	09/11/2019 16:57	09/11/2019 13:33	09/11/2019 16:57	3,39	9	30,53	CHI
20191169198	AMARALINA	MH12391965	NOVA CRIXAS	09/11/2019 13:33	12/11/2019 15:35	09/11/2019 13:33	12/11/2019 15:35	74,03	1	74,03	CHI
20191169198	MUNDO NOVO DE GOIAS	MH12391965	NOVA CRIXAS	09/11/2019 13:33	12/11/2019 15:35	09/11/2019 13:33	12/11/2019 15:35	74,03	11	814,37	CHI
20191169204	GOIANIA	14396968	FERROVIARIO S1	09/11/2019 13:35	09/11/2019 14:29	09/11/2019 13:35	09/11/2019 14:29	0,89	1	0,89	CHI

20191169207	SANTA HELENA DE GOIAS	SH12350872	SANTA HELENA S1	09/11/2019 13:35	12/11/2019 13:09	09/11/2019 13:35	12/11/2019 13:09	71,56	3	214,67	CHI
20191169219	APARECIDA DE GOIANIA	10002497644	INDEPENDENCIA S1	09/11/2019 13:37	09/11/2019 15:23	09/11/2019 13:37	09/11/2019 15:23	1,75	1	1,75	CHI
20191169226	GOIANIA	11125044	XAVANTES	09/11/2019 13:39	09/11/2019 15:33	09/11/2019 13:39	09/11/2019 15:33	1,88	1	1,88	CHI
20191169234	IPORA	IR11000015	IPORA	09/11/2019 14:10	09/11/2019 17:38	09/11/2019 14:10	09/11/2019 17:38	3,45	82	283,15	CHI
20191169236	ABADIA DE GOIAS	AO12399996	INDEPENDENCIA S2	09/11/2019 13:27	09/11/2019 18:16	09/11/2019 13:27	09/11/2019 18:16	4,82	21	101,13	CHI
20191169236	ARAGOIANIA	AO12399996	INDEPENDENCIA S2	09/11/2019 13:27	09/11/2019 18:16	09/11/2019 13:27	09/11/2019 18:16	4,82	52	250,42	CHI
20191169236	GUAPO	AO12399996	INDEPENDENCIA S2	09/11/2019 13:27	09/11/2019 18:16	09/11/2019 13:27	09/11/2019 18:16	4,82	14	67,42	CHI
20191169238	SAO JOAO D ALIANCA	JL12242952	SAO JOAO D ALIANCA	09/11/2019 13:42	09/11/2019 15:07	09/11/2019 13:42	09/11/2019 15:07	1,40	139	194,64	CHI
20191169247	URUTAI	UT12300817LD	PIRES DO RIO S2	09/11/2019 13:44	09/11/2019 18:25	09/11/2019 13:44	09/11/2019 18:25	4,68	1	4,68	CHI
20191169248	PIRES DO RIO	PR12051689	PIRES DO RIO S2	09/11/2019 13:44	09/11/2019 22:11	09/11/2019 13:44	09/11/2019 22:11	8,45	1	8,45	CHI
20191169248	SANTA CRUZ DE GOIAS	PR12051689	PIRES DO RIO S2	09/11/2019 13:44	09/11/2019 22:11	09/11/2019 13:44	09/11/2019 22:11	8,45	2	16,89	CHI
20191169252	NOVA VENEZA	10021912376	NEROPOLIS S1	09/11/2019 13:45	09/11/2019 17:24	09/11/2019 13:45	09/11/2019 17:24	3,66	1	3,66	CHI
20191169297	NOVA CRIXAS	NA21275824	MOZARLANDIA	09/11/2019 13:50	12/11/2019 19:34	09/11/2019 13:50	12/11/2019 19:34	77,74	1	77,74	CHI
20191169298	JATAI	JT12371545	JATAI S1	09/11/2019 13:50	11/11/2019 16:21	09/11/2019 13:50	11/11/2019 16:21	50,51	1	50,51	CHI
20191169307	ACREUNA	EA12257973	EDEIA	09/11/2019 13:26	11/11/2019 11:06	09/11/2019 13:26	11/11/2019 11:06	45,67	14	639,42	CHI
20191169307	EDEIA	EA12257973	EDEIA	09/11/2019 13:26	11/11/2019 11:06	09/11/2019 13:26	11/11/2019 11:06	45,67	24	1096,14	CHI
20191169307	INDIARA	EA12257973	EDEIA	09/11/2019 13:26	11/11/2019 11:06	09/11/2019 13:26	11/11/2019 11:06	45,67	7	319,71	CHI
20191169312	GOIANIA	13433118	FERROVIARIO S1	09/11/2019 13:51	09/11/2019 15:07	09/11/2019 13:51	09/11/2019 15:07	1,25	1	1,25	CHI
20191169314	PORANGATU	PO12020578	PORANGATU	09/11/2019 13:52	14/11/2019 11:04	09/11/2019 13:52	12/11/2019 18:42	76,83	14	1075,65	CHI
20191169314	PORANGATU	PO13375469	PORANGATU	09/11/2019 13:52	14/11/2019 11:04	09/11/2019 13:52	14/11/2019 11:04	117,19	9	1054,75	CHI
20191169316	GOIANIA	13353548	XAVANTES	09/11/2019 13:52	09/11/2019 14:41	09/11/2019 13:52	09/11/2019 14:41	0,80	1	0,80	CHI
20191169337	EDEIA	IY12205924	EDEIA	09/11/2019 12:52	09/11/2019 16:01	09/11/2019 12:52	09/11/2019 16:01	3,15	5	15,75	CHI
20191169337	INDIARA	IY12205924	EDEIA	09/11/2019 12:52	09/11/2019 16:01	09/11/2019 12:52	09/11/2019 16:01	3,15	429	1351,35	CHI
20191169337	JANDAIA	IY12205924	EDEIA	09/11/2019 12:52	09/11/2019 16:01	09/11/2019 12:52	09/11/2019 16:01	3,15	1	3,15	CHI
20191169340	GOIAS	IB12210550	ITABERAI S1	09/11/2019 13:57	09/11/2019 18:15	09/11/2019 13:57	09/11/2019 18:15	4,29	3	12,87	CHI
20191169340	ITABERAI	IB12210550	ITABERAI S1	09/11/2019 13:57	09/11/2019 18:15	09/11/2019 13:57	09/11/2019 18:15	4,29	35	150,10	CHI
20191169343	CAMPO ALEGRE DE GOIAS	CM21164130	CAMPO ALEGRE DE GOIAS	09/11/2019 13:58	10/11/2019 13:17	09/11/2019 13:58	10/11/2019 13:17	23,31	1	23,31	CHI
20191169365	ITAPACI	IW11074945	ITAPACI	09/11/2019 13:45	09/11/2019 19:12	09/11/2019 13:45	09/11/2019 19:12	5,44	132	718,01	CHI
20191169375	GOIANIA	15067336	GOYA S1	09/11/2019 14:05	10/11/2019 10:04	09/11/2019 14:05	10/11/2019 10:04	19,97	1	19,97	CHI
20191169379	ARAGUAPAZ	AZ11042951	MOZARLANDIA	09/11/2019 18:55	09/11/2019 19:20	09/11/2019 18:55	09/11/2019 19:20	0,42	95	40,24	CHI
20191169381	ACREUNA	00080244	ACREUNA	09/11/2019 14:06	10/11/2019 17:10	09/11/2019 14:06	09/11/2019 16:01	1,92	34	65,33	CHI
20191169381	ACREUNA	EU13000007	ACREUNA	09/11/2019 14:06	10/11/2019 17:10	09/11/2019 14:06	09/11/2019 19:28	5,36	550	2949,83	CHI
20191169381	EDEIA	EU13000007	ACREUNA	09/11/2019 14:06	10/11/2019 17:10	09/11/2019 14:06	09/11/2019 19:28	5,36	13	69,72	CHI



20191169381	TURVANIA	EU13000007	ACREUNA	09/11/2019 14:06	10/11/2019 17:10	09/11/2019 14:06	09/11/2019 19:28	5,36	1	5,36	CHI
20191169381	TURVELANDIA	EU13000007	ACREUNA	09/11/2019 14:06	10/11/2019 17:10	09/11/2019 14:06	09/11/2019 19:28	5,36	30	160,90	CHI
20191169381	ACREUNA	00080244	ACREUNA	09/11/2019 14:06	10/11/2019 17:10	09/11/2019 19:29	10/11/2019 00:19	4,83	33	159,44	CHI
20191169381	ACREUNA	EU13000007	ACREUNA	09/11/2019 14:06	10/11/2019 17:10	09/11/2019 19:29	10/11/2019 10:15	14,76	4	59,06	CHI
20191169381	ACREUNA	EU13000008	ACREUNA	09/11/2019 14:06	10/11/2019 17:10	09/11/2019 19:29	10/11/2019 17:10	21,68	547	11858,20	CHI
20191169381	EDEIA	EU13000008	ACREUNA	09/11/2019 14:06	10/11/2019 17:10	09/11/2019 19:29	10/11/2019 17:10	21,68	13	281,82	CHI
20191169381	TURVANIA	EU13000008	ACREUNA	09/11/2019 14:06	10/11/2019 17:10	09/11/2019 19:29	10/11/2019 17:10	21,68	1	21,68	CHI
20191169381	TURVELANDIA	EU13000008	ACREUNA	09/11/2019 14:06	10/11/2019 17:10	09/11/2019 19:29	10/11/2019 17:10	21,68	30	650,36	CHI
20191169384	NOVO BRASIL	NB21132379	JUSSARA	09/11/2019 14:07	13/11/2019 23:56	09/11/2019 14:07	13/11/2019 23:56	105,81	2	211,63	CHI
20191169385	CAMPINORTE	4740001793	PORANGATU	09/11/2019 14:07	09/11/2019 17:04	09/11/2019 14:07	09/11/2019 17:04	2,95	1	2,95	CHI
20191169397	ANAPOLIS	20887085	DAIA S1	09/11/2019 14:09	09/11/2019 18:48	09/11/2019 14:09	09/11/2019 18:48	4,64	1	4,64	CHI
20191169399	SAO LUIS DE MONTES BELOS	500013147	SAO LUIZ DOS MONTES BELOS	09/11/2019 14:10	09/11/2019 15:37	09/11/2019 14:10	09/11/2019 15:37	1,45	1	1,45	CHI
20191169406	MORRINHOS	150079916	MORRINHOS	09/11/2019 14:11	10/11/2019 08:42	09/11/2019 14:11	10/11/2019 08:42	18,52	1	18,52	CHI
20191169409	URUACU	UR11038715	URUACU	09/11/2019 14:11	09/11/2019 22:51	09/11/2019 14:11	09/11/2019 22:51	8,66	117	1013,71	CHI
20191169412	BURITINOPOLIS	BQ21355805	IACIARA S2	09/11/2019 14:12	09/11/2019 15:28	09/11/2019 14:12	09/11/2019 15:28	1,26	2	2,51	CHI
20191169415	NIQUELANDIA	NQ21232482	URUACU	09/11/2019 14:13	12/11/2019 16:37	09/11/2019 14:13	12/11/2019 16:37	74,39	1	74,39	CHI
20191169449	IPAMERI	IP21265569	CAMPO ALEGRE DE GOIAS	09/11/2019 14:20	09/11/2019 19:32	09/11/2019 14:20	09/11/2019 19:32	5,20	1	5,20	CHI
20191169463	BELA VISTA DE GOIAS	BV31067598	BELA VISTA S1	09/11/2019 14:23	09/11/2019 18:13	09/11/2019 14:23	09/11/2019 18:13	3,83	1	3,83	CHI
20191169467	RIO VERDE	630324049	RIO VERDE S1	09/11/2019 14:23	10/11/2019 08:40	09/11/2019 14:23	10/11/2019 08:40	18,28	1	18,28	CHI
20191169479	CALDAS NOVAS	CN11163548	SERRA DE CALDAS	09/11/2019 14:25	10/11/2019 11:03	09/11/2019 14:25	10/11/2019 11:03	20,62	14	288,75	CHI
20191169480	BARRO ALTO	BA11000002	BARRO ALTO	09/11/2019 14:14	09/11/2019 20:04	09/11/2019 14:14	09/11/2019 20:04	5,82	106	617,33	CHI
20191169481	MARA ROSA	MQ12391947	NOVA CRIXAS	09/11/2019 14:26	13/11/2019 11:21	09/11/2019 14:26	13/11/2019 11:21	92,92	3	278,75	CHI
20191169483	MORRINHOS	MR11000035	MORRINHOS	09/11/2019 14:26	09/11/2019 21:41	09/11/2019 14:26	09/11/2019 21:41	7,25	103	746,66	CHI
20191169501	MORRINHOS	MR12172979	MORRINHOS	09/11/2019 14:24	09/11/2019 16:45	09/11/2019 14:24	09/11/2019 16:45	2,35	69	162,05	CHI
20191169527	GOIANESIA	550148735	GOIANESIA S2	09/11/2019 15:21	10/11/2019 11:41	09/11/2019 15:21	10/11/2019 11:41	20,33	1	20,33	CHI
20191169529	SAO MIGUEL DO ARAGUAIA	SM13320951	NOVA CRIXAS	09/11/2019 13:19	11/11/2019 15:48	11/11/2019 15:42	11/11/2019 15:48	0,10	21	2,15	CHI
20191169535	SERRANOPOLIS	SX21158060	JATAI S1	09/11/2019 14:34	14/11/2019 03:45	09/11/2019 14:34	14/11/2019 03:45	109,17	1	109,17	CHI
20191169538	GOIANIA	GN11203717	CARAJAS S1	09/11/2019 14:22	10/11/2019 08:17	09/11/2019 14:22	10/11/2019 08:17	17,90	60	1074,18	CHI
20191169547	ANAPOLIS	20602110	ANAPOLIS UNIVERSITARIO S2	09/11/2019 14:37	09/11/2019 17:23	09/11/2019 14:37	09/11/2019 17:23	2,77	1	2,77	CHI
20191169553	PARAUNA	PU12194221	ACREUNA	09/11/2019 14:38	09/11/2019 20:18	09/11/2019 14:38	09/11/2019 20:18	5,66	37	209,54	CHI
20191169557	INHUMAS	IN21381644	INHUMAS S2	09/11/2019 14:39	10/11/2019 09:47	09/11/2019 14:39	10/11/2019 09:47	19,13	2	38,27	CHI
20191169580	CATALAO	CT11186684	CATALAO S2	09/11/2019 13:58	09/11/2019 15:08	09/11/2019 13:58	09/11/2019 15:08	1,15	127	146,61	CHI
20191169585	IPAMERI	IP21112278	IPAMERI	09/11/2019 14:42	10/11/2019 13:12	09/11/2019 14:42	10/11/2019 13:12	22,49	1	22,49	CHI

20191169586	IPORA	10006826715	IPORA	09/11/2019 14:42	09/11/2019 23:43	09/11/2019 14:42	09/11/2019 23:43	9,01	1	9,01	CHI
20191169600	ITAPACI	100003758	ITAPACI	09/11/2019 14:45	10/11/2019 09:00	09/11/2019 14:45	10/11/2019 09:00	18,24	1	18,24	CHI
20191169604	BELA VISTA DE GOIAS	BV12272141	BELA VISTA S2	09/11/2019 14:46	09/11/2019 17:26	09/11/2019 14:46	09/11/2019 17:26	2,65	32	84,92	CHI
20191169604	SAO MIGUEL DO PASSA QUATRO	BV12272141	BELA VISTA S2	09/11/2019 14:46	09/11/2019 17:26	09/11/2019 14:46	09/11/2019 17:26	2,65	89	236,20	CHI
20191169610	GOIANIA	14727560	GOIANIA LESTE S3	09/11/2019 14:47	09/11/2019 16:46	09/11/2019 14:47	09/11/2019 16:46	1,98	1	1,98	CHI
20191169617	ACREUNA	SH12271266	SANTA HELENA S1	09/11/2019 14:48	11/11/2019 08:40	09/11/2019 14:48	11/11/2019 08:40	41,86	3	125,59	CHI
20191169617	SANTA HELENA DE GOIAS	SH12271266	SANTA HELENA S1	09/11/2019 14:48	11/11/2019 08:40	09/11/2019 14:48	11/11/2019 08:40	41,86	2	83,73	CHI
20191169622	APARECIDA DE GOIANIA	15893297	REAL S1	09/11/2019 14:48	09/11/2019 17:39	09/11/2019 14:48	09/11/2019 17:39	2,84	1	2,84	CHI
20191169624	GOIANIA	GN11034639	FERROVIARIO S2	09/11/2019 14:49	09/11/2019 16:28	09/11/2019 14:49	09/11/2019 16:28	1,65	8	13,19	CHI
20191169630	SENADOR CANEDO	17182890	SENADOR CANEDO	09/11/2019 14:50	09/11/2019 18:16	09/11/2019 14:50	09/11/2019 18:16	3,43	1	3,43	CHI
20191169633	ITARUMA	IM21226537	CACHOEIRA ALTA	09/11/2019 14:51	11/11/2019 20:36	09/11/2019 14:51	11/11/2019 20:36	53,75	5	268,75	CHI
20191169634	GOIANIA	14183705	GOYA S2	09/11/2019 14:51	10/11/2019 09:23	09/11/2019 14:51	10/11/2019 09:23	18,53	1	18,53	CHI
20191169638	BOM JESUS DE GOIAS	BJ12222537	BOM JESUS DE GOIAS	09/11/2019 14:15	09/11/2019 18:20	09/11/2019 14:15	09/11/2019 18:20	4,08	187	762,54	CHI
20191169644	GOIANIA	GN11002160	FERROVIARIO S2	09/11/2019 13:51	09/11/2019 16:38	09/11/2019 13:51	09/11/2019 16:38	2,77	67	185,78	CHI
20191169648	APARECIDA DE GOIANIA	10009437868	INDEPENDENCIA S1	09/11/2019 14:53	09/11/2019 16:02	09/11/2019 14:53	09/11/2019 16:02	1,15	1	1,15	CHI
20191169654	GOIANESIA	GE11044647	GOIANESIA S2	09/11/2019 14:47	09/11/2019 17:44	09/11/2019 14:47	09/11/2019 17:44	2,94	141	413,91	CHI
20191169686	CACHOEIRA DOURADA	CD11000005	CACHOEIRA DOURADA	09/11/2019 12:33	09/11/2019 16:01	09/11/2019 12:33	09/11/2019 16:01	3,45	120	414,47	CHI
20191169694	CHAPADAO DO CEU	DJ12365007	CHAPADAO DO CEU	09/11/2019 14:59	11/11/2019 11:57	09/11/2019 14:59	11/11/2019 11:57	44,97	7	314,78	CHI
20191169694	MINEIROS	DJ12365007	CHAPADAO DO CEU	09/11/2019 14:59	11/11/2019 11:57	09/11/2019 14:59	11/11/2019 11:57	44,97	3	134,91	CHI
20191169695	ACREUNA	EU12207083	ACREUNA	09/11/2019 14:05	09/11/2019 22:13	09/11/2019 14:05	09/11/2019 22:13	8,12	611	4960,13	CHI
20191169697	SAO JOAO DA PARAUNA	RP12099240	FIRMINOPOLIS S2	09/11/2019 14:59	09/11/2019 16:30	09/11/2019 14:59	09/11/2019 16:30	1,50	4	6,01	CHI
20191169698	CACHOEIRA ALTA	QI12189166	CACHOEIRA ALTA	09/11/2019 14:59	11/11/2019 23:17	09/11/2019 14:59	11/11/2019 23:17	56,29	3	168,87	CHI
20191169698	QUIRINOPOLIS	QI12189166	CACHOEIRA ALTA	09/11/2019 14:59	11/11/2019 23:17	09/11/2019 14:59	11/11/2019 23:17	56,29	2	112,58	CHI
20191169710	TAQUARAL DE GOIAS	TQ12300097	ITABERAÍ S1	09/11/2019 14:12	11/11/2019 16:24	09/11/2019 14:12	11/11/2019 16:24	50,19	6	301,14	CHI
20191169720	GOIANIA	GN11002832	GOYA S2	09/11/2019 14:51	09/11/2019 21:06	09/11/2019 14:51	09/11/2019 21:06	6,24	174	1085,13	CHI
20191169736	JANDAIA	PL13000014	PALMEIRAS	09/11/2019 14:51	09/11/2019 20:51	09/11/2019 14:55	09/11/2019 17:01	2,12	117	247,52	CHI
20191169736	PALESTINA DE GOIAS	PL13000014	PALMEIRAS	09/11/2019 14:51	09/11/2019 20:51	09/11/2019 14:55	09/11/2019 17:01	2,12	1	2,12	CHI
20191169736	PALMEIRAS DE GOIAS	PL13000014	PALMEIRAS	09/11/2019 14:51	09/11/2019 20:51	09/11/2019 14:55	09/11/2019 17:01	2,12	72	152,32	CHI
20191169736	JANDAIA	PL13000014	PALMEIRAS	09/11/2019 14:51	09/11/2019 20:51	09/11/2019 16:16	09/11/2019 17:01	0,77	11	8,42	CHI
20191169736	PALMEIRAS DE GOIAS	PL13000014	PALMEIRAS	09/11/2019 14:51	09/11/2019 20:51	09/11/2019 16:16	09/11/2019 17:01	0,77	4	3,06	CHI
20191169736	PALMINOPOLIS	PL13000014	PALMEIRAS	09/11/2019 14:51	09/11/2019 20:51	09/11/2019 16:16	09/11/2019 17:01	0,77	14	10,72	CHI
20191169736	JANDAIA	PL10400683	PALMEIRAS	09/11/2019 14:51	09/11/2019 20:51	09/11/2019 14:51	09/11/2019 17:19	2,48	2	4,96	CHI
20191169736	PALMEIRAS DE GOIAS	PL10400683	PALMEIRAS	09/11/2019 14:51	09/11/2019 20:51	09/11/2019 14:51	09/11/2019 17:19	2,48	3	7,44	CHI

20191169736	JANDAIA	PL10400683	PALMEIRAS	09/11/2019 14:51	09/11/2019 20:51	09/11/2019 14:51	09/11/2019 19:43	4,87	24	116,96	CHI
20191169736	JANDAIA	PL10400683	PALMEIRAS	09/11/2019 14:51	09/11/2019 20:51	09/11/2019 17:21	09/11/2019 19:43	2,37	2	4,74	CHI
20191169736	PALMEIRAS DE GOIAS	PL10400683	PALMEIRAS	09/11/2019 14:51	09/11/2019 20:51	09/11/2019 17:21	09/11/2019 19:43	2,37	3	7,11	CHI
20191169736	JANDAIA	PL10400683	PALMEIRAS	09/11/2019 14:51	09/11/2019 20:51	09/11/2019 14:55	09/11/2019 20:08	5,22	1760	9195,51	CHI
20191169736	JANDAIA	PL10400683	PALMEIRAS	09/11/2019 14:51	09/11/2019 20:51	09/11/2019 14:55	09/11/2019 20:09	5,23	812	4249,24	CHI
20191169736	INDIARA	JD13361633	PALMEIRAS	09/11/2019 14:51	09/11/2019 20:51	09/11/2019 14:55	09/11/2019 20:33	5,64	133	750,56	CHI
20191169736	JANDAIA	JD13361633	PALMEIRAS	09/11/2019 14:51	09/11/2019 20:51	09/11/2019 14:55	09/11/2019 20:33	5,64	222	1252,82	CHI
20191169736	PALMEIRAS DE GOIAS	JD13361633	PALMEIRAS	09/11/2019 14:51	09/11/2019 20:51	09/11/2019 14:55	09/11/2019 20:33	5,64	38	214,45	CHI
20191169736	PARAUNA	JD13361633	PALMEIRAS	09/11/2019 14:51	09/11/2019 20:51	09/11/2019 14:55	09/11/2019 20:33	5,64	6	33,86	CHI
20191169736	JANDAIA	JD12289833	PALMEIRAS	09/11/2019 14:51	09/11/2019 20:51	09/11/2019 14:55	09/11/2019 20:50	5,93	110	652,24	CHI
20191169736	PARAUNA	JD12289833	PALMEIRAS	09/11/2019 14:51	09/11/2019 20:51	09/11/2019 14:55	09/11/2019 20:50	5,93	45	266,83	CHI
20191169736	JANDAIA	PL10400683	PALMEIRAS	09/11/2019 14:51	09/11/2019 20:51	09/11/2019 14:51	09/11/2019 20:51	6,00	1	6,00	CHI
20191169738	GOIANIA	12950890	XAVANTES	09/11/2019 15:05	09/11/2019 17:31	09/11/2019 15:05	09/11/2019 17:31	2,43	1	2,43	CHI
20191169739	NIQUELANDIA	NQ12133382	NIQUELANDIA SUBTRANSMISSAO	09/11/2019 15:02	09/11/2019 20:56	09/11/2019 15:02	09/11/2019 20:56	5,89	13	76,53	CHI
20191169741	SAO MIGUEL DO ARAGUAIA	SM12393978	SAO MIGUEL DO ARAGUAIA	09/11/2019 15:06	10/11/2019 14:30	09/11/2019 15:06	10/11/2019 14:30	23,40	59	1380,57	CHI
20191169760	SAO MIGUEL DO ARAGUAIA	SM12147083	SAO MIGUEL DO ARAGUAIA	09/11/2019 15:10	10/11/2019 10:58	09/11/2019 15:10	10/11/2019 10:58	19,80	17	336,57	CHI
20191169764	ARAGUAPAZ	1780019807	MOZARLANDIA	09/11/2019 15:10	10/11/2019 14:59	09/11/2019 15:10	10/11/2019 14:59	23,81	1	23,81	CHI
20191169765	PARANAIGUARA	PC12060517	QUIRINOPOLIS	09/11/2019 15:10	11/11/2019 19:00	09/11/2019 15:10	11/11/2019 19:00	51,83	1	51,83	CHI
20191169765	QUIRINOPOLIS	PC12060517	QUIRINOPOLIS	09/11/2019 15:10	11/11/2019 19:00	09/11/2019 15:10	11/11/2019 19:00	51,83	3	155,48	CHI
20191169777	MOSSAMEDES	MD21299604	ITABERAÍ S2	09/11/2019 15:11	10/11/2019 18:03	09/11/2019 15:11	10/11/2019 18:03	26,86	2	53,73	CHI
20191169780	GOIANDIRA	CT12075551	CATALAO S1	09/11/2019 15:12	10/11/2019 22:47	09/11/2019 15:12	10/11/2019 22:47	31,58	2	63,17	CHI
20191169788	JATAI	JT12303855	JATAI S1	09/11/2019 15:13	12/11/2019 18:17	09/11/2019 15:13	12/11/2019 18:17	75,05	6	450,30	CHI
20191169794	NIQUELANDIA	NQ12197539	NIQUELANDIA SUBTRANSMISSAO	09/11/2019 15:15	09/11/2019 23:50	09/11/2019 15:15	09/11/2019 23:50	8,58	14	120,14	CHI
20191169798	GOIANDIRA	CY21127678	CATALAO S1	09/11/2019 15:15	10/11/2019 10:59	09/11/2019 15:15	10/11/2019 10:59	19,73	1	19,73	CHI
20191169804	SANTA HELENA DE GOIAS	01660254	IPEGUARI	09/11/2019 15:13	09/11/2019 17:53	09/11/2019 15:13	09/11/2019 17:53	2,67	558	1487,22	CHI
20191169809	PIRENOPOLIS	220034187	CORUMBA	09/11/2019 15:16	09/11/2019 21:08	09/11/2019 15:16	09/11/2019 21:08	5,86	1	5,86	CHI
20191169810	GOIANIA	GN11001358	AEROPORTO S2	09/11/2019 14:35	09/11/2019 16:19	09/11/2019 14:35	09/11/2019 16:19	1,72	82	141,18	CHI
20191169821	MUNDO NOVO DE GOIAS	MH21092751	NOVA CRIXAS	09/11/2019 15:18	11/11/2019 10:26	09/11/2019 15:18	11/11/2019 10:26	43,13	1	43,13	CHI
20191169830	MINEIROS	MY12166286	CHAPADAO DO CEU	09/11/2019 14:42	09/11/2019 18:49	09/11/2019 14:42	09/11/2019 18:49	4,10	5	20,52	CHI
20191169830	SERRANOPOLIS	MY12166286	CHAPADAO DO CEU	09/11/2019 14:42	09/11/2019 18:49	09/11/2019 14:42	09/11/2019 18:49	4,10	10	41,04	CHI
20191169835	ITUMBIARA	IT21264027	CACHOEIRA DOURADA	09/11/2019 15:20	14/11/2019 17:32	09/11/2019 15:20	14/11/2019 17:32	122,19	1	122,19	CHI
20191169884	GOIANIA	GN21000981	GOIANIA LESTE S1	09/11/2019 15:27	09/11/2019 16:53	09/11/2019 15:27	09/11/2019 16:53	1,43	1	1,43	CHI
20191169885	LUZIANIA	LZ21264828	VIANOPOLIS	09/11/2019 15:27	10/11/2019 03:07	09/11/2019 15:27	10/11/2019 03:07	11,66	4	46,66	CHI

20191169886	GOIANIA	GN12164391	MEIA PONTE	09/11/2019 15:11	09/11/2019 17:50	09/11/2019 15:11	09/11/2019 17:50	2,65	241	638,38	CHI
20191169921	ANAPOLIS	AN12000193RE	ANAPOLIS UNIVERSITARIO S2	09/11/2019 13:57	09/11/2019 17:08	09/11/2019 13:57	09/11/2019 17:08	3,18	12	38,20	CHI
20191169921	PIRENOPOLIS	AN12000193RE	ANAPOLIS UNIVERSITARIO S2	09/11/2019 13:57	09/11/2019 17:08	09/11/2019 13:57	09/11/2019 17:08	3,18	4	12,73	CHI
20191169941	NIQUELANDIA	NQ11035206	NIQUELANDIA SUBTRANSMISSAO	09/11/2019 15:11	09/11/2019 17:35	09/11/2019 15:11	09/11/2019 17:35	2,39	124	296,50	CHI
20191169959	IPORA	730038361	IPORA	09/11/2019 15:37	11/11/2019 11:09	09/11/2019 15:37	11/11/2019 11:09	43,53	1	43,53	CHI
20191169960	MATRINCHA	MP21299718	MATRINCHA	09/11/2019 15:37	15/11/2019 09:43	09/11/2019 15:37	15/11/2019 09:43	138,11	1	138,11	CHI
20191169962	MINEIROS	MY12210441	PARQUE DAS EMAS	09/11/2019 15:37	11/11/2019 15:32	09/11/2019 15:37	11/11/2019 15:32	47,91	1	47,91	CHI
20191169964	AMORINOPOLIS	IR12091436	IPORA	09/11/2019 14:04	11/11/2019 16:15	09/11/2019 14:04	11/11/2019 16:15	50,18	3	150,54	CHI
20191169964	IPORA	IR12091436	IPORA	09/11/2019 14:04	11/11/2019 16:15	09/11/2019 14:04	11/11/2019 16:15	50,18	15	752,72	CHI
20191169966	JATAI	290187382	JATAI S2	09/11/2019 15:38	11/11/2019 09:50	09/11/2019 15:38	11/11/2019 09:50	42,20	1	42,20	CHI
20191169985	QUIRINOPOLIS	QI12295719	QUIRINOPOLIS	09/11/2019 14:44	10/11/2019 12:00	09/11/2019 14:44	10/11/2019 12:00	21,26	4	85,06	CHI
20191169988	CACHOEIRA DOURADA	CD12000302	CACHOEIRA DOURADA	09/11/2019 15:41	10/11/2019 13:40	09/11/2019 15:41	10/11/2019 13:40	21,99	4	87,96	CHI
20191169993	GOIANIRA	GR11138911	GOIANIRA	09/11/2019 15:41	09/11/2019 17:18	09/11/2019 15:41	09/11/2019 17:18	1,60	6	9,63	CHI
20191169994	SANTA HELENA DE GOIAS	400128639	IPEGUARI	09/11/2019 15:41	12/11/2019 10:05	09/11/2019 15:41	12/11/2019 10:05	66,39	1	66,39	CHI
20191169995	RIO VERDE	RV10371479	RIO VERDE S1	09/11/2019 15:39	11/11/2019 22:36	09/11/2019 15:39	10/11/2019 09:59	18,33	51	934,69	CHI
20191169995	RIO VERDE	RV10371479	RIO VERDE S1	09/11/2019 15:39	11/11/2019 22:36	09/11/2019 15:39	11/11/2019 01:41	34,02	73	2483,30	CHI
20191169995	RIO VERDE	RV13305835	RIO VERDE S1	09/11/2019 15:39	11/11/2019 22:36	09/11/2019 15:39	11/11/2019 01:41	34,02	245	8334,36	CHI
20191169995	SANTA HELENA DE GOIAS	RV10371479	RIO VERDE S1	09/11/2019 15:39	11/11/2019 22:36	09/11/2019 15:39	11/11/2019 01:41	34,02	11	374,20	CHI
20191169995	SANTA HELENA DE GOIAS	RV13305835	RIO VERDE S1	09/11/2019 15:39	11/11/2019 22:36	09/11/2019 15:39	11/11/2019 01:41	34,02	45	1530,80	CHI
20191169995	RIO VERDE	RV13305835	RIO VERDE S1	09/11/2019 15:39	11/11/2019 22:36	11/11/2019 01:43	11/11/2019 10:02	8,31	35	291,02	CHI
20191169995	RIO VERDE	RV12000199	RIO VERDE S1	09/11/2019 15:39	11/11/2019 22:36	09/11/2019 15:39	11/11/2019 10:47	43,13	1	43,13	CHI
20191169995	RIO VERDE	RV12000199	RIO VERDE S1	09/11/2019 15:39	11/11/2019 22:36	11/11/2019 01:43	11/11/2019 10:47	9,07	31	281,21	CHI
20191169995	SANTA HELENA DE GOIAS	RV12000199	RIO VERDE S1	09/11/2019 15:39	11/11/2019 22:36	11/11/2019 01:43	11/11/2019 10:47	9,07	11	99,79	CHI
20191169995	RIO VERDE	RV13305871	RIO VERDE S1	09/11/2019 15:39	11/11/2019 22:36	11/11/2019 01:43	11/11/2019 21:16	19,55	7	136,87	CHI
20191169995	RIO VERDE	RV12000203LD	RIO VERDE S1	09/11/2019 15:39	11/11/2019 22:36	09/11/2019 15:39	11/11/2019 22:09	54,49	1	54,49	CHI
20191169995	RIO VERDE	RV12000203LD	RIO VERDE S1	09/11/2019 15:39	11/11/2019 22:36	11/11/2019 01:43	11/11/2019 22:09	20,43	154	3146,52	CHI
20191169995	SANTA HELENA DE GOIAS	RV12000203LD	RIO VERDE S1	09/11/2019 15:39	11/11/2019 22:36	11/11/2019 01:43	11/11/2019 22:09	20,43	45	919,44	CHI
20191169995	RIO VERDE	RV12260726LD	RIO VERDE S1	09/11/2019 15:39	11/11/2019 22:36	09/11/2019 15:39	11/11/2019 22:36	54,94	2	109,88	CHI
20191169995	RIO VERDE	RV12260726LD	RIO VERDE S1	09/11/2019 15:39	11/11/2019 22:36	11/11/2019 01:43	11/11/2019 22:36	20,88	93	1942,20	CHI
20191169996	CAIAPONIA	DP12296462	JATAI S1	09/11/2019 15:04	13/11/2019 18:06	09/11/2019 15:04	09/11/2019 19:10	4,10	9	36,93	CHI
20191169996	PEROLANDIA	DP12296462	JATAI S1	09/11/2019 15:04	13/11/2019 18:06	09/11/2019 15:04	09/11/2019 19:10	4,10	8	32,82	CHI
20191169996	CAIAPONIA	DP12296462	JATAI S1	09/11/2019 15:04	13/11/2019 18:06	09/11/2019 15:04	10/11/2019 10:50	19,76	7	138,31	CHI
20191169996	CAIAPONIA	DP12296462	JATAI S1	09/11/2019 15:04	13/11/2019 18:06	09/11/2019 15:04	11/11/2019 12:53	45,82	3	137,45	CHI

20191169996	CAIAPONIA	DP12296462	JATAI S1	09/11/2019 15:04	13/11/2019 18:06	09/11/2019 15:04	12/11/2019 15:00	71,94	16	1150,97	CHI
20191169996	MINEIROS	DP12296462	JATAI S1	09/11/2019 15:04	13/11/2019 18:06	09/11/2019 15:04	12/11/2019 15:00	71,94	2	143,87	CHI
20191169996	CAIAPONIA	DP12296462	JATAI S1	09/11/2019 15:04	13/11/2019 18:06	09/11/2019 15:04	13/11/2019 18:06	99,02	3	297,07	CHI
20191169997	MINACU	IH11208312	MINACU	09/11/2019 15:41	09/11/2019 18:19	09/11/2019 15:41	09/11/2019 18:19	2,62	72	188,50	CHI
20191170003	CAMPINACU	IH12360453	MINACU	09/11/2019 15:42	09/11/2019 18:53	09/11/2019 15:42	09/11/2019 18:53	3,18	5	15,90	CHI
20191170003	MINACU	IH12360453	MINACU	09/11/2019 15:42	09/11/2019 18:53	09/11/2019 15:42	09/11/2019 18:53	3,18	72	229,02	CHI
20191170027	NIQUELANDIA	NQ12232335	NIQUELANDIA SUBTRANSMISSAO	09/11/2019 15:32	09/11/2019 19:57	09/11/2019 15:32	09/11/2019 19:57	4,41	35	154,40	CHI
20191170044	RIO VERDE	RV12249020	CABRIUVA S2	09/11/2019 15:22	12/11/2019 18:42	09/11/2019 15:22	12/11/2019 18:42	75,33	18	1355,88	CHI
20191170047	HIDROLANDIA	HD21346137	CEPAIGO S2	09/11/2019 15:44	09/11/2019 19:17	09/11/2019 15:44	09/11/2019 19:17	3,54	1	3,54	CHI
20191170051	UIRAPURU	UP21126843	SANTA TEREZINHA	09/11/2019 15:45	11/11/2019 12:18	09/11/2019 15:45	11/11/2019 12:18	44,54	1	44,54	CHI
20191170053	INACIOLANDIA	ID11304157	CACHOEIRA DOURADA	09/11/2019 15:45	10/11/2019 18:04	09/11/2019 15:45	10/11/2019 18:04	26,30	1	26,30	CHI
20191170055	BALIZA	BH11331288	CAIAPONIA	09/11/2019 15:46	12/11/2019 20:23	09/11/2019 15:46	12/11/2019 20:23	76,61	1	76,61	CHI
20191170064	ACREUNA	EU12271441	ACREUNA	09/11/2019 12:55	11/11/2019 13:25	09/11/2019 12:55	09/11/2019 23:29	10,57	193	2040,01	CHI
20191170064	ACREUNA	EU11271432	ACREUNA	09/11/2019 12:55	11/11/2019 13:25	09/11/2019 12:55	11/11/2019 13:25	48,50	73	3540,52	CHI
20191170074	CAVALCANTE	TI12162624	NIQUELANDIA SUBTRANSMISSAO	09/11/2019 15:47	09/11/2019 19:53	09/11/2019 15:47	09/11/2019 19:53	4,08	21	85,76	CHI
20191170074	COLINAS DO SUL	TI12162624	NIQUELANDIA SUBTRANSMISSAO	09/11/2019 15:47	09/11/2019 19:53	09/11/2019 15:47	09/11/2019 19:53	4,08	8	32,67	CHI
20191170079	GOUVELANDIA	GB21370139	QUIRINOPOLIS	09/11/2019 15:48	11/11/2019 18:01	09/11/2019 15:48	11/11/2019 18:01	50,21	1	50,21	CHI
20191170081	FIRMINOPOLIS	FR12126033	FIRMINOPOLIS S1	09/11/2019 15:29	09/11/2019 17:55	09/11/2019 15:29	09/11/2019 17:55	2,43	8	19,42	CHI
20191170086	EDEIA	EA12089863	EDEIA	09/11/2019 15:49	09/11/2019 16:04	09/11/2019 15:49	09/11/2019 16:04	0,25	3	0,75	CHI
20191170088	GOIANIA	GN12058032	GOYA S1	09/11/2019 15:12	09/11/2019 17:22	09/11/2019 15:12	09/11/2019 17:22	2,16	959	2070,91	CHI
20191170089	JATAI	JT12374278	JATAI S2	09/11/2019 15:17	09/11/2019 17:34	09/11/2019 15:17	09/11/2019 17:34	2,27	646	1465,88	CHI
20191170091	PORANGATU	PO12349233	MARA ROSA	09/11/2019 15:50	12/11/2019 01:09	09/11/2019 15:50	12/11/2019 01:09	57,32	7	401,21	CHI
20191170093	DOVERLANDIA	02610444	PARQUE DAS EMAS	09/11/2019 15:48	11/11/2019 16:15	09/11/2019 15:48	09/11/2019 16:11	0,37	1	0,37	CHI
20191170093	MINEIROS	02610444	PARQUE DAS EMAS	09/11/2019 15:48	11/11/2019 16:15	09/11/2019 15:48	09/11/2019 16:11	0,37	8	2,98	CHI
20191170093	MINEIROS	02610444	PARQUE DAS EMAS	09/11/2019 15:48	11/11/2019 16:15	09/11/2019 15:48	09/11/2019 16:11	0,37	13	4,84	CHI
20191170093	PORTELANDIA	02610444	PARQUE DAS EMAS	09/11/2019 15:48	11/11/2019 16:15	09/11/2019 15:48	09/11/2019 16:11	0,37	5	1,86	CHI
20191170093	PORTELANDIA	02610444	PARQUE DAS EMAS	09/11/2019 15:48	11/11/2019 16:15	09/11/2019 15:48	09/11/2019 16:11	0,37	59	21,98	CHI
20191170093	SANTA RITA DO ARAGUAIA	02610444	PARQUE DAS EMAS	09/11/2019 15:48	11/11/2019 16:15	09/11/2019 15:48	09/11/2019 16:11	0,37	1	0,37	CHI
20191170093	MINEIROS	02610444	PARQUE DAS EMAS	09/11/2019 15:48	11/11/2019 16:15	09/11/2019 15:48	09/11/2019 20:34	4,76	17	80,89	CHI
20191170093	PEROLANDIA	02610444	PARQUE DAS EMAS	09/11/2019 15:48	11/11/2019 16:15	09/11/2019 15:48	09/11/2019 20:34	4,76	19	90,41	CHI
20191170093	MINEIROS	02610444	PARQUE DAS EMAS	09/11/2019 15:48	11/11/2019 16:15	10/11/2019 00:17	10/11/2019 01:25	1,14	22	25,12	CHI
20191170093	PEROLANDIA	02610444	PARQUE DAS EMAS	09/11/2019 15:48	11/11/2019 16:15	10/11/2019 00:17	10/11/2019 01:25	1,14	23	26,26	CHI
20191170093	PORTELANDIA	02610444	PARQUE DAS EMAS	09/11/2019 15:48	11/11/2019 16:15	10/11/2019 00:17	10/11/2019 01:25	1,14	1	1,14	CHI

20191170093	DOVERLANDIA	02610444	PARQUE DAS EMAS	09/11/2019 15:48	11/11/2019 16:15	09/11/2019 15:48	10/11/2019 02:48	11,01	3	33,02	CHI
20191170093	MINEIROS	02610444	PARQUE DAS EMAS	09/11/2019 15:48	11/11/2019 16:15	09/11/2019 15:48	10/11/2019 02:48	11,01	14	154,08	CHI
20191170093	PEROLANDIA	02610444	PARQUE DAS EMAS	09/11/2019 15:48	11/11/2019 16:15	09/11/2019 15:48	10/11/2019 02:48	11,01	2	22,01	CHI
20191170093	PORTELANDIA	02610444	PARQUE DAS EMAS	09/11/2019 15:48	11/11/2019 16:15	09/11/2019 15:48	10/11/2019 02:48	11,01	5	55,03	CHI
20191170093	CAIAPONIA	PW13359437	PARQUE DAS EMAS	09/11/2019 15:48	11/11/2019 16:15	09/11/2019 16:11	10/11/2019 02:48	10,62	1	10,62	CHI
20191170093	DOVERLANDIA	PW13359437	PARQUE DAS EMAS	09/11/2019 15:48	11/11/2019 16:15	09/11/2019 16:11	10/11/2019 02:48	10,62	1	10,62	CHI
20191170093	MINEIROS	PW13359437	PARQUE DAS EMAS	09/11/2019 15:48	11/11/2019 16:15	09/11/2019 16:11	10/11/2019 02:48	10,62	2	21,25	CHI
20191170093	PEROLANDIA	PW13359437	PARQUE DAS EMAS	09/11/2019 15:48	11/11/2019 16:15	09/11/2019 16:11	10/11/2019 02:48	10,62	1	10,62	CHI
20191170093	PORTELANDIA	PW13359437	PARQUE DAS EMAS	09/11/2019 15:48	11/11/2019 16:15	09/11/2019 16:11	10/11/2019 02:48	10,62	2	21,25	CHI
20191170093	PORTELANDIA	02610444	PARQUE DAS EMAS	09/11/2019 15:48	11/11/2019 16:15	09/11/2019 15:48	10/11/2019 11:27	19,64	118	2317,55	CHI
20191170093	PORTELANDIA	PW13209698	PARQUE DAS EMAS	09/11/2019 15:48	11/11/2019 16:15	09/11/2019 16:11	10/11/2019 11:27	19,26	63	1213,31	CHI
20191170093	PORTELANDIA	PW13359437	PARQUE DAS EMAS	09/11/2019 15:48	11/11/2019 16:15	09/11/2019 16:11	10/11/2019 11:27	19,26	1	19,26	CHI
20191170093	PEROLANDIA	MY10396069	PARQUE DAS EMAS	09/11/2019 15:48	11/11/2019 16:15	10/11/2019 04:13	10/11/2019 11:36	7,39	7	51,73	CHI
20191170093	MINEIROS	MY13348945	PARQUE DAS EMAS	09/11/2019 15:48	11/11/2019 16:15	10/11/2019 04:13	10/11/2019 22:06	17,90	19	340,04	CHI
20191170093	PEROLANDIA	MY13348945	PARQUE DAS EMAS	09/11/2019 15:48	11/11/2019 16:15	10/11/2019 04:13	10/11/2019 22:06	17,90	12	214,76	CHI
20191170093	PORTELANDIA	MY13348945	PARQUE DAS EMAS	09/11/2019 15:48	11/11/2019 16:15	10/11/2019 04:13	10/11/2019 22:06	17,90	1	17,90	CHI
20191170093	PEROLANDIA	MY12348932	PARQUE DAS EMAS	09/11/2019 15:48	11/11/2019 16:15	10/11/2019 04:13	11/11/2019 08:34	28,37	2	56,73	CHI
20191170093	PEROLANDIA	MY12348932	PARQUE DAS EMAS	09/11/2019 15:48	11/11/2019 16:15	11/11/2019 09:22	11/11/2019 12:18	2,93	2	5,87	CHI
20191170093	PEROLANDIA	DP12306516	PARQUE DAS EMAS	09/11/2019 15:48	11/11/2019 16:15	10/11/2019 04:13	11/11/2019 13:38	33,43	1	33,43	CHI
20191170093	MINEIROS	MY13348931	PARQUE DAS EMAS	09/11/2019 15:48	11/11/2019 16:15	11/11/2019 14:23	11/11/2019 16:10	1,78	7	12,47	CHI
20191170093	PEROLANDIA	MY13348931	PARQUE DAS EMAS	09/11/2019 15:48	11/11/2019 16:15	11/11/2019 14:23	11/11/2019 16:10	1,78	3	5,34	CHI
20191170093	PEROLANDIA	MY21248371	PARQUE DAS EMAS	09/11/2019 15:48	11/11/2019 16:15	10/11/2019 04:13	11/11/2019 16:15	36,04	1	36,04	CHI
20191170098	DOVERLANDIA	DV12395475	CAIAPONIA	09/11/2019 15:50	09/11/2019 22:32	09/11/2019 15:50	09/11/2019 22:32	6,69	11	73,55	CHI
20191170102	EDEIA	EA21380549	EDEIA	09/11/2019 15:51	13/11/2019 21:49	09/11/2019 15:51	13/11/2019 21:49	101,96	1	101,96	CHI
20191170103	CAVALCANTE	CJ12308271	MINACU	09/11/2019 15:51	09/11/2019 18:59	09/11/2019 15:51	09/11/2019 18:59	3,13	2	6,25	CHI
20191170106	JARAGUA	70027973	JARAGUA	09/11/2019 15:51	09/11/2019 19:38	09/11/2019 15:51	09/11/2019 19:38	3,78	1	3,78	CHI
20191170116	NIQUELANDIA	NQ12181068	URUACU	09/11/2019 15:53	10/11/2019 05:08	09/11/2019 15:53	10/11/2019 05:08	13,25	102	1351,33	CHI
20191170118	NIQUELANDIA	NQ12280419	NIQUELANDIA SUBTRANSMISSAO	09/11/2019 15:53	09/11/2019 21:38	09/11/2019 15:53	09/11/2019 21:38	5,75	64	367,82	CHI
20191170143	GOIANIA	GN11205315	GOYA S1	09/11/2019 15:56	09/11/2019 21:30	09/11/2019 15:56	09/11/2019 21:30	5,57	107	595,46	CHI
20191170146	MINEIROS	MY10401436	PARQUE DAS EMAS	09/11/2019 15:55	10/11/2019 15:13	09/11/2019 21:08	10/11/2019 08:18	11,17	36	402,01	CHI
20191170146	MINEIROS	MY10401496	PARQUE DAS EMAS	09/11/2019 15:55	10/11/2019 15:13	09/11/2019 15:55	10/11/2019 11:28	19,56	1	19,56	CHI
20191170146	MINEIROS	MY10401496	PARQUE DAS EMAS	09/11/2019 15:55	10/11/2019 15:13	09/11/2019 15:55	10/11/2019 13:55	22,00	8	176,03	CHI
20191170146	MINEIROS	MY10401496	PARQUE DAS EMAS	09/11/2019 15:55	10/11/2019 15:13	09/11/2019 15:55	10/11/2019 15:13	23,30	13	302,89	CHI

20191170146	MINEIROS	MY13311787	PARQUE DAS EMAS	09/11/2019 15:55	10/11/2019 15:13	09/11/2019 15:55	10/11/2019 15:13	23,30	1	23,30	CHI
20191170154	APARECIDA DE GOIANIA	AP11079021	INDEPENDENCIA S1	09/11/2019 15:44	09/11/2019 17:18	09/11/2019 15:44	09/11/2019 17:18	1,56	83	129,30	CHI
20191170167	FAINA	2580000313	GOIAS	09/11/2019 15:58	11/11/2019 12:50	09/11/2019 15:58	11/11/2019 12:50	44,86	1	44,86	CHI
20191170172	NIQUELANDIA	NQ11243529	BARRO ALTO	09/11/2019 15:54	09/11/2019 19:30	09/11/2019 15:54	09/11/2019 19:30	3,60	126	453,35	CHI
20191170173	SILVANIA	SV11247202	VIANOPOLIS	09/11/2019 15:59	10/11/2019 10:01	09/11/2019 15:59	10/11/2019 10:01	18,03	2	36,06	CHI
20191170175	JATAI	JT11166029	JATAI S2	09/11/2019 15:27	09/11/2019 19:25	09/11/2019 15:27	09/11/2019 19:25	3,96	125	494,58	CHI
20191170177	QUIRINOPOLIS	QI12301490	QUIRINOPOLIS	09/11/2019 13:21	10/11/2019 10:25	09/11/2019 13:21	10/11/2019 10:25	21,06	8	168,48	CHI
20191170181	JANDAIA	PP10404111	PALMEIRAS	09/11/2019 15:52	09/11/2019 16:10	09/11/2019 15:52	09/11/2019 16:10	0,30	53	15,84	CHI
20191170181	PALMINOPOLIS	PP10404111	PALMEIRAS	09/11/2019 15:52	09/11/2019 16:10	09/11/2019 15:52	09/11/2019 16:10	0,30	161	48,12	CHI
20191170191	PORANGATU	PO12189564	PORANGATU	09/11/2019 16:00	10/11/2019 14:15	09/11/2019 16:00	10/11/2019 14:15	22,24	1	22,24	CHI
20191170193	APARECIDA DE GOIANIA	AP11193242	INDEPENDENCIA S2	09/11/2019 15:44	10/11/2019 02:01	09/11/2019 15:44	10/11/2019 02:01	10,28	180	1850,95	CHI
20191170210	SAO MIGUEL DO ARAGUAIA	SM12394084	SAO MIGUEL DO ARAGUAIA	09/11/2019 13:35	10/11/2019 10:31	09/11/2019 13:35	10/11/2019 10:31	20,92	13	272,00	CHI
20191170211	GOIAS	GS21259595	GOIAS	09/11/2019 16:01	10/11/2019 19:19	09/11/2019 16:01	10/11/2019 19:19	27,29	2	54,58	CHI
20191170218	TRINDADE	TR11000044	GOYA S1	09/11/2019 15:15	09/11/2019 18:46	09/11/2019 15:15	09/11/2019 18:46	3,51	91	319,18	CHI
20191170223	ITAPIRAPUA	RN10396175	BRITANIA	09/11/2019 15:06	11/11/2019 09:21	09/11/2019 15:06	09/11/2019 16:00	0,90	2	1,80	CHI
20191170223	SANTA FE DE GOIAS	RN10396175	BRITANIA	09/11/2019 15:06	11/11/2019 09:21	09/11/2019 15:06	09/11/2019 16:00	0,90	34	30,54	CHI
20191170223	SANTA FE DE GOIAS	RN10396175	BRITANIA	09/11/2019 15:06	11/11/2019 09:21	09/11/2019 16:06	10/11/2019 10:31	18,42	15	276,26	CHI
20191170223	SANTA FE DE GOIAS	RN12159290LD	BRITANIA	09/11/2019 15:06	11/11/2019 09:21	09/11/2019 16:06	10/11/2019 12:36	20,51	8	164,08	CHI
20191170223	ITAPIRAPUA	RN12298934LD	BRITANIA	09/11/2019 15:06	11/11/2019 09:21	09/11/2019 16:06	10/11/2019 16:26	24,33	2	48,67	CHI
20191170223	SANTA FE DE GOIAS	RN12298934LD	BRITANIA	09/11/2019 15:06	11/11/2019 09:21	09/11/2019 16:06	10/11/2019 16:26	24,33	6	146,00	CHI
20191170223	SANTA FE DE GOIAS	RN12346779	BRITANIA	09/11/2019 15:06	11/11/2019 09:21	09/11/2019 16:06	11/11/2019 09:21	41,26	5	206,31	CHI
20191170234	INACIOLANDIA	ID12088523	QUIRINOPOLIS	09/11/2019 15:32	09/11/2019 22:22	09/11/2019 15:32	09/11/2019 22:22	6,83	136	928,50	CHI
20191170235	CATURAI	CK21253096	INHUMAS S1	09/11/2019 16:04	10/11/2019 10:57	09/11/2019 16:04	10/11/2019 10:57	18,89	1	18,89	CHI
20191170239	APARECIDA DE GOIANIA	10025974570	INDEPENDENCIA S2	09/11/2019 16:04	09/11/2019 17:14	09/11/2019 16:04	09/11/2019 17:14	1,15	1	1,15	CHI
20191170246	BRITANIA	BT12210594	BRITANIA	09/11/2019 15:03	09/11/2019 20:30	09/11/2019 15:03	09/11/2019 20:30	5,44	61	332,04	CHI
20191170247	MINEIROS	MY11171859	PARQUE DAS EMAS	09/11/2019 16:06	09/11/2019 21:01	09/11/2019 16:06	09/11/2019 21:01	4,91	132	647,53	CHI
20191170248	CORUMBA DE GOIAS	CB21292222	ALEXANIA	09/11/2019 16:06	10/11/2019 12:11	09/11/2019 16:06	10/11/2019 12:11	20,07	1	20,07	CHI
20191170250	CRISTIANOPOLIS	CF21300741	CRISTIANOPOLIS	09/11/2019 16:06	09/11/2019 18:57	09/11/2019 16:06	09/11/2019 18:57	2,84	1	2,84	CHI
20191170253	PIRENOPOLIS	PV21273272	COCALZINHO	09/11/2019 16:07	09/11/2019 19:02	09/11/2019 16:07	09/11/2019 19:02	2,92	1	2,92	CHI
20191170258	GOIANIRA	GR12272387	MEIA PONTE	09/11/2019 16:07	09/11/2019 18:30	09/11/2019 16:07	09/11/2019 18:30	2,38	7	16,64	CHI
20191170259	INHUMAS	IX12016404	INHUMAS S1	09/11/2019 15:54	09/11/2019 18:48	09/11/2019 15:54	09/11/2019 18:48	2,89	1	2,89	CHI
20191170259	ITAUCU	IX12016404	INHUMAS S1	09/11/2019 15:54	09/11/2019 18:48	09/11/2019 15:54	09/11/2019 18:48	2,89	4	11,57	CHI
20191170260	JATAI	JT12306448	JATAI S1	09/11/2019 16:07	11/11/2019 12:55	09/11/2019 16:07	11/11/2019 12:55	44,79	16	716,60	CHI

20191170261	JATAI	JT11240376	JATAI S2	09/11/2019 23:00	10/11/2019 14:20	09/11/2019 23:00	10/11/2019 14:20	15,33	64	981,35	CHI
20191170264	GOIANESIA	550120786	GOIANESIA S2	09/11/2019 16:08	10/11/2019 18:22	09/11/2019 16:08	10/11/2019 18:22	26,22	1	26,22	CHI
20191170275	GOIANIA	GN11187581	FERROVIARIO S2	09/11/2019 15:19	09/11/2019 16:52	09/11/2019 15:19	09/11/2019 16:52	1,54	82	126,17	CHI
20191170282	IPORA	IR21172530	IPORA	09/11/2019 16:10	10/11/2019 21:00	09/11/2019 16:10	10/11/2019 21:00	28,84	1	28,84	CHI
20191170287	JARAGUA	JA11022751	JARAGUA	09/11/2019 15:21	09/11/2019 17:10	09/11/2019 15:21	09/11/2019 17:10	1,82	154	279,72	CHI
20191170295	CACHOEIRA DOURADA	00280314	CACHOEIRA DOURADA	09/11/2019 16:12	10/11/2019 17:11	10/11/2019 14:59	10/11/2019 17:10	2,18	78	170,26	CHI
20191170295	DISTRITO FEDERAL	00280314	CACHOEIRA DOURADA	09/11/2019 16:12	10/11/2019 17:11	10/11/2019 14:59	10/11/2019 17:10	2,18	1	2,18	CHI
20191170295	ITUMBIARA	00280314	CACHOEIRA DOURADA	09/11/2019 16:12	10/11/2019 17:11	10/11/2019 14:59	10/11/2019 17:10	2,18	6	13,10	CHI
20191170295	CACHOEIRA DOURADA	00280314	CACHOEIRA DOURADA	09/11/2019 16:12	10/11/2019 17:11	10/11/2019 14:59	10/11/2019 17:11	2,21	379	838,96	CHI
20191170295	ITUMBIARA	00280314	CACHOEIRA DOURADA	09/11/2019 16:12	10/11/2019 17:11	10/11/2019 14:59	10/11/2019 17:11	2,21	32	70,84	CHI
20191170297	ANICUNS	AC12035306	ANICUNS	09/11/2019 15:45	09/11/2019 18:49	09/11/2019 15:45	09/11/2019 18:49	3,06	20	61,21	CHI
20191170298	CAMPINACU	UC12285921	PORANGATU	09/11/2019 15:31	10/11/2019 08:05	09/11/2019 15:31	10/11/2019 08:05	16,56	39	645,70	CHI
20191170302	POSSE	PS21160025	IACIARA S2	09/11/2019 16:12	10/11/2019 01:31	09/11/2019 16:12	10/11/2019 01:31	9,30	1	9,30	CHI
20191170306	SANTA HELENA DE GOIAS	SH11056895	IPEGUARI	09/11/2019 16:07	11/11/2019 20:50	09/11/2019 16:07	11/11/2019 20:50	52,73	145	7645,13	CHI
20191170313	RIO VERDE	RV21271608	CABRIUVA S2	09/11/2019 16:14	10/11/2019 12:50	09/11/2019 16:14	10/11/2019 12:50	20,60	1	20,60	CHI
20191170317	GOIANIA	GN12057362	CARAJAS S1	09/11/2019 14:32	09/11/2019 18:00	09/11/2019 14:32	09/11/2019 18:00	3,47	45	156,14	CHI
20191170328	CATALAO	CT11316114	CATALAO S2	09/11/2019 16:12	09/11/2019 19:18	09/11/2019 16:12	09/11/2019 19:18	3,09	112	346,52	CHI
20191170334	GOIANESIA	550137610	GOIANESIA S2	09/11/2019 16:17	10/11/2019 13:18	09/11/2019 16:17	10/11/2019 13:18	21,01	1	21,01	CHI
20191170338	ITARUMA	IM21239564	ITAJA S2	09/11/2019 16:18	10/11/2019 17:57	09/11/2019 16:18	10/11/2019 17:57	25,65	1	25,65	CHI
20191170340	TRES RANCHOS	10012235855	CATALAO S1	09/11/2019 16:18	09/11/2019 22:31	09/11/2019 16:18	09/11/2019 22:31	6,22	1	6,22	CHI
20191170353	SAO MIGUEL DO ARAGUAIA	SM12192361	SAO MIGUEL DO ARAGUAIA	09/11/2019 13:21	10/11/2019 08:15	09/11/2019 13:21	10/11/2019 08:15	18,90	167	3156,25	CHI
20191170357	COLINAS DO SUL	TI21288517	MINACU	09/11/2019 16:20	10/11/2019 09:31	09/11/2019 16:20	10/11/2019 09:31	17,18	1	17,18	CHI
20191170359	GOIANESIA	GE12384154	GOIANESIA S2	09/11/2019 16:14	10/11/2019 13:10	09/11/2019 16:14	10/11/2019 13:10	20,92	3	62,77	CHI
20191170360	BONFINOPOLIS	BO12200295	GOIANIA LESTE S2	09/11/2019 16:19	09/11/2019 18:57	09/11/2019 16:19	09/11/2019 18:57	2,62	13	34,06	CHI
20191170360	SENADOR CANEDO	BO12200295	GOIANIA LESTE S2	09/11/2019 16:19	09/11/2019 18:57	09/11/2019 16:19	09/11/2019 18:57	2,62	31	81,23	CHI
20191170371	BOM JESUS DE GOIAS	IT12034458RE	CACHOEIRA DOURADA	09/11/2019 14:10	09/11/2019 19:08	09/11/2019 14:10	09/11/2019 19:08	4,95	3	14,86	CHI
20191170371	ITUMBIARA	IT12034458RE	CACHOEIRA DOURADA	09/11/2019 14:10	09/11/2019 19:08	09/11/2019 14:10	09/11/2019 19:08	4,95	63	312,04	CHI
20191170371	PANAMA	IT12034458RE	CACHOEIRA DOURADA	09/11/2019 14:10	09/11/2019 19:08	09/11/2019 14:10	09/11/2019 19:08	4,95	13	64,39	CHI
20191170374	NIQUELANDIA	NQ12035673	NIQUELANDIA SUBTRANSMISSAO	09/11/2019 16:02	09/11/2019 18:56	09/11/2019 16:02	09/11/2019 18:56	2,89	413	1193,46	CHI
20191170377	MONTES CLAROS DE GOIAS	ME21152618	IPORA	09/11/2019 16:22	10/11/2019 14:57	09/11/2019 16:22	10/11/2019 14:57	22,57	1	22,57	CHI
20191170397	MINACU	IH12052624	MINACU	09/11/2019 16:12	09/11/2019 19:49	09/11/2019 16:12	09/11/2019 19:49	3,61	16	57,71	CHI
20191170407	PALMEIRAS DE GOIAS	PL12000065	PALMEIRAS	09/11/2019 16:25	11/11/2019 20:07	09/11/2019 16:25	11/11/2019 20:07	51,70	9	465,29	CHI
20191170409	SANTA HELENA DE GOIAS	EU12026829	RIO DOS BOIS	09/11/2019 15:09	10/11/2019 14:59	09/11/2019 15:09	10/11/2019 14:59	23,82	18	428,73	CHI



20191170409	TURVELANDIA	EU12026829	RIO DOS BOIS	09/11/2019 15:09	10/11/2019 14:59	09/11/2019 15:09	10/11/2019 14:59	23,82	17	404,91	CHI
20191170415	DOVERLANDIA	DV12207962	CAIAPONIA	09/11/2019 16:27	13/11/2019 15:28	09/11/2019 16:27	13/11/2019 15:28	95,02	7	665,12	CHI
20191170419	GOIATUBA	7603089	RIO DOS BOIS	09/11/2019 16:27	11/11/2019 19:41	09/11/2019 16:27	11/11/2019 19:41	51,24	9	461,13	CHI
20191170421	INACIOLANDIA	ID12304325	CACHOEIRA DOURADA	09/11/2019 16:27	10/11/2019 18:40	09/11/2019 16:27	10/11/2019 18:40	26,20	6	157,22	CHI
20191170423	BOM JESUS DE GOIAS	ID12128250	QUIRINOPOLIS	09/11/2019 15:11	10/11/2019 12:02	09/11/2019 15:11	10/11/2019 12:02	20,85	69	1438,92	CHI
20191170423	INACIOLANDIA	ID12128250	QUIRINOPOLIS	09/11/2019 15:11	10/11/2019 12:02	09/11/2019 15:11	10/11/2019 12:02	20,85	9	187,69	CHI
20191170426	MINACU	TB12256991	PORANGATU	09/11/2019 15:36	10/11/2019 08:21	09/11/2019 15:36	10/11/2019 08:21	16,75	12	200,96	CHI
20191170426	TROMBAS	TB12256991	PORANGATU	09/11/2019 15:36	10/11/2019 08:21	09/11/2019 15:36	10/11/2019 08:21	16,75	22	368,42	CHI
20191170433	AURILANDIA	AI12000011	FIRMINOPOLIS S2	09/11/2019 16:23	09/11/2019 20:15	09/11/2019 16:23	09/11/2019 20:15	3,86	23	88,76	CHI
20191170433	FIRMINOPOLIS	AI12000011	FIRMINOPOLIS S2	09/11/2019 16:23	09/11/2019 20:15	09/11/2019 16:23	09/11/2019 20:15	3,86	58	223,83	CHI
20191170433	SAO JOAO DA PARAUNA	AI12000011	FIRMINOPOLIS S2	09/11/2019 16:23	09/11/2019 20:15	09/11/2019 16:23	09/11/2019 20:15	3,86	27	104,20	CHI
20191170435	APARECIDA DE GOIANIA	14717712	ATLANTICO S1	09/11/2019 16:29	09/11/2019 17:57	09/11/2019 16:29	09/11/2019 17:57	1,46	1	1,46	CHI
20191170442	JATAI	290243841	JATAI S3	09/11/2019 16:30	11/11/2019 09:45	09/11/2019 16:30	11/11/2019 09:45	41,24	1	41,24	CHI
20191170455	JUSSARA	BT12396220	BRITANIA	09/11/2019 16:31	10/11/2019 16:31	09/11/2019 16:31	10/11/2019 16:31	23,99	3	71,96	CHI
20191170460	CATALAO	CT10400805	CATALAO S2	09/11/2019 16:31	10/11/2019 10:45	09/11/2019 19:46	09/11/2019 19:55	0,14	1640	230,51	CHI
20191170460	CATALAO	CT13400844	CATALAO S2	09/11/2019 16:31	10/11/2019 10:45	09/11/2019 16:31	10/11/2019 10:45	18,22	80	1457,76	CHI
20191170460	CUMARI	CT13400844	CATALAO S2	09/11/2019 16:31	10/11/2019 10:45	09/11/2019 16:31	10/11/2019 10:45	18,22	50	911,10	CHI
20191170462	MONTIVIDIU	MV12010585	MONTIVIDIU T	09/11/2019 16:32	10/11/2019 01:48	09/11/2019 16:32	10/11/2019 01:48	9,27	26	240,93	CHI
20191170462	RIO VERDE	MV12010585	MONTIVIDIU T	09/11/2019 16:32	10/11/2019 01:48	09/11/2019 16:32	10/11/2019 01:48	9,27	20	185,33	CHI
20191170475	NIQUELANDIA	NQ12398045	URUACU	09/11/2019 16:33	10/11/2019 20:03	09/11/2019 16:33	10/11/2019 20:03	27,48	11	302,33	CHI
20191170489	INHUMAS	IN21358079	GOIANIRA	09/11/2019 16:34	09/11/2019 22:40	09/11/2019 16:34	09/11/2019 22:40	6,09	1	6,09	CHI
20191170494	JARAGUA	JA11205770	JARAGUA	09/11/2019 15:49	09/11/2019 17:44	09/11/2019 15:49	09/11/2019 17:44	1,91	51	97,57	CHI
20191170496	MONTIVIDIU DO NORTE	MX21156609	PORANGATU	09/11/2019 16:35	11/11/2019 12:46	09/11/2019 16:35	11/11/2019 12:46	44,17	1	44,17	CHI
20191170497	GOIANIA	10030348887	FERROVIARIO S1	09/11/2019 16:35	09/11/2019 18:41	09/11/2019 16:35	09/11/2019 18:41	2,09	1	2,09	CHI
20191170499	GOIANIA	17030651	MEIA PONTE	09/11/2019 16:36	10/11/2019 10:31	09/11/2019 16:36	10/11/2019 10:31	17,92	1	17,92	CHI
20191170507	JATAI	JT11394885	JATAI S3	09/11/2019 15:13	10/11/2019 01:23	09/11/2019 15:13	10/11/2019 01:23	10,17	69	701,46	CHI
20191170510	CORUMBAIBA	CI12000093RE	VILA CORUMBA	09/11/2019 15:37	09/11/2019 23:22	09/11/2019 15:37	09/11/2019 23:22	7,74	142	1099,04	CHI
20191170512	INACIOLANDIA	ID12094301	QUIRINOPOLIS	09/11/2019 16:37	11/11/2019 17:10	09/11/2019 16:37	11/11/2019 17:10	48,55	1	48,55	CHI
20191170513	URUACU	10027935580	URUACU	09/11/2019 16:37	11/11/2019 05:04	09/11/2019 16:37	11/11/2019 05:04	36,45	1	36,45	CHI
20191170520	ITAPACI	IW12201725	ITAPACI	09/11/2019 14:28	09/11/2019 18:41	09/11/2019 14:28	09/11/2019 18:41	4,21	663	2793,81	CHI
20191170523	MONTES CLAROS DE GOIAS	ME12193447	IPORA	09/11/2019 16:03	11/11/2019 13:58	09/11/2019 16:03	11/11/2019 13:58	45,91	4	183,65	CHI
20191170530	GOIANIA	GN12001784	GOYA S1	09/11/2019 15:15	09/11/2019 18:07	09/11/2019 15:15	09/11/2019 18:07	2,85	148	422,25	CHI
20191170531	IVOLANDIA	10024602955	IPORA	09/11/2019 16:39	11/11/2019 15:36	09/11/2019 16:39	11/11/2019 15:36	46,95	1	46,95	CHI

20191170540	CORUMBAIBA	CI21234698	CATALAO S1	09/11/2019 16:40	14/11/2019 11:48	09/11/2019 16:40	14/11/2019 11:48	115,13	1	115,13	CHI
20191170541	SAO JOAO D ALIANCA	3840005356	SAO JOAO D ALIANCA	09/11/2019 16:40	09/11/2019 18:25	09/11/2019 16:40	09/11/2019 18:25	1,75	1	1,75	CHI
20191170557	NIQUELANDIA	NQ12035683	URUACU	09/11/2019 16:42	10/11/2019 06:18	09/11/2019 16:42	10/11/2019 06:18	13,60	4	54,39	CHI
20191170563	MINEIROS	MY11066493	PARQUE DAS EMAS	09/11/2019 16:14	10/11/2019 03:51	09/11/2019 16:14	10/11/2019 03:51	11,60	172	1995,58	CHI
20191170568	CATALAO	CT12042362	CATALAO S1	09/11/2019 16:29	09/11/2019 20:58	09/11/2019 16:29	09/11/2019 20:58	4,48	1	4,48	CHI
20191170568	GOIANDIRA	CT12042362	CATALAO S1	09/11/2019 16:29	09/11/2019 20:58	09/11/2019 16:29	09/11/2019 20:58	4,48	1	4,48	CHI
20191170570	ABADIA DE GOIAS	LG11362814	INDEPENDENCIA S2	09/11/2019 16:43	10/11/2019 02:46	09/11/2019 16:43	10/11/2019 02:46	10,04	43	431,56	CHI
20191170571	GOIANESIA	550038164	GOIANESIA S2	09/11/2019 16:43	10/11/2019 13:01	09/11/2019 16:43	10/11/2019 13:01	20,29	1	20,29	CHI
20191170578	SANTA HELENA DE GOIAS	SH11038398	IPEGUARI	09/11/2019 15:51	10/11/2019 16:45	09/11/2019 15:51	10/11/2019 16:45	24,89	96	2389,73	CHI
20191170581	GOIATUBA	JV12000004RE	BOM JESUS DE GOIAS	09/11/2019 15:38	09/11/2019 18:35	09/11/2019 15:38	09/11/2019 18:35	2,94	107	314,85	CHI
20191170581	GOIATUBA	JV12000004RE	BOM JESUS DE GOIAS	09/11/2019 15:38	09/11/2019 18:35	09/11/2019 15:38	09/11/2019 18:35	2,94	77	226,57	CHI
20191170581	GOIATUBA	JV12000004RE	GOIATUBA S1	09/11/2019 15:38	09/11/2019 18:35	09/11/2019 15:38	09/11/2019 18:35	2,94	11	32,37	CHI
20191170581	JOVIANIA	JV12000004RE	GOIATUBA S1	09/11/2019 15:38	09/11/2019 18:35	09/11/2019 15:38	09/11/2019 18:35	2,94	19	55,91	CHI
20191170589	NIQUELANDIA	NQ21274799	BARRO ALTO	09/11/2019 16:46	13/11/2019 10:37	09/11/2019 16:46	13/11/2019 10:37	89,84	1	89,84	CHI
20191170590	COLINAS DO SUL	TI11197667	NIQUELANDIA SUBTRANSMISSAO	09/11/2019 16:47	09/11/2019 21:53	09/11/2019 16:47	09/11/2019 21:53	5,10	144	734,72	CHI
20191170598	TEREZOPOLIS DE GOIAS	TJ21328276	DAIA S2	09/11/2019 16:48	09/11/2019 18:30	09/11/2019 16:48	09/11/2019 18:30	1,70	1	1,70	CHI
20191170601	GOIANESIA	GE16404338	GOIANESIA S2	09/11/2019 17:57	10/11/2019 01:58	09/11/2019 17:57	09/11/2019 18:01	0,08	1804	142,82	CHI
20191170601	GOIANESIA	00560224	GOIANESIA S2	09/11/2019 17:57	10/11/2019 01:58	09/11/2019 18:32	09/11/2019 19:14	0,70	10039	7049,61	CHI
20191170601	SANTA ISABEL	00560224	GOIANESIA S2	09/11/2019 17:57	10/11/2019 01:58	09/11/2019 18:32	09/11/2019 19:14	0,70	1	0,70	CHI
20191170601	GOIANESIA	GE16404355	GOIANESIA S2	09/11/2019 17:57	10/11/2019 01:58	09/11/2019 18:32	09/11/2019 19:18	0,77	1	0,77	CHI
20191170601	GOIANESIA	00560224	GOIANESIA S2	09/11/2019 17:57	10/11/2019 01:58	09/11/2019 19:20	09/11/2019 20:05	0,74	4166	3075,90	CHI
20191170601	GOIANESIA	00560224	GOIANESIA S2	09/11/2019 17:57	10/11/2019 01:58	09/11/2019 19:20	09/11/2019 20:05	0,74	1	0,74	CHI
20191170601	GOIANESIA	GE11258981	GOIANESIA S2	09/11/2019 17:57	10/11/2019 01:58	09/11/2019 18:32	09/11/2019 23:28	4,94	74	365,40	CHI
20191170601	GOIANESIA	GE13140633	GOIANESIA S2	09/11/2019 17:57	10/11/2019 01:58	09/11/2019 18:32	09/11/2019 23:40	5,12	3293	16874,80	CHI
20191170601	GOIANESIA	GE13382802	GOIANESIA S2	09/11/2019 17:57	10/11/2019 01:58	09/11/2019 19:20	09/11/2019 23:56	4,59	4120	18911,94	CHI
20191170601	GOIANESIA	GE13339508	GOIANESIA S2	09/11/2019 17:57	10/11/2019 01:58	09/11/2019 19:20	10/11/2019 01:03	5,71	182	1038,41	CHI
20191170601	GOIANESIA	GE10396194	GOIANESIA S2	09/11/2019 17:57	10/11/2019 01:58	09/11/2019 19:20	10/11/2019 01:04	5,72	152	869,69	CHI
20191170601	SANTA ISABEL	GE10396194	GOIANESIA S2	09/11/2019 17:57	10/11/2019 01:58	09/11/2019 19:20	10/11/2019 01:04	5,72	1	5,72	CHI
20191170601	GOIANESIA	GE13000012	GOIANESIA S2	09/11/2019 17:57	10/11/2019 01:58	10/11/2019 00:32	10/11/2019 01:46	1,22	1798	2199,05	CHI
20191170601	GOIANESIA	GE13000014	GOIANESIA S2	09/11/2019 17:57	10/11/2019 01:58	09/11/2019 19:20	10/11/2019 01:58	6,64	1597	10596,54	CHI
20191170603	SANTA HELENA DE GOIAS	SH12123237LD	IPEGUARI	09/11/2019 15:42	10/11/2019 21:56	09/11/2019 15:42	10/11/2019 21:56	30,23	926	27994,01	CHI
20191170603	SANTA HELENA DE GOIAS	SH12123237LD	IPEGUARI	09/11/2019 15:42	10/11/2019 21:56	10/11/2019 20:12	10/11/2019 21:56	1,73	354	613,99	CHI
20191170605	MINACU	IH12341446	MINACU	09/11/2019 16:49	09/11/2019 21:32	09/11/2019 16:49	09/11/2019 21:32	4,71	36	169,66	CHI

20191170610	MINEIROS	MY12034906	PARQUE DAS EMAS	09/11/2019 16:49	10/11/2019 22:22	09/11/2019 16:49	10/11/2019 22:22	29,54	3	88,61	CHI
20191170615	JANDAIA	PU12205943	PARAUNA	09/11/2019 16:50	10/11/2019 10:00	09/11/2019 16:50	10/11/2019 10:00	17,15	3	51,46	CHI
20191170615	PARAUNA	PU12205943	PARAUNA	09/11/2019 16:50	10/11/2019 10:00	09/11/2019 16:50	10/11/2019 10:00	17,15	27	463,10	CHI
20191170616	JATAI	JT11172261	JATAI S3	09/11/2019 16:05	10/11/2019 09:39	09/11/2019 16:05	10/11/2019 09:39	17,55	93	1632,38	CHI
20191170617	PALMINOPOLIS	PP12307045	PALMEIRAS	09/11/2019 16:51	11/11/2019 09:32	09/11/2019 16:51	11/11/2019 09:32	40,68	4	162,73	CHI
20191170630	LUZIANIA	LZ21086768	VIANOPOLIS	09/11/2019 16:53	10/11/2019 08:22	09/11/2019 16:53	10/11/2019 08:22	15,47	2	30,95	CHI
20191170631	PIRANHAS	PH11052932	PIRANHAS	09/11/2019 16:21	09/11/2019 22:29	09/11/2019 16:21	09/11/2019 22:29	6,13	172	1053,69	CHI
20191170633	JATAI	JT12313252	JATAI S3	09/11/2019 16:23	10/11/2019 11:13	09/11/2019 16:23	10/11/2019 11:13	18,82	77	1449,38	CHI
20191170634	MINEIROS	MY11064635	PARQUE DAS EMAS	09/11/2019 16:40	10/11/2019 20:15	09/11/2019 16:40	10/11/2019 20:15	27,58	162	4468,32	CHI
20191170640	PIRANHAS	PH11188482	PIRANHAS	09/11/2019 16:09	09/11/2019 20:09	09/11/2019 16:09	09/11/2019 20:09	4,00	80	319,71	CHI
20191170647	NIQUELANDIA	NQ12197552	NIQUELANDIA SUBTRANSMISSAO	09/11/2019 16:13	10/11/2019 14:12	09/11/2019 16:13	10/11/2019 14:12	22,00	39	857,91	CHI
20191170658	NOVA CRIXAS	NA12096364	NOVA CRIXAS	09/11/2019 14:36	11/11/2019 02:31	09/11/2019 14:36	11/11/2019 02:31	35,91	5	179,54	CHI
20191170662	INDIARA	IY21198113	EDEIA	09/11/2019 16:57	10/11/2019 10:55	09/11/2019 16:57	10/11/2019 10:55	17,97	2	35,94	CHI
20191170664	NOVA CRIXAS	NA21328116	NOVA CRIXAS	09/11/2019 16:57	11/11/2019 18:35	09/11/2019 16:57	11/11/2019 18:35	49,64	1	49,64	CHI
20191170672	JATAI	JT21359292	JATAI S1	09/11/2019 16:59	11/11/2019 14:45	09/11/2019 16:59	11/11/2019 14:45	45,76	1	45,76	CHI
20191170675	URUACU	UR12065508	URUACU	09/11/2019 16:59	10/11/2019 03:52	09/11/2019 16:59	10/11/2019 03:52	10,88	109	1185,38	CHI
20191170676	NIQUELANDIA	NQ12095916	URUACU	09/11/2019 16:59	11/11/2019 11:23	09/11/2019 16:59	11/11/2019 11:23	42,40	2	84,80	CHI
20191170684	GOIANESIA	550170273	GOIANESIA S2	09/11/2019 17:01	10/11/2019 16:47	09/11/2019 17:01	10/11/2019 16:47	23,76	1	23,76	CHI
20191170686	URUACU	UR21128431	URUACU	09/11/2019 17:01	10/11/2019 13:45	09/11/2019 17:01	10/11/2019 13:45	20,73	1	20,73	CHI
20191170694	INHUMAS	IN11365566	INHUMAS S2	09/11/2019 15:36	09/11/2019 18:00	09/11/2019 15:36	09/11/2019 18:00	2,39	49	116,92	CHI
20191170698	MINEIROS	MY11095199	PARQUE DAS EMAS	09/11/2019 16:29	10/11/2019 02:25	09/11/2019 16:29	10/11/2019 02:25	9,92	194	1924,80	CHI
20191170717	QUIRINOPOLIS	QI12119879	QUIRINOPOLIS	09/11/2019 17:06	10/11/2019 15:02	09/11/2019 17:06	10/11/2019 15:02	21,93	21	460,54	CHI
20191170803	RUBIATABA	RB11284698	RUBIATABA	09/11/2019 15:23	09/11/2019 18:33	09/11/2019 15:23	09/11/2019 18:33	3,16	183	578,13	CHI
20191170806	GOIAS	GS12021591	GOIAS	09/11/2019 17:07	11/11/2019 16:38	09/11/2019 17:07	11/11/2019 16:38	47,53	6	285,15	CHI
20191170809	NOVA GLORIA	NG12328831	ITAPACI	09/11/2019 17:07	11/11/2019 10:11	09/11/2019 17:07	11/11/2019 10:11	41,07	4	164,26	CHI
20191170810	DOVERLANDIA	DV21215754	CAIAPONIA	09/11/2019 17:07	14/11/2019 11:49	09/11/2019 17:07	14/11/2019 11:49	114,69	1	114,69	CHI
20191170813	CATALAO	CT12130954	CATALAO S2	09/11/2019 16:33	09/11/2019 19:11	09/11/2019 16:33	09/11/2019 19:11	2,63	238	624,95	CHI
20191170814	INACIOLANDIA	ID31128263	QUIRINOPOLIS	09/11/2019 17:08	10/11/2019 15:13	09/11/2019 17:08	10/11/2019 15:13	22,08	1	22,08	CHI
20191170819	NOVA VENEZA	NV11293785	INHUMAS S1	09/11/2019 17:08	09/11/2019 19:32	09/11/2019 17:08	09/11/2019 19:32	2,39	81	193,59	CHI
20191170831	RIO VERDE	RV12303286	CABRIUVA S2	09/11/2019 17:09	11/11/2019 08:58	09/11/2019 17:09	11/11/2019 08:58	39,81	7	278,66	CHI
20191170833	PLANALTINA	PI21218328	PLANALTINA	09/11/2019 17:09	10/11/2019 16:37	09/11/2019 17:09	10/11/2019 16:37	23,45	1	23,45	CHI
20191170839	JATAI	JT11264287	JATAI S2	09/11/2019 16:53	09/11/2019 19:21	09/11/2019 16:53	09/11/2019 19:21	2,46	70	172,12	CHI
20191170850	PIRENOPOLIS	PV21370307	CORUMBA	09/11/2019 17:11	10/11/2019 17:45	09/11/2019 17:11	10/11/2019 17:45	24,55	1	24,55	CHI

20191170853	NIQUELANDIA	NQ12325258	SAO JOAO D ALIANCA	09/11/2019 17:11	11/11/2019 18:21	09/11/2019 17:11	11/11/2019 18:21	49,15	3	147,45	CHI
20191170859	MINACU	IH12230473	MINACU	09/11/2019 17:12	09/11/2019 22:40	09/11/2019 17:12	09/11/2019 22:40	5,46	7	38,22	CHI
20191170864	BARRO ALTO	BA12382469	BARRO ALTO	09/11/2019 16:32	09/11/2019 21:00	09/11/2019 16:32	09/11/2019 21:00	4,46	8	35,70	CHI
20191170866	MOZARLANDIA	MZ21373991	MOZARLANDIA	09/11/2019 17:13	10/11/2019 20:19	09/11/2019 17:13	10/11/2019 20:19	27,10	2	54,20	CHI
20191170872	NIQUELANDIA	NQ12094111	NIQUELANDIA SUBTRANSMISSAO	09/11/2019 15:15	09/11/2019 22:40	09/11/2019 15:15	09/11/2019 22:40	7,40	88	651,47	CHI
20191170875	PALMELO	450006979	PIRES DO RIO S2	09/11/2019 17:14	10/11/2019 09:30	09/11/2019 17:14	10/11/2019 09:30	16,28	1	16,28	CHI
20191170878	JATAI	JT21209737	JATAI S1	09/11/2019 17:14	10/11/2019 18:01	09/11/2019 17:14	10/11/2019 18:01	24,78	1	24,78	CHI
20191170883	INACIOLANDIA	ID21128180	QUIRINOPOLIS	09/11/2019 17:14	10/11/2019 17:04	09/11/2019 17:14	10/11/2019 17:04	23,82	2	47,64	CHI
20191170888	GOIANIA	15997911	XAVANTES	09/11/2019 17:15	09/11/2019 18:38	09/11/2019 17:15	09/11/2019 18:38	1,38	1	1,38	CHI
20191170896	PARAUNA	PU21348606	PARAUNA	09/11/2019 17:16	10/11/2019 13:35	09/11/2019 17:16	10/11/2019 13:35	20,31	1	20,31	CHI
20191170897	GOIANESIA	550077625	GOIANESIA S2	09/11/2019 17:16	10/11/2019 17:53	09/11/2019 17:16	10/11/2019 17:53	24,60	1	24,60	CHI
20191170898	NOVO BRASIL	NB12091822	JUSSARA	09/11/2019 17:17	10/11/2019 20:40	09/11/2019 17:17	10/11/2019 20:40	27,38	2	54,76	CHI
20191170902	SENADOR CANEDO	13650555	GOIANIA LESTE S2	09/11/2019 16:44	09/11/2019 19:33	09/11/2019 16:44	09/11/2019 19:33	2,81	1	2,81	CHI
20191170909	IPAMERI	IP21319002	IPAMERI	09/11/2019 13:25	09/11/2019 20:51	09/11/2019 13:25	09/11/2019 20:51	7,43	1	7,43	CHI
20191170926	PARAUNA	PU12301185LD	ACREUNA	09/11/2019 20:26	10/11/2019 13:21	09/11/2019 20:29	10/11/2019 11:10	14,68	1	14,68	CHI
20191170926	PARAUNA	PU12194221	ACREUNA	09/11/2019 20:26	10/11/2019 13:21	09/11/2019 20:26	10/11/2019 11:42	15,28	37	565,19	CHI
20191170926	PARAUNA	PU12194221	ACREUNA	09/11/2019 20:26	10/11/2019 13:21	10/11/2019 11:43	10/11/2019 11:46	0,06	37	2,23	CHI
20191170926	PARAUNA	PU12044570	ACREUNA	09/11/2019 20:26	10/11/2019 13:21	09/11/2019 20:29	10/11/2019 12:52	16,39	24	393,29	CHI
20191170926	PARAUNA	PU12295907	ACREUNA	09/11/2019 20:26	10/11/2019 13:21	09/11/2019 20:29	10/11/2019 13:21	16,87	5	84,34	CHI
20191171002	MINACU	IH12396740	MINACU	09/11/2019 17:13	10/11/2019 20:15	09/11/2019 17:13	09/11/2019 17:17	0,06	75	4,42	CHI
20191171002	MINACU	IH12396740	MINACU	09/11/2019 17:13	10/11/2019 20:15	10/11/2019 10:13	10/11/2019 11:49	1,60	159	254,31	CHI
20191171002	MINACU	IH12396740	MINACU	09/11/2019 17:13	10/11/2019 20:15	10/11/2019 11:55	10/11/2019 14:11	2,28	81	184,66	CHI
20191171002	MINACU	IH12348007	MINACU	09/11/2019 17:13	10/11/2019 20:15	10/11/2019 10:13	10/11/2019 15:17	5,07	25	126,76	CHI
20191171002	MINACU	IH13192307	MINACU	09/11/2019 17:13	10/11/2019 20:15	10/11/2019 11:55	10/11/2019 19:39	7,75	73	565,49	CHI
20191171002	MINACU	IH12320901	MINACU	09/11/2019 17:13	10/11/2019 20:15	10/11/2019 11:55	10/11/2019 20:15	8,35	5	41,73	CHI
20191171005	MONTIVIDIU	10011723856	MONTIVIDIU T	09/11/2019 17:17	10/11/2019 19:15	09/11/2019 17:17	10/11/2019 19:15	25,95	1	25,95	CHI
20191171010	INACIOLANDIA	ID11075622	QUIRINOPOLIS	09/11/2019 15:47	10/11/2019 08:54	09/11/2019 15:47	10/11/2019 08:54	17,11	89	1522,57	CHI
20191171013	JATAI	JT12182190	JATAI S1	09/11/2019 17:18	10/11/2019 11:32	09/11/2019 17:18	10/11/2019 11:32	18,23	25	455,64	CHI
20191171016	TRINDADE	TR12393432	GOIANIRA	09/11/2019 17:18	10/11/2019 14:58	09/11/2019 17:18	10/11/2019 14:58	21,65	3	64,96	CHI
20191171029	INDIARA	IY21093803	EDEIA	09/11/2019 17:20	10/11/2019 11:22	09/11/2019 17:20	10/11/2019 11:22	18,04	1	18,04	CHI
20191171033	PIRANHAS	PH11188473	PIRANHAS	09/11/2019 17:10	09/11/2019 20:52	09/11/2019 17:10	09/11/2019 20:52	3,68	126	464,20	CHI
20191171037	SANTA HELENA DE GOIAS	SH12271583	IPEGUARI	09/11/2019 15:25	10/11/2019 19:00	09/11/2019 15:25	10/11/2019 19:00	27,58	16	441,32	CHI
20191171038	NEROPOLIS	NR21000051	NEROPOLIS S2	09/11/2019 17:22	10/11/2019 00:22	09/11/2019 17:22	10/11/2019 00:22	7,00	1	7,00	CHI

20191171047	PARAUNA	PU12205936	PARAUNA	09/11/2019 17:23	10/11/2019 20:10	09/11/2019 17:23	10/11/2019 20:10	26,78	5	133,88	CHI
20191171054	PIRANHAS	PH12201811RE	PIRANHAS	09/11/2019 17:28	09/11/2019 18:57	09/11/2019 17:28	09/11/2019 18:57	1,47	51	75,18	CHI
20191171055	GOIANIA	10582629	ATLANTICO S2	09/11/2019 17:23	09/11/2019 19:03	09/11/2019 17:23	09/11/2019 19:03	1,65	1	1,65	CHI
20191171065	SANTO ANTONIO DE GOIAS	BW11158026	NEROPOLIS S1	09/11/2019 16:27	09/11/2019 20:35	09/11/2019 16:27	09/11/2019 20:35	4,12	24	98,97	CHI
20191171072	JATAI	JT11104542	JATAI S3	09/11/2019 15:25	10/11/2019 08:22	09/11/2019 15:25	10/11/2019 08:22	16,95	173	2931,53	CHI
20191171073	SANTA RITA DO ARAGUAIA	SU21184228	SANTA RITA DO ARAGUAIA	09/11/2019 17:25	09/11/2019 19:44	09/11/2019 17:25	09/11/2019 19:44	2,31	2	4,61	CHI
20191171075	PEROLANDIA	JT21142780	JATAI S1	09/11/2019 17:25	10/11/2019 18:20	09/11/2019 17:25	10/11/2019 18:20	24,90	1	24,90	CHI
20191171081	VICENTINOPOLIS	VI21028507	VICENTINOPOLIS	09/11/2019 17:26	14/11/2019 14:01	09/11/2019 17:26	14/11/2019 14:01	116,58	1	116,58	CHI
20191171091	APARECIDA DE GOIANIA	10025974570	INDEPENDENCIA S2	09/11/2019 17:27	09/11/2019 18:20	09/11/2019 17:27	09/11/2019 18:20	0,87	1	0,87	CHI
20191171092	LEOPOLDO DE BULHOES	LB21072591	DAIA S2	09/11/2019 17:27	10/11/2019 13:23	09/11/2019 17:27	10/11/2019 13:23	19,92	1	19,92	CHI
20191171102	MUTUNOPOLIS	MU11057915	MARA ROSA	09/11/2019 16:43	10/11/2019 14:18	09/11/2019 16:43	10/11/2019 14:18	21,57	80	1725,47	CHI
20191171109	NIQUELANDIA	NQ12232332	NIQUELANDIA SUBTRANSMISSAO	09/11/2019 17:29	10/11/2019 07:37	09/11/2019 17:29	10/11/2019 07:37	14,13	80	1130,49	CHI
20191171114	APARECIDA DO RIO DOCE	CC10394754	CACHOEIRA ALTA	09/11/2019 17:27	09/11/2019 18:46	09/11/2019 17:27	09/11/2019 18:45	1,29	10	12,93	CHI
20191171114	CACU	CC10394754	CACHOEIRA ALTA	09/11/2019 17:27	09/11/2019 18:46	09/11/2019 17:27	09/11/2019 18:45	1,29	160	206,89	CHI
20191171114	CACU	CC10400449	CACHOEIRA ALTA	09/11/2019 17:27	09/11/2019 18:46	09/11/2019 17:27	09/11/2019 18:46	1,32	118	155,37	CHI
20191171114	JATAI	CC10400449	CACHOEIRA ALTA	09/11/2019 17:27	09/11/2019 18:46	09/11/2019 17:27	09/11/2019 18:46	1,32	11	14,48	CHI
20191171114	QUIRINOPOLIS	CC10400449	CACHOEIRA ALTA	09/11/2019 17:27	09/11/2019 18:46	09/11/2019 17:27	09/11/2019 18:46	1,32	1	1,32	CHI
20191171122	RIO VERDE	RV12051746	MONTIVIDIU T	09/11/2019 14:41	10/11/2019 14:42	09/11/2019 14:41	10/11/2019 14:42	24,01	76	1824,91	CHI
20191171125	HIDROLANDIA	HD12000305	CEPAIGO S2	09/11/2019 16:00	09/11/2019 21:51	09/11/2019 16:00	09/11/2019 21:51	5,85	9	52,65	CHI
20191171127	SANTA HELENA DE GOIAS	SH11226272	IPEGUARI	09/11/2019 16:13	10/11/2019 23:20	09/11/2019 16:13	10/11/2019 23:20	31,10	36	1119,67	CHI
20191171143	SANTA RITA DO ARAGUAIA	SU12374325	SANTA RITA DO ARAGUAIA	09/11/2019 17:33	10/11/2019 08:14	09/11/2019 17:33	10/11/2019 08:14	14,68	29	425,66	CHI
20191171144	SANTA RITA DO NOVO DESTINO	DF12377521	BARRO ALTO	09/11/2019 17:06	10/11/2019 11:08	09/11/2019 17:06	10/11/2019 11:08	18,02	23	414,45	CHI
20191171148	SANTA RITA DO NOVO DESTINO	4470001765	BARRO ALTO	09/11/2019 17:33	09/11/2019 22:31	09/11/2019 17:33	09/11/2019 22:31	4,95	1	4,95	CHI
20191171163	MINEIROS	1390092474	PARQUE DAS EMAS	09/11/2019 17:35	11/11/2019 11:57	09/11/2019 17:35	11/11/2019 11:57	42,36	1	42,36	CHI
20191171169	GOIAS	GS11206855	GOIAS	09/11/2019 17:33	10/11/2019 11:29	09/11/2019 17:33	10/11/2019 11:29	17,95	12	215,35	CHI
20191171177	NIQUELANDIA	NQ12222634	NIQUELANDIA SUBTRANSMISSAO	09/11/2019 14:49	09/11/2019 22:49	09/11/2019 14:49	09/11/2019 22:49	7,99	59	471,26	CHI
20191171183	EDEIA	EA11160391	EDEIA	09/11/2019 16:58	10/11/2019 12:50	09/11/2019 16:58	10/11/2019 12:50	19,85	123	2442,10	CHI
20191171194	GOIANESIA	GE12321396	GOIANESIA S2	09/11/2019 17:07	10/11/2019 09:12	09/11/2019 17:07	10/11/2019 09:12	16,08	47	755,81	CHI
20191171194	VILA PROPICIO	GE12321396	GOIANESIA S2	09/11/2019 17:07	10/11/2019 09:12	09/11/2019 17:07	10/11/2019 09:12	16,08	18	289,46	CHI
20191171202	MINACU	IH12207388	MINACU	09/11/2019 17:25	09/11/2019 20:46	09/11/2019 17:25	09/11/2019 20:46	3,34	80	267,24	CHI
20191171208	CACHOEIRA ALTA	CC10251897	CACHOEIRA ALTA	09/11/2019 17:36	10/11/2019 10:58	09/11/2019 17:36	09/11/2019 19:30	1,90	99	188,02	CHI
20191171208	CACU	CC10251897	CACHOEIRA ALTA	09/11/2019 17:36	10/11/2019 10:58	09/11/2019 17:36	09/11/2019 19:30	1,90	1	1,90	CHI
20191171208	CACHOEIRA ALTA	CC10251897	CACHOEIRA ALTA	09/11/2019 17:36	10/11/2019 10:58	09/11/2019 19:26	09/11/2019 19:30	0,07	2	0,14	CHI

20191171208	CACHOEIRA ALTA	CC10251897	CACHOEIRA ALTA	09/11/2019 17:36	10/11/2019 10:58	09/11/2019 20:42	09/11/2019 21:43	1,03	101	104,06	CHI
20191171208	CACU	CC10251897	CACHOEIRA ALTA	09/11/2019 17:36	10/11/2019 10:58	09/11/2019 20:42	09/11/2019 21:43	1,03	1	1,03	CHI
20191171208	APARECIDA DO RIO DOCE	CC10251897	CACHOEIRA ALTA	09/11/2019 17:36	10/11/2019 10:58	09/11/2019 17:36	10/11/2019 10:58	17,37	594	10318,94	CHI
20191171208	APARECIDA DO RIO DOCE	CC10251897	CACHOEIRA ALTA	09/11/2019 17:36	10/11/2019 10:58	09/11/2019 17:36	10/11/2019 10:58	17,37	617	10718,49	CHI
20191171208	APARECIDA DO RIO DOCE	CC10251897	CACHOEIRA ALTA	09/11/2019 17:36	10/11/2019 10:58	09/11/2019 17:36	10/11/2019 10:58	17,37	24	416,93	CHI
20191171208	CACHOEIRA ALTA	CC10251897	CACHOEIRA ALTA	09/11/2019 17:36	10/11/2019 10:58	09/11/2019 17:36	10/11/2019 10:58	17,37	66	1146,55	CHI
20191171208	CACHOEIRA ALTA	CC10251897	CACHOEIRA ALTA	09/11/2019 17:36	10/11/2019 10:58	09/11/2019 17:36	10/11/2019 10:58	17,37	3	52,12	CHI
20191171208	CACHOEIRA ALTA	CC10251897	CACHOEIRA ALTA	09/11/2019 17:36	10/11/2019 10:58	09/11/2019 17:36	10/11/2019 10:58	17,37	48	833,85	CHI
20191171208	JATAI	CC10251897	CACHOEIRA ALTA	09/11/2019 17:36	10/11/2019 10:58	09/11/2019 17:36	10/11/2019 10:58	17,37	35	608,02	CHI
20191171208	JATAI	CC10251897	CACHOEIRA ALTA	09/11/2019 17:36	10/11/2019 10:58	09/11/2019 17:36	10/11/2019 10:58	17,37	1	17,37	CHI
20191171208	RIO VERDE	CC10251897	CACHOEIRA ALTA	09/11/2019 17:36	10/11/2019 10:58	09/11/2019 17:36	10/11/2019 10:58	17,37	8	138,98	CHI
20191171208	RIO VERDE	CC10251897	CACHOEIRA ALTA	09/11/2019 17:36	10/11/2019 10:58	09/11/2019 17:36	10/11/2019 10:58	17,37	160	2779,51	CHI
20191171208	RIO VERDE	CC10251897	CACHOEIRA ALTA	09/11/2019 17:36	10/11/2019 10:58	09/11/2019 17:36	10/11/2019 10:58	17,37	10	173,72	CHI
20191171209	RIO VERDE	630237025	CABRIUVA S1	09/11/2019 17:40	10/11/2019 12:25	09/11/2019 17:40	10/11/2019 12:25	18,75	1	18,75	CHI
20191171213	JATAI	JT12182034	JATAI S2	09/11/2019 16:15	10/11/2019 07:52	09/11/2019 16:15	10/11/2019 07:52	15,61	125	1951,74	CHI
20191171216	VIANOPOLIS	OZ21094966	VIANOPOLIS	09/11/2019 17:41	10/11/2019 11:40	09/11/2019 17:41	10/11/2019 11:40	17,98	1	17,98	CHI
20191171217	PIRANHAS	PH11260022	PIRANHAS	09/11/2019 16:30	09/11/2019 21:47	09/11/2019 16:30	09/11/2019 21:47	5,27	70	368,80	CHI
20191171221	NIQUELANDIA	NQ12290033	NIQUELANDIA SUBTRANSMISSAO	09/11/2019 17:41	12/11/2019 18:22	09/11/2019 17:41	12/11/2019 18:22	72,68	8	581,42	CHI
20191171225	ANICUNS	AC12307109	FIRMINOPOLIS S2	09/11/2019 17:34	09/11/2019 19:56	09/11/2019 17:34	09/11/2019 19:56	2,36	9	21,24	CHI
20191171254	INHUMAS	IN11365569	INHUMAS S2	09/11/2019 16:31	09/11/2019 18:50	09/11/2019 16:31	09/11/2019 18:50	2,31	74	170,61	CHI
20191171255	VARJAO	940003995	GUAPO S2	09/11/2019 17:45	10/11/2019 14:38	09/11/2019 17:45	10/11/2019 14:38	20,88	1	20,88	CHI
20191171280	MARZAGAO	10017264950	VILA CORUMBA	09/11/2019 17:47	10/11/2019 16:16	09/11/2019 17:47	10/11/2019 16:16	22,48	1	22,48	CHI
20191171281	ACREUNA	EU11207092	ACREUNA	09/11/2019 17:12	10/11/2019 12:32	09/11/2019 17:12	10/11/2019 12:32	19,34	63	1218,73	CHI
20191171290	RIO VERDE	RV21191825	CABRIUVA S2	09/11/2019 17:48	12/11/2019 12:43	09/11/2019 17:48	12/11/2019 12:43	66,92	1	66,92	CHI
20191171299	JATAI	JT12346022	JATAI S3	09/11/2019 15:42	10/11/2019 01:44	09/11/2019 15:42	10/11/2019 01:44	10,03	248	2486,34	CHI
20191171300	MINEIROS	MY11260333	PARQUE DAS EMAS	09/11/2019 16:06	10/11/2019 16:32	09/11/2019 16:06	10/11/2019 16:32	24,43	98	2394,22	CHI
20191171300	MINEIROS	MY12260337	PARQUE DAS EMAS	09/11/2019 16:06	10/11/2019 16:32	10/11/2019 16:17	10/11/2019 16:32	0,25	276	68,85	CHI
20191171303	JATAI	JT11264285	JATAI S2	09/11/2019 16:03	10/11/2019 10:23	09/11/2019 16:03	10/11/2019 10:23	18,33	97	1777,66	CHI
20191171307	GOIANESIA	GE11171632	GOIANESIA S2	09/11/2019 17:23	10/11/2019 05:11	09/11/2019 17:23	10/11/2019 05:11	11,79	111	1308,72	CHI
20191171309	ITAGUARU	IC11154617	ITABERAI S1	09/11/2019 16:53	09/11/2019 22:36	09/11/2019 16:53	09/11/2019 22:36	5,73	155	888,06	CHI
20191171316	VILA PROPICIO	NP12241241	GOIANESIA S1	09/11/2019 17:51	10/11/2019 19:08	09/11/2019 17:51	10/11/2019 19:08	25,27	4	101,09	CHI
20191171318	GOIANESIA	GE11140949	GOIANESIA S2	09/11/2019 17:36	10/11/2019 12:08	09/11/2019 17:36	10/11/2019 12:08	18,54	127	2354,26	CHI
20191171320	TRINDADE	TR11158286	GOYA S2	09/11/2019 17:16	09/11/2019 20:10	09/11/2019 17:16	09/11/2019 20:10	2,89	82	237,19	CHI

20191171322	ITABERAÍ	II12217217	ITABERAÍ S1	09/11/2019 17:26	09/11/2019 19:31	09/11/2019 17:26	09/11/2019 19:31	2,08	22	45,85	CHI
20191171322	ITAGUARI	II12217217	ITABERAÍ S1	09/11/2019 17:26	09/11/2019 19:31	09/11/2019 17:26	09/11/2019 19:31	2,08	42	87,52	CHI
20191171322	TAQUARAL DE GOIAS	II12217217	ITABERAÍ S1	09/11/2019 17:26	09/11/2019 19:31	09/11/2019 17:26	09/11/2019 19:31	2,08	43	89,61	CHI
20191171326	NOVA AURORA	10026749210	CATALAO S1	09/11/2019 17:52	10/11/2019 07:20	09/11/2019 17:52	10/11/2019 07:20	13,46	1	13,46	CHI
20191171340	MINEIROS	10024834961	PARQUE DAS EMAS	09/11/2019 17:54	11/11/2019 16:14	09/11/2019 17:54	11/11/2019 16:14	46,34	1	46,34	CHI
20191171342	MOZARLANDIA	10000167302	MOZARLANDIA	09/11/2019 17:54	12/11/2019 17:45	09/11/2019 17:54	12/11/2019 17:45	71,85	1	71,85	CHI
20191171344	ISRAELANDIA	IS12048170	IPORA	09/11/2019 17:41	10/11/2019 11:37	09/11/2019 17:41	10/11/2019 11:37	17,93	87	1559,77	CHI
20191171348	PETROLINA DE GOIAS	SF12273257RE	SAO FRANCISCO DE GOIAS	09/11/2019 17:40	09/11/2019 21:52	09/11/2019 17:40	09/11/2019 21:52	4,19	60	251,40	CHI
20191171348	PIRENOPOLIS	SF12273257RE	SAO FRANCISCO DE GOIAS	09/11/2019 17:40	09/11/2019 21:52	09/11/2019 17:40	09/11/2019 21:52	4,19	39	163,41	CHI
20191171348	SAO FRANCISCO DE GOIAS	SF12273257RE	SAO FRANCISCO DE GOIAS	09/11/2019 17:40	09/11/2019 21:52	09/11/2019 17:40	09/11/2019 21:52	4,19	42	175,98	CHI
20191171349	GOIANIA	GN12390550	ATLANTICO S3	09/11/2019 17:20	09/11/2019 19:43	09/11/2019 17:20	09/11/2019 19:43	2,38	533	1270,32	CHI
20191171351	CACU	CC11102485	CACHOEIRA ALTA	09/11/2019 17:43	10/11/2019 08:19	09/11/2019 17:43	10/11/2019 08:19	14,59	102	1487,92	CHI
20191171356	MINACU	IH21135023	MINACU	09/11/2019 17:57	09/11/2019 20:30	09/11/2019 17:57	09/11/2019 20:30	2,55	1	2,55	CHI
20191171362	ARUANA	AK11183275	ARUANA	09/11/2019 17:14	10/11/2019 11:44	09/11/2019 17:14	10/11/2019 11:44	18,49	91	1682,62	CHI
20191171366	JATAI	JT12182138	JATAI S1	09/11/2019 17:58	10/11/2019 17:45	09/11/2019 17:58	10/11/2019 17:45	23,78	9	214,02	CHI
20191171367	JATAI	JT11104540	JATAI S3	09/11/2019 15:17	10/11/2019 02:15	09/11/2019 15:17	10/11/2019 02:15	10,95	129	1413,02	CHI
20191171372	ITABERAÍ	50032057	ITABERAÍ S2	09/11/2019 17:58	10/11/2019 14:29	09/11/2019 17:58	10/11/2019 14:29	20,50	1	20,50	CHI
20191171375	GOIAS	GS12250872	GOIAS	09/11/2019 17:45	10/11/2019 10:57	09/11/2019 17:45	10/11/2019 10:57	17,20	33	567,46	CHI
20191171376	ALTO PARAISO DE GOIAS	BF21256412	NIQUELANDIA SUBTRANSMISSAO	09/11/2019 17:59	10/11/2019 08:44	09/11/2019 17:59	10/11/2019 08:44	14,74	2	29,48	CHI
20191171380	PIRES DO RIO	460039234	PIRES DO RIO S1	09/11/2019 17:59	10/11/2019 11:38	09/11/2019 17:59	10/11/2019 11:38	17,63	1	17,63	CHI
20191171381	AURILANDIA	AI11032154	FIRMINOPOLIS S2	09/11/2019 18:00	10/11/2019 16:24	09/11/2019 18:00	10/11/2019 16:14	22,24	40	889,79	CHI
20191171381	AURILANDIA	AI10401490	FIRMINOPOLIS S2	09/11/2019 18:00	10/11/2019 16:24	10/11/2019 15:03	10/11/2019 16:24	1,36	77	104,38	CHI
20191171381	FIRMINOPOLIS	AI10401490	FIRMINOPOLIS S2	09/11/2019 18:00	10/11/2019 16:24	10/11/2019 15:03	10/11/2019 16:24	1,36	15	20,33	CHI
20191171386	CACHOEIRA DOURADA	CD12104442	CACHOEIRA DOURADA	09/11/2019 18:00	19/11/2019 19:02	09/11/2019 18:00	19/11/2019 19:02	241,03	2	482,07	CHI
20191171387	CACHOEIRA DOURADA	CD12222445	CACHOEIRA DOURADA	09/11/2019 18:00	10/11/2019 11:15	09/11/2019 18:00	10/11/2019 11:15	17,24	1	17,24	CHI
20191171392	MUTUNOPOLIS	MU11003802	MARA ROSA	09/11/2019 15:42	09/11/2019 23:02	09/11/2019 15:42	09/11/2019 23:02	7,33	147	1077,55	CHI
20191171403	NIQUELANDIA	NQ11146978	URUACU	09/11/2019 18:02	10/11/2019 01:24	09/11/2019 18:02	10/11/2019 01:24	7,37	25	184,16	CHI
20191171404	GOIANESIA	GE12384165	GOIANESIA S2	09/11/2019 18:02	10/11/2019 17:14	09/11/2019 18:02	10/11/2019 17:14	23,20	1	23,20	CHI
20191171406	MONTIVIDIU DO NORTE	MX12168971	PORANGATU	09/11/2019 18:02	12/11/2019 21:35	09/11/2019 18:02	12/11/2019 21:35	75,54	51	3852,71	CHI
20191171410	GOIANESIA	GE11171628	GOIANESIA S2	09/11/2019 17:59	10/11/2019 08:24	09/11/2019 17:59	10/11/2019 08:24	14,41	74	1066,52	CHI
20191171411	ITUMBIARA	IT12257151	ITUMBIARA NOVA	09/11/2019 17:13	09/11/2019 19:53	09/11/2019 17:13	09/11/2019 19:53	2,66	245	651,97	CHI
20191171415	RIO VERDE	RV12303551	SANTA HELENA S1	09/11/2019 17:53	13/11/2019 16:54	09/11/2019 17:53	13/11/2019 16:54	95,02	3	285,05	CHI
20191171417	RIO QUENTE	5660000129	CALDAS NOVAS S1	09/11/2019 18:03	12/11/2019 17:14	09/11/2019 18:03	12/11/2019 17:14	71,17	1	71,17	CHI

20191171418	ADELANDIA	DN21259961	ANICUNS	09/11/2019 18:03	10/11/2019 08:09	09/11/2019 18:03	10/11/2019 08:09	14,10	1	14,10	CHI
20191171419	CAMPESTRE DE GOIAS	10005812842	TRINDADE	09/11/2019 18:03	11/11/2019 11:02	09/11/2019 18:03	11/11/2019 11:02	40,97	1	40,97	CHI
20191171423	RIO VERDE	RV11029066	SANTA HELENA S1	09/11/2019 17:15	12/11/2019 13:44	09/11/2019 17:15	12/11/2019 13:44	68,47	72	4930,04	CHI
20191171430	JATAI	JT11172861	JATAI S3	09/11/2019 15:25	10/11/2019 09:41	09/11/2019 15:25	10/11/2019 09:41	18,26	81	1479,31	CHI
20191171432	GOIAS	GS11037769	GOIAS	09/11/2019 17:51	09/11/2019 22:22	09/11/2019 17:51	09/11/2019 22:22	4,51	68	306,57	CHI
20191171434	ANAPOLIS	AN12273056	ANAPOLIS UNIVERSITARIO S2	09/11/2019 18:05	09/11/2019 21:11	09/11/2019 18:05	09/11/2019 21:11	3,10	1	3,10	CHI
20191171440	AURILANDIA	AI11000009	FIRMINOPOLIS S2	09/11/2019 18:05	09/11/2019 19:45	09/11/2019 18:05	09/11/2019 19:45	1,66	94	156,51	CHI
20191171450	BELA VISTA DE GOIAS	10008260891	BELA VISTA S1	09/11/2019 18:06	09/11/2019 19:42	09/11/2019 18:06	09/11/2019 19:42	1,59	1	1,59	CHI
20191171456	MINEIROS	MY12278368	PARQUE DAS EMAS	09/11/2019 14:39	10/11/2019 18:25	09/11/2019 14:39	10/11/2019 18:25	27,76	13	360,87	CHI
20191171456	SERRANOPOLIS	MY12278368	PARQUE DAS EMAS	09/11/2019 14:39	10/11/2019 18:25	09/11/2019 14:39	10/11/2019 18:25	27,76	7	194,31	CHI
20191171461	JATAI	JT11182142	JATAI S3	09/11/2019 17:44	10/11/2019 08:34	09/11/2019 17:44	10/11/2019 08:34	14,82	55	815,01	CHI
20191171470	HIDROLINA	HL11269818	URUACU	09/11/2019 17:49	09/11/2019 22:37	09/11/2019 17:49	09/11/2019 22:37	4,79	79	378,10	CHI
20191171477	MINEIROS	MY21232656	PARQUE DAS EMAS	09/11/2019 18:08	11/11/2019 19:06	09/11/2019 18:08	11/11/2019 19:06	48,96	2	97,93	CHI
20191171480	QUIRINOPOLIS	QI12303092LD	QUIRINOPOLIS	09/11/2019 18:08	14/11/2019 16:30	09/11/2019 18:08	13/11/2019 02:27	80,32	20	1606,31	CHI
20191171480	QUIRINOPOLIS	QI12303092LD	QUIRINOPOLIS	09/11/2019 18:08	14/11/2019 16:30	12/11/2019 19:40	13/11/2019 02:27	6,80	4	27,19	CHI
20191171480	QUIRINOPOLIS	QI12303092LD	QUIRINOPOLIS	09/11/2019 18:08	14/11/2019 16:30	13/11/2019 01:10	13/11/2019 02:27	1,28	135	173,03	CHI
20191171480	QUIRINOPOLIS	QI12116546	QUIRINOPOLIS	09/11/2019 18:08	14/11/2019 16:30	13/11/2019 21:12	14/11/2019 09:37	12,42	10	124,17	CHI
20191171480	QUIRINOPOLIS	QI12049545	QUIRINOPOLIS	09/11/2019 18:08	14/11/2019 16:30	13/11/2019 21:12	14/11/2019 16:30	19,30	11	212,31	CHI
20191171480	QUIRINOPOLIS	QI12049545	QUIRINOPOLIS	09/11/2019 18:08	14/11/2019 16:30	14/11/2019 09:38	14/11/2019 16:30	6,87	10	68,67	CHI
20191171481	CALDAS NOVAS	IP12195206	IPAMERI	09/11/2019 15:49	09/11/2019 22:02	09/11/2019 15:49	09/11/2019 22:02	6,21	3	18,64	CHI
20191171481	IPAMERI	IP12195206	IPAMERI	09/11/2019 15:49	09/11/2019 22:02	09/11/2019 15:49	09/11/2019 22:02	6,21	11	68,36	CHI
20191171482	CACU	CC10394736	CACHOEIRA ALTA	09/11/2019 17:57	11/11/2019 13:20	09/11/2019 17:57	09/11/2019 20:46	2,81	378	1061,13	CHI
20191171482	CACU	CC12264402LD	CACHOEIRA ALTA	09/11/2019 17:57	11/11/2019 13:20	09/11/2019 17:57	10/11/2019 10:53	16,93	32	541,64	CHI
20191171482	QUIRINOPOLIS	CC12264402LD	CACHOEIRA ALTA	09/11/2019 17:57	11/11/2019 13:20	09/11/2019 17:57	10/11/2019 10:53	16,93	1	16,93	CHI
20191171482	CACU	CC13349509	CACHOEIRA ALTA	09/11/2019 17:57	11/11/2019 13:20	09/11/2019 17:57	10/11/2019 12:30	18,55	9	166,99	CHI
20191171482	CACU	CC13219328	CACHOEIRA ALTA	09/11/2019 17:57	11/11/2019 13:20	09/11/2019 17:57	10/11/2019 19:27	25,50	6	153,02	CHI
20191171482	CACU	CC21078905	CACHOEIRA ALTA	09/11/2019 17:57	11/11/2019 13:20	09/11/2019 17:57	11/11/2019 12:15	42,31	1	42,31	CHI
20191171482	CACU	CC13219329	CACHOEIRA ALTA	09/11/2019 17:57	11/11/2019 13:20	09/11/2019 17:57	11/11/2019 13:20	43,38	31	1344,86	CHI
20191171485	GOIANIA	GN11000603	AEROPORTO S2	09/11/2019 15:24	09/11/2019 21:48	09/11/2019 15:24	09/11/2019 21:48	6,39	44	281,17	CHI
20191171486	URUACU	UR12050041	URUACU	09/11/2019 18:09	11/11/2019 10:03	09/11/2019 18:09	11/11/2019 10:03	39,89	8	319,14	CHI
20191171487	ADELANDIA	DN21276747	FIRMINOPOLIS S2	09/11/2019 18:09	10/11/2019 08:47	09/11/2019 18:09	10/11/2019 08:47	14,63	1	14,63	CHI
20191171490	CORREGO DO OURO	1070007526	FIRMINOPOLIS S2	09/11/2019 18:09	10/11/2019 00:26	09/11/2019 18:09	10/11/2019 00:26	6,28	1	6,28	CHI
20191171496	GOIAS	GS12029627	GOIAS	09/11/2019 18:10	10/11/2019 09:40	09/11/2019 18:10	10/11/2019 09:40	15,50	10	154,96	CHI



20191171501	BELA VISTA DE GOIAS	BV12086484	BELA VISTA S1	09/11/2019 18:10	10/11/2019 11:18	09/11/2019 18:10	10/11/2019 11:18	17,12	4	68,49	CHI
20191171513	APARECIDA DE GOIANIA	AP11132331	REAL S1	09/11/2019 18:11	09/11/2019 21:45	09/11/2019 18:11	09/11/2019 21:45	3,56	101	359,56	CHI
20191171514	MINEIROS	MY12156811	PARQUE DAS EMAS	09/11/2019 16:31	10/11/2019 15:46	09/11/2019 16:31	10/11/2019 15:46	23,25	17	395,21	CHI
20191171519	MOSSAMEDES	MD12188234	FIRMINOPOLIS S2	09/11/2019 18:10	10/11/2019 11:26	09/11/2019 18:10	10/11/2019 11:26	17,27	34	587,08	CHI
20191171527	BURITI DE GOIAS	BS21079943	FIRMINOPOLIS S2	09/11/2019 18:10	11/11/2019 14:27	09/11/2019 18:10	11/11/2019 14:27	44,28	1	44,28	CHI
20191171528	SANCLERLANDIA	1610005044	FIRMINOPOLIS S2	09/11/2019 18:13	11/11/2019 16:32	09/11/2019 18:13	11/11/2019 16:32	46,31	1	46,31	CHI
20191171529	SAO LUIZ DO NORTE	SZ12348617	ITAPACI	09/11/2019 17:57	10/11/2019 15:00	09/11/2019 17:57	10/11/2019 15:00	21,04	11	231,45	CHI
20191171541	ADELANDIA	10010160092	FIRMINOPOLIS S2	09/11/2019 18:14	10/11/2019 09:23	09/11/2019 18:14	10/11/2019 09:23	15,14	1	15,14	CHI
20191171544	GOIANESIA	GE21140624	GOIANESIA S2	09/11/2019 18:14	10/11/2019 18:23	09/11/2019 18:14	10/11/2019 18:23	24,14	1	24,14	CHI
20191171545	JAUPACI	JP21184777	IPORA	09/11/2019 18:14	11/11/2019 14:38	09/11/2019 18:14	11/11/2019 14:38	44,38	1	44,38	CHI
20191171546	BURITI DE GOIAS	BS21319369	FIRMINOPOLIS S2	09/11/2019 18:10	11/11/2019 13:44	09/11/2019 18:10	11/11/2019 13:44	43,57	1	43,57	CHI
20191171560	ANICUNS	AC21204355	FIRMINOPOLIS S2	09/11/2019 18:10	09/11/2019 22:51	09/11/2019 18:10	09/11/2019 22:51	4,70	1	4,70	CHI
20191171568	RIO VERDE	RV12230629	CABRIUVA S2	09/11/2019 17:06	10/11/2019 13:45	09/11/2019 17:06	10/11/2019 13:45	20,65	8	165,21	CHI
20191171574	ANICUNS	AC11021753	FIRMINOPOLIS S2	09/11/2019 18:10	09/11/2019 20:41	09/11/2019 18:10	09/11/2019 20:41	2,52	140	353,23	CHI
20191171580	PALMELO	PZ21000454	PIRES DO RIO S2	09/11/2019 18:18	10/11/2019 10:50	09/11/2019 18:18	10/11/2019 10:50	16,55	3	49,64	CHI
20191171589	CAMPINACU	UC12239723	PORANGATU	09/11/2019 18:18	10/11/2019 11:09	09/11/2019 18:18	10/11/2019 11:09	16,84	4	67,35	CHI
20191171611	ADELANDIA	10016657622	FIRMINOPOLIS S2	09/11/2019 18:20	10/11/2019 10:19	09/11/2019 18:20	10/11/2019 10:19	15,98	1	15,98	CHI
20191171614	JATAI	JT21150665	JATAI S1	09/11/2019 18:21	14/11/2019 10:04	09/11/2019 18:21	14/11/2019 10:04	111,70	1	111,70	CHI
20191171624	SANTO ANTONIO DA BARRA	BZ21214183	ACREUNA	09/11/2019 18:23	12/11/2019 17:20	09/11/2019 18:23	12/11/2019 17:20	70,93	1	70,93	CHI
20191171625	CACHOEIRA ALTA	QI12279632	QUIRINOPOLIS	09/11/2019 17:48	13/11/2019 12:07	09/11/2019 17:48	13/11/2019 12:07	90,31	7	632,14	CHI
20191171625	RIO VERDE	QI12279632	QUIRINOPOLIS	09/11/2019 17:48	13/11/2019 12:07	09/11/2019 17:48	13/11/2019 12:07	90,31	31	2799,49	CHI
20191171629	SAO MIGUEL DO ARAGUAIA	10024854636	SAO MIGUEL DO ARAGUAIA	09/11/2019 18:24	10/11/2019 14:48	09/11/2019 18:24	10/11/2019 14:48	20,41	1	20,41	CHI
20191171637	HIDROLANDIA	HD12389464	CEPAIGO S2	09/11/2019 18:24	10/11/2019 04:42	09/11/2019 18:24	10/11/2019 04:42	10,29	19	195,49	CHI
20191171644	SANTA HELENA DE GOIAS	SH11000032	IPEGUARI	09/11/2019 15:43	10/11/2019 19:50	09/11/2019 15:43	10/11/2019 19:50	28,10	110	3091,40	CHI
20191171656	GOIANIA	GN11220962	MEIA PONTE	09/11/2019 17:36	09/11/2019 20:09	09/11/2019 17:36	09/11/2019 20:09	2,55	108	275,28	CHI
20191171663	SANTO ANTONIO DO DESCOBERTO	SN11390559	ALEXANIA	09/11/2019 18:26	09/11/2019 19:26	09/11/2019 18:26	09/11/2019 19:26	0,99	63	62,39	CHI
20191171668	SANTA RITA DO ARAGUAIA	SU12360696LD	SANTA RITA DO ARAGUAIA	09/11/2019 17:35	10/11/2019 03:49	09/11/2019 17:35	09/11/2019 22:37	5,03	34	171,18	CHI
20191171668	SANTA RITA DO ARAGUAIA	SU12360696LD	SANTA RITA DO ARAGUAIA	09/11/2019 17:35	10/11/2019 03:49	09/11/2019 20:34	09/11/2019 22:37	2,05	5	10,27	CHI
20191171668	SANTA RITA DO ARAGUAIA	SU12360696LD	SANTA RITA DO ARAGUAIA	09/11/2019 17:35	10/11/2019 03:49	09/11/2019 17:35	10/11/2019 03:49	10,24	69	706,75	CHI
20191171668	BURITINOPOLIS	SU13055297	SANTA RITA DO ARAGUAIA	09/11/2019 17:35	10/11/2019 03:49	09/11/2019 20:34	10/11/2019 03:49	7,26	1	7,26	CHI
20191171668	SANTA RITA DO ARAGUAIA	SU13055297	SANTA RITA DO ARAGUAIA	09/11/2019 17:35	10/11/2019 03:49	09/11/2019 20:34	10/11/2019 03:49	7,26	54	392,13	CHI
20191171670	GOIAS	GS12217234	MATRINCHA	09/11/2019 18:17	15/11/2019 18:40	09/11/2019 18:17	11/11/2019 15:32	45,25	45	2036,23	CHI
20191171670	GOIAS	GS12217234	MATRINCHA	09/11/2019 18:17	15/11/2019 18:40	14/11/2019 13:40	14/11/2019 14:58	1,30	45	58,51	CHI

20191171670	GOIAS	GS12073672LD	MATRINCHA	09/11/2019 18:17	15/11/2019 18:40	09/11/2019 18:17	14/11/2019 16:00	117,71	1	117,71	CHI
20191171670	GOIAS	GS12217234	MATRINCHA	09/11/2019 18:17	15/11/2019 18:40	09/11/2019 18:17	14/11/2019 16:00	117,71	12	1412,47	CHI
20191171670	GOIAS	GS12217234	MATRINCHA	09/11/2019 18:17	15/11/2019 18:40	10/11/2019 16:15	14/11/2019 16:00	95,73	14	1340,28	CHI
20191171670	GOIAS	GS12217234	MATRINCHA	09/11/2019 18:17	15/11/2019 18:40	09/11/2019 18:17	14/11/2019 18:48	120,52	10	1205,18	CHI
20191171670	ITAPIRAPUA	GS12217234	MATRINCHA	09/11/2019 18:17	15/11/2019 18:40	09/11/2019 18:17	14/11/2019 18:48	120,52	1	120,52	CHI
20191171670	NOVO BRASIL	GS12217234	MATRINCHA	09/11/2019 18:17	15/11/2019 18:40	09/11/2019 18:17	14/11/2019 18:48	120,52	9	1084,66	CHI
20191171670	NOVO BRASIL	GS12217234	MATRINCHA	09/11/2019 18:17	15/11/2019 18:40	09/11/2019 18:17	14/11/2019 21:26	123,14	5	615,72	CHI
20191171670	GOIAS	NB12064413LD	MATRINCHA	09/11/2019 18:17	15/11/2019 18:40	14/11/2019 19:32	14/11/2019 21:26	1,90	1	1,90	CHI
20191171670	NOVO BRASIL	NB12064413LD	MATRINCHA	09/11/2019 18:17	15/11/2019 18:40	14/11/2019 19:32	14/11/2019 21:26	1,90	3	5,70	CHI
20191171670	GOIAS	NB12064413LD	MATRINCHA	09/11/2019 18:17	15/11/2019 18:40	15/11/2019 07:20	15/11/2019 14:25	7,10	1	7,10	CHI
20191171670	NOVO BRASIL	NB12064413LD	MATRINCHA	09/11/2019 18:17	15/11/2019 18:40	15/11/2019 07:20	15/11/2019 14:25	7,10	3	21,30	CHI
20191171670	NOVO BRASIL	NB12064413LD	MATRINCHA	09/11/2019 18:17	15/11/2019 18:40	15/11/2019 07:20	15/11/2019 17:37	10,29	5	51,45	CHI
20191171670	NOVO BRASIL	GS12217234	MATRINCHA	09/11/2019 18:17	15/11/2019 18:40	09/11/2019 18:17	15/11/2019 18:40	144,38	22	3176,37	CHI
20191171677	ANAPOLIS	AN11210686	ANAPOLIS UNIVERSITARIO S2	09/11/2019 18:28	09/11/2019 20:18	09/11/2019 18:28	09/11/2019 20:18	1,83	82	150,20	CHI
20191171688	GOIANIA	12313233	GOIANIA LESTE S1	09/11/2019 18:29	10/11/2019 08:16	09/11/2019 18:29	10/11/2019 08:16	13,78	1	13,78	CHI
20191171696	CACHOEIRA ALTA	CA21365488	CACHOEIRA ALTA	09/11/2019 18:29	10/11/2019 11:47	09/11/2019 18:29	10/11/2019 11:47	17,29	2	34,58	CHI
20191171697	NOVA CRIXAS	NA21321637	NOVA CRIXAS	09/11/2019 18:29	10/11/2019 15:25	09/11/2019 18:29	10/11/2019 15:25	20,93	1	20,93	CHI
20191171707	AURILANDIA	AI21026588	SAO LUIZ DOS MONTES BELOS	09/11/2019 18:16	10/11/2019 08:57	09/11/2019 18:16	10/11/2019 08:57	14,69	2	29,38	CHI
20191171708	JARAGUA	JA12328945	JARAGUA	09/11/2019 18:05	09/11/2019 23:57	09/11/2019 18:05	09/11/2019 23:57	5,85	11	64,40	CHI
20191171712	GOIANESIA	GE11258290	GOIANESIA S2	09/11/2019 17:26	10/11/2019 12:43	09/11/2019 17:26	10/11/2019 12:43	19,27	82	1580,28	CHI
20191171717	APARECIDA DE GOIANIA	AP11045812	REAL S1	09/11/2019 18:26	10/11/2019 00:35	09/11/2019 18:26	10/11/2019 00:35	6,13	189	1159,31	CHI
20191171733	CATALAO	CT12078234	CATALAO S2	09/11/2019 16:36	09/11/2019 19:52	09/11/2019 16:36	09/11/2019 19:52	3,25	100	325,36	CHI
20191171739	JARAGUA	JA12374667RE	JARAGUA	09/11/2019 13:19	09/11/2019 21:06	09/11/2019 13:19	09/11/2019 21:06	7,78	172	1337,87	CHI
20191171752	MINEIROS	MY11036559	PARQUE DAS EMAS	09/11/2019 16:43	10/11/2019 04:57	09/11/2019 16:43	10/11/2019 04:57	12,23	85	1039,83	CHI
20191171754	RIO VERDE	RV12371305	CABRIUVA S2	09/11/2019 18:34	10/11/2019 10:24	09/11/2019 18:34	10/11/2019 10:24	15,83	10	158,28	CHI
20191171757	GOIAS	GS12124703	GOIAS	09/11/2019 17:04	09/11/2019 22:04	09/11/2019 17:04	09/11/2019 22:04	4,99	177	882,39	CHI
20191171765	JATAI	JT12374278	JATAI S2	09/11/2019 17:44	10/11/2019 00:19	09/11/2019 17:44	10/11/2019 00:19	6,57	646	4242,61	CHI
20191171797	APARECIDA DE GOIANIA	AP11072666	INDEPENDENCIA S1	09/11/2019 18:27	09/11/2019 19:19	09/11/2019 18:27	09/11/2019 19:19	0,86	107	91,93	CHI
20191171798	CACU	CC10394735	CACHOEIRA ALTA	09/11/2019 18:34	10/11/2019 18:32	09/11/2019 18:34	10/11/2019 18:32	23,97	157	3763,33	CHI
20191171798	ITARUMA	CC10394735	CACHOEIRA ALTA	09/11/2019 18:34	10/11/2019 18:32	09/11/2019 18:34	10/11/2019 18:32	23,97	35	838,96	CHI
20191171799	RIO VERDE	RV21322322	CABRIUVA S2	09/11/2019 18:38	12/11/2019 11:39	09/11/2019 18:38	12/11/2019 11:39	65,02	1	65,02	CHI
20191171804	PIRANHAS	PH11188480	PIRANHAS	09/11/2019 18:37	10/11/2019 03:15	09/11/2019 18:37	10/11/2019 03:15	8,63	94	811,17	CHI
20191171843	JATAI	JT11166037	JATAI S2	09/11/2019 16:20	09/11/2019 21:16	09/11/2019 16:20	09/11/2019 21:16	4,93	141	694,50	CHI

20191171846	BARRO ALTO	BA11287705	BARRO ALTO	09/11/2019 15:47	09/11/2019 23:08	09/11/2019 15:47	09/11/2019 23:08	7,34	169	1239,76	CHI
20191171847	CORREGO DO OURO	CO11095409	FIRMINOPOLIS S2	09/11/2019 18:39	10/11/2019 09:18	09/11/2019 18:39	10/11/2019 09:18	14,65	92	1347,37	CHI
20191171856	ORIZONA	OZ12084921RE	PIRES DO RIO S2	09/11/2019 17:49	09/11/2019 22:26	09/11/2019 17:49	09/11/2019 22:26	4,62	111	512,33	CHI
20191171856	VIANOPOLIS	OZ12084921RE	PIRES DO RIO S2	09/11/2019 17:49	09/11/2019 22:26	09/11/2019 17:49	09/11/2019 22:26	4,62	17	78,46	CHI
20191171861	GOIAS	GS12206906	ITABERAÍ S1	09/11/2019 18:41	12/11/2019 08:45	09/11/2019 18:41	12/11/2019 08:45	62,06	2	124,12	CHI
20191171861	ITABERAÍ	GS12206906	ITABERAÍ S1	09/11/2019 18:41	12/11/2019 08:45	09/11/2019 18:41	12/11/2019 08:45	62,06	26	1613,60	CHI
20191171872	GUARANI DE GOIAS	GY21325388	IACIARA S1	09/11/2019 18:42	09/11/2019 21:33	09/11/2019 18:42	09/11/2019 21:33	2,84	1	2,84	CHI
20191171873	GOIANESIA	GE11273339	GOIANESIA S2	09/11/2019 16:03	10/11/2019 03:01	09/11/2019 16:03	10/11/2019 03:01	10,97	109	1195,19	CHI
20191171879	PALMEIRAS DE GOIAS	PL21393656	FIRMINOPOLIS S2	09/11/2019 18:43	11/11/2019 08:04	09/11/2019 18:43	11/11/2019 08:04	37,36	1	37,36	CHI
20191171880	MAIRIPOTABA	7923728	MORRINHOS	09/11/2019 17:41	10/11/2019 05:33	09/11/2019 17:41	10/11/2019 05:33	11,87	12	142,45	CHI
20191171880	MORRINHOS	7923728	MORRINHOS	09/11/2019 17:41	10/11/2019 05:33	09/11/2019 17:41	10/11/2019 05:33	11,87	191	2267,28	CHI
20191171880	PIRACANJUBA	7923728	MORRINHOS	09/11/2019 17:41	10/11/2019 05:33	09/11/2019 17:41	10/11/2019 05:33	11,87	79	937,77	CHI
20191171880	PONTALINA	7923728	MORRINHOS	09/11/2019 17:41	10/11/2019 05:33	09/11/2019 17:41	10/11/2019 05:33	11,87	15	178,06	CHI
20191171892	CATURAI	250014592	INHUMAS S1	09/11/2019 18:43	09/11/2019 23:14	09/11/2019 18:43	09/11/2019 23:14	4,50	1	4,50	CHI
20191171899	PIRANHAS	PH11041156	PIRANHAS	09/11/2019 18:33	10/11/2019 11:24	09/11/2019 18:33	10/11/2019 11:24	16,84	144	2425,08	CHI
20191171905	GOIANESIA	GE11091173	GOIANESIA S2	09/11/2019 17:57	10/11/2019 04:00	09/11/2019 17:57	10/11/2019 04:00	10,05	176	1768,65	CHI
20191171917	PIRANHAS	PH11023525	PIRANHAS	09/11/2019 18:28	10/11/2019 06:55	09/11/2019 18:28	10/11/2019 06:55	12,44	156	1941,25	CHI
20191171920	GOIAS	GS11224166	GOIAS	09/11/2019 18:01	09/11/2019 23:56	09/11/2019 18:01	09/11/2019 23:56	5,91	27	159,60	CHI
20191171924	SILVANIA	SV21341870	VIANOPOLIS	09/11/2019 18:46	10/11/2019 02:54	09/11/2019 18:46	10/11/2019 02:54	8,13	3	24,39	CHI
20191171936	JATAI	290230391	JATAI S3	09/11/2019 18:47	11/11/2019 09:18	09/11/2019 18:47	11/11/2019 09:18	38,52	1	38,52	CHI
20191171944	SAO LUIS DE MONTES BELOS	02020224	SAO LUIZ DOS MONTES BELOS	09/11/2019 18:46	10/11/2019 05:37	09/11/2019 18:46	09/11/2019 21:50	3,07	4406	13520,30	CHI
20191171944	SAO LUIS DE MONTES BELOS	02020224	SAO LUIZ DOS MONTES BELOS	09/11/2019 18:46	10/11/2019 05:37	09/11/2019 18:46	10/11/2019 05:37	10,86	284	3084,08	CHI
20191171951	SAO JOAO D ALIANCA	JL21325047	FLORES DE GOIAS	09/11/2019 18:47	10/11/2019 23:31	09/11/2019 18:47	10/11/2019 23:31	28,72	1	28,72	CHI
20191171952	ITAPACI	IW11162608	ITAPACI	09/11/2019 17:49	09/11/2019 20:51	09/11/2019 17:49	09/11/2019 20:51	3,03	137	414,92	CHI
20191171961	URUACU	UR11293596	URUACU	09/11/2019 17:42	10/11/2019 01:07	09/11/2019 17:42	10/11/2019 01:07	7,40	106	784,52	CHI
20191171968	VILA PROPICIO	GE12247163	GOIANESIA S2	09/11/2019 18:24	10/11/2019 11:34	09/11/2019 18:24	10/11/2019 11:34	17,16	8	137,31	CHI
20191171986	CACU	CC11059774	CACHOEIRA ALTA	09/11/2019 18:17	10/11/2019 10:36	09/11/2019 18:17	10/11/2019 10:36	16,30	105	1711,94	CHI
20191171996	MINEIROS	1390028875	PARQUE DAS EMAS	09/11/2019 18:49	10/11/2019 19:10	09/11/2019 18:49	10/11/2019 19:10	24,35	1	24,35	CHI
20191171997	TEREZOPOLIS DE GOIAS	1370015243	DAIA S2	09/11/2019 18:50	10/11/2019 10:03	09/11/2019 18:50	10/11/2019 10:03	15,22	1	15,22	CHI
20191172008	ANAPOLIS	20302435	ANAPOLIS UNIVERSITARIO S2	09/11/2019 18:50	09/11/2019 20:12	09/11/2019 18:50	09/11/2019 20:12	1,36	1	1,36	CHI
20191172015	GOIANIA	GN16403888	CAMPINAS S2	09/11/2019 18:50	10/11/2019 03:33	09/11/2019 18:50	09/11/2019 19:29	0,66	430	282,72	CHI
20191172015	GOIANIA	GN10380036	CAMPINAS S2	09/11/2019 18:50	10/11/2019 03:33	09/11/2019 18:50	09/11/2019 22:04	3,24	1779	5762,97	CHI
20191172015	GOIANIA	GN10380036	CAMPINAS S2	09/11/2019 18:50	10/11/2019 03:33	10/11/2019 02:41	10/11/2019 03:30	0,81	279	226,92	CHI

20191172015	GOIANIA	GN12000811	CAMPINAS S2	09/11/2019 18:50	10/11/2019 03:33	09/11/2019 18:50	10/11/2019 03:33	8,73	778	6789,56	CHI
20191172015	GOIANIA	GN13383141	CAMPINAS S2	09/11/2019 18:50	10/11/2019 03:33	10/11/2019 01:20	10/11/2019 03:33	2,22	1500	3324,58	CHI
20191172022	PIRANHAS	PH12041159	PIRANHAS	09/11/2019 18:51	10/11/2019 03:15	09/11/2019 18:51	10/11/2019 03:15	8,39	56	469,76	CHI
20191172023	ANAPOLIS	AN12026162	ANAPOLIS UNIVERSITARIO S2	09/11/2019 18:51	09/11/2019 22:04	09/11/2019 18:51	09/11/2019 22:04	3,20	1	3,20	CHI
20191172047	GOIANIA	GN11161512	XAVANTES	09/11/2019 18:49	10/11/2019 23:47	09/11/2019 18:49	10/11/2019 23:47	28,96	67	1940,00	CHI
20191172058	SANTO ANTONIO DA BARRA	BZ12301428	ACREUNA	09/11/2019 18:55	11/11/2019 07:38	09/11/2019 18:55	11/11/2019 07:38	36,71	5	183,53	CHI
20191172060	SANCLERLANDIA	SC11093499	FIRMINOPOLIS S2	09/11/2019 18:55	09/11/2019 21:36	09/11/2019 18:55	09/11/2019 21:36	2,67	157	418,88	CHI
20191172061	NOVA AURORA	NE21363960	CATALAO S1	09/11/2019 18:56	10/11/2019 07:50	09/11/2019 18:56	10/11/2019 07:50	12,90	5	64,50	CHI
20191172069	MINEIROS	MY21377392	PARQUE DAS EMAS	09/11/2019 18:56	12/11/2019 16:49	09/11/2019 18:56	12/11/2019 16:49	69,88	1	69,88	CHI
20191172071	RIO VERDE	RV12260701	CABRIUVA S1	09/11/2019 18:25	11/11/2019 12:00	09/11/2019 18:25	11/11/2019 12:00	41,57	2	83,14	CHI
20191172073	VIANOPOLIS	VN12282490	PIRES DO RIO S2	09/11/2019 18:56	10/11/2019 10:03	09/11/2019 18:56	10/11/2019 10:03	15,10	5	75,52	CHI
20191172075	RIO VERDE	RV11030697	RIO VERDE S1	09/11/2019 18:42	10/11/2019 23:22	09/11/2019 18:42	10/11/2019 11:15	16,53	146	2413,91	CHI
20191172075	RIO VERDE	RV11030697	RIO VERDE S1	09/11/2019 18:42	10/11/2019 23:22	10/11/2019 20:20	10/11/2019 23:22	3,03	146	442,83	CHI
20191172102	APARECIDA DE GOIANIA	AP11111850	INDEPENDENCIA S2	09/11/2019 18:47	09/11/2019 20:24	09/11/2019 18:47	09/11/2019 20:24	1,60	127	203,31	CHI
20191172105	GOIANIA	GN11002394	FERROVIARIO S2	09/11/2019 18:55	09/11/2019 22:37	09/11/2019 18:55	09/11/2019 22:37	3,70	209	773,24	CHI
20191172110	GOIANIA	GN11042131	FERROVIARIO S1	09/11/2019 18:50	10/11/2019 00:04	09/11/2019 18:50	10/11/2019 00:04	5,23	211	1103,41	CHI
20191172113	BALIZA	BH12251325	BOM JARDIM	09/11/2019 18:59	15/11/2019 09:13	09/11/2019 18:59	15/11/2019 09:13	134,24	1	134,24	CHI
20191172120	PIRANHAS	1930011559	PIRANHAS	09/11/2019 18:59	10/11/2019 17:17	09/11/2019 18:59	10/11/2019 17:17	22,29	1	22,29	CHI
20191172135	JATAI	JT11289400	JATAI S3	09/11/2019 16:36	10/11/2019 10:15	09/11/2019 16:36	10/11/2019 10:15	17,64	63	1111,57	CHI
20191172142	PIRANHAS	PH11023529	PIRANHAS	09/11/2019 18:52	10/11/2019 07:48	09/11/2019 18:52	10/11/2019 07:48	12,92	149	1925,08	CHI
20191172154	GOIANIA	GN13000132	FERROVIARIO S3	09/11/2019 19:00	10/11/2019 19:21	10/11/2019 00:11	10/11/2019 03:29	3,31	37	122,48	CHI
20191172154	GOIANIA	GN10383797	AEROPORTO S1	09/11/2019 19:00	10/11/2019 19:21	09/11/2019 19:00	10/11/2019 03:30	8,50	760	6457,26	CHI
20191172154	GOIANIA	GN10394631	AEROPORTO S1	09/11/2019 19:00	10/11/2019 19:21	09/11/2019 19:00	10/11/2019 04:20	9,34	380	3548,78	CHI
20191172154	GOIANIA	GN11217591	AEROPORTO S1	09/11/2019 19:00	10/11/2019 19:21	09/11/2019 19:00	10/11/2019 09:52	14,87	42	624,34	CHI
20191172154	GOIANIA	19870602	AEROPORTO S1	09/11/2019 19:00	10/11/2019 19:21	09/11/2019 19:00	10/11/2019 09:54	14,89	80	1191,27	CHI
20191172154	GOIANIA	GN11000438	AEROPORTO S1	09/11/2019 19:00	10/11/2019 19:21	09/11/2019 19:00	10/11/2019 19:07	24,11	139	3350,83	CHI
20191172154	GOIANIA	GN12001564	AEROPORTO S1	09/11/2019 19:00	10/11/2019 19:21	09/11/2019 19:00	10/11/2019 19:15	24,25	53	1285,12	CHI
20191172154	GOIANIA	GN11159237	AEROPORTO S1	09/11/2019 19:00	10/11/2019 19:21	09/11/2019 19:00	10/11/2019 19:21	24,36	137	3336,83	CHI
20191172156	PIRANHAS	PH12231072	PIRANHAS	09/11/2019 16:21	10/11/2019 01:27	09/11/2019 16:21	10/11/2019 01:27	9,09	162	1472,18	CHI
20191172177	JATAI	JT11159402	JATAI S3	09/11/2019 17:12	10/11/2019 13:46	09/11/2019 17:12	10/11/2019 13:46	20,56	98	2014,91	CHI
20191172179	GOIANAPOLIS	GP12285356	DAIA S2	09/11/2019 18:33	09/11/2019 20:41	09/11/2019 18:33	09/11/2019 20:41	2,13	8	17,01	CHI
20191172181	ANAPOLIS	AN11129347	ANAPOLIS UNIVERSITARIO S2	09/11/2019 18:57	09/11/2019 19:42	09/11/2019 18:57	09/11/2019 19:42	0,74	185	137,67	CHI
20191172182	SAO LUIS DE MONTES BELOS	500124292	SAO LUIZ DOS MONTES BELOS	09/11/2019 19:04	11/11/2019 00:49	09/11/2019 19:04	11/11/2019 00:49	29,75	1	29,75	CHI

20191172189	GOIANIA	GN11209261	MEIA PONTE	09/11/2019 19:02	10/11/2019 02:14	09/11/2019 19:02	10/11/2019 02:14	7,19	84	603,91	CHI
20191172204	GOIANIA	GN12151986	MEIA PONTE	09/11/2019 18:45	09/11/2019 23:26	09/11/2019 18:45	09/11/2019 23:26	4,67	542	2530,39	CHI
20191172209	GOIANIA	GN11229538	XAVANTES	09/11/2019 18:49	10/11/2019 09:40	09/11/2019 18:49	10/11/2019 09:40	14,84	70	1038,78	CHI
20191172213	GOIANESIA	GE12227047	GOIANESIA S2	09/11/2019 18:45	10/11/2019 10:54	09/11/2019 18:45	10/11/2019 10:54	16,14	7	113,01	CHI
20191172216	MORRINHOS	RQ12063040	RIO QUENTE	09/11/2019 19:07	12/11/2019 11:41	09/11/2019 19:07	12/11/2019 11:41	64,56	9	581,08	CHI
20191172216	RIO QUENTE	RQ12063040	RIO QUENTE	09/11/2019 19:07	12/11/2019 11:41	09/11/2019 19:07	12/11/2019 11:41	64,56	1	64,56	CHI
20191172221	APARECIDA DE GOIANIA	10004291911	REAL S1	09/11/2019 19:07	10/11/2019 10:16	09/11/2019 19:07	10/11/2019 10:16	15,14	1	15,14	CHI
20191172222	MOSSAMEDES	SC12060904	FIRMINOPOLIS S2	09/11/2019 18:10	10/11/2019 10:17	09/11/2019 18:10	10/11/2019 10:17	16,12	2	32,23	CHI
20191172222	SANCLERLANDIA	SC12060904	FIRMINOPOLIS S2	09/11/2019 18:10	10/11/2019 10:17	09/11/2019 18:10	10/11/2019 10:17	16,12	23	370,68	CHI
20191172224	GOIANIA	GN11002387	XAVANTES	09/11/2019 19:04	10/11/2019 00:30	09/11/2019 19:04	10/11/2019 00:30	5,43	165	896,27	CHI
20191172246	MINEIROS	MY11105596	PARQUE DAS EMAS	09/11/2019 16:39	10/11/2019 07:42	09/11/2019 16:39	10/11/2019 07:42	15,05	188	2828,67	CHI
20191172247	PONTALINA	PK21074608	PONTALINA	09/11/2019 19:09	11/11/2019 15:47	09/11/2019 19:09	11/11/2019 15:47	44,63	1	44,63	CHI
20191172249	IPORA	00850214	IPORA	09/11/2019 19:03	10/11/2019 02:04	09/11/2019 19:03	09/11/2019 19:58	0,91	5026	4570,87	CHI
20191172249	IVOLANDIA	00850214	IPORA	09/11/2019 19:03	10/11/2019 02:04	09/11/2019 19:03	09/11/2019 19:58	0,91	14	12,73	CHI
20191172249	IPORA	00850214	IPORA	09/11/2019 19:03	10/11/2019 02:04	09/11/2019 19:03	09/11/2019 20:26	1,38	3415	4696,57	CHI
20191172249	IPORA	00850214	IPORA	09/11/2019 19:03	10/11/2019 02:04	09/11/2019 19:03	10/11/2019 02:04	7,01	250	1751,74	CHI
20191172257	MONTIVIDIU	MV11301689	MONTIVIDIU T	09/11/2019 18:52	10/11/2019 01:20	09/11/2019 18:52	10/11/2019 01:20	6,45	63	406,65	CHI
20191172261	PIRANHAS	PH11157888	PIRANHAS	09/11/2019 18:52	10/11/2019 14:03	09/11/2019 18:52	10/11/2019 14:03	19,17	161	3086,33	CHI
20191172262	DIORAMA	00850424	IPORA	09/11/2019 19:04	12/11/2019 06:35	09/11/2019 19:04	09/11/2019 21:11	2,12	751	1593,16	CHI
20191172262	DIORAMA	00850424	IPORA	09/11/2019 19:04	12/11/2019 06:35	09/11/2019 19:04	09/11/2019 21:11	2,12	103	218,50	CHI
20191172262	IPORA	00850424	IPORA	09/11/2019 19:04	12/11/2019 06:35	09/11/2019 19:04	09/11/2019 21:11	2,12	17	36,06	CHI
20191172262	IPORA	00850424	IPORA	09/11/2019 19:04	12/11/2019 06:35	09/11/2019 19:04	09/11/2019 21:11	2,12	68	144,25	CHI
20191172262	ISRAELANDIA	00850424	IPORA	09/11/2019 19:04	12/11/2019 06:35	09/11/2019 19:04	09/11/2019 21:11	2,12	3	6,36	CHI
20191172262	JAUPACI	00850424	IPORA	09/11/2019 19:04	12/11/2019 06:35	09/11/2019 19:04	09/11/2019 21:11	2,12	22	46,67	CHI
20191172262	ARENOPOLIS	00850424	IPORA	09/11/2019 19:04	12/11/2019 06:35	09/11/2019 19:04	09/11/2019 21:23	2,32	106	246,07	CHI
20191172262	ARENOPOLIS	00850424	IPORA	09/11/2019 19:04	12/11/2019 06:35	09/11/2019 19:04	09/11/2019 21:23	2,32	131	304,10	CHI
20191172262	DIORAMA	00850424	IPORA	09/11/2019 19:04	12/11/2019 06:35	09/11/2019 19:04	09/11/2019 21:23	2,32	11	25,54	CHI
20191172262	DIORAMA	00850424	IPORA	09/11/2019 19:04	12/11/2019 06:35	09/11/2019 19:04	09/11/2019 21:23	2,32	65	150,89	CHI
20191172262	FAZENDA NOVA	00850424	IPORA	09/11/2019 19:04	12/11/2019 06:35	09/11/2019 19:04	09/11/2019 21:23	2,32	6	13,93	CHI
20191172262	IPORA	00850424	IPORA	09/11/2019 19:04	12/11/2019 06:35	09/11/2019 19:04	09/11/2019 21:23	2,32	3	6,96	CHI
20191172262	JAUPACI	00850424	IPORA	09/11/2019 19:04	12/11/2019 06:35	09/11/2019 19:04	09/11/2019 21:23	2,32	7	16,25	CHI
20191172262	JUSSARA	00850424	IPORA	09/11/2019 19:04	12/11/2019 06:35	09/11/2019 19:04	09/11/2019 21:23	2,32	364	844,99	CHI
20191172262	MONTE ALEGRE DE GOIAS	00850424	IPORA	09/11/2019 19:04	12/11/2019 06:35	09/11/2019 19:04	09/11/2019 21:23	2,32	2	4,64	CHI

20191172262	MONTES CLAROS DE GOIAS	00850424	IPORA	09/11/2019 19:04	12/11/2019 06:35	09/11/2019 19:04	09/11/2019 21:23	2,32	3223	7481,84	CHI
20191172262	MONTES CLAROS DE GOIAS	00850424	IPORA	09/11/2019 19:04	12/11/2019 06:35	09/11/2019 19:04	09/11/2019 21:23	2,32	82	190,35	CHI
20191172262	MONTES CLAROS DE GOIAS	00850424	IPORA	09/11/2019 19:04	12/11/2019 06:35	09/11/2019 19:04	09/11/2019 21:23	2,32	194	450,35	CHI
20191172262	MONTES CLAROS DE GOIAS	IR13402921	IPORA	09/11/2019 19:04	12/11/2019 06:35	09/11/2019 19:04	09/11/2019 21:23	2,32	753	1748,01	CHI
20191172262	ORIZONA	00850424	IPORA	09/11/2019 19:04	12/11/2019 06:35	09/11/2019 19:04	09/11/2019 21:23	2,32	39	90,53	CHI
20191172262	PIRANHAS	00850424	IPORA	09/11/2019 19:04	12/11/2019 06:35	09/11/2019 19:04	09/11/2019 21:23	2,32	2	4,64	CHI
20191172262	ARAGARCAS	IR13402921	IPORA	09/11/2019 19:04	12/11/2019 06:35	12/11/2019 00:35	12/11/2019 06:35	6,01	49	294,30	CHI
20191172262	ARENOPOLIS	IR13402921	IPORA	09/11/2019 19:04	12/11/2019 06:35	12/11/2019 00:35	12/11/2019 06:35	6,01	103	618,63	CHI
20191172262	ARENOPOLIS	IR13402921	IPORA	09/11/2019 19:04	12/11/2019 06:35	12/11/2019 00:35	12/11/2019 06:35	6,01	131	786,80	CHI
20191172262	BOM JARDIM DE GOIAS	IR13402921	IPORA	09/11/2019 19:04	12/11/2019 06:35	12/11/2019 00:35	12/11/2019 06:35	6,01	20	120,12	CHI
20191172262	DIORAMA	IR13402921	IPORA	09/11/2019 19:04	12/11/2019 06:35	12/11/2019 00:35	12/11/2019 06:35	6,01	11	66,07	CHI
20191172262	DIORAMA	IR13402921	IPORA	09/11/2019 19:04	12/11/2019 06:35	12/11/2019 00:35	12/11/2019 06:35	6,01	751	4510,59	CHI
20191172262	DIORAMA	IR13402921	IPORA	09/11/2019 19:04	12/11/2019 06:35	12/11/2019 00:35	12/11/2019 06:35	6,01	172	1033,05	CHI
20191172262	FAZENDA NOVA	IR13402921	IPORA	09/11/2019 19:04	12/11/2019 06:35	12/11/2019 00:35	12/11/2019 06:35	6,01	6	36,04	CHI
20191172262	IPORA	IR13402921	IPORA	09/11/2019 19:04	12/11/2019 06:35	12/11/2019 00:35	12/11/2019 06:35	6,01	17	102,10	CHI
20191172262	IPORA	IR13402921	IPORA	09/11/2019 19:04	12/11/2019 06:35	12/11/2019 00:35	12/11/2019 06:35	6,01	79	474,48	CHI
20191172262	ISRAELANDIA	IR13402921	IPORA	09/11/2019 19:04	12/11/2019 06:35	12/11/2019 00:35	12/11/2019 06:35	6,01	3	18,02	CHI
20191172262	JAUPACI	IR13402921	IPORA	09/11/2019 19:04	12/11/2019 06:35	12/11/2019 00:35	12/11/2019 06:35	6,01	7	42,04	CHI
20191172262	JAUPACI	IR13402921	IPORA	09/11/2019 19:04	12/11/2019 06:35	12/11/2019 00:35	12/11/2019 06:35	6,01	25	150,15	CHI
20191172262	JUSSARA	IR13402921	IPORA	09/11/2019 19:04	12/11/2019 06:35	12/11/2019 00:35	12/11/2019 06:35	6,01	355	2132,17	CHI
20191172262	MONTE ALEGRE DE GOIAS	IR13402921	IPORA	09/11/2019 19:04	12/11/2019 06:35	12/11/2019 00:35	12/11/2019 06:35	6,01	2	12,01	CHI
20191172262	MONTES CLAROS DE GOIAS	IR13402921	IPORA	09/11/2019 19:04	12/11/2019 06:35	12/11/2019 00:35	12/11/2019 06:35	6,01	3029	18192,51	CHI
20191172262	MONTES CLAROS DE GOIAS	IR13402921	IPORA	09/11/2019 19:04	12/11/2019 06:35	12/11/2019 00:35	12/11/2019 06:35	6,01	53	318,32	CHI
20191172262	MONTES CLAROS DE GOIAS	IR13402921	IPORA	09/11/2019 19:04	12/11/2019 06:35	12/11/2019 00:35	12/11/2019 06:35	6,01	668	4012,08	CHI
20191172262	ORIZONA	IR13402921	IPORA	09/11/2019 19:04	12/11/2019 06:35	12/11/2019 00:35	12/11/2019 06:35	6,01	39	234,24	CHI
20191172262	PIRANHAS	IR13402921	IPORA	09/11/2019 19:04	12/11/2019 06:35	12/11/2019 00:35	12/11/2019 06:35	6,01	2	12,01	CHI
20191172268	JATAI	JT12226459	JATAI S1	09/11/2019 19:10	12/11/2019 17:04	09/11/2019 19:10	12/11/2019 17:04	69,90	2	139,79	CHI
20191172286	PARAUNA	PU12191978	MONTIVIDIU T	09/11/2019 17:57	12/11/2019 20:30	09/11/2019 17:57	12/11/2019 20:30	74,54	4	298,15	CHI
20191172292	GOIANIA	GN11002923	XAVANTES	09/11/2019 18:51	10/11/2019 13:34	09/11/2019 18:51	10/11/2019 13:34	18,71	97	1815,33	CHI
20191172294	GOIANIA	GN12000480	FERROVIARIO S1	09/11/2019 18:44	09/11/2019 23:16	09/11/2019 18:44	09/11/2019 23:16	4,53	372	1684,33	CHI
20191172318	GOIANIA	GN11147725	MEIA PONTE	09/11/2019 18:56	10/11/2019 04:51	09/11/2019 18:56	10/11/2019 04:51	9,90	176	1742,55	CHI
20191172322	GOIANIA	GN12000603	CAMPINAS S3	09/11/2019 19:13	10/11/2019 00:23	09/11/2019 19:13	09/11/2019 22:45	3,54	258	912,39	CHI
20191172322	GOIANIA	GN11001840	CAMPINAS S3	09/11/2019 19:13	10/11/2019 00:23	09/11/2019 19:13	10/11/2019 00:23	5,16	137	707,53	CHI

20191172323	MINACU	IH12396740	MINACU	09/11/2019 17:33	09/11/2019 23:37	09/11/2019 17:33	09/11/2019 23:37	6,06	159	964,07	CHI
20191172329	PIRANHAS	PH12072404	PIRANHAS	09/11/2019 18:37	10/11/2019 07:39	09/11/2019 18:37	10/11/2019 07:39	13,03	101	1316,09	CHI
20191172343	JATAI	290325638	JATAI S2	09/11/2019 19:14	11/11/2019 09:48	09/11/2019 19:14	11/11/2019 09:48	38,56	1	38,56	CHI
20191172344	URUACU	UR12317135	URUACU	09/11/2019 17:09	10/11/2019 13:54	09/11/2019 17:09	10/11/2019 13:54	20,74	11	228,18	CHI
20191172357	SAO LUIS DE MONTES BELOS	SL21126215	FIRMINOPOLIS S1	09/11/2019 19:15	11/11/2019 08:40	09/11/2019 19:15	11/11/2019 08:40	37,42	1	37,42	CHI
20191172359	GOIATUBA	GT21050345	GOIATUBA S1	09/11/2019 19:15	13/11/2019 15:40	09/11/2019 19:15	13/11/2019 15:40	92,41	1	92,41	CHI
20191172362	APARECIDA DE GOIANIA	AP11164450	INDEPENDENCIA S2	09/11/2019 19:10	09/11/2019 21:07	09/11/2019 19:10	09/11/2019 21:07	1,94	153	296,48	CHI
20191172365	FORMOSO	FO12285491	PORANGATU	09/11/2019 17:32	10/11/2019 21:15	09/11/2019 17:32	10/11/2019 21:15	27,71	22	609,59	CHI
20191172387	GOIANIA	GN11100372	XAVANTES	09/11/2019 19:07	10/11/2019 13:28	09/11/2019 19:07	10/11/2019 13:28	18,34	109	1999,51	CHI
20191172415	GOIANIA	GN12164390	XAVANTES	09/11/2019 19:04	09/11/2019 22:12	09/11/2019 19:04	09/11/2019 22:12	3,13	735	2300,35	CHI
20191172416	APARECIDA DE GOIANIA	AP11003038	REAL S2	09/11/2019 19:10	09/11/2019 20:45	09/11/2019 19:10	09/11/2019 20:45	1,58	218	344,26	CHI
20191172427	GOIANIA	GN11042210	AEROPORTO S1	09/11/2019 19:09	09/11/2019 22:39	09/11/2019 19:09	09/11/2019 22:39	3,50	111	388,72	CHI
20191172450	GOIANIA	GN11144783	XAVANTES	09/11/2019 19:10	10/11/2019 14:16	09/11/2019 19:10	10/11/2019 14:16	19,10	235	4487,85	CHI
20191172453	INACIOLANDIA	ID12088533	QUIRINOPOLIS	09/11/2019 15:46	09/11/2019 21:58	09/11/2019 15:46	09/11/2019 21:58	6,19	161	995,83	CHI
20191172468	IPORA	IR11014385	IPORA	09/11/2019 19:16	10/11/2019 00:53	09/11/2019 19:16	10/11/2019 00:53	5,61	141	790,42	CHI
20191172474	GOIANIA	GN11035483	GOIANIA LESTE S2	09/11/2019 19:14	10/11/2019 03:24	09/11/2019 19:14	10/11/2019 03:24	8,15	52	423,89	CHI
20191172475	GOIANIA	GN12000739	XAVANTES	09/11/2019 18:49	10/11/2019 05:03	09/11/2019 18:49	10/11/2019 05:03	10,22	78	797,03	CHI
20191172476	JANDAIA	PL16407968	PALMEIRAS	09/11/2019 19:19	09/11/2019 20:24	09/11/2019 19:19	09/11/2019 20:24	1,09	92	100,41	CHI
20191172476	JANDAIA	PL16407968	PALMEIRAS	09/11/2019 19:19	09/11/2019 20:24	09/11/2019 19:19	09/11/2019 20:24	1,09	1	1,09	CHI
20191172476	PALESTINA DE GOIAS	PL16407968	PALMEIRAS	09/11/2019 19:19	09/11/2019 20:24	09/11/2019 19:19	09/11/2019 20:24	1,09	1	1,09	CHI
20191172476	PALMEIRAS DE GOIAS	PL16407968	PALMEIRAS	09/11/2019 19:19	09/11/2019 20:24	09/11/2019 19:19	09/11/2019 20:24	1,09	72	78,58	CHI
20191172476	PALMEIRAS DE GOIAS	PL16407968	PALMEIRAS	09/11/2019 19:19	09/11/2019 20:24	09/11/2019 19:19	09/11/2019 20:24	1,09	2420	2641,16	CHI
20191172476	PALMINOPOLIS	PL16407968	PALMEIRAS	09/11/2019 19:19	09/11/2019 20:24	09/11/2019 19:19	09/11/2019 20:24	1,09	12	13,10	CHI
20191172480	TRINDADE	40111696	TRINDADE	09/11/2019 19:23	10/11/2019 20:31	09/11/2019 19:23	10/11/2019 20:31	25,14	1	25,14	CHI
20191172492	GUAPO	03320226	GUAPO S2	09/11/2019 19:17	10/11/2019 11:05	09/11/2019 19:17	10/11/2019 11:05	15,80	130	2053,42	CHI
20191172492	VARJAO	03320226	GUAPO S2	09/11/2019 19:17	10/11/2019 11:05	09/11/2019 19:17	10/11/2019 11:05	15,80	200	3159,11	CHI
20191172498	JATAI	RV12000142	CABRIUVA S1	09/11/2019 11:49	09/11/2019 21:55	09/11/2019 11:49	09/11/2019 21:55	10,09	6	60,56	CHI
20191172498	RIO VERDE	RV12000142	CABRIUVA S1	09/11/2019 11:49	09/11/2019 21:55	09/11/2019 11:49	09/11/2019 21:55	10,09	78	787,24	CHI
20191172517	GOIANIA	GN12000318	GOIANIA LESTE S3	09/11/2019 19:17	10/11/2019 11:51	09/11/2019 19:17	10/11/2019 11:51	16,56	168	2782,22	CHI
20191172530	GOIANIA	GN11374103	FERROVIARIO S3	09/11/2019 19:06	10/11/2019 04:04	09/11/2019 19:06	10/11/2019 04:04	8,96	50	447,81	CHI
20191172536	GOIANIA	GN12346336	FERROVIARIO S3	09/11/2019 19:08	10/11/2019 00:26	09/11/2019 19:08	10/11/2019 00:26	5,30	693	3675,02	CHI
20191172537	GOIANIA	GN11132348	GOYA S1	09/11/2019 19:26	09/11/2019 23:13	09/11/2019 19:26	09/11/2019 23:13	3,77	123	464,29	CHI
20191172547	SAO LUIS DE MONTES BELOS	SL11076364	SAO LUIZ DOS MONTES BELOS	09/11/2019 19:17	10/11/2019 08:46	09/11/2019 19:17	10/11/2019 08:46	13,48	178	2399,59	CHI

20191172560	BURITI DE GOIAS	BS11055346	FIRMINOPOLIS S2	09/11/2019 18:10	10/11/2019 00:47	09/11/2019 18:10	10/11/2019 00:47	6,62	103	681,52	CHI
20191172561	GOIANIA	GN11086122	FERROVIARIO S3	09/11/2019 19:09	10/11/2019 04:30	09/11/2019 19:09	10/11/2019 04:30	9,34	74	690,79	CHI
20191172563	GOIANIA	GN11199197	ATLANTICO S1	09/11/2019 19:19	10/11/2019 15:00	09/11/2019 19:19	10/11/2019 15:00	19,67	92	1809,77	CHI
20191172567	GOIANIA	GN11162455	CARAJAS S2	09/11/2019 19:22	10/11/2019 12:12	09/11/2019 19:22	10/11/2019 12:12	16,82	172	2893,18	CHI
20191172569	GOIANIA	GN12205674	ATLANTICO S1	09/11/2019 19:18	10/11/2019 01:17	09/11/2019 19:18	10/11/2019 01:17	5,97	84	501,78	CHI
20191172579	GOIANIA	GN11189316	CAMPINAS S1	09/11/2019 19:16	10/11/2019 00:34	09/11/2019 19:16	10/11/2019 00:34	5,28	88	465,01	CHI
20191172586	NOVO BRASIL	NB12396218	JUSSARA	09/11/2019 19:31	13/11/2019 20:20	09/11/2019 19:31	13/11/2019 20:20	96,81	2	193,62	CHI
20191172592	ADELANDIA	DN12145856	FIRMINOPOLIS S2	09/11/2019 18:30	09/11/2019 21:37	09/11/2019 18:30	09/11/2019 21:37	3,11	20	62,19	CHI
20191172595	GOIANIA	GN12383183	XAVANTES	09/11/2019 18:47	10/11/2019 03:05	09/11/2019 18:47	10/11/2019 03:05	8,30	235	1949,85	CHI
20191172596	GOIANIA	GN11001997	AEROPORTO S2	09/11/2019 19:18	10/11/2019 06:41	09/11/2019 19:18	10/11/2019 06:41	11,37	106	1204,96	CHI
20191172603	MINEIROS	MY11337082	PARQUE DAS EMAS	09/11/2019 17:21	10/11/2019 18:45	09/11/2019 17:21	10/11/2019 18:45	25,39	59	1498,27	CHI
20191172609	GOIANIA	GN11002050	AEROPORTO S2	09/11/2019 19:12	11/11/2019 07:22	09/11/2019 19:12	11/11/2019 07:22	36,16	73	2639,48	CHI
20191172611	MORRINHOS	MR21412558	MORRINHOS	09/11/2019 19:33	10/11/2019 18:05	09/11/2019 19:33	10/11/2019 18:05	22,53	1	22,53	CHI
20191172614	GOIANIA	GN11002595	CAMPINAS S2	09/11/2019 19:23	10/11/2019 13:00	09/11/2019 19:23	10/11/2019 13:00	17,61	154	2711,98	CHI
20191172617	GOIANIA	GN11209293	MEIA PONTE	09/11/2019 19:14	09/11/2019 23:51	09/11/2019 19:14	09/11/2019 23:51	4,60	102	469,57	CHI
20191172618	PORANGATU	PO12208614	PORANGATU	09/11/2019 14:16	10/11/2019 17:21	09/11/2019 14:16	10/11/2019 17:21	27,08	8	216,62	CHI
20191172625	PIRACANJUBA	PJ12209123	PIRACANJUBA	09/11/2019 19:34	11/11/2019 10:47	09/11/2019 19:34	10/11/2019 12:10	16,60	3	49,81	CHI
20191172625	PIRACANJUBA	PJ13293370	PIRACANJUBA	09/11/2019 19:34	11/11/2019 10:47	09/11/2019 19:34	10/11/2019 17:06	21,55	4	86,20	CHI
20191172625	PIRACANJUBA	PJ12249833	PIRACANJUBA	09/11/2019 19:34	11/11/2019 10:47	09/11/2019 19:34	11/11/2019 10:47	39,22	45	1764,85	CHI
20191172626	APARECIDA DE GOIANIA	AP11072666	INDEPENDENCIA S1	09/11/2019 19:23	09/11/2019 22:16	09/11/2019 19:23	09/11/2019 22:16	2,87	107	307,57	CHI
20191172628	GOIANIA	GN11002223	FERROVIARIO S3	09/11/2019 19:00	10/11/2019 12:36	09/11/2019 19:00	10/11/2019 12:36	17,59	24	422,19	CHI
20191172631	APARECIDA DE GOIANIA	AP11224134	INDEPENDENCIA S1	09/11/2019 19:32	09/11/2019 22:57	09/11/2019 19:32	09/11/2019 22:57	3,42	171	584,20	CHI
20191172636	IPAMERI	IP21166823	CAMPO ALEGRE DE GOIAS	09/11/2019 19:35	09/11/2019 23:29	09/11/2019 19:35	09/11/2019 23:29	3,89	1	3,89	CHI
20191172644	GOIANIA	GN11165055	ATLANTICO S1	09/11/2019 19:19	10/11/2019 01:56	09/11/2019 19:19	10/11/2019 01:56	6,60	111	732,88	CHI
20191172661	GOIANIA	GN11000284	AEROPORTO S3	09/11/2019 19:11	09/11/2019 22:00	09/11/2019 19:11	09/11/2019 22:00	2,80	57	159,74	CHI
20191172666	GOIAS	GS12162492	GOIAS	09/11/2019 19:37	12/11/2019 13:39	09/11/2019 19:37	12/11/2019 11:32	63,91	1	63,91	CHI
20191172666	GOIAS	GS12162492	GOIAS	09/11/2019 19:37	12/11/2019 13:39	09/11/2019 19:37	12/11/2019 13:39	66,03	3	198,09	CHI
20191172669	GOIANIA	GN12000394	CAMPINAS S3	09/11/2019 19:12	09/11/2019 22:52	09/11/2019 19:12	09/11/2019 22:50	3,64	59	215,01	CHI
20191172669	GOIANIA	GN11172731	CAMPINAS S3	09/11/2019 19:12	09/11/2019 22:52	09/11/2019 19:12	09/11/2019 22:52	3,66	54	197,83	CHI
20191172670	APARECIDA DE GOIANIA	AP11326564	INDEPENDENCIA S2	09/11/2019 18:25	09/11/2019 21:02	09/11/2019 18:25	09/11/2019 21:02	2,61	49	127,75	CHI
20191172672	GOIANIA	GN11241317	CAMPINAS S1	09/11/2019 19:00	09/11/2019 22:19	09/11/2019 19:00	09/11/2019 22:19	3,31	55	181,97	CHI
20191172678	GOIANIA	8388177	FERROVIARIO S3	09/11/2019 19:20	10/11/2019 17:37	09/11/2019 19:20	10/11/2019 17:37	22,28	116	2584,58	CHI
20191172690	GOIANIA	12833289	CARAJAS S2	09/11/2019 19:40	09/11/2019 23:45	09/11/2019 19:40	09/11/2019 23:45	4,08	1	4,08	CHI



20191172694	RIO VERDE	RV11044657	CABRIUVA S1	09/11/2019 18:15	10/11/2019 06:08	09/11/2019 18:15	10/11/2019 06:08	11,88	166	1972,36	CHI
20191172704	PIRANHAS	PH12204900	PIRANHAS	09/11/2019 17:13	09/11/2019 22:31	09/11/2019 17:13	09/11/2019 22:31	5,29	341	1804,55	CHI
20191172715	GOIANESIA	GE12359356	GOIANESIA S2	09/11/2019 18:05	10/11/2019 11:23	10/11/2019 10:44	10/11/2019 11:23	0,65	108	70,59	CHI
20191172722	SENADOR CANEDO	13542497	GOIANIA LESTE S1	09/11/2019 19:43	09/11/2019 21:47	09/11/2019 19:43	09/11/2019 21:47	2,07	1	2,07	CHI
20191172725	GOIANIA	10282520	CAMPINAS S2	09/11/2019 19:43	10/11/2019 19:40	09/11/2019 19:43	10/11/2019 19:40	23,93	1	23,93	CHI
20191172726	ABADIA DE GOIAS	LG11272064	CARAJAS S1	09/11/2019 19:26	09/11/2019 23:39	09/11/2019 19:26	09/11/2019 23:39	4,20	166	697,66	CHI
20191172728	APARECIDA DE GOIANIA	AP11003030	INDEPENDENCIA S1	09/11/2019 19:17	10/11/2019 05:58	09/11/2019 19:17	10/11/2019 05:58	10,67	106	1130,84	CHI
20191172729	JATAI	290142192	JATAI S3	09/11/2019 19:44	11/11/2019 00:15	09/11/2019 19:44	11/11/2019 00:15	28,52	1	28,52	CHI
20191172730	GOIANIA	GN11086732	MEIA PONTE	09/11/2019 19:27	09/11/2019 21:06	09/11/2019 19:27	09/11/2019 21:06	1,64	180	295,25	CHI
20191172732	PIRANHAS	PH11023527	PIRANHAS	09/11/2019 19:43	10/11/2019 02:10	09/11/2019 19:43	10/11/2019 02:10	6,43	102	656,31	CHI
20191172739	GOIANIA	GN11199145	GOIANIA LESTE S2	09/11/2019 19:44	10/11/2019 09:09	09/11/2019 19:44	10/11/2019 09:09	13,41	97	1300,31	CHI
20191172742	SAO LUIS DE MONTES BELOS	500117597	SAO LUIZ DOS MONTES BELOS	09/11/2019 19:44	11/11/2019 02:01	09/11/2019 19:44	11/11/2019 02:01	30,28	1	30,28	CHI
20191172761	GOIANIA	GN12151308	ATLANTICO S1	09/11/2019 19:19	10/11/2019 05:23	09/11/2019 19:19	10/11/2019 05:23	10,05	172	1729,13	CHI
20191172777	GOIANIA	GN11000447	CAMPINAS S3	09/11/2019 19:48	10/11/2019 17:25	09/11/2019 19:48	10/11/2019 17:25	21,62	51	1102,75	CHI
20191172784	GOIANIA	10612774	AEROPORTO S2	09/11/2019 19:48	11/11/2019 08:00	09/11/2019 19:48	11/11/2019 08:00	36,19	1	36,19	CHI
20191172787	SAO LUIS DE MONTES BELOS	SL11000042	SAO LUIZ DOS MONTES BELOS	09/11/2019 19:36	10/11/2019 08:40	09/11/2019 19:36	10/11/2019 08:40	13,07	55	718,93	CHI
20191172793	GOIANIA	GN11000969	CAMPINAS S1	09/11/2019 19:47	09/11/2019 21:58	09/11/2019 19:47	09/11/2019 21:58	2,18	128	279,36	CHI
20191172794	IPORA	730016780	IPORA	09/11/2019 19:49	11/11/2019 15:42	09/11/2019 19:49	11/11/2019 15:42	43,87	1	43,87	CHI
20191172799	GOIANIA	GN11002381	FERROVIARIO S3	09/11/2019 19:10	10/11/2019 03:15	09/11/2019 19:10	10/11/2019 03:15	8,07	75	605,56	CHI
20191172808	BELA VISTA DE GOIAS	BV31172631	CEPAIGO S2	09/11/2019 19:51	10/11/2019 13:11	09/11/2019 19:51	10/11/2019 13:11	17,33	1	17,33	CHI
20191172809	GOIANIA	GN11000564	AEROPORTO S2	09/11/2019 19:40	10/11/2019 07:49	09/11/2019 19:40	10/11/2019 07:49	12,14	67	813,57	CHI
20191172811	GOIANIA	10013287280	XAVANTES	09/11/2019 19:51	10/11/2019 11:02	09/11/2019 19:51	10/11/2019 11:02	15,18	1	15,18	CHI
20191172812	GOIANIA	GN11002363	FERROVIARIO S3	09/11/2019 19:13	09/11/2019 22:38	09/11/2019 19:13	09/11/2019 22:38	3,40	64	217,81	CHI
20191172821	BURITI DE GOIAS	BS12076542	FIRMINOPOLIS S2	09/11/2019 18:39	10/11/2019 14:58	09/11/2019 18:39	10/11/2019 14:58	20,30	38	771,58	CHI
20191172829	MINEIROS	MY11274025	PARQUE DAS EMAS	09/11/2019 18:47	10/11/2019 09:13	09/11/2019 18:47	10/11/2019 09:13	14,42	169	2437,64	CHI
20191172841	PIRANHAS	PH11023533	PIRANHAS	09/11/2019 18:38	10/11/2019 11:15	09/11/2019 18:38	10/11/2019 11:15	16,61	86	1428,60	CHI
20191172842	GOIANIA	GN12201566	GOYA S2	09/11/2019 19:11	09/11/2019 23:34	09/11/2019 19:11	09/11/2019 23:34	4,38	295	1290,95	CHI
20191172843	GOIANIA	GN11189933	GOYA S2	09/11/2019 19:37	10/11/2019 16:52	09/11/2019 19:37	10/11/2019 16:52	21,24	141	2995,27	CHI
20191172844	GOIANIA	11257933	CAMPINAS S3	09/11/2019 19:54	10/11/2019 21:05	09/11/2019 19:54	10/11/2019 21:05	25,18	1	25,18	CHI
20191172857	GOIANIA	GN12000592	AEROPORTO S1	09/11/2019 19:21	09/11/2019 23:27	09/11/2019 19:21	09/11/2019 23:27	4,10	169	692,76	CHI
20191172859	GOIANIA	GN11180112	XAVANTES	09/11/2019 19:20	10/11/2019 01:37	09/11/2019 19:20	10/11/2019 01:37	6,29	115	723,19	CHI
20191172893	TRINDADE	TR10384949	TRINDADE	09/11/2019 19:50	10/11/2019 23:01	09/11/2019 19:50	09/11/2019 20:44	0,91	1691	1530,82	CHI
20191172893	TRINDADE	TR10384949	TRINDADE	09/11/2019 19:50	10/11/2019 23:01	09/11/2019 21:26	09/11/2019 21:31	0,09	1691	150,78	CHI

20191172893	TRINDADE	XX28535261	TRINDADE	09/11/2019 19:50	10/11/2019 23:01	09/11/2019 19:50	09/11/2019 21:50	2,00	1289	2576,57	CHI
20191172893	TRINDADE	TR12091829	TRINDADE	09/11/2019 19:50	10/11/2019 23:01	09/11/2019 19:50	09/11/2019 22:00	2,17	1624	3531,75	CHI
20191172893	TRINDADE	TR13403523	TRINDADE	09/11/2019 19:50	10/11/2019 23:01	09/11/2019 19:50	09/11/2019 22:41	2,86	9	25,72	CHI
20191172893	TRINDADE	XX28536435	TRINDADE	09/11/2019 19:50	10/11/2019 23:01	09/11/2019 23:04	09/11/2019 23:07	0,05	2132	110,15	CHI
20191172893	SANTA BARBARA DE GOIAS	TR13131440	TRINDADE	09/11/2019 19:50	10/11/2019 23:01	09/11/2019 19:50	10/11/2019 01:31	5,68	142	806,48	CHI
20191172893	TRINDADE	TR13131440	TRINDADE	09/11/2019 19:50	10/11/2019 23:01	09/11/2019 19:50	10/11/2019 01:31	5,68	100	567,94	CHI
20191172893	TRINDADE	TR13091758	TRINDADE	09/11/2019 19:50	10/11/2019 23:01	09/11/2019 19:50	10/11/2019 09:00	13,18	158	2082,00	CHI
20191172893	SANTA BARBARA DE GOIAS	TR12401103	TRINDADE	09/11/2019 19:50	10/11/2019 23:01	10/11/2019 11:54	10/11/2019 15:37	3,72	142	528,04	CHI
20191172893	TRINDADE	TR12401103	TRINDADE	09/11/2019 19:50	10/11/2019 23:01	10/11/2019 11:54	10/11/2019 15:37	3,72	93	345,83	CHI
20191172893	SANTA BARBARA DE GOIAS	TR13131440	TRINDADE	09/11/2019 19:50	10/11/2019 23:01	10/11/2019 18:26	10/11/2019 19:05	0,65	142	91,67	CHI
20191172893	TRINDADE	TR13131440	TRINDADE	09/11/2019 19:50	10/11/2019 23:01	10/11/2019 18:26	10/11/2019 19:05	0,65	101	65,20	CHI
20191172893	SANTA BARBARA DE GOIAS	TR13233214	TRINDADE	09/11/2019 19:50	10/11/2019 23:01	09/11/2019 19:50	10/11/2019 22:36	26,77	21	562,26	CHI
20191172893	TRINDADE	TR13233214	TRINDADE	09/11/2019 19:50	10/11/2019 23:01	09/11/2019 19:50	10/11/2019 22:36	26,77	121	3239,71	CHI
20191172893	SANTA BARBARA DE GOIAS	6689618	TRINDADE	09/11/2019 19:50	10/11/2019 23:01	10/11/2019 20:28	10/11/2019 23:00	2,55	142	362,06	CHI
20191172893	TRINDADE	6689618	TRINDADE	09/11/2019 19:50	10/11/2019 23:01	10/11/2019 20:28	10/11/2019 23:00	2,55	101	257,52	CHI
20191172893	TRINDADE	TR11091346	TRINDADE	09/11/2019 19:50	10/11/2019 23:01	09/11/2019 19:50	10/11/2019 23:01	27,18	107	2908,20	CHI
20191172904	ARAGOIANIA	AO11272623	INDEPENDENCIA S2	09/11/2019 19:59	10/11/2019 16:38	09/11/2019 19:59	10/11/2019 16:38	20,64	6	123,84	CHI
20191172905	GOIANIA	10014356692	CAMPINAS S2	09/11/2019 19:59	10/11/2019 03:30	09/11/2019 19:59	10/11/2019 03:30	7,52	1	7,52	CHI
20191172911	GOIANIA	GN12057812	ATLANTICO S2	09/11/2019 19:17	09/11/2019 23:15	09/11/2019 19:17	09/11/2019 23:15	3,95	319	1261,56	CHI
20191172918	GOIANIA	15215507	AEROPORTO S1	09/11/2019 20:01	10/11/2019 02:58	09/11/2019 20:01	10/11/2019 02:58	6,94	1	6,94	CHI
20191172924	GOIANIA	GN12044453	FERROVIARIO S2	09/11/2019 18:50	09/11/2019 21:59	09/11/2019 18:50	09/11/2019 21:59	3,13	169	529,58	CHI
20191172928	ARAGOIANIA	LG11282628	INDEPENDENCIA S2	09/11/2019 19:38	10/11/2019 10:38	09/11/2019 19:38	10/11/2019 10:38	15,01	25	375,28	CHI
20191172941	JATAI	JT12000231	JATAI S1	09/11/2019 19:24	10/11/2019 13:00	09/11/2019 19:24	10/11/2019 13:00	17,60	74	1302,42	CHI
20191172941	PEROLANDIA	JT12000231	JATAI S1	09/11/2019 19:24	10/11/2019 13:00	09/11/2019 19:24	10/11/2019 13:00	17,60	3	52,80	CHI
20191172954	GOIANIA	GN11002098	FERROVIARIO S3	09/11/2019 19:31	10/11/2019 03:40	09/11/2019 19:31	10/11/2019 03:40	8,13	106	862,28	CHI
20191172959	GOIANIA	14504686	FERROVIARIO S3	09/11/2019 20:07	10/11/2019 12:00	09/11/2019 20:07	10/11/2019 12:00	15,89	1	15,89	CHI
20191172960	PIRANHAS	PH12052937	PIRANHAS	09/11/2019 18:32	09/11/2019 23:20	09/11/2019 18:32	09/11/2019 23:20	4,79	209	1001,57	CHI
20191172962	MINACU	IH12242191	MINACU	09/11/2019 16:46	09/11/2019 23:32	09/11/2019 16:46	09/11/2019 23:32	6,77	7	47,36	CHI
20191172964	GOIANIA	GN12000576	AEROPORTO S2	09/11/2019 19:24	10/11/2019 06:16	09/11/2019 19:24	10/11/2019 06:16	10,87	104	1130,60	CHI
20191172977	GOIANIA	13709057	CAMPINAS S1	09/11/2019 20:09	10/11/2019 00:01	09/11/2019 20:09	10/11/2019 00:01	3,86	1	3,86	CHI
20191172985	GOIANIA	GN11144699	XAVANTES	09/11/2019 19:12	10/11/2019 01:25	09/11/2019 19:12	10/11/2019 01:25	6,21	137	850,73	CHI
20191172988	GOIANIA	GN11082036	XAVANTES	09/11/2019 19:42	10/11/2019 08:37	09/11/2019 19:42	10/11/2019 08:37	12,91	148	1911,17	CHI
20191172997	CALDAS NOVAS	CN12391202	CALDAS NOVAS S1	09/11/2019 20:11	10/11/2019 12:15	09/11/2019 20:11	10/11/2019 12:15	16,06	4	64,23	CHI

20191173000	SAO LUIS DE MONTES BELOS	SL21006784	SAO LUIZ DOS MONTES BELOS	09/11/2019 20:11	11/11/2019 12:11	09/11/2019 20:11	11/11/2019 12:11	40,00	1	40,00	CHI
20191173007	TRINDADE	10003608580	GOYA S1	09/11/2019 20:12	10/11/2019 12:35	09/11/2019 20:12	10/11/2019 12:35	16,37	1	16,37	CHI
20191173011	CALDAS NOVAS	10019019830	SERRA DE CALDAS	09/11/2019 20:12	10/11/2019 07:45	09/11/2019 20:12	10/11/2019 07:45	11,55	1	11,55	CHI
20191173013	CACHOEIRA DE GOIAS	CG12289761	FIRMINOPOLIS S2	09/11/2019 20:05	10/11/2019 19:21	09/11/2019 20:05	10/11/2019 19:21	23,27	18	418,80	CHI
20191173019	GOIANIA	GN11000356	GOIANIA LESTE S3	09/11/2019 20:13	10/11/2019 17:02	09/11/2019 20:13	10/11/2019 17:02	20,80	20	416,05	CHI
20191173023	BURITI DE GOIAS	BS12008825	FIRMINOPOLIS S2	09/11/2019 19:13	13/11/2019 20:09	09/11/2019 19:13	13/11/2019 20:09	96,94	24	2326,47	CHI
20191173024	GOIANIA	GN11041973	FERROVIARIO S2	09/11/2019 19:05	10/11/2019 04:14	09/11/2019 19:05	10/11/2019 04:14	9,14	36	328,90	CHI
20191173034	URUACU	UR12136315	CAMPINORTE	09/11/2019 15:23	10/11/2019 13:00	09/11/2019 15:23	10/11/2019 13:00	21,61	3	64,83	CHI
20191173045	BARRO ALTO	BA12035658	BARRO ALTO	09/11/2019 16:53	10/11/2019 17:18	09/11/2019 16:53	10/11/2019 17:18	24,41	13	317,33	CHI
20191173045	NIQUELANDIA	BA12035658	BARRO ALTO	09/11/2019 16:53	10/11/2019 17:18	09/11/2019 16:53	10/11/2019 17:18	24,41	4	97,64	CHI
20191173049	IPAMERI	IP12031357	IPAMERI	09/11/2019 20:17	10/11/2019 11:30	09/11/2019 20:17	10/11/2019 11:30	15,21	2	30,42	CHI
20191173050	GOIANIA	GN12000056	CAMPINAS S1	09/11/2019 19:10	09/11/2019 23:15	09/11/2019 19:10	09/11/2019 23:15	4,08	318	1297,00	CHI
20191173063	APARECIDA DE GOIANIA	200663823	ATLANTICO S1	09/11/2019 20:19	10/11/2019 12:42	09/11/2019 20:19	10/11/2019 12:42	16,37	1	16,37	CHI
20191173066	GOIANIA	GN11131268	GOIANIA LESTE S1	09/11/2019 19:55	10/11/2019 02:48	09/11/2019 19:55	10/11/2019 02:48	6,87	141	968,55	CHI
20191173070	GOIANIA	GN11340616	GOYA S2	09/11/2019 19:41	10/11/2019 09:40	09/11/2019 19:41	10/11/2019 09:40	13,97	55	768,32	CHI
20191173072	GOIANIA	GN11273545	GOYA S2	09/11/2019 19:52	10/11/2019 04:13	09/11/2019 19:52	10/11/2019 04:13	8,35	72	600,90	CHI
20191173074	PEROLANDIA	DP21240332	JATAI S1	09/11/2019 20:21	10/11/2019 14:24	09/11/2019 20:21	10/11/2019 14:24	18,05	1	18,05	CHI
20191173083	GOIANIA	GN11002108	FERROVIARIO S1	09/11/2019 20:22	09/11/2019 23:03	09/11/2019 20:22	09/11/2019 23:03	2,68	50	134,06	CHI
20191173097	GOIANIA	GN12031434	CARAJAS S1	09/11/2019 20:03	10/11/2019 09:06	09/11/2019 20:03	10/11/2019 09:06	13,04	1	13,04	CHI
20191173099	PIRANHAS	PH11023534	PIRANHAS	09/11/2019 18:58	10/11/2019 10:15	09/11/2019 18:58	10/11/2019 10:15	15,29	64	978,88	CHI
20191173109	IPORA	IR12074019	IPORA	09/11/2019 20:14	11/11/2019 12:10	09/11/2019 20:14	11/11/2019 12:10	39,93	15	598,89	CHI
20191173117	OUVIDOR	OU21250306	CATALAO S1	09/11/2019 20:27	11/11/2019 07:44	09/11/2019 20:27	11/11/2019 07:44	35,28	1	35,28	CHI
20191173120	TRINDADE	10019895990	GOYA S1	09/11/2019 20:27	10/11/2019 11:31	09/11/2019 20:27	10/11/2019 11:31	15,07	1	15,07	CHI
20191173135	AMORINOPOLIS	AM12000032	IPORA	09/11/2019 20:28	12/11/2019 17:55	09/11/2019 20:28	12/11/2019 17:55	69,44	6	416,64	CHI
20191173135	IVOLANDIA	AM12000032	IPORA	09/11/2019 20:28	12/11/2019 17:55	09/11/2019 20:28	12/11/2019 17:55	69,44	10	694,40	CHI
20191173139	IPORA	IR11040175	IPORA	09/11/2019 19:58	10/11/2019 01:13	09/11/2019 19:58	10/11/2019 01:13	5,24	99	518,57	CHI
20191173146	FIRMINOPOLIS	TV12111577	FIRMINOPOLIS S1	09/11/2019 18:59	10/11/2019 15:30	09/11/2019 18:59	10/11/2019 15:30	20,51	2	41,02	CHI
20191173146	TURVANIA	TV12111577	FIRMINOPOLIS S1	09/11/2019 18:59	10/11/2019 15:30	09/11/2019 18:59	10/11/2019 15:30	20,51	8	164,09	CHI
20191173156	INDIARA	2710006565	EDEIA	09/11/2019 20:31	10/11/2019 08:38	09/11/2019 20:31	10/11/2019 08:38	12,12	1	12,12	CHI
20191173181	GOIANIA	GN11001459	GOYA S1	09/11/2019 20:06	10/11/2019 07:16	09/11/2019 20:06	10/11/2019 07:16	11,16	163	1818,45	CHI
20191173189	JATAI	JT12214374LD	JATAI S3	09/11/2019 19:59	10/11/2019 12:43	09/11/2019 19:59	10/11/2019 12:43	16,72	6	100,30	CHI
20191173197	GOIANIRA	390005691	GOIANIRA	09/11/2019 20:36	10/11/2019 15:56	09/11/2019 20:36	10/11/2019 15:56	19,33	1	19,33	CHI
20191173202	MONTIVIDIU	MV12029321	MONTIVIDIU T	09/11/2019 20:37	11/11/2019 11:20	09/11/2019 20:37	11/11/2019 11:20	38,71	17	658,11	CHI

20191173202	RIO VERDE	MV12029321	MONTIVIDIU T	09/11/2019 20:37	11/11/2019 11:20	09/11/2019 20:37	11/11/2019 11:20	38,71	1	38,71	CHI
20191173203	PALMINOPOLIS	PP21307039	PALMEIRAS	09/11/2019 20:37	11/11/2019 11:31	09/11/2019 20:37	11/11/2019 11:31	38,90	1	38,90	CHI
20191173208	INDIARA	3740001316	EDEIA	09/11/2019 20:37	10/11/2019 16:15	09/11/2019 20:37	10/11/2019 16:15	19,63	1	19,63	CHI
20191173211	GOIANIA	GN11281150	CARAJAS S1	09/11/2019 20:11	10/11/2019 10:18	09/11/2019 20:11	10/11/2019 10:18	14,11	98	1383,02	CHI
20191173216	TRINDADE	TR11355944	TRINDADE	09/11/2019 20:39	11/11/2019 17:38	11/11/2019 15:44	11/11/2019 17:38	1,91	47	89,93	CHI
20191173219	APARECIDA DE GOIANIA	AP11123586	INDEPENDENCIA S1	09/11/2019 20:02	09/11/2019 23:04	09/11/2019 20:02	09/11/2019 23:04	3,03	142	429,83	CHI
20191173224	SAO LUIS DE MONTES BELOS	SC21003734	SAO LUIZ DOS MONTES BELOS	09/11/2019 18:16	10/11/2019 10:06	09/11/2019 18:16	10/11/2019 10:06	15,84	2	31,68	CHI
20191173225	IPORA	10013688128	IPORA	09/11/2019 20:40	11/11/2019 17:25	09/11/2019 20:40	11/11/2019 17:25	44,74	1	44,74	CHI
20191173229	GOIANIA	GN11199211	XAVANTES	09/11/2019 20:33	10/11/2019 08:57	09/11/2019 20:33	10/11/2019 08:57	12,40	92	1140,72	CHI
20191173230	GOIANIA	GN12130652	XAVANTES	09/11/2019 19:12	10/11/2019 05:29	09/11/2019 19:12	10/11/2019 05:29	10,28	597	6136,83	CHI
20191173234	SAO LUIS DE MONTES BELOS	SL11006848	SAO LUIZ DOS MONTES BELOS	09/11/2019 18:46	10/11/2019 09:23	09/11/2019 18:46	10/11/2019 09:23	14,62	164	2398,36	CHI
20191173252	CALDAS NOVAS	760117706	SERRA DE CALDAS	09/11/2019 20:45	10/11/2019 09:00	09/11/2019 20:45	10/11/2019 09:00	12,25	1	12,25	CHI
20191173253	SENADOR CANEDO	SW12203608	CEPAIGO S2	09/11/2019 20:45	09/11/2019 22:02	09/11/2019 20:45	09/11/2019 22:02	1,27	131	166,52	CHI
20191173259	GOIANIA	GN11000420	FERROVIARIO S3	09/11/2019 20:06	10/11/2019 05:47	09/11/2019 20:06	10/11/2019 05:47	9,67	110	1063,85	CHI
20191173262	GOIANIA	GN11040690	FERROVIARIO S2	09/11/2019 19:37	10/11/2019 03:29	09/11/2019 19:37	10/11/2019 03:29	7,85	75	588,90	CHI
20191173265	ISRAELANDIA	IS11015574	IPORA	09/11/2019 18:17	11/11/2019 09:58	09/11/2019 18:17	11/11/2019 09:58	39,68	93	3690,55	CHI
20191173278	SAO LUIS DE MONTES BELOS	SL10394730	SAO LUIZ DOS MONTES BELOS	09/11/2019 18:16	10/11/2019 02:54	09/11/2019 18:16	09/11/2019 21:35	3,32	263	873,23	CHI
20191173278	AURILANDIA	SL10394730	SAO LUIZ DOS MONTES BELOS	09/11/2019 18:16	10/11/2019 02:54	09/11/2019 18:16	10/11/2019 02:54	8,63	30	258,88	CHI
20191173278	CORREGO DO OURO	SL10394730	SAO LUIZ DOS MONTES BELOS	09/11/2019 18:16	10/11/2019 02:54	09/11/2019 18:16	10/11/2019 02:54	8,63	327	2821,83	CHI
20191173278	FIRMINOPOLIS	SL10394730	SAO LUIZ DOS MONTES BELOS	09/11/2019 18:16	10/11/2019 02:54	09/11/2019 18:16	10/11/2019 02:54	8,63	109	940,61	CHI
20191173278	MOIPORA	SL10394730	SAO LUIZ DOS MONTES BELOS	09/11/2019 18:16	10/11/2019 02:54	09/11/2019 18:16	10/11/2019 02:54	8,63	28	241,62	CHI
20191173278	SANCLERLANDIA	SL10394730	SAO LUIZ DOS MONTES BELOS	09/11/2019 18:16	10/11/2019 02:54	09/11/2019 18:16	10/11/2019 02:54	8,63	35	302,03	CHI
20191173278	SAO LUIS DE MONTES BELOS	SL10394730	SAO LUIZ DOS MONTES BELOS	09/11/2019 18:16	10/11/2019 02:54	09/11/2019 18:16	10/11/2019 02:54	8,63	495	4271,57	CHI
20191173283	AMORINOPOLIS	AM11000003	IPORA	09/11/2019 19:57	10/11/2019 04:28	09/11/2019 19:57	10/11/2019 04:28	8,51	99	842,77	CHI
20191173302	ARAGOIANIA	AO11132422	GUAPO S2	09/11/2019 20:53	10/11/2019 17:12	09/11/2019 20:53	10/11/2019 17:12	20,30	23	466,95	CHI
20191173303	PALESTINA DE GOIAS	PY21140062	PALESTINA	09/11/2019 20:54	12/11/2019 11:33	09/11/2019 20:54	12/11/2019 11:33	62,65	1	62,65	CHI
20191173313	SAO LUIS DE MONTES BELOS	SL21132260	SAO LUIZ DOS MONTES BELOS	09/11/2019 20:55	11/11/2019 13:53	09/11/2019 20:55	11/11/2019 13:53	40,96	3	122,89	CHI
20191173315	NAZARIO	NZ12000054	ANICUNS	09/11/2019 20:45	10/11/2019 01:10	09/11/2019 20:45	10/11/2019 01:10	4,41	2	8,83	CHI
20191173315	PALMEIRAS DE GOIAS	NZ12000054	ANICUNS	09/11/2019 20:45	10/11/2019 01:10	09/11/2019 20:45	10/11/2019 01:10	4,41	19	83,85	CHI
20191173315	SANTA BARBARA DE GOIAS	NZ12000054	ANICUNS	09/11/2019 20:45	10/11/2019 01:10	09/11/2019 20:45	10/11/2019 01:10	4,41	20	88,26	CHI
20191173316	ABADIA DE GOIAS	AO11007321	INDEPENDENCIA S2	09/11/2019 20:00	10/11/2019 01:04	09/11/2019 20:00	10/11/2019 01:04	5,06	42	212,60	CHI
20191173320	IPORA	10002591152	IPORA	09/11/2019 20:56	11/11/2019 16:41	09/11/2019 20:56	11/11/2019 16:41	43,74	1	43,74	CHI
20191173322	GOIANIA	GN11001014	CAMPINAS S1	09/11/2019 20:56	09/11/2019 22:48	09/11/2019 20:56	09/11/2019 22:48	1,85	136	251,71	CHI

20191173329	AMORINOPOLIS	AM12133498	IPORA	09/11/2019 20:13	10/11/2019 14:11	09/11/2019 20:13	10/11/2019 14:11	17,97	180	3234,35	CHI
20191173331	GOIANIA	GN11001006	CAMPINAS S1	09/11/2019 19:12	10/11/2019 01:39	09/11/2019 19:12	10/11/2019 01:39	6,44	92	592,58	CHI
20191173344	IPORA	IR11000019	IPORA	09/11/2019 20:59	10/11/2019 01:01	09/11/2019 20:59	10/11/2019 01:01	4,03	56	225,65	CHI
20191173363	IPORA	AM12402911	IPORA	09/11/2019 16:35	11/11/2019 15:09	09/11/2019 16:35	11/11/2019 15:09	46,56	45	2095,15	CHI
20191173371	SAO LUIS DE MONTES BELOS	500037103	SAO LUIZ DOS MONTES BELOS	09/11/2019 21:05	10/11/2019 10:36	09/11/2019 21:05	10/11/2019 10:36	13,51	1	13,51	CHI
20191173377	GOIANIA	GN11161521	FERROVIARIO S1	09/11/2019 18:42	10/11/2019 01:00	09/11/2019 18:42	10/11/2019 01:00	6,29	122	767,85	CHI
20191173382	MINEIROS	MY11182017	PARQUE DAS EMAS	09/11/2019 18:26	10/11/2019 09:45	09/11/2019 18:26	10/11/2019 09:45	15,31	31	474,66	CHI
20191173425	ORIZONA	2060043809	PIRES DO RIO S2	09/11/2019 21:02	10/11/2019 06:38	09/11/2019 21:02	10/11/2019 06:38	9,59	1	9,59	CHI
20191173431	GOIANIA	GN11137022	CAMPINAS S1	09/11/2019 19:43	09/11/2019 23:53	09/11/2019 19:43	09/11/2019 23:53	4,16	124	516,25	CHI
20191173432	DOVERLANDIA	DV12395479	CAIAPONIA	09/11/2019 23:26	13/11/2019 17:10	09/11/2019 23:26	13/11/2019 17:10	89,73	6	538,38	CHI
20191173502	CORREGO DO OURO	CO11000049	FIRMINOPOLIS S2	09/11/2019 18:23	10/11/2019 08:53	09/11/2019 18:23	10/11/2019 08:53	14,50	126	1827,04	CHI
20191173503	ARAGARCAS	BM12155745	BOM JARDIM	09/11/2019 20:30	10/11/2019 00:28	09/11/2019 20:30	10/11/2019 00:28	3,96	85	336,53	CHI
20191173503	BOM JARDIM DE GOIAS	BM12155745	BOM JARDIM	09/11/2019 20:30	10/11/2019 00:28	09/11/2019 20:30	10/11/2019 00:28	3,96	55	217,75	CHI
20191173511	PIRANHAS	PH11052935	PIRANHAS	09/11/2019 19:03	10/11/2019 11:06	09/11/2019 19:03	10/11/2019 11:06	16,05	148	2375,40	CHI
20191173514	GOIANIA	GN11281915	CARAJAS S2	09/11/2019 19:52	10/11/2019 02:51	09/11/2019 19:52	10/11/2019 02:51	6,98	55	383,73	CHI
20191173515	PALMEIRAS DE GOIAS	03300434	PALMEIRAS	09/11/2019 21:08	10/11/2019 14:25	09/11/2019 21:08	09/11/2019 21:11	0,06	1	0,06	CHI
20191173515	PALMEIRAS DE GOIAS	PL10406637	PALMEIRAS	09/11/2019 21:08	10/11/2019 14:25	09/11/2019 21:08	09/11/2019 22:28	1,33	7	9,32	CHI
20191173515	PALMEIRAS DE GOIAS	PL10406637	PALMEIRAS	09/11/2019 21:08	10/11/2019 14:25	09/11/2019 21:12	09/11/2019 22:28	1,26	5	6,31	CHI
20191173515	JANDAIA	PL13126035	PALMEIRAS	09/11/2019 21:08	10/11/2019 14:25	09/11/2019 21:08	10/11/2019 14:25	17,29	19	328,47	CHI
20191173515	PALMEIRAS DE GOIAS	PL10406637	PALMEIRAS	09/11/2019 21:08	10/11/2019 14:25	09/11/2019 21:08	10/11/2019 14:25	17,29	3	51,86	CHI
20191173515	PALMEIRAS DE GOIAS	PL13126035	PALMEIRAS	09/11/2019 21:08	10/11/2019 14:25	09/11/2019 21:08	10/11/2019 14:25	17,29	1	17,29	CHI
20191173515	PALMEIRAS DE GOIAS	PL13126035	PALMEIRAS	09/11/2019 21:08	10/11/2019 14:25	09/11/2019 21:12	10/11/2019 14:25	17,22	8	137,74	CHI
20191173518	GOIANIA	GN11043926	ATLANTICO S2	09/11/2019 19:56	10/11/2019 00:16	09/11/2019 19:56	10/11/2019 00:16	4,33	191	827,61	CHI
20191173520	APARECIDA DE GOIANIA	AP11144355	INDEPENDENCIA S1	09/11/2019 20:22	09/11/2019 23:57	09/11/2019 20:22	09/11/2019 23:57	3,57	195	696,31	CHI
20191173525	MINEIROS	MY12036636	PARQUE DAS EMAS	09/11/2019 16:39	10/11/2019 14:31	09/11/2019 16:39	10/11/2019 14:31	21,86	9	196,70	CHI
20191173533	GOIANIA	GN12044589	AEROPORTO S1	09/11/2019 19:25	10/11/2019 10:34	09/11/2019 19:25	10/11/2019 10:34	15,15	80	1211,64	CHI
20191173536	GOIAS	90003421	GOIAS	09/11/2019 21:14	12/11/2019 14:36	09/11/2019 21:14	12/11/2019 14:36	65,37	1	65,37	CHI
20191173541	MORRINHOS	MR21394169	MORRINHOS	09/11/2019 21:15	10/11/2019 11:26	09/11/2019 21:15	10/11/2019 11:26	14,17	1	14,17	CHI
20191173556	EDEALINA	ED12007679	PONTALINA	09/11/2019 16:51	10/11/2019 15:30	09/11/2019 16:51	10/11/2019 15:30	22,64	16	362,31	CHI
20191173561	JATAI	JT11166034	JATAI S2	09/11/2019 19:46	10/11/2019 12:17	09/11/2019 19:46	10/11/2019 12:17	16,51	111	1832,61	CHI
20191173567	INDIARA	2710031377	EDEIA	09/11/2019 21:20	10/11/2019 10:07	09/11/2019 21:20	10/11/2019 10:07	12,78	1	12,78	CHI
20191173596	GOIANIA	GN11001247	AEROPORTO S2	09/11/2019 19:37	10/11/2019 08:28	09/11/2019 19:37	10/11/2019 08:28	12,85	104	1336,31	CHI
20191173602	GOIANIA	GN12170695	GOIANIA LESTE S2	09/11/2019 19:14	10/11/2019 00:55	09/11/2019 19:14	10/11/2019 00:55	5,67	40	226,73	CHI

20191173607	PALMEIRAS DE GOIAS	01380224	PALMEIRAS	09/11/2019 21:08	10/11/2019 14:47	09/11/2019 21:08	09/11/2019 21:13	0,09	2112	181,87	CHI
20191173607	PALMEIRAS DE GOIAS	PL10396901	PALMEIRAS	09/11/2019 21:08	10/11/2019 14:47	09/11/2019 21:08	09/11/2019 21:14	0,09	1415	127,74	CHI
20191173607	PALMEIRAS DE GOIAS	PL16407968	PALMEIRAS	09/11/2019 21:08	10/11/2019 14:47	09/11/2019 21:08	09/11/2019 21:32	0,40	2268	902,16	CHI
20191173607	PALMEIRAS DE GOIAS	PL16407968	PALMEIRAS	09/11/2019 21:08	10/11/2019 14:47	09/11/2019 21:08	09/11/2019 22:33	1,41	37	52,26	CHI
20191173607	PALMEIRAS DE GOIAS	PL13000218	PALMEIRAS	09/11/2019 21:08	10/11/2019 14:47	09/11/2019 21:08	10/11/2019 01:38	4,49	14	62,83	CHI
20191173607	JANDAIA	PL13000020	PALMEIRAS	09/11/2019 21:08	10/11/2019 14:47	09/11/2019 21:08	10/11/2019 02:25	5,28	1	5,28	CHI
20191173607	PALMEIRAS DE GOIAS	PL13000020	PALMEIRAS	09/11/2019 21:08	10/11/2019 14:47	09/11/2019 21:08	10/11/2019 02:25	5,28	104	549,21	CHI
20191173607	PALMEIRAS DE GOIAS	01380224	PALMEIRAS	09/11/2019 21:08	10/11/2019 14:47	10/11/2019 02:26	10/11/2019 02:30	0,07	6173	445,83	CHI
20191173607	JANDAIA	PL13000020	PALMEIRAS	09/11/2019 21:08	10/11/2019 14:47	09/11/2019 21:08	10/11/2019 03:23	6,24	96	599,25	CHI
20191173607	PALESTINA DE GOIAS	PL13000020	PALMEIRAS	09/11/2019 21:08	10/11/2019 14:47	09/11/2019 21:08	10/11/2019 03:23	6,24	1	6,24	CHI
20191173607	PALMEIRAS DE GOIAS	PL13000020	PALMEIRAS	09/11/2019 21:08	10/11/2019 14:47	09/11/2019 21:08	10/11/2019 03:23	6,24	76	474,41	CHI
20191173607	PALMINOPOLIS	PL13000020	PALMEIRAS	09/11/2019 21:08	10/11/2019 14:47	09/11/2019 21:08	10/11/2019 03:23	6,24	14	87,39	CHI
20191173607	JANDAIA	PL13000020	PALMEIRAS	09/11/2019 21:08	10/11/2019 14:47	10/11/2019 02:26	10/11/2019 03:23	0,95	1	0,95	CHI
20191173607	PALMEIRAS DE GOIAS	PL13000020	PALMEIRAS	09/11/2019 21:08	10/11/2019 14:47	10/11/2019 02:26	10/11/2019 03:23	0,95	105	99,23	CHI
20191173607	PALMEIRAS DE GOIAS	6377246	PALMEIRAS	09/11/2019 21:08	10/11/2019 14:47	10/11/2019 02:26	10/11/2019 14:00	11,57	1	11,57	CHI
20191173607	INDIARA	PL13000014	PALMEIRAS	09/11/2019 21:08	10/11/2019 14:47	10/11/2019 14:42	10/11/2019 14:46	0,06	45	2,64	CHI
20191173607	JANDAIA	PL13000014	PALMEIRAS	09/11/2019 21:08	10/11/2019 14:47	10/11/2019 14:42	10/11/2019 14:46	0,06	2034	119,22	CHI
20191173607	PARAUNA	PL13000014	PALMEIRAS	09/11/2019 21:08	10/11/2019 14:47	10/11/2019 14:42	10/11/2019 14:46	0,06	45	2,64	CHI
20191173607	JANDAIA	PL13000014	PALMEIRAS	09/11/2019 21:08	10/11/2019 14:47	10/11/2019 14:42	10/11/2019 14:47	0,08	401	32,08	CHI
20191173607	PALESTINA DE GOIAS	PL13000014	PALMEIRAS	09/11/2019 21:08	10/11/2019 14:47	10/11/2019 14:42	10/11/2019 14:47	0,08	1	0,08	CHI
20191173607	PALMEIRAS DE GOIAS	PL13000014	PALMEIRAS	09/11/2019 21:08	10/11/2019 14:47	10/11/2019 14:42	10/11/2019 14:47	0,08	42	3,36	CHI
20191173607	PALMINOPOLIS	PL13000014	PALMEIRAS	09/11/2019 21:08	10/11/2019 14:47	10/11/2019 14:42	10/11/2019 14:47	0,08	13	1,04	CHI
20191173609	CALDAS NOVAS	CN11309388	SERRA DE CALDAS	09/11/2019 21:27	10/11/2019 03:13	09/11/2019 21:27	10/11/2019 03:13	5,76	18	103,73	CHI
20191173627	GOIANIA	GN11000892	XAVANTES	09/11/2019 19:35	10/11/2019 08:32	09/11/2019 19:35	10/11/2019 08:32	12,94	112	1449,06	CHI
20191173628	GOIANIA	GN11150494	GOYA S2	09/11/2019 20:33	10/11/2019 07:33	09/11/2019 20:33	10/11/2019 07:33	10,99	143	1571,81	CHI
20191173648	GOIANIA	GN11043396	CAMPINAS S1	09/11/2019 19:17	10/11/2019 04:35	09/11/2019 19:17	10/11/2019 04:35	9,29	34	315,92	CHI
20191173649	NOVO BRASIL	NB21315016	JUSSARA	09/11/2019 18:23	11/11/2019 21:00	09/11/2019 18:23	11/11/2019 21:00	50,60	2	101,21	CHI
20191173650	TRINDADE	TR12215978	TRINDADE	09/11/2019 19:59	10/11/2019 00:28	09/11/2019 19:59	10/11/2019 00:28	4,47	350	1565,28	CHI
20191173662	PALMEIRAS DE GOIAS	PL31159059	PALMEIRAS	09/11/2019 21:39	12/11/2019 12:53	09/11/2019 21:39	12/11/2019 12:53	63,22	1	63,22	CHI
20191173663	TRINDADE	TR11111547	TRINDADE	09/11/2019 20:09	10/11/2019 08:59	09/11/2019 20:09	10/11/2019 08:59	12,82	196	2513,70	CHI
20191173686	GOIANIA	GN11070244	FERROVIARIO S3	09/11/2019 19:59	10/11/2019 04:51	09/11/2019 19:59	10/11/2019 04:51	8,85	192	1699,25	CHI
20191173700	GOIATUBA	JV12000004RE	BOM JESUS DE GOIAS	09/11/2019 20:52	10/11/2019 03:08	09/11/2019 20:52	10/11/2019 03:08	6,28	130	816,33	CHI
20191173700	GOIATUBA	JV12000004RE	BOM JESUS DE GOIAS	09/11/2019 20:52	10/11/2019 03:08	09/11/2019 20:52	10/11/2019 03:08	6,28	102	640,50	CHI

20191173700	GOIATUBA	JV12000004RE	GOIATUBA S1	09/11/2019 20:52	10/11/2019 03:08	09/11/2019 20:52	10/11/2019 03:08	6,28	30	188,38	CHI
20191173700	JOVIANIA	JV12000004RE	GOIATUBA S1	09/11/2019 20:52	10/11/2019 03:08	09/11/2019 20:52	10/11/2019 03:08	6,28	36	226,06	CHI
20191173707	QUIRINOPOLIS	QI21350063	QUIRINOPOLIS	09/11/2019 21:51	10/11/2019 09:06	09/11/2019 21:51	10/11/2019 09:06	11,24	1	11,24	CHI
20191173720	CATALAO	CT11078243	CATALAO S2	09/11/2019 21:36	10/11/2019 01:01	09/11/2019 21:36	10/11/2019 01:01	3,40	86	292,76	CHI
20191173744	GOIANIA	GN11049374	ATLANTICO S3	09/11/2019 20:34	10/11/2019 02:24	09/11/2019 20:34	10/11/2019 02:24	5,83	120	699,27	CHI
20191173751	GOIANIA	GN12042279	FERROVIARIO S2	09/11/2019 19:17	09/11/2019 22:37	09/11/2019 19:17	09/11/2019 22:37	3,32	127	421,89	CHI
20191173752	LAGOA SANTA	LS21152640	CACHOEIRA ALTA	09/11/2019 22:03	10/11/2019 17:07	09/11/2019 22:03	10/11/2019 17:07	19,06	1	19,06	CHI
20191173759	CASTELANDIA	QI12053189	QUIRINOPOLIS	09/11/2019 16:25	10/11/2019 07:09	09/11/2019 16:25	10/11/2019 07:09	14,72	19	279,67	CHI
20191173759	QUIRINOPOLIS	QI12053189	QUIRINOPOLIS	09/11/2019 16:25	10/11/2019 07:09	09/11/2019 16:25	10/11/2019 07:09	14,72	20	294,39	CHI
20191173759	RIO VERDE	QI12053189	QUIRINOPOLIS	09/11/2019 16:25	10/11/2019 07:09	09/11/2019 16:25	10/11/2019 07:09	14,72	1	14,72	CHI
20191173765	IPORA	IR12014026	IPORA	09/11/2019 20:17	12/11/2019 20:00	09/11/2019 20:17	12/11/2019 20:00	71,72	4	286,89	CHI
20191173777	GOIANIA	GN11169109	GOYA S2	09/11/2019 19:23	10/11/2019 08:36	09/11/2019 19:23	10/11/2019 08:36	13,21	60	792,33	CHI
20191173788	NIQUELANDIA	NQ12348713	NIQUELANDIA SUBTRANSMISSAO	09/11/2019 16:23	09/11/2019 23:59	09/11/2019 16:23	09/11/2019 23:59	7,60	7	53,20	CHI
20191173810	VICENTINOPOLIS	1970004670	VICENTINOPOLIS	09/11/2019 22:20	11/11/2019 17:40	09/11/2019 22:20	11/11/2019 17:40	43,33	1	43,33	CHI
20191173813	GOIANIA	GN11151346	MEIA PONTE	09/11/2019 19:41	10/11/2019 04:02	09/11/2019 19:41	10/11/2019 04:02	8,34	169	1409,04	CHI
20191173820	RIO VERDE	RV21303310	ACREUNA	09/11/2019 22:24	10/11/2019 13:37	09/11/2019 22:24	10/11/2019 13:37	15,21	1	15,21	CHI
20191173825	MUNDO NOVO DE GOIAS	MH12391957	NOVA CRIXAS	09/11/2019 18:11	10/11/2019 15:23	09/11/2019 18:11	10/11/2019 15:23	21,19	8	169,52	CHI
20191173828	GOIANIA	GN11214740	XAVANTES	09/11/2019 19:50	10/11/2019 15:29	09/11/2019 19:50	10/11/2019 15:29	19,64	69	1355,39	CHI
20191173845	JATAI	SX12080854	JATAI S1	09/11/2019 14:37	10/11/2019 13:47	09/11/2019 14:37	10/11/2019 13:47	23,16	49	1134,87	CHI
20191173845	SERRANOPOLIS	SX12080854	JATAI S1	09/11/2019 14:37	10/11/2019 13:47	09/11/2019 14:37	10/11/2019 13:47	23,16	24	555,85	CHI
20191173846	CAMPO ALEGRE DE GOIAS	CT12166855	CATALAO S1	09/11/2019 22:32	10/11/2019 10:07	09/11/2019 22:32	10/11/2019 10:07	11,57	1	11,57	CHI
20191173846	CATALAO	CT12166855	CATALAO S1	09/11/2019 22:32	10/11/2019 10:07	09/11/2019 22:32	10/11/2019 10:07	11,57	3	34,72	CHI
20191173847	SAO LUIS DE MONTES BELOS	SL11259154	SAO LUIZ DOS MONTES BELOS	09/11/2019 21:42	10/11/2019 09:09	09/11/2019 21:42	10/11/2019 09:09	11,44	51	583,55	CHI
20191173848	JUSSARA	JR11390156	JUSSARA	09/11/2019 22:33	10/11/2019 12:29	09/11/2019 22:33	10/11/2019 12:29	13,93	6	83,59	CHI
20191173875	ADELANDIA	DN11024038	FIRMINOPOLIS S2	09/11/2019 18:16	10/11/2019 08:18	09/11/2019 18:16	10/11/2019 08:18	14,03	139	1949,82	CHI
20191173886	IPORA	IR12060655	IPORA	10/11/2019 05:04	11/11/2019 19:10	10/11/2019 05:04	10/11/2019 13:00	7,92	39	309,04	CHI
20191173886	AMORINOPOLIS	IR13091534	IPORA	10/11/2019 05:04	11/11/2019 19:10	10/11/2019 05:04	11/11/2019 03:20	22,27	8	178,12	CHI
20191173886	IPORA	IR13091534	IPORA	10/11/2019 05:04	11/11/2019 19:10	10/11/2019 05:04	11/11/2019 03:20	22,27	110	2449,18	CHI
20191173886	IVOLANDIA	IR13091534	IPORA	10/11/2019 05:04	11/11/2019 19:10	10/11/2019 05:04	11/11/2019 03:20	22,27	56	1246,86	CHI
20191173886	MOIPORA	IR13091534	IPORA	10/11/2019 05:04	11/11/2019 19:10	10/11/2019 05:04	11/11/2019 03:20	22,27	14	311,71	CHI
20191173886	IPORA	IR12013398	IPORA	10/11/2019 05:04	11/11/2019 19:10	11/11/2019 03:24	11/11/2019 19:10	15,77	15	236,58	CHI
20191173901	PALMEIRAS DE GOIAS	590079359	PALMEIRAS	09/11/2019 22:57	10/11/2019 07:49	09/11/2019 22:57	10/11/2019 07:49	8,86	1	8,86	CHI
20191173910	SAO LUIS DE MONTES BELOS	500003373	SAO LUIZ DOS MONTES BELOS	09/11/2019 23:04	10/11/2019 20:18	09/11/2019 23:04	10/11/2019 20:18	21,24	1	21,24	CHI

20191173915	PALMEIRAS DE GOIAS	PL11000025	PALMEIRAS	09/11/2019 21:09	10/11/2019 08:49	09/11/2019 21:09	10/11/2019 08:49	11,65	134	1561,32	CHI
20191173930	SAO LUIS DE MONTES BELOS	SL21259220	SAO LUIZ DOS MONTES BELOS	09/11/2019 23:13	10/11/2019 02:38	09/11/2019 23:13	10/11/2019 02:38	3,41	1	3,41	CHI
20191173948	PALMEIRAS DE GOIAS	PL12206414	PALMEIRAS	09/11/2019 23:25	10/11/2019 11:58	09/11/2019 23:25	10/11/2019 11:58	12,55	5	62,74	CHI
20191174033	GOIANIA	GN12390534	XAVANTES	09/11/2019 18:47	10/11/2019 05:34	09/11/2019 18:47	10/11/2019 05:34	10,77	198	2132,62	CHI
20191174040	GOIAS	GS11037769	GOIAS	09/11/2019 22:42	10/11/2019 09:55	09/11/2019 22:42	10/11/2019 09:55	11,20	68	761,92	CHI
20191174053	RIO VERDE	RV10400628	MONTIVIDIU T	10/11/2019 00:18	12/11/2019 22:50	10/11/2019 00:18	10/11/2019 18:39	18,34	3	55,03	CHI
20191174053	RIO VERDE	RV10400628	MONTIVIDIU T	10/11/2019 00:18	12/11/2019 22:50	10/11/2019 00:18	10/11/2019 19:04	18,75	2	37,51	CHI
20191174053	RIO VERDE	RV10400628	MONTIVIDIU T	10/11/2019 00:18	12/11/2019 22:50	10/11/2019 19:08	10/11/2019 19:55	0,78	5	3,89	CHI
20191174053	MONTIVIDIU	RV12219433	MONTIVIDIU T	10/11/2019 00:18	12/11/2019 22:50	10/11/2019 00:18	12/11/2019 22:50	70,52	30	2115,69	CHI
20191174053	RIO VERDE	RV12219433	MONTIVIDIU T	10/11/2019 00:18	12/11/2019 22:50	10/11/2019 00:18	12/11/2019 22:50	70,52	12	846,28	CHI
20191174059	JATAI	JT12219384RE	JATAI S3	09/11/2019 21:09	10/11/2019 11:49	09/11/2019 21:09	10/11/2019 11:49	14,66	76	1113,93	CHI
20191174062	ITUMBIARA	IT10396082	ITUMBIARA NOVA	09/11/2019 22:43	10/11/2019 12:01	09/11/2019 22:43	10/11/2019 09:25	10,71	7	74,99	CHI
20191174062	ITUMBIARA	IT10396082	ITUMBIARA NOVA	09/11/2019 22:43	10/11/2019 12:01	09/11/2019 22:43	10/11/2019 09:29	10,77	40	430,96	CHI
20191174062	ITUMBIARA	IT10396082	ITUMBIARA NOVA	09/11/2019 22:43	10/11/2019 12:01	09/11/2019 22:43	10/11/2019 12:01	13,30	184	2448,07	CHI
20191174062	ITUMBIARA	IT13000086	ITUMBIARA NOVA	09/11/2019 22:43	10/11/2019 12:01	09/11/2019 22:43	10/11/2019 12:01	13,30	59	784,98	CHI
20191174062	PANAMA	IT10396082	ITUMBIARA NOVA	09/11/2019 22:43	10/11/2019 12:01	09/11/2019 22:43	10/11/2019 12:01	13,30	81	1077,68	CHI
20191174062	PANAMA	IT13000086	ITUMBIARA NOVA	09/11/2019 22:43	10/11/2019 12:01	09/11/2019 22:43	10/11/2019 12:01	13,30	18	239,48	CHI
20191174071	PIRANHAS	PH11231076	PIRANHAS	10/11/2019 01:32	10/11/2019 10:30	10/11/2019 01:32	10/11/2019 10:30	8,96	88	788,90	CHI
20191174234	GOIANIA	GN11002460	XAVANTES	09/11/2019 18:47	10/11/2019 09:51	09/11/2019 18:47	10/11/2019 09:51	15,06	1	15,06	CHI
20191174242	MONTIVIDIU	MV12260781	MONTIVIDIU T	10/11/2019 03:40	12/11/2019 23:00	10/11/2019 03:40	12/11/2019 23:00	67,33	3	202,00	CHI
20191174242	RIO VERDE	MV12260781	MONTIVIDIU T	10/11/2019 03:40	12/11/2019 23:00	10/11/2019 03:40	12/11/2019 23:00	67,33	7	471,32	CHI
20191174252	GOIANESIA	GE12376588	GOIANESIA S2	09/11/2019 18:24	11/11/2019 16:02	09/11/2019 18:24	10/11/2019 10:50	16,43	7	115,00	CHI
20191174252	GOIANESIA	GE12376588	GOIANESIA S2	09/11/2019 18:24	11/11/2019 16:02	09/11/2019 18:24	11/11/2019 16:02	45,62	1	45,62	CHI
20191174252	VILA PROPICIO	GE12376588	GOIANESIA S2	09/11/2019 18:24	11/11/2019 16:02	09/11/2019 18:24	11/11/2019 16:02	45,62	2	91,25	CHI
20191174252	GOIANESIA	GE12376588	GOIANESIA S2	09/11/2019 18:24	11/11/2019 16:02	11/11/2019 13:25	11/11/2019 16:02	2,62	7	18,35	CHI
20191174284	IPORA	IR12139456	IPORA	10/11/2019 05:07	10/11/2019 08:32	10/11/2019 05:07	10/11/2019 08:32	3,41	16	54,56	CHI
20191174290	GOIAS	GS11020998	GOIAS	10/11/2019 03:19	10/11/2019 09:00	10/11/2019 03:19	10/11/2019 09:00	5,68	120	681,67	CHI
20191174308	AURILANDIA	AI21040572	SAO LUIZ DOS MONTES BELOS	10/11/2019 05:27	11/11/2019 15:30	10/11/2019 05:27	11/11/2019 15:30	34,05	1	34,05	CHI
20191174320	PALMINOPOLIS	PP12006641	PALMEIRAS	10/11/2019 05:26	11/11/2019 00:46	10/11/2019 05:26	11/11/2019 00:46	19,33	13	251,33	CHI
20191174334	CALDAS NOVAS	MR12392164	MORRINHOS	09/11/2019 23:25	10/11/2019 09:47	09/11/2019 23:25	10/11/2019 09:47	10,36	1	10,36	CHI
20191174334	MORRINHOS	MR12392164	MORRINHOS	09/11/2019 23:25	10/11/2019 09:47	09/11/2019 23:25	10/11/2019 09:47	10,36	29	300,49	CHI
20191174334	RIO QUENTE	MR12392164	MORRINHOS	09/11/2019 23:25	10/11/2019 09:47	09/11/2019 23:25	10/11/2019 09:47	10,36	19	196,87	CHI
20191174341	CACHOEIRA ALTA	CA12071611	CACHOEIRA ALTA	09/11/2019 18:15	10/11/2019 12:21	09/11/2019 18:15	10/11/2019 12:21	18,09	16	289,44	CHI



20191174360	CACU	CC12338616	CACHOEIRA ALTA	09/11/2019 20:34	11/11/2019 17:09	09/11/2019 20:34	11/11/2019 17:09	44,57	32	1426,39	CHI
20191174371	ISRAELANDIA	03690216	IPORA	10/11/2019 06:06	11/11/2019 23:38	10/11/2019 06:06	10/11/2019 20:53	14,79	5	73,97	CHI
20191174371	ISRAELANDIA	03690214	IPORA	10/11/2019 06:06	11/11/2019 23:38	10/11/2019 06:06	10/11/2019 20:53	14,79	1	14,79	CHI
20191174371	CORREGO DO OURO	03690216	IPORA	10/11/2019 06:06	11/11/2019 23:38	10/11/2019 06:06	11/11/2019 23:38	41,54	3	124,62	CHI
20191174371	FAZENDA NOVA	03690216	IPORA	10/11/2019 06:06	11/11/2019 23:38	10/11/2019 06:06	11/11/2019 23:38	41,54	201	8349,76	CHI
20191174371	ISRAELANDIA	03690216	IPORA	10/11/2019 06:06	11/11/2019 23:38	10/11/2019 06:06	11/11/2019 23:38	41,54	6	249,25	CHI
20191174375	IVOLANDIA	IV12158122	IPORA	09/11/2019 20:08	11/11/2019 11:36	09/11/2019 20:08	11/11/2019 11:36	39,45	9	355,07	CHI
20191174376	ITAJA	IJ121219250	ITAJA S2	10/11/2019 06:07	10/11/2019 08:11	10/11/2019 06:07	10/11/2019 08:11	2,06	1	2,06	CHI
20191174382	AMORINOPOLIS	IV12390141	IPORA	09/11/2019 20:49	11/11/2019 10:16	09/11/2019 20:49	11/11/2019 10:16	37,44	5	187,22	CHI
20191174382	IVOLANDIA	IV12390141	IPORA	09/11/2019 20:49	11/11/2019 10:16	09/11/2019 20:49	11/11/2019 10:16	37,44	60	2246,67	CHI
20191174384	IPORA	730100728	IPORA	10/11/2019 06:10	11/11/2019 12:37	10/11/2019 06:10	11/11/2019 12:37	30,44	1	30,44	CHI
20191174385	SAO LUIS DE MONTES BELOS	SL12021470	SAO LUIZ DOS MONTES BELOS	10/11/2019 06:11	10/11/2019 09:50	10/11/2019 06:11	10/11/2019 09:50	3,66	35	128,18	CHI
20191174413	JANDAIA	JD16404918	PALMEIRAS	10/11/2019 06:01	10/11/2019 18:23	10/11/2019 06:01	10/11/2019 18:23	12,37	378	4674,39	CHI
20191174423	PARAUNA	EU12296084	ACREUNA	09/11/2019 19:44	12/11/2019 18:30	09/11/2019 19:44	12/11/2019 18:30	70,76	7	495,33	CHI
20191174436	PALMEIRAS DE GOIAS	PL12000234	PALMEIRAS	10/11/2019 04:42	10/11/2019 07:50	10/11/2019 04:42	10/11/2019 07:50	3,12	14	43,74	CHI
20191174445	FAZENDA NOVA	FN12073782	IPORA	09/11/2019 19:43	11/11/2019 09:20	09/11/2019 19:43	11/11/2019 09:20	37,62	9	338,60	CHI
20191174457	IPORA	IR11207786	IPORA	10/11/2019 06:16	10/11/2019 10:50	10/11/2019 06:16	10/11/2019 10:50	4,56	113	515,28	CHI
20191174501	ITAJA	IJ121921514	ITAJA S2	10/11/2019 06:25	10/11/2019 06:41	10/11/2019 06:25	10/11/2019 06:41	0,26	136	35,81	CHI
20191174522	ITAJA	IJ12099910	ITAJA S2	10/11/2019 07:17	10/11/2019 07:39	10/11/2019 07:17	10/11/2019 07:39	0,36	78	28,23	CHI
20191174546	ACREUNA	EU12026734	RIO DOS BOIS	09/11/2019 16:29	10/11/2019 13:30	09/11/2019 16:29	10/11/2019 12:45	20,27	18	364,77	CHI
20191174546	TURVELANDIA	EU12026734	RIO DOS BOIS	09/11/2019 16:29	10/11/2019 13:30	09/11/2019 16:29	10/11/2019 12:45	20,27	19	385,04	CHI
20191174546	ACREUNA	TD12025721	RIO DOS BOIS	09/11/2019 16:29	10/11/2019 13:30	10/11/2019 12:54	10/11/2019 13:30	0,59	20	11,83	CHI
20191174546	TURVELANDIA	TD12025721	RIO DOS BOIS	09/11/2019 16:29	10/11/2019 13:30	10/11/2019 12:54	10/11/2019 13:30	0,59	33	19,53	CHI
20191174603	INACIOLANDIA	ID21341688	QUIRINOPOLIS	10/11/2019 06:43	10/11/2019 19:14	10/11/2019 06:43	10/11/2019 19:14	12,52	22	275,35	CHI
20191174610	INACIOLANDIA	ID21249052	QUIRINOPOLIS	10/11/2019 06:44	11/11/2019 18:30	10/11/2019 06:44	11/11/2019 18:30	35,76	1	35,76	CHI
20191174613	SAO LUIS DE MONTES BELOS	SL12388903	SAO LUIZ DOS MONTES BELOS	10/11/2019 06:14	10/11/2019 15:30	10/11/2019 06:14	10/11/2019 15:30	9,27	72	667,22	CHI
20191174622	RIO VERDE	RV12049032	RIO VERDE S1	10/11/2019 06:26	10/11/2019 08:33	10/11/2019 06:26	10/11/2019 08:33	2,12	171	362,71	CHI
20191174626	GOIAS	GS11408691	MATRINCHA	10/11/2019 06:51	14/11/2019 15:25	10/11/2019 06:51	14/11/2019 15:25	104,57	1	104,57	CHI
20191174629	BOM JESUS DE GOIAS	BJ12208130	BOM JESUS DE GOIAS	09/11/2019 20:54	10/11/2019 19:52	09/11/2019 20:54	10/11/2019 19:52	22,95	6	137,73	CHI
20191174630	JANDAIA	JD21215446	PALMEIRAS	10/11/2019 06:52	10/11/2019 22:22	10/11/2019 06:52	10/11/2019 22:22	15,50	1	15,50	CHI
20191174655	FIRMINOPOLIS	FR12028946	FIRMINOPOLIS S1	10/11/2019 04:53	10/11/2019 11:27	10/11/2019 04:53	10/11/2019 11:27	6,56	21	137,67	CHI
20191174667	FAZENDA NOVA	FN11019359	JUSSARA	10/11/2019 04:46	11/11/2019 09:53	10/11/2019 04:46	11/11/2019 01:04	20,31	69	1401,41	CHI
20191174667	FAZENDA NOVA	FN11019359	JUSSARA	10/11/2019 04:46	11/11/2019 09:53	11/11/2019 08:45	11/11/2019 09:53	1,14	69	78,78	CHI

20191174672	CORREGO DO OURO	CO12004045	FIRMINOPOLIS S2	09/11/2019 19:11	13/11/2019 13:57	09/11/2019 19:11	13/11/2019 13:57	90,76	16	1452,21	CHI
20191174673	IPORA	IR12222975	IPORA	09/11/2019 19:48	11/11/2019 09:40	09/11/2019 19:48	11/11/2019 09:40	37,86	68	2574,74	CHI
20191174673	IVOLANDIA	IR12222975	IPORA	09/11/2019 19:48	11/11/2019 09:40	09/11/2019 19:48	11/11/2019 09:40	37,86	6	227,18	CHI
20191174673	MOIPORA	IR12222975	IPORA	09/11/2019 19:48	11/11/2019 09:40	09/11/2019 19:48	11/11/2019 09:40	37,86	19	719,41	CHI
20191174684	NAZARIO	NZ12000021	ANICUNS	10/11/2019 06:33	10/11/2019 11:41	10/11/2019 06:33	10/11/2019 11:41	5,14	2	10,29	CHI
20191174684	PALMEIRAS DE GOIAS	NZ12000021	ANICUNS	10/11/2019 06:33	10/11/2019 11:41	10/11/2019 06:33	10/11/2019 11:41	5,14	19	97,72	CHI
20191174693	RIO VERDE	RV12226329	CABRIUVA S2	10/11/2019 05:12	10/11/2019 10:51	10/11/2019 05:12	10/11/2019 10:51	5,65	24	135,71	CHI
20191174695	GOIAS	GS12310414	ITABERAI S1	10/11/2019 04:30	11/11/2019 09:01	10/11/2019 04:30	11/11/2019 09:01	28,52	13	370,80	CHI
20191174715	CAIAPONIA	CP12247462	IPORA	09/11/2019 19:20	14/11/2019 17:10	09/11/2019 19:20	14/11/2019 17:10	117,83	5	589,16	CHI
20191174719	PIRANHAS	PH12079503	PIRANHAS	09/11/2019 19:23	10/11/2019 18:18	09/11/2019 19:23	10/11/2019 18:18	22,91	62	1420,44	CHI
20191174734	IPORA	IR11334792	IPORA	10/11/2019 06:59	10/11/2019 10:40	10/11/2019 06:59	10/11/2019 10:40	3,68	85	313,04	CHI
20191174735	FAZENDA NOVA	FN11109602	JUSSARA	10/11/2019 06:21	10/11/2019 23:10	10/11/2019 06:21	10/11/2019 23:10	16,82	125	2101,98	CHI
20191174736	IPORA	IR11107563	IPORA	10/11/2019 05:09	10/11/2019 15:08	10/11/2019 05:09	10/11/2019 15:08	9,97	89	887,13	CHI
20191174738	RIO VERDE	RV12191832	CABRIUVA S2	10/11/2019 07:14	11/11/2019 17:13	10/11/2019 07:14	11/11/2019 17:13	33,97	7	237,80	CHI
20191174741	IPORA	IR12204813	IPORA	10/11/2019 06:05	10/11/2019 08:50	10/11/2019 06:05	10/11/2019 08:50	2,74	155	424,74	CHI
20191174747	PALMEIRAS DE GOIAS	PL12000051	PALMEIRAS	10/11/2019 07:17	12/11/2019 08:40	10/11/2019 07:17	12/11/2019 08:40	49,40	4	197,59	CHI
20191174759	RIO VERDE	RV12207235	RIO VERDE S2	10/11/2019 07:19	10/11/2019 12:30	10/11/2019 07:19	10/11/2019 12:30	5,19	9	46,69	CHI
20191174761	QUIRINOPOLIS	QI32007538	QUIRINOPOLIS	09/11/2019 21:09	10/11/2019 16:48	09/11/2019 21:09	10/11/2019 16:48	19,64	40	785,69	CHI
20191174765	RIO VERDE	RV12029056	SANTA HELENA S1	10/11/2019 07:17	13/11/2019 15:46	10/11/2019 07:17	13/11/2019 15:46	80,48	27	2172,95	CHI
20191174784	SANTA HELENA DE GOIAS	SH12279733	IPEGUARI	10/11/2019 07:25	12/11/2019 14:19	10/11/2019 07:25	12/11/2019 14:19	54,90	1	54,90	CHI
20191174806	ITAGUARI	II12092952LD	ITABERAI S1	10/11/2019 07:26	10/11/2019 11:55	10/11/2019 07:26	10/11/2019 11:55	4,48	57	255,17	CHI
20191174812	ISRAELANDIA	IS12089375	IPORA	09/11/2019 19:57	11/11/2019 10:59	09/11/2019 19:57	11/11/2019 10:59	39,02	18	702,44	CHI
20191174815	GOIAS	GS11222213	GOIAS	10/11/2019 07:33	14/11/2019 10:10	10/11/2019 07:33	14/11/2019 10:10	98,60	1	98,60	CHI
20191174834	TROMBAS	TB12245290	PORANGATU	09/11/2019 16:11	10/11/2019 13:22	09/11/2019 16:11	10/11/2019 13:22	21,19	7	148,36	CHI
20191174857	ITARUMA	IM12340997	CACHOEIRA ALTA	10/11/2019 07:41	12/11/2019 22:50	10/11/2019 07:41	12/11/2019 22:50	63,15	2	126,30	CHI
20191174890	SANTA HELENA DE GOIAS	SH12301400	ACREUNA	10/11/2019 07:45	11/11/2019 12:26	10/11/2019 07:45	11/11/2019 12:26	28,67	4	114,69	CHI
20191174894	IPORA	IR12091549	IPORA	09/11/2019 20:19	11/11/2019 18:21	09/11/2019 20:19	11/11/2019 18:21	46,03	15	690,50	CHI
20191174904	RIO VERDE	RV21260627	CABRIUVA S1	10/11/2019 07:49	11/11/2019 13:35	10/11/2019 07:49	11/11/2019 13:35	29,76	1	29,76	CHI
20191174907	GUAPO	GC12000274	GUAPO S1	09/11/2019 20:12	10/11/2019 09:50	09/11/2019 20:12	10/11/2019 09:50	13,63	38	517,78	CHI
20191174907	TRINDADE	GC12000274	GUAPO S1	09/11/2019 20:12	10/11/2019 09:50	09/11/2019 20:12	10/11/2019 09:50	13,63	38	517,78	CHI
20191174920	MINEIROS	MY11095199	PARQUE DAS EMAS	10/11/2019 07:01	10/11/2019 10:29	10/11/2019 07:01	10/11/2019 10:29	3,47	194	672,26	CHI
20191174925	PALMEIRAS DE GOIAS	PL12000126	PALMEIRAS	10/11/2019 07:39	11/11/2019 13:06	10/11/2019 07:39	11/11/2019 13:06	29,44	15	441,64	CHI
20191174944	ISRAELANDIA	IS12223059	IPORA	10/11/2019 07:58	16/11/2019 12:30	10/11/2019 07:58	14/11/2019 12:07	100,16	2	200,32	CHI

20191174944	ISRAELANDIA	IS12223059	IPORA	10/11/2019 07:58	16/11/2019 12:30	16/11/2019 09:41	16/11/2019 10:15	0,58	2	1,15	CHI
20191174944	ISRAELANDIA	IS12272666LD	IPORA	10/11/2019 07:58	16/11/2019 12:30	10/11/2019 07:58	16/11/2019 12:30	148,53	1	148,53	CHI
20191174968	CAMPESTRE DE GOIAS	GC12312851	TRINDADE	09/11/2019 20:30	10/11/2019 10:08	09/11/2019 20:30	10/11/2019 10:08	13,64	38	518,36	CHI
20191174988	IPORA	IR12112737	IPORA	09/11/2019 20:54	14/11/2019 21:10	09/11/2019 20:54	13/11/2019 13:47	88,88	10	888,83	CHI
20191174988	IPORA	IR12112737	IPORA	09/11/2019 20:54	14/11/2019 21:10	14/11/2019 16:33	14/11/2019 17:07	0,57	10	5,66	CHI
20191174988	IPORA	IR121289259	IPORA	09/11/2019 20:54	14/11/2019 21:10	09/11/2019 20:54	14/11/2019 21:10	120,25	1	120,25	CHI
20191175013	ARUANA	MP12274498	MOZARLANDIA	10/11/2019 08:08	10/11/2019 10:41	10/11/2019 08:08	10/11/2019 10:41	2,54	3	7,61	CHI
20191175013	MATRINCHA	MP12274498	MOZARLANDIA	10/11/2019 08:08	10/11/2019 10:41	10/11/2019 08:08	10/11/2019 10:41	2,54	2	5,07	CHI
20191175018	RIO VERDE	RV12106528	MONTIVIDIU T	10/11/2019 08:09	10/11/2019 10:48	10/11/2019 08:09	10/11/2019 10:48	2,64	4	10,55	CHI
20191175033	ITARUMA	IM21357304	CACHOEIRA ALTA	10/11/2019 08:12	11/11/2019 19:58	10/11/2019 08:12	11/11/2019 19:58	35,76	1	35,76	CHI
20191175069	SANTO ANTONIO DA BARRA	BZ21279525	ACREUNA	10/11/2019 08:18	12/11/2019 08:32	10/11/2019 08:18	12/11/2019 08:32	48,23	1	48,23	CHI
20191175071	IPORA	IR12233159	IPORA	10/11/2019 05:42	10/11/2019 13:06	10/11/2019 05:42	10/11/2019 10:56	5,23	226	1182,36	CHI
20191175071	IPORA	IR11040212	IPORA	10/11/2019 05:42	10/11/2019 13:06	10/11/2019 05:42	10/11/2019 13:06	7,40	145	1073,32	CHI
20191175088	MINEIROS	MY21326735	PARQUE DAS EMAS	10/11/2019 08:25	11/11/2019 15:00	10/11/2019 08:25	11/11/2019 15:00	30,58	1	30,58	CHI
20191175110	PIRANHAS	PH11023525	PIRANHAS	10/11/2019 07:57	10/11/2019 12:28	10/11/2019 07:57	10/11/2019 12:28	4,51	156	703,47	CHI
20191175136	PALMINOPOLIS	PP21026127	PALMEIRAS	10/11/2019 08:34	12/11/2019 10:20	10/11/2019 08:34	12/11/2019 10:20	49,77	1	49,77	CHI
20191175164	JUSSARA	JR12204918	IPORA	10/11/2019 08:36	10/11/2019 18:08	10/11/2019 08:36	10/11/2019 18:08	9,52	35	333,35	CHI
20191175164	MONTES CLAROS DE GOIAS	JR12204918	IPORA	10/11/2019 08:36	10/11/2019 18:08	10/11/2019 08:36	10/11/2019 18:08	9,52	17	161,91	CHI
20191175166	RIO VERDE	RV11350345	RIO VERDE S2	10/11/2019 08:36	10/11/2019 10:23	10/11/2019 08:36	10/11/2019 10:23	1,77	58	102,63	CHI
20191175187	PALMEIRAS DE GOIAS	PL21085302	PALMEIRAS	10/11/2019 08:40	12/11/2019 11:03	10/11/2019 08:40	12/11/2019 11:03	50,39	1	50,39	CHI
20191175192	RIO VERDE	RV21153967	RIO VERDE S1	10/11/2019 08:40	12/11/2019 08:52	10/11/2019 08:40	12/11/2019 08:52	48,19	1	48,19	CHI
20191175198	JATAI	JT11184118	JATAI S2	10/11/2019 08:06	10/11/2019 16:22	10/11/2019 08:06	10/11/2019 16:22	8,26	42	347,12	CHI
20191175199	AMORINOPOLIS	AM12047170	IPORA	09/11/2019 21:19	11/11/2019 14:38	09/11/2019 21:19	11/11/2019 08:46	35,46	8	283,66	CHI
20191175199	AMORINOPOLIS	AM12000021	IPORA	09/11/2019 21:19	11/11/2019 14:38	11/11/2019 10:04	11/11/2019 14:38	4,56	63	287,52	CHI
20191175233	DOVERLANDIA	DV12217563	CAIAPONIA	10/11/2019 05:45	11/11/2019 09:42	10/11/2019 05:45	11/11/2019 09:42	27,95	124	3465,63	CHI
20191175235	ITAPURANGA	7358798	ITAPURANGA	10/11/2019 08:46	11/11/2019 14:40	10/11/2019 08:46	11/11/2019 14:40	29,90	13	388,76	CHI
20191175258	JATAI	JT12205194	JATAI S1	10/11/2019 08:48	10/11/2019 16:21	10/11/2019 08:48	10/11/2019 16:21	7,55	7	52,87	CHI
20191175279	MOSSAMEDES	KB21000006	ANICUNS	10/11/2019 08:51	10/11/2019 15:07	10/11/2019 08:51	10/11/2019 15:07	6,26	1	6,26	CHI
20191175280	QUIRINOPOLIS	QI21054854	QUIRINOPOLIS	10/11/2019 08:51	12/11/2019 10:52	10/11/2019 08:51	12/11/2019 10:52	50,01	1	50,01	CHI
20191175304	SAO SIMAO	2240025524	CACHOEIRA ALTA	10/11/2019 08:55	11/11/2019 07:19	10/11/2019 08:55	11/11/2019 07:19	22,39	0	0,00	CHI
20191175314	JATAI	290308331	JATAI S3	10/11/2019 08:57	12/11/2019 08:45	10/11/2019 08:57	12/11/2019 08:45	47,79	1	47,79	CHI
20191175341	GOIAS	GS12310594	ITABERAI S1	10/11/2019 08:05	11/11/2019 15:50	10/11/2019 08:05	11/11/2019 15:50	31,76	4	127,02	CHI
20191175341	ITABERAI	GS12310594	ITABERAI S1	10/11/2019 08:05	11/11/2019 15:50	10/11/2019 08:05	11/11/2019 15:50	31,76	27	857,41	CHI

20191175380	CORREGO DO OURO	CO11004039	FIRMINOPOLIS S2	10/11/2019 08:35	10/11/2019 09:50	10/11/2019 08:35	10/11/2019 09:50	1,25	170	211,93	CHI
20191175405	JANDAIA	JD11126078	PALMEIRAS	10/11/2019 06:33	10/11/2019 15:55	10/11/2019 06:33	10/11/2019 15:55	9,37	129	1208,77	CHI
20191175416	CASTELANDIA	DM12305932	RIO DOS BOIS	10/11/2019 06:21	10/11/2019 11:27	10/11/2019 06:21	10/11/2019 11:27	5,09	4	20,35	CHI
20191175416	QUIRINOPOLIS	DM12305932	RIO DOS BOIS	10/11/2019 06:21	10/11/2019 11:27	10/11/2019 06:21	10/11/2019 11:27	5,09	13	66,13	CHI
20191175431	BURITI DE GOIAS	BS11028028	FIRMINOPOLIS S2	10/11/2019 07:39	10/11/2019 14:13	10/11/2019 07:39	10/11/2019 14:13	6,57	129	847,10	CHI
20191175454	FAZENDA NOVA	FN12076130	JUSSARA	10/11/2019 01:17	15/11/2019 22:46	10/11/2019 01:17	14/11/2019 12:45	107,46	22	2364,21	CHI
20191175454	FAZENDA NOVA	FN12217146	JUSSARA	10/11/2019 01:17	15/11/2019 22:46	10/11/2019 01:17	15/11/2019 22:46	141,49	14	1980,89	CHI
20191175454	FAZENDA NOVA	FN13113517	JUSSARA	10/11/2019 01:17	15/11/2019 22:46	10/11/2019 01:17	15/11/2019 22:46	141,49	32	4527,74	CHI
20191175482	SAO LUIS DE MONTES BELOS	SL12259053	SAO LUIZ DOS MONTES BELOS	10/11/2019 07:57	10/11/2019 10:52	10/11/2019 07:57	10/11/2019 10:52	2,92	3	8,75	CHI
20191175501	ITARUMA	IM11370120	CACHOEIRA ALTA	10/11/2019 08:14	10/11/2019 16:32	10/11/2019 08:14	10/11/2019 16:32	8,31	56	465,16	CHI
20191175506	CORREGO DO OURO	CO12004043	FIRMINOPOLIS S2	10/11/2019 06:34	10/11/2019 14:08	10/11/2019 06:34	10/11/2019 14:08	7,58	7	53,07	CHI
20191175552	GOIAS	GS12188167	MATRINCHA	09/11/2019 21:50	13/11/2019 09:36	09/11/2019 21:50	13/11/2019 09:36	83,76	11	921,35	CHI
20191175572	JANDAIA	JD12008614	PALMEIRAS	10/11/2019 08:33	11/11/2019 20:55	10/11/2019 08:33	11/11/2019 20:55	36,37	23	836,48	CHI
20191175572	PARAUNA	JD12008614	PALMEIRAS	10/11/2019 08:33	11/11/2019 20:55	10/11/2019 08:33	11/11/2019 20:55	36,37	6	218,21	CHI
20191175636	GOIAS	GS12162491	GOIAS	10/11/2019 08:11	12/11/2019 13:39	10/11/2019 08:11	12/11/2019 13:39	53,46	49	2619,55	CHI
20191175644	BRITANIA	IU12020119	MATRINCHA	10/11/2019 05:02	13/11/2019 10:43	10/11/2019 05:02	13/11/2019 10:43	77,69	6	466,16	CHI
20191175644	ITAPIRAPUA	IU12020119	MATRINCHA	10/11/2019 05:02	13/11/2019 10:43	10/11/2019 05:02	13/11/2019 10:43	77,69	43	3340,78	CHI
20191175676	GOIAS	GS21319416	GOIAS	10/11/2019 07:55	11/11/2019 17:28	10/11/2019 07:55	11/11/2019 17:28	33,54	1	33,54	CHI
20191175695	NOVO BRASIL	NB12378883	JUSSARA	10/11/2019 07:35	13/11/2019 20:17	10/11/2019 07:35	13/11/2019 20:17	84,70	5	423,50	CHI
20191175700	SAO LUIS DE MONTES BELOS	SL11259146	SAO LUIZ DOS MONTES BELOS	10/11/2019 08:32	10/11/2019 12:30	10/11/2019 08:32	10/11/2019 12:30	3,95	29	114,67	CHI
20191175714	IVOLANDIA	IV12062833	IPORA	09/11/2019 23:37	11/11/2019 16:33	09/11/2019 23:37	11/11/2019 16:33	40,93	19	777,66	CHI
20191175831	ACREUNA	EU11189158	ACREUNA	10/11/2019 08:57	10/11/2019 19:10	10/11/2019 08:57	10/11/2019 19:10	10,21	45	459,66	CHI
20191175842	PIRANHAS	PH11023530	PIRANHAS	10/11/2019 07:12	10/11/2019 11:35	10/11/2019 07:12	10/11/2019 11:35	4,38	92	402,68	CHI
20191175885	SAO LUIS DE MONTES BELOS	SL32145768	SAO LUIZ DOS MONTES BELOS	10/11/2019 07:56	10/11/2019 15:20	10/11/2019 07:56	10/11/2019 15:20	7,39	29	214,28	CHI
20191175900	JATAI	RV12038514	CABRIUVA S1	10/11/2019 06:40	10/11/2019 14:50	10/11/2019 06:40	10/11/2019 14:50	8,18	6	49,05	CHI
20191175900	RIO VERDE	RV12038514	CABRIUVA S1	10/11/2019 06:40	10/11/2019 14:50	10/11/2019 06:40	10/11/2019 14:50	8,18	77	629,54	CHI
20191175980	PALESTINA DE GOIAS	PY11020927	PALESTINA	10/11/2019 07:34	10/11/2019 20:45	10/11/2019 07:34	10/11/2019 20:45	13,18	64	843,50	CHI
20191176035	DOVERLANDIA	DV12138334	CAIAPONIA	10/11/2019 08:54	15/11/2019 01:46	10/11/2019 08:54	11/11/2019 13:09	28,25	14	395,49	CHI
20191176035	DOVERLANDIA	DV21124040	CAIAPONIA	10/11/2019 08:54	15/11/2019 01:46	10/11/2019 08:54	15/11/2019 01:46	112,86	1	112,86	CHI
20191176105	RIO VERDE	RV11230853	RIO VERDE S2	10/11/2019 06:55	11/11/2019 01:26	10/11/2019 06:55	11/11/2019 01:26	18,51	75	1388,25	CHI
20191176196	BURITI DE GOIAS	CO13000026	FIRMINOPOLIS S2	10/11/2019 05:48	10/11/2019 23:39	10/11/2019 05:48	10/11/2019 23:39	17,85	31	553,43	CHI
20191176196	CORREGO DO OURO	CO13000026	FIRMINOPOLIS S2	10/11/2019 05:48	10/11/2019 23:39	10/11/2019 05:48	10/11/2019 23:39	17,85	141	2517,20	CHI
20191176196	FAZENDA NOVA	CO13000026	FIRMINOPOLIS S2	10/11/2019 05:48	10/11/2019 23:39	10/11/2019 05:48	10/11/2019 23:39	17,85	38	678,39	CHI

20191176196	CORREGO DO OURO	CO13000026	FIRMINOPOLIS S2	10/11/2019 05:48	10/11/2019 23:39	10/11/2019 22:53	10/11/2019 23:39	0,76	163	124,51	CHI
20191176206	ITABERAI	IB12000046	ITABERAI S2	10/11/2019 08:00	10/11/2019 16:23	10/11/2019 08:00	10/11/2019 16:23	8,38	5	41,91	CHI
20191176307	FAZENDA NOVA	FN11254594	JUSSARA	10/11/2019 07:07	11/11/2019 11:21	10/11/2019 07:07	11/11/2019 11:21	28,22	47	1326,52	CHI
20191176372	FAZENDA NOVA	IS12381080	IPORA	10/11/2019 07:40	14/11/2019 17:14	10/11/2019 07:40	14/11/2019 17:14	105,57	9	950,14	CHI
20191176372	ISRAELANDIA	IS12381080	IPORA	10/11/2019 07:40	14/11/2019 17:14	10/11/2019 07:40	14/11/2019 17:14	105,57	2	211,14	CHI
20191176399	FAZENDA NOVA	FN11183417	JUSSARA	10/11/2019 06:53	11/11/2019 10:17	10/11/2019 06:53	11/11/2019 10:17	27,39	58	1588,83	CHI
20191176457	PALMEIRAS DE GOIAS	PL12000092	PALMEIRAS	10/11/2019 07:50	11/11/2019 14:27	10/11/2019 07:50	11/11/2019 14:27	30,60	4	122,42	CHI
20191176463	FAZENDA NOVA	FN11362419	JUSSARA	10/11/2019 03:19	13/11/2019 11:57	10/11/2019 03:19	13/11/2019 11:57	80,62	27	2176,84	CHI
20191176494	PIRANHAS	1930005341	PIRANHAS	10/11/2019 06:26	10/11/2019 19:40	10/11/2019 06:26	10/11/2019 19:40	13,23	1	13,23	CHI
20191176786	SERRANOPOLIS	SX12182120	JATAI S1	10/11/2019 08:36	12/11/2019 18:35	10/11/2019 08:36	12/11/2019 18:35	57,98	15	869,73	CHI
20191176791	NOVO BRASIL	NB11019356	JUSSARA	09/11/2019 19:21	10/11/2019 19:19	09/11/2019 19:21	10/11/2019 19:19	23,96	146	3498,81	CHI
20191176794	IPORA	IR11014389	IPORA	09/11/2019 23:27	11/11/2019 09:20	09/11/2019 23:27	11/11/2019 09:20	33,88	79	2676,65	CHI
20191176854	SERRANOPOLIS	DJ12164061	CHAPADAO DO CEU	09/11/2019 17:06	11/11/2019 18:06	09/11/2019 17:06	11/11/2019 18:06	48,99	2	97,99	CHI
20191177008	JANDAIA	JD12391446	PALMEIRAS	10/11/2019 08:37	11/11/2019 20:55	10/11/2019 08:37	11/11/2019 20:55	36,29	4	145,15	CHI
20191177158	CAIAPONIA	CP12068509	IPORA	10/11/2019 07:27	12/11/2019 13:13	10/11/2019 07:27	12/11/2019 13:13	53,76	2	107,52	CHI
20191177158	IVOLANDIA	CP12068509	IPORA	10/11/2019 07:27	12/11/2019 13:13	10/11/2019 07:27	12/11/2019 13:13	53,76	2	107,52	CHI
20191177573	RIO VERDE	RV11029068	SANTA HELENA S1	10/11/2019 08:00	12/11/2019 17:28	10/11/2019 08:00	12/11/2019 17:28	57,46	77	4424,76	CHI
20191178381	MOSSAMEDES	MD12020758	ITABERAI S2	10/11/2019 06:36	10/11/2019 21:12	10/11/2019 06:36	10/11/2019 21:12	14,60	45	656,89	CHI
20191178746	JATAI	JT12105239	JATAI S1	09/11/2019 16:49	12/11/2019 18:26	09/11/2019 16:49	10/11/2019 22:00	29,18	3	87,55	CHI
20191178746	JATAI	JT12105239	JATAI S1	09/11/2019 16:49	12/11/2019 18:26	10/11/2019 22:01	12/11/2019 18:26	44,43	3	133,29	CHI
20191182037	PALMEIRAS DE GOIAS	PL21331970	PALMEIRAS	09/11/2019 14:35	11/11/2019 12:35	09/11/2019 14:35	11/11/2019 12:35	46,00	1	46,00	CHI
20191189423	DIORAMA	ME12124938	IPORA	09/11/2019 19:04	12/11/2019 12:30	12/11/2019 00:35	12/11/2019 12:30	11,92	1	11,92	CHI
20191189423	MONTES CLAROS DE GOIAS	ME12124938	IPORA	09/11/2019 19:04	12/11/2019 12:30	12/11/2019 00:35	12/11/2019 12:30	11,92	42	500,50	CHI
20191189705	MONTES CLAROS DE GOIAS	ME10400383	IPORA	09/11/2019 19:04	13/11/2019 21:54	11/11/2019 15:19	13/11/2019 10:34	43,26	8	346,07	CHI
20191189705	MONTES CLAROS DE GOIAS	ME10400383	IPORA	09/11/2019 19:04	13/11/2019 21:54	11/11/2019 15:19	13/11/2019 21:54	54,59	25	1364,74	CHI
20191189705	MONTES CLAROS DE GOIAS	ME10400383	IPORA	09/11/2019 19:04	13/11/2019 21:54	13/11/2019 10:35	13/11/2019 21:54	11,33	9	101,93	CHI
20191189705	MONTES CLAROS DE GOIAS	ME10400383	IPORA	09/11/2019 19:04	13/11/2019 21:54	13/11/2019 12:40	13/11/2019 21:54	9,24	31	286,51	CHI
20191189705	MONTES CLAROS DE GOIAS	ME10400383	IPORA	09/11/2019 19:04	13/11/2019 21:54	13/11/2019 12:40	13/11/2019 21:54	9,23	5	46,17	CHI
20191199566	ACREUNA	EU12085776	ACREUNA	09/11/2019 14:26	13/11/2019 18:54	09/11/2019 14:26	13/11/2019 18:54	100,47	7	703,26	CHI
201911105457	JATAI	10003355770	JATAI S1	09/11/2019 15:13	13/11/2019 17:57	09/11/2019 15:13	13/11/2019 17:57	98,72	1	98,72	CHI
201911137677	GOIAS	GS12307627	GOIAS	10/11/2019 08:33	17/11/2019 15:10	14/11/2019 14:20	14/11/2019 15:33	1,22	5	6,09	CHI
201911137677	GOIAS	GS12307627	GOIAS	10/11/2019 08:33	17/11/2019 15:10	14/11/2019 15:34	14/11/2019 18:55	3,35	3	10,04	CHI
201911137677	GOIAS	GS12307627	GOIAS	10/11/2019 08:33	17/11/2019 15:10	14/11/2019 19:05	14/11/2019 19:20	0,25	3	0,75	CHI

201911137677	GOIAS	GS12307627	GOIAS	10/11/2019 08:33	17/11/2019 15:10	15/11/2019 12:00	15/11/2019 21:35	9,58	3	28,75	CHI
201911137677	GOIAS	GS12325834LD	GOIAS	10/11/2019 08:33	17/11/2019 15:10	14/11/2019 15:34	17/11/2019 15:10	71,59	2	143,19	CHI
201911151287	QUIRINOPOLIS	QI12303092LD	QUIRINOPOLIS	09/11/2019 18:08	14/11/2019 16:30	09/11/2019 18:08	14/11/2019 16:30	118,35	1	118,35	CHI
201911151287	QUIRINOPOLIS	QI12303092LD	QUIRINOPOLIS	09/11/2019 18:08	14/11/2019 16:30	14/11/2019 11:16	14/11/2019 16:30	5,23	177	926,15	CHI
201911339203	GOIANIA	GN12002215	CAMPINAS S3	09/11/2019 18:59	09/11/2019 21:32	09/11/2019 18:59	09/11/2019 20:48	1,81	1039	1878,86	CHI
201911339203	GOIANIA	GN11002232	CAMPINAS S3	09/11/2019 18:59	09/11/2019 21:32	09/11/2019 18:59	09/11/2019 21:32	2,54	140	355,83	CHI
201911344183	FAZENDA NOVA	01340436	JUSSARA	09/11/2019 18:23	10/11/2019 01:23	09/11/2019 18:23	09/11/2019 23:18	4,90	1407	6900,94	CHI
201911344183	FAZENDA NOVA	01340436	JUSSARA	09/11/2019 18:23	10/11/2019 01:23	09/11/2019 18:23	09/11/2019 23:18	4,90	800	3923,78	CHI
201911344183	FAZENDA NOVA	01340436	JUSSARA	09/11/2019 18:23	10/11/2019 01:23	09/11/2019 18:23	10/11/2019 01:23	6,99	47	328,35	CHI
201911344183	NOVO BRASIL	01340436	JUSSARA	09/11/2019 18:23	10/11/2019 01:23	09/11/2019 18:23	10/11/2019 01:23	6,99	48	335,33	CHI
201911368157	RIO VERDE	01420414	SANTA HELENA S1	10/11/2019 08:00	13/11/2019 15:40	10/11/2019 08:00	10/11/2019 13:23	5,38	5	26,91	CHI
201911368157	RIO VERDE	RV13163262	SANTA HELENA S1	10/11/2019 08:00	13/11/2019 15:40	10/11/2019 08:00	10/11/2019 17:20	9,33	386	3601,70	CHI
201911368157	RIO VERDE	RV13301190	SANTA HELENA S1	10/11/2019 08:00	13/11/2019 15:40	10/11/2019 08:00	10/11/2019 17:20	9,33	53	494,53	CHI
201911368157	QUIRINOPOLIS	RV13018085	SANTA HELENA S1	10/11/2019 08:00	13/11/2019 15:40	10/11/2019 08:00	10/11/2019 21:53	13,88	42	583,12	CHI
201911368157	RIO VERDE	RV13018085	SANTA HELENA S1	10/11/2019 08:00	13/11/2019 15:40	10/11/2019 08:00	10/11/2019 21:53	13,88	394	5470,25	CHI
201911368157	MAURILANDIA	RV13255780	SANTA HELENA S1	10/11/2019 08:00	13/11/2019 15:40	10/11/2019 08:00	11/11/2019 20:54	36,90	6	221,40	CHI
201911368157	RIO VERDE	RV13255780	SANTA HELENA S1	10/11/2019 08:00	13/11/2019 15:40	10/11/2019 08:00	11/11/2019 20:54	36,90	6	221,40	CHI
201911368157	MAURILANDIA	01420414	SANTA HELENA S1	10/11/2019 08:00	13/11/2019 15:40	12/11/2019 13:45	12/11/2019 16:00	2,26	6	13,58	CHI
201911368157	RIO VERDE	01420414	SANTA HELENA S1	10/11/2019 08:00	13/11/2019 15:40	12/11/2019 13:45	12/11/2019 16:00	2,26	11	24,90	CHI
201911368157	RIO VERDE	RV13305722	SANTA HELENA S1	10/11/2019 08:00	13/11/2019 15:40	10/11/2019 08:00	12/11/2019 19:44	59,74	7	418,19	CHI
201911368157	QUIRINOPOLIS	QI12163448	SANTA HELENA S1	10/11/2019 08:00	13/11/2019 15:40	10/11/2019 08:00	12/11/2019 23:47	63,80	11	701,75	CHI
201911368157	RIO VERDE	QI12163448	SANTA HELENA S1	10/11/2019 08:00	13/11/2019 15:40	10/11/2019 08:00	12/11/2019 23:47	63,80	1	63,80	CHI
201911368157	RIO VERDE	RV13305722	SANTA HELENA S1	10/11/2019 08:00	13/11/2019 15:40	10/11/2019 08:00	13/11/2019 11:10	75,17	5	375,87	CHI
201911368157	RIO VERDE	RV13305722	SANTA HELENA S1	10/11/2019 08:00	13/11/2019 15:40	10/11/2019 08:00	13/11/2019 15:40	79,67	2	159,35	CHI
201911368157	RIO VERDE	RV13279864	SANTA HELENA S1	10/11/2019 08:00	13/11/2019 15:40	13/11/2019 13:12	13/11/2019 15:40	2,47	5	12,33	CHI
201911368313	GOIAS	GS12307627	GOIAS	10/11/2019 08:33	12/11/2019 19:15	10/11/2019 08:33	10/11/2019 18:01	9,47	3	28,40	CHI
201911368313	GOIAS	GS12307627	GOIAS	10/11/2019 08:33	12/11/2019 19:15	10/11/2019 08:33	12/11/2019 19:15	58,70	2	117,40	CHI
201911368313	GOIAS	GS12307627	GOIAS	10/11/2019 08:33	12/11/2019 19:15	10/11/2019 18:02	12/11/2019 19:15	49,22	3	147,65	CHI
201911368326	MAURILANDIA	14201	SANTA HELENA S1	09/11/2019 15:10	11/11/2019 17:25	09/11/2019 15:10	09/11/2019 17:11	2,01	28	56,15	CHI
201911368326	MAURILANDIA	01660434	SANTA HELENA S1	09/11/2019 15:10	11/11/2019 17:25	09/11/2019 15:10	09/11/2019 17:11	2,01	4	8,02	CHI
201911368326	QUIRINOPOLIS	36702	SANTA HELENA S1	09/11/2019 15:10	11/11/2019 17:25	09/11/2019 15:10	09/11/2019 17:11	2,01	42	84,22	CHI
201911368326	QUIRINOPOLIS	14231	SANTA HELENA S1	09/11/2019 15:10	11/11/2019 17:25	09/11/2019 15:10	09/11/2019 17:11	2,01	11	22,06	CHI
201911368326	RIO VERDE	14201	SANTA HELENA S1	09/11/2019 15:10	11/11/2019 17:25	09/11/2019 15:10	09/11/2019 17:11	2,01	628	1259,31	CHI

201911368326	RIO VERDE	36701	SANTA HELENA S1	09/11/2019 15:10	11/11/2019 17:25	09/11/2019 15:10	09/11/2019 17:11	2,01	386	774,04	CHI
201911368326	RIO VERDE	36702	SANTA HELENA S1	09/11/2019 15:10	11/11/2019 17:25	09/11/2019 15:10	09/11/2019 17:11	2,01	621	1245,28	CHI
201911368326	RIO VERDE	14231	SANTA HELENA S1	09/11/2019 15:10	11/11/2019 17:25	09/11/2019 15:10	09/11/2019 17:11	2,01	26	52,14	CHI
201911368326	RIO VERDE	01660434	SANTA HELENA S1	09/11/2019 15:10	11/11/2019 17:25	09/11/2019 15:10	09/11/2019 17:11	2,01	1	2,01	CHI
201911368326	SANTA HELENA DE GOIAS	14201	SANTA HELENA S1	09/11/2019 15:10	11/11/2019 17:25	09/11/2019 15:10	09/11/2019 17:11	2,01	53	106,28	CHI
201911368326	SANTA HELENA DE GOIAS	01660434	SANTA HELENA S1	09/11/2019 15:10	11/11/2019 17:25	09/11/2019 15:10	09/11/2019 17:11	2,01	4	8,02	CHI
201911368326	TURVELANDIA	01660434	SANTA HELENA S1	09/11/2019 15:10	11/11/2019 17:25	09/11/2019 15:10	09/11/2019 17:11	2,01	5	10,03	CHI
201911368326	MAURILANDIA	14231	SANTA HELENA S1	09/11/2019 15:10	11/11/2019 17:25	09/11/2019 15:10	09/11/2019 17:12	2,02	6	12,12	CHI
201911368326	SANTA HELENA DE GOIAS	01660434	SANTA HELENA S1	09/11/2019 15:10	11/11/2019 17:25	09/11/2019 15:10	09/11/2019 19:48	4,63	6	27,76	CHI
201911368326	SANTA HELENA DE GOIAS	01660424	SANTA HELENA S1	09/11/2019 15:10	11/11/2019 17:25	09/11/2019 15:17	09/11/2019 20:16	4,98	7	34,84	CHI
201911368326	SANTA HELENA DE GOIAS	01660424	SANTA HELENA S1	09/11/2019 15:10	11/11/2019 17:25	09/11/2019 15:17	09/11/2019 20:49	5,53	2	11,05	CHI
201911368326	SANTA HELENA DE GOIAS	01660424	SANTA HELENA S1	09/11/2019 15:10	11/11/2019 17:25	09/11/2019 15:17	10/11/2019 13:11	21,90	1	21,90	CHI
201911368326	SANTA HELENA DE GOIAS	01660434	SANTA HELENA S1	09/11/2019 15:10	11/11/2019 17:25	09/11/2019 15:10	10/11/2019 18:54	27,73	8	221,80	CHI
201911368326	SANTA HELENA DE GOIAS	01660424	SANTA HELENA S1	09/11/2019 15:10	11/11/2019 17:25	09/11/2019 15:17	11/11/2019 16:10	48,89	1	48,89	CHI
201911368326	MAURILANDIA	01660424	SANTA HELENA S1	09/11/2019 15:10	11/11/2019 17:25	09/11/2019 15:17	11/11/2019 17:15	49,97	4	199,90	CHI
201911368326	SANTA HELENA DE GOIAS	01660424	SANTA HELENA S1	09/11/2019 15:10	11/11/2019 17:25	09/11/2019 15:17	11/11/2019 17:15	49,97	8	399,80	CHI
201911368326	MAURILANDIA	14201	SANTA HELENA S1	09/11/2019 15:10	11/11/2019 17:25	11/11/2019 17:20	11/11/2019 17:25	0,07	28	1,99	CHI
201911368326	MAURILANDIA	01660434	SANTA HELENA S1	09/11/2019 15:10	11/11/2019 17:25	11/11/2019 17:20	11/11/2019 17:25	0,07	4	0,28	CHI
201911368326	QUIRINOPOLIS	36702	SANTA HELENA S1	09/11/2019 15:10	11/11/2019 17:25	11/11/2019 17:20	11/11/2019 17:25	0,07	42	2,99	CHI
201911368326	RIO VERDE	14201	SANTA HELENA S1	09/11/2019 15:10	11/11/2019 17:25	11/11/2019 17:20	11/11/2019 17:25	0,07	628	44,66	CHI
201911368326	RIO VERDE	36701	SANTA HELENA S1	09/11/2019 15:10	11/11/2019 17:25	11/11/2019 17:20	11/11/2019 17:25	0,07	386	27,45	CHI
201911368326	RIO VERDE	36702	SANTA HELENA S1	09/11/2019 15:10	11/11/2019 17:25	11/11/2019 17:20	11/11/2019 17:25	0,07	447	31,79	CHI
201911368326	RIO VERDE	14231	SANTA HELENA S1	09/11/2019 15:10	11/11/2019 17:25	11/11/2019 17:20	11/11/2019 17:25	0,07	5	0,36	CHI
201911368326	RIO VERDE	01660434	SANTA HELENA S1	09/11/2019 15:10	11/11/2019 17:25	11/11/2019 17:20	11/11/2019 17:25	0,07	1	0,07	CHI
201911368326	SANTA HELENA DE GOIAS	14201	SANTA HELENA S1	09/11/2019 15:10	11/11/2019 17:25	11/11/2019 17:20	11/11/2019 17:25	0,07	53	3,77	CHI
201911368326	SANTA HELENA DE GOIAS	01660434	SANTA HELENA S1	09/11/2019 15:10	11/11/2019 17:25	11/11/2019 17:20	11/11/2019 17:25	0,07	18	1,28	CHI
201911368326	TURVELANDIA	01660434	SANTA HELENA S1	09/11/2019 15:10	11/11/2019 17:25	11/11/2019 17:20	11/11/2019 17:25	0,07	5	0,36	CHI
2019110900021	BOM JESUS DE GOIAS	00235114	BOM JESUS DE GOIAS	09/11/2019 14:20	09/11/2019 14:34	09/11/2019 14:20	09/11/2019 14:34	0,23	1739	405,77	CHI
2019110900021	BOM JESUS DE GOIAS	00235114	BOM JESUS DE GOIAS	09/11/2019 14:20	09/11/2019 14:34	09/11/2019 14:20	09/11/2019 14:34	0,23	6806	1588,07	CHI
2019110900021	BOM JESUS DE GOIAS	00235114	BOM JESUS DE GOIAS	09/11/2019 14:20	09/11/2019 14:34	09/11/2019 14:20	09/11/2019 14:34	0,23	20	4,67	CHI
2019110900021	GOIATUBA	00235114	BOM JESUS DE GOIAS	09/11/2019 14:20	09/11/2019 14:34	09/11/2019 14:20	09/11/2019 14:34	0,23	100	23,33	CHI
2019110900021	GOIATUBA	00235114	BOM JESUS DE GOIAS	09/11/2019 14:20	09/11/2019 14:34	09/11/2019 14:20	09/11/2019 14:34	0,23	16	3,73	CHI
2019110900021	ITUMBIARA	00235114	BOM JESUS DE GOIAS	09/11/2019 14:20	09/11/2019 14:34	09/11/2019 14:20	09/11/2019 14:34	0,23	311	72,57	CHI

2019110900021	ITUMBIARA	00235114	BOM JESUS DE GOIAS	09/11/2019 14:20	09/11/2019 14:34	09/11/2019 14:20	09/11/2019 14:34	0,23	391	91,23	CHI
2019110900021	ITUMBIARA	00235114	BOM JESUS DE GOIAS	09/11/2019 14:20	09/11/2019 14:34	09/11/2019 14:20	09/11/2019 14:34	0,23	3	0,70	CHI
2019110900021	ITUMBIARA	00235114	BOM JESUS DE GOIAS	09/11/2019 14:20	09/11/2019 14:34	09/11/2019 14:20	09/11/2019 14:34	0,23	4	0,93	CHI
2019110900021	QUIRINOPOLIS	00235114	BOM JESUS DE GOIAS	09/11/2019 14:20	09/11/2019 14:34	09/11/2019 14:20	09/11/2019 14:34	0,23	6	1,40	CHI
2019110900021	INACIOLANDIA	00235114	CACHOEIRA DOURADA	09/11/2019 14:20	09/11/2019 14:34	09/11/2019 14:20	09/11/2019 14:34	0,23	4	0,93	CHI
2019110900060	BOM JESUS DE GOIAS	00230424	BOM JESUS DE GOIAS	09/11/2019 20:34	09/11/2019 20:37	09/11/2019 20:34	09/11/2019 20:37	0,05	22	1,10	CHI
2019110900060	GOIATUBA	00230424	BOM JESUS DE GOIAS	09/11/2019 20:34	09/11/2019 20:37	09/11/2019 20:34	09/11/2019 20:37	0,05	22	1,10	CHI
2019110900060	ITUMBIARA	00230424	BOM JESUS DE GOIAS	09/11/2019 20:34	09/11/2019 20:37	09/11/2019 20:34	09/11/2019 20:37	0,05	3	0,15	CHI
2019110900096	ADELANDIA	34802	ANICUNS	09/11/2019 18:10	09/11/2019 18:20	09/11/2019 18:10	09/11/2019 18:20	0,17	29	4,83	CHI
2019110900096	AMERICANO DO BRASIL	34802	ANICUNS	09/11/2019 18:10	09/11/2019 18:20	09/11/2019 18:10	09/11/2019 18:20	0,17	24	4,00	CHI
2019110900096	ANICUNS	34802	ANICUNS	09/11/2019 18:10	09/11/2019 18:20	09/11/2019 18:10	09/11/2019 18:20	0,17	38	6,33	CHI
2019110900096	MOSSAMEDES	34802	ANICUNS	09/11/2019 18:10	09/11/2019 18:20	09/11/2019 18:10	09/11/2019 18:20	0,17	32	5,33	CHI
2019110900096	ADELANDIA	34802	FIRMINOPOLIS S2	09/11/2019 18:10	09/11/2019 18:20	09/11/2019 18:10	09/11/2019 18:20	0,17	105	17,50	CHI
2019110900096	ADELANDIA	02020414	FIRMINOPOLIS S2	09/11/2019 18:10	09/11/2019 18:20	09/11/2019 18:10	09/11/2019 18:20	0,17	5	0,83	CHI
2019110900096	ANICUNS	34802	FIRMINOPOLIS S2	09/11/2019 18:10	09/11/2019 18:20	09/11/2019 18:10	09/11/2019 18:20	0,17	179	29,83	CHI
2019110900096	BURITI DE GOIAS	47301	FIRMINOPOLIS S2	09/11/2019 18:10	09/11/2019 18:20	09/11/2019 18:10	09/11/2019 18:20	0,17	1123	187,17	CHI
2019110900096	BURITI DE GOIAS	47302	FIRMINOPOLIS S2	09/11/2019 18:10	09/11/2019 18:20	09/11/2019 18:10	09/11/2019 18:20	0,17	300	50,00	CHI
2019110900096	BURITI DE GOIAS	16431	FIRMINOPOLIS S2	09/11/2019 18:10	09/11/2019 18:20	09/11/2019 18:10	09/11/2019 18:20	0,17	1	0,17	CHI
2019110900096	CORREGO DO OURO	47301	FIRMINOPOLIS S2	09/11/2019 18:10	09/11/2019 18:20	09/11/2019 18:10	09/11/2019 18:20	0,17	130	21,67	CHI
2019110900096	FIRMINOPOLIS	02020414	FIRMINOPOLIS S2	09/11/2019 18:10	09/11/2019 18:20	09/11/2019 18:10	09/11/2019 18:20	0,17	1	0,17	CHI
2019110900096	MOSSAMEDES	16401	FIRMINOPOLIS S2	09/11/2019 18:10	09/11/2019 18:20	09/11/2019 18:10	09/11/2019 18:20	0,17	30	5,00	CHI
2019110900096	MOSSAMEDES	34201	FIRMINOPOLIS S2	09/11/2019 18:10	09/11/2019 18:20	09/11/2019 18:10	09/11/2019 18:20	0,17	1821	303,50	CHI
2019110900096	MOSSAMEDES	16402	FIRMINOPOLIS S2	09/11/2019 18:10	09/11/2019 18:20	09/11/2019 18:10	09/11/2019 18:20	0,17	1	0,17	CHI
2019110900096	MOSSAMEDES	34802	FIRMINOPOLIS S2	09/11/2019 18:10	09/11/2019 18:20	09/11/2019 18:10	09/11/2019 18:20	0,17	5	0,83	CHI
2019110900096	MOSSAMEDES	47302	FIRMINOPOLIS S2	09/11/2019 18:10	09/11/2019 18:20	09/11/2019 18:10	09/11/2019 18:20	0,17	5	0,83	CHI
2019110900096	MOSSAMEDES	16432	FIRMINOPOLIS S2	09/11/2019 18:10	09/11/2019 18:20	09/11/2019 18:10	09/11/2019 18:20	0,17	100	16,67	CHI
2019110900096	NOVO BRASIL	47301	FIRMINOPOLIS S2	09/11/2019 18:10	09/11/2019 18:20	09/11/2019 18:10	09/11/2019 18:20	0,17	14	2,33	CHI
2019110900096	SANCLERLANDIA	16401	FIRMINOPOLIS S2	09/11/2019 18:10	09/11/2019 18:20	09/11/2019 18:10	09/11/2019 18:20	0,17	3023	503,83	CHI
2019110900096	SANCLERLANDIA	34201	FIRMINOPOLIS S2	09/11/2019 18:10	09/11/2019 18:20	09/11/2019 18:10	09/11/2019 18:20	0,17	8	1,33	CHI
2019110900096	SANCLERLANDIA	47301	FIRMINOPOLIS S2	09/11/2019 18:10	09/11/2019 18:20	09/11/2019 18:10	09/11/2019 18:20	0,17	296	49,33	CHI
2019110900096	SANCLERLANDIA	16402	FIRMINOPOLIS S2	09/11/2019 18:10	09/11/2019 18:20	09/11/2019 18:10	09/11/2019 18:20	0,17	654	109,00	CHI
2019110900096	SANCLERLANDIA	34802	FIRMINOPOLIS S2	09/11/2019 18:10	09/11/2019 18:20	09/11/2019 18:10	09/11/2019 18:20	0,17	30	5,00	CHI
2019110900096	SANCLERLANDIA	47302	FIRMINOPOLIS S2	09/11/2019 18:10	09/11/2019 18:20	09/11/2019 18:10	09/11/2019 18:20	0,17	1	0,17	CHI



2019110900096	SANCLERLANDIA	16431	FIRMINOPOLIS S2	09/11/2019 18:10	09/11/2019 18:20	09/11/2019 18:10	09/11/2019 18:20	0,17	7	1,17	CHI
2019110900096	SANCLERLANDIA	02020414	FIRMINOPOLIS S2	09/11/2019 18:10	09/11/2019 18:20	09/11/2019 18:10	09/11/2019 18:20	0,17	18	3,00	CHI
2019110900096	SANCLERLANDIA	16432	FIRMINOPOLIS S2	09/11/2019 18:10	09/11/2019 18:20	09/11/2019 18:10	09/11/2019 18:20	0,17	7	1,17	CHI
2019110900096	SAO LUIS DE MONTES BELOS	47301	FIRMINOPOLIS S2	09/11/2019 18:10	09/11/2019 18:20	09/11/2019 18:10	09/11/2019 18:20	0,17	52	8,67	CHI
2019110900096	SAO LUIS DE MONTES BELOS	16402	FIRMINOPOLIS S2	09/11/2019 18:10	09/11/2019 18:20	09/11/2019 18:10	09/11/2019 18:20	0,17	2	0,33	CHI
2019110900096	SAO LUIS DE MONTES BELOS	34802	FIRMINOPOLIS S2	09/11/2019 18:10	09/11/2019 18:20	09/11/2019 18:10	09/11/2019 18:20	0,17	66	11,00	CHI
2019110900096	SAO LUIS DE MONTES BELOS	02020414	FIRMINOPOLIS S2	09/11/2019 18:10	09/11/2019 18:20	09/11/2019 18:10	09/11/2019 18:20	0,17	176	29,33	CHI
2019110900100	GOIANIA	00610284	CAMPINAS S2	09/11/2019 18:45	09/11/2019 18:49	09/11/2019 18:45	09/11/2019 18:49	0,07	7725	515,00	CHI

# Plotagem das Ocorrências conforme a Espacialização das Chuvas

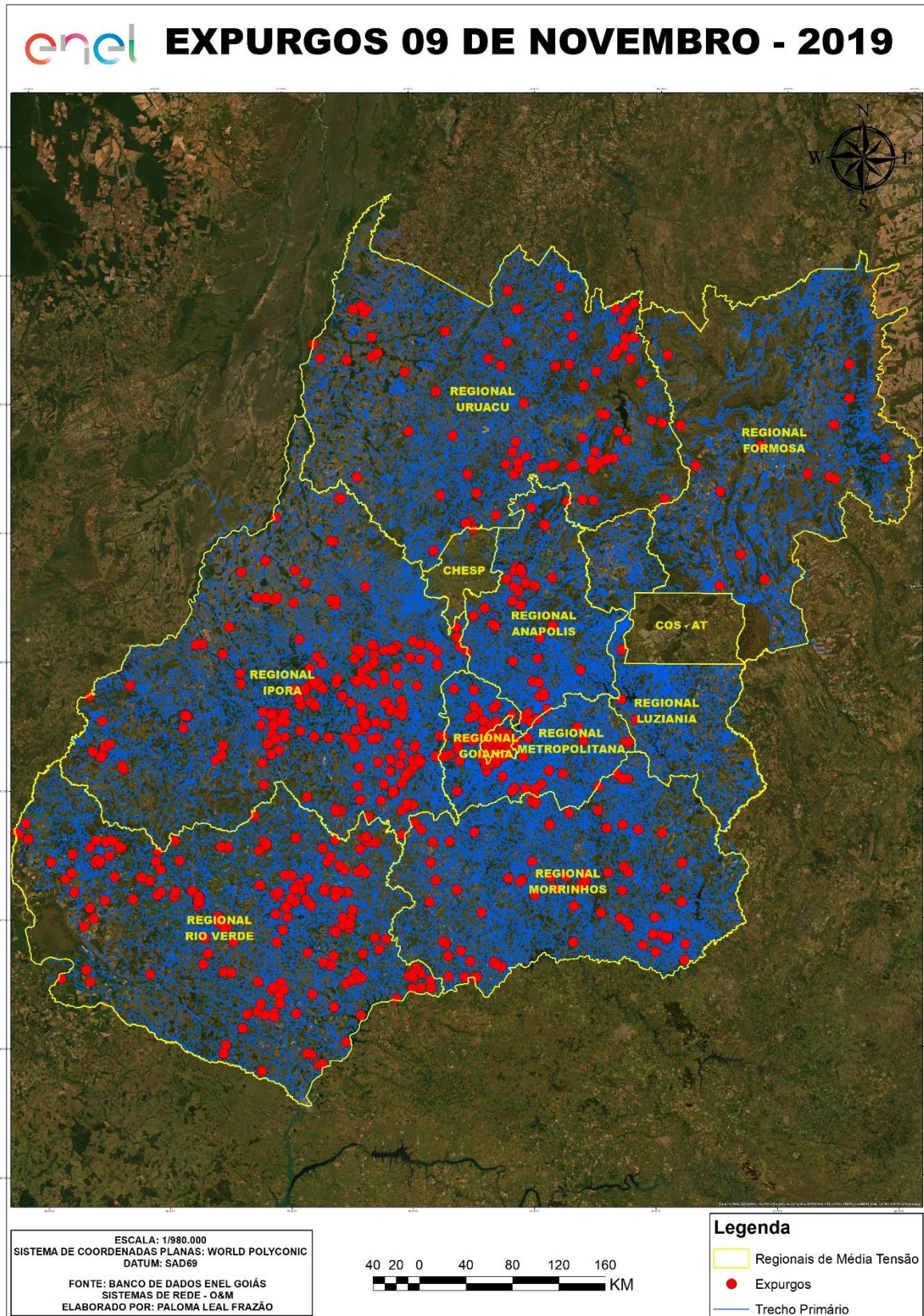



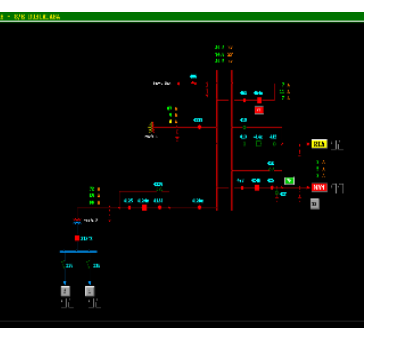
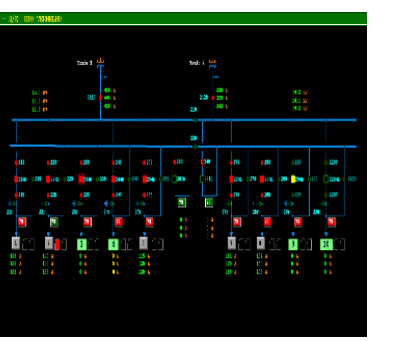
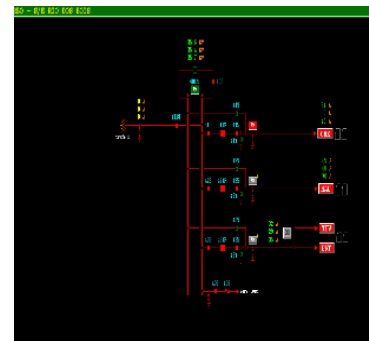
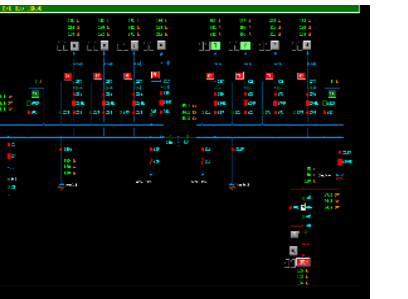
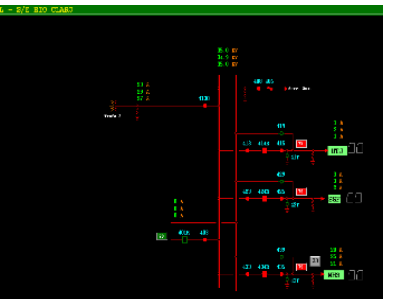
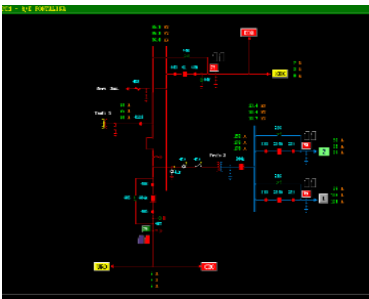
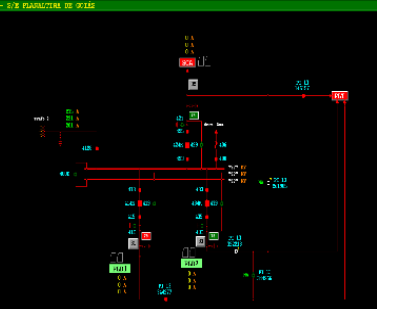
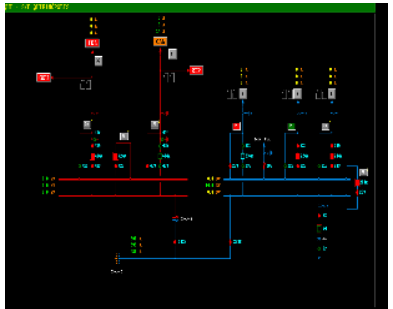
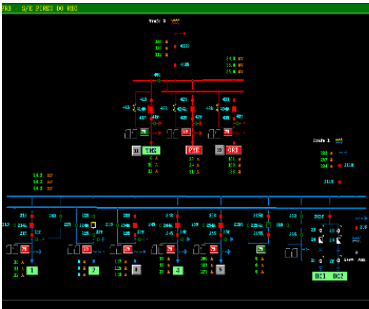
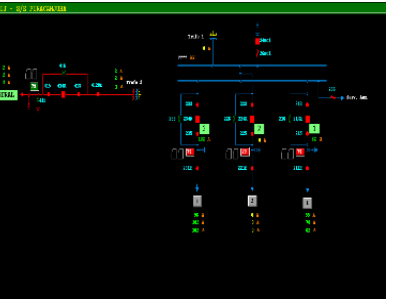
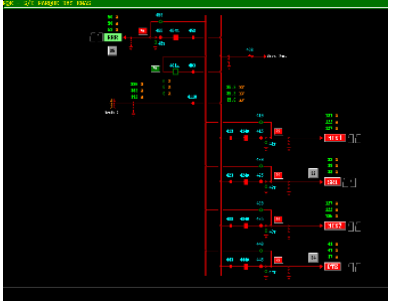
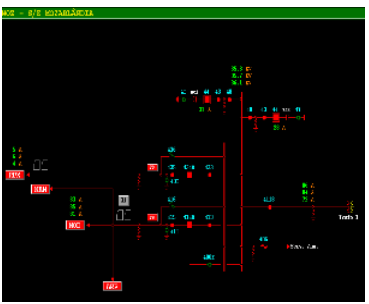
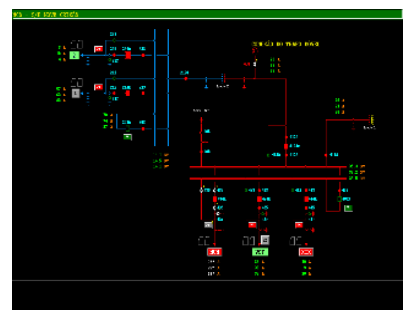



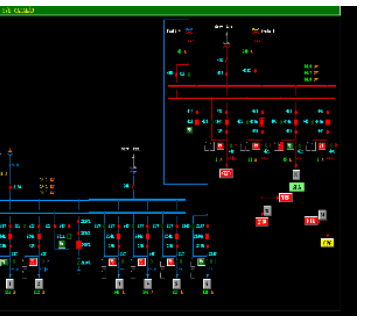
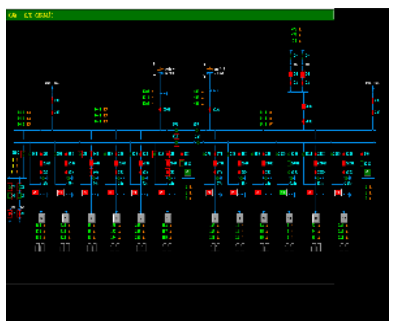
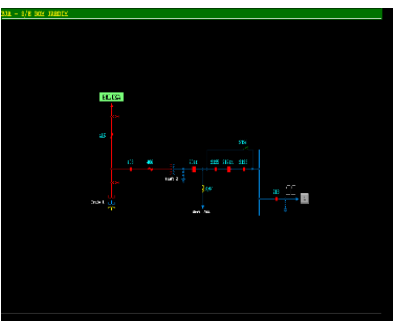
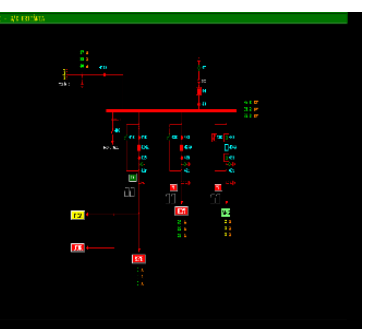
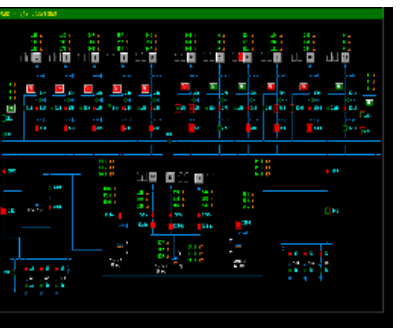
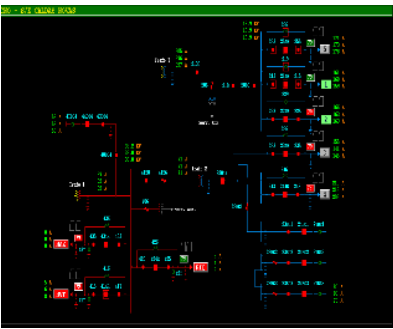
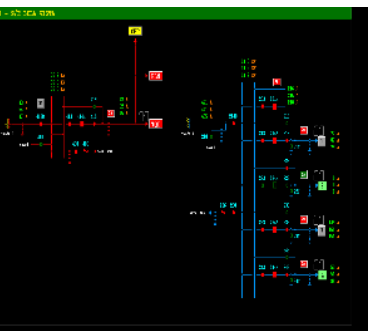
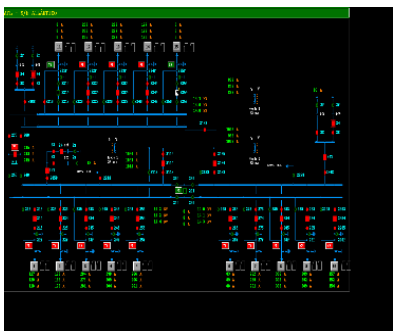
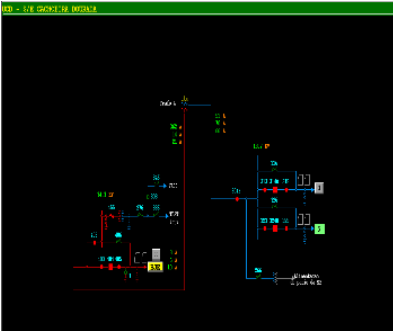
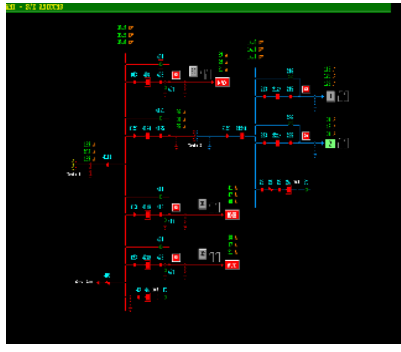
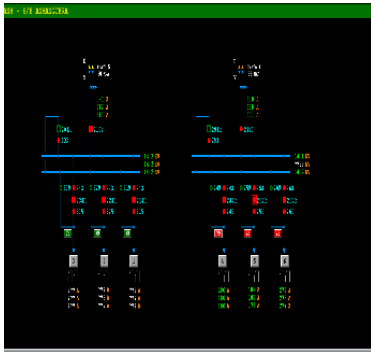
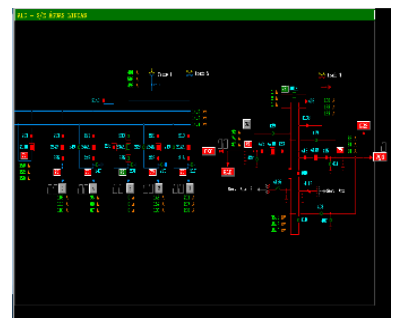
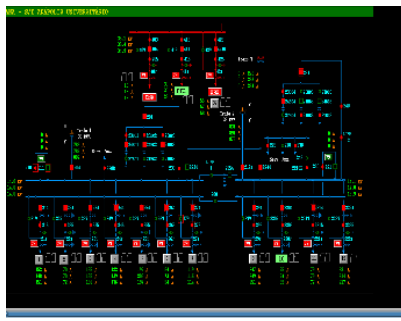
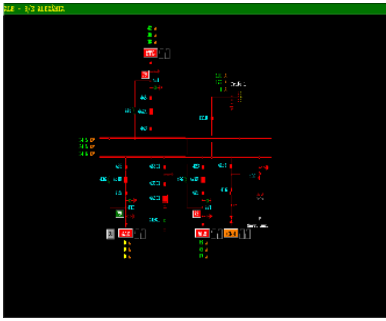

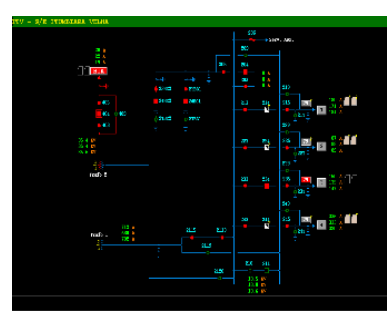
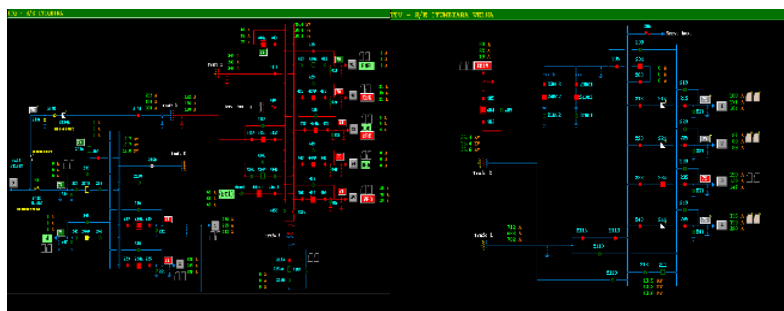
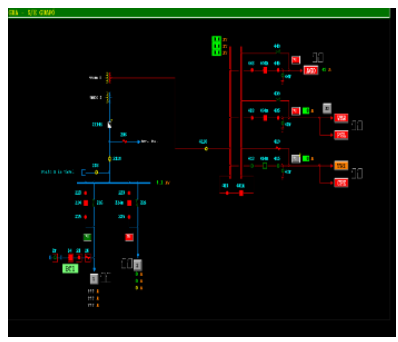
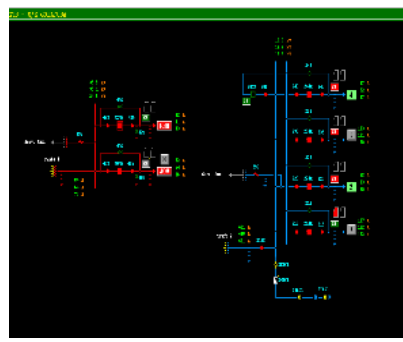
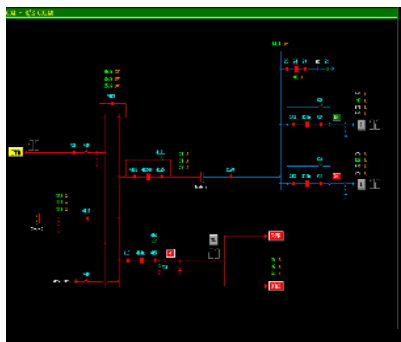
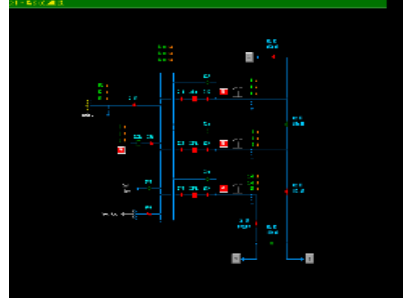
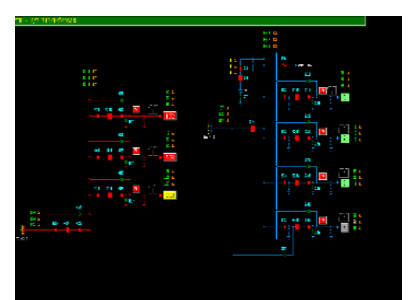
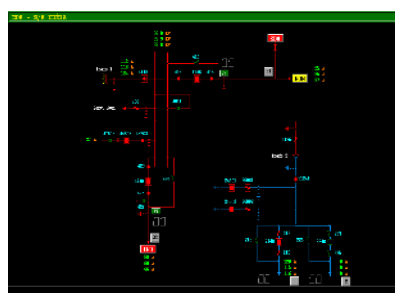
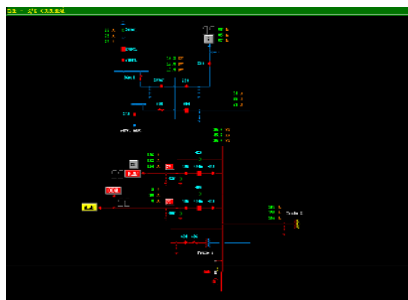
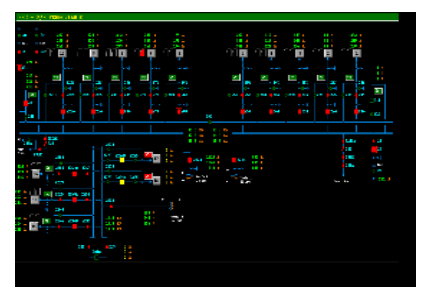
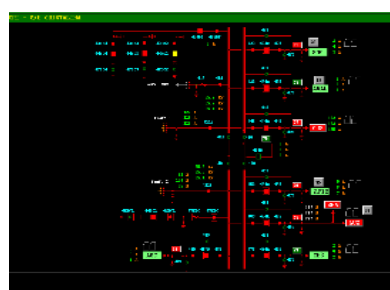
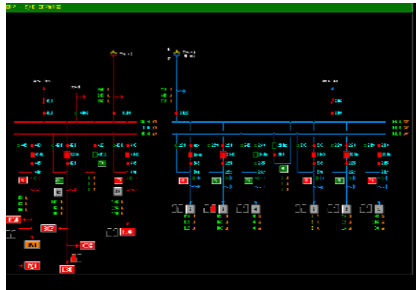
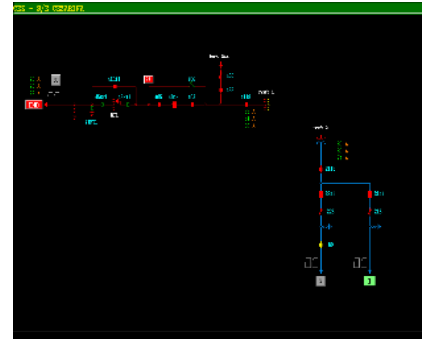
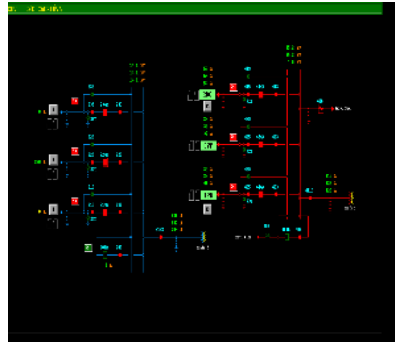
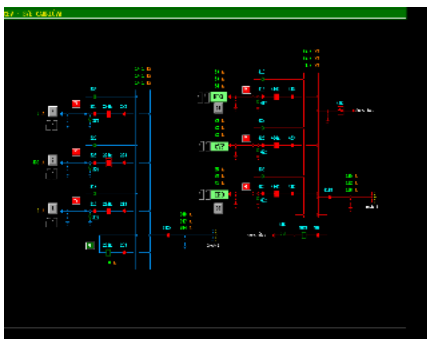

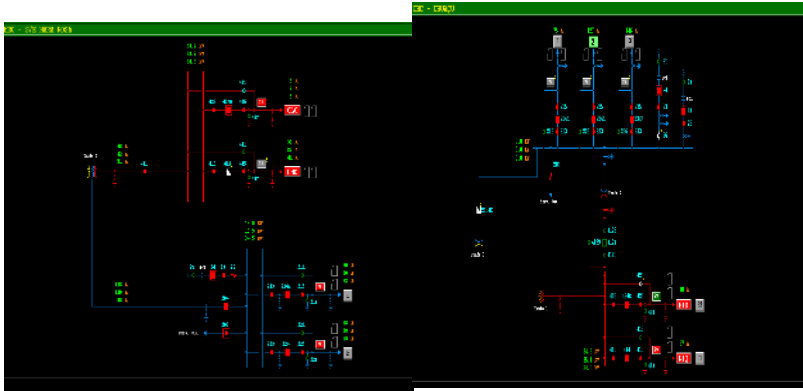
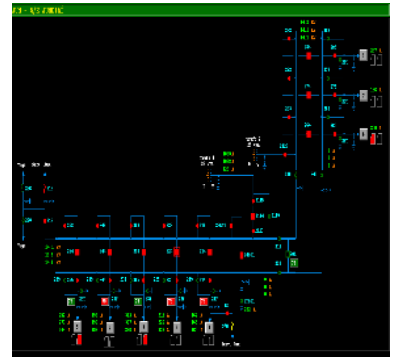
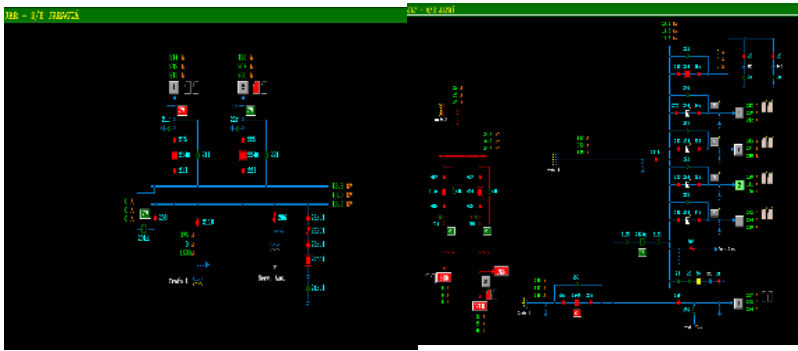



## DEMAIS EVIDÊNCIAS

### DADOS TÉCNICO - OPERACIONAIS ENEL GO

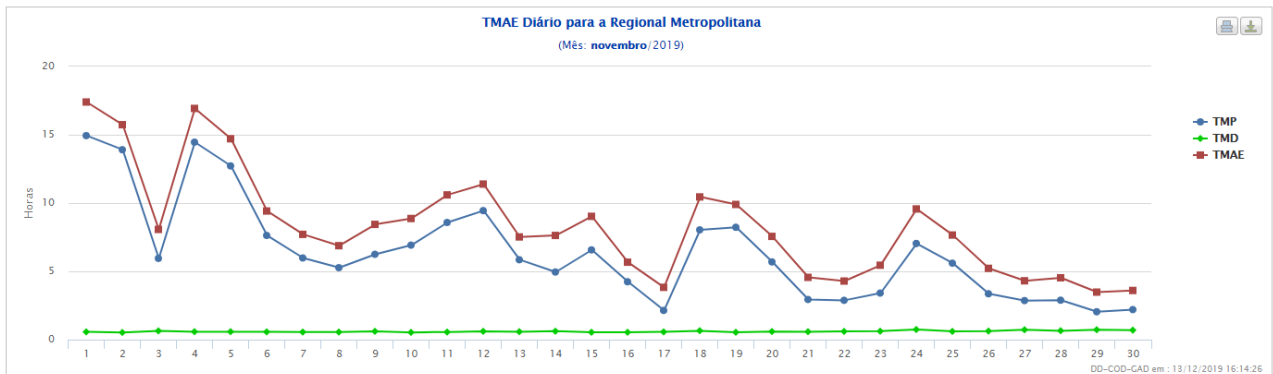
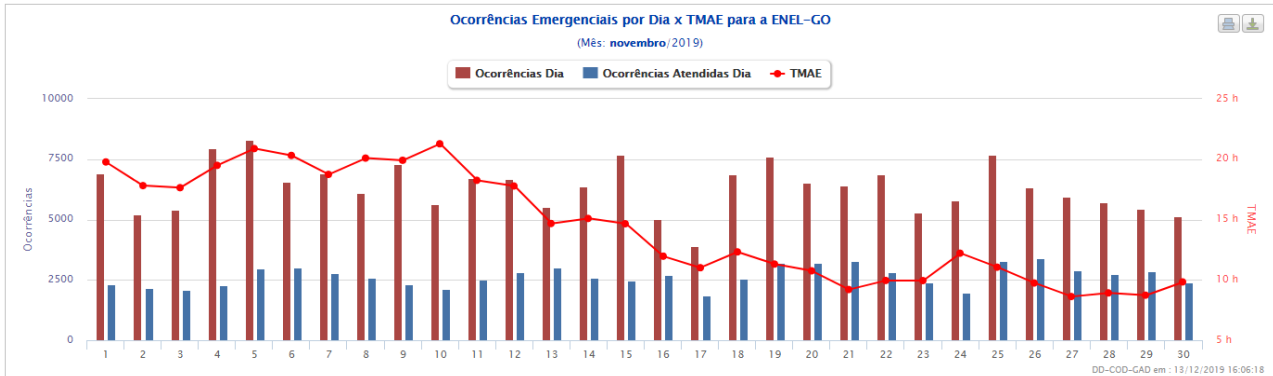
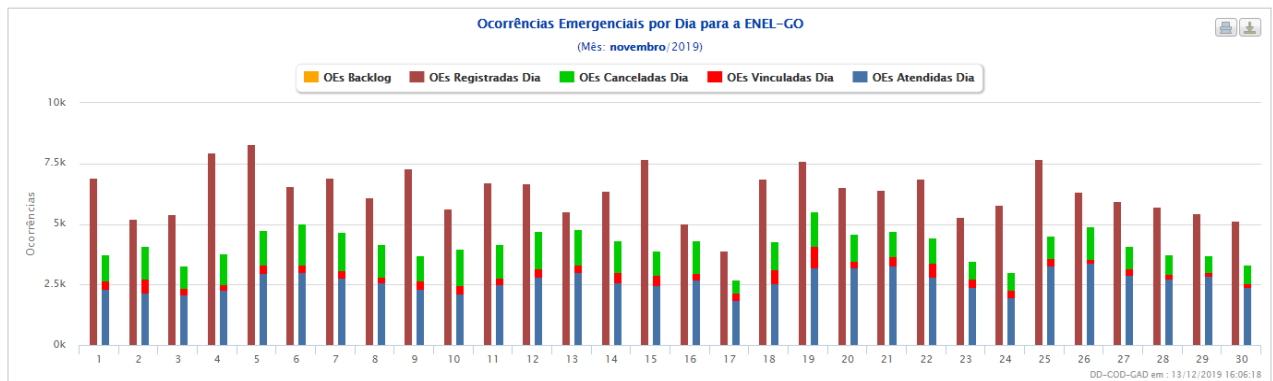
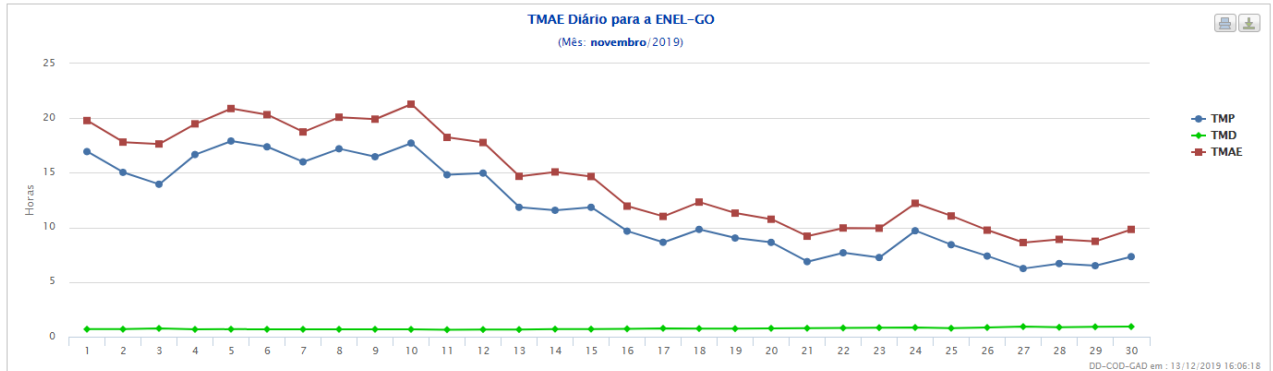

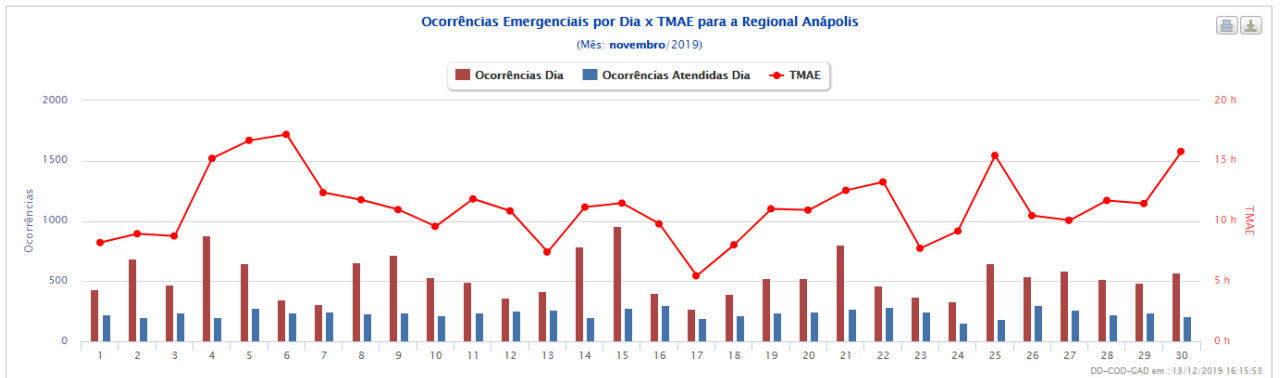
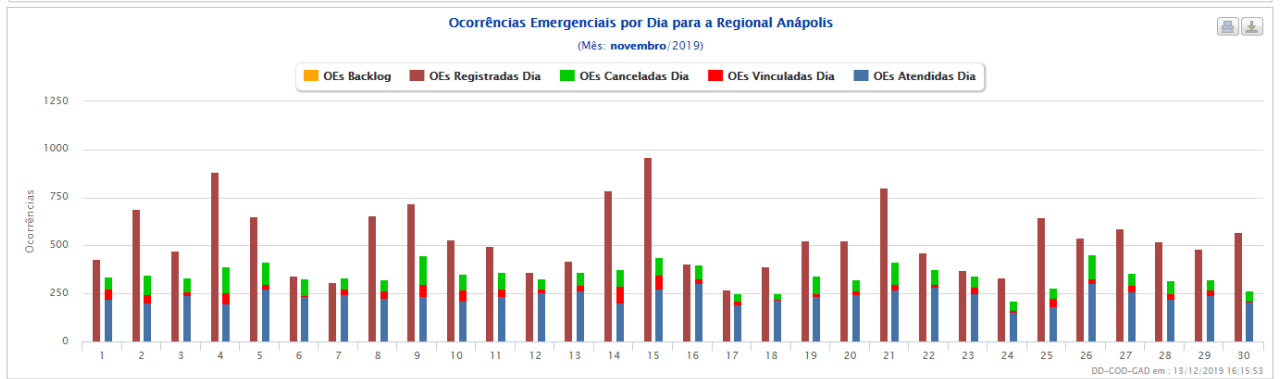
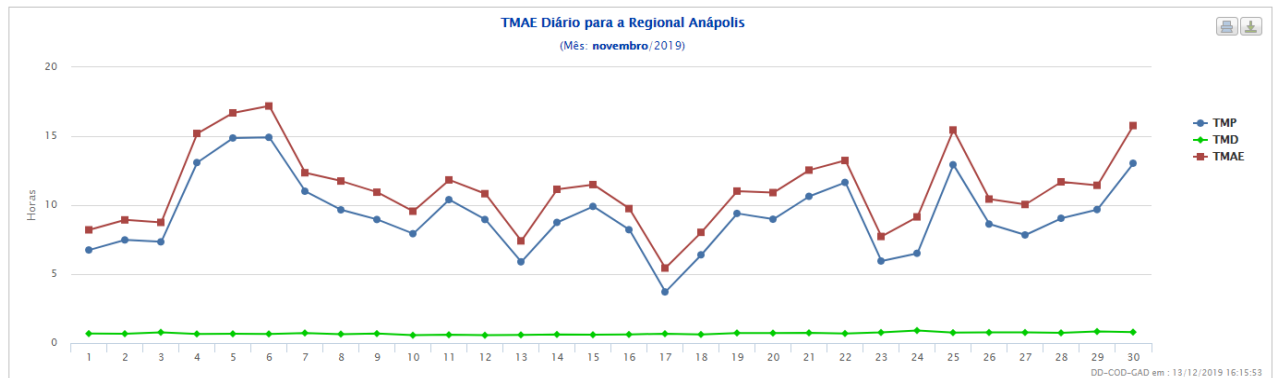
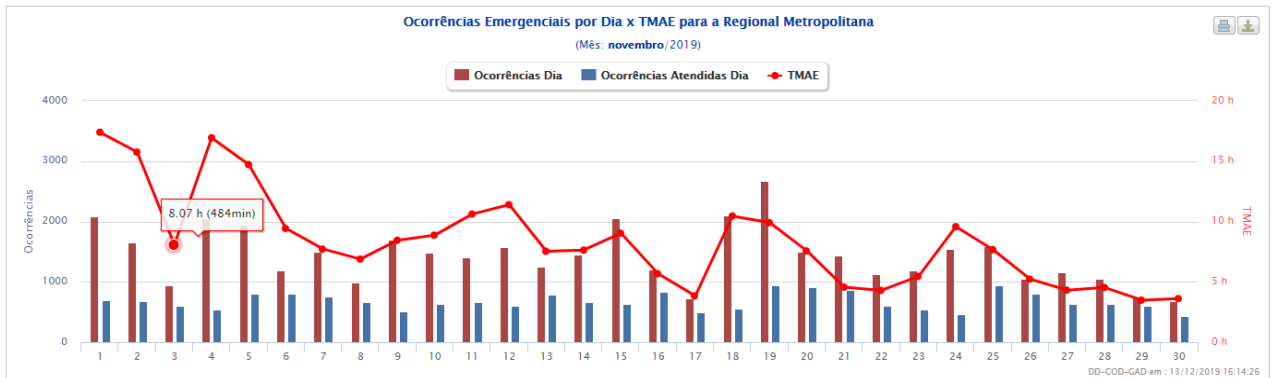
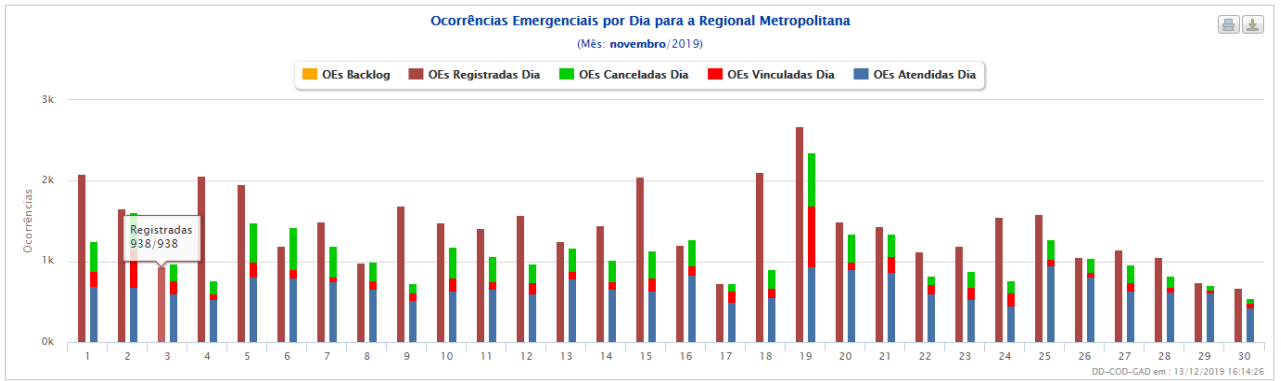

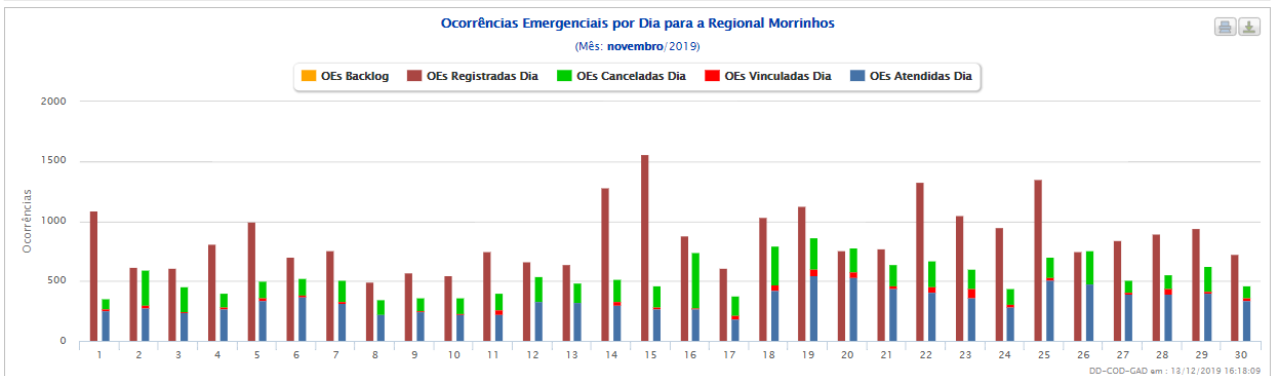
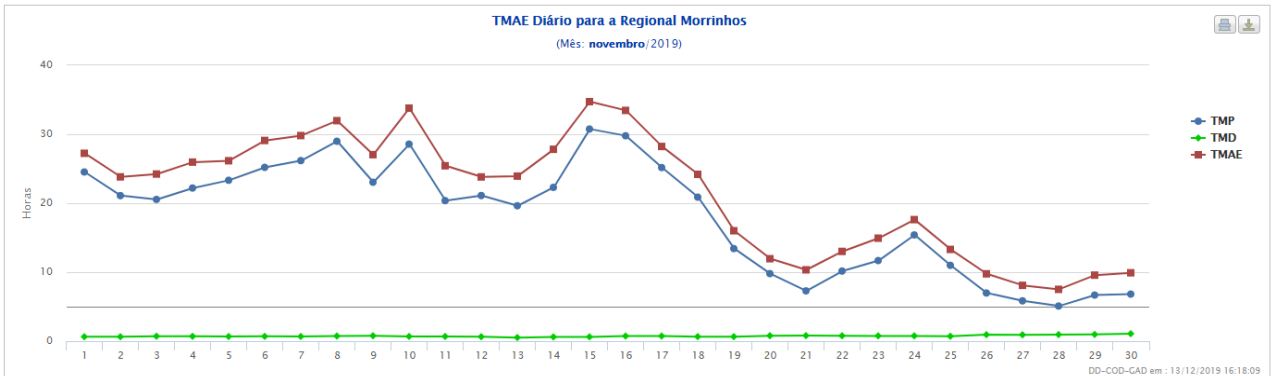
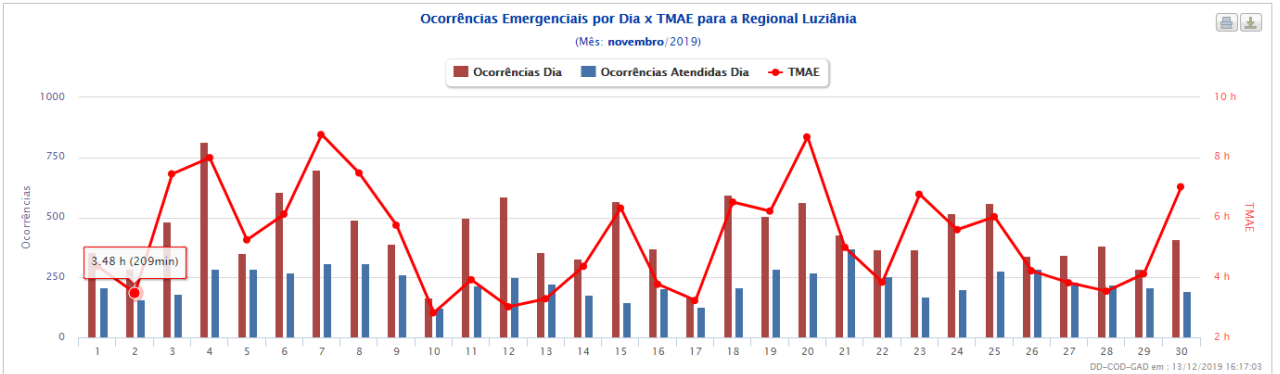
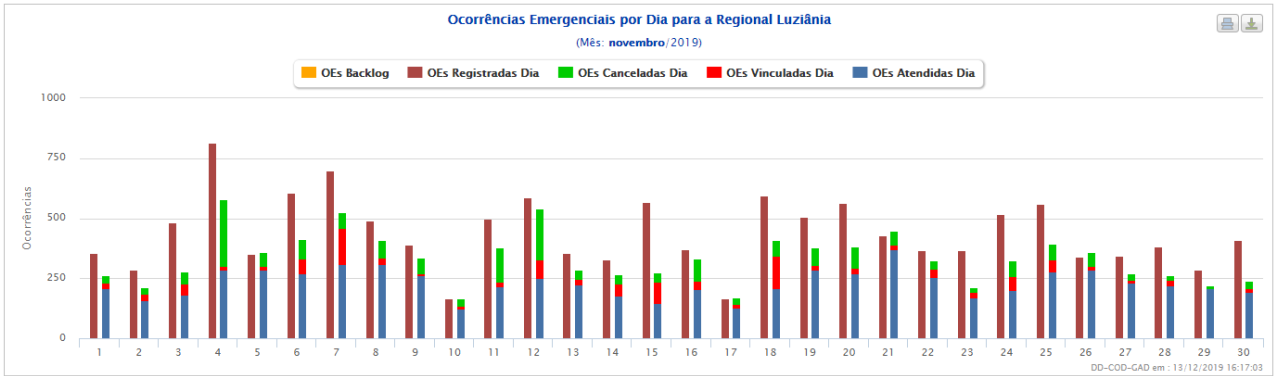
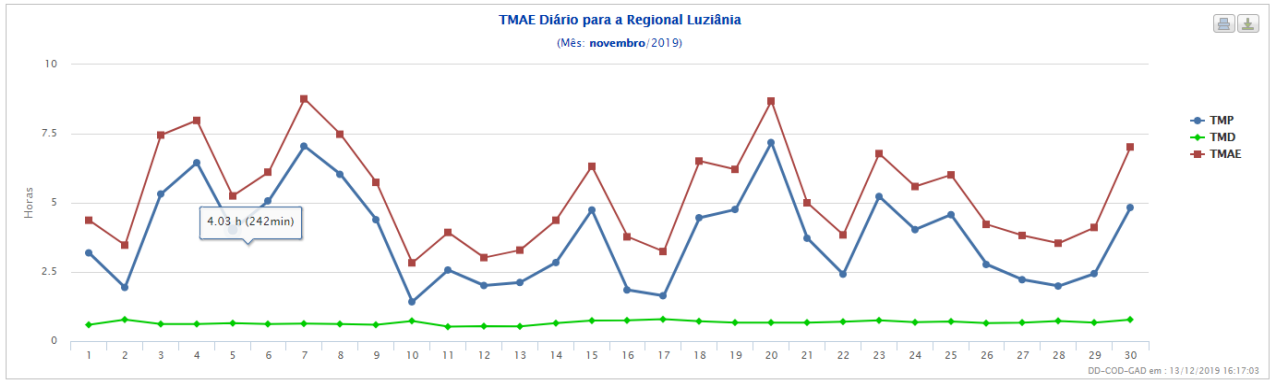

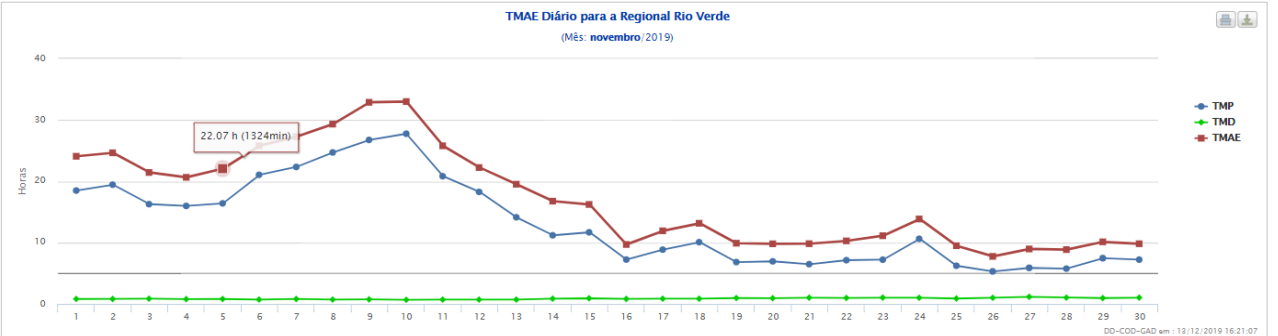
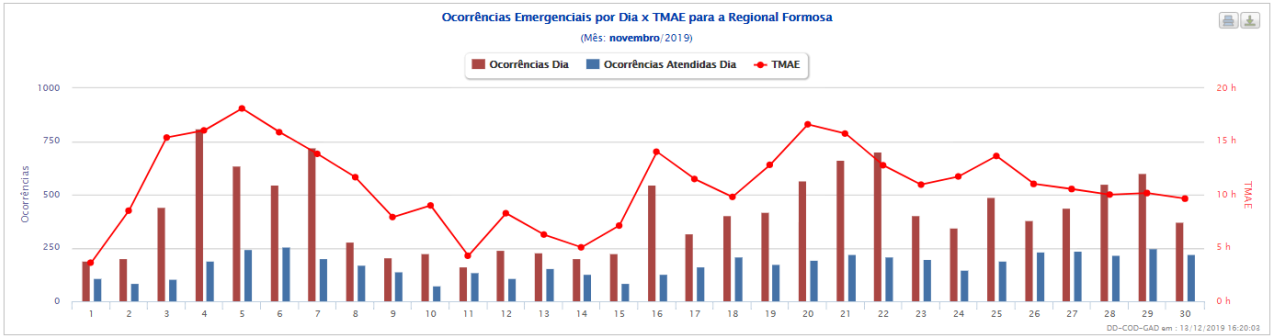
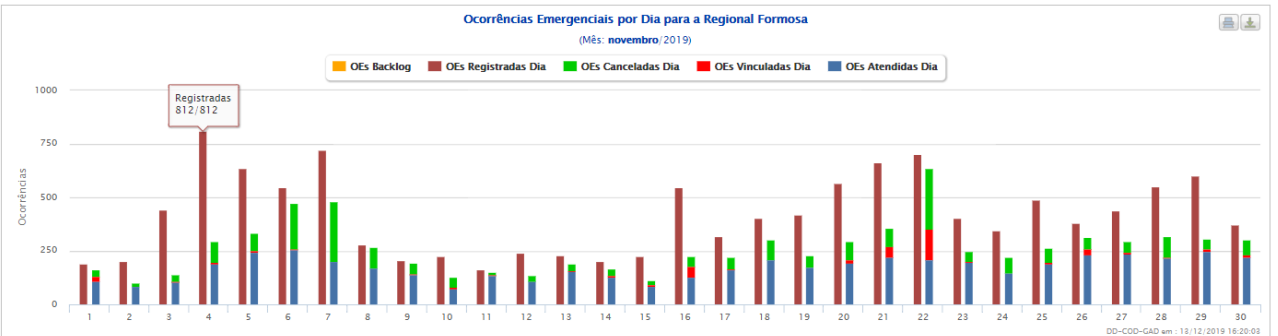
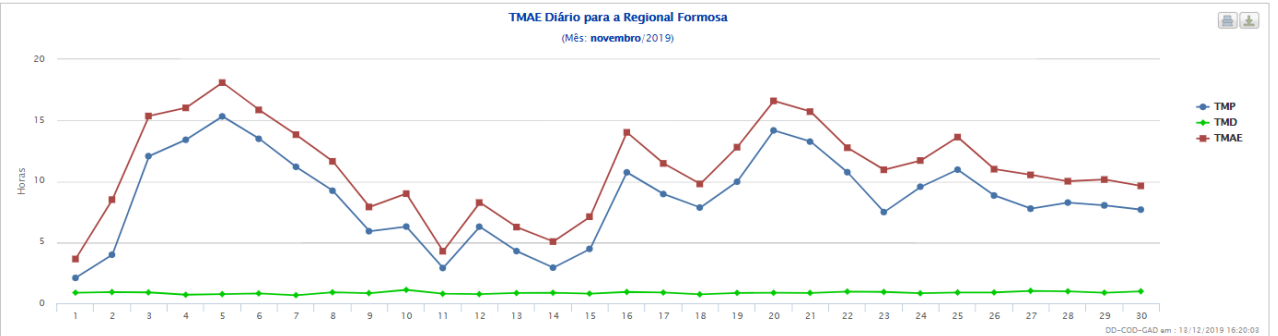
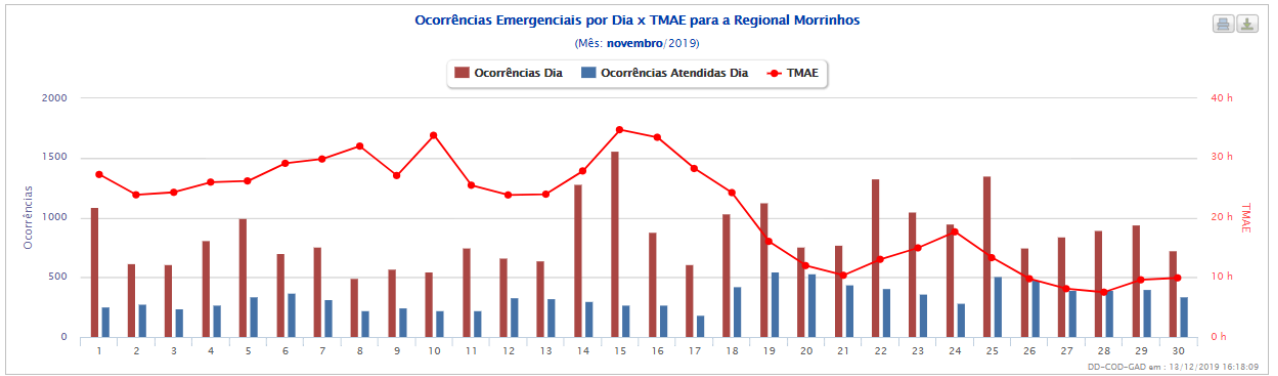

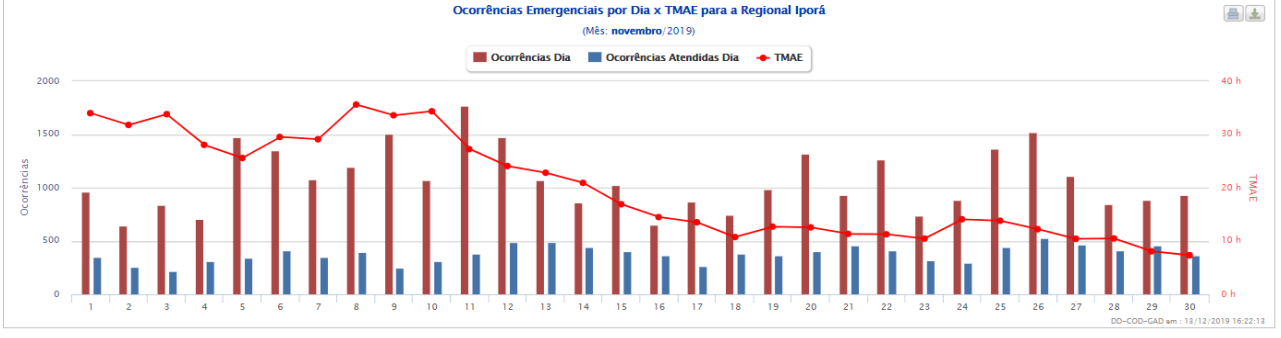
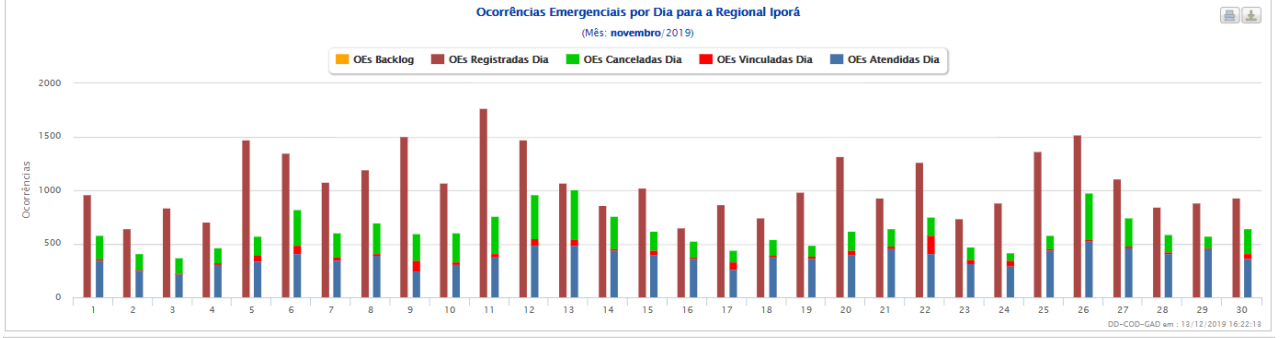
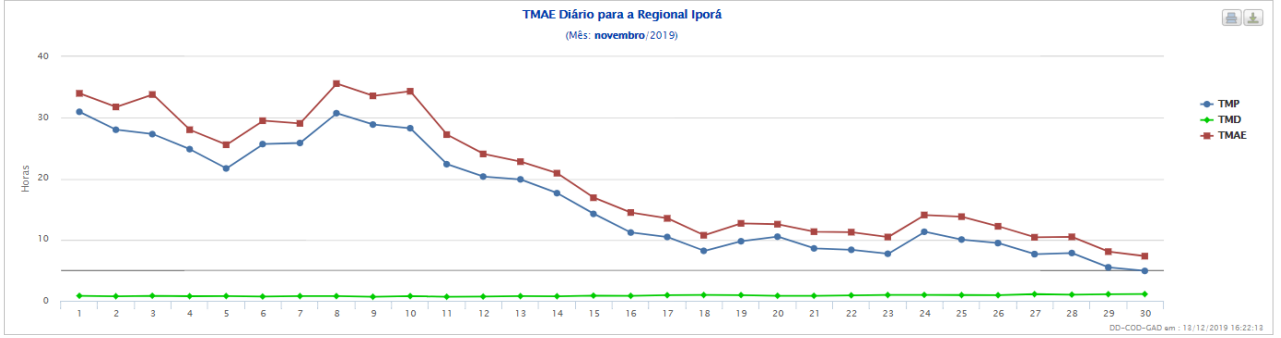
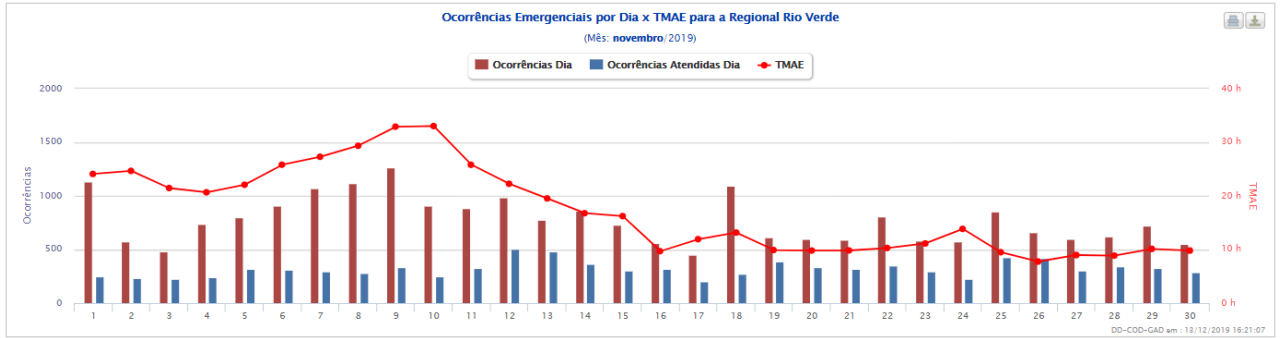
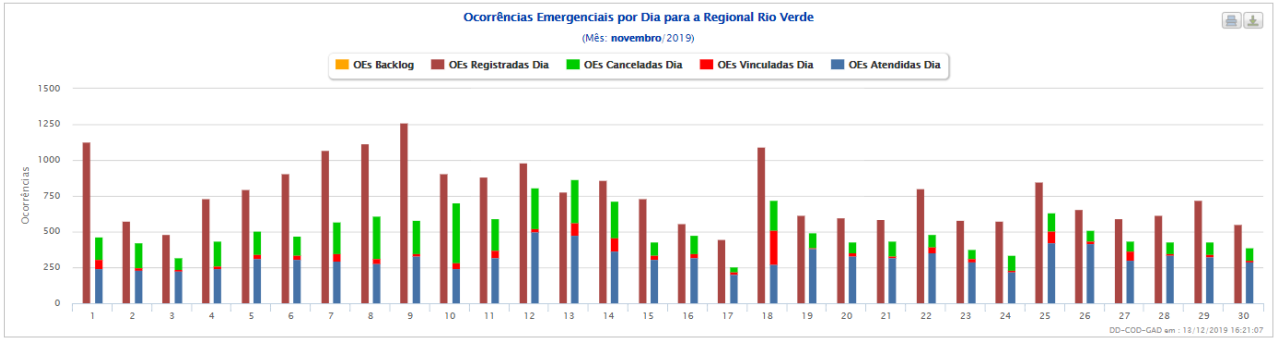

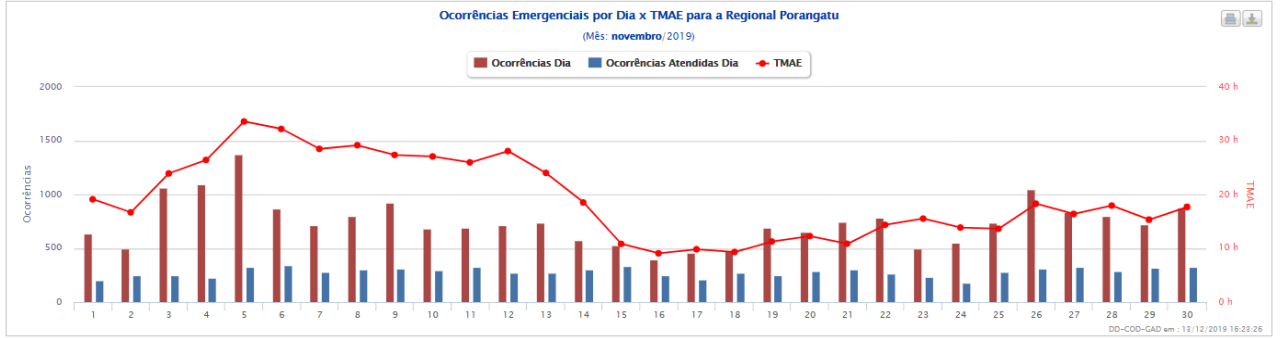
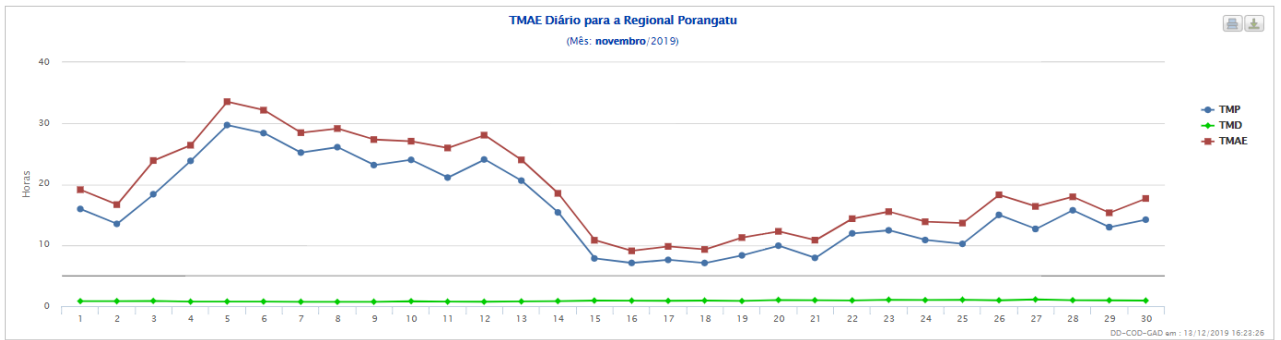

CLIMATEMPO

**Laudo Meteorológico de Evento Climático -  
CELG Distribuição S.A. - 09 de novembro  
de 2019**

São Paulo, SP, Brasil

Dezembro de 2019

## Sumário

<b>1</b>	<b>ANÁLISE DE EVENTO METEOROLÓGICO .....</b>	<b>2</b>
<b>1.1</b>	<b>Descrição do Evento.....</b>	<b>2</b>
<b>1.2</b>	<b>Abrangência do Evento .....</b>	<b>5</b>
<b>2</b>	<b>CLASSIFICAÇÃO COBRADE .....</b>	<b>9</b>
<b>3</b>	<b>RESUMO DO EVENTO .....</b>	<b>10</b>
<b>4</b>	<b>REFERÊNCIAS.....</b>	<b>14</b>



# 1 Análise de Evento Meteorológico

## 1.1 Descrição do Evento

Na figura a seguir é apresentada a área de concessão da CELG Distribuição, dividida em regiões, a serem analisadas neste relatório.



Figura 1 – Regiões de Goiás atendidas pela CELG Distribuição.

O ar quente e úmido favoreceu a formação de áreas de instabilidade que atuaram sobre o estado de Goiás a partir do fim da manhã do dia 09 de novembro de 2019. Na Figura 2 são apresentadas as descargas atmosféricas nuvem-solo (raios) e nuvem-nuvem detectadas pelo sistema Earth Networks. Entre as 11h00 do dia 09 e as 01h00 do dia 10 de novembro foram registrados 10560 raios nuvem-solo e 31437 descargas nuvem-nuvem sobre a área da CELG Distribuição em Goiás.

Na tabela 1 são apresentados os valores de rajada de vento iguais ou maiores a 50 km/h registradas nas estações meteorológicas do Instituto Nacional de Meteorologia (IN-

MET) representativas da região de interesse. As estações de Iporá e Mineiros registraram rajadas de vento superiores a 90 km/h, classificadas como tempestade pela escala Beaufort. Ventos com tal intensidade podem arrancar árvores e provocar danos em construções. No aeroporto de Goiânia foram registradas rajadas de vento de aproximadamente 64,8 km/h às 18h40 do dia 09 de novembro, classificado como ventania pela escala Beaufort.

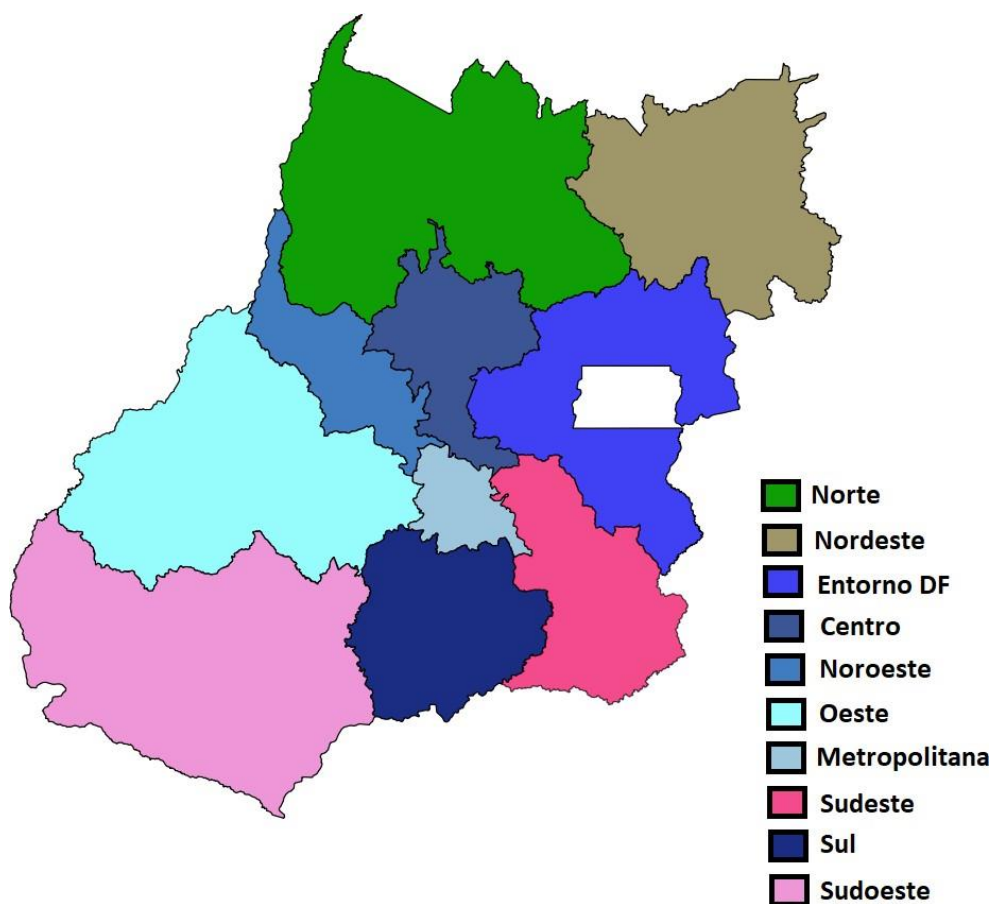
Tabela 1 – Rajadas de vento maiores ou iguais a 50 km/h registradas pelo INMET no dia 09 de novembro de 2019. Segundo a escala Beaufort, ventos entre 50 e 61 km/h são classificados como vento forte, entre 62 e 74 km/h como ventania, entre 75 e 88 km/h como ventania forte e entre 89 e 102 km/h como tempestade.

Estação	Horário	Rajada (km/h)
Catalão	Entre 15h e 16h do dia 9/11/2019	65.5
Goianésia	Entre 16h e 17h do dia 9/11/2019	56.2
Iporá	Entre 18h e 19h do dia 9/11/2019	64.1
Iporá	Entre 19h e 20h do dia 9/11/2019	92.9
Mineiros	Entre 15h e 16h do dia 9/11/2019	85.3
Mineiros	Entre 16h e 17h do dia 9/11/2019	91.4



Figura 2 – Descargas atmosféricas nuvem-solo (em preto) e nuvem-nuvem (em vermelho) detectadas pelo sistema Earth Networks entre 11h00 do dia 09 e 01h00 do dia 10 de novembro de 2019 sobre a área de concessão da CELG Distribuição.

## 1.2 Abrangência do Evento

A seguir são apresentadas as imagens realçadas do satélite GOES-16 entre as 13h00 do dia 09 e 03h00 do dia 10 de novembro de 2019. Os tons em vermelho e preto indicam a presença de nuvens de grande desenvolvimento vertical, geralmente associadas à ocorrência de tempo severo. Nestas imagens é possível observar o desenvolvimento e o deslocamento das instabilidades sobre o estado de Goiás durante o período.

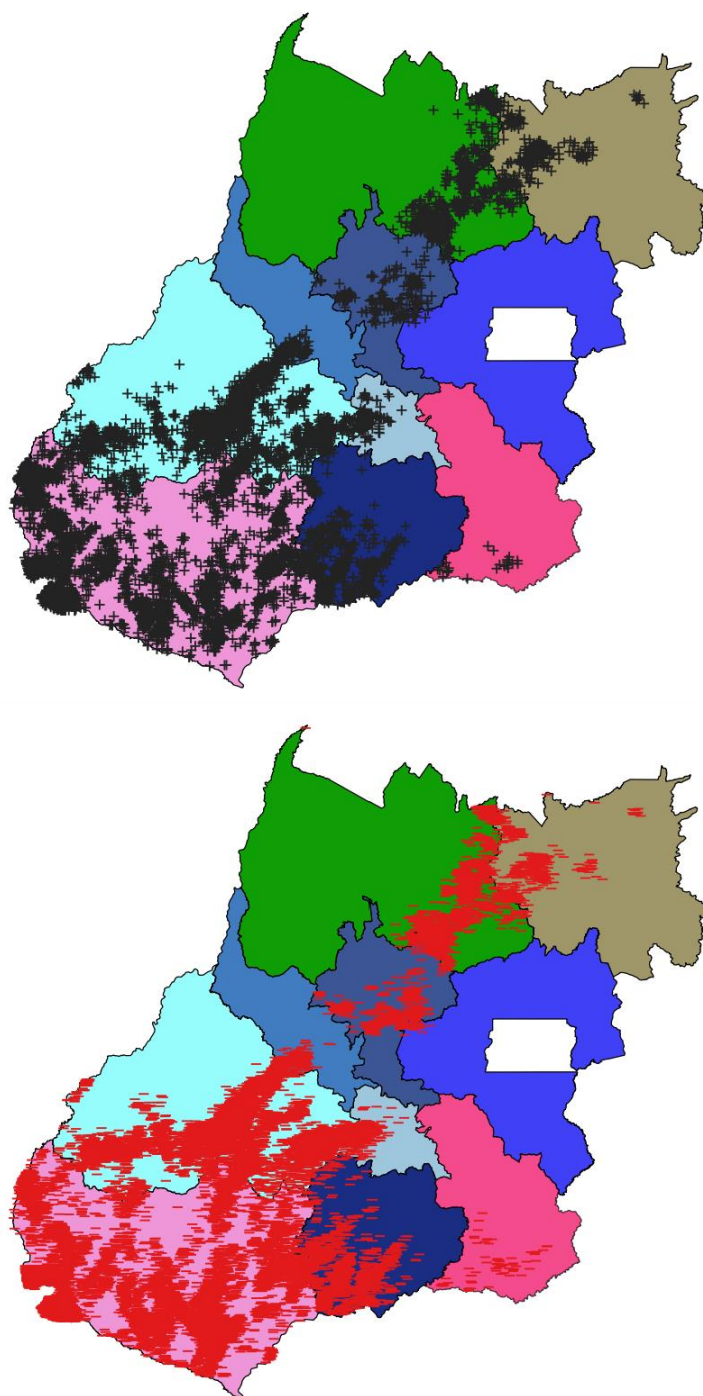

Figura 3 – Imagens realçadas do satélite GOES-16 das 13h00 do dia 09 de novembro de 2019. FONTE: Cptec/INPE.



Figura 4 – Imagens realçadas do satélite GOES-16 das 15h00 do dia 09 de novembro de 2019. FONTE: Cptec/INPE.

17h00 - 09 de novembro de 2019

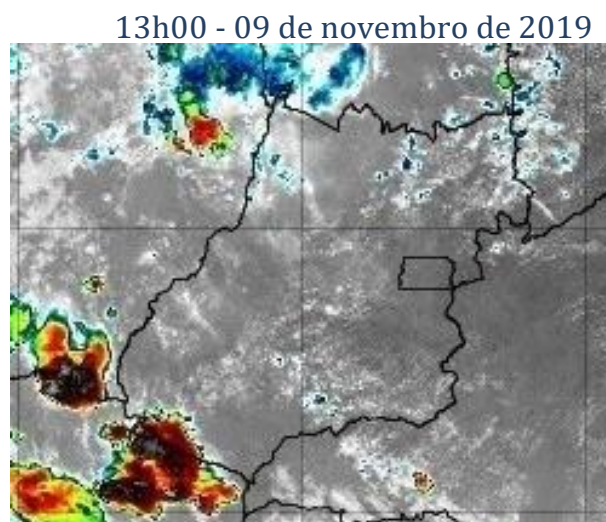

Figura 5 – Imagens realçadas do satélite GOES-16 das 17h00 do dia 09 de novembro de 2019. FONTE: Cptec/INPE.

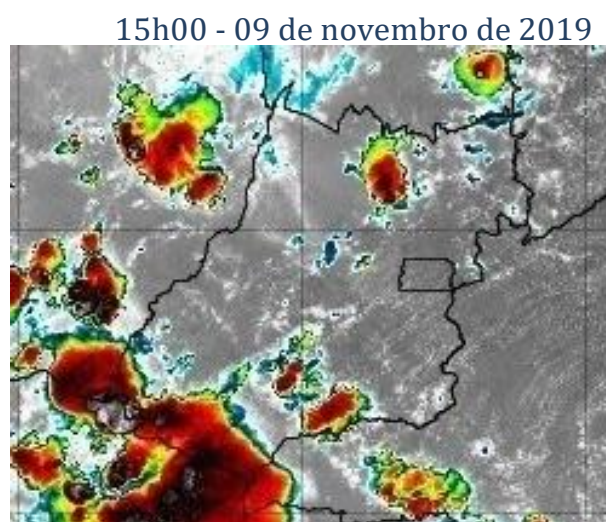
19h00 - 09 de novembro de 2019

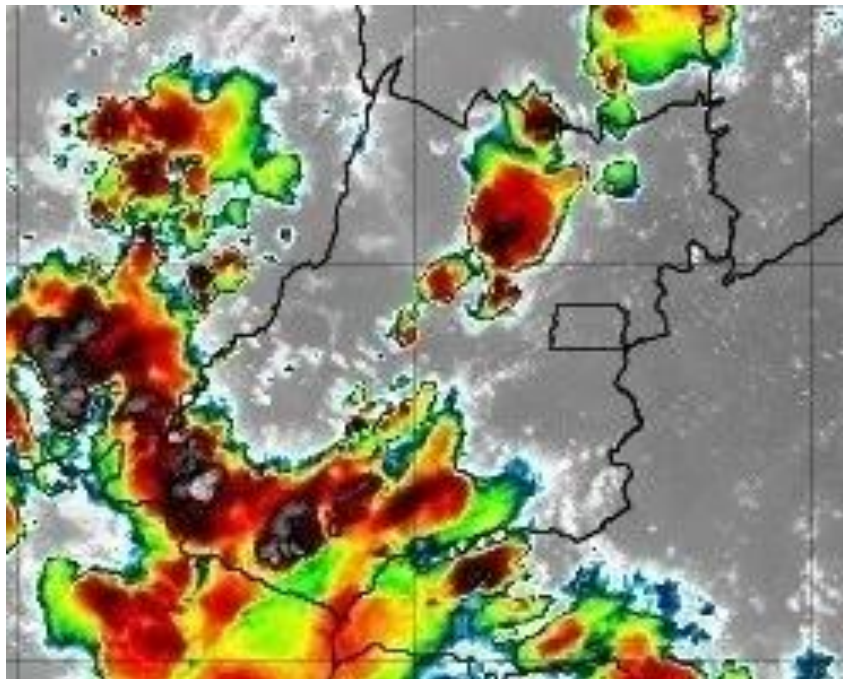

Figura 6 – Imagens realçadas do satélite GOES-16 das 19h00 do dia 09 de novembro de 2019. FONTE: Cptec/INPE.

21h00 - 09 de novembro de 2019

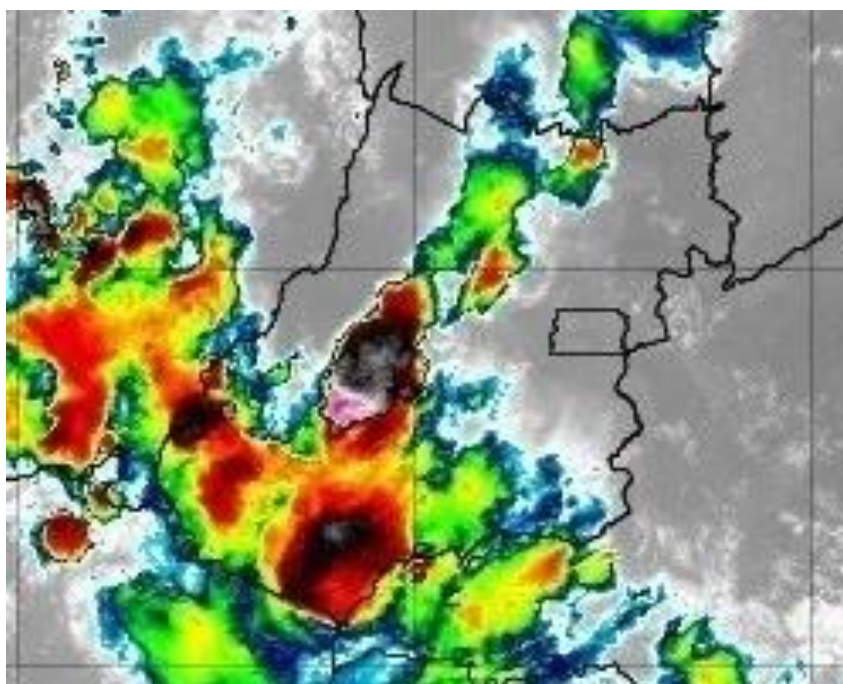

Figura 7 – Imagens realçadas do satélite GOES-16 das 21h00 do dia 09 de novembro de 2019. FONTE: Cptec/INPE.

23h00 - 09 de novembro de 2019

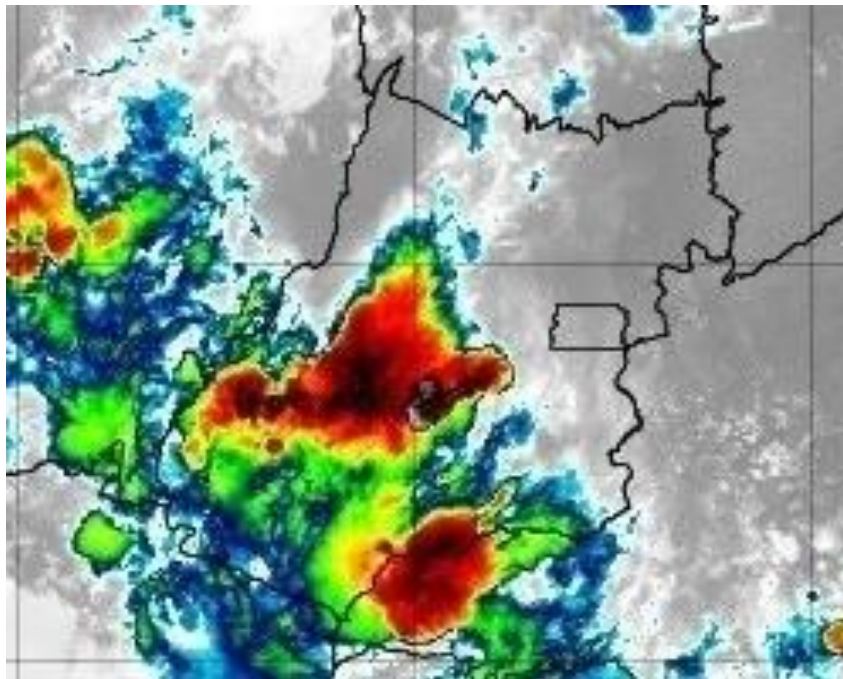

Figura 8 – Imagens realçadas do satélite GOES-16 das 23h00 do dia 09 de novembro de 2019. FONTE: Cptec/INPE.

01h00 - 10 de novembro de 2019

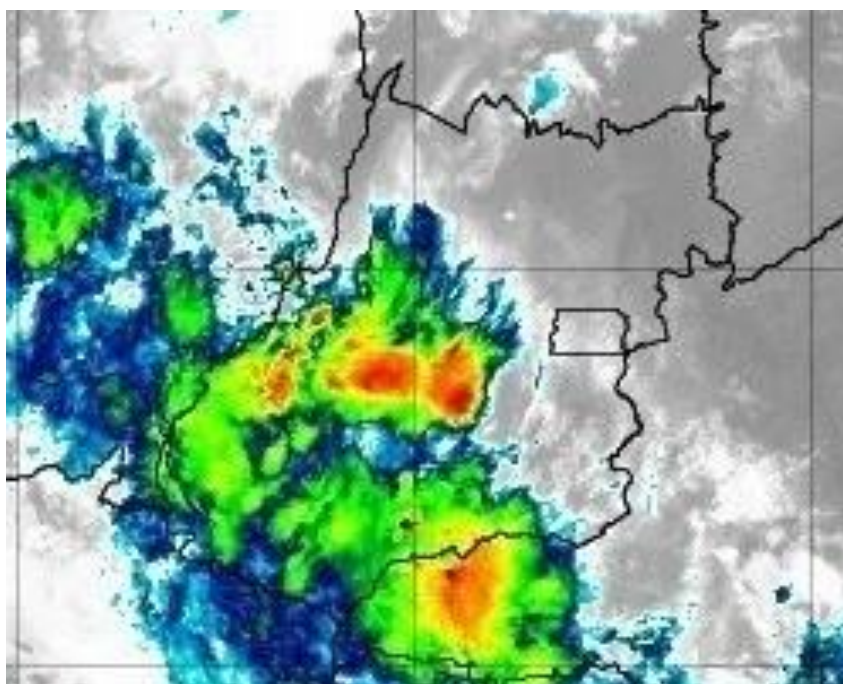

Figura 9 – Imagens realçadas do satélite GOES-16 das 01h00 do dia 10 de novembro de 2019. FONTE: Cptec/INPE.

03h00 - 10 de novembro de 2019

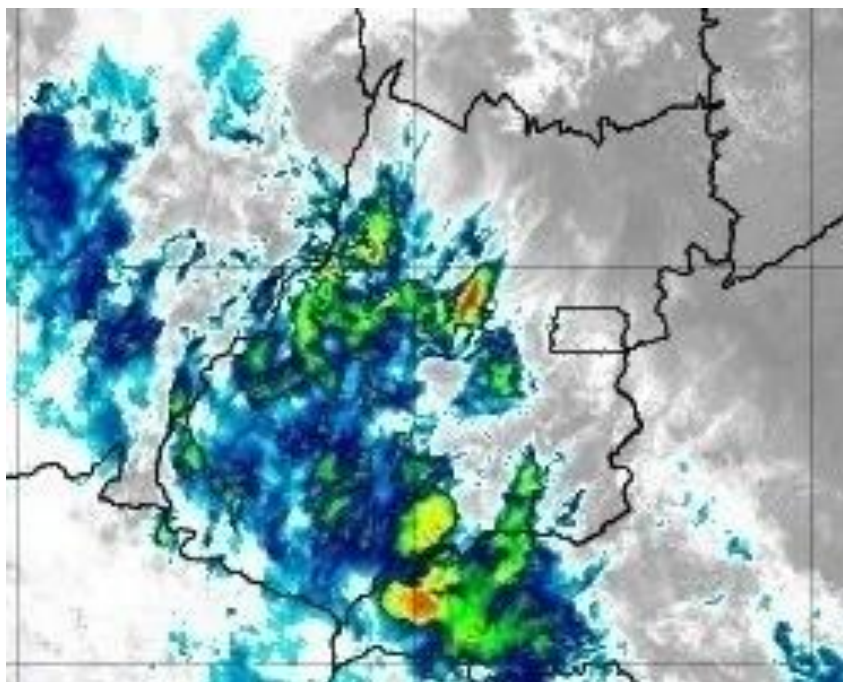

Figura 10 – Imagens realçadas do satélite GOES-16 das 03h00 do dia 10 de novembro de 2019. FONTE: Cptec/INPE.

## 2 Classificação COBRADE

O COBRADE (Classificação e Codificação Brasileira de Desastres) foi criado com o intuito de adequar a classificação brasileira à classificação utilizada pela ONU na classificação de desastres e nivelar o país aos demais organismos de gestão de desastres do mundo.

Baseados nos dados analisados nos itens anteriores, podemos classificar o evento ocorrido na CELG Distribuição como Tempestades - Vendaval (Código 1.3.2.1.5) e Tempestade de raios Código (1.3.2.1.2).

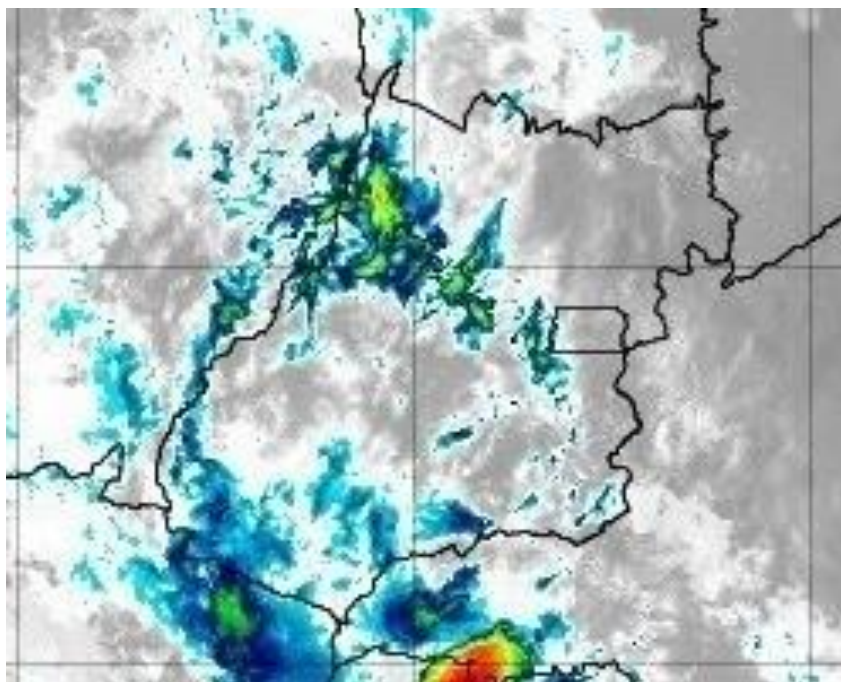

### 3 Resumo do Evento

Áreas de instabilidade associadas ao ar quente e úmido favoreceram a formação de nuvens de tempestade, do tipo Cumulonimbus, que avançaram sobre o estado de Goiás entre o fim da manhã do dia 09 de novembro e o início da madrugada do dia 10 de novembro de 2019.

O sistema de detecção EarthNetworks registrou 41997 descargas atmosféricas sobre a área de concessão da CELG Distribuição Goiás entre as 11h00 do dia 09 e 01h00 do dia 10 de novembro.

Rajadas de vento classificadas como tempestade pela escala Beaufort foram registradas nas estações de Iporá e Mineiros no dia 09 de novembro. Ventos com tal intensidade podem arrancar árvores e provocar danos estruturais em construções.

Tabela 2 – Resumo do evento Região Sudoeste

Número/Código do Evento	
Número/Código do Relatório	
Descrição	Forte deslocamento de uma massa de ar em uma região. Tempestade com intensa atividade elétrica no interior das nuvens, com grande desenvolvimento vertical.
Código COBRADE	1.3.2.1.5 - Tempestades-Vendaval e 1.3.2.1.2 - Tempestade de raios
Hora início do evento	11h00 do dia 09 de novembro de 2019
Hora de fim do evento	00h30 do dia 10 de novembro de 2019
Abrangência	Região Sudoeste da CELG Distribuição S.A.

Tabela 3 – Resumo do evento Região Sul

Número/Código do Evento	
Número/Código do Relatório	
Descrição	Forte deslocamento de uma massa de ar em uma região. Tempestade com intensa atividade elétrica no interior das nuvens, com grande desenvolvimento vertical.
Código COBRADE	1.3.2.1.5 - Tempestades-Vendaval e 1.3.2.1.2 - Tempestade de raios
Hora início do evento	12h30 do dia 09 de novembro de 2019
Hora de fim do evento	23h30 do dia 09 de novembro de 2019
Abrangência	Região Sul da CELG Distribuição S.A.

Tabela 4 – Resumo do evento Região Metropolitana

Número/Código do Evento	
Número/Código do Relatório	
Descrição	Forte deslocamento de uma massa de ar em uma região. Tempestade com intensa atividade elétrica no interior das nuvens, com grande desenvolvimento vertical.
Código COBRADE	1.3.2.1.5 - Tempestades-Vendaval e 1.3.2.1.2 - Tempestade de raios
Hora início do evento	13h00 do dia 09 de novembro de 2019
Hora de fim do evento	21h00 do dia 09 de novembro de 2019
Abrangência	Região Metropolitana da CELG Distribuição S.A.

Tabela 5 – Resumo do evento Região Oeste

Número/Código do Evento	
Número/Código do Relatório	
Descrição	Forte deslocamento de uma massa de ar em uma região. Tempestade com intensa atividade elétrica no interior das nuvens, com grande desenvolvimento vertical.
Código COBRADE	1.3.2.1.5 - Tempestades-Vendaval e 1.3.2.1.2 - Tempestade de raios
Hora início do evento	13h00 do dia 09 de novembro de 2019
Hora de fim do evento	01h00 do dia 10 de novembro de 2019
Abrangência	Região Oeste da CELG Distribuição S.A.

Tabela 6 – Resumo do evento Região Centro

Número/Código do Evento	
Número/Código do Relatório	
Descrição	Forte deslocamento de uma massa de ar em uma região. Tempestade com intensa atividade elétrica no interior das nuvens, com grande desenvolvimento vertical.
Código COBRADE	1.3.2.1.5 - Tempestades-Vendaval e 1.3.2.1.2 - Tempestade de raios
Hora início do evento	13h00 do dia 09 de novembro de 2019
Hora de fim do evento	19h00 do dia 09 de novembro de 2019
Abrangência	Região Centro da CELG Distribuição S.A.

Tabela 7 – Resumo do evento Região Noroeste

Número/Código do Evento	
Número/Código do Relatório	
Descrição	Forte deslocamento de uma massa de ar em uma região. Tempestade com intensa atividade elétrica no interior das nuvens, com grande desenvolvimento vertical.
Código COBRADE	1.3.2.1.5 - Tempestades-Vendaval e 1.3.2.1.2 - Tempestade de raios
Hora início do evento	15h30 do dia 09 de novembro de 2019
Hora de fim do evento	03h00 do dia 09 de novembro de 2019
Abrangência	Região Noroeste da CELG Distribuição S.A.

Tabela 8 – Resumo do evento Região Nordeste

Número/Código do Evento	
Número/Código do Relatório	
Descrição	Forte deslocamento de uma massa de ar em uma região. Tempestade com intensa atividade elétrica no interior das nuvens, com grande desenvolvimento vertical.
Código COBRADE	1.3.2.1.5 - Tempestades-Vendaval e 1.3.2.1.2 - Tempestade de raios
Hora início do evento	12h30 do dia 09 de novembro de 2019
Hora de fim do evento	19h00 do dia 09 de novembro de 2019
Abrangência	Região Nordeste da CELG Distribuição S.A.

Tabela 9 – Resumo do evento Região Norte

Número/Código do Evento	
Número/Código do Relatório	
Descrição	Forte deslocamento de uma massa de ar em uma região. Tempestade com intensa atividade elétrica no interior das nuvens, com grande desenvolvimento vertical.
Código COBRADE	1.3.2.1.5 - Tempestades-Vendaval e 1.3.2.1.2 - Tempestade de raios
Hora início do evento	12h00 do dia 09 de novembro de 2019
Hora de fim do evento	18h30 do dia 09 de novembro de 2019
Abrangência	Região Norte da CELG Distribuição S.A.

#### 4 Referências

- RMets Royal Meteorological Society – Beaufort Scale - <https://www.rmets.org/weather-and-climate/observing/beaufort-scale>
- Instituto Nacional de Meteorologia (INMET) - <http://www.inmet.gov.br>
- Cptec/INPE- <https://www.cptec.inpe.br/>
- Centro de Hidrografia da Marinha do Brasil - <https://www.marinha.mil.br/chm/>
- Meteorology Glossary - American Meteorological Society - <http://glossary.ametsoc.org/>

Anexos

A.1 Carta Sinótica da Marinha do Brasil



Figura A1 - Carta sinótica da Marinha do Brasil para as 1200Z do dia 09 de novembro de 2019 (09h00 do dia 09 de novembro de 2019, hora local).

## A.2 Notícias relacionadas

Após mais de 24 horas, energia é restabelecida em Goiânia -

<https://www.opopular.com.br/noticias/cidades/após-mais-de-24-horas-energia-é-restabelecida-em-goiânia-1.1929801>

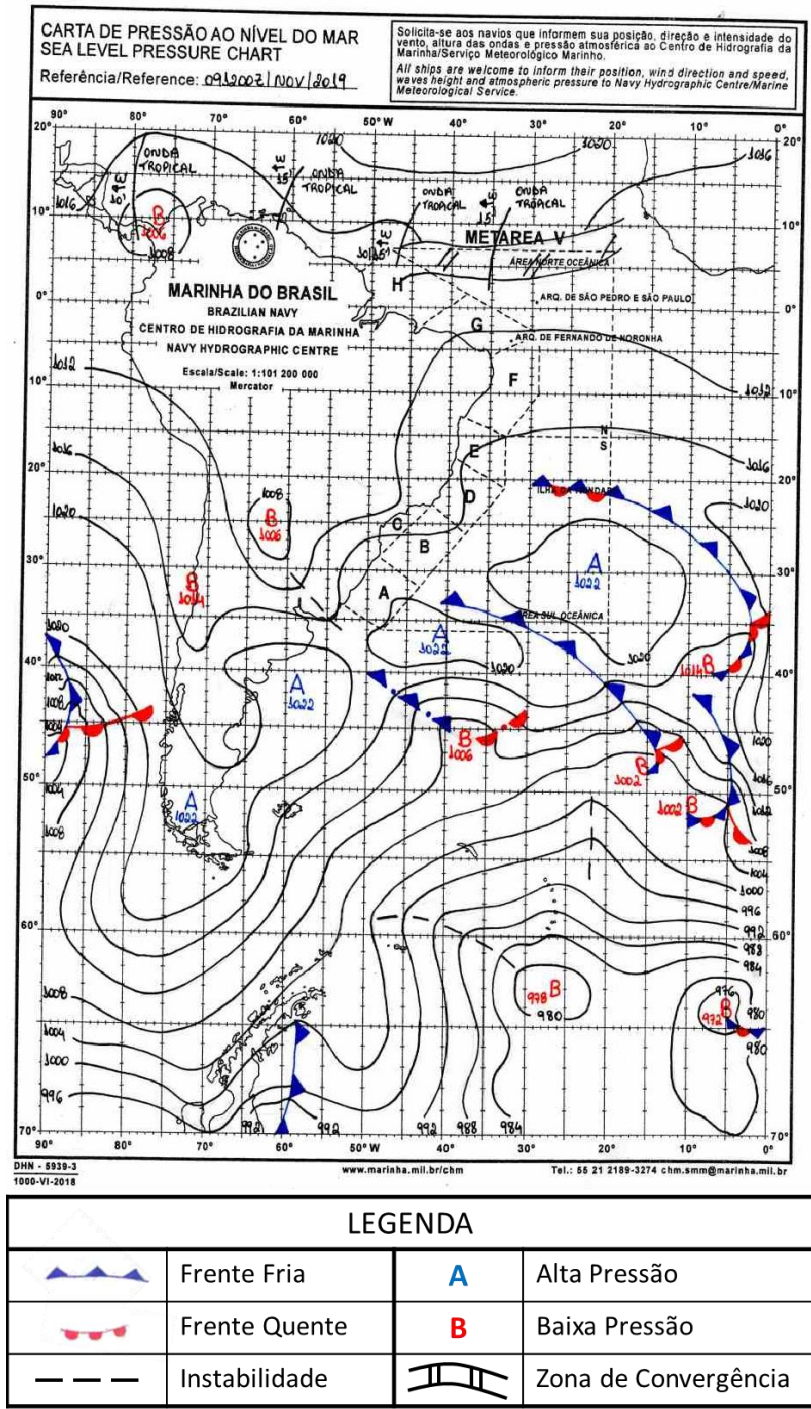
Temporal derruba postes da rede elétrica e árvores, e deixa bairros de Goiânia sem energia -

<https://www.opopular.com.br/noticias/cidades/temporal-derruba-postes-da-rede-elétrica-e-árvores-e-deixa-bairros-de-goiânia-sem-energia-1.1929174>

Bianca Lobo Silva

Meteorologista

CREA 5063840461

## Goiania - Estação CELG Estação Goiania 2 - Novembro de 2019

Para ver os dados horários clique no dia desejado

Dia	Precip.	Prec.Acum.	Vel. Vent. (m/s)	Dir. Vent.	Umid. Relat. AR (Max) %	Umid. Relat. AR (Min) %	Umid. Relat. AR (Média)%	Temp. Max. °C Dia	Temp. Min. °C Dia	Temp. Med. °C do Ar	Temp. 09:00h	Temp. 21:00h	Ponto orvalho	Razao Mistura
<a href="#">1</a>	0.00	0.00	0.5	NO	98.0	31.0	57.7	34.8	19.0	26.04	29	23.7	18.03750	14.2847
<a href="#">2</a>	0.60	0.60	0.7	SE	97.0	39.0	56.2	34.0	19.7	26.56	28.1	25.5	18.25417	14.2500
<a href="#">3</a>	0.00	0.60	0.7	N	81.0	41.0	65.7	30.9	21.7	25.56	26	24.6	18.49583	14.4514
<a href="#">4</a>	1.80	2.40	0.5	NO	95.0	33.0	60.5	34.9	20.7	26.5	29.5	23.7	18.94583	15.0417
<a href="#">5</a>	2.60	5.00	0.5	NO	99.0	39.0	68.5	33.6	19.4	25.7	28.7	23.4	19.69583	15.6667
<a href="#">6</a>	0.00	5.00	0.6	NO	96.0	43.0	69.5	32.0	20.5	25.32	25.5	24.3	19.92500	15.9931
<a href="#">7</a>	0.00	5.00	0.6	SE	98.0	44.0	73.5	33.2	20.5	24.96	28.3	21.4	19.97083	15.9306
<a href="#">8</a>	0.00	5.00	0.7	SE	94.0	61.0	76.5	29.4	20.5	24.26	23.8	23.8	20.37083	16.5278
<a href="#">9</a>	8.60	13.60	0.9	SE	93.0	30.0	63.7	36.0	20.8	26.02	30.5	21.4	18.98333	15.0903
<a href="#">10</a>	0.60	14.20	0.5	NO	100.0	35.0	62.7	34.1	19.9	25.66	26.9	23.7	18.85833	14.8750
<a href="#">11</a>	0.00	14.20	0.8	NO	98.0	33.0	59.5	35.6	19.5	26.28	28.3	24	18.67083	14.7222
<a href="#">12</a>	0.00	14.20	0.7	SE	82.0	29.0	56.7	35.7	22.3	27.34	27.7	25.5	18.29583	14.5347
<a href="#">13</a>	0.00	14.20	0.9	NO	95.0	28.0	-	34.2	19.4	-	29.5	-	16.57391	13.0000
<a href="#">14</a>	4.60	18.80	0.7	NO	91.0	40.0	63.7	33.7	21.0	26.42	28.8	24.3	19.51667	15.6181
<a href="#">15</a>	14.40	33.20	0.6	O	100.0	48.0	85	30.9	20.1	24.02	28.1	20.5	20.11667	16.1944
<a href="#">16</a>	0.40	33.60	0.3	NO	100.0	55.0	84	29.2	20.4	23.3	21.9	22.5	20.64167	16.7917
<a href="#">17</a>	0.00	33.60	0.7	NO	100.0	46.0	76.2	31.0	19.7	24.84	26.3	23.6	20.46667	16.5417
<a href="#">18</a>	29.80	63.40	0.7	SE	100.0	62.0	89.7	28.0	19.2	22.32	24.6	19.9	20.01667	16.0486
<a href="#">19</a>	0.60	64.00	0.4	L	100.0	66.0	83	28.3	19.6	23.56	25.7	22.1	20.70000	16.7083
<a href="#">20</a>	15.80	79.80	0.4	NO	100.0	57.0	93.5	29.3	19.5	23.32	26.4	20.7	20.42500	16.3333
<a href="#">21</a>	0.00	79.80	0.7	SE	100.0	52.0	77.5	30.2	19.2	23.38	24.7	21.4	19.60417	15.6250
<a href="#">22</a>	6.20	86.00	0.8	NO	100.0	51.0	72.2	29.9	19.4	24.08	25.7	22.7	19.60417	15.6597
<a href="#">23</a>	0.00	86.00	0.5	NO	99.0	47.0	78.5	31.2	20.6	24.68	28.2	21.7	20.11250	16.0000
<a href="#">24</a>	6.40	92.40	0.8	NO	100.0	39.0	78.2	32.2	19.3	24.04	27.3	20.7	19.73333	15.7500
<a href="#">25</a>	0.60	93.00	0.4	NO	100.0	61.0	76.7	29.1	19.6	24.28	25.9	23.4	20.53750	16.6736
<a href="#">26</a>	0.00	93.00	0.6	NO	99.0	55.0	76	30.6	19.5	25	26.7	24.1	20.37917	16.4028
<a href="#">27</a>	17.20	110.20	0.4	SE	100.0	71.0	90	27.9	20.9	23.74	26.1	21.9	21.55000	17.7014
<a href="#">28</a>	11.20	121.40	0.7	NO	100.0	62.0	91.5	29.2	20.5	23.38	25.8	20.7	21.32083	17.4236
<a href="#">29</a>	2.60	124.00	0.5	NO	100.0	61.0	92.5	29.5	20.3	23.94	23.7	23.1	21.51250	17.6597
<a href="#">30</a>	0.00	124.00	0.7	O	100.0	65.0	82	29.6	21.5	24.72	27.3	22.6	21.72917	17.8403

## Goiania - Estação Estação Hidro Goiânia Montante - GO - ANA - Novembro de 2019

Para ver os dados horários clique no dia desejado

Dia	Precip.	Prec.Acum.	Sensor Pressão min	Sensor Pressão max	Sensor Pressão media	Nível Régua	CodifEixo	Vazão min (m3/s)	Vazão max (m3/s)	Vazão media (m3/s)
<a href="#">1</a>	2.40	2.40	1.1	1.48	1.3	1.48	6.71	0.00	0.00	0.00
<a href="#">2</a>	1.40	3.80	1.18	1.62	1.3	1.62	6.71	0.00	0.00	0.00
<a href="#">3</a>	0.00	3.80	1.06	1.49	1.3	1.49	6.71	0.00	0.00	0.00
<a href="#">4</a>	2.80	6.60	0.95	1.52	1.4	1.52	6.71	0.00	0.00	0.00
<a href="#">5</a>	0.20	6.80	0.91	1.51	1.3	1.51	6.71	0.00	0.00	0.00
<a href="#">6</a>	0.00	6.80	1.01	1.45	1.3	1.45	6.71	0.00	0.00	0.00
<a href="#">7</a>	7.60	14.40	0.91	1.46	1.3	1.46	6.71	0.00	0.00	0.00
<a href="#">8</a>	0.00	14.40	0.9	1.47	1.3	1.47	6.71	0.00	0.00	0.00
<a href="#">9</a>	14.60	29.00	0.93	1.43	1.2	1.43	6.71	0.00	0.00	0.00
<a href="#">10</a>	0.00	29.00	0.92	1.42	1.2	1.42	6.71	0.00	0.00	0.00
<a href="#">11</a>	0.00	29.00	0.91	1.35	1.2	1.35	6.71	0.00	0.00	0.00
<a href="#">12</a>	0.00	29.00	1.06	1.33	1.2	1.33	6.71	0.00	0.00	0.00
<a href="#">13</a>	0.00	29.00	0.98	1.43	1.2	1.43	6.71	0.00	0.00	0.00
<a href="#">14</a>	0.00	29.00	0.98	1.4	1.2	1.4	6.71	0.00	0.00	0.00
<a href="#">15</a>	23.20	52.20	1.03	2.07	1.3	2.07	6.71	0.00	0.00	0.00
<a href="#">16</a>	0.60	52.80	1.03	1.5	1.3	1.5	6.71	0.00	0.00	0.00
<a href="#">17</a>	0.00	52.80	1.09	1.53	1.3	1.53	6.71	0.00	0.00	0.00
<a href="#">18</a>	37.00	89.80	1.1	2.45	1.5	2.45	6.71	0.00	0.00	0.00
<a href="#">19</a>	2.60	92.40	0.94	1.38	1.1	1.38	6.71	0.00	0.00	0.00
<a href="#">20</a>	11.20	103.60	1	1.39	1.1	1.39	6.71	0.00	0.00	0.00
<a href="#">21</a>	0.00	103.60	0	1.63	1.4	1.63	7.17	0.00	0.00	0.00
<a href="#">22</a>	-152.20	-48.60	1.4	1.55	1.5	1.55	7.17	0.00	0.00	0.00
<a href="#">23</a>	0.00	-48.60	1.33	1.45	1.4	1.45	7.17	0.00	0.00	0.00
<a href="#">24</a>	4.20	-44.40	1.33	1.51	1.4	1.51	7.17	0.00	0.00	0.00
<a href="#">25</a>	0.00	-44.40	1.38	1.5	1.4	1.5	7.17	0.00	0.00	0.00
<a href="#">26</a>	0.00	-44.40	1.46	1.58	1.5	1.58	7.17	0.00	0.00	0.00
<a href="#">27</a>	6.80	-37.60	1.54	1.69	1.6	1.69	7.17	0.00	0.00	0.00
<a href="#">28</a>	24.00	-13.60	1.49	1.74	1.6	1.74	7.17	0.00	0.00	0.00
<a href="#">29</a>	1.40	-12.20	1.44	1.59	1.5	1.59	7.17	0.00	0.00	0.00
<a href="#">30</a>	0.00	-12.20	1.42	1.56	1.5	1.56	7.17	0.00	0.00	0.00



Palmeiras de Goiás - Estação Palmeiras de Goiás - Novembro de 2019

Para ver os dados horários clique no dia desejado

Dia	Precip.	Prec. Acum.	Vel. Vent. (m/s)	Dir. Vent.	Umid. Relat. AR (Max) %	Umid. Relat. AR (Min) %	Umid. Relat. AR (Média) %	Temp. Max. °C Dia	Temp. Min. °C Dia	Temp. Med. °C do Ar	Temp. 09:00h	Temp. 21:00h	Ponto orvalho	Razao Mistura	Radiação Solar Diária MJ/m²
<a href="#">1</a>	0.00	0.00	2.5	S	96.0	34.0	60	35.3	21.3	26.9	27.7	25.1	-	-	21.8
<a href="#">2</a>	0.00	0.00	2.9	SO	96.0	34.0	50.5	34.3	20.5	27.78	27.9	28.1	-	-	-
<a href="#">3</a>	1.20	1.20	2.3	SO	90.0	48.0	69.7	30.1	22.0	25.66	26.8	24.7	-	-	-
<a href="#">4</a>	0.00	1.20	3.0	S	90.0	32.0	57.2	34.6	22.8	27.72	29	26.1	-	-	-
<a href="#">5</a>	14.80	16.00	2.4	SO	100.0	32.0	76.2	35.4	22.3	25.94	27.2	22.4	-	-	-
<a href="#">6</a>	0.20	16.20	1.1	S	100.0	43.0	80.5	32.6	21.2	25.22	23.3	24.5	-	-	-
<a href="#">7</a>	0.00	16.20	1.8	S	100.0	40.0	62.7	34.1	20.9	27.08	27	26.7	-	-	-
<a href="#">8</a>	0.00	16.20	2.8	SO	100.0	48.0	63	32.6	21.6	26.48	24.4	26.9	-	-	-
<a href="#">9</a>	39.60	55.80	1.8	S	100.0	35.0	74	34.7	19.8	24.94	29.6	20.3	-	-	-
<a href="#">10</a>	0.20	56.00	2.3	S	100.0	39.0	66	33.9	19.8	26.32	24.9	26.5	-	-	-
<a href="#">11</a>	18.00	74.00	2.2	S	100.0	31.0	75	35.9	22.2	26.22	28	22.5	-	-	-
<a href="#">12</a>	1.40	75.40	1.8	SO	100.0	41.0	71.2	34.6	21.5	26.02	24.8	24.6	-	-	-
<a href="#">13</a>	0.00	75.40	0.9	S	100.0	36.0	55	34.4	22.0	27.94	26.7	28.3	-	-	-
<a href="#">14</a>	0.00	75.40	1.1	S	92.0	35.0	52.2	34.7	22.3	28.48	28.2	28.6	-	-	-
<a href="#">15</a>	24.20	99.60	2.7	L	100.0	47.0	84.2	31.8	21.0	24.7	27.7	21.5	-	-	-
<a href="#">16</a>	0.20	99.80	1.1	L	100.0	52.0	80.2	30.3	21.2	25.1	23.4	25.3	-	-	-
<a href="#">17</a>	9.40	109.20	1.3	L	100.0	57.0	74.5	30.7	20.8	25.22	25.8	24.4	-	-	-
<a href="#">18</a>	2.20	111.40	1.4	SO	100.0	54.0	92.5	30.1	21.4	24.12	25.7	21.7	-	-	-
<a href="#">19</a>	0.20	111.60	0.6	O	100.0	56.0	90	29.5	20.6	23.84	24.5	22.3	-	-	-
<a href="#">20</a>	1.80	113.40	1.1	SO	100.0	41.0	92	31.9	21.1	24.68	26.4	22	-	-	-
<a href="#">21</a>	0.20	113.60	1.2	S	100.0	42.0	64.2	32.0	20.3	25.58	25.4	25.1	-	-	-
<a href="#">22</a>	18.40	132.00	1.9	S	100.0	54.0	73.7	30.0	19.3	24.96	25.3	25.1	-	-	-
<a href="#">23</a>	2.40	134.40	3.4	O	100.0	47.0	87	32.9	22.6	25.98	27.8	23.3	-	-	-
<a href="#">24</a>	2.20	136.60	1.7	S	100.0	46.0	86	32.8	21.8	24.94	26.1	22	-	-	-
<a href="#">25</a>	3.40	140.00	1.5	SO	100.0	59.0	88.7	31.0	20.0	24.36	25.4	22.7	-	-	-
<a href="#">26</a>	0.00	140.00	0.8	O	100.0	59.0	72.5	30.8	21.1	25.76	26.5	25.2	-	-	-
<a href="#">27</a>	5.80	145.80	1.3	L	100.0	77.0	93.5	27.7	21.8	24.7	26.2	23.9	-	-	-
<a href="#">28</a>	9.80	155.60	0.9	S	100.0	58.0	81.5	29.2	20.6	24.92	25	24.9	-	-	-
<a href="#">29</a>	2.40	158.00	1.9	O	100.0	63.0	89.7	30.8	22.0	24.96	24.6	23.7	-	-	-
<a href="#">30</a>	1.40	159.40	0.7	L	100.0	76.0	98.5	28.4	22.6	24.52	26.2	22.7	-	-	-

Parauna - Estação Estação Hidro Ponte Rodagem - GO - ANA - Novembro de 2019

Para ver os dados horários clique no dia desejado

Dia	Precip.	Prec. Acum.	Sensor Pressão min	Sensor Pressão max	Sensor Pressão media	Nível Régua	CodifEixo	Vazão min (m3/s)	Vazão max (m3/s)	Vazão media (m3/s)
<a href="#">1</a>	0.00	0.00	0.57	1.17	0.8	1.17	42.69	0.00	0.00	0.00
<a href="#">2</a>	0.00	0.00	0.6	1.01	0.7	1.01	42.69	0.00	0.00	0.00
<a href="#">3</a>	0.00	0.00	0.59	1.06	0.7	1.06	42.69	0.00	0.00	0.00
<a href="#">4</a>	0.00	0.00	0.61	1.2	0.8	1.2	42.69	0.00	0.00	0.00
<a href="#">5</a>	1.80	1.80	0.65	1.15	0.8	1.15	42.69	0.00	0.00	0.00
<a href="#">6</a>	9.40	11.20	0.66	1.07	0.8	1.07	42.69	0.00	0.00	0.00
<a href="#">7</a>	0.40	11.60	0.63	1.12	0.8	1.12	42.69	0.00	0.00	0.00
<a href="#">8</a>	6.60	18.20	0.71	1.34	0.8	1.34	42.69	0.00	0.00	0.00
<a href="#">9</a>	13.20	31.40	0.68	1.26	0.8	1.26	42.69	0.00	0.00	0.00
<a href="#">10</a>	0.20	31.60	0.65	1.28	0.8	1.28	42.69	0.00	0.00	0.00
<a href="#">11</a>	8.60	40.20	0.7	1.33	0.8	1.33	42.69	0.00	0.00	0.00
<a href="#">12</a>	0.20	40.40	0.68	1.23	0.8	1.23	42.69	0.00	0.00	0.00
<a href="#">13</a>	0.00	40.40	0.68	1.17	0.8	1.17	42.69	0.00	0.00	0.00
<a href="#">14</a>	3.00	43.40	0.66	1.09	0.8	1.09	42.69	0.00	0.00	0.00
<a href="#">15</a>	2.00	45.40	0	1.18	0.8	1.18	42.99	0.00	0.00	0.00
<a href="#">16</a>	-89.20	-43.80	0.89	1.33	1.1	1.33	42.99	0.00	0.00	0.00
<a href="#">17</a>	4.40	-39.40	0.92	1.36	1.1	1.36	42.99	0.00	0.00	0.00
<a href="#">18</a>	49.80	10.40	0.92	1.26	1.1	1.26	42.99	0.00	0.00	0.00
<a href="#">19</a>	3.80	14.20	0.91	1.41	1.1	1.41	42.99	0.00	0.00	0.00
<a href="#">20</a>	0.20	14.40	0.9	1.55	1.1	1.55	42.99	0.00	0.00	0.00
<a href="#">21</a>	0.00	14.40	0.93	1.46	1.1	1.46	42.99	0.00	0.00	0.00
<a href="#">22</a>	0.00	14.40	0.91	1.29	1.1	1.29	42.99	0.00	0.00	0.00
<a href="#">23</a>	4.40	18.80	0.95	1.53	1.1	1.53	42.99	0.00	0.00	0.00
<a href="#">24</a>	12.40	31.20	1	1.58	1.1	1.58	42.99	0.00	0.00	0.00
<a href="#">25</a>	8.40	39.60	1	1.49	1.1	1.49	42.99	0.00	0.00	0.00
<a href="#">26</a>	0.20	39.80	1	1.56	1.2	1.56	42.99	0.00	0.00	0.00
<a href="#">27</a>	9.00	48.80	1.03	1.45	1.2	1.45	42.99	0.00	0.00	0.00
<a href="#">28</a>	6.40	55.20	1.04	1.47	1.2	1.47	42.99	0.00	0.00	0.00
<a href="#">29</a>	7.60	62.80	1.06	1.65	1.2	1.65	42.99	0.00	0.00	0.00
<a href="#">30</a>	1.20	64.00	1.06	1.56	1.2	1.56	42.99	0.00	0.00	0.00

## Morrinhos - Estação Usina CEM - Morrinhos - Novembro de 2019

Para ver os dados horários clique no dia desejado

Dia	Precip.	Prec.Acum.	Vel. Vent. (m/s)	Dir. Vent.	Umid. Relat. AR (Max) %	Umid. Relat. AR (Min) %	Umid. Relat. AR (Média)%	Temp. Max. °C Dia	Temp. Min. °C Dia	Temp. Med. °C do Ar	Temp. 09:00h	Temp. 21:00h	Ponto orvalho	Razao Mistura	Radiação Solar Diária MJ/m²
<a href="#">1</a>	9.40	9.40	3.2	L	94.0	43.0	65	31.3	20.2	24.96	28.3	22.5	-	-	14.4
<a href="#">2</a>	0.00	9.40	2.1	L	89.0	43.0	61	31.6	19.3	25.26	24.8	25.3	-	-	20.7
<a href="#">3</a>	0.80	10.20	4.1	L	91.0	50.0	75.2	30.1	20.8	24.1	25.4	22.1	-	-	20
<a href="#">4</a>	0.00	10.20	2.7	N	94.0	49.0	66.7	30.5	20.7	25.3	28.3	23.5	-	-	14.4
<a href="#">5</a>	0.00	10.20	3.1	N	91.0	41.0	71.5	32.5	21.0	25.36	26.3	23.5	-	-	18
<a href="#">6</a>	0.00	10.20	2.5	N	100.0	54.0	77.5	30.9	21.0	24.84	26.1	23.1	-	-	19.4
<a href="#">7</a>	0.00	10.20	2.6	L	100.0	40.0	61.7	32.5	20.0	25.66	26	24.9	-	-	18.6
<a href="#">8</a>	0.00	10.20	2.9	S	100.0	53.0	69	30.5	19.9	24.2	22.6	24	-	-	15.6
<a href="#">9</a>	13.20	23.40	3.2	L	100.0	37.0	64.7	33.1	20.2	24.86	27.6	21.7	-	-	17.7
<a href="#">10</a>	6.80	30.20	2.2	S	100.0	55.0	85	30.9	19.4	23.46	24.6	21.2	-	-	16.6
<a href="#">11</a>	17.60	47.80	2.6	S	93.0	39.0	63.2	33.1	19.8	25.44	25.1	24.6	-	-	18.7
<a href="#">12</a>	1.00	48.80	2.5	S	96.0	42.0	61	33.3	21.0	26.68	24.9	27.1	-	-	22.8
<a href="#">13</a>	0.00	48.80	4.3	L	77.0	37.0	48	32.3	21.6	27.32	26.1	28.3	-	-	20.1
<a href="#">14</a>	4.20	53.00	2.1	S	100.0	55.0	86.2	29.8	20.4	24.06	27.1	21.5	-	-	14.3
<a href="#">15</a>	18.60	71.60	2.1	O	100.0	61.0	92	27.9	19.5	22.24	23.8	20	-	-	11.9
<a href="#">16</a>	0.00	71.60	2.3	L	100.0	74.0	85	26.4	19.3	22.86	22.6	23	-	-	13
<a href="#">17</a>	0.60	72.20	2.5	N	100.0	47.0	75.2	31.1	19.6	24.42	26.6	22.4	-	-	17.8
<a href="#">18</a>	11.40	83.60	4.1	N	100.0	69.0	94.2	25.8	19.8	21.76	22.6	20.3	-	-	11.4
<a href="#">19</a>	3.00	86.60	2.8	L	100.0	59.0	90.5	28.3	19.0	21.66	22.6	19.2	-	-	14.1
<a href="#">20</a>	0.00	86.60	3.1	L	100.0	55.0	79.2	29.3	18.8	22.98	24.8	21	-	-	20.5
<a href="#">21</a>	0.00	86.60	2.6	L	100.0	51.0	69.5	29.8	19.1	24.32	24.5	24.1	-	-	18.7
<a href="#">22</a>	33.00	119.60	4.1	L	100.0	63.0	89.7	28.0	17.5	22.8	23.3	22.6	-	-	16.9
<a href="#">23</a>	3.00	122.60	3.1	N	100.0	64.0	83.5	27.5	20.3	23.64	25.4	22.5	-	-	14.9
<a href="#">24</a>	0.00	122.60	3.3	N	100.0	59.0	84	28.5	19.6	23.1	24.4	21.5	-	-	14.3
<a href="#">25</a>	23.20	145.80	2.6	N	100.0	57.0	86	30.1	19.4	23.78	26.4	21.5	-	-	16.1
<a href="#">26</a>	0.40	146.20	3.0	L	100.0	63.0	87.7	28.6	20.2	24.18	24.9	23.6	-	-	16.9
<a href="#">27</a>	4.80	151.00	3.7	N	100.0	79.0	100	26.6	20.2	22.32	22.4	21.2	-	-	10.1
<a href="#">28</a>	0.80	151.80	3.0	N	100.0	72.0	91.7	28.1	20.3	23.16	23.6	21.9	-	-	15
<a href="#">29</a>	2.00	153.80	2.6	L	100.0	78.0	94.5	27.1	21.1	23.26	23.3	22.4	-	-	12.6
<a href="#">30</a>	1.20	155.00	3.5	N	100.0	65.0	92.7	28.4	20.4	23.12	22.8	22	-	-	11.2

## Bom Jesus de Goiás - Estação Usina Goiás - Bom Jesus de Goiás - Novembro de 2019

Para ver os dados horários clique no dia desejado

Dia	Precip.	Prec.Acum.	Vel. Vent. (m/s)	Dir. Vent.	Umid. Relat. AR (Max) %	Umid. Relat. AR (Min) %	Umid. Relat. AR (Média)%	Temp. Max. °C Dia	Temp. Min. °C Dia	Temp. Med. °C do Ar	Temp. 09:00h	Temp. 21:00h	Ponto orvalho	Razao Mistura	Radiação Solar Diária MJ/m²
<a href="#">1</a>	0.00	0.00	3.4	L	78.0	35.0	61.7	33.1	21.9	25.92	29	22.8	-	-	14.9
<a href="#">2</a>	0.00	0.00	2.7	L	90.0	30.0	50.2	33.8	19.8	26.76	25.6	27.3	-	-	19.9
<a href="#">3</a>	11.00	11.00	4.8	L	100.0	39.0	66.2	31.5	18.9	24.44	28	21.9	-	-	16.8
<a href="#">4</a>	0.00	11.00	2.8	L	84.0	40.0	63.2	32.7	22.1	26.28	26.4	25.1	-	-	19.5
<a href="#">5</a>	0.00	11.00	3.1	L	82.0	35.0	59	33.6	21.8	26.76	28.6	24.9	-	-	17.3
<a href="#">6</a>	0.20	11.20	3.0	S	90.0	50.0	73	31.1	21.8	24.82	26.6	22.3	-	-	17.5
<a href="#">7</a>	0.20	11.40	2.7	S	100.0	35.0	63.5	33.8	20.5	26.12	27.1	24.6	-	-	17.2
<a href="#">8</a>	0.00	11.40	3.2	S	100.0	42.0	66.7	29.9	19.5	23.62	21.7	23.5	-	-	13.2
<a href="#">9</a>	8.20	19.60	3.8	SE	97.0	37.0	73.7	33.0	21.1	25.42	28	22.5	-	-	13.1
<a href="#">10</a>	1.80	21.40	3.0	S	100.0	41.0	64.5	32.1	19.7	25.06	24.3	24.6	-	-	18.2
<a href="#">11</a>	0.00	21.40	3.4	S	89.0	31.0	56.7	34.0	21.3	26.48	26.1	25.5	-	-	15.8
<a href="#">12</a>	0.00	21.40	3.5	SO	93.0	36.0	54	33.1	21.6	27.58	26	28.6	-	-	19.5
<a href="#">13</a>	2.00	21.40	5.1	SE	71.0	33.0	49.7	33.2	24.6	27.82	29.1	26.1	-	-	17.4
<a href="#">14</a>	0.60	24.00	3.3	S	94.0	39.0	74	32.3	21.7	24.76	25.6	22.1	-	-	15.2
<a href="#">15</a>	7.80	31.80	2.3	O	100.0	53.0	91	29.1	19.8	22.8	25.5	19.8	-	-	10.2
<a href="#">16</a>	0.20	32.00	2.0	NO	100.0	45.0	69.7	30.9	19.6	24.16	23.1	23.6	-	-	16.8
<a href="#">17</a>	0.00	32.00	2.4	L	92.0	41.0	60.7	31.9	20.6	26.24	27.5	25.6	-	-	20
<a href="#">18</a>	5.00	37.00	3.4	N	95.0	60.0	83.2	27.8	20.9	23.18	24.6	21.3	-	-	12.4
<a href="#">19</a>	10.20	47.20	3.0	L	97.0	53.0	84.7	29.5	19.3	22.2	23.6	19.3	-	-	11.6
<a href="#">20</a>	0.00	47.20	2.8	L	91.0	45.0	67.5	30.4	19.5	24.12	26.1	22.3	-	-	16.9
<a href="#">21</a>	1.00	48.20	3.4	L	92.0	40.0	66.2	31.6	20.2	24.12	25.6	21.6	-	-	18.5
<a href="#">22</a>	10.60	58.80	4.5	L	98.0	57.0	78	28.6	17.1	23	24.1	22.6	-	-	17.2
<a href="#">23</a>	2.00	60.80	2.2	NO	86.0	48.0	71.7	30.4	21.9	25.56	26.9	24.3	-	-	15.3
<a href="#">24</a>	2.20	63.00	3.3	SO	99.0	56.0	75.7	29.1	20.8	23.42	23.6	21.8	-	-	11.9
<a href="#">25</a>	11.60	74.60	2.5	L	100.0	50.0	87.7	30.9	20.0	24.02	25.6	21.8	-	-	16
<a href="#">26</a>	0.00	74.60	2.8	L	100.0	53.0	77	29.9	21.0	24.72	25.1	23.8	-	-	14.3
<a href="#">27</a>	13.60	88.20	3.2	L	100.0	73.0	97.7	27.3	19.9	22.8	23.4	21.7	-	-	8.7
<a href="#">28</a>	30.60	118.80	2.3	NO	100.0	63.0	94	28.3	20.3	22.92	22.8	21.6	-	-	11.8
<a href="#">29</a>	21.00	139.80	1.8	NO	100.0	71.0	98.2	26.3	20.7	23.14	21.5	23.6	-	-	5.3
<a href="#">30</a>	0.60	140.40	2.6	N	100.0	69.0	85.7	26.8	20.4	23.06	24.1	22	-	-	10.9

Santa Helena de Goiás - Estação Usina Santa Helena - Santa Helena - Novembro de 2019

Para ver os dados horários clique no dia desejado

Dia	Precip.	Prec.Acum.	Vel. Vent. (m/s)	Dir. Vent.	Umid. Relat. AR (Max) %	Umid. Relat. AR (Min) %	Umid. Relat. AR (Média)%	Temp. Max. °C Dia	Temp. Min. °C Dia	Temp. Med. °C do Ar	Temp. 09:00h	Temp. 21:00h	Ponto orvalho	Razao Mistura	Radiação Solar Diária MJ/m²
<a href="#">1</a>	3.40	3.40	1.5	NO	89.0	36.0	67.7	34.6	22.3	27.28	30.3	24.6	-	-	11.8
<a href="#">2</a>	0.20	3.60	1.3	L	99.0	27.0	57.7	36.0	20.6	27.26	26.9	26.4	-	-	18.4
<a href="#">3</a>	6.80	10.40	1.9	N	96.0	46.0	83	31.6	23.4	26.88	29.8	24.8	-	-	12.6
<a href="#">4</a>	0.00	10.40	1.3	N	100.0	32.0	47	34.7	21.9	28.58	29.1	28.6	-	-	14.3
<a href="#">5</a>	1.80	12.20	1.8	NO	100.0	39.0	84.5	34.2	21.9	26.68	29.1	24.1	-	-	10.2
<a href="#">6</a>	0.20	12.40	1.6	NO	100.0	45.0	75.7	33.6	23.0	26.54	26.9	24.6	-	-	15.6
<a href="#">7</a>	0.00	12.40	1.4	O	100.0	39.0	62	34.8	21.9	27.62	27.6	26.9	-	-	16.9
<a href="#">8</a>	20.80	33.20	1.5	SE	100.0	63.0	91	28.4	20.9	23.8	22.1	23.8	-	-	8.5
<a href="#">9</a>	30.80	64.00	1.5	N	100.0	39.0	73.7	34.3	20.1	25.44	28.6	22.1	-	-	15.7
<a href="#">10</a>	0.00	64.00	1.0	L	100.0	48.0	73.7	32.8	21.1	25.8	25.1	25	-	-	14.9
<a href="#">11</a>	4.60	68.60	1.9	SE	100.0	34.0	69.7	35.1	22.1	26.36	29	22.8	-	-	18.2
<a href="#">12</a>	1.00	69.60	1.4	O	98.0	63.0	83.7	30.1	22.0	25.66	24	26.1	-	-	6.1
<a href="#">13</a>	0.00	69.60	1.7	N	95.0	36.0	57	34.2	23.9	28.48	29.1	27.6	-	-	16.5
<a href="#">14</a>	0.00	69.60	1.1	SE	100.0	38.0	71.5	34.3	22.4	26.5	26.6	24.6	-	-	13.4
<a href="#">15</a>	28.20	97.80	1.3	N	100.0	53.0	92	30.6	20.7	24.24	28.1	20.9	-	-	7.8
<a href="#">16</a>	0.00	97.80	1.0	O	100.0	46.0	81	32.0	20.5	25.32	25.9	24.1	-	-	17.8
<a href="#">17</a>	0.00	97.80	1.3	N	100.0	42.0	62.2	32.2	20.7	26.58	27.8	26.1	-	-	18.6
<a href="#">18</a>	3.40	101.20	2.1	N	100.0	44.0	83	32.0	21.6	24.76	27	21.6	-	-	16.8
<a href="#">19</a>	0.20	101.40	1.4	N	100.0	50.0	79.7	31.1	21.6	24.98	25.6	23.3	-	-	11
<a href="#">20</a>	0.00	101.40	1.4	N	100.0	43.0	73.5	32.5	21.4	25.64	27.1	23.6	-	-	13.9
<a href="#">21</a>	0.40	101.80	1.2	SE	100.0	37.0	67	33.6	20.5	25.64	27.3	23.4	-	-	17.1
<a href="#">22</a>	0.00	101.80	1.5	N	100.0	43.0	74.5	32.2	20.4	25.3	25.3	24.3	-	-	16.1
<a href="#">23</a>	2.60	104.40	1.2	NO	99.0	47.0	82.2	31.8	22.0	26.38	29.3	24.4	-	-	9.3
<a href="#">24</a>	0.20	104.60	1.2	N	100.0	51.0	80.5	31.6	22.1	25.72	27.1	23.9	-	-	10.9
<a href="#">25</a>	0.00	104.60	1.3	O	100.0	59.0	92.5	31.3	21.7	25.58	27.1	23.9	-	-	8.6
<a href="#">26</a>	0.00	104.60	1.4	N	100.0	49.0	76.2	32.0	21.7	26.7	26.6	26.6	-	-	15.2
<a href="#">27</a>	33.80	138.40	2.2	N	100.0	56.0	85	31.6	22.1	25.48	28.1	22.8	-	-	13.1
<a href="#">28</a>	29.40	167.80	1.1	NO	100.0	67.0	100	29.8	21.7	24.06	23.6	22.6	-	-	7.9
<a href="#">29</a>	0.60	168.40	1.2	N	100.0	64.0	92	29.1	22.3	25.22	24.1	25.3	-	-	12.7
<a href="#">30</a>	8.00	176.40	1.7	N	100.0	52.0	89	32.5	21.8	24.88	25.3	22.4	-	-	9.9

Maurilândia - Estação Usina Vale do Verdão - Maurilândia - Novembro de 2019

Para ver os dados horários clique no dia desejado

Dia	Precip.	Prec.Acum.	Vel. Vent. (m/s)	Dir. Vent.	Umid. Relat. AR (Max) %	Umid. Relat. AR (Min) %	Umid. Relat. AR (Média)%	Temp. Max. °C Dia	Temp. Min. °C Dia	Temp. Med. °C do Ar	Temp. 09:00h	Temp. 21:00h	Ponto orvalho	Razao Mistura	Radiação Solar Diária MJ/m²
<a href="#">1</a>	4.20	4.20	2.5	N	0.0	0.0	0	-10.0	-10.0	-10	-10	-10	-	-	14.9
<a href="#">2</a>	0.20	4.40	1.9	SE	0.0	0.0	0	-10.0	-10.0	-10	-10	-10	-	-	18.9
<a href="#">3</a>	0.00	4.40	2.8	O	0.0	0.0	0	-10.0	-10.0	-10	-10	-10	-	-	17.4
<a href="#">4</a>	0.00	4.40	1.9	NO	0.0	0.0	0	-10.0	-10.0	-10	-10	-10	-	-	17
<a href="#">5</a>	0.00	4.40	2.1	NO	0.0	0.0	0	-10.0	-10.0	-10	-10	-10	-	-	11.9
<a href="#">6</a>	0.40	4.80	2.3	NO	0.0	0.0	0	-10.0	-10.0	-10	-10	-10	-	-	17.6
<a href="#">7</a>	9.20	14.00	1.7	L	0.0	0.0	0	-10.0	-10.0	-10	-10	-10	-	-	16.9
<a href="#">8</a>	1.80	15.80	2.0	SE	0.0	0.0	0	-10.0	-10.0	-10	-10	-10	-	-	7.2
<a href="#">9</a>	14.20	30.00	2.0	SO	0.0	0.0	0	-10.0	-10.0	-10	-10	-10	-	-	15
<a href="#">10</a>	0.60	30.60	1.8	L	0.0	0.0	0	-10.0	-10.0	-10	-10	-10	-	-	16.8
<a href="#">11</a>	22.80	53.40	2.8	SE	0.0	0.0	0	-10.0	-10.0	-10	-10	-10	-	-	19.2
<a href="#">12</a>	0.00	53.40	3.1	S	0.0	0.0	0	-10.0	-10.0	-10	-10	-10	-	-	10.6
<a href="#">13</a>	0.00	53.40	3.0	S	0.0	0.0	0	-10.0	-10.0	-10	-10	-10	-	-	14.1
<a href="#">14</a>	2.00	55.40	2.1	S	0.0	0.0	0	-10.0	-10.0	-10	-10	-10	-	-	13.5
<a href="#">15</a>	14.00	69.40	1.5	S	0.0	0.0	0	-10.0	-10.0	-10	-10	-10	-	-	9.6
<a href="#">16</a>	1.20	70.60	1.3	O	0.0	0.0	0	-10.0	-10.0	-10	-10	-10	-	-	13.5
<a href="#">17</a>	0.00	70.60	2.0	NO	0.0	0.0	0	-10.0	-10.0	-10	-10	-10	-	-	17
<a href="#">18</a>	5.00	75.60	2.6	NO	0.0	0.0	0	-10.0	-10.0	-10	-10	-10	-	-	14.6
<a href="#">19</a>	0.00	75.60	1.5	NO	0.0	0.0	0	-10.0	-10.0	-10	-10	-10	-	-	12.9
<a href="#">20</a>	0.00	75.60	1.8	NO	0.0	0.0	0	-10.0	-10.0	-10	-10	-10	-	-	14.3
<a href="#">21</a>	18.80	94.40	2.0	L	0.0	0.0	0	-10.0	-10.0	-10	-10	-10	-	-	16
<a href="#">22</a>	3.20	97.60	1.9	NO	1.0	0.0	0	-10.0	-10.0	-10	-10	-10	-	-	15.4
<a href="#">23</a>	0.00	97.60	1.9	NO	4.0	0.0	0.5	-10.0	-10.0	-10	-10	-10	-	-	14.3
<a href="#">24</a>	3.60	101.20	2.0	S	4.0	0.0	1.2	-10.0	-10.0	-10	-10	-10	-	-	7.8
<a href="#">25</a>	0.40	101.60	1.6	NO	2.0	0.0	0.2	-10.0	-10.0	-10	-10	-10	-	-	11.4
<a href="#">26</a>	2.20	103.80	1.6	NO	2.0	0.0	0.5	-10.0	-10.0	-10	-10	-10	-	-	13.1
<a href="#">27</a>	56.20	160.00	2.5	N	1.0	0.0	0	-10.0	-10.0	-10	-10	-10	-	-	7.7
<a href="#">28</a>	10.20	170.20	1.4	NO	4.0	0.0	2	-10.0	-10.0	-10	-10	-10	-	-	10.5
<a href="#">29</a>	9.60	179.80	1.2	NO	4.0	0.0	1.5	-10.0	-10.0	-10	-10	-10	-	-	9.8
<a href="#">30</a>	45.20	225.00	2.2	NO	5.0	0.0	1.7	-10.0	-10.0	-10	-10	-10	-	-	9.4

## NOTÍCIAS RELACIONADAS

<https://www.opopular.com.br/noticias/cidades/temporal-derruba-postes-da-rede-el%C3%A9trica-e-%C3%A1rvores-e-deixa-bairros-de-goi%C3%A2nia-sem-energia-1.1929174>

**O Popular** 62 99995 2795 BUSCAR 2 ALEXANDRE

CAPA POLÍTICA ECONOMIA MUNDO CIDADES ESPORTE MAGAZINE LUDOVICA OPINIÃO ESPECIAIS VÍDEOS INFOCOMERCIAL GUIAS

**CIDADES**

**Temporal derruba postes da rede elétrica e árvores, e deixa bairros de Goiânia sem energia**

Não há previsão de quando a energia elétrica irá voltar

10/11/2019 - 11:57



Av. Z com Bernardo Sayão, no setor Centro Oeste (Foto: Fabio Lima)

O temporal que caiu na tarde de sábado (9) em alguns bairros de Goiânia atingiu postes da rede elétrica e árvores, que deixaram algumas regiões sem energia elétrica até este domingo (10).

É o caso do setor Centro Oeste, onde cerca de 400 moradores estão sem luz. No bairro, a chuva derrubou quatro postes da rede elétrica e uma árvore na Avenida Bernardo Sayão com a Rua Senador Jaime.

<https://www.opopular.com.br/noticias/cidades/ap%C3%B3s-mais-de-24-horas-energia-%C3%A9-restabelecida-em-goi%C3%A2nia-1.1929801>

**O Popular** 62 99995 2795 BUSCAR 3 ALEXANDRE

CAPA POLÍTICA ECONOMIA MUNDO CIDADES ESPORTE MAGAZINE LUDOVICA OPINIÃO ESPECIAIS VÍDEOS INFOCOMERCIAL GUIAS

**CIDADES**

**Após mais de 24 horas, energia é restabelecida em Goiânia**

Temporal, na tarde do último sábado (9), derrubou uma árvore e atingiu quatro postes

11/11/2019 - 11:58



Funcionários da Enel realizando os reparos na rede elétrica (Foto: Divulgação/Enel)

A energia no Setor Centro Oeste, em Goiânia, foi restabelecida, na noite deste domingo (10). Um temporal na tarde de sábado (9) derrubou uma árvore sobre a rede elétrica, quebrou quatro postes e danificou um transformador na Avenida

<https://g1.globo.com/go/goias/transito/noticia/2019/11/10/piloto-morre-e-garupa-fica-ferido-apos-moto-bater-em-arvore-caida-em-goiania.ghtml>



## Piloto morre e garupa fica ferido após moto bater em galho de árvore caído, em Goiânia

Investigações apontam que queda ocorreu durante chuva na Vila Jardim São Judas Tadeu.

Por Vanessa Martins, G1 GO

10/11/2019 11h18 - Atualizado há um mês



Moto bateu em árvore, piloto morreu no local e garupa ficou ferido — Foto: Divulgação/Dict

<https://globoplay.globo.com/v/8077974/>

globoplay Agora na Globo Novelas Séries Cinema Infantil Mais ▾

**JAI** TRANSTORNO NA AV. BERNARDO SAYÃO  
Queda de postes e árvores ainda reflete no trânsito

JA 1ª Edição >

### Postes caem após chuva e deixam comerciantes sem energia em Goiânia

4 min Exibição em 11 Nov 2019

Eles estão sem ter como abrir as lojas.



**MUNICÍPIO DE CALDAS NOVAS**

DECRETO Nº 1.774/2019

DE 31 DE OUTUBRO DE 2019.

**“DECLARA SITUAÇÃO DE EMERGÊNCIA EM  
RAZÃO DO TEMPORAL (ANTICLONE), NAS  
ÁREAS DO MUNICÍPIO DE CALDAS NOVAS,  
AFETADAS PELAS CHUVAS”**

**O PREFEITO DO MUNICÍPIO DE CALDAS NOVAS**, Estado de Goiás, no uso da competência e das atribuições que lhe conferem as Constituições da República e do Estado de Goiás, bem como a Lei Orgânica Municipal, e

**CONSIDERANDO** o caos instalado no Município em razão das chuvas acompanhadas das fortíssimas correntes de ventos na tarde do dia 27 (vinte e sete) de outubro de 2019, mais precisamente por volta das 16h (dezesesseis horas);

**CONSIDERANDO** o registro de índice pluviométrico muito superior ao habitual, com fortíssimas correntes de ventos, causando inúmeros prejuízos humanos e materiais ao município, em residências, em estabelecimentos comerciais, prédios, equipamentos públicos e hospitais;

**CONSIDERANDO** que as intempéries acarretaram uma série de problemas e danos em diversas regiões rurais, com a ocorrência de grande número de queda de árvores nas redes elétricas; o que causou diversas perdas, partindo cabos elétricos;

**CONSIDERANDO** ainda, os danos causados na zona urbana do município, como danos às calçadas, destelhamento de residências, destruição de fachadas de prédios comerciais e públicos;

**CONSIDERANDO** por fim que, de acordo com os serviços de meteorologia a cidade de Caldas Novas foi atingida por um anticiclone, com chuva de granizo, com ventos de mais de 100km/h, causando danos em vários bairros e assustando toda a população e os turistas.

**DECRETA:**

**Art. 1º.** Fica Decretada situação de emergência e estado de calamidade pública no município entre os dias 27 de outubro de 2019 à 15 de novembro de 2019.

**Art. 2º.** Autoriza-se a mobilização de todos os órgãos municipais para atuarem sob a coordenação do Órgão Municipal de Proteção e Defesa Civil, nas ações de resposta aos danos e reabilitação do cenário e reconstrução.

**Art. 3º.** Este Decreto entrará em vigor na data de sua publicação, para que surta todos os seus jurídicos e legais efeitos.

**Cumpra-se e Publique-se.**

GABINETE DO PREFEITO DE CALDAS NOVAS-GO, aos trinta e um dias do mês de outubro de 2019.

  
**EVANDO MAGAL ABADIA CORREIA SILVA**  
Prefeito de Caldas Novas/GO