

Resumo Executivo

O Presente Relatório tem como objetivo a incorporação de informações que sejam relevantes para que se possa fazer a devida associação aos dados contidos no corpo do documento objeto da classificação de Situação de Emergência caracterizada pelo Módulo 8 do Prodist, que tem como foco o impacto do evento sobre determinada rede geelétrica e cuja denominação é definida como CHI (Consumidor hora interrompido). O parâmetro para enquadramento nesta classificação de expurgo tem como premissa inicial o limite de Consumidor hora interrompido definido pela fórmula descrita no Módulo 01 do Prodist (Revisão - 9), acrescido de todos os outros informes e dados listados no Módulo 08 (Revisão 10) do Prodist. Este enquadramento se apresenta na maioria das vezes em condições climáticas adversas com severidade dos fatores inerentes a situação, caracterizado na maioria dos casos por fortes ventos e chuvas de grande intensidade e continuidade.

Entre o dia 14/11/2019 – quinta-feira – e a madrugada de 20/11/2019 – quarta-feira - Houveram áreas de instabilidade organizadas pela presença de uma frente fria, que avançaram sobre o continente e ajudaram a organizar áreas de instabilidade sobre as Regiões da Enel Distribuição Goiás.

Conforme informações do Climatempo Meteorologia, o Instituto Nacional de Meteorologia (INMET) detectou rajadas de vento acima de 50km/h durante o período. A máxima rajada registrada foi de 104,8km/h, sendo esse vento classificado como vento tempestade violenta pela escala Beaufort.

Entre as 06h30 do dia 14 e 02h30 do dia 21 de novembro de 2019 tivemos, em todo o Estado de Goiás, a incidências de 35.944 descargas atmosféricas (55.156 raios nuvem-solo e 92.806 descargas nuvem-nuvem) sobre a região, o que causou grande instabilidade na rede.

Temporal arranca telhado de fábrica e deixa dois funcionários feridos, em Itumbiara - Chuva também fez com que motos fossem arrastadas pela correnteza da água e causou a quedas de árvores. Instituto Nacional de Meteorologia alerta a população para ventos fortes até o início da tarde deste sábado. Acesso em: <https://g1.globo.com/go/goias/noticia/2019/11/15/temporal-arranca-telhado-de-fabrica-e-deixa-dois-funcionarios-feridos-em-itumbiara.ghtml/>

Chuva com vento forte derruba árvores e até o teto de um galpão em Goiás - Cerca de sete árvores caíram em Goiânia. Acesso em: <https://globoplay.globo.com/v/8088745/>

Cobertura de galpão industrial desaba durante temporal em Itumbiara - Goiânia - A chuva forte que caiu na tarde desta quinta-feira (14/11), em Itumbiara provocou transtornos na cidade.

Acesso em: <https://www.aredacao.com.br/noticias/126432/cobertura-de-galpao-industrial-desaba-durante-temporal-em-itumbiara>

Forte chuva destelha galpões e derruba barracão de empresa, em Itumbiara – Nesta sexta-feira de feriado (15/11), de acordo com a meteorologia, o dia será nublado a encoberto com pancadas de chuva e trovoadas isoladas na região Sul de Goiás.

Acesso em: https://diaonline.ig.com.br/2019/11/15/forte-huva-destelha-galpoes-e-derruba-barracao-de-empresa-em-itumbiara/?utm_source=Thy%C3%A9len+Lorruama&utm_campaign=diaonline-author

Relatório de Ocorrências do período

Em todo o Estado de Goiás verificou-se também que a intensidade da chuva e dos ventos danificaram a rede de distribuição de energia elétrica em diversos pontos, registrando aproximadamente 980 mil clientes com interrupção no fornecimento de energia elétrica devido a eventos relacionados ao temporal.

Para otimizar o volume de atendimentos e reduzir os tempos de interrupção foram mobilizados os recursos extras da empresa que aumentou o contingente em relação a situação normal de operação. O acompanhamento da quantidade de equipes e o Tempo Médio de Atendimento podem ser consultados na Pág.02 do Relatório em anexo.

O impacto e severidade do evento estão relatados em artigos de mídia, como fotos e reportagens que demonstram os danos na Rede de Distribuição, oriundos dos eventos climáticos no período. Eventos estes que afetaram 980.396 consumidores com CHI de 3.354.086,30 superior ao de 482.391,86 estabelecido como limite para definição de Situação de Emergência, conforme resumo das informações obrigatórias.

Empresa	ENEL DISTRIBUIÇÃO GOIÁS		
Código do Relatório	CHI-024 - ENEL DISTRIBUIÇÃO GOIÁS		
Evento:	TEMPORAL NA AREA DE CONCESSÃO DA ENEL DISTRIBUIÇÃO GOIAS		
Código COBRADE:	1.3.2.1.2, 1.3.2.1.3 e 1.3.2.1.5	Data Início	14/11/2019
Código do Evento:	CHI-024-ENEL GO	Data Término	21/11/2019
Valor CHI (Limite e Real)	482.391,86		3.354.086,30
Código do Decreto (Se Houver):			
Quantidade de Interrupções (Evento)	11.741		
Início 1ª Incidência (Data e Hora)	14/11/2019 06:51	Subestações Atingidas	<p>ABADIANA / ABC / ACREUNA / ADELANDIA / AEROPORTO / AGUA LIMPA (MARZAGAO) / AGUAS LINDAS / ALEXANIA / ALEXANIA TRANSMISSAO / ALMERINDONOPOLIS / ALOANDIA / ALPHAVILLE / ALTO BURITI / ALTO PARAISO DE GOIAS / ALVORADA DO NORTE / AMERICANO (RIO VERDE) / AMERICANO DO BRASIL / AMORINOPOLIS / ANAPOLIS UNIVERSITARIA / ANHANGUERA / ANICUNS / ANTONIO DO VITTO / APARECIDA DO RIO DOCE / APORE / ARACU / ARAGARCAS / ARAGOIANIA / ARAGUAPAZ / ARARAS / AREIAS / ARENOPOLIS / ARUANA / ARUANA (TRANSMISSAO) / ASA BRANCA / ATLANTICO / AURILANDIA / AVELINOPOLIS / BACURI (RIO VERDE) / BARBOSELANDIA / BARCELONA / BARREIRO (PORANGATU) / BARRO ALTO / BELA VISTA (TRANSMISSAO) / BOA VISTA / BOM JARDIM / BOM JESUS DE GOIAS / BONFINOPOLIS / BONITO / BONOPOLIS / BONSUCESSO (RIO VERDE) / BRAZABRANTES / BRITANIA / BRITANIA (TRANSMISSAO) / BURITI ALEGRE / BURITI DE GOIAS / CABECEIRAS / CABRIUVA (RIO VERDE) / CACHOEIRA ALTA / CACHOEIRA DOURADA / CACHOEIRA NOVA / CACHOEIRINHA (ITARUMA) / CACU / CAIAPONIA / CALCILANDIA / CALDAS NOVAS / CALDAZINHA / CAMPESTRE / CAMPINAS / CAMPINORTE / CAMPO ALEGRE DE GOIAS / CAMPO LIMPO DE GOIAS / CAMPO NOVO / CAMPOS BELOS / CAMPOS VERDES / CARAIBAS / CARAJAS / CASTELANDIA / CATALAO / CATURAI / CEBRASA FABRICA DA AMBEV / CEMAT/BALIZA / CEPAIGO / CEZARINA / CHAPADAO DO CEU / CIDADE ECLETICA / CIDADE OCIDENTAL / COCALZINHO / COLINACU / CORREGO DO OURO / CORUMBA / CORUMBAIBA / CRISTALINA / CRISTALINA TRANSMISSAO / CRISTIANOPOLIS / CRIXAS / CROMINIA / CUMARI / DAIA - ANAPOLIS / DAMOLANDIA / DAVINOPOLIS / DESFECHO / DESTILARIA ALTO PARAISO / DESTILARIA BRASIL CENTRAL / DIMIC / DIORAMA / DORCELINO PEIXOTO DE MORAES / DOVERLANDIA / EDEALINA / EDEIA / ENERSUL / ESTANIFERA / ESTRELA DO NORTE / FAINA / FAZENDA CANADA / FAZENDA NOVA / FERROVIARIO / FIRMINOPOLIS / FLORES DE GOIAS / FORMIGA / FORMOSO / FRONTEIRA / GAMELEIRA / GIRASSOL / GOIANAPOLIS / GOIANDIRA / GOIANESIA / GOIANIA LESTE / GOIANIRA / GOIAS / GOIATUBA / GOUVERLANDIA / GOYA / GUAPO / HEITORAI / HIDROLANDIA / HIDROLINA / IACIARA / INACIOLANDIA / INDEPENDENCIA / INDIARA / INHUMAS / IPAMERI / IPEGUARI / IPORA / ISRAELANDIA / ITABERAI / ITAGUARI / ITAGUARU / ITAJA / ITAPACI / ITAPACI (TRANSMISSAO) / ITAPIRAPUA / ITAPURANGA / ITARUMA / ITAUCU / ITUIQUIRA (FORMOSA) / ITUMBIARA NOVA / ITUMBIARA VELHA / JACILANDIA / JANDAIA / JARAGUA / JARANAPOLIS / JATAI / JAUPACI / JESUPOLIS / JOVIANIA / JUNDIAI / JURUMIRIM / JUSCELANDIA / JUSSARA / LAGES / LAGOA DA SERRA / LAGOA DO BAUZINHO (RIO VERDE) / LEOPOLDO DE BULHOES / LUZIANIA / LUZIANIA INDUSTRIAL / MAIRIPOTABA / MAMBAI / MARA ROSA / MARAJOARA / MARCIANOPOLIS / MARIAPOLIS (PADRE BERNARDO) / MARZAGAO / MATO GRANDE / MATRINCHA / MAURILANDIA / MEIA PONTE / MINACU / MINEIROS / MOIPORA / MONTE ALEGRE / MONTES CLAROS DE GOIAS / MONTIVIDIU T / MORRINHOS / MORRO AGUDO / MOSSAMEDES / MOZARLANDIA / MOZARLANDIA (TRANSMISSAO) / MUNDO NOVO DE GOIAS / MUTUNOPOLIS / NAVESLANDIA (JATAI) / NAZARIO / NEROPOLIS / NIQUELANDIA / NOVA AMERICA / NOVA AURORA / NOVA CRIXAS (TRANSMISSAO) / NOVA IGUACU / NOVA VENEZA / NOVO BRASIL / NOVO GAMA / NOVO PLANALTO / OLHOS DAGUA / OLOANA / ORIZONA / OURO VERDE DE GOIAS / OUVIDOR / PACAEMBU (NOVO GAMA) / PADRE BERNARDO / PALESTINA / PALMEIRAS / PALMEIRAS DE GOIAS / PALMELO / PALMINOPOLIS / PAMPLONA / PANAMA / PARANA / PARANAIBA / PARANAIGUARA / PARAUNA SE ALTA TENSÃO / PARQUE DAS EMAS (MINEIROS) / PARQUE DAS NACOES / PEROLANDIA / PETROLINA / PILAR / PILOANDIA / PIRACANJUBA / PIRANHAS T / PIRENOPOLIS / PIRES BELO / PIRES DO RIO / PLANALTINA / PLANALTINA (TRANSMISSAO) / PLANALTO / PONTALINA / PORANGATU / PORTEIRAO / PORTELANDIA / PORTO SAO SIMAO / POSSE / POSSELANDIA / PROFESSOR JAMIL / QUEBRA LINHA / QUIRINOPOLIS / REAL / RETIRO / GOIAS / RIO CLARO / JATAI MONTIVIDIU / RIO DO PEIXE / RIO DOS BOIS (MAURILANDIA) / RIO PRETO / RIO QUENTE / RIO VERDE / RIO VERMELHO / RIVERLANDIA (RIO VERDE) / ROCHEDO (UEH) / RUBIATABA / SANCLERLANDIA / SANTA BARBARA / SANTA FE DE GOIAS / SANTA HELENA / SANTA RITA DO ARAGUAIA / SANTA ROSA / SANTA ROSA DE GOIAS / SANTA ROSA DO MEIA PONTE / SANTA TEREZA DE GOIAS / SANTA TEREZINHA / SANTO ANTONIO DA BARRA / SANTO ANTONIO DE GOIAS / SANTO ANTONIO DO DESCOBERTO / SAO BARTOLOMEU / SAO DOMINGOS / SAO FRANCISCO DE GOIAS / SAO GABRIEL DE GOIAS / SAO JOAO D ALIANCA / SAO JOAO DA PARAUNA / SAO JUDAS TADEU / SAO LUIZ DOS MONTES BELOS / SAO MIGUEL DO ARAGUAIA / SAO MIGUEL DO PASSA QUATRO / SAO SIMAO / SENADOR CANEDO TRANSMISSAO / SERRA AZUL (JATAI) / SERRA DE CALDAS / SERRANOPOLIS / SILVANIA / SITIO DABADIA / SOUZALANDIA / SUCURI / TAIOBA / TAQUARAL / TAQUARI / TEREZOPOLIS / TERRA VERMELHA / TRAJANOPOLIS (PADRE BERNARDO) / TRES BARRAS / TRES RANCHOS / TRINDADE / TUCUNARE / TURVANIA / TURVELANDIA / URU / URUACU / URUTAI / USINA DE ACUCAR DE GOIANESIA / USINA MAMBAI / VALPARAISO / VARIAO / VENDA SECA / VIANOPOLIS / VICENTINOPOLIS / VILA BOA / VILA CORUMBA / VILA PROPICIO / XAVANTES / XIXA / ZELANDIA</p>
Início Ultima Incidência (Data e Hora)	21/11/2019 08:59	Municípios Atingidos	<p>ABADIA DE GOIAS / ABADIANA / ACREUNA / ADELANDIA / AGUA FRIA DE GOIAS / AGUA LIMPA / AGUAS LINDAS DE GOIAS / ALEXANIA / ALOANDIA / ALTO HORIZONTE / ALTO PARAISO DE GOIAS / ALVORADA DO NORTE / AMARALINA / AMERICANO DO BRASIL / AMORINOPOLIS / ANAPOLIS / ANHANGUERA / ANICUNS / APARECIDA DE GOIANIA / APARECIDA DO RIO DOCE / APORE / ARACU / ARAGARCAS / ARAGOIANIA / ARAGUAPAZ / ARENOPOLIS / ARUANA / AURILANDIA / AVELINOPOLIS / BALIZA / BARRO</p>
Média de Duração das Incidências (h)	11,77		
Duração da Incidência mais longa (h)	159,46		

Total de Clientes afetados	980.396	ALTO / BELA VISTA DE GOIAS / BOM JARDIM DE GOIAS / BOM JESUS DE GOIAS / BONFINOPOLIS / BONOPOLIS / BRAZABRANTES / BRITANIA / BURITI ALEGRE / BURITI DE GOIAS / BURITINOPOLIS / CABECEIRAS / CACHOEIRA ALTA / CACHOEIRA DE GOIAS / CACHOEIRA DOURADA / CACU / CAIAPONIA / CALDAS NOVAS / CALDAZINHA / CAMPESTRE DE GOIAS / CAMPINACU / CAMPINORTE / CAMPO ALEGRE DE GOIAS / CAMPO LIMPO / CAMPOS BELOS / CAMPOS VERDES / CASTELANDIA / CATALAO / CATURAI / CAVALCANTE / CERES / CEZARINA / CHAPADAO DO CEU / CIDADE OCIDENTAL / COCALZINHO DE GOIAS / COLINAS DO SUL / CORREGO DO OURO / CORUMBA DE GOIAS / CORUMBAIBA / CRISTALINA / CRISTIANOPOLIS / CRIXAS / CROMINIA / CUMARI / DAMIANOPOLIS / DAMOLANDIA / DAVINOPOLIS / DIORAMA / DISTRITO FEDERAL / DIVINOPOLIS DE GOIAS / DOVERLANDIA / EDEALINA / EDEIA / ESTRELA DO NORTE / FAINA / FAZENDA NOVA / FIRMINOPOLIS / FLORES DE GOIAS / FORMOSA / FORMOSO / GAMELEIRA DE GOIAS / GOIANAPOLIS / GOIANDIRA / GOIANESIA / GOIANIA / GOIANIRA / GOIAS / GOIATUBA / GOUVELANDIA / GUAPO / GUARAITA / GUARANI DE GOIAS / GUARINOS / HEITORAI / HIDROLANDIA / HIDROLINA / IACIARA / INACIOLANDIA / INDIARA / INHUMAS / IPAMERI / IPORA / ISRAELANDIA / ITABERAI / ITAGUARI / ITAGUARU / ITAJA / ITAPACI / ITAPIRAPUA / ITAPURANGA / ITARUMA / ITAUCU / ITUMBIARA / IVOLANDIA / JANDAIA / JARAGUA / JATAI / JAUPACI / JESUPOLIS / JOVIANIA / JUSSARA / LAGOA SANTA / LEOPOLDO DE BULHOES / LUZIANIA / MAIRIPOTABA / MAMBAI / MARA ROSA / MARZAGAO / MATRINCHA / MAURILANDIA / MIMOSO DE GOIAS / MINACU / MINEIROS / MOIPORA / MONTE ALEGRE DE GOIAS / MONTES CLAROS DE GOIAS / MONTIVIDIU / MONTIVIDIU DO NORTE / MORRINHOS / MORRO AGUDO DE GOIAS / MOSSAMEDES / MOZARLANDIA / MUNDO NOVO DE GOIAS / MUTUNOPOLIS / NAZARIO / NEROPOLIS / NIQUELANDIA / NOVA AMERICA / NOVA AURORA / NOVA CRIXAS / NOVA GLORIA / NOVA IGUACU DE GOIAS / NOVA ROMA / NOVA VENEZA / NOVO BRASIL / NOVO GAMA / NOVO PLANALTO / ORIZONA / OURO VERDE DE GOIAS / OUIDOR / PADRE BERNARDO / PALESTINA DE GOIAS / PALMEIRAS DE GOIAS / PALMELO / PALMINOPOLIS / PANAMA / PARANAIGUARA / PARAUNA / PEROLANDIA / PETROLINA DE GOIAS / PILAR DE GOIAS / PIRACANJUBA / PIRANHAS / PIRENOPOLIS / PIRES DO RIO / PLANALTINA / PONTALINA / PORANGATU / PORTEIRAO / PORTELANDIA / POSSE / PROFESSOR JAMIL SAFADY / QUIRINOPOLIS / RIALMA / RIO QUENTE / RIO VERDE / RUBIATABA / SANCLERLANDIA / SANTA BARBARA DE GOIAS / SANTA CRUZ DE GOIAS / SANTA FE DE GOIAS / SANTA HELENA DE GOIAS / SANTA ISABEL / SANTA RITA DO ARAGUAIA / SANTA RITA DO NOVO DESTINO / SANTA ROSA DE GOIAS / SANTA TEREZA DE GOIAS / SANTA TEREZINHA DE GOIAS / SANTO ANTONIO DA BARRA / SANTO ANTONIO DE GOIAS / SANTO ANTONIO DO DESCOBERTO / SAO DOMINGOS / SAO FRANCISCO DE GOIAS / SAO JOAO D ALIANCA / SAO JOAO DA PARAUNA / SAO LUIS DE MONTES BELOS / SAO LUIZ DO NORTE / SAO MIGUEL DO ARAGUAIA / SAO MIGUEL DO PASSA QUATRO / SAO SIMAO / SENADOR CANEDO / SERRANOPOLIS / SILVANIA / SIMOLANDIA / SITIO D ABADIA / TAQUARAL DE GOIAS / TERESINA DE GOIAS / TEREZOPOLIS DE GOIAS / TRES RANCHOS / TRINDADE / TROMBAS / TURVANIA / TURVELANDIA / UIRAPURU / URUACU / URUANA / URUTAI / VALPARAISO DE GOIAS / VARJAO / VIANOPOLIS / VICENTINOPOLIS / VILA BOA / VILA PROPICIO
-----------------------------------	---------	---

DANOS CAUSADOS			
Equipamentos Danificado	Importância para o Sistema	Local	Quantidade
Disjuntor/Religador Operado	Proteção do Alimentador	Área de Concessão	311
Chaves Fusíveis Operada	Proteção de Ramais de Alimentadores	Área de Concessão	3098
Transformador Operado	Proteção do Transformador	Área de Concessão	2712

Relato técnico sobre a Intervenção realizada em Goiânia e Região Metropolitana									
Informações sobre Equipes	14/11	15/11	16/11	17/11	18/11	19/11	20/11	21/11	
Quantidade Usual	530	530	530	530	530	530	530	530	turmas
Quantidade Adicional	90	22	0	0	83	154	141	224	turmas
Quantidade Total	620	552	528	405	613	684	671	754	turmas
Tempos Médios									
Preparação	11,54	11,90	9,66	8,64	9,79	8,99	8,65	6,82	Horas
Deslocamento	0,70	0,69	0,72	0,78	0,74	0,73	0,77	0,77	Horas
Execução	3,01	2,25	1,58	1,63	1,78	1,60	1,38	1,63	Horas
TMAE	15,26	14,85	11,97	11,05	12,32	11,32	10,79	9,22	Horas

Principais Dificuldades Encontradas:

Chuvas com ventos fortes provocaram muitos pontos de alagamento e enxurrada, trânsito impedido por vários semáforos desligados dificultando a chegada ao atendimento das ocorrências emergenciais. Em determinadas regiões, decorrente dos fortes ventos, houve o tombamento de árvores nas estruturas de alimentação de média tensão, danos em ramais de ligação dos clientes, impedimentos de acesso e atolamentos em estradas rurais.

Empresa	ENEL DISTRIBUIÇÃO GOIAS		
Valor CHI (Limite e Real)	482.391,86		3.354.086,30

DOC ORIGEM	MIUNICIPIO	EQP_ORIGEM	CONJUNTO	INI_OCORRENC	FIM_OCORRENC	DT_INI_EVENTO	DT_FIM_EVENTO	DURAÇ	UC INT	CHI	EXPURGO
20191169712	BOM JESUS DE GOIAS	BJ12000300	BOM JESUS DE GOIAS	14/11/2019 10:26	17/11/2019 11:01	14/11/2019 10:26	15/11/2019 19:33	33,11	3	99,33	CHI
20191169712	BOM JESUS DE GOIAS	BJ12000300	BOM JESUS DE GOIAS	14/11/2019 10:26	17/11/2019 11:01	15/11/2019 19:34	17/11/2019 11:01	39,45	3	118,35	CHI
20191194853	BOM JESUS DE GOIAS	BJ13000018	BOM JESUS DE GOIAS	15/11/2019 08:18	15/11/2019 18:18	15/11/2019 08:18	15/11/2019 15:51	7,56	43	324,90	CHI
20191194853	QUIRINOPOLIS	BJ13000018	BOM JESUS DE GOIAS	15/11/2019 08:18	15/11/2019 18:18	15/11/2019 08:18	15/11/2019 15:51	7,56	6	45,33	CHI
20191194853	BOM JESUS DE GOIAS	BJ12000088RE	BOM JESUS DE GOIAS	15/11/2019 08:18	15/11/2019 18:18	15/11/2019 08:18	15/11/2019 17:10	8,87	10	88,73	CHI
20191194853	GOIATUBA	BJ12000088RE	BOM JESUS DE GOIAS	15/11/2019 08:18	15/11/2019 18:18	15/11/2019 08:18	15/11/2019 17:10	8,87	45	399,27	CHI
20191194853	BOM JESUS DE GOIAS	BJ12000110LD	BOM JESUS DE GOIAS	15/11/2019 08:18	15/11/2019 18:18	15/11/2019 08:18	15/11/2019 18:18	10,00	8	80,00	CHI
20191194853	GOIATUBA	BJ12000110LD	BOM JESUS DE GOIAS	15/11/2019 08:18	15/11/2019 18:18	15/11/2019 08:18	15/11/2019 18:18	10,00	49	490,01	CHI
201911106483	BOM JESUS DE GOIAS	BJ12389738	BOM JESUS DE GOIAS	14/11/2019 06:57	15/11/2019 08:35	14/11/2019 06:57	15/11/2019 08:35	25,63	7	179,38	CHI
201911106483	GOIATUBA	BJ12389738	BOM JESUS DE GOIAS	14/11/2019 06:57	15/11/2019 08:35	14/11/2019 06:57	15/11/2019 08:35	25,63	5	128,13	CHI
201911122486	RIO VERDE	RV12213283LD	MONTIVIDIU T	17/11/2019 13:32	18/11/2019 16:25	17/11/2019 13:32	18/11/2019 16:25	26,87	50	1343,37	CHI
201911138020	RIO VERDE	RV21271514	CABRIUVA S2	14/11/2019 15:12	15/11/2019 10:52	14/11/2019 15:12	15/11/2019 10:52	19,65	1	19,65	CHI
201911138033	JUSSARA	JR12341198	JUSSARA	15/11/2019 11:03	16/11/2019 07:40	15/11/2019 11:03	16/11/2019 07:40	20,61	7	144,25	CHI
201911138081	PROFESSOR JAMIL SAFADY	JS21129278	ROCHEDO	14/11/2019 06:51	14/11/2019 16:14	14/11/2019 06:51	14/11/2019 16:14	9,38	2	18,76	CHI
201911139120	IPAMERI	IP12275536	CAMPO ALEGRE DE GOIAS	14/11/2019 07:42	15/11/2019 08:01	14/11/2019 07:42	15/11/2019 08:01	24,31	9	218,76	CHI
201911139150	CORUMBAIBA	CI21392081	VILA CORUMBA	14/11/2019 07:49	14/11/2019 16:22	14/11/2019 07:49	14/11/2019 16:22	8,54	1	8,54	CHI
201911139306	ORIZONA	OZ21200134	PIRES DO RIO S2	14/11/2019 07:53	14/11/2019 12:03	14/11/2019 07:53	14/11/2019 12:03	4,16	1	4,16	CHI
201911139426	ITUMBIARA	IT12222568	PARANAIBA	14/11/2019 17:30	16/11/2019 15:50	14/11/2019 17:30	16/11/2019 15:50	46,32	24	1111,71	CHI
201911139901	CAMPO ALEGRE DE GOIAS	CM21103634	CAMPO ALEGRE DE GOIAS	14/11/2019 08:07	18/11/2019 16:36	14/11/2019 08:07	18/11/2019 16:36	104,47	2	208,94	CHI
201911140303	EDEIA	1120036164	EDEIA	14/11/2019 08:13	14/11/2019 14:12	14/11/2019 08:13	14/11/2019 14:12	5,97	1	5,97	CHI
201911140309	CATALAO	CT12267145	CATALAO S1	14/11/2019 07:18	14/11/2019 11:33	14/11/2019 07:18	14/11/2019 11:33	4,24	12	50,87	CHI
201911140351	CACHOEIRA DOURADA	CD12000007RE	CACHOEIRA DOURADA	14/11/2019 07:35	19/11/2019 09:22	14/11/2019 07:35	19/11/2019 07:47	120,20	24	2884,83	CHI
201911140351	ITUMBIARA	CD12000007RE	CACHOEIRA DOURADA	14/11/2019 07:35	19/11/2019 09:22	14/11/2019 07:35	19/11/2019 07:47	120,20	26	3125,23	CHI
201911140351	CACHOEIRA DOURADA	CD12000007RE	CACHOEIRA DOURADA	14/11/2019 07:35	19/11/2019 09:22	14/11/2019 07:35	19/11/2019 09:22	121,78	3	365,34	CHI
201911142207	CALDAS NOVAS	CN11103231	SERRA DE CALDAS	14/11/2019 07:23	14/11/2019 10:56	14/11/2019 07:23	14/11/2019 10:56	3,54	116	410,54	CHI
201911142238	CATALAO	CT21127856	CATALAO S1	14/11/2019 08:51	14/11/2019 16:10	14/11/2019 08:51	14/11/2019 16:10	7,32	1	7,32	CHI
201911142252	PIRES DO RIO	460006708	PIRES DO RIO S1	14/11/2019 08:55	15/11/2019 07:31	14/11/2019 08:55	15/11/2019 07:31	22,60	1	22,60	CHI
201911143001	PIRES DO RIO	PR12337227	PIRES DO RIO S1	14/11/2019 08:05	14/11/2019 17:20	14/11/2019 08:05	14/11/2019 17:20	9,24	39	360,38	CHI
201911143001	SANTA CRUZ DE GOIAS	PR12337227	PIRES DO RIO S1	14/11/2019 08:05	14/11/2019 17:20	14/11/2019 08:05	14/11/2019 17:20	9,24	1	9,24	CHI
201911143001	URUTAI	PR12337227	PIRES DO RIO S1	14/11/2019 08:05	14/11/2019 17:20	14/11/2019 08:05	14/11/2019 17:20	9,24	1	9,24	CHI
201911143046	CATALAO	1990107166	CATALAO S2	14/11/2019 09:05	14/11/2019 15:36	14/11/2019 09:05	14/11/2019 15:36	6,51	1	6,51	CHI
201911143104	PORANGATU	PO12027986	PORANGATU	14/11/2019 17:20	15/11/2019 13:44	14/11/2019 17:20	15/11/2019 13:44	20,41	22	448,97	CHI

201911144901	GOIANDIRA	GD12377002	CATALAO S1	14/11/2019 09:12	14/11/2019 16:28	14/11/2019 09:12	14/11/2019 16:28	7,26	74	537,16	CHI
201911145624	CATALAO	CT11032136	CATALAO S2	14/11/2019 09:24	14/11/2019 12:27	14/11/2019 09:24	14/11/2019 12:27	3,04	24	73,05	CHI
201911145634	PANAMA	PX12378952	GOIATUBA S1	14/11/2019 09:26	17/11/2019 15:36	14/11/2019 09:26	17/11/2019 15:36	78,17	3	234,51	CHI
201911147207	CALDAS NOVAS	10029535210	SERRA DE CALDAS	14/11/2019 09:40	14/11/2019 11:30	14/11/2019 09:40	14/11/2019 11:30	1,82	1	1,82	CHI
201911147424	GOIATUBA	GT21389720	GOIATUBA S2	14/11/2019 09:45	14/11/2019 12:13	14/11/2019 09:45	14/11/2019 12:13	2,46	1	2,46	CHI
201911147906	PIRACANJUBA	PJ12209123	PIRACANJUBA	14/11/2019 09:52	14/11/2019 16:25	14/11/2019 09:52	14/11/2019 16:25	6,54	141	921,63	CHI
201911147918	MORRINHOS	MR11250083	GOIATUBA S1	14/11/2019 09:54	15/11/2019 17:47	14/11/2019 09:54	15/11/2019 17:47	31,87	1	31,87	CHI
201911147923	GOIATUBA	GT12044823	GOIATUBA S2	14/11/2019 09:40	15/11/2019 10:52	14/11/2019 09:40	15/11/2019 10:52	25,19	10	251,89	CHI
201911147923	MORRINHOS	GT12044823	GOIATUBA S2	14/11/2019 09:40	15/11/2019 10:52	14/11/2019 09:40	15/11/2019 10:52	25,19	8	201,51	CHI
201911148001	ORIZONA	OZ21199897	PIRES DO RIO S2	14/11/2019 10:00	14/11/2019 14:09	14/11/2019 10:00	14/11/2019 14:09	4,15	1	4,15	CHI
201911148327	ALOANDIA	7776890	GOIATUBA S1	14/11/2019 09:28	14/11/2019 12:10	14/11/2019 09:28	14/11/2019 12:10	2,69	3	8,06	CHI
201911148329	GOIATUBA	140075574	GOIATUBA S2	14/11/2019 10:06	14/11/2019 15:01	14/11/2019 10:06	14/11/2019 15:01	4,91	1	4,91	CHI
201911149346	CATALAO	1990285354	CATALAO S2	14/11/2019 10:23	14/11/2019 16:00	14/11/2019 10:23	14/11/2019 16:00	5,63	1	5,63	CHI
201911149362	URUTAI	UT21022343	URUTAI	14/11/2019 10:25	15/11/2019 19:50	14/11/2019 10:25	15/11/2019 19:50	33,41	1	33,41	CHI
201911149835	INDIARA	2710014331	EDEIA	14/11/2019 10:35	14/11/2019 14:21	14/11/2019 10:35	14/11/2019 14:21	3,77	1	3,77	CHI
201911149838	SANTO ANTONIO DO DESCOBERTO	2210070825	AGUAS LINDAS DE GOIAS S2	14/11/2019 10:35	14/11/2019 12:14	14/11/2019 10:35	14/11/2019 12:14	1,64	1	1,64	CHI
201911149848	INDIARA	2710003977	EDEIA	14/11/2019 10:37	14/11/2019 19:09	14/11/2019 10:37	14/11/2019 19:09	8,52	1	8,52	CHI
201911150102	IPAMERI	580027958	IPAMERI	14/11/2019 10:55	14/11/2019 16:58	14/11/2019 10:55	14/11/2019 16:58	6,04	1	6,04	CHI
201911150107	VALPARAISO DE GOIAS	10014488246	PACAEMBU S1	14/11/2019 10:57	14/11/2019 12:17	14/11/2019 10:57	14/11/2019 12:17	1,33	1	1,33	CHI
201911150215	NOVA CRIXAS	NA21251235	NOVA CRIXAS	14/11/2019 11:02	16/11/2019 11:30	14/11/2019 11:02	16/11/2019 11:30	48,46	1	48,46	CHI
201911150216	OUVIDOR	OU21215638	CATALAO S1	14/11/2019 11:02	14/11/2019 12:13	14/11/2019 11:02	14/11/2019 12:13	1,18	1	1,18	CHI
201911150242	NIQUELANDIA	NQ12359847	NIQUELANDIA SUBTRANSMISSAO	14/11/2019 11:10	15/11/2019 09:38	14/11/2019 11:10	15/11/2019 09:38	22,46	40	898,48	CHI
201911150259	INDIARA	IY21254046	EDEIA	14/11/2019 11:14	14/11/2019 15:45	14/11/2019 11:14	14/11/2019 15:45	4,52	1	4,52	CHI
201911150260	MINACU	IH21187830	MINACU	14/11/2019 11:14	14/11/2019 18:46	14/11/2019 11:14	14/11/2019 18:46	7,53	2	15,06	CHI
201911150274	IPAMERI	IP12197355	IPAMERI	14/11/2019 11:18	14/11/2019 16:21	14/11/2019 11:18	14/11/2019 16:21	5,05	5	25,23	CHI
201911150308	CATALAO	1990317057	CATALAO S2	14/11/2019 09:24	14/11/2019 15:30	14/11/2019 09:24	14/11/2019 15:30	6,10	1	6,10	CHI
201911150320	CORUMBAIBA	560028349	VILA CORUMBA	14/11/2019 11:28	14/11/2019 16:52	14/11/2019 11:28	14/11/2019 16:52	5,40	1	5,40	CHI
201911150348	ITUMBIARA	IT21062988	CACHOEIRA DOURADA	14/11/2019 11:35	14/11/2019 15:16	14/11/2019 11:35	14/11/2019 15:16	3,68	1	3,68	CHI
201911150375	IPORA	IR12380966	IPORA	15/11/2019 07:23	15/11/2019 11:00	15/11/2019 07:23	15/11/2019 11:00	3,62	5	18,10	CHI
201911150813	PALMELO	03540224	PIRES DO RIO S2	14/11/2019 10:25	14/11/2019 19:34	14/11/2019 16:27	14/11/2019 16:30	0,05	23	1,25	CHI
201911150813	PIRES DO RIO	03540224	PIRES DO RIO S2	14/11/2019 10:25	14/11/2019 19:34	14/11/2019 16:27	14/11/2019 16:30	0,05	33	1,80	CHI
201911150813	SANTA CRUZ DE GOIAS	03540224	PIRES DO RIO S2	14/11/2019 10:25	14/11/2019 19:34	14/11/2019 16:27	14/11/2019 16:30	0,05	4	0,22	CHI
201911150813	PALMELO	PZ12000507LD	PIRES DO RIO S2	14/11/2019 10:25	14/11/2019 19:34	14/11/2019 10:25	14/11/2019 19:34	9,15	43	393,44	CHI

201911150813	PIRES DO RIO	PZ12000507LD	PIRES DO RIO S2	14/11/2019 10:25	14/11/2019 19:34	14/11/2019 10:25	14/11/2019 19:34	9,15	12	109,80	CHI
201911150813	SANTA CRUZ DE GOIAS	PZ12000507LD	PIRES DO RIO S2	14/11/2019 10:25	14/11/2019 19:34	14/11/2019 10:25	14/11/2019 19:34	9,15	120	1097,97	CHI
201911150853	SANTA CRUZ DE GOIAS	450006475	PIRES DO RIO S2	14/11/2019 11:59	14/11/2019 15:43	14/11/2019 11:59	14/11/2019 15:43	3,72	1	3,72	CHI
201911150856	NOVO GAMA	10027548870	PACAEMBU S1	14/11/2019 12:00	14/11/2019 13:08	14/11/2019 12:00	14/11/2019 13:08	1,12	1	1,12	CHI
201911150880	ALTO HORIZONTE	AJ21210310	MARA ROSA	14/11/2019 12:07	16/11/2019 10:50	14/11/2019 12:07	16/11/2019 10:50	46,71	1	46,71	CHI
201911150883	CATALAO	CT12394029	CATALAO S1	14/11/2019 12:09	14/11/2019 15:00	14/11/2019 12:09	14/11/2019 15:00	2,85	8	22,79	CHI
201911150885	SANTO ANTONIO DO DESCOBERTO	SN12319997	ALEXANIA	14/11/2019 12:09	14/11/2019 14:02	14/11/2019 12:09	14/11/2019 14:02	1,87	238	445,26	CHI
201911150887	SAO MIGUEL DO ARAGUAIA	830005626	SAO MIGUEL DO ARAGUAIA	14/11/2019 12:11	14/11/2019 20:42	14/11/2019 12:11	14/11/2019 20:42	8,51	1	8,51	CHI
201911150888	CRIXAS	CX12322605	SERRA DO OURO	14/11/2019 12:11	14/11/2019 18:00	14/11/2019 12:11	14/11/2019 18:00	5,80	16	92,83	CHI
201911150899	SAO MIGUEL DO PASSA QUATRO	SQ12231382	CRISTIANOPOLIS	14/11/2019 11:33	14/11/2019 16:01	14/11/2019 11:33	14/11/2019 16:01	4,47	44	196,51	CHI
201911150909	BURITI ALEGRE	BG10400403	ITUMBIARA VELHA S2	14/11/2019 13:13	15/11/2019 22:00	14/11/2019 13:13	14/11/2019 17:55	4,71	79	371,91	CHI
201911150909	BURITI ALEGRE	BG10400403	ITUMBIARA VELHA S2	14/11/2019 13:13	15/11/2019 22:00	15/11/2019 00:16	15/11/2019 00:41	0,41	79	32,06	CHI
201911150909	BURITI ALEGRE	BG13000154	ITUMBIARA VELHA S2	14/11/2019 13:13	15/11/2019 22:00	14/11/2019 13:13	15/11/2019 10:37	21,40	11	235,42	CHI
201911150909	BURITI ALEGRE	BG10400403	ITUMBIARA VELHA S2	14/11/2019 13:13	15/11/2019 22:00	15/11/2019 15:40	15/11/2019 16:13	0,55	90	49,43	CHI
201911150909	BURITI ALEGRE	BG10400403	ITUMBIARA VELHA S2	14/11/2019 13:13	15/11/2019 22:00	15/11/2019 17:57	15/11/2019 18:28	0,51	90	46,05	CHI
201911150909	BURITI ALEGRE	BG13000154	ITUMBIARA VELHA S2	14/11/2019 13:13	15/11/2019 22:00	14/11/2019 13:13	15/11/2019 20:14	31,03	171	5305,70	CHI
201911150909	BURITI ALEGRE	BG12000137LD	ITUMBIARA VELHA S2	14/11/2019 13:13	15/11/2019 22:00	14/11/2019 13:13	15/11/2019 21:07	31,91	378	12061,35	CHI
201911150909	BURITI ALEGRE	BG12385714LD	ITUMBIARA VELHA S2	14/11/2019 13:13	15/11/2019 22:00	14/11/2019 13:13	15/11/2019 21:26	32,22	7	225,56	CHI
201911150909	BURITI ALEGRE	BG12203252	ITUMBIARA VELHA S2	14/11/2019 13:13	15/11/2019 22:00	14/11/2019 13:13	15/11/2019 21:45	32,55	184	5988,64	CHI
201911150909	BURITI ALEGRE	BG12000136	ITUMBIARA VELHA S2	14/11/2019 13:13	15/11/2019 22:00	14/11/2019 13:13	15/11/2019 22:00	32,78	5	163,91	CHI
201911150912	TRINDADE	TR11072664	TRINDADE	14/11/2019 13:31	14/11/2019 13:58	14/11/2019 13:31	14/11/2019 13:58	0,45	136	61,05	CHI
201911150920	CRISTIANOPOLIS	PJ10396076	PIRACANJUBA	14/11/2019 13:53	19/11/2019 10:41	14/11/2019 13:53	14/11/2019 22:24	8,53	5	42,64	CHI
201911150920	PIRACANJUBA	PJ10396076	PIRACANJUBA	14/11/2019 13:53	19/11/2019 10:41	14/11/2019 13:53	14/11/2019 22:24	8,53	42	358,18	CHI
201911150920	CRISTIANOPOLIS	PJ13067540	PIRACANJUBA	14/11/2019 13:53	19/11/2019 10:41	14/11/2019 13:53	14/11/2019 23:30	9,61	4	38,45	CHI
201911150920	PIRACANJUBA	PJ10396076	PIRACANJUBA	14/11/2019 13:53	19/11/2019 10:41	14/11/2019 13:53	14/11/2019 23:30	9,61	44	422,97	CHI
201911150920	PIRACANJUBA	PJ13067540	PIRACANJUBA	14/11/2019 13:53	19/11/2019 10:41	14/11/2019 13:53	14/11/2019 23:30	9,61	5	48,07	CHI
201911150920	SANTA CRUZ DE GOIAS	PJ10396076	PIRACANJUBA	14/11/2019 13:53	19/11/2019 10:41	14/11/2019 13:53	14/11/2019 23:30	9,61	1	9,61	CHI
201911150920	SANTA CRUZ DE GOIAS	PJ13067540	PIRACANJUBA	14/11/2019 13:53	19/11/2019 10:41	14/11/2019 13:53	14/11/2019 23:30	9,61	72	692,14	CHI
201911150920	CRISTIANOPOLIS	PJ10396076	PIRACANJUBA	14/11/2019 13:53	19/11/2019 10:41	14/11/2019 23:34	14/11/2019 23:38	0,05	5	0,27	CHI
201911150920	PIRACANJUBA	PJ10396076	PIRACANJUBA	14/11/2019 13:53	19/11/2019 10:41	14/11/2019 23:34	14/11/2019 23:38	0,05	42	2,28	CHI
201911150920	CRISTIANOPOLIS	PJ13067540	PIRACANJUBA	14/11/2019 13:53	19/11/2019 10:41	14/11/2019 23:34	18/11/2019 17:00	89,42	4	357,67	CHI
201911150920	PIRACANJUBA	PJ13067540	PIRACANJUBA	14/11/2019 13:53	19/11/2019 10:41	14/11/2019 23:34	18/11/2019 17:00	89,42	49	4381,47	CHI
201911150920	SANTA CRUZ DE GOIAS	PJ13067540	PIRACANJUBA	14/11/2019 13:53	19/11/2019 10:41	14/11/2019 23:34	18/11/2019 17:00	89,42	73	6527,50	CHI

201911150920	PIRACANJUBA	PJ10396076	PIRACANJUBA	14/11/2019 13:53	19/11/2019 10:41	14/11/2019 13:53	19/11/2019 10:41	116,81	15	1752,18	CHI
201911150920	SANTA CRUZ DE GOIAS	PJ10396076	PIRACANJUBA	14/11/2019 13:53	19/11/2019 10:41	14/11/2019 13:53	19/11/2019 10:41	116,81	33	3854,80	CHI
201911150923	ACREUNA	EU13111123	ACREUNA	14/11/2019 16:49	17/11/2019 22:36	14/11/2019 16:49	15/11/2019 09:50	17,01	61	1037,51	CHI
201911150923	SANTO ANTONIO DA BARRA	EU13111122	ACREUNA	14/11/2019 16:49	17/11/2019 22:36	14/11/2019 16:49	15/11/2019 12:00	19,17	1	19,17	CHI
201911150923	SANTO ANTONIO DA BARRA	BZ13338689	ACREUNA	14/11/2019 16:49	17/11/2019 22:36	14/11/2019 16:49	15/11/2019 12:55	20,09	9	180,84	CHI
201911150923	ACREUNA	01660414	ACREUNA	14/11/2019 16:49	17/11/2019 22:36	15/11/2019 16:53	15/11/2019 16:58	0,07	7	0,52	CHI
201911150923	PARAUNA	01660414	ACREUNA	14/11/2019 16:49	17/11/2019 22:36	15/11/2019 16:53	15/11/2019 16:58	0,07	157	11,56	CHI
201911150923	RIO VERDE	01660414	ACREUNA	14/11/2019 16:49	17/11/2019 22:36	15/11/2019 16:53	15/11/2019 16:58	0,07	96	7,07	CHI
201911150923	RIO VERDE	01660414	ACREUNA	14/11/2019 16:49	17/11/2019 22:36	15/11/2019 16:53	15/11/2019 16:58	0,07	24	1,77	CHI
201911150923	SANTA HELENA DE GOIAS	01660414	ACREUNA	14/11/2019 16:49	17/11/2019 22:36	15/11/2019 16:53	15/11/2019 16:58	0,07	83	6,11	CHI
201911150923	SANTO ANTONIO DA BARRA	01660414	ACREUNA	14/11/2019 16:49	17/11/2019 22:36	15/11/2019 16:53	15/11/2019 16:58	0,07	1631	120,06	CHI
201911150923	SANTO ANTONIO DA BARRA	01660414	ACREUNA	14/11/2019 16:49	17/11/2019 22:36	15/11/2019 16:53	15/11/2019 16:58	0,07	191	14,06	CHI
201911150923	RIO VERDE	01660414	SANTA HELENA S1	14/11/2019 16:49	17/11/2019 22:36	15/11/2019 16:53	15/11/2019 16:58	0,07	7	0,52	CHI
201911150923	SANTA HELENA DE GOIAS	01660414	SANTA HELENA S1	14/11/2019 16:49	17/11/2019 22:36	15/11/2019 16:53	15/11/2019 16:58	0,07	49	3,61	CHI
201911150923	SANTO ANTONIO DA BARRA	01660414	SANTA HELENA S1	14/11/2019 16:49	17/11/2019 22:36	15/11/2019 16:53	15/11/2019 16:58	0,07	21	1,55	CHI
201911150923	ACREUNA	01660414	ACREUNA	14/11/2019 16:49	17/11/2019 22:36	15/11/2019 17:14	15/11/2019 17:17	0,05	7	0,37	CHI
201911150923	PARAUNA	01660414	ACREUNA	14/11/2019 16:49	17/11/2019 22:36	15/11/2019 17:14	15/11/2019 17:17	0,05	157	8,29	CHI
201911150923	RIO VERDE	01660414	ACREUNA	14/11/2019 16:49	17/11/2019 22:36	15/11/2019 17:14	15/11/2019 17:17	0,05	98	5,17	CHI
201911150923	RIO VERDE	01660414	ACREUNA	14/11/2019 16:49	17/11/2019 22:36	15/11/2019 17:14	15/11/2019 17:17	0,05	24	1,27	CHI
201911150923	SANTA HELENA DE GOIAS	01660414	ACREUNA	14/11/2019 16:49	17/11/2019 22:36	15/11/2019 17:14	15/11/2019 17:17	0,05	83	4,38	CHI
201911150923	SANTO ANTONIO DA BARRA	01660414	ACREUNA	14/11/2019 16:49	17/11/2019 22:36	15/11/2019 17:14	15/11/2019 17:17	0,05	1631	86,08	CHI
201911150923	SANTO ANTONIO DA BARRA	01660414	ACREUNA	14/11/2019 16:49	17/11/2019 22:36	15/11/2019 17:14	15/11/2019 17:17	0,05	193	10,19	CHI
201911150923	RIO VERDE	01660414	SANTA HELENA S1	14/11/2019 16:49	17/11/2019 22:36	15/11/2019 17:14	15/11/2019 17:17	0,05	7	0,37	CHI
201911150923	SANTA HELENA DE GOIAS	01660414	SANTA HELENA S1	14/11/2019 16:49	17/11/2019 22:36	15/11/2019 17:14	15/11/2019 17:17	0,05	49	2,59	CHI
201911150923	SANTO ANTONIO DA BARRA	01660414	SANTA HELENA S1	14/11/2019 16:49	17/11/2019 22:36	15/11/2019 17:14	15/11/2019 17:17	0,05	21	1,11	CHI
201911150923	ACREUNA	01660414	ACREUNA	14/11/2019 16:49	17/11/2019 22:36	15/11/2019 17:18	15/11/2019 19:16	1,97	2	3,93	CHI
201911150923	PARAUNA	01660414	ACREUNA	14/11/2019 16:49	17/11/2019 22:36	15/11/2019 17:18	15/11/2019 19:16	1,97	157	308,64	CHI
201911150923	RIO VERDE	01660414	ACREUNA	14/11/2019 16:49	17/11/2019 22:36	15/11/2019 17:18	15/11/2019 19:16	1,97	98	192,65	CHI
201911150923	RIO VERDE	01660414	ACREUNA	14/11/2019 16:49	17/11/2019 22:36	15/11/2019 17:18	15/11/2019 19:16	1,97	1	1,97	CHI
201911150923	SANTO ANTONIO DA BARRA	01660414	ACREUNA	14/11/2019 16:49	17/11/2019 22:36	15/11/2019 17:18	15/11/2019 19:16	1,97	1630	3204,31	CHI
201911150923	SANTO ANTONIO DA BARRA	01660414	ACREUNA	14/11/2019 16:49	17/11/2019 22:36	15/11/2019 17:18	15/11/2019 19:16	1,97	25	49,15	CHI
201911150923	RIO VERDE	01660414	SANTA HELENA S1	14/11/2019 16:49	17/11/2019 22:36	15/11/2019 17:18	15/11/2019 21:39	4,35	3	13,05	CHI
201911150923	SANTA HELENA DE GOIAS	01660414	SANTA HELENA S1	14/11/2019 16:49	17/11/2019 22:36	15/11/2019 17:18	15/11/2019 21:39	4,35	40	174,02	CHI

201911150923	SANTA HELENA DE GOIAS	SH13191912	SANTA HELENA S1	14/11/2019 16:49	17/11/2019 22:36	15/11/2019 17:18	16/11/2019 18:45	25,45	9	229,03	CHI
201911150923	ACREUNA	01690224	ACREUNA	14/11/2019 16:49	17/11/2019 22:36	16/11/2019 15:27	16/11/2019 19:39	4,19	2	8,38	CHI
201911150923	RIO VERDE	01690224	ACREUNA	14/11/2019 16:49	17/11/2019 22:36	16/11/2019 15:27	16/11/2019 19:39	4,19	1	4,19	CHI
201911150923	SANTO ANTONIO DA BARRA	01690224	ACREUNA	14/11/2019 16:49	17/11/2019 22:36	16/11/2019 15:27	16/11/2019 19:39	4,19	26	108,98	CHI
201911150923	SANTO ANTONIO DA BARRA	01690224	ACREUNA	14/11/2019 16:49	17/11/2019 22:36	16/11/2019 18:13	16/11/2019 19:39	1,43	2	2,87	CHI
201911150923	RIO VERDE	01690224	ACREUNA	14/11/2019 16:49	17/11/2019 22:36	16/11/2019 15:27	16/11/2019 21:00	5,54	23	127,45	CHI
201911150923	SANTA HELENA DE GOIAS	01690224	ACREUNA	14/11/2019 16:49	17/11/2019 22:36	16/11/2019 15:27	16/11/2019 21:00	5,54	5	27,71	CHI
201911150923	SANTO ANTONIO DA BARRA	01690224	ACREUNA	14/11/2019 16:49	17/11/2019 22:36	16/11/2019 15:27	16/11/2019 21:00	5,54	143	792,38	CHI
201911150923	SANTO ANTONIO DA BARRA	BZ13159365	SANTA HELENA S1	14/11/2019 16:49	17/11/2019 22:36	15/11/2019 17:18	16/11/2019 21:18	28,01	1	28,01	CHI
201911150923	SANTA HELENA DE GOIAS	01690224	ACREUNA	14/11/2019 16:49	17/11/2019 22:36	16/11/2019 15:27	16/11/2019 22:30	7,04	4	28,17	CHI
201911150923	SANTO ANTONIO DA BARRA	01690224	ACREUNA	14/11/2019 16:49	17/11/2019 22:36	16/11/2019 15:27	16/11/2019 22:30	7,04	7	49,30	CHI
201911150923	SANTO ANTONIO DA BARRA	BZ12211442	SANTA HELENA S1	14/11/2019 16:49	17/11/2019 22:36	15/11/2019 17:18	17/11/2019 21:00	51,71	10	517,11	CHI
201911150923	RIO VERDE	BZ12327015LD	SANTA HELENA S1	14/11/2019 16:49	17/11/2019 22:36	15/11/2019 17:18	17/11/2019 22:36	53,30	4	213,19	CHI
201911150923	SANTO ANTONIO DA BARRA	BZ12327015LD	SANTA HELENA S1	14/11/2019 16:49	17/11/2019 22:36	15/11/2019 17:18	17/11/2019 22:36	53,30	10	532,98	CHI
201911150924	RIO VERDE	02450424	CABRIUVA S2	14/11/2019 14:06	14/11/2019 16:16	14/11/2019 14:06	14/11/2019 15:13	1,13	4	4,52	CHI
201911150924	RIO VERDE	RV13361146	CABRIUVA S2	14/11/2019 14:06	14/11/2019 16:16	14/11/2019 14:06	14/11/2019 16:16	2,17	2	4,34	CHI
201911150925	QUIRINOPOLIS	QI10400627	QUIRINOPOLIS	14/11/2019 14:07	15/11/2019 23:40	14/11/2019 14:07	14/11/2019 19:24	5,27	64	337,32	CHI
201911150925	QUIRINOPOLIS	QI10400627	QUIRINOPOLIS	14/11/2019 14:07	15/11/2019 23:40	14/11/2019 19:25	14/11/2019 23:36	4,19	34	142,48	CHI
201911150925	QUIRINOPOLIS	QI13303242	QUIRINOPOLIS	14/11/2019 14:07	15/11/2019 23:40	14/11/2019 19:25	15/11/2019 19:03	23,64	17	401,92	CHI
201911150925	QUIRINOPOLIS	QI13303243	QUIRINOPOLIS	14/11/2019 14:07	15/11/2019 23:40	14/11/2019 14:07	15/11/2019 23:10	33,04	13	429,47	CHI
201911150925	RIO VERDE	QI13303243	QUIRINOPOLIS	14/11/2019 14:07	15/11/2019 23:40	14/11/2019 14:07	15/11/2019 23:10	33,04	1	33,04	CHI
201911150925	QUIRINOPOLIS	QI12279796	QUIRINOPOLIS	14/11/2019 14:07	15/11/2019 23:40	14/11/2019 19:25	15/11/2019 23:40	28,25	13	367,24	CHI
201911150927	LUZIANIA	LZ12110889	RIO VERMELHO	14/11/2019 13:41	14/11/2019 16:38	14/11/2019 13:41	14/11/2019 16:38	2,95	7	20,63	CHI
201911150930	RIO VERDE	RV10400679	RIO VERDE S1	14/11/2019 14:32	18/11/2019 14:36	14/11/2019 14:32	14/11/2019 20:38	6,10	88	536,63	CHI
201911150930	RIO VERDE	RV10371479	RIO VERDE S1	14/11/2019 14:32	18/11/2019 14:36	15/11/2019 12:51	15/11/2019 19:34	6,71	51	342,39	CHI
201911150930	RIO VERDE	RV10371479	RIO VERDE S1	14/11/2019 14:32	18/11/2019 14:36	15/11/2019 12:51	15/11/2019 23:51	10,99	316	3473,81	CHI
201911150930	SANTA HELENA DE GOIAS	RV10371479	RIO VERDE S1	14/11/2019 14:32	18/11/2019 14:36	15/11/2019 12:51	15/11/2019 23:51	10,99	55	604,62	CHI
201911150930	RIO VERDE	RV10371479	RIO VERDE S1	14/11/2019 14:32	18/11/2019 14:36	15/11/2019 12:53	15/11/2019 23:51	10,96	1	10,96	CHI
201911150930	RIO VERDE	RV13271384	RIO VERDE S1	14/11/2019 14:32	18/11/2019 14:36	14/11/2019 14:32	18/11/2019 14:36	96,07	5	480,33	CHI
201911150937	CAMPO ALEGRE DE GOIAS	IP10400416	PIRES DO RIO S2	14/11/2019 14:47	17/11/2019 23:35	14/11/2019 14:47	14/11/2019 19:00	4,22	21	88,64	CHI
201911150937	IPAMERI	IP10400416	PIRES DO RIO S2	14/11/2019 14:47	17/11/2019 23:35	14/11/2019 14:47	14/11/2019 19:00	4,22	40	168,84	CHI
201911150937	CAMPO ALEGRE DE GOIAS	IP10400416	PIRES DO RIO S2	14/11/2019 14:47	17/11/2019 23:35	14/11/2019 20:40	14/11/2019 20:54	0,23	21	4,76	CHI
201911150937	IPAMERI	IP10400416	PIRES DO RIO S2	14/11/2019 14:47	17/11/2019 23:35	14/11/2019 20:40	14/11/2019 20:54	0,23	40	9,07	CHI

201911150937	CAMPO ALEGRE DE GOIAS	CM13166769	CAMPO ALEGRE DE GOIAS	14/11/2019 14:47	17/11/2019 23:35	14/11/2019 14:47	15/11/2019 12:57	22,17	78	1729,15	CHI
201911150937	CAMPO ALEGRE DE GOIAS	IP10400416	PIRES DO RIO S2	14/11/2019 14:47	17/11/2019 23:35	15/11/2019 15:24	15/11/2019 15:29	0,08	21	1,66	CHI
201911150937	IPAMERI	IP10400416	PIRES DO RIO S2	14/11/2019 14:47	17/11/2019 23:35	15/11/2019 15:24	15/11/2019 15:29	0,08	40	3,17	CHI
201911150937	CAMPO ALEGRE DE GOIAS	CM12086086	CAMPO ALEGRE DE GOIAS	14/11/2019 14:47	17/11/2019 23:35	14/11/2019 14:47	16/11/2019 07:38	40,85	6	245,09	CHI
201911150937	CAMPO ALEGRE DE GOIAS	IP13231410	CAMPO ALEGRE DE GOIAS	14/11/2019 14:47	17/11/2019 23:35	14/11/2019 14:47	17/11/2019 12:28	69,68	5	348,40	CHI
201911150937	IPAMERI	IP13231410	CAMPO ALEGRE DE GOIAS	14/11/2019 14:47	17/11/2019 23:35	14/11/2019 14:47	17/11/2019 12:28	69,68	19	1323,93	CHI
201911150937	CAMPO ALEGRE DE GOIAS	IP10400416	CAMPO ALEGRE DE GOIAS	14/11/2019 14:47	17/11/2019 23:35	17/11/2019 13:25	17/11/2019 13:47	0,37	5	1,83	CHI
201911150937	IPAMERI	IP10400416	CAMPO ALEGRE DE GOIAS	14/11/2019 14:47	17/11/2019 23:35	17/11/2019 13:25	17/11/2019 13:47	0,37	19	6,97	CHI
201911150937	CAMPO ALEGRE DE GOIAS	IP10400416	PIRES DO RIO S2	14/11/2019 14:47	17/11/2019 23:35	17/11/2019 13:25	17/11/2019 13:47	0,37	21	7,71	CHI
201911150937	IPAMERI	IP10400416	PIRES DO RIO S2	14/11/2019 14:47	17/11/2019 23:35	17/11/2019 13:25	17/11/2019 13:47	0,37	40	14,68	CHI
201911150937	IPAMERI	IP13231410	CAMPO ALEGRE DE GOIAS	14/11/2019 14:47	17/11/2019 23:35	14/11/2019 14:47	17/11/2019 23:35	80,79	43	3474,07	CHI
201911150943	CAMPO ALEGRE DE GOIAS	CM10397305	CAMPO ALEGRE DE GOIAS	14/11/2019 14:58	19/11/2019 07:55	14/11/2019 14:58	18/11/2019 22:01	103,05	8	824,41	CHI
201911150943	CAMPO ALEGRE DE GOIAS	CM10397305	CAMPO ALEGRE DE GOIAS	14/11/2019 14:58	19/11/2019 07:55	14/11/2019 14:58	18/11/2019 22:40	103,69	21	2177,47	CHI
201911150943	CAMPO ALEGRE DE GOIAS	CM13266056	CAMPO ALEGRE DE GOIAS	14/11/2019 14:58	19/11/2019 07:55	14/11/2019 14:58	19/11/2019 07:55	112,95	103	11634,02	CHI
201911150943	CATALAO	CM13266056	CAMPO ALEGRE DE GOIAS	14/11/2019 14:58	19/11/2019 07:55	14/11/2019 14:58	19/11/2019 07:55	112,95	21	2371,98	CHI
201911150943	DISTRITO FEDERAL	CM13266056	CAMPO ALEGRE DE GOIAS	14/11/2019 14:58	19/11/2019 07:55	14/11/2019 14:58	19/11/2019 07:55	112,95	1	112,95	CHI
201911150943	IPAMERI	CM13266056	CAMPO ALEGRE DE GOIAS	14/11/2019 14:58	19/11/2019 07:55	14/11/2019 14:58	19/11/2019 07:55	112,95	12	1355,42	CHI
201911150965	GOIATUBA	00730244	GOIATUBA S2	14/11/2019 15:30	16/11/2019 19:35	14/11/2019 15:30	14/11/2019 18:44	3,22	147	473,54	CHI
201911150965	GOIATUBA	00735128	GOIATUBA S2	14/11/2019 15:30	16/11/2019 19:35	14/11/2019 23:06	15/11/2019 00:11	1,09	2128	2318,93	CHI
201911150965	GOIATUBA	00735128	GOIATUBA S2	14/11/2019 15:30	16/11/2019 19:35	14/11/2019 23:06	15/11/2019 00:11	1,09	5135	5595,72	CHI
201911150965	GOIATUBA	00735128	GOIATUBA S2	14/11/2019 15:30	16/11/2019 19:35	14/11/2019 23:06	15/11/2019 00:11	1,09	147	160,19	CHI
201911150965	MORRINHOS	00735128	GOIATUBA S2	14/11/2019 15:30	16/11/2019 19:35	14/11/2019 23:06	15/11/2019 00:11	1,09	1	1,09	CHI
201911150965	GOIATUBA	00735128	GOIATUBA S1	14/11/2019 15:30	16/11/2019 19:35	14/11/2019 23:08	15/11/2019 00:11	1,05	5	5,27	CHI
201911150965	GOIATUBA	00735128	GOIATUBA S2	14/11/2019 15:30	16/11/2019 19:35	14/11/2019 23:08	15/11/2019 00:11	1,05	3180	3350,48	CHI
201911150965	GOIATUBA	00735128	GOIATUBA S2	14/11/2019 15:30	16/11/2019 19:35	14/11/2019 23:08	15/11/2019 00:11	1,05	3263	3437,93	CHI
201911150965	MORRINHOS	00735128	GOIATUBA S2	14/11/2019 15:30	16/11/2019 19:35	14/11/2019 23:08	15/11/2019 00:11	1,05	49	51,63	CHI
201911150965	MORRINHOS	00735128	GOIATUBA S2	14/11/2019 15:30	16/11/2019 19:35	14/11/2019 23:08	15/11/2019 00:11	1,05	3	3,16	CHI
201911150965	GOIATUBA	00735128	GOIATUBA S1	14/11/2019 15:30	16/11/2019 19:35	15/11/2019 12:06	15/11/2019 12:13	0,11	5	0,56	CHI
201911150965	GOIATUBA	00735128	GOIATUBA S2	14/11/2019 15:30	16/11/2019 19:35	15/11/2019 12:06	15/11/2019 12:13	0,11	5319	599,86	CHI
201911150965	GOIATUBA	00735128	GOIATUBA S2	14/11/2019 15:30	16/11/2019 19:35	15/11/2019 12:06	15/11/2019 12:13	0,11	3263	367,99	CHI
201911150965	GOIATUBA	00735128	GOIATUBA S2	14/11/2019 15:30	16/11/2019 19:35	15/11/2019 12:06	15/11/2019 12:13	0,11	4757	536,48	CHI
201911150965	MORRINHOS	00735128	GOIATUBA S2	14/11/2019 15:30	16/11/2019 19:35	15/11/2019 12:06	15/11/2019 12:13	0,11	58	6,54	CHI
201911150965	MORRINHOS	00735128	GOIATUBA S2	14/11/2019 15:30	16/11/2019 19:35	15/11/2019 12:06	15/11/2019 12:13	0,11	3	0,34	CHI

201911150965	GOIATUBA	00735128	GOIATUBA S2	14/11/2019 15:30	16/11/2019 19:35	15/11/2019 12:06	15/11/2019 12:19	0,22	147	32,22	CHI
201911150965	GOIATUBA	00735128	GOIATUBA S2	14/11/2019 15:30	16/11/2019 19:35	15/11/2019 13:10	15/11/2019 13:21	0,17	147	25,72	CHI
201911150965	GOIATUBA	00730244	GOIATUBA S2	14/11/2019 15:30	16/11/2019 19:35	14/11/2019 15:30	16/11/2019 17:55	50,42	58	2924,20	CHI
201911150965	GOIATUBA	00730244	GOIATUBA S2	14/11/2019 15:30	16/11/2019 19:35	14/11/2019 15:30	16/11/2019 18:23	50,87	53	2696,23	CHI
201911150965	GOIATUBA	GT12000095LD	GOIATUBA S2	14/11/2019 15:30	16/11/2019 19:35	14/11/2019 15:30	16/11/2019 18:23	50,87	76	3866,29	CHI
201911150965	GOIATUBA	00730244	GOIATUBA S2	14/11/2019 15:30	16/11/2019 19:35	14/11/2019 15:30	16/11/2019 19:35	52,08	21	1093,59	CHI
201911150966	ITUMBIARA	05210224	CACHOEIRA DOURADA	14/11/2019 15:30	18/11/2019 13:18	14/11/2019 15:30	14/11/2019 20:39	5,15	301	1548,81	CHI
201911150966	CACHOEIRA DOURADA	CD13000031	CACHOEIRA DOURADA	14/11/2019 15:30	18/11/2019 13:18	14/11/2019 15:30	18/11/2019 12:50	93,33	2	186,66	CHI
201911150966	ITUMBIARA	CD13000031	CACHOEIRA DOURADA	14/11/2019 15:30	18/11/2019 13:18	14/11/2019 15:30	18/11/2019 12:50	93,33	30	2799,92	CHI
201911150966	CACHOEIRA DOURADA	CD12000197RE	CACHOEIRA DOURADA	14/11/2019 15:30	18/11/2019 13:18	14/11/2019 15:30	18/11/2019 13:18	93,80	26	2438,87	CHI
201911150966	ITUMBIARA	CD12000197RE	CACHOEIRA DOURADA	14/11/2019 15:30	18/11/2019 13:18	14/11/2019 15:30	18/11/2019 13:18	93,80	29	2720,27	CHI
201911150977	AGUA LIMPA	MG10400583	VILA CORUMBA	14/11/2019 15:46	14/11/2019 23:36	14/11/2019 15:46	14/11/2019 18:54	3,13	16	50,09	CHI
201911150977	AGUA LIMPA	MG10400583	VILA CORUMBA	14/11/2019 15:46	14/11/2019 23:36	14/11/2019 15:46	14/11/2019 18:54	3,13	855	2676,86	CHI
201911150977	AGUA LIMPA	MG10400583	VILA CORUMBA	14/11/2019 15:46	14/11/2019 23:36	14/11/2019 15:46	14/11/2019 18:54	3,13	135	422,66	CHI
201911150977	AGUA LIMPA	MG10400583	VILA CORUMBA	14/11/2019 15:46	14/11/2019 23:36	14/11/2019 15:46	14/11/2019 18:54	3,13	8	25,05	CHI
201911150977	BURITI ALEGRE	MG10400583	VILA CORUMBA	14/11/2019 15:46	14/11/2019 23:36	14/11/2019 15:46	14/11/2019 18:54	3,13	3	9,39	CHI
201911150977	CALDAS NOVAS	MG10400583	VILA CORUMBA	14/11/2019 15:46	14/11/2019 23:36	14/11/2019 15:46	14/11/2019 18:54	3,13	20	62,62	CHI
201911150977	CORUMBAIBA	MG10400583	VILA CORUMBA	14/11/2019 15:46	14/11/2019 23:36	14/11/2019 15:46	14/11/2019 18:54	3,13	38	118,97	CHI
201911150977	MARZAGAO	MG10400583	VILA CORUMBA	14/11/2019 15:46	14/11/2019 23:36	14/11/2019 15:46	14/11/2019 18:54	3,13	1071	3353,12	CHI
201911150977	MARZAGAO	MG10400583	VILA CORUMBA	14/11/2019 15:46	14/11/2019 23:36	14/11/2019 15:46	14/11/2019 18:54	3,13	4	12,52	CHI
201911150977	MARZAGAO	MG10400583	VILA CORUMBA	14/11/2019 15:46	14/11/2019 23:36	14/11/2019 15:46	14/11/2019 18:54	3,13	34	106,45	CHI
201911150977	MARZAGAO	MG10400583	VILA CORUMBA	14/11/2019 15:46	14/11/2019 23:36	14/11/2019 15:46	14/11/2019 18:54	3,13	1	3,13	CHI
201911150977	MORRINHOS	MG10400583	VILA CORUMBA	14/11/2019 15:46	14/11/2019 23:36	14/11/2019 15:46	14/11/2019 18:54	3,13	55	172,20	CHI
201911150977	RIO QUENTE	MG10400583	VILA CORUMBA	14/11/2019 15:46	14/11/2019 23:36	14/11/2019 15:46	14/11/2019 18:54	3,13	4	12,52	CHI
201911150977	CALDAS NOVAS	MG13171718	VILA CORUMBA	14/11/2019 15:46	14/11/2019 23:36	14/11/2019 15:46	14/11/2019 22:09	6,38	4	25,53	CHI
201911150977	MARZAGAO	MG13171718	VILA CORUMBA	14/11/2019 15:46	14/11/2019 23:36	14/11/2019 15:46	14/11/2019 22:09	6,38	7	44,68	CHI
201911150977	CALDAS NOVAS	CN13263345	VILA CORUMBA	14/11/2019 15:46	14/11/2019 23:36	14/11/2019 15:46	14/11/2019 23:36	7,84	2	15,69	CHI
201911150979	FLORES DE GOIAS	FB12344375	FLORES DE GOIAS	14/11/2019 14:31	16/11/2019 01:15	14/11/2019 14:31	16/11/2019 01:15	34,73	2	69,46	CHI
201911150981	PORTEIRAO	CL12338603	RIO DOS BOIS	14/11/2019 16:15	19/11/2019 20:10	14/11/2019 16:15	19/11/2019 20:10	123,91	1	123,91	CHI
201911151009	MONTES CLAROS DE GOIAS	ME12193369	IPORA	15/11/2019 16:14	15/11/2019 23:18	15/11/2019 16:14	15/11/2019 16:40	0,42	20	8,48	CHI
201911151009	MONTES CLAROS DE GOIAS	ME21357458	IPORA	15/11/2019 16:14	15/11/2019 23:18	15/11/2019 16:14	15/11/2019 23:18	7,06	1	7,06	CHI
201911151121	NOVA AURORA	NE21315367	CATALAO S1	14/11/2019 12:26	14/11/2019 15:44	14/11/2019 12:26	14/11/2019 15:44	3,29	1	3,29	CHI
201911151124	DISTRITO FEDERAL	SN12237830	MARAJOARA	14/11/2019 12:27	15/11/2019 12:35	14/11/2019 12:27	15/11/2019 12:35	24,15	3	72,44	CHI

201911151124	SANTO ANTONIO DO DESCOBERTO	SN12237830	MARAJOARA	14/11/2019 12:27	15/11/2019 12:35	14/11/2019 12:27	15/11/2019 12:35	24,15	24	579,53	CHI
201911151125	SILVANIA	SV21078650	DAIA S2	14/11/2019 12:27	15/11/2019 04:06	14/11/2019 12:27	15/11/2019 04:06	15,64	1	15,64	CHI
201911151129	CAMPINACU	10019687328	PORANGATU	14/11/2019 12:28	15/11/2019 08:47	14/11/2019 12:28	15/11/2019 08:47	20,33	1	20,33	CHI
201911151135	SILVANIA	SV21143202	DAIA S2	14/11/2019 12:28	15/11/2019 09:22	14/11/2019 12:28	15/11/2019 09:22	20,89	1	20,89	CHI
201911151210	SILVANIA	SV21338931	DAIA S2	14/11/2019 12:30	14/11/2019 16:14	14/11/2019 12:30	14/11/2019 16:14	3,72	1	3,72	CHI
201911151215	INHUMAS	30105560	ARACU	14/11/2019 12:33	14/11/2019 21:48	14/11/2019 12:33	14/11/2019 21:48	9,25	1	9,25	CHI
201911151220	GOIANIA	GN12073227	GOYA S1	14/11/2019 14:40	14/11/2019 15:35	14/11/2019 14:40	14/11/2019 15:35	0,92	31	28,42	CHI
201911151224	LUZIANIA	LZ12085964	PACAEMBU S1	14/11/2019 12:35	14/11/2019 15:26	14/11/2019 12:35	14/11/2019 15:26	2,84	29	82,50	CHI
201911151224	NOVO GAMA	LZ12085964	PACAEMBU S1	14/11/2019 12:35	14/11/2019 15:26	14/11/2019 12:35	14/11/2019 15:26	2,84	17	48,36	CHI
201911151225	LEOPOLDO DE BULHOES	LB21084064	DAIA S2	14/11/2019 12:35	15/11/2019 18:53	14/11/2019 12:35	15/11/2019 18:53	30,29	2	60,58	CHI
201911151245	ABADIANIA	AA12085971	ANAPOLIS UNIVERSITARIO S1	14/11/2019 12:40	14/11/2019 17:49	14/11/2019 12:40	14/11/2019 17:49	5,15	12	61,79	CHI
201911151247	GUAPO	3040002105	GUAPO S2	14/11/2019 12:42	15/11/2019 12:47	14/11/2019 12:42	15/11/2019 12:47	24,07	1	24,07	CHI
201911151255	ALOANDIA	AD12013618	GOIATUBA S1	14/11/2019 09:00	18/11/2019 13:20	14/11/2019 09:00	18/11/2019 13:20	100,33	5	501,65	CHI
201911151255	JOVIANIA	AD12013618	GOIATUBA S1	14/11/2019 09:00	18/11/2019 13:20	14/11/2019 09:00	18/11/2019 13:20	100,33	10	1003,31	CHI
201911151255	ALOANDIA	AD12013618	GOIATUBA S1	14/11/2019 09:00	18/11/2019 13:20	14/11/2019 16:11	18/11/2019 13:20	93,15	2	186,29	CHI
201911151260	SILVANIA	SV21393231	DAIA S2	14/11/2019 12:45	15/11/2019 15:28	14/11/2019 12:45	15/11/2019 15:28	26,71	1	26,71	CHI
201911151279	LUZIANIA	LZ12336006	VIANOPOLIS	14/11/2019 12:49	14/11/2019 15:09	14/11/2019 12:49	14/11/2019 15:09	2,32	98	227,12	CHI
201911151284	ABADIANIA	AX12221526	ALEXANIA	14/11/2019 12:16	14/11/2019 15:29	14/11/2019 12:16	14/11/2019 15:29	3,21	13	41,70	CHI
201911151284	ALEXANIA	AX12221526	ALEXANIA	14/11/2019 12:16	14/11/2019 15:29	14/11/2019 12:16	14/11/2019 15:29	3,21	188	603,06	CHI
201911151285	SENADOR CANEDO	SW11094031	CEPAIGO S2	14/11/2019 12:53	14/11/2019 14:31	14/11/2019 12:53	14/11/2019 14:31	1,62	1	1,62	CHI
201911151292	LUZIANIA	LZ12086797	VIANOPOLIS	14/11/2019 12:55	14/11/2019 19:07	14/11/2019 12:55	14/11/2019 19:07	6,19	33	204,19	CHI
201911151293	CALDAS NOVAS	CN11000023	SERRA DE CALDAS	14/11/2019 12:37	15/11/2019 00:20	14/11/2019 12:37	15/11/2019 00:20	11,70	107	1252,20	CHI
201911151316	APARECIDA DE GOIANIA	11108824	REAL S2	14/11/2019 13:00	14/11/2019 15:49	14/11/2019 13:00	14/11/2019 15:49	2,80	1	2,80	CHI
201911151332	ALEXANIA	AX12000057	ALEXANIA	14/11/2019 13:03	14/11/2019 17:50	14/11/2019 13:03	14/11/2019 17:50	4,78	10	47,82	CHI
201911151332	SANTO ANTONIO DO DESCOBERTO	AX12000057	ALEXANIA	14/11/2019 13:03	14/11/2019 17:50	14/11/2019 13:03	14/11/2019 17:50	4,78	1	4,78	CHI
201911151335	AGUAS LINDAS DE GOIAS	10002525664	AGUAS LINDAS DE GOIAS S1	14/11/2019 13:06	14/11/2019 13:54	14/11/2019 13:06	14/11/2019 13:54	0,79	1	0,79	CHI
201911151337	APARECIDA DE GOIANIA	AP12167498	INDEPENDENCIA S1	14/11/2019 12:59	14/11/2019 18:21	14/11/2019 12:59	14/11/2019 18:21	5,35	135	722,47	CHI
201911151342	SANTO ANTONIO DO DESCOBERTO	SN21290592	AGUAS LINDAS DE GOIAS S2	14/11/2019 13:09	14/11/2019 15:45	14/11/2019 13:09	14/11/2019 15:45	2,59	2	5,19	CHI
201911151350	ANAPOLIS	20778521	JUNDIAI S1	14/11/2019 13:11	14/11/2019 16:34	14/11/2019 13:11	14/11/2019 16:34	3,38	1	3,38	CHI
201911151351	URUTAI	UT21146473	URUTAI	14/11/2019 13:11	16/11/2019 17:13	14/11/2019 13:11	16/11/2019 17:13	52,02	1	52,02	CHI
201911151352	PARAUNA	PU21306575	MONTIVIDIU T	14/11/2019 13:11	15/11/2019 12:08	14/11/2019 13:11	15/11/2019 12:08	22,95	1	22,95	CHI
201911151355	BONFINOPOLIS	920017034	CEPAIGO S2	14/11/2019 13:12	15/11/2019 08:39	14/11/2019 13:12	15/11/2019 08:39	19,44	1	19,44	CHI
201911151359	GOIANESIA	00560434	GOIANESIA S1	14/11/2019 13:06	14/11/2019 19:42	14/11/2019 13:06	14/11/2019 13:09	0,06	382	21,33	CHI

201911151359	GOIANESIA	00560434	GOIANESIA S1	14/11/2019 13:06	14/11/2019 19:42	14/11/2019 13:06	14/11/2019 13:09	0,06	600	33,50	CHI
201911151359	GOIANESIA	GE10400378	GOIANESIA S1	14/11/2019 13:06	14/11/2019 19:42	14/11/2019 13:06	14/11/2019 13:09	0,06	6	0,33	CHI
201911151359	NOVA GLORIA	00560434	GOIANESIA S1	14/11/2019 13:06	14/11/2019 19:42	14/11/2019 13:06	14/11/2019 13:09	0,06	2	0,11	CHI
201911151359	SANTA ISABEL	00560434	GOIANESIA S1	14/11/2019 13:06	14/11/2019 19:42	14/11/2019 13:06	14/11/2019 13:09	0,06	2	0,11	CHI
201911151359	SANTA ISABEL	00560434	GOIANESIA S1	14/11/2019 13:06	14/11/2019 19:42	14/11/2019 13:06	14/11/2019 13:09	0,06	31	1,73	CHI
201911151359	SAO LUIZ DO NORTE	00560434	GOIANESIA S1	14/11/2019 13:06	14/11/2019 19:42	14/11/2019 13:06	14/11/2019 13:09	0,06	21	1,17	CHI
201911151359	COCALZINHO DE GOIAS	00560434	GOIANESIA S1	14/11/2019 13:06	14/11/2019 19:42	14/11/2019 13:06	14/11/2019 19:42	6,61	257	1698,20	CHI
201911151359	GOIANESIA	GE10406648	GOIANESIA S1	14/11/2019 13:06	14/11/2019 19:42	14/11/2019 13:06	14/11/2019 19:42	6,61	13	85,90	CHI
201911151359	PIRENOPOLIS	00560434	GOIANESIA S1	14/11/2019 13:06	14/11/2019 19:42	14/11/2019 13:06	14/11/2019 19:42	6,61	34	224,66	CHI
201911151359	PIRENOPOLIS	00560434	GOIANESIA S1	14/11/2019 13:06	14/11/2019 19:42	14/11/2019 13:06	14/11/2019 19:42	6,61	1	6,61	CHI
201911151359	VILA PROPICIO	00560434	GOIANESIA S1	14/11/2019 13:06	14/11/2019 19:42	14/11/2019 13:06	14/11/2019 19:42	6,61	821	5424,99	CHI
201911151359	VILA PROPICIO	00560434	GOIANESIA S1	14/11/2019 13:06	14/11/2019 19:42	14/11/2019 13:06	14/11/2019 19:42	6,61	143	944,91	CHI
201911151359	VILA PROPICIO	00560434	GOIANESIA S1	14/11/2019 13:06	14/11/2019 19:42	14/11/2019 13:06	14/11/2019 19:42	6,61	176	1162,97	CHI
201911151359	VILA PROPICIO	GE10406648	GOIANESIA S1	14/11/2019 13:06	14/11/2019 19:42	14/11/2019 13:06	14/11/2019 19:42	6,61	137	905,27	CHI
201911151359	VILA PROPICIO	00560434	GOIANESIA S1	14/11/2019 13:06	14/11/2019 19:42	14/11/2019 13:09	14/11/2019 19:42	6,56	1	6,56	CHI
201911151515	ANAPOLIS	20492674	JUNDIAI S1	14/11/2019 13:18	14/11/2019 15:59	14/11/2019 13:18	14/11/2019 15:59	2,68	1	2,68	CHI
201911151520	CORUMBA DE GOIAS	SN12376780	ALEXANIA	14/11/2019 13:19	14/11/2019 18:21	14/11/2019 13:19	14/11/2019 18:21	5,02	13	65,29	CHI
201911151520	SANTO ANTONIO DO DESCOBERTO	SN12376780	ALEXANIA	14/11/2019 13:19	14/11/2019 18:21	14/11/2019 13:19	14/11/2019 18:21	5,02	17	85,38	CHI
201911151601	CRIXAS	CX21335786	RUBIATABA	14/11/2019 13:20	16/11/2019 12:10	14/11/2019 13:20	16/11/2019 12:10	46,83	1	46,83	CHI
201911151607	MORRINHOS	10001773389	MORRINHOS	14/11/2019 13:21	14/11/2019 16:00	14/11/2019 13:21	14/11/2019 16:00	2,64	1	2,64	CHI
201911151612	GOIANESIA	GE11058404	GOIANESIA S2	14/11/2019 12:06	14/11/2019 15:35	14/11/2019 12:06	14/11/2019 15:35	3,47	158	548,26	CHI
201911151617	GOIANIA	GN12395280	GOYA S2	14/11/2019 13:24	14/11/2019 16:47	14/11/2019 13:24	14/11/2019 16:47	3,37	58	195,36	CHI
201911151622	SITIO D ABADIA	SI12384217	IACIARA S2	14/11/2019 13:25	14/11/2019 15:45	14/11/2019 13:25	14/11/2019 15:45	2,32	10	23,20	CHI
201911151628	GUAPO	710014624	GUAPO S1	14/11/2019 13:27	14/11/2019 15:57	14/11/2019 13:27	14/11/2019 15:57	2,49	1	2,49	CHI
201911151629	VILA PROPICIO	NQ12252378	BARRO ALTO	14/11/2019 13:20	14/11/2019 19:48	14/11/2019 13:20	14/11/2019 19:48	6,47	15	97,00	CHI
201911151632	GOIANIA	GN11002720	ATLANTICO S1	14/11/2019 12:53	14/11/2019 14:12	14/11/2019 12:53	14/11/2019 14:12	1,31	96	125,36	CHI
201911151633	MAURILANDIA	1040015685	RIO DOS BOIS	14/11/2019 13:29	15/11/2019 09:25	14/11/2019 13:29	15/11/2019 09:25	19,92	1	19,92	CHI
201911151706	SAO MIGUEL DO ARAGUAIA	SM12253876	SAO MIGUEL DO ARAGUAIA	14/11/2019 12:58	15/11/2019 03:39	14/11/2019 12:58	15/11/2019 03:39	14,67	3	44,02	CHI
201911151710	GOIANIA	14970922	SENADOR CANEDO	14/11/2019 13:33	15/11/2019 10:05	14/11/2019 13:33	15/11/2019 10:05	20,53	1	20,53	CHI
201911151711	GOIANESIA	GE21258496	GOIANESIA S2	14/11/2019 13:34	16/11/2019 12:19	14/11/2019 13:34	16/11/2019 12:19	46,75	1	46,75	CHI
201911151714	BELA VISTA DE GOIAS	05240214	CRISTIANOPOLIS	14/11/2019 13:34	17/11/2019 12:10	15/11/2019 14:36	15/11/2019 14:46	0,17	84	14,61	CHI
201911151714	CRISTIANOPOLIS	05240214	CRISTIANOPOLIS	14/11/2019 13:34	17/11/2019 12:10	15/11/2019 14:36	15/11/2019 14:46	0,17	21	3,65	CHI
201911151714	SAO MIGUEL DO PASSA QUATRO	05240214	CRISTIANOPOLIS	14/11/2019 13:34	17/11/2019 12:10	15/11/2019 14:36	15/11/2019 14:46	0,17	273	47,47	CHI

201911151714	VIANOPOLIS	05240214	CRISTIANOPOLIS	14/11/2019 13:34	17/11/2019 12:10	15/11/2019 14:36	15/11/2019 14:46	0,17	3	0,52	CHI
201911151714	SAO MIGUEL DO PASSA QUATRO	SQ21085389	CRISTIANOPOLIS	14/11/2019 13:34	17/11/2019 12:10	14/11/2019 13:34	17/11/2019 12:00	70,43	1	70,43	CHI
201911151714	SAO MIGUEL DO PASSA QUATRO	BV12060449	CRISTIANOPOLIS	14/11/2019 13:34	17/11/2019 12:10	15/11/2019 14:36	17/11/2019 12:10	45,56	2	91,12	CHI
201911151715	HIDROLINA	HL21202123	URUACU	14/11/2019 13:35	15/11/2019 06:07	14/11/2019 13:35	15/11/2019 06:07	16,53	1	16,53	CHI
201911151718	JARAGUA	JA11000010	JARAGUA	14/11/2019 13:22	14/11/2019 15:20	14/11/2019 13:22	14/11/2019 15:20	1,96	81	158,54	CHI
201911152001	GOIANIA	10133021	FERROVIARIO S2	14/11/2019 13:38	14/11/2019 16:29	14/11/2019 13:38	14/11/2019 16:29	2,85	1	2,85	CHI
201911152004	LUZIANIA	LZ11168746	RIO VERMELHO	14/11/2019 13:38	14/11/2019 16:10	14/11/2019 13:38	14/11/2019 16:10	2,53	191	482,54	CHI
201911152016	CORUMBA DE GOIAS	CB21191466	CORUMBA	14/11/2019 13:39	14/11/2019 21:58	14/11/2019 13:39	14/11/2019 21:58	8,30	3	24,91	CHI
201911152024	VILA BOA	VB11042055	IACIARA S2	14/11/2019 13:41	14/11/2019 16:03	14/11/2019 13:41	14/11/2019 16:03	2,36	154	363,14	CHI
201911152026	SANTO ANTONIO DO DESCOBERTO	SN12085981	MARAJOARA	14/11/2019 13:41	14/11/2019 18:36	14/11/2019 13:41	14/11/2019 18:36	4,90	25	122,60	CHI
201911152032	CAMPO LIMPO	AN21246308	NEROPOLIS S1	14/11/2019 13:43	14/11/2019 15:58	14/11/2019 13:43	14/11/2019 15:58	2,24	1	2,24	CHI
201911152033	GUARINOS	GF21164869	SANTA TEREZINHA	14/11/2019 13:43	14/11/2019 20:02	14/11/2019 13:43	14/11/2019 20:02	6,30	1	6,30	CHI
201911152046	ALEXANIA	AX21099850	ALEXANIA	14/11/2019 13:45	14/11/2019 23:09	14/11/2019 13:45	14/11/2019 23:09	9,38	1	9,38	CHI
201911152107	CRISTALINA	KR11261766	CRISTALINA S2	14/11/2019 13:47	14/11/2019 16:12	14/11/2019 13:47	14/11/2019 16:12	2,41	182	437,86	CHI
201911152109	ALEXANIA	AX12384862	ALEXANIA	14/11/2019 13:47	15/11/2019 15:28	14/11/2019 13:47	15/11/2019 15:28	25,67	2	51,34	CHI
201911152110	RIO VERDE	630412285	RIO VERDE S1	14/11/2019 13:47	15/11/2019 13:31	14/11/2019 13:47	15/11/2019 13:31	23,72	1	23,72	CHI
201911152111	CATALAO	1990132641	CATALAO S2	14/11/2019 13:48	14/11/2019 15:01	14/11/2019 13:48	14/11/2019 15:01	1,23	1	1,23	CHI
201911152115	MORRINHOS	MR21041913	MORRINHOS	14/11/2019 14:14	14/11/2019 17:00	14/11/2019 14:14	14/11/2019 17:00	2,76	1	2,76	CHI
201911152120	ANAPOLIS	AN11135717	JUNDIAI S1	14/11/2019 13:49	14/11/2019 16:23	14/11/2019 13:49	14/11/2019 16:23	2,55	127	324,41	CHI
201911152124	SANTO ANTONIO DA BARRA	BZ21359447	ACREUNA	14/11/2019 13:50	15/11/2019 17:19	14/11/2019 13:50	15/11/2019 17:19	27,48	1	27,48	CHI
201911152126	SENADOR CANEDO	10014031327	CEPAIGO S2	14/11/2019 13:50	14/11/2019 14:56	14/11/2019 13:50	14/11/2019 14:56	1,09	1	1,09	CHI
201911152130	ORIZONA	OZ12026601	PIRES DO RIO S2	14/11/2019 13:51	14/11/2019 16:49	14/11/2019 13:51	14/11/2019 16:49	2,97	14	41,65	CHI
201911152133	INHUMAS	30176992	INHUMAS S2	14/11/2019 13:51	14/11/2019 21:50	14/11/2019 13:51	14/11/2019 21:50	7,97	1	7,97	CHI
201911152138	ABADIANIA	AA21322456	ANAPOLIS UNIVERSITARIO S1	14/11/2019 13:52	14/11/2019 17:05	14/11/2019 13:52	14/11/2019 17:05	3,20	1	3,20	CHI
201911152143	APARECIDA DE GOIANIA	AP11003038	REAL S2	14/11/2019 13:49	14/11/2019 16:40	14/11/2019 13:49	14/11/2019 16:40	2,84	218	619,79	CHI
201911152406	IACIARA	IA12232131	IACIARA S1	14/11/2019 13:55	14/11/2019 16:08	14/11/2019 13:55	14/11/2019 16:08	2,21	6	13,25	CHI
201911152413	LUZIANIA	LZ12330886	VIANOPOLIS	14/11/2019 13:57	14/11/2019 18:13	14/11/2019 13:57	14/11/2019 18:13	4,27	9	38,40	CHI
201911152417	PALMELO	PR12000096RE	PIRES DO RIO S1	14/11/2019 13:48	15/11/2019 02:40	14/11/2019 13:48	15/11/2019 02:40	12,85	6	77,13	CHI
201911152417	PIRES DO RIO	PR12000096RE	PIRES DO RIO S1	14/11/2019 13:48	15/11/2019 02:40	14/11/2019 13:48	15/11/2019 02:40	12,85	22	282,80	CHI
201911152420	ALTO PARAISO DE GOIAS	BF12365259	SAO JOAO D ALIANCA	14/11/2019 13:58	14/11/2019 16:21	14/11/2019 13:58	14/11/2019 16:21	2,38	5	11,91	CHI
201911152423	CEZARINA	CZ12099664	GUAPO S2	14/11/2019 13:37	14/11/2019 17:58	14/11/2019 13:37	14/11/2019 17:58	4,35	78	339,28	CHI
201911152423	INDIARA	CZ12099664	GUAPO S2	14/11/2019 13:37	14/11/2019 17:58	14/11/2019 13:37	14/11/2019 17:58	4,35	1	4,35	CHI
201911152427	MINEIROS	MY12064643	PARQUE DAS EMAS	14/11/2019 13:45	14/11/2019 17:46	14/11/2019 13:45	14/11/2019 17:46	4,01	133	533,63	CHI

201911152429	LUZIANIA	LZ11003829	RIO VERMELHO	14/11/2019 13:59	14/11/2019 16:39	14/11/2019 13:59	14/11/2019 16:39	2,66	118	314,27	CHI
201911152431	BELA VISTA DE GOIAS	SV12383417	DAIA S2	14/11/2019 13:59	14/11/2019 17:35	14/11/2019 13:59	14/11/2019 17:35	3,59	1	3,59	CHI
201911152431	CALDAZINHA	SV12383417	DAIA S2	14/11/2019 13:59	14/11/2019 17:35	14/11/2019 13:59	14/11/2019 17:35	3,59	34	122,04	CHI
201911152431	LEOPOLDO DE BULHOES	SV12383417	DAIA S2	14/11/2019 13:59	14/11/2019 17:35	14/11/2019 13:59	14/11/2019 17:35	3,59	3	10,77	CHI
201911152431	SILVANIA	SV12383417	DAIA S2	14/11/2019 13:59	14/11/2019 17:35	14/11/2019 13:59	14/11/2019 17:35	3,59	56	201,01	CHI
201911152432	ABADIANIA	AA12285384	ANAPOLIS UNIVERSITARIO S1	14/11/2019 12:28	14/11/2019 15:38	14/11/2019 12:28	14/11/2019 15:38	3,16	99	313,28	CHI
201911152432	GAMELEIRA DE GOIAS	AA12285384	ANAPOLIS UNIVERSITARIO S1	14/11/2019 12:28	14/11/2019 15:38	14/11/2019 12:28	14/11/2019 15:38	3,16	1	3,16	CHI
201911152434	ANAPOLIS	AN21258739	JUNDIAI S1	14/11/2019 14:00	14/11/2019 17:22	14/11/2019 14:00	14/11/2019 17:22	3,37	1	3,37	CHI
201911152439	NEROPOLIS	NR11159953	NEROPOLIS S2	14/11/2019 13:37	14/11/2019 14:58	14/11/2019 13:37	14/11/2019 14:58	1,34	172	230,81	CHI
201911152449	CEZARINA	CZ12010376	CEZARINA	14/11/2019 14:01	14/11/2019 19:43	14/11/2019 14:01	14/11/2019 19:43	5,71	129	736,23	CHI
201911152449	INDIARA	CZ12010376	CEZARINA	14/11/2019 14:01	14/11/2019 19:43	14/11/2019 14:01	14/11/2019 19:43	5,71	16	91,32	CHI
201911152450	LUZIANIA	LZ11067357	MARAJOARA	14/11/2019 14:01	14/11/2019 17:40	14/11/2019 14:01	14/11/2019 17:40	3,64	18	65,55	CHI
201911152517	CATALAO	CT21134413	CATALAO S1	14/11/2019 14:06	14/11/2019 21:13	14/11/2019 14:06	14/11/2019 21:13	7,11	1	7,11	CHI
201911152520	ANAPOLIS	AN21258697	JUNDIAI S1	14/11/2019 14:06	14/11/2019 18:28	14/11/2019 14:06	14/11/2019 18:28	4,36	1	4,36	CHI
201911152521	PIRES DO RIO	460136069	PIRES DO RIO S1	14/11/2019 14:06	15/11/2019 15:48	14/11/2019 14:06	15/11/2019 15:48	25,69	1	25,69	CHI
201911152524	RIO VERDE	RV21249080	CABRIUVA S2	14/11/2019 14:07	14/11/2019 16:56	14/11/2019 14:07	14/11/2019 16:56	2,82	1	2,82	CHI
201911152604	MONTES CLAROS DE GOIAS	1440029973	BRITANIA	14/11/2019 14:08	16/11/2019 16:18	14/11/2019 14:08	16/11/2019 16:18	50,16	1	50,16	CHI
201911152611	SAO MIGUEL DO ARAGUAIA	SM21328587	SAO MIGUEL DO ARAGUAIA	14/11/2019 14:10	14/11/2019 16:35	14/11/2019 14:10	14/11/2019 16:35	2,41	1	2,41	CHI
201911152615	CATALAO	1990065810	CATALAO S2	14/11/2019 14:12	14/11/2019 16:23	14/11/2019 14:12	14/11/2019 16:23	2,18	1	2,18	CHI
201911152712	GOIANESIA	GE11259018	GOIANESIA S2	14/11/2019 12:03	14/11/2019 20:04	14/11/2019 12:03	14/11/2019 20:04	8,01	41	328,42	CHI
201911152806	INHUMAS	IN11058666	INHUMAS S2	14/11/2019 14:08	14/11/2019 19:06	14/11/2019 14:08	14/11/2019 19:06	4,96	188	932,01	CHI
201911152813	CORUMBAIBA	CI12000093RE	VILA CORUMBA	14/11/2019 14:03	15/11/2019 12:56	14/11/2019 14:03	15/11/2019 12:56	22,88	102	2334,10	CHI
201911152815	ITABERAI	50065490	ITABERAI S2	14/11/2019 14:18	15/11/2019 17:11	14/11/2019 14:18	15/11/2019 17:11	26,88	1	26,88	CHI
201911152901	BURITI ALEGRE	BG21293164	ALTO BURITI	14/11/2019 14:20	17/11/2019 15:42	14/11/2019 14:20	17/11/2019 15:42	73,37	1	73,37	CHI
201911153303	SAO FRANCISCO DE GOIAS	SF12248837	SAO FRANCISCO DE GOIAS	14/11/2019 14:21	14/11/2019 18:34	14/11/2019 14:21	14/11/2019 18:34	4,21	4	16,84	CHI
201911153404	BARRO ALTO	10005708972	BARRO ALTO	14/11/2019 14:21	15/11/2019 10:40	14/11/2019 14:21	15/11/2019 10:40	20,30	1	20,30	CHI
201911153406	CACU	CC12371571	CACHOEIRA ALTA	14/11/2019 14:22	15/11/2019 15:22	14/11/2019 14:22	15/11/2019 15:22	25,00	1	25,00	CHI
201911153414	GOIANIA	10320490	CAMPINAS S1	14/11/2019 14:23	14/11/2019 18:06	14/11/2019 14:23	14/11/2019 18:06	3,71	1	3,71	CHI
201911153418	BURITI ALEGRE	BG12161937	ITUMBIARA VELHA S2	14/11/2019 14:00	18/11/2019 12:04	14/11/2019 14:00	18/11/2019 12:04	94,06	12	1128,72	CHI
201911153419	RIO VERDE	RV12305862LD	RIO VERDE S2	14/11/2019 14:24	15/11/2019 14:20	14/11/2019 14:24	15/11/2019 14:20	23,94	9	215,44	CHI
201911153503	CRISTALINA	KR21311480	CRISTALINA S1	14/11/2019 14:27	14/11/2019 17:59	14/11/2019 14:27	14/11/2019 17:59	3,53	1	3,53	CHI
201911153504	GOIANIA	11005609	FERROVIARIO S1	14/11/2019 14:27	14/11/2019 15:21	14/11/2019 14:27	14/11/2019 15:21	0,89	1	0,89	CHI
201911153516	PIRES DO RIO	PR12075745	PIRES DO RIO S1	14/11/2019 08:33	15/11/2019 01:51	14/11/2019 08:33	15/11/2019 01:51	17,29	18	311,27	CHI

201911153523	GOIANIA	GN11077154	GOIANIA LESTE S2	14/11/2019 14:30	14/11/2019 17:52	14/11/2019 14:30	14/11/2019 17:52	3,35	21	70,38	CHI
201911153529	MORRINHOS	MR12000170RE	MORRINHOS	14/11/2019 13:35	19/11/2019 13:13	14/11/2019 13:35	15/11/2019 09:03	19,47	18	350,43	CHI
201911153529	MORRINHOS	MR12000170RE	MORRINHOS	14/11/2019 13:35	19/11/2019 13:13	14/11/2019 13:35	15/11/2019 12:17	22,70	33	749,07	CHI
201911153529	MORRINHOS	MR12000170RE	MORRINHOS	14/11/2019 13:35	19/11/2019 13:13	15/11/2019 10:37	15/11/2019 12:17	1,68	20	33,52	CHI
201911153529	BURITI ALEGRE	MR12223445LD	MORRINHOS	14/11/2019 13:35	19/11/2019 13:13	14/11/2019 13:35	19/11/2019 13:13	119,64	1	119,64	CHI
201911153529	MORRINHOS	MR12223445LD	MORRINHOS	14/11/2019 13:35	19/11/2019 13:13	14/11/2019 13:35	19/11/2019 13:13	119,64	3	358,91	CHI
201911153543	RIO VERDE	RV21382635	RIO VERDE S1	14/11/2019 14:35	15/11/2019 11:15	14/11/2019 14:35	15/11/2019 11:15	20,67	1	20,67	CHI
201911153544	GOIANDIRA	GD21157999	CATALAO S1	14/11/2019 14:35	14/11/2019 17:20	14/11/2019 14:35	14/11/2019 17:20	2,75	1	2,75	CHI
201911153553	INHUMAS	IN12343069	INHUMAS S2	14/11/2019 12:40	14/11/2019 16:31	14/11/2019 12:40	14/11/2019 16:31	3,85	22	84,68	CHI
201911153556	CALDAS NOVAS	CN11246639	SERRA DE CALDAS	14/11/2019 13:51	14/11/2019 17:33	14/11/2019 13:51	14/11/2019 17:33	3,69	155	571,26	CHI
201911153558	INDIARA	10003964661	EDEIA	14/11/2019 14:38	15/11/2019 07:54	14/11/2019 14:38	15/11/2019 07:54	17,28	1	17,28	CHI
201911153601	BURITI ALEGRE	BG12218141	ALTO BURITI	14/11/2019 11:38	14/11/2019 18:45	14/11/2019 11:38	14/11/2019 18:45	7,11	63	447,65	CHI
201911154012	MORRINHOS	MR21015088	MORRINHOS	14/11/2019 14:43	15/11/2019 08:29	14/11/2019 14:43	15/11/2019 08:29	17,76	1	17,76	CHI
201911154103	RIO QUENTE	RQ21335217	MORRINHOS	14/11/2019 14:44	15/11/2019 08:48	14/11/2019 14:44	15/11/2019 08:48	18,06	11	198,67	CHI
201911154114	CHAPADAO DO CEU	9880003323	CHAPADAO DO CEU	14/11/2019 14:47	15/11/2019 16:30	14/11/2019 14:47	15/11/2019 16:30	25,71	1	25,71	CHI
201911154115	BURITI DE GOIAS	1680001453	FIRMINOPOLIS S2	14/11/2019 14:47	15/11/2019 13:52	14/11/2019 14:47	15/11/2019 13:52	23,08	1	23,08	CHI
201911154122	MINACU	4020063401	MINACU	14/11/2019 14:48	15/11/2019 05:30	14/11/2019 14:48	15/11/2019 05:30	14,69	1	14,69	CHI
201911154123	NAZARIO	NZ21144250	ANICUNS	14/11/2019 14:48	15/11/2019 19:21	14/11/2019 14:48	15/11/2019 19:21	28,53	1	28,53	CHI
201911154126	TRINDADE	40299570	TRINDADE	14/11/2019 14:49	15/11/2019 10:13	14/11/2019 14:49	15/11/2019 10:13	19,39	1	19,39	CHI
201911154131	PIRES DO RIO	460107471	PIRES DO RIO S1	14/11/2019 14:49	15/11/2019 10:30	14/11/2019 14:49	15/11/2019 10:30	19,67	1	19,67	CHI
201911154141	APARECIDA DE GOIANIA	AP11007358	INDEPENDENCIA S2	14/11/2019 14:40	14/11/2019 21:45	14/11/2019 14:40	14/11/2019 21:45	7,07	120	848,17	CHI
201911154143	SAO FRANCISCO DE GOIAS	SF12389750	SAO FRANCISCO DE GOIAS	14/11/2019 14:50	14/11/2019 17:23	14/11/2019 14:50	14/11/2019 17:23	2,54	14	35,58	CHI
201911154144	CRISTALINA	KR12248743	CRISTALINA S2	14/11/2019 14:51	14/11/2019 17:16	14/11/2019 14:51	14/11/2019 17:16	2,40	6	14,43	CHI
201911154150	GOIANIA	11410747	ATLANTICO S1	14/11/2019 14:53	14/11/2019 17:00	14/11/2019 14:53	14/11/2019 17:00	2,12	1	2,12	CHI
201911154158	VIANOPOLIS	10005899182	VIANOPOLIS	14/11/2019 14:54	14/11/2019 18:32	14/11/2019 14:54	14/11/2019 18:32	3,62	1	3,62	CHI
201911154170	LEOPOLDO DE BULHOES	LB21313046	DAIA S2	14/11/2019 14:56	15/11/2019 17:34	14/11/2019 14:56	15/11/2019 17:34	26,62	2	53,24	CHI
201911154172	NIQUELANDIA	NQ12239401	URUACU	14/11/2019 14:04	14/11/2019 18:29	14/11/2019 14:04	14/11/2019 18:29	4,41	39	171,97	CHI
201911154701	GUAPO	GA11099058	GUAPO S1	14/11/2019 14:52	14/11/2019 17:53	14/11/2019 14:52	14/11/2019 17:53	3,02	366	1104,30	CHI
201911154702	RIO VERDE	RV12200718	RIO VERDE S2	14/11/2019 14:28	14/11/2019 16:47	14/11/2019 14:28	14/11/2019 16:47	2,32	25	57,92	CHI
201911154702	SANTA HELENA DE GOIAS	RV12200718	RIO VERDE S2	14/11/2019 14:28	14/11/2019 16:47	14/11/2019 14:28	14/11/2019 16:47	2,32	70	162,19	CHI
201911154703	SANTA HELENA DE GOIAS	SH11159456	IPEGUARI	14/11/2019 14:58	15/11/2019 11:20	14/11/2019 14:58	15/11/2019 11:20	20,36	1	20,36	CHI
201911154710	TRINDADE	TR12393570	GOIANIRA	14/11/2019 14:59	14/11/2019 17:19	14/11/2019 14:59	14/11/2019 17:19	2,34	12	28,11	CHI
201911154711	MUTUNOPOLIS	MU12129781	MARA ROSA	14/11/2019 13:25	15/11/2019 03:30	14/11/2019 13:25	15/11/2019 03:30	14,08	7	98,58	CHI

201911154803	MORRINHOS	MR12119764RE	MORRINHOS	16/11/2019 08:30	16/11/2019 19:42	16/11/2019 08:30	16/11/2019 19:42	11,20	67	750,40	CHI
201911154807	GOIANIA	GN12127447	ATLANTICO S1	14/11/2019 14:53	14/11/2019 16:18	14/11/2019 14:53	14/11/2019 16:18	1,41	430	605,94	CHI
201911154808	GOIAS	GS21207722	ITABERAI S1	14/11/2019 15:01	15/11/2019 12:00	14/11/2019 15:01	15/11/2019 12:00	20,98	1	20,98	CHI
201911154832	MORRINHOS	MR21122173	MORRINHOS	14/11/2019 15:05	15/11/2019 07:19	14/11/2019 15:05	15/11/2019 07:19	16,22	4	64,88	CHI
201911154834	QUIRINOPOLIS	10016503242	QUIRINOPOLIS	14/11/2019 15:06	14/11/2019 17:26	14/11/2019 15:06	14/11/2019 17:26	2,33	1	2,33	CHI
201911154839	PORTELANDIA	PW21301838	PARQUE DAS EMAS	14/11/2019 15:05	15/11/2019 12:20	14/11/2019 15:05	15/11/2019 12:20	21,24	1	21,24	CHI
201911154840	LUZIANIA	LZ11277199	RIO VERMELHO	14/11/2019 15:06	14/11/2019 18:16	14/11/2019 15:06	14/11/2019 18:16	3,16	8	25,26	CHI
201911155010	TRINDADE	TR11378514	TRINDADE	14/11/2019 15:07	14/11/2019 16:48	14/11/2019 15:07	14/11/2019 16:48	1,67	98	163,44	CHI
201911155013	PLANALTINA	PI21043448	PLANALTINA	14/11/2019 15:08	14/11/2019 17:21	14/11/2019 15:08	14/11/2019 17:21	2,21	1	2,21	CHI
201911155015	MUTUNOPOLIS	MU21133916	MARA ROSA	14/11/2019 15:08	15/11/2019 02:52	14/11/2019 15:08	15/11/2019 02:52	11,72	13	152,41	CHI
201911155017	ALTO PARAISO DE GOIAS	BF12365282	SAO JOAO D ALIANCA	14/11/2019 14:21	14/11/2019 17:07	14/11/2019 14:21	14/11/2019 17:07	2,76	47	129,86	CHI
201911155026	GOIATUBA	GT12273783	GOIATUBA S2	14/11/2019 12:53	16/11/2019 18:23	14/11/2019 12:53	16/11/2019 18:23	53,49	40	2139,77	CHI
201911155027	PARAUNA	PU12044570	ACREUNA	14/11/2019 13:17	14/11/2019 20:24	14/11/2019 13:17	14/11/2019 20:24	7,11	24	170,63	CHI
201911155045	ALEXANIA	SN12330532	MARAJOARA	14/11/2019 12:22	14/11/2019 17:23	14/11/2019 12:22	14/11/2019 17:23	5,01	4	20,03	CHI
201911155045	SANTO ANTONIO DO DESCOBERTO	SN12330532	MARAJOARA	14/11/2019 12:22	14/11/2019 17:23	14/11/2019 12:22	14/11/2019 17:23	5,01	30	150,21	CHI
201911155049	GOIANIA	GN12201566	GOYA S2	14/11/2019 15:07	14/11/2019 15:57	14/11/2019 15:07	14/11/2019 15:57	0,83	295	245,34	CHI
201911155060	CRISTIANOPOLIS	CF12000002RE	CRISTIANOPOLIS	14/11/2019 14:28	15/11/2019 12:08	14/11/2019 14:28	14/11/2019 19:59	5,52	16	88,28	CHI
201911155060	CRISTIANOPOLIS	CF12000002RE	CRISTIANOPOLIS	14/11/2019 14:28	15/11/2019 12:08	14/11/2019 17:26	14/11/2019 19:59	2,55	39	99,35	CHI
201911155060	CRISTIANOPOLIS	CF12000002RE	CRISTIANOPOLIS	14/11/2019 14:28	15/11/2019 12:08	14/11/2019 14:28	15/11/2019 12:08	21,66	29	628,16	CHI
201911155060	PIRACANJUBA	CF12000002RE	CRISTIANOPOLIS	14/11/2019 14:28	15/11/2019 12:08	14/11/2019 14:28	15/11/2019 12:08	21,66	6	129,96	CHI
201911155060	CRISTIANOPOLIS	CF13326576	CRISTIANOPOLIS	14/11/2019 14:28	15/11/2019 12:08	14/11/2019 17:26	15/11/2019 12:08	18,69	16	299,04	CHI
201911155060	PIRACANJUBA	CF13326576	CRISTIANOPOLIS	14/11/2019 14:28	15/11/2019 12:08	14/11/2019 17:26	15/11/2019 12:08	18,69	150	2803,54	CHI
201911155206	CRISTALINA	KR12184821	CRISTALINA S2	14/11/2019 15:16	14/11/2019 19:21	14/11/2019 15:16	14/11/2019 19:21	4,07	4	16,27	CHI
201911155220	GOIANIA	GN11155695	CAMPINAS S2	14/11/2019 15:19	14/11/2019 18:41	14/11/2019 15:19	14/11/2019 18:41	3,36	163	546,87	CHI
201911155403	QUIRINOPOLIS	20386103	QUIRINOPOLIS	14/11/2019 15:20	15/11/2019 21:02	14/11/2019 15:20	15/11/2019 21:02	29,70	7	207,89	CHI
201911155601	BURITINOPOLIS	SU12374375	SANTA RITA DO ARAGUAIA	14/11/2019 15:20	15/11/2019 10:16	14/11/2019 15:20	15/11/2019 10:16	18,93	1	18,93	CHI
201911155601	SANTA RITA DO ARAGUAIA	SU12374375	SANTA RITA DO ARAGUAIA	14/11/2019 15:20	15/11/2019 10:16	14/11/2019 15:20	15/11/2019 10:16	18,93	5	94,64	CHI
201911155802	LEOPOLDO DE BULHOES	LB21227713	DAIA S2	14/11/2019 15:20	15/11/2019 10:19	14/11/2019 15:20	15/11/2019 10:19	18,98	1	18,98	CHI
201911156505	CAMPO ALEGRE DE GOIAS	CM12252408	CAMPO ALEGRE DE GOIAS	14/11/2019 14:42	14/11/2019 18:11	14/11/2019 14:42	14/11/2019 18:11	3,48	3	10,44	CHI
201911156518	CALDAS NOVAS	CN11000026	SERRA DE CALDAS	14/11/2019 15:17	14/11/2019 16:30	14/11/2019 15:17	14/11/2019 16:30	1,21	60	72,40	CHI
201911156519	MONTIVIDIU	05700414	MONTIVIDIU T	14/11/2019 15:20	18/11/2019 11:32	14/11/2019 15:20	14/11/2019 21:53	6,55	2	13,11	CHI
201911156519	RIO VERDE	05700414	MONTIVIDIU T	14/11/2019 15:20	18/11/2019 11:32	14/11/2019 15:20	14/11/2019 21:53	6,55	22	144,21	CHI
201911156519	MONTIVIDIU	05700414	MONTIVIDIU T	14/11/2019 15:20	18/11/2019 11:32	15/11/2019 11:47	15/11/2019 12:02	0,25	2	0,50	CHI

201911156519	RIO VERDE	05700414	MONTIVIDIU T	14/11/2019 15:20	18/11/2019 11:32	15/11/2019 11:47	15/11/2019 12:02	0,25	22	5,46	CHI
201911156519	RIO VERDE	RV13357265	MONTIVIDIU T	14/11/2019 15:20	18/11/2019 11:32	14/11/2019 15:20	15/11/2019 12:59	21,65	50	1082,51	CHI
201911156519	MONTIVIDIU	05700414	MONTIVIDIU T	14/11/2019 15:20	18/11/2019 11:32	15/11/2019 18:32	15/11/2019 19:01	0,48	2	0,97	CHI
201911156519	RIO VERDE	05700414	MONTIVIDIU T	14/11/2019 15:20	18/11/2019 11:32	15/11/2019 18:32	15/11/2019 19:01	0,48	22	10,66	CHI
201911156519	RIO VERDE	RV13383488	MONTIVIDIU T	14/11/2019 15:20	18/11/2019 11:32	14/11/2019 15:20	16/11/2019 14:09	46,82	41	1919,48	CHI
201911156519	RIO VERDE	RV13217801	MONTIVIDIU T	14/11/2019 15:20	18/11/2019 11:32	15/11/2019 11:47	16/11/2019 14:09	26,36	1	26,36	CHI
201911156519	RIO VERDE	05700414	CABRIUVA S2	14/11/2019 15:20	18/11/2019 11:32	14/11/2019 15:20	16/11/2019 14:09	46,82	18	842,71	CHI
201911156519	RIO VERDE	RV13383488	MONTIVIDIU T	14/11/2019 15:20	18/11/2019 11:32	14/11/2019 15:20	18/11/2019 10:50	91,51	4	366,02	CHI
201911156519	RIO VERDE	RV13383488	MONTIVIDIU T	14/11/2019 15:20	18/11/2019 11:32	14/11/2019 15:20	18/11/2019 11:32	92,21	12	1106,51	CHI
201911156520	RIO VERDE	RV21365470	CABRIUVA S2	14/11/2019 15:25	16/11/2019 20:58	14/11/2019 15:25	16/11/2019 20:58	53,55	1	53,55	CHI
201911156521	AMARALINA	MQ12170098	NOVA CRIXAS	14/11/2019 15:16	15/11/2019 00:05	14/11/2019 15:16	15/11/2019 00:05	8,81	10	88,13	CHI
201911156521	MARA ROSA	MQ12170098	NOVA CRIXAS	14/11/2019 15:16	15/11/2019 00:05	14/11/2019 15:16	15/11/2019 00:05	8,81	2	17,63	CHI
201911156812	ITAPACI	IW21287955	ITAPACI	14/11/2019 15:28	15/11/2019 19:41	14/11/2019 15:28	15/11/2019 19:41	28,21	1	28,21	CHI
201911156815	JARAGUA	JA12297949	JARAGUA	14/11/2019 15:06	14/11/2019 17:20	14/11/2019 15:06	14/11/2019 17:20	2,23	27	60,13	CHI
201911156825	SANTA TEREZA DE GOIAS	SE11000007	MARA ROSA	14/11/2019 14:42	14/11/2019 23:51	14/11/2019 14:42	14/11/2019 23:51	9,14	69	630,58	CHI
201911156828	CASTELANDIA	QI32050383	QUIRINOPOLIS	14/11/2019 15:30	14/11/2019 15:43	14/11/2019 15:30	14/11/2019 15:43	0,22	14	3,02	CHI
201911156828	QUIRINOPOLIS	QI32050383	QUIRINOPOLIS	14/11/2019 15:30	14/11/2019 15:43	14/11/2019 15:30	14/11/2019 15:43	0,22	1	0,22	CHI
201911156836	ALEXANIA	AX21114664	ALEXANIA	14/11/2019 15:31	15/11/2019 14:31	14/11/2019 15:31	15/11/2019 14:31	22,99	1	22,99	CHI
201911157001	APARECIDA DE GOIANIA	15235853	REAL S1	14/11/2019 15:32	14/11/2019 17:44	14/11/2019 15:32	14/11/2019 17:44	2,20	1	2,20	CHI
201911157413	MORRINHOS	MR12000148	MORRINHOS	14/11/2019 15:34	14/11/2019 20:13	14/11/2019 15:34	14/11/2019 20:13	4,63	25	115,87	CHI
201911157502	GOIANIA	GN12071600LD	GOIANIA LESTE S1	14/11/2019 15:35	14/11/2019 18:03	14/11/2019 15:35	14/11/2019 18:03	2,46	680	1673,56	CHI
201911157505	ITAPURANGA	IK12298410	ITAPURANGA	14/11/2019 14:05	14/11/2019 20:25	14/11/2019 14:05	14/11/2019 20:25	6,32	12	75,88	CHI
201911157506	CALDAS NOVAS	10017159090	SERRA DE CALDAS	14/11/2019 15:36	14/11/2019 17:58	14/11/2019 15:36	14/11/2019 17:58	2,37	1	2,37	CHI
201911157507	TRINDADE	40135925	GOYA S1	14/11/2019 15:36	14/11/2019 18:10	14/11/2019 15:36	14/11/2019 18:10	2,56	1	2,56	CHI
201911157512	CATALAO	CT21164154	CATALAO S2	14/11/2019 15:36	14/11/2019 17:02	14/11/2019 15:36	14/11/2019 17:02	1,42	1	1,42	CHI
201911157513	ABADIANIA	AA31089157	ANAPOLIS UNIVERSITARIO S1	14/11/2019 15:36	15/11/2019 10:56	14/11/2019 15:36	15/11/2019 10:56	19,32	1	19,32	CHI
201911157515	ITAGUARU	IC21168752	ITABERAI S1	14/11/2019 15:37	18/11/2019 10:01	14/11/2019 15:37	18/11/2019 10:01	90,39	1	90,39	CHI
201911157520	MONTES CLAROS DE GOIAS	ME21134098	BRITANIA	14/11/2019 15:38	16/11/2019 17:43	14/11/2019 15:38	16/11/2019 17:43	50,08	1	50,08	CHI
201911157535	RIO VERDE	RV21213485	CABRIUVA S2	14/11/2019 15:38	15/11/2019 16:14	14/11/2019 15:38	15/11/2019 16:14	24,61	1	24,61	CHI
201911157545	SANCLERLANDIA	SC21034203	FIRMINOPOLIS S2	14/11/2019 15:41	15/11/2019 08:45	14/11/2019 15:41	15/11/2019 08:45	17,07	1	17,07	CHI
201911157551	CAIAPONIA	CP21243939	PIRANHAS	14/11/2019 15:41	15/11/2019 14:55	14/11/2019 15:41	15/11/2019 14:55	23,22	1	23,22	CHI
201911157552	GOIANIA	GN11043393	GOIANIA LESTE S1	14/11/2019 15:37	15/11/2019 10:10	14/11/2019 15:37	15/11/2019 03:40	12,04	116	1396,12	CHI
201911157552	GOIANIA	GN12000199	GOIANIA LESTE S1	14/11/2019 15:37	15/11/2019 10:10	14/11/2019 15:38	15/11/2019 10:10	18,53	58	1074,93	CHI

201911157557	SERRANOPOLIS	SX12296482	JATAI S1	14/11/2019 13:13	15/11/2019 10:54	14/11/2019 13:13	15/11/2019 10:54	21,67	2	43,34	CHI
201911157703	JARAGUA	JA21000180	JARAGUA	14/11/2019 15:43	15/11/2019 08:23	14/11/2019 15:43	15/11/2019 08:23	16,66	2	33,32	CHI
201911157809	MINEIROS	7141958	PARQUE DAS EMAS	14/11/2019 15:44	15/11/2019 17:50	14/11/2019 15:44	15/11/2019 17:50	26,09	4	104,35	CHI
201911157810	CALDAS NOVAS	10022511308	CALDAS NOVAS S1	14/11/2019 15:44	15/11/2019 11:25	14/11/2019 15:44	15/11/2019 11:25	19,67	1	19,67	CHI
201911157833	CAMPO ALEGRE DE GOIAS	CM12042502	CAMPO ALEGRE DE GOIAS	14/11/2019 15:46	18/11/2019 08:33	14/11/2019 15:46	18/11/2019 08:33	88,77	9	798,91	CHI
201911157840	GOIANIA	GN11042210	AEROPORTO S1	14/11/2019 15:43	14/11/2019 20:05	14/11/2019 15:43	14/11/2019 20:05	4,35	111	483,40	CHI
201911157844	BALIZA	BH12142110	BOM JARDIM	14/11/2019 14:58	14/11/2019 19:20	14/11/2019 14:58	14/11/2019 19:20	4,36	84	366,24	CHI
201911157860	AGUA LIMPA	AL12075702	VILA CORUMBA	14/11/2019 15:50	15/11/2019 12:25	14/11/2019 15:50	15/11/2019 12:25	20,58	1	20,58	CHI
201911157867	MINEIROS	MY12278397	PARQUE DAS EMAS	14/11/2019 13:35	15/11/2019 09:43	14/11/2019 13:35	15/11/2019 09:43	20,13	5	100,66	CHI
201911157867	SERRANOPOLIS	MY12278397	PARQUE DAS EMAS	14/11/2019 13:35	15/11/2019 09:43	14/11/2019 13:35	15/11/2019 09:43	20,13	7	140,92	CHI
201911157879	LEOPOLDO DE BULHOES	LB12011166	DAIA S2	14/11/2019 15:52	15/11/2019 10:13	14/11/2019 15:52	15/11/2019 10:13	18,34	1	18,34	CHI
201911157879	SILVANIA	LB12011166	DAIA S2	14/11/2019 15:52	15/11/2019 10:13	14/11/2019 15:52	15/11/2019 10:13	18,34	2	36,68	CHI
201911157883	URUACU	UR21237469	URUACU	14/11/2019 15:52	15/11/2019 10:55	14/11/2019 15:52	15/11/2019 10:55	19,04	1	19,04	CHI
201911157901	CRIXAS	CX21364256	SERRA DO OURO	14/11/2019 15:53	15/11/2019 05:59	14/11/2019 15:53	15/11/2019 05:59	14,09	1	14,09	CHI
201911157909	AURILANDIA	CG12391407	FIRMINOPOLIS S2	14/11/2019 15:34	15/11/2019 15:25	14/11/2019 15:34	15/11/2019 00:02	8,47	2	16,94	CHI
201911157909	CACHOEIRA DE GOIAS	CG12391407	FIRMINOPOLIS S2	14/11/2019 15:34	15/11/2019 15:25	14/11/2019 15:34	15/11/2019 00:02	8,47	67	567,53	CHI
201911157909	PARAUNA	CG12391407	FIRMINOPOLIS S2	14/11/2019 15:34	15/11/2019 15:25	14/11/2019 15:34	15/11/2019 00:02	8,47	27	228,71	CHI
201911157909	PARAUNA	CG12391407	FIRMINOPOLIS S2	14/11/2019 15:34	15/11/2019 15:25	14/11/2019 15:34	15/11/2019 10:52	19,31	4	77,24	CHI
201911157909	AURILANDIA	CG12391407	FIRMINOPOLIS S2	14/11/2019 15:34	15/11/2019 15:25	15/11/2019 00:03	15/11/2019 10:52	10,83	2	21,65	CHI
201911157909	CACHOEIRA DE GOIAS	CG12391407	FIRMINOPOLIS S2	14/11/2019 15:34	15/11/2019 15:25	15/11/2019 00:03	15/11/2019 10:52	10,83	67	725,29	CHI
201911157909	PARAUNA	CG12391407	FIRMINOPOLIS S2	14/11/2019 15:34	15/11/2019 15:25	15/11/2019 00:03	15/11/2019 10:52	10,83	22	238,16	CHI
201911157909	PARAUNA	PU12383544LD	FIRMINOPOLIS S2	14/11/2019 15:34	15/11/2019 15:25	15/11/2019 00:03	15/11/2019 15:25	15,38	6	92,26	CHI
201911157924	MUNDO NOVO DE GOIAS	MH12391951	NOVA CRIXAS	14/11/2019 15:55	16/11/2019 00:00	14/11/2019 15:55	16/11/2019 00:00	32,08	18	577,36	CHI
201911157933	CALDAS NOVAS	760041003	SERRA DE CALDAS	14/11/2019 15:56	15/11/2019 09:55	14/11/2019 15:56	15/11/2019 09:55	17,97	1	17,97	CHI
201911157948	TRINDADE	10003546037	TRINDADE	14/11/2019 15:57	14/11/2019 19:53	14/11/2019 15:57	14/11/2019 19:53	3,92	1	3,92	CHI
201911158014	HIDROLANDIA	HD11000137	ANHANGUERA	14/11/2019 15:05	14/11/2019 18:52	14/11/2019 15:05	14/11/2019 18:52	3,78	56	211,42	CHI
201911158022	PALMEIRAS DE GOIAS	PL11000007	PALMEIRAS	14/11/2019 15:19	14/11/2019 23:10	14/11/2019 15:19	14/11/2019 23:10	7,85	157	1232,45	CHI
201911158023	GOIANIA	GN11001773	GOIANIA LESTE S1	14/11/2019 15:47	14/11/2019 21:58	14/11/2019 15:47	14/11/2019 21:58	6,17	77	475,41	CHI
201911158040	GOIANIA	GN12000242	GOIANIA LESTE S1	14/11/2019 15:40	14/11/2019 17:36	14/11/2019 15:40	14/11/2019 17:36	1,93	140	270,67	CHI
201911158043	CASTELANDIA	01560234	QUIRINOPOLIS	14/11/2019 16:02	14/11/2019 17:32	14/11/2019 16:02	14/11/2019 17:32	1,50	20	30,00	CHI
201911158043	GOUVELANDIA	01560234	QUIRINOPOLIS	14/11/2019 16:02	14/11/2019 17:32	14/11/2019 16:02	14/11/2019 17:32	1,50	314	471,00	CHI
201911158043	QUIRINOPOLIS	01560234	QUIRINOPOLIS	14/11/2019 16:02	14/11/2019 17:32	14/11/2019 16:02	14/11/2019 17:32	1,50	774	1161,00	CHI
201911158043	RIO VERDE	01560234	QUIRINOPOLIS	14/11/2019 16:02	14/11/2019 17:32	14/11/2019 16:02	14/11/2019 17:32	1,50	1	1,50	CHI

201911158046	SILVANIA	SV12310174	DAIA S2	14/11/2019 12:16	15/11/2019 14:15	14/11/2019 12:16	15/11/2019 14:15	25,98	15	389,65	CHI
201911158054	GOIANIA	10687804	ATLANTICO S2	14/11/2019 16:04	14/11/2019 17:35	14/11/2019 16:04	14/11/2019 17:35	1,51	1	1,51	CHI
201911158305	GOIANIA	GN11169427	REAL S1	14/11/2019 15:50	14/11/2019 20:02	14/11/2019 15:50	14/11/2019 20:02	4,21	60	252,47	CHI
201911158324	LUZIANIA	LZ21313620	CRISTALINA S2	14/11/2019 16:06	14/11/2019 18:04	14/11/2019 16:06	14/11/2019 18:04	1,96	1	1,96	CHI
201911158329	TRINDADE	40217127	TRINDADE	14/11/2019 16:06	14/11/2019 19:21	14/11/2019 16:06	14/11/2019 19:21	3,24	1	3,24	CHI
201911158335	GOIANIA	GN12000838	FERROVIARIO S2	14/11/2019 16:07	14/11/2019 18:35	14/11/2019 16:07	14/11/2019 18:35	2,46	589	1449,59	CHI
201911158346	SAO MIGUEL DO ARAGUAIA	SM12000065	SAO MIGUEL DO ARAGUAIA	15/11/2019 09:12	15/11/2019 11:58	15/11/2019 09:12	15/11/2019 11:58	2,77	24	66,45	CHI
201911158360	IPAMERI	IP21359958	IPAMERI	14/11/2019 16:09	14/11/2019 19:26	14/11/2019 16:09	14/11/2019 19:26	3,28	1	3,28	CHI
201911158366	GOIANIA	GN16404303	GOIANIA LESTE S3	14/11/2019 16:09	15/11/2019 08:58	14/11/2019 16:09	14/11/2019 16:56	0,77	668	514,55	CHI
201911158366	GOIANIA	GN16404305	GOIANIA LESTE S3	14/11/2019 16:09	15/11/2019 08:58	14/11/2019 16:09	14/11/2019 18:17	2,12	288	610,24	CHI
201911158366	GOIANIA	GN13390523	GOIANIA LESTE S3	14/11/2019 16:09	15/11/2019 08:58	14/11/2019 18:17	15/11/2019 08:58	14,69	2	29,37	CHI
201911158373	GOIANIA	GN12042924	FERROVIARIO S2	14/11/2019 16:10	14/11/2019 20:51	14/11/2019 16:10	14/11/2019 20:51	4,68	117	547,07	CHI
201911158382	BELA VISTA DE GOIAS	BV21215204	BELA VISTA S1	14/11/2019 16:11	15/11/2019 11:02	14/11/2019 16:11	15/11/2019 11:02	18,84	5	94,22	CHI
201911158386	CIDADE OCIDENTAL	DH12370611	MARAJOARA	14/11/2019 16:11	14/11/2019 17:52	14/11/2019 16:11	14/11/2019 17:52	1,67	5	8,37	CHI
201911158387	ABADIANIA	AX12258506	ALEXANIA	14/11/2019 15:55	14/11/2019 18:39	14/11/2019 15:55	14/11/2019 18:39	2,73	6	16,37	CHI
201911158387	ALEXANIA	AX12258506	ALEXANIA	14/11/2019 15:55	14/11/2019 18:39	14/11/2019 15:55	14/11/2019 18:39	2,73	44	120,05	CHI
201911158391	SENADOR CANEDO	16442349	GOIANIA LESTE S3	14/11/2019 16:11	14/11/2019 18:38	14/11/2019 16:11	14/11/2019 18:38	2,45	1	2,45	CHI
201911158395	GOIANIA	GN11048929	REAL S1	14/11/2019 15:58	15/11/2019 10:00	14/11/2019 15:58	15/11/2019 10:00	18,02	216	3893,10	CHI
201911158404	GOIANIA	GN11001392	GOIANIA LESTE S1	14/11/2019 15:45	14/11/2019 20:53	14/11/2019 15:45	14/11/2019 20:53	5,13	16	82,03	CHI
201911158408	QUIRINOPOLIS	01560404	QUIRINOPOLIS	14/11/2019 17:30	16/11/2019 15:35	14/11/2019 17:30	14/11/2019 18:15	0,75	198	148,77	CHI
201911158408	PARANAIGUARA	QI13000034	QUIRINOPOLIS	14/11/2019 17:30	16/11/2019 15:35	14/11/2019 17:30	14/11/2019 20:16	2,78	10	27,77	CHI
201911158408	QUIRINOPOLIS	01560404	QUIRINOPOLIS	14/11/2019 17:30	16/11/2019 15:35	14/11/2019 17:30	14/11/2019 20:16	2,78	60	166,63	CHI
201911158408	QUIRINOPOLIS	QI13000034	QUIRINOPOLIS	14/11/2019 17:30	16/11/2019 15:35	14/11/2019 17:30	14/11/2019 20:16	2,78	143	397,14	CHI
201911158408	PARANAIGUARA	QI13340800	QUIRINOPOLIS	14/11/2019 17:30	16/11/2019 15:35	14/11/2019 17:30	14/11/2019 21:17	3,79	97	367,39	CHI
201911158408	QUIRINOPOLIS	QI13340800	QUIRINOPOLIS	14/11/2019 17:30	16/11/2019 15:35	14/11/2019 17:30	14/11/2019 21:17	3,79	29	109,84	CHI
201911158408	PARANAIGUARA	PC13355060	QUIRINOPOLIS	14/11/2019 17:30	16/11/2019 15:35	14/11/2019 17:30	14/11/2019 22:12	4,70	46	216,33	CHI
201911158408	QUIRINOPOLIS	PC13355060	QUIRINOPOLIS	14/11/2019 17:30	16/11/2019 15:35	14/11/2019 17:30	14/11/2019 22:12	4,70	69	324,49	CHI
201911158408	PARANAIGUARA	PC13355060	QUIRINOPOLIS	14/11/2019 17:30	16/11/2019 15:35	14/11/2019 18:09	14/11/2019 22:12	4,05	10	40,52	CHI
201911158408	QUIRINOPOLIS	PC13355060	QUIRINOPOLIS	14/11/2019 17:30	16/11/2019 15:35	14/11/2019 18:09	14/11/2019 22:12	4,05	1	4,05	CHI
201911158408	PARANAIGUARA	PC10400581	QUIRINOPOLIS	14/11/2019 17:30	16/11/2019 15:35	14/11/2019 17:30	14/11/2019 22:30	5,00	37	185,17	CHI
201911158408	PARANAIGUARA	01560404	QUIRINOPOLIS	14/11/2019 17:30	16/11/2019 15:35	14/11/2019 22:13	14/11/2019 22:41	0,47	114	53,20	CHI
201911158408	QUIRINOPOLIS	01560404	QUIRINOPOLIS	14/11/2019 17:30	16/11/2019 15:35	14/11/2019 22:13	14/11/2019 22:41	0,47	57	26,60	CHI
201911158408	QUIRINOPOLIS	01560404	QUIRINOPOLIS	14/11/2019 17:30	16/11/2019 15:35	14/11/2019 22:13	14/11/2019 22:41	0,47	394	183,87	CHI

201911158408	PARANAIGUARA	PC10400581	QUIRINOPOLIS	14/11/2019 17:30	16/11/2019 15:35	15/11/2019 17:18	15/11/2019 20:28	3,18	41	130,31	CHI
201911158408	PARANAIGUARA	PC13355060	QUIRINOPOLIS	14/11/2019 17:30	16/11/2019 15:35	14/11/2019 22:13	16/11/2019 15:35	41,37	57	2358,28	CHI
201911158408	QUIRINOPOLIS	PC13355060	QUIRINOPOLIS	14/11/2019 17:30	16/11/2019 15:35	14/11/2019 22:13	16/11/2019 15:35	41,37	74	3061,63	CHI
201911158603	SANTO ANTONIO DO DESCOBERTO	SN11163879	AGUAS LINDAS DE GOIAS S2	14/11/2019 16:11	14/11/2019 19:12	14/11/2019 16:11	14/11/2019 19:12	3,01	126	379,82	CHI
201911158802	MUNDO NOVO DE GOIAS	MH11274946	NOVA CRIXAS	14/11/2019 16:14	16/11/2019 10:10	14/11/2019 16:14	16/11/2019 10:10	41,93	1	41,93	CHI
201911158806	GOIANESIA	GE10396194	GOIANESIA S2	14/11/2019 16:13	15/11/2019 01:27	14/11/2019 16:13	15/11/2019 01:27	9,24	156	1441,22	CHI
201911158806	SANTA ISABEL	GE10396194	GOIANESIA S2	14/11/2019 16:13	15/11/2019 01:27	14/11/2019 16:13	15/11/2019 01:27	9,24	1	9,24	CHI
201911158807	JARAGUA	JA21278912	JARAGUA	14/11/2019 16:14	14/11/2019 21:19	14/11/2019 16:14	14/11/2019 21:19	5,07	1	5,07	CHI
201911158808	INHUMAS	IN21015200	INHUMAS S2	14/11/2019 16:14	14/11/2019 20:35	14/11/2019 16:14	14/11/2019 20:35	4,34	2	8,68	CHI
201911158809	GOIANIA	GN12150043	FERROVIARIO S1	14/11/2019 16:02	14/11/2019 17:50	14/11/2019 16:02	14/11/2019 17:50	1,79	205	365,98	CHI
201911158811	GOIANIA	GN12164391	MEIA PONTE	14/11/2019 15:35	14/11/2019 17:09	14/11/2019 15:35	14/11/2019 17:09	1,57	241	377,43	CHI
201911158814	NIQUELANDIA	NQ21371153	NIQUELANDIA SUBTRANSMISSAO	14/11/2019 16:15	14/11/2019 20:27	14/11/2019 16:15	14/11/2019 20:27	4,20	2	8,39	CHI
201911158822	MORRINHOS	MR21000162	MORRINHOS	14/11/2019 16:15	14/11/2019 17:12	14/11/2019 16:15	14/11/2019 17:12	0,94	1	0,94	CHI
201911158823	PIRES DO RIO	PR12051695	PIRES DO RIO S2	14/11/2019 14:17	16/11/2019 19:21	14/11/2019 14:17	16/11/2019 19:21	53,05	9	477,48	CHI
201911158824	SAO JOAO D ALIANCA	JL12242952	SAO JOAO D ALIANCA	14/11/2019 15:52	14/11/2019 18:13	14/11/2019 15:52	14/11/2019 18:13	2,35	139	326,38	CHI
201911158854	COCALZINHO DE GOIAS	1200032345	COCALZINHO	14/11/2019 16:18	14/11/2019 21:21	14/11/2019 16:18	14/11/2019 21:21	5,05	1	5,05	CHI
201911158859	CALDAS NOVAS	CN11054003	SERRA DE CALDAS	14/11/2019 15:55	14/11/2019 19:41	14/11/2019 15:55	14/11/2019 19:41	3,77	221	832,25	CHI
201911158865	JATAI	JT21205161	JATAI S1	14/11/2019 16:18	14/11/2019 17:26	14/11/2019 16:18	14/11/2019 17:26	1,12	1	1,12	CHI
201911158878	SANTO ANTONIO DO DESCOBERTO	2210032587	AGUAS LINDAS DE GOIAS S2	14/11/2019 16:19	14/11/2019 20:57	14/11/2019 16:19	14/11/2019 20:57	4,62	1	4,62	CHI
201911158886	IACIARA	PS12195977	IACIARA S1	14/11/2019 16:20	14/11/2019 17:57	14/11/2019 16:20	14/11/2019 17:57	1,61	85	136,76	CHI
201911158886	POSSE	PS12195977	IACIARA S1	14/11/2019 16:20	14/11/2019 17:57	14/11/2019 16:20	14/11/2019 17:57	1,61	1	1,61	CHI
201911159004	SILVANIA	SV12161967	VIANOPOLIS	14/11/2019 14:33	14/11/2019 23:52	14/11/2019 14:33	14/11/2019 23:52	9,30	15	139,56	CHI
201911159014	GOIANIA	12094020	GOYA S1	14/11/2019 16:21	14/11/2019 19:33	14/11/2019 16:21	14/11/2019 19:33	3,18	1	3,18	CHI
201911159020	INHUMAS	IN11040751	INHUMAS S2	14/11/2019 15:01	14/11/2019 17:40	14/11/2019 15:01	14/11/2019 17:40	2,64	92	242,50	CHI
201911159026	SANTA ROSA DE GOIAS	SR21053362	INHUMAS S1	14/11/2019 16:23	14/11/2019 20:19	14/11/2019 16:23	14/11/2019 20:19	3,93	1	3,93	CHI
201911159039	PORTELANDIA	PW21237025	PARQUE DAS EMAS	14/11/2019 16:24	15/11/2019 09:32	14/11/2019 16:24	15/11/2019 09:32	17,13	1	17,13	CHI
201911159053	ARACU	AR11132830	ARACU	14/11/2019 16:25	15/11/2019 10:30	14/11/2019 16:25	15/11/2019 10:30	18,08	110	1989,08	CHI
201911159054	GOIANIA	GN11023410	REAL S1	14/11/2019 16:01	14/11/2019 20:40	14/11/2019 16:01	14/11/2019 20:40	4,64	231	1071,46	CHI
201911159057	NAZARIO	NZ31194078	ANICUNS	14/11/2019 16:24	15/11/2019 20:17	14/11/2019 16:24	15/11/2019 20:17	27,87	1	27,87	CHI
201911159203	NOVA IGUACU DE GOIAS	UR10410223	CAMPINORTE	14/11/2019 14:37	15/11/2019 13:53	15/11/2019 03:11	15/11/2019 03:32	0,35	15	5,28	CHI
201911159203	URUACU	UR10410223	CAMPINORTE	14/11/2019 14:37	15/11/2019 13:53	15/11/2019 03:11	15/11/2019 03:32	0,35	97	34,14	CHI
201911159203	URUACU	UR10410223	URUACU	14/11/2019 14:37	15/11/2019 13:53	15/11/2019 03:11	15/11/2019 03:32	0,35	57	20,06	CHI
201911159203	CAMPINORTE	UR13000021	CAMPINORTE	14/11/2019 14:37	15/11/2019 13:53	14/11/2019 14:37	15/11/2019 13:53	23,27	10	232,73	CHI

201911159204	ABADIA DE GOIAS	GN11268576	INDEPENDENCIA S2	15/11/2019 11:01	15/11/2019 12:19	15/11/2019 11:01	15/11/2019 12:19	1,30	16	20,76	CHI
201911159205	GOIANIA	GN11168662	REAL S1	14/11/2019 16:03	15/11/2019 12:53	14/11/2019 16:03	15/11/2019 12:53	20,82	38	791,05	CHI
201911159510	LUZIANIA	LZ21244103	VIANOPOLIS	14/11/2019 16:27	14/11/2019 21:10	14/11/2019 16:27	14/11/2019 21:10	4,71	1	4,71	CHI
201911159528	PALMEIRAS DE GOIAS	PL11312588	PALMEIRAS	14/11/2019 15:30	14/11/2019 18:01	14/11/2019 15:30	14/11/2019 18:01	2,51	332	833,87	CHI
201911159531	AMARALINA	MH12362454	NOVA CRIXAS	14/11/2019 15:06	14/11/2019 19:22	14/11/2019 15:06	14/11/2019 19:22	4,26	1	4,26	CHI
201911159531	MUNDO NOVO DE GOIAS	MH12362454	NOVA CRIXAS	14/11/2019 15:06	14/11/2019 19:22	14/11/2019 15:06	14/11/2019 19:22	4,26	238	1013,68	CHI
201911159533	DOVERLANDIA	DV11139978	CAIAPONIA	14/11/2019 15:28	14/11/2019 17:12	14/11/2019 15:28	14/11/2019 17:12	1,73	145	250,41	CHI
201911159534	SANTA HELENA DE GOIAS	SH11000002	IPEGUARI	14/11/2019 15:10	14/11/2019 20:20	14/11/2019 15:10	14/11/2019 20:20	5,15	95	489,72	CHI
201911159538	CHAPADAO DO CEU	DJ21160245	CHAPADAO DO CEU	14/11/2019 16:30	16/11/2019 12:24	14/11/2019 16:30	16/11/2019 12:24	43,89	1	43,89	CHI
201911159549	GOIANIA	GN11000870	FERROVIARIO S1	14/11/2019 16:13	14/11/2019 22:45	14/11/2019 16:13	14/11/2019 22:45	6,53	47	307,07	CHI
201911159704	MORRINHOS	MR21092123	MORRINHOS	14/11/2019 16:32	14/11/2019 17:33	14/11/2019 16:32	14/11/2019 17:33	1,02	3	3,06	CHI
201911160201	GOIANIA	GN11189272	FERROVIARIO S2	14/11/2019 16:30	14/11/2019 21:57	14/11/2019 16:30	14/11/2019 21:57	5,44	30	163,20	CHI
201911160404	LUZIANIA	LZ21172153	MARAJOARA	14/11/2019 16:33	14/11/2019 23:27	14/11/2019 16:33	14/11/2019 23:27	6,89	1	6,89	CHI
201911160503	CALDAS NOVAS	CN11044751	SERRA DE CALDAS	14/11/2019 16:34	15/11/2019 09:14	14/11/2019 16:34	15/11/2019 09:14	16,65	166	2764,45	CHI
201911160905	GOIANIA	GN21160881	CEPAIGO S1	14/11/2019 16:35	14/11/2019 22:05	14/11/2019 16:35	14/11/2019 22:05	5,50	1	5,50	CHI
201911161001	CAMPO ALEGRE DE GOIAS	CM12142253	CAMPO ALEGRE DE GOIAS	14/11/2019 16:35	15/11/2019 12:34	14/11/2019 16:35	15/11/2019 12:34	19,98	4	79,91	CHI
201911161204	GOIANIA	GN11002108	FERROVIARIO S1	14/11/2019 16:23	14/11/2019 22:48	14/11/2019 16:23	14/11/2019 22:48	6,41	50	320,37	CHI
201911161205	ITUMBIARA	IT11000061	PARANAIBA	14/11/2019 16:26	14/11/2019 20:42	14/11/2019 16:26	14/11/2019 20:42	4,26	129	548,90	CHI
201911161209	GOIANIA	11773339	REAL S1	14/11/2019 16:36	15/11/2019 20:42	14/11/2019 16:36	15/11/2019 20:42	28,09	1	28,09	CHI
201911161212	LUZIANIA	LZ11153074	MARAJOARA	14/11/2019 16:36	14/11/2019 19:03	14/11/2019 16:36	14/11/2019 19:03	2,44	165	402,65	CHI
201911161213	GOIANIA	GN11000333	GOIANIA LESTE S1	14/11/2019 15:48	14/11/2019 21:05	14/11/2019 15:48	14/11/2019 21:05	5,27	23	121,16	CHI
201911161302	GOIANIA	GN11265866	CEPAIGO S1	14/11/2019 16:37	14/11/2019 19:45	14/11/2019 16:37	14/11/2019 19:45	3,15	6	18,88	CHI
201911161601	JATAI	JT21129659	JATAI S1	14/11/2019 16:39	15/11/2019 11:56	14/11/2019 16:39	15/11/2019 11:56	19,28	1	19,28	CHI
201911161820	CALDAS NOVAS	CN21333280	RIO QUENTE	14/11/2019 16:41	15/11/2019 09:32	14/11/2019 16:41	15/11/2019 09:32	16,85	1	16,85	CHI
201911161821	LUZIANIA	LZ12025119	RIO VERMELHO	14/11/2019 16:41	14/11/2019 22:07	14/11/2019 16:41	14/11/2019 22:07	5,43	23	124,92	CHI
201911161823	APARECIDA DE GOIANIA	AP12165678	ANHANGUERA	14/11/2019 16:29	15/11/2019 04:46	14/11/2019 16:29	14/11/2019 19:05	2,60	193	500,89	CHI
201911161823	APARECIDA DE GOIANIA	AP12049712	ANHANGUERA	14/11/2019 16:29	15/11/2019 04:46	14/11/2019 16:29	15/11/2019 04:46	12,29	152	1867,91	CHI
201911161827	IPORA	IR11000012	IPORA	14/11/2019 16:41	14/11/2019 19:25	14/11/2019 16:41	14/11/2019 19:25	2,72	89	241,96	CHI
201911161836	AGUA FRIA DE GOIAS	TL12394158	SAO JOAO D ALIANCA	14/11/2019 15:54	14/11/2019 18:09	14/11/2019 15:54	14/11/2019 18:09	2,24	14	31,33	CHI
201911162220	MINACU	IH11052535	MINACU	14/11/2019 15:09	14/11/2019 22:35	14/11/2019 15:09	14/11/2019 22:35	7,43	106	787,34	CHI
201911162222	INHUMAS	IN12000054	INHUMAS S2	14/11/2019 15:24	14/11/2019 19:06	14/11/2019 15:24	14/11/2019 19:06	3,69	1	3,69	CHI
201911162231	CATALAO	CT21231547	CATALAO S1	14/11/2019 16:45	14/11/2019 18:13	14/11/2019 16:45	14/11/2019 18:13	1,45	2	2,91	CHI
201911162232	IPAMERI	IP12237222	IPAMERI	14/11/2019 16:45	15/11/2019 17:32	14/11/2019 16:45	15/11/2019 17:32	24,77	1	24,77	CHI

201911162237	APARECIDA DE GOIANIA	AP11203358	REAL S1	14/11/2019 16:13	14/11/2019 22:04	14/11/2019 16:13	14/11/2019 22:04	5,84	221	1290,52	CHI
201911162244	ANAPOLIS	20575981	JUNDAI S1	14/11/2019 16:46	14/11/2019 17:40	14/11/2019 16:46	14/11/2019 17:40	0,89	1	0,89	CHI
201911162256	GOIANESIA	GE11171628	GOIANESIA S2	14/11/2019 16:00	15/11/2019 03:25	14/11/2019 16:00	15/11/2019 03:25	11,41	74	844,44	CHI
201911162268	CATALAO	CT11215495	CATALAO S1	14/11/2019 16:48	14/11/2019 18:56	14/11/2019 16:48	14/11/2019 18:56	2,12	172	365,02	CHI
201911162274	INHUMAS	10019857894	INHUMAS S2	14/11/2019 16:49	15/11/2019 06:49	14/11/2019 16:49	15/11/2019 06:49	13,99	1	13,99	CHI
201911162302	GOIANIA	GN11048174	XAVANTES	14/11/2019 16:24	14/11/2019 23:50	14/11/2019 16:24	14/11/2019 23:50	7,42	130	964,60	CHI
201911162307	CALDAS NOVAS	CN11103226	CALDAS NOVAS S2	14/11/2019 15:53	15/11/2019 01:07	14/11/2019 15:53	15/11/2019 01:07	9,24	140	1293,33	CHI
201911162316	GOIANIA	20536830	GOIANIA LESTE S2	14/11/2019 15:43	14/11/2019 19:10	14/11/2019 15:43	14/11/2019 19:10	3,44	571	1967,09	CHI
201911162318	APARECIDA DE GOIANIA	10005107715	INDEPENDENCIA S2	14/11/2019 16:50	14/11/2019 18:38	14/11/2019 16:50	14/11/2019 18:38	1,79	1	1,79	CHI
201911162325	MINACU	IH11262689	MINACU	14/11/2019 16:45	14/11/2019 20:20	14/11/2019 16:45	14/11/2019 20:20	3,59	23	82,50	CHI
201911162910	NEROPOLIS	160070004	NEROPOLIS S2	14/11/2019 16:54	14/11/2019 19:53	14/11/2019 16:54	14/11/2019 19:53	2,98	1	2,98	CHI
201911162914	ISRAELANDIA	IS12218978	IPORA	14/11/2019 15:31	14/11/2019 17:58	14/11/2019 15:31	14/11/2019 17:58	2,45	7	17,12	CHI
201911162915	ANICUNS	AC12391417	ANICUNS	14/11/2019 15:26	14/11/2019 23:49	14/11/2019 15:26	14/11/2019 23:49	8,39	2	16,79	CHI
201911162915	TURVANIA	AC12391417	ANICUNS	14/11/2019 15:26	14/11/2019 23:49	14/11/2019 15:26	14/11/2019 23:49	8,39	3	25,18	CHI
201911162916	MUTUNOPOLIS	7539686	MARA ROSA	14/11/2019 16:54	15/11/2019 16:15	14/11/2019 16:54	15/11/2019 16:15	23,34	2	46,68	CHI
201911162935	MUNDO NOVO DE GOIAS	MH21091850	NOVA CRIXAS	14/11/2019 16:56	15/11/2019 12:53	14/11/2019 16:56	15/11/2019 12:53	19,95	1	19,95	CHI
201911162942	MINEIROS	MY21358859	PARQUE DAS EMAS	14/11/2019 16:56	15/11/2019 04:51	14/11/2019 16:56	15/11/2019 04:51	11,90	1	11,90	CHI
201911162957	CAMPO ALEGRE DE GOIAS	CM12156359	CAMPO ALEGRE DE GOIAS	14/11/2019 16:19	18/11/2019 07:49	14/11/2019 16:19	18/11/2019 07:49	87,49	31	2712,28	CHI
201911162961	ARAGOIANIA	AO11229593	GUAPO S2	14/11/2019 16:51	14/11/2019 23:21	14/11/2019 16:51	14/11/2019 23:21	6,49	128	830,44	CHI
201911163008	LEOPOLDO DE BULHOES	LB21378022	DAIA S2	14/11/2019 17:00	15/11/2019 09:41	14/11/2019 17:00	15/11/2019 09:41	16,67	1	16,67	CHI
201911163035	GOIANIA	GN11000872	FERROVIARIO S2	14/11/2019 16:26	14/11/2019 21:34	14/11/2019 16:26	14/11/2019 21:34	5,13	49	251,26	CHI
201911163036	PORANGATU	PO12262594	PORANGATU	14/11/2019 17:02	16/11/2019 10:57	14/11/2019 17:02	16/11/2019 10:57	41,91	1	41,91	CHI
201911163039	APARECIDA DE GOIANIA	10014895968	INDEPENDENCIA S1	14/11/2019 17:03	14/11/2019 18:31	14/11/2019 17:03	14/11/2019 18:31	1,46	1	1,46	CHI
201911163062	PIRES DO RIO	PR21099994	PIRES DO RIO S1	14/11/2019 17:05	15/11/2019 10:51	14/11/2019 17:05	15/11/2019 10:51	17,76	1	17,76	CHI
201911163063	AGUA FRIA DE GOIAS	TL12365112	SAO JOAO D ALIANCA	14/11/2019 17:01	15/11/2019 07:56	14/11/2019 17:01	15/11/2019 07:56	14,90	38	566,25	CHI
201911163069	JANDAIA	JD12308464	PALMEIRAS	14/11/2019 14:52	15/11/2019 11:29	14/11/2019 14:52	15/11/2019 11:29	20,60	12	247,25	CHI
201911163078	CATURAI	CK21253002	INHUMAS S1	14/11/2019 17:06	14/11/2019 20:10	14/11/2019 17:06	14/11/2019 20:10	3,06	1	3,06	CHI
201911163089	PORANGATU	PO12028196	PORANGATU	14/11/2019 17:07	15/11/2019 14:26	14/11/2019 17:07	15/11/2019 14:26	21,31	5	106,55	CHI
201911163105	GOIANIA	GN12023395	REAL S1	14/11/2019 16:02	14/11/2019 18:09	14/11/2019 16:02	14/11/2019 18:09	2,10	422	887,96	CHI
201911163417	ITUMBIARA	IT11000054	ITUMBIARA VELHA S1	14/11/2019 18:25	15/11/2019 08:26	14/11/2019 18:25	15/11/2019 08:26	14,00	188	2632,47	CHI
201911163426	SAO JOAO D ALIANCA	JL12146125	SAO JOAO D ALIANCA	14/11/2019 17:13	14/11/2019 23:02	14/11/2019 17:13	14/11/2019 23:02	5,81	3	17,42	CHI
201911163428	CATALAO	CT21317594	CATALAO S1	14/11/2019 17:13	15/11/2019 07:54	14/11/2019 17:13	15/11/2019 07:54	14,67	1	14,67	CHI
201911163435	CRISTIANOPOLIS	BC12300653	CRISTIANOPOLIS	14/11/2019 14:47	15/11/2019 22:15	14/11/2019 14:47	15/11/2019 22:15	31,46	11	346,05	CHI

201911163435	SANTA CRUZ DE GOIAS	BC12300653	CRISTIANOPOLIS	14/11/2019 14:47	15/11/2019 22:15	14/11/2019 14:47	15/11/2019 22:15	31,46	24	755,03	CHI
201911163440	CALDAS NOVAS	CN11100075	CALDAS NOVAS S1	14/11/2019 16:22	15/11/2019 16:59	14/11/2019 16:22	15/11/2019 16:59	24,61	9	221,52	CHI
201911163447	POSSE	1480029194	IACIARA S2	14/11/2019 17:14	14/11/2019 18:25	14/11/2019 17:14	14/11/2019 18:25	1,17	1	1,17	CHI
201911163463	SANTA TEREZA DE GOIAS	TB12182394	PORANGATU	14/11/2019 16:04	14/11/2019 18:51	14/11/2019 16:04	14/11/2019 18:51	2,77	3	8,31	CHI
201911163463	TROMBAS	TB12182394	PORANGATU	14/11/2019 16:04	14/11/2019 18:51	14/11/2019 16:04	14/11/2019 18:51	2,77	118	326,89	CHI
201911163464	AMORINOPOLIS	IR12188430	IPORA	14/11/2019 17:48	15/11/2019 04:29	14/11/2019 17:48	15/11/2019 04:29	10,68	41	437,95	CHI
201911163464	IPORA	IR12188430	IPORA	14/11/2019 17:48	15/11/2019 04:29	14/11/2019 17:48	15/11/2019 04:29	10,68	22	235,00	CHI
201911163464	IVOLANDIA	IR12188430	IPORA	14/11/2019 17:48	15/11/2019 04:29	14/11/2019 17:48	15/11/2019 04:29	10,68	104	1110,89	CHI
201911163464	PALESTINA DE GOIAS	IR12188430	IPORA	14/11/2019 17:48	15/11/2019 04:29	14/11/2019 17:48	15/11/2019 04:29	10,68	11	117,50	CHI
201911163476	ITAPACI	IW21079705	ITAPACI	14/11/2019 17:16	15/11/2019 17:57	14/11/2019 17:16	15/11/2019 17:57	24,67	1	24,67	CHI
201911163519	GOIANIA	GN11197043	FERROVIARIO S2	14/11/2019 16:33	14/11/2019 23:15	14/11/2019 16:33	14/11/2019 23:15	6,69	15	100,42	CHI
201911163523	APARECIDA DE GOIANIA	AP11150297	INDEPENDENCIA S2	14/11/2019 17:13	14/11/2019 20:13	14/11/2019 17:13	14/11/2019 20:13	3,00	23	68,97	CHI
201911163524	PORANGATU	PO21137702	PORANGATU	14/11/2019 17:20	15/11/2019 11:57	14/11/2019 17:20	15/11/2019 11:57	18,61	2	37,22	CHI
201911163526	PORANGATU	PO12020611	NOVO PLANALTO	14/11/2019 16:53	14/11/2019 18:38	14/11/2019 16:53	14/11/2019 18:38	1,74	8	13,95	CHI
201911163527	ALOANDIA	AD12013446	GOIATUBA S1	14/11/2019 16:28	15/11/2019 08:52	14/11/2019 16:28	15/11/2019 08:52	16,38	9	147,46	CHI
201911163527	PONTALINA	AD12013446	GOIATUBA S1	14/11/2019 16:28	15/11/2019 08:52	14/11/2019 16:28	15/11/2019 08:52	16,38	13	212,99	CHI
201911163528	TRES RANCHOS	TH21154696	CATALAO S1	14/11/2019 17:20	15/11/2019 07:50	14/11/2019 17:20	15/11/2019 07:50	14,49	3	43,47	CHI
201911163529	CORUMBAIBA	CI12263342	VILA CORUMBA	14/11/2019 14:41	15/11/2019 14:37	14/11/2019 14:41	15/11/2019 14:37	23,93	385	9211,55	CHI
201911163530	GOIANIA	GN12098425	CEPAIGO S1	14/11/2019 15:25	15/11/2019 16:35	14/11/2019 15:25	15/11/2019 04:16	12,85	11	141,34	CHI
201911163530	GOIANIA	GN12098425	CEPAIGO S1	14/11/2019 15:25	15/11/2019 16:35	15/11/2019 02:39	15/11/2019 04:16	1,61	1	1,61	CHI
201911163530	GOIANIA	GN12098425	CEPAIGO S1	14/11/2019 15:25	15/11/2019 16:35	14/11/2019 15:25	15/11/2019 08:51	17,43	77	1342,39	CHI
201911163530	GOIANIA	GN12098425	CEPAIGO S1	14/11/2019 15:25	15/11/2019 16:35	15/11/2019 04:17	15/11/2019 08:51	4,58	12	54,93	CHI
201911163530	GOIANIA	GN12098425	CEPAIGO S1	14/11/2019 15:25	15/11/2019 16:35	15/11/2019 08:52	15/11/2019 11:40	2,82	93	261,85	CHI
201911163530	GOIANIA	GN12098425	CEPAIGO S1	14/11/2019 15:25	15/11/2019 16:35	15/11/2019 11:41	15/11/2019 15:14	3,55	93	330,00	CHI
201911163530	GOIANIA	GN12098425	CEPAIGO S1	14/11/2019 15:25	15/11/2019 16:35	14/11/2019 15:25	15/11/2019 16:35	25,17	24	603,99	CHI
201911163601	BOM JESUS DE GOIAS	BJ10406695	BOM JESUS DE GOIAS	14/11/2019 16:52	14/11/2019 23:29	14/11/2019 16:52	14/11/2019 23:29	6,62	24	158,82	CHI
201911163601	ITUMBIARA	BJ10406695	BOM JESUS DE GOIAS	14/11/2019 16:52	14/11/2019 23:29	14/11/2019 16:52	14/11/2019 23:29	6,62	19	125,73	CHI
201911163603	OUVIDOR	2180003177	CATALAO S1	14/11/2019 17:22	15/11/2019 09:50	14/11/2019 17:22	15/11/2019 09:50	16,45	1	16,45	CHI
201911163607	TRES RANCHOS	2170004770	CATALAO S1	14/11/2019 17:23	15/11/2019 08:20	14/11/2019 17:23	15/11/2019 08:20	14,96	1	14,96	CHI
201911163608	ITUMBIARA	IT12000038LD	ITUMBIARA VELHA S1	14/11/2019 16:59	15/11/2019 13:44	14/11/2019 16:59	15/11/2019 13:44	20,74	175	3629,74	CHI
201911163701	ITUMBIARA	IT11305566	ITUMBIARA NOVA	14/11/2019 17:24	18/11/2019 11:56	14/11/2019 17:24	18/11/2019 11:56	90,53	1	90,53	CHI
201911163702	SENADOR CANEDO	190150701	SENADOR CANEDO	14/11/2019 17:24	14/11/2019 20:24	14/11/2019 17:24	14/11/2019 20:24	2,98	1	2,98	CHI
201911163707	ITUMBIARA	IT12222567	PARANAIBA	14/11/2019 16:35	15/11/2019 00:57	14/11/2019 16:35	15/11/2019 00:57	8,36	574	4795,93	CHI

201911163710	GOIANIA	16670760	GOIANIA LESTE S1	14/11/2019 17:26	15/11/2019 00:06	14/11/2019 17:26	15/11/2019 00:06	6,66	1	6,66	CHI
201911163717	PORANGATU	PO12240663	PORANGATU	14/11/2019 17:27	15/11/2019 15:10	14/11/2019 17:27	15/11/2019 15:10	21,71	3	65,12	CHI
201911163718	ITUMBIARA	IT11003830	PARANAIBA	14/11/2019 16:32	16/11/2019 11:13	14/11/2019 16:32	16/11/2019 11:13	42,67	68	2901,77	CHI
201911163801	SAO MIGUEL DO ARAGUAIA	SM11217900	SAO MIGUEL DO ARAGUAIA	14/11/2019 17:27	14/11/2019 19:40	14/11/2019 17:27	14/11/2019 19:40	2,21	80	177,04	CHI
201911164004	RIO VERDE	RV11018077	SANTA HELENA S1	14/11/2019 16:21	15/11/2019 10:12	14/11/2019 16:21	15/11/2019 10:12	17,85	94	1678,24	CHI
201911164013	SAO LUIS DE MONTES BELOS	SL12111612	FIRMINOPOLIS S1	14/11/2019 17:11	14/11/2019 19:00	14/11/2019 17:11	14/11/2019 19:00	1,83	3	5,48	CHI
201911164014	AGUAS LINDAS DE GOIAS	LA12350436	AGUAS LINDAS DE GOIAS S1	14/11/2019 17:30	14/11/2019 19:29	14/11/2019 17:30	14/11/2019 19:29	1,98	2	3,96	CHI
201911164017	GOIANIA	17054618	XAVANTES	14/11/2019 17:30	15/11/2019 08:39	14/11/2019 17:30	15/11/2019 08:39	15,15	1	15,15	CHI
201911164021	ABADIA DE GOIAS	TR31046106	CARAJAS S1	14/11/2019 17:30	15/11/2019 13:11	14/11/2019 17:30	15/11/2019 13:00	19,50	1	19,50	CHI
201911164021	ABADIA DE GOIAS	7965425	CARAJAS S1	14/11/2019 17:30	15/11/2019 13:11	14/11/2019 17:30	15/11/2019 13:11	19,68	1	19,68	CHI
201911164023	GOIANIA	GN11047512	GOIANIA LESTE S1	14/11/2019 15:43	15/11/2019 15:51	14/11/2019 15:43	15/11/2019 15:51	24,13	61	1471,93	CHI
201911164049	PIRANHAS	1930036222	PIRANHAS	14/11/2019 17:32	15/11/2019 09:33	14/11/2019 17:32	15/11/2019 09:33	16,01	1	16,01	CHI
201911164056	IACIARA	1550034628	IACIARA S1	14/11/2019 17:33	14/11/2019 18:43	14/11/2019 17:33	14/11/2019 18:43	1,15	1	1,15	CHI
201911164057	QUIRINOPOLIS	QI21296561	QUIRINOPOLIS	14/11/2019 17:33	15/11/2019 12:15	14/11/2019 17:33	15/11/2019 12:15	18,70	1	18,70	CHI
201911164058	SAO MIGUEL DO ARAGUAIA	830049137	SAO MIGUEL DO ARAGUAIA	14/11/2019 17:33	14/11/2019 20:00	14/11/2019 17:33	14/11/2019 20:00	2,43	1	2,43	CHI
201911164066	MUNDO NOVO DE GOIAS	NA12035650	NOVA CRIXAS	14/11/2019 16:11	15/11/2019 17:22	14/11/2019 16:11	15/11/2019 17:22	25,18	8	201,40	CHI
201911164066	NOVA CRIXAS	NA12035650	NOVA CRIXAS	14/11/2019 16:11	15/11/2019 17:22	14/11/2019 16:11	15/11/2019 17:22	25,18	23	579,04	CHI
201911164075	GOIANIA	GN11023420	REAL S1	14/11/2019 16:52	14/11/2019 19:57	14/11/2019 16:52	14/11/2019 19:57	3,08	106	326,54	CHI
201911164082	CAMPO LIMPO	AN12084813	NEROPOLIS S1	14/11/2019 16:44	14/11/2019 18:50	14/11/2019 16:44	14/11/2019 18:50	2,10	64	134,26	CHI
201911164082	OURO VERDE DE GOIAS	AN12084813	NEROPOLIS S1	14/11/2019 16:44	14/11/2019 18:50	14/11/2019 16:44	14/11/2019 18:50	2,10	1	2,10	CHI
201911164093	GOIANESIA	PV21097016	GOIANESIA S2	14/11/2019 17:37	15/11/2019 19:10	14/11/2019 17:37	15/11/2019 19:10	25,54	1	25,54	CHI
201911164099	CALDAS NOVAS	CN11040987	SERRA DE CALDAS	14/11/2019 17:02	15/11/2019 00:49	14/11/2019 17:02	15/11/2019 00:49	7,78	67	521,26	CHI
201911164105	GOIANIRA	GR11073180	GOIANIRA	14/11/2019 17:44	14/11/2019 21:00	14/11/2019 17:44	14/11/2019 21:00	3,27	103	336,38	CHI
201911164106	ITAPACI	SZ10395412	ITAPACI	14/11/2019 17:34	18/11/2019 15:44	14/11/2019 17:34	14/11/2019 19:03	1,47	3	4,42	CHI
201911164106	NOVA GLORIA	SZ10395412	ITAPACI	14/11/2019 17:34	18/11/2019 15:44	14/11/2019 17:34	14/11/2019 19:03	1,47	1	1,47	CHI
201911164106	SAO LUIZ DO NORTE	SZ10395412	ITAPACI	14/11/2019 17:34	18/11/2019 15:44	14/11/2019 17:34	14/11/2019 19:03	1,47	62	91,28	CHI
201911164106	SAO LUIZ DO NORTE	SZ13325211	ITAPACI	14/11/2019 17:34	18/11/2019 15:44	14/11/2019 17:34	14/11/2019 20:31	2,95	48	141,47	CHI
201911164106	ITAPACI	SZ10395412	ITAPACI	14/11/2019 17:34	18/11/2019 15:44	14/11/2019 21:15	14/11/2019 21:35	0,32	3	0,96	CHI
201911164106	NOVA GLORIA	SZ10395412	ITAPACI	14/11/2019 17:34	18/11/2019 15:44	14/11/2019 21:15	14/11/2019 21:35	0,32	1	0,32	CHI
201911164106	SAO LUIZ DO NORTE	SZ10395412	ITAPACI	14/11/2019 17:34	18/11/2019 15:44	14/11/2019 21:15	14/11/2019 21:35	0,32	110	35,32	CHI
201911164106	ITAPACI	SZ10395412	ITAPACI	14/11/2019 17:34	18/11/2019 15:44	15/11/2019 09:38	15/11/2019 09:50	0,19	3	0,58	CHI
201911164106	NOVA GLORIA	SZ10395412	ITAPACI	14/11/2019 17:34	18/11/2019 15:44	15/11/2019 09:38	15/11/2019 09:50	0,19	1	0,19	CHI
201911164106	SAO LUIZ DO NORTE	SZ10395412	ITAPACI	14/11/2019 17:34	18/11/2019 15:44	15/11/2019 09:38	15/11/2019 09:50	0,19	110	21,08	CHI

201911164106	SAO LUIZ DO NORTE	SZ13325204	ITAPACI	14/11/2019 17:34	18/11/2019 15:44	14/11/2019 17:34	15/11/2019 10:47	17,21	11	189,30	CHI
201911164106	ITAPACI	SZ10395412	ITAPACI	14/11/2019 17:34	18/11/2019 15:44	15/11/2019 11:22	15/11/2019 11:29	0,11	3	0,33	CHI
201911164106	NOVA GLORIA	SZ10395412	ITAPACI	14/11/2019 17:34	18/11/2019 15:44	15/11/2019 11:22	15/11/2019 11:29	0,11	1	0,11	CHI
201911164106	SAO LUIZ DO NORTE	SZ10395412	ITAPACI	14/11/2019 17:34	18/11/2019 15:44	15/11/2019 11:22	15/11/2019 11:29	0,11	121	13,44	CHI
201911164106	SAO LUIZ DO NORTE	SZ12046322LD	ITAPACI	14/11/2019 17:34	18/11/2019 15:44	14/11/2019 17:34	15/11/2019 12:52	19,30	104	2007,43	CHI
201911164106	ITAPACI	SZ10395412	ITAPACI	14/11/2019 17:34	18/11/2019 15:44	15/11/2019 14:49	15/11/2019 15:19	0,50	3	1,51	CHI
201911164106	NOVA GLORIA	SZ10395412	ITAPACI	14/11/2019 17:34	18/11/2019 15:44	15/11/2019 14:49	15/11/2019 15:19	0,50	1	0,50	CHI
201911164106	SAO LUIZ DO NORTE	SZ10395412	ITAPACI	14/11/2019 17:34	18/11/2019 15:44	15/11/2019 14:49	15/11/2019 15:19	0,50	225	113,56	CHI
201911164106	SAO LUIZ DO NORTE	SZ13325204	ITAPACI	14/11/2019 17:34	18/11/2019 15:44	14/11/2019 17:34	15/11/2019 17:37	24,04	10	240,38	CHI
201911164106	GOIANESIA	SZ13325204	ITAPACI	14/11/2019 17:34	18/11/2019 15:44	14/11/2019 17:34	15/11/2019 20:36	27,02	8	216,17	CHI
201911164106	SANTA ISABEL	SZ13325204	ITAPACI	14/11/2019 17:34	18/11/2019 15:44	14/11/2019 17:34	15/11/2019 20:36	27,02	4	108,08	CHI
201911164106	SAO LUIZ DO NORTE	SZ13325204	ITAPACI	14/11/2019 17:34	18/11/2019 15:44	14/11/2019 17:34	15/11/2019 20:36	27,02	28	756,59	CHI
201911164106	SAO LUIZ DO NORTE	SZ13325204	ITAPACI	14/11/2019 17:34	18/11/2019 15:44	14/11/2019 17:34	16/11/2019 09:37	40,05	3	120,15	CHI
201911164106	SAO LUIZ DO NORTE	SZ12351555LD	ITAPACI	14/11/2019 17:34	18/11/2019 15:44	14/11/2019 17:34	16/11/2019 10:24	40,83	1	40,83	CHI
201911164106	GOIANESIA	SZ10395412	ITAPACI	14/11/2019 17:34	18/11/2019 15:44	16/11/2019 10:25	16/11/2019 10:32	0,12	8	0,92	CHI
201911164106	ITAPACI	SZ10395412	ITAPACI	14/11/2019 17:34	18/11/2019 15:44	16/11/2019 10:25	16/11/2019 10:32	0,12	3	0,35	CHI
201911164106	NOVA GLORIA	SZ10395412	ITAPACI	14/11/2019 17:34	18/11/2019 15:44	16/11/2019 10:25	16/11/2019 10:32	0,12	1	0,12	CHI
201911164106	SANTA ISABEL	SZ10395412	ITAPACI	14/11/2019 17:34	18/11/2019 15:44	16/11/2019 10:25	16/11/2019 10:32	0,12	4	0,46	CHI
201911164106	SAO LUIZ DO NORTE	SZ10395412	ITAPACI	14/11/2019 17:34	18/11/2019 15:44	16/11/2019 10:25	16/11/2019 10:32	0,12	266	30,74	CHI
201911164106	GOIANESIA	SZ13325204	ITAPACI	14/11/2019 17:34	18/11/2019 15:44	14/11/2019 17:34	16/11/2019 11:10	41,60	3	124,80	CHI
201911164106	SANTA ISABEL	SZ13325204	ITAPACI	14/11/2019 17:34	18/11/2019 15:44	14/11/2019 17:34	16/11/2019 11:10	41,60	1	41,60	CHI
201911164106	SAO LUIZ DO NORTE	SZ12351555LD	ITAPACI	14/11/2019 17:34	18/11/2019 15:44	16/11/2019 10:25	17/11/2019 18:20	31,91	1	31,91	CHI
201911164106	GOIANESIA	SZ13325204	ITAPACI	14/11/2019 17:34	18/11/2019 15:44	14/11/2019 17:34	18/11/2019 15:44	94,16	1	94,16	CHI
201911164107	GOIANIA	GN11168030	GOIANIA LESTE S1	14/11/2019 15:39	14/11/2019 21:08	14/11/2019 15:39	14/11/2019 21:08	5,48	59	323,39	CHI
201911164112	SANTA HELENA DE GOIAS	SH12000184	IPEGUARI	14/11/2019 14:13	16/11/2019 16:56	14/11/2019 14:13	16/11/2019 16:56	50,72	1	50,72	CHI
201911164129	ARENOPOLIS	AY12180009	ARENOPOLIS	14/11/2019 19:12	15/11/2019 08:43	14/11/2019 19:12	15/11/2019 08:43	13,50	7	94,52	CHI
201911164151	GOIANIA	GN11023436	REAL S1	14/11/2019 15:55	15/11/2019 00:32	14/11/2019 15:55	15/11/2019 00:32	8,62	134	1154,63	CHI
201911164155	GOIATUBA	03010224	GOIATUBA S1	14/11/2019 21:16	16/11/2019 17:44	14/11/2019 21:16	15/11/2019 04:05	6,82	16	109,13	CHI
201911164155	PANAMA	03010224	GOIATUBA S1	14/11/2019 21:16	16/11/2019 17:44	14/11/2019 21:16	15/11/2019 04:05	6,82	82	559,29	CHI
201911164155	GOIATUBA	03010224	GOIATUBA S2	14/11/2019 21:16	16/11/2019 17:44	14/11/2019 21:16	15/11/2019 04:05	6,82	839	5722,45	CHI
201911164155	GOIATUBA	03010224	GOIATUBA S1	14/11/2019 21:16	16/11/2019 17:44	15/11/2019 09:45	15/11/2019 10:04	0,33	16	5,32	CHI
201911164155	PANAMA	03010224	GOIATUBA S1	14/11/2019 21:16	16/11/2019 17:44	15/11/2019 09:45	15/11/2019 10:04	0,33	83	27,57	CHI
201911164155	GOIATUBA	03010224	GOIATUBA S2	14/11/2019 21:16	16/11/2019 17:44	15/11/2019 09:45	15/11/2019 10:04	0,33	839	278,73	CHI

201911164155	GOIATUBA	PX13375440	GOIATUBA S1	14/11/2019 21:16	16/11/2019 17:44	14/11/2019 21:16	15/11/2019 11:24	14,13	15	211,95	CHI
201911164155	GOIATUBA	IT13222259	GOIATUBA S1	14/11/2019 21:16	16/11/2019 17:44	14/11/2019 21:16	15/11/2019 12:20	15,07	19	286,37	CHI
201911164155	PANAMA	IT13222259	GOIATUBA S1	14/11/2019 21:16	16/11/2019 17:44	14/11/2019 21:16	15/11/2019 12:20	15,07	9	135,65	CHI
201911164155	RUBIATABA	IT13222259	GOIATUBA S1	14/11/2019 21:16	16/11/2019 17:44	14/11/2019 21:16	15/11/2019 12:20	15,07	1	15,07	CHI
201911164155	GOIATUBA	IT13000050	GOIATUBA S1	14/11/2019 21:16	16/11/2019 17:44	15/11/2019 12:25	16/11/2019 13:30	25,10	19	476,84	CHI
201911164155	PANAMA	IT13000050	GOIATUBA S1	14/11/2019 21:16	16/11/2019 17:44	15/11/2019 12:25	16/11/2019 13:30	25,10	9	225,87	CHI
201911164155	RUBIATABA	IT13000050	GOIATUBA S1	14/11/2019 21:16	16/11/2019 17:44	15/11/2019 12:25	16/11/2019 13:30	25,10	1	25,10	CHI
201911164155	GOIATUBA	PX13375440	GOIATUBA S1	14/11/2019 21:16	16/11/2019 17:44	14/11/2019 21:16	16/11/2019 17:15	43,99	41	1803,50	CHI
201911164155	PANAMA	PX13375440	GOIATUBA S1	14/11/2019 21:16	16/11/2019 17:44	14/11/2019 21:16	16/11/2019 17:15	43,99	6	263,93	CHI
201911164155	BURITI ALEGRE	GT13000143	GOIATUBA S1	14/11/2019 21:16	16/11/2019 17:44	14/11/2019 21:16	16/11/2019 17:44	44,46	2	88,93	CHI
201911164155	GOIATUBA	GT13000143	GOIATUBA S1	14/11/2019 21:16	16/11/2019 17:44	14/11/2019 21:16	16/11/2019 17:44	44,46	53	2356,57	CHI
201911164158	BURITI DE GOIAS	SC10404262	FIRMINOPOLIS S2	14/11/2019 21:44	15/11/2019 13:31	14/11/2019 21:44	14/11/2019 22:58	1,24	52	64,34	CHI
201911164158	CORREGO DO OURO	SC10404262	FIRMINOPOLIS S2	14/11/2019 21:44	15/11/2019 13:31	14/11/2019 21:44	14/11/2019 22:58	1,24	93	115,06	CHI
201911164158	NOVO BRASIL	SC10404262	FIRMINOPOLIS S2	14/11/2019 21:44	15/11/2019 13:31	14/11/2019 21:44	14/11/2019 22:58	1,24	14	17,32	CHI
201911164158	SANCLERLANDIA	SC10404262	FIRMINOPOLIS S2	14/11/2019 21:44	15/11/2019 13:31	14/11/2019 21:44	14/11/2019 22:58	1,24	262	324,15	CHI
201911164158	SAO LUIS DE MONTES BELOS	SC10404262	FIRMINOPOLIS S2	14/11/2019 21:44	15/11/2019 13:31	14/11/2019 21:44	14/11/2019 22:58	1,24	52	64,34	CHI
201911164158	BURITI DE GOIAS	SC10404262	FIRMINOPOLIS S2	14/11/2019 21:44	15/11/2019 13:31	14/11/2019 23:01	15/11/2019 00:54	1,88	3	5,63	CHI
201911164158	SANCLERLANDIA	SC10404262	FIRMINOPOLIS S2	14/11/2019 21:44	15/11/2019 13:31	14/11/2019 23:01	15/11/2019 00:54	1,88	50	93,85	CHI
201911164158	SAO LUIS DE MONTES BELOS	SC10404262	FIRMINOPOLIS S2	14/11/2019 21:44	15/11/2019 13:31	14/11/2019 23:01	15/11/2019 00:54	1,88	52	97,60	CHI
201911164158	SANCLERLANDIA	SC13102361	FIRMINOPOLIS S2	14/11/2019 21:44	15/11/2019 13:31	14/11/2019 23:01	15/11/2019 09:27	10,43	209	2180,16	CHI
201911164158	CORREGO DO OURO	SC13102360	FIRMINOPOLIS S2	14/11/2019 21:44	15/11/2019 13:31	14/11/2019 23:01	15/11/2019 12:33	13,54	28	379,03	CHI
201911164158	SANCLERLANDIA	SC13102360	FIRMINOPOLIS S2	14/11/2019 21:44	15/11/2019 13:31	14/11/2019 23:01	15/11/2019 12:33	13,54	3	40,61	CHI
201911164158	BURITI DE GOIAS	CO13340181	FIRMINOPOLIS S2	14/11/2019 21:44	15/11/2019 13:31	14/11/2019 23:01	15/11/2019 13:31	14,50	49	710,49	CHI
201911164158	CORREGO DO OURO	CO13340181	FIRMINOPOLIS S2	14/11/2019 21:44	15/11/2019 13:31	14/11/2019 23:01	15/11/2019 13:31	14,50	65	942,48	CHI
201911164158	NOVO BRASIL	CO13340181	FIRMINOPOLIS S2	14/11/2019 21:44	15/11/2019 13:31	14/11/2019 23:01	15/11/2019 13:31	14,50	14	203,00	CHI
201911164158	CORREGO DO OURO	CO13340181	FIRMINOPOLIS S2	14/11/2019 21:44	15/11/2019 13:31	15/11/2019 11:31	15/11/2019 13:31	2,01	37	74,21	CHI
201911164171	CRIXAS	CX12391851	SANTA TEREZINHA	14/11/2019 23:13	16/11/2019 10:00	14/11/2019 23:13	16/11/2019 10:00	34,79	2	69,59	CHI
201911164172	GOIANIA	GN11024513	REAL S1	14/11/2019 16:02	15/11/2019 04:12	14/11/2019 16:02	15/11/2019 04:12	12,17	124	1508,70	CHI
201911164176	PORANGATU	PO11020581	PORANGATU	15/11/2019 04:06	15/11/2019 07:23	15/11/2019 04:06	15/11/2019 07:23	3,27	74	242,02	CHI
201911164203	APARECIDA DE GOIANIA	AP12127433	ANHANGUERA	14/11/2019 16:23	14/11/2019 20:10	14/11/2019 16:23	14/11/2019 20:10	3,77	37	139,66	CHI
201911164210	GOIANIA	10716932	ATLANTICO S2	14/11/2019 17:40	14/11/2019 20:23	14/11/2019 17:40	14/11/2019 20:23	2,71	1	2,71	CHI
201911164211	NOVO GAMA	NJ12219815	PACAEMBU S1	14/11/2019 17:40	14/11/2019 19:15	14/11/2019 17:40	14/11/2019 19:15	1,58	209	330,28	CHI
201911164216	CATALAO	CT12215606RE	CATALAO S1	14/11/2019 16:48	14/11/2019 19:43	14/11/2019 16:48	14/11/2019 19:43	2,91	18	52,36	CHI

201911164216	GOIANDIRA	CT12215606RE	CATALAO S1	14/11/2019 16:48	14/11/2019 19:43	14/11/2019 16:48	14/11/2019 19:43	2,91	18	52,36	CHI
201911164302	PARAUNA	10008649713	PARAUNA	14/11/2019 17:40	14/11/2019 23:55	14/11/2019 17:40	14/11/2019 23:55	6,25	1	6,25	CHI
201911164309	ITUMBIARA	IT11000132	PARANAIBA	14/11/2019 16:29	15/11/2019 17:00	14/11/2019 16:29	15/11/2019 17:00	24,51	29	710,92	CHI
201911164603	PIRACANJUBA	PJ12209123	PIRACANJUBA	14/11/2019 17:39	15/11/2019 09:31	14/11/2019 17:39	15/11/2019 09:31	15,85	45	713,44	CHI
201911164604	GOIANESIA	GE10394586	GOIANESIA S2	14/11/2019 17:46	15/11/2019 15:05	14/11/2019 17:46	15/11/2019 15:05	21,32	78	1662,57	CHI
201911164604	VILA PROPICIO	GE10394586	GOIANESIA S2	14/11/2019 17:46	15/11/2019 15:05	14/11/2019 17:46	15/11/2019 15:05	21,32	37	788,66	CHI
201911164605	APARECIDA DE GOIANIA	AP21000328	CEPAIGO S1	14/11/2019 17:43	14/11/2019 22:31	14/11/2019 17:43	14/11/2019 22:31	4,80	1	4,80	CHI
201911164611	NEROPOLIS	NR11167732	NEROPOLIS S2	14/11/2019 17:43	14/11/2019 19:29	14/11/2019 17:43	14/11/2019 19:29	1,76	120	210,90	CHI
201911164615	ARAGOIANIA	AO32030329	GUAPO S2	14/11/2019 17:44	15/11/2019 10:20	14/11/2019 17:44	15/11/2019 10:20	16,59	10	165,94	CHI
201911164617	APARECIDA DE GOIANIA	200435474	ANHANGUERA	14/11/2019 17:44	15/11/2019 08:19	14/11/2019 17:44	15/11/2019 08:19	14,58	1	14,58	CHI
201911164619	RIO VERDE	RV11260598	SANTA HELENA S1	14/11/2019 15:53	15/11/2019 10:48	14/11/2019 15:53	15/11/2019 10:48	18,92	26	491,83	CHI
201911164628	NOVA CRIXAS	NA21220420	NOVA CRIXAS	14/11/2019 17:45	15/11/2019 14:30	14/11/2019 17:45	15/11/2019 14:30	20,74	1	20,74	CHI
201911164632	GOIANIA	GN11169428	REAL S1	14/11/2019 16:52	14/11/2019 21:37	14/11/2019 16:52	14/11/2019 21:37	4,74	116	550,36	CHI
201911164635	PIRACANJUBA	60043799	PIRACANJUBA	14/11/2019 17:46	14/11/2019 19:59	14/11/2019 17:46	14/11/2019 19:59	2,21	1	2,21	CHI
201911164639	CALDAS NOVAS	760258934	SERRA DE CALDAS	14/11/2019 17:47	18/11/2019 14:31	14/11/2019 17:47	18/11/2019 14:31	92,74	1	92,74	CHI
201911164640	IPORA	IV12251378	IPORA	14/11/2019 17:47	15/11/2019 11:30	14/11/2019 17:47	15/11/2019 11:30	17,72	5	88,60	CHI
201911164640	IVOLANDIA	IV12251378	IPORA	14/11/2019 17:47	15/11/2019 11:30	14/11/2019 17:47	15/11/2019 11:30	17,72	4	70,88	CHI
201911164646	LUZIANIA	04210234	RIO VERMELHO	14/11/2019 18:09	14/11/2019 21:47	14/11/2019 18:09	14/11/2019 18:26	0,30	3227	955,55	CHI
201911164646	LUZIANIA	04210234	RIO VERMELHO	14/11/2019 18:09	14/11/2019 21:47	14/11/2019 18:09	14/11/2019 20:23	2,23	153	341,23	CHI
201911164646	LUZIANIA	04210234	RIO VERMELHO	14/11/2019 18:09	14/11/2019 21:47	14/11/2019 18:09	14/11/2019 21:14	3,08	296	912,75	CHI
201911164646	LUZIANIA	LZ10404048	RIO VERMELHO	14/11/2019 18:09	14/11/2019 21:47	14/11/2019 21:31	14/11/2019 21:47	0,26	153	40,42	CHI
201911164656	GOIANESIA	GE21000083	GOIANESIA S1	14/11/2019 17:49	15/11/2019 18:11	14/11/2019 17:49	15/11/2019 18:11	24,37	1	24,37	CHI
201911164701	GOIANIA	GN12049865	FERROVIARIO S1	14/11/2019 16:19	14/11/2019 20:17	14/11/2019 16:19	14/11/2019 20:17	3,96	100	395,92	CHI
201911164707	IVOLANDIA	IV21098458	IPORA	14/11/2019 17:49	15/11/2019 11:16	14/11/2019 17:49	15/11/2019 11:16	17,44	1	17,44	CHI
201911164709	CATALAO	CT12287025	CATALAO S1	14/11/2019 17:24	14/11/2019 19:06	14/11/2019 17:24	14/11/2019 19:06	1,70	5	8,48	CHI
201911164710	ARUANA	2380027967	MOZARLANDIA	14/11/2019 17:49	17/11/2019 18:02	14/11/2019 17:49	17/11/2019 18:02	72,21	1	72,21	CHI
201911164735	FORMOSA	610212837	ITUIQUIRA	14/11/2019 17:52	14/11/2019 18:40	14/11/2019 17:52	14/11/2019 18:40	0,80	1	0,80	CHI
201911164749	TURVELANDIA	TD12306032	RIO DOS BOIS	14/11/2019 17:53	14/11/2019 22:50	14/11/2019 17:53	14/11/2019 22:50	4,95	5	24,77	CHI
201911164759	SAO LUIS DE MONTES BELOS	SL32233528	SAO LUIZ DOS MONTES BELOS	14/11/2019 17:54	14/11/2019 21:32	14/11/2019 17:54	14/11/2019 21:32	3,63	1	3,63	CHI
201911164763	APORE	AE21169392	ITAJA S1	14/11/2019 17:54	15/11/2019 14:07	14/11/2019 17:54	15/11/2019 14:07	20,21	1	20,21	CHI
201911164768	CATALAO	CT12231650	CATALAO S1	14/11/2019 17:54	14/11/2019 19:39	14/11/2019 17:54	14/11/2019 19:39	1,74	115	199,65	CHI
201911164778	CALDAS NOVAS	CN12265590	SERRA DE CALDAS	14/11/2019 17:55	15/11/2019 01:30	14/11/2019 17:55	15/11/2019 01:30	7,57	167	1263,87	CHI
201911164806	GOIANIA	GN11000865	GOIANIA LESTE S3	14/11/2019 17:11	15/11/2019 10:27	14/11/2019 17:11	15/11/2019 10:27	17,26	80	1381,02	CHI

201911164807	CAMPO LIMPO	AN12351236	NEROPOLIS S1	14/11/2019 17:39	14/11/2019 19:28	14/11/2019 17:39	14/11/2019 19:28	1,80	7	12,61	CHI
201911164808	ITUMBIARA	IT12257047	PARANAIBA	14/11/2019 17:58	16/11/2019 14:50	14/11/2019 17:58	16/11/2019 14:50	44,85	3	134,56	CHI
201911164813	NAZARIO	440011486	ANICUNS	14/11/2019 17:59	15/11/2019 08:40	14/11/2019 17:59	15/11/2019 08:40	14,69	1	14,69	CHI
201911164816	GOIANIA	GN12023360	REAL S1	14/11/2019 16:04	14/11/2019 20:42	14/11/2019 16:04	14/11/2019 20:42	4,62	262	1211,02	CHI
201911164823	LUZIANIA	LZ11261712	RIO VERMELHO	14/11/2019 17:49	14/11/2019 19:26	14/11/2019 17:49	14/11/2019 19:26	1,61	125	201,25	CHI
201911164831	ITUMBIARA	IT11000063	PARANAIBA	14/11/2019 17:34	15/11/2019 09:29	14/11/2019 17:34	15/11/2019 09:29	15,90	192	3053,39	CHI
201911164832	CALDAS NOVAS	CN11031067	CALDAS NOVAS S2	14/11/2019 17:30	15/11/2019 11:10	14/11/2019 17:30	15/11/2019 11:10	17,66	27	476,78	CHI
201911164902	GOIANESIA	GE11185433	GOIANESIA S2	14/11/2019 18:01	15/11/2019 11:03	14/11/2019 18:01	15/11/2019 11:03	17,03	130	2213,61	CHI
201911164903	CALDAS NOVAS	CN12034233	CALDAS NOVAS S2	14/11/2019 17:43	15/11/2019 13:47	14/11/2019 17:43	15/11/2019 13:47	20,06	81	1624,73	CHI
201911165103	GOIANIA	GN12347548	REAL S1	14/11/2019 15:53	14/11/2019 23:47	14/11/2019 15:53	14/11/2019 23:47	7,90	246	1943,13	CHI
201911165201	GOIANIA	10003889694	GOYA S1	14/11/2019 18:02	15/11/2019 01:28	14/11/2019 18:02	15/11/2019 01:28	7,42	1	7,42	CHI
201911165305	ITUMBIARA	IT12035808	ITUMBIARA VELHA S1	14/11/2019 16:29	15/11/2019 09:03	14/11/2019 16:29	15/11/2019 09:03	16,57	296	4903,65	CHI
201911165309	BARRO ALTO	GE12000087	GOIANESIA S2	14/11/2019 17:33	16/11/2019 11:54	14/11/2019 17:33	16/11/2019 11:54	42,34	2	84,67	CHI
201911165309	GOIANESIA	GE12000087	GOIANESIA S2	14/11/2019 17:33	16/11/2019 11:54	14/11/2019 17:33	16/11/2019 11:54	42,34	14	592,71	CHI
201911165326	MAIRIPOTABA	PK12390276	PONTALINA	14/11/2019 17:20	15/11/2019 07:57	14/11/2019 17:20	15/11/2019 07:57	14,61	57	833,04	CHI
201911165332	CALDAS NOVAS	CN11392103	CALDAS NOVAS S1	14/11/2019 17:18	15/11/2019 02:48	14/11/2019 17:18	15/11/2019 02:48	9,49	49	465,21	CHI
201911165335	GOIANIA	GN11001557	GOIANIA LESTE S1	14/11/2019 16:50	15/11/2019 07:16	14/11/2019 16:50	15/11/2019 07:16	14,43	56	807,91	CHI
201911165336	GOIANIA	10004907653	GOYA S1	14/11/2019 18:08	15/11/2019 01:21	14/11/2019 18:08	15/11/2019 01:21	7,21	1	7,21	CHI
201911165339	INHUMAS	IN12011990	INHUMAS S1	14/11/2019 15:14	14/11/2019 20:52	14/11/2019 15:14	14/11/2019 20:52	5,62	54	303,42	CHI
201911165505	MONTES CLAROS DE GOIAS	ME21069024	IPORA	14/11/2019 18:09	15/11/2019 11:26	14/11/2019 18:09	15/11/2019 11:26	17,28	1	17,28	CHI
201911165613	PALESTINA DE GOIAS	PY21223232	PALESTINA	14/11/2019 18:11	15/11/2019 13:07	14/11/2019 18:11	15/11/2019 13:07	18,92	1	18,92	CHI
201911165704	APARECIDA DE GOIANIA	13514581	INDEPENDENCIA S1	14/11/2019 18:12	15/11/2019 11:32	14/11/2019 18:12	15/11/2019 11:32	17,33	1	17,33	CHI
201911165803	CAIAPONIA	CP11020865	CAIAPONIA	14/11/2019 17:54	14/11/2019 20:03	14/11/2019 17:54	14/11/2019 20:03	2,14	114	243,90	CHI
201911165805	ITUMBIARA	IT12000062	ITUMBIARA VELHA S1	14/11/2019 17:35	15/11/2019 13:29	14/11/2019 17:35	15/11/2019 13:29	19,89	115	2287,77	CHI
201911165808	NIQUELANDIA	2750036726	NIQUELANDIA SUBTRANSMISSAO	14/11/2019 18:14	14/11/2019 21:46	14/11/2019 18:14	14/11/2019 21:46	3,53	1	3,53	CHI
201911165822	VALPARAISO DE GOIAS	10024389356	MARAJOARA	14/11/2019 18:16	15/11/2019 00:40	14/11/2019 18:16	15/11/2019 00:40	6,39	1	6,39	CHI
201911166606	CALDAS NOVAS	CN12213749	CALDAS NOVAS S1	14/11/2019 16:43	15/11/2019 03:50	14/11/2019 16:43	15/11/2019 03:50	11,11	103	1144,36	CHI
201911166613	LUZIANIA	LZ12013828	VIANOPOLIS	14/11/2019 18:20	15/11/2019 09:26	14/11/2019 18:20	15/11/2019 09:26	15,09	7	105,62	CHI
201911166619	SÃO LUIZ DO NORTE	3090017189	ITAPACI	14/11/2019 18:21	15/11/2019 18:57	14/11/2019 18:21	15/11/2019 18:57	24,59	1	24,59	CHI
201911166626	IPAMERI	IP21275752	IPAMERI	14/11/2019 18:22	14/11/2019 22:13	14/11/2019 18:22	14/11/2019 22:13	3,85	3	11,54	CHI
201911166641	OUVIDOR	2180024314	CATALAO S1	14/11/2019 18:23	15/11/2019 11:40	14/11/2019 18:23	15/11/2019 11:40	17,28	1	17,28	CHI
201911166650	ITABERAI	IB11336373	ITABERAI S2	14/11/2019 18:24	15/11/2019 09:00	14/11/2019 18:24	15/11/2019 09:00	14,61	39	569,69	CHI
201911166652	ITUMBIARA	IT11000056	PARANAIBA	14/11/2019 16:52	15/11/2019 23:04	14/11/2019 16:52	15/11/2019 23:04	30,19	62	1872,06	CHI

201911166653	CALDAS NOVAS	CN11161249	SERRA DE CALDAS	14/11/2019 17:16	14/11/2019 23:00	14/11/2019 17:16	14/11/2019 23:00	5,72	30	171,62	CHI
201911166655	PEROLANDIA	DP12103843	JATAI S1	14/11/2019 18:24	14/11/2019 21:00	14/11/2019 18:24	14/11/2019 21:00	2,58	14	36,18	CHI
201911166663	TRINDADE	TR12200194	TRINDADE	14/11/2019 18:04	15/11/2019 10:39	14/11/2019 18:04	15/11/2019 08:53	14,81	17	251,77	CHI
201911166663	TRINDADE	TR12200194	TRINDADE	14/11/2019 18:04	15/11/2019 10:39	15/11/2019 08:54	15/11/2019 10:04	1,17	17	19,82	CHI
201911166663	TRINDADE	TR12200194	TRINDADE	14/11/2019 18:04	15/11/2019 10:39	14/11/2019 18:04	15/11/2019 10:39	16,58	5	82,90	CHI
201911166664	BOM JARDIM DE GOIAS	BM12155682	BOM JARDIM	14/11/2019 18:15	14/11/2019 23:47	14/11/2019 18:15	14/11/2019 23:47	5,53	14	77,36	CHI
201911166664	PIRANHAS	BM12155682	BOM JARDIM	14/11/2019 18:15	14/11/2019 23:47	14/11/2019 18:15	14/11/2019 23:47	5,53	4	22,10	CHI
201911166669	ABADIANIA	05730224	ANAPOLIS UNIVERSITARIO S1	14/11/2019 15:41	14/11/2019 20:49	14/11/2019 15:41	14/11/2019 20:49	5,12	10	51,17	CHI
201911166669	ABADIANIA	05730224	DAIA S2	14/11/2019 15:41	14/11/2019 20:49	14/11/2019 15:41	14/11/2019 20:49	5,12	59	301,92	CHI
201911166669	GAMELEIRA DE GOIAS	05730224	DAIA S2	14/11/2019 15:41	14/11/2019 20:49	14/11/2019 15:41	14/11/2019 20:49	5,12	1	5,12	CHI
201911166701	CAMPO ALEGRE DE GOIAS	CM12164124	CAMPO ALEGRE DE GOIAS	14/11/2019 16:27	15/11/2019 10:16	14/11/2019 16:27	15/11/2019 10:16	17,82	13	231,60	CHI
201911166706	GOIANIA	GN11197022	FERROVIARIO S1	14/11/2019 17:58	15/11/2019 12:17	14/11/2019 17:58	15/11/2019 12:17	18,32	78	1428,59	CHI
201911166714	GOIANIA	GN11000745	GOIANIA LESTE S3	14/11/2019 17:09	14/11/2019 21:23	14/11/2019 17:09	14/11/2019 21:23	4,22	130	548,67	CHI
201911166718	ITUMBIARA	IT11000053	ITUMBIARA VELHA S1	14/11/2019 16:58	15/11/2019 13:43	14/11/2019 16:58	15/11/2019 13:43	20,75	127	2635,21	CHI
201911166719	PONTALINA	PK21238404	PONTALINA	14/11/2019 18:29	15/11/2019 08:45	14/11/2019 18:29	15/11/2019 08:45	14,25	1	14,25	CHI
201911166748	SAO MIGUEL DO ARAGUAIA	10002765622	SAO MIGUEL DO ARAGUAIA	14/11/2019 18:33	15/11/2019 02:50	14/11/2019 18:33	15/11/2019 02:50	8,28	1	8,28	CHI
201911166750	PLANALTINA	PI21099509	PLANALTINA	14/11/2019 18:33	14/11/2019 20:18	14/11/2019 18:33	14/11/2019 20:18	1,74	1	1,74	CHI
201911166753	APARECIDA DE GOIANIA	11326189	REAL S2	14/11/2019 18:33	15/11/2019 08:13	14/11/2019 18:33	15/11/2019 08:13	13,65	1	13,65	CHI
201911166755	GOIANIA	12511560	CARAJAS S2	14/11/2019 18:34	14/11/2019 20:56	14/11/2019 18:34	14/11/2019 20:56	2,37	1	2,37	CHI
201911166759	APARECIDA DE GOIANIA	AP11201083	INDEPENDENCIA S1	14/11/2019 18:16	14/11/2019 20:58	14/11/2019 18:16	14/11/2019 20:58	2,70	134	361,54	CHI
201911166762	CATALAO	CT12011272	CATALAO S1	14/11/2019 17:48	17/11/2019 21:51	14/11/2019 17:48	15/11/2019 12:27	18,65	5	93,24	CHI
201911166762	CATALAO	CT12011272	CATALAO S1	14/11/2019 17:48	17/11/2019 21:51	14/11/2019 17:48	15/11/2019 13:03	19,25	61	1174,32	CHI
201911166762	CATALAO	CT12011272	CATALAO S1	14/11/2019 17:48	17/11/2019 21:51	14/11/2019 17:48	15/11/2019 13:33	19,75	96	1895,71	CHI
201911166762	CATALAO	CT12333638RE	CATALAO S1	14/11/2019 17:48	17/11/2019 21:51	15/11/2019 13:04	15/11/2019 16:02	2,98	50	148,86	CHI
201911166762	CATALAO	CT12333638RE	CATALAO S1	14/11/2019 17:48	17/11/2019 21:51	15/11/2019 16:03	15/11/2019 16:13	0,17	50	8,60	CHI
201911166762	CATALAO	CT12203163	CATALAO S1	14/11/2019 17:48	17/11/2019 21:51	15/11/2019 13:04	15/11/2019 16:13	3,16	11	34,80	CHI
201911166762	CATALAO	CT12333638RE	CATALAO S1	14/11/2019 17:48	17/11/2019 21:51	15/11/2019 16:14	17/11/2019 17:42	49,47	27	1335,68	CHI
201911166762	CATALAO	CT12215619	CATALAO S1	14/11/2019 17:48	17/11/2019 21:51	15/11/2019 16:14	17/11/2019 20:51	52,63	23	1210,45	CHI
201911166762	CATALAO	CT12203163	CATALAO S1	14/11/2019 17:48	17/11/2019 21:51	15/11/2019 16:14	17/11/2019 21:51	53,62	11	589,80	CHI
201911166767	CALDAS NOVAS	CN11148508	CALDAS NOVAS S2	14/11/2019 18:22	15/11/2019 04:45	14/11/2019 18:22	15/11/2019 04:45	10,38	79	819,67	CHI
201911166769	CALDAS NOVAS	CN12060250	CALDAS NOVAS S1	14/11/2019 15:58	19/11/2019 19:38	14/11/2019 15:58	19/11/2019 15:36	119,64	3	358,91	CHI
201911166769	SANTA CRUZ DE GOIAS	CN12060250	CALDAS NOVAS S1	14/11/2019 15:58	19/11/2019 19:38	14/11/2019 15:58	19/11/2019 15:36	119,64	7	837,46	CHI
201911166769	PIRACANJUBA	CN12060250	CALDAS NOVAS S1	14/11/2019 15:58	19/11/2019 19:38	14/11/2019 15:58	19/11/2019 19:38	123,67	7	865,66	CHI

201911166776	CATALAO	CT12000081	CATALAO S1	14/11/2019 17:07	15/11/2019 08:56	14/11/2019 17:07	15/11/2019 08:56	15,81	5	79,04	CHI
201911166778	GOIANIA	GN11023415	REAL S1	14/11/2019 18:04	15/11/2019 04:58	14/11/2019 18:04	15/11/2019 04:58	10,90	133	1449,29	CHI
201911166783	GOIANESIA	550113009	GOIANESIA S2	14/11/2019 18:37	15/11/2019 14:26	14/11/2019 18:37	15/11/2019 14:26	19,81	1	19,81	CHI
201911166790	CALDAS NOVAS	CN12100135	SERRA DE CALDAS	14/11/2019 14:23	18/11/2019 15:58	14/11/2019 14:23	18/11/2019 15:58	97,57	9	878,14	CHI
201911166796	MOSSAMEDES	MD12299584	ITABERAI S2	14/11/2019 15:52	14/11/2019 21:36	14/11/2019 15:52	14/11/2019 21:36	5,73	12	68,72	CHI
201911166901	SERRANOPOLIS	SX21287494	JATAI S1	14/11/2019 18:41	15/11/2019 13:36	14/11/2019 18:41	15/11/2019 13:36	18,91	1	18,91	CHI
201911166902	CATALAO	CT12333401	CATALAO S1	14/11/2019 18:41	15/11/2019 09:25	14/11/2019 18:41	15/11/2019 09:25	14,72	7	103,07	CHI
201911167303	ABADIANIA	AA11273289	CORUMBA	14/11/2019 18:42	14/11/2019 23:29	14/11/2019 18:42	14/11/2019 23:29	4,78	77	368,17	CHI
201911167304	GOIANIA	GN12088489	REAL S1	14/11/2019 15:52	14/11/2019 21:47	14/11/2019 15:52	14/11/2019 21:47	5,91	421	2488,34	CHI
201911167401	RIO VERDE	RV12000118	RIO VERDE S2	14/11/2019 17:04	15/11/2019 08:40	14/11/2019 17:04	15/11/2019 02:14	9,16	38	348,03	CHI
201911167401	RIO VERDE	RV12000118	RIO VERDE S2	14/11/2019 17:04	15/11/2019 08:40	14/11/2019 17:04	15/11/2019 08:40	15,60	25	390,12	CHI
201911167401	SANTA HELENA DE GOIAS	RV12000118	RIO VERDE S2	14/11/2019 17:04	15/11/2019 08:40	14/11/2019 17:04	15/11/2019 08:40	15,60	70	1092,33	CHI
201911167402	GOIANIA	GN11023413	REAL S1	14/11/2019 16:59	15/11/2019 00:25	14/11/2019 16:59	15/11/2019 00:25	7,43	118	876,74	CHI
201911167411	ITUMBIARA	IT11310077	ITUMBIARA NOVA	14/11/2019 15:18	15/11/2019 13:30	14/11/2019 15:18	15/11/2019 13:30	22,19	105	2330,18	CHI
201911167413	VALPARAISO DE GOIAS	3350031880	PACAEMBU S1	14/11/2019 18:43	14/11/2019 21:26	14/11/2019 18:43	14/11/2019 21:26	2,70	1	2,70	CHI
201911167423	OUVIDOR	OU21063826	CATALAO S1	14/11/2019 18:45	15/11/2019 12:59	14/11/2019 18:45	15/11/2019 12:59	18,23	1	18,23	CHI
201911167425	INHUMAS	30066864	INHUMAS S2	14/11/2019 18:45	15/11/2019 00:03	14/11/2019 18:45	15/11/2019 00:03	5,29	1	5,29	CHI
201911167430	GOIANIA	GN11002362	FERROVIARIO S3	14/11/2019 18:15	14/11/2019 20:29	14/11/2019 18:15	14/11/2019 20:29	2,22	64	142,06	CHI
201911167434	PIRES DO RIO	PR11186713	PIRES DO RIO S1	14/11/2019 18:42	14/11/2019 19:54	14/11/2019 18:42	14/11/2019 19:54	1,19	146	173,13	CHI
201911167437	APARECIDA DE GOIANIA	AP12362810	ANHANGUERA	14/11/2019 18:43	14/11/2019 22:38	14/11/2019 18:43	14/11/2019 22:38	3,91	158	617,43	CHI
201911167505	BARRO ALTO	BA21064546	BARRO ALTO	14/11/2019 18:47	15/11/2019 12:08	14/11/2019 18:47	15/11/2019 12:08	17,34	1	17,34	CHI
201911167506	MINACU	IH12207740	MINACU	14/11/2019 18:31	15/11/2019 03:06	14/11/2019 18:31	15/11/2019 03:06	8,58	98	840,84	CHI
201911167508	JARAGUA	JA12044169	JARAGUA	14/11/2019 15:11	14/11/2019 20:03	14/11/2019 15:11	14/11/2019 20:03	4,87	225	1094,88	CHI
201911167523	RIO VERDE	RV21286621	RIO VERDE S1	14/11/2019 18:49	15/11/2019 11:55	14/11/2019 18:49	15/11/2019 11:55	17,09	2	34,17	CHI
201911167524	GOIANESIA	GE12376583	GOIANESIA S2	14/11/2019 18:50	17/11/2019 10:54	14/11/2019 18:50	16/11/2019 18:24	47,58	1	47,58	CHI
201911167524	BARRO ALTO	8247806	GOIANESIA S2	14/11/2019 18:50	17/11/2019 10:54	14/11/2019 18:50	17/11/2019 10:54	64,07	1	64,07	CHI
201911167541	URUTAI	UT21359097	URUTAI	14/11/2019 18:52	15/11/2019 17:53	14/11/2019 18:52	15/11/2019 17:53	23,02	1	23,02	CHI
201911167544	APARECIDA DE GOIANIA	AP11131179	INDEPENDENCIA S2	14/11/2019 18:27	14/11/2019 22:39	14/11/2019 18:27	14/11/2019 22:39	4,19	110	460,44	CHI
201911167547	GOIANIA	GN12340567LD	GOYA S2	14/11/2019 18:49	15/11/2019 02:13	14/11/2019 18:49	15/11/2019 02:13	7,39	146	1079,22	CHI
201911167561	RIO VERDE	RV12412760	CABRIUVA S2	14/11/2019 14:06	15/11/2019 09:50	14/11/2019 14:06	15/11/2019 09:50	19,74	1	19,74	CHI
201911167565	MORRINHOS	20266224	MORRINHOS	14/11/2019 18:53	15/11/2019 15:30	14/11/2019 18:53	15/11/2019 15:30	20,61	3	61,83	CHI
201911167567	ITABERAI	50021035	ITABERAI S2	14/11/2019 18:53	15/11/2019 18:57	14/11/2019 18:53	15/11/2019 18:57	24,07	1	24,07	CHI
201911167568	DOVERLANDIA	DV12380883	CAIAPONIA	14/11/2019 18:53	15/11/2019 18:35	14/11/2019 18:53	15/11/2019 18:35	23,69	7	165,80	CHI

201911167570	INHUMAS	IN21033529	INHUMAS S1	14/11/2019 18:54	15/11/2019 15:35	14/11/2019 18:54	15/11/2019 15:35	20,70	2	41,39	CHI
201911167902	QUIRINOPOLIS	QI12116546	QUIRINOPOLIS	14/11/2019 18:59	17/11/2019 22:37	14/11/2019 18:59	15/11/2019 16:02	21,04	21	441,93	CHI
201911167902	QUIRINOPOLIS	QI12116546	QUIRINOPOLIS	14/11/2019 18:59	17/11/2019 22:37	14/11/2019 18:59	17/11/2019 22:37	75,64	1	75,64	CHI
201911167902	QUIRINOPOLIS	QI12116546	QUIRINOPOLIS	14/11/2019 18:59	17/11/2019 22:37	17/11/2019 16:39	17/11/2019 22:37	5,98	21	125,55	CHI
201911168019	EDEALINA	ED21223496	PONTALINA	14/11/2019 19:00	17/11/2019 10:05	14/11/2019 19:00	17/11/2019 10:05	63,07	1	63,07	CHI
201911168026	RIO VERDE	RV12249024	SANTA HELENA S1	14/11/2019 16:39	15/11/2019 09:20	14/11/2019 16:39	15/11/2019 09:20	16,69	7	116,82	CHI
201911168037	ANAPOLIS	20003500	JUNDIAI S2	14/11/2019 19:02	14/11/2019 20:33	14/11/2019 19:02	14/11/2019 20:33	1,50	1	1,50	CHI
201911168038	CALDAS NOVAS	CN11022656	CALDAS NOVAS S2	14/11/2019 18:01	15/11/2019 04:45	14/11/2019 18:01	15/11/2019 04:45	10,73	143	1534,07	CHI
201911168042	SANTA RITA DO NOVO DESTINO	DF21191331	GOIANESIA S1	14/11/2019 19:03	15/11/2019 03:06	14/11/2019 19:03	15/11/2019 03:06	8,04	1	8,04	CHI
201911168045	MONTES CLAROS DE GOIAS	ME21084313	IPORA	14/11/2019 19:04	15/11/2019 13:49	14/11/2019 19:04	15/11/2019 13:49	18,75	1	18,75	CHI
201911168205	ITAJA	IJ12092216	CACHOEIRA ALTA	14/11/2019 19:02	15/11/2019 09:05	14/11/2019 19:02	15/11/2019 09:05	14,05	5	70,25	CHI
201911168206	ITUMBIARA	10028936491	ITUMBIARA VELHA S1	14/11/2019 19:05	15/11/2019 04:30	14/11/2019 19:05	15/11/2019 04:30	9,42	1	9,42	CHI
201911168209	ITABERAI	IB21364754	ITABERAI S2	14/11/2019 19:05	15/11/2019 07:50	14/11/2019 19:05	15/11/2019 07:50	12,74	1	12,74	CHI
201911168210	BURITI ALEGRE	BG12254415	ITUMBIARA VELHA S2	14/11/2019 19:05	18/11/2019 17:40	14/11/2019 19:05	18/11/2019 17:40	94,57	2	189,15	CHI
201911168211	SENADOR CANEDO	10003502340	SENADOR CANEDO	14/11/2019 19:05	14/11/2019 19:47	14/11/2019 19:05	14/11/2019 19:47	0,69	1	0,69	CHI
201911168402	ANAPOLIS	AN11059829	JUNDIAI S1	14/11/2019 18:57	14/11/2019 22:23	14/11/2019 18:57	14/11/2019 22:23	3,43	80	274,56	CHI
201911168501	JATAI	JT12234308	JATAI S3	14/11/2019 19:06	15/11/2019 16:02	14/11/2019 19:06	15/11/2019 16:02	20,93	2	41,85	CHI
201911168504	ANAPOLIS	AN11084673	ANAPOLIS UNIVERSITARIO S2	14/11/2019 19:03	14/11/2019 21:27	14/11/2019 19:03	14/11/2019 21:27	2,40	39	93,59	CHI
201911168516	GOIANIA	16301481	XAVANTES	14/11/2019 19:08	15/11/2019 00:50	14/11/2019 19:08	15/11/2019 00:50	5,68	1	5,68	CHI
201911168601	BONFINOPOLIS	GP12210815	DAIA S2	14/11/2019 18:58	14/11/2019 23:23	14/11/2019 18:58	14/11/2019 23:23	4,42	52	229,58	CHI
201911168601	GAMELEIRA DE GOIAS	GP12210815	DAIA S2	14/11/2019 18:58	14/11/2019 23:23	14/11/2019 18:58	14/11/2019 23:23	4,42	2	8,83	CHI
201911168601	GOIANAPOLIS	GP12210815	DAIA S2	14/11/2019 18:58	14/11/2019 23:23	14/11/2019 18:58	14/11/2019 23:23	4,42	29	128,04	CHI
201911168601	LEOPOLDO DE BULHOES	GP12210815	DAIA S2	14/11/2019 18:58	14/11/2019 23:23	14/11/2019 18:58	14/11/2019 23:23	4,42	63	278,15	CHI
201911168801	MORRINHOS	150095053	MORRINHOS	14/11/2019 19:09	15/11/2019 09:35	14/11/2019 19:09	15/11/2019 09:35	14,43	1	14,43	CHI
201911169009	ACREUNA	EU12271441	ACREUNA	14/11/2019 17:37	14/11/2019 20:03	14/11/2019 17:37	14/11/2019 20:03	2,43	266	647,27	CHI
201911169011	NOVO PLANALTO	TA12192342	NOVO PLANALTO	14/11/2019 19:10	15/11/2019 08:59	14/11/2019 19:10	15/11/2019 08:59	13,81	1	13,81	CHI
201911169011	PORANGATU	TA12192342	NOVO PLANALTO	14/11/2019 19:10	15/11/2019 08:59	14/11/2019 19:10	15/11/2019 08:59	13,81	9	124,30	CHI
201911169015	GOIANESIA	GE21000063	GOIANESIA S2	14/11/2019 19:10	15/11/2019 12:29	14/11/2019 19:10	15/11/2019 12:29	17,31	1	17,31	CHI
201911169028	COLINAS DO SUL	TI21386686	MINACU	14/11/2019 19:12	15/11/2019 00:21	14/11/2019 19:12	15/11/2019 00:21	5,14	1	5,14	CHI
201911169031	PORANGATU	PO12328888	PORANGATU	14/11/2019 19:12	15/11/2019 15:38	14/11/2019 19:12	15/11/2019 15:38	20,42	5	102,10	CHI
201911169048	ACREUNA	EU21323085	RIO DOS BOIS	14/11/2019 19:13	19/11/2019 23:16	14/11/2019 19:13	19/11/2019 23:16	124,04	1	124,04	CHI
201911169053	EDEALINA	ED12244082	VICENTINOPOLIS	14/11/2019 17:58	16/11/2019 15:31	14/11/2019 17:58	16/11/2019 15:31	45,54	2	91,07	CHI
201911169055	NIQUELANDIA	NQ12171130	BARRO ALTO	14/11/2019 17:14	14/11/2019 22:56	14/11/2019 17:14	14/11/2019 22:56	5,70	13	74,04	CHI

201911169057	LUZIANIA	LZ1217677	RIO VERMELHO	14/11/2019 18:30	14/11/2019 20:59	14/11/2019 18:30	14/11/2019 20:59	2,47	86	212,28	CHI
201911169060	JARAGUA	10004780220	JARAGUA	14/11/2019 19:15	14/11/2019 22:47	14/11/2019 19:15	14/11/2019 22:47	3,52	1	3,52	CHI
201911169068	CAMPO LIMPO	CV21277812	NEROPOLIS S1	14/11/2019 19:16	14/11/2019 20:36	14/11/2019 19:16	14/11/2019 20:36	1,32	1	1,32	CHI
201911169069	PORANGATU	PO12145187	PORANGATU	14/11/2019 18:44	16/11/2019 11:07	14/11/2019 18:44	16/11/2019 11:07	40,38	8	323,03	CHI
201911169070	JATAI	JT12182140	JATAI S1	14/11/2019 18:08	14/11/2019 21:47	14/11/2019 18:08	14/11/2019 21:47	3,65	9	32,84	CHI
201911169070	SERRANOPOLIS	JT12182140	JATAI S1	14/11/2019 18:08	14/11/2019 21:47	14/11/2019 18:08	14/11/2019 21:47	3,65	2	7,30	CHI
201911169071	URUACU	UR12147094	CAMPINORTE	14/11/2019 19:17	15/11/2019 09:17	14/11/2019 19:17	15/11/2019 09:17	13,99	2	27,97	CHI
201911169076	BELA VISTA DE GOIAS	BV21202342	BELA VISTA S1	14/11/2019 19:18	15/11/2019 11:20	14/11/2019 19:18	15/11/2019 11:20	16,03	1	16,03	CHI
201911169085	APARECIDA DE GOIANIA	AP11070280	INDEPENDENCIA S2	14/11/2019 19:15	15/11/2019 03:22	14/11/2019 19:15	15/11/2019 03:22	8,10	205	1661,35	CHI
201911169097	SANTO ANTONIO DO DESCOBERTO	2210153494	AGUAS LINDAS DE GOIAS S2	14/11/2019 19:21	14/11/2019 22:47	14/11/2019 19:21	14/11/2019 22:47	3,42	1	3,42	CHI
201911169105	PIRES DO RIO	460129806	PIRES DO RIO S1	14/11/2019 19:23	15/11/2019 08:30	14/11/2019 19:23	15/11/2019 08:30	13,12	1	13,12	CHI
201911169110	RIO VERDE	RV21357262	RIO VERDE S1	14/11/2019 19:23	15/11/2019 13:51	14/11/2019 19:23	15/11/2019 13:51	18,46	3	55,38	CHI
201911169112	PORANGATU	PO11020581	PORANGATU	14/11/2019 18:58	14/11/2019 21:39	14/11/2019 18:58	14/11/2019 21:39	2,68	74	198,03	CHI
201911169125	CALDAS NOVAS	CN12213968	CALDAS NOVAS S1	14/11/2019 15:01	14/11/2019 23:09	14/11/2019 15:01	14/11/2019 23:09	8,13	145	1178,49	CHI
201911169406	CACU	CC21271665	CACHOEIRA ALTA	14/11/2019 19:26	16/11/2019 15:55	14/11/2019 19:26	16/11/2019 15:55	44,47	1	44,47	CHI
201911169407	ANAPOLIS	AN11096605	JUNDIAI S2	14/11/2019 19:18	15/11/2019 00:09	14/11/2019 19:18	15/11/2019 00:09	4,84	96	464,59	CHI
201911169411	ARAGARCAS	1880033875	IPORA	14/11/2019 19:25	16/11/2019 14:41	14/11/2019 19:25	16/11/2019 14:41	43,26	1	43,26	CHI
201911169415	PLANALTINA	PI12302825	SAO JOAO D ALIANCA	14/11/2019 18:26	15/11/2019 09:53	14/11/2019 18:26	15/11/2019 09:53	15,44	7	108,07	CHI
201911169813	BURITI DE GOIAS	BS12099749	FIRMINOPOLIS S2	14/11/2019 19:31	15/11/2019 17:59	14/11/2019 19:31	15/11/2019 17:59	22,48	8	179,84	CHI
201911169823	ITAPURANGA	IK11220251	ITAPURANGA	14/11/2019 17:50	14/11/2019 22:00	14/11/2019 17:50	14/11/2019 22:00	4,17	97	404,27	CHI
201911169829	SERRANOPOLIS	DJ12164269	CHAPADAO DO CEU	14/11/2019 19:32	15/11/2019 14:59	14/11/2019 19:32	15/11/2019 14:59	19,44	4	77,75	CHI
201911169833	PEROLANDIA	10004948554	JATAI S1	14/11/2019 19:34	14/11/2019 23:00	14/11/2019 19:34	14/11/2019 23:00	3,43	1	3,43	CHI
201911169836	CORUMBA DE GOIAS	CB12215044	CORUMBA	14/11/2019 19:31	14/11/2019 21:04	14/11/2019 19:31	14/11/2019 21:04	1,55	23	35,59	CHI
201911169836	PIRENOPOLIS	CB12215044	CORUMBA	14/11/2019 19:31	14/11/2019 21:04	14/11/2019 19:31	14/11/2019 21:04	1,55	2	3,09	CHI
201911169837	MINACU	IH12220633	MINACU	14/11/2019 18:55	15/11/2019 00:51	14/11/2019 18:55	15/11/2019 00:51	5,92	21	124,36	CHI
201911169848	CALDAS NOVAS	10003236950	SERRA DE CALDAS	14/11/2019 19:37	15/11/2019 09:04	14/11/2019 19:37	15/11/2019 09:04	13,45	1	13,45	CHI
201911169852	AMARALINA	MU12166513	MARA ROSA	14/11/2019 19:37	15/11/2019 12:13	14/11/2019 19:37	15/11/2019 12:13	16,58	20	331,69	CHI
201911169855	URUACU	UR21136330	CAMPINORTE	14/11/2019 19:38	15/11/2019 09:49	14/11/2019 19:38	15/11/2019 09:49	14,17	1	14,17	CHI
201911169856	MONTIVIDIU DO NORTE	MX12168971	PORANGATU	14/11/2019 13:49	14/11/2019 21:35	14/11/2019 13:49	14/11/2019 21:35	7,76	277	2149,67	CHI
201911169877	ABADIANIA	AA12033506	CORUMBA	14/11/2019 19:42	15/11/2019 08:38	14/11/2019 19:42	15/11/2019 08:38	12,92	8	103,39	CHI
201911169877	CORUMBA DE GOIAS	AA12033506	CORUMBA	14/11/2019 19:42	15/11/2019 08:38	14/11/2019 19:42	15/11/2019 08:38	12,92	2	25,85	CHI
201911169878	CRISTALINA	KR11184853	CRISTALINA S1	14/11/2019 19:42	14/11/2019 21:13	14/11/2019 19:42	14/11/2019 21:13	1,50	3	4,51	CHI
201911169882	ANAPOLIS	20680570	JUNDIAI S1	14/11/2019 19:43	15/11/2019 09:10	14/11/2019 19:43	15/11/2019 09:10	13,45	1	13,45	CHI

201911169887	GUAPO	710007140	GUAPO S1	14/11/2019 19:43	15/11/2019 16:35	14/11/2019 19:43	15/11/2019 16:35	20,85	1	20,85	CHI
201911169899	VIANOPOLIS	VN21063554	VIANOPOLIS	14/11/2019 19:46	15/11/2019 07:29	14/11/2019 19:46	15/11/2019 07:29	11,71	1	11,71	CHI
201911169911	TRINDADE	10012396980	GOYA S2	14/11/2019 19:47	15/11/2019 09:10	14/11/2019 19:47	15/11/2019 09:10	13,38	1	13,38	CHI
201911169915	MONTES CLAROS DE GOIAS	ME21259949	IPORA	14/11/2019 19:47	15/11/2019 14:19	14/11/2019 19:47	15/11/2019 14:19	18,52	1	18,52	CHI
201911169933	GOIATUBA	00735128	GOIATUBA S1	14/11/2019 19:41	14/11/2019 20:57	14/11/2019 19:41	14/11/2019 20:57	1,27	5	6,33	CHI
201911169933	GOIATUBA	00735128	GOIATUBA S2	14/11/2019 19:41	14/11/2019 20:57	14/11/2019 19:41	14/11/2019 20:57	1,27	5308	6723,47	CHI
201911169933	GOIATUBA	00735128	GOIATUBA S2	14/11/2019 19:41	14/11/2019 20:57	14/11/2019 19:41	14/11/2019 20:57	1,27	3263	4133,13	CHI
201911169933	GOIATUBA	00735128	GOIATUBA S2	14/11/2019 19:41	14/11/2019 20:57	14/11/2019 19:41	14/11/2019 20:57	1,27	5135	6504,33	CHI
201911169933	GOIATUBA	00735128	GOIATUBA S2	14/11/2019 19:41	14/11/2019 20:57	14/11/2019 19:41	14/11/2019 20:57	1,27	147	186,20	CHI
201911169933	MORRINHOS	00735128	GOIATUBA S2	14/11/2019 19:41	14/11/2019 20:57	14/11/2019 19:41	14/11/2019 20:57	1,27	50	63,33	CHI
201911169933	MORRINHOS	00735128	GOIATUBA S2	14/11/2019 19:41	14/11/2019 20:57	14/11/2019 19:41	14/11/2019 20:57	1,27	3	3,80	CHI
201911169934	GOIANIA	GN12000314	GOIANIA LESTE S1	14/11/2019 15:48	14/11/2019 21:47	14/11/2019 15:48	14/11/2019 21:47	5,98	73	436,62	CHI
201911169937	MINEIROS	MY12048095	PARQUE DAS EMAS	14/11/2019 17:31	15/11/2019 08:51	14/11/2019 17:31	15/11/2019 08:51	15,33	22	337,24	CHI
201911169938	ABADIANIA	AA21221279	CORUMBA	14/11/2019 19:50	15/11/2019 00:16	14/11/2019 19:50	15/11/2019 00:16	4,43	1	4,43	CHI
201911169949	BRITANIA	BT12009771	BRITANIA	14/11/2019 19:52	15/11/2019 12:00	14/11/2019 19:52	15/11/2019 12:00	16,14	14	225,89	CHI
201911169950	MONTE ALEGRE DE GOIAS	MA12211597	SAO DOMINGOS	14/11/2019 19:52	14/11/2019 21:19	14/11/2019 19:52	14/11/2019 21:19	1,44	10	14,38	CHI
201911169958	COCALZINHO DE GOIAS	ZN21221568	COCALZINHO	14/11/2019 19:52	14/11/2019 22:35	14/11/2019 19:52	14/11/2019 22:35	2,72	1	2,72	CHI
201911170104	PORANGATU	PO12021172	PORANGATU	14/11/2019 19:50	16/11/2019 08:22	14/11/2019 19:50	16/11/2019 08:22	36,54	5	182,69	CHI
201911170111	GOIANIA	GN11001769	FERROVIARIO S2	16/11/2019 15:47	16/11/2019 20:32	16/11/2019 15:47	16/11/2019 20:32	4,74	158	749,36	CHI
201911170119	MARA ROSA	MQ12141875	MARA ROSA	14/11/2019 19:45	15/11/2019 17:45	14/11/2019 19:45	15/11/2019 17:45	21,98	10	219,84	CHI
201911170122	CALDAS NOVAS	CN12186158	CALDAS NOVAS S2	14/11/2019 17:31	15/11/2019 08:02	14/11/2019 17:31	15/11/2019 08:02	14,51	97	1407,77	CHI
201911170123	MINEIROS	MY11105588	PARQUE DAS EMAS	14/11/2019 19:31	14/11/2019 22:08	14/11/2019 19:31	14/11/2019 22:08	2,61	138	359,84	CHI
201911170128	ANAPOLIS	AN12000193RE	ANAPOLIS UNIVERSITARIO S2	14/11/2019 19:50	15/11/2019 06:15	14/11/2019 19:50	15/11/2019 06:15	10,40	7	72,82	CHI
201911170128	PIRENOPOLIS	AN12000193RE	ANAPOLIS UNIVERSITARIO S2	14/11/2019 19:50	15/11/2019 06:15	14/11/2019 19:50	15/11/2019 06:15	10,40	1	10,40	CHI
201911170136	SAO LUIS DE MONTES BELOS	500096958	SAO LUIZ DOS MONTES BELOS	14/11/2019 19:59	15/11/2019 00:53	14/11/2019 19:59	15/11/2019 00:53	4,89	1	4,89	CHI
201911170144	MINACU	IH12236222	MINACU	14/11/2019 20:00	15/11/2019 07:50	14/11/2019 20:00	15/11/2019 07:50	11,83	19	224,72	CHI
201911170147	PORANGATU	PO12208614	PORANGATU	14/11/2019 18:11	15/11/2019 09:19	14/11/2019 18:11	15/11/2019 09:19	15,12	9	136,09	CHI
201911170150	GOIANIA	GN11137797	REAL S1	14/11/2019 19:41	14/11/2019 23:58	14/11/2019 19:41	14/11/2019 23:58	4,27	68	290,32	CHI
201911170152	CATALAO	CT11333375	CATALAO S2	14/11/2019 19:41	14/11/2019 21:04	14/11/2019 19:41	14/11/2019 21:04	1,38	118	162,48	CHI
201911170161	ITAPIRAPUA	IU12018785	MATRINCHA	14/11/2019 20:03	15/11/2019 00:40	14/11/2019 20:03	15/11/2019 00:40	4,61	83	382,28	CHI
201911170165	CAMPINORTE	CR11099002	PORANGATU	14/11/2019 16:56	15/11/2019 16:32	14/11/2019 16:56	15/11/2019 16:32	23,59	37	872,94	CHI
201911170172	CALDAS NOVAS	760329436	SERRA DE CALDAS	14/11/2019 20:29	14/11/2019 23:58	14/11/2019 20:29	14/11/2019 23:58	3,48	1	3,48	CHI
201911170177	CATALAO	CT12190444LD	CATALAO S2	14/11/2019 20:06	15/11/2019 10:17	14/11/2019 20:06	15/11/2019 10:17	14,18	176	2494,90	CHI

201911170180	LUZIANIA	120202657	RIO VERMELHO	14/11/2019 20:07	15/11/2019 00:29	14/11/2019 20:07	15/11/2019 00:29	4,36	1	4,36	CHI
201911170195	AGUAS LINDAS DE GOIAS	4830164142	AGUAS LINDAS DE GOIAS S2	14/11/2019 20:09	14/11/2019 20:38	14/11/2019 20:09	14/11/2019 20:38	0,47	1	0,47	CHI
201911170198	PORANGATU	PO12377623	PORANGATU	14/11/2019 20:09	16/11/2019 10:08	14/11/2019 20:09	16/11/2019 10:08	37,98	3	113,94	CHI
201911170202	GOIANIA	11873565	REAL S1	14/11/2019 20:10	15/11/2019 23:14	14/11/2019 20:10	15/11/2019 23:14	27,07	1	27,07	CHI
201911170204	AMERICANO DO BRASIL	IB12000062	ITABERAI S2	15/11/2019 07:00	15/11/2019 08:40	15/11/2019 07:00	15/11/2019 08:40	1,66	11	18,29	CHI
201911170204	ITABERAI	IB12000062	ITABERAI S2	15/11/2019 07:00	15/11/2019 08:40	15/11/2019 07:00	15/11/2019 08:40	1,66	18	29,93	CHI
201911170205	ABADIANIA	AA12072201	CORUMBA	14/11/2019 20:11	15/11/2019 13:12	14/11/2019 20:11	15/11/2019 13:12	17,01	34	578,33	CHI
201911170211	JATAI	JT21165918	JATAI S1	14/11/2019 20:12	15/11/2019 09:26	14/11/2019 20:12	15/11/2019 09:26	13,23	1	13,23	CHI
201911170217	AGUAS LINDAS DE GOIAS	LA11128741	AGUAS LINDAS DE GOIAS S1	14/11/2019 20:13	14/11/2019 21:38	14/11/2019 20:13	14/11/2019 21:38	1,40	83	116,27	CHI
201911170219	GOIAS	GS12162480LD	GOIAS	14/11/2019 20:14	17/11/2019 16:30	14/11/2019 20:14	17/11/2019 16:30	68,27	43	2935,47	CHI
201911170223	ANAPOLIS	AN11000331	JUNDIAI S2	14/11/2019 19:10	15/11/2019 00:52	14/11/2019 19:10	15/11/2019 00:52	5,69	67	381,51	CHI
201911170224	ANAPOLIS	AN12261233	ANAPOLIS UNIVERSITARIO S2	14/11/2019 18:30	14/11/2019 21:59	14/11/2019 18:30	14/11/2019 21:59	3,47	15	52,03	CHI
201911170225	ITAPIRAPUA	IU12341264	MATRINCHA	14/11/2019 18:06	15/11/2019 01:34	14/11/2019 18:06	15/11/2019 01:34	7,46	4	29,86	CHI
201911170229	CAMPO ALEGRE DE GOIAS	CM12266783	CAMPO ALEGRE DE GOIAS	14/11/2019 15:48	16/11/2019 18:25	14/11/2019 15:48	15/11/2019 09:51	18,03	7	126,24	CHI
201911170229	CAMPO ALEGRE DE GOIAS	CM12266783	CAMPO ALEGRE DE GOIAS	14/11/2019 15:48	16/11/2019 18:25	14/11/2019 15:48	15/11/2019 13:12	21,39	34	727,33	CHI
201911170229	CAMPO ALEGRE DE GOIAS	CM12166728	CAMPO ALEGRE DE GOIAS	14/11/2019 15:48	16/11/2019 18:25	15/11/2019 13:13	16/11/2019 13:52	24,66	14	345,26	CHI
201911170229	CAMPO ALEGRE DE GOIAS	CM12166728	CAMPO ALEGRE DE GOIAS	14/11/2019 15:48	16/11/2019 18:25	15/11/2019 13:13	16/11/2019 18:25	29,21	20	584,22	CHI
201911170229	CAMPO ALEGRE DE GOIAS	CM12166728	CAMPO ALEGRE DE GOIAS	14/11/2019 15:48	16/11/2019 18:25	16/11/2019 16:13	16/11/2019 18:25	2,21	14	30,95	CHI
201911170236	JATAI	JT12000231	JATAI S1	14/11/2019 19:41	15/11/2019 17:20	14/11/2019 19:41	15/11/2019 15:33	19,88	28	556,50	CHI
201911170236	PEROLANDIA	JT12000231	JATAI S1	14/11/2019 19:41	15/11/2019 17:20	14/11/2019 19:41	15/11/2019 15:33	19,88	3	59,63	CHI
201911170236	JATAI	JT13336940	JATAI S1	14/11/2019 19:41	15/11/2019 17:20	14/11/2019 19:41	15/11/2019 17:20	21,66	46	996,55	CHI
201911170237	CATALAO	10007595903	CATALAO S1	14/11/2019 20:19	15/11/2019 02:25	14/11/2019 20:19	15/11/2019 02:25	6,10	1	6,10	CHI
201911170240	CRISTALINA	KR11032618	PAMPLONA	14/11/2019 20:18	14/11/2019 21:22	14/11/2019 20:18	14/11/2019 21:22	1,06	65	68,97	CHI
201911170247	QUIRINOPOLIS	QI21191840	QUIRINOPOLIS	14/11/2019 20:20	15/11/2019 12:23	14/11/2019 20:20	15/11/2019 12:23	16,05	3	48,14	CHI
201911170252	VILA PROPICIO	NP21293997	GOIANESIA S1	14/11/2019 20:22	16/11/2019 15:30	14/11/2019 20:22	16/11/2019 15:30	43,13	1	43,13	CHI
201911170304	GOIAS	GS12307383	GOIAS	14/11/2019 20:07	15/11/2019 13:10	14/11/2019 20:07	15/11/2019 13:10	17,05	11	187,55	CHI
201911170305	CAMPINORTE	CR12234945	PORANGATU	14/11/2019 20:23	15/11/2019 17:33	14/11/2019 20:23	15/11/2019 17:33	21,15	6	126,92	CHI
201911170309	RIO VERDE	630432697	RIO VERDE S2	14/11/2019 20:24	15/11/2019 09:40	14/11/2019 20:24	15/11/2019 09:40	13,26	1	13,26	CHI
201911170312	PALMEIRAS DE GOIAS	10022911810	PALMEIRAS	14/11/2019 20:25	15/11/2019 08:27	14/11/2019 20:25	15/11/2019 08:27	12,04	1	12,04	CHI
201911170323	URUACU	UR21118005	URUACU	14/11/2019 20:26	15/11/2019 08:50	14/11/2019 20:26	15/11/2019 08:50	12,39	1	12,39	CHI
201911170328	MINACU	IH12134994	MINACU	14/11/2019 20:28	15/11/2019 11:28	14/11/2019 20:28	15/11/2019 11:28	15,00	11	164,95	CHI
201911170329	ITUMBIARA	IT12208051	PARANAIBA	14/11/2019 18:01	15/11/2019 14:25	14/11/2019 18:01	15/11/2019 14:25	20,39	98	1997,92	CHI
201911170330	GUARAITA	GK12234057	ITAPURANGA	14/11/2019 20:28	15/11/2019 08:35	14/11/2019 20:28	15/11/2019 08:35	12,11	5	60,54	CHI

201911170335	CALDAS NOVAS	CN12101874	CALDAS NOVAS S2	14/11/2019 17:55	14/11/2019 23:11	14/11/2019 17:55	14/11/2019 23:11	5,25	561	2946,81	CHI
201911170359	GOIANIA	GN11043859	GOIANIA LESTE S1	14/11/2019 20:32	14/11/2019 23:40	14/11/2019 20:32	14/11/2019 23:40	3,12	109	340,05	CHI
201911170361	GOIANESIA	GE11221556	GOIANESIA S2	14/11/2019 19:12	15/11/2019 01:21	14/11/2019 19:12	15/11/2019 01:21	6,14	150	921,42	CHI
201911170364	PORANGATU	PO11000023	PORANGATU	14/11/2019 17:36	15/11/2019 04:04	14/11/2019 17:36	15/11/2019 04:04	10,45	57	595,84	CHI
201911170368	GOIANIA	GN12127447	ATLANTICO S1	14/11/2019 20:26	14/11/2019 21:15	14/11/2019 20:26	14/11/2019 21:15	0,81	430	349,37	CHI
201911170380	CORREGO DO OURO	CO21126238	SAO LUIZ DOS MONTES BELOS	14/11/2019 20:37	15/11/2019 10:40	14/11/2019 20:37	15/11/2019 10:40	14,04	2	28,09	CHI
201911170381	GOIANESIA	GE12379116	GOIANESIA S2	14/11/2019 20:18	15/11/2019 09:51	14/11/2019 20:18	15/11/2019 09:51	13,54	99	1339,99	CHI
201911170382	PORANGATU	MU12266664	MARA ROSA	14/11/2019 12:58	15/11/2019 07:30	14/11/2019 12:58	15/11/2019 07:30	18,53	48	889,47	CHI
201911170383	PLANALTINA	PI11164644	PLANALTINA	14/11/2019 20:37	14/11/2019 21:24	14/11/2019 20:37	14/11/2019 21:24	0,77	111	85,13	CHI
201911170384	NOVA AMERICA	NM21399526	RUBIATABA	14/11/2019 20:38	15/11/2019 15:11	14/11/2019 20:38	15/11/2019 15:11	18,54	1	18,54	CHI
201911170390	URUACU	UR12088762	CAMPINORTE	14/11/2019 20:39	15/11/2019 10:24	14/11/2019 20:39	15/11/2019 10:24	13,74	2	27,48	CHI
201911170410	GOIANIA	10499799	GOIANIA LESTE S1	14/11/2019 20:44	15/11/2019 00:43	14/11/2019 20:44	15/11/2019 00:43	3,98	1	3,98	CHI
201911170427	GOIANESIA	GE12297424	GOIANESIA S1	14/11/2019 20:49	16/11/2019 13:52	14/11/2019 20:49	16/11/2019 13:52	41,04	1	41,04	CHI
201911170442	CRIXAS	CX12262895	SERRA DO OURO	14/11/2019 20:53	15/11/2019 11:54	14/11/2019 20:53	15/11/2019 11:54	15,01	9	135,06	CHI
201911170464	MARA ROSA	MQ12279137	MARA ROSA	14/11/2019 20:59	15/11/2019 13:55	14/11/2019 20:59	15/11/2019 13:55	16,92	2	33,84	CHI
201911170601	JATAI	10012283361	JATAI S2	14/11/2019 17:55	14/11/2019 23:06	14/11/2019 17:55	14/11/2019 23:06	5,18	1	5,18	CHI
201911170619	ITUMBIARA	IT11091623	ITUMBIARA NOVA	14/11/2019 21:03	15/11/2019 07:41	14/11/2019 21:03	15/11/2019 07:41	10,62	195	2070,36	CHI
201911170620	LEOPOLDO DE BULHOES	LB12011644	DAIA S2	14/11/2019 21:06	15/11/2019 14:18	14/11/2019 21:06	15/11/2019 14:18	17,19	2	34,38	CHI
201911170630	ITUMBIARA	IT12404221	PARANAIBA	14/11/2019 16:47	14/11/2019 22:53	14/11/2019 16:47	14/11/2019 22:53	6,10	26	158,55	CHI
201911170903	CAMPOS VERDES	VD12243626	SANTA TEREZINHA	14/11/2019 18:59	15/11/2019 00:37	14/11/2019 18:59	15/11/2019 00:37	5,62	20	112,39	CHI
201911170904	CAMPO LIMPO	AN12351236	NEROPOLIS S1	14/11/2019 21:05	16/11/2019 11:00	14/11/2019 21:05	16/11/2019 11:00	37,91	7	265,34	CHI
201911170909	FAZENDA NOVA	IS12381080	IPORA	14/11/2019 20:45	15/11/2019 20:15	14/11/2019 20:45	15/11/2019 18:49	22,07	6	132,42	CHI
201911170909	ISRAELANDIA	IS12381080	IPORA	14/11/2019 20:45	15/11/2019 20:15	14/11/2019 20:45	15/11/2019 18:49	22,07	2	44,14	CHI
201911170909	FAZENDA NOVA	IS12381080	IPORA	14/11/2019 20:45	15/11/2019 20:15	14/11/2019 20:45	15/11/2019 20:15	23,50	3	70,50	CHI
201911170910	SANTA CRUZ DE GOIAS	BC21025344	PIRES DO RIO S2	14/11/2019 21:16	16/11/2019 09:39	14/11/2019 21:16	16/11/2019 09:39	36,37	1	36,37	CHI
201911170914	GOIANIRA	390089140	MEIA PONTE	14/11/2019 21:17	15/11/2019 10:36	14/11/2019 21:17	15/11/2019 10:36	13,30	1	13,30	CHI
201911170916	GOIANIA	10000139163	GOYA S1	14/11/2019 21:19	15/11/2019 00:02	14/11/2019 21:19	15/11/2019 00:02	2,72	1	2,72	CHI
201911170917	AMARALINA	MH12391965	NOVA CRIXAS	14/11/2019 21:19	16/11/2019 06:30	14/11/2019 21:19	16/11/2019 06:30	33,18	1	33,18	CHI
201911170917	MUNDO NOVO DE GOIAS	MH12391965	NOVA CRIXAS	14/11/2019 21:19	16/11/2019 06:30	14/11/2019 21:19	16/11/2019 06:30	33,18	12	398,17	CHI
201911170928	ABADIANIA	AA12382488	ANAPOLIS UNIVERSITARIO S1	14/11/2019 15:57	15/11/2019 14:06	14/11/2019 15:57	15/11/2019 14:06	22,15	5	110,74	CHI
201911170929	CALDAS NOVAS	CN12110281	CALDAS NOVAS S1	14/11/2019 16:10	15/11/2019 09:23	14/11/2019 16:10	15/11/2019 09:23	17,21	17	292,54	CHI
201911170933	ITAPACI	NM21135255	RUBIATABA	14/11/2019 21:25	16/11/2019 10:35	14/11/2019 21:25	16/11/2019 10:35	37,15	1	37,15	CHI
201911170959	APARECIDA DE GOIANIA	AP11000016	INDEPENDENCIA S1	14/11/2019 21:17	15/11/2019 00:34	14/11/2019 21:17	15/11/2019 00:34	3,27	120	392,93	CHI

201911170973	SANTO ANTONIO DO DESCOBERTO	10030086602	MARAJOARA	14/11/2019 21:35	15/11/2019 14:40	14/11/2019 21:35	15/11/2019 14:40	17,07	1	17,07	CHI
201911170985	ANAPOLIS	20266996	JUNDIAI S2	14/11/2019 21:39	15/11/2019 10:48	14/11/2019 21:39	15/11/2019 10:48	13,14	1	13,14	CHI
201911170987	SAO DOMINGOS	SD12245178	SAO DOMINGOS	14/11/2019 21:40	14/11/2019 23:42	14/11/2019 21:40	14/11/2019 23:42	2,03	7	14,22	CHI
201911170992	CORREGO DO OURO	CO21079909	SAO LUIZ DOS MONTES BELOS	14/11/2019 21:41	15/11/2019 19:51	14/11/2019 21:41	15/11/2019 19:51	22,15	2	44,30	CHI
201911170994	GOIANIA	10106376	FERROVIARIO S1	14/11/2019 21:42	15/11/2019 08:14	14/11/2019 21:42	15/11/2019 08:14	10,52	1	10,52	CHI
201911170996	MARA ROSA	MQ12285215	MARA ROSA	14/11/2019 21:43	16/11/2019 13:37	14/11/2019 21:43	16/11/2019 13:37	39,90	1	39,90	CHI
201911170998	GOIANIA	GN11203354	GOYA S2	14/11/2019 21:24	15/11/2019 10:45	14/11/2019 21:24	15/11/2019 10:45	13,34	243	3240,47	CHI
201911171001	GOIANIA	GN21232704	GOIANIA LESTE S1	14/11/2019 21:46	15/11/2019 02:25	14/11/2019 21:46	15/11/2019 02:25	4,65	1	4,65	CHI
201911171010	CATALAO	CT12266069	CATALAO S1	14/11/2019 21:50	15/11/2019 07:09	14/11/2019 21:50	15/11/2019 07:09	9,31	1	9,31	CHI
201911171010	GOIANDIRA	CT12266069	CATALAO S1	14/11/2019 21:50	15/11/2019 07:09	14/11/2019 21:50	15/11/2019 07:09	9,31	3	27,92	CHI
201911171013	ITAPIRAPUA	IU12016406	MATRINCHA	14/11/2019 21:27	15/11/2019 02:24	14/11/2019 21:27	15/11/2019 02:24	4,95	12	59,36	CHI
201911171014	RUBIATABA	RB12246312	RUBIATABA	14/11/2019 20:39	14/11/2019 23:01	14/11/2019 20:39	14/11/2019 23:01	2,37	324	766,35	CHI
201911171201	ANAPOLIS	20921822	JUNDIAI S1	14/11/2019 21:56	15/11/2019 02:11	14/11/2019 21:56	15/11/2019 02:11	4,24	1	4,24	CHI
201911171205	PORANGATU	PO12020577	PORANGATU	14/11/2019 21:57	14/11/2019 23:07	14/11/2019 21:57	14/11/2019 23:07	1,15	136	157,00	CHI
201911171212	FORMOSA	FA21146163	ITUIQUIRA	14/11/2019 22:00	15/11/2019 10:43	14/11/2019 22:00	15/11/2019 10:43	12,70	1	12,70	CHI
201911171222	IPORA	730081370	IPORA	14/11/2019 22:03	15/11/2019 11:14	14/11/2019 22:03	15/11/2019 11:14	13,17	1	13,17	CHI
201911171227	ORIZONA	OZ21080795	PIRES DO RIO S2	14/11/2019 22:04	15/11/2019 07:45	14/11/2019 22:04	15/11/2019 07:45	9,67	1	9,67	CHI
201911171307	CALDAS NOVAS	CN11104517	SERRA DE CALDAS	14/11/2019 22:10	14/11/2019 23:38	14/11/2019 22:10	14/11/2019 23:38	1,46	80	117,07	CHI
201911171311	FORMOSO	SE12033994	MARA ROSA	14/11/2019 13:13	15/11/2019 01:10	14/11/2019 13:13	15/11/2019 01:10	11,94	98	1169,71	CHI
201911171314	SAO MIGUEL DO ARAGUAIA	830031030	SAO MIGUEL DO ARAGUAIA	14/11/2019 22:17	15/11/2019 00:40	14/11/2019 22:17	15/11/2019 00:40	2,38	1	2,38	CHI
201911171323	ABADIANIA	AA12377756	ANAPOLIS UNIVERSITARIO S1	14/11/2019 22:21	15/11/2019 12:24	14/11/2019 22:21	15/11/2019 12:24	14,05	6	84,28	CHI
201911171331	ANAPOLIS	AN12000073	JUNDIAI S2	14/11/2019 20:45	15/11/2019 00:45	14/11/2019 20:45	15/11/2019 00:45	3,99	289	1153,91	CHI
201911171332	BONOPOLIS	BX21134352	SAO MIGUEL DO ARAGUAIA	14/11/2019 22:25	15/11/2019 14:55	14/11/2019 22:25	15/11/2019 14:55	16,49	1	16,49	CHI
201911171347	GOIANESIA	GE11171632	GOIANESIA S2	14/11/2019 21:34	15/11/2019 00:37	14/11/2019 21:34	15/11/2019 00:37	3,04	111	337,56	CHI
201911171366	GOIANIA	10974155	FERROVIARIO S3	14/11/2019 22:36	15/11/2019 02:20	14/11/2019 22:36	15/11/2019 02:20	3,73	1	3,73	CHI
201911171367	VICENTINOPOLIS	VI12352541	VICENTINOPOLIS	14/11/2019 17:01	15/11/2019 12:08	14/11/2019 17:01	15/11/2019 12:08	19,10	4	76,40	CHI
201911171370	CATURAI	CK21132052	ARACU	14/11/2019 22:37	15/11/2019 10:39	14/11/2019 22:37	15/11/2019 10:39	12,05	1	12,05	CHI
201911171381	CALDAS NOVAS	CN12182800	SERRA DE CALDAS	14/11/2019 17:34	15/11/2019 13:45	14/11/2019 17:34	15/11/2019 13:45	20,17	10	201,68	CHI
201911171385	ITUMBIARA	IT11000155	PARANAIBA	14/11/2019 17:56	15/11/2019 14:21	14/11/2019 17:56	15/11/2019 14:21	20,41	74	1510,57	CHI
201911171387	ANAPOLIS	AN12261185	ANAPOLIS UNIVERSITARIO S2	14/11/2019 21:18	16/11/2019 11:16	14/11/2019 21:18	16/11/2019 11:16	37,97	12	455,67	CHI
201911171399	MONTIVIDIU DO NORTE	MX12203429	PORANGATU	14/11/2019 23:07	15/11/2019 09:06	14/11/2019 23:07	15/11/2019 09:06	9,97	21	209,39	CHI
201911171413	ITUMBIARA	10011326326	ITUMBIARA VELHA S1	14/11/2019 23:12	16/11/2019 15:34	14/11/2019 23:12	16/11/2019 15:34	40,36	1	40,36	CHI
201911171419	BALIZA	BH11074587	BOM JARDIM	14/11/2019 21:35	15/11/2019 12:13	14/11/2019 21:35	15/11/2019 12:13	14,62	77	1125,80	CHI

201911171422	ANAPOLIS	AN12060120	JUNDIAI S2	14/11/2019 22:42	15/11/2019 00:09	14/11/2019 22:42	15/11/2019 00:09	1,43	199	285,56	CHI
201911171425	PORANGATU	PO12020577	PORANGATU	15/11/2019 01:58	15/11/2019 02:56	15/11/2019 01:58	15/11/2019 02:56	0,96	136	130,37	CHI
201911171431	CAMPOS VERDES	VD11037451	SANTA TEREZINHA	14/11/2019 21:53	15/11/2019 11:40	14/11/2019 21:53	15/11/2019 11:16	13,39	61	816,96	CHI
201911171431	CAMPOS VERDES	VD12201664	SANTA TEREZINHA	14/11/2019 21:53	15/11/2019 11:40	15/11/2019 09:44	15/11/2019 11:40	1,94	45	87,21	CHI
201911171435	AVELINOPOLIS	AV12019682	ANICUNS	14/11/2019 23:27	15/11/2019 02:18	14/11/2019 23:27	15/11/2019 02:18	2,84	16	45,45	CHI
201911171447	GOIANIA	GN12203577	REAL S1	14/11/2019 20:01	15/11/2019 01:18	14/11/2019 20:01	15/11/2019 01:18	5,27	98	516,95	CHI
201911171449	GOIANIA	15042613	GOIANIA LESTE S1	14/11/2019 23:41	15/11/2019 01:42	14/11/2019 23:41	15/11/2019 01:42	2,01	1	2,01	CHI
201911171460	CIDADE OCIDENTAL	10004232141	MARAJOARA	14/11/2019 23:52	15/11/2019 01:25	14/11/2019 23:52	15/11/2019 01:25	1,54	1	1,54	CHI
201911171461	ANAPOLIS	AN21340034	DAIA S1	14/11/2019 23:53	15/11/2019 12:28	14/11/2019 23:53	15/11/2019 12:28	12,58	8	100,63	CHI
201911171462	APARECIDA DE GOIANIA	AP11168458	ANHANGUERA	14/11/2019 21:14	15/11/2019 01:55	14/11/2019 21:14	15/11/2019 01:55	4,68	57	266,65	CHI
201911171463	JATAI	290306784	JATAI S3	14/11/2019 23:55	15/11/2019 05:12	14/11/2019 23:55	15/11/2019 05:12	5,29	1	5,29	CHI
201911171503	ANAPOLIS	20484471	ANAPOLIS UNIVERSITARIO S1	15/11/2019 00:07	15/11/2019 15:21	15/11/2019 00:07	15/11/2019 15:21	15,23	1	15,23	CHI
201911171505	SENADOR CANEDO	190007837	SENADOR CANEDO	15/11/2019 00:15	15/11/2019 07:22	15/11/2019 00:15	15/11/2019 07:22	7,12	1	7,12	CHI
201911171512	CRISTIANOPOLIS	SQ21188517	CRISTIANOPOLIS	14/11/2019 23:39	15/11/2019 09:55	14/11/2019 23:39	15/11/2019 09:55	10,27	1	10,27	CHI
201911171516	HIDROLINA	UR12374572	URUACU	15/11/2019 00:40	15/11/2019 13:22	15/11/2019 00:40	15/11/2019 13:22	12,69	2	25,38	CHI
201911171516	URUACU	UR12374572	URUACU	15/11/2019 00:40	15/11/2019 13:22	15/11/2019 00:40	15/11/2019 13:22	12,69	6	76,15	CHI
201911171522	PALMEIRAS DE GOIAS	PL21294911	PALMEIRAS	15/11/2019 00:57	15/11/2019 16:00	15/11/2019 00:57	15/11/2019 16:00	15,05	1	15,05	CHI
201911171523	MOZARLANDIA	MZ12220375	MOZARLANDIA	15/11/2019 05:34	16/11/2019 14:15	15/11/2019 05:34	16/11/2019 14:15	32,68	34	1111,03	CHI
201911171524	GOIANESIA	550010336	GOIANESIA S2	15/11/2019 00:58	15/11/2019 12:52	15/11/2019 00:58	15/11/2019 12:52	11,89	1	11,89	CHI
201911171531	RIO VERDE	RV21159306	CABRIUVA S2	14/11/2019 17:19	15/11/2019 11:00	14/11/2019 17:19	15/11/2019 11:00	17,67	1	17,67	CHI
201911171535	RIO VERDE	RV21271369	CABRIUVA S2	14/11/2019 15:12	15/11/2019 10:37	14/11/2019 15:12	15/11/2019 10:37	19,40	1	19,40	CHI
201911171542	OUVIDOR	OU11161393	CATALAO S1	15/11/2019 01:36	15/11/2019 11:15	15/11/2019 01:36	15/11/2019 11:15	9,64	6	57,86	CHI
201911171545	CALDAS NOVAS	CN12142380	CALDAS NOVAS S2	14/11/2019 23:21	15/11/2019 04:45	14/11/2019 23:21	15/11/2019 04:45	5,39	907	4887,72	CHI
201911171546	ALEXANIA	AX12211846	ALEXANIA	15/11/2019 01:40	15/11/2019 09:36	15/11/2019 01:40	15/11/2019 09:36	7,92	213	1686,66	CHI
201911171555	CATALAO	CT11333743	CATALAO S2	15/11/2019 01:53	15/11/2019 08:26	15/11/2019 01:53	15/11/2019 08:26	6,55	5	32,73	CHI
201911171556	CALDAS NOVAS	CN11054003	SERRA DE CALDAS	15/11/2019 00:21	15/11/2019 13:04	15/11/2019 00:21	15/11/2019 13:04	12,72	221	2810,26	CHI
201911171557	BELA VISTA DE GOIAS	SQ21168273	CRISTIANOPOLIS	14/11/2019 23:39	15/11/2019 10:59	14/11/2019 23:39	15/11/2019 10:59	11,33	1	11,33	CHI
201911171568	SILVANIA	SV12317628	DAIA S2	15/11/2019 02:56	15/11/2019 08:58	15/11/2019 02:56	15/11/2019 08:58	6,02	73	439,50	CHI
201911171584	GOIANIA	10020779	CAMPINAS S3	15/11/2019 04:03	15/11/2019 07:56	15/11/2019 04:03	15/11/2019 07:56	3,88	1	3,88	CHI
201911171595	PIRENOPOLIS	PV11057878	CORUMBA	15/11/2019 04:15	15/11/2019 08:35	15/11/2019 04:15	15/11/2019 08:35	4,33	150	649,33	CHI
201911171601	CRISTALINA	KR21164804	PAMPLONA	15/11/2019 04:20	15/11/2019 07:59	15/11/2019 04:20	15/11/2019 07:59	3,63	1	3,63	CHI
201911171604	ABADIANIA	AX12221526	ALEXANIA	14/11/2019 18:50	15/11/2019 13:00	14/11/2019 18:50	15/11/2019 13:00	18,16	13	236,08	CHI
201911171604	ALEXANIA	AX12221526	ALEXANIA	14/11/2019 18:50	15/11/2019 13:00	14/11/2019 18:50	15/11/2019 13:00	18,16	188	3414,03	CHI

201911171608	URUACU	UR12341322	URUACU	15/11/2019 02:20	15/11/2019 10:04	15/11/2019 02:20	15/11/2019 10:04	7,72	7	54,06	CHI
201911171609	CEZARINA	03320416	GUAPO S2	15/11/2019 04:48	15/11/2019 10:10	15/11/2019 04:48	15/11/2019 10:05	5,27	215	1133,59	CHI
201911171609	GUAPO	03320416	GUAPO S2	15/11/2019 04:48	15/11/2019 10:10	15/11/2019 04:48	15/11/2019 10:05	5,27	3	15,82	CHI
201911171609	INDIARA	03320416	GUAPO S2	15/11/2019 04:48	15/11/2019 10:10	15/11/2019 04:48	15/11/2019 10:05	5,27	1	5,27	CHI
201911171609	VARJAO	03320416	GUAPO S2	15/11/2019 04:48	15/11/2019 10:10	15/11/2019 04:48	15/11/2019 10:05	5,27	1674	8826,16	CHI
201911171609	VARJAO	03320416	GUAPO S2	15/11/2019 04:48	15/11/2019 10:10	15/11/2019 04:48	15/11/2019 10:05	5,27	103	543,07	CHI
201911171609	GUAPO	VJ13000011	GUAPO S2	15/11/2019 04:48	15/11/2019 10:10	15/11/2019 04:48	15/11/2019 10:10	5,37	127	682,10	CHI
201911171609	VARJAO	VJ13000011	GUAPO S2	15/11/2019 04:48	15/11/2019 10:10	15/11/2019 04:48	15/11/2019 10:10	5,37	97	520,97	CHI
201911171616	PARAUNA	PU12205939	PARAUNA	15/11/2019 05:06	15/11/2019 19:25	15/11/2019 05:06	15/11/2019 19:25	14,31	8	114,52	CHI
201911171619	GOIANIA	GN11023411	REAL S1	15/11/2019 05:07	15/11/2019 11:11	15/11/2019 05:07	15/11/2019 11:11	6,06	162	981,67	CHI
201911171622	PALMEIRAS DE GOIAS	PL21308527	PALMEIRAS	15/11/2019 05:07	16/11/2019 08:10	15/11/2019 05:07	16/11/2019 08:10	27,04	1	27,04	CHI
201911171634	ANICUNS	AC21073824	ANICUNS	15/11/2019 05:07	15/11/2019 13:35	15/11/2019 05:07	15/11/2019 13:35	8,45	1	8,45	CHI
201911171636	QUIRINOPOLIS	80084710	QUIRINOPOLIS	15/11/2019 05:08	15/11/2019 07:14	15/11/2019 05:08	15/11/2019 07:14	2,10	1	2,10	CHI
201911171637	BELA VISTA DE GOIAS	BV21063015	BELA VISTA S1	15/11/2019 05:08	15/11/2019 15:09	15/11/2019 05:08	15/11/2019 15:09	10,02	1	10,02	CHI
201911171638	ANAPOLIS	AN11129469	JUNDIAI S2	15/11/2019 05:12	15/11/2019 13:37	15/11/2019 05:12	15/11/2019 13:37	8,41	113	950,27	CHI
201911171640	FORMOSO	SE12033994	MARA ROSA	15/11/2019 04:39	15/11/2019 07:30	15/11/2019 04:39	15/11/2019 07:30	2,83	100	283,42	CHI
201911171648	ALTO HORIZONTE	MQ12181177	MARA ROSA	15/11/2019 05:22	15/11/2019 10:00	15/11/2019 05:22	15/11/2019 10:00	4,63	3	13,89	CHI
201911171648	MARA ROSA	MQ12181177	MARA ROSA	15/11/2019 05:22	15/11/2019 10:00	15/11/2019 05:22	15/11/2019 10:00	4,63	28	129,61	CHI
201911171648	URUACU	MQ12181177	MARA ROSA	15/11/2019 05:22	15/11/2019 10:00	15/11/2019 05:22	15/11/2019 10:00	4,63	1	4,63	CHI
201911171658	INHUMAS	IN12011990	INHUMAS S1	15/11/2019 05:29	15/11/2019 14:10	15/11/2019 05:29	15/11/2019 10:24	4,91	38	186,63	CHI
201911171658	INHUMAS	IN12016060	INHUMAS S1	15/11/2019 05:29	15/11/2019 14:10	15/11/2019 05:29	15/11/2019 14:10	8,68	16	138,88	CHI
201911171667	PIRENOPOLIS	PV12000461	SAO FRANCISCO DE GOIAS	14/11/2019 20:32	15/11/2019 09:58	14/11/2019 20:32	15/11/2019 09:58	13,42	65	872,53	CHI
201911171668	TRES RANCHOS	TH12161405	CATALAO S1	14/11/2019 19:09	15/11/2019 07:35	14/11/2019 19:09	15/11/2019 07:35	12,42	17	211,16	CHI
201911171671	MUNDO NOVO DE GOIAS	MH12391949	NOVA CRIXAS	15/11/2019 05:38	15/11/2019 23:31	15/11/2019 05:38	15/11/2019 23:31	17,88	42	751,10	CHI
201911171673	ITUMBIARA	IT12273819	ITUMBIARA NOVA	15/11/2019 05:38	16/11/2019 16:15	15/11/2019 05:38	16/11/2019 16:15	34,61	8	276,92	CHI
201911171674	MOSSAMEDES	MD12299584	ITABERAI S2	15/11/2019 02:40	15/11/2019 22:45	15/11/2019 02:40	15/11/2019 22:45	20,07	12	240,82	CHI
201911171675	CATALAO	1990097926	CATALAO S2	15/11/2019 05:42	15/11/2019 16:08	15/11/2019 05:42	15/11/2019 16:08	10,44	1	10,44	CHI
201911171677	SAO JOAO D ALIANCA	JL21314654	SAO JOAO D ALIANCA	15/11/2019 05:42	15/11/2019 08:54	15/11/2019 05:42	15/11/2019 08:54	3,20	1	3,20	CHI
201911171688	MOZARLANDIA	MZ12057146	MOZARLANDIA	15/11/2019 05:49	16/11/2019 12:50	15/11/2019 05:49	16/11/2019 12:50	31,01	6	186,04	CHI
201911171688	NOVA CRIXAS	MZ12057146	MOZARLANDIA	15/11/2019 05:49	16/11/2019 12:50	15/11/2019 05:49	16/11/2019 12:50	31,01	31	961,19	CHI
201911171691	SANTA TEREZINHA DE GOIAS	SG12246311	SANTA TEREZINHA	15/11/2019 05:51	15/11/2019 08:20	15/11/2019 05:51	15/11/2019 08:20	2,47	4	9,89	CHI
201911171693	QUIRINOPOLIS	QI12303165	QUIRINOPOLIS	14/11/2019 19:52	16/11/2019 09:52	14/11/2019 19:52	16/11/2019 09:52	38,00	13	494,00	CHI
201911171696	ABADIANIA	AA21162745	DAIA S2	15/11/2019 05:54	16/11/2019 11:31	15/11/2019 05:54	16/11/2019 11:31	29,61	1	29,61	CHI

201911171713	JATAI	JT12320329	JATAI S2	15/11/2019 06:05	15/11/2019 09:14	15/11/2019 06:05	15/11/2019 09:14	3,14	563	1770,32	CHI
201911171715	NOVA IGUACU DE GOIAS	NH12202119	CAMPINORTE	15/11/2019 06:06	15/11/2019 12:36	15/11/2019 06:06	15/11/2019 12:36	6,49	8	51,88	CHI
201911171718	URUACU	CR12375637	CAMPINORTE	15/11/2019 05:56	15/11/2019 07:24	15/11/2019 05:56	15/11/2019 07:24	1,46	117	170,33	CHI
201911171719	CRIXAS	CX12181366	SANTA TEREZINHA	15/11/2019 06:07	15/11/2019 17:37	15/11/2019 06:07	15/11/2019 17:37	11,49	4	45,95	CHI
201911171720	CALDAS NOVAS	CN11103226	CALDAS NOVAS S2	15/11/2019 05:02	15/11/2019 09:29	15/11/2019 05:02	15/11/2019 09:29	4,43	140	620,90	CHI
201911171723	SANTA TEREZINHA DE GOIAS	SG12201785	SANTA TEREZINHA	15/11/2019 06:03	15/11/2019 08:42	15/11/2019 06:03	15/11/2019 08:42	2,64	44	116,22	CHI
201911171724	CRISTALINA	KR12163117	CRISTALINA S1	15/11/2019 06:09	15/11/2019 08:41	15/11/2019 06:09	15/11/2019 08:41	2,52	7	17,62	CHI
201911171728	GOIANIA	15136840	REAL S1	15/11/2019 06:12	15/11/2019 13:54	15/11/2019 06:12	15/11/2019 13:54	7,70	1	7,70	CHI
201911171729	CORUMBA DE GOIAS	CB21311913	CORUMBA	15/11/2019 06:12	16/11/2019 14:36	15/11/2019 06:12	16/11/2019 14:36	32,40	1	32,40	CHI
201911171737	PLANALTINA	PI12394160	SAO JOAO D ALIANCA	15/11/2019 06:13	15/11/2019 11:43	15/11/2019 06:13	15/11/2019 11:43	5,48	8	43,87	CHI
201911171738	DOVERLANDIA	DV12138334	CAIAPONIA	15/11/2019 06:14	15/11/2019 15:14	15/11/2019 06:14	15/11/2019 15:14	9,00	15	135,05	CHI
201911171739	FIRMINOPOLIS	FR11206058	FIRMINOPOLIS S1	15/11/2019 06:14	15/11/2019 07:50	15/11/2019 06:14	15/11/2019 07:50	1,60	132	210,69	CHI
201911171741	AVELINOPOLIS	990001040	ANICUNS	15/11/2019 06:14	15/11/2019 12:17	15/11/2019 06:14	15/11/2019 12:17	6,04	1	6,04	CHI
201911171747	JATAI	6129619	JATAI S1	15/11/2019 06:17	17/11/2019 19:13	15/11/2019 06:17	15/11/2019 20:25	14,13	2	28,26	CHI
201911171747	JATAI	6129619	JATAI S1	15/11/2019 06:17	17/11/2019 19:13	15/11/2019 06:17	17/11/2019 19:13	60,93	3	182,78	CHI
201911171747	JATAI	6129619	JATAI S1	15/11/2019 06:17	17/11/2019 19:13	17/11/2019 18:25	17/11/2019 19:13	0,79	2	1,57	CHI
201911171759	CORUMBA DE GOIAS	CB12062146	CORUMBA	15/11/2019 05:15	15/11/2019 09:32	15/11/2019 05:15	15/11/2019 09:32	4,28	10	42,77	CHI
201911171766	CALDAS NOVAS	10017777028	CALDAS NOVAS S1	15/11/2019 06:25	16/11/2019 05:45	15/11/2019 06:25	16/11/2019 05:45	23,32	1	23,32	CHI
201911171770	PIRES DO RIO	PR21186577	PIRES DO RIO S1	15/11/2019 06:27	16/11/2019 11:26	15/11/2019 06:27	16/11/2019 11:26	28,98	1	28,98	CHI
201911171771	ANAPOLIS	AN11068060	JUNDIAI S2	15/11/2019 06:27	15/11/2019 10:55	15/11/2019 06:27	15/11/2019 10:55	4,46	160	712,98	CHI
201911171774	SANTA FE DE GOIAS	RN12009765	BRITANIA	15/11/2019 06:30	17/11/2019 10:25	15/11/2019 06:30	17/11/2019 10:25	51,92	23	1194,06	CHI
201911171778	TRINDADE	TR11258430	TRINDADE	15/11/2019 06:34	15/11/2019 09:46	15/11/2019 06:34	15/11/2019 09:46	3,19	26	82,94	CHI
201911171786	CRIXAS	NA12156613	MOZARLANDIA	14/11/2019 20:05	15/11/2019 23:05	14/11/2019 20:05	15/11/2019 23:05	27,00	2	53,99	CHI
201911171786	NOVA CRIXAS	NA12156613	MOZARLANDIA	14/11/2019 20:05	15/11/2019 23:05	14/11/2019 20:05	15/11/2019 23:05	27,00	33	890,87	CHI
201911171787	FORMOSO	FO12243348	MARA ROSA	15/11/2019 06:37	16/11/2019 07:25	15/11/2019 06:37	16/11/2019 07:25	24,80	1	24,80	CHI
201911171795	SILVANIA	SV21166457	VIANOPOLIS	15/11/2019 06:38	15/11/2019 09:02	15/11/2019 06:38	15/11/2019 09:02	2,38	1	2,38	CHI
201911171798	GOIANIA	GN11023412	REAL S1	15/11/2019 06:39	15/11/2019 09:44	15/11/2019 06:39	15/11/2019 09:44	3,07	106	325,16	CHI
201911171801	ACREUNA	01690224	ACREUNA	15/11/2019 06:33	15/11/2019 15:20	15/11/2019 06:33	15/11/2019 07:42	1,15	2	2,29	CHI
201911171801	RIO VERDE	01690224	ACREUNA	15/11/2019 06:33	15/11/2019 15:20	15/11/2019 06:33	15/11/2019 07:42	1,15	1	1,15	CHI
201911171801	SANTO ANTONIO DA BARRA	01690224	ACREUNA	15/11/2019 06:33	15/11/2019 15:20	15/11/2019 06:33	15/11/2019 07:42	1,15	25	28,68	CHI
201911171801	RIO VERDE	01690224	ACREUNA	15/11/2019 06:33	15/11/2019 15:20	15/11/2019 06:33	15/11/2019 10:00	3,45	24	82,90	CHI
201911171801	SANTA HELENA DE GOIAS	01690224	ACREUNA	15/11/2019 06:33	15/11/2019 15:20	15/11/2019 06:33	15/11/2019 10:00	3,45	9	31,09	CHI
201911171801	SANTO ANTONIO DA BARRA	01690224	ACREUNA	15/11/2019 06:33	15/11/2019 15:20	15/11/2019 06:33	15/11/2019 10:00	3,45	154	531,94	CHI

201911171801	SANTO ANTONIO DA BARRA	BZ12219419	ACREUNA	15/11/2019 06:33	15/11/2019 15:20	15/11/2019 08:43	15/11/2019 10:00	1,28	1	1,28	CHI
201911171801	ACREUNA	01690224	ACREUNA	15/11/2019 06:33	15/11/2019 15:20	15/11/2019 06:33	15/11/2019 12:14	5,69	5	28,44	CHI
201911171801	SANTA HELENA DE GOIAS	01690224	ACREUNA	15/11/2019 06:33	15/11/2019 15:20	15/11/2019 06:33	15/11/2019 12:14	5,69	11	62,57	CHI
201911171801	SANTO ANTONIO DA BARRA	01690224	ACREUNA	15/11/2019 06:33	15/11/2019 15:20	15/11/2019 06:33	15/11/2019 12:14	5,69	16	91,01	CHI
201911171801	SANTA HELENA DE GOIAS	SH12246720	ACREUNA	15/11/2019 06:33	15/11/2019 15:20	15/11/2019 08:43	15/11/2019 12:14	3,52	2	7,03	CHI
201911171801	SANTA HELENA DE GOIAS	01690224	ACREUNA	15/11/2019 06:33	15/11/2019 15:20	15/11/2019 06:33	15/11/2019 13:09	6,61	32	211,54	CHI
201911171801	SANTA HELENA DE GOIAS	SH12246721LD	ACREUNA	15/11/2019 06:33	15/11/2019 15:20	15/11/2019 08:43	15/11/2019 13:09	4,44	1	4,44	CHI
201911171801	SANTA HELENA DE GOIAS	01690224	ACREUNA	15/11/2019 06:33	15/11/2019 15:20	15/11/2019 06:33	15/11/2019 13:48	7,25	25	181,19	CHI
201911171801	SANTA HELENA DE GOIAS	01690224	ACREUNA	15/11/2019 06:33	15/11/2019 15:20	15/11/2019 06:33	15/11/2019 15:00	8,45	4	33,78	CHI
201911171801	SANTA HELENA DE GOIAS	SH12271340LD	ACREUNA	15/11/2019 06:33	15/11/2019 15:20	15/11/2019 14:40	15/11/2019 15:20	0,67	11	7,34	CHI
201911171802	CATALAO	1990147036	CATALAO S2	15/11/2019 01:53	15/11/2019 09:07	15/11/2019 01:53	15/11/2019 09:07	7,23	1	7,23	CHI
201911171814	GOIANIA	GN12023384	REAL S1	15/11/2019 07:31	15/11/2019 09:54	15/11/2019 07:31	15/11/2019 09:54	2,37	118	279,53	CHI
201911171815	CATURAI	CK21253002	INHUMAS S1	15/11/2019 07:32	15/11/2019 15:04	15/11/2019 07:32	15/11/2019 15:04	7,53	1	7,53	CHI
201911171819	DOVERLANDIA	DV11204060	CAIAPONIA	14/11/2019 17:54	15/11/2019 11:00	14/11/2019 17:54	15/11/2019 11:00	17,10	1	17,10	CHI
201911171820	ITUMBIARA	IT11143915	ITUMBIARA VELHA S1	14/11/2019 17:02	16/11/2019 10:00	14/11/2019 17:02	16/11/2019 10:00	40,95	133	5446,68	CHI
201911171831	CATALAO	CT12166743RE	CATALAO S1	14/11/2019 17:58	15/11/2019 09:50	14/11/2019 17:58	15/11/2019 09:50	15,85	33	523,09	CHI
201911171855	GOIANIA	10014717296	GOIANIA LESTE S3	15/11/2019 09:31	15/11/2019 17:08	15/11/2019 09:31	15/11/2019 17:08	7,61	1	7,61	CHI
201911171857	RIO VERDE	RV21267695	CABRIUVA S2	15/11/2019 07:45	15/11/2019 08:48	15/11/2019 07:45	15/11/2019 08:48	1,05	1	1,05	CHI
201911171868	GOIANIA	GN11000791	GOIANIA LESTE S1	15/11/2019 10:20	15/11/2019 10:55	15/11/2019 10:20	15/11/2019 10:55	0,58	141	81,47	CHI
201911171879	GUARAITA	IK10396063	ITAPURANGA	15/11/2019 10:07	15/11/2019 19:10	15/11/2019 10:07	15/11/2019 19:10	9,04	1	9,04	CHI
201911171879	ITAPURANGA	IK10396063	ITAPURANGA	15/11/2019 10:07	15/11/2019 19:10	15/11/2019 10:07	15/11/2019 19:10	9,04	425	3840,23	CHI
201911171880	GOIANESIA	GE21229528	GOIANESIA S2	14/11/2019 20:07	16/11/2019 15:13	14/11/2019 20:07	16/11/2019 15:13	43,09	1	43,09	CHI
201911171883	FAZENDA NOVA	FN21116795	JUSSARA	15/11/2019 11:33	15/11/2019 12:08	15/11/2019 11:33	15/11/2019 12:08	0,57	1	0,57	CHI
201911171897	CABECEIRAS	FA13154418	ITUIQUIRA	15/11/2019 12:06	15/11/2019 13:18	15/11/2019 12:06	15/11/2019 13:18	1,19	1	1,19	CHI
201911171899	ALVORADA DO NORTE	FB10401474	FLORES DE GOIAS	15/11/2019 12:31	15/11/2019 22:36	15/11/2019 12:31	15/11/2019 14:27	1,93	54	104,00	CHI
201911171899	FLORES DE GOIAS	FB10401474	FLORES DE GOIAS	15/11/2019 12:31	15/11/2019 22:36	15/11/2019 12:31	15/11/2019 14:27	1,93	267	514,20	CHI
201911171899	FORMOSA	FB10401474	FLORES DE GOIAS	15/11/2019 12:31	15/11/2019 22:36	15/11/2019 12:31	15/11/2019 14:27	1,93	137	263,84	CHI
201911171899	FORMOSO	FB10401474	FLORES DE GOIAS	15/11/2019 12:31	15/11/2019 22:36	15/11/2019 12:31	15/11/2019 14:27	1,93	1	1,93	CHI
201911171899	IACIARA	FB10401474	FLORES DE GOIAS	15/11/2019 12:31	15/11/2019 22:36	15/11/2019 12:31	15/11/2019 14:27	1,93	16	30,81	CHI
201911171899	POSSE	FB10401474	FLORES DE GOIAS	15/11/2019 12:31	15/11/2019 22:36	15/11/2019 12:31	15/11/2019 14:27	1,93	2	3,85	CHI
201911171899	SAO JOAO D ALIANCA	FB10401474	FLORES DE GOIAS	15/11/2019 12:31	15/11/2019 22:36	15/11/2019 12:31	15/11/2019 14:27	1,93	5	9,63	CHI
201911171899	FLORES DE GOIAS	02830414	FLORES DE GOIAS	15/11/2019 12:31	15/11/2019 22:36	15/11/2019 12:31	15/11/2019 16:16	3,74	909	3402,19	CHI
201911171899	NOVA ROMA	02830414	FLORES DE GOIAS	15/11/2019 12:31	15/11/2019 22:36	15/11/2019 12:31	15/11/2019 16:16	3,74	2	7,49	CHI

201911171899	SAO JOAO D ALIANCA	02830414	FLORES DE GOIAS	15/11/2019 12:31	15/11/2019 22:36	15/11/2019 12:31	15/11/2019 16:16	3,74	108	404,22	CHI
201911171899	FLORES DE GOIAS	02830414	FLORES DE GOIAS	15/11/2019 12:31	15/11/2019 22:36	15/11/2019 12:31	15/11/2019 16:27	3,93	1238	4860,18	CHI
201911171899	FLORES DE GOIAS	02830414	FLORES DE GOIAS	15/11/2019 12:31	15/11/2019 22:36	15/11/2019 12:31	15/11/2019 22:36	10,08	91	916,95	CHI
201911171901	GOIANIA	GN11322265	FERROVIARIO S1	15/11/2019 06:40	15/11/2019 15:53	15/11/2019 06:40	15/11/2019 15:53	9,20	33	303,66	CHI
201911171903	AMARALINA	LC12215796	MARA ROSA	15/11/2019 05:13	15/11/2019 11:16	15/11/2019 05:13	15/11/2019 11:16	6,04	11	66,40	CHI
201911171904	SANTO ANTONIO DO DESCOBERTO	SN12085981	MARAJOARA	15/11/2019 06:41	15/11/2019 14:42	15/11/2019 06:41	15/11/2019 14:42	8,01	25	200,26	CHI
201911171909	TURVELANDIA	TD13371314	RIO DOS BOIS	15/11/2019 15:30	17/11/2019 20:30	15/11/2019 15:30	15/11/2019 18:25	2,92	9	26,28	CHI
201911171909	TURVELANDIA	TD13371314	RIO DOS BOIS	15/11/2019 15:30	17/11/2019 20:30	15/11/2019 17:16	15/11/2019 18:25	1,15	3	3,45	CHI
201911171909	TURVELANDIA	ML12213272LD	RIO DOS BOIS	15/11/2019 15:30	17/11/2019 20:30	15/11/2019 15:30	17/11/2019 20:30	53,00	9	477,00	CHI
201911171909	TURVELANDIA	ML12213272LD	RIO DOS BOIS	15/11/2019 15:30	17/11/2019 20:30	15/11/2019 17:16	17/11/2019 20:30	51,23	5	256,16	CHI
201911171914	CATALAO	CT12399870	CATALAO S1	15/11/2019 06:44	15/11/2019 15:38	15/11/2019 06:44	15/11/2019 15:38	8,89	12	106,63	CHI
201911171917	BALIZA	BH11227620	BOM JARDIM	15/11/2019 06:46	15/11/2019 19:28	15/11/2019 06:46	15/11/2019 19:28	12,70	1	12,70	CHI
201911171918	LUZIANIA	LZ11216266	RIO VERMELHO	15/11/2019 06:46	15/11/2019 14:01	15/11/2019 06:46	15/11/2019 12:00	5,23	141	737,90	CHI
201911171918	LUZIANIA	LZ12078402	RIO VERMELHO	15/11/2019 06:46	15/11/2019 14:01	15/11/2019 06:46	15/11/2019 14:01	7,25	159	1152,71	CHI
201911171920	MUNDO NOVO DE GOIAS	MH12269056	NOVA CRIXAS	15/11/2019 06:22	15/11/2019 18:00	15/11/2019 06:22	15/11/2019 18:00	11,64	22	256,04	CHI
201911171929	GOIANESIA	GE12399555LD	GOIANESIA S1	15/11/2019 06:49	16/11/2019 17:11	15/11/2019 06:49	16/11/2019 17:11	34,38	1	34,38	CHI
201911171933	SANTA HELENA DE GOIAS	SH12301071	RIO DOS BOIS	14/11/2019 20:31	15/11/2019 13:56	14/11/2019 20:31	15/11/2019 13:56	17,42	8	139,33	CHI
201911171933	TURVELANDIA	SH12301071	RIO DOS BOIS	14/11/2019 20:31	15/11/2019 13:56	14/11/2019 20:31	15/11/2019 13:56	17,42	2	34,83	CHI
201911171939	PLANALTINA	PI21099212	PLANALTINA	15/11/2019 06:52	15/11/2019 18:02	15/11/2019 06:52	15/11/2019 18:02	11,16	1	11,16	CHI
201911171945	RIO VERDE	630014358	RIO VERDE S2	15/11/2019 06:52	15/11/2019 16:23	15/11/2019 06:52	15/11/2019 16:23	9,51	1	9,51	CHI
201911171950	ABADIANIA	AA12384735	DAIA S2	14/11/2019 21:22	16/11/2019 10:46	14/11/2019 21:22	15/11/2019 15:30	18,13	15	271,91	CHI
201911171950	ABADIANIA	AA12384735	DAIA S2	14/11/2019 21:22	16/11/2019 10:46	15/11/2019 11:39	15/11/2019 15:30	3,85	10	38,51	CHI
201911171950	ABADIANIA	AA12384735	DAIA S2	14/11/2019 21:22	16/11/2019 10:46	15/11/2019 15:55	15/11/2019 20:10	4,25	23	97,77	CHI
201911171950	ABADIANIA	AA12384735	DAIA S2	14/11/2019 21:22	16/11/2019 10:46	14/11/2019 21:22	15/11/2019 21:45	24,38	1	24,38	CHI
201911171950	ABADIANIA	AA12130228	ANAPOLIS UNIVERSITARIO S1	14/11/2019 21:22	16/11/2019 10:46	15/11/2019 11:39	15/11/2019 21:45	10,10	10	101,01	CHI
201911171950	ABADIANIA	AA12130228	DAIA S2	14/11/2019 21:22	16/11/2019 10:46	15/11/2019 11:39	15/11/2019 21:45	10,10	21	212,12	CHI
201911171950	ABADIANIA	AA12388791	DAIA S2	14/11/2019 21:22	16/11/2019 10:46	15/11/2019 11:39	16/11/2019 09:05	21,44	3	64,32	CHI
201911171950	ABADIANIA	AA12384735	DAIA S2	14/11/2019 21:22	16/11/2019 10:46	14/11/2019 21:22	16/11/2019 09:17	35,91	3	107,72	CHI
201911171950	ABADIANIA	AA12413713	DAIA S2	14/11/2019 21:22	16/11/2019 10:46	15/11/2019 11:39	16/11/2019 09:17	21,63	47	1016,66	CHI
201911171950	ABADIANIA	AA12327809	DAIA S2	14/11/2019 21:22	16/11/2019 10:46	14/11/2019 21:22	16/11/2019 10:00	36,62	12	439,46	CHI
201911171950	ABADIANIA	AA12004083	DAIA S2	14/11/2019 21:22	16/11/2019 10:46	15/11/2019 15:55	16/11/2019 10:46	18,85	2	37,70	CHI
201911171957	MINACU	IH12207745	MINACU	15/11/2019 06:58	15/11/2019 09:24	15/11/2019 06:58	15/11/2019 09:24	2,43	8	19,42	CHI
201911171959	APARECIDA DE GOIANIA	AP11167674	INDEPENDENCIA S2	15/11/2019 05:56	15/11/2019 09:10	15/11/2019 05:56	15/11/2019 09:10	3,23	45	145,34	CHI

201911171960	MINEIROS	1390078660	PARQUE DAS EMAS	15/11/2019 06:58	15/11/2019 10:10	15/11/2019 06:58	15/11/2019 10:10	3,19	1	3,19	CHI
201911171970	GOIANIA	GN11001169	CAMPINAS S3	15/11/2019 12:39	15/11/2019 15:28	15/11/2019 12:39	15/11/2019 15:28	2,82	63	177,50	CHI
201911171975	CRIXAS	CX12318471	SERRA DO OURO	15/11/2019 07:01	15/11/2019 15:07	15/11/2019 07:01	15/11/2019 15:07	8,09	11	88,95	CHI
201911171977	BRITANIA	BT12210599	BRITANIA	15/11/2019 06:52	15/11/2019 09:34	15/11/2019 06:52	15/11/2019 09:34	2,69	475	1276,56	CHI
201911171981	TRINDADE	40290580	TRINDADE	15/11/2019 07:03	15/11/2019 14:02	15/11/2019 07:03	15/11/2019 14:02	6,99	1	6,99	CHI
201911171983	CRISTALINA	KR12209473	CRISTALINA S2	15/11/2019 07:03	15/11/2019 10:04	15/11/2019 07:03	15/11/2019 10:04	3,00	8	24,02	CHI
201911171986	ABADIANIA	AA12084772	ANAPOLIS UNIVERSITARIO S1	15/11/2019 06:28	15/11/2019 10:53	15/11/2019 06:28	15/11/2019 10:53	4,40	13	57,25	CHI
201911171991	ARAGOIANIA	AO21006253	INDEPENDENCIA S1	15/11/2019 07:05	15/11/2019 12:20	15/11/2019 07:05	15/11/2019 12:20	5,25	1	5,25	CHI
201911171993	APARECIDA DE GOIANIA	AP11164458	INDEPENDENCIA S2	15/11/2019 06:05	15/11/2019 10:59	15/11/2019 06:05	15/11/2019 10:59	4,89	153	748,38	CHI
201911171995	PALMINOPOLIS	PP12299141	FIRMINOPOLIS S2	15/11/2019 03:05	15/11/2019 09:35	15/11/2019 03:05	15/11/2019 09:35	6,51	14	91,10	CHI
201911172002	CRIXAS	CX21313394	SANTA TEREZINHA	15/11/2019 07:08	15/11/2019 21:57	15/11/2019 07:08	15/11/2019 21:57	14,81	1	14,81	CHI
201911172003	HIDROLINA	HL12372465	SANTA TEREZINHA	15/11/2019 07:08	15/11/2019 21:22	15/11/2019 07:08	15/11/2019 21:22	14,22	1	14,22	CHI
201911172004	TRES RANCHOS	TH21285935	CATALAO S1	15/11/2019 07:08	15/11/2019 09:38	15/11/2019 07:08	15/11/2019 09:38	2,50	1	2,50	CHI
201911172014	SAO MIGUEL DO ARAGUAIA	SM21013035	SAO MIGUEL DO ARAGUAIA	15/11/2019 07:11	15/11/2019 22:36	15/11/2019 07:11	15/11/2019 22:36	15,42	1	15,42	CHI
201911172015	FORMOSA	FA12000030	ITUIQUIRA	15/11/2019 07:11	15/11/2019 08:17	15/11/2019 07:11	15/11/2019 08:17	1,10	604	663,90	CHI
201911172017	PORANGATU	PO11000023	PORANGATU	15/11/2019 06:19	15/11/2019 13:01	15/11/2019 06:19	15/11/2019 13:01	6,69	57	381,46	CHI
201911172022	AMERICANO DO BRASIL	AC12391519	ANICUNS	15/11/2019 07:11	15/11/2019 09:01	15/11/2019 07:11	15/11/2019 09:01	1,85	1	1,85	CHI
201911172022	ANICUNS	AC12391519	ANICUNS	15/11/2019 07:11	15/11/2019 09:01	15/11/2019 07:11	15/11/2019 09:01	1,85	14	25,87	CHI
201911172025	SANCLERLANDIA	SC12068212	FIRMINOPOLIS S2	14/11/2019 20:43	15/11/2019 11:08	14/11/2019 20:43	15/11/2019 11:08	14,43	12	173,11	CHI
201911172031	PONTALINA	PK21046023	PONTALINA	15/11/2019 07:14	15/11/2019 09:01	15/11/2019 07:14	15/11/2019 09:01	1,78	1	1,78	CHI
201911172032	ITUMBIARA	IT11190993	ITUMBIARA NOVA	14/11/2019 19:01	15/11/2019 16:25	14/11/2019 19:01	15/11/2019 16:25	21,39	135	2887,28	CHI
201911172039	ACREUNA	EU12000181	ACREUNA	15/11/2019 07:14	15/11/2019 11:13	15/11/2019 07:14	15/11/2019 11:13	3,98	25	99,58	CHI
201911172039	SANTO ANTONIO DA BARRA	EU12000181	ACREUNA	15/11/2019 07:14	15/11/2019 11:13	15/11/2019 07:14	15/11/2019 11:13	3,98	1	3,98	CHI
201911172048	NIQUELANDIA	NQ12378011	NIQUELANDIA SUBTRANSMISSAO	15/11/2019 10:29	15/11/2019 16:30	15/11/2019 10:29	15/11/2019 16:30	6,01	1	6,01	CHI
201911172059	NOVA VENEZA	NV21332006	INHUMAS S1	15/11/2019 07:18	15/11/2019 09:41	15/11/2019 07:18	15/11/2019 09:41	2,37	3	7,11	CHI
201911172062	GOIANIA	10023394658	GOIANIA LESTE S1	15/11/2019 07:19	15/11/2019 09:57	15/11/2019 07:19	15/11/2019 09:57	2,63	1	2,63	CHI
201911172065	CALDAS NOVAS	CN11104517	SERRA DE CALDAS	15/11/2019 04:10	15/11/2019 12:12	15/11/2019 04:10	15/11/2019 12:12	8,03	80	642,09	CHI
201911172066	GOIANESIA	GE12302590	GOIANESIA S2	15/11/2019 07:20	16/11/2019 16:19	15/11/2019 07:20	16/11/2019 16:19	32,97	2	65,94	CHI
201911172067	JARAGUA	JA12112518	JARAGUA	14/11/2019 20:00	15/11/2019 09:07	14/11/2019 20:00	15/11/2019 09:07	13,10	16	209,65	CHI
201911172071	ALEXANIA	AX12377762RE	ALEXANIA	15/11/2019 04:27	15/11/2019 12:08	15/11/2019 04:27	15/11/2019 12:08	7,68	36	276,30	CHI
201911172071	CORUMBA DE GOIAS	AX12377762RE	ALEXANIA	15/11/2019 04:27	15/11/2019 12:08	15/11/2019 04:27	15/11/2019 12:08	7,68	5	38,38	CHI
201911172072	ANAPOLIS	AN11273398	ANAPOLIS UNIVERSITARIO S2	15/11/2019 07:23	15/11/2019 10:35	15/11/2019 07:23	15/11/2019 10:35	3,19	94	299,70	CHI
201911172074	PIRENOPOLIS	PV11264950	CORUMBA	15/11/2019 07:23	15/11/2019 15:33	15/11/2019 07:23	15/11/2019 15:33	8,16	35	285,62	CHI

201911172087	URUACU	640133952	URUACU	15/11/2019 07:26	15/11/2019 09:30	15/11/2019 07:26	15/11/2019 09:30	2,05	1	2,05	CHI
201911172090	ITAPIRAPUA	IU12030155	JUSSARA	15/11/2019 05:15	15/11/2019 09:35	15/11/2019 05:15	15/11/2019 09:35	4,33	41	177,36	CHI
201911172090	NOVO BRASIL	IU12030155	JUSSARA	15/11/2019 05:15	15/11/2019 09:35	15/11/2019 05:15	15/11/2019 09:35	4,33	1	4,33	CHI
201911172091	ANAPOLIS	21090208	JUNDAIAI S1	15/11/2019 07:27	15/11/2019 12:16	15/11/2019 07:27	15/11/2019 12:16	4,81	1	4,81	CHI
201911172093	TRINDADE	TR32052849	TRINDADE	15/11/2019 07:27	16/11/2019 20:10	15/11/2019 07:27	16/11/2019 20:10	36,70	11	403,71	CHI
201911172096	ANAPOLIS	AN12254173	JUNDAIAI S1	15/11/2019 07:29	15/11/2019 09:01	15/11/2019 07:29	15/11/2019 09:01	1,53	254	389,26	CHI
201911172108	AMARALINA	MU12192418	MARA ROSA	15/11/2019 07:31	15/11/2019 14:45	15/11/2019 07:31	15/11/2019 14:45	7,22	1	7,22	CHI
201911172108	PORANGATU	MU12192418	MARA ROSA	15/11/2019 07:31	15/11/2019 14:45	15/11/2019 07:31	15/11/2019 14:45	7,22	1	7,22	CHI
201911172116	SANTA HELENA DE GOIAS	10022939049	IPEGUARI	15/11/2019 07:33	16/11/2019 15:22	15/11/2019 07:33	16/11/2019 15:22	31,81	1	31,81	CHI
201911172117	INACIOLANDIA	ID21321704	QUIRINOPOLIS	15/11/2019 07:33	16/11/2019 12:18	15/11/2019 07:33	16/11/2019 12:18	28,74	1	28,74	CHI
201911172126	BONOPOLIS	PO12090602	MARA ROSA	15/11/2019 05:29	15/11/2019 12:30	15/11/2019 05:29	15/11/2019 12:30	7,01	2	14,03	CHI
201911172126	PORANGATU	PO12090602	MARA ROSA	15/11/2019 05:29	15/11/2019 12:30	15/11/2019 05:29	15/11/2019 12:30	7,01	66	462,90	CHI
201911172129	CATALAO	CT12333668	CATALAO S1	15/11/2019 07:01	19/11/2019 04:56	15/11/2019 07:01	19/11/2019 04:56	93,91	5	469,56	CHI
201911172130	NEROPOLIS	NR12009860	NEROPOLIS S2	15/11/2019 07:28	15/11/2019 08:29	15/11/2019 07:28	15/11/2019 08:29	1,02	4	4,07	CHI
201911172138	MARA ROSA	MQ12320754	MARA ROSA	15/11/2019 07:37	16/11/2019 15:40	15/11/2019 07:37	16/11/2019 15:40	32,04	1	32,04	CHI
201911172142	GOIANESIA	10025676553	GOIANESIA S2	15/11/2019 07:38	15/11/2019 11:52	15/11/2019 07:38	15/11/2019 11:52	4,22	1	4,22	CHI
201911172143	BRAZABRANTES	GR21000352	NEROPOLIS S1	15/11/2019 07:38	15/11/2019 10:23	15/11/2019 07:38	15/11/2019 10:23	2,73	1	2,73	CHI
201911172154	CATALAO	CT21376017	CATALAO S1	15/11/2019 07:41	16/11/2019 11:30	15/11/2019 07:41	16/11/2019 11:30	27,81	1	27,81	CHI
201911172155	MONTIVIDIU DO NORTE	MX12243327	PORANGATU	15/11/2019 07:41	15/11/2019 10:50	15/11/2019 07:41	15/11/2019 10:50	3,14	7	21,99	CHI
201911172157	ESTRELA DO NORTE	ET21168688	MARA ROSA	15/11/2019 07:41	15/11/2019 23:35	15/11/2019 07:41	15/11/2019 23:35	15,89	1	15,89	CHI
201911172165	ITUMBIARA	IT11290353	ITUMBIARA NOVA	15/11/2019 07:43	18/11/2019 12:08	15/11/2019 07:43	18/11/2019 12:08	76,41	1	76,41	CHI
201911172167	GOIANIA	GN12000795	FERROVIARIO S1	15/11/2019 06:31	15/11/2019 09:57	15/11/2019 06:31	15/11/2019 09:57	3,43	47	161,29	CHI
201911172168	CAMPINORTE	CR12202139	MARA ROSA	15/11/2019 07:32	15/11/2019 08:20	15/11/2019 07:32	15/11/2019 08:20	0,79	32	25,24	CHI
201911172168	URUACU	CR12202139	MARA ROSA	15/11/2019 07:32	15/11/2019 08:20	15/11/2019 07:32	15/11/2019 08:20	0,79	106	83,62	CHI
201911172172	ALEXANIA	CB12114195	CORUMBA	15/11/2019 07:44	15/11/2019 12:43	15/11/2019 07:44	15/11/2019 12:43	4,98	11	54,73	CHI
201911172172	CORUMBA DE GOIAS	CB12114195	CORUMBA	15/11/2019 07:44	15/11/2019 12:43	15/11/2019 07:44	15/11/2019 12:43	4,98	27	134,33	CHI
201911172182	PLANALTINA	PI12085617RE	PLANALTINA	15/11/2019 07:36	15/11/2019 08:32	15/11/2019 07:36	15/11/2019 08:32	0,93	389	361,34	CHI
201911172192	LUZIANIA	LZ12203332	VIANOPOLIS	15/11/2019 07:44	15/11/2019 11:24	15/11/2019 07:44	15/11/2019 11:24	3,66	10	36,56	CHI
201911172199	CAMPO ALEGRE DE GOIAS	CM12252408	CAMPO ALEGRE DE GOIAS	15/11/2019 07:48	18/11/2019 12:21	15/11/2019 07:48	18/11/2019 12:21	76,54	3	229,62	CHI
201911172202	CACHOEIRA ALTA	CA12371215	CACHOEIRA ALTA	15/11/2019 07:24	15/11/2019 09:34	15/11/2019 07:24	15/11/2019 09:34	2,16	21	45,32	CHI
201911172205	JUSSARA	JR12219993	JUSSARA	14/11/2019 23:06	15/11/2019 13:20	14/11/2019 23:06	15/11/2019 13:20	14,22	9	127,98	CHI
201911172207	CAMPO LIMPO	AN12390325	NEROPOLIS S1	15/11/2019 07:51	15/11/2019 10:32	15/11/2019 07:51	15/11/2019 10:32	2,67	8	21,34	CHI
201911172208	JUSSARA	JR12341214	BRITANIA	15/11/2019 07:24	16/11/2019 01:40	15/11/2019 07:24	16/11/2019 01:40	18,28	5	91,39	CHI

201911172209	APARECIDA DE GOIANIA	15817611	INDEPENDENCIA S1	15/11/2019 07:52	15/11/2019 12:15	15/11/2019 07:52	15/11/2019 12:15	4,38	1	4,38	CHI
201911172210	SANTA HELENA DE GOIAS	10002847149	IPEGUARI	15/11/2019 07:52	15/11/2019 14:00	15/11/2019 07:52	15/11/2019 14:00	6,13	1	6,13	CHI
201911172217	SAO MIGUEL DO ARAGUAIA	SM12089543	SAO MIGUEL DO ARAGUAIA	14/11/2019 20:31	16/11/2019 17:10	14/11/2019 20:31	16/11/2019 17:10	44,64	8	357,12	CHI
201911172218	SENADOR CANEDO	SW11158435	GOIANIA LESTE S2	15/11/2019 07:30	15/11/2019 10:17	15/11/2019 07:30	15/11/2019 10:17	2,77	45	124,86	CHI
201911172220	JATAI	JT12205194	JATAI S1	15/11/2019 07:45	15/11/2019 09:57	15/11/2019 07:45	15/11/2019 09:57	2,19	7	15,31	CHI
201911172221	NIQUELANDIA	NQ12208518	NIQUELANDIA SUBTRANSMISSAO	15/11/2019 06:41	15/11/2019 09:37	15/11/2019 06:41	15/11/2019 09:37	2,92	99	289,24	CHI
201911172225	FORMOSA	FA12040565	ITUIQUIRA	14/11/2019 22:25	15/11/2019 09:12	14/11/2019 22:25	15/11/2019 09:12	10,78	88	948,79	CHI
201911172226	CATALAO	CT21250462	CATALAO S1	15/11/2019 07:56	15/11/2019 15:50	15/11/2019 07:56	15/11/2019 15:50	7,88	1	7,88	CHI
201911172239	BELA VISTA DE GOIAS	BV21023159	CRISTIANOPOLIS	15/11/2019 08:01	15/11/2019 11:36	15/11/2019 08:01	15/11/2019 11:36	3,57	1	3,57	CHI
201911172241	PIRENOPOLIS	PV12384891	CORUMBA	15/11/2019 05:30	15/11/2019 13:27	15/11/2019 05:30	15/11/2019 13:27	7,94	14	111,18	CHI
201911172244	ANAPOLIS	10003849196	ANAPOLIS UNIVERSITARIO S2	15/11/2019 08:02	15/11/2019 14:48	15/11/2019 08:02	15/11/2019 14:48	6,76	1	6,76	CHI
201911172302	SAO SIMAO	SO21219321	CACHOEIRA ALTA	15/11/2019 08:03	15/11/2019 13:51	15/11/2019 08:03	15/11/2019 13:51	5,81	1	5,81	CHI
201911172303	NIQUELANDIA	NQ21292554	URUACU	15/11/2019 08:03	15/11/2019 18:22	15/11/2019 08:03	15/11/2019 18:22	10,31	1	10,31	CHI
201911172309	BELA VISTA DE GOIAS	BV21070270	CRISTIANOPOLIS	15/11/2019 08:04	15/11/2019 09:25	15/11/2019 08:04	15/11/2019 09:25	1,34	1	1,34	CHI
201911172311	GOIANIA	10004030441	GOYA S1	15/11/2019 08:04	15/11/2019 09:51	15/11/2019 08:04	15/11/2019 09:51	1,77	1	1,77	CHI
201911172315	SANTO ANTONIO DO DESCOBERTO	2210106017	AGUAS LINDAS DE GOIAS S2	15/11/2019 08:05	15/11/2019 10:05	15/11/2019 08:05	15/11/2019 10:05	1,99	1	1,99	CHI
201911172318	ABADIANIA	PV12272929	CORUMBA	14/11/2019 20:14	15/11/2019 22:16	14/11/2019 20:14	15/11/2019 22:16	26,03	3	78,09	CHI
201911172318	PIRENOPOLIS	PV12272929	CORUMBA	14/11/2019 20:14	15/11/2019 22:16	14/11/2019 20:14	15/11/2019 22:16	26,03	2	52,06	CHI
201911172321	OURO VERDE DE GOIAS	OV12115017	NEROPOLIS S1	15/11/2019 06:18	15/11/2019 11:15	15/11/2019 06:18	15/11/2019 11:15	4,94	9	44,46	CHI
201911172323	GOIANIA	10944023	FERROVIARIO S1	15/11/2019 08:06	15/11/2019 10:14	15/11/2019 08:06	15/11/2019 10:14	2,12	1	2,12	CHI
201911172331	CRIXAS	CX21181506	SANTA TEREZINHA	15/11/2019 08:08	15/11/2019 14:43	15/11/2019 08:08	15/11/2019 14:43	6,57	1	6,57	CHI
201911172338	PEROLANDIA	DP21346701	JATAI S1	15/11/2019 08:10	15/11/2019 09:50	15/11/2019 08:10	15/11/2019 09:50	1,68	1	1,68	CHI
201911172345	GOIANIA	13940478	MEIA PONTE	15/11/2019 08:10	15/11/2019 11:03	15/11/2019 08:10	15/11/2019 11:03	2,87	1	2,87	CHI
201911172346	PIRENOPOLIS	PV12392222	CORUMBA	15/11/2019 06:59	15/11/2019 18:24	15/11/2019 06:59	15/11/2019 18:24	11,41	9	102,67	CHI
201911172354	GOIANESIA	550157657	GOIANESIA S2	15/11/2019 08:11	15/11/2019 17:38	15/11/2019 08:11	15/11/2019 17:38	9,44	1	9,44	CHI
201911172355	CALDAS NOVAS	CN11148507	SERRA DE CALDAS	15/11/2019 06:26	15/11/2019 13:55	15/11/2019 06:26	15/11/2019 13:55	7,48	280	2094,09	CHI
201911172356	JATAI	10021080370	JATAI S2	15/11/2019 08:11	15/11/2019 23:55	15/11/2019 08:11	15/11/2019 23:55	15,72	1	15,72	CHI
201911172361	JATAI	JT21248406	JATAI S2	15/11/2019 08:12	15/11/2019 17:00	15/11/2019 08:12	15/11/2019 17:00	8,79	1	8,79	CHI
201911172363	PALMEIRAS DE GOIAS	PL12398710	PALMEIRAS	15/11/2019 08:12	15/11/2019 18:24	15/11/2019 08:12	15/11/2019 18:24	10,19	21	213,93	CHI
201911172373	COCALZINHO DE GOIAS	ZN12297582	COCALZINHO	15/11/2019 07:41	15/11/2019 14:24	15/11/2019 07:41	15/11/2019 14:24	6,71	2	13,42	CHI
201911172375	GOIANIA	11702631	GOIANIA LESTE S1	15/11/2019 08:16	15/11/2019 11:08	15/11/2019 08:16	15/11/2019 11:08	2,87	1	2,87	CHI
201911172376	TRES RANCHOS	TH12013700RE	CATALAO S1	15/11/2019 08:16	15/11/2019 09:25	15/11/2019 08:16	15/11/2019 09:25	1,14	9	10,29	CHI
201911172378	GOIANIA	13518732	FERROVIARIO S3	15/11/2019 08:16	15/11/2019 11:56	15/11/2019 08:16	15/11/2019 11:56	3,65	1	3,65	CHI

201911172384	AGUA FRIA DE GOIAS	TL121204704	SAO JOAO D ALIANCA	15/11/2019 08:17	15/11/2019 15:58	15/11/2019 08:17	15/11/2019 15:58	7,67	1	7,67	CHI
201911172386	AMARALINA	LC12168855	MARA ROSA	15/11/2019 08:18	15/11/2019 17:21	15/11/2019 08:18	15/11/2019 17:21	9,05	35	316,76	CHI
201911172386	MARA ROSA	LC12168855	MARA ROSA	15/11/2019 08:18	15/11/2019 17:21	15/11/2019 08:18	15/11/2019 17:21	9,05	8	72,40	CHI
201911172388	GOIANESIA	GE12317825RE	GOIANESIA S2	15/11/2019 06:01	15/11/2019 09:48	15/11/2019 06:01	15/11/2019 09:48	3,78	60	226,78	CHI
201911172390	GOIANIA	GN11002401	CARAJAS S1	15/11/2019 08:18	15/11/2019 09:33	15/11/2019 08:18	15/11/2019 09:33	1,23	61	75,27	CHI
201911172394	VIANOPOLIS	VN12041846	VIANOPOLIS	15/11/2019 08:20	15/11/2019 09:48	15/11/2019 08:20	15/11/2019 09:48	1,46	482	704,66	CHI
201911172396	FLORES DE GOIAS	FB21204170	FLORES DE GOIAS	15/11/2019 08:20	15/11/2019 09:02	15/11/2019 08:20	15/11/2019 09:02	0,69	2	1,38	CHI
201911172399	NIQUELANDIA	NQ21239429	URUACU	15/11/2019 08:20	16/11/2019 13:10	15/11/2019 08:20	16/11/2019 13:10	28,83	1	28,83	CHI
201911172407	TRINDADE	GC21139570	TRINDADE	15/11/2019 08:21	15/11/2019 15:54	15/11/2019 08:21	15/11/2019 15:54	7,54	1	7,54	CHI
201911172435	AURILANDIA	RP12304543	FIRMINOPOLIS S2	15/11/2019 06:36	15/11/2019 16:08	15/11/2019 06:36	15/11/2019 16:08	9,53	3	28,59	CHI
201911172435	PARAUNA	RP12304543	FIRMINOPOLIS S2	15/11/2019 06:36	15/11/2019 16:08	15/11/2019 06:36	15/11/2019 16:08	9,53	35	333,52	CHI
201911172445	QUIRINOPOLIS	QI12326762	QUIRINOPOLIS	15/11/2019 08:23	16/11/2019 07:19	15/11/2019 08:23	16/11/2019 07:19	22,92	5	114,62	CHI
201911172452	ARAGUAPAZ	FC12404558	GOIAS	15/11/2019 08:01	15/11/2019 11:43	15/11/2019 08:01	15/11/2019 11:43	3,69	4	14,76	CHI
201911172452	FAINA	FC12404558	GOIAS	15/11/2019 08:01	15/11/2019 11:43	15/11/2019 08:01	15/11/2019 11:43	3,69	3	11,07	CHI
201911172453	OUVIDOR	CT21000097	CATALAO S1	15/11/2019 08:29	16/11/2019 10:50	15/11/2019 08:29	16/11/2019 10:50	26,34	1	26,34	CHI
201911172455	SANTA TEREZA DE GOIAS	TB12170075	PORANGATU	15/11/2019 08:22	16/11/2019 06:09	15/11/2019 08:22	16/11/2019 06:09	21,77	3	65,32	CHI
201911172461	DOVERLANDIA	DV12235070	PARQUE DAS EMAS	15/11/2019 08:30	17/11/2019 12:58	15/11/2019 08:30	17/11/2019 12:58	52,45	5	262,25	CHI
201911172463	MORRINHOS	MR121232563	MORRINHOS	15/11/2019 08:31	18/11/2019 11:55	15/11/2019 08:31	18/11/2019 11:55	75,39	1	75,39	CHI
201911172469	JARAGUA	JA21298131	JARAGUA	15/11/2019 08:33	15/11/2019 10:21	15/11/2019 08:33	15/11/2019 10:21	1,80	2	3,60	CHI
201911172470	JOVIANIA	AD12074096	GOIATUBA S1	14/11/2019 21:06	15/11/2019 09:38	14/11/2019 21:06	15/11/2019 09:38	12,52	4	50,08	CHI
201911172470	PONTALINA	AD12074096	GOIATUBA S1	14/11/2019 21:06	15/11/2019 09:38	14/11/2019 21:06	15/11/2019 09:38	12,52	1	12,52	CHI
201911172473	SANTO ANTONIO DO DESCOBERTO	SN21285252	MARAJOARA	15/11/2019 08:34	15/11/2019 16:12	15/11/2019 08:34	15/11/2019 16:12	7,63	1	7,63	CHI
201911172476	ACREUNA	10000511143	ACREUNA	15/11/2019 08:34	15/11/2019 11:56	15/11/2019 08:34	15/11/2019 11:56	3,38	1	3,38	CHI
201911172478	GUARANI DE GOIAS	GY12160070	IACIARA S1	15/11/2019 08:34	15/11/2019 12:52	15/11/2019 08:34	15/11/2019 12:52	4,29	3	12,88	CHI
201911172478	IACIARA	GY12160070	IACIARA S1	15/11/2019 08:34	15/11/2019 12:52	15/11/2019 08:34	15/11/2019 12:52	4,29	2	8,59	CHI
201911172478	SAO DOMINGOS	GY12160070	IACIARA S1	15/11/2019 08:34	15/11/2019 12:52	15/11/2019 08:34	15/11/2019 12:52	4,29	1	4,29	CHI
201911172481	PALMEIRAS DE GOIAS	PL12308412	PALMEIRAS	15/11/2019 08:34	15/11/2019 10:40	15/11/2019 08:34	15/11/2019 10:40	2,10	2	4,20	CHI
201911172485	PORTELANDIA	PW11360802	PARQUE DAS EMAS	15/11/2019 08:35	15/11/2019 18:20	15/11/2019 08:35	15/11/2019 18:20	9,75	56	546,16	CHI
201911172493	INHUMAS	IX12016404	INHUMAS S1	15/11/2019 07:20	15/11/2019 09:54	15/11/2019 07:20	15/11/2019 09:54	2,56	1	2,56	CHI
201911172493	ITAUCU	IX12016404	INHUMAS S1	15/11/2019 07:20	15/11/2019 09:54	15/11/2019 07:20	15/11/2019 09:54	2,56	4	10,23	CHI
201911172494	MONTIVIDIU	MV12160710	MONTIVIDIU T	15/11/2019 08:38	16/11/2019 16:45	15/11/2019 08:38	16/11/2019 16:45	32,12	21	674,56	CHI
201911172502	PONTALINA	MI21349850	PONTALINA	15/11/2019 08:38	15/11/2019 09:57	15/11/2019 08:38	15/11/2019 09:57	1,30	1	1,30	CHI
201911172505	GOIANESIA	GE11379125	GOIANESIA S2	15/11/2019 08:39	15/11/2019 15:53	15/11/2019 08:39	15/11/2019 15:53	7,23	23	166,33	CHI

201911172511	RIO VERDE	RV12306377	CABRIUVA S2	15/11/2019 07:44	15/11/2019 21:10	15/11/2019 07:44	15/11/2019 21:10	13,43	20	268,61	CHI
201911172512	JANDAIA	JD21188568	PALMEIRAS	15/11/2019 08:40	15/11/2019 22:31	15/11/2019 08:40	15/11/2019 22:31	13,84	2	27,68	CHI
201911172519	ITABERAI	IB12379749	ITABERAI S2	15/11/2019 08:40	16/11/2019 08:28	15/11/2019 08:40	16/11/2019 08:28	23,79	4	95,16	CHI
201911172524	VALPARAISO DE GOIAS	VA12396809	PACAEMBU S2	15/11/2019 08:42	15/11/2019 11:17	15/11/2019 08:42	15/11/2019 11:17	2,58	2	5,17	CHI
201911172526	PARAUNA	PU12314958	PARAUNA	15/11/2019 08:39	15/11/2019 10:47	15/11/2019 08:39	15/11/2019 10:47	2,14	7	14,97	CHI
201911172526	RIO VERDE	PU12314958	PARAUNA	15/11/2019 08:39	15/11/2019 10:47	15/11/2019 08:39	15/11/2019 10:47	2,14	2	4,28	CHI
201911172528	PETROLINA DE GOIAS	PG21027929	PETROLINA	15/11/2019 08:42	15/11/2019 09:55	15/11/2019 08:42	15/11/2019 09:55	1,21	1	1,21	CHI
201911172529	PILAR DE GOIAS	GG12245205	SANTA TEREZINHA	15/11/2019 08:42	15/11/2019 14:20	15/11/2019 08:42	15/11/2019 14:20	5,62	15	84,29	CHI
201911172530	HIDROLANDIA	HD21299278	INDEPENDENCIA S1	15/11/2019 08:43	15/11/2019 12:12	15/11/2019 08:43	15/11/2019 12:12	3,48	2	6,96	CHI
201911172536	CAMPOS VERDES	VD12243626	SANTA TEREZINHA	15/11/2019 08:33	15/11/2019 13:52	15/11/2019 08:33	15/11/2019 13:52	5,30	20	106,03	CHI
201911172538	CACU	CC12028172	CACHOEIRA ALTA	15/11/2019 06:20	17/11/2019 22:30	15/11/2019 06:20	17/11/2019 22:30	64,17	20	1283,41	CHI
201911172545	ITAPIRAPUA	IU21316813	MATRINCHA	15/11/2019 08:47	15/11/2019 15:40	15/11/2019 08:47	15/11/2019 15:40	6,88	1	6,88	CHI
201911172547	GOIANIA	GN11209261	MEIA PONTE	15/11/2019 08:21	15/11/2019 09:33	15/11/2019 08:21	15/11/2019 09:33	1,19	84	99,87	CHI
201911172549	GOIANIA	10004611517	FERROVIARIO S3	15/11/2019 08:48	15/11/2019 10:36	15/11/2019 08:48	15/11/2019 10:36	1,79	1	1,79	CHI
201911172552	CRISTALINA	KR12248743	CRISTALINA S2	15/11/2019 08:49	15/11/2019 11:19	15/11/2019 08:49	15/11/2019 11:19	2,48	8	19,88	CHI
201911172558	ITUMBIARA	IT11000036	ITUMBIARA VELHA S1	15/11/2019 08:49	15/11/2019 22:43	15/11/2019 08:49	15/11/2019 22:43	13,91	90	1251,80	CHI
201911172559	CORUMBA DE GOIAS	AX21190661	CORUMBA	15/11/2019 08:51	15/11/2019 10:10	15/11/2019 08:51	15/11/2019 10:10	1,30	1	1,30	CHI
201911172562	ANAPOLIS	20949110	JUNDIAI S2	15/11/2019 08:52	15/11/2019 13:08	15/11/2019 08:52	15/11/2019 13:08	4,26	1	4,26	CHI
201911172564	PLANALTINA	PI12324293	SAO JOAO D ALIANCA	15/11/2019 05:37	15/11/2019 10:43	15/11/2019 05:37	15/11/2019 10:43	5,10	8	40,79	CHI
201911172566	SANTA HELENA DE GOIAS	SH11226298	IPEGUARI	15/11/2019 10:58	15/11/2019 14:19	15/11/2019 10:58	15/11/2019 14:19	3,35	120	402,03	CHI
201911172573	GOIANIA	17085986	CAMPINAS S1	15/11/2019 08:56	15/11/2019 11:17	15/11/2019 08:56	15/11/2019 11:17	2,34	1	2,34	CHI
201911172577	MONTIVIDIU DO NORTE	MX12226413	PORANGATU	15/11/2019 06:15	15/11/2019 11:54	15/11/2019 06:15	15/11/2019 11:54	5,64	40	225,63	CHI
201911172588	ITAPIRAPUA	IU12018846	MATRINCHA	15/11/2019 08:51	16/11/2019 13:43	15/11/2019 08:51	16/11/2019 13:43	28,86	4	115,46	CHI
201911172591	CACHOEIRA ALTA	CA21204130	CACHOEIRA ALTA	15/11/2019 08:59	15/11/2019 16:40	15/11/2019 08:59	15/11/2019 16:40	7,68	1	7,68	CHI
201911172596	SAO MIGUEL DO ARAGUAIA	SM12013046LD	SAO MIGUEL DO ARAGUAIA	15/11/2019 09:00	15/11/2019 17:30	15/11/2019 16:32	15/11/2019 17:30	0,96	3	2,89	CHI
201911172596	SAO MIGUEL DO ARAGUAIA	SM12192358	SAO MIGUEL DO ARAGUAIA	15/11/2019 09:00	15/11/2019 17:30	15/11/2019 09:00	15/11/2019 17:30	8,50	1	8,50	CHI
201911172598	GOIANIA	GN11037443	GOIANIA LESTE S3	15/11/2019 09:01	16/11/2019 18:13	15/11/2019 09:01	16/11/2019 18:13	33,20	1	33,20	CHI
201911172601	GOIANIA	17341590	CAMPINAS S2	15/11/2019 09:01	15/11/2019 16:21	15/11/2019 09:01	15/11/2019 16:21	7,32	1	7,32	CHI
201911172604	ANAPOLIS	21053996	JUNDIAI S1	15/11/2019 09:01	15/11/2019 15:21	15/11/2019 09:01	15/11/2019 15:21	6,32	1	6,32	CHI
201911172605	GOIANIA	GN12127447	ATLANTICO S1	15/11/2019 09:02	15/11/2019 10:45	15/11/2019 09:02	15/11/2019 10:45	1,71	430	736,26	CHI
201911172611	MIMOSO DE GOIAS	NQ12371855	BARRO ALTO	15/11/2019 12:48	15/11/2019 17:12	15/11/2019 12:48	15/11/2019 17:12	4,39	4	17,55	CHI
201911172611	NIQUELANDIA	NQ12371855	BARRO ALTO	15/11/2019 12:48	15/11/2019 17:12	15/11/2019 12:48	15/11/2019 17:12	4,39	243	1065,89	CHI
201911172622	ABADIANIA	AN12319767	ANAPOLIS UNIVERSITARIO S2	14/11/2019 21:30	16/11/2019 11:20	14/11/2019 21:30	16/11/2019 11:20	37,82	9	340,38	CHI

201911172624	CAMPO ALEGRE DE GOIAS	CT10394223	CATALAO S1	15/11/2019 17:03	19/11/2019 04:44	15/11/2019 17:03	16/11/2019 12:00	18,96	1	18,96	CHI
201911172624	CATALAO	CT10394223	CATALAO S1	15/11/2019 17:03	19/11/2019 04:44	15/11/2019 17:03	16/11/2019 12:00	18,96	25	473,98	CHI
201911172624	DAVINOPOLIS	CT10394223	CATALAO S1	15/11/2019 17:03	19/11/2019 04:44	15/11/2019 17:03	16/11/2019 12:00	18,96	6	113,76	CHI
201911172624	CAMPO ALEGRE DE GOIAS	CT10394223	CATALAO S1	15/11/2019 17:03	19/11/2019 04:44	16/11/2019 13:29	16/11/2019 14:34	1,07	1	1,07	CHI
201911172624	CATALAO	CT10394223	CATALAO S1	15/11/2019 17:03	19/11/2019 04:44	16/11/2019 13:29	16/11/2019 14:34	1,07	25	26,74	CHI
201911172624	DAVINOPOLIS	CT10394223	CATALAO S1	15/11/2019 17:03	19/11/2019 04:44	16/11/2019 13:29	16/11/2019 14:34	1,07	6	6,42	CHI
201911172624	CAMPO ALEGRE DE GOIAS	CT10394223	CATALAO S1	15/11/2019 17:03	19/11/2019 04:44	16/11/2019 15:59	16/11/2019 19:10	3,18	1	3,18	CHI
201911172624	CATALAO	CT10394223	CATALAO S1	15/11/2019 17:03	19/11/2019 04:44	16/11/2019 15:59	16/11/2019 19:10	3,18	25	79,42	CHI
201911172624	DAVINOPOLIS	CT10394223	CATALAO S1	15/11/2019 17:03	19/11/2019 04:44	16/11/2019 15:59	16/11/2019 19:10	3,18	6	19,06	CHI
201911172624	CATALAO	CT10394223	CATALAO S1	15/11/2019 17:03	19/11/2019 04:44	15/11/2019 17:03	17/11/2019 01:04	32,01	2	64,03	CHI
201911172624	CATALAO	CT12134367	CATALAO S1	15/11/2019 17:03	19/11/2019 04:44	15/11/2019 17:03	17/11/2019 01:29	32,44	11	356,80	CHI
201911172624	CATALAO	CT10394223	CATALAO S1	15/11/2019 17:03	19/11/2019 04:44	15/11/2019 17:03	17/11/2019 02:13	33,17	11	364,86	CHI
201911172624	CATALAO	CT12203164	CATALAO S1	15/11/2019 17:03	19/11/2019 04:44	15/11/2019 17:03	17/11/2019 02:41	33,63	986	33162,19	CHI
201911172624	CATALAO	CT12077392LD	CATALAO S1	15/11/2019 17:03	19/11/2019 04:44	15/11/2019 17:03	17/11/2019 03:16	34,21	117	4002,63	CHI
201911172624	CATALAO	CT10394223	CATALAO S1	15/11/2019 17:03	19/11/2019 04:44	15/11/2019 17:03	17/11/2019 03:52	34,81	185	6439,85	CHI
201911172624	CAMPO ALEGRE DE GOIAS	CT10394223	CATALAO S1	15/11/2019 17:03	19/11/2019 04:44	15/11/2019 17:03	17/11/2019 03:52	34,82	2	69,65	CHI
201911172624	CATALAO	CT10394223	CATALAO S1	15/11/2019 17:03	19/11/2019 04:44	15/11/2019 17:03	17/11/2019 03:52	34,82	225	7835,13	CHI
201911172624	DISTRITO FEDERAL	CT10394223	CATALAO S1	15/11/2019 17:03	19/11/2019 04:44	15/11/2019 17:03	17/11/2019 03:52	34,82	1	34,82	CHI
201911172624	CATALAO	CT10400687	CATALAO S1	15/11/2019 17:03	19/11/2019 04:44	17/11/2019 01:01	17/11/2019 08:24	7,38	49	361,40	CHI
201911172624	CATALAO	CT13323144	CATALAO S1	15/11/2019 17:03	19/11/2019 04:44	17/11/2019 01:01	17/11/2019 09:40	8,64	30	259,13	CHI
201911172624	CAMPO ALEGRE DE GOIAS	CT10400688	CATALAO S1	15/11/2019 17:03	19/11/2019 04:44	17/11/2019 10:43	17/11/2019 10:52	0,14	1	0,14	CHI
201911172624	CATALAO	CT10400688	CATALAO S1	15/11/2019 17:03	19/11/2019 04:44	17/11/2019 10:43	17/11/2019 10:52	0,14	547	79,01	CHI
201911172624	CATALAO	CT10400688	CATALAO S1	15/11/2019 17:03	19/11/2019 04:44	17/11/2019 10:43	17/11/2019 10:52	0,14	293	42,32	CHI
201911172624	CATALAO	CT10400688	CATALAO S1	15/11/2019 17:03	19/11/2019 04:44	17/11/2019 10:43	17/11/2019 10:52	0,14	1	0,14	CHI
201911172624	CATALAO	CT10400687	CATALAO S1	15/11/2019 17:03	19/11/2019 04:44	17/11/2019 10:43	17/11/2019 11:16	0,55	84	46,01	CHI
201911172624	CATALAO	CT13338691	CATALAO S1	15/11/2019 17:03	19/11/2019 04:44	17/11/2019 01:01	17/11/2019 12:10	11,15	57	635,57	CHI
201911172624	CAMPO ALEGRE DE GOIAS	CT13338691	CATALAO S1	15/11/2019 17:03	19/11/2019 04:44	17/11/2019 01:01	18/11/2019 01:14	24,20	1	24,20	CHI
201911172624	CATALAO	CT13338691	CATALAO S1	15/11/2019 17:03	19/11/2019 04:44	17/11/2019 01:01	18/11/2019 01:14	24,20	23	556,70	CHI
201911172624	CATALAO	CT12318667	CATALAO S1	15/11/2019 17:03	19/11/2019 04:44	15/11/2019 17:03	18/11/2019 01:15	56,19	3	168,58	CHI
201911172624	DAVINOPOLIS	CT12318667	CATALAO S1	15/11/2019 17:03	19/11/2019 04:44	15/11/2019 17:03	18/11/2019 01:15	56,19	4	224,77	CHI
201911172624	CATALAO	CT12318674	CATALAO S1	15/11/2019 17:03	19/11/2019 04:44	18/11/2019 13:40	18/11/2019 14:12	0,55	2	1,10	CHI
201911172624	DAVINOPOLIS	CT12318674	CATALAO S1	15/11/2019 17:03	19/11/2019 04:44	18/11/2019 13:40	18/11/2019 14:12	0,55	3	1,65	CHI
201911172624	DAVINOPOLIS	CT12149165	CATALAO S1	15/11/2019 17:03	19/11/2019 04:44	15/11/2019 17:03	19/11/2019 04:44	83,68	2	167,36	CHI

201911172630	SENADOR CANEDO	10016177922	SENADOR CANEDO	15/11/2019 09:04	15/11/2019 11:52	15/11/2019 09:04	15/11/2019 11:52	2,79	1	2,79	CHI
201911172637	ARAGUAPAZ	AZ12042877	MOZARLANDIA	15/11/2019 08:24	15/11/2019 10:41	15/11/2019 08:24	15/11/2019 10:41	2,27	86	195,17	CHI
201911172637	MOZARLANDIA	AZ12042877	MOZARLANDIA	15/11/2019 08:24	15/11/2019 10:41	15/11/2019 08:24	15/11/2019 10:41	2,27	2	4,54	CHI
201911172639	MOSSAMEDES	MD11274191	FIRMINOPOLIS S2	15/11/2019 20:17	15/11/2019 21:19	15/11/2019 20:17	15/11/2019 21:19	1,03	86	88,89	CHI
201911172643	GOIANIA	10566600	REAL S2	15/11/2019 09:06	15/11/2019 12:12	15/11/2019 09:06	15/11/2019 12:12	3,09	1	3,09	CHI
201911172646	SILVANIA	SV21199915	VIANOPOLIS	15/11/2019 09:07	15/11/2019 10:38	15/11/2019 09:07	15/11/2019 10:38	1,51	1	1,51	CHI
201911172653	CAMPO ALEGRE DE GOIAS	CM21079171	CAMPO ALEGRE DE GOIAS	15/11/2019 09:08	18/11/2019 16:01	15/11/2019 09:08	18/11/2019 16:01	78,87	1	78,87	CHI
201911172657	MINEIROS	MY12278360	PARQUE DAS EMAS	15/11/2019 09:09	15/11/2019 13:17	15/11/2019 09:09	15/11/2019 13:17	4,13	2	8,25	CHI
201911172658	GOIANIA	10015147680	REAL S1	15/11/2019 09:09	15/11/2019 11:25	15/11/2019 09:09	15/11/2019 11:25	2,26	1	2,26	CHI
201911172659	GOIANIA	GN11199192	ATLANTICO S3	15/11/2019 09:02	15/11/2019 09:36	15/11/2019 09:02	15/11/2019 09:36	0,55	122	67,51	CHI
201911172674	BURITI DE GOIAS	10009170136	FIRMINOPOLIS S2	15/11/2019 09:12	15/11/2019 14:48	15/11/2019 09:12	15/11/2019 14:48	5,59	1	5,59	CHI
201911172682	GOIANIA	GN11042210	AEROPORTO S1	15/11/2019 09:15	15/11/2019 12:50	15/11/2019 09:15	15/11/2019 12:50	3,57	111	396,46	CHI
201911172692	GOIANIA	10918255	GOIANIA LESTE S1	15/11/2019 09:16	15/11/2019 14:09	15/11/2019 09:16	15/11/2019 14:09	4,87	1	4,87	CHI
201911172695	GOIANIA	GN21169939	GOIANIA LESTE S3	15/11/2019 09:17	15/11/2019 12:10	15/11/2019 09:17	15/11/2019 12:10	2,88	1	2,88	CHI
201911172696	GOIAS	GS12234111	GOIAS	15/11/2019 09:18	17/11/2019 16:30	15/11/2019 09:18	17/11/2019 16:30	55,19	8	441,55	CHI
201911172702	URUACU	UR21168826	CAMPINORTE	15/11/2019 08:12	15/11/2019 11:20	15/11/2019 08:12	15/11/2019 11:20	3,12	60	187,10	CHI
201911172704	JATAI	290225747	JATAI S2	15/11/2019 09:19	16/11/2019 11:59	15/11/2019 09:19	16/11/2019 11:59	26,66	1	26,66	CHI
201911172711	ALEXANIA	AX12379444	ALEXANIA	15/11/2019 08:08	15/11/2019 15:46	15/11/2019 08:08	15/11/2019 15:46	7,62	4	30,47	CHI
201911172718	MARA ROSA	MQ12028228	MARA ROSA	15/11/2019 09:23	15/11/2019 11:46	15/11/2019 09:23	15/11/2019 11:46	2,37	15	35,61	CHI
201911172721	MINACU	IH12208344	MINACU	15/11/2019 09:19	15/11/2019 11:36	15/11/2019 09:19	15/11/2019 11:36	2,27	26	59,01	CHI
201911172721	TROMBAS	IH12208344	MINACU	15/11/2019 09:19	15/11/2019 11:36	15/11/2019 09:19	15/11/2019 11:36	2,27	2	4,54	CHI
201911172722	RUBIATABA	RB11003324	RUBIATABA	15/11/2019 08:35	15/11/2019 11:22	15/11/2019 08:35	15/11/2019 11:22	2,78	98	272,68	CHI
201911172723	ANAPOLIS	10005480319	ANAPOLIS UNIVERSITARIO S2	15/11/2019 09:24	15/11/2019 14:02	15/11/2019 09:24	15/11/2019 14:02	4,64	1	4,64	CHI
201911172724	APARECIDA DE GOIANIA	AP11150297	INDEPENDENCIA S2	15/11/2019 09:04	15/11/2019 11:37	15/11/2019 09:04	15/11/2019 11:37	2,54	23	58,48	CHI
201911172726	QUIRINOPOLIS	QI21126474	QUIRINOPOLIS	15/11/2019 09:25	16/11/2019 09:48	15/11/2019 09:25	16/11/2019 09:48	24,38	1	24,38	CHI
201911172727	MINACU	IH12252329	MINACU	15/11/2019 09:25	16/11/2019 00:45	15/11/2019 09:25	16/11/2019 00:45	15,32	1	15,32	CHI
201911172729	ABADIANIA	260026542	CORUMBA	15/11/2019 09:26	16/11/2019 11:44	15/11/2019 09:26	16/11/2019 11:44	26,30	1	26,30	CHI
201911172730	SAO FRANCISCO DE GOIAS	SF21185862	SAO FRANCISCO DE GOIAS	15/11/2019 09:26	15/11/2019 11:31	15/11/2019 09:26	15/11/2019 11:31	2,08	2	4,16	CHI
201911172743	APARECIDA DE GOIANIA	AP11193245	REAL S1	15/11/2019 09:28	15/11/2019 19:52	15/11/2019 09:28	15/11/2019 19:52	10,39	64	665,03	CHI
201911172745	PROFESSOR JAMIL SAFADY	PJ12293365	PIRACANJUBA	15/11/2019 09:29	15/11/2019 17:48	15/11/2019 09:29	15/11/2019 17:48	8,31	1	8,31	CHI
201911172757	GOIANIA	10575935	GOIANIA LESTE S2	15/11/2019 09:32	15/11/2019 22:41	15/11/2019 09:32	15/11/2019 22:41	13,15	1	13,15	CHI
201911172759	GOIAS	GS12299343	ITAPURANGA	15/11/2019 09:32	18/11/2019 13:41	15/11/2019 09:32	18/11/2019 13:41	76,14	1	76,14	CHI
201911172766	APARECIDA DE GOIANIA	10006612200	INDEPENDENCIA S1	15/11/2019 09:35	15/11/2019 13:11	15/11/2019 09:35	15/11/2019 13:11	3,60	1	3,60	CHI

201911172773	RIO VERDE	10006744662	RIO VERDE S2	15/11/2019 09:36	16/11/2019 09:27	15/11/2019 09:36	16/11/2019 09:27	23,85	1	23,85	CHI
201911172780	PARAUNA	PU21228099	PARAUNA	15/11/2019 09:37	15/11/2019 16:23	15/11/2019 09:37	15/11/2019 16:23	6,76	2	13,52	CHI
201911172785	OUIDOR	OOU21333564	CATALAO S1	15/11/2019 09:38	15/11/2019 13:50	15/11/2019 09:38	15/11/2019 13:50	4,19	15	62,85	CHI
201911172912	CHAPADAO DO CEU	DJ12164067	CHAPADAO DO CEU	15/11/2019 09:30	15/11/2019 16:05	15/11/2019 09:30	15/11/2019 16:05	6,57	5	32,86	CHI
201911172913	NIQUELANDIA	NQ12262808	BARRO ALTO	15/11/2019 09:39	15/11/2019 11:51	15/11/2019 09:39	15/11/2019 11:51	2,20	26	57,18	CHI
201911172917	GOUVELANDIA	GB12213510LD	QUIRINOPOLIS	15/11/2019 09:42	16/11/2019 11:51	15/11/2019 09:42	16/11/2019 11:51	26,15	110	2876,65	CHI
201911172917	QUIRINOPOLIS	GB12213510LD	QUIRINOPOLIS	15/11/2019 09:42	16/11/2019 11:51	15/11/2019 09:42	16/11/2019 11:51	26,15	88	2301,32	CHI
201911172924	CASTELANDIA	1890011335	RIO DOS BOIS	15/11/2019 09:44	15/11/2019 11:37	15/11/2019 09:44	15/11/2019 11:37	1,87	1	1,87	CHI
201911172925	ITAPIRAPUA	IU21037344	JUSSARA	15/11/2019 09:45	15/11/2019 15:34	15/11/2019 09:45	15/11/2019 15:34	5,81	1	5,81	CHI
201911172930	ABADIANIA	AA21308806	ANAPOLIS UNIVERSITARIO S1	15/11/2019 09:45	16/11/2019 09:03	15/11/2019 09:45	16/11/2019 09:03	23,29	1	23,29	CHI
201911172944	SANTA HELENA DE GOIAS	400014970	IPEGUARI	15/11/2019 09:48	15/11/2019 12:35	15/11/2019 09:48	15/11/2019 12:35	2,78	1	2,78	CHI
201911172947	CATALAO	05060214	CATALAO S2	15/11/2019 09:40	15/11/2019 18:52	15/11/2019 09:40	15/11/2019 18:52	9,21	82	754,86	CHI
201911172947	CUMARI	05060214	CATALAO S2	15/11/2019 09:40	15/11/2019 18:52	15/11/2019 09:40	15/11/2019 18:52	9,21	168	1546,53	CHI
201911172947	GOIANDIRA	05060214	CATALAO S2	15/11/2019 09:40	15/11/2019 18:52	15/11/2019 09:40	15/11/2019 18:52	9,21	3	27,62	CHI
201911172947	CATALAO	05060214	CATALAO S2	15/11/2019 09:40	15/11/2019 18:52	15/11/2019 09:42	15/11/2019 18:52	9,18	12	110,15	CHI
201911172947	CUMARI	05060214	CATALAO S2	15/11/2019 09:40	15/11/2019 18:52	15/11/2019 09:42	15/11/2019 18:52	9,18	33	302,90	CHI
201911172947	GOIANDIRA	05060214	CATALAO S2	15/11/2019 09:40	15/11/2019 18:52	15/11/2019 09:42	15/11/2019 18:52	9,18	3	27,54	CHI
201911172954	PEROLANDIA	DP21182230	JATAI S1	15/11/2019 09:50	15/11/2019 10:40	15/11/2019 09:50	15/11/2019 10:40	0,82	1	0,82	CHI
201911172955	AVELINOPOLIS	AV21028423	ANICUNS	15/11/2019 09:50	15/11/2019 14:33	15/11/2019 09:50	15/11/2019 14:33	4,70	1	4,70	CHI
201911172958	ANAPOLIS	21015740	ANAPOLIS UNIVERSITARIO S2	15/11/2019 09:51	15/11/2019 12:14	15/11/2019 09:51	15/11/2019 12:14	2,38	1	2,38	CHI
201911172959	PIRES DO RIO	PR12000083	PIRES DO RIO S1	15/11/2019 05:46	15/11/2019 18:10	15/11/2019 05:46	15/11/2019 18:10	12,40	3	37,21	CHI
201911172963	GOIANIA	12408610	GOYA S2	15/11/2019 09:51	15/11/2019 12:19	15/11/2019 09:51	15/11/2019 12:19	2,45	1	2,45	CHI
201911172966	CIDADE OCIDENTAL	10001323006	MARAJOARA	15/11/2019 09:52	15/11/2019 10:51	15/11/2019 09:52	15/11/2019 10:51	0,97	1	0,97	CHI
201911172989	GOIATUBA	GT12073585	GOIATUBA S2	15/11/2019 09:03	15/11/2019 12:00	15/11/2019 09:03	15/11/2019 12:00	2,95	258	761,10	CHI
201911172990	CIDADE OCIDENTAL	LZ12060260	MARAJOARA	15/11/2019 09:57	15/11/2019 12:40	15/11/2019 09:57	15/11/2019 12:40	2,71	7	18,97	CHI
201911172992	APARECIDA DE GOIANIA	200253840	INDEPENDENCIA S2	15/11/2019 09:57	15/11/2019 15:17	15/11/2019 09:57	15/11/2019 15:17	5,33	1	5,33	CHI
201911172997	ABADIANIA	AA21111222	ANAPOLIS UNIVERSITARIO S1	15/11/2019 09:58	16/11/2019 12:59	15/11/2019 09:58	16/11/2019 12:59	27,01	1	27,01	CHI
201911173005	ITUMBIARA	IT11000017	ITUMBIARA VELHA S1	15/11/2019 09:20	15/11/2019 11:37	15/11/2019 09:20	15/11/2019 11:37	2,28	91	207,13	CHI
201911173006	GOIANDIRA	1990119089	CATALAO S1	15/11/2019 09:28	15/11/2019 15:28	15/11/2019 09:28	15/11/2019 15:28	6,00	1	6,00	CHI
201911173010	ANAPOLIS	AN31054489	JUNDIAI S1	15/11/2019 10:00	16/11/2019 15:48	15/11/2019 10:00	16/11/2019 15:48	29,78	1	29,78	CHI
201911173012	GOIANIA	15403520	FERROVIARIO S1	15/11/2019 10:01	16/11/2019 13:48	15/11/2019 10:01	16/11/2019 13:48	27,78	1	27,78	CHI
201911173017	GOIANIA	12031227	REAL S1	15/11/2019 10:01	15/11/2019 22:44	15/11/2019 10:01	15/11/2019 22:44	12,70	1	12,70	CHI
201911173020	ITABERAI	IB12000043	ITABERAI S2	15/11/2019 10:02	16/11/2019 20:50	15/11/2019 10:02	16/11/2019 20:50	34,79	2	69,59	CHI

201911173023	APARECIDA DE GOIANIA	AP11157120	INDEPENDENCIA S2	15/11/2019 10:02	15/11/2019 17:59	15/11/2019 10:02	15/11/2019 17:59	7,94	7	55,57	CHI
201911173029	PARANAIGUARA	10005419520	CACHOEIRA ALTA	15/11/2019 10:04	15/11/2019 16:16	15/11/2019 10:04	15/11/2019 16:16	6,20	1	6,20	CHI
201911173041	MOZARLANDIA	MZ12066086	MOZARLANDIA	15/11/2019 08:33	16/11/2019 13:25	15/11/2019 08:33	16/11/2019 13:25	28,87	5	144,33	CHI
201911173047	CATALAO	CT11316066	CATALAO S2	15/11/2019 02:27	15/11/2019 16:08	15/11/2019 02:27	15/11/2019 16:08	13,68	43	588,03	CHI
201911173049	APARECIDA DE GOIANIA	AP11101601	ANHANGUERA	15/11/2019 10:05	15/11/2019 12:59	15/11/2019 10:05	15/11/2019 12:59	2,89	428	1237,40	CHI
201911173055	TEREZOPOLIS DE GOIAS	TJ12068717	NEROPOLIS S1	15/11/2019 10:08	16/11/2019 16:12	15/11/2019 10:08	16/11/2019 16:12	30,06	2	60,12	CHI
201911173057	MONTES CLAROS DE GOIAS	ME21138399	IPORA	15/11/2019 10:08	16/11/2019 10:20	15/11/2019 10:08	16/11/2019 10:20	24,20	1	24,20	CHI
201911173059	GOIANIA	GN11193040	GOIANIA LESTE S3	15/11/2019 10:09	15/11/2019 10:59	15/11/2019 10:09	15/11/2019 10:59	0,83	9	7,48	CHI
201911173060	CORUMBA DE GOIAS	CB21196904	CORUMBA	15/11/2019 10:09	15/11/2019 17:36	15/11/2019 10:09	15/11/2019 17:36	7,45	1	7,45	CHI
201911173063	GOIATUBA	VI12329055	VICENTINOPOLIS	15/11/2019 05:47	15/11/2019 11:28	15/11/2019 05:47	15/11/2019 11:28	5,67	11	62,35	CHI
201911173063	VICENTINOPOLIS	VI12329055	VICENTINOPOLIS	15/11/2019 05:47	15/11/2019 11:28	15/11/2019 05:47	15/11/2019 11:28	5,67	24	136,03	CHI
201911173068	GOIANIA	11855228	REAL S1	15/11/2019 10:10	15/11/2019 16:54	15/11/2019 10:10	15/11/2019 16:54	6,73	1	6,73	CHI
201911173071	GOIANIA	14808924	GOYA S2	15/11/2019 10:12	15/11/2019 12:27	15/11/2019 10:12	15/11/2019 12:27	2,25	1	2,25	CHI
201911173074	CEZARINA	CZ21215295	CEZARINA	15/11/2019 10:12	16/11/2019 10:45	15/11/2019 10:12	16/11/2019 10:45	24,55	1	24,55	CHI
201911173080	CAIAPONIA	CP21349128	CAIAPONIA	15/11/2019 10:13	15/11/2019 20:32	15/11/2019 10:13	15/11/2019 20:32	10,31	1	10,31	CHI
201911173082	NOVA IGUACU DE GOIAS	NH12202113	SANTA TEREZINHA	15/11/2019 10:13	15/11/2019 14:13	15/11/2019 10:13	15/11/2019 14:13	3,99	63	251,20	CHI
201911173088	SAO JOAO DA PARAUNA	RP21252505	FIRMINOPOLIS S2	15/11/2019 10:15	15/11/2019 11:50	15/11/2019 10:15	15/11/2019 11:50	1,60	1	1,60	CHI
201911173091	ITAPURANGA	IK12299456	ITAPURANGA	15/11/2019 06:01	15/11/2019 17:40	15/11/2019 06:01	15/11/2019 17:40	11,66	8	93,25	CHI
201911173096	MINACU	IH21208290	MINACU	15/11/2019 10:16	15/11/2019 18:24	15/11/2019 10:16	15/11/2019 18:24	8,13	2	16,25	CHI
201911173102	JATAI	JT12196017	JATAI S1	15/11/2019 07:45	16/11/2019 00:45	15/11/2019 07:45	16/11/2019 00:45	17,00	7	119,00	CHI
201911173104	CEZARINA	CZ21384699	GUAPO S2	15/11/2019 10:18	16/11/2019 11:20	15/11/2019 10:18	16/11/2019 11:20	25,03	1	25,03	CHI
201911173110	PIRENOPOLIS	PV12117850	CORUMBA	15/11/2019 10:18	16/11/2019 19:03	15/11/2019 10:18	16/11/2019 19:03	32,74	2	65,48	CHI
201911173115	CALDAS NOVAS	CN12186158	CALDAS NOVAS S2	15/11/2019 09:51	15/11/2019 11:07	15/11/2019 09:51	15/11/2019 11:07	1,25	97	121,63	CHI
201911173120	CACHOEIRA ALTA	CA21075274	CACHOEIRA ALTA	15/11/2019 10:20	15/11/2019 19:51	15/11/2019 10:20	15/11/2019 19:51	9,51	1	9,51	CHI
201911173131	ANAPOLIS	20410001	JUNDIAI S2	15/11/2019 10:21	15/11/2019 13:07	15/11/2019 10:21	15/11/2019 13:07	2,76	1	2,76	CHI
201911173138	MONTES CLAROS DE GOIAS	ME12204928	IPORA	15/11/2019 10:23	16/11/2019 13:22	15/11/2019 10:23	16/11/2019 13:22	26,98	5	134,88	CHI
201911173145	PILAR DE GOIAS	GG21288819	URUACU	15/11/2019 10:24	15/11/2019 16:35	15/11/2019 10:24	15/11/2019 16:35	6,17	1	6,17	CHI
201911173146	ITABERAI	IB12381355	ANICUNS	15/11/2019 10:07	15/11/2019 19:21	15/11/2019 10:07	15/11/2019 19:21	9,22	15	138,32	CHI
201911173147	QUIRINOPOLIS	QI12163451	QUIRINOPOLIS	15/11/2019 10:25	16/11/2019 08:13	15/11/2019 10:25	16/11/2019 08:13	21,80	1	21,80	CHI
201911173155	GOIANIA	14020245	REAL S1	15/11/2019 10:26	15/11/2019 12:47	15/11/2019 10:26	15/11/2019 12:47	2,34	1	2,34	CHI
201911173157	LUZIANIA	LZ12336006	VIANOPOLIS	15/11/2019 10:09	15/11/2019 14:21	15/11/2019 10:09	15/11/2019 14:21	4,20	98	411,16	CHI
201911173159	SAO SIMAO	SO11134070	CACHOEIRA ALTA	15/11/2019 10:18	15/11/2019 12:05	15/11/2019 10:18	15/11/2019 12:05	1,77	151	267,90	CHI
201911173160	CRISTIANOPOLIS	CF21195133	CRISTIANOPOLIS	15/11/2019 10:28	17/11/2019 15:59	15/11/2019 10:28	17/11/2019 15:59	53,51	1	53,51	CHI

201911173167	ITUMBIARA	IT21000097	PARANAIBA	14/11/2019 17:42	21/11/2019 09:10	14/11/2019 17:42	21/11/2019 09:10	159,46	1	159,46	CHI
201911173183	ITAJA	IJ21161292	ITAJA S2	15/11/2019 10:31	15/11/2019 15:00	15/11/2019 10:31	15/11/2019 15:00	4,49	1	4,49	CHI
201911173198	FORMOSO	FO12328885	PORANGATU	15/11/2019 07:43	15/11/2019 22:34	15/11/2019 07:43	15/11/2019 22:34	14,85	4	59,38	CHI
201911173198	SANTA TEREZA DE GOIAS	FO12328885	PORANGATU	15/11/2019 07:43	15/11/2019 22:34	15/11/2019 07:43	15/11/2019 22:34	14,85	12	178,14	CHI
201911173202	CORUMBA DE GOIAS	CB12072262	COCALZINHO	15/11/2019 08:42	15/11/2019 14:58	15/11/2019 08:42	15/11/2019 14:58	6,26	5	31,29	CHI
201911173208	MONTIVIDIU	MV21093142	MONTIVIDIU T	15/11/2019 10:35	16/11/2019 12:49	15/11/2019 10:35	16/11/2019 12:49	26,23	1	26,23	CHI
201911173216	NIQUELANDIA	NQ12262919	NIQUELANDIA SUBTRANSMISSAO	15/11/2019 07:16	15/11/2019 12:35	15/11/2019 07:16	15/11/2019 12:35	5,32	10	53,16	CHI
201911173217	RUBIATABA	RB12255942	RUBIATABA	15/11/2019 07:48	15/11/2019 16:25	15/11/2019 07:48	15/11/2019 16:25	8,61	46	396,06	CHI
201911173223	CAIAPONIA	CP12345390	CAIAPONIA	15/11/2019 10:39	15/11/2019 20:02	15/11/2019 10:39	15/11/2019 20:02	9,38	1	9,38	CHI
201911173225	RIO VERDE	RV11018077	SANTA HELENA S1	15/11/2019 10:39	15/11/2019 14:31	15/11/2019 10:39	15/11/2019 14:31	3,85	94	362,14	CHI
201911173227	SAO LUIZ DO NORTE	SZ12237361	BARRO ALTO	15/11/2019 10:39	15/11/2019 17:52	15/11/2019 10:39	15/11/2019 17:52	7,20	6	43,21	CHI
201911173237	GOIANIA	10000339391	XAVANTES	15/11/2019 10:43	15/11/2019 13:06	15/11/2019 10:43	15/11/2019 13:06	2,38	1	2,38	CHI
201911173242	MUNDO NOVO DE GOIAS	4240006029	NOVA CRIXAS	15/11/2019 10:43	15/11/2019 21:50	15/11/2019 10:43	15/11/2019 21:50	11,10	1	11,10	CHI
201911173246	FORMOSO	SE12170967	MARA ROSA	15/11/2019 08:10	16/11/2019 07:56	15/11/2019 08:10	16/11/2019 07:56	23,76	3	71,27	CHI
201911173254	GOIANIRA	10005246057	GOIANIRA	15/11/2019 10:46	15/11/2019 13:50	15/11/2019 10:46	15/11/2019 13:50	3,05	1	3,05	CHI
201911173255	PADRE BERNARDO	PB12346973	PADRE BERNARDO	15/11/2019 10:47	15/11/2019 17:13	15/11/2019 10:47	15/11/2019 17:13	6,43	3	19,30	CHI
201911173258	NIQUELANDIA	NQ12398039	NIQUELANDIA SUBTRANSMISSAO	15/11/2019 08:09	15/11/2019 16:01	15/11/2019 08:09	15/11/2019 16:01	7,87	51	401,17	CHI
201911173259	SILVANIA	SV21198309	DAIA S2	15/11/2019 10:47	15/11/2019 16:13	15/11/2019 10:47	15/11/2019 16:13	5,42	1	5,42	CHI
201911173263	JATAI	290321554	JATAI S2	15/11/2019 10:48	15/11/2019 16:33	15/11/2019 10:48	15/11/2019 16:33	5,74	1	5,74	CHI
201911173267	ANAPOLIS	10030523204	ANAPOLIS UNIVERSITARIO S2	15/11/2019 10:49	15/11/2019 17:28	15/11/2019 10:49	15/11/2019 17:28	6,64	0	0,00	CHI
201911173287	SAO MIGUEL DO ARAGUAIA	SM12211095	SAO MIGUEL DO ARAGUAIA	15/11/2019 10:53	15/11/2019 12:40	15/11/2019 10:53	15/11/2019 12:40	1,78	131	233,25	CHI
201911173291	PIRENOPOLIS	PV12273035	SAO FRANCISCO DE GOIAS	15/11/2019 10:31	15/11/2019 20:14	15/11/2019 10:31	15/11/2019 20:14	9,71	13	126,24	CHI
201911173296	CAMPO ALEGRE DE GOIAS	CM12166746	CAMPO ALEGRE DE GOIAS	15/11/2019 10:55	15/11/2019 13:32	15/11/2019 10:55	15/11/2019 13:32	2,61	12	31,30	CHI
201911173298	GOIANIA	15271020	CARAJAS S1	15/11/2019 10:55	15/11/2019 11:59	15/11/2019 10:55	15/11/2019 11:59	1,05	1	1,05	CHI
201911173299	MONTIVIDIU	MV12340904	MONTIVIDIU T	15/11/2019 09:19	18/11/2019 11:56	15/11/2019 09:19	18/11/2019 11:56	74,62	12	895,39	CHI
201911173311	PADRE BERNARDO	10010955990	PADRE BERNARDO	15/11/2019 10:59	15/11/2019 13:08	15/11/2019 10:59	15/11/2019 13:08	2,15	1	2,15	CHI
201911173315	SILVANIA	SV12233209	VIANOPOLIS	15/11/2019 11:00	15/11/2019 16:03	15/11/2019 11:00	15/11/2019 16:03	5,05	6	30,30	CHI
201911173319	GOIANESIA	GE11191264	GOIANESIA S2	15/11/2019 11:00	15/11/2019 15:49	15/11/2019 11:00	15/11/2019 15:49	4,81	54	259,50	CHI
201911173321	AGUA FRIA DE GOIAS	TL12302766	SAO JOAO D ALIANCA	15/11/2019 10:49	15/11/2019 11:57	15/11/2019 10:49	15/11/2019 11:57	1,13	74	83,31	CHI
201911173321	SAO JOAO D ALIANCA	TL12302766	SAO JOAO D ALIANCA	15/11/2019 10:49	15/11/2019 11:57	15/11/2019 10:49	15/11/2019 11:57	1,13	1	1,13	CHI
201911173326	SANTO ANTONIO DO DESCOBERTO	SN12401712	ALEXANIA	15/11/2019 10:31	16/11/2019 11:43	15/11/2019 10:31	15/11/2019 16:27	5,94	3	17,81	CHI
201911173326	SANTO ANTONIO DO DESCOBERTO	SN12401712	ALEXANIA	15/11/2019 10:31	16/11/2019 11:43	15/11/2019 10:31	16/11/2019 11:43	25,21	2	50,41	CHI
201911173326	SANTO ANTONIO DO DESCOBERTO	SN12401712	ALEXANIA	15/11/2019 10:31	16/11/2019 11:43	15/11/2019 17:46	16/11/2019 11:43	17,95	3	53,85	CHI

201911173328	JATAI	290205256	JATAI S3	15/11/2019 11:02	15/11/2019 14:10	15/11/2019 11:02	15/11/2019 14:10	3,13	1	3,13	CHI
201911173330	QUIRINOPOLIS	Q12000344	QUIRINOPOLIS	15/11/2019 11:03	18/11/2019 14:20	15/11/2019 11:03	18/11/2019 14:20	75,29	8	602,32	CHI
201911173331	GOIAS	GS12035930	GOIAS	15/11/2019 11:04	15/11/2019 16:15	15/11/2019 11:04	15/11/2019 16:15	5,18	40	207,23	CHI
201911173331	HEITORAI	GS12035930	GOIAS	15/11/2019 11:04	15/11/2019 16:15	15/11/2019 11:04	15/11/2019 16:15	5,18	29	150,24	CHI
201911173331	ITABERAI	GS12035930	GOIAS	15/11/2019 11:04	15/11/2019 16:15	15/11/2019 11:04	15/11/2019 16:15	5,18	2	10,36	CHI
201911173331	ITAPURANGA	GS12035930	GOIAS	15/11/2019 11:04	15/11/2019 16:15	15/11/2019 11:04	15/11/2019 16:15	5,18	3	15,54	CHI
201911173342	ANAPOLIS	10000507804	JUNDAI S1	15/11/2019 11:08	15/11/2019 11:51	15/11/2019 11:08	15/11/2019 11:51	0,71	1	0,71	CHI
201911173344	FORMOSA	610280715	ITUIQUIRA	15/11/2019 11:08	15/11/2019 12:18	15/11/2019 11:08	15/11/2019 12:18	1,15	1	1,15	CHI
201911173354	JATAI	290314008	JATAI S2	15/11/2019 11:11	15/11/2019 18:42	15/11/2019 11:11	15/11/2019 18:42	7,53	1	7,53	CHI
201911173361	GOIANESIA	GE21236919	GOIANESIA S2	15/11/2019 08:23	16/11/2019 17:02	15/11/2019 08:23	16/11/2019 17:02	32,64	1	32,64	CHI
201911173364	ANAPOLIS	AN11273398	ANAPOLIS UNIVERSITARIO S2	15/11/2019 10:54	15/11/2019 12:24	15/11/2019 10:54	15/11/2019 12:24	1,49	94	139,93	CHI
201911173367	PALMEIRAS DE GOIAS	PL21000112	PALMEIRAS	15/11/2019 11:14	16/11/2019 07:50	15/11/2019 11:14	16/11/2019 07:50	20,59	1	20,59	CHI
201911173369	GOIANIA	GN11001287	GOIANIA LESTE S2	15/11/2019 11:09	15/11/2019 13:55	15/11/2019 11:09	15/11/2019 13:55	2,76	68	187,94	CHI
201911173370	ACREUNA	TD10400615	RIO DOS BOIS	15/11/2019 16:26	15/11/2019 19:40	15/11/2019 16:26	15/11/2019 17:06	0,66	13	8,57	CHI
201911173370	EDEIA	TD10400615	RIO DOS BOIS	15/11/2019 16:26	15/11/2019 19:40	15/11/2019 16:26	15/11/2019 17:06	0,66	47	30,97	CHI
201911173370	GOIATUBA	TD10400615	RIO DOS BOIS	15/11/2019 16:26	15/11/2019 19:40	15/11/2019 16:26	15/11/2019 17:06	0,66	18	11,86	CHI
201911173370	PORTEIRAO	TD10400615	RIO DOS BOIS	15/11/2019 16:26	15/11/2019 19:40	15/11/2019 16:26	15/11/2019 17:06	0,66	34	22,40	CHI
201911173370	TURVELANDIA	TD10400615	RIO DOS BOIS	15/11/2019 16:26	15/11/2019 19:40	15/11/2019 16:26	15/11/2019 17:06	0,66	12	7,91	CHI
201911173370	PORTEIRAO	TD10400615	RIO DOS BOIS	15/11/2019 16:26	15/11/2019 19:40	15/11/2019 17:02	15/11/2019 17:06	0,07	13	0,87	CHI
201911173370	PORTEIRAO	TD10400615	RIO DOS BOIS	15/11/2019 16:26	15/11/2019 19:40	15/11/2019 17:02	15/11/2019 17:06	0,07	1548	103,20	CHI
201911173370	PORTEIRAO	TD10400615	RIO DOS BOIS	15/11/2019 16:26	15/11/2019 19:40	15/11/2019 17:02	15/11/2019 17:06	0,07	4	0,27	CHI
201911173370	PORTEIRAO	TD10400615	RIO DOS BOIS	15/11/2019 16:26	15/11/2019 19:40	15/11/2019 17:02	15/11/2019 17:06	0,07	9	0,60	CHI
201911173370	TURVELANDIA	TD10400615	RIO DOS BOIS	15/11/2019 16:26	15/11/2019 19:40	15/11/2019 17:02	15/11/2019 17:06	0,07	1	0,07	CHI
201911173370	MAURILANDIA	TD13230823	RIO DOS BOIS	15/11/2019 16:26	15/11/2019 19:40	15/11/2019 19:17	15/11/2019 19:40	0,38	3	1,14	CHI
201911173370	PORTEIRAO	TD13230823	RIO DOS BOIS	15/11/2019 16:26	15/11/2019 19:40	15/11/2019 19:17	15/11/2019 19:40	0,38	28	10,59	CHI
201911173371	BURITI ALEGRE	BG12229307	ITUMBIARA VELHA S2	15/11/2019 11:14	18/11/2019 10:52	15/11/2019 11:14	18/11/2019 10:52	71,62	2	143,25	CHI
201911173372	INHUMAS	IN12013796	INHUMAS S2	15/11/2019 11:14	15/11/2019 15:35	15/11/2019 11:14	15/11/2019 15:35	4,35	6	26,10	CHI
201911173383	TRINDADE	10001785875	TRINDADE	15/11/2019 11:16	15/11/2019 13:06	15/11/2019 11:16	15/11/2019 13:06	1,83	1	1,83	CHI
201911173388	JANDAIA	1180003953	PALMEIRAS	15/11/2019 11:17	15/11/2019 15:42	15/11/2019 11:17	15/11/2019 15:42	4,40	1	4,40	CHI
201911173390	GOIANIA	10011743598	INDEPENDENCIA S2	15/11/2019 11:18	15/11/2019 15:35	15/11/2019 11:18	15/11/2019 15:35	4,28	1	4,28	CHI
201911173395	MORRINHOS	MR21000042	MORRINHOS	15/11/2019 11:19	15/11/2019 19:45	15/11/2019 11:19	15/11/2019 19:10	7,86	1	7,86	CHI
201911173395	MORRINHOS	MR12000106LD	MORRINHOS	15/11/2019 11:19	15/11/2019 19:45	15/11/2019 16:50	15/11/2019 19:45	2,92	16	46,67	CHI
201911173415	SAO MIGUEL DO ARAGUAIA	SM12000055	SAO MIGUEL DO ARAGUAIA	15/11/2019 07:53	15/11/2019 17:40	15/11/2019 07:53	15/11/2019 17:40	9,78	2	19,55	CHI

201911173416	COCALZINHO DE GOIAS	ZN11100290	COCALZINHO	15/11/2019 07:31	16/11/2019 21:32	15/11/2019 07:31	16/11/2019 21:32	38,02	10	380,16	CHI
201911173417	GOIANIA	10008238349	CARAJAS S2	15/11/2019 11:25	15/11/2019 16:05	15/11/2019 11:25	15/11/2019 16:05	4,67	1	4,67	CHI
201911173419	VIANOPOLIS	VN12387794	VIANOPOLIS	15/11/2019 16:41	15/11/2019 20:00	15/11/2019 16:41	15/11/2019 20:00	3,30	237	783,15	CHI
201911173420	PIRES DO RIO	460042993	PIRES DO RIO S1	15/11/2019 11:27	16/11/2019 02:03	15/11/2019 11:27	16/11/2019 02:03	14,59	1	14,59	CHI
201911173422	CRISTALINA	KR12163676	PAMPLONA	15/11/2019 10:26	15/11/2019 11:48	15/11/2019 10:26	15/11/2019 11:48	1,37	25	34,17	CHI
201911173422	DISTRITO FEDERAL	KR12163676	PAMPLONA	15/11/2019 10:26	15/11/2019 11:48	15/11/2019 10:26	15/11/2019 11:48	1,37	4	5,47	CHI
201911173430	DIVINOPOLIS DE GOIAS	MA12398387	SAO DOMINGOS	15/11/2019 09:37	15/11/2019 11:57	15/11/2019 09:37	15/11/2019 11:57	2,32	1	2,32	CHI
201911173430	MONTE ALEGRE DE GOIAS	MA12398387	SAO DOMINGOS	15/11/2019 09:37	15/11/2019 11:57	15/11/2019 09:37	15/11/2019 11:57	2,32	16	37,16	CHI
201911173433	PADRE BERNARDO	10010545334	PADRE BERNARDO	15/11/2019 11:31	15/11/2019 14:08	15/11/2019 11:31	15/11/2019 14:08	2,61	1	2,61	CHI
201911173446	PORANGATU	PO12349233	MARA ROSA	15/11/2019 08:36	15/11/2019 23:22	15/11/2019 08:36	15/11/2019 23:22	14,76	7	103,34	CHI
201911173454	NIQUELANDIA	NQ12256380	NIQUELANDIA SUBTRANSMISSAO	15/11/2019 10:11	15/11/2019 18:46	15/11/2019 10:11	15/11/2019 18:46	8,57	12	102,90	CHI
201911173460	ITABERAI	IB21274424	ITABERAI S1	15/11/2019 11:37	16/11/2019 08:46	15/11/2019 11:37	16/11/2019 08:46	21,14	1	21,14	CHI
201911173462	TEREZOPOLIS DE GOIAS	TJ11273110	DAIA S2	15/11/2019 11:25	15/11/2019 15:38	15/11/2019 11:25	15/11/2019 15:38	4,21	62	261,07	CHI
201911173476	GOIANIA	14283487	GOIANIA LESTE S2	15/11/2019 11:40	15/11/2019 14:22	15/11/2019 11:40	15/11/2019 14:22	2,69	1	2,69	CHI
201911173477	GUAPO	GA31079487	GUAPO S2	15/11/2019 11:40	16/11/2019 09:41	15/11/2019 11:40	16/11/2019 09:41	22,01	1	22,01	CHI
201911173479	SAO LUIZ DO NORTE	SZ21332886	BARRO ALTO	15/11/2019 11:40	17/11/2019 10:04	15/11/2019 11:40	17/11/2019 10:04	46,39	1	46,39	CHI
201911173482	JATAI	JT12205194	JATAI S1	15/11/2019 11:41	16/11/2019 09:24	15/11/2019 11:41	16/11/2019 09:24	21,71	7	151,97	CHI
201911173488	RIO VERDE	RV12230829	MONTIVIDIU T	15/11/2019 11:43	17/11/2019 12:16	15/11/2019 11:43	17/11/2019 12:16	48,54	16	776,63	CHI
201911173489	CATALAO	CT12266322	CATALAO S1	15/11/2019 09:34	15/11/2019 15:47	15/11/2019 09:34	15/11/2019 15:47	6,22	39	242,40	CHI
201911173491	GOIANIA	GN11170635	GOIANIA LESTE S2	15/11/2019 13:19	15/11/2019 13:23	15/11/2019 13:19	15/11/2019 13:23	0,07	74	4,93	CHI
201911173505	AGUA FRIA DE GOIAS	TL21180521	SAO JOAO D ALIANCA	15/11/2019 11:47	16/11/2019 11:50	15/11/2019 11:47	16/11/2019 11:50	24,04	1	24,04	CHI
201911173511	GOIANIRA	10015680183	GOIANIRA	15/11/2019 11:48	15/11/2019 14:35	15/11/2019 11:48	15/11/2019 14:35	2,77	1	2,77	CHI
201911173512	JATAI	JT11322254	JATAI S2	15/11/2019 11:28	15/11/2019 13:06	15/11/2019 11:28	15/11/2019 13:06	1,62	44	71,29	CHI
201911173513	CEZARINA	1650004350	CEZARINA	15/11/2019 11:49	15/11/2019 16:17	15/11/2019 11:49	15/11/2019 16:17	4,47	1	4,47	CHI
201911173517	FORMOSA	FA12085474	ITIQUEIRA	15/11/2019 11:49	15/11/2019 14:55	15/11/2019 11:49	15/11/2019 14:55	3,09	29	89,54	CHI
201911173520	ALTO PARAISO DE GOIAS	ND12302636	IACIARA S2	15/11/2019 11:39	15/11/2019 13:23	15/11/2019 11:39	15/11/2019 13:23	1,72	18	30,91	CHI
201911173520	NOVA ROMA	ND12302636	IACIARA S2	15/11/2019 11:39	15/11/2019 13:23	15/11/2019 11:39	15/11/2019 13:23	1,72	96	164,85	CHI
201911173520	SAO JOAO D ALIANCA	ND12302636	IACIARA S2	15/11/2019 11:39	15/11/2019 13:23	15/11/2019 11:39	15/11/2019 13:23	1,72	12	20,61	CHI
201911173521	GOIANIA	15613276	GOYA S2	15/11/2019 11:51	15/11/2019 13:58	15/11/2019 11:51	15/11/2019 13:58	2,11	1	2,11	CHI
201911173525	NEROPOLIS	NR11167735	NEROPOLIS S2	15/11/2019 11:52	15/11/2019 16:12	15/11/2019 11:52	15/11/2019 16:12	4,33	69	298,48	CHI
201911173531	BALIZA	BH12331384	CAIAPONIA	15/11/2019 09:42	15/11/2019 18:14	15/11/2019 09:42	15/11/2019 18:14	8,53	7	59,74	CHI
201911173535	SANTO ANTONIO DE GOIAS	BW12343445	NEROPOLIS S1	15/11/2019 11:47	15/11/2019 15:39	15/11/2019 11:47	15/11/2019 15:39	3,85	16	61,62	CHI
201911173537	APARECIDA DE GOIANIA	AP11164458	INDEPENDENCIA S2	15/11/2019 11:44	15/11/2019 18:24	15/11/2019 11:44	15/11/2019 18:24	6,65	153	1017,66	CHI

201911173539	MINEIROS	MY12264422LD	SANTA RITA DO ARAGUAIA	15/11/2019 11:57	15/11/2019 15:25	15/11/2019 11:57	15/11/2019 15:25	3,46	1	3,46	CHI
201911173542	ANAPOLIS	21236318	JUNDAI S1	15/11/2019 11:57	15/11/2019 14:18	15/11/2019 11:57	15/11/2019 14:18	2,34	1	2,34	CHI
201911173545	SAO JOAO D ALIANCA	JL12324141	SAO JOAO D ALIANCA	15/11/2019 11:58	16/11/2019 18:01	15/11/2019 11:58	16/11/2019 18:01	30,04	4	120,18	CHI
201911173548	AURILANDIA	AI12126016	FIRMINOPOLIS S2	15/11/2019 10:40	15/11/2019 16:47	15/11/2019 10:40	15/11/2019 16:47	6,10	23	140,33	CHI
201911173563	PONTALINA	PK12263674	GOIATUBA S1	15/11/2019 12:01	16/11/2019 20:28	15/11/2019 12:01	16/11/2019 20:28	32,45	3	97,34	CHI
201911173569	INHUMAS	IN21228300	INHUMAS S1	15/11/2019 12:05	15/11/2019 12:44	15/11/2019 12:05	15/11/2019 12:44	0,64	1	0,64	CHI
201911173570	RIO VERDE	RV32191873	QUIRINOPOLIS	15/11/2019 12:06	17/11/2019 11:26	15/11/2019 12:06	17/11/2019 11:26	47,33	12	568,00	CHI
201911173571	JATAI	290193758	JATAI S3	15/11/2019 12:06	15/11/2019 14:39	15/11/2019 12:06	15/11/2019 14:39	2,54	1	2,54	CHI
201911173573	ANICUNS	AC21278643	FIRMINOPOLIS S2	15/11/2019 12:06	15/11/2019 18:58	15/11/2019 12:06	15/11/2019 18:58	6,87	1	6,87	CHI
201911173575	GOIANIRA	390037758	GOIANIRA	15/11/2019 12:06	15/11/2019 15:33	15/11/2019 12:06	15/11/2019 15:33	3,44	1	3,44	CHI
201911173583	COCALZINHO DE GOIAS	ZN12137406	AGUAS LINDAS DE GOIAS S2	15/11/2019 12:02	15/11/2019 13:59	15/11/2019 12:02	15/11/2019 13:59	1,95	140	272,69	CHI
201911173592	JUSSARA	JR21324634	BRITANIA	15/11/2019 12:09	16/11/2019 18:52	15/11/2019 12:09	16/11/2019 18:52	30,71	1	30,71	CHI
201911173600	LAGOA SANTA	3900000394	ITAJA S2	15/11/2019 12:11	15/11/2019 16:03	15/11/2019 12:11	15/11/2019 16:03	3,86	1	3,86	CHI
201911173602	CAIAPONIA	PH12259516	CAIAPONIA	15/11/2019 11:58	15/11/2019 19:30	15/11/2019 11:58	15/11/2019 19:30	7,53	3	22,58	CHI
201911173602	PIRANHAS	PH12259516	CAIAPONIA	15/11/2019 11:58	15/11/2019 19:30	15/11/2019 11:58	15/11/2019 19:30	7,53	69	519,26	CHI
201911173615	NOVA CRIXAS	NA21092708	NOVA CRIXAS	15/11/2019 12:13	16/11/2019 14:15	15/11/2019 12:13	16/11/2019 14:15	26,03	1	26,03	CHI
201911173616	CABECEIRAS	CW21150197	ITUIQUIRA	15/11/2019 12:13	15/11/2019 17:03	15/11/2019 12:13	15/11/2019 17:03	4,83	1	4,83	CHI
201911173617	GOIANIA	13959645	MEIA PONTE	15/11/2019 12:13	16/11/2019 07:44	15/11/2019 12:13	16/11/2019 07:44	19,52	1	19,52	CHI
201911173620	ANAPOLIS	20519023	ANAPOLIS UNIVERSITARIO S2	15/11/2019 12:14	16/11/2019 06:47	15/11/2019 12:14	16/11/2019 06:47	18,55	1	18,55	CHI
201911173633	APARECIDA DE GOIANIA	AP11193731	ANHANGUERA	15/11/2019 11:09	15/11/2019 14:51	15/11/2019 11:09	15/11/2019 14:51	3,68	123	453,22	CHI
201911173646	MAURILANDIA	ML12271555	RIO DOS BOIS	15/11/2019 11:44	15/11/2019 18:00	15/11/2019 11:44	15/11/2019 18:00	6,26	1	6,26	CHI
201911173646	RIO VERDE	ML12271555	RIO DOS BOIS	15/11/2019 11:44	15/11/2019 18:00	15/11/2019 11:44	15/11/2019 18:00	6,26	7	43,82	CHI
201911173654	SENADOR CANEDO	SW21192241	SENADOR CANEDO	15/11/2019 12:18	15/11/2019 14:13	15/11/2019 12:18	15/11/2019 14:13	1,92	1	1,92	CHI
201911173664	CRISTIANOPOLIS	BV21023169	CRISTIANOPOLIS	15/11/2019 12:18	18/11/2019 11:43	15/11/2019 12:18	18/11/2019 11:43	71,40	1	71,40	CHI
201911173666	GOIANIA	GN11197043	FERROVIARIO S2	15/11/2019 12:19	15/11/2019 15:11	15/11/2019 12:19	15/11/2019 15:11	2,86	15	42,94	CHI
201911173673	PORANGATU	PO12170957	PORANGATU	15/11/2019 11:48	15/11/2019 14:17	15/11/2019 11:48	15/11/2019 14:17	2,48	184	456,73	CHI
201911173674	PLANALTINA	10000396140	PLANALTINA	15/11/2019 12:20	15/11/2019 15:41	15/11/2019 12:20	15/11/2019 15:41	3,34	1	3,34	CHI
201911173692	HIDROLANDIA	HD11251739	ANHANGUERA	15/11/2019 12:22	16/11/2019 08:58	15/11/2019 12:22	16/11/2019 08:58	20,59	74	1524,03	CHI
201911173703	SAO SIMAO	10015858802	CACHOEIRA ALTA	15/11/2019 12:24	15/11/2019 20:35	15/11/2019 12:24	15/11/2019 20:35	8,18	1	8,18	CHI
201911173706	PETROLINA DE GOIAS	PG21248857	SAO FRANCISCO DE GOIAS	15/11/2019 12:24	15/11/2019 18:41	15/11/2019 12:24	15/11/2019 18:41	6,27	1	6,27	CHI
201911173718	NOVA CRIXAS	NA21328592	NOVA CRIXAS	15/11/2019 12:26	16/11/2019 16:16	15/11/2019 12:26	16/11/2019 16:16	27,82	1	27,82	CHI
201911173724	SANTA HELENA DE GOIAS	SH12279869	IPEGUARI	15/11/2019 12:18	18/11/2019 21:20	15/11/2019 12:18	15/11/2019 14:25	2,12	146	309,15	CHI
201911173724	SANTA HELENA DE GOIAS	SH12279869	IPEGUARI	15/11/2019 12:18	18/11/2019 21:20	15/11/2019 12:18	18/11/2019 21:20	81,03	22	1782,73	CHI

201911173727	NOVA CRIXAS	NA21115806	NOVA CRIXAS	15/11/2019 12:27	16/11/2019 11:13	15/11/2019 12:27	16/11/2019 11:13	22,76	1	22,76	CHI
201911173729	FAZENDA NOVA	10024695546	IPORA	15/11/2019 12:28	16/11/2019 15:40	15/11/2019 12:28	16/11/2019 15:40	27,21	1	27,21	CHI
201911173744	AMARALINA	LC12278480	MARA ROSA	15/11/2019 05:48	15/11/2019 23:58	15/11/2019 05:48	15/11/2019 23:58	18,16	3	54,48	CHI
201911173745	JATAI	JT12000160	JATAI S2	15/11/2019 12:04	15/11/2019 15:29	15/11/2019 12:04	15/11/2019 15:29	3,41	37	126,14	CHI
201911173747	MORRINHOS	MR21015623	MORRINHOS	15/11/2019 12:32	16/11/2019 12:30	15/11/2019 12:32	16/11/2019 11:16	22,73	1	22,73	CHI
201911173747	MORRINHOS	MR12015624	MORRINHOS	15/11/2019 12:32	16/11/2019 12:30	15/11/2019 12:32	16/11/2019 12:30	23,96	1	23,96	CHI
201911173764	SANTO ANTONIO DO DESCOBERTO	2210153494	AGUAS LINDAS DE GOIAS S2	15/11/2019 12:36	15/11/2019 15:29	15/11/2019 12:36	15/11/2019 15:29	2,87	1	2,87	CHI
201911173766	JUSSARA	1290007564	JUSSARA	15/11/2019 12:37	15/11/2019 17:40	15/11/2019 12:37	15/11/2019 17:40	5,05	1	5,05	CHI
201911173772	HIDROLANDIA	HD12000190	ANHANGUERA	15/11/2019 12:38	15/11/2019 20:35	15/11/2019 12:38	15/11/2019 20:35	7,95	802	6375,68	CHI
201911173777	GOIANIA	10849350	GOIANIA LESTE S1	15/11/2019 12:38	15/11/2019 17:06	15/11/2019 12:38	15/11/2019 17:06	4,45	1	4,45	CHI
201911173781	JATAI	290250250	JATAI S3	15/11/2019 12:39	15/11/2019 16:08	15/11/2019 12:39	15/11/2019 16:08	3,49	1	3,49	CHI
201911173789	PIRES DO RIO	PR11186713	PIRES DO RIO S1	15/11/2019 12:35	15/11/2019 14:00	15/11/2019 12:35	15/11/2019 14:00	1,41	146	205,50	CHI
201911173791	GOIANAPOLIS	950002318	DAIA S2	15/11/2019 12:41	16/11/2019 19:35	15/11/2019 12:41	16/11/2019 19:35	30,90	1	30,90	CHI
201911173794	DAMOLANDIA	DL12098268	INHUMAS S1	15/11/2019 12:41	15/11/2019 18:01	15/11/2019 12:41	15/11/2019 18:01	5,32	6	31,93	CHI
201911173794	INHUMAS	DL12098268	INHUMAS S1	15/11/2019 12:41	15/11/2019 18:01	15/11/2019 12:41	15/11/2019 18:01	5,32	50	266,11	CHI
201911173795	TAQUARAL DE GOIAS	TQ21299559	ITABERAI S1	15/11/2019 12:41	16/11/2019 09:30	15/11/2019 12:41	16/11/2019 09:30	20,80	2	41,61	CHI
201911173804	EDEALINA	VI10400586	VICENTINOPOLIS	15/11/2019 13:19	15/11/2019 22:03	15/11/2019 13:19	15/11/2019 19:28	6,15	34	209,13	CHI
201911173804	EDEIA	VI10400586	VICENTINOPOLIS	15/11/2019 13:19	15/11/2019 22:03	15/11/2019 13:19	15/11/2019 19:28	6,15	1	6,15	CHI
201911173804	GOIATUBA	VI10400586	VICENTINOPOLIS	15/11/2019 13:19	15/11/2019 22:03	15/11/2019 13:19	15/11/2019 19:28	6,15	11	67,66	CHI
201911173804	VICENTINOPOLIS	VI10400586	VICENTINOPOLIS	15/11/2019 13:19	15/11/2019 22:03	15/11/2019 13:19	15/11/2019 19:28	6,15	52	319,84	CHI
201911173804	VICENTINOPOLIS	VI13166480	VICENTINOPOLIS	15/11/2019 13:19	15/11/2019 22:03	15/11/2019 13:19	15/11/2019 20:47	7,46	21	156,73	CHI
201911173804	EDEALINA	VI10400586	VICENTINOPOLIS	15/11/2019 13:19	15/11/2019 22:03	15/11/2019 13:19	15/11/2019 21:30	8,18	12	98,12	CHI
201911173804	EDEIA	VI10400586	VICENTINOPOLIS	15/11/2019 13:19	15/11/2019 22:03	15/11/2019 13:19	15/11/2019 21:30	8,18	11	89,94	CHI
201911173804	EDEIA	VI10400586	VICENTINOPOLIS	15/11/2019 13:19	15/11/2019 22:03	15/11/2019 13:19	15/11/2019 21:30	8,18	32	261,64	CHI
201911173804	EDEIA	EA13267229	VICENTINOPOLIS	15/11/2019 13:19	15/11/2019 22:03	15/11/2019 13:19	15/11/2019 21:30	8,18	1	8,18	CHI
201911173804	PONTALINA	VI10400586	VICENTINOPOLIS	15/11/2019 13:19	15/11/2019 22:03	15/11/2019 13:19	15/11/2019 21:30	8,18	1	8,18	CHI
201911173804	VICENTINOPOLIS	VI10400586	VICENTINOPOLIS	15/11/2019 13:19	15/11/2019 22:03	15/11/2019 13:19	15/11/2019 21:30	8,18	1	8,18	CHI
201911173804	VICENTINOPOLIS	VI10400586	VICENTINOPOLIS	15/11/2019 13:19	15/11/2019 22:03	15/11/2019 13:19	15/11/2019 21:30	8,18	2	16,35	CHI
201911173804	VICENTINOPOLIS	EA13267229	VICENTINOPOLIS	15/11/2019 13:19	15/11/2019 22:03	15/11/2019 13:19	15/11/2019 21:30	8,18	11	89,94	CHI
201911173804	EDEIA	VI12328992LD	VICENTINOPOLIS	15/11/2019 13:19	15/11/2019 22:03	15/11/2019 13:19	15/11/2019 22:03	8,73	8	69,84	CHI
201911173804	VICENTINOPOLIS	VI12328992LD	VICENTINOPOLIS	15/11/2019 13:19	15/11/2019 22:03	15/11/2019 13:19	15/11/2019 22:03	8,73	23	200,80	CHI
201911173808	TEREZOPOLIS DE GOIAS	TJ11144796	DAIA S2	15/11/2019 11:25	15/11/2019 17:10	15/11/2019 11:25	15/11/2019 17:10	5,76	183	1053,37	CHI
201911173809	EDEIA	EA10400409	EDEIA	15/11/2019 13:46	17/11/2019 13:04	15/11/2019 13:46	16/11/2019 13:23	23,61	26	613,95	CHI

201911173809	EDEIA	EA10400409	EDEIA	15/11/2019 13:46	17/11/2019 13:04	15/11/2019 13:46	16/11/2019 15:51	26,09	15	391,34	CHI
201911173809	EDEIA	EA10400409	EDEIA	15/11/2019 13:46	17/11/2019 13:04	16/11/2019 15:52	16/11/2019 16:06	0,24	26	6,15	CHI
201911173809	EDEIA	EA13390278	EDEIA	15/11/2019 13:46	17/11/2019 13:04	16/11/2019 15:52	17/11/2019 11:15	19,39	15	290,79	CHI
201911173809	EDEIA	EA12223551RE	EDEIA	15/11/2019 13:46	17/11/2019 13:04	15/11/2019 13:46	17/11/2019 11:36	45,84	60	2750,40	CHI
201911173809	INDIARA	EA12223551RE	EDEIA	15/11/2019 13:46	17/11/2019 13:04	15/11/2019 13:46	17/11/2019 11:36	45,84	4	183,36	CHI
201911173809	PONTALINA	EA12223551RE	EDEIA	15/11/2019 13:46	17/11/2019 13:04	15/11/2019 13:46	17/11/2019 11:36	45,84	1	45,84	CHI
201911173809	EDEALINA	EA12223550RE	EDEIA	15/11/2019 13:46	17/11/2019 13:04	15/11/2019 13:46	17/11/2019 11:48	46,03	50	2301,69	CHI
201911173809	EDEIA	EA12223550RE	EDEIA	15/11/2019 13:46	17/11/2019 13:04	15/11/2019 13:46	17/11/2019 11:48	46,03	25	1150,85	CHI
201911173809	INDIARA	EA12223550RE	EDEIA	15/11/2019 13:46	17/11/2019 13:04	15/11/2019 13:46	17/11/2019 11:48	46,03	7	322,24	CHI
201911173809	EDEIA	EA21156873	EDEIA	15/11/2019 13:46	17/11/2019 13:04	17/11/2019 11:20	17/11/2019 13:04	1,73	1	1,73	CHI
201911173811	CALDAS NOVAS	760315474	CALDAS NOVAS S1	15/11/2019 13:56	15/11/2019 16:56	15/11/2019 13:56	15/11/2019 16:56	3,00	1	3,00	CHI
201911173815	APARECIDA DO RIO DOCE	RV13355110	CABRIUVA S2	15/11/2019 14:13	16/11/2019 18:22	15/11/2019 14:13	15/11/2019 16:15	2,03	6	12,21	CHI
201911173815	JATAI	RV13355110	CABRIUVA S2	15/11/2019 14:13	16/11/2019 18:22	15/11/2019 14:13	15/11/2019 16:15	2,03	28	56,97	CHI
201911173815	RIO VERDE	RV13355110	CABRIUVA S2	15/11/2019 14:13	16/11/2019 18:22	15/11/2019 14:13	15/11/2019 16:15	2,03	137	278,76	CHI
201911173815	RIO VERDE	RV13355110	CABRIUVA S2	15/11/2019 14:13	16/11/2019 18:22	15/11/2019 14:13	15/11/2019 16:15	2,03	111	225,85	CHI
201911173815	RIO VERDE	02450434	CABRIUVA S2	15/11/2019 14:13	16/11/2019 18:22	15/11/2019 14:13	15/11/2019 17:58	3,74	32	119,61	CHI
201911173815	RIO VERDE	RV10400562	CABRIUVA S2	15/11/2019 14:13	16/11/2019 18:22	15/11/2019 14:15	15/11/2019 17:58	3,70	1	3,70	CHI
201911173815	RIO VERDE	02450434	CABRIUVA S2	15/11/2019 14:13	16/11/2019 18:22	15/11/2019 14:13	15/11/2019 18:13	3,99	17	67,86	CHI
201911173815	RIO VERDE	02450434	CABRIUVA S2	15/11/2019 14:13	16/11/2019 18:22	15/11/2019 14:15	15/11/2019 18:13	3,95	1	3,95	CHI
201911173815	RIO VERDE	02450434	CABRIUVA S2	15/11/2019 14:13	16/11/2019 18:22	15/11/2019 14:13	16/11/2019 17:50	27,61	22	607,44	CHI
201911173815	RIO VERDE	RV13172876	CABRIUVA S2	15/11/2019 14:13	16/11/2019 18:22	15/11/2019 14:13	16/11/2019 17:50	27,61	43	1187,27	CHI
201911173815	RIO VERDE	RV13172876	CABRIUVA S2	15/11/2019 14:13	16/11/2019 18:22	15/11/2019 14:15	16/11/2019 17:50	27,58	4	110,34	CHI
201911173815	RIO VERDE	RV13191199	CABRIUVA S2	15/11/2019 14:13	16/11/2019 18:22	16/11/2019 18:16	16/11/2019 18:22	0,10	33	3,25	CHI
201911173816	PONTALINA	01510224	PONTALINA	15/11/2019 14:18	15/11/2019 19:00	15/11/2019 14:18	15/11/2019 16:05	1,79	3310	5927,66	CHI
201911173816	PONTALINA	01510224	PONTALINA	15/11/2019 14:18	15/11/2019 19:00	15/11/2019 14:18	15/11/2019 17:04	2,77	436	1207,11	CHI
201911173816	PONTALINA	PK12000018LD	PONTALINA	15/11/2019 14:18	15/11/2019 19:00	15/11/2019 18:10	15/11/2019 18:47	0,62	436	268,38	CHI
201911173816	PONTALINA	01510224	PONTALINA	15/11/2019 14:18	15/11/2019 19:00	15/11/2019 14:18	15/11/2019 19:00	4,69	94	441,09	CHI
201911173818	ITUMBIARA	03840214	PARANAIBA	15/11/2019 14:38	16/11/2019 20:49	15/11/2019 14:38	15/11/2019 15:41	1,05	24	25,19	CHI
201911173818	ITUMBIARA	03840214	PARANAIBA	15/11/2019 14:38	16/11/2019 20:49	15/11/2019 14:38	15/11/2019 15:41	1,05	150	157,46	CHI
201911173818	ITUMBIARA	03840214	PARANAIBA	15/11/2019 14:38	16/11/2019 20:49	15/11/2019 14:38	16/11/2019 09:20	18,70	9	168,27	CHI
201911173818	ITUMBIARA	03840214	PARANAIBA	15/11/2019 14:38	16/11/2019 20:49	15/11/2019 14:38	16/11/2019 13:00	22,36	36	804,98	CHI
201911173818	BURITI ALEGRE	03840214	PARANAIBA	15/11/2019 14:38	16/11/2019 20:49	15/11/2019 14:38	16/11/2019 13:30	22,87	8	182,96	CHI
201911173818	GOIATUBA	03840214	PARANAIBA	15/11/2019 14:38	16/11/2019 20:49	15/11/2019 14:38	16/11/2019 13:30	22,87	6	137,22	CHI

201911173818	ITUMBIARA	03840214	PARANAIBA	15/11/2019 14:38	16/11/2019 20:49	15/11/2019 14:38	16/11/2019 13:30	22,87	31	708,95	CHI
201911173818	PANAMA	03840214	PARANAIBA	15/11/2019 14:38	16/11/2019 20:49	15/11/2019 14:38	16/11/2019 13:30	22,87	41	937,65	CHI
201911173818	ITUMBIARA	IT12378962LD	PARANAIBA	15/11/2019 14:38	16/11/2019 20:49	15/11/2019 14:38	16/11/2019 20:49	30,18	1	30,18	CHI
201911173821	MORRINHOS	02940214	MORRINHOS	15/11/2019 14:55	18/11/2019 13:36	15/11/2019 14:55	15/11/2019 15:00	0,07	21	1,42	CHI
201911173821	MORRINHOS	02940214	MORRINHOS	15/11/2019 14:55	18/11/2019 13:36	15/11/2019 14:55	15/11/2019 17:04	2,15	227	487,61	CHI
201911173821	MORRINHOS	02940214	MORRINHOS	15/11/2019 14:55	18/11/2019 13:36	15/11/2019 14:56	15/11/2019 17:04	2,14	2	4,27	CHI
201911173821	MORRINHOS	02940214	MORRINHOS	15/11/2019 14:55	18/11/2019 13:36	15/11/2019 15:01	15/11/2019 17:04	2,06	21	43,34	CHI
201911173821	MORRINHOS	MR13000010	MORRINHOS	15/11/2019 14:55	18/11/2019 13:36	15/11/2019 17:05	16/11/2019 21:10	28,08	50	1404,11	CHI
201911173821	MORRINHOS	02940214	MORRINHOS	15/11/2019 14:55	18/11/2019 13:36	15/11/2019 17:05	17/11/2019 00:40	31,59	39	1231,85	CHI
201911173821	MORRINHOS	02940214	MORRINHOS	15/11/2019 14:55	18/11/2019 13:36	15/11/2019 14:55	17/11/2019 02:06	35,18	77	2708,86	CHI
201911173821	MORRINHOS	MR13264006	MORRINHOS	15/11/2019 14:55	18/11/2019 13:36	15/11/2019 15:01	17/11/2019 02:06	35,10	6	210,57	CHI
201911173821	MORRINHOS	02940214	MORRINHOS	15/11/2019 14:55	18/11/2019 13:36	15/11/2019 17:05	17/11/2019 20:00	50,93	22	1120,40	CHI
201911173821	MORRINHOS	MR10406639	MORRINHOS	15/11/2019 14:55	18/11/2019 13:36	15/11/2019 17:05	18/11/2019 13:33	68,47	86	5888,01	CHI
201911173821	MORRINHOS	MR10406639	MORRINHOS	15/11/2019 14:55	18/11/2019 13:36	15/11/2019 17:05	18/11/2019 13:36	68,52	53	3631,59	CHI
201911173833	GOIANESIA	GE16404354	GOIANESIA S2	15/11/2019 15:20	15/11/2019 16:34	15/11/2019 15:20	15/11/2019 15:23	0,05	698	36,84	CHI
201911173833	GOIANESIA	GE16404339	GOIANESIA S2	15/11/2019 15:20	15/11/2019 16:34	15/11/2019 15:20	15/11/2019 15:26	0,11	3986	431,82	CHI
201911173833	GOIANESIA	GE16404329	GOIANESIA S2	15/11/2019 15:20	15/11/2019 16:34	15/11/2019 15:20	15/11/2019 16:34	1,23	1362	1677,53	CHI
201911173838	DIORAMA	IR10403921	ARENOPOLIS	15/11/2019 15:22	18/11/2019 16:02	15/11/2019 15:22	15/11/2019 15:25	0,05	113	6,12	CHI
201911173838	IPORA	IR10403921	ARENOPOLIS	15/11/2019 15:22	18/11/2019 16:02	15/11/2019 15:22	15/11/2019 15:25	0,05	9	0,49	CHI
201911173838	MONTES CLAROS DE GOIAS	IR10403921	ARENOPOLIS	15/11/2019 15:22	18/11/2019 16:02	15/11/2019 15:22	15/11/2019 15:25	0,05	40	2,17	CHI
201911173838	DIORAMA	IR10403921	ARENOPOLIS	15/11/2019 15:22	18/11/2019 16:02	15/11/2019 15:26	15/11/2019 19:32	4,11	27	110,95	CHI
201911173838	IPORA	IR10403921	ARENOPOLIS	15/11/2019 15:22	18/11/2019 16:02	15/11/2019 15:26	15/11/2019 19:32	4,11	9	36,98	CHI
201911173838	MONTES CLAROS DE GOIAS	IR10403921	ARENOPOLIS	15/11/2019 15:22	18/11/2019 16:02	15/11/2019 15:26	15/11/2019 19:32	4,11	9	36,98	CHI
201911173838	DIORAMA	DI12231269	ARENOPOLIS	15/11/2019 15:22	18/11/2019 16:02	15/11/2019 15:26	16/11/2019 14:02	22,60	86	1943,98	CHI
201911173838	MONTES CLAROS DE GOIAS	DI12231269	ARENOPOLIS	15/11/2019 15:22	18/11/2019 16:02	15/11/2019 15:26	16/11/2019 14:02	22,60	31	700,74	CHI
201911173838	DIORAMA	DI12231254LD	ARENOPOLIS	15/11/2019 15:22	18/11/2019 16:02	16/11/2019 15:07	17/11/2019 12:25	21,29	16	340,72	CHI
201911173838	MONTES CLAROS DE GOIAS	DI12231254LD	ARENOPOLIS	15/11/2019 15:22	18/11/2019 16:02	16/11/2019 15:07	17/11/2019 12:25	21,29	1	21,29	CHI
201911173838	DIORAMA	DI13231246	ARENOPOLIS	15/11/2019 15:22	18/11/2019 16:02	16/11/2019 15:07	18/11/2019 12:13	45,09	3	135,28	CHI
201911173838	MONTES CLAROS DE GOIAS	DI13231246	ARENOPOLIS	15/11/2019 15:22	18/11/2019 16:02	16/11/2019 15:07	18/11/2019 12:13	45,09	1	45,09	CHI
201911173838	DIORAMA	ME13193427	ARENOPOLIS	15/11/2019 15:22	18/11/2019 16:02	16/11/2019 15:07	18/11/2019 15:04	47,94	1	47,94	CHI
201911173838	MONTES CLAROS DE GOIAS	ME13193427	ARENOPOLIS	15/11/2019 15:22	18/11/2019 16:02	16/11/2019 15:07	18/11/2019 15:04	47,94	3	143,81	CHI
201911173838	DIORAMA	DI12188303	ARENOPOLIS	15/11/2019 15:22	18/11/2019 16:02	16/11/2019 15:07	18/11/2019 15:30	48,37	27	1305,98	CHI
201911173838	MONTES CLAROS DE GOIAS	DI12188303	ARENOPOLIS	15/11/2019 15:22	18/11/2019 16:02	16/11/2019 15:07	18/11/2019 15:30	48,37	1	48,37	CHI

201911173838	MONTES CLAROS DE GOIAS	ME12091253	ARENOPOLIS	15/11/2019 15:22	18/11/2019 16:02	16/11/2019 15:07	18/11/2019 16:02	48,91	11	537,98	CHI
201911173839	GOIANIRA	GR11138911	GOIANIRA	15/11/2019 15:41	15/11/2019 18:20	15/11/2019 15:41	15/11/2019 18:20	2,63	6	15,81	CHI
201911173881	TEREZOPOLIS DE GOIAS	TJ11210826	DAIA S2	15/11/2019 15:48	15/11/2019 16:12	15/11/2019 15:48	15/11/2019 16:12	0,39	131	51,45	CHI
201911173884	CORUMBAIBA	CI16411354	VILA CORUMBA	16/11/2019 07:50	16/11/2019 13:21	16/11/2019 07:50	16/11/2019 13:20	5,50	168	923,39	CHI
201911173884	CORUMBAIBA	CI16411367	VILA CORUMBA	16/11/2019 07:50	16/11/2019 13:21	16/11/2019 07:50	16/11/2019 13:21	5,51	198	1090,71	CHI
201911173886	CATALAO	00342144	CATALAO S1	15/11/2019 16:35	16/11/2019 17:10	15/11/2019 16:35	15/11/2019 20:20	3,74	1734	6489,49	CHI
201911173886	GOIANDIRA	00342144	CATALAO S1	15/11/2019 16:35	16/11/2019 17:10	15/11/2019 16:35	15/11/2019 20:20	3,74	78	291,91	CHI
201911173886	OUVIDOR	00342144	CATALAO S1	15/11/2019 16:35	16/11/2019 17:10	15/11/2019 16:35	15/11/2019 20:20	3,74	2	7,48	CHI
201911173886	CATALAO	00342144	CATALAO S1	15/11/2019 16:35	16/11/2019 17:10	15/11/2019 20:21	15/11/2019 21:01	0,67	1489	994,73	CHI
201911173886	OUVIDOR	00342144	CATALAO S1	15/11/2019 16:35	16/11/2019 17:10	15/11/2019 20:21	15/11/2019 21:01	0,67	2	1,34	CHI
201911173886	CATALAO	CT13333748	CATALAO S1	15/11/2019 16:35	16/11/2019 17:10	15/11/2019 16:35	15/11/2019 21:58	5,37	482	2586,87	CHI
201911173886	CATALAO	CT13333748	CATALAO S1	15/11/2019 16:35	16/11/2019 17:10	15/11/2019 20:21	15/11/2019 21:58	1,62	54	87,30	CHI
201911173886	GOIANDIRA	CT13333748	CATALAO S1	15/11/2019 16:35	16/11/2019 17:10	15/11/2019 20:21	15/11/2019 21:58	1,62	17	27,48	CHI
201911173886	CATALAO	00342144	CATALAO S1	15/11/2019 16:35	16/11/2019 17:10	15/11/2019 22:05	15/11/2019 22:10	0,08	1489	124,08	CHI
201911173886	OUVIDOR	00342144	CATALAO S1	15/11/2019 16:35	16/11/2019 17:10	15/11/2019 22:05	15/11/2019 22:10	0,08	2	0,17	CHI
201911173886	CATALAO	00342144	CATALAO S1	15/11/2019 16:35	16/11/2019 17:10	16/11/2019 02:39	16/11/2019 02:56	0,29	1489	434,71	CHI
201911173886	OUVIDOR	00342144	CATALAO S1	15/11/2019 16:35	16/11/2019 17:10	16/11/2019 02:39	16/11/2019 02:56	0,29	2	0,58	CHI
201911173886	CATALAO	00342144	CATALAO S1	15/11/2019 16:35	16/11/2019 17:10	15/11/2019 21:59	16/11/2019 15:53	17,90	494	8842,19	CHI
201911173886	CATALAO	00342144	CATALAO S1	15/11/2019 16:35	16/11/2019 17:10	15/11/2019 22:05	16/11/2019 15:53	17,82	37	659,18	CHI
201911173886	CATALAO	00342144	CATALAO S1	15/11/2019 16:35	16/11/2019 17:10	15/11/2019 22:05	16/11/2019 16:27	18,37	17	312,35	CHI
201911173886	GOIANDIRA	00342144	CATALAO S1	15/11/2019 16:35	16/11/2019 17:10	15/11/2019 22:05	16/11/2019 16:27	18,37	17	312,35	CHI
201911173886	CATALAO	CT13000018	CATALAO S1	15/11/2019 16:35	16/11/2019 17:10	15/11/2019 20:21	16/11/2019 16:49	20,48	198	4054,55	CHI
201911173886	GOIANDIRA	CT13000018	CATALAO S1	15/11/2019 16:35	16/11/2019 17:10	15/11/2019 20:21	16/11/2019 16:49	20,48	61	1249,13	CHI
201911173886	CATALAO	CT12063921	CATALAO S1	15/11/2019 16:35	16/11/2019 17:10	16/11/2019 16:50	16/11/2019 17:10	0,33	12	4,00	CHI
201911173890	CATALAO	05060254	CATALAO S2	15/11/2019 17:02	16/11/2019 12:18	15/11/2019 17:02	15/11/2019 19:36	2,57	30	77,13	CHI
201911173890	CATALAO	05060254	CATALAO S2	15/11/2019 17:02	16/11/2019 12:18	15/11/2019 17:02	15/11/2019 20:25	3,38	495	1673,38	CHI
201911173890	CATALAO	05060254	CATALAO S2	15/11/2019 17:02	16/11/2019 12:18	15/11/2019 17:02	15/11/2019 20:40	3,63	464	1686,51	CHI
201911173890	CATALAO	05060254	CATALAO S2	15/11/2019 17:02	16/11/2019 12:18	15/11/2019 17:02	16/11/2019 12:18	19,28	1	19,28	CHI
201911173891	GOIANIA	GN12347637	REAL S1	15/11/2019 17:07	15/11/2019 18:40	15/11/2019 17:07	15/11/2019 18:40	1,54	118	181,98	CHI
201911173896	CATALAO	00340434	CATALAO S1	15/11/2019 17:08	16/11/2019 21:24	15/11/2019 17:08	15/11/2019 20:14	3,10	24	74,48	CHI
201911173896	GOIANDIRA	00340434	CATALAO S1	15/11/2019 17:08	16/11/2019 21:24	15/11/2019 17:08	15/11/2019 20:14	3,10	11	34,14	CHI
201911173896	CATALAO	00340434	CATALAO S1	15/11/2019 17:08	16/11/2019 21:24	15/11/2019 21:39	15/11/2019 21:53	0,24	24	5,77	CHI
201911173896	GOIANDIRA	00340434	CATALAO S1	15/11/2019 17:08	16/11/2019 21:24	15/11/2019 21:39	15/11/2019 21:53	0,24	11	2,65	CHI

201911173896	GOIANDIRA	CT13203100	CATALAO S1	15/11/2019 17:08	16/11/2019 21:24	15/11/2019 17:08	16/11/2019 00:58	7,85	8	62,79	CHI
201911173896	GOIANDIRA	00340434	CATALAO S1	15/11/2019 17:08	16/11/2019 21:24	15/11/2019 17:08	16/11/2019 01:21	8,22	886	7285,14	CHI
201911173896	ANHANGUERA	00340434	CATALAO S1	15/11/2019 17:08	16/11/2019 21:24	15/11/2019 17:08	16/11/2019 01:32	8,41	574	4826,86	CHI
201911173896	CORUMBAIBA	00340434	CATALAO S1	15/11/2019 17:08	16/11/2019 21:24	15/11/2019 17:08	16/11/2019 01:32	8,41	4	33,64	CHI
201911173896	CUMARI	00340434	CATALAO S1	15/11/2019 17:08	16/11/2019 21:24	15/11/2019 17:08	16/11/2019 01:32	8,41	1208	10158,27	CHI
201911173896	CUMARI	00340434	CATALAO S1	15/11/2019 17:08	16/11/2019 21:24	15/11/2019 17:08	16/11/2019 01:32	8,41	313	2632,07	CHI
201911173896	CUMARI	GD13231562	CATALAO S1	15/11/2019 17:08	16/11/2019 21:24	15/11/2019 17:08	16/11/2019 01:32	8,41	5	42,05	CHI
201911173896	GOIANDIRA	00340434	CATALAO S1	15/11/2019 17:08	16/11/2019 21:24	15/11/2019 17:08	16/11/2019 01:32	8,41	13	109,32	CHI
201911173896	GOIANDIRA	GD13231562	CATALAO S1	15/11/2019 17:08	16/11/2019 21:24	15/11/2019 17:08	16/11/2019 01:32	8,41	35	294,32	CHI
201911173896	NOVA AURORA	00340434	CATALAO S1	15/11/2019 17:08	16/11/2019 21:24	15/11/2019 17:08	16/11/2019 01:32	8,41	1	8,41	CHI
201911173896	CORUMBAIBA	00340434	CATALAO S1	15/11/2019 17:08	16/11/2019 21:24	15/11/2019 17:08	16/11/2019 02:17	9,15	135	1235,25	CHI
201911173896	GOIANDIRA	00340434	CATALAO S1	15/11/2019 17:08	16/11/2019 21:24	15/11/2019 17:08	16/11/2019 02:17	9,15	7	64,05	CHI
201911173896	IPAMERI	00340434	CATALAO S1	15/11/2019 17:08	16/11/2019 21:24	15/11/2019 17:08	16/11/2019 02:17	9,15	15	137,25	CHI
201911173896	MORRINHOS	00340434	CATALAO S1	15/11/2019 17:08	16/11/2019 21:24	15/11/2019 17:08	16/11/2019 02:17	9,15	1	9,15	CHI
201911173896	NOVA AURORA	00340434	CATALAO S1	15/11/2019 17:08	16/11/2019 21:24	15/11/2019 17:08	16/11/2019 02:17	9,15	1112	10174,80	CHI
201911173896	NOVA AURORA	00340434	CATALAO S1	15/11/2019 17:08	16/11/2019 21:24	15/11/2019 17:08	16/11/2019 02:17	9,15	13	118,95	CHI
201911173896	NOVA AURORA	GD13147715	CATALAO S1	15/11/2019 17:08	16/11/2019 21:24	15/11/2019 17:08	16/11/2019 02:17	9,15	3	27,45	CHI
201911173896	CATALAO	00340434	CATALAO S1	15/11/2019 17:08	16/11/2019 21:24	15/11/2019 17:08	16/11/2019 04:46	11,65	40	465,99	CHI
201911173896	GOIANDIRA	00340434	CATALAO S1	15/11/2019 17:08	16/11/2019 21:24	15/11/2019 17:08	16/11/2019 04:46	11,65	556	6477,25	CHI
201911173896	IPAMERI	00340434	CATALAO S1	15/11/2019 17:08	16/11/2019 21:24	15/11/2019 17:08	16/11/2019 04:46	11,65	7	81,55	CHI
201911173896	NOVA AURORA	00340434	CATALAO S1	15/11/2019 17:08	16/11/2019 21:24	15/11/2019 17:08	16/11/2019 04:46	11,65	15	174,75	CHI
201911173896	GOIANDIRA	00340434	CATALAO S1	15/11/2019 17:08	16/11/2019 21:24	15/11/2019 17:08	16/11/2019 05:39	12,53	1259	15778,07	CHI
201911173896	GOIANDIRA	GD13203053	CATALAO S1	15/11/2019 17:08	16/11/2019 21:24	16/11/2019 18:19	16/11/2019 21:24	3,08	52	160,19	CHI
201911173896	CORUMBAIBA	00540436	CATALAO S1	15/11/2019 17:08	16/11/2019 21:24	16/11/2019 02:18	16/11/2019 21:24	19,09	135	2576,89	CHI
201911173896	GOIANDIRA	00540436	CATALAO S1	15/11/2019 17:08	16/11/2019 21:24	16/11/2019 02:18	16/11/2019 21:24	19,09	7	133,62	CHI
201911173896	IPAMERI	00540436	CATALAO S1	15/11/2019 17:08	16/11/2019 21:24	16/11/2019 02:18	16/11/2019 21:24	19,09	15	286,32	CHI
201911173896	MORRINHOS	00540436	CATALAO S1	15/11/2019 17:08	16/11/2019 21:24	16/11/2019 02:18	16/11/2019 21:24	19,09	1	19,09	CHI
201911173896	NOVA AURORA	00540436	CATALAO S1	15/11/2019 17:08	16/11/2019 21:24	16/11/2019 02:18	16/11/2019 21:24	19,09	1112	21225,92	CHI
201911173896	NOVA AURORA	00540436	CATALAO S1	15/11/2019 17:08	16/11/2019 21:24	16/11/2019 02:18	16/11/2019 21:24	19,09	13	248,14	CHI
201911173896	NOVA AURORA	GD13147718	CATALAO S1	15/11/2019 17:08	16/11/2019 21:24	16/11/2019 02:18	16/11/2019 21:24	19,09	3	57,26	CHI
201911173903	ITARUMA	IM12041673	CACHOEIRA ALTA	15/11/2019 12:43	15/11/2019 17:25	15/11/2019 12:43	15/11/2019 17:25	4,70	3	14,09	CHI
201911173907	CRISTALINA	KR21410595	CRISTALINA S2	15/11/2019 12:44	15/11/2019 15:29	15/11/2019 12:44	15/11/2019 15:29	2,75	7	19,25	CHI
201911173913	GOIANIRA	GR11234823	GOIANIRA	15/11/2019 12:45	15/11/2019 15:50	15/11/2019 12:45	15/11/2019 15:50	3,08	43	132,40	CHI

201911173921	TEREZOPOLIS DE GOIAS	TJ11144797	DAIA S2	15/11/2019 12:26	15/11/2019 18:29	15/11/2019 12:26	15/11/2019 18:29	6,04	219	1322,03	CHI
201911173925	CRIXAS	CX12249587	SANTA TEREZINHA	15/11/2019 12:48	15/11/2019 21:58	15/11/2019 12:48	15/11/2019 21:58	9,16	2	18,33	CHI
201911173935	JATAI	JT12324668	JATAI S3	15/11/2019 12:16	15/11/2019 16:59	15/11/2019 12:16	15/11/2019 16:59	4,70	54	253,92	CHI
201911173937	RIO VERDE	630359659	RIO VERDE S1	15/11/2019 12:50	16/11/2019 10:47	15/11/2019 12:50	16/11/2019 10:47	21,95	1	21,95	CHI
201911173947	FORMOSA	VB12262281	ITIQUEIRA	15/11/2019 12:51	15/11/2019 21:40	15/11/2019 12:51	15/11/2019 21:40	8,82	16	141,15	CHI
201911173963	ALEXANIA	AX11146816	ALEXANIA	15/11/2019 10:58	15/11/2019 16:55	15/11/2019 10:58	15/11/2019 16:55	5,95	28	166,52	CHI
201911173974	MINEIROS	1390041119	PARQUE DAS EMAS	15/11/2019 12:54	15/11/2019 18:42	15/11/2019 12:54	15/11/2019 18:42	5,79	1	5,79	CHI
201911173975	CIDADE OCIDENTAL	LZ12060260	MARAJOARA	15/11/2019 12:55	15/11/2019 14:00	15/11/2019 12:55	15/11/2019 14:00	1,08	7	7,56	CHI
201911173978	GOIANIA	GN12151986	MEIA PONTE	15/11/2019 12:38	15/11/2019 14:21	15/11/2019 12:38	15/11/2019 14:21	1,71	542	924,71	CHI
201911173998	JARAGUA	JA21000102	JARAGUA	15/11/2019 12:56	16/11/2019 11:41	15/11/2019 12:56	16/11/2019 11:41	22,74	3	68,23	CHI
201911174001	SAO DOMINGOS	SD12218642	SAO DOMINGOS	15/11/2019 12:57	15/11/2019 15:24	15/11/2019 12:57	15/11/2019 15:24	2,45	80	195,67	CHI
201911174010	GOIANIA	GN12151339	MEIA PONTE	15/11/2019 12:47	15/11/2019 15:27	15/11/2019 12:47	15/11/2019 15:27	2,65	296	784,89	CHI
201911174018	FORMOSA	FA11053597	ITIQUEIRA	15/11/2019 12:58	16/11/2019 12:45	15/11/2019 12:58	16/11/2019 12:45	23,77	6	142,64	CHI
201911174022	GOIANIA	GN11236317	GOYA S2	15/11/2019 12:53	15/11/2019 21:11	15/11/2019 12:53	15/11/2019 21:11	8,30	128	1062,29	CHI
201911174026	GOIANIA	GN11089169	FERROVIARIO S1	15/11/2019 12:51	15/11/2019 15:27	15/11/2019 12:51	15/11/2019 15:27	2,58	120	310,17	CHI
201911174027	GOIANIA	GN11002589	CAMPINAS S2	15/11/2019 12:54	15/11/2019 23:09	15/11/2019 12:54	15/11/2019 23:09	10,25	154	1578,46	CHI
201911174032	GOIANIA	GN12001501	XAVANTES	15/11/2019 12:54	15/11/2019 14:53	15/11/2019 12:54	15/11/2019 14:53	1,98	213	422,27	CHI
201911174033	PORANGATU	PO21145215	PORANGATU	15/11/2019 13:00	15/11/2019 21:48	15/11/2019 13:00	15/11/2019 21:48	8,80	1	8,80	CHI
201911174038	SANTA HELENA DE GOIAS	400036496	IPEGUARI	15/11/2019 13:00	16/11/2019 01:05	15/11/2019 13:00	16/11/2019 01:05	12,07	1	12,07	CHI
201911174039	CRISTIANOPOLIS	CF11020369	CRISTIANOPOLIS	16/11/2019 10:00	16/11/2019 13:59	16/11/2019 10:00	16/11/2019 13:59	3,98	232	923,04	CHI
201911174047	JATAI	RV12279568	CABRIUVA S1	15/11/2019 13:02	16/11/2019 10:34	15/11/2019 13:02	16/11/2019 10:34	21,53	2	43,06	CHI
201911174047	RIO VERDE	RV12279568	CABRIUVA S1	15/11/2019 13:02	16/11/2019 10:34	15/11/2019 13:02	16/11/2019 10:34	21,53	5	107,66	CHI
201911174051	ANAPOLIS	AN21258756	JUNDIAI S2	15/11/2019 13:03	15/11/2019 19:48	15/11/2019 13:03	15/11/2019 19:48	6,75	3	20,24	CHI
201911174054	AGUAS LINDAS DE GOIAS	LA11149831	AGUAS LINDAS DE GOIAS S1	15/11/2019 12:50	15/11/2019 14:26	15/11/2019 12:50	15/11/2019 14:26	1,59	345	548,84	CHI
201911174055	DOVERLANDIA	DV12400429	CAIAPONIA	15/11/2019 12:57	15/11/2019 15:51	15/11/2019 12:57	15/11/2019 15:51	2,90	61	176,61	CHI
201911174062	URUTAI	UT21016917	URUTAI	15/11/2019 13:04	15/11/2019 18:40	15/11/2019 13:04	15/11/2019 18:40	5,59	1	5,59	CHI
201911174063	ADELANDIA	DN11047422	FIRMINOPOLIS S2	15/11/2019 13:04	15/11/2019 16:28	15/11/2019 13:04	15/11/2019 16:28	3,40	89	302,97	CHI
201911174069	FORMOSA	FA12278155	ITIQUEIRA	15/11/2019 12:54	15/11/2019 15:50	15/11/2019 12:54	15/11/2019 15:50	2,92	32	93,41	CHI
201911174069	VILA BOA	FA12278155	ITIQUEIRA	15/11/2019 12:54	15/11/2019 15:50	15/11/2019 12:54	15/11/2019 15:50	2,92	4	11,68	CHI
201911174070	ORIZONA	OZ12143757	PIRES DO RIO S2	15/11/2019 13:05	15/11/2019 15:31	15/11/2019 13:05	15/11/2019 15:31	2,42	39	94,43	CHI
201911174071	SANTO ANTONIO DO DESCOBERTO	2210163621	AGUAS LINDAS DE GOIAS S2	15/11/2019 13:05	15/11/2019 14:30	15/11/2019 13:05	15/11/2019 14:30	1,40	1	1,40	CHI
201911174085	RIO VERDE	RV21159306	CABRIUVA S2	15/11/2019 13:06	16/11/2019 17:25	15/11/2019 13:06	16/11/2019 17:25	28,31	1	28,31	CHI
201911174092	GOIANIA	GN11100964	MEIA PONTE	15/11/2019 12:48	15/11/2019 15:15	15/11/2019 12:48	15/11/2019 15:15	2,44	242	591,49	CHI

201911174094	GOIANIA	GN11002584	MEIA PONTE	15/11/2019 13:02	15/11/2019 16:14	15/11/2019 13:02	15/11/2019 16:14	3,19	82	261,40	CHI
201911174096	RIO VERDE	RV12327024	CABRIUVA S2	15/11/2019 12:57	16/11/2019 11:48	15/11/2019 12:57	16/11/2019 10:05	21,12	3	63,37	CHI
201911174096	RIO VERDE	RV12327024	CABRIUVA S2	15/11/2019 12:57	16/11/2019 11:48	16/11/2019 10:08	16/11/2019 11:10	1,04	2	2,08	CHI
201911174096	RIO VERDE	RV12412027	CABRIUVA S2	15/11/2019 12:57	16/11/2019 11:48	16/11/2019 10:08	16/11/2019 11:48	1,67	1	1,67	CHI
201911174097	SILVANIA	SV21017148	DAIA S2	15/11/2019 13:10	16/11/2019 16:37	15/11/2019 13:10	16/11/2019 16:37	27,45	1	27,45	CHI
201911174098	GOIANIA	GN11041972	FERROVIARIO S1	15/11/2019 12:55	15/11/2019 14:39	15/11/2019 12:55	15/11/2019 14:39	1,73	121	209,13	CHI
201911174103	GOIANESIA	GE12384152	GOIANESIA S2	15/11/2019 12:52	15/11/2019 20:58	15/11/2019 12:52	15/11/2019 20:58	8,10	3	24,31	CHI
201911174105	GOIANIA	GN11001266	CAMPINAS S1	15/11/2019 13:06	15/11/2019 13:52	15/11/2019 13:06	15/11/2019 13:52	0,76	133	101,38	CHI
201911174106	AGUAS LINDAS DE GOIAS	4830101375	AGUAS LINDAS DE GOIAS S1	15/11/2019 13:11	15/11/2019 16:39	15/11/2019 13:11	15/11/2019 16:39	3,47	1	3,47	CHI
201911174109	AMARALINA	MU12060988	MARA ROSA	15/11/2019 12:40	15/11/2019 15:50	15/11/2019 12:40	15/11/2019 15:50	3,15	141	444,27	CHI
201911174109	MUTUNOPOLIS	MU12060988	MARA ROSA	15/11/2019 12:40	15/11/2019 15:50	15/11/2019 12:40	15/11/2019 15:50	3,15	30	94,52	CHI
201911174110	NEROPOLIS	NR21324580	NEROPOLIS S2	15/11/2019 13:12	16/11/2019 03:04	15/11/2019 13:12	16/11/2019 03:04	13,88	2	27,76	CHI
201911174114	RIO VERDE	RV12260123	CABRIUVA S1	15/11/2019 13:12	17/11/2019 20:40	15/11/2019 13:12	16/11/2019 16:11	26,99	3	80,96	CHI
201911174114	RIO VERDE	RV12260695	CABRIUVA S1	15/11/2019 13:12	17/11/2019 20:40	15/11/2019 13:12	17/11/2019 20:40	55,47	14	776,54	CHI
201911174121	GOIANIA	GN11002099	FERROVIARIO S3	15/11/2019 12:58	15/11/2019 16:10	15/11/2019 12:58	15/11/2019 16:10	3,20	97	309,94	CHI
201911174124	ALTO PARAISO DE GOIAS	BF12231960	NIQUELANDIA SUBTRANSMISSAO	15/11/2019 13:05	15/11/2019 14:28	15/11/2019 13:05	15/11/2019 14:28	1,38	20	27,59	CHI
201911174130	BONFINOPOLIS	BO12060486	DAIA S2	15/11/2019 12:50	15/11/2019 22:13	15/11/2019 12:50	15/11/2019 22:13	9,37	15	140,52	CHI
201911174130	GOIANAPOLIS	BO12060486	DAIA S2	15/11/2019 12:50	15/11/2019 22:13	15/11/2019 12:50	15/11/2019 22:13	9,37	10	93,68	CHI
201911174134	MINACU	IH12328091	MINACU	15/11/2019 12:44	15/11/2019 20:05	15/11/2019 12:44	15/11/2019 20:05	7,34	8	58,73	CHI
201911174137	NEROPOLIS	NR12000048	NEROPOLIS S2	15/11/2019 13:06	15/11/2019 19:59	15/11/2019 13:06	15/11/2019 19:59	6,88	16	110,08	CHI
201911174140	SAO FRANCISCO DE GOIAS	490011160	SAO FRANCISCO DE GOIAS	15/11/2019 13:16	16/11/2019 10:19	15/11/2019 13:16	16/11/2019 10:19	21,04	1	21,04	CHI
201911174145	GOIANIA	GN11150303	GOYA S2	15/11/2019 12:39	15/11/2019 14:51	15/11/2019 12:39	15/11/2019 14:51	2,19	160	350,58	CHI
201911174147	GOIANIA	10012094461	INDEPENDENCIA S2	15/11/2019 13:17	15/11/2019 17:03	15/11/2019 13:17	15/11/2019 17:03	3,76	1	3,76	CHI
201911174150	SILVANIA	SV21324247	VIANOPOLIS	15/11/2019 13:17	15/11/2019 20:55	15/11/2019 13:17	15/11/2019 20:55	7,62	5	38,11	CHI
201911174166	GOIANIA	13011054	CAMPINAS S3	15/11/2019 13:19	15/11/2019 15:33	15/11/2019 13:19	15/11/2019 15:33	2,23	1	2,23	CHI
201911174172	SILVANIA	SV21161973	VIANOPOLIS	15/11/2019 13:19	15/11/2019 19:25	15/11/2019 13:19	15/11/2019 19:25	6,09	2	12,17	CHI
201911174173	NEROPOLIS	NR12000051	NEROPOLIS S2	15/11/2019 12:34	15/11/2019 20:52	15/11/2019 12:34	15/11/2019 20:52	8,30	25	207,44	CHI
201911174173	OURO VERDE DE GOIAS	NR12000051	NEROPOLIS S2	15/11/2019 12:34	15/11/2019 20:52	15/11/2019 12:34	15/11/2019 20:52	8,30	107	887,86	CHI
201911174177	DIORAMA	DI12188336	IPORA	15/11/2019 13:20	16/11/2019 14:17	15/11/2019 13:20	16/11/2019 14:17	24,95	1	24,95	CHI
201911174178	DOVERLANDIA	DV21156577	CAIAPONIA	15/11/2019 13:20	18/11/2019 17:20	15/11/2019 13:20	18/11/2019 17:20	75,99	1	75,99	CHI
201911174179	MONTE ALEGRE DE GOIAS	MA12208683	SAO DOMINGOS	15/11/2019 12:47	15/11/2019 18:18	15/11/2019 12:47	15/11/2019 17:32	4,75	222	1053,64	CHI
201911174179	NOVA ROMA	MA12208683	SAO DOMINGOS	15/11/2019 12:47	15/11/2019 18:18	15/11/2019 12:47	15/11/2019 17:32	4,75	55	261,04	CHI
201911174179	CAVALCANTE	MA12236749LD	SAO DOMINGOS	15/11/2019 12:47	15/11/2019 18:18	15/11/2019 12:47	15/11/2019 18:18	5,52	169	932,22	CHI

201911174179	MONTE ALEGRE DE GOIAS	MA12236749LD	SAO DOMINGOS	15/11/2019 12:47	15/11/2019 18:18	15/11/2019 12:47	15/11/2019 18:18	5,52	214	1180,45	CHI
201911174181	PALMEIRAS DE GOIAS	590017330	PALMEIRAS	15/11/2019 13:20	15/11/2019 22:50	15/11/2019 13:20	15/11/2019 22:50	9,50	1	9,50	CHI
201911174184	PIRACANJUBA	BV12036142	BELA VISTA S1	15/11/2019 12:21	15/11/2019 21:31	15/11/2019 12:21	15/11/2019 21:31	9,16	87	797,28	CHI
201911174186	LUZIANIA	LZ11349238	VIANOPOLIS	15/11/2019 13:20	15/11/2019 18:03	15/11/2019 13:20	15/11/2019 18:03	4,70	3	14,11	CHI
201911174187	BELA VISTA DE GOIAS	BV21010759	BELA VISTA S1	15/11/2019 13:20	16/11/2019 09:34	15/11/2019 13:20	16/11/2019 09:34	20,22	1	20,22	CHI
201911174208	GOIANIA	GN11001284	FERROVIARIO S3	15/11/2019 10:57	15/11/2019 15:11	15/11/2019 10:57	15/11/2019 15:11	4,22	88	371,16	CHI
201911174214	GOIANIA	12846958	GOYA S2	15/11/2019 13:25	15/11/2019 17:32	15/11/2019 13:25	15/11/2019 17:32	4,11	1	4,11	CHI
201911174215	APORE	AE21348898	ITAJA S1	15/11/2019 13:25	16/11/2019 13:25	15/11/2019 13:25	16/11/2019 13:25	23,99	1	23,99	CHI
201911174216	GOIANIA	GN11024529	REAL S1	15/11/2019 13:10	15/11/2019 16:21	15/11/2019 13:10	15/11/2019 16:21	3,17	109	345,83	CHI
201911174226	GOIANIA	GN12000545	CAMPINAS S3	15/11/2019 13:26	15/11/2019 14:40	15/11/2019 13:26	15/11/2019 14:40	1,22	301	366,38	CHI
201911174227	GOIANIA	GN12133722	GOIANIA LESTE S2	15/11/2019 13:27	15/11/2019 19:15	15/11/2019 13:27	15/11/2019 19:15	5,80	4	23,18	CHI
201911174229	GOIANIA	10282970	CAMPINAS S2	15/11/2019 13:27	15/11/2019 16:56	15/11/2019 13:27	15/11/2019 16:56	3,48	1	3,48	CHI
201911174307	LEOPOLDO DE BULHOES	LB12322348	DAIA S2	15/11/2019 12:49	17/11/2019 15:43	15/11/2019 12:49	16/11/2019 10:30	21,69	15	325,28	CHI
201911174307	LEOPOLDO DE BULHOES	LB31270661	DAIA S2	15/11/2019 12:49	17/11/2019 15:43	15/11/2019 12:49	17/11/2019 15:43	50,91	1	50,91	CHI
201911174308	MINACU	IH11205609	MINACU	15/11/2019 13:30	16/11/2019 08:24	15/11/2019 13:30	16/11/2019 08:24	18,90	2	37,79	CHI
201911174312	COLINAS DO SUL	9700008611	NIQUELANDIA SUBTRANSMISSAO	15/11/2019 13:30	15/11/2019 18:36	15/11/2019 13:30	15/11/2019 18:36	5,09	1	5,09	CHI
201911174313	INHUMAS	IX12016404	INHUMAS S1	15/11/2019 12:27	15/11/2019 17:51	15/11/2019 12:27	15/11/2019 17:51	5,39	1	5,39	CHI
201911174313	ITAUCU	IX12016404	INHUMAS S1	15/11/2019 12:27	15/11/2019 17:51	15/11/2019 12:27	15/11/2019 17:51	5,39	4	21,56	CHI
201911174314	BONFINOPOLIS	BO12265380	CEPAIGO S2	15/11/2019 12:56	15/11/2019 16:44	15/11/2019 12:56	15/11/2019 16:44	3,79	17	64,35	CHI
201911174315	CEZARINA	CZ12099664	GUAPO S2	15/11/2019 13:31	15/11/2019 18:12	15/11/2019 13:31	15/11/2019 18:12	4,69	75	351,40	CHI
201911174315	INDIARA	CZ12099664	GUAPO S2	15/11/2019 13:31	15/11/2019 18:12	15/11/2019 13:31	15/11/2019 18:12	4,69	1	4,69	CHI
201911174321	GOIANIA	10001131794	FERROVIARIO S1	15/11/2019 13:32	15/11/2019 14:22	15/11/2019 13:32	15/11/2019 14:22	0,83	1	0,83	CHI
201911174329	NOVA VENEZA	NV12010268	INHUMAS S1	15/11/2019 13:33	16/11/2019 10:29	15/11/2019 13:33	16/11/2019 10:29	20,92	16	334,71	CHI
201911174331	GOIANIA	14363525	GOYA S2	15/11/2019 13:34	15/11/2019 17:10	15/11/2019 13:34	15/11/2019 17:10	3,60	1	3,60	CHI
201911174336	ANAPOLIS	20956435	ANAPOLIS UNIVERSITARIO S2	15/11/2019 13:35	15/11/2019 15:14	15/11/2019 13:35	15/11/2019 15:14	1,65	1	1,65	CHI
201911174338	DAMOLANDIA	DL21272298	INHUMAS S1	15/11/2019 13:35	16/11/2019 07:41	15/11/2019 13:35	16/11/2019 07:41	18,10	2	36,19	CHI
201911174339	ANAPOLIS	AN21258661	ANAPOLIS UNIVERSITARIO S2	15/11/2019 13:35	16/11/2019 19:36	15/11/2019 13:35	16/11/2019 19:36	30,01	1	30,01	CHI
201911174348	NIQUELANDIA	NQ21067959	URUACU	15/11/2019 13:37	15/11/2019 23:44	15/11/2019 13:37	15/11/2019 23:44	10,11	1	10,11	CHI
201911174350	JARAGUA	JA12044169	JARAGUA	15/11/2019 13:18	15/11/2019 14:51	15/11/2019 13:18	15/11/2019 14:51	1,53	225	345,19	CHI
201911174351	GOIANIA	GN11040692	FERROVIARIO S2	15/11/2019 13:28	15/11/2019 15:38	15/11/2019 13:28	15/11/2019 15:38	2,15	76	163,46	CHI
201911174359	GOIANIA	GN11151320	SENADOR CANEDO	15/11/2019 13:20	15/11/2019 16:00	15/11/2019 13:20	15/11/2019 16:00	2,65	185	490,97	CHI
201911174360	SENADOR CANEDO	SW11054753	SENADOR CANEDO	15/11/2019 13:39	15/11/2019 16:10	15/11/2019 13:39	15/11/2019 16:10	2,51	136	341,28	CHI
201911174362	GOIANIA	GN12050431	GOIANIA LESTE S2	15/11/2019 13:22	15/11/2019 15:15	15/11/2019 13:22	15/11/2019 15:15	1,88	325	610,46	CHI

201911174366	CALDAS NOVAS	CN12186158	CALDAS NOVAS S2	15/11/2019 12:57	15/11/2019 15:56	15/11/2019 12:57	15/11/2019 15:56	2,97	97	288,39	CHI
201911174372	CALDAS NOVAS	CN11298788	SERRA DE CALDAS	15/11/2019 11:29	15/11/2019 14:50	15/11/2019 11:29	15/11/2019 14:50	3,34	5	16,68	CHI
201911174374	CRISTALINA	IP12165527	CRISTALINA S1	15/11/2019 13:41	15/11/2019 15:26	15/11/2019 13:41	15/11/2019 15:26	1,75	14	24,55	CHI
201911174376	VIANOPOLIS	VN12194266	VIANOPOLIS	15/11/2019 13:41	15/11/2019 17:39	15/11/2019 13:41	15/11/2019 17:39	3,96	5	19,79	CHI
201911174378	COCALZINHO DE GOIAS	10021044528	COCALZINHO	15/11/2019 13:41	16/11/2019 20:27	15/11/2019 13:41	16/11/2019 20:27	30,76	1	30,76	CHI
201911174388	CRISTIANOPOLIS	CF12000002RE	CRISTIANOPOLIS	15/11/2019 12:29	16/11/2019 19:58	15/11/2019 12:29	15/11/2019 17:16	4,77	16	76,36	CHI
201911174388	CRISTIANOPOLIS	CF13326576	CRISTIANOPOLIS	15/11/2019 12:29	16/11/2019 19:58	15/11/2019 12:29	16/11/2019 19:58	31,47	42	1321,70	CHI
201911174388	PIRACANJUBA	CF13326576	CRISTIANOPOLIS	15/11/2019 12:29	16/11/2019 19:58	15/11/2019 12:29	16/11/2019 19:58	31,47	149	4688,91	CHI
201911174392	INDIARA	IY12010960	EDEIA	15/11/2019 13:33	15/11/2019 15:15	15/11/2019 13:33	15/11/2019 15:15	1,70	19	32,36	CHI
201911174393	ANAPOLIS	AN12077949	ANAPOLIS UNIVERSITARIO S2	15/11/2019 17:44	15/11/2019 18:24	15/11/2019 17:44	15/11/2019 18:24	0,67	390	261,41	CHI
201911174402	RIO QUENTE	RQ11249799	RIO QUENTE	15/11/2019 09:38	15/11/2019 17:34	15/11/2019 09:38	15/11/2019 17:34	7,93	17	134,84	CHI
201911174422	GOIANIA	12836588	MEIA PONTE	15/11/2019 13:47	15/11/2019 16:55	15/11/2019 13:47	15/11/2019 16:55	3,13	1	3,13	CHI
201911174424	NIQUELANDIA	NQ12257447	BARRO ALTO	15/11/2019 12:33	16/11/2019 15:58	15/11/2019 12:33	16/11/2019 15:58	27,40	2	54,80	CHI
201911174425	JATAI	290175033	JATAI S3	15/11/2019 13:47	15/11/2019 18:15	15/11/2019 13:47	15/11/2019 18:15	4,46	1	4,46	CHI
201911174428	GOIANIA	GN11001446	GOIANIA LESTE S2	15/11/2019 13:46	15/11/2019 17:07	15/11/2019 13:46	15/11/2019 17:07	3,35	10	33,49	CHI
201911174429	JARAGUA	JA12298117	JARAGUA	15/11/2019 13:47	16/11/2019 09:19	15/11/2019 13:47	16/11/2019 09:19	19,52	3	58,55	CHI
201911174429	PIRENOPOLIS	JA12298117	JARAGUA	15/11/2019 13:47	16/11/2019 09:19	15/11/2019 13:47	16/11/2019 09:19	19,52	20	390,35	CHI
201911174439	GOIANIA	GN11001371	CAMPINAS S1	15/11/2019 13:45	15/11/2019 17:20	15/11/2019 13:45	15/11/2019 17:20	3,57	80	285,78	CHI
201911174446	MONTES CLAROS DE GOIAS	ME12334949	IPORA	15/11/2019 09:58	16/11/2019 10:36	15/11/2019 09:58	16/11/2019 10:36	24,63	7	172,40	CHI
201911174450	AGUAS LINDAS DE GOIAS	10009255158	AGUAS LINDAS DE GOIAS S1	15/11/2019 13:51	15/11/2019 15:46	15/11/2019 13:51	15/11/2019 15:46	1,91	1	1,91	CHI
201911174453	GOIANIA	AP11169101	INDEPENDENCIA S2	15/11/2019 13:18	15/11/2019 18:48	15/11/2019 13:18	15/11/2019 18:48	5,50	86	473,02	CHI
201911174454	SENADOR CANEDO	SW11161111	SENADOR CANEDO	15/11/2019 13:21	15/11/2019 16:44	15/11/2019 13:21	15/11/2019 16:44	3,38	175	591,35	CHI
201911174468	COLINAS DO SUL	TI12156244RE	MINACU	15/11/2019 12:00	15/11/2019 17:29	15/11/2019 12:00	15/11/2019 17:29	5,47	66	361,08	CHI
201911174469	CAIAPONIA	CP12158231	CAIAPONIA	15/11/2019 13:53	16/11/2019 13:18	15/11/2019 13:53	16/11/2019 13:18	23,41	2	46,81	CHI
201911174478	SAO FRANCISCO DE GOIAS	SF12248837	SAO FRANCISCO DE GOIAS	15/11/2019 13:54	16/11/2019 09:22	15/11/2019 13:54	16/11/2019 09:22	19,46	4	77,83	CHI
201911174481	FORMOSA	FA12149075	ITUIQUIRA	15/11/2019 13:55	17/11/2019 10:12	15/11/2019 13:55	17/11/2019 10:12	44,28	5	221,40	CHI
201911174489	CAIAPONIA	CP12269004	CAIAPONIA	15/11/2019 13:56	16/11/2019 15:16	15/11/2019 13:56	16/11/2019 15:16	25,32	4	101,29	CHI
201911174491	GOIANIA	16213610	MEIA PONTE	15/11/2019 13:56	15/11/2019 16:32	15/11/2019 13:56	15/11/2019 16:32	2,59	1	2,59	CHI
201911174496	ANAPOLIS	AN11090382	ANAPOLIS UNIVERSITARIO S1	15/11/2019 13:31	15/11/2019 16:06	15/11/2019 13:31	15/11/2019 16:06	2,57	171	439,04	CHI
201911174497	CRISTALINA	KR12068384	PAMPLONA	15/11/2019 13:57	16/11/2019 12:07	15/11/2019 13:57	16/11/2019 12:07	22,17	28	620,67	CHI
201911174498	ANAPOLIS	21065342	ANAPOLIS UNIVERSITARIO S1	15/11/2019 13:57	15/11/2019 18:07	15/11/2019 13:57	15/11/2019 18:07	4,16	1	4,16	CHI
201911174503	CRISTALINA	KR12206728	PAMPLONA	15/11/2019 13:57	15/11/2019 17:26	15/11/2019 13:57	15/11/2019 17:26	3,48	133	463,32	CHI
201911174504	SENADOR CANEDO	SW11246299	SENADOR CANEDO	15/11/2019 13:46	15/11/2019 15:25	15/11/2019 13:46	15/11/2019 15:25	1,65	124	204,53	CHI

201911174507	CATURAI	CK21018894	INHUMAS S1	15/11/2019 13:58	16/11/2019 11:05	15/11/2019 13:58	16/11/2019 11:05	21,11	1	21,11	CHI
201911174511	SAO MIGUEL DO ARAGUAIA	SM12393978	SAO MIGUEL DO ARAGUAIA	15/11/2019 13:39	15/11/2019 17:12	15/11/2019 13:39	15/11/2019 17:12	3,55	59	209,66	CHI
201911174513	ARAGOIANIA	03500216	GUAPO S2	15/11/2019 13:49	15/11/2019 16:04	15/11/2019 13:49	15/11/2019 16:04	2,24	1415	3175,50	CHI
201911174513	HIDROLANDIA	03500216	GUAPO S2	15/11/2019 13:49	15/11/2019 16:04	15/11/2019 13:49	15/11/2019 16:04	2,24	110	246,86	CHI
201911174513	MAIRIPOTABA	03500216	GUAPO S2	15/11/2019 13:49	15/11/2019 16:04	15/11/2019 13:49	15/11/2019 16:04	2,24	2	4,49	CHI
201911174513	VARJAO	03500216	GUAPO S2	15/11/2019 13:49	15/11/2019 16:04	15/11/2019 13:49	15/11/2019 16:04	2,24	70	157,09	CHI
201911174519	ITABERAI	IB12274525	ITABERAI S1	15/11/2019 13:59	16/11/2019 08:45	15/11/2019 13:59	16/11/2019 08:45	18,77	6	112,62	CHI
201911174524	APARECIDA DE GOIANIA	AP11150297	INDEPENDENCIA S2	15/11/2019 13:37	15/11/2019 19:33	15/11/2019 13:37	15/11/2019 19:33	5,92	23	136,24	CHI
201911174526	NOVO GAMA	4990108669	PACAEMBU S1	15/11/2019 14:00	15/11/2019 16:20	15/11/2019 14:00	15/11/2019 16:20	2,33	1	2,33	CHI
201911174527	AMORINOPOLIS	AM12000021	IPORA	15/11/2019 12:57	15/11/2019 16:28	15/11/2019 12:57	15/11/2019 16:28	3,52	63	222,04	CHI
201911174532	HIDROLANDIA	02200234	CEPAIGO S2	15/11/2019 13:59	15/11/2019 22:25	15/11/2019 13:59	15/11/2019 19:44	5,75	1	5,75	CHI
201911174532	BELA VISTA DE GOIAS	02200234	CEPAIGO S2	15/11/2019 13:59	15/11/2019 22:25	15/11/2019 13:59	15/11/2019 20:48	6,82	1	6,82	CHI
201911174532	HIDROLANDIA	02200234	CEPAIGO S2	15/11/2019 13:59	15/11/2019 22:25	15/11/2019 13:59	15/11/2019 20:48	6,82	640	4367,29	CHI
201911174532	HIDROLANDIA	02200234	CEPAIGO S2	15/11/2019 13:59	15/11/2019 22:25	15/11/2019 13:59	15/11/2019 21:59	8,00	8	63,98	CHI
201911174532	BELA VISTA DE GOIAS	02200234	CEPAIGO S2	15/11/2019 13:59	15/11/2019 22:25	15/11/2019 13:59	15/11/2019 22:25	8,43	8	67,43	CHI
201911174532	HIDROLANDIA	02200234	CEPAIGO S2	15/11/2019 13:59	15/11/2019 22:25	15/11/2019 13:59	15/11/2019 22:25	8,43	266	2241,94	CHI
201911174538	SAO FRANCISCO DE GOIAS	SF12211814	SAO FRANCISCO DE GOIAS	15/11/2019 13:53	15/11/2019 15:10	15/11/2019 13:53	15/11/2019 15:10	1,28	14	17,90	CHI
201911174543	FORMOSA	FA12071048	ITUIQUIRA	15/11/2019 13:54	15/11/2019 15:34	15/11/2019 13:54	15/11/2019 15:34	1,66	14	23,26	CHI
201911174552	GOIANIA	13420343	GOIANIA LESTE S3	15/11/2019 14:02	15/11/2019 21:08	15/11/2019 14:02	15/11/2019 21:08	7,09	1	7,09	CHI
201911174556	TEREZOPOLIS DE GOIAS	TJ12193124	DAIA S2	15/11/2019 12:18	15/11/2019 16:20	15/11/2019 12:18	15/11/2019 16:20	4,03	306	1232,16	CHI
201911174559	GOIANIA	11473370	GOIANIA LESTE S2	15/11/2019 14:03	15/11/2019 17:46	15/11/2019 14:03	15/11/2019 17:46	3,71	1	3,71	CHI
201911174562	TRINDADE	TR21053503	TRINDADE	15/11/2019 14:03	15/11/2019 16:08	15/11/2019 14:03	15/11/2019 16:08	2,07	1	2,07	CHI
201911174567	DAMOLANDIA	OV12272462	INHUMAS S1	15/11/2019 12:49	15/11/2019 22:26	15/11/2019 12:49	15/11/2019 22:26	9,61	3	28,83	CHI
201911174567	NEROPOLIS	OV12272462	INHUMAS S1	15/11/2019 12:49	15/11/2019 22:26	15/11/2019 12:49	15/11/2019 22:26	9,61	2	19,22	CHI
201911174567	NOVA VENEZA	OV12272462	INHUMAS S1	15/11/2019 12:49	15/11/2019 22:26	15/11/2019 12:49	15/11/2019 22:26	9,61	19	182,62	CHI
201911174567	OURO VERDE DE GOIAS	OV12272462	INHUMAS S1	15/11/2019 12:49	15/11/2019 22:26	15/11/2019 12:49	15/11/2019 22:26	9,61	19	182,62	CHI
201911174578	GOIANIA	GN11150492	GOYA S2	15/11/2019 12:59	15/11/2019 15:16	15/11/2019 12:59	15/11/2019 15:16	2,28	157	358,13	CHI
201911174580	ANAPOLIS	AN11000137	ANAPOLIS UNIVERSITARIO S2	15/11/2019 13:22	16/11/2019 22:32	15/11/2019 13:22	15/11/2019 15:26	2,06	91	187,61	CHI
201911174580	ANAPOLIS	AN11000137	ANAPOLIS UNIVERSITARIO S2	15/11/2019 13:22	16/11/2019 22:32	16/11/2019 21:05	16/11/2019 22:32	1,46	91	132,48	CHI
201911174581	CAIAPONIA	CP12370955	MONTIVIDIU T	15/11/2019 14:06	17/11/2019 10:50	15/11/2019 14:06	17/11/2019 10:50	44,73	2	89,46	CHI
201911174591	TRINDADE	TR11129538	GOYA S2	15/11/2019 13:33	16/11/2019 00:38	15/11/2019 13:33	16/11/2019 00:38	11,07	65	719,62	CHI
201911174593	CRISTALINA	KR21328927	CRISTALINA S1	15/11/2019 14:06	15/11/2019 15:46	15/11/2019 14:06	15/11/2019 15:46	1,65	1	1,65	CHI
201911174596	ARUANA	AK12066603	ARUANA	15/11/2019 14:07	16/11/2019 12:17	15/11/2019 14:07	16/11/2019 12:17	22,16	4	88,65	CHI

201911174618	LUZIANIA	LZ21086762	VIANOPOLIS	15/11/2019 14:09	15/11/2019 18:32	15/11/2019 14:09	15/11/2019 18:32	4,37	1	4,37	CHI
201911174631	ARAGARCAS	1820026854	ARAGARCAS	15/11/2019 14:09	15/11/2019 17:33	15/11/2019 14:09	15/11/2019 17:33	3,38	1	3,38	CHI
201911174635	FORMOSA	FA11397668	ITUIQUIRA	15/11/2019 14:10	15/11/2019 16:59	15/11/2019 14:10	15/11/2019 16:59	2,81	1	2,81	CHI
201911174644	PIRES DO RIO	PR12337219	PIRES DO RIO S1	15/11/2019 14:01	15/11/2019 16:17	15/11/2019 14:01	15/11/2019 16:17	2,25	4	9,01	CHI
201911174648	CRISTALINA	KR12389576	CRISTALINA S2	15/11/2019 13:53	15/11/2019 15:47	15/11/2019 13:53	15/11/2019 15:47	1,89	7	13,25	CHI
201911174649	PIRACANJUBA	PJ12000096	PIRACANJUBA	15/11/2019 14:10	18/11/2019 10:00	15/11/2019 14:10	18/11/2019 10:00	67,83	32	2170,48	CHI
201911174652	IACIARA	IA12000006	IACIARA S1	15/11/2019 14:11	15/11/2019 15:04	15/11/2019 14:11	15/11/2019 15:04	0,88	3	2,63	CHI
201911174663	PIRENOPOLIS	PV12273422	CORUMBA	15/11/2019 14:10	15/11/2019 16:10	15/11/2019 14:10	15/11/2019 16:10	1,99	6	11,94	CHI
201911174664	ANAPOLIS	AN12288618	JUNDIAI S2	15/11/2019 13:59	15/11/2019 15:13	15/11/2019 13:59	15/11/2019 15:13	1,23	89	109,32	CHI
201911174665	PIRENOPOLIS	PV11057878	CORUMBA	15/11/2019 14:13	15/11/2019 20:06	15/11/2019 14:13	15/11/2019 20:06	5,88	150	881,92	CHI
201911174668	ABADIANIA	AX12258506	ALEXANIA	15/11/2019 13:15	16/11/2019 00:53	15/11/2019 13:15	16/11/2019 00:53	11,62	6	69,73	CHI
201911174668	ALEXANIA	AX12258506	ALEXANIA	15/11/2019 13:15	16/11/2019 00:53	15/11/2019 13:15	16/11/2019 00:53	11,62	44	511,34	CHI
201911174671	BOM JARDIM DE GOIAS	PH12041074	PIRANHAS	15/11/2019 19:05	16/11/2019 03:09	15/11/2019 19:05	16/11/2019 03:09	8,05	13	104,71	CHI
201911174671	PIRANHAS	PH12041074	PIRANHAS	15/11/2019 19:05	16/11/2019 03:09	15/11/2019 19:05	16/11/2019 03:09	8,05	33	265,81	CHI
201911174672	GOIANIA	GN11161503	REAL S1	15/11/2019 13:20	15/11/2019 15:46	15/11/2019 13:20	15/11/2019 15:46	2,42	101	244,81	CHI
201911174673	NOVA CRIXAS	NA21115417	NOVA CRIXAS	15/11/2019 14:14	16/11/2019 12:14	15/11/2019 14:14	16/11/2019 12:14	21,99	1	21,99	CHI
201911174687	PALMEIRAS DE GOIAS	PL12076534	PALMEIRAS	15/11/2019 13:19	15/11/2019 19:35	15/11/2019 13:19	15/11/2019 19:35	6,26	7	43,83	CHI
201911174694	GOIANIA	GN21232704	GOIANIA LESTE S1	15/11/2019 14:16	15/11/2019 19:38	15/11/2019 14:16	15/11/2019 19:38	5,36	1	5,36	CHI
201911174705	PIRACANJUBA	PJ12000104	CALDAS NOVAS S1	15/11/2019 14:16	18/11/2019 16:21	15/11/2019 14:16	18/11/2019 16:21	74,09	12	889,05	CHI
201911174718	MINACU	IH21129785	MINACU	15/11/2019 14:17	17/11/2019 10:21	15/11/2019 14:17	17/11/2019 10:21	44,06	1	44,06	CHI
201911174730	LUZIANIA	LZ11090128	RIO VERMELHO	15/11/2019 14:03	15/11/2019 16:32	15/11/2019 14:03	15/11/2019 16:32	2,47	159	393,44	CHI
201911174732	SANTA TEREZINHA DE GOIAS	10009778274	SANTA TEREZINHA	15/11/2019 14:18	15/11/2019 16:47	15/11/2019 14:18	15/11/2019 16:47	2,48	1	2,48	CHI
201911174733	GOIANIA	11879567	MEIA PONTE	15/11/2019 14:18	15/11/2019 16:55	15/11/2019 14:18	15/11/2019 16:55	2,62	1	2,62	CHI
201911174737	PIRENOPOLIS	PV12316020	CORUMBA	15/11/2019 13:40	17/11/2019 23:05	15/11/2019 13:40	16/11/2019 11:20	21,66	6	129,95	CHI
201911174737	PIRENOPOLIS	PV12316020	CORUMBA	15/11/2019 13:40	17/11/2019 23:05	15/11/2019 13:40	17/11/2019 23:05	57,42	8	459,36	CHI
201911174737	PIRENOPOLIS	PV12316020	CORUMBA	15/11/2019 13:40	17/11/2019 23:05	17/11/2019 21:08	17/11/2019 23:05	1,95	6	11,69	CHI
201911174743	JARAGUA	JA12059976	JARAGUA	15/11/2019 13:55	16/11/2019 17:04	15/11/2019 13:55	16/11/2019 17:04	27,16	2	54,32	CHI
201911174743	PIRENOPOLIS	JA12059976	JARAGUA	15/11/2019 13:55	16/11/2019 17:04	15/11/2019 13:55	16/11/2019 17:04	27,16	97	2634,39	CHI
201911174755	BALIZA	BH21228520	BOM JARDIM	15/11/2019 14:20	15/11/2019 21:23	15/11/2019 14:20	15/11/2019 21:23	7,05	2	14,10	CHI
201911174766	BRAZABRANTES	BR21219100	INHUMAS S1	15/11/2019 14:21	15/11/2019 17:04	15/11/2019 14:21	15/11/2019 17:04	2,72	1	2,72	CHI
201911174767	SAO MIGUEL DO ARAGUAIA	SM21208440	SAO MIGUEL DO ARAGUAIA	15/11/2019 14:21	15/11/2019 18:10	15/11/2019 14:21	15/11/2019 18:10	3,82	1	3,82	CHI
201911174785	PORANGATU	PO12391930	PORANGATU	15/11/2019 11:11	17/11/2019 14:39	15/11/2019 11:11	16/11/2019 09:28	22,29	28	624,17	CHI
201911174785	PORANGATU	PO12391930	PORANGATU	15/11/2019 11:11	17/11/2019 14:39	15/11/2019 11:11	16/11/2019 17:43	30,54	14	427,59	CHI

201911174785	PORANGATU	PO13371099	PORANGATU	15/11/2019 11:11	17/11/2019 14:39	15/11/2019 11:11	16/11/2019 17:43	30,54	1	30,54	CHI
201911174785	PORANGATU	PO13371099	PORANGATU	15/11/2019 11:11	17/11/2019 14:39	16/11/2019 08:41	16/11/2019 17:43	9,04	2	18,07	CHI
201911174785	PORANGATU	PO12391930	PORANGATU	15/11/2019 11:11	17/11/2019 14:39	17/11/2019 09:55	17/11/2019 11:33	1,65	47	77,34	CHI
201911174785	PORANGATU	PO12391930	PORANGATU	15/11/2019 11:11	17/11/2019 14:39	15/11/2019 11:11	17/11/2019 13:03	49,87	6	299,21	CHI
201911174785	PORANGATU	PO12391930	PORANGATU	15/11/2019 11:11	17/11/2019 14:39	15/11/2019 11:11	17/11/2019 14:39	51,48	3	154,43	CHI
201911174789	AGUAS LINDAS DE GOIAS	10012436788	AGUAS LINDAS DE GOIAS S1	15/11/2019 14:23	15/11/2019 16:20	15/11/2019 14:23	15/11/2019 16:20	1,94	1	1,94	CHI
201911174795	PIRENOPOLIS	PV11258177	CORUMBA	15/11/2019 13:56	15/11/2019 21:07	15/11/2019 13:56	15/11/2019 21:07	7,17	85	609,52	CHI
201911174799	GOIANIA	GN11213713	XAVANTES	15/11/2019 14:06	15/11/2019 17:06	15/11/2019 14:06	15/11/2019 17:06	3,00	92	275,57	CHI
201911174801	JATAI	JT12196245	JATAI S1	15/11/2019 14:25	15/11/2019 22:21	15/11/2019 14:25	15/11/2019 22:21	7,92	4	31,69	CHI
201911174802	SENADOR CANEDO	SW12079685	CEPAIGO S2	15/11/2019 14:25	15/11/2019 16:54	15/11/2019 14:25	15/11/2019 16:54	2,47	7	17,29	CHI
201911174807	ANAPOLIS	AN12285315	ANAPOLIS UNIVERSITARIO S2	15/11/2019 14:26	15/11/2019 18:59	15/11/2019 14:26	15/11/2019 18:59	4,56	15	68,38	CHI
201911174816	CRISTALINA	KR11206723	PAMPLONA	15/11/2019 14:21	16/11/2019 11:23	15/11/2019 14:21	16/11/2019 11:23	21,03	100	2102,56	CHI
201911174841	ALEXANIA	AX12377762RE	ALEXANIA	15/11/2019 13:11	16/11/2019 10:56	15/11/2019 13:11	16/11/2019 10:56	21,74	36	782,69	CHI
201911174841	CORUMBA DE GOIAS	AX12377762RE	ALEXANIA	15/11/2019 13:11	16/11/2019 10:56	15/11/2019 13:11	16/11/2019 10:56	21,74	5	108,71	CHI
201911174843	SILVANIA	660055200	VIANOPOLIS	15/11/2019 14:29	15/11/2019 18:09	15/11/2019 14:29	15/11/2019 18:09	3,67	1	3,67	CHI
201911174852	CRISTALINA	KR10400735	MARAJOARA	15/11/2019 14:18	16/11/2019 18:47	15/11/2019 14:18	15/11/2019 15:52	1,57	1	1,57	CHI
201911174852	LUZIANIA	KR10400735	MARAJOARA	15/11/2019 14:18	16/11/2019 18:47	15/11/2019 14:18	15/11/2019 15:52	1,57	98	153,56	CHI
201911174852	LUZIANIA	01090414	MARAJOARA	15/11/2019 14:18	16/11/2019 18:47	15/11/2019 14:18	15/11/2019 19:18	4,99	1	4,99	CHI
201911174852	LUZIANIA	01090414	MARAJOARA	15/11/2019 14:18	16/11/2019 18:47	15/11/2019 14:18	15/11/2019 20:40	6,36	14	89,03	CHI
201911174852	LUZIANIA	01090414	MARAJOARA	15/11/2019 14:18	16/11/2019 18:47	15/11/2019 14:18	15/11/2019 20:52	6,56	240	1575,07	CHI
201911174852	LUZIANIA	01090414	MARAJOARA	15/11/2019 14:18	16/11/2019 18:47	15/11/2019 20:53	15/11/2019 21:02	0,17	15	2,48	CHI
201911174852	LUZIANIA	01090414	MARAJOARA	15/11/2019 14:18	16/11/2019 18:47	15/11/2019 21:58	15/11/2019 22:06	0,14	15	2,06	CHI
201911174852	LUZIANIA	LZ10408031	MARAJOARA	15/11/2019 14:18	16/11/2019 18:47	15/11/2019 20:53	15/11/2019 23:10	2,30	183	420,49	CHI
201911174852	LUZIANIA	LZ13282756	MARAJOARA	15/11/2019 14:18	16/11/2019 18:47	15/11/2019 20:53	16/11/2019 02:09	5,28	51	269,31	CHI
201911174852	LUZIANIA	LZ13282756	MARAJOARA	15/11/2019 14:18	16/11/2019 18:47	15/11/2019 20:53	16/11/2019 11:32	14,66	6	87,93	CHI
201911174852	LUZIANIA	01090414	MARAJOARA	15/11/2019 14:18	16/11/2019 18:47	15/11/2019 14:18	16/11/2019 14:17	23,98	10	239,78	CHI
201911174852	CRISTALINA	6177612	MARAJOARA	15/11/2019 14:18	16/11/2019 18:47	16/11/2019 18:44	16/11/2019 18:47	0,06	1	0,06	CHI
201911174852	LUZIANIA	6177612	MARAJOARA	15/11/2019 14:18	16/11/2019 18:47	16/11/2019 18:44	16/11/2019 18:47	0,06	344	20,16	CHI
201911174856	CALDAS NOVAS	CN12363765	CALDAS NOVAS S1	15/11/2019 14:31	16/11/2019 20:16	15/11/2019 14:31	16/11/2019 20:16	29,75	18	535,45	CHI
201911174862	ACREUNA	TD12025721	RIO DOS BOIS	15/11/2019 14:31	16/11/2019 12:15	15/11/2019 14:31	15/11/2019 17:40	3,15	15	47,30	CHI
201911174862	TURVELANDIA	TD12025721	RIO DOS BOIS	15/11/2019 14:31	16/11/2019 12:15	15/11/2019 14:31	15/11/2019 17:40	3,15	19	59,91	CHI
201911174862	ACREUNA	TD12025721	RIO DOS BOIS	15/11/2019 14:31	16/11/2019 12:15	15/11/2019 16:54	15/11/2019 17:40	0,78	2	1,56	CHI
201911174862	TURVELANDIA	TD12025721	RIO DOS BOIS	15/11/2019 14:31	16/11/2019 12:15	15/11/2019 16:54	15/11/2019 17:40	0,78	15	11,70	CHI

201911174862	ACREUNA	EU12317009	RIO DOS BOIS	15/11/2019 14:31	16/11/2019 12:15	15/11/2019 14:31	16/11/2019 12:15	21,73	3	65,18	CHI
201911174873	LUZIANIA	LZ21237823	VIANOPOLIS	15/11/2019 14:32	16/11/2019 01:02	15/11/2019 14:32	16/11/2019 01:02	10,48	2	20,97	CHI
201911174874	BELA VISTA DE GOIAS	BV12131458	BELA VISTA S1	15/11/2019 14:18	15/11/2019 16:15	15/11/2019 14:18	15/11/2019 16:15	1,94	52	101,10	CHI
201911174900	AMORINOPOLIS	IV12390141	IPORA	15/11/2019 14:28	18/11/2019 12:28	15/11/2019 14:28	15/11/2019 22:40	8,20	5	40,99	CHI
201911174900	IVOLANDIA	IV12390141	IPORA	15/11/2019 14:28	18/11/2019 12:28	15/11/2019 14:28	15/11/2019 22:40	8,20	32	262,35	CHI
201911174900	IVOLANDIA	IV12390141	IPORA	15/11/2019 14:28	18/11/2019 12:28	15/11/2019 14:28	16/11/2019 09:49	19,35	18	348,37	CHI
201911174900	IVOLANDIA	IV12390141	IPORA	15/11/2019 14:28	18/11/2019 12:28	15/11/2019 14:28	16/11/2019 15:21	24,88	10	248,84	CHI
201911174900	AMORINOPOLIS	IV12390141	IPORA	15/11/2019 14:28	18/11/2019 12:28	16/11/2019 15:24	16/11/2019 16:32	1,12	5	5,62	CHI
201911174900	IVOLANDIA	IV12390141	IPORA	15/11/2019 14:28	18/11/2019 12:28	16/11/2019 15:24	16/11/2019 16:32	1,12	50	56,15	CHI
201911174900	IVOLANDIA	IV12207850LD	IPORA	15/11/2019 14:28	18/11/2019 12:28	16/11/2019 15:22	17/11/2019 20:10	28,79	4	115,16	CHI
201911174900	IVOLANDIA	IV12236564	IPORA	15/11/2019 14:28	18/11/2019 12:28	16/11/2019 15:22	17/11/2019 21:05	29,72	6	178,33	CHI
201911174900	IVOLANDIA	IV12236564	IPORA	15/11/2019 14:28	18/11/2019 12:28	17/11/2019 21:09	17/11/2019 22:26	1,29	5	6,43	CHI
201911174900	IVOLANDIA	IV12236564	IPORA	15/11/2019 14:28	18/11/2019 12:28	17/11/2019 22:27	18/11/2019 11:19	12,87	3	38,62	CHI
201911174900	IVOLANDIA	IV12242724LD	IPORA	15/11/2019 14:28	18/11/2019 12:28	17/11/2019 21:09	18/11/2019 11:58	14,81	1	14,81	CHI
201911174900	IVOLANDIA	IV12364575LD	IPORA	15/11/2019 14:28	18/11/2019 12:28	17/11/2019 22:27	18/11/2019 12:28	14,02	2	28,04	CHI
201911174903	GOIANIA	GN11001922	CARAJAS S1	15/11/2019 13:34	15/11/2019 17:03	15/11/2019 13:34	15/11/2019 17:03	3,47	100	347,28	CHI
201911174912	CORUMBA DE GOIAS	CB12065715	CORUMBA	15/11/2019 14:21	15/11/2019 18:16	15/11/2019 14:21	15/11/2019 18:16	3,91	8	31,29	CHI
201911174915	ALVORADA DO NORTE	AQ12257608	FLORES DE GOIAS	15/11/2019 14:36	15/11/2019 18:38	15/11/2019 14:36	15/11/2019 18:38	4,02	10	40,18	CHI
201911174915	IACIARA	AQ12257608	FLORES DE GOIAS	15/11/2019 14:36	15/11/2019 18:38	15/11/2019 14:36	15/11/2019 18:38	4,02	4	16,07	CHI
201911174915	POSSE	AQ12257608	FLORES DE GOIAS	15/11/2019 14:36	15/11/2019 18:38	15/11/2019 14:36	15/11/2019 18:38	4,02	2	8,04	CHI
201911174919	BRAZABRANTES	IN12009604	INHUMAS S1	15/11/2019 14:37	15/11/2019 20:17	15/11/2019 14:37	15/11/2019 20:17	5,66	2	11,33	CHI
201911174919	INHUMAS	IN12009604	INHUMAS S1	15/11/2019 14:37	15/11/2019 20:17	15/11/2019 14:37	15/11/2019 20:17	5,66	11	62,31	CHI
201911174923	CALDAS NOVAS	00320416	CALDAS NOVAS S1	15/11/2019 14:31	17/11/2019 10:15	15/11/2019 14:31	16/11/2019 03:47	13,27	1	13,27	CHI
201911174923	CALDAS NOVAS	00320416	CALDAS NOVAS S1	15/11/2019 14:31	17/11/2019 10:15	15/11/2019 14:31	16/11/2019 03:47	13,27	5	66,34	CHI
201911174923	CALDAS NOVAS	CN13182952	CALDAS NOVAS S1	15/11/2019 14:31	17/11/2019 10:15	15/11/2019 14:31	16/11/2019 03:47	13,27	253	3356,82	CHI
201911174923	PIRACANJUBA	00320416	CALDAS NOVAS S1	15/11/2019 14:31	17/11/2019 10:15	15/11/2019 14:31	16/11/2019 03:47	13,27	154	2043,28	CHI
201911174923	PIRACANJUBA	00320416	CALDAS NOVAS S1	15/11/2019 14:31	17/11/2019 10:15	15/11/2019 14:31	16/11/2019 03:47	13,27	74	981,84	CHI
201911174923	PIRACANJUBA	CN13182952	CALDAS NOVAS S1	15/11/2019 14:31	17/11/2019 10:15	15/11/2019 14:31	16/11/2019 03:47	13,27	1	13,27	CHI
201911174923	SANTA CRUZ DE GOIAS	00320416	CALDAS NOVAS S1	15/11/2019 14:31	17/11/2019 10:15	15/11/2019 14:31	16/11/2019 03:47	13,27	1	13,27	CHI
201911174923	PIRACANJUBA	00320416	PIRACANJUBA	15/11/2019 14:31	17/11/2019 10:15	15/11/2019 14:31	16/11/2019 03:47	13,27	65	862,42	CHI
201911174923	CALDAS NOVAS	00320416	CALDAS NOVAS S1	15/11/2019 14:31	17/11/2019 10:15	16/11/2019 03:48	16/11/2019 05:00	1,21	8	9,68	CHI
201911174923	CALDAS NOVAS	CN13214040	CALDAS NOVAS S1	15/11/2019 14:31	17/11/2019 10:15	15/11/2019 14:31	16/11/2019 14:12	23,68	28	663,15	CHI
201911174923	CALDAS NOVAS	CN13182952	CALDAS NOVAS S1	15/11/2019 14:31	17/11/2019 10:15	16/11/2019 20:48	16/11/2019 23:00	2,20	36	79,12	CHI

201911174923	CALDAS NOVAS	00320416	CALDAS NOVAS S1	15/11/2019 14:31	17/11/2019 10:15	16/11/2019 03:48	17/11/2019 07:56	28,13	238	6695,73	CHI
201911174923	CALDAS NOVAS	00320416	CALDAS NOVAS S1	15/11/2019 14:31	17/11/2019 10:15	16/11/2019 03:48	17/11/2019 08:30	28,70	1	28,70	CHI
201911174923	CALDAS NOVAS	00320416	CALDAS NOVAS S1	15/11/2019 14:31	17/11/2019 10:15	16/11/2019 03:48	17/11/2019 08:30	28,70	5	143,50	CHI
201911174923	CALDAS NOVAS	00320416	CALDAS NOVAS S1	15/11/2019 14:31	17/11/2019 10:15	16/11/2019 03:48	17/11/2019 08:30	28,70	7	200,90	CHI
201911174923	PIRACANJUBA	00320416	CALDAS NOVAS S1	15/11/2019 14:31	17/11/2019 10:15	16/11/2019 03:48	17/11/2019 08:30	28,70	154	4419,84	CHI
201911174923	PIRACANJUBA	00320416	CALDAS NOVAS S1	15/11/2019 14:31	17/11/2019 10:15	16/11/2019 03:48	17/11/2019 08:30	28,70	74	2123,82	CHI
201911174923	PIRACANJUBA	00320416	CALDAS NOVAS S1	15/11/2019 14:31	17/11/2019 10:15	16/11/2019 03:48	17/11/2019 08:30	28,70	1	28,70	CHI
201911174923	SANTA CRUZ DE GOIAS	00320416	CALDAS NOVAS S1	15/11/2019 14:31	17/11/2019 10:15	16/11/2019 03:48	17/11/2019 08:30	28,70	1	28,70	CHI
201911174923	PIRACANJUBA	00320416	PIRACANJUBA	15/11/2019 14:31	17/11/2019 10:15	16/11/2019 03:48	17/11/2019 08:30	28,70	65	1865,52	CHI
201911174923	CALDAS NOVAS	CN12213873	CALDAS NOVAS S2	15/11/2019 14:31	17/11/2019 10:15	16/11/2019 23:01	17/11/2019 10:15	11,23	8	89,87	CHI
201911174928	ANAPOLIS	AN11382443	ANAPOLIS UNIVERSITARIO S2	15/11/2019 13:58	15/11/2019 18:05	15/11/2019 13:58	15/11/2019 18:05	4,11	50	205,74	CHI
201911174932	LUZIANIA	LZ12097148	RIO VERMELHO	15/11/2019 14:38	15/11/2019 16:14	15/11/2019 14:38	15/11/2019 16:14	1,59	32	50,75	CHI
201911174935	LUZIANIA	120269971	RIO VERMELHO	15/11/2019 14:39	16/11/2019 02:50	15/11/2019 14:39	16/11/2019 02:50	12,18	1	12,18	CHI
201911174951	TEREZOPOLIS DE GOIAS	GP12302305	JUNDIAI S1	15/11/2019 14:39	15/11/2019 16:54	15/11/2019 14:39	15/11/2019 16:54	2,24	2	4,48	CHI
201911174952	FORMOSA	FA21211683	ITUIQUIRA	15/11/2019 14:39	16/11/2019 18:52	15/11/2019 14:39	16/11/2019 18:52	28,21	2	56,41	CHI
201911174957	GOIANIA	11830141	REAL S1	15/11/2019 14:40	16/11/2019 14:11	15/11/2019 14:40	16/11/2019 14:11	23,51	1	23,51	CHI
201911174959	JARAGUA	JA11140591	JARAGUA	15/11/2019 14:39	15/11/2019 15:15	15/11/2019 14:39	15/11/2019 15:15	0,60	134	79,92	CHI
201911174962	AGUAS LINDAS DE GOIAS	LA11099951	AGUAS LINDAS DE GOIAS S1	15/11/2019 13:18	15/11/2019 16:45	15/11/2019 13:18	15/11/2019 16:45	3,44	54	185,50	CHI
201911174963	ITABERAI	IB12066172	ITABERAI S1	15/11/2019 14:41	15/11/2019 16:45	15/11/2019 14:41	15/11/2019 16:45	2,07	13	26,85	CHI
201911174967	LUZIANIA	LZ12376191	RIO VERMELHO	15/11/2019 14:41	15/11/2019 21:35	15/11/2019 14:41	15/11/2019 21:35	6,89	6	41,35	CHI
201911174969	ANICUNS	AC21000048	ANICUNS	15/11/2019 14:41	15/11/2019 15:51	15/11/2019 14:41	15/11/2019 15:51	1,15	1	1,15	CHI
201911174976	PLANALTINA	2960118930	PLANALTINA	15/11/2019 14:42	15/11/2019 16:44	15/11/2019 14:42	15/11/2019 16:44	2,03	1	2,03	CHI
201911174987	GOIANIA	GN11170635	GOIANIA LESTE S2	15/11/2019 13:41	16/11/2019 00:42	15/11/2019 13:41	16/11/2019 00:42	11,01	74	814,66	CHI
201911174988	VARJAO	VJ21129140	GUAPO S2	15/11/2019 14:42	16/11/2019 12:49	15/11/2019 14:42	16/11/2019 12:49	22,10	1	22,10	CHI
201911174995	VIANOPOLIS	VN21103702	VIANOPOLIS	15/11/2019 14:43	15/11/2019 18:51	15/11/2019 14:43	15/11/2019 18:51	4,12	1	4,12	CHI
201911174999	CATURAI	IN12376878	ARACU	15/11/2019 14:43	16/11/2019 11:30	15/11/2019 14:43	16/11/2019 11:30	20,77	3	62,32	CHI
201911175003	INHUMAS	IN13000020	INHUMAS S2	15/11/2019 15:21	15/11/2019 17:32	15/11/2019 16:36	15/11/2019 16:57	0,36	2264	806,24	CHI
201911175003	INHUMAS	IN11040751	INHUMAS S2	15/11/2019 15:21	15/11/2019 17:32	15/11/2019 15:21	15/11/2019 17:32	2,19	92	201,12	CHI
201911175028	ANAPOLIS	AN12000074	JUNDIAI S2	15/11/2019 14:45	15/11/2019 16:18	15/11/2019 14:45	15/11/2019 16:18	1,54	182	280,58	CHI
201911175036	GOIANIA	GN11060859	CARAJAS S1	15/11/2019 14:35	15/11/2019 16:47	15/11/2019 14:35	15/11/2019 16:47	2,19	57	124,96	CHI
201911175043	TRINDADE	TR11095981	MEIA PONTE	15/11/2019 14:47	15/11/2019 18:55	15/11/2019 14:47	15/11/2019 18:55	4,13	168	694,31	CHI
201911175044	GOIANIA	GN11147725	MEIA PONTE	15/11/2019 13:50	15/11/2019 17:14	15/11/2019 13:50	15/11/2019 17:14	3,39	176	596,54	CHI
201911175045	LUZIANIA	LZ11351325	MARAJOARA	15/11/2019 14:46	15/11/2019 16:03	15/11/2019 14:46	15/11/2019 16:03	1,27	13	16,55	CHI

201911175047	INHUMAS	IN21125343	INHUMAS S1	15/11/2019 12:41	16/11/2019 11:59	15/11/2019 12:41	16/11/2019 11:59	23,29	1	23,29	CHI
201911175051	AGUA FRIA DE GOIAS	TL21242866	SAO JOAO D ALIANCA	15/11/2019 14:48	15/11/2019 20:06	15/11/2019 14:48	15/11/2019 20:06	5,30	2	10,60	CHI
201911175054	JATAI	JT12060140LD	JATAI S2	15/11/2019 12:46	16/11/2019 00:30	15/11/2019 12:46	16/11/2019 00:30	11,73	179	2099,17	CHI
201911175054	JATAI	JT12060140LD	JATAI S2	15/11/2019 12:46	16/11/2019 00:30	15/11/2019 21:38	16/11/2019 00:30	2,85	540	1541,55	CHI
201911175061	ITUMBIARA	IT11091623	ITUMBIARA NOVA	15/11/2019 14:34	15/11/2019 21:41	15/11/2019 14:34	15/11/2019 21:41	7,12	195	1389,10	CHI
201911175068	NIQUELANDIA	2750002121	NIQUELANDIA SUBTRANSMISSAO	15/11/2019 14:50	15/11/2019 22:44	15/11/2019 14:50	15/11/2019 22:44	7,90	1	7,90	CHI
201911175088	VIANOPOLIS	VN12060845	VIANOPOLIS	15/11/2019 14:51	16/11/2019 11:24	15/11/2019 14:51	16/11/2019 11:24	20,54	2	41,09	CHI
201911175092	BELA VISTA DE GOIAS	BV21097964	BELA VISTA S1	15/11/2019 14:51	16/11/2019 11:54	15/11/2019 14:51	16/11/2019 11:54	21,04	3	63,12	CHI
201911175093	BELA VISTA DE GOIAS	240059074	BELA VISTA S2	15/11/2019 14:51	15/11/2019 19:02	15/11/2019 14:51	15/11/2019 19:02	4,17	1	4,17	CHI
201911175105	ANAPOLIS	10024620910	ANAPOLIS UNIVERSITARIO S2	15/11/2019 14:52	16/11/2019 08:03	15/11/2019 14:52	16/11/2019 08:03	17,17	1	17,17	CHI
201911175130	PALMEIRAS DE GOIAS	PL12086232	PALMEIRAS	15/11/2019 14:36	16/11/2019 09:45	15/11/2019 14:36	16/11/2019 09:45	19,16	6	114,97	CHI
201911175131	JANDAIA	JD12046344	PALMEIRAS	15/11/2019 08:26	15/11/2019 21:58	15/11/2019 08:26	15/11/2019 21:58	13,52	5	67,61	CHI
201911175132	JARAGUA	JA11000029	JARAGUA	15/11/2019 13:10	15/11/2019 18:05	15/11/2019 13:10	15/11/2019 18:05	4,90	94	460,65	CHI
201911175153	RIO VERDE	630045112	RIO VERDE S1	15/11/2019 14:56	16/11/2019 15:57	15/11/2019 14:56	16/11/2019 15:57	25,02	1	25,02	CHI
201911175157	SANTA HELENA DE GOIAS	400053342	IPEGUARI	15/11/2019 14:56	15/11/2019 23:10	15/11/2019 14:56	15/11/2019 23:10	8,23	1	8,23	CHI
201911175181	ITUMBIARA	BG12384533	ITUMBIARA VELHA S2	15/11/2019 10:54	16/11/2019 12:11	15/11/2019 10:54	16/11/2019 12:11	25,28	35	884,92	CHI
201911175184	ANAPOLIS	20010035	JUNDIAI S1	15/11/2019 14:58	15/11/2019 16:34	15/11/2019 14:58	15/11/2019 16:34	1,60	1	1,60	CHI
201911175187	TRES RANCHOS	TH12131071	CATALAO S1	15/11/2019 13:44	15/11/2019 17:23	15/11/2019 13:44	15/11/2019 17:23	3,64	14	50,98	CHI
201911175194	ALOANDIA	AD12013446	GOIATUBA S1	15/11/2019 14:17	16/11/2019 00:00	15/11/2019 14:17	16/11/2019 00:00	9,71	9	87,35	CHI
201911175194	PONTALINA	AD12013446	GOIATUBA S1	15/11/2019 14:17	16/11/2019 00:00	15/11/2019 14:17	16/11/2019 00:00	9,71	13	126,17	CHI
201911175207	PIRES DO RIO	OZ12022847	PIRES DO RIO S2	15/11/2019 15:00	15/11/2019 20:30	15/11/2019 15:00	15/11/2019 20:30	5,50	9	49,48	CHI
201911175208	GOIANIA	AP11169102	INDEPENDENCIA S2	15/11/2019 13:12	15/11/2019 19:42	15/11/2019 13:12	15/11/2019 19:42	6,49	27	175,36	CHI
201911175213	CAVALCANTE	TI12295044RE	MINACU	15/11/2019 13:46	15/11/2019 21:48	15/11/2019 13:46	15/11/2019 21:48	8,02	22	176,48	CHI
201911175213	COLINAS DO SUL	TI12295044RE	MINACU	15/11/2019 13:46	15/11/2019 21:48	15/11/2019 13:46	15/11/2019 21:48	8,02	5	40,11	CHI
201911175214	PIRACANJUBA	01620514	ROCHEDO	15/11/2019 14:48	15/11/2019 16:41	15/11/2019 14:48	15/11/2019 16:41	1,88	48	90,40	CHI
201911175214	PIRACANJUBA	01620514	ROCHEDO	15/11/2019 14:48	15/11/2019 16:41	15/11/2019 14:48	15/11/2019 16:41	1,88	309	581,95	CHI
201911175214	PROFESSOR JAMIL SAFADY	01620514	ROCHEDO	15/11/2019 14:48	15/11/2019 16:41	15/11/2019 14:48	15/11/2019 16:41	1,88	25	47,08	CHI
201911175228	SAO SIMAO	SO11371242	CACHOEIRA ALTA	15/11/2019 15:01	15/11/2019 19:10	15/11/2019 15:01	15/11/2019 19:10	4,14	49	202,96	CHI
201911175259	MOZARLANDIA	MZ12058538	MOZARLANDIA	15/11/2019 15:04	15/11/2019 17:10	15/11/2019 15:04	15/11/2019 17:10	2,09	8	16,72	CHI
201911175269	CABECEIRAS	CW11206145	ITUIQUIRA	15/11/2019 14:17	15/11/2019 18:27	15/11/2019 14:17	15/11/2019 18:27	4,17	122	509,25	CHI
201911175274	MINEIROS	MY12064642	PARQUE DAS EMAS	15/11/2019 14:28	15/11/2019 21:45	15/11/2019 14:28	15/11/2019 21:45	7,27	162	1177,38	CHI
201911175275	SANTO ANTONIO DO DESCOBERTO	SN12085981	MARAJOARA	15/11/2019 15:06	15/11/2019 20:11	15/11/2019 15:06	15/11/2019 20:11	5,07	25	126,80	CHI
201911175277	PONTALINA	PK12249930	PONTALINA	15/11/2019 14:27	16/11/2019 09:01	15/11/2019 14:27	16/11/2019 09:01	18,56	8	148,50	CHI

201911175278	GOIATUBA	GT12052882	GOIATUBA S1	15/11/2019 15:01	16/11/2019 11:54	15/11/2019 15:01	16/11/2019 11:54	20,88	28	584,59	CHI
201911175280	PONTALINA	PK12047209	PONTALINA	15/11/2019 14:33	16/11/2019 08:00	15/11/2019 14:33	16/11/2019 08:00	17,44	12	209,23	CHI
201911175286	LUZIANIA	LZ12389577	VIANOPOLIS	15/11/2019 15:08	16/11/2019 09:28	15/11/2019 15:08	16/11/2019 09:28	18,33	3	54,99	CHI
201911175294	GOIANIA	GN11041237	GOIANIA LESTE S3	15/11/2019 13:40	15/11/2019 17:43	15/11/2019 13:40	15/11/2019 17:43	4,04	164	661,97	CHI
201911175501	EDEALINA	1130006752	PONTALINA	16/11/2019 14:53	16/11/2019 20:13	16/11/2019 14:53	16/11/2019 20:13	5,34	1	5,34	CHI
201911175506	FORMOSA	FA12204612	ITUIQUIRA	15/11/2019 14:29	15/11/2019 19:26	15/11/2019 14:29	15/11/2019 19:26	4,95	12	59,41	CHI
201911175509	GOIANIA	10588310	ATLANTICO S3	15/11/2019 15:11	15/11/2019 18:21	15/11/2019 15:11	15/11/2019 18:21	3,15	1	3,15	CHI
201911175522	ABADIA DE GOIAS	AO11049430	INDEPENDENCIA S2	15/11/2019 14:57	15/11/2019 19:05	15/11/2019 14:57	15/11/2019 19:05	4,13	19	78,49	CHI
201911175535	SENADOR CANEDO	SW21317419	SENADOR CANEDO	15/11/2019 15:14	19/11/2019 15:49	15/11/2019 15:14	19/11/2019 15:49	96,58	3	289,75	CHI
201911175545	BRITANIA	BT21360140	BRITANIA	15/11/2019 15:16	15/11/2019 18:10	15/11/2019 15:16	15/11/2019 18:10	2,90	1	2,90	CHI
201911175546	ORIZONA	OZ11172789	PIRES DO RIO S2	15/11/2019 15:16	15/11/2019 16:36	15/11/2019 15:16	15/11/2019 16:36	1,33	74	98,15	CHI
201911175564	GOIANIA	16276954	MEIA PONTE	15/11/2019 15:18	16/11/2019 10:39	15/11/2019 15:18	16/11/2019 10:39	19,34	1	19,34	CHI
201911175574	URUACU	UR21243624	URUACU	15/11/2019 15:19	15/11/2019 17:36	15/11/2019 15:19	15/11/2019 17:36	2,27	2	4,54	CHI
201911175579	SENADOR CANEDO	16653890	GOIANIA LESTE S1	15/11/2019 15:20	16/11/2019 14:33	15/11/2019 15:20	16/11/2019 14:33	23,22	1	23,22	CHI
201911175583	GOIANAPOLIS	TJ12388821	DAIA S2	15/11/2019 13:22	16/11/2019 00:38	15/11/2019 13:22	16/11/2019 00:38	11,28	3	33,84	CHI
201911175589	GOIANAPOLIS	TJ11073013	DAIA S2	15/11/2019 13:01	15/11/2019 20:41	15/11/2019 13:01	15/11/2019 20:41	7,66	84	643,51	CHI
201911175603	MONTIVIDIU DO NORTE	PO12094115	PORANGATU	15/11/2019 15:19	15/11/2019 19:06	15/11/2019 15:19	15/11/2019 19:06	3,78	5	18,88	CHI
201911175603	PORANGATU	PO12094115	PORANGATU	15/11/2019 15:19	15/11/2019 19:06	15/11/2019 15:19	15/11/2019 19:06	3,78	70	264,35	CHI
201911175606	CACU	CC12125875	CACHOEIRA ALTA	15/11/2019 14:49	16/11/2019 14:46	15/11/2019 14:49	16/11/2019 14:46	23,94	2	47,87	CHI
201911175619	ANAPOLIS	AN12000235	ANAPOLIS UNIVERSITARIO S2	15/11/2019 15:01	15/11/2019 20:57	15/11/2019 15:01	15/11/2019 20:57	5,94	109	647,55	CHI
201911175627	TEREZOPOLIS DE GOIAS	TJ12075859	DAIA S2	15/11/2019 13:52	15/11/2019 17:04	15/11/2019 13:52	15/11/2019 17:04	3,19	371	1183,59	CHI
201911175635	ANAPOLIS	AN11288606	JUNDIAI S2	15/11/2019 15:26	15/11/2019 17:43	15/11/2019 15:26	15/11/2019 17:43	2,28	12	27,31	CHI
201911175640	ANAPOLIS	00050254	ANAPOLIS UNIVERSITARIO S1	15/11/2019 15:18	15/11/2019 15:43	15/11/2019 15:18	15/11/2019 15:39	0,34	7321	2525,74	CHI
201911175640	ANAPOLIS	AN10383408	ANAPOLIS UNIVERSITARIO S1	15/11/2019 15:18	15/11/2019 15:43	15/11/2019 15:18	15/11/2019 15:42	0,40	4232	1689,27	CHI
201911175640	ANAPOLIS	AN16405458	ANAPOLIS UNIVERSITARIO S1	15/11/2019 15:18	15/11/2019 15:43	15/11/2019 15:18	15/11/2019 15:42	0,41	1470	603,11	CHI
201911175640	ANAPOLIS	AN16402632	ANAPOLIS UNIVERSITARIO S1	15/11/2019 15:18	15/11/2019 15:43	15/11/2019 15:18	15/11/2019 15:43	0,42	2151	906,41	CHI
201911175640	ANAPOLIS	AN16402633	ANAPOLIS UNIVERSITARIO S1	15/11/2019 15:18	15/11/2019 15:43	15/11/2019 15:18	15/11/2019 15:43	0,43	872	372,30	CHI
201911175643	PALMEIRAS DE GOIAS	PL12124132	PALMEIRAS	15/11/2019 14:46	15/11/2019 16:54	15/11/2019 14:46	15/11/2019 16:54	2,13	9	19,18	CHI
201911175665	APARECIDA DE GOIANIA	AP11079021	INDEPENDENCIA S1	15/11/2019 14:32	15/11/2019 19:20	15/11/2019 14:32	15/11/2019 19:20	4,79	83	397,64	CHI
201911175681	JARAGUA	JA12161736	JARAGUA	15/11/2019 14:36	15/11/2019 16:18	15/11/2019 14:36	15/11/2019 16:18	1,69	229	387,77	CHI
201911175689	NOVO GAMA	2460064210	PACAEMBU S1	15/11/2019 15:30	15/11/2019 17:10	15/11/2019 15:30	15/11/2019 17:10	1,66	1	1,66	CHI
201911175690	PIRANHAS	PH12204964	PIRANHAS	15/11/2019 15:30	15/11/2019 21:15	15/11/2019 15:30	15/11/2019 21:15	5,74	5	28,71	CHI
201911175700	CRISTALINA	KR12349171	PAMPLONA	15/11/2019 15:31	16/11/2019 09:49	15/11/2019 15:31	16/11/2019 09:49	18,30	1	18,30	CHI

201911175700	LUZIANIA	KR12349171	PAMPLONA	15/11/2019 15:31	16/11/2019 09:49	15/11/2019 15:31	16/11/2019 09:49	18,30	32	585,49	CHI
201911175729	ARAGARCAS	AG21152383	ARAGARCAS	15/11/2019 15:33	16/11/2019 16:19	15/11/2019 15:33	16/11/2019 16:19	24,77	1	24,77	CHI
201911175768	CORUMBA DE GOIAS	CB12203650	ALEXANIA	15/11/2019 15:36	16/11/2019 17:42	15/11/2019 15:36	16/11/2019 17:42	26,08	3	78,25	CHI
201911175769	BELA VISTA DE GOIAS	BV12068885	BELA VISTA S1	15/11/2019 15:28	15/11/2019 18:57	15/11/2019 15:28	15/11/2019 18:57	3,48	17	59,15	CHI
201911175771	IACIARA	1550004879	IACIARA S1	15/11/2019 15:37	15/11/2019 17:21	15/11/2019 15:37	15/11/2019 17:21	1,73	1	1,73	CHI
201911175787	CAIAPONIA	DV12023480	CAIAPONIA	16/11/2019 06:28	16/11/2019 20:10	16/11/2019 06:28	16/11/2019 20:10	13,69	48	657,31	CHI
201911175787	DOVERLANDIA	DV12023480	CAIAPONIA	16/11/2019 06:28	16/11/2019 20:10	16/11/2019 06:28	16/11/2019 20:10	13,69	11	150,63	CHI
201911175787	PIRANHAS	DV12023480	CAIAPONIA	16/11/2019 06:28	16/11/2019 20:10	16/11/2019 06:28	16/11/2019 20:10	13,69	76	1040,74	CHI
201911175796	GOIANIA	15923423	SENADOR CANEDO	15/11/2019 15:39	15/11/2019 18:35	15/11/2019 15:39	15/11/2019 18:35	2,92	1	2,92	CHI
201911175797	AGUA FRIA DE GOIAS	TL21238735	SAO JOAO D ALIANCA	15/11/2019 15:40	16/11/2019 14:47	15/11/2019 15:40	16/11/2019 14:47	23,12	1	23,12	CHI
201911175809	ITUMBIARA	IT11000085	ITUMBIARA NOVA	15/11/2019 14:51	16/11/2019 15:09	15/11/2019 14:51	16/11/2019 15:09	24,28	186	4516,91	CHI
201911175810	NIQUELANDIA	NQ12171829	NIQUELANDIA SUBTRANSMISSAO	15/11/2019 10:38	15/11/2019 23:31	15/11/2019 10:38	15/11/2019 23:31	12,90	353	4552,33	CHI
201911175812	MATRINCHA	MP21299762	MATRINCHA	15/11/2019 15:41	16/11/2019 14:32	15/11/2019 15:41	16/11/2019 14:32	22,85	1	22,85	CHI
201911175817	BELA VISTA DE GOIAS	BV21152509	BELA VISTA S1	15/11/2019 15:42	16/11/2019 12:11	15/11/2019 15:42	16/11/2019 12:11	20,48	2	40,97	CHI
201911175818	MONTES CLAROS DE GOIAS	ME12204902	IPORA	15/11/2019 15:41	16/11/2019 09:45	15/11/2019 15:41	16/11/2019 09:45	18,06	6	108,37	CHI
201911175822	CACHOEIRA DOURADA	CD12000008RE	CACHOEIRA DOURADA	15/11/2019 07:40	20/11/2019 19:02	15/11/2019 07:40	19/11/2019 11:00	99,33	14	1390,58	CHI
201911175822	ITUMBIARA	CD12000008RE	CACHOEIRA DOURADA	15/11/2019 07:40	20/11/2019 19:02	15/11/2019 07:40	19/11/2019 11:00	99,33	15	1489,91	CHI
201911175822	ITUMBIARA	CD13000004	CACHOEIRA DOURADA	15/11/2019 07:40	20/11/2019 19:02	15/11/2019 07:40	20/11/2019 19:02	131,36	1	131,36	CHI
201911175822	CACHOEIRA DOURADA	CD13000004	CACHOEIRA DOURADA	15/11/2019 07:40	20/11/2019 19:02	20/11/2019 17:41	20/11/2019 19:02	1,35	5	6,74	CHI
201911175822	ITUMBIARA	CD13000004	CACHOEIRA DOURADA	15/11/2019 07:40	20/11/2019 19:02	20/11/2019 17:41	20/11/2019 19:02	1,35	19	25,60	CHI
201911175823	SILVANIA	SV21056826	VIANOPOLIS	15/11/2019 15:42	16/11/2019 07:42	15/11/2019 15:42	16/11/2019 07:42	15,99	1	15,99	CHI
201911175835	PALMEIRAS DE GOIAS	PL21271981	PALMEIRAS	15/11/2019 15:44	16/11/2019 11:20	15/11/2019 15:44	16/11/2019 11:14	19,49	1	19,49	CHI
201911175835	PALMEIRAS DE GOIAS	PL21197369	PALMEIRAS	15/11/2019 15:44	16/11/2019 11:20	16/11/2019 11:00	16/11/2019 11:20	0,33	1	0,33	CHI
201911175836	SILVANIA	SV21161981	VIANOPOLIS	15/11/2019 15:44	16/11/2019 08:45	15/11/2019 15:44	16/11/2019 08:45	17,00	2	34,00	CHI
201911175837	COCALZINHO DE GOIAS	ZN21297809	COCALZINHO	15/11/2019 15:44	16/11/2019 16:14	15/11/2019 15:44	16/11/2019 16:14	24,48	1	24,48	CHI
201911175841	QUIRINOPOLIS	QI21152633	QUIRINOPOLIS	15/11/2019 15:45	16/11/2019 08:58	15/11/2019 15:45	16/11/2019 08:58	17,21	5	86,07	CHI
201911175849	PIRACANJUBA	PJ21000042	PIRACANJUBA	15/11/2019 15:46	17/11/2019 16:47	15/11/2019 15:46	17/11/2019 16:47	49,03	1	49,03	CHI
201911175851	CAIAPONIA	CP12184786	CAIAPONIA	16/11/2019 07:55	16/11/2019 11:37	16/11/2019 07:55	16/11/2019 11:37	3,70	35	129,36	CHI
201911175851	DOVERLANDIA	CP12184786	CAIAPONIA	16/11/2019 07:55	16/11/2019 11:37	16/11/2019 07:55	16/11/2019 11:37	3,70	1	3,70	CHI
201911175855	ANAPOLIS	AN11135813	ANAPOLIS UNIVERSITARIO S1	15/11/2019 14:45	15/11/2019 23:10	15/11/2019 14:45	15/11/2019 23:10	8,41	121	1017,85	CHI
201911175856	GOIANIA	GN12222920	ATLANTICO S2	15/11/2019 15:46	15/11/2019 17:38	15/11/2019 15:46	15/11/2019 17:38	1,86	201	373,19	CHI
201911175862	ISRAELANDIA	IS21218987	IPORA	15/11/2019 15:46	16/11/2019 12:20	15/11/2019 15:46	16/11/2019 12:20	20,56	1	20,56	CHI
201911175901	RIO VERDE	630071160	CABRIUVA S1	15/11/2019 15:48	16/11/2019 09:25	15/11/2019 15:48	16/11/2019 09:25	17,61	1	17,61	CHI

201911175902	PIRENOPOLIS	PV11198350	CORUMBA	15/11/2019 14:02	15/11/2019 19:43	15/11/2019 14:02	15/11/2019 19:43	5,68	48	272,65	CHI
201911175904	SERRANOPOLIS	SX12037674	JATAI S1	15/11/2019 15:14	15/11/2019 18:38	15/11/2019 15:14	15/11/2019 18:38	3,39	37	125,28	CHI
201911175910	NEROPOLIS	10009556875	NEROPOLIS S2	15/11/2019 15:49	15/11/2019 17:18	15/11/2019 15:49	15/11/2019 17:18	1,47	1	1,47	CHI
201911175916	CAMPO ALEGRE DE GOIAS	CM12358430RE	CAMPO ALEGRE DE GOIAS	15/11/2019 15:10	15/11/2019 18:25	15/11/2019 15:10	15/11/2019 18:25	3,25	33	107,13	CHI
201911175916	IPAMERI	CM12358430RE	CAMPO ALEGRE DE GOIAS	15/11/2019 15:10	15/11/2019 18:25	15/11/2019 15:10	15/11/2019 18:25	3,25	38	123,36	CHI
201911175917	CACU	CC12075913	CACHOEIRA ALTA	15/11/2019 15:51	15/11/2019 22:30	15/11/2019 15:51	15/11/2019 22:30	6,65	13	86,51	CHI
201911175917	ITARUMA	CC12075913	CACHOEIRA ALTA	15/11/2019 15:51	15/11/2019 22:30	15/11/2019 15:51	15/11/2019 22:30	6,65	31	206,30	CHI
201911175923	TRINDADE	TR11002505	TRINDADE	15/11/2019 15:51	15/11/2019 17:50	15/11/2019 15:51	15/11/2019 17:50	1,97	194	381,96	CHI
201911175926	CRISTALINA	10010536920	CRISTALINA S1	15/11/2019 15:52	15/11/2019 17:56	15/11/2019 15:52	15/11/2019 17:56	2,06	1	2,06	CHI
201911175927	GOIANIA	14498900	CAMPINAS S3	15/11/2019 15:52	15/11/2019 21:01	15/11/2019 15:52	15/11/2019 21:01	5,15	1	5,15	CHI
201911175928	ANAPOLIS	20405110	JUNDIAI S2	15/11/2019 15:52	15/11/2019 17:03	15/11/2019 15:52	15/11/2019 17:03	1,17	1	1,17	CHI
201911175929	JARAGUA	JA12194403	JARAGUA	15/11/2019 15:52	16/11/2019 05:15	15/11/2019 15:52	16/11/2019 05:15	13,37	30	401,07	CHI
201911175932	SANTA HELENA DE GOIAS	SH12271563	IPEGUARI	15/11/2019 15:47	16/11/2019 08:19	15/11/2019 15:47	16/11/2019 08:19	16,52	28	462,63	CHI
201911175932	TURVELANDIA	SH12271563	IPEGUARI	15/11/2019 15:47	16/11/2019 08:19	15/11/2019 15:47	16/11/2019 08:19	16,52	12	198,27	CHI
201911175939	JARAGUA	70047029	JARAGUA	15/11/2019 15:54	16/11/2019 10:23	15/11/2019 15:54	16/11/2019 10:23	18,48	1	18,48	CHI
201911176002	SERRANOPOLIS	SX12166082	JATAI S1	15/11/2019 15:03	15/11/2019 17:18	15/11/2019 15:03	15/11/2019 17:18	2,24	19	42,50	CHI
201911176014	ARAGARCAS	ME12193486	IPORA	15/11/2019 15:04	15/11/2019 22:52	15/11/2019 15:04	15/11/2019 22:52	7,80	1	7,80	CHI
201911176014	MONTES CLAROS DE GOIAS	ME12193486	IPORA	15/11/2019 15:04	15/11/2019 22:52	15/11/2019 15:04	15/11/2019 22:52	7,80	3	23,40	CHI
201911176016	JARAGUA	10019937944	JARAGUA	15/11/2019 15:56	16/11/2019 10:04	15/11/2019 15:56	16/11/2019 10:04	18,13	1	18,13	CHI
201911176023	GOIANIA	AP12106560	REAL S2	15/11/2019 15:54	15/11/2019 17:30	15/11/2019 15:54	15/11/2019 17:30	1,59	593	942,38	CHI
201911176028	PIRACANJUBA	PJ21051397	PIRACANJUBA	15/11/2019 15:57	18/11/2019 22:07	15/11/2019 15:57	18/11/2019 22:07	78,15	1	78,15	CHI
201911176036	BONOPOLIS	BX12391924	SAO MIGUEL DO ARAGUAIA	15/11/2019 15:58	15/11/2019 17:44	15/11/2019 15:58	15/11/2019 17:44	1,75	26	45,58	CHI
201911176036	SAO MIGUEL DO ARAGUAIA	BX12391924	SAO MIGUEL DO ARAGUAIA	15/11/2019 15:58	15/11/2019 17:44	15/11/2019 15:58	15/11/2019 17:44	1,75	0	0,00	CHI
201911176040	PIRACANJUBA	PJ12000079	PIRACANJUBA	15/11/2019 15:58	16/11/2019 03:28	15/11/2019 15:58	16/11/2019 03:28	11,49	26	298,87	CHI
201911176048	GOIANAPOLIS	TJ11055758	DAIA S2	15/11/2019 14:01	15/11/2019 20:23	15/11/2019 14:01	15/11/2019 20:23	6,36	107	680,01	CHI
201911176051	BRITANIA	BT12396220	BRITANIA	15/11/2019 15:59	16/11/2019 20:10	15/11/2019 15:59	15/11/2019 21:35	5,61	2	11,22	CHI
201911176051	JUSSARA	BT12396220	BRITANIA	15/11/2019 15:59	16/11/2019 20:10	15/11/2019 15:59	15/11/2019 21:35	5,61	5	28,05	CHI
201911176051	JUSSARA	BT12396220	BRITANIA	15/11/2019 15:59	16/11/2019 20:10	15/11/2019 15:59	16/11/2019 20:10	28,18	4	112,71	CHI
201911176052	TRES RANCHOS	2170020130	CATALAO S1	15/11/2019 15:59	16/11/2019 17:29	15/11/2019 15:59	16/11/2019 17:29	25,49	1	25,49	CHI
201911176056	CIDADE OCIDENTAL	LZ21070081	MARAJOARA	15/11/2019 15:59	16/11/2019 01:48	15/11/2019 15:59	16/11/2019 00:52	8,89	1	8,89	CHI
201911176056	CIDADE OCIDENTAL	LZ12060260	MARAJOARA	15/11/2019 15:59	16/11/2019 01:48	15/11/2019 19:26	16/11/2019 01:48	6,37	6	38,20	CHI
201911176059	RIO VERDE	RV12360702	MONTIVIDIU T	15/11/2019 14:53	16/11/2019 21:33	15/11/2019 14:53	16/11/2019 21:33	30,68	12	368,14	CHI
201911176073	TRINDADE	40243436	TRINDADE	15/11/2019 16:00	15/11/2019 16:52	15/11/2019 16:00	15/11/2019 16:52	0,85	1	0,85	CHI

201911176091	LUZIANIA	LZ11168701	MARAJOARA	15/11/2019 16:02	15/11/2019 17:52	15/11/2019 16:02	15/11/2019 17:52	1,82	148	268,95	CHI
201911176098	GOIANIA	GN11347642	REAL S1	15/11/2019 16:01	15/11/2019 16:46	15/11/2019 16:01	15/11/2019 16:46	0,75	115	86,22	CHI
201911176100	PIRENOPOLIS	PV11057879	CORUMBA	15/11/2019 11:15	15/11/2019 18:58	15/11/2019 11:15	15/11/2019 18:58	7,70	92	708,81	CHI
201911176111	CACU	CC21026103	CACHOEIRA ALTA	15/11/2019 16:05	16/11/2019 18:12	15/11/2019 16:05	16/11/2019 18:12	26,11	1	26,11	CHI
201911176114	TRINDADE	TR32033242	TRINDADE	15/11/2019 13:36	15/11/2019 20:10	15/11/2019 13:36	15/11/2019 20:10	6,56	5	32,82	CHI
201911176122	SANTA HELENA DE GOIAS	SH21325240	RIO DOS BOIS	15/11/2019 16:06	16/11/2019 10:36	15/11/2019 16:06	16/11/2019 10:36	18,49	1	18,49	CHI
201911176137	POSSE	PS21124636	IACIARA S2	15/11/2019 16:07	15/11/2019 17:11	15/11/2019 16:07	15/11/2019 17:11	1,06	1	1,06	CHI
201911176138	CALDAS NOVAS	CN12122123	SERRA DE CALDAS	15/11/2019 15:39	18/11/2019 08:58	15/11/2019 15:39	18/11/2019 08:58	65,32	4	261,27	CHI
201911176141	GOIANIA	GN11041885	CAMPINAS S1	15/11/2019 16:01	16/11/2019 15:08	15/11/2019 16:01	16/11/2019 15:08	23,11	85	1964,21	CHI
201911176171	SANTO ANTONIO DO DESCOBERTO	7596983	ALEXANIA	15/11/2019 16:11	15/11/2019 23:51	15/11/2019 16:11	15/11/2019 23:51	7,66	8	61,32	CHI
201911176172	CRISTALINA	KR12228876	CRISTALINA S2	15/11/2019 16:11	16/11/2019 08:17	15/11/2019 16:11	16/11/2019 08:17	16,10	10	160,98	CHI
201911176173	LUZIANIA	LZ11277199	RIO VERMELHO	15/11/2019 16:11	16/11/2019 07:22	15/11/2019 16:11	16/11/2019 07:22	15,18	8	121,44	CHI
201911176176	IPAMERI	IP12071423RE	PIRES DO RIO S2	15/11/2019 16:11	20/11/2019 09:33	15/11/2019 16:11	18/11/2019 14:43	70,54	18	1269,68	CHI
201911176176	IPAMERI	IP12265542LD	PIRES DO RIO S2	15/11/2019 16:11	20/11/2019 09:33	18/11/2019 15:47	19/11/2019 16:50	25,05	14	350,70	CHI
201911176176	IPAMERI	IP12215692	PIRES DO RIO S2	15/11/2019 16:11	20/11/2019 09:33	15/11/2019 16:11	20/11/2019 09:33	113,36	3	340,09	CHI
201911176183	ANAPOLIS	AN11319761	JUNDIAI S1	15/11/2019 16:11	15/11/2019 21:10	15/11/2019 16:11	15/11/2019 21:10	4,98	17	84,67	CHI
201911176188	NOVA VENEZA	NV12010101	INHUMAS S1	15/11/2019 15:04	15/11/2019 21:23	15/11/2019 15:04	15/11/2019 21:23	6,31	16	100,93	CHI
201911176189	SANTA HELENA DE GOIAS	SH12296117	IPEGUARI	15/11/2019 14:45	16/11/2019 15:12	15/11/2019 14:45	16/11/2019 15:12	24,44	5	122,21	CHI
201911176197	COCALZINHO DE GOIAS	10020666916	AGUAS LINDAS DE GOIAS S2	15/11/2019 16:12	15/11/2019 17:32	15/11/2019 16:12	15/11/2019 17:32	1,32	1	1,32	CHI
201911176198	NIQUELANDIA	NQ21262961	NIQUELANDIA SUBTRANSMISSAO	15/11/2019 15:17	15/11/2019 20:40	15/11/2019 15:17	15/11/2019 20:40	5,37	66	354,53	CHI
201911176212	RIO VERDE	RV12260701	CABRIUVA S1	15/11/2019 15:54	16/11/2019 22:52	15/11/2019 15:54	16/11/2019 22:52	30,96	2	61,93	CHI
201911176216	CRISTALINA	03460414	PAMPLONA	15/11/2019 15:59	16/11/2019 01:19	15/11/2019 15:59	16/11/2019 01:19	9,34	90	840,28	CHI
201911176216	LUZIANIA	03460414	PAMPLONA	15/11/2019 15:59	16/11/2019 01:19	15/11/2019 15:59	16/11/2019 01:19	9,34	42	392,13	CHI
201911176218	GOIANIA	GN11238228	GOYA S1	15/11/2019 16:15	15/11/2019 18:29	15/11/2019 16:15	15/11/2019 18:29	2,23	7	15,63	CHI
201911176234	MORRINHOS	150003663	MORRINHOS	15/11/2019 16:16	16/11/2019 11:10	15/11/2019 16:16	16/11/2019 11:10	18,89	1	18,89	CHI
201911176235	APARECIDA DE GOIANIA	AP11167712	REAL S1	15/11/2019 16:09	16/11/2019 02:54	15/11/2019 16:09	16/11/2019 02:54	10,75	121	1300,25	CHI
201911176245	RIO VERDE	8317071	MONTIVIDIU T	15/11/2019 15:06	18/11/2019 15:40	15/11/2019 15:06	18/11/2019 15:40	72,57	4	290,28	CHI
201911176245	RIO VERDE	8317071	MONTIVIDIU T	15/11/2019 15:06	18/11/2019 15:40	16/11/2019 19:04	18/11/2019 15:40	44,61	2	89,21	CHI
201911176251	APARECIDA DE GOIANIA	AP12241426	REAL S1	15/11/2019 16:00	15/11/2019 21:32	15/11/2019 16:00	15/11/2019 21:32	5,52	791	4365,44	CHI
201911176258	GOIANIA	GN11203582	REAL S1	15/11/2019 16:06	16/11/2019 06:31	15/11/2019 16:06	16/11/2019 06:31	14,40	136	1958,85	CHI
201911176262	PADRE BERNARDO	PB11195543	PADRE BERNARDO	15/11/2019 16:19	15/11/2019 18:22	15/11/2019 16:19	15/11/2019 18:22	2,05	5	10,24	CHI
201911176268	SAO JOAO DA PARAUNA	1000007150	FIRMINOPOLIS S2	15/11/2019 16:19	15/11/2019 19:49	15/11/2019 16:19	15/11/2019 19:49	3,50	1	3,50	CHI
201911176269	ABADIANIA	AA11027003	ANAPOLIS UNIVERSITARIO S1	15/11/2019 14:00	16/11/2019 02:53	15/11/2019 14:00	16/11/2019 02:53	12,88	37	476,61	CHI

201911176286	PORANGATU	PO12027986	PORANGATU	15/11/2019 16:21	15/11/2019 23:14	15/11/2019 16:21	15/11/2019 23:14	6,88	9	61,94	CHI
201911176291	ITARUMA	IM21204143	CACHOEIRA ALTA	15/11/2019 16:21	16/11/2019 14:07	15/11/2019 16:21	16/11/2019 14:07	21,76	1	21,76	CHI
201911176297	NIQUELANDIA	NQ21139056	NIQUELANDIA SUBTRANSMISSAO	15/11/2019 16:22	16/11/2019 11:20	15/11/2019 16:22	16/11/2019 11:20	18,96	1	18,96	CHI
201911176298	SENADOR CANEDO	190039905	SENADOR CANEDO	15/11/2019 16:22	16/11/2019 11:40	15/11/2019 16:22	16/11/2019 11:40	19,29	1	19,29	CHI
201911176306	GAMELEIRA DE GOIAS	SV12013378	DAIA S2	15/11/2019 15:05	16/11/2019 00:09	15/11/2019 15:05	16/11/2019 00:09	9,07	6	54,40	CHI
201911176308	PALMEIRAS DE GOIAS	590084148	PALMEIRAS	15/11/2019 16:23	16/11/2019 00:11	15/11/2019 16:23	16/11/2019 00:11	7,79	1	7,79	CHI
201911176310	CALDAS NOVAS	RQ12100189	RIO QUENTE	15/11/2019 15:36	16/11/2019 10:19	15/11/2019 15:36	16/11/2019 10:19	18,71	60	1122,47	CHI
201911176310	RIO QUENTE	RQ12100189	RIO QUENTE	15/11/2019 15:36	16/11/2019 10:19	15/11/2019 15:36	16/11/2019 10:19	18,71	106	1983,02	CHI
201911176322	ALEXANIA	AX11061988	ALEXANIA	15/11/2019 15:17	15/11/2019 19:40	15/11/2019 15:17	15/11/2019 19:40	4,37	160	698,89	CHI
201911176333	MORRINHOS	MR12028754	MORRINHOS	15/11/2019 15:09	15/11/2019 21:02	15/11/2019 15:09	15/11/2019 21:02	5,88	43	252,85	CHI
201911176336	SERRANOPOLIS	SX12216620	JATAI S1	15/11/2019 16:26	17/11/2019 10:47	15/11/2019 16:26	17/11/2019 10:47	42,35	5	211,73	CHI
201911176338	BOM JESUS DE GOIAS	BJ10406695	BOM JESUS DE GOIAS	15/11/2019 14:02	15/11/2019 23:35	15/11/2019 14:02	15/11/2019 23:35	9,55	24	229,15	CHI
201911176338	ITUMBIARA	BJ10406695	BOM JESUS DE GOIAS	15/11/2019 14:02	15/11/2019 23:35	15/11/2019 14:02	15/11/2019 23:35	9,55	19	181,41	CHI
201911176341	ANAPOLIS	AN11003263	ANAPOLIS UNIVERSITARIO S2	15/11/2019 14:41	15/11/2019 20:01	15/11/2019 14:41	15/11/2019 20:01	5,32	6	31,90	CHI
201911176346	MONTES CLAROS DE GOIAS	ME21370282	IPORA	15/11/2019 16:27	16/11/2019 15:49	15/11/2019 16:27	16/11/2019 15:49	23,36	1	23,36	CHI
201911176358	CATALAO	CM12069030	CAMPO ALEGRE DE GOIAS	15/11/2019 16:28	16/11/2019 12:49	15/11/2019 16:28	16/11/2019 12:49	20,34	1	20,34	CHI
201911176363	DIORAMA	030902214	IPORA	15/11/2019 16:13	15/11/2019 18:23	15/11/2019 16:13	15/11/2019 18:23	2,15	12	25,84	CHI
201911176363	FAZENDA NOVA	030902214	IPORA	15/11/2019 16:13	15/11/2019 18:23	15/11/2019 16:13	15/11/2019 18:23	2,15	22	47,38	CHI
201911176363	JAUPACI	030902214	IPORA	15/11/2019 16:13	15/11/2019 18:23	15/11/2019 16:13	15/11/2019 18:23	2,15	1385	2982,75	CHI
201911176366	FORMOSA	FA11359139	ITUIQUIRA	15/11/2019 16:29	15/11/2019 17:53	15/11/2019 16:29	15/11/2019 17:53	1,40	1	1,40	CHI
201911176373	DOVERLANDIA	DV12237150LD	CAIAPONIA	15/11/2019 23:53	16/11/2019 01:46	16/11/2019 00:45	16/11/2019 01:40	0,91	4	3,64	CHI
201911176373	DOVERLANDIA	DV21138037	CAIAPONIA	15/11/2019 23:53	16/11/2019 01:46	15/11/2019 23:53	16/11/2019 01:46	1,89	2	3,79	CHI
201911176380	ARAGOIANIA	AO31053270	GUAPO S2	15/11/2019 16:29	16/11/2019 10:25	15/11/2019 16:29	16/11/2019 10:25	17,92	1	17,92	CHI
201911176388	RIO VERDE	RV12249024	SANTA HELENA S1	19/11/2019 10:17	19/11/2019 12:14	19/11/2019 10:17	19/11/2019 12:14	1,95	7	13,65	CHI
201911176390	BALIZA	BH11330972	CAIAPONIA	15/11/2019 16:30	16/11/2019 19:00	15/11/2019 16:30	16/11/2019 19:00	26,48	1	26,48	CHI
201911176396	SANTO ANTONIO DO DESCOBERTO	SN12330527	MARAJOARA	15/11/2019 16:31	15/11/2019 21:09	15/11/2019 16:31	15/11/2019 21:09	4,62	11	50,81	CHI
201911176403	JARAGUA	JA12205816	JARAGUA	15/11/2019 16:21	15/11/2019 18:43	15/11/2019 16:21	15/11/2019 18:43	2,36	22	52,01	CHI
201911176407	BOM JARDIM DE GOIAS	BM12334783	BOM JARDIM	15/11/2019 16:32	16/11/2019 06:53	15/11/2019 16:32	16/11/2019 06:53	14,34	12	172,10	CHI
201911176408	PETROLINA DE GOIAS	PG12021488	PETROLINA	15/11/2019 16:32	15/11/2019 20:48	15/11/2019 16:32	15/11/2019 20:48	4,26	4	17,03	CHI
201911176414	CRISTALINA	KR11313887	PAMPLONA	15/11/2019 15:47	16/11/2019 11:05	15/11/2019 15:47	16/11/2019 11:05	19,31	105	2027,26	CHI
201911176422	MORRINHOS	MR12000166	MORRINHOS	15/11/2019 15:52	16/11/2019 00:51	15/11/2019 15:52	16/11/2019 00:51	8,97	5	44,84	CHI
201911176430	JATAI	JT21078460	JATAI S2	15/11/2019 16:35	15/11/2019 18:39	15/11/2019 16:35	15/11/2019 18:39	2,06	1	2,06	CHI
201911176431	HIDROLANDIA	PJ12000097	PIRACANJUBA	15/11/2019 15:15	16/11/2019 11:15	15/11/2019 15:15	16/11/2019 11:15	20,00	7	139,99	CHI

201911176431	PIRACANJUBA	PJ12000097	PIRACANJUBA	15/11/2019 15:15	16/11/2019 11:15	15/11/2019 15:15	16/11/2019 11:15	20,00	33	659,96	CHI
201911176443	CATALAO	CT12306674RE	CATALAO S1	15/11/2019 16:29	19/11/2019 07:45	15/11/2019 16:29	17/11/2019 09:58	41,49	128	5311,36	CHI
201911176443	CATALAO	CT12306674RE	CATALAO S1	15/11/2019 16:29	19/11/2019 07:45	15/11/2019 16:37	17/11/2019 09:58	41,36	7	289,52	CHI
201911176443	CATALAO	CT13341893	CATALAO S1	15/11/2019 16:29	19/11/2019 07:45	15/11/2019 16:37	17/11/2019 11:54	43,30	122	5282,16	CHI
201911176443	CATALAO	CT12306674RE	CATALAO S1	15/11/2019 16:29	19/11/2019 07:45	17/11/2019 11:55	17/11/2019 12:10	0,24	135	31,84	CHI
201911176443	CATALAO	CT13341893	CATALAO S1	15/11/2019 16:29	19/11/2019 07:45	17/11/2019 11:55	18/11/2019 11:10	23,25	168	3906,42	CHI
201911176443	CATALAO	CT12306674RE	CATALAO S1	15/11/2019 16:29	19/11/2019 07:45	18/11/2019 14:10	18/11/2019 15:59	1,81	135	244,24	CHI
201911176443	CATALAO	CT12306674RE	CATALAO S1	15/11/2019 16:29	19/11/2019 07:45	18/11/2019 14:10	18/11/2019 22:42	8,53	48	409,65	CHI
201911176443	CATALAO	CT12306674RE	CATALAO S1	15/11/2019 16:29	19/11/2019 07:45	18/11/2019 19:43	18/11/2019 22:42	2,98	135	401,85	CHI
201911176443	CATALAO	CT12215709RE	CATALAO S1	15/11/2019 16:29	19/11/2019 07:45	18/11/2019 14:10	19/11/2019 00:53	10,72	120	1286,40	CHI
201911176443	CAMPO ALEGRE DE GOIAS	CT13358293	CATALAO S1	15/11/2019 16:29	19/11/2019 07:45	18/11/2019 12:03	19/11/2019 07:45	19,71	1	19,71	CHI
201911176443	CATALAO	CT13358293	CATALAO S1	15/11/2019 16:29	19/11/2019 07:45	18/11/2019 12:03	19/11/2019 07:45	19,71	33	650,46	CHI
201911176444	GOIANIA	GN12045310	GOYA S2	15/11/2019 15:05	15/11/2019 19:18	15/11/2019 15:05	15/11/2019 19:18	4,22	44	185,46	CHI
201911176460	PLANALTINA	PI12361252	PLANALTINA	15/11/2019 16:40	15/11/2019 21:35	15/11/2019 16:40	15/11/2019 21:35	4,91	33	162,19	CHI
201911176467	CAMPOS VERDES	VD12390436	SANTA TEREZINHA	15/11/2019 16:42	15/11/2019 19:14	15/11/2019 16:42	15/11/2019 19:14	2,53	8	20,27	CHI
201911176471	PALMELO	PR12000096RE	PIRES DO RIO S1	15/11/2019 16:29	15/11/2019 22:00	15/11/2019 16:29	15/11/2019 22:00	5,52	6	33,09	CHI
201911176471	PIRES DO RIO	PR12000096RE	PIRES DO RIO S1	15/11/2019 16:29	15/11/2019 22:00	15/11/2019 16:29	15/11/2019 22:00	5,52	21	115,83	CHI
201911176486	PIRENOPOLIS	PV21318040	CORUMBA	15/11/2019 16:43	16/11/2019 14:54	15/11/2019 16:43	16/11/2019 14:54	22,17	1	22,17	CHI
201911176489	PORANGATU	PO21134077	PORANGATU	15/11/2019 16:43	16/11/2019 12:03	15/11/2019 16:43	16/11/2019 12:03	19,32	1	19,32	CHI
201911176496	MORRINHOS	MR11171715	MORRINHOS	15/11/2019 16:10	15/11/2019 19:13	15/11/2019 16:10	15/11/2019 19:13	3,04	179	544,36	CHI
201911176500	CORUMBA DE GOIAS	CB12382152	CORUMBA	15/11/2019 15:09	16/11/2019 08:44	15/11/2019 15:09	16/11/2019 08:44	17,58	5	87,89	CHI
201911176504	AGUA LIMPA	03750214	VILA CORUMBA	15/11/2019 16:05	15/11/2019 19:57	15/11/2019 16:05	15/11/2019 19:57	3,87	857	3312,54	CHI
201911176504	BURITI ALEGRE	03750214	VILA CORUMBA	15/11/2019 16:05	15/11/2019 19:57	15/11/2019 16:05	15/11/2019 19:57	3,87	2	7,73	CHI
201911176513	SANTO ANTONIO DO DESCOBERTO	SN12305157	MARAJOARA	15/11/2019 15:47	15/11/2019 19:49	15/11/2019 15:47	15/11/2019 19:49	4,03	13	52,41	CHI
201911176517	ANAPOLIS	10001364624	JUNDIAI S2	15/11/2019 16:46	16/11/2019 07:08	15/11/2019 16:46	16/11/2019 07:08	14,36	1	14,36	CHI
201911176518	ORIZONA	OZ21111508	PIRES DO RIO S2	15/11/2019 16:46	16/11/2019 11:19	15/11/2019 16:46	16/11/2019 11:19	18,55	1	18,55	CHI
201911176522	BOM JARDIM DE GOIAS	BM12064234	BOM JARDIM	15/11/2019 18:58	16/11/2019 08:44	15/11/2019 18:58	16/11/2019 08:44	13,76	4	55,04	CHI
201911176528	IVOLANDIA	PU12349487	MONTIVIDIU T	15/11/2019 16:47	17/11/2019 11:00	15/11/2019 16:47	17/11/2019 11:00	42,21	6	253,28	CHI
201911176543	MORRINHOS	MR21182937	MORRINHOS	15/11/2019 16:49	18/11/2019 23:45	15/11/2019 16:49	18/11/2019 23:45	78,93	2	157,85	CHI
201911176555	BELA VISTA DE GOIAS	240025775	BELA VISTA S1	15/11/2019 16:51	16/11/2019 08:21	15/11/2019 16:51	16/11/2019 08:21	15,49	1	15,49	CHI
201911176564	ALEXANIA	AX12350772	ALEXANIA	15/11/2019 16:53	16/11/2019 05:49	15/11/2019 16:53	16/11/2019 05:49	12,93	1	12,93	CHI
201911176579	CRISTALINA	KR12304800	CRISTALINA S2	15/11/2019 16:12	16/11/2019 02:45	15/11/2019 16:12	16/11/2019 02:45	10,54	12	126,51	CHI
201911176584	NIQUELANDIA	NQ12335361	NIQUELANDIA SUBTRANSMISSAO	15/11/2019 16:56	16/11/2019 11:01	15/11/2019 16:56	16/11/2019 11:01	18,08	8	144,61	CHI

201911176589	CAMPINORTE	CR11000026	CAMPINORTE	15/11/2019 16:56	15/11/2019 22:41	15/11/2019 16:56	15/11/2019 22:41	5,74	80	459,02	CHI
201911176592	PIRACANJUBA	PJ12320293	PIRACANJUBA	15/11/2019 16:27	19/11/2019 11:14	15/11/2019 16:27	19/11/2019 11:14	90,77	8	726,16	CHI
201911176600	CRISTALINA	KR21209626	PAMPLONA	15/11/2019 16:57	16/11/2019 15:43	15/11/2019 16:57	16/11/2019 15:43	22,76	1	22,76	CHI
201911176605	RIO VERDE	RV12260579	RIO VERDE S1	15/11/2019 15:54	16/11/2019 02:04	15/11/2019 15:54	16/11/2019 02:04	10,16	16	162,52	CHI
201911176612	SENADOR CANEDO	10001298052	SENADOR CANEDO	15/11/2019 16:58	16/11/2019 09:12	15/11/2019 16:58	16/11/2019 09:12	16,22	1	16,22	CHI
201911176620	ITAUCU	IX11180183	INHUMAS S1	15/11/2019 16:34	16/11/2019 13:00	15/11/2019 16:34	15/11/2019 20:50	4,28	92	393,66	CHI
201911176620	ITAUCU	IX11180183	INHUMAS S1	15/11/2019 16:34	16/11/2019 13:00	16/11/2019 10:39	16/11/2019 13:00	2,35	92	216,05	CHI
201911176622	APARECIDA DE GOIANIA	AP11383870	REAL S1	15/11/2019 16:10	15/11/2019 22:56	15/11/2019 16:10	15/11/2019 22:56	6,75	124	837,14	CHI
201911176626	ISRAELANDIA	IS21139428	IPORA	15/11/2019 16:59	16/11/2019 12:15	15/11/2019 16:59	16/11/2019 12:15	19,26	1	19,26	CHI
201911176627	SAO DOMINGOS	SD12218642	SAO DOMINGOS	15/11/2019 16:59	15/11/2019 18:08	15/11/2019 16:59	15/11/2019 18:08	1,14	80	91,20	CHI
201911176633	ARAGARCAS	AG21155803	ARAGARCAS	15/11/2019 16:59	16/11/2019 15:30	15/11/2019 16:59	16/11/2019 15:30	22,51	1	22,51	CHI
201911176639	GOIANIA	GN11001111	REAL S2	15/11/2019 15:59	15/11/2019 19:47	15/11/2019 15:59	15/11/2019 19:47	3,79	193	732,33	CHI
201911176640	GOIANIA	GN12023380	REAL S1	15/11/2019 16:17	15/11/2019 23:51	15/11/2019 16:17	15/11/2019 23:51	7,55	98	740,06	CHI
201911176642	IPAMERI	IP12337216	IPAMERI	16/11/2019 08:06	16/11/2019 17:33	16/11/2019 08:06	16/11/2019 17:33	9,44	4	37,77	CHI
201911176642	NOVA AURORA	IP12337216	IPAMERI	16/11/2019 08:06	16/11/2019 17:33	16/11/2019 08:06	16/11/2019 17:33	9,44	2	18,88	CHI
201911176651	BURITINOPOLIS	BQ12194634	IACIARA S2	15/11/2019 17:00	15/11/2019 18:41	15/11/2019 17:00	15/11/2019 18:41	1,67	51	85,33	CHI
201911176651	MAMBAI	BQ12194634	IACIARA S2	15/11/2019 17:00	15/11/2019 18:41	15/11/2019 17:00	15/11/2019 18:41	1,67	1	1,67	CHI
201911176657	CALDAS NOVAS	CN11309430	SERRA DE CALDAS	15/11/2019 17:01	16/11/2019 11:27	15/11/2019 17:01	16/11/2019 11:27	18,43	8	147,46	CHI
201911176677	CATALAO	10011524608	CATALAO S2	15/11/2019 17:01	17/11/2019 08:23	15/11/2019 17:01	17/11/2019 08:23	39,36	1	39,36	CHI
201911176685	JATAI	JT12303012	JATAI S1	15/11/2019 17:02	16/11/2019 11:45	15/11/2019 17:02	16/11/2019 11:45	18,71	3	56,14	CHI
201911176687	ITUMBIARA	IT11208053	PARANAIBA	15/11/2019 15:47	15/11/2019 23:30	15/11/2019 15:47	15/11/2019 23:30	7,71	41	316,16	CHI
201911176695	GOIANIA	14556194	CARAJAS S2	15/11/2019 17:02	16/11/2019 10:06	15/11/2019 17:02	16/11/2019 10:06	17,06	1	17,06	CHI
201911176707	IPAMERI	IP11250197	IPAMERI	15/11/2019 16:48	15/11/2019 21:47	15/11/2019 16:48	15/11/2019 21:47	4,98	67	333,49	CHI
201911176710	PONTALINA	PK21102511	PONTALINA	15/11/2019 17:03	16/11/2019 16:22	15/11/2019 17:03	16/11/2019 16:22	23,31	1	23,31	CHI
201911176713	PONTALINA	PK12063352	PONTALINA	15/11/2019 16:57	16/11/2019 14:45	15/11/2019 16:57	16/11/2019 14:45	21,79	16	348,65	CHI
201911176728	JATAI	JT21150955	JATAI S1	15/11/2019 17:03	16/11/2019 13:06	15/11/2019 17:03	16/11/2019 13:06	20,03	1	20,03	CHI
201911176733	JARAGUA	PV12394331RE	CORUMBA	15/11/2019 16:42	15/11/2019 22:00	15/11/2019 16:42	15/11/2019 22:00	5,30	13	68,90	CHI
201911176733	PIRENOPOLIS	PV12394331RE	CORUMBA	15/11/2019 16:42	15/11/2019 22:00	15/11/2019 16:42	15/11/2019 22:00	5,30	76	402,82	CHI
201911176739	PIRENOPOLIS	PV11000012	CORUMBA	15/11/2019 15:17	15/11/2019 19:14	15/11/2019 15:17	15/11/2019 19:14	3,94	148	583,41	CHI
201911176756	PLANALTINA	PI21152793	SAO JOAO D ALIANCA	15/11/2019 17:05	15/11/2019 22:21	15/11/2019 17:05	15/11/2019 22:21	5,25	1	5,25	CHI
201911176777	ALEXANIA	AX11322454	ALEXANIA	15/11/2019 16:27	15/11/2019 20:19	15/11/2019 16:27	15/11/2019 20:19	3,86	139	536,04	CHI
201911176785	CAMPO ALEGRE DE GOIAS	CM12077272	CAMPO ALEGRE DE GOIAS	15/11/2019 14:39	18/11/2019 08:54	15/11/2019 14:39	18/11/2019 08:54	66,24	7	463,69	CHI
201911176803	EDEIA	10015020388	EDEIA	15/11/2019 17:08	17/11/2019 11:26	15/11/2019 17:08	17/11/2019 11:26	42,28	1	42,28	CHI

201911176806	ANAPOLIS	AN11335078	ANAPOLIS UNIVERSITARIO S2	15/11/2019 15:03	15/11/2019 22:57	15/11/2019 15:03	15/11/2019 22:57	7,90	38	300,04	CHI
201911176812	CACHOEIRA ALTA	CA12384078	CACHOEIRA ALTA	15/11/2019 16:58	16/11/2019 14:38	15/11/2019 16:58	16/11/2019 14:38	21,66	8	173,30	CHI
201911176812	CACU	CA12384078	CACHOEIRA ALTA	15/11/2019 16:58	16/11/2019 14:38	15/11/2019 16:58	16/11/2019 14:38	21,66	1	21,66	CHI
201911176819	JARAGUA	JA12258144	JARAGUA	15/11/2019 15:16	15/11/2019 20:29	15/11/2019 15:16	15/11/2019 20:29	5,21	42	218,73	CHI
201911176827	ARUANA	AK21135086	BRITANIA	15/11/2019 17:10	18/11/2019 17:19	15/11/2019 17:10	18/11/2019 17:19	72,14	1	72,14	CHI
201911176830	RIO VERDE	RV21301280	SANTA HELENA S1	15/11/2019 17:18	15/11/2019 17:35	15/11/2019 17:18	15/11/2019 17:35	0,28	1	0,28	CHI
201911176831	JATAI	JT11274030	JATAI S2	15/11/2019 17:10	15/11/2019 20:55	15/11/2019 17:10	15/11/2019 20:55	3,76	104	391,04	CHI
201911176836	CAMPO ALEGRE DE GOIAS	CM12042424	CAMPO ALEGRE DE GOIAS	15/11/2019 16:06	18/11/2019 15:21	15/11/2019 16:06	18/11/2019 15:21	71,24	25	1781,11	CHI
201911176859	IPAMERI	IP21167002	IPAMERI	15/11/2019 17:12	16/11/2019 10:17	15/11/2019 17:12	16/11/2019 10:17	17,07	1	17,07	CHI
201911176868	CRISTIANOPOLIS	CF21247351	CRISTIANOPOLIS	15/11/2019 12:29	18/11/2019 19:12	15/11/2019 12:29	18/11/2019 19:12	78,70	2	157,40	CHI
201911176883	CAMPESTRE DE GOIAS	GC12050512	TRINDADE	15/11/2019 16:54	15/11/2019 20:50	15/11/2019 16:54	15/11/2019 20:50	3,92	10	39,18	CHI
201911176887	BURITINOPOLIS	MB12314303	IACIARA S2	15/11/2019 17:07	15/11/2019 20:53	15/11/2019 17:07	15/11/2019 20:53	3,76	2	7,52	CHI
201911176887	MAMBAI	MB12314303	IACIARA S2	15/11/2019 17:07	15/11/2019 20:53	15/11/2019 17:07	15/11/2019 20:53	3,76	3	11,28	CHI
201911176898	APARECIDA DE GOIANIA	11066556	ATLANTICO S1	15/11/2019 17:15	16/11/2019 09:31	15/11/2019 17:15	16/11/2019 09:31	16,27	1	16,27	CHI
201911176914	JAUPACI	JP12035039	IPORA	15/11/2019 17:08	16/11/2019 17:45	15/11/2019 17:08	16/11/2019 17:45	24,60	13	319,85	CHI
201911176921	SERRANOPOLIS	SX21308108	PARQUE DAS EMAS	15/11/2019 17:16	16/11/2019 14:52	15/11/2019 17:16	16/11/2019 14:52	21,60	1	21,60	CHI
201911176933	NAZARIO	NZ11377153	ANICUNS	15/11/2019 16:50	15/11/2019 19:30	15/11/2019 16:50	15/11/2019 19:30	2,66	74	197,05	CHI
201911176936	VILA PROPICIO	PV21396645	GOIANESIA S1	15/11/2019 17:16	16/11/2019 16:58	15/11/2019 17:16	16/11/2019 16:58	23,68	1	23,68	CHI
201911176953	CATALAO	1990247742	CATALAO S2	15/11/2019 17:17	16/11/2019 10:18	15/11/2019 17:17	16/11/2019 10:18	17,01	1	17,01	CHI
201911176971	JARAGUA	JA12019758	JARAGUA	15/11/2019 17:19	16/11/2019 11:20	15/11/2019 17:19	16/11/2019 11:20	18,01	5	90,07	CHI
201911176984	SENADOR CANEDO	SW13161932	SENADOR CANEDO	15/11/2019 17:19	16/11/2019 13:03	15/11/2019 18:41	15/11/2019 19:49	1,13	416	470,31	CHI
201911176984	SENADOR CANEDO	SW13399998	SENADOR CANEDO	15/11/2019 17:19	16/11/2019 13:03	15/11/2019 18:41	15/11/2019 19:59	1,29	382	494,48	CHI
201911176984	BELA VISTA DE GOIAS	XX07379778	SENADOR CANEDO	15/11/2019 17:19	16/11/2019 13:03	15/11/2019 17:19	15/11/2019 20:01	2,69	1	2,69	CHI
201911176984	CALDAZINHA	XX07379778	SENADOR CANEDO	15/11/2019 17:19	16/11/2019 13:03	15/11/2019 17:19	15/11/2019 20:01	2,69	6	16,17	CHI
201911176984	SENADOR CANEDO	XX07379778	SENADOR CANEDO	15/11/2019 17:19	16/11/2019 13:03	15/11/2019 17:19	15/11/2019 20:01	2,69	213	573,86	CHI
201911176984	SENADOR CANEDO	SW10400624	SENADOR CANEDO	15/11/2019 17:19	16/11/2019 13:03	15/11/2019 17:19	15/11/2019 20:45	3,42	6	20,55	CHI
201911176984	SENADOR CANEDO	XX07379778	SENADOR CANEDO	15/11/2019 17:19	16/11/2019 13:03	15/11/2019 17:19	15/11/2019 22:24	5,08	642	3260,29	CHI
201911176984	SENADOR CANEDO	SW10395403	SENADOR CANEDO	15/11/2019 17:19	16/11/2019 13:03	15/11/2019 18:41	16/11/2019 01:14	6,55	680	4457,21	CHI
201911176984	SENADOR CANEDO	SW11166617	SENADOR CANEDO	15/11/2019 17:19	16/11/2019 13:03	16/11/2019 07:00	16/11/2019 11:03	4,05	94	380,70	CHI
201911176984	SENADOR CANEDO	SW11375187	SENADOR CANEDO	15/11/2019 17:19	16/11/2019 13:03	16/11/2019 07:10	16/11/2019 11:12	4,03	83	334,58	CHI
201911176984	BELA VISTA DE GOIAS	SW10395411	SENADOR CANEDO	15/11/2019 17:19	16/11/2019 13:03	16/11/2019 12:10	16/11/2019 12:14	0,07	25	1,67	CHI
201911176984	CALDAZINHA	SW10395411	SENADOR CANEDO	15/11/2019 17:19	16/11/2019 13:03	16/11/2019 12:10	16/11/2019 12:14	0,07	57	3,82	CHI
201911176984	SENADOR CANEDO	SW10395411	SENADOR CANEDO	15/11/2019 17:19	16/11/2019 13:03	16/11/2019 12:10	16/11/2019 12:14	0,07	1631	109,19	CHI

201911176984	SENADOR CANEDO	SW10395403	SENADOR CANEDO	15/11/2019 17:19	16/11/2019 13:03	16/11/2019 12:58	16/11/2019 13:03	0,08	382	32,26	CHI
201911176992	PARAUNA	PU21126045	PARAUNA	15/11/2019 17:20	15/11/2019 21:40	15/11/2019 17:20	15/11/2019 21:40	4,33	2	8,66	CHI
201911176993	JATAI	JT11136032	JATAI S3	15/11/2019 16:55	16/11/2019 17:26	15/11/2019 16:55	16/11/2019 17:26	24,50	125	3062,71	CHI
201911176999	SANTA FE DE GOIAS	2070019592	BRITANIA	15/11/2019 17:21	16/11/2019 17:30	15/11/2019 17:21	16/11/2019 17:30	24,15	1	24,15	CHI
201911177000	JATAI	JT12306444	JATAI S3	15/11/2019 18:06	16/11/2019 08:23	15/11/2019 18:06	16/11/2019 08:23	14,28	6	85,65	CHI
201911177009	RIO VERDE	630033031	RIO VERDE S1	15/11/2019 17:21	16/11/2019 13:24	15/11/2019 17:21	16/11/2019 13:24	20,04	1	20,04	CHI
201911177010	LUZIANIA	LZ11183958	RIO VERMELHO	15/11/2019 17:21	15/11/2019 19:29	15/11/2019 17:21	15/11/2019 19:29	2,12	14	29,68	CHI
201911177011	JARAGUA	JA11348280	JARAGUA	15/11/2019 17:01	15/11/2019 18:44	15/11/2019 17:01	15/11/2019 18:44	1,70	32	54,51	CHI
201911177038	APARECIDA DE GOIANIA	10024385806	INDEPENDENCIA S2	15/11/2019 17:23	16/11/2019 10:34	15/11/2019 17:23	16/11/2019 10:34	17,18	1	17,18	CHI
201911177048	SENADOR CANEDO	10020147668	SENADOR CANEDO	15/11/2019 17:24	16/11/2019 12:47	15/11/2019 17:24	16/11/2019 12:47	19,38	1	19,38	CHI
201911177060	SENADOR CANEDO	190012766	SENADOR CANEDO	15/11/2019 17:25	16/11/2019 17:50	15/11/2019 17:25	16/11/2019 17:50	24,42	1	24,42	CHI
201911177062	ANAPOLIS	20308401	ANAPOLIS UNIVERSITARIO S2	15/11/2019 17:25	16/11/2019 14:29	15/11/2019 17:25	16/11/2019 14:29	21,06	1	21,06	CHI
201911177064	PIRENOPOLIS	PV11057882	CORUMBA	15/11/2019 14:06	15/11/2019 20:45	15/11/2019 14:06	15/11/2019 20:45	6,64	159	1055,45	CHI
201911177077	CACHOEIRA DOURADA	CD12000327	CACHOEIRA DOURADA	15/11/2019 15:45	17/11/2019 17:08	15/11/2019 15:45	17/11/2019 17:08	49,38	3	148,15	CHI
201911177086	RIO QUENTE	RQ11182912	RIO QUENTE	15/11/2019 15:54	16/11/2019 14:14	15/11/2019 15:54	16/11/2019 14:14	22,32	40	892,74	CHI
201911177112	AMORINOPOLIS	IR12188430	IPORA	15/11/2019 16:37	15/11/2019 21:10	15/11/2019 16:37	15/11/2019 21:10	4,54	44	199,74	CHI
201911177112	IPORA	IR12188430	IPORA	15/11/2019 16:37	15/11/2019 21:10	15/11/2019 16:37	15/11/2019 21:10	4,54	98	444,87	CHI
201911177112	IVOLANDIA	IR12188430	IPORA	15/11/2019 16:37	15/11/2019 21:10	15/11/2019 16:37	15/11/2019 21:10	4,54	90	408,55	CHI
201911177112	PALESTINA DE GOIAS	IR12188430	IPORA	15/11/2019 16:37	15/11/2019 21:10	15/11/2019 16:37	15/11/2019 21:10	4,54	33	149,80	CHI
201911177119	MINACU	IH12242192	MINACU	15/11/2019 17:28	15/11/2019 21:24	15/11/2019 17:28	15/11/2019 21:24	3,92	48	188,24	CHI
201911177159	ALEXANIA	AX11061849	ALEXANIA	15/11/2019 17:30	16/11/2019 04:31	15/11/2019 17:30	16/11/2019 04:31	11,00	2	22,00	CHI
201911177171	CORUMBAIBA	CI21090555	VILA CORUMBA	15/11/2019 17:31	18/11/2019 16:48	15/11/2019 17:31	18/11/2019 16:48	71,27	1	71,27	CHI
201911177179	IPORA	AM12402911	IPORA	15/11/2019 17:07	15/11/2019 22:36	15/11/2019 17:07	15/11/2019 22:36	5,48	45	246,63	CHI
201911177193	SENADOR CANEDO	12883256	SENADOR CANEDO	15/11/2019 17:33	16/11/2019 13:34	15/11/2019 17:33	16/11/2019 13:34	20,01	1	20,01	CHI
201911177209	GOIANIA	14273275	ATLANTICO S1	15/11/2019 17:34	16/11/2019 04:31	15/11/2019 17:34	16/11/2019 04:31	10,95	1	10,95	CHI
201911177220	AGUA LIMPA	AL12391496RE	VILA CORUMBA	15/11/2019 16:20	15/11/2019 23:31	15/11/2019 16:20	15/11/2019 23:31	7,18	31	222,60	CHI
201911177220	MORRINHOS	AL12391496RE	VILA CORUMBA	15/11/2019 16:20	15/11/2019 23:31	15/11/2019 16:20	15/11/2019 23:31	7,18	9	64,63	CHI
201911177250	IPORA	IR12204945	IPORA	15/11/2019 17:28	17/11/2019 20:41	15/11/2019 17:28	17/11/2019 20:41	51,21	4	204,85	CHI
201911177260	ABADIANIA	1400000900	CORUMBA	15/11/2019 17:37	16/11/2019 13:11	15/11/2019 17:37	16/11/2019 13:11	19,56	1	19,56	CHI
201911177264	FAINA	MP10400391	MATRINCHA	15/11/2019 17:21	16/11/2019 11:44	15/11/2019 17:21	16/11/2019 11:44	18,38	12	220,54	CHI
201911177264	MATRINCHA	MP10400391	MATRINCHA	15/11/2019 17:21	16/11/2019 11:44	15/11/2019 17:21	16/11/2019 11:44	18,38	45	827,03	CHI
201911177268	CACHOEIRA ALTA	PC12078919	CACHOEIRA ALTA	15/11/2019 17:13	16/11/2019 15:00	15/11/2019 17:13	16/11/2019 15:00	21,78	3	65,33	CHI
201911177268	PARANAIGUARA	PC12078919	CACHOEIRA ALTA	15/11/2019 17:13	16/11/2019 15:00	15/11/2019 17:13	16/11/2019 15:00	21,78	2	43,56	CHI

201911177272	BARRO ALTO	GE12255886	GOIANESIA S1	15/11/2019 17:33	16/11/2019 15:20	15/11/2019 17:33	16/11/2019 15:20	21,77	1	21,77	CHI
201911177272	GOIANESIA	GE12255886	GOIANESIA S1	15/11/2019 17:33	16/11/2019 15:20	15/11/2019 17:33	16/11/2019 15:20	21,77	4	87,08	CHI
201911177291	CATALAO	1990189936	CATALAO S2	15/11/2019 17:39	17/11/2019 10:15	15/11/2019 17:39	17/11/2019 10:15	40,59	1	40,59	CHI
201911177311	TRINDADE	10023968085	GOYA S1	15/11/2019 17:41	15/11/2019 19:53	15/11/2019 17:41	15/11/2019 19:53	2,20	1	2,20	CHI
201911177324	CATALAO	CT11203034	CATALAO S2	15/11/2019 17:32	16/11/2019 00:53	15/11/2019 17:32	16/11/2019 00:53	7,35	98	720,25	CHI
201911177327	SENADOR CANEDO	12225230	CEPAIGO S2	15/11/2019 17:42	16/11/2019 18:02	15/11/2019 17:42	16/11/2019 18:02	24,34	1	24,34	CHI
201911177337	BONFINOPOLIS	LB12000017	CEPAIGO S2	15/11/2019 17:17	15/11/2019 19:46	15/11/2019 17:17	15/11/2019 19:46	2,48	68	168,62	CHI
201911177337	LEOPOLDO DE BULHOES	LB12000017	CEPAIGO S2	15/11/2019 17:17	15/11/2019 19:46	15/11/2019 17:17	15/11/2019 19:46	2,48	13	32,24	CHI
201911177341	JARAGUA	JA11255159	JARAGUA	15/11/2019 15:46	15/11/2019 19:34	15/11/2019 15:46	15/11/2019 19:34	3,78	82	310,28	CHI
201911177342	AMARALINA	MU12166513	MARA ROSA	15/11/2019 17:43	16/11/2019 08:37	15/11/2019 17:43	16/11/2019 08:37	14,90	20	297,97	CHI
201911177350	BOM JARDIM DE GOIAS	BM12381018	ARAGARCAS	15/11/2019 17:43	16/11/2019 17:23	15/11/2019 17:43	16/11/2019 17:23	23,66	2	47,32	CHI
201911177351	AGUAS LINDAS DE GOIAS	4830008429	AGUAS LINDAS DE GOIAS S1	15/11/2019 17:43	15/11/2019 19:25	15/11/2019 17:43	15/11/2019 19:25	1,69	1	1,69	CHI
201911177356	ALEXANIA	AX12381241	ALEXANIA	15/11/2019 17:43	16/11/2019 13:11	15/11/2019 17:43	16/11/2019 13:11	19,45	3	58,36	CHI
201911177361	MORRINHOS	MR12119786	MORRINHOS	15/11/2019 17:44	18/11/2019 11:40	15/11/2019 17:44	18/11/2019 11:40	65,94	6	395,61	CHI
201911177375	OURO VERDE DE GOIAS	OV21000023	NEROPOLIS S1	15/11/2019 17:45	16/11/2019 17:09	15/11/2019 17:45	16/11/2019 17:09	23,39	1	23,39	CHI
201911177380	CATALAO	CT12077316	CATALAO S2	15/11/2019 17:12	15/11/2019 21:08	15/11/2019 17:12	15/11/2019 21:08	3,93	414	1625,87	CHI
201911177405	MUNDO NOVO DE GOIAS	MH12269270	NOVA CRIXAS	15/11/2019 14:50	15/11/2019 20:09	15/11/2019 14:50	15/11/2019 20:09	5,31	39	207,11	CHI
201911177422	APARECIDA DE GOIANIA	10003278377	REAL S1	15/11/2019 17:50	16/11/2019 13:32	15/11/2019 17:50	16/11/2019 13:32	19,70	1	19,70	CHI
201911177423	ANAPOLIS	10008511797	ANAPOLIS UNIVERSITARIO S2	15/11/2019 17:50	16/11/2019 19:39	15/11/2019 17:50	16/11/2019 19:39	25,82	1	25,82	CHI
201911177435	BONFINOPOLIS	BO11045917	CEPAIGO S2	15/11/2019 17:43	16/11/2019 00:32	15/11/2019 17:43	16/11/2019 00:32	6,81	204	1388,56	CHI
201911177444	PALMEIRAS DE GOIAS	590034832	PALMEIRAS	15/11/2019 17:51	15/11/2019 21:49	15/11/2019 17:51	15/11/2019 21:49	3,96	1	3,96	CHI
201911177448	TEREZOPOLIS DE GOIAS	TJ11144796	DAIA S2	15/11/2019 17:26	16/11/2019 11:33	15/11/2019 17:26	16/11/2019 11:33	18,10	183	3312,81	CHI
201911177449	MATRINCHA	MP11073658	MATRINCHA	15/11/2019 17:19	16/11/2019 08:00	15/11/2019 17:19	16/11/2019 08:00	14,67	106	1555,29	CHI
201911177452	CATALAO	CT11333580	CATALAO S2	15/11/2019 17:35	16/11/2019 17:52	15/11/2019 17:35	16/11/2019 17:52	24,27	90	2184,22	CHI
201911177456	ORIZONA	OZ12143757	PIRES DO RIO S2	15/11/2019 16:23	15/11/2019 22:42	15/11/2019 16:23	15/11/2019 22:42	6,31	39	246,05	CHI
201911177457	MUTUNOPOLIS	MU12141105	MARA ROSA	15/11/2019 17:52	16/11/2019 11:20	15/11/2019 17:52	16/11/2019 11:20	17,46	25	436,58	CHI
201911177460	FORMOSA	FA12164536	ITIQUEIRA	15/11/2019 17:45	16/11/2019 10:51	15/11/2019 17:45	16/11/2019 10:51	17,10	2	34,19	CHI
201911177460	SAO JOAO D ALIANCA	FA12164536	ITIQUEIRA	15/11/2019 17:45	16/11/2019 10:51	15/11/2019 17:45	16/11/2019 10:51	17,10	225	3846,56	CHI
201911177464	CALDAS NOVAS	CN11231306	CALDAS NOVAS S2	15/11/2019 13:14	21/11/2019 01:24	15/11/2019 13:14	21/11/2019 01:24	132,17	8	1057,40	CHI
201911177469	PIRACANJUBA	PJ12105715	MORRINHOS	15/11/2019 17:42	16/11/2019 22:10	15/11/2019 17:42	16/11/2019 22:10	28,48	4	113,92	CHI
201911177482	CALDAS NOVAS	MG21000356	VILA CORUMBA	15/11/2019 17:53	18/11/2019 16:20	15/11/2019 17:53	18/11/2019 16:20	70,45	1	70,45	CHI
201911177487	LUZIANIA	LZ21230215	RIO VERMELHO	15/11/2019 17:53	16/11/2019 03:00	15/11/2019 17:53	16/11/2019 03:00	9,11	1	9,11	CHI
201911177489	SAO FRANCISCO DE GOIAS	SF21211920	SAO FRANCISCO DE GOIAS	15/11/2019 17:53	16/11/2019 10:33	15/11/2019 17:53	16/11/2019 10:33	16,66	1	16,66	CHI

201911177501	INHUMAS	IN11092659	INHUMAS S2	15/11/2019 17:53	15/11/2019 22:00	15/11/2019 17:53	15/11/2019 22:00	4,11	13	53,40	CHI
201911177507	DAVINOPOLIS	02630224	CATALAO S1	15/11/2019 17:08	17/11/2019 09:01	15/11/2019 17:08	15/11/2019 17:16	0,14	9	1,30	CHI
201911177507	OUVIDOR	02630224	CATALAO S1	15/11/2019 17:08	17/11/2019 09:01	15/11/2019 17:08	15/11/2019 17:16	0,14	515	74,53	CHI
201911177507	TRES RANCHOS	02630224	CATALAO S1	15/11/2019 17:08	17/11/2019 09:01	15/11/2019 17:08	15/11/2019 17:16	0,14	25	3,62	CHI
201911177507	OUVIDOR	02630224	CATALAO S1	15/11/2019 17:08	17/11/2019 09:01	15/11/2019 17:26	16/11/2019 09:54	16,46	2	32,93	CHI
201911177507	OUVIDOR	OU13333483	CATALAO S1	15/11/2019 17:08	17/11/2019 09:01	15/11/2019 17:26	16/11/2019 11:48	18,36	117	2147,54	CHI
201911177507	OUVIDOR	OU13149225	CATALAO S1	15/11/2019 17:08	17/11/2019 09:01	15/11/2019 17:26	16/11/2019 13:29	20,05	235	4711,75	CHI
201911177507	TRES RANCHOS	OU13149225	CATALAO S1	15/11/2019 17:08	17/11/2019 09:01	15/11/2019 17:26	16/11/2019 13:29	20,05	25	501,25	CHI
201911177507	OUVIDOR	OU13149227	CATALAO S1	15/11/2019 17:08	17/11/2019 09:01	15/11/2019 17:26	17/11/2019 07:31	38,07	46	1751,45	CHI
201911177507	OUVIDOR	OU12077558	CATALAO S1	15/11/2019 17:08	17/11/2019 09:01	15/11/2019 17:26	17/11/2019 08:47	39,34	19	747,50	CHI
201911177507	DAVINOPOLIS	OU13384408	CATALAO S1	15/11/2019 17:08	17/11/2019 09:01	15/11/2019 17:26	17/11/2019 09:01	39,59	10	395,87	CHI
201911177507	OUVIDOR	OU13384408	CATALAO S1	15/11/2019 17:08	17/11/2019 09:01	15/11/2019 17:26	17/11/2019 09:01	39,59	182	7204,82	CHI
201911177509	CAMPO ALEGRE DE GOIAS	CT10400690	CATALAO S1	15/11/2019 16:26	18/11/2019 12:01	15/11/2019 16:26	15/11/2019 19:00	2,56	1	2,56	CHI
201911177509	CATALAO	CT10400690	CATALAO S1	15/11/2019 16:26	18/11/2019 12:01	15/11/2019 16:26	15/11/2019 19:00	2,56	185	473,29	CHI
201911177509	CATALAO	CT10400688	CATALAO S1	15/11/2019 16:26	18/11/2019 12:01	15/11/2019 16:29	16/11/2019 14:15	21,77	459	9994,60	CHI
201911177509	CATALAO	CT10400688	CATALAO S1	15/11/2019 16:26	18/11/2019 12:01	15/11/2019 16:29	16/11/2019 14:15	21,77	1	21,77	CHI
201911177509	CAMPO ALEGRE DE GOIAS	CT10400688	CATALAO S1	15/11/2019 16:26	18/11/2019 12:01	15/11/2019 16:29	16/11/2019 16:40	24,18	1	24,18	CHI
201911177509	CATALAO	CT10400688	CATALAO S1	15/11/2019 16:26	18/11/2019 12:01	15/11/2019 16:29	16/11/2019 16:40	24,18	154	3724,19	CHI
201911177509	CATALAO	CT10400690	CATALAO S1	15/11/2019 16:26	18/11/2019 12:01	15/11/2019 16:26	17/11/2019 08:24	39,96	5	199,78	CHI
201911177509	CATALAO	CT10400688	CATALAO S1	15/11/2019 16:26	18/11/2019 12:01	15/11/2019 16:29	17/11/2019 11:54	43,43	46	1997,84	CHI
201911177509	CATALAO	CT10400690	CATALAO S1	15/11/2019 16:26	18/11/2019 12:01	15/11/2019 16:26	17/11/2019 12:10	43,73	2	87,46	CHI
201911177509	CATALAO	CT10400690	CATALAO S1	15/11/2019 16:26	18/11/2019 12:01	15/11/2019 16:26	18/11/2019 01:14	56,78	4	227,14	CHI
201911177509	CAMPO ALEGRE DE GOIAS	CT10400688	CATALAO S1	15/11/2019 16:26	18/11/2019 12:01	15/11/2019 16:29	18/11/2019 12:01	67,53	1	67,53	CHI
201911177509	CATALAO	CT10400688	CATALAO S1	15/11/2019 16:26	18/11/2019 12:01	15/11/2019 16:29	18/11/2019 12:01	67,53	33	2228,61	CHI
201911177521	BOM JESUS DE GOIAS	BJ10400764	BOM JESUS DE GOIAS	16/11/2019 06:14	16/11/2019 22:04	16/11/2019 06:14	16/11/2019 21:38	15,39	31	476,96	CHI
201911177521	QUIRINOPOLIS	BJ10400764	BOM JESUS DE GOIAS	16/11/2019 06:14	16/11/2019 22:04	16/11/2019 06:14	16/11/2019 21:38	15,39	6	92,31	CHI
201911177521	BOM JESUS DE GOIAS	BJ12263542	BOM JESUS DE GOIAS	16/11/2019 06:14	16/11/2019 22:04	16/11/2019 06:14	16/11/2019 22:04	15,82	1	15,82	CHI
201911177526	CABECEIRAS	FA10410993	ITIQUEIRA	15/11/2019 20:16	16/11/2019 12:59	15/11/2019 20:16	15/11/2019 20:28	0,20	27	5,52	CHI
201911177526	FORMOSA	FA10410993	ITIQUEIRA	15/11/2019 20:16	16/11/2019 12:59	15/11/2019 20:16	15/11/2019 20:28	0,20	2	0,41	CHI
201911177526	CABECEIRAS	FA10410993	ITIQUEIRA	15/11/2019 20:16	16/11/2019 12:59	15/11/2019 20:40	15/11/2019 20:45	0,09	27	2,47	CHI
201911177526	FORMOSA	FA10410993	ITIQUEIRA	15/11/2019 20:16	16/11/2019 12:59	15/11/2019 20:40	15/11/2019 20:45	0,09	2	0,18	CHI
201911177526	CABECEIRAS	FA10410993	ITIQUEIRA	15/11/2019 20:16	16/11/2019 12:59	15/11/2019 21:14	15/11/2019 21:22	0,15	27	4,02	CHI
201911177526	FORMOSA	FA10410993	ITIQUEIRA	15/11/2019 20:16	16/11/2019 12:59	15/11/2019 21:14	15/11/2019 21:22	0,15	2	0,30	CHI

201911177526	CABECEIRAS	CW10401455	ITIQUEIRA	15/11/2019 20:16	16/11/2019 12:59	15/11/2019 20:16	15/11/2019 23:58	3,71	5	18,53	CHI
201911177526	CABECEIRAS	CW10401455	ITIQUEIRA	15/11/2019 20:16	16/11/2019 12:59	15/11/2019 20:16	16/11/2019 01:30	5,24	53	277,75	CHI
201911177526	CABECEIRAS	CW10401455	ITIQUEIRA	15/11/2019 20:16	16/11/2019 12:59	15/11/2019 20:16	16/11/2019 01:38	5,37	100	537,11	CHI
201911177526	CABECEIRAS	FA10410993	ITIQUEIRA	15/11/2019 20:16	16/11/2019 12:59	16/11/2019 01:49	16/11/2019 01:58	0,16	27	4,21	CHI
201911177526	FORMOSA	FA10410993	ITIQUEIRA	15/11/2019 20:16	16/11/2019 12:59	16/11/2019 01:49	16/11/2019 01:58	0,16	2	0,31	CHI
201911177526	CABECEIRAS	CW10401455	ITIQUEIRA	15/11/2019 20:16	16/11/2019 12:59	16/11/2019 01:49	16/11/2019 02:01	0,20	58	11,70	CHI
201911177526	CABECEIRAS	CW10401455	ITIQUEIRA	15/11/2019 20:16	16/11/2019 12:59	16/11/2019 01:49	16/11/2019 02:01	0,21	100	20,86	CHI
201911177526	CABECEIRAS	FA10410993	ITIQUEIRA	15/11/2019 20:16	16/11/2019 12:59	16/11/2019 02:10	16/11/2019 02:16	0,10	27	2,81	CHI
201911177526	FORMOSA	FA10410993	ITIQUEIRA	15/11/2019 20:16	16/11/2019 12:59	16/11/2019 02:10	16/11/2019 02:16	0,10	2	0,21	CHI
201911177526	CABECEIRAS	CW10401455	ITIQUEIRA	15/11/2019 20:16	16/11/2019 12:59	16/11/2019 02:10	16/11/2019 02:17	0,12	58	6,69	CHI
201911177526	CABECEIRAS	CW10401454	ITIQUEIRA	15/11/2019 20:16	16/11/2019 12:59	16/11/2019 02:10	16/11/2019 02:17	0,12	100	12,08	CHI
201911177526	CABECEIRAS	FA10410993	ITIQUEIRA	15/11/2019 20:16	16/11/2019 12:59	15/11/2019 20:16	16/11/2019 02:38	6,36	23	146,27	CHI
201911177526	DISTRITO FEDERAL	FA10410993	ITIQUEIRA	15/11/2019 20:16	16/11/2019 12:59	15/11/2019 20:16	16/11/2019 02:38	6,36	1	6,36	CHI
201911177526	CABECEIRAS	CW10401455	ITIQUEIRA	15/11/2019 20:16	16/11/2019 12:59	15/11/2019 20:16	16/11/2019 12:59	16,72	14	234,13	CHI
201911177601	ISRAELANDIA	IS21278793	IPORA	15/11/2019 17:54	16/11/2019 15:51	15/11/2019 17:54	16/11/2019 15:51	21,95	2	43,90	CHI
201911177602	FAZENDA NOVA	FN12229876	JUSSARA	15/11/2019 17:27	17/11/2019 21:17	15/11/2019 17:27	17/11/2019 21:17	51,83	5	259,14	CHI
201911177605	GOIAS	GS12035930	GOIAS	15/11/2019 17:06	17/11/2019 20:40	16/11/2019 10:10	16/11/2019 13:10	3,00	16	48,00	CHI
201911177605	GOIAS	IK12299970	GOIAS	15/11/2019 17:06	17/11/2019 20:40	15/11/2019 17:06	17/11/2019 17:40	48,56	6	291,34	CHI
201911177605	HEITORAI	IK12299970	GOIAS	15/11/2019 17:06	17/11/2019 20:40	15/11/2019 17:06	17/11/2019 17:40	48,56	29	1408,14	CHI
201911177605	GOIAS	IK12299970	GOIAS	15/11/2019 17:06	17/11/2019 20:40	15/11/2019 17:06	17/11/2019 18:11	49,08	14	687,07	CHI
201911177605	ITABERAI	IK12299970	GOIAS	15/11/2019 17:06	17/11/2019 20:40	15/11/2019 17:06	17/11/2019 18:11	49,08	2	98,15	CHI
201911177605	ITAPURANGA	IK12299970	GOIAS	15/11/2019 17:06	17/11/2019 20:40	15/11/2019 17:06	17/11/2019 18:11	49,08	3	147,23	CHI
201911177605	GOIAS	IK12299970	GOIAS	15/11/2019 17:06	17/11/2019 20:40	15/11/2019 17:06	17/11/2019 20:40	51,57	4	206,28	CHI
201911177613	MORRINHOS	MR21102239	MORRINHOS	15/11/2019 17:55	18/11/2019 21:10	15/11/2019 17:55	18/11/2019 21:10	75,25	1	75,25	CHI
201911177619	GOIANIA	GN11056289	CARAJAS S2	15/11/2019 17:49	15/11/2019 19:11	15/11/2019 17:49	15/11/2019 19:11	1,35	151	204,02	CHI
201911177629	PORANGATU	PO11218984	PORANGATU	15/11/2019 17:47	15/11/2019 23:27	15/11/2019 17:47	15/11/2019 23:27	5,66	24	135,74	CHI
201911177642	CAMPO LIMPO	960006394	NEROPOLIS S1	15/11/2019 17:57	16/11/2019 08:42	15/11/2019 17:57	16/11/2019 08:42	14,74	1	14,74	CHI
201911177648	CRISTALINA	KR12248700	CRISTALINA S2	15/11/2019 17:57	16/11/2019 08:41	15/11/2019 17:57	16/11/2019 08:41	14,72	13	191,35	CHI
201911177657	CASTELANDIA	10010611213	RIO DOS BOIS	15/11/2019 17:58	16/11/2019 10:52	15/11/2019 17:58	16/11/2019 10:52	16,89	1	16,89	CHI
201911177671	MINEIROS	MY21203391	PARQUE DAS EMAS	15/11/2019 17:59	16/11/2019 12:54	15/11/2019 17:59	16/11/2019 12:54	18,90	1	18,90	CHI
201911177676	INHUMAS	IN11092628	INHUMAS S2	15/11/2019 18:00	16/11/2019 11:44	15/11/2019 18:00	16/11/2019 11:44	17,73	75	1329,44	CHI
201911177678	SANTA HELENA DE GOIAS	SH12296134	IPEGUARI	15/11/2019 17:20	16/11/2019 10:51	15/11/2019 17:20	16/11/2019 10:51	17,52	10	175,19	CHI
201911177691	CRISTALINA	1060081201	CRISTALINA S1	15/11/2019 18:01	15/11/2019 22:05	15/11/2019 18:01	15/11/2019 22:05	4,05	1	4,05	CHI

201911177694	CAMPO LIMPO	10003754187	NEROPOLIS S1	15/11/2019 18:02	16/11/2019 10:06	15/11/2019 18:02	16/11/2019 10:06	16,06	1	16,06	CHI
201911177696	JATAI	JT21241653	JATAI S3	15/11/2019 18:17	15/11/2019 19:50	15/11/2019 18:17	15/11/2019 19:50	1,56	1	1,56	CHI
201911177697	JATAI	290341310	JATAI S3	15/11/2019 18:02	16/11/2019 12:58	15/11/2019 18:02	16/11/2019 12:58	18,93	1	18,93	CHI
201911177699	RIO VERDE	RV12092821	MONTIVIDIU T	15/11/2019 17:08	16/11/2019 20:10	15/11/2019 17:08	16/11/2019 20:10	27,03	11	297,28	CHI
201911177700	GOIANIA	GN11000715	REAL S2	15/11/2019 16:17	15/11/2019 20:35	15/11/2019 16:17	15/11/2019 20:35	4,29	114	489,22	CHI
201911177708	SANTA RITA DO NOVO DESTINO	DF11315651	BARRO ALTO	15/11/2019 18:03	17/11/2019 09:27	15/11/2019 18:03	17/11/2019 09:27	39,39	1	39,39	CHI
201911177710	VIANOPOLIS	VN12117204	VIANOPOLIS	15/11/2019 18:03	16/11/2019 15:58	16/11/2019 14:39	16/11/2019 15:35	0,94	10	9,38	CHI
201911177710	VIANOPOLIS	VN21117196	VIANOPOLIS	15/11/2019 18:03	16/11/2019 15:58	15/11/2019 18:03	16/11/2019 15:58	21,92	1	21,92	CHI
201911177714	CRIXAS	CX12243498	SERRA DO OURO	15/11/2019 18:04	15/11/2019 20:46	15/11/2019 18:04	15/11/2019 20:46	2,70	1	2,70	CHI
201911177723	GOIANIA	GN12001501	XAVANTES	15/11/2019 16:24	15/11/2019 20:07	15/11/2019 16:24	15/11/2019 20:07	3,70	217	803,68	CHI
201911177725	APARECIDA DE GOIANIA	17444342	REAL S1	15/11/2019 18:04	16/11/2019 08:20	15/11/2019 18:04	16/11/2019 08:20	14,25	1	14,25	CHI
201911177728	CALDAS NOVAS	CN12123546	SERRA DE CALDAS	15/11/2019 17:09	15/11/2019 23:33	15/11/2019 17:09	15/11/2019 23:33	6,39	63	402,55	CHI
201911177731	LEOPOLDO DE BULHOES	LB12028215	DAIA S2	15/11/2019 18:05	17/11/2019 15:48	15/11/2019 18:05	17/11/2019 15:48	45,72	4	182,90	CHI
201911177734	MOSSAMEDES	MD12057741	FIRMINOPOLIS S2	15/11/2019 18:05	16/11/2019 00:40	15/11/2019 18:05	16/11/2019 00:40	6,58	18	118,42	CHI
201911177734	SANCLERLANDIA	MD12057741	FIRMINOPOLIS S2	15/11/2019 18:05	16/11/2019 00:40	15/11/2019 18:05	16/11/2019 00:40	6,58	1	6,58	CHI
201911177742	JATAI	JT11025403	JATAI S2	15/11/2019 17:07	15/11/2019 20:28	15/11/2019 17:07	15/11/2019 20:28	3,35	46	154,01	CHI
201911177757	ACREUNA	EU12219448	ACREUNA	15/11/2019 18:07	15/11/2019 22:22	15/11/2019 18:07	15/11/2019 21:47	3,66	2	7,33	CHI
201911177757	PARAUNA	EU12219448	ACREUNA	15/11/2019 18:07	15/11/2019 22:22	15/11/2019 18:07	15/11/2019 21:47	3,66	3	10,99	CHI
201911177757	ACREUNA	EU12246844LD	ACREUNA	15/11/2019 18:07	15/11/2019 22:22	15/11/2019 18:07	15/11/2019 22:22	4,25	2	8,49	CHI
201911177768	IPAMERI	IP12231489	IPAMERI	15/11/2019 17:02	15/11/2019 21:47	15/11/2019 17:02	15/11/2019 21:47	4,74	61	289,44	CHI
201911177774	LUZIANIA	LZ12376129	CRISTALINA S2	15/11/2019 16:25	16/11/2019 04:10	15/11/2019 16:25	16/11/2019 04:10	11,74	21	246,56	CHI
201911177785	APARECIDA DE GOIANIA	200312224	INDEPENDENCIA S1	15/11/2019 18:09	16/11/2019 11:41	15/11/2019 18:09	16/11/2019 11:41	17,54	1	17,54	CHI
201911177791	CEZARINA	CZ21310224	GUAPO S2	15/11/2019 13:31	16/11/2019 11:58	15/11/2019 13:31	16/11/2019 11:58	22,46	3	67,37	CHI
201911177793	ARUANA	AK21217218	MOZARLANDIA	15/11/2019 18:09	17/11/2019 19:11	15/11/2019 18:09	17/11/2019 19:11	49,02	1	49,02	CHI
201911177810	CATALAO	CT11000068	CATALAO S2	15/11/2019 17:18	16/11/2019 08:53	15/11/2019 17:18	16/11/2019 08:53	15,57	128	1992,89	CHI
201911177816	GOIANIA	12405218	GOYA S2	15/11/2019 18:12	16/11/2019 11:20	15/11/2019 18:12	16/11/2019 11:20	17,13	1	17,13	CHI
201911177823	PONTALINA	PK12118100RE	PONTALINA	15/11/2019 18:12	16/11/2019 12:51	15/11/2019 18:12	16/11/2019 12:51	18,65	41	764,64	CHI
201911177824	CAIAPONIA	CP12207993	PALESTINA	15/11/2019 17:57	16/11/2019 01:46	15/11/2019 17:57	16/11/2019 01:46	7,82	3	23,45	CHI
201911177833	MORRINHOS	MR12060321RE	VILA CORUMBA	15/11/2019 16:22	15/11/2019 23:48	15/11/2019 16:22	15/11/2019 23:48	7,42	37	274,48	CHI
201911177844	GOIANIA	16361994	GOYA S2	15/11/2019 18:15	16/11/2019 13:36	15/11/2019 18:15	16/11/2019 13:36	19,35	1	19,35	CHI
201911177846	SENADOR CANEDO	SW11322950	SENADOR CANEDO	15/11/2019 18:15	16/11/2019 15:52	15/11/2019 18:15	16/11/2019 15:52	21,61	13	280,94	CHI
201911177856	CALDAZINHA	10014059272	SENADOR CANEDO	15/11/2019 18:16	16/11/2019 18:05	15/11/2019 18:16	16/11/2019 18:05	23,83	1	23,83	CHI
201911177859	CALDAS NOVAS	CN11051667	CALDAS NOVAS S2	15/11/2019 16:11	15/11/2019 22:01	15/11/2019 16:11	15/11/2019 22:01	5,83	227	1323,47	CHI

201911177860	ANAPOLIS	21003208	JUNDIAI S1	15/11/2019 18:16	16/11/2019 08:41	15/11/2019 18:16	16/11/2019 08:41	14,41	1	14,41	CHI
201911177873	GOIANIA	GN11165730	ATLANTICO S3	15/11/2019 17:26	15/11/2019 19:53	15/11/2019 17:26	15/11/2019 19:53	2,44	61	148,79	CHI
201911177877	GOIANIA	10021198169	CAMPINAS S3	15/11/2019 18:18	16/11/2019 00:45	15/11/2019 18:18	16/11/2019 00:45	6,45	1	6,45	CHI
201911177891	ANAPOLIS	AN21258626	JUNDIAI S1	15/11/2019 18:20	16/11/2019 13:17	15/11/2019 18:20	16/11/2019 13:17	18,94	1	18,94	CHI
201911177906	OURO VERDE DE GOIAS	OV12384176	NEROPOLIS S1	15/11/2019 17:58	16/11/2019 14:40	15/11/2019 17:58	16/11/2019 14:40	20,69	11	227,63	CHI
201911177921	LUZIANIA	LZ11294712	RIO VERMELHO	15/11/2019 17:44	16/11/2019 03:32	15/11/2019 17:44	16/11/2019 03:32	9,79	9	88,14	CHI
201911177925	SAO FRANCISCO DE GOIAS	SF12389747	SAO FRANCISCO DE GOIAS	15/11/2019 18:22	16/11/2019 12:47	15/11/2019 18:22	16/11/2019 12:47	18,40	1	18,40	CHI
201911177929	GOIANESIA	GE12004544	GOIANESIA S2	15/11/2019 17:56	16/11/2019 00:54	15/11/2019 17:56	16/11/2019 00:54	6,96	9	62,60	CHI
201911177929	VILA PROPICIO	GE12004544	GOIANESIA S2	15/11/2019 17:56	16/11/2019 00:54	15/11/2019 17:56	16/11/2019 00:54	6,96	28	194,75	CHI
201911177930	CAMPO LIMPO	AN21258616	NEROPOLIS S1	15/11/2019 18:23	16/11/2019 11:35	15/11/2019 18:23	16/11/2019 11:35	17,20	1	17,20	CHI
201911177931	LUZIANIA	LZ21276295	MARAJOARA	15/11/2019 18:23	16/11/2019 10:59	15/11/2019 18:23	16/11/2019 10:59	16,59	1	16,59	CHI
201911177936	ANAPOLIS	10012997453	JUNDIAI S2	15/11/2019 18:23	16/11/2019 07:55	15/11/2019 18:23	16/11/2019 07:55	13,52	1	13,52	CHI
201911177937	GOIANIA	10291891	CAMPINAS S2	15/11/2019 18:23	16/11/2019 13:01	15/11/2019 18:23	16/11/2019 13:01	18,62	1	18,62	CHI
201911177938	FORMOSA	FA31085553	ITUIQUIRA	15/11/2019 18:23	17/11/2019 10:21	15/11/2019 18:23	17/11/2019 10:21	39,95	1	39,95	CHI
201911177940	GOIANAPOLIS	GP21283827	DAIA S2	15/11/2019 18:24	15/11/2019 23:13	15/11/2019 18:24	15/11/2019 23:13	4,82	2	9,63	CHI
201911177948	CALDAS NOVAS	CN21298758	CALDAS NOVAS S1	15/11/2019 18:24	17/11/2019 12:30	15/11/2019 18:24	17/11/2019 12:30	42,11	1	42,11	CHI
201911177963	BELA VISTA DE GOIAS	BV21122501	BELA VISTA S2	15/11/2019 18:25	16/11/2019 10:51	15/11/2019 18:25	16/11/2019 10:51	16,42	2	32,85	CHI
201911177968	SENADOR CANEDO	AP12400466	SENADOR CANEDO	15/11/2019 17:23	16/11/2019 02:52	15/11/2019 17:23	16/11/2019 02:52	9,47	64	606,10	CHI
201911177982	ALEXANIA	AX11119962	ALEXANIA	15/11/2019 12:33	16/11/2019 03:23	15/11/2019 12:33	16/11/2019 03:23	14,83	70	1037,79	CHI
201911177988	JARAGUA	JA12297837	JARAGUA	15/11/2019 17:06	15/11/2019 19:30	15/11/2019 17:06	15/11/2019 19:30	2,40	9	21,59	CHI
201911177996	INHUMAS	IN12000054	INHUMAS S2	15/11/2019 17:59	15/11/2019 21:45	15/11/2019 17:59	15/11/2019 21:45	3,75	189	709,22	CHI
201911178003	IPAMERI	IP12026517	IPAMERI	15/11/2019 18:28	16/11/2019 07:26	15/11/2019 18:28	16/11/2019 07:26	12,95	8	103,62	CHI
201911178007	GOIANIA	GN11001007	CAMPINAS S1	15/11/2019 18:22	15/11/2019 22:00	15/11/2019 18:22	15/11/2019 22:00	3,63	126	457,77	CHI
201911178008	QUIRINOPOLIS	QI12355062	QUIRINOPOLIS	15/11/2019 18:29	15/11/2019 22:57	15/11/2019 18:29	15/11/2019 22:57	4,46	44	196,35	CHI
201911178009	GOIANIA	GN11154614	CARAJAS S1	15/11/2019 17:55	15/11/2019 20:07	15/11/2019 17:55	15/11/2019 20:07	2,19	176	386,22	CHI
201911178011	PIRACANJUBA	PJ12160404	PIRACANJUBA	15/11/2019 15:43	15/11/2019 23:40	15/11/2019 15:43	15/11/2019 23:40	7,95	204	1621,57	CHI
201911178022	PALMEIRAS DE GOIAS	PL21312436	PALMEIRAS	15/11/2019 18:30	16/11/2019 12:48	15/11/2019 18:30	16/11/2019 12:48	18,30	1	18,30	CHI
201911178023	ITUMBIARA	690006974	ITUMBIARA VELHA S1	15/11/2019 18:30	17/11/2019 06:37	15/11/2019 18:30	17/11/2019 06:37	36,11	1	36,11	CHI
201911178041	PIRENOPOLIS	PV11000017	CORUMBA	15/11/2019 15:45	15/11/2019 19:58	15/11/2019 15:45	15/11/2019 19:58	4,20	74	310,98	CHI
201911178047	PIRENOPOLIS	PV12360322	CORUMBA	15/11/2019 17:50	16/11/2019 19:45	15/11/2019 17:50	16/11/2019 19:45	25,91	8	207,30	CHI
201911178048	TRINDADE	TR12095985	MEIA PONTE	15/11/2019 17:24	15/11/2019 22:30	15/11/2019 17:24	15/11/2019 22:30	5,10	184	937,68	CHI
201911178052	LUZIANIA	LZ12396831	MARAJOARA	15/11/2019 18:31	15/11/2019 23:44	15/11/2019 18:31	15/11/2019 23:44	5,20	18	93,64	CHI
201911178061	BALIZA	BH12343730	BOM JARDIM	15/11/2019 18:17	15/11/2019 22:23	15/11/2019 18:17	15/11/2019 22:23	4,10	8	32,79	CHI

201911178064	SAO MIGUEL DO PASSA QUATRO	1490013470	CRISTIANOPOLIS	15/11/2019 18:33	16/11/2019 18:01	15/11/2019 18:33	16/11/2019 18:01	23,45	1	23,45	CHI
201911178073	ALEXANIA	AX21284155	ALEXANIA	15/11/2019 18:34	16/11/2019 09:45	15/11/2019 18:34	16/11/2019 09:45	15,18	2	30,35	CHI
201911178074	CRISTALINA	KR12383029	CRISTALINA S2	15/11/2019 16:28	16/11/2019 08:41	15/11/2019 16:28	16/11/2019 08:41	16,21	5	81,07	CHI
201911178075	NEROPOLIS	GN21211120	NEROPOLIS S2	15/11/2019 18:34	16/11/2019 11:12	15/11/2019 18:34	16/11/2019 11:12	16,62	1	16,62	CHI
201911178078	ANAPOLIS	20734943	JUNDIAI S1	15/11/2019 18:35	16/11/2019 15:17	15/11/2019 18:35	16/11/2019 15:17	20,70	0	0,00	CHI
201911178079	ALEXANIA	AX12328297	ALEXANIA	15/11/2019 10:30	16/11/2019 11:45	15/11/2019 10:30	16/11/2019 11:45	25,25	3	75,74	CHI
201911178086	URUACU	UR21147161	URUACU	15/11/2019 18:35	16/11/2019 07:57	15/11/2019 18:35	16/11/2019 07:57	13,35	1	13,35	CHI
201911178091	LUZIANIA	LZ12396834	MARAJOARA	15/11/2019 18:32	15/11/2019 22:23	15/11/2019 18:32	15/11/2019 22:23	3,85	30	115,50	CHI
201911178092	QUIRINOPOLIS	QI32052457	QUIRINOPOLIS	15/11/2019 18:31	16/11/2019 08:37	15/11/2019 18:31	16/11/2019 08:37	14,09	9	126,83	CHI
201911178095	GOIANIA	10019818708	GOIANIA LESTE S1	15/11/2019 18:37	16/11/2019 08:09	15/11/2019 18:37	16/11/2019 08:09	13,53	1	13,53	CHI
201911178107	GOIANIA	GN12151986	MEIA PONTE	15/11/2019 18:21	15/11/2019 20:16	15/11/2019 18:21	15/11/2019 20:16	1,92	542	1038,23	CHI
201911178130	TRES RANCHOS	2170000611	CATALAO S1	15/11/2019 18:39	16/11/2019 17:31	15/11/2019 18:39	16/11/2019 17:31	22,87	1	22,87	CHI
201911178146	GOIANIA	GN11002372	FERROVIARIO S1	15/11/2019 18:20	15/11/2019 21:56	15/11/2019 18:20	15/11/2019 21:56	3,59	99	355,68	CHI
201911178147	SANTO ANTONIO DO DESCOBERTO	SN11163877	ALEXANIA	15/11/2019 18:41	16/11/2019 13:33	15/11/2019 18:41	16/11/2019 13:33	18,86	93	1754,13	CHI
201911178151	CAMPO LIMPO	AN21258886	NEROPOLIS S1	15/11/2019 18:41	16/11/2019 11:17	15/11/2019 18:41	16/11/2019 11:17	16,59	1	16,59	CHI
201911178153	GOIANIA	10055496	CAMPINAS S1	15/11/2019 18:41	16/11/2019 03:13	15/11/2019 18:41	16/11/2019 03:13	8,52	1	8,52	CHI
201911178176	JARAGUA	JA11345538	JARAGUA	15/11/2019 16:57	15/11/2019 20:47	15/11/2019 16:57	15/11/2019 20:47	3,83	50	191,61	CHI
201911178177	VIANOPOLIS	VN21282496	VIANOPOLIS	15/11/2019 18:43	16/11/2019 10:51	15/11/2019 18:43	16/11/2019 10:51	16,13	1	16,13	CHI
201911178182	CAIAPONIA	CP11355575	CAIAPONIA	15/11/2019 18:44	17/11/2019 08:46	15/11/2019 18:44	17/11/2019 08:46	38,03	0	0,00	CHI
201911178183	CORUMBA DE GOIAS	CB21295518	CORUMBA	15/11/2019 18:44	16/11/2019 15:23	15/11/2019 18:44	16/11/2019 15:23	20,65	1	20,65	CHI
201911178195	PALMEIRAS DE GOIAS	PL12000034	PALMEIRAS	15/11/2019 17:40	16/11/2019 09:05	15/11/2019 17:40	16/11/2019 09:05	15,42	3	46,27	CHI
201911178198	VALPARAISO DE GOIAS	10018604860	PACAEMBU S1	15/11/2019 18:45	15/11/2019 20:02	15/11/2019 18:45	15/11/2019 20:02	1,28	1	1,28	CHI
201911178201	ANAPOLIS	10016181180	JUNDIAI S1	15/11/2019 18:46	16/11/2019 13:40	15/11/2019 18:46	16/11/2019 13:40	18,90	1	18,90	CHI
201911178213	GOIANIA	GN11000684	GOIANIA LESTE S1	15/11/2019 17:55	16/11/2019 03:01	15/11/2019 17:55	16/11/2019 03:01	9,09	117	1063,37	CHI
201911178217	CALDAS NOVAS	CN12059865RE	VILA CORUMBA	15/11/2019 16:38	17/11/2019 17:58	15/11/2019 16:38	17/11/2019 17:58	49,33	20	986,59	CHI
201911178218	BARRO ALTO	PV12069121	GOIANESIA S1	15/11/2019 18:15	16/11/2019 15:21	15/11/2019 18:15	16/11/2019 15:21	21,11	1	21,11	CHI
201911178218	VILA PROPICIO	PV12069121	GOIANESIA S1	15/11/2019 18:15	16/11/2019 15:21	15/11/2019 18:15	16/11/2019 15:21	21,11	34	717,63	CHI
201911178226	AMERICANO DO BRASIL	KB12065192	ANICUNS	15/11/2019 17:53	15/11/2019 21:19	15/11/2019 17:53	15/11/2019 21:19	3,43	11	37,69	CHI
201911178230	IPORA	730150008	IPORA	15/11/2019 18:49	16/11/2019 07:10	15/11/2019 18:49	16/11/2019 07:10	12,35	1	12,35	CHI
201911178232	SENADOR CANEDO	SW11167655	SENADOR CANEDO	15/11/2019 18:26	16/11/2019 01:24	15/11/2019 18:26	16/11/2019 01:24	6,96	96	667,92	CHI
201911178241	ANICUNS	AC12391421	ANICUNS	15/11/2019 18:50	15/11/2019 23:03	15/11/2019 18:50	15/11/2019 23:03	4,21	3	12,62	CHI
201911178270	MONTIVIDIU	MV21010589	MONTIVIDIU T	15/11/2019 18:52	15/11/2019 21:32	15/11/2019 18:52	15/11/2019 21:32	2,66	2	5,31	CHI
201911178272	LUZIANIA	LZ12349111	MARAJOARA	15/11/2019 18:31	15/11/2019 21:58	15/11/2019 18:31	15/11/2019 21:58	3,45	107	368,67	CHI

201911178283	GOIANIA	AP11169722	INDEPENDENCIA S1	15/11/2019 17:53	15/11/2019 21:02	15/11/2019 17:53	15/11/2019 21:02	3,15	63	198,26	CHI
201911178291	FORMOSA	FA12366173	ITUIQUIRA	15/11/2019 18:54	16/11/2019 08:03	15/11/2019 18:54	16/11/2019 08:03	13,15	3	39,44	CHI
201911178294	CAIAPONIA	CP12135376	CAIAPONIA	15/11/2019 18:25	16/11/2019 18:45	15/11/2019 18:25	16/11/2019 18:45	24,32	8	194,59	CHI
201911178303	CATALAO	CT11316066	CATALAO S2	15/11/2019 17:14	16/11/2019 11:55	15/11/2019 17:14	16/11/2019 11:55	18,68	43	803,32	CHI
201911178304	GOIANIA	GN11085832	ATLANTICO S2	15/11/2019 18:50	15/11/2019 20:41	15/11/2019 18:50	15/11/2019 20:41	1,84	104	191,13	CHI
201911178311	JATAI	JT12260285	JATAI S3	15/11/2019 18:56	16/11/2019 11:24	15/11/2019 18:56	16/11/2019 11:24	16,46	3	49,38	CHI
201911178313	TRINDADE	TR12130455	MEIA PONTE	15/11/2019 15:56	15/11/2019 21:00	15/11/2019 15:56	15/11/2019 21:00	5,06	116	586,64	CHI
201911178338	RIO VERDE	RV12240539	MONTIVIDIU T	15/11/2019 17:31	16/11/2019 11:55	15/11/2019 17:31	16/11/2019 11:55	18,39	2	36,79	CHI
201911178340	HIDROLANDIA	HD11000143	ANHANGUERA	15/11/2019 16:30	16/11/2019 08:21	15/11/2019 16:30	16/11/2019 08:21	15,84	85	1346,52	CHI
201911178345	GOIANIA	10976024	AEROPORTO S1	15/11/2019 18:59	16/11/2019 02:29	15/11/2019 18:59	16/11/2019 02:29	7,50	1	7,50	CHI
201911178349	INHUMAS	CK21318926	INHUMAS S2	15/11/2019 18:59	15/11/2019 22:35	15/11/2019 18:59	15/11/2019 22:35	3,59	2	7,18	CHI
201911178351	GOIANIA	GN12059904	REAL S2	15/11/2019 18:11	16/11/2019 16:55	15/11/2019 18:11	16/11/2019 02:24	8,22	6	49,30	CHI
201911178351	GOIANIA	GN12276911LD	REAL S2	15/11/2019 18:11	16/11/2019 16:55	15/11/2019 18:11	16/11/2019 16:55	22,73	76	1727,29	CHI
201911178352	ABADIANIA	AA12382488	ANAPOLIS UNIVERSITARIO S1	15/11/2019 18:59	16/11/2019 14:49	15/11/2019 18:59	16/11/2019 14:49	19,82	4	79,29	CHI
201911178355	FIRMINOPOLIS	900008404	FIRMINOPOLIS S1	15/11/2019 18:59	16/11/2019 01:33	15/11/2019 18:59	16/11/2019 01:33	6,55	1	6,55	CHI
201911178360	TROMBAS	TB12245290	PORANGATU	15/11/2019 18:17	16/11/2019 01:04	15/11/2019 18:17	16/11/2019 01:04	6,78	7	47,48	CHI
201911178367	RIO VERDE	10024909023	RIO VERDE S1	15/11/2019 19:00	16/11/2019 18:40	15/11/2019 19:00	16/11/2019 18:40	23,67	1	23,67	CHI
201911178371	MONTIVIDIU DO NORTE	TB12143685	PORANGATU	15/11/2019 18:49	16/11/2019 00:00	15/11/2019 18:49	16/11/2019 00:00	5,17	10	51,68	CHI
201911178371	TROMBAS	TB12143685	PORANGATU	15/11/2019 18:49	16/11/2019 00:00	15/11/2019 18:49	16/11/2019 00:00	5,17	18	93,03	CHI
201911178377	INHUMAS	IN12272280	INHUMAS S1	15/11/2019 18:42	16/11/2019 14:12	15/11/2019 18:42	16/11/2019 13:15	18,56	2	37,11	CHI
201911178377	INHUMAS	IN12098279	INHUMAS S1	15/11/2019 18:42	16/11/2019 14:12	15/11/2019 18:42	16/11/2019 13:52	19,17	10	191,75	CHI
201911178377	INHUMAS	IN12272290	INHUMAS S1	15/11/2019 18:42	16/11/2019 14:12	15/11/2019 18:42	16/11/2019 14:00	19,30	6	115,79	CHI
201911178377	INHUMAS	IN12014094	INHUMAS S1	15/11/2019 18:42	16/11/2019 14:12	15/11/2019 18:42	16/11/2019 14:12	19,50	9	175,54	CHI
201911178384	RIO VERDE	630152755	RIO VERDE S2	15/11/2019 19:03	16/11/2019 10:30	15/11/2019 19:03	16/11/2019 10:30	15,45	1	15,45	CHI
201911178385	NOVO BRASIL	NB11020195	JUSSARA	15/11/2019 17:25	16/11/2019 08:10	15/11/2019 17:25	16/11/2019 08:10	14,73	126	1856,58	CHI
201911178386	JARAGUA	JA11000023	JARAGUA	15/11/2019 16:21	15/11/2019 21:18	15/11/2019 16:21	15/11/2019 21:18	4,95	30	148,40	CHI
201911178389	MUTUNOPOLIS	MU21133916	MARA ROSA	15/11/2019 19:03	16/11/2019 11:00	15/11/2019 19:03	16/11/2019 11:00	15,94	13	207,26	CHI
201911178401	CIDADE OCIDENTAL	LZ11072413	MARAJOARA	15/11/2019 19:04	15/11/2019 20:55	15/11/2019 19:04	15/11/2019 20:55	1,85	10	18,49	CHI
201911178405	ITUMBIARA	690315077	ITUMBIARA NOVA	15/11/2019 19:04	17/11/2019 00:46	15/11/2019 19:04	17/11/2019 00:46	29,71	1	29,71	CHI
201911178407	RIO VERDE	RV11384638	CABRIUVA S1	15/11/2019 18:01	16/11/2019 18:50	15/11/2019 18:01	16/11/2019 18:50	24,80	52	1289,72	CHI
201911178416	GOIANIA	GN21000361	GOIANIA LESTE S1	15/11/2019 18:50	16/11/2019 11:10	15/11/2019 18:50	16/11/2019 11:10	16,33	69	1126,48	CHI
201911178417	CAIAPONIA	CP21151371	CAIAPONIA	15/11/2019 19:05	16/11/2019 23:56	15/11/2019 19:05	16/11/2019 23:56	28,84	1	28,84	CHI
201911178420	NIQUELANDIA	NQ12341309	NIQUELANDIA SUBTRANSMISSAO	15/11/2019 17:35	16/11/2019 18:58	15/11/2019 17:35	16/11/2019 18:58	25,39	95	2411,63	CHI

201911178422	CHAPADAO DO CEU	DJ12182111	CHAPADAO DO CEU	15/11/2019 17:40	16/11/2019 13:42	15/11/2019 17:40	16/11/2019 13:42	20,03	22	440,59	CHI
201911178427	ACREUNA	BZ12219419	ACREUNA	15/11/2019 17:18	16/11/2019 10:41	15/11/2019 17:18	16/11/2019 10:41	17,38	5	86,91	CHI
201911178427	RIO VERDE	BZ12219419	ACREUNA	15/11/2019 17:18	16/11/2019 10:41	15/11/2019 17:18	16/11/2019 10:41	17,38	23	399,80	CHI
201911178427	SANTA HELENA DE GOIAS	BZ12219419	ACREUNA	15/11/2019 17:18	16/11/2019 10:41	15/11/2019 17:18	16/11/2019 10:41	17,38	83	1442,77	CHI
201911178427	SANTO ANTONIO DA BARRA	BZ12219419	ACREUNA	15/11/2019 17:18	16/11/2019 10:41	15/11/2019 17:18	16/11/2019 10:41	17,38	168	2920,31	CHI
201911178427	RIO VERDE	BZ12219419	ACREUNA	15/11/2019 17:18	16/11/2019 10:41	15/11/2019 18:07	16/11/2019 10:41	16,56	1	16,56	CHI
201911178427	SANTA HELENA DE GOIAS	BZ12219419	ACREUNA	15/11/2019 17:18	16/11/2019 10:41	15/11/2019 18:07	16/11/2019 10:41	16,56	1	16,56	CHI
201911178427	SANTO ANTONIO DA BARRA	BZ12219419	ACREUNA	15/11/2019 17:18	16/11/2019 10:41	15/11/2019 18:07	16/11/2019 10:41	16,56	3	49,68	CHI
201911178434	IPAMERI	IP12272798	IPAMERI	15/11/2019 18:50	16/11/2019 10:38	15/11/2019 18:50	16/11/2019 10:38	15,80	7	110,57	CHI
201911178437	APARECIDA DE GOIANIA	AP12393876	REAL S1	15/11/2019 16:57	16/11/2019 00:00	15/11/2019 16:57	16/11/2019 00:00	7,04	132	928,84	CHI
201911178440	INHUMAS	IX12016404	INHUMAS S1	15/11/2019 18:51	15/11/2019 21:55	15/11/2019 18:51	15/11/2019 21:55	3,06	1	3,06	CHI
201911178440	ITAUCU	IX12016404	INHUMAS S1	15/11/2019 18:51	15/11/2019 21:55	15/11/2019 18:51	15/11/2019 21:55	3,06	4	12,22	CHI
201911178449	CAMPO ALEGRE DE GOIAS	CT12165148	CAMPO ALEGRE DE GOIAS	15/11/2019 18:21	18/11/2019 16:30	15/11/2019 18:21	18/11/2019 16:30	70,14	3	210,41	CHI
201911178449	CATALAO	CT12165148	CAMPO ALEGRE DE GOIAS	15/11/2019 18:21	18/11/2019 16:30	15/11/2019 18:21	18/11/2019 16:30	70,14	3	210,41	CHI
201911178451	ANAPOLIS	20148197	JUNDIAI S2	15/11/2019 19:09	16/11/2019 07:54	15/11/2019 19:09	16/11/2019 07:54	12,75	1	12,75	CHI
201911178459	GOIANIA	GN11024515	REAL S1	15/11/2019 17:58	16/11/2019 01:53	15/11/2019 17:58	16/11/2019 01:53	7,91	28	221,54	CHI
201911178463	SENADOR CANEDO	10023917626	SENADOR CANEDO	15/11/2019 19:11	16/11/2019 03:56	15/11/2019 19:11	16/11/2019 03:56	8,75	1	8,75	CHI
201911178467	SANTO ANTONIO DA BARRA	BZ21286644	ACREUNA	15/11/2019 17:18	16/11/2019 10:00	15/11/2019 17:18	16/11/2019 10:00	16,71	1	16,71	CHI
201911178468	TRES RANCHOS	TH12195259RE	CATALAO S1	15/11/2019 17:51	16/11/2019 11:40	15/11/2019 17:51	16/11/2019 11:40	17,81	297	5290,56	CHI
201911178469	JUSSARA	JR11167550	JUSSARA	15/11/2019 18:09	15/11/2019 21:56	15/11/2019 18:09	15/11/2019 21:56	3,77	207	780,22	CHI
201911178471	CALDAS NOVAS	CN21354119	VILA CORUMBA	15/11/2019 19:12	17/11/2019 15:54	15/11/2019 19:12	17/11/2019 15:54	44,69	1	44,69	CHI
201911178473	IPAMERI	IP11215523	IPAMERI	15/11/2019 17:28	15/11/2019 23:40	15/11/2019 17:28	15/11/2019 23:40	6,19	20	123,81	CHI
201911178474	CALDAS NOVAS	CN12213917	CALDAS NOVAS S1	15/11/2019 17:03	15/11/2019 22:34	15/11/2019 17:03	15/11/2019 22:34	5,51	36	198,24	CHI
201911178478	BELA VISTA DE GOIAS	BV12360000	BELA VISTA S2	15/11/2019 19:13	16/11/2019 12:45	15/11/2019 19:13	16/11/2019 12:45	17,53	3	52,58	CHI
201911178479	PLANALTINA	PI21372437	PADRE BERNARDO	15/11/2019 19:13	16/11/2019 17:29	15/11/2019 19:13	16/11/2019 17:29	22,25	1	22,25	CHI
201911178481	ORIZONA	OZ12297216	PIRES DO RIO S2	15/11/2019 18:46	16/11/2019 19:01	15/11/2019 18:46	16/11/2019 19:01	24,24	4	96,97	CHI
201911178497	ANAPOLIS	10000003580	ANAPOLIS UNIVERSITARIO S2	15/11/2019 19:15	16/11/2019 10:00	15/11/2019 19:15	16/11/2019 10:00	14,75	1	14,75	CHI
201911178513	RIO VERDE	RV11000003	RIO VERDE S1	15/11/2019 18:51	16/11/2019 11:47	15/11/2019 18:51	16/11/2019 11:47	16,92	59	998,18	CHI
201911178526	CALDAZINHA	BV12043268	CEPAIGO S2	15/11/2019 18:03	16/11/2019 16:08	15/11/2019 18:03	16/11/2019 16:08	22,07	40	882,74	CHI
201911178536	GOIANIA	GN11197491	XAVANTES	15/11/2019 19:15	16/11/2019 02:16	15/11/2019 19:15	16/11/2019 02:16	7,00	18	126,03	CHI
201911178542	INDIARA	IY12158916	CEZARINA	15/11/2019 15:21	15/11/2019 21:20	15/11/2019 15:21	15/11/2019 21:20	5,98	3	17,93	CHI
201911178548	LUZIANIA	120381977	RIO VERMELHO	15/11/2019 19:18	16/11/2019 03:29	15/11/2019 19:18	16/11/2019 03:29	8,17	1	8,17	CHI
201911178550	URUACU	640048559	URUACU	15/11/2019 19:18	16/11/2019 01:54	15/11/2019 19:18	16/11/2019 01:54	6,58	1	6,58	CHI

201911178557	CALDAS NOVAS	CN12404748	CALDAS NOVAS S1	17/11/2019 18:22	18/11/2019 13:12	17/11/2019 18:22	18/11/2019 13:12	18,83	5	94,16	CHI
201911178557	RIO QUENTE	CN12404748	CALDAS NOVAS S1	17/11/2019 18:22	18/11/2019 13:12	17/11/2019 18:22	18/11/2019 13:12	18,83	40	753,26	CHI
201911178567	NOVO GAMA	10002964633	PACAEMBU S1	15/11/2019 19:19	15/11/2019 20:57	15/11/2019 19:19	15/11/2019 20:57	1,62	1	1,62	CHI
201911178574	MINEIROS	10012979617	PARQUE DAS EMAS	15/11/2019 19:20	15/11/2019 21:05	15/11/2019 19:20	15/11/2019 21:05	1,74	1	1,74	CHI
201911178584	MORRINHOS	150023698	MORRINHOS	15/11/2019 19:21	16/11/2019 08:55	15/11/2019 19:21	16/11/2019 08:55	13,56	1	13,56	CHI
201911178587	CORREGO DO OURO	IS13349695	IPORA	15/11/2019 07:22	16/11/2019 08:55	15/11/2019 07:22	16/11/2019 08:55	25,56	3	76,67	CHI
201911178587	FAZENDA NOVA	IS13349695	IPORA	15/11/2019 07:22	16/11/2019 08:55	15/11/2019 07:22	16/11/2019 08:55	25,56	97	2478,86	CHI
201911178587	ISRAELANDIA	IS13349695	IPORA	15/11/2019 07:22	16/11/2019 08:55	15/11/2019 07:22	16/11/2019 08:55	25,56	95	2427,75	CHI
201911178589	MORRINHOS	MR12405524	MORRINHOS	15/11/2019 15:39	16/11/2019 02:01	15/11/2019 15:39	16/11/2019 02:01	10,36	11	113,99	CHI
201911178627	SENADOR CANEDO	10024623570	SENADOR CANEDO	15/11/2019 19:25	17/11/2019 04:19	15/11/2019 19:25	17/11/2019 04:19	32,89	1	32,89	CHI
201911178628	JATAI	JT12234319	JATAI S3	15/11/2019 16:07	16/11/2019 16:38	15/11/2019 16:07	16/11/2019 16:38	24,52	4	98,08	CHI
201911178635	ARAGOIANIA	10005767855	GUAPO S2	15/11/2019 19:26	16/11/2019 12:03	15/11/2019 19:26	16/11/2019 12:03	16,61	1	16,61	CHI
201911178636	GOIAS	IB12022205	ITABERAI S2	15/11/2019 18:59	15/11/2019 21:10	15/11/2019 18:59	15/11/2019 21:10	2,17	40	86,72	CHI
201911178636	ITABERAI	IB12022205	ITABERAI S2	15/11/2019 18:59	15/11/2019 21:10	15/11/2019 18:59	15/11/2019 21:10	2,17	14	30,35	CHI
201911178651	ITABERAI	IB11274425	ITABERAI S1	15/11/2019 19:27	16/11/2019 12:40	15/11/2019 19:27	16/11/2019 12:40	17,22	68	1170,71	CHI
201911178666	FORMOSA	FA12376643	ITUIQUIRA	15/11/2019 18:39	15/11/2019 21:26	15/11/2019 18:39	15/11/2019 21:26	2,77	81	224,39	CHI
201911178668	CATALAO	CT12215603RE	CATALAO S2	15/11/2019 19:29	18/11/2019 12:40	15/11/2019 19:29	18/11/2019 12:40	65,18	3	195,55	CHI
201911178668	CUMARI	CT12215603RE	CATALAO S2	15/11/2019 19:29	18/11/2019 12:40	15/11/2019 19:29	18/11/2019 12:40	65,18	13	847,37	CHI
201911178668	GOIANDIRA	CT12215603RE	CATALAO S2	15/11/2019 19:29	18/11/2019 12:40	15/11/2019 19:29	18/11/2019 12:40	65,18	3	195,55	CHI
201911178686	FAZENDA NOVA	00480416	JUSSARA	15/11/2019 16:32	15/11/2019 22:46	15/11/2019 16:32	15/11/2019 22:46	6,24	1362	8501,53	CHI
201911178686	FAZENDA NOVA	00480416	JUSSARA	15/11/2019 16:32	15/11/2019 22:46	15/11/2019 16:32	15/11/2019 22:46	6,24	575	3589,12	CHI
201911178690	APARECIDA DE GOIANIA	AP11162422	REAL S1	15/11/2019 18:27	16/11/2019 01:57	15/11/2019 18:27	16/11/2019 01:57	7,49	114	853,76	CHI
201911178702	BOM JESUS DE GOIAS	BJ10400402	BOM JESUS DE GOIAS	15/11/2019 19:16	15/11/2019 22:31	15/11/2019 19:16	15/11/2019 22:31	3,25	822	2667,62	CHI
201911178702	GOIATUBA	BJ10400402	BOM JESUS DE GOIAS	15/11/2019 19:16	15/11/2019 22:31	15/11/2019 19:16	15/11/2019 22:31	3,25	5	16,23	CHI
201911178703	MONTES CLAROS DE GOIAS	ME12210017	IPORA	15/11/2019 15:27	15/11/2019 23:50	15/11/2019 15:27	15/11/2019 23:50	8,37	26	217,72	CHI
201911178705	SENADOR CANEDO	SW11080243	SENADOR CANEDO	15/11/2019 17:18	15/11/2019 23:51	15/11/2019 17:18	15/11/2019 23:51	6,54	117	764,99	CHI
201911178710	GUAPO	GA11000010	GUAPO S1	15/11/2019 18:40	16/11/2019 03:23	15/11/2019 18:40	16/11/2019 03:23	8,73	75	654,60	CHI
201911178717	GOIANIA	14673319	XAVANTES	15/11/2019 19:33	16/11/2019 04:02	15/11/2019 19:33	16/11/2019 04:02	8,48	1	8,48	CHI
201911178718	GOIANIA	GN12001256	AEROPORTO S2	15/11/2019 18:45	15/11/2019 23:30	15/11/2019 18:45	15/11/2019 23:30	4,75	212	1007,00	CHI
201911178721	BOM JESUS DE GOIAS	BJ12208038	BOM JESUS DE GOIAS	15/11/2019 19:07	15/11/2019 22:21	15/11/2019 19:07	15/11/2019 22:21	3,22	682	2195,47	CHI
201911178726	RIO VERDE	10019108069	RIO VERDE S1	15/11/2019 19:34	16/11/2019 10:15	15/11/2019 19:34	16/11/2019 10:15	14,69	1	14,69	CHI
201911178732	MINACU	IH12208345	MINACU	15/11/2019 19:34	16/11/2019 01:50	15/11/2019 19:34	16/11/2019 01:50	6,25	96	600,32	CHI
201911178733	VARJAO	VJ11000011	GUAPO S2	15/11/2019 19:35	16/11/2019 07:50	15/11/2019 19:35	16/11/2019 07:50	12,25	99	1212,75	CHI

201911178754	SENADOR CANEDO	13511350	GOIANIA LESTE S1	15/11/2019 19:36	16/11/2019 15:28	15/11/2019 19:36	16/11/2019 15:28	19,85	1	19,85	CHI
201911178768	FORMOSA	FA12085474	ITUIQUIRA	15/11/2019 19:38	15/11/2019 21:40	15/11/2019 19:38	15/11/2019 21:40	2,03	29	58,73	CHI
201911178772	GOIANIA	GN12000504	FERROVIARIO S1	15/11/2019 18:22	15/11/2019 20:27	15/11/2019 18:22	15/11/2019 20:27	2,08	319	663,52	CHI
201911178780	URUACU	CR12375637	CAMPINORTE	15/11/2019 19:29	15/11/2019 23:45	15/11/2019 19:29	15/11/2019 23:45	4,26	117	498,19	CHI
201911178783	APARECIDA DE GOIANIA	AP12132702	ANHANGUERA	15/11/2019 18:01	16/11/2019 09:14	15/11/2019 18:01	16/11/2019 09:14	15,22	17	258,67	CHI
201911178789	ADELANDIA	DN12323607	FIRMINOPOLIS S2	15/11/2019 19:34	15/11/2019 22:23	15/11/2019 19:34	15/11/2019 22:23	2,81	7	19,64	CHI
201911178789	SAO LUIS DE MONTES BELOS	DN12323607	FIRMINOPOLIS S2	15/11/2019 19:34	15/11/2019 22:23	15/11/2019 19:34	15/11/2019 22:23	2,81	7	19,64	CHI
201911178792	CACHOEIRA ALTA	1090011584	CACHOEIRA ALTA	15/11/2019 19:46	16/11/2019 00:58	15/11/2019 19:46	16/11/2019 00:58	5,19	1	5,19	CHI
201911178793	SENADOR CANEDO	SW11340717	SENADOR CANEDO	16/11/2019 18:52	16/11/2019 21:20	16/11/2019 18:52	16/11/2019 21:20	2,46	80	197,11	CHI
201911178801	AURILANDIA	AI21143068	FIRMINOPOLIS S2	15/11/2019 19:43	15/11/2019 22:40	15/11/2019 19:43	15/11/2019 22:40	2,95	1	2,95	CHI
201911178804	GOIAS	HE12250700	ITAPURANGA	15/11/2019 18:56	16/11/2019 22:10	15/11/2019 18:56	16/11/2019 22:10	27,23	9	245,07	CHI
201911178804	HEITORAI	HE12250700	ITAPURANGA	15/11/2019 18:56	16/11/2019 22:10	15/11/2019 18:56	16/11/2019 22:10	27,23	6	163,38	CHI
201911178805	GOIANIA	02402214	AEROPORTO S2	15/11/2019 19:45	16/11/2019 00:02	15/11/2019 19:45	15/11/2019 20:52	1,12	3011	3362,28	CHI
201911178805	GOIANIA	02402214	AEROPORTO S2	15/11/2019 19:45	16/11/2019 00:02	15/11/2019 19:45	15/11/2019 22:11	2,43	998	2427,08	CHI
201911178805	GOIANIA	02402214	AEROPORTO S2	15/11/2019 19:45	16/11/2019 00:02	15/11/2019 19:45	16/11/2019 00:02	4,28	469	2008,23	CHI
201911178807	ANAPOLIS	AN11084673	ANAPOLIS UNIVERSITARIO S2	15/11/2019 19:44	16/11/2019 10:45	15/11/2019 19:44	16/11/2019 10:45	15,01	39	585,48	CHI
201911178810	CATALAO	IP12222966	IPAMERI	15/11/2019 19:44	16/11/2019 10:01	15/11/2019 19:44	16/11/2019 10:01	14,27	2	28,54	CHI
201911178810	IPAMERI	IP12222966	IPAMERI	15/11/2019 19:44	16/11/2019 10:01	15/11/2019 19:44	16/11/2019 10:01	14,27	5	71,34	CHI
201911178812	RIO VERDE	630605038	RIO VERDE S2	15/11/2019 19:45	16/11/2019 10:50	15/11/2019 19:45	16/11/2019 10:50	15,08	1	15,08	CHI
201911178817	IPORA	730139797	IPORA	15/11/2019 19:45	16/11/2019 09:25	15/11/2019 19:45	16/11/2019 09:25	13,66	1	13,66	CHI
201911178819	GOIAS	GS12310400	ITABERAI S1	15/11/2019 19:19	16/11/2019 15:25	15/11/2019 19:19	16/11/2019 15:25	20,09	46	924,05	CHI
201911178819	ITABERAI	GS12310400	ITABERAI S1	15/11/2019 19:19	16/11/2019 15:25	15/11/2019 19:19	16/11/2019 15:25	20,09	27	542,38	CHI
201911178825	ANAPOLIS	AN12317783	ANAPOLIS UNIVERSITARIO S2	15/11/2019 18:38	16/11/2019 14:03	15/11/2019 18:38	16/11/2019 14:03	19,41	12	232,91	CHI
201911178835	APARECIDA DE GOIANIA	AP11383412	ANHANGUERA	15/11/2019 19:47	16/11/2019 12:13	15/11/2019 19:47	16/11/2019 12:13	16,44	64	1052,43	CHI
201911178844	SAO LUIS DE MONTES BELOS	500120699	SAO LUIZ DOS MONTES BELOS	15/11/2019 19:48	16/11/2019 08:38	15/11/2019 19:48	16/11/2019 08:38	12,84	1	12,84	CHI
201911178852	OUVIDOR	OU12390633	CATALAO S1	15/11/2019 19:49	18/11/2019 16:39	15/11/2019 19:49	18/11/2019 16:39	68,82	6	412,93	CHI
201911178858	BOM JESUS DE GOIAS	1250055742	BOM JESUS DE GOIAS	15/11/2019 19:50	16/11/2019 01:14	15/11/2019 19:50	16/11/2019 01:14	5,40	1	5,40	CHI
201911178865	FORMOSA	FA21264644	ITUIQUIRA	15/11/2019 19:50	15/11/2019 21:12	15/11/2019 19:50	15/11/2019 21:12	1,36	3	4,08	CHI
201911178867	CRISTIANOPOLIS	CF21149463	CRISTIANOPOLIS	15/11/2019 19:50	16/11/2019 15:06	15/11/2019 19:50	16/11/2019 15:06	19,26	1	19,26	CHI
201911178869	PADRE BERNARDO	PB12163217	PADRE BERNARDO	15/11/2019 19:50	16/11/2019 01:33	15/11/2019 19:50	16/11/2019 01:33	5,71	112	639,15	CHI
201911178872	TURVELANDIA	TD11058861	RIO DOS BOIS	15/11/2019 13:32	16/11/2019 16:19	15/11/2019 13:32	16/11/2019 16:19	26,78	175	4686,40	CHI
201911178894	JARAGUA	JA21007224	JARAGUA	15/11/2019 19:52	16/11/2019 11:10	15/11/2019 19:52	16/11/2019 11:10	15,29	1	15,29	CHI
201911178907	PARANAIGUARA	2230014992	CACHOEIRA ALTA	15/11/2019 19:54	16/11/2019 08:28	15/11/2019 19:54	16/11/2019 08:28	12,56	1	12,56	CHI

201911178914	OUVIDOR	10004851828	CATALAO S1	15/11/2019 19:55	18/11/2019 15:06	15/11/2019 19:55	18/11/2019 15:06	67,18	1	67,18	CHI
201911178915	CATALAO	CT11192501	CATALAO S2	15/11/2019 19:07	16/11/2019 07:16	15/11/2019 19:07	16/11/2019 07:16	12,15	63	765,34	CHI
201911178916	APARECIDA DE GOIANIA	AP11000052	INDEPENDENCIA S1	15/11/2019 19:15	15/11/2019 22:25	15/11/2019 19:15	15/11/2019 22:25	3,15	208	655,89	CHI
201911178921	PIRES DO RIO	PR21159617	PIRES DO RIO S1	15/11/2019 19:56	16/11/2019 16:13	15/11/2019 19:56	16/11/2019 16:13	20,28	1	20,28	CHI
201911178927	CALDAS NOVAS	CN12298762	SERRA DE CALDAS	15/11/2019 17:07	16/11/2019 13:21	15/11/2019 17:07	16/11/2019 13:21	20,23	31	627,22	CHI
201911178937	CALDAS NOVAS	10023189337	SERRA DE CALDAS	15/11/2019 19:59	18/11/2019 10:51	15/11/2019 19:59	18/11/2019 10:51	62,87	1	62,87	CHI
201911178944	CATALAO	CT11287100	CATALAO S2	15/11/2019 19:15	16/11/2019 06:54	15/11/2019 19:15	16/11/2019 06:54	11,64	118	1373,16	CHI
201911178948	LUZIANIA	LZ11041555	RIO VERMELHO	15/11/2019 19:08	15/11/2019 21:09	15/11/2019 19:08	15/11/2019 21:09	2,02	175	352,87	CHI
201911178949	GOIANIA	GN10404120	AEROPORTO S2	15/11/2019 19:48	15/11/2019 19:51	15/11/2019 19:48	15/11/2019 19:51	0,05	3065	162,62	CHI
201911178965	PIRENOPOLIS	PV11000022	CORUMBA	15/11/2019 19:22	15/11/2019 20:53	15/11/2019 19:22	15/11/2019 20:53	1,51	309	467,53	CHI
201911178969	BOM JARDIM DE GOIAS	BM12395485	BOM JARDIM	15/11/2019 19:22	16/11/2019 10:10	15/11/2019 19:22	16/11/2019 10:10	14,78	7	103,49	CHI
201911178970	GOIANIA	12501451	CAMPINAS S1	15/11/2019 20:04	16/11/2019 02:31	15/11/2019 20:04	16/11/2019 02:31	6,44	1	6,44	CHI
201911178971	SAO JOAO D ALIANCA	3840003360	SAO JOAO D ALIANCA	15/11/2019 20:04	16/11/2019 08:51	15/11/2019 20:04	16/11/2019 08:51	12,78	1	12,78	CHI
201911178974	CAMPINORTE	CR12285376	CAMPINORTE	15/11/2019 19:29	15/11/2019 22:44	15/11/2019 19:29	15/11/2019 22:44	3,24	6	19,43	CHI
201911178977	BALIZA	BH11227620	BOM JARDIM	15/11/2019 20:05	16/11/2019 08:44	15/11/2019 20:05	16/11/2019 08:44	12,64	1	12,64	CHI
201911178978	IPAMERI	IP12000071	IPAMERI	15/11/2019 20:05	16/11/2019 00:03	15/11/2019 20:05	16/11/2019 00:03	3,96	5	19,78	CHI
201911178979	GOIANIA	GN11023423	REAL S1	15/11/2019 19:13	16/11/2019 02:24	15/11/2019 19:13	16/11/2019 02:24	7,17	78	559,04	CHI
201911178980	SAO MIGUEL DO ARAGUAIA	830075446	SAO MIGUEL DO ARAGUAIA	15/11/2019 20:05	16/11/2019 01:20	15/11/2019 20:05	16/11/2019 01:20	5,24	1	5,24	CHI
201911178982	AURILANDIA	1010003279	FIRMINOPOLIS S2	15/11/2019 20:06	15/11/2019 23:48	15/11/2019 20:06	15/11/2019 23:48	3,71	1	3,71	CHI
201911178984	CALDAS NOVAS	760246520	SERRA DE CALDAS	15/11/2019 20:06	18/11/2019 14:58	15/11/2019 20:06	18/11/2019 14:58	66,86	1	66,86	CHI
201911178992	TRINDADE	40268263	TRINDADE	15/11/2019 20:07	15/11/2019 23:36	15/11/2019 20:07	15/11/2019 23:36	3,48	1	3,48	CHI
201911178993	CUMARI	CT21013684	CATALAO S2	15/11/2019 20:07	18/11/2019 07:57	15/11/2019 20:07	18/11/2019 07:57	59,82	1	59,82	CHI
201911179006	MONTIVIDIU	MV10400618	MONTIVIDIU T	15/11/2019 17:38	19/11/2019 19:42	15/11/2019 17:38	15/11/2019 23:54	6,26	14	87,63	CHI
201911179006	RIO VERDE	MV10400618	MONTIVIDIU T	15/11/2019 17:38	19/11/2019 19:42	15/11/2019 17:38	15/11/2019 23:54	6,26	50	312,96	CHI
201911179006	RIO VERDE	MV10400618	MONTIVIDIU T	15/11/2019 17:38	19/11/2019 19:42	15/11/2019 17:38	16/11/2019 01:04	7,43	13	96,62	CHI
201911179006	CAIAPONIA	MV10226416	MONTIVIDIU T	15/11/2019 17:38	19/11/2019 19:42	19/11/2019 12:40	19/11/2019 13:36	0,92	63	58,15	CHI
201911179006	IVOLANDIA	MV10226416	MONTIVIDIU T	15/11/2019 17:38	19/11/2019 19:42	19/11/2019 12:40	19/11/2019 13:36	0,92	29	26,77	CHI
201911179006	MONTIVIDIU	MV10226416	MONTIVIDIU T	15/11/2019 17:38	19/11/2019 19:42	19/11/2019 12:40	19/11/2019 13:36	0,92	176	162,46	CHI
201911179006	PARAUNA	MV10226416	MONTIVIDIU T	15/11/2019 17:38	19/11/2019 19:42	19/11/2019 12:40	19/11/2019 13:36	0,92	148	136,61	CHI
201911179006	RIO VERDE	MV10226416	MONTIVIDIU T	15/11/2019 17:38	19/11/2019 19:42	19/11/2019 12:40	19/11/2019 13:36	0,92	317	292,61	CHI
201911179006	RIO VERDE	MV10226416	MONTIVIDIU T	15/11/2019 17:38	19/11/2019 19:42	19/11/2019 12:41	19/11/2019 13:36	0,91	4	3,65	CHI
201911179006	RIO VERDE	MV10400618	MONTIVIDIU T	15/11/2019 17:38	19/11/2019 19:42	15/11/2019 17:38	19/11/2019 19:42	98,06	19	1863,19	CHI
201911179026	GUARANI DE GOIAS	GY12465246	IACIARA S1	15/11/2019 20:11	15/11/2019 23:25	15/11/2019 20:11	15/11/2019 23:25	3,23	13	42,00	CHI

201911179026	IACIARA	GY12465246	IACIARA S1	15/11/2019 20:11	15/11/2019 23:25	15/11/2019 20:11	15/11/2019 23:25	3,23	3	9,69	CHI
201911179045	APARECIDA DE GOIANIA	AP21033768	REAL S1	15/11/2019 20:14	16/11/2019 08:06	15/11/2019 20:14	16/11/2019 08:06	11,86	1	11,86	CHI
201911179047	CAIAPONIA	CP21339873	PALESTINA	15/11/2019 20:14	16/11/2019 10:20	15/11/2019 20:14	16/11/2019 10:20	14,09	1	14,09	CHI
201911179048	FORMOSA	FA12042605	ITUIQUIRA	15/11/2019 20:14	15/11/2019 22:54	15/11/2019 20:14	15/11/2019 22:54	2,65	1	2,65	CHI
201911179050	CATALAO	CT12130908	CATALAO S2	15/11/2019 18:06	15/11/2019 21:28	15/11/2019 18:06	15/11/2019 21:28	3,36	248	834,18	CHI
201911179054	GOIANIA	GN11001010	CAMPINAS S1	15/11/2019 17:31	16/11/2019 01:28	15/11/2019 17:31	16/11/2019 01:28	7,94	78	619,10	CHI
201911179059	ACREUNA	2440076941	ACREUNA	15/11/2019 20:15	15/11/2019 22:29	15/11/2019 20:15	15/11/2019 22:29	2,23	1	2,23	CHI
201911179071	PIRENOPOLIS	PV21244323	CORUMBA	15/11/2019 20:17	16/11/2019 13:00	15/11/2019 20:17	16/11/2019 13:00	16,71	1	16,71	CHI
201911179072	SAO MIGUEL DO ARAGUAIA	SM11276059	SAO MIGUEL DO ARAGUAIA	15/11/2019 20:17	16/11/2019 13:00	15/11/2019 20:17	16/11/2019 13:00	16,71	1	16,71	CHI
201911179076	SILVANIA	SV12384972	DAIA S2	15/11/2019 19:37	16/11/2019 03:59	15/11/2019 19:37	16/11/2019 03:59	8,36	4	33,46	CHI
201911179084	MORRINHOS	MR12059838	MORRINHOS	15/11/2019 18:31	17/11/2019 11:50	15/11/2019 18:31	17/11/2019 11:50	41,31	2	82,62	CHI
201911179085	GOIANIA	16472652	GOIANIA LESTE S3	15/11/2019 20:19	16/11/2019 12:05	15/11/2019 20:19	16/11/2019 12:05	15,76	1	15,76	CHI
201911179093	LUZIANIA	LZ12040417	RIO VERMELHO	15/11/2019 20:21	16/11/2019 08:56	15/11/2019 20:21	16/11/2019 08:56	12,57	15	188,51	CHI
201911179094	GOIANIA	GN11097479	CAMPINAS S3	15/11/2019 18:35	16/11/2019 03:53	15/11/2019 18:35	16/11/2019 00:45	6,16	61	375,66	CHI
201911179094	GOIANIA	GN21132693	CAMPINAS S3	15/11/2019 18:35	16/11/2019 03:53	15/11/2019 18:35	16/11/2019 03:50	9,24	14	129,34	CHI
201911179094	GOIANIA	GN11097479	CAMPINAS S3	15/11/2019 18:35	16/11/2019 03:53	16/11/2019 00:46	16/11/2019 03:51	3,08	61	187,96	CHI
201911179094	GOIANIA	GN11002217	CAMPINAS S3	15/11/2019 18:35	16/11/2019 03:53	15/11/2019 18:35	16/11/2019 03:52	9,27	65	602,68	CHI
201911179094	GOIANIA	GN21391081	CAMPINAS S3	15/11/2019 18:35	16/11/2019 03:53	15/11/2019 18:35	16/11/2019 03:53	9,29	1	9,29	CHI
201911179097	GOIANESIA	GE21156350	GOIANESIA S1	15/11/2019 20:22	16/11/2019 13:01	15/11/2019 20:22	16/11/2019 13:01	16,64	1	16,64	CHI
201911179098	ARUANA	AK12158747	ARUANA	16/11/2019 03:48	16/11/2019 09:26	16/11/2019 03:48	16/11/2019 09:26	5,63	135	759,53	CHI
201911179109	POSSE	PS21168764	IACIARA S2	15/11/2019 20:23	15/11/2019 22:14	15/11/2019 20:23	15/11/2019 22:14	1,83	1	1,83	CHI
201911179113	MARA ROSA	MQ12117969	MARA ROSA	15/11/2019 14:15	16/11/2019 04:34	15/11/2019 14:15	16/11/2019 04:34	14,32	32	458,08	CHI
201911179121	JAUPACI	JP12349721	IPORA	15/11/2019 19:14	16/11/2019 19:27	15/11/2019 19:14	16/11/2019 19:27	24,23	7	169,59	CHI
201911179134	CALDAS NOVAS	760039598	SERRA DE CALDAS	15/11/2019 20:27	19/11/2019 01:13	15/11/2019 20:27	19/11/2019 01:13	76,75	1	76,75	CHI
201911179135	GOIANIA	GN11268058	GOYA S1	15/11/2019 20:23	15/11/2019 22:16	15/11/2019 20:23	15/11/2019 22:16	1,87	133	249,26	CHI
201911179138	QUIRINOPOLIS	QI12013483	QUIRINOPOLIS	15/11/2019 18:59	16/11/2019 10:14	15/11/2019 18:59	16/11/2019 10:14	15,24	5	76,20	CHI
201911179145	GOIANIA	GN12066360	ATLANTICO S3	15/11/2019 18:17	15/11/2019 21:32	15/11/2019 18:17	15/11/2019 21:32	3,25	418	1357,22	CHI
201911179149	GOIANIA	GN11213733	GOYA S1	15/11/2019 20:26	15/11/2019 22:35	15/11/2019 20:26	15/11/2019 22:35	2,15	263	565,82	CHI
201911179151	COCALZINHO DE GOIAS	ZN12389400	AGUAS LINDAS DE GOIAS S2	15/11/2019 19:54	15/11/2019 22:02	15/11/2019 19:54	15/11/2019 22:02	2,13	103	219,62	CHI
201911179151	PADRE BERNARDO	ZN12389400	AGUAS LINDAS DE GOIAS S2	15/11/2019 19:54	15/11/2019 22:02	15/11/2019 19:54	15/11/2019 22:02	2,13	4	8,53	CHI
201911179153	BONOPOLIS	BX12202590	SAO MIGUEL DO ARAGUAIA	15/11/2019 20:29	16/11/2019 10:12	15/11/2019 20:29	16/11/2019 10:12	13,70	11	150,72	CHI
201911179154	CRIXAS	CX12102899	SERRA DO OURO	15/11/2019 20:29	16/11/2019 00:07	15/11/2019 20:29	16/11/2019 00:07	3,63	63	228,53	CHI
201911179165	SAO MIGUEL DO ARAGUAIA	SM12113573	SAO MIGUEL DO ARAGUAIA	15/11/2019 19:51	16/11/2019 10:15	15/11/2019 19:51	16/11/2019 08:12	12,36	5	61,78	CHI

201911179165	SAO MIGUEL DO ARAGUAIA	SM12113573	SAO MIGUEL DO ARAGUAIA	15/11/2019 19:51	16/11/2019 10:15	16/11/2019 06:58	16/11/2019 08:12	1,24	2	2,48	CHI
201911179165	SAO MIGUEL DO ARAGUAIA	SM12165452LD	SAO MIGUEL DO ARAGUAIA	15/11/2019 19:51	16/11/2019 10:15	16/11/2019 06:58	16/11/2019 10:15	3,28	1	3,28	CHI
201911179172	AMARALINA	MQ12170098	NOVA CRIXAS	15/11/2019 15:47	15/11/2019 22:07	15/11/2019 15:47	15/11/2019 22:07	6,33	10	63,31	CHI
201911179172	MARA ROSA	MQ12170098	NOVA CRIXAS	15/11/2019 15:47	15/11/2019 22:07	15/11/2019 15:47	15/11/2019 22:07	6,33	2	12,66	CHI
201911179177	CEZARINA	10023916417	CEZARINA	15/11/2019 20:34	15/11/2019 23:05	15/11/2019 20:34	15/11/2019 23:05	2,51	1	2,51	CHI
201911179185	PORANGATU	PO12100833	PORANGATU	15/11/2019 20:35	16/11/2019 07:39	15/11/2019 20:35	16/11/2019 07:39	11,06	3	33,19	CHI
201911179186	GOIANIA	11922722	GOIANIA LESTE S2	15/11/2019 20:35	16/11/2019 09:18	15/11/2019 20:35	16/11/2019 09:18	12,71	1	12,71	CHI
201911179193	ANAPOLIS	21031563	ANAPOLIS UNIVERSITARIO S2	15/11/2019 20:36	16/11/2019 08:36	15/11/2019 20:36	16/11/2019 08:36	11,99	1	11,99	CHI
201911179195	ITAPURANGA	IK12300238	ITAPURANGA	15/11/2019 19:06	15/11/2019 22:40	15/11/2019 19:06	15/11/2019 22:40	3,56	131	465,85	CHI
201911179196	ANAPOLIS	AN12000959	ANAPOLIS UNIVERSITARIO S2	15/11/2019 19:00	16/11/2019 01:35	15/11/2019 19:00	16/11/2019 01:35	6,59	19	125,18	CHI
201911179198	GOIANESIA	GE21000083	GOIANESIA S1	15/11/2019 20:37	17/11/2019 10:05	15/11/2019 20:37	17/11/2019 10:05	37,46	1	37,46	CHI
201911179199	GOIANIA	GN11126753	XAVANTES	15/11/2019 18:23	16/11/2019 01:10	15/11/2019 18:23	16/11/2019 01:10	6,78	24	162,79	CHI
201911179203	BRAZABRANTES	DL12027274	INHUMAS S1	15/11/2019 20:38	16/11/2019 12:51	15/11/2019 20:38	16/11/2019 12:51	16,21	21	340,47	CHI
201911179204	ANAPOLIS	10012120535	JUNDIAI S1	15/11/2019 20:38	15/11/2019 23:35	15/11/2019 20:38	15/11/2019 23:35	2,96	1	2,96	CHI
201911179208	MONTIVIDIU DO NORTE	MX12168971	PORANGATU	15/11/2019 10:00	15/11/2019 23:15	15/11/2019 10:00	15/11/2019 23:15	13,24	49	648,62	CHI
201911179222	MUNDO NOVO DE GOIAS	MH11269598	NOVA CRIXAS	15/11/2019 20:40	16/11/2019 11:00	15/11/2019 20:40	16/11/2019 11:00	14,32	1	14,32	CHI
201911179223	URUACU	UR13400664B	URUACU	15/11/2019 20:36	16/11/2019 01:40	15/11/2019 20:36	16/11/2019 01:40	5,07	214	1085,04	CHI
201911179226	MARA ROSA	MQ12208421	MARA ROSA	15/11/2019 20:41	16/11/2019 11:17	15/11/2019 20:41	16/11/2019 11:17	14,61	15	219,13	CHI
201911179227	BONOPOLIS	BX12202542	SAO MIGUEL DO ARAGUAIA	15/11/2019 20:15	16/11/2019 10:15	15/11/2019 20:15	16/11/2019 10:15	13,99	55	769,65	CHI
201911179227	PORANGATU	BX12202542	SAO MIGUEL DO ARAGUAIA	15/11/2019 20:15	16/11/2019 10:15	15/11/2019 20:15	16/11/2019 10:15	13,99	1	13,99	CHI
201911179228	CAMPINACU	UC12197170	PORANGATU	15/11/2019 20:42	16/11/2019 09:06	15/11/2019 20:42	16/11/2019 09:06	12,39	13	161,08	CHI
201911179228	MINACU	UC12197170	PORANGATU	15/11/2019 20:42	16/11/2019 09:06	15/11/2019 20:42	16/11/2019 09:06	12,39	1	12,39	CHI
201911179232	AGUAS LINDAS DE GOIAS	LA11335960	AGUAS LINDAS DE GOIAS S1	15/11/2019 20:43	15/11/2019 21:56	15/11/2019 20:43	15/11/2019 21:56	1,21	61	73,89	CHI
201911179244	BONFINOPOLIS	BO21281334	CEPAIGO S2	15/11/2019 20:45	17/11/2019 12:49	15/11/2019 20:45	17/11/2019 12:49	40,05	1	40,05	CHI
201911179251	ITABERAI	50024772	ITABERAI S2	15/11/2019 20:47	17/11/2019 08:03	15/11/2019 20:47	17/11/2019 08:03	35,26	1	35,26	CHI
201911179254	MOZARLANDIA	MZ11273493	MOZARLANDIA	15/11/2019 20:38	16/11/2019 09:25	15/11/2019 20:38	16/11/2019 09:25	12,78	179	2286,97	CHI
201911179257	ANAPOLIS	10014769016	ANAPOLIS UNIVERSITARIO S2	15/11/2019 20:51	16/11/2019 09:09	15/11/2019 20:51	16/11/2019 09:09	12,30	1	12,30	CHI
201911179259	LUZIANIA	LZ12396833	MARAJOARA	15/11/2019 17:01	15/11/2019 23:26	15/11/2019 17:01	15/11/2019 23:26	6,41	18	115,46	CHI
201911179261	BONOPOLIS	BX21257850	SAO MIGUEL DO ARAGUAIA	15/11/2019 20:51	16/11/2019 10:52	15/11/2019 20:51	16/11/2019 10:52	14,00	1	14,00	CHI
201911179269	GUARANI DE GOIAS	IA12117792	IACIARA S1	15/11/2019 20:28	15/11/2019 22:02	15/11/2019 20:28	15/11/2019 22:02	1,56	16	24,99	CHI
201911179269	IACIARA	IA12117792	IACIARA S1	15/11/2019 20:28	15/11/2019 22:02	15/11/2019 20:28	15/11/2019 22:02	1,56	24	37,48	CHI
201911179269	SAO DOMINGOS	IA12117792	IACIARA S1	15/11/2019 20:28	15/11/2019 22:02	15/11/2019 20:28	15/11/2019 22:02	1,56	1	1,56	CHI
201911179274	GUARINOS	GF12051406	SANTA TEREZINHA	15/11/2019 20:53	15/11/2019 22:42	15/11/2019 20:53	15/11/2019 22:42	1,80	9	16,21	CHI

201911179274	SANTA TEREZINHA DE GOIAS	GF12051406	SANTA TEREZINHA	15/11/2019 20:53	15/11/2019 22:42	15/11/2019 20:53	15/11/2019 22:42	1,80	3	5,40	CHI
201911179277	CALDAS NOVAS	CN12392138	VILA CORUMBA	15/11/2019 18:05	17/11/2019 16:25	15/11/2019 18:05	17/11/2019 16:25	46,32	4	185,30	CHI
201911179284	CAMPINORTE	CR11257396	PORANGATU	15/11/2019 20:56	16/11/2019 10:13	15/11/2019 20:56	16/11/2019 10:13	13,28	1	13,28	CHI
201911179286	BONFINOPOLIS	LB12205526	GOIANIA LESTE S2	15/11/2019 20:56	17/11/2019 10:31	15/11/2019 20:56	17/11/2019 10:31	37,57	2	75,14	CHI
201911179294	CRISTALINA	KR12287383	CRISTALINA S1	15/11/2019 17:22	16/11/2019 01:02	15/11/2019 17:22	16/11/2019 01:02	7,66	76	582,03	CHI
201911179306	SAO MIGUEL DO PASSA QUATRO	SQ21111732	BELA VISTA S2	15/11/2019 21:02	16/11/2019 15:16	15/11/2019 21:02	16/11/2019 15:16	18,22	1	18,22	CHI
201911179308	NIQUELANDIA	NQ11243420	NIQUELANDIA SUBTRANSMISSAO	15/11/2019 21:02	16/11/2019 07:58	15/11/2019 21:02	16/11/2019 07:58	10,92	17	185,63	CHI
201911179309	SAO LUIS DE MONTES BELOS	500025162	SAO LUIZ DOS MONTES BELOS	15/11/2019 21:02	16/11/2019 08:48	15/11/2019 21:02	16/11/2019 08:48	11,77	1	11,77	CHI
201911179311	SAO LUIS DE MONTES BELOS	SL12021470	SAO LUIZ DOS MONTES BELOS	15/11/2019 20:40	16/11/2019 16:13	15/11/2019 20:40	16/11/2019 14:37	17,96	20	359,11	CHI
201911179311	SAO LUIS DE MONTES BELOS	SL12049622LD	SAO LUIZ DOS MONTES BELOS	15/11/2019 20:40	16/11/2019 16:13	15/11/2019 20:40	16/11/2019 16:13	19,55	15	293,22	CHI
201911179319	GOIANIA	GN12000071	CAMPINAS S1	15/11/2019 17:24	15/11/2019 23:32	15/11/2019 17:24	15/11/2019 23:32	6,12	194	1188,25	CHI
201911179325	BALIZA	BH12380942	BOM JARDIM	15/11/2019 21:07	16/11/2019 14:42	15/11/2019 21:07	16/11/2019 14:42	17,58	7	123,07	CHI
201911179326	CABECEIRAS	CW21150197	ITUIQUIRA	15/11/2019 21:06	17/11/2019 20:11	15/11/2019 21:06	17/11/2019 20:11	47,08	1	47,08	CHI
201911179334	GOIANIA	GN11000400	FERROVIARIO S1	15/11/2019 13:48	16/11/2019 11:18	15/11/2019 13:48	16/11/2019 11:18	21,49	113	2428,81	CHI
201911179340	GOIANIA	10581870	ATLANTICO S3	15/11/2019 21:09	16/11/2019 09:35	15/11/2019 21:09	16/11/2019 09:35	12,42	1	12,42	CHI
201911179349	BOM JESUS DE GOIAS	BJ21000149	BOM JESUS DE GOIAS	15/11/2019 21:12	19/11/2019 00:45	15/11/2019 21:12	19/11/2019 00:45	75,53	1	75,53	CHI
201911179353	GOIANIA	15042698	GOIANIA LESTE S3	15/11/2019 21:15	16/11/2019 09:46	15/11/2019 21:15	16/11/2019 09:46	12,51	1	12,51	CHI
201911179359	NIQUELANDIA	NQ21342808	URUACU	15/11/2019 21:16	16/11/2019 16:18	15/11/2019 21:16	16/11/2019 16:18	19,02	1	19,02	CHI
201911179364	GOIAS	GS12307383	GOIAS	15/11/2019 18:25	17/11/2019 09:55	15/11/2019 18:25	17/11/2019 09:55	39,49	11	434,36	CHI
201911179367	COLINAS DO SUL	TI12236622LD	MINACU	16/11/2019 18:25	17/11/2019 17:21	16/11/2019 18:25	17/11/2019 16:37	22,21	5	111,06	CHI
201911179367	COLINAS DO SUL	TI12236621	MINACU	16/11/2019 18:25	17/11/2019 17:21	16/11/2019 18:25	17/11/2019 17:21	22,95	14	321,24	CHI
201911179370	TEREZOPOLIS DE GOIAS	TJ11193113	DAIA S2	15/11/2019 21:17	16/11/2019 10:27	15/11/2019 21:17	16/11/2019 10:27	13,15	24	315,67	CHI
201911179376	LUZIANIA	LZ21365636	VIANOPOLIS	15/11/2019 21:19	16/11/2019 10:58	15/11/2019 21:19	16/11/2019 10:58	13,65	1	13,65	CHI
201911179378	GOIANIA	10015626006	GOYA S2	15/11/2019 21:20	16/11/2019 10:24	15/11/2019 21:20	16/11/2019 10:24	13,06	1	13,06	CHI
201911179381	GOIANESIA	GE12353258	GOIANESIA S2	15/11/2019 14:55	16/11/2019 00:00	15/11/2019 14:55	16/11/2019 00:00	9,08	166	1507,70	CHI
201911179381	VILA PROPICIO	GE12353258	GOIANESIA S2	15/11/2019 14:55	16/11/2019 00:00	15/11/2019 14:55	16/11/2019 00:00	9,08	18	163,49	CHI
201911179402	JARAGUA	JA12273265	JARAGUA	15/11/2019 18:14	16/11/2019 03:54	15/11/2019 18:14	16/11/2019 03:54	9,66	16	154,58	CHI
201911179409	ALEXANIA	AX12311876	ALEXANIA	15/11/2019 20:24	16/11/2019 02:21	15/11/2019 20:24	16/11/2019 02:21	5,93	111	658,69	CHI
201911179413	JANDAIA	JD12314915	PALMEIRAS	15/11/2019 15:40	16/11/2019 08:10	15/11/2019 15:40	16/11/2019 08:10	16,50	8	131,96	CHI
201911179421	ALEXANIA	AX21370363	ALEXANIA	15/11/2019 21:33	16/11/2019 06:25	15/11/2019 21:33	16/11/2019 06:25	8,86	1	8,86	CHI
201911179437	JATAI	10021026341	JATAI S2	15/11/2019 21:39	16/11/2019 12:54	15/11/2019 21:39	16/11/2019 12:54	15,25	1	15,25	CHI
201911179438	LUZIANIA	LZ21000524	MARAJOARA	15/11/2019 21:39	16/11/2019 10:05	15/11/2019 21:39	16/11/2019 10:05	12,43	1	12,43	CHI
201911179440	MIMOSO DE GOIAS	04560406	BARRO ALTO	15/11/2019 21:10	16/11/2019 02:50	15/11/2019 21:10	16/11/2019 02:50	5,65	11	62,16	CHI

201911179440	MIMOSO DE GOIAS	04560406	BARRO ALTO	15/11/2019 21:10	16/11/2019 02:50	15/11/2019 21:10	16/11/2019 02:50	5,65	4	22,60	CHI
201911179440	NIQUELANDIA	04560406	BARRO ALTO	15/11/2019 21:10	16/11/2019 02:50	15/11/2019 21:10	16/11/2019 02:50	5,65	175	988,85	CHI
201911179440	NIQUELANDIA	04560406	BARRO ALTO	15/11/2019 21:10	16/11/2019 02:50	15/11/2019 21:10	16/11/2019 02:50	5,65	422	2384,53	CHI
201911179440	NIQUELANDIA	NQ12292484	BARRO ALTO	15/11/2019 21:10	16/11/2019 02:50	15/11/2019 21:10	16/11/2019 02:50	5,65	591	3339,48	CHI
201911179440	VILA PROPICIO	04560406	BARRO ALTO	15/11/2019 21:10	16/11/2019 02:50	15/11/2019 21:10	16/11/2019 02:50	5,65	42	237,32	CHI
201911179440	VILA PROPICIO	04560406	BARRO ALTO	15/11/2019 21:10	16/11/2019 02:50	15/11/2019 21:10	16/11/2019 02:50	5,65	18	101,71	CHI
201911179442	NIQUELANDIA	NQ12239432	URUACU	15/11/2019 21:40	15/11/2019 23:40	15/11/2019 21:40	15/11/2019 23:40	2,00	18	35,96	CHI
201911179445	APARECIDA DE GOIANIA	AP11144617	REAL S1	15/11/2019 21:41	16/11/2019 11:52	15/11/2019 21:41	16/11/2019 11:52	14,18	45	638,15	CHI
201911179446	OURO VERDE DE GOIAS	NR21169147	NEROPOLIS S2	15/11/2019 21:41	16/11/2019 01:51	15/11/2019 21:41	16/11/2019 01:51	4,16	2	8,33	CHI
201911179449	PALMEIRAS DE GOIAS	PL12000240	PALMEIRAS	15/11/2019 18:58	16/11/2019 08:40	15/11/2019 18:58	16/11/2019 08:40	13,69	5	68,45	CHI
201911179454	ANAPOLIS	AN21273186	JUNDIAI S2	15/11/2019 21:29	15/11/2019 23:26	15/11/2019 21:29	15/11/2019 23:26	1,95	2	3,90	CHI
201911179458	DOVERLANDIA	DV12380848	CAIAPONIA	14/11/2019 14:01	17/11/2019 10:21	14/11/2019 14:01	17/11/2019 10:21	68,32	11	751,53	CHI
201911179459	APARECIDA DE GOIANIA	13756011	INDEPENDENCIA S1	15/11/2019 21:44	16/11/2019 10:55	15/11/2019 21:44	16/11/2019 10:55	13,17	1	13,17	CHI
201911179460	PORANGATU	PO12093802	PORANGATU	15/11/2019 21:45	16/11/2019 11:37	15/11/2019 21:45	16/11/2019 11:37	13,86	2	27,72	CHI
201911179463	NIQUELANDIA	NQ12396807	URUACU	15/11/2019 21:46	17/11/2019 21:05	15/11/2019 21:46	17/11/2019 21:05	47,30	1	47,30	CHI
201911179463	NIQUELANDIA	NQ12396807	URUACU	15/11/2019 21:46	17/11/2019 21:05	17/11/2019 16:58	17/11/2019 21:05	4,11	3	12,33	CHI
201911179466	APARECIDA DE GOIANIA	AP11108966	INDEPENDENCIA S1	15/11/2019 19:52	16/11/2019 07:31	15/11/2019 19:52	16/11/2019 07:31	11,65	121	1409,15	CHI
201911179476	MARA ROSA	MQ21155995	MARA ROSA	15/11/2019 21:51	16/11/2019 09:28	15/11/2019 21:51	16/11/2019 09:28	11,61	1	11,61	CHI
201911179480	ABADIANIA	350024947	ANAPOLIS UNIVERSITARIO S1	15/11/2019 21:54	16/11/2019 08:37	15/11/2019 21:54	16/11/2019 08:37	10,72	1	10,72	CHI
201911179483	ABADIANIA	AA12221505	DAIA S2	15/11/2019 18:19	16/11/2019 01:10	15/11/2019 18:19	16/11/2019 01:10	6,85	120	821,60	CHI
201911179487	PARAUNA	PU12301182LD	ACREUNA	15/11/2019 21:55	16/11/2019 08:55	15/11/2019 21:55	16/11/2019 08:55	10,99	24	263,65	CHI
201911179488	CAMPOS BELOS	MA12383373	SAO DOMINGOS	15/11/2019 21:55	15/11/2019 23:12	15/11/2019 21:55	15/11/2019 23:12	1,27	2	2,53	CHI
201911179488	MONTE ALEGRE DE GOIAS	MA12383373	SAO DOMINGOS	15/11/2019 21:55	15/11/2019 23:12	15/11/2019 21:55	15/11/2019 23:12	1,27	4	5,07	CHI
201911179491	GUARANI DE GOIAS	GY12393812	IACIARA S1	15/11/2019 21:00	15/11/2019 23:57	15/11/2019 21:00	15/11/2019 23:57	2,95	22	64,86	CHI
201911179496	IPORA	730038816	IPORA	15/11/2019 21:58	16/11/2019 11:50	15/11/2019 21:58	16/11/2019 11:50	13,86	1	13,86	CHI
201911179505	INHUMAS	10002078870	INHUMAS S1	15/11/2019 18:31	16/11/2019 16:10	15/11/2019 18:31	16/11/2019 16:10	21,64	1	21,64	CHI
201911179511	BELA VISTA DE GOIAS	BV12011713	BELA VISTA S1	15/11/2019 14:27	16/11/2019 10:24	15/11/2019 14:27	16/11/2019 10:24	19,95	14	279,26	CHI
201911179602	ANAPOLIS	AN11335100	ANAPOLIS UNIVERSITARIO S2	15/11/2019 22:01	15/11/2019 23:39	15/11/2019 22:01	15/11/2019 23:39	1,63	22	35,85	CHI
201911179610	CATURAI	CK21318928	TRINDADE	15/11/2019 22:07	16/11/2019 16:38	15/11/2019 22:07	16/11/2019 16:38	18,52	1	18,52	CHI
201911179614	GOIANIA	16696773	FERROVIARIO S1	15/11/2019 22:09	16/11/2019 09:02	15/11/2019 22:09	16/11/2019 09:02	10,88	1	10,88	CHI
201911179625	GOIANIA	10604340	AEROPORTO S2	15/11/2019 22:15	16/11/2019 11:05	15/11/2019 22:15	16/11/2019 11:05	12,82	1	12,82	CHI
201911179635	GOIANIA	14102390	CAMPINAS S2	15/11/2019 22:25	16/11/2019 07:58	15/11/2019 22:25	16/11/2019 07:58	9,54	1	9,54	CHI
201911179640	PARAUNA	PU12395671	PARAUNA	15/11/2019 22:30	16/11/2019 01:24	15/11/2019 22:30	16/11/2019 01:24	2,90	336	975,61	CHI

201911179640	PARAUNA	PU12395671	PARAUNA	15/11/2019 22:30	16/11/2019 01:24	15/11/2019 22:30	16/11/2019 01:24	2,90	1	2,90	CHI
201911179642	PALMEIRAS DE GOIAS	PL12169788	PALMEIRAS	15/11/2019 22:31	16/11/2019 00:45	15/11/2019 22:31	16/11/2019 00:45	2,23	8	17,81	CHI
201911179645	FORMOSA	PI12208713	PLANALTINA	15/11/2019 22:33	16/11/2019 07:57	15/11/2019 22:33	16/11/2019 07:57	9,40	1	9,40	CHI
201911179645	PLANALTINA	PI12208713	PLANALTINA	15/11/2019 22:33	16/11/2019 07:57	15/11/2019 22:33	16/11/2019 07:57	9,40	239	2245,80	CHI
201911179653	GOIANIA	GN11002673	CAMPINAS S1	15/11/2019 21:40	16/11/2019 00:56	15/11/2019 21:40	16/11/2019 00:56	3,26	119	387,87	CHI
201911179659	CEZARINA	10014933657	CEZARINA	15/11/2019 22:40	16/11/2019 10:58	15/11/2019 22:40	16/11/2019 10:58	12,29	1	12,29	CHI
201911179660	CAIAPONIA	CP11193459	CAIAPONIA	15/11/2019 21:18	16/11/2019 01:22	15/11/2019 21:18	16/11/2019 01:22	4,05	39	158,08	CHI
201911179662	APARECIDA DE GOIANIA	AP11193132	REAL S1	15/11/2019 21:58	16/11/2019 10:09	15/11/2019 21:58	16/11/2019 10:09	12,17	111	1350,56	CHI
201911179663	SÃO LUIS DE MONTES BELOS	SL21108202	FIRMINOPOLIS S2	15/11/2019 22:43	16/11/2019 12:30	15/11/2019 22:43	16/11/2019 12:30	13,78	1	13,78	CHI
201911179665	SERRANOPOLIS	SX12260314	JATAI S1	16/11/2019 06:15	16/11/2019 10:53	16/11/2019 06:15	16/11/2019 10:53	4,62	4	18,48	CHI
201911179668	RIO VERDE	630517952	RIO VERDE S1	15/11/2019 22:47	16/11/2019 09:44	15/11/2019 22:47	16/11/2019 09:44	10,96	1	10,96	CHI
201911179672	JARAGUA	JA12000206	JARAGUA	15/11/2019 16:30	16/11/2019 09:21	15/11/2019 16:30	16/11/2019 09:21	16,85	4	67,39	CHI
201911179674	AGUAS LINDAS DE GOIAS	LA11146691	AGUAS LINDAS DE GOIAS S2	15/11/2019 22:53	16/11/2019 07:37	15/11/2019 22:53	16/11/2019 07:37	8,73	89	777,04	CHI
201911179676	MOZARLANDIA	410043564	MOZARLANDIA	15/11/2019 22:53	16/11/2019 20:15	15/11/2019 22:53	16/11/2019 20:15	21,37	1	21,37	CHI
201911179680	CRIXAS	CX12248300	SERRA DO OURO	15/11/2019 22:58	16/11/2019 02:46	15/11/2019 22:58	16/11/2019 02:46	3,80	5	18,98	CHI
201911179686	MAIRIPOTABA	MI21038122	PONTALINA	15/11/2019 23:01	16/11/2019 08:12	15/11/2019 23:01	16/11/2019 08:12	9,18	1	9,18	CHI
201911179688	NIQUELANDIA	NQ12400321	URUACU	15/11/2019 22:08	16/11/2019 08:09	15/11/2019 22:08	16/11/2019 08:09	10,02	192	1924,37	CHI
201911179689	GOIANIA	13276463	XAVANTES	15/11/2019 23:07	16/11/2019 09:03	15/11/2019 23:07	16/11/2019 09:03	9,93	1	9,93	CHI
201911179694	CALDAS NOVAS	760331534	SERRA DE CALDAS	15/11/2019 23:08	18/11/2019 15:45	15/11/2019 23:08	18/11/2019 15:45	64,61	1	64,61	CHI
201911179705	FAZENDA NOVA	FN21259908	BRITANIA	15/11/2019 23:12	16/11/2019 23:30	15/11/2019 23:12	16/11/2019 23:30	24,29	32	777,27	CHI
201911179706	JUSSARA	JR12341251	IPORA	15/11/2019 21:00	16/11/2019 02:01	15/11/2019 21:00	16/11/2019 02:01	5,01	159	795,93	CHI
201911179706	MONTES CLAROS DE GOIAS	JR12341251	IPORA	15/11/2019 21:00	16/11/2019 02:01	15/11/2019 21:00	16/11/2019 02:01	5,01	17	85,10	CHI
201911179713	APARECIDA DE GOIANIA	11617329	INDEPENDENCIA S2	15/11/2019 23:16	16/11/2019 10:56	15/11/2019 23:16	16/11/2019 10:56	11,65	1	11,65	CHI
201911179721	SÃO LUIS DE MONTES BELOS	SL21006795	SÃO LUIZ DOS MONTES BELOS	15/11/2019 23:20	16/11/2019 07:55	15/11/2019 23:20	16/11/2019 07:55	8,58	3	25,73	CHI
201911179722	MORRINHOS	MR11000041	MORRINHOS	16/11/2019 15:25	16/11/2019 17:40	16/11/2019 15:25	16/11/2019 17:40	2,25	99	223,11	CHI
201911179723	FORMOSA	610036981	ITUIQUIRA	15/11/2019 23:23	16/11/2019 00:56	15/11/2019 23:23	16/11/2019 00:56	1,54	1	1,54	CHI
201911179730	CALDAS NOVAS	CN12207647	CALDAS NOVAS S2	15/11/2019 23:28	21/11/2019 10:11	15/11/2019 23:28	21/11/2019 01:24	121,93	8	975,47	CHI
201911179730	CALDAS NOVAS	CN12207647	CALDAS NOVAS S2	15/11/2019 23:28	21/11/2019 10:11	21/11/2019 01:25	21/11/2019 01:37	0,20	16	3,21	CHI
201911179730	CALDAS NOVAS	CN11182808	CALDAS NOVAS S2	15/11/2019 23:28	21/11/2019 10:11	15/11/2019 23:28	21/11/2019 01:55	122,44	1	122,44	CHI
201911179730	CALDAS NOVAS	19757009	CALDAS NOVAS S2	15/11/2019 23:28	21/11/2019 10:11	15/11/2019 23:28	21/11/2019 10:11	130,70	5	653,52	CHI
201911179731	SENADOR CANEDO	10012812143	SENADOR CANEDO	15/11/2019 23:28	16/11/2019 12:02	15/11/2019 23:28	16/11/2019 12:02	12,55	1	12,55	CHI
201911179735	PORANGATU	PO11020558	PORANGATU	15/11/2019 22:38	16/11/2019 12:02	15/11/2019 22:38	16/11/2019 12:02	13,39	120	1606,77	CHI
201911179737	CATALAO	1990151891	CATALAO S2	15/11/2019 23:32	16/11/2019 21:36	15/11/2019 23:32	16/11/2019 21:36	22,07	1	22,07	CHI

201911179738	AGUAS LINDAS DE GOIAS	LA11335960	AGUAS LINDAS DE GOIAS S1	15/11/2019 22:38	16/11/2019 01:35	15/11/2019 22:38	16/11/2019 01:35	2,94	61	179,42	CHI
201911179742	FLORES DE GOIAS	FB11043496	FLORES DE GOIAS	15/11/2019 23:36	16/11/2019 07:43	15/11/2019 23:36	16/11/2019 07:43	8,10	80	648,31	CHI
201911179747	URUACU	UR12221685	URUACU	15/11/2019 23:45	16/11/2019 07:19	15/11/2019 23:45	16/11/2019 07:19	7,56	20	151,12	CHI
201911179750	AGUA FRIA DE GOIAS	5330000298	SAO JOAO D ALIANCA	15/11/2019 14:02	16/11/2019 09:28	15/11/2019 14:02	16/11/2019 09:28	19,42	1	19,42	CHI
201911179767	AGUAS LINDAS DE GOIAS	10007193066	AGUAS LINDAS DE GOIAS S1	16/11/2019 00:02	16/11/2019 09:02	16/11/2019 00:02	16/11/2019 09:02	9,00	1	9,00	CHI
201911179776	GOIANIA	GN11001177	CAMPINAS S1	15/11/2019 21:26	16/11/2019 02:02	15/11/2019 21:26	16/11/2019 02:02	4,59	80	367,42	CHI
201911179785	LUZIANIA	LZ21000475	RIO VERMELHO	16/11/2019 00:30	16/11/2019 09:47	16/11/2019 00:30	16/11/2019 09:47	9,27	1	9,27	CHI
201911179789	FORMOSA	FA12042622	ITIQUEIRA	16/11/2019 00:42	16/11/2019 15:15	16/11/2019 00:42	16/11/2019 15:15	14,55	3	43,66	CHI
201911179790	FLORES DE GOIAS	FA13361342	ITIQUEIRA	16/11/2019 10:54	16/11/2019 21:55	16/11/2019 10:54	16/11/2019 15:54	5,00	3	14,99	CHI
201911179790	FORMOSA	FA13361342	ITIQUEIRA	16/11/2019 10:54	16/11/2019 21:55	16/11/2019 10:54	16/11/2019 15:54	5,00	260	1298,84	CHI
201911179790	VILA BOA	FA13361342	ITIQUEIRA	16/11/2019 10:54	16/11/2019 21:55	16/11/2019 10:54	16/11/2019 15:54	5,00	4	19,98	CHI
201911179790	FORMOSA	FA12204762LD	ITIQUEIRA	16/11/2019 10:54	16/11/2019 21:55	16/11/2019 10:54	16/11/2019 19:13	8,31	313	2601,81	CHI
201911179790	VILA BOA	FA12204762LD	ITIQUEIRA	16/11/2019 10:54	16/11/2019 21:55	16/11/2019 10:54	16/11/2019 19:13	8,31	2	16,62	CHI
201911179790	FORMOSA	FA12164536	ITIQUEIRA	16/11/2019 10:54	16/11/2019 21:55	16/11/2019 10:54	16/11/2019 21:55	11,02	2	22,05	CHI
201911179790	SAO JOAO D ALIANCA	FA12164536	ITIQUEIRA	16/11/2019 10:54	16/11/2019 21:55	16/11/2019 10:54	16/11/2019 21:55	11,02	225	2480,37	CHI
201911179794	ISRAELANDIA	1270003991	IPORA	16/11/2019 00:49	16/11/2019 17:01	16/11/2019 00:49	16/11/2019 17:01	16,20	1	16,20	CHI
201911179798	SAO SIMAO	SO21000132	CACHOEIRA ALTA	16/11/2019 00:58	16/11/2019 18:48	16/11/2019 00:58	16/11/2019 18:48	17,82	1	17,82	CHI
201911179800	INDIARA	3740001298	EDEIA	16/11/2019 01:03	16/11/2019 17:05	16/11/2019 01:03	16/11/2019 17:05	16,02	1	16,02	CHI
201911179828	JATAI	JT21334168	JATAI S3	15/11/2019 17:21	16/11/2019 09:43	15/11/2019 17:21	16/11/2019 09:43	16,37	1	16,37	CHI
201911179831	JATAI	JT11228775	JATAI S3	15/11/2019 18:58	16/11/2019 08:51	15/11/2019 18:58	16/11/2019 08:51	13,87	1	13,87	CHI
201911179832	QUIRINOPOLIS	QI21052818	QUIRINOPOLIS	16/11/2019 07:33	16/11/2019 07:48	16/11/2019 07:33	16/11/2019 07:48	0,24	1	0,24	CHI
201911179836	GOIANIA	GN16404628	GOYA S2	16/11/2019 08:04	16/11/2019 08:07	16/11/2019 08:04	16/11/2019 08:07	0,06	623	35,48	CHI
201911179861	IPAMERI	IP21333506	IPAMERI	16/11/2019 09:06	17/11/2019 23:54	16/11/2019 09:06	17/11/2019 23:54	38,79	1	38,79	CHI
201911179862	RIO VERDE	RV21023919	RIO VERDE S2	15/11/2019 16:49	16/11/2019 12:15	15/11/2019 16:49	16/11/2019 12:15	19,44	1	19,44	CHI
201911179904	FLORES DE GOIAS	FB12248238	FLORES DE GOIAS	16/11/2019 01:11	16/11/2019 08:20	16/11/2019 01:11	16/11/2019 08:20	7,14	95	678,38	CHI
201911179904	SAO JOAO D ALIANCA	FB12248238	FLORES DE GOIAS	16/11/2019 01:11	16/11/2019 08:20	16/11/2019 01:11	16/11/2019 08:20	7,14	40	285,63	CHI
201911179908	ANAPOLIS	AN12000547	JUNDIAI S1	16/11/2019 00:57	16/11/2019 04:55	16/11/2019 00:57	16/11/2019 04:55	3,96	477	1889,32	CHI
201911179909	ITAGUARI	II11089946	ITABERAI S1	16/11/2019 01:25	16/11/2019 09:50	16/11/2019 01:25	16/11/2019 09:50	8,41	70	588,84	CHI
201911179917	GOIANIA	GN11167704	GOIANIA LESTE S2	15/11/2019 23:25	16/11/2019 05:03	15/11/2019 23:25	16/11/2019 05:03	5,63	56	315,16	CHI
201911179918	RIO QUENTE	RQ12050875	VILA CORUMBA	16/11/2019 08:51	16/11/2019 10:47	16/11/2019 08:51	16/11/2019 10:47	1,92	13	25,00	CHI
201911179941	SENADOR CANEDO	SW12060624	CEPAIGO S2	16/11/2019 01:51	16/11/2019 13:30	16/11/2019 01:51	16/11/2019 13:30	11,65	5	58,25	CHI
201911179942	GOIANIA	GN11213733	GOYA S1	15/11/2019 22:36	16/11/2019 04:11	15/11/2019 22:36	16/11/2019 04:11	5,57	263	1465,57	CHI
201911179943	PALESTINA DE GOIAS	PY12244052	PALESTINA	16/11/2019 02:00	16/11/2019 20:23	16/11/2019 02:00	16/11/2019 20:23	18,39	1	18,39	CHI

201911179946	APARECIDA DE GOIANIA	AP11212317	REAL S1	15/11/2019 21:41	16/11/2019 04:17	15/11/2019 21:41	16/11/2019 04:17	6,59	189	1246,14	CHI
201911179948	IPORA	IR11353730	IPORA	16/11/2019 02:13	16/11/2019 15:35	16/11/2019 02:13	16/11/2019 15:35	13,38	1	13,38	CHI
201911179956	GOIANIA	GN11268058	GOYA S1	15/11/2019 22:35	16/11/2019 07:43	15/11/2019 22:35	16/11/2019 07:43	9,12	133	1212,81	CHI
201911179965	MINEIROS	MY11374370	PARQUE DAS EMAS	16/11/2019 03:06	16/11/2019 09:06	16/11/2019 03:06	16/11/2019 09:06	5,99	47	281,70	CHI
201911179972	JARAGUA	SF12297981	SAO FRANCISCO DE GOIAS	15/11/2019 21:51	16/11/2019 08:35	15/11/2019 21:51	16/11/2019 08:35	10,72	107	1147,25	CHI
201911179972	JESUPOLIS	SF12297981	SAO FRANCISCO DE GOIAS	15/11/2019 21:51	16/11/2019 08:35	15/11/2019 21:51	16/11/2019 08:35	10,72	5	53,61	CHI
201911179972	SAO FRANCISCO DE GOIAS	SF12297981	SAO FRANCISCO DE GOIAS	15/11/2019 21:51	16/11/2019 08:35	15/11/2019 21:51	16/11/2019 08:35	10,72	2	21,44	CHI
201911179975	PIRES DO RIO	PR12045810	PIRES DO RIO S1	16/11/2019 04:00	17/11/2019 08:51	16/11/2019 04:00	16/11/2019 10:11	6,19	368	2279,56	CHI
201911179975	PIRES DO RIO	PR11272852	PIRES DO RIO S1	16/11/2019 04:00	17/11/2019 08:51	16/11/2019 10:30	17/11/2019 08:51	22,36	109	2437,36	CHI
201911179978	POSSE	PS21160025	IACIARA S2	16/11/2019 04:12	16/11/2019 09:27	16/11/2019 04:12	16/11/2019 09:27	5,24	1	5,24	CHI
201911179980	CAMPINORTE	MQ12208355	MARA ROSA	16/11/2019 04:19	16/11/2019 08:36	16/11/2019 04:19	16/11/2019 08:36	4,27	1	4,27	CHI
201911179984	ANAPOLIS	20533007	JUNDIAI S1	16/11/2019 04:36	16/11/2019 08:39	16/11/2019 04:36	16/11/2019 08:39	4,03	1	4,03	CHI
201911179990	BARRO ALTO	BA12342218	GOIANESIA S1	15/11/2019 18:15	16/11/2019 18:26	15/11/2019 18:15	16/11/2019 18:26	24,17	3	72,52	CHI
201911179999	ITUMBIARA	IT12033049	BOM JESUS DE GOIAS	16/11/2019 05:11	16/11/2019 18:49	16/11/2019 05:11	16/11/2019 18:49	13,63	7	95,39	CHI
201911180002	AGUA LIMPA	AL12238064	VILA CORUMBA	15/11/2019 17:47	18/11/2019 13:21	15/11/2019 17:47	18/11/2019 13:21	67,56	5	337,81	CHI
201911180003	APARECIDA DO RIO DOCE	JT21234198	JATAI S1	16/11/2019 05:18	16/11/2019 17:11	16/11/2019 05:18	16/11/2019 17:11	11,88	1	11,88	CHI
201911180005	JUSSARA	JR12124817	BRITANIA	16/11/2019 01:33	16/11/2019 17:25	16/11/2019 01:33	16/11/2019 17:25	15,86	11	174,46	CHI
201911180013	INACIOLANDIA	IT11304152	CACHOEIRA DOURADA	16/11/2019 05:25	19/11/2019 07:15	16/11/2019 05:25	19/11/2019 07:15	73,83	1	73,83	CHI
201911180015	ARENOPOLIS	AY12390167	ARENOPOLIS	16/11/2019 05:27	16/11/2019 13:04	16/11/2019 05:27	16/11/2019 13:04	7,61	14	106,58	CHI
201911180016	MORRINHOS	MR12263331	MORRINHOS	16/11/2019 05:27	16/11/2019 12:30	16/11/2019 05:27	16/11/2019 12:30	7,05	9	63,41	CHI
201911180018	CALDAS NOVAS	CN11106309	CALDAS NOVAS S2	16/11/2019 02:22	16/11/2019 09:25	16/11/2019 02:22	16/11/2019 09:25	7,05	107	754,32	CHI
201911180020	ITABERAI	II12217217	ITABERAI S1	15/11/2019 19:35	16/11/2019 09:00	15/11/2019 19:35	16/11/2019 09:00	13,41	22	295,08	CHI
201911180020	ITAGUARI	II12217217	ITABERAI S1	15/11/2019 19:35	16/11/2019 09:00	15/11/2019 19:35	16/11/2019 09:00	13,41	42	563,34	CHI
201911180020	TAQUARAL DE GOIAS	II12217217	ITABERAI S1	15/11/2019 19:35	16/11/2019 09:00	15/11/2019 19:35	16/11/2019 09:00	13,41	46	616,99	CHI
201911180021	ALVORADA DO NORTE	AQ21068782	FLORES DE GOIAS	16/11/2019 05:32	16/11/2019 09:13	16/11/2019 05:32	16/11/2019 09:13	3,68	1	3,68	CHI
201911180027	CATALAO	OU12195337	CATALAO S1	15/11/2019 21:34	16/11/2019 09:25	15/11/2019 21:34	16/11/2019 09:25	11,84	5	59,21	CHI
201911180027	OUVIDOR	OU12195337	CATALAO S1	15/11/2019 21:34	16/11/2019 09:25	15/11/2019 21:34	16/11/2019 09:25	11,84	13	153,95	CHI
201911180027	TRES RANCHOS	OU12195337	CATALAO S1	15/11/2019 21:34	16/11/2019 09:25	15/11/2019 21:34	16/11/2019 09:25	11,84	1	11,84	CHI
201911180031	JUSSARA	JR12299654	IPORA	16/11/2019 05:34	18/11/2019 15:04	16/11/2019 05:34	18/11/2019 15:04	57,49	6	344,96	CHI
201911180047	SILVANIA	SV21393231	DAIA S2	16/11/2019 05:45	16/11/2019 15:50	16/11/2019 05:45	16/11/2019 15:50	10,07	1	10,07	CHI
201911180048	SILVANIA	SV21321126	DAIA S2	16/11/2019 05:45	16/11/2019 16:18	16/11/2019 05:45	16/11/2019 16:18	10,54	1	10,54	CHI
201911180049	SILVANIA	SV21400901	DAIA S2	16/11/2019 05:45	16/11/2019 14:31	16/11/2019 05:45	16/11/2019 14:31	8,75	1	8,75	CHI
201911180051	ACREUNA	6624629	ACREUNA	16/11/2019 05:48	16/11/2019 11:21	16/11/2019 05:48	16/11/2019 11:21	5,56	2	11,11	CHI

201911180051	SANTO ANTONIO DA BARRA	6624629	ACREUNA	16/11/2019 05:48	16/11/2019 11:21	16/11/2019 05:48	16/11/2019 11:21	5,56	13	72,23	CHI
201911180063	TEREZOPOLIS DE GOIAS	1370015450	DAIA S2	16/11/2019 05:54	16/11/2019 12:00	16/11/2019 05:54	16/11/2019 12:00	6,09	1	6,09	CHI
201911180064	MOSSAMEDES	MD21299585	ITABERAI S2	16/11/2019 05:54	16/11/2019 08:32	16/11/2019 05:54	16/11/2019 08:32	2,62	1	2,62	CHI
201911180067	CALDAS NOVAS	CN12213871	CALDAS NOVAS S1	16/11/2019 05:56	18/11/2019 10:48	16/11/2019 05:56	18/11/2019 10:48	52,86	5	264,32	CHI
201911180070	SAO LUIS DE MONTES BELOS	500011424	SAO LUIZ DOS MONTES BELOS	16/11/2019 05:59	16/11/2019 09:57	16/11/2019 05:59	16/11/2019 09:57	3,97	1	3,97	CHI
201911180073	CACHOEIRA DOURADA	CD12000067	CACHOEIRA DOURADA	15/11/2019 18:34	17/11/2019 15:39	15/11/2019 18:34	17/11/2019 15:39	45,09	16	721,44	CHI
201911180073	INACIOLANDIA	CD12000067	CACHOEIRA DOURADA	15/11/2019 18:34	17/11/2019 15:39	15/11/2019 18:34	17/11/2019 15:39	45,09	56	2525,06	CHI
201911180073	ITUMBIARA	CD12000067	CACHOEIRA DOURADA	15/11/2019 18:34	17/11/2019 15:39	15/11/2019 18:34	17/11/2019 15:39	45,09	3	135,27	CHI
201911180084	BOM JESUS DE GOIAS	BJ21000337	BOM JESUS DE GOIAS	16/11/2019 06:05	16/11/2019 10:21	16/11/2019 06:05	16/11/2019 10:21	4,26	1	4,26	CHI
201911180100	CRISTALINA	KR12304800	CRISTALINA S2	16/11/2019 05:42	16/11/2019 07:58	16/11/2019 05:42	16/11/2019 07:58	2,26	64	144,78	CHI
201911180101	CRISTALINA	KR12163791	PAMPLONA	15/11/2019 23:20	16/11/2019 13:22	15/11/2019 23:20	16/11/2019 13:22	14,02	27	378,64	CHI
201911180102	GOIAS	HE12250707	ITABERAI S1	16/11/2019 06:11	16/11/2019 10:40	16/11/2019 06:11	16/11/2019 10:40	4,48	30	134,40	CHI
201911180112	PALMINOPOLIS	PP12307055	PALMEIRAS	16/11/2019 06:15	16/11/2019 11:27	16/11/2019 06:15	16/11/2019 11:27	5,18	2	10,37	CHI
201911180119	TURVANIA	TV12026469	FIRMINOPOLIS S1	16/11/2019 06:19	16/11/2019 09:02	16/11/2019 06:19	16/11/2019 09:02	2,71	7	18,98	CHI
201911180121	ITAPURANGA	IK12299882	ITAPURANGA	16/11/2019 01:10	16/11/2019 08:39	16/11/2019 01:10	16/11/2019 08:39	7,49	10	74,92	CHI
201911180123	DISTRITO FEDERAL	IJ12200625	ITAJA S2	16/11/2019 06:21	16/11/2019 10:35	16/11/2019 06:21	16/11/2019 10:35	4,23	1	4,23	CHI
201911180123	ITAJA	IJ12200625	ITAJA S2	16/11/2019 06:21	16/11/2019 10:35	16/11/2019 06:21	16/11/2019 10:35	4,23	3	12,69	CHI
201911180123	LAGOA SANTA	IJ12200625	ITAJA S2	16/11/2019 06:21	16/11/2019 10:35	16/11/2019 06:21	16/11/2019 10:35	4,23	30	126,87	CHI
201911180128	ANICUNS	AC12075338	FIRMINOPOLIS S2	16/11/2019 04:51	16/11/2019 09:48	16/11/2019 04:51	16/11/2019 09:48	4,95	16	79,16	CHI
201911180140	RIO VERDE	RV11295129	RIO VERDE S1	16/11/2019 06:29	16/11/2019 08:04	16/11/2019 06:29	16/11/2019 08:04	1,57	161	253,13	CHI
201911180143	PORANGATU	PO12139105	PORANGATU	16/11/2019 06:30	16/11/2019 14:34	16/11/2019 06:30	16/11/2019 14:34	8,08	3	24,25	CHI
201911180145	PIRACANJUBA	PJ12293350	BELA VISTA S1	15/11/2019 21:58	17/11/2019 17:30	15/11/2019 21:58	17/11/2019 17:30	43,52	15	652,84	CHI
201911180148	DIVINOPOLIS DE GOIAS	MA12398387	SAO DOMINGOS	16/11/2019 01:14	16/11/2019 07:45	16/11/2019 01:14	16/11/2019 07:45	6,51	3	19,52	CHI
201911180148	MONTE ALEGRE DE GOIAS	MA12398387	SAO DOMINGOS	16/11/2019 01:14	16/11/2019 07:45	16/11/2019 01:14	16/11/2019 07:45	6,51	16	104,11	CHI
201911180149	PIRES DO RIO	PR21114566	PIRES DO RIO S1	16/11/2019 06:33	17/11/2019 02:02	16/11/2019 06:33	17/11/2019 02:02	19,48	1	19,48	CHI
201911180150	GOIANIA	GN11023409	REAL S1	16/11/2019 05:58	16/11/2019 07:58	16/11/2019 05:58	16/11/2019 07:58	1,99	98	194,88	CHI
201911180163	TRINDADE	10002119445	TRINDADE	16/11/2019 06:36	16/11/2019 08:57	16/11/2019 06:36	16/11/2019 08:57	2,34	1	2,34	CHI
201911180164	IPAMERI	10006892807	IPAMERI	16/11/2019 06:37	16/11/2019 09:04	16/11/2019 06:37	16/11/2019 09:04	2,45	1	2,45	CHI
201911180165	RIO VERDE	01420204	SANTA HELENA S1	15/11/2019 18:59	18/11/2019 15:36	15/11/2019 18:59	16/11/2019 10:38	15,63	26	406,48	CHI
201911180165	SANTA HELENA DE GOIAS	01420204	SANTA HELENA S1	15/11/2019 18:59	18/11/2019 15:36	15/11/2019 18:59	16/11/2019 10:38	15,63	47	734,79	CHI
201911180165	MAURILANDIA	RV13260080	SANTA HELENA S1	15/11/2019 18:59	18/11/2019 15:36	15/11/2019 18:59	16/11/2019 11:41	16,69	25	417,35	CHI
201911180165	RIO VERDE	RV13260080	SANTA HELENA S1	15/11/2019 18:59	18/11/2019 15:36	15/11/2019 18:59	16/11/2019 11:41	16,69	586	9782,78	CHI
201911180165	SANTA HELENA DE GOIAS	RV13260080	SANTA HELENA S1	15/11/2019 18:59	18/11/2019 15:36	15/11/2019 18:59	16/11/2019 11:41	16,69	2	33,39	CHI

201911180165	RIO VERDE	RV12018072LD	SANTA HELENA S1	15/11/2019 18:59	18/11/2019 15:36	15/11/2019 18:59	16/11/2019 13:16	18,27	9	164,40	CHI
201911180165	RIO VERDE	RV13018083	SANTA HELENA S1	15/11/2019 18:59	18/11/2019 15:36	15/11/2019 18:59	16/11/2019 15:40	20,67	2	41,35	CHI
201911180165	RIO VERDE	RV13018084	SANTA HELENA S1	15/11/2019 18:59	18/11/2019 15:36	15/11/2019 18:59	18/11/2019 15:36	68,60	1	68,60	CHI
201911180172	GOUVELANDIA	QI12000166	QUIRINOPOLIS	15/11/2019 22:11	16/11/2019 17:27	15/11/2019 22:11	16/11/2019 17:27	19,26	19	365,86	CHI
201911180175	FAZENDA NOVA	FN12076130	JUSSARA	16/11/2019 04:08	16/11/2019 18:43	16/11/2019 04:08	16/11/2019 16:25	12,27	90	1104,48	CHI
201911180175	FAZENDA NOVA	20351459	JUSSARA	16/11/2019 04:08	16/11/2019 18:43	16/11/2019 04:08	16/11/2019 18:27	14,31	3	42,93	CHI
201911180175	FAZENDA NOVA	20351459	JUSSARA	16/11/2019 04:08	16/11/2019 18:43	16/11/2019 18:28	16/11/2019 18:43	0,26	3	0,78	CHI
201911180179	PORANGATU	PO12064911	NOVO PLANALTO	16/11/2019 04:52	16/11/2019 09:39	16/11/2019 04:52	16/11/2019 09:39	4,78	126	602,00	CHI
201911180188	ALTO HORIZONTE	AJ12384910	MARA ROSA	16/11/2019 05:07	16/11/2019 09:45	16/11/2019 05:07	16/11/2019 09:45	4,62	34	157,13	CHI
201911180188	MARA ROSA	AJ12384910	MARA ROSA	16/11/2019 05:07	16/11/2019 09:45	16/11/2019 05:07	16/11/2019 09:45	4,62	5	23,11	CHI
201911180189	GOIANIRA	TR12016262	GOIANIRA	16/11/2019 06:46	16/11/2019 09:09	16/11/2019 06:46	16/11/2019 09:09	2,38	1	2,38	CHI
201911180189	TRINDADE	TR12016262	GOIANIRA	16/11/2019 06:46	16/11/2019 09:09	16/11/2019 06:46	16/11/2019 09:09	2,38	31	73,75	CHI
201911180197	CAMPINACU	UC12280055	MARA ROSA	16/11/2019 06:48	16/11/2019 08:50	16/11/2019 06:48	16/11/2019 08:50	2,02	12	24,24	CHI
201911180199	CRISTALINA	KR21351945	CRISTALINA S1	16/11/2019 06:48	16/11/2019 12:21	16/11/2019 06:48	16/11/2019 12:21	5,54	2	11,07	CHI
201911180205	ARAGOIANIA	AO12251688	GUAPO S2	16/11/2019 04:52	16/11/2019 09:33	16/11/2019 04:52	16/11/2019 09:33	4,67	97	452,99	CHI
201911180207	BELA VISTA DE GOIAS	BV12116190	BELA VISTA S1	16/11/2019 06:52	16/11/2019 10:17	16/11/2019 06:52	16/11/2019 10:17	3,42	7	23,91	CHI
201911180209	URUACU	UR12232449RE	URUACU	16/11/2019 06:52	16/11/2019 08:52	16/11/2019 06:52	16/11/2019 08:52	1,99	53	105,40	CHI
201911180212	RIO VERDE	630549540	RIO VERDE S2	16/11/2019 06:53	16/11/2019 12:40	16/11/2019 06:53	16/11/2019 12:40	5,78	1	5,78	CHI
201911180214	RIO VERDE	RV12305862LD	RIO VERDE S2	16/11/2019 06:53	16/11/2019 09:35	16/11/2019 06:53	16/11/2019 09:35	2,68	8	21,48	CHI
201911180216	BURITINOPOLIS	PS12189370	IACIARA S2	16/11/2019 06:53	16/11/2019 08:49	16/11/2019 06:53	16/11/2019 08:49	1,93	2	3,86	CHI
201911180216	MAMBAI	PS12189370	IACIARA S2	16/11/2019 06:53	16/11/2019 08:49	16/11/2019 06:53	16/11/2019 08:49	1,93	25	48,28	CHI
201911180216	POSSE	PS12189370	IACIARA S2	16/11/2019 06:53	16/11/2019 08:49	16/11/2019 06:53	16/11/2019 08:49	1,93	4	7,73	CHI
201911180220	ORIZONA	OZ21209349	PIRES DO RIO S2	16/11/2019 06:55	16/11/2019 11:27	16/11/2019 06:55	16/11/2019 11:27	4,54	1	4,54	CHI
201911180225	PIRENOPOLIS	PV12352327	CORUMBA	16/11/2019 06:08	16/11/2019 19:26	16/11/2019 06:08	16/11/2019 19:26	13,30	17	226,03	CHI
201911180226	FAZENDA NOVA	1080007470	JUSSARA	16/11/2019 06:57	16/11/2019 16:40	16/11/2019 06:57	16/11/2019 16:40	9,72	1	9,72	CHI
201911180229	ALTO PARAISO DE GOIAS	BF12105397	SAO JOAO D ALIANCA	16/11/2019 06:58	16/11/2019 09:43	16/11/2019 06:58	16/11/2019 09:43	2,74	207	567,53	CHI
201911180238	GOIANIA	GN11000991	CAMPINAS S1	16/11/2019 04:30	16/11/2019 19:48	16/11/2019 04:30	16/11/2019 19:48	15,29	143	2186,27	CHI
201911180239	SANTA TEREZINHA DE GOIAS	6665144	SANTA TEREZINHA	16/11/2019 07:00	16/11/2019 11:18	16/11/2019 07:00	16/11/2019 11:18	4,29	3	12,88	CHI
201911180249	BONFINOPOLIS	10022188302	CEPAIGO S2	16/11/2019 07:02	17/11/2019 08:03	16/11/2019 07:02	17/11/2019 08:03	25,00	1	25,00	CHI
201911180263	PONTALINA	PK12080060	PONTALINA	16/11/2019 05:44	16/11/2019 11:03	16/11/2019 05:44	16/11/2019 11:03	5,30	28	148,45	CHI
201911180269	GOIANIA	GN11196703	CARAJAS S2	16/11/2019 05:48	16/11/2019 10:53	16/11/2019 05:48	16/11/2019 10:53	5,07	86	435,76	CHI
201911180270	ANAPOLIS	10022017613	JUNDIAI S2	16/11/2019 07:07	16/11/2019 15:53	16/11/2019 07:07	16/11/2019 15:53	8,75	1	8,75	CHI
201911180280	DOVERLANDIA	DV12204324	CAIAPONIA	15/11/2019 22:13	16/11/2019 22:38	15/11/2019 22:13	16/11/2019 22:38	24,41	11	268,46	CHI

201911180284	SAO MIGUEL DO ARAGUAIA	SM12253876	SAO MIGUEL DO ARAGUAIA	16/11/2019 07:08	16/11/2019 11:20	16/11/2019 07:08	16/11/2019 11:20	4,20	3	12,61	CHI
201911180292	GOIATUBA	BJ12392121	BOM JESUS DE GOIAS	16/11/2019 07:11	18/11/2019 09:26	16/11/2019 07:11	18/11/2019 09:26	50,23	16	803,74	CHI
201911180294	AGUA FRIA DE GOIAS	TL21205629	SAO JOAO D ALIANCA	16/11/2019 07:12	16/11/2019 15:55	16/11/2019 07:12	16/11/2019 15:55	8,71	2	17,42	CHI
201911180295	FAINA	FC21084314	GOIAS	16/11/2019 07:12	18/11/2019 09:50	16/11/2019 07:12	18/11/2019 09:50	50,62	1	50,62	CHI
201911180305	IPAMERI	IP21088377	IPAMERI	16/11/2019 07:15	17/11/2019 21:15	16/11/2019 07:15	17/11/2019 21:15	37,99	1	37,99	CHI
201911180308	DIORAMA	JP12074459	IPORA	16/11/2019 07:16	16/11/2019 10:12	16/11/2019 07:16	16/11/2019 10:12	2,93	3	8,80	CHI
201911180308	JAUPACI	JP12074459	IPORA	16/11/2019 07:16	16/11/2019 10:12	16/11/2019 07:16	16/11/2019 10:12	2,93	5	14,66	CHI
201911180310	ANAPOLIS	AN12000959	ANAPOLIS UNIVERSITARIO S2	16/11/2019 07:16	16/11/2019 11:09	16/11/2019 07:16	16/11/2019 11:09	3,88	19	73,69	CHI
201911180311	SENADOR CANEDO	SW11235043	SENADOR CANEDO	16/11/2019 04:41	16/11/2019 10:38	16/11/2019 04:41	16/11/2019 10:38	5,96	21	125,14	CHI
201911180312	PORANGATU	PO11218984	PORANGATU	16/11/2019 03:54	16/11/2019 09:08	16/11/2019 03:54	16/11/2019 09:08	5,23	24	125,57	CHI
201911180314	ALEXANIA	AX21328174	ALEXANIA	16/11/2019 07:17	17/11/2019 11:29	16/11/2019 07:17	17/11/2019 11:29	28,19	1	28,19	CHI
201911180315	CATALAO	CT11203034	CATALAO S2	16/11/2019 05:19	16/11/2019 09:43	16/11/2019 05:19	16/11/2019 09:43	4,40	98	430,74	CHI
201911180319	CABECEIRAS	CW21342486	ITUIQUIRA	16/11/2019 07:18	17/11/2019 09:14	16/11/2019 07:18	17/11/2019 09:14	25,93	1	25,93	CHI
201911180321	SAO DOMINGOS	SD12317850	SAO DOMINGOS	16/11/2019 07:18	16/11/2019 19:03	16/11/2019 07:18	16/11/2019 13:52	6,57	1	6,57	CHI
201911180321	SAO DOMINGOS	SD12317850	SAO DOMINGOS	16/11/2019 07:18	16/11/2019 19:03	16/11/2019 14:22	16/11/2019 15:08	0,75	1	0,75	CHI
201911180321	SAO DOMINGOS	SD13317908	SAO DOMINGOS	16/11/2019 07:18	16/11/2019 19:03	16/11/2019 07:18	16/11/2019 16:32	9,24	33	304,79	CHI
201911180321	SAO DOMINGOS	SD12317864	SAO DOMINGOS	16/11/2019 07:18	16/11/2019 19:03	16/11/2019 07:18	16/11/2019 16:56	9,63	33	317,86	CHI
201911180321	SAO DOMINGOS	SD12317855	SAO DOMINGOS	16/11/2019 07:18	16/11/2019 19:03	16/11/2019 07:18	16/11/2019 19:03	11,75	2	23,50	CHI
201911180329	IACIARA	IA12232131	IACIARA S1	16/11/2019 07:19	16/11/2019 10:37	16/11/2019 07:19	16/11/2019 10:37	3,29	6	19,75	CHI
201911180335	PONTALINA	PK12263503	PONTALINA	16/11/2019 06:15	16/11/2019 16:25	16/11/2019 06:15	16/11/2019 16:25	10,15	14	142,13	CHI
201911180336	GOIATUBA	GT21041276	GOIATUBA S2	16/11/2019 07:20	20/11/2019 11:05	16/11/2019 07:20	20/11/2019 11:05	99,75	1	99,75	CHI
201911180339	DAMOLANDIA	DL12200062	INHUMAS S1	16/11/2019 07:10	16/11/2019 09:51	16/11/2019 07:10	16/11/2019 09:51	2,67	7	18,67	CHI
201911180342	GOIANAPOLIS	GP21035201	DAIA S2	16/11/2019 07:21	16/11/2019 11:45	16/11/2019 07:21	16/11/2019 11:45	4,40	2	8,80	CHI
201911180343	FORMOSA	FA12404498	ITUIQUIRA	16/11/2019 07:21	16/11/2019 09:23	16/11/2019 07:21	16/11/2019 09:23	2,03	1	2,03	CHI
201911180344	ALVORADA DO NORTE	FB10401476	FLORES DE GOIAS	16/11/2019 05:25	16/11/2019 08:57	16/11/2019 05:25	16/11/2019 08:57	3,52	53	186,56	CHI
201911180344	FLORES DE GOIAS	FB10401476	FLORES DE GOIAS	16/11/2019 05:25	16/11/2019 08:57	16/11/2019 05:25	16/11/2019 08:57	3,52	269	946,88	CHI
201911180344	FORMOSA	FB10401476	FLORES DE GOIAS	16/11/2019 05:25	16/11/2019 08:57	16/11/2019 05:25	16/11/2019 08:57	3,52	137	482,24	CHI
201911180344	FORMOSO	FB10401476	FLORES DE GOIAS	16/11/2019 05:25	16/11/2019 08:57	16/11/2019 05:25	16/11/2019 08:57	3,52	1	3,52	CHI
201911180344	IACIARA	FB10401476	FLORES DE GOIAS	16/11/2019 05:25	16/11/2019 08:57	16/11/2019 05:25	16/11/2019 08:57	3,52	16	56,32	CHI
201911180344	POSSE	FB10401476	FLORES DE GOIAS	16/11/2019 05:25	16/11/2019 08:57	16/11/2019 05:25	16/11/2019 08:57	3,52	2	7,04	CHI
201911180344	SAO JOAO D ALIANCA	FB10401476	FLORES DE GOIAS	16/11/2019 05:25	16/11/2019 08:57	16/11/2019 05:25	16/11/2019 08:57	3,52	5	17,60	CHI
201911180350	BOM JARDIM DE GOIAS	BM12335411	BOM JARDIM	15/11/2019 16:47	16/11/2019 09:15	15/11/2019 16:47	16/11/2019 09:15	16,46	6	98,75	CHI
201911180351	ANAPOLIS	10022842789	ANAPOLIS UNIVERSITARIO S2	16/11/2019 07:24	16/11/2019 09:18	16/11/2019 07:24	16/11/2019 09:18	1,90	1	1,90	CHI

201911180352	SANTA ROSA DE GOIAS	SR21339444	INHUMAS S1	16/11/2019 07:24	16/11/2019 16:33	16/11/2019 07:24	16/11/2019 16:33	9,15	1	9,15	CHI
201911180356	RIO VERDE	630180878	RIO VERDE S1	16/11/2019 07:24	17/11/2019 05:25	16/11/2019 07:24	17/11/2019 05:25	22,01	1	22,01	CHI
201911180357	FAINA	MS12036227	ITAPURANGA	16/11/2019 03:06	16/11/2019 13:50	16/11/2019 03:06	16/11/2019 13:50	10,73	11	118,02	CHI
201911180357	MORRO AGUDO DE GOIAS	MS12036227	ITAPURANGA	16/11/2019 03:06	16/11/2019 13:50	16/11/2019 03:06	16/11/2019 13:50	10,73	27	289,68	CHI
201911180358	GOIANESIA	GE21000074	GOIANESIA S2	16/11/2019 07:25	16/11/2019 18:02	16/11/2019 07:25	16/11/2019 18:02	10,61	1	10,61	CHI
201911180359	APARECIDA DE GOIANIA	200408938	INDEPENDENCIA S2	16/11/2019 07:25	16/11/2019 13:35	16/11/2019 07:25	16/11/2019 13:35	6,16	1	6,16	CHI
201911180361	BALIZA	BH12253667	BOM JARDIM	16/11/2019 07:25	16/11/2019 16:38	16/11/2019 07:25	16/11/2019 16:38	9,21	1	9,21	CHI
201911180362	PORANGATU	PO12202569	PORANGATU	16/11/2019 07:25	16/11/2019 15:00	16/11/2019 07:25	16/11/2019 15:00	7,58	7	53,03	CHI
201911180368	APARECIDA DE GOIANIA	200277753	INDEPENDENCIA S1	16/11/2019 07:26	16/11/2019 12:59	16/11/2019 07:26	16/11/2019 12:59	5,54	1	5,54	CHI
201911180372	INHUMAS	IN12000222	INHUMAS S2	16/11/2019 07:27	16/11/2019 11:06	16/11/2019 07:27	16/11/2019 11:06	3,65	1224	4464,88	CHI
201911180373	BOM JARDIM DE GOIAS	BM12231063	BOM JARDIM	16/11/2019 07:19	16/11/2019 11:53	16/11/2019 07:19	16/11/2019 11:53	4,56	106	483,36	CHI
201911180375	ANICUNS	AC21104755	ANICUNS	16/11/2019 07:27	16/11/2019 08:36	16/11/2019 07:27	16/11/2019 08:36	1,14	1	1,14	CHI
201911180376	MATRINCHA	MP12206480	MATRINCHA	16/11/2019 07:28	16/11/2019 18:27	16/11/2019 07:28	16/11/2019 18:27	10,99	11	120,85	CHI
201911180377	FLORES DE GOIAS	FB12285966	FLORES DE GOIAS	16/11/2019 04:41	16/11/2019 11:47	16/11/2019 04:41	16/11/2019 11:47	7,09	67	474,84	CHI
201911180387	GOIANIA	10283330	CAMPINAS S2	16/11/2019 07:30	16/11/2019 15:11	16/11/2019 07:30	16/11/2019 15:11	7,68	1	7,68	CHI
201911180388	COCALZINHO DE GOIAS	NP12402058	GOIANESIA S1	15/11/2019 20:05	16/11/2019 10:45	15/11/2019 20:05	16/11/2019 10:45	14,67	1	14,67	CHI
201911180388	PADRE BERNARDO	NP12402058	GOIANESIA S1	15/11/2019 20:05	16/11/2019 10:45	15/11/2019 20:05	16/11/2019 10:45	14,67	10	146,66	CHI
201911180388	VILA PROPICIO	NP12402058	GOIANESIA S1	15/11/2019 20:05	16/11/2019 10:45	15/11/2019 20:05	16/11/2019 10:45	14,67	95	1393,23	CHI
201911180393	FORMOSA	FA12248883	ITUIQUIRA	16/11/2019 06:01	16/11/2019 13:00	16/11/2019 06:01	16/11/2019 13:00	6,98	18	125,62	CHI
201911180398	JATAI	JT12184058	JATAI S2	16/11/2019 07:05	16/11/2019 09:44	16/11/2019 07:05	16/11/2019 09:44	2,64	4	10,56	CHI
201911180403	ITAGUARI	II12204145	ITABERAI S1	16/11/2019 07:31	16/11/2019 18:30	16/11/2019 07:31	16/11/2019 18:30	10,97	2	21,95	CHI
201911180407	COLINAS DO SUL	TI12239430	MINACU	15/11/2019 19:41	16/11/2019 13:30	15/11/2019 19:41	16/11/2019 13:30	17,81	26	463,12	CHI
201911180407	NIQUELANDIA	TI12239430	MINACU	15/11/2019 19:41	16/11/2019 13:30	15/11/2019 19:41	16/11/2019 13:30	17,81	1	17,81	CHI
201911180409	ITUMBIARA	10013910335	ITUMBIARA NOVA	16/11/2019 07:32	19/11/2019 09:48	16/11/2019 07:32	19/11/2019 09:48	74,26	1	74,26	CHI
201911180412	ISRAELANDIA	IS12101898	IPORA	16/11/2019 07:32	16/11/2019 14:03	16/11/2019 07:32	16/11/2019 14:03	6,51	3	19,52	CHI
201911180415	MORRINHOS	MR12239051	MORRINHOS	16/11/2019 07:31	16/11/2019 14:19	16/11/2019 07:31	16/11/2019 14:19	6,80	10	67,97	CHI
201911180416	BELA VISTA DE GOIAS	BV21008273	BELA VISTA S2	16/11/2019 07:32	16/11/2019 16:15	16/11/2019 07:32	16/11/2019 16:15	8,70	2	17,40	CHI
201911180426	SANTA CRUZ DE GOIAS	BC21280312	PIRES DO RIO S2	16/11/2019 07:34	16/11/2019 10:12	16/11/2019 07:34	16/11/2019 10:12	2,62	1	2,62	CHI
201911180435	AMARALINA	8272548	NOVA CRIXAS	16/11/2019 07:35	16/11/2019 12:39	16/11/2019 07:35	16/11/2019 12:39	5,05	1	5,05	CHI
201911180435	MUNDO NOVO DE GOIAS	8272548	NOVA CRIXAS	16/11/2019 07:35	16/11/2019 12:39	16/11/2019 07:35	16/11/2019 12:39	5,05	6	30,32	CHI
201911180440	CABECEIRAS	CW12151419	ITUIQUIRA	15/11/2019 21:50	16/11/2019 23:15	15/11/2019 21:50	16/11/2019 23:15	25,40	20	508,07	CHI
201911180442	AGUAS LINDAS DE GOIAS	10009364798	AGUAS LINDAS DE GOIAS S1	16/11/2019 07:36	16/11/2019 09:51	16/11/2019 07:36	16/11/2019 09:51	2,23	1	2,23	CHI
201911180444	ITUMBIARA	IT21305341	CACHOEIRA DOURADA	16/11/2019 07:37	17/11/2019 10:54	16/11/2019 07:37	17/11/2019 10:54	27,28	2	54,56	CHI

201911180455	ANAPOLIS	AN31000965	JUNDIAI S2	16/11/2019 07:38	16/11/2019 15:08	16/11/2019 07:38	16/11/2019 15:08	7,49	1	7,49	CHI
201911180457	PORANGATU	PO12285222	PORANGATU	16/11/2019 07:39	16/11/2019 17:26	16/11/2019 07:39	16/11/2019 17:26	9,78	14	136,96	CHI
201911180463	CORREGO DO OURO	CO21153369	FIRMINOPOLIS S2	16/11/2019 07:39	16/11/2019 13:10	16/11/2019 07:39	16/11/2019 13:10	5,51	1	5,51	CHI
201911180480	DOVERLANDIA	DV12131595	CAIAPONIA	16/11/2019 07:42	16/11/2019 22:04	16/11/2019 07:42	16/11/2019 22:04	14,36	2	28,72	CHI
201911180482	NOVO BRASIL	NB21169673	JUSSARA	16/11/2019 07:42	16/11/2019 14:18	16/11/2019 07:42	16/11/2019 14:18	6,59	1	6,59	CHI
201911180484	ISRAELANDIA	IS12048170	IPORA	16/11/2019 07:42	16/11/2019 10:18	16/11/2019 07:42	16/11/2019 10:18	2,60	87	226,47	CHI
201911180485	NEROPOLIS	NR21324580	NEROPOLIS S2	16/11/2019 07:42	16/11/2019 11:43	16/11/2019 07:42	16/11/2019 11:43	4,01	2	8,01	CHI
201911180491	GOIANIA	GN11001965	AEROPORTO S2	16/11/2019 07:07	16/11/2019 09:54	16/11/2019 07:07	16/11/2019 09:54	2,78	82	227,94	CHI
201911180495	CRISTALINA	KR21392955	PAMPLONA	16/11/2019 07:44	16/11/2019 15:01	16/11/2019 07:44	16/11/2019 15:01	7,28	1	7,28	CHI
201911180501	AGUAS LINDAS DE GOIAS	4830322999	AGUAS LINDAS DE GOIAS S1	16/11/2019 07:45	16/11/2019 09:32	16/11/2019 07:45	16/11/2019 09:32	1,77	1	1,77	CHI
201911180603	ANAPOLIS	20594240	JUNDIAI S2	16/11/2019 07:46	16/11/2019 08:43	16/11/2019 07:46	16/11/2019 08:43	0,95	1	0,95	CHI
201911180614	GOIANAPOLIS	TJ11055758	DAIA S2	16/11/2019 07:47	16/11/2019 11:18	16/11/2019 07:47	16/11/2019 11:18	3,51	107	375,48	CHI
201911180617	CHAPADAO DO CEU	DJ12365007	CHAPADAO DO CEU	16/11/2019 07:47	16/11/2019 15:23	16/11/2019 07:47	16/11/2019 15:23	7,58	7	53,09	CHI
201911180617	MINEIROS	DJ12365007	CHAPADAO DO CEU	16/11/2019 07:47	16/11/2019 15:23	16/11/2019 07:47	16/11/2019 15:23	7,58	3	22,75	CHI
201911180618	AGUAS LINDAS DE GOIAS	LA11099951	AGUAS LINDAS DE GOIAS S1	16/11/2019 07:48	16/11/2019 08:58	16/11/2019 07:48	16/11/2019 08:58	1,17	54	62,96	CHI
201911180625	RIO VERDE	10001076610	SANTA HELENA S1	16/11/2019 07:48	16/11/2019 21:00	16/11/2019 07:48	16/11/2019 21:00	13,20	1	13,20	CHI
201911180630	CORUMBA DE GOIAS	CB12215044	CORUMBA	16/11/2019 07:00	16/11/2019 11:01	16/11/2019 07:00	16/11/2019 11:01	4,01	24	96,13	CHI
201911180630	PIRENOPOLIS	CB12215044	CORUMBA	16/11/2019 07:00	16/11/2019 11:01	16/11/2019 07:00	16/11/2019 11:01	4,01	2	8,01	CHI
201911180636	RIO VERDE	RV12295113	RIO VERDE S1	16/11/2019 06:31	16/11/2019 09:20	16/11/2019 06:31	16/11/2019 09:20	2,80	1524	4270,16	CHI
201911180638	HIDROLANDIA	HD11198183	ANHANGUERA	16/11/2019 07:51	16/11/2019 10:22	16/11/2019 07:51	16/11/2019 10:22	2,51	37	92,97	CHI
201911180642	CIDADE OCIDENTAL	LZ21084509	MARAJOARA	16/11/2019 07:51	16/11/2019 09:22	16/11/2019 07:51	16/11/2019 09:22	1,50	1	1,50	CHI
201911180660	RIO VERDE	RV11000114	CABRIUVA S1	16/11/2019 12:26	16/11/2019 18:51	16/11/2019 12:26	16/11/2019 18:40	6,22	55	342,24	CHI
201911180660	RIO VERDE	RV11207049	CABRIUVA S1	16/11/2019 12:26	16/11/2019 18:51	16/11/2019 13:23	16/11/2019 18:51	5,47	121	661,37	CHI
201911180664	ITAPIRAPUA	IU12396097	JUSSARA	16/11/2019 07:05	16/11/2019 09:00	16/11/2019 07:05	16/11/2019 09:00	1,92	2	3,85	CHI
201911180667	ISRAELANDIA	IS12018686	IPORA	16/11/2019 07:55	16/11/2019 17:47	16/11/2019 07:55	16/11/2019 17:47	9,87	25	246,66	CHI
201911180667	JAUPACI	IS12018686	IPORA	16/11/2019 07:55	16/11/2019 17:47	16/11/2019 07:55	16/11/2019 17:47	9,87	36	355,19	CHI
201911180669	COCALZINHO DE GOIAS	ZN21153766	COCALZINHO	17/11/2019 08:50	17/11/2019 12:20	17/11/2019 08:50	17/11/2019 12:20	3,50	1	3,50	CHI
201911180671	FIRMINOPOLIS	RP12206100	FIRMINOPOLIS S2	16/11/2019 07:55	16/11/2019 10:55	16/11/2019 07:55	16/11/2019 10:55	3,01	3	9,03	CHI
201911180671	SAO JOAO DA PARAUNA	RP12206100	FIRMINOPOLIS S2	16/11/2019 07:55	16/11/2019 10:55	16/11/2019 07:55	16/11/2019 10:55	3,01	4	12,04	CHI
201911180673	GOIANIA	GN12038712	XAVANTES	16/11/2019 07:55	16/11/2019 11:53	16/11/2019 07:55	16/11/2019 11:53	3,96	1	3,96	CHI
201911180683	SANTO ANTONIO DO DESCOBERTO	SN12345926	MARAJOARA	16/11/2019 07:57	16/11/2019 11:01	16/11/2019 07:57	16/11/2019 11:01	3,06	2	6,11	CHI
201911180685	MORRINHOS	150086064	MORRINHOS	16/11/2019 07:58	16/11/2019 09:56	16/11/2019 07:58	16/11/2019 09:56	1,98	1	1,98	CHI
201911180686	BELA VISTA DE GOIAS	BV12011059	BELA VISTA S1	16/11/2019 07:36	16/11/2019 12:15	16/11/2019 07:36	16/11/2019 12:15	4,65	3	13,95	CHI

201911180691	LUZIANIA	LZ12000276RE	MARAJOARA	16/11/2019 07:58	16/11/2019 13:58	16/11/2019 07:58	16/11/2019 13:58	5,99	2	11,98	CHI
201911180697	FIRMINOPOLIS	SL12111569	FIRMINOPOLIS S1	16/11/2019 05:41	16/11/2019 10:35	16/11/2019 05:41	16/11/2019 10:35	4,89	23	112,54	CHI
201911180697	SAO LUIS DE MONTES BELOS	SL12111569	FIRMINOPOLIS S1	16/11/2019 05:41	16/11/2019 10:35	16/11/2019 05:41	16/11/2019 10:35	4,89	149	729,07	CHI
201911180697	TURVANIA	SL12111569	FIRMINOPOLIS S1	16/11/2019 05:41	16/11/2019 10:35	16/11/2019 05:41	16/11/2019 10:35	4,89	8	39,14	CHI
201911180698	PADRE BERNARDO	PB12084665	PADRE BERNARDO	16/11/2019 05:29	16/11/2019 15:20	16/11/2019 05:29	16/11/2019 12:54	7,42	56	415,46	CHI
201911180698	PADRE BERNARDO	6354694	PADRE BERNARDO	16/11/2019 05:29	16/11/2019 15:20	16/11/2019 05:29	16/11/2019 15:20	9,85	2	19,69	CHI
201911180702	SANTA RITA DO NOVO DESTINO	BA12152774	BARRO ALTO	15/11/2019 21:50	16/11/2019 12:00	15/11/2019 21:50	16/11/2019 12:00	14,16	71	1005,04	CHI
201911180705	CABECEIRAS	CW12049386	ITUIQUIRA	16/11/2019 07:59	16/11/2019 19:52	16/11/2019 07:59	16/11/2019 19:52	11,87	3	35,60	CHI
201911180708	ABADIANIA	AX12221526	ALEXANIA	16/11/2019 07:18	16/11/2019 22:36	16/11/2019 07:18	16/11/2019 21:10	13,85	6	83,13	CHI
201911180708	ALEXANIA	AX12221526	ALEXANIA	16/11/2019 07:18	16/11/2019 22:36	16/11/2019 07:18	16/11/2019 21:10	13,85	126	1745,63	CHI
201911180708	ABADIANIA	AX12351038	ALEXANIA	16/11/2019 07:18	16/11/2019 22:36	16/11/2019 07:18	16/11/2019 22:36	15,30	7	107,08	CHI
201911180708	ALEXANIA	AX12351038	ALEXANIA	16/11/2019 07:18	16/11/2019 22:36	16/11/2019 07:18	16/11/2019 22:36	15,30	62	948,43	CHI
201911180713	URUACU	UR12339123	MARA ROSA	16/11/2019 08:01	16/11/2019 11:09	16/11/2019 08:01	16/11/2019 11:09	3,12	1	3,12	CHI
201911180715	NIQUELANDIA	NQ12235223	NIQUELANDIA SUBTRANSMISSAO	16/11/2019 07:52	16/11/2019 09:35	16/11/2019 07:52	16/11/2019 09:35	1,71	27	46,15	CHI
201911180721	MORRINHOS	10025846653	MORRINHOS	16/11/2019 08:03	16/11/2019 10:12	16/11/2019 08:03	16/11/2019 10:12	2,15	1	2,15	CHI
201911180730	INHUMAS	IN21332626	INHUMAS S1	16/11/2019 08:04	16/11/2019 15:32	16/11/2019 08:04	16/11/2019 15:32	7,45	1	7,45	CHI
201911180731	AGUAS LINDAS DE GOIAS	10008816725	AGUAS LINDAS DE GOIAS S1	16/11/2019 08:04	16/11/2019 11:02	16/11/2019 08:04	16/11/2019 11:02	2,95	1	2,95	CHI
201911180732	PLANALTINA	PI12322780	SAO JOAO D ALIANCA	16/11/2019 08:05	16/11/2019 10:31	16/11/2019 08:05	16/11/2019 10:31	2,43	7	17,00	CHI
201911180735	NEROPOLIS	NR11157320	NEROPOLIS S2	16/11/2019 08:05	16/11/2019 09:36	16/11/2019 08:05	16/11/2019 09:36	1,50	1	1,50	CHI
201911180743	BOM JARDIM DE GOIAS	BM21201518	BOM JARDIM	16/11/2019 08:06	16/11/2019 21:42	16/11/2019 08:06	16/11/2019 21:42	13,59	1	13,59	CHI
201911180746	LUZIANIA	120252922	RIO VERMELHO	16/11/2019 08:07	16/11/2019 10:59	16/11/2019 08:07	16/11/2019 10:59	2,87	1	2,87	CHI
201911180750	LEOPOLDO DE BULHOES	LB21125722	DAIA S2	16/11/2019 08:07	17/11/2019 14:49	16/11/2019 08:07	17/11/2019 14:49	30,69	1	30,69	CHI
201911180753	POSSE	PS12344418	IACIARA S1	16/11/2019 08:08	16/11/2019 11:09	16/11/2019 08:08	16/11/2019 11:09	3,01	41	123,52	CHI
201911180904	QUIRINOPOLIS	QI12144242	QUIRINOPOLIS	16/11/2019 05:41	16/11/2019 10:33	16/11/2019 05:41	16/11/2019 10:33	4,85	5	24,27	CHI
201911180906	FORMOSA	FA12254248	ITUIQUIRA	16/11/2019 07:31	16/11/2019 17:20	16/11/2019 07:31	16/11/2019 17:20	9,82	6	58,91	CHI
201911180925	AMARALINA	LC12270117	SAO MIGUEL DO ARAGUAIA	16/11/2019 07:44	16/11/2019 11:15	16/11/2019 07:44	16/11/2019 11:15	3,53	9	31,75	CHI
201911181101	GOIAS	GS12217234	MATRINCHA	16/11/2019 08:14	18/11/2019 01:50	16/11/2019 08:14	18/11/2019 01:50	41,59	44	1830,16	CHI
201911181101	ITAPIRAPUA	GS12217234	MATRINCHA	16/11/2019 08:14	18/11/2019 01:50	16/11/2019 08:14	18/11/2019 01:50	41,59	1	41,59	CHI
201911181101	NOVO BRASIL	GS12217234	MATRINCHA	16/11/2019 08:14	18/11/2019 01:50	16/11/2019 08:14	18/11/2019 01:50	41,59	35	1455,81	CHI
201911181201	INHUMAS	IN21129639	INHUMAS S1	16/11/2019 08:14	16/11/2019 16:19	16/11/2019 08:14	16/11/2019 16:19	8,08	1	8,08	CHI
201911181203	GOIANIA	11188509	GOIANIA LESTE S3	16/11/2019 08:14	16/11/2019 16:49	16/11/2019 08:14	16/11/2019 16:49	8,58	1	8,58	CHI
201911181205	MAIRIPOTABA	04260216	MORRINHOS	19/11/2019 04:35	19/11/2019 07:50	19/11/2019 04:35	19/11/2019 07:50	3,26	12	39,07	CHI
201911181205	MORRINHOS	04260216	MORRINHOS	19/11/2019 04:35	19/11/2019 07:50	19/11/2019 04:35	19/11/2019 07:50	3,26	193	628,32	CHI

201911181205	PIRACANJUBA	04260216	MORRINHOS	19/11/2019 04:35	19/11/2019 07:50	19/11/2019 04:35	19/11/2019 07:50	3,26	79	257,19	CHI
201911181205	PONTALINA	04260216	MORRINHOS	19/11/2019 04:35	19/11/2019 07:50	19/11/2019 04:35	19/11/2019 07:50	3,26	15	48,83	CHI
201911181301	ITAUCU	IX21016405	INHUMAS S1	16/11/2019 08:14	16/11/2019 11:31	16/11/2019 08:14	16/11/2019 11:31	3,27	1	3,27	CHI
201911181304	BONFINOPOLIS	BO12060486	DAIA S2	16/11/2019 07:52	16/11/2019 13:37	16/11/2019 07:52	16/11/2019 13:37	5,74	15	86,10	CHI
201911181304	GOIANAPOLIS	BO12060486	DAIA S2	16/11/2019 07:52	16/11/2019 13:37	16/11/2019 07:52	16/11/2019 13:37	5,74	10	57,40	CHI
201911181518	MUNDO NOVO DE GOIAS	MH21035578	NOVA CRIXAS	16/11/2019 08:17	16/11/2019 13:22	16/11/2019 08:17	16/11/2019 13:22	5,08	1	5,08	CHI
201911181525	ITARUMA	AE12216728	ITAJA S1	16/11/2019 08:18	17/11/2019 12:17	16/11/2019 08:18	17/11/2019 12:17	28,00	1	28,00	CHI
201911181526	SANTA HELENA DE GOIAS	400038043	IPEGUARI	16/11/2019 08:18	16/11/2019 14:10	16/11/2019 08:18	16/11/2019 14:10	5,87	1	5,87	CHI
201911181534	CATALAO	10005911280	CATALAO S2	16/11/2019 07:14	16/11/2019 10:16	16/11/2019 07:14	16/11/2019 10:16	3,04	1	3,04	CHI
201911181540	GOIANIA	15846957	REAL S1	16/11/2019 08:19	16/11/2019 16:36	16/11/2019 08:19	16/11/2019 16:36	8,27	1	8,27	CHI
201911181541	JATAI	JT12150958	JATAI S1	16/11/2019 05:16	16/11/2019 11:46	16/11/2019 05:16	16/11/2019 11:46	6,50	34	220,97	CHI
201911181545	GOIANIA	12033091	REAL S1	16/11/2019 08:20	17/11/2019 08:52	16/11/2019 08:20	17/11/2019 08:52	24,52	1	24,52	CHI
201911181548	LEOPOLDO DE BULHOES	LB12200131	CEPAIGO S2	16/11/2019 07:38	16/11/2019 16:13	16/11/2019 07:38	16/11/2019 16:13	8,58	27	231,53	CHI
201911181553	PORANGATU	PO11354480	NOVO PLANALTO	16/11/2019 08:21	16/11/2019 11:17	16/11/2019 08:21	16/11/2019 11:17	2,92	1	2,92	CHI
201911181556	GOIANIA	10000686954	XAVANTES	16/11/2019 08:21	16/11/2019 10:21	16/11/2019 08:21	16/11/2019 10:21	1,99	1	1,99	CHI
201911181557	GOIAS	GS12310404	ITABERAI S1	15/11/2019 21:35	16/11/2019 16:30	15/11/2019 21:35	16/11/2019 16:30	18,92	45	851,21	CHI
201911181557	ITABERAI	GS12310404	ITABERAI S1	15/11/2019 21:35	16/11/2019 16:30	15/11/2019 21:35	16/11/2019 16:30	18,92	2	37,83	CHI
201911181559	PLANALTINA	PI12085566	PLANALTINA	16/11/2019 08:22	16/11/2019 10:57	16/11/2019 08:22	16/11/2019 10:57	2,58	9	23,24	CHI
201911181560	GOIANIA	GN12000071	CAMPINAS S1	16/11/2019 07:02	16/11/2019 09:51	16/11/2019 07:02	16/11/2019 09:51	2,81	272	765,00	CHI
201911181561	CAMPOS BELOS	CH21164684	SAO DOMINGOS	16/11/2019 08:22	16/11/2019 09:07	16/11/2019 08:22	16/11/2019 09:07	0,75	2	1,50	CHI
201911181562	ABADIANIA	AA21161193	CORUMBA	16/11/2019 08:22	17/11/2019 13:35	16/11/2019 08:22	17/11/2019 13:35	29,22	1	29,22	CHI
201911181564	PIRANHAS	PH12201806	PIRANHAS	16/11/2019 06:45	16/11/2019 16:27	16/11/2019 06:45	16/11/2019 16:27	9,69	40	387,43	CHI
201911181580	FAZENDA NOVA	FN11043015	JUSSARA	16/11/2019 07:51	16/11/2019 12:34	16/11/2019 07:51	16/11/2019 12:34	4,71	89	419,12	CHI
201911181581	GOIANIA	GN11036370	AEROPORTO S1	16/11/2019 07:21	16/11/2019 13:30	16/11/2019 07:21	16/11/2019 13:30	6,15	23	141,44	CHI
201911181589	IPAMERI	IP12036044	URUTAI	16/11/2019 07:30	19/11/2019 10:07	16/11/2019 07:30	19/11/2019 10:07	74,60	10	746,01	CHI
201911181592	GOIANIA	13768323	FERROVIARIO S1	16/11/2019 08:26	16/11/2019 14:23	16/11/2019 08:26	16/11/2019 14:23	5,96	1	5,96	CHI
201911181606	PLANALTINA	PI21131782	PLANALTINA	16/11/2019 08:27	18/11/2019 17:49	16/11/2019 08:27	17/11/2019 12:45	28,30	1	28,30	CHI
201911181606	PLANALTINA	PI12344170	PLANALTINA	16/11/2019 08:27	18/11/2019 17:49	17/11/2019 18:27	18/11/2019 17:49	23,38	1	23,38	CHI
201911181607	SANTA RITA DO NOVO DESTINO	DF11315664	BARRO ALTO	16/11/2019 08:27	17/11/2019 09:48	16/11/2019 08:27	17/11/2019 09:48	25,34	1	25,34	CHI
201911181619	CAMPOS BELOS	CH12150394	SAO DOMINGOS	16/11/2019 08:29	16/11/2019 09:53	16/11/2019 08:29	16/11/2019 09:53	1,40	10	13,97	CHI
201911181640	TRINDADE	TR12000046	TRINDADE	16/11/2019 08:31	16/11/2019 15:34	16/11/2019 08:31	16/11/2019 15:34	7,06	29	204,64	CHI
201911181641	AGUAS LINDAS DE GOIAS	10008810301	AGUAS LINDAS DE GOIAS S1	16/11/2019 08:31	16/11/2019 12:16	16/11/2019 08:31	16/11/2019 12:16	3,75	1	3,75	CHI
201911181642	APARECIDA DE GOIANIA	15106536	INDEPENDENCIA S2	16/11/2019 08:31	16/11/2019 16:15	16/11/2019 08:31	16/11/2019 16:15	7,72	1	7,72	CHI

201911181645	GOIANIA	GN21000309	XAVANTES	16/11/2019 08:32	16/11/2019 10:44	16/11/2019 08:32	16/11/2019 10:44	2,19	1	2,19	CHI
201911181646	PIRANHAS	10022389863	PIRANHAS	16/11/2019 08:32	16/11/2019 17:00	16/11/2019 08:32	16/11/2019 17:00	8,46	1	8,46	CHI
201911181650	COCALZINHO DE GOIAS	10008417286	AGUAS LINDAS DE GOIAS S2	16/11/2019 08:32	16/11/2019 09:55	16/11/2019 08:32	16/11/2019 09:55	1,37	1	1,37	CHI
201911181654	MINACU	IH21182997	MINACU	16/11/2019 08:33	16/11/2019 13:17	16/11/2019 08:33	16/11/2019 13:17	4,72	2	9,44	CHI
201911181672	QUIRINOPOLIS	QJ32052817	QUIRINOPOLIS	16/11/2019 08:34	16/11/2019 09:56	16/11/2019 08:34	16/11/2019 09:56	1,35	2	2,70	CHI
201911181677	ARAGARCAS	AG12154718	ARAGARCAS	16/11/2019 07:38	16/11/2019 12:17	16/11/2019 07:38	16/11/2019 12:17	4,65	20	92,95	CHI
201911181681	GOIANIA	GN11160122	REAL S1	16/11/2019 07:15	16/11/2019 09:16	16/11/2019 07:15	16/11/2019 09:16	2,00	78	156,02	CHI
201911181684	QUIRINOPOLIS	80085118	QUIRINOPOLIS	16/11/2019 08:36	16/11/2019 10:41	16/11/2019 08:36	16/11/2019 10:41	2,08	1	2,08	CHI
201911181686	LUZIANIA	LZ12065466	MARAJOARA	16/11/2019 08:36	16/11/2019 16:12	16/11/2019 08:36	16/11/2019 16:12	7,59	14	106,31	CHI
201911181694	ABADIANIA	AA12377756	ANAPOLIS UNIVERSITARIO S1	16/11/2019 08:37	16/11/2019 15:56	16/11/2019 08:37	16/11/2019 15:56	7,31	2	14,61	CHI
201911181706	AMERICANO DO BRASIL	AC12391519	ANICUNS	16/11/2019 08:39	16/11/2019 10:33	16/11/2019 08:39	16/11/2019 10:33	1,90	1	1,90	CHI
201911181706	ANICUNS	AC12391519	ANICUNS	16/11/2019 08:39	16/11/2019 10:33	16/11/2019 08:39	16/11/2019 10:33	1,90	14	26,64	CHI
201911181723	BONFINOPOLIS	920032849	CEPAIGO S2	16/11/2019 08:41	17/11/2019 09:29	16/11/2019 08:41	17/11/2019 09:29	24,80	1	24,80	CHI
201911181724	NOVA VENEZA	NR12009855	INHUMAS S1	16/11/2019 08:41	16/11/2019 11:26	16/11/2019 08:41	16/11/2019 11:26	2,75	3	8,24	CHI
201911181725	ANAPOLIS	AN11226820	ANAPOLIS UNIVERSITARIO S2	16/11/2019 07:12	16/11/2019 17:35	16/11/2019 07:12	16/11/2019 17:35	10,37	28	290,44	CHI
201911181727	SANTA FE DE GOIAS	RN12183329	JUSSARA	16/11/2019 08:41	17/11/2019 13:58	16/11/2019 08:41	17/11/2019 13:58	29,28	4	117,10	CHI
201911181731	MINACU	IH12182288	MINACU	16/11/2019 08:42	16/11/2019 14:00	16/11/2019 08:42	16/11/2019 14:00	5,29	2	10,58	CHI
201911181732	DAMOLANDIA	DL11064935	INHUMAS S1	16/11/2019 08:28	16/11/2019 13:54	16/11/2019 08:28	16/11/2019 13:54	5,42	114	618,13	CHI
201911181738	ORIZONA	OZ12113015	VIANOPOLIS	15/11/2019 21:37	17/11/2019 22:17	15/11/2019 21:37	17/11/2019 22:17	48,67	2	97,35	CHI
201911181738	VIANOPOLIS	OZ12113015	VIANOPOLIS	15/11/2019 21:37	17/11/2019 22:17	15/11/2019 21:37	17/11/2019 22:17	48,67	21	1022,12	CHI
201911181740	ALVORADA DO NORTE	SI12211393	IACIARA S2	16/11/2019 08:43	16/11/2019 11:56	16/11/2019 08:43	16/11/2019 11:56	3,21	3	9,64	CHI
201911181740	SITIO D ABADIA	SI12211393	IACIARA S2	16/11/2019 08:43	16/11/2019 11:56	16/11/2019 08:43	16/11/2019 11:56	3,21	1	3,21	CHI
201911181746	CALDAS NOVAS	CN12298642	CALDAS NOVAS S2	16/11/2019 10:13	20/11/2019 19:15	16/11/2019 10:13	16/11/2019 22:47	12,58	14	176,06	CHI
201911181746	CALDAS NOVAS	CN12298642	CALDAS NOVAS S2	16/11/2019 10:13	20/11/2019 19:15	16/11/2019 22:48	20/11/2019 11:40	84,87	5	424,37	CHI
201911181746	CALDAS NOVAS	CN12298768	CALDAS NOVAS S2	16/11/2019 10:13	20/11/2019 19:15	20/11/2019 11:41	20/11/2019 16:20	4,65	5	23,25	CHI
201911181746	CALDAS NOVAS	CN13000212	CALDAS NOVAS S2	16/11/2019 10:13	20/11/2019 19:15	16/11/2019 22:48	20/11/2019 19:15	92,45	9	832,01	CHI
201911181747	CATALAO	CT11192507	CATALAO S2	16/11/2019 06:19	16/11/2019 12:15	16/11/2019 06:19	16/11/2019 12:15	5,93	61	361,68	CHI
201911181753	MUNDO NOVO DE GOIAS	MH11269247	NOVA CRIXAS	16/11/2019 08:44	16/11/2019 16:05	16/11/2019 08:44	16/11/2019 16:05	7,34	1	7,34	CHI
201911181755	GUARINOS	GF21280903	SANTA TEREZINHA	16/11/2019 08:45	16/11/2019 14:33	16/11/2019 08:45	16/11/2019 14:33	5,80	2	11,59	CHI
201911181756	GOIANIA	13780578	FERROVIARIO S1	16/11/2019 08:45	16/11/2019 18:01	16/11/2019 08:45	16/11/2019 18:01	9,27	1	9,27	CHI
201911181757	JARAGUA	JA21031519	JARAGUA	16/11/2019 08:46	16/11/2019 12:45	16/11/2019 08:46	16/11/2019 12:45	3,98	1	3,98	CHI
201911181763	BARRO ALTO	BA12000049	BARRO ALTO	16/11/2019 08:29	16/11/2019 15:19	16/11/2019 08:29	16/11/2019 15:19	6,83	7	47,79	CHI
201911181766	GOIANESIA	GE12255899	GOIANESIA S2	16/11/2019 08:47	16/11/2019 16:23	16/11/2019 08:47	16/11/2019 16:23	7,60	1	7,60	CHI

201911181768	GOIANESIA	GE11191265	GOIANESIA S2	16/11/2019 07:19	16/11/2019 11:27	16/11/2019 07:19	16/11/2019 11:27	4,12	100	411,89	CHI
201911181771	PLANALTINA	2960018042	PLANALTINA	16/11/2019 08:47	16/11/2019 12:00	16/11/2019 08:47	16/11/2019 12:00	3,21	1	3,21	CHI
201911181773	CAMPO LIMPO	AN12265111	ANAPOLIS UNIVERSITARIO S2	15/11/2019 20:53	16/11/2019 14:55	15/11/2019 20:53	16/11/2019 14:55	18,03	6	108,18	CHI
201911181775	VICENTINOPOLIS	V112352541	VICENTINOPOLIS	16/11/2019 08:48	16/11/2019 11:41	16/11/2019 08:48	16/11/2019 11:41	2,87	4	11,50	CHI
201911181776	JATAI	JT12219503	JATAI S3	16/11/2019 08:48	16/11/2019 12:50	16/11/2019 08:48	16/11/2019 12:50	4,02	5	20,12	CHI
201911181777	LUZIANIA	LZ12376136	CRISTALINA S2	16/11/2019 08:48	16/11/2019 10:48	16/11/2019 08:48	16/11/2019 10:48	1,99	1	1,99	CHI
201911181792	GOIANIA	10939210	FERROVIARIO S1	16/11/2019 08:50	16/11/2019 11:07	16/11/2019 08:50	16/11/2019 11:07	2,27	1	2,27	CHI
201911181797	PALMEIRAS DE GOIAS	590075585	PALMEIRAS	16/11/2019 08:51	16/11/2019 10:14	16/11/2019 08:51	16/11/2019 10:14	1,38	1	1,38	CHI
201911181798	ITUMBIARA	690109088	ITUMBIARA VELHA S1	16/11/2019 08:52	18/11/2019 17:59	16/11/2019 08:52	18/11/2019 17:59	57,13	1	57,13	CHI
201911181802	VILA BOA	FA21065578	ITUIQUIRA	16/11/2019 08:53	18/11/2019 16:45	16/11/2019 08:53	18/11/2019 16:45	55,87	1	55,87	CHI
201911181808	SERRANOPOLIS	SX12166103	JATAI S1	16/11/2019 07:10	16/11/2019 11:11	16/11/2019 07:10	16/11/2019 11:11	4,00	5	20,00	CHI
201911181809	NIQUELANDIA	NQ21285602	BARRO ALTO	16/11/2019 08:54	17/11/2019 11:40	16/11/2019 08:54	17/11/2019 11:40	26,76	1	26,76	CHI
201911181823	BRAZABRANTES	DL21027992	INHUMAS S1	16/11/2019 08:55	16/11/2019 11:38	16/11/2019 08:55	16/11/2019 11:38	2,71	1	2,71	CHI
201911181825	PALESTINA DE GOIAS	PY21392568	PALESTINA	16/11/2019 08:56	18/11/2019 11:51	16/11/2019 08:56	18/11/2019 11:51	50,92	1	50,92	CHI
201911181828	PARAUNA	IV21009692	IPORA	16/11/2019 08:57	16/11/2019 10:50	16/11/2019 08:57	16/11/2019 10:50	1,88	1	1,88	CHI
201911181830	ITABERAI	IB12379749	ITABERAI S2	16/11/2019 08:57	16/11/2019 11:41	16/11/2019 08:57	16/11/2019 11:41	2,73	7	19,10	CHI
201911181832	IPORA	IR12014035	IPORA	16/11/2019 08:58	16/11/2019 16:01	16/11/2019 08:58	16/11/2019 16:01	7,04	18	126,76	CHI
201911181835	PLANALTINA	PI21152793	SAO JOAO D ALIANCA	16/11/2019 08:58	16/11/2019 11:22	16/11/2019 08:58	16/11/2019 11:22	2,39	1	2,39	CHI
201911181836	COCALZINHO DE GOIAS	ZN12068617	GOIANESIA S1	16/11/2019 08:43	16/11/2019 14:39	16/11/2019 08:43	16/11/2019 14:39	5,93	7	41,51	CHI
201911181842	GOIANIA	15841157	REAL S1	16/11/2019 08:59	16/11/2019 16:43	16/11/2019 08:59	16/11/2019 16:43	7,72	1	7,72	CHI
201911181845	GOIANIA	10626529	AEROPORTO S2	16/11/2019 08:59	16/11/2019 21:39	16/11/2019 08:59	16/11/2019 21:39	12,65	1	12,65	CHI
201911181847	OURO VERDE DE GOIAS	OV12329151	NEROPOLIS S2	15/11/2019 22:27	16/11/2019 13:09	15/11/2019 22:27	16/11/2019 13:09	14,69	69	1013,94	CHI
201911181848	NEROPOLIS	NR12319494	NEROPOLIS S2	16/11/2019 05:56	16/11/2019 09:50	16/11/2019 05:56	16/11/2019 09:50	3,90	1	3,90	CHI
201911181848	OURO VERDE DE GOIAS	NR12319494	NEROPOLIS S2	16/11/2019 05:56	16/11/2019 09:50	16/11/2019 05:56	16/11/2019 09:50	3,90	21	81,91	CHI
201911181851	OURO VERDE DE GOIAS	OV12215905	NEROPOLIS S2	16/11/2019 06:47	16/11/2019 13:50	16/11/2019 06:47	16/11/2019 13:50	7,05	11	77,50	CHI
201911181853	FAINA	FC12067580	GOIAS	15/11/2019 21:48	16/11/2019 16:21	15/11/2019 21:48	16/11/2019 16:21	18,54	3	55,63	CHI
201911181854	FAZENDA NOVA	FN11259913	JUSSARA	16/11/2019 08:27	16/11/2019 14:38	16/11/2019 08:27	16/11/2019 14:38	6,17	68	419,43	CHI
201911181855	SERRANOPOLIS	3000007876	JATAI S1	16/11/2019 09:00	16/11/2019 18:55	16/11/2019 09:00	16/11/2019 18:55	9,92	1	9,92	CHI
201911181859	GOIAS	GS12091169	MATRINCHA	16/11/2019 08:12	18/11/2019 01:50	16/11/2019 08:12	18/11/2019 01:50	41,63	9	374,63	CHI
201911181865	PADRE BERNARDO	PB11192971	PADRE BERNARDO	16/11/2019 05:34	16/11/2019 13:06	16/11/2019 05:34	16/11/2019 13:06	7,53	52	391,43	CHI
201911181868	FAINA	FC21332553	GOIAS	16/11/2019 09:01	16/11/2019 09:25	16/11/2019 09:01	16/11/2019 09:25	0,40	1	0,40	CHI
201911181873	ANAPOLIS	21018704	ANAPOLIS UNIVERSITARIO S2	16/11/2019 09:01	16/11/2019 17:32	16/11/2019 09:01	16/11/2019 17:32	8,50	1	8,50	CHI
201911181877	CAIAPONIA	CP12395453	PALESTINA	16/11/2019 09:02	16/11/2019 17:42	16/11/2019 09:02	16/11/2019 17:42	8,66	6	51,99	CHI

201911181879	DOVERLANDIA	DV12139919	CAIAPONIA	16/11/2019 08:16	16/11/2019 23:17	16/11/2019 08:16	16/11/2019 23:17	15,00	49	735,04	CHI
201911181882	ITAGUARI	II11049704	ITABERAI S1	16/11/2019 07:10	16/11/2019 11:50	16/11/2019 07:10	16/11/2019 11:50	4,67	130	607,10	CHI
201911181883	TRINDADE	40118836	TRINDADE	16/11/2019 09:03	16/11/2019 11:34	16/11/2019 09:03	16/11/2019 11:34	2,52	1	2,52	CHI
201911181885	FLORES DE GOIAS	FB12302732LD	FLORES DE GOIAS	16/11/2019 18:38	16/11/2019 22:05	16/11/2019 19:05	16/11/2019 21:46	2,69	11	29,62	CHI
201911181885	FLORES DE GOIAS	FB11043496	FLORES DE GOIAS	16/11/2019 18:38	16/11/2019 22:05	16/11/2019 18:38	16/11/2019 22:05	3,45	80	276,11	CHI
201911181886	PIRACANJUBA	PJ11064631	PIRACANJUBA	16/11/2019 07:17	16/11/2019 17:50	16/11/2019 07:17	16/11/2019 17:50	10,55	53	559,19	CHI
201911181887	JATAI	JT21000189	JATAI S1	16/11/2019 09:03	16/11/2019 13:44	16/11/2019 09:03	16/11/2019 13:44	4,67	1	4,67	CHI
201911181901	PEROLANDIA	DP12260465	JATAI S1	16/11/2019 09:04	16/11/2019 10:10	16/11/2019 09:04	16/11/2019 10:10	1,09	10	10,87	CHI
201911181903	AGUAS LINDAS DE GOIAS	LA11149059	AGUAS LINDAS DE GOIAS S1	16/11/2019 09:05	16/11/2019 11:51	16/11/2019 09:05	16/11/2019 11:51	2,76	97	268,07	CHI
201911181908	TRES RANCHOS	TH12032046	CATALAO S1	16/11/2019 07:29	17/11/2019 10:21	16/11/2019 07:29	17/11/2019 10:21	26,86	16	429,81	CHI
201911181912	CRISTALINA	KR11183933	CRISTALINA S1	16/11/2019 09:06	16/11/2019 10:28	16/11/2019 09:06	16/11/2019 10:28	1,36	210	285,19	CHI
201911181917	GOIANIA	GN11167704	GOIANIA LESTE S2	16/11/2019 07:45	16/11/2019 14:21	16/11/2019 07:45	16/11/2019 14:21	6,60	56	369,35	CHI
201911181919	GOIAS	GS11073670	MATRINCHA	16/11/2019 07:38	18/11/2019 01:50	16/11/2019 07:38	18/11/2019 01:50	42,19	29	1223,64	CHI
201911181921	ANAPOLIS	AN12084838	NEROPOLIS S1	16/11/2019 08:42	16/11/2019 15:41	16/11/2019 08:42	16/11/2019 15:41	6,97	12	83,67	CHI
201911181921	PIRENOPOLIS	AN12084838	NEROPOLIS S1	16/11/2019 08:42	16/11/2019 15:41	16/11/2019 08:42	16/11/2019 15:41	6,97	1	6,97	CHI
201911181926	LUZIANIA	LZ21209486	RIO VERMELHO	16/11/2019 09:09	16/11/2019 13:02	16/11/2019 09:09	16/11/2019 13:02	3,88	1	3,88	CHI
201911181933	CALDAS NOVAS	CN11114784	CALDAS NOVAS S1	16/11/2019 08:13	16/11/2019 10:34	16/11/2019 08:13	16/11/2019 10:34	2,35	167	392,45	CHI
201911181935	RUBIATABA	RB12003306	RUBIATABA	16/11/2019 09:09	17/11/2019 06:35	16/11/2019 09:09	17/11/2019 06:35	21,42	4	85,67	CHI
201911181944	FLORES DE GOIAS	FB12255011	FLORES DE GOIAS	16/11/2019 07:06	16/11/2019 11:07	16/11/2019 07:06	16/11/2019 11:07	4,01	378	1516,51	CHI
201911181944	NOVA ROMA	FB12255011	FLORES DE GOIAS	16/11/2019 07:06	16/11/2019 11:07	16/11/2019 07:06	16/11/2019 11:07	4,01	2	8,02	CHI
201911181944	SAO JOAO D ALIANCA	FB12255011	FLORES DE GOIAS	16/11/2019 07:06	16/11/2019 11:07	16/11/2019 07:06	16/11/2019 11:07	4,01	48	192,57	CHI
201911181948	GOIANIA	10007568337	GOIANIA LESTE S1	16/11/2019 09:11	16/11/2019 16:17	16/11/2019 09:11	16/11/2019 16:17	7,09	1	7,09	CHI
201911181952	MOIPORA	1450005760	IPORA	16/11/2019 09:12	16/11/2019 12:45	16/11/2019 09:12	16/11/2019 12:45	3,55	1	3,55	CHI
201911181956	CAMPOS VERDES	VD21181191	SANTA TEREZINHA	16/11/2019 09:12	16/11/2019 12:07	16/11/2019 09:12	16/11/2019 12:07	2,91	1	2,91	CHI
201911181964	PORANGATU	PO21202517	PORANGATU	16/11/2019 09:14	16/11/2019 14:57	16/11/2019 09:14	16/11/2019 14:57	5,71	1	5,71	CHI
201911181973	PADRE BERNARDO	PB12351378	PADRE BERNARDO	16/11/2019 09:15	16/11/2019 14:52	16/11/2019 09:15	16/11/2019 14:52	5,62	4	22,46	CHI
201911181975	ITUMBIARA	BJ12389714	BOM JESUS DE GOIAS	16/11/2019 07:46	16/11/2019 17:21	16/11/2019 07:46	16/11/2019 17:21	9,58	8	76,67	CHI
201911181989	PIRENOPOLIS	PV12384820	CORUMBA	16/11/2019 08:39	17/11/2019 10:37	16/11/2019 08:39	17/11/2019 10:37	25,97	5	129,83	CHI
201911181990	APARECIDA DE GOIANIA	AP12058747	INDEPENDENCIA S2	16/11/2019 09:17	16/11/2019 13:47	16/11/2019 09:17	16/11/2019 13:47	4,50	1	4,50	CHI
201911181991	COCALZINHO DE GOIAS	ZN12000140	COCALZINHO	16/11/2019 07:42	16/11/2019 12:23	16/11/2019 07:42	16/11/2019 12:23	4,68	11	51,51	CHI
201911181994	BARRO ALTO	BA21211739	BARRO ALTO	16/11/2019 09:18	17/11/2019 11:42	16/11/2019 09:18	17/11/2019 11:42	26,39	1	26,39	CHI
201911182000	GOIANIA	10000015022	REAL S1	16/11/2019 09:19	16/11/2019 18:50	16/11/2019 09:19	16/11/2019 18:50	9,51	1	9,51	CHI
201911182002	LUZIANIA	OZ12186218	PIRES DO RIO S2	16/11/2019 17:19	16/11/2019 21:08	16/11/2019 17:19	16/11/2019 21:08	3,80	4	15,21	CHI

201911182002	ORIZONA	OZ12186218	PIRES DO RIO S2	16/11/2019 17:19	16/11/2019 21:08	16/11/2019 17:19	16/11/2019 21:08	3,80	3	11,41	CHI
201911182010	FORMOSA	FA11062235	ITIQUIRA	16/11/2019 09:19	16/11/2019 18:10	16/11/2019 09:19	16/11/2019 18:10	8,84	3	26,51	CHI
201911182011	ANAPOLIS	AN21000650	ANAPOLIS UNIVERSITARIO S2	16/11/2019 09:20	16/11/2019 11:18	16/11/2019 09:20	16/11/2019 11:18	1,96	1	1,96	CHI
201911182013	ITUMBARA	IT12208051	PARANAIBA	16/11/2019 07:06	16/11/2019 16:15	16/11/2019 07:06	16/11/2019 16:15	9,13	98	895,23	CHI
201911182017	GOIANIA	17037128	XAVANTES	16/11/2019 09:20	16/11/2019 11:30	16/11/2019 09:20	16/11/2019 11:30	2,15	1	2,15	CHI
201911182018	GOIANIA	GN11000348	GOIANIA LESTE S1	16/11/2019 09:19	16/11/2019 16:50	16/11/2019 09:19	16/11/2019 16:50	7,50	101	757,84	CHI
201911182023	SENADOR CANEDO	190126127	SENADOR CANEDO	16/11/2019 09:22	16/11/2019 12:00	16/11/2019 09:22	16/11/2019 12:00	2,63	1	2,63	CHI
201911182028	CATALAO	CT11161380	CATALAO S2	16/11/2019 06:47	16/11/2019 13:40	16/11/2019 06:47	16/11/2019 13:40	6,87	56	384,84	CHI
201911182034	ANAPOLIS	21280990	ANAPOLIS UNIVERSITARIO S2	16/11/2019 09:23	16/11/2019 18:03	16/11/2019 09:23	16/11/2019 18:03	8,66	1	8,66	CHI
201911182041	LEOPOLDO DE BULHOES	LB21313046	DAIA S2	16/11/2019 09:24	16/11/2019 17:08	16/11/2019 09:24	16/11/2019 17:08	7,73	2	15,45	CHI
201911182042	RIO VERDE	RV12207235	RIO VERDE S2	16/11/2019 09:24	16/11/2019 12:40	16/11/2019 09:24	16/11/2019 12:40	3,27	7	22,92	CHI
201911182046	GOIANIA	11986128	XAVANTES	16/11/2019 09:25	16/11/2019 11:22	16/11/2019 09:25	16/11/2019 11:22	1,95	1	1,95	CHI
201911182048	MARA ROSA	MQ21325193	MARA ROSA	16/11/2019 09:25	16/11/2019 13:16	16/11/2019 09:25	16/11/2019 13:16	3,84	1	3,84	CHI
201911182051	ARAGOIANIA	10005595051	GUAPO S2	16/11/2019 09:26	16/11/2019 12:17	16/11/2019 09:26	16/11/2019 12:17	2,85	1	2,85	CHI
201911182054	GOIANIA	10014680740	CAMPINAS S2	16/11/2019 09:27	16/11/2019 11:02	16/11/2019 09:27	16/11/2019 11:02	1,58	1	1,58	CHI
201911182055	PIRES DO RIO	PR21195144	PIRES DO RIO S1	16/11/2019 09:27	16/11/2019 17:54	16/11/2019 09:27	16/11/2019 17:54	8,45	1	8,45	CHI
201911182060	MONTES CLAROS DE GOIAS	ME12187647	IPORA	16/11/2019 09:28	16/11/2019 18:00	16/11/2019 09:28	16/11/2019 18:00	8,54	11	93,98	CHI
201911182064	LUZIANIA	LZ21192757	VIANOPOLIS	16/11/2019 09:28	16/11/2019 13:49	16/11/2019 09:28	16/11/2019 13:49	4,34	2	8,69	CHI
201911182068	APARECIDA DE GOIANIA	AP11137037	INDEPENDENCIA S2	16/11/2019 09:28	16/11/2019 16:47	16/11/2019 09:28	16/11/2019 16:47	7,30	4	29,20	CHI
201911182072	CABECEIRAS	CW12255614	ITIQUIRA	16/11/2019 08:24	16/11/2019 23:48	16/11/2019 08:24	16/11/2019 23:48	15,39	10	153,87	CHI
201911182075	FORMOSA	FA11139693	ITIQUIRA	16/11/2019 09:29	18/11/2019 11:02	16/11/2019 09:29	18/11/2019 11:02	49,55	17	842,30	CHI
201911182077	VARJAO	VJ21287675	GUAPO S2	16/11/2019 09:30	16/11/2019 17:22	16/11/2019 09:30	16/11/2019 17:22	7,86	1	7,86	CHI
201911182079	ANAPOLIS	AN11121965	JUNDIAI S1	16/11/2019 09:30	16/11/2019 15:41	16/11/2019 09:30	16/11/2019 15:41	6,18	117	723,06	CHI
201911182081	GOIANIA	10605411	AEROPORTO S1	16/11/2019 09:30	16/11/2019 11:41	16/11/2019 09:30	16/11/2019 11:41	2,18	1	2,18	CHI
201911182084	GOIANIA	10285313	CAMPINAS S2	16/11/2019 09:30	16/11/2019 16:53	16/11/2019 09:30	16/11/2019 16:53	7,37	1	7,37	CHI
201911182087	IPORA	IR12070185	IPORA	16/11/2019 08:24	16/11/2019 10:25	16/11/2019 08:24	16/11/2019 10:25	2,01	178	358,32	CHI
201911182088	CALDAS NOVAS	760278088	CALDAS NOVAS S1	16/11/2019 09:31	18/11/2019 04:22	16/11/2019 09:31	18/11/2019 04:22	42,86	1	42,86	CHI
201911182089	CACHOEIRA ALTA	CA12402274	CACHOEIRA ALTA	16/11/2019 09:24	16/11/2019 12:54	16/11/2019 09:24	16/11/2019 12:54	3,50	83	290,20	CHI
201911182089	CACU	CA12402274	CACHOEIRA ALTA	16/11/2019 09:24	16/11/2019 12:54	16/11/2019 09:24	16/11/2019 12:54	3,50	10	34,96	CHI
201911182089	ITARUMA	CA12402274	CACHOEIRA ALTA	16/11/2019 09:24	16/11/2019 12:54	16/11/2019 09:24	16/11/2019 12:54	3,50	6	20,98	CHI
201911182091	APARECIDA DE GOIANIA	200066699	INDEPENDENCIA S1	16/11/2019 09:31	16/11/2019 17:12	16/11/2019 09:31	16/11/2019 17:12	7,67	1	7,67	CHI
201911182094	RIO VERDE	630192650	RIO VERDE S2	16/11/2019 09:31	17/11/2019 10:34	16/11/2019 09:31	17/11/2019 10:34	25,05	1	25,05	CHI
201911182095	PALMEIRAS DE GOIAS	590054960	PALMEIRAS	16/11/2019 09:31	16/11/2019 11:24	16/11/2019 09:31	16/11/2019 11:24	1,88	1	1,88	CHI

201911182099	GOIANIA	12487820	GOIANIA LESTE S1	16/11/2019 09:32	16/11/2019 12:58	16/11/2019 09:32	16/11/2019 12:58	3,43	1	3,43	CHI
201911182100	NOVO BRASIL	NB11289187	JUSSARA	16/11/2019 07:38	16/11/2019 13:38	16/11/2019 07:38	16/11/2019 13:38	5,99	63	377,37	CHI
201911182102	ANAPOLIS	20326105	ANAPOLIS UNIVERSITARIO S2	16/11/2019 09:32	16/11/2019 10:29	16/11/2019 09:32	16/11/2019 10:29	0,94	1	0,94	CHI
201911182107	ARAGOIANIA	AO21147013	INDEPENDENCIA S1	16/11/2019 09:32	16/11/2019 17:40	16/11/2019 09:32	16/11/2019 17:40	8,12	1	8,12	CHI
201911182110	NIQUELANDIA	NQ12256633	NIQUELANDIA SUBTRANSMISSAO	16/11/2019 09:33	16/11/2019 11:32	16/11/2019 09:33	16/11/2019 11:32	1,98	1	1,98	CHI
201911182111	ORIZONA	OZ21138976	PIRES DO RIO S2	16/11/2019 09:33	18/11/2019 12:24	16/11/2019 09:33	18/11/2019 12:24	50,84	1	50,84	CHI
201911182113	VARJAO	VJ31007520	GUAPO S2	16/11/2019 09:33	16/11/2019 18:00	16/11/2019 09:33	16/11/2019 18:00	8,44	1	8,44	CHI
201911182120	GOIATUBA	GT12316707	GOIATUBA S2	16/11/2019 09:01	20/11/2019 22:12	16/11/2019 09:01	20/11/2019 22:12	109,18	7	764,24	CHI
201911182120	MORRINHOS	GT12316707	GOIATUBA S2	16/11/2019 09:01	20/11/2019 22:12	16/11/2019 09:01	20/11/2019 22:12	109,18	5	545,88	CHI
201911182122	TRINDADE	TR31052875	TRINDADE	16/11/2019 09:35	16/11/2019 16:34	16/11/2019 09:35	16/11/2019 16:34	6,98	1	6,98	CHI
201911182124	SAO MIGUEL DO PASSA QUATRO	SQ21250195	CRISTIANOPOLIS	16/11/2019 09:35	16/11/2019 16:25	16/11/2019 09:35	16/11/2019 16:25	6,82	1	6,82	CHI
201911182126	ANAPOLIS	20871260	ANAPOLIS UNIVERSITARIO S2	16/11/2019 09:36	16/11/2019 11:40	16/11/2019 09:36	16/11/2019 11:40	2,07	1	2,07	CHI
201911182127	PILAR DE GOIAS	GG12181337	SANTA TEREZINHA	16/11/2019 09:36	16/11/2019 15:00	16/11/2019 09:36	16/11/2019 15:00	5,40	10	53,99	CHI
201911182130	NIQUELANDIA	NQ12255072	BARRO ALTO	16/11/2019 08:47	17/11/2019 11:01	16/11/2019 08:47	17/11/2019 11:01	26,22	7	183,55	CHI
201911182132	TRES RANCHOS	TH21131014	CATALAO S1	16/11/2019 09:37	16/11/2019 17:43	16/11/2019 09:37	16/11/2019 17:43	8,10	1	8,10	CHI
201911182135	GOIAS	GS12061061	ITAPURANGA	16/11/2019 08:29	17/11/2019 00:00	16/11/2019 08:29	17/11/2019 00:00	15,51	34	527,40	CHI
201911182143	CAMPINORTE	CR12234938	PORANGATU	16/11/2019 09:35	16/11/2019 11:13	16/11/2019 09:35	16/11/2019 11:13	1,62	18	29,22	CHI
201911182143	MINACU	CR12234938	PORANGATU	16/11/2019 09:35	16/11/2019 11:13	16/11/2019 09:35	16/11/2019 11:13	1,62	41	66,55	CHI
201911182149	LUZIANIA	LZ12118890	MARAJOARA	16/11/2019 09:38	16/11/2019 14:39	16/11/2019 09:38	16/11/2019 14:39	5,00	2	10,00	CHI
201911182152	BURITINOPOLIS	MB12314303	IACIARA S2	16/11/2019 09:39	16/11/2019 10:00	16/11/2019 09:39	16/11/2019 10:00	0,33	2	0,67	CHI
201911182152	MAMBAI	MB12314303	IACIARA S2	16/11/2019 09:39	16/11/2019 10:00	16/11/2019 09:39	16/11/2019 10:00	0,33	3	1,00	CHI
201911182160	MORRINHOS	MR12304043	MORRINHOS	16/11/2019 09:40	16/11/2019 17:11	16/11/2019 09:40	16/11/2019 17:11	7,50	3	22,51	CHI
201911182162	MARA ROSA	MQ12187920	MARA ROSA	16/11/2019 09:41	16/11/2019 17:03	16/11/2019 09:41	16/11/2019 17:03	7,36	5	36,79	CHI
201911182167	SENADOR CANEDO	SW11168679	SENADOR CANEDO	16/11/2019 08:02	16/11/2019 12:21	16/11/2019 08:02	16/11/2019 12:21	4,31	61	262,77	CHI
201911182173	APARECIDA DE GOIANIA	14977898	INDEPENDENCIA S1	16/11/2019 09:43	16/11/2019 13:04	16/11/2019 09:43	16/11/2019 13:04	3,34	1	3,34	CHI
201911182178	ANAPOLIS	LB12078506	DAIA S2	16/11/2019 08:54	16/11/2019 16:06	16/11/2019 08:54	16/11/2019 16:06	7,19	8	57,51	CHI
201911182178	LEOPOLDO DE BULHOES	LB12078506	DAIA S2	16/11/2019 08:54	16/11/2019 16:06	16/11/2019 08:54	16/11/2019 16:06	7,19	6	43,13	CHI
201911182185	GOIANIA	10005389788	INDEPENDENCIA S2	16/11/2019 09:45	16/11/2019 15:57	16/11/2019 09:45	16/11/2019 15:57	6,19	1	6,19	CHI
201911182192	GOIANIA	15351180	MEIA PONTE	16/11/2019 09:46	16/11/2019 12:35	16/11/2019 09:46	16/11/2019 12:35	2,81	1	2,81	CHI
201911182194	GOIANIA	16977610	INDEPENDENCIA S2	16/11/2019 09:46	16/11/2019 13:02	16/11/2019 09:46	16/11/2019 13:02	3,26	1	3,26	CHI
201911182196	SERRANOPOLIS	SX12266486	JATAI S1	16/11/2019 06:28	16/11/2019 20:17	16/11/2019 06:28	16/11/2019 20:17	13,80	7	96,62	CHI
201911182197	NEROPOLIS	160068186	NEROPOLIS S2	16/11/2019 09:47	16/11/2019 15:31	16/11/2019 09:47	16/11/2019 15:31	5,73	1	5,73	CHI
201911182201	PARAUNA	PU21308455	ACREUNA	16/11/2019 09:47	16/11/2019 12:05	16/11/2019 09:47	16/11/2019 12:05	2,29	1	2,29	CHI

201911182203	GOIANIA	11266030	AEROPORTO S1	16/11/2019 09:47	16/11/2019 12:57	16/11/2019 09:47	16/11/2019 12:57	3,16	1	3,16	CHI
201911182205	ANAPOLIS	AN12000105	ANAPOLIS UNIVERSITARIO S2	16/11/2019 09:48	16/11/2019 15:07	16/11/2019 09:48	16/11/2019 15:07	5,31	46	244,45	CHI
201911182210	SANTA HELENA DE GOIAS	SH12301331	IPEGUARI	16/11/2019 09:26	16/11/2019 16:00	16/11/2019 09:26	16/11/2019 16:00	6,58	5	32,89	CHI
201911182215	QUIRINOPOLIS	QJ31049540	QUIRINOPOLIS	16/11/2019 09:50	16/11/2019 11:42	16/11/2019 09:50	16/11/2019 11:42	1,86	1	1,86	CHI
201911182216	HIDROLANDIA	HD12000142	CEPAIGO S2	16/11/2019 05:36	16/11/2019 15:05	16/11/2019 05:36	16/11/2019 15:05	9,47	14	132,54	CHI
201911182220	VALPARAISO DE GOIAS	10002228279	PACAEMBU S2	16/11/2019 09:52	16/11/2019 12:06	16/11/2019 09:52	16/11/2019 12:06	2,23	1	2,23	CHI
201911182221	GOIANIA	10008488582	REAL S1	16/11/2019 09:52	16/11/2019 17:28	16/11/2019 09:52	16/11/2019 17:28	7,59	1	7,59	CHI
201911182222	PIRANHAS	PH12204952	PIRANHAS	16/11/2019 09:52	17/11/2019 02:00	16/11/2019 09:52	17/11/2019 02:00	16,13	2	32,25	CHI
201911182223	ITUMBIARA	IT12000227	ITUMBIARA NOVA	16/11/2019 09:52	16/11/2019 15:22	16/11/2019 09:52	16/11/2019 15:22	5,49	2	10,98	CHI
201911182226	ALEXANIA	AX21099850	ALEXANIA	16/11/2019 09:52	16/11/2019 17:07	16/11/2019 09:52	16/11/2019 17:07	7,24	1	7,24	CHI
201911182228	ITABERAI	50057480	ITABERAI S2	16/11/2019 09:53	17/11/2019 09:30	16/11/2019 09:53	17/11/2019 09:30	23,61	1	23,61	CHI
201911182231	CAIAPONIA	CP21336565	IPORA	16/11/2019 09:53	18/11/2019 17:18	16/11/2019 09:53	18/11/2019 17:18	55,40	1	55,40	CHI
201911182232	RIO VERDE	RV21020009	CABRIUVA S2	16/11/2019 09:53	16/11/2019 22:55	16/11/2019 09:53	16/11/2019 22:55	13,03	1	13,03	CHI
201911182234	AMARALINA	LC12168855	MARA ROSA	16/11/2019 07:54	16/11/2019 18:20	16/11/2019 07:54	16/11/2019 18:20	10,42	34	354,39	CHI
201911182234	MARA ROSA	LC12168855	MARA ROSA	16/11/2019 07:54	16/11/2019 18:20	16/11/2019 07:54	16/11/2019 18:20	10,42	8	83,39	CHI
201911182238	GOIANIA	13697330	INDEPENDENCIA S1	16/11/2019 09:55	16/11/2019 14:25	16/11/2019 09:55	16/11/2019 14:25	4,50	1	4,50	CHI
201911182239	SENADOR CANEDO	10020718258	SENADOR CANEDO	16/11/2019 09:55	16/11/2019 11:34	16/11/2019 09:55	16/11/2019 11:34	1,64	1	1,64	CHI
201911182253	CAIAPONIA	10006765929	PIRANHAS	16/11/2019 09:57	16/11/2019 20:12	16/11/2019 09:57	16/11/2019 20:12	10,25	1	10,25	CHI
201911182258	PALMEIRAS DE GOIAS	PL12092550	PALMEIRAS	16/11/2019 08:30	16/11/2019 12:05	16/11/2019 08:30	16/11/2019 12:05	3,58	6	21,49	CHI
201911182264	BELA VISTA DE GOIAS	BV31195000	BELA VISTA S1	16/11/2019 09:58	16/11/2019 16:30	16/11/2019 09:58	16/11/2019 16:30	6,53	1	6,53	CHI
201911182266	RIO VERDE	RV12200774	CABRIUVA S2	16/11/2019 19:05	16/11/2019 21:16	16/11/2019 19:05	16/11/2019 21:16	2,17	12	26,00	CHI
201911182269	NOVA ROMA	ND21229383	IACIARA S2	16/11/2019 09:59	16/11/2019 13:00	16/11/2019 09:59	16/11/2019 13:00	3,01	1	3,01	CHI
201911182270	ORIZONA	OZ12143757	PIRES DO RIO S2	16/11/2019 08:24	16/11/2019 20:41	16/11/2019 08:24	16/11/2019 20:41	12,27	39	478,61	CHI
201911182273	CAIAPONIA	CP12259379	CAIAPONIA	16/11/2019 09:59	16/11/2019 13:16	16/11/2019 09:59	16/11/2019 13:16	3,27	2	6,54	CHI
201911182287	FLORES DE GOIAS	FB12204157	FLORES DE GOIAS	16/11/2019 10:02	19/11/2019 20:11	16/11/2019 10:02	19/11/2019 17:47	79,74	13	1036,68	CHI
201911182287	FLORES DE GOIAS	FB12204157	FLORES DE GOIAS	16/11/2019 10:02	19/11/2019 20:11	19/11/2019 17:53	19/11/2019 20:11	2,31	13	29,98	CHI
201911182293	GOIANIA	15304814	CARAJAS S1	16/11/2019 10:04	16/11/2019 15:20	16/11/2019 10:04	16/11/2019 15:20	5,26	1	5,26	CHI
201911182297	NIQUELANDIA	NQ12400321	URUACU	16/11/2019 09:12	16/11/2019 17:45	16/11/2019 09:12	16/11/2019 17:45	8,54	192	1639,84	CHI
201911182299	CORREGO DO OURO	CO21003688	SAO LUIZ DOS MONTES BELOS	16/11/2019 10:05	16/11/2019 19:02	16/11/2019 10:05	16/11/2019 19:02	8,95	1	8,95	CHI
201911182302	NIQUELANDIA	NQ21237379	URUACU	16/11/2019 10:05	16/11/2019 22:55	16/11/2019 10:05	16/11/2019 22:55	12,83	1	12,83	CHI
201911182308	ALEXANIA	AX11061849	ALEXANIA	16/11/2019 10:06	17/11/2019 09:00	16/11/2019 10:06	17/11/2019 09:00	22,89	2	45,78	CHI
201911182311	BELA VISTA DE GOIAS	240047175	BELA VISTA S1	16/11/2019 10:07	16/11/2019 12:33	16/11/2019 10:07	16/11/2019 12:33	2,42	1	2,42	CHI
201911182316	CATALAO	CT12077346	CATALAO S2	16/11/2019 08:39	16/11/2019 10:56	16/11/2019 08:39	16/11/2019 10:56	2,27	487	1107,25	CHI

201911182320	FORMOSA	610036981	ITIQUEIRA	16/11/2019 10:09	16/11/2019 16:15	16/11/2019 10:09	16/11/2019 16:15	6,09	1	6,09	CHI
201911182329	VILA PROPICIO	GE21185202	GOIANESIA S2	16/11/2019 10:11	16/11/2019 17:51	16/11/2019 10:11	16/11/2019 17:51	7,66	1	7,66	CHI
201911182333	ALTO PARAISO DE GOIAS	BF21163417	NIQUELANDIA SUBTRANSMISSAO	16/11/2019 10:11	16/11/2019 12:01	16/11/2019 10:11	16/11/2019 12:01	1,82	1	1,82	CHI
201911182335	ANAPOLIS	21263267	ANAPOLIS UNIVERSITARIO S2	16/11/2019 10:12	16/11/2019 15:54	16/11/2019 10:12	16/11/2019 15:54	5,69	1	5,69	CHI
201911182341	LUZIANIA	LZ12383053LD	CRISTALINA S2	16/11/2019 16:28	17/11/2019 15:14	16/11/2019 16:28	17/11/2019 15:14	22,76	42	956,03	CHI
201911182342	FORMOSO	FO12145300	PORANGATU	16/11/2019 09:54	16/11/2019 11:50	16/11/2019 09:54	16/11/2019 11:50	1,92	11	21,12	CHI
201911182343	GOIANIA	11567703	CAMPINAS S2	16/11/2019 10:13	16/11/2019 14:55	16/11/2019 10:13	16/11/2019 14:55	4,68	1	4,68	CHI
201911182345	GOIANIA	10010541614	CAMPINAS S1	16/11/2019 10:15	16/11/2019 16:02	16/11/2019 10:15	16/11/2019 16:02	5,78	1	5,78	CHI
201911182350	SERRANOPOLIS	6607241	JATAI S1	16/11/2019 09:26	16/11/2019 19:44	16/11/2019 09:26	16/11/2019 19:44	10,30	22	226,57	CHI
201911182351	SERRANOPOLIS	SX12037674	JATAI S1	16/11/2019 09:50	16/11/2019 19:38	16/11/2019 09:50	16/11/2019 19:38	9,81	1	9,81	CHI
201911182351	SERRANOPOLIS	SX12037674	JATAI S1	16/11/2019 09:50	16/11/2019 19:38	16/11/2019 15:56	16/11/2019 19:38	3,71	7	25,95	CHI
201911182360	RIO VERDE	RV21152721	QUIRINOPOLIS	16/11/2019 10:16	17/11/2019 09:09	16/11/2019 10:16	17/11/2019 09:09	22,87	1	22,87	CHI
201911182361	GOIANIA	GN13000068	GOIANIA LESTE S3	16/11/2019 13:46	16/11/2019 13:58	16/11/2019 13:46	16/11/2019 13:58	0,21	290	59,69	CHI
201911182365	SANTA TEREZINHA DE GOIAS	SG21320671	SANTA TEREZINHA	16/11/2019 10:18	16/11/2019 14:40	16/11/2019 10:18	16/11/2019 14:40	4,36	1	4,36	CHI
201911182383	GOIANIA	GN21001040	GOIANIA LESTE S2	16/11/2019 10:21	16/11/2019 15:04	16/11/2019 10:21	16/11/2019 15:04	4,71	17	80,13	CHI
201911182384	MINEIROS	MY21209988	PARQUE DAS EMAS	16/11/2019 10:21	16/11/2019 11:46	16/11/2019 10:21	16/11/2019 11:46	1,41	1	1,41	CHI
201911182391	DAMOLANDIA	DL12384816	INHUMAS S1	16/11/2019 10:24	16/11/2019 15:28	16/11/2019 10:24	16/11/2019 15:28	5,06	31	156,93	CHI
201911182391	OURO VERDE DE GOIAS	DL12384816	INHUMAS S1	16/11/2019 10:24	16/11/2019 15:28	16/11/2019 10:24	16/11/2019 15:28	5,06	12	60,75	CHI
201911182391	PETROLINA DE GOIAS	DL12384816	INHUMAS S1	16/11/2019 10:24	16/11/2019 15:28	16/11/2019 10:24	16/11/2019 15:28	5,06	6	30,37	CHI
201911182395	MINEIROS	1390129886	PARQUE DAS EMAS	16/11/2019 10:26	16/11/2019 12:12	16/11/2019 10:26	16/11/2019 12:12	1,78	1	1,78	CHI
201911182402	GOIANIA	12137406	GOYA S1	16/11/2019 10:29	16/11/2019 18:51	16/11/2019 10:29	16/11/2019 18:51	8,36	1	8,36	CHI
201911182403	BELA VISTA DE GOIAS	BV31043513	BELA VISTA S1	16/11/2019 10:30	16/11/2019 14:39	16/11/2019 10:30	16/11/2019 14:39	4,15	1	4,15	CHI
201911182405	GOIANIRA	GR32045904	TRINDADE	16/11/2019 10:30	16/11/2019 20:38	16/11/2019 10:30	16/11/2019 20:38	10,13	4	40,51	CHI
201911182405	TRINDADE	GR32045904	TRINDADE	16/11/2019 10:30	16/11/2019 20:38	16/11/2019 10:30	16/11/2019 20:38	10,13	4	40,51	CHI
201911182409	LUZIANIA	LZ12376129	CRISTALINA S2	16/11/2019 08:18	16/11/2019 13:31	16/11/2019 08:18	16/11/2019 13:31	5,22	19	99,19	CHI
201911182409	LUZIANIA	LZ12376129	CRISTALINA S2	16/11/2019 08:18	16/11/2019 13:31	16/11/2019 12:34	16/11/2019 13:31	0,95	43	40,97	CHI
201911182411	SAO MIGUEL DO PASSA QUATRO	1490005174	CRISTIANOPOLIS	16/11/2019 10:31	16/11/2019 17:11	16/11/2019 10:31	16/11/2019 17:11	6,65	1	6,65	CHI
201911182412	CALDAS NOVAS	CN21058830	RIO QUENTE	16/11/2019 10:31	19/11/2019 15:21	16/11/2019 10:31	19/11/2019 15:21	76,83	1	76,83	CHI
201911182417	SILVANIA	SV12288449	VIANOPOLIS	16/11/2019 10:32	16/11/2019 19:32	16/11/2019 10:32	16/11/2019 19:32	8,99	1	8,99	CHI
201911182425	BALIZA	BH11331050	CAIAPONIA	16/11/2019 10:33	16/11/2019 21:10	16/11/2019 10:33	16/11/2019 21:10	10,61	1	10,61	CHI
201911182434	JARAGUA	PV12334639	JARAGUA	16/11/2019 10:34	16/11/2019 15:12	16/11/2019 10:34	16/11/2019 15:12	4,62	8	36,94	CHI
201911182439	GOIANIA	12100043	GOYA S1	16/11/2019 10:35	16/11/2019 17:15	16/11/2019 10:35	16/11/2019 17:15	6,66	1	6,66	CHI
201911182441	AMORINOPOLIS	AM12047170	IPORA	16/11/2019 09:21	17/11/2019 16:20	16/11/2019 09:21	17/11/2019 16:20	30,98	8	247,81	CHI

201911182444	JATAI	290334548	JATAI S2	16/11/2019 10:35	16/11/2019 18:47	16/11/2019 10:35	16/11/2019 18:47	8,18	1	8,18	CHI
201911182452	AMERICANO DO BRASIL	1410001377	ANICUNS	16/11/2019 10:37	16/11/2019 11:38	16/11/2019 10:37	16/11/2019 11:38	1,01	1	1,01	CHI
201911182459	SAO LUIS DE MONTES BELOS	SL11159055	SAO LUIZ DOS MONTES BELOS	16/11/2019 10:39	16/11/2019 11:55	16/11/2019 10:39	16/11/2019 11:55	1,27	153	193,71	CHI
201911182464	JATAI	JT12000118	JATAI S2	16/11/2019 10:40	16/11/2019 15:52	16/11/2019 10:40	16/11/2019 15:52	5,20	25	129,94	CHI
201911182471	ITAJA	IJ11153968	ITAJA S2	16/11/2019 09:44	16/11/2019 11:55	16/11/2019 09:44	16/11/2019 11:55	2,17	148	320,75	CHI
201911182475	JATAI	JT21334182	JATAI S1	16/11/2019 10:42	16/11/2019 15:08	16/11/2019 10:42	16/11/2019 15:08	4,43	1	4,43	CHI
201911182481	SENADOR CANEDO	SW21171838	GOIANIA LESTE S2	16/11/2019 10:44	17/11/2019 11:31	16/11/2019 10:44	17/11/2019 11:31	24,78	2	49,57	CHI
201911182484	PALMEIRAS DE GOIAS	PL21366262	TRINDADE	16/11/2019 10:44	16/11/2019 12:05	16/11/2019 10:44	16/11/2019 12:05	1,35	1	1,35	CHI
201911182488	JARAGUA	JA12299632	ITABERAI S1	16/11/2019 10:45	16/11/2019 23:40	16/11/2019 10:45	16/11/2019 23:40	12,91	139	1795,03	CHI
201911182491	CORREGO DO OURO	CO12004040	FIRMINOPOLIS S2	16/11/2019 10:45	16/11/2019 16:21	16/11/2019 10:45	16/11/2019 16:21	5,59	4	22,38	CHI
201911182495	SERRANOPOLIS	SX12260467	JATAI S1	16/11/2019 10:46	16/11/2019 19:46	16/11/2019 10:46	16/11/2019 19:46	8,99	7	62,94	CHI
201911182496	SAO MIGUEL DO ARAGUAIA	SM21208440	SAO MIGUEL DO ARAGUAIA	16/11/2019 10:46	16/11/2019 15:12	16/11/2019 10:46	16/11/2019 15:12	4,43	1	4,43	CHI
201911182504	ITUMBIARA	690367806	PARANAIBA	16/11/2019 10:48	19/11/2019 18:28	16/11/2019 10:48	19/11/2019 18:28	79,67	1	79,67	CHI
201911182506	FAINA	GS12362364	MATRINCHA	16/11/2019 06:09	17/11/2019 09:40	16/11/2019 06:09	17/11/2019 09:40	27,51	8	220,08	CHI
201911182506	GOIAS	GS12362364	MATRINCHA	16/11/2019 06:09	17/11/2019 09:40	16/11/2019 06:09	17/11/2019 09:40	27,51	8	220,08	CHI
201911182506	MATRINCHA	GS12362364	MATRINCHA	16/11/2019 06:09	17/11/2019 09:40	16/11/2019 06:09	17/11/2019 09:40	27,51	1	27,51	CHI
201911182507	ANAPOLIS	AN12107991	JUNDIAI S2	16/11/2019 08:54	16/11/2019 12:19	16/11/2019 08:54	16/11/2019 12:19	3,40	266	905,58	CHI
201911182608	MAURILANDIA	ML21303313	RIO DOS BOIS	16/11/2019 10:50	17/11/2019 00:00	16/11/2019 10:50	17/11/2019 00:00	13,16	2	26,32	CHI
201911182610	ITAJA	IJ12226576	ITAJA S2	16/11/2019 10:50	16/11/2019 14:30	16/11/2019 10:50	16/11/2019 14:30	3,66	4	14,64	CHI
201911182612	AMORINOPOLIS	AM21031318	IPORA	16/11/2019 10:50	18/11/2019 11:20	16/11/2019 10:50	18/11/2019 11:20	48,50	1	48,50	CHI
201911182615	GOIANIA	GN11203807	CARAJAS S2	16/11/2019 10:42	16/11/2019 12:10	16/11/2019 10:42	16/11/2019 12:10	1,47	156	228,54	CHI
201911182617	PALMINOPOLIS	PP21039179	PALMEIRAS	16/11/2019 10:52	17/11/2019 19:39	16/11/2019 10:52	17/11/2019 19:39	32,78	1	32,78	CHI
201911182626	DAMOLANDIA	DL21051994	INHUMAS S1	16/11/2019 10:53	16/11/2019 14:29	16/11/2019 10:53	16/11/2019 14:29	3,59	1	3,59	CHI
201911182631	CALDAZINHA	SW12217284	CEPAIGO S2	16/11/2019 08:18	16/11/2019 14:20	16/11/2019 08:18	16/11/2019 14:20	6,02	6	36,11	CHI
201911182631	LEOPOLDO DE BULHOES	SW12217284	CEPAIGO S2	16/11/2019 08:18	16/11/2019 14:20	16/11/2019 08:18	16/11/2019 14:20	6,02	52	312,98	CHI
201911182642	GOIANIA	17165878	INDEPENDENCIA S2	16/11/2019 10:57	16/11/2019 15:23	16/11/2019 10:57	16/11/2019 15:23	4,43	1	4,43	CHI
201911182703	TRES RANCHOS	TH12281446	CATALAO S1	16/11/2019 09:58	17/11/2019 13:07	16/11/2019 09:58	17/11/2019 12:50	26,86	7	188,00	CHI
201911182703	TRES RANCHOS	TH12082408LD	CATALAO S1	16/11/2019 09:58	17/11/2019 13:07	16/11/2019 09:58	17/11/2019 13:07	27,16	1	27,16	CHI
201911182705	BURITINOPOLIS	SU12374375	SANTA RITA DO ARAGUAIA	16/11/2019 08:02	17/11/2019 00:03	16/11/2019 08:02	17/11/2019 00:03	16,00	1	16,00	CHI
201911182705	SANTA RITA DO ARAGUAIA	SU12374375	SANTA RITA DO ARAGUAIA	16/11/2019 08:02	17/11/2019 00:03	16/11/2019 08:02	17/11/2019 00:03	16,00	5	80,01	CHI
201911182706	LUZIANIA	10021730626	MARAJOARA	16/11/2019 11:00	16/11/2019 11:52	16/11/2019 11:00	16/11/2019 11:52	0,86	1	0,86	CHI
201911182708	QUIRINOPOLIS	QI21143189	QUIRINOPOLIS	16/11/2019 11:01	16/11/2019 14:05	16/11/2019 11:01	16/11/2019 14:05	3,06	1	3,06	CHI
201911182709	MONTIVIDIU DO NORTE	MX11203337	PORANGATU	16/11/2019 11:01	17/11/2019 12:53	16/11/2019 11:01	17/11/2019 12:53	25,86	2	51,72	CHI

201911182711	FIRMINOPOLIS	SL12125617	FIRMINOPOLIS S1	16/11/2019 10:46	16/11/2019 15:05	16/11/2019 10:46	16/11/2019 15:05	4,30	17	73,10	CHI
201911182711	SAO LUIS DE MONTES BELOS	SL12125617	FIRMINOPOLIS S1	16/11/2019 10:46	16/11/2019 15:05	16/11/2019 10:46	16/11/2019 15:05	4,30	53	227,91	CHI
201911182711	TURVANIA	SL12125617	FIRMINOPOLIS S1	16/11/2019 10:46	16/11/2019 15:05	16/11/2019 10:46	16/11/2019 15:05	4,30	8	34,40	CHI
201911182712	APARECIDA DE GOIANIA	10007434055	REAL S1	16/11/2019 11:01	16/11/2019 14:32	16/11/2019 11:01	16/11/2019 14:32	3,50	1	3,50	CHI
201911182717	JATAI	JT21158532	JATAI S1	16/11/2019 11:03	16/11/2019 16:15	16/11/2019 11:03	16/11/2019 16:15	5,20	1	5,20	CHI
201911182721	ANICUNS	AC21126099	ANICUNS	16/11/2019 11:04	16/11/2019 14:24	16/11/2019 11:04	16/11/2019 14:24	3,35	1	3,35	CHI
201911182725	MARA ROSA	MQ11000008	MARA ROSA	16/11/2019 10:31	16/11/2019 15:59	16/11/2019 10:31	16/11/2019 15:59	5,45	156	850,59	CHI
201911182730	SANTA HELENA DE GOIAS	SH12271561	IPEGUARI	16/11/2019 09:10	16/11/2019 12:15	16/11/2019 09:10	16/11/2019 12:15	3,08	11	33,88	CHI
201911182731	NOVA VENEZA	NV21098768	INHUMAS S1	16/11/2019 11:07	16/11/2019 17:27	16/11/2019 11:07	16/11/2019 17:27	6,33	1	6,33	CHI
201911182733	ITUMBIARA	IT12033779RE	CACHOEIRA DOURADA	16/11/2019 08:41	16/11/2019 13:44	16/11/2019 08:41	16/11/2019 13:44	5,05	54	272,61	CHI
201911182735	GOIANIA	14372940	AEROPORTO S1	16/11/2019 11:08	16/11/2019 14:21	16/11/2019 11:08	16/11/2019 14:21	3,23	1	3,23	CHI
201911182745	ARACU	AR12019237	ARACU	16/11/2019 11:06	16/11/2019 14:45	16/11/2019 11:06	16/11/2019 14:45	3,65	15	54,72	CHI
201911182751	CALDAS NOVAS	CN11213842	CALDAS NOVAS S1	16/11/2019 10:09	16/11/2019 16:12	16/11/2019 10:09	16/11/2019 16:12	6,04	50	302,04	CHI
201911182753	CALDAS NOVAS	10022074331	SERRA DE CALDAS	16/11/2019 11:10	18/11/2019 09:52	16/11/2019 11:10	18/11/2019 09:52	46,69	1	46,69	CHI
201911182756	IPORA	IR12380966	IPORA	16/11/2019 08:57	16/11/2019 17:40	16/11/2019 08:57	16/11/2019 17:40	8,71	5	43,56	CHI
201911182764	BOM JESUS DE GOIAS	BJ12000202	CACHOEIRA DOURADA	16/11/2019 09:58	16/11/2019 21:46	16/11/2019 09:58	16/11/2019 21:46	11,80	20	235,90	CHI
201911182764	GOIATUBA	BJ12000202	CACHOEIRA DOURADA	16/11/2019 09:58	16/11/2019 21:46	16/11/2019 09:58	16/11/2019 21:46	11,80	7	82,57	CHI
201911182764	PANAMA	BJ12000202	CACHOEIRA DOURADA	16/11/2019 09:58	16/11/2019 21:46	16/11/2019 09:58	16/11/2019 21:46	11,80	2	23,59	CHI
201911182765	PORANGATU	PO21193528	PORANGATU	16/11/2019 11:13	16/11/2019 14:00	16/11/2019 11:13	16/11/2019 14:00	2,78	1	2,78	CHI
201911182772	PETROLINA DE GOIAS	PG121241132	PETROLINA	16/11/2019 11:14	16/11/2019 15:38	16/11/2019 11:14	16/11/2019 15:38	4,39	2	8,78	CHI
201911182773	PALMEIRAS DE GOIAS	PL12398710	PALMEIRAS	16/11/2019 10:34	16/11/2019 11:45	16/11/2019 10:34	16/11/2019 11:45	1,18	21	24,78	CHI
201911182776	NIQUELANDIA	NQ12256380	NIQUELANDIA SUBTRANSMISSAO	16/11/2019 11:10	16/11/2019 19:49	16/11/2019 11:10	16/11/2019 19:49	8,64	12	103,64	CHI
201911182782	BARRO ALTO	BA12382485	BARRO ALTO	16/11/2019 07:48	16/11/2019 19:13	16/11/2019 07:48	16/11/2019 19:13	11,41	8	91,25	CHI
201911182789	SAO JOAO D ALIANCA	JL11218468	SAO JOAO D ALIANCA	16/11/2019 11:21	16/11/2019 14:08	16/11/2019 11:21	16/11/2019 14:08	2,78	2	5,55	CHI
201911182791	RUBIATABA	NM21187173	RUBIATABA	16/11/2019 11:21	16/11/2019 16:17	16/11/2019 11:21	16/11/2019 16:17	4,92	2	9,84	CHI
201911182792	ANAPOLIS	20227802	JUNDIAI S2	16/11/2019 11:22	16/11/2019 18:47	16/11/2019 11:22	16/11/2019 18:47	7,41	1	7,41	CHI
201911182794	APARECIDA DE GOIANIA	15123285	ATLANTICO S2	16/11/2019 11:23	16/11/2019 15:28	16/11/2019 11:23	16/11/2019 15:28	4,08	1	4,08	CHI
201911182798	INDIARA	2710030944	EDEIA	16/11/2019 11:24	16/11/2019 16:45	16/11/2019 11:24	16/11/2019 16:45	5,35	1	5,35	CHI
201911182800	FORMOSA	FA12071048	ITUIQUIRA	16/11/2019 10:11	16/11/2019 16:44	16/11/2019 10:11	16/11/2019 16:44	6,54	14	91,57	CHI
201911182807	PARANAIGUARA	QI12306101	QUIRINOPOLIS	16/11/2019 11:50	16/11/2019 13:10	16/11/2019 11:50	16/11/2019 13:10	1,33	6	7,97	CHI
201911182807	QUIRINOPOLIS	QI12306101	QUIRINOPOLIS	16/11/2019 11:50	16/11/2019 13:10	16/11/2019 11:50	16/11/2019 13:10	1,33	2	2,66	CHI
201911182811	GUAPO	GA21098731	GUAPO S1	16/11/2019 11:59	16/11/2019 12:40	16/11/2019 11:59	16/11/2019 12:40	0,68	2	1,36	CHI
201911182847	CACHOEIRA ALTA	7178076	CACHOEIRA ALTA	16/11/2019 16:29	16/11/2019 16:35	16/11/2019 16:29	16/11/2019 16:35	0,09	2	0,19	CHI

201911182855	ALTO PARAISO DE GOIAS	BF10395392	NIQUELANDIA SUBTRANSMISSAO	16/11/2019 16:36	18/11/2019 09:13	16/11/2019 16:36	16/11/2019 16:54	0,31	24	7,41	CHI
201911182855	CAVALCANTE	BF10395392	NIQUELANDIA SUBTRANSMISSAO	16/11/2019 16:36	18/11/2019 09:13	16/11/2019 16:36	16/11/2019 16:54	0,31	55	16,97	CHI
201911182855	COLINAS DO SUL	BF10395392	NIQUELANDIA SUBTRANSMISSAO	16/11/2019 16:36	18/11/2019 09:13	16/11/2019 16:36	16/11/2019 16:54	0,31	67	20,68	CHI
201911182855	NIQUELANDIA	BF10395392	NIQUELANDIA SUBTRANSMISSAO	16/11/2019 16:36	18/11/2019 09:13	16/11/2019 16:36	16/11/2019 16:54	0,31	4	1,23	CHI
201911182855	ALTO PARAISO DE GOIAS	BF10395392	NIQUELANDIA SUBTRANSMISSAO	16/11/2019 16:36	18/11/2019 09:13	16/11/2019 16:36	16/11/2019 22:30	5,90	407	2400,73	CHI
201911182855	ALTO PARAISO DE GOIAS	BF10395392	NIQUELANDIA SUBTRANSMISSAO	16/11/2019 16:36	18/11/2019 09:13	16/11/2019 16:36	17/11/2019 00:45	8,15	7	57,04	CHI
201911182855	ALTO PARAISO DE GOIAS	BF10395392	NIQUELANDIA SUBTRANSMISSAO	16/11/2019 16:36	18/11/2019 09:13	16/11/2019 16:36	17/11/2019 19:03	26,45	78	2062,93	CHI
201911182855	ALTO PARAISO DE GOIAS	BF13120586	NIQUELANDIA SUBTRANSMISSAO	16/11/2019 16:36	18/11/2019 09:13	16/11/2019 16:37	17/11/2019 19:03	26,42	6	158,51	CHI
201911182855	ALTO PARAISO DE GOIAS	BF13120586	NIQUELANDIA SUBTRANSMISSAO	16/11/2019 16:36	18/11/2019 09:13	16/11/2019 16:40	17/11/2019 19:03	26,38	19	501,16	CHI
201911182855	ALTO PARAISO DE GOIAS	BF13120567	NIQUELANDIA SUBTRANSMISSAO	16/11/2019 16:36	18/11/2019 09:13	17/11/2019 19:45	18/11/2019 09:13	13,48	7	94,37	CHI
201911182857	IPORA	IR21014087	IPORA	16/11/2019 17:05	16/11/2019 18:35	16/11/2019 17:05	16/11/2019 18:35	1,49	1	1,49	CHI
201911182858	PARANAIGUARA	PC10400581	QUIRINOPOLIS	16/11/2019 17:04	16/11/2019 18:30	16/11/2019 17:04	16/11/2019 18:30	1,43	41	58,48	CHI
201911182865	SANTA RITA DO ARAGUAIA	SU10400564	SANTA RITA DO ARAGUAIA	16/11/2019 17:09	17/11/2019 22:55	16/11/2019 17:09	16/11/2019 19:52	2,72	54	147,09	CHI
201911182865	MINEIROS	SU10400564	SANTA RITA DO ARAGUAIA	16/11/2019 17:09	17/11/2019 22:55	16/11/2019 17:09	16/11/2019 21:55	4,77	14	66,71	CHI
201911182865	SANTA RITA DO ARAGUAIA	SU10400564	SANTA RITA DO ARAGUAIA	16/11/2019 17:09	17/11/2019 22:55	16/11/2019 17:09	16/11/2019 21:55	4,77	11	52,42	CHI
201911182865	MINEIROS	SU10400564	SANTA RITA DO ARAGUAIA	16/11/2019 17:09	17/11/2019 22:55	16/11/2019 17:09	17/11/2019 22:55	29,78	15	446,69	CHI
201911182865	MINEIROS	SU13209790	SANTA RITA DO ARAGUAIA	16/11/2019 17:09	17/11/2019 22:55	16/11/2019 17:09	17/11/2019 22:55	29,78	1	29,78	CHI
201911182865	SANTA RITA DO ARAGUAIA	SU10400564	SANTA RITA DO ARAGUAIA	16/11/2019 17:09	17/11/2019 22:55	16/11/2019 17:09	17/11/2019 22:55	29,78	4	119,12	CHI
201911182870	ALTO PARAISO DE GOIAS	BF10400692	FLORES DE GOIAS	16/11/2019 17:53	17/11/2019 18:47	16/11/2019 17:53	17/11/2019 09:31	15,63	153	2391,77	CHI
201911182870	ALTO PARAISO DE GOIAS	BF10400692	FLORES DE GOIAS	16/11/2019 17:53	17/11/2019 18:47	17/11/2019 13:00	17/11/2019 16:35	3,59	133	477,21	CHI
201911182870	ALTO PARAISO DE GOIAS	BF13000002	FLORES DE GOIAS	16/11/2019 17:53	17/11/2019 18:47	16/11/2019 17:53	17/11/2019 18:47	24,91	60	1494,67	CHI
201911182870	SAO JOAO D ALIANCA	BF13000002	FLORES DE GOIAS	16/11/2019 17:53	17/11/2019 18:47	16/11/2019 17:53	17/11/2019 18:47	24,91	1	24,91	CHI
201911182870	ALTO PARAISO DE GOIAS	BF13000002	FLORES DE GOIAS	16/11/2019 17:53	17/11/2019 18:47	17/11/2019 13:00	17/11/2019 18:47	5,79	20	115,89	CHI
201911182889	BURITI ALEGRE	BG12000136	ITUMBIARA VELHA S2	16/11/2019 18:59	17/11/2019 13:58	16/11/2019 18:59	17/11/2019 13:58	18,99	5	94,97	CHI
201911182890	PIRENOPOLIS	PV21123675	JARAGUA	16/11/2019 18:12	17/11/2019 11:55	16/11/2019 18:12	17/11/2019 11:55	17,70	1	17,70	CHI
201911182906	ANAPOLIS	AN11359347	JUNDIAI S1	16/11/2019 11:09	16/11/2019 13:40	16/11/2019 11:09	16/11/2019 13:40	2,50	63	157,73	CHI
201911182908	FAZENDA NOVA	FN12223049	IPORA	16/11/2019 10:53	16/11/2019 21:30	16/11/2019 10:53	16/11/2019 21:30	10,61	8	84,91	CHI
201911182908	ISRAELANDIA	FN12223049	IPORA	16/11/2019 10:53	16/11/2019 21:30	16/11/2019 10:53	16/11/2019 21:30	10,61	2	21,23	CHI
201911182913	NIQUELANDIA	NQ12140184	SAO JOAO D ALIANCA	16/11/2019 11:28	17/11/2019 20:47	16/11/2019 11:28	17/11/2019 20:47	33,31	57	1898,73	CHI
201911182929	ANAPOLIS	21063436	JUNDIAI S1	16/11/2019 11:32	16/11/2019 17:25	16/11/2019 11:32	16/11/2019 17:25	5,89	1	5,89	CHI
201911182933	IPAMERI	IP12399213	IPAMERI	16/11/2019 11:33	17/11/2019 10:19	16/11/2019 11:33	17/11/2019 10:19	22,76	1	22,76	CHI
201911182939	CORUMBA DE GOIAS	CB21171988	CORUMBA	16/11/2019 11:34	16/11/2019 16:04	16/11/2019 11:34	16/11/2019 16:04	4,50	1	4,50	CHI
201911182944	MINACU	IH21208281	MINACU	16/11/2019 11:35	16/11/2019 19:33	16/11/2019 11:35	16/11/2019 19:33	7,97	2	15,93	CHI

201911182959	GOIANIA	15429120	XAVANTES	16/11/2019 11:38	16/11/2019 13:56	16/11/2019 11:38	16/11/2019 13:56	2,30	1	2,30	CHI
201911182961	CAIAPONIA	CP11056139	CAIAPONIA	16/11/2019 11:38	16/11/2019 14:50	16/11/2019 11:38	16/11/2019 14:50	3,20	94	300,38	CHI
201911182965	IPAMERI	IP21300915	IPAMERI	16/11/2019 11:38	18/11/2019 09:33	16/11/2019 11:38	18/11/2019 09:33	45,90	1	45,90	CHI
201911182966	SAO LUIS DE MONTES BELOS	SL21342920	SAO LUIZ DOS MONTES BELOS	16/11/2019 11:39	16/11/2019 18:13	16/11/2019 11:39	16/11/2019 18:13	6,57	1	6,57	CHI
201911182967	AGUAS LINDAS DE GOIAS	4830077750	AGUAS LINDAS DE GOIAS S1	16/11/2019 11:39	16/11/2019 13:38	16/11/2019 11:39	16/11/2019 13:38	1,97	1	1,97	CHI
201911182969	CATALAO	CT11203027	CATALAO S2	16/11/2019 10:44	16/11/2019 12:50	16/11/2019 10:44	16/11/2019 12:50	2,10	59	123,85	CHI
201911182974	CACHOEIRA ALTA	CA12013266	CACHOEIRA ALTA	16/11/2019 11:42	17/11/2019 23:04	16/11/2019 11:42	16/11/2019 18:09	6,45	11	70,93	CHI
201911182974	CACHOEIRA ALTA	CA12074128	CACHOEIRA ALTA	16/11/2019 11:42	17/11/2019 23:04	16/11/2019 11:42	17/11/2019 23:04	35,36	5	176,82	CHI
201911182977	CRISTALINA	1060108050	CRISTALINA S1	16/11/2019 11:42	16/11/2019 12:30	16/11/2019 11:42	16/11/2019 12:30	0,79	1	0,79	CHI
201911182978	ARAGOIANIA	AO12038066	GUAPO S2	16/11/2019 11:43	16/11/2019 14:45	16/11/2019 11:43	16/11/2019 14:45	3,03	2	6,07	CHI
201911182982	OUVIDOR	2180015260	CATALAO S1	16/11/2019 11:43	17/11/2019 09:35	16/11/2019 11:43	17/11/2019 09:35	21,86	1	21,86	CHI
201911182986	GOIANIA	16612929	CARAJAS S1	16/11/2019 11:44	16/11/2019 17:32	16/11/2019 11:44	16/11/2019 17:32	5,79	1	5,79	CHI
201911182994	RIO VERDE	630224845	RIO VERDE S2	16/11/2019 11:46	16/11/2019 17:50	16/11/2019 11:46	16/11/2019 17:50	6,07	1	6,07	CHI
201911182997	JANDAIA	PU12215442	PARAUNA	16/11/2019 11:47	16/11/2019 18:15	16/11/2019 11:47	16/11/2019 18:15	6,47	3	19,40	CHI
201911183001	ANAPOLIS	AN21261230	ANAPOLIS UNIVERSITARIO S2	16/11/2019 11:47	16/11/2019 18:22	16/11/2019 11:47	16/11/2019 18:22	6,57	2	13,14	CHI
201911183002	PLANALTINA	3890011315	PLANALTINA	16/11/2019 11:49	16/11/2019 13:31	16/11/2019 11:49	16/11/2019 13:31	1,70	0	0,00	CHI
201911183004	PIRENOPOLIS	AN31196851	ANAPOLIS UNIVERSITARIO S2	16/11/2019 11:49	17/11/2019 09:11	16/11/2019 11:49	17/11/2019 09:11	21,36	1	21,36	CHI
201911183014	CAMPOS VERDES	SG12171809	SANTA TEREZINHA	16/11/2019 10:31	16/11/2019 13:55	16/11/2019 10:31	16/11/2019 13:55	3,39	12	40,67	CHI
201911183020	ALEXANIA	AX12329596	ALEXANIA	16/11/2019 11:53	16/11/2019 20:17	16/11/2019 11:53	16/11/2019 20:17	8,39	3	25,16	CHI
201911183025	RIO VERDE	630132562	RIO VERDE S1	16/11/2019 11:55	16/11/2019 23:35	16/11/2019 11:55	16/11/2019 23:35	11,66	1	11,66	CHI
201911183026	GOIANIA	12827460	REAL S1	16/11/2019 11:55	16/11/2019 15:16	16/11/2019 11:55	16/11/2019 15:16	3,34	1	3,34	CHI
201911183028	GOIANIA	12896070	GOIANIA LESTE S1	16/11/2019 11:55	16/11/2019 17:32	16/11/2019 11:55	16/11/2019 17:32	5,60	1	5,60	CHI
201911183033	PIRES DO RIO	PR11265546	PIRES DO RIO S1	16/11/2019 11:57	16/11/2019 15:18	16/11/2019 11:57	16/11/2019 15:18	3,35	5	16,74	CHI
201911183040	AGUAS LINDAS DE GOIAS	4830319393	AGUAS LINDAS DE GOIAS S1	16/11/2019 11:58	16/11/2019 13:16	16/11/2019 11:58	16/11/2019 13:16	1,30	1	1,30	CHI
201911183041	GOIANIA	12079297	GOYA S1	16/11/2019 11:58	16/11/2019 16:01	16/11/2019 11:58	16/11/2019 16:01	4,04	1	4,04	CHI
201911183047	JARAGUA	JA21035313	JARAGUA	16/11/2019 12:00	16/11/2019 16:49	16/11/2019 12:00	16/11/2019 16:49	4,80	1	4,80	CHI
201911183056	AGUAS LINDAS DE GOIAS	4830086647	AGUAS LINDAS DE GOIAS S2	16/11/2019 12:04	16/11/2019 13:02	16/11/2019 12:04	16/11/2019 13:02	0,96	1	0,96	CHI
201911183059	PLANALTINA	2960034060	PLANALTINA	16/11/2019 12:05	16/11/2019 17:19	16/11/2019 12:05	16/11/2019 17:19	5,22	1	5,22	CHI
201911183067	OURO VERDE DE GOIAS	370016713	NEROPOLIS S2	16/11/2019 12:07	16/11/2019 22:40	16/11/2019 12:07	16/11/2019 22:40	10,54	1	10,54	CHI
201911183069	FIRMINOPOLIS	SL12206323	FIRMINOPOLIS S1	16/11/2019 10:45	16/11/2019 15:46	16/11/2019 10:45	16/11/2019 15:46	5,00	6	30,02	CHI
201911183069	SAO LUIS DE MONTES BELOS	SL12206323	FIRMINOPOLIS S1	16/11/2019 10:45	16/11/2019 15:46	16/11/2019 10:45	16/11/2019 15:46	5,00	48	240,17	CHI
201911183071	PONTALINA	PK21181914	PONTALINA	16/11/2019 12:09	16/11/2019 15:18	16/11/2019 12:09	16/11/2019 15:18	3,15	2	6,30	CHI
201911183078	SENADOR CANEDO	SW11099165	SENADOR CANEDO	16/11/2019 11:57	16/11/2019 17:24	16/11/2019 11:57	16/11/2019 17:24	5,45	119	648,45	CHI

201911183081	SENADOR CANEDO	190155863	SENADOR CANEDO	16/11/2019 12:11	16/11/2019 18:36	16/11/2019 12:11	16/11/2019 18:36	6,41	1	6,41	CHI
201911183088	NOVO PLANALTO	TA12139153	SAO MIGUEL DO ARAGUAIA	16/11/2019 12:13	16/11/2019 14:33	16/11/2019 12:13	16/11/2019 14:33	2,33	5	11,64	CHI
201911183097	GOIANIA	12593163	GOIANIA LESTE S1	16/11/2019 12:15	16/11/2019 18:13	16/11/2019 12:15	16/11/2019 18:13	5,97	1	5,97	CHI
201911183104	TRINDADE	TR31004751	TRINDADE	16/11/2019 12:16	16/11/2019 23:30	16/11/2019 12:16	16/11/2019 23:30	11,22	1	11,22	CHI
201911183107	RUBIATABA	780064367	RUBIATABA	16/11/2019 12:17	16/11/2019 20:34	16/11/2019 12:17	16/11/2019 20:34	8,28	1	8,28	CHI
201911183112	CUMARI	CY12000309	CATALAO S1	16/11/2019 07:45	18/11/2019 10:30	16/11/2019 07:45	18/11/2019 10:30	50,75	12	608,99	CHI
201911183123	TRES RANCHOS	TH21161403	CATALAO S1	16/11/2019 12:20	18/11/2019 07:34	16/11/2019 12:20	18/11/2019 07:34	43,23	2	86,46	CHI
201911183125	JANDAIA	JD12005438	PALMEIRAS	16/11/2019 12:07	16/11/2019 14:50	16/11/2019 12:07	16/11/2019 14:50	2,70	55	148,70	CHI
201911183125	PALMEIRAS DE GOIAS	JD12005438	PALMEIRAS	16/11/2019 12:07	16/11/2019 14:50	16/11/2019 12:07	16/11/2019 14:50	2,70	8	21,63	CHI
201911183125	PALMINOPOLIS	JD12005438	PALMEIRAS	16/11/2019 12:07	16/11/2019 14:50	16/11/2019 12:07	16/11/2019 14:50	2,70	14	37,85	CHI
201911183127	BRAZABRANTES	DL12026638	INHUMAS S1	16/11/2019 08:55	16/11/2019 11:30	16/11/2019 08:55	16/11/2019 11:30	2,57	8	20,55	CHI
201911183127	DAMOLANDIA	DL12026638	INHUMAS S1	16/11/2019 08:55	16/11/2019 11:30	16/11/2019 08:55	16/11/2019 11:30	2,57	7	17,98	CHI
201911183128	MINEIROS	MY12149301	PARQUE DAS EMAS	16/11/2019 12:21	16/11/2019 14:14	16/11/2019 12:21	16/11/2019 14:14	1,88	17	31,97	CHI
201911183128	PEROLANDIA	MY12149301	PARQUE DAS EMAS	16/11/2019 12:21	16/11/2019 14:14	16/11/2019 12:21	16/11/2019 14:14	1,88	1	1,88	CHI
201911183129	APARECIDA DE GOIANIA	AP11091761	INDEPENDENCIA S1	16/11/2019 12:15	16/11/2019 14:33	16/11/2019 12:15	16/11/2019 14:33	2,29	172	393,69	CHI
201911183130	FORMOSA	FA12087475	ITUIQUIRA	16/11/2019 12:21	18/11/2019 12:37	16/11/2019 12:21	18/11/2019 12:37	48,26	2	96,51	CHI
201911183133	MARZAGAO	MG21118565	VILA CORUMBA	16/11/2019 12:22	18/11/2019 17:59	16/11/2019 12:22	18/11/2019 17:59	53,61	1	53,61	CHI
201911183139	APARECIDA DE GOIANIA	13671716	REAL S2	16/11/2019 12:23	16/11/2019 15:31	16/11/2019 12:23	16/11/2019 15:31	3,13	1	3,13	CHI
201911183143	AGUA LIMPA	AL12000267RE	VILA CORUMBA	16/11/2019 12:23	18/11/2019 23:13	16/11/2019 12:23	18/11/2019 23:13	58,83	10	588,28	CHI
201911183146	ITABERAI	AV21019664	ANICUNS	16/11/2019 12:24	16/11/2019 14:33	16/11/2019 12:24	16/11/2019 14:33	2,16	2	4,33	CHI
201911183148	DOVERLANDIA	DV21342710	CAIAPONIA	16/11/2019 12:24	17/11/2019 16:13	16/11/2019 12:24	17/11/2019 16:13	27,81	1	27,81	CHI
201911183149	COCALZINHO DE GOIAS	10007774840	AGUAS LINDAS DE GOIAS S2	16/11/2019 12:24	16/11/2019 14:28	16/11/2019 12:24	16/11/2019 14:28	2,06	1	2,06	CHI
201911183153	GOIANIA	15735485	GOIANIA LESTE S3	16/11/2019 12:25	16/11/2019 15:08	16/11/2019 12:25	16/11/2019 15:08	2,71	1	2,71	CHI
201911183161	ALEXANIA	480015247	ALEXANIA	16/11/2019 12:28	17/11/2019 10:01	16/11/2019 12:28	17/11/2019 10:01	21,54	1	21,54	CHI
201911183170	TRINDADE	10017277866	MEIA PONTE	16/11/2019 12:30	16/11/2019 17:29	16/11/2019 12:30	16/11/2019 17:29	4,98	1	4,98	CHI
201911183171	APARECIDA DE GOIANIA	11384244	REAL S2	16/11/2019 12:30	16/11/2019 14:43	16/11/2019 12:30	16/11/2019 14:43	2,21	1	2,21	CHI
201911183176	CALDAZINHA	DE21113341	CEPAIGO S2	16/11/2019 12:31	17/11/2019 09:37	16/11/2019 12:31	17/11/2019 09:37	21,09	2	42,19	CHI
201911183177	VALPARAISO DE GOIAS	10028963235	MARAJOARA	16/11/2019 12:31	16/11/2019 17:12	16/11/2019 12:31	16/11/2019 17:12	4,67	1	4,67	CHI
201911183194	SAO JOAO D ALIANCA	JL12324133	SAO JOAO D ALIANCA	16/11/2019 12:36	16/11/2019 18:01	16/11/2019 12:36	16/11/2019 18:01	5,41	5	27,07	CHI
201911183209	LUZIANIA	LZ12013828	VIANOPOLIS	16/11/2019 12:28	17/11/2019 12:51	16/11/2019 12:28	16/11/2019 20:54	8,44	3	25,32	CHI
201911183209	LUZIANIA	LZ12079208LD	VIANOPOLIS	16/11/2019 12:28	17/11/2019 12:51	16/11/2019 12:28	17/11/2019 12:51	24,39	4	97,56	CHI
201911183211	GOIANIA	GN12001654	GOIANIA LESTE S3	16/11/2019 12:42	16/11/2019 15:55	16/11/2019 12:42	16/11/2019 15:55	3,21	14	44,92	CHI
201911183213	GOIANIA	GN11251626	ATLANTICO S3	16/11/2019 12:34	16/11/2019 15:54	16/11/2019 12:34	16/11/2019 15:54	3,33	73	242,87	CHI

201911183217	AGUA FRIA DE GOIAS	TL11211661	SAO JOAO D ALIANCA	16/11/2019 12:44	16/11/2019 13:50	16/11/2019 12:44	16/11/2019 13:50	1,09	85	92,44	CHI
201911183221	APARECIDA DE GOIANIA	15416902	REAL S1	16/11/2019 12:45	16/11/2019 16:02	16/11/2019 12:45	16/11/2019 16:02	3,29	1	3,29	CHI
201911183234	ANAPOLIS	10025578497	ANAPOLIS UNIVERSITARIO S1	16/11/2019 12:47	16/11/2019 18:10	16/11/2019 12:47	16/11/2019 18:10	5,38	1	5,38	CHI
201911183238	BELA VISTA DE GOIAS	240042542	BELA VISTA S1	16/11/2019 12:47	16/11/2019 14:31	16/11/2019 12:47	16/11/2019 14:31	1,72	1	1,72	CHI
201911183240	ANAPOLIS	AN12000959	ANAPOLIS UNIVERSITARIO S2	16/11/2019 11:29	16/11/2019 14:02	16/11/2019 11:29	16/11/2019 14:02	2,55	19	48,36	CHI
201911183242	MOSSAMEDES	MD12299584	ITABERAI S2	16/11/2019 12:47	16/11/2019 15:48	16/11/2019 12:47	16/11/2019 15:48	3,02	12	36,20	CHI
201911183245	URUACU	640132224	URUACU	16/11/2019 12:50	16/11/2019 19:48	16/11/2019 12:50	16/11/2019 19:48	6,97	1	6,97	CHI
201911183255	SAO LUIS DE MONTES BELOS	SL11159055	SAO LUIZ DOS MONTES BELOS	16/11/2019 12:23	16/11/2019 15:40	16/11/2019 12:23	16/11/2019 15:40	3,29	153	503,20	CHI
201911183256	ITAJA	IJ21160696	ITAJA S2	16/11/2019 12:53	16/11/2019 17:14	16/11/2019 12:53	16/11/2019 17:14	4,34	1	4,34	CHI
201911183257	AGUAS LINDAS DE GOIAS	4830210450	AGUAS LINDAS DE GOIAS S1	16/11/2019 12:53	16/11/2019 14:28	16/11/2019 12:53	16/11/2019 14:28	1,57	1	1,57	CHI
201911183265	SILVANIA	SV21197129	DAIA S2	16/11/2019 12:55	16/11/2019 15:26	16/11/2019 12:55	16/11/2019 15:26	2,52	1	2,52	CHI
201911183275	RIO VERDE	RV21412028	CABRIUVA S2	16/11/2019 12:55	16/11/2019 18:10	16/11/2019 12:55	16/11/2019 18:10	5,24	1	5,24	CHI
201911183284	CALDAS NOVAS	760275877	SERRA DE CALDAS	15/11/2019 19:32	19/11/2019 16:38	15/11/2019 19:32	19/11/2019 16:38	93,10	1	93,10	CHI
201911183291	CASTELANDIA	DM12246722	RIO DOS BOIS	16/11/2019 06:12	16/11/2019 13:00	16/11/2019 06:12	16/11/2019 13:00	6,81	5	34,07	CHI
201911183293	GOIANIA	GN21027628	XAVANTES	16/11/2019 13:01	16/11/2019 14:33	16/11/2019 13:01	16/11/2019 14:33	1,53	1	1,53	CHI
201911183295	NAZARIO	NZ21000024	ANICUNS	16/11/2019 13:02	16/11/2019 15:50	16/11/2019 13:02	16/11/2019 15:50	2,80	1	2,80	CHI
201911183296	CABECEIRAS	CW11206145	ITUIQUIRA	16/11/2019 08:30	16/11/2019 16:08	16/11/2019 08:30	16/11/2019 16:08	7,63	122	930,32	CHI
201911183297	RUBIATABA	RB21241488	RUBIATABA	16/11/2019 13:02	17/11/2019 04:56	16/11/2019 13:02	17/11/2019 04:56	15,89	4	63,56	CHI
201911183298	BALIZA	BH12064258	BOM JARDIM	16/11/2019 13:02	16/11/2019 18:29	16/11/2019 13:02	16/11/2019 18:29	5,44	11	59,82	CHI
201911183300	GOIANESIA	550127460	GOIANESIA S2	16/11/2019 13:04	16/11/2019 17:57	16/11/2019 13:04	16/11/2019 17:57	4,88	1	4,88	CHI
201911183310	IVOLANDIA	PU12090442	MONTIVIDIU T	17/11/2019 10:12	17/11/2019 11:38	17/11/2019 10:12	17/11/2019 11:38	1,44	22	31,58	CHI
201911183310	PARAUNA	PU12090442	MONTIVIDIU T	17/11/2019 10:12	17/11/2019 11:38	17/11/2019 10:12	17/11/2019 11:38	1,44	48	68,91	CHI
201911183315	BRAZABRANTES	BR12013941	INHUMAS S2	16/11/2019 12:16	16/11/2019 15:37	16/11/2019 12:16	16/11/2019 14:45	2,48	113	280,37	CHI
201911183315	BRAZABRANTES	BR12013959	INHUMAS S2	16/11/2019 12:16	16/11/2019 15:37	16/11/2019 12:16	16/11/2019 15:37	3,34	108	360,78	CHI
201911183316	RIO VERDE	630588740	RIO VERDE S1	16/11/2019 13:08	16/11/2019 16:37	16/11/2019 13:08	16/11/2019 16:37	3,48	1	3,48	CHI
201911183317	CACU	CC12027354	CACHOEIRA ALTA	16/11/2019 12:04	16/11/2019 18:30	16/11/2019 12:04	16/11/2019 18:30	6,43	5	32,15	CHI
201911183320	GOIANIA	11047331	REAL S2	16/11/2019 13:10	16/11/2019 18:40	16/11/2019 13:10	16/11/2019 18:40	5,50	1	5,50	CHI
201911183322	BARRO ALTO	GE21129088	GOIANESIA S2	16/11/2019 13:10	16/11/2019 20:21	16/11/2019 13:10	16/11/2019 20:21	7,18	1	7,18	CHI
201911183323	MINACU	IH21242189	MINACU	16/11/2019 13:10	16/11/2019 17:36	16/11/2019 13:10	16/11/2019 17:36	4,43	1	4,43	CHI
201911183324	TERESINA DE GOIAS	TE11131902	FLORES DE GOIAS	16/11/2019 13:11	17/11/2019 12:56	16/11/2019 13:11	17/11/2019 12:56	23,75	117	2778,20	CHI
201911183325	NIQUELANDIA	NQ21330260	NIQUELANDIA SUBTRANSMISSAO	16/11/2019 13:12	16/11/2019 21:55	16/11/2019 13:12	16/11/2019 21:55	8,72	1	8,72	CHI
201911183347	ALTO PARAISO DE GOIAS	BF21244615	SAO JOAO D ALIANCA	16/11/2019 13:20	16/11/2019 15:14	16/11/2019 13:20	16/11/2019 15:14	1,89	2	3,78	CHI
201911183349	VARJAO	10027759146	GUAPO S2	16/11/2019 13:20	16/11/2019 17:00	16/11/2019 13:20	16/11/2019 17:00	3,65	1	3,65	CHI

201911183354	ARAGOIANIA	AO32000019	GUAPO S2	16/11/2019 13:21	16/11/2019 16:31	16/11/2019 13:21	16/11/2019 16:31	3,16	15	47,37	CHI
201911183356	ALTO PARAISO DE GOIAS	JL12257606	SAO JOAO D ALIANCA	16/11/2019 13:22	16/11/2019 18:01	16/11/2019 13:22	16/11/2019 18:01	4,65	2	9,30	CHI
201911183356	SAO JOAO D ALIANCA	JL12257606	SAO JOAO D ALIANCA	16/11/2019 13:22	16/11/2019 18:01	16/11/2019 13:22	16/11/2019 18:01	4,65	72	334,66	CHI
201911183369	MONTIVIDIU	MV12214244	MONTIVIDIU T	16/11/2019 09:57	16/11/2019 17:57	16/11/2019 09:57	16/11/2019 17:57	8,00	15	120,00	CHI
201911183369	RIO VERDE	MV12214244	MONTIVIDIU T	16/11/2019 09:57	16/11/2019 17:57	16/11/2019 09:57	16/11/2019 17:57	8,00	2	16,00	CHI
201911183372	SERRANOPOLIS	SX12216731	JATAI S1	16/11/2019 12:37	16/11/2019 23:40	16/11/2019 12:37	16/11/2019 23:40	11,05	75	828,44	CHI
201911183380	BELA VISTA DE GOIAS	BV31197966	BELA VISTA S1	16/11/2019 13:28	16/11/2019 14:52	16/11/2019 13:28	16/11/2019 14:52	1,39	1	1,39	CHI
201911183383	PALMEIRAS DE GOIAS	PL12391507	PALMEIRAS	16/11/2019 11:34	16/11/2019 14:53	16/11/2019 11:34	16/11/2019 14:53	3,31	7	23,19	CHI
201911183384	PALMEIRAS DE GOIAS	PL21086235	PALMEIRAS	16/11/2019 13:29	16/11/2019 14:13	16/11/2019 13:29	16/11/2019 14:13	0,73	1	0,73	CHI
201911183386	GOIANIA	10857849	GOIANIA LESTE S1	16/11/2019 13:30	16/11/2019 16:15	16/11/2019 13:30	16/11/2019 16:15	2,74	1	2,74	CHI
201911183389	CORUMBAIBA	IP12152359	IPAMERI	16/11/2019 13:30	17/11/2019 08:18	16/11/2019 13:30	17/11/2019 08:18	18,79	8	150,29	CHI
201911183389	IPAMERI	IP12152359	IPAMERI	16/11/2019 13:30	17/11/2019 08:18	16/11/2019 13:30	17/11/2019 08:18	18,79	7	131,50	CHI
201911183391	CATALAO	IO12363431	CATALAO S1	16/11/2019 13:30	18/11/2019 13:26	16/11/2019 13:30	18/11/2019 13:26	47,92	1	47,92	CHI
201911183391	DAVINOPOLIS	IO12363431	CATALAO S1	16/11/2019 13:30	18/11/2019 13:26	16/11/2019 13:30	18/11/2019 13:26	47,92	15	718,78	CHI
201911183391	OUVIDOR	IO12363431	CATALAO S1	16/11/2019 13:30	18/11/2019 13:26	16/11/2019 13:30	18/11/2019 13:26	47,92	7	335,43	CHI
201911183393	ALTO PARAISO DE GOIAS	BF12349123	FLORES DE GOIAS	16/11/2019 13:23	16/11/2019 15:08	16/11/2019 13:23	16/11/2019 15:08	1,74	4	6,96	CHI
201911183393	SAO JOAO D ALIANCA	BF12349123	FLORES DE GOIAS	16/11/2019 13:23	16/11/2019 15:08	16/11/2019 13:23	16/11/2019 15:08	1,74	3	5,22	CHI
201911183398	MAIRIPOTABA	MI21027601	PONTALINA	16/11/2019 13:32	16/11/2019 15:10	16/11/2019 13:32	16/11/2019 15:10	1,62	1	1,62	CHI
201911183399	ABADIANIA	AA21157317	ANAPOLIS UNIVERSITARIO S1	16/11/2019 13:33	16/11/2019 15:58	16/11/2019 13:33	16/11/2019 15:58	2,41	1	2,41	CHI
201911183400	GOIANIA	15955424	ATLANTICO S2	16/11/2019 13:34	16/11/2019 15:03	16/11/2019 13:34	16/11/2019 15:03	1,48	1	1,48	CHI
201911183401	GOIANIA	12271202	GOYA S1	16/11/2019 13:34	16/11/2019 16:39	16/11/2019 13:34	16/11/2019 16:39	3,08	1	3,08	CHI
201911183403	OURO VERDE DE GOIAS	OV12326130	NEROPOLIS S2	16/11/2019 13:34	16/11/2019 16:34	16/11/2019 13:34	16/11/2019 16:34	2,99	18	53,74	CHI
201911183404	CRIXAS	CX12221633	RUBIATABA	16/11/2019 13:35	16/11/2019 21:27	16/11/2019 13:35	16/11/2019 21:27	7,86	132	1037,70	CHI
201911183404	NOVA CRIXAS	CX12221633	RUBIATABA	16/11/2019 13:35	16/11/2019 21:27	16/11/2019 13:35	16/11/2019 21:27	7,86	1	7,86	CHI
201911183405	GOIANIA	10014491182	MEIA PONTE	16/11/2019 13:35	16/11/2019 18:34	16/11/2019 13:35	16/11/2019 18:34	4,97	1	4,97	CHI
201911183407	MIMOSO DE GOIAS	MJ12071960	PADRE BERNARDO	16/11/2019 12:44	16/11/2019 18:19	16/11/2019 12:44	16/11/2019 18:19	5,57	158	879,93	CHI
201911183407	NIQUELANDIA	MJ12071960	PADRE BERNARDO	16/11/2019 12:44	16/11/2019 18:19	16/11/2019 12:44	16/11/2019 18:19	5,57	1	5,57	CHI
201911183424	CAMPINORTE	MQ21338257	MARA ROSA	16/11/2019 13:39	16/11/2019 21:47	16/11/2019 13:39	16/11/2019 21:47	8,13	1	8,13	CHI
201911183430	OURO VERDE DE GOIAS	10017293250	NEROPOLIS S2	16/11/2019 13:39	16/11/2019 22:41	16/11/2019 13:39	16/11/2019 22:41	9,03	1	9,03	CHI
201911183435	CRISTALINA	KR21245993	CRISTALINA S2	16/11/2019 13:41	16/11/2019 15:16	16/11/2019 13:41	16/11/2019 15:16	1,58	1	1,58	CHI
201911183436	INHUMAS	AR12247240	ARACU	16/11/2019 13:04	16/11/2019 16:00	16/11/2019 13:04	16/11/2019 16:00	2,92	8	23,39	CHI
201911183438	RIO VERDE	RV12384663	RIO VERDE S1	16/11/2019 13:41	17/11/2019 09:51	16/11/2019 13:41	17/11/2019 09:51	20,15	14	282,12	CHI
201911183441	CRISTALINA	KR21163119	CRISTALINA S2	16/11/2019 13:42	16/11/2019 16:46	16/11/2019 13:42	16/11/2019 16:46	3,06	1	3,06	CHI

201911183445	ITARUMA	IM21150299	CACHOEIRA ALTA	16/11/2019 13:44	16/11/2019 19:42	16/11/2019 13:44	16/11/2019 19:42	5,95	1	5,95	CHI
201911183450	ITABERAI	IB12016899	INHUMAS S1	16/11/2019 13:36	16/11/2019 18:15	16/11/2019 13:36	16/11/2019 18:15	4,64	30	139,23	CHI
201911183455	FAZENDA NOVA	FN12354616LD	BRITANIA	16/11/2019 11:53	20/11/2019 05:47	16/11/2019 11:53	16/11/2019 21:00	9,12	42	383,10	CHI
201911183455	JUSSARA	FN12354616LD	BRITANIA	16/11/2019 11:53	20/11/2019 05:47	16/11/2019 11:53	16/11/2019 21:00	9,12	11	100,34	CHI
201911183455	FAZENDA NOVA	FN12354616LD	BRITANIA	16/11/2019 11:53	20/11/2019 05:47	16/11/2019 21:01	17/11/2019 20:08	23,12	2	46,25	CHI
201911183455	FAZENDA NOVA	FN12354616LD	BRITANIA	16/11/2019 11:53	20/11/2019 05:47	18/11/2019 09:13	18/11/2019 10:36	1,38	2	2,76	CHI
201911183455	FAZENDA NOVA	FN13362429	BRITANIA	16/11/2019 11:53	20/11/2019 05:47	16/11/2019 21:01	18/11/2019 13:46	40,76	41	1671,23	CHI
201911183455	JUSSARA	FN13362429	BRITANIA	16/11/2019 11:53	20/11/2019 05:47	16/11/2019 21:01	18/11/2019 13:46	40,76	11	448,38	CHI
201911183455	FAZENDA NOVA	FN12354616LD	BRITANIA	16/11/2019 11:53	20/11/2019 05:47	18/11/2019 16:03	18/11/2019 16:36	0,56	2	1,11	CHI
201911183455	FAZENDA NOVA	FN13362429	BRITANIA	16/11/2019 11:53	20/11/2019 05:47	18/11/2019 13:47	18/11/2019 23:43	9,95	34	338,27	CHI
201911183455	JUSSARA	FN13362429	BRITANIA	16/11/2019 11:53	20/11/2019 05:47	18/11/2019 13:47	18/11/2019 23:43	9,95	11	109,44	CHI
201911183455	FAZENDA NOVA	FN12354616LD	BRITANIA	16/11/2019 11:53	20/11/2019 05:47	19/11/2019 00:17	19/11/2019 01:28	1,19	2	2,38	CHI
201911183455	FAZENDA NOVA	FN13362429	BRITANIA	16/11/2019 11:53	20/11/2019 05:47	18/11/2019 23:51	19/11/2019 17:30	17,65	33	582,60	CHI
201911183455	JUSSARA	FN13362429	BRITANIA	16/11/2019 11:53	20/11/2019 05:47	18/11/2019 23:51	19/11/2019 17:30	17,65	11	194,20	CHI
201911183455	FAZENDA NOVA	FN13362429	BRITANIA	16/11/2019 11:53	20/11/2019 05:47	18/11/2019 13:47	20/11/2019 05:47	40,01	7	280,06	CHI
201911183455	FAZENDA NOVA	FN13362429	BRITANIA	16/11/2019 11:53	20/11/2019 05:47	20/11/2019 03:49	20/11/2019 05:47	1,97	33	64,99	CHI
201911183455	JUSSARA	FN13362429	BRITANIA	16/11/2019 11:53	20/11/2019 05:47	20/11/2019 03:49	20/11/2019 05:47	1,97	11	21,66	CHI
201911183457	GOIANIRA	10009248534	GOIANIRA	16/11/2019 13:49	16/11/2019 15:48	16/11/2019 13:49	16/11/2019 15:48	1,98	1	1,98	CHI
201911183459	COCALZINHO DE GOIAS	1200001701	COCALZINHO	16/11/2019 13:49	17/11/2019 11:54	16/11/2019 13:49	17/11/2019 11:54	22,07	1	22,07	CHI
201911183460	VICENTINOPOLIS	VI21286298	VICENTINOPOLIS	16/11/2019 13:49	18/11/2019 08:05	16/11/2019 13:49	18/11/2019 08:05	42,25	1	42,25	CHI
201911183604	PORANGATU	PO12253874	PORANGATU	16/11/2019 13:52	16/11/2019 17:31	16/11/2019 13:52	16/11/2019 17:31	3,65	5	18,24	CHI
201911183702	GOIANIA	16083568	AEROPORTO S1	16/11/2019 13:52	16/11/2019 17:42	16/11/2019 13:52	16/11/2019 17:42	3,83	1	3,83	CHI
201911183705	ITABERAI	IB21300327	ITABERAI S2	16/11/2019 13:52	17/11/2019 20:21	16/11/2019 13:52	17/11/2019 20:21	30,47	1	30,47	CHI
201911183709	TERESINA DE GOIAS	TE11257467	FLORES DE GOIAS	16/11/2019 13:16	17/11/2019 09:31	16/11/2019 13:16	17/11/2019 09:31	20,24	65	1315,80	CHI
201911183710	PALMEIRAS DE GOIAS	590064332	PALMEIRAS	16/11/2019 13:54	16/11/2019 15:39	16/11/2019 13:54	16/11/2019 15:39	1,74	1	1,74	CHI
201911183713	MINEIROS	MY21358859	PARQUE DAS EMAS	16/11/2019 13:55	16/11/2019 15:31	16/11/2019 13:55	16/11/2019 15:31	1,59	1	1,59	CHI
201911183721	VALPARAISO DE GOIAS	VA11344818	PACAEMBU S1	16/11/2019 13:37	16/11/2019 16:43	16/11/2019 13:37	16/11/2019 16:43	3,09	60	185,20	CHI
201911183722	MINACU	IH12171869	MINACU	16/11/2019 13:38	16/11/2019 16:11	16/11/2019 13:38	16/11/2019 16:11	2,53	74	187,49	CHI
201911183726	SANTA CRUZ DE GOIAS	BC12110027RE	PIRES DO RIO S2	16/11/2019 11:28	17/11/2019 00:12	16/11/2019 11:28	17/11/2019 00:12	12,72	27	343,53	CHI
201911183727	GOIANIA	10585722	ATLANTICO S2	16/11/2019 13:57	16/11/2019 16:43	16/11/2019 13:57	16/11/2019 16:43	2,77	1	2,77	CHI
201911183729	APARECIDA DE GOIANIA	200211407	INDEPENDENCIA S2	16/11/2019 13:58	17/11/2019 07:46	16/11/2019 13:58	17/11/2019 07:46	17,81	1	17,81	CHI
201911183740	ITABERAI	IB12063192	ITABERAI S1	16/11/2019 09:40	16/11/2019 17:32	16/11/2019 09:40	16/11/2019 17:32	7,86	4	31,43	CHI
201911183744	BOM JARDIM DE GOIAS	1880006471	BOM JARDIM	16/11/2019 14:00	17/11/2019 01:09	16/11/2019 14:00	17/11/2019 01:09	11,14	1	11,14	CHI

201911183746	RIO VERDE	RV11214210	CABRIUVA S1	16/11/2019 14:01	16/11/2019 19:40	16/11/2019 14:01	16/11/2019 19:40	5,64	266	1500,24	CHI
201911183749	FORMOSA	2920013010	ITUIQUIRA	16/11/2019 14:02	18/11/2019 15:59	16/11/2019 14:02	18/11/2019 15:59	49,95	1	49,95	CHI
201911183754	TRINDADE	40263988	TRINDADE	16/11/2019 14:02	16/11/2019 19:30	16/11/2019 14:02	16/11/2019 19:30	5,45	1	5,45	CHI
201911183757	AMARALINA	LC12135635	NOVA CRIXAS	16/11/2019 14:04	16/11/2019 22:35	16/11/2019 14:04	16/11/2019 22:35	8,52	1	8,52	CHI
201911183757	MARA ROSA	LC12135635	NOVA CRIXAS	16/11/2019 14:04	16/11/2019 22:35	16/11/2019 14:04	16/11/2019 22:35	8,52	6	51,10	CHI
201911183780	MOZARLANDIA	MZ12132889	MOZARLANDIA	16/11/2019 14:10	19/11/2019 14:58	16/11/2019 14:10	19/11/2019 14:58	72,80	1	72,80	CHI
201911183783	AGUAS LINDAS DE GOIAS	10007517660	AGUAS LINDAS DE GOIAS S1	16/11/2019 14:11	16/11/2019 15:32	16/11/2019 14:11	16/11/2019 15:32	1,35	1	1,35	CHI
201911183788	SAO JOAO D ALIANCA	JL21286370	FLORES DE GOIAS	16/11/2019 14:13	17/11/2019 20:01	16/11/2019 14:13	17/11/2019 20:01	29,80	1	29,80	CHI
201911183790	CORUMBA DE GOIAS	CB21129442	CORUMBA	16/11/2019 14:13	17/11/2019 09:19	16/11/2019 14:13	17/11/2019 09:19	19,10	1	19,10	CHI
201911183791	NOVA ROMA	5270000500	IACIARA S2	16/11/2019 14:13	16/11/2019 16:47	16/11/2019 14:13	16/11/2019 16:47	2,56	1	2,56	CHI
201911183792	LUZIANIA	LZ21183951	RIO VERMELHO	16/11/2019 14:13	16/11/2019 15:49	16/11/2019 14:13	16/11/2019 15:49	1,59	1	1,59	CHI
201911183793	GOIANIRA	10007910922	MEIA PONTE	16/11/2019 14:14	16/11/2019 18:40	16/11/2019 14:14	16/11/2019 18:40	4,43	1	4,43	CHI
201911183797	SERRANOPOLIS	SX21287495	JATAI S1	16/11/2019 14:15	17/11/2019 12:41	16/11/2019 14:15	17/11/2019 12:41	22,43	1	22,43	CHI
201911183798	IPAMERI	580028653	IPAMERI	16/11/2019 14:15	16/11/2019 23:02	16/11/2019 14:15	16/11/2019 23:02	8,77	1	8,77	CHI
201911183805	MORRINHOS	MR21231869	MORRINHOS	16/11/2019 14:16	17/11/2019 17:01	16/11/2019 14:16	17/11/2019 17:01	26,73	1	26,73	CHI
201911183809	RIO VERDE	RV12249020	CABRIUVA S2	16/11/2019 14:10	16/11/2019 14:50	16/11/2019 14:10	16/11/2019 14:50	0,67	2	1,34	CHI
201911183815	JARAGUA	10022037908	JARAGUA	16/11/2019 14:19	17/11/2019 09:11	16/11/2019 14:19	17/11/2019 09:11	18,86	1	18,86	CHI
201911183824	AGUAS LINDAS DE GOIAS	4830469160	AGUAS LINDAS DE GOIAS S1	16/11/2019 14:20	16/11/2019 16:31	16/11/2019 14:20	16/11/2019 16:31	2,17	1	2,17	CHI
201911183825	PADRE BERNARDO	PB12290557	PADRE BERNARDO	16/11/2019 06:09	16/11/2019 16:30	16/11/2019 06:09	16/11/2019 16:30	10,34	44	454,96	CHI
201911183829	ISRAELANDIA	IS21329875	IPORA	16/11/2019 14:22	16/11/2019 20:21	16/11/2019 14:22	16/11/2019 20:21	5,97	1	5,97	CHI
201911183830	BELA VISTA DE GOIAS	BV21063015	BELA VISTA S1	16/11/2019 14:22	16/11/2019 15:29	16/11/2019 14:22	16/11/2019 15:29	1,10	1	1,10	CHI
201911183834	BONOPOLIS	BX21083866	SAO MIGUEL DO ARAGUAIA	16/11/2019 14:23	16/11/2019 17:50	16/11/2019 14:23	16/11/2019 17:50	3,45	1	3,45	CHI
201911183835	PALESTINA DE GOIAS	10006589667	PALESTINA	16/11/2019 14:23	17/11/2019 12:58	16/11/2019 14:23	17/11/2019 12:58	22,58	1	22,58	CHI
201911183842	NOVO PLANALTO	TA12192342	NOVO PLANALTO	16/11/2019 14:25	16/11/2019 16:00	16/11/2019 14:25	16/11/2019 16:00	1,58	1	1,58	CHI
201911183842	PORANGATU	TA12192342	NOVO PLANALTO	16/11/2019 14:25	16/11/2019 16:00	16/11/2019 14:25	16/11/2019 16:00	1,58	9	14,19	CHI
201911183850	QUIRINOPOLIS	QI21143145	QUIRINOPOLIS	16/11/2019 14:26	17/11/2019 07:20	16/11/2019 14:26	17/11/2019 07:20	16,89	1	16,89	CHI
201911183857	GOIANIA	GN11212451	CAMPINAS S2	16/11/2019 14:12	16/11/2019 16:21	16/11/2019 14:12	16/11/2019 16:21	2,15	115	247,19	CHI
201911183864	GOIANIA	10055496	CAMPINAS S1	16/11/2019 14:31	16/11/2019 17:03	16/11/2019 14:31	16/11/2019 17:03	2,53	1	2,53	CHI
201911183866	SAO LUIS DE MONTES BELOS	500070325	SAO LUIZ DOS MONTES BELOS	16/11/2019 14:31	16/11/2019 16:34	16/11/2019 14:31	16/11/2019 16:34	2,05	1	2,05	CHI
201911183868	GOIANIA	10881384	GOIANIA LESTE S2	16/11/2019 14:32	16/11/2019 17:30	16/11/2019 14:32	16/11/2019 17:30	2,96	1	2,96	CHI
201911183877	JATAI	RV12279568	CABRIUVA S1	16/11/2019 12:20	16/11/2019 18:00	16/11/2019 12:20	16/11/2019 18:00	5,66	2	11,32	CHI
201911183877	RIO VERDE	RV12279568	CABRIUVA S1	16/11/2019 12:20	16/11/2019 18:00	16/11/2019 12:20	16/11/2019 18:00	5,66	5	28,30	CHI
201911183880	CATALAO	1990277175	CATALAO S2	16/11/2019 14:35	17/11/2019 07:15	16/11/2019 14:35	17/11/2019 07:15	16,67	1	16,67	CHI

201911183881	NOVA CRIXAS	8570024814	MOZARLANDIA	16/11/2019 18:34	17/11/2019 21:35	16/11/2019 18:34	17/11/2019 21:35	27,01	1	27,01	CHI
201911183882	NOVA CRIXAS	8570002375	NOVA CRIXAS	16/11/2019 14:35	16/11/2019 17:50	16/11/2019 14:35	16/11/2019 17:50	3,25	1	3,25	CHI
201911183883	SANTO ANTONIO DE GOIAS	10020232070	NEROPOLIS S1	16/11/2019 14:35	16/11/2019 16:47	16/11/2019 14:35	16/11/2019 16:47	2,19	1	2,19	CHI
201911183885	PLANALTINA	2960035155	PLANALTINA	16/11/2019 14:36	16/11/2019 18:27	16/11/2019 14:36	16/11/2019 18:27	3,84	1	3,84	CHI
201911183886	CABECEIRAS	CW21108833	ITIQUEIRA	16/11/2019 14:36	17/11/2019 10:47	16/11/2019 14:36	17/11/2019 10:47	20,18	1	20,18	CHI
201911183892	URUACU	UR21375636	URUACU	16/11/2019 14:37	16/11/2019 17:44	16/11/2019 14:37	16/11/2019 17:44	3,12	1	3,12	CHI
201911183893	NIQUELANDIA	NQ21312190	NIQUELANDIA SUBTRANSMISSAO	16/11/2019 14:37	17/11/2019 14:02	16/11/2019 14:37	17/11/2019 14:02	23,41	1	23,41	CHI
201911183899	URUACU	UR21333914	URUACU	16/11/2019 14:37	16/11/2019 20:35	16/11/2019 14:37	16/11/2019 20:35	5,95	1	5,95	CHI
201911183904	NOVA ROMA	ND11322706	IACIARA S2	16/11/2019 14:38	16/11/2019 18:10	16/11/2019 14:38	16/11/2019 18:10	3,52	53	186,75	CHI
201911183905	FAINA	FC21072183	GOIAS	16/11/2019 14:38	18/11/2019 11:45	16/11/2019 14:38	18/11/2019 11:45	45,11	1	45,11	CHI
201911183913	PLANALTINA	PI21125285	SAO JOAO D ALIANCA	16/11/2019 14:41	16/11/2019 19:08	16/11/2019 14:41	16/11/2019 19:08	4,45	1	4,45	CHI
201911183914	SANTA BARBARA DE GOIAS	TR12062862	TRINDADE	16/11/2019 12:46	16/11/2019 16:42	16/11/2019 12:46	16/11/2019 16:42	3,93	10	39,32	CHI
201911183914	TRINDADE	TR12062862	TRINDADE	16/11/2019 12:46	16/11/2019 16:42	16/11/2019 12:46	16/11/2019 16:42	3,93	20	78,64	CHI
201911183915	NOVA ROMA	ND12256420	IACIARA S2	16/11/2019 14:41	16/11/2019 19:19	16/11/2019 14:41	16/11/2019 19:19	4,62	28	129,38	CHI
201911183919	NIQUELANDIA	NQ21281648	BARRO ALTO	16/11/2019 14:42	17/11/2019 19:49	16/11/2019 14:42	17/11/2019 19:49	29,11	1	29,11	CHI
201911183923	APARECIDA DE GOIANIA	14836592	ANHANGUERA	16/11/2019 14:42	16/11/2019 18:34	16/11/2019 14:42	16/11/2019 18:34	3,85	1	3,85	CHI
201911183925	LUZIANIA	10010825060	MARAJOARA	16/11/2019 14:43	16/11/2019 16:23	16/11/2019 14:43	16/11/2019 16:23	1,66	1	1,66	CHI
201911183939	APARECIDA DE GOIANIA	10018975907	INDEPENDENCIA S2	16/11/2019 14:45	16/11/2019 17:47	16/11/2019 14:45	16/11/2019 17:47	3,02	1	3,02	CHI
201911183943	CRIXAS	CX21135650	SANTA TEREZINHA	16/11/2019 14:46	16/11/2019 22:15	16/11/2019 14:46	16/11/2019 22:15	7,47	1	7,47	CHI
201911183945	JOVIANIA	JV12394181	GOIATUBA S1	16/11/2019 08:14	17/11/2019 10:35	16/11/2019 08:14	17/11/2019 10:35	26,35	2	52,71	CHI
201911183949	GOUVELANDIA	QI12000340	QUIRINOPOLIS	16/11/2019 14:48	16/11/2019 17:47	16/11/2019 14:48	16/11/2019 17:47	2,98	16	47,67	CHI
201911183950	ITUMBIARA	IT11000093	ITUMBIARA NOVA	16/11/2019 12:54	16/11/2019 18:12	16/11/2019 12:54	16/11/2019 18:12	5,30	134	709,72	CHI
201911183951	MORRINHOS	MR12249892	VILA CORUMBA	16/11/2019 14:49	18/11/2019 14:18	16/11/2019 14:49	18/11/2019 14:18	47,48	5	237,40	CHI
201911183959	COCALZINHO DE GOIAS	ZN12043653	COCALZINHO	16/11/2019 10:18	17/11/2019 10:47	16/11/2019 10:18	17/11/2019 10:47	24,48	11	269,30	CHI
201911183968	CAIAPONIA	CP12207988	CAIAPONIA	16/11/2019 08:14	16/11/2019 18:03	16/11/2019 08:14	16/11/2019 18:03	9,81	2	19,62	CHI
201911183992	LUZIANIA	LZ12390041	CRISTALINA S2	16/11/2019 14:59	16/11/2019 16:49	16/11/2019 14:59	16/11/2019 16:49	1,82	1	1,82	CHI
201911183993	GOIANIA	10373111	CARAJAS S2	16/11/2019 14:59	16/11/2019 17:44	16/11/2019 14:59	16/11/2019 17:44	2,73	1	2,73	CHI
201911183996	RIO VERDE	RV12200052	MONTIVIDIU T	16/11/2019 15:01	17/11/2019 21:42	16/11/2019 15:01	17/11/2019 21:42	30,68	2	61,36	CHI
201911184001	ANAPOLIS	10023070305	JUNDIAI S1	16/11/2019 15:02	17/11/2019 12:18	16/11/2019 15:02	17/11/2019 12:18	21,27	1	21,27	CHI
201911184003	LUZIANIA	LZ12261082	VIANOPOLIS	16/11/2019 15:02	17/11/2019 00:38	16/11/2019 15:02	17/11/2019 00:38	9,59	3	28,76	CHI
201911184015	CABECEIRAS	CW12218489	ITIQUEIRA	16/11/2019 15:06	17/11/2019 01:04	16/11/2019 15:06	17/11/2019 01:04	9,95	9	89,59	CHI
201911184016	CATALAO	1990213161	CATALAO S2	16/11/2019 15:06	17/11/2019 18:26	16/11/2019 15:06	17/11/2019 18:26	27,32	1	27,32	CHI
201911184031	SITIO D ABADIA	SI12247434	IACIARA S2	16/11/2019 15:11	16/11/2019 18:04	16/11/2019 15:11	16/11/2019 18:04	2,88	5	14,38	CHI

201911184032	GOIANAPOLIS	GP21188813	DAIA S2	16/11/2019 15:11	17/11/2019 07:47	16/11/2019 15:11	17/11/2019 07:47	16,59	3	49,78	CHI
201911184034	CACU	CC21346010	CACHOEIRA ALTA	16/11/2019 15:12	17/11/2019 09:29	16/11/2019 15:12	17/11/2019 09:29	18,28	1	18,28	CHI
201911184047	PIRACANJUBA	PJ21284026	ROCHEDO	16/11/2019 15:14	18/11/2019 11:49	16/11/2019 15:14	18/11/2019 11:49	44,58	6	267,45	CHI
201911184052	FORMOSA	FA12404372	ITIQUEIRA	16/11/2019 09:25	16/11/2019 22:50	16/11/2019 09:25	16/11/2019 22:50	13,41	167	2238,77	CHI
201911184054	JARAGUA	70142762	JARAGUA	16/11/2019 15:16	17/11/2019 08:48	16/11/2019 15:16	17/11/2019 08:48	17,53	1	17,53	CHI
201911184055	SILVANIA	SV12400022	VIANOPOLIS	16/11/2019 15:16	16/11/2019 22:43	16/11/2019 15:16	16/11/2019 22:43	7,44	27	200,92	CHI
201911184057	LUZIANIA	LZ12149807	MARAJOARA	16/11/2019 00:06	16/11/2019 18:16	16/11/2019 00:06	16/11/2019 18:16	18,16	19	344,96	CHI
201911184064	APARECIDA DE GOIANIA	10009798801	REAL S1	16/11/2019 15:17	16/11/2019 16:43	16/11/2019 15:17	16/11/2019 16:43	1,42	1	1,42	CHI
201911184067	JUSSARA	JR12090187	JUSSARA	16/11/2019 14:04	16/11/2019 22:16	16/11/2019 14:04	16/11/2019 22:16	8,19	3	24,58	CHI
201911184070	BONOPOLIS	BX21128379	SAO MIGUEL DO ARAGUAIA	16/11/2019 15:19	16/11/2019 18:57	16/11/2019 15:19	16/11/2019 18:57	3,62	1	3,62	CHI
201911184073	JESUPOLIS	SF12066019	SAO FRANCISCO DE GOIAS	16/11/2019 15:03	16/11/2019 18:42	16/11/2019 15:03	16/11/2019 18:42	3,64	12	43,65	CHI
201911184073	SAO FRANCISCO DE GOIAS	SF12066019	SAO FRANCISCO DE GOIAS	16/11/2019 15:03	16/11/2019 18:42	16/11/2019 15:03	16/11/2019 18:42	3,64	10	36,38	CHI
201911184074	FLORES DE GOIAS	FB12211535	IACIARA S2	16/11/2019 15:21	16/11/2019 17:15	16/11/2019 15:21	16/11/2019 17:15	1,90	53	100,60	CHI
201911184076	GOIANIRA	10006069400	MEIA PONTE	16/11/2019 15:21	16/11/2019 20:37	16/11/2019 15:21	16/11/2019 20:37	5,27	1	5,27	CHI
201911184077	CRISTALINA	KR21206514	PAMPLONA	16/11/2019 15:22	16/11/2019 20:01	16/11/2019 15:22	16/11/2019 20:01	4,65	1	4,65	CHI
201911184078	CATALAO	7432212	CATALAO S2	16/11/2019 11:14	16/11/2019 19:09	16/11/2019 11:14	16/11/2019 19:09	7,90	190	1501,11	CHI
201911184079	ALEXANIA	10019482173	ALEXANIA	16/11/2019 15:22	17/11/2019 12:08	16/11/2019 15:22	17/11/2019 12:08	20,76	1	20,76	CHI
201911184097	LUZIANIA	LZ21041460	MARAJOARA	16/11/2019 15:27	16/11/2019 17:15	16/11/2019 15:27	16/11/2019 17:15	1,79	1	1,79	CHI
201911184098	ANAPOLIS	AN11163699	JUNDIAI S1	16/11/2019 15:27	16/11/2019 16:41	16/11/2019 15:27	16/11/2019 16:41	1,23	160	196,27	CHI
201911184100	ANAPOLIS	AN11096605	JUNDIAI S2	16/11/2019 15:01	16/11/2019 17:31	16/11/2019 15:01	16/11/2019 17:31	2,50	96	239,79	CHI
201911184113	NOVA ROMA	ND21117705	IACIARA S2	16/11/2019 15:32	16/11/2019 18:11	16/11/2019 15:32	16/11/2019 18:11	2,64	1	2,64	CHI
201911184115	BELA VISTA DE GOIAS	SQ12066258	BELA VISTA S1	16/11/2019 15:33	16/11/2019 19:32	16/11/2019 15:33	16/11/2019 19:32	3,98	10	39,82	CHI
201911184119	AGUA FRIA DE GOIAS	TL21330873	SAO JOAO D ALIANCA	16/11/2019 15:34	16/11/2019 17:51	16/11/2019 15:34	16/11/2019 17:51	2,28	1	2,28	CHI
201911184122	BURITINOPOLIS	PS12189370	IACIARA S2	16/11/2019 15:35	16/11/2019 19:04	16/11/2019 15:35	16/11/2019 19:04	3,48	2	6,96	CHI
201911184122	MAMBAI	PS12189370	IACIARA S2	16/11/2019 15:35	16/11/2019 19:04	16/11/2019 15:35	16/11/2019 19:04	3,48	25	87,03	CHI
201911184122	POSSE	PS12189370	IACIARA S2	16/11/2019 15:35	16/11/2019 19:04	16/11/2019 15:35	16/11/2019 19:04	3,48	4	13,93	CHI
201911184127	JARAGUA	70065780	JARAGUA	16/11/2019 15:36	17/11/2019 09:41	16/11/2019 15:36	17/11/2019 09:41	18,08	1	18,08	CHI
201911184129	ALVORADA DO NORTE	AQ12085499	IACIARA S2	16/11/2019 15:36	16/11/2019 19:11	16/11/2019 15:36	16/11/2019 19:11	3,57	3	10,71	CHI
201911184129	FLORES DE GOIAS	AQ12085499	IACIARA S2	16/11/2019 15:36	16/11/2019 19:11	16/11/2019 15:36	16/11/2019 19:11	3,57	2	7,14	CHI
201911184130	MONTE ALEGRE DE GOIAS	MA12212608	SAO DOMINGOS	16/11/2019 15:36	16/11/2019 17:22	16/11/2019 15:36	16/11/2019 17:22	1,75	55	96,40	CHI
201911184136	GOIANIA	11131100	AEROPORTO S2	16/11/2019 15:37	16/11/2019 16:48	16/11/2019 15:37	16/11/2019 16:48	1,18	1	1,18	CHI
201911184139	MAMBAI	MB12190551	IACIARA S2	16/11/2019 15:39	17/11/2019 13:28	16/11/2019 15:39	17/11/2019 13:28	21,82	3	65,45	CHI
201911184142	ANAPOLIS	20949110	JUNDIAI S2	16/11/2019 15:39	16/11/2019 17:39	16/11/2019 15:39	16/11/2019 17:39	1,99	1	1,99	CHI

201911184147	AGUAS LINDAS DE GOIAS	04190406	AGUAS LINDAS DE GOIAS S2	16/11/2019 15:40	17/11/2019 15:18	16/11/2019 17:43	16/11/2019 18:30	0,78	3	2,35	CHI
201911184147	COCALZINHO DE GOIAS	04190406	AGUAS LINDAS DE GOIAS S2	16/11/2019 15:40	17/11/2019 15:18	16/11/2019 17:43	16/11/2019 18:30	0,78	177	138,65	CHI
201911184147	CORUMBA DE GOIAS	04190406	AGUAS LINDAS DE GOIAS S2	16/11/2019 15:40	17/11/2019 15:18	16/11/2019 17:43	16/11/2019 18:30	0,78	7	5,48	CHI
201911184147	SANTO ANTONIO DO DESCOBERTO	04190406	AGUAS LINDAS DE GOIAS S2	16/11/2019 15:40	17/11/2019 15:18	16/11/2019 17:43	16/11/2019 18:30	0,78	98	76,77	CHI
201911184147	COCALZINHO DE GOIAS	04190214	AGUAS LINDAS DE GOIAS S2	16/11/2019 15:40	17/11/2019 15:18	16/11/2019 18:31	16/11/2019 19:11	0,67	30	20,06	CHI
201911184147	COCALZINHO DE GOIAS	04190226	AGUAS LINDAS DE GOIAS S2	16/11/2019 15:40	17/11/2019 15:18	16/11/2019 15:40	16/11/2019 19:33	3,88	2341	9082,43	CHI
201911184147	RIALMA	04190226	AGUAS LINDAS DE GOIAS S2	16/11/2019 15:40	17/11/2019 15:18	16/11/2019 15:40	16/11/2019 19:33	3,88	6	23,28	CHI
201911184147	COCALZINHO DE GOIAS	ZN12206521LD	AGUAS LINDAS DE GOIAS S2	16/11/2019 15:40	17/11/2019 15:18	16/11/2019 15:40	16/11/2019 20:14	4,56	508	2318,46	CHI
201911184147	PADRE BERNARDO	ZN12206521LD	AGUAS LINDAS DE GOIAS S2	16/11/2019 15:40	17/11/2019 15:18	16/11/2019 15:40	16/11/2019 20:14	4,56	4	18,26	CHI
201911184147	COCALZINHO DE GOIAS	ZN12206521LD	AGUAS LINDAS DE GOIAS S2	16/11/2019 15:40	17/11/2019 15:18	16/11/2019 20:17	16/11/2019 20:42	0,42	556	235,06	CHI
201911184147	PADRE BERNARDO	ZN12206521LD	AGUAS LINDAS DE GOIAS S2	16/11/2019 15:40	17/11/2019 15:18	16/11/2019 20:17	16/11/2019 20:42	0,42	4	1,69	CHI
201911184147	COCALZINHO DE GOIAS	ZN12137406	AGUAS LINDAS DE GOIAS S2	16/11/2019 15:40	17/11/2019 15:18	16/11/2019 20:14	16/11/2019 20:53	0,65	14	9,16	CHI
201911184147	AGUAS LINDAS DE GOIAS	ZN10398171	AGUAS LINDAS DE GOIAS S2	16/11/2019 15:40	17/11/2019 15:18	16/11/2019 18:31	16/11/2019 20:59	2,47	3	7,40	CHI
201911184147	COCALZINHO DE GOIAS	ZN10398171	AGUAS LINDAS DE GOIAS S2	16/11/2019 15:40	17/11/2019 15:18	16/11/2019 18:31	16/11/2019 20:59	2,47	147	362,64	CHI
201911184147	CORUMBA DE GOIAS	ZN10398171	AGUAS LINDAS DE GOIAS S2	16/11/2019 15:40	17/11/2019 15:18	16/11/2019 18:31	16/11/2019 20:59	2,47	7	17,27	CHI
201911184147	SANTO ANTONIO DO DESCOBERTO	ZN10398171	AGUAS LINDAS DE GOIAS S2	16/11/2019 15:40	17/11/2019 15:18	16/11/2019 18:31	16/11/2019 20:59	2,47	98	241,76	CHI
201911184147	COCALZINHO DE GOIAS	ZN10398171	AGUAS LINDAS DE GOIAS S2	16/11/2019 15:40	17/11/2019 15:18	16/11/2019 21:00	16/11/2019 22:01	1,03	16	16,44	CHI
201911184147	AGUAS LINDAS DE GOIAS	ZN12072264LD	AGUAS LINDAS DE GOIAS S2	16/11/2019 15:40	17/11/2019 15:18	16/11/2019 21:00	16/11/2019 22:10	1,17	3	3,51	CHI
201911184147	COCALZINHO DE GOIAS	ZN12072264LD	AGUAS LINDAS DE GOIAS S2	16/11/2019 15:40	17/11/2019 15:18	16/11/2019 21:00	16/11/2019 22:10	1,17	42	49,11	CHI
201911184147	COCALZINHO DE GOIAS	ZN12376764LD	AGUAS LINDAS DE GOIAS S2	16/11/2019 15:40	17/11/2019 15:18	16/11/2019 21:00	17/11/2019 01:21	4,35	14	60,93	CHI
201911184147	SANTO ANTONIO DO DESCOBERTO	ZN12376764LD	AGUAS LINDAS DE GOIAS S2	16/11/2019 15:40	17/11/2019 15:18	16/11/2019 21:00	17/11/2019 01:21	4,35	17	73,99	CHI
201911184147	COCALZINHO DE GOIAS	ZN12313683LD	AGUAS LINDAS DE GOIAS S2	16/11/2019 15:40	17/11/2019 15:18	16/11/2019 21:00	17/11/2019 01:23	4,40	82	360,57	CHI
201911184147	CORUMBA DE GOIAS	ZN12313683LD	AGUAS LINDAS DE GOIAS S2	16/11/2019 15:40	17/11/2019 15:18	16/11/2019 21:00	17/11/2019 01:23	4,40	7	30,78	CHI
201911184147	SANTO ANTONIO DO DESCOBERTO	ZN12313683LD	AGUAS LINDAS DE GOIAS S2	16/11/2019 15:40	17/11/2019 15:18	16/11/2019 21:00	17/11/2019 01:23	4,40	81	356,18	CHI
201911184147	COCALZINHO DE GOIAS	ZN12313683LD	AGUAS LINDAS DE GOIAS S2	16/11/2019 15:40	17/11/2019 15:18	17/11/2019 02:31	17/11/2019 03:02	0,52	42	21,83	CHI
201911184147	CORUMBA DE GOIAS	ZN12313683LD	AGUAS LINDAS DE GOIAS S2	16/11/2019 15:40	17/11/2019 15:18	17/11/2019 02:31	17/11/2019 03:02	0,52	2	1,04	CHI
201911184147	COCALZINHO DE GOIAS	ZN11137322	AGUAS LINDAS DE GOIAS S2	16/11/2019 15:40	17/11/2019 15:18	16/11/2019 15:40	17/11/2019 05:17	13,62	126	1715,98	CHI
201911184147	AGUAS LINDAS DE GOIAS	04190214	AGUAS LINDAS DE GOIAS S2	16/11/2019 15:40	17/11/2019 15:18	17/11/2019 10:13	17/11/2019 10:34	0,36	3	1,07	CHI
201911184147	COCALZINHO DE GOIAS	04190214	AGUAS LINDAS DE GOIAS S2	16/11/2019 15:40	17/11/2019 15:18	17/11/2019 10:13	17/11/2019 10:34	0,36	144	51,20	CHI
201911184147	CORUMBA DE GOIAS	04190214	AGUAS LINDAS DE GOIAS S2	16/11/2019 15:40	17/11/2019 15:18	17/11/2019 10:13	17/11/2019 10:34	0,36	2	0,71	CHI
201911184147	SANTO ANTONIO DO DESCOBERTO	04190214	AGUAS LINDAS DE GOIAS S2	16/11/2019 15:40	17/11/2019 15:18	17/11/2019 10:13	17/11/2019 10:34	0,36	17	6,04	CHI
201911184147	COCALZINHO DE GOIAS	ZN12290914LD	AGUAS LINDAS DE GOIAS S2	16/11/2019 15:40	17/11/2019 15:18	17/11/2019 02:14	17/11/2019 13:30	11,28	12	135,31	CHI
201911184147	SANTO ANTONIO DO DESCOBERTO	ZN12290914LD	AGUAS LINDAS DE GOIAS S2	16/11/2019 15:40	17/11/2019 15:18	17/11/2019 02:14	17/11/2019 13:30	11,28	1	11,28	CHI

201911184147	COCALZINHO DE GOIAS	ZN12261437	AGUAS LINDAS DE GOIAS S2	16/11/2019 15:40	17/11/2019 15:18	17/11/2019 02:14	17/11/2019 14:13	11,99	5	59,96	CHI
201911184147	CORUMBA DE GOIAS	ZN12261437	AGUAS LINDAS DE GOIAS S2	16/11/2019 15:40	17/11/2019 15:18	17/11/2019 02:14	17/11/2019 14:13	11,99	5	59,96	CHI
201911184147	COCALZINHO DE GOIAS	ZN12357357	AGUAS LINDAS DE GOIAS S2	16/11/2019 15:40	17/11/2019 15:18	17/11/2019 02:14	17/11/2019 14:34	12,33	14	172,57	CHI
201911184147	SANTO ANTONIO DO DESCOBERTO	ZN12357357	AGUAS LINDAS DE GOIAS S2	16/11/2019 15:40	17/11/2019 15:18	17/11/2019 02:14	17/11/2019 14:34	12,33	66	813,52	CHI
201911184147	COCALZINHO DE GOIAS	ZN12096649	AGUAS LINDAS DE GOIAS S2	16/11/2019 15:40	17/11/2019 15:18	17/11/2019 02:14	17/11/2019 14:55	12,68	5	63,40	CHI
201911184147	SANTO ANTONIO DO DESCOBERTO	ZN12096649	AGUAS LINDAS DE GOIAS S2	16/11/2019 15:40	17/11/2019 15:18	17/11/2019 02:14	17/11/2019 14:55	12,68	14	177,52	CHI
201911184147	COCALZINHO DE GOIAS	ZN12091140	AGUAS LINDAS DE GOIAS S2	16/11/2019 15:40	17/11/2019 15:18	17/11/2019 02:14	17/11/2019 15:18	13,07	7	91,50	CHI
201911184157	ALOANDIA	AD21320780	GOIATUBA S1	16/11/2019 15:42	18/11/2019 16:24	16/11/2019 15:42	18/11/2019 16:24	48,69	1	48,69	CHI
201911184159	ITUMBIARA	690088050	ITUMBIARA NOVA	16/11/2019 15:43	18/11/2019 16:55	16/11/2019 15:43	18/11/2019 16:55	49,21	1	49,21	CHI
201911184164	TRINDADE	10013405525	TRINDADE	16/11/2019 15:44	16/11/2019 17:52	16/11/2019 15:44	16/11/2019 17:52	2,13	1	2,13	CHI
201911184168	MATRINCHA	MP21090456	MATRINCHA	16/11/2019 15:45	17/11/2019 18:05	16/11/2019 15:45	17/11/2019 18:05	26,33	1	26,33	CHI
201911184177	SITIO D ABADIA	AQ12344369	IACIARA S2	16/11/2019 15:48	16/11/2019 21:07	16/11/2019 15:48	16/11/2019 21:07	5,31	15	79,67	CHI
201911184178	MOIPORA	MO12004152	SAO LUIZ DOS MONTES BELOS	16/11/2019 14:52	17/11/2019 00:27	16/11/2019 14:52	17/11/2019 00:27	9,57	5	47,86	CHI
201911184182	GOIANIA	10192815	AEROPORTO S1	16/11/2019 15:49	16/11/2019 22:20	16/11/2019 15:49	16/11/2019 22:20	6,51	1	6,51	CHI
201911184189	SAO LUIS DE MONTES BELOS	500053704	SAO LUIZ DOS MONTES BELOS	16/11/2019 15:50	16/11/2019 18:10	16/11/2019 15:50	16/11/2019 18:10	2,33	1	2,33	CHI
201911184191	SANTA HELENA DE GOIAS	SH12280603	IPEGUARI	16/11/2019 15:50	16/11/2019 20:36	16/11/2019 15:50	16/11/2019 20:36	4,76	534	2541,84	CHI
201911184192	MONTE ALEGRE DE GOIAS	MA12211597	SAO DOMINGOS	16/11/2019 15:51	16/11/2019 18:01	16/11/2019 15:51	16/11/2019 18:01	2,16	10	21,65	CHI
201911184193	ANAPOLIS	20871053	ANAPOLIS UNIVERSITARIO S1	16/11/2019 15:51	17/11/2019 02:52	16/11/2019 15:51	17/11/2019 02:52	11,01	1	11,01	CHI
201911184197	QUIRINOPOLIS	QI21360844	QUIRINOPOLIS	16/11/2019 10:50	16/11/2019 21:57	16/11/2019 10:50	16/11/2019 21:57	11,11	1	11,11	CHI
201911184198	DIORAMA	DI12023270	IPORA	16/11/2019 15:51	17/11/2019 16:22	16/11/2019 15:51	17/11/2019 16:22	24,50	4	98,00	CHI
201911184204	PONTALINA	AD21141767	GOIATUBA S1	16/11/2019 15:53	19/11/2019 17:58	16/11/2019 15:53	19/11/2019 17:58	74,08	7	518,53	CHI
201911184207	CROMINIA	CQ21221772	PONTALINA	16/11/2019 15:54	17/11/2019 08:35	16/11/2019 15:54	17/11/2019 08:35	16,68	1	16,68	CHI
201911184212	ITAPIRAPUA	IU12142824	MATRINCHA	16/11/2019 15:20	16/11/2019 18:16	16/11/2019 15:20	16/11/2019 18:16	2,93	13	38,08	CHI
201911184224	CORUMBA DE GOIAS	PV12377711	CORUMBA	16/11/2019 14:11	16/11/2019 17:28	16/11/2019 14:11	16/11/2019 17:28	3,27	18	58,92	CHI
201911184224	PIRENOPOLIS	PV12377711	CORUMBA	16/11/2019 14:11	16/11/2019 17:28	16/11/2019 14:11	16/11/2019 17:28	3,27	13	42,55	CHI
201911184225	CUMARI	CT21164148	CATALAO S2	16/11/2019 15:58	18/11/2019 10:27	16/11/2019 15:58	18/11/2019 10:27	42,48	1	42,48	CHI
201911184244	GOIANIRA	10003955069	GOIANIRA	16/11/2019 16:03	18/11/2019 11:17	16/11/2019 16:03	18/11/2019 11:17	43,23	1	43,23	CHI
201911184248	MINACU	IH21208332	MINACU	16/11/2019 16:04	16/11/2019 21:15	16/11/2019 16:04	16/11/2019 21:15	5,18	2	10,37	CHI
201911184251	MAMBAI	1570018379	IACIARA S2	16/11/2019 16:04	17/11/2019 14:59	16/11/2019 16:04	17/11/2019 14:59	22,91	1	22,91	CHI
201911184269	FORMOSO	FO12392284	PORANGATU	16/11/2019 16:08	16/11/2019 18:16	16/11/2019 16:08	16/11/2019 18:16	2,12	13	27,59	CHI
201911184269	SANTA TEREZA DE GOIAS	FO12392284	PORANGATU	16/11/2019 16:08	16/11/2019 18:16	16/11/2019 16:08	16/11/2019 18:16	2,12	5	10,61	CHI
201911184273	MINACU	IH12290425	MINACU	16/11/2019 16:09	16/11/2019 17:57	16/11/2019 16:09	16/11/2019 17:57	1,80	1	1,80	CHI
201911184277	FORMOSA	FA21180864	ITUIQUIRA	16/11/2019 16:10	18/11/2019 10:57	16/11/2019 16:10	18/11/2019 10:57	42,78	1	42,78	CHI

201911184283	CRISTALINA	KR21199502	PAMPLONA	16/11/2019 16:11	16/11/2019 18:30	16/11/2019 16:11	16/11/2019 18:30	2,31	2	4,62	CHI
201911184292	ITARUMA	IM12296697	CACHOEIRA ALTA	16/11/2019 15:55	16/11/2019 18:07	16/11/2019 15:55	16/11/2019 18:07	2,18	13	28,39	CHI
201911184295	BRAZABRANTES	BR12013941	INHUMAS S2	16/11/2019 17:31	16/11/2019 20:47	16/11/2019 17:31	16/11/2019 20:44	3,20	47	150,52	CHI
201911184295	BRAZABRANTES	BR12013959	INHUMAS S2	16/11/2019 17:31	16/11/2019 20:47	16/11/2019 17:31	16/11/2019 20:47	3,25	108	351,24	CHI
201911184302	NOVA CRIXAS	NA11397710	NOVA CRIXAS	16/11/2019 16:15	16/11/2019 17:58	16/11/2019 16:15	16/11/2019 17:58	1,72	1	1,72	CHI
201911184311	GOIANIA	10022660486	CARAJAS S2	16/11/2019 16:18	16/11/2019 17:35	16/11/2019 16:18	16/11/2019 17:35	1,28	1	1,28	CHI
201911184315	URUACU	UR11094190	URUACU	16/11/2019 18:15	16/11/2019 19:06	16/11/2019 18:15	16/11/2019 19:06	0,84	134	112,37	CHI
201911184320	SITIO D ABADIA	FB12285685	IACIARA S2	16/11/2019 16:19	16/11/2019 21:23	16/11/2019 16:19	16/11/2019 21:23	5,05	66	333,61	CHI
201911184321	NOVA CRIXAS	8570000925	NOVA CRIXAS	16/11/2019 16:19	16/11/2019 18:35	16/11/2019 16:19	16/11/2019 18:35	2,26	1	2,26	CHI
201911184323	PADRE BERNARDO	2760053460	PADRE BERNARDO	16/11/2019 16:20	16/11/2019 22:06	16/11/2019 16:20	16/11/2019 22:06	5,76	1	5,76	CHI
201911184326	RIO VERDE	RV21331591	MONTIVIDIU T	16/11/2019 16:21	16/11/2019 18:10	16/11/2019 16:21	16/11/2019 18:10	1,83	1	1,83	CHI
201911184327	CAMPINORTE	CR21262822	MARA ROSA	16/11/2019 16:21	17/11/2019 10:30	16/11/2019 16:21	17/11/2019 10:30	18,14	1	18,14	CHI
201911184330	ANAPOLIS	AN31054489	JUNDIAI S1	16/11/2019 16:22	17/11/2019 09:26	16/11/2019 16:22	17/11/2019 09:26	17,05	1	17,05	CHI
201911184336	SANTA TEREZINHA DE GOIAS	2480042644	SANTA TEREZINHA	16/11/2019 16:23	16/11/2019 17:05	16/11/2019 16:23	16/11/2019 17:05	0,69	1	0,69	CHI
201911184338	CRIXAS	CX21239580	SANTA TEREZINHA	16/11/2019 16:21	16/11/2019 19:41	16/11/2019 16:21	16/11/2019 19:41	3,33	1	3,33	CHI
201911184339	CAMPOS VERDES	VD21327223	SANTA TEREZINHA	16/11/2019 16:21	16/11/2019 20:19	16/11/2019 16:21	16/11/2019 20:19	3,97	1	3,97	CHI
201911184342	CAMPOS VERDES	10002171927	SANTA TEREZINHA	16/11/2019 16:25	16/11/2019 18:56	16/11/2019 16:25	16/11/2019 18:56	2,51	1	2,51	CHI
201911184343	ALTO HORIZONTE	10014071760	SANTA TEREZINHA	16/11/2019 16:25	17/11/2019 12:21	16/11/2019 16:25	17/11/2019 12:21	19,93	1	19,93	CHI
201911184345	RIO VERDE	10015275335	CABRIUVA S1	16/11/2019 16:25	17/11/2019 09:45	16/11/2019 16:25	17/11/2019 09:45	17,34	1	17,34	CHI
201911184349	ANAPOLIS	AN21261162	ANAPOLIS UNIVERSITARIO S1	16/11/2019 16:26	16/11/2019 20:39	16/11/2019 16:26	16/11/2019 20:39	4,21	1	4,21	CHI
201911184350	QUIRINOPOLIS	QI12279590	QUIRINOPOLIS	16/11/2019 15:37	16/11/2019 23:50	16/11/2019 15:37	16/11/2019 23:50	8,20	7	57,43	CHI
201911184356	PIRACANJUBA	PJ12000034	PIRACANJUBA	16/11/2019 16:05	16/11/2019 17:35	16/11/2019 16:05	16/11/2019 17:35	1,49	361	539,19	CHI
201911184358	GUARINOS	GF21118840	SANTA TEREZINHA	16/11/2019 16:28	16/11/2019 20:50	16/11/2019 16:28	16/11/2019 20:50	4,36	1	4,36	CHI
201911184361	COLINAS DO SUL	TI12135666	NIQUELANDIA SUBTRANSMISSAO	16/11/2019 15:07	16/11/2019 18:09	16/11/2019 15:07	16/11/2019 18:09	3,03	33	99,90	CHI
201911184370	DAMIANOPOLIS	DA12196513	IACIARA S2	16/11/2019 16:28	16/11/2019 19:19	16/11/2019 16:28	16/11/2019 19:19	2,84	58	164,99	CHI
201911184371	PIRACANJUBA	60031130	PIRACANJUBA	16/11/2019 16:33	17/11/2019 18:32	16/11/2019 16:33	17/11/2019 18:32	25,99	1	25,99	CHI
201911184379	RIO QUENTE	RQ11182912	RIO QUENTE	16/11/2019 16:15	17/11/2019 11:30	16/11/2019 16:15	17/11/2019 11:30	19,26	40	770,21	CHI
201911184388	GOIANIA	10629713	AEROPORTO S3	16/11/2019 16:38	16/11/2019 19:23	16/11/2019 16:38	16/11/2019 19:23	2,74	1	2,74	CHI
201911184395	FLORES DE GOIAS	FB12384211	IACIARA S2	16/11/2019 15:33	16/11/2019 18:44	16/11/2019 15:33	16/11/2019 18:44	3,17	124	393,18	CHI
201911184395	FORMOSA	FB12384211	IACIARA S2	16/11/2019 15:33	16/11/2019 18:44	16/11/2019 15:33	16/11/2019 18:44	3,17	1	3,17	CHI
201911184395	VILA BOA	FB12384211	IACIARA S2	16/11/2019 15:33	16/11/2019 18:44	16/11/2019 15:33	16/11/2019 18:44	3,17	4	12,68	CHI
201911184396	FORMOSA	FA12248883	ITIQUEIRA	16/11/2019 16:40	18/11/2019 15:36	17/11/2019 15:41	17/11/2019 16:38	0,96	3	2,89	CHI
201911184396	FORMOSA	7681466	ITIQUEIRA	16/11/2019 16:40	18/11/2019 15:36	16/11/2019 16:40	18/11/2019 15:36	46,93	15	704,00	CHI

201911184413	MINACU	IH12223931	MINACU	16/11/2019 16:45	16/11/2019 18:54	16/11/2019 16:45	16/11/2019 18:54	2,14	7	14,97	CHI
201911184417	ORIZONA	OZ21204186	PIRES DO RIO S2	16/11/2019 16:46	18/11/2019 12:26	16/11/2019 16:46	18/11/2019 12:26	43,67	2	87,33	CHI
201911184441	TRINDADE	TR21216495	TRINDADE	16/11/2019 16:51	17/11/2019 03:13	16/11/2019 16:51	17/11/2019 03:13	10,36	1	10,36	CHI
201911184442	PIRENOPOLIS	PV21000013	CORUMBA	16/11/2019 16:51	17/11/2019 17:03	16/11/2019 16:51	17/11/2019 17:03	24,19	3	72,58	CHI
201911184453	RIO VERDE	630059147	RIO VERDE S1	16/11/2019 16:53	17/11/2019 12:10	16/11/2019 16:53	17/11/2019 12:10	19,29	1	19,29	CHI
201911184457	ANAPOLIS	21250110	JUNDIAI S2	16/11/2019 16:54	17/11/2019 08:42	16/11/2019 16:54	17/11/2019 08:42	15,80	1	15,80	CHI
201911184459	MINACU	IH11205576	MINACU	16/11/2019 16:54	16/11/2019 23:00	16/11/2019 16:54	16/11/2019 23:00	6,10	3	18,29	CHI
201911184462	ORIZONA	OZ21189452	PIRES DO RIO S2	16/11/2019 16:55	16/11/2019 22:25	16/11/2019 16:55	16/11/2019 22:25	5,50	1	5,50	CHI
201911184464	SAO SIMAO	2240048469	CACHOEIRA ALTA	16/11/2019 16:55	18/11/2019 10:57	16/11/2019 16:55	18/11/2019 10:57	42,02	1	42,02	CHI
201911184468	ANAPOLIS	AN21226639	DAIA S1	16/11/2019 16:56	17/11/2019 09:46	16/11/2019 16:56	17/11/2019 09:46	16,83	1	16,83	CHI
201911184469	ITUMBIARA	IT12222530	PARANAIBA	16/11/2019 15:54	17/11/2019 10:11	16/11/2019 15:54	17/11/2019 10:11	18,29	102	1865,95	CHI
201911184470	CALDAS NOVAS	CN12226663	CALDAS NOVAS S1	16/11/2019 09:24	18/11/2019 14:04	16/11/2019 09:24	18/11/2019 14:04	52,65	5	263,27	CHI
201911184471	BONFINOPOLIS	BO12400463	CEPAIGO S2	16/11/2019 11:23	17/11/2019 02:13	16/11/2019 11:23	17/11/2019 02:13	14,83	25	370,63	CHI
201911184471	LEOPOLDO DE BULHOES	BO12400463	CEPAIGO S2	16/11/2019 11:23	17/11/2019 02:13	16/11/2019 11:23	17/11/2019 02:13	14,83	13	192,73	CHI
201911184486	NOVA ROMA	ND12208720	IACIARA S2	16/11/2019 17:02	16/11/2019 21:59	16/11/2019 17:02	16/11/2019 21:59	4,94	5	24,71	CHI
201911184488	VILA PROPICIO	NP21388601	GOIANESIA S1	16/11/2019 17:02	16/11/2019 21:21	16/11/2019 17:02	16/11/2019 21:21	4,31	1	4,31	CHI
201911184491	JATAI	JT11361774	JATAI S2	16/11/2019 17:03	17/11/2019 09:11	16/11/2019 17:03	17/11/2019 09:11	16,13	1	16,13	CHI
201911184507	MAMBAI	MB13170568	IACIARA S2	16/11/2019 22:09	17/11/2019 12:26	16/11/2019 22:09	17/11/2019 12:26	14,30	122	1744,16	CHI
201911184509	CABECEIRAS	CW12264696	ITUIQUIRA	16/11/2019 17:07	16/11/2019 20:40	16/11/2019 17:07	16/11/2019 20:40	3,55	111	393,56	CHI
201911184512	ARUANA	AK21016466	ARUANA	16/11/2019 17:07	17/11/2019 09:30	16/11/2019 17:07	17/11/2019 09:30	16,38	2	32,75	CHI
201911184513	APARECIDA DE GOIANIA	AP11144794	REAL S1	16/11/2019 17:05	16/11/2019 20:05	16/11/2019 17:05	16/11/2019 20:05	2,99	191	571,94	CHI
201911184514	GUARINOS	GF21164866	SANTA TEREZINHA	16/11/2019 17:08	17/11/2019 00:03	16/11/2019 17:08	17/11/2019 00:03	6,90	1	6,90	CHI
201911184516	BRAZABRANTES	1110000355	INHUMAS S2	16/11/2019 17:08	17/11/2019 00:13	16/11/2019 17:08	17/11/2019 00:13	7,08	1	7,08	CHI
201911184524	ANAPOLIS	AN11084673	ANAPOLIS UNIVERSITARIO S2	16/11/2019 17:03	16/11/2019 19:02	16/11/2019 17:03	16/11/2019 19:02	1,97	39	76,71	CHI
201911184527	POSSE	PS12237062	IACIARA S2	16/11/2019 16:53	16/11/2019 21:19	16/11/2019 16:53	16/11/2019 21:19	4,43	17	75,25	CHI
201911184530	SANTA HELENA DE GOIAS	400032788	IPEGUARI	16/11/2019 17:10	17/11/2019 08:20	16/11/2019 17:10	17/11/2019 08:20	15,16	1	15,16	CHI
201911184549	PIRACANJUBA	PJ21064628	PIRACANJUBA	16/11/2019 17:15	20/11/2019 09:38	16/11/2019 17:15	20/11/2019 09:38	88,38	1	88,38	CHI
201911184550	CATALAO	1990185268	CATALAO S2	16/11/2019 17:15	17/11/2019 11:37	16/11/2019 17:15	17/11/2019 11:37	18,36	1	18,36	CHI
201911184551	BRAZABRANTES	BR21011967	NEROPOLIS S1	16/11/2019 17:15	16/11/2019 18:15	16/11/2019 17:15	16/11/2019 18:15	0,99	1	0,99	CHI
201911184553	GOIANIA	GN12228891	GOIANIA LESTE S1	16/11/2019 14:57	16/11/2019 18:00	16/11/2019 14:57	16/11/2019 18:00	3,04	83	251,97	CHI
201911184556	SENADOR CANEDO	SW11366013	SENADOR CANEDO	16/11/2019 16:09	16/11/2019 19:26	16/11/2019 16:09	16/11/2019 19:26	3,28	49	160,87	CHI
201911184560	LUZIANIA	LZ11000031	RIO VERMELHO	16/11/2019 16:24	16/11/2019 21:25	16/11/2019 16:24	16/11/2019 21:25	5,01	92	460,66	CHI
201911184567	MINACU	CR12234940	PORANGATU	16/11/2019 17:09	16/11/2019 20:06	16/11/2019 17:09	16/11/2019 20:06	2,95	8	23,59	CHI

201911184581	RIO VERDE	RV11402446	RIO VERDE S2	16/11/2019 17:12	17/11/2019 02:23	16/11/2019 17:12	17/11/2019 02:23	9,18	91	835,33	CHI
201911184585	AGUA FRIA DE GOIAS	JL13270102	SAO JOAO D ALIANCA	17/11/2019 07:24	17/11/2019 15:28	17/11/2019 07:24	17/11/2019 15:28	8,07	76	613,26	CHI
201911184585	NIQUELANDIA	JL13270102	SAO JOAO D ALIANCA	17/11/2019 07:24	17/11/2019 15:28	17/11/2019 07:24	17/11/2019 15:28	8,07	156	1258,79	CHI
201911184585	SAO JOAO D ALIANCA	JL13270102	SAO JOAO D ALIANCA	17/11/2019 07:24	17/11/2019 15:28	17/11/2019 07:24	17/11/2019 15:28	8,07	118	952,16	CHI
201911184599	BRAZABRANTES	10027342253	INHUMAS S2	16/11/2019 17:20	17/11/2019 00:12	16/11/2019 17:20	17/11/2019 00:12	6,86	1	6,86	CHI
201911184621	NIQUELANDIA	NQ12254469	URUACU	16/11/2019 15:31	16/11/2019 20:08	16/11/2019 15:31	16/11/2019 20:08	4,60	8	36,81	CHI
201911184630	PIRENOPOLIS	4290000953	JARAGUA	16/11/2019 17:23	17/11/2019 11:26	16/11/2019 17:23	17/11/2019 11:26	18,05	1	18,05	CHI
201911184638	JATAI	JT21184069	MONTIVIDIU T	16/11/2019 17:24	17/11/2019 10:40	16/11/2019 17:24	17/11/2019 10:40	17,27	1	17,27	CHI
201911184650	CABECEIRAS	CW21151429	ITIQUEIRA	16/11/2019 17:24	17/11/2019 11:31	16/11/2019 17:24	17/11/2019 11:31	18,10	1	18,10	CHI
201911184655	JANDAIA	JD12308479	PALMEIRAS	16/11/2019 17:24	16/11/2019 19:41	16/11/2019 17:24	16/11/2019 19:41	2,28	154	351,03	CHI
201911184655	PARAUNA	JD12308479	PALMEIRAS	16/11/2019 17:24	16/11/2019 19:41	16/11/2019 17:24	16/11/2019 19:41	2,28	6	13,68	CHI
201911184656	GOIANIA	10115936	CAMPINAS S1	16/11/2019 17:25	16/11/2019 19:16	16/11/2019 17:25	16/11/2019 19:16	1,84	1	1,84	CHI
201911184657	MINEIROS	2130014891	SANTA RITA DO ARAGUAIA	16/11/2019 17:25	16/11/2019 20:13	16/11/2019 17:25	16/11/2019 20:13	2,81	1	2,81	CHI
201911184670	CAIAPONIA	CP21277018	CAIAPONIA	16/11/2019 17:25	18/11/2019 23:04	16/11/2019 17:25	18/11/2019 23:04	53,64	2	107,28	CHI
201911184677	RIO QUENTE	RQ12050875	VILA CORUMBA	16/11/2019 14:23	17/11/2019 18:00	16/11/2019 14:23	17/11/2019 18:00	27,62	13	359,02	CHI
201911184682	SENADOR CANEDO	SW11291698	CEPAIGO S1	15/11/2019 17:50	16/11/2019 22:11	15/11/2019 17:50	16/11/2019 22:11	28,35	58	1644,07	CHI
201911184693	SAO JOAO D ALIANCA	JL12314646	FLORES DE GOIAS	16/11/2019 14:26	17/11/2019 19:27	16/11/2019 14:26	17/11/2019 19:27	29,00	9	261,01	CHI
201911184695	NOVO PLANALTO	SM12074646	SAO MIGUEL DO ARAGUAIA	16/11/2019 17:29	16/11/2019 20:39	16/11/2019 17:29	16/11/2019 20:39	3,15	6	18,90	CHI
201911184695	SAO MIGUEL DO ARAGUAIA	SM12074646	SAO MIGUEL DO ARAGUAIA	16/11/2019 17:29	16/11/2019 20:39	16/11/2019 17:29	16/11/2019 20:39	3,15	378	1191,01	CHI
201911184700	SITIO D ABADIA	SI12245344	IACIARA S2	16/11/2019 17:30	17/11/2019 16:02	16/11/2019 17:30	17/11/2019 16:02	22,52	8	180,14	CHI
201911184701	RIO VERDE	RV21207169	CABRIUVA S2	16/11/2019 17:29	16/11/2019 18:55	16/11/2019 17:29	16/11/2019 18:55	1,42	1	1,42	CHI
201911184713	GOIANESIA	550133574	GOIANESIA S2	16/11/2019 17:32	17/11/2019 12:01	16/11/2019 17:32	17/11/2019 12:01	18,47	1	18,47	CHI
201911184715	CATALAO	CT12394011RE	CATALAO S1	16/11/2019 12:49	16/11/2019 19:40	16/11/2019 12:49	16/11/2019 19:40	6,84	46	314,86	CHI
201911184715	OUVIDOR	CT12394011RE	CATALAO S1	16/11/2019 12:49	16/11/2019 19:40	16/11/2019 12:49	16/11/2019 19:40	6,84	37	253,25	CHI
201911184717	FORMOSA	FA12404505	ITIQUEIRA	16/11/2019 16:39	18/11/2019 10:26	16/11/2019 16:39	18/11/2019 10:26	41,78	2	83,56	CHI
201911184718	VALPARAISO DE GOIAS	10006205125	MARAJOARA	16/11/2019 17:33	16/11/2019 19:16	16/11/2019 17:33	16/11/2019 19:16	1,71	1	1,71	CHI
201911184724	SENADOR CANEDO	13182389	GOIANIA LESTE S2	16/11/2019 17:34	17/11/2019 09:57	16/11/2019 17:34	17/11/2019 09:57	16,38	1	16,38	CHI
201911184730	JATAI	JT21332108	JATAI S2	16/11/2019 17:35	17/11/2019 08:04	16/11/2019 17:35	17/11/2019 08:04	14,48	1	14,48	CHI
201911184733	MAURILANDIA	1040000530	RIO DOS BOIS	16/11/2019 17:35	16/11/2019 23:15	16/11/2019 17:35	16/11/2019 23:15	5,67	1	5,67	CHI
201911184740	TRINDADE	40320900	GOYA S1	16/11/2019 17:37	17/11/2019 09:27	16/11/2019 17:37	17/11/2019 09:27	15,83	1	15,83	CHI
201911184741	DAMIANOPOLIS	MB12180672	IACIARA S2	16/11/2019 17:37	17/11/2019 14:04	16/11/2019 17:37	17/11/2019 14:04	20,44	9	183,93	CHI
201911184743	ANAPOLIS	21235820	JUNDIAI S2	16/11/2019 17:38	16/11/2019 19:06	16/11/2019 17:38	16/11/2019 19:06	1,47	1	1,47	CHI
201911184750	CATALAO	CT21037319	CATALAO S1	16/11/2019 17:38	18/11/2019 00:06	16/11/2019 17:38	18/11/2019 00:06	30,45	1	30,45	CHI

201911184754	GOIANIA	15425460	REAL S1	16/11/2019 17:39	16/11/2019 23:25	16/11/2019 17:39	16/11/2019 23:25	5,76	1	5,76	CHI
201911184756	FORMOSA	FA11278117	ITIQUEIRA	16/11/2019 17:39	18/11/2019 09:49	16/11/2019 17:39	18/11/2019 09:49	40,16	1	40,16	CHI
201911184757	FORMOSA	FA21257562	ITIQUEIRA	16/11/2019 17:39	18/11/2019 09:11	16/11/2019 17:39	18/11/2019 09:11	39,53	1	39,53	CHI
201911184790	CATALAO	CT21286308	CATALAO S1	16/11/2019 17:42	17/11/2019 23:12	16/11/2019 17:42	17/11/2019 23:12	29,49	1	29,49	CHI
201911184801	DAMIANOPOLIS	DA12218425	IACIARA S2	16/11/2019 17:43	17/11/2019 12:19	16/11/2019 17:43	17/11/2019 12:19	18,59	1	18,59	CHI
201911184802	FORMOSA	FA21322758	ITIQUEIRA	16/11/2019 17:44	18/11/2019 11:35	16/11/2019 17:44	18/11/2019 11:35	41,85	1	41,85	CHI
201911184804	POSSE	PS12195974	IACIARA S2	16/11/2019 17:22	17/11/2019 12:50	16/11/2019 17:22	16/11/2019 23:36	6,24	167	1042,64	CHI
201911184804	POSSE	PS12217661	IACIARA S2	16/11/2019 17:22	17/11/2019 12:50	16/11/2019 17:22	17/11/2019 09:18	15,95	44	701,68	CHI
201911184804	POSSE	PS12332777LD	IACIARA S2	16/11/2019 17:22	17/11/2019 12:50	16/11/2019 17:22	17/11/2019 12:50	19,48	67	1305,14	CHI
201911184821	BONFINOPOLIS	920002122	CEPAIGO S2	16/11/2019 17:46	17/11/2019 13:09	16/11/2019 17:46	17/11/2019 13:09	19,37	1	19,37	CHI
201911184826	CORUMBA DE GOIAS	260003141	CORUMBA	16/11/2019 17:47	17/11/2019 08:07	16/11/2019 17:47	17/11/2019 08:07	14,33	1	14,33	CHI
201911184844	ALTO PARAISO DE GOIAS	3870005528	FLORES DE GOIAS	16/11/2019 17:49	18/11/2019 12:40	16/11/2019 17:49	18/11/2019 12:40	42,84	1	42,84	CHI
201911184847	MORRINHOS	MR11338602	MORRINHOS	16/11/2019 17:22	16/11/2019 21:57	16/11/2019 17:22	16/11/2019 21:57	4,58	90	412,37	CHI
201911184857	QUIRINOPOLIS	QI12101226	QUIRINOPOLIS	16/11/2019 17:51	16/11/2019 22:31	16/11/2019 17:51	16/11/2019 22:31	4,68	18	84,19	CHI
201911184861	CACHOEIRA DOURADA	CD12000105	CACHOEIRA DOURADA	16/11/2019 16:48	18/11/2019 17:42	16/11/2019 16:48	18/11/2019 17:42	48,90	3	146,69	CHI
201911184861	ITUMBIARA	CD12000105	CACHOEIRA DOURADA	16/11/2019 16:48	18/11/2019 17:42	16/11/2019 16:48	18/11/2019 17:42	48,90	4	195,59	CHI
201911184864	IVOLANDIA	IV12231159	IPORA	16/11/2019 17:51	17/11/2019 18:25	16/11/2019 17:51	17/11/2019 18:25	24,55	2	49,10	CHI
201911184870	PADRE BERNARDO	PB12375013	PADRE BERNARDO	16/11/2019 17:30	16/11/2019 19:52	16/11/2019 17:30	16/11/2019 19:52	2,36	15	35,39	CHI
201911184874	ANAPOLIS	AN21357359	ANAPOLIS UNIVERSITARIO S2	16/11/2019 17:52	17/11/2019 08:03	16/11/2019 17:52	17/11/2019 08:03	14,17	1	14,17	CHI
201911184880	MAMBAI	MB12239972	IACIARA S2	16/11/2019 16:31	17/11/2019 09:08	16/11/2019 16:31	17/11/2019 09:08	16,60	41	680,76	CHI
201911184890	SAO MIGUEL DO ARAGUAIA	SM13349178	SAO MIGUEL DO ARAGUAIA	16/11/2019 17:46	17/11/2019 12:54	16/11/2019 17:46	17/11/2019 12:54	19,12	83	1587,08	CHI
201911184897	BELA VISTA DE GOIAS	BV21311465	BELA VISTA S1	16/11/2019 17:57	17/11/2019 10:43	16/11/2019 17:57	17/11/2019 10:43	16,76	1	16,76	CHI
201911184899	CATALAO	CT21278956	CATALAO S1	16/11/2019 17:57	16/11/2019 22:00	16/11/2019 17:57	16/11/2019 22:00	4,03	1	4,03	CHI
201911184901	POSSE	PS12124656	IACIARA S2	16/11/2019 17:46	16/11/2019 19:57	16/11/2019 17:46	16/11/2019 19:57	2,17	21	45,66	CHI
201911184906	PORANGATU	PO12020611	NOVO PLANALTO	16/11/2019 17:59	17/11/2019 09:50	16/11/2019 17:59	17/11/2019 09:50	15,84	8	126,74	CHI
201911184915	ABADIA DE GOIAS	5581998788	INDEPENDENCIA S2	16/11/2019 18:00	17/11/2019 05:56	16/11/2019 18:00	17/11/2019 05:56	11,92	1	11,92	CHI
201911184917	CRISTALINA	KR21163119	CRISTALINA S2	16/11/2019 18:01	17/11/2019 00:23	16/11/2019 18:01	17/11/2019 00:23	6,36	1	6,36	CHI
201911184920	CATALAO	CT12072921	CAMPO ALEGRE DE GOIAS	16/11/2019 18:01	19/11/2019 11:20	16/11/2019 18:01	19/11/2019 11:20	65,32	3	195,96	CHI
201911184921	TRES RANCHOS	TH21165231	CATALAO S1	16/11/2019 18:01	18/11/2019 12:40	16/11/2019 18:01	18/11/2019 12:40	42,64	1	42,64	CHI
201911185106	ANAPOLIS	AN21140399	ANAPOLIS UNIVERSITARIO S2	16/11/2019 18:05	17/11/2019 07:17	16/11/2019 18:05	17/11/2019 07:17	13,19	3	39,57	CHI
201911185107	SAO JOAO D ALIANCA	JL11130015	SAO JOAO D ALIANCA	16/11/2019 18:04	17/11/2019 11:01	16/11/2019 18:04	17/11/2019 11:01	16,95	7	118,65	CHI
201911185130	ABADIANIA	AA11025499	DAIA S2	16/11/2019 17:59	17/11/2019 10:01	16/11/2019 17:59	17/11/2019 10:01	16,03	37	592,94	CHI
201911185136	GOIANIA	16427658	XAVANTES	16/11/2019 18:10	17/11/2019 02:40	16/11/2019 18:10	17/11/2019 02:40	8,49	1	8,49	CHI

201911185140	DAMIANOPOLIS	MB12180675	IACIARA S2	16/11/2019 17:39	17/11/2019 10:21	16/11/2019 17:39	17/11/2019 10:21	16,69	8	133,50	CHI
201911185141	APARECIDA DE GOIANIA	10020651218	INDEPENDENCIA S1	16/11/2019 18:11	17/11/2019 07:32	16/11/2019 18:11	17/11/2019 07:32	13,35	1	13,35	CHI
201911185149	JARAGUA	SF21339502	SAO FRANCISCO DE GOIAS	16/11/2019 18:12	17/11/2019 11:33	16/11/2019 18:12	17/11/2019 11:33	17,34	1	17,34	CHI
201911185150	PIRENOPOLIS	PV21374619	JARAGUA	16/11/2019 17:53	17/11/2019 13:51	16/11/2019 17:53	17/11/2019 13:51	19,96	1	19,96	CHI
201911185151	PALMELO	PZ12063775RE	PIRES DO RIO S2	16/11/2019 17:13	16/11/2019 23:19	16/11/2019 17:13	16/11/2019 20:40	3,44	16	55,00	CHI
201911185151	PIRES DO RIO	PZ12063775RE	PIRES DO RIO S2	16/11/2019 17:13	16/11/2019 23:19	16/11/2019 17:13	16/11/2019 20:40	3,44	5	17,19	CHI
201911185151	SANTA CRUZ DE GOIAS	PZ12063775RE	PIRES DO RIO S2	16/11/2019 17:13	16/11/2019 23:19	16/11/2019 17:13	16/11/2019 20:40	3,44	26	89,38	CHI
201911185151	PALMELO	PZ12063772	PIRES DO RIO S2	16/11/2019 17:13	16/11/2019 23:19	16/11/2019 17:13	16/11/2019 23:19	6,09	7	42,61	CHI
201911185151	PIRES DO RIO	PZ12063772	PIRES DO RIO S2	16/11/2019 17:13	16/11/2019 23:19	16/11/2019 17:13	16/11/2019 23:19	6,09	1	6,09	CHI
201911185157	POSSE	PS12067857	IACIARA S2	16/11/2019 17:20	16/11/2019 20:22	16/11/2019 17:20	16/11/2019 20:22	3,03	241	730,36	CHI
201911185161	FLORES DE GOIAS	FB12248238	FLORES DE GOIAS	16/11/2019 17:31	19/11/2019 18:08	16/11/2019 17:31	17/11/2019 01:14	7,73	88	680,00	CHI
201911185161	SAO JOAO D ALIANCA	FB12248238	FLORES DE GOIAS	16/11/2019 17:31	19/11/2019 18:08	16/11/2019 17:31	17/11/2019 01:14	7,73	32	247,27	CHI
201911185161	FLORES DE GOIAS	FB12254512LD	FLORES DE GOIAS	16/11/2019 17:31	19/11/2019 18:08	16/11/2019 17:31	18/11/2019 16:33	47,04	1	47,04	CHI
201911185161	FLORES DE GOIAS	FB13254501	FLORES DE GOIAS	16/11/2019 17:31	19/11/2019 18:08	16/11/2019 17:31	18/11/2019 21:56	52,42	4	209,68	CHI
201911185161	FLORES DE GOIAS	FB13254502	FLORES DE GOIAS	16/11/2019 17:31	19/11/2019 18:08	16/11/2019 17:31	19/11/2019 16:56	71,42	2	142,83	CHI
201911185161	SAO JOAO D ALIANCA	FB13254502	FLORES DE GOIAS	16/11/2019 17:31	19/11/2019 18:08	16/11/2019 17:31	19/11/2019 16:56	71,42	1	71,42	CHI
201911185161	SAO JOAO D ALIANCA	FB12254528	FLORES DE GOIAS	16/11/2019 17:31	19/11/2019 18:08	16/11/2019 17:31	19/11/2019 18:08	72,62	7	508,37	CHI
201911185164	MINACU	IH12396688	MINACU	16/11/2019 18:15	17/11/2019 09:03	16/11/2019 18:15	17/11/2019 09:03	14,79	32	473,29	CHI
201911185168	ITUMBIARA	690305989	ITUMBIARA VELHA S1	16/11/2019 18:16	19/11/2019 12:25	16/11/2019 18:16	19/11/2019 12:25	66,16	1	66,16	CHI
201911185172	MINEIROS	1390090040	PARQUE DAS EMAS	16/11/2019 18:16	16/11/2019 20:00	16/11/2019 18:16	16/11/2019 20:00	1,72	1	1,72	CHI
201911185180	APARECIDA DE GOIANIA	13491957	REAL S1	16/11/2019 18:18	17/11/2019 08:59	16/11/2019 18:18	17/11/2019 08:59	14,68	1	14,68	CHI
201911185181	ALTO PARAISO DE GOIAS	BF12244579	SAO JOAO D ALIANCA	16/11/2019 16:52	18/11/2019 10:09	16/11/2019 16:52	18/11/2019 10:09	41,27	33	1361,89	CHI
201911185183	MOZARLANDIA	410038544	MOZARLANDIA	16/11/2019 18:20	16/11/2019 20:17	16/11/2019 18:20	16/11/2019 20:17	1,96	1	1,96	CHI
201911185185	ANAPOLIS	10025735991	ANAPOLIS UNIVERSITARIO S2	16/11/2019 18:20	17/11/2019 10:51	16/11/2019 18:20	17/11/2019 10:51	16,51	1	16,51	CHI
201911185189	SITIO D ABADIA	SI21238721	IACIARA S2	16/11/2019 18:22	16/11/2019 22:35	16/11/2019 18:22	16/11/2019 22:35	4,22	1	4,22	CHI
201911185190	FAZENDA NOVA	FN12054011	BRITANIA	16/11/2019 18:22	17/11/2019 00:28	16/11/2019 18:22	17/11/2019 00:28	6,10	5	30,49	CHI
201911185191	SENADOR CANEDO	190108393	SENADOR CANEDO	16/11/2019 18:21	17/11/2019 08:52	16/11/2019 18:21	17/11/2019 08:52	14,50	1	14,50	CHI
201911185192	NOVA ROMA	ND12392237	IACIARA S2	16/11/2019 18:22	16/11/2019 21:24	16/11/2019 18:22	16/11/2019 21:24	3,03	3	9,09	CHI
201911185195	VILA PROPICIO	NP12339454	GOIANESIA S1	16/11/2019 10:18	16/11/2019 20:24	16/11/2019 10:18	16/11/2019 20:24	10,10	114	1151,18	CHI
201911185196	GOIANESIA	10020790269	GOIANESIA S2	16/11/2019 18:23	17/11/2019 14:45	16/11/2019 18:23	17/11/2019 14:45	20,37	1	20,37	CHI
201911185204	FORMOSA	FA12404381	ITUIQUIRA	16/11/2019 17:09	17/11/2019 13:00	16/11/2019 17:09	17/11/2019 13:00	19,86	4	79,44	CHI
201911185225	ALTO PARAISO DE GOIAS	BF11320577	FLORES DE GOIAS	16/11/2019 17:40	17/11/2019 12:21	16/11/2019 17:40	17/11/2019 12:21	18,68	76	1419,91	CHI
201911185231	GOIAS	GS11220172	GOIAS	16/11/2019 18:28	16/11/2019 21:46	16/11/2019 18:28	16/11/2019 21:46	3,29	122	401,38	CHI

201911185236	IPAMERI	OZ12137542RE	PIRES DO RIO S2	16/11/2019 18:31	16/11/2019 22:50	16/11/2019 18:31	16/11/2019 22:50	4,32	9	38,84	CHI
201911185238	GOUVELANDIA	GB12000207	QUIRINOPOLIS	16/11/2019 18:31	16/11/2019 18:54	16/11/2019 18:31	16/11/2019 18:54	0,38	4	1,50	CHI
201911185239	JAUPACI	JP11281879	IPORA	16/11/2019 18:31	17/11/2019 13:04	16/11/2019 18:31	17/11/2019 13:04	18,55	30	556,65	CHI
201911185246	JARAGUA	70008292	JARAGUA	16/11/2019 18:32	17/11/2019 09:49	16/11/2019 18:32	17/11/2019 09:49	15,27	1	15,27	CHI
201911185247	FLORES DE GOIAS	FB12106993	FLORES DE GOIAS	16/11/2019 18:33	17/11/2019 01:54	16/11/2019 18:33	17/11/2019 01:54	7,35	15	110,25	CHI
201911185247	FORMOSA	FB12106993	FLORES DE GOIAS	16/11/2019 18:33	17/11/2019 01:54	16/11/2019 18:33	17/11/2019 01:54	7,35	137	1006,99	CHI
201911185247	FORMOSO	FB12106993	FLORES DE GOIAS	16/11/2019 18:33	17/11/2019 01:54	16/11/2019 18:33	17/11/2019 01:54	7,35	1	7,35	CHI
201911185247	SAO JOAO D ALIANCA	FB12106993	FLORES DE GOIAS	16/11/2019 18:33	17/11/2019 01:54	16/11/2019 18:33	17/11/2019 01:54	7,35	5	36,75	CHI
201911185248	DIVINOPOLIS DE GOIAS	GH12074067	SAO DOMINGOS	16/11/2019 18:26	16/11/2019 21:09	16/11/2019 18:26	16/11/2019 21:09	2,71	363	983,53	CHI
201911185248	MONTE ALEGRE DE GOIAS	GH12074067	SAO DOMINGOS	16/11/2019 18:26	16/11/2019 21:09	16/11/2019 18:26	16/11/2019 21:09	2,71	15	40,64	CHI
201911185248	SAO DOMINGOS	GH12074067	SAO DOMINGOS	16/11/2019 18:26	16/11/2019 21:09	16/11/2019 18:26	16/11/2019 21:09	2,71	1	2,71	CHI
201911185250	OURO VERDE DE GOIAS	370015253	NEROPOLIS S2	16/11/2019 18:33	16/11/2019 22:42	16/11/2019 18:33	16/11/2019 22:42	4,16	1	4,16	CHI
201911185254	BELA VISTA DE GOIAS	BV12185857	CEPAIGO S2	16/11/2019 18:33	17/11/2019 12:40	16/11/2019 18:33	17/11/2019 12:40	18,10	3	54,31	CHI
201911185255	ITUMBIAIRA	IT11257144	PARANAIBA	16/11/2019 18:16	16/11/2019 21:51	16/11/2019 18:16	16/11/2019 21:51	3,59	21	75,36	CHI
201911185258	SAO MIGUEL DO ARAGUAIA	SM21013068	SAO MIGUEL DO ARAGUAIA	16/11/2019 18:34	17/11/2019 08:58	16/11/2019 18:34	17/11/2019 08:58	14,40	1	14,40	CHI
201911185268	GOIANIA	10659080	CAMPINAS S3	16/11/2019 18:36	16/11/2019 19:16	16/11/2019 18:36	16/11/2019 19:16	0,66	1	0,66	CHI
201911185270	BURITINOPOLIS	MB11037521	IACIARA S2	16/11/2019 18:36	17/11/2019 14:04	16/11/2019 18:36	17/11/2019 14:04	19,45	2	38,91	CHI
201911185279	SILVANIA	SV12199936	VIANOPOLIS	16/11/2019 18:39	17/11/2019 08:44	16/11/2019 18:39	17/11/2019 08:44	14,08	10	140,82	CHI
201911185291	PORANGATU	PO21151792	PORANGATU	16/11/2019 18:40	17/11/2019 11:34	16/11/2019 18:40	17/11/2019 11:34	16,89	1	16,89	CHI
201911185292	FORMOSA	FA12257423	ITUIQUIRA	16/11/2019 15:37	17/11/2019 01:07	16/11/2019 15:37	17/11/2019 01:07	9,50	16	151,99	CHI
201911185295	CALDAS NOVAS	CN11103878	SERRA DE CALDAS	16/11/2019 16:05	17/11/2019 12:04	16/11/2019 16:05	17/11/2019 12:04	19,98	55	1098,96	CHI
201911185304	ABADIANIA	AA12221505	DAIA S2	16/11/2019 18:42	17/11/2019 00:28	16/11/2019 18:42	17/11/2019 00:28	5,76	120	690,93	CHI
201911185307	FORMOSA	FA21218494	ITUIQUIRA	16/11/2019 18:42	18/11/2019 11:03	16/11/2019 18:42	18/11/2019 11:03	40,34	1	40,34	CHI
201911185312	VALPARAISO DE GOIAS	2860149412	MARAJOARA	16/11/2019 18:43	16/11/2019 20:09	16/11/2019 18:43	16/11/2019 20:09	1,43	1	1,43	CHI
201911185315	SANTA HELENA DE GOIAS	400023489	IPEGUARI	16/11/2019 18:43	16/11/2019 23:01	16/11/2019 18:43	16/11/2019 23:01	4,30	1	4,30	CHI
201911185332	BELA VISTA DE GOIAS	SQ21209352	BELA VISTA S1	16/11/2019 18:46	17/11/2019 09:17	16/11/2019 18:46	17/11/2019 09:17	14,52	1	14,52	CHI
201911185333	LUZIANIA	LZ21086762	VIANOPOLIS	16/11/2019 18:46	17/11/2019 00:44	16/11/2019 18:46	17/11/2019 00:44	5,97	1	5,97	CHI
201911185337	GOIATUBA	GT31043207	GOIATUBA S2	16/11/2019 18:46	20/11/2019 11:43	16/11/2019 18:46	20/11/2019 11:43	88,93	1	88,93	CHI
201911185338	LUZIANIA	LZ12336006	VIANOPOLIS	16/11/2019 18:39	17/11/2019 00:21	16/11/2019 18:39	17/11/2019 00:21	5,70	98	558,14	CHI
201911185341	AGUAS LINDAS DE GOIAS	4830197676	AGUAS LINDAS DE GOIAS S2	16/11/2019 18:47	16/11/2019 19:51	16/11/2019 18:47	16/11/2019 19:51	1,06	1	1,06	CHI
201911185342	APARECIDA DE GOIANIA	11646070	INDEPENDENCIA S2	16/11/2019 18:47	16/11/2019 20:57	16/11/2019 18:47	16/11/2019 20:57	2,15	1	2,15	CHI
201911185346	ACREUNA	EU21271616	ACREUNA	16/11/2019 18:47	16/11/2019 20:10	16/11/2019 18:47	16/11/2019 20:10	1,37	1	1,37	CHI
201911185353	AGUA FRIA DE GOIAS	JL12262352	SAO JOAO D ALIANCA	16/11/2019 17:46	17/11/2019 00:14	16/11/2019 17:46	17/11/2019 00:14	6,46	6	38,75	CHI

201911185353	SAO JOAO D ALIANCA	JL12262352	SAO JOAO D ALIANCA	16/11/2019 17:46	17/11/2019 00:14	16/11/2019 17:46	17/11/2019 00:14	6,46	107	691,01	CHI
201911185362	BELA VISTA DE GOIAS	BV12086489	CEPAIGO S2	16/11/2019 18:44	16/11/2019 22:45	16/11/2019 18:44	16/11/2019 22:45	4,00	13	52,02	CHI
201911185373	CABECEIRAS	CW21242914	ITUIQUIRA	16/11/2019 18:51	17/11/2019 14:44	16/11/2019 18:51	17/11/2019 14:44	19,87	1	19,87	CHI
201911185376	COLINAS DO SUL	TI12396761	MINACU	16/11/2019 18:52	17/11/2019 14:45	16/11/2019 18:52	17/11/2019 14:45	19,88	3	59,64	CHI
201911185377	GOIAS	GS21307634	ITABERAI S1	16/11/2019 18:52	18/11/2019 12:57	16/11/2019 18:52	18/11/2019 12:40	41,81	1	41,81	CHI
201911185377	GOIAS	HE12250706	ITABERAI S1	16/11/2019 18:52	18/11/2019 12:57	18/11/2019 10:20	18/11/2019 12:57	2,62	13	34,07	CHI
201911185378	URUACU	10009812871	URUACU	16/11/2019 18:52	16/11/2019 19:58	16/11/2019 18:52	16/11/2019 19:58	1,09	1	1,09	CHI
201911185384	GUAPO	GA11365563	GUAPO S2	16/11/2019 18:31	17/11/2019 03:32	16/11/2019 18:31	17/11/2019 03:32	9,01	35	315,37	CHI
201911185387	NOVO PLANALTO	TA11248589	NOVO PLANALTO	16/11/2019 18:53	17/11/2019 00:00	16/11/2019 18:53	17/11/2019 00:00	5,10	266	1356,67	CHI
201911185388	GOIANIA	14080606	GOYA S2	16/11/2019 18:54	16/11/2019 19:58	16/11/2019 18:54	16/11/2019 19:58	1,07	1	1,07	CHI
201911185389	URUTAI	UT12318952	PIRES DO RIO S2	16/11/2019 18:54	18/11/2019 08:16	16/11/2019 18:54	18/11/2019 08:16	37,36	5	186,82	CHI
201911185395	CATALAO	1990185700	CATALAO S2	16/11/2019 18:54	17/11/2019 09:29	16/11/2019 18:54	17/11/2019 09:29	14,57	1	14,57	CHI
201911185414	GOIANESIA	550129613	GOIANESIA S2	16/11/2019 18:56	17/11/2019 13:21	16/11/2019 18:56	17/11/2019 13:21	18,40	1	18,40	CHI
201911185415	ARENOPOLIS	AY12390169	ARENOPOLIS	16/11/2019 18:21	17/11/2019 07:12	16/11/2019 18:21	17/11/2019 07:12	12,85	24	308,33	CHI
201911185415	DIORAMA	AY12390169	ARENOPOLIS	16/11/2019 18:21	17/11/2019 07:12	16/11/2019 18:21	17/11/2019 07:12	12,85	3	38,54	CHI
201911185419	GOIANIA	12028680	ATLANTICO S1	16/11/2019 18:57	16/11/2019 20:16	16/11/2019 18:57	16/11/2019 20:16	1,31	1	1,31	CHI
201911185422	NIQUELANDIA	NQ21197684	NIQUELANDIA SUBTRANSMISSAO	16/11/2019 18:57	17/11/2019 22:35	16/11/2019 18:57	17/11/2019 22:35	27,62	1	27,62	CHI
201911185425	GOUVELANDIA	QI12000166	QUIRINOPOLIS	16/11/2019 18:59	17/11/2019 19:12	16/11/2019 18:59	17/11/2019 19:12	24,23	19	460,34	CHI
201911185431	SANTA BARBARA DE GOIAS	TR12062862	TRINDADE	16/11/2019 18:39	16/11/2019 21:31	16/11/2019 18:39	16/11/2019 21:31	2,86	21	60,14	CHI
201911185431	TRINDADE	TR12062862	TRINDADE	16/11/2019 18:39	16/11/2019 21:31	16/11/2019 18:39	16/11/2019 21:31	2,86	20	57,28	CHI
201911185434	CATALAO	CT12266145	CATALAO S1	16/11/2019 19:00	19/11/2019 11:21	16/11/2019 19:00	19/11/2019 11:21	64,34	1	64,34	CHI
201911185438	PIRENOPOLIS	PV21376516	CORUMBA	16/11/2019 19:01	17/11/2019 17:02	16/11/2019 19:01	17/11/2019 17:02	22,00	1	22,00	CHI
201911185439	PARANAIGUARA	PC12060517	QUIRINOPOLIS	16/11/2019 18:26	17/11/2019 18:41	16/11/2019 18:26	17/11/2019 18:41	24,24	1	24,24	CHI
201911185439	QUIRINOPOLIS	PC12060517	QUIRINOPOLIS	16/11/2019 18:26	17/11/2019 18:41	16/11/2019 18:26	17/11/2019 18:41	24,24	3	72,72	CHI
201911185442	NIQUELANDIA	NQ21266050	NIQUELANDIA SUBTRANSMISSAO	16/11/2019 19:02	17/11/2019 01:05	16/11/2019 19:02	17/11/2019 01:05	6,04	1	6,04	CHI
201911185446	MINACU	IH12207741	MINACU	16/11/2019 18:44	17/11/2019 04:21	16/11/2019 18:44	17/11/2019 04:21	9,61	8	76,89	CHI
201911185454	RIO VERDE	RV12246752	CABRIUVA S2	16/11/2019 18:42	17/11/2019 19:50	16/11/2019 18:42	17/11/2019 19:50	25,12	18	452,11	CHI
201911185469	CATALAO	1990042755	CATALAO S2	16/11/2019 15:16	17/11/2019 19:11	16/11/2019 15:16	17/11/2019 19:11	27,91	1	27,91	CHI
201911185470	AGUA FRIA DE GOIAS	JL12261887	SAO JOAO D ALIANCA	16/11/2019 19:03	16/11/2019 21:18	16/11/2019 19:03	16/11/2019 21:18	2,24	9	20,17	CHI
201911185470	SAO JOAO D ALIANCA	JL12261887	SAO JOAO D ALIANCA	16/11/2019 19:03	16/11/2019 21:18	16/11/2019 19:03	16/11/2019 21:18	2,24	17	38,10	CHI
201911185472	GOIANIA	GN11001012	CAMPINAS S1	16/11/2019 18:46	16/11/2019 21:48	16/11/2019 18:46	16/11/2019 21:48	3,03	92	278,84	CHI
201911185476	MINEIROS	1390023166	PARQUE DAS EMAS	16/11/2019 19:07	16/11/2019 20:20	16/11/2019 19:07	16/11/2019 20:20	1,22	1	1,22	CHI
201911185479	ANAPOLIS	AN21258686	JUNDIAI S1	16/11/2019 19:08	17/11/2019 08:57	16/11/2019 19:08	17/11/2019 08:57	13,81	2	27,61	CHI

201911185480	ORIZONA	OZ12186216	PIRES DO RIO S2	16/11/2019 07:52	16/11/2019 23:58	16/11/2019 07:52	16/11/2019 23:58	16,09	10	160,94	CHI
201911185489	CIDADE OCIDENTAL	DH11353932	MARAJOARA	16/11/2019 19:10	16/11/2019 21:19	16/11/2019 19:10	16/11/2019 21:19	2,15	54	116,06	CHI
201911185490	CATALAO	CT12358247	CATALAO S1	16/11/2019 18:35	17/11/2019 06:30	16/11/2019 18:35	17/11/2019 06:30	11,91	35	416,68	CHI
201911185492	GOIANIA	13001759	REAL S1	16/11/2019 19:10	16/11/2019 21:41	16/11/2019 19:10	16/11/2019 21:41	2,51	1	2,51	CHI
201911185506	JARAGUA	JA21019759	JARAGUA	16/11/2019 18:38	16/11/2019 22:42	16/11/2019 18:38	16/11/2019 22:42	4,05	1	4,05	CHI
201911185511	SANTO ANTONIO DO DESCOBERTO	SN12314001	MARAJOARA	16/11/2019 19:13	16/11/2019 21:50	16/11/2019 19:13	16/11/2019 21:50	2,61	132	344,67	CHI
201911185512	SAO MIGUEL DO ARAGUAIA	10009005631	SAO MIGUEL DO ARAGUAIA	16/11/2019 19:13	16/11/2019 22:54	16/11/2019 19:13	16/11/2019 22:54	3,69	1	3,69	CHI
201911185516	TRINDADE	40250994	TRINDADE	16/11/2019 19:14	16/11/2019 22:50	16/11/2019 19:14	16/11/2019 22:50	3,60	1	3,60	CHI
201911185532	FLORES DE GOIAS	FB12302693	IACIARA S2	16/11/2019 19:17	17/11/2019 11:15	16/11/2019 19:17	17/11/2019 11:15	15,95	2	31,90	CHI
201911185536	BRAZABRANTES	10014908440	INHUMAS S2	16/11/2019 16:08	17/11/2019 00:11	16/11/2019 16:08	17/11/2019 00:11	8,05	1	8,05	CHI
201911185539	GOIANIA	GN12399273	GOIANIA LESTE S1	16/11/2019 20:31	16/11/2019 23:25	16/11/2019 20:31	16/11/2019 23:25	2,89	1	2,89	CHI
201911185553	INDIARA	IY12010960	EDEIA	16/11/2019 20:25	17/11/2019 16:50	16/11/2019 20:25	17/11/2019 16:50	20,42	19	388,03	CHI
201911185556	RIO QUENTE	RQ21263199	RIO QUENTE	16/11/2019 19:21	17/11/2019 16:30	16/11/2019 19:21	17/11/2019 16:30	21,14	1	21,14	CHI
201911185564	APARECIDA DE GOIANIA	AP11007355	INDEPENDENCIA S1	16/11/2019 19:17	16/11/2019 22:51	16/11/2019 19:17	16/11/2019 22:51	3,56	64	227,79	CHI
201911185567	SENADOR CANEDO	190043799	SENADOR CANEDO	16/11/2019 19:23	16/11/2019 20:33	16/11/2019 19:23	16/11/2019 20:33	1,16	1	1,16	CHI
201911185589	ARAGARCAS	AG12000003	ARAGARCAS	16/11/2019 18:50	16/11/2019 19:22	16/11/2019 18:50	16/11/2019 19:22	0,54	99	53,10	CHI
201911185592	AURILANDIA	AI21194120	FIRMINOPOLIS S2	16/11/2019 19:27	16/11/2019 21:14	16/11/2019 19:27	16/11/2019 21:14	1,77	1	1,77	CHI
201911185596	SAO JOAO D ALIANCA	JL12253236	SAO JOAO D ALIANCA	16/11/2019 19:28	17/11/2019 14:11	16/11/2019 19:28	17/11/2019 14:11	18,71	14	261,95	CHI
201911185599	COLINAS DO SUL	TI12277661	MINACU	17/11/2019 15:46	18/11/2019 15:03	17/11/2019 15:46	18/11/2019 15:03	23,28	10	232,82	CHI
201911185606	LUZIANIA	LZ12390041	CRISTALINA S2	16/11/2019 18:39	17/11/2019 01:59	16/11/2019 18:39	17/11/2019 01:59	7,33	2	14,66	CHI
201911185609	JATAI	290231395	JATAI S2	16/11/2019 19:29	17/11/2019 14:15	16/11/2019 19:29	17/11/2019 14:15	18,76	1	18,76	CHI
201911185611	APARECIDA DE GOIANIA	AP11350709	INDEPENDENCIA S2	16/11/2019 19:29	16/11/2019 22:15	16/11/2019 19:29	16/11/2019 22:15	2,75	89	245,05	CHI
201911185613	ANAPOLIS	AN11211781	ANAPOLIS UNIVERSITARIO S2	16/11/2019 19:27	16/11/2019 21:19	16/11/2019 19:27	16/11/2019 21:19	1,86	136	253,53	CHI
201911185624	HIDROLANDIA	180067497	ANHANGUERA	16/11/2019 19:32	16/11/2019 22:02	16/11/2019 19:32	16/11/2019 22:02	2,50	1	2,50	CHI
201911185627	CATALAO	CT12266231	CATALAO S1	16/11/2019 18:28	16/11/2019 20:38	16/11/2019 18:28	16/11/2019 20:38	2,16	469	1013,56	CHI
201911185632	INHUMAS	IN21000023	INHUMAS S1	16/11/2019 19:32	17/11/2019 15:38	16/11/2019 19:32	17/11/2019 15:38	20,09	1	20,09	CHI
201911185634	SAO SIMAO	2240022730	CACHOEIRA ALTA	16/11/2019 19:33	18/11/2019 08:30	16/11/2019 19:33	18/11/2019 08:30	36,94	1	36,94	CHI
201911185640	MONTE ALEGRE DE GOIAS	MA12217827	SAO DOMINGOS	16/11/2019 19:25	17/11/2019 08:07	16/11/2019 19:25	17/11/2019 08:07	12,69	28	355,27	CHI
201911185643	GOIANIA	GN12000882	GOIANIA LESTE S2	16/11/2019 19:35	16/11/2019 23:37	16/11/2019 19:35	16/11/2019 23:37	4,02	262	1053,17	CHI
201911185654	NOVO GAMA	2460017796	PACAEMBU S1	16/11/2019 19:37	16/11/2019 21:34	16/11/2019 19:37	16/11/2019 21:34	1,94	1	1,94	CHI
201911185656	GOIANIA	12433743	CAMPINAS S2	16/11/2019 19:37	16/11/2019 20:57	16/11/2019 19:37	16/11/2019 20:57	1,32	1	1,32	CHI
201911185662	SAO MIGUEL DO ARAGUAIA	SM12182432	SAO MIGUEL DO ARAGUAIA	16/11/2019 18:49	17/11/2019 13:33	16/11/2019 18:49	17/11/2019 13:33	18,73	8	149,85	CHI
201911185664	ITAPACI	IW12239133	ITAPACI	16/11/2019 14:43	17/11/2019 22:44	16/11/2019 14:43	17/11/2019 22:30	31,79	3	95,36	CHI

201911185664	ITAPACI	IW12239133	ITAPACI	16/11/2019 14:43	17/11/2019 22:44	17/11/2019 21:02	17/11/2019 22:30	1,46	21	30,74	CHI
201911185664	ITAPACI	IW12363459LD	ITAPACI	16/11/2019 14:43	17/11/2019 22:44	16/11/2019 14:43	17/11/2019 22:44	32,01	2	64,02	CHI
201911185665	TRINDADE	TR21232951	TRINDADE	16/11/2019 19:38	17/11/2019 04:20	16/11/2019 19:38	17/11/2019 04:20	8,68	1	8,68	CHI
201911185688	QUIRINOPOLIS	QI11226325	QUIRINOPOLIS	16/11/2019 19:35	16/11/2019 22:34	16/11/2019 19:35	16/11/2019 22:34	2,97	151	449,06	CHI
201911185689	ITAPIRAPUA	IU11070527	MATRINCHA	16/11/2019 19:28	17/11/2019 07:42	16/11/2019 19:28	17/11/2019 07:42	12,22	121	1478,99	CHI
201911185696	MORRINHOS	MR11000041	MORRINHOS	16/11/2019 18:17	16/11/2019 22:23	16/11/2019 18:17	16/11/2019 22:23	4,09	99	404,74	CHI
201911185707	ARENOPOLIS	AY12000049	ARENOPOLIS	16/11/2019 19:51	17/11/2019 08:15	16/11/2019 19:51	17/11/2019 08:15	12,40	42	520,60	CHI
201911185707	IPORA	AY12000049	ARENOPOLIS	16/11/2019 19:51	17/11/2019 08:15	16/11/2019 19:51	17/11/2019 08:15	12,40	10	123,95	CHI
201911185711	SAO MIGUEL DO PASSA QUATRO	SQ11162915	CRISTIANOPOLIS	16/11/2019 19:36	16/11/2019 21:00	16/11/2019 19:36	16/11/2019 21:00	1,39	142	197,89	CHI
201911185717	NOVO GAMA	VA11351262	PACAEMBU S1	16/11/2019 19:54	17/11/2019 00:34	16/11/2019 19:54	17/11/2019 00:34	4,65	14	65,11	CHI
201911185720	GOIANIA	10494716	GOIANIA LESTE S3	16/11/2019 19:55	17/11/2019 00:28	16/11/2019 19:55	17/11/2019 00:28	4,54	1	4,54	CHI
201911185732	GOIANDIRA	CT21134393	CATALAO S1	16/11/2019 19:59	17/11/2019 22:54	16/11/2019 19:59	17/11/2019 22:54	26,92	1	26,92	CHI
201911185734	MINEIROS	MY12209668	PARQUE DAS EMAS	16/11/2019 19:36	17/11/2019 12:16	16/11/2019 19:36	17/11/2019 12:16	16,67	89	1483,33	CHI
201911185745	GOIANIA	GN11002201	GOIANIA LESTE S3	16/11/2019 18:54	16/11/2019 23:54	16/11/2019 18:54	16/11/2019 23:54	5,01	202	1011,07	CHI
201911185746	ACREUNA	SH12271266	SANTA HELENA S1	16/11/2019 20:02	17/11/2019 11:15	16/11/2019 20:02	17/11/2019 11:15	15,21	3	45,64	CHI
201911185746	SANTA HELENA DE GOIAS	SH12271266	SANTA HELENA S1	16/11/2019 20:02	17/11/2019 11:15	16/11/2019 20:02	17/11/2019 11:15	15,21	3	45,64	CHI
201911185750	GUARANI DE GOIAS	GY12465246	IACIARA S1	16/11/2019 20:02	17/11/2019 08:50	16/11/2019 20:02	17/11/2019 08:50	12,78	14	178,97	CHI
201911185750	IACIARA	GY12465246	IACIARA S1	16/11/2019 20:02	17/11/2019 08:50	16/11/2019 20:02	17/11/2019 08:50	12,78	3	38,35	CHI
201911185758	IPAMERI	IP21088379	IPAMERI	16/11/2019 20:05	17/11/2019 21:36	16/11/2019 20:05	17/11/2019 21:36	25,52	1	25,52	CHI
201911185759	CORUMBA DE GOIAS	ZN12382309	COCALZINHO	16/11/2019 20:04	17/11/2019 10:46	16/11/2019 20:04	17/11/2019 02:35	6,51	61	397,25	CHI
201911185759	CORUMBA DE GOIAS	19801785	COCALZINHO	16/11/2019 20:04	17/11/2019 10:46	16/11/2019 20:04	17/11/2019 10:46	14,71	1	14,71	CHI
201911185762	ITUMBIARA	IT21000258	PARANAIBA	16/11/2019 20:05	18/11/2019 18:10	16/11/2019 20:05	18/11/2019 18:10	46,08	1	46,08	CHI
201911185764	NIQUELANDIA	10014905564	NIQUELANDIA SUBTRANSMISSAO	16/11/2019 20:07	16/11/2019 22:31	16/11/2019 20:07	16/11/2019 22:31	2,40	1	2,40	CHI
201911185767	SANTA HELENA DE GOIAS	400046131	IPEGUARI	16/11/2019 20:07	17/11/2019 00:10	16/11/2019 20:07	17/11/2019 00:10	4,05	1	4,05	CHI
201911185775	GOIANIA	15714032	FERROVIARIO S1	16/11/2019 20:09	17/11/2019 00:18	16/11/2019 20:09	17/11/2019 00:18	4,14	1	4,14	CHI
201911185776	PORANGATU	PO12297140	PORANGATU	16/11/2019 18:26	16/11/2019 22:08	16/11/2019 18:26	16/11/2019 22:08	3,68	16	58,95	CHI
201911185776	SANTA TEREZA DE GOIAS	PO12297140	PORANGATU	16/11/2019 18:26	16/11/2019 22:08	16/11/2019 18:26	16/11/2019 22:08	3,68	11	40,53	CHI
201911185776	TROMBAS	PO12297140	PORANGATU	16/11/2019 18:26	16/11/2019 22:08	16/11/2019 18:26	16/11/2019 22:08	3,68	170	626,31	CHI
201911185781	GOIANIRA	10004534130	GOIANIRA	16/11/2019 19:43	16/11/2019 21:47	16/11/2019 19:43	16/11/2019 21:47	2,06	1	2,06	CHI
201911185790	ANICUNS	TV12304696	FIRMINOPOLIS S2	17/11/2019 07:45	17/11/2019 09:29	17/11/2019 07:45	17/11/2019 09:29	1,74	3	5,22	CHI
201911185790	TURVANIA	TV12304696	FIRMINOPOLIS S2	17/11/2019 07:45	17/11/2019 09:29	17/11/2019 07:45	17/11/2019 09:29	1,74	14	24,38	CHI
201911185795	CAMPINORTE	MQ21181673	MARA ROSA	16/11/2019 20:12	17/11/2019 00:11	16/11/2019 20:12	17/11/2019 00:11	3,97	1	3,97	CHI
201911185819	NIQUELANDIA	NQ12234038	NIQUELANDIA SUBTRANSMISSAO	16/11/2019 15:40	17/11/2019 00:26	16/11/2019 15:40	17/11/2019 00:26	8,75	4	35,01	CHI

201911185821	ORIZONA	OZ12143757	PIRES DO RIO S2	16/11/2019 21:27	18/11/2019 11:19	16/11/2019 21:27	17/11/2019 09:20	11,89	18	213,97	CHI
201911185821	ORIZONA	OZ12143757	PIRES DO RIO S2	16/11/2019 21:27	18/11/2019 11:19	17/11/2019 09:21	17/11/2019 10:24	1,04	13	13,54	CHI
201911185821	ORIZONA	OZ12143757	PIRES DO RIO S2	16/11/2019 21:27	18/11/2019 11:19	16/11/2019 21:27	18/11/2019 11:19	37,87	19	719,47	CHI
201911185821	ORIZONA	OZ12143757	PIRES DO RIO S2	16/11/2019 21:27	18/11/2019 11:19	17/11/2019 09:21	18/11/2019 11:19	25,96	5	129,82	CHI
201911185821	ORIZONA	OZ12143757	PIRES DO RIO S2	16/11/2019 21:27	18/11/2019 11:19	17/11/2019 10:25	18/11/2019 11:19	24,90	13	323,64	CHI
201911185822	ALVORADA DO NORTE	00010434	IACIARA S2	16/11/2019 23:58	17/11/2019 03:58	16/11/2019 23:58	17/11/2019 00:16	0,30	178	52,96	CHI
201911185822	BURITINOPOLIS	00010434	IACIARA S2	16/11/2019 23:58	17/11/2019 03:58	16/11/2019 23:58	17/11/2019 00:16	0,30	439	130,60	CHI
201911185822	BURITINOPOLIS	00010434	IACIARA S2	16/11/2019 23:58	17/11/2019 03:58	16/11/2019 23:58	17/11/2019 00:16	0,30	7	2,08	CHI
201911185822	DAMIANOPOLIS	00010434	IACIARA S2	16/11/2019 23:58	17/11/2019 03:58	16/11/2019 23:58	17/11/2019 00:16	0,30	1484	441,49	CHI
201911185822	DAMIANOPOLIS	00010434	IACIARA S2	16/11/2019 23:58	17/11/2019 03:58	16/11/2019 23:58	17/11/2019 00:16	0,30	3	0,89	CHI
201911185822	MAMBAI	00010434	IACIARA S2	16/11/2019 23:58	17/11/2019 03:58	16/11/2019 23:58	17/11/2019 00:16	0,30	2695	801,76	CHI
201911185822	MAMBAI	00010434	IACIARA S2	16/11/2019 23:58	17/11/2019 03:58	16/11/2019 23:58	17/11/2019 00:16	0,30	83	24,69	CHI
201911185822	MAMBAI	00010434	IACIARA S2	16/11/2019 23:58	17/11/2019 03:58	16/11/2019 23:58	17/11/2019 00:16	0,30	17	5,06	CHI
201911185822	SITIO D ABADIA	00010434	IACIARA S2	16/11/2019 23:58	17/11/2019 03:58	16/11/2019 23:58	17/11/2019 00:16	0,30	115	34,21	CHI
201911185822	SITIO D ABADIA	00010434	IACIARA S2	16/11/2019 23:58	17/11/2019 03:58	16/11/2019 23:58	17/11/2019 00:16	0,30	90	26,78	CHI
201911185822	SITIO D ABADIA	00010434	IACIARA S2	16/11/2019 23:58	17/11/2019 03:58	16/11/2019 23:58	17/11/2019 00:16	0,30	1	0,30	CHI
201911185822	SITIO D ABADIA	00010434	IACIARA S2	16/11/2019 23:58	17/11/2019 03:58	16/11/2019 23:58	17/11/2019 00:16	0,30	479	142,50	CHI
201911185822	SITIO D ABADIA	00010434	IACIARA S2	16/11/2019 23:58	17/11/2019 03:58	16/11/2019 23:58	17/11/2019 00:16	0,30	36	10,71	CHI
201911185822	DAMIANOPOLIS	SI13320458	IACIARA S2	16/11/2019 23:58	17/11/2019 03:58	16/11/2019 23:58	17/11/2019 03:58	3,99	130	519,35	CHI
201911185822	SITIO D ABADIA	SI13320458	IACIARA S2	16/11/2019 23:58	17/11/2019 03:58	16/11/2019 23:58	17/11/2019 03:58	3,99	253	1010,73	CHI
201911185823	JARAGUA	10010123251	JARAGUA	16/11/2019 19:12	17/11/2019 11:21	16/11/2019 19:12	17/11/2019 11:21	16,14	1	16,14	CHI
201911185830	BALIZA	DV10354680	CAIAPONIA	16/11/2019 23:21	17/11/2019 22:21	16/11/2019 23:21	16/11/2019 23:24	0,05	577	31,25	CHI
201911185830	DOVERLANDIA	DV10354680	CAIAPONIA	16/11/2019 23:21	17/11/2019 22:21	16/11/2019 23:21	16/11/2019 23:24	0,05	111	6,01	CHI
201911185830	BALIZA	DV10354680	CAIAPONIA	16/11/2019 23:21	17/11/2019 22:21	16/11/2019 23:25	17/11/2019 02:10	2,76	1	2,76	CHI
201911185830	DOVERLANDIA	DV10354680	CAIAPONIA	16/11/2019 23:21	17/11/2019 22:21	16/11/2019 23:25	17/11/2019 02:10	2,76	93	256,53	CHI
201911185830	BALIZA	DV13133316	CAIAPONIA	16/11/2019 23:21	17/11/2019 22:21	16/11/2019 23:21	17/11/2019 08:59	9,63	48	462,31	CHI
201911185830	DOVERLANDIA	DV13133316	CAIAPONIA	16/11/2019 23:21	17/11/2019 22:21	16/11/2019 23:21	17/11/2019 08:59	9,63	344	3313,20	CHI
201911185830	DOVERLANDIA	DV10354680	CAIAPONIA	16/11/2019 23:21	17/11/2019 22:21	16/11/2019 23:25	17/11/2019 08:59	9,57	18	172,21	CHI
201911185830	BALIZA	DV12212840LD	CAIAPONIA	16/11/2019 23:21	17/11/2019 22:21	16/11/2019 23:25	17/11/2019 12:53	13,47	377	5079,13	CHI
201911185830	BALIZA	BH13259451	CAIAPONIA	16/11/2019 23:21	17/11/2019 22:21	17/11/2019 16:57	17/11/2019 21:40	4,72	107	504,71	CHI
201911185830	BALIZA	DV10354680	CAIAPONIA	16/11/2019 23:21	17/11/2019 22:21	16/11/2019 23:25	17/11/2019 22:21	22,94	199	4564,34	CHI
201911185831	MOZARLANDIA	MZ10400707	MOZARLANDIA	16/11/2019 21:56	19/11/2019 08:53	16/11/2019 21:56	17/11/2019 09:24	11,47	34	389,99	CHI
201911185831	NOVA CRIXAS	MZ10400707	MOZARLANDIA	16/11/2019 21:56	19/11/2019 08:53	16/11/2019 21:56	17/11/2019 09:24	11,47	31	355,58	CHI

201911185831	NOVA CRIXAS	MZ10400707	MOZARLANDIA	16/11/2019 21:56	19/11/2019 08:53	16/11/2019 21:56	17/11/2019 10:33	12,62	51	643,44	CHI
201911185831	NOVA CRIXAS	MZ10400707	MOZARLANDIA	16/11/2019 21:56	19/11/2019 08:53	16/11/2019 21:56	17/11/2019 12:51	14,92	20	298,32	CHI
201911185831	CRIXAS	MZ10400707	NOVA CRIXAS	16/11/2019 21:56	19/11/2019 08:53	16/11/2019 21:56	17/11/2019 17:10	19,24	3	57,73	CHI
201911185831	NOVA CRIXAS	MZ10400707	NOVA CRIXAS	16/11/2019 21:56	19/11/2019 08:53	16/11/2019 21:56	17/11/2019 17:10	19,24	30	577,33	CHI
201911185831	NOVA CRIXAS	NA12057420LD	MOZARLANDIA	16/11/2019 21:56	19/11/2019 08:53	16/11/2019 21:56	17/11/2019 19:40	21,74	13	282,57	CHI
201911185831	NOVA CRIXAS	NA12057420LD	MOZARLANDIA	16/11/2019 21:56	19/11/2019 08:53	16/11/2019 21:56	17/11/2019 19:40	21,73	1	21,73	CHI
201911185831	CRIXAS	NA13294704	NOVA CRIXAS	16/11/2019 21:56	19/11/2019 08:53	18/11/2019 11:15	18/11/2019 12:00	0,75	3	2,25	CHI
201911185831	NOVA CRIXAS	NA13294704	NOVA CRIXAS	16/11/2019 21:56	19/11/2019 08:53	18/11/2019 11:15	18/11/2019 12:00	0,75	30	22,51	CHI
201911185831	NOVA CRIXAS	NA12057420LD	MOZARLANDIA	16/11/2019 21:56	19/11/2019 08:53	16/11/2019 21:56	18/11/2019 18:00	44,07	1	44,07	CHI
201911185831	NOVA CRIXAS	NA12057420LD	MOZARLANDIA	16/11/2019 21:56	19/11/2019 08:53	17/11/2019 20:54	18/11/2019 18:00	21,10	7	147,68	CHI
201911185831	NOVA CRIXAS	NA12057420LD	MOZARLANDIA	16/11/2019 21:56	19/11/2019 08:53	18/11/2019 11:15	18/11/2019 18:00	6,75	3	20,25	CHI
201911185831	NOVA CRIXAS	NA13309256	MOZARLANDIA	16/11/2019 21:56	19/11/2019 08:53	17/11/2019 20:54	18/11/2019 18:25	21,51	7	150,60	CHI
201911185831	CRIXAS	MZ10400707	MOZARLANDIA	16/11/2019 21:56	19/11/2019 08:53	16/11/2019 21:56	19/11/2019 08:53	58,95	1	58,95	CHI
201911185831	NOVA CRIXAS	MZ10400707	MOZARLANDIA	16/11/2019 21:56	19/11/2019 08:53	16/11/2019 21:56	19/11/2019 08:53	58,95	20	1179,06	CHI
201911185831	NOVA CRIXAS	MZ10400707	NOVA CRIXAS	16/11/2019 21:56	19/11/2019 08:53	16/11/2019 21:56	19/11/2019 08:53	58,95	1	58,95	CHI
201911185845	FLORES DE GOIAS	FB11037517	FLORES DE GOIAS	17/11/2019 02:13	17/11/2019 02:33	17/11/2019 02:13	17/11/2019 02:33	0,32	11	3,54	CHI
201911185849	GOIANDIRA	GD12165167LD	CATALAO S1	15/11/2019 17:08	17/11/2019 12:39	15/11/2019 17:08	17/11/2019 12:39	43,52	12	522,26	CHI
201911185851	CAVALCANTE	TI10396052	MINACU	17/11/2019 02:58	17/11/2019 22:29	17/11/2019 02:58	17/11/2019 08:53	5,92	80	473,93	CHI
201911185851	COLINAS DO SUL	TI10396052	MINACU	17/11/2019 02:58	17/11/2019 22:29	17/11/2019 02:58	17/11/2019 08:53	5,92	379	2245,26	CHI
201911185851	NIQUELANDIA	TI10396052	MINACU	17/11/2019 02:58	17/11/2019 22:29	17/11/2019 02:58	17/11/2019 08:53	5,92	1	5,92	CHI
201911185851	URUACU	TI10396052	MINACU	17/11/2019 02:58	17/11/2019 22:29	17/11/2019 02:58	17/11/2019 08:53	5,92	1	5,92	CHI
201911185851	COLINAS DO SUL	TI10401551	MINACU	17/11/2019 02:58	17/11/2019 22:29	17/11/2019 02:58	17/11/2019 09:34	6,60	15	98,98	CHI
201911185851	CAVALCANTE	TI12304945LD	MINACU	17/11/2019 02:58	17/11/2019 22:29	17/11/2019 02:58	17/11/2019 22:29	19,53	267	5214,06	CHI
201911185851	COLINAS DO SUL	TI12304945LD	MINACU	17/11/2019 02:58	17/11/2019 22:29	17/11/2019 02:58	17/11/2019 22:29	19,53	8	156,23	CHI
201911185853	IPORA	IR10396053	IPORA	17/11/2019 03:55	17/11/2019 15:45	17/11/2019 03:55	17/11/2019 06:43	2,80	27	75,52	CHI
201911185853	IPORA	IR12000017LD	IPORA	17/11/2019 03:55	17/11/2019 15:45	17/11/2019 03:55	17/11/2019 10:42	6,79	355	2411,04	CHI
201911185853	IVOLANDIA	IR12000017LD	IPORA	17/11/2019 03:55	17/11/2019 15:45	17/11/2019 03:55	17/11/2019 10:42	6,79	14	95,08	CHI
201911185853	IPORA	IR10396053	IPORA	17/11/2019 03:55	17/11/2019 15:45	17/11/2019 10:49	17/11/2019 14:06	3,28	156	511,42	CHI
201911185853	IPORA	IR10396053	IPORA	17/11/2019 03:55	17/11/2019 15:45	17/11/2019 14:01	17/11/2019 14:06	0,07	27	1,91	CHI
201911185853	IPORA	IR10400606	IPORA	17/11/2019 03:55	17/11/2019 15:45	17/11/2019 10:49	17/11/2019 14:09	3,34	194	647,91	CHI
201911185853	IVOLANDIA	IR10400606	IPORA	17/11/2019 03:55	17/11/2019 15:45	17/11/2019 10:49	17/11/2019 14:09	3,34	14	46,76	CHI
201911185853	IPORA	8630961	IPORA	17/11/2019 03:55	17/11/2019 15:45	17/11/2019 10:49	17/11/2019 15:02	4,22	4	16,90	CHI
201911185853	IPORA	IR12013991	IPORA	17/11/2019 03:55	17/11/2019 15:45	17/11/2019 03:55	17/11/2019 15:45	11,83	45	532,48	CHI

201911185859	NOVA CRIXAS	SM10406657	SAO MIGUEL DO ARAGUAIA	17/11/2019 06:35	17/11/2019 17:58	17/11/2019 06:35	17/11/2019 08:02	1,44	1	1,44	CHI
201911185859	SAO MIGUEL DO ARAGUAIA	SM10406657	SAO MIGUEL DO ARAGUAIA	17/11/2019 06:35	17/11/2019 17:58	17/11/2019 06:35	17/11/2019 08:02	1,44	281	405,11	CHI
201911185859	SAO MIGUEL DO ARAGUAIA	SM13086462	SAO MIGUEL DO ARAGUAIA	17/11/2019 06:35	17/11/2019 17:58	17/11/2019 06:35	17/11/2019 10:00	3,41	617	2107,05	CHI
201911185859	SAO MIGUEL DO ARAGUAIA	SM13374526	SAO MIGUEL DO ARAGUAIA	17/11/2019 06:35	17/11/2019 17:58	17/11/2019 06:35	17/11/2019 12:38	6,04	25	151,08	CHI
201911185859	SAO MIGUEL DO ARAGUAIA	SM12334369LD	SAO MIGUEL DO ARAGUAIA	17/11/2019 06:35	17/11/2019 17:58	17/11/2019 06:35	17/11/2019 17:58	11,39	105	1195,80	CHI
201911185868	NIQUELANDIA	10012982413	NIQUELANDIA SUBTRANSMISSAO	17/11/2019 07:51	17/11/2019 19:57	17/11/2019 07:51	17/11/2019 19:57	12,09	1	12,09	CHI
201911185870	LUZIANIA	LZ11261574	RIO VERMELHO	17/11/2019 07:56	17/11/2019 11:02	17/11/2019 07:56	17/11/2019 11:02	3,08	85	262,20	CHI
201911185886	MINEIROS	MY11084401	PARQUE DAS EMAS	17/11/2019 09:40	17/11/2019 11:10	17/11/2019 09:40	17/11/2019 11:10	1,49	71	105,79	CHI
201911185892	FIRMINOPOLIS	SL13277752	FIRMINOPOLIS S1	17/11/2019 14:00	17/11/2019 19:50	17/11/2019 14:00	17/11/2019 19:50	5,83	17	99,17	CHI
201911185892	SAO LUIS DE MONTES BELOS	SL13277752	FIRMINOPOLIS S1	17/11/2019 14:00	17/11/2019 19:50	17/11/2019 14:00	17/11/2019 19:50	5,83	11	64,17	CHI
201911185892	TURVANIA	SL13277752	FIRMINOPOLIS S1	17/11/2019 14:00	17/11/2019 19:50	17/11/2019 14:00	17/11/2019 19:50	5,83	8	46,67	CHI
201911185904	RIO VERDE	630043723	RIO VERDE S1	16/11/2019 20:14	17/11/2019 13:10	16/11/2019 20:14	17/11/2019 13:10	16,93	1	16,93	CHI
201911185909	ANAPOLIS	20718664	JUNDIAI S2	16/11/2019 20:16	17/11/2019 09:49	16/11/2019 20:16	17/11/2019 09:49	13,54	1	13,54	CHI
201911185910	URUACU	UR12390488	URUACU	16/11/2019 20:12	16/11/2019 23:22	16/11/2019 20:12	16/11/2019 23:22	3,16	9	28,42	CHI
201911185918	PIRENOPOLIS	PV21031645	CORUMBA	16/11/2019 20:18	17/11/2019 12:18	16/11/2019 20:18	17/11/2019 12:18	15,99	1	15,99	CHI
201911185925	FORMOSA	FA12053564	ITUIQUIRA	16/11/2019 20:19	17/11/2019 20:34	16/11/2019 20:19	17/11/2019 20:34	24,24	6	145,44	CHI
201911185927	IACIARA	IA12302910	IACIARA S1	16/11/2019 20:19	17/11/2019 06:44	16/11/2019 20:19	17/11/2019 06:44	10,40	11	114,45	CHI
201911185935	PIRENOPOLIS	PV11057886	CORUMBA	16/11/2019 20:17	16/11/2019 23:47	16/11/2019 20:17	16/11/2019 23:47	3,48	95	330,97	CHI
201911185939	FORMOSA	10003871116	ITUIQUIRA	16/11/2019 20:22	16/11/2019 21:50	16/11/2019 20:22	16/11/2019 21:50	1,46	1	1,46	CHI
201911185944	ADELANDIA	DN12323607	FIRMINOPOLIS S2	16/11/2019 20:22	16/11/2019 21:38	16/11/2019 20:22	16/11/2019 21:38	1,27	7	8,88	CHI
201911185944	SAO LUIS DE MONTES BELOS	DN12323607	FIRMINOPOLIS S2	16/11/2019 20:22	16/11/2019 21:38	16/11/2019 20:22	16/11/2019 21:38	1,27	6	7,61	CHI
201911185960	RIO VERDE	630081347	RIO VERDE S2	16/11/2019 20:29	17/11/2019 11:16	16/11/2019 20:29	17/11/2019 11:16	14,79	1	14,79	CHI
201911185962	LUZIANIA	LZ12349111	MARAJOARA	16/11/2019 20:05	16/11/2019 22:51	16/11/2019 20:05	16/11/2019 22:51	2,75	155	426,98	CHI
201911185968	PORANGATU	PO12202402	PORANGATU	16/11/2019 20:30	17/11/2019 13:37	16/11/2019 20:30	17/11/2019 13:37	17,10	21	359,18	CHI
201911185970	CRISTALINA	KR11133160	CRISTALINA S2	16/11/2019 19:25	16/11/2019 23:54	16/11/2019 19:25	16/11/2019 23:54	4,48	120	538,00	CHI
201911185988	IPAMERI	IP21195198	IPAMERI	16/11/2019 20:38	17/11/2019 09:16	16/11/2019 20:38	17/11/2019 09:16	12,62	1	12,62	CHI
201911185997	CAIAPONIA	PH12259516	CAIAPONIA	16/11/2019 20:41	17/11/2019 10:13	16/11/2019 20:41	17/11/2019 10:13	13,53	3	40,58	CHI
201911185997	PIRANHAS	PH12259516	CAIAPONIA	16/11/2019 20:41	17/11/2019 10:13	16/11/2019 20:41	17/11/2019 10:13	13,53	69	933,40	CHI
201911186000	GOIATUBA	GT11275015	GOIATUBA S2	16/11/2019 18:29	17/11/2019 09:21	16/11/2019 18:29	17/11/2019 09:21	14,86	139	2065,04	CHI
201911186011	APARECIDA DE GOIANIA	17100288	INDEPENDENCIA S2	16/11/2019 20:44	17/11/2019 09:17	16/11/2019 20:44	17/11/2019 09:17	12,54	1	12,54	CHI
201911186021	ITAGUARI	IC12035368	ITABERAI S1	16/11/2019 19:58	17/11/2019 14:58	16/11/2019 19:58	17/11/2019 14:58	19,00	27	512,95	CHI
201911186021	JARAGUA	IC12035368	ITABERAI S1	16/11/2019 19:58	17/11/2019 14:58	16/11/2019 19:58	17/11/2019 14:58	19,00	8	151,98	CHI
201911186024	PADRE BERNARDO	PB21158116	PADRE BERNARDO	16/11/2019 20:49	16/11/2019 23:49	16/11/2019 20:49	16/11/2019 23:49	2,98	1	2,98	CHI

201911186029	JATAI	JT12182138	JATAI S1	16/11/2019 17:39	17/11/2019 14:47	16/11/2019 17:39	17/11/2019 14:47	21,13	9	190,20	CHI
201911186031	GOIANIA	13520477	MEIA PONTE	16/11/2019 20:51	17/11/2019 05:21	16/11/2019 20:51	17/11/2019 05:21	8,50	1	8,50	CHI
201911186033	FORMOSA	PI12208713	PLANALTINA	16/11/2019 20:46	17/11/2019 19:20	16/11/2019 20:46	17/11/2019 03:09	6,37	1	6,37	CHI
201911186033	PLANALTINA	PI12208713	PLANALTINA	16/11/2019 20:46	17/11/2019 19:20	16/11/2019 20:46	17/11/2019 03:09	6,37	224	1427,88	CHI
201911186033	FORMOSA	PI12208713	PLANALTINA	16/11/2019 20:46	17/11/2019 19:20	17/11/2019 03:12	17/11/2019 07:51	4,66	1	4,66	CHI
201911186033	PLANALTINA	PI12208713	PLANALTINA	16/11/2019 20:46	17/11/2019 19:20	17/11/2019 03:12	17/11/2019 07:51	4,66	228	1062,35	CHI
201911186033	PLANALTINA	PI12208713	PLANALTINA	16/11/2019 20:46	17/11/2019 19:20	16/11/2019 20:46	17/11/2019 10:25	13,65	10	136,47	CHI
201911186033	FORMOSA	PI12208713	PLANALTINA	16/11/2019 20:46	17/11/2019 19:20	17/11/2019 08:32	17/11/2019 10:25	1,88	1	1,88	CHI
201911186033	PLANALTINA	PI12208713	PLANALTINA	16/11/2019 20:46	17/11/2019 19:20	17/11/2019 08:32	17/11/2019 10:25	1,88	228	429,59	CHI
201911186033	FORMOSA	PI12208713	PLANALTINA	16/11/2019 20:46	17/11/2019 19:20	17/11/2019 10:49	17/11/2019 18:27	7,63	1	7,63	CHI
201911186033	PLANALTINA	PI12208713	PLANALTINA	16/11/2019 20:46	17/11/2019 19:20	17/11/2019 10:49	17/11/2019 18:27	7,63	46	351,08	CHI
201911186033	PLANALTINA	PI12383322	PLANALTINA	16/11/2019 20:46	17/11/2019 19:20	17/11/2019 10:49	17/11/2019 18:50	8,01	112	897,06	CHI
201911186033	PLANALTINA	PI12242877	PLANALTINA	16/11/2019 20:46	17/11/2019 19:20	17/11/2019 10:49	17/11/2019 19:20	8,51	80	681,18	CHI
201911186037	GOIANIA	GN12000371	FERROVIARIO S2	16/11/2019 17:11	16/11/2019 21:27	16/11/2019 17:11	16/11/2019 21:27	4,27	1783	7615,89	CHI
201911186038	MARA ROSA	MQ12086247	MARA ROSA	16/11/2019 20:53	17/11/2019 07:15	16/11/2019 20:53	17/11/2019 07:15	10,36	7	72,52	CHI
201911186042	ITUMBIARA	IT21218153	PARANAIBA	16/11/2019 20:53	16/11/2019 23:03	16/11/2019 20:53	16/11/2019 23:03	2,15	1	2,15	CHI
201911186043	FORMOSA	FA32042714	SAO JOAO D ALIANCA	16/11/2019 20:07	17/11/2019 15:09	16/11/2019 20:07	17/11/2019 15:09	19,03	8	152,21	CHI
201911186045	VALPARAISO DE GOIAS	3350023937	PACAEMBU S2	16/11/2019 20:54	16/11/2019 22:28	16/11/2019 20:54	16/11/2019 22:28	1,55	1	1,55	CHI
201911186050	SENADOR CANEDO	16646332	GOIANIA LESTE S1	16/11/2019 20:57	17/11/2019 11:20	16/11/2019 20:57	17/11/2019 11:20	14,37	1	14,37	CHI
201911186067	FORMOSO	FO12285186	PORANGATU	16/11/2019 20:58	17/11/2019 00:07	16/11/2019 20:58	17/11/2019 00:07	3,15	78	245,59	CHI
201911186068	MUNDO NOVO DE GOIAS	NA12035650	NOVA CRIXAS	16/11/2019 19:27	17/11/2019 08:00	16/11/2019 19:27	17/11/2019 08:00	12,55	8	100,42	CHI
201911186068	NOVA CRIXAS	NA12035650	NOVA CRIXAS	16/11/2019 19:27	17/11/2019 08:00	16/11/2019 19:27	17/11/2019 08:00	12,55	24	301,27	CHI
201911186069	GOIANIA	GN12154060	CAMPINAS S2	16/11/2019 21:00	16/11/2019 22:09	16/11/2019 21:00	16/11/2019 22:09	1,14	79	90,06	CHI
201911186073	ORIZONA	OZ21136908	PIRES DO RIO S2	16/11/2019 21:06	18/11/2019 11:50	16/11/2019 21:06	18/11/2019 11:50	38,72	1	38,72	CHI
201911186075	ORIZONA	OZ21200133	PIRES DO RIO S2	16/11/2019 21:07	18/11/2019 12:52	16/11/2019 21:07	18/11/2019 12:52	39,73	1	39,73	CHI
201911186078	JUSSARA	JR12204867	IPORA	16/11/2019 21:09	17/11/2019 16:41	16/11/2019 21:09	17/11/2019 16:41	19,53	12	234,33	CHI
201911186083	CAMPESTRE DE GOIAS	GC12312851	TRINDADE	16/11/2019 21:11	17/11/2019 02:00	16/11/2019 21:11	17/11/2019 02:00	4,81	38	182,64	CHI
201911186090	POSSE	PS12234976	IACIARA S2	16/11/2019 21:13	17/11/2019 08:50	16/11/2019 21:13	17/11/2019 08:50	11,61	25	290,14	CHI
201911186097	ITABERAI	IB12016899	INHUMAS S1	16/11/2019 21:04	16/11/2019 23:20	16/11/2019 21:04	16/11/2019 23:20	2,26	30	67,77	CHI
201911186100	FORMOSO	FO12391929	PORANGATU	16/11/2019 21:17	17/11/2019 01:14	16/11/2019 21:17	17/11/2019 01:14	3,95	11	43,41	CHI
201911186105	SILVANIA	SV21027339	VIANOPOLIS	16/11/2019 21:19	17/11/2019 10:52	16/11/2019 21:19	17/11/2019 10:52	13,55	1	13,55	CHI
201911186108	ALTO HORIZONTE	AJ21065842	MARA ROSA	16/11/2019 21:19	17/11/2019 22:39	16/11/2019 21:19	17/11/2019 22:39	25,32	2	50,64	CHI
201911186119	AGUAS LINDAS DE GOIAS	10000462797	AGUAS LINDAS DE GOIAS S2	16/11/2019 21:24	16/11/2019 22:00	16/11/2019 21:24	16/11/2019 22:00	0,59	1	0,59	CHI

201911186123	SENADOR CANEDO	SW12092691	CEPAIGO S1	16/11/2019 21:25	17/11/2019 02:23	17/11/2019 01:10	17/11/2019 02:22	1,20	22	26,39	CHI
201911186123	SENADOR CANEDO	SW11198398	CEPAIGO S1	16/11/2019 21:25	17/11/2019 02:23	16/11/2019 21:25	17/11/2019 02:23	4,96	12	59,57	CHI
201911186128	GOIANIRA	GR11356809	GOIANIRA	16/11/2019 19:52	16/11/2019 22:28	16/11/2019 19:52	16/11/2019 22:28	2,59	86	222,53	CHI
201911186130	ANAPOLIS	AN11003272	JUNDAI S1	16/11/2019 21:18	16/11/2019 22:35	16/11/2019 21:18	16/11/2019 22:35	1,28	138	177,06	CHI
201911186131	CRIXAS	CX12102899	SERRA DO OURO	16/11/2019 20:51	17/11/2019 12:28	16/11/2019 20:51	17/11/2019 12:28	15,61	63	983,36	CHI
201911186137	MINACU	IH12171869	MINACU	16/11/2019 21:24	17/11/2019 01:34	16/11/2019 21:24	17/11/2019 01:34	4,16	74	307,53	CHI
201911186144	RIO VERDE	10011929675	CABRIUVA S1	16/11/2019 21:34	17/11/2019 09:31	16/11/2019 21:34	17/11/2019 09:31	11,95	1	11,95	CHI
201911186147	PALMEIRAS DE GOIAS	PL12194014	PALMEIRAS	16/11/2019 21:13	17/11/2019 08:30	16/11/2019 21:13	17/11/2019 08:30	11,28	60	677,03	CHI
201911186149	PILAR DE GOIAS	GG12405274	ITAPACI	16/11/2019 21:36	17/11/2019 10:31	16/11/2019 21:36	17/11/2019 10:31	12,91	16	206,60	CHI
201911186153	VICENTINOPOLIS	VI12218173	VICENTINOPOLIS	16/11/2019 21:39	18/11/2019 08:37	16/11/2019 21:39	18/11/2019 08:37	34,96	1	34,96	CHI
201911186157	GOIANIA	GN11002778	ATLANTICO S3	16/11/2019 21:36	16/11/2019 23:56	16/11/2019 21:36	16/11/2019 23:56	2,32	148	343,15	CHI
201911186160	MORRINHOS	MR21120839	MORRINHOS	16/11/2019 21:42	18/11/2019 17:32	16/11/2019 21:42	18/11/2019 17:32	43,82	1	43,82	CHI
201911186170	ITAPIRAPUA	IU12259711	MATRINCHA	16/11/2019 21:45	17/11/2019 09:14	16/11/2019 21:45	17/11/2019 09:14	11,48	5	57,40	CHI
201911186171	QUIRINOPOLIS	QI31255731	QUIRINOPOLIS	16/11/2019 15:51	16/11/2019 22:53	16/11/2019 15:51	16/11/2019 22:53	7,02	1	7,02	CHI
201911186183	ALEXANIA	AX11326404	ALEXANIA	16/11/2019 21:34	17/11/2019 03:39	16/11/2019 21:34	17/11/2019 03:39	6,08	22	133,73	CHI
201911186185	APARECIDA DE GOIANIA	15158202	REAL S1	16/11/2019 21:58	17/11/2019 08:33	16/11/2019 21:58	17/11/2019 08:33	10,57	1	10,57	CHI
201911186186	PANAMA	PX12171365	GOIATUBA S1	16/11/2019 21:59	19/11/2019 12:42	16/11/2019 21:59	19/11/2019 12:42	62,73	6	376,36	CHI
201911186191	GOIANIA	10943663	FERROVIARIO S2	16/11/2019 22:03	17/11/2019 04:02	16/11/2019 22:03	17/11/2019 04:02	5,98	1	5,98	CHI
201911186198	JARAGUA	JA21116896	JARAGUA	16/11/2019 22:05	17/11/2019 10:43	16/11/2019 22:05	17/11/2019 10:43	12,63	1	12,63	CHI
201911186212	FORMOSO	TB12139109	PORANGATU	16/11/2019 22:11	16/11/2019 23:33	16/11/2019 22:11	16/11/2019 23:33	1,36	5	6,79	CHI
201911186212	TROMBAS	TB12139109	PORANGATU	16/11/2019 22:11	16/11/2019 23:33	16/11/2019 22:11	16/11/2019 23:33	1,36	10	13,59	CHI
201911186213	JATAI	JT11058494	JATAI S3	16/11/2019 23:20	17/11/2019 01:35	16/11/2019 23:20	17/11/2019 01:35	2,25	124	279,00	CHI
201911186218	NIQUELANDIA	NQ12182461	NIQUELANDIA SUBTRANSMISSAO	16/11/2019 22:18	17/11/2019 21:37	16/11/2019 22:18	17/11/2019 21:37	23,31	5	116,53	CHI
201911186219	ARAGOIANIA	680017379	GUAPO S2	16/11/2019 22:19	17/11/2019 15:35	16/11/2019 22:19	17/11/2019 15:35	17,26	1	17,26	CHI
201911186227	BALIZA	BM12390150	BOM JARDIM	16/11/2019 22:25	17/11/2019 22:26	16/11/2019 22:25	17/11/2019 13:17	14,86	46	683,62	CHI
201911186227	BOM JARDIM DE GOIAS	BM12390150	BOM JARDIM	16/11/2019 22:25	17/11/2019 22:26	16/11/2019 22:25	17/11/2019 13:17	14,86	8	118,89	CHI
201911186227	BALIZA	BM12390150	BOM JARDIM	16/11/2019 22:25	17/11/2019 22:26	16/11/2019 22:25	17/11/2019 22:26	24,01	4	96,05	CHI
201911186227	BOM JARDIM DE GOIAS	BM12390150	BOM JARDIM	16/11/2019 22:25	17/11/2019 22:26	16/11/2019 22:25	17/11/2019 22:26	24,01	1	24,01	CHI
201911186229	NIQUELANDIA	NQ12342798	BARRO ALTO	16/11/2019 22:07	17/11/2019 02:48	16/11/2019 22:07	17/11/2019 02:48	4,68	3	14,04	CHI
201911186240	RIO VERDE	RV12371578	RIO VERDE S1	16/11/2019 22:29	17/11/2019 01:13	16/11/2019 22:29	17/11/2019 01:13	2,73	90	245,72	CHI
201911186241	SERRANOPOLIS	SX12296514	JATAI S1	16/11/2019 22:29	17/11/2019 13:20	16/11/2019 22:29	17/11/2019 13:20	14,84	11	163,22	CHI
201911186242	CAMPINORTE	2040003557	CAMPINORTE	16/11/2019 22:31	17/11/2019 13:22	16/11/2019 22:31	17/11/2019 13:22	14,84	1	14,84	CHI
201911186246	INHUMAS	30082535	INHUMAS S2	16/11/2019 22:34	17/11/2019 09:59	16/11/2019 22:34	17/11/2019 09:59	11,41	1	11,41	CHI

201911186248	GOIANIA	13995224	GOIANIA LESTE S3	16/11/2019 22:35	17/11/2019 07:17	16/11/2019 22:35	17/11/2019 07:17	8,69	1	8,69	CHI
201911186252	GOIAS	GS12274373	GOIAS	16/11/2019 22:28	17/11/2019 09:55	16/11/2019 22:28	17/11/2019 09:55	11,44	12	137,32	CHI
201911186253	RIO VERDE	630174957	CABRIUVA S1	16/11/2019 22:39	17/11/2019 12:04	16/11/2019 22:39	17/11/2019 12:04	13,41	1	13,41	CHI
201911186262	PORTELANDIA	PW12205299	PARQUE DAS EMAS	16/11/2019 22:46	17/11/2019 09:59	16/11/2019 22:46	17/11/2019 09:59	11,21	3	33,64	CHI
201911186263	AGUAS LINDAS DE GOIAS	LA11090229	AGUAS LINDAS DE GOIAS S1	16/11/2019 22:47	17/11/2019 01:01	16/11/2019 22:47	17/11/2019 01:01	2,22	108	240,09	CHI
201911186268	PALMEIRAS DE GOIAS	590061069	PALMEIRAS	16/11/2019 22:49	17/11/2019 00:30	16/11/2019 22:49	17/11/2019 00:30	1,67	1	1,67	CHI
201911186275	GOIATUBA	GT12000265	GOIATUBA S2	16/11/2019 17:09	19/11/2019 11:12	17/11/2019 12:39	17/11/2019 13:20	0,68	4	2,74	CHI
201911186275	GOIATUBA	8555559	GOIATUBA S2	16/11/2019 17:09	19/11/2019 11:12	16/11/2019 17:09	19/11/2019 11:12	66,06	1	66,06	CHI
201911186279	PORANGATU	PO21151762	PORANGATU	16/11/2019 22:57	17/11/2019 10:28	16/11/2019 22:57	17/11/2019 10:28	11,52	1	11,52	CHI
201911186281	SENADOR CANEDO	SW11092646	SENADOR CANEDO	16/11/2019 22:45	17/11/2019 03:09	16/11/2019 22:45	17/11/2019 03:09	4,40	137	602,57	CHI
201911186282	MOZARLANDIA	MZ11299829	MOZARLANDIA	16/11/2019 22:48	17/11/2019 11:15	16/11/2019 22:48	17/11/2019 11:15	12,45	95	1182,57	CHI
201911186285	MARA ROSA	MQ12135696	MARA ROSA	16/11/2019 23:00	17/11/2019 10:10	16/11/2019 23:00	17/11/2019 10:10	11,16	10	111,58	CHI
201911186403	GUARANI DE GOIAS	GY12267340	IACIARA S2	17/11/2019 06:41	17/11/2019 19:28	17/11/2019 06:41	17/11/2019 12:10	5,48	5	27,40	CHI
201911186403	GUARANI DE GOIAS	GY12267340	IACIARA S2	17/11/2019 06:41	17/11/2019 19:28	17/11/2019 06:41	17/11/2019 13:55	7,23	18	130,15	CHI
201911186403	GUARANI DE GOIAS	GY12267340	IACIARA S2	17/11/2019 06:41	17/11/2019 19:28	17/11/2019 06:41	17/11/2019 18:33	11,87	38	451,22	CHI
201911186403	GUARANI DE GOIAS	GY12267340	IACIARA S2	17/11/2019 06:41	17/11/2019 19:28	17/11/2019 18:52	17/11/2019 19:28	0,60	60	35,98	CHI
201911186405	JATAI	290185154	JATAI S2	16/11/2019 23:05	17/11/2019 12:48	16/11/2019 23:05	17/11/2019 12:48	13,71	1	13,71	CHI
201911186406	GOIANIA	10000152054	INDEPENDENCIA S2	16/11/2019 23:05	17/11/2019 00:54	16/11/2019 23:05	17/11/2019 00:54	1,80	1	1,80	CHI
201911186411	ACREUNA	EU12200726	ACREUNA	16/11/2019 23:07	17/11/2019 10:35	16/11/2019 23:07	17/11/2019 10:35	11,45	1	11,45	CHI
201911186411	TURVELANDIA	EU12200726	ACREUNA	16/11/2019 23:07	17/11/2019 10:35	16/11/2019 23:07	17/11/2019 10:35	11,45	3	34,36	CHI
201911186412	NOVA CRIXAS	NA12229610	NOVA CRIXAS	16/11/2019 22:21	17/11/2019 06:49	16/11/2019 22:21	17/11/2019 06:49	8,46	10	84,63	CHI
201911186420	GOIATUBA	GT12000018	GOIATUBA S2	16/11/2019 19:21	17/11/2019 08:57	16/11/2019 19:21	17/11/2019 08:57	13,60	156	2120,99	CHI
201911186427	GOIANIA	GN11281891	CARAJAS S1	16/11/2019 23:20	17/11/2019 01:34	16/11/2019 23:20	17/11/2019 01:34	2,23	47	104,72	CHI
201911186431	URUACU	CR21387928	MARA ROSA	16/11/2019 23:29	17/11/2019 12:26	16/11/2019 23:29	17/11/2019 12:26	12,94	1	12,94	CHI
201911186437	CRISTALINA	1060092909	CRISTALINA S1	16/11/2019 23:39	17/11/2019 06:34	16/11/2019 23:39	17/11/2019 06:34	6,90	1	6,90	CHI
201911186440	CABECEIRAS	10020843877	ITUIQUIRA	16/11/2019 23:43	17/11/2019 12:25	16/11/2019 23:43	17/11/2019 12:25	12,70	1	12,70	CHI
201911186443	PARAUNA	PU21301125	ACREUNA	16/11/2019 23:44	17/11/2019 08:13	16/11/2019 23:44	17/11/2019 08:13	8,48	1	8,48	CHI
201911186446	GOIANIA	GN11403126	GOIANIA LESTE S1	16/11/2019 20:31	17/11/2019 06:07	16/11/2019 20:31	17/11/2019 05:50	9,30	21	195,36	CHI
201911186446	GOIANIA	GN12399273	GOIANIA LESTE S1	16/11/2019 20:31	17/11/2019 06:07	17/11/2019 05:29	17/11/2019 06:07	0,64	1	0,64	CHI
201911186451	BRAZABRANTES	BR11013958	INHUMAS S2	16/11/2019 16:10	17/11/2019 09:00	16/11/2019 16:10	17/11/2019 09:00	16,82	66	1110,07	CHI
201911186452	BALIZA	BM12208861	BOM JARDIM	17/11/2019 08:05	17/11/2019 12:13	17/11/2019 08:05	17/11/2019 12:13	4,13	1	4,13	CHI
201911186452	BOM JARDIM DE GOIAS	BM12208861	BOM JARDIM	17/11/2019 08:05	17/11/2019 12:13	17/11/2019 08:05	17/11/2019 12:13	4,13	58	239,51	CHI
201911186455	RUBIATABA	780046419	RUBIATABA	17/11/2019 00:17	17/11/2019 01:45	17/11/2019 00:17	17/11/2019 01:45	1,46	1	1,46	CHI

201911186457	ITARUMA	IM21040270	CACHOEIRA ALTA	17/11/2019 00:20	17/11/2019 08:50	17/11/2019 00:20	17/11/2019 08:50	8,50	1	8,50	CHI
201911186493	PALESTINA DE GOIAS	PY12223011	PALESTINA	17/11/2019 03:54	17/11/2019 10:30	17/11/2019 03:54	17/11/2019 10:30	6,59	114	751,26	CHI
201911186495	QUIRINOPOLIS	QI32038046	QUIRINOPOLIS	15/11/2019 17:29	17/11/2019 08:07	15/11/2019 17:29	17/11/2019 08:07	38,62	24	926,91	CHI
201911186503	NIQUELANDIA	NQ12316271	BARRO ALTO	17/11/2019 02:01	17/11/2019 06:03	17/11/2019 02:01	17/11/2019 06:03	4,02	3	12,06	CHI
201911186509	GOIANIA	11042138	GOYA S1	17/11/2019 02:31	17/11/2019 07:45	17/11/2019 02:31	17/11/2019 07:45	5,23	1	5,23	CHI
201911186510	ALEXANIA	AX11326403	ALEXANIA	16/11/2019 21:55	17/11/2019 13:06	16/11/2019 21:55	17/11/2019 13:06	15,17	34	515,87	CHI
201911186521	FORMOSO	FO12071118	PORANGATU	17/11/2019 03:46	17/11/2019 08:57	17/11/2019 03:46	17/11/2019 08:57	5,18	5	25,91	CHI
201911186526	GUAPO	GA11365563	GUAPO S2	17/11/2019 03:55	17/11/2019 11:32	17/11/2019 03:55	17/11/2019 11:32	7,62	35	266,54	CHI
201911186527	CORUMBAIBA	NE13203056	CATALAO S1	17/11/2019 03:56	17/11/2019 13:36	17/11/2019 13:18	17/11/2019 13:35	0,28	135	38,25	CHI
201911186527	IPAMERI	NE13203056	CATALAO S1	17/11/2019 03:56	17/11/2019 13:36	17/11/2019 13:18	17/11/2019 13:35	0,28	15	4,25	CHI
201911186527	MORRINHOS	NE13203056	CATALAO S1	17/11/2019 03:56	17/11/2019 13:36	17/11/2019 13:18	17/11/2019 13:35	0,28	1	0,28	CHI
201911186527	NOVA AURORA	NE13203056	CATALAO S1	17/11/2019 03:56	17/11/2019 13:36	17/11/2019 13:18	17/11/2019 13:35	0,28	1112	315,07	CHI
201911186527	GOIANDIRA	NE13203055	CATALAO S1	17/11/2019 03:56	17/11/2019 13:36	17/11/2019 03:56	17/11/2019 13:36	9,66	7	67,62	CHI
201911186527	NOVA AURORA	NE13203055	CATALAO S1	17/11/2019 03:56	17/11/2019 13:36	17/11/2019 03:56	17/11/2019 13:36	9,66	13	125,58	CHI
201911186530	RIO VERDE	RV12271289	CABRIUVA S2	17/11/2019 04:07	19/11/2019 11:37	17/11/2019 04:07	17/11/2019 12:26	8,33	4	33,31	CHI
201911186530	RIO VERDE	RV12194426LD	CABRIUVA S2	17/11/2019 04:07	19/11/2019 11:37	17/11/2019 04:07	17/11/2019 13:47	9,67	7	67,70	CHI
201911186530	RIO VERDE	RV12213750	CABRIUVA S2	17/11/2019 04:07	19/11/2019 11:37	17/11/2019 04:07	17/11/2019 15:57	11,84	11	130,22	CHI
201911186530	RIO VERDE	RV12106375	CABRIUVA S2	17/11/2019 04:07	19/11/2019 11:37	17/11/2019 04:07	19/11/2019 07:41	51,56	6	309,39	CHI
201911186530	RIO VERDE	RV12106375	CABRIUVA S2	17/11/2019 04:07	19/11/2019 11:37	17/11/2019 04:07	19/11/2019 08:27	52,34	5	261,70	CHI
201911186530	RIO VERDE	RV12135924LD	CABRIUVA S2	17/11/2019 04:07	19/11/2019 11:37	17/11/2019 04:07	19/11/2019 09:57	53,85	6	323,07	CHI
201911186530	RIO VERDE	RV12271289	CABRIUVA S2	17/11/2019 04:07	19/11/2019 11:37	19/11/2019 09:58	19/11/2019 11:37	1,65	38	62,88	CHI
201911186538	MINACU	IH12182453	MINACU	17/11/2019 04:28	17/11/2019 13:42	17/11/2019 04:28	17/11/2019 11:14	6,76	94	635,34	CHI
201911186538	MINACU	IH12182453	MINACU	17/11/2019 04:28	17/11/2019 13:42	17/11/2019 04:28	17/11/2019 13:42	9,23	88	811,85	CHI
201911186539	BELA VISTA DE GOIAS	BV21317575	BELA VISTA S1	17/11/2019 04:29	17/11/2019 10:00	17/11/2019 04:29	17/11/2019 10:00	5,51	1	5,51	CHI
201911186540	ARAGARCAS	BM12204856	BOM JARDIM	16/11/2019 23:01	17/11/2019 07:00	16/11/2019 23:01	17/11/2019 07:00	7,97	23	183,34	CHI
201911186540	BALIZA	BM12204856	BOM JARDIM	16/11/2019 23:01	17/11/2019 07:00	16/11/2019 23:01	17/11/2019 07:00	7,97	49	390,58	CHI
201911186541	CAMPINACU	IH12320899	MINACU	16/11/2019 22:21	17/11/2019 07:51	16/11/2019 22:21	17/11/2019 07:51	9,49	13	123,36	CHI
201911186541	MINACU	IH12320899	MINACU	16/11/2019 22:21	17/11/2019 07:51	16/11/2019 22:21	17/11/2019 07:51	9,49	9	85,40	CHI
201911186545	MINEIROS	PW12219569	PARQUE DAS EMAS	17/11/2019 04:55	17/11/2019 14:48	17/11/2019 04:55	17/11/2019 14:48	9,88	43	424,90	CHI
201911186545	PORTELANDIA	PW12219569	PARQUE DAS EMAS	17/11/2019 04:55	17/11/2019 14:48	17/11/2019 04:55	17/11/2019 14:48	9,88	5	49,41	CHI
201911186546	RUBIATABA	RB12114296	RUBIATABA	17/11/2019 05:07	17/11/2019 10:37	17/11/2019 05:07	17/11/2019 10:37	5,50	1	5,50	CHI
201911186548	PORANGATU	PO12391676	NOVO PLANALTO	17/11/2019 05:08	17/11/2019 12:54	17/11/2019 05:08	17/11/2019 12:54	7,76	5	38,82	CHI
201911186553	SAO MIGUEL DO ARAGUAIA	SM12239670	SAO MIGUEL DO ARAGUAIA	17/11/2019 05:15	17/11/2019 11:31	17/11/2019 05:15	17/11/2019 11:31	6,26	11	68,86	CHI

201911186555	BARRO ALTO	BA21161172	GOIANESIA S1	17/11/2019 05:19	17/11/2019 12:22	17/11/2019 05:19	17/11/2019 12:22	7,04	2	14,08	CHI
201911186561	PORTELANDIA	PW21226541	PARQUE DAS EMAS	17/11/2019 05:23	17/11/2019 10:53	17/11/2019 05:23	17/11/2019 10:53	5,49	1	5,49	CHI
201911186567	GOUVELANDIA	GB12213510LD	QUIRINOPOLIS	17/11/2019 05:29	17/11/2019 11:52	17/11/2019 05:29	17/11/2019 11:52	6,38	27	172,27	CHI
201911186567	QUIRINOPOLIS	GB12213510LD	QUIRINOPOLIS	17/11/2019 05:29	17/11/2019 11:52	17/11/2019 05:29	17/11/2019 11:52	6,38	5	31,90	CHI
201911186567	GOUVELANDIA	GB12213510LD	QUIRINOPOLIS	17/11/2019 05:29	17/11/2019 11:52	17/11/2019 10:48	17/11/2019 11:52	1,07	71	75,65	CHI
201911186567	QUIRINOPOLIS	GB12213510LD	QUIRINOPOLIS	17/11/2019 05:29	17/11/2019 11:52	17/11/2019 10:48	17/11/2019 11:52	1,07	5	5,33	CHI
201911186579	AGUAS LINDAS DE GOIAS	4830165870	AGUAS LINDAS DE GOIAS S2	17/11/2019 05:46	17/11/2019 07:44	17/11/2019 05:46	17/11/2019 07:44	1,96	1	1,96	CHI
201911186583	AMARALINA	LC12278480	MARA ROSA	17/11/2019 05:50	17/11/2019 08:10	17/11/2019 05:50	17/11/2019 08:10	2,33	3	6,99	CHI
201911186584	GOIANIA	GN11238206	ATLANTICO S3	17/11/2019 05:22	17/11/2019 07:27	17/11/2019 05:22	17/11/2019 07:27	2,08	123	256,15	CHI
201911186587	FORMOSO	FO12088777	MARA ROSA	17/11/2019 05:55	17/11/2019 07:53	17/11/2019 05:55	17/11/2019 07:53	1,97	35	68,78	CHI
201911186598	PORANGATU	PO12141124	NOVO PLANALTO	17/11/2019 05:25	17/11/2019 12:35	17/11/2019 05:25	17/11/2019 12:35	7,16	20	143,28	CHI
201911186607	MUNDO NOVO DE GOIAS	MH12362454	NOVA CRIXAS	17/11/2019 04:18	17/11/2019 12:21	17/11/2019 04:18	17/11/2019 10:19	6,01	219	1316,80	CHI
201911186607	MUNDO NOVO DE GOIAS	MH12362454	NOVA CRIXAS	17/11/2019 04:18	17/11/2019 12:21	17/11/2019 08:34	17/11/2019 10:19	1,74	58	101,05	CHI
201911186607	MUNDO NOVO DE GOIAS	MH12362454	NOVA CRIXAS	17/11/2019 04:18	17/11/2019 12:21	17/11/2019 04:18	17/11/2019 11:45	7,44	8	59,52	CHI
201911186607	MUNDO NOVO DE GOIAS	MH13262749	NOVA CRIXAS	17/11/2019 04:18	17/11/2019 12:21	17/11/2019 08:34	17/11/2019 11:45	3,17	2	6,34	CHI
201911186607	AMARALINA	MH12362454	NOVA CRIXAS	17/11/2019 04:18	17/11/2019 12:21	17/11/2019 04:18	17/11/2019 12:21	8,06	1	8,06	CHI
201911186607	MUNDO NOVO DE GOIAS	MH12362454	NOVA CRIXAS	17/11/2019 04:18	17/11/2019 12:21	17/11/2019 04:18	17/11/2019 12:21	8,06	12	96,67	CHI
201911186609	MONTE ALEGRE DE GOIAS	MA21233188	SAO DOMINGOS	17/11/2019 06:09	17/11/2019 14:59	17/11/2019 06:09	17/11/2019 14:59	8,83	3	26,48	CHI
201911186613	LUZIANIA	3200209535	MARAJOARA	17/11/2019 06:10	17/11/2019 07:30	17/11/2019 06:10	17/11/2019 07:30	1,32	1	1,32	CHI
201911186617	FORMOSA	FA12278155	ITIQUEIRA	17/11/2019 05:36	17/11/2019 09:42	17/11/2019 05:36	17/11/2019 09:42	4,09	31	126,68	CHI
201911186617	VILA BOA	FA12278155	ITIQUEIRA	17/11/2019 05:36	17/11/2019 09:42	17/11/2019 05:36	17/11/2019 09:42	4,09	4	16,35	CHI
201911186619	ABADIANIA	AA12377756	ANAPOLIS UNIVERSITARIO S1	17/11/2019 06:13	17/11/2019 19:12	17/11/2019 06:13	17/11/2019 19:12	12,98	6	77,91	CHI
201911186621	URUACU	UR12341322	URUACU	17/11/2019 06:14	17/11/2019 09:05	17/11/2019 06:14	17/11/2019 09:05	2,84	2	5,69	CHI
201911186626	GOIANIA	10026782969	CARAJAS S2	17/11/2019 06:16	17/11/2019 08:42	17/11/2019 06:16	17/11/2019 08:42	2,43	1	2,43	CHI
201911186630	GOIANIA	GN12170698	GOIANIA LESTE S2	17/11/2019 06:18	17/11/2019 09:27	17/11/2019 06:18	17/11/2019 08:55	2,61	199	519,94	CHI
201911186630	GOIANIA	GN12170698	GOIANIA LESTE S2	17/11/2019 06:18	17/11/2019 09:27	17/11/2019 06:18	17/11/2019 09:27	3,15	53	167,16	CHI
201911186631	NIQUELANDIA	NQ12288338	NIQUELANDIA SUBTRANSMISSAO	17/11/2019 06:19	17/11/2019 11:57	17/11/2019 06:19	17/11/2019 11:57	5,63	5	28,15	CHI
201911186636	APARECIDA DE GOIANIA	AP11291458	CEPAIGO S1	17/11/2019 04:10	17/11/2019 08:48	17/11/2019 04:10	17/11/2019 08:48	4,63	183	847,59	CHI
201911186637	NIQUELANDIA	NQ12335361	NIQUELANDIA SUBTRANSMISSAO	17/11/2019 06:20	17/11/2019 09:28	17/11/2019 06:20	17/11/2019 09:28	3,12	8	24,95	CHI
201911186638	ITABERAI	IB12105484	ITABERAI S2	17/11/2019 06:14	17/11/2019 10:08	17/11/2019 06:14	17/11/2019 10:08	3,89	9	35,02	CHI
201911186638	ITAPURANGA	IB12105484	ITABERAI S2	17/11/2019 06:14	17/11/2019 10:08	17/11/2019 06:14	17/11/2019 10:08	3,89	1	3,89	CHI
201911186639	IPAMERI	IP21017040	IPAMERI	17/11/2019 06:21	17/11/2019 23:41	17/11/2019 06:21	17/11/2019 23:41	17,32	1	17,32	CHI
201911186641	DOVERLANDIA	DV12380883	CAIAPONIA	17/11/2019 06:22	18/11/2019 10:15	17/11/2019 06:22	18/11/2019 10:15	27,87	7	195,12	CHI

201911186642	ACREUNA	EU21260899	ACREUNA	17/11/2019 06:23	17/11/2019 09:40	17/11/2019 06:23	17/11/2019 09:40	3,28	1	3,28	CHI
201911186648	VICENTINOPOLIS	VI21166485	VICENTINOPOLIS	17/11/2019 06:29	18/11/2019 09:09	17/11/2019 06:29	18/11/2019 09:09	26,66	1	26,66	CHI
201911186659	SANTA RITA DO NOVO DESTINO	BA12152774	BARRO ALTO	17/11/2019 04:52	17/11/2019 08:39	17/11/2019 04:52	17/11/2019 08:39	3,78	70	264,37	CHI
201911186660	FORMOSA	FA12207282	ITIQUEIRA	17/11/2019 05:21	17/11/2019 12:49	17/11/2019 05:21	17/11/2019 12:49	7,46	15	111,95	CHI
201911186672	IACIARA	ND12218839	IACIARA S2	17/11/2019 04:12	18/11/2019 16:33	17/11/2019 04:12	17/11/2019 10:31	6,32	15	94,81	CHI
201911186672	IACIARA	ND12218839	IACIARA S2	17/11/2019 04:12	18/11/2019 16:33	17/11/2019 04:12	17/11/2019 21:19	17,12	3	51,37	CHI
201911186672	IACIARA	ND12218839	IACIARA S2	17/11/2019 04:12	18/11/2019 16:33	17/11/2019 12:45	17/11/2019 21:19	8,57	15	128,53	CHI
201911186672	IACIARA	ND12218839	IACIARA S2	17/11/2019 04:12	18/11/2019 16:33	17/11/2019 04:12	18/11/2019 16:33	36,35	4	145,40	CHI
201911186672	SAO DOMINGOS	ND12218839	IACIARA S2	17/11/2019 04:12	18/11/2019 16:33	17/11/2019 04:12	18/11/2019 16:33	36,35	3	109,05	CHI
201911186672	IACIARA	IA13218879	IACIARA S2	17/11/2019 04:12	18/11/2019 16:33	17/11/2019 08:18	18/11/2019 16:33	32,25	2	64,50	CHI
201911186675	MARA ROSA	MQ12263046	MARA ROSA	17/11/2019 05:40	17/11/2019 09:20	17/11/2019 05:40	17/11/2019 09:20	3,66	7	25,65	CHI
201911186676	CASTELANDIA	DM21193857	QUIRINOPOLIS	17/11/2019 06:41	17/11/2019 12:08	17/11/2019 06:41	17/11/2019 12:08	5,46	1	5,46	CHI
201911186679	ANAPOLIS	10020549707	ANAPOLIS UNIVERSITARIO S2	17/11/2019 06:42	17/11/2019 13:45	17/11/2019 06:42	17/11/2019 13:45	7,04	1	7,04	CHI
201911186682	PORANGATU	PO12202569	PORANGATU	17/11/2019 06:44	17/11/2019 13:39	17/11/2019 06:44	17/11/2019 13:39	6,90	6	41,42	CHI
201911186683	ITAPURANGA	IK21310850	ITAPURANGA	17/11/2019 06:44	17/11/2019 17:00	17/11/2019 06:44	17/11/2019 17:00	10,27	2	20,54	CHI
201911186693	CORREGO DO OURO	FN12253655	IPORA	17/11/2019 06:48	18/11/2019 11:16	17/11/2019 06:48	18/11/2019 11:16	28,45	3	85,35	CHI
201911186693	FAZENDA NOVA	FN12253655	IPORA	17/11/2019 06:48	18/11/2019 11:16	17/11/2019 06:48	18/11/2019 11:16	28,45	11	312,96	CHI
201911186696	FIRMINOPOLIS	FR12000064	FIRMINOPOLIS S1	17/11/2019 06:33	17/11/2019 08:43	17/11/2019 06:33	17/11/2019 08:43	2,17	43	93,26	CHI
201911186697	CATALAO	CT12266940	CATALAO S1	17/11/2019 06:50	17/11/2019 20:19	17/11/2019 06:50	17/11/2019 20:19	13,48	2	26,96	CHI
201911186701	SANTA TEREZA DE GOIAS	SE12053785	MARA ROSA	17/11/2019 06:52	17/11/2019 11:58	17/11/2019 06:52	17/11/2019 11:58	5,09	5	25,46	CHI
201911186703	FORMOSA	FA21233563	ITIQUEIRA	17/11/2019 06:54	18/11/2019 14:40	17/11/2019 06:54	18/11/2019 14:40	31,76	1	31,76	CHI
201911186705	PALMEIRAS DE GOIAS	PL21323514	PALMEIRAS	17/11/2019 06:55	17/11/2019 08:32	17/11/2019 06:55	17/11/2019 08:32	1,62	2	3,24	CHI
201911186708	ABADIA DE GOIAS	LG11227476	CARAJAS S1	17/11/2019 05:45	17/11/2019 08:52	17/11/2019 05:45	17/11/2019 08:52	3,11	120	372,83	CHI
201911186709	BARRO ALTO	DF12205803	GOIANESIA S1	17/11/2019 06:13	17/11/2019 08:34	17/11/2019 06:13	17/11/2019 08:34	2,34	7	16,41	CHI
201911186709	SANTA RITA DO NOVO DESTINO	DF12205803	GOIANESIA S1	17/11/2019 06:13	17/11/2019 08:34	17/11/2019 06:13	17/11/2019 08:34	2,34	10	23,44	CHI
201911186710	IACIARA	IA12394108	IACIARA S1	17/11/2019 06:56	17/11/2019 11:35	17/11/2019 06:56	17/11/2019 11:35	4,64	7	32,51	CHI
201911186712	PARAUNA	JD12143018	PALMEIRAS	17/11/2019 06:56	17/11/2019 11:16	17/11/2019 06:56	17/11/2019 11:16	4,32	21	90,67	CHI
201911186716	FLORES DE GOIAS	3480015540	FLORES DE GOIAS	17/11/2019 06:57	18/11/2019 12:58	17/11/2019 06:57	18/11/2019 12:58	30,01	1	30,01	CHI
201911186718	MINACU	IH12307129	MINACU	17/11/2019 06:58	17/11/2019 19:59	17/11/2019 06:58	17/11/2019 19:59	13,01	12	156,08	CHI
201911186722	FORMOSA	FA21329740	ITIQUEIRA	17/11/2019 06:59	18/11/2019 11:52	17/11/2019 06:59	18/11/2019 11:52	28,88	1	28,88	CHI
201911186724	ARAGOIANIA	AO31064815	GUAPO S2	17/11/2019 07:02	17/11/2019 09:50	17/11/2019 07:02	17/11/2019 09:50	2,79	1	2,79	CHI
201911186727	NIQUELANDIA	NQ12347179	NIQUELANDIA SUBTRANSMISSAO	16/11/2019 19:09	17/11/2019 10:35	16/11/2019 19:09	17/11/2019 10:35	15,42	15	231,26	CHI
201911186730	GOIAS	GS12220477	GOIAS	17/11/2019 07:04	17/11/2019 12:05	17/11/2019 07:04	17/11/2019 12:05	5,01	11	55,06	CHI

201911186734	EDEIA	IY12399332	EDEIA	16/11/2019 20:27	17/11/2019 10:11	16/11/2019 20:27	17/11/2019 10:11	13,74	4	54,98	CHI
201911186734	INDIARA	IY12399332	EDEIA	16/11/2019 20:27	17/11/2019 10:11	16/11/2019 20:27	17/11/2019 10:11	13,74	426	5855,01	CHI
201911186734	JANDAIA	IY12399332	EDEIA	16/11/2019 20:27	17/11/2019 10:11	16/11/2019 20:27	17/11/2019 10:11	13,74	1	13,74	CHI
201911186738	CUMARI	10007363344	CATALAO S1	17/11/2019 07:07	18/11/2019 15:50	17/11/2019 07:07	18/11/2019 15:50	32,70	1	32,70	CHI
201911186744	IACIARA	IA12232131	IACIARA S1	17/11/2019 07:10	17/11/2019 10:05	17/11/2019 07:10	17/11/2019 10:05	2,91	6	17,46	CHI
201911186746	CAIAPONIA	CP12060853	CAIAPONIA	16/11/2019 23:59	17/11/2019 14:31	16/11/2019 23:59	17/11/2019 14:31	14,52	90	1307,23	CHI
201911186746	DOVERLANDIA	CP12060853	CAIAPONIA	16/11/2019 23:59	17/11/2019 14:31	16/11/2019 23:59	17/11/2019 14:31	14,52	3	43,57	CHI
201911186751	ARAGUAPAZ	AZ12188220	MOZARLANDIA	17/11/2019 07:12	17/11/2019 19:15	17/11/2019 07:12	17/11/2019 18:11	10,98	4	43,91	CHI
201911186751	ARAGUAPAZ	AZ12188220	MOZARLANDIA	17/11/2019 07:12	17/11/2019 19:15	17/11/2019 07:12	17/11/2019 18:50	11,62	5	58,12	CHI
201911186751	ARAGUAPAZ	AZ12188220	MOZARLANDIA	17/11/2019 07:12	17/11/2019 19:15	17/11/2019 07:12	17/11/2019 18:55	11,71	14	163,90	CHI
201911186751	ARAGUAPAZ	AZ12188220	MOZARLANDIA	17/11/2019 07:12	17/11/2019 19:15	17/11/2019 07:12	17/11/2019 19:15	12,04	12	144,48	CHI
201911186751	MOZARLANDIA	AZ12188220	MOZARLANDIA	17/11/2019 07:12	17/11/2019 19:15	17/11/2019 07:12	17/11/2019 19:15	12,04	7	84,28	CHI
201911186755	INHUMAS	10017478802	INHUMAS S2	17/11/2019 07:15	17/11/2019 08:45	17/11/2019 07:15	17/11/2019 08:45	1,51	1	1,51	CHI
201911186756	BOM JARDIM DE GOIAS	7046428	BOM JARDIM	17/11/2019 07:15	17/11/2019 14:50	17/11/2019 07:15	17/11/2019 14:50	7,58	1	7,58	CHI
201911186763	ARAGUAPAZ	AZ12042908	MOZARLANDIA	17/11/2019 07:16	17/11/2019 10:17	17/11/2019 07:16	17/11/2019 10:17	3,01	46	138,43	CHI
201911186764	SAO MIGUEL DO ARAGUAIA	SM12081437	SAO MIGUEL DO ARAGUAIA	17/11/2019 07:16	17/11/2019 10:14	17/11/2019 07:16	17/11/2019 10:14	2,96	23	68,17	CHI
201911186765	NOVA CRIXAS	NA21213679	NOVA CRIXAS	17/11/2019 07:17	17/11/2019 09:02	17/11/2019 07:17	17/11/2019 09:02	1,73	2	3,47	CHI
201911186769	CORREGO DO OURO	CO21300419	SAO LUIZ DOS MONTES BELOS	17/11/2019 07:18	17/11/2019 18:47	17/11/2019 07:18	17/11/2019 18:47	11,47	1	11,47	CHI
201911186771	CALDAS NOVAS	CN11114789	SERRA DE CALDAS	17/11/2019 06:07	17/11/2019 12:03	17/11/2019 06:07	17/11/2019 12:03	5,93	76	451,00	CHI
201911186772	PEROLANDIA	DP12103843	JATAI S1	17/11/2019 06:29	17/11/2019 08:40	17/11/2019 06:29	17/11/2019 08:40	2,17	14	30,36	CHI
201911186778	GOIANIA	16462567	ATLANTICO S3	17/11/2019 07:22	17/11/2019 09:14	17/11/2019 07:22	17/11/2019 09:14	1,86	1	1,86	CHI
201911186780	VILA BOA	FA21042059	ITIQUEIRA	17/11/2019 07:22	17/11/2019 14:36	17/11/2019 07:22	17/11/2019 14:36	7,23	1	7,23	CHI
201911186783	ARUANA	04300216	MOZARLANDIA	17/11/2019 07:23	18/11/2019 19:32	17/11/2019 07:23	17/11/2019 16:05	8,70	8	69,60	CHI
201911186783	MOZARLANDIA	04300216	MOZARLANDIA	17/11/2019 07:23	18/11/2019 19:32	17/11/2019 07:23	17/11/2019 16:05	8,70	20	174,01	CHI
201911186783	NOVA CRIXAS	04300216	MOZARLANDIA	17/11/2019 07:23	18/11/2019 19:32	17/11/2019 07:23	17/11/2019 16:05	8,70	1	8,70	CHI
201911186783	MOZARLANDIA	MZ13220371	MOZARLANDIA	17/11/2019 07:23	18/11/2019 19:32	17/11/2019 15:30	17/11/2019 16:49	1,32	33	43,67	CHI
201911186783	MOZARLANDIA	04300216	MOZARLANDIA	17/11/2019 07:23	18/11/2019 19:32	17/11/2019 07:23	18/11/2019 09:47	26,41	20	528,25	CHI
201911186783	NOVA CRIXAS	04300216	MOZARLANDIA	17/11/2019 07:23	18/11/2019 19:32	17/11/2019 07:23	18/11/2019 09:47	26,41	34	898,02	CHI
201911186783	MOZARLANDIA	04300216	MOZARLANDIA	17/11/2019 07:23	18/11/2019 19:32	17/11/2019 07:23	18/11/2019 13:04	29,69	8	237,54	CHI
201911186783	MOZARLANDIA	04300216	MOZARLANDIA	17/11/2019 07:23	18/11/2019 19:32	17/11/2019 07:23	18/11/2019 19:32	36,15	19	686,86	CHI
201911186790	JATAI	JT21274137	JATAI S2	17/11/2019 07:24	17/11/2019 11:13	17/11/2019 07:24	17/11/2019 11:13	3,80	1	3,80	CHI
201911186792	SANTA HELENA DE GOIAS	400036976	IPEGUARI	17/11/2019 07:25	17/11/2019 10:20	17/11/2019 07:25	17/11/2019 10:20	2,92	1	2,92	CHI
201911186793	CAMPINACU	UC12269889	MARA ROSA	17/11/2019 07:25	18/11/2019 12:40	17/11/2019 07:25	18/11/2019 12:40	29,24	6	175,46	CHI

201911186794	MUTUNOPOLIS	MU12391657	MARA ROSA	17/11/2019 07:25	17/11/2019 11:06	17/11/2019 07:25	17/11/2019 11:06	3,67	15	55,11	CHI
201911186797	ALTO PARAISO DE GOIAS	BF12096495	SAO JOAO D ALIANCA	16/11/2019 22:58	18/11/2019 09:24	16/11/2019 22:58	18/11/2019 09:24	34,43	8	275,46	CHI
201911186800	MAURILANDIA	RV12028634	SANTA HELENA S1	17/11/2019 07:26	17/11/2019 14:03	17/11/2019 07:26	17/11/2019 14:03	6,61	2	13,22	CHI
201911186804	GOIANIA	12489918	GOIANIA LESTE S1	17/11/2019 07:27	17/11/2019 09:49	17/11/2019 07:27	17/11/2019 09:49	2,36	1	2,36	CHI
201911186807	PARANAIGUARA	QI12101708	QUIRINOPOLIS	17/11/2019 07:25	17/11/2019 17:21	17/11/2019 07:25	17/11/2019 17:21	9,92	3	29,77	CHI
201911186807	QUIRINOPOLIS	QI12101708	QUIRINOPOLIS	17/11/2019 07:25	17/11/2019 17:21	17/11/2019 07:25	17/11/2019 17:21	9,92	10	99,22	CHI
201911186809	LUZIANIA	120363720	RIO VERMELHO	17/11/2019 07:28	17/11/2019 08:52	17/11/2019 07:28	17/11/2019 08:52	1,39	1	1,39	CHI
201911186813	URUACU	UR21271951	MARA ROSA	17/11/2019 07:30	17/11/2019 14:19	17/11/2019 07:30	17/11/2019 14:19	6,81	2	13,62	CHI
201911186820	MINACU	IH12334376	MINACU	17/11/2019 07:33	18/11/2019 19:07	17/11/2019 07:33	18/11/2019 19:07	35,57	3	106,71	CHI
201911186820	MINACU	IH12334376	MINACU	17/11/2019 07:33	18/11/2019 19:07	18/11/2019 14:47	18/11/2019 19:07	4,32	266	1150,23	CHI
201911186822	EDEIA	1120014065	EDEIA	17/11/2019 07:33	17/11/2019 12:00	17/11/2019 07:33	17/11/2019 12:00	4,44	1	4,44	CHI
201911186824	ALTO HORIZONTE	AJ21266639	SANTA TEREZINHA	17/11/2019 07:34	17/11/2019 13:22	17/11/2019 07:34	17/11/2019 13:22	5,80	1	5,80	CHI
201911186827	FAINA	FC12321457	GOIAS	17/11/2019 07:35	19/11/2019 09:50	17/11/2019 07:35	19/11/2019 09:50	50,24	20	1004,76	CHI
201911186830	SERRANOPOLIS	SX12260314	JATAI S1	17/11/2019 07:36	17/11/2019 16:06	17/11/2019 07:36	17/11/2019 16:06	8,50	4	33,99	CHI
201911186832	ACREUNA	980050777	ACREUNA	17/11/2019 07:36	17/11/2019 12:00	17/11/2019 07:36	17/11/2019 12:00	4,41	1	4,41	CHI
201911186833	PARAUNA	PU21295909	ACREUNA	17/11/2019 07:36	17/11/2019 13:28	17/11/2019 07:36	17/11/2019 13:28	5,86	1	5,86	CHI
201911186835	GUARAITA	GK12299340	ITAPURANGA	17/11/2019 06:58	17/11/2019 11:15	17/11/2019 06:58	17/11/2019 11:15	4,29	22	94,36	CHI
201911186836	JATAI	JT21267512	JATAI S3	17/11/2019 07:36	17/11/2019 09:42	17/11/2019 07:36	17/11/2019 09:42	2,09	1	2,09	CHI
201911186840	GOIANIA	10942348	FERROVIARIO S2	17/11/2019 07:39	17/11/2019 08:57	17/11/2019 07:39	17/11/2019 08:57	1,30	1	1,30	CHI
201911186841	IPAMERI	IP21300940	IPAMERI	17/11/2019 07:39	18/11/2019 10:39	17/11/2019 07:39	18/11/2019 10:39	26,99	1	26,99	CHI
201911186844	ANICUNS	AC12391418	ANICUNS	17/11/2019 07:39	17/11/2019 11:30	17/11/2019 07:39	17/11/2019 11:30	3,84	17	65,32	CHI
201911186850	GOIANIA	13568553	GOIANIA LESTE S3	17/11/2019 07:40	17/11/2019 10:53	17/11/2019 07:40	17/11/2019 10:53	3,21	1	3,21	CHI
201911186860	MINACU	IH12171869	MINACU	17/11/2019 07:25	17/11/2019 10:20	17/11/2019 07:25	17/11/2019 10:20	2,91	74	215,11	CHI
201911186862	SAO MIGUEL DO ARAGUAIA	SM12151000	SAO MIGUEL DO ARAGUAIA	17/11/2019 06:49	17/11/2019 15:55	17/11/2019 06:49	17/11/2019 15:55	9,09	19	172,73	CHI
201911186864	SAO DOMINGOS	SD12161807	SAO DOMINGOS	17/11/2019 07:18	17/11/2019 09:24	17/11/2019 07:18	17/11/2019 09:24	2,09	18	37,55	CHI
201911186865	FORMOSA	FA12106823	ITIQUIRA	17/11/2019 07:42	17/11/2019 12:19	17/11/2019 07:42	17/11/2019 12:19	4,60	2	9,20	CHI
201911186867	ARAGUAPAZ	AZ12259733	GOIAS	17/11/2019 07:43	18/11/2019 21:15	17/11/2019 07:43	18/11/2019 21:15	37,53	26	975,68	CHI
201911186867	FAINA	AZ12259733	GOIAS	17/11/2019 07:43	18/11/2019 21:15	17/11/2019 07:43	18/11/2019 21:15	37,53	9	337,73	CHI
201911186873	FORMOSA	FA21306760	ITIQUIRA	17/11/2019 12:50	17/11/2019 21:55	17/11/2019 12:50	17/11/2019 21:55	9,08	1	9,08	CHI
201911186878	INHUMAS	10013945686	INHUMAS S2	17/11/2019 07:47	17/11/2019 11:10	17/11/2019 07:47	17/11/2019 11:10	3,37	1	3,37	CHI
201911186882	CAIAPONIA	CP12395452	PALESTINA	17/11/2019 07:48	18/11/2019 08:45	17/11/2019 07:48	18/11/2019 08:45	24,95	28	698,57	CHI
201911186895	JUSSARA	JR12089548	JUSSARA	17/11/2019 01:08	17/11/2019 12:05	17/11/2019 01:08	17/11/2019 12:05	10,94	4	43,77	CHI
201911186897	VIANOPOLIS	VN12383414	VIANOPOLIS	17/11/2019 07:50	17/11/2019 16:09	17/11/2019 07:50	17/11/2019 16:09	8,31	1	8,31	CHI

201911186904	CRISTALINA	KR12209473	CRISTALINA S2	17/11/2019 07:51	17/11/2019 10:48	17/11/2019 07:51	17/11/2019 10:48	2,94	7	20,60	CHI
201911186906	INHUMAS	10027745110	INHUMAS S2	17/11/2019 07:51	17/11/2019 11:32	17/11/2019 07:51	17/11/2019 11:32	3,68	1	3,68	CHI
201911186913	PORANGATU	PO12391655	NOVO PLANALTO	17/11/2019 07:52	17/11/2019 18:12	17/11/2019 07:52	17/11/2019 18:12	10,32	4	41,30	CHI
201911186918	GOIANIA	GN12045252	MEIA PONTE	17/11/2019 07:53	17/11/2019 09:26	17/11/2019 07:53	17/11/2019 09:26	1,54	166	255,50	CHI
201911186923	GOIANIA	15161778	GOYA S2	17/11/2019 07:56	17/11/2019 09:04	17/11/2019 07:56	17/11/2019 09:04	1,12	1	1,12	CHI
201911186929	LUZIANIA	LZ12041476	RIO VERMELHO	17/11/2019 07:58	17/11/2019 10:14	17/11/2019 07:58	17/11/2019 10:14	2,27	21	47,57	CHI
201911186933	ARUANA	AK12404527	MOZARLANDIA	17/11/2019 07:59	17/11/2019 11:27	17/11/2019 07:59	17/11/2019 11:27	3,47	34	117,86	CHI
201911186935	GOIANIA	GN11198416	GOYA S1	17/11/2019 07:59	17/11/2019 10:11	17/11/2019 07:59	17/11/2019 10:11	2,19	77	168,67	CHI
201911186936	BONOPOLIS	BX12391924	SAO MIGUEL DO ARAGUAIA	17/11/2019 08:00	17/11/2019 10:11	17/11/2019 08:00	17/11/2019 10:11	2,18	26	56,73	CHI
201911186936	SAO MIGUEL DO ARAGUAIA	BX12391924	SAO MIGUEL DO ARAGUAIA	17/11/2019 08:00	17/11/2019 10:11	17/11/2019 08:00	17/11/2019 10:11	2,18	0	0,00	CHI
201911186942	BARRO ALTO	BA12161223	GOIANESIA S1	17/11/2019 08:00	17/11/2019 12:04	17/11/2019 08:00	17/11/2019 12:04	4,05	13	52,65	CHI
201911186943	FAINA	FC12307366	GOIAS	17/11/2019 06:35	17/11/2019 17:24	17/11/2019 06:35	17/11/2019 17:24	10,81	9	97,25	CHI
201911186952	ITAPURANGA	IK12204277	ITAPURANGA	17/11/2019 08:01	17/11/2019 16:33	17/11/2019 08:01	17/11/2019 16:33	8,53	18	153,54	CHI
201911186953	PORANGATU	PO11350086	PORANGATU	17/11/2019 08:03	17/11/2019 11:05	17/11/2019 08:03	17/11/2019 11:05	3,03	1	3,03	CHI
201911186957	CRISTALINA	KR12219640	PAMPLONA	17/11/2019 08:04	17/11/2019 11:38	17/11/2019 08:04	17/11/2019 11:38	3,56	12	42,67	CHI
201911186958	CORREGO DO OURO	CO12079990	SAO LUIZ DOS MONTES BELOS	17/11/2019 07:46	17/11/2019 14:39	17/11/2019 07:46	17/11/2019 14:39	6,88	35	240,76	CHI
201911186958	MOIPORA	CO12079990	SAO LUIZ DOS MONTES BELOS	17/11/2019 07:46	17/11/2019 14:39	17/11/2019 07:46	17/11/2019 14:39	6,88	2	13,76	CHI
201911186959	GOIAS	GS12274362	GOIAS	17/11/2019 05:21	17/11/2019 10:40	17/11/2019 05:21	17/11/2019 10:40	5,32	7	37,21	CHI
201911186964	LUZIANIA	LZ12037192	RIO VERMELHO	17/11/2019 07:26	17/11/2019 10:13	17/11/2019 07:26	17/11/2019 10:13	2,77	7	19,38	CHI
201911186971	PORANGATU	TA12114216	NOVO PLANALTO	17/11/2019 08:06	17/11/2019 16:50	17/11/2019 08:06	17/11/2019 16:50	8,72	6	52,35	CHI
201911186974	RIO VERDE	RV121305785	MONTIVIDIU T	17/11/2019 08:06	17/11/2019 18:43	17/11/2019 08:06	17/11/2019 18:43	10,60	1	10,60	CHI
201911186976	SANTA CRUZ DE GOIAS	BC12311715	PIRES DO RIO S2	16/11/2019 22:16	17/11/2019 11:03	16/11/2019 22:16	17/11/2019 11:03	12,78	8	102,20	CHI
201911186983	NOVA CRIXAS	NA12380421	NOVA CRIXAS	17/11/2019 06:57	17/11/2019 12:10	17/11/2019 06:57	17/11/2019 12:10	5,22	48	250,79	CHI
201911186986	ALTO HORIZONTE	GG12150758	SANTA TEREZINHA	16/11/2019 22:34	17/11/2019 10:58	16/11/2019 22:34	17/11/2019 10:58	12,39	11	136,33	CHI
201911186988	UIRAPURU	UP21333195	SANTA TEREZINHA	17/11/2019 08:10	17/11/2019 11:00	17/11/2019 08:10	17/11/2019 11:00	2,84	1	2,84	CHI
201911186991	SAO JOAO D ALIANCA	JL12238309	ITUIQUIRA	17/11/2019 07:25	18/11/2019 21:17	17/11/2019 07:25	18/11/2019 21:17	37,88	30	1136,40	CHI
201911186997	FIRMINOPOLIS	TV21098065	FIRMINOPOLIS S1	17/11/2019 08:12	17/11/2019 10:13	17/11/2019 08:12	17/11/2019 10:13	2,00	1	2,00	CHI
201911187000	NOVA CRIXAS	NA12126918	NOVA CRIXAS	17/11/2019 08:13	17/11/2019 12:18	17/11/2019 08:13	17/11/2019 12:18	4,08	10	40,82	CHI
201911187001	SENADOR CANEDO	13824284	GOIANIA LESTE S1	17/11/2019 08:14	17/11/2019 12:33	17/11/2019 08:14	17/11/2019 12:33	4,31	1	4,31	CHI
201911187002	JUSSARA	JR11370526	IPORA	17/11/2019 08:14	18/11/2019 11:32	17/11/2019 08:14	18/11/2019 11:32	27,30	1	27,30	CHI
201911187003	RIO VERDE	RV12200741	CABRIUVA S2	17/11/2019 08:03	17/11/2019 09:07	17/11/2019 08:03	17/11/2019 09:07	1,06	12	12,70	CHI
201911187009	GOIANESIA	GE21000046	GOIANESIA S2	17/11/2019 08:16	17/11/2019 19:52	17/11/2019 08:16	17/11/2019 19:52	11,59	1	11,59	CHI
201911187020	ITAPIRAPUA	IU12018752	MATRINCHA	17/11/2019 08:19	17/11/2019 18:19	17/11/2019 08:19	17/11/2019 18:19	9,99	7	69,94	CHI

201911187027	GOIANIA	13013439	GOIANIA LESTE S1	17/11/2019 08:20	17/11/2019 10:12	17/11/2019 08:20	17/11/2019 10:12	1,85	1	1,85	CHI
201911187031	ITABERAI	IB11333980	ITABERAI S2	17/11/2019 08:21	17/11/2019 10:21	17/11/2019 08:21	17/11/2019 10:21	1,99	65	129,26	CHI
201911187033	PORANGATU	PO11350127	PORANGATU	17/11/2019 08:21	17/11/2019 10:31	17/11/2019 08:21	17/11/2019 10:31	2,15	2	4,30	CHI
201911187037	CATALAO	CT12000107	CATALAO S1	17/11/2019 08:22	18/11/2019 09:50	17/11/2019 08:22	18/11/2019 09:50	25,46	15	381,95	CHI
201911187037	OUVIDOR	CT12000107	CATALAO S1	17/11/2019 08:22	18/11/2019 09:50	17/11/2019 08:22	18/11/2019 09:50	25,46	10	254,63	CHI
201911187044	IPORA	IR21187289	IPORA	17/11/2019 06:19	17/11/2019 14:28	17/11/2019 06:19	17/11/2019 14:28	8,14	1	8,14	CHI
201911187046	FORMOSO	TB12185317	PORANGATU	17/11/2019 08:24	17/11/2019 10:25	17/11/2019 08:24	17/11/2019 10:25	2,01	5	10,06	CHI
201911187046	TROMBAS	TB12185317	PORANGATU	17/11/2019 08:24	17/11/2019 10:25	17/11/2019 08:24	17/11/2019 10:25	2,01	1	2,01	CHI
201911187048	SANTA RITA DO NOVO DESTINO	GE21000095	GOIANESIA S1	17/11/2019 08:24	17/11/2019 11:52	17/11/2019 08:24	17/11/2019 11:52	3,46	1	3,46	CHI
201911187049	BARRO ALTO	GE12255886	GOIANESIA S1	17/11/2019 06:16	17/11/2019 09:10	17/11/2019 06:16	17/11/2019 09:10	2,89	1	2,89	CHI
201911187049	GOIANESIA	GE12255886	GOIANESIA S1	17/11/2019 06:16	17/11/2019 09:10	17/11/2019 06:16	17/11/2019 09:10	2,89	4	11,55	CHI
201911187057	CRISTIANOPOLIS	CF31107686	CRISTIANOPOLIS	17/11/2019 08:26	17/11/2019 15:22	17/11/2019 08:26	17/11/2019 15:22	6,93	1	6,93	CHI
201911187060	MAMBAI	PS12189370	IACIARA S2	17/11/2019 08:06	17/11/2019 12:00	17/11/2019 11:15	17/11/2019 12:00	0,75	22	16,46	CHI
201911187060	POSSE	PS12189370	IACIARA S2	17/11/2019 08:06	17/11/2019 12:00	17/11/2019 11:15	17/11/2019 12:00	0,75	4	2,99	CHI
201911187060	BURITINOPOLIS	MB12314303	IACIARA S2	17/11/2019 08:06	17/11/2019 12:00	17/11/2019 08:06	17/11/2019 12:00	3,91	2	7,81	CHI
201911187060	MAMBAI	MB12314303	IACIARA S2	17/11/2019 08:06	17/11/2019 12:00	17/11/2019 08:06	17/11/2019 12:00	3,91	3	11,72	CHI
201911187063	AMORINOPOLIS	AM12060715	IPORA	17/11/2019 08:27	17/11/2019 13:15	17/11/2019 08:27	17/11/2019 13:15	4,81	22	105,85	CHI
201911187063	IPORA	AM12060715	IPORA	17/11/2019 08:27	17/11/2019 13:15	17/11/2019 08:27	17/11/2019 13:15	4,81	4	19,25	CHI
201911187068	MINEIROS	MY12253766	PARQUE DAS EMAS	17/11/2019 08:27	17/11/2019 17:01	17/11/2019 08:27	17/11/2019 17:01	8,55	1	8,55	CHI
201911187069	GOIANAPOLIS	GP12351033	DAIA S2	17/11/2019 08:27	17/11/2019 14:06	17/11/2019 08:27	17/11/2019 14:06	5,64	17	95,82	CHI
201911187070	CAIAPONIA	CP12251347	CAIAPONIA	16/11/2019 20:33	18/11/2019 11:40	16/11/2019 20:33	18/11/2019 11:40	39,11	7	273,80	CHI
201911187071	PIRES DO RIO	PR21195228	PIRES DO RIO S1	17/11/2019 08:28	18/11/2019 12:02	17/11/2019 08:28	18/11/2019 12:02	27,56	1	27,56	CHI
201911187072	DAMOLANDIA	10022476030	INHUMAS S1	17/11/2019 08:28	17/11/2019 12:39	17/11/2019 08:28	17/11/2019 12:39	4,19	1	4,19	CHI
201911187078	MOZARLANDIA	MZ21058581	MOZARLANDIA	17/11/2019 08:29	20/11/2019 09:24	17/11/2019 08:29	19/11/2019 14:00	53,50	1	53,50	CHI
201911187078	MOZARLANDIA	MZ21058581	MOZARLANDIA	17/11/2019 08:29	20/11/2019 09:24	19/11/2019 19:52	20/11/2019 09:24	13,54	1	13,54	CHI
201911187088	GOIANIA	GN11352973	GOYA S1	17/11/2019 08:31	17/11/2019 10:45	17/11/2019 08:31	17/11/2019 10:45	2,23	53	118,18	CHI
201911187089	AMERICANO DO BRASIL	10008576260	ANICUNS	17/11/2019 08:31	17/11/2019 11:51	17/11/2019 08:31	17/11/2019 11:51	3,33	1	3,33	CHI
201911187092	CATALAO	9580002234	CATALAO S1	17/11/2019 08:31	17/11/2019 18:38	17/11/2019 08:31	17/11/2019 18:38	10,10	1	10,10	CHI
201911187093	NAZARIO	NZ11160177	ANICUNS	17/11/2019 08:32	17/11/2019 11:10	17/11/2019 08:32	17/11/2019 11:10	2,64	88	231,90	CHI
201911187104	GOIANIA	GN12345849	GOYA S1	17/11/2019 08:34	17/11/2019 10:45	17/11/2019 08:34	17/11/2019 10:45	2,17	188	407,96	CHI
201911187106	GOIANESIA	550088623	GOIANESIA S2	17/11/2019 08:34	17/11/2019 19:43	17/11/2019 08:34	17/11/2019 19:43	11,13	1	11,13	CHI
201911187110	MINACU	IH11207298	MINACU	17/11/2019 08:35	18/11/2019 13:36	17/11/2019 08:35	18/11/2019 13:36	29,01	3	87,02	CHI
201911187111	GOIANDIRA	GD21127540	CATALAO S1	17/11/2019 08:35	20/11/2019 22:06	17/11/2019 08:35	20/11/2019 22:06	85,52	2	171,04	CHI

201911187115	CALDAZINHA	BO12400523	CEPAIGO S2	17/11/2019 07:27	17/11/2019 11:19	17/11/2019 07:27	17/11/2019 11:19	3,85	2	7,70	CHI
201911187115	LEOPOLDO DE BULHOES	BO12400523	CEPAIGO S2	17/11/2019 07:27	17/11/2019 11:19	17/11/2019 07:27	17/11/2019 11:19	3,85	32	123,24	CHI
201911187116	MATRINCHA	MP12206480	MATRINCHA	17/11/2019 08:36	17/11/2019 23:16	17/11/2019 08:36	17/11/2019 23:16	14,66	15	219,90	CHI
201911187118	ORIZONA	OZ12000351RE	PIRES DO RIO S1	17/11/2019 08:29	18/11/2019 14:00	17/11/2019 08:29	18/11/2019 14:00	29,50	55	1622,70	CHI
201911187118	PIRES DO RIO	OZ12000351RE	PIRES DO RIO S1	17/11/2019 08:29	18/11/2019 14:00	17/11/2019 08:29	18/11/2019 14:00	29,50	4	118,01	CHI
201911187121	MATRINCHA	MP12122364	MATRINCHA	17/11/2019 08:36	18/11/2019 11:22	17/11/2019 08:36	18/11/2019 11:22	26,76	10	267,55	CHI
201911187126	GOIAS	GS12068548	MATRINCHA	17/11/2019 02:07	18/11/2019 08:52	17/11/2019 02:07	18/11/2019 08:52	30,76	41	1261,07	CHI
201911187127	GOIANESIA	GE21000289	GOIANESIA S1	17/11/2019 08:38	17/11/2019 12:02	17/11/2019 08:38	17/11/2019 12:02	3,40	1	3,40	CHI
201911187128	ITAPIRAPUA	IU12018852	MATRINCHA	16/11/2019 23:03	17/11/2019 17:40	16/11/2019 23:03	17/11/2019 17:40	18,62	35	651,54	CHI
201911187129	NIQUELANDIA	NQ21086242	NIQUELANDIA SUBTRANSMISSAO	17/11/2019 08:38	17/11/2019 10:54	17/11/2019 08:38	17/11/2019 10:54	2,26	1	2,26	CHI
201911187136	AMERICANO DO BRASIL	1410021431	ANICUNS	17/11/2019 08:38	17/11/2019 12:04	17/11/2019 08:38	17/11/2019 12:04	3,42	1	3,42	CHI
201911187138	SILVANIA	SV21056826	VIANOPOLIS	17/11/2019 08:38	17/11/2019 11:19	17/11/2019 08:38	17/11/2019 11:19	2,67	1	2,67	CHI
201911187141	FAINA	IK12299351	ITAPURANGA	17/11/2019 08:36	17/11/2019 15:40	17/11/2019 08:36	17/11/2019 15:40	7,05	16	112,87	CHI
201911187141	ITAPURANGA	IK12299351	ITAPURANGA	17/11/2019 08:36	17/11/2019 15:40	17/11/2019 08:36	17/11/2019 15:40	7,05	1	7,05	CHI
201911187146	ARAGUAPAZ	AZ21329919	GOIAS	17/11/2019 08:39	19/11/2019 12:48	17/11/2019 08:39	19/11/2019 12:48	52,14	1	52,14	CHI
201911187153	ARAGARCAS	AG21131702	ARAGARCAS	17/11/2019 08:41	17/11/2019 09:57	17/11/2019 08:41	17/11/2019 09:57	1,25	1	1,25	CHI
201911187155	CRIXAS	CX21244496	SANTA TEREZINHA	17/11/2019 08:42	17/11/2019 10:40	17/11/2019 08:42	17/11/2019 10:40	1,97	2	3,95	CHI
201911187156	GOIANESIA	550113575	GOIANESIA S2	17/11/2019 08:42	17/11/2019 16:52	17/11/2019 08:42	17/11/2019 16:52	8,16	1	8,16	CHI
201911187157	ALTO PARAISO DE GOIAS	BF12264707	FLORES DE GOIAS	17/11/2019 08:42	17/11/2019 20:39	17/11/2019 08:42	17/11/2019 20:39	11,94	18	215,01	CHI
201911187164	MARA ROSA	MQ121879990LD	MARA ROSA	17/11/2019 05:20	19/11/2019 01:31	17/11/2019 05:20	17/11/2019 19:48	14,48	2	28,95	CHI
201911187164	NOVA IGUACU DE GOIAS	MQ121879990LD	MARA ROSA	17/11/2019 05:20	19/11/2019 01:31	17/11/2019 05:20	17/11/2019 19:48	14,48	8	115,81	CHI
201911187164	MARA ROSA	MQ121879990LD	MARA ROSA	17/11/2019 05:20	19/11/2019 01:31	17/11/2019 20:01	17/11/2019 20:28	0,44	2	0,89	CHI
201911187164	NOVA IGUACU DE GOIAS	MQ121879990LD	MARA ROSA	17/11/2019 05:20	19/11/2019 01:31	17/11/2019 20:01	17/11/2019 20:28	0,44	8	3,54	CHI
201911187164	ALTO HORIZONTE	03400234	SANTA TEREZINHA	17/11/2019 05:20	19/11/2019 01:31	18/11/2019 04:12	18/11/2019 04:18	0,11	1803	192,32	CHI
201911187164	NOVA IGUACU DE GOIAS	03400234	SANTA TEREZINHA	17/11/2019 05:20	19/11/2019 01:31	18/11/2019 04:12	18/11/2019 04:18	0,11	2	0,21	CHI
201911187164	ALTO HORIZONTE	03400234	SANTA TEREZINHA	17/11/2019 05:20	19/11/2019 01:31	18/11/2019 04:12	18/11/2019 04:43	0,52	435	226,08	CHI
201911187164	ALTO HORIZONTE	MQ10403947	MARA ROSA	17/11/2019 05:20	19/11/2019 01:31	18/11/2019 04:42	18/11/2019 04:49	0,10	83	8,42	CHI
201911187164	MARA ROSA	MQ10403947	MARA ROSA	17/11/2019 05:20	19/11/2019 01:31	18/11/2019 04:42	18/11/2019 04:49	0,10	192	19,47	CHI
201911187164	NOVA IGUACU DE GOIAS	MQ10403947	MARA ROSA	17/11/2019 05:20	19/11/2019 01:31	18/11/2019 04:42	18/11/2019 04:49	0,10	20	2,03	CHI
201911187164	URUACU	MQ10403947	MARA ROSA	17/11/2019 05:20	19/11/2019 01:31	18/11/2019 04:42	18/11/2019 04:49	0,10	1	0,10	CHI
201911187164	ALTO HORIZONTE	AJ16408540	SANTA TEREZINHA	17/11/2019 05:20	19/11/2019 01:31	18/11/2019 04:44	18/11/2019 08:16	3,52	435	1532,53	CHI
201911187164	ALTO HORIZONTE	AJ16408540	SANTA TEREZINHA	17/11/2019 05:20	19/11/2019 01:31	18/11/2019 08:17	18/11/2019 09:37	1,34	382	511,46	CHI
201911187164	ALTO HORIZONTE	AJ12213250	SANTA TEREZINHA	17/11/2019 05:20	19/11/2019 01:31	18/11/2019 08:17	18/11/2019 11:16	2,98	7	20,88	CHI

201911187164	MARA ROSA	MQ21141957	MARA ROSA	17/11/2019 05:20	19/11/2019 01:31	18/11/2019 11:42	18/11/2019 12:53	1,19	1	1,19	CHI
201911187164	ALTO HORIZONTE	AJ12320992	SANTA TEREZINHA	17/11/2019 05:20	19/11/2019 01:31	18/11/2019 08:17	18/11/2019 17:07	8,85	36	318,45	CHI
201911187164	NOVA IGUACU DE GOIAS	MQ12202529	MARA ROSA	17/11/2019 05:20	19/11/2019 01:31	17/11/2019 05:20	18/11/2019 18:31	37,19	4	148,76	CHI
201911187164	ALTO HORIZONTE	AJ12202017	SANTA TEREZINHA	17/11/2019 05:20	19/11/2019 01:31	18/11/2019 08:17	18/11/2019 19:19	11,05	8	88,37	CHI
201911187164	ALTO HORIZONTE	MQ10403947	MARA ROSA	17/11/2019 05:20	19/11/2019 01:31	18/11/2019 23:49	19/11/2019 00:06	0,29	83	23,77	CHI
201911187164	MARA ROSA	MQ10403947	MARA ROSA	17/11/2019 05:20	19/11/2019 01:31	18/11/2019 23:49	19/11/2019 00:06	0,29	194	55,56	CHI
201911187164	NOVA IGUACU DE GOIAS	MQ10403947	MARA ROSA	17/11/2019 05:20	19/11/2019 01:31	18/11/2019 23:49	19/11/2019 00:06	0,29	20	5,73	CHI
201911187164	URUACU	MQ10403947	MARA ROSA	17/11/2019 05:20	19/11/2019 01:31	18/11/2019 23:49	19/11/2019 00:06	0,29	1	0,29	CHI
201911187164	NOVA IGUACU DE GOIAS	MQ10403947	MARA ROSA	17/11/2019 05:20	19/11/2019 01:31	18/11/2019 18:32	19/11/2019 00:57	6,42	4	25,67	CHI
201911187164	ALTO HORIZONTE	MQ10403947	MARA ROSA	17/11/2019 05:20	19/11/2019 01:31	19/11/2019 00:23	19/11/2019 00:57	0,56	83	46,16	CHI
201911187164	MARA ROSA	MQ10403947	MARA ROSA	17/11/2019 05:20	19/11/2019 01:31	19/11/2019 00:23	19/11/2019 00:57	0,56	194	107,89	CHI
201911187164	NOVA IGUACU DE GOIAS	MQ10403947	MARA ROSA	17/11/2019 05:20	19/11/2019 01:31	19/11/2019 00:23	19/11/2019 00:57	0,56	20	11,12	CHI
201911187164	URUACU	MQ10403947	MARA ROSA	17/11/2019 05:20	19/11/2019 01:31	19/11/2019 00:23	19/11/2019 00:57	0,56	1	0,56	CHI
201911187164	ALTO HORIZONTE	19699501	SANTA TEREZINHA	17/11/2019 05:20	19/11/2019 01:31	18/11/2019 08:17	19/11/2019 01:30	17,23	2	34,45	CHI
201911187164	MARA ROSA	MQ12248106LD	MARA ROSA	17/11/2019 05:20	19/11/2019 01:31	17/11/2019 05:20	19/11/2019 01:31	44,18	5	220,89	CHI
201911187167	FAINA	FC12067580	GOIAS	17/11/2019 07:51	17/11/2019 17:06	17/11/2019 07:51	17/11/2019 17:06	9,24	3	27,73	CHI
201911187173	CORREGO DO OURO	CO21406121	SAO LUIZ DOS MONTES BELOS	17/11/2019 08:45	17/11/2019 23:48	17/11/2019 08:45	17/11/2019 23:48	15,04	1	15,04	CHI
201911187177	JANDAIA	JD12233370	PALMEIRAS	17/11/2019 08:46	17/11/2019 11:30	17/11/2019 08:46	17/11/2019 11:30	2,73	13	35,54	CHI
201911187181	URUACU	UR21168826	CAMPINORTE	17/11/2019 08:47	17/11/2019 12:04	17/11/2019 08:47	17/11/2019 12:04	3,28	60	196,87	CHI
201911187195	ALEXANIA	AX12329596	ALEXANIA	17/11/2019 08:48	17/11/2019 14:24	17/11/2019 08:48	17/11/2019 14:24	5,59	3	16,76	CHI
201911187197	GOIANIA	11428697	GOYA S1	17/11/2019 08:48	17/11/2019 10:57	17/11/2019 08:48	17/11/2019 10:57	2,14	1	2,14	CHI
201911187198	VICENTINOPOLIS	VI12352541	VICENTINOPOLIS	17/11/2019 08:49	18/11/2019 07:55	17/11/2019 08:49	18/11/2019 07:55	23,10	3	69,29	CHI
201911187208	GOIANESIA	JA12297408	GOIANESIA S2	17/11/2019 08:50	17/11/2019 10:56	17/11/2019 08:50	17/11/2019 10:56	2,09	1	2,09	CHI
201911187208	JARAGUA	JA12297408	GOIANESIA S2	17/11/2019 08:50	17/11/2019 10:56	17/11/2019 08:50	17/11/2019 10:56	2,09	13	27,14	CHI
201911187223	GOIANIA	13977805	GOYA S2	17/11/2019 08:52	17/11/2019 09:52	17/11/2019 08:52	17/11/2019 09:52	0,99	1	0,99	CHI
201911187233	CATALAO	CT21267099	CATALAO S1	17/11/2019 08:53	18/11/2019 21:08	17/11/2019 08:53	18/11/2019 21:08	36,25	3	108,76	CHI
201911187237	FAINA	FC12228838	GOIAS	17/11/2019 08:54	18/11/2019 17:14	17/11/2019 08:54	18/11/2019 17:14	32,32	5	161,62	CHI
201911187238	ITAPURANGA	IK12157850	ITAPURANGA	17/11/2019 07:39	17/11/2019 12:15	17/11/2019 07:39	17/11/2019 12:15	4,59	7	32,12	CHI
201911187244	PARAUNA	PU12039209	PARAUNA	17/11/2019 08:55	17/11/2019 15:09	17/11/2019 08:55	17/11/2019 15:09	6,22	5	31,12	CHI
201911187246	FORMOSA	FA12270556	ITUIQUIRA	17/11/2019 07:32	17/11/2019 11:38	17/11/2019 07:32	17/11/2019 11:38	4,10	14	57,36	CHI
201911187247	SANTA BARBARA DE GOIAS	SB21110980	TRINDADE	17/11/2019 08:55	18/11/2019 08:26	17/11/2019 08:55	18/11/2019 08:26	23,50	1	23,50	CHI
201911187250	NOVO BRASIL	3080001859	JUSSARA	17/11/2019 08:56	19/11/2019 10:00	17/11/2019 08:56	19/11/2019 10:00	49,07	1	49,07	CHI
201911187251	SANTA RITA DO NOVO DESTINO	BA12211708	BARRO ALTO	16/11/2019 22:33	17/11/2019 12:59	16/11/2019 22:33	17/11/2019 12:59	14,42	5	72,10	CHI

201911187254	MORRINHOS	MR12071536	MORRINHOS	16/11/2019 21:15	18/11/2019 16:07	16/11/2019 21:15	18/11/2019 16:07	42,86	16	685,74	CHI
201911187262	CORREGO DO OURO	1070009572	FIRMINOPOLIS S2	17/11/2019 08:58	17/11/2019 13:02	17/11/2019 08:58	17/11/2019 13:02	4,07	1	4,07	CHI
201911187274	MINACU	IH12245140	MINACU	17/11/2019 09:00	17/11/2019 11:17	17/11/2019 09:00	17/11/2019 11:17	2,28	6	13,68	CHI
201911187284	JOVIANIA	570008001	GOIATUBA S1	17/11/2019 09:01	19/11/2019 09:48	17/11/2019 09:01	19/11/2019 09:48	48,78	1	48,78	CHI
201911187289	FORMOSA	FA11237672	SAO JOAO D ALIANCA	17/11/2019 09:01	20/11/2019 12:02	17/11/2019 09:01	20/11/2019 12:02	75,00	1	75,00	CHI
201911187294	INHUMAS	IN11037441	INHUMAS S2	17/11/2019 06:37	17/11/2019 10:48	17/11/2019 06:37	17/11/2019 10:48	4,17	170	709,28	CHI
201911187296	SAO DOMINGOS	SD12398369	SAO DOMINGOS	17/11/2019 09:03	17/11/2019 11:04	17/11/2019 09:03	17/11/2019 11:04	2,01	8	16,11	CHI
201911187304	RIO VERDE	630242252	RIO VERDE S2	17/11/2019 09:03	17/11/2019 16:51	17/11/2019 09:03	17/11/2019 16:51	7,80	1	7,80	CHI
201911187322	JATAI	JT12061506	JATAI S2	17/11/2019 09:07	17/11/2019 11:13	17/11/2019 09:07	17/11/2019 11:13	2,10	14	29,39	CHI
201911187326	JANDAIA	1180030555	PALMEIRAS	17/11/2019 09:07	17/11/2019 12:26	17/11/2019 09:07	17/11/2019 12:26	3,31	1	3,31	CHI
201911187329	SANTO ANTONIO DO DESCOBERTO	SN21305061	ALEXANIA	17/11/2019 09:08	17/11/2019 18:22	17/11/2019 09:08	17/11/2019 18:22	9,23	1	9,23	CHI
201911187338	GUARAITA	GK12250513	ITAPURANGA	17/11/2019 09:03	17/11/2019 11:38	17/11/2019 09:03	17/11/2019 11:38	2,59	7	18,10	CHI
201911187340	GOIATUBA	GT13000025	GOIATUBA S2	17/11/2019 08:31	17/11/2019 12:44	17/11/2019 08:31	17/11/2019 12:44	4,22	206	869,43	CHI
201911187340	GOIATUBA	GT13000025	GOIATUBA S2	17/11/2019 08:31	17/11/2019 12:44	17/11/2019 10:32	17/11/2019 12:44	2,20	2	4,41	CHI
201911187341	SANTA RITA DO NOVO DESTINO	BA11068058	GOIANESIA S1	17/11/2019 08:03	17/11/2019 11:21	17/11/2019 08:03	17/11/2019 11:21	3,31	88	290,96	CHI
201911187345	PALESTINA DE GOIAS	CP12395428	PALESTINA	17/11/2019 09:10	18/11/2019 16:14	17/11/2019 09:10	18/11/2019 16:14	31,06	4	124,23	CHI
201911187349	RIO VERDE	630165671	RIO VERDE S1	17/11/2019 09:11	17/11/2019 15:43	17/11/2019 09:11	17/11/2019 15:43	6,54	1	6,54	CHI
201911187353	CATALAO	CT21231656	CATALAO S1	17/11/2019 09:11	18/11/2019 12:49	17/11/2019 09:11	18/11/2019 12:49	27,62	1	27,62	CHI
201911187354	GOIANIA	GN12001501	XAVANTES	17/11/2019 09:02	17/11/2019 11:40	17/11/2019 09:02	17/11/2019 11:40	2,63	218	573,10	CHI
201911187358	CATALAO	CT21412588	CATALAO S1	17/11/2019 09:12	17/11/2019 14:18	17/11/2019 09:12	17/11/2019 14:18	5,09	1	5,09	CHI
201911187362	BARRO ALTO	BA21144547	GOIANESIA S1	17/11/2019 09:13	17/11/2019 16:03	17/11/2019 09:13	17/11/2019 16:03	6,83	1	6,83	CHI
201911187363	GOIANIA	11804373	CAMPINAS S2	17/11/2019 09:14	17/11/2019 10:59	17/11/2019 09:14	17/11/2019 10:59	1,75	1	1,75	CHI
201911187368	NOVO GAMA	NJ11136618	PACAEMBU S1	17/11/2019 09:14	17/11/2019 11:19	17/11/2019 09:14	17/11/2019 11:19	2,07	242	501,88	CHI
201911187369	COLINAS DO SUL	TI21155526	MINACU	17/11/2019 09:14	17/11/2019 15:18	17/11/2019 09:14	17/11/2019 15:18	6,05	2	12,11	CHI
201911187372	CRIXAS	CX12221633	RUBIATABA	17/11/2019 08:38	17/11/2019 17:35	17/11/2019 08:38	17/11/2019 17:35	8,94	132	1179,75	CHI
201911187372	NOVA CRIXAS	CX12221633	RUBIATABA	17/11/2019 08:38	17/11/2019 17:35	17/11/2019 08:38	17/11/2019 17:35	8,94	1	8,94	CHI
201911187373	FORMOSO	2410001264	PORANGATU	17/11/2019 09:15	17/11/2019 19:19	17/11/2019 09:15	17/11/2019 19:19	10,06	1	10,06	CHI
201911187380	SANTA RITA DO NOVO DESTINO	DF12377521	BARRO ALTO	17/11/2019 09:15	17/11/2019 10:17	17/11/2019 09:15	17/11/2019 10:17	1,02	23	23,52	CHI
201911187382	CATALAO	CT12149164RE	CATALAO S1	17/11/2019 05:09	17/11/2019 14:56	17/11/2019 05:09	17/11/2019 14:56	9,77	144	1407,16	CHI
201911187383	GOIANESIA	GE21247677	GOIANESIA S2	17/11/2019 09:17	17/11/2019 12:38	17/11/2019 09:17	17/11/2019 12:38	3,35	1	3,35	CHI
201911187387	PARAUNA	PU21167143	PALMEIRAS	17/11/2019 06:56	17/11/2019 12:58	17/11/2019 06:56	17/11/2019 12:58	6,03	1	6,03	CHI
201911187390	TRINDADE	TR12293992	TRINDADE	17/11/2019 08:45	17/11/2019 12:59	17/11/2019 08:45	17/11/2019 12:59	4,22	11	46,40	CHI
201911187392	JUSSARA	JR21019335	JUSSARA	17/11/2019 09:19	17/11/2019 23:34	17/11/2019 09:19	17/11/2019 23:34	14,25	1	14,25	CHI

201911187397	PONTALINA	PK11148032	PONTALINA	17/11/2019 07:41	17/11/2019 12:03	17/11/2019 07:41	17/11/2019 12:03	4,35	92	400,48	CHI
201911187398	NOVA ROMA	ND12392238	IACIARA S2	17/11/2019 09:20	17/11/2019 10:58	17/11/2019 09:20	17/11/2019 10:58	1,63	240	390,40	CHI
201911187403	MARA ROSA	MQ21182376	MARA ROSA	17/11/2019 09:22	17/11/2019 14:50	17/11/2019 09:22	17/11/2019 14:50	5,47	1	5,47	CHI
201911187406	PORANGATU	PO12182336	PORANGATU	17/11/2019 09:22	17/11/2019 11:22	17/11/2019 09:22	17/11/2019 11:22	1,99	5	9,93	CHI
201911187414	NOVA ROMA	ND12256420	IACIARA S2	17/11/2019 08:37	17/11/2019 12:02	17/11/2019 08:37	17/11/2019 12:02	3,41	28	95,48	CHI
201911187415	CACHOEIRA ALTA	CA21144472	CACHOEIRA ALTA	17/11/2019 09:24	18/11/2019 16:33	17/11/2019 09:24	18/11/2019 16:33	31,15	1	31,15	CHI
201911187420	ITABERAI	IB12000043	ITABERAI S2	17/11/2019 09:24	17/11/2019 17:33	17/11/2019 09:24	17/11/2019 17:33	8,15	2	16,30	CHI
201911187423	CACHOEIRA ALTA	AW21249004	CACHOEIRA ALTA	17/11/2019 09:24	18/11/2019 17:32	17/11/2019 09:24	18/11/2019 17:32	32,12	1	32,12	CHI
201911187426	ALTO HORIZONTE	AJ21318476	SANTA TEREZINHA	17/11/2019 09:25	17/11/2019 17:39	17/11/2019 09:25	17/11/2019 17:39	8,23	2	16,45	CHI
201911187427	ARAGUAPAZ	AZ12198622	GOIAS	17/11/2019 08:31	19/11/2019 20:38	17/11/2019 08:31	17/11/2019 19:21	10,84	4	43,35	CHI
201911187427	FAINA	AZ12198622	GOIAS	17/11/2019 08:31	19/11/2019 20:38	17/11/2019 08:31	17/11/2019 19:21	10,84	1	10,84	CHI
201911187427	ARAGUAPAZ	AZ12198622	GOIAS	17/11/2019 08:31	19/11/2019 20:38	17/11/2019 19:29	19/11/2019 20:02	48,55	1	48,55	CHI
201911187427	ARAGUAPAZ	AZ12198622	GOIAS	17/11/2019 08:31	19/11/2019 20:38	17/11/2019 19:29	19/11/2019 20:14	48,76	1	48,76	CHI
201911187427	ARAGUAPAZ	AZ12198622	GOIAS	17/11/2019 08:31	19/11/2019 20:38	17/11/2019 08:31	19/11/2019 20:38	60,13	11	661,45	CHI
201911187427	ARAGUAPAZ	AZ12198622	GOIAS	17/11/2019 08:31	19/11/2019 20:38	17/11/2019 19:29	19/11/2019 20:38	49,16	1	49,16	CHI
201911187427	ARAGUAPAZ	AZ12198622	GOIAS	17/11/2019 08:31	19/11/2019 20:38	17/11/2019 19:29	19/11/2019 20:38	49,16	1	49,16	CHI
201911187427	FAINA	AZ12198622	GOIAS	17/11/2019 08:31	19/11/2019 20:38	17/11/2019 19:29	19/11/2019 20:38	49,16	1	49,16	CHI
201911187432	TERESINA DE GOIAS	TE11256125	FLORES DE GOIAS	17/11/2019 09:26	17/11/2019 16:01	17/11/2019 09:26	17/11/2019 16:01	6,58	1	6,58	CHI
201911187434	TRINDADE	19907277	TRINDADE	17/11/2019 09:26	17/11/2019 12:10	17/11/2019 09:26	17/11/2019 12:10	2,73	1	2,73	CHI
201911187437	VILA PROPICIO	PV12196944	GOIANESIA S1	17/11/2019 09:18	17/11/2019 10:48	17/11/2019 09:18	17/11/2019 10:48	1,49	11	16,35	CHI
201911187438	FORMOSA	10018614564	ITIQUIRA	17/11/2019 09:26	18/11/2019 00:53	17/11/2019 09:26	18/11/2019 00:53	15,45	1	15,45	CHI
201911187445	FAZENDA NOVA	FN12220464	JUSSARA	18/11/2019 07:22	18/11/2019 22:50	18/11/2019 07:22	18/11/2019 14:15	6,88	9	61,90	CHI
201911187445	FAZENDA NOVA	FN12220464	JUSSARA	18/11/2019 07:22	18/11/2019 22:50	18/11/2019 07:22	18/11/2019 22:50	15,46	20	309,13	CHI
201911187445	FAZENDA NOVA	FN12220464	JUSSARA	18/11/2019 07:22	18/11/2019 22:50	18/11/2019 21:22	18/11/2019 22:50	1,46	9	13,13	CHI
201911187449	APARECIDA DE GOIANIA	10003674809	INDEPENDENCIA S1	17/11/2019 09:28	17/11/2019 10:53	17/11/2019 09:28	17/11/2019 10:53	1,41	1	1,41	CHI
201911187452	FORMOSA	FA12241131	ITIQUIRA	17/11/2019 06:43	17/11/2019 13:28	17/11/2019 06:43	17/11/2019 13:28	6,75	3	20,24	CHI
201911187459	FORMOSA	FA12269923	ITIQUIRA	17/11/2019 07:31	17/11/2019 17:40	17/11/2019 07:31	17/11/2019 17:40	10,15	9	91,32	CHI
201911187464	JATAI	290267857	JATAI S2	17/11/2019 09:30	17/11/2019 16:52	17/11/2019 09:30	17/11/2019 16:52	7,37	1	7,37	CHI
201911187466	CATALAO	1990129459	CATALAO S2	17/11/2019 09:30	17/11/2019 15:09	17/11/2019 09:30	17/11/2019 15:09	5,65	1	5,65	CHI
201911187467	INHUMAS	IN12013737	INHUMAS S2	16/11/2019 22:54	17/11/2019 10:37	16/11/2019 22:54	17/11/2019 10:37	11,71	13	152,23	CHI
201911187467	ITAUCU	IN12013737	INHUMAS S2	16/11/2019 22:54	17/11/2019 10:37	16/11/2019 22:54	17/11/2019 10:37	11,71	23	269,34	CHI
201911187467	PETROLINA DE GOIAS	IN12013737	INHUMAS S2	16/11/2019 22:54	17/11/2019 10:37	16/11/2019 22:54	17/11/2019 10:37	11,71	2	23,42	CHI
201911187468	PANAMA	PX21121256	GOIATUBA S1	17/11/2019 07:20	19/11/2019 12:07	17/11/2019 07:20	19/11/2019 12:07	52,77	1	52,77	CHI

201911187470	APARECIDA DE GOIANIA	16522813	ANHANGUERA	17/11/2019 09:31	17/11/2019 11:32	17/11/2019 09:31	17/11/2019 11:32	2,01	1	2,01	CHI
201911187473	APORE	AE12280377	ITAJA S1	17/11/2019 09:32	17/11/2019 16:35	17/11/2019 09:32	17/11/2019 16:35	7,05	4	28,18	CHI
201911187476	SANTA HELENA DE GOIAS	400046131	IPEGUARI	17/11/2019 09:32	17/11/2019 13:03	17/11/2019 09:32	17/11/2019 13:03	3,52	1	3,52	CHI
201911187478	FORMOSA	FA12257276	ITUIQUIRA	17/11/2019 09:32	17/11/2019 16:34	17/11/2019 09:32	17/11/2019 16:34	7,02	8	56,15	CHI
201911187480	SAO LUIS DE MONTES BELOS	SL11159055	SAO LUIZ DOS MONTES BELOS	17/11/2019 09:29	17/11/2019 12:24	17/11/2019 09:29	17/11/2019 12:24	2,91	153	444,80	CHI
201911187485	ITAGUARI	JA12300098	ITABERAI S1	17/11/2019 09:29	18/11/2019 08:43	17/11/2019 09:29	18/11/2019 08:43	23,22	1	23,22	CHI
201911187485	JARAGUA	JA12300098	ITABERAI S1	17/11/2019 09:29	18/11/2019 08:43	17/11/2019 09:29	18/11/2019 08:43	23,22	11	255,41	CHI
201911187487	CALDAZINHA	SW12218045	CEPAIGO S2	17/11/2019 08:54	17/11/2019 14:47	17/11/2019 08:54	17/11/2019 14:47	5,88	3	17,64	CHI
201911187491	MINACU	IH12313441	MINACU	17/11/2019 09:34	17/11/2019 20:20	17/11/2019 09:34	17/11/2019 20:20	10,77	4	43,06	CHI
201911187500	SAO MIGUEL DO ARAGUAIA	SM21138218	SAO MIGUEL DO ARAGUAIA	17/11/2019 09:35	17/11/2019 17:00	17/11/2019 09:35	17/11/2019 17:00	7,42	1	7,42	CHI
201911187503	AGUAS LINDAS DE GOIAS	4830139408	AGUAS LINDAS DE GOIAS S2	17/11/2019 09:36	17/11/2019 12:33	17/11/2019 09:36	17/11/2019 12:33	2,94	1	2,94	CHI
201911187506	ALTO PARAISO DE GOIAS	BF21244595	SAO JOAO D ALIANCA	17/11/2019 09:37	18/11/2019 11:48	17/11/2019 09:37	18/11/2019 11:48	26,18	1	26,18	CHI
201911187520	PLANALTINA	PI21088240	PLANALTINA	17/11/2019 09:38	17/11/2019 12:32	17/11/2019 09:38	17/11/2019 12:32	2,89	1	2,89	CHI
201911187524	GOIAS	90058422	MATRINCHA	17/11/2019 09:39	18/11/2019 16:25	17/11/2019 09:39	18/11/2019 16:25	30,76	1	30,76	CHI
201911187526	ALTO HORIZONTE	AJ21146942	MARA ROSA	17/11/2019 09:40	17/11/2019 16:19	17/11/2019 09:40	17/11/2019 16:19	6,66	1	6,66	CHI
201911187528	CAMPOS BELOS	820011400	SAO DOMINGOS	17/11/2019 09:40	17/11/2019 11:25	17/11/2019 09:40	17/11/2019 11:25	1,74	1	1,74	CHI
201911187529	BURITI DE GOIAS	1680007807	FIRMINOPOLIS S2	17/11/2019 09:40	17/11/2019 16:10	17/11/2019 09:40	17/11/2019 16:10	6,49	1	6,49	CHI
201911187531	FORMOSA	FA11129922	ITUIQUIRA	17/11/2019 09:40	18/11/2019 13:48	17/11/2019 09:40	18/11/2019 13:48	28,12	6	168,70	CHI
201911187538	CATALAO	1990249581	CATALAO S2	17/11/2019 09:41	17/11/2019 18:05	17/11/2019 09:41	17/11/2019 18:05	8,39	1	8,39	CHI
201911187539	FLORES DE GOIAS	FB12239102	IACIARA S2	17/11/2019 09:41	17/11/2019 12:48	17/11/2019 09:41	17/11/2019 12:48	3,10	19	58,91	CHI
201911187540	ARAGARCAS	AG12154718	ARAGARCAS	17/11/2019 09:42	17/11/2019 15:59	17/11/2019 09:42	17/11/2019 15:59	6,28	20	125,56	CHI
201911187562	MARA ROSA	MQ12117969	MARA ROSA	17/11/2019 09:09	17/11/2019 22:31	17/11/2019 09:09	17/11/2019 22:31	13,36	32	427,48	CHI
201911187574	MONTE ALEGRE DE GOIAS	MA21358015	SAO DOMINGOS	17/11/2019 09:49	17/11/2019 17:50	17/11/2019 09:49	17/11/2019 17:50	8,01	1	8,01	CHI
201911187576	SAO LUIS DE MONTES BELOS	10015451494	SAO LUIZ DOS MONTES BELOS	17/11/2019 09:49	17/11/2019 16:08	17/11/2019 09:49	17/11/2019 16:08	6,31	1	6,31	CHI
201911187577	ISRAELANDIA	IS12139329	IPORA	17/11/2019 09:49	17/11/2019 15:27	17/11/2019 09:49	17/11/2019 15:27	5,62	2	11,25	CHI
201911187593	CEZARINA	CZ21323389	GUAPO S2	17/11/2019 09:52	17/11/2019 12:26	17/11/2019 09:52	17/11/2019 12:26	2,57	1	2,57	CHI
201911187597	PLANALTINA	PI21302773	SAO JOAO D ALIANCA	17/11/2019 09:52	17/11/2019 18:15	17/11/2019 09:52	17/11/2019 18:15	8,38	1	8,38	CHI
201911187604	MOSSAMEDES	MD12024167	FIRMINOPOLIS S2	17/11/2019 09:41	17/11/2019 10:44	17/11/2019 09:41	17/11/2019 10:44	1,04	46	47,80	CHI
201911187604	SANCLERLANDIA	MD12024167	FIRMINOPOLIS S2	17/11/2019 09:41	17/11/2019 10:44	17/11/2019 09:41	17/11/2019 10:44	1,04	7	7,27	CHI
201911187611	PORANGATU	PO12208614	PORANGATU	17/11/2019 09:53	17/11/2019 11:42	17/11/2019 09:53	17/11/2019 11:42	1,81	9	16,29	CHI
201911187613	CATALAO	1990195286	CATALAO S2	17/11/2019 09:54	17/11/2019 21:00	17/11/2019 09:54	17/11/2019 21:00	11,09	1	11,09	CHI
201911187616	ITAPURANGA	IK21156768	ITAPURANGA	17/11/2019 09:54	17/11/2019 18:00	17/11/2019 09:54	17/11/2019 18:00	8,09	1	8,09	CHI
201911187618	CAMPOS VERDES	VD21143281	SANTA TEREZINHA	17/11/2019 09:55	17/11/2019 12:47	17/11/2019 09:55	17/11/2019 12:47	2,88	1	2,88	CHI

201911187629	GOIATUBA	GT11316702	GOIATUBA S2	17/11/2019 07:09	18/11/2019 11:40	17/11/2019 07:09	18/11/2019 11:40	28,51	28	798,30	CHI
201911187632	JUSSARA	JR12259818	JUSSARA	17/11/2019 09:56	19/11/2019 10:06	17/11/2019 09:56	19/11/2019 10:06	48,17	2	96,33	CHI
201911187633	JARAGUA	10002445148	GOIANESIA S2	17/11/2019 09:59	17/11/2019 19:30	17/11/2019 09:59	17/11/2019 19:30	9,51	1	9,51	CHI
201911187640	ARAGUAPAZ	AZ21157587	MOZARLANDIA	17/11/2019 10:00	18/11/2019 16:22	17/11/2019 10:00	18/11/2019 16:22	30,36	1	30,36	CHI
201911187641	JUSSARA	JR12092772	JUSSARA	17/11/2019 10:00	17/11/2019 12:45	17/11/2019 10:00	17/11/2019 12:45	2,75	11	30,25	CHI
201911187643	CABECEIRAS	CW12218490	ITUIQUIRA	17/11/2019 08:07	17/11/2019 11:58	17/11/2019 08:07	17/11/2019 11:58	3,85	10	38,49	CHI
201911187648	JAUPACI	JP21184758	IPORA	17/11/2019 10:03	18/11/2019 08:43	17/11/2019 10:03	18/11/2019 08:43	22,68	1	22,68	CHI
201911187650	MUTUNOPOLIS	SE12352924	MARA ROSA	17/11/2019 09:38	17/11/2019 12:37	17/11/2019 09:38	17/11/2019 12:37	2,97	5	14,84	CHI
201911187650	SANTA TEREZA DE GOIAS	SE12352924	MARA ROSA	17/11/2019 09:38	17/11/2019 12:37	17/11/2019 09:38	17/11/2019 12:37	2,97	1	2,97	CHI
201911187660	LUZIANIA	3200145697	MARAJOARA	17/11/2019 10:05	17/11/2019 11:14	17/11/2019 10:05	17/11/2019 11:14	1,15	1	1,15	CHI
201911187662	APARECIDA DE GOIANIA	200236179	INDEPENDENCIA S1	17/11/2019 10:05	17/11/2019 12:34	17/11/2019 10:05	17/11/2019 12:34	2,47	1	2,47	CHI
201911187664	CAMPESTRE DE GOIAS	GC21137194	TRINDADE	17/11/2019 10:06	18/11/2019 09:42	17/11/2019 10:06	18/11/2019 09:42	23,60	1	23,60	CHI
201911187681	GOIANIA	GN11167564	MEIA PONTE	17/11/2019 09:45	17/11/2019 11:50	17/11/2019 09:45	17/11/2019 11:50	2,08	74	153,59	CHI
201911187682	AGUA FRIA DE GOIAS	TL21337432	SAO JOAO D ALIANCA	17/11/2019 10:09	17/11/2019 15:39	17/11/2019 10:09	17/11/2019 15:39	5,50	1	5,50	CHI
201911187686	BURITI ALEGRE	BG12143977	ITUMBIARA VELHA S2	17/11/2019 07:48	17/11/2019 13:58	17/11/2019 07:48	17/11/2019 13:58	6,17	168	1036,05	CHI
201911187688	AMARALINA	LC12230319	NOVA CRIXAS	17/11/2019 10:10	17/11/2019 19:47	17/11/2019 10:10	17/11/2019 19:47	9,61	3	28,82	CHI
201911187692	TRES RANCHOS	TH21195266	CATALAO S1	17/11/2019 10:11	18/11/2019 09:28	17/11/2019 10:11	18/11/2019 09:28	23,29	1	23,29	CHI
201911187703	AGUA FRIA DE GOIAS	TL11279964	SAO JOAO D ALIANCA	17/11/2019 10:13	17/11/2019 18:40	17/11/2019 10:13	17/11/2019 18:40	8,44	1	8,44	CHI
201911187704	MINACU	IH12396740	MINACU	17/11/2019 06:54	17/11/2019 12:40	17/11/2019 06:54	17/11/2019 12:40	5,76	76	437,68	CHI
201911187706	SITIO D ABADIA	SI21132433	IACIARA S2	17/11/2019 10:13	19/11/2019 16:04	17/11/2019 10:13	19/11/2019 16:04	53,83	1	53,83	CHI
201911187707	ANAPOLIS	20858826	JUNDIAI S1	17/11/2019 10:14	17/11/2019 15:14	17/11/2019 10:14	17/11/2019 15:14	5,00	1	5,00	CHI
201911187709	APARECIDA DE GOIANIA	10018211150	INDEPENDENCIA S1	17/11/2019 10:15	17/11/2019 12:27	17/11/2019 10:15	17/11/2019 12:27	2,20	1	2,20	CHI
201911187710	APARECIDA DE GOIANIA	200668780	INDEPENDENCIA S2	17/11/2019 10:15	17/11/2019 14:32	17/11/2019 10:15	17/11/2019 14:32	4,28	1	4,28	CHI
201911187717	IPAMERI	IP12071023	IPAMERI	17/11/2019 10:17	17/11/2019 20:33	17/11/2019 10:17	17/11/2019 20:33	10,27	2	20,53	CHI
201911187724	SANTO ANTONIO DA BARRA	BZ12301385	ACREUNA	17/11/2019 10:17	17/11/2019 15:44	17/11/2019 10:17	17/11/2019 15:44	5,44	7	38,11	CHI
201911187727	MINACU	IH12207743	MINACU	17/11/2019 10:03	17/11/2019 16:55	17/11/2019 10:03	17/11/2019 16:55	6,86	16	109,72	CHI
201911187728	RIO VERDE	10010817121	CABRIUVA S1	17/11/2019 10:18	17/11/2019 12:05	17/11/2019 10:18	17/11/2019 12:05	1,79	1	1,79	CHI
201911187737	HIDROLANDIA	HD12000305	CEPAIGO S2	17/11/2019 10:20	17/11/2019 15:46	17/11/2019 10:20	17/11/2019 15:46	5,43	22	119,49	CHI
201911187742	ANAPOLIS	20244125	ANAPOLIS UNIVERSITARIO S2	17/11/2019 10:20	17/11/2019 12:57	17/11/2019 10:20	17/11/2019 12:57	2,61	1	2,61	CHI
201911187747	GOIANIA	AP12171223	INDEPENDENCIA S2	17/11/2019 10:02	17/11/2019 11:07	17/11/2019 10:02	17/11/2019 11:07	1,08	440	473,86	CHI
201911187749	CIDADE OCIDENTAL	10021166216	MARAJOARA	17/11/2019 10:21	17/11/2019 11:30	17/11/2019 10:21	17/11/2019 11:30	1,14	1	1,14	CHI
201911187751	MORRINHOS	MR11263702	MORRINHOS	17/11/2019 10:21	17/11/2019 12:30	17/11/2019 10:21	17/11/2019 12:30	2,15	10	21,50	CHI
201911187754	NIQUELANDIA	NQ12262920	BARRO ALTO	17/11/2019 08:39	17/11/2019 17:02	17/11/2019 08:39	17/11/2019 17:02	8,37	3	25,11	CHI

201911187761	AGUA FRIA DE GOIAS	6910045	SAO JOAO D ALIANCA	17/11/2019 10:25	18/11/2019 12:44	17/11/2019 10:25	18/11/2019 12:44	26,31	1	26,31	CHI
201911187762	GOIANIA	GN11140402	XAVANTES	17/11/2019 10:25	17/11/2019 15:43	17/11/2019 10:25	17/11/2019 15:43	5,29	59	312,24	CHI
201911187766	JARAGUA	10004780220	JARAGUA	17/11/2019 10:26	17/11/2019 11:53	17/11/2019 10:26	17/11/2019 11:53	1,44	1	1,44	CHI
201911187775	CAMPINACU	FO12197186	PORANGATU	17/11/2019 10:28	18/11/2019 20:10	17/11/2019 10:28	18/11/2019 20:10	33,69	4	134,75	CHI
201911187775	CAMPINORTE	FO12197186	PORANGATU	17/11/2019 10:28	18/11/2019 20:10	17/11/2019 10:28	18/11/2019 20:10	33,69	29	976,91	CHI
201911187775	FORMOSO	FO12197186	PORANGATU	17/11/2019 10:28	18/11/2019 20:10	17/11/2019 10:28	18/11/2019 20:10	33,69	3	101,06	CHI
201911187776	SENADOR CANEDO	15070300	CEPAIGO S1	17/11/2019 10:29	17/11/2019 14:16	17/11/2019 10:29	17/11/2019 14:16	3,78	1	3,78	CHI
201911187791	TRINDADE	14594810	GOYA S2	17/11/2019 10:32	17/11/2019 19:44	17/11/2019 10:32	17/11/2019 19:44	9,20	1	9,20	CHI
201911187792	RIO VERDE	RV11000019	RIO VERDE S2	17/11/2019 07:15	17/11/2019 18:30	17/11/2019 07:15	17/11/2019 18:30	11,26	86	968,34	CHI
201911187794	FAZENDA NOVA	FN12119562	IPORA	17/11/2019 09:33	19/11/2019 21:56	17/11/2019 09:33	19/11/2019 21:55	60,37	10	603,67	CHI
201911187794	FAZENDA NOVA	FN12247868LD	IPORA	17/11/2019 09:33	19/11/2019 21:56	17/11/2019 09:33	19/11/2019 21:56	60,40	1	60,40	CHI
201911187796	HIDROLINA	HL12068284	URUACU	17/11/2019 08:47	17/11/2019 21:45	17/11/2019 08:47	17/11/2019 21:45	12,96	22	285,16	CHI
201911187797	JATAI	290306589	JATAI S3	17/11/2019 10:33	17/11/2019 19:10	17/11/2019 10:33	17/11/2019 19:10	8,63	1	8,63	CHI
201911187801	FAINA	FC12299837	GOIAS	17/11/2019 07:12	19/11/2019 13:20	17/11/2019 07:12	19/11/2019 13:20	54,14	6	324,84	CHI
201911187802	MONTIVIDIU DO NORTE	MX12364202	PORANGATU	17/11/2019 09:06	17/11/2019 17:59	17/11/2019 09:06	17/11/2019 17:59	8,88	23	204,16	CHI
201911187814	MORRINHOS	MR12033268	MORRINHOS	17/11/2019 10:32	17/11/2019 17:03	17/11/2019 10:32	17/11/2019 17:03	6,50	8	52,02	CHI
201911187815	PALMEIRAS DE GOIAS	PL12000234	PALMEIRAS	17/11/2019 10:39	17/11/2019 12:20	17/11/2019 10:39	17/11/2019 12:20	1,67	14	23,42	CHI
201911187817	GOUVELANDIA	QI12000340	QUIRINOPOLIS	17/11/2019 10:41	17/11/2019 13:22	17/11/2019 10:41	17/11/2019 13:22	2,68	10	26,78	CHI
201911187819	IPAMERI	IP12068500	CRISTALINA S2	17/11/2019 10:41	17/11/2019 12:51	17/11/2019 10:41	17/11/2019 12:51	2,16	4	8,65	CHI
201911187820	JUSSARA	JR21313201	JUSSARA	17/11/2019 10:41	17/11/2019 23:04	17/11/2019 10:41	17/11/2019 23:04	12,38	1	12,38	CHI
201911187823	IVOLANDIA	IV21079425	ARENOPOLIS	17/11/2019 10:41	18/11/2019 11:14	17/11/2019 10:41	18/11/2019 11:14	24,55	1	24,55	CHI
201911187831	PIRACANJUBA	PJ21086458	BELA VISTA S1	19/11/2019 09:08	20/11/2019 09:06	19/11/2019 09:08	20/11/2019 09:06	23,96	1	23,96	CHI
201911187834	CAVALCANTE	CJ12256476	FLORES DE GOIAS	17/11/2019 08:09	17/11/2019 14:31	17/11/2019 08:09	17/11/2019 14:31	6,36	123	782,55	CHI
201911187835	SANTO ANTONIO DO DESCOBERTO	SN21082865	MARAJOARA	17/11/2019 10:45	17/11/2019 18:00	17/11/2019 10:45	17/11/2019 18:00	7,24	2	14,49	CHI
201911187836	NOVO BRASIL	NB11020195	JUSSARA	17/11/2019 08:59	17/11/2019 17:47	17/11/2019 08:59	17/11/2019 17:47	8,79	126	1107,68	CHI
201911187838	ANAPOLIS	LB12078506	DAIA S2	17/11/2019 10:05	17/11/2019 11:56	17/11/2019 10:05	17/11/2019 11:56	1,85	8	14,77	CHI
201911187838	LEOPOLDO DE BULHOES	LB12078506	DAIA S2	17/11/2019 10:05	17/11/2019 11:56	17/11/2019 10:05	17/11/2019 11:56	1,85	6	11,08	CHI
201911187864	BOM JESUS DE GOIAS	BJ11093527	BOM JESUS DE GOIAS	17/11/2019 10:33	17/11/2019 15:38	17/11/2019 10:33	17/11/2019 15:38	5,08	122	619,96	CHI
201911187878	SANTA TEREZINHA DE GOIAS	SG21181022	SANTA TEREZINHA	17/11/2019 10:54	17/11/2019 12:03	17/11/2019 10:54	17/11/2019 12:03	1,15	1	1,15	CHI
201911187885	GOIANIA	13393510	ATLANTICO S1	17/11/2019 10:55	17/11/2019 13:23	17/11/2019 10:55	17/11/2019 13:23	2,46	1	2,46	CHI
201911187888	MINACU	IH11339061	MINACU	17/11/2019 10:56	17/11/2019 17:44	17/11/2019 10:56	17/11/2019 17:44	6,80	1	6,80	CHI
201911187893	SANCLERLANDIA	1210026421	FIRMINOPOLIS S2	17/11/2019 10:57	17/11/2019 15:02	17/11/2019 10:57	17/11/2019 15:02	4,08	1	4,08	CHI
201911187896	SANTO ANTONIO DO DESCOBERTO	2210193870	AGUAS LINDAS DE GOIAS S2	17/11/2019 10:58	17/11/2019 12:07	17/11/2019 10:58	17/11/2019 12:07	1,15	1	1,15	CHI

201911187897	FAZENDA NOVA	FN11254594	JUSSARA	17/11/2019 09:38	18/11/2019 00:21	17/11/2019 09:38	18/11/2019 00:21	14,71	47	691,50	CHI
201911187901	MONTE ALEGRE DE GOIAS	MA11405806	SAO DOMINGOS	17/11/2019 10:59	17/11/2019 16:34	17/11/2019 10:59	17/11/2019 16:34	5,57	1	5,57	CHI
201911187902	PALMEIRAS DE GOIAS	PL21126011	PALMEIRAS	17/11/2019 10:59	17/11/2019 15:37	17/11/2019 10:59	17/11/2019 15:37	4,62	2	9,25	CHI
201911187904	FORMOSA	FA21195773	ITUIQUIRA	17/11/2019 11:00	17/11/2019 21:25	17/11/2019 11:00	17/11/2019 21:25	10,41	1	10,41	CHI
201911187907	GOIANIA	10010208605	CAMPINAS S2	17/11/2019 11:00	17/11/2019 13:00	17/11/2019 11:00	17/11/2019 13:00	1,99	1	1,99	CHI
201911187908	SAO JOAO D ALIANCA	JL12324133	SAO JOAO D ALIANCA	17/11/2019 11:00	17/11/2019 20:01	17/11/2019 11:00	17/11/2019 20:01	9,00	4	36,02	CHI
201911187909	GOIAS	GS12021591	GOIAS	17/11/2019 11:00	17/11/2019 18:51	17/11/2019 11:00	17/11/2019 18:51	7,84	6	47,03	CHI
201911187910	PILAR DE GOIAS	GG21288854	SANTA TEREZINHA	17/11/2019 11:01	18/11/2019 14:15	17/11/2019 11:01	18/11/2019 14:15	27,23	1	27,23	CHI
201911187913	CORUMBA DE GOIAS	CB12384887	CORUMBA	17/11/2019 10:53	17/11/2019 13:17	17/11/2019 10:53	17/11/2019 13:17	2,39	5	11,93	CHI
201911187922	CACU	CC12000120	CACHOEIRA ALTA	17/11/2019 11:05	18/11/2019 17:50	17/11/2019 11:05	18/11/2019 17:50	30,74	4	122,96	CHI
201911187929	RIO VERDE	7599484	SANTA HELENA S1	17/11/2019 11:06	18/11/2019 13:40	17/11/2019 11:06	18/11/2019 13:40	26,56	3	79,67	CHI
201911187931	MINACU	5310000463	MINACU	17/11/2019 11:08	17/11/2019 18:23	17/11/2019 11:08	17/11/2019 18:23	7,24	1	7,24	CHI
201911187937	RIO VERDE	630320354	RIO VERDE S1	17/11/2019 11:09	17/11/2019 16:17	17/11/2019 11:09	17/11/2019 16:17	5,13	1	5,13	CHI
201911187943	AGUA FRIA DE GOIAS	TL12205638	SAO JOAO D ALIANCA	16/11/2019 17:19	17/11/2019 22:43	16/11/2019 17:19	17/11/2019 22:43	29,39	13	382,11	CHI
201911187953	BALIZA	BH12207585	BOM JARDIM	17/11/2019 11:12	17/11/2019 22:26	17/11/2019 11:12	17/11/2019 22:26	11,23	2	22,46	CHI
201911187954	CABECEIRAS	CW21288891	ITUIQUIRA	17/11/2019 11:12	17/11/2019 15:37	17/11/2019 11:12	17/11/2019 15:37	4,41	1	4,41	CHI
201911187955	NIQUELANDIA	NQ12243394	NIQUELANDIA SUBTRANSMISSAO	17/11/2019 11:12	17/11/2019 15:03	17/11/2019 11:12	17/11/2019 15:03	3,84	37	141,96	CHI
201911187959	POSSE	PS12256208	IACIARA S2	17/11/2019 11:13	17/11/2019 13:21	17/11/2019 11:13	17/11/2019 13:21	2,12	3	6,37	CHI
201911187962	VIANOPOLIS	VN21159828	VIANOPOLIS	17/11/2019 11:14	17/11/2019 12:51	17/11/2019 11:14	17/11/2019 12:51	1,61	1	1,61	CHI
201911187967	GOIANDIRA	GD11077667	CATALAO S1	17/11/2019 11:15	18/11/2019 13:07	17/11/2019 11:15	18/11/2019 13:07	25,86	93	2405,14	CHI
201911187974	ARUANA	AK12310706RE	MOZARLANDIA	17/11/2019 11:16	17/11/2019 11:59	17/11/2019 11:16	17/11/2019 11:59	0,71	9	6,35	CHI
201911187981	VILA PROPICIO	NP21298291	GOIANESIA S1	17/11/2019 11:18	18/11/2019 00:01	17/11/2019 11:18	18/11/2019 00:01	12,71	1	12,71	CHI
201911187983	CAIAPONIA	930040170	CAIAPONIA	17/11/2019 11:18	18/11/2019 10:25	17/11/2019 11:18	18/11/2019 10:25	23,10	1	23,10	CHI
201911187984	CRISTALINA	KR10400355	PAMPLONA	17/11/2019 11:16	17/11/2019 15:52	17/11/2019 11:16	17/11/2019 13:09	1,87	27	50,60	CHI
201911187984	CRISTALINA	KR10400355	PAMPLONA	17/11/2019 11:16	17/11/2019 15:52	17/11/2019 11:16	17/11/2019 14:06	2,83	73	206,91	CHI
201911187984	CRISTALINA	KR10400355	PAMPLONA	17/11/2019 11:16	17/11/2019 15:52	17/11/2019 11:16	17/11/2019 15:21	4,08	6	24,46	CHI
201911187984	CRISTALINA	KR10400355	PAMPLONA	17/11/2019 11:16	17/11/2019 15:52	17/11/2019 11:16	17/11/2019 15:52	4,59	7	32,15	CHI
201911187987	AGUAS LINDAS DE GOIAS	LA21228598	AGUAS LINDAS DE GOIAS S2	17/11/2019 11:21	17/11/2019 14:30	17/11/2019 11:21	17/11/2019 14:30	3,14	1	3,14	CHI
201911187991	ITABERAI	AR21249457	ARACU	17/11/2019 11:22	17/11/2019 17:39	17/11/2019 11:22	17/11/2019 17:39	6,28	1	6,28	CHI
201911187993	JARAGUA	JA21059952	JARAGUA	17/11/2019 11:22	17/11/2019 14:21	17/11/2019 11:22	17/11/2019 14:21	2,97	1	2,97	CHI
201911188002	APARECIDA DE GOIANIA	AP11169491	REAL S2	17/11/2019 11:16	17/11/2019 11:48	17/11/2019 11:16	17/11/2019 11:48	0,53	61	32,50	CHI
201911188005	ITAGUARI	II12300106	ITABERAI S1	17/11/2019 08:05	18/11/2019 04:00	17/11/2019 08:05	18/11/2019 04:00	19,91	5	99,57	CHI
201911188018	SANTA HELENA DE GOIAS	01660214	IPEGUARI	17/11/2019 12:10	17/11/2019 15:57	17/11/2019 12:10	17/11/2019 13:08	0,98	1000	978,89	CHI

201911188018	RIO VERDE	01660214	IPEGUARI	17/11/2019 12:10	17/11/2019 15:57	17/11/2019 12:10	17/11/2019 13:42	1,55	2	3,09	CHI
201911188018	SANTA HELENA DE GOIAS	01660214	IPEGUARI	17/11/2019 12:10	17/11/2019 15:57	17/11/2019 12:10	17/11/2019 13:42	1,55	2005	3102,74	CHI
201911188018	SANTA HELENA DE GOIAS	01660214	IPEGUARI	17/11/2019 12:10	17/11/2019 15:57	17/11/2019 13:09	17/11/2019 15:07	1,97	43	84,61	CHI
201911188018	SANTA HELENA DE GOIAS	01660214	IPEGUARI	17/11/2019 12:10	17/11/2019 15:57	17/11/2019 15:09	17/11/2019 15:15	0,09	43	3,88	CHI
201911188018	SANTA HELENA DE GOIAS	01660214	IPEGUARI	17/11/2019 12:10	17/11/2019 15:57	17/11/2019 13:09	17/11/2019 15:28	2,32	759	1758,35	CHI
201911188018	SANTA HELENA DE GOIAS	01660214	IPEGUARI	17/11/2019 12:10	17/11/2019 15:57	17/11/2019 13:09	17/11/2019 15:40	2,52	198	498,35	CHI
201911188018	RIO VERDE	SH13394798	IPEGUARI	17/11/2019 12:10	17/11/2019 15:57	17/11/2019 15:53	17/11/2019 15:57	0,05	2	0,11	CHI
201911188018	SANTA HELENA DE GOIAS	SH13394798	IPEGUARI	17/11/2019 12:10	17/11/2019 15:57	17/11/2019 15:53	17/11/2019 15:57	0,05	2005	105,82	CHI
201911188053	PALMELO	01480424	PIRES DO RIO S2	17/11/2019 16:18	17/11/2019 19:06	17/11/2019 16:21	17/11/2019 16:25	0,08	1	0,08	CHI
201911188053	PIRES DO RIO	01480424	PIRES DO RIO S2	17/11/2019 16:18	17/11/2019 19:06	17/11/2019 16:21	17/11/2019 16:25	0,08	173	13,22	CHI
201911188053	BELA VISTA DE GOIAS	01480424	PIRES DO RIO S2	17/11/2019 16:18	17/11/2019 19:06	17/11/2019 16:18	17/11/2019 16:38	0,34	2	0,68	CHI
201911188053	CRISTIANOPOLIS	01480424	PIRES DO RIO S2	17/11/2019 16:18	17/11/2019 19:06	17/11/2019 16:18	17/11/2019 16:38	0,34	27	9,17	CHI
201911188053	PALMELO	01480424	PIRES DO RIO S2	17/11/2019 16:18	17/11/2019 19:06	17/11/2019 16:18	17/11/2019 16:38	0,34	858	291,48	CHI
201911188053	PIRES DO RIO	01480424	PIRES DO RIO S2	17/11/2019 16:18	17/11/2019 19:06	17/11/2019 16:18	17/11/2019 16:38	0,34	88	29,90	CHI
201911188053	SANTA CRUZ DE GOIAS	01480424	PIRES DO RIO S2	17/11/2019 16:18	17/11/2019 19:06	17/11/2019 16:18	17/11/2019 16:38	0,34	1325	450,13	CHI
201911188053	PALMELO	01480424	PIRES DO RIO S2	17/11/2019 16:18	17/11/2019 19:06	17/11/2019 16:18	17/11/2019 17:41	1,39	23	32,04	CHI
201911188053	PIRES DO RIO	01480424	PIRES DO RIO S2	17/11/2019 16:18	17/11/2019 19:06	17/11/2019 16:18	17/11/2019 17:41	1,39	33	45,97	CHI
201911188053	SANTA CRUZ DE GOIAS	01480424	PIRES DO RIO S2	17/11/2019 16:18	17/11/2019 19:06	17/11/2019 16:18	17/11/2019 17:41	1,39	4	5,57	CHI
201911188053	PALMELO	01480424	PIRES DO RIO S2	17/11/2019 16:18	17/11/2019 19:06	17/11/2019 16:18	17/11/2019 19:06	2,80	43	120,41	CHI
201911188053	PIRES DO RIO	01480424	PIRES DO RIO S2	17/11/2019 16:18	17/11/2019 19:06	17/11/2019 16:18	17/11/2019 19:06	2,80	12	33,60	CHI
201911188053	SANTA CRUZ DE GOIAS	01480424	PIRES DO RIO S2	17/11/2019 16:18	17/11/2019 19:06	17/11/2019 16:18	17/11/2019 19:06	2,80	120	336,03	CHI
201911188053	SANTA CRUZ DE GOIAS	PZ13408025B	PIRES DO RIO S2	17/11/2019 16:18	17/11/2019 19:06	17/11/2019 16:38	17/11/2019 19:06	2,46	1	2,46	CHI
201911188057	ALOANDIA	01040424	GOIATUBA S1	17/11/2019 14:35	17/11/2019 14:41	17/11/2019 14:35	17/11/2019 14:41	0,10	238	22,81	CHI
201911188057	ALOANDIA	01040424	GOIATUBA S1	17/11/2019 14:35	17/11/2019 14:41	17/11/2019 14:35	17/11/2019 14:41	0,10	867	83,09	CHI
201911188057	ALOANDIA	01040424	GOIATUBA S1	17/11/2019 14:35	17/11/2019 14:41	17/11/2019 14:35	17/11/2019 14:41	0,10	1	0,10	CHI
201911188057	JOVIANIA	01040424	GOIATUBA S1	17/11/2019 14:35	17/11/2019 14:41	17/11/2019 14:35	17/11/2019 14:41	0,10	8	0,77	CHI
201911188057	JOVIANIA	01040424	GOIATUBA S1	17/11/2019 14:35	17/11/2019 14:41	17/11/2019 14:35	17/11/2019 14:41	0,10	5	0,48	CHI
201911188057	JOVIANIA	01040424	GOIATUBA S1	17/11/2019 14:35	17/11/2019 14:41	17/11/2019 14:35	17/11/2019 14:41	0,10	7	0,67	CHI
201911188057	MORRINHOS	01040424	GOIATUBA S1	17/11/2019 14:35	17/11/2019 14:41	17/11/2019 14:35	17/11/2019 14:41	0,10	23	2,20	CHI
201911188057	MORRINHOS	01040424	GOIATUBA S1	17/11/2019 14:35	17/11/2019 14:41	17/11/2019 14:35	17/11/2019 14:41	0,10	246	23,58	CHI
201911188057	PONTALINA	01040424	GOIATUBA S1	17/11/2019 14:35	17/11/2019 14:41	17/11/2019 14:35	17/11/2019 14:41	0,10	119	11,40	CHI
201911188065	ACREUNA	00080424	ACREUNA	17/11/2019 18:51	17/11/2019 21:47	17/11/2019 18:51	17/11/2019 19:44	0,88	28	24,60	CHI
201911188065	JANDAIA	00080424	ACREUNA	17/11/2019 18:51	17/11/2019 21:47	17/11/2019 18:51	17/11/2019 19:44	0,88	2	1,76	CHI

201911188065	PARAUNA	00080424	ACREUNA	17/11/2019 18:51	17/11/2019 21:47	17/11/2019 18:51	17/11/2019 19:44	0,88	1	0,88	CHI
201911188065	JANDAIA	EU13074471	ACREUNA	17/11/2019 18:51	17/11/2019 21:47	17/11/2019 18:51	17/11/2019 20:51	1,99	14	27,88	CHI
201911188065	INDIARA	EU13074469	ACREUNA	17/11/2019 18:51	17/11/2019 21:47	17/11/2019 18:51	17/11/2019 21:27	2,59	3	7,78	CHI
201911188065	JANDAIA	EU13074469	ACREUNA	17/11/2019 18:51	17/11/2019 21:47	17/11/2019 18:51	17/11/2019 21:27	2,59	17	44,11	CHI
201911188065	ACREUNA	00080424	ACREUNA	17/11/2019 18:51	17/11/2019 21:47	17/11/2019 21:41	17/11/2019 21:47	0,10	28	2,89	CHI
201911188065	INDIARA	00080424	ACREUNA	17/11/2019 18:51	17/11/2019 21:47	17/11/2019 21:41	17/11/2019 21:47	0,10	3	0,31	CHI
201911188065	JANDAIA	00080424	ACREUNA	17/11/2019 18:51	17/11/2019 21:47	17/11/2019 21:41	17/11/2019 21:47	0,10	33	3,40	CHI
201911188065	PARAUNA	00080424	ACREUNA	17/11/2019 18:51	17/11/2019 21:47	17/11/2019 21:41	17/11/2019 21:47	0,10	1	0,10	CHI
201911188066	PORANGATU	PO21119304	NOVO PLANALTO	17/11/2019 16:38	17/11/2019 18:20	17/11/2019 16:38	17/11/2019 18:20	1,69	1	1,69	CHI
201911188071	RIO VERDE	RV10396180	CABRIUVA S2	17/11/2019 19:43	18/11/2019 20:05	17/11/2019 19:43	18/11/2019 01:27	5,74	12	68,92	CHI
201911188071	RIO VERDE	RV12242605LD	CABRIUVA S2	17/11/2019 19:43	18/11/2019 20:05	17/11/2019 19:43	18/11/2019 10:45	15,04	7	105,27	CHI
201911188071	RIO VERDE	RV10396180	CABRIUVA S2	17/11/2019 19:43	18/11/2019 20:05	17/11/2019 19:43	18/11/2019 14:17	18,57	10	185,66	CHI
201911188071	RIO VERDE	RV10396180	CABRIUVA S2	17/11/2019 19:43	18/11/2019 20:05	18/11/2019 14:18	18/11/2019 14:32	0,24	19	4,61	CHI
201911188071	RIO VERDE	RV10396180	CABRIUVA S2	17/11/2019 19:43	18/11/2019 20:05	18/11/2019 14:18	18/11/2019 18:25	4,13	10	41,29	CHI
201911188071	RIO VERDE	RV12279477	CABRIUVA S2	17/11/2019 19:43	18/11/2019 20:05	17/11/2019 19:43	18/11/2019 19:24	23,69	6	142,14	CHI
201911188071	RIO VERDE	RV13383958	CABRIUVA S2	17/11/2019 19:43	18/11/2019 20:05	17/11/2019 19:43	18/11/2019 20:05	24,37	12	292,39	CHI
201911188072	MAMBAI	7110001038	IACIARA S2	17/11/2019 19:55	17/11/2019 20:25	17/11/2019 19:55	17/11/2019 20:25	0,49	1	0,49	CHI
201911188090	CAMPINACU	IH12132432	MINACU	17/11/2019 18:38	18/11/2019 03:23	17/11/2019 18:38	18/11/2019 03:23	8,74	22	192,21	CHI
201911188090	MINACU	IH12132432	MINACU	17/11/2019 18:38	18/11/2019 03:23	17/11/2019 18:38	18/11/2019 03:23	8,74	109	952,30	CHI
201911188099	ACREUNA	EU12207513	ACREUNA	14/11/2019 16:49	17/11/2019 22:55	14/11/2019 16:49	17/11/2019 22:55	78,09	1	78,09	CHI
201911188099	SANTO ANTONIO DA BARRA	EU12207513	ACREUNA	14/11/2019 16:49	17/11/2019 22:55	14/11/2019 16:49	17/11/2019 22:55	78,09	5	390,46	CHI
201911188100	ACREUNA	SH12246720	ACREUNA	16/11/2019 15:27	18/11/2019 14:52	16/11/2019 15:27	18/11/2019 14:52	47,41	5	237,05	CHI
201911188100	SANTA HELENA DE GOIAS	SH12246720	ACREUNA	16/11/2019 15:27	18/11/2019 14:52	16/11/2019 15:27	18/11/2019 14:52	47,41	73	3460,99	CHI
201911188100	SANTO ANTONIO DA BARRA	SH12246720	ACREUNA	16/11/2019 15:27	18/11/2019 14:52	16/11/2019 15:27	18/11/2019 14:52	47,41	16	758,57	CHI
201911188100	SANTA HELENA DE GOIAS	SH12246720	ACREUNA	16/11/2019 15:27	18/11/2019 14:52	16/11/2019 18:13	18/11/2019 14:52	44,65	2	89,30	CHI
201911188101	GOIANIA	GN11012784	FERROVIARIO S1	17/11/2019 11:22	17/11/2019 12:07	17/11/2019 11:22	17/11/2019 12:07	0,74	81	59,69	CHI
201911188122	GOIAS	GS12073642	MATRINCHA	17/11/2019 11:28	18/11/2019 14:30	17/11/2019 11:28	18/11/2019 14:30	27,02	26	702,55	CHI
201911188130	AGUAS LINDAS DE GOIAS	4830071152	AGUAS LINDAS DE GOIAS S1	17/11/2019 11:31	17/11/2019 14:09	17/11/2019 11:31	17/11/2019 14:09	2,62	1	2,62	CHI
201911188137	GOIANIA	10000538840	GOYA S1	17/11/2019 11:33	17/11/2019 15:25	17/11/2019 11:33	17/11/2019 15:25	3,86	1	3,86	CHI
201911188139	SAO LUIS DE MONTES BELOS	500125168	SAO LUIZ DOS MONTES BELOS	17/11/2019 11:34	17/11/2019 14:37	17/11/2019 11:34	17/11/2019 14:37	3,05	1	3,05	CHI
201911188140	ARACU	AR12019600	ARACU	17/11/2019 11:02	17/11/2019 15:02	17/11/2019 11:02	17/11/2019 15:02	4,00	2	8,00	CHI
201911188140	ITABERAI	AR12019600	ARACU	17/11/2019 11:02	17/11/2019 15:02	17/11/2019 11:02	17/11/2019 15:02	4,00	4	16,00	CHI
201911188141	GOIANIA	17016174	GOYA S2	17/11/2019 11:34	17/11/2019 13:59	17/11/2019 11:34	17/11/2019 13:59	2,41	1	2,41	CHI

201911188147	SANTA RITA DO NOVO DESTINO	1330001713	GOIANESIA S1	17/11/2019 11:37	17/11/2019 17:40	17/11/2019 11:37	17/11/2019 17:40	6,04	1	6,04	CHI
201911188154	OUVIDOR	OU21063826	CATALAO S1	17/11/2019 11:38	19/11/2019 10:50	17/11/2019 11:38	19/11/2019 10:50	47,18	1	47,18	CHI
201911188155	CATALAO	1990175925	CATALAO S2	17/11/2019 11:39	17/11/2019 15:47	17/11/2019 11:39	17/11/2019 15:47	4,14	1	4,14	CHI
201911188156	IPORA	IS21188425	IPORA	17/11/2019 11:39	17/11/2019 16:31	17/11/2019 11:39	17/11/2019 16:31	4,87	1	4,87	CHI
201911188160	GOIANIA	GN11089529	REAL S1	17/11/2019 11:45	17/11/2019 13:55	17/11/2019 11:45	17/11/2019 13:55	2,16	137	296,41	CHI
201911188161	CACHOEIRA DOURADA	CD11000007	CACHOEIRA DOURADA	17/11/2019 11:05	17/11/2019 22:40	17/11/2019 11:05	17/11/2019 22:40	11,59	78	904,19	CHI
201911188168	PIRACANJUBA	PJ21072824	PIRACANJUBA	17/11/2019 11:41	18/11/2019 23:05	17/11/2019 11:41	18/11/2019 23:05	35,40	1	35,40	CHI
201911188174	SAO DOMINGOS	SD12132214	SAO DOMINGOS	17/11/2019 11:44	17/11/2019 16:46	17/11/2019 11:44	17/11/2019 16:46	5,03	3	15,08	CHI
201911188189	PALMEIRAS DE GOIAS	PL12000225	PALMEIRAS	17/11/2019 11:49	17/11/2019 15:40	17/11/2019 11:49	17/11/2019 15:40	3,85	11	42,33	CHI
201911188190	CRISTALINA	KR21199526	PAMPLONA	17/11/2019 11:49	17/11/2019 20:15	17/11/2019 11:49	17/11/2019 20:15	8,43	1	8,43	CHI
201911188192	MONTES CLAROS DE GOIAS	ME12204921	IPORA	17/11/2019 10:18	18/11/2019 03:27	17/11/2019 10:18	18/11/2019 03:27	17,14	47	805,68	CHI
201911188197	FORMOSA	FA12404996	ITUIQUIRA	17/11/2019 11:49	17/11/2019 20:05	17/11/2019 11:49	17/11/2019 20:05	8,25	2	16,51	CHI
201911188202	ARUANA	MP12099916	MATRINCHA	17/11/2019 11:52	18/11/2019 18:46	17/11/2019 11:52	18/11/2019 18:46	30,89	5	154,47	CHI
201911188202	MATRINCHA	MP12099916	MATRINCHA	17/11/2019 11:52	18/11/2019 18:46	17/11/2019 11:52	18/11/2019 18:46	30,89	2	61,79	CHI
201911188203	ANAPOLIS	00050274	ANAPOLIS UNIVERSITARIO S2	17/11/2019 11:51	17/11/2019 12:12	17/11/2019 11:51	17/11/2019 12:12	0,34	10177	3482,80	CHI
201911188207	ANAPOLIS	AN11003273	JUNDIAI S1	17/11/2019 11:40	17/11/2019 13:39	17/11/2019 11:40	17/11/2019 13:39	1,97	123	242,38	CHI
201911188209	GOIANIA	GN12047178	XAVANTES	17/11/2019 11:53	17/11/2019 14:17	17/11/2019 11:53	17/11/2019 14:17	2,38	391	932,53	CHI
201911188210	CORUMBA DE GOIAS	CB11351483	CORUMBA	17/11/2019 11:54	17/11/2019 13:58	17/11/2019 11:54	17/11/2019 13:58	2,06	47	96,91	CHI
201911188217	CAMPINORTE	CR12234938	PORANGATU	17/11/2019 10:21	17/11/2019 15:05	17/11/2019 10:21	17/11/2019 15:05	4,72	19	89,72	CHI
201911188217	MINACU	CR12234938	PORANGATU	17/11/2019 10:21	17/11/2019 15:05	17/11/2019 10:21	17/11/2019 15:05	4,72	42	198,33	CHI
201911188221	MOZARLANDIA	MZ12055627	MOZARLANDIA	17/11/2019 08:41	18/11/2019 16:12	17/11/2019 08:41	18/11/2019 16:12	31,52	4	126,07	CHI
201911188224	JAUPACI	JP12235888	IPORA	17/11/2019 11:55	17/11/2019 18:20	17/11/2019 11:55	17/11/2019 18:20	6,42	3	19,27	CHI
201911188225	ALTO PARAISO DE GOIAS	BF12349123	FLORES DE GOIAS	17/11/2019 06:33	18/11/2019 14:20	17/11/2019 06:33	18/11/2019 14:20	31,78	3	95,33	CHI
201911188225	SAO JOAO D ALIANCA	BF12349123	FLORES DE GOIAS	17/11/2019 06:33	18/11/2019 14:20	17/11/2019 06:33	18/11/2019 14:20	31,78	3	95,33	CHI
201911188226	CRIXAS	CX12134501	RUBIATABA	17/11/2019 11:55	17/11/2019 20:38	17/11/2019 11:55	17/11/2019 20:38	8,70	57	496,17	CHI
201911188226	NOVA IGUACU DE GOIAS	CX12134501	RUBIATABA	17/11/2019 11:55	17/11/2019 20:38	17/11/2019 11:55	17/11/2019 20:38	8,70	1	8,70	CHI
201911188228	ALVORADA DO NORTE	AQ12000012	IACIARA S2	17/11/2019 11:56	17/11/2019 18:18	17/11/2019 11:56	17/11/2019 15:15	3,33	84	279,51	CHI
201911188228	ALVORADA DO NORTE	AQ11000006	IACIARA S2	17/11/2019 11:56	17/11/2019 18:18	17/11/2019 11:56	17/11/2019 18:18	6,37	83	528,36	CHI
201911188229	GOIANIA	GN11003194	AEROPORTO S2	17/11/2019 11:56	17/11/2019 16:18	17/11/2019 11:56	17/11/2019 16:18	4,37	4	17,46	CHI
201911188247	ARAGUAPAZ	AZ21017273	MOZARLANDIA	17/11/2019 11:58	17/11/2019 21:55	17/11/2019 11:58	17/11/2019 21:55	9,96	1	9,96	CHI
201911188261	GOIAS	GS12307383	GOIAS	17/11/2019 11:20	17/11/2019 14:28	17/11/2019 11:20	17/11/2019 14:28	3,12	11	34,32	CHI
201911188264	BOM JESUS DE GOIAS	BJ12000015	BOM JESUS DE GOIAS	17/11/2019 10:45	17/11/2019 13:06	17/11/2019 10:45	17/11/2019 13:06	2,34	227	531,68	CHI
201911188274	NOVA CRIXAS	NA21077102	NOVA CRIXAS	17/11/2019 12:00	17/11/2019 15:00	17/11/2019 12:00	17/11/2019 15:00	2,99	1	2,99	CHI

201911188280	GOUVELANDIA	GB21101386	QUIRINOPOLIS	17/11/2019 12:01	17/11/2019 13:52	17/11/2019 12:01	17/11/2019 13:52	1,84	1	1,84	CHI
201911188285	PIRES DO RIO	PR21203223	PIRES DO RIO S1	17/11/2019 12:02	17/11/2019 19:09	17/11/2019 12:02	17/11/2019 19:09	7,11	1	7,11	CHI
201911188287	GOIANIA	GN11001904	CAMPINAS S1	17/11/2019 11:33	17/11/2019 14:20	17/11/2019 11:33	17/11/2019 14:20	2,77	65	180,36	CHI
201911188294	GOUVELANDIA	QJ31054861	QUIRINOPOLIS	17/11/2019 12:04	17/11/2019 21:34	17/11/2019 12:04	17/11/2019 21:34	9,50	2	18,99	CHI
201911188305	CORUMBA DE GOIAS	CB21357028	CORUMBA	17/11/2019 12:06	17/11/2019 15:50	17/11/2019 12:06	17/11/2019 15:50	3,73	3	11,18	CHI
201911188319	ARENOPOLIS	AY12103482	ARENOPOLIS	17/11/2019 08:29	18/11/2019 07:32	17/11/2019 08:29	18/11/2019 07:32	23,05	11	253,53	CHI
201911188319	DIORAMA	AY12103482	ARENOPOLIS	17/11/2019 08:29	18/11/2019 07:32	17/11/2019 08:29	18/11/2019 07:32	23,05	9	207,43	CHI
201911188320	SANTA RITA DO NOVO DESTINO	DF21191331	GOIANESIA S1	17/11/2019 12:08	17/11/2019 15:27	17/11/2019 12:08	17/11/2019 15:27	3,31	1	3,31	CHI
201911188321	GOIANESIA	GE12382867	GOIANESIA S1	17/11/2019 10:28	17/11/2019 14:41	17/11/2019 10:28	17/11/2019 14:41	4,21	4	16,83	CHI
201911188322	GOIANIA	GN11200595	XAVANTES	17/11/2019 12:09	17/11/2019 13:51	17/11/2019 12:09	17/11/2019 13:51	1,69	54	91,27	CHI
201911188324	GUARAITA	19638115	ITAPURANGA	17/11/2019 11:41	17/11/2019 13:31	17/11/2019 11:41	17/11/2019 13:31	1,82	14	25,52	CHI
201911188329	PORANGATU	PO10391977	PORANGATU	17/11/2019 12:10	17/11/2019 20:44	17/11/2019 12:10	17/11/2019 12:50	0,67	212	141,22	CHI
201911188329	PORANGATU	PO12057986LD	PORANGATU	17/11/2019 12:10	17/11/2019 20:44	17/11/2019 12:10	17/11/2019 14:54	2,73	10	27,30	CHI
201911188329	PORANGATU	PO13057987	PORANGATU	17/11/2019 12:10	17/11/2019 20:44	17/11/2019 12:10	17/11/2019 18:31	6,35	118	749,56	CHI
201911188329	PORANGATU	PO12100797LD	PORANGATU	17/11/2019 12:10	17/11/2019 20:44	17/11/2019 12:10	17/11/2019 18:44	6,56	8	52,52	CHI
201911188329	PORANGATU	PO12252122LD	PORANGATU	17/11/2019 12:10	17/11/2019 20:44	17/11/2019 12:10	17/11/2019 19:46	7,60	12	91,24	CHI
201911188329	PORANGATU	PO13320936	PORANGATU	17/11/2019 12:10	17/11/2019 20:44	17/11/2019 12:10	17/11/2019 20:44	8,57	6	51,40	CHI
201911188332	RIO VERDE	630238133	RIO VERDE S1	17/11/2019 12:12	17/11/2019 15:54	17/11/2019 12:12	17/11/2019 15:54	3,70	1	3,70	CHI
201911188333	MINEIROS	MY11337106	PARQUE DAS EMAS	17/11/2019 12:09	17/11/2019 12:43	17/11/2019 12:09	17/11/2019 12:43	0,56	73	40,80	CHI
201911188336	GOIANIA	17108949	CARAJAS S2	17/11/2019 12:14	17/11/2019 16:45	17/11/2019 12:14	17/11/2019 16:45	4,53	1	4,53	CHI
201911188339	GOIANIRA	10023871790	MEIA PONTE	17/11/2019 12:14	17/11/2019 15:00	17/11/2019 12:14	17/11/2019 15:00	2,76	1	2,76	CHI
201911188344	SENADOR CANEDO	SW11384223	SENADOR CANEDO	17/11/2019 12:03	17/11/2019 19:09	17/11/2019 12:03	17/11/2019 19:09	7,10	118	837,67	CHI
201911188347	APARECIDA DE GOIANIA	16367029	INDEPENDENCIA S2	17/11/2019 12:15	17/11/2019 13:41	17/11/2019 12:15	17/11/2019 13:41	1,42	1	1,42	CHI
201911188350	SILVANIA	SV12112243	VIANOPOLIS	17/11/2019 12:16	17/11/2019 15:30	17/11/2019 12:16	17/11/2019 15:30	3,23	5	16,13	CHI
201911188356	MINEIROS	MY21070312	PARQUE DAS EMAS	17/11/2019 12:18	17/11/2019 14:34	17/11/2019 12:18	17/11/2019 14:34	2,26	1	2,26	CHI
201911188359	CAIAPONIA	CP21193806	IPORA	17/11/2019 12:19	18/11/2019 15:38	17/11/2019 12:19	18/11/2019 15:38	27,31	1	27,31	CHI
201911188367	JANDAIA	JD12308457	PALMEIRAS	17/11/2019 09:07	17/11/2019 14:40	17/11/2019 09:07	17/11/2019 14:40	5,55	18	99,82	CHI
201911188371	INHUMAS	IX12013297	INHUMAS S2	17/11/2019 12:16	17/11/2019 14:04	17/11/2019 12:16	17/11/2019 14:04	1,79	13	23,31	CHI
201911188379	JUSSARA	JR12198795	JUSSARA	17/11/2019 10:39	17/11/2019 15:43	17/11/2019 10:39	17/11/2019 15:43	5,06	72	364,34	CHI
201911188382	GOIANIA	11554149	CAMPINAS S2	17/11/2019 12:25	17/11/2019 14:55	17/11/2019 12:25	17/11/2019 14:55	2,49	1	2,49	CHI
201911188385	IACIARA	ND21381621	IACIARA S2	17/11/2019 12:26	17/11/2019 17:34	17/11/2019 12:26	17/11/2019 17:34	5,12	1	5,12	CHI
201911188387	PORANGATU	PO11254784	PORANGATU	17/11/2019 12:26	17/11/2019 20:03	17/11/2019 12:26	17/11/2019 20:03	7,60	3	22,80	CHI
201911188389	CAMPOS BELOS	CH12224199	SAO DOMINGOS	17/11/2019 12:27	18/11/2019 10:54	17/11/2019 12:27	18/11/2019 10:54	22,44	4	89,75	CHI

201911188392	LUZIANIA	10006150967	RIO VERMELHO	17/11/2019 12:30	17/11/2019 14:52	17/11/2019 12:30	17/11/2019 14:52	2,36	1	2,36	CHI
201911188398	ITAPURANGA	170067361	ITAPURANGA	17/11/2019 12:32	18/11/2019 16:20	17/11/2019 12:32	18/11/2019 16:20	27,80	1	27,80	CHI
201911188400	NEROPOLIS	NR21214653	NEROPOLIS S2	17/11/2019 12:35	17/11/2019 13:21	17/11/2019 12:35	17/11/2019 13:21	0,76	1	0,76	CHI
201911188403	GOIANDIRA	GD11363422	CATALAO S1	17/11/2019 08:38	18/11/2019 07:17	17/11/2019 08:38	18/11/2019 07:17	22,64	4	90,56	CHI
201911188404	CAIAPONIA	PH12259516	CAIAPONIA	17/11/2019 12:36	17/11/2019 17:31	17/11/2019 12:36	17/11/2019 17:31	4,91	3	14,74	CHI
201911188404	PIRANHAS	PH12259516	CAIAPONIA	17/11/2019 12:36	17/11/2019 17:31	17/11/2019 12:36	17/11/2019 17:31	4,91	69	339,06	CHI
201911188409	CORUMBA DE GOIAS	CB12297776	CORUMBA	17/11/2019 08:58	17/11/2019 17:45	17/11/2019 08:58	17/11/2019 17:45	8,77	5	43,84	CHI
201911188417	PILAR DE GOIAS	GG12262855	ITAPACI	17/11/2019 12:39	18/11/2019 15:23	17/11/2019 12:39	18/11/2019 15:23	26,73	5	133,64	CHI
201911188430	MORRINHOS	MR12041262RE	MORRINHOS	17/11/2019 12:21	17/11/2019 16:53	17/11/2019 12:21	17/11/2019 16:53	4,54	163	739,25	CHI
201911188435	GUARANI DE GOIAS	PS21264749	IACIARA S2	17/11/2019 12:44	17/11/2019 20:37	17/11/2019 12:44	17/11/2019 20:37	7,87	2	15,74	CHI
201911188441	AMARALINA	LC12135635	NOVA CRIXAS	17/11/2019 08:21	17/11/2019 18:34	17/11/2019 08:21	17/11/2019 18:34	10,21	1	10,21	CHI
201911188441	MARA ROSA	LC12135635	NOVA CRIXAS	17/11/2019 08:21	17/11/2019 18:34	17/11/2019 08:21	17/11/2019 18:34	10,21	6	61,24	CHI
201911188444	TRES RANCHOS	TH21032049	CATALAO S1	17/11/2019 12:46	18/11/2019 13:16	17/11/2019 12:46	18/11/2019 13:16	24,49	1	24,49	CHI
201911188448	GOIANIA	GN11275371	GOYA S1	17/11/2019 12:47	17/11/2019 15:19	17/11/2019 12:47	17/11/2019 15:19	2,52	63	158,87	CHI
201911188456	JUSSARA	JR21114104	JUSSARA	17/11/2019 12:49	18/11/2019 08:38	17/11/2019 12:49	18/11/2019 08:38	19,81	1	19,81	CHI
201911188457	DIORAMA	DI12063493	IPORA	17/11/2019 10:46	18/11/2019 05:04	17/11/2019 10:46	18/11/2019 05:04	18,29	38	695,14	CHI
201911188457	IPORA	DI12063493	IPORA	17/11/2019 10:46	18/11/2019 05:04	17/11/2019 10:46	18/11/2019 05:04	18,29	3	54,88	CHI
201911188457	MONTES CLAROS DE GOIAS	DI12063493	IPORA	17/11/2019 10:46	18/11/2019 05:04	17/11/2019 10:46	18/11/2019 05:04	18,29	7	128,05	CHI
201911188470	GOIANIA	GN11161503	REAL S1	17/11/2019 12:54	17/11/2019 14:53	17/11/2019 12:54	17/11/2019 14:53	1,97	101	198,77	CHI
201911188472	CRISTALINA	KR21246098	CRISTALINA S1	17/11/2019 12:55	17/11/2019 15:43	17/11/2019 12:55	17/11/2019 15:43	2,79	2	5,59	CHI
201911188475	APARECIDA DE GOIANIA	16459568	REAL S1	17/11/2019 12:56	17/11/2019 16:12	17/11/2019 12:56	17/11/2019 16:12	3,26	1	3,26	CHI
201911188479	NEROPOLIS	TJ21155847	DAIA S2	17/11/2019 12:57	17/11/2019 15:42	17/11/2019 12:57	17/11/2019 15:42	2,74	2	5,48	CHI
201911188481	GOIANIA	11655057	CAMPINAS S2	17/11/2019 12:59	17/11/2019 16:22	17/11/2019 12:59	17/11/2019 16:22	3,38	1	3,38	CHI
201911188483	JATAI	3920000156	JATAI S1	17/11/2019 12:59	17/11/2019 17:15	17/11/2019 12:59	17/11/2019 17:15	4,26	1	4,26	CHI
201911188486	BOM JARDIM DE GOIAS	BM12335411	BOM JARDIM	17/11/2019 07:51	17/11/2019 15:26	17/11/2019 07:51	17/11/2019 15:26	7,57	6	45,44	CHI
201911188494	MONTIVIDIU	MV12219446	MONTIVIDIU T	17/11/2019 13:04	17/11/2019 18:05	17/11/2019 13:04	17/11/2019 18:05	5,00	1	5,00	CHI
201911188504	CIDADE OCIDENTAL	DH11335922	MARAJOARA	17/11/2019 16:00	17/11/2019 20:40	17/11/2019 16:00	17/11/2019 16:28	0,47	69	32,66	CHI
201911188504	CIDADE OCIDENTAL	DH11335922	MARAJOARA	17/11/2019 16:00	17/11/2019 20:40	17/11/2019 18:20	17/11/2019 20:40	2,33	69	161,02	CHI
201911188506	ITABERAI	50056062	ITABERAI S2	17/11/2019 13:09	18/11/2019 02:04	17/11/2019 13:09	18/11/2019 02:04	12,91	1	12,91	CHI
201911188508	PLANALTINA	PI11149012	PLANALTINA	17/11/2019 13:09	17/11/2019 15:27	17/11/2019 13:09	17/11/2019 15:27	2,29	33	75,59	CHI
201911188510	RIO VERDE	RV11054317	RIO VERDE S1	17/11/2019 11:32	17/11/2019 14:44	17/11/2019 11:32	17/11/2019 14:44	3,20	176	563,10	CHI
201911188512	ANAPOLIS	AN11167584	ANAPOLIS UNIVERSITARIO S2	17/11/2019 13:04	17/11/2019 15:26	17/11/2019 13:04	17/11/2019 15:26	2,35	158	371,83	CHI
201911188515	ITAJA	2300011664	ITAJA S2	17/11/2019 13:13	17/11/2019 15:01	17/11/2019 13:13	17/11/2019 15:01	1,79	1	1,79	CHI

201911188516	VALPARAISO DE GOIAS	3350041903	PACAEMBU S2	17/11/2019 13:13	17/11/2019 14:59	17/11/2019 13:13	17/11/2019 14:59	1,76	1	1,76	CHI
201911188524	GOIANIA	GN11281916	CARAJAS S2	17/11/2019 13:06	17/11/2019 18:10	17/11/2019 13:06	17/11/2019 18:10	5,06	30	151,79	CHI
201911188531	MINEIROS	10030321865	PARQUE DAS EMAS	17/11/2019 13:21	17/11/2019 14:30	17/11/2019 13:21	17/11/2019 14:30	1,14	1	1,14	CHI
201911188532	PALMEIRAS DE GOIAS	590050187	PALMEIRAS	17/11/2019 13:21	17/11/2019 15:11	17/11/2019 13:21	17/11/2019 15:11	1,83	1	1,83	CHI
201911188535	MORRO AGUDO DE GOIAS	RB12156092	RUBIATABA	17/11/2019 07:07	17/11/2019 17:34	17/11/2019 07:07	17/11/2019 17:34	10,44	10	104,41	CHI
201911188537	HIDROLANDIA	PJ12293368	ROCHEDO	17/11/2019 07:18	18/11/2019 12:24	17/11/2019 07:18	18/11/2019 12:24	29,10	9	261,86	CHI
201911188537	PIRACANJUBA	PJ12293368	ROCHEDO	17/11/2019 07:18	18/11/2019 12:24	17/11/2019 07:18	18/11/2019 12:24	29,10	2	58,19	CHI
201911188540	CORREGO DO OURO	CO12004040	FIRMINOPOLIS S2	17/11/2019 13:23	17/11/2019 16:02	17/11/2019 13:23	17/11/2019 16:02	2,64	4	10,57	CHI
201911188541	PADRE BERNARDO	PB11377629	PADRE BERNARDO	17/11/2019 13:24	17/11/2019 15:59	17/11/2019 13:24	17/11/2019 15:59	2,58	28	72,13	CHI
201911188550	SANTA HELENA DE GOIAS	400015420	IPEGUARI	17/11/2019 13:27	17/11/2019 18:10	17/11/2019 13:27	17/11/2019 18:10	4,71	1	4,71	CHI
201911188552	INHUMAS	10004394460	INHUMAS S2	17/11/2019 13:28	17/11/2019 18:07	17/11/2019 13:28	17/11/2019 18:07	4,64	1	4,64	CHI
201911188554	ALEXANIA	AX12211853	ALEXANIA	17/11/2019 12:48	17/11/2019 15:22	17/11/2019 12:48	17/11/2019 15:22	2,55	55	140,51	CHI
201911188555	RIO VERDE	RV21123294	CACHOEIRA ALTA	17/11/2019 13:29	18/11/2019 09:00	17/11/2019 13:29	18/11/2019 09:00	19,50	1	19,50	CHI
201911188558	CORUMBA DE GOIAS	CB12000010	CORUMBA	17/11/2019 11:36	17/11/2019 14:45	17/11/2019 11:36	17/11/2019 14:45	3,13	8	25,07	CHI
201911188559	GOIANIA	GN13407272B	REAL S1	17/11/2019 16:57	17/11/2019 17:19	17/11/2019 16:57	17/11/2019 17:19	0,36	535	189,93	CHI
201911188561	ANICUNS	AC12159716	ANICUNS	17/11/2019 13:31	17/11/2019 16:28	17/11/2019 13:31	17/11/2019 16:28	2,94	2	5,87	CHI
201911188561	AVELINOPOLIS	AC12159716	ANICUNS	17/11/2019 13:31	17/11/2019 16:28	17/11/2019 13:31	17/11/2019 16:28	2,94	4	11,75	CHI
201911188567	IPAMERI	IP12404713	IPAMERI	17/11/2019 13:33	19/11/2019 13:05	17/11/2019 13:33	17/11/2019 16:39	3,11	5	15,57	CHI
201911188567	IPAMERI	IP12404713	IPAMERI	17/11/2019 13:33	19/11/2019 13:05	17/11/2019 16:40	19/11/2019 13:05	44,42	54	2398,59	CHI
201911188569	GOIANIA	15271146	GOYA S2	17/11/2019 13:35	17/11/2019 15:11	17/11/2019 13:35	17/11/2019 15:11	1,59	1	1,59	CHI
201911188573	PALESTINA DE GOIAS	PY21023461	PALESTINA	17/11/2019 13:36	18/11/2019 12:23	17/11/2019 13:36	18/11/2019 12:23	22,77	1	22,77	CHI
201911188574	SAO JOAO D ALIANCA	JL12049201	SAO JOAO D ALIANCA	17/11/2019 13:37	17/11/2019 22:00	17/11/2019 13:37	17/11/2019 22:00	8,38	96	804,85	CHI
201911188577	JARAGUA	JA12009229	JARAGUA	17/11/2019 13:38	17/11/2019 16:23	17/11/2019 13:38	17/11/2019 16:23	2,74	3	8,21	CHI
201911188578	BOM JARDIM DE GOIAS	PH12343340B	PIRANHAS	17/11/2019 07:18	17/11/2019 15:03	17/11/2019 07:18	17/11/2019 15:03	7,74	5	38,71	CHI
201911188578	PIRANHAS	PH12343340B	PIRANHAS	17/11/2019 07:18	17/11/2019 15:03	17/11/2019 07:18	17/11/2019 15:03	7,74	100	774,25	CHI
201911188580	PONTALINA	PK21197126	VICENTINOPOLIS	17/11/2019 13:39	18/11/2019 10:14	17/11/2019 13:39	18/11/2019 10:14	20,58	1	20,58	CHI
201911188587	NOVO GAMA	10003433070	MARAJOARA	17/11/2019 13:40	17/11/2019 14:35	17/11/2019 13:40	17/11/2019 14:35	0,90	1	0,90	CHI
201911188588	CIDADE OCIDENTAL	2680149069	MARAJOARA	17/11/2019 13:41	17/11/2019 16:39	17/11/2019 13:41	17/11/2019 16:39	2,96	1	2,96	CHI
201911188590	MINEIROS	MY11248474	PARQUE DAS EMAS	17/11/2019 13:43	17/11/2019 14:53	17/11/2019 13:43	17/11/2019 14:53	1,16	18	20,95	CHI
201911188594	JATAI	10011544374	JATAI S2	17/11/2019 13:45	18/11/2019 08:15	17/11/2019 13:45	18/11/2019 08:15	18,51	1	18,51	CHI
201911188601	ITARUMA	IM12226504	CACHOEIRA ALTA	17/11/2019 13:46	18/11/2019 08:30	17/11/2019 13:46	18/11/2019 08:30	18,72	1	18,72	CHI
201911188607	ITAPIRAPUA	IU12077173	JUSSARA	17/11/2019 10:28	17/11/2019 15:30	17/11/2019 10:28	17/11/2019 15:30	5,02	6	30,12	CHI
201911188609	APARECIDA DE GOIANIA	AP11072158	INDEPENDENCIA S1	17/11/2019 13:36	17/11/2019 16:30	17/11/2019 13:36	17/11/2019 16:30	2,89	229	662,45	CHI

201911188618	GOIANESIA	550182445	GOIANESIA S2	17/11/2019 13:53	17/11/2019 16:10	17/11/2019 13:53	17/11/2019 16:10	2,27	1	2,27	CHI
201911188621	TURVANIA	10009380548	FIRMINOPOLIS S2	17/11/2019 13:55	17/11/2019 16:41	17/11/2019 13:55	17/11/2019 16:41	2,76	1	2,76	CHI
201911188623	CALDAS NOVAS	760174702	SERRA DE CALDAS	17/11/2019 13:55	18/11/2019 12:30	17/11/2019 13:55	18/11/2019 12:30	22,58	1	22,58	CHI
201911188627	URUACU	640016923	URUACU	17/11/2019 13:56	17/11/2019 19:52	17/11/2019 13:56	17/11/2019 19:52	5,92	1	5,92	CHI
201911188630	GUARINOS	GF21280903	SANTA TEREZINHA	17/11/2019 13:58	17/11/2019 17:14	17/11/2019 13:58	17/11/2019 17:14	3,28	2	6,56	CHI
201911188633	BOM JARDIM DE GOIAS	BM11209244	BOM JARDIM	17/11/2019 13:58	17/11/2019 17:46	17/11/2019 13:58	17/11/2019 17:46	3,80	1	3,80	CHI
201911188637	CRISTALINA	KR12276471	CRISTALINA S2	17/11/2019 12:55	17/11/2019 20:55	17/11/2019 12:55	17/11/2019 20:55	7,99	11	87,92	CHI
201911188642	TRES RANCHOS	TH21161067	CATALAO S1	14/11/2019 09:48	18/11/2019 10:34	14/11/2019 09:48	18/11/2019 10:34	96,77	1	96,77	CHI
201911188643	GOIANDIRA	GD12281470	CATALAO S1	17/11/2019 14:03	18/11/2019 08:40	17/11/2019 14:03	18/11/2019 08:40	18,61	5	93,06	CHI
201911188646	GOIANIA	10007375881	REAL S1	17/11/2019 14:06	17/11/2019 17:40	17/11/2019 14:06	17/11/2019 17:40	3,56	1	3,56	CHI
201911188649	NOVA ROMA	IA12180523	IACIARA S2	17/11/2019 14:08	17/11/2019 17:55	17/11/2019 14:08	17/11/2019 17:55	3,78	3	11,33	CHI
201911188653	ITAPURANGA	IK12298443	ITAPURANGA	17/11/2019 13:47	17/11/2019 16:00	17/11/2019 13:47	17/11/2019 16:00	2,22	5	11,09	CHI
201911188654	LUZIANIA	LZ21239800	VIANOPOLIS	17/11/2019 14:10	17/11/2019 23:24	17/11/2019 14:10	17/11/2019 23:24	9,23	1	9,23	CHI
201911188655	TRES RANCHOS	TH21337582	CATALAO S1	17/11/2019 14:10	18/11/2019 12:12	17/11/2019 14:10	18/11/2019 12:12	22,03	1	22,03	CHI
201911188656	GOIANIA	10989419	FERROVIARIO S2	17/11/2019 14:10	17/11/2019 17:28	17/11/2019 14:10	17/11/2019 17:28	3,29	1	3,29	CHI
201911188658	GOIANIA	GN21092621	CEPAIGO S1	17/11/2019 14:10	17/11/2019 15:05	17/11/2019 14:10	17/11/2019 15:05	0,90	2	1,80	CHI
201911188659	MINEIROS	MY11274021	PARQUE DAS EMAS	17/11/2019 14:11	17/11/2019 16:08	17/11/2019 14:11	17/11/2019 16:08	1,95	141	274,40	CHI
201911188660	TRINDADE	14924596	GOYA S2	17/11/2019 14:11	17/11/2019 16:29	17/11/2019 14:11	17/11/2019 16:29	2,30	1	2,30	CHI
201911188662	GOIANIA	10001231713	GOYA S1	17/11/2019 14:12	17/11/2019 15:49	17/11/2019 14:12	17/11/2019 15:49	1,61	1	1,61	CHI
201911188665	NOVA ROMA	ND11322706	IACIARA S2	17/11/2019 14:13	17/11/2019 16:24	17/11/2019 14:13	17/11/2019 16:24	2,18	53	115,36	CHI
201911188666	ITAPACI	IW12268825	SANTA TEREZINHA	17/11/2019 14:14	18/11/2019 18:40	17/11/2019 14:14	18/11/2019 18:40	28,44	2	56,89	CHI
201911188667	DIVINOPOLIS DE GOIAS	GH12241948	SAO DOMINGOS	17/11/2019 14:10	17/11/2019 16:51	17/11/2019 14:10	17/11/2019 16:51	2,67	7	18,72	CHI
201911188669	DIORAMA	DI12065693	IPORA	17/11/2019 14:15	17/11/2019 16:43	17/11/2019 14:15	17/11/2019 16:43	2,46	8	19,70	CHI
201911188671	SAO JOAO D ALIANCA	3840023681	SAO JOAO D ALIANCA	17/11/2019 14:15	17/11/2019 22:25	17/11/2019 14:15	17/11/2019 22:25	8,16	1	8,16	CHI
201911188673	RIO VERDE	RV12271290	CABRIUVA S2	17/11/2019 13:49	18/11/2019 11:23	17/11/2019 13:49	18/11/2019 11:23	21,57	24	517,76	CHI
201911188675	JATAI	JT21234391	JATAI S3	17/11/2019 14:16	17/11/2019 20:50	17/11/2019 14:16	17/11/2019 20:50	6,55	1	6,55	CHI
201911188676	CRIXAS	CX21360138	SERRA DO OURO	17/11/2019 14:16	17/11/2019 16:01	17/11/2019 14:16	17/11/2019 16:01	1,73	1	1,73	CHI
201911188679	SENADOR CANEDO	190127168	CEPAIGO S2	17/11/2019 14:18	17/11/2019 16:25	17/11/2019 14:18	17/11/2019 16:25	2,11	1	2,11	CHI
201911188688	NOVA AURORA	NE21143432	CATALAO S1	17/11/2019 14:23	18/11/2019 18:14	17/11/2019 14:23	18/11/2019 18:14	27,85	1	27,85	CHI
201911188689	SAO JOAO D ALIANCA	JL12144641	SAO JOAO D ALIANCA	17/11/2019 14:23	18/11/2019 15:50	17/11/2019 14:23	18/11/2019 15:50	25,43	6	152,60	CHI
201911188692	BURITINOPOLIS	SA12384201	IACIARA S2	17/11/2019 14:25	17/11/2019 18:02	17/11/2019 14:25	17/11/2019 18:02	3,62	1	3,62	CHI
201911188692	POSSE	SA12384201	IACIARA S2	17/11/2019 14:25	17/11/2019 18:02	17/11/2019 14:25	17/11/2019 18:02	3,62	19	68,70	CHI
201911188692	SIMOLANDIA	SA12384201	IACIARA S2	17/11/2019 14:25	17/11/2019 18:02	17/11/2019 14:25	17/11/2019 18:02	3,62	2	7,23	CHI

201911188702	CIDADE OCIDENTAL	LZ12025241	MARAJOARA	17/11/2019 14:30	18/11/2019 12:30	17/11/2019 14:30	18/11/2019 12:30	21,99	1	21,99	CHI
201911188712	ORIZONA	OZ12022855	PIRES DO RIO S2	17/11/2019 14:36	17/11/2019 16:54	17/11/2019 14:36	17/11/2019 16:54	2,30	8	18,37	CHI
201911188713	PIRACANJUBA	PJ21082258	PIRACANJUBA	17/11/2019 14:36	17/11/2019 16:49	17/11/2019 14:36	17/11/2019 16:49	2,20	1	2,20	CHI
201911188714	GOIANIA	16096629	MEIA PONTE	17/11/2019 14:37	17/11/2019 16:08	17/11/2019 14:37	17/11/2019 16:08	1,51	1	1,51	CHI
201911188720	ABADIANIA	AA12221505	DAIA S2	17/11/2019 14:38	17/11/2019 16:50	17/11/2019 14:38	17/11/2019 16:50	2,19	120	262,67	CHI
201911188725	MONTE ALEGRE DE GOIAS	MA12285597	SAO DOMINGOS	17/11/2019 09:54	17/11/2019 19:56	17/11/2019 09:54	17/11/2019 19:56	10,02	6	60,13	CHI
201911188726	GOIAS	GS21169269	ITAPURANGA	17/11/2019 14:41	18/11/2019 16:57	17/11/2019 14:41	18/11/2019 16:57	26,28	1	26,28	CHI
201911188732	GOIANIA	GN11189272	FERROVIARIO S2	17/11/2019 14:35	17/11/2019 20:10	17/11/2019 14:35	17/11/2019 20:10	5,59	30	167,62	CHI
201911188735	JARAGUA	JA11140591	JARAGUA	17/11/2019 14:42	17/11/2019 17:46	17/11/2019 14:42	17/11/2019 17:46	3,06	134	409,93	CHI
201911188736	GOIANIA	GN11023412	REAL S1	17/11/2019 14:38	17/11/2019 23:50	17/11/2019 14:38	17/11/2019 23:50	9,19	106	974,11	CHI
201911188741	CAMPINORTE	UR12243278	MARA ROSA	17/11/2019 14:25	17/11/2019 19:44	17/11/2019 14:25	17/11/2019 19:44	5,32	7	37,21	CHI
201911188741	URUACU	UR12243278	MARA ROSA	17/11/2019 14:25	17/11/2019 19:44	17/11/2019 14:25	17/11/2019 19:44	5,32	15	79,73	CHI
201911188743	GOIAS	GS21249340	GOIAS	17/11/2019 14:45	18/11/2019 10:38	17/11/2019 14:45	18/11/2019 10:38	19,89	1	19,89	CHI
201911188746	LUZIANIA	LZ12072245	VIANOPOLIS	17/11/2019 14:46	17/11/2019 16:29	17/11/2019 14:46	17/11/2019 16:29	1,71	11	18,79	CHI
201911188747	JOVIANIA	JV12052761	GOIATUBA S1	18/11/2019 05:54	18/11/2019 18:28	18/11/2019 05:54	18/11/2019 18:28	12,58	6	75,49	CHI
201911188750	FORMOSA	FA12243044	ITUIQUIRA	17/11/2019 14:48	17/11/2019 20:09	17/11/2019 14:48	17/11/2019 20:09	5,34	1	5,34	CHI
201911188752	SAO MIGUEL DO ARAGUAIA	SM12262623	SAO MIGUEL DO ARAGUAIA	17/11/2019 09:53	17/11/2019 18:07	17/11/2019 09:53	17/11/2019 18:07	8,22	3	24,67	CHI
201911188753	MORRINHOS	MR12276015	GOIATUBA S1	17/11/2019 09:07	19/11/2019 14:55	17/11/2019 09:07	19/11/2019 14:55	53,79	4	215,18	CHI
201911188754	APARECIDA DE GOIANIA	AP11051629	REAL S1	17/11/2019 14:50	17/11/2019 16:23	17/11/2019 14:50	17/11/2019 16:23	1,55	273	423,00	CHI
201911188756	NIQUELANDIA	NQ21369959	NIQUELANDIA SUBTRANSMISSAO	17/11/2019 14:52	18/11/2019 08:22	17/11/2019 14:52	18/11/2019 08:22	17,49	1	17,49	CHI
201911188759	ITAPURANGA	IK12311030	ITAPURANGA	17/11/2019 09:18	17/11/2019 18:45	17/11/2019 09:18	17/11/2019 18:45	9,45	3	28,36	CHI
201911188762	MUNDO NOVO DE GOIAS	MH12391964	NOVA CRIXAS	17/11/2019 14:20	18/11/2019 00:27	17/11/2019 14:20	18/11/2019 00:27	10,11	9	90,97	CHI
201911188764	BELA VISTA DE GOIAS	BV12242071	BELA VISTA S1	17/11/2019 14:56	17/11/2019 17:15	17/11/2019 14:56	17/11/2019 17:15	2,31	3	6,93	CHI
201911188767	CRISTALINA	KR12209473	CRISTALINA S2	17/11/2019 14:56	17/11/2019 17:40	17/11/2019 14:56	17/11/2019 17:40	2,73	4	10,91	CHI
201911188768	RIO VERDE	BZ12295804LD	ACREUNA	17/11/2019 11:48	17/11/2019 17:25	17/11/2019 11:48	17/11/2019 17:25	5,60	3	16,80	CHI
201911188768	SANTO ANTONIO DA BARRA	BZ12295804LD	ACREUNA	17/11/2019 11:48	17/11/2019 17:25	17/11/2019 11:48	17/11/2019 17:25	5,60	7	39,21	CHI
201911188769	AGUA FRIA DE GOIAS	PI11164643	SAO JOAO D ALIANCA	17/11/2019 14:57	19/11/2019 14:35	17/11/2019 14:57	19/11/2019 14:35	47,63	14	666,82	CHI
201911188771	POSSE	PS12255382	IACIARA S2	17/11/2019 13:55	17/11/2019 16:58	17/11/2019 13:55	17/11/2019 16:58	3,05	38	115,88	CHI
201911188772	SAO LUIS DE MONTES BELOS	500004948	SAO LUIZ DOS MONTES BELOS	17/11/2019 14:59	17/11/2019 19:13	17/11/2019 14:59	17/11/2019 19:13	4,22	1	4,22	CHI
201911188774	RIO VERDE	630518634	RIO VERDE S2	17/11/2019 14:59	18/11/2019 17:55	17/11/2019 14:59	18/11/2019 17:55	26,94	1	26,94	CHI
201911188776	ITAPIRAPUA	IU12018846	MATRINCHA	17/11/2019 11:09	17/11/2019 17:19	17/11/2019 11:09	17/11/2019 17:19	6,16	4	24,63	CHI
201911188779	BOM JARDIM DE GOIAS	BM12286263	BOM JARDIM	17/11/2019 15:01	18/11/2019 07:03	17/11/2019 15:01	18/11/2019 07:03	16,02	4	64,09	CHI
201911188784	MAURILANDIA	10003683948	RIO DOS BOIS	17/11/2019 15:05	18/11/2019 14:50	17/11/2019 15:05	18/11/2019 14:50	23,75	1	23,75	CHI

201911188790	PIRANHAS	1930021978	PIRANHAS	17/11/2019 15:06	17/11/2019 19:42	17/11/2019 15:06	17/11/2019 19:42	4,61	1	4,61	CHI
201911188792	COCALZINHO DE GOIAS	ZN21345324	COCALZINHO	17/11/2019 15:08	17/11/2019 20:09	17/11/2019 15:08	17/11/2019 20:09	5,02	2	10,03	CHI
201911188793	QUIRINOPOLIS	GB12116585	QUIRINOPOLIS	17/11/2019 15:08	18/11/2019 11:04	17/11/2019 15:08	18/11/2019 11:04	19,93	14	279,00	CHI
201911188794	PIRACANJUBA	PJ21200024	BELA VISTA S1	17/11/2019 15:08	19/11/2019 09:35	17/11/2019 15:08	19/11/2019 09:35	42,45	2	84,89	CHI
201911188796	IPAMERI	IP21311642	IPAMERI	17/11/2019 15:08	18/11/2019 12:36	17/11/2019 15:08	18/11/2019 12:36	21,46	1	21,46	CHI
201911188798	GOIANIA	GN11041388	AEROPORTO S2	17/11/2019 15:08	17/11/2019 15:49	17/11/2019 15:08	17/11/2019 15:49	0,68	62	42,26	CHI
201911188799	SENADOR CANEDO	190148573	SENADOR CANEDO	17/11/2019 15:09	17/11/2019 17:38	17/11/2019 15:09	17/11/2019 17:38	2,47	1	2,47	CHI
201911188814	IPORA	IR10400607	IPORA	17/11/2019 15:18	17/11/2019 18:20	17/11/2019 15:18	17/11/2019 18:20	3,03	141	427,66	CHI
201911188828	SENADOR CANEDO	SW12047585	CEPAIGO S1	17/11/2019 15:22	17/11/2019 18:44	17/11/2019 15:22	17/11/2019 18:44	3,35	1	3,35	CHI
201911188829	SANTA HELENA DE GOIAS	SH21295820	IPEGUARI	17/11/2019 15:23	18/11/2019 07:50	17/11/2019 15:23	18/11/2019 07:50	16,46	2	32,92	CHI
201911188836	APARECIDA DE GOIANIA	200271740	INDEPENDENCIA S1	17/11/2019 15:27	17/11/2019 17:37	17/11/2019 15:27	17/11/2019 17:37	2,15	1	2,15	CHI
201911188842	VICENTINOPOLIS	VI12263322	VICENTINOPOLIS	17/11/2019 09:38	18/11/2019 08:01	17/11/2019 09:38	18/11/2019 08:01	22,37	8	178,97	CHI
201911188845	MAMBAI	MB21190514	IACIARA S2	17/11/2019 15:32	17/11/2019 21:10	17/11/2019 15:32	17/11/2019 21:10	5,63	1	5,63	CHI
201911188854	ORIZONA	OZ12017072	PIRES DO RIO S2	17/11/2019 14:30	18/11/2019 17:43	17/11/2019 14:30	18/11/2019 17:43	27,21	5	136,03	CHI
201911188858	CALDAS NOVAS	CN12298658	CALDAS NOVAS S1	17/11/2019 15:39	18/11/2019 12:24	17/11/2019 15:39	18/11/2019 12:24	20,74	1	20,74	CHI
201911188860	GOIANIA	GN11151976	MEIA PONTE	17/11/2019 15:21	17/11/2019 19:53	17/11/2019 15:21	17/11/2019 19:53	4,53	94	425,72	CHI
201911188866	GOIANIA	10193686	AEROPORTO S1	17/11/2019 15:41	17/11/2019 17:30	17/11/2019 15:41	17/11/2019 17:30	1,82	1	1,82	CHI
201911188868	APARECIDA DE GOIANIA	AP11157653	INDEPENDENCIA S2	17/11/2019 15:42	17/11/2019 17:12	17/11/2019 15:42	17/11/2019 17:12	1,49	257	383,57	CHI
201911188871	CIDADE OCIDENTAL	DH12370609	MARAJOARA	17/11/2019 15:43	17/11/2019 17:31	17/11/2019 15:43	17/11/2019 17:31	1,79	23	41,07	CHI
201911188877	ORIZONA	OZ12000368	PIRES DO RIO S2	17/11/2019 15:44	17/11/2019 17:47	17/11/2019 15:44	17/11/2019 17:47	2,04	641	1306,57	CHI
201911188878	MOSSAMEDES	KB21172438	ANICUNS	17/11/2019 15:45	17/11/2019 18:33	17/11/2019 15:45	17/11/2019 18:33	2,80	1	2,80	CHI
201911188881	BARRO ALTO	BA21101506	GOIANESIA S1	17/11/2019 15:46	17/11/2019 19:57	17/11/2019 15:46	17/11/2019 19:57	4,18	1	4,18	CHI
201911188882	GOIANIRA	GR11202927	GOIANIRA	17/11/2019 15:46	17/11/2019 17:29	17/11/2019 15:46	17/11/2019 17:29	1,71	13	22,20	CHI
201911188890	VICENTINOPOLIS	VI12218213	VICENTINOPOLIS	17/11/2019 04:08	17/11/2019 16:20	17/11/2019 04:08	17/11/2019 16:20	12,20	7	85,40	CHI
201911188892	BELA VISTA DE GOIAS	BV21197925	CEPAIGO S2	17/11/2019 15:49	17/11/2019 20:09	17/11/2019 15:49	17/11/2019 20:09	4,32	1	4,32	CHI
201911188894	AMARALINA	LC12278480	MARA ROSA	17/11/2019 14:32	17/11/2019 23:32	17/11/2019 14:32	17/11/2019 23:32	8,99	3	26,97	CHI
201911188895	POSSE	PS12184932	IACIARA S2	17/11/2019 15:50	17/11/2019 19:10	17/11/2019 15:50	17/11/2019 19:10	3,33	5	16,63	CHI
201911188897	ITAPURANGA	170071650	ITAPURANGA	17/11/2019 15:51	17/11/2019 23:10	17/11/2019 15:51	17/11/2019 23:10	7,30	1	7,30	CHI
201911188898	MAMBAI	MB12302924	IACIARA S2	17/11/2019 15:40	17/11/2019 19:48	17/11/2019 15:40	17/11/2019 19:48	4,13	30	123,96	CHI
201911188901	SENADOR CANEDO	SW12323510	CEPAIGO S2	17/11/2019 15:53	17/11/2019 19:09	17/11/2019 15:53	17/11/2019 19:09	3,25	2	6,50	CHI
201911188902	NOVO GAMA	NJ11313729	MARAJOARA	17/11/2019 15:54	17/11/2019 16:44	17/11/2019 15:54	17/11/2019 16:44	0,83	113	93,57	CHI
201911188904	APARECIDA DE GOIANIA	17059604	REAL S1	17/11/2019 15:54	17/11/2019 17:44	17/11/2019 15:54	17/11/2019 17:44	1,82	1	1,82	CHI
201911188905	AURILANDIA	AI12194035	FIRMINOPOLIS S2	17/11/2019 15:54	17/11/2019 23:48	17/11/2019 15:54	17/11/2019 23:48	7,89	3	23,67	CHI

201911188909	JATAI	290271654	JATAI S3	17/11/2019 15:55	17/11/2019 21:28	17/11/2019 15:55	17/11/2019 21:28	5,55	1	5,55	CHI
201911188911	CRIXAS	CX12074656	RUBIATABA	17/11/2019 15:56	18/11/2019 16:49	17/11/2019 15:56	18/11/2019 16:49	24,88	15	373,22	CHI
201911188914	INACIOLANDIA	ID12306349	CACHOEIRA DOURADA	17/11/2019 15:58	18/11/2019 11:41	17/11/2019 15:58	18/11/2019 11:41	19,71	49	965,90	CHI
201911188916	NOVA AMERICA	2160000936	RUBIATABA	17/11/2019 15:59	17/11/2019 23:32	17/11/2019 15:59	17/11/2019 23:32	7,55	1	7,55	CHI
201911188921	FAINA	FC21268563	GOIAS	17/11/2019 16:01	19/11/2019 16:05	17/11/2019 16:01	19/11/2019 16:05	48,06	2	96,12	CHI
201911188925	PALMEIRAS DE GOIAS	PL21327736	PALMEIRAS	17/11/2019 16:03	17/11/2019 18:07	17/11/2019 16:03	17/11/2019 18:07	2,07	1	2,07	CHI
201911188926	DAMIANOPOLIS	DA12253914	IACIARA S2	17/11/2019 08:05	18/11/2019 00:00	17/11/2019 08:05	18/11/2019 00:00	15,90	4	63,61	CHI
201911188930	ALEXANIA	AX12329596	ALEXANIA	17/11/2019 16:03	18/11/2019 23:48	17/11/2019 16:03	17/11/2019 19:55	3,87	3	11,61	CHI
201911188930	ALEXANIA	AX12329596	ALEXANIA	17/11/2019 16:03	18/11/2019 23:48	18/11/2019 20:46	18/11/2019 23:48	3,04	3	9,12	CHI
201911188946	BELA VISTA DE GOIAS	HD12323100	CEPAIGO S2	17/11/2019 16:08	17/11/2019 18:18	17/11/2019 16:08	17/11/2019 18:18	2,16	8	17,31	CHI
201911188946	HIDROLANDIA	HD12323100	CEPAIGO S2	17/11/2019 16:08	17/11/2019 18:18	17/11/2019 16:08	17/11/2019 18:18	2,16	99	214,25	CHI
201911188949	SILVANIA	SV21113612	DAIA S2	17/11/2019 16:09	17/11/2019 17:57	17/11/2019 16:09	17/11/2019 17:57	1,80	2	3,60	CHI
201911188961	POSSE	PS11164557	IACIARA S2	17/11/2019 16:10	17/11/2019 20:03	17/11/2019 16:10	17/11/2019 20:03	3,87	4	15,47	CHI
201911188963	APARECIDA DE GOIANIA	AP11168036	INDEPENDENCIA S2	17/11/2019 16:05	17/11/2019 18:25	17/11/2019 16:05	17/11/2019 18:25	2,33	106	247,22	CHI
201911188964	BOM JARDIM DE GOIAS	BM12334736	BOM JARDIM	17/11/2019 16:11	18/11/2019 12:16	17/11/2019 16:11	18/11/2019 12:16	20,08	1	20,08	CHI
201911188967	SAO MIGUEL DO ARAGUAIA	SM21208920	SAO MIGUEL DO ARAGUAIA	17/11/2019 16:12	17/11/2019 19:46	17/11/2019 16:12	17/11/2019 19:46	3,56	1	3,56	CHI
201911188973	FAINA	FC12124752	GOIAS	17/11/2019 09:48	18/11/2019 09:48	17/11/2019 09:48	18/11/2019 09:48	24,00	25	600,00	CHI
201911188977	BURITI DE GOIAS	BS12215292	FIRMINOPOLIS S2	17/11/2019 16:14	17/11/2019 20:15	17/11/2019 16:14	17/11/2019 20:15	4,02	36	144,63	CHI
201911188977	NOVO BRASIL	BS12215292	FIRMINOPOLIS S2	17/11/2019 16:14	17/11/2019 20:15	17/11/2019 16:14	17/11/2019 20:15	4,02	14	56,25	CHI
201911188983	JARAGUA	JA21273410	JARAGUA	17/11/2019 16:16	17/11/2019 18:00	17/11/2019 16:16	17/11/2019 18:00	1,73	6	10,38	CHI
201911188985	EDEALINA	EA12058626	PONTALINA	17/11/2019 05:10	18/11/2019 10:00	17/11/2019 05:10	18/11/2019 10:00	28,83	10	288,29	CHI
201911188990	GOIANIA	GN12323221	MEIA PONTE	17/11/2019 16:17	17/11/2019 17:41	17/11/2019 16:17	17/11/2019 17:41	1,40	281	392,07	CHI
201911188995	CAIAPONIA	CP12207863	CAIAPONIA	17/11/2019 10:59	17/11/2019 19:28	17/11/2019 10:59	17/11/2019 19:28	8,48	76	644,12	CHI
201911188995	DOVERLANDIA	CP12207863	CAIAPONIA	17/11/2019 10:59	17/11/2019 19:28	17/11/2019 10:59	17/11/2019 19:28	8,48	6	50,85	CHI
201911188998	GOIANESIA	GE12379116	GOIANESIA S2	17/11/2019 16:19	17/11/2019 17:29	17/11/2019 16:19	17/11/2019 17:29	1,15	99	113,91	CHI
201911189004	GOIANIA	GN12059752	GOYA S1	17/11/2019 16:20	17/11/2019 19:18	17/11/2019 16:20	17/11/2019 19:18	2,96	70	207,43	CHI
201911189008	GOIANIA	10001663257	GOYA S2	17/11/2019 16:20	17/11/2019 20:48	17/11/2019 16:20	17/11/2019 20:48	4,47	1	4,47	CHI
201911189012	SERRANOPOLIS	SX21365185	JATAI S1	17/11/2019 16:21	17/11/2019 18:37	17/11/2019 16:21	17/11/2019 18:37	2,26	1	2,26	CHI
201911189026	SAO JOAO D ALIANCA	JL12332960	SAO JOAO D ALIANCA	17/11/2019 16:04	19/11/2019 12:41	17/11/2019 16:04	19/11/2019 12:41	44,60	2	89,21	CHI
201911189029	POSSE	IA12060874	IACIARA S2	17/11/2019 16:25	17/11/2019 18:59	17/11/2019 16:25	17/11/2019 18:59	2,55	42	107,23	CHI
201911189033	JATAI	JT12303012	JATAI S1	17/11/2019 16:26	18/11/2019 17:27	17/11/2019 16:26	18/11/2019 12:40	20,24	2	40,47	CHI
201911189033	JATAI	JT12306463LD	JATAI S1	17/11/2019 16:26	18/11/2019 17:27	17/11/2019 16:26	18/11/2019 17:27	25,01	1	25,01	CHI
201911189037	PIRANHAS	PH12341757	CAIAPONIA	17/11/2019 18:03	18/11/2019 18:03	17/11/2019 18:03	18/11/2019 17:34	23,52	2	47,03	CHI

201911189037	PIRANHAS	PH12343587	CAIAPONIA	17/11/2019 18:03	18/11/2019 18:03	18/11/2019 17:18	18/11/2019 18:03	0,75	10	7,50	CHI
201911189038	AGUA FRIA DE GOIAS	JL12325732	SAO JOAO D ALIANCA	17/11/2019 16:26	18/11/2019 16:02	17/11/2019 16:26	18/11/2019 16:02	23,58	2	47,17	CHI
201911189038	SAO JOAO D ALIANCA	JL12325732	SAO JOAO D ALIANCA	17/11/2019 16:26	18/11/2019 16:02	17/11/2019 16:26	18/11/2019 16:02	23,58	1	23,58	CHI
201911189039	GOIANIA	15115495	CARAJAS S1	17/11/2019 16:26	17/11/2019 19:09	17/11/2019 16:26	17/11/2019 19:09	2,70	1	2,70	CHI
201911189042	CRISTALINA	KR12163713	CRISTALINA S2	17/11/2019 14:53	17/11/2019 19:37	17/11/2019 14:53	17/11/2019 19:37	4,73	5	23,67	CHI
201911189044	IACIARA	IA21218827	IACIARA S2	17/11/2019 16:28	17/11/2019 22:16	17/11/2019 16:28	17/11/2019 22:16	5,79	1	5,79	CHI
201911189052	CORREGO DO OURO	CO12004043	FIRMINOPOLIS S2	17/11/2019 16:30	17/11/2019 22:22	17/11/2019 16:30	17/11/2019 22:22	5,86	11	64,51	CHI
201911189053	ITAGUARI	II2300335	ITABERAI S1	17/11/2019 16:30	19/11/2019 11:57	17/11/2019 16:30	19/11/2019 11:57	43,45	2	86,89	CHI
201911189056	PALMEIRAS DE GOIAS	PL12000070	PALMEIRAS	17/11/2019 16:30	17/11/2019 21:23	17/11/2019 16:30	17/11/2019 21:23	4,87	19	92,61	CHI
201911189057	PALMEIRAS DE GOIAS	PL12000104	PALMEIRAS	17/11/2019 16:31	17/11/2019 19:06	17/11/2019 16:31	17/11/2019 19:06	2,59	9	23,28	CHI
201911189061	GOIATUBA	GT11000061	GOIATUBA S2	17/11/2019 16:29	18/11/2019 09:15	17/11/2019 16:29	18/11/2019 09:15	16,76	136	2279,55	CHI
201911189062	GOIANIA	10604558	AEROPORTO S2	17/11/2019 16:32	17/11/2019 19:15	17/11/2019 16:32	17/11/2019 19:15	2,71	1	2,71	CHI
201911189070	PIRES DO RIO	PR21328157	PIRES DO RIO S1	17/11/2019 16:34	17/11/2019 21:12	17/11/2019 16:34	17/11/2019 21:12	4,62	1	4,62	CHI
201911189072	IPAMERI	UT12016916	URUTAI	17/11/2019 15:18	18/11/2019 08:53	17/11/2019 15:18	18/11/2019 08:53	17,58	3	52,75	CHI
201911189072	URUTAI	UT12016916	URUTAI	17/11/2019 15:18	18/11/2019 08:53	17/11/2019 15:18	18/11/2019 08:53	17,58	20	351,66	CHI
201911189073	ALTO PARAISO DE GOIAS	BF21208749	NIQUELANDIA SUBTRANSMISSAO	17/11/2019 16:35	18/11/2019 10:54	17/11/2019 16:35	18/11/2019 10:54	18,31	1	18,31	CHI
201911189081	ACREUNA	JD12323641	ACREUNA	17/11/2019 16:29	19/11/2019 12:25	17/11/2019 16:29	17/11/2019 19:00	2,51	7	17,60	CHI
201911189081	INDIARA	JD12323641	ACREUNA	17/11/2019 16:29	19/11/2019 12:25	17/11/2019 16:29	17/11/2019 19:00	2,51	24	60,35	CHI
201911189081	INDIARA	IY13209766	ACREUNA	17/11/2019 16:29	19/11/2019 12:25	17/11/2019 21:50	18/11/2019 12:23	14,55	6	87,29	CHI
201911189081	INDIARA	IY13207111	ACREUNA	17/11/2019 16:29	19/11/2019 12:25	17/11/2019 21:50	18/11/2019 13:50	16,01	14	224,11	CHI
201911189081	ACREUNA	IY13097068	ACREUNA	17/11/2019 16:29	19/11/2019 12:25	17/11/2019 21:50	19/11/2019 12:25	38,58	7	270,09	CHI
201911189081	INDIARA	IY13097068	ACREUNA	17/11/2019 16:29	19/11/2019 12:25	17/11/2019 21:50	19/11/2019 12:25	38,58	4	154,34	CHI
201911189082	ALTO PARAISO DE GOIAS	BF21163462	FLORES DE GOIAS	17/11/2019 16:38	18/11/2019 15:06	17/11/2019 16:38	18/11/2019 15:06	22,46	1	22,46	CHI
201911189083	PORANGATU	PO21066566	NOVO PLANALTO	17/11/2019 15:57	17/11/2019 17:46	17/11/2019 15:57	17/11/2019 17:46	1,83	1	1,83	CHI
201911189087	DOVERLANDIA	DV12400429	CAIAPONIA	17/11/2019 09:10	17/11/2019 19:10	17/11/2019 09:10	17/11/2019 19:10	9,99	72	718,94	CHI
201911189100	ALEXANIA	AX12061884	ALEXANIA	17/11/2019 16:44	17/11/2019 19:17	17/11/2019 16:44	17/11/2019 19:17	2,55	16	40,77	CHI
201911189102	POSSE	PS12132045	IACIARA S2	17/11/2019 16:01	17/11/2019 17:46	17/11/2019 16:01	17/11/2019 17:46	1,75	197	343,82	CHI
201911189105	CAMPO LIMPO	AN12084813	NEROPOLIS S1	17/11/2019 16:45	17/11/2019 19:08	17/11/2019 16:45	17/11/2019 19:08	2,38	64	152,23	CHI
201911189105	OURO VERDE DE GOIAS	AN12084813	NEROPOLIS S1	17/11/2019 16:45	17/11/2019 19:08	17/11/2019 16:45	17/11/2019 19:08	2,38	1	2,38	CHI
201911189109	NEROPOLIS	NR21283816	NEROPOLIS S2	17/11/2019 16:46	17/11/2019 19:30	17/11/2019 16:46	17/11/2019 19:30	2,72	2	5,45	CHI
201911189111	LUZIANIA	LZ12072245	VIANOPOLIS	17/11/2019 16:38	17/11/2019 18:57	17/11/2019 16:38	17/11/2019 18:57	2,31	10	23,09	CHI
201911189116	ITUMBIARA	IT12062988	CACHOEIRA DOURADA	15/11/2019 07:46	18/11/2019 14:06	15/11/2019 07:46	18/11/2019 14:06	78,33	6	469,98	CHI
201911189117	TRINDADE	40234988	TRINDADE	17/11/2019 16:47	17/11/2019 23:06	17/11/2019 16:47	17/11/2019 23:06	6,31	1	6,31	CHI

201911189119	SILVANIA	SV12041094	DAIA S1	17/11/2019 16:48	18/11/2019 12:30	17/11/2019 16:48	18/11/2019 12:30	19,70	7	137,89	CHI
201911189127	CASTELANDIA	Q12296614	QUIRINOPOLIS	17/11/2019 16:43	18/11/2019 10:26	17/11/2019 16:43	18/11/2019 10:26	17,71	1	17,71	CHI
201911189127	QUIRINOPOLIS	Q12296614	QUIRINOPOLIS	17/11/2019 16:43	18/11/2019 10:26	17/11/2019 16:43	18/11/2019 10:26	17,71	10	177,05	CHI
201911189128	POSSE	PS11329722	IACIARA S2	17/11/2019 16:26	17/11/2019 18:29	17/11/2019 16:26	17/11/2019 18:29	2,04	79	160,92	CHI
201911189130	LUZIANIA	LZ21244629	CRISTALINA S2	17/11/2019 16:52	17/11/2019 18:43	17/11/2019 16:52	17/11/2019 18:43	1,84	1	1,84	CHI
201911189132	FIRMINOPOLIS	900001926	FIRMINOPOLIS S1	17/11/2019 16:53	17/11/2019 18:39	17/11/2019 16:53	17/11/2019 18:39	1,76	1	1,76	CHI
201911189135	PORANGATU	PO12020578	PORANGATU	18/11/2019 10:02	18/11/2019 12:35	18/11/2019 10:02	18/11/2019 12:35	2,55	23	58,66	CHI
201911189140	GOIANIA	GN11240966	MEIA PONTE	17/11/2019 16:28	17/11/2019 18:35	17/11/2019 16:28	17/11/2019 18:35	2,10	146	306,96	CHI
201911189142	QUIRINOPOLIS	Q12370085	QUIRINOPOLIS	17/11/2019 16:55	18/11/2019 18:09	17/11/2019 16:55	18/11/2019 18:09	25,23	2	50,46	CHI
201911189143	PALMEIRAS DE GOIAS	PL21000040	PALMEIRAS	17/11/2019 16:55	17/11/2019 20:26	17/11/2019 16:55	17/11/2019 20:26	3,51	2	7,02	CHI
201911189149	HIDROLANDIA	HD21007395	CEPAIGO S2	17/11/2019 16:57	17/11/2019 19:05	17/11/2019 16:57	17/11/2019 19:05	2,12	1	2,12	CHI
201911189150	AGUAS LINDAS DE GOIAS	4830350387	AGUAS LINDAS DE GOIAS S1	17/11/2019 16:57	17/11/2019 18:18	17/11/2019 16:57	17/11/2019 18:18	1,35	1	1,35	CHI
201911189151	GOIANIA	10907142	GOIANIA LESTE S2	17/11/2019 16:57	17/11/2019 19:00	17/11/2019 16:57	17/11/2019 19:00	2,04	1	2,04	CHI
201911189157	BELA VISTA DE GOIAS	BV12000009	BELA VISTA S1	17/11/2019 16:58	17/11/2019 18:12	17/11/2019 16:58	17/11/2019 18:12	1,23	233	285,81	CHI
201911189158	IPAMERI	IP21323368	CRISTALINA S1	17/11/2019 16:58	19/11/2019 13:10	17/11/2019 16:58	19/11/2019 13:10	44,19	1	44,19	CHI
201911189160	SAO DOMINGOS	SD21279966	SAO DOMINGOS	17/11/2019 16:58	17/11/2019 18:13	17/11/2019 16:58	17/11/2019 18:13	1,24	2	2,47	CHI
201911189163	SENADOR CANEDO	SW21076757	CEPAIGO S1	17/11/2019 16:58	17/11/2019 19:23	17/11/2019 16:58	17/11/2019 19:23	2,40	1	2,40	CHI
201911189167	JARAGUA	JA12278909	JARAGUA	17/11/2019 16:59	17/11/2019 20:17	17/11/2019 16:59	17/11/2019 20:17	3,29	3	9,88	CHI
201911189170	LUZIANIA	LZ21241221	VIANOPOLIS	17/11/2019 17:00	18/11/2019 02:56	17/11/2019 17:00	18/11/2019 02:56	9,93	1	9,93	CHI
201911189183	RUBIATABA	RB21303970	RUBIATABA	17/11/2019 09:49	17/11/2019 21:46	17/11/2019 09:49	17/11/2019 21:46	11,96	1	11,96	CHI
201911189186	ALTO PARAISO DE GOIAS	BF21129911	FLORES DE GOIAS	17/11/2019 17:04	18/11/2019 14:45	17/11/2019 17:04	18/11/2019 14:45	21,68	1	21,68	CHI
201911189190	MINEIROS	MY12324537	PARQUE DAS EMAS	17/11/2019 16:59	17/11/2019 17:58	17/11/2019 16:59	17/11/2019 17:58	0,97	10	9,72	CHI
201911189191	CAIAPONIA	CP12301812	CAIAPONIA	17/11/2019 17:04	17/11/2019 21:53	17/11/2019 17:04	17/11/2019 21:53	4,81	9	43,25	CHI
201911189197	IPORA	730037903	IPORA	17/11/2019 17:05	17/11/2019 21:35	17/11/2019 17:05	17/11/2019 21:35	4,49	1	4,49	CHI
201911189198	GOIANESIA	GE21227042	GOIANESIA S2	17/11/2019 17:06	18/11/2019 14:26	17/11/2019 17:06	18/11/2019 14:26	21,33	2	42,65	CHI
201911189203	GOIANIRA	GR11280117	MEIA PONTE	17/11/2019 17:02	17/11/2019 18:00	17/11/2019 17:02	17/11/2019 18:00	0,95	97	92,45	CHI
201911189207	CRISTALINA	KR12163791	PAMPLONA	17/11/2019 16:54	17/11/2019 18:36	17/11/2019 16:54	17/11/2019 18:36	1,70	27	45,82	CHI
201911189209	MINEIROS	MY12349070	PARQUE DAS EMAS	17/11/2019 17:08	17/11/2019 20:00	17/11/2019 17:08	17/11/2019 20:00	2,85	4	11,42	CHI
201911189301	IVOLANDIA	PU12090442	MONTIVIDIU T	17/11/2019 11:45	17/11/2019 13:21	17/11/2019 11:45	17/11/2019 13:21	1,60	22	35,14	CHI
201911189301	PARAUNA	PU12090442	MONTIVIDIU T	17/11/2019 11:45	17/11/2019 13:21	17/11/2019 11:45	17/11/2019 13:21	1,60	48	76,68	CHI
201911189307	SAO JOAO D ALIANCA	JL21184913	SAO JOAO D ALIANCA	17/11/2019 17:10	18/11/2019 21:36	17/11/2019 17:10	18/11/2019 21:36	28,43	2	56,86	CHI
201911189310	NOVA CRIXAS	NA12262740	NOVA CRIXAS	17/11/2019 14:43	17/11/2019 20:36	17/11/2019 14:43	17/11/2019 20:36	5,87	100	586,78	CHI
201911189317	JANDAIA	EU12000110	ACREUNA	17/11/2019 17:11	18/11/2019 00:40	17/11/2019 17:11	18/11/2019 00:40	7,48	1	7,48	CHI

201911189317	PARAUNA	EU12000110	ACREUNA	17/11/2019 17:11	18/11/2019 00:40	17/11/2019 17:11	18/11/2019 00:40	7,48	10	74,75	CHI
201911189320	ITUMBIARA	IT12033049	BOM JESUS DE GOIAS	17/11/2019 17:12	18/11/2019 17:53	17/11/2019 17:12	18/11/2019 17:53	24,68	3	74,04	CHI
201911189323	TRINDADE	TR12390004	GOYA S2	17/11/2019 16:30	17/11/2019 18:30	17/11/2019 16:30	17/11/2019 18:30	1,99	344	683,32	CHI
201911189330	GOIANIA	10785784	CARAJAS S1	17/11/2019 17:14	17/11/2019 19:08	17/11/2019 17:14	17/11/2019 19:08	1,90	1	1,90	CHI
201911189333	MARA ROSA	MQ12141875	MARA ROSA	17/11/2019 16:05	18/11/2019 14:19	17/11/2019 16:05	18/11/2019 11:49	19,73	10	197,33	CHI
201911189333	MARA ROSA	MQ12237778	MARA ROSA	17/11/2019 16:05	18/11/2019 14:19	18/11/2019 11:48	18/11/2019 14:19	2,52	1	2,52	CHI
201911189334	QUIRINOPOLIS	10025769330	QUIRINOPOLIS	17/11/2019 17:15	17/11/2019 20:37	17/11/2019 17:15	17/11/2019 20:37	3,35	1	3,35	CHI
201911189336	SANTO ANTONIO DO DESCOBERTO	2210176317	ALEXANIA	17/11/2019 17:16	17/11/2019 18:53	17/11/2019 17:16	17/11/2019 18:53	1,62	1	1,62	CHI
201911189338	CATALAO	CT21072377	CATALAO S1	17/11/2019 17:16	19/11/2019 08:40	17/11/2019 17:16	19/11/2019 08:40	39,40	1	39,40	CHI
201911189340	JATAI	JT12306448	JATAI S1	17/11/2019 17:16	18/11/2019 07:51	17/11/2019 17:16	18/11/2019 07:51	14,57	7	101,97	CHI
201911189344	GOIANIA	12844226	CAMPINAS S1	17/11/2019 17:18	17/11/2019 18:52	17/11/2019 17:18	17/11/2019 18:52	1,56	1	1,56	CHI
201911189349	NIQUELANDIA	NQ12271070	BARRO ALTO	17/11/2019 17:20	18/11/2019 13:28	17/11/2019 17:20	18/11/2019 13:28	20,12	9	181,07	CHI
201911189353	SANTA CRUZ DE GOIAS	BC21095251	PIRES DO RIO S2	17/11/2019 17:22	18/11/2019 17:20	17/11/2019 17:22	18/11/2019 17:20	23,95	1	23,95	CHI
201911189355	PLANALTINA	2960040278	PLANALTINA	17/11/2019 17:23	17/11/2019 20:16	17/11/2019 17:23	17/11/2019 20:16	2,88	1	2,88	CHI
201911189356	GOIANIA	10834000	GOIANIA LESTE S1	17/11/2019 17:23	17/11/2019 18:27	17/11/2019 17:23	17/11/2019 18:27	1,06	1	1,06	CHI
201911189360	TRINDADE	TR32033242	TRINDADE	17/11/2019 16:03	17/11/2019 22:07	17/11/2019 16:03	17/11/2019 22:07	6,06	5	30,31	CHI
201911189362	CORUMBAIBA	2220007206	CATALAO S1	17/11/2019 17:25	18/11/2019 18:05	17/11/2019 17:25	18/11/2019 18:05	24,67	1	24,67	CHI
201911189364	ITUMBIARA	IT11000029	ITUMBIARA VELHA S1	17/11/2019 17:11	17/11/2019 21:20	17/11/2019 17:11	17/11/2019 21:20	4,15	146	605,86	CHI
201911189367	PORANGATU	PO21015309	PORANGATU	17/11/2019 17:26	18/11/2019 11:03	17/11/2019 17:26	18/11/2019 11:03	17,61	12	211,36	CHI
201911189370	ALTO PARAISO DE GOIAS	BF21129910	FLORES DE GOIAS	17/11/2019 17:26	18/11/2019 15:36	17/11/2019 17:26	18/11/2019 15:36	22,16	1	22,16	CHI
201911189376	URUACU	UR11038732	URUACU	17/11/2019 17:11	17/11/2019 18:40	17/11/2019 17:11	17/11/2019 18:40	1,47	240	352,60	CHI
201911189380	DIORAMA	JP12074459	IPORA	17/11/2019 15:47	17/11/2019 22:56	17/11/2019 15:47	17/11/2019 22:56	7,14	3	21,41	CHI
201911189380	JAUPACI	JP12074459	IPORA	17/11/2019 15:47	17/11/2019 22:56	17/11/2019 15:47	17/11/2019 22:56	7,14	5	35,69	CHI
201911189382	PIRENOPOLIS	220046463	CORUMBA	17/11/2019 17:32	17/11/2019 20:46	17/11/2019 17:32	17/11/2019 20:46	3,22	1	3,22	CHI
201911189386	CABECEIRAS	CW21150247	ITUIQUIRA	17/11/2019 17:33	17/11/2019 19:27	17/11/2019 17:33	17/11/2019 19:27	1,89	1	1,89	CHI
201911189387	SANTO ANTONIO DO DESCOBERTO	2210092950	ALEXANIA	17/11/2019 17:33	17/11/2019 19:50	17/11/2019 17:33	17/11/2019 19:50	2,28	1	2,28	CHI
201911189388	RIO VERDE	RV11246807	RIO VERDE S2	17/11/2019 15:17	18/11/2019 07:57	17/11/2019 15:17	18/11/2019 07:57	16,65	25	416,35	CHI
201911189389	SAO DOMINGOS	8680009443	SAO DOMINGOS	17/11/2019 17:34	17/11/2019 23:07	17/11/2019 17:34	17/11/2019 23:07	5,55	1	5,55	CHI
201911189399	SILVANIA	SV12247192	VIANOPOLIS	17/11/2019 17:37	19/11/2019 10:41	17/11/2019 17:37	18/11/2019 12:26	18,81	3	56,44	CHI
201911189399	SILVANIA	SV12247192	VIANOPOLIS	17/11/2019 17:37	19/11/2019 10:41	17/11/2019 17:37	18/11/2019 17:55	24,29	5	121,47	CHI
201911189399	SILVANIA	SV12247192	VIANOPOLIS	17/11/2019 17:37	19/11/2019 10:41	18/11/2019 17:37	18/11/2019 17:55	0,29	3	0,88	CHI
201911189399	SILVANIA	SV12247190LD	VIANOPOLIS	17/11/2019 17:37	19/11/2019 10:41	18/11/2019 17:56	19/11/2019 10:41	16,77	6	100,59	CHI
201911189402	APARECIDA DE GOIANIA	13914352	ATLANTICO S2	17/11/2019 17:38	17/11/2019 19:25	17/11/2019 17:38	17/11/2019 19:25	1,78	1	1,78	CHI

201911189406	JAUPACI	JP12045494	IPORA	17/11/2019 17:37	17/11/2019 21:45	17/11/2019 17:37	17/11/2019 21:45	4,12	10	41,17	CHI
201911189408	GUAPO	GA31008567	GUAPO S2	17/11/2019 17:39	18/11/2019 11:00	17/11/2019 17:39	18/11/2019 11:00	17,34	1	17,34	CHI
201911189410	NIQUELANDIA	NQ21366186	SAO JOAO D ALIANCA	17/11/2019 17:40	18/11/2019 18:59	17/11/2019 17:40	18/11/2019 18:59	25,31	1	25,31	CHI
201911189413	CATALAO	CT12266154	CATALAO S1	17/11/2019 08:58	17/11/2019 22:16	17/11/2019 08:58	17/11/2019 22:16	13,29	5	66,47	CHI
201911189413	GOIANDIRA	CT12266154	CATALAO S1	17/11/2019 08:58	17/11/2019 22:16	17/11/2019 08:58	17/11/2019 22:16	13,29	1	13,29	CHI
201911189414	ALTO PARAISO DE GOIAS	BF21146073	FLORES DE GOIAS	17/11/2019 17:41	17/11/2019 19:51	17/11/2019 17:41	17/11/2019 19:51	2,16	1	2,16	CHI
201911189415	GUARANI DE GOIAS	GY12265440	IACIARA S1	17/11/2019 15:49	17/11/2019 20:01	17/11/2019 15:49	17/11/2019 20:01	4,18	20	83,70	CHI
201911189422	MINACU	IH12181712	MINACU	17/11/2019 17:44	17/11/2019 22:00	17/11/2019 17:44	17/11/2019 22:00	4,27	75	319,98	CHI
201911189432	ITABERAI	IB21169308	ITABERAI S1	17/11/2019 17:45	18/11/2019 11:19	17/11/2019 17:45	18/11/2019 11:19	17,55	1	17,55	CHI
201911189438	PALMINOPOLIS	PP12159022	PALMEIRAS	17/11/2019 17:46	17/11/2019 19:55	17/11/2019 17:46	17/11/2019 19:55	2,15	359	770,75	CHI
201911189439	NIQUELANDIA	NQ21292644	SAO JOAO D ALIANCA	17/11/2019 17:47	18/11/2019 17:56	17/11/2019 17:47	18/11/2019 17:56	24,16	1	24,16	CHI
201911189444	SITIO D ABADIA	SI12211385	IACIARA S2	17/11/2019 17:48	18/11/2019 14:46	17/11/2019 17:48	18/11/2019 14:46	20,96	2	41,91	CHI
201911189445	SILVANIA	SV12087254	DAIA S2	17/11/2019 17:48	18/11/2019 10:21	17/11/2019 17:48	18/11/2019 10:21	16,54	12	198,43	CHI
201911189451	GOIANIA	10372477	CARAJAS S2	17/11/2019 17:50	17/11/2019 20:08	17/11/2019 17:50	17/11/2019 20:08	2,29	1	2,29	CHI
201911189452	OUVIDOR	OU12061139	CATALAO S1	17/11/2019 09:48	19/11/2019 19:49	17/11/2019 09:48	19/11/2019 19:49	58,01	5	290,06	CHI
201911189463	BELA VISTA DE GOIAS	SQ12066258	BELA VISTA S1	17/11/2019 17:54	17/11/2019 22:51	17/11/2019 17:54	17/11/2019 22:51	4,93	11	54,28	CHI
201911189464	RIO QUENTE	RQ11249799	RIO QUENTE	17/11/2019 17:27	19/11/2019 14:27	17/11/2019 17:27	19/11/2019 14:27	44,99	17	764,91	CHI
201911189470	ARAGUAPAZ	MP12355886	MATRINCHA	17/11/2019 08:07	18/11/2019 00:55	17/11/2019 08:07	18/11/2019 00:55	16,79	1	16,79	CHI
201911189470	FAINA	MP12355886	MATRINCHA	17/11/2019 08:07	18/11/2019 00:55	17/11/2019 08:07	18/11/2019 00:55	16,79	1	16,79	CHI
201911189475	PALMINOPOLIS	PP12312505	PALMEIRAS	17/11/2019 17:53	17/11/2019 20:37	17/11/2019 17:53	17/11/2019 20:37	2,74	10	27,35	CHI
201911189479	PALMEIRAS DE GOIAS	PL12206047	PALMEIRAS	17/11/2019 17:55	17/11/2019 19:53	17/11/2019 17:55	17/11/2019 19:53	1,95	317	619,12	CHI
201911189481	FORMOSA	FA21195775	ITIQUEIRA	17/11/2019 18:00	18/11/2019 13:00	17/11/2019 18:00	18/11/2019 13:00	18,99	1	18,99	CHI
201911189488	FAZENDA NOVA	NB12061633	JUSSARA	17/11/2019 17:41	19/11/2019 15:06	17/11/2019 17:41	19/11/2019 15:06	45,43	1	45,43	CHI
201911189488	JUSSARA	NB12061633	JUSSARA	17/11/2019 17:41	19/11/2019 15:06	17/11/2019 17:41	19/11/2019 15:06	45,43	11	499,68	CHI
201911189488	NOVO BRASIL	NB12061633	JUSSARA	17/11/2019 17:41	19/11/2019 15:06	17/11/2019 17:41	19/11/2019 15:06	45,43	12	545,11	CHI
201911189497	GOIANIA	10003003483	XAVANTES	17/11/2019 18:04	17/11/2019 20:41	17/11/2019 18:04	17/11/2019 20:41	2,61	1	2,61	CHI
201911189498	GOIANIA	10010503755	GOYA S1	17/11/2019 18:05	17/11/2019 20:07	17/11/2019 18:05	17/11/2019 20:07	2,02	1	2,02	CHI
201911189515	PIRES DO RIO	PR21099997	PIRES DO RIO S1	17/11/2019 18:10	17/11/2019 20:16	17/11/2019 18:10	17/11/2019 20:16	2,09	1	2,09	CHI
201911189519	ESTRELA DO NORTE	ET12094692	MARA ROSA	17/11/2019 18:11	18/11/2019 00:19	17/11/2019 18:11	18/11/2019 00:19	6,12	13	79,61	CHI
201911189519	SANTA TEREZA DE GOIAS	ET12094692	MARA ROSA	17/11/2019 18:11	18/11/2019 00:19	17/11/2019 18:11	18/11/2019 00:19	6,12	4	24,50	CHI
201911189521	GOIANIA	GR12061576	MEIA PONTE	17/11/2019 18:13	17/11/2019 21:35	17/11/2019 18:13	17/11/2019 21:35	3,36	4	13,45	CHI
201911189523	GOIAS	GS21411998	GOIAS	17/11/2019 18:13	19/11/2019 11:35	17/11/2019 18:13	19/11/2019 11:35	41,35	1	41,35	CHI
201911189535	ITUMBIARA	IT12000308RE	PARANAIBA	17/11/2019 11:14	18/11/2019 15:08	17/11/2019 11:14	18/11/2019 12:07	24,88	61	1517,92	CHI

201911189535	ITUMBIARA	IT13222484	PARANAIBA	17/11/2019 11:14	18/11/2019 15:08	17/11/2019 11:14	18/11/2019 15:08	27,89	31	864,56	CHI
201911189537	VIANOPOLIS	VN12051613	VIANOPOLIS	17/11/2019 18:17	21/11/2019 14:40	20/11/2019 23:22	21/11/2019 00:04	0,70	13	9,15	CHI
201911189537	VIANOPOLIS	VN12051613	VIANOPOLIS	17/11/2019 18:17	21/11/2019 14:40	17/11/2019 18:17	21/11/2019 14:40	92,39	2	184,77	CHI
201911189537	VIANOPOLIS	VN12051613	VIANOPOLIS	17/11/2019 18:17	21/11/2019 14:40	21/11/2019 10:34	21/11/2019 14:40	4,10	13	53,29	CHI
201911189544	GOIANDIRA	CT12338786	CATALAO S1	17/11/2019 18:19	19/11/2019 19:11	17/11/2019 18:19	19/11/2019 19:11	48,86	2	97,72	CHI
201911189551	URUACU	10024104289	URUACU	17/11/2019 18:22	17/11/2019 21:30	17/11/2019 18:22	17/11/2019 21:30	3,13	1	3,13	CHI
201911189553	ALEXANIA	AX21061948	ALEXANIA	17/11/2019 18:22	18/11/2019 10:07	17/11/2019 18:22	18/11/2019 10:07	15,75	1	15,75	CHI
201911189558	IPORA	730104163	IPORA	17/11/2019 18:23	17/11/2019 22:56	17/11/2019 18:23	17/11/2019 22:56	4,56	1	4,56	CHI
201911189566	SAO MIGUEL DO ARAGUAIA	SM12332430	SAO MIGUEL DO ARAGUAIA	17/11/2019 18:14	17/11/2019 22:53	17/11/2019 18:14	17/11/2019 22:53	4,65	35	162,73	CHI
201911189570	APARECIDA DE GOIANIA	AP11000052	INDEPENDENCIA S1	17/11/2019 18:25	17/11/2019 19:30	17/11/2019 18:25	17/11/2019 19:30	1,07	208	223,20	CHI
201911189571	BONFINOPOLIS	SW10395397	GOIANIA LESTE S2	17/11/2019 18:25	18/11/2019 11:31	17/11/2019 18:25	17/11/2019 20:30	2,08	1	2,08	CHI
201911189571	GOIANAPOLIS	SW10395397	GOIANIA LESTE S2	17/11/2019 18:25	18/11/2019 11:31	17/11/2019 18:25	17/11/2019 20:30	2,08	20	41,61	CHI
201911189571	GOIANIA	SW10395397	GOIANIA LESTE S2	17/11/2019 18:25	18/11/2019 11:31	17/11/2019 18:25	17/11/2019 20:30	2,08	68	141,48	CHI
201911189571	SENADOR CANEDO	SW10395397	GOIANIA LESTE S2	17/11/2019 18:25	18/11/2019 11:31	17/11/2019 18:25	17/11/2019 20:30	2,08	26	54,09	CHI
201911189571	BONFINOPOLIS	SW10395397	GOIANIA LESTE S2	17/11/2019 18:25	18/11/2019 11:31	17/11/2019 21:30	17/11/2019 21:46	0,27	1	0,27	CHI
201911189571	GOIANAPOLIS	SW10395397	GOIANIA LESTE S2	17/11/2019 18:25	18/11/2019 11:31	17/11/2019 21:30	17/11/2019 21:46	0,27	20	5,42	CHI
201911189571	GOIANIA	SW10395397	GOIANIA LESTE S2	17/11/2019 18:25	18/11/2019 11:31	17/11/2019 21:30	17/11/2019 21:46	0,27	68	18,44	CHI
201911189571	SENADOR CANEDO	SW10395397	GOIANIA LESTE S2	17/11/2019 18:25	18/11/2019 11:31	17/11/2019 21:30	17/11/2019 21:46	0,27	26	7,05	CHI
201911189571	BONFINOPOLIS	BO12247920LD	GOIANIA LESTE S2	17/11/2019 18:25	18/11/2019 11:31	17/11/2019 18:25	18/11/2019 08:28	14,05	31	435,66	CHI
201911189571	GOIANAPOLIS	BO12247920LD	GOIANIA LESTE S2	17/11/2019 18:25	18/11/2019 11:31	17/11/2019 18:25	18/11/2019 08:28	14,05	1	14,05	CHI
201911189571	GOIANIA	BO12247920LD	GOIANIA LESTE S2	17/11/2019 18:25	18/11/2019 11:31	17/11/2019 18:25	18/11/2019 08:28	14,05	49	688,63	CHI
201911189571	SENADOR CANEDO	BO12247920LD	GOIANIA LESTE S2	17/11/2019 18:25	18/11/2019 11:31	17/11/2019 18:25	18/11/2019 08:28	14,05	52	730,79	CHI
201911189571	BONFINOPOLIS	LB12029184	GOIANIA LESTE S2	17/11/2019 18:25	18/11/2019 11:31	17/11/2019 18:25	18/11/2019 09:30	15,08	53	799,42	CHI
201911189571	BONFINOPOLIS	BO12247920LD	GOIANIA LESTE S2	17/11/2019 18:25	18/11/2019 11:31	17/11/2019 18:25	18/11/2019 11:31	17,11	1	17,11	CHI
201911189571	GOIANAPOLIS	BO12247920LD	GOIANIA LESTE S2	17/11/2019 18:25	18/11/2019 11:31	17/11/2019 18:25	18/11/2019 11:31	17,11	8	136,90	CHI
201911189572	SENADOR CANEDO	190140082	SENADOR CANEDO	17/11/2019 18:26	17/11/2019 20:07	17/11/2019 18:26	17/11/2019 20:07	1,68	1	1,68	CHI
201911189573	MINEIROS	MY21232673	PARQUE DAS EMAS	17/11/2019 18:26	17/11/2019 23:17	17/11/2019 18:26	17/11/2019 23:17	4,84	1	4,84	CHI
201911189574	DIVINOPOLIS DE GOIAS	6882487	SAO DOMINGOS	17/11/2019 18:26	17/11/2019 20:34	17/11/2019 18:26	17/11/2019 20:34	2,12	5	10,62	CHI
201911189585	CALDAS NOVAS	CN11106309	CALDAS NOVAS S2	17/11/2019 16:20	18/11/2019 12:19	17/11/2019 16:20	18/11/2019 12:19	19,97	107	2136,64	CHI
201911189586	ITAGUARI	IC12035368	ITABERAI S1	17/11/2019 17:11	18/11/2019 20:30	17/11/2019 17:11	18/11/2019 19:21	26,17	27	706,52	CHI
201911189586	JARAGUA	IC12035368	ITABERAI S1	17/11/2019 17:11	18/11/2019 20:30	17/11/2019 17:11	18/11/2019 19:21	26,17	6	157,00	CHI
201911189586	JARAGUA	IC21035366	ITABERAI S1	17/11/2019 17:11	18/11/2019 20:30	18/11/2019 19:23	18/11/2019 20:30	1,11	1	1,11	CHI
201911189594	SAO MIGUEL DO ARAGUAIA	SM11332481	SAO MIGUEL DO ARAGUAIA	17/11/2019 18:30	17/11/2019 23:32	17/11/2019 18:30	17/11/2019 23:32	5,03	1	5,03	CHI

201911189597	FORMOSO	FO12143711	MARA ROSA	17/11/2019 18:16	17/11/2019 21:22	17/11/2019 18:16	17/11/2019 21:22	3,09	22	68,00	CHI
201911189607	GOIANIA	GN11295098	CARAJAS S1	17/11/2019 18:11	17/11/2019 21:48	17/11/2019 18:11	17/11/2019 21:48	3,62	182	658,44	CHI
201911189618	VILA PROPICIO	NP21251963	GOIANESIA S1	17/11/2019 18:34	17/11/2019 23:08	17/11/2019 18:34	17/11/2019 23:08	4,56	1	4,56	CHI
201911189625	CALDAS NOVAS	760125168	CALDAS NOVAS S2	17/11/2019 14:46	20/11/2019 08:19	17/11/2019 14:46	20/11/2019 08:19	65,54	1	65,54	CHI
201911189630	EDEIA	EA21017134	VICENTINOPOLIS	17/11/2019 18:36	18/11/2019 11:49	17/11/2019 18:36	18/11/2019 11:49	17,20	1	17,20	CHI
201911189632	AGUA FRIA DE GOIAS	TL21322495	SAO JOAO D ALIANCA	17/11/2019 18:37	18/11/2019 16:11	17/11/2019 18:37	18/11/2019 16:11	21,56	1	21,56	CHI
201911189634	GOIANIA	10402160	GOIANIA LESTE S2	17/11/2019 18:37	17/11/2019 19:31	17/11/2019 18:37	17/11/2019 19:31	0,89	1	0,89	CHI
201911189641	BURITINOPOLIS	SA21254999	IACIARA S2	17/11/2019 18:38	17/11/2019 19:39	17/11/2019 18:38	17/11/2019 19:39	1,01	1	1,01	CHI
201911189643	MINACU	IH12052624	MINACU	17/11/2019 15:15	18/11/2019 01:57	17/11/2019 15:15	18/11/2019 01:57	10,69	16	171,10	CHI
201911189644	TRINDADE	TR21012975	TRINDADE	17/11/2019 18:39	18/11/2019 01:24	17/11/2019 18:39	18/11/2019 01:24	6,75	1	6,75	CHI
201911189649	BONFINOPOLIS	10010390217	CEPAIGO S2	17/11/2019 18:41	17/11/2019 20:03	17/11/2019 18:41	17/11/2019 20:03	1,37	1	1,37	CHI
201911189651	SANTA FE DE GOIAS	RN12089861	BRITANIA	17/11/2019 18:41	18/11/2019 12:45	17/11/2019 18:41	18/11/2019 12:45	18,06	7	126,42	CHI
201911189660	JATAI	JT11007838	JATAI S2	17/11/2019 18:26	18/11/2019 12:23	17/11/2019 18:26	18/11/2019 12:23	17,94	81	1452,85	CHI
201911189670	ORIZONA	OZ11250449	PIRES DO RIO S2	17/11/2019 17:11	17/11/2019 23:53	17/11/2019 17:11	17/11/2019 23:53	6,70	82	549,01	CHI
201911189673	CAIAPONIA	CP12204876	CAIAPONIA	17/11/2019 12:44	18/11/2019 10:46	17/11/2019 12:44	18/11/2019 10:46	22,02	4	88,08	CHI
201911189687	SAO LUIS DE MONTES BELOS	10019174479	SAO LUIZ DOS MONTES BELOS	17/11/2019 18:47	17/11/2019 20:01	17/11/2019 18:47	17/11/2019 20:01	1,23	1	1,23	CHI
201911189697	ALEXANIA	AX12000005	ALEXANIA	17/11/2019 18:45	18/11/2019 14:31	17/11/2019 18:45	18/11/2019 14:31	19,76	12	237,12	CHI
201911189700	SENADOR CANEDO	SW12092691	CEPAIGO S1	17/11/2019 18:49	17/11/2019 20:25	17/11/2019 18:49	17/11/2019 20:25	1,60	34	54,39	CHI
201911189705	PLANALTINA	10020535617	PLANALTINA	17/11/2019 18:50	17/11/2019 19:39	17/11/2019 18:50	17/11/2019 19:39	0,80	1	0,80	CHI
201911189706	GOIANIA	11779846	REAL S1	17/11/2019 18:50	17/11/2019 19:38	17/11/2019 18:50	17/11/2019 19:38	0,79	1	0,79	CHI
201911189707	ALEXANIA	AX21155287	ALEXANIA	17/11/2019 18:50	19/11/2019 01:22	17/11/2019 18:50	19/11/2019 01:22	30,52	1	30,52	CHI
201911189723	BOM JARDIM DE GOIAS	BM12208863	BOM JARDIM	17/11/2019 18:17	18/11/2019 09:56	17/11/2019 18:17	18/11/2019 09:56	15,65	8	125,23	CHI
201911189725	BARRO ALTO	BA21342222	GOIANESIA S1	17/11/2019 18:52	18/11/2019 11:44	17/11/2019 18:52	18/11/2019 11:44	16,86	1	16,86	CHI
201911189727	JATAI	JT12072680	JATAI S1	17/11/2019 18:52	18/11/2019 09:43	17/11/2019 18:52	18/11/2019 09:43	14,84	15	222,61	CHI
201911189741	UIRAPURU	MH12391944	NOVA CRIXAS	17/11/2019 18:54	18/11/2019 09:20	17/11/2019 18:54	18/11/2019 09:20	14,42	6	86,51	CHI
201911189747	APARECIDA DE GOIANIA	16804612	INDEPENDENCIA S1	17/11/2019 18:55	17/11/2019 20:31	17/11/2019 18:55	17/11/2019 20:31	1,60	1	1,60	CHI
201911189762	ALEXANIA	AX21381467	ALEXANIA	17/11/2019 18:57	18/11/2019 00:55	17/11/2019 18:57	18/11/2019 00:55	5,95	1	5,95	CHI
201911189770	JATAI	JT12324668	JATAI S3	17/11/2019 18:14	18/11/2019 18:16	17/11/2019 18:14	18/11/2019 03:32	9,29	5	46,47	CHI
201911189770	JATAI	JT12324668	JATAI S3	17/11/2019 18:14	18/11/2019 18:16	18/11/2019 07:29	18/11/2019 08:20	0,85	5	4,25	CHI
201911189770	JATAI	JT13324664	JATAI S3	17/11/2019 18:14	18/11/2019 18:16	17/11/2019 18:14	18/11/2019 11:31	17,27	37	639,13	CHI
201911189770	JATAI	JT12306515	JATAI S3	17/11/2019 18:14	18/11/2019 18:16	17/11/2019 18:14	18/11/2019 12:13	17,98	6	107,87	CHI
201911189770	JATAI	JT12234457	JATAI S3	17/11/2019 18:14	18/11/2019 18:16	17/11/2019 18:14	18/11/2019 18:16	24,03	6	144,19	CHI
201911189775	PIRES DO RIO	460060739	PIRES DO RIO S1	17/11/2019 18:59	17/11/2019 22:20	17/11/2019 18:59	17/11/2019 22:20	3,35	1	3,35	CHI

201911189777	ABADIANIA	AX12221526	ALEXANIA	17/11/2019 18:04	17/11/2019 21:39	17/11/2019 18:04	17/11/2019 21:39	3,58	13	46,57	CHI
201911189777	ALEXANIA	AX12221526	ALEXANIA	17/11/2019 18:04	17/11/2019 21:39	17/11/2019 18:04	17/11/2019 21:39	3,58	188	673,41	CHI
201911189787	NAZARIO	NZ21285452	ANICUNS	17/11/2019 19:01	17/11/2019 22:40	17/11/2019 19:01	17/11/2019 22:40	3,65	1	3,65	CHI
201911189800	POSSE	1480031498	IACIARA S2	17/11/2019 19:04	18/11/2019 10:28	17/11/2019 19:04	18/11/2019 10:28	15,39	1	15,39	CHI
201911189809	SAO DOMINGOS	SD12211512	SAO DOMINGOS	17/11/2019 19:07	18/11/2019 15:57	17/11/2019 19:07	18/11/2019 15:57	20,83	10	208,29	CHI
201911189813	NOVO PLANALTO	TA21137642	NOVO PLANALTO	17/11/2019 19:08	18/11/2019 01:14	17/11/2019 19:08	18/11/2019 01:14	6,09	1	6,09	CHI
201911189819	ANAPOLIS	AN11186982	ANAPOLIS UNIVERSITARIO S2	17/11/2019 19:09	17/11/2019 20:01	17/11/2019 19:09	17/11/2019 20:01	0,86	87	75,13	CHI
201911189829	AGUAS LINDAS DE GOIAS	10005210540	AGUAS LINDAS DE GOIAS S1	17/11/2019 19:10	17/11/2019 19:45	17/11/2019 19:10	17/11/2019 19:45	0,58	1	0,58	CHI
201911189832	NOVO GAMA	NJ11169053	PACAEMBU S1	17/11/2019 19:11	17/11/2019 19:54	17/11/2019 19:11	17/11/2019 19:54	0,71	94	66,87	CHI
201911189835	IPAMERI	580116098	IPAMERI	17/11/2019 19:11	18/11/2019 16:31	17/11/2019 19:11	18/11/2019 16:31	21,32	1	21,32	CHI
201911189839	GOIANIA	11917763	CAMPINAS S2	17/11/2019 19:13	17/11/2019 20:31	17/11/2019 19:13	17/11/2019 20:31	1,29	1	1,29	CHI
201911189840	MONTIVIDIU	MV21200751	MONTIVIDIU T	17/11/2019 19:13	18/11/2019 08:58	17/11/2019 19:13	18/11/2019 08:58	13,74	1	13,74	CHI
201911189841	RIO VERDE	RV11360678	RIO VERDE S2	18/11/2019 08:19	18/11/2019 10:18	18/11/2019 08:19	18/11/2019 10:18	1,97	9	17,71	CHI
201911189846	GOIANIA	12489918	GOIANIA LESTE S1	17/11/2019 19:15	17/11/2019 20:27	17/11/2019 19:15	17/11/2019 20:27	1,19	1	1,19	CHI
201911189865	PORTELANDIA	10020675621	PARQUE DAS EMAS	17/11/2019 19:21	18/11/2019 08:20	17/11/2019 19:21	18/11/2019 08:20	12,98	1	12,98	CHI
201911189870	GOIANIA	11004368	FERROVIARIO S2	17/11/2019 19:22	17/11/2019 21:38	17/11/2019 19:22	17/11/2019 21:38	2,26	1	2,26	CHI
201911189871	CALDAS NOVAS	PJ12223314RE	CALDAS NOVAS S1	17/11/2019 19:00	18/11/2019 13:00	17/11/2019 19:00	18/11/2019 13:00	18,00	5	90,00	CHI
201911189871	PIRACANJUBA	PJ12223314RE	CALDAS NOVAS S1	17/11/2019 19:00	18/11/2019 13:00	17/11/2019 19:00	18/11/2019 13:00	18,00	32	576,00	CHI
201911189871	SANTA CRUZ DE GOIAS	PJ12223314RE	CALDAS NOVAS S1	17/11/2019 19:00	18/11/2019 13:00	17/11/2019 19:00	18/11/2019 13:00	18,00	1	18,00	CHI
201911189875	PANAMA	PX12378952	GOIATUBA S1	17/11/2019 19:23	20/11/2019 16:36	17/11/2019 19:23	20/11/2019 16:36	69,21	4	276,83	CHI
201911189878	GOIANESIA	GE12382313	GOIANESIA S2	17/11/2019 18:27	17/11/2019 20:43	17/11/2019 18:27	17/11/2019 20:43	2,27	18	40,79	CHI
201911189885	POSSE	PS12235404	IACIARA S2	17/11/2019 19:08	17/11/2019 21:28	17/11/2019 19:08	17/11/2019 21:28	2,32	32	74,36	CHI
201911189886	PONTALINA	PK12047392	VICENTINOPOLIS	17/11/2019 17:14	18/11/2019 08:44	17/11/2019 17:14	18/11/2019 08:44	15,50	19	294,44	CHI
201911189887	CRISTALINA	KR12376280	PAMPLONA	17/11/2019 19:25	17/11/2019 21:36	17/11/2019 19:25	17/11/2019 21:36	2,18	57	124,20	CHI
201911189889	APARECIDA DE GOIANIA	10019077090	INDEPENDENCIA S2	17/11/2019 19:25	17/11/2019 21:36	17/11/2019 19:25	17/11/2019 21:36	2,17	1	2,17	CHI
201911189893	BRITANIA	BT12005362	BRITANIA	17/11/2019 19:26	18/11/2019 08:08	17/11/2019 19:26	18/11/2019 08:08	12,71	2	25,42	CHI
201911189894	MONTES CLAROS DE GOIAS	ME12132529	IPORA	17/11/2019 17:12	18/11/2019 08:06	17/11/2019 17:12	18/11/2019 08:06	14,90	31	461,80	CHI
201911189895	DOVERLANDIA	DV12259474	CAIAPONIA	17/11/2019 19:26	18/11/2019 15:34	17/11/2019 19:26	18/11/2019 15:34	20,12	38	764,71	CHI
201911189906	ORIZONA	OZ21114432	PIRES DO RIO S2	17/11/2019 19:29	18/11/2019 12:21	17/11/2019 19:29	18/11/2019 12:21	16,86	3	50,57	CHI
201911189914	GOIANIRA	390013286	GOIANIRA	17/11/2019 19:31	17/11/2019 21:16	17/11/2019 19:31	17/11/2019 21:16	1,76	1	1,76	CHI
201911189916	ABADIANIA	AA12285384	ANAPOLIS UNIVERSITARIO S1	17/11/2019 19:07	17/11/2019 20:34	17/11/2019 19:07	17/11/2019 20:34	1,44	99	142,09	CHI
201911189916	GAMELEIRA DE GOIAS	AA12285384	ANAPOLIS UNIVERSITARIO S1	17/11/2019 19:07	17/11/2019 20:34	17/11/2019 19:07	17/11/2019 20:34	1,44	1	1,44	CHI
201911189917	CATALAO	CT12130948	CATALAO S1	17/11/2019 17:46	18/11/2019 12:43	17/11/2019 17:46	18/11/2019 12:43	18,94	7	132,59	CHI

201911189922	MINEIROS	MY21374364	PARQUE DAS EMAS	17/11/2019 19:33	17/11/2019 20:36	17/11/2019 19:33	17/11/2019 20:36	1,04	1	1,04	CHI
201911189936	OURO VERDE DE GOIAS	OV21028612	INHUMAS S1	17/11/2019 19:35	17/11/2019 22:18	17/11/2019 19:35	17/11/2019 22:18	2,71	1	2,71	CHI
201911189938	PORANGATU	PO12363572	PORANGATU	17/11/2019 17:30	17/11/2019 20:20	17/11/2019 17:30	17/11/2019 20:20	2,83	8	22,62	CHI
201911189946	PIRES DO RIO	BC21137539	PIRES DO RIO S2	17/11/2019 19:38	18/11/2019 15:44	17/11/2019 19:38	18/11/2019 15:44	20,10	1	20,10	CHI
201911189947	URUACU	640042170	URUACU	17/11/2019 19:38	17/11/2019 22:35	17/11/2019 19:38	17/11/2019 22:35	2,94	1	2,94	CHI
201911189961	SANTA RITA DO NOVO DESTINO	1330000654	GOIANESIA S1	17/11/2019 19:42	18/11/2019 04:41	17/11/2019 19:42	18/11/2019 04:41	8,97	1	8,97	CHI
201911189963	NEROPOLIS	NR12029257	NEROPOLIS S2	17/11/2019 19:42	17/11/2019 22:48	17/11/2019 19:42	17/11/2019 22:48	3,08	11	33,92	CHI
201911189969	ARAGUAPAZ	1780002765	MOZARLANDIA	17/11/2019 19:45	18/11/2019 15:55	17/11/2019 19:45	18/11/2019 15:55	20,17	1	20,17	CHI
201911189971	TRINDADE	TR21241045	GOYA S2	17/11/2019 19:45	17/11/2019 22:15	17/11/2019 19:45	17/11/2019 22:15	2,49	1	2,49	CHI
201911189974	ALTO HORIZONTE	AJ12375615	SANTA TEREZINHA	17/11/2019 19:46	18/11/2019 00:40	17/11/2019 19:46	18/11/2019 00:40	4,89	8	39,12	CHI
201911189976	PORANGATU	PO12020611	NOVO PLANALTO	17/11/2019 19:47	18/11/2019 00:17	17/11/2019 19:47	18/11/2019 00:17	4,50	8	35,97	CHI
201911189977	CALDAS NOVAS	CN12331847	CALDAS NOVAS S1	17/11/2019 18:27	18/11/2019 01:50	17/11/2019 18:27	18/11/2019 01:50	7,38	34	250,84	CHI
201911189985	BALIZA	BM12390150	BOM JARDIM	17/11/2019 15:02	17/11/2019 22:26	17/11/2019 15:02	17/11/2019 22:26	7,38	46	339,70	CHI
201911189985	BOM JARDIM DE GOIAS	BM12390150	BOM JARDIM	17/11/2019 15:02	17/11/2019 22:26	17/11/2019 15:02	17/11/2019 22:26	7,38	8	59,08	CHI
201911189989	ITUMBIARA	690359573	ITUMBIARA NOVA	17/11/2019 19:53	19/11/2019 10:15	17/11/2019 19:53	19/11/2019 10:15	38,37	1	38,37	CHI
201911189992	PIRENOPOLIS	220016811	CORUMBA	17/11/2019 19:53	17/11/2019 22:50	17/11/2019 19:53	17/11/2019 22:50	2,94	1	2,94	CHI
201911189995	ITUMBIARA	10011653963	ITUMBIARA VELHA S1	17/11/2019 19:55	18/11/2019 06:02	17/11/2019 19:55	18/11/2019 06:02	10,11	1	10,11	CHI
201911189996	SANTA CRUZ DE GOIAS	BC21344712	PIRES DO RIO S2	17/11/2019 19:55	18/11/2019 00:31	17/11/2019 19:55	18/11/2019 00:31	4,59	1	4,59	CHI
201911190000	ALEXANIA	AX12295664	ALEXANIA	17/11/2019 19:56	18/11/2019 11:47	17/11/2019 19:56	18/11/2019 11:47	15,84	17	269,26	CHI
201911190002	GOIANIA	GN12001206	MEIA PONTE	17/11/2019 19:48	17/11/2019 21:00	17/11/2019 19:48	17/11/2019 21:00	1,20	18	21,60	CHI
201911190002	GOIANIRA	GN12001206	MEIA PONTE	17/11/2019 19:48	17/11/2019 21:00	17/11/2019 19:48	17/11/2019 21:00	1,20	10	12,00	CHI
201911190005	GOIANIA	GN11131188	FERROVIARIO S1	17/11/2019 19:59	17/11/2019 21:38	17/11/2019 19:59	17/11/2019 21:38	1,64	99	162,61	CHI
201911190009	ABADIANIA	AA21295633	DAIA S2	17/11/2019 20:01	18/11/2019 11:18	17/11/2019 20:01	18/11/2019 11:18	15,28	2	30,55	CHI
201911190010	NOVA IGUAQU DE GOIAS	NH21086279	MARA ROSA	17/11/2019 20:02	18/11/2019 09:38	17/11/2019 20:02	18/11/2019 09:38	13,59	1	13,59	CHI
201911190012	SAO MIGUEL DO ARAGUAIA	4650003685	SAO MIGUEL DO ARAGUAIA	17/11/2019 20:03	18/11/2019 08:13	17/11/2019 20:03	18/11/2019 08:13	12,15	1	12,15	CHI
201911190018	GOIANIA	GN11238206	ATLANTICO S3	17/11/2019 20:05	17/11/2019 21:04	17/11/2019 20:05	17/11/2019 21:04	0,97	123	119,51	CHI
201911190019	GOIANIA	12869776	GOIANIA LESTE S3	17/11/2019 20:05	17/11/2019 21:20	17/11/2019 20:05	17/11/2019 21:20	1,24	1	1,24	CHI
201911190025	FORMOSA	FA11257282	ITUIQUIRA	17/11/2019 20:06	18/11/2019 13:19	17/11/2019 20:06	18/11/2019 13:19	17,20	1	17,20	CHI
201911190028	ITAPURANGA	IK12298443	ITAPURANGA	17/11/2019 20:06	17/11/2019 21:30	17/11/2019 20:06	17/11/2019 21:30	1,39	5	6,93	CHI
201911190037	AMARALINA	MU12087485	MARA ROSA	17/11/2019 20:13	18/11/2019 10:17	17/11/2019 20:13	18/11/2019 10:17	14,06	5	70,29	CHI
201911190037	MUTUNOPOLIS	MU12087485	MARA ROSA	17/11/2019 20:13	18/11/2019 10:17	17/11/2019 20:13	18/11/2019 10:17	14,06	10	140,58	CHI
201911190054	BOM JARDIM DE GOIAS	BM12355343	BOM JARDIM	17/11/2019 20:17	18/11/2019 11:18	17/11/2019 20:17	18/11/2019 11:18	15,01	1	15,01	CHI
201911190058	MINEIROS	MY12070299	PARQUE DAS EMAS	17/11/2019 20:18	17/11/2019 21:51	17/11/2019 20:18	17/11/2019 21:51	1,55	27	41,72	CHI

201911190061	MONTES CLAROS DE GOIAS	ME12212902	IPORA	17/11/2019 20:19	18/11/2019 15:15	17/11/2019 20:19	18/11/2019 15:15	18,94	10	189,39	CHI
201911190069	RIO VERDE	RV12379653	RIO VERDE S2	17/11/2019 20:23	18/11/2019 12:48	17/11/2019 20:23	18/11/2019 12:48	16,40	22	360,90	CHI
201911190070	GOIANIA	10729367	ATLANTICO S3	17/11/2019 20:23	17/11/2019 21:27	17/11/2019 20:23	17/11/2019 21:27	1,05	1	1,05	CHI
201911190073	PORANGATU	PO11343300	PORANGATU	17/11/2019 20:25	18/11/2019 13:33	17/11/2019 20:25	18/11/2019 13:33	17,13	1	17,13	CHI
201911190081	PORANGATU	PO11056150	PORANGATU	17/11/2019 20:13	17/11/2019 23:22	17/11/2019 20:13	17/11/2019 23:22	3,15	138	434,28	CHI
201911190082	LUZIANIA	LZ11261574	RIO VERMELHO	17/11/2019 20:28	18/11/2019 00:26	17/11/2019 20:28	18/11/2019 00:26	3,97	85	337,12	CHI
201911190090	ESTRELA DO NORTE	ET12136395	MARA ROSA	17/11/2019 20:33	18/11/2019 04:11	17/11/2019 20:33	18/11/2019 04:11	7,62	10	76,23	CHI
201911190090	MARA ROSA	ET12136395	MARA ROSA	17/11/2019 20:33	18/11/2019 04:11	17/11/2019 20:33	18/11/2019 04:11	7,62	8	60,99	CHI
201911190094	RIO VERDE	RV11000036	RIO VERDE S2	17/11/2019 19:47	18/11/2019 12:08	17/11/2019 19:47	18/11/2019 12:08	16,34	162	2647,49	CHI
201911190102	CACHOEIRA ALTA	CA21075136	CACHOEIRA ALTA	17/11/2019 20:36	18/11/2019 10:12	17/11/2019 20:36	18/11/2019 10:12	13,60	1	13,60	CHI
201911190103	DIVINOPOLIS DE GOIAS	GH12241928	SAO DOMINGOS	18/11/2019 06:11	18/11/2019 09:50	18/11/2019 06:11	18/11/2019 09:50	3,65	37	134,97	CHI
201911190103	MONTE ALEGRE DE GOIAS	GH12241928	SAO DOMINGOS	18/11/2019 06:11	18/11/2019 09:50	18/11/2019 06:11	18/11/2019 09:50	3,65	3	10,94	CHI
201911190103	SAO DOMINGOS	GH12241928	SAO DOMINGOS	18/11/2019 06:11	18/11/2019 09:50	18/11/2019 06:11	18/11/2019 09:50	3,65	12	43,77	CHI
201911190105	GOIANIA	17239760	CARAJAS S1	17/11/2019 20:37	17/11/2019 21:35	17/11/2019 20:37	17/11/2019 21:35	0,95	1	0,95	CHI
201911190113	PORANGATU	PO12391671	PORANGATU	17/11/2019 20:42	18/11/2019 10:21	17/11/2019 20:42	18/11/2019 10:21	13,65	24	327,54	CHI
201911190115	BRITANIA	BT12316174	BRITANIA	17/11/2019 20:42	18/11/2019 12:58	17/11/2019 20:42	18/11/2019 12:58	16,26	3	48,77	CHI
201911190117	GOIANESIA	550031327	GOIANESIA S2	17/11/2019 20:43	17/11/2019 22:24	17/11/2019 20:43	17/11/2019 22:24	1,67	1	1,67	CHI
201911190118	GOIANIA	15037060	GOIANIA LESTE S1	17/11/2019 20:43	17/11/2019 21:56	17/11/2019 20:43	17/11/2019 21:56	1,20	1	1,20	CHI
201911190119	TRINDADE	10008068753	TRINDADE	17/11/2019 20:44	18/11/2019 00:32	17/11/2019 20:44	18/11/2019 00:32	3,81	1	3,81	CHI
201911190120	GUARANI DE GOIAS	GY12276037	IACIARA S1	17/11/2019 18:18	18/11/2019 09:04	17/11/2019 18:18	18/11/2019 09:04	14,75	77	1136,05	CHI
201911190122	PLANALTINA	PI12355794	PLANALTINA	17/11/2019 20:31	18/11/2019 01:48	17/11/2019 20:31	18/11/2019 01:48	5,27	15	79,05	CHI
201911190123	PALMEIRAS DE GOIAS	PL12000126	PALMEIRAS	17/11/2019 20:45	17/11/2019 22:08	17/11/2019 20:45	17/11/2019 22:08	1,38	15	20,71	CHI
201911190129	ITAUCU	IX21219151	INHUMAS S1	17/11/2019 20:46	18/11/2019 00:09	17/11/2019 20:46	18/11/2019 00:09	3,37	1	3,37	CHI
201911190152	GOIANAPOLIS	1370020810	DAIA S2	17/11/2019 20:53	18/11/2019 00:34	17/11/2019 20:53	18/11/2019 00:34	3,67	1	3,67	CHI
201911190158	ACREUNA	EU12200726	ACREUNA	17/11/2019 20:56	18/11/2019 09:27	17/11/2019 20:56	18/11/2019 09:27	12,51	1	12,51	CHI
201911190158	TURVELANDIA	EU12200726	ACREUNA	17/11/2019 20:56	18/11/2019 09:27	17/11/2019 20:56	18/11/2019 09:27	12,51	3	37,54	CHI
201911190163	PLANALTINA	PI12099511	PLANALTINA	17/11/2019 19:54	17/11/2019 23:41	17/11/2019 19:54	17/11/2019 23:41	3,77	17	64,11	CHI
201911190165	IPAMERI	IP12056197	IPAMERI	17/11/2019 20:59	19/11/2019 11:21	17/11/2019 20:59	19/11/2019 11:21	38,37	3	115,10	CHI
201911190169	CACHOEIRA DOURADA	CD12000085	CACHOEIRA DOURADA	17/11/2019 16:11	19/11/2019 17:18	17/11/2019 16:11	19/11/2019 17:18	49,10	14	687,41	CHI
201911190173	PARAUNA	PU21233463	PARAUNA	17/11/2019 21:02	18/11/2019 01:20	17/11/2019 21:02	18/11/2019 01:20	4,30	1	4,30	CHI
201911190175	JATAI	SX12264387	JATAI S1	17/11/2019 21:03	18/11/2019 15:22	17/11/2019 21:03	18/11/2019 15:22	18,32	7	128,25	CHI
201911190175	SERRANOPOLIS	SX12264387	JATAI S1	17/11/2019 21:03	18/11/2019 15:22	17/11/2019 21:03	18/11/2019 15:22	18,32	22	403,06	CHI
201911190176	SERRANOPOLIS	SX12216725	JATAI S1	17/11/2019 21:04	18/11/2019 11:25	17/11/2019 21:04	18/11/2019 11:25	14,34	19	272,54	CHI

201911190178	NOVA ROMA	ND12096857	IACIARA S2	17/11/2019 21:04	18/11/2019 11:54	17/11/2019 21:04	18/11/2019 11:54	14,82	8	118,57	CHI
201911190178	SAO DOMINGOS	ND12096857	IACIARA S2	17/11/2019 21:04	18/11/2019 11:54	17/11/2019 21:04	18/11/2019 11:54	14,82	3	44,46	CHI
201911190182	ARUANA	AK21210621	ARUANA	17/11/2019 21:06	19/11/2019 13:50	17/11/2019 21:06	18/11/2019 14:30	17,40	1	17,40	CHI
201911190182	ARUANA	AK12066603	ARUANA	17/11/2019 21:06	19/11/2019 13:50	17/11/2019 21:06	19/11/2019 13:50	40,74	3	122,22	CHI
201911190187	NIQUELANDIA	NQ12374578	URUACU	17/11/2019 21:08	18/11/2019 08:56	17/11/2019 21:08	18/11/2019 08:56	11,79	1	11,79	CHI
201911190194	GOIANIA	12626107	GOIANIA LESTE S1	17/11/2019 21:15	17/11/2019 22:40	17/11/2019 21:15	17/11/2019 22:40	1,40	1	1,40	CHI
201911190197	GOIANIA	15401194	SENADOR CANEDO	17/11/2019 21:17	17/11/2019 22:36	17/11/2019 21:17	17/11/2019 22:36	1,30	1	1,30	CHI
201911190198	MORRINHOS	MR12239042	MORRINHOS	17/11/2019 21:17	19/11/2019 11:23	17/11/2019 21:17	19/11/2019 11:23	38,10	3	114,29	CHI
201911190199	FORMOSO	FO12088777	MARA ROSA	17/11/2019 21:18	18/11/2019 09:32	17/11/2019 21:18	18/11/2019 09:32	12,22	34	415,63	CHI
201911190203	IPORA	IR12243781	IPORA	17/11/2019 15:44	18/11/2019 10:32	17/11/2019 15:44	18/11/2019 10:32	18,80	4	75,22	CHI
201911190205	QUIRINOPOLIS	80122620	QUIRINOPOLIS	17/11/2019 21:21	18/11/2019 07:29	17/11/2019 21:21	18/11/2019 07:29	10,12	1	10,12	CHI
201911190217	MINEIROS	1390076432	PARQUE DAS EMAS	17/11/2019 21:27	17/11/2019 23:02	17/11/2019 21:27	17/11/2019 23:02	1,57	1	1,57	CHI
201911190221	FORMOSA	610045180	ITUIQUIRA	17/11/2019 21:31	18/11/2019 00:57	17/11/2019 21:31	18/11/2019 00:57	3,43	1	3,43	CHI
201911190225	NOVA CRIXAS	NA11282178	NOVA CRIXAS	17/11/2019 21:09	18/11/2019 00:08	17/11/2019 21:09	18/11/2019 00:08	2,98	70	208,35	CHI
201911190228	PALMINOPOLIS	PP21168176	PALMEIRAS	17/11/2019 21:33	18/11/2019 01:08	17/11/2019 21:33	18/11/2019 01:08	3,58	2	7,17	CHI
201911190231	GUARANI DE GOIAS	GY12265440	IACIARA S1	17/11/2019 21:35	18/11/2019 18:45	17/11/2019 21:35	18/11/2019 14:17	16,70	9	150,29	CHI
201911190231	GUARANI DE GOIAS	GY12257836LD	IACIARA S1	17/11/2019 21:35	18/11/2019 18:45	17/11/2019 21:35	18/11/2019 18:25	20,83	10	208,33	CHI
201911190231	GUARANI DE GOIAS	GY13267346	IACIARA S2	17/11/2019 21:35	18/11/2019 18:45	18/11/2019 16:48	18/11/2019 18:45	1,94	56	108,44	CHI
201911190236	CACHOEIRA ALTA	CA12370028	CACHOEIRA ALTA	17/11/2019 21:38	18/11/2019 12:24	17/11/2019 21:38	18/11/2019 12:24	14,76	1	14,76	CHI
201911190240	GOIANIA	10137543	ATLANTICO S1	17/11/2019 21:39	17/11/2019 22:24	17/11/2019 21:39	17/11/2019 22:24	0,74	1	0,74	CHI
201911190244	CALDAS NOVAS	CN11123208	SERRA DE CALDAS	17/11/2019 18:37	17/11/2019 23:55	17/11/2019 18:37	17/11/2019 23:55	5,29	125	660,83	CHI
201911190251	INACIOLANDIA	ID12359397	QUIRINOPOLIS	17/11/2019 21:46	18/11/2019 10:54	17/11/2019 21:46	18/11/2019 10:54	13,12	56	734,92	CHI
201911190251	ITUMBIARA	ID12359397	QUIRINOPOLIS	17/11/2019 21:46	18/11/2019 10:54	17/11/2019 21:46	18/11/2019 10:54	13,12	4	52,49	CHI
201911190258	JANDAIA	JD12055081	PALMEIRAS	17/11/2019 21:32	18/11/2019 00:51	17/11/2019 21:32	18/11/2019 00:51	3,33	11	36,61	CHI
201911190275	GOIANIA	17314616	XAVANTES	17/11/2019 22:00	17/11/2019 23:04	17/11/2019 22:00	17/11/2019 23:04	1,05	1	1,05	CHI
201911190276	GOIANIA	10027435103	CAMPINAS S1	17/11/2019 22:02	18/11/2019 00:34	17/11/2019 22:02	18/11/2019 00:34	2,53	1	2,53	CHI
201911190277	RIO VERDE	RV11018077	SANTA HELENA S1	17/11/2019 18:26	18/11/2019 10:53	17/11/2019 18:26	18/11/2019 10:53	16,44	94	1545,31	CHI
201911190278	PALMEIRAS DE GOIAS	10019058894	PALMEIRAS	17/11/2019 22:02	18/11/2019 08:41	17/11/2019 22:02	18/11/2019 08:41	10,65	1	10,65	CHI
201911190281	RUBIATABA	10014294905	RUBIATABA	17/11/2019 22:04	18/11/2019 02:52	17/11/2019 22:04	18/11/2019 02:52	4,79	1	4,79	CHI
201911190282	JANDAIA	JD12083934	PALMEIRAS	17/11/2019 21:57	18/11/2019 00:04	17/11/2019 21:57	18/11/2019 00:04	2,11	13	27,47	CHI
201911190283	JATAI	JT12000231	JATAI S1	17/11/2019 22:06	18/11/2019 09:50	17/11/2019 22:06	18/11/2019 09:50	11,73	74	868,25	CHI
201911190283	PEROLANDIA	JT12000231	JATAI S1	17/11/2019 22:06	18/11/2019 09:50	17/11/2019 22:06	18/11/2019 09:50	11,73	3	35,20	CHI
201911190286	ITUMBIARA	IT11000029	ITUMBIARA VELHA S1	17/11/2019 21:41	18/11/2019 00:51	17/11/2019 21:41	18/11/2019 00:51	3,17	146	463,51	CHI

201911190287	NIQUELANDIA	NQ12375622	NIQUELANDIA SUBTRANSMISSAO	17/11/2019 22:08	18/11/2019 06:36	17/11/2019 22:08	18/11/2019 06:36	8,45	7	59,17	CHI
201911190297	ESTRELA DO NORTE	MU12076698	MARA ROSA	17/11/2019 23:12	18/11/2019 06:47	17/11/2019 23:12	18/11/2019 06:47	7,57	1	7,57	CHI
201911190297	MUTUNOPOLIS	MU12076698	MARA ROSA	17/11/2019 23:12	18/11/2019 06:47	17/11/2019 23:12	18/11/2019 06:47	7,57	32	242,27	CHI
201911190301	IACIARA	IA11039967	IACIARA S1	17/11/2019 22:10	18/11/2019 00:09	17/11/2019 22:10	18/11/2019 00:09	1,97	132	260,22	CHI
201911190303	MARA ROSA	MQ12313418	MARA ROSA	17/11/2019 22:08	18/11/2019 19:17	17/11/2019 22:08	18/11/2019 19:17	21,14	6	126,82	CHI
201911190308	NIQUELANDIA	NQ12359847	NIQUELANDIA SUBTRANSMISSAO	17/11/2019 22:20	18/11/2019 11:30	17/11/2019 22:20	18/11/2019 11:30	13,17	43	566,25	CHI
201911190311	GOIANIA	10965154	CAMPINAS S3	17/11/2019 22:22	18/11/2019 00:29	17/11/2019 22:22	18/11/2019 00:29	2,10	1	2,10	CHI
201911190314	APARECIDA DE GOIANIA	200222387	ANHANGUERA	17/11/2019 22:24	18/11/2019 00:12	17/11/2019 22:24	18/11/2019 00:12	1,79	1	1,79	CHI
201911190326	MONTIVIDIU DO NORTE	MX12226413	PORANGATU	17/11/2019 22:40	18/11/2019 11:36	17/11/2019 22:40	18/11/2019 11:36	12,93	40	517,16	CHI
201911190336	PORANGATU	PO12038327	PORANGATU	17/11/2019 22:52	18/11/2019 07:15	17/11/2019 22:52	18/11/2019 07:15	8,37	2	16,74	CHI
201911190343	GOIANDIRA	CT21075577	CATALAO S1	17/11/2019 22:57	20/11/2019 10:52	17/11/2019 22:57	20/11/2019 10:52	59,92	1	59,92	CHI
201911190351	PALMINOPOLIS	PP12077093	PALMEIRAS	17/11/2019 23:04	18/11/2019 09:20	17/11/2019 23:04	18/11/2019 09:20	10,25	2	20,51	CHI
201911190354	SANTA RITA DO NOVO DESTINO	BA12163300	BARRO ALTO	17/11/2019 23:11	18/11/2019 15:19	17/11/2019 23:11	18/11/2019 15:19	16,12	20	322,42	CHI
201911190357	IPAMERI	IP12216237	IPAMERI	17/11/2019 16:41	18/11/2019 08:47	17/11/2019 16:41	18/11/2019 08:47	16,09	22	353,95	CHI
201911190358	VARJAO	VJ21113937	GUAPO S2	17/11/2019 23:15	18/11/2019 11:18	17/11/2019 23:15	18/11/2019 11:18	12,04	1	12,04	CHI
201911190364	PONTALINA	210033708	PONTALINA	17/11/2019 23:23	18/11/2019 08:26	17/11/2019 23:23	18/11/2019 08:26	9,05	1	9,05	CHI
201911190369	RIO VERDE	10003209456	RIO VERDE S1	17/11/2019 23:28	18/11/2019 15:59	17/11/2019 23:28	18/11/2019 15:59	16,51	1	16,51	CHI
201911190371	CAMPINACU	IH12360453	MINACU	17/11/2019 15:15	18/11/2019 03:48	17/11/2019 15:15	18/11/2019 03:48	12,54	5	62,72	CHI
201911190371	MINACU	IH12360453	MINACU	17/11/2019 15:15	18/11/2019 03:48	17/11/2019 15:15	18/11/2019 03:48	12,54	71	890,62	CHI
201911190372	MORRINHOS	150129440	MORRINHOS	17/11/2019 23:30	18/11/2019 11:40	17/11/2019 23:30	18/11/2019 11:40	12,16	1	12,16	CHI
201911190389	AVELINOPOLIS	AV21054109	ANICUNS	17/11/2019 23:56	18/11/2019 08:30	17/11/2019 23:56	18/11/2019 08:30	8,55	1	8,55	CHI
201911190392	MORRINHOS	MR21363836	MORRINHOS	18/11/2019 00:04	18/11/2019 23:27	18/11/2019 00:04	18/11/2019 23:27	23,38	3	70,15	CHI
201911190393	SAO LUIS DE MONTES BELOS	SL11259146	SAO LUIZ DOS MONTES BELOS	17/11/2019 22:58	18/11/2019 00:40	17/11/2019 22:58	18/11/2019 00:40	1,71	29	49,49	CHI
201911190420	CRISTALINA	03470464	CRISTALINA S2	17/11/2019 23:26	18/11/2019 17:02	17/11/2019 23:26	18/11/2019 01:03	1,62	431	696,78	CHI
201911190420	CRISTALINA	KR10400735	CRISTALINA S2	17/11/2019 23:26	18/11/2019 17:02	17/11/2019 23:26	18/11/2019 01:03	1,62	27	43,65	CHI
201911190420	LUZIANIA	03470464	CRISTALINA S2	17/11/2019 23:26	18/11/2019 17:02	17/11/2019 23:26	18/11/2019 01:03	1,62	252	407,40	CHI
201911190420	LUZIANIA	KR10400735	CRISTALINA S2	17/11/2019 23:26	18/11/2019 17:02	17/11/2019 23:26	18/11/2019 01:03	1,62	213	344,35	CHI
201911190420	CRISTALINA	03470464	CRISTALINA S2	17/11/2019 23:26	18/11/2019 17:02	17/11/2019 23:26	18/11/2019 06:10	6,73	97	652,38	CHI
201911190420	CRISTALINA	03470464	CRISTALINA S2	17/11/2019 23:26	18/11/2019 17:02	17/11/2019 23:26	18/11/2019 16:03	16,61	105	1744,25	CHI
201911190420	CRISTALINA	03470464	CRISTALINA S2	17/11/2019 23:26	18/11/2019 17:02	17/11/2019 23:26	18/11/2019 16:25	16,98	1	16,98	CHI
201911190420	CRISTALINA	03470464	CRISTALINA S2	17/11/2019 23:26	18/11/2019 17:02	17/11/2019 23:26	18/11/2019 17:02	17,60	24	422,32	CHI
201911190423	CABECEIRAS	03740424	ITIQUEIRA	18/11/2019 01:06	18/11/2019 16:42	18/11/2019 01:06	18/11/2019 01:11	0,08	45	3,56	CHI
201911190423	FORMOSA	03740424	ITIQUEIRA	18/11/2019 01:06	18/11/2019 16:42	18/11/2019 01:06	18/11/2019 01:11	0,08	6	0,47	CHI

201911190423	CABECEIRAS	03740424	ITIQUEIRA	18/11/2019 01:06	18/11/2019 16:42	18/11/2019 16:36	18/11/2019 16:42	0,11	47	5,38	CHI
201911190423	FORMOSA	03740424	ITIQUEIRA	18/11/2019 01:06	18/11/2019 16:42	18/11/2019 16:36	18/11/2019 16:42	0,11	6	0,69	CHI
201911190502	RUBIATABA	RB12372527	RUBIATABA	17/11/2019 20:58	18/11/2019 01:12	17/11/2019 20:58	18/11/2019 01:12	4,23	71	300,17	CHI
201911190504	MINACU	IH11052676	MINACU	17/11/2019 22:10	18/11/2019 03:11	17/11/2019 22:10	18/11/2019 03:11	5,02	126	632,03	CHI
201911190509	IPAMERI	IP12316540	PIRES DO RIO S2	18/11/2019 00:41	21/11/2019 18:54	18/11/2019 00:41	21/11/2019 18:54	90,21	1	90,21	CHI
201911190516	TRES RANCHOS	TH12161405	CATALAO S1	18/11/2019 01:01	18/11/2019 06:53	18/11/2019 01:01	18/11/2019 06:53	5,86	17	99,59	CHI
201911190535	AMARALINA	LC12189854	MARA ROSA	18/11/2019 03:10	18/11/2019 15:32	18/11/2019 03:10	18/11/2019 15:32	12,36	7	86,50	CHI
201911190535	MARA ROSA	LC12189854	MARA ROSA	18/11/2019 03:10	18/11/2019 15:32	18/11/2019 03:10	18/11/2019 15:32	12,36	2	24,71	CHI
201911190536	PLANALTINA	PI12262312	PLANALTINA	18/11/2019 03:17	18/11/2019 11:31	18/11/2019 03:17	18/11/2019 11:31	8,22	10	82,20	CHI
201911190540	BURITINOPOLIS	04990216	IACIARA S2	18/11/2019 02:59	18/11/2019 07:41	18/11/2019 02:59	18/11/2019 07:41	4,69	423	1983,99	CHI
201911190540	MAMBAI	04990216	IACIARA S2	18/11/2019 02:59	18/11/2019 07:41	18/11/2019 02:59	18/11/2019 07:41	4,69	2860	13414,19	CHI
201911190540	SITIO D ABADIA	04990216	IACIARA S2	18/11/2019 02:59	18/11/2019 07:41	18/11/2019 02:59	18/11/2019 07:41	4,69	1	4,69	CHI
201911190542	CRISTALINA	03460444	PAMPLONA	18/11/2019 03:12	18/11/2019 22:18	18/11/2019 09:04	18/11/2019 18:37	9,54	1875	17888,02	CHI
201911190542	CRISTALINA	03460444	PAMPLONA	18/11/2019 03:12	18/11/2019 22:18	18/11/2019 09:04	18/11/2019 18:37	9,54	77	734,60	CHI
201911190542	CRISTALINA	KR13095496	PAMPLONA	18/11/2019 03:12	18/11/2019 22:18	18/11/2019 09:04	18/11/2019 18:37	9,54	1	9,54	CHI
201911190542	LUZIANIA	03460444	PAMPLONA	18/11/2019 03:12	18/11/2019 22:18	18/11/2019 09:04	18/11/2019 18:37	9,54	6	57,24	CHI
201911190542	CRISTALINA	KR10400355	PAMPLONA	18/11/2019 03:12	18/11/2019 22:18	18/11/2019 03:12	18/11/2019 22:18	19,10	113	2158,52	CHI
201911190546	URUACU	UR12341322	URUACU	18/11/2019 03:50	19/11/2019 02:24	18/11/2019 03:50	19/11/2019 02:24	22,56	7	157,90	CHI
201911190547	ORIZONA	OZ12114502	PIRES DO RIO S2	17/11/2019 21:43	18/11/2019 08:35	17/11/2019 21:43	18/11/2019 08:35	10,87	16	173,95	CHI
201911190551	CATALAO	CT12000053RE	CATALAO S1	18/11/2019 04:11	19/11/2019 18:27	18/11/2019 04:11	19/11/2019 18:27	38,26	39	1492,18	CHI
201911190551	OUVIDOR	CT12000053RE	CATALAO S1	18/11/2019 04:11	19/11/2019 18:27	18/11/2019 04:11	19/11/2019 18:27	38,26	1	38,26	CHI
201911190561	BALIZA	BH21228520	BOM JARDIM	18/11/2019 06:10	18/11/2019 14:01	18/11/2019 06:10	18/11/2019 11:40	5,49	2	10,98	CHI
201911190561	BALIZA	BM12390150	BOM JARDIM	18/11/2019 06:10	18/11/2019 14:01	18/11/2019 06:10	18/11/2019 14:01	7,84	50	392,00	CHI
201911190561	BOM JARDIM DE GOIAS	BM12390150	BOM JARDIM	18/11/2019 06:10	18/11/2019 14:01	18/11/2019 06:10	18/11/2019 14:01	7,84	9	70,56	CHI
201911190568	PIRENOPOLIS	PV12084700	SAO FRANCISCO DE GOIAS	18/11/2019 04:38	18/11/2019 08:32	18/11/2019 04:38	18/11/2019 08:32	3,89	13	50,63	CHI
201911190572	FORMOSA	610036981	ITIQUEIRA	18/11/2019 04:46	18/11/2019 10:29	18/11/2019 04:46	18/11/2019 10:29	5,71	1	5,71	CHI
201911190578	ALTO HORIZONTE	VD12390494	SANTA TEREZINHA	18/11/2019 04:52	18/11/2019 09:20	18/11/2019 04:52	18/11/2019 09:20	4,46	9	40,11	CHI
201911190578	CAMPOS VERDES	VD12390494	SANTA TEREZINHA	18/11/2019 04:52	18/11/2019 09:20	18/11/2019 04:52	18/11/2019 09:20	4,46	1	4,46	CHI
201911190578	MARA ROSA	VD12390494	SANTA TEREZINHA	18/11/2019 04:52	18/11/2019 09:20	18/11/2019 04:52	18/11/2019 09:20	4,46	65	289,70	CHI
201911190585	INDIARA	IY12010960	EDEIA	18/11/2019 01:45	18/11/2019 08:10	18/11/2019 01:45	18/11/2019 08:10	6,40	19	121,66	CHI
201911190586	RIO QUENTE	RQ12100101RE	RIO QUENTE	17/11/2019 22:35	18/11/2019 16:23	17/11/2019 22:35	18/11/2019 16:23	17,79	40	711,42	CHI
201911190599	NOVA AMERICA	RB12320982	RUBIATABA	18/11/2019 05:16	18/11/2019 14:05	18/11/2019 05:16	18/11/2019 14:05	8,80	3	26,41	CHI
201911190599	RUBIATABA	RB12320982	RUBIATABA	18/11/2019 05:16	18/11/2019 14:05	18/11/2019 05:16	18/11/2019 14:05	8,80	23	202,48	CHI

201911190608	BONOPOLIS	BX12079321	SAO MIGUEL DO ARAGUAIA	18/11/2019 05:23	18/11/2019 06:42	18/11/2019 05:23	18/11/2019 06:42	1,30	58	75,56	CHI
201911190609	MORRINHOS	MR21142324	MORRINHOS	18/11/2019 05:24	19/11/2019 09:28	18/11/2019 05:24	19/11/2019 09:28	28,06	1	28,06	CHI
201911190615	MUTUNOPOLIS	MU12170091	MARA ROSA	18/11/2019 05:29	18/11/2019 08:36	18/11/2019 05:29	18/11/2019 08:36	3,12	18	56,10	CHI
201911190624	GOIANESIA	GE12317825RE	GOIANESIA S2	18/11/2019 04:20	18/11/2019 13:45	18/11/2019 04:20	18/11/2019 13:45	9,42	81	763,11	CHI
201911190626	LUZIANIA	LZ10404053	RIO VERMELHO	18/11/2019 05:35	18/11/2019 13:07	18/11/2019 05:35	18/11/2019 07:36	2,02	133	268,62	CHI
201911190626	LUZIANIA	LZ10404053	RIO VERMELHO	18/11/2019 05:35	18/11/2019 13:07	18/11/2019 05:35	18/11/2019 07:51	2,28	487	1108,47	CHI
201911190626	LUZIANIA	LZ10404053	RIO VERMELHO	18/11/2019 05:35	18/11/2019 13:07	18/11/2019 05:35	18/11/2019 08:36	3,02	451	1362,90	CHI
201911190626	CIDADE OCIDENTAL	LZ12261658LD	RIO VERMELHO	18/11/2019 05:35	18/11/2019 13:07	18/11/2019 05:35	18/11/2019 13:07	7,54	7	52,81	CHI
201911190626	LUZIANIA	LZ12261658LD	RIO VERMELHO	18/11/2019 05:35	18/11/2019 13:07	18/11/2019 05:35	18/11/2019 13:07	7,54	42	316,86	CHI
201911190627	FORMOSA	FA12261997	ITIQUIRA	17/11/2019 19:20	18/11/2019 09:49	17/11/2019 19:20	18/11/2019 09:49	14,47	64	926,40	CHI
201911190627	VILA BOA	FA12261997	ITIQUIRA	17/11/2019 19:20	18/11/2019 09:49	17/11/2019 19:20	18/11/2019 09:49	14,47	4	57,90	CHI
201911190628	SAO JOAO DA PARAUNA	RP12079710	FIRMINOPOLIS S2	18/11/2019 05:39	18/11/2019 08:50	18/11/2019 05:39	18/11/2019 08:50	3,18	4	12,71	CHI
201911190630	PALMEIRAS DE GOIAS	PL21000168	PALMEIRAS	18/11/2019 05:39	18/11/2019 08:02	18/11/2019 05:39	18/11/2019 08:02	2,37	1	2,37	CHI
201911190644	MARA ROSA	MQ12263046	MARA ROSA	17/11/2019 18:54	18/11/2019 18:33	17/11/2019 18:54	18/11/2019 18:33	23,64	7	165,45	CHI
201911190646	CEZARINA	CZ12000034	CEZARINA	18/11/2019 04:18	18/11/2019 09:17	18/11/2019 04:18	18/11/2019 09:17	4,97	21	104,31	CHI
201911190646	INDIARA	CZ12000034	CEZARINA	18/11/2019 04:18	18/11/2019 09:17	18/11/2019 04:18	18/11/2019 09:17	4,97	9	44,71	CHI
201911190647	CAMPINORTE	UR12243278	MARA ROSA	18/11/2019 05:40	18/11/2019 11:33	18/11/2019 05:40	18/11/2019 11:33	5,88	7	41,13	CHI
201911190647	URUACU	UR12243278	MARA ROSA	18/11/2019 05:40	18/11/2019 11:33	18/11/2019 05:40	18/11/2019 11:33	5,88	15	88,13	CHI
201911190658	DISTRITO FEDERAL	FA12383392	ITIQUIRA	18/11/2019 05:49	18/11/2019 09:43	18/11/2019 05:49	18/11/2019 09:43	3,89	2	7,79	CHI
201911190659	BONOPOLIS	PO12090602	MARA ROSA	18/11/2019 05:49	18/11/2019 09:15	18/11/2019 05:49	18/11/2019 09:15	3,42	2	6,84	CHI
201911190659	PORANGATU	PO12090602	MARA ROSA	18/11/2019 05:49	18/11/2019 09:15	18/11/2019 05:49	18/11/2019 09:15	3,42	65	222,44	CHI
201911190667	LUZIANIA	SV12013810	VIANOPOLIS	18/11/2019 05:27	18/11/2019 09:50	18/11/2019 05:27	18/11/2019 09:50	4,38	62	271,51	CHI
201911190667	ORIZONA	SV12013810	VIANOPOLIS	18/11/2019 05:27	18/11/2019 09:50	18/11/2019 05:27	18/11/2019 09:50	4,38	68	297,78	CHI
201911190667	SILVANIA	SV12013810	VIANOPOLIS	18/11/2019 05:27	18/11/2019 09:50	18/11/2019 05:27	18/11/2019 09:50	4,38	16	70,07	CHI
201911190671	IACIARA	IA12264201	IACIARA S1	18/11/2019 05:56	18/11/2019 11:35	18/11/2019 05:56	18/11/2019 11:35	5,65	2	11,30	CHI
201911190672	GOIAS	GS12203880	GOIAS	18/11/2019 05:56	18/11/2019 20:32	18/11/2019 05:56	18/11/2019 20:32	14,60	26	379,52	CHI
201911190673	CALDAS NOVAS	00320416	CALDAS NOVAS S1	18/11/2019 05:56	18/11/2019 11:33	18/11/2019 05:56	18/11/2019 11:33	5,62	1	5,62	CHI
201911190673	CALDAS NOVAS	00320416	CALDAS NOVAS S1	18/11/2019 05:56	18/11/2019 11:33	18/11/2019 05:56	18/11/2019 11:33	5,62	286	1607,16	CHI
201911190673	PIRACANJUBA	00320416	CALDAS NOVAS S1	18/11/2019 05:56	18/11/2019 11:33	18/11/2019 05:56	18/11/2019 11:33	5,62	148	831,68	CHI
201911190673	PIRACANJUBA	00320416	CALDAS NOVAS S1	18/11/2019 05:56	18/11/2019 11:33	18/11/2019 05:56	18/11/2019 11:33	5,62	43	241,64	CHI
201911190673	PIRACANJUBA	00320416	CALDAS NOVAS S1	18/11/2019 05:56	18/11/2019 11:33	18/11/2019 05:56	18/11/2019 11:33	5,62	1	5,62	CHI
201911190673	PIRACANJUBA	00320416	PIRACANJUBA	18/11/2019 05:56	18/11/2019 11:33	18/11/2019 05:56	18/11/2019 11:33	5,62	49	275,35	CHI
201911190674	IPAMERI	IP12275536	CAMPO ALEGRE DE GOIAS	17/11/2019 20:41	18/11/2019 11:48	17/11/2019 20:41	18/11/2019 11:48	15,10	9	135,92	CHI

201911190683	ANAPOLIS	AN12258063	JUNDIAI S1	18/11/2019 05:59	18/11/2019 07:15	18/11/2019 05:59	18/11/2019 07:15	1,27	775	980,81	CHI
201911190687	BOM JARDIM DE GOIAS	BM21335380	BOM JARDIM	18/11/2019 06:01	18/11/2019 09:51	18/11/2019 06:01	18/11/2019 09:51	3,83	1	3,83	CHI
201911190692	ITABERAI	IB12206779	ITABERAI S1	18/11/2019 05:00	18/11/2019 07:05	18/11/2019 05:00	18/11/2019 07:05	2,08	27	56,09	CHI
201911190693	ITAJA	IJ12191517	ITAJA S2	17/11/2019 19:37	18/11/2019 08:01	17/11/2019 19:37	18/11/2019 08:01	12,40	3	37,19	CHI
201911190697	SANTO ANTONIO DO DESCOBERTO	SN21313994	MARAJOARA	18/11/2019 06:04	18/11/2019 15:57	18/11/2019 06:04	18/11/2019 15:57	9,88	1	9,88	CHI
201911190699	SERRANOPOLIS	SX12296514	JATAI S1	17/11/2019 21:04	18/11/2019 10:43	17/11/2019 21:04	18/11/2019 10:43	13,64	5	68,22	CHI
201911190701	MORRINHOS	03410214	MORRINHOS	18/11/2019 05:25	19/11/2019 21:35	18/11/2019 05:25	18/11/2019 11:48	6,39	38	242,88	CHI
201911190701	CALDAS NOVAS	03410214	MORRINHOS	18/11/2019 05:25	19/11/2019 21:35	18/11/2019 05:25	19/11/2019 16:35	35,17	1	35,17	CHI
201911190701	MORRINHOS	03410214	MORRINHOS	18/11/2019 05:25	19/11/2019 21:35	18/11/2019 05:25	19/11/2019 16:35	35,17	39	1371,67	CHI
201911190701	RIO QUENTE	03410214	MORRINHOS	18/11/2019 05:25	19/11/2019 21:35	18/11/2019 05:25	19/11/2019 16:35	35,17	19	668,25	CHI
201911190701	CALDAS NOVAS	03410214	MORRINHOS	18/11/2019 05:25	19/11/2019 21:35	18/11/2019 05:25	19/11/2019 21:35	40,16	1	40,16	CHI
201911190701	MORRINHOS	03410214	MORRINHOS	18/11/2019 05:25	19/11/2019 21:35	18/11/2019 05:25	19/11/2019 21:35	40,16	159	6385,71	CHI
201911190805	PARAUNA	PU12081327	FIRMINOPOLIS S2	18/11/2019 06:05	18/11/2019 12:15	18/11/2019 06:05	18/11/2019 12:15	6,16	19	117,00	CHI
201911190807	COLINAS DO SUL	TI11197667	NIQUELANDIA SUBTRANSMISSAO	18/11/2019 06:05	18/11/2019 09:50	18/11/2019 06:05	18/11/2019 09:50	3,74	144	537,96	CHI
201911190812	MONTES CLAROS DE GOIAS	ME12390172	IPORA	18/11/2019 05:42	18/11/2019 10:10	18/11/2019 05:42	18/11/2019 10:10	4,46	30	133,74	CHI
201911190816	GOIAS	IK12299970	GOIAS	17/11/2019 20:51	18/11/2019 10:01	17/11/2019 20:51	18/11/2019 10:01	13,15	24	315,63	CHI
201911190816	HEITORAI	IK12299970	GOIAS	17/11/2019 20:51	18/11/2019 10:01	17/11/2019 20:51	18/11/2019 10:01	13,15	29	381,39	CHI
201911190816	ITABERAI	IK12299970	GOIAS	17/11/2019 20:51	18/11/2019 10:01	17/11/2019 20:51	18/11/2019 10:01	13,15	2	26,30	CHI
201911190816	ITAPURANGA	IK12299970	GOIAS	17/11/2019 20:51	18/11/2019 10:01	17/11/2019 20:51	18/11/2019 10:01	13,15	3	39,45	CHI
201911190818	MORRINHOS	MR21236942	GOIATUBA S2	20/11/2019 11:54	20/11/2019 15:42	20/11/2019 11:54	20/11/2019 15:42	3,79	1	3,79	CHI
201911190819	GOIAS	GS12250574	GOIAS	18/11/2019 12:23	18/11/2019 17:08	18/11/2019 12:23	18/11/2019 17:08	4,74	8	37,94	CHI
201911190840	ITABERAI	TQ12009078LD	ITABERAI S1	17/11/2019 21:57	18/11/2019 12:55	17/11/2019 21:57	18/11/2019 12:55	14,96	3	44,89	CHI
201911190840	TAQUARAL DE GOIAS	TQ12009078LD	ITABERAI S1	17/11/2019 21:57	18/11/2019 12:55	17/11/2019 21:57	18/11/2019 12:55	14,96	20	299,24	CHI
201911190840	TAQUARAL DE GOIAS	TQ12009078LD	ITABERAI S1	17/11/2019 21:57	18/11/2019 12:55	18/11/2019 11:25	18/11/2019 12:55	1,50	6	9,00	CHI
201911190845	SERRANOPOLIS	SX12296496	JATAI S1	18/11/2019 01:09	18/11/2019 09:36	18/11/2019 01:09	18/11/2019 09:36	8,45	129	1089,66	CHI
201911190854	CORREGO DO OURO	CO12004040	FIRMINOPOLIS S2	18/11/2019 05:49	18/11/2019 08:32	18/11/2019 05:49	18/11/2019 08:32	2,71	4	10,86	CHI
201911190855	FORMOSA	19553754	ITUIQUIRA	18/11/2019 05:57	18/11/2019 07:29	18/11/2019 05:57	18/11/2019 07:29	1,52	124	188,48	CHI
201911190858	CACHOEIRA DOURADA	CD12000005	CACHOEIRA DOURADA	18/11/2019 06:05	18/11/2019 15:57	18/11/2019 06:05	18/11/2019 15:57	9,86	9	88,78	CHI
201911190858	ITUMBIARA	CD12000005	CACHOEIRA DOURADA	18/11/2019 06:05	18/11/2019 15:57	18/11/2019 06:05	18/11/2019 15:57	9,86	20	197,28	CHI
201911190860	AGUA FRIA DE GOIAS	TL12131760	SAO JOAO D ALIANCA	18/11/2019 05:12	18/11/2019 08:55	18/11/2019 05:12	18/11/2019 08:55	3,71	20	74,12	CHI
201911190860	FORMOSA	TL12131760	SAO JOAO D ALIANCA	18/11/2019 05:12	18/11/2019 08:55	18/11/2019 05:12	18/11/2019 08:55	3,71	2	7,41	CHI
201911190863	ITAPIRAPUA	IU12014848	MATRINCHA	17/11/2019 22:40	19/11/2019 12:36	17/11/2019 22:40	18/11/2019 08:16	9,59	2	19,18	CHI
201911190863	ITAPIRAPUA	IU12014848	MATRINCHA	17/11/2019 22:40	19/11/2019 12:36	17/11/2019 22:40	18/11/2019 11:40	12,99	39	506,69	CHI

201911190863	ITAPIRAPUA	IU12014848	MATRINCHA	17/11/2019 22:40	19/11/2019 12:36	18/11/2019 09:33	18/11/2019 11:40	2,10	2	4,21	CHI
201911190863	ITAPIRAPUA	IU12121437	MATRINCHA	17/11/2019 22:40	19/11/2019 12:36	17/11/2019 22:40	19/11/2019 12:36	37,93	16	606,82	CHI
201911190868	BELA VISTA DE GOIAS	BV11323324	BELA VISTA S1	18/11/2019 06:16	18/11/2019 17:15	18/11/2019 06:16	18/11/2019 17:15	10,97	122	1338,04	CHI
201911190871	SAO DOMINGOS	SD12170576	SAO DOMINGOS	18/11/2019 06:20	18/11/2019 11:15	18/11/2019 06:20	18/11/2019 11:15	4,91	36	176,86	CHI
201911190877	MORRINHOS	MR21000156	MORRINHOS	18/11/2019 06:22	18/11/2019 10:08	18/11/2019 06:22	18/11/2019 10:08	3,76	2	7,53	CHI
201911190878	IVOLANDIA	IV12223012	IPORA	18/11/2019 06:22	18/11/2019 13:50	18/11/2019 06:22	18/11/2019 13:50	7,47	11	82,16	CHI
201911190883	GOIANIA	GN11162092	CAMPINAS S3	18/11/2019 06:22	18/11/2019 11:19	18/11/2019 06:22	18/11/2019 11:19	4,94	42	207,31	CHI
201911190890	PIRES DO RIO	PR21075723	PIRES DO RIO S1	18/11/2019 06:24	18/11/2019 10:03	18/11/2019 06:24	18/11/2019 10:03	3,66	1	3,66	CHI
201911190891	NIQUELANDIA	NQ12140184	SAO JOAO D ALIANCA	18/11/2019 08:21	19/11/2019 10:35	18/11/2019 08:21	19/11/2019 10:35	26,23	57	1495,00	CHI
201911190892	GOIANIA	GN11356928	REAL S2	18/11/2019 06:24	18/11/2019 08:13	18/11/2019 06:24	18/11/2019 08:13	1,81	75	135,79	CHI
201911190900	SILVANIA	SV12205355	DAIA S2	18/11/2019 06:27	18/11/2019 09:35	18/11/2019 06:27	18/11/2019 09:35	3,13	4	12,53	CHI
201911190902	CRISTALINA	03460424	PAMPLONA	18/11/2019 05:54	18/11/2019 13:41	18/11/2019 05:54	18/11/2019 08:30	2,59	68	176,42	CHI
201911190902	CRISTALINA	03460424	PAMPLONA	18/11/2019 05:54	18/11/2019 13:41	18/11/2019 05:54	18/11/2019 12:41	6,78	3	20,34	CHI
201911190902	CRISTALINA	03460424	PAMPLONA	18/11/2019 05:54	18/11/2019 13:41	18/11/2019 09:59	18/11/2019 12:41	2,69	3	8,08	CHI
201911190902	CRISTALINA	KR13261577	PAMPLONA	18/11/2019 05:54	18/11/2019 13:41	18/11/2019 05:54	18/11/2019 13:09	7,25	66	478,59	CHI
201911190902	CRISTALINA	KR13376291	PAMPLONA	18/11/2019 05:54	18/11/2019 13:41	18/11/2019 09:59	18/11/2019 13:41	3,70	66	244,20	CHI
201911190924	MINACU	IH12392286	MINACU	18/11/2019 07:33	18/11/2019 19:40	18/11/2019 07:33	18/11/2019 19:40	12,11	19	230,03	CHI
201911190929	RIO VERDE	630451539	RIO VERDE S2	18/11/2019 09:26	18/11/2019 14:55	18/11/2019 09:26	18/11/2019 14:55	5,47	1	5,47	CHI
201911190948	CIDADE OCIDENTAL	00380454	MARAJOARA	18/11/2019 09:30	18/11/2019 12:54	18/11/2019 09:30	18/11/2019 09:34	0,06	2	0,13	CHI
201911190948	CIDADE OCIDENTAL	00380454	MARAJOARA	18/11/2019 09:30	18/11/2019 12:54	18/11/2019 09:30	18/11/2019 09:36	0,09	65	6,05	CHI
201911190948	CIDADE OCIDENTAL	00380454	MARAJOARA	18/11/2019 09:30	18/11/2019 12:54	18/11/2019 09:30	18/11/2019 09:36	0,09	672	62,53	CHI
201911190948	CIDADE OCIDENTAL	00380454	MARAJOARA	18/11/2019 09:30	18/11/2019 12:54	18/11/2019 09:30	18/11/2019 09:36	0,09	2691	250,41	CHI
201911190948	CIDADE OCIDENTAL	00380454	MARAJOARA	18/11/2019 09:30	18/11/2019 12:54	18/11/2019 09:44	18/11/2019 12:45	3,02	2	6,04	CHI
201911190948	CIDADE OCIDENTAL	00380454	MARAJOARA	18/11/2019 09:30	18/11/2019 12:54	18/11/2019 09:44	18/11/2019 12:53	3,15	672	2115,31	CHI
201911190948	CIDADE OCIDENTAL	00380454	MARAJOARA	18/11/2019 09:30	18/11/2019 12:54	18/11/2019 09:44	18/11/2019 12:54	3,16	66	208,76	CHI
201911190948	CIDADE OCIDENTAL	00380454	MARAJOARA	18/11/2019 09:30	18/11/2019 12:54	18/11/2019 09:44	18/11/2019 12:54	3,16	2691	8513,28	CHI
201911190974	CATALAO	CT10400356	CATALAO S2	18/11/2019 11:07	18/11/2019 18:46	18/11/2019 11:07	18/11/2019 14:39	3,53	36	127,24	CHI
201911190974	CATALAO	CT10400356	CATALAO S2	18/11/2019 11:07	18/11/2019 18:46	18/11/2019 11:18	18/11/2019 14:39	3,36	2	6,73	CHI
201911190974	CATALAO	CT12130961LD	CATALAO S2	18/11/2019 11:07	18/11/2019 18:46	18/11/2019 11:07	18/11/2019 16:59	5,87	7	41,06	CHI
201911190974	CATALAO	CT12149166LD	CATALAO S2	18/11/2019 11:07	18/11/2019 18:46	18/11/2019 11:07	18/11/2019 17:34	6,45	18	116,05	CHI
201911190974	CUMARI	CT12149166LD	CATALAO S2	18/11/2019 11:07	18/11/2019 18:46	18/11/2019 11:07	18/11/2019 17:34	6,45	22	141,84	CHI
201911190974	CATALAO	CT10400356	CATALAO S2	18/11/2019 11:07	18/11/2019 18:46	18/11/2019 11:07	18/11/2019 18:21	7,23	1	7,23	CHI
201911190974	CUMARI	CT10400356	CATALAO S2	18/11/2019 11:07	18/11/2019 18:46	18/11/2019 11:07	18/11/2019 18:21	7,23	10	72,31	CHI

201911190974	CATALAO	CT12266679LD	CATALAO S2	18/11/2019 11:07	18/11/2019 18:46	18/11/2019 11:07	18/11/2019 18:46	7,65	11	84,14	CHI
201911190974	CUMARI	CT12266679LD	CATALAO S2	18/11/2019 11:07	18/11/2019 18:46	18/11/2019 11:07	18/11/2019 18:46	7,65	18	137,68	CHI
201911190984	ITUMBIARA	00990244	ITUMBIARA VELHA S1	18/11/2019 12:35	18/11/2019 17:32	18/11/2019 12:35	18/11/2019 14:20	1,74	2474	4293,08	CHI
201911190984	ITUMBIARA	00990244	ITUMBIARA VELHA S1	18/11/2019 12:35	18/11/2019 17:32	18/11/2019 12:35	18/11/2019 15:09	2,55	2321	5921,13	CHI
201911190984	ITUMBIARA	IT13000064	ITUMBIARA VELHA S1	18/11/2019 12:35	18/11/2019 17:32	18/11/2019 15:42	18/11/2019 15:51	0,13	557	75,04	CHI
201911190984	ITUMBIARA	00990244	ITUMBIARA VELHA S1	18/11/2019 12:35	18/11/2019 17:32	18/11/2019 12:35	18/11/2019 17:02	4,43	905	4012,92	CHI
201911190984	ITUMBIARA	00990244	ITUMBIARA VELHA S1	18/11/2019 12:35	18/11/2019 17:32	18/11/2019 12:35	18/11/2019 17:26	4,85	50	242,42	CHI
201911190984	ITUMBIARA	IT10404104	ITUMBIARA VELHA S1	18/11/2019 12:35	18/11/2019 17:32	18/11/2019 12:35	18/11/2019 17:32	4,95	632	3126,47	CHI
201911191000	RIO VERDE	BZ12211442	SANTA HELENA S1	18/11/2019 12:47	18/11/2019 19:12	18/11/2019 12:47	18/11/2019 19:12	6,41	4	25,62	CHI
201911191000	SANTO ANTONIO DA BARRA	BZ12211442	SANTA HELENA S1	18/11/2019 12:47	18/11/2019 19:12	18/11/2019 12:47	18/11/2019 19:12	6,41	19	121,70	CHI
201911191005	CORUMBA DE GOIAS	CB12284947	CORUMBA	18/11/2019 06:28	18/11/2019 14:27	18/11/2019 06:28	18/11/2019 14:27	7,98	4	31,91	CHI
201911191010	PORANGATU	PO11372631	PORANGATU	18/11/2019 06:30	18/11/2019 08:42	18/11/2019 06:30	18/11/2019 08:42	2,20	95	208,68	CHI
201911191011	CAMPINACU	UC12300538	PORANGATU	18/11/2019 06:30	18/11/2019 09:10	18/11/2019 06:30	18/11/2019 09:10	2,66	15	39,90	CHI
201911191014	BELA VISTA DE GOIAS	BV13138924	BELA VISTA S2	18/11/2019 06:06	19/11/2019 13:25	18/11/2019 06:06	18/11/2019 06:12	0,09	966	86,40	CHI
201911191014	BELA VISTA DE GOIAS	BV10400380	BELA VISTA S2	18/11/2019 06:06	19/11/2019 13:25	18/11/2019 06:06	18/11/2019 06:12	0,10	42	4,29	CHI
201911191014	SAO MIGUEL DO PASSA QUATRO	BV10400380	BELA VISTA S2	18/11/2019 06:06	19/11/2019 13:25	18/11/2019 06:06	18/11/2019 06:12	0,10	20	2,04	CHI
201911191014	SILVANIA	BV10400380	BELA VISTA S2	18/11/2019 06:06	19/11/2019 13:25	18/11/2019 06:06	18/11/2019 06:12	0,10	5	0,51	CHI
201911191014	BELA VISTA DE GOIAS	BV13138924	BELA VISTA S2	18/11/2019 06:06	19/11/2019 13:25	18/11/2019 06:06	18/11/2019 07:47	1,68	24	40,25	CHI
201911191014	BELA VISTA DE GOIAS	BV10400380	BELA VISTA S2	18/11/2019 06:06	19/11/2019 13:25	18/11/2019 08:32	18/11/2019 08:38	0,10	399	40,57	CHI
201911191014	BELA VISTA DE GOIAS	BV10400380	BELA VISTA S2	18/11/2019 06:06	19/11/2019 13:25	18/11/2019 08:32	18/11/2019 08:38	0,10	42	4,27	CHI
201911191014	CALDAZINHA	BV10400380	BELA VISTA S2	18/11/2019 06:06	19/11/2019 13:25	18/11/2019 08:32	18/11/2019 08:38	0,10	7	0,71	CHI
201911191014	SAO MIGUEL DO PASSA QUATRO	BV10400380	BELA VISTA S2	18/11/2019 06:06	19/11/2019 13:25	18/11/2019 08:32	18/11/2019 08:38	0,10	132	13,42	CHI
201911191014	SAO MIGUEL DO PASSA QUATRO	BV10400380	BELA VISTA S2	18/11/2019 06:06	19/11/2019 13:25	18/11/2019 08:32	18/11/2019 08:38	0,10	20	2,03	CHI
201911191014	SILVANIA	BV10400380	BELA VISTA S2	18/11/2019 06:06	19/11/2019 13:25	18/11/2019 08:32	18/11/2019 08:38	0,10	82	8,34	CHI
201911191014	SILVANIA	BV10400380	BELA VISTA S2	18/11/2019 06:06	19/11/2019 13:25	18/11/2019 08:32	18/11/2019 08:38	0,10	5	0,51	CHI
201911191014	BELA VISTA DE GOIAS	BV13138924	BELA VISTA S2	18/11/2019 06:06	19/11/2019 13:25	18/11/2019 06:06	18/11/2019 09:14	3,14	108	338,82	CHI
201911191014	BELA VISTA DE GOIAS	BV10401411	BELA VISTA S2	18/11/2019 06:06	19/11/2019 13:25	18/11/2019 09:11	18/11/2019 09:14	0,07	24	1,57	CHI
201911191014	BELA VISTA DE GOIAS	BV10400380	BELA VISTA S2	18/11/2019 06:06	19/11/2019 13:25	18/11/2019 08:40	18/11/2019 09:15	0,59	6	3,54	CHI
201911191014	BELA VISTA DE GOIAS	BV13138924	BELA VISTA S2	18/11/2019 06:06	19/11/2019 13:25	18/11/2019 06:06	18/11/2019 10:31	4,41	479	2112,12	CHI
201911191014	BELA VISTA DE GOIAS	BV13071540	BELA VISTA S2	18/11/2019 06:06	19/11/2019 13:25	18/11/2019 08:40	18/11/2019 10:34	1,90	23	43,66	CHI
201911191014	BELA VISTA DE GOIAS	BV13138924	BELA VISTA S2	18/11/2019 06:06	19/11/2019 13:25	18/11/2019 06:06	18/11/2019 11:58	5,87	17	99,72	CHI
201911191014	BELA VISTA DE GOIAS	BV10400380	BELA VISTA S2	18/11/2019 06:06	19/11/2019 13:25	18/11/2019 08:40	18/11/2019 12:25	3,76	399	1499,46	CHI
201911191014	BELA VISTA DE GOIAS	BV13071544	BELA VISTA S2	18/11/2019 06:06	19/11/2019 13:25	18/11/2019 08:40	18/11/2019 12:25	3,76	5	18,79	CHI

201911191014	CALDAZINHA	BV10400380	BELA VISTA S2	18/11/2019 06:06	19/11/2019 13:25	18/11/2019 08:40	18/11/2019 12:25	3,76	7	26,31	CHI
201911191014	SAO MIGUEL DO PASSA QUATRO	BV10400380	BELA VISTA S2	18/11/2019 06:06	19/11/2019 13:25	18/11/2019 08:40	18/11/2019 12:25	3,76	132	496,06	CHI
201911191014	SAO MIGUEL DO PASSA QUATRO	BV13071544	BELA VISTA S2	18/11/2019 06:06	19/11/2019 13:25	18/11/2019 08:40	18/11/2019 12:25	3,76	4	15,03	CHI
201911191014	SILVANIA	BV10400380	BELA VISTA S2	18/11/2019 06:06	19/11/2019 13:25	18/11/2019 08:40	18/11/2019 12:25	3,76	82	308,16	CHI
201911191014	SAO MIGUEL DO PASSA QUATRO	BV13378599	BELA VISTA S2	18/11/2019 06:06	19/11/2019 13:25	18/11/2019 08:40	18/11/2019 14:04	5,40	16	86,39	CHI
201911191014	SILVANIA	BV13378599	BELA VISTA S2	18/11/2019 06:06	19/11/2019 13:25	18/11/2019 08:40	18/11/2019 14:04	5,40	2	10,80	CHI
201911191014	BELA VISTA DE GOIAS	BV12126689LD	BELA VISTA S2	18/11/2019 06:06	19/11/2019 13:25	18/11/2019 08:40	18/11/2019 14:51	6,19	8	49,48	CHI
201911191014	SILVANIA	SV12358037	BELA VISTA S2	18/11/2019 06:06	19/11/2019 13:25	18/11/2019 08:40	18/11/2019 15:40	7,00	3	20,99	CHI
201911191014	BELA VISTA DE GOIAS	BV13138924	BELA VISTA S2	18/11/2019 06:06	19/11/2019 13:25	18/11/2019 06:06	19/11/2019 00:03	17,95	1	17,95	CHI
201911191014	BELA VISTA DE GOIAS	BV13138924	BELA VISTA S2	18/11/2019 06:06	19/11/2019 13:25	18/11/2019 06:06	19/11/2019 12:11	30,08	2	60,15	CHI
201911191014	BELA VISTA DE GOIAS	BV13138924	BELA VISTA S2	18/11/2019 06:06	19/11/2019 13:25	18/11/2019 06:06	19/11/2019 13:25	31,30	1	31,30	CHI
201911191018	ARENOPOLIS	AY12259445	IPORA	18/11/2019 06:32	18/11/2019 10:41	18/11/2019 06:32	18/11/2019 10:41	4,15	5	20,75	CHI
201911191018	PIRANHAS	AY12259445	IPORA	18/11/2019 06:32	18/11/2019 10:41	18/11/2019 06:32	18/11/2019 10:41	4,15	1	4,15	CHI
201911191019	GOIANESIA	GE12379116	GOIANESIA S2	18/11/2019 06:32	18/11/2019 08:22	18/11/2019 06:32	18/11/2019 08:22	1,82	99	180,26	CHI
201911191022	SAO LUIS DE MONTES BELOS	SL12259191	FIRMINOPOLIS S2	18/11/2019 06:33	18/11/2019 08:50	18/11/2019 06:33	18/11/2019 08:50	2,29	2	4,58	CHI
201911191023	JESUPOLIS	SF12066036	SAO FRANCISCO DE GOIAS	18/11/2019 06:33	18/11/2019 10:22	18/11/2019 06:33	18/11/2019 10:22	3,81	16	61,00	CHI
201911191029	PALMINOPOLIS	PP12307055	PALMEIRAS	18/11/2019 06:34	18/11/2019 11:40	18/11/2019 06:34	18/11/2019 11:40	5,11	2	10,22	CHI
201911191034	CRISTALINA	KR12290718	CRISTALINA S1	18/11/2019 06:35	18/11/2019 10:22	18/11/2019 06:35	18/11/2019 10:22	3,78	35	132,34	CHI
201911191044	NOVA CRIXAS	NA12087039	NOVA CRIXAS	18/11/2019 06:26	18/11/2019 07:30	18/11/2019 06:26	18/11/2019 07:30	1,06	4	4,22	CHI
201911191049	SIMOLANDIA	SA12221147	IACIARA S2	18/11/2019 06:38	18/11/2019 10:50	18/11/2019 06:38	18/11/2019 10:50	4,20	18	75,67	CHI
201911191051	NOVA ROMA	ND12256420	IACIARA S2	18/11/2019 06:35	18/11/2019 10:48	18/11/2019 06:35	18/11/2019 10:48	4,21	28	117,98	CHI
201911191056	PORANGATU	PO12102902	PORANGATU	18/11/2019 06:01	18/11/2019 17:15	18/11/2019 06:01	18/11/2019 16:48	10,78	1	10,78	CHI
201911191056	PORANGATU	PO12102902	PORANGATU	18/11/2019 06:01	18/11/2019 17:15	18/11/2019 15:01	18/11/2019 16:48	1,78	2	3,56	CHI
201911191056	PORANGATU	PO12088782	PORANGATU	18/11/2019 06:01	18/11/2019 17:15	18/11/2019 06:01	18/11/2019 17:15	11,23	5	56,15	CHI
201911191057	GOIANIA	16839602	CARAJAS S2	18/11/2019 06:39	18/11/2019 07:35	18/11/2019 06:39	18/11/2019 07:35	0,93	1	0,93	CHI
201911191061	JATAI	SX12205192	JATAI S1	18/11/2019 06:20	18/11/2019 16:23	18/11/2019 06:20	18/11/2019 16:23	10,04	3	30,11	CHI
201911191061	SERRANOPOLIS	SX12205192	JATAI S1	18/11/2019 06:20	18/11/2019 16:23	18/11/2019 06:20	18/11/2019 16:23	10,04	15	150,53	CHI
201911191061	SERRANOPOLIS	SX12205192	JATAI S1	18/11/2019 06:20	18/11/2019 16:23	18/11/2019 14:57	18/11/2019 16:23	1,43	3	4,30	CHI
201911191065	ARAGUAPAZ	AZ12404546	MOZARLANDIA	17/11/2019 22:18	19/11/2019 10:19	17/11/2019 22:18	19/11/2019 10:19	36,00	7	252,03	CHI
201911191076	IACIARA	1550025731	IACIARA S2	18/11/2019 06:43	18/11/2019 19:32	18/11/2019 06:43	18/11/2019 19:32	12,83	1	12,83	CHI
201911191083	HIDROLANDIA	HD12000142	CEPAIGO S2	17/11/2019 22:29	18/11/2019 22:00	17/11/2019 22:29	18/11/2019 22:00	23,50	14	329,00	CHI
201911191086	TRINDADE	10008068753	TRINDADE	18/11/2019 06:44	18/11/2019 10:55	18/11/2019 06:44	18/11/2019 10:55	4,17	1	4,17	CHI
201911191090	RIO VERDE	RV12123367	RIO VERDE S1	18/11/2019 00:15	18/11/2019 11:12	18/11/2019 00:15	18/11/2019 11:12	10,95	67	733,37	CHI

201911191092	JANDAIA	6783770	PALMEIRAS	18/11/2019 06:45	18/11/2019 11:04	18/11/2019 06:45	18/11/2019 11:04	4,31	4	17,24	CHI
201911191093	AMARALINA	MH12362454	NOVA CRIXAS	18/11/2019 04:27	18/11/2019 08:13	18/11/2019 04:27	18/11/2019 08:13	3,75	1	3,75	CHI
201911191093	MUNDO NOVO DE GOIAS	MH12362454	NOVA CRIXAS	18/11/2019 04:27	18/11/2019 08:13	18/11/2019 04:27	18/11/2019 08:13	3,75	238	893,49	CHI
201911191099	MUTUNOPOLIS	MU21000003	MARA ROSA	18/11/2019 06:47	18/11/2019 14:00	18/11/2019 06:47	18/11/2019 14:00	7,21	1	7,21	CHI
201911191101	AGUA FRIA DE GOIAS	TL12302766	SAO JOAO D ALIANCA	18/11/2019 05:49	18/11/2019 09:58	18/11/2019 05:49	18/11/2019 09:58	4,15	75	311,04	CHI
201911191101	SAO JOAO D ALIANCA	TL12302766	SAO JOAO D ALIANCA	18/11/2019 05:49	18/11/2019 09:58	18/11/2019 05:49	18/11/2019 09:58	4,15	1	4,15	CHI
201911191118	SAO MIGUEL DO ARAGUAIA	SM12358723	SAO MIGUEL DO ARAGUAIA	18/11/2019 06:51	18/11/2019 14:32	18/11/2019 06:51	18/11/2019 14:32	7,68	24	184,42	CHI
201911191126	CRISTIANOPOLIS	CF12300888	CRISTIANOPOLIS	18/11/2019 06:33	19/11/2019 19:26	18/11/2019 06:33	19/11/2019 19:26	36,89	4	147,57	CHI
201911191126	SANTA CRUZ DE GOIAS	CF12300888	CRISTIANOPOLIS	18/11/2019 06:33	19/11/2019 19:26	18/11/2019 06:33	19/11/2019 19:26	36,89	2	73,79	CHI
201911191129	IACIARA	IA12222743	IACIARA S1	18/11/2019 06:52	18/11/2019 17:11	18/11/2019 06:52	18/11/2019 11:42	4,83	1	4,83	CHI
201911191129	IACIARA	IA13222762	IACIARA S1	18/11/2019 06:52	18/11/2019 17:11	18/11/2019 06:52	18/11/2019 17:11	10,32	5	51,58	CHI
201911191131	MARA ROSA	ET12208267	MARA ROSA	18/11/2019 06:52	18/11/2019 23:28	18/11/2019 06:52	18/11/2019 23:28	16,59	1	16,59	CHI
201911191133	AMARALINA	LC11270230	SAO MIGUEL DO ARAGUAIA	18/11/2019 06:53	18/11/2019 14:34	18/11/2019 06:53	18/11/2019 14:34	7,68	1	7,68	CHI
201911191139	PORANGATU	840061080	PORANGATU	18/11/2019 06:54	18/11/2019 15:29	18/11/2019 06:54	18/11/2019 15:29	8,57	1	8,57	CHI
201911191142	MINACU	4020057668	MINACU	18/11/2019 06:55	18/11/2019 18:14	18/11/2019 06:55	18/11/2019 18:14	11,31	1	11,31	CHI
201911191144	GAMELEIRA DE GOIAS	SV12070048	DAIA S2	18/11/2019 06:46	18/11/2019 09:18	18/11/2019 06:46	18/11/2019 09:18	2,52	1	2,52	CHI
201911191144	SILVANIA	SV12070048	DAIA S2	18/11/2019 06:46	18/11/2019 09:18	18/11/2019 06:46	18/11/2019 09:18	2,52	15	37,82	CHI
201911191150	JARAGUA	70087015	JARAGUA	18/11/2019 06:56	18/11/2019 09:21	18/11/2019 06:56	18/11/2019 09:21	2,40	1	2,40	CHI
201911191156	ITAPIRAPUA	IU12030113	MATRINCHA	17/11/2019 19:28	18/11/2019 10:40	17/11/2019 19:28	18/11/2019 10:40	15,20	11	167,25	CHI
201911191161	NIQUELANDIA	NQ12374575	NIQUELANDIA SUBTRANSMISSAO	18/11/2019 06:58	18/11/2019 09:23	18/11/2019 06:58	18/11/2019 09:23	2,40	12	28,82	CHI
201911191174	PALESTINA DE GOIAS	CP21357482	PALESTINA	18/11/2019 07:00	18/11/2019 16:59	18/11/2019 07:00	18/11/2019 16:59	9,97	1	9,97	CHI
201911191178	CRIXAS	CX12297041	SERRA DO OURO	18/11/2019 07:01	18/11/2019 12:45	18/11/2019 07:01	18/11/2019 12:45	5,73	1	5,73	CHI
201911191180	GOUVELANDIA	QI12000140	QUIRINOPOLIS	18/11/2019 07:01	18/11/2019 09:51	18/11/2019 07:01	18/11/2019 09:51	2,83	12	33,97	CHI
201911191181	MORRINHOS	MR21153545	MORRINHOS	18/11/2019 07:01	18/11/2019 18:56	18/11/2019 07:01	18/11/2019 18:56	11,91	1	11,91	CHI
201911191185	ARUANA	AK12307445	MOZARLANDIA	18/11/2019 07:03	18/11/2019 12:43	18/11/2019 07:03	18/11/2019 12:43	5,66	12	67,91	CHI
201911191188	NOVO BRASIL	NB12120651LD	MATRINCHA	18/11/2019 07:04	18/11/2019 12:18	18/11/2019 07:04	18/11/2019 12:18	5,23	22	115,11	CHI
201911191196	ITAUCU	IX21110711	INHUMAS S1	18/11/2019 07:05	18/11/2019 16:12	18/11/2019 07:05	18/11/2019 16:12	9,10	1	9,10	CHI
201911191198	CAMPOS VERDES	VD12243665	SANTA TEREZINHA	18/11/2019 06:47	18/11/2019 20:42	18/11/2019 06:47	18/11/2019 20:42	13,90	9	125,11	CHI
201911191200	SANTA CRUZ DE GOIAS	PZ12356971	PIRES DO RIO S2	18/11/2019 07:06	18/11/2019 13:43	18/11/2019 07:06	18/11/2019 13:43	6,61	1	6,61	CHI
201911191201	CAMPOS BELOS	CH12384785	SAO DOMINGOS	18/11/2019 07:06	18/11/2019 22:41	18/11/2019 07:06	18/11/2019 22:41	15,57	6	93,44	CHI
201911191207	AGUA FRIA DE GOIAS	TL12330870	SAO JOAO D ALIANCA	18/11/2019 07:07	18/11/2019 19:28	18/11/2019 07:07	18/11/2019 19:28	12,34	1	12,34	CHI
201911191210	URUTAI	UT12115680	PIRES DO RIO S2	18/11/2019 06:22	18/11/2019 08:53	18/11/2019 06:22	18/11/2019 08:53	2,51	32	80,33	CHI
201911191215	PIRACANJUBA	PJ21282980	PIRACANJUBA	18/11/2019 07:08	18/11/2019 19:19	18/11/2019 07:08	18/11/2019 19:19	12,17	1	12,17	CHI

201911191220	BURITINOPOLIS	PS12189370	IACIARA S2	18/11/2019 06:14	18/11/2019 10:02	18/11/2019 06:14	18/11/2019 10:02	3,80	2	7,59	CHI
201911191220	MAMBAI	PS12189370	IACIARA S2	18/11/2019 06:14	18/11/2019 10:02	18/11/2019 06:14	18/11/2019 10:02	3,80	25	94,92	CHI
201911191220	POSSE	PS12189370	IACIARA S2	18/11/2019 06:14	18/11/2019 10:02	18/11/2019 06:14	18/11/2019 10:02	3,80	4	15,19	CHI
201911191221	SANTO ANTONIO DA BARRA	BZ12207151	ACREUNA	18/11/2019 07:09	18/11/2019 11:27	18/11/2019 07:09	18/11/2019 11:27	4,29	9	38,60	CHI
201911191222	MORRINHOS	MR12000104	MORRINHOS	18/11/2019 07:09	18/11/2019 11:31	18/11/2019 07:09	18/11/2019 11:31	4,35	18	78,36	CHI
201911191226	JATAI	JT21013900	JATAI S2	18/11/2019 07:10	18/11/2019 10:12	18/11/2019 07:10	18/11/2019 10:12	3,03	1	3,03	CHI
201911191227	BELA VISTA DE GOIAS	BV31089442	BELA VISTA S1	18/11/2019 07:10	20/11/2019 15:30	18/11/2019 07:10	20/11/2019 15:10	56,01	2	112,01	CHI
201911191227	BELA VISTA DE GOIAS	BV32089444LD	BELA VISTA S1	18/11/2019 07:10	20/11/2019 15:30	20/11/2019 11:45	20/11/2019 15:30	3,75	7	26,24	CHI
201911191228	JARAGUA	JA21298059	GOIANESIA S2	18/11/2019 07:11	18/11/2019 17:00	18/11/2019 07:11	18/11/2019 17:00	9,82	1	9,82	CHI
201911191230	ITABERAI	IB12220162	ITABERAI S1	18/11/2019 07:11	18/11/2019 08:05	18/11/2019 07:11	18/11/2019 08:05	0,89	4	3,57	CHI
201911191233	TURVELANDIA	7277178	RIO DOS BOIS	18/11/2019 07:12	19/11/2019 11:20	18/11/2019 07:12	19/11/2019 11:20	28,14	11	309,51	CHI
201911191238	SAO SIMAO	10009158969	CACHOEIRA ALTA	18/11/2019 07:12	18/11/2019 09:35	18/11/2019 07:12	18/11/2019 09:35	2,37	1	2,37	CHI
201911191239	CAIAPONIA	CP21123265	MONTIVIDIU T	18/11/2019 07:12	19/11/2019 13:54	18/11/2019 07:12	19/11/2019 13:54	30,69	1	30,69	CHI
201911191240	AMARALINA	LC12286013	NOVA CRIXAS	18/11/2019 07:12	18/11/2019 19:52	18/11/2019 07:12	18/11/2019 19:52	12,66	9	113,90	CHI
201911191240	MARA ROSA	LC12286013	NOVA CRIXAS	18/11/2019 07:12	18/11/2019 19:52	18/11/2019 07:12	18/11/2019 19:52	12,66	1	12,66	CHI
201911191242	SENADOR CANEDO	SW31060142	GOIANIA LESTE S1	18/11/2019 07:12	18/11/2019 13:35	18/11/2019 07:12	18/11/2019 13:35	6,37	1	6,37	CHI
201911191243	PIRACANJUBA	CN21298732	CALDAS NOVAS S2	18/11/2019 07:12	19/11/2019 10:00	18/11/2019 07:12	19/11/2019 10:00	26,79	1	26,79	CHI
201911191248	TRINDADE	TR12052787	TRINDADE	18/11/2019 06:38	18/11/2019 10:27	18/11/2019 06:38	18/11/2019 10:27	3,82	58	221,62	CHI
201911191260	RUBIATABA	RB12161677	RUBIATABA	18/11/2019 06:10	18/11/2019 17:36	18/11/2019 06:10	18/11/2019 17:36	11,43	12	137,13	CHI
201911191262	BURITINOPOLIS	MB12361385	IACIARA S2	17/11/2019 22:23	18/11/2019 08:59	17/11/2019 22:23	18/11/2019 08:59	10,58	18	190,51	CHI
201911191263	SAO JOAO D ALIANCA	JL12335712	SAO JOAO D ALIANCA	18/11/2019 07:17	19/11/2019 12:58	18/11/2019 07:17	19/11/2019 12:58	29,68	1	29,68	CHI
201911191267	IACIARA	IA21046267	IACIARA S1	18/11/2019 07:18	18/11/2019 20:07	18/11/2019 07:18	18/11/2019 20:07	12,81	2	25,63	CHI
201911191268	MONTE ALEGRE DE GOIAS	MA21218649	SAO DOMINGOS	18/11/2019 07:18	18/11/2019 20:40	18/11/2019 07:18	18/11/2019 20:40	13,36	3	40,09	CHI
201911191269	BALIZA	BH12331510	CAIAPONIA	18/11/2019 00:01	18/11/2019 13:41	18/11/2019 00:01	18/11/2019 13:41	13,67	29	396,32	CHI
201911191272	GOIANIA	12243395	GOYA S2	18/11/2019 07:18	18/11/2019 10:29	18/11/2019 07:18	18/11/2019 10:29	3,17	1	3,17	CHI
201911191273	CATALAO	CT12376079	CATALAO S1	18/11/2019 07:18	18/11/2019 17:43	18/11/2019 07:18	18/11/2019 17:43	10,40	1	10,40	CHI
201911191276	AURILANDIA	AI21071802	FIRMINOPOLIS S2	18/11/2019 07:19	18/11/2019 14:29	18/11/2019 07:19	18/11/2019 14:29	7,18	1	7,18	CHI
201911191282	PORANGATU	PO12141124	NOVO PLANALTO	18/11/2019 05:21	18/11/2019 21:57	18/11/2019 05:21	18/11/2019 21:57	16,60	20	331,97	CHI
201911191293	PALMEIRAS DE GOIAS	PL21206393	PALMEIRAS	18/11/2019 07:21	18/11/2019 09:00	18/11/2019 07:21	18/11/2019 09:00	1,65	2	3,30	CHI
201911191297	MORRINHOS	MR32076974	MORRINHOS	18/11/2019 01:34	18/11/2019 12:00	18/11/2019 01:34	18/11/2019 12:00	10,43	9	93,87	CHI
201911191302	RIO QUENTE	RQ21310348	VILA CORUMBA	18/11/2019 07:23	20/11/2019 09:14	18/11/2019 07:23	20/11/2019 09:14	49,84	1	49,84	CHI
201911191305	PIRES DO RIO	460020055	PIRES DO RIO S1	18/11/2019 07:23	18/11/2019 18:12	18/11/2019 07:23	18/11/2019 18:12	10,81	1	10,81	CHI
201911191307	GOIATUBA	GT21372739	GOIATUBA S2	18/11/2019 07:24	20/11/2019 13:15	18/11/2019 07:24	20/11/2019 13:15	53,86	2	107,72	CHI

201911191318	RIO VERDE	RV12240539	MONTIVIDIU T	18/11/2019 01:09	19/11/2019 00:04	18/11/2019 01:09	19/11/2019 00:04	22,93	2	45,86	CHI
201911191319	CAMPOS BELOS	MA12209854	SAO DOMINGOS	18/11/2019 06:52	18/11/2019 11:14	18/11/2019 06:52	18/11/2019 11:14	4,37	4	17,47	CHI
201911191319	MONTE ALEGRE DE GOIAS	MA12209854	SAO DOMINGOS	18/11/2019 06:52	18/11/2019 11:14	18/11/2019 06:52	18/11/2019 11:14	4,37	18	78,60	CHI
201911191322	GOIANIA	GN21212388	GOIANIA LESTE S3	18/11/2019 07:26	18/11/2019 09:00	18/11/2019 07:26	18/11/2019 09:00	1,55	1	1,55	CHI
201911191344	GOIANIA	10460895	AEROPORTO S1	18/11/2019 07:28	18/11/2019 09:40	18/11/2019 07:28	18/11/2019 09:40	2,19	1	2,19	CHI
201911191350	PLANALTINA	PI12063560	PLANALTINA	18/11/2019 07:29	18/11/2019 08:49	18/11/2019 07:29	18/11/2019 08:49	1,32	9	11,88	CHI
201911191354	ARAGUAPAZ	AZ12188011	MOZARLANDIA	18/11/2019 16:35	18/11/2019 18:43	18/11/2019 16:35	18/11/2019 18:43	2,12	8	16,95	CHI
201911191354	MOZARLANDIA	AZ12188011	MOZARLANDIA	18/11/2019 16:35	18/11/2019 18:43	18/11/2019 16:35	18/11/2019 18:43	2,12	2	4,24	CHI
201911191366	NIQUELANDIA	NQ12392024	URUACU	18/11/2019 05:34	18/11/2019 09:11	18/11/2019 05:34	18/11/2019 09:11	3,61	28	101,14	CHI
201911191371	SAO MIGUEL DO PASSA QUATRO	SQ12231522	CRISTIANOPOLIS	18/11/2019 07:05	18/11/2019 10:42	18/11/2019 07:05	18/11/2019 10:42	3,62	12	43,38	CHI
201911191371	VIANOPOLIS	SQ12231522	CRISTIANOPOLIS	18/11/2019 07:05	18/11/2019 10:42	18/11/2019 07:05	18/11/2019 10:42	3,62	18	65,07	CHI
201911191372	CAMPINORTE	CR12282384	MARA ROSA	18/11/2019 07:33	18/11/2019 15:14	18/11/2019 07:33	18/11/2019 15:14	7,68	1	7,68	CHI
201911191372	URUACU	CR12282384	MARA ROSA	18/11/2019 07:33	18/11/2019 15:14	18/11/2019 07:33	18/11/2019 15:14	7,68	3	23,04	CHI
201911191386	ORIZONA	OZ12079953	VIANOPOLIS	18/11/2019 07:08	18/11/2019 17:27	18/11/2019 07:08	18/11/2019 17:27	10,31	4	41,24	CHI
201911191386	VIANOPOLIS	OZ12079953	VIANOPOLIS	18/11/2019 07:08	18/11/2019 17:27	18/11/2019 07:08	18/11/2019 17:27	10,31	12	123,73	CHI
201911191389	PALMEIRAS DE GOIAS	PL12000070	PALMEIRAS	18/11/2019 07:33	18/11/2019 10:55	18/11/2019 07:33	18/11/2019 10:55	3,35	19	63,70	CHI
201911191393	MOZARLANDIA	MZ21063725	MOZARLANDIA	18/11/2019 07:34	19/11/2019 17:00	18/11/2019 07:34	19/11/2019 17:00	33,44	1	33,44	CHI
201911191394	SAO MIGUEL DO ARAGUAIA	SM21147664	SAO MIGUEL DO ARAGUAIA	18/11/2019 07:34	18/11/2019 08:32	18/11/2019 07:34	18/11/2019 08:32	0,96	1	0,96	CHI
201911191397	MONTES CLAROS DE GOIAS	ME12204921	IPORA	18/11/2019 07:34	19/11/2019 11:41	18/11/2019 07:34	19/11/2019 11:41	28,11	47	1321,38	CHI
201911191406	LUZIANIA	LZ12162291	CRISTALINA S1	18/11/2019 07:36	18/11/2019 11:45	18/11/2019 07:36	18/11/2019 11:45	4,15	15	62,22	CHI
201911191407	ITABERAI	IB21188717	INHUMAS S1	18/11/2019 07:36	18/11/2019 19:10	18/11/2019 07:36	18/11/2019 19:10	11,58	1	11,58	CHI
201911191412	TRES RANCHOS	TH21161400	CATALAO S1	18/11/2019 07:36	18/11/2019 11:40	18/11/2019 07:36	18/11/2019 11:40	4,07	1	4,07	CHI
201911191418	CIDADE OCIDENTAL	LZ21000416	MARAJOARA	18/11/2019 07:37	18/11/2019 18:41	18/11/2019 07:37	18/11/2019 18:41	11,07	2	22,13	CHI
201911191423	VALPARAISO DE GOIAS	2860184886	MARAJOARA	18/11/2019 07:38	18/11/2019 19:46	18/11/2019 07:38	18/11/2019 19:46	12,12	1	12,12	CHI
201911191425	PLANALTINA	PI12355794	PLANALTINA	18/11/2019 07:25	19/11/2019 15:26	18/11/2019 07:25	19/11/2019 15:26	32,02	13	416,23	CHI
201911191431	CAMPOS VERDES	VD12257334	SANTA TEREZINHA	18/11/2019 07:39	18/11/2019 17:32	18/11/2019 07:39	18/11/2019 17:32	9,88	6	59,26	CHI
201911191432	SAO FRANCISCO DE GOIAS	SF21021091	SAO FRANCISCO DE GOIAS	18/11/2019 07:39	18/11/2019 11:00	18/11/2019 07:39	18/11/2019 11:00	3,34	2	6,69	CHI
201911191436	CAIAPONIA	CP12242698	CAIAPONIA	18/11/2019 07:40	18/11/2019 11:22	18/11/2019 07:40	18/11/2019 11:22	3,70	9	33,26	CHI
201911191441	TRINDADE	12296454	GOYA S2	18/11/2019 07:40	18/11/2019 11:30	18/11/2019 07:40	18/11/2019 11:30	3,82	1	3,82	CHI
201911191446	ITAGUARI	IC21250501	ITABERAI S1	18/11/2019 07:41	19/11/2019 11:47	18/11/2019 07:41	19/11/2019 11:47	28,10	1	28,10	CHI
201911191452	JAUPACI	JP21229141	IPORA	18/11/2019 07:42	18/11/2019 09:39	18/11/2019 07:42	18/11/2019 09:39	1,95	1	1,95	CHI
201911191463	PIRACANJUBA	MR21122136	MORRINHOS	18/11/2019 07:43	18/11/2019 19:50	18/11/2019 07:43	18/11/2019 19:50	12,11	1	12,11	CHI
201911191470	RIO VERDE	RV12306603	RIO VERDE S2	18/11/2019 07:45	18/11/2019 11:25	18/11/2019 07:45	18/11/2019 11:25	3,66	3	10,99	CHI

201911191471	CORUMBA DE GOIAS	260032724	CORUMBA	18/11/2019 07:45	18/11/2019 16:09	18/11/2019 07:45	18/11/2019 16:09	8,39	1	8,39	CHI
201911191473	GOIANIA	10000012902	GOYA S1	18/11/2019 07:45	18/11/2019 09:22	18/11/2019 07:45	18/11/2019 09:22	1,61	1	1,61	CHI
201911191474	CRIXAS	CX21102890	SERRA DO OURO	18/11/2019 07:45	18/11/2019 10:25	18/11/2019 07:45	18/11/2019 10:25	2,65	1	2,65	CHI
201911191481	PORANGATU	PO12377623	PORANGATU	18/11/2019 07:36	18/11/2019 08:55	18/11/2019 07:36	18/11/2019 08:55	1,31	3	3,93	CHI
201911191482	ANAPOLIS	AN12326412	ANAPOLIS UNIVERSITARIO S1	18/11/2019 07:47	18/11/2019 11:08	18/11/2019 07:47	18/11/2019 11:08	3,34	210	701,17	CHI
201911191483	CIDADE OCIDENTAL	LZ21070089	MARAJOARA	18/11/2019 08:48	18/11/2019 20:00	18/11/2019 08:48	18/11/2019 20:00	11,19	1	11,19	CHI
201911191484	MORRINHOS	MR12041895	MORRINHOS	18/11/2019 05:49	18/11/2019 11:36	18/11/2019 05:49	18/11/2019 11:36	5,78	18	103,96	CHI
201911191489	INDIARA	IY12205923	EDEIA	18/11/2019 05:31	18/11/2019 10:17	18/11/2019 05:31	18/11/2019 10:17	4,75	32	152,09	CHI
201911191489	PALMEIRAS DE GOIAS	IY12205923	EDEIA	18/11/2019 05:31	18/11/2019 10:17	18/11/2019 05:31	18/11/2019 10:17	4,75	5	23,76	CHI
201911191491	ORIZONA	OZ21199897	PIRES DO RIO S2	18/11/2019 07:48	18/11/2019 09:32	18/11/2019 07:48	18/11/2019 09:32	1,74	1	1,74	CHI
201911191492	IVOLANDIA	PU12090442	MONTIVIDIU T	18/11/2019 07:48	18/11/2019 17:49	18/11/2019 07:48	18/11/2019 17:49	10,01	22	220,13	CHI
201911191492	PARAUNA	PU12090442	MONTIVIDIU T	18/11/2019 07:48	18/11/2019 17:49	18/11/2019 07:48	18/11/2019 17:49	10,01	48	480,29	CHI
201911191497	BARRO ALTO	10030385170	BARRO ALTO	18/11/2019 07:49	19/11/2019 11:17	18/11/2019 07:49	19/11/2019 11:17	27,46	1	27,46	CHI
201911191501	LUZIANIA	3200034346	MARAJOARA	18/11/2019 07:50	18/11/2019 16:27	18/11/2019 07:50	18/11/2019 16:27	8,62	1	8,62	CHI
201911191502	CRISTALINA	KR11184834	CRISTALINA S1	18/11/2019 07:50	18/11/2019 16:43	18/11/2019 07:50	18/11/2019 16:43	8,88	1	8,88	CHI
201911191503	NIQUELANDIA	NQ21232530	URUACU	18/11/2019 07:50	18/11/2019 12:23	18/11/2019 07:50	18/11/2019 12:23	4,55	1	4,55	CHI
201911191504	NOVA VENEZA	300014960	INHUMAS S1	18/11/2019 07:50	18/11/2019 09:20	18/11/2019 07:50	18/11/2019 09:20	1,51	1	1,51	CHI
201911191507	EDEALINA	ED12007679	PONTALINA	18/11/2019 07:14	19/11/2019 07:58	18/11/2019 07:14	19/11/2019 07:58	24,73	16	395,72	CHI
201911191513	RIO VERDE	RV12091961	SANTA HELENA S1	18/11/2019 07:51	19/11/2019 14:30	18/11/2019 07:51	19/11/2019 14:30	30,65	3	91,95	CHI
201911191515	FAZENDA NOVA	FN11242287	IPORA	18/11/2019 07:51	20/11/2019 11:21	18/11/2019 07:51	20/11/2019 11:21	51,49	1	51,49	CHI
201911191516	JATAI	JT12008872	JATAI S1	18/11/2019 07:51	18/11/2019 11:15	18/11/2019 07:51	18/11/2019 11:15	3,39	10	33,93	CHI
201911191525	CRISTALINA	KR12389576	CRISTALINA S2	18/11/2019 07:18	19/11/2019 22:02	18/11/2019 07:18	18/11/2019 18:10	10,88	4	43,52	CHI
201911191525	CRISTALINA	KR12389576	CRISTALINA S2	18/11/2019 07:18	19/11/2019 22:02	18/11/2019 16:07	18/11/2019 18:10	2,05	12	24,65	CHI
201911191525	CRISTALINA	KR12389576	CRISTALINA S2	18/11/2019 07:18	19/11/2019 22:02	18/11/2019 07:18	18/11/2019 22:29	15,19	3	45,58	CHI
201911191525	CRISTALINA	KR13320215	CRISTALINA S2	18/11/2019 07:18	19/11/2019 22:02	18/11/2019 16:07	18/11/2019 22:29	6,37	9	57,32	CHI
201911191525	CRISTALINA	KR12261084	CRISTALINA S2	18/11/2019 07:18	19/11/2019 22:02	18/11/2019 16:07	19/11/2019 17:42	25,58	2	51,15	CHI
201911191525	CRISTALINA	KR12261084	CRISTALINA S2	18/11/2019 07:18	19/11/2019 22:02	18/11/2019 16:07	19/11/2019 22:02	29,91	1	29,91	CHI
201911191542	APORE	AE12000045	ITAJA S1	18/11/2019 06:37	18/11/2019 08:47	18/11/2019 06:37	18/11/2019 08:47	2,16	2	4,32	CHI
201911191542	DISTRITO FEDERAL	AE12000045	ITAJA S1	18/11/2019 06:37	18/11/2019 08:47	18/11/2019 06:37	18/11/2019 08:47	2,16	1	2,16	CHI
201911191542	JATAI	AE12000045	ITAJA S1	18/11/2019 06:37	18/11/2019 08:47	18/11/2019 06:37	18/11/2019 08:47	2,16	1	2,16	CHI
201911191543	ARAGUAPAZ	FC12158868	GOIAS	18/11/2019 07:21	18/11/2019 22:06	18/11/2019 07:21	18/11/2019 16:34	9,21	16	147,39	CHI
201911191543	FAINA	FC12158868	GOIAS	18/11/2019 07:21	18/11/2019 22:06	18/11/2019 07:21	18/11/2019 16:34	9,21	12	110,54	CHI
201911191543	ARAGUAPAZ	AZ12299824LD	GOIAS	18/11/2019 07:21	18/11/2019 22:06	18/11/2019 07:21	18/11/2019 22:06	14,76	26	383,63	CHI

201911191543	FAINA	AZ12299824LD	GOIAS	18/11/2019 07:21	18/11/2019 22:06	18/11/2019 07:21	18/11/2019 22:06	14,76	4	59,02	CHI
201911191544	JARAGUA	JA21000006	JARAGUA	18/11/2019 07:54	18/11/2019 11:49	18/11/2019 07:54	18/11/2019 11:49	3,91	1	3,91	CHI
201911191549	ACREUNA	EU12301163	ACREUNA	18/11/2019 07:54	18/11/2019 15:32	18/11/2019 07:54	18/11/2019 15:32	7,63	1	7,63	CHI
201911191552	MAIRIPOTABA	MI12000231	PONTALINA	18/11/2019 05:28	19/11/2019 11:47	18/11/2019 05:28	19/11/2019 11:47	30,31	1	30,31	CHI
201911191552	PROFESSOR JAMIL SAFADY	MI12000231	PONTALINA	18/11/2019 05:28	19/11/2019 11:47	18/11/2019 05:28	19/11/2019 11:47	30,31	13	393,97	CHI
201911191554	SANTA RITA DO ARAGUAIA	2130010319	SANTA RITA DO ARAGUAIA	18/11/2019 07:55	18/11/2019 09:21	18/11/2019 07:55	18/11/2019 09:21	1,43	1	1,43	CHI
201911191562	APARECIDA DE GOIANIA	200304914	INDEPENDENCIA S2	18/11/2019 07:57	18/11/2019 19:44	18/11/2019 07:57	18/11/2019 19:44	11,78	1	11,78	CHI
201911191564	SANTO ANTONIO DE GOIAS	GR31018510	NEROPOLIS S1	18/11/2019 07:57	18/11/2019 11:10	18/11/2019 07:57	18/11/2019 11:10	3,21	1	3,21	CHI
201911191566	DIVINOPOLIS DE GOIAS	MA12398387	SAO DOMINGOS	18/11/2019 06:26	18/11/2019 15:53	18/11/2019 06:26	18/11/2019 15:53	9,45	3	28,35	CHI
201911191566	MONTE ALEGRE DE GOIAS	MA12398387	SAO DOMINGOS	18/11/2019 06:26	18/11/2019 15:53	18/11/2019 06:26	18/11/2019 15:53	9,45	16	151,17	CHI
201911191568	JATAI	290085410	JATAI S3	18/11/2019 07:57	18/11/2019 12:44	18/11/2019 07:57	18/11/2019 12:44	4,77	1	4,77	CHI
201911191569	QUIRINOPOLIS	QI21246863	QUIRINOPOLIS	18/11/2019 07:57	18/11/2019 09:40	18/11/2019 07:57	18/11/2019 09:40	1,71	1	1,71	CHI
201911191570	SAO MIGUEL DO ARAGUAIA	SM21147663	SAO MIGUEL DO ARAGUAIA	18/11/2019 07:57	18/11/2019 09:11	18/11/2019 07:57	18/11/2019 09:11	1,22	1	1,22	CHI
201911191577	PORANGATU	PO12292385	PORANGATU	18/11/2019 07:58	18/11/2019 11:12	18/11/2019 07:58	18/11/2019 11:12	3,22	1	3,22	CHI
201911191588	ITAPURANGA	IK11051545	ITAPURANGA	18/11/2019 07:27	18/11/2019 12:12	18/11/2019 07:27	18/11/2019 12:12	4,75	41	194,72	CHI
201911191590	POSSE	PS12232199	IACIARA S2	18/11/2019 07:59	18/11/2019 19:34	18/11/2019 07:59	18/11/2019 19:34	11,57	1	11,57	CHI
201911191591	CACHOEIRA ALTA	CA21074166	CACHOEIRA ALTA	18/11/2019 08:00	18/11/2019 09:11	18/11/2019 08:00	18/11/2019 09:11	1,18	1	1,18	CHI
201911191598	NIQUELANDIA	NQ21134931	NIQUELANDIA SUBTRANSMISSAO	18/11/2019 08:00	18/11/2019 22:46	18/11/2019 08:00	18/11/2019 22:46	14,75	1	14,75	CHI
201911191606	MINEIROS	1390176700	PARQUE DAS EMAS	18/11/2019 08:02	18/11/2019 11:18	18/11/2019 08:02	18/11/2019 11:18	3,27	1	3,27	CHI
201911191610	CRISTALINA	KR12276471	CRISTALINA S2	18/11/2019 07:59	18/11/2019 15:46	18/11/2019 07:59	18/11/2019 15:46	7,77	11	85,47	CHI
201911191612	CRIXAS	CX11398106	SERRA DO OURO	18/11/2019 08:02	18/11/2019 20:57	18/11/2019 08:02	18/11/2019 20:57	12,90	1	12,90	CHI
201911191617	LUZIANIA	LZ11000105	RIO VERMELHO	18/11/2019 08:03	18/11/2019 09:09	18/11/2019 08:03	18/11/2019 09:09	1,09	242	263,65	CHI
201911191618	SANTA HELENA DE GOIAS	SH12301344	IPEGUARI	18/11/2019 08:03	18/11/2019 14:06	18/11/2019 08:03	18/11/2019 14:06	6,04	4	24,15	CHI
201911191618	TURVELANDIA	SH12301344	IPEGUARI	18/11/2019 08:03	18/11/2019 14:06	18/11/2019 08:03	18/11/2019 14:06	6,04	3	18,11	CHI
201911191625	CATALAO	CT11149143	CATALAO S2	19/11/2019 14:48	19/11/2019 15:41	19/11/2019 14:48	19/11/2019 15:41	0,88	158	139,57	CHI
201911191801	ANAPOLIS	AN12258131	ANAPOLIS UNIVERSITARIO S2	18/11/2019 07:39	18/11/2019 10:14	18/11/2019 07:39	18/11/2019 10:14	2,57	16	41,12	CHI
201911191807	GOIANIA	GN21340524	AEROPORTO S2	18/11/2019 08:06	18/11/2019 20:41	18/11/2019 08:06	18/11/2019 20:41	12,58	1	12,58	CHI
201911191808	CRISTALINA	03460414	PAMPLONA	18/11/2019 07:56	18/11/2019 10:23	18/11/2019 07:56	18/11/2019 07:59	0,05	94	4,70	CHI
201911191808	LUZIANIA	03460414	PAMPLONA	18/11/2019 07:56	18/11/2019 10:23	18/11/2019 07:56	18/11/2019 07:59	0,05	76	3,80	CHI
201911191808	CRISTALINA	03460414	PAMPLONA	18/11/2019 07:56	18/11/2019 10:23	18/11/2019 08:01	18/11/2019 10:09	2,14	48	102,57	CHI
201911191808	LUZIANIA	03460414	PAMPLONA	18/11/2019 07:56	18/11/2019 10:23	18/11/2019 08:01	18/11/2019 10:09	2,14	76	162,41	CHI
201911191808	CRISTALINA	KR1222993046LD	PAMPLONA	18/11/2019 07:56	18/11/2019 10:23	18/11/2019 08:01	18/11/2019 10:23	2,37	46	108,82	CHI
201911191812	GOIATUBA	GT12034065	BOM JESUS DE GOIAS	18/11/2019 08:06	19/11/2019 17:55	18/11/2019 08:06	19/11/2019 17:55	33,80	29	980,29	CHI

201911191815	GOIATUBA	3320000819	RIO DOS BOIS	18/11/2019 08:06	20/11/2019 11:35	18/11/2019 08:06	20/11/2019 11:35	51,47	1	51,47	CHI
201911191816	TRES RANCHOS	TH21141031	CATALAO S1	18/11/2019 08:07	18/11/2019 13:13	18/11/2019 08:07	18/11/2019 13:13	5,10	2	10,21	CHI
201911191821	RIO VERDE	RV21271328	CABRIUVA S2	18/11/2019 08:07	18/11/2019 19:07	18/11/2019 08:07	18/11/2019 19:07	11,00	1	11,00	CHI
201911191831	CABECEIRAS	CW21151429	ITUIQUIRA	18/11/2019 08:07	18/11/2019 21:00	18/11/2019 08:07	18/11/2019 21:00	12,87	1	12,87	CHI
201911191834	ITUMBIARA	IT12037085	CACHOEIRA DOURADA	17/11/2019 22:48	18/11/2019 16:30	17/11/2019 22:48	18/11/2019 16:30	17,69	12	212,29	CHI
201911191834	PANAMA	IT12037085	CACHOEIRA DOURADA	17/11/2019 22:48	18/11/2019 16:30	17/11/2019 22:48	18/11/2019 16:30	17,69	12	212,29	CHI
201911191835	PIRANHAS	PH12396109	PIRANHAS	18/11/2019 08:08	18/11/2019 17:37	18/11/2019 08:08	18/11/2019 17:37	9,48	14	132,69	CHI
201911191836	MINACU	4020055192	MINACU	18/11/2019 08:08	18/11/2019 11:05	18/11/2019 08:08	18/11/2019 11:05	2,94	1	2,94	CHI
201911191844	BELA VISTA DE GOIAS	BV21244194	BELA VISTA S1	18/11/2019 08:09	18/11/2019 22:36	18/11/2019 08:09	18/11/2019 22:36	14,45	1	14,45	CHI
201911191846	SAO SIMAO	10004468510	CACHOEIRA ALTA	18/11/2019 08:07	18/11/2019 11:49	18/11/2019 08:07	18/11/2019 11:49	3,69	1	3,69	CHI
201911191906	POSSE	PS12256208	IACIARA S2	18/11/2019 08:09	18/11/2019 12:22	18/11/2019 08:09	18/11/2019 12:22	4,21	3	12,63	CHI
201911191908	BONOPOLIS	BX21128385	SAO MIGUEL DO ARAGUAIA	18/11/2019 08:09	18/11/2019 10:32	18/11/2019 08:09	18/11/2019 10:32	2,38	1	2,38	CHI
201911191909	PONTALINA	210009524	PONTALINA	18/11/2019 08:09	18/11/2019 15:01	18/11/2019 08:09	18/11/2019 15:01	6,86	1	6,86	CHI
201911191911	DIORAMA	DI11023259	IPORA	18/11/2019 08:02	18/11/2019 09:25	18/11/2019 08:02	18/11/2019 09:25	1,37	108	148,23	CHI
201911191912	COCALZINHO DE GOIAS	ZN12297780	COCALZINHO	18/11/2019 06:04	18/11/2019 12:03	18/11/2019 06:04	18/11/2019 12:03	5,98	9	53,80	CHI
201911191917	MORRINHOS	MR21221951	MORRINHOS	18/11/2019 08:10	18/11/2019 16:15	18/11/2019 08:10	18/11/2019 16:15	8,07	1	8,07	CHI
201911191918	CATALAO	CT12266103	CATALAO S1	18/11/2019 07:19	18/11/2019 12:07	18/11/2019 07:19	18/11/2019 12:07	4,80	2	9,60	CHI
201911191918	DAVINOPOLIS	CT12266103	CATALAO S1	18/11/2019 07:19	18/11/2019 12:07	18/11/2019 07:19	18/11/2019 12:07	4,80	41	196,74	CHI
201911191918	OUVIDOR	CT12266103	CATALAO S1	18/11/2019 07:19	18/11/2019 12:07	18/11/2019 07:19	18/11/2019 12:07	4,80	5	23,99	CHI
201911191920	MARA ROSA	MQ12279137	MARA ROSA	18/11/2019 08:10	19/11/2019 07:27	18/11/2019 08:10	19/11/2019 07:27	23,27	2	46,54	CHI
201911191923	MIMOSO DE GOIAS	MJ12305276	PADRE BERNARDO	18/11/2019 08:11	18/11/2019 10:23	18/11/2019 08:11	18/11/2019 10:23	2,20	7	15,39	CHI
201911191928	INHUMAS	30080873	INHUMAS S2	18/11/2019 08:12	18/11/2019 15:49	18/11/2019 08:12	18/11/2019 15:49	7,62	1	7,62	CHI
201911191932	FAZENDA NOVA	FN12390152	IPORA	18/11/2019 08:12	18/11/2019 10:20	18/11/2019 08:12	18/11/2019 10:20	2,13	12	25,53	CHI
201911191932	ISRAELANDIA	FN12390152	IPORA	18/11/2019 08:12	18/11/2019 10:20	18/11/2019 08:12	18/11/2019 10:20	2,13	2	4,25	CHI
201911191937	SILVANIA	SV12101286	VIANOPOLIS	18/11/2019 14:32	19/11/2019 10:34	18/11/2019 14:32	19/11/2019 10:34	20,02	17	340,33	CHI
201911191940	CATALAO	CT12078234	CATALAO S2	18/11/2019 07:38	18/11/2019 10:10	18/11/2019 07:38	18/11/2019 10:10	2,52	100	251,78	CHI
201911191942	INHUMAS	IN21247246	INHUMAS S2	18/11/2019 08:13	18/11/2019 11:29	18/11/2019 08:13	18/11/2019 11:29	3,26	1	3,26	CHI
201911191945	NOVO BRASIL	NB21123871	JUSSARA	18/11/2019 08:13	18/11/2019 16:55	18/11/2019 08:13	18/11/2019 16:55	8,69	1	8,69	CHI
201911191950	RIO VERDE	630378150	CABRIUVA S1	18/11/2019 08:14	18/11/2019 12:20	18/11/2019 08:14	18/11/2019 12:20	4,11	1	4,11	CHI
201911191952	ANAPOLIS	20050896	JUNDIAI S1	18/11/2019 08:14	18/11/2019 09:45	18/11/2019 08:14	18/11/2019 09:45	1,51	1	1,51	CHI
201911191953	RIO QUENTE	RQ21316157	VILA CORUMBA	18/11/2019 08:14	19/11/2019 13:20	18/11/2019 08:14	19/11/2019 13:20	29,09	1	29,09	CHI
201911191954	ITARUMA	JT12141851	CACHOEIRA ALTA	18/11/2019 05:23	19/11/2019 09:45	18/11/2019 05:23	19/11/2019 09:45	28,36	2	56,72	CHI
201911191954	SERRANOPOLIS	JT12141851	CACHOEIRA ALTA	18/11/2019 05:23	19/11/2019 09:45	18/11/2019 05:23	19/11/2019 09:45	28,36	11	311,96	CHI

201911191957	SANTO ANTONIO DA BARRA	RV21034122	ACREUNA	18/11/2019 08:15	18/11/2019 11:30	18/11/2019 08:15	18/11/2019 11:30	3,25	1	3,25	CHI
201911191958	ALEXANIA	AX21155177	ALEXANIA	18/11/2019 08:15	19/11/2019 09:37	18/11/2019 08:15	19/11/2019 09:37	25,37	2	50,73	CHI
201911191960	CAMPOS BELOS	CH12242796	SAO DOMINGOS	18/11/2019 08:15	18/11/2019 13:40	18/11/2019 08:15	18/11/2019 13:40	5,41	9	48,73	CHI
201911191961	PLANALTINA	10017617411	PLANALTINA	18/11/2019 08:15	18/11/2019 11:11	18/11/2019 08:15	18/11/2019 11:11	2,93	1	2,93	CHI
201911191963	SITIO D ABADIA	SI21373967	IACIARA S2	18/11/2019 08:15	18/11/2019 12:11	18/11/2019 08:15	18/11/2019 12:11	3,93	1	3,93	CHI
201911191964	MAMBAI	MB11189373	IACIARA S2	18/11/2019 08:15	18/11/2019 16:29	18/11/2019 08:15	18/11/2019 16:29	8,22	2	16,45	CHI
201911191965	ORIZONA	OZ12052341	PIRES DO RIO S2	18/11/2019 08:11	18/11/2019 14:47	18/11/2019 08:11	18/11/2019 14:47	6,60	3	19,80	CHI
201911191969	CALDAZINHA	LB12056588	CEPAIGO S2	18/11/2019 08:15	18/11/2019 14:38	18/11/2019 08:15	18/11/2019 14:38	6,37	43	273,79	CHI
201911191969	SILVANIA	LB12056588	CEPAIGO S2	18/11/2019 08:15	18/11/2019 14:38	18/11/2019 08:15	18/11/2019 14:38	6,37	2	12,73	CHI
201911191971	ABADIANIA	10002469039	ANAPOLIS UNIVERSITARIO S1	18/11/2019 08:16	18/11/2019 11:22	18/11/2019 08:16	18/11/2019 11:22	3,10	1	3,10	CHI
201911191972	GOIANIA	GN11356719	AEROPORTO S2	18/11/2019 08:16	18/11/2019 12:26	18/11/2019 08:16	18/11/2019 12:26	4,16	16	66,55	CHI
201911191975	INDIARA	2710014331	EDEIA	18/11/2019 08:16	18/11/2019 09:51	18/11/2019 08:16	18/11/2019 09:51	1,59	1	1,59	CHI
201911191976	ALTO PARAISO DE GOIAS	BF21266428	FLORES DE GOIAS	18/11/2019 08:16	19/11/2019 12:17	18/11/2019 08:16	19/11/2019 12:17	28,01	1	28,01	CHI
201911191986	AGUAS LINDAS DE GOIAS	10028972714	AGUAS LINDAS DE GOIAS S1	18/11/2019 08:18	18/11/2019 10:21	18/11/2019 08:18	18/11/2019 10:21	2,04	1	2,04	CHI
201911191987	SAO JOAO DA PARAUNA	RP12391404	FIRMINOPOLIS S2	18/11/2019 08:18	18/11/2019 12:12	18/11/2019 08:18	18/11/2019 12:12	3,89	5	19,47	CHI
201911191994	JARAGUA	JA21191289	JARAGUA	18/11/2019 08:19	18/11/2019 10:29	18/11/2019 08:19	18/11/2019 10:29	2,15	1	2,15	CHI
201911192204	PORANGATU	840111034	PORANGATU	18/11/2019 08:20	18/11/2019 13:53	18/11/2019 08:20	18/11/2019 13:53	5,54	1	5,54	CHI
201911192301	BALIZA	BH12331413	CAIAPONIA	18/11/2019 08:20	18/11/2019 14:16	18/11/2019 08:20	18/11/2019 14:16	5,92	13	76,95	CHI
201911192306	RIO VERDE	RV21152724	CABRIUVA S2	18/11/2019 08:21	19/11/2019 08:43	18/11/2019 08:21	19/11/2019 08:43	24,35	1	24,35	CHI
201911192310	TRINDADE	14399192	GOYA S2	18/11/2019 08:22	18/11/2019 17:06	18/11/2019 08:22	18/11/2019 17:06	8,73	1	8,73	CHI
201911192311	ARAGOIANIA	AO32000366	GUAPO S2	18/11/2019 06:24	18/11/2019 11:13	18/11/2019 06:24	18/11/2019 11:13	4,81	3	14,43	CHI
201911192314	TRES RANCHOS	TH21266789	CATALAO S1	18/11/2019 08:22	18/11/2019 10:25	18/11/2019 08:22	18/11/2019 10:25	2,05	1	2,05	CHI
201911192315	MINACU	IH12236119	MINACU	18/11/2019 08:22	18/11/2019 10:16	18/11/2019 08:22	18/11/2019 10:16	1,89	1	1,89	CHI
201911192317	LUZIANIA	LZ21168117	CRISTALINA S2	18/11/2019 08:22	18/11/2019 13:11	18/11/2019 08:22	18/11/2019 13:11	4,80	1	4,80	CHI
201911192326	GOIAS	GS21252459	GOIAS	18/11/2019 08:23	19/11/2019 16:20	18/11/2019 08:23	19/11/2019 16:20	31,95	1	31,95	CHI
201911192327	JATAI	290176931	JATAI S2	18/11/2019 08:23	18/11/2019 11:08	18/11/2019 08:23	18/11/2019 11:08	2,75	1	2,75	CHI
201911192332	SAO JOAO D ALIANCA	JL12383340	SAO JOAO D ALIANCA	18/11/2019 06:24	18/11/2019 18:45	18/11/2019 06:24	18/11/2019 18:45	12,35	69	852,26	CHI
201911192333	FIRMINOPOLIS	FR21248930	FIRMINOPOLIS S1	18/11/2019 08:24	18/11/2019 13:33	18/11/2019 08:24	18/11/2019 13:33	5,15	1	5,15	CHI
201911192337	GOIANIA	AP12005089	REAL S2	18/11/2019 08:24	18/11/2019 08:45	18/11/2019 08:24	18/11/2019 08:45	0,34	310	105,57	CHI
201911192338	RIO VERDE	RV21076186	CABRIUVA S2	18/11/2019 08:24	20/11/2019 10:17	18/11/2019 08:24	20/11/2019 10:17	49,88	1	49,88	CHI
201911192340	CRISTALINA	120154468	PAMPLONA	18/11/2019 08:24	18/11/2019 11:45	18/11/2019 08:24	18/11/2019 11:45	3,34	1	3,34	CHI
201911192344	CIDADE OCIDENTAL	10017532467	MARAJOARA	18/11/2019 08:25	18/11/2019 09:44	18/11/2019 08:25	18/11/2019 09:44	1,31	1	1,31	CHI
201911192347	PALMEIRAS DE GOIAS	10003055564	PALMEIRAS	18/11/2019 08:25	18/11/2019 09:41	18/11/2019 08:25	18/11/2019 09:41	1,27	1	1,27	CHI

201911192350	SAO DOMINGOS	SD12317855	SAO DOMINGOS	18/11/2019 08:25	18/11/2019 12:02	18/11/2019 08:25	18/11/2019 12:02	3,60	2	7,21	CHI
201911192353	LUZIANIA	LZ21153869	MARAJOARA	18/11/2019 08:26	18/11/2019 22:23	18/11/2019 08:26	18/11/2019 22:23	13,95	2	27,90	CHI
201911192354	ITUMBIARA	IT12273819	ITUMBIARA NOVA	18/11/2019 08:26	20/11/2019 18:05	18/11/2019 08:26	19/11/2019 22:22	37,94	13	493,28	CHI
201911192354	ITUMBIARA	IT12273819	ITUMBIARA NOVA	18/11/2019 08:26	20/11/2019 18:05	19/11/2019 22:27	20/11/2019 18:05	19,64	13	255,29	CHI
201911192378	SILVANIA	SV21131992	DAIA S2	18/11/2019 08:28	19/11/2019 16:22	18/11/2019 08:28	19/11/2019 16:22	31,89	2	63,78	CHI
201911192380	SANTA RITA DO NOVO DESTINO	BA12211708	BARRO ALTO	18/11/2019 07:39	18/11/2019 14:18	18/11/2019 07:39	18/11/2019 14:18	6,65	5	33,24	CHI
201911192382	GOIANIA	13677690	FERROVIARIO S1	18/11/2019 08:29	18/11/2019 10:03	18/11/2019 08:29	18/11/2019 10:03	1,57	1	1,57	CHI
201911192383	ALTO PARAISO DE GOIAS	BF12121220	NIQUELANDIA SUBTRANSMISSAO	18/11/2019 08:29	18/11/2019 17:44	18/11/2019 08:29	18/11/2019 17:44	9,25	1	9,25	CHI
201911192387	TRINDADE	10003428450	TRINDADE	18/11/2019 08:29	18/11/2019 11:48	18/11/2019 08:29	18/11/2019 11:48	3,31	1	3,31	CHI
201911192504	PALMEIRAS DE GOIAS	PL12169788	PALMEIRAS	18/11/2019 08:30	18/11/2019 19:10	18/11/2019 08:30	18/11/2019 12:03	3,54	4	14,15	CHI
201911192504	PALMEIRAS DE GOIAS	PL12169788	PALMEIRAS	18/11/2019 08:30	18/11/2019 19:10	18/11/2019 08:30	18/11/2019 19:10	10,67	4	42,67	CHI
201911192511	GOIANIA	10190478	AEROPORTO S2	18/11/2019 08:31	18/11/2019 13:19	18/11/2019 08:31	18/11/2019 13:19	4,79	1	4,79	CHI
201911192512	BELA VISTA DE GOIAS	BV12070273	CRISTIANOPOLIS	18/11/2019 05:20	19/11/2019 10:10	18/11/2019 05:20	19/11/2019 10:10	28,84	10	288,38	CHI
201911192513	GOIANIA	10661128	AEROPORTO S2	18/11/2019 08:32	18/11/2019 11:37	18/11/2019 08:32	18/11/2019 11:37	3,07	1	3,07	CHI
201911192515	JARAGUA	JA12382495RE	JARAGUA	18/11/2019 06:58	18/11/2019 16:00	18/11/2019 06:58	18/11/2019 16:00	9,02	127	1145,82	CHI
201911192515	PIRENOPOLIS	JA12382495RE	JARAGUA	18/11/2019 06:58	18/11/2019 16:00	18/11/2019 06:58	18/11/2019 16:00	9,02	97	875,16	CHI
201911192516	INDIARA	IY21037369	EDEIA	18/11/2019 08:17	18/11/2019 11:00	18/11/2019 08:17	18/11/2019 11:00	2,71	1	2,71	CHI
201911192519	GOIANIA	17144840	CAMPINAS S1	18/11/2019 08:33	18/11/2019 10:18	18/11/2019 08:33	18/11/2019 10:18	1,75	1	1,75	CHI
201911192521	ABADIA DE GOIAS	5583721241	CARAJAS S1	18/11/2019 08:33	18/11/2019 12:01	18/11/2019 08:33	18/11/2019 12:01	3,46	1	3,46	CHI
201911192524	ALEXANIA	AX12351036	ALEXANIA	18/11/2019 08:33	19/11/2019 09:17	18/11/2019 08:33	19/11/2019 09:17	24,72	3	74,16	CHI
201911192525	SANTO ANTONIO DA BARRA	BZ21279524	ACREUNA	18/11/2019 08:33	18/11/2019 10:58	18/11/2019 08:33	18/11/2019 10:58	2,40	1	2,40	CHI
201911192528	CATALAO	10009910210	CATALAO S2	18/11/2019 08:34	18/11/2019 11:20	18/11/2019 08:34	18/11/2019 11:20	2,76	1	2,76	CHI
201911192531	CROMINIA	CQ21025265	PONTALINA	18/11/2019 08:34	19/11/2019 09:56	18/11/2019 08:34	19/11/2019 09:56	25,35	1	25,35	CHI
201911192534	APARECIDA DO RIO DOCE	7421836	CACHOEIRA ALTA	18/11/2019 07:28	18/11/2019 12:10	18/11/2019 07:28	18/11/2019 12:10	4,68	5	23,42	CHI
201911192534	JATAI	7421836	CACHOEIRA ALTA	18/11/2019 07:28	18/11/2019 12:10	18/11/2019 07:28	18/11/2019 12:10	4,68	1	4,68	CHI
201911192534	RIO VERDE	7421836	CACHOEIRA ALTA	18/11/2019 07:28	18/11/2019 12:10	18/11/2019 07:28	18/11/2019 12:10	4,68	19	89,01	CHI
201911192535	APARECIDA DE GOIANIA	AP11137110	INDEPENDENCIA S1	18/11/2019 07:53	18/11/2019 11:51	18/11/2019 07:53	18/11/2019 11:51	3,95	164	648,39	CHI
201911192536	SAO LUIS DE MONTES BELOS	SL12043779	SAO LUIZ DOS MONTES BELOS	18/11/2019 08:35	18/11/2019 09:35	18/11/2019 08:35	18/11/2019 09:35	1,00	2	2,01	CHI
201911192539	CALDAS NOVAS	CN12059865RE	VILA CORUMBA	18/11/2019 06:56	18/11/2019 11:20	18/11/2019 06:56	18/11/2019 11:20	4,39	20	87,88	CHI
201911192543	LUZIANIA	LZ12330544	MARAJOARA	18/11/2019 08:36	18/11/2019 12:37	18/11/2019 08:36	18/11/2019 12:37	4,01	8	32,05	CHI
201911192544	MOSSAMEDES	MD12277723	FIRMINOPOLIS S2	18/11/2019 08:36	18/11/2019 13:02	18/11/2019 08:36	18/11/2019 13:02	4,42	4	17,68	CHI
201911192546	IACIARA	IA11160060	IACIARA S1	18/11/2019 06:42	18/11/2019 11:22	18/11/2019 06:42	18/11/2019 11:22	4,66	139	647,89	CHI
201911192550	APARECIDA DE GOIANIA	10020643320	INDEPENDENCIA S2	18/11/2019 08:37	18/11/2019 16:49	18/11/2019 08:37	18/11/2019 16:49	8,20	1	8,20	CHI

201911192552	LUZIANIA	LZ12383014	VIANOPOLIS	18/11/2019 08:37	18/11/2019 17:49	18/11/2019 08:37	18/11/2019 17:49	9,19	50	459,62	CHI
201911192560	PADRE BERNARDO	10001657346	PADRE BERNARDO	18/11/2019 08:38	18/11/2019 13:09	18/11/2019 08:38	18/11/2019 13:09	4,51	1	4,51	CHI
201911192562	JATAI	290034164	JATAI S3	18/11/2019 08:38	18/11/2019 11:12	18/11/2019 08:38	18/11/2019 11:12	2,56	1	2,56	CHI
201911192565	PADRE BERNARDO	PB12275093	PADRE BERNARDO	18/11/2019 08:38	18/11/2019 11:47	18/11/2019 08:38	18/11/2019 11:47	3,14	7	21,95	CHI
201911192567	COCALZINHO DE GOIAS	ZN12216781	PADRE BERNARDO	18/11/2019 08:39	18/11/2019 13:14	18/11/2019 08:39	18/11/2019 13:14	4,58	11	50,40	CHI
201911192570	SITIO D ABADIA	SI12325441	IACIARA S2	18/11/2019 07:36	18/11/2019 11:15	18/11/2019 07:36	18/11/2019 11:15	3,64	4	14,56	CHI
201911192604	GOIANIA	10007568337	GOIANIA LESTE S1	18/11/2019 08:41	18/11/2019 10:41	18/11/2019 08:41	18/11/2019 10:41	1,99	1	1,99	CHI
201911192616	CORREGO DO OURO	CO21300419	SAO LUIZ DOS MONTES BELOS	18/11/2019 08:42	18/11/2019 16:56	18/11/2019 08:42	18/11/2019 16:56	8,22	1	8,22	CHI
201911192617	SANTA TEREZINHA DE GOIAS	SG12242338	SANTA TEREZINHA	18/11/2019 04:24	18/11/2019 11:17	18/11/2019 04:24	18/11/2019 11:17	6,87	13	89,32	CHI
201911192618	CALDAZINHA	BV12090617	CEPAIGO S2	18/11/2019 08:42	18/11/2019 18:16	18/11/2019 08:42	18/11/2019 18:16	9,55	1	9,55	CHI
201911192622	GOIAS	GS11162320	GOIAS	18/11/2019 08:43	19/11/2019 10:48	18/11/2019 08:43	19/11/2019 10:48	26,08	2	52,16	CHI
201911192623	GOIATUBA	GT12030782	RIO DOS BOIS	17/11/2019 21:35	18/11/2019 14:44	17/11/2019 21:35	18/11/2019 14:44	17,15	1	17,15	CHI
201911192623	GOIATUBA	GT12030782	RIO DOS BOIS	17/11/2019 21:35	18/11/2019 14:44	17/11/2019 21:35	18/11/2019 14:44	17,15	18	308,70	CHI
201911192623	PORTEIRAO	GT12030782	RIO DOS BOIS	17/11/2019 21:35	18/11/2019 14:44	17/11/2019 21:35	18/11/2019 14:44	17,15	3	51,45	CHI
201911192623	PORTEIRAO	GT12030782	RIO DOS BOIS	17/11/2019 21:35	18/11/2019 14:44	17/11/2019 21:35	18/11/2019 14:44	17,15	4	68,60	CHI
201911192624	GOIANIA	GN11001675	CAMPINAS S1	18/11/2019 08:04	18/11/2019 13:46	18/11/2019 08:04	18/11/2019 13:46	5,69	62	352,80	CHI
201911192627	MUTUNOPOLIS	MU12129783	MARA ROSA	18/11/2019 07:49	18/11/2019 11:18	18/11/2019 07:49	18/11/2019 11:18	3,48	9	31,36	CHI
201911192631	GOIATUBA	140071593	GOIATUBA S2	18/11/2019 08:42	18/11/2019 19:29	18/11/2019 08:42	18/11/2019 19:29	10,78	1	10,78	CHI
201911192632	RIO VERDE	RV21207169	CABRIUVA S2	18/11/2019 08:44	19/11/2019 12:15	18/11/2019 08:44	19/11/2019 12:15	27,51	1	27,51	CHI
201911192639	ALTO PARAISO DE GOIAS	BF21047995	FLORES DE GOIAS	18/11/2019 08:45	19/11/2019 08:51	18/11/2019 08:45	19/11/2019 08:51	24,10	2	48,20	CHI
201911192640	MAMBAI	MB11170557	IACIARA S2	18/11/2019 08:45	18/11/2019 15:21	18/11/2019 08:45	18/11/2019 15:21	6,60	2	13,19	CHI
201911192658	CALDAS NOVAS	CN12213968	CALDAS NOVAS S1	18/11/2019 07:59	18/11/2019 15:18	18/11/2019 07:59	18/11/2019 15:18	7,32	145	1060,84	CHI
201911192666	MORRINHOS	MR21089818	MORRINHOS	18/11/2019 08:48	20/11/2019 17:25	18/11/2019 08:48	20/11/2019 17:25	56,60	1	56,60	CHI
201911192676	MINACU	IH12242031	MINACU	18/11/2019 08:49	19/11/2019 08:20	18/11/2019 08:49	19/11/2019 08:20	23,51	4	94,02	CHI
201911192678	ANAPOLIS	20033278	ANAPOLIS UNIVERSITARIO S2	18/11/2019 08:49	18/11/2019 15:13	18/11/2019 08:49	18/11/2019 15:13	6,39	1	6,39	CHI
201911192680	ANICUNS	910041660	ANICUNS	18/11/2019 08:50	18/11/2019 09:58	18/11/2019 08:50	18/11/2019 09:58	1,13	1	1,13	CHI
201911192682	QUIRINOPOLIS	GB31116538	QUIRINOPOLIS	18/11/2019 08:50	18/11/2019 11:25	18/11/2019 08:50	18/11/2019 11:25	2,57	1	2,57	CHI
201911192688	EDEIA	EA12084053	EDEIA	18/11/2019 08:51	19/11/2019 19:30	18/11/2019 08:51	19/11/2019 19:30	34,66	5	173,31	CHI
201911192689	NOVA CRIXAS	9320000869	NOVA CRIXAS	18/11/2019 08:51	18/11/2019 11:25	18/11/2019 08:51	18/11/2019 11:25	2,57	1	2,57	CHI
201911192692	NOVO GAMA	2900066688	MARAJOARA	18/11/2019 08:51	18/11/2019 12:25	18/11/2019 08:51	18/11/2019 12:25	3,56	1	3,56	CHI
201911192700	CEZARINA	CZ12010861	CEZARINA	18/11/2019 08:20	18/11/2019 10:20	18/11/2019 08:20	18/11/2019 10:20	2,00	23	45,93	CHI
201911192700	PALMEIRAS DE GOIAS	CZ12010861	CEZARINA	18/11/2019 08:20	18/11/2019 10:20	18/11/2019 08:20	18/11/2019 10:20	2,00	12	23,96	CHI
201911192709	GOIANESIA	550085373	GOIANESIA S2	18/11/2019 08:53	18/11/2019 19:56	18/11/2019 08:53	18/11/2019 19:56	11,04	1	11,04	CHI

201911192715	PONTALINA	PK12047233	PONTALINA	18/11/2019 08:24	19/11/2019 12:00	18/11/2019 08:24	19/11/2019 12:00	27,58	13	358,60	CHI
201911192724	LUZIANIA	LZ12305050	CRISTALINA S2	18/11/2019 08:56	18/11/2019 16:07	18/11/2019 08:56	18/11/2019 16:07	7,18	21	150,81	CHI
201911192725	SANTO ANTONIO DO DESCOBERTO	SN10404175	ALEXANIA	18/11/2019 08:34	19/11/2019 18:16	18/11/2019 08:34	18/11/2019 13:23	4,82	25	120,55	CHI
201911192725	SANTO ANTONIO DO DESCOBERTO	SN12379435LD	ALEXANIA	18/11/2019 08:34	19/11/2019 18:16	18/11/2019 08:34	19/11/2019 18:16	33,71	10	337,13	CHI
201911192727	VILA PROPICIO	NP11327866	GOIANESIA S1	18/11/2019 08:56	19/11/2019 00:02	18/11/2019 08:56	19/11/2019 00:02	15,09	1	15,09	CHI
201911192734	SERRANOPOLIS	SX21371616	CHAPADAO DO CEU	18/11/2019 08:57	18/11/2019 12:30	18/11/2019 08:57	18/11/2019 12:30	3,55	1	3,55	CHI
201911192736	SENADOR CANEDO	10029775114	SENADOR CANEDO	18/11/2019 08:57	18/11/2019 13:42	18/11/2019 08:57	18/11/2019 13:42	4,76	1	4,76	CHI
201911192740	SAO LUIS DE MONTES BELOS	SL12098083	FIRMINOPOLIS S2	18/11/2019 08:58	18/11/2019 18:40	18/11/2019 08:58	18/11/2019 18:40	9,71	1	9,71	CHI
201911192751	GOIANIA	GN11000545	AEROPORTO S1	18/11/2019 08:46	18/11/2019 10:53	18/11/2019 08:46	18/11/2019 10:53	2,11	76	160,70	CHI
201911192758	DIORAMA	DI12056935	ARENOPOLIS	18/11/2019 09:01	18/11/2019 16:37	18/11/2019 09:01	18/11/2019 16:37	7,60	2	15,20	CHI
201911192760	FIRMINOPOLIS	FR21027834	FIRMINOPOLIS S1	18/11/2019 09:01	18/11/2019 18:33	18/11/2019 09:01	18/11/2019 18:33	9,53	2	19,05	CHI
201911192763	FORMOSA	FA31042763	ITUIQUIRA	18/11/2019 09:01	18/11/2019 10:40	18/11/2019 09:01	18/11/2019 10:40	1,64	1	1,64	CHI
201911192771	MORRINHOS	MR12121217	MORRINHOS	18/11/2019 06:26	18/11/2019 16:54	18/11/2019 06:26	18/11/2019 16:54	10,46	15	156,86	CHI
201911192772	RIO VERDE	RV12249024	SANTA HELENA S1	18/11/2019 09:02	18/11/2019 12:04	18/11/2019 09:02	18/11/2019 12:04	3,03	7	21,19	CHI
201911192776	PARAUNA	PU21350192	PARAUNA	18/11/2019 09:02	18/11/2019 19:56	18/11/2019 09:02	18/11/2019 19:56	10,89	1	10,89	CHI
201911192781	NIQUELANDIA	NQ12171829	NIQUELANDIA SUBTRANSMISSAO	18/11/2019 09:03	18/11/2019 11:30	18/11/2019 09:03	18/11/2019 11:30	2,45	308	755,28	CHI
201911192785	MINACU	IH21230343	MINACU	18/11/2019 09:03	19/11/2019 02:20	18/11/2019 09:03	19/11/2019 02:20	17,27	1	17,27	CHI
201911192792	SAO MIGUEL DO PASSA QUATRO	VN12311677	PIRES DO RIO S2	18/11/2019 08:40	18/11/2019 14:34	18/11/2019 08:40	18/11/2019 14:34	5,90	2	11,79	CHI
201911192792	VIANOPOLIS	VN12311677	PIRES DO RIO S2	18/11/2019 08:40	18/11/2019 14:34	18/11/2019 08:40	18/11/2019 14:34	5,90	8	47,18	CHI
201911192793	SILVANIA	SV21039578	VIANOPOLIS	18/11/2019 09:04	18/11/2019 11:24	18/11/2019 09:04	18/11/2019 11:24	2,33	1	2,33	CHI
201911192795	JATAI	JT10400238	JATAI S1	18/11/2019 09:04	19/11/2019 17:53	18/11/2019 15:13	18/11/2019 17:27	2,22	19	42,24	CHI
201911192795	SERRANOPOLIS	JT10400238	JATAI S1	18/11/2019 09:04	19/11/2019 17:53	18/11/2019 15:13	18/11/2019 17:27	2,22	6	13,34	CHI
201911192795	JATAI	SX10400642	JATAI S1	18/11/2019 09:04	19/11/2019 17:53	18/11/2019 17:28	18/11/2019 20:02	2,56	1	2,56	CHI
201911192795	SERRANOPOLIS	SX10400642	JATAI S1	18/11/2019 09:04	19/11/2019 17:53	18/11/2019 17:28	18/11/2019 20:02	2,56	6	15,34	CHI
201911192795	JATAI	JT12336920	JATAI S1	18/11/2019 09:04	19/11/2019 17:53	18/11/2019 09:04	18/11/2019 20:03	10,98	10	109,78	CHI
201911192795	CHAPADAO DO CEU	02430414	CHAPADAO DO CEU	18/11/2019 09:04	19/11/2019 17:53	19/11/2019 06:22	19/11/2019 06:34	0,19	11	2,11	CHI
201911192795	MINEIROS	02430414	CHAPADAO DO CEU	18/11/2019 09:04	19/11/2019 17:53	19/11/2019 06:22	19/11/2019 06:34	0,19	25	4,80	CHI
201911192795	SERRANOPOLIS	02430414	CHAPADAO DO CEU	18/11/2019 09:04	19/11/2019 17:53	19/11/2019 06:22	19/11/2019 06:34	0,19	82	15,74	CHI
201911192795	CHAPADAO DO CEU	02430414	CHAPADAO DO CEU	18/11/2019 09:04	19/11/2019 17:53	19/11/2019 13:09	19/11/2019 13:47	0,63	11	6,93	CHI
201911192795	MINEIROS	02430414	CHAPADAO DO CEU	18/11/2019 09:04	19/11/2019 17:53	19/11/2019 13:09	19/11/2019 13:47	0,63	25	15,75	CHI
201911192795	SERRANOPOLIS	02430414	CHAPADAO DO CEU	18/11/2019 09:04	19/11/2019 17:53	19/11/2019 13:09	19/11/2019 13:47	0,63	82	51,66	CHI
201911192795	JATAI	JT10400238	JATAI S1	18/11/2019 09:04	19/11/2019 17:53	18/11/2019 15:13	19/11/2019 17:15	26,02	7	182,17	CHI
201911192795	JATAI	JT10400238	JATAI S1	18/11/2019 09:04	19/11/2019 17:53	18/11/2019 17:28	19/11/2019 17:15	23,77	19	451,65	CHI

201911192795	JATAI	02430414	JATAI S1	18/11/2019 09:04	19/11/2019 17:53	19/11/2019 06:22	19/11/2019 17:15	10,88	1	10,88	CHI
201911192795	SERRANOPOLIS	02430414	JATAI S1	18/11/2019 09:04	19/11/2019 17:53	19/11/2019 06:22	19/11/2019 17:15	10,88	6	65,25	CHI
201911192795	JATAI	JT12336920	JATAI S1	18/11/2019 09:04	19/11/2019 17:53	18/11/2019 20:04	19/11/2019 17:53	21,82	10	218,22	CHI
201911192800	BARRO ALTO	BA12342218	GOIANESIA S1	18/11/2019 09:04	18/11/2019 21:22	18/11/2019 09:04	18/11/2019 21:22	12,29	3	36,88	CHI
201911192809	GOIANIA	GN11000556	AEROPORTO S1	18/11/2019 08:44	18/11/2019 14:30	18/11/2019 08:44	18/11/2019 14:30	5,76	28	161,34	CHI
201911192815	GAMELEIRA DE GOIAS	SV12056396	DAIA S2	18/11/2019 07:38	18/11/2019 23:12	18/11/2019 07:38	18/11/2019 15:59	8,34	55	458,79	CHI
201911192815	GAMELEIRA DE GOIAS	SV12056333	DAIA S2	18/11/2019 07:38	18/11/2019 23:12	18/11/2019 07:38	18/11/2019 16:31	8,88	36	319,73	CHI
201911192815	SILVANIA	SV12056333	DAIA S2	18/11/2019 07:38	18/11/2019 23:12	18/11/2019 07:38	18/11/2019 16:31	8,88	1	8,88	CHI
201911192815	GAMELEIRA DE GOIAS	SV32093678	DAIA S2	18/11/2019 07:38	18/11/2019 23:12	18/11/2019 07:38	18/11/2019 22:33	14,90	8	119,24	CHI
201911192815	GAMELEIRA DE GOIAS	SV12056396	DAIA S2	18/11/2019 07:38	18/11/2019 23:12	18/11/2019 20:19	18/11/2019 22:33	2,22	91	202,32	CHI
201911192815	SILVANIA	SV12056396	DAIA S2	18/11/2019 07:38	18/11/2019 23:12	18/11/2019 20:19	18/11/2019 22:33	2,22	1	2,22	CHI
201911192815	GAMELEIRA DE GOIAS	SV32096690	DAIA S2	18/11/2019 07:38	18/11/2019 23:12	18/11/2019 07:38	18/11/2019 23:12	15,57	3	46,70	CHI
201911192818	SAO MIGUEL DO PASSA QUATRO	SQ12088077	CRISTIANOPOLIS	18/11/2019 08:37	19/11/2019 15:58	18/11/2019 08:37	19/11/2019 13:35	28,97	17	492,57	CHI
201911192818	SAO MIGUEL DO PASSA QUATRO	SQ21133979	CRISTIANOPOLIS	18/11/2019 08:37	19/11/2019 15:58	18/11/2019 08:37	19/11/2019 15:58	31,36	1	31,36	CHI
201911192830	GOIANIA	GN21198279	AEROPORTO S2	18/11/2019 09:07	18/11/2019 10:35	18/11/2019 09:07	18/11/2019 10:35	1,46	3	4,38	CHI
201911192838	GOIANIA	10029635177	MEIA PONTE	18/11/2019 09:08	18/11/2019 11:03	18/11/2019 09:08	18/11/2019 11:03	1,91	1	1,91	CHI
201911192858	LUZIANIA	LZ12080547	CRISTALINA S2	18/11/2019 09:11	19/11/2019 00:23	18/11/2019 09:11	19/11/2019 00:23	15,20	6	91,18	CHI
201911192859	RIO VERDE	RV11000074	RIO VERDE S2	18/11/2019 09:02	18/11/2019 10:22	18/11/2019 09:02	18/11/2019 10:22	1,34	59	79,08	CHI
201911192861	BELA VISTA DE GOIAS	DE12389424	CEPAIGO S2	18/11/2019 06:04	18/11/2019 11:47	18/11/2019 06:04	18/11/2019 11:47	5,70	176	1003,79	CHI
201911192861	CALDAZINHA	DE12389424	CEPAIGO S2	18/11/2019 06:04	18/11/2019 11:47	18/11/2019 06:04	18/11/2019 11:47	5,70	66	376,42	CHI
201911192862	CAVALCANTE	CJ12346073	MINACU	18/11/2019 07:38	18/11/2019 17:47	18/11/2019 07:38	18/11/2019 17:47	10,15	88	892,78	CHI
201911192863	CALDAS NOVAS	760190586	SERRA DE CALDAS	18/11/2019 09:12	18/11/2019 11:55	18/11/2019 09:12	18/11/2019 11:55	2,71	1	2,71	CHI
201911192865	JARAGUA	JA12064321	JARAGUA	18/11/2019 08:49	18/11/2019 13:35	18/11/2019 08:49	18/11/2019 13:35	4,76	4	19,06	CHI
201911192875	SANTA RITA DO NOVO DESTINO	DF21191331	GOIANESIA S1	18/11/2019 09:15	18/11/2019 16:48	18/11/2019 09:15	18/11/2019 16:48	7,54	1	7,54	CHI
201911192885	GOIATUBA	GT12073585	GOIATUBA S2	18/11/2019 06:23	18/11/2019 10:24	18/11/2019 06:23	18/11/2019 10:24	4,01	378	1516,62	CHI
201911192888	LUZIANIA	10007495844	MARAJOARA	18/11/2019 09:17	18/11/2019 14:05	18/11/2019 09:17	18/11/2019 14:05	4,79	1	4,79	CHI
201911192890	JATAI	RV12279568	CABRIUVA S1	18/11/2019 09:17	18/11/2019 18:55	18/11/2019 09:17	18/11/2019 18:55	9,62	2	19,25	CHI
201911192890	RIO VERDE	RV12279568	CABRIUVA S1	18/11/2019 09:17	18/11/2019 18:55	18/11/2019 09:17	18/11/2019 18:55	9,62	5	48,12	CHI
201911192892	RIO VERDE	4090003340	SANTA HELENA S1	18/11/2019 09:17	19/11/2019 19:20	18/11/2019 09:17	19/11/2019 19:20	34,05	1	34,05	CHI
201911192894	SERRANOPOLIS	SX12166103	JATAI S1	18/11/2019 07:08	18/11/2019 13:29	18/11/2019 07:08	18/11/2019 13:29	6,35	5	31,75	CHI
201911192896	MONTE ALEGRE DE GOIAS	MA21282314	SAO DOMINGOS	18/11/2019 09:18	18/11/2019 19:10	18/11/2019 09:18	18/11/2019 19:10	9,86	1	9,86	CHI
201911192898	ACREUNA	SH12279542	SANTA HELENA S1	18/11/2019 08:36	18/11/2019 14:40	18/11/2019 08:36	18/11/2019 14:40	6,06	3	18,18	CHI
201911192898	SANTA HELENA DE GOIAS	SH12279542	SANTA HELENA S1	18/11/2019 08:36	18/11/2019 14:40	18/11/2019 08:36	18/11/2019 14:40	6,06	9	54,54	CHI

201911192898	SANTO ANTONIO DA BARRA	SH12279542	SANTA HELENA S1	18/11/2019 08:36	18/11/2019 14:40	18/11/2019 08:36	18/11/2019 14:40	6,06	1	6,06	CHI
201911192900	POSSE	PS11264639	IACIARA S2	18/11/2019 09:19	18/11/2019 18:28	18/11/2019 09:19	18/11/2019 18:28	9,15	5	45,75	CHI
201911192903	NOVO PLANALTO	SM12328903	SAO MIGUEL DO ARAGUAIA	18/11/2019 09:19	18/11/2019 13:21	18/11/2019 09:19	18/11/2019 13:21	4,03	10	40,28	CHI
201911192904	PALMINOPOLIS	PP12008241	PALMEIRAS	18/11/2019 07:59	18/11/2019 11:10	18/11/2019 07:59	18/11/2019 11:10	3,19	22	70,10	CHI
201911192914	CRISTALINA	KR10400358	PAMPLONA	18/11/2019 09:17	19/11/2019 13:57	18/11/2019 09:17	19/11/2019 11:41	26,40	1	26,40	CHI
201911192914	CRISTALINA	KR10400358	PAMPLONA	18/11/2019 09:17	19/11/2019 13:57	18/11/2019 09:17	19/11/2019 12:05	26,80	1	26,80	CHI
201911192914	CRISTALINA	KR10400358	PAMPLONA	18/11/2019 09:17	19/11/2019 13:57	18/11/2019 09:17	19/11/2019 12:24	27,11	47	1274,18	CHI
201911192914	DISTRITO FEDERAL	KR10400358	PAMPLONA	18/11/2019 09:17	19/11/2019 13:57	18/11/2019 09:17	19/11/2019 12:24	27,11	4	108,44	CHI
201911192914	LUZIANIA	KR10400358	PAMPLONA	18/11/2019 09:17	19/11/2019 13:57	18/11/2019 09:17	19/11/2019 12:24	27,11	2	54,22	CHI
201911192914	CRISTALINA	KR10400358	PAMPLONA	18/11/2019 09:17	19/11/2019 13:57	18/11/2019 09:17	19/11/2019 13:57	28,67	1	28,67	CHI
201911192921	INHUMAS	IN21244941	INHUMAS S1	18/11/2019 09:21	18/11/2019 22:10	18/11/2019 09:21	18/11/2019 22:10	12,81	2	25,61	CHI
201911192923	ALVORADA DO NORTE	AQ12204159	IACIARA S2	18/11/2019 08:10	18/11/2019 13:16	18/11/2019 08:10	18/11/2019 13:16	5,08	22	111,85	CHI
201911192926	GOIANAPOLIS	950009805	DAIA S2	18/11/2019 09:22	18/11/2019 17:24	18/11/2019 09:22	18/11/2019 17:24	8,03	1	8,03	CHI
201911192927	PORANGATU	PO12348863	PORANGATU	18/11/2019 09:08	18/11/2019 16:10	18/11/2019 09:08	18/11/2019 16:10	7,02	9	63,16	CHI
201911192930	MONTES CLAROS DE GOIAS	ME21193424	IPORA	18/11/2019 09:22	18/11/2019 18:20	18/11/2019 09:22	18/11/2019 18:20	8,96	2	17,91	CHI
201911192935	URUTAI	UT21187127	PIRES DO RIO S2	18/11/2019 09:23	20/11/2019 00:01	18/11/2019 09:23	20/11/2019 00:01	38,62	1	38,62	CHI
201911192936	URUTAI	UT21016974	URUTAI	18/11/2019 09:23	20/11/2019 12:38	18/11/2019 09:23	20/11/2019 12:38	51,25	1	51,25	CHI
201911192938	PORANGATU	PO12182336	PORANGATU	18/11/2019 09:24	18/11/2019 15:35	18/11/2019 09:24	18/11/2019 15:35	6,19	5	30,96	CHI
201911192941	APARECIDA DE GOIANIA	10005775319	ANHANGUERA	18/11/2019 09:24	18/11/2019 11:08	18/11/2019 09:24	18/11/2019 11:08	1,73	1	1,73	CHI
201911192942	QUIRINOPOLIS	80074169	QUIRINOPOLIS	18/11/2019 09:24	18/11/2019 12:01	18/11/2019 09:24	18/11/2019 12:01	2,61	1	2,61	CHI
201911192947	VIANOPOLIS	VN12282733	VIANOPOLIS	18/11/2019 09:10	18/11/2019 15:10	18/11/2019 09:10	18/11/2019 15:10	6,00	11	65,95	CHI
201911192953	CATALAO	CT10401403	CATALAO S1	18/11/2019 12:28	21/11/2019 16:40	18/11/2019 12:28	20/11/2019 10:59	46,52	3	139,55	CHI
201911192953	CAMPO ALEGRE DE GOIAS	CT13165178	CATALAO S1	18/11/2019 12:28	21/11/2019 16:40	18/11/2019 12:28	20/11/2019 14:11	49,71	2	99,42	CHI
201911192953	CATALAO	CT13165178	CATALAO S1	18/11/2019 12:28	21/11/2019 16:40	18/11/2019 12:28	20/11/2019 14:11	49,71	97	4822,06	CHI
201911192953	DISTRITO FEDERAL	CT13165178	CATALAO S1	18/11/2019 12:28	21/11/2019 16:40	18/11/2019 12:28	20/11/2019 14:11	49,71	1	49,71	CHI
201911192953	CAMPO ALEGRE DE GOIAS	CT10401403	CATALAO S1	18/11/2019 12:28	21/11/2019 16:40	20/11/2019 19:49	20/11/2019 19:55	0,11	2	0,22	CHI
201911192953	CATALAO	CT10401403	CATALAO S1	18/11/2019 12:28	21/11/2019 16:40	20/11/2019 19:49	20/11/2019 19:55	0,11	100	10,83	CHI
201911192953	DISTRITO FEDERAL	CT10401403	CATALAO S1	18/11/2019 12:28	21/11/2019 16:40	20/11/2019 19:49	20/11/2019 19:55	0,11	1	0,11	CHI
201911192953	CATALAO	CT12013670	CATALAO S1	18/11/2019 12:28	21/11/2019 16:40	18/11/2019 12:28	21/11/2019 16:40	76,19	5	380,97	CHI
201911192960	ISRAELANDIA	IS21086863	IPORA	18/11/2019 09:26	18/11/2019 17:16	18/11/2019 09:26	18/11/2019 17:16	7,83	2	15,65	CHI
201911192962	LUZIANIA	LZ12320184	VIANOPOLIS	18/11/2019 09:26	18/11/2019 11:40	18/11/2019 09:26	18/11/2019 11:40	2,22	4	8,87	CHI
201911192964	GOIANIA	14512580	REAL S2	18/11/2019 09:27	18/11/2019 12:29	18/11/2019 09:27	18/11/2019 12:29	3,03	1	3,03	CHI
201911192965	URUACU	UR21288348	URUACU	18/11/2019 09:27	18/11/2019 10:39	18/11/2019 09:27	18/11/2019 10:39	1,20	1	1,20	CHI

201911192967	JARAGUA	JA12234242	JARAGUA	18/11/2019 08:22	18/11/2019 10:42	18/11/2019 08:22	18/11/2019 10:42	2,33	14	32,57	CHI
201911192971	SERRANOPOLIS	SX21216600	JATAI S1	18/11/2019 09:27	18/11/2019 16:25	18/11/2019 09:27	18/11/2019 16:25	6,95	1	6,95	CHI
201911192974	GOIANESIA	GE21326315	GOIANESIA S2	18/11/2019 09:28	19/11/2019 03:31	18/11/2019 09:28	19/11/2019 03:31	18,05	1	18,05	CHI
201911192977	ORIZONA	2060010646	PIRES DO RIO S2	18/11/2019 09:29	18/11/2019 16:39	18/11/2019 09:29	18/11/2019 16:39	7,17	1	7,17	CHI
201911192979	PIRENOPOLIS	PV12273171	CORUMBA	18/11/2019 09:30	18/11/2019 11:37	18/11/2019 09:30	18/11/2019 11:37	2,11	20	42,28	CHI
201911192987	ARAGARCAS	10006604720	ARAGARCAS	18/11/2019 09:31	18/11/2019 15:26	18/11/2019 09:31	18/11/2019 15:26	5,91	1	5,91	CHI
201911192990	MINACU	IH12392287	MINACU	18/11/2019 09:32	18/11/2019 15:03	18/11/2019 09:32	18/11/2019 15:03	5,51	5	27,55	CHI
201911193001	GOIANESIA	GE21332764	GOIANESIA S2	18/11/2019 09:34	18/11/2019 15:04	18/11/2019 09:34	18/11/2019 15:04	5,49	2	10,98	CHI
201911193004	CATALAO	CT21150915	CATALAO S1	18/11/2019 09:35	20/11/2019 15:15	18/11/2019 09:35	20/11/2019 15:15	53,67	2	107,33	CHI
201911193007	CALDAS NOVAS	760161902	SERRA DE CALDAS	18/11/2019 09:35	19/11/2019 11:31	18/11/2019 09:35	19/11/2019 11:31	25,92	1	25,92	CHI
201911193009	DIORAMA	DI12024588	ARENOPOLIS	18/11/2019 09:36	18/11/2019 14:34	18/11/2019 09:36	18/11/2019 14:34	4,96	1	4,96	CHI
201911193009	IPORA	DI12024588	ARENOPOLIS	18/11/2019 09:36	18/11/2019 14:34	18/11/2019 09:36	18/11/2019 14:34	4,96	5	24,80	CHI
201911193011	PIRACANJUBA	PJ21153413	PIRACANJUBA	18/11/2019 09:36	21/11/2019 09:00	18/11/2019 09:36	21/11/2019 09:00	71,39	2	142,79	CHI
201911193012	CORUMBA DE GOIAS	CB21090368	CORUMBA	18/11/2019 09:36	18/11/2019 21:53	18/11/2019 09:36	18/11/2019 21:53	12,28	1	12,28	CHI
201911193021	GAMELEIRA DE GOIAS	SV12116679	DAIA S2	18/11/2019 09:07	18/11/2019 17:15	18/11/2019 09:07	18/11/2019 17:15	8,12	15	121,79	CHI
201911193021	SILVANIA	SV12116679	DAIA S2	18/11/2019 09:07	18/11/2019 17:15	18/11/2019 09:07	18/11/2019 17:15	8,12	5	40,60	CHI
201911193037	SANTA FE DE GOIAS	RN11102108	BRITANIA	18/11/2019 09:39	18/11/2019 18:20	18/11/2019 09:39	18/11/2019 18:20	8,69	126	1094,69	CHI
201911193044	AGUA FRIA DE GOIAS	TL21325558	SAO JOAO D ALIANCA	18/11/2019 09:40	19/11/2019 15:06	18/11/2019 09:40	19/11/2019 15:06	29,43	1	29,43	CHI
201911193047	CALDAS NOVAS	CN12363765	CALDAS NOVAS S1	18/11/2019 08:42	18/11/2019 13:39	18/11/2019 08:42	18/11/2019 13:39	4,93	18	88,80	CHI
201911193048	MUTUNOPOLIS	MU21170052	MARA ROSA	17/11/2019 20:13	18/11/2019 11:19	17/11/2019 20:13	18/11/2019 11:19	15,09	1	15,09	CHI
201911193059	VIANOPOLIS	VN12093853	VIANOPOLIS	18/11/2019 09:41	19/11/2019 14:52	18/11/2019 09:41	19/11/2019 14:52	29,17	8	233,36	CHI
201911193060	SILVANIA	SV21017148	DAIA S2	18/11/2019 09:41	19/11/2019 03:11	18/11/2019 09:41	19/11/2019 03:11	17,48	1	17,48	CHI
201911193066	MAURILANDIA	10007836277	RIO DOS BOIS	18/11/2019 09:43	19/11/2019 11:46	18/11/2019 09:43	19/11/2019 11:46	26,05	1	26,05	CHI
201911193067	IACIARA	IA21195751	IACIARA S1	18/11/2019 09:43	18/11/2019 17:15	18/11/2019 09:43	18/11/2019 17:15	7,53	1	7,53	CHI
201911193070	QUIRINOPOLIS	QI12327522	QUIRINOPOLIS	17/11/2019 22:10	18/11/2019 14:13	17/11/2019 22:10	18/11/2019 14:13	16,05	1	16,05	CHI
201911193084	LEOPOLDO DE BULHOES	LB21322366	DAIA S2	18/11/2019 09:46	19/11/2019 09:50	18/11/2019 09:46	19/11/2019 09:50	24,06	1	24,06	CHI
201911193102	TERESINA DE GOIAS	2650000837	FLORES DE GOIAS	18/11/2019 09:47	19/11/2019 13:57	18/11/2019 09:47	19/11/2019 13:57	28,16	1	28,16	CHI
201911193104	ITAUCU	IX21110695	INHUMAS S1	18/11/2019 09:47	18/11/2019 17:52	18/11/2019 09:47	18/11/2019 17:52	8,07	2	16,14	CHI
201911193106	LUZIANIA	LZ12237853	CRISTALINA S2	18/11/2019 09:48	18/11/2019 16:45	18/11/2019 09:48	18/11/2019 16:45	6,95	1	6,95	CHI
201911193109	MINACU	IH12386704	MINACU	18/11/2019 09:48	18/11/2019 12:51	18/11/2019 09:48	18/11/2019 12:51	3,04	2	6,07	CHI
201911193111	CALDAS NOVAS	760130838	SERRA DE CALDAS	18/11/2019 09:48	18/11/2019 20:38	18/11/2019 09:48	18/11/2019 20:38	10,82	1	10,82	CHI
201911193112	SERRANOPOLIS	SX12216620	JATAI S1	18/11/2019 07:36	18/11/2019 12:02	18/11/2019 07:36	18/11/2019 12:02	4,43	5	22,15	CHI
201911193115	JOVIANIA	JV12263662	GOIATUBA S1	18/11/2019 09:49	18/11/2019 19:16	18/11/2019 09:49	18/11/2019 19:16	9,46	4	37,85	CHI

201911193120	GOIANIA	15200991	GOIANIA LESTE S1	18/11/2019 09:49	18/11/2019 13:51	18/11/2019 09:49	18/11/2019 13:51	4,02	1	4,02	CHI
201911193121	PIRACANJUBA	PJ12293350	BELA VISTA S1	18/11/2019 09:49	18/11/2019 18:37	18/11/2019 09:49	18/11/2019 18:37	8,80	12	105,54	CHI
201911193126	PARAUNA	PU12301178	ACREUNA	18/11/2019 09:50	18/11/2019 21:02	18/11/2019 09:50	18/11/2019 21:02	11,20	8	89,64	CHI
201911193127	GOIAS	GS11162355	GOIAS	18/11/2019 09:50	19/11/2019 10:12	18/11/2019 09:50	19/11/2019 10:12	24,36	2	48,72	CHI
201911193133	SAO JOAO D ALIANCA	JL12404385	SAO JOAO D ALIANCA	18/11/2019 09:34	18/11/2019 21:02	18/11/2019 09:34	18/11/2019 21:02	11,46	55	630,28	CHI
201911193134	PARAUNA	PU12205936	PARAUNA	18/11/2019 09:50	18/11/2019 14:05	18/11/2019 09:50	18/11/2019 14:05	4,25	5	21,23	CHI
201911193135	APARECIDA DE GOIANIA	15007285	INDEPENDENCIA S2	18/11/2019 09:52	18/11/2019 16:22	18/11/2019 09:52	18/11/2019 16:22	6,49	1	6,49	CHI
201911193142	NOVA VENEZA	NV21091698	INHUMAS S1	18/11/2019 09:52	18/11/2019 12:07	18/11/2019 09:52	18/11/2019 12:07	2,23	1	2,23	CHI
201911193147	PIRES DO RIO	460059518	PIRES DO RIO S1	18/11/2019 09:54	18/11/2019 15:31	18/11/2019 09:54	18/11/2019 15:31	5,62	1	5,62	CHI
201911193149	LUZIANIA	LZ12390016	MARAJOARA	18/11/2019 09:54	18/11/2019 13:05	18/11/2019 09:54	18/11/2019 13:05	3,17	115	364,81	CHI
201911193150	GOIATUBA	140049526	GOIATUBA S2	18/11/2019 09:54	18/11/2019 20:49	18/11/2019 09:54	18/11/2019 20:49	10,90	1	10,90	CHI
201911193159	GOIANIA	AP12005089	REAL S2	18/11/2019 08:15	18/11/2019 16:30	18/11/2019 11:00	18/11/2019 11:30	0,49	310	152,93	CHI
201911193159	GOIANIA	GN11356928	REAL S2	18/11/2019 08:15	18/11/2019 16:30	18/11/2019 08:15	18/11/2019 16:30	8,24	75	617,96	CHI
201911193162	ITABERAI	750002517	ARACU	18/11/2019 09:56	20/11/2019 14:00	18/11/2019 09:56	20/11/2019 14:00	52,07	1	52,07	CHI
201911193164	BELA VISTA DE GOIAS	BV12000023LD	BELA VISTA S1	18/11/2019 09:14	18/11/2019 19:55	18/11/2019 09:14	18/11/2019 19:55	10,67	148	1579,04	CHI
201911193164	HIDROLANDIA	BV12000023LD	BELA VISTA S1	18/11/2019 09:14	18/11/2019 19:55	18/11/2019 09:14	18/11/2019 19:55	10,67	1	10,67	CHI
201911193164	PIRACANJUBA	BV12000023LD	BELA VISTA S1	18/11/2019 09:14	18/11/2019 19:55	18/11/2019 09:14	18/11/2019 19:55	10,67	38	405,43	CHI
201911193164	BELA VISTA DE GOIAS	BV12000023LD	BELA VISTA S1	18/11/2019 09:14	18/11/2019 19:55	18/11/2019 15:02	18/11/2019 19:55	4,89	44	214,95	CHI
201911193165	MORRINHOS	MR21098638	MORRINHOS	18/11/2019 09:56	18/11/2019 14:26	18/11/2019 09:56	18/11/2019 14:26	4,48	1	4,48	CHI
201911193167	PIRES DO RIO	PR11064844	PIRES DO RIO S1	18/11/2019 08:21	18/11/2019 12:41	18/11/2019 08:21	18/11/2019 12:41	4,32	134	578,51	CHI
201911193207	MINACU	IH12341446	MINACU	18/11/2019 08:34	18/11/2019 12:00	18/11/2019 08:34	18/11/2019 12:00	3,43	35	119,94	CHI
201911193215	JARAGUA	70129563	JARAGUA	18/11/2019 10:00	18/11/2019 11:35	18/11/2019 10:00	18/11/2019 11:35	1,58	1	1,58	CHI
201911193224	GOIANIA	10022759610	AEROPORTO S1	18/11/2019 10:01	18/11/2019 13:26	18/11/2019 10:01	18/11/2019 13:26	3,41	1	3,41	CHI
201911193230	SANTA HELENA DE GOIAS	400055594	IPEGUARI	18/11/2019 10:02	19/11/2019 10:48	18/11/2019 10:02	19/11/2019 10:48	24,76	1	24,76	CHI
201911193233	IACIARA	IA12232131	IACIARA S1	18/11/2019 06:57	18/11/2019 18:02	18/11/2019 06:57	18/11/2019 18:02	11,07	6	66,40	CHI
201911193235	GOIANIA	10029780533	GOIANIA LESTE S1	18/11/2019 10:02	18/11/2019 11:25	18/11/2019 10:02	18/11/2019 11:25	1,37	1	1,37	CHI
201911193238	INHUMAS	IN31051774	INHUMAS S1	18/11/2019 10:02	18/11/2019 21:02	18/11/2019 10:02	18/11/2019 21:02	10,98	1	10,98	CHI
201911193243	PEROLANDIA	DP21169575	PARQUE DAS EMAS	18/11/2019 10:03	18/11/2019 14:10	18/11/2019 10:03	18/11/2019 14:10	4,11	1	4,11	CHI
201911193251	GOIANIA	GN11000546	AEROPORTO S2	18/11/2019 08:40	18/11/2019 12:20	18/11/2019 08:40	18/11/2019 12:20	3,66	106	387,52	CHI
201911193252	GOIANIA	10190790	AEROPORTO S1	18/11/2019 10:05	18/11/2019 19:39	18/11/2019 10:05	18/11/2019 19:39	9,56	1	9,56	CHI
201911193304	LUZIANIA	LZ12013824	VIANOPOLIS	18/11/2019 08:28	18/11/2019 20:09	18/11/2019 08:28	18/11/2019 20:09	11,67	16	186,74	CHI
201911193318	URUACU	UR12190184	URUACU	18/11/2019 10:08	18/11/2019 12:09	18/11/2019 10:08	18/11/2019 12:09	2,01	2	4,03	CHI
201911193319	LUZIANIA	120414302	RIO VERMELHO	18/11/2019 10:08	18/11/2019 11:39	18/11/2019 10:08	18/11/2019 11:39	1,53	1	1,53	CHI

201911193321	BELA VISTA DE GOIAS	BV12011697	BELA VISTA S1	18/11/2019 10:08	18/11/2019 16:10	18/11/2019 10:08	18/11/2019 16:10	6,02	10	60,23	CHI
201911193330	MINACU	IH12192380	MINACU	18/11/2019 10:09	19/11/2019 08:00	18/11/2019 10:09	19/11/2019 08:00	21,85	1	21,85	CHI
201911193334	ANAPOLIS	21197350	JUNDIAI S2	18/11/2019 10:09	18/11/2019 13:17	18/11/2019 10:09	18/11/2019 13:17	3,12	1	3,12	CHI
201911193335	MOSSAMEDES	MD12024167	FIRMINOPOLIS S2	18/11/2019 10:09	18/11/2019 15:24	18/11/2019 10:09	18/11/2019 15:24	5,24	46	241,14	CHI
201911193335	SANCLERLANDIA	MD12024167	FIRMINOPOLIS S2	18/11/2019 10:09	18/11/2019 15:24	18/11/2019 10:09	18/11/2019 15:24	5,24	7	36,70	CHI
201911193345	CAMPOS BELOS	CH21264896	SAO DOMINGOS	18/11/2019 10:11	18/11/2019 19:14	18/11/2019 10:11	18/11/2019 19:14	9,05	3	27,15	CHI
201911193346	GOIANIA	16500921	GOYA S2	18/11/2019 10:11	18/11/2019 12:19	18/11/2019 10:11	18/11/2019 12:19	2,13	1	2,13	CHI
201911193359	ITABERAI	50017081	ITABERAI S2	18/11/2019 10:13	18/11/2019 12:08	18/11/2019 10:13	18/11/2019 12:08	1,92	1	1,92	CHI
201911193361	MUNDO NOVO DE GOIAS	MH11274889	NOVA CRIXAS	18/11/2019 10:13	18/11/2019 11:42	18/11/2019 10:13	18/11/2019 11:42	1,48	1	1,48	CHI
201911193362	GAMELEIRA DE GOIAS	SV21236994	DAIA S2	18/11/2019 10:13	21/11/2019 01:39	18/11/2019 10:13	21/11/2019 01:39	63,42	4	253,70	CHI
201911193364	PLANALTINA	PI21152793	SAO JOAO D ALIANCA	18/11/2019 10:13	18/11/2019 13:44	18/11/2019 10:13	18/11/2019 13:44	3,50	1	3,50	CHI
201911193365	QUIRINOPOLIS	Q113000038	QUIRINOPOLIS	18/11/2019 10:13	18/11/2019 14:40	18/11/2019 10:13	18/11/2019 14:40	4,44	58	257,28	CHI
201911193370	NOVO GAMA	2460039548	PACAEMBU S1	18/11/2019 10:14	18/11/2019 11:58	18/11/2019 10:14	18/11/2019 11:58	1,72	1	1,72	CHI
201911193378	SANTA RITA DO NOVO DESTINO	GE21115066	GOIANESIA S1	18/11/2019 10:16	18/11/2019 17:38	18/11/2019 10:16	18/11/2019 17:38	7,36	1	7,36	CHI
201911193381	ANAPOLIS	AN11000331	JUNDIAI S2	18/11/2019 10:16	18/11/2019 16:09	18/11/2019 10:16	18/11/2019 16:09	5,87	67	393,36	CHI
201911193384	GOIANIA	11687228	GOIANIA LESTE S2	18/11/2019 10:17	19/11/2019 09:06	18/11/2019 10:17	19/11/2019 09:06	22,81	1	22,81	CHI
201911193386	MONTIVIDIU DO NORTE	MX12192265	PORANGATU	18/11/2019 10:17	18/11/2019 14:00	18/11/2019 10:17	18/11/2019 14:00	3,70	63	233,26	CHI
201911193394	MORRINHOS	150128861	MORRINHOS	18/11/2019 10:18	18/11/2019 12:33	18/11/2019 10:18	18/11/2019 12:33	2,24	1	2,24	CHI
201911193397	APARECIDA DE GOIANIA	200159343	ANHANGUERA	18/11/2019 10:18	18/11/2019 13:31	18/11/2019 10:18	18/11/2019 13:31	3,21	1	3,21	CHI
201911193399	PIRACANJUBA	HD21324547	ROCHEDO	18/11/2019 10:19	18/11/2019 18:44	18/11/2019 10:19	18/11/2019 18:44	8,41	1	8,41	CHI
201911193403	CALDAS NOVAS	CN11000026	SERRA DE CALDAS	18/11/2019 10:04	18/11/2019 14:56	18/11/2019 10:04	18/11/2019 14:56	4,87	60	291,92	CHI
201911193405	EDEALINA	ED12047071	PONTALINA	18/11/2019 08:53	18/11/2019 15:53	18/11/2019 08:53	18/11/2019 15:53	6,99	3	20,98	CHI
201911193405	EDEIA	ED12047071	PONTALINA	18/11/2019 08:53	18/11/2019 15:53	18/11/2019 08:53	18/11/2019 15:53	6,99	2	13,99	CHI
201911193406	CATALAO	CT21293312	CATALAO S2	18/11/2019 10:20	18/11/2019 18:53	18/11/2019 10:20	18/11/2019 18:53	8,54	1	8,54	CHI
201911193410	ANAPOLIS	20302484	JUNDIAI S1	18/11/2019 10:20	18/11/2019 12:22	18/11/2019 10:20	18/11/2019 12:22	2,02	1	2,02	CHI
201911193419	HIDROLANDIA	10030422955	CEPAIGO S2	18/11/2019 10:22	18/11/2019 15:25	18/11/2019 10:22	18/11/2019 15:25	5,04	1	5,04	CHI
201911193432	AGUA FRIA DE GOIAS	TL21205629	SAO JOAO D ALIANCA	18/11/2019 10:24	19/11/2019 16:08	18/11/2019 10:24	19/11/2019 16:08	29,73	2	59,46	CHI
201911193436	JATAI	JT13306447	JATAI S1	18/11/2019 10:25	18/11/2019 12:50	18/11/2019 10:25	18/11/2019 12:50	2,41	6	14,49	CHI
201911193438	CACHOEIRA ALTA	Q112191652	CACHOEIRA ALTA	18/11/2019 10:25	18/11/2019 15:33	18/11/2019 10:25	18/11/2019 15:33	5,13	3	15,39	CHI
201911193438	QUIRINOPOLIS	Q112191652	CACHOEIRA ALTA	18/11/2019 10:25	18/11/2019 15:33	18/11/2019 10:25	18/11/2019 15:33	5,13	9	46,17	CHI
201911193439	PIRES DO RIO	PR21278069	PIRES DO RIO S1	18/11/2019 10:25	18/11/2019 11:32	18/11/2019 10:25	18/11/2019 11:32	1,12	1	1,12	CHI
201911193442	TRINDADE	40099349	GOYA S1	18/11/2019 10:26	18/11/2019 12:15	18/11/2019 10:26	18/11/2019 12:15	1,81	1	1,81	CHI
201911193444	FAZENDA NOVA	JR12231355	JUSSARA	18/11/2019 10:26	19/11/2019 19:57	18/11/2019 10:26	19/11/2019 19:57	33,51	6	201,07	CHI

201911193444	JUSSARA	JR12231355	JUSSARA	18/11/2019 10:26	19/11/2019 19:57	18/11/2019 10:26	19/11/2019 19:57	33,51	9	301,61	CHI
201911193451	ALTO PARAISO DE GOIAS	3870023361	FLORES DE GOIAS	18/11/2019 10:26	19/11/2019 09:27	18/11/2019 10:26	19/11/2019 09:27	23,00	1	23,00	CHI
201911193452	DOVERLANDIA	DV11204234	CAIAPONIA	18/11/2019 10:26	19/11/2019 00:04	18/11/2019 10:26	19/11/2019 00:04	13,62	2	27,24	CHI
201911193701	ALTO PARAISO DE GOIAS	BF12385529	NIQUELANDIA SUBTRANSMISSAO	18/11/2019 10:27	18/11/2019 17:39	18/11/2019 10:27	18/11/2019 17:39	7,19	2	14,37	CHI
201911193705	NOVA AURORA	NE21035390	CATALAO S1	18/11/2019 10:28	18/11/2019 17:02	18/11/2019 10:28	18/11/2019 17:02	6,56	2	13,13	CHI
201911193707	PIRACANJUBA	PJ21009447	CRISTIANOPOLIS	18/11/2019 10:28	18/11/2019 18:38	18/11/2019 10:28	18/11/2019 18:38	8,15	1	8,15	CHI
201911193711	BELA VISTA DE GOIAS	BV12000009	BELA VISTA S1	18/11/2019 08:27	18/11/2019 11:00	18/11/2019 08:27	18/11/2019 11:00	2,56	233	597,64	CHI
201911193904	CACHOEIRA ALTA	CA21200039	CACHOEIRA ALTA	18/11/2019 10:31	19/11/2019 11:53	18/11/2019 10:31	19/11/2019 11:53	25,36	1	25,36	CHI
201911193906	CALDAS NOVAS	MR12059843	MORRINHOS	18/11/2019 06:43	19/11/2019 01:35	18/11/2019 06:43	19/11/2019 01:35	18,87	7	132,06	CHI
201911193906	MORRINHOS	MR12059843	MORRINHOS	18/11/2019 06:43	19/11/2019 01:35	18/11/2019 06:43	19/11/2019 01:35	18,87	12	226,39	CHI
201911193906	PIRACANJUBA	MR12059843	MORRINHOS	18/11/2019 06:43	19/11/2019 01:35	18/11/2019 06:43	19/11/2019 01:35	18,87	3	56,60	CHI
201911193908	CATALAO	10008386135	CATALAO S1	18/11/2019 10:32	18/11/2019 15:54	18/11/2019 10:32	18/11/2019 15:54	5,35	1	5,35	CHI
201911193918	JATAI	JT12219503	JATAI S3	18/11/2019 10:34	18/11/2019 14:21	18/11/2019 10:34	18/11/2019 14:21	3,78	5	18,88	CHI
201911193926	LUZIANIA	LZ12370737	MARAJOARA	18/11/2019 10:34	18/11/2019 15:27	18/11/2019 10:34	18/11/2019 15:27	4,87	4	19,48	CHI
201911193930	MOIPORA	1450002253	IPORA	18/11/2019 10:35	18/11/2019 18:32	18/11/2019 10:35	18/11/2019 18:32	7,94	1	7,94	CHI
201911193931	CORREGO DO OURO	CO12383517	FIRMINOPOLIS S2	18/11/2019 09:50	18/11/2019 15:35	18/11/2019 09:50	18/11/2019 15:35	5,74	8	45,88	CHI
201911193934	CABECEIRAS	CW11280719	ITUIQUIRA	18/11/2019 10:36	18/11/2019 21:25	18/11/2019 10:36	18/11/2019 21:25	10,81	1	10,81	CHI
201911193942	BOM JARDIM DE GOIAS	BM12334813	IPORA	18/11/2019 07:47	18/11/2019 14:30	18/11/2019 07:47	18/11/2019 14:30	6,72	15	100,74	CHI
201911193944	CRIXAS	CX12252944	SERRA DO OURO	18/11/2019 10:38	18/11/2019 21:46	18/11/2019 10:38	18/11/2019 21:46	11,13	1	11,13	CHI
201911193947	ANICUNS	910069554	ANICUNS	18/11/2019 10:38	18/11/2019 14:13	18/11/2019 10:38	18/11/2019 14:13	3,58	0	0,00	CHI
201911193948	GOIANIA	10022258378	CAMPINAS S3	18/11/2019 10:38	18/11/2019 12:06	18/11/2019 10:38	18/11/2019 12:06	1,46	1	1,46	CHI
201911193949	PIRES DO RIO	460007804	PIRES DO RIO S1	18/11/2019 10:38	18/11/2019 16:50	18/11/2019 10:38	18/11/2019 16:50	6,19	1	6,19	CHI
201911193951	BELA VISTA DE GOIAS	BV21134172	BELA VISTA S1	18/11/2019 10:38	18/11/2019 17:33	18/11/2019 10:38	18/11/2019 17:33	6,90	1	6,90	CHI
201911193957	SAO LUIS DE MONTES BELOS	SL11412965	SAO LUIZ DOS MONTES BELOS	18/11/2019 10:39	18/11/2019 11:20	18/11/2019 10:39	18/11/2019 11:20	0,68	3	2,03	CHI
201911193966	SANTA TEREZA DE GOIAS	SE12288750	PORANGATU	18/11/2019 07:30	18/11/2019 17:04	18/11/2019 07:30	18/11/2019 17:04	9,55	4	38,20	CHI
201911193973	ANAPOLIS	21172468	ANAPOLIS UNIVERSITARIO S2	18/11/2019 10:42	18/11/2019 17:20	18/11/2019 10:42	18/11/2019 17:20	6,63	1	6,63	CHI
201911193974	SANTO ANTONIO DO DESCOBERTO	SN21313798	ALEXANIA	18/11/2019 10:42	18/11/2019 12:38	18/11/2019 10:42	18/11/2019 12:38	1,93	1	1,93	CHI
201911193975	SANTO ANTONIO DO DESCOBERTO	SN12261733	MARAJOARA	18/11/2019 10:42	19/11/2019 15:06	18/11/2019 10:42	19/11/2019 14:04	27,36	2	54,72	CHI
201911193975	SANTO ANTONIO DO DESCOBERTO	SN12261733	MARAJOARA	18/11/2019 10:42	19/11/2019 15:06	18/11/2019 10:42	19/11/2019 15:06	28,40	6	170,40	CHI
201911193984	HEITORAI	HE12023216	ITAPURANGA	18/11/2019 10:44	18/11/2019 16:50	18/11/2019 10:44	18/11/2019 16:50	6,11	2	12,22	CHI
201911193986	PIRANHAS	PH21343534	CAIAPONIA	18/11/2019 10:44	19/11/2019 01:27	18/11/2019 10:44	19/11/2019 01:27	14,73	1	14,73	CHI
201911193990	BOM JESUS DE GOIAS	10004987568	BOM JESUS DE GOIAS	18/11/2019 10:44	18/11/2019 18:24	18/11/2019 10:44	18/11/2019 18:24	7,65	1	7,65	CHI
201911193991	GOIANESIA	550190715	GOIANESIA S2	18/11/2019 10:45	18/11/2019 20:54	18/11/2019 10:45	18/11/2019 20:54	10,15	1	10,15	CHI

201911194003	DAMOLANDIA	IN12021259	INHUMAS S1	18/11/2019 17:22	18/11/2019 22:10	18/11/2019 17:22	18/11/2019 22:10	4,79	6	28,74	CHI
201911194003	INHUMAS	IN12021259	INHUMAS S1	18/11/2019 17:22	18/11/2019 22:10	18/11/2019 17:22	18/11/2019 22:10	4,79	4	19,16	CHI
201911194006	HIDROLINA	1020007609	URUACU	18/11/2019 10:48	18/11/2019 19:14	18/11/2019 10:48	18/11/2019 19:14	8,42	1	8,42	CHI
201911194008	RIO VERDE	4090006157	SANTA HELENA S1	18/11/2019 10:48	19/11/2019 19:55	18/11/2019 10:48	19/11/2019 19:55	33,11	1	33,11	CHI
201911194009	ANAPOLIS	20033254	JUNDIAI S1	18/11/2019 10:48	18/11/2019 16:53	18/11/2019 10:48	18/11/2019 16:53	6,07	1	6,07	CHI
201911194012	JAUPACI	JP12391432	IPORA	18/11/2019 10:50	19/11/2019 09:27	18/11/2019 10:50	19/11/2019 09:27	22,61	8	180,92	CHI
201911194015	ITAPACI	100008859	ITAPACI	18/11/2019 10:50	18/11/2019 16:41	18/11/2019 10:50	18/11/2019 16:41	5,85	1	5,85	CHI
201911194020	MORRINHOS	MR12056688	MORRINHOS	18/11/2019 10:51	18/11/2019 17:53	18/11/2019 10:51	18/11/2019 17:53	7,04	8	56,32	CHI
201911194021	NIQUELANDIA	NQ21055117	NIQUELANDIA SUBTRANSMISSAO	18/11/2019 10:51	18/11/2019 14:44	18/11/2019 10:51	18/11/2019 14:44	3,88	0	0,00	CHI
201911194023	PONTALINA	PK21082179	VICENTINOPOLIS	18/11/2019 10:51	18/11/2019 16:36	18/11/2019 10:51	18/11/2019 16:36	5,74	1	5,74	CHI
201911194037	GUAPO	710042590	GUAPO S1	18/11/2019 10:54	18/11/2019 14:54	18/11/2019 10:54	18/11/2019 14:54	4,00	1	4,00	CHI
201911194045	JARAGUA	70132501	JARAGUA	18/11/2019 10:55	18/11/2019 12:58	18/11/2019 10:55	18/11/2019 12:58	2,04	1	2,04	CHI
201911194047	PILAR DE GOIAS	GG12341538	SANTA TEREZINHA	18/11/2019 10:55	18/11/2019 14:10	18/11/2019 10:55	18/11/2019 14:10	3,25	14	45,55	CHI
201911194048	MORRINHOS	MR21102218	MORRINHOS	18/11/2019 10:55	18/11/2019 17:00	18/11/2019 10:55	18/11/2019 17:00	6,07	1	6,07	CHI
201911194062	COLINAS DO SUL	TI12256389	NIQUELANDIA SUBTRANSMISSAO	18/11/2019 09:06	19/11/2019 17:43	18/11/2019 09:06	19/11/2019 17:43	32,60	1	32,60	CHI
201911194062	NIQUELANDIA	TI12256389	NIQUELANDIA SUBTRANSMISSAO	18/11/2019 09:06	19/11/2019 17:43	18/11/2019 09:06	19/11/2019 17:43	32,60	4	130,42	CHI
201911194065	SILVANIA	660033288	VIANOPOLIS	18/11/2019 10:59	18/11/2019 12:54	18/11/2019 10:59	18/11/2019 12:54	1,91	1	1,91	CHI
201911194069	JATAI	10012462657	JATAI S2	18/11/2019 11:00	18/11/2019 15:37	18/11/2019 11:00	18/11/2019 15:37	4,61	1	4,61	CHI
201911194071	GOIAS	GS11188172	GOIAS	18/11/2019 11:00	19/11/2019 09:35	18/11/2019 11:00	19/11/2019 09:35	22,57	1	22,57	CHI
201911194080	ALVORADA DO NORTE	FB12143258	IACIARA S2	18/11/2019 10:05	18/11/2019 14:45	18/11/2019 10:05	18/11/2019 14:45	4,65	30	139,54	CHI
201911194080	FLORES DE GOIAS	FB12143258	IACIARA S2	18/11/2019 10:05	18/11/2019 14:45	18/11/2019 10:05	18/11/2019 14:45	4,65	27	125,59	CHI
201911194083	PLANALTINA	10019953389	PLANALTINA	18/11/2019 11:03	18/11/2019 18:31	18/11/2019 11:03	18/11/2019 18:31	7,46	1	7,46	CHI
201911194087	BELA VISTA DE GOIAS	10023307135	BELA VISTA S1	18/11/2019 11:05	18/11/2019 15:27	18/11/2019 11:05	18/11/2019 15:27	4,35	1	4,35	CHI
201911194104	CUMARI	CY21317588	CATALAO S1	18/11/2019 11:08	19/11/2019 20:55	18/11/2019 11:08	19/11/2019 20:55	33,78	1	33,78	CHI
201911194108	URUACU	UR21262789	URUACU	18/11/2019 11:08	18/11/2019 12:08	18/11/2019 11:08	18/11/2019 12:08	0,99	1	0,99	CHI
201911194111	IACIARA	IA12344241	IACIARA S1	18/11/2019 08:14	18/11/2019 14:19	18/11/2019 08:14	18/11/2019 14:19	6,08	45	273,60	CHI
201911194113	OURO VERDE DE GOIAS	OV12319823	NEROPOLIS S1	18/11/2019 10:53	18/11/2019 14:02	18/11/2019 10:53	18/11/2019 14:02	3,15	23	72,41	CHI
201911194116	IPAMERI	IP12321692	IPAMERI	18/11/2019 11:09	19/11/2019 14:30	18/11/2019 11:09	19/11/2019 14:30	27,34	1	27,34	CHI
201911194117	GOIANIA	10028521046	GOIANIA LESTE S3	18/11/2019 11:10	18/11/2019 14:13	18/11/2019 11:10	18/11/2019 14:13	3,05	1	3,05	CHI
201911194119	GOIANIA	GN11000515	CAMPINAS S3	18/11/2019 11:10	18/11/2019 20:28	18/11/2019 11:10	18/11/2019 20:28	9,29	72	669,12	CHI
201911194121	PIRENOPOLIS	PV21000013	CORUMBA	18/11/2019 11:10	18/11/2019 20:23	18/11/2019 11:10	18/11/2019 20:23	9,20	3	27,61	CHI
201911194130	GOIAS	IK12250721	GOIAS	18/11/2019 10:30	18/11/2019 19:14	18/11/2019 10:30	18/11/2019 19:14	8,73	14	122,24	CHI
201911194130	ITABERAI	IK12250721	GOIAS	18/11/2019 10:30	18/11/2019 19:14	18/11/2019 10:30	18/11/2019 19:14	8,73	2	17,46	CHI

201911194130	ITAPURANGA	IK12250721	GOIAS	18/11/2019 10:30	18/11/2019 19:14	18/11/2019 10:30	18/11/2019 19:14	8,73	3	26,19	CHI
201911194132	JARAGUA	70007056	JARAGUA	18/11/2019 11:14	18/11/2019 22:14	18/11/2019 11:14	18/11/2019 22:14	11,00	1	11,00	CHI
201911194138	BELA VISTA DE GOIAS	BV12079681	BELA VISTA S1	18/11/2019 08:26	18/11/2019 16:56	18/11/2019 08:26	18/11/2019 16:56	8,49	12	101,84	CHI
201911194141	FAZENDA NOVA	1080002252	JUSSARA	18/11/2019 11:15	18/11/2019 20:34	18/11/2019 11:15	18/11/2019 20:34	9,32	1	9,32	CHI
201911194142	MUNDO NOVO DE GOIAS	MH12391964	NOVA CRIXAS	18/11/2019 10:55	18/11/2019 14:35	18/11/2019 10:55	18/11/2019 14:35	3,65	9	32,89	CHI
201911194143	JATAI	290262100	JATAI S2	18/11/2019 11:15	18/11/2019 16:35	18/11/2019 11:15	18/11/2019 16:35	5,32	1	5,32	CHI
201911194148	SAO DOMINGOS	SD12128037	SAO DOMINGOS	18/11/2019 10:41	18/11/2019 12:54	18/11/2019 10:41	18/11/2019 12:54	2,20	4	8,80	CHI
201911194151	CRISTALINA	KR12171525	PAMPLONA	18/11/2019 10:54	18/11/2019 18:32	18/11/2019 10:54	18/11/2019 18:32	7,62	17	129,56	CHI
201911194154	SANTA TEREZINHA DE GOIAS	SG12181444	SANTA TEREZINHA	18/11/2019 11:17	19/11/2019 11:00	18/11/2019 11:17	19/11/2019 11:00	23,71	1	23,71	CHI
201911194154	UIRAPURU	SG12181444	SANTA TEREZINHA	18/11/2019 11:17	19/11/2019 11:00	18/11/2019 11:17	19/11/2019 11:00	23,71	2	47,41	CHI
201911194159	APARECIDA DE GOIANIA	AP11101601	ANHANGUERA	18/11/2019 11:18	18/11/2019 14:24	18/11/2019 11:18	18/11/2019 14:24	3,10	428	1326,68	CHI
201911194165	SAO JOAO D ALIANCA	JL21314621	SAO JOAO D ALIANCA	18/11/2019 11:19	19/11/2019 17:00	18/11/2019 11:19	19/11/2019 17:00	29,70	1	29,70	CHI
201911194167	MINACU	IH12207743	MINACU	18/11/2019 09:42	18/11/2019 21:32	18/11/2019 09:42	18/11/2019 21:32	11,83	18	212,86	CHI
201911194176	QUIRINOPOLIS	80101598	QUIRINOPOLIS	18/11/2019 11:20	19/11/2019 13:32	18/11/2019 11:20	19/11/2019 13:32	26,20	1	26,20	CHI
201911194178	FLORES DE GOIAS	10021670518	FLORES DE GOIAS	18/11/2019 11:20	19/11/2019 11:28	18/11/2019 11:20	19/11/2019 11:28	24,13	1	24,13	CHI
201911194183	NIQUELANDIA	NQ21197587	URUACU	18/11/2019 11:21	18/11/2019 15:33	18/11/2019 11:21	18/11/2019 15:33	4,20	1	4,20	CHI
201911194193	GOIANESIA	GE21256029	GOIANESIA S2	18/11/2019 11:22	18/11/2019 15:46	18/11/2019 11:22	18/11/2019 15:46	4,40	1	4,40	CHI
201911194195	MORRINHOS	10020562746	MORRINHOS	18/11/2019 11:23	19/11/2019 03:36	18/11/2019 11:23	19/11/2019 03:36	16,22	1	16,22	CHI
201911194201	NIQUELANDIA	NQ21323942	NIQUELANDIA SUBTRANSMISSAO	18/11/2019 11:23	19/11/2019 03:50	18/11/2019 11:23	19/11/2019 03:50	16,44	2	32,88	CHI
201911194205	CACU	CC12078923	CACHOEIRA ALTA	18/11/2019 11:24	18/11/2019 19:40	18/11/2019 11:24	18/11/2019 19:40	8,26	19	156,90	CHI
201911194208	BELA VISTA DE GOIAS	BV12097973	BELA VISTA S1	18/11/2019 10:33	18/11/2019 15:13	18/11/2019 10:33	18/11/2019 15:13	4,67	6	28,02	CHI
201911194209	CALDAZINHA	SW12217284	CEPAIGO S2	18/11/2019 11:25	18/11/2019 15:16	18/11/2019 11:25	18/11/2019 15:16	3,85	6	23,09	CHI
201911194209	LEOPOLDO DE BULHOES	SW12217284	CEPAIGO S2	18/11/2019 11:25	18/11/2019 15:16	18/11/2019 11:25	18/11/2019 15:16	3,85	52	200,10	CHI
201911194221	GOIANIA	11089430	ATLANTICO S2	18/11/2019 11:27	18/11/2019 12:44	18/11/2019 11:27	18/11/2019 12:44	1,27	1	1,27	CHI
201911194231	GOIANDIRA	1050000812	CATALAO S1	18/11/2019 11:29	18/11/2019 20:42	18/11/2019 11:29	18/11/2019 20:42	9,21	1	9,21	CHI
201911194238	IPAMERI	IP12107648	IPAMERI	18/11/2019 10:57	18/11/2019 17:49	18/11/2019 10:57	18/11/2019 17:49	6,86	21	144,14	CHI
201911194301	GOIANIA	GN12001058	XAVANTES	18/11/2019 11:32	18/11/2019 16:59	18/11/2019 11:32	18/11/2019 16:59	5,44	13	70,74	CHI
201911194406	MONTIVIDIU	MV21370217	MONTIVIDIU T	18/11/2019 11:33	19/11/2019 08:55	18/11/2019 11:33	19/11/2019 08:55	21,35	1	21,35	CHI
201911194501	AGUAS LINDAS DE GOIAS	4830017250	AGUAS LINDAS DE GOIAS S1	18/11/2019 11:36	18/11/2019 13:31	18/11/2019 11:36	18/11/2019 13:31	1,92	1	1,92	CHI
201911194520	IPAMERI	IP12027098	URUTAI	18/11/2019 10:44	19/11/2019 20:49	18/11/2019 10:44	19/11/2019 20:49	34,08	8	272,63	CHI
201911194525	ALTO PARAISO DE GOIAS	BF12231960	NIQUELANDIA SUBTRANSMISSAO	18/11/2019 09:27	18/11/2019 16:54	18/11/2019 09:27	18/11/2019 16:54	7,44	20	148,85	CHI
201911194528	HIDROLANDIA	HD21329356	CEPAIGO S2	18/11/2019 11:40	18/11/2019 16:51	18/11/2019 11:40	18/11/2019 16:51	5,18	1	5,18	CHI
201911194532	CAMPESTRE DE GOIAS	GC12366261	TRINDADE	18/11/2019 11:40	18/11/2019 16:00	18/11/2019 11:40	18/11/2019 16:00	4,32	1	4,32	CHI

201911194532	PALMEIRAS DE GOIAS	GC12366261	TRINDADE	18/11/2019 11:40	18/11/2019 16:00	18/11/2019 11:40	18/11/2019 16:00	4,32	1	4,32	CHI
201911194538	RUBIATABA	RB21211757	RUBIATABA	18/11/2019 11:41	18/11/2019 20:46	18/11/2019 11:41	18/11/2019 20:46	9,07	2	18,14	CHI
201911194540	MORRINHOS	MR21000069	MORRINHOS	18/11/2019 11:42	20/11/2019 18:06	18/11/2019 11:42	20/11/2019 18:06	54,39	1	54,39	CHI
201911194542	CAIAPONIA	CP21154335	CAIAPONIA	18/11/2019 11:42	19/11/2019 11:04	18/11/2019 11:42	19/11/2019 11:04	23,36	1	23,36	CHI
201911194546	SAO JOAO D ALIANCA	JL12314646	FLORES DE GOIAS	18/11/2019 11:43	21/11/2019 18:54	18/11/2019 11:43	21/11/2019 01:37	61,91	9	557,18	CHI
201911194546	SAO JOAO D ALIANCA	JL12314646	FLORES DE GOIAS	18/11/2019 11:43	21/11/2019 18:54	21/11/2019 01:40	21/11/2019 18:54	17,23	9	155,10	CHI
201911194552	TRINDADE	40238775	TRINDADE	18/11/2019 11:44	19/11/2019 00:25	18/11/2019 11:44	19/11/2019 00:25	12,69	1	12,69	CHI
201911194562	GOIANIA	GN12000545	CAMPINAS S3	18/11/2019 11:11	18/11/2019 12:36	18/11/2019 11:11	18/11/2019 12:36	1,40	301	421,57	CHI
201911194563	CALDAZINHA	BV12282442	CEPAIGO S2	18/11/2019 06:40	18/11/2019 15:30	18/11/2019 06:40	18/11/2019 15:30	8,84	28	247,57	CHI
201911194565	MATRINCHA	MP12206480	MATRINCHA	18/11/2019 11:46	18/11/2019 18:56	18/11/2019 11:46	18/11/2019 18:56	7,17	15	107,50	CHI
201911194567	SERRANOPOLIS	JT12363406	JATAI S1	18/11/2019 11:47	18/11/2019 15:05	18/11/2019 11:47	18/11/2019 15:05	3,30	11	36,30	CHI
201911194568	SANTA FE DE GOIAS	RN12009764	BRITANIA	18/11/2019 10:20	18/11/2019 13:40	18/11/2019 10:20	18/11/2019 13:40	3,32	5	16,62	CHI
201911194572	IACIARA	IA11039967	IACIARA S1	18/11/2019 08:38	18/11/2019 14:20	18/11/2019 08:38	18/11/2019 14:20	5,70	132	751,89	CHI
201911194591	LUZIANIA	LZ12097566	CRISTALINA S2	18/11/2019 11:51	18/11/2019 18:39	18/11/2019 11:51	18/11/2019 18:39	6,79	13	88,29	CHI
201911194595	ABADIANIA	10018849545	ANAPOLIS UNIVERSITARIO S1	18/11/2019 11:52	18/11/2019 16:05	18/11/2019 11:52	18/11/2019 16:05	4,21	1	4,21	CHI
201911194596	DIVINOPOLIS DE GOIAS	GH21266552	SAO DOMINGOS	18/11/2019 11:52	18/11/2019 12:34	18/11/2019 11:52	18/11/2019 12:34	0,69	1	0,69	CHI
201911194601	MARA ROSA	VD12201669	SANTA TEREZINHA	18/11/2019 11:53	19/11/2019 19:15	18/11/2019 11:53	19/11/2019 19:15	31,36	2	62,72	CHI
201911194608	GOIANIA	GN11034939	FERROVIARIO S1	18/11/2019 11:55	18/11/2019 13:44	18/11/2019 11:55	18/11/2019 13:44	1,82	69	125,27	CHI
201911194609	GUARANI DE GOIAS	GY21019855	IACIARA S1	18/11/2019 11:55	18/11/2019 23:20	18/11/2019 11:55	18/11/2019 23:20	11,41	1	11,41	CHI
201911194612	SENADOR CANEDO	190136339	SENADOR CANEDO	18/11/2019 11:55	18/11/2019 14:27	18/11/2019 11:55	18/11/2019 14:27	2,52	1	2,52	CHI
201911194807	MATRINCHA	MP12122364	MATRINCHA	18/11/2019 11:58	18/11/2019 14:51	18/11/2019 11:58	18/11/2019 14:51	2,87	10	28,74	CHI
201911194901	FORMOSA	FA12375559	PLANALTINA	18/11/2019 08:56	18/11/2019 13:05	18/11/2019 08:56	18/11/2019 13:05	4,14	10	41,39	CHI
201911194903	COLINAS DO SUL	TI12135666	NIQUELANDIA SUBTRANSMISSAO	18/11/2019 11:27	18/11/2019 13:50	18/11/2019 11:27	18/11/2019 13:50	2,38	33	78,53	CHI
201911194904	RIO VERDE	RV21200742	CABRIUVA S2	18/11/2019 11:59	19/11/2019 17:43	18/11/2019 11:59	19/11/2019 17:43	29,73	1	29,73	CHI
201911194906	NOVA CRIXAS	10020088750	NOVA CRIXAS	18/11/2019 11:59	18/11/2019 20:46	18/11/2019 11:59	18/11/2019 20:46	8,77	1	8,77	CHI
201911194917	ITUMBIARA	690156029	ITUMBIARA NOVA	18/11/2019 12:01	18/11/2019 15:48	18/11/2019 12:01	18/11/2019 15:48	3,78	1	3,78	CHI
201911194926	NOVO BRASIL	NB12376361	FIRMINOPOLIS S2	18/11/2019 11:21	18/11/2019 14:03	18/11/2019 11:21	18/11/2019 14:03	2,70	6	16,21	CHI
201911194930	AGUAS LINDAS DE GOIAS	4830037995	AGUAS LINDAS DE GOIAS S1	18/11/2019 12:02	18/11/2019 14:44	18/11/2019 12:02	18/11/2019 14:44	2,69	1	2,69	CHI
201911194932	ANAPOLIS	20581993	JUNDIAI S1	18/11/2019 12:02	18/11/2019 20:45	18/11/2019 12:02	18/11/2019 20:45	8,71	1	8,71	CHI
201911194933	INHUMAS	IN12131460	INHUMAS S1	18/11/2019 12:02	18/11/2019 18:07	18/11/2019 12:02	18/11/2019 18:07	6,07	4	24,28	CHI
201911194937	AVELINOPOLIS	990007042	ANICUNS	18/11/2019 12:03	19/11/2019 00:30	18/11/2019 12:03	19/11/2019 00:30	12,44	1	12,44	CHI
201911194939	ISRAELANDIA	IS12289307	IPORA	18/11/2019 12:05	18/11/2019 16:15	18/11/2019 12:05	18/11/2019 16:15	4,16	2	8,31	CHI
201911194941	ANICUNS	AC11076713	ANICUNS	18/11/2019 12:05	18/11/2019 15:45	18/11/2019 12:05	18/11/2019 15:45	3,66	9	32,93	CHI

201911194946	DAMIANOPOLIS	DA11180580	IACIARA S2	18/11/2019 12:07	18/11/2019 12:34	18/11/2019 12:07	18/11/2019 12:34	0,45	12	5,40	CHI
201911194956	RIO VERDE	RV21062672	CABRIUVA S2	18/11/2019 12:10	19/11/2019 11:25	18/11/2019 12:10	19/11/2019 11:25	23,25	1	23,25	CHI
201911194971	GOIANIA	GN12023386	REAL S1	18/11/2019 11:46	19/11/2019 19:03	18/11/2019 11:46	19/11/2019 19:03	31,28	133	4159,61	CHI
201911194983	HIDROLANDIA	HD12393260	CEPAIGO S2	18/11/2019 10:49	18/11/2019 16:17	18/11/2019 10:49	18/11/2019 16:17	5,46	5	27,28	CHI
201911194984	PIRACANJUBA	60038950	PIRACANJUBA	18/11/2019 12:15	18/11/2019 18:42	18/11/2019 12:15	18/11/2019 18:42	6,45	1	6,45	CHI
201911194990	GAMELEIRA DE GOIAS	GL21017568	DAIA S2	18/11/2019 12:16	20/11/2019 12:03	18/11/2019 12:16	20/11/2019 12:03	47,78	1	47,78	CHI
201911194998	ALTO PARAISO DE GOIAS	BF12105395	SAO JOAO D ALIANCA	18/11/2019 12:17	19/11/2019 16:03	18/11/2019 12:17	19/11/2019 16:03	27,76	14	388,62	CHI
201911194999	MORRINHOS	150084640	MORRINHOS	18/11/2019 12:18	20/11/2019 08:11	18/11/2019 12:18	20/11/2019 08:11	43,88	1	43,88	CHI
201911195004	GOIAS	GS11162308	GOIAS	18/11/2019 12:19	19/11/2019 11:11	18/11/2019 12:19	19/11/2019 11:11	22,86	2	45,72	CHI
201911195006	GAMELEIRA DE GOIAS	SV21212401	VIANOPOLIS	18/11/2019 12:19	21/11/2019 10:05	18/11/2019 12:19	21/11/2019 10:05	69,76	1	69,76	CHI
201911195015	LUZIANIA	LZ12109847	VIANOPOLIS	18/11/2019 10:24	18/11/2019 21:08	18/11/2019 10:24	18/11/2019 21:08	10,72	5	53,59	CHI
201911195021	ALTO PARAISO DE GOIAS	BF12218456	NIQUELANDIA SUBTRANSMISSAO	18/11/2019 12:20	18/11/2019 18:27	18/11/2019 12:20	18/11/2019 18:27	6,10	5	30,50	CHI
201911195022	CALDAS NOVAS	CN11098156	CALDAS NOVAS S1	18/11/2019 12:18	18/11/2019 17:55	18/11/2019 12:18	18/11/2019 17:55	5,60	133	745,43	CHI
201911195031	CUMARI	CT21164148	CATALAO S2	18/11/2019 12:24	19/11/2019 09:13	18/11/2019 12:24	19/11/2019 09:13	20,81	1	20,81	CHI
201911195051	ITUMBIARA	IT12000145	ITUMBIARA VELHA S1	18/11/2019 11:21	18/11/2019 17:40	18/11/2019 11:21	18/11/2019 17:40	6,31	126	794,64	CHI
201911195054	RIO VERDE	RV11230664	MONTIVIDIU T	18/11/2019 12:30	19/11/2019 15:30	18/11/2019 12:30	19/11/2019 15:30	27,00	1	27,00	CHI
201911195059	ITUMBIARA	IT12113986	CACHOEIRA DOURADA	18/11/2019 12:30	19/11/2019 14:59	18/11/2019 12:30	19/11/2019 14:59	26,49	1	26,49	CHI
201911195061	GOIANIA	12585270	INDEPENDENCIA S1	18/11/2019 12:30	18/11/2019 16:55	18/11/2019 12:30	18/11/2019 16:55	4,40	1	4,40	CHI
201911195063	GOIANIA	GN11193167	GOIANIA LESTE S1	18/11/2019 12:31	18/11/2019 15:13	18/11/2019 12:31	18/11/2019 15:13	2,70	106	286,17	CHI
201911195066	CAMPOS BELOS	MA12209854	SAO DOMINGOS	18/11/2019 12:28	18/11/2019 17:37	18/11/2019 12:28	18/11/2019 17:37	5,14	4	20,57	CHI
201911195066	MONTE ALEGRE DE GOIAS	MA12209854	SAO DOMINGOS	18/11/2019 12:28	18/11/2019 17:37	18/11/2019 12:28	18/11/2019 17:37	5,14	18	92,56	CHI
201911195070	SILVANIA	660055727	VIANOPOLIS	18/11/2019 12:32	18/11/2019 15:51	18/11/2019 12:32	18/11/2019 15:51	3,31	1	3,31	CHI
201911195071	GOIAS	GS21348103	ITABERAI S1	18/11/2019 12:32	18/11/2019 16:30	18/11/2019 12:32	18/11/2019 16:30	3,96	1	3,96	CHI
201911195077	ITUMBIARA	IT11000081	ITUMBIARA VELHA S1	18/11/2019 12:10	18/11/2019 18:55	18/11/2019 12:10	18/11/2019 18:55	6,76	213	1439,58	CHI
201911195089	CALDAS NOVAS	760206510	SERRA DE CALDAS	18/11/2019 12:38	18/11/2019 16:15	18/11/2019 12:38	18/11/2019 16:15	3,63	1	3,63	CHI
201911195092	GOIANIA	10989419	FERROVIARIO S2	18/11/2019 12:38	18/11/2019 14:38	18/11/2019 12:38	18/11/2019 14:38	1,99	1	1,99	CHI
201911195096	SILVANIA	SV21284619	VIANOPOLIS	18/11/2019 12:39	21/11/2019 13:50	18/11/2019 12:39	21/11/2019 13:50	73,18	1	73,18	CHI
201911195100	CATALAO	CT12267054	CATALAO S1	18/11/2019 10:01	18/11/2019 16:41	18/11/2019 10:01	18/11/2019 16:41	6,66	19	126,47	CHI
201911195102	IPAMERI	IP12197355	IPAMERI	18/11/2019 12:39	19/11/2019 08:50	18/11/2019 12:39	19/11/2019 08:50	20,18	5	100,91	CHI
201911195103	CATALAO	CT12037322	CATALAO S1	18/11/2019 11:53	18/11/2019 17:10	18/11/2019 11:53	18/11/2019 17:10	5,28	5	26,39	CHI
201911195109	JATAI	JT12191107	JATAI S1	18/11/2019 10:36	18/11/2019 17:11	18/11/2019 10:36	18/11/2019 17:11	6,58	5	32,89	CHI
201911195111	URUACU	CR21068070	MARA ROSA	18/11/2019 12:43	18/11/2019 19:52	18/11/2019 12:43	18/11/2019 19:52	7,14	1	7,14	CHI
201911195125	CORREGO DO OURO	CO12004040	FIRMINOPOLIS S2	18/11/2019 09:02	18/11/2019 17:11	18/11/2019 09:02	18/11/2019 17:11	8,14	4	32,57	CHI

201911195129	CAMPO ALEGRE DE GOIAS	CM21192726	CAMPO ALEGRE DE GOIAS	18/11/2019 12:47	19/11/2019 14:15	18/11/2019 12:47	19/11/2019 14:15	25,45	1	25,45	CHI
201911195132	PONTALINA	PK21111976	PONTALINA	18/11/2019 12:48	18/11/2019 17:35	18/11/2019 12:48	18/11/2019 17:35	4,78	1	4,78	CHI
201911195136	SAO LUIZ DO NORTE	SZ21344746	BARRO ALTO	18/11/2019 12:48	18/11/2019 21:24	18/11/2019 12:48	18/11/2019 21:24	8,59	1	8,59	CHI
201911195143	ITUMBIAIRA	IT12000128	PARANAIBA	18/11/2019 07:56	18/11/2019 19:04	18/11/2019 07:56	18/11/2019 19:04	11,13	110	1223,87	CHI
201911195146	PORANGATU	PO12240663	PORANGATU	18/11/2019 12:50	18/11/2019 19:12	18/11/2019 12:50	18/11/2019 19:12	6,36	3	19,07	CHI
201911195153	NIQUELANDIA	NQ12222644	URUACU	18/11/2019 12:52	18/11/2019 16:46	18/11/2019 12:52	18/11/2019 16:46	3,90	3	11,70	CHI
201911195156	MINACU	4020040711	MINACU	18/11/2019 08:23	18/11/2019 16:46	18/11/2019 08:23	18/11/2019 16:46	8,38	1	8,38	CHI
201911195157	PLANALTINA	10012819326	PLANALTINA	18/11/2019 12:52	19/11/2019 15:28	18/11/2019 12:52	19/11/2019 15:28	26,59	1	26,59	CHI
201911195164	BELA VISTA DE GOIAS	BV31163465	BELA VISTA S1	18/11/2019 12:53	19/11/2019 15:32	18/11/2019 12:53	19/11/2019 15:32	26,64	1	26,64	CHI
201911195167	FAZENDA NOVA	1080014114	JUSSARA	18/11/2019 07:58	18/11/2019 17:55	18/11/2019 07:58	18/11/2019 17:55	9,95	1	9,95	CHI
201911195171	IPORA	IR21040188	IPORA	18/11/2019 12:53	18/11/2019 16:09	18/11/2019 12:53	18/11/2019 16:09	3,27	1	3,27	CHI
201911195174	PONTALINA	PK12263503	PONTALINA	18/11/2019 12:54	18/11/2019 17:07	18/11/2019 12:54	18/11/2019 17:07	4,21	14	58,99	CHI
201911195176	RIO VERDE	RV21279862	CABRIUVA S2	18/11/2019 12:54	19/11/2019 10:14	18/11/2019 12:54	19/11/2019 10:14	21,33	1	21,33	CHI
201911195178	AGUAS LINDAS DE GOIAS	10008861674	AGUAS LINDAS DE GOIAS S1	18/11/2019 12:55	18/11/2019 14:18	18/11/2019 12:55	18/11/2019 14:18	1,38	1	1,38	CHI
201911195184	MINEIROS	1390080757	PARQUE DAS EMAS	18/11/2019 12:56	18/11/2019 14:54	18/11/2019 12:56	18/11/2019 14:54	1,95	1	1,95	CHI
201911195192	ANAPOLIS	21225709	JUNDIAI S1	18/11/2019 12:58	19/11/2019 05:47	18/11/2019 12:58	19/11/2019 05:47	16,81	1	16,81	CHI
201911195193	GOIANIA	12102222	ATLANTICO S3	18/11/2019 12:59	18/11/2019 14:53	18/11/2019 12:59	18/11/2019 14:53	1,90	1	1,90	CHI
201911195196	SAO MIGUEL DO ARAGUAIA	SM11153741	SAO MIGUEL DO ARAGUAIA	18/11/2019 12:56	18/11/2019 20:51	18/11/2019 12:56	18/11/2019 20:51	7,92	67	530,38	CHI
201911195200	NOVO GAMA	10015282404	PACAEMBU S1	18/11/2019 13:01	18/11/2019 15:00	18/11/2019 13:01	18/11/2019 15:00	1,97	1	1,97	CHI
201911195206	RIO VERDE	RV11054317	RIO VERDE S1	18/11/2019 12:31	18/11/2019 15:59	18/11/2019 12:31	18/11/2019 15:59	3,45	176	607,25	CHI
201911195231	FLORES DE GOIAS	FB12277935	IACIARA S2	18/11/2019 13:05	18/11/2019 19:40	18/11/2019 13:05	18/11/2019 19:40	6,57	5	32,86	CHI
201911195231	SITIO D ABADIA	FB12277935	IACIARA S2	18/11/2019 13:05	18/11/2019 19:40	18/11/2019 13:05	18/11/2019 19:40	6,57	3	19,71	CHI
201911195233	CAMPOS BELOS	MA12163484	SAO DOMINGOS	18/11/2019 13:06	18/11/2019 21:21	18/11/2019 13:06	18/11/2019 21:21	8,25	5	41,23	CHI
201911195233	MONTE ALEGRE DE GOIAS	MA12163484	SAO DOMINGOS	18/11/2019 13:06	18/11/2019 21:21	18/11/2019 13:06	18/11/2019 21:21	8,25	4	32,98	CHI
201911195238	GOIANIA	GN12001102	CAMPINAS S1	18/11/2019 13:05	19/11/2019 16:21	18/11/2019 13:05	19/11/2019 16:21	27,26	1	27,26	CHI
201911195245	CRISTALINA	KR12249948	PAMPLONA	18/11/2019 05:42	19/11/2019 02:35	18/11/2019 05:42	19/11/2019 02:35	20,89	12	250,64	CHI
201911195252	GOIANIA	13929288	MEIA PONTE	18/11/2019 13:09	18/11/2019 21:26	18/11/2019 13:09	18/11/2019 21:26	8,28	1	8,28	CHI
201911195253	PORANGATU	TA12114216	NOVO PLANALTO	18/11/2019 09:53	18/11/2019 23:30	18/11/2019 09:53	18/11/2019 23:30	13,60	6	81,61	CHI
201911195264	VIANOPOLIS	VN12011745	VIANOPOLIS	18/11/2019 13:11	20/11/2019 13:18	18/11/2019 13:11	20/11/2019 13:18	48,11	6	288,69	CHI
201911195267	BURITINOPOLIS	MB12314303	IACIARA S2	18/11/2019 11:13	18/11/2019 17:00	18/11/2019 11:13	18/11/2019 17:00	5,78	2	11,56	CHI
201911195267	MAMBAI	MB12314303	IACIARA S2	18/11/2019 11:13	18/11/2019 17:00	18/11/2019 11:13	18/11/2019 17:00	5,78	3	17,35	CHI
201911195275	CALDAS NOVAS	760187782	CALDAS NOVAS S1	18/11/2019 13:13	18/11/2019 14:40	18/11/2019 13:13	18/11/2019 14:40	1,45	1	1,45	CHI
201911195276	PALMEIRAS DE GOIAS	590084148	PALMEIRAS	18/11/2019 13:13	19/11/2019 13:11	18/11/2019 13:13	19/11/2019 13:11	23,98	1	23,98	CHI

201911195278	JARAGUA	JA21234882	JARAGUA	18/11/2019 13:13	18/11/2019 17:28	18/11/2019 13:13	18/11/2019 17:28	4,24	1	4,24	CHI
201911195286	TRINDADE	TR11258430	TRINDADE	18/11/2019 13:14	18/11/2019 14:47	18/11/2019 13:14	18/11/2019 14:47	1,54	26	39,94	CHI
201911195288	MONTES CLAROS DE GOIAS	ME12243845	IPORA	18/11/2019 13:15	18/11/2019 16:07	18/11/2019 13:15	18/11/2019 16:07	2,86	4	11,46	CHI
201911195290	PADRE BERNARDO	2760004576	PADRE BERNARDO	18/11/2019 13:15	18/11/2019 16:45	18/11/2019 13:15	18/11/2019 16:45	3,49	1	3,49	CHI
201911195293	APARECIDA DE GOIANIA	14328732	INDEPENDENCIA S2	18/11/2019 13:15	18/11/2019 16:08	18/11/2019 13:15	18/11/2019 16:08	2,87	1	2,87	CHI
201911195300	ITAPACI	IW21150537	ITAPACI	18/11/2019 13:16	19/11/2019 09:27	18/11/2019 13:16	19/11/2019 09:27	20,17	1	20,17	CHI
201911195301	CAMPO ALEGRE DE GOIAS	IP21192514	PIRES DO RIO S2	18/11/2019 13:16	19/11/2019 13:06	18/11/2019 13:16	19/11/2019 13:06	23,83	2	47,66	CHI
201911195302	EDEIA	VI12352542	VICENTINOPOLIS	18/11/2019 12:53	19/11/2019 09:13	18/11/2019 12:53	19/11/2019 09:13	20,33	8	162,60	CHI
201911195302	VICENTINOPOLIS	VI12352542	VICENTINOPOLIS	18/11/2019 12:53	19/11/2019 09:13	18/11/2019 12:53	19/11/2019 09:13	20,33	13	264,23	CHI
201911195304	BELA VISTA DE GOIAS	10006019275	BELA VISTA S1	18/11/2019 13:17	18/11/2019 15:59	18/11/2019 13:17	18/11/2019 15:59	2,70	1	2,70	CHI
201911195307	BELA VISTA DE GOIAS	BV31097918	BELA VISTA S2	18/11/2019 13:17	19/11/2019 18:12	18/11/2019 13:17	19/11/2019 18:12	28,91	2	57,81	CHI
201911195324	EDEALINA	EA12223550RE	EDEIA	18/11/2019 12:48	19/11/2019 10:50	18/11/2019 12:48	19/11/2019 10:50	22,03	50	1101,57	CHI
201911195324	EDEIA	EA12223550RE	EDEIA	18/11/2019 12:48	19/11/2019 10:50	18/11/2019 12:48	19/11/2019 10:50	22,03	25	550,78	CHI
201911195324	INDIARA	EA12223550RE	EDEIA	18/11/2019 12:48	19/11/2019 10:50	18/11/2019 12:48	19/11/2019 10:50	22,03	7	154,22	CHI
201911195325	PIRACANJUBA	60038214	PIRACANJUBA	18/11/2019 13:21	19/11/2019 14:49	18/11/2019 13:21	19/11/2019 14:49	25,47	1	25,47	CHI
201911195326	RIO VERDE	RV21232716	MONTIVIDIU T	18/11/2019 13:21	18/11/2019 20:15	18/11/2019 13:21	18/11/2019 20:15	6,89	1	6,89	CHI
201911195327	ABADIANIA	AA21210679	ANAPOLIS UNIVERSITARIO S1	18/11/2019 13:21	18/11/2019 18:17	18/11/2019 13:21	18/11/2019 18:17	4,92	1	4,92	CHI
201911195333	NOVA AURORA	NE21315363	CATALAO S1	18/11/2019 13:23	19/11/2019 15:31	18/11/2019 13:23	19/11/2019 15:31	26,14	1	26,14	CHI
201911195336	CAMPINORTE	CR12234938	PORANGATU	18/11/2019 13:00	18/11/2019 20:59	18/11/2019 13:00	18/11/2019 20:59	7,98	19	151,64	CHI
201911195336	MINACU	CR12234938	PORANGATU	18/11/2019 13:00	18/11/2019 20:59	18/11/2019 13:00	18/11/2019 20:59	7,98	42	335,19	CHI
201911195337	PIRES DO RIO	460012642	PIRES DO RIO S1	18/11/2019 13:23	18/11/2019 22:18	18/11/2019 13:23	18/11/2019 22:18	8,91	1	8,91	CHI
201911195338	ANAPOLIS	PV31115028	NEROPOLIS S1	18/11/2019 13:23	19/11/2019 07:43	18/11/2019 13:23	19/11/2019 07:43	18,33	1	18,33	CHI
201911195339	PALMEIRAS DE GOIAS	PL12000118	PALMEIRAS	18/11/2019 12:57	18/11/2019 21:01	18/11/2019 12:57	18/11/2019 20:43	7,77	5	38,83	CHI
201911195339	NAZARIO	PL12000118	PALMEIRAS	18/11/2019 12:57	18/11/2019 21:01	18/11/2019 12:57	18/11/2019 21:01	8,06	3	24,17	CHI
201911195339	PALMEIRAS DE GOIAS	PL12000118	PALMEIRAS	18/11/2019 12:57	18/11/2019 21:01	18/11/2019 12:57	18/11/2019 21:01	8,06	19	153,08	CHI
201911195345	NOVA ROMA	ND12256420	IACIARA S2	18/11/2019 13:23	18/11/2019 20:02	18/11/2019 13:23	18/11/2019 20:02	6,64	28	185,85	CHI
201911195346	GOIANESIA	10000690676	GOIANESIA S2	18/11/2019 13:23	18/11/2019 16:48	18/11/2019 13:23	18/11/2019 16:48	3,40	1	3,40	CHI
201911195348	GOIANIA	GN11000545	AEROPORTO S1	18/11/2019 13:19	18/11/2019 14:30	18/11/2019 13:19	18/11/2019 14:30	1,18	76	89,36	CHI
201911195354	ARAGOIANIA	AO31064189	GUAPO S2	18/11/2019 13:25	18/11/2019 16:17	18/11/2019 13:25	18/11/2019 16:17	2,87	2	5,73	CHI
201911195357	CIDADE OCIDENTAL	DH21170614	MARAJOARA	18/11/2019 13:25	18/11/2019 20:05	18/11/2019 13:25	18/11/2019 20:05	6,65	2	13,30	CHI
201911195358	CALDAS NOVAS	10029215755	SERRA DE CALDAS	18/11/2019 13:26	18/11/2019 17:31	18/11/2019 13:26	18/11/2019 17:31	4,08	1	4,08	CHI
201911195361	GOIANDIRA	GD21078342	CATALAO S1	18/11/2019 10:33	19/11/2019 19:16	18/11/2019 10:33	19/11/2019 19:16	32,70	1	32,70	CHI
201911195364	RIO VERDE	630034655	RIO VERDE S2	18/11/2019 13:28	18/11/2019 16:36	18/11/2019 13:28	18/11/2019 16:36	3,14	1	3,14	CHI

201911195369	NOVO GAMA	4990091542	MARAJOARA	18/11/2019 13:28	18/11/2019 16:46	18/11/2019 13:28	18/11/2019 16:46	3,29	1	3,29	CHI
201911195370	JUSSARA	JR12118238	JUSSARA	18/11/2019 13:28	20/11/2019 20:09	18/11/2019 13:28	20/11/2019 20:09	54,67	1	54,67	CHI
201911195371	NOVO GAMA	2460060010	PACAEMBU S1	18/11/2019 13:29	18/11/2019 16:03	18/11/2019 13:29	18/11/2019 16:03	2,57	1	2,57	CHI
201911195375	PORANGATU	PO12391931LD	PORANGATU	18/11/2019 13:29	19/11/2019 02:25	18/11/2019 13:29	19/11/2019 02:25	12,93	13	168,12	CHI
201911195382	CACU	CC12338616	CACHOEIRA ALTA	18/11/2019 13:20	18/11/2019 16:37	18/11/2019 13:20	18/11/2019 16:37	3,28	32	105,07	CHI
201911195388	ITAUCU	IX21000026	INHUMAS S1	18/11/2019 13:31	18/11/2019 16:05	18/11/2019 13:31	18/11/2019 16:05	2,56	1	2,56	CHI
201911195391	BALIZA	BH12362214	BOM JARDIM	18/11/2019 13:32	19/11/2019 11:53	18/11/2019 13:32	19/11/2019 11:53	22,35	4	89,41	CHI
201911195404	LUZIANIA	LZ12149936	MARAJOARA	18/11/2019 08:23	18/11/2019 16:57	18/11/2019 08:23	18/11/2019 16:57	8,56	13	111,24	CHI
201911195414	CALDAS NOVAS	760137407	CALDAS NOVAS S1	18/11/2019 13:37	20/11/2019 12:19	18/11/2019 13:37	20/11/2019 12:19	46,71	1	46,71	CHI
201911195423	CALDAS NOVAS	CN12392080	CALDAS NOVAS S2	17/11/2019 18:06	18/11/2019 16:26	17/11/2019 18:06	18/11/2019 16:26	22,32	17	379,45	CHI
201911195425	GOIANIA	11527869	GOIANIA LESTE S1	18/11/2019 13:37	18/11/2019 15:33	18/11/2019 13:37	18/11/2019 15:33	1,92	1	1,92	CHI
201911195427	ANAPOLIS	AN12054439	ANAPOLIS UNIVERSITARIO S2	18/11/2019 13:38	18/11/2019 23:22	18/11/2019 13:38	18/11/2019 23:22	9,74	1	9,74	CHI
201911195428	CALDAS NOVAS	CN12099537RE	RIO QUENTE	18/11/2019 12:43	21/11/2019 14:17	18/11/2019 12:43	18/11/2019 15:58	3,25	31	100,74	CHI
201911195428	MORRINHOS	CN12099537RE	RIO QUENTE	18/11/2019 12:43	21/11/2019 14:17	18/11/2019 12:43	18/11/2019 15:58	3,25	7	22,75	CHI
201911195428	RIO QUENTE	CN12099537RE	RIO QUENTE	18/11/2019 12:43	21/11/2019 14:17	18/11/2019 12:43	18/11/2019 15:58	3,25	2	6,50	CHI
201911195428	CALDAS NOVAS	CN12212735LD	RIO QUENTE	18/11/2019 12:43	21/11/2019 14:17	18/11/2019 12:43	18/11/2019 18:31	5,79	18	104,24	CHI
201911195428	CALDAS NOVAS	CN13298630	RIO QUENTE	18/11/2019 12:43	21/11/2019 14:17	18/11/2019 12:43	21/11/2019 14:17	73,55	48	3530,41	CHI
201911195428	MORRINHOS	CN13298630	RIO QUENTE	18/11/2019 12:43	21/11/2019 14:17	18/11/2019 12:43	21/11/2019 14:17	73,55	1	73,55	CHI
201911195428	PIRACANJUBA	CN13298630	RIO QUENTE	18/11/2019 12:43	21/11/2019 14:17	18/11/2019 12:43	21/11/2019 14:17	73,55	1	73,55	CHI
201911195430	CABECEIRAS	CW21218424	ITIQUEIRA	18/11/2019 13:39	18/11/2019 22:04	18/11/2019 13:39	18/11/2019 22:04	8,41	1	8,41	CHI
201911195431	JATAI	290206844	JATAI S3	18/11/2019 13:39	18/11/2019 18:05	18/11/2019 13:39	18/11/2019 18:05	4,44	1	4,44	CHI
201911195435	APARECIDA DE GOIANIA	10022308197	INDEPENDENCIA S2	18/11/2019 13:40	19/11/2019 08:21	18/11/2019 13:40	19/11/2019 08:21	18,67	1	18,67	CHI
201911195450	IVOLANDIA	IV12108126	IPORA	18/11/2019 13:42	18/11/2019 14:51	18/11/2019 13:42	18/11/2019 14:51	1,14	16	18,20	CHI
201911195450	PALESTINA DE GOIAS	IV12108126	IPORA	18/11/2019 13:42	18/11/2019 14:51	18/11/2019 13:42	18/11/2019 14:51	1,14	33	37,53	CHI
201911195453	FORMOSA	FA12257423	ITIQUEIRA	18/11/2019 12:51	18/11/2019 18:52	18/11/2019 12:51	18/11/2019 18:52	6,00	16	96,03	CHI
201911195459	JUSSARA	1290042813	JUSSARA	18/11/2019 13:43	18/11/2019 14:49	18/11/2019 13:43	18/11/2019 14:49	1,09	1	1,09	CHI
201911195465	IPAMERI	IP21384512	IPAMERI	18/11/2019 13:45	19/11/2019 11:50	18/11/2019 13:45	19/11/2019 11:50	22,08	1	22,08	CHI
201911195474	CRISTALINA	KR21339727	PAMPLONA	18/11/2019 13:46	19/11/2019 15:31	18/11/2019 13:46	19/11/2019 15:31	25,75	1	25,75	CHI
201911195479	GAMELEIRA DE GOIAS	SV12089856	DAIA S2	18/11/2019 11:11	18/11/2019 17:33	18/11/2019 11:11	18/11/2019 17:33	6,36	15	95,35	CHI
201911195488	GOIANESIA	GE12384196	GOIANESIA S1	18/11/2019 13:47	18/11/2019 18:15	18/11/2019 13:47	18/11/2019 18:15	4,48	4	17,90	CHI
201911195502	GOIANIA	GN11001127	FERROVIARIO S1	18/11/2019 13:49	18/11/2019 16:16	18/11/2019 13:49	18/11/2019 16:16	2,45	102	249,90	CHI
201911195521	EDEIA	EA21289296	EDEIA	18/11/2019 13:50	19/11/2019 13:34	18/11/2019 13:50	19/11/2019 13:34	23,72	1	23,72	CHI
201911195525	SANTA HELENA DE GOIAS	SH11226298	IPEGUARI	18/11/2019 14:30	18/11/2019 15:54	18/11/2019 14:30	18/11/2019 15:54	1,40	120	168,03	CHI

201911195536	INDIARA	2710025134	EDEIA	18/11/2019 13:53	18/11/2019 15:34	18/11/2019 13:53	18/11/2019 15:34	1,68	1	1,68	CHI
201911195542	APARECIDA DE GOIANIA	AP11077147	INDEPENDENCIA S2	18/11/2019 12:46	18/11/2019 21:08	18/11/2019 12:46	18/11/2019 21:08	8,37	138	1154,56	CHI
201911195555	POSSE	IA12060874	IACIARA S2	18/11/2019 11:07	18/11/2019 15:50	18/11/2019 11:07	18/11/2019 15:50	4,71	42	197,61	CHI
201911195556	SILVANIA	660021572	VIANOPOLIS	18/11/2019 13:54	19/11/2019 08:53	18/11/2019 13:54	19/11/2019 08:53	18,97	1	18,97	CHI
201911195567	NOVO GAMA	2460103214	PACAEMBU S1	18/11/2019 13:55	18/11/2019 17:29	18/11/2019 13:55	18/11/2019 17:29	3,55	1	3,55	CHI
201911195575	JOVIANIA	570022587	GOIATUBA S1	18/11/2019 13:56	19/11/2019 10:34	18/11/2019 13:56	19/11/2019 10:34	20,62	1	20,62	CHI
201911195577	GOIANESIA	GE12297424	GOIANESIA S1	18/11/2019 13:57	18/11/2019 16:40	18/11/2019 13:57	18/11/2019 16:40	2,72	1	2,72	CHI
201911195597	SANCLERLANDIA	SC21006135	FIRMINOPOLIS S2	18/11/2019 13:58	18/11/2019 20:56	18/11/2019 13:58	18/11/2019 20:56	6,97	1	6,97	CHI
201911195605	PALMEIRAS DE GOIAS	PL16407970	PALMEIRAS	18/11/2019 13:53	18/11/2019 19:09	18/11/2019 13:53	18/11/2019 14:23	0,50	9	4,48	CHI
201911195605	PALMEIRAS DE GOIAS	04880224	PALMEIRAS	18/11/2019 13:53	18/11/2019 19:09	18/11/2019 13:53	18/11/2019 15:24	1,53	5	7,63	CHI
201911195605	PALMEIRAS DE GOIAS	04880224	PALMEIRAS	18/11/2019 13:53	18/11/2019 19:09	18/11/2019 13:53	18/11/2019 15:56	2,04	1	2,04	CHI
201911195605	PALMEIRAS DE GOIAS	04880224	PALMEIRAS	18/11/2019 13:53	18/11/2019 19:09	18/11/2019 13:53	18/11/2019 19:09	5,26	18	94,67	CHI
201911195605	PALMEIRAS DE GOIAS	PL13194026	PALMEIRAS	18/11/2019 13:53	18/11/2019 19:09	18/11/2019 13:53	18/11/2019 19:09	5,26	114	599,58	CHI
201911195612	PIRACANJUBA	PJ12349777	PIRACANJUBA	18/11/2019 14:35	21/11/2019 22:38	18/11/2019 14:35	21/11/2019 22:38	80,04	1	80,04	CHI
201911195653	GOIANIA	GN10404269	ATLANTICO S3	18/11/2019 15:20	18/11/2019 15:53	18/11/2019 15:20	18/11/2019 15:44	0,40	2085	838,05	CHI
201911195653	GOIANIA	GN10385816	ATLANTICO S1	18/11/2019 15:20	18/11/2019 15:53	18/11/2019 15:20	18/11/2019 15:49	0,47	2204	1045,06	CHI
201911195653	GOIANIA	GN10385816	CARAJAS S1	18/11/2019 15:20	18/11/2019 15:53	18/11/2019 15:20	18/11/2019 15:49	0,47	3625	1718,85	CHI
201911195653	GOIANIA	GN16404935	CARAJAS S1	18/11/2019 15:20	18/11/2019 15:53	18/11/2019 15:20	18/11/2019 15:53	0,55	4018	2196,51	CHI
201911195656	QUIRINOPOLIS	QI21296558	QUIRINOPOLIS	18/11/2019 16:02	18/11/2019 16:38	18/11/2019 16:02	18/11/2019 16:38	0,59	2	1,18	CHI
201911195666	GOIANIRA	GR11313230	MEIA PONTE	18/11/2019 16:18	18/11/2019 17:01	18/11/2019 16:18	18/11/2019 17:01	0,71	113	80,51	CHI
201911195669	MORRINHOS	02940214	MORRINHOS	18/11/2019 16:34	19/11/2019 12:30	18/11/2019 16:34	18/11/2019 19:40	3,10	56	173,43	CHI
201911195669	IPAMERI	02940214	MORRINHOS	18/11/2019 16:34	19/11/2019 12:30	18/11/2019 16:34	18/11/2019 21:14	4,67	1	4,67	CHI
201911195669	MORRINHOS	02940214	MORRINHOS	18/11/2019 16:34	19/11/2019 12:30	18/11/2019 16:34	18/11/2019 21:14	4,67	79	368,75	CHI
201911195669	MORRINHOS	02940214	MORRINHOS	18/11/2019 16:34	19/11/2019 12:30	18/11/2019 16:36	18/11/2019 21:14	4,64	2	9,27	CHI
201911195669	MORRINHOS	02940214	MORRINHOS	18/11/2019 16:34	19/11/2019 12:30	18/11/2019 19:41	18/11/2019 21:14	1,55	15	23,25	CHI
201911195669	MORRINHOS	MR13308030	MORRINHOS	18/11/2019 16:34	19/11/2019 12:30	18/11/2019 19:41	19/11/2019 00:37	4,93	19	93,72	CHI
201911195669	MORRINHOS	MR13031184	MORRINHOS	18/11/2019 16:34	19/11/2019 12:30	18/11/2019 19:41	19/11/2019 12:30	16,81	22	369,87	CHI
201911195683	SANTA HELENA DE GOIAS	SH10394752	IPEGUARI	18/11/2019 17:17	19/11/2019 16:29	18/11/2019 17:17	18/11/2019 21:03	3,77	76	286,88	CHI
201911195683	SANTA HELENA DE GOIAS	SH12279533	IPEGUARI	18/11/2019 17:17	19/11/2019 16:29	18/11/2019 17:17	19/11/2019 16:29	23,19	32	742,23	CHI
201911195687	GOIANAPOLIS	GP12029287	JUNDIAI S1	18/11/2019 17:43	18/11/2019 18:06	18/11/2019 17:43	18/11/2019 18:06	0,38	64	24,21	CHI
201911195688	MORRINHOS	10001851860	MORRINHOS	16/11/2019 14:49	19/11/2019 08:39	16/11/2019 14:49	19/11/2019 08:39	65,83	1	65,83	CHI
201911195689	ITAJA	IJ10352428	ITAJA S2	18/11/2019 17:35	20/11/2019 01:54	18/11/2019 17:35	18/11/2019 17:44	0,15	9	1,34	CHI
201911195689	LAGOA SANTA	IJ10352428	CACHOEIRA ALTA	18/11/2019 17:35	20/11/2019 01:54	18/11/2019 17:35	18/11/2019 18:12	0,61	16	9,76	CHI

201911195689	APORE	IJ10352428	ITAJA S2	18/11/2019 17:35	20/11/2019 01:54	18/11/2019 17:35	18/11/2019 18:12	0,61	1	0,61	CHI
201911195689	DISTRITO FEDERAL	IJ10352428	ITAJA S2	18/11/2019 17:35	20/11/2019 01:54	18/11/2019 17:35	18/11/2019 18:12	0,61	10	6,10	CHI
201911195689	ITAJA	IJ10352428	ITAJA S2	18/11/2019 17:35	20/11/2019 01:54	18/11/2019 17:35	18/11/2019 18:12	0,61	45	27,46	CHI
201911195689	ITAJA	IJ10352428	ITAJA S2	18/11/2019 17:35	20/11/2019 01:54	18/11/2019 17:35	18/11/2019 18:12	0,61	1768	1078,97	CHI
201911195689	LAGOA SANTA	IJ10352428	ITAJA S2	18/11/2019 17:35	20/11/2019 01:54	18/11/2019 17:35	18/11/2019 18:12	0,61	759	463,20	CHI
201911195689	APORE	IJ10352428	ITAJA S2	18/11/2019 17:35	20/11/2019 01:54	18/11/2019 17:35	18/11/2019 18:16	0,67	3	2,02	CHI
201911195689	ITAJA	IJ10352428	ITAJA S2	18/11/2019 17:35	20/11/2019 01:54	18/11/2019 17:35	18/11/2019 18:16	0,67	99	66,63	CHI
201911195689	ITARUMA	IJ10352428	ITAJA S2	18/11/2019 17:35	20/11/2019 01:54	18/11/2019 17:35	18/11/2019 18:16	0,67	99	66,63	CHI
201911195689	ITAJA	IM10401499	ITAJA S2	18/11/2019 17:35	20/11/2019 01:54	18/11/2019 18:17	18/11/2019 21:37	3,33	12	40,01	CHI
201911195689	ITARUMA	IM10401499	ITAJA S2	18/11/2019 17:35	20/11/2019 01:54	18/11/2019 18:17	18/11/2019 21:37	3,33	98	326,72	CHI
201911195689	ITAJA	IJ10401500	ITAJA S2	18/11/2019 17:35	20/11/2019 01:54	18/11/2019 18:17	19/11/2019 12:24	18,12	31	561,76	CHI
201911195689	APORE	IM13082115	ITAJA S2	18/11/2019 17:35	20/11/2019 01:54	18/11/2019 18:17	20/11/2019 01:54	31,63	3	94,88	CHI
201911195689	ITAJA	IM13082115	ITAJA S2	18/11/2019 17:35	20/11/2019 01:54	18/11/2019 18:17	20/11/2019 01:54	31,63	56	1771,02	CHI
201911195689	ITARUMA	IM13082115	ITAJA S2	18/11/2019 17:35	20/11/2019 01:54	18/11/2019 18:17	20/11/2019 01:54	31,63	1	31,63	CHI
201911195692	IACIARA	IA21286091	IACIARA S2	18/11/2019 17:58	18/11/2019 18:14	18/11/2019 17:58	18/11/2019 18:14	0,25	1	0,25	CHI
201911195694	CIDADE OCIDENTAL	LZ12072636	MARAJOARA	18/11/2019 08:54	19/11/2019 07:25	18/11/2019 08:54	19/11/2019 07:25	22,50	18	405,08	CHI
201911195702	JATAI	JT21239524	JATAI S1	18/11/2019 13:59	18/11/2019 17:15	18/11/2019 13:59	18/11/2019 17:15	3,26	1	3,26	CHI
201911195703	ALEXANIA	AX21032757	ALEXANIA	18/11/2019 13:59	19/11/2019 15:13	18/11/2019 13:59	19/11/2019 15:13	25,22	1	25,22	CHI
201911195707	ANAPOLIS	10028703489	ANAPOLIS UNIVERSITARIO S2	18/11/2019 14:00	18/11/2019 16:51	18/11/2019 14:00	18/11/2019 16:51	2,84	1	2,84	CHI
201911195710	BELA VISTA DE GOIAS	XX03592455	CEPAIGO S2	18/11/2019 14:01	20/11/2019 18:32	18/11/2019 14:01	20/11/2019 18:32	52,53	1	52,53	CHI
201911195712	GOIANIA	10002208197	GOIANIA LESTE S2	18/11/2019 14:01	18/11/2019 15:53	18/11/2019 14:01	18/11/2019 15:53	1,86	1	1,86	CHI
201911195721	VALPARAISO DE GOIAS	10007065823	PACAEMBU S2	18/11/2019 14:02	18/11/2019 15:45	18/11/2019 14:02	18/11/2019 15:45	1,71	1	1,71	CHI
201911195723	MONTES CLAROS DE GOIAS	ME21198136	IPORA	18/11/2019 14:02	18/11/2019 16:59	18/11/2019 14:02	18/11/2019 16:59	2,93	1	2,93	CHI
201911195733	PEROLANDIA	2370000631	JATAI S1	18/11/2019 14:01	18/11/2019 15:42	18/11/2019 14:01	18/11/2019 15:42	1,67	1	1,67	CHI
201911195753	BELA VISTA DE GOIAS	BV11058657	BELA VISTA S2	18/11/2019 14:08	19/11/2019 17:28	18/11/2019 14:08	19/11/2019 17:28	27,33	5	136,63	CHI
201911195757	IACIARA	IA21286073	FLORES DE GOIAS	18/11/2019 14:08	19/11/2019 23:01	18/11/2019 14:08	19/11/2019 23:01	32,88	1	32,88	CHI
201911195757	IACIARA	7201344	FLORES DE GOIAS	18/11/2019 14:08	19/11/2019 23:01	19/11/2019 20:43	19/11/2019 23:01	2,31	3	6,93	CHI
201911195760	CAMPO ALEGRE DE GOIAS	CM12216102	CAMPO ALEGRE DE GOIAS	18/11/2019 14:09	19/11/2019 11:44	18/11/2019 14:09	19/11/2019 11:44	21,58	10	215,81	CHI
201911195763	GOIANIA	15207134	REAL S1	18/11/2019 14:09	18/11/2019 18:02	18/11/2019 14:09	18/11/2019 18:02	3,88	1	3,88	CHI
201911195766	RUBIATABA	RB12066220	RUBIATABA	18/11/2019 08:04	18/11/2019 16:17	18/11/2019 08:04	18/11/2019 16:17	8,21	5	41,05	CHI
201911195771	CACU	1140013595	CACHOEIRA ALTA	18/11/2019 14:10	19/11/2019 16:33	18/11/2019 14:10	19/11/2019 16:33	26,37	1	26,37	CHI
201911195777	PLANALTINA	2960203453	PLANALTINA	18/11/2019 14:11	18/11/2019 16:20	18/11/2019 14:11	18/11/2019 16:20	2,15	1	2,15	CHI
201911195783	CAMPO LIMPO	AN12267847	NEROPOLIS S1	18/11/2019 14:07	18/11/2019 17:03	18/11/2019 14:07	18/11/2019 17:03	2,93	63	184,50	CHI

201911195788	APARECIDA DE GOIANIA	12925093	REAL S1	18/11/2019 14:12	18/11/2019 16:02	18/11/2019 14:12	18/11/2019 16:02	1,83	1	1,83	CHI
201911195810	NOVO BRASIL	NB21237288	MATRINCHA	18/11/2019 14:13	18/11/2019 18:50	18/11/2019 14:13	18/11/2019 18:50	4,61	1	4,61	CHI
201911195813	ITABERAI	10025180680	INHUMAS S1	18/11/2019 14:14	19/11/2019 15:21	18/11/2019 14:14	19/11/2019 15:21	25,10	1	25,10	CHI
201911195821	RIO VERDE	RV10400366	RIO VERDE S2	18/11/2019 13:28	18/11/2019 21:45	18/11/2019 13:28	18/11/2019 16:09	2,69	5812	15621,36	CHI
201911195821	RIO VERDE	RV16408210	RIO VERDE S2	18/11/2019 13:28	18/11/2019 21:45	18/11/2019 13:28	18/11/2019 16:34	3,10	467	1446,66	CHI
201911195821	RIO VERDE	RV16408210	RIO VERDE S2	18/11/2019 13:28	18/11/2019 21:45	18/11/2019 13:28	18/11/2019 21:33	8,09	969	7838,40	CHI
201911195821	RIO VERDE	RV16408210	RIO VERDE S2	18/11/2019 13:28	18/11/2019 21:45	18/11/2019 21:29	18/11/2019 21:33	0,08	467	35,67	CHI
201911195821	RIO VERDE	RV10406626	RIO VERDE S2	18/11/2019 13:28	18/11/2019 21:45	18/11/2019 13:28	18/11/2019 21:44	8,26	210	1734,02	CHI
201911195821	RIO VERDE	RV10406626	RIO VERDE S2	18/11/2019 13:28	18/11/2019 21:45	18/11/2019 13:28	18/11/2019 21:44	8,27	166	1372,96	CHI
201911195821	RIO VERDE	RV10406626	RIO VERDE S2	18/11/2019 13:28	18/11/2019 21:45	18/11/2019 13:28	18/11/2019 21:45	8,27	145	1199,67	CHI
201911195821	RIO VERDE	RV10406626	RIO VERDE S2	18/11/2019 13:28	18/11/2019 21:45	18/11/2019 13:28	18/11/2019 21:45	8,28	100	827,67	CHI
201911195830	SAO LUIS DE MONTES BELOS	SL11000014	SAO LUIZ DOS MONTES BELOS	18/11/2019 14:16	18/11/2019 16:42	18/11/2019 14:16	18/11/2019 16:42	2,43	151	366,34	CHI
201911195833	GOIANIRA	GR12313284	MEIA PONTE	18/11/2019 13:54	18/11/2019 16:08	18/11/2019 13:54	18/11/2019 16:08	2,23	287	639,93	CHI
201911195834	CAMPO ALEGRE DE GOIAS	CM21155528	CAMPO ALEGRE DE GOIAS	18/11/2019 14:17	22/11/2019 22:21	18/11/2019 14:17	22/11/2019 22:21	104,08	1	104,08	CHI
201911195840	CRIXAS	2490029739	SERRA DO OURO	18/11/2019 14:17	18/11/2019 17:37	18/11/2019 14:17	18/11/2019 17:37	3,33	1	3,33	CHI
201911195844	ANAPOLIS	20944159	ANAPOLIS UNIVERSITARIO S2	18/11/2019 14:18	18/11/2019 17:35	18/11/2019 14:18	18/11/2019 17:35	3,28	1	3,28	CHI
201911195848	ARAGOIANIA	AO21033824	GUAPO S2	18/11/2019 14:19	18/11/2019 17:27	18/11/2019 14:19	18/11/2019 17:27	3,13	1	3,13	CHI
201911195850	ARAGOIANIA	AO12251688	GUAPO S2	18/11/2019 14:19	19/11/2019 19:03	18/11/2019 14:19	18/11/2019 16:59	2,67	69	183,96	CHI
201911195850	ARAGOIANIA	AO12251690LD	GUAPO S2	18/11/2019 14:19	19/11/2019 19:03	18/11/2019 14:19	19/11/2019 19:02	28,71	30	861,20	CHI
201911195850	ARAGOIANIA	AO11159700	GUAPO S2	18/11/2019 14:19	19/11/2019 19:03	19/11/2019 11:01	19/11/2019 19:03	8,04	22	176,95	CHI
201911195852	QUIRINOPOLIS	10018100226	QUIRINOPOLIS	18/11/2019 14:19	19/11/2019 10:47	18/11/2019 14:19	19/11/2019 10:47	20,46	1	20,46	CHI
201911195857	SAO MIGUEL DO ARAGUAIA	830014470	SAO MIGUEL DO ARAGUAIA	18/11/2019 14:20	18/11/2019 19:24	18/11/2019 14:20	18/11/2019 19:24	5,06	1	5,06	CHI
201911195858	SANTA BARBARA DE GOIAS	1030007904	TRINDADE	18/11/2019 14:18	18/11/2019 17:09	18/11/2019 14:18	18/11/2019 17:09	2,85	1	2,85	CHI
201911195859	GOIANIA	GN12000545	CAMPINAS S3	18/11/2019 13:46	18/11/2019 22:43	18/11/2019 13:46	18/11/2019 22:43	8,93	301	2689,35	CHI
201911195862	BELA VISTA DE GOIAS	10017156368	BELA VISTA S1	18/11/2019 14:21	19/11/2019 13:09	18/11/2019 14:21	19/11/2019 13:09	22,80	1	22,80	CHI
201911196006	ANAPOLIS	AN12239275	ANAPOLIS UNIVERSITARIO S2	18/11/2019 14:07	18/11/2019 16:04	18/11/2019 14:07	18/11/2019 16:04	1,95	235	457,53	CHI
201911196007	CALDAS NOVAS	CN21390639	CALDAS NOVAS S1	18/11/2019 14:22	19/11/2019 15:30	18/11/2019 14:22	19/11/2019 15:30	25,12	1	25,12	CHI
201911196008	ANAPOLIS	AN11189930	ANAPOLIS UNIVERSITARIO S2	18/11/2019 14:22	18/11/2019 18:00	18/11/2019 14:22	18/11/2019 18:00	3,63	120	435,70	CHI
201911196010	GOIAS	GS21140285	MATRINCHA	18/11/2019 14:23	19/11/2019 14:30	18/11/2019 14:23	19/11/2019 14:30	24,13	2	48,26	CHI
201911196014	GOIANIA	GN11273545	GOYA S2	18/11/2019 14:23	18/11/2019 17:41	18/11/2019 14:23	18/11/2019 17:41	3,29	72	236,62	CHI
201911196020	RIO VERDE	RV21249098	MONTIVIDIU T	18/11/2019 14:24	19/11/2019 00:22	18/11/2019 14:24	19/11/2019 00:22	9,96	2	19,92	CHI
201911196024	MINEIROS	10021541360	PARQUE DAS EMAS	18/11/2019 14:24	18/11/2019 17:27	18/11/2019 14:24	18/11/2019 17:27	3,03	1	3,03	CHI
201911196026	IPAMERI	IP21275752	IPAMERI	18/11/2019 14:25	19/11/2019 12:06	18/11/2019 14:25	19/11/2019 12:06	21,68	3	65,05	CHI

201911196030	CRISTALINA	KR21304899	PAMPLONA	18/11/2019 14:25	19/11/2019 17:45	18/11/2019 14:25	19/11/2019 17:45	27,33	1	27,33	CHI
201911196105	ITUMBIARA	690258975	ITUMBIARA NOVA	18/11/2019 14:27	18/11/2019 18:08	18/11/2019 14:27	18/11/2019 18:08	3,68	1	3,68	CHI
201911196108	NOVA VENEZA	300023637	INHUMAS S1	18/11/2019 14:27	18/11/2019 16:19	18/11/2019 14:27	18/11/2019 16:19	1,86	1	1,86	CHI
201911196113	TAQUARAL DE GOIAS	340003844	ITABERAI S1	18/11/2019 14:28	18/11/2019 16:49	18/11/2019 14:28	18/11/2019 16:49	2,35	1	2,35	CHI
201911196118	CATALAO	10015779260	CATALAO S1	18/11/2019 14:29	22/11/2019 03:21	18/11/2019 14:29	22/11/2019 03:21	84,87	1	84,87	CHI
201911196121	BOM JARDIM DE GOIAS	BM12260019	BOM JARDIM	18/11/2019 14:29	18/11/2019 16:42	18/11/2019 14:29	18/11/2019 16:42	2,20	4	8,80	CHI
201911196137	GOIANDIRA	CT21134393	CATALAO S1	18/11/2019 14:31	20/11/2019 11:18	18/11/2019 14:31	20/11/2019 11:18	44,78	1	44,78	CHI
201911196143	RIO VERDE	RV11251852	RIO VERDE S1	18/11/2019 14:17	18/11/2019 16:50	18/11/2019 14:17	18/11/2019 16:50	2,55	114	290,19	CHI
201911196152	PORANGATU	PO12145187	PORANGATU	18/11/2019 13:55	18/11/2019 23:43	18/11/2019 13:55	18/11/2019 23:43	9,80	8	78,39	CHI
201911196163	JATAI	290319730	JATAI S2	18/11/2019 14:35	18/11/2019 19:45	18/11/2019 14:35	18/11/2019 19:45	5,15	1	5,15	CHI
201911196180	JARAGUA	JA11258174	JARAGUA	18/11/2019 14:38	18/11/2019 18:57	18/11/2019 14:38	18/11/2019 18:57	4,30	27	116,20	CHI
201911196183	GOIANIA	GN11160122	REAL S1	18/11/2019 14:39	19/11/2019 11:46	18/11/2019 14:39	19/11/2019 11:46	21,12	78	1647,04	CHI
201911196196	RIO VERDE	RV13271384	RIO VERDE S1	18/11/2019 14:39	18/11/2019 15:58	18/11/2019 14:39	18/11/2019 15:58	1,31	5	6,57	CHI
201911196203	PADRE BERNARDO	PB12170167	PADRE BERNARDO	18/11/2019 14:18	18/11/2019 15:45	18/11/2019 14:18	18/11/2019 15:45	1,43	50	71,71	CHI
201911196311	IPORA	IR12065120	IPORA	18/11/2019 09:25	18/11/2019 16:26	18/11/2019 09:25	18/11/2019 16:26	7,00	7	49,00	CHI
201911196315	ANAPOLIS	AN12258789	ANAPOLIS UNIVERSITARIO S1	18/11/2019 10:22	18/11/2019 20:35	18/11/2019 10:22	18/11/2019 20:35	10,20	13	132,66	CHI
201911196316	RIO VERDE	RV12200787	CABRIUVA S1	18/11/2019 14:43	19/11/2019 09:05	18/11/2019 14:43	19/11/2019 09:05	18,36	2	36,72	CHI
201911196325	RIO VERDE	RV12365472	RIO VERDE S2	18/11/2019 13:56	18/11/2019 16:00	18/11/2019 13:56	18/11/2019 16:00	2,07	184	380,22	CHI
201911196332	ITUMBIARA	IT12257023RE	ITUMBIARA NOVA	18/11/2019 13:17	19/11/2019 07:41	18/11/2019 13:17	19/11/2019 07:41	18,40	63	1158,97	CHI
201911196345	DISTRITO FEDERAL	AE12000027	ITAJA S1	18/11/2019 14:47	19/11/2019 19:18	18/11/2019 14:47	19/11/2019 19:18	28,51	1	28,51	CHI
201911196348	JATAI	JT21150940	JATAI S1	18/11/2019 14:46	18/11/2019 23:30	18/11/2019 14:46	18/11/2019 20:20	5,57	1	5,57	CHI
201911196348	JATAI	JT12302009LD	JATAI S1	18/11/2019 14:46	18/11/2019 23:30	18/11/2019 18:20	18/11/2019 23:30	5,17	9	46,54	CHI
201911196351	JUSSARA	JR21378811	JUSSARA	18/11/2019 14:47	20/11/2019 17:18	18/11/2019 14:47	20/11/2019 17:18	50,50	1	50,50	CHI
201911196367	MINEIROS	1390143068	PARQUE DAS EMAS	18/11/2019 14:50	18/11/2019 16:15	18/11/2019 14:50	18/11/2019 16:15	1,40	1	1,40	CHI
201911196370	CUMARI	CY12027445	CATALAO S1	18/11/2019 14:51	19/11/2019 19:36	18/11/2019 14:51	19/11/2019 19:36	28,74	3	86,22	CHI
201911196398	TURVELANDIA	SH12026451	RIO DOS BOIS	18/11/2019 14:54	20/11/2019 07:50	18/11/2019 14:54	20/11/2019 07:50	40,92	1	40,92	CHI
201911196400	BELA VISTA DE GOIAS	BV32249964	BELA VISTA S1	18/11/2019 14:54	18/11/2019 16:48	18/11/2019 14:54	18/11/2019 16:48	1,89	48	90,80	CHI
201911196405	GOIANIA	00590294	FERROVIARIO S2	18/11/2019 14:54	18/11/2019 17:20	18/11/2019 14:54	18/11/2019 17:20	2,43	307	746,95	CHI
201911196406	JUSSARA	JR21091914	JUSSARA	18/11/2019 14:56	19/11/2019 17:39	18/11/2019 14:56	19/11/2019 17:39	26,72	1	26,72	CHI
201911196419	URUACU	UR21339934	URUACU	18/11/2019 14:58	18/11/2019 16:51	18/11/2019 14:58	18/11/2019 16:51	1,88	1	1,88	CHI
201911196420	ALTO PARAISO DE GOIAS	BF21163415	NIQUELANDIA SUBTRANSMISSAO	18/11/2019 14:58	18/11/2019 19:17	18/11/2019 14:58	18/11/2019 19:17	4,31	1	4,31	CHI
201911196424	GOIANIA	GN12027625	XAVANTES	18/11/2019 14:59	18/11/2019 23:40	18/11/2019 14:59	18/11/2019 23:40	8,68	4	34,71	CHI
201911196427	SAO MIGUEL DO ARAGUAIA	SM21262603	SAO MIGUEL DO ARAGUAIA	18/11/2019 14:59	19/11/2019 00:05	18/11/2019 14:59	19/11/2019 00:05	9,09	1	9,09	CHI

201911196430	COCALZINHO DE GOIAS	1200034093	COCALZINHO	18/11/2019 14:59	19/11/2019 14:57	18/11/2019 14:59	19/11/2019 14:57	23,95	1	23,95	CHI
201911196433	ALTO PARAISO DE GOIAS	BF21329676	NIQUELANDIA SUBTRANSMISSAO	18/11/2019 15:00	18/11/2019 18:05	18/11/2019 15:00	18/11/2019 18:05	3,08	2	6,17	CHI
201911196438	BELA VISTA DE GOIAS	BV11188883	BELA VISTA S1	18/11/2019 13:42	18/11/2019 17:47	18/11/2019 13:42	18/11/2019 17:47	4,08	60	244,90	CHI
201911196439	ITUMBIARA	IT21346110	ITUMBIARA NOVA	18/11/2019 15:00	19/11/2019 16:37	18/11/2019 15:00	19/11/2019 16:37	25,61	1	25,61	CHI
201911196501	PORANGATU	PO12371842	NOVO PLANALTO	18/11/2019 15:01	18/11/2019 21:00	18/11/2019 15:01	18/11/2019 21:00	5,97	1	5,97	CHI
201911196504	SILVANIA	SV12161967	VIANOPOLIS	18/11/2019 12:43	19/11/2019 04:40	18/11/2019 12:43	19/11/2019 04:40	15,94	15	239,07	CHI
201911196507	MINACU	4020039150	MINACU	18/11/2019 12:43	19/11/2019 00:30	18/11/2019 12:43	19/11/2019 00:30	11,77	1	11,77	CHI
201911196508	IPAMERI	580073397	IPAMERI	18/11/2019 15:03	19/11/2019 17:06	18/11/2019 15:03	19/11/2019 17:06	26,05	1	26,05	CHI
201911196510	CIDADE OCIDENTAL	DH12170601	MARAJOARA	18/11/2019 15:03	18/11/2019 20:46	18/11/2019 15:03	18/11/2019 20:46	5,71	17	97,12	CHI
201911196515	BRAZABRANTES	DL12026638	INHUMAS S1	18/11/2019 14:30	20/11/2019 16:40	18/11/2019 14:30	18/11/2019 23:57	9,44	9	84,92	CHI
201911196515	DAMOLANDIA	DL12026638	INHUMAS S1	18/11/2019 14:30	20/11/2019 16:40	18/11/2019 14:30	18/11/2019 23:57	9,44	7	66,05	CHI
201911196515	BRAZABRANTES	DL12027276	INHUMAS S1	18/11/2019 14:30	20/11/2019 16:40	19/11/2019 10:29	19/11/2019 16:17	5,79	2	11,58	CHI
201911196515	DAMOLANDIA	DL12027276	INHUMAS S1	18/11/2019 14:30	20/11/2019 16:40	19/11/2019 10:29	19/11/2019 16:17	5,79	3	17,37	CHI
201911196515	BRAZABRANTES	DL12027274	INHUMAS S1	18/11/2019 14:30	20/11/2019 16:40	18/11/2019 14:30	20/11/2019 16:40	50,15	21	1053,21	CHI
201911196517	APARECIDA DE GOIANIA	AP11237264	REAL S1	18/11/2019 14:17	18/11/2019 16:37	18/11/2019 14:17	18/11/2019 16:37	2,33	89	207,07	CHI
201911196523	GOUVELANDIA	GB21193901	QUIRINOPOLIS	18/11/2019 15:04	18/11/2019 19:41	18/11/2019 15:04	18/11/2019 19:41	4,61	1	4,61	CHI
201911196534	SAO LUIS DE MONTES BELOS	SL21180344	FIRMINOPOLIS S2	18/11/2019 15:05	18/11/2019 17:49	18/11/2019 15:05	18/11/2019 17:49	2,73	1	2,73	CHI
201911196535	CASTELANDIA	ML12064391	RIO DOS BOIS	18/11/2019 15:05	19/11/2019 12:23	18/11/2019 15:05	19/11/2019 12:23	21,30	1	21,30	CHI
201911196535	MAURILANDIA	ML12064391	RIO DOS BOIS	18/11/2019 15:05	19/11/2019 12:23	18/11/2019 15:05	19/11/2019 12:23	21,30	3	63,89	CHI
201911196553	JATAI	290299615	JATAI S2	18/11/2019 15:07	18/11/2019 18:40	18/11/2019 15:07	18/11/2019 18:40	3,55	1	3,55	CHI
201911196559	GOIANAPOLIS	TJ12273240	DAIA S2	18/11/2019 15:07	18/11/2019 20:10	18/11/2019 15:07	18/11/2019 19:10	4,04	7	28,25	CHI
201911196559	GOIANAPOLIS	TJ12273240	DAIA S2	18/11/2019 15:07	18/11/2019 20:10	18/11/2019 15:07	18/11/2019 20:10	5,04	3	15,12	CHI
201911196564	GOIANIA	10000885132	CAMPINAS S1	18/11/2019 15:08	19/11/2019 09:04	18/11/2019 15:08	19/11/2019 09:04	17,93	1	17,93	CHI
201911196569	TRINDADE	TR31041140	TRINDADE	18/11/2019 15:09	19/11/2019 11:40	18/11/2019 15:09	19/11/2019 11:40	20,51	1	20,51	CHI
201911196702	CRISTALINA	KR12404430	CRISTALINA S1	18/11/2019 14:30	18/11/2019 16:49	18/11/2019 14:30	18/11/2019 16:49	2,31	15	34,67	CHI
201911196715	PARANAIGUARA	PC12248277	CACHOEIRA ALTA	18/11/2019 14:59	18/11/2019 18:55	18/11/2019 14:59	18/11/2019 18:55	3,93	22	86,51	CHI
201911196728	EDEIA	EA21328987	VICENTINOPOLIS	18/11/2019 15:13	21/11/2019 14:52	18/11/2019 15:13	21/11/2019 14:52	71,65	1	71,65	CHI
201911196728	EDEIA	EA21328988	VICENTINOPOLIS	18/11/2019 15:13	21/11/2019 14:52	18/11/2019 15:13	21/11/2019 14:52	71,65	2	143,30	CHI
201911196730	IPAMERI	IP12056192	IPAMERI	18/11/2019 15:13	19/11/2019 18:51	18/11/2019 15:13	19/11/2019 18:51	27,63	2	55,25	CHI
201911196735	FAINA	FC12026041	GOIAS	18/11/2019 15:12	19/11/2019 15:35	18/11/2019 15:12	19/11/2019 15:35	24,38	2	48,76	CHI
201911196736	ALEXANIA	AX12297672	ALEXANIA	18/11/2019 07:39	19/11/2019 11:28	18/11/2019 07:39	19/11/2019 11:28	27,81	3	83,44	CHI
201911196741	ANICUNS	AC12212648	ANICUNS	18/11/2019 15:14	18/11/2019 18:20	18/11/2019 15:14	18/11/2019 18:20	3,10	1	3,10	CHI
201911196748	SANTA CRUZ DE GOIAS	BC21109657	PIRES DO RIO S2	18/11/2019 15:14	19/11/2019 14:03	18/11/2019 15:14	19/11/2019 14:03	22,80	1	22,80	CHI

201911196753	ANAPOLIS	AN12353433	JUNDIAI S1	18/11/2019 15:15	18/11/2019 17:18	18/11/2019 15:15	18/11/2019 17:18	2,04	5	10,18	CHI
201911196760	GOIANIA	GN12189783	GOIANIA LESTE S3	18/11/2019 15:16	18/11/2019 20:04	18/11/2019 15:16	18/11/2019 20:04	4,79	10	47,86	CHI
201911196761	APARECIDA DE GOIANIA	AP12000012	INDEPENDENCIA S2	18/11/2019 14:34	18/11/2019 18:33	18/11/2019 14:34	18/11/2019 18:33	3,98	861	3424,15	CHI
201911196902	BURITI DE GOIAS	BS21307629	FIRMINOPOLIS S2	18/11/2019 15:18	18/11/2019 22:30	18/11/2019 15:18	18/11/2019 22:30	7,20	1	7,20	CHI
201911196906	BELA VISTA DE GOIAS	BV12402755	BELA VISTA S1	18/11/2019 15:08	18/11/2019 20:52	18/11/2019 15:08	18/11/2019 20:52	5,72	10	57,19	CHI
201911196906	CALDAZINHA	BV12402755	BELA VISTA S1	18/11/2019 15:08	18/11/2019 20:52	18/11/2019 15:08	18/11/2019 20:52	5,72	17	97,23	CHI
201911196907	MORRINHOS	MR21160398	MORRINHOS	18/11/2019 15:18	19/11/2019 09:00	18/11/2019 15:18	19/11/2019 09:00	17,69	2	35,39	CHI
201911196910	GOIANAPOLIS	GP11029286	JUNDIAI S1	18/11/2019 15:19	18/11/2019 17:24	18/11/2019 15:19	18/11/2019 17:24	2,08	41	85,33	CHI
201911196914	ALTO PARAISO DE GOIAS	BF12159157	NIQUELANDIA SUBTRANSMISSAO	18/11/2019 12:47	18/11/2019 17:23	18/11/2019 12:47	18/11/2019 17:23	4,59	16	73,45	CHI
201911196923	BARRO ALTO	BA21342222	GOIANESIA S1	18/11/2019 15:20	18/11/2019 21:53	18/11/2019 15:20	18/11/2019 21:53	6,54	1	6,54	CHI
201911196929	CATALAO	CT21318883	CATALAO S1	18/11/2019 15:21	18/11/2019 19:22	18/11/2019 15:21	18/11/2019 19:22	4,01	2	8,03	CHI
201911196942	MORRINHOS	MR32056716	MORRINHOS	18/11/2019 05:58	19/11/2019 08:59	18/11/2019 05:58	19/11/2019 08:59	27,02	6	162,09	CHI
201911196992	CUMARI	CY21026392	CATALAO S1	18/11/2019 14:51	19/11/2019 19:51	18/11/2019 14:51	19/11/2019 19:51	28,99	1	28,99	CHI
201911196995	GOIANIA	GN12130512	CARAJAS S1	18/11/2019 15:11	18/11/2019 17:16	18/11/2019 15:11	18/11/2019 17:16	2,07	216	446,64	CHI
201911197004	SANTO ANTONIO DO DESCOBERTO	2210129194	ALEXANIA	18/11/2019 15:25	18/11/2019 19:19	18/11/2019 15:25	18/11/2019 19:19	3,89	1	3,89	CHI
201911197020	LUZIANIA	LZ12153292	VIANOPOLIS	18/11/2019 14:46	18/11/2019 18:46	18/11/2019 14:46	18/11/2019 18:46	4,00	13	51,95	CHI
201911197213	POSSE	PS12257684	IACIARA S2	18/11/2019 15:30	18/11/2019 16:48	18/11/2019 15:30	18/11/2019 16:48	1,29	5	6,44	CHI
201911197244	ACREUNA	SH12246720	ACREUNA	18/11/2019 14:58	18/11/2019 20:25	18/11/2019 14:58	18/11/2019 20:25	5,44	5	27,22	CHI
201911197244	SANTA HELENA DE GOIAS	SH12246720	ACREUNA	18/11/2019 14:58	18/11/2019 20:25	18/11/2019 14:58	18/11/2019 20:25	5,44	75	408,31	CHI
201911197244	SANTO ANTONIO DA BARRA	SH12246720	ACREUNA	18/11/2019 14:58	18/11/2019 20:25	18/11/2019 14:58	18/11/2019 20:25	5,44	16	87,11	CHI
201911197257	RIO VERDE	RV21200078	MONTIVIDIU T	18/11/2019 07:25	19/11/2019 01:05	18/11/2019 07:25	19/11/2019 01:05	17,65	1	17,65	CHI
201911197267	GAMELEIRA DE GOIAS	SV12062486	DAIA S2	18/11/2019 07:53	18/11/2019 18:33	18/11/2019 07:53	18/11/2019 18:33	10,66	16	170,58	CHI
201911197271	GOIANIA	GN11135273	REAL S2	18/11/2019 15:33	19/11/2019 14:00	18/11/2019 15:33	19/11/2019 14:00	22,45	81	1818,43	CHI
201911197281	MINEIROS	MY12248466	PARQUE DAS EMAS	18/11/2019 15:37	19/11/2019 14:58	18/11/2019 15:37	19/11/2019 14:58	23,34	3	70,02	CHI
201911197303	RIO VERDE	RV12271283	CABRIUVA S2	18/11/2019 15:38	18/11/2019 20:10	18/11/2019 15:38	18/11/2019 20:10	4,54	20	90,79	CHI
201911197313	POSSE	10026949839	IACIARA S2	18/11/2019 15:39	18/11/2019 22:19	18/11/2019 15:39	18/11/2019 22:19	6,66	1	6,66	CHI
201911197315	APARECIDA DE GOIANIA	AP11132331	REAL S1	18/11/2019 15:27	18/11/2019 18:07	18/11/2019 15:27	18/11/2019 18:07	2,66	101	268,66	CHI
201911197619	HIDROLANDIA	VJ21064218	PONTALINA	18/11/2019 15:41	19/11/2019 16:13	18/11/2019 15:41	19/11/2019 16:13	24,52	1	24,52	CHI
201911197647	CEZARINA	10010741885	CEZARINA	18/11/2019 15:44	19/11/2019 00:20	18/11/2019 15:44	19/11/2019 00:20	8,59	1	8,59	CHI
201911197654	ABADIANIA	AA21297769	ANAPOLIS UNIVERSITARIO S1	18/11/2019 15:45	19/11/2019 09:08	18/11/2019 15:45	19/11/2019 09:08	17,37	1	17,37	CHI
201911197672	SAO FRANCISCO DE GOIAS	SF12211814	SAO FRANCISCO DE GOIAS	18/11/2019 15:29	18/11/2019 16:38	18/11/2019 15:29	18/11/2019 16:38	1,14	13	14,81	CHI
201911197676	CRISTALINA	10005526769	CRISTALINA S1	18/11/2019 15:49	19/11/2019 00:02	18/11/2019 15:49	19/11/2019 00:02	8,22	1	8,22	CHI
201911197679	MINACU	IH21130488	MINACU	18/11/2019 15:49	18/11/2019 22:00	18/11/2019 15:49	18/11/2019 22:00	6,19	1	6,19	CHI

201911197682	CAVALCANTE	CJ11264700	FLORES DE GOIAS	18/11/2019 15:49	19/11/2019 13:24	18/11/2019 15:49	19/11/2019 13:24	21,57	49	1057,00	CHI
201911197689	ANAPOLIS	20692444	ANAPOLIS UNIVERSITARIO S2	18/11/2019 15:50	18/11/2019 17:56	18/11/2019 15:50	18/11/2019 17:56	2,10	1	2,10	CHI
201911197691	CAMPO LIMPO	AN21351162	NEROPOLIS S1	18/11/2019 15:50	18/11/2019 18:12	18/11/2019 15:50	18/11/2019 18:12	2,36	1	2,36	CHI
201911197697	NOVA GLORIA	NG12262859	ITAPACI	18/11/2019 14:36	19/11/2019 10:52	18/11/2019 14:36	19/11/2019 10:52	20,26	10	202,64	CHI
201911197700	SENADOR CANEDO	190071620	SENADOR CANEDO	18/11/2019 15:50	19/11/2019 03:04	18/11/2019 15:50	19/11/2019 03:04	11,22	0	0,00	CHI
201911197706	IVOLANDIA	IV21193302	IPORA	18/11/2019 15:51	18/11/2019 21:43	18/11/2019 15:51	18/11/2019 21:43	5,86	1	5,86	CHI
201911197707	ORIZONA	OZ12114508	PIRES DO RIO S2	18/11/2019 06:23	19/11/2019 11:54	18/11/2019 06:23	19/11/2019 11:54	29,51	11	324,59	CHI
201911197711	SAO MIGUEL DO ARAGUAIA	830042787	SAO MIGUEL DO ARAGUAIA	18/11/2019 15:51	19/11/2019 01:37	18/11/2019 15:51	19/11/2019 01:37	9,75	1	9,75	CHI
201911197719	MINEIROS	MY12303820	PARQUE DAS EMAS	18/11/2019 15:44	18/11/2019 20:32	18/11/2019 15:44	18/11/2019 20:32	4,79	28	134,17	CHI
201911197719	SANTA RITA DO ARAGUAIA	MY12303820	PARQUE DAS EMAS	18/11/2019 15:44	18/11/2019 20:32	18/11/2019 15:44	18/11/2019 20:32	4,79	2	9,58	CHI
201911197722	IVOLANDIA	IV12358531	IPORA	18/11/2019 15:53	19/11/2019 09:36	18/11/2019 15:53	19/11/2019 09:36	17,71	16	283,36	CHI
201911197734	LUZIANIA	LZ21320175	CRISTALINA S2	18/11/2019 04:49	18/11/2019 19:54	18/11/2019 04:49	18/11/2019 19:54	15,08	1	15,08	CHI
201911197737	PIRES DO RIO	460068520	PIRES DO RIO S1	18/11/2019 15:54	18/11/2019 20:36	18/11/2019 15:54	18/11/2019 20:36	4,68	1	4,68	CHI
201911197744	JATAI	290198331	JATAI S3	18/11/2019 15:55	19/11/2019 16:50	18/11/2019 15:55	19/11/2019 16:50	24,91	1	24,91	CHI
201911197749	JARAGUA	JA12266573	JARAGUA	18/11/2019 15:17	18/11/2019 17:35	18/11/2019 15:17	18/11/2019 17:35	2,29	201	460,07	CHI
201911197760	NIQUELANDIA	NQ21284691	NIQUELANDIA SUBTRANSMISSAO	18/11/2019 15:57	19/11/2019 00:25	18/11/2019 15:57	19/11/2019 00:25	8,46	2	16,93	CHI
201911197762	LUZIANIA	LZ12085956	CRISTALINA S2	18/11/2019 15:57	18/11/2019 17:31	18/11/2019 15:57	18/11/2019 17:31	1,56	15	23,46	CHI
201911197763	ARAGOIANIA	AO32000019	GUAPO S2	18/11/2019 15:47	19/11/2019 13:32	18/11/2019 15:47	19/11/2019 13:32	21,74	15	326,08	CHI
201911197766	GOIANIA	GN11343046	ATLANTICO S1	18/11/2019 15:55	18/11/2019 19:05	18/11/2019 15:55	18/11/2019 19:05	3,15	92	289,98	CHI
201911197767	HIDROLANDIA	HD12138931	INDEPENDENCIA S1	18/11/2019 15:54	19/11/2019 14:33	18/11/2019 15:54	19/11/2019 14:33	22,65	15	339,75	CHI
201911197772	NEROPOLIS	NR12325422	NEROPOLIS S2	18/11/2019 15:58	18/11/2019 17:40	18/11/2019 15:58	18/11/2019 17:40	1,69	8	13,55	CHI
201911197773	JUSSARA	JR12137858	BRITANIA	18/11/2019 15:54	18/11/2019 18:08	18/11/2019 15:54	18/11/2019 18:08	2,23	3	6,68	CHI
201911197793	CATALAO	CT21042382	CATALAO S1	18/11/2019 16:00	20/11/2019 10:00	18/11/2019 16:00	20/11/2019 10:00	42,01	1	42,01	CHI
201911197794	RIO VERDE	630061385	RIO VERDE S1	18/11/2019 16:00	18/11/2019 17:37	18/11/2019 16:00	18/11/2019 17:37	1,62	1	1,62	CHI
201911197806	ANAPOLIS	AN21347812	DAIA S1	18/11/2019 16:01	18/11/2019 19:22	18/11/2019 16:01	18/11/2019 19:22	3,34	1	3,34	CHI
201911198101	ABADIANIA	AA21062581	ANAPOLIS UNIVERSITARIO S1	18/11/2019 16:02	18/11/2019 18:45	18/11/2019 16:02	18/11/2019 18:45	2,71	2	5,42	CHI
201911198109	APARECIDA DE GOIANIA	AP11162219	INDEPENDENCIA S1	18/11/2019 15:47	19/11/2019 02:42	18/11/2019 15:47	19/11/2019 02:42	10,91	108	1178,19	CHI
201911198114	GOIANIA	GN12133722	GOIANIA LESTE S2	18/11/2019 16:03	19/11/2019 01:36	18/11/2019 16:03	19/11/2019 01:36	9,54	2	19,08	CHI
201911198116	GOIANIA	GN12200567	CARAJAS S1	18/11/2019 15:46	18/11/2019 17:26	18/11/2019 15:46	18/11/2019 17:26	1,66	143	237,42	CHI
201911198118	RIO VERDE	4090000600	SANTA HELENA S1	18/11/2019 16:03	19/11/2019 21:52	18/11/2019 16:03	19/11/2019 21:52	29,81	1	29,81	CHI
201911198126	GOIANIA	14254839	CARAJAS S2	18/11/2019 16:04	19/11/2019 10:09	18/11/2019 16:04	19/11/2019 10:09	18,08	1	18,08	CHI
201911198127	BRAZABRANTES	BR11193250	NEROPOLIS S1	18/11/2019 16:04	18/11/2019 23:03	18/11/2019 16:04	18/11/2019 23:03	7,00	154	1077,27	CHI
201911198130	CACU	1140032000	CACHOEIRA ALTA	18/11/2019 16:03	19/11/2019 18:03	18/11/2019 16:03	19/11/2019 18:03	25,99	1	25,99	CHI

201911198206	BALIZA	BH12210020	BOM JARDIM	18/11/2019 21:11	19/11/2019 08:17	18/11/2019 21:11	19/11/2019 08:17	11,10	93	1032,20	CHI
201911198213	GOIANIA	GN11365747	SENADOR CANEDO	18/11/2019 16:06	19/11/2019 05:14	18/11/2019 16:06	19/11/2019 05:14	13,12	48	629,67	CHI
201911198219	MAMBAI	MB21314311	IACIARA S2	18/11/2019 16:07	18/11/2019 17:27	18/11/2019 16:07	18/11/2019 17:27	1,32	1	1,32	CHI
201911198602	ABADIANIA	AA12377766	ANAPOLIS UNIVERSITARIO S1	18/11/2019 14:28	18/11/2019 17:13	18/11/2019 14:28	18/11/2019 17:13	2,75	9	24,71	CHI
201911198606	RIO VERDE	QI21239481	QUIRINOPOLIS	18/11/2019 16:09	19/11/2019 00:16	18/11/2019 16:09	19/11/2019 00:16	8,11	1	8,11	CHI
201911198610	GOIANIA	GN11169908	ATLANTICO S3	18/11/2019 15:45	18/11/2019 21:07	18/11/2019 15:45	18/11/2019 21:07	5,37	115	617,13	CHI
201911198611	GOIANIA	GN21323255	CAMPINAS S1	18/11/2019 15:30	18/11/2019 22:12	18/11/2019 15:30	18/11/2019 22:00	6,49	1	6,49	CHI
201911198611	GOIANIA	GN12000071	CAMPINAS S1	18/11/2019 15:30	18/11/2019 22:12	18/11/2019 15:30	18/11/2019 22:12	6,70	271	1815,02	CHI
201911198612	GOIANIA	GN21013460	XAVANTES	18/11/2019 16:10	19/11/2019 00:07	18/11/2019 16:10	19/11/2019 00:07	7,95	1	7,95	CHI
201911198701	PORTELANDIA	1470000055	PARQUE DAS EMAS	18/11/2019 16:11	19/11/2019 15:31	18/11/2019 16:11	19/11/2019 15:31	23,33	1	23,33	CHI
201911198902	GOIANIA	GN12140153	AEROPORTO S2	18/11/2019 15:48	18/11/2019 19:55	18/11/2019 15:48	18/11/2019 19:55	4,12	43	177,00	CHI
201911199209	RIO VERDE	630087830	RIO VERDE S2	18/11/2019 16:12	19/11/2019 11:50	18/11/2019 16:12	19/11/2019 11:50	19,63	1	19,63	CHI
201911199212	JARAGUA	JA21234246	JARAGUA	18/11/2019 16:12	19/11/2019 09:59	18/11/2019 16:12	19/11/2019 09:59	17,77	2	35,54	CHI
201911199216	CEZARINA	VJ12378550	GUAPO S2	18/11/2019 15:38	19/11/2019 19:34	18/11/2019 15:38	19/11/2019 19:34	27,92	8	223,40	CHI
201911199216	VARJAO	VJ12378550	GUAPO S2	18/11/2019 15:38	19/11/2019 19:34	18/11/2019 15:38	19/11/2019 19:34	27,92	43	1200,75	CHI
201911199220	JESUPOLIS	JE21268995	SAO FRANCISCO DE GOIAS	18/11/2019 16:13	18/11/2019 17:26	18/11/2019 16:13	18/11/2019 17:26	1,21	1	1,21	CHI
201911199227	CRISTALINA	KR21214806	PAMPLONA	18/11/2019 16:14	19/11/2019 15:30	18/11/2019 16:14	19/11/2019 15:30	23,25	1	23,25	CHI
201911199228	QUIRINOPOLIS	QI11095017	QUIRINOPOLIS	18/11/2019 16:14	18/11/2019 18:53	18/11/2019 16:14	18/11/2019 18:53	2,64	107	282,27	CHI
201911199231	APARECIDA DE GOIANIA	10020245856	INDEPENDENCIA S2	18/11/2019 16:14	19/11/2019 11:24	18/11/2019 16:14	19/11/2019 11:24	19,16	1	19,16	CHI
201911199301	JUSSARA	JR21259709	JUSSARA	18/11/2019 16:15	18/11/2019 19:32	18/11/2019 16:15	18/11/2019 19:32	3,28	1	3,28	CHI
201911199401	GOIANIA	GN11041879	FERROVIARIO S2	18/11/2019 15:33	19/11/2019 01:24	18/11/2019 15:33	19/11/2019 01:24	9,85	127	1250,53	CHI
201911199505	RIO VERDE	SH12018087	SANTA HELENA S1	18/11/2019 16:16	19/11/2019 10:35	18/11/2019 16:16	19/11/2019 10:35	18,32	3	54,96	CHI
201911199705	ORIZONA	OZ12275794	PIRES DO RIO S2	18/11/2019 13:32	18/11/2019 21:08	18/11/2019 13:32	18/11/2019 21:08	7,59	12	91,09	CHI
201911199714	GOIATUBA	VI12329055	VICENTINOPOLIS	18/11/2019 08:52	19/11/2019 17:20	18/11/2019 08:52	19/11/2019 17:20	32,46	13	421,94	CHI
201911199714	VICENTINOPOLIS	VI12329055	VICENTINOPOLIS	18/11/2019 08:52	19/11/2019 17:20	18/11/2019 08:52	19/11/2019 17:20	32,46	28	908,80	CHI
201911200001	GOIANIA	GN11329616	CARAJAS S2	18/11/2019 15:46	18/11/2019 18:18	18/11/2019 15:46	18/11/2019 18:18	2,53	24	60,79	CHI
201911200003	TRINDADE	40316373	TRINDADE	18/11/2019 16:18	19/11/2019 05:17	18/11/2019 16:18	19/11/2019 05:17	12,97	1	12,97	CHI
201911200017	ABADIANIA	AA12050405	ANAPOLIS UNIVERSITARIO S1	18/11/2019 16:08	18/11/2019 20:51	18/11/2019 16:08	18/11/2019 20:51	4,72	15	70,73	CHI
201911200019	SENADOR CANEDO	10006277703	SENADOR CANEDO	18/11/2019 16:20	18/11/2019 19:39	18/11/2019 16:20	18/11/2019 19:39	3,30	1	3,30	CHI
201911200021	APARECIDA DE GOIANIA	AP11000016	INDEPENDENCIA S1	18/11/2019 15:57	18/11/2019 19:04	18/11/2019 15:57	18/11/2019 19:04	3,12	120	373,97	CHI
201911200038	GOIANIA	GN12098425	CEPAIGO S1	18/11/2019 16:23	18/11/2019 21:15	18/11/2019 16:23	18/11/2019 21:15	4,86	117	568,94	CHI
201911200044	PARAUNA	PU21336664	FIRMINOPOLIS S2	18/11/2019 16:24	19/11/2019 00:58	18/11/2019 16:24	19/11/2019 00:58	8,57	1	8,57	CHI
201911200055	APARECIDA DE GOIANIA	AP13001019	ATLANTICO S1	18/11/2019 15:46	18/11/2019 22:42	18/11/2019 15:46	18/11/2019 22:40	6,89	697	4800,59	CHI

201911200055	GOIANIA	AP13001019	ATLANTICO S1	18/11/2019 15:46	18/11/2019 22:42	18/11/2019 21:57	18/11/2019 22:40	0,72	1061	760,09	CHI
201911200055	GOIANIA	AP11168055	ATLANTICO S1	18/11/2019 15:46	18/11/2019 22:42	18/11/2019 21:42	18/11/2019 22:42	1,00	26	25,99	CHI
201911200056	PIRENOPOLIS	PV10219138	CORUMBA	18/11/2019 16:23	18/11/2019 19:03	18/11/2019 16:23	18/11/2019 18:49	2,44	60	146,33	CHI
201911200056	PIRENOPOLIS	PV10219138	CORUMBA	18/11/2019 16:23	18/11/2019 19:03	18/11/2019 16:23	18/11/2019 19:03	2,67	330	879,91	CHI
201911200056	PIRENOPOLIS	PV13221402	CORUMBA	18/11/2019 16:23	18/11/2019 19:03	18/11/2019 17:47	18/11/2019 19:03	1,27	29	36,71	CHI
201911200056	ANAPOLIS	PV10219138	CORUMBA	18/11/2019 16:23	18/11/2019 19:03	18/11/2019 16:23	18/11/2019 19:03	2,68	1	2,68	CHI
201911200056	GOIANESIA	PV10219138	CORUMBA	18/11/2019 16:23	18/11/2019 19:03	18/11/2019 16:23	18/11/2019 19:03	2,68	11	29,44	CHI
201911200056	JARAGUA	PV10219138	CORUMBA	18/11/2019 16:23	18/11/2019 19:03	18/11/2019 16:23	18/11/2019 19:03	2,68	4	10,71	CHI
201911200056	PIRENOPOLIS	PV10219138	CORUMBA	18/11/2019 16:23	18/11/2019 19:03	18/11/2019 16:23	18/11/2019 19:03	2,68	989	2647,22	CHI
201911200056	VILA PROPICIO	PV10219138	CORUMBA	18/11/2019 16:23	18/11/2019 19:03	18/11/2019 16:23	18/11/2019 19:03	2,68	16	42,83	CHI
201911200057	APARECIDA DE GOIANIA	10002993471	INDEPENDENCIA S2	18/11/2019 16:26	19/11/2019 16:52	18/11/2019 16:26	19/11/2019 16:52	24,43	1	24,43	CHI
201911200060	BONFINOPOLIS	BO11329165	CEPAIGO S2	18/11/2019 15:06	18/11/2019 18:47	18/11/2019 15:06	18/11/2019 18:47	3,68	117	430,04	CHI
201911200063	CRISTALINA	KR12168153	CRISTALINA S2	18/11/2019 16:18	18/11/2019 18:40	18/11/2019 16:18	18/11/2019 18:40	2,36	12	28,33	CHI
201911200066	LEOPOLDO DE BULHOES	LB12026675	DAIA S2	18/11/2019 16:27	19/11/2019 09:18	18/11/2019 16:27	19/11/2019 09:18	16,84	4	67,35	CHI
201911200067	APARECIDA DE GOIANIA	AP11078462	INDEPENDENCIA S2	18/11/2019 16:09	19/11/2019 02:17	18/11/2019 16:09	19/11/2019 02:17	10,13	170	1722,29	CHI
201911200068	GOIANIA	GN11229367	CARAJAS S1	18/11/2019 15:50	18/11/2019 20:24	18/11/2019 15:50	18/11/2019 20:24	4,56	137	624,07	CHI
201911200070	SILVANIA	SV21245043	VIANOPOLIS	18/11/2019 16:27	19/11/2019 11:18	18/11/2019 16:27	19/11/2019 11:18	18,83	1	18,83	CHI
201911200102	TROMBAS	TB11391674	PORANGATU	18/11/2019 16:11	18/11/2019 17:18	18/11/2019 16:11	18/11/2019 17:18	1,11	56	62,11	CHI
201911200203	APARECIDA DE GOIANIA	AP11062062	ATLANTICO S2	18/11/2019 15:38	18/11/2019 19:00	18/11/2019 15:38	18/11/2019 19:00	3,35	26	87,23	CHI
201911200301	TRINDADE	TR31045871	TRINDADE	18/11/2019 16:30	19/11/2019 15:28	18/11/2019 16:30	19/11/2019 15:28	22,96	1	22,96	CHI
201911200303	MORRINHOS	150048841	MORRINHOS	18/11/2019 16:30	19/11/2019 05:05	18/11/2019 16:30	19/11/2019 05:05	12,57	1	12,57	CHI
201911200307	NOVA AURORA	NE12042356	CATALAO S1	18/11/2019 16:31	19/11/2019 15:31	18/11/2019 16:31	19/11/2019 15:31	23,00	3	69,01	CHI
201911200307	GOIANDIRA	7289851	CATALAO S1	18/11/2019 16:31	19/11/2019 15:31	18/11/2019 16:31	19/11/2019 15:31	23,00	2	46,01	CHI
201911200307	NOVA AURORA	7289851	CATALAO S1	18/11/2019 16:31	19/11/2019 15:31	18/11/2019 16:31	19/11/2019 15:31	23,00	9	207,03	CHI
201911200308	CALDAS NOVAS	CN11207277	SERRA DE CALDAS	18/11/2019 16:31	19/11/2019 16:41	18/11/2019 16:31	19/11/2019 16:41	24,17	1	24,17	CHI
201911200318	GOIANIA	GN11130378	ATLANTICO S1	18/11/2019 16:00	19/11/2019 05:21	18/11/2019 16:00	19/11/2019 05:21	13,35	161	2148,63	CHI
201911200328	CEZARINA	1650017203	CEZARINA	18/11/2019 16:33	19/11/2019 09:46	18/11/2019 16:33	19/11/2019 09:46	17,22	1	17,22	CHI
201911200330	PALMINOPOLIS	PP21375303	PALMEIRAS	18/11/2019 16:33	18/11/2019 22:50	18/11/2019 16:33	18/11/2019 22:50	6,29	1	6,29	CHI
201911200339	ARAGOIANIA	AO13291325	GUAPO S2	18/11/2019 15:37	19/11/2019 17:15	18/11/2019 15:37	19/11/2019 04:11	12,56	50	627,78	CHI
201911200339	HIDROLANDIA	AO13291325	GUAPO S2	18/11/2019 15:37	19/11/2019 17:15	18/11/2019 15:37	19/11/2019 04:11	12,56	107	1343,44	CHI
201911200339	MAIRIPOTABA	AO13291325	GUAPO S2	18/11/2019 15:37	19/11/2019 17:15	18/11/2019 15:37	19/11/2019 04:11	12,56	2	25,11	CHI
201911200339	VARJAO	AO13291325	GUAPO S2	18/11/2019 15:37	19/11/2019 17:15	18/11/2019 15:37	19/11/2019 04:11	12,56	70	878,89	CHI
201911200339	ARAGOIANIA	03500214	GUAPO S2	18/11/2019 15:37	19/11/2019 17:15	19/11/2019 04:11	19/11/2019 04:16	0,08	1146	89,13	CHI

201911200339	ARAGOIANIA	AO13291325	GUAPO S2	18/11/2019 15:37	19/11/2019 17:15	19/11/2019 02:44	19/11/2019 04:27	1,72	203	349,05	CHI
201911200339	HIDROLANDIA	AO13291325	GUAPO S2	18/11/2019 15:37	19/11/2019 17:15	19/11/2019 02:44	19/11/2019 04:27	1,72	3	5,16	CHI
201911200339	ARAGOIANIA	AO32000285	GUAPO S2	18/11/2019 15:37	19/11/2019 17:15	19/11/2019 04:15	19/11/2019 13:23	9,14	22	200,99	CHI
201911200339	ARAGOIANIA	AO32000285	GUAPO S2	18/11/2019 15:37	19/11/2019 17:15	19/11/2019 04:15	19/11/2019 16:15	12,00	1	12,00	CHI
201911200339	HIDROLANDIA	AO32000285	GUAPO S2	18/11/2019 15:37	19/11/2019 17:15	19/11/2019 04:15	19/11/2019 16:15	12,00	53	636,00	CHI
201911200339	ARAGOIANIA	AO32000285	GUAPO S2	18/11/2019 15:37	19/11/2019 17:15	19/11/2019 04:15	19/11/2019 16:30	12,26	8	98,05	CHI
201911200339	HIDROLANDIA	AO32000285	GUAPO S2	18/11/2019 15:37	19/11/2019 17:15	19/11/2019 04:15	19/11/2019 16:30	12,26	38	465,74	CHI
201911200339	ARAGOIANIA	AO32000285	GUAPO S2	18/11/2019 15:37	19/11/2019 17:15	19/11/2019 04:15	19/11/2019 16:40	12,42	10	124,17	CHI
201911200339	HIDROLANDIA	AO32000285	GUAPO S2	18/11/2019 15:37	19/11/2019 17:15	19/11/2019 04:15	19/11/2019 16:40	12,42	16	198,67	CHI
201911200339	MAIRIPOTABA	AO32000285	GUAPO S2	18/11/2019 15:37	19/11/2019 17:15	19/11/2019 04:15	19/11/2019 16:40	12,42	2	24,83	CHI
201911200339	VARJAO	AO32000285	GUAPO S2	18/11/2019 15:37	19/11/2019 17:15	19/11/2019 04:15	19/11/2019 16:40	12,42	70	869,17	CHI
201911200339	ARAGOIANIA	AO32097633	GUAPO S2	18/11/2019 15:37	19/11/2019 17:15	19/11/2019 04:15	19/11/2019 17:15	13,00	9	117,00	CHI
201911200346	JARAGUA	70078210	JARAGUA	18/11/2019 16:35	18/11/2019 19:29	18/11/2019 16:35	18/11/2019 19:29	2,90	1	2,90	CHI
201911200347	RIO VERDE	RV16404250	RIO VERDE S1	18/11/2019 14:04	18/11/2019 14:13	18/11/2019 14:04	18/11/2019 14:08	0,07	1557	101,64	CHI
201911200347	RIO VERDE	RV16404241	RIO VERDE S1	18/11/2019 14:04	18/11/2019 14:13	18/11/2019 14:10	18/11/2019 14:13	0,05	297	16,09	CHI
201911200358	RIO VERDE	BZ12219419	ACREUNA	18/11/2019 16:18	18/11/2019 20:25	18/11/2019 16:18	18/11/2019 20:25	4,11	24	98,65	CHI
201911200358	SANTA HELENA DE GOIAS	BZ12219419	ACREUNA	18/11/2019 16:18	18/11/2019 20:25	18/11/2019 16:18	18/11/2019 20:25	4,11	9	36,99	CHI
201911200358	SANTO ANTONIO DA BARRA	BZ12219419	ACREUNA	18/11/2019 16:18	18/11/2019 20:25	18/11/2019 16:18	18/11/2019 20:25	4,11	155	637,09	CHI
201911200363	GOIANIA	GN11060916	XAVANTES	18/11/2019 15:14	18/11/2019 22:16	18/11/2019 15:14	18/11/2019 22:16	7,03	91	639,43	CHI
201911200404	GOIANIA	GN11000705	ATLANTICO S2	18/11/2019 15:44	18/11/2019 20:40	18/11/2019 15:44	18/11/2019 20:40	4,93	167	823,22	CHI
201911200506	GOIATUBA	GT12000178	BOM JESUS DE GOIAS	18/11/2019 16:38	19/11/2019 00:08	18/11/2019 16:38	19/11/2019 00:08	7,50	27	202,37	CHI
201911200508	GOIANIA	GN12001754	CARAJAS S1	18/11/2019 16:22	18/11/2019 18:15	18/11/2019 16:22	18/11/2019 18:15	1,87	168	313,83	CHI
201911200518	BALIZA	BH21207596	BOM JARDIM	18/11/2019 16:39	19/11/2019 13:10	18/11/2019 16:39	19/11/2019 13:10	20,53	1	20,53	CHI
201911200520	NOVO GAMA	4990081081	PACAEMBU S1	18/11/2019 16:39	18/11/2019 18:48	18/11/2019 16:39	18/11/2019 18:48	2,14	1	2,14	CHI
201911200522	APARECIDA DE GOIANIA	AP11193242	INDEPENDENCIA S2	18/11/2019 16:08	18/11/2019 19:47	18/11/2019 16:08	18/11/2019 19:47	3,65	180	657,75	CHI
201911200524	NOVO GAMA	NJ11162892	PACAEMBU S1	18/11/2019 16:40	18/11/2019 23:24	18/11/2019 16:40	18/11/2019 23:24	6,73	4	26,93	CHI
201911200525	SILVANIA	SV12026710	VIANOPOLIS	18/11/2019 16:11	19/11/2019 01:33	18/11/2019 16:11	19/11/2019 01:33	9,36	9	84,28	CHI
201911200553	MAMBAI	8123075	IACIARA S2	18/11/2019 16:43	18/11/2019 19:19	18/11/2019 16:43	18/11/2019 19:19	2,60	2	5,19	CHI
201911200563	CALDAS NOVAS	CN21119148	CALDAS NOVAS S1	18/11/2019 16:44	19/11/2019 11:13	18/11/2019 16:44	19/11/2019 11:13	18,48	1	18,48	CHI
201911200573	GOIANIA	GN11169145	ATLANTICO S3	18/11/2019 16:26	18/11/2019 17:50	18/11/2019 16:26	18/11/2019 17:50	1,39	85	117,98	CHI
201911200573	GOIANIA	GN12169139	ATLANTICO S3	18/11/2019 16:26	18/11/2019 17:50	18/11/2019 17:20	18/11/2019 17:50	0,50	75	37,48	CHI
201911200576	GOIANIA	GN11241441	GOIANIA LESTE S3	18/11/2019 15:43	18/11/2019 22:41	18/11/2019 15:43	18/11/2019 22:41	6,97	55	383,17	CHI
201911200590	ARAGOIANIA	AO21091703	GUAPO S2	18/11/2019 16:46	19/11/2019 10:32	18/11/2019 16:46	19/11/2019 10:32	17,76	1	17,76	CHI

201911200594	SANTO ANTONIO DO DESCOBERTO	2210161181	AGUAS LINDAS DE GOIAS S2	18/11/2019 16:47	18/11/2019 18:57	18/11/2019 16:47	18/11/2019 18:57	2,16	1	2,16	CHI
201911200598	GOIANIA	GN11383179	GOIANIA LESTE S3	18/11/2019 16:32	19/11/2019 04:48	18/11/2019 16:32	19/11/2019 04:48	12,26	19	232,86	CHI
201911200601	TRINDADE	TR32033242	TRINDADE	18/11/2019 16:48	18/11/2019 18:40	18/11/2019 16:48	18/11/2019 18:40	1,86	5	9,28	CHI
201911200617	MONTE ALEGRE DE GOIAS	MA11397610	SAO DOMINGOS	18/11/2019 16:50	18/11/2019 19:21	18/11/2019 16:50	18/11/2019 19:21	2,51	1	2,51	CHI
201911200624	APARECIDA DE GOIANIA	AP12002086	INDEPENDENCIA S2	18/11/2019 16:20	18/11/2019 21:46	18/11/2019 16:20	18/11/2019 21:46	5,43	438	2379,19	CHI
201911200625	GOIANIA	GN11049375	ATLANTICO S3	18/11/2019 16:28	18/11/2019 20:13	18/11/2019 16:28	18/11/2019 20:13	3,75	191	715,67	CHI
201911200630	APARECIDA DE GOIANIA	AP11378566	CEPAIGO S1	18/11/2019 16:00	18/11/2019 23:37	18/11/2019 16:00	18/11/2019 23:37	7,63	187	1426,19	CHI
201911200632	DAMOLANDIA	DL12319228	INHUMAS S1	18/11/2019 12:36	19/11/2019 02:55	18/11/2019 12:36	19/11/2019 02:55	14,31	1	14,31	CHI
201911200632	OURO VERDE DE GOIAS	DL12319228	INHUMAS S1	18/11/2019 12:36	19/11/2019 02:55	18/11/2019 12:36	19/11/2019 02:55	14,31	4	57,23	CHI
201911200636	COCALZINHO DE GOIAS	ZN21063260	AGUAS LINDAS DE GOIAS S2	18/11/2019 16:52	18/11/2019 20:57	18/11/2019 16:52	18/11/2019 20:57	4,07	2	8,14	CHI
201911200639	AGUAS LINDAS DE GOIAS	10002012551	AGUAS LINDAS DE GOIAS S1	18/11/2019 16:53	18/11/2019 18:55	18/11/2019 16:53	18/11/2019 18:55	2,03	1	2,03	CHI
201911200642	RIO VERDE	10003079234	RIO VERDE S2	18/11/2019 16:53	20/11/2019 08:39	18/11/2019 16:53	20/11/2019 08:39	39,75	1	39,75	CHI
201911200644	GOIANIA	GN11074579	ATLANTICO S1	18/11/2019 16:00	18/11/2019 20:27	18/11/2019 16:00	18/11/2019 20:27	4,44	107	475,32	CHI
201911200647	MATRINCHA	MP21065249	MATRINCHA	18/11/2019 16:54	19/11/2019 23:38	18/11/2019 16:54	19/11/2019 23:38	30,72	1	30,72	CHI
201911200648	NOVA AURORA	2220009343	CATALAO S1	18/11/2019 16:54	20/11/2019 22:21	18/11/2019 16:54	20/11/2019 22:21	53,44	1	53,44	CHI
201911200650	RIO VERDE	RV21213349	SANTA HELENA S1	18/11/2019 16:54	20/11/2019 11:20	18/11/2019 16:54	20/11/2019 11:20	42,42	1	42,42	CHI
201911200653	BURITI DE GOIAS	BS12099749	FIRMINOPOLIS S2	18/11/2019 16:55	18/11/2019 20:35	18/11/2019 16:55	18/11/2019 20:35	3,66	8	29,32	CHI
201911200655	DOVERLANDIA	MY12219553	PARQUE DAS EMAS	18/11/2019 15:29	18/11/2019 19:00	18/11/2019 15:29	18/11/2019 19:00	3,51	46	161,61	CHI
201911200656	CATALAO	CT21250462	CATALAO S1	18/11/2019 16:55	20/11/2019 09:53	18/11/2019 16:55	20/11/2019 09:53	40,96	1	40,96	CHI
201911200658	PILAR DE GOIAS	GG21288854	SANTA TEREZINHA	18/11/2019 16:55	18/11/2019 21:52	18/11/2019 16:55	18/11/2019 21:52	4,93	1	4,93	CHI
201911200672	INDIARA	IY12312412	CEZARINA	18/11/2019 16:57	19/11/2019 10:40	18/11/2019 16:57	19/11/2019 10:40	17,71	6	106,27	CHI
201911200673	PALMEIRAS DE GOIAS	590054193	PALMEIRAS	18/11/2019 16:58	19/11/2019 00:35	18/11/2019 16:58	19/11/2019 00:35	7,62	1	7,62	CHI
201911200681	PARAUNA	BZ10394760	ACREUNA	18/11/2019 16:11	19/11/2019 14:17	18/11/2019 16:11	18/11/2019 16:58	0,79	157	123,55	CHI
201911200681	RIO VERDE	BZ10394760	ACREUNA	18/11/2019 16:11	19/11/2019 14:17	18/11/2019 16:11	18/11/2019 16:58	0,79	142	111,75	CHI
201911200681	SANTO ANTONIO DA BARRA	BZ10394760	ACREUNA	18/11/2019 16:11	19/11/2019 14:17	18/11/2019 16:11	18/11/2019 16:58	0,79	83	65,32	CHI
201911200681	RIO VERDE	BZ10394760	ACREUNA	18/11/2019 16:11	19/11/2019 14:17	18/11/2019 16:59	18/11/2019 22:23	5,41	43	232,56	CHI
201911200681	SANTO ANTONIO DA BARRA	BZ10394760	ACREUNA	18/11/2019 16:11	19/11/2019 14:17	18/11/2019 16:59	18/11/2019 22:23	5,41	79	427,26	CHI
201911200681	PARAUNA	BZ13400197B	ACREUNA	18/11/2019 16:11	19/11/2019 14:17	18/11/2019 16:59	19/11/2019 00:12	7,22	19	137,26	CHI
201911200681	RIO VERDE	BZ13400197B	ACREUNA	18/11/2019 16:11	19/11/2019 14:17	18/11/2019 16:59	19/11/2019 00:12	7,22	24	173,39	CHI
201911200681	SANTO ANTONIO DA BARRA	BZ13400197B	ACREUNA	18/11/2019 16:11	19/11/2019 14:17	18/11/2019 16:59	19/11/2019 00:12	7,22	4	28,90	CHI
201911200681	PARAUNA	BZ10394760	ACREUNA	18/11/2019 16:11	19/11/2019 14:17	19/11/2019 01:34	19/11/2019 01:42	0,13	19	2,51	CHI
201911200681	RIO VERDE	BZ10394760	ACREUNA	18/11/2019 16:11	19/11/2019 14:17	19/11/2019 01:34	19/11/2019 01:42	0,13	67	8,86	CHI
201911200681	SANTO ANTONIO DA BARRA	BZ10394760	ACREUNA	18/11/2019 16:11	19/11/2019 14:17	19/11/2019 01:34	19/11/2019 01:42	0,13	83	10,97	CHI

201911200681	RIO VERDE	RV12219435LD	ACREUNA	18/11/2019 16:11	19/11/2019 14:17	18/11/2019 16:59	19/11/2019 12:08	19,15	4	76,61	CHI
201911200681	PARAUNA	RV13303774	ACREUNA	18/11/2019 16:11	19/11/2019 14:17	18/11/2019 16:59	19/11/2019 13:10	20,18	28	565,12	CHI
201911200681	RIO VERDE	RV13303774	ACREUNA	18/11/2019 16:11	19/11/2019 14:17	18/11/2019 16:59	19/11/2019 13:10	20,18	28	565,12	CHI
201911200681	PARAUNA	RV12219435LD	ACREUNA	18/11/2019 16:11	19/11/2019 14:17	18/11/2019 16:59	19/11/2019 14:16	21,30	110	2342,60	CHI
201911200681	RIO VERDE	RV12219435LD	ACREUNA	18/11/2019 16:11	19/11/2019 14:17	18/11/2019 16:59	19/11/2019 14:16	21,30	1	21,30	CHI
201911200681	RIO VERDE	RV12219435LD	ACREUNA	18/11/2019 16:11	19/11/2019 14:17	18/11/2019 16:59	19/11/2019 14:17	21,30	42	894,49	CHI
201911200684	SENADOR CANEDO	SW11291698	CEPAIGO S1	18/11/2019 16:53	19/11/2019 17:25	18/11/2019 16:53	19/11/2019 17:25	24,54	58	1423,16	CHI
201911200688	FORMOSA	FA10400694	ITIQUEIRA	18/11/2019 16:39	19/11/2019 15:39	18/11/2019 16:39	18/11/2019 22:54	6,24	1	6,24	CHI
201911200688	FORMOSA	FA13164680	ITIQUEIRA	18/11/2019 16:39	19/11/2019 15:39	19/11/2019 09:25	19/11/2019 09:52	0,45	11294	5060,34	CHI
201911200688	FORMOSA	FA10400694	ITIQUEIRA	18/11/2019 16:39	19/11/2019 15:39	18/11/2019 16:39	19/11/2019 13:50	21,18	6	127,08	CHI
201911200688	FORMOSA	FA12042025	ITIQUEIRA	18/11/2019 16:39	19/11/2019 15:39	18/11/2019 16:39	19/11/2019 14:10	21,52	3	64,55	CHI
201911200688	FORMOSA	FA10400694	ITIQUEIRA	18/11/2019 16:39	19/11/2019 15:39	18/11/2019 16:39	19/11/2019 14:25	21,76	1	21,76	CHI
201911200688	FORMOSA	FA12013352	ITIQUEIRA	18/11/2019 16:39	19/11/2019 15:39	18/11/2019 16:39	19/11/2019 15:03	22,39	3	67,16	CHI
201911200688	FORMOSA	FA10400694	ITIQUEIRA	18/11/2019 16:39	19/11/2019 15:39	18/11/2019 16:39	19/11/2019 15:39	22,99	1	22,99	CHI
201911200701	CIDADE OCIDENTAL	DH12136589	MARAJOARA	18/11/2019 14:24	18/11/2019 19:07	18/11/2019 14:24	18/11/2019 19:07	4,71	9	42,41	CHI
201911200702	JATAI	JT11182121	JATAI S3	18/11/2019 16:54	18/11/2019 22:45	18/11/2019 16:54	18/11/2019 22:45	5,84	129	753,79	CHI
201911200710	IACIARA	IA12257594	IACIARA S2	18/11/2019 17:01	18/11/2019 17:39	18/11/2019 17:01	18/11/2019 17:39	0,63	5	3,14	CHI
201911200716	MONTES CLAROS DE GOIAS	ME21198141	ARENOPOLIS	18/11/2019 17:01	21/11/2019 12:40	18/11/2019 17:01	21/11/2019 12:40	67,64	1	67,64	CHI
201911200723	SILVANIA	SV21284492	VIANOPOLIS	18/11/2019 17:02	19/11/2019 09:16	18/11/2019 17:02	19/11/2019 09:16	16,22	1	16,22	CHI
201911200731	GOIANESIA	550054480	GOIANESIA S2	18/11/2019 17:03	20/11/2019 03:59	18/11/2019 17:03	20/11/2019 03:59	34,92	1	34,92	CHI
201911200732	ABADIANIA	AA12000610	ANAPOLIS UNIVERSITARIO S1	18/11/2019 15:53	18/11/2019 21:45	18/11/2019 15:53	18/11/2019 21:45	5,85	6	35,11	CHI
201911200733	CALDAS NOVAS	10026843763	CALDAS NOVAS S1	18/11/2019 17:03	20/11/2019 16:19	18/11/2019 17:03	20/11/2019 16:19	47,25	1	47,25	CHI
201911200736	JUSSARA	1290053483	JUSSARA	18/11/2019 17:04	19/11/2019 10:50	18/11/2019 17:04	19/11/2019 10:50	17,76	1	17,76	CHI
201911200740	SÃO LUIZ DO NORTE	DF12241242	BARRO ALTO	18/11/2019 17:05	19/11/2019 13:56	18/11/2019 17:05	19/11/2019 13:56	20,84	5	104,18	CHI
201911200745	GOUVELANDIA	GB21370111	QUIRINOPOLIS	18/11/2019 17:06	18/11/2019 17:38	18/11/2019 17:06	18/11/2019 17:38	0,52	1	0,52	CHI
201911200752	GOIANIA	GN11001336	XAVANTES	18/11/2019 17:07	19/11/2019 02:46	18/11/2019 17:07	19/11/2019 02:46	9,64	88	848,49	CHI
201911200757	MONTES CLAROS DE GOIAS	ME12212902	IPORA	18/11/2019 17:07	19/11/2019 15:10	18/11/2019 17:07	19/11/2019 15:10	22,05	10	220,45	CHI
201911200764	IPAMERI	IP12095243	IPAMERI	18/11/2019 16:45	19/11/2019 08:36	18/11/2019 16:45	19/11/2019 08:36	15,84	7	110,85	CHI
201911200766	GOIANIA	14567477	CAMPINAS S3	18/11/2019 17:09	19/11/2019 05:13	18/11/2019 17:09	19/11/2019 05:13	12,07	1	12,07	CHI
201911200777	CAMPO ALEGRE DE GOIAS	CM21164115	CAMPO ALEGRE DE GOIAS	18/11/2019 17:11	19/11/2019 13:22	18/11/2019 17:11	19/11/2019 13:22	20,17	1	20,17	CHI
201911200784	CACHOEIRA DOURADA	CD21190997	CACHOEIRA DOURADA	18/11/2019 17:12	19/11/2019 13:42	18/11/2019 17:12	19/11/2019 13:42	20,50	1	20,50	CHI
201911200787	TRES RANCHOS	TH12160657	CATALAO S1	18/11/2019 15:01	19/11/2019 11:30	18/11/2019 15:01	19/11/2019 11:30	20,48	18	368,70	CHI
201911200788	NIQUELANDIA	NQ21254341	NIQUELANDIA SUBTRANSMISSAO	18/11/2019 17:13	19/11/2019 04:28	18/11/2019 17:13	19/11/2019 04:28	11,24	1	11,24	CHI

201911200797	CEZARINA	CZ12011071	CEZARINA	18/11/2019 16:07	19/11/2019 08:26	18/11/2019 16:07	19/11/2019 08:26	16,32	4	65,29	CHI
201911200797	PALMEIRAS DE GOIAS	CZ12011071	CEZARINA	18/11/2019 16:07	19/11/2019 08:26	18/11/2019 16:07	19/11/2019 08:26	16,32	4	65,29	CHI
201911200799	MOZARLANDIA	AZ21042904	MOZARLANDIA	18/11/2019 17:14	19/11/2019 11:38	18/11/2019 17:14	19/11/2019 11:38	18,39	2	36,78	CHI
201911200801	CIDADE OCIDENTAL	DH11277125	MARAJOARA	18/11/2019 17:14	19/11/2019 12:02	18/11/2019 17:14	19/11/2019 12:02	18,79	2	37,58	CHI
201911200811	CALDAS NOVAS	IP12404739	IPAMERI	18/11/2019 15:50	20/11/2019 09:48	18/11/2019 15:50	20/11/2019 09:48	41,96	2	83,92	CHI
201911200811	IPAMERI	IP12404739	IPAMERI	18/11/2019 15:50	20/11/2019 09:48	18/11/2019 15:50	20/11/2019 09:48	41,96	2	83,92	CHI
201911200823	NOVA CRIXAS	NA12334349	NOVA CRIXAS	18/11/2019 16:48	19/11/2019 16:42	18/11/2019 16:48	18/11/2019 23:30	6,70	79	528,95	CHI
201911200823	NOVA CRIXAS	NA12158762LD	NOVA CRIXAS	18/11/2019 16:48	19/11/2019 16:42	18/11/2019 16:48	19/11/2019 16:42	23,90	7	167,29	CHI
201911200832	BRAZABRANTES	IN21195709	INHUMAS S2	18/11/2019 17:18	19/11/2019 09:56	18/11/2019 17:18	19/11/2019 09:56	16,63	7	116,40	CHI
201911200834	SAO MIGUEL DO PASSA QUATRO	SQ21105285	PIRES DO RIO S2	18/11/2019 17:18	20/11/2019 22:22	18/11/2019 17:18	20/11/2019 22:22	53,05	1	53,05	CHI
201911200837	LUZIANIA	LZ12383049	CRISTALINA S2	19/11/2019 10:47	19/11/2019 16:28	19/11/2019 10:47	19/11/2019 11:55	1,13	117	132,05	CHI
201911200837	LUZIANIA	6759716	CRISTALINA S2	19/11/2019 10:47	19/11/2019 16:28	19/11/2019 12:13	19/11/2019 16:28	4,26	2	8,52	CHI
201911200841	JUSSARA	JR21289300	IPORA	18/11/2019 17:19	19/11/2019 15:00	18/11/2019 17:19	19/11/2019 15:00	21,68	1	21,68	CHI
201911200850	PALMEIRAS DE GOIAS	PL12398710	PALMEIRAS	18/11/2019 17:20	18/11/2019 22:00	18/11/2019 17:20	18/11/2019 22:00	4,66	21	97,90	CHI
201911200853	JARAGUA	JA21273410	JARAGUA	18/11/2019 17:21	18/11/2019 20:07	18/11/2019 17:21	18/11/2019 20:07	2,75	6	16,52	CHI
201911200856	MINEIROS	MY11360060	PARQUE DAS EMAS	18/11/2019 17:01	18/11/2019 20:56	18/11/2019 17:01	18/11/2019 20:56	3,91	34	133,05	CHI
201911200873	APARECIDA DE GOIANIA	13239326	INDEPENDENCIA S2	18/11/2019 19:51	18/11/2019 20:56	18/11/2019 19:51	18/11/2019 20:56	1,08	1	1,08	CHI
201911200876	PALMEIRAS DE GOIAS	10028779841	PALMEIRAS	18/11/2019 17:24	19/11/2019 08:04	18/11/2019 17:24	19/11/2019 08:04	14,67	1	14,67	CHI
201911200878	APARECIDA DE GOIANIA	10023965450	INDEPENDENCIA S2	18/11/2019 17:24	18/11/2019 19:10	18/11/2019 17:24	18/11/2019 19:10	1,76	1	1,76	CHI
201911200886	GOIANIA	GN12390550	ATLANTICO S3	18/11/2019 16:43	18/11/2019 20:13	18/11/2019 16:43	18/11/2019 20:13	3,49	233	812,01	CHI
201911200893	APARECIDA DE GOIANIA	AP11162130	REAL S1	18/11/2019 16:04	18/11/2019 19:51	18/11/2019 16:04	18/11/2019 19:51	3,78	90	340,12	CHI
201911200899	SITIO D ABADIA	SI21235084	IACIARA S2	18/11/2019 17:26	19/11/2019 16:19	18/11/2019 17:26	19/11/2019 16:19	22,88	1	22,88	CHI
201911200900	GOIANIA	GN12001665	CAMPINAS S2	18/11/2019 16:12	18/11/2019 20:14	18/11/2019 16:12	18/11/2019 20:14	4,03	198	797,83	CHI
201911200901	ACREUNA	SH12279542	SANTA HELENA S1	18/11/2019 16:59	18/11/2019 20:10	18/11/2019 16:59	18/11/2019 20:10	3,18	3	9,53	CHI
201911200901	SANTA HELENA DE GOIAS	SH12279542	SANTA HELENA S1	18/11/2019 16:59	18/11/2019 20:10	18/11/2019 16:59	18/11/2019 20:10	3,18	9	28,60	CHI
201911200901	SANTO ANTONIO DA BARRA	SH12279542	SANTA HELENA S1	18/11/2019 16:59	18/11/2019 20:10	18/11/2019 16:59	18/11/2019 20:10	3,18	1	3,18	CHI
201911200908	GOIANIA	13916464	XAVANTES	18/11/2019 17:28	20/11/2019 09:00	18/11/2019 17:28	20/11/2019 09:00	39,53	1	39,53	CHI
201911200914	FORMOSA	FA12164536	ITIQUEIRA	18/11/2019 16:57	18/11/2019 20:10	18/11/2019 16:57	18/11/2019 20:10	3,22	2	6,43	CHI
201911200914	SAO JOAO D ALIANCA	FA12164536	ITIQUEIRA	18/11/2019 16:57	18/11/2019 20:10	18/11/2019 16:57	18/11/2019 20:10	3,22	195	627,09	CHI
201911200915	GOIANIA	GN12041838	ATLANTICO S2	18/11/2019 16:36	18/11/2019 20:12	18/11/2019 16:36	18/11/2019 20:12	3,58	58	207,90	CHI
201911200916	GOIAS	IU12060535	MATRINCHA	18/11/2019 17:28	18/11/2019 22:19	18/11/2019 17:28	18/11/2019 22:19	4,83	1	4,83	CHI
201911200916	ITAPIRAPUA	IU12060535	MATRINCHA	18/11/2019 17:28	18/11/2019 22:19	18/11/2019 17:28	18/11/2019 22:19	4,83	11	53,17	CHI
201911200918	MONTES CLAROS DE GOIAS	ME21138648	IPORA	18/11/2019 17:29	19/11/2019 16:30	18/11/2019 17:29	19/11/2019 16:30	23,01	1	23,01	CHI

201911200932	MONTIVIDIU DO NORTE	MX21272762	PORANGATU	18/11/2019 17:30	19/11/2019 09:13	18/11/2019 17:30	19/11/2019 09:13	15,70	1	15,70	CHI
201911200939	GOIANIA	13240109	AEROPORTO S1	18/11/2019 17:31	19/11/2019 02:00	18/11/2019 17:31	19/11/2019 02:00	8,47	1	8,47	CHI
201911200940	LUZIANIA	LZ12313691	CRISTALINA S2	18/11/2019 13:46	18/11/2019 22:19	18/11/2019 13:46	18/11/2019 22:19	8,54	19	162,22	CHI
201911200942	MORRINHOS	MR21249860	MORRINHOS	18/11/2019 17:32	19/11/2019 07:32	18/11/2019 17:32	19/11/2019 07:32	14,00	1	14,00	CHI
201911200948	GOIANIA	GN12152082	SENADOR CANEDO	18/11/2019 16:23	18/11/2019 18:57	18/11/2019 16:23	18/11/2019 18:57	2,56	155	397,45	CHI
201911200952	NOVA GLORIA	IW21221102	RUBIATABA	18/11/2019 17:33	19/11/2019 11:56	18/11/2019 17:33	19/11/2019 11:56	18,38	1	18,38	CHI
201911200954	URUACU	UR21265534	MARA ROSA	18/11/2019 17:33	19/11/2019 11:10	18/11/2019 17:33	19/11/2019 11:10	17,60	1	17,60	CHI
201911200956	GOIANIA	14034001	MEIA PONTE	18/11/2019 17:34	19/11/2019 08:57	18/11/2019 17:34	19/11/2019 08:57	15,38	1	15,38	CHI
201911200958	PLANALTINA	PI12131790	PLANALTINA	18/11/2019 17:34	18/11/2019 20:41	18/11/2019 17:34	18/11/2019 20:41	3,11	18	56,07	CHI
201911200959	ANAPOLIS	AN12319607	DAIA S1	18/11/2019 17:30	18/11/2019 19:52	18/11/2019 17:30	18/11/2019 19:52	2,36	6	14,17	CHI
201911200959	LEOPOLDO DE BULHOES	AN12319607	DAIA S1	18/11/2019 17:30	18/11/2019 19:52	18/11/2019 17:30	18/11/2019 19:52	2,36	6	14,17	CHI
201911200962	CRISTALINA	KR12163890	CRISTALINA S2	18/11/2019 13:12	18/11/2019 19:59	18/11/2019 13:12	18/11/2019 19:59	6,77	91	616,27	CHI
201911200962	LUZIANIA	KR12163890	CRISTALINA S2	18/11/2019 13:12	18/11/2019 19:59	18/11/2019 13:12	18/11/2019 19:59	6,77	8	54,18	CHI
201911200964	PORTEIRAO	CL12214128	RIO DOS BOIS	18/11/2019 17:34	21/11/2019 18:20	18/11/2019 17:34	21/11/2019 18:20	72,76	4	291,03	CHI
201911200974	INDIARA	IY12233476	EDEIA	18/11/2019 17:36	21/11/2019 19:42	18/11/2019 17:36	20/11/2019 01:20	31,74	26	825,30	CHI
201911200974	INDIARA	IY12233476	EDEIA	18/11/2019 17:36	21/11/2019 19:42	20/11/2019 01:21	20/11/2019 09:15	7,90	15	118,45	CHI
201911200974	INDIARA	IY12391394	EDEIA	18/11/2019 17:36	21/11/2019 19:42	18/11/2019 17:36	20/11/2019 14:40	45,06	5	225,32	CHI
201911200974	INDIARA	IY12299110LD	EDEIA	18/11/2019 17:36	21/11/2019 19:42	18/11/2019 17:36	21/11/2019 19:42	74,10	7	518,73	CHI
201911200974	INDIARA	IY12299110LD	EDEIA	18/11/2019 17:36	21/11/2019 19:42	20/11/2019 01:21	21/11/2019 19:42	42,36	11	465,91	CHI
201911200974	INDIARA	IY12299110LD	EDEIA	18/11/2019 17:36	21/11/2019 19:42	21/11/2019 18:13	21/11/2019 19:42	1,49	20	29,81	CHI
201911200975	SANTO ANTONIO DA BARRA	2270004006	ACREUNA	18/11/2019 17:36	20/11/2019 14:45	18/11/2019 17:36	20/11/2019 14:45	45,14	1	45,14	CHI
201911200976	PIRES DO RIO	460066419	PIRES DO RIO S1	18/11/2019 17:36	19/11/2019 07:37	18/11/2019 17:36	19/11/2019 07:37	14,01	1	14,01	CHI
201911200979	CRISTALINA	KR12330875	CRISTALINA S2	18/11/2019 17:09	19/11/2019 11:38	18/11/2019 17:09	19/11/2019 11:38	18,48	4	73,91	CHI
201911200985	CAMPESTRE DE GOIAS	GC12000273	GUAPO S1	18/11/2019 17:37	18/11/2019 21:58	18/11/2019 17:37	18/11/2019 21:58	4,35	2	8,69	CHI
201911200986	JARAGUA	JA21000180	JARAGUA	18/11/2019 17:37	19/11/2019 12:55	18/11/2019 17:37	19/11/2019 12:55	19,29	2	38,59	CHI
201911200997	GOIANIA	GN11165046	ATLANTICO S1	18/11/2019 16:31	18/11/2019 19:47	18/11/2019 16:31	18/11/2019 19:47	3,25	79	257,12	CHI
201911201001	LEOPOLDO DE BULHOES	870012472	DAIA S2	18/11/2019 17:38	19/11/2019 11:36	18/11/2019 17:38	19/11/2019 11:36	17,96	1	17,96	CHI
201911201003	GOIANIA	13995224	GOIANIA LESTE S3	18/11/2019 17:38	19/11/2019 10:26	18/11/2019 17:38	19/11/2019 10:26	16,78	1	16,78	CHI
201911201004	GOIANIA	GN11347749	GOYA S2	18/11/2019 17:19	18/11/2019 19:33	18/11/2019 17:19	18/11/2019 19:33	2,22	109	242,28	CHI
201911201008	GOIANIA	GN11000970	CAMPINAS S1	18/11/2019 15:10	18/11/2019 21:53	18/11/2019 15:10	18/11/2019 21:53	6,70	195	1306,93	CHI
201911201018	IPAMERI	IP12332968	IPAMERI	18/11/2019 11:09	19/11/2019 07:49	18/11/2019 11:09	19/11/2019 07:49	20,66	30	619,74	CHI
201911201019	IPAMERI	IP12332964	IPAMERI	18/11/2019 11:23	19/11/2019 07:09	18/11/2019 11:23	19/11/2019 07:09	19,76	41	810,15	CHI
201911201034	GOIANIA	GN21340447	XAVANTES	18/11/2019 17:41	19/11/2019 14:31	18/11/2019 17:41	19/11/2019 14:31	20,83	1	20,83	CHI

201911201045	ITUMBIARA	IT12305396	CACHOEIRA DOURADA	18/11/2019 15:21	20/11/2019 19:37	18/11/2019 15:21	19/11/2019 11:39	20,30	8	162,40	CHI
201911201045	PANAMA	IT12305396	CACHOEIRA DOURADA	18/11/2019 15:21	20/11/2019 19:37	18/11/2019 15:21	19/11/2019 11:39	20,30	2	40,60	CHI
201911201045	ITUMBIARA	IT12305396	CACHOEIRA DOURADA	18/11/2019 15:21	20/11/2019 19:37	18/11/2019 15:21	19/11/2019 13:17	21,94	13	285,26	CHI
201911201045	PANAMA	IT12305396	CACHOEIRA DOURADA	18/11/2019 15:21	20/11/2019 19:37	18/11/2019 15:21	19/11/2019 13:17	21,94	3	65,83	CHI
201911201045	ITUMBIARA	IT12305396	CACHOEIRA DOURADA	18/11/2019 15:21	20/11/2019 19:37	18/11/2019 15:21	20/11/2019 19:37	52,27	1	52,27	CHI
201911201045	ITUMBIARA	IT12305396	CACHOEIRA DOURADA	18/11/2019 15:21	20/11/2019 19:37	20/11/2019 18:05	20/11/2019 19:37	1,54	21	32,29	CHI
201911201045	PANAMA	IT12305396	CACHOEIRA DOURADA	18/11/2019 15:21	20/11/2019 19:37	20/11/2019 18:05	20/11/2019 19:37	1,54	5	7,69	CHI
201911201047	MONTES CLAROS DE GOIAS	ME12204930	IPORA	18/11/2019 16:05	18/11/2019 22:14	18/11/2019 16:05	18/11/2019 22:14	6,15	4	24,58	CHI
201911201048	CRISTALINA	KR12090782	PAMPLONA	18/11/2019 17:44	20/11/2019 13:14	18/11/2019 17:44	20/11/2019 13:14	43,50	7	304,50	CHI
201911201055	BRAZABRANTES	10015139725	NEROPOLIS S1	18/11/2019 17:44	18/11/2019 18:53	18/11/2019 17:44	18/11/2019 18:53	1,15	1	1,15	CHI
201911201061	CRISTALINA	KR12305295	CRISTALINA S2	18/11/2019 17:45	19/11/2019 18:13	18/11/2019 17:45	19/11/2019 18:13	24,46	2	48,92	CHI
201911201074	APARECIDA DE GOIANIA	10019615297	ATLANTICO S3	18/11/2019 17:47	18/11/2019 22:09	18/11/2019 17:47	18/11/2019 22:09	4,36	1	4,36	CHI
201911201086	FORMOSA	610158053	ITUIQUIRA	18/11/2019 17:48	19/11/2019 12:00	18/11/2019 17:48	19/11/2019 12:00	18,20	1	18,20	CHI
201911201093	PARANAIGUARA	PC12060518	QUIRINOPOLIS	18/11/2019 17:44	18/11/2019 19:10	18/11/2019 17:44	18/11/2019 19:10	1,42	5	7,11	CHI
201911201102	NIQUELANDIA	NQ21197736	NIQUELANDIA SUBTRANSMISSAO	18/11/2019 17:51	19/11/2019 04:47	18/11/2019 17:51	19/11/2019 04:47	10,92	1	10,92	CHI
201911201104	GOIANIRA	GR11095868	GOIANIRA	18/11/2019 17:44	18/11/2019 20:03	18/11/2019 17:44	18/11/2019 20:03	2,30	84	193,34	CHI
201911201105	ITUMBIARA	IT12000208	ITUMBIARA NOVA	18/11/2019 16:25	20/11/2019 22:22	18/11/2019 16:25	18/11/2019 22:39	6,24	1	6,24	CHI
201911201105	ITUMBIARA	IT12000208	ITUMBIARA NOVA	18/11/2019 16:25	20/11/2019 22:22	18/11/2019 22:53	20/11/2019 22:22	47,48	1	47,48	CHI
201911201109	VARJAO	VJ31009121	GUAPO S2	18/11/2019 17:53	19/11/2019 18:10	18/11/2019 17:53	19/11/2019 18:10	24,28	1	24,28	CHI
201911201110	APARECIDA DE GOIANIA	AP11202946	ANHANGUERA	18/11/2019 17:47	18/11/2019 21:38	18/11/2019 17:47	18/11/2019 21:38	3,84	246	945,12	CHI
201911201113	GOIANIA	10090848	CAMPINAS S3	18/11/2019 17:53	19/11/2019 10:39	18/11/2019 17:53	19/11/2019 10:39	16,75	1	16,75	CHI
201911201131	ITUMBIARA	IT11390080	ITUMBIARA VELHA S1	18/11/2019 17:55	19/11/2019 15:16	18/11/2019 17:55	19/11/2019 15:16	21,34	58	1237,66	CHI
201911201135	ACREUNA	EU11085780	ACREUNA	18/11/2019 17:23	19/11/2019 00:05	18/11/2019 17:23	19/11/2019 00:05	6,71	128	858,45	CHI
201911201136	ANAPOLIS	AN21288976	JUNDIAI S2	18/11/2019 17:56	19/11/2019 09:39	18/11/2019 17:56	19/11/2019 09:39	15,71	1	15,71	CHI
201911201138	ALTO PARAISO DE GOIAS	3870015066	FLORES DE GOIAS	18/11/2019 17:56	19/11/2019 10:31	18/11/2019 17:56	19/11/2019 10:31	16,57	1	16,57	CHI
201911201509	CATALAO	CT11144776	CATALAO S2	18/11/2019 17:58	18/11/2019 23:51	18/11/2019 17:58	18/11/2019 23:51	5,88	84	493,62	CHI
201911201512	SERRANOPOLIS	SX12267588	JATAI S1	18/11/2019 17:59	18/11/2019 23:08	18/11/2019 17:59	18/11/2019 23:08	5,15	6	30,92	CHI
201911201513	ALTO PARAISO DE GOIAS	BF12163414	NIQUELANDIA SUBTRANSMISSAO	18/11/2019 17:59	18/11/2019 20:04	18/11/2019 17:59	18/11/2019 20:04	2,08	10	20,77	CHI
201911201519	GOIANIA	GN12001868	GOIANIA LESTE S1	18/11/2019 17:44	18/11/2019 20:04	18/11/2019 17:44	18/11/2019 20:04	2,32	318	737,05	CHI
201911201520	QUIRINOPOLIS	QI12047560	QUIRINOPOLIS	18/11/2019 17:14	18/11/2019 19:50	18/11/2019 17:14	18/11/2019 19:50	2,59	497	1284,88	CHI
201911201533	ALEXANIA	480020450	ALEXANIA	18/11/2019 18:01	19/11/2019 18:30	18/11/2019 18:01	19/11/2019 18:30	24,47	1	24,47	CHI
201911201534	FORMOSA	FA12000031	ITUIQUIRA	18/11/2019 16:46	18/11/2019 19:54	18/11/2019 16:46	18/11/2019 19:54	3,13	932	2914,83	CHI
201911201537	BONOPOLIS	BX11168230	SAO MIGUEL DO ARAGUAIA	18/11/2019 18:02	18/11/2019 21:58	18/11/2019 18:02	18/11/2019 21:58	3,93	141	554,44	CHI

201911201544	RIO VERDE	RV12296050	RIO VERDE S1	18/11/2019 18:02	19/11/2019 13:03	18/11/2019 18:02	19/11/2019 13:03	19,01	10	190,05	CHI
201911201545	GOIANIA	GN12396183	GOYA S1	18/11/2019 15:18	18/11/2019 20:19	18/11/2019 15:18	18/11/2019 20:19	5,00	63	315,11	CHI
201911201552	GOIANIA	GN11002836	XAVANTES	18/11/2019 16:22	19/11/2019 01:52	18/11/2019 16:22	19/11/2019 01:52	9,49	32	303,82	CHI
201911201562	ARAGOIANIA	AO21007310	INDEPENDENCIA S2	18/11/2019 18:04	20/11/2019 10:45	18/11/2019 18:04	20/11/2019 10:45	40,69	2	81,38	CHI
201911201570	GOIANIA	GN11216854	ATLANTICO S1	18/11/2019 17:30	18/11/2019 19:26	18/11/2019 17:30	18/11/2019 19:26	1,93	54	104,02	CHI
201911201572	GOIANIA	10028617841	CAMPINAS S1	18/11/2019 18:06	18/11/2019 20:47	18/11/2019 18:06	18/11/2019 20:47	2,69	1	2,69	CHI
201911201585	ANAPOLIS	AN11273322	ANAPOLIS UNIVERSITARIO S2	18/11/2019 17:31	18/11/2019 22:03	18/11/2019 17:31	18/11/2019 22:03	4,53	119	538,81	CHI
201911201590	APARECIDA DE GOIANIA	AP12212351	ANHANGUERA	18/11/2019 18:09	18/11/2019 19:35	18/11/2019 18:09	18/11/2019 19:35	1,44	14	20,14	CHI
201911201592	FORMOSA	610024050	ITUIQUIRA	18/11/2019 18:09	19/11/2019 02:59	18/11/2019 18:09	19/11/2019 02:59	8,82	1	8,82	CHI
201911201594	SANTA FE DE GOIAS	RN12009764	BRITANIA	18/11/2019 16:09	19/11/2019 08:01	18/11/2019 16:09	19/11/2019 08:01	15,86	6	95,13	CHI
201911201597	TRINDADE	10017538317	TRINDADE	18/11/2019 18:10	19/11/2019 07:48	18/11/2019 18:10	19/11/2019 07:48	13,63	1	13,63	CHI
201911201602	PIRES DO RIO	PR21000055	PIRES DO RIO S1	18/11/2019 18:11	19/11/2019 02:46	18/11/2019 18:11	19/11/2019 02:46	8,58	1	8,58	CHI
201911201621	ALVORADA DO NORTE	AQ12184985	IACIARA S2	18/11/2019 18:18	18/11/2019 20:24	18/11/2019 18:18	18/11/2019 20:24	2,10	43	90,29	CHI
201911201623	CROMINIA	520007475	PONTALINA	18/11/2019 18:13	19/11/2019 08:02	18/11/2019 18:13	19/11/2019 08:02	13,80	1	13,80	CHI
201911201629	MORRINHOS	MR12275848	GOIATUBA S1	18/11/2019 16:35	19/11/2019 12:03	18/11/2019 16:35	19/11/2019 12:03	19,46	3	58,39	CHI
201911201636	TAQUARAL DE GOIAS	TQ21299564	ITABERAI S1	18/11/2019 18:15	19/11/2019 09:27	18/11/2019 18:15	19/11/2019 09:27	15,20	1	15,20	CHI
201911201639	ITAPACI	RB12392300	RUBIATABA	18/11/2019 18:15	19/11/2019 19:26	18/11/2019 18:15	19/11/2019 19:26	25,19	8	201,54	CHI
201911201643	RIO VERDE	RV12091975	MONTIVIDIU T	18/11/2019 18:15	18/11/2019 23:10	18/11/2019 18:15	18/11/2019 23:10	4,91	5	24,53	CHI
201911201651	APARECIDA DE GOIANIA	AP12200191	REAL S1	18/11/2019 17:58	18/11/2019 21:53	18/11/2019 17:58	18/11/2019 21:53	3,90	612	2388,16	CHI
201911201653	APARECIDA DE GOIANIA	AP12147249	ATLANTICO S2	18/11/2019 17:21	18/11/2019 20:57	18/11/2019 17:21	18/11/2019 20:57	3,59	323	1159,12	CHI
201911201655	ALEXANIA	480025162	ALEXANIA	18/11/2019 18:16	19/11/2019 13:28	18/11/2019 18:16	19/11/2019 13:28	19,19	1	19,19	CHI
201911201656	GOIANIRA	GR12016121	GOIANIRA	18/11/2019 18:16	19/11/2019 11:00	18/11/2019 18:16	19/11/2019 08:18	14,03	1	14,03	CHI
201911201656	GOIANIRA	GR12016122LD	GOIANIRA	18/11/2019 18:16	19/11/2019 11:00	18/11/2019 18:16	19/11/2019 11:00	16,72	6	100,33	CHI
201911201673	GOIANIA	GN11002224	CAMPINAS S3	18/11/2019 16:21	18/11/2019 22:09	18/11/2019 16:21	18/11/2019 22:09	5,79	62	358,89	CHI
201911201677	GAMELEIRA DE GOIAS	GL21319215	DAIA S2	18/11/2019 18:18	20/11/2019 23:38	18/11/2019 18:18	20/11/2019 23:38	53,34	1	53,34	CHI
201911201680	MORRINHOS	MR21157270	MORRINHOS	18/11/2019 18:18	19/11/2019 09:28	18/11/2019 18:18	19/11/2019 09:28	15,15	1	15,15	CHI
201911201683	INDIARA	IY12205932	EDEIA	18/11/2019 17:59	19/11/2019 12:23	18/11/2019 17:59	19/11/2019 12:23	18,38	4	73,54	CHI
201911201686	SAO MIGUEL DO ARAGUAIA	4650003685	SAO MIGUEL DO ARAGUAIA	18/11/2019 18:19	19/11/2019 02:54	18/11/2019 18:19	19/11/2019 02:54	8,58	1	8,58	CHI
201911201689	GOIANIA	GN12000021	CAMPINAS S1	18/11/2019 17:58	18/11/2019 21:20	18/11/2019 17:58	18/11/2019 21:20	3,37	456	1536,34	CHI
201911201691	JATAI	JT12324668	JATAI S3	18/11/2019 18:19	18/11/2019 22:50	18/11/2019 18:19	18/11/2019 22:50	4,51	54	243,43	CHI
201911201694	ORIZONA	OZ21052334	PIRES DO RIO S2	18/11/2019 18:19	19/11/2019 17:10	18/11/2019 18:19	19/11/2019 17:10	22,83	1	22,83	CHI
201911201695	RIO VERDE	10018246409	RIO VERDE S1	18/11/2019 18:19	19/11/2019 05:15	18/11/2019 18:19	19/11/2019 05:15	10,92	1	10,92	CHI
201911201704	GAMELEIRA DE GOIAS	SV21232897	DAIA S1	18/11/2019 18:21	19/11/2019 11:25	18/11/2019 18:21	19/11/2019 11:25	17,06	2	34,12	CHI

201911201705	ITARUMA	IM12074941	CACHOEIRA ALTA	19/11/2019 09:00	20/11/2019 04:06	19/11/2019 09:00	19/11/2019 10:55	1,91	12	22,91	CHI
201911201705	ITARUMA	IM12074941	CACHOEIRA ALTA	19/11/2019 09:00	20/11/2019 04:06	19/11/2019 09:00	20/11/2019 04:06	19,10	8	152,82	CHI
201911201711	JATAI	JT21191746	JATAI S1	18/11/2019 18:22	18/11/2019 20:32	18/11/2019 18:22	18/11/2019 20:32	2,16	1	2,16	CHI
201911201713	APARECIDA DE GOIANIA	AP12258426	INDEPENDENCIA S2	18/11/2019 14:52	18/11/2019 19:53	18/11/2019 14:52	18/11/2019 19:53	5,00	941	4709,18	CHI
201911201714	CRISTALINA	KR12305272	CRISTALINA S2	18/11/2019 17:40	19/11/2019 04:05	18/11/2019 17:40	19/11/2019 04:05	10,40	11	114,41	CHI
201911201727	INDIARA	IY21010852	EDEIA	18/11/2019 18:23	19/11/2019 15:04	18/11/2019 18:23	19/11/2019 15:04	20,67	2	41,35	CHI
201911201729	APARECIDA DE GOIANIA	200406073	INDEPENDENCIA S1	18/11/2019 18:24	19/11/2019 08:54	18/11/2019 18:24	19/11/2019 08:54	14,50	1	14,50	CHI
201911201730	MAMBAI	1570016024	IACIARA S2	18/11/2019 18:24	18/11/2019 20:25	18/11/2019 18:24	18/11/2019 20:25	2,01	1	2,01	CHI
201911201731	INHUMAS	IN32066288	INHUMAS S2	18/11/2019 18:11	18/11/2019 23:58	18/11/2019 18:11	18/11/2019 23:58	5,77	8	46,14	CHI
201911201734	MINEIROS	MY12305765	PARQUE DAS EMAS	18/11/2019 18:24	19/11/2019 08:10	18/11/2019 18:24	19/11/2019 08:10	13,76	5	68,80	CHI
201911201736	CRISTALINA	KR12383045	CRISTALINA S2	18/11/2019 17:17	19/11/2019 04:52	18/11/2019 17:17	19/11/2019 04:52	11,58	12	138,95	CHI
201911201738	GOIANIA	14303358	MEIA PONTE	18/11/2019 18:24	19/11/2019 09:55	18/11/2019 18:24	19/11/2019 09:55	15,50	1	15,50	CHI
201911201746	MAURILANDIA	ML21301535	SANTA HELENA S1	18/11/2019 18:26	19/11/2019 15:37	18/11/2019 18:26	19/11/2019 15:37	21,18	1	21,18	CHI
201911201747	GOIANIA	GN12383187	XAVANTES	18/11/2019 18:14	19/11/2019 00:52	18/11/2019 18:14	19/11/2019 00:52	6,62	232	1535,78	CHI
201911201748	GOIAS	NB12092962	MATRINCHA	18/11/2019 18:26	18/11/2019 23:34	18/11/2019 18:26	18/11/2019 23:34	5,13	3	15,39	CHI
201911201748	ITAPIRAPUA	NB12092962	MATRINCHA	18/11/2019 18:26	18/11/2019 23:34	18/11/2019 18:26	18/11/2019 23:34	5,13	1	5,13	CHI
201911201748	NOVO BRASIL	NB12092962	MATRINCHA	18/11/2019 18:26	18/11/2019 23:34	18/11/2019 18:26	18/11/2019 23:34	5,13	5	25,65	CHI
201911201758	QUIRINOPOLIS	10004324640	QUIRINOPOLIS	18/11/2019 18:27	19/11/2019 10:19	18/11/2019 18:27	19/11/2019 10:19	15,88	1	15,88	CHI
201911201760	SAO LUIS DE MONTES BELOS	500089218	SAO LUIZ DOS MONTES BELOS	18/11/2019 18:27	19/11/2019 09:55	18/11/2019 18:27	19/11/2019 09:55	15,47	1	15,47	CHI
201911201761	ANICUNS	AC12158912	FIRMINOPOLIS S2	18/11/2019 17:43	18/11/2019 20:10	18/11/2019 17:43	18/11/2019 20:10	2,44	60	146,22	CHI
201911201763	MOIPORA	1450002290	IPORA	18/11/2019 18:27	18/11/2019 21:21	18/11/2019 18:27	18/11/2019 21:21	2,90	1	2,90	CHI
201911201764	PARAUNA	980023762	PARAUNA	18/11/2019 18:27	18/11/2019 20:05	18/11/2019 18:27	18/11/2019 20:05	1,62	1	1,62	CHI
201911201773	GOIANIA	GN11168593	FERROVIARIO S2	18/11/2019 17:15	18/11/2019 23:29	18/11/2019 17:15	18/11/2019 23:29	6,23	59	367,62	CHI
201911201783	TURVANIA	TV12005582	FIRMINOPOLIS S2	18/11/2019 18:30	18/11/2019 20:31	18/11/2019 18:30	18/11/2019 20:31	2,02	49	98,91	CHI
201911201785	CORREGO DO OURO	CO11004039	FIRMINOPOLIS S2	18/11/2019 18:30	18/11/2019 23:07	18/11/2019 18:30	18/11/2019 23:07	4,61	170	783,56	CHI
201911201798	GOIANIA	11575025	ATLANTICO S3	18/11/2019 18:32	19/11/2019 08:12	18/11/2019 18:32	19/11/2019 08:12	13,66	1	13,66	CHI
201911201819	ANICUNS	AC12391418	ANICUNS	18/11/2019 17:45	18/11/2019 20:30	18/11/2019 17:45	18/11/2019 20:30	2,74	17	46,65	CHI
201911201842	APARECIDA DE GOIANIA	AP11085130	REAL S2	18/11/2019 18:38	21/11/2019 17:53	21/11/2019 13:29	21/11/2019 17:53	4,40	131	576,15	CHI
201911201845	GOIANIA	GN12044467	GOYA S2	18/11/2019 18:17	18/11/2019 21:15	18/11/2019 18:17	18/11/2019 21:15	2,96	127	375,50	CHI
201911201872	GOIANIA	16176479	CARAJAS S1	18/11/2019 18:40	19/11/2019 09:04	18/11/2019 18:40	19/11/2019 09:04	14,38	1	14,38	CHI
201911201875	ABADIANIA	AA21164400	ANAPOLIS UNIVERSITARIO S1	18/11/2019 18:41	19/11/2019 10:50	18/11/2019 18:41	19/11/2019 10:50	16,15	1	16,15	CHI
201911201877	GOIANIA	GN11189927	CARAJAS S2	18/11/2019 18:03	19/11/2019 09:53	18/11/2019 18:03	19/11/2019 09:53	15,82	88	1392,31	CHI
201911201878	ANICUNS	AC21289746	ANICUNS	18/11/2019 18:40	19/11/2019 08:08	18/11/2019 18:40	19/11/2019 08:08	13,46	1	13,46	CHI

201911201905	FORMOSA	610297430	ITIQUEIRA	18/11/2019 18:44	19/11/2019 10:19	18/11/2019 18:44	19/11/2019 10:19	15,58	1	15,58	CHI
201911201908	GOIANIA	10011816153	CARAJAS S1	18/11/2019 18:45	19/11/2019 11:37	18/11/2019 18:45	19/11/2019 11:37	16,87	1	16,87	CHI
201911201917	GOIANIA	AP21000076	CEPAIGO S1	18/11/2019 18:46	19/11/2019 06:32	18/11/2019 18:46	19/11/2019 06:32	11,76	1	11,76	CHI
201911201923	ANAPOLIS	20578349	JUNDAIA S2	18/11/2019 18:46	18/11/2019 19:43	18/11/2019 18:46	18/11/2019 19:43	0,94	1	0,94	CHI
201911201924	SANTA HELENA DE GOIAS	SH11207101	IPEGUARI	18/11/2019 23:18	19/11/2019 18:06	18/11/2019 23:18	19/11/2019 18:06	18,82	37	696,20	CHI
201911201927	MORRINHOS	MR12335174RE	MORRINHOS	18/11/2019 17:16	18/11/2019 21:35	18/11/2019 17:16	18/11/2019 21:35	4,31	73	314,89	CHI
201911201934	IVOLANDIA	10030082127	IPORA	18/11/2019 18:47	18/11/2019 21:21	18/11/2019 18:47	18/11/2019 21:21	2,57	1	2,57	CHI
201911201940	EDEIA	EA12257973	EDEIA	18/11/2019 18:30	24/11/2019 14:50	18/11/2019 18:30	21/11/2019 09:39	63,14	1	63,14	CHI
201911201940	INDIARA	EA12257973	EDEIA	18/11/2019 18:30	24/11/2019 14:50	18/11/2019 18:30	21/11/2019 09:39	63,14	2	126,28	CHI
201911201940	ACREUNA	EA12257973	EDEIA	18/11/2019 18:30	24/11/2019 14:50	18/11/2019 18:30	21/11/2019 15:30	68,99	8	551,90	CHI
201911201940	INDIARA	EA12257973	EDEIA	18/11/2019 18:30	24/11/2019 14:50	18/11/2019 18:30	21/11/2019 15:30	68,99	4	275,95	CHI
201911201940	EDEIA	EA12257973	EDEIA	18/11/2019 18:30	24/11/2019 14:50	21/11/2019 15:31	21/11/2019 16:49	1,29	1	1,29	CHI
201911201940	INDIARA	EA12257973	EDEIA	18/11/2019 18:30	24/11/2019 14:50	21/11/2019 15:31	21/11/2019 16:49	1,29	3	3,86	CHI
201911201940	EDEIA	EA12257973	EDEIA	18/11/2019 18:30	24/11/2019 14:50	21/11/2019 16:51	22/11/2019 10:29	17,64	1	17,64	CHI
201911201940	INDIARA	EA12257973	EDEIA	18/11/2019 18:30	24/11/2019 14:50	21/11/2019 16:51	22/11/2019 10:29	17,64	2	35,27	CHI
201911201940	INDIARA	EA12056563LD	EDEIA	18/11/2019 18:30	24/11/2019 14:50	21/11/2019 16:51	22/11/2019 15:47	22,94	1	22,94	CHI
201911201940	ACREUNA	IY12039705	EDEIA	18/11/2019 18:30	24/11/2019 14:50	21/11/2019 15:31	22/11/2019 16:17	24,77	8	198,14	CHI
201911201940	INDIARA	IY12039705	EDEIA	18/11/2019 18:30	24/11/2019 14:50	21/11/2019 15:31	22/11/2019 16:17	24,77	3	74,30	CHI
201911201940	ACREUNA	EA12257973	EDEIA	18/11/2019 18:30	24/11/2019 14:50	18/11/2019 18:30	22/11/2019 16:39	94,14	6	564,84	CHI
201911201940	EDEIA	EA12257973	EDEIA	18/11/2019 18:30	24/11/2019 14:50	18/11/2019 18:30	22/11/2019 16:39	94,14	20	1882,81	CHI
201911201940	INDIARA	EA12257973	EDEIA	18/11/2019 18:30	24/11/2019 14:50	18/11/2019 18:30	22/11/2019 16:39	94,14	1	94,14	CHI
201911201940	EDEIA	EA12257973	EDEIA	18/11/2019 18:30	24/11/2019 14:50	18/11/2019 18:30	24/11/2019 14:50	140,33	3	421,00	CHI
201911201942	INHUMAS	IN12012230	INHUMAS S2	18/11/2019 18:33	18/11/2019 20:30	18/11/2019 18:33	18/11/2019 20:30	1,95	362	704,79	CHI
201911201943	CATALAO	CT21294964	CATALAO S1	18/11/2019 18:48	20/11/2019 14:05	18/11/2019 18:48	20/11/2019 14:05	43,28	1	43,28	CHI
201911201946	MINACU	IH12288127	MINACU	18/11/2019 18:49	19/11/2019 09:47	18/11/2019 18:49	19/11/2019 09:47	14,96	6	89,78	CHI
201911201950	FLORES DE GOIAS	3480022891	FLORES DE GOIAS	18/11/2019 18:50	19/11/2019 12:22	18/11/2019 18:50	19/11/2019 12:22	17,53	1	17,53	CHI
201911201951	ALOANDIA	AD21384517	GOIATUBA S1	18/11/2019 18:50	19/11/2019 16:18	18/11/2019 18:50	19/11/2019 16:18	21,46	1	21,46	CHI
201911201952	ANAPOLIS	21026634	ANAPOLIS UNIVERSITARIO S2	18/11/2019 18:50	18/11/2019 20:32	18/11/2019 18:50	18/11/2019 20:32	1,69	1	1,69	CHI
201911201960	CALDAS NOVAS	10000136580	SERRA DE CALDAS	18/11/2019 18:51	20/11/2019 16:59	18/11/2019 18:51	20/11/2019 16:59	46,14	1	46,14	CHI
201911201961	APARECIDA DE GOIANIA	AP12352471	INDEPENDENCIA S2	18/11/2019 16:59	18/11/2019 21:40	18/11/2019 16:59	18/11/2019 21:40	4,68	215	1005,48	CHI
201911201963	QUIRINOPOLIS	QI12000224	QUIRINOPOLIS	19/11/2019 06:02	20/11/2019 00:00	19/11/2019 06:02	19/11/2019 20:29	14,45	59	852,40	CHI
201911201963	QUIRINOPOLIS	QI12000225	QUIRINOPOLIS	19/11/2019 06:02	20/11/2019 00:00	19/11/2019 06:02	20/11/2019 00:00	17,97	34	610,88	CHI
201911201963	QUIRINOPOLIS	QI12000225	QUIRINOPOLIS	19/11/2019 06:02	20/11/2019 00:00	19/11/2019 20:30	20/11/2019 00:00	3,51	12	42,14	CHI

201911201975	GOIANIA	10009500993	CARAJAS S2	18/11/2019 18:52	19/11/2019 11:26	18/11/2019 18:52	19/11/2019 11:26	16,55	1	16,55	CHI
201911201981	SAO MIGUEL DO ARAGUAIA	SM12391612	SAO MIGUEL DO ARAGUAIA	18/11/2019 18:53	19/11/2019 10:26	18/11/2019 18:53	19/11/2019 10:26	15,56	2	31,12	CHI
201911201988	QUIRINOPOLIS	QI12163457	QUIRINOPOLIS	18/11/2019 18:54	19/11/2019 13:20	18/11/2019 18:54	19/11/2019 13:20	18,43	1	18,43	CHI
201911201991	SAO LUIS DE MONTES BELOS	SL11206077	SAO LUIZ DOS MONTES BELOS	18/11/2019 18:46	18/11/2019 22:18	18/11/2019 18:46	18/11/2019 22:18	3,53	95	335,22	CHI
201911201993	MINACU	IH12182357	MINACU	18/11/2019 12:27	18/11/2019 23:15	18/11/2019 12:27	18/11/2019 23:15	10,78	3	32,35	CHI
201911201997	MAIRIPOTABA	MI12000430	PONTALINA	18/11/2019 18:33	19/11/2019 14:21	18/11/2019 18:33	19/11/2019 14:21	19,79	4	79,16	CHI
201911202002	CATALAO	CT21231774	CATALAO S1	18/11/2019 18:56	19/11/2019 10:47	18/11/2019 18:56	19/11/2019 10:47	15,85	1	15,85	CHI
201911202010	CACU	CC11059774	CACHOEIRA ALTA	18/11/2019 23:45	19/11/2019 13:05	18/11/2019 23:45	19/11/2019 13:05	13,33	105	1400,03	CHI
201911202011	JARAGUA	JA21021802	JARAGUA	18/11/2019 18:57	19/11/2019 14:42	18/11/2019 18:57	19/11/2019 14:42	19,75	1	19,75	CHI
201911202018	CAMPO LIMPO	AN12258169	NEROPOLIS S1	18/11/2019 18:58	19/11/2019 11:20	18/11/2019 18:58	19/11/2019 11:20	16,36	3	49,08	CHI
201911202019	LUZIANIA	120276320	RIO VERMELHO	18/11/2019 18:58	19/11/2019 02:23	18/11/2019 18:58	19/11/2019 02:23	7,41	1	7,41	CHI
201911202021	PIRES DO RIO	PR21207641	PIRES DO RIO S1	18/11/2019 18:58	19/11/2019 10:26	18/11/2019 18:58	19/11/2019 10:26	15,45	1	15,45	CHI
201911202023	BELA VISTA DE GOIAS	HD12323100	CEPAIGO S2	18/11/2019 18:27	19/11/2019 07:41	18/11/2019 18:27	19/11/2019 07:41	13,23	8	105,83	CHI
201911202023	HIDROLANDIA	HD12323100	CEPAIGO S2	18/11/2019 18:27	19/11/2019 07:41	18/11/2019 18:27	19/11/2019 07:41	13,23	99	1309,61	CHI
201911202031	GOIATUBA	JV12000028	GOIATUBA S1	18/11/2019 16:26	19/11/2019 13:14	18/11/2019 16:26	19/11/2019 13:14	20,79	9	187,09	CHI
201911202031	JOVIANIA	JV12000028	GOIATUBA S1	18/11/2019 16:26	19/11/2019 13:14	18/11/2019 16:26	19/11/2019 13:14	20,79	12	249,46	CHI
201911202031	VICENTINOPOLIS	JV12000028	GOIATUBA S1	18/11/2019 16:26	19/11/2019 13:14	18/11/2019 16:26	19/11/2019 13:14	20,79	3	62,36	CHI
201911202032	GOIANIA	10359825	CAMPINAS S1	18/11/2019 19:00	19/11/2019 09:45	18/11/2019 19:00	19/11/2019 09:45	14,74	1	14,74	CHI
201911202033	ALTO PARAISO DE GOIAS	BF21286628	NIQUELANDIA SUBTRANSMISSAO	18/11/2019 19:00	18/11/2019 21:09	18/11/2019 19:00	18/11/2019 21:09	2,14	1	2,14	CHI
201911202035	PORANGATU	PO12390257	PORANGATU	18/11/2019 19:00	21/11/2019 05:38	18/11/2019 19:00	21/11/2019 05:38	58,63	4	234,50	CHI
201911202036	PILAR DE GOIAS	GG21244233	URUACU	18/11/2019 19:00	18/11/2019 23:21	18/11/2019 19:00	18/11/2019 23:21	4,34	1	4,34	CHI
201911202039	CRISTALINA	KR21338008	PAMPLONA	18/11/2019 19:00	19/11/2019 01:51	18/11/2019 19:00	19/11/2019 01:51	6,83	1	6,83	CHI
201911202044	CRISTALINA	KR12348534	PAMPLONA	18/11/2019 14:54	19/11/2019 10:15	18/11/2019 14:54	19/11/2019 10:15	19,35	5	96,74	CHI
201911202047	APARECIDA DE GOIANIA	AP11167711	ATLANTICO S1	18/11/2019 17:39	19/11/2019 00:27	18/11/2019 17:39	19/11/2019 00:27	6,79	95	645,37	CHI
201911202048	BRAZABRANTES	BR11366003	NEROPOLIS S1	18/11/2019 19:01	18/11/2019 21:26	18/11/2019 19:01	18/11/2019 21:26	2,41	59	142,03	CHI
201911202054	LUZIANIA	LZ21183970	RIO VERMELHO	18/11/2019 19:01	19/11/2019 13:25	18/11/2019 19:01	19/11/2019 13:25	18,38	2	36,77	CHI
201911202055	SANTA TEREZA DE GOIAS	SE21288214	PORANGATU	18/11/2019 19:02	19/11/2019 10:33	18/11/2019 19:02	19/11/2019 10:33	15,52	1	15,52	CHI
201911202071	CRISTALINA	KR21097534	CRISTALINA S2	18/11/2019 19:04	19/11/2019 15:11	18/11/2019 19:04	19/11/2019 15:11	20,11	1	20,11	CHI
201911202074	ITAPACI	100045091	ITAPACI	18/11/2019 19:04	18/11/2019 23:58	18/11/2019 19:04	18/11/2019 23:58	4,89	1	4,89	CHI
201911202075	QUIRINOPOLIS	QI11361076	QUIRINOPOLIS	18/11/2019 18:57	19/11/2019 11:41	18/11/2019 18:57	19/11/2019 11:41	16,73	74	1237,81	CHI
201911202083	CATALAO	CT11166796	CATALAO S2	18/11/2019 18:37	18/11/2019 22:47	18/11/2019 18:37	18/11/2019 22:47	4,17	25	104,13	CHI
201911202085	INDIARA	IY21037367	EDEIA	18/11/2019 19:06	20/11/2019 17:55	18/11/2019 19:06	20/11/2019 17:55	46,81	1	46,81	CHI
201911202088	CATALAO	CT11379402	CATALAO S2	18/11/2019 18:55	18/11/2019 22:01	18/11/2019 18:55	18/11/2019 22:01	3,09	55	170,21	CHI

201911202091	RIO VERDE	RV11279782	RIO VERDE S2	18/11/2019 18:25	18/11/2019 23:50	18/11/2019 18:25	18/11/2019 23:50	5,41	44	238,00	CHI
201911202094	ISRAELANDIA	1270002895	IPORA	18/11/2019 19:08	19/11/2019 13:44	18/11/2019 19:08	19/11/2019 13:44	18,61	1	18,61	CHI
201911202097	MOZARLANDIA	AZ21143345	MOZARLANDIA	18/11/2019 19:08	19/11/2019 14:01	18/11/2019 19:08	19/11/2019 14:01	18,88	1	18,88	CHI
201911202102	ABADIA DE GOIAS	LG12373007	INDEPENDENCIA S2	20/11/2019 09:35	20/11/2019 11:10	20/11/2019 09:35	20/11/2019 11:10	1,58	29	45,81	CHI
201911202102	ARAGOIANIA	LG12373007	INDEPENDENCIA S2	20/11/2019 09:35	20/11/2019 11:10	20/11/2019 09:35	20/11/2019 11:10	1,58	5	7,90	CHI
201911202114	APARECIDA DE GOIANIA	AP11377665	INDEPENDENCIA S2	18/11/2019 18:52	18/11/2019 21:48	18/11/2019 18:52	18/11/2019 21:48	2,94	105	308,73	CHI
201911202118	APARECIDA DE GOIANIA	14349656	INDEPENDENCIA S2	18/11/2019 19:11	19/11/2019 11:41	18/11/2019 19:11	19/11/2019 11:41	16,49	1	16,49	CHI
201911202120	APARECIDA DE GOIANIA	AP11408731	INDEPENDENCIA S2	18/11/2019 17:02	19/11/2019 09:23	18/11/2019 17:02	19/11/2019 09:23	16,34	36	588,39	CHI
201911202137	APARECIDA DE GOIANIA	AP11000052	INDEPENDENCIA S1	18/11/2019 19:06	19/11/2019 01:22	18/11/2019 19:06	19/11/2019 01:22	6,26	208	1301,27	CHI
201911202139	CATURAI	IN21382720	ARACU	18/11/2019 19:14	19/11/2019 16:30	18/11/2019 19:14	19/11/2019 16:30	21,26	2	42,51	CHI
201911202152	PIRENOPOLIS	PV12381213	CORUMBA	18/11/2019 14:39	18/11/2019 22:16	18/11/2019 14:39	18/11/2019 22:16	7,61	5	38,07	CHI
201911202154	EDEIA	1120029263	EDEIA	18/11/2019 19:17	19/11/2019 11:22	18/11/2019 19:17	19/11/2019 11:22	16,08	1	16,08	CHI
201911202157	CACHOEIRA ALTA	CA12196131	CACHOEIRA ALTA	18/11/2019 19:08	19/11/2019 10:59	18/11/2019 19:08	19/11/2019 10:59	15,84	12	190,12	CHI
201911202160	APARECIDA DE GOIANIA	10022955010	INDEPENDENCIA S2	18/11/2019 16:10	18/11/2019 21:51	18/11/2019 16:10	18/11/2019 21:51	5,68	1	5,68	CHI
201911202161	CATALAO	CT12394029	CATALAO S1	18/11/2019 19:18	20/11/2019 14:05	18/11/2019 19:18	20/11/2019 14:05	42,78	7	299,48	CHI
201911202162	NOVA IGUACU DE GOIAS	NH12202113	SANTA TEREZINHA	18/11/2019 19:18	18/11/2019 22:13	18/11/2019 19:18	18/11/2019 22:13	2,91	63	183,03	CHI
201911202164	GAMELEIRA DE GOIAS	SV12093679	DAIA S2	18/11/2019 19:15	19/11/2019 09:49	18/11/2019 19:15	19/11/2019 09:49	14,56	8	116,44	CHI
201911202165	MINEIROS	10030478578	PARQUE DAS EMAS	18/11/2019 19:19	18/11/2019 22:49	18/11/2019 19:19	18/11/2019 22:49	3,50	0	0,00	CHI
201911202171	GOIANIRA	GR11313227	MEIA PONTE	18/11/2019 18:28	19/11/2019 11:30	18/11/2019 18:28	19/11/2019 11:30	17,02	78	1327,62	CHI
201911202175	SAO JOAO D ALIANCA	JL12324141	SAO JOAO D ALIANCA	18/11/2019 19:20	18/11/2019 22:58	18/11/2019 19:20	18/11/2019 22:58	3,62	4	14,50	CHI
201911202180	APARECIDA DE GOIANIA	AP11043245	INDEPENDENCIA S1	18/11/2019 17:35	19/11/2019 03:04	18/11/2019 17:35	19/11/2019 03:04	9,48	76	720,12	CHI
201911202182	ITUMBIARA	IT11257144	PARANAIBA	18/11/2019 19:04	19/11/2019 11:56	18/11/2019 19:04	19/11/2019 11:56	16,86	21	354,05	CHI
201911202185	CRISTALINA	KR11032621	PAMPLONA	18/11/2019 19:03	18/11/2019 22:22	18/11/2019 19:03	18/11/2019 22:22	3,31	77	255,21	CHI
201911202187	RIO VERDE	RV11000117	RIO VERDE S2	18/11/2019 18:24	18/11/2019 23:04	18/11/2019 18:24	18/11/2019 23:04	4,66	107	499,15	CHI
201911202188	PIRENOPOLIS	PV12273171	CORUMBA	18/11/2019 19:23	18/11/2019 21:01	18/11/2019 19:23	18/11/2019 21:01	1,62	20	32,43	CHI
201911202190	GOIANIRA	GR31045886	TRINDADE	18/11/2019 19:23	20/11/2019 12:00	18/11/2019 19:23	20/11/2019 12:00	40,61	1	40,61	CHI
201911202196	APARECIDA DE GOIANIA	200257353	CEPAIGO S1	18/11/2019 19:24	19/11/2019 13:46	18/11/2019 19:24	19/11/2019 13:46	18,36	1	18,36	CHI
201911202208	GOIANIA	14597044	ATLANTICO S1	18/11/2019 20:07	18/11/2019 22:08	18/11/2019 20:07	18/11/2019 22:08	2,00	1	2,00	CHI
201911202209	JUSSARA	01050424	JUSSARA	19/11/2019 13:58	19/11/2019 14:25	19/11/2019 13:58	19/11/2019 14:25	0,45	163	73,67	CHI
201911202209	SANTA FE DE GOIAS	01050424	JUSSARA	19/11/2019 13:58	19/11/2019 14:25	19/11/2019 13:58	19/11/2019 14:25	0,45	28	12,65	CHI
201911202210	GOIANIA	GN11002203	FERROVIARIO S3	18/11/2019 20:10	18/11/2019 21:00	18/11/2019 20:10	18/11/2019 21:00	0,83	131	108,98	CHI
201911202211	SAO JOAO D ALIANCA	JL21255328	SAO JOAO D ALIANCA	17/11/2019 12:54	18/11/2019 22:56	17/11/2019 12:54	18/11/2019 22:56	34,03	1	34,03	CHI
201911202236	APARECIDA DE GOIANIA	AP11004667	INDEPENDENCIA S2	18/11/2019 14:52	19/11/2019 04:11	18/11/2019 14:52	19/11/2019 04:11	13,30	122	1623,18	CHI

201911202250	APARECIDA DE GOIANIA	AP11060843	INDEPENDENCIA S2	18/11/2019 21:12	19/11/2019 04:51	18/11/2019 21:12	19/11/2019 04:51	7,64	219	1674,13	CHI
201911202257	APARECIDA DE GOIANIA	AP11003040	REAL S2	19/11/2019 01:27	19/11/2019 08:14	19/11/2019 01:27	19/11/2019 08:14	6,78	72	488,14	CHI
201911202258	MARA ROSA	MQ12248106LD	MARA ROSA	19/11/2019 01:32	19/11/2019 10:47	19/11/2019 01:32	19/11/2019 10:47	9,26	5	46,30	CHI
201911202259	ALTO HORIZONTE	AJ21317715	SANTA TEREZINHA	19/11/2019 01:34	20/11/2019 07:43	19/11/2019 01:34	20/11/2019 07:04	29,50	1	29,50	CHI
201911202259	ALTO HORIZONTE	AJ21202024	SANTA TEREZINHA	19/11/2019 01:34	20/11/2019 07:43	19/11/2019 01:34	20/11/2019 07:43	30,15	1	30,15	CHI
201911202260	GOIANIA	00582004	GOIANIA LESTE S3	19/11/2019 02:10	19/11/2019 04:33	19/11/2019 02:10	19/11/2019 02:14	0,07	8879	604,27	CHI
201911202260	GOIANIA	00582004	GOIANIA LESTE S3	19/11/2019 02:10	19/11/2019 04:33	19/11/2019 02:10	19/11/2019 02:16	0,12	5171	596,10	CHI
201911202260	GOIANIA	00582004	GOIANIA LESTE S3	19/11/2019 02:10	19/11/2019 04:33	19/11/2019 02:10	19/11/2019 02:46	0,61	884	540,71	CHI
201911202260	GOIANIA	GN16401534	GOIANIA LESTE S3	19/11/2019 02:10	19/11/2019 04:33	19/11/2019 02:10	19/11/2019 04:25	2,25	951	2138,69	CHI
201911202260	GOIANIA	GN13000581	GOIANIA LESTE S3	19/11/2019 02:10	19/11/2019 04:33	19/11/2019 04:29	19/11/2019 04:33	0,06	884	52,30	CHI
201911202261	CRIXAS	SG10394720	SANTA TEREZINHA	19/11/2019 03:31	19/11/2019 16:08	19/11/2019 03:31	19/11/2019 10:19	6,80	274	1862,82	CHI
201911202261	GUARINOS	SG10394720	SANTA TEREZINHA	19/11/2019 03:31	19/11/2019 16:08	19/11/2019 03:31	19/11/2019 10:19	6,80	865	5880,80	CHI
201911202261	ITAPACI	SG10394720	SANTA TEREZINHA	19/11/2019 03:31	19/11/2019 16:08	19/11/2019 03:31	19/11/2019 10:19	6,80	6	40,79	CHI
201911202261	PILAR DE GOIAS	SG10394720	SANTA TEREZINHA	19/11/2019 03:31	19/11/2019 16:08	19/11/2019 03:31	19/11/2019 10:19	6,80	45	305,94	CHI
201911202261	SANTA TEREZINHA DE GOIAS	SG10394720	SANTA TEREZINHA	19/11/2019 03:31	19/11/2019 16:08	19/11/2019 03:31	19/11/2019 10:19	6,80	202	1373,32	CHI
201911202261	CRIXAS	CX12097448	SANTA TEREZINHA	19/11/2019 03:31	19/11/2019 16:08	19/11/2019 03:31	19/11/2019 15:15	11,74	2	23,47	CHI
201911202261	GUARINOS	CX12097448	SANTA TEREZINHA	19/11/2019 03:31	19/11/2019 16:08	19/11/2019 03:31	19/11/2019 15:15	11,74	47	551,62	CHI
201911202261	CRIXAS	CX12164859	SANTA TEREZINHA	19/11/2019 03:31	19/11/2019 16:08	19/11/2019 03:31	19/11/2019 15:36	12,09	17	205,45	CHI
201911202261	CRIXAS	CX12380727	SANTA TEREZINHA	19/11/2019 03:31	19/11/2019 16:08	19/11/2019 03:31	19/11/2019 16:08	12,61	6	75,66	CHI
201911202264	CATALAO	CT12042366	CATALAO S1	19/11/2019 05:24	19/11/2019 09:30	19/11/2019 05:24	19/11/2019 09:30	4,09	19	77,76	CHI
201911202271	BALIZA	10014567960	BOM JARDIM	18/11/2019 16:05	19/11/2019 13:24	18/11/2019 16:05	19/11/2019 13:24	21,32	1	21,32	CHI
201911202274	GOIAS	GS10408581	GOIAS	19/11/2019 06:05	19/11/2019 08:27	19/11/2019 06:05	19/11/2019 08:27	2,36	177	417,03	CHI
201911202274	GUARAITA	GS10408581	GOIAS	19/11/2019 06:05	19/11/2019 08:27	19/11/2019 06:05	19/11/2019 08:27	2,36	2	4,71	CHI
201911202274	HEITORAI	GS10408581	GOIAS	19/11/2019 06:05	19/11/2019 08:27	19/11/2019 06:05	19/11/2019 08:27	2,36	29	68,33	CHI
201911202274	ITABERAI	GS10408581	GOIAS	19/11/2019 06:05	19/11/2019 08:27	19/11/2019 06:05	19/11/2019 08:27	2,36	2	4,71	CHI
201911202274	ITAPURANGA	GS10408581	GOIAS	19/11/2019 06:05	19/11/2019 08:27	19/11/2019 06:05	19/11/2019 08:27	2,36	5	11,78	CHI
201911202283	FORMOSA	FA11000013	ITUIQUIRA	19/11/2019 08:59	19/11/2019 09:50	19/11/2019 08:59	19/11/2019 09:50	0,86	195	166,94	CHI
201911202314	APARECIDA DE GOIANIA	200238103	INDEPENDENCIA S2	18/11/2019 19:26	19/11/2019 15:30	18/11/2019 19:26	19/11/2019 15:30	20,05	1	20,05	CHI
201911202316	ESTRELA DO NORTE	MU12075219	MARA ROSA	18/11/2019 16:22	18/11/2019 22:30	18/11/2019 16:22	18/11/2019 22:30	6,13	1	6,13	CHI
201911202316	MUTUNOPOLIS	MU12075219	MARA ROSA	18/11/2019 16:22	18/11/2019 22:30	18/11/2019 16:22	18/11/2019 22:30	6,13	9	55,17	CHI
201911202317	ITABERAI	IX12321505	INHUMAS S1	18/11/2019 19:27	18/11/2019 22:24	18/11/2019 19:27	18/11/2019 22:24	2,94	1	2,94	CHI
201911202317	ITAUCU	IX12321505	INHUMAS S1	18/11/2019 19:27	18/11/2019 22:24	18/11/2019 19:27	18/11/2019 22:24	2,94	19	55,80	CHI
201911202322	MUNDO NOVO DE GOIAS	10017226455	NOVA CRIXAS	18/11/2019 19:28	18/11/2019 21:27	18/11/2019 19:28	18/11/2019 21:27	1,98	1	1,98	CHI

201911202328	APARECIDA DE GOIANIA	AP11313327	INDEPENDENCIA S2	18/11/2019 19:17	19/11/2019 12:31	18/11/2019 19:17	19/11/2019 12:31	17,23	94	1619,91	CHI
201911202337	LUZIANIA	3200089839	MARAJOARA	18/11/2019 19:30	18/11/2019 23:18	18/11/2019 19:30	18/11/2019 23:18	3,79	1	3,79	CHI
201911202341	ITUMBIARA	IT12257058	ITUMBIARA NOVA	18/11/2019 19:23	19/11/2019 17:27	18/11/2019 19:23	19/11/2019 17:27	22,05	2	44,10	CHI
201911202342	CALDAS NOVAS	CN12391202	CALDAS NOVAS S1	18/11/2019 19:31	20/11/2019 11:22	18/11/2019 19:31	20/11/2019 11:22	39,84	4	159,37	CHI
201911202344	CATALAO	CT12061265RE	CATALAO S1	18/11/2019 15:06	18/11/2019 23:26	18/11/2019 15:06	18/11/2019 23:26	8,34	15	125,08	CHI
201911202344	DAVINOPOLIS	CT12061265RE	CATALAO S1	18/11/2019 15:06	18/11/2019 23:26	18/11/2019 15:06	18/11/2019 23:26	8,34	71	592,06	CHI
201911202344	OUVIDOR	CT12061265RE	CATALAO S1	18/11/2019 15:06	18/11/2019 23:26	18/11/2019 15:06	18/11/2019 23:26	8,34	52	433,62	CHI
201911202350	SANTO ANTONIO DO DESCOBERTO	10004581405	ALEXANIA	18/11/2019 19:32	18/11/2019 20:48	18/11/2019 19:32	18/11/2019 20:48	1,26	1	1,26	CHI
201911202354	ANAPOLIS	21194300	JUNDIAI S2	18/11/2019 19:32	18/11/2019 23:44	18/11/2019 19:32	18/11/2019 23:44	4,19	1	4,19	CHI
201911202360	HIDROLANDIA	HD31046382	PONTALINA	18/11/2019 19:34	19/11/2019 12:03	18/11/2019 19:34	19/11/2019 12:03	16,48	1	16,48	CHI
201911202362	LUZIANIA	LZ12389577	VIANOPOLIS	18/11/2019 19:34	19/11/2019 00:06	18/11/2019 19:34	19/11/2019 00:06	4,52	3	13,57	CHI
201911202364	GOIANIA	10659444	AEROPORTO S2	18/11/2019 19:34	19/11/2019 10:36	18/11/2019 19:34	19/11/2019 10:36	15,03	1	15,03	CHI
201911202380	MINACU	IH12245147	MINACU	18/11/2019 09:38	19/11/2019 01:09	18/11/2019 09:38	19/11/2019 01:09	15,50	2	31,01	CHI
201911202398	GOIANIA	10966468	CAMPINAS S3	18/11/2019 19:40	19/11/2019 09:09	18/11/2019 19:40	19/11/2019 09:09	13,47	1	13,47	CHI
201911202424	INHUMAS	10002777124	INHUMAS S2	18/11/2019 19:46	19/11/2019 03:44	18/11/2019 19:46	19/11/2019 03:44	7,97	1	7,97	CHI
201911202426	RIO VERDE	630057710	RIO VERDE S1	18/11/2019 19:46	19/11/2019 03:40	18/11/2019 19:46	19/11/2019 03:40	7,89	1	7,89	CHI
201911202429	GOIANIA	GN12222920	ATLANTICO S2	18/11/2019 16:46	18/11/2019 22:30	18/11/2019 16:46	18/11/2019 22:30	5,73	201	1152,01	CHI
201911202445	PORANGATU	PO12297140	PORANGATU	18/11/2019 19:50	19/11/2019 01:52	18/11/2019 19:50	19/11/2019 01:52	6,02	16	96,39	CHI
201911202445	SANTA TEREZA DE GOIAS	PO12297140	PORANGATU	18/11/2019 19:50	19/11/2019 01:52	18/11/2019 19:50	19/11/2019 01:52	6,02	11	66,27	CHI
201911202445	TROMBAS	PO12297140	PORANGATU	18/11/2019 19:50	19/11/2019 01:52	18/11/2019 19:50	19/11/2019 01:52	6,02	170	1024,11	CHI
201911202447	JUSSARA	JR12016151	BRITANIA	18/11/2019 19:50	19/11/2019 11:33	18/11/2019 19:50	19/11/2019 11:33	15,71	19	298,42	CHI
201911202448	ABADIA DE GOIAS	LG11251434	CARAJAS S1	18/11/2019 17:37	19/11/2019 09:20	18/11/2019 17:37	19/11/2019 09:20	15,71	84	1319,52	CHI
201911202449	GOIANIA	12202230	CARAJAS S1	18/11/2019 19:50	19/11/2019 09:18	18/11/2019 19:50	19/11/2019 09:18	13,45	1	13,45	CHI
201911202452	ANAPOLIS	10012205670	JUNDIAI S1	18/11/2019 19:51	18/11/2019 23:09	18/11/2019 19:51	18/11/2019 23:09	3,30	1	3,30	CHI
201911202457	RIO VERDE	RV10408114	CABRIUVA S2	18/11/2019 14:49	18/11/2019 17:25	18/11/2019 14:49	18/11/2019 17:25	2,60	60	156,08	CHI
201911202464	ITAGUARI	I121327352	ITABERAI S1	18/11/2019 19:53	19/11/2019 10:13	18/11/2019 19:53	19/11/2019 10:13	14,33	1	14,33	CHI
201911202465	JATAI	290212030	JATAI S2	18/11/2019 19:53	18/11/2019 23:56	18/11/2019 19:53	18/11/2019 23:56	4,05	1	4,05	CHI
201911202470	JATAI	290342090	JATAI S3	18/11/2019 19:54	18/11/2019 23:49	18/11/2019 19:54	18/11/2019 23:49	3,92	1	3,92	CHI
201911202476	GOIANIA	GN11151322	SENADOR CANEDO	18/11/2019 19:32	18/11/2019 23:47	18/11/2019 19:32	18/11/2019 23:47	4,25	155	658,36	CHI
201911202477	TRINDADE	16607296	GOYA S2	18/11/2019 19:55	18/11/2019 22:18	18/11/2019 19:55	18/11/2019 22:18	2,38	1	2,38	CHI
201911202478	ARENOPOLIS	AY12381016	IPORA	18/11/2019 16:49	19/11/2019 08:13	18/11/2019 16:49	19/11/2019 08:13	15,40	45	692,94	CHI
201911202478	PIRANHAS	AY12381016	IPORA	18/11/2019 16:49	19/11/2019 08:13	18/11/2019 16:49	19/11/2019 08:13	15,40	1	15,40	CHI
201911202482	GOIANIA	12624883	GOIANIA LESTE S1	18/11/2019 19:56	19/11/2019 17:40	18/11/2019 19:56	19/11/2019 17:40	21,73	1	21,73	CHI

201911202489	BELA VISTA DE GOIAS	BV21097975	BELA VISTA S1	18/11/2019 19:57	18/11/2019 22:54	18/11/2019 19:57	18/11/2019 22:54	2,94	1	2,94	CHI
201911202498	MOZARLANDIA	AZ21143384	MOZARLANDIA	18/11/2019 19:59	19/11/2019 14:06	18/11/2019 19:59	19/11/2019 14:06	18,10	1	18,10	CHI
201911202506	GOIANIA	GN11292155	GOYA S2	18/11/2019 19:57	18/11/2019 21:05	18/11/2019 19:57	18/11/2019 21:05	1,12	198	221,70	CHI
201911202513	MINEIROS	PW12219569	PARQUE DAS EMAS	18/11/2019 20:03	19/11/2019 12:26	18/11/2019 20:03	19/11/2019 12:26	16,38	69	1129,95	CHI
201911202513	PORTELANDIA	PW12219569	PARQUE DAS EMAS	18/11/2019 20:03	19/11/2019 12:26	18/11/2019 20:03	19/11/2019 12:26	16,38	5	81,88	CHI
201911202516	MONTIVIDIU	MV12260796	MONTIVIDIU T	18/11/2019 20:03	19/11/2019 16:13	18/11/2019 20:03	19/11/2019 16:13	20,16	2	40,32	CHI
201911202516	RIO VERDE	MV12260796	MONTIVIDIU T	18/11/2019 20:03	19/11/2019 16:13	18/11/2019 20:03	19/11/2019 16:13	20,16	2	40,32	CHI
201911202523	SAO JOAO D ALIANCA	JL12144641	SAO JOAO D ALIANCA	18/11/2019 20:04	20/11/2019 07:05	18/11/2019 20:04	20/11/2019 07:05	35,02	6	210,11	CHI
201911202524	GOIANIA	GN11001039	CARAJAS S1	18/11/2019 19:22	18/11/2019 23:12	18/11/2019 19:22	18/11/2019 23:12	3,83	73	279,61	CHI
201911202528	MARA ROSA	MQ12320749	MARA ROSA	18/11/2019 20:05	19/11/2019 19:53	18/11/2019 20:05	19/11/2019 19:53	23,79	2	47,58	CHI
201911202534	PALMEIRAS DE GOIAS	PP12000036	PALMEIRAS	18/11/2019 20:06	18/11/2019 21:46	18/11/2019 20:06	18/11/2019 21:46	1,67	52	86,80	CHI
201911202534	PALMINOPOLIS	PP12000036	PALMEIRAS	18/11/2019 20:06	18/11/2019 21:46	18/11/2019 20:06	18/11/2019 21:46	1,67	38	63,43	CHI
201911202537	ESTRELA DO NORTE	ET12012488	MARA ROSA	18/11/2019 18:29	19/11/2019 00:18	18/11/2019 18:29	19/11/2019 00:18	5,80	18	104,47	CHI
201911202545	GOIANIA	10009450007	MEIA PONTE	18/11/2019 20:08	19/11/2019 09:35	18/11/2019 20:08	19/11/2019 09:35	13,44	1	13,44	CHI
201911202548	SAO MIGUEL DO ARAGUAIA	10010212394	SAO MIGUEL DO ARAGUAIA	18/11/2019 20:09	19/11/2019 03:44	18/11/2019 20:09	19/11/2019 03:44	7,60	1	7,60	CHI
201911202549	SAO LUIS DE MONTES BELOS	500046426	SAO LUIZ DOS MONTES BELOS	18/11/2019 20:09	19/11/2019 08:42	18/11/2019 20:09	19/11/2019 08:42	12,55	1	12,55	CHI
201911202553	APARECIDA DE GOIANIA	AP12210390	ATLANTICO S3	18/11/2019 18:27	18/11/2019 23:20	18/11/2019 18:27	18/11/2019 23:20	4,87	275	1340,47	CHI
201911202555	APARECIDA DE GOIANIA	200130663	INDEPENDENCIA S2	18/11/2019 20:10	19/11/2019 10:34	18/11/2019 20:10	19/11/2019 10:34	14,40	1	14,40	CHI
201911202562	APARECIDA DE GOIANIA	200370236	ANHANGUERA	18/11/2019 20:13	19/11/2019 12:58	18/11/2019 20:13	19/11/2019 12:58	16,75	1	16,75	CHI
201911202565	SERRANOPOLIS	SX21266455	JATAI S1	18/11/2019 20:13	20/11/2019 14:28	18/11/2019 20:13	20/11/2019 14:28	42,25	1	42,25	CHI
201911202566	GOIANIA	10029779608	CAMPINAS S1	18/11/2019 20:13	18/11/2019 21:35	18/11/2019 20:13	18/11/2019 21:35	1,36	1	1,36	CHI
201911202567	IPAMERI	10004050000	IPAMERI	18/11/2019 20:14	19/11/2019 11:02	18/11/2019 20:14	19/11/2019 11:02	14,81	1	14,81	CHI
201911202572	SENADOR CANEDO	SW12002157	SENADOR CANEDO	18/11/2019 15:48	19/11/2019 08:47	18/11/2019 15:48	19/11/2019 08:47	16,97	5	84,87	CHI
201911202576	ITAPACI	10028770143	ITAPACI	18/11/2019 20:16	18/11/2019 22:52	18/11/2019 20:16	18/11/2019 22:52	2,59	1	2,59	CHI
201911202578	AGUAS LINDAS DE GOIAS	10010248941	AGUAS LINDAS DE GOIAS S1	18/11/2019 20:17	18/11/2019 22:40	18/11/2019 20:17	18/11/2019 22:40	2,38	1	2,38	CHI
201911202579	GOIANIA	11051607	ATLANTICO S1	18/11/2019 20:17	19/11/2019 13:42	18/11/2019 20:17	19/11/2019 13:42	17,41	1	17,41	CHI
201911202583	CAIAPONIA	CP21357568	MONTIVIDIU T	18/11/2019 20:18	19/11/2019 15:52	18/11/2019 20:18	19/11/2019 15:52	19,56	1	19,56	CHI
201911202594	SANTA HELENA DE GOIAS	400112796	IPEGUARI	18/11/2019 20:22	18/11/2019 23:50	18/11/2019 20:22	18/11/2019 23:50	3,46	1	3,46	CHI
201911202603	JARAGUA	JA21370309	CORUMBA	18/11/2019 20:24	19/11/2019 12:05	18/11/2019 20:24	19/11/2019 12:05	15,67	2	31,35	CHI
201911202604	FORMOSA	FA11053531	ITUIQUIRA	18/11/2019 18:35	18/11/2019 22:16	18/11/2019 18:35	18/11/2019 22:16	3,68	118	434,24	CHI
201911202605	ANAPOLIS	20019567	JUNDIAI S2	18/11/2019 20:26	18/11/2019 22:50	18/11/2019 20:26	18/11/2019 22:50	2,40	1	2,40	CHI
201911202609	APARECIDA DE GOIANIA	10001824153	INDEPENDENCIA S2	18/11/2019 20:27	19/11/2019 14:17	18/11/2019 20:27	19/11/2019 14:17	17,83	1	17,83	CHI
201911202610	ITUMBIARA	IT12316685	ITUMBIARA NOVA	18/11/2019 17:36	19/11/2019 11:30	18/11/2019 17:36	19/11/2019 11:30	17,89	40	715,48	CHI

201911202612	PIRENOPOLIS	220007366	CORUMBA	18/11/2019 20:27	19/11/2019 19:30	18/11/2019 20:27	19/11/2019 19:30	23,04	1	23,04	CHI
201911202615	GOIANIA	16234959	FERROVIARIO S1	18/11/2019 20:28	19/11/2019 10:01	18/11/2019 20:28	19/11/2019 10:01	13,54	1	13,54	CHI
201911202620	CAMPOS VERDES	VD12257334	SANTA TEREZINHA	18/11/2019 20:27	18/11/2019 21:41	18/11/2019 20:27	18/11/2019 21:41	1,23	6	7,35	CHI
201911202624	CRISTALINA	KR21171350	PAMPLONA	18/11/2019 20:31	19/11/2019 11:45	18/11/2019 20:31	19/11/2019 11:45	15,23	1	15,23	CHI
201911202627	PIRENOPOLIS	PV11273104	CORUMBA	18/11/2019 20:26	18/11/2019 23:13	18/11/2019 20:26	18/11/2019 23:13	2,77	117	324,15	CHI
201911202631	SENADOR CANEDO	10009492273	SENADOR CANEDO	18/11/2019 20:33	19/11/2019 06:15	18/11/2019 20:33	19/11/2019 06:15	9,70	1	9,70	CHI
201911202638	RIO VERDE	BZ12200724	ACREUNA	18/11/2019 20:35	18/11/2019 23:15	18/11/2019 20:35	18/11/2019 23:15	2,67	24	64,19	CHI
201911202638	SANTA HELENA DE GOIAS	BZ12200724	ACREUNA	18/11/2019 20:35	18/11/2019 23:15	18/11/2019 20:35	18/11/2019 23:15	2,67	5	13,37	CHI
201911202638	SANTO ANTONIO DA BARRA	BZ12200724	ACREUNA	18/11/2019 20:35	18/11/2019 23:15	18/11/2019 20:35	18/11/2019 23:15	2,67	139	371,79	CHI
201911202648	RUBIATABA	10029202939	RUBIATABA	18/11/2019 20:39	18/11/2019 22:13	18/11/2019 20:39	18/11/2019 22:13	1,56	1	1,56	CHI
201911202650	MINEIROS	PW12296306	PARQUE DAS EMAS	18/11/2019 20:39	19/11/2019 10:45	18/11/2019 20:39	19/11/2019 10:45	14,10	27	380,57	CHI
201911202650	PORTELANDIA	PW12296306	PARQUE DAS EMAS	18/11/2019 20:39	19/11/2019 10:45	18/11/2019 20:39	19/11/2019 10:45	14,10	8	112,76	CHI
201911202652	GOIANIA	14100939	MEIA PONTE	18/11/2019 20:39	19/11/2019 12:36	18/11/2019 20:39	19/11/2019 12:36	15,94	1	15,94	CHI
201911202657	JATAI	290149551	JATAI S2	18/11/2019 20:40	19/11/2019 18:24	18/11/2019 20:40	19/11/2019 18:24	21,72	1	21,72	CHI
201911202663	JARAGUA	JA21283336	JARAGUA	18/11/2019 20:41	19/11/2019 12:16	18/11/2019 20:41	19/11/2019 12:16	15,58	2	31,16	CHI
201911202665	ANAPOLIS	AN11000007	ANAPOLIS UNIVERSITARIO S2	18/11/2019 20:32	18/11/2019 22:11	18/11/2019 20:32	18/11/2019 22:11	1,64	64	105,17	CHI
201911202670	SENADOR CANEDO	10008497620	SENADOR CANEDO	18/11/2019 20:43	19/11/2019 02:47	18/11/2019 20:43	19/11/2019 02:47	6,07	1	6,07	CHI
201911202671	RUBIATABA	780037698	RUBIATABA	18/11/2019 20:43	18/11/2019 23:01	18/11/2019 20:43	18/11/2019 23:01	2,30	1	2,30	CHI
201911202680	GOIANIA	GN11276933	ATLANTICO S2	18/11/2019 20:41	19/11/2019 00:00	18/11/2019 20:41	19/11/2019 00:00	3,31	27	89,45	CHI
201911202681	CRIXAS	CX12319064	SERRA DO OURO	18/11/2019 20:47	19/11/2019 21:53	18/11/2019 20:47	19/11/2019 21:53	25,10	3	75,29	CHI
201911202684	CATALAO	CT11316114	CATALAO S2	18/11/2019 19:45	19/11/2019 06:12	18/11/2019 19:45	19/11/2019 06:12	10,45	112	1170,18	CHI
201911202690	BELA VISTA DE GOIAS	BC12389811	PIRES DO RIO S2	18/11/2019 10:49	19/11/2019 10:31	18/11/2019 10:49	19/11/2019 10:31	23,69	2	47,39	CHI
201911202690	CRISTIANOPOLIS	BC12389811	PIRES DO RIO S2	18/11/2019 10:49	19/11/2019 10:31	18/11/2019 10:49	19/11/2019 10:31	23,69	3	71,08	CHI
201911202692	POSSE	SA12384202	IACIARA S2	18/11/2019 20:53	18/11/2019 21:46	18/11/2019 20:53	18/11/2019 21:46	0,88	37	32,44	CHI
201911202692	SIMOLANDIA	SA12384202	IACIARA S2	18/11/2019 20:53	18/11/2019 21:46	18/11/2019 20:53	18/11/2019 21:46	0,88	19	16,66	CHI
201911202696	MINACU	IH21242186	MINACU	18/11/2019 20:54	19/11/2019 13:28	18/11/2019 20:54	19/11/2019 13:28	16,57	1	16,57	CHI
201911202699	GUAPO	GA21122846	GUAPO S2	18/11/2019 20:54	20/11/2019 12:27	18/11/2019 20:54	20/11/2019 12:27	39,54	1	39,54	CHI
201911202703	TRES RANCHOS	2170018070	CATALAO S1	18/11/2019 20:56	19/11/2019 07:50	18/11/2019 20:56	19/11/2019 07:50	10,90	1	10,90	CHI
201911202704	PONTALINA	PK12047065	PONTALINA	18/11/2019 20:07	19/11/2019 09:05	18/11/2019 20:07	19/11/2019 09:05	12,95	10	129,54	CHI
201911202705	GOIANIA	10722932	ATLANTICO S2	18/11/2019 20:56	19/11/2019 01:14	18/11/2019 20:56	19/11/2019 01:14	4,30	1	4,30	CHI
201911202710	JATAI	290155563	JATAI S2	18/11/2019 20:58	19/11/2019 18:54	18/11/2019 20:58	19/11/2019 18:54	21,93	1	21,93	CHI
201911202716	BOM JARDIM DE GOIAS	BM12152659	BOM JARDIM	18/11/2019 21:00	19/11/2019 11:50	18/11/2019 21:00	19/11/2019 11:50	14,83	6	88,98	CHI
201911202719	FORMOSA	FA11180623	ITUIQUIRA	18/11/2019 21:00	18/11/2019 22:35	18/11/2019 21:00	18/11/2019 22:35	1,58	208	328,70	CHI

201911202725	RIO QUENTE	RQ21311751	RIO QUENTE	18/11/2019 17:00	19/11/2019 19:25	18/11/2019 17:00	19/11/2019 19:25	26,42	1	26,42	CHI
201911202730	CAIAPONIA	CP12345397	CAIAPONIA	18/11/2019 21:03	19/11/2019 15:45	18/11/2019 21:03	19/11/2019 15:45	18,69	7	130,85	CHI
201911202739	GOIANIA	12191152	GOYA S2	18/11/2019 21:04	19/11/2019 13:13	18/11/2019 21:04	19/11/2019 13:13	16,13	1	16,13	CHI
201911202744	NOVA CRIXAS	NA12391603	NOVA CRIXAS	18/11/2019 21:05	19/11/2019 01:07	18/11/2019 21:05	19/11/2019 01:07	4,02	41	164,77	CHI
201911202745	SENADOR CANEDO	10013805361	SENADOR CANEDO	18/11/2019 21:05	19/11/2019 01:00	18/11/2019 21:05	19/11/2019 01:00	3,90	1	3,90	CHI
201911202747	LUZIANIA	LZ11313728	RIO VERMELHO	18/11/2019 20:38	18/11/2019 21:40	18/11/2019 20:38	18/11/2019 21:40	1,02	145	148,10	CHI
201911202750	GOIANIA	AP11281958	REAL S1	18/11/2019 18:10	18/11/2019 22:45	18/11/2019 18:10	18/11/2019 22:45	4,58	96	439,76	CHI
201911202753	GOIANIA	17095918	XAVANTES	18/11/2019 21:07	19/11/2019 00:17	18/11/2019 21:07	19/11/2019 00:17	3,16	1	3,16	CHI
201911202758	GOIANIA	15445630	GOYA S1	18/11/2019 21:09	19/11/2019 15:53	18/11/2019 21:09	19/11/2019 15:53	18,73	1	18,73	CHI
201911202766	PIRENOPOLIS	220073120	CORUMBA	18/11/2019 21:11	19/11/2019 20:09	18/11/2019 21:11	19/11/2019 20:09	22,96	1	22,96	CHI
201911202778	APARECIDA DE GOIANIA	10005009551	CARAJAS S1	18/11/2019 21:14	19/11/2019 15:58	18/11/2019 21:14	19/11/2019 15:58	18,73	1	18,73	CHI
201911202779	GOIANIRA	10013067948	GOIANIRA	18/11/2019 21:15	19/11/2019 13:47	18/11/2019 21:15	19/11/2019 13:47	16,53	1	16,53	CHI
201911202781	GOIANIA	GN11160123	CAMPINAS S1	18/11/2019 21:05	18/11/2019 23:50	18/11/2019 21:05	18/11/2019 23:50	2,74	73	200,20	CHI
201911202791	APARECIDA DE GOIANIA	10027642010	INDEPENDENCIA S2	18/11/2019 21:08	18/11/2019 23:23	18/11/2019 21:08	18/11/2019 23:23	2,25	1	2,25	CHI
201911202793	GOIAS	IB12300059	ITABERAI S2	18/11/2019 20:21	19/11/2019 00:10	18/11/2019 20:21	19/11/2019 00:10	3,82	66	251,92	CHI
201911202793	ITABERAI	IB12300059	ITABERAI S2	18/11/2019 20:21	19/11/2019 00:10	18/11/2019 20:21	19/11/2019 00:10	3,82	13	49,62	CHI
201911202806	INHUMAS	IN11012217	INHUMAS S2	18/11/2019 21:20	19/11/2019 00:30	18/11/2019 21:20	19/11/2019 00:30	3,16	199	629,45	CHI
201911202807	SAO JOAO D ALIANCA	JL11239936	ITUIQUIRA	18/11/2019 21:22	18/11/2019 22:05	18/11/2019 21:22	18/11/2019 22:05	0,72	1	0,72	CHI
201911202813	JARAGUA	JA12221349	JARAGUA	18/11/2019 21:24	19/11/2019 16:46	18/11/2019 21:24	19/11/2019 16:46	19,36	6	116,18	CHI
201911202814	PORTELANDIA	PW11000033	PARQUE DAS EMAS	18/11/2019 19:16	19/11/2019 10:35	18/11/2019 19:16	19/11/2019 10:35	15,31	80	1225,07	CHI
201911202816	ANAPOLIS	20877742	DAIA S1	18/11/2019 21:27	19/11/2019 08:29	18/11/2019 21:27	19/11/2019 08:29	11,03	1	11,03	CHI
201911202827	LUZIANIA	LZ21212091	MARAJOARA	18/11/2019 21:30	19/11/2019 02:10	18/11/2019 21:30	19/11/2019 02:10	4,65	3	13,96	CHI
201911202828	JUSSARA	RN12079527	BRITANIA	18/11/2019 21:30	19/11/2019 18:15	18/11/2019 21:30	19/11/2019 18:15	20,75	2	41,49	CHI
201911202828	SANTA FE DE GOIAS	RN12079527	BRITANIA	18/11/2019 21:30	19/11/2019 18:15	18/11/2019 21:30	19/11/2019 18:15	20,75	11	228,21	CHI
201911202829	GOIAS	GS21249340	GOIAS	18/11/2019 21:31	19/11/2019 12:00	18/11/2019 21:31	19/11/2019 12:00	14,49	1	14,49	CHI
201911202836	ITAPURANGA	IK12250609	ITAPURANGA	18/11/2019 21:33	19/11/2019 07:30	18/11/2019 21:33	19/11/2019 07:30	9,94	22	218,68	CHI
201911202842	GOIANIA	GN11002902	CARAJAS S1	18/11/2019 21:27	19/11/2019 17:30	18/11/2019 21:27	19/11/2019 17:30	20,05	84	1683,97	CHI
201911202844	CATALAO	1990301876	CATALAO S2	18/11/2019 21:38	19/11/2019 09:35	18/11/2019 21:38	19/11/2019 09:35	11,94	1	11,94	CHI
201911202850	RUBIATABA	10010316971	RUBIATABA	18/11/2019 21:42	19/11/2019 02:36	18/11/2019 21:42	19/11/2019 02:36	4,90	1	4,90	CHI
201911202855	APARECIDA DE GOIANIA	AP11234804	INDEPENDENCIA S1	18/11/2019 18:27	19/11/2019 02:16	18/11/2019 18:27	19/11/2019 02:16	7,80	38	296,55	CHI
201911202856	CAMPINACU	UC12292264	MARA ROSA	18/11/2019 21:37	19/11/2019 09:02	18/11/2019 21:37	19/11/2019 09:02	11,42	40	456,67	CHI
201911202857	ABADIANIA	AA12327809	DAIA S2	18/11/2019 20:38	19/11/2019 09:38	18/11/2019 20:38	19/11/2019 09:38	13,00	12	155,96	CHI
201911202867	INHUMAS	30159350	INHUMAS S2	18/11/2019 21:49	19/11/2019 05:06	18/11/2019 21:49	19/11/2019 05:06	7,28	1	7,28	CHI

201911202869	CROMINIA	CQ21028544	PONTALINA	18/11/2019 21:49	19/11/2019 11:41	18/11/2019 21:49	19/11/2019 11:41	13,85	1	13,85	CHI
201911202871	PORANGATU	PO21217355	PORANGATU	18/11/2019 21:50	19/11/2019 09:23	18/11/2019 21:50	19/11/2019 09:23	11,54	1	11,54	CHI
201911202873	MINEIROS	MY12148260	PARQUE DAS EMAS	18/11/2019 21:50	19/11/2019 10:35	18/11/2019 21:50	19/11/2019 10:35	12,74	5	63,68	CHI
201911202880	APARECIDA DE GOIANIA	AP12392737	INDEPENDENCIA S2	18/11/2019 21:53	18/11/2019 22:39	18/11/2019 21:53	18/11/2019 22:39	0,76	58	43,90	CHI
201911202881	GOIANIA	11851510	CAMPINAS S1	18/11/2019 21:53	19/11/2019 09:17	18/11/2019 21:53	19/11/2019 09:17	11,39	1	11,39	CHI
201911202882	APARECIDA DE GOIANIA	AP12060751	REAL S2	18/11/2019 17:03	19/11/2019 01:22	18/11/2019 17:03	19/11/2019 00:24	7,34	107	785,47	CHI
201911202882	GOIANIA	AP12060751	REAL S2	18/11/2019 17:03	19/11/2019 01:22	18/11/2019 17:03	19/11/2019 00:24	7,34	141	1035,06	CHI
201911202882	APARECIDA DE GOIANIA	AP12060751	REAL S2	18/11/2019 17:03	19/11/2019 01:22	19/11/2019 01:05	19/11/2019 01:22	0,28	107	30,29	CHI
201911202882	GOIANIA	AP12060751	REAL S2	18/11/2019 17:03	19/11/2019 01:22	19/11/2019 01:05	19/11/2019 01:22	0,28	141	39,91	CHI
201911202883	JARAGUA	SR12321527	INHUMAS S1	18/11/2019 16:35	19/11/2019 10:51	18/11/2019 16:35	19/11/2019 10:51	18,26	9	164,30	CHI
201911202885	INHUMAS	IN11365566	INHUMAS S2	18/11/2019 21:00	19/11/2019 01:44	18/11/2019 21:00	19/11/2019 01:44	4,72	49	231,33	CHI
201911202890	JESUPOLIS	SF12066036	SAO FRANCISCO DE GOIAS	18/11/2019 21:48	19/11/2019 05:10	18/11/2019 21:48	19/11/2019 05:10	7,36	16	117,72	CHI
201911202892	GOIANIA	13689599	CAMPINAS S1	18/11/2019 22:00	19/11/2019 03:41	18/11/2019 22:00	19/11/2019 03:41	5,67	1	5,67	CHI
201911202894	FORMOSA	610149635	ITIQUEIRA	18/11/2019 22:02	19/11/2019 12:10	18/11/2019 22:02	19/11/2019 12:10	14,14	1	14,14	CHI
201911202896	INHUMAS	IN12014094	INHUMAS S1	18/11/2019 10:24	19/11/2019 09:23	18/11/2019 10:24	19/11/2019 09:23	22,97	9	206,72	CHI
201911202910	GOIANIA	10009468984	CARAJAS S1	18/11/2019 22:10	19/11/2019 08:11	18/11/2019 22:10	19/11/2019 08:11	10,01	1	10,01	CHI
201911202912	ABADIANIA	AA21059855	ANAPOLIS UNIVERSITARIO S1	18/11/2019 22:12	19/11/2019 12:39	18/11/2019 22:12	19/11/2019 12:39	14,45	1	14,45	CHI
201911202921	CAMPOS VERDES	VD12243665	SANTA TEREZINHA	18/11/2019 22:17	19/11/2019 22:00	18/11/2019 22:17	19/11/2019 22:00	23,71	9	213,43	CHI
201911202925	MUTUNOPOLIS	PO12374520	PORANGATU	18/11/2019 22:22	19/11/2019 00:34	18/11/2019 22:22	19/11/2019 00:34	2,20	18	39,54	CHI
201911202925	PORANGATU	PO12374520	PORANGATU	18/11/2019 22:22	19/11/2019 00:34	18/11/2019 22:22	19/11/2019 00:34	2,20	19	41,74	CHI
201911202931	PARAUNA	PU12080492	PARAUNA	18/11/2019 22:23	18/11/2019 23:12	18/11/2019 22:23	18/11/2019 23:12	0,80	51	40,83	CHI
201911202931	PARAUNA	PU12080492	PARAUNA	18/11/2019 22:23	18/11/2019 23:12	18/11/2019 22:23	18/11/2019 23:12	0,80	1	0,80	CHI
201911202945	VALPARAISO DE GOIAS	2860004641	MARAJOARA	18/11/2019 22:35	19/11/2019 00:21	18/11/2019 22:35	19/11/2019 00:21	1,75	1	1,75	CHI
201911202947	INHUMAS	IN21125343	INHUMAS S1	18/11/2019 20:50	18/11/2019 22:25	18/11/2019 20:50	18/11/2019 22:25	1,58	1	1,58	CHI
201911202953	DAVINOPOLIS	IO12071453	CATALAO S1	18/11/2019 15:40	19/11/2019 18:05	18/11/2019 15:40	19/11/2019 18:05	26,41	6	158,44	CHI
201911202953	OUVIDOR	IO12071453	CATALAO S1	18/11/2019 15:40	19/11/2019 18:05	18/11/2019 15:40	19/11/2019 18:05	26,41	1	26,41	CHI
201911202960	BONOPOLIS	BX12198529	NOVO PLANALTO	18/11/2019 22:44	19/11/2019 10:51	18/11/2019 22:44	19/11/2019 10:51	12,11	1	12,11	CHI
201911202966	NIQUELANDIA	NQ11171125	BARRO ALTO	18/11/2019 22:49	19/11/2019 03:03	18/11/2019 22:49	19/11/2019 03:03	4,22	2	8,44	CHI
201911202967	APARECIDA DE GOIANIA	AP11277471	ATLANTICO S2	18/11/2019 21:55	19/11/2019 01:23	18/11/2019 21:55	19/11/2019 01:23	3,46	38	131,59	CHI
201911202968	ARUANA	AK11183270	ARUANA	18/11/2019 22:51	19/11/2019 13:05	18/11/2019 22:51	19/11/2019 13:05	14,23	45	640,36	CHI
201911202972	SAO LUIS DE MONTES BELOS	10001837298	SAO LUIZ DOS MONTES BELOS	18/11/2019 22:55	19/11/2019 00:50	18/11/2019 22:55	19/11/2019 00:50	1,93	1	1,93	CHI
201911202973	MORRINHOS	MR12040536	MORRINHOS	18/11/2019 22:31	20/11/2019 22:04	18/11/2019 22:31	20/11/2019 22:04	47,55	7	332,87	CHI
201911202980	MORRINHOS	MR12000166	MORRINHOS	18/11/2019 22:01	19/11/2019 11:30	18/11/2019 22:01	19/11/2019 11:30	13,47	5	67,37	CHI

201911202990	LEOPOLDO DE BULHOES	LB12000624	DAIA S1	18/11/2019 21:58	19/11/2019 09:08	18/11/2019 21:58	19/11/2019 09:08	11,15	32	356,92	CHI
201911202995	GOIANIA	10651597	CAMPINAS S1	18/11/2019 23:27	19/11/2019 10:39	18/11/2019 23:27	19/11/2019 10:39	11,19	1	11,19	CHI
201911202998	RIO VERDE	630180878	RIO VERDE S1	18/11/2019 23:28	19/11/2019 11:52	18/11/2019 23:28	19/11/2019 11:52	12,39	1	12,39	CHI
201911203008	ITAPIRAPUA	IU12259711	MATRINCHA	18/11/2019 23:20	19/11/2019 07:50	18/11/2019 23:20	19/11/2019 07:50	8,49	5	42,45	CHI
201911203013	AMARALINA	LC12189854	MARA ROSA	18/11/2019 23:45	19/11/2019 10:16	18/11/2019 23:45	19/11/2019 10:16	10,50	7	73,52	CHI
201911203013	MARA ROSA	LC12189854	MARA ROSA	18/11/2019 23:45	19/11/2019 10:16	18/11/2019 23:45	19/11/2019 10:16	10,50	2	21,01	CHI
201911203020	NOVA CRIXAS	NA12354854	NOVA CRIXAS	19/11/2019 00:01	19/11/2019 01:53	19/11/2019 00:01	19/11/2019 01:53	1,86	9	16,77	CHI
201911203021	JATAI	JT11228780	JATAI S3	19/11/2019 00:01	19/11/2019 14:22	19/11/2019 00:01	19/11/2019 14:22	14,33	1	14,33	CHI
201911203027	JATAI	SX12264387	JATAI S1	19/11/2019 00:10	19/11/2019 11:06	19/11/2019 00:10	19/11/2019 11:06	10,93	7	76,49	CHI
201911203027	SERRANOPOLIS	SX12264387	JATAI S1	19/11/2019 00:10	19/11/2019 11:06	19/11/2019 00:10	19/11/2019 11:06	10,93	22	240,39	CHI
201911203036	NIQUELANDIA	NQ12316271	BARRO ALTO	19/11/2019 00:04	19/11/2019 07:51	19/11/2019 00:04	19/11/2019 07:51	7,77	3	23,32	CHI
201911203038	GOIANIA	13380643	FERROVIARIO S2	19/11/2019 00:28	19/11/2019 13:45	19/11/2019 00:28	19/11/2019 13:45	13,28	1	13,28	CHI
201911203039	MARA ROSA	MQ12263046	MARA ROSA	19/11/2019 00:29	19/11/2019 23:06	19/11/2019 00:29	19/11/2019 23:06	22,61	7	158,29	CHI
201911203040	FORMOSA	FA12164536	ITUIQUIRA	19/11/2019 00:29	19/11/2019 12:10	19/11/2019 00:29	19/11/2019 12:10	11,68	2	23,37	CHI
201911203040	SAO JOAO D ALIANCA	FA12164536	ITUIQUIRA	19/11/2019 00:29	19/11/2019 12:10	19/11/2019 00:29	19/11/2019 12:10	11,68	225	2628,81	CHI
201911203047	JATAI	JT12334216	JATAI S1	19/11/2019 00:38	19/11/2019 17:16	19/11/2019 00:38	19/11/2019 17:16	16,63	3	49,88	CHI
201911203052	ORIZONA	PR12404788	PIRES DO RIO S1	19/11/2019 00:39	19/11/2019 17:03	19/11/2019 00:39	19/11/2019 17:03	16,40	1	16,40	CHI
201911203052	PIRES DO RIO	PR12404788	PIRES DO RIO S1	19/11/2019 00:39	19/11/2019 17:03	19/11/2019 00:39	19/11/2019 17:03	16,40	13	213,15	CHI
201911203060	GOIANIA	GN12000598	CAMPINAS S3	19/11/2019 00:27	19/11/2019 11:16	19/11/2019 00:27	19/11/2019 11:16	10,81	131	1416,26	CHI
201911203062	LUZIANIA	3200182475	MARAJOARA	19/11/2019 00:57	19/11/2019 02:54	19/11/2019 00:57	19/11/2019 02:54	1,94	1	1,94	CHI
201911203103	PIRENOPOLIS	10024415764	CORUMBA	19/11/2019 01:05	19/11/2019 08:00	19/11/2019 01:05	19/11/2019 08:00	6,91	1	6,91	CHI
201911203104	GOIANIA	12923771	FERROVIARIO S1	19/11/2019 01:06	19/11/2019 09:21	19/11/2019 01:06	19/11/2019 09:21	8,25	1	8,25	CHI
201911203106	PIRENOPOLIS	PV21352347	CORUMBA	19/11/2019 01:11	19/11/2019 21:18	19/11/2019 01:11	19/11/2019 21:18	20,10	2	40,21	CHI
201911203110	GOIANIA	15652210	CARAJAS S2	19/11/2019 01:18	19/11/2019 09:17	19/11/2019 01:18	19/11/2019 09:17	7,97	1	7,97	CHI
201911203113	AMARALINA	LC12050751	MARA ROSA	19/11/2019 00:24	19/11/2019 10:44	19/11/2019 00:24	19/11/2019 10:44	10,33	12	123,91	CHI
201911203113	MARA ROSA	LC12050751	MARA ROSA	19/11/2019 00:24	19/11/2019 10:44	19/11/2019 00:24	19/11/2019 10:44	10,33	5	51,63	CHI
201911203134	PLANALTINA	PI21131780	PLANALTINA	19/11/2019 03:09	19/11/2019 04:58	19/11/2019 03:09	19/11/2019 04:58	1,81	1	1,81	CHI
201911203135	GOIANIA	14759561	ATLANTICO S1	18/11/2019 18:32	19/11/2019 07:07	18/11/2019 18:32	19/11/2019 07:07	12,59	1	12,59	CHI
201911203142	CRIXAS	MZ12055628	MOZARLANDIA	19/11/2019 03:45	19/11/2019 09:15	19/11/2019 03:45	19/11/2019 09:15	5,49	26	142,63	CHI
201911203142	MOZARLANDIA	MZ12055628	MOZARLANDIA	19/11/2019 03:45	19/11/2019 09:15	19/11/2019 03:45	19/11/2019 09:15	5,49	38	208,46	CHI
201911203153	GOIANIA	11179223	XAVANTES	19/11/2019 04:28	20/11/2019 09:53	19/11/2019 04:28	20/11/2019 09:53	29,42	1	29,42	CHI
201911203155	DOVERLANDIA	DV12221021	CAIAPONIA	19/11/2019 01:03	19/11/2019 06:55	19/11/2019 01:03	19/11/2019 06:55	5,86	22	128,89	CHI
201911203161	GOIANIA	GN11127351	ATLANTICO S3	18/11/2019 16:43	19/11/2019 07:00	18/11/2019 16:43	19/11/2019 07:00	14,27	109	1555,25	CHI

201911203162	ANAPOLIS	AN11003264	ANAPOLIS UNIVERSITARIO S2	19/11/2019 04:45	19/11/2019 08:38	19/11/2019 04:45	19/11/2019 08:38	3,88	156	605,71	CHI
201911203169	FORMOSO	SE12033994	MARA ROSA	19/11/2019 00:44	20/11/2019 00:33	19/11/2019 00:44	19/11/2019 10:22	9,65	65	626,94	CHI
201911203169	FORMOSO	FO12088777	MARA ROSA	19/11/2019 00:44	20/11/2019 00:33	19/11/2019 00:44	19/11/2019 12:03	11,33	16	181,22	CHI
201911203169	FORMOSO	FO12143609	MARA ROSA	19/11/2019 00:44	20/11/2019 00:33	19/11/2019 00:44	19/11/2019 14:14	13,51	11	148,62	CHI
201911203169	FORMOSO	FO12088777	MARA ROSA	19/11/2019 00:44	20/11/2019 00:33	19/11/2019 15:48	19/11/2019 18:12	2,40	16	38,40	CHI
201911203169	FORMOSO	SE12033994	MARA ROSA	19/11/2019 00:44	20/11/2019 00:33	19/11/2019 17:20	19/11/2019 18:12	0,85	65	55,27	CHI
201911203169	FORMOSO	FO12143609	MARA ROSA	19/11/2019 00:44	20/11/2019 00:33	19/11/2019 15:48	19/11/2019 18:46	2,97	11	32,69	CHI
201911203169	FORMOSO	FO12185309	MARA ROSA	19/11/2019 00:44	20/11/2019 00:33	19/11/2019 00:44	19/11/2019 23:59	23,25	7	162,78	CHI
201911203169	FORMOSO	FO12285224LD	MARA ROSA	19/11/2019 00:44	20/11/2019 00:33	19/11/2019 00:44	20/11/2019 00:33	23,82	1	23,82	CHI
201911203174	OURO VERDE DE GOIAS	OV21040244	NEROPOLIS S2	19/11/2019 05:02	19/11/2019 12:24	19/11/2019 05:02	19/11/2019 12:24	7,35	1	7,35	CHI
201911203176	MOZARLANDIA	MZ12220375	MOZARLANDIA	18/11/2019 21:12	19/11/2019 17:15	18/11/2019 21:12	19/11/2019 17:15	20,05	34	681,58	CHI
201911203178	GOIAS	GS12068549	MATRINCHA	18/11/2019 22:09	19/11/2019 10:45	18/11/2019 22:09	19/11/2019 10:45	12,60	8	100,79	CHI
201911203179	MINEIROS	MY12336398	PARQUE DAS EMAS	18/11/2019 19:50	19/11/2019 12:26	18/11/2019 19:50	19/11/2019 12:26	16,60	25	414,90	CHI
201911203182	ITARUMA	IM12107406	CACHOEIRA ALTA	19/11/2019 05:08	19/11/2019 15:26	19/11/2019 05:08	19/11/2019 15:26	10,30	17	175,08	CHI
201911203189	DOVERLANDIA	DV12303682	PARQUE DAS EMAS	19/11/2019 05:18	19/11/2019 12:14	19/11/2019 05:18	19/11/2019 12:14	6,92	8	55,40	CHI
201911203190	BONOPOLIS	BX12079321	SAO MIGUEL DO ARAGUAIA	19/11/2019 05:18	19/11/2019 08:53	19/11/2019 05:18	19/11/2019 08:53	3,57	58	207,00	CHI
201911203192	HEITORAI	HE12300120	ITAPURANGA	19/11/2019 05:22	19/11/2019 14:40	19/11/2019 05:22	19/11/2019 14:40	9,30	10	93,00	CHI
201911203197	ANAPOLIS	OV12115764	NEROPOLIS S1	19/11/2019 05:28	19/11/2019 09:30	19/11/2019 05:28	19/11/2019 09:30	4,02	8	32,16	CHI
201911203197	PETROLINA DE GOIAS	OV12115764	NEROPOLIS S1	19/11/2019 05:28	19/11/2019 09:30	19/11/2019 05:28	19/11/2019 09:30	4,02	9	36,18	CHI
201911203197	PIRENOPOLIS	OV12115764	NEROPOLIS S1	19/11/2019 05:28	19/11/2019 09:30	19/11/2019 05:28	19/11/2019 09:30	4,02	30	120,58	CHI
201911203203	GOIAS	IB12300059	ITABERAI S2	19/11/2019 05:33	19/11/2019 07:55	19/11/2019 05:33	19/11/2019 07:55	2,35	66	155,23	CHI
201911203203	ITABERAI	IB12300059	ITABERAI S2	19/11/2019 05:33	19/11/2019 07:55	19/11/2019 05:33	19/11/2019 07:55	2,35	13	30,58	CHI
201911203211	CRISTALINA	KR21338008	PAMPLONA	19/11/2019 05:40	19/11/2019 13:12	19/11/2019 05:40	19/11/2019 13:12	7,53	1	7,53	CHI
201911203219	PANAMA	PX21263937	GOIATUBA S1	19/11/2019 05:45	19/11/2019 16:23	19/11/2019 05:45	19/11/2019 16:23	10,63	1	10,63	CHI
201911203220	CAIAPONIA	CP12248274	IPORA	19/11/2019 05:47	19/11/2019 19:15	19/11/2019 05:47	19/11/2019 19:15	13,47	3	40,40	CHI
201911203222	ITUMBIARA	IT12062988	CACHOEIRA DOURADA	19/11/2019 05:48	20/11/2019 23:00	19/11/2019 05:48	20/11/2019 23:00	41,19	6	247,17	CHI
201911203233	MUTUNOPOLIS	MU12354548	MARA ROSA	19/11/2019 05:55	19/11/2019 16:29	19/11/2019 05:55	19/11/2019 16:29	10,56	2	21,12	CHI
201911203240	PONTALINA	PK21080009	PONTALINA	19/11/2019 05:58	19/11/2019 12:16	19/11/2019 05:58	19/11/2019 12:16	6,30	2	12,59	CHI
201911203241	APARECIDA DE GOIANIA	AP12060751	REAL S2	19/11/2019 05:58	19/11/2019 07:29	19/11/2019 05:58	19/11/2019 07:29	1,51	107	161,93	CHI
201911203241	GOIANIA	AP12060751	REAL S2	19/11/2019 05:58	19/11/2019 07:29	19/11/2019 05:58	19/11/2019 07:29	1,51	141	213,38	CHI
201911203245	SANTA HELENA DE GOIAS	SH12271563	IPEGUARI	18/11/2019 22:46	19/11/2019 08:30	18/11/2019 22:46	19/11/2019 08:30	9,74	28	272,74	CHI
201911203245	TURVELANDIA	SH12271563	IPEGUARI	18/11/2019 22:46	19/11/2019 08:30	18/11/2019 22:46	19/11/2019 08:30	9,74	12	116,89	CHI
201911203246	PALMEIRAS DE GOIAS	PL12000058	PALMEIRAS	18/11/2019 18:43	19/11/2019 08:00	18/11/2019 18:43	19/11/2019 08:00	13,29	6	79,73	CHI

201911203258	PIRACANJUBA	PJ12068868	PIRACANJUBA	19/11/2019 06:04	19/11/2019 11:51	19/11/2019 06:04	19/11/2019 11:51	5,78	8	46,21	CHI
201911203262	SANTA RITA DO ARAGUAIA	SU12306507	SANTA RITA DO ARAGUAIA	19/11/2019 05:02	19/11/2019 08:00	19/11/2019 05:02	19/11/2019 08:00	2,96	15	44,41	CHI
201911203264	BALIZA	BH12396127	BOM JARDIM	19/11/2019 06:06	21/11/2019 13:45	19/11/2019 06:06	21/11/2019 13:45	55,64	1	55,64	CHI
201911203264	BOM JARDIM DE GOIAS	BH12396127	BOM JARDIM	19/11/2019 06:06	21/11/2019 13:45	19/11/2019 06:06	21/11/2019 13:45	55,64	1	55,64	CHI
201911203269	AMORINOPOLIS	IV12165613	IPORA	19/11/2019 06:09	19/11/2019 09:46	19/11/2019 06:09	19/11/2019 09:46	3,63	5	18,13	CHI
201911203269	IVOLANDIA	IV12165613	IPORA	19/11/2019 06:09	19/11/2019 09:46	19/11/2019 06:09	19/11/2019 09:46	3,63	5	18,13	CHI
201911203272	DAMOLANDIA	DL12319228	INHUMAS S1	19/11/2019 06:09	19/11/2019 11:59	19/11/2019 06:09	19/11/2019 11:59	5,82	1	5,82	CHI
201911203272	OURO VERDE DE GOIAS	DL12319228	INHUMAS S1	19/11/2019 06:09	19/11/2019 11:59	19/11/2019 06:09	19/11/2019 11:59	5,82	4	23,28	CHI
201911203278	ANICUNS	AC12391418	ANICUNS	18/11/2019 22:02	19/11/2019 08:14	18/11/2019 22:02	19/11/2019 08:14	10,19	17	173,15	CHI
201911203279	PARANAIGUARA	QI12054841	QUIRINOPOLIS	19/11/2019 05:08	19/11/2019 14:40	19/11/2019 05:08	19/11/2019 14:40	9,53	2	19,06	CHI
201911203279	QUIRINOPOLIS	QI12054841	QUIRINOPOLIS	19/11/2019 05:08	19/11/2019 14:40	19/11/2019 05:08	19/11/2019 14:40	9,53	17	162,01	CHI
201911203280	BRITANIA	2110026735	BRITANIA	19/11/2019 06:12	19/11/2019 17:17	19/11/2019 06:12	19/11/2019 17:17	11,09	1	11,09	CHI
201911203281	ITABERAI	50081410	ITABERAI S1	19/11/2019 06:13	19/11/2019 08:43	19/11/2019 06:13	19/11/2019 08:43	2,50	1	2,50	CHI
201911203283	CAIAPONIA	CP12251347	CAIAPONIA	19/11/2019 05:47	19/11/2019 10:22	19/11/2019 05:47	19/11/2019 10:22	4,57	7	32,02	CHI
201911203286	ITABERAI	IB12031259	ITABERAI S2	19/11/2019 05:32	19/11/2019 08:55	19/11/2019 05:32	19/11/2019 08:55	3,38	3	10,14	CHI
201911203288	PIRENOPOLIS	PV21020001	ANAPOLIS UNIVERSITARIO S2	19/11/2019 06:14	19/11/2019 10:17	19/11/2019 06:14	19/11/2019 10:17	4,04	1	4,04	CHI
201911203289	COCALZINHO DE GOIAS	ZN21221568	COCALZINHO	19/11/2019 06:14	19/11/2019 12:44	19/11/2019 06:14	19/11/2019 12:44	6,49	1	6,49	CHI
201911203292	MINACU	IH12132061	MINACU	19/11/2019 00:20	19/11/2019 07:59	19/11/2019 00:20	19/11/2019 07:59	7,65	2	15,30	CHI
201911203294	JATAI	JT12213671	JATAI S1	19/11/2019 06:16	19/11/2019 10:44	19/11/2019 06:16	19/11/2019 10:44	4,46	5	22,32	CHI
201911203295	BALIZA	BH12193416	BOM JARDIM	19/11/2019 06:16	19/11/2019 09:37	19/11/2019 06:16	19/11/2019 09:37	3,34	3	10,03	CHI
201911203295	BOM JARDIM DE GOIAS	BH12193416	BOM JARDIM	19/11/2019 06:16	19/11/2019 09:37	19/11/2019 06:16	19/11/2019 09:37	3,34	5	16,72	CHI
201911203305	GOIAS	GS12310594	ITABERAI S1	19/11/2019 06:17	19/11/2019 20:23	19/11/2019 06:17	19/11/2019 20:23	14,09	4	56,36	CHI
201911203305	ITABERAI	GS12310594	ITABERAI S1	19/11/2019 06:17	19/11/2019 20:23	19/11/2019 06:17	19/11/2019 20:23	14,09	27	380,43	CHI
201911203312	IVOLANDIA	IV12165613	IPORA	19/11/2019 06:19	19/11/2019 09:46	19/11/2019 06:19	19/11/2019 09:46	3,45	1	3,45	CHI
201911203314	NIQUELANDIA	NQ12171084	BARRO ALTO	19/11/2019 06:17	19/11/2019 10:34	19/11/2019 06:17	19/11/2019 10:34	4,28	43	183,88	CHI
201911203316	VILA PROPICIO	NQ12252378	BARRO ALTO	19/11/2019 06:20	19/11/2019 13:54	19/11/2019 06:20	19/11/2019 13:54	7,56	1	7,56	CHI
201911203321	IACIARA	IA21190565	IACIARA S2	19/11/2019 06:22	19/11/2019 13:09	19/11/2019 06:22	19/11/2019 13:09	6,78	1	6,78	CHI
201911203322	BARRO ALTO	BA12210748	BARRO ALTO	19/11/2019 06:22	19/11/2019 14:48	19/11/2019 06:22	19/11/2019 14:48	8,43	8	67,42	CHI
201911203324	MAURILANDIA	ML12303334	RIO DOS BOIS	19/11/2019 06:19	19/11/2019 09:10	19/11/2019 06:19	19/11/2019 09:10	2,85	13	37,04	CHI
201911203324	RIO VERDE	ML12303334	RIO DOS BOIS	19/11/2019 06:19	19/11/2019 09:10	19/11/2019 06:19	19/11/2019 09:10	2,85	2	5,70	CHI
201911203327	PARANAIGUARA	PC12000018	CACHOEIRA ALTA	19/11/2019 06:26	19/11/2019 12:29	19/11/2019 06:26	19/11/2019 12:29	6,05	5	30,25	CHI
201911203327	SAO SIMAO	PC12000018	CACHOEIRA ALTA	19/11/2019 06:26	19/11/2019 12:29	19/11/2019 06:26	19/11/2019 12:29	6,05	5	30,25	CHI
201911203331	CALDAZINHA	LB12056588	CEPAIGO S2	19/11/2019 06:27	19/11/2019 17:08	19/11/2019 06:27	19/11/2019 17:08	10,67	27	288,18	CHI

201911203331	SILVANIA	LB12056588	CEPAIGO S2	19/11/2019 06:27	19/11/2019 17:08	19/11/2019 06:27	19/11/2019 17:08	10,67	2	21,35	CHI
201911203332	APARECIDA DE GOIANIA	AP11166584	INDEPENDENCIA S2	19/11/2019 06:16	19/11/2019 08:27	19/11/2019 06:16	19/11/2019 08:27	2,18	96	208,99	CHI
201911203336	VILA PROPICIO	NP21251963	GOIANESIA S1	19/11/2019 06:28	19/11/2019 15:58	19/11/2019 06:28	19/11/2019 15:58	9,50	1	9,50	CHI
201911203339	ITABERAI	IB12108138	ITABERAI S2	19/11/2019 06:28	19/11/2019 11:10	19/11/2019 06:28	19/11/2019 11:10	4,69	28	131,40	CHI
201911203341	GOIANIA	GN11151322	SENADOR CANEDO	19/11/2019 06:29	19/11/2019 09:24	19/11/2019 06:29	19/11/2019 09:24	2,91	155	451,27	CHI
201911203344	GOIATUBA	GT11000057	GOIATUBA S2	19/11/2019 04:35	19/11/2019 10:51	19/11/2019 04:35	19/11/2019 10:51	6,26	115	719,64	CHI
201911203347	NOVA ROMA	ND12117611	IACIARA S2	19/11/2019 06:31	19/11/2019 12:27	19/11/2019 06:31	19/11/2019 12:27	5,93	8	47,41	CHI
201911203349	TURVANIA	TV12009562	FIRMINOPOLIS S2	19/11/2019 06:31	19/11/2019 16:24	19/11/2019 06:31	19/11/2019 16:24	9,88	3	29,65	CHI
201911203350	MONTE ALEGRE DE GOIAS	MA12130281	SAO DOMINGOS	19/11/2019 06:31	19/11/2019 12:23	19/11/2019 06:31	19/11/2019 12:23	5,85	9	52,67	CHI
201911203352	PORANGATU	PO12390358	PORANGATU	19/11/2019 06:04	19/11/2019 10:32	19/11/2019 06:04	19/11/2019 10:32	4,45	7	31,16	CHI
201911203356	CALDAZINHA	DE12113316	CEPAIGO S2	18/11/2019 19:14	20/11/2019 09:43	18/11/2019 19:14	20/11/2019 09:43	38,47	10	384,71	CHI
201911203358	URUACU	20396483	MARA ROSA	19/11/2019 06:33	19/11/2019 15:40	19/11/2019 06:33	19/11/2019 15:40	9,10	14	127,40	CHI
201911203359	ANAPOLIS	AN11072568	JUNDIAI S1	19/11/2019 06:34	19/11/2019 08:12	19/11/2019 06:34	19/11/2019 08:12	1,62	145	235,10	CHI
201911203360	RIO VERDE	RV21230957	RIO VERDE S2	19/11/2019 06:34	19/11/2019 09:00	19/11/2019 06:34	19/11/2019 09:00	2,42	2	4,84	CHI
201911203361	SANTO ANTONIO DA BARRA	BZ21207512	ACREUNA	19/11/2019 06:34	19/11/2019 19:34	19/11/2019 06:34	19/11/2019 19:34	12,99	2	25,97	CHI
201911203365	EDEALINA	ED21218137	PONTALINA	19/11/2019 06:35	19/11/2019 14:59	19/11/2019 06:35	19/11/2019 14:59	8,39	1	8,39	CHI
201911203366	GOIANIA	11966180	CAMPINAS S2	19/11/2019 06:35	19/11/2019 10:25	19/11/2019 06:35	19/11/2019 10:25	3,83	1	3,83	CHI
201911203369	FORMOSA	FA12318517	ITUIQUIRA	19/11/2019 06:38	20/11/2019 14:56	19/11/2019 06:38	20/11/2019 14:56	32,30	4	129,18	CHI
201911203374	RIO VERDE	RV21098539	MONTIVIDIU T	19/11/2019 06:40	19/11/2019 16:06	19/11/2019 06:40	19/11/2019 16:06	9,43	1	9,43	CHI
201911203376	ITARUMA	IM21136172	CACHEOIRA ALTA	19/11/2019 06:41	19/11/2019 17:21	19/11/2019 06:41	19/11/2019 17:21	10,66	1	10,66	CHI
201911203380	SENADOR CANEDO	10008497620	SENADOR CANEDO	19/11/2019 06:42	19/11/2019 16:37	19/11/2019 06:42	19/11/2019 16:37	9,92	1	9,92	CHI
201911203381	GOIANIA	GN21000663	GOYA S2	19/11/2019 06:42	19/11/2019 09:46	19/11/2019 06:42	19/11/2019 09:46	3,05	1	3,05	CHI
201911203383	SENADOR CANEDO	SW11053061	SENADOR CANEDO	19/11/2019 06:43	19/11/2019 09:53	19/11/2019 06:43	19/11/2019 09:53	3,17	136	430,55	CHI
201911203385	CATALAO	10004724125	CATALAO S2	19/11/2019 06:43	19/11/2019 07:58	19/11/2019 06:43	19/11/2019 07:58	1,23	1	1,23	CHI
201911203387	MORRINHOS	10015574189	MORRINHOS	19/11/2019 06:44	19/11/2019 11:22	19/11/2019 06:44	19/11/2019 11:22	4,65	1	4,65	CHI
201911203388	GOIANIA	GN12000910	NEROPOLIS S1	19/11/2019 06:44	19/11/2019 14:30	19/11/2019 06:44	19/11/2019 14:00	7,25	3	21,75	CHI
201911203388	SANTO ANTONIO DE GOIAS	GN12000910	NEROPOLIS S1	19/11/2019 06:44	19/11/2019 14:30	19/11/2019 06:44	19/11/2019 14:00	7,25	1	7,25	CHI
201911203388	GOIANIA	NR12000019	NEROPOLIS S1	19/11/2019 06:44	19/11/2019 14:30	19/11/2019 06:44	19/11/2019 14:30	7,75	3	23,25	CHI
201911203388	SANTO ANTONIO DE GOIAS	NR12000019	NEROPOLIS S1	19/11/2019 06:44	19/11/2019 14:30	19/11/2019 06:44	19/11/2019 14:30	7,75	1	7,75	CHI
201911203394	SANTA RITA DO ARAGUAIA	SU12374325	SANTA RITA DO ARAGUAIA	18/11/2019 22:58	19/11/2019 09:59	18/11/2019 22:58	19/11/2019 09:59	11,01	29	319,19	CHI
201911203395	MUNDO NOVO DE GOIAS	MH12391964	NOVA CRIXAS	19/11/2019 06:46	19/11/2019 10:38	19/11/2019 06:46	19/11/2019 10:38	3,86	9	34,73	CHI
201911203403	SANTO ANTONIO DA BARRA	BZ21136108	ACREUNA	19/11/2019 06:48	19/11/2019 20:31	19/11/2019 06:48	19/11/2019 20:31	13,71	1	13,71	CHI
201911203404	FAINA	FC21126952	GOIAS	19/11/2019 06:48	19/11/2019 13:45	19/11/2019 06:48	19/11/2019 13:45	6,95	1	6,95	CHI

201911203406	MUTUNOPOLIS	MU21320983	MARA ROSA	19/11/2019 06:49	19/11/2019 13:09	19/11/2019 06:49	19/11/2019 13:09	6,33	2	12,66	CHI
201911203410	CAMPOS VERDES	VD12243626	SANTA TEREZINHA	19/11/2019 06:50	19/11/2019 16:43	19/11/2019 06:50	19/11/2019 16:43	9,88	20	197,61	CHI
201911203412	CAMPINORTE	CR12181314	MARA ROSA	19/11/2019 06:50	19/11/2019 10:56	19/11/2019 06:50	19/11/2019 10:56	4,09	6	24,55	CHI
201911203412	URUACU	CR12181314	MARA ROSA	19/11/2019 06:50	19/11/2019 10:56	19/11/2019 06:50	19/11/2019 10:56	4,09	29	118,64	CHI
201911203419	PORTELANDIA	PW12303420	PARQUE DAS EMAS	19/11/2019 06:51	19/11/2019 09:15	19/11/2019 06:51	19/11/2019 09:15	2,39	14	33,40	CHI
201911203420	GOIANIA	14370268	INDEPENDENCIA S2	19/11/2019 06:52	19/11/2019 15:21	19/11/2019 06:52	19/11/2019 15:21	8,47	1	8,47	CHI
201911203428	APORE	AE21348898	ITAJA S1	19/11/2019 06:55	19/11/2019 12:09	19/11/2019 06:55	19/11/2019 12:09	5,23	1	5,23	CHI
201911203431	CAMPOS VERDES	VD12049799	SANTA TEREZINHA	18/11/2019 21:46	19/11/2019 08:49	18/11/2019 21:46	19/11/2019 08:49	11,04	21	231,82	CHI
201911203431	PILAR DE GOIAS	VD12049799	SANTA TEREZINHA	18/11/2019 21:46	19/11/2019 08:49	18/11/2019 21:46	19/11/2019 08:49	11,04	6	66,23	CHI
201911203431	SANTA TEREZINHA DE GOIAS	VD12049799	SANTA TEREZINHA	18/11/2019 21:46	19/11/2019 08:49	18/11/2019 21:46	19/11/2019 08:49	11,04	3	33,12	CHI
201911203432	PIRACANJUBA	PJ12293360	PIRACANJUBA	19/11/2019 06:55	22/11/2019 11:57	19/11/2019 06:55	19/11/2019 09:49	2,90	3	8,70	CHI
201911203432	PIRACANJUBA	PJ13139516	PIRACANJUBA	19/11/2019 06:55	22/11/2019 11:57	19/11/2019 06:55	20/11/2019 21:01	38,09	3	114,27	CHI
201911203432	PIRACANJUBA	PJ13139515	PIRACANJUBA	19/11/2019 06:55	22/11/2019 11:57	19/11/2019 06:55	21/11/2019 12:39	53,72	7	376,03	CHI
201911203432	PIRACANJUBA	PJ13139516	PIRACANJUBA	19/11/2019 06:55	22/11/2019 11:57	21/11/2019 22:47	22/11/2019 11:57	13,17	10	131,72	CHI
201911203435	NOVA CRIXAS	8570014092	NOVA CRIXAS	19/11/2019 06:56	19/11/2019 09:00	19/11/2019 06:56	19/11/2019 09:00	2,06	1	2,06	CHI
201911203436	CAMPO ALEGRE DE GOIAS	CM21250387	CAMPO ALEGRE DE GOIAS	19/11/2019 06:57	19/11/2019 10:30	19/11/2019 06:57	19/11/2019 10:30	3,56	1	3,56	CHI
201911203437	PONTALINA	PK12000100	PONTALINA	19/11/2019 05:57	19/11/2019 07:57	19/11/2019 05:57	19/11/2019 07:57	2,00	11	21,97	CHI
201911203438	LEOPOLDO DE BULHOES	LB21186575	JUNDIAI S1	19/11/2019 06:57	19/11/2019 16:38	19/11/2019 06:57	19/11/2019 16:38	9,68	1	9,68	CHI
201911203440	SILVANIA	SV12241057	VIANOPOLIS	19/11/2019 06:57	19/11/2019 14:08	19/11/2019 06:57	19/11/2019 14:08	7,19	1	7,19	CHI
201911203440	VIANOPOLIS	SV12241057	VIANOPOLIS	19/11/2019 06:57	19/11/2019 14:08	19/11/2019 06:57	19/11/2019 14:08	7,19	3	21,57	CHI
201911203442	URUACU	UR12256445	URUACU	19/11/2019 06:58	19/11/2019 09:29	19/11/2019 06:58	19/11/2019 09:29	2,51	11	27,59	CHI
201911203443	JATAI	JT12035975	CACHOEIRA ALTA	19/11/2019 06:58	20/11/2019 22:06	19/11/2019 06:58	20/11/2019 22:06	39,13	5	195,65	CHI
201911203450	COCALZINHO DE GOIAS	ZN12201362LD	AGUAS LINDAS DE GOIAS S2	19/11/2019 12:20	19/11/2019 15:57	19/11/2019 12:20	19/11/2019 15:57	3,62	4	14,48	CHI
201911203455	SANTO ANTONIO DO DESCOBERTO	SN12094547	MARAJOARA	19/11/2019 07:00	19/11/2019 19:22	19/11/2019 07:00	19/11/2019 19:22	12,36	2	24,71	CHI
201911203457	ITUMBIARA	IT12097341	ITUMBIARA VELHA S1	18/11/2019 19:58	19/11/2019 16:45	18/11/2019 19:58	19/11/2019 16:45	20,78	2	41,56	CHI
201911203460	POSSE	PS21195756	IACIARA S1	19/11/2019 07:01	19/11/2019 09:46	19/11/2019 07:01	19/11/2019 09:46	2,74	1	2,74	CHI
201911203462	PALMEIRAS DE GOIAS	PL21085302	PALMEIRAS	19/11/2019 07:01	19/11/2019 09:30	19/11/2019 07:01	19/11/2019 09:30	2,49	1	2,49	CHI
201911203477	CABECEIRAS	CW21151429	ITUIQUIRA	19/11/2019 07:04	19/11/2019 08:23	19/11/2019 07:04	19/11/2019 08:23	1,30	1	1,30	CHI
201911203486	GOIANIA	GN12053037	AEROPORTO S3	19/11/2019 07:06	19/11/2019 10:20	19/11/2019 07:06	19/11/2019 10:20	3,23	81	261,29	CHI
201911203487	PLANALTINA	PI21049032	PLANALTINA	19/11/2019 07:06	20/11/2019 16:20	19/11/2019 07:06	20/11/2019 16:20	33,23	1	33,23	CHI
201911203490	IVOLANDIA	IV12390185	IPORA	19/11/2019 07:07	19/11/2019 11:35	19/11/2019 07:07	19/11/2019 11:35	4,47	13	58,16	CHI
201911203492	APARECIDA DE GOIANIA	GN21216835	REAL S1	19/11/2019 07:07	19/11/2019 08:36	19/11/2019 07:07	19/11/2019 08:36	1,47	1	1,47	CHI
201911203494	MINACU	IH12396737	MINACU	19/11/2019 07:07	19/11/2019 15:19	19/11/2019 07:07	19/11/2019 15:19	8,19	14	114,63	CHI

201911203495	CRISTALINA	KR21332511	PAMPLONA	19/11/2019 07:08	19/11/2019 15:01	19/11/2019 07:08	19/11/2019 15:01	7,88	1	7,88	CHI
201911203498	TRINDADE	14534642	GOYA S2	19/11/2019 07:08	19/11/2019 09:05	19/11/2019 07:08	19/11/2019 09:05	1,94	1	1,94	CHI
201911203501	PONTALINA	MI12320239	PONTALINA	19/11/2019 07:09	21/11/2019 01:34	19/11/2019 07:09	21/11/2019 01:34	42,42	4	169,68	CHI
201911203504	BELA VISTA DE GOIAS	BV21343195	BELA VISTA S1	19/11/2019 07:09	19/11/2019 10:40	19/11/2019 07:09	19/11/2019 10:40	3,50	1	3,50	CHI
201911203513	CORREGO DO OURO	CO12062738	FIRMINOPOLIS S2	19/11/2019 07:12	19/11/2019 08:32	19/11/2019 07:12	19/11/2019 08:32	1,33	4	5,32	CHI
201911203515	ITARUMA	IM12107442	CACHOEIRA ALTA	19/11/2019 06:27	19/11/2019 16:14	19/11/2019 06:27	19/11/2019 16:14	9,78	40	391,07	CHI
201911203517	CATALAO	CT12009669	CATALAO S1	19/11/2019 07:13	20/11/2019 00:09	19/11/2019 07:13	20/11/2019 00:09	16,93	2	33,86	CHI
201911203520	ACREUNA	EU21045537	ACREUNA	19/11/2019 07:13	19/11/2019 10:31	19/11/2019 07:13	19/11/2019 10:31	3,29	1	3,29	CHI
201911203522	TRINDADE	40030842	TRINDADE	19/11/2019 07:14	19/11/2019 09:18	19/11/2019 07:14	19/11/2019 09:18	2,06	1	2,06	CHI
201911203525	APARECIDA DE GOIANIA	AP12399972LD	ANHANGUERA	19/11/2019 07:14	19/11/2019 16:43	19/11/2019 07:14	19/11/2019 16:43	9,47	9	85,26	CHI
201911203526	GOIANIA	GN21027628	XAVANTES	19/11/2019 07:14	19/11/2019 12:28	19/11/2019 07:14	19/11/2019 12:28	5,22	1	5,22	CHI
201911203528	IPORA	IR12334815	IPORA	19/11/2019 07:15	19/11/2019 14:20	19/11/2019 07:15	19/11/2019 14:20	7,09	11	78,00	CHI
201911203529	ITAPURANGA	IK12250603	ITAPURANGA	19/11/2019 07:15	19/11/2019 09:30	19/11/2019 07:15	19/11/2019 09:30	2,25	21	47,18	CHI
201911203532	ANAPOLIS	AN21258965	JUNDIAI S2	19/11/2019 07:16	19/11/2019 10:34	19/11/2019 07:16	19/11/2019 10:34	3,30	1	3,30	CHI
201911203534	CACHOEIRA DOURADA	CD21190996	CACHOEIRA DOURADA	19/11/2019 07:16	19/11/2019 13:37	19/11/2019 07:16	19/11/2019 13:37	6,34	1	6,34	CHI
201911203535	CRISTALINA	KR21211932	PAMPLONA	19/11/2019 07:16	19/11/2019 14:21	19/11/2019 07:16	19/11/2019 14:21	7,08	1	7,08	CHI
201911203536	AMORINOPOLIS	IR12091436	IPORA	19/11/2019 07:16	19/11/2019 09:50	19/11/2019 07:16	19/11/2019 09:50	2,55	3	7,66	CHI
201911203536	IPORA	IR12091436	IPORA	19/11/2019 07:16	19/11/2019 09:50	19/11/2019 07:16	19/11/2019 09:50	2,55	15	38,31	CHI
201911203537	CAIAPONIA	CP12410631	CAIAPONIA	19/11/2019 07:17	20/11/2019 23:00	19/11/2019 07:17	20/11/2019 23:00	39,71	18	714,84	CHI
201911203539	GOIANIA	15886931	GOIANIA LESTE S3	19/11/2019 07:17	19/11/2019 13:07	19/11/2019 07:17	19/11/2019 13:07	5,83	1	5,83	CHI
201911203547	BONOPOLIS	BX12136924	SAO MIGUEL DO ARAGUAIA	19/11/2019 07:19	19/11/2019 13:12	19/11/2019 07:19	19/11/2019 13:12	5,88	5	29,39	CHI
201911203548	PIRANHAS	PH12247809	PIRANHAS	18/11/2019 19:24	19/11/2019 10:00	18/11/2019 19:24	19/11/2019 10:00	14,60	11	160,56	CHI
201911203556	PIRACANJUBA	PJ11251575	ROCHEDO	19/11/2019 07:22	19/11/2019 16:42	19/11/2019 07:22	19/11/2019 16:42	9,32	68	633,74	CHI
201911203557	ITARUMA	Z310012513	CACHOEIRA ALTA	19/11/2019 07:22	19/11/2019 14:11	19/11/2019 07:22	19/11/2019 14:11	6,80	1	6,80	CHI
201911203559	PIRACANJUBA	10011710401	PIRACANJUBA	19/11/2019 07:23	21/11/2019 15:39	19/11/2019 07:23	21/11/2019 15:39	56,27	1	56,27	CHI
201911203574	MONTIVIDIU	MV12160710	MONTIVIDIU T	19/11/2019 07:26	19/11/2019 14:15	19/11/2019 07:26	19/11/2019 14:15	6,81	21	143,11	CHI
201911203575	CAIAPONIA	CP12200875	CAIAPONIA	18/11/2019 21:21	19/11/2019 08:58	18/11/2019 21:21	19/11/2019 08:58	11,61	9	104,53	CHI
201911203584	PORANGATU	PO12328896LD	PORANGATU	19/11/2019 07:28	20/11/2019 18:35	19/11/2019 07:28	20/11/2019 18:35	35,11	1	35,11	CHI
201911203584	PORANGATU	PO12328896LD	PORANGATU	19/11/2019 07:28	20/11/2019 18:35	20/11/2019 14:36	20/11/2019 18:35	3,98	23	91,55	CHI
201911203592	CRISTALINA	KR21211936	CRISTALINA S2	19/11/2019 07:30	19/11/2019 13:14	19/11/2019 07:30	19/11/2019 13:14	5,73	1	5,73	CHI
201911203593	IVOLANDIA	MO12336568	IPORA	19/11/2019 07:09	19/11/2019 14:48	19/11/2019 07:09	19/11/2019 14:48	7,64	6	45,85	CHI
201911203593	MOIPORA	MO12336568	IPORA	19/11/2019 07:09	19/11/2019 14:48	19/11/2019 07:09	19/11/2019 14:48	7,64	6	45,85	CHI
201911203596	JARAGUA	JA12116881	JARAGUA	19/11/2019 04:42	19/11/2019 13:50	19/11/2019 04:42	19/11/2019 13:50	9,12	12	109,47	CHI

201911203598	HIDROLANDIA	PJ12000121	PIRACANJUBA	19/11/2019 06:47	19/11/2019 10:58	19/11/2019 06:47	19/11/2019 10:58	4,17	3	12,50	CHI
201911203598	PIRACANJUBA	PJ12000121	PIRACANJUBA	19/11/2019 06:47	19/11/2019 10:58	19/11/2019 06:47	19/11/2019 10:58	4,17	12	50,01	CHI
201911203606	FLORES DE GOIAS	FB12357886	IACIARA S2	19/11/2019 07:32	20/11/2019 17:49	19/11/2019 07:32	20/11/2019 17:49	34,28	3	102,85	CHI
201911203615	GAMELEIRA DE GOIAS	AN12285354	JUNDIAI S1	19/11/2019 07:23	19/11/2019 10:32	19/11/2019 07:23	19/11/2019 10:32	3,14	9	28,22	CHI
201911203615	SILVANIA	AN12285354	JUNDIAI S1	19/11/2019 07:23	19/11/2019 10:32	19/11/2019 07:23	19/11/2019 10:32	3,14	20	62,72	CHI
201911203618	CATALAO	1990047881	CATALAO S2	19/11/2019 07:33	19/11/2019 11:58	19/11/2019 07:33	19/11/2019 11:58	4,41	1	4,41	CHI
201911203621	ANAPOLIS	AN12319607	DAIA S1	19/11/2019 06:47	19/11/2019 09:40	19/11/2019 06:47	19/11/2019 09:40	2,87	6	17,23	CHI
201911203621	LEOPOLDO DE BULHOES	AN12319607	DAIA S1	19/11/2019 06:47	19/11/2019 09:40	19/11/2019 06:47	19/11/2019 09:40	2,87	6	17,23	CHI
201911203628	CAMPINORTE	2040000740	CAMPINORTE	19/11/2019 07:34	19/11/2019 10:07	19/11/2019 07:34	19/11/2019 10:07	2,54	1	2,54	CHI
201911203641	AGUA FRIA DE GOIAS	TL21233993	SAO JOAO D ALIANCA	19/11/2019 07:36	21/11/2019 22:13	19/11/2019 07:36	21/11/2019 20:46	61,18	1	61,18	CHI
201911203641	AGUA FRIA DE GOIAS	TL12164607	SAO JOAO D ALIANCA	19/11/2019 07:36	21/11/2019 22:13	21/11/2019 16:05	21/11/2019 22:13	6,14	15	92,05	CHI
201911203642	GOIANIA	GN12383187	XAVANTES	19/11/2019 05:27	19/11/2019 11:42	19/11/2019 05:27	19/11/2019 11:42	6,24	233	1452,95	CHI
201911203643	GOIAS	8528819	GOIAS	19/11/2019 07:36	19/11/2019 17:18	19/11/2019 07:36	19/11/2019 17:18	9,69	13	126,02	CHI
201911203650	TRINDADE	TR21181935	TRINDADE	19/11/2019 07:37	19/11/2019 16:33	19/11/2019 07:37	19/11/2019 16:33	8,92	2	17,85	CHI
201911203657	BALIZA	BH21207593	BOM JARDIM	19/11/2019 07:38	19/11/2019 14:20	19/11/2019 07:38	19/11/2019 14:20	6,70	1	6,70	CHI
201911203658	LUZIANIA	LZ12000543	MARAJOARA	19/11/2019 06:37	19/11/2019 09:11	19/11/2019 06:37	19/11/2019 09:11	2,56	40	102,38	CHI
201911203659	OUIDOR	OU21215639	CATALAO S1	19/11/2019 07:38	21/11/2019 09:47	19/11/2019 07:38	21/11/2019 09:47	50,14	1	50,14	CHI
201911203660	INHUMAS	IN21000172	INHUMAS S1	19/11/2019 07:39	19/11/2019 15:39	19/11/2019 07:39	19/11/2019 15:39	8,00	1	8,00	CHI
201911203666	BOM JESUS DE GOIAS	BJ11093525	BOM JESUS DE GOIAS	19/11/2019 06:32	19/11/2019 08:55	19/11/2019 06:32	19/11/2019 08:55	2,37	76	179,89	CHI
201911203671	PIRENOPOLIS	PV12355915	CORUMBA	19/11/2019 07:25	19/11/2019 09:14	19/11/2019 07:25	19/11/2019 09:14	1,81	21	37,97	CHI
201911203673	GOIATUBA	GT21283879	GOIATUBA S1	19/11/2019 07:40	21/11/2019 12:42	19/11/2019 07:40	21/11/2019 12:42	53,04	1	53,04	CHI
201911203675	GOIANIA	15804318	CAMPINAS S2	19/11/2019 07:40	19/11/2019 15:41	19/11/2019 07:40	19/11/2019 15:41	8,01	1	8,01	CHI
201911203676	JOVIANIA	VI12218198RE	VICENTINOPOLIS	19/11/2019 02:20	19/11/2019 11:36	19/11/2019 02:20	19/11/2019 11:36	9,26	12	111,10	CHI
201911203676	PONTALINA	VI12218198RE	VICENTINOPOLIS	19/11/2019 02:20	19/11/2019 11:36	19/11/2019 02:20	19/11/2019 11:36	9,26	25	231,45	CHI
201911203676	VICENTINOPOLIS	VI12218198RE	VICENTINOPOLIS	19/11/2019 02:20	19/11/2019 11:36	19/11/2019 02:20	19/11/2019 11:36	9,26	12	111,10	CHI
201911203677	COCALZINHO DE GOIAS	ZN12273061	COCALZINHO	19/11/2019 06:15	19/11/2019 14:00	19/11/2019 06:15	19/11/2019 14:00	7,75	26	201,48	CHI
201911203678	GOIANIA	11177974	GOIANIA LESTE S3	19/11/2019 07:41	19/11/2019 11:25	19/11/2019 07:41	19/11/2019 11:25	3,73	1	3,73	CHI
201911203683	GUARANI DE GOIAS	GY12393812	IACIARA S1	19/11/2019 07:41	19/11/2019 11:21	19/11/2019 07:41	19/11/2019 11:21	3,65	22	80,35	CHI
201911203684	MORRINHOS	MR21120817	MORRINHOS	19/11/2019 07:42	19/11/2019 10:50	19/11/2019 07:42	19/11/2019 10:50	3,13	1	3,13	CHI
201911203686	GOIANIRA	10013162592	GOIANIRA	19/11/2019 07:42	19/11/2019 20:24	19/11/2019 07:42	19/11/2019 20:24	12,69	1	12,69	CHI
201911203689	SERRANOPOLIS	SX12390581	JATAI S1	18/11/2019 23:32	20/11/2019 16:30	18/11/2019 23:32	20/11/2019 16:30	40,95	5	204,76	CHI
201911203693	CORUMBAIBA	CI12110161	VILA CORUMBA	18/11/2019 19:48	19/11/2019 16:14	18/11/2019 19:48	19/11/2019 16:14	20,42	44	898,41	CHI
201911203694	INDIARA	JD12005508	PALMEIRAS	19/11/2019 06:31	19/11/2019 10:49	19/11/2019 06:31	19/11/2019 10:49	4,28	28	119,94	CHI

201911203694	JANDAIA	JD12005508	PALMEIRAS	19/11/2019 06:31	19/11/2019 10:49	19/11/2019 06:31	19/11/2019 10:49	4,28	6	25,70	CHI
201911203695	IPORA	IR11024616	ARENOPOLIS	19/11/2019 07:43	19/11/2019 09:00	19/11/2019 07:43	19/11/2019 09:00	1,29	15	19,30	CHI
201911203697	MORRINHOS	MR11171715	MORRINHOS	19/11/2019 06:59	20/11/2019 08:45	19/11/2019 06:59	20/11/2019 08:45	25,76	179	4611,29	CHI
201911203699	ITARUMA	CC12000108	CACHOEIRA ALTA	19/11/2019 04:52	19/11/2019 15:38	19/11/2019 04:52	19/11/2019 15:38	10,77	17	183,03	CHI
201911203705	GOIANIA	11131883	ATLANTICO S1	19/11/2019 07:45	19/11/2019 09:22	19/11/2019 07:45	19/11/2019 09:22	1,61	1	1,61	CHI
201911203712	MAURILANDIA	RV12026877	RIO DOS BOIS	19/11/2019 07:46	19/11/2019 10:40	19/11/2019 07:46	19/11/2019 10:40	2,89	11	31,79	CHI
201911203719	CAMPOS VERDES	VD12251079	SANTA TEREZINHA	19/11/2019 05:37	19/11/2019 12:41	19/11/2019 05:37	19/11/2019 12:41	7,06	3	21,19	CHI
201911203719	SANTA TEREZINHA DE GOIAS	VD12251079	SANTA TEREZINHA	19/11/2019 05:37	19/11/2019 12:41	19/11/2019 05:37	19/11/2019 12:41	7,06	3	21,19	CHI
201911203720	PORANGATU	PO12239639	MARA ROSA	19/11/2019 05:37	19/11/2019 11:12	19/11/2019 05:37	19/11/2019 11:12	5,58	30	167,34	CHI
201911203721	FORMOSO	FO12208460	PORANGATU	19/11/2019 07:48	19/11/2019 16:01	19/11/2019 07:48	19/11/2019 16:01	8,21	11	90,36	CHI
201911203722	MARA ROSA	MQ12325668	SANTA TEREZINHA	19/11/2019 07:43	19/11/2019 17:10	19/11/2019 07:43	19/11/2019 17:10	9,45	48	453,53	CHI
201911203739	AMARALINA	LC12270111	SAO MIGUEL DO ARAGUAIA	19/11/2019 07:35	19/11/2019 09:59	19/11/2019 07:35	19/11/2019 09:59	2,39	4	9,56	CHI
201911203746	GOIANIA	17386275	GOYA S1	19/11/2019 07:52	19/11/2019 16:34	19/11/2019 07:52	19/11/2019 16:34	8,70	1	8,70	CHI
201911203747	MONTES CLAROS DE GOIAS	ME12074048	IPORA	19/11/2019 07:52	19/11/2019 20:53	19/11/2019 07:52	19/11/2019 20:53	13,03	1	13,03	CHI
201911203750	BOM JARDIM DE GOIAS	BM12342013	BOM JARDIM	19/11/2019 05:21	19/11/2019 09:31	19/11/2019 05:21	19/11/2019 09:31	4,16	11	45,80	CHI
201911203752	PORANGATU	PO12202421	PORANGATU	19/11/2019 06:45	19/11/2019 12:50	19/11/2019 06:45	19/11/2019 12:50	6,07	6	36,42	CHI
201911203756	CALDAZINHA	SW12217284	CEPAIGO S2	19/11/2019 07:52	20/11/2019 12:47	19/11/2019 07:52	20/11/2019 12:47	28,90	6	173,40	CHI
201911203756	LEOPOLDO DE BULHOES	SW12217284	CEPAIGO S2	19/11/2019 07:52	20/11/2019 12:47	19/11/2019 07:52	20/11/2019 12:47	28,90	52	1502,83	CHI
201911203760	CHAPADAO DO CEU	9880007286	CHAPADAO DO CEU	19/11/2019 07:53	19/11/2019 10:50	19/11/2019 07:53	19/11/2019 10:50	2,95	1	2,95	CHI
201911203764	JANDAIA	JD12008627	PALMEIRAS	19/11/2019 07:49	19/11/2019 11:46	19/11/2019 07:49	19/11/2019 11:46	3,94	3	11,83	CHI
201911203765	NIQUELANDIA	NQ12235223	NIQUELANDIA SUBTRANSMISSAO	19/11/2019 07:54	19/11/2019 19:40	19/11/2019 07:54	19/11/2019 19:40	11,75	27	317,33	CHI
201911203803	BELA VISTA DE GOIAS	240045087	BELA VISTA S1	19/11/2019 07:55	19/11/2019 12:14	19/11/2019 07:55	19/11/2019 12:14	4,31	1	4,31	CHI
201911203804	EDEIA	EA21182693	EDEIA	19/11/2019 07:55	19/11/2019 16:42	19/11/2019 07:55	19/11/2019 16:42	8,78	1	8,78	CHI
201911203808	TEREZOPOLIS DE GOIAS	1370013192	DAIA S2	19/11/2019 07:55	19/11/2019 14:08	19/11/2019 07:55	19/11/2019 14:08	6,22	1	6,22	CHI
201911203816	ANAPOLIS	AN21130438	NEROPOLIS S1	19/11/2019 07:56	19/11/2019 15:40	19/11/2019 07:56	19/11/2019 15:40	7,72	2	15,45	CHI
201911203822	ACREUNA	EU12260933	ACREUNA	19/11/2019 07:57	19/11/2019 13:40	19/11/2019 07:57	19/11/2019 13:40	5,71	1	5,71	CHI
201911203825	JESUPOLIS	SF21170301	SAO FRANCISCO DE GOIAS	19/11/2019 07:58	20/11/2019 09:12	19/11/2019 07:58	20/11/2019 09:12	25,23	1	25,23	CHI
201911203828	CAVALCANTE	CJ21295049	MINACU	19/11/2019 07:58	19/11/2019 13:40	19/11/2019 07:58	19/11/2019 13:40	5,69	1	5,69	CHI
201911203832	TRES RANCHOS	2170013101	CATALAO S1	19/11/2019 07:58	19/11/2019 15:12	19/11/2019 07:58	19/11/2019 15:12	7,23	1	7,23	CHI
201911203833	ACREUNA	SH12271266	SANTA HELENA S1	19/11/2019 07:58	20/11/2019 14:05	19/11/2019 07:58	20/11/2019 14:05	30,12	3	90,35	CHI
201911203833	SANTA HELENA DE GOIAS	SH12271266	SANTA HELENA S1	19/11/2019 07:58	20/11/2019 14:05	19/11/2019 07:58	20/11/2019 14:05	30,12	3	90,35	CHI
201911203841	PIRENOPOLIS	PV12146619	CORUMBA	19/11/2019 08:00	19/11/2019 23:47	19/11/2019 08:00	19/11/2019 23:47	15,78	7	110,45	CHI
201911203842	BONFINOPOLIS	920027659	CEPAIGO S2	19/11/2019 08:00	19/11/2019 13:41	19/11/2019 08:00	19/11/2019 13:41	5,68	1	5,68	CHI

201911203843	CRISTALINA	KR12383045	CRISTALINA S2	19/11/2019 07:49	19/11/2019 12:48	19/11/2019 07:49	19/11/2019 12:48	4,98	12	59,74	CHI
201911203852	RIO VERDE	RV21025945	CABRIUVA S2	19/11/2019 08:01	19/11/2019 12:10	19/11/2019 08:01	19/11/2019 12:10	4,14	1	4,14	CHI
201911203860	GOUVELANDIA	GB21279600	QUIRINOPOLIS	19/11/2019 08:03	19/11/2019 10:50	19/11/2019 08:03	19/11/2019 10:50	2,78	1	2,78	CHI
201911203861	JATAI	3920000867	JATAI S1	19/11/2019 08:03	19/11/2019 10:27	19/11/2019 08:03	19/11/2019 10:27	2,40	1	2,40	CHI
201911203868	PIRACANJUBA	PJ12412508	CRISTIANOPOLIS	19/11/2019 07:42	19/11/2019 12:00	19/11/2019 07:42	19/11/2019 12:00	4,29	12	51,50	CHI
201911203870	AMARALINA	LC12270203	SAO MIGUEL DO ARAGUAIA	19/11/2019 08:04	19/11/2019 11:06	19/11/2019 08:04	19/11/2019 11:06	3,03	9	27,25	CHI
201911203871	GOIANIA	GN12000021	CAMPINAS S1	19/11/2019 12:05	19/11/2019 12:35	19/11/2019 12:05	19/11/2019 12:35	0,50	651	325,68	CHI
201911204010	LUZIANIA	LZ12382235	MARAJOARA	19/11/2019 07:38	19/11/2019 13:48	19/11/2019 07:38	19/11/2019 13:48	6,16	7	43,15	CHI
201911204014	MOZARLANDIA	410010492	MOZARLANDIA	19/11/2019 08:06	20/11/2019 14:00	19/11/2019 08:06	20/11/2019 14:00	29,89	1	29,89	CHI
201911204018	CORUMBAlBA	6120000119	VILA CORUMBA	19/11/2019 08:07	19/11/2019 15:14	19/11/2019 08:07	19/11/2019 15:14	7,11	1	7,11	CHI
201911204027	FIRMINOPOLIS	FR21105342	FIRMINOPOLIS S1	19/11/2019 08:08	19/11/2019 10:10	19/11/2019 08:08	19/11/2019 10:10	2,03	1	2,03	CHI
201911204030	NOVO GAMA	NJ21305152	MARAJOARA	19/11/2019 08:08	19/11/2019 10:17	19/11/2019 08:08	19/11/2019 10:17	2,14	1	2,14	CHI
201911204032	SANTA HELENA DE GOIAS	SH11063086	IPEGUARI	19/11/2019 14:32	19/11/2019 16:10	19/11/2019 14:32	19/11/2019 16:10	1,63	173	282,61	CHI
201911204035	CATURAI	CK21018938	INHUMAS S1	19/11/2019 08:09	19/11/2019 14:01	19/11/2019 08:09	19/11/2019 14:01	5,86	2	11,72	CHI
201911204037	ALTO PARAISO DE GOIAS	JL12383337	SAO JOAO D ALIANCA	19/11/2019 08:09	19/11/2019 19:04	19/11/2019 08:09	19/11/2019 19:04	10,91	1	10,91	CHI
201911204037	SAO JOAO D ALIANCA	JL12383337	SAO JOAO D ALIANCA	19/11/2019 08:09	19/11/2019 19:04	19/11/2019 08:09	19/11/2019 19:04	10,91	13	141,79	CHI
201911204041	NOVA CRIXAS	NA12283851	MOZARLANDIA	19/11/2019 08:10	22/11/2019 18:30	19/11/2019 08:10	22/11/2019 18:30	82,34	1	82,34	CHI
201911204043	PORANGATU	PO12208558	PORANGATU	19/11/2019 06:06	19/11/2019 09:22	19/11/2019 06:06	19/11/2019 09:22	3,26	14	45,62	CHI
201911204047	LEOPOLDO DE BULHOES	950006178	DAIA S2	19/11/2019 08:11	19/11/2019 11:00	19/11/2019 08:11	19/11/2019 11:00	2,83	1	2,83	CHI
201911204048	GOIANIA	10029208082	CARAJAS S1	19/11/2019 08:11	19/11/2019 18:48	19/11/2019 08:11	19/11/2019 18:48	10,61	1	10,61	CHI
201911204052	POSSE	PS12255357	IACIARA S2	19/11/2019 08:12	19/11/2019 10:57	19/11/2019 08:12	19/11/2019 10:57	2,75	5	13,74	CHI
201911204057	CRISTALINA	KR21219637	PAMPLONA	19/11/2019 08:12	19/11/2019 14:36	19/11/2019 08:12	19/11/2019 14:36	6,40	1	6,40	CHI
201911204063	LUZIANIA	LZ12390041	CRISTALINA S2	18/11/2019 20:50	19/11/2019 12:26	18/11/2019 20:50	19/11/2019 12:26	15,60	9	140,40	CHI
201911204064	CACHOEIRA ALTA	CA12100724	CACHOEIRA ALTA	19/11/2019 08:12	19/11/2019 12:00	19/11/2019 08:12	19/11/2019 12:00	3,79	2	7,57	CHI
201911204065	ITUMBIARA	IT12304246	ITUMBIARA NOVA	18/11/2019 20:52	19/11/2019 12:06	18/11/2019 20:52	19/11/2019 12:06	15,23	3	45,69	CHI
201911204066	BELA VISTA DE GOIAS	BV12402769	BELA VISTA S1	18/11/2019 23:12	19/11/2019 11:47	18/11/2019 23:12	19/11/2019 11:47	12,58	11	138,37	CHI
201911204067	LUZIANIA	10006150967	RIO VERMELHO	19/11/2019 08:13	19/11/2019 09:41	19/11/2019 08:13	19/11/2019 09:41	1,46	1	1,46	CHI
201911204070	BOM JARDIM DE GOIAS	BM11209247	BOM JARDIM	19/11/2019 08:13	19/11/2019 15:26	19/11/2019 08:13	19/11/2019 15:26	7,21	2	14,42	CHI
201911204074	LUZIANIA	LZ12085956	CRISTALINA S2	19/11/2019 08:14	19/11/2019 13:23	19/11/2019 08:14	19/11/2019 13:23	5,15	15	77,18	CHI
201911204076	BOM JESUS DE GOIAS	1250069650	BOM JESUS DE GOIAS	19/11/2019 08:12	19/11/2019 10:08	19/11/2019 08:12	19/11/2019 10:08	1,92	1	1,92	CHI
201911204077	ARENOPOLIS	AY12010416	ARENOPOLIS	19/11/2019 08:14	19/11/2019 11:13	19/11/2019 08:14	19/11/2019 11:13	2,97	5	14,86	CHI
201911204078	FORMOSA	610130031	ITUIQUIRA	19/11/2019 08:14	19/11/2019 17:02	19/11/2019 08:14	19/11/2019 17:02	8,79	1	8,79	CHI
201911204080	PALESTINA DE GOIAS	PY12334768	ARENOPOLIS	19/11/2019 08:14	19/11/2019 12:00	19/11/2019 08:14	19/11/2019 12:00	3,75	8	30,02	CHI

201911204081	GOIANIA	GN12227549	CEPAIGO S1	19/11/2019 08:15	19/11/2019 16:18	19/11/2019 08:15	19/11/2019 16:18	8,04	4	32,18	CHI
201911204085	GOIANIA	14727055	ATLANTICO S3	19/11/2019 08:15	19/11/2019 10:41	19/11/2019 08:15	19/11/2019 10:41	2,42	1	2,42	CHI
201911204089	GOIANIA	10004616233	INDEPENDENCIA S2	19/11/2019 08:16	19/11/2019 16:55	19/11/2019 08:16	19/11/2019 16:55	8,64	1	8,64	CHI
201911204098	CRIXAS	CX21102890	SERRA DO OURO	19/11/2019 08:17	19/11/2019 12:01	19/11/2019 08:17	19/11/2019 12:01	3,73	1	3,73	CHI
201911204105	GOIANIRA	GR11076552	GOIANIRA	19/11/2019 07:48	19/11/2019 11:38	19/11/2019 07:48	19/11/2019 11:38	3,82	222	848,10	CHI
201911204106	ITABERAI	IB21388563	ITABERAI S1	19/11/2019 08:18	20/11/2019 17:06	19/11/2019 08:18	20/11/2019 17:06	32,80	1	32,80	CHI
201911204112	SERRANOPOLIS	SX12182120	JATAI S1	19/11/2019 05:07	19/11/2019 16:47	19/11/2019 05:07	19/11/2019 16:47	11,66	16	186,61	CHI
201911204113	ITUMBIAIRA	10018829838	PARANAIBA	19/11/2019 08:17	19/11/2019 11:03	19/11/2019 08:17	19/11/2019 11:03	2,75	1	2,75	CHI
201911204115	MINEIROS	MY11348941	PARQUE DAS EMAS	19/11/2019 08:07	19/11/2019 10:17	19/11/2019 08:07	19/11/2019 10:17	2,16	20	43,14	CHI
201911204118	MUTUNOPOLIS	MU11269530	MARA ROSA	19/11/2019 08:19	19/11/2019 14:19	19/11/2019 08:19	19/11/2019 14:19	5,99	1	5,99	CHI
201911204119	APARECIDA DE GOIANIA	AP12058379	INDEPENDENCIA S1	19/11/2019 07:00	19/11/2019 10:28	19/11/2019 07:00	19/11/2019 10:28	3,46	448	1551,08	CHI
201911204122	GOIANIA	10024189	GOIANIA LESTE S2	19/11/2019 08:19	20/11/2019 12:05	19/11/2019 08:19	20/11/2019 12:05	27,75	1	27,75	CHI
201911204130	LUZIANIA	LZ12239789	VIANOPOLIS	19/11/2019 08:13	19/11/2019 15:19	19/11/2019 08:13	19/11/2019 15:19	7,08	5	35,42	CHI
201911204133	GOIANIA	GN12133722	GOIANIA LESTE S2	19/11/2019 08:21	19/11/2019 16:25	19/11/2019 08:21	19/11/2019 16:25	8,06	4	32,24	CHI
201911204137	ABADIANIA	AA21297801	ANAPOLIS UNIVERSITARIO S1	19/11/2019 08:22	19/11/2019 13:10	19/11/2019 08:22	19/11/2019 13:10	4,80	2	9,60	CHI
201911204145	CORREGO DO OURO	1070004537	FIRMINOPOLIS S2	19/11/2019 08:23	19/11/2019 10:27	19/11/2019 08:23	19/11/2019 10:27	2,06	1	2,06	CHI
201911204146	GOIANIA	GN11001624	CAMPINAS S1	19/11/2019 08:06	19/11/2019 09:14	19/11/2019 08:06	19/11/2019 09:14	1,12	102	114,55	CHI
201911204147	COCALZINHO DE GOIAS	ZN12320080	AGUAS LINDAS DE GOIAS S1	19/11/2019 08:23	19/11/2019 13:57	19/11/2019 08:23	19/11/2019 13:57	5,55	4	22,20	CHI
201911204149	SERRANOPOLIS	SX12226484	JATAI S1	19/11/2019 07:06	19/11/2019 18:21	19/11/2019 07:06	19/11/2019 18:21	11,24	14	157,42	CHI
201911204155	SENADOR CANEDO	SW21158141	SENADOR CANEDO	19/11/2019 08:26	19/11/2019 17:19	19/11/2019 08:26	19/11/2019 17:19	8,88	1	8,88	CHI
201911204156	CRIXAS	CX12181251	SERRA DO OURO	19/11/2019 08:26	19/11/2019 23:55	19/11/2019 08:26	19/11/2019 23:55	15,48	3	46,44	CHI
201911204158	CRISTALINA	KR12168494	CRISTALINA S2	19/11/2019 08:26	19/11/2019 16:25	19/11/2019 08:26	19/11/2019 16:25	7,99	23	183,66	CHI
201911204159	GOIANIA	10003891052	GOYA S1	19/11/2019 08:26	19/11/2019 16:26	19/11/2019 08:26	19/11/2019 16:26	8,00	1	8,00	CHI
201911204161	POSSE	PS21143786	IACIARA S2	19/11/2019 08:27	19/11/2019 10:01	19/11/2019 08:27	19/11/2019 10:01	1,56	1	1,56	CHI
201911204168	SENADOR CANEDO	SW21283637	SENADOR CANEDO	19/11/2019 08:28	19/11/2019 10:38	19/11/2019 08:28	19/11/2019 10:38	2,17	1	2,17	CHI
201911204171	CACU	CC21323944	CACHOEIRA ALTA	19/11/2019 08:29	19/11/2019 18:02	19/11/2019 08:29	19/11/2019 18:02	9,55	1	9,55	CHI
201911204172	GOIAS	GS12087523	GOIAS	19/11/2019 04:50	19/11/2019 11:40	19/11/2019 04:50	19/11/2019 11:40	6,83	68	464,42	CHI
201911204177	GOIANIRA	GR11340621	GOIANIRA	20/11/2019 10:00	20/11/2019 11:30	20/11/2019 10:00	20/11/2019 11:30	1,50	45	67,50	CHI
201911204178	CATALAO	CT12103631	CATALAO S1	19/11/2019 08:30	19/11/2019 12:47	19/11/2019 08:30	19/11/2019 12:47	4,28	4	17,11	CHI
201911204180	MUTUNOPOLIS	MU12129781	MARA ROSA	19/11/2019 07:11	19/11/2019 12:05	19/11/2019 07:11	19/11/2019 12:05	4,88	7	34,19	CHI
201911204181	CATALAO	CT21378460	CATALAO S1	19/11/2019 08:30	19/11/2019 09:36	19/11/2019 08:30	19/11/2019 09:36	1,09	1	1,09	CHI
201911204183	JARAGUA	JA21146827	JARAGUA	19/11/2019 08:30	19/11/2019 15:46	19/11/2019 08:30	19/11/2019 15:46	7,25	1	7,25	CHI
201911204186	PARANAIGUARA	PC12248277	CACHOEIRA ALTA	19/11/2019 08:18	19/11/2019 13:59	19/11/2019 08:18	19/11/2019 13:59	5,67	22	124,70	CHI

201911204187	BRAZABRANTES	BR11193250	NEROPOLIS S1	19/11/2019 06:02	19/11/2019 11:35	19/11/2019 06:02	19/11/2019 11:35	5,55	154	854,53	CHI
201911204188	LUZIANIA	120224239	RIO VERMELHO	19/11/2019 08:31	19/11/2019 09:44	19/11/2019 08:31	19/11/2019 09:44	1,21	1	1,21	CHI
201911204190	TRINDADE	40069771	TRINDADE	19/11/2019 08:31	19/11/2019 10:10	19/11/2019 08:31	19/11/2019 10:10	1,65	1	1,65	CHI
201911204191	TRES RANCHOS	TH12057694	CATALAO S1	19/11/2019 08:31	19/11/2019 09:08	19/11/2019 08:31	19/11/2019 09:08	0,62	56	34,46	CHI
201911204192	MAIRIPOTABA	MI12078688	PONTALINA	19/11/2019 06:52	20/11/2019 01:21	19/11/2019 06:52	20/11/2019 01:21	18,47	8	147,76	CHI
201911204193	CATALAO	CT21192557	CATALAO S1	19/11/2019 08:31	19/11/2019 10:26	19/11/2019 08:31	19/11/2019 10:26	1,90	1	1,90	CHI
201911204194	GOIANIA	GN11001431	AEROPORTO S3	19/11/2019 08:25	19/11/2019 09:59	19/11/2019 08:25	19/11/2019 09:59	1,57	33	51,71	CHI
201911204208	SANTO ANTONIO DO DESCOBERTO	SN12275494	MARAJOARA	19/11/2019 11:19	19/11/2019 16:38	19/11/2019 11:19	19/11/2019 16:38	5,32	8	42,53	CHI
201911204225	ABADIA DE GOIAS	10014691610	CARAJAS S1	19/11/2019 09:31	20/11/2019 11:33	19/11/2019 09:31	20/11/2019 11:33	26,03	1	26,03	CHI
201911204238	NIQUELANDIA	NQ13374776	URUACU	19/11/2019 10:18	19/11/2019 12:34	19/11/2019 10:18	19/11/2019 11:07	0,81	1180	953,83	CHI
201911204238	MARA ROSA	NQ10400364	URUACU	19/11/2019 10:18	19/11/2019 12:34	19/11/2019 10:18	19/11/2019 11:47	1,49	1	1,49	CHI
201911204238	NIQUELANDIA	NQ10400364	URUACU	19/11/2019 10:18	19/11/2019 12:34	19/11/2019 10:18	19/11/2019 11:47	1,49	123	183,13	CHI
201911204238	NIQUELANDIA	NQ10400364	URUACU	19/11/2019 10:18	19/11/2019 12:34	19/11/2019 10:18	19/11/2019 11:58	1,67	114	190,35	CHI
201911204238	NIQUELANDIA	NQ10400364	URUACU	19/11/2019 10:18	19/11/2019 12:34	19/11/2019 10:18	19/11/2019 12:18	1,99	158	314,55	CHI
201911204238	NIQUELANDIA	NQ13080920	URUACU	19/11/2019 10:18	19/11/2019 12:34	19/11/2019 12:30	19/11/2019 12:34	0,07	272	18,51	CHI
201911204255	PANAMA	PX12000451	GOIATUBA S1	17/11/2019 07:20	19/11/2019 10:22	17/11/2019 07:20	19/11/2019 10:22	51,03	20	1020,67	CHI
201911204310	ANAPOLIS	20475391	ANAPOLIS UNIVERSITARIO S2	19/11/2019 08:32	19/11/2019 10:57	19/11/2019 08:32	19/11/2019 10:57	2,40	1	2,40	CHI
201911204314	JARAGUA	JA12033436	JARAGUA	19/11/2019 08:33	19/11/2019 13:50	19/11/2019 08:33	19/11/2019 13:50	5,28	19	100,37	CHI
201911204315	SANTA HELENA DE GOIAS	SH11000045	IPEGUARI	19/11/2019 08:33	20/11/2019 12:27	19/11/2019 08:33	20/11/2019 12:27	27,90	163	4547,47	CHI
201911204316	RIO VERDE	RV11159387	RIO VERDE S1	19/11/2019 08:22	19/11/2019 12:29	19/11/2019 08:22	19/11/2019 12:29	4,10	302	1238,62	CHI
201911204321	MATRINCHA	MP21227995	MATRINCHA	19/11/2019 08:33	19/11/2019 16:53	19/11/2019 08:33	19/11/2019 16:53	8,32	1	8,32	CHI
201911204401	AMARALINA	LC12215796	MARA ROSA	18/11/2019 23:08	19/11/2019 11:57	18/11/2019 23:08	19/11/2019 11:57	12,81	13	166,59	CHI
201911204403	GOIANIA	GN12001206	MEIA PONTE	19/11/2019 08:33	19/11/2019 11:08	19/11/2019 08:33	19/11/2019 11:08	2,57	18	46,23	CHI
201911204403	GOIANIRA	GN12001206	MEIA PONTE	19/11/2019 08:33	19/11/2019 11:08	19/11/2019 08:33	19/11/2019 11:08	2,57	10	25,68	CHI
201911204507	PALMEIRAS DE GOIAS	PP12000036	PALMEIRAS	19/11/2019 09:26	19/11/2019 17:50	19/11/2019 09:26	19/11/2019 17:50	8,40	52	436,76	CHI
201911204507	PALMINOPOLIS	PP12000036	PALMEIRAS	19/11/2019 09:26	19/11/2019 17:50	19/11/2019 09:26	19/11/2019 17:50	8,40	38	319,17	CHI
201911204511	ITAPURANGA	IK12071747	ITAPURANGA	19/11/2019 05:37	19/11/2019 13:55	19/11/2019 05:37	19/11/2019 13:55	8,30	53	439,87	CHI
201911204512	ALTO PARAISO DE GOIAS	BF21204274	FLORES DE GOIAS	19/11/2019 08:34	19/11/2019 09:59	19/11/2019 08:34	19/11/2019 09:59	1,40	1	1,40	CHI
201911204519	NIQUELANDIA	NQ12254342	NIQUELANDIA SUBTRANSMISSAO	19/11/2019 08:36	19/11/2019 10:48	19/11/2019 08:36	19/11/2019 10:48	2,20	1	2,20	CHI
201911204520	GOIANIA	15500172	CAMPINAS S1	19/11/2019 08:36	19/11/2019 12:58	19/11/2019 08:36	19/11/2019 12:58	4,37	1	4,37	CHI
201911204522	GOIANIA	GN11199199	CAMPINAS S1	19/11/2019 07:52	19/11/2019 11:13	19/11/2019 07:52	19/11/2019 11:13	3,35	28	93,67	CHI
201911204525	GOIANESIA	550000409	GOIANESIA S2	19/11/2019 08:36	20/11/2019 16:12	19/11/2019 08:36	20/11/2019 16:12	31,59	1	31,59	CHI
201911204529	INHUMAS	IN12294040	INHUMAS S1	19/11/2019 08:37	19/11/2019 16:37	19/11/2019 08:37	19/11/2019 16:37	8,00	2	16,00	CHI

201911204531	MIMOSO DE GOIAS	04560224	BARRO ALTO	19/11/2019 08:30	20/11/2019 14:43	19/11/2019 08:30	19/11/2019 13:54	5,40	4	21,60	CHI
201911204531	NIQUELANDIA	04560224	BARRO ALTO	19/11/2019 08:30	20/11/2019 14:43	19/11/2019 08:30	19/11/2019 13:54	5,40	931	5027,66	CHI
201911204531	VILA PROPICIO	04560224	BARRO ALTO	19/11/2019 08:30	20/11/2019 14:43	19/11/2019 08:30	19/11/2019 13:54	5,40	17	91,80	CHI
201911204531	NIQUELANDIA	NQ13364089	BARRO ALTO	19/11/2019 08:30	20/11/2019 14:43	19/11/2019 08:30	19/11/2019 16:30	8,01	20	160,14	CHI
201911204531	NIQUELANDIA	NQ12345160LD	BARRO ALTO	19/11/2019 08:30	20/11/2019 14:43	19/11/2019 08:30	19/11/2019 19:43	11,22	70	785,13	CHI
201911204531	MIMOSO DE GOIAS	04560224	BARRO ALTO	19/11/2019 08:30	20/11/2019 14:43	19/11/2019 18:30	19/11/2019 19:43	1,21	4	4,86	CHI
201911204531	NIQUELANDIA	04560224	BARRO ALTO	19/11/2019 08:30	20/11/2019 14:43	19/11/2019 18:30	19/11/2019 19:43	1,21	951	1154,94	CHI
201911204531	VILA PROPICIO	04560224	BARRO ALTO	19/11/2019 08:30	20/11/2019 14:43	19/11/2019 18:30	19/11/2019 19:43	1,21	18	21,86	CHI
201911204531	NIQUELANDIA	NQ21117589	BARRO ALTO	19/11/2019 08:30	20/11/2019 14:43	19/11/2019 08:30	20/11/2019 14:43	30,22	1	30,22	CHI
201911204532	JATAI	JT12080483	JATAI S1	19/11/2019 08:37	19/11/2019 11:23	19/11/2019 08:37	19/11/2019 11:23	2,76	13	35,92	CHI
201911204533	ISRAELANDIA	MO12073401	IPORA	19/11/2019 08:06	19/11/2019 11:05	19/11/2019 08:06	19/11/2019 11:05	2,98	3	8,93	CHI
201911204533	MOIPORA	MO12073401	IPORA	19/11/2019 08:06	19/11/2019 11:05	19/11/2019 08:06	19/11/2019 11:05	2,98	2	5,95	CHI
201911204535	GOIANIA	15059674	CARAJAS S2	19/11/2019 08:37	19/11/2019 14:31	19/11/2019 08:37	19/11/2019 14:31	5,89	1	5,89	CHI
201911204539	GOIANIA	16029227	CAMPINAS S2	19/11/2019 08:38	19/11/2019 13:06	19/11/2019 08:38	19/11/2019 13:06	4,47	1	4,47	CHI
201911204553	CRIXAS	CX11070751	SERRA DO OURO	19/11/2019 08:39	19/11/2019 10:40	19/11/2019 08:39	19/11/2019 10:40	2,00	121	242,44	CHI
201911204557	APARECIDA DE GOIANIA	15306884	INDEPENDENCIA S2	19/11/2019 08:40	19/11/2019 12:19	19/11/2019 08:40	19/11/2019 12:19	3,64	1	3,64	CHI
201911204561	JATAI	290200120	JATAI S2	19/11/2019 08:41	19/11/2019 11:57	19/11/2019 08:41	19/11/2019 11:57	3,27	1	3,27	CHI
201911204564	PIRACANJUBA	150033758	MORRINHOS	19/11/2019 08:41	20/11/2019 22:58	19/11/2019 08:41	20/11/2019 22:58	38,28	1	38,28	CHI
201911204565	NOVA CRIXAS	NA21131264	NOVA CRIXAS	19/11/2019 08:41	19/11/2019 13:15	19/11/2019 08:41	19/11/2019 13:15	4,56	1	4,56	CHI
201911204567	TRINDADE	TR12000048	TRINDADE	19/11/2019 08:24	19/11/2019 10:07	19/11/2019 08:24	19/11/2019 10:07	1,71	4	6,85	CHI
201911204582	CAIAPONIA	CP12254646	JATAI S1	19/11/2019 07:53	19/11/2019 12:21	19/11/2019 07:53	19/11/2019 12:21	4,45	5	22,27	CHI
201911204584	CAIAPONIA	CP21191772	MONTIVIDIU T	19/11/2019 08:44	19/11/2019 16:50	19/11/2019 08:44	19/11/2019 16:50	8,09	1	8,09	CHI
201911204592	RIO VERDE	10003207704	RIO VERDE S2	19/11/2019 08:45	19/11/2019 11:07	19/11/2019 08:45	19/11/2019 11:07	2,37	1	2,37	CHI
201911204593	GAMELEIRA DE GOIAS	GL21319238	DAIA S2	19/11/2019 08:45	21/11/2019 11:21	19/11/2019 08:45	21/11/2019 11:21	50,59	1	50,59	CHI
201911204594	TRES RANCHOS	TH21161061	CATALAO S1	19/11/2019 08:42	19/11/2019 20:11	19/11/2019 08:42	19/11/2019 20:11	11,47	2	22,94	CHI
201911204600	GOIANESIA	GE11191257	GOIANESIA S2	19/11/2019 06:41	19/11/2019 10:00	19/11/2019 06:41	19/11/2019 10:00	3,31	106	351,24	CHI
201911204602	APARECIDA DE GOIANIA	12953003	INDEPENDENCIA S2	19/11/2019 08:46	19/11/2019 16:37	19/11/2019 08:46	19/11/2019 16:37	7,83	1	7,83	CHI
201911204603	GOIANAPOLIS	950039792	DAIA S2	19/11/2019 08:47	19/11/2019 17:07	19/11/2019 08:47	19/11/2019 17:07	8,33	1	8,33	CHI
201911204614	GOIANIA	16671946	GOYA S2	19/11/2019 08:48	19/11/2019 19:00	19/11/2019 08:48	19/11/2019 19:00	10,20	1	10,20	CHI
201911204626	CAIAPONIA	CP12301812	CAIAPONIA	19/11/2019 08:49	20/11/2019 21:09	19/11/2019 08:49	20/11/2019 21:09	36,32	9	326,90	CHI
201911204629	CEZARINA	CZ12011071	CEZARINA	19/11/2019 08:49	19/11/2019 11:39	19/11/2019 08:49	19/11/2019 11:39	2,84	4	11,34	CHI
201911204629	PALMEIRAS DE GOIAS	CZ12011071	CEZARINA	19/11/2019 08:49	19/11/2019 11:39	19/11/2019 08:49	19/11/2019 11:39	2,84	4	11,34	CHI
201911204630	APARECIDA DE GOIANIA	10027438951	REAL S1	19/11/2019 08:49	19/11/2019 13:29	19/11/2019 08:49	19/11/2019 13:29	4,65	1	4,65	CHI

201911204633	EDEIA	EA21320275	VICENTINOPOLIS	19/11/2019 08:49	20/11/2019 09:37	19/11/2019 08:49	20/11/2019 09:37	24,79	1	24,79	CHI
201911204637	IPORA	IR12380966	IPORA	19/11/2019 07:58	19/11/2019 14:33	19/11/2019 07:58	19/11/2019 14:33	6,57	3	19,71	CHI
201911204641	ANAPOLIS	AN12327784	JUNDIAI S1	19/11/2019 08:51	19/11/2019 09:40	19/11/2019 08:51	19/11/2019 09:40	0,82	52	42,44	CHI
201911204642	GAMELEIRA DE GOIAS	SV12027617	DAIA S2	19/11/2019 05:25	19/11/2019 16:37	19/11/2019 05:25	19/11/2019 16:37	11,20	22	246,39	CHI
201911204651	BRAZABRANTES	DL12012174	INHUMAS S1	19/11/2019 08:32	20/11/2019 01:28	19/11/2019 08:32	20/11/2019 01:28	16,92	2	33,83	CHI
201911204651	DAMOLANDIA	DL12012174	INHUMAS S1	19/11/2019 08:32	20/11/2019 01:28	19/11/2019 08:32	20/11/2019 01:28	16,92	34	575,18	CHI
201911204651	INHUMAS	DL12012174	INHUMAS S1	19/11/2019 08:32	20/11/2019 01:28	19/11/2019 08:32	20/11/2019 01:28	16,92	18	304,51	CHI
201911204666	CALDAS NOVAS	CN21142360	SERRA DE CALDAS	19/11/2019 08:54	19/11/2019 14:11	19/11/2019 08:54	19/11/2019 14:11	5,28	1	5,28	CHI
201911204670	APARECIDA DE GOIANIA	11490871	REAL S2	19/11/2019 08:55	20/11/2019 08:45	19/11/2019 08:55	20/11/2019 08:45	23,83	1	23,83	CHI
201911204672	CAMPINORTE	CR12234938	PORANGATU	19/11/2019 08:07	19/11/2019 11:39	19/11/2019 08:07	19/11/2019 11:39	3,53	19	66,98	CHI
201911204672	MINACU	CR12234938	PORANGATU	19/11/2019 08:07	19/11/2019 11:39	19/11/2019 08:07	19/11/2019 11:39	3,53	42	148,05	CHI
201911204673	GOIANIA	GN12001865	CARAJAS S1	19/11/2019 08:45	19/11/2019 13:22	19/11/2019 08:45	19/11/2019 13:22	4,60	297	1366,78	CHI
201911204675	DOVERLANDIA	DV12187350	CAIAPONIA	19/11/2019 07:05	19/11/2019 10:34	19/11/2019 07:05	19/11/2019 10:34	3,48	17	59,21	CHI
201911204679	CRISTALINA	KR21171023	CRISTALINA S2	19/11/2019 08:56	20/11/2019 10:35	19/11/2019 08:56	20/11/2019 10:35	25,63	2	51,27	CHI
201911204680	SENADOR CANEDO	14809813	SENADOR CANEDO	19/11/2019 08:57	19/11/2019 14:17	19/11/2019 08:57	19/11/2019 14:17	5,33	1	5,33	CHI
201911204686	EDEIA	EA12390301	EDEIA	19/11/2019 07:46	20/11/2019 09:36	19/11/2019 07:46	20/11/2019 09:36	25,83	7	180,84	CHI
201911204688	UIRAPURU	UP12352423	SANTA TEREZINHA	19/11/2019 08:58	19/11/2019 13:08	19/11/2019 08:58	19/11/2019 13:08	4,16	4	16,64	CHI
201911204693	ACREUNA	2440009514	ACREUNA	19/11/2019 08:55	19/11/2019 13:50	19/11/2019 08:55	19/11/2019 13:50	4,92	1	4,92	CHI
201911204697	ARAGUAPAZ	AZ21376352	GOIAS	19/11/2019 08:58	21/11/2019 15:20	19/11/2019 08:58	21/11/2019 15:20	54,35	1	54,35	CHI
201911204701	SENADOR CANEDO	SW12062065	SENADOR CANEDO	19/11/2019 07:07	19/11/2019 12:02	19/11/2019 07:07	19/11/2019 12:02	4,90	11	53,94	CHI
201911204707	APARECIDA DE GOIANIA	10001380573	INDEPENDENCIA S2	19/11/2019 08:59	19/11/2019 11:24	19/11/2019 08:59	19/11/2019 11:24	2,42	1	2,42	CHI
201911204713	CRISTALINA	KR21092819	PAMPLONA	19/11/2019 09:00	19/11/2019 16:17	19/11/2019 09:00	19/11/2019 16:17	7,28	1	7,28	CHI
201911204715	AGUA FRIA DE GOIAS	TL21169881	SAO JOAO D ALIANCA	19/11/2019 08:50	19/11/2019 10:35	19/11/2019 08:50	19/11/2019 10:35	1,74	2	3,48	CHI
201911204721	NOVA ROMA	ND12256420	IACIARA S2	19/11/2019 09:01	19/11/2019 10:49	19/11/2019 09:01	19/11/2019 10:49	1,80	28	50,34	CHI
201911204729	MINACU	4020101335	MINACU	19/11/2019 09:01	20/11/2019 01:38	19/11/2019 09:01	20/11/2019 01:38	16,62	1	16,62	CHI
201911204734	INHUMAS	IX12016404	INHUMAS S1	19/11/2019 07:34	19/11/2019 15:28	19/11/2019 07:34	19/11/2019 15:28	7,89	1	7,89	CHI
201911204734	ITAUCU	IX12016404	INHUMAS S1	19/11/2019 07:34	19/11/2019 15:28	19/11/2019 07:34	19/11/2019 15:28	7,89	4	31,55	CHI
201911204748	SANTA RITA DO ARAGUAIA	SU12184139	SANTA RITA DO ARAGUAIA	19/11/2019 09:02	19/11/2019 14:25	19/11/2019 09:02	19/11/2019 14:25	5,37	1	5,37	CHI
201911204750	CATALAO	1990168313	CATALAO S2	19/11/2019 09:02	19/11/2019 15:02	19/11/2019 09:02	19/11/2019 15:02	5,98	1	5,98	CHI
201911204759	APARECIDA DE GOIANIA	AP11224134	INDEPENDENCIA S1	19/11/2019 16:37	19/11/2019 23:00	19/11/2019 16:37	19/11/2019 23:00	6,37	171	1090,03	CHI
201911204768	BELA VISTA DE GOIAS	240088578	CEPAIGO S2	19/11/2019 09:04	19/11/2019 14:03	19/11/2019 09:04	19/11/2019 14:03	4,97	1	4,97	CHI
201911204771	CRISTALINA	KR11032627	PAMPLONA	19/11/2019 09:05	19/11/2019 17:45	19/11/2019 09:05	19/11/2019 17:45	8,66	95	822,96	CHI
201911204774	GOIANIA	GN12340746	GOYA S2	19/11/2019 08:52	19/11/2019 14:53	19/11/2019 08:52	19/11/2019 14:53	6,01	29	174,31	CHI

201911204777	CRISTALINA	KR123206686	CRISTALINA S2	19/11/2019 08:25	19/11/2019 12:27	19/11/2019 08:25	19/11/2019 12:27	4,03	7	28,21	CHI
201911204777	LUZIANIA	KR123206686	CRISTALINA S2	19/11/2019 08:25	19/11/2019 12:27	19/11/2019 08:25	19/11/2019 12:27	4,03	6	24,18	CHI
201911204779	PIRANHAS	PH11259348	PIRANHAS	19/11/2019 09:06	19/11/2019 11:13	19/11/2019 09:06	19/11/2019 11:13	2,11	20	42,25	CHI
201911204780	CRIXAS	NA21148391	MOZARLANDIA	19/11/2019 09:06	22/11/2019 17:20	19/11/2019 09:06	22/11/2019 17:20	80,23	1	80,23	CHI
201911204783	FORMOSA	610178611	ITIQUEIRA	19/11/2019 09:07	19/11/2019 17:41	19/11/2019 09:07	19/11/2019 17:41	8,57	1	8,57	CHI
201911204784	FORMOSA	FA12404505	ITIQUEIRA	19/11/2019 08:08	20/11/2019 13:05	19/11/2019 08:08	20/11/2019 13:05	28,95	3	86,84	CHI
201911204786	CATALAO	IO12363431	CATALAO S1	19/11/2019 08:12	19/11/2019 11:36	19/11/2019 08:12	19/11/2019 11:36	3,39	1	3,39	CHI
201911204786	DAVINOPOLIS	IO12363431	CATALAO S1	19/11/2019 08:12	19/11/2019 11:36	19/11/2019 08:12	19/11/2019 11:36	3,39	15	50,87	CHI
201911204786	OUVIDOR	IO12363431	CATALAO S1	19/11/2019 08:12	19/11/2019 11:36	19/11/2019 08:12	19/11/2019 11:36	3,39	7	23,74	CHI
201911204787	FAINA	MS12036227	ITAPURANGA	19/11/2019 06:08	19/11/2019 11:00	19/11/2019 06:08	19/11/2019 11:00	4,85	11	53,38	CHI
201911204787	MORRO AGUDO DE GOIAS	MS12036227	ITAPURANGA	19/11/2019 06:08	19/11/2019 11:00	19/11/2019 06:08	19/11/2019 11:00	4,85	27	131,03	CHI
201911204790	GOIANIA	10083870	REAL S2	19/11/2019 09:07	19/11/2019 11:13	19/11/2019 09:07	19/11/2019 11:13	2,09	1	2,09	CHI
201911204803	FORMOSA	FA21320491	ITIQUEIRA	19/11/2019 09:09	19/11/2019 18:27	19/11/2019 09:09	19/11/2019 18:27	9,29	1	9,29	CHI
201911204805	PARAUNA	980047845	PARAUNA	19/11/2019 09:09	19/11/2019 11:28	19/11/2019 09:09	19/11/2019 11:28	2,32	1	2,32	CHI
201911204808	JUSSARA	JR12022269	BRITANIA	19/11/2019 10:55	19/11/2019 17:28	19/11/2019 10:55	19/11/2019 17:28	6,55	29	189,91	CHI
201911204808	MONTES CLAROS DE GOIAS	JR12022269	BRITANIA	19/11/2019 10:55	19/11/2019 17:28	19/11/2019 10:55	19/11/2019 17:28	6,55	257	1682,99	CHI
201911204816	GOIANIA	13754361	CAMPINAS S1	19/11/2019 09:10	19/11/2019 10:55	19/11/2019 09:10	19/11/2019 10:55	1,74	1	1,74	CHI
201911204823	GOIANIA	11120873	CAMPINAS S3	19/11/2019 09:12	19/11/2019 13:06	19/11/2019 09:12	19/11/2019 13:06	3,90	1	3,90	CHI
201911204829	GOIANIA	10140359	FERROVIARIO S3	19/11/2019 09:12	19/11/2019 16:01	19/11/2019 09:12	19/11/2019 16:01	6,81	1	6,81	CHI
201911204833	ANAPOLIS	AN12258718	JUNDIAI S2	19/11/2019 09:04	19/11/2019 12:00	19/11/2019 09:04	19/11/2019 12:00	2,92	20	58,48	CHI
201911204836	GOIANIA	14937165	ATLANTICO S3	19/11/2019 09:13	19/11/2019 11:11	19/11/2019 09:13	19/11/2019 11:11	1,96	1	1,96	CHI
201911204841	NOVA CRIXAS	NA12057172	MOZARLANDIA	19/11/2019 09:14	20/11/2019 18:30	19/11/2019 09:14	20/11/2019 18:30	33,26	22	731,64	CHI
201911204844	MINACU	IH12245140	MINACU	19/11/2019 09:14	19/11/2019 17:03	19/11/2019 09:14	19/11/2019 17:03	7,80	6	46,81	CHI
201911204845	GOIANIA	GN11378758	ATLANTICO S2	19/11/2019 07:50	19/11/2019 11:06	19/11/2019 07:50	19/11/2019 11:06	3,26	51	166,09	CHI
201911204905	GAMELEIRA DE GOIAS	SV12056396	DAIA S2	19/11/2019 08:53	19/11/2019 14:37	19/11/2019 08:53	19/11/2019 14:37	5,73	102	584,46	CHI
201911204905	SILVANIA	SV12056396	DAIA S2	19/11/2019 08:53	19/11/2019 14:37	19/11/2019 08:53	19/11/2019 14:37	5,73	1	5,73	CHI
201911204906	CIDADE OCIDENTAL	DH12170619	MARAJOARA	19/11/2019 09:12	20/11/2019 15:28	19/11/2019 09:12	20/11/2019 15:28	30,26	4	121,05	CHI
201911204907	ANAPOLIS	AN21261214	ANAPOLIS UNIVERSITARIO S2	19/11/2019 09:16	19/11/2019 19:22	19/11/2019 09:16	19/11/2019 19:22	10,10	1	10,10	CHI
201911204912	CALDAZINHA	LB12011210	DAIA S2	19/11/2019 09:16	21/11/2019 00:10	19/11/2019 09:16	21/11/2019 00:10	38,90	1	38,90	CHI
201911204917	CALDAS NOVAS	MG12000353	VILA CORUMBA	19/11/2019 09:17	20/11/2019 11:41	19/11/2019 09:17	20/11/2019 11:41	26,39	4	105,57	CHI
201911204918	GOIANIA	GN11326184	REAL S1	19/11/2019 09:17	19/11/2019 14:50	19/11/2019 09:17	19/11/2019 14:50	5,54	5	27,71	CHI
201911204922	MINACU	IH11370903	MINACU	19/11/2019 09:17	19/11/2019 11:45	19/11/2019 09:17	19/11/2019 11:45	2,45	77	188,69	CHI
201911204927	MORRINHOS	MR21182937	MORRINHOS	19/11/2019 09:18	19/11/2019 16:40	19/11/2019 09:18	19/11/2019 16:40	7,36	2	14,71	CHI

201911204931	CACU	CC12340974	CACHOEIRA ALTA	19/11/2019 09:19	19/11/2019 14:46	19/11/2019 09:19	19/11/2019 14:46	5,45	6	32,68	CHI
201911204932	VALPARAISO DE GOIAS	2860125389	PACAEMBU S1	19/11/2019 09:19	19/11/2019 11:55	19/11/2019 09:19	19/11/2019 11:55	2,60	1	2,60	CHI
201911204933	IACIARA	IA12232131	IACIARA S1	19/11/2019 07:02	19/11/2019 10:44	19/11/2019 07:02	19/11/2019 10:44	3,70	6	22,18	CHI
201911204934	GOIANIA	GN11037445	GOIANIA LESTE S1	19/11/2019 09:19	19/11/2019 15:11	19/11/2019 09:19	19/11/2019 15:11	5,86	5	29,30	CHI
201911204938	SENADOR CANEDO	10013065368	SENADOR CANEDO	19/11/2019 09:20	19/11/2019 10:57	19/11/2019 09:20	19/11/2019 10:57	1,61	1	1,61	CHI
201911204949	GOIANIA	17068770	AEROPORTO S1	19/11/2019 09:21	19/11/2019 14:26	19/11/2019 09:21	19/11/2019 14:26	5,07	1	5,07	CHI
201911204961	CIDADE OCIDENTAL	19782162	MARAJOARA	19/11/2019 09:23	19/11/2019 14:11	19/11/2019 09:23	19/11/2019 14:11	4,79	5	23,97	CHI
201911204964	GOIANESIA	550197424	GOIANESIA S2	19/11/2019 09:23	20/11/2019 10:22	19/11/2019 09:23	20/11/2019 10:22	24,98	1	24,98	CHI
201911204966	GOIAS	NB12113795LD	MATRINCHA	19/11/2019 09:24	21/11/2019 15:49	19/11/2019 09:24	20/11/2019 15:38	30,23	3	90,70	CHI
201911204966	ITAPIRAPUA	NB12113795LD	MATRINCHA	19/11/2019 09:24	21/11/2019 15:49	19/11/2019 09:24	20/11/2019 15:38	30,23	1	30,23	CHI
201911204966	NOVO BRASIL	NB12113795LD	MATRINCHA	19/11/2019 09:24	21/11/2019 15:49	19/11/2019 09:24	20/11/2019 15:38	30,23	1	30,23	CHI
201911204966	GOIAS	NB12113795LD	MATRINCHA	19/11/2019 09:24	21/11/2019 15:49	20/11/2019 15:39	21/11/2019 15:49	24,17	3	72,50	CHI
201911204966	ITAPIRAPUA	NB12113795LD	MATRINCHA	19/11/2019 09:24	21/11/2019 15:49	20/11/2019 15:39	21/11/2019 15:49	24,17	1	24,17	CHI
201911204966	NOVO BRASIL	NB12113795LD	MATRINCHA	19/11/2019 09:24	21/11/2019 15:49	20/11/2019 15:39	21/11/2019 15:49	24,17	1	24,17	CHI
201911204969	PORANGATU	PO12021172	PORANGATU	19/11/2019 08:39	19/11/2019 13:54	19/11/2019 08:39	19/11/2019 13:54	5,24	5	26,21	CHI
201911204973	RIO VERDE	RV21271331	CABRIUVA S2	19/11/2019 09:25	19/11/2019 15:38	19/11/2019 09:25	19/11/2019 15:38	6,21	1	6,21	CHI
201911204978	FORMOSA	FA10396048	ITIQUEIRA	19/11/2019 09:20	20/11/2019 12:04	19/11/2019 09:20	19/11/2019 12:47	3,46	107	370,28	CHI
201911204978	FORMOSA	FA10396048	ITIQUEIRA	19/11/2019 09:20	20/11/2019 12:04	19/11/2019 13:03	19/11/2019 13:30	0,44	107	47,32	CHI
201911204978	FORMOSA	FA13041144	ITIQUEIRA	19/11/2019 09:20	20/11/2019 12:04	19/11/2019 09:20	19/11/2019 16:08	6,81	6	40,83	CHI
201911204978	FORMOSA	FA10396048	ITIQUEIRA	19/11/2019 09:20	20/11/2019 12:04	19/11/2019 18:02	19/11/2019 19:14	1,19	113	134,94	CHI
201911204978	FORMOSA	FA13041144	ITIQUEIRA	19/11/2019 09:20	20/11/2019 12:04	19/11/2019 09:20	20/11/2019 09:32	24,21	92	2226,91	CHI
201911204978	FORMOSA	FA13041144	ITIQUEIRA	19/11/2019 09:20	20/11/2019 12:04	19/11/2019 09:20	20/11/2019 11:43	26,40	184	4857,19	CHI
201911204978	FORMOSA	FA13041144	ITIQUEIRA	19/11/2019 09:20	20/11/2019 12:04	19/11/2019 09:20	20/11/2019 12:04	26,74	62	1657,66	CHI
201911204986	GOIANIA	13033803	REAL S1	19/11/2019 09:26	19/11/2019 11:19	19/11/2019 09:26	19/11/2019 11:19	1,87	1	1,87	CHI
201911204993	QUIRINOPOLIS	QI21360931	QUIRINOPOLIS	19/11/2019 09:27	19/11/2019 11:41	19/11/2019 09:27	19/11/2019 11:41	2,22	2	4,44	CHI
201911204994	RIO VERDE	RV21111053	MONTIVIDIU T	19/11/2019 09:27	20/11/2019 14:01	19/11/2019 09:27	20/11/2019 14:01	28,55	1	28,55	CHI
201911204999	IPAMERI	IP12270585	IPAMERI	19/11/2019 09:28	20/11/2019 11:23	19/11/2019 09:28	20/11/2019 11:23	25,91	1	25,91	CHI
201911205002	GOIANIA	15213997	GOIANIA LESTE S3	19/11/2019 09:28	19/11/2019 14:38	19/11/2019 09:28	19/11/2019 14:38	5,16	1	5,16	CHI
201911205004	BARRO ALTO	1150008316	BARRO ALTO	19/11/2019 09:28	19/11/2019 17:55	19/11/2019 09:28	19/11/2019 17:55	8,44	1	8,44	CHI
201911205009	TROMBAS	TB12202556	PORANGATU	19/11/2019 09:29	19/11/2019 10:50	19/11/2019 09:29	19/11/2019 10:50	1,35	2	2,69	CHI
201911205014	JUSSARA	JR21137864	BRITANIA	19/11/2019 09:29	20/11/2019 08:31	19/11/2019 09:29	20/11/2019 08:31	23,02	1	23,02	CHI
201911205020	LUZIANIA	LZ21209546	CRISTALINA S2	19/11/2019 09:31	19/11/2019 17:23	19/11/2019 09:31	19/11/2019 17:23	7,86	1	7,86	CHI
201911205021	ACREUNA	8590757	ACREUNA	19/11/2019 12:40	19/11/2019 17:30	19/11/2019 12:40	19/11/2019 17:30	4,83	15	72,43	CHI

201911205028	LUZIANIA	120120082	RIO VERMELHO	19/11/2019 09:32	19/11/2019 10:06	19/11/2019 09:32	19/11/2019 10:06	0,56	1	0,56	CHI
201911205030	ALEXANIA	AX21384810	ALEXANIA	19/11/2019 09:32	20/11/2019 16:45	19/11/2019 09:32	20/11/2019 16:45	31,20	1	31,20	CHI
201911205031	APARECIDA DE GOIANIA	10020246615	REAL S1	19/11/2019 09:32	20/11/2019 14:02	19/11/2019 09:32	20/11/2019 14:02	28,50	1	28,50	CHI
201911205033	CACHOEIRA ALTA	CA21315237	CACHOEIRA ALTA	19/11/2019 09:32	19/11/2019 11:28	19/11/2019 09:32	19/11/2019 11:28	1,92	1	1,92	CHI
201911205037	ANAPOLIS	AN21003517	ANAPOLIS UNIVERSITARIO S1	19/11/2019 09:33	19/11/2019 19:47	19/11/2019 09:33	19/11/2019 19:47	10,22	1	10,22	CHI
201911205203	LUZIANIA	120316201	RIO VERMELHO	19/11/2019 09:34	19/11/2019 10:24	19/11/2019 09:34	19/11/2019 10:24	0,82	1	0,82	CHI
201911205206	ALTO PARAISO DE GOIAS	3870022356	FLORES DE GOIAS	19/11/2019 09:34	20/11/2019 16:54	19/11/2019 09:34	20/11/2019 16:54	31,32	1	31,32	CHI
201911205501	LUZIANIA	120276320	RIO VERMELHO	19/11/2019 09:35	19/11/2019 15:26	19/11/2019 09:35	19/11/2019 15:26	5,84	1	5,84	CHI
201911205502	GOIANIA	GN11001625	CAMPINAS S1	19/11/2019 09:27	19/11/2019 11:39	19/11/2019 09:27	19/11/2019 11:39	2,19	58	127,29	CHI
201911205505	ANAPOLIS	10024463149	JUNDAI S1	19/11/2019 09:35	19/11/2019 09:52	19/11/2019 09:35	19/11/2019 09:52	0,27	1	0,27	CHI
201911205516	GOIANAPOLIS	10030245832	DAIA S2	19/11/2019 09:37	19/11/2019 13:57	19/11/2019 09:37	19/11/2019 13:57	4,34	1	4,34	CHI
201911205518	CAMPINORTE	CR11003478	CAMPINORTE	19/11/2019 09:04	19/11/2019 14:15	19/11/2019 09:04	19/11/2019 13:50	4,76	89	423,66	CHI
201911205518	CAMPINORTE	CR12003468	CAMPINORTE	19/11/2019 09:04	19/11/2019 14:15	19/11/2019 14:08	19/11/2019 14:15	0,11	89	10,04	CHI
201911205519	APARECIDA DE GOIANIA	15273088	ANHANGUERA	19/11/2019 09:37	19/11/2019 10:22	19/11/2019 09:37	19/11/2019 10:22	0,75	1	0,75	CHI
201911205528	GOIANIA	GN12000545	CAMPINAS S3	19/11/2019 09:34	19/11/2019 11:44	19/11/2019 09:34	19/11/2019 11:44	2,15	301	647,23	CHI
201911205529	PORANGATU	PO21151009	PORANGATU	19/11/2019 09:38	19/11/2019 13:23	19/11/2019 09:38	19/11/2019 13:23	3,74	1	3,74	CHI
201911205532	CAIAPONIA	CP12075058	CAIAPONIA	19/11/2019 09:39	19/11/2019 12:36	19/11/2019 09:39	19/11/2019 12:36	2,94	23	67,69	CHI
201911205532	JATAI	CP12075058	CAIAPONIA	19/11/2019 09:39	19/11/2019 12:36	19/11/2019 09:39	19/11/2019 12:36	2,94	3	8,83	CHI
201911205532	RIO VERDE	CP12075058	CAIAPONIA	19/11/2019 09:39	19/11/2019 12:36	19/11/2019 09:39	19/11/2019 12:36	2,94	4	11,77	CHI
201911205535	VALPARAISO DE GOIAS	10008912813	MARAJOARA	19/11/2019 09:39	19/11/2019 17:24	19/11/2019 09:39	19/11/2019 17:24	7,75	1	7,75	CHI
201911205537	GOIAS	4050001069	MATRINCHA	19/11/2019 09:39	19/11/2019 12:35	19/11/2019 09:39	19/11/2019 12:35	2,92	0	0,00	CHI
201911205538	PIRENOPOLIS	PV12000015	CORUMBA	19/11/2019 09:39	19/11/2019 22:02	19/11/2019 09:39	19/11/2019 22:02	12,37	2	24,74	CHI
201911205544	RIO VERDE	RV12029056	SANTA HELENA S1	19/11/2019 09:40	19/11/2019 16:00	19/11/2019 09:40	19/11/2019 16:00	6,33	28	177,22	CHI
201911205545	CALDAZINHA	SW12317421	SENADOR CANEDO	19/11/2019 09:13	19/11/2019 16:18	19/11/2019 09:13	19/11/2019 16:18	7,08	25	177,01	CHI
201911205545	SENADOR CANEDO	SW12317421	SENADOR CANEDO	19/11/2019 09:13	19/11/2019 16:18	19/11/2019 09:13	19/11/2019 16:18	7,08	6	42,48	CHI
201911205546	CAMPO ALEGRE DE GOIAS	CM12122416	CAMPO ALEGRE DE GOIAS	19/11/2019 09:40	22/11/2019 17:25	19/11/2019 09:40	22/11/2019 17:25	79,76	2	159,52	CHI
201911205548	MINACU	IH11052676	MINACU	19/11/2019 08:32	19/11/2019 21:13	19/11/2019 08:32	19/11/2019 21:13	12,69	126	1598,48	CHI
201911205550	CEZARINA	CZ21134874	CEZARINA	19/11/2019 09:40	19/11/2019 15:57	19/11/2019 09:40	19/11/2019 15:57	6,27	1	6,27	CHI
201911205556	MONTE ALEGRE DE GOIAS	MA21358013	SAO DOMINGOS	19/11/2019 09:41	19/11/2019 14:31	19/11/2019 09:41	19/11/2019 14:31	4,82	1	4,82	CHI
201911205562	BALIZA	BH21142109	BOM JARDIM	19/11/2019 09:42	19/11/2019 16:13	19/11/2019 09:42	19/11/2019 16:13	6,52	1	6,52	CHI
201911205568	APARECIDA DE GOIANIA	10025104916	INDEPENDENCIA S2	19/11/2019 09:43	19/11/2019 15:02	19/11/2019 09:43	19/11/2019 15:02	5,31	1	5,31	CHI
201911205572	PARAUNA	PU12304549	PARAUNA	19/11/2019 09:14	19/11/2019 10:18	19/11/2019 09:14	19/11/2019 10:18	1,07	12	12,86	CHI
201911205573	LEOPOLDO DE BULHOES	LB21078534	DAIA S2	19/11/2019 09:44	19/11/2019 17:35	19/11/2019 09:44	19/11/2019 17:35	7,84	1	7,84	CHI

201911205576	AGUA FRIA DE GOIAS	TL21151815	SAO JOAO D ALIANCA	19/11/2019 09:00	19/11/2019 11:00	19/11/2019 09:00	19/11/2019 11:00	2,00	1	2,00	CHI
201911205577	SANTO ANTONIO DA BARRA	BZ11093032	ACREUNA	19/11/2019 07:04	19/11/2019 13:35	19/11/2019 07:04	19/11/2019 13:35	6,51	95	618,24	CHI
201911205603	ITABERAI	IB12124892	ITABERAI S2	19/11/2019 17:00	19/11/2019 19:38	19/11/2019 17:00	19/11/2019 19:38	2,64	11	29,01	CHI
201911205604	INACIOLANDIA	ID21306048	QUIRINOPOLIS	19/11/2019 09:46	19/11/2019 12:49	19/11/2019 09:46	19/11/2019 12:49	3,05	1	3,05	CHI
201911205609	INHUMAS	30045149	INHUMAS S2	19/11/2019 09:46	19/11/2019 19:25	19/11/2019 09:46	19/11/2019 19:25	9,64	1	9,64	CHI
201911205623	EDEIA	1120018058	EDEIA	19/11/2019 09:48	20/11/2019 15:05	19/11/2019 09:48	20/11/2019 15:05	29,27	1	29,27	CHI
201911205631	IPORA	IR11040214	IPORA	19/11/2019 09:49	19/11/2019 15:00	19/11/2019 09:49	19/11/2019 15:00	5,19	147	763,05	CHI
201911205633	RIO VERDE	RV21271514	CABRIUVA S2	19/11/2019 09:49	19/11/2019 14:34	19/11/2019 09:49	19/11/2019 14:34	4,74	1	4,74	CHI
201911205636	MINEIROS	MY12290177	PARQUE DAS EMAS	19/11/2019 09:49	19/11/2019 11:42	19/11/2019 09:49	19/11/2019 11:42	1,88	3	5,63	CHI
201911205638	ADELANDIA	10018983322	FIRMINOPOLIS S2	19/11/2019 09:50	19/11/2019 12:01	19/11/2019 09:50	19/11/2019 12:01	2,18	1	2,18	CHI
201911205640	ALEXANIA	10015361410	ALEXANIA	19/11/2019 09:50	20/11/2019 19:26	19/11/2019 09:50	20/11/2019 19:26	33,59	1	33,59	CHI
201911205647	GOIANIA	GN21078174	XAVANTES	19/11/2019 09:51	19/11/2019 12:40	19/11/2019 09:51	19/11/2019 12:40	2,81	1	2,81	CHI
201911205648	GOIAS	IB12300059	ITABERAI S2	19/11/2019 09:51	20/11/2019 21:16	19/11/2019 09:51	19/11/2019 19:12	9,36	14	130,98	CHI
201911205648	ITABERAI	IB12300059	ITABERAI S2	19/11/2019 09:51	20/11/2019 21:16	19/11/2019 09:51	19/11/2019 19:12	9,36	13	121,63	CHI
201911205648	GOIAS	IB12300059	ITABERAI S2	19/11/2019 09:51	20/11/2019 21:16	19/11/2019 09:51	20/11/2019 21:16	35,41	52	1841,29	CHI
201911205648	GOIAS	IB12300059	ITABERAI S2	19/11/2019 09:51	20/11/2019 21:16	20/11/2019 19:42	20/11/2019 21:16	1,56	14	21,89	CHI
201911205648	ITABERAI	IB12300059	ITABERAI S2	19/11/2019 09:51	20/11/2019 21:16	20/11/2019 19:42	20/11/2019 21:16	1,56	13	20,33	CHI
201911205664	INHUMAS	IN12000023	INHUMAS S2	19/11/2019 09:51	19/11/2019 11:56	19/11/2019 09:51	19/11/2019 11:56	2,07	227	470,71	CHI
201911205668	FORMOSA	FA21020063	ITUIQUIRA	19/11/2019 09:53	20/11/2019 16:47	19/11/2019 09:53	20/11/2019 16:47	30,89	2	61,78	CHI
201911205676	NOVA IGUACU DE GOIAS	NH21275869	SANTA TEREZINHA	19/11/2019 09:54	20/11/2019 09:24	19/11/2019 09:54	20/11/2019 09:24	23,49	1	23,49	CHI
201911205677	PORANGATU	PO21288205	PORANGATU	19/11/2019 09:54	19/11/2019 17:05	19/11/2019 09:54	19/11/2019 17:05	7,17	1	7,17	CHI
201911205681	QUIRINOPOLIS	QI21101214	QUIRINOPOLIS	19/11/2019 09:55	19/11/2019 12:31	19/11/2019 09:55	19/11/2019 12:31	2,59	1	2,59	CHI
201911205683	URUACU	UR21270586	URUACU	19/11/2019 09:56	19/11/2019 11:09	19/11/2019 09:56	19/11/2019 11:09	1,21	2	2,42	CHI
201911205686	SAO JOAO D ALIANCA	JL12383340	SAO JOAO D ALIANCA	19/11/2019 09:57	19/11/2019 19:28	19/11/2019 09:57	19/11/2019 19:28	9,52	69	656,65	CHI
201911205688	GOIANIA	GN11073917	MEIA PONTE	19/11/2019 09:41	19/11/2019 13:39	19/11/2019 09:41	19/11/2019 13:39	3,95	253	999,42	CHI
201911205692	GOIAS	GS12299699	GOIAS	19/11/2019 08:59	19/11/2019 14:10	19/11/2019 08:59	19/11/2019 14:10	5,18	31	160,49	CHI
201911205801	SAO LUIS DE MONTES BELOS	3940000484	SAO LUIZ DOS MONTES BELOS	19/11/2019 10:00	19/11/2019 12:11	19/11/2019 10:00	19/11/2019 12:11	2,18	1	2,18	CHI
201911205802	JATAI	290188994	JATAI S3	19/11/2019 10:00	19/11/2019 12:05	19/11/2019 10:00	19/11/2019 12:05	2,08	1	2,08	CHI
201911205803	CRIXAS	CX21349182	MOZARLANDIA	19/11/2019 10:00	20/11/2019 18:35	19/11/2019 10:00	20/11/2019 18:35	32,58	1	32,58	CHI
201911205804	PORANGATU	PO12361688	NOVO PLANALTO	19/11/2019 10:00	19/11/2019 15:50	19/11/2019 10:00	19/11/2019 15:50	5,83	2	11,65	CHI
201911205805	IPAMERI	IP12332852	IPAMERI	19/11/2019 10:00	19/11/2019 11:25	19/11/2019 10:00	19/11/2019 11:25	1,41	6	8,45	CHI
201911205820	FORMOSA	FA12375559	PLANALTINA	19/11/2019 08:05	19/11/2019 15:37	19/11/2019 08:05	19/11/2019 15:37	7,53	10	75,28	CHI
201911205825	GOIANIA	12066801	ATLANTICO S2	19/11/2019 10:02	19/11/2019 14:14	19/11/2019 10:02	19/11/2019 14:14	4,20	1	4,20	CHI

201911205829	PORANGATU	PO21391922	PORANGATU	19/11/2019 10:03	19/11/2019 15:56	19/11/2019 10:03	19/11/2019 15:56	5,88	1	5,88	CHI
201911205832	JATAI	JT12360228	JATAI S1	19/11/2019 10:03	19/11/2019 16:48	19/11/2019 10:03	19/11/2019 16:48	6,74	3	20,23	CHI
201911205845	AGUA FRIA DE GOIAS	JL12270093	SAO JOAO D ALIANCA	19/11/2019 10:04	19/11/2019 18:53	19/11/2019 10:04	19/11/2019 18:53	8,81	1	8,81	CHI
201911205858	SAO FRANCISCO DE GOIAS	SF12211814	SAO FRANCISCO DE GOIAS	19/11/2019 05:53	19/11/2019 16:21	19/11/2019 05:53	19/11/2019 16:21	10,45	14	146,31	CHI
201911205860	GOIANIA	14062914	CARAJAS S1	19/11/2019 10:07	19/11/2019 22:07	19/11/2019 10:07	19/11/2019 22:07	11,99	1	11,99	CHI
201911205871	GOIANIA	11023831	FERROVIARIO S3	19/11/2019 10:09	20/11/2019 10:39	19/11/2019 10:09	20/11/2019 10:39	24,50	1	24,50	CHI
201911205886	NOVA CRIXAS	NA12300441	MOZARLANDIA	19/11/2019 09:25	19/11/2019 14:30	19/11/2019 09:25	19/11/2019 14:30	5,07	4	20,30	CHI
201911205891	GOIANIRA	10013127355	GOIANIRA	19/11/2019 10:12	19/11/2019 15:19	19/11/2019 10:12	19/11/2019 15:19	5,10	1	5,10	CHI
201911205894	PIRENOPOLIS	PV12062557	ANAPOLIS UNIVERSITARIO S2	19/11/2019 10:13	19/11/2019 11:52	19/11/2019 10:13	19/11/2019 11:52	1,65	1	1,65	CHI
201911205895	CAIAPONIA	CP12395438	PALESTINA	19/11/2019 10:13	20/11/2019 17:00	19/11/2019 10:13	20/11/2019 17:00	30,78	5	153,89	CHI
201911205895	PALESTINA DE GOIAS	CP12395438	PALESTINA	19/11/2019 10:13	20/11/2019 17:00	19/11/2019 10:13	20/11/2019 17:00	30,78	1	30,78	CHI
201911205897	SANTA FE DE GOIAS	RN21009750	BRITANIA	19/11/2019 10:13	21/11/2019 08:04	19/11/2019 10:13	21/11/2019 08:04	45,84	1	45,84	CHI
201911205915	GOIANIA	12164148	GOYA S2	19/11/2019 10:15	19/11/2019 19:07	19/11/2019 10:15	19/11/2019 19:07	8,85	1	8,85	CHI
201911206001	APARECIDA DE GOIANIA	00360434	CEPAIGO S2	19/11/2019 10:07	19/11/2019 22:13	19/11/2019 10:07	19/11/2019 10:13	0,09	2	0,18	CHI
201911206001	ARAGOIANIA	00360434	CEPAIGO S2	19/11/2019 10:07	19/11/2019 22:13	19/11/2019 10:07	19/11/2019 11:35	1,46	13	18,95	CHI
201911206001	HIDROLANDIA	00360434	CEPAIGO S2	19/11/2019 10:07	19/11/2019 22:13	19/11/2019 10:07	19/11/2019 11:35	1,46	1970	2871,28	CHI
201911206001	HIDROLANDIA	00360434	CEPAIGO S2	19/11/2019 10:07	19/11/2019 22:13	19/11/2019 10:09	19/11/2019 11:35	1,42	2	2,85	CHI
201911206001	HIDROLANDIA	HD13200318	CEPAIGO S2	19/11/2019 10:07	19/11/2019 22:13	19/11/2019 10:12	19/11/2019 11:35	1,38	2	2,75	CHI
201911206001	HIDROLANDIA	00360434	CEPAIGO S2	19/11/2019 10:07	19/11/2019 22:13	19/11/2019 10:07	19/11/2019 11:51	1,73	62	107,17	CHI
201911206001	PIRACANJUBA	00360434	CEPAIGO S2	19/11/2019 10:07	19/11/2019 22:13	19/11/2019 10:07	19/11/2019 11:51	1,73	4	6,91	CHI
201911206001	PROFESSOR JAMIL SAFADY	00360434	CEPAIGO S2	19/11/2019 10:07	19/11/2019 22:13	19/11/2019 10:07	19/11/2019 11:51	1,73	1	1,73	CHI
201911206001	HIDROLANDIA	00360434	CEPAIGO S2	19/11/2019 10:07	19/11/2019 22:13	19/11/2019 10:09	19/11/2019 11:51	1,70	1	1,70	CHI
201911206001	HIDROLANDIA	PJ13200328	CEPAIGO S2	19/11/2019 10:07	19/11/2019 22:13	19/11/2019 10:12	19/11/2019 11:51	1,65	1	1,65	CHI
201911206001	HIDROLANDIA	00360434	CEPAIGO S2	19/11/2019 10:07	19/11/2019 22:13	19/11/2019 10:07	19/11/2019 12:37	2,49	2260	5629,28	CHI
201911206001	HIDROLANDIA	00360434	CEPAIGO S2	19/11/2019 10:07	19/11/2019 22:13	19/11/2019 10:07	19/11/2019 12:43	2,59	1162	3005,06	CHI
201911206001	HIDROLANDIA	00360434	CEPAIGO S2	19/11/2019 10:07	19/11/2019 22:13	19/11/2019 10:07	19/11/2019 12:45	2,62	564	1479,72	CHI
201911206001	HIDROLANDIA	HD10395394	CEPAIGO S2	19/11/2019 10:07	19/11/2019 22:13	19/11/2019 12:38	19/11/2019 12:46	0,15	255	37,61	CHI
201911206001	HIDROLANDIA	00360434	CEPAIGO S2	19/11/2019 10:07	19/11/2019 22:13	19/11/2019 10:07	19/11/2019 12:54	2,78	228	633,08	CHI
201911206001	HIDROLANDIA	HD10400768	CEPAIGO S2	19/11/2019 10:07	19/11/2019 22:13	19/11/2019 10:12	19/11/2019 12:54	2,69	1	2,69	CHI
201911206001	ARAGOIANIA	HD12341895LD	CEPAIGO S2	19/11/2019 10:07	19/11/2019 22:13	19/11/2019 12:34	19/11/2019 13:28	0,90	13	11,70	CHI
201911206001	HIDROLANDIA	HD12341895LD	CEPAIGO S2	19/11/2019 10:07	19/11/2019 22:13	19/11/2019 12:34	19/11/2019 13:28	0,90	276	248,48	CHI
201911206001	BELA VISTA DE GOIAS	00360434	CEPAIGO S2	19/11/2019 10:07	19/11/2019 22:13	19/11/2019 10:07	19/11/2019 15:39	5,53	9	49,81	CHI
201911206001	HIDROLANDIA	00360434	CEPAIGO S2	19/11/2019 10:07	19/11/2019 22:13	19/11/2019 10:07	19/11/2019 15:39	5,53	894	4947,30	CHI

201911206001	HIDROLANDIA	00360434	CEPAIGO S2	19/11/2019 10:07	19/11/2019 22:13	19/11/2019 10:09	19/11/2019 15:39	5,50	3	16,50	CHI
201911206001	HIDROLANDIA	HD13326683	CEPAIGO S2	19/11/2019 10:07	19/11/2019 22:13	19/11/2019 10:12	19/11/2019 15:39	5,45	3	16,36	CHI
201911206001	APARECIDA DE GOIANIA	HD10383712	CEPAIGO S2	19/11/2019 10:07	19/11/2019 22:13	19/11/2019 10:07	19/11/2019 19:07	9,00	1	9,00	CHI
201911206001	HIDROLANDIA	HD10383712	CEPAIGO S2	19/11/2019 10:07	19/11/2019 22:13	19/11/2019 10:07	19/11/2019 19:07	9,00	2	18,00	CHI
201911206001	HIDROLANDIA	HD10383712	CEPAIGO S2	19/11/2019 10:07	19/11/2019 22:13	19/11/2019 10:07	19/11/2019 20:53	10,75	10	107,54	CHI
201911206001	HIDROLANDIA	HD13229288	CEPAIGO S2	19/11/2019 10:07	19/11/2019 22:13	19/11/2019 10:12	19/11/2019 20:53	10,67	1	10,67	CHI
201911206001	HIDROLANDIA	00360234	CEPAIGO S2	19/11/2019 10:07	19/11/2019 22:13	19/11/2019 20:42	19/11/2019 21:38	0,93	4245	3953,75	CHI
201911206001	BELA VISTA DE GOIAS	00360234	CEPAIGO S2	19/11/2019 10:07	19/11/2019 22:13	19/11/2019 20:42	19/11/2019 21:49	1,11	1	1,11	CHI
201911206001	HIDROLANDIA	00360234	CEPAIGO S2	19/11/2019 10:07	19/11/2019 22:13	19/11/2019 20:42	19/11/2019 21:49	1,11	817	910,95	CHI
201911206001	HIDROLANDIA	HD13200318	CEPAIGO S2	19/11/2019 10:07	19/11/2019 22:13	19/11/2019 22:01	19/11/2019 22:13	0,20	1416	283,59	CHI
201911206102	NOVA VENEZA	NV11219025	NEROPOLIS S1	19/11/2019 10:16	19/11/2019 16:56	19/11/2019 10:16	19/11/2019 16:56	6,66	32	213,12	CHI
201911206105	FORMOSA	FA12071048	ITIQUEIRA	19/11/2019 10:16	19/11/2019 17:12	19/11/2019 10:16	19/11/2019 17:12	6,92	14	96,92	CHI
201911206109	AGUAS LINDAS DE GOIAS	LA11164946	AGUAS LINDAS DE GOIAS S1	19/11/2019 10:16	19/11/2019 12:36	19/11/2019 10:16	19/11/2019 12:36	2,32	186	431,21	CHI
201911206113	CAMPINORTE	5740001199	MARA ROSA	19/11/2019 10:17	19/11/2019 12:36	19/11/2019 10:17	19/11/2019 12:36	2,31	1	2,31	CHI
201911206114	TURVANIA	TV12005552	FIRMINOPOLIS S2	19/11/2019 10:17	19/11/2019 11:20	19/11/2019 10:17	19/11/2019 11:20	1,05	2	2,09	CHI
201911206115	PIRENOPOLIS	PV21172900	CORUMBA	19/11/2019 10:17	19/11/2019 18:48	19/11/2019 10:17	19/11/2019 18:48	8,50	1	8,50	CHI
201911206117	CATURAI	CK12014362	INHUMAS S1	19/11/2019 09:52	19/11/2019 15:59	19/11/2019 09:52	19/11/2019 15:59	6,10	1	6,10	CHI
201911206117	INHUMAS	CK12014362	INHUMAS S1	19/11/2019 09:52	19/11/2019 15:59	19/11/2019 09:52	19/11/2019 15:59	6,10	2	12,20	CHI
201911206118	ANAPOLIS	AN31196826	NEROPOLIS S1	19/11/2019 10:17	19/11/2019 17:34	19/11/2019 10:17	19/11/2019 17:34	7,27	2	14,54	CHI
201911206119	BURITI DE GOIAS	BS12308352	FIRMINOPOLIS S2	19/11/2019 10:18	19/11/2019 17:51	19/11/2019 10:18	19/11/2019 17:51	7,56	4	30,23	CHI
201911206122	MONTE ALEGRE DE GOIAS	MA21230262	SAO DOMINGOS	19/11/2019 10:18	19/11/2019 20:37	19/11/2019 10:18	19/11/2019 20:37	10,30	1	10,30	CHI
201911206125	GOIATUBA	GT12392084	GOIATUBA S2	19/11/2019 10:16	20/11/2019 16:51	19/11/2019 10:16	20/11/2019 16:51	30,58	20	611,56	CHI
201911206126	SANTO ANTONIO DA BARRA	BZ12301385	ACREUNA	19/11/2019 10:20	21/11/2019 11:40	19/11/2019 10:20	21/11/2019 11:40	49,34	2	98,68	CHI
201911206126	SANTO ANTONIO DA BARRA	BZ12301385	ACREUNA	19/11/2019 10:20	21/11/2019 11:40	21/11/2019 08:20	21/11/2019 11:40	3,34	7	23,38	CHI
201911206130	VILA PROPICIO	GE21185202	GOIANESIA S2	19/11/2019 10:20	20/11/2019 11:20	19/11/2019 10:20	20/11/2019 11:20	24,99	1	24,99	CHI
201911206201	PADRE BERNARDO	9980022376	PADRE BERNARDO	19/11/2019 10:20	19/11/2019 17:25	19/11/2019 10:20	19/11/2019 17:25	7,07	1	7,07	CHI
201911206202	CORREGO DO OURO	CO21227457	FIRMINOPOLIS S2	19/11/2019 10:21	19/11/2019 14:00	19/11/2019 10:21	19/11/2019 14:00	3,66	1	3,66	CHI
201911206403	APARECIDA DE GOIANIA	12065985	REAL S1	19/11/2019 10:21	19/11/2019 18:02	19/11/2019 10:21	19/11/2019 18:02	7,67	1	7,67	CHI
201911206408	TROMBAS	TB12288317	PORANGATU	19/11/2019 10:21	19/11/2019 12:24	19/11/2019 10:21	19/11/2019 12:24	2,04	6	12,22	CHI
201911206409	SAO MIGUEL DO ARAGUAIA	SM10388763	SAO MIGUEL DO ARAGUAIA	19/11/2019 10:21	21/11/2019 04:04	20/11/2019 22:32	20/11/2019 22:50	0,30	53	15,90	CHI
201911206409	SAO MIGUEL DO ARAGUAIA	SM13182440	SAO MIGUEL DO ARAGUAIA	19/11/2019 10:21	21/11/2019 04:04	20/11/2019 22:32	21/11/2019 02:21	3,82	252	962,92	CHI
201911206409	SAO MIGUEL DO ARAGUAIA	SM12031421	SAO MIGUEL DO ARAGUAIA	19/11/2019 10:21	21/11/2019 04:04	19/11/2019 10:21	21/11/2019 04:04	41,70	18	750,63	CHI
201911206413	SANTO ANTONIO DO DESCOBERTO	SN12330527	MARAJOARA	19/11/2019 10:22	19/11/2019 16:40	19/11/2019 10:22	19/11/2019 16:40	6,29	9	56,59	CHI

201911206418	CAMPINACU	UC12354229	MARA ROSA	19/11/2019 10:23	19/11/2019 12:51	19/11/2019 10:23	19/11/2019 12:51	2,46	16	39,37	CHI
201911206420	POSSE	PS12256102	IACIARA S2	19/11/2019 08:38	19/11/2019 11:54	19/11/2019 08:38	19/11/2019 11:54	3,26	6	19,55	CHI
201911206429	JARAGUA	3230002074	GOIANESIA S2	19/11/2019 10:24	20/11/2019 14:52	19/11/2019 10:24	20/11/2019 14:52	28,45	1	28,45	CHI
201911206433	SAO JOAO D ALIANCA	JL21159894	SAO JOAO D ALIANCA	19/11/2019 10:25	20/11/2019 16:08	19/11/2019 10:25	20/11/2019 16:08	29,71	1	29,71	CHI
201911206435	PORANGATU	PO12363572	PORANGATU	19/11/2019 09:40	20/11/2019 17:15	19/11/2019 09:40	20/11/2019 16:06	30,44	6	182,66	CHI
201911206435	PORANGATU	PO12236178	PORANGATU	19/11/2019 09:40	20/11/2019 17:15	19/11/2019 09:40	20/11/2019 17:15	31,58	3	94,74	CHI
201911206440	LUZIANIA	LZ12261608	VIANOPOLIS	19/11/2019 10:25	19/11/2019 13:04	19/11/2019 10:25	19/11/2019 13:04	2,64	69	181,83	CHI
201911206443	SAO MIGUEL DO PASSA QUATRO	SQ12373971	BELA VISTA S2	19/11/2019 10:26	20/11/2019 13:05	19/11/2019 10:26	20/11/2019 13:05	26,65	2	53,29	CHI
201911206444	CEZARINA	CZ12010355	CEZARINA	19/11/2019 09:52	19/11/2019 11:50	19/11/2019 09:52	19/11/2019 11:50	1,97	8	15,76	CHI
201911206446	TRINDADE	TR21323248	TRINDADE	19/11/2019 10:26	20/11/2019 02:53	19/11/2019 10:26	20/11/2019 02:53	16,44	1	16,44	CHI
201911206447	ANAPOLIS	10019942883	JUNDIAI S1	19/11/2019 10:27	19/11/2019 17:11	19/11/2019 10:27	19/11/2019 17:11	6,74	1	6,74	CHI
201911206449	TURVELANDIA	TD21240353	RIO DOS BOIS	19/11/2019 10:27	20/11/2019 09:16	19/11/2019 10:27	20/11/2019 09:16	22,81	3	68,44	CHI
201911206460	VIANOPOLIS	OZ21339035	VIANOPOLIS	19/11/2019 10:29	20/11/2019 11:13	19/11/2019 10:29	20/11/2019 11:13	24,73	2	49,46	CHI
201911206506	DOVERLANDIA	DV12171957	CAIAPONIA	19/11/2019 10:30	19/11/2019 20:13	19/11/2019 10:30	19/11/2019 20:13	9,71	20	194,22	CHI
201911206508	PLANALTINA	2960168155	PLANALTINA	19/11/2019 10:30	19/11/2019 15:51	19/11/2019 10:30	19/11/2019 15:51	5,34	1	5,34	CHI
201911206525	LEOPOLDO DE BULHOES	LB31068732	DAIA S1	19/11/2019 10:32	19/11/2019 18:32	19/11/2019 10:32	19/11/2019 18:32	7,99	2	15,98	CHI
201911206526	INDIARA	JD12323638	ACREUNA	19/11/2019 07:55	19/11/2019 14:19	19/11/2019 07:55	19/11/2019 14:19	6,40	3	19,20	CHI
201911206526	JANDAIA	JD12323638	ACREUNA	19/11/2019 07:55	19/11/2019 14:19	19/11/2019 07:55	19/11/2019 14:19	6,40	12	76,80	CHI
201911206536	PORANGATU	TA12114216	NOVO PLANALTO	19/11/2019 10:34	19/11/2019 19:00	19/11/2019 10:34	19/11/2019 19:00	8,43	6	50,58	CHI
201911206541	EDEIA	EA21040328	EDEIA	19/11/2019 10:34	19/11/2019 15:37	19/11/2019 10:34	19/11/2019 15:37	5,04	1	5,04	CHI
201911206543	VALPARAISO DE GOIAS	10008129884	MARAJOARA	19/11/2019 10:35	19/11/2019 18:01	19/11/2019 10:35	19/11/2019 18:01	7,43	1	7,43	CHI
201911206546	GOIANAPOLIS	10000890837	DAIA S2	19/11/2019 10:35	19/11/2019 19:30	19/11/2019 10:35	19/11/2019 19:30	8,91	1	8,91	CHI
201911206549	CRISTIANOPOLIS	470007023	CRISTIANOPOLIS	19/11/2019 10:34	20/11/2019 10:02	19/11/2019 10:34	20/11/2019 10:02	23,45	1	23,45	CHI
201911206701	ALTO PARAISO DE GOIAS	BF12180774	FLORES DE GOIAS	19/11/2019 06:41	19/11/2019 14:51	19/11/2019 06:41	19/11/2019 14:51	8,16	13	106,13	CHI
201911206902	CRISTALINA	KR12068384	PAMPLONA	19/11/2019 10:26	19/11/2019 12:45	19/11/2019 10:26	19/11/2019 12:45	2,30	28	64,53	CHI
201911206903	ABADIANIA	AA21062504	ANAPOLIS UNIVERSITARIO S1	19/11/2019 10:36	19/11/2019 14:55	19/11/2019 10:36	19/11/2019 14:55	4,32	1	4,32	CHI
201911206911	RIO VERDE	630565594	RIO VERDE S2	19/11/2019 10:37	19/11/2019 13:19	19/11/2019 10:37	19/11/2019 13:19	2,70	1	2,70	CHI
201911206913	CATALAO	CT21268400	CATALAO S1	19/11/2019 10:38	20/11/2019 03:33	19/11/2019 10:38	20/11/2019 03:33	16,92	1	16,92	CHI
201911206915	DIORAMA	DI12024600	ARENOPOLIS	19/11/2019 10:38	20/11/2019 22:33	19/11/2019 10:38	20/11/2019 22:33	35,91	4	143,66	CHI
201911206915	MONTES CLAROS DE GOIAS	DI12024600	ARENOPOLIS	19/11/2019 10:38	20/11/2019 22:33	19/11/2019 10:38	20/11/2019 22:33	35,91	1	35,91	CHI
201911206919	CATALAO	1990065767	CATALAO S2	19/11/2019 10:39	19/11/2019 14:21	19/11/2019 10:39	19/11/2019 14:21	3,69	1	3,69	CHI
201911207302	VILA PROPICIO	NP21140605	GOIANESIA S1	19/11/2019 10:41	19/11/2019 16:45	19/11/2019 10:41	19/11/2019 16:45	6,06	1	6,06	CHI
201911207305	SANTA FE DE GOIAS	RN12009764	BRITANIA	19/11/2019 10:39	20/11/2019 20:10	19/11/2019 10:39	20/11/2019 20:10	33,50	6	201,02	CHI

201911207402	IPAMERI	580117443	IPAMERI	19/11/2019 10:42	19/11/2019 17:34	19/11/2019 10:42	19/11/2019 17:34	6,87	1	6,87	CHI
201911207406	NOVO GAMA	NJ21373442	MARAJOARA	19/11/2019 10:43	19/11/2019 13:19	19/11/2019 10:43	19/11/2019 13:19	2,60	3	7,80	CHI
201911207410	LUZIANIA	LZ21315946	MARAJOARA	19/11/2019 10:44	19/11/2019 20:58	19/11/2019 10:44	19/11/2019 20:58	10,23	1	10,23	CHI
201911207418	LUZIANIA	10004822232	RIO VERMELHO	19/11/2019 10:46	19/11/2019 11:33	19/11/2019 10:46	19/11/2019 11:33	0,78	0	0,00	CHI
201911207602	MINACU	IH11262700	MINACU	19/11/2019 10:47	20/11/2019 03:55	19/11/2019 10:47	20/11/2019 03:55	17,13	17	291,13	CHI
201911207607	AGUA FRIA DE GOIAS	10004492305	SAO JOAO D ALIANCA	19/11/2019 10:48	21/11/2019 00:55	19/11/2019 10:48	21/11/2019 00:55	38,11	1	38,11	CHI
201911207610	SANTA RITA DO ARAGUAIA	SU12324789	SANTA RITA DO ARAGUAIA	19/11/2019 10:49	19/11/2019 18:59	19/11/2019 10:49	19/11/2019 18:59	8,16	4	32,66	CHI
201911207611	PARAUNA	PU21159079	PARAUNA	19/11/2019 10:49	20/11/2019 18:29	19/11/2019 10:49	20/11/2019 18:29	31,68	1	31,68	CHI
201911207614	SERRANOPOLIS	300006082	JATAI S1	19/11/2019 10:49	19/11/2019 14:46	19/11/2019 10:49	19/11/2019 14:46	3,94	1	3,94	CHI
201911207619	CATALAO	IO12077586	CATALAO S1	19/11/2019 10:48	19/11/2019 16:39	19/11/2019 10:48	19/11/2019 16:24	5,61	1	5,61	CHI
201911207619	DAVINOPOLIS	IO12077586	CATALAO S1	19/11/2019 10:48	19/11/2019 16:39	19/11/2019 10:48	19/11/2019 16:24	5,61	15	84,14	CHI
201911207619	CATALAO	IO12077586	CATALAO S1	19/11/2019 10:48	19/11/2019 16:39	19/11/2019 16:25	19/11/2019 16:39	0,22	1	0,22	CHI
201911207619	DAVINOPOLIS	IO12077586	CATALAO S1	19/11/2019 10:48	19/11/2019 16:39	19/11/2019 16:25	19/11/2019 16:39	0,22	15	3,36	CHI
201911207621	CATALAO	CT21165283	CATALAO S1	19/11/2019 10:50	20/11/2019 00:47	19/11/2019 10:50	20/11/2019 00:47	13,93	1	13,93	CHI
201911207622	JARAGUA	JA12273002	JARAGUA	19/11/2019 10:51	19/11/2019 18:38	19/11/2019 10:51	19/11/2019 18:38	7,78	25	194,58	CHI
201911207623	MINEIROS	MY12184176	PARQUE DAS EMAS	19/11/2019 10:51	19/11/2019 11:16	19/11/2019 10:51	19/11/2019 11:16	0,41	7	2,87	CHI
201911207624	ANAPOLIS	10000469252	JUNDIAI S1	19/11/2019 10:51	19/11/2019 20:18	19/11/2019 10:51	19/11/2019 20:18	9,44	1	9,44	CHI
201911207719	LUZIANIA	10016676228	RIO VERMELHO	19/11/2019 10:53	19/11/2019 11:42	19/11/2019 10:53	19/11/2019 11:42	0,81	1	0,81	CHI
201911207721	BURITI DE GOIAS	BS12099749	FIRMINOPOLIS S2	19/11/2019 10:54	19/11/2019 12:02	19/11/2019 10:54	19/11/2019 12:02	1,13	8	9,03	CHI
201911207725	DISTRITO FEDERAL	CW21325463	ITUIQUIRA	19/11/2019 10:54	19/11/2019 14:08	19/11/2019 10:54	19/11/2019 14:08	3,22	1	3,22	CHI
201911207729	PETROLINA DE GOIAS	OV21193776	NEROPOLIS S1	19/11/2019 10:55	19/11/2019 16:47	19/11/2019 10:55	19/11/2019 16:47	5,86	2	11,72	CHI
201911207733	GOIANIA	GN11076705	MEIA PONTE	19/11/2019 10:21	19/11/2019 15:40	19/11/2019 10:21	19/11/2019 15:40	5,31	232	1231,21	CHI
201911207736	NOVO GAMA	4990055148	PACAEMBU S1	19/11/2019 10:56	19/11/2019 12:30	19/11/2019 10:56	19/11/2019 12:30	1,56	1	1,56	CHI
201911207739	ABADIANIA	AA21141865	ANAPOLIS UNIVERSITARIO S1	19/11/2019 10:56	20/11/2019 09:26	19/11/2019 10:56	20/11/2019 09:26	22,49	1	22,49	CHI
201911207740	CAMPINORTE	10003163120	CAMPINORTE	19/11/2019 10:56	19/11/2019 17:41	19/11/2019 10:56	19/11/2019 17:41	6,74	1	6,74	CHI
201911207743	CACHOEIRA DOURADA	CD12000005	CACHOEIRA DOURADA	19/11/2019 09:26	19/11/2019 15:31	19/11/2019 09:26	19/11/2019 15:31	6,08	16	97,27	CHI
201911207743	ITUMBIARA	CD12000005	CACHOEIRA DOURADA	19/11/2019 09:26	19/11/2019 15:31	19/11/2019 09:26	19/11/2019 15:31	6,08	10	60,79	CHI
201911207748	CAIAPONIA	CP11245319	CAIAPONIA	19/11/2019 10:58	20/11/2019 14:13	19/11/2019 10:58	20/11/2019 14:13	27,25	1	27,25	CHI
201911207749	ITUMBIARA	IT12273840RE	ITUMBIARA NOVA	19/11/2019 09:07	19/11/2019 12:36	19/11/2019 09:07	19/11/2019 12:36	3,48	44	152,96	CHI
201911207809	ANAPOLIS	20507847	ANAPOLIS UNIVERSITARIO S1	19/11/2019 11:01	19/11/2019 12:01	19/11/2019 11:01	19/11/2019 12:01	0,99	1	0,99	CHI
201911207815	CAMPO ALEGRE DE GOIAS	CM12358430RE	CAMPO ALEGRE DE GOIAS	19/11/2019 07:22	22/11/2019 00:31	19/11/2019 07:22	19/11/2019 17:08	9,77	29	283,26	CHI
201911207815	IPAMERI	CM12358430RE	CAMPO ALEGRE DE GOIAS	19/11/2019 07:22	22/11/2019 00:31	19/11/2019 07:22	19/11/2019 17:08	9,77	20	195,35	CHI
201911207815	CAMPO ALEGRE DE GOIAS	IP13265554	CAMPO ALEGRE DE GOIAS	19/11/2019 07:22	22/11/2019 00:31	19/11/2019 07:22	20/11/2019 09:25	26,06	4	104,24	CHI

201911207815	IPAMERI	IP13265554	CAMPO ALEGRE DE GOIAS	19/11/2019 07:22	22/11/2019 00:31	19/11/2019 07:22	20/11/2019 09:25	26,06	53	1381,19	CHI
201911207815	CAMPO ALEGRE DE GOIAS	CM12358430RE	CAMPO ALEGRE DE GOIAS	19/11/2019 07:22	22/11/2019 00:31	19/11/2019 17:25	20/11/2019 20:32	27,12	8	216,96	CHI
201911207815	CAMPO ALEGRE DE GOIAS	CM13270752	CAMPO ALEGRE DE GOIAS	19/11/2019 07:22	22/11/2019 00:31	19/11/2019 17:25	22/11/2019 00:31	55,10	21	1157,15	CHI
201911207815	IPAMERI	CM13270752	CAMPO ALEGRE DE GOIAS	19/11/2019 07:22	22/11/2019 00:31	19/11/2019 17:25	22/11/2019 00:31	55,10	20	1102,05	CHI
201911207830	BARRO ALTO	GE12256025	GOIANESIA S1	19/11/2019 11:05	19/11/2019 16:04	19/11/2019 11:05	19/11/2019 16:04	4,97	1	4,97	CHI
201911207830	GOIANESIA	GE12256025	GOIANESIA S1	19/11/2019 11:05	19/11/2019 16:04	19/11/2019 11:05	19/11/2019 16:04	4,97	2	9,94	CHI
201911207843	JATAI	10005378301	JATAI S2	19/11/2019 11:07	19/11/2019 15:45	19/11/2019 11:07	19/11/2019 15:45	4,63	1	4,63	CHI
201911207855	ITUMBUIARA	IT12392119	BOM JESUS DE GOIAS	19/11/2019 11:09	19/11/2019 14:50	19/11/2019 11:09	19/11/2019 14:50	3,68	6	22,06	CHI
201911207861	ARAGUAPAZ	AZ21388227	GOIAS	19/11/2019 11:10	21/11/2019 14:16	19/11/2019 11:10	21/11/2019 14:16	51,09	1	51,09	CHI
201911207871	MINACU	4020043633	MINACU	19/11/2019 11:13	20/11/2019 09:42	19/11/2019 11:13	20/11/2019 09:42	22,47	1	22,47	CHI
201911207875	JATAI	10017809086	JATAI S3	19/11/2019 11:13	19/11/2019 16:43	19/11/2019 11:13	19/11/2019 16:43	5,49	1	5,49	CHI
201911207876	LUZIANIA	10009113779	RIO VERMELHO	19/11/2019 11:14	19/11/2019 13:58	19/11/2019 11:14	19/11/2019 13:58	2,73	1	2,73	CHI
201911207879	PIRENOPOLIS	PV21135417	JARAGUA	19/11/2019 11:14	20/11/2019 16:52	19/11/2019 11:14	20/11/2019 16:52	29,62	1	29,62	CHI
201911207881	AGUA LIMPA	AL21166420	VILA CORUMBA	19/11/2019 11:14	20/11/2019 20:35	19/11/2019 11:14	20/11/2019 20:35	33,34	1	33,34	CHI
201911207889	VALPARAISO DE GOIAS	10004624074	PACAEMBU S2	19/11/2019 11:16	19/11/2019 17:15	19/11/2019 11:16	19/11/2019 17:15	5,97	1	5,97	CHI
201911207890	CALDAS NOVAS	CN21193833	CALDAS NOVAS S1	19/11/2019 11:17	20/11/2019 18:01	19/11/2019 11:17	20/11/2019 18:01	30,73	2	61,46	CHI
201911207897	TRINDADE	TR11230644	TRINDADE	19/11/2019 10:55	19/11/2019 13:00	19/11/2019 10:55	19/11/2019 13:00	2,07	68	140,87	CHI
201911207898	SILVANIA	660073985	VIANOPOLIS	19/11/2019 11:18	19/11/2019 17:02	19/11/2019 11:18	19/11/2019 17:02	5,73	1	5,73	CHI
201911207912	PORANGATU	PO12297141	PORANGATU	19/11/2019 11:21	21/11/2019 12:05	19/11/2019 11:21	20/11/2019 21:01	33,67	3	101,02	CHI
201911207912	PORANGATU	PO12297141	PORANGATU	19/11/2019 11:21	21/11/2019 12:05	19/11/2019 11:21	21/11/2019 05:38	42,28	5	211,40	CHI
201911207912	PORANGATU	PO12297141	PORANGATU	19/11/2019 11:21	21/11/2019 12:05	19/11/2019 11:21	21/11/2019 12:05	48,73	7	341,08	CHI
201911207913	TURVELANDIA	TD21281221	RIO DOS BOIS	19/11/2019 11:21	20/11/2019 11:20	19/11/2019 11:21	20/11/2019 11:20	23,97	2	47,94	CHI
201911207917	GOIANIA	GN11065327	AEROPORTO S1	19/11/2019 11:24	19/11/2019 23:41	19/11/2019 11:24	19/11/2019 23:41	12,29	16	196,56	CHI
201911207920	NOVO BRASIL	NB21290153	JUSSARA	19/11/2019 11:24	20/11/2019 18:58	19/11/2019 11:24	20/11/2019 18:58	31,57	1	31,57	CHI
201911207926	FORMOSO	FO12145300	PORANGATU	19/11/2019 11:24	20/11/2019 01:40	19/11/2019 11:24	20/11/2019 01:40	14,25	11	156,76	CHI
201911207927	APARECIDA DE GOIANIA	14630011	INDEPENDENCIA S2	19/11/2019 11:25	19/11/2019 17:22	19/11/2019 11:25	19/11/2019 17:22	5,95	1	5,95	CHI
201911207930	BOM JARDIM DE GOIAS	BM12325755	BOM JARDIM	19/11/2019 06:47	20/11/2019 13:16	19/11/2019 06:47	20/11/2019 13:16	30,48	6	182,89	CHI
201911207944	GOIANIA	10013884326	CARAJAS S1	19/11/2019 11:27	19/11/2019 23:45	19/11/2019 11:27	19/11/2019 23:45	12,30	1	12,30	CHI
201911207948	AGUAS LINDAS DE GOIAS	6830007867	AGUAS LINDAS DE GOIAS S2	19/11/2019 11:28	19/11/2019 15:47	19/11/2019 11:28	19/11/2019 15:47	4,30	1	4,30	CHI
201911207957	IPAMERI	IP21275748	IPAMERI	19/11/2019 11:29	20/11/2019 12:07	19/11/2019 11:29	20/11/2019 12:07	24,62	1	24,62	CHI
201911207961	NIQUELANDIA	NQ21147659	URUACU	19/11/2019 11:31	20/11/2019 09:47	19/11/2019 11:31	20/11/2019 09:47	22,26	1	22,26	CHI
201911207965	MORRINHOS	MR21102239	MORRINHOS	19/11/2019 11:31	19/11/2019 17:20	19/11/2019 11:31	19/11/2019 17:20	5,81	1	5,81	CHI
201911207975	GOIANIA	GN11001597	GOIANIA LESTE S1	19/11/2019 11:33	19/11/2019 16:52	19/11/2019 11:33	19/11/2019 16:52	5,31	60	318,63	CHI

201911207985	GOIAS	GS21116961	MATRINCHA	19/11/2019 11:36	19/11/2019 17:25	19/11/2019 11:36	19/11/2019 17:25	5,81	1	5,81	CHI
201911207988	GOIANIA	GN11166706	CAMPINAS S2	19/11/2019 11:36	19/11/2019 18:52	19/11/2019 11:36	19/11/2019 18:52	7,26	77	558,70	CHI
201911207989	MORRINHOS	MR21120816	MORRINHOS	19/11/2019 09:09	19/11/2019 14:30	19/11/2019 09:09	19/11/2019 14:30	5,35	1	5,35	CHI
201911208010	ACREUNA	00080424	ACREUNA	19/11/2019 12:12	19/11/2019 12:43	19/11/2019 12:12	19/11/2019 12:43	0,51	28	14,36	CHI
201911208010	INDIARA	00080424	ACREUNA	19/11/2019 12:12	19/11/2019 12:43	19/11/2019 12:12	19/11/2019 12:43	0,51	20	10,26	CHI
201911208010	JANDAIA	00080424	ACREUNA	19/11/2019 12:12	19/11/2019 12:43	19/11/2019 12:12	19/11/2019 12:43	0,51	21	10,77	CHI
201911208010	PARAUNA	00080424	ACREUNA	19/11/2019 12:12	19/11/2019 12:43	19/11/2019 12:12	19/11/2019 12:43	0,51	1	0,51	CHI
201911208011	QUIRINOPOLIS	QI32052465	SANTA HELENA S1	17/11/2019 18:44	20/11/2019 23:40	17/11/2019 18:44	20/11/2019 23:35	76,85	6	461,10	CHI
201911208011	QUIRINOPOLIS	QI32052465	SANTA HELENA S1	17/11/2019 18:44	20/11/2019 23:40	20/11/2019 23:36	20/11/2019 23:40	0,06	6	0,38	CHI
201911208014	PIRACANJUBA	01460214	PIRACANJUBA	19/11/2019 12:38	19/11/2019 21:11	19/11/2019 12:38	19/11/2019 14:08	1,49	2991	4449,11	CHI
201911208014	PIRACANJUBA	01460214	PIRACANJUBA	19/11/2019 12:38	19/11/2019 21:11	19/11/2019 12:38	19/11/2019 21:11	8,55	297	2539,19	CHI
201911208014	PROFESSOR JAMIL SAFADY	01460214	PIRACANJUBA	19/11/2019 12:38	19/11/2019 21:11	19/11/2019 12:38	19/11/2019 21:11	8,55	3	25,65	CHI
201911208014	PIRACANJUBA	PJ13083731	PIRACANJUBA	19/11/2019 12:38	19/11/2019 21:11	19/11/2019 12:40	19/11/2019 21:11	8,52	1	8,52	CHI
201911208043	PARAUNA	05760414	PARAUNA	19/11/2019 14:35	20/11/2019 13:07	19/11/2019 14:35	19/11/2019 17:23	2,81	45	126,57	CHI
201911208043	JANDAIA	05760414	PARAUNA	19/11/2019 14:35	20/11/2019 13:07	19/11/2019 14:35	19/11/2019 20:38	6,06	3	18,17	CHI
201911208043	PARAUNA	05760414	PARAUNA	19/11/2019 14:35	20/11/2019 13:07	19/11/2019 14:35	19/11/2019 20:38	6,06	44	266,53	CHI
201911208043	PARAUNA	05760414	PARAUNA	19/11/2019 14:35	20/11/2019 13:07	19/11/2019 20:39	19/11/2019 20:49	0,16	45	7,01	CHI
201911208043	JANDAIA	PU13100616	PARAUNA	19/11/2019 14:35	20/11/2019 13:07	19/11/2019 20:39	19/11/2019 22:25	1,76	3	5,27	CHI
201911208043	PARAUNA	PU13100616	PARAUNA	19/11/2019 14:35	20/11/2019 13:07	19/11/2019 20:39	19/11/2019 22:25	1,76	42	73,78	CHI
201911208043	PARAUNA	05760414	PARAUNA	19/11/2019 14:35	20/11/2019 13:07	19/11/2019 14:35	20/11/2019 00:04	9,49	152	1441,89	CHI
201911208043	RIO VERDE	05760414	PARAUNA	19/11/2019 14:35	20/11/2019 13:07	19/11/2019 14:35	20/11/2019 00:04	9,49	2	18,97	CHI
201911208043	PARAUNA	PU13152645	PARAUNA	19/11/2019 14:35	20/11/2019 13:07	19/11/2019 20:39	20/11/2019 13:07	16,45	2	32,91	CHI
201911208060	GOIANIA	GN11352973	GOYA S1	19/11/2019 12:02	19/11/2019 15:20	19/11/2019 12:02	19/11/2019 15:20	3,29	53	174,40	CHI
201911208080	SAO DOMINGOS	SD12035858	SAO DOMINGOS	19/11/2019 15:36	19/11/2019 17:39	19/11/2019 15:36	19/11/2019 17:39	2,04	904	1841,90	CHI
201911208100	SAO MIGUEL DO ARAGUAIA	01710414	SAO MIGUEL DO ARAGUAIA	19/11/2019 16:31	19/11/2019 19:54	19/11/2019 16:35	19/11/2019 17:48	1,23	9	11,07	CHI
201911208100	SAO MIGUEL DO ARAGUAIA	SM13220857	SAO MIGUEL DO ARAGUAIA	19/11/2019 16:31	19/11/2019 19:54	19/11/2019 16:35	19/11/2019 18:50	2,26	20	45,19	CHI
201911208100	SAO MIGUEL DO ARAGUAIA	SM13394733B	SAO MIGUEL DO ARAGUAIA	19/11/2019 16:31	19/11/2019 19:54	19/11/2019 16:35	19/11/2019 19:40	3,09	178	549,97	CHI
201911208100	NOVA CRIXAS	01710414	SAO MIGUEL DO ARAGUAIA	19/11/2019 16:31	19/11/2019 19:54	19/11/2019 16:31	19/11/2019 19:54	3,38	1	3,38	CHI
201911208100	SAO MIGUEL DO ARAGUAIA	01710414	SAO MIGUEL DO ARAGUAIA	19/11/2019 16:31	19/11/2019 19:54	19/11/2019 16:31	19/11/2019 19:54	3,38	1028	3475,50	CHI
201911208100	SAO MIGUEL DO ARAGUAIA	SM13086467	SAO MIGUEL DO ARAGUAIA	19/11/2019 16:31	19/11/2019 19:54	19/11/2019 16:35	19/11/2019 19:54	3,32	16	53,08	CHI
201911208102	SENADOR CANEDO	SW11356060	SENADOR CANEDO	19/11/2019 11:37	19/11/2019 13:51	19/11/2019 11:37	19/11/2019 13:51	2,22	52	115,45	CHI
201911208106	MOSSAMEDES	8080000167	FIRMINOPOLIS S2	19/11/2019 11:39	19/11/2019 14:27	19/11/2019 11:39	19/11/2019 14:27	2,79	1	2,79	CHI
201911208108	ABADIANIA	AA21297772	ANAPOLIS UNIVERSITARIO S1	19/11/2019 11:39	20/11/2019 08:18	19/11/2019 11:39	20/11/2019 08:18	20,64	1	20,64	CHI

201911208110	NOVA ROMA	ND12256420	IACIARA S2	19/11/2019 11:06	19/11/2019 17:00	19/11/2019 11:06	19/11/2019 17:00	5,89	28	164,94	CHI
201911208117	ANAPOLIS	AN21212519	JUNDIAI S2	19/11/2019 11:42	20/11/2019 10:29	19/11/2019 11:42	20/11/2019 10:29	22,78	1	22,78	CHI
201911208126	GOIANIA	10905832	FERROVIARIO S2	19/11/2019 11:44	19/11/2019 18:43	19/11/2019 11:44	19/11/2019 18:43	6,98	1	6,98	CHI
201911208132	FLORES DE GOIAS	FB12404369	FLORES DE GOIAS	19/11/2019 11:45	20/11/2019 15:19	19/11/2019 11:45	20/11/2019 15:19	27,57	38	1047,69	CHI
201911208134	GOIANIA	16647944	XAVANTES	19/11/2019 11:45	19/11/2019 17:31	19/11/2019 11:45	19/11/2019 17:31	5,75	1	5,75	CHI
201911208144	PIRACANJUBA	PJ12036384	CRISTIANOPOLIS	19/11/2019 10:36	19/11/2019 13:07	19/11/2019 10:36	19/11/2019 13:07	2,53	14	35,42	CHI
201911208145	ITAJA	IJ21154804	ITAJA S2	19/11/2019 11:47	19/11/2019 13:56	19/11/2019 11:47	19/11/2019 13:56	2,14	1	2,14	CHI
201911208147	ITUMBIARA	IT12310071	ITUMBIARA VELHA S1	19/11/2019 11:48	19/11/2019 12:15	19/11/2019 11:48	19/11/2019 12:15	0,45	12	5,36	CHI
201911208148	BONFINOPOLIS	BV12258434	GOIANIA LESTE S2	19/11/2019 11:48	20/11/2019 15:47	19/11/2019 11:48	20/11/2019 15:47	27,98	1	27,98	CHI
201911208148	SENADOR CANEDO	BV12258434	GOIANIA LESTE S2	19/11/2019 11:48	20/11/2019 15:47	19/11/2019 11:48	20/11/2019 15:47	27,98	4	111,92	CHI
201911208155	AGUAS LINDAS DE GOIAS	10004882855	AGUAS LINDAS DE GOIAS S1	19/11/2019 11:49	19/11/2019 14:19	19/11/2019 11:49	19/11/2019 14:19	2,50	1	2,50	CHI
201911208157	PIRANHAS	10016644113	PIRANHAS	19/11/2019 11:49	19/11/2019 17:41	19/11/2019 11:49	19/11/2019 17:41	5,87	1	5,87	CHI
201911208162	AGUA FRIA DE GOIAS	4140005090	SAO JOAO D ALIANCA	19/11/2019 11:50	20/11/2019 02:25	19/11/2019 11:50	20/11/2019 02:25	14,58	1	14,58	CHI
201911208304	JARAGUA	JA12000152	JARAGUA	19/11/2019 11:54	19/11/2019 19:13	19/11/2019 11:54	19/11/2019 19:13	7,32	1	7,32	CHI
201911208305	ADELANDIA	DN12145856	FIRMINOPOLIS S2	19/11/2019 11:54	19/11/2019 14:37	19/11/2019 11:54	19/11/2019 14:37	2,72	20	54,49	CHI
201911208306	BELA VISTA DE GOIAS	DE12389424	CEPAIGO S2	19/11/2019 07:29	19/11/2019 16:27	19/11/2019 07:29	19/11/2019 16:27	8,95	176	1575,98	CHI
201911208306	CALDAZINHA	DE12389424	CEPAIGO S2	19/11/2019 07:29	19/11/2019 16:27	19/11/2019 07:29	19/11/2019 16:27	8,95	66	590,99	CHI
201911208312	BALIZA	BH21193429	BOM JARDIM	19/11/2019 11:54	19/11/2019 14:41	19/11/2019 11:54	19/11/2019 14:41	2,77	1	2,77	CHI
201911208317	TRINDADE	TR11014605	TRINDADE	19/11/2019 10:54	19/11/2019 13:38	19/11/2019 10:54	19/11/2019 13:38	2,72	235	638,94	CHI
201911208325	GOIANDIRA	2010008577	CATALAO S1	19/11/2019 11:57	19/11/2019 17:12	19/11/2019 11:57	19/11/2019 17:12	5,24	1	5,24	CHI
201911208326	APARECIDA DE GOIANIA	AP11003039	REAL S2	19/11/2019 11:30	19/11/2019 22:56	19/11/2019 11:30	19/11/2019 22:56	11,43	107	1223,16	CHI
201911208331	RIO VERDE	02450414	MONTIVIDIU T	19/11/2019 13:10	21/11/2019 14:11	19/11/2019 13:10	19/11/2019 15:53	2,71	41	111,04	CHI
201911208331	RIO VERDE	02450414	CABRIUVA S2	19/11/2019 13:10	21/11/2019 14:11	19/11/2019 13:10	19/11/2019 21:57	8,77	59	517,43	CHI
201911208331	RIO VERDE	RV10212406	CABRIUVA S2	19/11/2019 13:10	21/11/2019 14:11	19/11/2019 13:11	19/11/2019 21:57	8,76	1	8,76	CHI
201911208331	RIO VERDE	02450414	CABRIUVA S2	19/11/2019 13:10	21/11/2019 14:11	19/11/2019 13:10	21/11/2019 03:00	37,82	1	37,82	CHI
201911208331	RIO VERDE	RV13357269	CABRIUVA S2	19/11/2019 13:10	21/11/2019 14:11	20/11/2019 16:09	21/11/2019 03:00	10,84	1	10,84	CHI
201911208331	RIO VERDE	RV13357269	CABRIUVA S2	19/11/2019 13:10	21/11/2019 14:11	20/11/2019 19:35	21/11/2019 03:00	7,42	11	81,59	CHI
201911208331	RIO VERDE	02450414	CABRIUVA S2	19/11/2019 13:10	21/11/2019 14:11	19/11/2019 13:10	21/11/2019 14:11	49,00	18	882,02	CHI
201911208401	ITARUMA	IM21150299	CACHOEIRA ALTA	19/11/2019 11:59	19/11/2019 16:49	19/11/2019 11:59	19/11/2019 16:49	4,82	1	4,82	CHI
201911208503	JATAI	290232340	JATAI S2	19/11/2019 12:00	19/11/2019 23:59	19/11/2019 12:00	19/11/2019 23:59	11,98	1	11,98	CHI
201911208506	CORUMBA DE GOIAS	ZN12185652	COCALZINHO	19/11/2019 12:01	19/11/2019 18:14	19/11/2019 12:01	19/11/2019 18:14	6,21	7	43,50	CHI
201911208509	JARAGUA	JA21299633	ITABERAI S1	19/11/2019 12:02	20/11/2019 11:59	19/11/2019 12:02	20/11/2019 11:59	23,96	1	23,96	CHI
201911208511	GOIANIA	GN12345849	GOYA S1	19/11/2019 12:02	19/11/2019 15:03	19/11/2019 12:02	19/11/2019 15:03	3,01	188	565,36	CHI

201911208514	NOVA CRIXAS	NA12213190	MOZARLANDIA	19/11/2019 10:01	19/11/2019 22:55	19/11/2019 10:01	19/11/2019 22:55	12,90	23	296,70	CHI
201911208809	CIDADE OCIDENTAL	LZ21000401	MARAJOARA	19/11/2019 12:08	19/11/2019 16:23	19/11/2019 12:08	19/11/2019 16:23	4,23	1	4,23	CHI
201911208813	RIO VERDE	RV12322328	CABRIUVA S2	19/11/2019 12:10	19/11/2019 17:59	19/11/2019 12:10	19/11/2019 17:59	5,82	4	23,26	CHI
201911208814	NIQUELANDIA	NQ12359232	NIQUELANDIA SUBTRANSMISSAO	19/11/2019 11:26	20/11/2019 15:56	19/11/2019 11:26	20/11/2019 15:56	28,49	3	85,48	CHI
201911208819	NEROPOLIS	NR12029257	NEROPOLIS S2	19/11/2019 12:12	19/11/2019 14:35	19/11/2019 12:12	19/11/2019 14:35	2,37	11	26,09	CHI
201911208826	MONTE ALEGRE DE GOIAS	GH12209852	SAO DOMINGOS	19/11/2019 11:48	19/11/2019 22:01	19/11/2019 11:48	19/11/2019 22:01	10,21	14	142,93	CHI
201911208829	LUZIANIA	10025820131	RIO VERMELHO	19/11/2019 12:14	19/11/2019 13:07	19/11/2019 12:14	19/11/2019 13:07	0,88	1	0,88	CHI
201911208830	INHUMAS	IN21129639	INHUMAS S1	19/11/2019 12:14	20/11/2019 10:45	19/11/2019 12:14	20/11/2019 10:45	22,51	1	22,51	CHI
201911208836	BONOPOLIS	SM10396890	SAO MIGUEL DO ARAGUAIA	19/11/2019 12:15	21/11/2019 14:08	19/11/2019 12:15	19/11/2019 16:01	3,78	104	392,69	CHI
201911208836	SAO MIGUEL DO ARAGUAIA	SM10396890	SAO MIGUEL DO ARAGUAIA	19/11/2019 12:15	21/11/2019 14:08	19/11/2019 12:15	19/11/2019 16:01	3,78	112	422,89	CHI
201911208836	BONOPOLIS	SM10396890	SAO MIGUEL DO ARAGUAIA	19/11/2019 12:15	21/11/2019 14:08	19/11/2019 16:02	19/11/2019 17:45	1,71	104	178,36	CHI
201911208836	SAO MIGUEL DO ARAGUAIA	SM10396890	SAO MIGUEL DO ARAGUAIA	19/11/2019 12:15	21/11/2019 14:08	19/11/2019 16:02	19/11/2019 17:45	1,71	93	159,49	CHI
201911208836	SAO MIGUEL DO ARAGUAIA	SM10396890	SAO MIGUEL DO ARAGUAIA	19/11/2019 12:15	21/11/2019 14:08	19/11/2019 16:02	19/11/2019 19:52	3,83	19	72,72	CHI
201911208836	SAO MIGUEL DO ARAGUAIA	SM10396890	SAO MIGUEL DO ARAGUAIA	19/11/2019 12:15	21/11/2019 14:08	19/11/2019 17:55	19/11/2019 19:52	1,94	46	89,34	CHI
201911208836	SAO MIGUEL DO ARAGUAIA	SM13182483	SAO MIGUEL DO ARAGUAIA	19/11/2019 12:15	21/11/2019 14:08	19/11/2019 17:55	20/11/2019 09:07	15,20	38	577,59	CHI
201911208836	BONOPOLIS	SM13282213	SAO MIGUEL DO ARAGUAIA	19/11/2019 12:15	21/11/2019 14:08	19/11/2019 17:55	20/11/2019 13:19	19,40	4	77,58	CHI
201911208836	SAO MIGUEL DO ARAGUAIA	SM13282213	SAO MIGUEL DO ARAGUAIA	19/11/2019 12:15	21/11/2019 14:08	19/11/2019 17:55	20/11/2019 13:19	19,40	9	174,56	CHI
201911208836	BONOPOLIS	BX12377680LD	SAO MIGUEL DO ARAGUAIA	19/11/2019 12:15	21/11/2019 14:08	19/11/2019 17:55	20/11/2019 15:32	21,62	77	1664,57	CHI
201911208836	SAO MIGUEL DO ARAGUAIA	BX12377680LD	SAO MIGUEL DO ARAGUAIA	19/11/2019 12:15	21/11/2019 14:08	19/11/2019 17:55	20/11/2019 15:32	21,62	0	0,00	CHI
201911208836	BONOPOLIS	BX12045611LD	SAO MIGUEL DO ARAGUAIA	19/11/2019 12:15	21/11/2019 14:08	19/11/2019 17:55	21/11/2019 01:09	31,23	16	499,64	CHI
201911208836	BONOPOLIS	BX12262454LD	SAO MIGUEL DO ARAGUAIA	19/11/2019 12:15	21/11/2019 14:08	19/11/2019 17:55	21/11/2019 14:08	44,21	7	309,46	CHI
201911208838	GOIANESIA	GE21114630	GOIANESIA S2	19/11/2019 12:15	20/11/2019 01:58	19/11/2019 12:15	20/11/2019 01:58	13,71	1	13,71	CHI
201911208840	GOIANIA	13995224	GOIANIA LESTE S3	19/11/2019 12:15	19/11/2019 13:27	19/11/2019 12:15	19/11/2019 13:27	1,19	1	1,19	CHI
201911208843	PALESTINA DE GOIAS	PY21240391	PALESTINA	19/11/2019 12:16	19/11/2019 15:01	19/11/2019 12:16	19/11/2019 15:01	2,75	1	2,75	CHI
201911209009	GOIAS	GS12274373	GOIAS	19/11/2019 11:54	20/11/2019 10:15	19/11/2019 11:54	20/11/2019 10:15	22,35	11	245,85	CHI
201911209016	ARUANA	AK11183263	ARUANA	19/11/2019 11:40	19/11/2019 17:46	19/11/2019 11:40	19/11/2019 17:46	6,10	143	871,66	CHI
201911209024	CAMPOS BELOS	1840000834	SAO DOMINGOS	19/11/2019 12:22	20/11/2019 09:08	19/11/2019 12:22	20/11/2019 09:08	20,75	1	20,75	CHI
201911209027	SERRANOPOLIS	3000019064	JATAI S1	19/11/2019 12:24	20/11/2019 19:37	19/11/2019 12:24	20/11/2019 19:37	31,21	1	31,21	CHI
201911209029	APARECIDA DE GOIANIA	200426000	INDEPENDENCIA S2	19/11/2019 12:25	19/11/2019 16:27	19/11/2019 12:25	19/11/2019 16:27	4,03	1	4,03	CHI
201911209033	INHUMAS	IN21293422	ARACU	19/11/2019 12:25	19/11/2019 18:04	19/11/2019 12:25	19/11/2019 18:04	5,65	1	5,65	CHI
201911209038	INDIARA	IY12010846	EDEIA	19/11/2019 12:27	19/11/2019 15:45	19/11/2019 12:27	19/11/2019 15:45	3,31	14	46,33	CHI
201911209041	CRISTALINA	KR12133633	PAMPLONA	19/11/2019 12:28	19/11/2019 16:50	19/11/2019 12:28	19/11/2019 16:50	4,36	3	13,08	CHI
201911209042	GOIANIA	10013173772	CARAJAS S2	19/11/2019 12:28	19/11/2019 19:31	19/11/2019 12:28	19/11/2019 19:31	7,04	1	7,04	CHI

201911209045	INACIOLANDIA	2810014043	QUIRINOPOLIS	19/11/2019 12:28	19/11/2019 13:39	19/11/2019 12:28	19/11/2019 13:39	1,17	1	1,17	CHI
201911209047	GOIANIA	GN11000995	CAMPINAS S1	19/11/2019 12:28	19/11/2019 14:30	19/11/2019 12:28	19/11/2019 14:30	2,02	99	199,76	CHI
201911209053	CACHOEIRA DOURADA	CD12000188	CACHOEIRA DOURADA	19/11/2019 10:49	19/11/2019 19:18	19/11/2019 10:49	19/11/2019 19:18	8,48	7	59,37	CHI
201911209053	ITUMBIARA	CD12000188	CACHOEIRA DOURADA	19/11/2019 10:49	19/11/2019 19:18	19/11/2019 10:49	19/11/2019 19:18	8,48	2	16,96	CHI
201911209055	INHUMAS	IN21010455	INHUMAS S2	19/11/2019 12:31	19/11/2019 17:29	19/11/2019 12:31	19/11/2019 17:29	4,96	1	4,96	CHI
201911209058	APARECIDA DE GOIANIA	13589283	INDEPENDENCIA S1	19/11/2019 12:32	19/11/2019 16:54	19/11/2019 12:32	19/11/2019 16:54	4,35	1	4,35	CHI
201911209059	ITUMBIARA	10024365279	ITUMBIARA VELHA S1	19/11/2019 12:33	19/11/2019 14:59	19/11/2019 12:33	19/11/2019 14:59	2,43	1	2,43	CHI
201911209060	CAMPOS VERDES	VD21252833	SANTA TEREZINHA	19/11/2019 12:33	20/11/2019 08:42	19/11/2019 12:33	20/11/2019 08:42	20,15	1	20,15	CHI
201911209065	IVOLANDIA	IV12108126	IPORA	19/11/2019 12:33	19/11/2019 21:20	19/11/2019 12:33	19/11/2019 21:20	8,77	16	140,39	CHI
201911209065	PALESTINA DE GOIAS	IV12108126	IPORA	19/11/2019 12:33	19/11/2019 21:20	19/11/2019 12:33	19/11/2019 21:20	8,77	33	289,56	CHI
201911209066	LUZIANIA	LZ21313696	CRISTALINA S2	19/11/2019 12:33	20/11/2019 13:01	19/11/2019 12:33	20/11/2019 13:01	24,45	1	24,45	CHI
201911209067	RIO VERDE	RV12260714	RIO VERDE S1	19/11/2019 11:26	19/11/2019 14:10	19/11/2019 11:26	19/11/2019 14:10	2,73	2	5,46	CHI
201911209071	PANAMA	310007859	GOIATUBA S1	16/11/2019 22:47	19/11/2019 14:56	16/11/2019 22:47	19/11/2019 14:56	64,13	1	64,13	CHI
201911209076	DIORAMA	1530009215	ARENOPOLIS	19/11/2019 12:35	20/11/2019 11:22	19/11/2019 12:35	20/11/2019 11:22	22,78	1	22,78	CHI
201911209078	CALDAZINHA	BO12400523	CEPAIGO S2	19/11/2019 12:33	19/11/2019 16:54	19/11/2019 12:33	19/11/2019 16:54	4,34	2	8,69	CHI
201911209078	LEOPOLDO DE BULHOES	BO12400523	CEPAIGO S2	19/11/2019 12:33	19/11/2019 16:54	19/11/2019 12:33	19/11/2019 16:54	4,34	32	138,98	CHI
201911209082	NIQUELANDIA	NQ11035678	NIQUELANDIA SUBTRANSMISSAO	19/11/2019 12:08	19/11/2019 15:33	19/11/2019 12:08	19/11/2019 15:33	3,41	95	323,90	CHI
201911209083	TRINDADE	40316397	TRINDADE	19/11/2019 12:37	19/11/2019 20:34	19/11/2019 12:37	19/11/2019 20:34	7,94	1	7,94	CHI
201911209204	GOIANESIA	550040055	GOIANESIA S2	19/11/2019 12:38	20/11/2019 09:37	19/11/2019 12:38	20/11/2019 09:37	20,97	1	20,97	CHI
201911209206	GOIAS	GS11220077	GOIAS	19/11/2019 12:13	19/11/2019 16:08	19/11/2019 12:13	19/11/2019 16:08	3,92	1	3,92	CHI
201911209210	SILVANIA	SV21161978	VIANOPOLIS	19/11/2019 12:40	21/11/2019 11:54	19/11/2019 12:40	21/11/2019 11:54	47,23	1	47,23	CHI
201911209212	IPAMERI	IP21146423	IPAMERI	19/11/2019 12:40	20/11/2019 06:56	19/11/2019 12:40	20/11/2019 06:56	18,26	1	18,26	CHI
201911209224	LUZIANIA	LZ12351401RE	MARAJOARA	19/11/2019 11:42	19/11/2019 16:08	19/11/2019 11:42	19/11/2019 16:08	4,42	28	123,77	CHI
201911209228	PARAUNA	PU12079039	PARAUNA	19/11/2019 11:01	19/11/2019 15:46	19/11/2019 11:01	19/11/2019 15:46	4,76	37	176,10	CHI
201911209231	ANAPOLIS	AN11032920	JUNDIAI S1	19/11/2019 12:36	19/11/2019 15:34	19/11/2019 12:36	19/11/2019 15:34	2,95	122	360,04	CHI
201911209302	TAQUARAL DE GOIAS	TQ21336352	ITABERAI S2	19/11/2019 12:44	20/11/2019 19:20	19/11/2019 12:44	20/11/2019 19:20	30,61	2	61,21	CHI
201911209310	GOIANIA	15429842	CARAJAS S2	19/11/2019 12:45	19/11/2019 21:13	19/11/2019 12:45	19/11/2019 21:13	8,46	1	8,46	CHI
201911209311	TURVELANDIA	TD21240362	RIO DOS BOIS	19/11/2019 12:45	20/11/2019 13:21	19/11/2019 12:45	20/11/2019 13:21	24,59	1	24,59	CHI
201911209407	MONTIVIDIU	MV12054362	MONTIVIDIU T	19/11/2019 12:43	19/11/2019 13:30	19/11/2019 12:43	19/11/2019 13:30	0,77	6	4,61	CHI
201911209408	BRAZABRANTES	BR12009628	INHUMAS S1	19/11/2019 08:20	19/11/2019 14:20	19/11/2019 08:20	19/11/2019 14:20	6,00	26	155,88	CHI
201911209409	NIQUELANDIA	NQ12171084	BARRO ALTO	19/11/2019 12:38	20/11/2019 00:21	19/11/2019 12:38	20/11/2019 00:21	11,71	43	503,41	CHI
201911209420	CATURAI	CK21015363	INHUMAS S1	19/11/2019 12:47	19/11/2019 16:46	19/11/2019 12:47	19/11/2019 16:46	3,97	1	3,97	CHI
201911209427	ANAPOLIS	AN12273408RE	ANAPOLIS UNIVERSITARIO S2	19/11/2019 12:49	20/11/2019 01:24	19/11/2019 12:49	20/11/2019 01:24	12,58	5	62,90	CHI

201911209427	PIRENOPOLIS	AN12273408RE	ANAPOLIS UNIVERSITARIO S2	19/11/2019 12:49	20/11/2019 01:24	19/11/2019 12:49	20/11/2019 01:24	12,58	3	37,74	CHI
201911209433	JATAI	290067157	JATAI S2	19/11/2019 12:50	19/11/2019 20:01	19/11/2019 12:50	19/11/2019 20:01	7,17	1	7,17	CHI
201911209441	LUZIANIA	LZ21165896	CRISTALINA S2	19/11/2019 12:51	20/11/2019 13:24	19/11/2019 12:51	20/11/2019 13:24	24,54	2	49,08	CHI
201911209454	ALTO PARAISO DE GOIAS	BF12365393	NIQUELANDIA SUBTRANSMISSAO	19/11/2019 11:53	19/11/2019 19:13	19/11/2019 11:53	19/11/2019 19:13	7,32	2	14,64	CHI
201911209455	URUACU	UR21310341	URUACU	19/11/2019 12:54	19/11/2019 15:09	19/11/2019 12:54	19/11/2019 15:09	2,24	1	2,24	CHI
201911209460	PALESTINA DE GOIAS	PY12223011	PALESTINA	19/11/2019 12:55	19/11/2019 14:35	19/11/2019 12:55	19/11/2019 14:35	1,68	115	192,94	CHI
201911209462	ANAPOLIS	10015083967	ANAPOLIS UNIVERSITARIO S2	19/11/2019 12:55	19/11/2019 15:12	19/11/2019 12:55	19/11/2019 15:12	2,27	1	2,27	CHI
201911209476	GOIANIA	10030322373	GOIANIA LESTE S1	19/11/2019 12:57	19/11/2019 17:01	19/11/2019 12:57	19/11/2019 17:01	4,06	1	4,06	CHI
201911209485	PORTELANDIA	PW21303424	PARQUE DAS EMAS	19/11/2019 12:59	19/11/2019 18:12	19/11/2019 12:59	19/11/2019 18:12	5,21	1	5,21	CHI
201911209487	ITUMBIARA	IT11065318	ITUMBIARA VELHA S1	19/11/2019 13:00	19/11/2019 15:24	19/11/2019 13:00	19/11/2019 15:24	2,40	188	451,10	CHI
201911209501	ALEXANIA	AX12000154	CORUMBA	19/11/2019 12:53	19/11/2019 14:12	19/11/2019 12:53	19/11/2019 14:12	1,31	21	27,59	CHI
201911209501	CORUMBA DE GOIAS	AX12000154	CORUMBA	19/11/2019 12:53	19/11/2019 14:12	19/11/2019 12:53	19/11/2019 14:12	1,31	4	5,25	CHI
201911209502	IPAMERI	IP21232038	IPAMERI	19/11/2019 13:02	20/11/2019 21:05	19/11/2019 13:02	20/11/2019 21:05	32,04	1	32,04	CHI
201911209510	ANAPOLIS	AN12096781	ANAPOLIS UNIVERSITARIO S2	19/11/2019 13:05	19/11/2019 19:42	19/11/2019 13:05	19/11/2019 19:42	6,61	13	85,99	CHI
201911209518	GOIAS	GS21364851	GOIAS	19/11/2019 13:06	19/11/2019 15:11	19/11/2019 13:06	19/11/2019 15:11	2,07	1	2,07	CHI
201911209530	CABECEIRAS	CW21163621	ITUIQUIRA	19/11/2019 13:09	19/11/2019 15:23	19/11/2019 13:09	19/11/2019 15:23	2,23	1	2,23	CHI
201911209536	MINACU	IH10284240	MINACU	19/11/2019 13:04	20/11/2019 05:16	19/11/2019 13:04	19/11/2019 14:20	1,27	1463	1857,20	CHI
201911209536	TROMBAS	IH10284240	MINACU	19/11/2019 13:04	20/11/2019 05:16	19/11/2019 13:04	19/11/2019 14:20	1,27	6	7,62	CHI
201911209536	CAMPINACU	IH10284240	MINACU	19/11/2019 13:04	20/11/2019 05:16	19/11/2019 13:04	19/11/2019 14:34	1,49	27	40,36	CHI
201911209536	MINACU	IH10284240	MINACU	19/11/2019 13:04	20/11/2019 05:16	19/11/2019 13:04	19/11/2019 14:34	1,49	314	469,34	CHI
201911209536	MINACU	IH10284240	MINACU	19/11/2019 13:04	20/11/2019 05:16	19/11/2019 14:21	19/11/2019 14:34	0,22	86	18,90	CHI
201911209536	CAMPINACU	IH10284240	MINACU	19/11/2019 13:04	20/11/2019 05:16	19/11/2019 15:49	19/11/2019 16:31	0,70	26	18,21	CHI
201911209536	MINACU	IH10284240	MINACU	19/11/2019 13:04	20/11/2019 05:16	19/11/2019 15:49	19/11/2019 16:31	0,70	399	279,52	CHI
201911209536	MINACU	IH13377677	MINACU	19/11/2019 13:04	20/11/2019 05:16	19/11/2019 14:21	19/11/2019 17:04	2,73	17	46,41	CHI
201911209536	MINACU	IH13377677	MINACU	19/11/2019 13:04	20/11/2019 05:16	19/11/2019 14:21	19/11/2019 21:31	7,18	55	394,88	CHI
201911209536	MINACU	IH13404041B	MINACU	19/11/2019 13:04	20/11/2019 05:16	19/11/2019 14:21	19/11/2019 21:31	7,18	1268	9103,89	CHI
201911209536	TROMBAS	IH13404041B	MINACU	19/11/2019 13:04	20/11/2019 05:16	19/11/2019 14:21	19/11/2019 21:31	7,18	6	43,08	CHI
201911209536	CAMPINACU	IH10284240	MINACU	19/11/2019 13:04	20/11/2019 05:16	19/11/2019 21:32	19/11/2019 21:41	0,15	26	3,79	CHI
201911209536	MINACU	IH10284240	MINACU	19/11/2019 13:04	20/11/2019 05:16	19/11/2019 21:32	19/11/2019 21:41	0,15	422	61,54	CHI
201911209536	MINACU	IH13377677	MINACU	19/11/2019 13:04	20/11/2019 05:16	19/11/2019 23:13	20/11/2019 02:45	3,53	17	59,96	CHI
201911209536	MINACU	IH13377677	MINACU	19/11/2019 13:04	20/11/2019 05:16	19/11/2019 14:21	20/11/2019 04:31	14,18	20	283,51	CHI
201911209536	MINACU	IH16404036	MINACU	19/11/2019 13:04	20/11/2019 05:16	19/11/2019 21:32	20/11/2019 04:31	6,99	1322	9239,31	CHI
201911209536	TROMBAS	IH16404036	MINACU	19/11/2019 13:04	20/11/2019 05:16	19/11/2019 21:32	20/11/2019 04:31	6,99	6	41,93	CHI

201911209536	MINACU	IH12230480	MINACU	19/11/2019 13:04	20/11/2019 05:16	19/11/2019 14:21	20/11/2019 04:56	14,59	17	247,98	CHI
201911209536	MINACU	IH16404036	MINACU	19/11/2019 13:04	20/11/2019 05:16	19/11/2019 21:32	20/11/2019 05:16	7,74	1	7,74	CHI
201911209538	PIRENOPOLIS	PV12295641	SAO FRANCISCO DE GOIAS	19/11/2019 12:50	19/11/2019 17:42	19/11/2019 12:50	19/11/2019 17:42	4,86	185	898,53	CHI
201911209542	CAIAPONIA	CP12245718	CAIAPONIA	19/11/2019 13:11	20/11/2019 09:54	19/11/2019 13:11	20/11/2019 09:54	20,71	1	20,71	CHI
201911209549	ALTO PARAISO DE GOIAS	BF21163462	FLORES DE GOIAS	19/11/2019 13:12	20/11/2019 17:28	19/11/2019 13:12	20/11/2019 17:28	28,26	1	28,26	CHI
201911209551	FORMOSA	610062244	ITUIQUIRA	19/11/2019 13:14	20/11/2019 18:53	19/11/2019 13:14	20/11/2019 18:53	29,66	1	29,66	CHI
201911209554	NIQUELANDIA	NQ21345191	BARRO ALTO	19/11/2019 08:30	20/11/2019 01:53	19/11/2019 08:30	20/11/2019 01:53	17,38	1	17,38	CHI
201911209559	RIO VERDE	RV21207074	CABRIUVA S1	19/11/2019 13:15	19/11/2019 15:58	19/11/2019 13:15	19/11/2019 15:58	2,71	1	2,71	CHI
201911209560	MONTIVIDIU DO NORTE	PO12094115	PORANGATU	19/11/2019 12:41	19/11/2019 15:27	19/11/2019 12:41	19/11/2019 15:27	2,76	5	13,82	CHI
201911209560	PORANGATU	PO12094115	PORANGATU	19/11/2019 12:41	19/11/2019 15:27	19/11/2019 12:41	19/11/2019 15:27	2,76	71	196,22	CHI
201911209562	MUTUNOPOLIS	MU12244469	MARA ROSA	19/11/2019 13:16	20/11/2019 10:55	19/11/2019 13:16	20/11/2019 10:55	21,64	3	64,93	CHI
201911209564	PORANGATU	PO12141124	NOVO PLANALTO	19/11/2019 13:16	19/11/2019 16:49	19/11/2019 13:16	19/11/2019 16:49	3,54	20	70,81	CHI
201911209568	OUVIDOR	CT21266267	CATALAO S1	19/11/2019 13:17	20/11/2019 08:15	19/11/2019 13:17	20/11/2019 08:15	18,98	1	18,98	CHI
201911209574	VALPARAISO DE GOIAS	2860005177	MARAJOARA	19/11/2019 13:17	19/11/2019 18:37	19/11/2019 13:17	19/11/2019 18:37	5,32	1	5,32	CHI
201911209577	GOIANIA	14265461	GOYA S2	19/11/2019 13:18	19/11/2019 21:45	19/11/2019 13:18	19/11/2019 21:45	8,44	1	8,44	CHI
201911209578	CRISTALINA	7508694	CRISTALINA S1	19/11/2019 13:18	20/11/2019 12:18	19/11/2019 13:18	20/11/2019 12:18	22,99	1	22,99	CHI
201911209580	VALPARAISO DE GOIAS	10007847970	PACAEMBU S2	19/11/2019 13:18	19/11/2019 16:25	19/11/2019 13:18	19/11/2019 16:25	3,11	1	3,11	CHI
201911209599	FIRMINOPOLIS	FR12126033	FIRMINOPOLIS S1	19/11/2019 13:01	19/11/2019 14:20	19/11/2019 13:01	19/11/2019 14:20	1,32	8	10,58	CHI
201911209602	LUZIANIA	LZ12313691	CRISTALINA S2	19/11/2019 12:52	19/11/2019 18:33	19/11/2019 12:52	19/11/2019 18:33	5,67	19	107,76	CHI
201911209605	APARECIDA DE GOIANIA	14827621	INDEPENDENCIA S2	19/11/2019 13:23	19/11/2019 16:28	19/11/2019 13:23	19/11/2019 16:28	3,08	1	3,08	CHI
201911209608	JARAGUA	JA21235797	JARAGUA	19/11/2019 13:24	20/11/2019 13:37	19/11/2019 13:24	20/11/2019 13:37	24,21	1	24,21	CHI
201911209615	ABADIANIA	AA21254919	DAIA S2	19/11/2019 13:25	20/11/2019 11:36	19/11/2019 13:25	20/11/2019 11:36	22,17	1	22,17	CHI
201911209620	ANAPOLIS	LB12078506	DAIA S2	19/11/2019 13:16	19/11/2019 17:52	19/11/2019 13:16	19/11/2019 17:52	4,59	8	36,75	CHI
201911209620	LEOPOLDO DE BULHOES	LB12078506	DAIA S2	19/11/2019 13:16	19/11/2019 17:52	19/11/2019 13:16	19/11/2019 17:52	4,59	6	27,56	CHI
201911209628	ISRAELANDIA	IS21380912	IPORA	19/11/2019 13:27	20/11/2019 12:52	19/11/2019 13:27	20/11/2019 12:52	23,41	1	23,41	CHI
201911209633	CRISTALINA	KR12400836	CRISTALINA S1	19/11/2019 13:28	20/11/2019 18:00	19/11/2019 13:28	20/11/2019 18:00	28,54	4	114,16	CHI
201911209638	PARAUNA	10015938466	PARAUNA	19/11/2019 13:29	19/11/2019 19:13	19/11/2019 13:29	19/11/2019 19:13	5,73	1	5,73	CHI
201911209639	ITAPURANGA	IK21311438	ITAPURANGA	19/11/2019 13:29	20/11/2019 11:20	19/11/2019 13:29	20/11/2019 11:20	21,84	1	21,84	CHI
201911209640	GOIANIA	17457130	GOYA S1	19/11/2019 13:29	19/11/2019 17:49	19/11/2019 13:29	19/11/2019 17:49	4,32	1	4,32	CHI
201911209644	VALPARAISO DE GOIAS	10016792465	MARAJOARA	19/11/2019 13:30	19/11/2019 17:36	19/11/2019 13:30	19/11/2019 17:36	4,10	1	4,10	CHI
201911209647	MOSSAMEDES	MD21294192	FIRMINOPOLIS S2	19/11/2019 13:30	19/11/2019 16:11	19/11/2019 13:30	19/11/2019 16:11	2,67	1	2,67	CHI
201911209648	PALMINOPOLIS	PP21307021	PALMEIRAS	19/11/2019 13:30	19/11/2019 19:15	19/11/2019 13:30	19/11/2019 19:15	5,76	2	11,51	CHI
201911209653	CATALAO	CT21215531	CATALAO S1	19/11/2019 13:31	20/11/2019 01:49	19/11/2019 13:31	20/11/2019 01:49	12,30	1	12,30	CHI

201911209654	CORUMBA DE GOIAS	CB12302154	ALEXANIA	19/11/2019 13:06	20/11/2019 01:30	19/11/2019 13:06	20/11/2019 01:30	12,39	14	173,47	CHI
201911209655	JATAI	JT12131457	JATAI S1	19/11/2019 18:46	20/11/2019 18:38	19/11/2019 18:46	20/11/2019 18:38	23,87	13	310,30	CHI
201911209657	MUNDO NOVO DE GOIAS	MH12391964	NOVA CRIXAS	19/11/2019 13:31	19/11/2019 16:10	19/11/2019 13:31	19/11/2019 16:10	2,64	9	23,76	CHI
201911209663	CORUMBAIBA	NE12384411	CATALAO S1	19/11/2019 13:31	19/11/2019 22:57	19/11/2019 13:31	19/11/2019 22:57	9,42	122	1149,24	CHI
201911209663	IPAMERI	NE12384411	CATALAO S1	19/11/2019 13:31	19/11/2019 22:57	19/11/2019 13:31	19/11/2019 22:57	9,42	15	141,30	CHI
201911209663	MORRINHOS	NE12384411	CATALAO S1	19/11/2019 13:31	19/11/2019 22:57	19/11/2019 13:31	19/11/2019 22:57	9,42	1	9,42	CHI
201911209663	NOVA AURORA	NE12384411	CATALAO S1	19/11/2019 13:31	19/11/2019 22:57	19/11/2019 13:31	19/11/2019 22:57	9,42	207	1949,94	CHI
201911209674	APARECIDA DE GOIANIA	AP12075580	CEPAIGO S1	19/11/2019 13:33	19/11/2019 18:24	19/11/2019 13:33	19/11/2019 18:24	4,85	19	92,09	CHI
201911209677	AMORINOPOLIS	IV12165613	IPORA	19/11/2019 13:34	19/11/2019 16:45	19/11/2019 13:34	19/11/2019 16:45	3,18	5	15,92	CHI
201911209677	IVOLANDIA	IV12165613	IPORA	19/11/2019 13:34	19/11/2019 16:45	19/11/2019 13:34	19/11/2019 16:45	3,18	6	19,10	CHI
201911209680	APARECIDA DE GOIANIA	AP11345614	CEPAIGO S1	19/11/2019 13:14	20/11/2019 01:20	19/11/2019 13:14	20/11/2019 01:20	12,10	160	1936,00	CHI
201911209681	GOIANIA	GN21000087	REAL S2	19/11/2019 13:34	19/11/2019 14:23	19/11/2019 13:34	19/11/2019 14:23	0,81	1	0,81	CHI
201911209685	MOSSAMEDES	MD12206495	FIRMINOPOLIS S2	19/11/2019 13:27	19/11/2019 15:58	19/11/2019 13:27	19/11/2019 15:58	2,50	19	47,52	CHI
201911209685	SANCLERLANDIA	MD12206495	FIRMINOPOLIS S2	19/11/2019 13:27	19/11/2019 15:58	19/11/2019 13:27	19/11/2019 15:58	2,50	6	15,01	CHI
201911209686	SANTA TEREZINHA DE GOIAS	SG21252873	SANTA TEREZINHA	19/11/2019 13:35	19/11/2019 23:30	19/11/2019 13:35	19/11/2019 23:30	9,91	1	9,91	CHI
201911209688	ANAPOLIS	20195230	JUNDIAI S2	19/11/2019 13:35	19/11/2019 15:06	19/11/2019 13:35	19/11/2019 15:06	1,51	1	1,51	CHI
201911209694	CIDADE OCIDENTAL	DH11172222	MARAJOARA	19/11/2019 12:57	19/11/2019 17:45	19/11/2019 12:57	19/11/2019 17:45	4,79	75	359,25	CHI
201911209696	MORRINHOS	MR11393835	MORRINHOS	19/11/2019 13:37	19/11/2019 17:07	19/11/2019 13:37	19/11/2019 17:07	3,49	79	275,40	CHI
201911209699	CACHOEIRA DOURADA	130028149	CACHOEIRA DOURADA	19/11/2019 13:38	20/11/2019 15:40	19/11/2019 13:38	20/11/2019 15:40	26,03	1	26,03	CHI
201911209703	LUZIANIA	OZ12402562RE	PIRES DO RIO S2	19/11/2019 13:24	19/11/2019 22:30	19/11/2019 13:24	19/11/2019 22:30	9,09	131	1190,90	CHI
201911209703	ORIZONA	OZ12402562RE	PIRES DO RIO S2	19/11/2019 13:24	19/11/2019 22:30	19/11/2019 13:24	19/11/2019 22:30	9,09	7	63,64	CHI
201911209710	ANAPOLIS	AN12000433	ANAPOLIS UNIVERSITARIO S2	19/11/2019 13:40	19/11/2019 17:39	19/11/2019 13:40	19/11/2019 17:39	3,98	18	71,59	CHI
201911209710	PIRENOPOLIS	AN12000433	ANAPOLIS UNIVERSITARIO S2	19/11/2019 13:40	19/11/2019 17:39	19/11/2019 13:40	19/11/2019 17:39	3,98	9	35,80	CHI
201911209713	COLINAS DO SUL	TI21347093	MINACU	19/11/2019 13:40	20/11/2019 00:54	19/11/2019 13:40	20/11/2019 00:54	11,22	1	11,22	CHI
201911209720	ITABERAI	IB12379742	ITABERAI S2	19/11/2019 13:41	19/11/2019 16:15	19/11/2019 13:41	19/11/2019 15:55	2,22	186	412,46	CHI
201911209720	ITABERAI	IB12379749	ITABERAI S2	19/11/2019 13:41	19/11/2019 16:15	19/11/2019 13:41	19/11/2019 16:15	2,55	7	17,86	CHI
201911209724	NEROPOLIS	NR21009275	NEROPOLIS S2	19/11/2019 13:42	19/11/2019 15:32	19/11/2019 13:42	19/11/2019 15:32	1,83	2	3,66	CHI
201911209726	GOIANIRA	10012272009	GOIANIRA	19/11/2019 13:42	19/11/2019 21:21	19/11/2019 13:42	19/11/2019 21:21	7,64	1	7,64	CHI
201911209731	GOIANIA	14506634	FERROVIARIO S1	19/11/2019 13:43	19/11/2019 20:38	19/11/2019 13:43	19/11/2019 20:38	6,91	1	6,91	CHI
201911209734	SANTA RITA DO NOVO DESTINO	DF21191331	GOIANESIA S1	19/11/2019 13:44	19/11/2019 18:06	19/11/2019 13:44	19/11/2019 18:06	4,37	1	4,37	CHI
201911209742	PLANALTINA	PI21362470	SAO JOAO D ALIANCA	19/11/2019 13:45	21/11/2019 10:31	19/11/2019 13:45	21/11/2019 10:31	44,76	1	44,76	CHI
201911209748	GOIATUBA	GT21190874	BOM JESUS DE GOIAS	19/11/2019 13:46	21/11/2019 11:31	19/11/2019 13:46	21/11/2019 11:31	45,74	1	45,74	CHI
201911209756	GOIANIA	12707636	GOYA S1	19/11/2019 13:47	19/11/2019 18:07	19/11/2019 13:47	19/11/2019 18:07	4,34	1	4,34	CHI

201911210002	ALEXANIA	AX10404067	CORUMBA	19/11/2019 13:46	19/11/2019 17:39	19/11/2019 13:46	19/11/2019 16:17	2,52	58	146,19	CHI
201911210002	CORUMBA DE GOIAS	AX10404067	CORUMBA	19/11/2019 13:46	19/11/2019 17:39	19/11/2019 13:46	19/11/2019 16:17	2,52	5	12,60	CHI
201911210002	ALEXANIA	AX13101833	CORUMBA	19/11/2019 13:46	19/11/2019 17:39	19/11/2019 13:46	19/11/2019 17:13	3,44	11	37,84	CHI
201911210002	CORUMBA DE GOIAS	AX13101833	CORUMBA	19/11/2019 13:46	19/11/2019 17:39	19/11/2019 13:46	19/11/2019 17:13	3,44	291	1000,96	CHI
201911210002	ALEXANIA	CB12312010	CORUMBA	19/11/2019 13:46	19/11/2019 17:39	19/11/2019 13:46	19/11/2019 17:39	3,87	11	42,59	CHI
201911210002	CORUMBA DE GOIAS	CB12312010	CORUMBA	19/11/2019 13:46	19/11/2019 17:39	19/11/2019 13:46	19/11/2019 17:39	3,87	51	197,47	CHI
201911210108	FORMOSA	FA12376671	ITUIQUIRA	19/11/2019 13:20	20/11/2019 13:28	19/11/2019 13:20	20/11/2019 13:28	24,12	34	820,03	CHI
201911210109	FAZENDA NOVA	NB12396253	JUSSARA	19/11/2019 13:36	19/11/2019 23:58	19/11/2019 13:36	19/11/2019 23:58	10,37	13	134,76	CHI
201911210109	JUSSARA	NB12396253	JUSSARA	19/11/2019 13:36	19/11/2019 23:58	19/11/2019 13:36	19/11/2019 23:58	10,37	1	10,37	CHI
201911210114	DIORAMA	03090216	IPORA	19/11/2019 13:51	19/11/2019 17:09	19/11/2019 13:51	19/11/2019 17:09	3,29	12	39,51	CHI
201911210114	FAZENDA NOVA	03090216	IPORA	19/11/2019 13:51	19/11/2019 17:09	19/11/2019 13:51	19/11/2019 17:09	3,29	22	72,44	CHI
201911210114	JAUPACI	03090216	IPORA	19/11/2019 13:51	19/11/2019 17:09	19/11/2019 13:51	19/11/2019 17:09	3,29	1378	4537,07	CHI
201911210115	INDIARA	JD12323641	ACREUNA	19/11/2019 13:38	21/11/2019 20:10	19/11/2019 13:38	20/11/2019 13:19	23,67	20	473,37	CHI
201911210115	ACREUNA	IY13097068	ACREUNA	19/11/2019 13:38	21/11/2019 20:10	19/11/2019 13:38	20/11/2019 19:41	30,03	1	30,03	CHI
201911210115	INDIARA	IY13097068	ACREUNA	19/11/2019 13:38	21/11/2019 20:10	19/11/2019 13:38	20/11/2019 19:41	30,03	2	60,07	CHI
201911210115	ACREUNA	00080424	ACREUNA	19/11/2019 13:38	21/11/2019 20:10	20/11/2019 19:42	20/11/2019 19:55	0,22	28	6,25	CHI
201911210115	INDIARA	00080424	ACREUNA	19/11/2019 13:38	21/11/2019 20:10	20/11/2019 19:42	20/11/2019 19:55	0,22	23	5,14	CHI
201911210115	JANDAIA	00080424	ACREUNA	19/11/2019 13:38	21/11/2019 20:10	20/11/2019 19:42	20/11/2019 19:55	0,22	33	7,37	CHI
201911210115	PARAUNA	00080424	ACREUNA	19/11/2019 13:38	21/11/2019 20:10	20/11/2019 19:42	20/11/2019 19:55	0,22	1	0,22	CHI
201911210115	ACREUNA	IY13097068	ACREUNA	19/11/2019 13:38	21/11/2019 20:10	20/11/2019 19:42	21/11/2019 18:59	23,28	1	23,28	CHI
201911210115	INDIARA	IY13097068	ACREUNA	19/11/2019 13:38	21/11/2019 20:10	20/11/2019 19:42	21/11/2019 18:59	23,28	2	46,56	CHI
201911210115	ACREUNA	IY13167236	ACREUNA	19/11/2019 13:38	21/11/2019 20:10	19/11/2019 13:38	21/11/2019 20:10	54,53	6	327,19	CHI
201911210115	INDIARA	IY13167236	ACREUNA	19/11/2019 13:38	21/11/2019 20:10	19/11/2019 13:38	21/11/2019 20:10	54,53	2	109,06	CHI
201911210121	NOVO BRASIL	NB11020195	JUSSARA	19/11/2019 13:45	19/11/2019 15:37	19/11/2019 13:45	19/11/2019 15:37	1,86	126	234,53	CHI
201911210122	SANTO ANTONIO DE GOIAS	GR12002136	NEROPOLIS S1	19/11/2019 13:52	19/11/2019 15:55	19/11/2019 13:52	19/11/2019 15:55	2,03	3	6,10	CHI
201911210126	GOIANIA	14254839	CARAJAS S2	19/11/2019 13:53	20/11/2019 11:28	19/11/2019 13:53	20/11/2019 11:28	21,58	1	21,58	CHI
201911210132	ANAPOLIS	AN12000524	JUNDIAI S1	19/11/2019 13:53	19/11/2019 19:30	19/11/2019 13:53	19/11/2019 19:30	5,61	5	28,03	CHI
201911210141	PLANALTINA	PI21238606	SAO JOAO D ALIANCA	19/11/2019 13:55	20/11/2019 17:37	19/11/2019 13:55	20/11/2019 17:37	27,70	1	27,70	CHI
201911210146	NOVO GAMA	NJ11183623	PACAEMBU S1	19/11/2019 13:53	20/11/2019 01:38	19/11/2019 13:53	20/11/2019 01:38	11,75	129	1515,14	CHI
201911210149	GOIANIA	GN11002584	MEIA PONTE	19/11/2019 13:27	19/11/2019 16:45	19/11/2019 13:27	19/11/2019 16:45	3,29	82	269,94	CHI
201911210150	CAMPOS BELOS	MA12209854	SAO DOMINGOS	19/11/2019 10:13	19/11/2019 20:05	19/11/2019 10:13	19/11/2019 20:05	9,85	4	39,42	CHI
201911210150	MONTE ALEGRE DE GOIAS	MA12209854	SAO DOMINGOS	19/11/2019 10:13	19/11/2019 20:05	19/11/2019 10:13	19/11/2019 20:05	9,85	17	167,52	CHI
201911210159	MONTES CLAROS DE GOIAS	ME21334819	IPORA	19/11/2019 13:58	19/11/2019 18:50	19/11/2019 13:58	19/11/2019 18:50	4,86	1	4,86	CHI

201911210161	ORIZONA	OZ12079953	VIANOPOLIS	19/11/2019 12:20	20/11/2019 10:23	19/11/2019 12:20	20/11/2019 10:23	22,05	4	88,19	CHI
201911210161	VIANOPOLIS	OZ12079953	VIANOPOLIS	19/11/2019 12:20	20/11/2019 10:23	19/11/2019 12:20	20/11/2019 10:23	22,05	12	264,57	CHI
201911210162	ITUMBIARA	690010758	ITUMBIARA VELHA S1	19/11/2019 13:58	19/11/2019 15:52	19/11/2019 13:58	19/11/2019 15:52	1,88	1	1,88	CHI
201911210166	CAMPOS VERDES	VD12266622	SANTA TEREZINHA	19/11/2019 13:58	20/11/2019 12:12	19/11/2019 13:58	20/11/2019 12:12	22,22	1	22,22	CHI
201911210181	SAO MIGUEL DO PASSA QUATRO	SQ12231522	CRISTIANOPOLIS	19/11/2019 13:49	19/11/2019 22:52	19/11/2019 13:49	19/11/2019 22:52	9,03	12	108,41	CHI
201911210181	VIANOPOLIS	SQ12231522	CRISTIANOPOLIS	19/11/2019 13:49	19/11/2019 22:52	19/11/2019 13:49	19/11/2019 22:52	9,03	17	153,59	CHI
201911210182	ARAGUAPAZ	FC12071270	GOIAS	19/11/2019 11:24	19/11/2019 17:46	19/11/2019 11:24	19/11/2019 17:46	6,37	4	25,46	CHI
201911210182	FAINA	FC12071270	GOIAS	19/11/2019 11:24	19/11/2019 17:46	19/11/2019 11:24	19/11/2019 17:46	6,37	3	19,10	CHI
201911210187	ITAPIRAPUA	IU11018875	MATRINCHA	19/11/2019 12:45	19/11/2019 16:00	19/11/2019 12:45	19/11/2019 16:00	3,25	114	370,72	CHI
201911210190	BELA VISTA DE GOIAS	BV21020408	BELA VISTA S2	19/11/2019 14:03	20/11/2019 16:37	19/11/2019 14:03	20/11/2019 16:37	26,56	1	26,56	CHI
201911210196	PADRE BERNARDO	PB12000025	PADRE BERNARDO	19/11/2019 14:04	19/11/2019 16:16	19/11/2019 14:04	19/11/2019 16:16	2,19	8	17,51	CHI
201911210198	JUSSARA	JR12198791	JUSSARA	19/11/2019 13:45	19/11/2019 15:06	19/11/2019 13:45	19/11/2019 15:06	1,34	110	147,25	CHI
201911210199	IPAMERI	IP12332967	IPAMERI	19/11/2019 12:47	20/11/2019 23:02	19/11/2019 12:47	20/11/2019 23:02	34,24	14	479,40	CHI
201911210200	MOSSAMEDES	MD12024167	FIRMINOPOLIS S2	19/11/2019 13:46	19/11/2019 15:22	19/11/2019 13:46	19/11/2019 15:22	1,59	26	41,35	CHI
201911210200	SANCLERLANDIA	MD12024167	FIRMINOPOLIS S2	19/11/2019 13:46	19/11/2019 15:22	19/11/2019 13:46	19/11/2019 15:22	1,59	1	1,59	CHI
201911210203	AGUAS LINDAS DE GOIAS	LA11136656	AGUAS LINDAS DE GOIAS S1	19/11/2019 14:05	19/11/2019 17:42	19/11/2019 14:05	19/11/2019 17:42	3,60	200	720,33	CHI
201911210209	NAZARIO	NZ12003986	ANICUNS	19/11/2019 14:06	19/11/2019 16:11	19/11/2019 14:06	19/11/2019 16:11	2,08	5	10,38	CHI
201911210211	NOVO GAMA	2460039524	PACAEMBU S1	19/11/2019 14:07	19/11/2019 16:48	19/11/2019 14:07	19/11/2019 16:48	2,68	1	2,68	CHI
201911210213	OUVIDOR	IO21064057	CATALAO S1	19/11/2019 14:08	20/11/2019 11:04	19/11/2019 14:08	20/11/2019 11:04	20,93	1	20,93	CHI
201911210216	MINACU	4020079585	MINACU	19/11/2019 14:08	20/11/2019 16:23	19/11/2019 14:08	20/11/2019 16:23	26,24	1	26,24	CHI
201911210217	QUIRINOPOLIS	QI21360931	QUIRINOPOLIS	19/11/2019 14:08	20/11/2019 10:00	19/11/2019 14:08	20/11/2019 10:00	19,86	2	39,72	CHI
201911210219	PORANGATU	PO12021172	PORANGATU	19/11/2019 14:08	21/11/2019 14:00	19/11/2019 14:08	20/11/2019 20:24	30,26	2	60,52	CHI
201911210219	PORANGATU	PO12021172	PORANGATU	19/11/2019 14:08	21/11/2019 14:00	19/11/2019 14:08	21/11/2019 14:00	47,85	3	143,56	CHI
201911210219	PORANGATU	PO12021172	PORANGATU	19/11/2019 14:08	21/11/2019 14:00	21/11/2019 13:12	21/11/2019 14:00	0,80	2	1,60	CHI
201911210221	FAZENDA NOVA	FN21113491	JUSSARA	19/11/2019 14:09	20/11/2019 14:47	19/11/2019 14:09	20/11/2019 14:47	24,63	1	24,63	CHI
201911210227	IVOLANDIA	IR21068809	IPORA	19/11/2019 14:09	19/11/2019 21:30	19/11/2019 14:09	19/11/2019 21:30	7,33	2	14,67	CHI
201911210228	CACHOEIRA ALTA	CA12013266	CACHOEIRA ALTA	19/11/2019 14:10	19/11/2019 15:56	19/11/2019 14:10	19/11/2019 15:56	1,76	16	28,14	CHI
201911210238	SAO MIGUEL DO ARAGUAIA	4650003685	SAO MIGUEL DO ARAGUAIA	19/11/2019 14:11	20/11/2019 11:31	19/11/2019 14:11	20/11/2019 11:31	21,32	1	21,32	CHI
201911210239	PORTEIRAO	CL21384600	RIO DOS BOIS	19/11/2019 14:11	19/11/2019 17:25	19/11/2019 14:11	19/11/2019 17:25	3,22	1	3,22	CHI
201911210243	APARECIDA DE GOIANIA	10004855351	INDEPENDENCIA S2	19/11/2019 14:12	19/11/2019 16:27	19/11/2019 14:12	19/11/2019 16:27	2,24	1	2,24	CHI
201911210245	BONOPOLIS	PO12374529	SAO MIGUEL DO ARAGUAIA	19/11/2019 14:11	19/11/2019 22:15	19/11/2019 14:11	19/11/2019 22:15	8,06	3	24,18	CHI
201911210263	GOIANIA	10018021261	XAVANTES	19/11/2019 14:15	19/11/2019 18:02	19/11/2019 14:15	19/11/2019 18:02	3,77	1	3,77	CHI
201911210265	PORANGATU	PO12391930	PORANGATU	19/11/2019 14:09	19/11/2019 16:20	19/11/2019 14:09	19/11/2019 16:20	2,17	46	99,99	CHI

201911210267	SAO DOMINGOS	SD12218642	SAO DOMINGOS	19/11/2019 14:16	19/11/2019 16:15	19/11/2019 14:16	19/11/2019 16:15	1,97	80	157,93	CHI
201911210268	CACHOEIRA DE GOIAS	PU12093868	FIRMINOPOLIS S2	19/11/2019 14:16	20/11/2019 16:53	19/11/2019 14:16	20/11/2019 16:53	26,61	2	53,22	CHI
201911210268	PARAUNA	PU12093868	FIRMINOPOLIS S2	19/11/2019 14:16	20/11/2019 16:53	19/11/2019 14:16	20/11/2019 16:53	26,61	5	133,05	CHI
201911210269	CIDADE OCIDENTAL	2680162177	MARAJOARA	19/11/2019 14:16	19/11/2019 15:31	19/11/2019 14:16	19/11/2019 15:31	1,24	1	1,24	CHI
201911210274	ANAPOLIS	20037478	ANAPOLIS UNIVERSITARIO S2	19/11/2019 14:17	20/11/2019 03:07	19/11/2019 14:17	20/11/2019 03:07	12,83	1	12,83	CHI
201911210292	TRINDADE	TR31034671	TRINDADE	19/11/2019 14:19	20/11/2019 12:32	19/11/2019 14:19	20/11/2019 12:32	22,20	5	111,02	CHI
201911210314	GOIANIA	16780528	GOYA S1	19/11/2019 14:22	19/11/2019 17:23	19/11/2019 14:22	19/11/2019 17:23	3,01	1	3,01	CHI
201911210318	TRINDADE	TR32045872	TRINDADE	19/11/2019 14:22	20/11/2019 08:27	19/11/2019 14:22	20/11/2019 08:27	18,08	5	90,38	CHI
201911210324	CRISTALINA	KR12168463	CRISTALINA S1	19/11/2019 14:23	19/11/2019 21:05	19/11/2019 14:23	19/11/2019 17:12	2,83	2	5,65	CHI
201911210324	CRISTALINA	KR12168463	CRISTALINA S1	19/11/2019 14:23	19/11/2019 21:05	19/11/2019 14:23	19/11/2019 21:05	6,70	1	6,70	CHI
201911210324	CRISTALINA	KR12168463	CRISTALINA S1	19/11/2019 14:23	19/11/2019 21:05	19/11/2019 18:10	19/11/2019 21:05	2,91	2	5,83	CHI
201911210333	INHUMAS	IN21287267	INHUMAS S1	19/11/2019 14:23	19/11/2019 16:40	19/11/2019 14:23	19/11/2019 16:40	2,27	2	4,54	CHI
201911210337	PIRENOPOLIS	220037115	CORUMBA	19/11/2019 14:24	19/11/2019 22:27	19/11/2019 14:24	19/11/2019 22:27	8,05	1	8,05	CHI
201911210339	APARECIDA DE GOIANIA	AP11383878	INDEPENDENCIA S1	19/11/2019 14:20	20/11/2019 03:01	19/11/2019 14:20	20/11/2019 03:01	12,68	40	507,20	CHI
201911210403	ANAPOLIS	AN21258532	JUNDIAI S1	19/11/2019 14:26	19/11/2019 17:50	19/11/2019 14:26	19/11/2019 17:50	3,41	1	3,41	CHI
201911210407	JARAGUA	JA21288435	ITABERAI S1	19/11/2019 14:26	20/11/2019 09:53	19/11/2019 14:26	20/11/2019 09:53	19,45	1	19,45	CHI
201911210420	CACHOEIRA DE GOIAS	CG12018660	FIRMINOPOLIS S2	19/11/2019 14:25	19/11/2019 16:30	19/11/2019 14:25	19/11/2019 16:30	2,09	37	77,28	CHI
201911210427	ORIZONA	10022001555	PIRES DO RIO S2	19/11/2019 14:28	19/11/2019 16:45	19/11/2019 14:28	19/11/2019 16:45	2,29	1	2,29	CHI
201911210433	LUZIANIA	LZ11217749	RIO VERMELHO	19/11/2019 14:19	19/11/2019 16:06	19/11/2019 14:19	19/11/2019 16:06	1,78	92	163,89	CHI
201911210436	MARA ROSA	MQ21248123	MARA ROSA	19/11/2019 14:28	20/11/2019 00:17	19/11/2019 14:28	20/11/2019 00:17	9,81	1	9,81	CHI
201911210443	JARAGUA	SR12019009	INHUMAS S1	19/11/2019 14:17	19/11/2019 18:26	19/11/2019 14:17	19/11/2019 18:26	4,14	2	8,28	CHI
201911210443	SANTA ROSA DE GOIAS	SR12019009	INHUMAS S1	19/11/2019 14:17	19/11/2019 18:26	19/11/2019 14:17	19/11/2019 18:26	4,14	69	285,58	CHI
201911210443	TAQUARAL DE GOIAS	SR12019009	INHUMAS S1	19/11/2019 14:17	19/11/2019 18:26	19/11/2019 14:17	19/11/2019 18:26	4,14	44	182,11	CHI
201911210451	APARECIDA DE GOIANIA	AP12000261	ANHANGUERA	19/11/2019 13:19	19/11/2019 17:48	19/11/2019 13:19	19/11/2019 17:48	4,47	680	3042,06	CHI
201911210455	LUZIANIA	10008209985	MARAJOARA	19/11/2019 14:31	19/11/2019 19:58	19/11/2019 14:31	19/11/2019 19:58	5,45	1	5,45	CHI
201911210478	GOIANIA	GN21000532	CAMPINAS S3	19/11/2019 14:33	19/11/2019 17:34	19/11/2019 14:33	19/11/2019 17:34	3,01	1	3,01	CHI
201911210482	APARECIDA DE GOIANIA	AP11154044	ANHANGUERA	19/11/2019 11:54	19/11/2019 23:45	19/11/2019 11:54	19/11/2019 23:45	11,84	188	2225,35	CHI
201911210484	SANTA CRUZ DE GOIAS	BC21140726	PIRACANJUBA	19/11/2019 14:34	21/11/2019 01:00	19/11/2019 14:34	21/11/2019 01:00	34,43	1	34,43	CHI
201911210490	CALDAS NOVAS	760115369	CALDAS NOVAS S1	19/11/2019 14:34	20/11/2019 15:49	19/11/2019 14:34	20/11/2019 15:49	25,24	1	25,24	CHI
201911210499	APARECIDA DE GOIANIA	AP12135389	ANHANGUERA	19/11/2019 14:27	19/11/2019 20:35	19/11/2019 14:27	19/11/2019 20:35	6,12	364	2227,68	CHI
201911210525	IPAMERI	IP11332846	IPAMERI	19/11/2019 14:41	20/11/2019 22:04	19/11/2019 14:41	20/11/2019 22:04	31,38	1	31,38	CHI
201911210530	SILVANIA	SV12087254	DAIA S2	19/11/2019 07:34	19/11/2019 21:04	19/11/2019 07:34	19/11/2019 21:04	13,49	12	161,89	CHI
201911210901	SAO JOAO D ALIANCA	JL12404385	SAO JOAO D ALIANCA	19/11/2019 07:22	20/11/2019 09:25	19/11/2019 07:22	20/11/2019 09:25	26,05	55	1432,66	CHI

201911210910	CABECEIRAS	CW21202244	ITUIQUIRA	19/11/2019 14:44	19/11/2019 18:38	19/11/2019 14:44	19/11/2019 18:38	3,89	1	3,89	CHI
201911210924	RIO VERDE	RV12393335	MONTIVIDIU T	19/11/2019 14:34	19/11/2019 17:20	19/11/2019 14:34	19/11/2019 17:20	2,76	5	13,79	CHI
201911210926	GOIANAPOLIS	10007044192	DAIA S2	19/11/2019 14:47	19/11/2019 15:48	19/11/2019 14:47	19/11/2019 15:48	1,02	1	1,02	CHI
201911210927	SANTA ROSA DE GOIAS	SR21117272	INHUMAS S1	19/11/2019 14:47	19/11/2019 19:01	19/11/2019 14:47	19/11/2019 19:01	4,22	2	8,44	CHI
201911210930	APARECIDA DE GOIANIA	14088204	INDEPENDENCIA S2	19/11/2019 14:48	19/11/2019 17:00	19/11/2019 14:48	19/11/2019 17:00	2,20	1	2,20	CHI
201911210941	CAMPO ALEGRE DE GOIAS	CM12324026	CAMPO ALEGRE DE GOIAS	19/11/2019 14:16	20/11/2019 10:00	19/11/2019 14:16	20/11/2019 10:00	19,73	5	98,66	CHI
201911210944	MONTE ALEGRE DE GOIAS	MA21130285	SAO DOMINGOS	19/11/2019 14:51	20/11/2019 10:24	19/11/2019 14:51	20/11/2019 10:24	19,55	2	39,09	CHI
201911210950	PARAUNA	PU12205939	PARAUNA	19/11/2019 14:33	19/11/2019 19:45	19/11/2019 14:33	19/11/2019 19:45	5,20	8	41,60	CHI
201911210952	ITABERAI	IB11220456	ITABERAI S2	19/11/2019 13:41	19/11/2019 17:11	19/11/2019 13:41	19/11/2019 17:11	3,50	156	546,17	CHI
201911210954	CRIXAS	CX21319092	SERRA DO OURO	19/11/2019 14:52	20/11/2019 01:18	19/11/2019 14:52	20/11/2019 01:18	10,42	1	10,42	CHI
201911210955	PORANGATU	840036565	PORANGATU	19/11/2019 14:52	19/11/2019 17:44	19/11/2019 14:52	19/11/2019 17:44	2,85	1	2,85	CHI
201911210957	JUSSARA	JR12103806	JUSSARA	19/11/2019 14:04	19/11/2019 23:50	19/11/2019 14:04	19/11/2019 18:15	4,20	57	239,21	CHI
201911210957	JUSSARA	JR11103804	JUSSARA	19/11/2019 14:04	19/11/2019 23:50	19/11/2019 14:04	19/11/2019 23:50	9,77	65	634,83	CHI
201911210958	CRISTALINA	KR21163100	CRISTALINA S2	19/11/2019 14:53	19/11/2019 16:59	19/11/2019 14:53	19/11/2019 15:45	0,87	1	0,87	CHI
201911210958	CRISTALINA	KR12304869	CRISTALINA S2	19/11/2019 14:53	19/11/2019 16:59	19/11/2019 14:53	19/11/2019 16:59	2,10	13	27,25	CHI
201911210959	ITABERAI	IB12000034	ITABERAI S2	19/11/2019 14:50	20/11/2019 00:17	19/11/2019 14:50	19/11/2019 16:49	1,97	257	506,79	CHI
201911210959	ITABERAI	IB12000034	ITABERAI S2	19/11/2019 14:50	20/11/2019 00:17	19/11/2019 14:50	20/11/2019 00:17	9,44	28	264,28	CHI
201911210963	CATALAO	CT12209404	CATALAO S1	19/11/2019 14:54	19/11/2019 17:38	19/11/2019 14:54	19/11/2019 17:38	2,73	3	8,19	CHI
201911210964	SENADOR CANEDO	14130294	CEPAIGO S1	19/11/2019 14:54	19/11/2019 17:55	19/11/2019 14:54	19/11/2019 17:55	3,01	1	3,01	CHI
201911210968	ITABERAI	IB12172690	ITABERAI S2	19/11/2019 14:47	20/11/2019 09:20	19/11/2019 14:47	20/11/2019 09:20	18,55	6	111,30	CHI
201911210978	NOVA CRIXAS	NA21077118	NOVA CRIXAS	19/11/2019 14:57	19/11/2019 20:00	19/11/2019 14:57	19/11/2019 20:00	5,05	1	5,05	CHI
201911211105	PIRENOPOLIS	PV11185189	CORUMBA	19/11/2019 14:58	19/11/2019 18:15	19/11/2019 14:58	19/11/2019 18:15	3,28	117	383,66	CHI
201911211106	RIO VERDE	RV12303875	ACREUNA	19/11/2019 14:58	21/11/2019 17:15	19/11/2019 14:58	19/11/2019 21:00	6,03	16	96,56	CHI
201911211106	RIO VERDE	RV12073311LD	ACREUNA	19/11/2019 14:58	21/11/2019 17:15	19/11/2019 14:58	20/11/2019 12:05	21,11	25	527,78	CHI
201911211106	RIO VERDE	RV12303875	ACREUNA	19/11/2019 14:58	21/11/2019 17:15	20/11/2019 11:55	20/11/2019 12:05	0,16	16	2,52	CHI
201911211106	RIO VERDE	6621769	ACREUNA	19/11/2019 14:58	21/11/2019 17:15	19/11/2019 14:58	21/11/2019 17:15	50,27	1	50,27	CHI
201911211213	APARECIDA DE GOIANIA	200310124	INDEPENDENCIA S2	19/11/2019 15:00	20/11/2019 08:52	19/11/2019 15:00	20/11/2019 08:52	17,86	1	17,86	CHI
201911211401	APARECIDA DE GOIANIA	AP11000059	INDEPENDENCIA S1	19/11/2019 14:38	20/11/2019 07:54	19/11/2019 14:38	20/11/2019 07:54	17,27	165	2848,82	CHI
201911211410	SAO MIGUEL DO PASSA QUATRO	SQ12022826	CRISTIANOPOLIS	19/11/2019 14:47	21/11/2019 10:49	19/11/2019 14:47	21/11/2019 10:49	44,03	8	352,26	CHI
201911211414	DIVINOPOLIS DE GOIAS	GH12389051	SAO DOMINGOS	19/11/2019 15:01	19/11/2019 19:47	19/11/2019 15:01	19/11/2019 19:47	4,75	23	109,32	CHI
201911211420	ITABERAI	IB21040384	ITABERAI S2	19/11/2019 15:03	19/11/2019 20:00	19/11/2019 15:03	19/11/2019 20:00	4,95	1	4,95	CHI
201911212003	POSSE	PS21143798	IACIARA S2	19/11/2019 15:04	19/11/2019 20:17	19/11/2019 15:04	19/11/2019 20:17	5,20	2	10,41	CHI
201911212102	SANTO ANTONIO DO DESCOBERTO	SN21313794	MARAJOARA	19/11/2019 15:05	19/11/2019 20:43	19/11/2019 15:05	19/11/2019 20:43	5,62	3	16,86	CHI

201911212301	MORRINHOS	MR21157270	MORRINHOS	19/11/2019 15:06	19/11/2019 19:34	19/11/2019 15:06	19/11/2019 19:34	4,46	1	4,46	CHI
201911212303	GOIANIA	GN11340747	GOYA S2	19/11/2019 15:02	19/11/2019 15:45	19/11/2019 15:02	19/11/2019 15:45	0,71	29	20,55	CHI
201911212304	CORREGO DO OURO	CO12383517	FIRMINOPOLIS S2	19/11/2019 15:03	19/11/2019 20:13	19/11/2019 15:03	19/11/2019 20:13	5,17	8	41,35	CHI
201911212311	ESTRELA DO NORTE	ET21283170	MARA ROSA	19/11/2019 15:06	20/11/2019 00:29	19/11/2019 15:06	20/11/2019 00:29	9,37	1	9,37	CHI
201911212316	JATAI	290111493	JATAI S2	19/11/2019 15:07	19/11/2019 17:07	19/11/2019 15:07	19/11/2019 17:07	1,99	1	1,99	CHI
201911212321	NEROPOLIS	NR21254808	NEROPOLIS S2	19/11/2019 15:07	20/11/2019 08:50	19/11/2019 15:07	20/11/2019 08:50	17,70	1	17,70	CHI
201911212324	MAIRIPOTABA	MR12000060RE	MORRINHOS	19/11/2019 15:08	19/11/2019 18:50	19/11/2019 15:08	19/11/2019 18:50	3,70	12	44,41	CHI
201911212324	MORRINHOS	MR12000060RE	MORRINHOS	19/11/2019 15:08	19/11/2019 18:50	19/11/2019 15:08	19/11/2019 18:50	3,70	32	118,44	CHI
201911212324	PIRACANJUBA	MR12000060RE	MORRINHOS	19/11/2019 15:08	19/11/2019 18:50	19/11/2019 15:08	19/11/2019 18:50	3,70	7	25,91	CHI
201911212324	PONTALINA	MR12000060RE	MORRINHOS	19/11/2019 15:08	19/11/2019 18:50	19/11/2019 15:08	19/11/2019 18:50	3,70	10	37,01	CHI
201911212325	CORUMBAIBA	CI21298741	VILA CORUMBA	19/11/2019 15:08	20/11/2019 12:50	19/11/2019 15:08	20/11/2019 12:50	21,69	13	281,93	CHI
201911212326	QUIRINOPOLIS	QI11000050	QUIRINOPOLIS	19/11/2019 16:06	19/11/2019 20:22	19/11/2019 16:06	19/11/2019 20:22	4,27	89	379,76	CHI
201911212328	MUTUNOPOLIS	MU11057915	MARA ROSA	19/11/2019 15:05	19/11/2019 20:19	19/11/2019 15:05	19/11/2019 20:19	5,22	80	417,84	CHI
201911212330	IPAMERI	IP12252405	PIRES DO RIO S2	19/11/2019 15:09	21/11/2019 22:02	21/11/2019 20:20	21/11/2019 22:01	1,68	1	1,68	CHI
201911212330	IPAMERI	IP12252405	PIRES DO RIO S2	19/11/2019 15:09	21/11/2019 22:02	19/11/2019 15:09	21/11/2019 22:02	54,87	6	329,22	CHI
201911212330	IPAMERI	IP12235406LD	PIRES DO RIO S2	19/11/2019 15:09	21/11/2019 22:02	21/11/2019 20:20	21/11/2019 22:02	1,69	4	6,74	CHI
201911212331	ITUMBIARA	10025214908	ITUMBIARA NOVA	19/11/2019 15:10	19/11/2019 17:52	19/11/2019 15:10	19/11/2019 17:52	2,70	1	2,70	CHI
201911212337	GOIANESIA	550072007	GOIANESIA S2	19/11/2019 15:10	20/11/2019 18:05	19/11/2019 15:10	20/11/2019 18:05	26,90	1	26,90	CHI
201911212338	MARA ROSA	MQ21150741	MARA ROSA	19/11/2019 15:11	19/11/2019 20:59	19/11/2019 15:11	19/11/2019 20:59	5,80	1	5,80	CHI
201911212341	CRISTALINA	KR21041576	CRISTALINA S2	19/11/2019 15:11	19/11/2019 17:54	19/11/2019 15:11	19/11/2019 17:54	2,71	1	2,71	CHI
201911212344	SANCLERLANDIA	1210012707	FIRMINOPOLIS S2	19/11/2019 15:11	19/11/2019 18:59	19/11/2019 15:11	19/11/2019 18:59	3,79	1	3,79	CHI
201911212345	RIO VERDE	BZ12295804LD	ACREUNA	19/11/2019 15:11	19/11/2019 17:35	19/11/2019 15:11	19/11/2019 17:35	2,39	24	57,37	CHI
201911212345	SANTA HELENA DE GOIAS	BZ12295804LD	ACREUNA	19/11/2019 15:11	19/11/2019 17:35	19/11/2019 15:11	19/11/2019 17:35	2,39	5	11,95	CHI
201911212345	SANTO ANTONIO DA BARRA	BZ12295804LD	ACREUNA	19/11/2019 15:11	19/11/2019 17:35	19/11/2019 15:11	19/11/2019 17:35	2,39	44	105,17	CHI
201911212351	ALEXANIA	AX12066452	ALEXANIA	19/11/2019 14:17	19/11/2019 18:58	19/11/2019 14:17	19/11/2019 18:58	4,67	25	116,71	CHI
201911212355	VIANOPOLIS	510015062	VIANOPOLIS	19/11/2019 15:12	21/11/2019 13:33	19/11/2019 15:12	21/11/2019 13:33	46,35	1	46,35	CHI
201911212356	JATAI	JT11036332	JATAI S3	19/11/2019 15:12	19/11/2019 17:25	19/11/2019 15:12	19/11/2019 17:25	2,21	116	256,91	CHI
201911212357	AMARALINA	03520224	MARA ROSA	19/11/2019 15:12	19/11/2019 20:26	19/11/2019 15:12	19/11/2019 20:26	5,22	141	736,06	CHI
201911212357	ESTRELA DO NORTE	03520224	MARA ROSA	19/11/2019 15:12	19/11/2019 20:26	19/11/2019 15:12	19/11/2019 20:26	5,22	1	5,22	CHI
201911212357	MUTUNOPOLIS	03520224	MARA ROSA	19/11/2019 15:12	19/11/2019 20:26	19/11/2019 15:12	19/11/2019 20:26	5,22	1347	7031,71	CHI
201911212905	TRES RANCHOS	TH21063869	CATALAO S1	19/11/2019 15:14	20/11/2019 11:16	19/11/2019 15:14	20/11/2019 11:16	20,02	1	20,02	CHI
201911213201	NEROPOLIS	NR12353500	DAIA S2	19/11/2019 15:14	19/11/2019 18:05	19/11/2019 15:14	19/11/2019 18:05	2,83	7	19,84	CHI
201911213202	APARECIDA DE GOIANIA	13222855	REAL S1	19/11/2019 15:15	20/11/2019 11:31	19/11/2019 15:15	20/11/2019 11:31	20,26	1	20,26	CHI

201911213504	GOIANESIA	550016284	GOIANESIA S2	19/11/2019 15:16	20/11/2019 17:44	19/11/2019 15:16	20/11/2019 17:44	26,46	1	26,46	CHI
201911213512	APARECIDA DE GOIANIA	AP11277444	ANHANGUERA	19/11/2019 14:51	19/11/2019 23:09	19/11/2019 14:51	19/11/2019 23:09	8,30	191	1584,77	CHI
201911213522	LUZIANIA	LZ12353712	VIANOPOLIS	19/11/2019 15:18	19/11/2019 17:03	19/11/2019 15:18	19/11/2019 17:03	1,75	30	52,41	CHI
201911213523	CRISTALINA	KR12245539LD	CRISTALINA S1	19/11/2019 14:12	19/11/2019 16:44	19/11/2019 14:12	19/11/2019 16:44	2,52	21	52,87	CHI
201911213523	IPAMERI	KR12245539LD	CRISTALINA S1	19/11/2019 14:12	19/11/2019 16:44	19/11/2019 14:12	19/11/2019 16:44	2,52	1234	3106,60	CHI
201911213528	MINEIROS	1390123240	PARQUE DAS EMAS	19/11/2019 15:19	19/11/2019 16:58	19/11/2019 15:19	19/11/2019 16:58	1,64	1	1,64	CHI
201911213531	GOIANIA	12888382	XAVANTES	19/11/2019 12:13	19/11/2019 20:03	19/11/2019 12:13	19/11/2019 20:03	7,83	1	7,83	CHI
201911213533	CABECEIRAS	CW21181841	ITUIQUIRA	19/11/2019 15:19	19/11/2019 18:13	19/11/2019 15:19	19/11/2019 18:13	2,89	1	2,89	CHI
201911213603	APARECIDA DE GOIANIA	AP11193217	INDEPENDENCIA S1	19/11/2019 15:04	20/11/2019 00:25	19/11/2019 15:04	20/11/2019 00:25	9,34	219	2044,61	CHI
201911213606	ITUMBIARA	IT12392117	ITUMBIARA VELHA S1	19/11/2019 15:20	19/11/2019 15:38	19/11/2019 15:20	19/11/2019 15:38	0,28	7	1,99	CHI
201911213609	GOIANIA	16208663	CARAJAS S1	19/11/2019 15:21	19/11/2019 18:30	19/11/2019 15:21	19/11/2019 18:30	3,15	1	3,15	CHI
201911213610	MONTIVIDIU DO NORTE	MX12275253	PORANGATU	19/11/2019 15:17	20/11/2019 13:24	19/11/2019 15:17	20/11/2019 13:24	22,11	22	486,36	CHI
201911213612	JATAI	SX12013892	JATAI S1	19/11/2019 14:29	19/11/2019 19:45	19/11/2019 14:29	19/11/2019 19:45	5,26	14	73,65	CHI
201911213612	SERRANOPOLIS	SX12013892	JATAI S1	19/11/2019 14:29	19/11/2019 19:45	19/11/2019 14:29	19/11/2019 19:45	5,26	141	741,74	CHI
201911213613	GOIANESIA	GE12372415	GOIANESIA S1	19/11/2019 15:20	20/11/2019 01:02	19/11/2019 15:20	20/11/2019 01:02	9,70	28	271,58	CHI
201911213614	PIRENOPOLIS	220043280	CORUMBA	19/11/2019 15:21	20/11/2019 16:22	19/11/2019 15:21	20/11/2019 16:22	25,01	1	25,01	CHI
201911213615	BOM JESUS DE GOIAS	BJ12000013	BOM JESUS DE GOIAS	19/11/2019 15:12	19/11/2019 16:58	19/11/2019 15:12	19/11/2019 16:58	1,75	167	292,30	CHI
201911213615	GOIATUBA	BJ12000013	BOM JESUS DE GOIAS	19/11/2019 15:12	19/11/2019 16:58	19/11/2019 15:12	19/11/2019 16:58	1,75	5	8,75	CHI
201911213617	GOIANIA	GN12066444	CAMPINAS S2	19/11/2019 15:22	19/11/2019 20:45	19/11/2019 15:22	19/11/2019 20:45	5,38	4	21,53	CHI
201911213622	GOIANIA	GN11149909	CARAJAS S1	19/11/2019 15:23	19/11/2019 20:56	19/11/2019 15:23	19/11/2019 20:56	5,55	138	765,90	CHI
201911213624	GOIANIA	14776492	INDEPENDENCIA S2	19/11/2019 15:23	19/11/2019 21:01	19/11/2019 15:23	19/11/2019 21:01	5,63	1	5,63	CHI
201911213626	CRISTALINA	KR21290492	CRISTALINA S2	19/11/2019 15:23	20/11/2019 11:50	19/11/2019 15:23	20/11/2019 11:50	20,44	1	20,44	CHI
201911213629	POSSE	PS12218770	IACIARA S1	19/11/2019 15:23	19/11/2019 19:24	19/11/2019 15:23	19/11/2019 19:24	4,01	141	564,74	CHI
201911213630	PIRENOPOLIS	PV21040450	CORUMBA	19/11/2019 15:18	20/11/2019 18:41	19/11/2019 15:18	20/11/2019 18:41	27,38	1	27,38	CHI
201911213635	MONTIVIDIU DO NORTE	MX11203302	PORANGATU	19/11/2019 15:23	20/11/2019 15:25	19/11/2019 15:23	20/11/2019 15:25	24,02	2	48,04	CHI
201911213637	ARENOPOLIS	AY21118151	ARENOPOLIS	19/11/2019 15:24	20/11/2019 10:01	19/11/2019 15:24	20/11/2019 10:01	18,62	1	18,62	CHI
201911213640	SAO JOAO D ALIANCA	3840013365	SAO JOAO D ALIANCA	19/11/2019 15:24	20/11/2019 11:44	19/11/2019 15:24	20/11/2019 11:44	20,33	1	20,33	CHI
201911213644	RIO VERDE	630291512	RIO VERDE S1	19/11/2019 15:24	19/11/2019 17:04	19/11/2019 15:24	19/11/2019 17:04	1,66	1	1,66	CHI
201911213645	NEROPOLIS	160040048	NEROPOLIS S2	19/11/2019 15:24	19/11/2019 17:14	19/11/2019 15:24	19/11/2019 17:14	1,82	1	1,82	CHI
201911213654	ABADIANIA	AA21122888	DAIA S2	19/11/2019 15:25	20/11/2019 12:29	19/11/2019 15:25	20/11/2019 12:29	21,06	1	21,06	CHI
201911213656	BURITINOPOLIS	MB12314303	IACIARA S2	19/11/2019 15:17	20/11/2019 11:21	19/11/2019 15:17	20/11/2019 11:21	20,05	2	40,10	CHI
201911213656	MAMBAI	MB12314303	IACIARA S2	19/11/2019 15:17	20/11/2019 11:21	19/11/2019 15:17	20/11/2019 11:21	20,05	3	60,15	CHI
201911213659	SERRANOPOLIS	SX21137487	JATAI S1	19/11/2019 15:25	20/11/2019 18:13	19/11/2019 15:25	20/11/2019 18:13	26,79	1	26,79	CHI

201911213660	CEZARINA	CZ12010861	CEZARINA	19/11/2019 15:25	19/11/2019 19:59	19/11/2019 15:25	19/11/2019 19:59	4,57	23	105,02	CHI
201911213660	PALMEIRAS DE GOIAS	CZ12010861	CEZARINA	19/11/2019 15:25	19/11/2019 19:59	19/11/2019 15:25	19/11/2019 19:59	4,57	12	54,79	CHI
201911213701	RIO VERDE	RV21303563	SANTA HELENA S1	19/11/2019 15:26	20/11/2019 11:10	19/11/2019 15:26	20/11/2019 11:10	19,72	1	19,72	CHI
201911214001	AGUAS LINDAS DE GOIAS	10015043019	AGUAS LINDAS DE GOIAS S1	19/11/2019 15:26	19/11/2019 17:06	19/11/2019 15:26	19/11/2019 17:06	1,66	1	1,66	CHI
201911214204	BRITANIA	IU12025071	MATRINCHA	19/11/2019 15:27	20/11/2019 12:00	19/11/2019 15:27	20/11/2019 12:00	20,54	6	123,27	CHI
201911214204	ITAPIRAPUA	IU12025071	MATRINCHA	19/11/2019 15:27	20/11/2019 12:00	19/11/2019 15:27	20/11/2019 12:00	20,54	8	164,36	CHI
201911214209	ARAGARCAS	BM12204862	IPORA	19/11/2019 15:28	19/11/2019 19:39	19/11/2019 15:28	19/11/2019 19:39	4,19	2	8,38	CHI
201911214223	CACU	CC11397858	CACHOEIRA ALTA	19/11/2019 15:30	20/11/2019 14:12	19/11/2019 15:30	20/11/2019 14:12	22,69	1	22,69	CHI
201911214225	CRIXAS	CX12190247	SANTA TEREZINHA	19/11/2019 15:30	20/11/2019 10:43	19/11/2019 15:30	20/11/2019 10:43	19,21	5	96,03	CHI
201911214227	GOIANIA	16489809	CAMPINAS S1	19/11/2019 15:30	19/11/2019 23:42	19/11/2019 15:30	19/11/2019 23:42	8,19	1	8,19	CHI
201911214240	SILVANIA	SV21017148	DAIA S2	19/11/2019 15:33	21/11/2019 10:34	19/11/2019 15:33	21/11/2019 10:34	43,00	1	43,00	CHI
201911214245	RIO VERDE	7113564	CABRIUVA S2	19/11/2019 15:34	19/11/2019 22:50	19/11/2019 15:34	19/11/2019 22:50	7,27	1	7,27	CHI
201911214251	CAIAPONIA	10028352457	CAIAPONIA	19/11/2019 15:33	20/11/2019 17:15	19/11/2019 15:33	20/11/2019 17:15	25,69	1	25,69	CHI
201911214254	FORMOSA	610052809	ITUIQUIRA	19/11/2019 15:35	19/11/2019 17:39	19/11/2019 15:35	19/11/2019 17:39	2,06	1	2,06	CHI
201911214257	IACIARA	1550013339	IACIARA S1	19/11/2019 15:35	19/11/2019 20:38	19/11/2019 15:35	19/11/2019 20:38	5,04	1	5,04	CHI
201911214267	CABECEIRAS	CW12264683	ITUIQUIRA	19/11/2019 15:37	19/11/2019 20:03	19/11/2019 15:37	19/11/2019 20:03	4,42	1	4,42	CHI
201911214276	INHUMAS	30139703	INHUMAS S2	19/11/2019 15:39	19/11/2019 19:10	19/11/2019 15:39	19/11/2019 19:10	3,52	1	3,52	CHI
201911214280	SILVANIA	SV12346293	VIANOPOLIS	19/11/2019 15:39	20/11/2019 14:44	19/11/2019 15:39	20/11/2019 14:44	23,08	4	92,32	CHI
201911214287	CRISTALINA	KR21183948	CRISTALINA S1	19/11/2019 15:39	20/11/2019 08:55	19/11/2019 15:39	20/11/2019 08:55	17,25	1	17,25	CHI
201911214288	BELA VISTA DE GOIAS	BV12053016	BELA VISTA S1	19/11/2019 13:44	19/11/2019 18:00	19/11/2019 13:44	19/11/2019 18:00	4,26	9	38,30	CHI
201911214307	MONTIVIDIU DO NORTE	MX12391987	PORANGATU	19/11/2019 14:12	19/11/2019 22:37	19/11/2019 14:12	19/11/2019 22:37	8,41	18	151,37	CHI
201911214320	CAMPINORTE	2040015468	CAMPINORTE	19/11/2019 15:44	19/11/2019 22:11	19/11/2019 15:44	19/11/2019 22:11	6,45	1	6,45	CHI
201911214322	HEITORAI	HE11224017	ITAPURANGA	19/11/2019 15:44	19/11/2019 19:54	19/11/2019 15:44	19/11/2019 19:54	4,17	1	4,17	CHI
201911214404	CEZARINA	CZ11076513	CEZARINA	19/11/2019 15:12	19/11/2019 17:23	19/11/2019 15:12	19/11/2019 17:23	2,19	164	359,93	CHI
201911214407	ITUMBIARA	IT21143952	ITUMBIARA VELHA S1	19/11/2019 15:45	20/11/2019 00:16	19/11/2019 15:45	20/11/2019 00:16	8,52	1	8,52	CHI
201911214414	JOVIANIA	VI12208231RE	VICENTINOPOLIS	19/11/2019 15:34	20/11/2019 20:53	19/11/2019 15:34	19/11/2019 18:59	3,42	1	3,42	CHI
201911214414	VICENTINOPOLIS	VI12208231RE	VICENTINOPOLIS	19/11/2019 15:34	20/11/2019 20:53	19/11/2019 15:34	19/11/2019 18:59	3,42	12	40,99	CHI
201911214414	JOVIANIA	VI12218198RE	VICENTINOPOLIS	19/11/2019 15:34	20/11/2019 20:53	19/11/2019 15:34	20/11/2019 20:53	29,31	10	293,06	CHI
201911214414	PONTALINA	VI12218198RE	VICENTINOPOLIS	19/11/2019 15:34	20/11/2019 20:53	19/11/2019 15:34	20/11/2019 20:53	29,31	7	205,14	CHI
201911214414	VICENTINOPOLIS	VI12218198RE	VICENTINOPOLIS	19/11/2019 15:34	20/11/2019 20:53	19/11/2019 15:34	20/11/2019 20:53	29,31	9	263,75	CHI
201911214417	LUZIANIA	LZ12322801	MARAJOARA	19/11/2019 15:46	20/11/2019 08:20	19/11/2019 15:46	20/11/2019 08:20	16,55	6	99,32	CHI
201911214421	TURVELANDIA	CL21058233	RIO DOS BOIS	19/11/2019 15:47	20/11/2019 14:28	19/11/2019 15:47	20/11/2019 14:28	22,68	1	22,68	CHI
201911214423	JATAI	JT11337021	JATAI S2	19/11/2019 15:47	19/11/2019 18:14	19/11/2019 15:47	19/11/2019 18:14	2,45	88	215,18	CHI

201911214425	EDEALINA	1130004949	PONTALINA	19/11/2019 15:47	19/11/2019 17:46	19/11/2019 15:47	19/11/2019 17:46	1,97	1	1,97	CHI
201911214429	ITUMBIARA	IT21309993	ITUMBIARA VELHA S1	19/11/2019 15:48	19/11/2019 15:58	19/11/2019 15:48	19/11/2019 15:58	0,17	1	0,17	CHI
201911214432	PARAUNA	PU12007913	PARAUNA	19/11/2019 15:13	20/11/2019 17:57	19/11/2019 15:13	20/11/2019 17:57	26,73	9	240,54	CHI
201911214433	PARANAIGUARA	PC12306052	QUIRINOPOLIS	19/11/2019 15:37	19/11/2019 21:30	19/11/2019 15:37	19/11/2019 21:30	5,88	6	35,26	CHI
201911214433	QUIRINOPOLIS	PC12306052	QUIRINOPOLIS	19/11/2019 15:37	19/11/2019 21:30	19/11/2019 15:37	19/11/2019 21:30	5,88	3	17,63	CHI
201911214436	CATALAO	CT21243760	CATALAO S1	19/11/2019 15:48	19/11/2019 18:55	19/11/2019 15:48	19/11/2019 18:55	3,12	2	6,24	CHI
201911214438	PADRE BERNARDO	PB12322766	PADRE BERNARDO	19/11/2019 15:48	20/11/2019 11:48	19/11/2019 15:48	20/11/2019 11:48	19,99	1	19,99	CHI
201911214440	CAMPINORTE	10009314332	CAMPINORTE	19/11/2019 15:48	19/11/2019 17:35	19/11/2019 15:48	19/11/2019 17:35	1,77	1	1,77	CHI
201911214442	ALOANDIA	AD12013446	GOIATUBA S1	19/11/2019 14:25	19/11/2019 16:56	19/11/2019 14:25	19/11/2019 16:56	2,51	9	22,61	CHI
201911214442	PONTALINA	AD12013446	GOIATUBA S1	19/11/2019 14:25	19/11/2019 16:56	19/11/2019 14:25	19/11/2019 16:56	2,51	13	32,65	CHI
201911214444	LUZIANIA	LZ21198700	MARAJOARA	19/11/2019 15:49	20/11/2019 13:53	19/11/2019 15:49	20/11/2019 13:53	22,06	1	22,06	CHI
201911214451	PARANAIGUARA	QI21150605	QUIRINOPOLIS	19/11/2019 15:49	19/11/2019 19:40	19/11/2019 15:49	19/11/2019 19:40	3,84	1	3,84	CHI
201911214453	RIO VERDE	10017720212	RIO VERDE S1	19/11/2019 15:50	19/11/2019 18:00	19/11/2019 15:50	19/11/2019 18:00	2,17	1	2,17	CHI
201911214454	ITAPURANGA	IK11051549	ITAPURANGA	19/11/2019 15:50	19/11/2019 17:41	19/11/2019 15:50	19/11/2019 17:41	1,86	197	366,37	CHI
201911214458	HIDROLANDIA	HD21400505	CEPAIGO S2	19/11/2019 15:50	20/11/2019 12:37	19/11/2019 15:50	20/11/2019 12:37	20,77	1	20,77	CHI
201911214459	IPAMERI	IP21197356	IPAMERI	19/11/2019 14:36	20/11/2019 13:23	19/11/2019 14:36	20/11/2019 13:23	22,78	1	22,78	CHI
201911214461	ORIZONA	OZ12114545	PIRES DO RIO S2	19/11/2019 13:04	20/11/2019 13:20	19/11/2019 13:04	20/11/2019 13:20	24,25	28	679,10	CHI
201911214465	ARACU	AR11132830	ARACU	19/11/2019 15:41	19/11/2019 21:53	19/11/2019 15:41	19/11/2019 21:53	6,19	110	681,18	CHI
201911214467	FORMOSA	FA11359137	ITIQUEIRA	19/11/2019 15:48	20/11/2019 11:59	19/11/2019 15:48	20/11/2019 11:59	20,18	1	20,18	CHI
201911214473	ITUMBIARA	BG12384533	ITUMBIARA VELHA S2	19/11/2019 15:51	19/11/2019 23:33	19/11/2019 15:51	19/11/2019 23:33	7,69	29	222,97	CHI
201911214474	JATAI	JT21209807	JATAI S1	19/11/2019 15:52	19/11/2019 21:14	19/11/2019 15:52	19/11/2019 21:14	5,36	1	5,36	CHI
201911214492	CAMPINACU	UC12239728	PORANGATU	19/11/2019 15:53	20/11/2019 15:31	19/11/2019 15:53	20/11/2019 15:31	23,62	9	212,56	CHI
201911214495	CAMPOS BELOS	CH12302822	SAO DOMINGOS	19/11/2019 15:55	20/11/2019 12:44	19/11/2019 15:55	20/11/2019 12:44	20,82	3	62,47	CHI
201911214510	LUZIANIA	LZ12153292	VIANOPOLIS	19/11/2019 15:13	19/11/2019 18:33	19/11/2019 15:13	19/11/2019 18:33	3,33	13	43,30	CHI
201911214514	GOIANIA	12848190	MEIA PONTE	19/11/2019 15:57	20/11/2019 08:12	19/11/2019 15:57	20/11/2019 08:12	16,24	1	16,24	CHI
201911214515	ITABERAI	10021706687	ITABERAI S2	19/11/2019 15:57	19/11/2019 18:13	19/11/2019 15:57	19/11/2019 18:13	2,25	1	2,25	CHI
201911214519	PIRENOPOLIS	PV12000046	CORUMBA	19/11/2019 15:58	19/11/2019 21:57	19/11/2019 15:58	19/11/2019 21:57	5,97	50	298,65	CHI
201911214522	SITIO D ABADIA	SI12318211	IACIARA S2	19/11/2019 15:58	19/11/2019 18:22	19/11/2019 15:58	19/11/2019 18:22	2,39	1	2,39	CHI
201911214526	ANAPOLIS	20670023	ANAPOLIS UNIVERSITARIO S2	19/11/2019 15:58	19/11/2019 17:08	19/11/2019 15:58	19/11/2019 17:08	1,15	1	1,15	CHI
201911214528	ANAPOLIS	AN11297556	JUNDIAI S2	19/11/2019 15:49	19/11/2019 18:31	19/11/2019 15:49	19/11/2019 18:31	2,69	56	150,66	CHI
201911214529	PADRE BERNARDO	PB12375013	PADRE BERNARDO	19/11/2019 15:59	20/11/2019 02:50	19/11/2019 15:59	20/11/2019 02:50	10,84	15	162,67	CHI
201911214533	GOIANIA	15265250	AEROPORTO S2	19/11/2019 15:59	20/11/2019 07:28	19/11/2019 15:59	20/11/2019 07:28	15,47	1	15,47	CHI
201911214535	TRINDADE	14133908	GOYA S2	19/11/2019 15:59	19/11/2019 17:57	19/11/2019 15:59	19/11/2019 17:57	1,95	1	1,95	CHI

201911214536	JATAI	JT12324668	JATAI S3	19/11/2019 15:59	21/11/2019 21:55	19/11/2019 15:59	19/11/2019 23:25	7,43	44	327,09	CHI
201911214536	JATAI	JT12166054	JATAI S3	19/11/2019 15:59	21/11/2019 21:55	19/11/2019 15:59	21/11/2019 21:55	53,92	5	269,61	CHI
201911214546	JATAI	JT21274071	JATAI S1	19/11/2019 16:00	20/11/2019 11:59	19/11/2019 16:00	20/11/2019 11:59	19,98	1	19,98	CHI
201911214557	PADRE BERNARDO	PB12290558	PADRE BERNARDO	19/11/2019 16:01	19/11/2019 17:03	19/11/2019 16:01	19/11/2019 17:03	1,03	13	13,38	CHI
201911214558	MAIRIPOTABA	CQ21028524	PONTALINA	19/11/2019 16:01	20/11/2019 09:24	19/11/2019 16:01	20/11/2019 09:24	17,38	1	17,38	CHI
201911214565	SILVANIA	SV12087781	DAIA S2	19/11/2019 16:02	20/11/2019 12:10	19/11/2019 16:02	20/11/2019 12:10	20,13	9	181,18	CHI
201911214573	GOIANIA	13306110	REAL S1	19/11/2019 16:02	19/11/2019 19:32	19/11/2019 16:02	19/11/2019 19:32	3,49	1	3,49	CHI
201911214575	ORIZONA	OZ12022888	PIRES DO RIO S2	19/11/2019 14:47	19/11/2019 19:13	19/11/2019 14:47	19/11/2019 19:13	4,43	33	146,08	CHI
201911214580	SENADOR CANEDO	DE12398863	SENADOR CANEDO	19/11/2019 12:53	19/11/2019 18:47	19/11/2019 12:53	19/11/2019 18:47	5,90	3	17,70	CHI
201911214701	APARECIDA DE GOIANIA	AP11395354	ANHANGUERA	19/11/2019 14:33	19/11/2019 19:07	19/11/2019 14:33	19/11/2019 19:07	4,56	83	378,53	CHI
201911214804	FORMOSA	610121765	ITIQUEIRA	19/11/2019 16:03	19/11/2019 19:59	19/11/2019 16:03	19/11/2019 19:59	3,93	1	3,93	CHI
201911214814	ITARUMA	FA21085582	ITIQUEIRA	19/11/2019 16:05	20/11/2019 16:16	19/11/2019 16:05	20/11/2019 16:16	24,17	2	48,34	CHI
201911214818	GOIANIA	17451840	CAMPINAS S2	19/11/2019 16:06	19/11/2019 22:11	19/11/2019 16:06	19/11/2019 22:11	6,08	1	6,08	CHI
201911214901	LUZIANIA	3200182475	MARAJOARA	19/11/2019 16:07	19/11/2019 18:58	19/11/2019 16:07	19/11/2019 18:58	2,85	1	2,85	CHI
201911215004	DIORAMA	DI12334940	ARENOPOLIS	19/11/2019 16:07	19/11/2019 17:46	19/11/2019 16:07	19/11/2019 17:46	1,64	2	3,28	CHI
201911215009	MORRINHOS	MR12381119	MORRINHOS	19/11/2019 16:08	20/11/2019 14:34	19/11/2019 16:08	20/11/2019 14:34	22,44	2	44,88	CHI
201911215017	RIO VERDE	RV12279613	RIO VERDE S1	19/11/2019 16:09	19/11/2019 19:21	19/11/2019 16:09	19/11/2019 19:21	3,19	10	31,88	CHI
201911215023	JATAI	JT12213671	JATAI S1	19/11/2019 16:10	20/11/2019 11:51	19/11/2019 16:10	20/11/2019 11:51	19,68	5	98,38	CHI
201911215038	LUZIANIA	LZ12000519	RIO VERMELHO	19/11/2019 14:51	19/11/2019 19:13	19/11/2019 14:51	19/11/2019 19:13	4,35	87	378,50	CHI
201911215050	PORANGATU	PO12020611	NOVO PLANALTO	19/11/2019 15:51	19/11/2019 18:54	19/11/2019 15:51	19/11/2019 18:54	3,04	8	24,35	CHI
201911215053	BONFINOPOLIS	LB21351051	DAIA S2	19/11/2019 16:09	19/11/2019 20:10	19/11/2019 16:09	19/11/2019 20:10	4,02	1	4,02	CHI
201911215302	FORMOSA	FA12261997	ITIQUEIRA	19/11/2019 15:38	19/11/2019 23:00	19/11/2019 15:38	19/11/2019 23:00	7,36	65	478,29	CHI
201911215302	VILA BOA	FA12261997	ITIQUEIRA	19/11/2019 15:38	19/11/2019 23:00	19/11/2019 15:38	19/11/2019 23:00	7,36	4	29,43	CHI
201911215508	GOIANESIA	GE21068622	GOIANESIA S2	19/11/2019 16:12	20/11/2019 15:30	19/11/2019 16:12	20/11/2019 15:30	23,30	2	46,59	CHI
201911215511	ORIZONA	OZ21280189	PIRES DO RIO S2	19/11/2019 16:09	20/11/2019 07:57	19/11/2019 16:09	20/11/2019 07:57	15,80	1	15,80	CHI
201911215523	IVOLANDIA	1560000603	IPORA	19/11/2019 16:12	19/11/2019 18:57	19/11/2019 16:12	19/11/2019 18:57	2,74	1	2,74	CHI
201911215543	LEOPOLDO DE BULHOES	GP21211761	DAIA S2	19/11/2019 16:13	20/11/2019 08:30	19/11/2019 16:13	20/11/2019 08:30	16,29	1	16,29	CHI
201911215552	GOIAS	GS12183485	GOIAS	19/11/2019 16:13	20/11/2019 15:42	19/11/2019 16:13	20/11/2019 15:42	23,47	4	93,90	CHI
201911215555	GAMELEIRA DE GOIAS	SV12062620	DAIA S2	19/11/2019 14:44	20/11/2019 10:30	19/11/2019 14:44	20/11/2019 10:30	19,77	4	79,06	CHI
201911215566	SENADOR CANEDO	SW21099395	SENADOR CANEDO	19/11/2019 16:09	19/11/2019 18:19	19/11/2019 16:09	19/11/2019 18:19	2,17	1	2,17	CHI
201911215569	VIANOPOLIS	VN12282733	VIANOPOLIS	19/11/2019 13:19	20/11/2019 18:44	19/11/2019 13:19	20/11/2019 18:44	29,41	11	323,56	CHI
201911215592	CAMPOS BELOS	CH12376678	SAO DOMINGOS	19/11/2019 16:14	20/11/2019 10:40	19/11/2019 16:14	20/11/2019 10:40	18,43	16	294,82	CHI
201911215614	SANTA CRUZ DE GOIAS	BC21186563	PIRES DO RIO S2	19/11/2019 16:14	20/11/2019 21:12	19/11/2019 16:14	20/11/2019 21:12	28,95	1	28,95	CHI

201911215624	TROMBAS	6487535	PORANGATU	19/11/2019 16:15	20/11/2019 08:29	19/11/2019 16:15	20/11/2019 08:29	16,23	7	113,63	CHI
201911216109	PALMELO	BC21166914	PIRES DO RIO S1	19/11/2019 16:09	20/11/2019 19:30	19/11/2019 16:09	20/11/2019 19:30	27,35	1	27,35	CHI
201911216127	URUTAI	UT21244890	URUTAI	19/11/2019 16:09	19/11/2019 23:42	19/11/2019 16:09	19/11/2019 23:42	7,55	1	7,55	CHI
201911216184	VIANOPOLIS	510035980	VIANOPOLIS	19/11/2019 16:16	21/11/2019 14:07	19/11/2019 16:16	21/11/2019 14:07	45,85	1	45,85	CHI
201911216271	GOIANIA	10015357277	XAVANTES	19/11/2019 16:18	19/11/2019 23:31	19/11/2019 16:18	19/11/2019 23:31	7,20	1	7,20	CHI
201911216286	ORIZONA	OZ21186573	PIRES DO RIO S2	19/11/2019 16:09	20/11/2019 17:22	19/11/2019 16:09	20/11/2019 17:22	25,22	1	25,22	CHI
201911217111	SANTO ANTONIO DO DESCOBERTO	2210117210	AGUAS LINDAS DE GOIAS S2	19/11/2019 16:19	19/11/2019 18:54	19/11/2019 16:19	19/11/2019 18:54	2,57	1	2,57	CHI
201911217141	ORIZONA	OZ21219125	PIRES DO RIO S2	19/11/2019 16:20	20/11/2019 08:27	19/11/2019 16:20	20/11/2019 08:27	16,11	1	16,11	CHI
201911217189	APARECIDA DE GOIANIA	AP21012585	INDEPENDENCIA S1	19/11/2019 16:21	20/11/2019 11:32	19/11/2019 16:21	20/11/2019 11:32	19,18	1	19,18	CHI
201911217266	GOIANIA	GN11043926	ATLANTICO S2	19/11/2019 16:09	19/11/2019 17:30	19/11/2019 16:09	19/11/2019 17:30	1,35	191	257,85	CHI
201911217303	GOIANIA	12888345	XAVANTES	19/11/2019 12:43	19/11/2019 18:43	19/11/2019 12:43	19/11/2019 18:43	6,00	1	6,00	CHI
201911217360	AGUA FRIA DE GOIAS	TL10402672	SAO JOAO D ALIANCA	19/11/2019 19:31	20/11/2019 23:39	19/11/2019 19:31	20/11/2019 23:39	28,15	38	1069,58	CHI
201911217373	APARECIDA DE GOIANIA	AP11378274	ANHANGUERA	19/11/2019 16:58	20/11/2019 01:32	19/11/2019 16:58	20/11/2019 01:32	8,55	62	530,29	CHI
201911217383	FORMOSA	FA10376698	ITIQUIRA	19/11/2019 21:55	20/11/2019 11:50	19/11/2019 22:00	20/11/2019 00:09	2,16	108	232,80	CHI
201911217383	FORMOSA	FA10376698	ITIQUIRA	19/11/2019 21:55	20/11/2019 11:50	20/11/2019 00:12	20/11/2019 01:08	0,93	35	32,55	CHI
201911217383	FORMOSA	FA13383239	ITIQUIRA	19/11/2019 21:55	20/11/2019 11:50	19/11/2019 22:00	20/11/2019 11:49	13,82	128	1768,57	CHI
201911217383	FORMOSA	FA13383239	ITIQUIRA	19/11/2019 21:55	20/11/2019 11:50	20/11/2019 00:12	20/11/2019 11:49	11,61	73	847,53	CHI
201911217383	FORMOSA	FA10400654	ITIQUIRA	19/11/2019 21:55	20/11/2019 11:50	19/11/2019 21:55	20/11/2019 11:50	13,90	38	528,22	CHI
201911217383	FORMOSA	FA10400655	ITIQUIRA	19/11/2019 21:55	20/11/2019 11:50	19/11/2019 21:55	20/11/2019 11:50	13,90	40	556,03	CHI
201911217386	CAMPO ALEGRE DE GOIAS	02250424	CAMPO ALEGRE DE GOIAS	19/11/2019 22:17	22/11/2019 14:30	19/11/2019 22:17	19/11/2019 23:33	1,26	60	75,67	CHI
201911217386	CAMPO ALEGRE DE GOIAS	02250424	CAMPO ALEGRE DE GOIAS	19/11/2019 22:17	22/11/2019 14:30	19/11/2019 22:19	19/11/2019 23:33	1,24	5	6,19	CHI
201911217386	CAMPO ALEGRE DE GOIAS	02250424	CAMPO ALEGRE DE GOIAS	19/11/2019 22:17	22/11/2019 14:30	20/11/2019 03:56	20/11/2019 04:07	0,18	65	11,56	CHI
201911217386	CAMPO ALEGRE DE GOIAS	02250424	CAMPO ALEGRE DE GOIAS	19/11/2019 22:17	22/11/2019 14:30	19/11/2019 22:17	20/11/2019 05:29	7,20	51	367,20	CHI
201911217386	CAMPO ALEGRE DE GOIAS	02250424	CAMPO ALEGRE DE GOIAS	19/11/2019 22:17	22/11/2019 14:30	19/11/2019 22:17	20/11/2019 11:59	13,69	42	575,18	CHI
201911217386	CAMPO ALEGRE DE GOIAS	CM13266893	CAMPO ALEGRE DE GOIAS	19/11/2019 22:17	22/11/2019 14:30	19/11/2019 22:17	20/11/2019 11:59	13,69	29	397,15	CHI
201911217386	CATALAO	CM13266893	CAMPO ALEGRE DE GOIAS	19/11/2019 22:17	22/11/2019 14:30	19/11/2019 22:17	20/11/2019 11:59	13,69	1	13,69	CHI
201911217386	CAMPO ALEGRE DE GOIAS	CM13266893	CAMPO ALEGRE DE GOIAS	19/11/2019 22:17	22/11/2019 14:30	20/11/2019 03:56	20/11/2019 11:59	8,04	3	24,13	CHI
201911217386	CAMPO ALEGRE DE GOIAS	02250424	CAMPO ALEGRE DE GOIAS	19/11/2019 22:17	22/11/2019 14:30	20/11/2019 20:36	20/11/2019 21:09	0,55	238	130,70	CHI
201911217386	CATALAO	02250424	CAMPO ALEGRE DE GOIAS	19/11/2019 22:17	22/11/2019 14:30	20/11/2019 20:36	20/11/2019 21:09	0,55	21	11,53	CHI
201911217386	DISTRITO FEDERAL	02250424	CAMPO ALEGRE DE GOIAS	19/11/2019 22:17	22/11/2019 14:30	20/11/2019 20:36	20/11/2019 21:09	0,55	1	0,55	CHI
201911217386	IPAMERI	02250424	CAMPO ALEGRE DE GOIAS	19/11/2019 22:17	22/11/2019 14:30	20/11/2019 20:36	20/11/2019 21:09	0,55	12	6,59	CHI
201911217386	CAMPO ALEGRE DE GOIAS	02250424	CAMPO ALEGRE DE GOIAS	19/11/2019 22:17	22/11/2019 14:30	19/11/2019 22:17	22/11/2019 14:30	64,20	28	1797,70	CHI
201911217396	POSSE	PS10400659	IACIARA S2	19/11/2019 23:00	20/11/2019 17:33	19/11/2019 23:00	20/11/2019 07:38	8,64	17	146,82	CHI

201911217396	POSSE	PS10400659	IACIARA S2	19/11/2019 23:00	20/11/2019 17:33	20/11/2019 08:30	20/11/2019 08:45	0,24	17	4,09	CHI
201911217396	POSSE	PS10400659	IACIARA S2	19/11/2019 23:00	20/11/2019 17:33	20/11/2019 10:35	20/11/2019 10:50	0,25	17	4,27	CHI
201911217396	POSSE	PS13104979	IACIARA S2	19/11/2019 23:00	20/11/2019 17:33	19/11/2019 23:00	20/11/2019 17:33	18,54	351	6507,54	CHI
201911217397	RIO QUENTE	10019097504	MORRINHOS	19/11/2019 16:47	20/11/2019 15:05	19/11/2019 16:47	20/11/2019 15:05	22,30	1	22,30	CHI
201911217604	RIO VERDE	630087830	RIO VERDE S2	19/11/2019 16:24	19/11/2019 18:40	19/11/2019 16:24	19/11/2019 18:40	2,27	1	2,27	CHI
201911217607	VIANOPOLIS	VN21105257	VIANOPOLIS	19/11/2019 16:24	19/11/2019 18:57	19/11/2019 16:24	19/11/2019 18:57	2,55	1	2,55	CHI
201911217611	PARAUNA	PU12079038	PARAUNA	19/11/2019 16:24	20/11/2019 11:35	19/11/2019 16:24	20/11/2019 11:35	19,18	2	38,36	CHI
201911217640	ORIZONA	OZ21080262	PIRES DO RIO S2	19/11/2019 16:25	20/11/2019 07:39	19/11/2019 16:25	20/11/2019 07:39	15,23	1	15,23	CHI
201911217655	VIANOPOLIS	510045601	VIANOPOLIS	19/11/2019 16:25	21/11/2019 14:35	19/11/2019 16:25	21/11/2019 14:35	46,16	1	46,16	CHI
201911217691	SAO MIGUEL DO ARAGUAIA	SM12074646	SAO MIGUEL DO ARAGUAIA	19/11/2019 14:54	22/11/2019 09:28	19/11/2019 14:54	21/11/2019 09:45	42,85	1	42,85	CHI
201911217691	SAO MIGUEL DO ARAGUAIA	SM12074646	SAO MIGUEL DO ARAGUAIA	19/11/2019 14:54	22/11/2019 09:28	19/11/2019 14:54	21/11/2019 10:13	43,32	3	129,95	CHI
201911217691	SAO MIGUEL DO ARAGUAIA	SM12074646	SAO MIGUEL DO ARAGUAIA	19/11/2019 14:54	22/11/2019 09:28	19/11/2019 14:54	21/11/2019 11:01	44,13	2	88,26	CHI
201911217691	SAO MIGUEL DO ARAGUAIA	SM12074646	SAO MIGUEL DO ARAGUAIA	19/11/2019 14:54	22/11/2019 09:28	19/11/2019 14:54	21/11/2019 11:19	44,42	25	1110,39	CHI
201911217691	SAO MIGUEL DO ARAGUAIA	SM12074646	SAO MIGUEL DO ARAGUAIA	19/11/2019 14:54	22/11/2019 09:28	19/11/2019 14:54	21/11/2019 12:10	45,27	1	45,27	CHI
201911217691	NOVO PLANALTO	SM12074646	SAO MIGUEL DO ARAGUAIA	19/11/2019 14:54	22/11/2019 09:28	19/11/2019 14:54	21/11/2019 12:20	45,43	6	272,57	CHI
201911217691	SAO MIGUEL DO ARAGUAIA	SM12074646	SAO MIGUEL DO ARAGUAIA	19/11/2019 14:54	22/11/2019 09:28	19/11/2019 14:54	21/11/2019 12:20	45,43	345	15672,78	CHI
201911217691	SAO MIGUEL DO ARAGUAIA	SM12074646	SAO MIGUEL DO ARAGUAIA	19/11/2019 14:54	22/11/2019 09:28	19/11/2019 14:54	21/11/2019 13:48	46,90	1	46,90	CHI
201911217691	SAO MIGUEL DO ARAGUAIA	SM12137060	SAO MIGUEL DO ARAGUAIA	19/11/2019 14:54	22/11/2019 09:28	21/11/2019 11:02	22/11/2019 09:28	22,43	2	44,87	CHI
201911217693	LUZIANIA	SV12013810	VIANOPOLIS	20/11/2019 08:03	20/11/2019 09:53	20/11/2019 08:03	20/11/2019 09:53	1,82	62	113,12	CHI
201911217693	ORIZONA	SV12013810	VIANOPOLIS	20/11/2019 08:03	20/11/2019 09:53	20/11/2019 08:03	20/11/2019 09:53	1,82	56	102,17	CHI
201911217693	SILVANIA	SV12013810	VIANOPOLIS	20/11/2019 08:03	20/11/2019 09:53	20/11/2019 08:03	20/11/2019 09:53	1,82	16	29,19	CHI
201911217712	ITUMBIARA	IT12000033	ITUMBIARA VELHA S1	19/11/2019 16:52	19/11/2019 19:12	19/11/2019 16:52	19/11/2019 19:12	2,34	3	7,02	CHI
201911217733	ITARUMA	IM21247826	CACHEOIRA ALTA	19/11/2019 16:28	19/11/2019 18:04	19/11/2019 16:28	19/11/2019 18:04	1,59	1	1,59	CHI
201911217802	FAZENDA NOVA	FN11195506	JUSSARA	19/11/2019 16:53	19/11/2019 19:03	19/11/2019 16:53	19/11/2019 19:03	2,17	50	108,51	CHI
201911218310	GUARANI DE GOIAS	GY12215935	IACIARA S1	19/11/2019 16:29	19/11/2019 22:30	19/11/2019 16:29	19/11/2019 22:30	6,01	8	48,11	CHI
201911218329	GOIANIA	15483769	XAVANTES	19/11/2019 16:29	20/11/2019 03:20	19/11/2019 16:29	20/11/2019 03:20	10,84	1	10,84	CHI
201911218346	LUZIANIA	LZ21103543	PAMPLONA	19/11/2019 16:30	19/11/2019 18:33	19/11/2019 16:30	19/11/2019 18:33	2,04	1	2,04	CHI
201911218372	ABADIANIA	AN21319656	ANAPOLIS UNIVERSITARIO S1	19/11/2019 16:31	20/11/2019 00:36	19/11/2019 16:31	20/11/2019 00:36	8,08	1	8,08	CHI
201911218393	MONTE ALEGRE DE GOIAS	MA12233174	SAO DOMINGOS	19/11/2019 16:31	19/11/2019 22:02	19/11/2019 16:31	19/11/2019 22:02	5,50	17	93,51	CHI
201911218407	NEROPOLIS	160016629	NEROPOLIS S2	19/11/2019 16:32	19/11/2019 17:41	19/11/2019 16:32	19/11/2019 17:41	1,14	1	1,14	CHI
201911218422	PALESTINA DE GOIAS	PY12023466	PALESTINA	19/11/2019 16:00	19/11/2019 17:15	19/11/2019 16:00	19/11/2019 17:15	1,25	3	3,75	CHI
201911218433	GOIANIA	AP11034267	ATLANTICO S1	19/11/2019 15:03	19/11/2019 20:55	19/11/2019 15:03	19/11/2019 20:55	5,86	121	708,76	CHI
201911218436	ALEXANIA	03240416	CORUMBA	20/11/2019 15:30	20/11/2019 21:23	20/11/2019 15:30	20/11/2019 21:23	5,88	847	4983,42	CHI

201911218436	CORUMBA DE GOIAS	03240416	CORUMBA	20/11/2019 15:30	20/11/2019 21:23	20/11/2019 15:30	20/11/2019 21:23	5,88	357	2100,45	CHI
201911218439	SILVANIA	SV12026710	VIANOPOLIS	19/11/2019 16:33	20/11/2019 12:25	19/11/2019 16:33	20/11/2019 12:25	19,86	6	119,18	CHI
201911218444	APARECIDA DE GOIANIA	200316280	ANHANGUERA	19/11/2019 16:33	19/11/2019 19:08	19/11/2019 16:33	19/11/2019 19:08	2,58	1	2,58	CHI
201911218448	VALPARAISO DE GOIAS	2860034750	MARAJOARA	19/11/2019 16:33	19/11/2019 18:14	19/11/2019 16:33	19/11/2019 18:14	1,67	1	1,67	CHI
201911218455	GOIAS	GS12203880	GOIAS	19/11/2019 16:02	20/11/2019 08:45	19/11/2019 16:02	20/11/2019 08:45	16,70	26	434,21	CHI
201911218457	CACU	CA12013274	CACHOEIRA ALTA	19/11/2019 16:34	21/11/2019 19:38	19/11/2019 16:34	20/11/2019 20:25	27,86	6	167,17	CHI
201911218457	CACU	CA12013274	CACHOEIRA ALTA	19/11/2019 16:34	21/11/2019 19:38	20/11/2019 20:26	21/11/2019 19:38	23,21	6	139,29	CHI
201911218463	BRAZABRANTES	IN21195709	INHUMAS S2	19/11/2019 16:34	20/11/2019 09:18	19/11/2019 16:34	20/11/2019 09:18	16,73	7	117,10	CHI
201911218479	GOIANESIA	GE12093160	GOIANESIA S2	19/11/2019 16:35	19/11/2019 22:09	19/11/2019 16:35	19/11/2019 22:09	5,56	47	261,49	CHI
201911218481	JATAI	JT11036255	JATAI S3	19/11/2019 16:35	19/11/2019 18:46	19/11/2019 16:35	19/11/2019 18:14	1,66	138	229,12	CHI
201911218481	JATAI	JT12036258	JATAI S3	19/11/2019 16:35	19/11/2019 18:46	19/11/2019 16:35	19/11/2019 18:46	2,18	27	58,92	CHI
201911218488	ABADIANIA	AN21098124	ANAPOLIS UNIVERSITARIO S1	19/11/2019 16:35	21/11/2019 01:08	19/11/2019 16:35	21/11/2019 01:08	32,54	1	32,54	CHI
201911218490	SILVANIA	SV21011724	VIANOPOLIS	19/11/2019 16:35	20/11/2019 08:52	19/11/2019 16:35	20/11/2019 08:52	16,28	1	16,28	CHI
201911218495	PLANALTINA	PI11361426	PLANALTINA	19/11/2019 16:23	19/11/2019 18:36	19/11/2019 16:23	19/11/2019 18:36	2,20	182	400,91	CHI
201911218506	GOIAS	GS12188167	MATRINCHA	19/11/2019 16:36	20/11/2019 11:00	19/11/2019 16:36	20/11/2019 11:00	18,40	32	588,70	CHI
201911218511	FORMOSA	FA12383248	ITUIQUIRA	19/11/2019 17:29	19/11/2019 17:43	19/11/2019 17:29	19/11/2019 17:43	0,23	3	0,69	CHI
201911218514	CRISTALINA	KR21143716	CRISTALINA S2	19/11/2019 14:53	19/11/2019 17:51	19/11/2019 14:53	19/11/2019 17:51	2,95	1	2,95	CHI
201911218516	CRISTALINA	KR12163676	PAMPLONA	19/11/2019 12:26	20/11/2019 02:26	19/11/2019 12:26	20/11/2019 02:26	13,99	24	335,77	CHI
201911218516	DISTRITO FEDERAL	KR12163676	PAMPLONA	19/11/2019 12:26	20/11/2019 02:26	19/11/2019 12:26	20/11/2019 02:26	13,99	4	55,96	CHI
201911218516	LUZIANIA	KR12163676	PAMPLONA	19/11/2019 12:26	20/11/2019 02:26	19/11/2019 12:26	20/11/2019 02:26	13,99	2	27,98	CHI
201911218518	FORMOSO	FO12071131	PORANGATU	19/11/2019 14:23	19/11/2019 22:45	19/11/2019 14:23	19/11/2019 22:45	8,36	22	184,02	CHI
201911218525	APARECIDA DE GOIANIA	10008615290	INDEPENDENCIA S1	19/11/2019 16:37	20/11/2019 16:38	19/11/2019 16:37	20/11/2019 16:38	24,01	1	24,01	CHI
201911218527	CATALAO	1990314240	CATALAO S2	19/11/2019 16:37	20/11/2019 09:28	19/11/2019 16:37	20/11/2019 09:28	16,85	1	16,85	CHI
201911218544	APARECIDA DE GOIANIA	AP11165012	INDEPENDENCIA S2	19/11/2019 16:38	20/11/2019 15:23	19/11/2019 16:38	20/11/2019 15:23	22,74	71	1614,48	CHI
201911218550	ANICUNS	AC12391421	ANICUNS	19/11/2019 16:38	19/11/2019 19:30	19/11/2019 16:38	19/11/2019 19:30	2,85	3	8,56	CHI
201911218554	SANTA CRUZ DE GOIAS	PZ21000458	PIRES DO RIO S2	19/11/2019 16:39	20/11/2019 23:17	19/11/2019 16:39	20/11/2019 23:17	30,63	1	30,63	CHI
201911218571	VIANOPOLIS	VN21067593	VIANOPOLIS	19/11/2019 16:40	20/11/2019 12:24	19/11/2019 16:40	20/11/2019 12:24	19,73	1	19,73	CHI
201911218572	ALVORADA DO NORTE	AQ12384212	IACIARA S2	19/11/2019 16:46	19/11/2019 18:23	19/11/2019 16:46	19/11/2019 18:23	1,60	237	380,32	CHI
201911218573	BELA VISTA DE GOIAS	BV10401411	BELA VISTA S2	19/11/2019 17:02	19/11/2019 17:11	19/11/2019 17:02	19/11/2019 17:11	0,14	620	87,14	CHI
201911218586	IVOLANDIA	IV12390185	IPORA	19/11/2019 16:41	20/11/2019 13:00	19/11/2019 16:41	20/11/2019 13:00	20,32	13	264,10	CHI
201911218594	CRISTALINA	KR21037186	CRISTALINA S1	19/11/2019 14:12	20/11/2019 10:35	19/11/2019 14:12	20/11/2019 10:35	20,37	1	20,37	CHI
201911218595	PONTALINA	PK21111929	PONTALINA	19/11/2019 16:41	20/11/2019 10:12	19/11/2019 16:41	20/11/2019 10:12	17,51	1	17,51	CHI
201911218603	ITAGUARU	JA12021562	JARAGUA	19/11/2019 16:41	19/11/2019 21:30	19/11/2019 16:41	19/11/2019 21:30	4,80	17	81,64	CHI

201911218603	JARAGUA	JA12021562	JARAGUA	19/11/2019 16:41	19/11/2019 21:30	19/11/2019 16:41	19/11/2019 21:30	4,80	74	355,38	CHI
201911218603	URUANA	JA12021562	JARAGUA	19/11/2019 16:41	19/11/2019 21:30	19/11/2019 16:41	19/11/2019 21:30	4,80	8	38,42	CHI
201911218604	JATAI	290040190	JATAI S2	19/11/2019 16:41	19/11/2019 17:54	19/11/2019 16:41	19/11/2019 17:54	1,21	1	1,21	CHI
201911218605	CALDAS NOVAS	CN21286173	CALDAS NOVAS S1	19/11/2019 16:42	20/11/2019 09:48	19/11/2019 16:42	20/11/2019 09:48	17,10	1	17,10	CHI
201911218606	ITABERAÍ	50132532	ITABERAÍ S2	19/11/2019 16:42	20/11/2019 08:30	19/11/2019 16:42	20/11/2019 08:30	15,80	1	15,80	CHI
201911218622	TEREZOPOLIS DE GOIAS	10006772100	DAIA S2	19/11/2019 16:43	20/11/2019 10:04	19/11/2019 16:43	20/11/2019 10:04	17,35	1	17,35	CHI
201911218628	CAMPINACU	FO12197186	PORANGATU	19/11/2019 16:43	20/11/2019 08:50	19/11/2019 16:43	20/11/2019 08:50	16,11	3	48,33	CHI
201911218628	CAMPINORTE	FO12197186	PORANGATU	19/11/2019 16:43	20/11/2019 08:50	19/11/2019 16:43	20/11/2019 08:50	16,11	29	467,21	CHI
201911218628	FORMOSO	FO12197186	PORANGATU	19/11/2019 16:43	20/11/2019 08:50	19/11/2019 16:43	20/11/2019 08:50	16,11	3	48,33	CHI
201911218631	SERRANOPOLIS	SX21303364	CACHOEIRA ALTA	19/11/2019 16:43	20/11/2019 16:17	19/11/2019 16:43	20/11/2019 16:17	23,55	1	23,55	CHI
201911218639	LUZIANIA	LZ21366202	VIANOPOLIS	19/11/2019 16:44	19/11/2019 19:48	19/11/2019 16:44	19/11/2019 19:48	3,06	1	3,06	CHI
201911218640	PADRE BERNARDO	PB11089642	PADRE BERNARDO	19/11/2019 16:44	19/11/2019 21:48	19/11/2019 16:44	19/11/2019 21:48	5,06	188	951,12	CHI
201911218645	JAUPACI	1280001577	IPORA	19/11/2019 16:45	19/11/2019 18:20	19/11/2019 16:45	19/11/2019 18:20	1,58	1	1,58	CHI
201911218655	NIQUELANDIA	NQ11281257	NIQUELANDIA SUBTRANSMISSAO	19/11/2019 16:46	20/11/2019 11:52	19/11/2019 16:46	20/11/2019 11:52	19,09	2	38,19	CHI
201911218658	ITAPURANGA	IK21325997	ITAPURANGA	19/11/2019 16:46	20/11/2019 18:08	19/11/2019 16:46	20/11/2019 18:08	25,36	1	25,36	CHI
201911218662	MORRINHOS	MR21182935	MORRINHOS	19/11/2019 16:46	20/11/2019 15:46	19/11/2019 16:46	20/11/2019 15:46	22,99	1	22,99	CHI
201911218670	BALIZA	BM12390150	BOM JARDIM	19/11/2019 16:46	20/11/2019 08:31	19/11/2019 16:46	20/11/2019 08:31	15,74	51	802,90	CHI
201911218670	BOM JARDIM DE GOIAS	BM12390150	BOM JARDIM	19/11/2019 16:46	20/11/2019 08:31	19/11/2019 16:46	20/11/2019 08:31	15,74	8	125,94	CHI
201911218671	VILA PROPICIO	NP12188681	GOIANESIA S1	19/11/2019 16:47	19/11/2019 21:06	19/11/2019 16:47	19/11/2019 21:06	4,30	87	374,51	CHI
201911219006	JAUPACI	JP21207843	IPORA	19/11/2019 13:51	20/11/2019 14:52	19/11/2019 13:51	20/11/2019 14:52	25,01	1	25,01	CHI
201911219022	RIO VERDE	RV12327049	CABRIUVA S2	19/11/2019 16:49	19/11/2019 19:27	19/11/2019 16:49	19/11/2019 19:27	2,62	2	5,24	CHI
201911219036	PORANGATU	PO12391665	PORANGATU	19/11/2019 16:01	20/11/2019 00:00	19/11/2019 16:01	20/11/2019 00:00	7,97	19	151,41	CHI
201911219040	CAIAPONIA	CP21011319	CAIAPONIA	19/11/2019 16:51	20/11/2019 17:15	19/11/2019 16:51	20/11/2019 17:15	24,39	1	24,39	CHI
201911219041	CALDAZINHA	DE21129644	CEPAIGO S2	19/11/2019 16:51	21/11/2019 18:48	19/11/2019 16:51	21/11/2019 18:48	49,93	2	99,87	CHI
201911219045	MONTIVIDIU	MV12267612	MONTIVIDIU T	19/11/2019 16:51	20/11/2019 10:18	19/11/2019 16:51	20/11/2019 10:18	17,45	8	139,56	CHI
201911219047	ANAPOLIS	AN21297696	ANAPOLIS UNIVERSITARIO S2	19/11/2019 16:52	20/11/2019 22:00	19/11/2019 16:52	20/11/2019 21:35	28,72	2	57,43	CHI
201911219047	ANAPOLIS	AN12297708	ANAPOLIS UNIVERSITARIO S2	19/11/2019 16:52	20/11/2019 22:00	20/11/2019 18:40	20/11/2019 22:00	3,32	8	26,58	CHI
201911219054	AMARALINA	LC12170975	MARA ROSA	19/11/2019 16:53	20/11/2019 02:11	19/11/2019 16:53	20/11/2019 02:11	9,30	11	102,25	CHI
201911219066	CAMPOS VERDES	VD12054418	SANTA TEREZINHA	19/11/2019 16:39	20/11/2019 08:14	19/11/2019 16:39	20/11/2019 08:14	15,57	6	93,44	CHI
201911219073	CRISTALINA	KR12230241	CRISTALINA S2	19/11/2019 16:54	20/11/2019 04:58	19/11/2019 16:54	20/11/2019 04:58	12,06	5	60,28	CHI
201911219083	ALTO PARAISO DE GOIAS	BF12329675	NIQUELANDIA SUBTRANSMISSAO	19/11/2019 09:16	19/11/2019 20:38	19/11/2019 09:16	19/11/2019 20:38	11,37	6	68,20	CHI
201911219084	PARANAIGUARA	PC21230896	QUIRINOPOLIS	19/11/2019 16:55	20/11/2019 16:41	19/11/2019 16:55	20/11/2019 16:41	23,76	1	23,76	CHI
201911219089	FLORES DE GOIAS	FA12404371	ITUIQUIRA	19/11/2019 16:32	20/11/2019 19:45	19/11/2019 16:32	20/11/2019 19:45	27,20	1	27,20	CHI

201911219089	FORMOSA	FA12404371	ITQUIRA	19/11/2019 16:32	20/11/2019 19:45	19/11/2019 16:32	20/11/2019 19:45	27,20	90	2448,35	CHI
201911219095	ITAPACI	10017950560	ITAPACI	19/11/2019 16:56	19/11/2019 23:01	19/11/2019 16:56	19/11/2019 23:01	6,07	1	6,07	CHI
201911219097	GOIAS	GS12310423	ITABERAI S1	19/11/2019 16:56	20/11/2019 10:14	19/11/2019 16:56	20/11/2019 10:14	17,29	7	121,01	CHI
201911219100	APARECIDA DE GOIANIA	AP11169475	INDEPENDENCIA S2	19/11/2019 16:48	20/11/2019 02:35	19/11/2019 16:48	20/11/2019 02:35	9,78	176	1720,60	CHI
201911219102	EDEALINA	EA12223550RE	EDEIA	19/11/2019 16:33	20/11/2019 10:18	19/11/2019 16:33	20/11/2019 10:18	17,74	50	886,82	CHI
201911219102	EDEIA	EA12223550RE	EDEIA	19/11/2019 16:33	20/11/2019 10:18	19/11/2019 16:33	20/11/2019 10:18	17,74	25	443,41	CHI
201911219102	INDIARA	EA12223550RE	EDEIA	19/11/2019 16:33	20/11/2019 10:18	19/11/2019 16:33	20/11/2019 10:18	17,74	7	124,15	CHI
201911219104	GOIANIA	10016263691	MEIA PONTE	19/11/2019 16:57	19/11/2019 22:18	19/11/2019 16:57	19/11/2019 22:18	5,34	1	5,34	CHI
201911219107	RUBIATABA	780025556	RUBIATABA	19/11/2019 16:58	20/11/2019 12:51	19/11/2019 16:58	20/11/2019 12:51	19,89	1	19,89	CHI
201911219128	PONTALINA	PK21228206	PONTALINA	19/11/2019 17:00	20/11/2019 08:07	19/11/2019 17:00	20/11/2019 08:07	15,11	1	15,11	CHI
201911219135	LUZIANIA	LZ12203332	VIANOPOLIS	19/11/2019 15:07	19/11/2019 22:45	19/11/2019 15:07	19/11/2019 22:45	7,62	15	114,30	CHI
201911219137	APARECIDA DE GOIANIA	14384097	INDEPENDENCIA S1	19/11/2019 17:00	19/11/2019 19:14	19/11/2019 17:00	19/11/2019 19:14	2,22	1	2,22	CHI
201911219138	JATAI	290248152	JATAI S2	19/11/2019 17:00	19/11/2019 19:38	19/11/2019 17:00	19/11/2019 19:38	2,63	1	2,63	CHI
201911219141	DOVERLANDIA	DV21253610	CAIAPONIA	19/11/2019 17:01	21/11/2019 08:30	19/11/2019 17:01	21/11/2019 08:30	39,48	1	39,48	CHI
201911219148	JATAI	SX12260522	JATAI S1	19/11/2019 14:24	19/11/2019 21:00	19/11/2019 14:24	19/11/2019 21:00	6,60	3	19,80	CHI
201911219148	SERRANOPOLIS	SX12260522	JATAI S1	19/11/2019 14:24	19/11/2019 21:00	19/11/2019 14:24	19/11/2019 21:00	6,60	9	59,39	CHI
201911219401	PONTALINA	PK21204455	PONTALINA	19/11/2019 17:02	20/11/2019 10:51	19/11/2019 17:02	20/11/2019 10:51	17,82	1	17,82	CHI
201911219506	MINACU	TB12185305	PORANGATU	19/11/2019 13:45	19/11/2019 19:31	19/11/2019 13:45	19/11/2019 19:31	5,75	12	69,01	CHI
201911219506	TROMBAS	TB12185305	PORANGATU	19/11/2019 13:45	19/11/2019 19:31	19/11/2019 13:45	19/11/2019 19:31	5,75	95	546,36	CHI
201911219509	CORUMBAIBA	CI12025121	VILA CORUMBA	19/11/2019 17:03	20/11/2019 19:00	19/11/2019 17:03	20/11/2019 19:00	25,95	32	830,30	CHI
201911219512	GOIANIA	10004031456	GOYA S1	19/11/2019 17:03	19/11/2019 21:58	19/11/2019 17:03	19/11/2019 21:58	4,90	1	4,90	CHI
201911219514	FIRMINOPOLIS	FR21105342	FIRMINOPOLIS S1	19/11/2019 17:03	20/11/2019 09:40	19/11/2019 17:03	20/11/2019 09:40	16,62	1	16,62	CHI
201911219515	PANAMA	PX21171908	GOIATUBA S1	19/11/2019 17:04	20/11/2019 04:38	19/11/2019 17:04	20/11/2019 04:38	11,57	1	11,57	CHI
201911219523	HEITORAI	HE12032466	ITAPURANGA	19/11/2019 16:44	19/11/2019 18:54	19/11/2019 16:44	19/11/2019 18:54	2,16	461	997,30	CHI
201911219535	APARECIDA DE GOIANIA	AP11191055	INDEPENDENCIA S2	19/11/2019 16:34	19/11/2019 22:04	19/11/2019 16:34	19/11/2019 22:04	5,50	113	621,19	CHI
201911219550	LUZIANIA	LZ21237879	CRISTALINA S2	19/11/2019 17:07	19/11/2019 20:42	19/11/2019 17:07	19/11/2019 20:42	3,58	1	3,58	CHI
201911219552	MAIRIPOTABA	MI12000433	PONTALINA	19/11/2019 17:45	20/11/2019 15:39	19/11/2019 17:45	20/11/2019 15:39	21,89	1	21,89	CHI
201911219559	APARECIDA DE GOIANIA	13574905	CARAJAS S1	19/11/2019 17:07	20/11/2019 10:03	19/11/2019 17:07	20/11/2019 10:03	16,92	1	16,92	CHI
201911219560	JUSSARA	JR21022268	BRITANIA	19/11/2019 10:55	20/11/2019 11:27	19/11/2019 10:55	20/11/2019 11:27	24,55	1	24,55	CHI
201911219561	GUAPO	GA10401434	GUAPO S2	19/11/2019 14:58	19/11/2019 21:33	19/11/2019 20:33	19/11/2019 20:36	0,05	1	0,05	CHI
201911219561	GUAPO	03320226	GUAPO S2	19/11/2019 14:58	19/11/2019 21:33	19/11/2019 14:58	19/11/2019 21:22	6,39	3	19,18	CHI
201911219561	VARJAO	03320226	GUAPO S2	19/11/2019 14:58	19/11/2019 21:33	19/11/2019 14:58	19/11/2019 21:22	6,39	102	652,09	CHI
201911219561	CEZARINA	03320416	GUAPO S2	19/11/2019 14:58	19/11/2019 21:33	19/11/2019 19:20	19/11/2019 21:28	2,13	221	471,41	CHI

201911219561	INDIARA	03320416	GUAPO S2	19/11/2019 14:58	19/11/2019 21:33	19/11/2019 19:20	19/11/2019 21:28	2,13	1	2,13	CHI
201911219561	VARJAO	03320416	GUAPO S2	19/11/2019 14:58	19/11/2019 21:33	19/11/2019 19:20	19/11/2019 21:28	2,13	1528	3259,31	CHI
201911219561	GUAPO	VJ13000011	GUAPO S2	19/11/2019 14:58	19/11/2019 21:33	19/11/2019 14:58	19/11/2019 21:33	6,58	127	835,20	CHI
201911219561	VARJAO	VJ13000011	GUAPO S2	19/11/2019 14:58	19/11/2019 21:33	19/11/2019 14:58	19/11/2019 21:33	6,58	97	637,91	CHI
201911219568	JUSSARA	JR11183444	JUSSARA	19/11/2019 15:52	19/11/2019 21:58	19/11/2019 15:52	19/11/2019 21:58	6,09	110	669,72	CHI
201911219569	ANICUNS	AC12391418	ANICUNS	19/11/2019 17:00	20/11/2019 08:55	19/11/2019 17:00	20/11/2019 08:55	15,91	17	270,44	CHI
201911219586	MATRINCHA	MP12165386	MOZARLANDIA	19/11/2019 17:10	20/11/2019 08:44	19/11/2019 17:10	20/11/2019 08:44	15,55	1	15,55	CHI
201911219590	JATAI	JT12184194	JATAI S1	19/11/2019 17:11	19/11/2019 19:52	19/11/2019 17:11	19/11/2019 19:52	2,68	12	32,16	CHI
201911219593	LUZIANIA	10009422941	MARAJOARA	19/11/2019 17:11	20/11/2019 01:06	19/11/2019 17:11	20/11/2019 01:06	7,91	1	7,91	CHI
201911219596	SANTO ANTONIO DA BARRA	2270015570	ACREUNA	19/11/2019 17:11	20/11/2019 15:30	19/11/2019 17:11	20/11/2019 15:30	22,31	1	22,31	CHI
201911219608	GOIANIA	16087574	XAVANTES	19/11/2019 17:13	20/11/2019 04:43	19/11/2019 17:13	20/11/2019 04:43	11,49	1	11,49	CHI
201911219701	GOIANIA	16829669	FERROVIARIO S1	19/11/2019 17:13	19/11/2019 23:09	19/11/2019 17:13	19/11/2019 23:09	5,92	1	5,92	CHI
201911219703	ARACU	750014398	ARACU	19/11/2019 17:14	20/11/2019 16:03	19/11/2019 17:14	20/11/2019 16:03	22,83	1	22,83	CHI
201911219704	APARECIDA DE GOIANIA	AP12394694	ANHANGUERA	19/11/2019 16:56	20/11/2019 02:44	19/11/2019 16:56	20/11/2019 02:44	9,79	17	166,45	CHI
201911219708	JARAGUA	JA21299637	ITABERAI S1	19/11/2019 17:14	20/11/2019 10:26	19/11/2019 17:14	20/11/2019 10:26	17,20	1	17,20	CHI
201911219712	AMARALINA	MU12269538	MARA ROSA	19/11/2019 17:04	19/11/2019 21:57	19/11/2019 17:04	19/11/2019 21:57	4,88	40	195,22	CHI
201911219712	MUTUNOPOLIS	MU12269538	MARA ROSA	19/11/2019 17:04	19/11/2019 21:57	19/11/2019 17:04	19/11/2019 21:57	4,88	42	204,98	CHI
201911219806	CRIXAS	CX12322605	SERRA DO OURO	19/11/2019 14:20	19/11/2019 22:10	19/11/2019 14:20	19/11/2019 22:10	7,82	16	125,14	CHI
201911219807	LUZIANIA	120261819	RIO VERMELHO	19/11/2019 17:15	19/11/2019 21:01	19/11/2019 17:15	19/11/2019 21:01	3,76	1	3,76	CHI
201911219811	CRISTALINA	KR12153067	CRISTALINA S2	19/11/2019 17:01	20/11/2019 00:23	19/11/2019 17:01	20/11/2019 00:23	7,36	3	22,09	CHI
201911219814	GOIANIA	16722632	CAMPINAS S2	19/11/2019 17:16	20/11/2019 02:03	19/11/2019 17:16	20/11/2019 02:03	8,78	1	8,78	CHI
201911219815	CRISTALINA	KR21219771	CRISTALINA S2	19/11/2019 17:16	20/11/2019 05:47	19/11/2019 17:16	20/11/2019 05:47	12,51	1	12,51	CHI
201911219830	VILA PROPICIO	NP11273281	GOIANESIA S1	19/11/2019 15:10	19/11/2019 20:30	19/11/2019 15:10	19/11/2019 20:30	5,32	80	425,67	CHI
201911219840	CALDAS NOVAS	CN21254654	SERRA DE CALDAS	19/11/2019 17:19	20/11/2019 12:19	19/11/2019 17:19	20/11/2019 12:19	18,99	1	18,99	CHI
201911219844	PALESTINA DE GOIAS	PY21342752	PALESTINA	19/11/2019 17:20	20/11/2019 11:26	19/11/2019 17:20	20/11/2019 11:26	18,11	1	18,11	CHI
201911219845	GOIANIA	GN21138925	MEIA PONTE	19/11/2019 17:20	19/11/2019 20:47	19/11/2019 17:20	19/11/2019 20:47	3,44	1	3,44	CHI
201911219848	APARECIDA DE GOIANIA	AP21065848	INDEPENDENCIA S1	19/11/2019 17:20	20/11/2019 15:50	19/11/2019 17:20	20/11/2019 15:50	22,50	1	22,50	CHI
201911219852	CRISTALINA	KR21163054	PAMPLONA	19/11/2019 17:21	20/11/2019 15:10	19/11/2019 17:21	20/11/2019 15:10	21,82	1	21,82	CHI
201911219862	PADRE BERNARDO	PB11093025	PADRE BERNARDO	19/11/2019 17:21	19/11/2019 22:02	19/11/2019 17:21	19/11/2019 22:02	4,67	143	667,65	CHI
201911219869	GOIANIA	10004156585	GOIANIA LESTE S3	19/11/2019 17:22	20/11/2019 01:32	19/11/2019 17:22	20/11/2019 01:32	8,15	1	8,15	CHI
201911219871	CRISTALINA	KR21168134	CRISTALINA S2	19/11/2019 17:22	20/11/2019 13:09	19/11/2019 17:22	20/11/2019 13:09	19,77	1	19,77	CHI
201911219876	SAO FRANCISCO DE GOIAS	SF21017615	SAO FRANCISCO DE GOIAS	19/11/2019 17:23	20/11/2019 15:19	19/11/2019 17:23	20/11/2019 15:19	21,93	1	21,93	CHI
201911219877	NIQUELANDIA	NQ12396807	URUACU	19/11/2019 16:20	20/11/2019 17:23	19/11/2019 16:20	20/11/2019 17:23	25,05	4	100,20	CHI

201911219883	MINEIROS	1390106722	PARQUE DAS EMAS	19/11/2019 17:23	19/11/2019 19:54	19/11/2019 17:23	19/11/2019 19:54	2,50	1	2,50	CHI
201911219885	PALMEIRAS DE GOIAS	590023640	PALMEIRAS	19/11/2019 17:23	19/11/2019 19:41	19/11/2019 17:23	19/11/2019 19:41	2,29	1	2,29	CHI
201911219895	CRISTALINA	KR12209611	PAMPLONA	19/11/2019 17:25	20/11/2019 15:31	19/11/2019 17:25	20/11/2019 15:31	22,09	3	66,26	CHI
201911219898	JARAGUA	JA12059983	JARAGUA	19/11/2019 16:49	19/11/2019 19:32	19/11/2019 16:49	19/11/2019 19:32	2,71	89	241,29	CHI
201911219903	NEROPOLIS	160082195	NEROPOLIS S2	19/11/2019 17:26	19/11/2019 19:02	19/11/2019 17:26	19/11/2019 19:02	1,59	1	1,59	CHI
201911219904	RIO VERDE	RV12092821	MONTIVIDIU T	19/11/2019 17:26	20/11/2019 12:50	19/11/2019 17:26	20/11/2019 12:50	19,39	11	213,32	CHI
201911219905	BOM JARDIM DE GOIAS	BM12155682	BOM JARDIM	19/11/2019 16:53	20/11/2019 07:49	19/11/2019 16:53	20/11/2019 07:49	14,93	14	208,98	CHI
201911219905	PIRANHAS	BM12155682	BOM JARDIM	19/11/2019 16:53	20/11/2019 07:49	19/11/2019 16:53	20/11/2019 07:49	14,93	4	59,71	CHI
201911219906	FAINA	FC12378894	MATRINCHA	19/11/2019 17:26	20/11/2019 07:13	19/11/2019 17:26	20/11/2019 07:13	13,78	10	137,76	CHI
201911219906	MATRINCHA	FC12378894	MATRINCHA	19/11/2019 17:26	20/11/2019 07:13	19/11/2019 17:26	20/11/2019 07:13	13,78	6	82,66	CHI
201911219907	CRISTALINA	19845604	CRISTALINA S2	19/11/2019 17:26	20/11/2019 14:46	19/11/2019 17:26	20/11/2019 14:46	21,32	3	63,96	CHI
201911219914	SAO MIGUEL DO ARAGUAIA	SM11217901	SAO MIGUEL DO ARAGUAIA	19/11/2019 16:15	19/11/2019 23:39	19/11/2019 16:15	19/11/2019 23:39	7,39	98	724,52	CHI
201911219917	CAMPINORTE	2040000740	CAMPINORTE	19/11/2019 17:27	19/11/2019 21:12	19/11/2019 17:27	19/11/2019 21:12	3,73	1	3,73	CHI
201911219925	IPORA	730142802	IPORA	19/11/2019 17:28	19/11/2019 21:17	19/11/2019 17:28	19/11/2019 21:17	3,81	1	3,81	CHI
201911219926	JATAI	JT12205195	JATAI S1	19/11/2019 17:19	19/11/2019 21:50	19/11/2019 17:19	19/11/2019 21:50	4,51	45	203,06	CHI
201911219929	ARAGOIANIA	GA31098704	GUAPO S2	19/11/2019 17:29	20/11/2019 15:12	19/11/2019 17:29	20/11/2019 15:12	21,73	1	21,73	CHI
201911219939	URUACU	UR12003415	URUACU	19/11/2019 17:30	19/11/2019 20:35	19/11/2019 17:30	19/11/2019 20:35	3,08	24	73,99	CHI
201911219940	APARECIDA DO RIO DOCE	3650008796	JATAI S1	19/11/2019 17:30	20/11/2019 13:32	19/11/2019 17:30	20/11/2019 13:32	20,04	1	20,04	CHI
201911219954	PADRE BERNARDO	PB12163217	PADRE BERNARDO	19/11/2019 17:31	20/11/2019 12:20	19/11/2019 17:31	20/11/2019 12:20	18,80	20	376,04	CHI
201911219955	GOIANIA	GN21001343	GOYA S1	19/11/2019 17:31	19/11/2019 20:23	19/11/2019 17:31	19/11/2019 20:23	2,85	1	2,85	CHI
201911219958	CORUMBAIBA	CI11166832	VILA CORUMBA	19/11/2019 17:05	20/11/2019 17:48	19/11/2019 17:05	20/11/2019 17:48	24,71	99	2445,99	CHI
201911219966	RIO VERDE	RV12230810	MONTIVIDIU T	19/11/2019 17:33	20/11/2019 14:50	19/11/2019 17:33	20/11/2019 14:50	21,28	1	21,28	CHI
201911219970	ALEXANIA	10004970762	CORUMBA	19/11/2019 17:33	20/11/2019 20:00	19/11/2019 17:33	20/11/2019 20:00	26,44	1	26,44	CHI
201911219974	PLANALTINA	2960146949	PLANALTINA	19/11/2019 17:34	19/11/2019 18:56	19/11/2019 17:34	19/11/2019 18:56	1,36	1	1,36	CHI
201911219976	ADELANDIA	DN11206044	FIRMINOPOLIS S2	19/11/2019 17:30	19/11/2019 20:44	19/11/2019 17:30	19/11/2019 20:44	3,24	84	272,32	CHI
201911219981	PLANALTINA	PI12325516	PLANALTINA	19/11/2019 17:35	20/11/2019 18:50	19/11/2019 17:35	20/11/2019 18:50	25,25	9	227,23	CHI
201911219990	APARECIDA DE GOIANIA	200257638	ANHANGUERA	19/11/2019 17:36	20/11/2019 11:39	19/11/2019 17:36	20/11/2019 11:39	18,05	1	18,05	CHI
201911219993	CRISTALINA	KR21311486	CRISTALINA S1	19/11/2019 17:36	20/11/2019 13:12	19/11/2019 17:36	20/11/2019 13:12	19,59	1	19,59	CHI
201911219996	APARECIDA DE GOIANIA	10011628004	ANHANGUERA	19/11/2019 17:37	20/11/2019 13:37	19/11/2019 17:37	20/11/2019 13:37	20,00	1	20,00	CHI
201911220002	ISRAELANDIA	IS12009675	IPORA	19/11/2019 17:38	20/11/2019 15:30	19/11/2019 17:38	20/11/2019 15:30	21,88	1	21,88	CHI
201911220012	RIO VERDE	RV12100652	MONTIVIDIU T	19/11/2019 17:38	20/11/2019 14:01	19/11/2019 17:38	20/11/2019 14:01	20,38	9	183,42	CHI
201911220016	PORANGATU	PO12088782	PORANGATU	19/11/2019 16:04	20/11/2019 11:01	19/11/2019 16:04	20/11/2019 11:01	18,94	5	94,71	CHI
201911220024	MONTIVIDIU	MV12207748	MONTIVIDIU T	19/11/2019 16:22	20/11/2019 13:25	19/11/2019 16:22	20/11/2019 13:25	21,04	8	168,34	CHI

201911220025	MUTUNOPOLIS	MU12127950	MARA ROSA	19/11/2019 17:39	20/11/2019 09:34	19/11/2019 17:39	20/11/2019 09:34	15,92	2	31,83	CHI
201911220027	NIQUELANDIA	NQ12375605	URUACU	20/11/2019 07:43	20/11/2019 11:00	20/11/2019 07:43	20/11/2019 11:00	3,27	42	137,44	CHI
201911220038	CRISTALINA	KR12330533	CRISTALINA S1	19/11/2019 17:39	19/11/2019 23:41	19/11/2019 17:39	19/11/2019 23:41	6,02	34	204,63	CHI
201911220038	IPAMERI	KR12330533	CRISTALINA S1	19/11/2019 17:39	19/11/2019 23:41	19/11/2019 17:39	19/11/2019 23:41	6,02	1	6,02	CHI
201911220038	LUZIANIA	KR12330533	CRISTALINA S1	19/11/2019 17:39	19/11/2019 23:41	19/11/2019 17:39	19/11/2019 23:41	6,02	8	48,15	CHI
201911220039	PADRE BERNARDO	PB11382975	PADRE BERNARDO	19/11/2019 17:39	20/11/2019 00:16	19/11/2019 17:39	20/11/2019 00:16	6,60	2	13,20	CHI
201911220042	SERRANOPOLIS	SX21267482	JATAI S1	19/11/2019 17:40	20/11/2019 18:10	19/11/2019 17:40	20/11/2019 18:10	24,49	1	24,49	CHI
201911220043	CALDAS NOVAS	CN12363800	SERRA DE CALDAS	19/11/2019 17:40	20/11/2019 15:15	19/11/2019 17:40	20/11/2019 15:15	21,57	3	64,71	CHI
201911220044	GOIANIA	GN11048174	XAVANTES	19/11/2019 17:32	19/11/2019 22:32	19/11/2019 17:32	19/11/2019 22:32	4,98	130	648,05	CHI
201911220054	CATALAO	CT12266116	CATALAO S1	19/11/2019 15:34	20/11/2019 08:04	19/11/2019 15:34	20/11/2019 08:04	16,49	3	49,47	CHI
201911220059	CATALAO	10008052652	CATALAO S1	19/11/2019 17:42	20/11/2019 09:47	19/11/2019 17:42	20/11/2019 09:47	16,08	1	16,08	CHI
201911220074	LUZIANIA	LZ12313611	VIANOPOLIS	19/11/2019 16:02	19/11/2019 22:04	19/11/2019 16:02	19/11/2019 22:04	6,02	12	72,24	CHI
201911220077	RIO VERDE	BZ12048964	ACREUNA	19/11/2019 16:03	20/11/2019 08:15	19/11/2019 16:03	20/11/2019 08:15	16,19	21	339,97	CHI
201911220077	SANTO ANTONIO DA BARRA	BZ12048964	ACREUNA	19/11/2019 16:03	20/11/2019 08:15	19/11/2019 16:03	20/11/2019 08:15	16,19	37	598,99	CHI
201911220078	ANAPOLIS	20724913	ANAPOLIS UNIVERSITARIO S1	19/11/2019 17:44	20/11/2019 09:14	19/11/2019 17:44	20/11/2019 09:14	15,49	1	15,49	CHI
201911220079	BALIZA	BM12156550	BOM JARDIM	19/11/2019 17:17	19/11/2019 23:41	19/11/2019 17:17	19/11/2019 23:41	6,39	1	6,39	CHI
201911220079	BOM JARDIM DE GOIAS	BM12156550	BOM JARDIM	19/11/2019 17:17	19/11/2019 23:41	19/11/2019 17:17	19/11/2019 23:41	6,39	92	587,52	CHI
201911220087	NOVO GAMA	4990098305	PACAEMBU S1	19/11/2019 17:45	19/11/2019 19:30	19/11/2019 17:45	19/11/2019 19:30	1,75	1	1,75	CHI
201911220089	CAMPINORTE	2040021900	CAMPINORTE	19/11/2019 17:45	19/11/2019 20:30	19/11/2019 17:45	19/11/2019 20:30	2,74	1	2,74	CHI
201911220090	GUAPO	GA12000172	GUAPO S1	19/11/2019 17:26	20/11/2019 11:55	19/11/2019 17:26	20/11/2019 11:55	18,48	5	92,41	CHI
201911220091	MONTES CLAROS DE GOIAS	ME12223057	IPORA	19/11/2019 17:45	20/11/2019 10:21	19/11/2019 17:45	20/11/2019 10:21	16,59	1	16,59	CHI
201911220094	GOIANIA	14737449	CARAJAS S1	19/11/2019 17:45	20/11/2019 01:16	19/11/2019 17:45	20/11/2019 01:16	7,50	1	7,50	CHI
201911220301	ALEXANIA	480081591	ALEXANIA	19/11/2019 17:46	20/11/2019 07:11	19/11/2019 17:46	20/11/2019 07:11	13,41	1	13,41	CHI
201911220306	CASTELANDIA	ML12303542	RIO DOS BOIS	19/11/2019 16:57	19/11/2019 21:45	19/11/2019 16:57	19/11/2019 21:45	4,78	5	23,92	CHI
201911220306	MAURILANDIA	ML12303542	RIO DOS BOIS	19/11/2019 16:57	19/11/2019 21:45	19/11/2019 16:57	19/11/2019 21:45	4,78	15	71,77	CHI
201911220310	SAO DOMINGOS	SD21265492	SAO DOMINGOS	19/11/2019 17:47	20/11/2019 11:10	19/11/2019 17:47	20/11/2019 11:10	17,37	1	17,37	CHI
201911220315	MAIRIPOTABA	MI12060613	PONTALINA	19/11/2019 16:42	20/11/2019 16:33	19/11/2019 16:42	20/11/2019 16:33	23,84	4	95,37	CHI
201911220321	MORRINHOS	MR21112471	MORRINHOS	19/11/2019 17:48	20/11/2019 11:36	19/11/2019 17:48	20/11/2019 11:36	17,80	1	17,80	CHI
201911220323	IPAMERI	580078383	IPAMERI	19/11/2019 17:48	19/11/2019 23:55	19/11/2019 17:48	19/11/2019 23:55	6,10	1	6,10	CHI
201911220324	GOIANESIA	GE21138771	CORUMBA	19/11/2019 17:48	20/11/2019 17:55	19/11/2019 17:48	20/11/2019 17:55	24,11	1	24,11	CHI
201911220325	ANAPOLIS	AN12221522	JUNDIAI S2	19/11/2019 17:48	19/11/2019 22:22	19/11/2019 17:48	19/11/2019 22:22	4,55	5	22,76	CHI
201911220329	GOIANIA	GN12001378	FERROVIARIO S2	19/11/2019 16:04	19/11/2019 19:22	19/11/2019 16:04	19/11/2019 19:22	3,29	27	88,72	CHI
201911220341	MORRINHOS	MR12335174RE	MORRINHOS	19/11/2019 16:46	20/11/2019 20:30	19/11/2019 16:46	20/11/2019 20:30	27,73	74	2052,16	CHI

201911220344	CRISTALINA	KR12349104	CRISTALINA S1	19/11/2019 15:06	20/11/2019 08:59	19/11/2019 15:06	20/11/2019 08:59	17,87	8	142,96	CHI
201911220353	CALDAS NOVAS	CN12363790	SERRA DE CALDAS	19/11/2019 17:25	19/11/2019 20:07	19/11/2019 17:25	19/11/2019 20:07	2,69	72	194,00	CHI
201911220366	URUACU	UR21190065	URUACU	19/11/2019 17:53	20/11/2019 04:26	19/11/2019 17:53	20/11/2019 04:26	10,54	1	10,54	CHI
201911220367	APARECIDA DE GOIANIA	AP11000060	ANHANGUERA	19/11/2019 15:00	20/11/2019 00:32	19/11/2019 15:00	20/11/2019 00:32	9,52	136	1294,53	CHI
201911220372	GOIANESIA	10014001070	GOIANESIA S2	19/11/2019 17:55	20/11/2019 02:46	19/11/2019 17:55	20/11/2019 02:46	8,84	1	8,84	CHI
201911220373	VICENTINOPOLIS	VI12166491	VICENTINOPOLIS	19/11/2019 16:12	20/11/2019 07:49	19/11/2019 16:12	20/11/2019 07:49	15,62	26	406,01	CHI
201911220379	CRIXAS	10027299374	SERRA DO OURO	19/11/2019 17:56	20/11/2019 02:44	19/11/2019 17:56	20/11/2019 02:44	8,79	1	8,79	CHI
201911220382	ALOANDIA	AD12150204	GOIATUBA S1	19/11/2019 17:30	20/11/2019 09:00	19/11/2019 17:30	20/11/2019 09:00	15,49	21	325,31	CHI
201911220385	PIRENOPOLIS	220075682	CORUMBA	19/11/2019 17:57	20/11/2019 17:21	19/11/2019 17:57	20/11/2019 17:21	23,39	1	23,39	CHI
201911220388	ORIZONA	OZ12113707	PIRES DO RIO S2	19/11/2019 15:47	20/11/2019 12:33	19/11/2019 15:47	20/11/2019 12:33	20,75	4	83,01	CHI
201911220389	FAZENDA NOVA	FN12292871	IPORA	19/11/2019 17:18	20/11/2019 11:48	19/11/2019 17:18	20/11/2019 11:48	18,49	34	628,66	CHI
201911220393	ORIZONA	OZ12372377	PIRES DO RIO S2	19/11/2019 13:47	19/11/2019 23:07	19/11/2019 13:47	19/11/2019 23:07	9,33	28	261,24	CHI
201911220400	GAMELEIRA DE GOIAS	SV32093678	DAIA S2	19/11/2019 16:53	20/11/2019 09:48	19/11/2019 16:53	20/11/2019 09:48	16,91	8	135,29	CHI
201911220403	ALEXANIA	AX12155965	CORUMBA	19/11/2019 15:55	20/11/2019 18:05	19/11/2019 15:55	19/11/2019 22:08	6,22	3	18,65	CHI
201911220403	ALEXANIA	AX12155965	CORUMBA	19/11/2019 15:55	20/11/2019 18:05	19/11/2019 15:55	20/11/2019 14:31	22,61	1	22,61	CHI
201911220403	CORUMBA DE GOIAS	AX12155965	CORUMBA	19/11/2019 15:55	20/11/2019 18:05	19/11/2019 15:55	20/11/2019 14:31	22,61	10	226,09	CHI
201911220403	CORUMBA DE GOIAS	AX12155965	CORUMBA	19/11/2019 15:55	20/11/2019 18:05	19/11/2019 15:55	20/11/2019 14:31	22,61	3	67,83	CHI
201911220403	CORUMBA DE GOIAS	AX12155965	CORUMBA	19/11/2019 15:55	20/11/2019 18:05	19/11/2019 15:55	20/11/2019 18:05	26,17	15	392,54	CHI
201911220406	FORMOSA	10027500347	ITUIQUIRA	19/11/2019 18:00	20/11/2019 16:15	19/11/2019 18:00	20/11/2019 16:15	22,25	1	22,25	CHI
201911220412	SAO FRANCISCO DE GOIAS	SF12211814	SAO FRANCISCO DE GOIAS	19/11/2019 17:51	20/11/2019 02:03	19/11/2019 17:51	20/11/2019 02:03	8,18	14	114,58	CHI
201911220415	PONTALINA	PK12080054	PONTALINA	19/11/2019 14:15	20/11/2019 08:57	19/11/2019 14:15	20/11/2019 08:57	18,70	95	1776,26	CHI
201911220417	JATAI	JT12109029	JATAI S1	19/11/2019 17:44	19/11/2019 23:45	19/11/2019 17:44	19/11/2019 23:45	6,00	28	168,05	CHI
201911220422	GOIANIA	11257441	GOIANIA LESTE S1	19/11/2019 18:01	20/11/2019 00:29	19/11/2019 18:01	20/11/2019 00:29	6,47	1	6,47	CHI
201911220428	ITUMBIARA	10007698869	ITUMBIARA NOVA	19/11/2019 18:02	20/11/2019 00:21	19/11/2019 18:02	20/11/2019 00:21	6,32	1	6,32	CHI
201911220439	BOM JARDIM DE GOIAS	BM12380951	ARAGARCAS	19/11/2019 18:03	20/11/2019 07:43	19/11/2019 18:03	20/11/2019 07:43	13,66	16	218,61	CHI
201911220449	PADRE BERNARDO	PB11390439	PADRE BERNARDO	19/11/2019 17:13	20/11/2019 04:40	19/11/2019 17:13	20/11/2019 04:40	11,44	82	937,67	CHI
201911220451	APARECIDA DE GOIANIA	AP11166692	ANHANGUERA	19/11/2019 17:23	20/11/2019 00:05	19/11/2019 17:23	20/11/2019 00:05	6,69	148	989,91	CHI
201911220455	CRIXAS	CX12252919	RUBIATABA	19/11/2019 09:48	20/11/2019 01:56	19/11/2019 09:48	20/11/2019 01:56	16,12	6	96,75	CHI
201911220459	DOVERLANDIA	DV21156577	CAIAPONIA	19/11/2019 18:05	20/11/2019 11:25	19/11/2019 18:05	20/11/2019 11:25	17,33	1	17,33	CHI
201911220465	ANAPOLIS	AN11096605	JUNDIAI S2	19/11/2019 17:57	19/11/2019 21:09	19/11/2019 17:57	19/11/2019 21:09	3,20	96	307,17	CHI
201911220467	ALTO PARAISO DE GOIAS	BF21312345	NIQUELANDIA SUBTRANSMISSAO	19/11/2019 18:06	19/11/2019 23:18	19/11/2019 18:06	19/11/2019 23:18	5,20	1	5,20	CHI
201911220469	RIO VERDE	BZ12211442	SANTA HELENA S1	19/11/2019 15:21	20/11/2019 18:35	19/11/2019 15:21	20/11/2019 18:35	27,24	4	108,96	CHI
201911220469	SANTO ANTONIO DA BARRA	BZ12211442	SANTA HELENA S1	19/11/2019 15:21	20/11/2019 18:35	19/11/2019 15:21	20/11/2019 18:35	27,24	20	544,78	CHI

201911220472	RIO VERDE	10002687729	RIO VERDE S1	19/11/2019 18:06	19/11/2019 22:38	19/11/2019 18:06	19/11/2019 22:38	4,53	1	4,53	CHI
201911220473	SITIO D ABADIA	AQ12344369	IACIARA S2	19/11/2019 18:06	19/11/2019 22:16	19/11/2019 18:06	19/11/2019 22:16	4,15	3	12,46	CHI
201911220477	GOIANIA	GN21044124	GOYA S1	19/11/2019 18:07	19/11/2019 21:35	19/11/2019 18:07	19/11/2019 21:35	3,46	2	6,93	CHI
201911220480	MONTIVIDIU	MV12267609	MONTIVIDIU T	19/11/2019 18:07	20/11/2019 19:22	19/11/2019 18:07	20/11/2019 19:22	25,25	5	126,25	CHI
201911220482	CRISTALINA	KR12316249	PAMPLONA	19/11/2019 18:07	20/11/2019 10:18	19/11/2019 18:07	20/11/2019 10:18	16,17	1	16,17	CHI
201911220487	ANAPOLIS	AN12258114	JUNDIAI S2	19/11/2019 18:06	19/11/2019 20:48	19/11/2019 18:06	19/11/2019 20:48	2,70	19	51,27	CHI
201911220488	MUNDO NOVO DE GOIAS	MH12291173	NOVA CRIXAS	19/11/2019 18:08	19/11/2019 23:35	19/11/2019 18:08	19/11/2019 23:35	5,45	1	5,45	CHI
201911220497	CALDAS NOVAS	760160351	SERRA DE CALDAS	19/11/2019 18:08	20/11/2019 10:56	19/11/2019 18:08	20/11/2019 10:56	16,78	1	16,78	CHI
201911220500	RIO VERDE	RV21228693	CABRIUVA S2	19/11/2019 18:09	19/11/2019 21:44	19/11/2019 18:09	19/11/2019 21:44	3,58	1	3,58	CHI
201911220508	CATALAO	CT12042461	CATALAO S1	19/11/2019 12:05	20/11/2019 03:05	19/11/2019 12:05	20/11/2019 03:05	14,99	6	89,95	CHI
201911220511	PIRACANJUBA	60007000	PIRACANJUBA	19/11/2019 18:10	19/11/2019 20:08	19/11/2019 18:10	19/11/2019 20:08	1,96	1	1,96	CHI
201911220516	ANAPOLIS	20969004	ANAPOLIS UNIVERSITARIO S1	19/11/2019 18:10	20/11/2019 12:43	19/11/2019 18:10	20/11/2019 12:43	18,55	1	18,55	CHI
201911220524	ALEXANIA	AX12000108	CORUMBA	19/11/2019 13:46	20/11/2019 08:35	19/11/2019 13:46	20/11/2019 08:35	18,81	1	18,81	CHI
201911220524	ALEXANIA	AX12000108	CORUMBA	19/11/2019 13:46	20/11/2019 08:35	19/11/2019 15:05	20/11/2019 08:35	17,49	1	17,49	CHI
201911220525	PLANALTINA	PI12355773	PLANALTINA	19/11/2019 18:10	20/11/2019 08:39	19/11/2019 18:10	20/11/2019 08:39	14,48	48	695,09	CHI
201911220528	RIO VERDE	RV12338688	MONTIVIDIU T	19/11/2019 14:11	20/11/2019 22:54	19/11/2019 14:11	20/11/2019 22:54	32,72	4	130,89	CHI
201911220529	HIDROLANDIA	HD32097688LD	GUAPO S2	19/11/2019 17:44	21/11/2019 16:24	19/11/2019 17:44	21/11/2019 16:24	46,67	41	1913,53	CHI
201911220530	PIRES DO RIO	PR21075725	PIRES DO RIO S1	19/11/2019 18:12	19/11/2019 21:26	19/11/2019 18:12	19/11/2019 21:26	3,23	1	3,23	CHI
201911220532	GOIANIA	10025015018	CEPAIGO S1	19/11/2019 18:12	19/11/2019 23:39	19/11/2019 18:12	19/11/2019 23:39	5,44	1	5,44	CHI
201911220538	GOIANIA	GN11197030	FERROVIARIO S2	19/11/2019 17:04	19/11/2019 19:41	19/11/2019 17:04	19/11/2019 19:41	2,61	24	62,55	CHI
201911220543	ITUMBIARA	BG12000148	ITUMBIARA VELHA S2	19/11/2019 17:36	20/11/2019 12:00	19/11/2019 17:36	20/11/2019 12:00	18,38	4	73,54	CHI
201911220544	ABADIA DE GOIAS	LG11221730	CARAJAS S1	19/11/2019 17:46	20/11/2019 10:36	19/11/2019 17:46	20/11/2019 10:36	16,82	83	1396,18	CHI
201911220550	FORMOSO	TB12372648	PORANGATU	19/11/2019 14:32	19/11/2019 20:21	19/11/2019 14:32	19/11/2019 20:21	5,81	1	5,81	CHI
201911220550	TROMBAS	TB12372648	PORANGATU	19/11/2019 14:32	19/11/2019 20:21	19/11/2019 14:32	19/11/2019 20:21	5,81	67	389,14	CHI
201911220560	URUACU	UR21339082	URUACU	19/11/2019 18:15	20/11/2019 05:47	19/11/2019 18:15	20/11/2019 05:47	11,53	1	11,53	CHI
201911220563	PORANGATU	PO12391671	PORANGATU	19/11/2019 14:43	19/11/2019 23:41	19/11/2019 14:43	19/11/2019 23:41	8,95	24	214,87	CHI
201911220566	GUAPO	680002832	GUAPO S1	19/11/2019 18:16	20/11/2019 16:32	19/11/2019 18:16	20/11/2019 16:32	22,27	1	22,27	CHI
201911220567	ALVORADA DO NORTE	AQ12302809	IACIARA S2	19/11/2019 18:16	20/11/2019 22:56	19/11/2019 18:16	20/11/2019 22:56	28,66	1	28,66	CHI
201911220571	TURVANIA	TV12005582	FIRMINOPOLIS S2	19/11/2019 17:55	19/11/2019 20:27	19/11/2019 17:55	19/11/2019 20:27	2,53	49	124,17	CHI
201911220572	SERRANOPOLIS	SX11049360	JATAI S1	19/11/2019 17:23	20/11/2019 11:20	19/11/2019 17:23	20/11/2019 11:20	17,96	110	1976,03	CHI
201911220577	CORUMBAIBA	CI12035399	VILA CORUMBA	19/11/2019 18:17	20/11/2019 10:52	19/11/2019 18:17	20/11/2019 10:52	16,58	7	116,09	CHI
201911220581	ITARUMA	IM12058485	CACHOEIRA ALTA	19/11/2019 18:18	20/11/2019 11:23	19/11/2019 18:18	20/11/2019 11:23	17,08	3	51,24	CHI
201911220582	CRISTALINA	KR12261120	PAMPLONA	19/11/2019 18:18	20/11/2019 11:05	19/11/2019 18:18	20/11/2019 11:05	16,78	1	16,78	CHI

201911220585	CAMPOS BELOS	8565238	SAO DOMINGOS	19/11/2019 13:03	20/11/2019 03:41	19/11/2019 13:03	20/11/2019 01:47	12,73	319	4059,72	CHI
201911220585	CAMPOS BELOS	CH12224199	SAO DOMINGOS	19/11/2019 13:03	20/11/2019 03:41	19/11/2019 13:03	20/11/2019 03:41	14,63	3	43,90	CHI
201911220587	ORIZONA	OZ21036970	PIRES DO RIO S2	19/11/2019 18:19	20/11/2019 13:46	19/11/2019 18:19	20/11/2019 13:46	19,45	1	19,45	CHI
201911220589	URUACU	UR21202001	URUACU	19/11/2019 18:19	20/11/2019 03:27	19/11/2019 18:19	20/11/2019 03:27	9,13	2	18,26	CHI
201911220590	CATURAI	CK21035357	INHUMAS S1	19/11/2019 18:19	20/11/2019 15:57	19/11/2019 18:19	20/11/2019 15:57	21,63	1	21,63	CHI
201911220592	SAO LUIS DE MONTES BELOS	SL12092476	SAO LUIZ DOS MONTES BELOS	19/11/2019 18:19	20/11/2019 11:00	19/11/2019 18:19	20/11/2019 11:00	16,69	4	66,74	CHI
201911220596	GOIANIA	11325124	ATLANTICO S2	19/11/2019 18:19	19/11/2019 22:03	19/11/2019 18:19	19/11/2019 22:03	3,72	1	3,72	CHI
201911220600	BELA VISTA DE GOIAS	BV32060709	BELA VISTA S1	19/11/2019 15:40	20/11/2019 07:21	19/11/2019 15:40	20/11/2019 07:21	15,68	12	188,12	CHI
201911220611	NOVA IGUACU DE GOIAS	UR12046188	URUACU	19/11/2019 18:10	20/11/2019 07:58	19/11/2019 18:10	20/11/2019 07:58	13,79	20	275,75	CHI
201911220611	PILAR DE GOIAS	UR12046188	URUACU	19/11/2019 18:10	20/11/2019 07:58	19/11/2019 18:10	20/11/2019 07:58	13,79	1	13,79	CHI
201911220611	URUACU	UR12046188	URUACU	19/11/2019 18:10	20/11/2019 07:58	19/11/2019 18:10	20/11/2019 07:58	13,79	60	827,25	CHI
201911220614	APARECIDA DE GOIANIA	16193659	ATLANTICO S2	19/11/2019 18:22	20/11/2019 12:06	19/11/2019 18:22	20/11/2019 12:06	17,72	0	0,00	CHI
201911220619	RIO QUENTE	RQ12392077	VILA CORUMBA	19/11/2019 14:39	20/11/2019 10:15	19/11/2019 14:39	20/11/2019 10:15	19,60	7	137,22	CHI
201911220624	GOIAS	GS21203867	GOIAS	19/11/2019 18:23	21/11/2019 01:12	19/11/2019 18:23	21/11/2019 01:12	30,83	1	30,83	CHI
201911220625	PIRENOPOLIS	PV12236310	CORUMBA	19/11/2019 17:05	20/11/2019 09:00	19/11/2019 17:05	20/11/2019 09:00	15,93	4	63,71	CHI
201911220628	GOIANIA	10004569766	MEIA PONTE	19/11/2019 18:23	20/11/2019 00:15	19/11/2019 18:23	20/11/2019 00:15	5,86	1	5,86	CHI
201911220629	PALMEIRAS DE GOIAS	TV12186371	FIRMINOPOLIS S2	19/11/2019 18:23	20/11/2019 08:55	19/11/2019 18:23	20/11/2019 08:55	14,52	5	72,62	CHI
201911220631	JANDAIA	PP21307066	PALMEIRAS	19/11/2019 18:23	19/11/2019 22:30	19/11/2019 18:23	19/11/2019 22:30	4,12	1	4,12	CHI
201911220633	GOIANIA	11427267	FERROVIARIO S1	19/11/2019 18:23	19/11/2019 21:45	19/11/2019 18:23	19/11/2019 21:45	3,35	1	3,35	CHI
201911220641	CRISTALINA	KR12029221	CRISTALINA S1	19/11/2019 15:21	19/11/2019 21:31	19/11/2019 15:21	19/11/2019 21:31	6,15	4	24,60	CHI
201911220642	MORRINHOS	MR12352600	MORRINHOS	19/11/2019 17:05	20/11/2019 07:38	19/11/2019 17:05	20/11/2019 07:38	14,54	230	3345,16	CHI
201911220645	APARECIDA DE GOIANIA	AP11154520	INDEPENDENCIA S2	19/11/2019 16:46	20/11/2019 10:57	19/11/2019 16:46	20/11/2019 10:57	18,18	93	1690,48	CHI
201911220649	PIRACANJUBA	PJ12097877	BELA VISTA S1	19/11/2019 18:25	20/11/2019 12:01	19/11/2019 18:25	20/11/2019 12:01	17,59	3	52,77	CHI
201911220650	CALDAS NOVAS	CN12298669RE	SERRA DE CALDAS	19/11/2019 17:59	20/11/2019 09:09	19/11/2019 17:59	20/11/2019 09:09	15,16	78	1182,85	CHI
201911220654	PORANGATU	PO12028196	PORANGATU	19/11/2019 18:26	20/11/2019 17:30	19/11/2019 18:26	20/11/2019 17:30	23,05	5	115,27	CHI
201911220655	AMORINOPOLIS	IV12165613	IPORA	19/11/2019 18:26	20/11/2019 11:24	19/11/2019 18:26	20/11/2019 11:24	16,95	5	84,77	CHI
201911220655	IVOLANDIA	IV12165613	IPORA	19/11/2019 18:26	20/11/2019 11:24	19/11/2019 18:26	20/11/2019 11:24	16,95	6	101,72	CHI
201911220656	CIDADE OCIDENTAL	LZ21161298	MARAJOARA	19/11/2019 18:26	20/11/2019 07:40	19/11/2019 18:26	20/11/2019 07:40	13,22	2	26,44	CHI
201911220657	MORRINHOS	MR12033268	MORRINHOS	19/11/2019 16:54	20/11/2019 09:53	19/11/2019 16:54	20/11/2019 09:53	16,98	24	407,48	CHI
201911220659	GOUVELANDIA	QI12000340	QUIRINOPOLIS	19/11/2019 18:27	19/11/2019 22:50	19/11/2019 18:27	19/11/2019 22:50	4,38	16	70,13	CHI
201911220660	MORRINHOS	MR12204553RE	MORRINHOS	19/11/2019 15:46	20/11/2019 08:41	19/11/2019 15:46	20/11/2019 08:41	16,91	38	642,41	CHI
201911220669	COCALZINHO DE GOIAS	ZN21186981	COCALZINHO	19/11/2019 18:27	20/11/2019 12:21	19/11/2019 18:27	20/11/2019 12:21	17,89	1	17,89	CHI
201911220672	APARECIDA DE GOIANIA	AP11038688	INDEPENDENCIA S1	19/11/2019 14:22	20/11/2019 07:21	19/11/2019 14:22	20/11/2019 07:21	16,97	87	1476,27	CHI

201911220673	GOIANDIRA	GD21237124	CATALAO S1	19/11/2019 18:28	19/11/2019 23:15	19/11/2019 18:28	19/11/2019 23:15	4,77	1	4,77	CHI
201911220677	CAIAPONIA	CP12054805	CAIAPONIA	19/11/2019 12:52	20/11/2019 07:46	19/11/2019 12:52	20/11/2019 07:46	18,89	20	377,74	CHI
201911220677	PIRANHAS	CP12054805	CAIAPONIA	19/11/2019 12:52	20/11/2019 07:46	19/11/2019 12:52	20/11/2019 07:46	18,89	76	1435,43	CHI
201911220680	BELA VISTA DE GOIAS	BV31319499	BELA VISTA S1	19/11/2019 18:29	21/11/2019 09:11	19/11/2019 18:29	21/11/2019 09:11	38,69	1	38,69	CHI
201911220682	GOIATUBA	GT12052886	GOIATUBA S1	19/11/2019 18:27	20/11/2019 16:06	19/11/2019 18:27	20/11/2019 16:06	21,65	1	21,65	CHI
201911220682	MORRINHOS	GT12052886	GOIATUBA S1	19/11/2019 18:27	20/11/2019 16:06	19/11/2019 18:27	20/11/2019 16:06	21,65	25	541,24	CHI
201911220684	CAMPOS BELOS	CH21317909	SAO DOMINGOS	19/11/2019 18:30	20/11/2019 11:28	19/11/2019 18:30	20/11/2019 11:28	16,97	1	16,97	CHI
201911220686	GOIANIA	16940192	MEIA PONTE	19/11/2019 18:30	20/11/2019 09:27	19/11/2019 18:30	20/11/2019 09:27	14,95	1	14,95	CHI
201911220690	CAVALCANTE	CJ12346073	MINACU	19/11/2019 08:20	20/11/2019 14:59	19/11/2019 08:20	20/11/2019 14:59	30,65	85	2604,87	CHI
201911220693	APARECIDA DE GOIANIA	AP11193731	ANHANGUERA	19/11/2019 18:31	20/11/2019 00:23	19/11/2019 18:31	20/11/2019 00:23	5,86	123	720,95	CHI
201911220701	GOIAS	GS12259614	GOIAS	19/11/2019 16:25	20/11/2019 12:05	19/11/2019 16:25	20/11/2019 12:05	19,65	13	255,47	CHI
201911220702	BURITI DE GOIAS	BS21308351	FIRMINOPOLIS S2	19/11/2019 18:32	19/11/2019 21:19	19/11/2019 18:32	19/11/2019 21:19	2,78	1	2,78	CHI
201911220705	LUZIANIA	LZ12085956	CRISTALINA S2	19/11/2019 18:33	20/11/2019 13:18	19/11/2019 18:33	20/11/2019 13:18	18,75	15	281,20	CHI
201911220707	URUACU	UR12038758	URUACU	19/11/2019 17:33	19/11/2019 21:12	19/11/2019 17:33	19/11/2019 21:12	3,64	2	7,28	CHI
201911220708	JARAGUA	JA12374696	JARAGUA	19/11/2019 18:34	20/11/2019 12:31	19/11/2019 18:34	20/11/2019 12:31	17,94	1	17,94	CHI
201911220709	GOIATUBA	GT11000037	GOIATUBA S2	19/11/2019 18:01	20/11/2019 11:07	19/11/2019 18:01	20/11/2019 11:07	17,10	116	1983,47	CHI
201911220714	CORUMBA DE GOIAS	CB21285281	CORUMBA	19/11/2019 18:34	20/11/2019 21:23	19/11/2019 18:34	20/11/2019 21:23	26,80	2	53,60	CHI
201911220718	GOIAS	GS12068606	GOIAS	19/11/2019 18:35	20/11/2019 19:45	19/11/2019 18:35	20/11/2019 19:45	25,16	1	25,16	CHI
201911220720	GOIANIA	12422101	CARAJAS S1	19/11/2019 18:35	20/11/2019 10:54	19/11/2019 18:35	20/11/2019 10:54	16,31	1	16,31	CHI
201911220726	ITABERAI	IB21299534	ITABERAI S1	19/11/2019 18:36	20/11/2019 17:39	19/11/2019 18:36	20/11/2019 17:39	23,04	2	46,08	CHI
201911220727	APARECIDA DE GOIANIA	200098780	INDEPENDENCIA S2	19/11/2019 18:36	20/11/2019 13:04	19/11/2019 18:36	20/11/2019 13:04	18,46	1	18,46	CHI
201911220733	GOIANIA	11094023	GOIANIA LESTE S2	19/11/2019 18:37	20/11/2019 00:04	19/11/2019 18:37	20/11/2019 00:04	5,45	1	5,45	CHI
201911220737	AGUAS LINDAS DE GOIAS	10004506837	AGUAS LINDAS DE GOIAS S1	19/11/2019 18:38	19/11/2019 21:26	19/11/2019 18:38	19/11/2019 21:26	2,80	1	2,80	CHI
201911220741	MINEIROS	1390121358	PARQUE DAS EMAS	19/11/2019 18:39	19/11/2019 21:46	19/11/2019 18:39	19/11/2019 21:46	3,12	1	3,12	CHI
201911220751	GUAPO	GA12276561	GUAPO S2	19/11/2019 18:36	20/11/2019 10:20	19/11/2019 18:36	20/11/2019 10:20	15,73	18	283,13	CHI
201911220755	PALMEIRAS DE GOIAS	PL12087671	PALMEIRAS	19/11/2019 18:40	19/11/2019 21:25	19/11/2019 18:40	19/11/2019 21:25	2,76	1	2,76	CHI
201911220756	PALESTINA DE GOIAS	PY12223011	PALESTINA	19/11/2019 18:40	19/11/2019 23:12	19/11/2019 18:40	19/11/2019 23:12	4,53	115	520,50	CHI
201911220758	VALPARAISO DE GOIAS	2860118580	MARAJOARA	19/11/2019 18:40	19/11/2019 22:02	19/11/2019 18:40	19/11/2019 22:02	3,35	1	3,35	CHI
201911220764	ITUMBIARA	IT12304170	ITUMBIARA NOVA	19/11/2019 18:41	20/11/2019 13:35	19/11/2019 18:41	20/11/2019 13:35	18,89	7	132,24	CHI
201911220766	PLANALTINA	10016045716	PLANALTINA	19/11/2019 18:42	20/11/2019 16:39	19/11/2019 18:42	20/11/2019 16:39	21,94	1	21,94	CHI
201911220768	CRISTALINA	1060034818	CRISTALINA S1	19/11/2019 18:42	19/11/2019 19:31	19/11/2019 18:42	19/11/2019 19:31	0,81	1	0,81	CHI
201911220769	LUZIANIA	LZ21155620	CRISTALINA S2	19/11/2019 18:42	20/11/2019 10:41	19/11/2019 18:42	20/11/2019 10:41	15,97	1	15,97	CHI
201911220775	ITUMBIARA	IT11134523	ITUMBIARA NOVA	19/11/2019 17:42	19/11/2019 21:39	19/11/2019 17:42	19/11/2019 21:39	3,94	269	1059,79	CHI

201911220776	BOM JESUS DE GOIAS	BJ21026444	BOM JESUS DE GOIAS	19/11/2019 18:43	20/11/2019 09:32	19/11/2019 18:43	20/11/2019 09:32	14,81	1	14,81	CHI
201911220779	CRISTALINA	KR12389576	CRISTALINA S2	19/11/2019 15:28	19/11/2019 22:02	19/11/2019 15:28	19/11/2019 22:02	6,55	3	19,66	CHI
201911220784	APARECIDA DE GOIANIA	AP21137061	CEPAIGO S1	19/11/2019 18:43	20/11/2019 14:53	19/11/2019 18:43	20/11/2019 14:53	20,15	1	20,15	CHI
201911220788	CAIAPONIA	CP12151179	CAIAPONIA	19/11/2019 15:03	19/11/2019 21:30	19/11/2019 15:03	19/11/2019 21:30	6,44	78	502,65	CHI
201911220798	DAMIANOPOLIS	01110214	IACIARA S2	19/11/2019 18:37	19/11/2019 22:20	19/11/2019 18:37	19/11/2019 22:20	3,71	130	482,41	CHI
201911220798	SITIO D ABADIA	01110214	IACIARA S2	19/11/2019 18:37	19/11/2019 22:20	19/11/2019 18:37	19/11/2019 22:20	3,71	377	1398,98	CHI
201911220803	MORRINHOS	150000431	MORRINHOS	19/11/2019 18:46	19/11/2019 22:05	19/11/2019 18:46	19/11/2019 22:05	3,31	1	3,31	CHI
201911220809	GOIANESIA	550167742	GOIANESIA S2	19/11/2019 18:46	20/11/2019 16:31	19/11/2019 18:46	20/11/2019 16:31	21,74	1	21,74	CHI
201911220810	ANAPOLIS	20382017	JUNDIAI S2	19/11/2019 18:47	20/11/2019 08:00	19/11/2019 18:47	20/11/2019 08:00	13,21	1	13,21	CHI
201911220812	MAIRIPOTABA	CQ21227122	PONTALINA	19/11/2019 18:47	20/11/2019 10:28	19/11/2019 18:47	20/11/2019 10:28	15,68	1	15,68	CHI
201911220814	PIRES DO RIO	PR11020461	PIRES DO RIO S1	19/11/2019 18:43	20/11/2019 02:01	19/11/2019 18:43	20/11/2019 02:01	7,30	91	664,55	CHI
201911220819	ANAPOLIS	AN12077921	JUNDIAI S1	19/11/2019 18:48	20/11/2019 15:08	19/11/2019 18:48	20/11/2019 15:08	20,32	2	40,65	CHI
201911220825	INHUMAS	IN21247256	INHUMAS S1	19/11/2019 18:49	20/11/2019 15:05	19/11/2019 18:49	20/11/2019 15:05	20,27	1	20,27	CHI
201911220827	GUAPO	710047708	GUAPO S1	19/11/2019 18:49	20/11/2019 00:28	19/11/2019 18:49	20/11/2019 00:28	5,64	1	5,64	CHI
201911220830	FORMOSA	610247281	ITUIQUIRA	19/11/2019 18:49	20/11/2019 15:46	19/11/2019 18:49	20/11/2019 15:46	20,94	1	20,94	CHI
201911221001	SENADOR CANEDO	190053331	SENADOR CANEDO	19/11/2019 18:50	20/11/2019 00:11	19/11/2019 18:50	20/11/2019 00:11	5,35	1	5,35	CHI
201911221003	COLINAS DO SUL	10001172113	NIQUELANDIA SUBTRANSMISSAO	19/11/2019 18:50	19/11/2019 23:18	19/11/2019 18:50	19/11/2019 23:18	4,46	1	4,46	CHI
201911221008	RIO VERDE	RV21338637	RIO VERDE S2	19/11/2019 18:51	20/11/2019 11:18	19/11/2019 18:51	20/11/2019 11:18	16,45	1	16,45	CHI
201911221009	GOIANIA	16793602	GOYA S2	19/11/2019 18:51	20/11/2019 10:19	19/11/2019 18:51	20/11/2019 10:19	15,46	1	15,46	CHI
201911221012	GOIANDIRA	GD12000007LD	CATALAO S1	19/11/2019 17:03	19/11/2019 21:10	19/11/2019 17:03	19/11/2019 21:10	4,10	104	426,83	CHI
201911221012	NOVA AURORA	GD12000007LD	CATALAO S1	19/11/2019 17:03	19/11/2019 21:10	19/11/2019 17:03	19/11/2019 21:10	4,10	15	61,56	CHI
201911221016	LUZIANIA	LZ12080547	CRISTALINA S2	19/11/2019 17:56	19/11/2019 22:51	19/11/2019 17:56	19/11/2019 22:51	4,91	6	29,44	CHI
201911221017	TROMBAS	TB12202552	PORANGATU	19/11/2019 14:30	19/11/2019 21:47	19/11/2019 14:30	19/11/2019 21:47	7,27	3	21,81	CHI
201911221018	SAO LUIS DE MONTES BELOS	SL11000037	SAO LUIZ DOS MONTES BELOS	19/11/2019 17:49	19/11/2019 20:14	19/11/2019 17:49	19/11/2019 20:14	2,41	133	320,23	CHI
201911221107	SANTO ANTONIO DE GOIAS	1360000061	NEROPOLIS S1	19/11/2019 18:52	20/11/2019 10:22	19/11/2019 18:52	20/11/2019 10:22	15,49	1	15,49	CHI
201911221109	LEOPOLDO DE BULHOES	LB12000624	DAIA S1	19/11/2019 18:52	20/11/2019 09:41	19/11/2019 18:52	20/11/2019 09:41	14,82	32	474,13	CHI
201911221121	NOVA AURORA	NE21157544	CATALAO S1	19/11/2019 18:54	20/11/2019 15:34	19/11/2019 18:54	20/11/2019 15:34	20,66	2	41,32	CHI
201911221125	SANTA TEREZA DE GOIAS	SE12000012	MARA ROSA	19/11/2019 16:47	19/11/2019 20:44	19/11/2019 16:47	19/11/2019 20:44	3,94	463	1822,55	CHI
201911221128	CALDAS NOVAS	CN12110086	SERRA DE CALDAS	19/11/2019 17:59	20/11/2019 02:39	19/11/2019 17:59	20/11/2019 02:39	8,66	83	718,94	CHI
201911221134	CRISTALINA	KR21229248	CRISTALINA S1	19/11/2019 18:55	20/11/2019 15:14	19/11/2019 18:55	20/11/2019 15:14	20,30	2	40,61	CHI
201911221136	MONTIVIDIU	MV12200770	MONTIVIDIU T	19/11/2019 18:11	20/11/2019 09:28	19/11/2019 18:11	20/11/2019 09:28	15,28	7	106,93	CHI
201911221139	APARECIDA DE GOIANIA	AP12144801	ANHANGUERA	19/11/2019 17:46	19/11/2019 22:20	19/11/2019 17:46	19/11/2019 22:20	4,56	72	328,04	CHI
201911221140	ANICUNS	10008442906	ANICUNS	19/11/2019 18:56	20/11/2019 07:47	19/11/2019 18:56	20/11/2019 07:47	12,85	1	12,85	CHI

201911221145	PALMEIRAS DE GOIAS	PL21386431	PALMEIRAS	19/11/2019 18:57	20/11/2019 07:55	19/11/2019 18:57	20/11/2019 07:55	12,97	4	51,89	CHI
201911221146	URUACU	640101677	URUACU	19/11/2019 18:57	19/11/2019 20:44	19/11/2019 18:57	19/11/2019 20:44	1,78	1	1,78	CHI
201911221148	TRINDADE	10021726483	GOYA S2	19/11/2019 18:57	19/11/2019 21:49	19/11/2019 18:57	19/11/2019 21:49	2,86	1	2,86	CHI
201911221165	AGUAS LINDAS DE GOIAS	LA11078160	AGUAS LINDAS DE GOIAS S1	19/11/2019 18:53	19/11/2019 20:30	19/11/2019 18:53	19/11/2019 20:30	1,61	264	426,29	CHI
201911221169	BRAZABRANTES	IN12009604	INHUMAS S1	19/11/2019 14:06	19/11/2019 22:20	19/11/2019 14:06	19/11/2019 22:20	8,23	2	16,46	CHI
201911221169	INHUMAS	IN12009604	INHUMAS S1	19/11/2019 14:06	19/11/2019 22:20	19/11/2019 14:06	19/11/2019 22:20	8,23	11	90,53	CHI
201911221170	MONTES CLAROS DE GOIAS	ME12228426	IPORA	19/11/2019 19:00	20/11/2019 09:19	19/11/2019 19:00	20/11/2019 09:19	14,31	3	42,94	CHI
201911221171	CALDAS NOVAS	CN12331847	CALDAS NOVAS S1	19/11/2019 19:00	20/11/2019 12:23	19/11/2019 19:00	20/11/2019 12:23	17,38	34	590,86	CHI
201911221172	GOIATUBA	10021309785	GOIATUBA S2	19/11/2019 19:00	20/11/2019 17:53	19/11/2019 19:00	20/11/2019 17:53	22,88	1	22,88	CHI
201911221174	FIRMINOPOLIS	FR12000059	FIRMINOPOLIS S1	19/11/2019 19:01	20/11/2019 10:50	19/11/2019 19:01	20/11/2019 10:50	15,81	3	47,44	CHI
201911221175	MINEIROS	MY21224093	PARQUE DAS EMAS	19/11/2019 19:01	20/11/2019 10:48	19/11/2019 19:01	20/11/2019 10:48	15,77	1	15,77	CHI
201911221180	DAMOLANDIA	IN21026257	INHUMAS S1	19/11/2019 19:02	20/11/2019 11:26	19/11/2019 19:02	20/11/2019 11:26	16,39	3	49,18	CHI
201911221184	APARECIDA DE GOIANIA	AP11383412	ANHANGUERA	19/11/2019 17:42	19/11/2019 21:51	19/11/2019 17:42	19/11/2019 21:51	4,14	64	264,96	CHI
201911221186	ITUMBIARA	690058792	ITUMBIARA VELHA S1	19/11/2019 19:03	20/11/2019 02:30	19/11/2019 19:03	20/11/2019 02:30	7,46	1	7,46	CHI
201911221192	SENADOR CANEDO	10008497620	SENADOR CANEDO	19/11/2019 19:04	19/11/2019 21:16	19/11/2019 19:04	19/11/2019 21:16	2,19	1	2,19	CHI
201911221193	ANAPOLIS	20714208	JUNDIAI S2	19/11/2019 19:04	20/11/2019 08:21	19/11/2019 19:04	20/11/2019 08:21	13,27	1	13,27	CHI
201911221199	IACIARA	IA21190522	IACIARA S1	19/11/2019 19:05	20/11/2019 16:22	19/11/2019 19:05	20/11/2019 16:22	21,28	1	21,28	CHI
201911221201	JATAI	JT12264392	JATAI S1	19/11/2019 19:05	20/11/2019 08:13	19/11/2019 19:05	20/11/2019 08:13	13,12	1	13,12	CHI
201911221207	AGUA LIMPA	AL21000265	VILA CORUMBA	19/11/2019 19:06	21/11/2019 09:58	19/11/2019 19:06	21/11/2019 09:58	38,85	1	38,85	CHI
201911221215	ITUMBIARA	IT12000100RE	PARANAIBA	19/11/2019 18:11	20/11/2019 09:15	19/11/2019 18:11	20/11/2019 09:15	15,06	32	482,07	CHI
201911221216	CRISTALINA	KR11128713	CRISTALINA S1	19/11/2019 19:08	19/11/2019 20:07	19/11/2019 19:08	19/11/2019 20:07	0,98	123	120,20	CHI
201911221221	SAO LUIS DE MONTES BELOS	500109746	SAO LUIZ DOS MONTES BELOS	19/11/2019 19:09	20/11/2019 09:35	19/11/2019 19:09	20/11/2019 09:35	14,43	1	14,43	CHI
201911221223	APARECIDA DE GOIANIA	AP11395354	ANHANGUERA	19/11/2019 19:18	19/11/2019 20:44	19/11/2019 19:18	19/11/2019 20:44	1,43	83	118,37	CHI
201911221241	URUACU	UR21291140	URUACU	19/11/2019 19:12	20/11/2019 02:33	19/11/2019 19:12	20/11/2019 02:33	7,34	1	7,34	CHI
201911221246	AGUA FRIA DE GOIAS	4140004138	SAO JOAO D ALIANCA	19/11/2019 19:13	20/11/2019 17:20	19/11/2019 19:13	20/11/2019 17:20	22,12	1	22,12	CHI
201911221251	JATAI	290095712	JATAI S2	19/11/2019 19:14	20/11/2019 06:20	19/11/2019 19:14	20/11/2019 06:20	11,11	1	11,11	CHI
201911221260	MORRINHOS	MR12000116	MORRINHOS	19/11/2019 19:15	20/11/2019 16:01	19/11/2019 19:15	20/11/2019 11:36	16,35	19	310,64	CHI
201911221260	MORRINHOS	MR12000116	MORRINHOS	19/11/2019 19:15	20/11/2019 16:01	20/11/2019 11:37	20/11/2019 16:01	4,41	2	8,82	CHI
201911221265	QUIRINOPOLIS	QI32011354	QUIRINOPOLIS	19/11/2019 19:10	19/11/2019 21:45	19/11/2019 19:10	19/11/2019 21:45	2,59	12	31,04	CHI
201911221266	SANTA CRUZ DE GOIAS	BC21221800	PIRACANJUBA	19/11/2019 19:15	20/11/2019 16:58	19/11/2019 19:15	20/11/2019 16:58	21,70	1	21,70	CHI
201911221304	GOIANIA	10002528353	GOYA S2	19/11/2019 19:17	20/11/2019 08:57	19/11/2019 19:17	20/11/2019 08:57	13,66	0	0,00	CHI
201911221307	MINACU	IH12088797	MINACU	19/11/2019 21:47	21/11/2019 03:37	19/11/2019 21:47	20/11/2019 11:58	14,18	63	893,32	CHI
201911221307	MINACU	IH12088797	MINACU	19/11/2019 21:47	21/11/2019 03:37	20/11/2019 12:13	20/11/2019 12:20	0,12	63	7,72	CHI

201911221307	MINACU	IH12242204LD	MINACU	19/11/2019 21:47	21/11/2019 03:37	19/11/2019 21:47	20/11/2019 13:01	15,22	57	867,79	CHI
201911221307	MINACU	IH13240765	MINACU	19/11/2019 21:47	21/11/2019 03:37	19/11/2019 21:47	20/11/2019 14:51	17,06	29	494,67	CHI
201911221307	MINACU	IH12242204LD	MINACU	19/11/2019 21:47	21/11/2019 03:37	20/11/2019 15:06	20/11/2019 15:42	0,60	58	34,67	CHI
201911221307	MINACU	IH13240765	MINACU	19/11/2019 21:47	21/11/2019 03:37	19/11/2019 21:47	21/11/2019 03:37	29,83	14	417,65	CHI
201911221307	MINACU	IH13240765	MINACU	19/11/2019 21:47	21/11/2019 03:37	20/11/2019 15:06	21/11/2019 03:37	12,51	29	362,89	CHI
201911221308	GOIANIA	17234906	AEROPORTO S1	19/11/2019 19:17	20/11/2019 02:00	19/11/2019 19:17	20/11/2019 02:00	6,70	1	6,70	CHI
201911221409	GOIANIRA	390070002	GOIANIRA	19/11/2019 19:19	20/11/2019 00:11	19/11/2019 19:19	20/11/2019 00:11	4,85	1	4,85	CHI
201911221411	PARANAIGUARA	PC2133338	CACHOEIRA ALTA	19/11/2019 19:20	20/11/2019 17:45	19/11/2019 19:20	20/11/2019 17:45	22,42	2	44,83	CHI
201911221420	TURVANIA	TV12005581	FIRMINOPOLIS S2	19/11/2019 17:42	19/11/2019 20:47	19/11/2019 17:42	19/11/2019 20:47	3,08	12	37,00	CHI
201911221434	PALMEIRAS DE GOIAS	PP12005727	FIRMINOPOLIS S2	19/11/2019 18:30	19/11/2019 22:24	19/11/2019 18:30	19/11/2019 22:24	3,90	12	46,79	CHI
201911221434	PALMINOPOLIS	PP12005727	FIRMINOPOLIS S2	19/11/2019 18:30	19/11/2019 22:24	19/11/2019 18:30	19/11/2019 22:24	3,90	39	152,06	CHI
201911221438	CRISTALINA	KR21246098	CRISTALINA S1	19/11/2019 19:24	20/11/2019 11:25	19/11/2019 19:24	20/11/2019 11:25	16,01	2	32,03	CHI
201911221451	APARECIDA DE GOIANIA	AP11037526	INDEPENDENCIA S2	19/11/2019 19:20	19/11/2019 23:28	19/11/2019 19:20	19/11/2019 23:28	4,13	211	871,96	CHI
201911221453	AGUA FRIA DE GOIAS	TL12279981	SAO JOAO D ALIANCA	19/11/2019 19:21	20/11/2019 19:46	19/11/2019 19:21	20/11/2019 19:46	24,41	41	1000,87	CHI
201911221457	JARAGUA	JA12064321	JARAGUA	19/11/2019 19:21	19/11/2019 23:25	19/11/2019 19:21	19/11/2019 23:25	4,07	4	16,26	CHI
201911221460	VILA PROPICIO	8470003382	BARRO ALTO	19/11/2019 19:28	20/11/2019 11:29	19/11/2019 19:28	20/11/2019 11:29	16,02	1	16,02	CHI
201911221463	TURVANIA	TV12005714	FIRMINOPOLIS S2	19/11/2019 19:28	20/11/2019 11:30	19/11/2019 19:28	20/11/2019 11:30	16,02	2	32,05	CHI
201911221467	PIRACANJUBA	10000830923	PIRACANJUBA	19/11/2019 19:29	19/11/2019 22:58	19/11/2019 19:29	19/11/2019 22:58	3,48	1	3,48	CHI
201911221469	PLANALTINA	PI11355373	PLANALTINA	19/11/2019 19:29	20/11/2019 12:28	19/11/2019 19:29	20/11/2019 12:28	16,98	1	16,98	CHI
201911221472	FLORES DE GOIAS	FB12045259	IACIARA S2	20/11/2019 04:00	20/11/2019 09:00	20/11/2019 04:00	20/11/2019 09:00	4,99	405	2019,94	CHI
201911221472	SITIO D ABADIA	FB12045259	IACIARA S2	20/11/2019 04:00	20/11/2019 09:00	20/11/2019 04:00	20/11/2019 09:00	4,99	114	568,57	CHI
201911221478	PALMINOPOLIS	PP21007762	PALMEIRAS	19/11/2019 19:33	20/11/2019 10:51	19/11/2019 19:33	20/11/2019 10:51	15,30	1	15,30	CHI
201911221486	ANAPOLIS	AN21000695	ANAPOLIS UNIVERSITARIO S2	19/11/2019 19:34	21/11/2019 02:14	19/11/2019 19:34	21/11/2019 02:14	30,65	1	30,65	CHI
201911221501	LUZIANIA	LZ21212091	MARAJOARA	19/11/2019 19:37	20/11/2019 10:33	19/11/2019 19:37	20/11/2019 10:33	14,93	3	44,80	CHI
201911221505	SANCLERLANDIA	1210012598	FIRMINOPOLIS S2	19/11/2019 19:38	20/11/2019 08:07	19/11/2019 19:38	20/11/2019 08:07	12,48	1	12,48	CHI
201911221512	SANTO ANTONIO DE GOIAS	BW12406479	NEROPOLIS S1	19/11/2019 19:37	19/11/2019 20:52	19/11/2019 19:37	19/11/2019 20:52	1,24	3	3,72	CHI
201911221515	PADRE BERNARDO	PB11060427	PADRE BERNARDO	19/11/2019 18:43	19/11/2019 22:06	19/11/2019 18:43	19/11/2019 22:06	3,37	33	111,35	CHI
201911221540	FORMOSA	FA21329740	ITUIQUIRA	19/11/2019 19:43	20/11/2019 13:43	19/11/2019 19:43	20/11/2019 13:43	18,00	1	18,00	CHI
201911221555	GOIATUBA	GT13000017	GOIATUBA S1	19/11/2019 17:28	20/11/2019 03:42	19/11/2019 17:28	20/11/2019 03:33	10,09	5	50,44	CHI
201911221555	GOIATUBA	GT13000017	GOIATUBA S2	19/11/2019 17:28	20/11/2019 03:42	19/11/2019 17:28	20/11/2019 03:33	10,09	1254	12650,42	CHI
201911221555	GOIATUBA	GT13000017	GOIATUBA S2	19/11/2019 17:28	20/11/2019 03:42	20/11/2019 01:31	20/11/2019 03:33	2,05	103	210,95	CHI
201911221555	GOIATUBA	GT13000018	GOIATUBA S2	19/11/2019 17:28	20/11/2019 03:42	20/11/2019 01:31	20/11/2019 03:42	2,18	486	1061,50	CHI
201911221555	MORRINHOS	GT13000018	GOIATUBA S2	19/11/2019 17:28	20/11/2019 03:42	20/11/2019 01:31	20/11/2019 03:42	2,18	3	6,55	CHI

201911221560	APORE	AE21168306	ITAJA S1	19/11/2019 19:47	20/11/2019 12:11	19/11/2019 19:47	20/11/2019 12:11	16,39	1	16,39	CHI
201911221569	GOIANIA	10028814167	GOYA S2	19/11/2019 19:48	20/11/2019 11:54	19/11/2019 19:48	20/11/2019 11:54	16,09	1	16,09	CHI
201911221577	ITAPIRAPUA	IU11018875	MATRINCHA	19/11/2019 19:50	20/11/2019 11:15	19/11/2019 19:50	20/11/2019 11:15	15,41	114	1756,61	CHI
201911221578	CATALAO	1990280617	CATALAO S2	19/11/2019 19:50	20/11/2019 09:30	19/11/2019 19:50	20/11/2019 09:30	13,67	1	13,67	CHI
201911221584	GOIATUBA	VI12329055	VICENTINOPOLIS	19/11/2019 19:49	20/11/2019 08:41	19/11/2019 19:49	20/11/2019 08:41	12,86	13	167,20	CHI
201911221584	VICENTINOPOLIS	VI12329055	VICENTINOPOLIS	19/11/2019 19:49	20/11/2019 08:41	19/11/2019 19:49	20/11/2019 08:41	12,86	24	308,68	CHI
201911221587	APARECIDA DE GOIANIA	12771533	REAL S2	19/11/2019 19:51	20/11/2019 09:40	19/11/2019 19:51	20/11/2019 09:40	13,81	1	13,81	CHI
201911221588	MORRINHOS	MR12212264RE	GOIATUBA S1	20/11/2019 07:21	20/11/2019 17:45	20/11/2019 07:21	20/11/2019 17:45	10,40	59	613,47	CHI
201911221595	AMORINOPOLIS	AM12133498	IPORA	19/11/2019 17:07	20/11/2019 02:01	19/11/2019 17:07	20/11/2019 02:01	8,89	180	1600,70	CHI
201911221601	CALDAS NOVAS	IP12153045	IPAMERI	19/11/2019 15:14	20/11/2019 09:34	19/11/2019 15:14	20/11/2019 09:34	18,32	5	91,60	CHI
201911221601	IPAMERI	IP12153045	IPAMERI	19/11/2019 15:14	20/11/2019 09:34	19/11/2019 15:14	20/11/2019 09:34	18,32	30	549,61	CHI
201911221604	NIQUELANDIA	NQ12235223	NIQUELANDIA SUBTRANSMISSAO	19/11/2019 19:53	20/11/2019 23:03	19/11/2019 19:53	20/11/2019 23:03	27,17	27	733,50	CHI
201911221606	FORMOSA	FA12233645	SAO JOAO D ALIANCA	19/11/2019 19:51	20/11/2019 14:02	19/11/2019 19:51	20/11/2019 14:02	18,17	13	236,23	CHI
201911221608	FIRMINOPOLIS	900008386	FIRMINOPOLIS S1	19/11/2019 19:53	20/11/2019 00:33	19/11/2019 19:53	20/11/2019 00:33	4,66	1	4,66	CHI
201911221610	FIRMINOPOLIS	SL12125617	FIRMINOPOLIS S1	19/11/2019 19:47	19/11/2019 22:10	19/11/2019 19:47	19/11/2019 22:10	2,38	16	38,09	CHI
201911221610	SAO LUIS DE MONTES BELOS	SL12125617	FIRMINOPOLIS S1	19/11/2019 19:47	19/11/2019 22:10	19/11/2019 19:47	19/11/2019 22:10	2,38	53	126,18	CHI
201911221610	TURVANIA	SL12125617	FIRMINOPOLIS S1	19/11/2019 19:47	19/11/2019 22:10	19/11/2019 19:47	19/11/2019 22:10	2,38	8	19,05	CHI
201911221622	JARAGUA	JA12221349	JARAGUA	19/11/2019 19:46	20/11/2019 04:32	19/11/2019 19:46	20/11/2019 04:32	8,76	6	52,57	CHI
201911221623	CALDAS NOVAS	760274587	SERRA DE CALDAS	19/11/2019 19:56	20/11/2019 15:03	19/11/2019 19:56	20/11/2019 15:03	19,11	1	19,11	CHI
201911221638	RIO VERDE	MV12260795	MONTIVIDIU T	19/11/2019 19:59	20/11/2019 18:15	19/11/2019 19:59	20/11/2019 18:15	22,28	3	66,83	CHI
201911221643	ARENOPOLIS	AY12370595	PIRANHAS	19/11/2019 19:59	20/11/2019 11:42	19/11/2019 19:59	20/11/2019 11:42	15,70	1	15,70	CHI
201911221644	CIDADE OCIDENTAL	DH11335922	MARAJOARA	19/11/2019 20:00	19/11/2019 21:35	19/11/2019 20:00	19/11/2019 21:35	1,58	69	109,12	CHI
201911221647	PANAMA	PX21035242	ITUMBIARA NOVA	19/11/2019 20:00	20/11/2019 17:47	19/11/2019 20:00	20/11/2019 17:47	21,77	2	43,55	CHI
201911221659	FORMOSA	610036981	ITUIQUIRA	19/11/2019 20:02	20/11/2019 09:40	19/11/2019 20:02	20/11/2019 09:40	13,63	1	13,63	CHI
201911221665	TURVANIA	TV21289723	FIRMINOPOLIS S2	19/11/2019 20:04	19/11/2019 21:39	19/11/2019 20:04	19/11/2019 21:39	1,59	3	4,78	CHI
201911221666	GOIANIA	11642981	INDEPENDENCIA S2	19/11/2019 20:04	19/11/2019 23:07	19/11/2019 20:04	19/11/2019 23:07	3,04	1	3,04	CHI
201911221668	SANTA HELENA DE GOIAS	SH12279542	SANTA HELENA S1	19/11/2019 12:29	20/11/2019 11:30	19/11/2019 12:29	20/11/2019 11:30	23,02	6	138,10	CHI
201911221668	SANTO ANTONIO DA BARRA	SH12279542	SANTA HELENA S1	19/11/2019 12:29	20/11/2019 11:30	19/11/2019 12:29	20/11/2019 11:30	23,02	1	23,02	CHI
201911221672	CALDAZINHA	DE21239239	SENADOR CANEDO	19/11/2019 20:05	19/11/2019 22:21	19/11/2019 20:05	19/11/2019 22:21	2,26	4	9,03	CHI
201911221678	RIO VERDE	630573797	RIO VERDE S2	19/11/2019 20:06	20/11/2019 00:48	19/11/2019 20:06	20/11/2019 00:48	4,69	1	4,69	CHI
201911221681	PIRANHAS	PH11188484	PIRANHAS	19/11/2019 19:17	19/11/2019 23:30	19/11/2019 19:17	19/11/2019 23:30	4,20	71	298,38	CHI
201911221693	PIRENOPOLIS	PV12285301	CORUMBA	19/11/2019 15:39	19/11/2019 22:44	19/11/2019 15:39	19/11/2019 22:44	7,08	54	382,12	CHI
201911221705	JUSSARA	1290088631	JUSSARA	19/11/2019 20:10	20/11/2019 09:49	19/11/2019 20:10	20/11/2019 09:49	13,64	1	13,64	CHI

201911221707	GOIANIA	AP10396920	INDEPENDENCIA S2	19/11/2019 20:05	19/11/2019 21:34	19/11/2019 20:05	19/11/2019 21:34	1,49	1843	2741,97	CHI
201911221707	ABADIA DE GOIAS	AP10396920	INDEPENDENCIA S2	19/11/2019 20:05	19/11/2019 21:34	19/11/2019 21:27	19/11/2019 21:34	0,13	112	14,03	CHI
201911221707	GOIANIA	AP10396920	INDEPENDENCIA S2	19/11/2019 20:05	19/11/2019 21:34	19/11/2019 21:27	19/11/2019 21:34	0,13	344	43,10	CHI
201911221711	TRINDADE	TR32001819	TRINDADE	19/11/2019 20:11	19/11/2019 22:48	19/11/2019 20:11	19/11/2019 22:48	2,61	2	5,21	CHI
201911221712	ITUMBIARA	CD21000130	CACHOEIRA DOURADA	19/11/2019 20:11	20/11/2019 15:30	19/11/2019 20:11	20/11/2019 15:30	19,31	1	19,31	CHI
201911221715	SERRANOPOLIS	SX12296509	CACHOEIRA ALTA	19/11/2019 17:16	20/11/2019 08:27	19/11/2019 17:16	20/11/2019 08:27	15,17	7	106,18	CHI
201911221725	ANAPOLIS	AN11186982	ANAPOLIS UNIVERSITARIO S2	19/11/2019 19:50	19/11/2019 22:06	19/11/2019 19:50	19/11/2019 22:06	2,26	87	196,35	CHI
201911221735	AGUAS LINDAS DE GOIAS	10000565294	AGUAS LINDAS DE GOIAS S1	19/11/2019 20:16	19/11/2019 21:39	19/11/2019 20:16	19/11/2019 21:39	1,37	1	1,37	CHI
201911221742	SANTA ROSA DE GOIAS	SR21053362	INHUMAS S1	19/11/2019 20:17	20/11/2019 10:00	19/11/2019 20:17	20/11/2019 10:00	13,71	1	13,71	CHI
201911221752	GOIANIA	10746687	CAMPINAS S1	19/11/2019 20:19	20/11/2019 05:26	19/11/2019 20:19	20/11/2019 05:26	9,11	0	0,00	CHI
201911221753	PORANGATU	PO11182417	PORANGATU	19/11/2019 20:19	20/11/2019 16:32	19/11/2019 20:19	20/11/2019 16:32	20,21	3	60,62	CHI
201911221764	APARECIDA DE GOIANIA	10024157145	INDEPENDENCIA S1	19/11/2019 20:22	20/11/2019 17:49	19/11/2019 20:22	20/11/2019 17:49	21,45	1	21,45	CHI
201911221772	MOSSAMEDES	MD12024152	FIRMINOPOLIS S2	19/11/2019 20:15	19/11/2019 22:25	19/11/2019 20:15	19/11/2019 22:25	2,15	109	234,44	CHI
201911221772	SANCLERLANDIA	MD12024152	FIRMINOPOLIS S2	19/11/2019 20:15	19/11/2019 22:25	19/11/2019 20:15	19/11/2019 22:25	2,15	8	17,21	CHI
201911221773	AURILANDIA	AI12206461	FIRMINOPOLIS S2	19/11/2019 20:03	20/11/2019 11:48	19/11/2019 20:03	20/11/2019 11:48	15,75	14	220,50	CHI
201911221773	FIRMINOPOLIS	AI12206461	FIRMINOPOLIS S2	19/11/2019 20:03	20/11/2019 11:48	19/11/2019 20:03	20/11/2019 11:48	15,75	15	236,25	CHI
201911221774	NOVO PLANALTO	TA21121347	SAO MIGUEL DO ARAGUAIA	19/11/2019 20:25	20/11/2019 10:41	19/11/2019 20:25	20/11/2019 10:41	14,26	1	14,26	CHI
201911221775	MOZARLANDIA	MZ21238766	MOZARLANDIA	19/11/2019 20:25	20/11/2019 15:17	19/11/2019 20:25	20/11/2019 15:17	18,85	1	18,85	CHI
201911221785	ITARUMA	IM21376826	CACHOEIRA ALTA	19/11/2019 20:27	20/11/2019 09:05	19/11/2019 20:27	20/11/2019 09:05	12,63	1	12,63	CHI
201911221786	GOIAS	GS21307432	GOIAS	19/11/2019 20:28	20/11/2019 13:16	19/11/2019 20:28	20/11/2019 13:16	16,80	1	16,80	CHI
201911221788	GOIANIA	GN11000995	CAMPINAS S1	19/11/2019 16:26	19/11/2019 22:38	19/11/2019 16:26	19/11/2019 22:38	6,19	99	612,40	CHI
201911221790	JATAI	290149551	JATAI S2	19/11/2019 20:28	20/11/2019 08:03	19/11/2019 20:28	20/11/2019 08:03	11,58	1	11,58	CHI
201911221798	SAO MIGUEL DO ARAGUAIA	SM12000053	SAO MIGUEL DO ARAGUAIA	19/11/2019 17:27	20/11/2019 01:40	19/11/2019 17:27	20/11/2019 01:40	8,20	4	32,82	CHI
201911221803	CATALAO	CT21292308	CATALAO S1	19/11/2019 20:32	20/11/2019 07:16	19/11/2019 20:32	20/11/2019 07:16	10,72	1	10,72	CHI
201911221804	COCALZINHO DE GOIAS	1200011238	COCALZINHO	19/11/2019 20:32	20/11/2019 09:55	19/11/2019 20:32	20/11/2019 09:55	13,37	1	13,37	CHI
201911221807	FIRMINOPOLIS	FR11194168	FIRMINOPOLIS S1	19/11/2019 20:04	19/11/2019 21:52	19/11/2019 20:04	19/11/2019 21:52	1,79	186	333,87	CHI
201911221827	PANAMA	PX12263940	GOIATUBA S1	19/11/2019 19:31	20/11/2019 04:57	19/11/2019 19:31	20/11/2019 04:57	9,43	20	188,51	CHI
201911221828	RIO VERDE	10026001118	RIO VERDE S1	19/11/2019 20:37	20/11/2019 04:51	19/11/2019 20:37	20/11/2019 04:51	8,22	1	8,22	CHI
201911221829	GUARANI DE GOIAS	GY12393812	IACIARA S1	19/11/2019 20:36	19/11/2019 21:42	19/11/2019 20:36	19/11/2019 21:42	1,10	22	24,19	CHI
201911221830	DAVINOPOLIS	IO21156384	CATALAO S1	19/11/2019 20:38	20/11/2019 12:21	19/11/2019 20:38	20/11/2019 12:21	15,70	1	15,70	CHI
201911221833	TRINDADE	TR21193541	TRINDADE	19/11/2019 20:39	20/11/2019 09:22	19/11/2019 20:39	20/11/2019 09:22	12,71	1	12,71	CHI
201911221834	INHUMAS	IN21106237	INHUMAS S1	19/11/2019 20:39	20/11/2019 15:41	19/11/2019 20:39	20/11/2019 15:41	19,02	1	19,02	CHI
201911221846	MOZARLANDIA	MZ21055720	MOZARLANDIA	19/11/2019 20:42	20/11/2019 14:43	19/11/2019 20:42	20/11/2019 14:43	18,01	2	36,02	CHI

201911221849	ITUMBIARA	IT12024221	CACHOEIRA DOURADA	19/11/2019 15:27	20/11/2019 11:20	19/11/2019 15:27	20/11/2019 11:20	19,89	3	59,67	CHI
201911222102	VALPARAISO DE GOIAS	3350025259	PACAEMBU S1	19/11/2019 20:44	19/11/2019 23:28	19/11/2019 20:44	19/11/2019 23:28	2,72	1	2,72	CHI
201911222119	ADELANDIA	DN21021819	FIRMINOPOLIS S2	19/11/2019 20:51	20/11/2019 08:40	19/11/2019 20:51	20/11/2019 08:40	11,81	2	23,62	CHI
201911222123	APARECIDA DE GOIANIA	AP12135389	ANHANGUERA	19/11/2019 14:27	20/11/2019 01:03	19/11/2019 14:27	20/11/2019 01:03	10,59	77	815,19	CHI
201911222123	APARECIDA DE GOIANIA	AP12135389	ANHANGUERA	19/11/2019 14:27	20/11/2019 01:03	19/11/2019 20:52	20/11/2019 01:03	4,18	364	1521,82	CHI
201911222131	GOIANESIA	GE12016189	GOIANESIA S2	19/11/2019 18:22	20/11/2019 08:05	19/11/2019 18:22	20/11/2019 08:05	13,70	5	68,52	CHI
201911222140	COCALZINHO DE GOIAS	1200032266	COCALZINHO	19/11/2019 20:57	20/11/2019 21:55	19/11/2019 20:57	20/11/2019 21:55	24,95	1	24,95	CHI
201911222144	RIO VERDE	630293983	RIO VERDE S2	19/11/2019 20:59	20/11/2019 02:00	19/11/2019 20:59	20/11/2019 02:00	5,01	0	0,00	CHI
201911222149	GOIANIA	15112731	CAMPINAS S1	19/11/2019 21:01	20/11/2019 09:15	19/11/2019 21:01	20/11/2019 09:15	12,23	1	12,23	CHI
201911222160	AMARALINA	MQ12208443	NOVA CRIXAS	19/11/2019 21:05	20/11/2019 17:56	19/11/2019 21:05	20/11/2019 17:56	20,84	1	20,84	CHI
201911222160	MARA ROSA	MQ12208443	NOVA CRIXAS	19/11/2019 21:05	20/11/2019 17:56	19/11/2019 21:05	20/11/2019 17:56	20,84	1	20,84	CHI
201911222161	APARECIDA DE GOIANIA	12247212	INDEPENDENCIA S2	19/11/2019 21:06	20/11/2019 11:50	19/11/2019 21:06	20/11/2019 11:50	14,72	1	14,72	CHI
201911222172	PLANALTINA	PI12078400	PLANALTINA	19/11/2019 21:09	20/11/2019 21:10	19/11/2019 21:09	19/11/2019 21:21	0,20	318	63,78	CHI
201911222172	PLANALTINA	PI12078400	PLANALTINA	19/11/2019 21:09	20/11/2019 21:10	20/11/2019 19:39	20/11/2019 21:10	1,52	318	482,83	CHI
201911222174	RIO VERDE	RV12207197	MONTIVIDIU T	19/11/2019 17:43	20/11/2019 10:36	19/11/2019 17:43	20/11/2019 10:36	16,88	18	303,90	CHI
201911222181	MOZARLANDIA	MZ12220375	MOZARLANDIA	19/11/2019 18:00	20/11/2019 15:50	19/11/2019 18:00	20/11/2019 15:50	21,82	27	589,13	CHI
201911222183	PORANGATU	PO12189561	PORANGATU	19/11/2019 21:13	20/11/2019 15:20	19/11/2019 21:13	20/11/2019 15:20	18,12	7	126,81	CHI
201911222187	AGUAS LINDAS DE GOIAS	10009502660	AGUAS LINDAS DE GOIAS S1	19/11/2019 21:16	19/11/2019 23:01	19/11/2019 21:16	19/11/2019 23:01	1,74	1	1,74	CHI
201911222188	JUSSARA	10021595044	JUSSARA	19/11/2019 21:17	20/11/2019 15:12	19/11/2019 21:17	20/11/2019 15:12	17,90	1	17,90	CHI
201911222192	SANTA RITA DO ARAGUAIA	SU12188579	PARQUE DAS EMAS	19/11/2019 21:21	19/11/2019 23:55	19/11/2019 21:21	19/11/2019 23:55	2,55	5	12,75	CHI
201911222201	GOIANIA	12156619	GOYA S2	19/11/2019 21:24	19/11/2019 22:38	19/11/2019 21:24	19/11/2019 22:38	1,23	1	1,23	CHI
201911222210	PEROLANDIA	20116768	PARQUE DAS EMAS	19/11/2019 21:27	20/11/2019 10:21	19/11/2019 21:27	20/11/2019 10:21	12,90	2	25,79	CHI
201911222216	ITUMBIARA	IT12399537	PARANAIBA	19/11/2019 18:45	20/11/2019 07:25	19/11/2019 18:45	20/11/2019 07:25	12,66	5	63,32	CHI
201911222220	PALMEIRAS DE GOIAS	PL12038207	PALMEIRAS	19/11/2019 21:30	20/11/2019 10:40	19/11/2019 21:30	20/11/2019 10:40	13,16	3	39,49	CHI
201911222222	PIRANHAS	PH12244913	PIRANHAS	19/11/2019 21:25	20/11/2019 09:23	19/11/2019 21:25	20/11/2019 09:23	11,96	4	47,86	CHI
201911222227	MUTUNOPOLIS	SE12352924	MARA ROSA	19/11/2019 21:33	20/11/2019 09:25	19/11/2019 21:33	20/11/2019 09:25	11,85	6	71,11	CHI
201911222227	SANTA TEREZA DE GOIAS	SE12352924	MARA ROSA	19/11/2019 21:33	20/11/2019 09:25	19/11/2019 21:33	20/11/2019 09:25	11,85	1	11,85	CHI
201911222229	ITAPURANGA	IK11051549	ITAPURANGA	19/11/2019 21:28	20/11/2019 03:25	19/11/2019 21:28	20/11/2019 03:25	5,94	197	1170,51	CHI
201911222233	GOIANIRA	GR21228311	INHUMAS S1	19/11/2019 21:36	19/11/2019 22:43	19/11/2019 21:36	19/11/2019 22:43	1,11	2	2,21	CHI
201911222235	GOIANIA	16807212	CARAJAS S2	19/11/2019 21:37	20/11/2019 17:02	19/11/2019 21:37	20/11/2019 17:02	19,41	1	19,41	CHI
201911222241	ALEXANIA	AX12066452	ALEXANIA	19/11/2019 19:06	21/11/2019 11:26	19/11/2019 19:06	21/11/2019 07:23	36,29	25	907,24	CHI
201911222241	ALEXANIA	AX12066452	ALEXANIA	19/11/2019 19:06	21/11/2019 11:26	21/11/2019 07:24	21/11/2019 11:26	4,03	25	100,84	CHI
201911222247	SAO LUIZ DO NORTE	SZ11336120	BARRO ALTO	19/11/2019 21:45	20/11/2019 15:17	19/11/2019 21:45	20/11/2019 15:17	17,52	1	17,52	CHI

201911222251	AMARALINA	LC12050751	MARA ROSA	19/11/2019 21:41	20/11/2019 00:57	19/11/2019 21:41	20/11/2019 00:57	3,26	12	39,15	CHI
201911222251	MARA ROSA	LC12050751	MARA ROSA	19/11/2019 21:41	20/11/2019 00:57	19/11/2019 21:41	20/11/2019 00:57	3,26	5	16,31	CHI
201911222260	ITUMBIARA	690183252	ITUMBIARA VELHA S1	19/11/2019 21:50	20/11/2019 05:20	19/11/2019 21:50	20/11/2019 05:20	7,49	1	7,49	CHI
201911222267	FAZENDA NOVA	FN12042812	JUSSARA	19/11/2019 21:43	20/11/2019 12:33	19/11/2019 21:43	20/11/2019 12:33	14,82	10	148,22	CHI
201911222268	ADELANDIA	DN11206044	FIRMINOPOLIS S2	19/11/2019 21:08	20/11/2019 00:10	19/11/2019 21:08	20/11/2019 00:10	3,02	84	253,91	CHI
201911222273	NOVA CRIXAS	NA12354854	NOVA CRIXAS	19/11/2019 21:59	20/11/2019 02:58	19/11/2019 21:59	20/11/2019 02:58	4,97	9	44,77	CHI
201911222276	LUZIANIA	10008203081	RIO VERMELHO	19/11/2019 22:01	19/11/2019 23:17	19/11/2019 22:01	19/11/2019 23:17	1,26	1	1,26	CHI
201911222282	JAUPACI	JP12045494	IPORA	19/11/2019 22:02	20/11/2019 01:18	19/11/2019 22:02	20/11/2019 01:18	3,26	10	32,59	CHI
201911222293	CAIAPONIA	CP12200873	PALESTINA	19/11/2019 22:06	20/11/2019 10:15	19/11/2019 22:06	20/11/2019 10:15	12,15	54	656,12	CHI
201911222301	SAO LUIZ DO NORTE	DF21236817	BARRO ALTO	19/11/2019 22:10	20/11/2019 14:31	19/11/2019 22:10	20/11/2019 14:31	16,34	1	16,34	CHI
201911222303	ITABERAI	IB12124898	ITABERAI S2	19/11/2019 20:53	20/11/2019 00:52	19/11/2019 20:53	20/11/2019 00:52	3,98	193	769,00	CHI
201911222308	MINEIROS	MY21156634	PARQUE DAS EMAS	19/11/2019 22:16	20/11/2019 11:04	19/11/2019 22:16	20/11/2019 11:04	12,79	1	12,79	CHI
201911222311	GOIAS	GS12162498	GOIAS	19/11/2019 22:06	20/11/2019 17:30	19/11/2019 22:06	20/11/2019 17:30	19,39	11	213,32	CHI
201911222316	LUZIANIA	LZ21199709	MARAJOARA	19/11/2019 22:22	20/11/2019 02:08	19/11/2019 22:22	20/11/2019 02:08	3,76	4	15,04	CHI
201911222321	GOIANIA	15276326	ATLANTICO S3	19/11/2019 22:25	20/11/2019 09:38	19/11/2019 22:25	20/11/2019 09:38	11,20	1	11,20	CHI
201911222329	CAMPO ALEGRE DE GOIAS	CM13266056	CAMPO ALEGRE DE GOIAS	19/11/2019 10:28	20/11/2019 18:00	19/11/2019 10:28	20/11/2019 18:00	31,53	99	3121,55	CHI
201911222329	CATALAO	CM13266056	CAMPO ALEGRE DE GOIAS	19/11/2019 10:28	20/11/2019 18:00	19/11/2019 10:28	20/11/2019 18:00	31,53	20	630,62	CHI
201911222329	DISTRITO FEDERAL	CM13266056	CAMPO ALEGRE DE GOIAS	19/11/2019 10:28	20/11/2019 18:00	19/11/2019 10:28	20/11/2019 18:00	31,53	1	31,53	CHI
201911222329	IPAMERI	CM13266056	CAMPO ALEGRE DE GOIAS	19/11/2019 10:28	20/11/2019 18:00	19/11/2019 10:28	20/11/2019 18:00	31,53	12	378,37	CHI
201911222329	CAMPO ALEGRE DE GOIAS	CM13266056	CAMPO ALEGRE DE GOIAS	19/11/2019 10:28	20/11/2019 18:00	20/11/2019 17:06	20/11/2019 18:00	0,90	3	2,70	CHI
201911222338	CAMPESTRE DE GOIAS	GC12312851	TRINDADE	19/11/2019 22:28	20/11/2019 10:03	19/11/2019 22:28	20/11/2019 10:03	11,57	20	231,42	CHI
201911222342	GOIAS	GS12217234	MATRINCHA	20/11/2019 05:54	20/11/2019 11:42	20/11/2019 05:54	20/11/2019 11:42	5,81	47	272,98	CHI
201911222342	NOVO BRASIL	GS12217234	MATRINCHA	20/11/2019 05:54	20/11/2019 11:42	20/11/2019 05:54	20/11/2019 11:42	5,81	35	203,28	CHI
201911222345	URUACU	UR12364104	URUACU	19/11/2019 22:31	20/11/2019 02:22	19/11/2019 22:31	20/11/2019 02:22	3,85	87	334,83	CHI
201911222346	GOIANIA	GN11193560	CARAJAS S2	19/11/2019 22:35	20/11/2019 00:09	19/11/2019 22:35	20/11/2019 00:09	1,56	104	161,84	CHI
201911222347	ITUMBIARA	IT12033777	CACHOEIRA DOURADA	19/11/2019 21:35	20/11/2019 10:59	19/11/2019 21:35	20/11/2019 10:59	13,38	13	174,00	CHI
201911222351	ANAPOLIS	AN21379425	ANAPOLIS UNIVERSITARIO S1	19/11/2019 22:34	20/11/2019 15:36	19/11/2019 22:34	20/11/2019 15:36	17,02	3	51,05	CHI
201911222352	SANTA TEREZINHA DE GOIAS	SG12246311	SANTA TEREZINHA	19/11/2019 22:35	20/11/2019 11:37	19/11/2019 22:35	20/11/2019 11:37	13,03	4	52,12	CHI
201911222359	ADELANDIA	DN12277724	FIRMINOPOLIS S2	19/11/2019 19:13	20/11/2019 08:07	19/11/2019 19:13	20/11/2019 08:07	12,89	59	760,36	CHI
201911222359	MOSSAMEDES	DN12277724	FIRMINOPOLIS S2	19/11/2019 19:13	20/11/2019 08:07	19/11/2019 19:13	20/11/2019 08:07	12,89	5	64,44	CHI
201911222359	SANCLERLANDIA	DN12277724	FIRMINOPOLIS S2	19/11/2019 19:13	20/11/2019 08:07	19/11/2019 19:13	20/11/2019 08:07	12,89	30	386,62	CHI
201911222359	SAO LUIS DE MONTES BELOS	DN12277724	FIRMINOPOLIS S2	19/11/2019 19:13	20/11/2019 08:07	19/11/2019 19:13	20/11/2019 08:07	12,89	66	850,57	CHI
201911222370	RIO QUENTE	2530008500	RIO QUENTE	19/11/2019 22:43	20/11/2019 16:13	19/11/2019 22:43	20/11/2019 16:13	17,50	1	17,50	CHI

201911222373	GOIANIA	13601568	XAVANTES	19/11/2019 22:44	20/11/2019 02:13	19/11/2019 22:44	20/11/2019 02:13	3,48	1	3,48	CHI
201911222374	NIQUELANDIA	2750082220	NIQUELANDIA SUBTRANSMISSAO	19/11/2019 22:45	20/11/2019 14:01	19/11/2019 22:45	20/11/2019 14:01	15,26	1	15,26	CHI
201911222376	RIO VERDE	RV12123344	RIO VERDE S1	19/11/2019 22:47	20/11/2019 10:06	19/11/2019 22:47	20/11/2019 10:06	11,32	3	33,95	CHI
201911222377	APARECIDA DE GOIANIA	AP11350709	INDEPENDENCIA S2	19/11/2019 19:41	20/11/2019 08:09	19/11/2019 19:41	20/11/2019 08:09	12,46	89	1109,29	CHI
201911222384	CAIAPONIA	10017662654	MONTIVIDIU T	19/11/2019 22:54	20/11/2019 23:20	19/11/2019 22:54	20/11/2019 23:20	24,44	1	24,44	CHI
201911222401	AGUAS LINDAS DE GOIAS	4830363450	AGUAS LINDAS DE GOIAS S1	19/11/2019 23:00	20/11/2019 07:15	19/11/2019 23:00	20/11/2019 07:15	8,25	1	8,25	CHI
201911222402	PIRENOPOLIS	PV12285256	CORUMBA	19/11/2019 22:50	20/11/2019 22:28	19/11/2019 22:50	20/11/2019 22:28	23,63	12	283,60	CHI
201911222407	MINEIROS	MY21302944	PARQUE DAS EMAS	19/11/2019 23:05	20/11/2019 11:33	19/11/2019 23:05	20/11/2019 11:33	12,46	1	12,46	CHI
201911222416	GOIANIA	15577818	GOIANIA LESTE S1	19/11/2019 23:12	20/11/2019 00:58	19/11/2019 23:12	20/11/2019 00:58	1,76	1	1,76	CHI
201911222417	MOSSAMEDES	MD12000176	FIRMINOPOLIS S2	19/11/2019 21:56	20/11/2019 12:51	19/11/2019 21:56	20/11/2019 09:34	11,62	16	186,00	CHI
201911222417	MOSSAMEDES	MD12000176	FIRMINOPOLIS S2	19/11/2019 21:56	20/11/2019 12:51	20/11/2019 01:29	20/11/2019 09:34	8,07	2	16,15	CHI
201911222417	MOSSAMEDES	MD12000176	FIRMINOPOLIS S2	19/11/2019 21:56	20/11/2019 12:51	19/11/2019 21:56	20/11/2019 10:03	12,11	1	12,11	CHI
201911222417	MOSSAMEDES	MD12000176	FIRMINOPOLIS S2	19/11/2019 21:56	20/11/2019 12:51	19/11/2019 21:56	20/11/2019 12:06	14,16	9	127,47	CHI
201911222417	MOSSAMEDES	MD12000176	FIRMINOPOLIS S2	19/11/2019 21:56	20/11/2019 12:51	19/11/2019 21:56	20/11/2019 12:51	14,92	9	134,25	CHI
201911222419	BALIZA	BH12334535	BOM JARDIM	19/11/2019 23:16	20/11/2019 12:20	19/11/2019 23:16	20/11/2019 12:20	13,06	18	235,10	CHI
201911222424	FAINA	FC12232835	GOIAS	19/11/2019 23:19	20/11/2019 11:42	19/11/2019 23:19	20/11/2019 11:42	12,38	10	123,76	CHI
201911222441	ANAPOLIS	20699440	ANAPOLIS UNIVERSITARIO S2	19/11/2019 23:24	20/11/2019 20:15	19/11/2019 23:24	20/11/2019 20:15	20,84	1	20,84	CHI
201911222447	CAMPO ALEGRE DE GOIAS	CM12379366	CAMPO ALEGRE DE GOIAS	19/11/2019 23:29	20/11/2019 14:05	19/11/2019 23:29	20/11/2019 14:05	14,59	1	14,59	CHI
201911222449	ALTO HORIZONTE	MQ12181177	MARA ROSA	19/11/2019 23:43	20/11/2019 08:05	19/11/2019 23:43	20/11/2019 08:05	8,36	3	25,07	CHI
201911222449	MARA ROSA	MQ12181177	MARA ROSA	19/11/2019 23:43	20/11/2019 08:05	19/11/2019 23:43	20/11/2019 08:05	8,36	28	234,01	CHI
201911222449	URUACU	MQ12181177	MARA ROSA	19/11/2019 23:43	20/11/2019 08:05	19/11/2019 23:43	20/11/2019 08:05	8,36	1	8,36	CHI
201911222461	FORMOSA	610292535	ITUIQUIRA	20/11/2019 00:05	20/11/2019 03:20	20/11/2019 00:05	20/11/2019 03:20	3,24	1	3,24	CHI
201911222463	MARA ROSA	MQ12072578	MARA ROSA	20/11/2019 00:15	20/11/2019 09:00	20/11/2019 00:15	20/11/2019 09:00	8,74	6	52,46	CHI
201911222464	RIO QUENTE	RQ21060768	RIO QUENTE	20/11/2019 00:15	20/11/2019 20:42	20/11/2019 00:15	20/11/2019 20:42	20,44	3	61,32	CHI
201911222474	FORMOSA	610127603	ITUIQUIRA	20/11/2019 00:35	20/11/2019 03:24	20/11/2019 00:35	20/11/2019 03:24	2,82	1	2,82	CHI
201911222476	ACREUNA	EU21044249	ACREUNA	20/11/2019 00:38	20/11/2019 21:50	20/11/2019 00:38	20/11/2019 21:49	21,19	2	42,38	CHI
201911222476	ACREUNA	EU12296083LD	ACREUNA	20/11/2019 00:38	20/11/2019 21:50	20/11/2019 19:34	20/11/2019 21:50	2,26	4	9,04	CHI
201911222478	VARJAO	VJ32066172	GUAPO S2	19/11/2019 22:40	20/11/2019 10:55	19/11/2019 22:40	20/11/2019 10:55	12,26	16	196,14	CHI
201911222492	GOIAS	GS12250578	ITABERAI S1	20/11/2019 01:23	20/11/2019 09:25	20/11/2019 01:23	20/11/2019 09:25	8,03	3	24,09	CHI
201911222494	DOVERLANDIA	DV12138334	CAIAPONIA	20/11/2019 01:27	20/11/2019 10:29	20/11/2019 01:27	20/11/2019 10:29	9,03	15	135,46	CHI
201911222603	ALTO PARAISO DE GOIAS	BF10400373	SAO JOAO D ALIANCA	20/11/2019 00:00	20/11/2019 07:22	20/11/2019 00:00	20/11/2019 01:02	1,04	34	35,26	CHI
201911222603	ALTO PARAISO DE GOIAS	BF10400373	SAO JOAO D ALIANCA	20/11/2019 00:00	20/11/2019 07:22	20/11/2019 00:00	20/11/2019 02:41	2,69	235	631,82	CHI
201911222603	ALTO PARAISO DE GOIAS	JL10400375	SAO JOAO D ALIANCA	20/11/2019 00:00	20/11/2019 07:22	20/11/2019 00:00	20/11/2019 04:44	4,74	9	42,64	CHI

201911222603	ALTO PARAISO DE GOIAS	BF10400373	SAO JOAO D ALIANCA	20/11/2019 00:00	20/11/2019 07:22	20/11/2019 00:00	20/11/2019 07:05	7,10	3	21,29	CHI
201911222603	SAO JOAO D ALIANCA	BF10400373	SAO JOAO D ALIANCA	20/11/2019 00:00	20/11/2019 07:22	20/11/2019 00:00	20/11/2019 07:05	7,10	288	2044,00	CHI
201911222603	ALTO PARAISO DE GOIAS	BF10400373	SAO JOAO D ALIANCA	20/11/2019 00:00	20/11/2019 07:22	20/11/2019 00:00	20/11/2019 07:22	7,37	9	66,30	CHI
201911222603	SAO JOAO D ALIANCA	BF10400373	SAO JOAO D ALIANCA	20/11/2019 00:00	20/11/2019 07:22	20/11/2019 00:00	20/11/2019 07:22	7,37	3	22,10	CHI
201911222603	ALTO PARAISO DE GOIAS	JL133903745	SAO JOAO D ALIANCA	20/11/2019 00:00	20/11/2019 07:22	20/11/2019 04:21	20/11/2019 07:22	3,01	1	3,01	CHI
201911222604	VARJAO	VJ11329588	GUAPO S2	19/11/2019 19:13	20/11/2019 17:37	19/11/2019 19:13	20/11/2019 17:37	22,39	101	2261,47	CHI
201911222622	MINACU	IH21145748	MINACU	20/11/2019 05:19	21/11/2019 16:31	20/11/2019 05:19	21/11/2019 16:31	35,21	1	35,21	CHI
201911222625	BELA VISTA DE GOIAS	01480424	PIRES DO RIO S2	19/11/2019 16:30	19/11/2019 16:36	19/11/2019 16:30	19/11/2019 16:36	0,11	2	0,23	CHI
201911222625	CRISTIANOPOLIS	01480424	PIRES DO RIO S2	19/11/2019 16:30	19/11/2019 16:36	19/11/2019 16:30	19/11/2019 16:36	0,11	27	3,08	CHI
201911222625	PALMELO	01480424	PIRES DO RIO S2	19/11/2019 16:30	19/11/2019 16:36	19/11/2019 16:30	19/11/2019 16:36	0,11	858	97,95	CHI
201911222625	PALMELO	01480424	PIRES DO RIO S2	19/11/2019 16:30	19/11/2019 16:36	19/11/2019 16:30	19/11/2019 16:36	0,11	66	7,53	CHI
201911222625	PALMELO	01480424	PIRES DO RIO S2	19/11/2019 16:30	19/11/2019 16:36	19/11/2019 16:30	19/11/2019 16:36	0,11	1	0,11	CHI
201911222625	PIRES DO RIO	01480424	PIRES DO RIO S2	19/11/2019 16:30	19/11/2019 16:36	19/11/2019 16:30	19/11/2019 16:36	0,11	86	9,82	CHI
201911222625	PIRES DO RIO	01480424	PIRES DO RIO S2	19/11/2019 16:30	19/11/2019 16:36	19/11/2019 16:30	19/11/2019 16:36	0,11	45	5,14	CHI
201911222625	PIRES DO RIO	01480424	PIRES DO RIO S2	19/11/2019 16:30	19/11/2019 16:36	19/11/2019 16:30	19/11/2019 16:36	0,11	173	19,75	CHI
201911222625	SANTA CRUZ DE GOIAS	01480424	PIRES DO RIO S2	19/11/2019 16:30	19/11/2019 16:36	19/11/2019 16:30	19/11/2019 16:36	0,11	1321	150,81	CHI
201911222625	SANTA CRUZ DE GOIAS	01480424	PIRES DO RIO S2	19/11/2019 16:30	19/11/2019 16:36	19/11/2019 16:30	19/11/2019 16:36	0,11	122	13,93	CHI
201911222644	GOIANIA	GN11000525	CAMPINAS S3	20/11/2019 07:13	20/11/2019 09:03	20/11/2019 07:13	20/11/2019 09:03	1,82	3	5,46	CHI
201911222702	CRISTALINA	KR21313605	CRISTALINA S2	20/11/2019 02:00	20/11/2019 10:13	20/11/2019 02:00	20/11/2019 10:13	8,21	1	8,21	CHI
201911222707	ANAPOLIS	21380296	JUNDIAI S1	20/11/2019 02:27	20/11/2019 08:13	20/11/2019 02:27	20/11/2019 08:13	5,76	1	5,76	CHI
201911222712	RIO VERDE	630463920	RIO VERDE S2	20/11/2019 03:03	20/11/2019 09:41	20/11/2019 03:03	20/11/2019 09:41	6,62	1	6,62	CHI
201911222714	RIO VERDE	RV12365428	CABRIUVA S2	20/11/2019 03:17	20/11/2019 10:38	20/11/2019 03:17	20/11/2019 10:38	7,34	5	36,72	CHI
201911222716	BOM JESUS DE GOIAS	BJ12000088RE	BOM JESUS DE GOIAS	20/11/2019 06:19	20/11/2019 11:27	20/11/2019 06:19	20/11/2019 11:27	5,12	10	51,21	CHI
201911222716	GOIATUBA	BJ12000088RE	BOM JESUS DE GOIAS	20/11/2019 06:19	20/11/2019 11:27	20/11/2019 06:19	20/11/2019 11:27	5,12	44	225,34	CHI
201911222806	APARECIDA DE GOIANIA	AP12049712	ANHANGUERA	20/11/2019 01:12	20/11/2019 07:45	20/11/2019 01:12	20/11/2019 07:45	6,53	124	810,20	CHI
201911222812	ARENOPOLIS	AY12259445	IPORA	20/11/2019 04:16	20/11/2019 19:40	20/11/2019 04:16	20/11/2019 19:40	15,39	5	76,97	CHI
201911222812	PIRANHAS	AY12259445	IPORA	20/11/2019 04:16	20/11/2019 19:40	20/11/2019 04:16	20/11/2019 19:40	15,39	1	15,39	CHI
201911222814	URUACU	UR12221685	URUACU	20/11/2019 04:20	20/11/2019 08:29	20/11/2019 04:20	20/11/2019 08:29	4,14	20	82,81	CHI
201911222816	SAO FRANCISCO DE GOIAS	SF12211814	SAO FRANCISCO DE GOIAS	20/11/2019 04:33	20/11/2019 13:22	20/11/2019 04:33	20/11/2019 13:22	8,81	14	123,27	CHI
201911222818	ALTO HORIZONTE	VD12390494	SANTA TEREZINHA	19/11/2019 17:30	20/11/2019 10:36	19/11/2019 17:30	20/11/2019 10:36	17,08	9	153,76	CHI
201911222818	CAMPOS VERDES	VD12390494	SANTA TEREZINHA	19/11/2019 17:30	20/11/2019 10:36	19/11/2019 17:30	20/11/2019 10:36	17,08	1	17,08	CHI
201911222818	MARA ROSA	VD12390494	SANTA TEREZINHA	19/11/2019 17:30	20/11/2019 10:36	19/11/2019 17:30	20/11/2019 10:36	17,08	66	1127,57	CHI
201911222832	QUIRINOPOLIS	QI12271537	QUIRINOPOLIS	20/11/2019 04:46	20/11/2019 17:55	20/11/2019 04:46	20/11/2019 12:26	7,67	51	391,07	CHI

201911222832	QUIRINOPOLIS	QI12271537	QUIRINOPOLIS	20/11/2019 04:46	20/11/2019 17:55	20/11/2019 04:46	20/11/2019 17:55	13,14	39	512,56	CHI
201911222833	MARA ROSA	MQ12156002	MARA ROSA	20/11/2019 04:58	20/11/2019 12:21	20/11/2019 04:58	20/11/2019 12:21	7,38	20	147,62	CHI
201911222835	FORMOSO	FO12200415	MARA ROSA	20/11/2019 05:02	20/11/2019 20:37	20/11/2019 05:02	20/11/2019 20:37	15,57	18	280,30	CHI
201911222839	BONOPOLIS	BX12168214	SAO MIGUEL DO ARAGUAIA	20/11/2019 04:37	20/11/2019 07:41	20/11/2019 04:37	20/11/2019 07:41	3,06	91	278,49	CHI
201911222843	JARAGUA	SF12000122	SAO FRANCISCO DE GOIAS	20/11/2019 01:01	20/11/2019 07:40	20/11/2019 01:01	20/11/2019 07:40	6,64	89	590,91	CHI
201911222843	SAO FRANCISCO DE GOIAS	SF12000122	SAO FRANCISCO DE GOIAS	20/11/2019 01:01	20/11/2019 07:40	20/11/2019 01:01	20/11/2019 07:40	6,64	6	39,84	CHI
201911222847	POSSE	PS12132043	IACIARA S2	20/11/2019 07:00	20/11/2019 13:04	20/11/2019 07:00	20/11/2019 13:04	6,06	37	224,23	CHI
201911222848	AMARALINA	MU12391981	MARA ROSA	20/11/2019 05:13	20/11/2019 12:07	20/11/2019 05:13	20/11/2019 12:07	6,89	5	34,45	CHI
201911222848	MUTUNOPOLIS	MU12391981	MARA ROSA	20/11/2019 05:13	20/11/2019 12:07	20/11/2019 05:13	20/11/2019 12:07	6,89	5	34,45	CHI
201911222849	IPORA	IR12065120	IPORA	20/11/2019 05:14	20/11/2019 12:56	20/11/2019 05:14	20/11/2019 12:56	7,69	7	53,86	CHI
201911222852	ITAGUARI	IC12219941	ITABERAI S1	20/11/2019 05:16	20/11/2019 10:00	20/11/2019 05:16	20/11/2019 10:00	4,73	31	146,54	CHI
201911222852	ITAGUARU	IC12219941	ITABERAI S1	20/11/2019 05:16	20/11/2019 10:00	20/11/2019 05:16	20/11/2019 10:00	4,73	19	89,82	CHI
201911222853	GUAPO	VJ13000011	GUAPO S2	20/11/2019 05:16	20/11/2019 17:32	20/11/2019 05:16	20/11/2019 09:45	4,49	96	431,25	CHI
201911222853	VARJAO	VJ13000011	GUAPO S2	20/11/2019 05:16	20/11/2019 17:32	20/11/2019 05:16	20/11/2019 09:45	4,49	97	435,75	CHI
201911222853	GUAPO	VJ13000011	GUAPO S2	20/11/2019 05:16	20/11/2019 17:32	20/11/2019 09:25	20/11/2019 09:45	0,33	31	10,13	CHI
201911222853	GUAPO	VJ13312879	GUAPO S2	20/11/2019 05:16	20/11/2019 17:32	20/11/2019 05:16	20/11/2019 11:06	5,85	3	17,55	CHI
201911222853	VARJAO	VJ13312879	GUAPO S2	20/11/2019 05:16	20/11/2019 17:32	20/11/2019 05:16	20/11/2019 11:06	5,85	11	64,35	CHI
201911222853	VARJAO	VJ32066140LD	GUAPO S2	20/11/2019 05:16	20/11/2019 17:32	20/11/2019 05:16	20/11/2019 17:32	12,28	91	1117,38	CHI
201911222911	RIO QUENTE	RQ12087020	RIO QUENTE	20/11/2019 05:26	20/11/2019 21:10	20/11/2019 05:26	20/11/2019 21:10	15,73	10	157,25	CHI
201911222915	BELA VISTA DE GOIAS	HD12323100	CEPAIGO S2	19/11/2019 20:24	20/11/2019 11:13	19/11/2019 20:24	20/11/2019 11:13	14,81	8	118,52	CHI
201911222915	HIDROLANDIA	HD12323100	CEPAIGO S2	19/11/2019 20:24	20/11/2019 11:13	19/11/2019 20:24	20/11/2019 11:13	14,81	93	1377,74	CHI
201911222925	LUZIANIA	LZ21321287	VIANOPOLIS	20/11/2019 05:32	20/11/2019 23:04	20/11/2019 05:32	20/11/2019 18:25	12,89	1	12,89	CHI
201911222925	LUZIANIA	LZ12261082	VIANOPOLIS	20/11/2019 05:32	20/11/2019 23:04	20/11/2019 05:32	20/11/2019 23:04	17,54	2	35,09	CHI
201911222930	FORMOSO	FO12391929	PORANGATU	20/11/2019 05:29	20/11/2019 08:45	20/11/2019 05:29	20/11/2019 08:45	3,26	11	35,90	CHI
201911222931	IACIARA	IA12000014	IACIARA S1	20/11/2019 05:34	20/11/2019 11:48	20/11/2019 05:34	20/11/2019 11:48	6,22	24	149,39	CHI
201911222933	MARA ROSA	ET12391906	MARA ROSA	20/11/2019 05:35	20/11/2019 13:15	20/11/2019 05:35	20/11/2019 13:15	7,66	10	76,59	CHI
201911222936	MINEIROS	MY12149315	PARQUE DAS EMAS	19/11/2019 23:17	20/11/2019 08:24	19/11/2019 23:17	20/11/2019 08:24	9,11	27	245,91	CHI
201911222937	MARA ROSA	MQ12125574	MARA ROSA	20/11/2019 05:36	20/11/2019 11:17	20/11/2019 05:36	20/11/2019 11:17	5,67	13	73,67	CHI
201911222940	ITAPIRAPUA	IU12259711	MATRINCHA	19/11/2019 23:24	20/11/2019 10:00	19/11/2019 23:24	20/11/2019 10:00	10,60	5	52,99	CHI
201911222943	ITAPACI	IW12167977	ITAPACI	20/11/2019 00:19	20/11/2019 08:30	20/11/2019 00:19	20/11/2019 08:30	8,17	20	163,42	CHI
201911222947	JATAI	JT12182159	JATAI S1	20/11/2019 05:39	20/11/2019 10:50	20/11/2019 05:39	20/11/2019 10:50	5,18	1	5,18	CHI
201911222961	ARAGUAPAZ	AZ12064165	GOIAS	20/11/2019 05:46	20/11/2019 10:39	20/11/2019 05:46	20/11/2019 10:39	4,88	4	19,50	CHI
201911222965	SERRANOPOLIS	SX21214376	JATAI S1	20/11/2019 05:47	20/11/2019 11:15	20/11/2019 05:47	20/11/2019 11:15	5,45	1	5,45	CHI

201911222974	SANTA TEREZA DE GOIAS	2430013673	MARA ROSA	20/11/2019 05:51	20/11/2019 12:00	20/11/2019 05:51	20/11/2019 12:00	6,14	1	6,14	CHI
201911222975	URUACU	UR12201756	URUACU	20/11/2019 05:52	20/11/2019 14:01	20/11/2019 05:52	20/11/2019 14:01	8,15	3	24,44	CHI
201911222976	MOSSAMEDES	MD12121049	ITABERAI S2	19/11/2019 22:06	20/11/2019 15:57	19/11/2019 22:06	20/11/2019 15:57	17,85	25	446,17	CHI
201911222981	GOIAS	GS12336536	GOIAS	20/11/2019 05:54	20/11/2019 20:40	20/11/2019 05:54	20/11/2019 20:40	14,77	9	132,95	CHI
201911222984	ALTO PARAISO DE GOIAS	BF10400725	NIQUELANDIA SUBTRANSMISSAO	20/11/2019 05:52	20/11/2019 15:23	20/11/2019 05:52	20/11/2019 10:45	4,88	406	1981,05	CHI
201911222984	ALTO PARAISO DE GOIAS	BF10400725	NIQUELANDIA SUBTRANSMISSAO	20/11/2019 05:52	20/11/2019 15:23	20/11/2019 05:52	20/11/2019 13:00	7,13	7	49,92	CHI
201911222984	ALTO PARAISO DE GOIAS	BF10400725	NIQUELANDIA SUBTRANSMISSAO	20/11/2019 05:52	20/11/2019 15:23	20/11/2019 05:52	20/11/2019 14:16	8,41	104	874,21	CHI
201911222984	ALTO PARAISO DE GOIAS	BF13120586	NIQUELANDIA SUBTRANSMISSAO	20/11/2019 05:52	20/11/2019 15:23	20/11/2019 15:12	20/11/2019 15:23	0,17	106	18,43	CHI
201911222985	BONOPOLIS	BX12079317	SAO MIGUEL DO ARAGUAIA	20/11/2019 05:37	20/11/2019 08:46	20/11/2019 05:37	20/11/2019 08:46	3,15	37	116,56	CHI
201911222991	SANTA CRUZ DE GOIAS	BC21302056	PIRACANJUBA	20/11/2019 05:56	20/11/2019 22:12	20/11/2019 05:56	20/11/2019 22:12	16,25	1	16,25	CHI
201911222995	PARAUNA	PU12391518	PARAUNA	20/11/2019 01:05	20/11/2019 11:07	20/11/2019 01:05	20/11/2019 11:07	10,04	24	240,91	CHI
201911223002	SANTO ANTONIO DA BARRA	BZ12301428	ACREUNA	20/11/2019 05:59	20/11/2019 09:09	20/11/2019 05:59	20/11/2019 09:09	3,17	5	15,83	CHI
201911223003	BALIZA	BH12380942	BOM JARDIM	20/11/2019 05:59	20/11/2019 15:18	20/11/2019 05:59	20/11/2019 15:18	9,31	7	65,16	CHI
201911223004	SERRANOPOLIS	SX12359290	JATAI S1	20/11/2019 06:00	21/11/2019 08:49	20/11/2019 06:00	21/11/2019 08:49	26,81	4	107,23	CHI
201911223011	CATALAO	CT12042366	CATALAO S1	19/11/2019 18:07	20/11/2019 17:48	19/11/2019 18:07	20/11/2019 17:48	23,68	18	426,16	CHI
201911223013	MONTE ALEGRE DE GOIAS	MA12236002	SAO DOMINGOS	20/11/2019 06:03	20/11/2019 08:09	20/11/2019 06:03	20/11/2019 08:09	2,10	14	29,38	CHI
201911223014	PIRANHAS	PH12187435	PIRANHAS	20/11/2019 06:03	20/11/2019 14:40	20/11/2019 06:03	20/11/2019 14:40	8,62	8	68,96	CHI
201911223015	PIRANHAS	PH12343619	PIRANHAS	20/11/2019 06:03	20/11/2019 16:20	20/11/2019 06:03	20/11/2019 16:20	10,29	1	10,29	CHI
201911223020	CRISTIANOPOLIS	CF21107170	CRISTIANOPOLIS	20/11/2019 06:04	20/11/2019 11:33	20/11/2019 06:04	20/11/2019 11:33	5,48	1	5,48	CHI
201911223032	JANDAIA	JD12024301	PALMEIRAS	20/11/2019 06:06	20/11/2019 08:31	20/11/2019 06:06	20/11/2019 08:31	2,42	9	21,78	CHI
201911223034	BALIZA	BH12331469	CAIAPONIA	20/11/2019 01:13	20/11/2019 12:00	20/11/2019 01:13	20/11/2019 12:00	10,80	21	226,74	CHI
201911223035	CALDAS NOVAS	MR12189844	MORRINHOS	20/11/2019 06:07	20/11/2019 10:49	20/11/2019 06:07	20/11/2019 10:49	4,69	3	14,08	CHI
201911223035	MORRINHOS	MR12189844	MORRINHOS	20/11/2019 06:07	20/11/2019 10:49	20/11/2019 06:07	20/11/2019 10:49	4,69	4	18,78	CHI
201911223035	PIRACANJUBA	MR12189844	MORRINHOS	20/11/2019 06:07	20/11/2019 10:49	20/11/2019 06:07	20/11/2019 10:49	4,69	5	23,47	CHI
201911223036	MAMBAI	PS12189370	IACIARA S2	19/11/2019 18:23	20/11/2019 11:21	19/11/2019 18:23	20/11/2019 11:21	16,96	22	373,05	CHI
201911223036	POSSE	PS12189370	IACIARA S2	19/11/2019 18:23	20/11/2019 11:21	19/11/2019 18:23	20/11/2019 11:21	16,96	4	67,83	CHI
201911223043	IACIARA	IA21264221	IACIARA S1	20/11/2019 06:09	20/11/2019 17:41	20/11/2019 06:09	20/11/2019 17:41	11,53	1	11,53	CHI
201911223045	NIQUELANDIA	NQ12245210	NIQUELANDIA SUBTRANSMISSAO	20/11/2019 06:09	21/11/2019 06:04	20/11/2019 06:09	21/11/2019 06:04	23,91	34	812,97	CHI
201911223055	DOVERLANDIA	DV11228255	CAIAPONIA	20/11/2019 06:11	20/11/2019 12:06	20/11/2019 06:11	20/11/2019 12:06	5,91	1	5,91	CHI
201911223057	MAIRIPOTABA	MI12000231	PONTALINA	20/11/2019 03:33	20/11/2019 14:21	20/11/2019 03:33	20/11/2019 14:21	10,78	1	10,78	CHI
201911223057	PROFESSOR JAMIL SAFADY	MI12000231	PONTALINA	20/11/2019 03:33	20/11/2019 14:21	20/11/2019 03:33	20/11/2019 14:21	10,78	14	150,97	CHI
201911223062	FLORES DE GOIAS	IA12046295	IACIARA S2	20/11/2019 06:12	20/11/2019 18:42	20/11/2019 06:12	20/11/2019 18:42	12,51	1	12,51	CHI
201911223062	IACIARA	IA12046295	IACIARA S2	20/11/2019 06:12	20/11/2019 18:42	20/11/2019 06:12	20/11/2019 18:42	12,51	89	1112,99	CHI

201911223064	PORANGATU	PO12217306	PORANGATU	20/11/2019 06:12	21/11/2019 02:10	20/11/2019 06:12	21/11/2019 02:10	19,95	13	259,41	CHI
201911223070	BURITINOPOLIS	MB12026276	IACIARA S2	20/11/2019 06:14	21/11/2019 12:19	20/11/2019 06:14	21/11/2019 12:19	30,08	2	60,15	CHI
201911223104	FORMOSA	7196090	ITUIQUIRA	20/11/2019 04:51	20/11/2019 10:35	20/11/2019 04:51	20/11/2019 10:35	5,73	147	842,55	CHI
201911223105	APARECIDA DE GOIANIA	10024110076	ANHANGUERA	20/11/2019 06:15	20/11/2019 13:21	20/11/2019 06:15	20/11/2019 13:21	7,08	1	7,08	CHI
201911223107	SITIO D ABADIA	SI12318211	IACIARA S2	20/11/2019 06:16	20/11/2019 10:57	20/11/2019 06:16	20/11/2019 10:57	4,68	1	4,68	CHI
201911223108	BOM JESUS DE GOIAS	BJ12256996	BOM JESUS DE GOIAS	20/11/2019 02:26	20/11/2019 13:25	20/11/2019 02:26	20/11/2019 13:25	10,97	14	153,58	CHI
201911223108	GOIATUBA	BJ12256996	BOM JESUS DE GOIAS	20/11/2019 02:26	20/11/2019 13:25	20/11/2019 02:26	20/11/2019 13:25	10,97	52	570,44	CHI
201911223115	MAURILANDIA	ML12271555	RIO DOS BOIS	20/11/2019 06:17	20/11/2019 12:03	20/11/2019 06:17	20/11/2019 12:03	5,76	1	5,76	CHI
201911223115	RIO VERDE	ML12271555	RIO DOS BOIS	20/11/2019 06:17	20/11/2019 12:03	20/11/2019 06:17	20/11/2019 12:03	5,76	9	51,85	CHI
201911223120	BURITI ALEGRE	BG12263642	ITUMBIARA VELHA S2	20/11/2019 06:19	20/11/2019 19:40	20/11/2019 06:19	20/11/2019 19:40	13,34	1	13,34	CHI
201911223120	ITUMBIARA	BG12263642	ITUMBIARA VELHA S2	20/11/2019 06:19	20/11/2019 19:40	20/11/2019 06:19	20/11/2019 19:40	13,34	2	26,68	CHI
201911223122	BELA VISTA DE GOIAS	BV12060471	BELA VISTA S1	20/11/2019 00:31	20/11/2019 08:53	20/11/2019 00:31	20/11/2019 08:53	8,36	6	50,18	CHI
201911223127	FORMOSO	FO21313419	MARA ROSA	20/11/2019 06:20	20/11/2019 15:30	20/11/2019 06:20	20/11/2019 15:30	9,15	1	9,15	CHI
201911223130	PORANGATU	PO12230420	NOVO PLANALTO	20/11/2019 06:21	20/11/2019 22:44	20/11/2019 06:21	20/11/2019 22:44	16,38	3	49,13	CHI
201911223133	CRIXAS	CX12202067	SERRA DO OURO	20/11/2019 06:21	20/11/2019 10:30	20/11/2019 06:21	20/11/2019 10:30	4,13	1	4,13	CHI
201911223134	NIQUELANDIA	NQ12245210	NIQUELANDIA SUBTRANSMISSAO	20/11/2019 06:22	20/11/2019 12:30	20/11/2019 06:22	20/11/2019 12:30	6,13	37	226,81	CHI
201911223136	MORRINHOS	MR21160447	MORRINHOS	20/11/2019 06:22	21/11/2019 09:10	20/11/2019 06:22	21/11/2019 09:10	26,81	1	26,81	CHI
201911223137	GOIAS	GS21355644	MATRINCHA	20/11/2019 06:22	21/11/2019 10:20	20/11/2019 06:22	21/11/2019 10:20	27,97	1	27,97	CHI
201911223141	PALMEIRAS DE GOIAS	PL12313331	TRINDADE	20/11/2019 06:22	20/11/2019 08:34	20/11/2019 06:22	20/11/2019 08:34	2,20	6	13,17	CHI
201911223144	MARA ROSA	MQ12208423	MARA ROSA	20/11/2019 06:24	20/11/2019 10:43	20/11/2019 06:24	20/11/2019 10:43	4,32	12	51,78	CHI
201911223145	CORREGO DO OURO	CO21227457	FIRMINOPOLIS S2	20/11/2019 06:24	20/11/2019 15:04	20/11/2019 06:24	20/11/2019 15:04	8,66	1	8,66	CHI
201911223147	MORRINHOS	MR12402502	GOIATUBA S1	20/11/2019 06:25	21/11/2019 11:45	20/11/2019 06:25	21/11/2019 11:45	29,33	8	234,62	CHI
201911223154	BOM JARDIM DE GOIAS	BM12342013	BOM JARDIM	20/11/2019 05:49	20/11/2019 18:33	20/11/2019 05:49	20/11/2019 18:33	12,73	11	139,98	CHI
201911223156	MINEIROS	MY12332631	PARQUE DAS EMAS	20/11/2019 06:28	20/11/2019 15:33	20/11/2019 06:28	20/11/2019 15:33	9,07	7	63,51	CHI
201911223158	AGUA FRIA DE GOIAS	TL12262407	SAO JOAO D ALIANCA	20/11/2019 06:29	20/11/2019 12:36	20/11/2019 06:29	20/11/2019 12:36	6,11	9	54,99	CHI
201911223159	URUACU	UR12003425	URUACU	20/11/2019 06:29	20/11/2019 09:39	20/11/2019 06:29	20/11/2019 09:39	3,16	4	12,64	CHI
201911223173	SITIO D ABADIA	SI12211621	IACIARA S2	20/11/2019 06:32	20/11/2019 12:07	20/11/2019 06:32	20/11/2019 12:07	5,58	4	22,32	CHI
201911223176	JARAGUA	JA12200814	JARAGUA	20/11/2019 06:32	20/11/2019 11:10	20/11/2019 06:32	20/11/2019 11:10	4,63	11	50,90	CHI
201911223182	BOM JARDIM DE GOIAS	BM12065725	BOM JARDIM	20/11/2019 04:38	20/11/2019 09:02	20/11/2019 04:38	20/11/2019 09:02	4,39	20	87,78	CHI
201911223182	PIRANHAS	BM12065725	BOM JARDIM	20/11/2019 04:38	20/11/2019 09:02	20/11/2019 04:38	20/11/2019 09:02	4,39	1	4,39	CHI
201911223191	MINEIROS	SU12184123	SANTA RITA DO ARAGUAIA	20/11/2019 06:36	20/11/2019 11:50	20/11/2019 06:36	20/11/2019 11:50	5,23	15	78,42	CHI
201911223191	SANTA RITA DO ARAGUAIA	SU12184123	SANTA RITA DO ARAGUAIA	20/11/2019 06:36	20/11/2019 11:50	20/11/2019 06:36	20/11/2019 11:50	5,23	6	31,37	CHI
201911223192	CALDAS NOVAS	760024650	SERRA DE CALDAS	20/11/2019 06:37	20/11/2019 11:46	20/11/2019 06:37	20/11/2019 11:46	5,15	1	5,15	CHI

201911223194	FIRMINOPOLIS	SL12206323	FIRMINOPOLIS S1	20/11/2019 06:37	20/11/2019 09:25	20/11/2019 06:37	20/11/2019 09:25	2,79	6	16,71	CHI
201911223194	SAO LUIS DE MONTES BELOS	SL12206323	FIRMINOPOLIS S1	20/11/2019 06:37	20/11/2019 09:25	20/11/2019 06:37	20/11/2019 09:25	2,79	47	130,93	CHI
201911223196	CACHOEIRA DE GOIAS	CG12377182	FIRMINOPOLIS S2	20/11/2019 06:09	20/11/2019 09:11	20/11/2019 06:09	20/11/2019 09:11	3,03	10	30,31	CHI
201911223197	AURILANDIA	AI12008106	FIRMINOPOLIS S2	19/11/2019 22:22	20/11/2019 10:36	19/11/2019 22:22	20/11/2019 10:36	12,22	7	85,57	CHI
201911223205	IPAMERI	NE12086750	CATALAO S1	20/11/2019 05:41	20/11/2019 14:46	20/11/2019 05:41	20/11/2019 14:46	9,07	14	126,97	CHI
201911223205	NOVA AURORA	NE12086750	CATALAO S1	20/11/2019 05:41	20/11/2019 14:46	20/11/2019 05:41	20/11/2019 14:46	9,07	2	18,14	CHI
201911223213	TRINDADE	TR12134046	GOYA S2	20/11/2019 06:41	20/11/2019 10:45	20/11/2019 06:41	20/11/2019 10:45	4,06	262	1064,52	CHI
201911223222	PORANGATU	PO12020611	NOVO PLANALTO	20/11/2019 06:39	20/11/2019 09:10	20/11/2019 06:39	20/11/2019 09:10	2,51	8	20,09	CHI
201911223224	CAMPOS BELOS	CH12150394	SAO DOMINGOS	20/11/2019 06:43	20/11/2019 13:22	20/11/2019 06:43	20/11/2019 13:22	6,64	10	66,37	CHI
201911223229	MIMOSO DE GOIAS	MJ12382208	PADRE BERNARDO	20/11/2019 06:39	20/11/2019 15:23	20/11/2019 06:39	20/11/2019 15:23	8,73	8	69,85	CHI
201911223229	PADRE BERNARDO	MJ12382208	PADRE BERNARDO	20/11/2019 06:39	20/11/2019 15:23	20/11/2019 06:39	20/11/2019 15:23	8,73	6	52,39	CHI
201911223231	APARECIDA DE GOIANIA	10018896845	ANHANGUERA	20/11/2019 06:45	20/11/2019 16:18	20/11/2019 06:45	20/11/2019 16:18	9,54	1	9,54	CHI
201911223232	NIQUELANDIA	NQ12140184	SAO JOAO D ALIANCA	19/11/2019 21:50	24/11/2019 14:54	19/11/2019 21:50	22/11/2019 12:57	63,13	9	568,17	CHI
201911223232	NIQUELANDIA	NQ12140184	SAO JOAO D ALIANCA	19/11/2019 21:50	24/11/2019 14:54	22/11/2019 17:59	22/11/2019 20:05	2,10	9	18,94	CHI
201911223232	NIQUELANDIA	NQ12140184	SAO JOAO D ALIANCA	19/11/2019 21:50	24/11/2019 14:54	22/11/2019 22:29	22/11/2019 23:19	0,84	9	7,58	CHI
201911223232	NIQUELANDIA	NQ12140184	SAO JOAO D ALIANCA	19/11/2019 21:50	24/11/2019 14:54	23/11/2019 09:27	23/11/2019 13:42	4,24	9	38,16	CHI
201911223232	NIQUELANDIA	NQ12342500LD	SAO JOAO D ALIANCA	19/11/2019 21:50	24/11/2019 14:54	19/11/2019 21:50	23/11/2019 14:30	88,67	13	1152,66	CHI
201911223232	NIQUELANDIA	NQ12140184	SAO JOAO D ALIANCA	19/11/2019 21:50	24/11/2019 14:54	23/11/2019 14:38	23/11/2019 15:48	1,16	9	10,47	CHI
201911223232	NIQUELANDIA	NQ12342500LD	SAO JOAO D ALIANCA	19/11/2019 21:50	24/11/2019 14:54	23/11/2019 14:38	24/11/2019 05:09	14,52	13	188,72	CHI
201911223232	NIQUELANDIA	NQ12344324	SAO JOAO D ALIANCA	19/11/2019 21:50	24/11/2019 14:54	19/11/2019 21:50	24/11/2019 10:39	108,82	3	326,47	CHI
201911223232	NIQUELANDIA	NQ12371149	SAO JOAO D ALIANCA	19/11/2019 21:50	24/11/2019 14:54	19/11/2019 21:50	24/11/2019 12:25	110,58	33	3649,28	CHI
201911223232	NIQUELANDIA	NQ12371149	SAO JOAO D ALIANCA	19/11/2019 21:50	24/11/2019 14:54	19/11/2019 21:50	24/11/2019 14:54	113,07	2	226,15	CHI
201911223235	CAIAPONIA	DP12296462	JATAI S1	20/11/2019 05:34	20/11/2019 11:07	20/11/2019 05:34	20/11/2019 11:07	5,53	38	210,32	CHI
201911223235	MINEIROS	DP12296462	JATAI S1	20/11/2019 05:34	20/11/2019 11:07	20/11/2019 05:34	20/11/2019 11:07	5,53	2	11,07	CHI
201911223235	PEROLANDIA	DP12296462	JATAI S1	20/11/2019 05:34	20/11/2019 11:07	20/11/2019 05:34	20/11/2019 11:07	5,53	10	55,35	CHI
201911223236	MONTIVIDIU	MV21267629	MONTIVIDIU T	20/11/2019 06:46	20/11/2019 12:06	20/11/2019 06:46	20/11/2019 12:06	5,32	1	5,32	CHI
201911223237	SAO DOMINGOS	SD12170576	SAO DOMINGOS	19/11/2019 19:45	20/11/2019 09:27	19/11/2019 19:45	20/11/2019 09:27	13,69	36	492,80	CHI
201911223242	PALMEIRAS DE GOIAS	590007660	PALMEIRAS	20/11/2019 06:48	20/11/2019 17:02	20/11/2019 06:48	20/11/2019 17:02	10,24	1	10,24	CHI
201911223243	GOIAS	GS12234099	GOIAS	20/11/2019 06:48	20/11/2019 15:16	20/11/2019 06:48	20/11/2019 15:16	8,46	3	25,37	CHI
201911223247	ANAPOLIS	AN12403263	JUNDIAI S2	20/11/2019 06:49	20/11/2019 12:01	20/11/2019 06:49	20/11/2019 12:01	5,19	27	140,23	CHI
201911223250	SILVANIA	SV12389456	VIANOPOLIS	20/11/2019 06:23	20/11/2019 10:50	20/11/2019 06:23	20/11/2019 10:50	4,44	104	461,30	CHI
201911223253	ITAPIRAPUA	IU12018756	MATRINCHA	19/11/2019 22:03	20/11/2019 16:58	19/11/2019 22:03	20/11/2019 16:58	18,91	7	132,38	CHI
201911223253	SANTA FE DE GOIAS	IU12018756	MATRINCHA	19/11/2019 22:03	20/11/2019 16:58	19/11/2019 22:03	20/11/2019 16:58	18,91	12	226,94	CHI

201911223256	GOIANIA	GN11000357	GOIANIA LESTE S3	20/11/2019 06:51	20/11/2019 08:16	20/11/2019 06:51	20/11/2019 08:16	1,41	41	57,96	CHI
201911223261	EDEIA	IY12010954	EDEIA	20/11/2019 06:51	20/11/2019 11:42	20/11/2019 06:51	20/11/2019 11:42	4,84	5	24,19	CHI
201911223261	INDIARA	IY12010954	EDEIA	20/11/2019 06:51	20/11/2019 11:42	20/11/2019 06:51	20/11/2019 11:42	4,84	46	222,55	CHI
201911223268	SAO MIGUEL DO PASSA QUATRO	SV12012186	BELA VISTA S2	20/11/2019 06:53	20/11/2019 13:49	20/11/2019 06:53	20/11/2019 13:49	6,92	6	41,55	CHI
201911223271	LUZIANIA	LZ12330886	VIANOPOIS	20/11/2019 06:13	20/11/2019 17:37	20/11/2019 06:13	20/11/2019 17:37	11,40	9	102,61	CHI
201911223272	JANDAIA	PP12006686	PALMEIRAS	20/11/2019 06:53	20/11/2019 10:25	20/11/2019 06:53	20/11/2019 10:25	3,52	7	24,65	CHI
201911223272	PALMINOPOLIS	PP12006686	PALMEIRAS	20/11/2019 06:53	20/11/2019 10:25	20/11/2019 06:53	20/11/2019 10:25	3,52	2	7,04	CHI
201911223277	PALMEIRAS DE GOIAS	PL12000070	PALMEIRAS	20/11/2019 06:55	20/11/2019 14:57	20/11/2019 06:55	20/11/2019 14:57	8,04	19	152,79	CHI
201911223278	NIQUELANDIA	NQ12235367	NIQUELANDIA SUBTRANSMISSAO	20/11/2019 06:12	20/11/2019 10:55	20/11/2019 06:12	20/11/2019 10:55	4,71	11	51,81	CHI
201911223287	CORUMBAIBA	CI12107485	VILA CORUMBA	19/11/2019 21:48	20/11/2019 12:37	19/11/2019 21:48	20/11/2019 12:37	14,80	19	281,26	CHI
201911223291	ANICUNS	AC12391421	ANICUNS	19/11/2019 19:56	20/11/2019 10:40	19/11/2019 19:56	20/11/2019 10:40	14,73	3	44,20	CHI
201911223299	JARAGUA	JA12241597	JARAGUA	20/11/2019 06:15	20/11/2019 08:59	20/11/2019 06:15	20/11/2019 08:59	2,72	18	48,93	CHI
201911223300	NIQUELANDIA	NQ12208518	NIQUELANDIA SUBTRANSMISSAO	20/11/2019 05:03	20/11/2019 08:41	20/11/2019 05:03	20/11/2019 08:41	3,62	99	358,65	CHI
201911223303	IACIARA	ND12218839	IACIARA S2	20/11/2019 05:23	20/11/2019 10:30	20/11/2019 05:23	20/11/2019 10:30	5,11	24	122,54	CHI
201911223303	SAO DOMINGOS	ND12218839	IACIARA S2	20/11/2019 05:23	20/11/2019 10:30	20/11/2019 05:23	20/11/2019 10:30	5,11	3	15,32	CHI
201911223319	AMORINOPOLIS	AM12133498	IPORA	20/11/2019 06:51	20/11/2019 09:30	20/11/2019 06:51	20/11/2019 09:30	2,63	180	474,20	CHI
201911223321	BELA VISTA DE GOIAS	BV12118838	BELA VISTA S1	20/11/2019 07:03	20/11/2019 13:36	20/11/2019 07:03	20/11/2019 13:36	6,54	7	45,77	CHI
201911223323	MINACU	IH12236222	MINACU	20/11/2019 07:03	20/11/2019 19:30	20/11/2019 07:03	20/11/2019 19:30	12,43	19	236,24	CHI
201911223324	PEROLANDIA	MY12348932	PARQUE DAS EMAS	20/11/2019 07:04	20/11/2019 10:40	20/11/2019 07:04	20/11/2019 10:40	3,60	3	10,79	CHI
201911223325	PORANGATU	PO12022073	PORANGATU	19/11/2019 22:27	21/11/2019 09:32	19/11/2019 22:27	20/11/2019 21:01	22,58	6	135,46	CHI
201911223325	PORANGATU	PO12022073	PORANGATU	19/11/2019 22:27	21/11/2019 09:32	20/11/2019 14:26	20/11/2019 21:01	6,59	2	13,18	CHI
201911223325	PORANGATU	PO12022073	PORANGATU	19/11/2019 22:27	21/11/2019 09:32	20/11/2019 21:07	21/11/2019 05:38	8,52	11	93,73	CHI
201911223325	PORANGATU	PO13071687	PORANGATU	19/11/2019 22:27	21/11/2019 09:32	19/11/2019 22:27	21/11/2019 09:32	35,08	18	631,39	CHI
201911223328	CRIXAS	CX21057019	SERRA DO OURO	20/11/2019 07:04	20/11/2019 12:49	20/11/2019 07:04	20/11/2019 12:49	5,74	1	5,74	CHI
201911223330	CORUMBAIBA	IP12242504	IPAMERI	20/11/2019 07:04	20/11/2019 10:47	20/11/2019 07:04	20/11/2019 10:47	3,70	1	3,70	CHI
201911223330	IPAMERI	IP12242504	IPAMERI	20/11/2019 07:04	20/11/2019 10:47	20/11/2019 07:04	20/11/2019 10:47	3,70	8	29,62	CHI
201911223333	ITAGUARU	IC12353099	ITABERAI S1	20/11/2019 05:31	21/11/2019 12:20	20/11/2019 05:31	20/11/2019 11:55	6,40	68	434,94	CHI
201911223333	URUANA	IC12353099	ITABERAI S1	20/11/2019 05:31	21/11/2019 12:20	20/11/2019 05:31	20/11/2019 11:55	6,40	10	63,96	CHI
201911223333	ITAGUARU	IC12353099	ITABERAI S1	20/11/2019 05:31	21/11/2019 12:20	20/11/2019 11:56	20/11/2019 13:46	1,85	68	125,69	CHI
201911223333	URUANA	IC12353099	ITABERAI S1	20/11/2019 05:31	21/11/2019 12:20	20/11/2019 11:56	20/11/2019 13:46	1,85	10	18,48	CHI
201911223333	ITAGUARU	IC12353099	ITABERAI S1	20/11/2019 05:31	21/11/2019 12:20	20/11/2019 13:40	20/11/2019 17:10	3,50	3	10,51	CHI
201911223333	ITAGUARU	IC12353099	ITABERAI S1	20/11/2019 05:31	21/11/2019 12:20	20/11/2019 13:48	20/11/2019 17:10	3,37	67	225,85	CHI
201911223333	URUANA	IC12353099	ITABERAI S1	20/11/2019 05:31	21/11/2019 12:20	20/11/2019 13:48	20/11/2019 17:10	3,37	9	30,34	CHI

201911223333	ITAGUARU	IC21185818	ITABERAI S1	20/11/2019 05:31	21/11/2019 12:20	20/11/2019 13:48	21/11/2019 12:20	22,53	1	22,53	CHI
201911223336	URUACU	UR12256445	URUACU	20/11/2019 07:05	20/11/2019 10:47	20/11/2019 07:05	20/11/2019 10:47	3,69	11	40,64	CHI
201911223337	GOIANIA	8485154	GOYA S1	20/11/2019 07:05	20/11/2019 12:09	20/11/2019 07:05	20/11/2019 12:09	5,06	1	5,06	CHI
201911223338	PLANALTINA	PI11355714	PLANALTINA	20/11/2019 07:05	20/11/2019 12:41	20/11/2019 07:05	20/11/2019 12:41	5,59	1	5,59	CHI
201911223341	FORMOSA	FA11000009	ITUIQUIRA	20/11/2019 05:53	20/11/2019 08:11	20/11/2019 05:53	20/11/2019 08:11	2,28	156	356,37	CHI
201911223343	ADELANDIA	2330001806	FIRMINOPOLIS S2	20/11/2019 07:05	20/11/2019 11:17	20/11/2019 07:05	20/11/2019 11:17	4,19	1	4,19	CHI
201911223344	GOIANIA	13587006	GOIANIA LESTE S3	20/11/2019 07:06	20/11/2019 08:17	20/11/2019 07:06	20/11/2019 08:17	1,18	1	1,18	CHI
201911223348	PIRACANJUBA	PJ21249793	CALDAS NOVAS S1	20/11/2019 07:06	20/11/2019 13:18	20/11/2019 07:06	20/11/2019 13:18	6,19	1	6,19	CHI
201911223350	CUMARI	CY12078706	CATALAO S1	20/11/2019 02:02	20/11/2019 10:00	20/11/2019 02:02	20/11/2019 10:00	7,97	9	71,76	CHI
201911223352	LUZIANIA	LZ12080547	CRISTALINA S2	20/11/2019 06:25	20/11/2019 13:33	20/11/2019 06:25	20/11/2019 13:33	7,13	6	42,76	CHI
201911223356	CALDAS NOVAS	CN12110086	SERRA DE CALDAS	20/11/2019 04:06	20/11/2019 09:42	20/11/2019 04:06	20/11/2019 09:42	5,59	83	463,90	CHI
201911223357	PILAR DE GOIAS	GG12341540	SANTA TEREZINHA	20/11/2019 07:07	20/11/2019 11:48	20/11/2019 07:07	20/11/2019 11:48	4,67	3	14,01	CHI
201911223360	ALTO HORIZONTE	AJ12232302	SANTA TEREZINHA	19/11/2019 21:15	20/11/2019 11:11	19/11/2019 21:15	20/11/2019 11:11	13,93	9	125,37	CHI
201911223360	CAMPOS VERDES	AJ12232302	SANTA TEREZINHA	19/11/2019 21:15	20/11/2019 11:11	19/11/2019 21:15	20/11/2019 11:11	13,93	5	69,65	CHI
201911223363	CATALAO	10000872677	CATALAO S2	20/11/2019 07:08	20/11/2019 08:51	20/11/2019 07:08	20/11/2019 08:51	1,71	1	1,71	CHI
201911223368	VIANOPOLIS	VN12052202	VIANOPOLIS	20/11/2019 06:08	20/11/2019 10:19	20/11/2019 06:08	20/11/2019 10:19	4,17	22	91,77	CHI
201911223370	OURO VERDE DE GOIAS	OV21000012	NEROPOLIS S1	20/11/2019 07:09	20/11/2019 15:09	20/11/2019 07:09	20/11/2019 15:09	7,99	1	7,99	CHI
201911223373	JATAI	10018202240	JATAI S2	20/11/2019 07:10	20/11/2019 13:02	20/11/2019 07:10	20/11/2019 13:02	5,86	1	5,86	CHI
201911223381	NIQUELANDIA	NQ12213022	NIQUELANDIA SUBTRANSMISSAO	20/11/2019 07:11	20/11/2019 09:35	20/11/2019 07:11	20/11/2019 09:35	2,39	8	19,12	CHI
201911223386	APARECIDA DE GOIANIA	13464115	ATLANTICO S3	20/11/2019 07:12	20/11/2019 10:57	20/11/2019 07:12	20/11/2019 10:57	3,74	1	3,74	CHI
201911223398	LUZIANIA	LZ12320196	RIO VERMELHO	20/11/2019 07:14	20/11/2019 10:30	20/11/2019 07:14	20/11/2019 10:30	3,25	11	35,77	CHI
201911223399	SANTA CRUZ DE GOIAS	BC12068916	PIRES DO RIO S2	20/11/2019 07:15	20/11/2019 14:43	20/11/2019 07:15	20/11/2019 14:43	7,46	9	67,15	CHI
201911223400	ITUMBIARA	IT21000020	ITUMBIARA VELHA S1	20/11/2019 07:15	20/11/2019 09:43	20/11/2019 07:15	20/11/2019 09:43	2,46	1	2,46	CHI
201911223401	MUNDO NOVO DE GOIAS	MH21037828	NOVA CRIXAS	20/11/2019 07:15	20/11/2019 09:10	20/11/2019 07:15	20/11/2019 09:10	1,91	1	1,91	CHI
201911223407	FIRMINOPOLIS	900011660	FIRMINOPOLIS S1	20/11/2019 07:15	20/11/2019 08:50	20/11/2019 07:15	20/11/2019 08:50	1,60	1	1,60	CHI
201911223413	GOIANIA	14058583	FERROVIARIO S2	20/11/2019 07:17	20/11/2019 08:44	20/11/2019 07:17	20/11/2019 08:44	1,45	1	1,45	CHI
201911223422	PORANGATU	PO12192315	PORANGATU	20/11/2019 06:14	20/11/2019 16:12	20/11/2019 06:14	20/11/2019 16:12	9,95	19	189,10	CHI
201911223425	PANAMA	PX21171908	GOIATUBA S1	20/11/2019 07:19	20/11/2019 17:53	20/11/2019 07:19	20/11/2019 17:53	10,56	1	10,56	CHI
201911223431	CORUMBAIBA	CI12060020	CATALAO S1	20/11/2019 05:43	20/11/2019 14:44	20/11/2019 05:43	20/11/2019 14:44	9,02	117	1054,95	CHI
201911223431	MORRINHOS	CI12060020	CATALAO S1	20/11/2019 05:43	20/11/2019 14:44	20/11/2019 05:43	20/11/2019 14:44	9,02	1	9,02	CHI
201911223431	NOVA AURORA	CI12060020	CATALAO S1	20/11/2019 05:43	20/11/2019 14:44	20/11/2019 05:43	20/11/2019 14:44	9,02	9	81,15	CHI
201911223440	FAZENDA NOVA	FN21144579	BRITANIA	20/11/2019 07:23	20/11/2019 09:00	20/11/2019 07:23	20/11/2019 09:00	1,61	2	3,23	CHI
201911223502	CRIXAS	CX12151609	SANTA TEREZINHA	20/11/2019 06:54	20/11/2019 09:07	20/11/2019 06:54	20/11/2019 09:07	2,21	36	79,69	CHI

201911223503	MONTIVIDIU DO NORTE	TB12156640	PORANGATU	20/11/2019 06:49	21/11/2019 13:11	20/11/2019 09:47	20/11/2019 10:57	1,17	1	1,17	CHI
201911223503	TROMBAS	TB12156640	PORANGATU	20/11/2019 06:49	21/11/2019 13:11	20/11/2019 09:47	20/11/2019 10:57	1,17	81	94,91	CHI
201911223503	TROMBAS	TB12345570	PORANGATU	20/11/2019 06:49	21/11/2019 13:11	20/11/2019 06:49	21/11/2019 11:21	28,54	12	342,42	CHI
201911223503	TROMBAS	TB13285997	PORANGATU	20/11/2019 06:49	21/11/2019 13:11	20/11/2019 06:49	21/11/2019 13:11	30,37	4	121,47	CHI
201911223504	URUACU	UR21242671	URUACU	20/11/2019 07:25	20/11/2019 15:32	20/11/2019 07:25	20/11/2019 15:32	8,11	1	8,11	CHI
201911223507	MINEIROS	PW12045348	PARQUE DAS EMAS	20/11/2019 07:07	20/11/2019 09:11	20/11/2019 07:07	20/11/2019 09:11	2,06	1	2,06	CHI
201911223507	PORTELANDIA	PW12045348	PARQUE DAS EMAS	20/11/2019 07:07	20/11/2019 09:11	20/11/2019 07:07	20/11/2019 09:11	2,06	5	10,30	CHI
201911223512	ABADIANIA	AA21086533	ANAPOLIS UNIVERSITARIO S1	20/11/2019 07:26	20/11/2019 13:58	20/11/2019 07:26	20/11/2019 13:58	6,52	1	6,52	CHI
201911223516	SANCLERLANDIA	SC12019473	SAO LUIZ DOS MONTES BELOS	20/11/2019 05:58	20/11/2019 16:53	20/11/2019 05:58	20/11/2019 16:53	10,90	5	54,50	CHI
201911223519	JAUPACI	JP21188266	IPORA	20/11/2019 07:27	20/11/2019 10:00	20/11/2019 07:27	20/11/2019 10:00	2,55	1	2,55	CHI
201911223522	JATAI	JT12184006	JATAI S3	20/11/2019 07:27	20/11/2019 11:19	20/11/2019 07:27	20/11/2019 11:19	3,86	2	7,71	CHI
201911223525	APARECIDA DE GOIANIA	AP21015167	CEPAIGO S1	20/11/2019 07:28	20/11/2019 17:24	20/11/2019 07:28	20/11/2019 17:24	9,93	1	9,93	CHI
201911223526	PLANALTINA	PI12379178	PLANALTINA	20/11/2019 07:28	20/11/2019 10:07	20/11/2019 07:28	20/11/2019 10:07	2,64	1	2,64	CHI
201911223527	POSSE	SA12211553	IACIARA S2	20/11/2019 07:28	20/11/2019 23:54	20/11/2019 07:28	20/11/2019 15:13	7,74	10	77,42	CHI
201911223527	SIMOLANDIA	SA12211553	IACIARA S2	20/11/2019 07:28	20/11/2019 23:54	20/11/2019 07:28	20/11/2019 15:13	7,74	17	131,62	CHI
201911223527	POSSE	SA12195812LD	IACIARA S2	20/11/2019 07:28	20/11/2019 23:54	20/11/2019 07:28	20/11/2019 23:54	16,42	17	279,22	CHI
201911223527	SIMOLANDIA	SA12195812LD	IACIARA S2	20/11/2019 07:28	20/11/2019 23:54	20/11/2019 07:28	20/11/2019 23:54	16,42	21	344,92	CHI
201911223531	CAIAPONIA	CP12119577	CAIAPONIA	20/11/2019 01:08	20/11/2019 12:10	20/11/2019 01:08	20/11/2019 12:10	11,04	66	728,35	CHI
201911223531	DOVERLANDIA	CP12119577	CAIAPONIA	20/11/2019 01:08	20/11/2019 12:10	20/11/2019 01:08	20/11/2019 12:10	11,04	7	77,25	CHI
201911223603	ABADIANIA	AA21319738	ANAPOLIS UNIVERSITARIO S1	20/11/2019 07:29	21/11/2019 10:35	20/11/2019 07:29	21/11/2019 10:35	27,10	1	27,10	CHI
201911223604	SILVANIA	SV21056826	VIANOPOLIS	20/11/2019 07:29	20/11/2019 09:40	20/11/2019 07:29	20/11/2019 09:40	2,19	1	2,19	CHI
201911223607	PIRACANJUBA	PJ21021077	CRISTIANOPOLIS	20/11/2019 07:28	20/11/2019 13:19	20/11/2019 07:28	20/11/2019 13:19	5,84	1	5,84	CHI
201911223608	RIO VERDE	RV12365438	MONTIVIDIU T	20/11/2019 07:29	20/11/2019 16:03	20/11/2019 07:29	20/11/2019 16:03	8,57	2	17,14	CHI
201911223611	ANAPOLIS	AN12196811	NEROPOLIS S1	20/11/2019 06:20	21/11/2019 03:41	20/11/2019 06:20	21/11/2019 03:41	21,35	8	170,79	CHI
201911223614	CAMPINORTE	CR12282384	MARA ROSA	20/11/2019 07:30	20/11/2019 11:54	20/11/2019 07:30	20/11/2019 11:54	4,40	1	4,40	CHI
201911223614	URUACU	CR12282384	MARA ROSA	20/11/2019 07:30	20/11/2019 11:54	20/11/2019 07:30	20/11/2019 11:54	4,40	4	17,60	CHI
201911223619	JATAI	JT12196245	JATAI S1	20/11/2019 07:30	20/11/2019 13:42	20/11/2019 07:30	20/11/2019 13:42	6,19	4	24,75	CHI
201911223620	IPAMERI	IP12315241	IPAMERI	20/11/2019 07:30	20/11/2019 20:40	20/11/2019 07:30	20/11/2019 20:40	13,15	2	26,30	CHI
201911223621	TURVELANDIA	TD12301554	RIO DOS BOIS	20/11/2019 07:30	20/11/2019 11:12	20/11/2019 07:30	20/11/2019 11:12	3,70	3	11,10	CHI
201911223622	GOUVELANDIA	QI21035316	QUIRINOPOLIS	20/11/2019 07:31	20/11/2019 14:24	20/11/2019 07:31	20/11/2019 14:24	6,88	1	6,88	CHI
201911223625	ARAGARCAS	BM12316457	BOM JARDIM	20/11/2019 07:31	20/11/2019 10:33	20/11/2019 07:31	20/11/2019 10:33	3,03	2	6,05	CHI
201911223625	BOM JARDIM DE GOIAS	BM12316457	BOM JARDIM	20/11/2019 07:31	20/11/2019 10:33	20/11/2019 07:31	20/11/2019 10:33	3,03	4	12,11	CHI
201911223632	FAINA	FC12226831	GOIAS	20/11/2019 07:32	20/11/2019 15:03	20/11/2019 07:32	20/11/2019 15:03	7,51	2	15,02	CHI

201911223633	GOIAS	GS12378882	MATRINCHA	20/11/2019 07:17	20/11/2019 16:03	20/11/2019 07:17	20/11/2019 16:03	8,77	7	61,37	CHI
201911223634	CRISTALINA	KR12039306	CRISTALINA S1	20/11/2019 07:32	20/11/2019 16:26	20/11/2019 07:32	20/11/2019 16:26	8,89	2	17,77	CHI
201911223802	EDEALINA	ED11108008	PONTALINA	20/11/2019 06:51	20/11/2019 15:00	20/11/2019 06:51	20/11/2019 15:00	8,15	115	936,83	CHI
201911223803	ITAJA	IJ12226576	ITAJA S2	20/11/2019 07:33	20/11/2019 10:39	20/11/2019 07:33	20/11/2019 10:39	3,10	6	18,58	CHI
201911223808	FAZENDA NOVA	FN12078803	IPORA	20/11/2019 07:33	21/11/2019 10:13	20/11/2019 07:33	21/11/2019 10:13	26,65	16	426,47	CHI
201911223814	CORUMBAIBA	CI12076939	VILA CORUMBA	20/11/2019 07:34	20/11/2019 15:30	20/11/2019 07:34	20/11/2019 15:30	7,93	7	55,49	CHI
201911223818	ORIZONA	OZ12404726	PIRES DO RIO S1	20/11/2019 07:34	20/11/2019 10:25	20/11/2019 07:34	20/11/2019 10:25	2,85	8	22,83	CHI
201911223901	MIMOSO DE GOIAS	MJ12333277	PADRE BERNARDO	20/11/2019 07:34	20/11/2019 16:23	20/11/2019 07:34	20/11/2019 16:23	8,80	15	132,01	CHI
201911223901	PADRE BERNARDO	MJ12333277	PADRE BERNARDO	20/11/2019 07:34	20/11/2019 16:23	20/11/2019 07:34	20/11/2019 16:23	8,80	1	8,80	CHI
201911224201	SANCLERLANDIA	SC12308641	FIRMINOPOLIS S2	20/11/2019 07:35	20/11/2019 11:24	20/11/2019 07:35	20/11/2019 11:24	3,81	2	7,61	CHI
201911224202	ORIZONA	PR12333485	PIRES DO RIO S2	20/11/2019 07:23	20/11/2019 09:00	20/11/2019 07:23	20/11/2019 09:00	1,61	5	8,06	CHI
201911224202	PIRES DO RIO	PR12333485	PIRES DO RIO S2	20/11/2019 07:23	20/11/2019 09:00	20/11/2019 07:23	20/11/2019 09:00	1,61	5	8,06	CHI
201911224204	MAURILANDIA	10003695237	RIO DOS BOIS	20/11/2019 07:36	20/11/2019 19:43	20/11/2019 07:36	20/11/2019 19:43	12,13	1	12,13	CHI
201911224208	ESTRELA DO NORTE	MU12391986	MARA ROSA	20/11/2019 05:22	20/11/2019 08:29	20/11/2019 05:22	20/11/2019 08:29	3,11	1	3,11	CHI
201911224208	MUTUNOPOLIS	MU12391986	MARA ROSA	20/11/2019 05:22	20/11/2019 08:29	20/11/2019 05:22	20/11/2019 08:29	3,11	101	313,77	CHI
201911224209	GOIANDIRA	GD12127627	CATALAO S1	20/11/2019 07:36	20/11/2019 20:26	20/11/2019 07:36	20/11/2019 20:26	12,82	1	12,82	CHI
201911224212	NOVA AURORA	NE21311815	CATALAO S1	20/11/2019 07:37	20/11/2019 15:29	20/11/2019 07:37	20/11/2019 15:29	7,87	1	7,87	CHI
201911224213	GOIANIA	10572340	GOIANIA LESTE S2	20/11/2019 07:37	20/11/2019 09:31	20/11/2019 07:37	20/11/2019 09:31	1,90	1	1,90	CHI
201911224215	SAO JOAO D ALIANCA	JL21344260	SAO JOAO D ALIANCA	20/11/2019 07:37	20/11/2019 10:04	20/11/2019 07:37	20/11/2019 10:04	2,44	1	2,44	CHI
201911224219	LUZIANIA	LZ21244584	VIANOPOLIS	20/11/2019 07:37	20/11/2019 17:37	20/11/2019 07:37	20/11/2019 17:37	10,00	1	10,00	CHI
201911224226	PIRES DO RIO	OZ12372381	PIRES DO RIO S2	19/11/2019 21:25	21/11/2019 16:14	19/11/2019 21:25	21/11/2019 14:23	40,97	7	286,80	CHI
201911224226	PIRES DO RIO	OZ12372381	PIRES DO RIO S2	19/11/2019 21:25	21/11/2019 16:14	19/11/2019 21:25	21/11/2019 16:14	42,82	3	128,47	CHI
201911224226	VIANOPOLIS	OZ12372381	PIRES DO RIO S2	19/11/2019 21:25	21/11/2019 16:14	19/11/2019 21:25	21/11/2019 16:14	42,82	19	813,65	CHI
201911224229	TROMBAS	TB21185280	PORANGATU	20/11/2019 07:39	20/11/2019 13:28	20/11/2019 07:39	20/11/2019 13:28	5,81	1	5,81	CHI
201911224231	LUZIANIA	LZ12203332	VIANOPOLIS	20/11/2019 07:39	20/11/2019 17:37	20/11/2019 07:39	20/11/2019 17:37	9,96	5	49,82	CHI
201911224233	LUZIANIA	LZ12349077	PAMPLONA	20/11/2019 07:39	20/11/2019 15:16	20/11/2019 07:39	20/11/2019 15:16	7,60	10	76,01	CHI
201911224234	FORMOSA	FA12262405	ITUIQUIRA	20/11/2019 07:08	20/11/2019 15:21	20/11/2019 07:08	20/11/2019 15:21	8,21	91	747,39	CHI
201911224236	ISRAELANDIA	IS21184701	IPORA	20/11/2019 07:40	20/11/2019 18:10	20/11/2019 07:40	20/11/2019 18:10	10,51	1	10,51	CHI
201911224244	CACHOEIRA ALTA	CA21119087	CACHOEIRA ALTA	20/11/2019 07:41	20/11/2019 12:01	20/11/2019 07:41	20/11/2019 12:01	4,33	1	4,33	CHI
201911224249	EDEIA	EA12394167	EDEIA	19/11/2019 21:43	20/11/2019 11:01	19/11/2019 21:43	20/11/2019 11:01	13,28	6	79,70	CHI
201911224250	SITIO D ABADIA	SI12384215	IACIARA S2	20/11/2019 07:29	20/11/2019 13:16	20/11/2019 07:29	20/11/2019 13:16	5,77	13	74,98	CHI
201911224253	GOIAS	GS12378886	MATRINCHA	20/11/2019 07:30	20/11/2019 17:11	20/11/2019 07:30	20/11/2019 17:11	9,69	4	38,75	CHI
201911224254	MUNDO NOVO DE GOIAS	MH12394971	NOVA CRIXAS	20/11/2019 07:42	20/11/2019 21:53	20/11/2019 07:42	20/11/2019 21:53	14,18	5	70,88	CHI

201911224256	PLANALTINA	PI21103515	PLANALTINA	20/11/2019 07:42	20/11/2019 20:21	20/11/2019 07:42	20/11/2019 20:21	12,64	1	12,64	CHI
201911224257	PADRE BERNARDO	PB12013157	PADRE BERNARDO	20/11/2019 07:09	20/11/2019 12:34	20/11/2019 07:09	20/11/2019 12:34	5,42	21	113,72	CHI
201911224259	JATAI	290110270	JATAI S2	20/11/2019 07:43	20/11/2019 09:21	20/11/2019 07:43	20/11/2019 09:21	1,63	1	1,63	CHI
201911224261	APARECIDA DE GOIANIA	AP21240958	CEPAIGO S1	20/11/2019 07:43	20/11/2019 16:24	20/11/2019 07:43	20/11/2019 16:24	8,68	1	8,68	CHI
201911224266	BOM JESUS DE GOIAS	10021736080	BOM JESUS DE GOIAS	20/11/2019 07:43	20/11/2019 09:01	20/11/2019 07:43	20/11/2019 09:01	1,29	1	1,29	CHI
201911224302	BURITINOPOLIS	BQ11190592	IACIARA S2	20/11/2019 07:43	20/11/2019 10:24	20/11/2019 07:43	20/11/2019 10:24	2,67	8	21,37	CHI
201911224317	MARA ROSA	MQ12263046	MARA ROSA	20/11/2019 07:45	20/11/2019 13:37	20/11/2019 07:45	20/11/2019 13:37	5,86	7	41,02	CHI
201911224323	NIQUELANDIA	NQ12265763	NIQUELANDIA SUBTRANSMISSAO	20/11/2019 07:46	20/11/2019 11:40	20/11/2019 07:46	20/11/2019 11:40	3,90	7	27,28	CHI
201911224324	MINACU	9950000627	MINACU	20/11/2019 07:46	21/11/2019 04:25	20/11/2019 07:46	21/11/2019 04:25	20,66	1	20,66	CHI
201911224330	NIQUELANDIA	NQ12235658	URUACU	20/11/2019 07:46	20/11/2019 16:19	20/11/2019 07:46	20/11/2019 16:19	8,53	13	110,95	CHI
201911224334	RIO VERDE	RV12153966	MONTIVIDIU T	20/11/2019 07:47	20/11/2019 22:35	20/11/2019 07:47	20/11/2019 22:35	14,79	2	29,59	CHI
201911224343	ITAPACI	IW12405204	ITAPACI	20/11/2019 05:43	20/11/2019 09:18	20/11/2019 05:43	20/11/2019 09:18	3,58	17	60,90	CHI
201911224345	SITIO D ABADIA	SI21295251	IACIARA S2	20/11/2019 07:49	20/11/2019 11:36	20/11/2019 07:49	20/11/2019 11:36	3,77	1	3,77	CHI
201911224350	INHUMAS	IX12016404	INHUMAS S1	20/11/2019 06:39	20/11/2019 11:26	20/11/2019 06:39	20/11/2019 11:26	4,78	1	4,78	CHI
201911224350	ITAUCU	IX12016404	INHUMAS S1	20/11/2019 06:39	20/11/2019 11:26	20/11/2019 06:39	20/11/2019 11:26	4,78	4	19,12	CHI
201911224358	MINACU	IH21182308	MINACU	20/11/2019 07:51	21/11/2019 10:49	20/11/2019 07:51	21/11/2019 10:49	26,96	4	107,83	CHI
201911224359	GOIANDIRA	GD12078359	CATALAO S1	20/11/2019 06:38	20/11/2019 10:55	20/11/2019 06:38	20/11/2019 10:55	4,29	26	111,58	CHI
201911224361	ITAPIRAPUA	IU21365113	BRITANIA	20/11/2019 07:51	22/11/2019 02:36	20/11/2019 07:51	22/11/2019 02:36	42,73	1	42,73	CHI
201911224364	BELA VISTA DE GOIAS	BV21012789	BELA VISTA S2	20/11/2019 07:52	20/11/2019 18:23	20/11/2019 07:52	20/11/2019 18:23	10,51	3	31,53	CHI
201911224367	MINEIROS	MY12193782	PARQUE DAS EMAS	20/11/2019 07:52	20/11/2019 11:49	20/11/2019 07:52	20/11/2019 11:49	3,94	4	15,76	CHI
201911224371	CROMINIA	520016543	PONTALINA	20/11/2019 07:53	21/11/2019 17:14	20/11/2019 07:53	21/11/2019 17:14	33,35	1	33,35	CHI
201911224373	MORRINHOS	MR11349774	MORRINHOS	20/11/2019 07:53	20/11/2019 09:38	20/11/2019 07:53	20/11/2019 09:38	1,76	126	221,13	CHI
201911224374	INHUMAS	IN32066319	INHUMAS S2	20/11/2019 06:53	20/11/2019 09:45	20/11/2019 06:53	20/11/2019 09:45	2,85	24	68,45	CHI
201911224375	GOIANIA	GN12067653	CAMPINAS S1	20/11/2019 07:24	20/11/2019 08:44	20/11/2019 07:24	20/11/2019 08:44	1,33	81	107,44	CHI
201911224376	GOIANIA	14758933	CAMPINAS S1	20/11/2019 07:54	20/11/2019 10:28	20/11/2019 07:54	20/11/2019 10:28	2,57	1	2,57	CHI
201911224377	ITUMBIARA	690289261	ITUMBIARA NOVA	20/11/2019 07:54	20/11/2019 10:38	20/11/2019 07:54	20/11/2019 10:38	2,73	1	2,73	CHI
201911224378	HIDROLANDIA	HD12120557	CEPAIGO S2	20/11/2019 07:54	20/11/2019 12:22	20/11/2019 07:54	20/11/2019 12:22	4,46	18	80,23	CHI
201911224379	AGUA FRIA DE GOIAS	JL12117446	SAO JOAO D ALIANCA	20/11/2019 07:54	20/11/2019 11:36	20/11/2019 07:54	20/11/2019 11:36	3,69	19	70,05	CHI
201911224379	SAO JOAO D ALIANCA	JL12117446	SAO JOAO D ALIANCA	20/11/2019 07:54	20/11/2019 11:36	20/11/2019 07:54	20/11/2019 11:36	3,69	23	84,80	CHI
201911224382	BRAZABRANTES	BR12166574	NEROPOLIS S1	20/11/2019 07:23	20/11/2019 11:32	20/11/2019 07:23	20/11/2019 11:32	4,15	2	8,30	CHI
201911224382	GOIANIRA	BR12166574	NEROPOLIS S1	20/11/2019 07:23	20/11/2019 11:32	20/11/2019 07:23	20/11/2019 11:32	4,15	22	91,25	CHI
201911224382	SANTO ANTONIO DE GOIAS	BR12166574	NEROPOLIS S1	20/11/2019 07:23	20/11/2019 11:32	20/11/2019 07:23	20/11/2019 11:32	4,15	5	20,74	CHI
201911224385	ORIZONA	PR12272876	PIRES DO RIO S1	20/11/2019 07:55	20/11/2019 11:49	20/11/2019 07:55	20/11/2019 11:49	3,91	5	19,55	CHI

201911224385	PIRES DO RIO	PR12272876	PIRES DO RIO S1	20/11/2019 07:55	20/11/2019 11:49	20/11/2019 07:55	20/11/2019 11:49	3,91	7	27,38	CHI
201911224386	MINEIROS	MY11105590	PARQUE DAS EMAS	20/11/2019 07:55	20/11/2019 14:00	20/11/2019 07:55	20/11/2019 14:00	6,08	141	857,87	CHI
201911224388	VILA PROPICIO	NP12382400	GOIANESIA S1	19/11/2019 20:05	20/11/2019 13:48	19/11/2019 20:05	20/11/2019 13:48	17,72	6	106,29	CHI
201911224391	CRISTALINA	KR12228851	CRISTALINA S2	20/11/2019 07:50	20/11/2019 22:47	20/11/2019 07:50	20/11/2019 22:47	14,94	3	44,81	CHI
201911224392	GOIANIA	GN11000518	CAMPINAS S3	20/11/2019 07:55	20/11/2019 09:59	20/11/2019 07:55	20/11/2019 09:59	2,06	91	187,08	CHI
201911224393	CRISTALINA	KR11032618	PAMPLONA	20/11/2019 06:29	20/11/2019 11:10	20/11/2019 06:29	20/11/2019 11:10	4,67	65	303,71	CHI
201911224394	BURITI ALEGRE	BG12066333	ITUMBIARA VELHA S2	20/11/2019 06:16	21/11/2019 10:42	20/11/2019 06:16	21/11/2019 10:42	28,42	1	28,42	CHI
201911224394	ITUMBIARA	BG12066333	ITUMBIARA VELHA S2	20/11/2019 06:16	21/11/2019 10:42	20/11/2019 06:16	21/11/2019 10:42	28,42	6	170,52	CHI
201911224396	CRISTIANOPOLIS	CF12027894	CRISTIANOPOLIS	20/11/2019 06:42	20/11/2019 08:37	20/11/2019 06:42	20/11/2019 08:37	1,90	8	15,22	CHI
201911224397	APARECIDA DE GOIANIA	AP11000060	ANHANGUERA	20/11/2019 05:31	20/11/2019 09:40	20/11/2019 05:31	20/11/2019 09:40	4,15	136	564,29	CHI
201911224399	CALDAS NOVAS	CN21011482	CALDAS NOVAS S1	20/11/2019 07:56	20/11/2019 10:36	20/11/2019 07:56	20/11/2019 10:36	2,66	1	2,66	CHI
201911224401	APARECIDA DO RIO DOCE	JT12211312	JATAI S1	20/11/2019 06:59	20/11/2019 10:55	20/11/2019 06:59	20/11/2019 10:55	3,92	2	7,84	CHI
201911224401	JATAI	JT12211312	JATAI S1	20/11/2019 06:59	20/11/2019 10:55	20/11/2019 06:59	20/11/2019 10:55	3,92	1	3,92	CHI
201911224501	PLANALTINA	2960106563	PLANALTINA	20/11/2019 07:56	20/11/2019 17:20	20/11/2019 07:56	20/11/2019 17:20	9,40	1	9,40	CHI
201911224602	GOIANIA	15068160	CAMPINAS S2	20/11/2019 07:57	20/11/2019 10:18	20/11/2019 07:57	20/11/2019 10:18	2,35	1	2,35	CHI
201911224603	ANICUNS	AC12266584	ANICUNS	20/11/2019 07:57	20/11/2019 11:46	20/11/2019 07:57	20/11/2019 11:46	3,81	1	3,81	CHI
201911224603	TURVANIA	AC12266584	ANICUNS	20/11/2019 07:57	20/11/2019 11:46	20/11/2019 07:57	20/11/2019 11:46	3,81	5	19,05	CHI
201911224604	URUACU	UR12341275	URUACU	20/11/2019 07:57	20/11/2019 12:45	20/11/2019 07:57	20/11/2019 12:45	4,79	1	4,79	CHI
201911224605	CEZARINA	CZ10406616	CEZARINA	20/11/2019 06:47	20/11/2019 23:02	20/11/2019 06:47	20/11/2019 12:51	6,06	359	2175,14	CHI
201911224605	INDIARA	CZ10406616	CEZARINA	20/11/2019 06:47	20/11/2019 23:02	20/11/2019 06:47	20/11/2019 12:51	6,06	53	321,12	CHI
201911224605	CEZARINA	CZ21027992	CEZARINA	20/11/2019 06:47	20/11/2019 23:02	20/11/2019 20:58	20/11/2019 23:02	2,07	2	4,15	CHI
201911224703	PORANGATU	TB12208457	PORANGATU	20/11/2019 05:38	20/11/2019 10:29	20/11/2019 05:38	20/11/2019 10:29	4,85	1	4,85	CHI
201911224703	TROMBAS	TB12208457	PORANGATU	20/11/2019 05:38	20/11/2019 10:29	20/11/2019 05:38	20/11/2019 10:29	4,85	16	77,53	CHI
201911224806	TRES RANCHOS	2170002668	CATALAO S1	20/11/2019 07:58	20/11/2019 12:23	20/11/2019 07:58	20/11/2019 12:23	4,40	1	4,40	CHI
201911225002	ITUMBIARA	IT12263732	CACHEOIRA DOURADA	20/11/2019 08:01	20/11/2019 11:35	20/11/2019 08:01	20/11/2019 11:35	3,56	3	10,69	CHI
201911225010	ORIZONA	OZ12404781	PIRES DO RIO S1	20/11/2019 05:28	20/11/2019 09:20	20/11/2019 05:28	20/11/2019 09:20	3,88	15	58,20	CHI
201911225012	APARECIDA DE GOIANIA	13306390	REAL S1	20/11/2019 08:02	20/11/2019 14:16	20/11/2019 08:02	20/11/2019 14:16	6,22	1	6,22	CHI
201911225102	SILVANIA	SV21105539	VIANOPOLIS	20/11/2019 08:03	20/11/2019 11:00	20/11/2019 08:03	20/11/2019 11:00	2,95	14	41,28	CHI
201911225104	GOIANIA	13404090	ATLANTICO S1	20/11/2019 08:03	20/11/2019 09:39	20/11/2019 08:03	20/11/2019 09:39	1,59	1	1,59	CHI
201911225107	TRES RANCHOS	TH11054835	CATALAO S1	20/11/2019 07:41	20/11/2019 10:02	20/11/2019 07:41	20/11/2019 10:02	2,35	72	169,18	CHI
201911225207	ALEXANIA	AX12155965	CORUMBA	19/11/2019 21:57	20/11/2019 22:32	19/11/2019 21:57	20/11/2019 14:31	16,57	1	16,57	CHI
201911225207	CORUMBA DE GOIAS	CB13221577	CORUMBA	19/11/2019 21:57	20/11/2019 22:32	19/11/2019 21:57	20/11/2019 18:05	20,13	13	261,70	CHI
201911225207	ABADIANIA	CB13221578	CORUMBA	19/11/2019 21:57	20/11/2019 22:32	20/11/2019 20:28	20/11/2019 20:38	0,17	84	14,02	CHI

201911225207	CORUMBA DE GOIAS	CB13221578	CORUMBA	19/11/2019 21:57	20/11/2019 22:32	20/11/2019 20:28	20/11/2019 20:38	0,17	128	21,37	CHI
201911225207	CORUMBA DE GOIAS	CB12382364LD	CORUMBA	19/11/2019 21:57	20/11/2019 22:32	20/11/2019 22:16	20/11/2019 22:32	0,28	8	2,24	CHI
201911225213	BOM JESUS DE GOIAS	BJ12000040	BOM JESUS DE GOIAS	20/11/2019 08:05	20/11/2019 10:47	20/11/2019 08:05	20/11/2019 10:47	2,70	4	10,79	CHI
201911225216	PIRACANJUBA	60041006	PIRACANJUBA	20/11/2019 07:04	20/11/2019 13:39	20/11/2019 07:04	20/11/2019 13:39	6,59	1	6,59	CHI
201911225217	PIRACANJUBA	PJ12223375	ROCHEDO	19/11/2019 22:24	20/11/2019 11:47	19/11/2019 22:24	20/11/2019 11:47	13,38	3	40,14	CHI
201911225224	URUACU	UR21136319	URUACU	20/11/2019 08:07	20/11/2019 10:44	20/11/2019 08:07	20/11/2019 10:44	2,61	1	2,61	CHI
201911225230	SAO JOAO D ALIANCA	JL21218598	SAO JOAO D ALIANCA	20/11/2019 08:07	20/11/2019 12:52	20/11/2019 08:07	20/11/2019 12:52	4,74	1	4,74	CHI
201911225238	IPORA	IR12014557	IPORA	20/11/2019 04:55	20/11/2019 11:28	20/11/2019 04:55	20/11/2019 11:28	6,54	22	143,94	CHI
201911225239	BELA VISTA DE GOIAS	BV12000036	BELA VISTA S1	20/11/2019 08:08	21/11/2019 12:04	20/11/2019 08:08	21/11/2019 12:04	27,93	1	27,93	CHI
201911225240	CAVALCANTE	CJ12400322	MINACU	20/11/2019 08:08	20/11/2019 19:51	20/11/2019 08:08	20/11/2019 19:51	11,71	2	23,42	CHI
201911225243	GAMELEIRA DE GOIAS	10005207248	DAIA S2	20/11/2019 08:08	21/11/2019 13:38	20/11/2019 08:08	21/11/2019 13:38	29,50	1	29,50	CHI
201911225244	SANTO ANTONIO DO DESCOBERTO	SN21214800	ALEXANIA	20/11/2019 08:08	20/11/2019 10:05	20/11/2019 08:08	20/11/2019 10:05	1,94	2	3,88	CHI
201911225247	NIQUELANDIA	NQ12321413	NIQUELANDIA SUBTRANSMISSAO	20/11/2019 08:09	20/11/2019 16:44	20/11/2019 08:09	20/11/2019 16:44	8,58	5	42,91	CHI
201911225301	AGUA FRIA DE GOIAS	TL12204662	SAO JOAO D ALIANCA	20/11/2019 07:43	21/11/2019 11:58	20/11/2019 07:43	21/11/2019 11:58	28,24	16	451,89	CHI
201911225302	MINEIROS	MY21248499	PARQUE DAS EMAS	20/11/2019 08:09	20/11/2019 12:35	20/11/2019 08:09	20/11/2019 12:35	4,42	1	4,42	CHI
201911225304	FAINA	FC12194565	GOIAS	20/11/2019 07:00	20/11/2019 09:58	20/11/2019 07:00	20/11/2019 09:58	2,95	8	23,63	CHI
201911225403	POSSE	PS21256085	IACIARA S1	20/11/2019 08:10	20/11/2019 22:18	20/11/2019 08:10	20/11/2019 22:18	14,13	1	14,13	CHI
201911225404	SAO MIGUEL DO ARAGUAIA	SM12020623	SAO MIGUEL DO ARAGUAIA	20/11/2019 08:10	20/11/2019 18:21	20/11/2019 08:10	20/11/2019 18:21	10,18	6	61,06	CHI
201911225504	DISTRITO FEDERAL	FA12322759	ITIQUIRA	20/11/2019 08:08	20/11/2019 13:52	20/11/2019 08:08	20/11/2019 13:52	5,73	1	5,73	CHI
201911225504	FORMOSA	FA12322759	ITIQUIRA	20/11/2019 08:08	20/11/2019 13:52	20/11/2019 08:08	20/11/2019 13:52	5,73	16	91,72	CHI
201911225505	DOVERLANDIA	DV12138342	CAIAPONIA	20/11/2019 07:56	20/11/2019 21:31	20/11/2019 07:56	20/11/2019 21:31	13,58	8	108,61	CHI
201911225507	IPAMERI	IP21133652	CRISTALINA S2	20/11/2019 08:11	21/11/2019 00:19	20/11/2019 08:11	21/11/2019 00:19	16,13	1	16,13	CHI
201911225511	ITUMBIARA	IT21088609	PARANAIBA	20/11/2019 08:11	20/11/2019 15:57	20/11/2019 08:11	20/11/2019 15:57	7,75	1	7,75	CHI
201911225512	VICENTINOPOLIS	VI12208244	VICENTINOPOLIS	20/11/2019 08:11	20/11/2019 12:46	20/11/2019 08:11	20/11/2019 12:46	4,57	3	13,70	CHI
201911225514	SAO MIGUEL DO ARAGUAIA	SM21328037	SAO MIGUEL DO ARAGUAIA	20/11/2019 08:12	20/11/2019 19:45	20/11/2019 08:12	20/11/2019 19:45	11,56	1	11,56	CHI
201911225515	SAO DOMINGOS	SD21218574	SAO DOMINGOS	20/11/2019 08:12	20/11/2019 12:31	20/11/2019 08:12	20/11/2019 12:31	4,31	1	4,31	CHI
201911225524	MAIRIPOTABA	PK12063360	PONTALINA	20/11/2019 08:13	20/11/2019 16:57	20/11/2019 08:13	20/11/2019 16:57	8,73	5	43,66	CHI
201911225526	MUNDO NOVO DE GOIAS	MH12189540	NOVA CRIXAS	20/11/2019 08:13	20/11/2019 19:05	20/11/2019 08:13	20/11/2019 19:05	10,86	5	54,32	CHI
201911225529	GUARANI DE GOIAS	GY12180835	IACIARA S1	20/11/2019 01:14	20/11/2019 10:06	20/11/2019 01:14	20/11/2019 10:06	8,85	316	2797,57	CHI
201911225529	IACIARA	GY12180835	IACIARA S1	20/11/2019 01:14	20/11/2019 10:06	20/11/2019 01:14	20/11/2019 10:06	8,85	2	17,71	CHI
201911225544	ITAPIRAPUA	IU12396097	JUSSARA	20/11/2019 08:14	20/11/2019 21:45	20/11/2019 08:14	20/11/2019 21:45	13,52	2	27,03	CHI
201911225546	GOIANIA	10010555119	GOYA S1	20/11/2019 08:15	20/11/2019 10:52	20/11/2019 08:15	20/11/2019 10:52	2,61	1	2,61	CHI
201911225711	ITAJA	IJ12306259	ITAJA S2	20/11/2019 08:17	20/11/2019 14:26	20/11/2019 08:17	20/11/2019 14:26	6,15	1	6,15	CHI

201911225712	VILA BOA	FA12309083	ITIQUEIRA	20/11/2019 08:17	20/11/2019 18:28	20/11/2019 08:17	20/11/2019 18:28	10,18	4	40,72	CHI
201911225713	MAIRIPOTABA	MI12394189	PONTALINA	20/11/2019 08:17	21/11/2019 11:43	20/11/2019 08:17	21/11/2019 11:43	27,42	1	27,42	CHI
201911225713	PONTALINA	MI12394189	PONTALINA	20/11/2019 08:17	21/11/2019 11:43	20/11/2019 08:17	21/11/2019 11:43	27,42	3	82,27	CHI
201911225718	CATALAO	CT21166721	CATALAO S1	20/11/2019 08:18	21/11/2019 10:04	20/11/2019 08:18	21/11/2019 10:04	25,76	2	51,52	CHI
201911225719	CAMPOS VERDES	3790025961	SANTA TEREZINHA	20/11/2019 08:18	20/11/2019 10:35	20/11/2019 08:18	20/11/2019 10:35	2,28	1	2,28	CHI
201911225727	RIO VERDE	630307635	RIO VERDE S1	20/11/2019 08:19	20/11/2019 12:50	20/11/2019 08:19	20/11/2019 12:50	4,52	1	4,52	CHI
201911225736	APARECIDA DE GOIANIA	200035976	INDEPENDENCIA S1	20/11/2019 08:20	20/11/2019 13:10	20/11/2019 08:20	20/11/2019 13:10	4,82	1	4,82	CHI
201911225738	IACIARA	IA12232131	IACIARA S1	20/11/2019 07:45	20/11/2019 15:01	20/11/2019 07:45	20/11/2019 15:01	7,25	6	43,51	CHI
201911225801	PIRENOPOLIS	PV11382896	CORUMBA	20/11/2019 14:32	20/11/2019 16:00	20/11/2019 14:32	20/11/2019 16:00	1,47	20	29,33	CHI
201911225808	ANAPOLIS	AN11071651	ANAPOLIS UNIVERSITARIO S2	20/11/2019 08:26	20/11/2019 12:42	20/11/2019 08:26	20/11/2019 12:42	4,27	11	46,93	CHI
201911225812	PIRACANJUBA	8220060428	ROCHEDO	20/11/2019 08:14	20/11/2019 12:16	20/11/2019 08:14	20/11/2019 12:16	4,02	1	4,02	CHI
201911225820	CIDADE OCIDENTAL	DH11172222	MARAJOARA	20/11/2019 10:07	20/11/2019 10:54	20/11/2019 10:07	20/11/2019 10:54	0,78	75	58,21	CHI
201911225828	CALDAS NOVAS	CN12122123	SERRA DE CALDAS	19/11/2019 12:16	20/11/2019 16:23	19/11/2019 12:16	20/11/2019 16:23	28,10	5	140,51	CHI
201911225841	ACREUNA	00080424	ACREUNA	20/11/2019 09:26	20/11/2019 11:08	20/11/2019 09:26	20/11/2019 11:08	1,69	28	47,38	CHI
201911225841	INDIARA	00080424	ACREUNA	20/11/2019 09:26	20/11/2019 11:08	20/11/2019 09:26	20/11/2019 11:08	1,69	3	5,08	CHI
201911225841	JANDAIA	00080424	ACREUNA	20/11/2019 09:26	20/11/2019 11:08	20/11/2019 09:26	20/11/2019 11:08	1,69	33	55,84	CHI
201911225841	PARAUNA	00080424	ACREUNA	20/11/2019 09:26	20/11/2019 11:08	20/11/2019 09:26	20/11/2019 11:08	1,69	1	1,69	CHI
201911225883	HIDROLANDIA	180037778	PIRACANJUBA	20/11/2019 08:06	20/11/2019 17:42	20/11/2019 08:06	20/11/2019 17:42	9,60	1	9,60	CHI
201911225884	PIRENOPOLIS	PV12353230	CORUMBA	20/11/2019 06:57	21/11/2019 09:08	20/11/2019 06:57	21/11/2019 09:08	26,17	9	235,51	CHI
201911225887	AMORINOPOLIS	AM12312073LD	IPORA	20/11/2019 12:51	20/11/2019 14:22	20/11/2019 12:51	20/11/2019 14:22	1,53	1	1,53	CHI
201911225888	SAO LUIS DE MONTES BELOS	SL10394730	SAO LUIZ DOS MONTES BELOS	20/11/2019 12:46	21/11/2019 08:42	20/11/2019 12:46	20/11/2019 14:47	2,01	263	528,70	CHI
201911225888	SAO LUIS DE MONTES BELOS	SL10394730	SAO LUIZ DOS MONTES BELOS	20/11/2019 12:46	21/11/2019 08:42	20/11/2019 18:32	20/11/2019 18:40	0,12	263	32,14	CHI
201911225888	SAO LUIS DE MONTES BELOS	SL10394730	SAO LUIZ DOS MONTES BELOS	20/11/2019 12:46	21/11/2019 08:42	20/11/2019 12:46	20/11/2019 19:59	7,22	29	209,35	CHI
201911225888	SAO LUIS DE MONTES BELOS	SL10394730	SAO LUIZ DOS MONTES BELOS	20/11/2019 12:46	21/11/2019 08:42	20/11/2019 19:53	20/11/2019 19:59	0,11	263	27,76	CHI
201911225888	AURILANDIA	SL10394730	SAO LUIZ DOS MONTES BELOS	20/11/2019 12:46	21/11/2019 08:42	20/11/2019 12:46	20/11/2019 20:00	7,24	32	231,54	CHI
201911225888	CORREGO DO OURO	SL10394730	SAO LUIZ DOS MONTES BELOS	20/11/2019 12:46	21/11/2019 08:42	20/11/2019 12:46	20/11/2019 20:00	7,24	327	2366,03	CHI
201911225888	FIRMINOPOLIS	SL10394730	SAO LUIZ DOS MONTES BELOS	20/11/2019 12:46	21/11/2019 08:42	20/11/2019 12:46	20/11/2019 20:00	7,24	109	788,68	CHI
201911225888	MOIPORA	SL10394730	SAO LUIZ DOS MONTES BELOS	20/11/2019 12:46	21/11/2019 08:42	20/11/2019 12:46	20/11/2019 20:00	7,24	28	202,60	CHI
201911225888	SANCLERLANDIA	SL10394730	SAO LUIZ DOS MONTES BELOS	20/11/2019 12:46	21/11/2019 08:42	20/11/2019 12:46	20/11/2019 20:00	7,24	35	253,24	CHI
201911225888	SAO LUIS DE MONTES BELOS	SL10394730	SAO LUIZ DOS MONTES BELOS	20/11/2019 12:46	21/11/2019 08:42	20/11/2019 12:46	20/11/2019 20:00	7,24	359	2597,56	CHI
201911225888	SAO LUIS DE MONTES BELOS	SL10394730	SAO LUIZ DOS MONTES BELOS	20/11/2019 12:46	21/11/2019 08:42	20/11/2019 12:46	21/11/2019 08:42	19,93	109	2172,40	CHI
201911225888	AURILANDIA	SL10394730	SAO LUIZ DOS MONTES BELOS	20/11/2019 12:46	21/11/2019 08:42	21/11/2019 08:38	21/11/2019 08:42	0,06	32	1,82	CHI
201911225888	CORREGO DO OURO	SL10394730	SAO LUIZ DOS MONTES BELOS	20/11/2019 12:46	21/11/2019 08:42	21/11/2019 08:38	21/11/2019 08:42	0,06	327	18,62	CHI

201911225888	FIRMINOPOLIS	SL10394730	SAO LUIZ DOS MONTES BELOS	20/11/2019 12:46	21/11/2019 08:42	21/11/2019 08:38	21/11/2019 08:42	0,06	109	6,21	CHI
201911225888	MOIPORA	SL10394730	SAO LUIZ DOS MONTES BELOS	20/11/2019 12:46	21/11/2019 08:42	21/11/2019 08:38	21/11/2019 08:42	0,06	28	1,59	CHI
201911225888	SANCLERLANDIA	SL10394730	SAO LUIZ DOS MONTES BELOS	20/11/2019 12:46	21/11/2019 08:42	21/11/2019 08:38	21/11/2019 08:42	0,06	35	1,99	CHI
201911225888	SAO LUIS DE MONTES BELOS	SL10394730	SAO LUIZ DOS MONTES BELOS	20/11/2019 12:46	21/11/2019 08:42	21/11/2019 08:38	21/11/2019 08:42	0,06	631	35,93	CHI
201911225890	PIRENOPOLIS	10026917740	CORUMBA	20/11/2019 10:45	20/11/2019 14:30	20/11/2019 10:45	20/11/2019 14:30	3,73	1	3,73	CHI
201911226102	MINACU	IH12208347	MINACU	20/11/2019 08:21	21/11/2019 09:50	20/11/2019 08:21	21/11/2019 09:50	25,47	23	585,87	CHI
201911226105	MINACU	IH12182453	MINACU	20/11/2019 07:27	20/11/2019 18:39	20/11/2019 07:27	20/11/2019 18:39	11,20	182	2037,69	CHI
201911226106	ABADIA DE GOIAS	TR32099080	GUAPO S1	20/11/2019 07:15	20/11/2019 10:56	20/11/2019 07:15	20/11/2019 10:56	3,68	13	47,79	CHI
201911226106	TRINDADE	TR32099080	GUAPO S1	20/11/2019 07:15	20/11/2019 10:56	20/11/2019 07:15	20/11/2019 10:56	3,68	1	3,68	CHI
201911226201	PARAUNA	PU12079036	FIRMINOPOLIS S2	20/11/2019 06:58	20/11/2019 17:54	20/11/2019 06:58	20/11/2019 17:54	10,92	8	87,40	CHI
201911226206	JARAGUA	70005370	JARAGUA	20/11/2019 08:23	20/11/2019 14:55	20/11/2019 08:23	20/11/2019 14:55	6,53	1	6,53	CHI
201911226215	PIRACANJUBA	PJ12316606	BELA VISTA S1	18/11/2019 12:49	20/11/2019 09:41	18/11/2019 12:49	20/11/2019 09:41	44,86	5	224,31	CHI
201911226223	VIANOPOLIS	10024655706	VIANOPOLIS	20/11/2019 08:23	21/11/2019 13:30	20/11/2019 08:23	21/11/2019 13:30	29,11	1	29,11	CHI
201911226231	RIO VERDE	RV21326917	RIO VERDE S2	20/11/2019 08:26	20/11/2019 10:28	20/11/2019 08:26	20/11/2019 10:28	2,03	1	2,03	CHI
201911226237	LUZIANIA	LZ21230063	CRISTALINA S2	20/11/2019 08:26	20/11/2019 11:10	20/11/2019 08:26	20/11/2019 11:10	2,73	2	5,46	CHI
201911226241	ITAPURANGA	170013492	ITAPURANGA	20/11/2019 08:26	20/11/2019 09:21	20/11/2019 08:26	20/11/2019 09:21	0,90	1	0,90	CHI
201911226250	FAINA	MP12194509	MATRINCHA	20/11/2019 08:27	20/11/2019 15:35	20/11/2019 08:27	20/11/2019 15:35	7,12	3	21,37	CHI
201911226250	MATRINCHA	MP12194509	MATRINCHA	20/11/2019 08:27	20/11/2019 15:35	20/11/2019 08:27	20/11/2019 15:35	7,12	3	21,37	CHI
201911226255	NAZARIO	440031163	ANICUNS	20/11/2019 08:28	20/11/2019 09:04	20/11/2019 08:28	20/11/2019 09:04	0,60	1	0,60	CHI
201911226256	URUACU	640027970	URUACU	20/11/2019 08:29	20/11/2019 11:41	20/11/2019 08:29	20/11/2019 11:41	3,20	1	3,20	CHI
201911226257	BURITINOPOLIS	MB12344322RE	IACIARA S2	20/11/2019 07:29	20/11/2019 09:23	20/11/2019 07:29	20/11/2019 09:23	1,90	30	56,91	CHI
201911226257	MAMBAI	MB12344322RE	IACIARA S2	20/11/2019 07:29	20/11/2019 09:23	20/11/2019 07:29	20/11/2019 09:23	1,90	129	244,71	CHI
201911226258	AMERICANO DO BRASIL	AC12391519	ANICUNS	20/11/2019 13:47	20/11/2019 16:25	20/11/2019 13:47	20/11/2019 16:25	2,62	1	2,62	CHI
201911226258	ANICUNS	AC12391519	ANICUNS	20/11/2019 13:47	20/11/2019 16:25	20/11/2019 13:47	20/11/2019 16:25	2,62	14	36,66	CHI
201911226259	CALDAS NOVAS	760208608	SERRA DE CALDAS	20/11/2019 08:29	20/11/2019 11:59	20/11/2019 08:29	20/11/2019 11:59	3,49	1	3,49	CHI
201911226262	PROFESSOR JAMIL SAFADY	JS21109201	ROCHEDO	19/11/2019 17:28	20/11/2019 16:50	19/11/2019 17:28	20/11/2019 16:50	23,37	1	23,37	CHI
201911226269	PALMEIRAS DE GOIAS	PP21005760	FIRMINOPOLIS S2	20/11/2019 08:30	20/11/2019 20:50	20/11/2019 08:30	20/11/2019 20:50	12,34	2	24,68	CHI
201911226277	SAO MIGUEL DO ARAGUAIA	SM21170898	SAO MIGUEL DO ARAGUAIA	20/11/2019 08:31	20/11/2019 22:35	20/11/2019 08:31	20/11/2019 22:35	14,05	1	14,05	CHI
201911226282	CIDADE OCIDENTAL	2680031903	MARAJOARA	20/11/2019 08:32	20/11/2019 11:18	20/11/2019 08:32	20/11/2019 11:18	2,76	1	2,76	CHI
201911226283	PALMEIRAS DE GOIAS	PL12000053	PALMEIRAS	20/11/2019 08:32	20/11/2019 14:00	20/11/2019 08:32	20/11/2019 14:00	5,47	2	10,94	CHI
201911226283	PALMEIRAS DE GOIAS	PL12000053	PALMEIRAS	20/11/2019 08:32	20/11/2019 14:00	20/11/2019 10:10	20/11/2019 14:00	3,83	37	141,83	CHI
201911226286	JARAGUA	JA12064321	JARAGUA	20/11/2019 07:39	20/11/2019 10:52	20/11/2019 07:39	20/11/2019 10:52	3,21	4	12,84	CHI
201911226291	GOIATUBA	140017483	GOIATUBA S2	20/11/2019 08:33	21/11/2019 12:19	20/11/2019 08:33	21/11/2019 12:19	27,76	1	27,76	CHI

201911226294	JARAGUA	JA12240112	JARAGUA	19/11/2019 20:41	20/11/2019 09:47	19/11/2019 20:41	20/11/2019 09:47	13,09	24	314,27	CHI
201911226297	ORIZONA	OZ12000353	PIRES DO RIO S1	20/11/2019 07:52	20/11/2019 10:55	20/11/2019 07:52	20/11/2019 10:55	3,04	32	97,29	CHI
201911226299	BELA VISTA DE GOIAS	240034703	BELA VISTA S1	20/11/2019 08:34	21/11/2019 02:34	20/11/2019 08:34	21/11/2019 02:34	17,99	1	17,99	CHI
201911226302	GOIANIA	15828359	ATLANTICO S3	20/11/2019 08:34	20/11/2019 10:09	20/11/2019 08:34	20/11/2019 10:09	1,57	1	1,57	CHI
201911226602	JATAI	JT12306843	JATAI S1	20/11/2019 08:36	20/11/2019 14:59	20/11/2019 08:36	20/11/2019 14:59	6,38	2	12,77	CHI
201911226703	TROMBAS	TB21256975	PORANGATU	20/11/2019 08:36	20/11/2019 13:51	20/11/2019 08:36	20/11/2019 13:51	5,24	1	5,24	CHI
201911226705	HIDROLANDIA	HD21198434	CEPAIGO S1	20/11/2019 08:36	20/11/2019 15:55	20/11/2019 08:36	20/11/2019 15:55	7,31	1	7,31	CHI
201911226710	BURITI ALEGRE	IT12000099RE	PARANAIBA	20/11/2019 07:05	20/11/2019 20:33	20/11/2019 07:05	20/11/2019 20:33	13,47	2	26,95	CHI
201911226710	ITUMBIARA	IT12000099RE	PARANAIBA	20/11/2019 07:05	20/11/2019 20:33	20/11/2019 07:05	20/11/2019 20:33	13,47	29	390,75	CHI
201911226710	PANAMA	IT12000099RE	PARANAIBA	20/11/2019 07:05	20/11/2019 20:33	20/11/2019 07:05	20/11/2019 20:33	13,47	11	148,22	CHI
201911226710	ITUMBIARA	IT12000099RE	PARANAIBA	20/11/2019 07:05	20/11/2019 20:33	20/11/2019 13:44	20/11/2019 20:33	6,82	33	225,20	CHI
201911226710	GOIATUBA	IT12000099RE	PARANAIBA	20/11/2019 07:05	20/11/2019 20:33	20/11/2019 19:20	20/11/2019 20:33	1,23	6	7,36	CHI
201911226710	ITUMBIARA	IT12000099RE	PARANAIBA	20/11/2019 07:05	20/11/2019 20:33	20/11/2019 19:20	20/11/2019 20:33	1,23	2	2,45	CHI
201911226710	PANAMA	IT12000099RE	PARANAIBA	20/11/2019 07:05	20/11/2019 20:33	20/11/2019 19:20	20/11/2019 20:33	1,23	9	11,04	CHI
201911227005	RIO VERDE	RV12301462	ACREUNA	20/11/2019 08:37	20/11/2019 19:37	20/11/2019 08:37	20/11/2019 19:37	10,99	16	175,83	CHI
201911227005	SANTO ANTONIO DA BARRA	RV12301462	ACREUNA	20/11/2019 08:37	20/11/2019 19:37	20/11/2019 08:37	20/11/2019 19:37	10,99	1	10,99	CHI
201911227101	JUSSARA	JR12396256	JUSSARA	20/11/2019 07:42	20/11/2019 17:46	20/11/2019 07:42	20/11/2019 17:46	10,06	5	50,28	CHI
201911227106	MINEIROS	MY12212642	PARQUE DAS EMAS	20/11/2019 08:38	21/11/2019 09:42	20/11/2019 08:38	21/11/2019 09:42	25,06	3	75,17	CHI
201911227108	MONTIVIDIU DO NORTE	MX12240692	PORANGATU	20/11/2019 08:38	20/11/2019 22:44	20/11/2019 08:38	20/11/2019 22:44	14,09	2	28,17	CHI
201911227108	TROMBAS	MX12240692	PORANGATU	20/11/2019 08:38	20/11/2019 22:44	20/11/2019 08:38	20/11/2019 22:44	14,09	1	14,09	CHI
201911227110	CALDAS NOVAS	760034965	SERRA DE CALDAS	20/11/2019 08:39	20/11/2019 17:19	20/11/2019 08:39	20/11/2019 17:19	8,67	1	8,67	CHI
201911227112	ITABERAI	IB21183004	ITABERAI S1	20/11/2019 08:39	20/11/2019 11:50	20/11/2019 08:39	20/11/2019 11:50	3,18	2	6,36	CHI
201911227115	JATAI	JT21142796	JATAI S1	20/11/2019 08:39	20/11/2019 11:07	20/11/2019 08:39	20/11/2019 11:07	2,45	1	2,45	CHI
201911227122	MORRINHOS	MR12028956	MORRINHOS	20/11/2019 08:40	21/11/2019 12:54	20/11/2019 08:40	21/11/2019 12:54	28,23	5	141,13	CHI
201911227126	APARECIDA DE GOIANIA	AP11000062	ANHANGUERA	20/11/2019 08:41	20/11/2019 11:05	20/11/2019 08:41	20/11/2019 11:05	2,40	17	40,80	CHI
201911227129	MORRO AGUDO DE GOIAS	MS21086903	ITAPURANGA	20/11/2019 08:40	21/11/2019 11:25	20/11/2019 08:40	21/11/2019 11:25	26,75	1	26,75	CHI
201911227131	NOVA CRIXAS	NA21309189	MOZARLANDIA	20/11/2019 08:40	20/11/2019 13:49	20/11/2019 08:40	20/11/2019 13:49	5,14	1	5,14	CHI
201911227134	RIO VERDE	RV11038393	RIO VERDE S1	20/11/2019 09:47	20/11/2019 12:10	20/11/2019 09:47	20/11/2019 12:10	2,38	98	233,57	CHI
201911227141	MORRINHOS	MR21000126	MORRINHOS	20/11/2019 08:44	21/11/2019 07:10	20/11/2019 08:44	21/11/2019 07:10	22,42	1	22,42	CHI
201911227142	JATAI	290155563	JATAI S2	20/11/2019 08:44	20/11/2019 11:06	20/11/2019 08:44	20/11/2019 11:06	2,35	1	2,35	CHI
201911227144	AMARALINA	LC12245307	MARA ROSA	20/11/2019 08:44	20/11/2019 16:03	20/11/2019 08:44	20/11/2019 16:03	7,30	5	36,51	CHI
201911227145	MONTE ALEGRE DE GOIAS	MA21195847	SAO DOMINGOS	20/11/2019 08:45	20/11/2019 09:39	20/11/2019 08:45	20/11/2019 09:39	0,90	1	0,90	CHI
201911227146	IVOLANDIA	IV12231245	ARENOPOLIS	20/11/2019 08:45	20/11/2019 12:00	20/11/2019 08:45	20/11/2019 12:00	3,24	13	42,17	CHI

201911227146	PALESTINA DE GOIAS	IV12231245	ARENOPOLIS	20/11/2019 08:45	20/11/2019 12:00	20/11/2019 08:45	20/11/2019 12:00	3,24	4	12,98	CHI
201911227201	MUNDO NOVO DE GOIAS	MH11220599	NOVA CRIXAS	20/11/2019 08:46	20/11/2019 11:50	20/11/2019 08:46	20/11/2019 11:50	3,06	1	3,06	CHI
201911227301	ESTRELA DO NORTE	MU12076698	MARA ROSA	20/11/2019 08:46	20/11/2019 14:45	20/11/2019 08:46	20/11/2019 14:45	5,98	1	5,98	CHI
201911227301	MUTUNOPOLIS	MU12076698	MARA ROSA	20/11/2019 08:46	20/11/2019 14:45	20/11/2019 08:46	20/11/2019 14:45	5,98	32	191,24	CHI
201911227401	GOIANIA	13178428	ATLANTICO S2	20/11/2019 08:46	20/11/2019 11:57	20/11/2019 08:46	20/11/2019 11:57	3,18	1	3,18	CHI
201911227407	PIRES DO RIO	PR21159617	PIRES DO RIO S1	20/11/2019 08:47	21/11/2019 13:08	20/11/2019 08:47	21/11/2019 13:08	28,35	1	28,35	CHI
201911227408	APARECIDA DE GOIANIA	AP21180119	ANHANGUERA	20/11/2019 08:47	20/11/2019 14:06	20/11/2019 08:47	20/11/2019 14:06	5,31	1	5,31	CHI
201911227414	NIQUELANDIA	NQ12397516	NIQUELANDIA SUBTRANSMISSAO	20/11/2019 08:48	20/11/2019 17:30	20/11/2019 08:48	20/11/2019 17:30	8,70	3	26,09	CHI
201911227416	TERESINA DE GOIAS	TE11320541	FLORES DE GOIAS	20/11/2019 07:47	20/11/2019 19:07	20/11/2019 07:47	20/11/2019 19:07	11,32	42	475,62	CHI
201911227417	MARA ROSA	MQ21150741	MARA ROSA	20/11/2019 08:48	20/11/2019 21:29	20/11/2019 08:48	20/11/2019 21:29	12,67	1	12,67	CHI
201911227418	GOIANESIA	GE21258494	GOIANESIA S2	20/11/2019 08:48	20/11/2019 17:19	20/11/2019 08:48	20/11/2019 17:19	8,50	1	8,50	CHI
201911227420	PANAMA	PX21263931	GOIATUBA S1	20/11/2019 08:49	20/11/2019 17:18	20/11/2019 08:49	20/11/2019 17:18	8,48	1	8,48	CHI
201911227421	ALTO PARAISO DE GOIAS	10017426543	FLORES DE GOIAS	20/11/2019 08:49	20/11/2019 19:57	20/11/2019 08:49	20/11/2019 19:57	11,13	1	11,13	CHI
201911227426	FORMOSA	610011340	ITUIQUIRA	20/11/2019 08:49	21/11/2019 02:28	20/11/2019 08:49	21/11/2019 02:28	17,64	1	17,64	CHI
201911227427	CIDADE OCIDENTAL	10001289274	MARAJOARA	20/11/2019 08:50	20/11/2019 09:52	20/11/2019 08:50	20/11/2019 09:52	1,03	1	1,03	CHI
201911227438	ABADIA DE GOIAS	10024486963	INDEPENDENCIA S2	20/11/2019 08:51	20/11/2019 14:29	20/11/2019 08:51	20/11/2019 14:29	5,62	1	5,62	CHI
201911227440	SAO MIGUEL DO PASSA QUATRO	SQ12088077	CRISTIANOPOLIS	19/11/2019 22:28	20/11/2019 10:17	19/11/2019 22:28	20/11/2019 10:17	11,80	18	212,48	CHI
201911227441	IPAMERI	IP12000086	IPAMERI	20/11/2019 08:52	20/11/2019 14:38	20/11/2019 08:52	20/11/2019 14:38	5,76	4	23,03	CHI
201911227449	CASTELANDIA	QI12053189	QUIRINOPOLIS	20/11/2019 08:53	20/11/2019 10:38	20/11/2019 08:53	20/11/2019 10:38	1,74	1	1,74	CHI
201911227449	QUIRINOPOLIS	QI12053189	QUIRINOPOLIS	20/11/2019 08:53	20/11/2019 10:38	20/11/2019 08:53	20/11/2019 10:38	1,74	17	29,66	CHI
201911227449	RIO VERDE	QI12053189	QUIRINOPOLIS	20/11/2019 08:53	20/11/2019 10:38	20/11/2019 08:53	20/11/2019 10:38	1,74	1	1,74	CHI
201911227451	QUIRINOPOLIS	80096580	QUIRINOPOLIS	20/11/2019 08:53	21/11/2019 11:31	20/11/2019 08:53	21/11/2019 11:31	26,62	1	26,62	CHI
201911227504	BOM JARDIM DE GOIAS	BM21259441	BOM JARDIM	20/11/2019 04:38	20/11/2019 11:23	20/11/2019 04:38	20/11/2019 11:23	6,74	1	6,74	CHI
201911227505	NOVA ROMA	ND12256420	IACIARA S2	20/11/2019 06:40	20/11/2019 10:40	20/11/2019 06:40	20/11/2019 10:40	3,99	28	111,75	CHI
201911227512	ITUMBIARA	IT21088591	PARANAIBA	20/11/2019 08:55	22/11/2019 12:04	20/11/2019 08:55	21/11/2019 13:30	28,58	1	28,58	CHI
201911227512	ITUMBIARA	IT21088591	PARANAIBA	20/11/2019 08:55	22/11/2019 12:04	21/11/2019 13:31	22/11/2019 12:04	22,54	1	22,54	CHI
201911227519	LUZIANIA	LZ21332067	VIANOPOLIS	20/11/2019 08:57	20/11/2019 23:12	20/11/2019 08:57	20/11/2019 23:12	14,24	2	28,48	CHI
201911227524	MORRINHOS	MR21000098	MORRINHOS	20/11/2019 08:58	20/11/2019 11:48	20/11/2019 08:58	20/11/2019 11:48	2,84	1	2,84	CHI
201911227525	MINACU	IH12396740	MINACU	20/11/2019 05:21	20/11/2019 21:30	20/11/2019 05:21	20/11/2019 21:30	16,14	184	2970,53	CHI
201911227527	CALDAS NOVAS	CN21000016	CALDAS NOVAS S2	20/11/2019 08:59	20/11/2019 14:56	20/11/2019 08:59	20/11/2019 14:56	5,95	1	5,95	CHI
201911227528	PONTALINA	PK21127720	PONTALINA	20/11/2019 08:59	21/11/2019 17:38	20/11/2019 08:59	21/11/2019 17:38	32,65	2	65,29	CHI
201911227530	PLANALTINA	PI21322771	PLANALTINA	20/11/2019 08:59	21/11/2019 09:27	20/11/2019 08:59	21/11/2019 09:27	24,46	1	24,46	CHI
201911227534	ITUMBIARA	IT11166333	PARANAIBA	20/11/2019 08:59	20/11/2019 16:20	20/11/2019 08:59	20/11/2019 16:20	7,34	38	278,80	CHI

201911227538	ABADIANIA	AA12050405	ANAPOLIS UNIVERSITARIO S1	20/11/2019 08:00	20/11/2019 11:23	20/11/2019 08:00	20/11/2019 11:23	3,38	15	50,68	CHI
201911227545	GOIANIA	11877170	CAMPINAS S2	20/11/2019 09:01	20/11/2019 12:15	20/11/2019 09:01	20/11/2019 12:15	3,23	1	3,23	CHI
201911227546	IPAMERI	IP21075962	PIRES DO RIO S2	20/11/2019 09:01	21/11/2019 10:32	20/11/2019 09:01	21/11/2019 10:32	25,51	1	25,51	CHI
201911227547	PIRACANJUBA	PJ21286225	PIRACANJUBA	20/11/2019 09:01	20/11/2019 11:08	20/11/2019 09:01	20/11/2019 11:08	2,11	1	2,11	CHI
201911227548	NAZARIO	440014190	ANICUNS	20/11/2019 09:01	20/11/2019 09:48	20/11/2019 09:01	20/11/2019 09:48	0,78	1	0,78	CHI
201911227557	TROMBAS	TB12258046	PORANGATU	20/11/2019 09:02	20/11/2019 16:34	20/11/2019 09:02	20/11/2019 16:34	7,53	3	22,58	CHI
201911227561	CRISTALINA	KR12330533	CRISTALINA S1	20/11/2019 00:48	20/11/2019 12:29	20/11/2019 00:48	20/11/2019 12:29	11,68	34	397,08	CHI
201911227561	IPAMERI	KR12330533	CRISTALINA S1	20/11/2019 00:48	20/11/2019 12:29	20/11/2019 00:48	20/11/2019 12:29	11,68	1	11,68	CHI
201911227561	LUZIANIA	KR12330533	CRISTALINA S1	20/11/2019 00:48	20/11/2019 12:29	20/11/2019 00:48	20/11/2019 12:29	11,68	8	93,43	CHI
201911227563	CRISTALINA	KR12351414	PAMPLONA	20/11/2019 09:03	20/11/2019 13:08	20/11/2019 09:03	20/11/2019 13:08	4,08	6	24,51	CHI
201911227565	AGUA FRIA DE GOIAS	TL12381390	SAO JOAO D ALIANCA	20/11/2019 06:40	21/11/2019 10:57	20/11/2019 06:40	21/11/2019 10:57	28,27	3	84,82	CHI
201911227565	PLANALTINA	TL12381390	SAO JOAO D ALIANCA	20/11/2019 06:40	21/11/2019 10:57	20/11/2019 06:40	21/11/2019 10:57	28,27	20	565,44	CHI
201911227570	SITIO D ABADIA	SI21157615	IACIARA S2	20/11/2019 09:04	20/11/2019 13:56	20/11/2019 09:04	20/11/2019 13:56	4,86	1	4,86	CHI
201911227571	NIQUELANDIA	NQ21381309	URUACU	20/11/2019 09:04	20/11/2019 15:40	20/11/2019 09:04	20/11/2019 15:40	6,59	1	6,59	CHI
201911227572	TRINDADE	TR21187616	TRINDADE	20/11/2019 09:04	20/11/2019 09:33	20/11/2019 09:04	20/11/2019 09:33	0,48	1	0,48	CHI
201911227578	URUACU	UR21295351	URUACU	20/11/2019 09:05	20/11/2019 11:59	20/11/2019 09:05	20/11/2019 11:59	2,89	1	2,89	CHI
201911227580	TRINDADE	40059455	TRINDADE	20/11/2019 09:05	20/11/2019 11:25	20/11/2019 09:05	20/11/2019 11:25	2,33	1	2,33	CHI
201911227581	GOIANIA	14512580	REAL S2	20/11/2019 09:05	20/11/2019 10:25	20/11/2019 09:05	20/11/2019 10:25	1,32	1	1,32	CHI
201911227582	FAINA	FC12299836	GOIAS	20/11/2019 09:03	21/11/2019 11:06	20/11/2019 09:03	21/11/2019 11:06	26,03	2	52,07	CHI
201911227586	GOIANIA	10608060	AEROPORTO S2	20/11/2019 09:06	20/11/2019 11:00	20/11/2019 09:06	20/11/2019 11:00	1,89	1	1,89	CHI
201911227591	PIRENOPOLIS	PV12000046	CORUMBA	20/11/2019 07:52	20/11/2019 12:57	20/11/2019 07:52	20/11/2019 12:57	5,08	50	253,96	CHI
201911227593	FORMOSA	FA12404372	ITUIQUIRA	20/11/2019 07:54	20/11/2019 10:35	20/11/2019 07:54	20/11/2019 10:35	2,67	20	53,38	CHI
201911227596	CALDAS NOVAS	760129745	SERRA DE CALDAS	20/11/2019 08:04	20/11/2019 10:28	20/11/2019 08:04	20/11/2019 10:28	2,39	1	2,39	CHI
201911227801	GOIANIA	10020801120	XAVANTES	20/11/2019 09:08	20/11/2019 11:42	20/11/2019 09:08	20/11/2019 11:42	2,56	1	2,56	CHI
201911228002	GUAPO	10007572458	GUAPO S1	20/11/2019 09:08	20/11/2019 17:34	20/11/2019 09:08	20/11/2019 17:34	8,42	1	8,42	CHI
201911228013	MORRINHOS	10001602916	MORRINHOS	20/11/2019 09:07	21/11/2019 11:15	20/11/2019 09:07	21/11/2019 11:15	26,15	1	26,15	CHI
201911228016	NIQUELANDIA	NQ12171829	NIQUELANDIA SUBTRANSMISSAO	20/11/2019 06:58	20/11/2019 10:27	20/11/2019 06:58	20/11/2019 10:27	3,48	217	754,62	CHI
201911228023	ITAPIRAPUA	IU12250542	MATRINCHA	20/11/2019 07:41	20/11/2019 15:36	20/11/2019 07:41	20/11/2019 15:36	7,91	9	71,18	CHI
201911228024	ANAPOLIS	20033254	JUNDIAI S1	20/11/2019 09:11	20/11/2019 10:19	20/11/2019 09:11	20/11/2019 10:19	1,12	1	1,12	CHI
201911228026	RIO VERDE	630552745	RIO VERDE S1	20/11/2019 09:11	20/11/2019 12:05	20/11/2019 09:11	20/11/2019 12:05	2,90	1	2,90	CHI
201911228028	MORRINHOS	MR21121291	MORRINHOS	20/11/2019 09:11	20/11/2019 18:47	20/11/2019 09:11	20/11/2019 18:47	9,59	1	9,59	CHI
201911228030	JATAI	290011413	JATAI S2	20/11/2019 09:11	20/11/2019 11:58	20/11/2019 09:11	20/11/2019 11:58	2,77	1	2,77	CHI
201911228031	BELA VISTA DE GOIAS	10014269994	BELA VISTA S1	20/11/2019 09:12	20/11/2019 10:03	20/11/2019 09:12	20/11/2019 10:03	0,84	1	0,84	CHI

201911228032	PADRE BERNARDO	PB12195545	PADRE BERNARDO	20/11/2019 08:53	20/11/2019 12:23	20/11/2019 08:53	20/11/2019 12:23	3,50	33	115,35	CHI
201911228033	APARECIDA DE GOIANIA	200380485	INDEPENDENCIA S1	20/11/2019 09:13	20/11/2019 14:48	20/11/2019 09:13	20/11/2019 14:48	5,58	1	5,58	CHI
201911228034	MUNDO NOVO DE GOIAS	MH12034680	NOVA CRIXAS	20/11/2019 09:13	20/11/2019 21:53	20/11/2019 09:13	20/11/2019 21:53	12,66	24	303,88	CHI
201911228046	RIO VERDE	RV12246754	CABRIUVA S2	20/11/2019 09:14	20/11/2019 11:32	20/11/2019 09:14	20/11/2019 11:32	2,30	1	2,30	CHI
201911228047	ITAPIRAPUA	IU12336387	MATRINCHA	20/11/2019 09:14	21/11/2019 21:03	20/11/2019 09:14	21/11/2019 21:03	35,81	2	71,63	CHI
201911228048	SAO MIGUEL DO ARAGUAIA	SM11246987	SAO MIGUEL DO ARAGUAIA	20/11/2019 09:15	20/11/2019 10:45	20/11/2019 09:15	20/11/2019 10:45	1,50	1	1,50	CHI
201911228050	FLORES DE GOIAS	FB12398309	IACIARA S2	20/11/2019 07:49	20/11/2019 21:30	20/11/2019 07:49	20/11/2019 21:30	13,67	55	752,00	CHI
201911228058	NOVO GAMA	4990002934	PACAEMBU S1	20/11/2019 09:15	20/11/2019 10:32	20/11/2019 09:15	20/11/2019 10:32	1,27	1	1,27	CHI
201911228059	GOIANIA	12465847	GOIANIA LESTE S1	20/11/2019 09:15	20/11/2019 10:11	20/11/2019 09:15	20/11/2019 10:11	0,92	1	0,92	CHI
201911228064	URUACU	UR21136371	URUACU	20/11/2019 09:16	20/11/2019 18:08	20/11/2019 09:16	20/11/2019 18:08	8,86	1	8,86	CHI
201911228069	IPAMERI	IP21156114	PIRES DO RIO S2	20/11/2019 09:17	20/11/2019 14:55	20/11/2019 09:17	20/11/2019 14:55	5,62	1	5,62	CHI
201911228075	FLORES DE GOIAS	3480009394	FLORES DE GOIAS	20/11/2019 09:18	21/11/2019 19:19	20/11/2019 09:18	21/11/2019 19:19	34,01	1	34,01	CHI
201911228082	PALMEIRAS DE GOIAS	TV21203445	FIRMINOPOLIS S2	20/11/2019 09:20	20/11/2019 10:08	20/11/2019 09:20	20/11/2019 10:08	0,80	2	1,60	CHI
201911228085	ARUANA	AK21094393	MOZARLANDIA	20/11/2019 09:20	21/11/2019 16:52	20/11/2019 09:20	21/11/2019 16:52	31,53	1	31,53	CHI
201911228087	MONTE ALEGRE DE GOIAS	MA12233174	SAO DOMINGOS	20/11/2019 09:20	20/11/2019 11:45	20/11/2019 09:20	20/11/2019 11:45	2,41	17	40,94	CHI
201911228089	BALIZA	BH12331338	CAIAPONIA	20/11/2019 06:17	20/11/2019 14:06	20/11/2019 06:17	20/11/2019 14:06	7,81	59	460,69	CHI
201911228092	APARECIDA DE GOIANIA	10005982993	INDEPENDENCIA S2	20/11/2019 09:21	20/11/2019 16:04	20/11/2019 09:21	20/11/2019 16:04	6,71	1	6,71	CHI
201911228093	PIRENOPOLIS	PV21221339	CORUMBA	20/11/2019 09:21	21/11/2019 14:05	20/11/2019 09:21	21/11/2019 14:05	28,73	1	28,73	CHI
201911228094	CRISTALINA	KR12029221	CRISTALINA S1	20/11/2019 09:21	21/11/2019 20:26	20/11/2019 09:21	21/11/2019 20:26	35,08	4	140,32	CHI
201911228097	IPAMERI	6940005105	CRISTALINA S1	20/11/2019 09:21	20/11/2019 11:51	20/11/2019 09:21	20/11/2019 11:51	2,49	1	2,49	CHI
201911228098	CORUMBA DE GOIAS	CB12302154	ALEXANIA	20/11/2019 08:06	20/11/2019 11:42	20/11/2019 08:06	20/11/2019 11:42	3,59	14	50,23	CHI
201911228103	PONTALINA	PK12046026	GOIATUBA S1	19/11/2019 23:22	20/11/2019 11:01	19/11/2019 23:22	20/11/2019 11:01	11,65	23	267,86	CHI
201911228104	PONTALINA	PK21130605	GOIATUBA S1	20/11/2019 09:22	21/11/2019 17:48	20/11/2019 09:22	21/11/2019 17:00	31,64	1	31,64	CHI
201911228104	JOVIANIA	JV12025428	GOIATUBA S1	20/11/2019 09:22	21/11/2019 17:48	20/11/2019 18:34	21/11/2019 17:48	23,25	7	162,74	CHI
201911228104	PONTALINA	JV12025428	GOIATUBA S1	20/11/2019 09:22	21/11/2019 17:48	20/11/2019 18:34	21/11/2019 17:48	23,25	21	488,22	CHI
201911228110	PLANALTINA	PI12262312	PLANALTINA	20/11/2019 07:36	20/11/2019 13:56	20/11/2019 07:36	20/11/2019 13:56	6,33	10	63,31	CHI
201911228114	IPAMERI	IP12292701	IPAMERI	20/11/2019 06:01	21/11/2019 09:28	20/11/2019 06:01	21/11/2019 09:28	27,44	8	219,48	CHI
201911228117	DOVERLANDIA	DV12207830	CAIAPONIA	19/11/2019 23:10	20/11/2019 22:00	19/11/2019 23:10	20/11/2019 22:00	22,83	5	114,16	CHI
201911228133	MINACU	IH21230533	MINACU	20/11/2019 09:25	21/11/2019 14:03	20/11/2019 09:25	21/11/2019 14:03	28,62	1	28,62	CHI
201911228137	BURITI ALEGRE	BG12066316	ITUMBIARA VELHA S2	20/11/2019 09:26	20/11/2019 14:20	20/11/2019 09:26	20/11/2019 14:20	4,90	1	4,90	CHI
201911228202	LUZIANIA	LZ12097577	VIANOPOLIS	20/11/2019 08:38	21/11/2019 12:46	20/11/2019 08:38	21/11/2019 12:46	28,13	3	84,39	CHI
201911228209	CERES	JA12273283	RUBIATABA	20/11/2019 09:28	20/11/2019 11:38	20/11/2019 09:28	20/11/2019 11:38	2,15	4	8,61	CHI
201911228217	JATAI	JT12080473	JATAI S1	20/11/2019 09:29	20/11/2019 14:57	20/11/2019 09:29	20/11/2019 14:57	5,45	2	10,90	CHI

201911228219	BELA VISTA DE GOIAS	03220414	BELA VISTA S2	20/11/2019 11:29	20/11/2019 14:03	20/11/2019 11:29	20/11/2019 11:39	0,15	397	60,21	CHI
201911228219	BELA VISTA DE GOIAS	03220414	BELA VISTA S2	20/11/2019 11:29	20/11/2019 14:03	20/11/2019 11:29	20/11/2019 11:39	0,15	1635	247,98	CHI
201911228219	CALDAZINHA	03220414	BELA VISTA S2	20/11/2019 11:29	20/11/2019 14:03	20/11/2019 11:29	20/11/2019 11:39	0,15	7	1,06	CHI
201911228219	SAO MIGUEL DO PASSA QUATRO	03220414	BELA VISTA S2	20/11/2019 11:29	20/11/2019 14:03	20/11/2019 11:29	20/11/2019 11:39	0,15	123	18,66	CHI
201911228219	SAO MIGUEL DO PASSA QUATRO	03220414	BELA VISTA S2	20/11/2019 11:29	20/11/2019 14:03	20/11/2019 11:29	20/11/2019 11:39	0,15	17	2,58	CHI
201911228219	SILVANIA	03220414	BELA VISTA S2	20/11/2019 11:29	20/11/2019 14:03	20/11/2019 11:29	20/11/2019 11:39	0,15	72	10,92	CHI
201911228219	SILVANIA	03220414	BELA VISTA S2	20/11/2019 11:29	20/11/2019 14:03	20/11/2019 11:29	20/11/2019 11:39	0,15	5	0,76	CHI
201911228219	BELA VISTA DE GOIAS	BV11323324	BELA VISTA S1	20/11/2019 11:29	20/11/2019 14:03	20/11/2019 12:05	20/11/2019 14:03	1,98	122	241,59	CHI
201911228222	CRISTALINA	1060129258	CRISTALINA S1	20/11/2019 09:30	20/11/2019 16:39	20/11/2019 09:30	20/11/2019 16:39	7,14	1	7,14	CHI
201911228236	MONTIVIDIU DO NORTE	MX12187844	PORANGATU	20/11/2019 06:46	20/11/2019 20:15	20/11/2019 06:46	20/11/2019 20:15	13,48	45	606,66	CHI
201911228239	INDIARA	IY12391437	EDEIA	20/11/2019 07:52	20/11/2019 15:40	20/11/2019 07:52	20/11/2019 15:40	7,79	2	15,58	CHI
201911228241	ITABERAI	IB12108113	ITABERAI S2	20/11/2019 09:33	20/11/2019 11:59	20/11/2019 09:33	20/11/2019 11:59	2,43	22	53,40	CHI
201911228243	MINACU	IH12189548	MINACU	20/11/2019 09:33	21/11/2019 17:16	20/11/2019 09:33	21/11/2019 17:16	31,71	4	126,84	CHI
201911228245	CORREGO DO OURO	BS12009575	FIRMINOPOLIS S2	20/11/2019 09:22	20/11/2019 14:12	20/11/2019 09:22	20/11/2019 14:12	4,82	9	43,42	CHI
201911228319	PALMEIRAS DE GOIAS	PL12026608	PALMEIRAS	20/11/2019 09:10	20/11/2019 18:35	20/11/2019 09:10	20/11/2019 18:35	9,41	7	65,89	CHI
201911228603	CRISTALINA	KR12230164LD	PAMPLONA	20/11/2019 09:38	21/11/2019 13:41	20/11/2019 09:38	21/11/2019 13:41	28,05	3	84,16	CHI
201911228606	FAINA	2580007083	GOIAS	20/11/2019 09:39	20/11/2019 12:38	20/11/2019 09:39	20/11/2019 12:38	2,98	1	2,98	CHI
201911228613	CRISTALINA	KR21163143	CRISTALINA S1	20/11/2019 09:40	20/11/2019 21:35	20/11/2019 09:40	20/11/2019 21:35	11,91	1	11,91	CHI
201911228615	JARAGUA	JA12221349	JARAGUA	20/11/2019 06:40	20/11/2019 19:49	20/11/2019 06:40	20/11/2019 19:49	13,16	6	78,99	CHI
201911228617	BELA VISTA DE GOIAS	240038575	BELA VISTA S1	20/11/2019 09:40	20/11/2019 17:13	20/11/2019 09:40	20/11/2019 17:13	7,54	1	7,54	CHI
201911228618	NIQUELANDIA	NQ12265966	NIQUELANDIA SUBTRANSMISSAO	20/11/2019 08:32	20/11/2019 11:10	20/11/2019 08:32	20/11/2019 11:10	2,62	24	62,92	CHI
201911228621	CAIAPONIA	CP12054806	CAIAPONIA	20/11/2019 09:41	20/11/2019 23:19	20/11/2019 09:41	20/11/2019 22:55	13,22	3	39,67	CHI
201911228621	CAIAPONIA	PH12187421	CAIAPONIA	20/11/2019 09:41	20/11/2019 23:19	20/11/2019 22:50	20/11/2019 22:57	0,11	4	0,44	CHI
201911228621	PIRANHAS	PH12187421	CAIAPONIA	20/11/2019 09:41	20/11/2019 23:19	20/11/2019 22:50	20/11/2019 22:57	0,11	1	0,11	CHI
201911228621	CAIAPONIA	PH21187307	CAIAPONIA	20/11/2019 09:41	20/11/2019 23:19	20/11/2019 22:50	20/11/2019 23:19	0,47	1	0,47	CHI
201911228626	VICENTINOPOLIS	VI12263852	VICENTINOPOLIS	20/11/2019 05:20	20/11/2019 12:15	20/11/2019 05:20	20/11/2019 12:15	6,90	7	48,33	CHI
201911228627	SANCLERLANDIA	1210010796	FIRMINOPOLIS S2	20/11/2019 09:42	20/11/2019 19:26	20/11/2019 09:42	20/11/2019 19:26	9,74	1	9,74	CHI
201911228628	PALMEIRAS DE GOIAS	590038527	PALMEIRAS	20/11/2019 09:42	20/11/2019 23:29	20/11/2019 09:42	20/11/2019 23:29	13,78	1	13,78	CHI
201911228635	INDIARA	10017850728	EDEIA	20/11/2019 09:43	20/11/2019 14:20	20/11/2019 09:43	20/11/2019 14:20	4,63	1	4,63	CHI
201911228641	TRINDADE	TR32033242	TRINDADE	20/11/2019 09:43	20/11/2019 15:46	20/11/2019 09:43	20/11/2019 15:46	6,04	5	30,19	CHI
201911228647	GOIANIA	11193396	GOIANIA LESTE S3	20/11/2019 09:44	20/11/2019 12:58	20/11/2019 09:44	20/11/2019 12:58	3,23	1	3,23	CHI
201911228653	GOIATUBA	140087310	GOIATUBA S2	20/11/2019 09:45	21/11/2019 09:42	20/11/2019 09:45	21/11/2019 09:42	23,94	1	23,94	CHI
201911228654	CAIAPONIA	CP12060853	CAIAPONIA	19/11/2019 22:52	20/11/2019 11:39	19/11/2019 22:52	20/11/2019 11:39	12,77	63	804,53	CHI

201911228654	DOVERLANDIA	CP12060853	CAIAPONIA	19/11/2019 22:52	20/11/2019 11:39	19/11/2019 22:52	20/11/2019 11:39	12,77	3	38,31	CHI
201911228656	PIRENOPOLIS	PV12196877	CORUMBA	19/11/2019 17:50	20/11/2019 09:40	19/11/2019 17:50	20/11/2019 09:40	15,83	4	63,32	CHI
201911228660	PLANALTINA	TL12320532	SAO JOAO D ALIANCA	20/11/2019 09:46	21/11/2019 11:50	20/11/2019 09:46	21/11/2019 11:50	26,07	5	130,33	CHI
201911228661	SAO JOAO DA PARAUNA	RP21299211	FIRMINOPOLIS S2	20/11/2019 09:46	21/11/2019 14:00	20/11/2019 09:46	21/11/2019 14:00	28,23	1	28,23	CHI
201911228703	GOIAS	GS11061619	ITABERAI S1	20/11/2019 09:47	20/11/2019 11:11	20/11/2019 09:47	20/11/2019 11:11	1,39	29	40,29	CHI
201911228709	MONTIVIDIU	MV21200189	MONTIVIDIU T	20/11/2019 09:48	21/11/2019 09:00	20/11/2019 09:48	21/11/2019 09:00	23,19	1	23,19	CHI
201911228716	NIQUELANDIA	NQ21235459	NIQUELANDIA SUBTRANSMISSAO	20/11/2019 09:49	20/11/2019 15:54	20/11/2019 09:49	20/11/2019 15:54	6,08	1	6,08	CHI
201911228722	SAO LUIS DE MONTES BELOS	SL12391451	FIRMINOPOLIS S1	20/11/2019 09:44	20/11/2019 11:50	20/11/2019 09:44	20/11/2019 11:50	2,10	13	27,31	CHI
201911228723	GOIANIA	GN11362594	FERROVIARIO S1	20/11/2019 09:50	20/11/2019 12:51	20/11/2019 09:50	20/11/2019 12:51	3,01	70	210,74	CHI
201911228728	MATRINCHA	MP21124874	MATRINCHA	20/11/2019 09:51	21/11/2019 14:02	20/11/2019 09:51	21/11/2019 14:02	28,18	1	28,18	CHI
201911229001	AGUAS LINDAS DE GOIAS	4830003225	AGUAS LINDAS DE GOIAS S1	20/11/2019 09:52	20/11/2019 11:22	20/11/2019 09:52	20/11/2019 11:22	1,50	1	1,50	CHI
201911229203	RIO VERDE	630573797	RIO VERDE S2	20/11/2019 09:52	20/11/2019 13:16	20/11/2019 09:52	20/11/2019 13:16	3,39	1	3,39	CHI
201911229215	INHUMAS	30042173	INHUMAS S2	20/11/2019 09:53	20/11/2019 19:20	20/11/2019 09:53	20/11/2019 19:20	9,45	1	9,45	CHI
201911229302	MINACU	IH11052676	MINACU	20/11/2019 09:52	20/11/2019 15:29	20/11/2019 09:52	20/11/2019 15:29	5,61	126	706,62	CHI
201911229306	NIQUELANDIA	NQ12370600	NIQUELANDIA SUBTRANSMISSAO	20/11/2019 09:54	20/11/2019 19:15	20/11/2019 09:54	20/11/2019 19:15	9,35	2	18,69	CHI
201911229312	RIO VERDE	RV10400561	CABRIUVA S2	20/11/2019 09:37	20/11/2019 12:47	20/11/2019 09:37	20/11/2019 12:47	3,16	132	416,72	CHI
201911229313	PLANALTINA	PI12355789	PLANALTINA	20/11/2019 09:55	20/11/2019 11:44	20/11/2019 09:55	20/11/2019 11:44	1,80	8	14,43	CHI
201911229401	URUACU	UR12003395	URUACU	20/11/2019 09:21	20/11/2019 11:32	20/11/2019 09:21	20/11/2019 11:32	2,18	8	17,43	CHI
201911229402	QUIRINOPOLIS	QI11341060	QUIRINOPOLIS	20/11/2019 09:56	20/11/2019 11:52	20/11/2019 09:56	20/11/2019 11:52	1,92	27	51,97	CHI
201911229504	ANAPOLIS	20520610	ANAPOLIS UNIVERSITARIO S2	20/11/2019 09:58	20/11/2019 11:44	20/11/2019 09:58	20/11/2019 11:44	1,76	1	1,76	CHI
201911229506	NIQUELANDIA	NQ12292134	NIQUELANDIA SUBTRANSMISSAO	20/11/2019 08:23	20/11/2019 14:46	20/11/2019 08:23	20/11/2019 14:46	6,38	27	172,29	CHI
201911229516	NIQUELANDIA	2750088910	NIQUELANDIA SUBTRANSMISSAO	20/11/2019 10:01	20/11/2019 16:11	20/11/2019 10:01	20/11/2019 16:11	6,16	1	6,16	CHI
201911229520	URUACU	UR12281580	URUACU	20/11/2019 10:02	20/11/2019 21:24	20/11/2019 10:02	20/11/2019 21:24	11,36	6	68,16	CHI
201911229521	GOIATUBA	140111621	GOIATUBA S2	20/11/2019 10:03	20/11/2019 19:44	20/11/2019 10:03	20/11/2019 19:44	9,68	1	9,68	CHI
201911229524	ITAPIRAPUA	IU12014785	MATRINCHA	20/11/2019 09:20	21/11/2019 08:18	20/11/2019 09:20	21/11/2019 08:18	22,96	8	183,66	CHI
201911229901	QUIRINOPOLIS	80105350	QUIRINOPOLIS	20/11/2019 10:04	20/11/2019 20:52	20/11/2019 10:04	20/11/2019 20:52	10,79	1	10,79	CHI
201911229902	FORMOSO	TB12185306	PORANGATU	20/11/2019 06:15	20/11/2019 12:38	20/11/2019 06:15	20/11/2019 12:38	6,38	1	6,38	CHI
201911229902	TROMBAS	TB12185306	PORANGATU	20/11/2019 06:15	20/11/2019 12:38	20/11/2019 06:15	20/11/2019 12:38	6,38	10	63,82	CHI
201911229903	ORIZONA	OZ21172810	PIRES DO RIO S2	20/11/2019 10:05	20/11/2019 18:12	20/11/2019 10:05	20/11/2019 18:12	8,11	1	8,11	CHI
201911229904	ITABERAI	IB11183167	ITABERAI S2	20/11/2019 09:35	20/11/2019 14:01	20/11/2019 09:35	20/11/2019 14:01	4,43	107	474,37	CHI
201911229905	APARECIDA DE GOIANIA	AP11003040	REAL S2	20/11/2019 10:05	20/11/2019 12:46	20/11/2019 10:05	20/11/2019 12:46	2,67	72	192,32	CHI
201911229906	CAIAPONIA	10000882770	JATAI S1	19/11/2019 17:50	20/11/2019 20:37	19/11/2019 17:50	20/11/2019 20:37	26,79	1	26,79	CHI
201911229920	NIQUELANDIA	NQ12072538	NIQUELANDIA SUBTRANSMISSAO	20/11/2019 10:06	20/11/2019 13:14	20/11/2019 10:06	20/11/2019 13:14	3,12	2	6,25	CHI

201911229921	GUARAITA	GK12299446	ITAPURANGA	20/11/2019 08:23	20/11/2019 12:40	20/11/2019 08:23	20/11/2019 12:40	4,28	11	47,03	CHI
201911230101	RIO VERDE	4100006550	SANTA HELENA S1	20/11/2019 10:07	20/11/2019 12:16	20/11/2019 10:07	20/11/2019 12:16	2,15	1	2,15	CHI
201911230201	APARECIDA DE GOIANIA	AP12002068	ANHANGUERA	20/11/2019 10:07	20/11/2019 17:18	20/11/2019 10:07	20/11/2019 17:18	7,18	2	14,35	CHI
201911230602	PIRES DO RIO	460038606	PIRES DO RIO S1	20/11/2019 10:09	20/11/2019 17:39	20/11/2019 10:09	20/11/2019 17:39	7,50	1	7,50	CHI
201911230701	CALDAS NOVAS	760206478	SERRA DE CALDAS	20/11/2019 10:10	20/11/2019 19:22	20/11/2019 10:10	20/11/2019 19:22	9,20	0	0,00	CHI
201911230706	ARAGARCAS	AG12234256	ARAGARCAS	20/11/2019 10:07	20/11/2019 15:49	20/11/2019 10:07	20/11/2019 15:49	5,69	17	96,72	CHI
201911230707	MINACU	4020004834	MINACU	20/11/2019 10:10	21/11/2019 08:10	20/11/2019 10:10	21/11/2019 08:10	21,99	1	21,99	CHI
201911230802	NOVA VENEZA	10000661242	INHUMAS S1	20/11/2019 10:10	20/11/2019 11:42	20/11/2019 10:10	20/11/2019 11:42	1,52	1	1,52	CHI
201911230804	RIO VERDE	RV12279418	ACREUNA	20/11/2019 10:11	21/11/2019 16:30	20/11/2019 10:11	21/11/2019 16:30	30,31	1	30,31	CHI
201911230808	BOM JARDIM DE GOIAS	BM12097835	BOM JARDIM	20/11/2019 10:08	20/11/2019 13:27	20/11/2019 10:08	20/11/2019 13:27	3,32	8	26,53	CHI
201911230903	PORANGATU	PO21265804	PORANGATU	20/11/2019 10:12	21/11/2019 08:24	20/11/2019 10:12	21/11/2019 08:24	22,19	1	22,19	CHI
201911230910	ITAPURANGA	170045523	ITAPURANGA	20/11/2019 10:13	20/11/2019 11:30	20/11/2019 10:13	20/11/2019 11:30	1,28	1	1,28	CHI
201911230911	CORUMBAIBA	CI11298777	VILA CORUMBA	20/11/2019 09:22	20/11/2019 22:55	20/11/2019 09:22	20/11/2019 22:55	13,54	64	866,77	CHI
201911230912	PIRENOPOLIS	PV21121842	CORUMBA	20/11/2019 10:14	21/11/2019 13:46	20/11/2019 10:14	21/11/2019 13:46	27,53	1	27,53	CHI
201911230914	GOIANIA	14116017	CARAJAS S2	20/11/2019 10:14	20/11/2019 13:37	20/11/2019 10:14	20/11/2019 13:37	3,37	1	3,37	CHI
201911230915	MINACU	4020008049	MINACU	20/11/2019 10:14	21/11/2019 10:17	20/11/2019 10:14	21/11/2019 10:17	24,05	1	24,05	CHI
201911230917	FORMOSA	FA12218592	ITUIQUIRA	20/11/2019 06:52	20/11/2019 13:23	20/11/2019 06:52	20/11/2019 13:23	6,51	6	39,08	CHI
201911231002	GOIANIA	10017557133	GOYA S2	20/11/2019 10:15	20/11/2019 11:05	20/11/2019 10:15	20/11/2019 11:05	0,83	1	0,83	CHI
201911231203	QUIRINOPOLIS	QI32053165	QUIRINOPOLIS	20/11/2019 16:04	20/11/2019 19:16	20/11/2019 16:04	20/11/2019 19:16	3,19	8	25,52	CHI
201911231206	MARZAGAO	970011544	VILA CORUMBA	20/11/2019 10:16	20/11/2019 13:59	20/11/2019 10:16	20/11/2019 13:59	3,71	1	3,71	CHI
201911231207	ITUMBIARA	690341519	PARANAIBA	20/11/2019 10:17	20/11/2019 14:34	20/11/2019 10:17	20/11/2019 14:34	4,28	1	4,28	CHI
201911231212	CALDAS NOVAS	PJ12293372	CALDAS NOVAS S1	20/11/2019 08:50	21/11/2019 11:03	20/11/2019 08:50	21/11/2019 11:03	26,20	1	26,20	CHI
201911231212	PIRACANJUBA	PJ12293372	CALDAS NOVAS S1	20/11/2019 08:50	21/11/2019 11:03	20/11/2019 08:50	21/11/2019 11:03	26,20	5	131,02	CHI
201911231711	GOIANIA	10012056500	CAMPINAS S1	20/11/2019 10:20	21/11/2019 07:43	20/11/2019 10:20	21/11/2019 07:43	21,38	1	21,38	CHI
201911231715	CAIAPONIA	CP12014170	PALESTINA	20/11/2019 09:24	20/11/2019 15:02	20/11/2019 09:24	20/11/2019 15:02	5,62	2	11,24	CHI
201911231715	PALESTINA DE GOIAS	CP12014170	PALESTINA	20/11/2019 09:24	20/11/2019 15:02	20/11/2019 09:24	20/11/2019 15:02	5,62	6	33,72	CHI
201911231801	CAMPINACU	IH12192447	MINACU	20/11/2019 05:25	21/11/2019 02:10	20/11/2019 05:25	21/11/2019 02:10	20,74	5	103,68	CHI
201911231801	MINACU	IH12192447	MINACU	20/11/2019 05:25	21/11/2019 02:10	20/11/2019 05:25	21/11/2019 02:10	20,74	24	497,65	CHI
201911231902	AGUA FRIA DE GOIAS	NQ12270128RE	SAO JOAO D ALIANCA	20/11/2019 10:21	22/11/2019 21:43	21/11/2019 16:41	21/11/2019 17:08	0,44	70	31,11	CHI
201911231902	NIQUELANDIA	NQ12270128RE	SAO JOAO D ALIANCA	20/11/2019 10:21	22/11/2019 21:43	21/11/2019 16:41	21/11/2019 17:08	0,44	18	8,00	CHI
201911231902	AGUA FRIA DE GOIAS	NQ12270128RE	SAO JOAO D ALIANCA	20/11/2019 10:21	22/11/2019 21:43	21/11/2019 22:24	22/11/2019 21:43	23,32	70	1632,36	CHI
201911231902	NIQUELANDIA	NQ12270128RE	SAO JOAO D ALIANCA	20/11/2019 10:21	22/11/2019 21:43	21/11/2019 22:24	22/11/2019 21:43	23,32	18	419,75	CHI
201911231904	MARA ROSA	MQ12320749	MARA ROSA	20/11/2019 10:21	21/11/2019 15:25	20/11/2019 10:21	21/11/2019 15:25	29,05	2	58,11	CHI

201911231906	LUZIANIA	LZ21214988	VIANOPOLIS	20/11/2019 10:21	21/11/2019 09:21	20/11/2019 10:21	21/11/2019 09:21	22,98	1	22,98	CHI
201911231907	PALESTINA DE GOIAS	PY12396120	PALESTINA	20/11/2019 06:42	20/11/2019 13:20	20/11/2019 06:42	20/11/2019 13:20	6,63	12	79,53	CHI
201911232101	INHUMAS	IN21132798	INHUMAS S2	20/11/2019 10:24	20/11/2019 15:30	20/11/2019 10:24	20/11/2019 15:30	5,09	1	5,09	CHI
201911232105	LUZIANIA	LZ12389577	VIANOPOLIS	20/11/2019 10:25	21/11/2019 10:13	20/11/2019 10:25	21/11/2019 10:13	23,79	3	71,38	CHI
201911232108	FLORES DE GOIAS	FB12245566	IACIARA S2	20/11/2019 09:57	20/11/2019 12:59	20/11/2019 09:57	20/11/2019 12:59	3,02	71	214,58	CHI
201911232108	SITIO D ABADIA	FB12245566	IACIARA S2	20/11/2019 09:57	20/11/2019 12:59	20/11/2019 09:57	20/11/2019 12:59	3,02	38	114,84	CHI
201911232109	LUZIANIA	120408582	RIO VERMELHO	20/11/2019 10:25	20/11/2019 12:14	20/11/2019 10:25	20/11/2019 12:14	1,81	1	1,81	CHI
201911232111	CALDAS NOVAS	10029420260	SERRA DE CALDAS	20/11/2019 10:25	20/11/2019 16:53	20/11/2019 10:25	20/11/2019 16:53	6,46	1	6,46	CHI
201911232112	INHUMAS	30143226	INHUMAS S2	20/11/2019 10:25	20/11/2019 14:29	20/11/2019 10:25	20/11/2019 14:29	4,05	1	4,05	CHI
201911232118	PIRENOPOLIS	220052037	CORUMBA	20/11/2019 10:27	21/11/2019 14:17	20/11/2019 10:27	21/11/2019 14:17	27,83	1	27,83	CHI
201911232121	MOZARLANDIA	MZ21093347	MOZARLANDIA	20/11/2019 10:27	20/11/2019 15:43	20/11/2019 10:27	20/11/2019 15:43	5,25	1	5,25	CHI
201911232123	SAO DOMINGOS	SD11262206	SAO DOMINGOS	20/11/2019 10:28	20/11/2019 18:55	20/11/2019 10:28	20/11/2019 18:55	8,45	134	1131,82	CHI
201911232605	IACIARA	GY21379721	IACIARA S1	20/11/2019 10:09	21/11/2019 14:27	20/11/2019 10:09	21/11/2019 14:27	28,29	1	28,29	CHI
201911232608	DAVINOPOLIS	IO12000011RE	CATALAO S1	20/11/2019 09:08	20/11/2019 20:14	20/11/2019 09:08	20/11/2019 20:14	11,09	33	366,10	CHI
201911232608	DISTRITO FEDERAL	IO12000011RE	CATALAO S1	20/11/2019 09:08	20/11/2019 20:14	20/11/2019 09:08	20/11/2019 20:14	11,09	3	33,28	CHI
201911232608	OUVIDOR	IO12000011RE	CATALAO S1	20/11/2019 09:08	20/11/2019 20:14	20/11/2019 09:08	20/11/2019 20:14	11,09	12	133,13	CHI
201911232608	TRES RANCHOS	IO12000011RE	CATALAO S1	20/11/2019 09:08	20/11/2019 20:14	20/11/2019 09:08	20/11/2019 20:14	11,09	4	44,38	CHI
201911232609	ARAGOIANIA	680009322	GUAPO S2	20/11/2019 10:31	20/11/2019 22:44	20/11/2019 10:31	20/11/2019 22:44	12,22	1	12,22	CHI
201911232616	IPORA	IR21070228	IPORA	20/11/2019 10:32	20/11/2019 14:25	20/11/2019 10:32	20/11/2019 14:25	3,88	2	7,75	CHI
201911232623	JARAGUA	JA21059952	JARAGUA	20/11/2019 10:33	20/11/2019 16:07	20/11/2019 10:33	20/11/2019 16:07	5,56	1	5,56	CHI
201911232633	RIO VERDE	RV12338538	MONTIVIDIU T	20/11/2019 08:57	20/11/2019 21:40	20/11/2019 08:57	20/11/2019 21:40	12,72	11	139,91	CHI
201911232636	GOIANIA	11716289	CARAJAS S2	20/11/2019 10:36	20/11/2019 15:42	20/11/2019 10:36	20/11/2019 15:42	5,09	1	5,09	CHI
201911232639	MINEIROS	1390023488	PARQUE DAS EMAS	20/11/2019 10:37	20/11/2019 13:55	20/11/2019 10:37	20/11/2019 13:55	3,30	1	3,30	CHI
201911232645	MONTIVIDIU	MV12295835	MONTIVIDIU T	20/11/2019 10:37	21/11/2019 11:30	20/11/2019 10:37	21/11/2019 11:30	24,88	1	24,88	CHI
201911232647	GOIATUBA	VI12257172	VICENTINOPOLIS	20/11/2019 10:37	20/11/2019 14:54	20/11/2019 10:37	20/11/2019 14:54	4,27	2	8,54	CHI
201911232801	GOIANIRA	10013017223	GOIANIRA	20/11/2019 10:39	20/11/2019 17:09	20/11/2019 10:39	20/11/2019 17:09	6,50	1	6,50	CHI
201911232804	PLANALTINA	PI21218353	PLANALTINA	20/11/2019 10:40	21/11/2019 12:29	20/11/2019 10:40	21/11/2019 12:29	25,83	1	25,83	CHI
201911232805	GOIANIA	15652245	FERROVIARIO S2	20/11/2019 10:40	20/11/2019 17:09	20/11/2019 10:40	20/11/2019 17:09	6,47	1	6,47	CHI
201911232806	SAO JOAO D ALIANCA	3840012051	SAO JOAO D ALIANCA	20/11/2019 10:40	20/11/2019 18:03	20/11/2019 10:40	20/11/2019 18:03	7,37	1	7,37	CHI
201911232807	PONTALINA	PK12109373	PONTALINA	20/11/2019 09:39	20/11/2019 14:17	20/11/2019 09:39	20/11/2019 14:17	4,63	5	23,16	CHI
201911232810	MARA ROSA	MQ12072578	MARA ROSA	20/11/2019 10:41	20/11/2019 15:31	20/11/2019 10:41	20/11/2019 15:31	4,83	6	28,97	CHI
201911232902	CRISTALINA	KR12230156	PAMPLONA	20/11/2019 09:54	20/11/2019 12:51	20/11/2019 09:54	20/11/2019 12:51	2,94	16	47,01	CHI
201911233103	NOVO BRASIL	NB12396223	JUSSARA	20/11/2019 07:47	21/11/2019 15:44	20/11/2019 07:47	21/11/2019 15:44	31,95	4	127,79	CHI

201911233113	PIRENOPOLIS	PV12334636	CORUMBA	20/11/2019 09:16	20/11/2019 13:47	20/11/2019 09:16	20/11/2019 13:47	4,51	13	58,57	CHI
201911233201	GOIANIA	10726093	ATLANTICO S3	20/11/2019 10:47	20/11/2019 21:43	20/11/2019 10:47	20/11/2019 21:43	10,92	1	10,92	CHI
201911233204	BOM JARDIM DE GOIAS	BM21184276	BOM JARDIM	20/11/2019 10:47	20/11/2019 15:01	20/11/2019 10:47	20/11/2019 15:01	4,22	2	8,44	CHI
201911233212	EDEIA	EA21204405	EDEIA	20/11/2019 10:50	21/11/2019 09:55	20/11/2019 10:50	21/11/2019 09:55	23,08	1	23,08	CHI
201911233404	BARRO ALTO	BA21294088	BARRO ALTO	20/11/2019 10:51	22/11/2019 02:21	20/11/2019 10:51	22/11/2019 02:21	39,49	1	39,49	CHI
201911233410	SENADOR CANEDO	DE12398863	SENADOR CANEDO	20/11/2019 10:52	20/11/2019 13:17	20/11/2019 10:52	20/11/2019 13:17	2,41	3	7,22	CHI
201911233601	URUACU	UR21117935	URUACU	20/11/2019 10:53	20/11/2019 12:50	20/11/2019 10:53	20/11/2019 12:50	1,94	1	1,94	CHI
201911233705	GOIATUBA	GT12044612	GOIATUBA S1	20/11/2019 10:54	20/11/2019 11:46	20/11/2019 10:54	20/11/2019 11:46	0,86	2	1,72	CHI
201911233708	SAO LUIS DE MONTES BELOS	10005960647	SAO LUIZ DOS MONTES BELOS	20/11/2019 10:52	20/11/2019 14:27	20/11/2019 10:52	20/11/2019 14:27	3,59	1	3,59	CHI
201911233719	OUVIDOR	OU21140980	CATALAO S1	20/11/2019 10:55	20/11/2019 14:08	20/11/2019 10:55	20/11/2019 14:08	3,22	2	6,43	CHI
201911233723	APARECIDA DE GOIANIA	14096651	ATLANTICO S2	20/11/2019 10:55	20/11/2019 12:11	20/11/2019 10:55	20/11/2019 12:11	1,26	1	1,26	CHI
201911233725	PADRE BERNARDO	PB12093757	PADRE BERNARDO	20/11/2019 10:55	20/11/2019 21:17	20/11/2019 10:55	20/11/2019 21:17	10,35	4	41,41	CHI
201911233726	AGUA FRIA DE GOIAS	JL12342443	SAO JOAO D ALIANCA	20/11/2019 10:39	22/11/2019 09:19	20/11/2019 10:39	22/11/2019 09:19	46,65	4	186,62	CHI
201911233726	NIQUELANDIA	JL12342443	SAO JOAO D ALIANCA	20/11/2019 10:39	22/11/2019 09:19	20/11/2019 10:39	22/11/2019 09:19	46,65	2	93,31	CHI
201911233726	SAO JOAO D ALIANCA	JL12342443	SAO JOAO D ALIANCA	20/11/2019 10:39	22/11/2019 09:19	20/11/2019 10:39	22/11/2019 09:19	46,65	3	139,96	CHI
201911233727	ORIZONA	OZ12372377	PIRES DO RIO S2	20/11/2019 08:50	20/11/2019 19:42	20/11/2019 08:50	20/11/2019 19:42	10,86	28	303,96	CHI
201911233902	DOVERLANDIA	DV133953835	CAIAPONIA	20/11/2019 16:15	20/11/2019 17:23	20/11/2019 16:15	20/11/2019 17:23	1,13	227	256,51	CHI
201911233903	AGUA LIMPA	RQ12050878	VILA CORUMBA	20/11/2019 10:56	21/11/2019 01:41	20/11/2019 10:56	21/11/2019 01:41	14,74	2	29,48	CHI
201911233904	RIO VERDE	RV12340902	RIO VERDE S1	20/11/2019 10:56	20/11/2019 20:29	20/11/2019 10:56	20/11/2019 20:29	9,54	35	333,93	CHI
201911233906	GOIANIA	14719502	ATLANTICO S1	20/11/2019 10:57	20/11/2019 17:30	20/11/2019 10:57	20/11/2019 17:30	6,54	1	6,54	CHI
201911233921	VILA BOA	VB12394154	ITUIQUIRA	20/11/2019 05:58	20/11/2019 23:42	20/11/2019 05:58	20/11/2019 23:42	17,73	3	53,19	CHI
201911233923	NIQUELANDIA	10002762208	NIQUELANDIA SUBTRANSMISSAO	20/11/2019 09:14	20/11/2019 23:41	20/11/2019 09:14	20/11/2019 23:41	14,45	1	14,45	CHI
201911234102	GOIAS	90035148	GOIAS	20/11/2019 11:00	20/11/2019 12:41	20/11/2019 11:00	20/11/2019 12:41	1,68	1	1,68	CHI
201911234105	ITUMBIARA	IT21097342	ITUMBIARA VELHA S1	20/11/2019 11:00	20/11/2019 15:33	20/11/2019 11:00	20/11/2019 15:33	4,54	1	4,54	CHI
201911234110	ANAPOLIS	20160288	ANAPOLIS UNIVERSITARIO S2	20/11/2019 11:01	20/11/2019 15:13	20/11/2019 11:01	20/11/2019 15:13	4,19	1	4,19	CHI
201911234113	GOUVELANDIA	2250018462	QUIRINOPOLIS	20/11/2019 11:02	20/11/2019 18:05	20/11/2019 11:02	20/11/2019 18:05	7,06	1	7,06	CHI
201911234115	RIO VERDE	RV12098515	MONTIVIDIU T	20/11/2019 11:02	21/11/2019 13:04	20/11/2019 11:02	21/11/2019 13:04	26,02	1	26,02	CHI
201911234122	ARAGOIANIA	AO32000019	GUAPO S2	20/11/2019 10:46	20/11/2019 20:55	20/11/2019 10:46	20/11/2019 20:55	10,14	15	152,11	CHI
201911234125	NIQUELANDIA	NQ12251000	URUACU	20/11/2019 11:04	20/11/2019 19:14	20/11/2019 11:04	20/11/2019 19:14	8,15	62	505,58	CHI
201911234126	CALDAS NOVAS	CN21244269	SERRA DE CALDAS	20/11/2019 11:05	20/11/2019 17:26	20/11/2019 11:05	20/11/2019 17:26	6,35	1	6,35	CHI
201911234127	GOIANDIRA	GD21042539	CATALAO S1	20/11/2019 11:05	20/11/2019 18:54	20/11/2019 11:05	20/11/2019 18:54	7,82	1	7,82	CHI
201911234128	GOIATUBA	BJ21030802	RIO DOS BOIS	20/11/2019 11:05	21/11/2019 11:42	20/11/2019 11:05	21/11/2019 11:42	24,61	1	24,61	CHI
201911234137	LEOPOLDO DE BULHOES	LB31068732	DAIA S1	20/11/2019 11:06	21/11/2019 09:43	20/11/2019 11:06	21/11/2019 09:43	22,61	2	45,22	CHI

201911234138	JATAI	JT21267767	JATAI S1	20/11/2019 11:06	21/11/2019 16:15	20/11/2019 11:06	21/11/2019 16:15	29,14	1	29,14	CHI
201911234143	FIRMINOPOLIS	FR21125170	FIRMINOPOLIS S1	20/11/2019 11:07	20/11/2019 16:15	20/11/2019 11:07	20/11/2019 16:15	5,12	1	5,12	CHI
201911234155	FORMOSO	FO12185308	PORANGATU	20/11/2019 05:43	20/11/2019 13:10	20/11/2019 05:43	20/11/2019 13:10	7,44	4	29,76	CHI
201911234305	AGUA FRIA DE GOIAS	TL10394719	SAO JOAO D ALIANCA	20/11/2019 10:55	20/11/2019 18:33	20/11/2019 10:55	20/11/2019 13:17	2,38	1613	3841,63	CHI
201911234305	MIMOSO DE GOIAS	TL10394719	SAO JOAO D ALIANCA	20/11/2019 10:55	20/11/2019 18:33	20/11/2019 10:55	20/11/2019 13:17	2,38	28	66,69	CHI
201911234305	AGUA FRIA DE GOIAS	TL10394719	SAO JOAO D ALIANCA	20/11/2019 10:55	20/11/2019 18:33	20/11/2019 14:16	20/11/2019 14:19	0,06	1613	92,30	CHI
201911234305	MIMOSO DE GOIAS	TL10394719	SAO JOAO D ALIANCA	20/11/2019 10:55	20/11/2019 18:33	20/11/2019 14:16	20/11/2019 14:19	0,06	28	1,60	CHI
201911234305	AGUA FRIA DE GOIAS	TL12265501LD	SAO JOAO D ALIANCA	20/11/2019 10:55	20/11/2019 18:33	20/11/2019 10:55	20/11/2019 15:40	4,76	34	161,89	CHI
201911234305	PLANALTINA	TL12265501LD	SAO JOAO D ALIANCA	20/11/2019 10:55	20/11/2019 18:33	20/11/2019 10:55	20/11/2019 15:40	4,76	250	1190,35	CHI
201911234305	AGUA FRIA DE GOIAS	TL12265501LD	SAO JOAO D ALIANCA	20/11/2019 10:55	20/11/2019 18:33	20/11/2019 10:55	20/11/2019 18:33	7,64	1	7,64	CHI
201911234306	CALDAS NOVAS	CN12186173	SERRA DE CALDAS	20/11/2019 11:12	20/11/2019 23:04	20/11/2019 11:12	20/11/2019 23:04	11,87	7	83,06	CHI
201911234308	CAIAPONIA	CP12395452	PALESTINA	20/11/2019 11:12	20/11/2019 16:15	20/11/2019 11:12	20/11/2019 16:15	5,05	28	141,31	CHI
201911234401	ANAPOLIS	AN12341958LD	ANAPOLIS UNIVERSITARIO S2	20/11/2019 10:49	20/11/2019 19:07	20/11/2019 10:49	20/11/2019 19:07	8,30	225	1866,69	CHI
201911234405	JATAI	290259241	JATAI S1	20/11/2019 11:13	21/11/2019 16:24	20/11/2019 11:13	21/11/2019 16:24	29,18	1	29,18	CHI
201911234426	CATALAO	CT21250339	CATALAO S1	20/11/2019 11:16	20/11/2019 17:10	20/11/2019 11:16	20/11/2019 17:10	5,90	2	11,79	CHI
201911234801	VIANOPOLIS	VN21107962	VIANOPOLIS	20/11/2019 11:18	21/11/2019 18:31	20/11/2019 11:18	21/11/2019 18:31	31,22	2	62,44	CHI
201911234803	MARA ROSA	MQ12353877	SANTA TEREZINHA	20/11/2019 11:18	21/11/2019 10:01	20/11/2019 11:18	21/11/2019 10:01	22,70	4	90,81	CHI
201911234806	RIO VERDE	630129836	RIO VERDE S2	20/11/2019 11:19	20/11/2019 15:34	20/11/2019 11:19	20/11/2019 15:34	4,26	1	4,26	CHI
201911234810	SIMOLANDIA	1940005957	IACIARA S2	20/11/2019 11:19	21/11/2019 17:48	20/11/2019 11:19	21/11/2019 17:48	30,48	1	30,48	CHI
201911235003	SANTA BARBARA DE GOIAS	1030015226	TRINDADE	20/11/2019 11:21	20/11/2019 16:05	20/11/2019 11:21	20/11/2019 16:05	4,72	1	4,72	CHI
201911235006	PIRACANJUBA	PJ21161201	PIRACANJUBA	20/11/2019 16:40	21/11/2019 12:33	20/11/2019 16:40	21/11/2019 12:19	19,65	2	39,30	CHI
201911235006	PIRACANJUBA	PJ12212207	PIRACANJUBA	20/11/2019 16:40	21/11/2019 12:33	21/11/2019 11:09	21/11/2019 12:33	1,39	7	9,70	CHI
201911235007	GOIANIA	GN11001669	ATLANTICO S3	20/11/2019 10:54	20/11/2019 15:34	20/11/2019 10:54	20/11/2019 15:34	4,65	58	269,89	CHI
201911235010	JATAI	JT21274149	JATAI S3	20/11/2019 11:23	20/11/2019 11:29	20/11/2019 11:23	20/11/2019 11:29	0,09	1	0,09	CHI
201911235013	COLINAS DO SUL	10030473762	MINACU	20/11/2019 11:23	20/11/2019 21:19	20/11/2019 11:23	20/11/2019 21:19	9,92	0	0,00	CHI
201911235014	APARECIDA DE GOIANIA	13284289	INDEPENDENCIA S1	20/11/2019 11:24	20/11/2019 17:34	20/11/2019 11:24	20/11/2019 17:34	6,15	1	6,15	CHI
201911235015	TURVANIA	TV21005626	FIRMINOPOLIS S2	20/11/2019 11:25	20/11/2019 13:15	20/11/2019 11:25	20/11/2019 13:15	1,84	1	1,84	CHI
201911235016	VIANOPOLIS	VN21052220	VIANOPOLIS	20/11/2019 11:25	21/11/2019 12:42	20/11/2019 11:25	21/11/2019 12:42	25,29	1	25,29	CHI
201911235019	RIO VERDE	RV12260652	MONTIVIDIU T	20/11/2019 11:25	21/11/2019 10:11	20/11/2019 11:25	21/11/2019 10:11	22,77	2	45,53	CHI
201911235104	MINACU	IH21220734	MINACU	20/11/2019 11:26	21/11/2019 12:48	20/11/2019 11:26	21/11/2019 12:48	25,35	2	50,71	CHI
201911235106	CAMPOS VERDES	3790013120	SANTA TEREZINHA	20/11/2019 11:27	20/11/2019 15:23	20/11/2019 11:27	20/11/2019 15:23	3,93	1	3,93	CHI
201911235110	EDEIA	EA21044022	EDEIA	20/11/2019 11:28	21/11/2019 11:22	20/11/2019 11:28	21/11/2019 11:22	23,91	1	23,91	CHI
201911235111	FORMOSA	FA21042020	ITUIQUIRA	20/11/2019 11:28	21/11/2019 15:33	20/11/2019 11:28	21/11/2019 15:33	28,09	1	28,09	CHI

201911235301	ARUANA	AK12274204	ARUANA	20/11/2019 11:28	20/11/2019 16:43	20/11/2019 11:28	20/11/2019 16:43	5,24	1	5,24	CHI
201911235403	IACIARA	IA11195976	IACIARA S1	20/11/2019 10:18	20/11/2019 13:44	20/11/2019 10:18	20/11/2019 13:44	3,43	62	212,85	CHI
201911235417	CAIAPONIA	CP12191771	MONTIVIDIU T	20/11/2019 11:32	20/11/2019 17:30	20/11/2019 11:32	20/11/2019 17:30	5,97	10	59,66	CHI
201911235417	JATAI	CP12191771	MONTIVIDIU T	20/11/2019 11:32	20/11/2019 17:30	20/11/2019 11:32	20/11/2019 17:30	5,97	7	41,76	CHI
201911235417	RIO VERDE	CP12191771	MONTIVIDIU T	20/11/2019 11:32	20/11/2019 17:30	20/11/2019 11:32	20/11/2019 17:30	5,97	9	53,70	CHI
201911235421	ABADIANIA	AN12001083	ANAPOLIS UNIVERSITARIO S2	20/11/2019 10:13	20/11/2019 15:51	20/11/2019 10:13	20/11/2019 15:51	5,62	30	168,62	CHI
201911235422	TRINDADE	13935598	GOYA S2	20/11/2019 11:32	20/11/2019 14:16	20/11/2019 11:32	20/11/2019 14:16	2,73	1	2,73	CHI
201911235423	CRIXAS	CX21154189	RUBIATABA	20/11/2019 11:32	20/11/2019 23:56	20/11/2019 11:32	20/11/2019 23:56	12,39	1	12,39	CHI
201911235426	CORREGO DO OURO	CO12277714	FIRMINOPOLIS S2	20/11/2019 11:06	21/11/2019 11:20	20/11/2019 11:06	21/11/2019 11:20	24,23	13	314,96	CHI
201911235427	PIRENOPOLIS	PV12381209	CORUMBA	20/11/2019 08:24	20/11/2019 18:29	20/11/2019 08:24	20/11/2019 18:29	10,07	3	30,21	CHI
201911235428	FLORES DE GOIAS	FB12384211	IACIARA S2	20/11/2019 05:37	20/11/2019 21:57	20/11/2019 05:37	20/11/2019 21:57	16,33	124	2024,68	CHI
201911235428	FORMOSA	FB12384211	IACIARA S2	20/11/2019 05:37	20/11/2019 21:57	20/11/2019 05:37	20/11/2019 21:57	16,33	1	16,33	CHI
201911235428	VILA BOA	FB12384211	IACIARA S2	20/11/2019 05:37	20/11/2019 21:57	20/11/2019 05:37	20/11/2019 21:57	16,33	4	65,31	CHI
201911235432	PORANGATU	PO12403391	PORANGATU	20/11/2019 11:00	21/11/2019 00:38	20/11/2019 11:00	21/11/2019 00:38	13,63	31	422,45	CHI
201911235440	CAMPOS BELOS	CH12224199	SAO DOMINGOS	20/11/2019 11:35	20/11/2019 14:35	20/11/2019 11:35	20/11/2019 14:35	2,99	4	11,96	CHI
201911235442	BELA VISTA DE GOIAS	BV21364034	BELA VISTA S1	20/11/2019 11:35	21/11/2019 09:50	20/11/2019 11:35	21/11/2019 09:50	22,23	2	44,47	CHI
201911235443	PORTELANDIA	PW12046135	PARQUE DAS EMAS	20/11/2019 11:19	20/11/2019 15:30	20/11/2019 11:19	20/11/2019 15:30	4,18	168	701,63	CHI
201911235506	BELA VISTA DE GOIAS	BV31168318	BELA VISTA S2	20/11/2019 11:37	20/11/2019 19:05	20/11/2019 11:37	20/11/2019 19:05	7,47	1	7,47	CHI
201911235507	SANTO ANTONIO DO DESCOBERTO	2210177784	AGUAS LINDAS DE GOIAS S2	20/11/2019 11:37	20/11/2019 13:02	20/11/2019 11:37	20/11/2019 13:02	1,41	1	1,41	CHI
201911235515	INDIARA	2710011925	EDEIA	20/11/2019 11:38	20/11/2019 15:50	20/11/2019 11:38	20/11/2019 15:50	4,21	1	4,21	CHI
201911235517	SENADOR CANEDO	10020509934	SENADOR CANEDO	20/11/2019 11:38	20/11/2019 14:59	20/11/2019 11:38	20/11/2019 14:59	3,34	1	3,34	CHI
201911235518	GOIANIA	16553457	FERROVIARIO S1	20/11/2019 11:38	20/11/2019 20:06	20/11/2019 11:38	20/11/2019 20:06	8,47	1	8,47	CHI
201911235520	GOIANIA	15297871	ATLANTICO S1	20/11/2019 11:38	21/11/2019 12:38	20/11/2019 11:38	21/11/2019 12:38	24,99	1	24,99	CHI
201911235525	MORRINHOS	MR12031171	MORRINHOS	20/11/2019 11:39	20/11/2019 12:58	20/11/2019 11:39	20/11/2019 12:58	1,31	100	130,75	CHI
201911235530	COCALZINHO DE GOIAS	ZN11315371	GOIANESIA S1	20/11/2019 11:40	21/11/2019 11:15	20/11/2019 11:40	21/11/2019 11:15	23,58	1	23,58	CHI
201911235533	CALDAS NOVAS	CN12182834	SERRA DE CALDAS	20/11/2019 11:40	20/11/2019 16:08	20/11/2019 11:40	20/11/2019 16:08	4,46	2	8,92	CHI
201911235536	COLINAS DO SUL	BF12253204	NIQUELANDIA SUBTRANSMISSAO	20/11/2019 11:40	20/11/2019 15:21	20/11/2019 11:40	20/11/2019 15:21	3,68	8	29,41	CHI
201911235536	NIQUELANDIA	BF12253204	NIQUELANDIA SUBTRANSMISSAO	20/11/2019 11:40	20/11/2019 15:21	20/11/2019 11:40	20/11/2019 15:21	3,68	3	11,03	CHI
201911235538	BELA VISTA DE GOIAS	BV21238099	BELA VISTA S2	20/11/2019 11:40	21/11/2019 10:53	20/11/2019 11:40	21/11/2019 10:53	23,20	1	23,20	CHI
201911235544	PIRANHAS	PH12201806	PIRANHAS	20/11/2019 09:02	20/11/2019 16:32	20/11/2019 09:02	20/11/2019 16:32	7,50	40	300,18	CHI
201911235606	SIMOLANDIA	1940020855	IACIARA S2	20/11/2019 11:43	21/11/2019 18:13	20/11/2019 11:43	21/11/2019 18:13	30,50	1	30,50	CHI
201911235613	CRISTALINA	3490008430	PAMPLONA	20/11/2019 11:43	21/11/2019 13:00	20/11/2019 11:43	21/11/2019 13:00	25,27	1	25,27	CHI
201911235614	GOIANIA	11545604	FERROVIARIO S1	20/11/2019 11:43	20/11/2019 20:09	20/11/2019 11:43	20/11/2019 20:09	8,42	1	8,42	CHI

201911235615	PILAR DE GOIAS	GG21237788	URUACU	20/11/2019 11:44	20/11/2019 14:43	20/11/2019 11:44	20/11/2019 14:43	2,98	1	2,98	CHI
201911235616	GOIANIA	10026919549	GOYA S2	20/11/2019 11:43	21/11/2019 12:16	20/11/2019 11:43	21/11/2019 12:16	24,54	1	24,54	CHI
201911235617	JUSSARA	JR21138347	IPORA	20/11/2019 11:44	21/11/2019 10:30	20/11/2019 11:44	21/11/2019 10:30	22,76	1	22,76	CHI
201911235621	RIO VERDE	10014108370	RIO VERDE S1	20/11/2019 11:45	20/11/2019 14:59	20/11/2019 11:45	20/11/2019 14:59	3,23	1	3,23	CHI
201911235627	ARAGOIANIA	680041965	GUAPO S2	20/11/2019 11:47	21/11/2019 00:18	20/11/2019 11:47	21/11/2019 00:18	12,53	1	12,53	CHI
201911235635	ANAPOLIS	AN11096605	JUNDIAI S2	20/11/2019 11:37	20/11/2019 18:52	20/11/2019 11:37	20/11/2019 18:52	7,24	96	694,64	CHI
201911235636	SAO JOAO D ALIANCA	10007222066	SAO JOAO D ALIANCA	20/11/2019 11:48	20/11/2019 21:21	20/11/2019 11:48	20/11/2019 21:21	9,54	1	9,54	CHI
201911235637	GOIANIA	14683581	CARAJAS S1	20/11/2019 11:48	20/11/2019 15:46	20/11/2019 11:48	20/11/2019 15:46	3,96	1	3,96	CHI
201911235648	FLORES DE GOIAS	FB12106993	FLORES DE GOIAS	20/11/2019 05:44	20/11/2019 17:49	20/11/2019 05:44	20/11/2019 17:49	12,09	15	181,33	CHI
201911235648	FORMOSA	FB12106993	FLORES DE GOIAS	20/11/2019 05:44	20/11/2019 17:49	20/11/2019 05:44	20/11/2019 17:49	12,09	137	1656,10	CHI
201911235648	FORMOSO	FB12106993	FLORES DE GOIAS	20/11/2019 05:44	20/11/2019 17:49	20/11/2019 05:44	20/11/2019 17:49	12,09	1	12,09	CHI
201911235648	SAO JOAO D ALIANCA	FB12106993	FLORES DE GOIAS	20/11/2019 05:44	20/11/2019 17:49	20/11/2019 05:44	20/11/2019 17:49	12,09	5	60,44	CHI
201911235652	PONTALINA	PK21045488	PONTALINA	20/11/2019 11:50	21/11/2019 08:41	20/11/2019 11:50	21/11/2019 08:41	20,84	1	20,84	CHI
201911235654	PLANALTINA	PI11355713	PLANALTINA	20/11/2019 11:50	21/11/2019 20:18	20/11/2019 11:50	21/11/2019 20:18	32,45	1	32,45	CHI
201911235661	JATAI	290207885	JATAI S2	20/11/2019 11:52	20/11/2019 18:11	20/11/2019 11:52	20/11/2019 18:11	6,31	1	6,31	CHI
201911235663	CACHOEIRA DOURADA	CD21000149	CACHOEIRA DOURADA	20/11/2019 11:53	20/11/2019 17:39	20/11/2019 11:53	20/11/2019 17:39	5,76	1	5,76	CHI
201911235665	MUTUNOPOLIS	MU21000004	MARA ROSA	20/11/2019 11:53	21/11/2019 06:32	20/11/2019 11:53	21/11/2019 06:32	18,64	1	18,64	CHI
201911235669	CAVALCANTE	CJ11264700	FLORES DE GOIAS	20/11/2019 11:54	21/11/2019 18:21	20/11/2019 11:54	21/11/2019 18:21	30,44	49	1491,71	CHI
201911235674	GOIAS	GS12183182	GOIAS	20/11/2019 11:55	20/11/2019 20:40	20/11/2019 11:55	20/11/2019 20:40	8,74	7	61,21	CHI
201911235675	PLANALTINA	PI11325432	PLANALTINA	20/11/2019 11:47	20/11/2019 14:40	20/11/2019 11:47	20/11/2019 14:40	2,87	80	229,42	CHI
201911235676	HIDROLANDIA	HD12000306	CEPAIGO S2	20/11/2019 11:56	20/11/2019 20:18	20/11/2019 11:56	20/11/2019 20:18	8,36	5	41,80	CHI
201911235802	GOIANIA	GN11000816	XAVANTES	20/11/2019 11:15	20/11/2019 15:38	20/11/2019 11:15	20/11/2019 15:38	4,37	83	362,76	CHI
201911235804	ABADIA DE GOIAS	LG11373005	INDEPENDENCIA S2	20/11/2019 11:56	20/11/2019 13:25	20/11/2019 11:56	20/11/2019 13:25	1,47	26	38,15	CHI
201911235805	GOIANIA	GN11002143	GOYA S1	20/11/2019 11:01	20/11/2019 16:26	20/11/2019 11:01	20/11/2019 16:26	5,43	42	228,02	CHI
201911235807	FORMOSA	610027591	ITIQUEIRA	20/11/2019 11:57	21/11/2019 08:16	20/11/2019 11:57	21/11/2019 08:16	20,31	1	20,31	CHI
201911235812	PADRE BERNARDO	PB11277160	PADRE BERNARDO	20/11/2019 11:58	20/11/2019 20:55	20/11/2019 11:58	20/11/2019 20:55	8,95	23	205,78	CHI
201911235818	PIRENOPOLIS	PV21185078	CORUMBA	20/11/2019 11:58	20/11/2019 19:08	20/11/2019 11:58	20/11/2019 19:08	7,16	1	7,16	CHI
201911235822	NIQUELANDIA	10011036654	NIQUELANDIA SUBTRANSMISSAO	20/11/2019 09:43	21/11/2019 08:00	20/11/2019 09:43	21/11/2019 08:00	22,27	1	22,27	CHI
201911235823	ORIZONA	2060013970	PIRES DO RIO S2	20/11/2019 11:59	20/11/2019 12:47	20/11/2019 11:59	20/11/2019 12:47	0,79	1	0,79	CHI
201911235824	GOIANESIA	GE21258496	GOIANESIA S2	20/11/2019 11:59	20/11/2019 19:22	20/11/2019 11:59	20/11/2019 19:22	7,38	1	7,38	CHI
201911235827	FORMOSA	610180198	ITIQUEIRA	20/11/2019 12:00	21/11/2019 13:12	20/11/2019 12:00	21/11/2019 13:12	25,19	1	25,19	CHI
201911235831	LUZIANIA	LZ12304874	MARAJOARA	20/11/2019 09:17	20/11/2019 17:12	20/11/2019 09:17	20/11/2019 17:12	7,91	2	15,83	CHI
201911235833	ANAPOLIS	AN12341987	ANAPOLIS UNIVERSITARIO S2	20/11/2019 11:48	20/11/2019 14:50	20/11/2019 11:48	20/11/2019 14:50	3,03	198	600,32	CHI

201911236107	CRISTALINA	KR12230241	CRISTALINA S2	20/11/2019 11:46	20/11/2019 13:55	20/11/2019 11:46	20/11/2019 13:55	2,15	5	10,74	CHI
201911236108	CABECEIRAS	CW21163621	ITUIQUIRA	20/11/2019 12:03	20/11/2019 18:12	20/11/2019 12:03	20/11/2019 18:12	6,14	1	6,14	CHI
201911236112	GOIANIA	13502438	CARAJAS S2	20/11/2019 12:04	20/11/2019 16:01	20/11/2019 12:04	20/11/2019 16:01	3,95	1	3,95	CHI
201911236115	RIO VERDE	RV12393335	MONTIVIDIU T	20/11/2019 11:43	20/11/2019 23:42	20/11/2019 11:43	20/11/2019 23:42	11,98	17	203,68	CHI
201911236120	MORRINHOS	10024579066	MORRINHOS	20/11/2019 12:06	21/11/2019 12:13	20/11/2019 12:06	21/11/2019 12:13	24,11	1	24,11	CHI
201911236123	MINEIROS	MY21324402	PARQUE DAS EMAS	20/11/2019 12:07	20/11/2019 16:00	20/11/2019 12:07	20/11/2019 16:00	3,88	1	3,88	CHI
201911236131	ABADIA DE GOIAS	10020089170	INDEPENDENCIA S2	20/11/2019 12:08	20/11/2019 15:19	20/11/2019 12:08	20/11/2019 15:19	3,17	1	3,17	CHI
201911236133	SANTO ANTONIO DO DESCOBERTO	SN21252045	AGUAS LINDAS DE GOIAS S2	20/11/2019 12:08	20/11/2019 15:18	20/11/2019 12:08	20/11/2019 15:18	3,15	1	3,15	CHI
201911236136	ALTO PARAISO DE GOIAS	3870007240	FLORES DE GOIAS	20/11/2019 12:09	20/11/2019 20:45	20/11/2019 12:09	20/11/2019 20:45	8,59	1	8,59	CHI
201911236137	GOIANIA	10018295027	CARAJAS S2	20/11/2019 12:09	20/11/2019 17:40	20/11/2019 12:09	20/11/2019 17:40	5,52	1	5,52	CHI
201911236138	FORMOSA	FA11325901	ITUIQUIRA	20/11/2019 11:36	20/11/2019 14:23	20/11/2019 11:36	20/11/2019 14:23	2,78	130	361,44	CHI
201911236139	APARECIDA DE GOIANIA	200275549	ANHANGUERA	20/11/2019 12:10	20/11/2019 15:41	20/11/2019 12:10	20/11/2019 15:41	3,52	1	3,52	CHI
201911236142	PORANGATU	TA12114216	NOVO PLANALTO	20/11/2019 12:11	21/11/2019 11:30	20/11/2019 12:11	21/11/2019 11:30	23,30	6	139,82	CHI
201911236143	MINACU	IH11257866	MINACU	20/11/2019 11:16	21/11/2019 11:40	20/11/2019 11:16	21/11/2019 11:40	24,39	15	365,80	CHI
201911236144	SAO LUIZ DO NORTE	DF12241242	BARRO ALTO	20/11/2019 12:12	22/11/2019 11:21	20/11/2019 12:12	22/11/2019 11:21	47,14	4	188,57	CHI
201911236146	SANTA TEREZINHA DE GOIAS	SG21252873	SANTA TEREZINHA	20/11/2019 12:12	20/11/2019 15:03	20/11/2019 12:12	20/11/2019 15:03	2,84	1	2,84	CHI
201911236147	URUACU	UR12243703	URUACU	20/11/2019 12:13	20/11/2019 22:44	20/11/2019 12:13	20/11/2019 22:44	10,52	2	21,03	CHI
201911236148	JATAI	10012889898	JATAI S3	20/11/2019 12:13	21/11/2019 11:08	20/11/2019 12:13	21/11/2019 11:08	22,91	1	22,91	CHI
201911236149	APARECIDA DE GOIANIA	13523107	ATLANTICO S2	20/11/2019 12:13	20/11/2019 15:39	20/11/2019 12:13	20/11/2019 15:39	3,43	1	3,43	CHI
201911236205	AGUAS LINDAS DE GOIAS	10023335570	AGUAS LINDAS DE GOIAS S2	20/11/2019 12:14	20/11/2019 12:52	20/11/2019 12:14	20/11/2019 12:52	0,62	1	0,62	CHI
201911236208	PLANALTINA	PI11053637	PLANALTINA	20/11/2019 12:15	21/11/2019 15:20	20/11/2019 12:15	21/11/2019 15:20	27,10	6	162,57	CHI
201911236212	ANAPOLIS	20380150	JUNDIAI S1	20/11/2019 12:16	20/11/2019 14:52	20/11/2019 12:16	20/11/2019 14:52	2,60	1	2,60	CHI
201911236213	MINEIROS	MY12274100	PARQUE DAS EMAS	20/11/2019 12:16	20/11/2019 16:00	20/11/2019 12:16	20/11/2019 16:00	3,73	10	37,29	CHI
201911236216	CALDAS NOVAS	CN12182822	SERRA DE CALDAS	20/11/2019 10:48	21/11/2019 11:44	20/11/2019 10:48	21/11/2019 11:44	24,92	64	1594,95	CHI
201911236217	APARECIDA DE GOIANIA	200380485	INDEPENDENCIA S1	19/11/2019 09:04	19/11/2019 16:37	19/11/2019 09:04	19/11/2019 16:37	7,56	1	7,56	CHI
201911236219	CALDAS NOVAS	10017237490	SERRA DE CALDAS	20/11/2019 12:18	20/11/2019 15:50	20/11/2019 12:18	20/11/2019 15:50	3,53	1	3,53	CHI
201911236221	GOIANIA	13606244	GOIANIA LESTE S1	20/11/2019 12:18	20/11/2019 18:03	20/11/2019 12:18	20/11/2019 18:03	5,75	1	5,75	CHI
201911236225	CAVALCANTE	CJ21404471	MINACU	20/11/2019 12:19	20/11/2019 18:31	20/11/2019 12:19	20/11/2019 18:31	6,19	1	6,19	CHI
201911236230	ITABERAI	10004277439	ITABERAI S2	20/11/2019 12:20	20/11/2019 14:38	20/11/2019 12:20	20/11/2019 14:38	2,29	1	2,29	CHI
201911236231	PADRE BERNARDO	2760045402	PADRE BERNARDO	20/11/2019 12:20	20/11/2019 20:12	20/11/2019 12:20	20/11/2019 20:12	7,85	1	7,85	CHI
201911236235	APARECIDA DE GOIANIA	200380485	INDEPENDENCIA S1	19/11/2019 09:04	19/11/2019 16:37	19/11/2019 09:04	19/11/2019 16:37	7,56	1	7,56	CHI
201911236401	URUACU	640079623	URUACU	20/11/2019 12:21	20/11/2019 16:39	20/11/2019 12:21	20/11/2019 16:39	4,29	1	4,29	CHI
201911236704	MORRINHOS	MR21182936	MORRINHOS	20/11/2019 12:23	20/11/2019 16:35	20/11/2019 12:23	20/11/2019 16:35	4,20	1	4,20	CHI

201911236710	MORRINHOS	MR21381192	PONTALINA	20/11/2019 12:26	21/11/2019 11:34	20/11/2019 12:26	21/11/2019 11:34	23,13	1	23,13	CHI
201911236714	GOIANIA	14525471	CARAJAS S1	20/11/2019 12:26	20/11/2019 18:13	20/11/2019 12:26	20/11/2019 18:13	5,78	1	5,78	CHI
201911236722	APARECIDA DE GOIANIA	AP11162220	INDEPENDENCIA S1	20/11/2019 12:22	20/11/2019 14:47	20/11/2019 12:22	20/11/2019 14:47	2,42	112	270,57	CHI
201911236724	AGUAS LINDAS DE GOIAS	10007921878	AGUAS LINDAS DE GOIAS S1	20/11/2019 12:27	20/11/2019 16:06	20/11/2019 12:27	20/11/2019 16:06	3,64	1	3,64	CHI
201911236726	MINEIROS	1390011425	PARQUE DAS EMAS	20/11/2019 12:29	20/11/2019 16:31	20/11/2019 12:29	20/11/2019 16:31	4,03	1	4,03	CHI
201911236727	CACHOEIRA ALTA	CA12196131	CACHOEIRA ALTA	20/11/2019 12:29	20/11/2019 16:03	20/11/2019 12:29	20/11/2019 16:03	3,56	12	42,77	CHI
201911236732	MORRINHOS	10002780028	MORRINHOS	20/11/2019 12:31	20/11/2019 17:13	20/11/2019 12:31	20/11/2019 17:13	4,70	1	4,70	CHI
201911236735	APARECIDA DE GOIANIA	AP11007360	INDEPENDENCIA S1	20/11/2019 12:31	20/11/2019 17:48	20/11/2019 12:31	20/11/2019 17:48	5,28	69	363,98	CHI
201911236747	SAO JOAO D ALIANCA	JL21324138	SAO JOAO D ALIANCA	20/11/2019 12:34	22/11/2019 17:09	20/11/2019 12:34	22/11/2019 17:09	52,58	1	52,58	CHI
201911236901	NOVO GAMA	NJ11351310	PACAEMBU S1	20/11/2019 12:34	20/11/2019 15:54	20/11/2019 12:34	20/11/2019 15:54	3,32	8	26,59	CHI
201911236904	RUBIATABA	RB11282271	RUBIATABA	20/11/2019 12:17	20/11/2019 21:19	20/11/2019 12:17	20/11/2019 21:19	9,02	18	162,35	CHI
201911236907	JATAI	10017917865	JATAI S2	20/11/2019 12:36	20/11/2019 14:41	20/11/2019 12:36	20/11/2019 14:41	2,07	1	2,07	CHI
201911236908	FORMOSA	FA21243174	ITUIQUIRA	20/11/2019 12:36	21/11/2019 21:10	20/11/2019 12:36	21/11/2019 21:10	32,55	1	32,55	CHI
201911236916	SANTA HELENA DE GOIAS	SH21279732	IPEGUARI	20/11/2019 12:38	20/11/2019 14:45	20/11/2019 12:38	20/11/2019 14:45	2,11	1	2,11	CHI
201911236929	COCALZINHO DE GOIAS	ZN12069171	COCALZINHO	20/11/2019 05:15	20/11/2019 16:42	20/11/2019 05:15	20/11/2019 16:42	11,44	2	22,88	CHI
201911236929	PIRENOPOLIS	ZN12069171	COCALZINHO	20/11/2019 05:15	20/11/2019 16:42	20/11/2019 05:15	20/11/2019 16:42	11,44	5	57,20	CHI
201911236932	CRIXAS	CX12266441	SANTA TEREZINHA	20/11/2019 12:43	20/11/2019 21:44	20/11/2019 12:43	20/11/2019 21:44	9,00	7	63,02	CHI
201911236933	PORANGATU	PO21270924	PORANGATU	20/11/2019 12:43	21/11/2019 09:28	20/11/2019 12:43	21/11/2019 09:28	20,74	1	20,74	CHI
201911236937	PADRE BERNARDO	3160002169	PADRE BERNARDO	20/11/2019 12:44	20/11/2019 22:02	20/11/2019 12:44	20/11/2019 22:02	9,29	1	9,29	CHI
201911236938	SANTO ANTONIO DO DESCOBERTO	2210113990	ALEXANIA	20/11/2019 12:44	20/11/2019 16:29	20/11/2019 12:44	20/11/2019 16:29	3,74	1	3,74	CHI
201911236939	NOVA IGUACU DE GOIAS	UR12237466	URUACU	20/11/2019 10:42	20/11/2019 23:49	20/11/2019 10:42	20/11/2019 23:49	13,11	2	26,21	CHI
201911236939	URUACU	UR12237466	URUACU	20/11/2019 10:42	20/11/2019 23:49	20/11/2019 10:42	20/11/2019 23:49	13,11	4	52,43	CHI
201911236941	GOIAS	GS12093357	MATRINCHA	20/11/2019 10:09	20/11/2019 16:09	20/11/2019 10:09	20/11/2019 16:09	5,99	6	35,92	CHI
201911236943	ANAPOLIS	21085456	ANAPOLIS UNIVERSITARIO S2	20/11/2019 12:46	21/11/2019 10:24	20/11/2019 12:46	21/11/2019 10:24	21,64	1	21,64	CHI
201911236947	BOM JARDIM DE GOIAS	BM21065652	BOM JARDIM	20/11/2019 12:46	21/11/2019 14:10	20/11/2019 12:46	21/11/2019 14:10	25,39	1	25,39	CHI
201911236948	URUACU	UR12243646	URUACU	20/11/2019 11:47	20/11/2019 22:05	20/11/2019 11:47	20/11/2019 22:05	10,29	5	51,43	CHI
201911237003	CAIAPONIA	CP12204879	PIRANHAS	20/11/2019 12:45	21/11/2019 11:56	20/11/2019 12:45	21/11/2019 11:56	23,19	16	370,98	CHI
201911237005	ITARUMA	IM12204279	ITAJA S2	20/11/2019 10:38	20/11/2019 19:20	20/11/2019 10:38	20/11/2019 19:20	8,69	2	17,38	CHI
201911237006	OUIDOR	CT21112611	CATALAO S1	20/11/2019 12:49	20/11/2019 23:13	20/11/2019 12:49	20/11/2019 23:13	10,40	1	10,40	CHI
201911237007	AMORINOPOLIS	IR12188355	IPORA	20/11/2019 12:49	21/11/2019 07:16	20/11/2019 12:49	21/11/2019 07:16	18,44	7	129,06	CHI
201911237007	IPORA	IR12188355	IPORA	20/11/2019 12:49	21/11/2019 07:16	20/11/2019 12:49	21/11/2019 07:16	18,44	3	55,31	CHI
201911237008	FLORES DE GOIAS	FB12252159	FLORES DE GOIAS	20/11/2019 12:49	22/11/2019 16:30	20/11/2019 12:49	22/11/2019 16:30	51,67	1	51,67	CHI
201911237009	ITAGUARI	IC21168382	ITABERAI S1	20/11/2019 12:50	20/11/2019 21:42	20/11/2019 12:50	20/11/2019 21:42	8,86	2	17,72	CHI

201911237012	LUZIANIA	10021477440	RIO VERMELHO	20/11/2019 12:51	20/11/2019 14:46	20/11/2019 12:51	20/11/2019 14:46	1,91	1	1,91	CHI
201911237021	CRISTALINA	KR12404434	CRISTALINA S1	20/11/2019 12:53	21/11/2019 02:07	20/11/2019 12:53	21/11/2019 02:07	13,23	4	52,93	CHI
201911237023	SAO JOAO D ALIANCA	FB11314731	FLORES DE GOIAS	20/11/2019 12:53	22/11/2019 14:31	20/11/2019 12:53	22/11/2019 14:31	49,62	1	49,62	CHI
201911237032	JATAI	290065732	JATAI S2	20/11/2019 12:55	21/11/2019 09:48	20/11/2019 12:55	21/11/2019 09:48	20,88	1	20,88	CHI
201911237034	CAIAPONIA	PY12040163	PALESTINA	20/11/2019 12:55	20/11/2019 16:30	20/11/2019 12:55	20/11/2019 16:30	3,59	43	154,27	CHI
201911237034	PALESTINA DE GOIAS	PY12040163	PALESTINA	20/11/2019 12:55	20/11/2019 16:30	20/11/2019 12:55	20/11/2019 16:30	3,59	102	365,95	CHI
201911237039	GOIANIA	13032781	AEROPORTO S3	20/11/2019 12:57	20/11/2019 21:50	20/11/2019 12:57	20/11/2019 21:50	8,88	1	8,88	CHI
201911237041	ANAPOLIS	10001328059	ANAPOLIS UNIVERSITARIO S2	20/11/2019 12:57	20/11/2019 17:40	20/11/2019 12:57	20/11/2019 17:40	4,71	1	4,71	CHI
201911237042	SANTO ANTONIO DO DESCOBERTO	SN21376769	AGUAS LINDAS DE GOIAS S2	20/11/2019 12:57	20/11/2019 15:20	20/11/2019 12:57	20/11/2019 15:20	2,38	2	4,75	CHI
201911237043	ITUMBIARA	690052479	ITUMBIARA VELHA S1	20/11/2019 12:57	20/11/2019 15:50	20/11/2019 12:57	20/11/2019 15:50	2,88	1	2,88	CHI
201911237045	FORMOSA	FA11245390	ITUIQUIRA	20/11/2019 12:58	21/11/2019 15:15	20/11/2019 12:58	21/11/2019 15:15	26,28	5	131,41	CHI
201911237048	QUIRINOPOLIS	10012807107	QUIRINOPOLIS	20/11/2019 12:59	21/11/2019 00:35	20/11/2019 12:59	21/11/2019 00:35	11,60	1	11,60	CHI
201911237302	BOM JESUS DE GOIAS	4060000049	BOM JESUS DE GOIAS	20/11/2019 13:02	20/11/2019 17:41	20/11/2019 13:02	20/11/2019 17:41	4,64	1	4,64	CHI
201911237306	ITAJA	IJ21398608	ITAJA S2	20/11/2019 13:02	20/11/2019 15:02	20/11/2019 13:02	20/11/2019 15:02	1,98	1	1,98	CHI
201911237307	FAZENDA NOVA	JR12231376	JUSSARA	20/11/2019 13:03	21/11/2019 13:00	20/11/2019 13:03	21/11/2019 13:00	23,95	3	71,85	CHI
201911237320	BELA VISTA DE GOIAS	BV32097981	BELA VISTA S1	20/11/2019 13:05	21/11/2019 13:50	20/11/2019 13:05	21/11/2019 13:50	24,74	9	222,65	CHI
201911237321	ADELANDIA	DN21108207	FIRMINOPOLIS S2	20/11/2019 13:05	20/11/2019 20:25	20/11/2019 13:05	20/11/2019 20:25	7,33	1	7,33	CHI
201911237329	GOIANIA	GN10385815	FERROVIARIO S2	20/11/2019 12:53	20/11/2019 18:27	20/11/2019 12:53	20/11/2019 12:56	0,05	884	47,88	CHI
201911237329	GOIANIA	GN10385815	MEIA PONTE	20/11/2019 12:53	20/11/2019 18:27	20/11/2019 12:53	20/11/2019 12:56	0,05	1384	74,97	CHI
201911237329	GOIANIA	GN10385815	XAVANTES	20/11/2019 12:53	20/11/2019 18:27	20/11/2019 12:53	20/11/2019 12:56	0,05	5094	275,93	CHI
201911237329	GOIANIA	00590234	FERROVIARIO S1	20/11/2019 12:53	20/11/2019 18:27	20/11/2019 13:37	20/11/2019 14:44	1,12	801	895,34	CHI
201911237329	GOIANIA	GN10385815	FERROVIARIO S1	20/11/2019 12:53	20/11/2019 18:27	20/11/2019 13:37	20/11/2019 14:55	1,31	1	1,31	CHI
201911237329	GOIANIA	GN13363102	FERROVIARIO S1	20/11/2019 12:53	20/11/2019 18:27	20/11/2019 13:37	20/11/2019 17:03	3,44	49	168,74	CHI
201911237329	GOIANIA	GN10385815	FERROVIARIO S1	20/11/2019 12:53	20/11/2019 18:27	20/11/2019 18:07	20/11/2019 18:27	0,33	1	0,33	CHI
201911237329	GOIANIA	00590234	FERROVIARIO S1	20/11/2019 12:53	20/11/2019 18:27	20/11/2019 18:22	20/11/2019 18:27	0,09	850	73,19	CHI
201911237330	GUAPO	GA11276615	GUAPO S2	20/11/2019 13:07	20/11/2019 22:58	20/11/2019 13:07	20/11/2019 22:58	9,85	1	9,85	CHI
201911237336	MUTUNOPOLIS	MU21357177	MARA ROSA	20/11/2019 13:08	21/11/2019 10:37	20/11/2019 13:08	21/11/2019 10:37	21,47	1	21,47	CHI
201911237337	SANTA FE DE GOIAS	RN12079527	BRITANIA	20/11/2019 13:08	22/11/2019 21:28	20/11/2019 13:08	21/11/2019 13:51	24,70	5	123,51	CHI
201911237337	JUSSARA	RN12100632LD	BRITANIA	20/11/2019 13:08	22/11/2019 21:28	20/11/2019 13:08	22/11/2019 21:28	56,32	2	112,64	CHI
201911237337	SANTA FE DE GOIAS	RN12100632LD	BRITANIA	20/11/2019 13:08	22/11/2019 21:28	20/11/2019 13:08	22/11/2019 21:28	56,32	6	337,91	CHI
201911237340	SITIO D ABADIA	SI12235082	IACIARA S2	20/11/2019 13:09	22/11/2019 15:33	20/11/2019 13:09	22/11/2019 15:33	50,39	2	100,78	CHI
201911237344	ANAPOLIS	AN11090384	ANAPOLIS UNIVERSITARIO S1	20/11/2019 13:04	20/11/2019 16:31	20/11/2019 13:04	20/11/2019 16:31	3,44	95	326,40	CHI
201911237345	ANICUNS	AC12259091	ANICUNS	20/11/2019 12:19	21/11/2019 21:09	20/11/2019 12:19	20/11/2019 16:10	3,84	8	30,71	CHI

201911237345	ANICUNS	AC12259091	ANICUNS	20/11/2019 12:19	21/11/2019 21:09	20/11/2019 12:19	20/11/2019 17:01	4,69	14	65,68	CHI
201911237345	ANICUNS	AC12259091	ANICUNS	20/11/2019 12:19	21/11/2019 21:09	20/11/2019 12:19	20/11/2019 19:59	7,66	10	76,56	CHI
201911237345	ANICUNS	AC12259091	ANICUNS	20/11/2019 12:19	21/11/2019 21:09	20/11/2019 12:19	21/11/2019 21:09	32,84	11	361,21	CHI
201911237345	ANICUNS	AC12038677LD	ANICUNS	20/11/2019 12:19	21/11/2019 21:09	21/11/2019 20:09	21/11/2019 21:09	1,01	24	24,19	CHI
201911237347	IPAMERI	IP21292706	IPAMERI	20/11/2019 13:10	21/11/2019 17:40	20/11/2019 13:10	21/11/2019 17:40	28,49	2	56,98	CHI
201911237403	JANDAIA	PP12006684	PALMEIRAS	20/11/2019 13:11	21/11/2019 11:34	20/11/2019 13:11	21/11/2019 11:34	22,39	8	179,09	CHI
201911237403	PALMINOPOLIS	PP12006684	PALMEIRAS	20/11/2019 13:11	21/11/2019 11:34	20/11/2019 13:11	21/11/2019 11:34	22,39	5	111,93	CHI
201911237502	CAMPINORTE	UR12243278	MARA ROSA	20/11/2019 12:04	20/11/2019 15:25	20/11/2019 12:04	20/11/2019 15:25	3,34	7	23,35	CHI
201911237502	URUACU	UR12243278	MARA ROSA	20/11/2019 12:04	20/11/2019 15:25	20/11/2019 12:04	20/11/2019 15:25	3,34	15	50,04	CHI
201911237513	MONTIVIDIU	MV12267743	MONTIVIDIU T	20/11/2019 13:13	22/11/2019 16:40	20/11/2019 13:13	22/11/2019 16:40	51,44	1	51,44	CHI
201911237803	RIO VERDE	RV12301460	ACREUNA	20/11/2019 11:13	20/11/2019 20:36	20/11/2019 11:13	20/11/2019 20:36	9,38	7	65,65	CHI
201911237803	SANTO ANTONIO DA BARRA	RV12301460	ACREUNA	20/11/2019 11:13	20/11/2019 20:36	20/11/2019 11:13	20/11/2019 20:36	9,38	2	18,76	CHI
201911237810	SERRANOPOLIS	SX12049395	JATAI S1	20/11/2019 11:51	20/11/2019 14:27	20/11/2019 11:51	20/11/2019 14:27	2,59	110	284,66	CHI
201911237819	RIO VERDE	RV21123240	CABRIUVA S2	20/11/2019 13:15	20/11/2019 18:02	20/11/2019 13:15	20/11/2019 18:02	4,77	1	4,77	CHI
201911237901	CATALAO	CT11379388	CATALAO S2	20/11/2019 13:16	20/11/2019 19:03	20/11/2019 13:16	20/11/2019 19:03	5,78	28	161,73	CHI
201911238001	ARENOPOLIS	AY12337174	ARENOPOLIS	20/11/2019 13:16	21/11/2019 12:53	20/11/2019 13:16	21/11/2019 12:53	23,61	13	306,89	CHI
201911238001	PALESTINA DE GOIAS	AY12337174	ARENOPOLIS	20/11/2019 13:16	21/11/2019 12:53	20/11/2019 13:16	21/11/2019 12:53	23,61	3	70,82	CHI
201911238007	GOIANIA	11022796	FERROVIARIO S3	20/11/2019 13:17	20/11/2019 18:33	20/11/2019 13:17	20/11/2019 18:33	5,26	1	5,26	CHI
201911238014	GOIANIA	GN21134329	SENADOR CANEDO	20/11/2019 13:19	20/11/2019 15:45	20/11/2019 13:19	20/11/2019 15:45	2,43	1	2,43	CHI
201911238015	GOIANIA	GN11000418	FERROVIARIO S3	20/11/2019 13:14	20/11/2019 23:18	20/11/2019 13:14	20/11/2019 23:18	10,06	116	1166,57	CHI
201911238016	GOIANAPOLIS	950021982	DAIA S2	20/11/2019 13:19	21/11/2019 08:00	20/11/2019 13:19	21/11/2019 08:00	18,67	1	18,67	CHI
201911238019	NIQUELANDIA	NQ12133382	NIQUELANDIA SUBTRANSMISSAO	20/11/2019 13:20	21/11/2019 03:35	20/11/2019 13:20	21/11/2019 03:35	14,25	13	185,23	CHI
201911238022	SENADOR CANEDO	SW11080243	SENADOR CANEDO	20/11/2019 13:20	20/11/2019 14:52	20/11/2019 13:20	20/11/2019 14:52	1,52	117	178,13	CHI
201911238023	CAIAPONIA	PY12020934	PALESTINA	20/11/2019 13:20	20/11/2019 17:15	20/11/2019 13:20	20/11/2019 17:15	3,92	161	630,81	CHI
201911238023	PALESTINA DE GOIAS	PY12020934	PALESTINA	20/11/2019 13:20	20/11/2019 17:15	20/11/2019 13:20	20/11/2019 17:15	3,92	24	94,03	CHI
201911238026	RIO VERDE	RV21284339	CABRIUVA S2	20/11/2019 13:20	20/11/2019 18:02	20/11/2019 13:20	20/11/2019 18:02	4,69	1	4,69	CHI
201911238032	GOIANIA	GN12077158	GOIANIA LESTE S2	20/11/2019 12:57	20/11/2019 17:04	20/11/2019 12:57	20/11/2019 17:04	4,11	55	226,16	CHI
201911238032	SENADOR CANEDO	GN12077158	GOIANIA LESTE S2	20/11/2019 12:57	20/11/2019 17:04	20/11/2019 12:57	20/11/2019 17:04	4,11	24	98,69	CHI
201911238034	CATALAO	CT21231550	CATALAO S1	20/11/2019 13:23	21/11/2019 15:46	20/11/2019 13:23	21/11/2019 15:46	26,38	1	26,38	CHI
201911238036	SAO LUIS DE MONTES BELOS	SL12259124	SAO LUIZ DOS MONTES BELOS	20/11/2019 13:23	20/11/2019 14:52	20/11/2019 13:23	20/11/2019 14:52	1,48	164	242,72	CHI
201911238039	GOIATUBA	BJ21000092	BOM JESUS DE GOIAS	20/11/2019 13:24	21/11/2019 09:58	20/11/2019 13:24	21/11/2019 09:58	20,56	1	20,56	CHI
201911238040	ITUMBIARA	BG21293150	ITUMBIARA VELHA S2	20/11/2019 13:24	20/11/2019 16:20	20/11/2019 13:24	20/11/2019 16:20	2,93	1	2,93	CHI
201911238102	CAIAPONIA	CP12238699	PALESTINA	20/11/2019 13:25	20/11/2019 19:18	20/11/2019 13:25	20/11/2019 19:18	5,87	7	41,09	CHI

201911238108	BOM JESUS DE GOIAS	BJ21293330	BOM JESUS DE GOIAS	20/11/2019 13:26	21/11/2019 11:17	20/11/2019 13:26	21/11/2019 11:17	21,85	1	21,85	CHI
201911238115	ACREUNA	3330004718	ACREUNA	20/11/2019 13:27	20/11/2019 16:25	20/11/2019 13:27	20/11/2019 16:25	2,97	1	2,97	CHI
201911238124	GOIANIA	16456555	XAVANTES	20/11/2019 13:29	20/11/2019 16:39	20/11/2019 13:29	20/11/2019 16:39	3,16	1	3,16	CHI
201911238125	ABADIANIA	AA21141552	DAIA S2	20/11/2019 13:28	20/11/2019 15:28	20/11/2019 13:28	20/11/2019 15:28	2,00	1	2,00	CHI
201911238201	GAMELEIRA DE GOIAS	AN12285354	JUNDIAI S1	20/11/2019 13:25	20/11/2019 17:57	20/11/2019 13:25	20/11/2019 17:57	4,52	9	40,70	CHI
201911238201	SILVANIA	AN12285354	JUNDIAI S1	20/11/2019 13:25	20/11/2019 17:57	20/11/2019 13:25	20/11/2019 17:57	4,52	20	90,44	CHI
201911238301	JUSSARA	JR12038166	BRITANIA	20/11/2019 13:29	21/11/2019 20:29	20/11/2019 13:29	21/11/2019 20:29	31,01	5	155,03	CHI
201911238408	CAIAPONIA	CP12062930	IPORA	20/11/2019 13:30	21/11/2019 11:25	20/11/2019 13:30	21/11/2019 11:25	21,92	49	1074,20	CHI
201911238409	GOIANIA	GN11000592	AEROPORTO S3	20/11/2019 13:24	20/11/2019 15:34	20/11/2019 13:24	20/11/2019 15:34	2,16	103	222,68	CHI
201911238410	PILAR DE GOIAS	GG12325151	SANTA TEREZINHA	20/11/2019 13:30	20/11/2019 17:38	20/11/2019 13:30	20/11/2019 17:38	4,13	6	24,76	CHI
201911238503	INDIARA	IY12170319	EDEIA	20/11/2019 13:30	20/11/2019 18:35	20/11/2019 13:30	20/11/2019 18:35	5,07	5	25,36	CHI
201911238503	PALMEIRAS DE GOIAS	IY12170319	EDEIA	20/11/2019 13:30	20/11/2019 18:35	20/11/2019 13:30	20/11/2019 18:35	5,07	6	30,43	CHI
201911238601	GOIANIA	GN11043266	CAMPINAS S1	20/11/2019 13:20	20/11/2019 17:30	20/11/2019 13:20	20/11/2019 17:30	4,17	118	492,32	CHI
201911238602	GOIANIA	00580224	GOIANIA LESTE S3	20/11/2019 13:29	20/11/2019 16:50	20/11/2019 13:29	20/11/2019 14:34	1,09	1241	1349,24	CHI
201911238602	GOIANIA	00580224	GOIANIA LESTE S3	20/11/2019 13:29	20/11/2019 16:50	20/11/2019 13:29	20/11/2019 16:50	3,35	119	398,55	CHI
201911238603	LUZIANIA	LZ21211927	CRISTALINA S2	20/11/2019 13:32	21/11/2019 10:28	20/11/2019 13:32	21/11/2019 10:28	20,93	1	20,93	CHI
201911238609	LUZIANIA	LZ21290719	CRISTALINA S2	20/11/2019 13:33	21/11/2019 03:28	20/11/2019 13:33	21/11/2019 03:28	13,92	1	13,92	CHI
201911238801	CAMPOS BELOS	MA12209854	SAO DOMINGOS	20/11/2019 13:17	20/11/2019 16:23	20/11/2019 13:17	20/11/2019 16:23	3,10	4	12,40	CHI
201911238801	MONTE ALEGRE DE GOIAS	MA12209854	SAO DOMINGOS	20/11/2019 13:17	20/11/2019 16:23	20/11/2019 13:17	20/11/2019 16:23	3,10	18	55,78	CHI
201911238905	RIO VERDE	10014121598	CABRIUVA S1	20/11/2019 13:35	20/11/2019 15:35	20/11/2019 13:35	20/11/2019 15:35	2,01	1	2,01	CHI
201911238910	NOVA CRIXAS	NA21057188	MOZARLANDIA	20/11/2019 13:35	21/11/2019 17:43	20/11/2019 13:35	21/11/2019 17:43	28,13	1	28,13	CHI
201911239104	ARENOPOLIS	AY12087158	ARENOPOLIS	20/11/2019 13:33	21/11/2019 17:05	20/11/2019 13:33	21/11/2019 17:05	27,53	10	275,33	CHI
201911239301	CRISTALINA	KR21171564	CRISTALINA S2	20/11/2019 13:36	21/11/2019 07:35	20/11/2019 13:36	21/11/2019 07:35	17,98	2	35,96	CHI
201911239309	CRISTALINA	KR21163079	CRISTALINA S2	20/11/2019 13:37	21/11/2019 09:20	20/11/2019 13:37	21/11/2019 09:20	19,71	1	19,71	CHI
201911239310	MINEIROS	10025015239	PARQUE DAS EMAS	20/11/2019 13:37	20/11/2019 15:31	20/11/2019 13:37	20/11/2019 15:31	1,90	1	1,90	CHI
201911239313	GOIANIA	GN11002802	CAMPINAS S2	20/11/2019 13:23	20/11/2019 20:20	20/11/2019 13:23	20/11/2019 20:20	6,95	53	368,32	CHI
201911239315	APARECIDA DE GOIANIA	AP11060000	INDEPENDENCIA S2	20/11/2019 18:15	20/11/2019 18:53	20/11/2019 18:15	20/11/2019 18:53	0,62	142	87,80	CHI
201911239320	GOIANIA	GN11167762	ATLANTICO S3	20/11/2019 13:31	20/11/2019 17:22	20/11/2019 13:31	20/11/2019 17:22	3,85	70	269,40	CHI
201911239341	NIQUELANDIA	NQ12290031	NIQUELANDIA SUBTRANSMISSAO	20/11/2019 13:39	21/11/2019 10:51	20/11/2019 13:39	21/11/2019 10:51	21,21	20	424,11	CHI
201911239343	MUNDO NOVO DE GOIAS	MH11269274	NOVA CRIXAS	20/11/2019 13:40	21/11/2019 11:17	20/11/2019 13:40	21/11/2019 11:17	21,60	1	21,60	CHI
201911239404	ORIZONA	OZ12083185	PIRES DO RIO S1	20/11/2019 12:26	20/11/2019 18:49	20/11/2019 12:26	20/11/2019 18:49	6,37	3	19,11	CHI
201911239425	FORMOSA	610129922	ITUIQUIRA	20/11/2019 13:43	21/11/2019 06:39	20/11/2019 13:43	21/11/2019 06:39	16,93	1	16,93	CHI
201911239609	GOIANIA	GN11002810	GOYA S2	20/11/2019 13:29	20/11/2019 20:00	20/11/2019 13:29	20/11/2019 20:00	6,51	143	931,17	CHI

201911239611	CACHOEIRA DE GOIAS	CG12206059	FIRMINOPOLIS S2	20/11/2019 13:17	20/11/2019 21:33	20/11/2019 13:17	20/11/2019 21:33	8,26	24	198,16	CHI
201911239612	GOIANIA	GN12001195	CAMPINAS S1	20/11/2019 13:31	20/11/2019 16:44	20/11/2019 13:31	20/11/2019 16:44	3,21	931	2986,96	CHI
201911239613	APARECIDA DE GOIANIA	15993899	REAL S2	20/11/2019 13:45	20/11/2019 16:35	20/11/2019 13:45	20/11/2019 16:35	2,82	1	2,82	CHI
201911239615	GOIANIA	15818251	CAMPINAS S2	20/11/2019 13:46	21/11/2019 05:00	20/11/2019 13:46	21/11/2019 05:00	15,23	1	15,23	CHI
201911239620	ANAPOLIS	20622156	ANAPOLIS UNIVERSITARIO S1	20/11/2019 13:47	20/11/2019 18:53	20/11/2019 13:47	20/11/2019 18:53	5,11	1	5,11	CHI
201911239623	GOIANIA	GN10396877	CAMPINAS S2	20/11/2019 13:13	20/11/2019 19:23	20/11/2019 13:13	20/11/2019 19:23	6,16	235	1448,58	CHI
201911239623	GOIANIA	GN10396877	CAMPINAS S2	20/11/2019 13:13	20/11/2019 19:23	20/11/2019 19:17	20/11/2019 19:23	0,09	322	30,41	CHI
201911239628	ALTO PARAISO DE GOIAS	BF10400692	FLORES DE GOIAS	20/11/2019 13:08	20/11/2019 17:59	20/11/2019 13:08	20/11/2019 17:59	4,85	214	1037,07	CHI
201911239628	SAO JOAO D ALIANCA	BF10400692	FLORES DE GOIAS	20/11/2019 13:08	20/11/2019 17:59	20/11/2019 13:08	20/11/2019 17:59	4,85	2	9,69	CHI
201911239633	FORMOSO	2410007060	PORANGATU	20/11/2019 13:48	21/11/2019 01:30	20/11/2019 13:48	21/11/2019 01:30	11,70	1	11,70	CHI
201911239634	MINEIROS	SU12157170	SANTA RITA DO ARAGUAIA	20/11/2019 13:48	20/11/2019 21:18	20/11/2019 13:48	20/11/2019 21:18	7,50	5	37,49	CHI
201911239635	PADRE BERNARDO	PB12370880	PADRE BERNARDO	20/11/2019 13:48	20/11/2019 20:56	20/11/2019 13:48	20/11/2019 20:56	7,13	4	28,52	CHI
201911239641	DIORAMA	DI11023259	IPORA	20/11/2019 13:01	20/11/2019 15:15	20/11/2019 13:01	20/11/2019 15:15	2,22	108	239,55	CHI
201911239643	LUZIANIA	LZ21229313	VIANOPOLIS	20/11/2019 13:48	21/11/2019 12:03	20/11/2019 13:48	21/11/2019 12:03	22,25	1	22,25	CHI
201911239656	GAMELEIRA DE GOIAS	AN12165598	DAIA S2	20/11/2019 13:50	21/11/2019 14:16	20/11/2019 13:50	21/11/2019 14:16	24,42	3	73,26	CHI
201911239656	SILVANIA	AN12165598	DAIA S2	20/11/2019 13:50	21/11/2019 14:16	20/11/2019 13:50	21/11/2019 14:16	24,42	1	24,42	CHI
201911239661	CAIAPONIA	CP12075059	CAIAPONIA	20/11/2019 13:31	20/11/2019 17:51	20/11/2019 13:31	20/11/2019 17:51	4,32	83	358,58	CHI
201911239662	CRISTALINA	KR12330533	CRISTALINA S1	20/11/2019 13:26	20/11/2019 21:00	20/11/2019 13:26	20/11/2019 21:00	7,55	33	249,21	CHI
201911239662	IPAMERI	KR12330533	CRISTALINA S1	20/11/2019 13:26	20/11/2019 21:00	20/11/2019 13:26	20/11/2019 21:00	7,55	1	7,55	CHI
201911239662	LUZIANIA	KR12330533	CRISTALINA S1	20/11/2019 13:26	20/11/2019 21:00	20/11/2019 13:26	20/11/2019 21:00	7,55	8	60,42	CHI
201911239667	FLORES DE GOIAS	FB12252148	FLORES DE GOIAS	20/11/2019 09:20	21/11/2019 12:05	20/11/2019 09:20	21/11/2019 12:05	26,75	9	240,76	CHI
201911239668	SAO JOAO D ALIANCA	JL21144676	SAO JOAO D ALIANCA	20/11/2019 13:52	21/11/2019 10:50	20/11/2019 13:52	21/11/2019 10:50	20,96	1	20,96	CHI
201911239705	BALIZA	BM12390150	BOM JARDIM	20/11/2019 10:52	20/11/2019 19:51	20/11/2019 10:52	20/11/2019 19:51	8,97	51	457,40	CHI
201911239705	BOM JARDIM DE GOIAS	BM12390150	BOM JARDIM	20/11/2019 10:52	20/11/2019 19:51	20/11/2019 10:52	20/11/2019 19:51	8,97	8	71,75	CHI
201911239721	GOIATUBA	GT21293081	GOIATUBA S2	18/11/2019 05:25	20/11/2019 15:45	18/11/2019 05:25	20/11/2019 15:45	58,33	1	58,33	CHI
201911239722	GOIATUBA	GT21074955	GOIATUBA S2	18/11/2019 06:09	20/11/2019 15:49	18/11/2019 06:09	20/11/2019 15:49	57,66	2	115,33	CHI
201911239723	GOIATUBA	GT31044919	GOIATUBA S2	20/11/2019 06:33	20/11/2019 15:47	20/11/2019 06:33	20/11/2019 15:47	9,22	1	9,22	CHI
201911239734	GOIANIA	GN11163701	CARAJAS S1	20/11/2019 14:46	20/11/2019 18:00	20/11/2019 14:46	20/11/2019 18:00	3,24	135	437,03	CHI
201911239738	CHAPADAO DO CEU	DJ10395374	CHAPADAO DO CEU	20/11/2019 15:08	21/11/2019 22:00	20/11/2019 15:08	20/11/2019 17:14	2,12	4	8,47	CHI
201911239738	CHAPADAO DO CEU	DJ12219562	CHAPADAO DO CEU	20/11/2019 15:08	21/11/2019 22:00	20/11/2019 15:08	21/11/2019 11:10	20,03	7	140,24	CHI
201911239738	MINEIROS	DJ12219562	CHAPADAO DO CEU	20/11/2019 15:08	21/11/2019 22:00	20/11/2019 15:08	21/11/2019 11:10	20,03	5	100,17	CHI
201911239738	CHAPADAO DO CEU	DJ13303410	CHAPADAO DO CEU	20/11/2019 15:08	21/11/2019 22:00	20/11/2019 15:08	21/11/2019 11:28	20,34	1	20,34	CHI
201911239738	MINEIROS	DJ12164268	CHAPADAO DO CEU	20/11/2019 15:08	21/11/2019 22:00	20/11/2019 15:08	21/11/2019 22:00	30,87	2	61,73	CHI

201911239740	RIO VERDE	02450434	CABRIUVA S2	20/11/2019 15:08	21/11/2019 17:05	20/11/2019 15:08	20/11/2019 16:48	1,67	33	55,20	CHI
201911239740	RIO VERDE	02450434	CABRIUVA S2	20/11/2019 15:08	21/11/2019 17:05	20/11/2019 15:09	20/11/2019 17:28	2,33	18	41,92	CHI
201911239740	RIO VERDE	02450434	CABRIUVA S2	20/11/2019 15:08	21/11/2019 17:05	20/11/2019 15:09	21/11/2019 00:40	9,52	4	38,08	CHI
201911239740	RIO VERDE	RV13172876	CABRIUVA S2	20/11/2019 15:08	21/11/2019 17:05	20/11/2019 15:09	21/11/2019 00:40	9,52	46	437,96	CHI
201911239740	RIO VERDE	02450434	CABRIUVA S2	20/11/2019 15:08	21/11/2019 17:05	20/11/2019 15:09	21/11/2019 17:05	25,93	18	466,78	CHI
201911239747	ITUMBIARA	IT11316730	PARANAIBA	20/11/2019 08:59	21/11/2019 11:36	20/11/2019 08:59	21/11/2019 11:36	26,60	6	159,62	CHI
201911239757	PLANALTINA	PI12131790	PLANALTINA	20/11/2019 10:33	20/11/2019 16:20	20/11/2019 10:33	20/11/2019 16:20	5,78	16	92,46	CHI
201911239768	BOM JESUS DE GOIAS	1250067409	BOM JESUS DE GOIAS	20/11/2019 16:21	20/11/2019 17:55	20/11/2019 16:21	20/11/2019 17:55	1,56	1	1,56	CHI
201911239770	ITAPACI	IW11232386	ITAPACI	20/11/2019 16:56	21/11/2019 16:35	20/11/2019 16:56	21/11/2019 16:35	23,66	7	165,60	CHI
201911239798	MORRINHOS	MR12223453	GOIATUBA S1	20/11/2019 05:32	20/11/2019 20:43	20/11/2019 05:32	20/11/2019 20:43	15,17	35	530,91	CHI
201911240106	ITAPACI	100084874	ITAPACI	20/11/2019 13:55	20/11/2019 15:57	20/11/2019 13:55	20/11/2019 15:57	2,02	1	2,02	CHI
201911240108	CRISTALINA	KR21246100	CRISTALINA S2	20/11/2019 13:55	21/11/2019 03:42	20/11/2019 13:55	21/11/2019 03:42	13,77	1	13,77	CHI
201911240110	GUARINOS	GG12316076	ITAPACI	20/11/2019 13:55	21/11/2019 11:55	20/11/2019 13:55	21/11/2019 11:55	21,98	3	65,95	CHI
201911240117	GOIANIA	12059160	GOIANIA LESTE S3	20/11/2019 13:57	20/11/2019 20:12	20/11/2019 13:57	20/11/2019 20:12	6,24	1	6,24	CHI
201911240122	IACIARA	10020142887	IACIARA S1	20/11/2019 13:58	20/11/2019 19:48	20/11/2019 13:58	20/11/2019 19:48	5,83	1	5,83	CHI
201911240207	AGUA FRIA DE GOIAS	10014600372	SAO JOAO D ALIANCA	20/11/2019 14:00	21/11/2019 01:01	20/11/2019 14:00	21/11/2019 01:01	11,02	1	11,02	CHI
201911240208	CAMPESTRE DE GOIAS	GC21039610	TRINDADE	20/11/2019 14:00	20/11/2019 18:00	20/11/2019 14:00	20/11/2019 18:00	4,00	1	4,00	CHI
201911240301	CAMPINACU	UC12312614	PORANGATU	20/11/2019 14:01	21/11/2019 08:17	20/11/2019 14:01	21/11/2019 08:17	18,26	8	146,09	CHI
201911240408	GOIANIA	10020879359	CARAJAS S2	19/11/2019 18:03	19/11/2019 22:35	19/11/2019 18:03	19/11/2019 22:35	4,53	1	4,53	CHI
201911240423	GOIANIA	GN11155695	CAMPINAS S2	20/11/2019 13:50	20/11/2019 17:55	20/11/2019 13:50	20/11/2019 17:55	4,08	163	664,81	CHI
201911241202	ALTO PARAISO DE GOIAS	BF21194788	SAO JOAO D ALIANCA	20/11/2019 14:04	20/11/2019 23:28	20/11/2019 14:04	20/11/2019 23:28	9,39	1	9,39	CHI
201911241203	ANAPOLIS	AN12000675	JUNDIAI S1	20/11/2019 14:05	20/11/2019 16:09	20/11/2019 14:05	20/11/2019 16:09	2,07	719	1485,93	CHI
201911241501	MUTUNOPOLIS	SE12352924	MARA ROSA	20/11/2019 14:05	21/11/2019 03:02	20/11/2019 14:05	21/11/2019 03:02	12,94	6	77,62	CHI
201911241501	SANTA TEREZA DE GOIAS	SE12352924	MARA ROSA	20/11/2019 14:05	21/11/2019 03:02	20/11/2019 14:05	21/11/2019 03:02	12,94	1	12,94	CHI
201911241707	PIRACANJUBA	PJ12233807	ROCHEDO	20/11/2019 11:56	20/11/2019 18:50	20/11/2019 11:56	20/11/2019 18:50	6,89	8	55,12	CHI
201911241717	AGUAS LINDAS DE GOIAS	SN12103544	AGUAS LINDAS DE GOIAS S1	20/11/2019 14:08	20/11/2019 17:41	20/11/2019 14:08	20/11/2019 16:28	2,33	1	2,33	CHI
201911241717	AGUAS LINDAS DE GOIAS	20295206	AGUAS LINDAS DE GOIAS S1	20/11/2019 14:08	20/11/2019 17:41	20/11/2019 14:08	20/11/2019 17:41	3,55	4	14,18	CHI
201911241720	MINEIROS	MY12360839	PARQUE DAS EMAS	20/11/2019 14:08	20/11/2019 15:16	20/11/2019 14:08	20/11/2019 15:16	1,13	32	36,06	CHI
201911241726	GOIANIA	14197613	REAL S1	20/11/2019 14:09	20/11/2019 16:12	20/11/2019 14:09	20/11/2019 16:12	2,04	1	2,04	CHI
201911241733	FORMOSA	FA11269915	ITUIQUIRA	20/11/2019 14:10	21/11/2019 13:44	20/11/2019 14:10	21/11/2019 13:44	23,56	1	23,56	CHI
201911241734	GOIANIA	15655866	FERROVIARIO S2	20/11/2019 14:10	20/11/2019 16:50	20/11/2019 14:10	20/11/2019 16:50	2,66	1	2,66	CHI
201911241735	GOIANIA	GN11002326	GOIANIA LESTE S1	20/11/2019 13:59	20/11/2019 17:17	20/11/2019 13:59	20/11/2019 17:17	3,29	77	253,05	CHI
201911241739	JARAGUA	JA12166643	JARAGUA	20/11/2019 06:01	20/11/2019 15:58	20/11/2019 06:01	20/11/2019 15:58	9,95	7	69,63	CHI

201911241750	GOIANIA	GN11001681	CAMPINAS S1	20/11/2019 13:49	20/11/2019 20:36	20/11/2019 13:49	20/11/2019 20:36	6,78	38	257,71	CHI
201911241801	OUVIDOR	OU21250300	CATALAO S1	20/11/2019 14:14	20/11/2019 22:14	20/11/2019 14:14	20/11/2019 22:14	7,98	1	7,98	CHI
201911241802	JARAGUA	JA12297982	SAO FRANCISCO DE GOIAS	20/11/2019 14:15	20/11/2019 18:18	20/11/2019 14:15	20/11/2019 18:18	4,05	23	93,14	CHI
201911241802	JESUPOLIS	JA12297982	SAO FRANCISCO DE GOIAS	20/11/2019 14:15	20/11/2019 18:18	20/11/2019 14:15	20/11/2019 18:18	4,05	5	20,25	CHI
201911241808	CAMPESTRE DE GOIAS	1230003621	TRINDADE	20/11/2019 14:15	20/11/2019 16:06	20/11/2019 14:15	20/11/2019 16:06	1,84	1	1,84	CHI
201911241811	GOIANIA	GN11002803	CAMPINAS S2	20/11/2019 13:20	21/11/2019 00:57	20/11/2019 13:20	21/11/2019 00:57	11,62	45	522,73	CHI
201911241819	PARAUNA	PU12380688	MONTIVIDIU T	20/11/2019 14:17	21/11/2019 11:14	20/11/2019 14:17	21/11/2019 11:14	20,95	2	41,89	CHI
201911241821	GAMELEIRA DE GOIAS	GL10395380	DAIA S2	20/11/2019 14:14	21/11/2019 16:47	20/11/2019 14:14	20/11/2019 16:52	2,64	120	316,37	CHI
201911241821	SILVANIA	GL10395380	DAIA S2	20/11/2019 14:14	21/11/2019 16:47	20/11/2019 14:14	20/11/2019 16:52	2,64	1	2,64	CHI
201911241821	GAMELEIRA DE GOIAS	GL10395380	DAIA S2	20/11/2019 14:14	21/11/2019 16:47	20/11/2019 18:21	20/11/2019 18:33	0,20	124	25,35	CHI
201911241821	SILVANIA	GL10395380	DAIA S2	20/11/2019 14:14	21/11/2019 16:47	20/11/2019 18:21	20/11/2019 18:33	0,20	1	0,20	CHI
201911241821	GAMELEIRA DE GOIAS	GL10395380	DAIA S2	20/11/2019 14:14	21/11/2019 16:47	21/11/2019 11:30	21/11/2019 12:43	1,22	124	151,18	CHI
201911241821	SILVANIA	GL10395380	DAIA S2	20/11/2019 14:14	21/11/2019 16:47	21/11/2019 11:30	21/11/2019 12:43	1,22	1	1,22	CHI
201911241821	ABADIANIA	GL10395380	DAIA S2	20/11/2019 14:14	21/11/2019 16:47	20/11/2019 14:14	21/11/2019 16:47	26,54	4	106,16	CHI
201911241821	ANAPOLIS	GL10395380	DAIA S2	20/11/2019 14:14	21/11/2019 16:47	20/11/2019 14:14	21/11/2019 16:47	26,54	4	106,16	CHI
201911241821	GAMELEIRA DE GOIAS	GL10395380	DAIA S2	20/11/2019 14:14	21/11/2019 16:47	20/11/2019 14:14	21/11/2019 16:47	26,54	143	3795,22	CHI
201911241821	GAMELEIRA DE GOIAS	GL13265250	DAIA S2	20/11/2019 14:14	21/11/2019 16:47	21/11/2019 11:30	21/11/2019 16:47	5,28	6	31,69	CHI
201911241827	GOIANIA	11188273	GOIANIA LESTE S2	20/11/2019 14:18	20/11/2019 22:30	20/11/2019 14:18	20/11/2019 22:30	8,19	1	8,19	CHI
201911241834	AGUAS LINDAS DE GOIAS	10004489037	AGUAS LINDAS DE GOIAS S2	20/11/2019 14:19	20/11/2019 21:42	20/11/2019 14:19	20/11/2019 21:42	7,37	1	7,37	CHI
201911241839	SANTA HELENA DE GOIAS	SH21249045	SANTA HELENA S1	20/11/2019 12:11	20/11/2019 16:52	20/11/2019 12:11	20/11/2019 16:52	4,68	1	4,68	CHI
201911241840	BOM JARDIM DE GOIAS	BM12253665	BOM JARDIM	20/11/2019 13:14	21/11/2019 17:05	20/11/2019 13:14	21/11/2019 17:05	27,85	3	83,55	CHI
201911241840	PIRANHAS	BM12253665	BOM JARDIM	20/11/2019 13:14	21/11/2019 17:05	20/11/2019 13:14	21/11/2019 17:05	27,85	3	83,55	CHI
201911241842	CATALAO	CT21250371	CATALAO S1	20/11/2019 14:20	21/11/2019 08:40	20/11/2019 14:20	21/11/2019 08:40	18,32	1	18,32	CHI
201911241844	GOIANIA	GN12329372	AEROPORTO S2	20/11/2019 12:56	20/11/2019 20:40	20/11/2019 12:56	20/11/2019 20:40	7,73	85	657,12	CHI
201911241904	PALMEIRAS DE GOIAS	PL12092997	PALMEIRAS	20/11/2019 14:21	20/11/2019 16:15	20/11/2019 14:21	20/11/2019 16:15	1,89	33	62,35	CHI
201911241908	BOM JARDIM DE GOIAS	1880019519	BOM JARDIM	20/11/2019 14:21	21/11/2019 09:47	20/11/2019 14:21	21/11/2019 09:47	19,45	1	19,45	CHI
201911241909	PILAR DE GOIAS	GG21237786	URUACU	20/11/2019 14:22	20/11/2019 18:15	20/11/2019 14:22	20/11/2019 18:15	3,89	1	3,89	CHI
201911241920	ARACU	AV12020305	ANICUNS	20/11/2019 14:04	20/11/2019 15:48	20/11/2019 14:04	20/11/2019 15:48	1,73	13	22,46	CHI
201911241920	AVELINOPOLIS	AV12020305	ANICUNS	20/11/2019 14:04	20/11/2019 15:48	20/11/2019 14:04	20/11/2019 15:48	1,73	175	302,41	CHI
201911241920	CATURAI	AV12020305	ANICUNS	20/11/2019 14:04	20/11/2019 15:48	20/11/2019 14:04	20/11/2019 15:48	1,73	8	13,82	CHI
201911241920	ITABERAI	AV12020305	ANICUNS	20/11/2019 14:04	20/11/2019 15:48	20/11/2019 14:04	20/11/2019 15:48	1,73	19	32,83	CHI
201911241920	SANTA BARBARA DE GOIAS	AV12020305	ANICUNS	20/11/2019 14:04	20/11/2019 15:48	20/11/2019 14:04	20/11/2019 15:48	1,73	8	13,82	CHI
201911241930	GOIANIA	GN11042202	GOYA S2	20/11/2019 13:13	20/11/2019 23:48	20/11/2019 13:13	20/11/2019 23:48	10,57	166	1754,21	CHI

201911242003	ALTO PARAISO DE GOIAS	BF12218456	NIQUELANDIA SUBTRANSMISSAO	20/11/2019 14:26	21/11/2019 14:45	20/11/2019 14:26	21/11/2019 14:45	24,31	3	72,92	CHI
201911242004	GOIANIA	10413091	GOIANIA LESTE S2	20/11/2019 14:26	20/11/2019 16:12	20/11/2019 14:26	20/11/2019 16:12	1,77	1	1,77	CHI
201911242006	CAIAPONIA	CP12200875	CAIAPONIA	20/11/2019 14:16	21/11/2019 08:30	20/11/2019 14:16	21/11/2019 08:30	18,23	9	164,09	CHI
201911242008	APARECIDA DE GOIANIA	10011452453	INDEPENDENCIA S1	20/11/2019 14:27	20/11/2019 19:43	20/11/2019 14:27	20/11/2019 19:43	5,26	1	5,26	CHI
201911242009	APARECIDA DE GOIANIA	10007058436	ANHANGUERA	20/11/2019 14:27	20/11/2019 16:37	20/11/2019 14:27	20/11/2019 16:37	2,16	1	2,16	CHI
201911242103	RIO VERDE	RV21212482	MONTIVIDIU T	20/11/2019 14:28	21/11/2019 18:28	20/11/2019 14:28	21/11/2019 18:28	27,99	1	27,99	CHI
201911242203	FIRMINOPOLIS	FR12391442	FIRMINOPOLIS S2	20/11/2019 14:29	20/11/2019 16:16	20/11/2019 14:29	20/11/2019 16:16	1,78	65	115,84	CHI
201911242203	SAO JOAO DA PARAUNA	FR12391442	FIRMINOPOLIS S2	20/11/2019 14:29	20/11/2019 16:16	20/11/2019 14:29	20/11/2019 16:16	1,78	71	126,54	CHI
201911242206	GOIANIA	GN12154060	CAMPINAS S2	20/11/2019 13:18	20/11/2019 16:42	20/11/2019 13:18	20/11/2019 16:42	3,40	79	268,56	CHI
201911242210	CATALAO	10018123560	CATALAO S2	20/11/2019 14:29	21/11/2019 09:37	20/11/2019 14:29	21/11/2019 09:37	19,13	1	19,13	CHI
201911242301	RIO VERDE	630156372	RIO VERDE S2	20/11/2019 14:29	20/11/2019 18:26	20/11/2019 14:29	20/11/2019 18:26	3,95	1	3,95	CHI
201911242804	GOIANIA	10137099	ATLANTICO S1	20/11/2019 14:31	20/11/2019 19:18	20/11/2019 14:31	20/11/2019 19:18	4,78	1	4,78	CHI
201911242811	GOIANIA	GN11194305	FERROVIARIO S2	20/11/2019 10:58	20/11/2019 17:30	20/11/2019 10:58	20/11/2019 17:30	6,52	48	313,08	CHI
201911242901	SILVANIA	SV12389456	VIANOPOLIS	20/11/2019 14:25	21/11/2019 10:33	20/11/2019 14:25	21/11/2019 10:33	20,13	104	2093,17	CHI
201911243102	PARAUNA	PU11000005	PARAUNA	20/11/2019 13:44	20/11/2019 21:24	20/11/2019 13:44	20/11/2019 21:24	7,66	63	482,67	CHI
201911243105	RUBIATABA	780007803	RUBIATABA	20/11/2019 14:33	20/11/2019 22:57	20/11/2019 14:33	20/11/2019 22:57	8,41	1	8,41	CHI
201911243108	GOIANIA	GN21002495	AEROPORTO S3	20/11/2019 14:34	20/11/2019 17:40	20/11/2019 14:34	20/11/2019 17:40	3,10	1	3,10	CHI
201911243501	AURILANDIA	CG12153727	FIRMINOPOLIS S2	20/11/2019 08:06	21/11/2019 08:55	20/11/2019 08:06	21/11/2019 08:55	24,81	3	74,42	CHI
201911243501	CACHOEIRA DE GOIAS	CG12153727	FIRMINOPOLIS S2	20/11/2019 08:06	21/11/2019 08:55	20/11/2019 08:06	21/11/2019 08:55	24,81	1	24,81	CHI
201911243503	PILAR DE GOIAS	GG21309335	SANTA TEREZINHA	20/11/2019 14:35	20/11/2019 20:46	20/11/2019 14:35	20/11/2019 20:46	6,17	1	6,17	CHI
201911243506	GOIANIA	GN11000960	CAMPINAS S1	20/11/2019 13:41	20/11/2019 20:52	20/11/2019 13:41	20/11/2019 20:52	7,18	153	1099,30	CHI
201911243518	BELA VISTA DE GOIAS	BV21020423	BELA VISTA S2	20/11/2019 14:38	21/11/2019 19:05	20/11/2019 14:38	21/11/2019 19:05	28,44	1	28,44	CHI
201911243526	SAO JOAO D ALIANCA	JL12180616	SAO JOAO D ALIANCA	20/11/2019 14:39	21/11/2019 09:05	20/11/2019 14:39	21/11/2019 09:05	18,43	5	92,13	CHI
201911243606	CACU	2910006020	CACHOEIRA ALTA	20/11/2019 14:42	20/11/2019 19:25	20/11/2019 14:42	20/11/2019 19:25	4,72	1	4,72	CHI
201911243607	JARAGUA	70072267	JARAGUA	20/11/2019 14:42	20/11/2019 20:48	20/11/2019 14:42	20/11/2019 20:48	6,09	1	6,09	CHI
201911243701	URUTAI	10009759601	URUTAI	20/11/2019 14:43	21/11/2019 09:29	20/11/2019 14:43	21/11/2019 09:29	18,76	1	18,76	CHI
201911243802	CORUMBA DE GOIAS	CB21312026	ALEXANIA	20/11/2019 14:43	21/11/2019 12:25	20/11/2019 14:43	21/11/2019 12:25	21,70	1	21,70	CHI
201911243808	SANTA TEREZA DE GOIAS	TB12170075	PORANGATU	20/11/2019 12:16	21/11/2019 10:08	20/11/2019 12:16	21/11/2019 10:08	21,86	3	65,57	CHI
201911243810	GOIAS	GS12274373	GOIAS	20/11/2019 14:44	21/11/2019 18:13	20/11/2019 14:44	21/11/2019 18:13	27,48	12	329,76	CHI
201911243812	ABADIANIA	350027651	ANAPOLIS UNIVERSITARIO S1	20/11/2019 14:44	20/11/2019 16:10	20/11/2019 14:44	20/11/2019 16:10	1,43	1	1,43	CHI
201911243814	CRISTALINA	KR12209473	CRISTALINA S2	20/11/2019 14:44	21/11/2019 11:02	20/11/2019 14:44	21/11/2019 11:02	20,30	8	162,40	CHI
201911243816	CRISTALINA	03940214	CRISTALINA S2	20/11/2019 13:33	20/11/2019 17:10	20/11/2019 13:33	20/11/2019 17:10	3,62	284	1027,21	CHI
201911244101	RIO VERDE	RV21249080	CABRIUVA S2	20/11/2019 14:48	20/11/2019 18:10	20/11/2019 14:48	20/11/2019 18:10	3,37	1	3,37	CHI

201911244401	ITAPIRAPUA	IU21018821	MATRINCHA	20/11/2019 14:48	21/11/2019 10:56	20/11/2019 14:48	21/11/2019 10:56	20,13	1	20,13	CHI
201911244404	SAO SIMAO	10000745390	CACHOEIRA ALTA	20/11/2019 14:44	21/11/2019 16:56	20/11/2019 14:44	21/11/2019 16:56	26,20	1	26,20	CHI
201911244410	RIO VERDE	RV21200095	MONTIVIDIU T	20/11/2019 14:48	21/11/2019 13:30	20/11/2019 14:48	21/11/2019 13:30	22,68	1	22,68	CHI
201911244415	PALESTINA DE GOIAS	PY12023472	PALESTINA	20/11/2019 14:49	20/11/2019 16:10	20/11/2019 14:49	20/11/2019 16:10	1,34	8	10,71	CHI
201911244427	URUACU	UR12237468	URUACU	20/11/2019 11:18	21/11/2019 00:15	20/11/2019 11:18	21/11/2019 00:15	12,93	7	90,54	CHI
201911244501	SANTO ANTONIO DO DESCOBERTO	SN11023429	ALEXANIA	20/11/2019 14:53	20/11/2019 17:40	20/11/2019 14:53	20/11/2019 17:40	2,78	96	266,96	CHI
201911244502	CALDAS NOVAS	760228930	SERRA DE CALDAS	20/11/2019 14:53	20/11/2019 16:40	20/11/2019 14:53	20/11/2019 16:40	1,78	1	1,78	CHI
201911244503	HIDROLANDIA	HD21269028	CEPAIGO S2	20/11/2019 14:53	20/11/2019 18:11	20/11/2019 14:53	20/11/2019 18:11	3,30	3	9,89	CHI
201911244504	ANAPOLIS	10030496223	ANAPOLIS UNIVERSITARIO S2	20/11/2019 14:53	20/11/2019 18:35	20/11/2019 14:53	20/11/2019 18:35	3,70	1	3,70	CHI
201911244516	NEROPOLIS	NR21364339	NEROPOLIS S2	20/11/2019 14:55	20/11/2019 20:42	20/11/2019 14:55	20/11/2019 20:42	5,77	1	5,77	CHI
201911244517	PLANALTINA	PI12355773	PLANALTINA	20/11/2019 14:56	21/11/2019 20:18	20/11/2019 14:56	21/11/2019 20:18	29,36	47	1380,04	CHI
201911244604	ANICUNS	AC21278638	FIRMINOPOLIS S2	20/11/2019 14:56	21/11/2019 07:53	20/11/2019 14:56	21/11/2019 07:53	16,94	1	16,94	CHI
201911244606	MINACU	IH21182274	MINACU	20/11/2019 14:56	21/11/2019 12:41	20/11/2019 14:56	21/11/2019 12:41	21,74	1	21,74	CHI
201911244607	TROMBAS	TB21256984	PORANGATU	20/11/2019 14:57	21/11/2019 12:48	20/11/2019 14:57	21/11/2019 12:48	21,85	1	21,85	CHI
201911244803	VICENTINOPOLIS	VI12263322	VICENTINOPOLIS	20/11/2019 09:36	20/11/2019 16:08	20/11/2019 09:36	20/11/2019 16:08	6,53	8	52,27	CHI
201911245106	GOIATUBA	GT21352573	BOM JESUS DE GOIAS	20/11/2019 15:00	20/11/2019 19:42	20/11/2019 15:00	20/11/2019 19:42	4,69	2	9,38	CHI
201911245304	MONTES CLAROS DE GOIAS	ME12187647	IPORA	20/11/2019 15:00	21/11/2019 12:38	20/11/2019 15:00	21/11/2019 12:38	21,62	8	172,96	CHI
201911245310	FAZENDA NOVA	JP12089836	IPORA	20/11/2019 15:01	20/11/2019 17:47	20/11/2019 15:01	20/11/2019 17:47	2,76	59	162,99	CHI
201911245311	CAIAPONIA	CP21119598	CAIAPONIA	20/11/2019 15:01	21/11/2019 11:12	20/11/2019 15:01	21/11/2019 11:12	20,17	1	20,17	CHI
201911245313	ANAPOLIS	10002738005	ANAPOLIS UNIVERSITARIO S2	20/11/2019 15:02	21/11/2019 08:39	20/11/2019 15:02	21/11/2019 08:39	17,61	1	17,61	CHI
201911245403	CAMPINORTE	CR12172313LD	MARA ROSA	20/11/2019 15:02	21/11/2019 17:18	20/11/2019 15:02	21/11/2019 17:18	26,26	2	52,51	CHI
201911245410	SANTA RITA DO ARAGUAIA	2130016644	SANTA RITA DO ARAGUAIA	20/11/2019 15:03	21/11/2019 16:20	20/11/2019 15:03	21/11/2019 16:20	25,28	1	25,28	CHI
201911245412	CALDAS NOVAS	CN21110307	CALDAS NOVAS S2	20/11/2019 15:03	21/11/2019 09:23	20/11/2019 15:03	21/11/2019 09:23	18,32	1	18,32	CHI
201911245413	AGUA FRIA DE GOIAS	TL12180857	SAO JOAO D ALIANCA	20/11/2019 15:04	22/11/2019 12:01	20/11/2019 15:04	22/11/2019 12:01	44,95	4	179,79	CHI
201911245418	NOVO GAMA	NJ11059740	PACAEMBU S1	20/11/2019 14:43	20/11/2019 17:00	20/11/2019 14:43	20/11/2019 17:00	2,27	125	283,68	CHI
201911245420	GOIANIA	GN11001666	REAL S1	20/11/2019 14:48	20/11/2019 18:00	20/11/2019 14:48	20/11/2019 18:00	3,20	114	364,64	CHI
201911245422	RIO VERDE	630304180	RIO VERDE S2	20/11/2019 15:04	20/11/2019 17:09	20/11/2019 15:04	20/11/2019 17:09	2,07	1	2,07	CHI
201911245424	AGUA LIMPA	AL12075701	VILA CORUMBA	20/11/2019 07:48	20/11/2019 17:20	20/11/2019 07:48	20/11/2019 17:20	9,53	5	47,63	CHI
201911245426	APARECIDA DE GOIANIA	200047292	ANHANGUERA	20/11/2019 15:05	20/11/2019 18:06	20/11/2019 15:05	20/11/2019 18:06	3,01	1	3,01	CHI
201911245431	GOIANIA	GN11034288	FERROVIARIO S2	20/11/2019 15:06	20/11/2019 18:50	20/11/2019 15:06	20/11/2019 18:50	3,73	98	365,68	CHI
201911245703	PALMEIRAS DE GOIAS	PP12005727	FIRMINOPOLIS S2	20/11/2019 10:09	20/11/2019 20:50	20/11/2019 10:09	20/11/2019 20:50	10,70	10	106,96	CHI
201911245703	PALMINOPOLIS	PP12005727	FIRMINOPOLIS S2	20/11/2019 10:09	20/11/2019 20:50	20/11/2019 10:09	20/11/2019 20:50	10,70	39	417,13	CHI
201911245707	FORMOSA	FA12071048	ITIQUEIRA	20/11/2019 13:37	20/11/2019 19:20	20/11/2019 13:37	20/11/2019 19:20	5,71	14	79,88	CHI

201911245801	FORMOSA	610279245	ITUIQUIRA	20/11/2019 15:07	21/11/2019 12:32	20/11/2019 15:07	21/11/2019 12:32	21,41	1	21,41	CHI
201911246004	HIDROLANDIA	HD21000271	CEPAIGO S2	20/11/2019 15:08	22/11/2019 13:57	20/11/2019 15:08	22/11/2019 13:57	46,81	1	46,81	CHI
201911246005	PALMELO	PZ11216193	PIRES DO RIO S2	20/11/2019 15:08	21/11/2019 12:58	20/11/2019 15:08	21/11/2019 12:58	21,82	46	1003,90	CHI
201911246012	INDIARA	2710027635	EDEIA	20/11/2019 15:09	21/11/2019 10:07	20/11/2019 15:09	21/11/2019 10:07	18,97	1	18,97	CHI
201911246021	GOIANIA	GN11000210	AEROPORTO S1	20/11/2019 14:25	20/11/2019 19:33	20/11/2019 14:25	20/11/2019 19:33	5,13	67	343,45	CHI
201911246023	GOIANIA	GN12000625	CAMPINAS S2	20/11/2019 15:06	20/11/2019 17:04	20/11/2019 15:06	20/11/2019 17:04	1,96	122	238,95	CHI
201911246504	AMORINOPOLIS	AM12000037	IPORA	20/11/2019 14:21	20/11/2019 16:27	20/11/2019 14:21	20/11/2019 16:27	2,09	9	18,80	CHI
201911246504	IVOLANDIA	AM12000037	IPORA	20/11/2019 14:21	20/11/2019 16:27	20/11/2019 14:21	20/11/2019 16:27	2,09	9	18,80	CHI
201911246516	ANICUNS	AC11021753	FIRMINOPOLIS S2	20/11/2019 15:03	20/11/2019 18:08	20/11/2019 15:03	20/11/2019 18:08	3,08	140	431,63	CHI
201911246702	COCALZINHO DE GOIAS	ZN12273327	AGUAS LINDAS DE GOIAS S2	20/11/2019 15:15	20/11/2019 17:14	20/11/2019 15:15	20/11/2019 17:14	1,98	4	7,90	CHI
201911247011	AGUA FRIA DE GOIAS	JL21270091	SAO JOAO D ALIANCA	20/11/2019 15:17	21/11/2019 19:40	20/11/2019 15:17	21/11/2019 19:40	28,37	1	28,37	CHI
201911247012	GOIANIA	SW10395406	SENADOR CANEDO	20/11/2019 15:15	20/11/2019 19:42	20/11/2019 15:15	20/11/2019 19:42	4,45	8	35,63	CHI
201911247012	SENADOR CANEDO	SW10395406	SENADOR CANEDO	20/11/2019 15:15	20/11/2019 19:42	20/11/2019 15:15	20/11/2019 19:42	4,45	1599	7121,32	CHI
201911247204	NEROPOLIS	NR12402741	NEROPOLIS S2	20/11/2019 15:19	20/11/2019 19:46	20/11/2019 15:19	20/11/2019 19:46	4,45	3	13,34	CHI
201911247303	APARECIDA DE GOIANIA	AP12000024	INDEPENDENCIA S2	20/11/2019 15:18	20/11/2019 19:39	20/11/2019 15:18	20/11/2019 19:39	4,34	598	2595,82	CHI
201911247305	SANTO ANTONIO DA BARRA	2270006118	ACREUNA	20/11/2019 15:18	20/11/2019 21:19	20/11/2019 15:18	20/11/2019 21:19	6,02	1	6,02	CHI
201911247306	JATAI	10030537256	JATAI S2	20/11/2019 15:19	21/11/2019 15:45	20/11/2019 15:19	21/11/2019 15:45	24,42	1	24,42	CHI
201911247501	MINEIROS	MY12362701	PARQUE DAS EMAS	20/11/2019 15:20	20/11/2019 22:39	20/11/2019 15:20	20/11/2019 22:39	7,30	4	29,22	CHI
201911247502	ANAPOLIS	20673541	ANAPOLIS UNIVERSITARIO S2	20/11/2019 15:20	20/11/2019 16:42	20/11/2019 15:20	20/11/2019 16:42	1,35	1	1,35	CHI
201911247601	NEROPOLIS	NR21000017	NEROPOLIS S2	20/11/2019 15:20	20/11/2019 17:29	20/11/2019 15:20	20/11/2019 17:29	2,14	3	6,41	CHI
201911247701	SILVANIA	SV12190403	DAIA S2	20/11/2019 14:47	20/11/2019 20:22	20/11/2019 14:47	20/11/2019 20:22	5,57	57	317,51	CHI
201911247702	GOIANIA	GN11001592	GOIANIA LESTE S2	20/11/2019 14:38	20/11/2019 19:52	20/11/2019 14:38	20/11/2019 19:52	5,23	180	941,70	CHI
201911247704	CRISTALINA	KR21244613	CRISTALINA S2	20/11/2019 15:21	21/11/2019 11:27	20/11/2019 15:21	21/11/2019 11:27	20,10	1	20,10	CHI
201911247705	RIO VERDE	RV12031480	RIO VERDE S1	20/11/2019 15:21	20/11/2019 17:20	20/11/2019 15:21	20/11/2019 17:20	1,99	52	103,31	CHI
201911247710	CRISTALINA	KR21229248	CRISTALINA S1	20/11/2019 15:22	20/11/2019 18:35	20/11/2019 15:22	20/11/2019 18:35	3,21	2	6,42	CHI
201911247801	INDIARA	PL12376414	PALMEIRAS	20/11/2019 15:22	21/11/2019 02:32	20/11/2019 15:22	21/11/2019 02:32	11,16	3	33,49	CHI
201911247801	PALMEIRAS DE GOIAS	PL12376414	PALMEIRAS	20/11/2019 15:22	21/11/2019 02:32	20/11/2019 15:22	21/11/2019 02:32	11,16	47	524,72	CHI
201911247802	MORRINHOS	MR31056662	MORRINHOS	20/11/2019 15:22	21/11/2019 01:41	20/11/2019 15:22	21/11/2019 01:41	10,31	1	10,31	CHI
201911248101	RIO VERDE	RV10400561	CABRIUVA S2	20/11/2019 13:22	20/11/2019 18:02	20/11/2019 13:22	20/11/2019 18:02	4,66	125	582,53	CHI
201911248112	FAZENDA NOVA	FN21020242	JUSSARA	20/11/2019 15:24	21/11/2019 16:56	20/11/2019 15:24	21/11/2019 16:56	25,53	1	25,53	CHI
201911248405	MORRINHOS	MR12204554	MORRINHOS	20/11/2019 15:25	21/11/2019 11:38	20/11/2019 15:25	21/11/2019 11:38	20,21	4	80,83	CHI
201911248503	NOVO GAMA	4990039817	PACAEMBU S1	20/11/2019 15:26	20/11/2019 22:32	20/11/2019 15:26	20/11/2019 22:32	7,09	1	7,09	CHI
201911248703	RIO VERDE	RV21214146	CABRIUVA S2	20/11/2019 15:27	20/11/2019 17:37	20/11/2019 15:27	20/11/2019 17:37	2,16	1	2,16	CHI

201911248710	ITAPURANGA	IK12298506	ITAPURANGA	20/11/2019 13:32	20/11/2019 16:53	20/11/2019 13:32	20/11/2019 16:53	3,35	6	20,07	CHI
201911248715	ITABERAÍ	IB11337291	INHUMAS S1	20/11/2019 15:28	20/11/2019 17:00	20/11/2019 15:28	20/11/2019 17:00	1,53	1	1,53	CHI
201911248901	ANAPOLIS	AN21000628	ANAPOLIS UNIVERSITARIO S2	20/11/2019 15:29	21/11/2019 11:22	20/11/2019 15:29	21/11/2019 11:22	19,87	1	19,87	CHI
201911249001	SERRANOPOLIS	8045884	JATAI S1	20/11/2019 15:29	20/11/2019 19:22	20/11/2019 15:29	20/11/2019 19:22	3,87	2	7,74	CHI
201911249101	INDIARA	IY13407335B	EDEIA	20/11/2019 15:29	21/11/2019 03:57	21/11/2019 01:21	21/11/2019 03:40	2,32	121	280,38	CHI
201911249101	PALMEIRAS DE GOIAS	IY13407335B	EDEIA	20/11/2019 15:29	21/11/2019 03:57	21/11/2019 01:21	21/11/2019 03:40	2,32	1	2,32	CHI
201911249101	INDIARA	IY11048154	EDEIA	20/11/2019 15:29	21/11/2019 03:57	20/11/2019 15:29	21/11/2019 03:57	12,47	174	2168,96	CHI
201911249110	BURITI ALEGRE	BG21363807	ALTO BURITI	20/11/2019 15:31	21/11/2019 16:37	20/11/2019 15:31	21/11/2019 16:37	25,10	1	25,10	CHI
201911249202	LUZIANIA	LZ12000543	MARAJOARA	20/11/2019 15:26	20/11/2019 17:20	20/11/2019 15:26	20/11/2019 17:20	1,89	39	73,57	CHI
201911249413	GOIANIA	GN11003127	CAMPINAS S2	20/11/2019 13:29	20/11/2019 17:18	20/11/2019 13:29	20/11/2019 17:18	3,80	155	589,60	CHI
201911249414	ARENOPOLIS	AY13354681	ARENOPOLIS	20/11/2019 14:37	21/11/2019 12:53	20/11/2019 14:37	21/11/2019 12:40	22,04	87	1917,87	CHI
201911249414	DIORAMA	AY13354681	ARENOPOLIS	20/11/2019 14:37	21/11/2019 12:53	20/11/2019 14:37	21/11/2019 12:40	22,04	12	264,53	CHI
201911249414	MONTES CLAROS DE GOIAS	AY13354681	ARENOPOLIS	20/11/2019 14:37	21/11/2019 12:53	20/11/2019 14:37	21/11/2019 12:40	22,04	24	529,07	CHI
201911249414	PIRANHAS	AY13354681	ARENOPOLIS	20/11/2019 14:37	21/11/2019 12:53	20/11/2019 14:37	21/11/2019 12:40	22,04	21	462,93	CHI
201911249414	ARENOPOLIS	AY13349753	ARENOPOLIS	20/11/2019 14:37	21/11/2019 12:53	20/11/2019 14:37	21/11/2019 12:53	22,26	108	2404,02	CHI
201911249414	PIRANHAS	AY13349753	ARENOPOLIS	20/11/2019 14:37	21/11/2019 12:53	20/11/2019 14:37	21/11/2019 12:53	22,26	4	89,04	CHI
201911249508	ANAPOLIS	AN21135146	ANAPOLIS UNIVERSITARIO S2	20/11/2019 15:35	21/11/2019 12:38	20/11/2019 15:35	21/11/2019 12:38	21,04	1	21,04	CHI
201911249514	GOIANIRA	10012190096	GOIANIRA	20/11/2019 15:36	21/11/2019 02:31	20/11/2019 15:36	21/11/2019 02:31	10,91	1	10,91	CHI
201911249519	GOIANIRA	10019593650	GOIANIRA	20/11/2019 15:36	20/11/2019 23:57	20/11/2019 15:36	20/11/2019 23:57	8,34	1	8,34	CHI
201911249520	NIQUELANDIA	NQ21213019	NIQUELANDIA SUBTRANSMISSAO	20/11/2019 15:36	21/11/2019 09:40	20/11/2019 15:36	21/11/2019 09:40	18,05	1	18,05	CHI
201911249531	PARAUNA	PU12103374	PARAUNA	20/11/2019 15:37	21/11/2019 09:25	20/11/2019 15:37	21/11/2019 09:25	17,79	12	213,43	CHI
201911249601	SENADOR CANEDO	190041365	SENADOR CANEDO	20/11/2019 15:40	20/11/2019 22:07	20/11/2019 15:40	20/11/2019 22:07	6,45	1	6,45	CHI
201911249604	DIORAMA	DI12184429	IPORA	20/11/2019 15:39	20/11/2019 17:45	20/11/2019 15:39	20/11/2019 17:45	2,09	9	18,77	CHI
201911249608	GOIANIA	14459528	CARAJAS S1	20/11/2019 15:40	20/11/2019 18:25	20/11/2019 15:40	20/11/2019 18:25	2,74	1	2,74	CHI
201911249609	TURVANIA	TV12005720	FIRMINOPOLIS S2	20/11/2019 14:27	20/11/2019 19:45	20/11/2019 14:27	20/11/2019 19:45	5,30	14	74,19	CHI
201911249625	ANAPOLIS	AN12270323	ANAPOLIS UNIVERSITARIO S2	20/11/2019 15:40	20/11/2019 17:16	20/11/2019 15:40	20/11/2019 17:16	1,60	3	4,80	CHI
201911249625	PIRENOPOLIS	AN12270323	ANAPOLIS UNIVERSITARIO S2	20/11/2019 15:40	20/11/2019 17:16	20/11/2019 15:40	20/11/2019 17:16	1,60	2	3,20	CHI
201911249806	PONTALINA	PK21080043	PONTALINA	20/11/2019 15:44	21/11/2019 11:41	20/11/2019 15:44	21/11/2019 11:41	19,94	1	19,94	CHI
201911249810	ANAPOLIS	AN11000893	ANAPOLIS UNIVERSITARIO S2	20/11/2019 15:44	20/11/2019 17:02	20/11/2019 15:44	20/11/2019 17:02	1,29	66	84,85	CHI
201911250203	CAIAPONIA	CP12390147	CAIAPONIA	20/11/2019 15:45	20/11/2019 20:42	20/11/2019 15:45	20/11/2019 20:42	4,94	8	39,50	CHI
201911250204	BELA VISTA DE GOIAS	HD32047725	CEPAIGO S2	20/11/2019 15:43	21/11/2019 13:04	20/11/2019 15:43	21/11/2019 13:04	21,33	7	149,34	CHI
201911250204	HIDROLANDIA	HD32047725	CEPAIGO S2	20/11/2019 15:43	21/11/2019 13:04	20/11/2019 15:43	21/11/2019 13:04	21,33	1	21,33	CHI
201911250206	AMORINOPOLIS	AM12000032	IPORA	20/11/2019 13:51	20/11/2019 17:36	20/11/2019 13:51	20/11/2019 17:36	3,75	6	22,47	CHI

201911250206	IVOLANDIA	AM12000032	IPORA	20/11/2019 13:51	20/11/2019 17:36	20/11/2019 13:51	20/11/2019 17:36	3,75	10	37,46	CHI
201911250209	NEROPOLIS	NR12391379	NEROPOLIS S2	20/11/2019 15:46	20/11/2019 17:12	20/11/2019 15:46	20/11/2019 17:12	1,43	10	14,28	CHI
201911250210	GOIANIA	11411016	CAMPINAS S2	20/11/2019 15:46	21/11/2019 01:41	20/11/2019 15:46	21/11/2019 01:41	9,91	1	9,91	CHI
201911250213	LUZIANIA	LZ12000511	MARAJOARA	20/11/2019 15:46	21/11/2019 05:08	20/11/2019 15:46	21/11/2019 05:08	13,35	2	26,71	CHI
201911250218	FIRMINOPOLIS	FR12096845	FIRMINOPOLIS S1	20/11/2019 15:42	21/11/2019 08:30	20/11/2019 15:42	21/11/2019 08:30	16,80	17	285,65	CHI
201911250219	CALDAS NOVAS	CN12102170	CALDAS NOVAS S1	20/11/2019 10:54	20/11/2019 19:37	20/11/2019 10:54	20/11/2019 19:37	8,72	142	1237,69	CHI
201911250510	FORMOSA	FA21329740	ITIQUEIRA	20/11/2019 15:48	21/11/2019 20:19	20/11/2019 15:48	21/11/2019 20:19	28,50	1	28,50	CHI
201911250515	FIRMINOPOLIS	FR21299251	FIRMINOPOLIS S2	20/11/2019 15:49	21/11/2019 14:27	20/11/2019 15:49	21/11/2019 14:27	22,62	2	45,25	CHI
201911250516	GOIANIA	10489022	GOIANIA LESTE S3	20/11/2019 15:49	21/11/2019 19:26	20/11/2019 15:49	21/11/2019 19:26	27,60	1	27,60	CHI
201911250517	VALPARAISO DE GOIAS	2860066350	PACAEMBU S1	20/11/2019 15:50	21/11/2019 00:16	20/11/2019 15:50	21/11/2019 00:16	8,43	1	8,43	CHI
201911250519	RIO VERDE	630293673	RIO VERDE S2	20/11/2019 15:50	20/11/2019 17:41	20/11/2019 15:50	20/11/2019 17:41	1,85	1	1,85	CHI
201911250527	CRISTALINA	KR21246098	CRISTALINA S1	20/11/2019 15:51	21/11/2019 15:43	20/11/2019 15:51	21/11/2019 15:43	23,85	2	47,70	CHI
201911250528	ANAPOLIS	AN11198365	ANAPOLIS UNIVERSITARIO S2	20/11/2019 14:59	20/11/2019 17:55	20/11/2019 14:59	20/11/2019 17:55	2,93	133	389,14	CHI
201911250531	SENADOR CANEDO	SW11167715	SENADOR CANEDO	20/11/2019 13:55	20/11/2019 20:31	20/11/2019 13:55	20/11/2019 20:31	6,59	152	1002,40	CHI
201911250532	SANTO ANTONIO DO DESCOBERTO	SN12261733	MARAJOARA	20/11/2019 15:52	21/11/2019 09:53	20/11/2019 15:52	21/11/2019 09:53	18,01	8	144,05	CHI
201911250535	SANTO ANTONIO DO DESCOBERTO	SN12379433	ALEXANIA	20/11/2019 15:53	20/11/2019 21:48	20/11/2019 15:53	20/11/2019 21:48	5,92	24	141,98	CHI
201911250542	SAO JOAO D ALIANCA	JL21332922	SAO JOAO D ALIANCA	20/11/2019 15:55	22/11/2019 17:09	20/11/2019 15:55	22/11/2019 17:09	49,23	1	49,23	CHI
201911250544	GOIANIA	11161620	CAMPINAS S2	20/11/2019 15:55	20/11/2019 23:24	20/11/2019 15:55	20/11/2019 23:24	7,48	1	7,48	CHI
201911250550	ORIZONA	OZ21000354	PIRES DO RIO S2	20/11/2019 15:56	21/11/2019 08:49	20/11/2019 15:56	21/11/2019 08:49	16,89	1	16,89	CHI
201911250551	IPORA	730093621	ARENOPOLIS	20/11/2019 15:56	21/11/2019 04:17	20/11/2019 15:56	21/11/2019 04:17	12,34	1	12,34	CHI
201911250552	GOIANDIRA	GD12000015	CATALAO S1	20/11/2019 08:47	20/11/2019 18:00	20/11/2019 08:47	20/11/2019 18:00	9,20	6	55,23	CHI
201911250559	BOM JARDIM DE GOIAS	BM12395433	BOM JARDIM	20/11/2019 14:04	21/11/2019 15:05	20/11/2019 14:04	21/11/2019 15:05	25,02	7	175,11	CHI
201911250560	ARACU	AR21019450	ARACU	20/11/2019 15:57	21/11/2019 12:28	20/11/2019 15:57	21/11/2019 09:13	17,26	1	17,26	CHI
201911250560	ARACU	AR12019445	ARACU	20/11/2019 15:57	21/11/2019 12:28	21/11/2019 09:12	21/11/2019 12:28	3,27	20	65,33	CHI
201911250560	ITABERAÍ	AR12019445	ARACU	20/11/2019 15:57	21/11/2019 12:28	21/11/2019 09:12	21/11/2019 12:28	3,27	12	39,20	CHI
201911250561	SITIO D ABADIA	SI12099872	IACIARA S2	20/11/2019 14:37	20/11/2019 17:57	20/11/2019 14:37	20/11/2019 17:57	3,33	30	99,94	CHI
201911250563	PADRE BERNARDO	PB11081397	PADRE BERNARDO	20/11/2019 14:02	20/11/2019 22:04	20/11/2019 14:02	20/11/2019 22:04	8,02	84	674,03	CHI
201911250566	GOIANIA	GN11196685	GOIANIA LESTE S2	20/11/2019 15:01	20/11/2019 18:20	20/11/2019 15:01	20/11/2019 18:20	3,31	141	467,26	CHI
201911250604	PADRE BERNARDO	PB21201428	PADRE BERNARDO	20/11/2019 15:59	20/11/2019 19:03	20/11/2019 15:59	20/11/2019 19:03	3,07	5	15,33	CHI
201911250605	FORMOSA	FA12404381	ITIQUEIRA	20/11/2019 15:59	21/11/2019 18:35	20/11/2019 15:59	21/11/2019 18:35	26,61	4	106,43	CHI
201911250608	GOIANDIRA	GD12075612	CATALAO S1	20/11/2019 13:23	20/11/2019 18:06	20/11/2019 13:23	20/11/2019 18:06	4,71	9	42,39	CHI
201911250609	ARAGARCAS	BM12155745	BOM JARDIM	20/11/2019 15:31	20/11/2019 20:35	20/11/2019 15:31	20/11/2019 20:35	5,06	85	429,86	CHI
201911250609	BOM JARDIM DE GOIAS	BM12155745	BOM JARDIM	20/11/2019 15:31	20/11/2019 20:35	20/11/2019 15:31	20/11/2019 20:35	5,06	55	278,15	CHI

201911250610	CORUMBA DE GOIAS	10014965958	CORUMBA	20/11/2019 16:00	21/11/2019 09:09	20/11/2019 16:00	21/11/2019 09:09	17,14	1	17,14	CHI
201911250617	CAIAPONIA	IV12249611	IPORA	20/11/2019 15:43	21/11/2019 17:17	20/11/2019 15:43	21/11/2019 17:17	25,55	2	51,11	CHI
201911250617	IVOLANDIA	IV12249611	IPORA	20/11/2019 15:43	21/11/2019 17:17	20/11/2019 15:43	21/11/2019 17:17	25,55	7	178,88	CHI
201911250621	LUZIANIA	LZ21118939	RIO VERMELHO	20/11/2019 16:02	20/11/2019 23:00	20/11/2019 16:02	20/11/2019 23:00	6,98	1	6,98	CHI
201911250623	MOSSAMEDES	MD12024167	FIRMINOPOLIS S2	20/11/2019 15:16	20/11/2019 20:36	20/11/2019 15:16	20/11/2019 20:36	5,33	46	245,01	CHI
201911250623	SANCLERLANDIA	MD12024167	FIRMINOPOLIS S2	20/11/2019 15:16	20/11/2019 20:36	20/11/2019 15:16	20/11/2019 20:36	5,33	7	37,28	CHI
201911250701	CRISTALINA	KR10400355	PAMPLONA	20/11/2019 15:50	20/11/2019 15:54	20/11/2019 15:50	20/11/2019 15:54	0,07	113	7,38	CHI
201911250702	GOIANESIA	GE11140702	GOIANESIA S1	20/11/2019 16:02	20/11/2019 20:37	20/11/2019 16:02	20/11/2019 20:37	4,57	11	50,24	CHI
201911250901	PIRANHAS	PH12273643	PIRANHAS	20/11/2019 14:28	21/11/2019 16:09	20/11/2019 14:28	21/11/2019 16:09	25,67	15	385,10	CHI
201911251101	GOIANIA	GN11035917	CAMPINAS S2	20/11/2019 15:25	21/11/2019 11:09	20/11/2019 15:25	21/11/2019 11:09	19,73	133	2624,27	CHI
201911251102	ANAPOLIS	20583746	JUNDIAI S2	20/11/2019 16:03	20/11/2019 17:21	20/11/2019 16:03	20/11/2019 17:21	1,29	1	1,29	CHI
201911251203	PIRENOPOLIS	PV12000046	CORUMBA	20/11/2019 13:29	20/11/2019 19:59	20/11/2019 13:29	20/11/2019 19:59	6,49	50	324,56	CHI
201911251204	CRISTALINA	KR12168460	CRISTALINA S1	20/11/2019 11:02	20/11/2019 21:18	20/11/2019 11:02	20/11/2019 21:18	10,26	5	51,28	CHI
201911251205	ITAJA	IJ12095827	ITAJA S2	20/11/2019 16:04	20/11/2019 22:50	20/11/2019 16:04	20/11/2019 22:50	6,77	3	20,30	CHI
201911251307	ANAPOLIS	20340825	ANAPOLIS UNIVERSITARIO S2	20/11/2019 16:05	21/11/2019 07:14	20/11/2019 16:05	21/11/2019 07:14	15,14	1	15,14	CHI
201911251310	ARAGARCAS	AG12188251	ARAGARCAS	20/11/2019 16:01	20/11/2019 17:58	20/11/2019 16:01	20/11/2019 17:58	1,94	53	102,91	CHI
201911251312	CRISTALINA	KR21067377	CRISTALINA S2	20/11/2019 16:06	20/11/2019 18:00	20/11/2019 16:06	20/11/2019 18:00	1,89	1	1,89	CHI
201911251401	CRIXAS	CX21125965	RUBIATABA	20/11/2019 16:06	21/11/2019 02:17	20/11/2019 16:06	21/11/2019 02:17	10,17	1	10,17	CHI
201911251502	AURILANDIA	AI12000008	FIRMINOPOLIS S2	20/11/2019 13:13	20/11/2019 19:56	20/11/2019 13:13	20/11/2019 17:59	4,76	175	833,83	CHI
201911251502	AURILANDIA	AI11082724	FIRMINOPOLIS S2	20/11/2019 13:13	20/11/2019 19:56	20/11/2019 13:13	20/11/2019 19:03	5,83	187	1090,42	CHI
201911251502	AURILANDIA	AI11377171	FIRMINOPOLIS S2	20/11/2019 13:13	20/11/2019 19:56	20/11/2019 13:13	20/11/2019 19:56	6,71	135	906,45	CHI
201911251507	RIO VERDE	630159257	RIO VERDE S1	20/11/2019 16:08	20/11/2019 18:22	20/11/2019 16:08	20/11/2019 18:22	2,22	1	2,22	CHI
201911251512	JATAI	JT12000231	JATAI S1	20/11/2019 16:07	20/11/2019 19:20	20/11/2019 16:07	20/11/2019 19:20	3,21	74	237,29	CHI
201911251512	PEROLANDIA	JT12000231	JATAI S1	20/11/2019 16:07	20/11/2019 19:20	20/11/2019 16:07	20/11/2019 19:20	3,21	3	9,62	CHI
201911251516	CAIAPONIA	CP12378168	CAIAPONIA	20/11/2019 14:04	20/11/2019 23:42	20/11/2019 14:04	20/11/2019 22:17	8,21	1	8,21	CHI
201911251516	CAIAPONIA	CP12119231	CAIAPONIA	20/11/2019 14:04	20/11/2019 23:42	20/11/2019 14:04	20/11/2019 23:40	9,60	3	28,80	CHI
201911251516	CAIAPONIA	CP12384681	CAIAPONIA	20/11/2019 14:04	20/11/2019 23:42	20/11/2019 14:04	20/11/2019 23:42	9,64	1	9,64	CHI
201911251540	IACIARA	ND12046258	IACIARA S2	20/11/2019 16:11	22/11/2019 12:35	20/11/2019 16:11	22/11/2019 12:35	44,39	2	88,77	CHI
201911251540	NOVA ROMA	ND12046258	IACIARA S2	20/11/2019 16:11	22/11/2019 12:35	20/11/2019 16:11	22/11/2019 12:35	44,39	4	177,55	CHI
201911251545	ANAPOLIS	AN12096781	ANAPOLIS UNIVERSITARIO S2	20/11/2019 15:34	21/11/2019 08:27	20/11/2019 15:34	21/11/2019 08:27	16,87	13	219,34	CHI
201911251546	GAMELEIRA DE GOIAS	GL21017568	DAIA S2	20/11/2019 16:12	21/11/2019 11:31	20/11/2019 16:12	21/11/2019 11:31	19,31	1	19,31	CHI
201911251547	COLINAS DO SUL	TI12243076	NIQUELANDIA SUBTRANSMISSAO	20/11/2019 16:12	21/11/2019 07:15	20/11/2019 16:12	21/11/2019 07:15	15,04	3	45,12	CHI
201911251552	PROFESSOR JAMIL SAFADY	JS21321267	PONTALINA	20/11/2019 16:13	20/11/2019 22:05	20/11/2019 16:13	20/11/2019 22:05	5,86	1	5,86	CHI

201911251554	JATAI	290118177	JATAI S2	20/11/2019 16:14	21/11/2019 10:59	20/11/2019 16:14	21/11/2019 10:59	18,75	1	18,75	CHI
201911251558	COCALZINHO DE GOIAS	ZN11327480	GOIANESIA S1	20/11/2019 16:14	21/11/2019 10:48	20/11/2019 16:14	21/11/2019 10:48	18,56	1	18,56	CHI
201911251566	BALIZA	BH12331486	CAIAPONIA	20/11/2019 15:55	21/11/2019 13:52	20/11/2019 15:55	21/11/2019 13:52	21,95	8	175,57	CHI
201911251603	CIDADE OCIDENTAL	DH11199627	MARAJOARA	20/11/2019 16:16	20/11/2019 18:40	20/11/2019 16:16	20/11/2019 18:40	2,41	11	26,49	CHI
201911251605	BOM JARDIM DE GOIAS	BM12064234	BOM JARDIM	20/11/2019 16:16	21/11/2019 20:18	20/11/2019 16:16	21/11/2019 20:18	28,03	4	112,12	CHI
201911251617	CRISTALINA	KR12351414	PAMPLONA	20/11/2019 16:17	21/11/2019 11:11	20/11/2019 16:17	21/11/2019 11:11	18,90	6	113,37	CHI
201911251804	BOM JARDIM DE GOIAS	BM12380951	ARAGARCAS	20/11/2019 13:11	21/11/2019 13:18	20/11/2019 13:11	21/11/2019 13:18	24,11	16	385,78	CHI
201911251901	CRISTIANOPOLIS	470013503	CRISTIANOPOLIS	20/11/2019 16:18	21/11/2019 09:59	20/11/2019 16:18	21/11/2019 09:59	17,68	1	17,68	CHI
201911251919	URUACU	640020859	URUACU	20/11/2019 16:20	20/11/2019 22:05	20/11/2019 16:20	20/11/2019 22:05	5,75	1	5,75	CHI
201911252213	DOVERLANDIA	DV12138334	CAIAPONIA	20/11/2019 14:50	20/11/2019 23:50	20/11/2019 14:50	20/11/2019 23:50	8,99	15	134,79	CHI
201911252220	MIMOSO DE GOIAS	MJ12165657	PADRE BERNARDO	20/11/2019 15:11	20/11/2019 23:11	20/11/2019 15:11	20/11/2019 23:11	8,00	31	247,88	CHI
201911252226	CRISTALINA	KR21214809	CRISTALINA S1	20/11/2019 16:24	20/11/2019 18:49	20/11/2019 16:24	20/11/2019 18:49	2,41	1	2,41	CHI
201911252227	RIO VERDE	630348819	CABRIUVA S1	20/11/2019 16:24	21/11/2019 08:53	20/11/2019 16:24	21/11/2019 08:53	16,47	1	16,47	CHI
201911252228	CRIXAS	2490028991	SERRA DO OURO	20/11/2019 16:24	20/11/2019 18:57	20/11/2019 16:24	20/11/2019 18:57	2,53	1	2,53	CHI
201911252229	ITAUCU	IX11000012	INHUMAS S1	20/11/2019 13:17	20/11/2019 18:23	20/11/2019 13:17	20/11/2019 18:23	5,09	19	96,75	CHI
201911252230	GOIANIA	GN11104832	CAMPINAS S2	20/11/2019 13:14	20/11/2019 21:22	20/11/2019 13:14	20/11/2019 21:22	8,14	142	1155,21	CHI
201911252254	BALIZA	BM12156550	BOM JARDIM	20/11/2019 09:00	20/11/2019 18:33	20/11/2019 09:00	20/11/2019 18:33	9,55	1	9,55	CHI
201911252254	BOM JARDIM DE GOIAS	BM12156550	BOM JARDIM	20/11/2019 09:00	20/11/2019 18:33	20/11/2019 09:00	20/11/2019 18:33	9,55	81	773,21	CHI
201911252301	SAO JOAO DA PARAUNA	RP12024465	FIRMINOPOLIS S2	20/11/2019 16:28	21/11/2019 10:30	20/11/2019 16:28	21/11/2019 10:30	18,03	6	108,17	CHI
201911252701	NIQUELANDIA	NQ12117625	BARRO ALTO	20/11/2019 16:29	21/11/2019 11:40	20/11/2019 16:29	21/11/2019 11:40	19,18	5	95,91	CHI
201911252703	PIRES DO RIO	460021606	PIRES DO RIO S1	20/11/2019 16:29	20/11/2019 18:26	20/11/2019 16:29	20/11/2019 18:26	1,95	1	1,95	CHI
201911252707	MOZARLANDIA	MZ12063703	MOZARLANDIA	20/11/2019 15:56	21/11/2019 12:30	20/11/2019 15:56	21/11/2019 12:30	20,56	10	205,58	CHI
201911252720	CRISTALINA	KR12383057	CRISTALINA S2	20/11/2019 14:49	21/11/2019 09:52	20/11/2019 14:49	21/11/2019 09:52	19,04	6	114,21	CHI
201911252723	SAO JOAO D ALIANCA	JL21144662	SAO JOAO D ALIANCA	20/11/2019 16:31	21/11/2019 10:30	20/11/2019 16:31	21/11/2019 10:30	17,98	2	35,96	CHI
201911252728	ITARUMA	IM21321281	CACHOEIRA ALTA	20/11/2019 16:31	21/11/2019 09:51	20/11/2019 16:31	21/11/2019 09:51	17,32	1	17,32	CHI
201911252731	ARAGARCAS	AG11354634	ARAGARCAS	20/11/2019 16:08	20/11/2019 22:17	20/11/2019 16:08	20/11/2019 22:17	6,14	85	521,81	CHI
201911252801	SANTO ANTONIO DO DESCOBERTO	SN12330527	MARAJOARA	20/11/2019 16:33	21/11/2019 16:37	20/11/2019 16:33	21/11/2019 16:37	24,07	12	288,86	CHI
201911252901	SAO LUIS DE MONTES BELOS	SL11000042	SAO LUIZ DOS MONTES BELOS	20/11/2019 16:33	21/11/2019 02:50	20/11/2019 16:33	21/11/2019 02:50	10,28	55	565,45	CHI
201911253403	ITUMBIARA	IT21305574	ITUMBIARA VELHA S2	20/11/2019 16:34	21/11/2019 11:02	20/11/2019 16:34	21/11/2019 11:02	18,46	2	36,91	CHI
201911253404	JATAI	290341310	JATAI S3	20/11/2019 16:34	21/11/2019 12:23	20/11/2019 16:34	21/11/2019 12:23	19,80	1	19,80	CHI
201911253406	JAUPACI	JP12316445	IPORA	20/11/2019 16:34	21/11/2019 10:35	20/11/2019 16:34	21/11/2019 10:35	18,01	3	54,03	CHI
201911253407	ADELANDIA	DN12323607	FIRMINOPOLIS S2	20/11/2019 16:28	20/11/2019 19:40	20/11/2019 16:28	20/11/2019 19:40	3,19	7	22,33	CHI
201911253407	SAO LUIS DE MONTES BELOS	DN12323607	FIRMINOPOLIS S2	20/11/2019 16:28	20/11/2019 19:40	20/11/2019 16:28	20/11/2019 19:40	3,19	7	22,33	CHI

201911253409	IVOLANDIA	MO12165608	IPORA	20/11/2019 15:37	21/11/2019 09:59	20/11/2019 15:37	21/11/2019 09:59	18,37	17	312,23	CHI
201911253409	MOIPORA	MO12165608	IPORA	20/11/2019 15:37	21/11/2019 09:59	20/11/2019 15:37	21/11/2019 09:59	18,37	1	18,37	CHI
201911253601	CAIAPONIA	930057685	CAIAPONIA	20/11/2019 16:34	21/11/2019 18:46	20/11/2019 16:34	21/11/2019 18:46	26,19	1	26,19	CHI
201911253606	MONTES CLAROS DE GOIAS	ME12140008	IPORA	20/11/2019 15:44	21/11/2019 08:19	20/11/2019 15:44	21/11/2019 08:19	16,58	17	281,91	CHI
201911253607	CRISTALINA	KR12163676	PAMPLONA	20/11/2019 16:15	20/11/2019 21:05	20/11/2019 16:15	20/11/2019 21:05	4,83	24	115,80	CHI
201911253607	DISTRITO FEDERAL	KR12163676	PAMPLONA	20/11/2019 16:15	20/11/2019 21:05	20/11/2019 16:15	20/11/2019 21:05	4,83	4	19,30	CHI
201911253607	LUZIANIA	KR12163676	PAMPLONA	20/11/2019 16:15	20/11/2019 21:05	20/11/2019 16:15	20/11/2019 21:05	4,83	2	9,65	CHI
201911254006	JATAI	JT12324668	JATAI S3	20/11/2019 16:02	22/11/2019 21:00	20/11/2019 16:02	21/11/2019 11:41	19,64	12	235,70	CHI
201911254006	JATAI	JT12324668	JATAI S3	20/11/2019 16:02	22/11/2019 21:00	20/11/2019 16:02	21/11/2019 21:55	29,87	37	1105,26	CHI
201911254006	JATAI	JT12306515	JATAI S3	20/11/2019 16:02	22/11/2019 21:00	21/11/2019 22:04	21/11/2019 22:12	0,14	6	0,82	CHI
201911254006	JATAI	JT12306515	JATAI S3	20/11/2019 16:02	22/11/2019 21:00	22/11/2019 12:26	22/11/2019 13:42	1,27	6	7,60	CHI
201911254006	JATAI	6145145	JATAI S3	20/11/2019 16:02	22/11/2019 21:00	21/11/2019 22:04	22/11/2019 13:42	15,63	6	93,80	CHI
201911254006	JATAI	JT12324668	JATAI S3	20/11/2019 16:02	22/11/2019 21:00	22/11/2019 14:12	22/11/2019 15:00	0,79	6	4,73	CHI
201911254006	JATAI	JT12324668	JATAI S3	20/11/2019 16:02	22/11/2019 21:00	22/11/2019 14:12	22/11/2019 15:00	0,79	6	4,73	CHI
201911254006	JATAI	JT12209803	JATAI S3	20/11/2019 16:02	22/11/2019 21:00	21/11/2019 22:04	22/11/2019 15:15	17,18	24	412,35	CHI
201911254006	JATAI	JT12234457	JATAI S3	20/11/2019 16:02	22/11/2019 21:00	21/11/2019 22:04	22/11/2019 15:36	17,53	6	105,18	CHI
201911254006	JATAI	JT12306444	JATAI S3	20/11/2019 16:02	22/11/2019 21:00	21/11/2019 22:04	22/11/2019 18:24	20,33	1	20,33	CHI
201911254006	JATAI	JT12306444	JATAI S3	20/11/2019 16:02	22/11/2019 21:00	21/11/2019 22:04	22/11/2019 21:00	22,92	5	114,61	CHI
201911254007	SERRANOPOLIS	SX12260314	JATAI S1	20/11/2019 16:40	21/11/2019 11:16	20/11/2019 16:40	21/11/2019 11:16	18,60	4	74,39	CHI
201911254011	SANCLERLANDIA	1210006525	FIRMINOPOLIS S2	20/11/2019 16:40	21/11/2019 01:11	20/11/2019 16:40	21/11/2019 01:11	8,50	1	8,50	CHI
201911254202	TURVANIA	TV12005549	FIRMINOPOLIS S2	20/11/2019 16:40	21/11/2019 09:20	20/11/2019 16:40	21/11/2019 09:20	16,65	2	33,30	CHI
201911254203	CROMINIA	CQ21025265	PONTALINA	20/11/2019 16:41	21/11/2019 14:00	20/11/2019 16:41	21/11/2019 14:00	21,33	1	21,33	CHI
201911254610	ITUMBIARA	690137710	ITUMBIARA NOVA	20/11/2019 16:43	21/11/2019 11:10	20/11/2019 16:43	21/11/2019 11:10	18,45	1	18,45	CHI
201911254614	FAZENDA NOVA	FN12073623	BRITANIA	20/11/2019 16:20	21/11/2019 06:02	20/11/2019 16:20	21/11/2019 06:02	13,70	19	260,24	CHI
201911254617	GOIANIA	GN11164769	CAMPINAS S2	20/11/2019 13:13	21/11/2019 01:27	20/11/2019 13:13	21/11/2019 01:27	12,22	74	904,34	CHI
201911254618	FIRMINOPOLIS	FR12126033	FIRMINOPOLIS S1	20/11/2019 16:18	20/11/2019 21:57	20/11/2019 16:18	20/11/2019 21:57	5,64	8	45,12	CHI
201911254620	PIRACANJUBA	PJ21229199	CALDAS NOVAS S1	20/11/2019 16:44	21/11/2019 11:52	20/11/2019 16:44	21/11/2019 11:52	19,13	1	19,13	CHI
201911254621	MOSSAMEDES	MD12188234	FIRMINOPOLIS S2	20/11/2019 16:14	20/11/2019 21:06	20/11/2019 16:14	20/11/2019 21:06	4,86	34	165,21	CHI
201911254804	LUZIANIA	LZ12112942	PAMPLONA	20/11/2019 16:22	20/11/2019 22:14	20/11/2019 16:22	20/11/2019 22:14	5,87	10	58,67	CHI
201911254808	GOIANESIA	GE21309580	GOIANESIA S1	20/11/2019 16:45	20/11/2019 21:43	20/11/2019 16:45	20/11/2019 21:43	4,95	1	4,95	CHI
201911254813	GOIANESIA	GE21140704	GOIANESIA S1	20/11/2019 16:46	20/11/2019 21:20	20/11/2019 16:46	20/11/2019 21:20	4,55	1	4,55	CHI
201911254901	ANAPOLIS	10000410690	JUNDIAI S1	20/11/2019 16:48	21/11/2019 11:32	20/11/2019 16:48	21/11/2019 11:32	18,72	1	18,72	CHI
201911255102	ABADIANIA	AA21297629	ANAPOLIS UNIVERSITARIO S1	20/11/2019 16:49	21/11/2019 11:55	20/11/2019 16:49	21/11/2019 11:55	19,09	2	38,18	CHI

201911255103	ORIZONA	OZ21043241	PIRES DO RIO S2	20/11/2019 16:49	21/11/2019 09:56	20/11/2019 16:49	21/11/2019 09:56	17,10	1	17,10	CHI
201911255303	ANICUNS	910024182	ANICUNS	20/11/2019 16:50	21/11/2019 00:50	20/11/2019 16:50	21/11/2019 00:50	8,01	1	8,01	CHI
201911255305	ANICUNS	TV12382591	FIRMINOPOLIS S2	20/11/2019 14:14	20/11/2019 19:56	20/11/2019 14:14	20/11/2019 19:56	5,69	24	136,53	CHI
201911255305	TURVANIA	TV12382591	FIRMINOPOLIS S2	20/11/2019 14:14	20/11/2019 19:56	20/11/2019 14:14	20/11/2019 19:56	5,69	20	113,78	CHI
201911255312	NOVA AURORA	NE12082774	CATALAO S1	20/11/2019 17:00	21/11/2019 18:57	20/11/2019 17:00	20/11/2019 17:06	0,09	14	1,25	CHI
201911255312	IPAMERI	NE12082774	CATALAO S1	20/11/2019 17:00	21/11/2019 18:57	20/11/2019 17:00	21/11/2019 18:57	25,94	14	363,19	CHI
201911255312	NOVA AURORA	NE12082774	CATALAO S1	20/11/2019 17:00	21/11/2019 18:57	20/11/2019 17:00	21/11/2019 18:57	25,94	2	51,88	CHI
201911255312	NOVA AURORA	NE12082774	CATALAO S1	20/11/2019 17:00	21/11/2019 18:57	21/11/2019 11:40	21/11/2019 18:57	7,29	14	102,07	CHI
201911255401	MINEIROS	MY12248466	PARQUE DAS EMAS	20/11/2019 16:51	21/11/2019 14:06	20/11/2019 16:51	21/11/2019 14:06	21,24	3	63,72	CHI
201911255601	CALDAS NOVAS	IP12311622	IPAMERI	20/11/2019 14:57	21/11/2019 12:22	20/11/2019 14:57	21/11/2019 12:22	21,40	5	107,02	CHI
201911255601	IPAMERI	IP12311622	IPAMERI	20/11/2019 14:57	21/11/2019 12:22	20/11/2019 14:57	21/11/2019 12:22	21,40	8	171,23	CHI
201911255801	JARAGUA	10022948480	JARAGUA	20/11/2019 16:52	20/11/2019 18:46	20/11/2019 16:52	20/11/2019 18:46	1,89	1	1,89	CHI
201911256002	CABECEIRAS	CW10401454	ITIQUEIRA	20/11/2019 16:30	20/11/2019 16:33	20/11/2019 16:30	20/11/2019 16:33	0,05	100	5,00	CHI
201911256002	CABECEIRAS	CW10407049	ITIQUEIRA	20/11/2019 16:30	20/11/2019 16:33	20/11/2019 16:30	20/11/2019 16:33	0,05	14	0,72	CHI
201911256002	CABECEIRAS	FA10410993	ITIQUEIRA	20/11/2019 16:30	20/11/2019 16:33	20/11/2019 16:30	20/11/2019 16:33	0,05	24	1,24	CHI
201911256002	DISTRITO FEDERAL	FA10410993	ITIQUEIRA	20/11/2019 16:30	20/11/2019 16:33	20/11/2019 16:30	20/11/2019 16:33	0,05	1	0,05	CHI
201911256102	JAUPACI	JP12123940	IPORA	20/11/2019 15:16	21/11/2019 09:50	20/11/2019 15:16	21/11/2019 09:50	18,57	12	222,88	CHI
201911256104	NIQUELANDIA	NQ12274796	BARRO ALTO	20/11/2019 16:53	21/11/2019 13:16	20/11/2019 16:53	21/11/2019 13:16	20,38	1	20,38	CHI
201911256109	GOIATUBA	140039594	GOIATUBA S2	20/11/2019 16:53	21/11/2019 15:45	20/11/2019 16:53	21/11/2019 15:45	22,86	1	22,86	CHI
201911256110	JATAI	JT12125855	JATAI S1	20/11/2019 16:48	21/11/2019 09:51	20/11/2019 16:48	21/11/2019 09:51	17,03	4	68,14	CHI
201911256110	PEROLANDIA	JT12125855	JATAI S1	20/11/2019 16:48	21/11/2019 09:51	20/11/2019 16:48	21/11/2019 09:51	17,03	4	68,14	CHI
201911256111	JATAI	JT12196090	JATAI S2	20/11/2019 16:53	21/11/2019 09:31	20/11/2019 16:53	21/11/2019 09:31	16,62	12	199,43	CHI
201911256112	DIORAMA	IR12091410	IPORA	20/11/2019 16:53	20/11/2019 19:10	20/11/2019 16:53	20/11/2019 19:10	2,27	10	22,69	CHI
201911256112	IPORA	IR12091410	IPORA	20/11/2019 16:53	20/11/2019 19:10	20/11/2019 16:53	20/11/2019 19:10	2,27	7	15,88	CHI
201911256112	JAUPACI	IR12091410	IPORA	20/11/2019 16:53	20/11/2019 19:10	20/11/2019 16:53	20/11/2019 19:10	2,27	5	11,34	CHI
201911256114	SANTA HELENA DE GOIAS	SH12267725	SANTA HELENA S1	20/11/2019 16:54	21/11/2019 08:57	20/11/2019 16:54	21/11/2019 08:57	16,05	4	64,22	CHI
201911256212	ARUANA	O3200444	ARUANA	20/11/2019 17:18	21/11/2019 10:07	20/11/2019 17:18	20/11/2019 20:28	3,15	226	712,34	CHI
201911256212	ARUANA	O3200444	ARUANA	20/11/2019 17:18	21/11/2019 10:07	20/11/2019 17:18	21/11/2019 08:18	14,99	59	884,41	CHI
201911256212	ARUANA	AK13247704	ARUANA	20/11/2019 17:18	21/11/2019 10:07	20/11/2019 17:18	21/11/2019 08:18	14,99	1	14,99	CHI
201911256212	ARUANA	AK13247706	ARUANA	20/11/2019 17:18	21/11/2019 10:07	20/11/2019 17:18	21/11/2019 10:07	16,81	6	100,88	CHI
201911256216	APORE	AE13311589	ITAJA S1	20/11/2019 18:18	21/11/2019 19:24	20/11/2019 18:18	21/11/2019 01:52	7,58	96	727,63	CHI
201911256216	SERRANOPOLIS	AE13311589	ITAJA S1	20/11/2019 18:18	21/11/2019 19:24	20/11/2019 18:18	21/11/2019 01:52	7,58	45	341,08	CHI
201911256216	APORE	00100414	ITAJA S1	20/11/2019 18:18	21/11/2019 19:24	20/11/2019 18:18	21/11/2019 12:46	18,47	4	73,89	CHI

201911256216	APORE	AE13311580	ITAJA S1	20/11/2019 18:18	21/11/2019 19:24	21/11/2019 12:47	21/11/2019 14:00	1,21	3	3,64	CHI
201911256216	APORE	00100414	ITAJA S1	20/11/2019 18:18	21/11/2019 19:24	20/11/2019 18:18	21/11/2019 14:34	20,27	1	20,27	CHI
201911256216	APORE	AE13311580	ITAJA S1	20/11/2019 18:18	21/11/2019 19:24	21/11/2019 14:01	21/11/2019 15:05	1,08	2	2,17	CHI
201911256216	APORE	AE13311581	ITAJA S1	20/11/2019 18:18	21/11/2019 19:24	21/11/2019 14:01	21/11/2019 18:43	4,70	1	4,70	CHI
201911256216	APORE	AE13311582	ITAJA S1	20/11/2019 18:18	21/11/2019 19:24	21/11/2019 12:47	21/11/2019 19:04	6,28	1	6,28	CHI
201911256216	APORE	AE13311583	ITAJA S1	20/11/2019 18:18	21/11/2019 19:24	20/11/2019 18:18	21/11/2019 19:24	25,12	2	50,23	CHI
201911256218	VIANOPOLIS	VN12159680	VIANOPOLIS	20/11/2019 07:58	21/11/2019 17:59	20/11/2019 07:58	21/11/2019 17:59	34,02	7	238,12	CHI
201911256225	GOIANIA	GN11001685	CAMPINAS S2	20/11/2019 13:13	20/11/2019 23:58	20/11/2019 13:13	20/11/2019 23:58	10,74	49	526,38	CHI
201911256268	GUARANI DE GOIAS	SD10401447	SAO DOMINGOS	20/11/2019 20:46	22/11/2019 14:45	20/11/2019 20:46	21/11/2019 01:28	4,70	8	37,64	CHI
201911256268	SAO DOMINGOS	SD10401447	SAO DOMINGOS	20/11/2019 20:46	22/11/2019 14:45	20/11/2019 20:46	21/11/2019 01:28	4,70	457	2150,06	CHI
201911256268	GUARANI DE GOIAS	SD12134706LD	SAO DOMINGOS	20/11/2019 20:46	22/11/2019 14:45	20/11/2019 20:46	21/11/2019 01:49	5,04	139	700,91	CHI
201911256268	SAO DOMINGOS	SD12134706LD	SAO DOMINGOS	20/11/2019 20:46	22/11/2019 14:45	20/11/2019 20:46	21/11/2019 01:49	5,04	20	100,85	CHI
201911256268	MONTE ALEGRE DE GOIAS	SD10401447	SAO DOMINGOS	20/11/2019 20:46	22/11/2019 14:45	20/11/2019 20:46	21/11/2019 02:23	5,62	2	11,25	CHI
201911256268	NOVA ROMA	SD10401447	SAO DOMINGOS	20/11/2019 20:46	22/11/2019 14:45	20/11/2019 20:46	21/11/2019 02:23	5,62	3	16,87	CHI
201911256268	SAO DOMINGOS	SD10401447	SAO DOMINGOS	20/11/2019 20:46	22/11/2019 14:45	20/11/2019 20:46	21/11/2019 02:23	5,62	179	1006,63	CHI
201911256268	GUARANI DE GOIAS	SD10401447	SAO DOMINGOS	20/11/2019 20:46	22/11/2019 14:45	21/11/2019 01:50	21/11/2019 02:23	0,56	8	4,47	CHI
201911256268	SAO DOMINGOS	SD10401447	SAO DOMINGOS	20/11/2019 20:46	22/11/2019 14:45	21/11/2019 01:50	21/11/2019 02:23	0,56	457	255,41	CHI
201911256268	SAO DOMINGOS	SD12134706LD	SAO DOMINGOS	20/11/2019 20:46	22/11/2019 14:45	21/11/2019 01:50	21/11/2019 14:12	12,36	6	74,18	CHI
201911256268	GUARANI DE GOIAS	SD10401447	SAO DOMINGOS	20/11/2019 20:46	22/11/2019 14:45	21/11/2019 16:09	21/11/2019 17:23	1,23	8	9,85	CHI
201911256268	MONTE ALEGRE DE GOIAS	SD10401447	SAO DOMINGOS	20/11/2019 20:46	22/11/2019 14:45	21/11/2019 16:09	21/11/2019 17:23	1,23	2	2,46	CHI
201911256268	NOVA ROMA	SD10401447	SAO DOMINGOS	20/11/2019 20:46	22/11/2019 14:45	21/11/2019 16:09	21/11/2019 17:23	1,23	3	3,70	CHI
201911256268	SAO DOMINGOS	SD10401447	SAO DOMINGOS	20/11/2019 20:46	22/11/2019 14:45	21/11/2019 16:09	21/11/2019 17:23	1,23	615	757,48	CHI
201911256268	GUARANI DE GOIAS	SD12261971LD	SAO DOMINGOS	20/11/2019 20:46	22/11/2019 14:45	21/11/2019 01:50	22/11/2019 13:39	35,82	1	35,82	CHI
201911256268	GUARANI DE GOIAS	SD12261971LD	SAO DOMINGOS	20/11/2019 20:46	22/11/2019 14:45	21/11/2019 01:50	22/11/2019 14:45	36,93	138	5095,96	CHI
201911256268	SAO DOMINGOS	SD12261971LD	SAO DOMINGOS	20/11/2019 20:46	22/11/2019 14:45	21/11/2019 01:50	22/11/2019 14:45	36,93	14	516,98	CHI
201911256287	IPORA	IR12222997	ARENOPOLIS	20/11/2019 15:41	21/11/2019 09:15	20/11/2019 15:41	21/11/2019 09:15	17,57	11	193,29	CHI
201911256287	IVOLANDIA	IR12222997	ARENOPOLIS	20/11/2019 15:41	21/11/2019 09:15	20/11/2019 15:41	21/11/2019 09:15	17,57	34	597,44	CHI
201911256287	PALESTINA DE GOIAS	IR12222997	ARENOPOLIS	20/11/2019 15:41	21/11/2019 09:15	20/11/2019 15:41	21/11/2019 09:15	17,57	37	650,15	CHI
201911256501	SANTA RITA DO NOVO DESTINO	1330005019	GOIANESIA S1	20/11/2019 16:54	21/11/2019 13:07	20/11/2019 16:54	21/11/2019 13:07	20,20	1	20,20	CHI
201911256802	NOVO GAMA	10010137554	MARAJOARA	20/11/2019 16:57	20/11/2019 18:15	20/11/2019 16:57	20/11/2019 18:15	1,30	1	1,30	CHI
201911256803	ITUMBIARA	BG21293150	ITUMBIARA VELHA S2	20/11/2019 16:57	21/11/2019 14:11	20/11/2019 16:57	21/11/2019 14:11	21,23	1	21,23	CHI
201911257206	CRIXAS	NM12141217	RUBIATABA	20/11/2019 16:58	20/11/2019 22:18	20/11/2019 16:58	20/11/2019 22:18	5,32	3	15,97	CHI
201911257206	NOVA AMERICA	NM12141217	RUBIATABA	20/11/2019 16:58	20/11/2019 22:18	20/11/2019 16:58	20/11/2019 22:18	5,32	1	5,32	CHI

201911257207	AGUA FRIA DE GOIAS	TL21189644	SAO JOAO D ALIANCA	20/11/2019 16:58	22/11/2019 15:44	20/11/2019 16:58	22/11/2019 15:44	46,76	1	46,76	CHI
201911257301	LUZIANIA	120121724	RIO VERMELHO	20/11/2019 16:59	21/11/2019 03:45	20/11/2019 16:59	21/11/2019 03:45	10,77	1	10,77	CHI
201911257401	ITABERAI	IB12300094	ITABERAI S1	20/11/2019 16:27	20/11/2019 18:40	20/11/2019 16:27	20/11/2019 18:40	2,23	2	4,46	CHI
201911257601	EDEIA	EA21044494	EDEIA	20/11/2019 16:59	21/11/2019 11:28	20/11/2019 16:59	21/11/2019 11:28	18,49	1	18,49	CHI
201911257604	RIO VERDE	630294770	RIO VERDE S1	20/11/2019 16:59	20/11/2019 22:00	20/11/2019 16:59	20/11/2019 22:00	5,02	1	5,02	CHI
201911257605	IPAMERI	IP12080281	PIRES DO RIO S2	20/11/2019 16:59	21/11/2019 09:17	20/11/2019 16:59	21/11/2019 09:17	16,29	1	16,29	CHI
201911257607	MOSSAMEDES	MD21121029	ITABERAI S2	20/11/2019 16:59	21/11/2019 08:57	20/11/2019 16:59	21/11/2019 08:57	15,96	1	15,96	CHI
201911257608	AGUA FRIA DE GOIAS	TL12067535	SAO JOAO D ALIANCA	20/11/2019 16:59	22/11/2019 12:08	20/11/2019 16:59	22/11/2019 12:08	43,14	5	215,69	CHI
201911257610	ABADIANIA	AA21096612	ANAPOLIS UNIVERSITARIO S1	20/11/2019 17:00	21/11/2019 08:55	20/11/2019 17:00	21/11/2019 08:55	15,92	3	47,75	CHI
201911257611	ITAJA	2300021773	ITAJA S2	20/11/2019 17:00	20/11/2019 23:50	20/11/2019 17:00	20/11/2019 23:50	6,83	1	6,83	CHI
201911257901	FORMOSA	FA12248883	ITIQUEIRA	20/11/2019 17:01	21/11/2019 10:28	20/11/2019 17:01	21/11/2019 10:28	17,45	18	314,10	CHI
201911257907	VALPARAISO DE GOIAS	VA12199531LD	PACAEMBU S1	20/11/2019 16:56	20/11/2019 21:32	20/11/2019 16:56	20/11/2019 21:32	4,60	34	156,36	CHI
201911258203	NIQUELANDIA	NQ12375622	NIQUELANDIA SUBTRANSMISSAO	20/11/2019 17:02	21/11/2019 08:25	20/11/2019 17:02	21/11/2019 08:25	15,38	7	107,66	CHI
201911258204	NOVO GAMA	LZ11000572	PACAEMBU S1	20/11/2019 17:02	21/11/2019 14:19	20/11/2019 17:02	21/11/2019 14:19	21,28	6	127,66	CHI
201911258205	LUZIANIA	LZ12349110	MARAJOARA	20/11/2019 15:26	20/11/2019 22:07	20/11/2019 15:26	20/11/2019 22:07	6,67	16	106,71	CHI
201911258401	FORMOSA	FA21017449	ITIQUEIRA	20/11/2019 17:02	21/11/2019 10:48	20/11/2019 17:02	21/11/2019 10:48	17,75	1	17,75	CHI
201911258402	GOIANIA	GN11000435	CAMPINAS S3	20/11/2019 14:52	20/11/2019 18:02	20/11/2019 14:52	20/11/2019 18:02	3,15	141	444,70	CHI
201911258404	JOVIANIA	JV21050248	VICENTINOPOLIS	20/11/2019 17:03	21/11/2019 09:00	20/11/2019 17:03	21/11/2019 09:00	15,96	1	15,96	CHI
201911258710	BALIZA	BH12243875	CAIAPONIA	20/11/2019 17:04	22/11/2019 10:36	20/11/2019 17:04	22/11/2019 10:36	41,52	4	166,09	CHI
201911258711	CATALAO	1990190847	CATALAO S2	20/11/2019 17:05	20/11/2019 23:27	20/11/2019 17:05	20/11/2019 23:27	6,36	1	6,36	CHI
201911258714	IVOLANDIA	IV21133551	IPORA	20/11/2019 17:06	20/11/2019 18:30	20/11/2019 17:06	20/11/2019 18:30	1,40	2	2,80	CHI
201911258726	JATAI	JT12205176	JATAI S1	20/11/2019 17:20	21/11/2019 16:25	20/11/2019 17:20	21/11/2019 16:25	23,08	3	69,24	CHI
201911259005	DIORAMA	DI12168628	IPORA	20/11/2019 17:09	21/11/2019 11:33	20/11/2019 17:09	21/11/2019 11:33	18,40	13	239,21	CHI
201911259008	FORMOSA	610005698	ITIQUEIRA	20/11/2019 17:09	21/11/2019 09:00	20/11/2019 17:09	21/11/2019 09:00	15,85	1	15,85	CHI
201911259012	MORRINHOS	MR12381119	MORRINHOS	20/11/2019 17:09	21/11/2019 19:11	20/11/2019 17:09	21/11/2019 19:11	26,04	2	52,07	CHI
201911259015	RIO VERDE	630244972	RIO VERDE S1	20/11/2019 17:10	20/11/2019 21:05	20/11/2019 17:10	20/11/2019 21:05	3,93	1	3,93	CHI
201911259017	AGUAS LINDAS DE GOIAS	4830427141	AGUAS LINDAS DE GOIAS S2	20/11/2019 17:10	21/11/2019 09:39	20/11/2019 17:10	21/11/2019 09:39	16,48	1	16,48	CHI
201911259022	PALMEIRAS DE GOIAS	PL12312577	PALMEIRAS	20/11/2019 15:09	20/11/2019 23:12	20/11/2019 15:09	20/11/2019 23:12	8,06	7	56,39	CHI
201911259103	BALIZA	BH11331103	CAIAPONIA	20/11/2019 17:11	22/11/2019 14:49	20/11/2019 17:11	22/11/2019 14:49	45,62	1	45,62	CHI
201911259203	COLINAS DO SUL	9700006729	NIQUELANDIA SUBTRANSMISSAO	20/11/2019 17:12	21/11/2019 08:38	20/11/2019 17:12	21/11/2019 08:38	15,42	1	15,42	CHI
201911259501	SAO LUIS DE MONTES BELOS	SL21324284	FIRMINOPOLIS S1	20/11/2019 17:13	20/11/2019 22:57	20/11/2019 17:13	20/11/2019 22:57	5,72	2	11,45	CHI
201911259605	PIRANHAS	PH12245935	PIRANHAS	20/11/2019 15:31	21/11/2019 15:05	20/11/2019 15:31	21/11/2019 15:05	23,56	16	376,92	CHI
201911259608	AGUAS LINDAS DE GOIAS	LA12096325	AGUAS LINDAS DE GOIAS S1	20/11/2019 17:14	20/11/2019 22:28	20/11/2019 17:14	20/11/2019 22:28	5,22	22	114,85	CHI

201911259702	ALEXANIA	AX12190681	ALEXANIA	20/11/2019 17:00	20/11/2019 23:39	20/11/2019 17:00	20/11/2019 23:39	6,64	21	139,35	CHI
201911259703	LUZIANIA	10014935161	MARAJOARA	20/11/2019 17:16	21/11/2019 12:10	20/11/2019 17:16	21/11/2019 12:10	18,90	1	18,90	CHI
201911259705	PIRACANJUBA	PJ21257900	PIRACANJUBA	20/11/2019 17:16	22/11/2019 10:31	20/11/2019 17:16	22/11/2019 10:31	41,25	1	41,25	CHI
201911259707	CORUMBA DE GOIAS	CB11297188	CORUMBA	20/11/2019 16:17	21/11/2019 09:40	20/11/2019 16:17	21/11/2019 09:40	17,38	76	1321,01	CHI
201911259801	CRISTALINA	KR12335919	PAMPLONA	20/11/2019 17:14	21/11/2019 10:38	20/11/2019 17:14	21/11/2019 10:38	17,40	2	34,79	CHI
201911259803	JARAGUA	JA21152274	JARAGUA	20/11/2019 17:17	21/11/2019 01:31	20/11/2019 17:17	21/11/2019 01:31	8,23	1	8,23	CHI
201911259813	MINEIROS	MY21101971	PARQUE DAS EMAS	20/11/2019 17:18	21/11/2019 08:07	20/11/2019 17:18	21/11/2019 08:07	14,82	1	14,82	CHI
201911260101	MAIRIPOTABA	MI11251698	PONTALINA	20/11/2019 16:18	20/11/2019 20:54	20/11/2019 16:18	20/11/2019 20:54	4,60	93	427,44	CHI
201911260201	FIRMINOPOLIS	AI21101618	FIRMINOPOLIS S2	20/11/2019 17:20	21/11/2019 15:43	20/11/2019 17:20	21/11/2019 15:43	22,39	1	22,39	CHI
201911260202	JATAI	JT12390597	JATAI S1	20/11/2019 16:43	21/11/2019 10:46	20/11/2019 16:43	21/11/2019 10:46	18,04	13	234,46	CHI
201911260202	PEROLANDIA	JT12390597	JATAI S1	20/11/2019 16:43	21/11/2019 10:46	20/11/2019 16:43	21/11/2019 10:46	18,04	6	108,21	CHI
201911260604	JATAI	JT12205194	JATAI S1	20/11/2019 16:41	21/11/2019 08:26	20/11/2019 16:41	21/11/2019 08:26	15,75	7	110,22	CHI
201911260701	BURITI ALEGRE	BG12263599	ITUMBIARA VELHA S2	20/11/2019 17:22	21/11/2019 16:25	20/11/2019 17:22	21/11/2019 16:25	23,04	11	253,44	CHI
201911260703	ALVORADA DO NORTE	SI12118076LD	IACIARA S2	20/11/2019 17:22	22/11/2019 15:43	20/11/2019 17:22	20/11/2019 22:56	5,55	50	277,69	CHI
201911260703	SITIO D ABADIA	SI12118076LD	IACIARA S2	20/11/2019 17:22	22/11/2019 15:43	20/11/2019 17:22	20/11/2019 22:56	5,55	2	11,11	CHI
201911260703	ALVORADA DO NORTE	SI12118076LD	IACIARA S2	20/11/2019 17:22	22/11/2019 15:43	20/11/2019 17:22	22/11/2019 15:43	46,34	1	46,34	CHI
201911260705	MONTE ALEGRE DE GOIAS	MA21267358	SAO DOMINGOS	20/11/2019 17:22	20/11/2019 22:31	20/11/2019 17:22	20/11/2019 22:31	5,14	1	5,14	CHI
201911260710	LEOPOLDO DE BULHOES	LB12057538	DAIA S1	20/11/2019 13:44	20/11/2019 23:34	20/11/2019 13:44	20/11/2019 23:34	9,84	11	108,20	CHI
201911260710	SILVANIA	LB12057538	DAIA S1	20/11/2019 13:44	20/11/2019 23:34	20/11/2019 13:44	20/11/2019 23:34	9,84	23	226,24	CHI
201911260801	LUZIANIA	LZ12237925	MARAJOARA	20/11/2019 15:31	21/11/2019 02:21	20/11/2019 15:31	21/11/2019 02:21	10,83	41	444,11	CHI
201911261204	ALTO PARAISO DE GOIAS	BF21047995	FLORES DE GOIAS	20/11/2019 17:26	21/11/2019 16:06	20/11/2019 17:26	21/11/2019 16:06	22,66	2	45,33	CHI
201911261207	JANDAIA	JD11007163	PALMEIRAS	20/11/2019 16:16	21/11/2019 07:40	20/11/2019 16:16	21/11/2019 07:40	15,40	154	2371,51	CHI
201911261213	DOVERLANDIA	DV12169484	CAIAPONIA	20/11/2019 16:35	21/11/2019 10:43	20/11/2019 16:35	21/11/2019 10:43	18,13	45	815,67	CHI
201911261219	CROMINIA	CQ21037431	PONTALINA	20/11/2019 17:28	21/11/2019 12:34	20/11/2019 17:28	21/11/2019 12:34	19,10	2	38,20	CHI
201911261301	PADRE BERNARDO	PB12170167	PADRE BERNARDO	20/11/2019 17:29	21/11/2019 11:49	20/11/2019 17:29	21/11/2019 11:49	18,32	47	860,92	CHI
201911261407	PIRENOPOLIS	PV21295526	SAO FRANCISCO DE GOIAS	20/11/2019 17:31	21/11/2019 09:04	20/11/2019 17:31	21/11/2019 09:04	15,56	1	15,56	CHI
201911261502	LUZIANIA	LZ11103532	MARAJOARA	20/11/2019 16:28	21/11/2019 08:26	20/11/2019 16:28	21/11/2019 08:26	15,95	16	255,21	CHI
201911261703	ANAPOLIS	AN21261162	ANAPOLIS UNIVERSITARIO S1	20/11/2019 17:32	21/11/2019 11:17	20/11/2019 17:32	21/11/2019 11:17	17,75	1	17,75	CHI
201911262502	PLANALTINA	PI21150800	PLANALTINA	20/11/2019 17:33	21/11/2019 13:36	20/11/2019 17:33	21/11/2019 13:36	20,04	1	20,04	CHI
201911262504	JATAI	JT12260493	JATAI S1	20/11/2019 17:12	20/11/2019 22:50	20/11/2019 17:12	20/11/2019 22:50	5,64	18	101,49	CHI
201911262607	CAIAPONIA	CP12377303	JATAI S1	20/11/2019 16:34	21/11/2019 10:30	20/11/2019 16:34	21/11/2019 10:30	17,92	3	53,75	CHI
201911262701	FORMOSA	FA12262114	ITUIQUIRA	20/11/2019 17:36	20/11/2019 22:45	20/11/2019 17:36	20/11/2019 22:45	5,15	6	30,87	CHI
201911263101	TURVANIA	TV12259071	FIRMINOPOLIS S2	20/11/2019 17:37	21/11/2019 10:50	20/11/2019 17:37	21/11/2019 10:50	17,21	6	103,28	CHI

201911263301	DISTRITO FEDERAL	FA12146118	ITUIQUIRA	21/11/2019 07:13	22/11/2019 02:33	21/11/2019 14:25	22/11/2019 02:33	12,13	1	12,13	CHI
201911263301	FORMOSA	FA12146118	ITUIQUIRA	21/11/2019 07:13	22/11/2019 02:33	21/11/2019 14:25	22/11/2019 02:33	12,13	35	424,69	CHI
201911263401	SAO JOAO D ALIANCA	JL21344155	SAO JOAO D ALIANCA	20/11/2019 17:37	21/11/2019 20:57	20/11/2019 17:37	21/11/2019 20:57	27,32	1	27,32	CHI
201911263705	PIRES DO RIO	PR11195085	PIRES DO RIO S1	20/11/2019 15:38	21/11/2019 07:07	20/11/2019 15:38	21/11/2019 07:07	15,47	67	1036,38	CHI
201911264001	BALIZA	BH11331149	CAIAPONIA	20/11/2019 17:39	22/11/2019 11:44	20/11/2019 17:39	22/11/2019 11:44	42,07	1	42,07	CHI
201911264117	GOIANIA	GN11001434	CAMPINAS S2	20/11/2019 15:41	21/11/2019 02:05	20/11/2019 15:41	21/11/2019 02:05	10,39	111	1153,04	CHI
201911264128	SANTO ANTONIO DO DESCOBERTO	10018396117	ALEXANIA	20/11/2019 17:43	20/11/2019 19:00	20/11/2019 17:43	20/11/2019 19:00	1,28	1	1,28	CHI
201911264129	NIQUELANDIA	NQ12243514	BARRO ALTO	20/11/2019 16:04	21/11/2019 08:42	20/11/2019 16:04	21/11/2019 08:42	16,63	25	415,78	CHI
201911264133	ANAPOLIS	20043831	JUNDIAI S2	20/11/2019 17:44	21/11/2019 09:03	20/11/2019 17:44	21/11/2019 09:03	15,31	1	15,31	CHI
201911264202	JARAGUA	JA21355752	JARAGUA	20/11/2019 17:47	20/11/2019 23:51	20/11/2019 17:47	20/11/2019 23:51	6,05	1	6,05	CHI
201911264301	GOIANESIA	GE11321356	GOIANESIA S2	20/11/2019 17:47	21/11/2019 14:48	20/11/2019 17:47	21/11/2019 14:48	21,00	1	21,00	CHI
201911264501	AGUAS LINDAS DE GOIAS	LA12078092	AGUAS LINDAS DE GOIAS S1	20/11/2019 15:27	20/11/2019 20:31	20/11/2019 15:27	20/11/2019 20:31	5,06	21	106,18	CHI
201911264701	AGUAS LINDAS DE GOIAS	10008879700	AGUAS LINDAS DE GOIAS S1	20/11/2019 17:50	21/11/2019 09:45	20/11/2019 17:50	21/11/2019 09:45	15,90	1	15,90	CHI
201911264702	CRISTALINA	KR21305288	CRISTALINA S1	20/11/2019 17:50	21/11/2019 00:51	20/11/2019 17:50	21/11/2019 00:51	7,00	1	7,00	CHI
201911264807	ITUMBIARA	10017896000	ITUMBIARA NOVA	20/11/2019 17:51	21/11/2019 07:59	20/11/2019 17:51	21/11/2019 07:59	14,12	1	14,12	CHI
201911264808	ARENOPOLIS	AY12000008B	ARENOPOLIS	20/11/2019 14:53	20/11/2019 22:33	20/11/2019 14:53	20/11/2019 22:33	7,66	205	1569,39	CHI
201911264808	DIORAMA	AY12000008B	ARENOPOLIS	20/11/2019 14:53	20/11/2019 22:33	20/11/2019 14:53	20/11/2019 22:33	7,66	163	1247,86	CHI
201911264808	IPORA	AY12000008B	ARENOPOLIS	20/11/2019 14:53	20/11/2019 22:33	20/11/2019 14:53	20/11/2019 22:33	7,66	137	1048,81	CHI
201911264808	MONTES CLAROS DE GOIAS	AY12000008B	ARENOPOLIS	20/11/2019 14:53	20/11/2019 22:33	20/11/2019 14:53	20/11/2019 22:33	7,66	39	298,57	CHI
201911264906	GOIANAPOLIS	10024819733	DAIA S2	20/11/2019 17:53	21/11/2019 10:28	20/11/2019 17:53	21/11/2019 10:28	16,58	1	16,58	CHI
201911264908	ALTO PARAISO DE GOIAS	BF12396333	SAO JOAO D ALIANCA	20/11/2019 17:53	21/11/2019 17:40	20/11/2019 17:53	21/11/2019 17:40	23,78	2	47,56	CHI
201911264916	RIO VERDE	RV11359448	RIO VERDE S1	20/11/2019 22:20	20/11/2019 23:25	20/11/2019 22:20	20/11/2019 23:25	1,08	152	164,67	CHI
201911264917	ITAPIRAPUA	IU21089792	MATRINCHA	20/11/2019 17:54	21/11/2019 15:20	20/11/2019 17:54	21/11/2019 15:20	21,43	1	21,43	CHI
201911265002	ANAPOLIS	20209034	ANAPOLIS UNIVERSITARIO S2	20/11/2019 17:55	20/11/2019 19:55	20/11/2019 17:55	20/11/2019 19:55	2,00	1	2,00	CHI
201911265006	BARRO ALTO	BA21163352	BARRO ALTO	20/11/2019 17:55	22/11/2019 03:59	20/11/2019 17:55	22/11/2019 03:59	34,06	1	34,06	CHI
201911265007	MOSSAMEDES	MD21204368	FIRMINOPOLIS S2	20/11/2019 17:55	22/11/2019 00:24	20/11/2019 17:55	22/11/2019 00:24	30,47	1	30,47	CHI
201911265101	FIRMINOPOLIS	FR12096973	FIRMINOPOLIS S1	20/11/2019 17:55	20/11/2019 23:30	20/11/2019 17:55	20/11/2019 23:30	5,57	9	50,14	CHI
201911265202	CRISTALINA	KR11171045	CRISTALINA S2	20/11/2019 17:55	21/11/2019 15:25	20/11/2019 17:55	21/11/2019 15:25	21,49	2	42,97	CHI
201911265301	ORIZONA	PR12404788	PIRES DO RIO S1	20/11/2019 17:42	21/11/2019 10:48	20/11/2019 17:42	21/11/2019 10:48	17,09	10	170,93	CHI
201911265301	PIRES DO RIO	PR12404788	PIRES DO RIO S1	20/11/2019 17:42	21/11/2019 10:48	20/11/2019 17:42	21/11/2019 10:48	17,09	50	854,67	CHI
201911265307	RIO VERDE	MV21260811	MONTIVIDIU T	20/11/2019 17:57	21/11/2019 15:06	20/11/2019 17:57	21/11/2019 15:06	21,15	1	21,15	CHI
201911265309	SAO SIMAO	10005081007	CACHOEIRA ALTA	20/11/2019 17:57	21/11/2019 12:19	20/11/2019 17:57	21/11/2019 12:19	18,36	1	18,36	CHI
201911265312	GOIANESIA	BA12163310	GOIANESIA S1	20/11/2019 16:42	20/11/2019 20:20	20/11/2019 16:42	20/11/2019 20:20	3,63	3	10,90	CHI

201911265312	VILA PROPICIO	BA12163310	GOIANESIA S1	20/11/2019 16:42	20/11/2019 20:20	20/11/2019 16:42	20/11/2019 20:20	3,63	11	39,96	CHI
201911265313	DOVERLANDIA	DV21137996	CAIAPONIA	20/11/2019 17:57	21/11/2019 20:51	20/11/2019 17:57	21/11/2019 20:51	26,89	1	26,89	CHI
201911265314	ANAPOLIS	AN21319830	ANAPOLIS UNIVERSITARIO S1	20/11/2019 17:57	21/11/2019 11:41	20/11/2019 17:57	21/11/2019 11:41	17,72	1	17,72	CHI
201911265319	MOSSAMEDES	MD12000176	FIRMINOPOLIS S2	20/11/2019 17:57	20/11/2019 21:48	20/11/2019 17:57	20/11/2019 21:48	3,84	22	84,43	CHI
201911265320	CRISTALINA	KR10400710	PAMPLONA	20/11/2019 18:06	21/11/2019 19:44	20/11/2019 18:06	20/11/2019 19:52	1,77	21	37,14	CHI
201911265320	CRISTALINA	KR10400710	PAMPLONA	20/11/2019 18:06	21/11/2019 19:44	20/11/2019 18:06	20/11/2019 21:40	3,56	12	42,71	CHI
201911265320	CRISTALINA	KR12320123LD	PAMPLONA	20/11/2019 18:06	21/11/2019 19:44	20/11/2019 18:06	21/11/2019 14:20	20,23	6	121,36	CHI
201911265320	CRISTALINA	KR12320123LD	PAMPLONA	20/11/2019 18:06	21/11/2019 19:44	21/11/2019 17:42	21/11/2019 17:53	0,18	8	1,46	CHI
201911265320	CRISTALINA	KR10400710	PAMPLONA	20/11/2019 18:06	21/11/2019 19:44	20/11/2019 18:06	21/11/2019 18:46	24,66	3	73,99	CHI
201911265320	CRISTALINA	KR12323382	PAMPLONA	20/11/2019 18:06	21/11/2019 19:44	20/11/2019 18:06	21/11/2019 19:44	25,64	2	51,28	CHI
201911265320	CRISTALINA	KR12323382	PAMPLONA	20/11/2019 18:06	21/11/2019 19:44	20/11/2019 20:50	21/11/2019 19:44	22,91	19	435,38	CHI
201911265336	GOIANIA	GN11323305	CARAJAS S1	20/11/2019 14:05	20/11/2019 19:41	20/11/2019 14:05	20/11/2019 19:41	5,59	121	675,79	CHI
201911265339	NOVO GAMA	NJ11277154	PACAEMBU S1	20/11/2019 16:54	20/11/2019 19:23	20/11/2019 16:54	20/11/2019 19:23	2,47	21	51,92	CHI
201911265340	GAMELEIRA DE GOIAS	GL21386337	DAIA S2	20/11/2019 18:00	21/11/2019 14:31	20/11/2019 18:00	21/11/2019 14:31	20,50	1	20,50	CHI
201911265341	PALMEIRAS DE GOIAS	PL21197871	PALMEIRAS	20/11/2019 18:00	21/11/2019 13:02	20/11/2019 18:00	21/11/2019 13:02	19,02	1	19,02	CHI
201911265401	LEOPOLDO DE BULHOES	LB12012193	DAIA S2	20/11/2019 17:42	21/11/2019 02:03	20/11/2019 17:42	21/11/2019 02:03	8,34	186	1551,40	CHI
201911265402	JARAGUA	JA21059952	JARAGUA	20/11/2019 18:01	20/11/2019 20:11	20/11/2019 18:01	20/11/2019 20:11	2,16	1	2,16	CHI
201911265501	SAO LUIS DE MONTES BELOS	SL32111610	FIRMINOPOLIS S1	20/11/2019 15:26	20/11/2019 21:51	20/11/2019 15:26	20/11/2019 21:51	6,41	30	192,15	CHI
201911265502	CORUMBA DE GOIAS	CB12297792	CORUMBA	20/11/2019 18:02	21/11/2019 17:37	20/11/2019 18:02	21/11/2019 17:37	23,58	2	47,17	CHI
201911265509	CORUMBA DE GOIAS	CB11000001	CORUMBA	20/11/2019 18:04	21/11/2019 08:04	20/11/2019 18:04	21/11/2019 08:04	14,00	82	1147,70	CHI
201911265601	ANAPOLIS	AN11327819	JUNDIAI S1	20/11/2019 17:31	20/11/2019 20:41	20/11/2019 17:31	20/11/2019 20:41	3,15	68	214,37	CHI
201911265623	BALIZA	BH12331164	CAIAPONIA	20/11/2019 18:01	22/11/2019 20:28	20/11/2019 18:01	22/11/2019 20:28	50,44	9	453,94	CHI
201911265624	JATAI	SX12205192	JATAI S1	20/11/2019 18:06	21/11/2019 07:58	20/11/2019 18:06	21/11/2019 07:58	13,86	3	41,57	CHI
201911265624	SERRANOPOLIS	SX12205192	JATAI S1	20/11/2019 18:06	21/11/2019 07:58	20/11/2019 18:06	21/11/2019 07:58	13,86	18	249,42	CHI
201911265629	SAO JOAO D ALIANCA	JL12324133	SAO JOAO D ALIANCA	20/11/2019 18:06	21/11/2019 19:24	20/11/2019 18:06	21/11/2019 19:24	25,28	4	101,14	CHI
201911265630	CABECEIRAS	CW11280645	ITIQUEIRA	20/11/2019 18:07	20/11/2019 19:30	20/11/2019 18:07	20/11/2019 19:30	1,38	1	1,38	CHI
201911265632	AGUA FRIA DE GOIAS	4140009379	SAO JOAO D ALIANCA	20/11/2019 18:07	22/11/2019 15:41	20/11/2019 18:07	22/11/2019 15:41	45,57	1	45,57	CHI
201911265633	PLANALTINA	PI12248182	PLANALTINA	20/11/2019 17:09	21/11/2019 10:24	20/11/2019 17:09	21/11/2019 10:24	17,25	26	448,42	CHI
201911265906	AGUAS LINDAS DE GOIAS	LA12087830	AGUAS LINDAS DE GOIAS S1	20/11/2019 17:27	20/11/2019 20:40	20/11/2019 17:27	20/11/2019 20:40	3,20	240	768,87	CHI
201911265908	PALMEIRAS DE GOIAS	PL32050546	PALMEIRAS	20/11/2019 18:05	21/11/2019 11:50	20/11/2019 18:05	21/11/2019 11:50	17,75	8	141,98	CHI
201911265910	VALPARAISO DE GOIAS	VA11149886	MARAJOARA	20/11/2019 17:11	21/11/2019 00:03	20/11/2019 17:11	21/11/2019 00:03	6,85	74	507,11	CHI
201911265911	DIORAMA	DI12070162	IPORA	20/11/2019 15:02	21/11/2019 08:34	20/11/2019 15:02	21/11/2019 08:34	17,55	1	17,55	CHI
201911265911	JAUPACI	DI12070162	IPORA	20/11/2019 15:02	21/11/2019 08:34	20/11/2019 15:02	21/11/2019 08:34	17,55	8	140,36	CHI

201911266002	CABECEIRAS	CW21015460	ITUIQUIRA	20/11/2019 18:12	20/11/2019 22:26	20/11/2019 18:12	20/11/2019 22:26	4,23	1	4,23	CHI
201911266207	NIQUELANDIA	NQ12267383	BARRO ALTO	20/11/2019 18:14	21/11/2019 10:27	20/11/2019 18:14	21/11/2019 10:27	16,20	5	81,02	CHI
201911266208	JATAI	JT12260451	JATAI S1	20/11/2019 18:15	20/11/2019 21:25	20/11/2019 18:15	20/11/2019 21:25	3,17	4	12,68	CHI
201911266208	SERRANOPOLIS	JT12260451	JATAI S1	20/11/2019 18:15	20/11/2019 21:25	20/11/2019 18:15	20/11/2019 21:25	3,17	1	3,17	CHI
201911266209	COCALZINHO DE GOIAS	NP12402058	GOIANESIA S1	20/11/2019 17:14	21/11/2019 03:55	20/11/2019 17:14	21/11/2019 03:55	10,67	1	10,67	CHI
201911266209	PADRE BERNARDO	NP12402058	GOIANESIA S1	20/11/2019 17:14	21/11/2019 03:55	20/11/2019 17:14	21/11/2019 03:55	10,67	10	106,74	CHI
201911266209	VILA PROPICIO	NP12402058	GOIANESIA S1	20/11/2019 17:14	21/11/2019 03:55	20/11/2019 17:14	21/11/2019 03:55	10,67	95	1014,07	CHI
201911266210	PIRACANJUBA	PJ21223391	ROCHEDO	20/11/2019 18:15	20/11/2019 20:04	20/11/2019 18:15	20/11/2019 20:04	1,81	1	1,81	CHI
201911266228	VILA PROPICIO	PV21069135	GOIANESIA S1	20/11/2019 18:18	22/11/2019 00:32	20/11/2019 18:18	22/11/2019 00:32	30,22	2	60,45	CHI
201911266237	PIRACANJUBA	PJ12212150RE	PIRACANJUBA	20/11/2019 19:25	22/11/2019 16:29	20/11/2019 19:25	22/11/2019 16:29	45,07	66	2974,42	CHI
201911266241	LUZIANIA	LZ21139703	MARAJOARA	20/11/2019 18:19	21/11/2019 14:29	20/11/2019 18:19	21/11/2019 14:29	20,16	1	20,16	CHI
201911266244	ITAJA	10014184743	ITAJA S2	20/11/2019 18:20	21/11/2019 07:29	20/11/2019 18:20	21/11/2019 07:29	13,15	1	13,15	CHI
201911266245	RUBIATABA	780002910	RUBIATABA	20/11/2019 18:20	20/11/2019 20:35	20/11/2019 18:20	20/11/2019 20:35	2,25	1	2,25	CHI
201911266251	AGUAS LINDAS DE GOIAS	LA11148955	AGUAS LINDAS DE GOIAS S1	20/11/2019 17:41	20/11/2019 23:08	20/11/2019 17:41	20/11/2019 23:08	5,45	133	724,74	CHI
201911266301	LEOPOLDO DE BULHOES	LB12353166	DAIA S2	20/11/2019 18:21	21/11/2019 12:07	20/11/2019 18:21	21/11/2019 12:07	17,75	4	71,01	CHI
201911266522	SERRANOPOLIS	SX12318831	JATAI S1	20/11/2019 18:25	21/11/2019 11:33	20/11/2019 18:25	21/11/2019 11:33	17,13	5	85,65	CHI
201911266523	BELA VISTA DE GOIAS	DE12389424	CEPAIGO S2	20/11/2019 13:42	21/11/2019 10:55	20/11/2019 13:42	21/11/2019 09:50	20,12	80	1609,62	CHI
201911266523	CALDAZINHA	DE12389424	CEPAIGO S2	20/11/2019 13:42	21/11/2019 10:55	20/11/2019 13:42	21/11/2019 09:50	20,12	66	1327,94	CHI
201911266523	BELA VISTA DE GOIAS	BV12052642	CEPAIGO S2	20/11/2019 13:42	21/11/2019 10:55	20/11/2019 13:42	21/11/2019 10:55	21,20	96	2035,55	CHI
201911266524	MINEIROS	PW12045348	PARQUE DAS EMAS	20/11/2019 17:51	21/11/2019 00:35	20/11/2019 17:51	21/11/2019 00:35	6,73	3	20,18	CHI
201911266524	PORTELANDIA	PW12045348	PARQUE DAS EMAS	20/11/2019 17:51	21/11/2019 00:35	20/11/2019 17:51	21/11/2019 00:35	6,73	10	67,26	CHI
201911266528	LUZIANIA	10004709517	MARAJOARA	20/11/2019 18:25	21/11/2019 12:41	20/11/2019 18:25	21/11/2019 12:41	18,25	1	18,25	CHI
201911266605	ITAPURANGA	IK11051549	ITAPURANGA	20/11/2019 16:35	20/11/2019 19:00	20/11/2019 16:35	20/11/2019 19:00	2,42	197	476,30	CHI
201911266704	GOIATUBA	GT12000351	GOIATUBA S2	20/11/2019 18:28	21/11/2019 11:11	20/11/2019 18:28	21/11/2019 11:11	16,71	1	16,71	CHI
201911266708	GOIANIA	GN11000241	AEROPORTO S1	20/11/2019 13:50	20/11/2019 20:20	20/11/2019 13:50	20/11/2019 20:20	6,49	33	214,17	CHI
201911267002	CRISTALINA	KR11032618	PAMPLONA	20/11/2019 18:22	21/11/2019 18:25	20/11/2019 18:22	21/11/2019 18:25	24,05	65	1563,11	CHI
201911267003	LUZIANIA	10001771238	RIO VERMELHO	20/11/2019 18:29	21/11/2019 10:59	20/11/2019 18:29	21/11/2019 10:59	16,50	1	16,50	CHI
201911267101	SAO LUIS DE MONTES BELOS	SL12259124	SAO LUIZ DOS MONTES BELOS	20/11/2019 15:07	20/11/2019 19:16	20/11/2019 15:07	20/11/2019 19:16	4,15	164	680,10	CHI
201911267206	DOVERLANDIA	DV12131595	CAIAPONIA	20/11/2019 18:30	21/11/2019 16:23	20/11/2019 18:30	21/11/2019 16:23	21,87	2	43,74	CHI
201911267215	SANTA RITA DO ARAGUAIA	SU21188571	SANTA RITA DO ARAGUAIA	20/11/2019 18:31	21/11/2019 18:28	20/11/2019 18:31	21/11/2019 18:28	23,94	1	23,94	CHI
201911267219	BELA VISTA DE GOIAS	BV12012779	BELA VISTA S2	20/11/2019 13:11	20/11/2019 20:06	20/11/2019 13:11	20/11/2019 20:06	6,91	7	48,40	CHI
201911267304	SAO DOMINGOS	SD11256734	SAO DOMINGOS	20/11/2019 16:23	20/11/2019 19:09	20/11/2019 16:23	20/11/2019 19:09	2,76	76	210,01	CHI
201911267315	PIRENOPOLIS	PV12302141	SAO FRANCISCO DE GOIAS	20/11/2019 18:19	20/11/2019 22:29	20/11/2019 18:19	20/11/2019 22:29	4,17	94	391,54	CHI

201911267317	CABECEIRAS	CW21154405	ITIQUEIRA	20/11/2019 18:35	20/11/2019 21:24	20/11/2019 18:35	20/11/2019 21:24	2,81	1	2,81	CHI
201911267320	GOIANIA	GN11197045	GOYA S2	20/11/2019 13:58	21/11/2019 02:48	20/11/2019 13:58	21/11/2019 02:48	12,83	61	782,39	CHI
201911267321	VIANOPOLIS	VN11139618	VIANOPOLIS	20/11/2019 14:47	21/11/2019 17:18	20/11/2019 14:47	21/11/2019 17:18	26,50	189	5009,34	CHI
201911267322	IPAMERI	580063136	IPAMERI	20/11/2019 18:36	21/11/2019 15:51	20/11/2019 18:36	21/11/2019 15:51	21,24	1	21,24	CHI
201911267325	COCALZINHO DE GOIAS	LA12382945	AGUAS LINDAS DE GOIAS S2	20/11/2019 18:36	21/11/2019 18:01	20/11/2019 18:36	21/11/2019 18:01	23,40	1	23,40	CHI
201911267328	BALIZA	BH12331395	CAIAPONIA	20/11/2019 15:43	21/11/2019 13:27	20/11/2019 15:43	21/11/2019 13:27	21,73	67	1456,00	CHI
201911267403	AMARALINA	LC12266010	MARA ROSA	20/11/2019 17:09	21/11/2019 10:06	20/11/2019 17:09	21/11/2019 10:06	16,95	5	84,73	CHI
201911267403	MARA ROSA	LC12266010	MARA ROSA	20/11/2019 17:09	21/11/2019 10:06	20/11/2019 17:09	21/11/2019 10:06	16,95	0	0,00	CHI
201911267405	IPAMERI	IP12332968	IPAMERI	20/11/2019 10:33	20/11/2019 23:02	20/11/2019 10:33	20/11/2019 23:02	12,47	16	199,55	CHI
201911267407	NOVO GAMA	2460070786	PACAEMBU S1	20/11/2019 18:39	20/11/2019 20:22	20/11/2019 18:39	20/11/2019 20:22	1,72	1	1,72	CHI
201911267501	AGUA FRIA DE GOIAS	TL21096452	SAO JOAO D ALIANCA	20/11/2019 18:40	21/11/2019 12:30	20/11/2019 18:40	21/11/2019 12:30	17,83	1	17,83	CHI
201911267609	DIVINOPOLIS DE GOIAS	2570006379	SAO DOMINGOS	20/11/2019 18:41	22/11/2019 17:00	20/11/2019 18:41	22/11/2019 17:00	46,32	1	46,32	CHI
201911267618	MONTIVIDIU	CP21106365	MONTIVIDIU T	20/11/2019 18:43	21/11/2019 09:54	20/11/2019 18:43	21/11/2019 09:54	15,17	1	15,17	CHI
201911267619	JANDAIA	JD12008652	PALMEIRAS	20/11/2019 15:40	21/11/2019 09:50	20/11/2019 15:40	21/11/2019 09:50	18,16	14	254,22	CHI
201911267809	PIRACANJUBA	60022425	PIRACANJUBA	20/11/2019 18:45	21/11/2019 07:17	20/11/2019 18:45	21/11/2019 07:17	12,52	1	12,52	CHI
201911267817	MUNDO NOVO DE GOIAS	MH12391948	NOVA CRIXAS	20/11/2019 11:50	21/11/2019 01:08	20/11/2019 11:50	21/11/2019 01:08	13,30	15	199,47	CHI
201911267825	CALDAS NOVAS	CN12391202	CALDAS NOVAS S1	20/11/2019 18:48	21/11/2019 12:22	20/11/2019 18:48	21/11/2019 12:22	17,55	4	70,21	CHI
201911267830	FORMOSA	FA11233780	SAO JOAO D ALIANCA	20/11/2019 18:49	21/11/2019 14:46	20/11/2019 18:49	21/11/2019 14:46	19,94	1	19,94	CHI
201911267831	BRITANIA	IU12025071	MATRINCHA	20/11/2019 14:48	21/11/2019 08:28	20/11/2019 14:48	21/11/2019 08:28	17,66	6	105,99	CHI
201911267831	ITAPIRAPUA	IU12025071	MATRINCHA	20/11/2019 14:48	21/11/2019 08:28	20/11/2019 14:48	21/11/2019 08:28	17,66	8	141,31	CHI
201911267838	QUIRINOPOLIS	QI21036482	QUIRINOPOLIS	20/11/2019 18:49	21/11/2019 09:07	20/11/2019 18:49	21/11/2019 09:07	14,30	1	14,30	CHI
201911268211	BALIZA	BH12331370	CAIAPONIA	20/11/2019 16:00	21/11/2019 18:07	20/11/2019 16:00	21/11/2019 18:07	26,11	13	339,42	CHI
201911268212	MORRINHOS	MR21064833	GOIATUBA S1	20/11/2019 18:19	21/11/2019 13:45	20/11/2019 18:19	21/11/2019 13:45	19,42	1	19,42	CHI
201911268214	ITAGUARI	JA12300098	ITABERAI S1	20/11/2019 17:28	21/11/2019 10:10	20/11/2019 17:28	21/11/2019 10:10	16,70	1	16,70	CHI
201911268214	JARAGUA	JA12300098	ITABERAI S1	20/11/2019 17:28	21/11/2019 10:10	20/11/2019 17:28	21/11/2019 10:10	16,70	11	183,65	CHI
201911268217	PONTALINA	PK21270881	PONTALINA	20/11/2019 18:54	21/11/2019 17:50	20/11/2019 18:54	21/11/2019 17:50	22,93	1	22,93	CHI
201911268401	VILA PROPICIO	PV12082549	GOIANESIA S1	20/11/2019 17:42	21/11/2019 10:15	20/11/2019 17:42	21/11/2019 10:15	16,55	29	479,83	CHI
201911268501	MINEIROS	MY21216304	PARQUE DAS EMAS	20/11/2019 18:55	21/11/2019 11:40	20/11/2019 18:55	21/11/2019 11:40	16,74	1	16,74	CHI
201911268601	MINEIROS	MY12197100	PARQUE DAS EMAS	20/11/2019 18:52	21/11/2019 12:19	20/11/2019 18:52	21/11/2019 12:19	17,46	6	104,75	CHI
201911268703	MORRINHOS	MR21142324	MORRINHOS	20/11/2019 18:56	21/11/2019 01:44	20/11/2019 18:56	21/11/2019 01:44	6,80	1	6,80	CHI
201911268801	CAMPOS VERDES	VD21252868	SANTA TEREZINHA	20/11/2019 18:57	21/11/2019 09:00	20/11/2019 18:57	21/11/2019 09:00	14,06	1	14,06	CHI
201911268802	NOVA CRIXAS	NA12220366	MOZARLANDIA	20/11/2019 18:01	21/11/2019 00:24	20/11/2019 18:01	21/11/2019 00:24	6,38	6	38,25	CHI
201911268807	PONTALINA	PK21230559	VICENTINOPOLIS	20/11/2019 18:57	21/11/2019 10:02	20/11/2019 18:57	21/11/2019 10:02	15,07	1	15,07	CHI

201911268808	BURITI ALEGRE	BG12000158	ITUMBIARA VELHA S2	20/11/2019 18:58	21/11/2019 14:28	20/11/2019 18:58	21/11/2019 14:28	19,51	4	78,02	CHI
201911268901	MINEIROS	PW21206292	PARQUE DAS EMAS	20/11/2019 18:58	21/11/2019 12:18	20/11/2019 18:58	21/11/2019 12:18	17,33	1	17,33	CHI
201911268914	FORMOSA	10007742973	ITUIQUIRA	20/11/2019 18:59	21/11/2019 06:04	20/11/2019 18:59	21/11/2019 06:04	11,07	1	11,07	CHI
201911268915	NIQUELANDIA	2750082220	NIQUELANDIA SUBTRANSMISSAO	20/11/2019 18:59	20/11/2019 21:04	20/11/2019 18:59	20/11/2019 21:04	2,07	1	2,07	CHI
201911269103	NOVA AURORA	NE12127536	CATALAO S1	20/11/2019 18:26	21/11/2019 22:10	20/11/2019 18:26	21/11/2019 22:10	27,72	9	249,50	CHI
201911269130	CRISTALINA	KR21133543	CRISTALINA S1	20/11/2019 19:09	21/11/2019 12:03	20/11/2019 19:09	21/11/2019 12:03	16,89	1	16,89	CHI
201911269138	CROMINIA	CQ21100122	PONTALINA	20/11/2019 19:10	21/11/2019 12:50	20/11/2019 19:10	21/11/2019 12:50	17,65	1	17,65	CHI
201911269142	CATALAO	1990152240	CATALAO S2	20/11/2019 19:11	20/11/2019 21:20	20/11/2019 19:11	20/11/2019 21:20	2,14	1	2,14	CHI
201911269145	CAIAPONIA	CP12241163	CAIAPONIA	20/11/2019 09:51	21/11/2019 15:54	20/11/2019 09:51	21/11/2019 15:54	30,04	4	120,16	CHI
201911269503	LUZIANIA	LZ12389556	PACAEMBU S1	20/11/2019 17:48	21/11/2019 02:26	20/11/2019 17:48	21/11/2019 02:26	8,64	35	302,43	CHI
201911269536	CAIAPONIA	CP12244220	CAIAPONIA	20/11/2019 13:39	21/11/2019 10:33	20/11/2019 13:39	21/11/2019 10:33	20,89	10	208,89	CHI
201911269539	ABADIANIA	05720426	DAIA S2	20/11/2019 17:02	21/11/2019 10:14	21/11/2019 00:37	21/11/2019 04:10	3,56	1	3,56	CHI
201911269539	ABADIANIA	AA21141454	DAIA S2	20/11/2019 17:02	21/11/2019 10:14	21/11/2019 00:34	21/11/2019 04:11	3,61	1	3,61	CHI
201911269539	ABADIANIA	05730414	DAIA S2	20/11/2019 17:02	21/11/2019 10:14	20/11/2019 17:02	21/11/2019 09:49	16,78	60	1006,90	CHI
201911269539	GAMELEIRA DE GOIAS	05730414	DAIA S2	20/11/2019 17:02	21/11/2019 10:14	20/11/2019 17:02	21/11/2019 09:49	16,78	1	16,78	CHI
201911269539	ABADIANIA	05730414	DAIA S2	20/11/2019 17:02	21/11/2019 10:14	20/11/2019 17:02	21/11/2019 10:14	17,20	264	4540,43	CHI
201911269544	RIO VERDE	RV11245480	RIO VERDE S2	20/11/2019 17:32	20/11/2019 22:30	20/11/2019 17:32	20/11/2019 22:30	4,97	71	353,22	CHI
201911269607	AGUAS LINDAS DE GOIAS	4830297087	AGUAS LINDAS DE GOIAS S2	20/11/2019 19:18	21/11/2019 10:56	20/11/2019 19:18	21/11/2019 10:56	15,63	1	15,63	CHI
201911269613	QUIRINOPOLIS	QI11083351	QUIRINOPOLIS	20/11/2019 19:07	20/11/2019 21:32	20/11/2019 19:07	20/11/2019 21:32	2,40	108	259,74	CHI
201911269617	GOIATUBA	JV12208115RE	GOIATUBA S1	20/11/2019 15:48	20/11/2019 23:15	20/11/2019 15:48	20/11/2019 23:15	7,45	25	186,14	CHI
201911269617	JOVIANIA	JV12208115RE	GOIATUBA S1	20/11/2019 15:48	20/11/2019 23:15	20/11/2019 15:48	20/11/2019 23:15	7,45	46	342,50	CHI
201911269617	VICENTINOPOLIS	JV12208115RE	GOIATUBA S1	20/11/2019 15:48	20/11/2019 23:15	20/11/2019 15:48	20/11/2019 23:15	7,45	35	260,59	CHI
201911269701	LUZIANIA	LZ12000543	MARAJOARA	20/11/2019 19:07	21/11/2019 01:23	20/11/2019 19:07	21/11/2019 01:23	6,27	40	250,69	CHI
201911269817	RIO VERDE	RV21190352	CABRIUVA S2	20/11/2019 19:25	21/11/2019 09:12	20/11/2019 19:25	21/11/2019 09:12	13,77	1	13,77	CHI
201911269828	MORRINHOS	MR21236344	MORRINHOS	20/11/2019 19:27	21/11/2019 09:46	20/11/2019 19:27	21/11/2019 09:46	14,31	1	14,31	CHI
201911269906	GOIATUBA	GT12247742	BOM JESUS DE GOIAS	20/11/2019 19:28	21/11/2019 09:42	20/11/2019 19:28	21/11/2019 09:42	14,22	3	42,66	CHI
201911270003	MONTIVIDIU	2840029103	MONTIVIDIU T	20/11/2019 19:28	21/11/2019 11:45	20/11/2019 19:28	21/11/2019 11:45	16,27	1	16,27	CHI
201911270202	MORRINHOS	MR21101262	MORRINHOS	20/11/2019 19:31	21/11/2019 01:48	20/11/2019 19:31	21/11/2019 01:48	6,28	1	6,28	CHI
201911270207	RIO VERDE	630232489	RIO VERDE S1	20/11/2019 19:33	20/11/2019 22:51	20/11/2019 19:33	20/11/2019 22:51	3,31	1	3,31	CHI
201911270406	SANTA RITA DO ARAGUAIA	SU12248425	SANTA RITA DO ARAGUAIA	20/11/2019 18:39	20/11/2019 22:46	20/11/2019 18:39	20/11/2019 22:46	4,12	36	148,14	CHI
201911270414	NOVO GAMA	4990098305	PACAEMBU S1	20/11/2019 19:37	20/11/2019 21:15	20/11/2019 19:37	20/11/2019 21:15	1,62	1	1,62	CHI
201911270415	MINEIROS	MY12043894	PARQUE DAS EMAS	20/11/2019 18:09	21/11/2019 00:05	20/11/2019 18:09	21/11/2019 00:05	5,92	100	592,00	CHI
201911270602	PIRACANJUBA	PJ12226339	PIRACANJUBA	20/11/2019 17:53	21/11/2019 08:17	20/11/2019 17:53	21/11/2019 08:17	14,38	44	632,93	CHI

201911270603	SANTA RITA DO ARAGUAIA	SU12142710	SANTA RITA DO ARAGUAIA	20/11/2019 19:39	20/11/2019 23:27	20/11/2019 19:39	20/11/2019 23:27	3,78	10	37,84	CHI
201911270629	VALPARAISO DE GOIAS	VA11183712	MARAJOARA	20/11/2019 19:41	20/11/2019 23:19	20/11/2019 19:41	20/11/2019 23:19	3,63	60	217,52	CHI
201911270703	CIDADE OCIDENTAL	DH11350427	MARAJOARA	20/11/2019 16:25	21/11/2019 07:35	20/11/2019 16:25	21/11/2019 07:35	15,16	70	1060,99	CHI
201911270707	DISTRITO FEDERAL	2900001384	MARAJOARA	20/11/2019 19:47	21/11/2019 12:52	20/11/2019 19:47	21/11/2019 12:52	17,08	1	17,08	CHI
201911270726	ALVORADA DO NORTE	AQ12302818	IACIARA S2	20/11/2019 19:51	22/11/2019 15:43	20/11/2019 19:51	22/11/2019 15:43	43,85	2	87,71	CHI
201911270733	SAO DOMINGOS	SD11071319	SAO DOMINGOS	20/11/2019 19:32	20/11/2019 22:46	20/11/2019 19:32	20/11/2019 22:46	3,23	132	426,21	CHI
201911270744	CRISTALINA	KR12210364	CRISTALINA S2	20/11/2019 13:56	21/11/2019 07:51	20/11/2019 13:56	21/11/2019 07:51	17,91	2	35,83	CHI
201911270747	BURITI ALEGRE	BG11208092	ITUMBIARA VELHA S2	20/11/2019 19:58	21/11/2019 18:00	20/11/2019 19:58	21/11/2019 18:00	22,02	6	132,15	CHI
201911270748	MONTE ALEGRE DE GOIAS	MA12233174	SAO DOMINGOS	20/11/2019 19:58	20/11/2019 23:14	20/11/2019 19:58	20/11/2019 23:14	3,26	17	55,37	CHI
201911270757	PONTALINA	PK12099030	PONTALINA	20/11/2019 16:26	21/11/2019 09:21	20/11/2019 16:26	21/11/2019 09:21	16,90	16	270,42	CHI
201911270766	BOM JARDIM DE GOIAS	1880015540	BOM JARDIM	20/11/2019 15:09	21/11/2019 10:35	20/11/2019 15:09	21/11/2019 10:35	19,42	1	19,42	CHI
201911270773	PILAR DE GOIAS	GG12293454	URUACU	20/11/2019 18:51	21/11/2019 01:04	20/11/2019 18:51	21/11/2019 01:04	6,22	3	18,65	CHI
201911270791	PARANAIGUARA	6390001	CACHOEIRA ALTA	20/11/2019 20:06	21/11/2019 16:13	21/11/2019 14:54	21/11/2019 16:13	1,31	58	76,27	CHI
201911270806	INDIARA	10001628508	EDEIA	20/11/2019 20:12	21/11/2019 08:49	20/11/2019 20:12	21/11/2019 08:49	12,60	1	12,60	CHI
201911270812	AGUA FRIA DE GOIAS	PI12048037	SAO JOAO D ALIANCA	20/11/2019 16:31	21/11/2019 12:38	20/11/2019 16:31	21/11/2019 12:38	20,11	7	140,76	CHI
201911270839	EDEIA	EA12029037	EDEIA	20/11/2019 20:21	21/11/2019 15:15	20/11/2019 20:21	21/11/2019 15:15	18,90	6	113,42	CHI
201911270873	LUZIANIA	LZ11261728	RIO VERMELHO	20/11/2019 19:49	21/11/2019 02:07	20/11/2019 19:49	21/11/2019 02:07	6,28	28	175,97	CHI
201911270874	RIO VERDE	RV12260722	RIO VERDE S1	20/11/2019 20:34	21/11/2019 10:40	20/11/2019 20:34	21/11/2019 10:40	14,10	4	56,41	CHI
201911270879	AURILANDIA	AI12194040	FIRMINOPOLIS S2	20/11/2019 16:03	21/11/2019 20:30	20/11/2019 16:03	21/11/2019 20:30	28,46	5	142,28	CHI
201911270885	SANTA HELENA DE GOIAS	400015584	IPEGUARI	20/11/2019 20:36	21/11/2019 10:45	20/11/2019 20:36	21/11/2019 10:45	14,15	1	14,15	CHI
201911270890	POSSE	PS12181886	IACIARA S2	20/11/2019 20:35	20/11/2019 23:12	20/11/2019 20:35	20/11/2019 23:12	2,60	54	140,51	CHI
201911270918	ABADIANIA	350022926	DAIA S2	20/11/2019 16:53	21/11/2019 12:51	20/11/2019 16:53	21/11/2019 12:51	19,96	1	19,96	CHI
201911270925	PLANALTINA	PI11248187	PLANALTINA	20/11/2019 20:50	21/11/2019 11:25	20/11/2019 20:50	21/11/2019 11:25	14,57	1	14,57	CHI
201911270935	CACHOEIRA DOURADA	3290001542	CACHOEIRA DOURADA	20/11/2019 20:56	21/11/2019 12:45	20/11/2019 20:56	21/11/2019 12:45	15,83	1	15,83	CHI
201911270940	PANAMA	PX21034331	PARANAIBA	20/11/2019 20:58	21/11/2019 10:07	20/11/2019 20:58	21/11/2019 10:07	13,14	2	26,29	CHI
201911270952	CAIAPONIA	RV10400619	MONTIVIDIU T	20/11/2019 22:34	21/11/2019 04:01	20/11/2019 22:34	20/11/2019 23:05	0,52	35	18,04	CHI
201911270952	IVOLANDIA	RV10400619	MONTIVIDIU T	20/11/2019 22:34	21/11/2019 04:01	20/11/2019 22:34	20/11/2019 23:05	0,52	28	14,44	CHI
201911270952	MONTIVIDIU	RV10400619	MONTIVIDIU T	20/11/2019 22:34	21/11/2019 04:01	20/11/2019 22:34	20/11/2019 23:05	0,52	23	11,86	CHI
201911270952	PARAUNA	RV10400619	MONTIVIDIU T	20/11/2019 22:34	21/11/2019 04:01	20/11/2019 22:34	20/11/2019 23:05	0,52	147	75,79	CHI
201911270952	RIO VERDE	RV10400619	MONTIVIDIU T	20/11/2019 22:34	21/11/2019 04:01	20/11/2019 22:34	20/11/2019 23:05	0,52	137	70,63	CHI
201911270952	CAIAPONIA	PU13152644	MONTIVIDIU T	20/11/2019 22:34	21/11/2019 04:01	21/11/2019 01:06	21/11/2019 01:29	0,38	35	13,27	CHI
201911270952	IVOLANDIA	PU13152644	MONTIVIDIU T	20/11/2019 22:34	21/11/2019 04:01	21/11/2019 01:06	21/11/2019 01:29	0,38	28	10,62	CHI
201911270952	MONTIVIDIU	PU13152644	MONTIVIDIU T	20/11/2019 22:34	21/11/2019 04:01	21/11/2019 01:06	21/11/2019 01:29	0,38	23	8,72	CHI

201911270952	PARAUNA	PU13152644	MONTIVIDIU T	20/11/2019 22:34	21/11/2019 04:01	21/11/2019 01:06	21/11/2019 01:29	0,38	147	55,74	CHI
201911270952	RIO VERDE	PU13152644	MONTIVIDIU T	20/11/2019 22:34	21/11/2019 04:01	21/11/2019 01:06	21/11/2019 01:29	0,38	137	51,95	CHI
201911270952	CAIAPONIA	RV10400619	MONTIVIDIU T	20/11/2019 22:34	21/11/2019 04:01	21/11/2019 03:54	21/11/2019 04:01	0,12	35	4,14	CHI
201911270952	IVOLANDIA	RV10400619	MONTIVIDIU T	20/11/2019 22:34	21/11/2019 04:01	21/11/2019 03:54	21/11/2019 04:01	0,12	28	3,31	CHI
201911270952	MONTIVIDIU	RV10400619	MONTIVIDIU T	20/11/2019 22:34	21/11/2019 04:01	21/11/2019 03:54	21/11/2019 04:01	0,12	23	2,72	CHI
201911270952	PARAUNA	RV10400619	MONTIVIDIU T	20/11/2019 22:34	21/11/2019 04:01	21/11/2019 03:54	21/11/2019 04:01	0,12	146	17,28	CHI
201911270952	RIO VERDE	RV10400619	MONTIVIDIU T	20/11/2019 22:34	21/11/2019 04:01	21/11/2019 03:54	21/11/2019 04:01	0,12	137	16,21	CHI
201911271021	MINEIROS	MY21341157	PARQUE DAS EMAS	20/11/2019 10:43	21/11/2019 11:02	20/11/2019 10:43	21/11/2019 11:02	24,31	1	24,31	CHI
201911271022	JATAI	JT11166036	JATAI S2	21/11/2019 08:09	21/11/2019 08:24	21/11/2019 08:09	21/11/2019 08:24	0,24	58	14,13	CHI
201911271028	ALEXANIA	AX12000099	ALEXANIA	20/11/2019 16:57	21/11/2019 10:45	20/11/2019 16:57	21/11/2019 10:45	17,80	12	213,58	CHI
201911271106	BONFINOPOLIS	LB12258821	DAIA S2	20/11/2019 13:39	21/11/2019 08:59	20/11/2019 13:39	21/11/2019 08:59	19,32	1	19,32	CHI
201911271106	LEOPOLDO DE BULHOES	LB12258821	DAIA S2	20/11/2019 13:39	21/11/2019 08:59	20/11/2019 13:39	21/11/2019 08:59	19,32	6	115,95	CHI
201911271110	SAO JOAO D ALIANCA	JL21164691	SAO JOAO D ALIANCA	20/11/2019 21:17	21/11/2019 18:37	20/11/2019 21:17	21/11/2019 18:37	21,32	3	63,95	CHI
201911271411	QUIRINOPOLIS	QI12198335	QUIRINOPOLIS	20/11/2019 21:25	21/11/2019 11:41	20/11/2019 21:25	21/11/2019 11:41	14,27	3	42,81	CHI
201911271413	CAVALCANTE	740015242	FLORES DE GOIAS	20/11/2019 11:54	21/11/2019 01:11	20/11/2019 11:54	21/11/2019 01:11	13,28	1	13,28	CHI
201911271419	MORRINHOS	MR12000403	MORRINHOS	20/11/2019 21:28	21/11/2019 15:20	20/11/2019 21:28	21/11/2019 15:20	17,87	13	232,30	CHI
201911271429	SAO JOAO D ALIANCA	JL21313371	SAO JOAO D ALIANCA	20/11/2019 21:34	22/11/2019 17:09	20/11/2019 21:34	22/11/2019 17:09	43,57	3	130,72	CHI
201911271431	SANTA RITA DO ARAGUAIA	SU11271642	SANTA RITA DO ARAGUAIA	20/11/2019 19:01	21/11/2019 09:30	20/11/2019 19:01	21/11/2019 09:30	14,48	81	1172,79	CHI
201911271439	IACIARA	IA12085526	IACIARA S1	20/11/2019 21:41	21/11/2019 10:21	20/11/2019 21:41	21/11/2019 10:21	12,65	36	455,58	CHI
201911271454	MINEIROS	MY12266436	CHAPADAO DO CEU	20/11/2019 20:52	21/11/2019 16:34	20/11/2019 20:52	21/11/2019 16:34	19,69	8	157,51	CHI
201911271457	SERRANOPOLIS	SX12267588	JATAI S1	20/11/2019 17:29	21/11/2019 10:20	20/11/2019 17:29	21/11/2019 10:20	16,84	6	101,06	CHI
201911271462	RIO VERDE	630228486	RIO VERDE S1	20/11/2019 21:53	21/11/2019 09:10	20/11/2019 21:53	21/11/2019 09:10	11,27	1	11,27	CHI
201911271466	IACIARA	IA21295146	IACIARA S2	20/11/2019 21:54	22/11/2019 17:19	20/11/2019 21:54	22/11/2019 17:19	43,41	1	43,41	CHI
201911271605	QUIRINOPOLIS	80129857	QUIRINOPOLIS	20/11/2019 22:33	21/11/2019 16:50	20/11/2019 22:33	21/11/2019 16:50	18,28	1	18,28	CHI
201911271645	ALTO PARAISO DE GOIAS	BF21194785	SAO JOAO D ALIANCA	20/11/2019 14:04	20/11/2019 23:55	20/11/2019 14:04	20/11/2019 23:55	9,83	1	9,83	CHI
201911271647	JATAI	10006175480	JATAI S3	20/11/2019 22:55	21/11/2019 09:54	20/11/2019 22:55	21/11/2019 09:54	10,97	1	10,97	CHI
201911271706	MONTE ALEGRE DE GOIAS	MA12211597	SAO DOMINGOS	21/11/2019 07:21	21/11/2019 12:02	21/11/2019 07:21	21/11/2019 12:02	4,68	10	46,75	CHI
201911271713	RIO VERDE	RV11231012	RIO VERDE S2	20/11/2019 23:16	21/11/2019 06:00	20/11/2019 23:16	21/11/2019 06:00	6,72	135	907,69	CHI
201911271842	PLANALTINA	PI12324293	SAO JOAO D ALIANCA	20/11/2019 17:57	21/11/2019 09:53	20/11/2019 17:57	21/11/2019 09:53	15,92	7	111,43	CHI
201911271843	CACU	1140035578	CACHOEIRA ALTA	21/11/2019 00:44	21/11/2019 20:37	21/11/2019 00:44	21/11/2019 20:37	19,88	1	19,88	CHI
201911271902	SAO SIMAO	2240033880	CACHOEIRA ALTA	21/11/2019 01:14	21/11/2019 08:52	21/11/2019 01:14	21/11/2019 08:52	7,63	1	7,63	CHI
201911271904	RIO VERDE	RV21306378	CABRIUVA S2	21/11/2019 08:36	21/11/2019 22:47	21/11/2019 08:36	21/11/2019 22:47	14,17	1	14,17	CHI
201911271907	AVELINOPOLIS	AV12272366	ANICUNS	20/11/2019 16:36	21/11/2019 08:25	20/11/2019 16:36	21/11/2019 08:25	15,81	5	79,04	CHI

201911271907	CATURAI	AV12272366	ANICUNS	20/11/2019 16:36	21/11/2019 08:25	20/11/2019 16:36	21/11/2019 08:25	15,81	7	110,65	CHI
201911271909	AGUA FRIA DE GOIAS	6910045	SAO JOAO D ALIANCA	21/11/2019 01:38	22/11/2019 19:06	21/11/2019 01:38	22/11/2019 19:06	41,45	1	41,45	CHI
201911271912	PARAUNA	PU11233920	MONTIVIDIU T	21/11/2019 01:44	21/11/2019 15:32	21/11/2019 01:44	21/11/2019 15:32	13,80	1	13,80	CHI
201911271927	POSSE	PS12124656	IACIARA S2	20/11/2019 23:20	22/11/2019 11:44	20/11/2019 23:20	22/11/2019 11:44	36,39	93	3384,17	CHI
201911271927	POSSE	PS12124656	IACIARA S2	20/11/2019 23:20	22/11/2019 11:44	21/11/2019 02:45	22/11/2019 11:44	32,98	2	65,96	CHI
201911271928	ACREUNA	EU12077053	ACREUNA	21/11/2019 02:48	21/11/2019 10:13	21/11/2019 02:48	21/11/2019 10:13	7,42	26	192,84	CHI
201911271938	MINEIROS	MY12034227	PARQUE DAS EMAS	21/11/2019 03:16	21/11/2019 10:45	21/11/2019 03:16	21/11/2019 10:45	7,48	30	224,38	CHI
201911271938	SANTA RITA DO ARAGUAIA	MY12034227	PARQUE DAS EMAS	21/11/2019 03:16	21/11/2019 10:45	21/11/2019 03:16	21/11/2019 10:45	7,48	2	14,96	CHI
201911271980	QUIRINOPOLIS	QI12000225	QUIRINOPOLIS	21/11/2019 04:57	21/11/2019 07:21	21/11/2019 04:57	21/11/2019 07:21	2,39	46	110,11	CHI
201911272003	PLANALTINA	2960249295	PLANALTINA	21/11/2019 05:14	21/11/2019 08:37	21/11/2019 05:14	21/11/2019 08:37	3,37	1	3,37	CHI
201911272027	FORMOSA	FA12376643	ITIQUEIRA	21/11/2019 05:26	21/11/2019 10:15	21/11/2019 05:26	21/11/2019 10:15	4,81	100	481,08	CHI
201911272113	SANTA RITA DO ARAGUAIA	SU12090636	SANTA RITA DO ARAGUAIA	21/11/2019 06:28	21/11/2019 11:34	21/11/2019 06:28	21/11/2019 11:34	5,08	3	15,25	CHI
201911272142	RIO VERDE	RV21360383	CABRIUVA S2	20/11/2019 23:28	21/11/2019 11:00	20/11/2019 23:28	21/11/2019 11:00	11,53	1	11,53	CHI
201911272259	RIO VERDE	630107865	RIO VERDE S2	21/11/2019 06:08	21/11/2019 18:29	21/11/2019 06:08	21/11/2019 18:29	12,35	1	12,35	CHI
201911272276	SANTO ANTONIO DA BARRA	BZ12303298	ACREUNA	21/11/2019 06:12	21/11/2019 21:30	21/11/2019 06:12	21/11/2019 21:30	15,30	1	15,30	CHI
201911272277	PORANGATU	PO12240663	PORANGATU	20/11/2019 18:33	22/11/2019 03:37	20/11/2019 18:33	22/11/2019 03:37	33,06	3	99,19	CHI
201911272348	SANTA RITA DO ARAGUAIA	SU12202828	SANTA RITA DO ARAGUAIA	21/11/2019 06:27	21/11/2019 20:53	21/11/2019 06:27	21/11/2019 20:53	14,43	3	43,30	CHI
201911272359	DIVINOPOLIS DE GOIAS	MA12398387	SAO DOMINGOS	21/11/2019 06:29	21/11/2019 12:02	21/11/2019 06:29	21/11/2019 12:02	5,54	3	16,62	CHI
201911272359	MONTE ALEGRE DE GOIAS	MA12398387	SAO DOMINGOS	21/11/2019 06:29	21/11/2019 12:02	21/11/2019 06:29	21/11/2019 12:02	5,54	16	88,64	CHI
201911272364	GUARANI DE GOIAS	IA12117792	IACIARA S1	21/11/2019 05:22	21/11/2019 09:40	21/11/2019 05:22	21/11/2019 09:40	4,29	18	77,24	CHI
201911272364	IACIARA	IA12117792	IACIARA S1	21/11/2019 05:22	21/11/2019 09:40	21/11/2019 05:22	21/11/2019 09:40	4,29	24	102,99	CHI
201911272364	SAO DOMINGOS	IA12117792	IACIARA S1	21/11/2019 05:22	21/11/2019 09:40	21/11/2019 05:22	21/11/2019 09:40	4,29	1	4,29	CHI
201911272367	ALVORADA DO NORTE	AQ12257628	FLORES DE GOIAS	20/11/2019 19:41	21/11/2019 10:21	20/11/2019 19:41	21/11/2019 10:21	14,66	10	146,57	CHI
201911272367	POSSE	AQ12257628	FLORES DE GOIAS	20/11/2019 19:41	21/11/2019 10:21	20/11/2019 19:41	21/11/2019 10:21	14,66	1	14,66	CHI
201911272383	BURITINOPOLIS	6259200	IACIARA S2	20/11/2019 23:20	21/11/2019 10:18	20/11/2019 23:20	21/11/2019 10:18	10,96	2	21,91	CHI
201911272383	GUARANI DE GOIAS	6259200	IACIARA S2	20/11/2019 23:20	21/11/2019 10:18	20/11/2019 23:20	21/11/2019 10:18	10,96	97	1062,72	CHI
201911272383	IACIARA	6259200	IACIARA S2	20/11/2019 23:20	21/11/2019 10:18	20/11/2019 23:20	21/11/2019 10:18	10,96	1	10,96	CHI
201911272383	MAMBAI	6259200	IACIARA S2	20/11/2019 23:20	21/11/2019 10:18	20/11/2019 23:20	21/11/2019 10:18	10,96	25	273,90	CHI
201911272383	POSSE	6259200	IACIARA S2	20/11/2019 23:20	21/11/2019 10:18	20/11/2019 23:20	21/11/2019 10:18	10,96	6561	71881,22	CHI
201911272383	POSSE	6259200	IACIARA S2	20/11/2019 23:20	21/11/2019 10:18	20/11/2019 23:20	21/11/2019 10:18	10,96	867	9498,71	CHI
201911272383	POSSE	6259200	IACIARA S2	20/11/2019 23:20	21/11/2019 10:18	20/11/2019 23:20	21/11/2019 10:18	10,96	3138	34379,40	CHI
201911272383	POSSE	6259200	IACIARA S2	20/11/2019 23:20	21/11/2019 10:18	20/11/2019 23:20	21/11/2019 10:18	10,96	82	898,38	CHI
201911272383	POSSE	6259200	IACIARA S2	20/11/2019 23:20	21/11/2019 10:18	20/11/2019 23:20	21/11/2019 10:18	10,96	1123	12303,40	CHI

201911272383	IACIARA	01230434	IACIARA S2	20/11/2019 23:20	21/11/2019 10:18	21/11/2019 07:16	21/11/2019 10:18	3,02	20	60,45	CHI
201911272383	POSSE	01230434	IACIARA S2	20/11/2019 23:20	21/11/2019 10:18	21/11/2019 07:16	21/11/2019 10:18	3,02	37	111,83	CHI
201911272399	JATAI	JT12213671	JATAI S1	21/11/2019 06:25	21/11/2019 09:27	21/11/2019 06:25	21/11/2019 09:27	3,02	5	15,12	CHI
201911272421	GOIATUBA	GT12273783	GOIATUBA S2	20/11/2019 18:58	21/11/2019 12:25	20/11/2019 18:58	21/11/2019 12:25	17,44	57	994,29	CHI
201911272421	MORRINHOS	GT12273783	GOIATUBA S2	20/11/2019 18:58	21/11/2019 12:25	20/11/2019 18:58	21/11/2019 12:25	17,44	3	52,33	CHI
201911272441	IACIARA	IA12000014	IACIARA S1	21/11/2019 05:24	21/11/2019 11:12	21/11/2019 05:24	21/11/2019 11:12	5,79	24	138,93	CHI
201911272470	SERRANOPOLIS	SX12296514	JATAI S1	21/11/2019 06:58	21/11/2019 09:46	21/11/2019 06:58	21/11/2019 09:46	2,80	5	13,99	CHI
201911272504	SITIO D ABADIA	SI12131972	IACIARA S2	21/11/2019 05:52	21/11/2019 10:46	21/11/2019 05:52	21/11/2019 10:46	4,89	44	214,96	CHI
201911272511	JATAI	JT12211164	JATAI S2	21/11/2019 07:05	21/11/2019 12:18	21/11/2019 07:05	21/11/2019 12:18	5,20	9	46,84	CHI
201911272561	RIO VERDE	RV12338688	MONTIVIDIU T	21/11/2019 07:17	21/11/2019 17:00	21/11/2019 07:17	21/11/2019 11:01	3,74	3	11,22	CHI
201911272561	RIO VERDE	RV12338688	MONTIVIDIU T	21/11/2019 07:17	21/11/2019 17:00	21/11/2019 07:17	21/11/2019 17:00	9,71	2	19,43	CHI
201911272645	RIO VERDE	630434529	RIO VERDE S1	21/11/2019 07:33	21/11/2019 11:18	21/11/2019 07:33	21/11/2019 11:18	3,75	1	3,75	CHI
201911272668	FORMOSA	FA12404372	ITIQUEIRA	21/11/2019 05:42	21/11/2019 10:45	21/11/2019 05:42	21/11/2019 10:45	5,04	166	835,99	CHI
201911272674	PORTELANDIA	PW21301993	PARQUE DAS EMAS	21/11/2019 07:36	21/11/2019 10:34	21/11/2019 07:36	21/11/2019 10:34	2,95	1	2,95	CHI
201911272676	SAO DOMINGOS	SD12384774	SAO DOMINGOS	21/11/2019 08:14	22/11/2019 15:45	21/11/2019 08:14	22/11/2019 15:45	31,51	40	1260,40	CHI
201911272691	SAO DOMINGOS	SD11071319	SAO DOMINGOS	21/11/2019 07:04	21/11/2019 10:07	21/11/2019 07:04	21/11/2019 10:07	3,03	132	400,58	CHI
201911272744	SAO DOMINGOS	SD12218814	SAO DOMINGOS	21/11/2019 07:45	22/11/2019 16:52	21/11/2019 07:45	22/11/2019 16:52	33,10	7	231,70	CHI
201911272752	MONTE ALEGRE DE GOIAS	MA12233174	SAO DOMINGOS	21/11/2019 07:46	21/11/2019 16:30	21/11/2019 07:46	21/11/2019 16:30	8,72	17	148,29	CHI
201911272753	CAVALCANTE	CJ11071301	FLORES DE GOIAS	21/11/2019 07:09	21/11/2019 09:57	21/11/2019 07:09	21/11/2019 09:57	2,80	50	139,82	CHI
201911272769	CACHOEIRA ALTA	CA21034599	CACHOEIRA ALTA	21/11/2019 07:48	21/11/2019 12:20	21/11/2019 07:48	21/11/2019 12:20	4,53	1	4,53	CHI
201911272777	SANTO ANTONIO DA BARRA	10029411570	ACREUNA	21/11/2019 07:49	21/11/2019 10:41	21/11/2019 07:49	21/11/2019 10:41	2,85	1	2,85	CHI
201911272778	MONTIVIDIU	MV21305743	MONTIVIDIU T	21/11/2019 07:49	21/11/2019 15:25	21/11/2019 07:49	21/11/2019 15:25	7,59	1	7,59	CHI
201911272794	ALTO PARAISO DE GOIAS	BF21224076	SAO JOAO D ALIANCA	21/11/2019 07:51	21/11/2019 18:07	21/11/2019 07:51	21/11/2019 18:07	10,26	1	10,26	CHI
201911272810	QUIRINOPOLIS	QI32011354	QUIRINOPOLIS	21/11/2019 07:07	21/11/2019 08:59	21/11/2019 07:07	21/11/2019 08:59	1,86	11	20,48	CHI
201911272822	MONTE ALEGRE DE GOIAS	MA12240201	SAO DOMINGOS	21/11/2019 07:54	21/11/2019 18:10	21/11/2019 07:54	21/11/2019 18:10	10,25	13	133,29	CHI
201911272834	JATAI	JT21226649	JATAI S1	21/11/2019 07:57	21/11/2019 15:21	21/11/2019 07:57	21/11/2019 15:21	7,40	1	7,40	CHI
201911272839	FORMOSA	FA12042563	ITIQUEIRA	20/11/2019 22:23	21/11/2019 09:55	20/11/2019 22:23	21/11/2019 09:55	11,52	53	610,66	CHI
201911272896	CABECEIRAS	CW21150015	ITIQUEIRA	21/11/2019 08:04	21/11/2019 11:47	21/11/2019 08:04	21/11/2019 11:47	3,72	2	7,43	CHI
201911273001	PONTALINA	PK12263674	GOIATUBA S1	20/11/2019 21:12	21/11/2019 14:00	20/11/2019 21:12	21/11/2019 14:00	16,79	3	50,36	CHI
201911273612	MONTIVIDIU	MV21373903	MONTIVIDIU T	21/11/2019 08:19	21/11/2019 13:12	21/11/2019 08:19	21/11/2019 13:12	4,88	1	4,88	CHI
201911273616	SAO JOAO D ALIANCA	JL12404385	SAO JOAO D ALIANCA	21/11/2019 08:19	22/11/2019 17:09	21/11/2019 08:19	22/11/2019 17:09	32,82	50	1641,03	CHI
201911273622	SERRANOPOLIS	SX21216586	JATAI S1	21/11/2019 08:20	21/11/2019 18:05	21/11/2019 08:20	21/11/2019 18:05	9,75	1	9,75	CHI
201911273623	APARECIDA DO RIO DOCE	AW12191577	CACHOEIRA ALTA	21/11/2019 08:12	22/11/2019 21:17	21/11/2019 08:12	22/11/2019 21:17	37,07	10	370,71	CHI

201911273702	MINEIROS	MY12197152	PARQUE DAS EMAS	21/11/2019 08:22	21/11/2019 14:18	21/11/2019 08:22	21/11/2019 14:18	5,93	3	17,79	CHI
201911273727	PORTELANDIA	1470011480	PARQUE DAS EMAS	21/11/2019 08:27	21/11/2019 13:54	21/11/2019 08:27	21/11/2019 13:54	5,45	1	5,45	CHI
201911273728	MONTIVIDIU	MV21075308	MONTIVIDIU T	21/11/2019 08:26	21/11/2019 14:35	21/11/2019 08:26	21/11/2019 14:35	6,14	1	6,14	CHI
201911274001	RIO VERDE	RV12230653	MONTIVIDIU T	21/11/2019 08:28	21/11/2019 12:47	21/11/2019 08:28	21/11/2019 12:47	4,31	2	8,62	CHI
201911274212	ALTO PARAISO DE GOIAS	BF21248537	FLORES DE GOIAS	21/11/2019 08:29	22/11/2019 12:19	21/11/2019 08:29	22/11/2019 12:19	27,82	1	27,82	CHI
201911274235	QUIRINOPOLIS	10026955790	QUIRINOPOLIS	21/11/2019 08:33	22/11/2019 08:23	21/11/2019 08:33	22/11/2019 08:23	23,83	1	23,83	CHI
201911274311	RIO VERDE	RV12093111	MONTIVIDIU T	21/11/2019 08:35	21/11/2019 17:00	21/11/2019 08:35	21/11/2019 17:00	8,41	1	8,41	CHI
201911274403	SAO JOAO D ALIANCA	JL12237037	ITIQUEIRA	21/11/2019 06:38	22/11/2019 14:05	21/11/2019 06:38	22/11/2019 14:05	31,44	21	660,22	CHI
201911274411	DIVINOPOLIS DE GOIAS	GH21133352	SAO DOMINGOS	21/11/2019 08:38	22/11/2019 19:30	21/11/2019 08:38	22/11/2019 19:30	34,87	1	34,87	CHI
201911274417	FORMOSA	610025065	ITIQUEIRA	21/11/2019 08:39	21/11/2019 11:44	21/11/2019 08:39	21/11/2019 11:44	3,09	1	3,09	CHI
201911274423	SERRANOPOLIS	SX21135939	CACHOEIRA ALTA	21/11/2019 08:39	21/11/2019 16:02	21/11/2019 08:39	21/11/2019 16:02	7,37	1	7,37	CHI
201911274483	MINEIROS	MY12224093	PARQUE DAS EMAS	21/11/2019 08:47	21/11/2019 11:57	21/11/2019 08:47	21/11/2019 11:57	3,16	1	3,16	CHI
201911274491	CASTELANDIA	ML12064391	RIO DOS BOIS	21/11/2019 08:49	21/11/2019 14:51	21/11/2019 08:49	21/11/2019 14:51	6,03	1	6,03	CHI
201911274491	MAURILANDIA	ML12064391	RIO DOS BOIS	21/11/2019 08:49	21/11/2019 14:51	21/11/2019 08:49	21/11/2019 14:51	6,03	3	18,09	CHI
201911274707	SITIO D ABADIA	SI12143367	IACIARA S2	21/11/2019 08:51	21/11/2019 20:02	21/11/2019 08:51	21/11/2019 20:02	11,18	22	245,96	CHI
201911274708	MONTE ALEGRE DE GOIAS	MA12290214	SAO DOMINGOS	21/11/2019 06:07	21/11/2019 11:02	21/11/2019 06:07	21/11/2019 11:02	4,91	12	58,96	CHI
201911274710	FORMOSA	2920005632	ITIQUEIRA	21/11/2019 08:51	21/11/2019 16:00	21/11/2019 08:51	21/11/2019 16:00	7,14	1	7,14	CHI
201911274801	MONTIVIDIU	MV21205313	MONTIVIDIU T	21/11/2019 08:53	21/11/2019 13:25	21/11/2019 08:53	21/11/2019 13:25	4,52	1	4,52	CHI
201911274915	GUARANI DE GOIAS	GY12393812	IACIARA S1	20/11/2019 21:50	21/11/2019 12:30	20/11/2019 21:50	21/11/2019 12:30	14,66	22	322,58	CHI
201911274924	SERRANOPOLIS	SX21131228	JATAI S1	21/11/2019 08:59	21/11/2019 18:28	21/11/2019 08:59	21/11/2019 18:28	9,47	1	9,47	CHI
201911278229	GUARANI DE GOIAS	GY12257673	IACIARA S1	20/11/2019 21:52	21/11/2019 11:39	20/11/2019 21:52	21/11/2019 11:39	13,78	95	1309,21	CHI
201911278229	IACIARA	GY12257673	IACIARA S1	20/11/2019 21:52	21/11/2019 11:39	20/11/2019 21:52	21/11/2019 11:39	13,78	5	68,91	CHI
201911278847	FORMOSA	FA21309101	ITIQUEIRA	20/11/2019 19:12	22/11/2019 15:38	20/11/2019 19:12	22/11/2019 15:38	44,43	1	44,43	CHI
201911278851	PEROLANDIA	DP12182230LD	JATAI S1	21/11/2019 06:35	21/11/2019 16:20	21/11/2019 06:35	21/11/2019 16:20	9,75	5	48,76	CHI
201911278957	DOVERLANDIA	DV12259474	CAIAPONIA	20/11/2019 13:48	21/11/2019 11:16	20/11/2019 13:48	21/11/2019 11:16	21,46	38	815,52	CHI
201911285601	IACIARA	IA12257653	IACIARA S1	21/11/2019 08:12	22/11/2019 14:38	21/11/2019 08:12	22/11/2019 14:38	30,42	6	182,55	CHI
201911287993	APARECIDA DE GOIANIA	13567469	INDEPENDENCIA S2	20/11/2019 13:57	20/11/2019 18:15	20/11/2019 13:57	20/11/2019 18:15	4,30	1	4,30	CHI
201911292571	FLORES DE GOIAS	FB12141432	IACIARA S2	21/11/2019 05:05	21/11/2019 19:58	21/11/2019 05:05	21/11/2019 19:58	14,88	62	922,82	CHI
201911292571	FORMOSA	FB12141432	IACIARA S2	21/11/2019 05:05	21/11/2019 19:58	21/11/2019 05:05	21/11/2019 19:58	14,88	1	14,88	CHI
201911292571	VILA BOA	FB12141432	IACIARA S2	21/11/2019 05:05	21/11/2019 19:58	21/11/2019 05:05	21/11/2019 19:58	14,88	4	59,54	CHI
201911293711	SERRANOPOLIS	SX21238899	JATAI S1	21/11/2019 08:57	21/11/2019 18:36	21/11/2019 08:57	21/11/2019 18:36	9,64	1	9,64	CHI
201911293881	FLORES DE GOIAS	FB12245566	IACIARA S2	20/11/2019 14:58	21/11/2019 22:33	20/11/2019 14:58	21/11/2019 22:33	31,58	71	2242,30	CHI
201911293881	SITIO D ABADIA	FB12245566	IACIARA S2	20/11/2019 14:58	21/11/2019 22:33	20/11/2019 14:58	21/11/2019 22:33	31,58	38	1200,10	CHI

201911295595	CAIAPONIA	CP12160847	PALESTINA	20/11/2019 13:15	22/11/2019 10:56	20/11/2019 13:15	22/11/2019 10:56	45,67	26	1187,54	CHI
201911302591	FORMOSA	FA12256663	ITIQUEIRA	20/11/2019 14:47	22/11/2019 13:38	20/11/2019 14:47	22/11/2019 13:38	46,84	2	93,67	CHI
201911302591	VILA BOA	FA12256663	ITIQUEIRA	20/11/2019 14:47	22/11/2019 13:38	20/11/2019 14:47	22/11/2019 13:38	46,84	2	93,67	CHI
201911302595	FLORES DE GOIAS	FB12248173	IACIARA S2	21/11/2019 06:59	22/11/2019 15:07	21/11/2019 06:59	22/11/2019 15:07	32,13	19	610,54	CHI
201911329380	PLANALTINA	PI21106121	PLANALTINA	17/11/2019 17:14	17/11/2019 18:27	17/11/2019 17:14	17/11/2019 18:27	1,22	3	3,65	CHI
201911329380	PLANALTINA	PI21244739	PLANALTINA	17/11/2019 17:14	17/11/2019 18:27	17/11/2019 17:14	17/11/2019 18:27	1,22	2	2,43	CHI
201911329380	PLANALTINA	PI21362464	PLANALTINA	17/11/2019 17:14	17/11/2019 18:27	17/11/2019 17:14	17/11/2019 18:27	1,22	1	1,22	CHI
201911329380	PLANALTINA	PI21369974	PLANALTINA	17/11/2019 17:14	17/11/2019 18:27	17/11/2019 17:14	17/11/2019 18:27	1,22	1	1,22	CHI
201911331050	INACIOLANDIA	ID12304325	CACHOEIRA DOURADA	18/11/2019 13:50	18/11/2019 21:31	18/11/2019 13:50	18/11/2019 21:31	7,67	6	46,02	CHI
201911332108	CRISTIANOPOLIS	470009718	CRISTIANOPOLIS	15/11/2019 13:00	16/11/2019 10:00	15/11/2019 13:00	16/11/2019 10:00	20,99	1	20,99	CHI
201911336075	GOIANIA	GN13000171	AEROPORTO S1	20/11/2019 15:06	20/11/2019 16:32	20/11/2019 15:06	20/11/2019 16:32	1,43	442	633,66	CHI
201911339114	CRISTALINA	00430424	CRISTALINA S1	15/11/2019 16:28	15/11/2019 21:32	15/11/2019 16:28	15/11/2019 16:32	0,06	6669	416,81	CHI
201911339114	CRISTALINA	00430424	CRISTALINA S1	15/11/2019 16:28	15/11/2019 21:32	15/11/2019 16:35	15/11/2019 17:08	0,55	6669	3688,33	CHI
201911339114	CRISTALINA	00430424	CRISTALINA S1	15/11/2019 16:28	15/11/2019 21:32	15/11/2019 16:28	15/11/2019 17:12	0,73	848	621,40	CHI
201911339114	CRISTALINA	KR10400552	CRISTALINA S1	15/11/2019 16:28	15/11/2019 21:32	15/11/2019 16:28	15/11/2019 17:12	0,74	20	14,77	CHI
201911339114	CRISTALINA	KR10400792	CRISTALINA S1	15/11/2019 16:28	15/11/2019 21:32	15/11/2019 16:28	15/11/2019 18:24	1,93	628	1209,25	CHI
201911339114	CRISTALINA	KR13410078B	CRISTALINA S1	15/11/2019 16:28	15/11/2019 21:32	15/11/2019 16:28	15/11/2019 21:32	5,07	937	4755,01	CHI
201911346395	GOIANIA	GN12023393	REAL S1	14/11/2019 15:55	14/11/2019 20:54	14/11/2019 15:55	14/11/2019 20:54	4,99	109	543,52	CHI
201911349743	MAIRIPOTABA	04260214	MORRINHOS	14/11/2019 16:28	14/11/2019 19:56	14/11/2019 16:28	14/11/2019 19:56	3,46	12	41,56	CHI
201911349743	MORRINHOS	04260214	MORRINHOS	14/11/2019 16:28	14/11/2019 19:56	14/11/2019 16:28	14/11/2019 19:56	3,46	186	644,18	CHI
201911349743	MORRINHOS	04260214	MORRINHOS	14/11/2019 16:28	14/11/2019 19:56	14/11/2019 16:28	14/11/2019 19:56	3,46	13	45,02	CHI
201911349743	PIRACANJUBA	04260214	MORRINHOS	14/11/2019 16:28	14/11/2019 19:56	14/11/2019 16:28	14/11/2019 19:56	3,46	79	273,60	CHI
201911349743	PONTALINA	04260214	MORRINHOS	14/11/2019 16:28	14/11/2019 19:56	14/11/2019 16:28	14/11/2019 19:56	3,46	15	51,95	CHI
201911352876	GOIANIA	SW16401514	CEPAIGO S1	15/11/2019 17:50	16/11/2019 22:35	15/11/2019 17:50	16/11/2019 20:04	26,24	46	1206,90	CHI
201911352876	SENADOR CANEDO	SW16401514	CEPAIGO S1	15/11/2019 17:50	16/11/2019 22:35	15/11/2019 17:50	16/11/2019 20:04	26,24	385	10101,22	CHI
201911352876	APARECIDA DE GOIANIA	AP13402720	CEPAIGO S1	15/11/2019 17:50	16/11/2019 22:35	15/11/2019 17:50	16/11/2019 20:19	26,49	33	874,33	CHI
201911352876	GOIANIA	AP13402720	CEPAIGO S1	15/11/2019 17:50	16/11/2019 22:35	15/11/2019 17:50	16/11/2019 20:19	26,49	346	9167,27	CHI
201911352876	SENADOR CANEDO	AP13402720	CEPAIGO S1	15/11/2019 17:50	16/11/2019 22:35	15/11/2019 17:50	16/11/2019 20:19	26,49	307	8133,96	CHI
201911352876	APARECIDA DE GOIANIA	AP13313033	CEPAIGO S1	15/11/2019 17:50	16/11/2019 22:35	15/11/2019 17:50	16/11/2019 22:35	28,75	57	1638,51	CHI
201911352876	GOIANIA	AP13313033	CEPAIGO S1	15/11/2019 17:50	16/11/2019 22:35	15/11/2019 17:50	16/11/2019 22:35	28,75	4	114,98	CHI
201911352876	APARECIDA DE GOIANIA	AP13313033	CEPAIGO S1	15/11/2019 17:50	16/11/2019 22:35	16/11/2019 12:51	16/11/2019 22:35	9,73	19	184,91	CHI
201911353225	CALDAS NOVAS	CN12404748	CALDAS NOVAS S1	15/11/2019 15:45	15/11/2019 19:18	15/11/2019 15:45	15/11/2019 19:18	3,56	6	21,36	CHI
201911353225	RIO QUENTE	CN12404748	CALDAS NOVAS S1	15/11/2019 15:45	15/11/2019 19:18	15/11/2019 15:45	15/11/2019 19:18	3,56	40	142,37	CHI

201911353322	CATALAO	CT12078234	CATALAO S2	15/11/2019 17:30	16/11/2019 07:57	15/11/2019 17:30	16/11/2019 07:57	14,44	100	1443,97	CHI
201911356125	PADRE BERNARDO	00070214	PADRE BERNARDO	15/11/2019 21:15	15/11/2019 23:22	15/11/2019 21:15	15/11/2019 23:22	2,11	1353	2857,46	CHI
201911356125	PLANALTINA	00070214	PADRE BERNARDO	15/11/2019 21:15	15/11/2019 23:22	15/11/2019 21:15	15/11/2019 23:22	2,11	63	133,05	CHI
201911356240	BARRO ALTO	BA21342222	GOIANESIA S1	16/11/2019 04:48	17/11/2019 17:41	16/11/2019 04:48	17/11/2019 17:41	36,87	1	36,87	CHI
201911357252	EDEALINA	04970224	VICENTINOPOLIS	17/11/2019 18:32	18/11/2019 11:00	17/11/2019 18:32	18/11/2019 11:00	16,46	15	246,93	CHI
201911357252	EDEIA	04970224	VICENTINOPOLIS	17/11/2019 18:32	18/11/2019 11:00	17/11/2019 18:32	18/11/2019 11:00	16,46	32	526,79	CHI
201911357252	PONTALINA	04970224	VICENTINOPOLIS	17/11/2019 18:32	18/11/2019 11:00	17/11/2019 18:32	18/11/2019 11:00	16,46	1	16,46	CHI
201911357252	VICENTINOPOLIS	04970224	VICENTINOPOLIS	17/11/2019 18:32	18/11/2019 11:00	17/11/2019 18:32	18/11/2019 11:00	16,46	2	32,92	CHI
201911357480	SANTO ANTONIO DA BARRA	BZ12214088LD	SANTA HELENA S1	18/11/2019 09:05	18/11/2019 19:12	18/11/2019 09:05	18/11/2019 19:12	10,12	1	10,12	CHI
201911357527	ITABERAI	IB12379749	ITABERAI S2	18/11/2019 15:01	19/11/2019 07:30	18/11/2019 15:01	19/11/2019 07:30	16,48	7	115,38	CHI
201911358646	LUZIANIA	LZ21239799	MARAJOARA	15/11/2019 19:28	16/11/2019 20:15	15/11/2019 19:28	16/11/2019 20:15	24,78	1	24,78	CHI
201911358708	ABADIANIA	AA12384735	DAIA S2	14/11/2019 12:57	15/11/2019 21:45	14/11/2019 12:57	14/11/2019 20:49	7,87	97	762,96	CHI
201911358708	ABADIANIA	AA12384735	DAIA S2	14/11/2019 12:57	15/11/2019 21:45	14/11/2019 12:57	15/11/2019 02:32	13,58	15	203,73	CHI
201911358708	ABADIANIA	AA12384735	DAIA S2	14/11/2019 12:57	15/11/2019 21:45	14/11/2019 12:57	15/11/2019 21:45	32,80	8	262,43	CHI
201911358736	FORMOSA	FA12394153	ITUIQUIRA	15/11/2019 18:38	15/11/2019 21:26	15/11/2019 18:38	15/11/2019 21:26	2,80	19	53,15	CHI
201911358779	BOM JESUS DE GOIAS	01560414	QUIRINOPOLIS	14/11/2019 15:48	14/11/2019 17:30	14/11/2019 15:48	14/11/2019 17:30	1,68	69	116,25	CHI
201911358779	GOUVELANDIA	01560414	QUIRINOPOLIS	14/11/2019 15:48	14/11/2019 17:30	14/11/2019 15:48	14/11/2019 17:30	1,68	2001	3371,13	CHI
201911358779	GOUVELANDIA	01560414	QUIRINOPOLIS	14/11/2019 15:48	14/11/2019 17:30	14/11/2019 15:48	14/11/2019 17:30	1,68	13	21,90	CHI
201911358779	INACIOLANDIA	01560414	QUIRINOPOLIS	14/11/2019 15:48	14/11/2019 17:30	14/11/2019 15:48	14/11/2019 17:30	1,68	2665	4489,78	CHI
201911358779	INACIOLANDIA	01560414	QUIRINOPOLIS	14/11/2019 15:48	14/11/2019 17:30	14/11/2019 15:48	14/11/2019 17:30	1,68	3	5,05	CHI
201911358779	ITUMBIARA	01560414	QUIRINOPOLIS	14/11/2019 15:48	14/11/2019 17:30	14/11/2019 15:48	14/11/2019 17:30	1,68	8	13,48	CHI
201911358779	QUIRINOPOLIS	01560414	QUIRINOPOLIS	14/11/2019 15:48	14/11/2019 17:30	14/11/2019 15:48	14/11/2019 17:30	1,68	88	148,26	CHI
201911358779	QUIRINOPOLIS	01560414	QUIRINOPOLIS	14/11/2019 15:48	14/11/2019 17:30	14/11/2019 15:48	14/11/2019 17:30	1,68	23	38,75	CHI
201911358919	CAIAPONIA	MV12065973	MONTIVIDIU T	14/11/2019 14:18	14/11/2019 14:31	14/11/2019 14:18	14/11/2019 14:31	0,21	1	0,21	CHI
201911358919	MONTIVIDIU	MV12065973	MONTIVIDIU T	14/11/2019 14:18	14/11/2019 14:31	14/11/2019 14:18	14/11/2019 14:31	0,21	5	1,07	CHI
201911359460	APARECIDA DE GOIANIA	AP12049712	ANHANGUERA	19/11/2019 13:39	19/11/2019 20:21	19/11/2019 13:39	19/11/2019 20:21	6,70	152	1017,98	CHI
201911368062	ITAPIRAPUA	IU10400394	MATRINCHA	19/11/2019 15:15	19/11/2019 15:22	19/11/2019 15:15	19/11/2019 15:22	0,11	12	1,35	CHI
201911368062	GOIAS	IU10400394	MATRINCHA	19/11/2019 15:15	19/11/2019 15:22	19/11/2019 15:15	19/11/2019 15:22	0,11	560	64,24	CHI
201911368062	ITAPIRAPUA	IU10400394	MATRINCHA	19/11/2019 15:15	19/11/2019 15:22	19/11/2019 15:15	19/11/2019 15:22	0,11	1654	189,75	CHI
201911368062	ITAPIRAPUA	IU10400394	MATRINCHA	19/11/2019 15:15	19/11/2019 15:22	19/11/2019 15:15	19/11/2019 15:22	0,11	1390	159,46	CHI
201911368062	NOVO BRASIL	IU10400394	MATRINCHA	19/11/2019 15:15	19/11/2019 15:22	19/11/2019 15:15	19/11/2019 15:22	0,11	35	4,02	CHI
201911368064	JATAI	JT12337022	JATAI S2	19/11/2019 19:49	20/11/2019 00:06	19/11/2019 19:49	20/11/2019 00:06	4,28	88	376,74	CHI
201911368070	PANAMA	GT12249848	GOIATUBA S1	19/11/2019 18:51	20/11/2019 20:33	19/11/2019 18:51	20/11/2019 20:33	25,71	9	231,37	CHI

201911368074	PIRACANJUBA	PJ12000214	PIRACANJUBA	15/11/2019 16:17	16/11/2019 19:05	15/11/2019 16:17	16/11/2019 19:05	26,79	6	160,72	CHI
201911368075	BURITI ALEGRE	BG12304195	PARANAIBA	20/11/2019 07:01	20/11/2019 11:26	20/11/2019 07:01	20/11/2019 11:26	4,41	6	26,44	CHI
201911368076	JATAI	JT12320329	JATAI S2	20/11/2019 07:30	20/11/2019 11:15	20/11/2019 07:30	20/11/2019 11:15	3,74	563	2105,93	CHI
201911368077	CUMARI	CY12073841	CATALAO S1	16/11/2019 12:54	19/11/2019 15:31	16/11/2019 12:54	19/11/2019 15:31	74,60	1	74,60	CHI
201911368079	GOUVELANDIA	QI12000340	QUIRINOPOLIS	16/11/2019 19:14	16/11/2019 21:45	16/11/2019 19:14	16/11/2019 21:45	2,50	16	40,04	CHI
201911368080	GOIANIA	GN12023386	REAL S1	20/11/2019 12:31	20/11/2019 15:01	20/11/2019 12:31	20/11/2019 15:01	2,49	133	330,58	CHI
201911368081	INACIOLANDIA	CD12011456	CACHOEIRA DOURADA	20/11/2019 19:29	21/11/2019 17:00	20/11/2019 19:29	21/11/2019 17:00	21,52	5	107,61	CHI
201911368082	JANDAIA	JD12308457	PALMEIRAS	17/11/2019 18:36	17/11/2019 23:01	17/11/2019 18:36	17/11/2019 23:01	4,42	18	79,59	CHI
201911368083	GAMELEIRA DE GOIAS	SV32093678	DAIA S2	20/11/2019 11:05	20/11/2019 16:00	20/11/2019 11:05	20/11/2019 16:00	4,91	7	34,34	CHI
201911368084	DOVERLANDIA	4220021414	CAIAPONIA	20/11/2019 11:14	20/11/2019 18:09	20/11/2019 11:14	20/11/2019 18:09	6,92	1	6,92	CHI
201911368085	PADRE BERNARDO	00070214	PADRE BERNARDO	15/11/2019 15:12	15/11/2019 19:05	15/11/2019 15:12	15/11/2019 19:05	3,88	1353	5246,63	CHI
201911368085	PLANALTINA	00070214	PADRE BERNARDO	15/11/2019 15:12	15/11/2019 19:05	15/11/2019 15:12	15/11/2019 19:05	3,88	65	252,06	CHI
201911368086	FAINA	FC12199793	GOIAS	18/11/2019 18:37	19/11/2019 11:32	18/11/2019 18:37	19/11/2019 11:32	16,92	17	287,56	CHI
201911368147	GOIANESIA	GE13362247	GOIANESIA S2	15/11/2019 12:56	17/11/2019 07:10	15/11/2019 12:56	17/11/2019 07:10	42,23	180	7600,90	CHI
201911368147	JARAGUA	GE13362247	GOIANESIA S2	15/11/2019 12:56	17/11/2019 07:10	15/11/2019 12:56	17/11/2019 07:10	42,23	478	20184,61	CHI
201911368147	PIRENOPOLIS	GE13362247	GOIANESIA S2	15/11/2019 12:56	17/11/2019 07:10	15/11/2019 12:56	17/11/2019 07:10	42,23	1	42,23	CHI
201911368151	CORUMBAIBA	CI12392156	VILA CORUMBA	16/11/2019 14:46	19/11/2019 11:00	16/11/2019 14:46	19/11/2019 11:00	68,23	8	545,81	CHI
201911368152	GOIATUBA	10018011347	GOIATUBA S2	16/11/2019 13:57	16/11/2019 18:29	16/11/2019 13:57	16/11/2019 18:29	4,53	1	4,53	CHI
201911368155	PIRACANJUBA	240018850	BELA VISTA S1	19/11/2019 15:03	19/11/2019 16:09	19/11/2019 15:03	19/11/2019 16:09	1,10	1	1,10	CHI
201911368172	SENADOR CANEDO	10016595406	SENADOR CANEDO	15/11/2019 19:42	16/11/2019 18:52	15/11/2019 19:42	16/11/2019 18:52	23,17	1	23,17	CHI
201911368202	PLANALTINA	PI12146249	PLANALTINA	20/11/2019 15:30	21/11/2019 12:20	20/11/2019 15:30	21/11/2019 12:20	20,83	443	9228,06	CHI
201911368207	FLORES DE GOIAS	9620007080	IACIARA S2	19/11/2019 19:30	20/11/2019 04:00	19/11/2019 19:30	20/11/2019 04:00	8,50	1	8,50	CHI
201911368210	AGUA FRIA DE GOIAS	4440004533	SAO JOAO D ALIANCA	20/11/2019 10:21	21/11/2019 16:41	20/11/2019 10:21	21/11/2019 16:41	30,33	1	30,33	CHI
201911368211	GOIANIA	10942348	FERROVIARIO S2	14/11/2019 19:55	16/11/2019 15:47	14/11/2019 19:55	16/11/2019 15:47	43,86	1	43,86	CHI
201911368242	CACHOEIRA ALTA	CC10251897	CACHOEIRA ALTA	15/11/2019 16:08	16/11/2019 10:41	15/11/2019 16:08	15/11/2019 20:39	4,52	101	456,52	CHI
201911368242	CACU	CC10251897	CACHOEIRA ALTA	15/11/2019 16:08	16/11/2019 10:41	15/11/2019 16:08	15/11/2019 20:39	4,52	1	4,52	CHI
201911368242	APARECIDA DO RIO DOCE	00270454	CACHOEIRA ALTA	15/11/2019 16:08	16/11/2019 10:41	15/11/2019 16:08	16/11/2019 00:10	8,04	598	4810,58	CHI
201911368242	APARECIDA DO RIO DOCE	00270454	CACHOEIRA ALTA	15/11/2019 16:08	16/11/2019 10:41	15/11/2019 16:08	16/11/2019 00:10	8,04	622	5003,64	CHI
201911368242	CACHOEIRA ALTA	00270454	CACHOEIRA ALTA	15/11/2019 16:08	16/11/2019 10:41	15/11/2019 16:08	16/11/2019 00:10	8,04	65	522,89	CHI
201911368242	CACHOEIRA ALTA	00270454	CACHOEIRA ALTA	15/11/2019 16:08	16/11/2019 10:41	15/11/2019 16:08	16/11/2019 00:10	8,04	3	24,13	CHI
201911368242	CACHOEIRA ALTA	CC10251897	CACHOEIRA ALTA	15/11/2019 16:08	16/11/2019 10:41	15/11/2019 16:08	16/11/2019 00:10	8,04	56	450,49	CHI
201911368242	JATAI	00270454	CACHOEIRA ALTA	15/11/2019 16:08	16/11/2019 10:41	15/11/2019 16:08	16/11/2019 00:10	8,04	35	281,56	CHI
201911368242	JATAI	00270454	CACHOEIRA ALTA	15/11/2019 16:08	16/11/2019 10:41	15/11/2019 16:08	16/11/2019 00:10	8,04	1	8,04	CHI

201911368242	RIO VERDE	00270454	CACHOEIRA ALTA	15/11/2019 16:08	16/11/2019 10:41	15/11/2019 16:08	16/11/2019 00:10	8,04	8	64,36	CHI
201911368242	RIO VERDE	00270454	CACHOEIRA ALTA	15/11/2019 16:08	16/11/2019 10:41	15/11/2019 16:08	16/11/2019 00:10	8,04	166	1335,38	CHI
201911368242	RIO VERDE	CC10251897	CACHOEIRA ALTA	15/11/2019 16:08	16/11/2019 10:41	15/11/2019 16:08	16/11/2019 00:10	8,04	10	80,44	CHI
201911368242	APARECIDA DO RIO DOCE	00270454	CACHOEIRA ALTA	15/11/2019 16:08	16/11/2019 10:41	16/11/2019 00:11	16/11/2019 00:26	0,25	10	2,49	CHI
201911368242	CACHOEIRA ALTA	00270454	CACHOEIRA ALTA	15/11/2019 16:08	16/11/2019 10:41	16/11/2019 00:11	16/11/2019 00:26	0,25	261	64,96	CHI
201911368242	CACHOEIRA ALTA	00270454	CACHOEIRA ALTA	15/11/2019 16:08	16/11/2019 10:41	16/11/2019 00:11	16/11/2019 00:26	0,25	144	35,84	CHI
201911368242	CACU	00270454	CACHOEIRA ALTA	15/11/2019 16:08	16/11/2019 10:41	16/11/2019 00:11	16/11/2019 00:26	0,25	3776	939,80	CHI
201911368242	CACU	00270454	CACHOEIRA ALTA	15/11/2019 16:08	16/11/2019 10:41	16/11/2019 00:11	16/11/2019 00:26	0,25	1978	492,30	CHI
201911368242	CACU	00270454	CACHOEIRA ALTA	15/11/2019 16:08	16/11/2019 10:41	16/11/2019 00:11	16/11/2019 00:26	0,25	13	3,24	CHI
201911368242	ITARUMA	00270454	CACHOEIRA ALTA	15/11/2019 16:08	16/11/2019 10:41	16/11/2019 00:11	16/11/2019 00:26	0,25	35	8,71	CHI
201911368242	JATAI	00270454	CACHOEIRA ALTA	15/11/2019 16:08	16/11/2019 10:41	16/11/2019 00:11	16/11/2019 00:26	0,25	11	2,74	CHI
201911368242	QUIRINOPOLIS	00270454	CACHOEIRA ALTA	15/11/2019 16:08	16/11/2019 10:41	16/11/2019 00:11	16/11/2019 00:26	0,25	29	7,22	CHI
201911368242	QUIRINOPOLIS	00270454	CACHOEIRA ALTA	15/11/2019 16:08	16/11/2019 10:41	16/11/2019 00:11	16/11/2019 00:26	0,25	1	0,25	CHI
201911368242	APARECIDA DO RIO DOCE	00270454	CACHOEIRA ALTA	15/11/2019 16:08	16/11/2019 10:41	16/11/2019 00:11	16/11/2019 10:12	10,01	598	5985,32	CHI
201911368242	APARECIDA DO RIO DOCE	00270454	CACHOEIRA ALTA	15/11/2019 16:08	16/11/2019 10:41	16/11/2019 00:11	16/11/2019 10:12	10,01	622	6225,53	CHI
201911368242	CACHOEIRA ALTA	00270454	CACHOEIRA ALTA	15/11/2019 16:08	16/11/2019 10:41	16/11/2019 00:11	16/11/2019 10:12	10,01	65	650,58	CHI
201911368242	CACHOEIRA ALTA	00270454	CACHOEIRA ALTA	15/11/2019 16:08	16/11/2019 10:41	16/11/2019 00:11	16/11/2019 10:12	10,01	3	30,03	CHI
201911368242	CACHOEIRA ALTA	CA13136187	CACHOEIRA ALTA	15/11/2019 16:08	16/11/2019 10:41	16/11/2019 00:11	16/11/2019 10:12	10,01	56	560,50	CHI
201911368242	JATAI	00270454	CACHOEIRA ALTA	15/11/2019 16:08	16/11/2019 10:41	16/11/2019 00:11	16/11/2019 10:12	10,01	35	350,31	CHI
201911368242	JATAI	00270454	CACHOEIRA ALTA	15/11/2019 16:08	16/11/2019 10:41	16/11/2019 00:11	16/11/2019 10:12	10,01	1	10,01	CHI
201911368242	RIO VERDE	00270454	CACHOEIRA ALTA	15/11/2019 16:08	16/11/2019 10:41	16/11/2019 00:11	16/11/2019 10:12	10,01	8	80,07	CHI
201911368242	RIO VERDE	00270454	CACHOEIRA ALTA	15/11/2019 16:08	16/11/2019 10:41	16/11/2019 00:11	16/11/2019 10:12	10,01	166	1661,48	CHI
201911368242	RIO VERDE	CA13136187	CACHOEIRA ALTA	15/11/2019 16:08	16/11/2019 10:41	16/11/2019 00:11	16/11/2019 10:12	10,01	10	100,09	CHI
201911368242	APARECIDA DO RIO DOCE	CC10251897	CACHOEIRA ALTA	15/11/2019 16:08	16/11/2019 10:41	15/11/2019 16:08	16/11/2019 10:41	18,55	25	463,85	CHI
201911368252	JATAI	10002974493	JATAI S1	17/11/2019 08:32	18/11/2019 10:57	17/11/2019 08:32	18/11/2019 10:57	26,40	1	26,40	CHI
201911368253	CATALAO	1990179530	CATALAO S2	18/11/2019 08:04	19/11/2019 14:48	18/11/2019 08:04	19/11/2019 14:48	30,73	1	30,73	CHI
201911368254	ITAGUARI	770011287	ITABERAI S1	18/11/2019 13:08	19/11/2019 10:23	18/11/2019 13:08	19/11/2019 10:23	21,25	1	21,25	CHI
201911368255	ITAGUARI	770012050	ITABERAI S1	19/11/2019 07:55	19/11/2019 10:23	19/11/2019 07:55	19/11/2019 10:23	2,46	1	2,46	CHI
201911368256	ALEXANIA	2790001565	CORUMBA	19/11/2019 16:33	20/11/2019 15:30	19/11/2019 16:33	20/11/2019 15:30	22,95	1	22,95	CHI
201911368262	MOSSAMEDES	1310002750	FIRMINOPOLIS S2	15/11/2019 09:06	15/11/2019 20:17	15/11/2019 09:06	15/11/2019 20:17	11,20	1	11,20	CHI
201911368264	MOSSAMEDES	1310005543	FIRMINOPOLIS S2	15/11/2019 18:33	15/11/2019 20:17	15/11/2019 18:33	15/11/2019 20:17	1,74	1	1,74	CHI
201911368265	MOSSAMEDES	1310005646	FIRMINOPOLIS S2	15/11/2019 19:17	15/11/2019 20:17	15/11/2019 19:17	15/11/2019 20:17	1,00	1	1,00	CHI
201911368271	JATAI	290262288	JATAI S2	20/11/2019 21:45	21/11/2019 08:09	20/11/2019 21:45	21/11/2019 08:09	10,39	1	10,39	CHI

201911368274	JUSSARA	7187555	BRITANIA	16/11/2019 22:10	18/11/2019 03:38	16/11/2019 22:10	18/11/2019 03:38	29,47	187	5511,72	CHI
201911368274	JUSSARA	7187555	BRITANIA	16/11/2019 22:10	18/11/2019 03:38	16/11/2019 22:10	18/11/2019 03:38	29,47	109	3212,71	CHI
201911368274	MONTES CLAROS DE GOIAS	7187555	BRITANIA	16/11/2019 22:10	18/11/2019 03:38	16/11/2019 22:10	18/11/2019 03:38	29,47	414	12202,42	CHI
201911368274	SANTA FE DE GOIAS	7187555	BRITANIA	16/11/2019 22:10	18/11/2019 03:38	16/11/2019 22:10	18/11/2019 03:38	29,47	21	618,96	CHI
201911368274	JUSSARA	02700424	BRITANIA	16/11/2019 22:10	18/11/2019 03:38	17/11/2019 17:19	18/11/2019 03:38	10,33	15	154,93	CHI
201911368280	RIO VERDE	630507788	RIO VERDE S2	17/11/2019 19:14	18/11/2019 08:19	17/11/2019 19:14	18/11/2019 08:19	13,10	1	13,10	CHI
201911368282	CALDAS NOVAS	00320244	CALDAS NOVAS S1	16/11/2019 17:13	17/11/2019 01:34	16/11/2019 17:16	16/11/2019 17:21	0,07	8373	602,39	CHI
201911368282	SANTA CRUZ DE GOIAS	00320244	CALDAS NOVAS S1	16/11/2019 17:13	17/11/2019 01:34	16/11/2019 17:16	16/11/2019 17:21	0,07	102	7,34	CHI
201911368282	CALDAS NOVAS	CN16404028	SERRA DE CALDAS	16/11/2019 17:13	17/11/2019 01:34	16/11/2019 17:13	16/11/2019 17:33	0,32	6367	2062,20	CHI
201911368282	CALDAS NOVAS	CN10408437	CALDAS NOVAS S1	16/11/2019 17:13	17/11/2019 01:34	16/11/2019 17:40	16/11/2019 18:31	0,86	178	153,23	CHI
201911368282	SANTA CRUZ DE GOIAS	CN10408437	CALDAS NOVAS S1	16/11/2019 17:13	17/11/2019 01:34	16/11/2019 17:40	16/11/2019 18:31	0,86	102	87,80	CHI
201911368282	CALDAS NOVAS	04890224	SERRA DE CALDAS	16/11/2019 17:13	17/11/2019 01:34	16/11/2019 17:16	16/11/2019 18:37	1,35	1423	1923,42	CHI
201911368282	CALDAS NOVAS	CN16407539	SERRA DE CALDAS	16/11/2019 17:13	17/11/2019 01:34	16/11/2019 18:30	16/11/2019 18:39	0,15	6367	939,13	CHI
201911368282	CALDAS NOVAS	CN16404028	SERRA DE CALDAS	16/11/2019 17:13	17/11/2019 01:34	16/11/2019 17:13	16/11/2019 18:40	1,44	598	862,95	CHI
201911368282	CALDAS NOVAS	CN16404028	SERRA DE CALDAS	16/11/2019 17:13	17/11/2019 01:34	16/11/2019 17:13	16/11/2019 18:40	1,45	3580	5205,92	CHI
201911368282	CALDAS NOVAS	CN12198385LD	SERRA DE CALDAS	16/11/2019 17:13	17/11/2019 01:34	16/11/2019 17:16	17/11/2019 01:34	8,30	20	166,05	CHI
201911368284	ABADIA DE GOIAS	5580006097	INDEPENDENCIA S2	14/11/2019 16:25	15/11/2019 11:01	14/11/2019 16:25	15/11/2019 11:01	18,59	1	18,59	CHI
201911368285	BOM JESUS DE GOIAS	BJ10406684	BOM JESUS DE GOIAS	14/11/2019 14:49	18/11/2019 19:20	14/11/2019 14:49	14/11/2019 14:55	0,09	296	26,39	CHI
201911368285	ITUMBIARA	BJ10406684	BOM JESUS DE GOIAS	14/11/2019 14:49	18/11/2019 19:20	14/11/2019 14:49	14/11/2019 14:55	0,09	72	6,42	CHI
201911368285	BOM JESUS DE GOIAS	BJ10406684	BOM JESUS DE GOIAS	14/11/2019 14:49	18/11/2019 19:20	14/11/2019 14:56	14/11/2019 17:38	2,71	290	786,22	CHI
201911368285	ITUMBIARA	BJ10406684	BOM JESUS DE GOIAS	14/11/2019 14:49	18/11/2019 19:20	14/11/2019 14:56	14/11/2019 17:38	2,71	72	195,20	CHI
201911368285	BOM JESUS DE GOIAS	BJ10406684	BOM JESUS DE GOIAS	14/11/2019 14:49	18/11/2019 19:20	14/11/2019 14:49	14/11/2019 17:39	2,83	150	424,42	CHI
201911368285	GOIATUBA	BJ10406684	BOM JESUS DE GOIAS	14/11/2019 14:49	18/11/2019 19:20	14/11/2019 14:49	14/11/2019 17:39	2,83	94	265,97	CHI
201911368285	ITUMBIARA	BJ10406684	BOM JESUS DE GOIAS	14/11/2019 14:49	18/11/2019 19:20	14/11/2019 14:49	14/11/2019 17:39	2,83	2	5,66	CHI
201911368285	QUIRINOPOLIS	BJ10406684	BOM JESUS DE GOIAS	14/11/2019 14:49	18/11/2019 19:20	14/11/2019 14:49	14/11/2019 17:39	2,83	6	16,98	CHI
201911368285	BOM JESUS DE GOIAS	BJ10406684	BOM JESUS DE GOIAS	14/11/2019 14:49	18/11/2019 19:20	14/11/2019 14:49	14/11/2019 17:48	2,98	986	2941,84	CHI
201911368285	BOM JESUS DE GOIAS	BJ10400402	BOM JESUS DE GOIAS	14/11/2019 14:49	18/11/2019 19:20	14/11/2019 17:44	14/11/2019 18:53	1,15	290	333,82	CHI
201911368285	ITUMBIARA	BJ10400402	BOM JESUS DE GOIAS	14/11/2019 14:49	18/11/2019 19:20	14/11/2019 17:44	14/11/2019 18:53	1,15	69	79,43	CHI
201911368285	BOM JESUS DE GOIAS	BJ10397297	BOM JESUS DE GOIAS	14/11/2019 14:49	18/11/2019 19:20	14/11/2019 17:44	14/11/2019 18:57	1,23	177	217,32	CHI
201911368285	GOIATUBA	BJ10397297	BOM JESUS DE GOIAS	14/11/2019 14:49	18/11/2019 19:20	14/11/2019 17:44	14/11/2019 18:57	1,23	94	115,41	CHI
201911368285	ITUMBIARA	BJ10397297	BOM JESUS DE GOIAS	14/11/2019 14:49	18/11/2019 19:20	14/11/2019 17:44	14/11/2019 18:57	1,23	2	2,46	CHI
201911368285	QUIRINOPOLIS	BJ10397297	BOM JESUS DE GOIAS	14/11/2019 14:49	18/11/2019 19:20	14/11/2019 17:44	14/11/2019 18:57	1,23	6	7,37	CHI
201911368285	BOM JESUS DE GOIAS	BJ10406684	BOM JESUS DE GOIAS	14/11/2019 14:49	18/11/2019 19:20	14/11/2019 14:49	14/11/2019 19:00	4,18	64	267,75	CHI

201911368285	GOIATUBA	BJ10406684	BOM JESUS DE GOIAS	14/11/2019 14:49	18/11/2019 19:20	14/11/2019 14:49	14/11/2019 19:00	4,18	9	37,65	CHI
201911368285	ITUMBIARA	BJ10406684	BOM JESUS DE GOIAS	14/11/2019 14:49	18/11/2019 19:20	14/11/2019 17:44	14/11/2019 19:47	2,06	2	4,13	CHI
201911368285	BOM JESUS DE GOIAS	BJ12208038	BOM JESUS DE GOIAS	14/11/2019 14:49	18/11/2019 19:20	14/11/2019 19:48	14/11/2019 21:15	1,46	1477	2151,09	CHI
201911368285	BOM JESUS DE GOIAS	BJ12208038	BOM JESUS DE GOIAS	14/11/2019 14:49	18/11/2019 19:20	14/11/2019 19:48	14/11/2019 21:15	1,46	682	993,26	CHI
201911368285	GOIATUBA	BJ12208038	BOM JESUS DE GOIAS	14/11/2019 14:49	18/11/2019 19:20	14/11/2019 19:48	14/11/2019 21:15	1,46	103	150,01	CHI
201911368285	ITUMBIARA	BJ12208038	BOM JESUS DE GOIAS	14/11/2019 14:49	18/11/2019 19:20	14/11/2019 19:48	14/11/2019 21:15	1,46	71	103,40	CHI
201911368285	QUIRINOPOLIS	BJ12208038	BOM JESUS DE GOIAS	14/11/2019 14:49	18/11/2019 19:20	14/11/2019 19:48	14/11/2019 21:15	1,46	6	8,74	CHI
201911368285	BOM JESUS DE GOIAS	BJ10400402	BOM JESUS DE GOIAS	14/11/2019 14:49	18/11/2019 19:20	14/11/2019 21:16	14/11/2019 22:45	1,48	427	630,66	CHI
201911368285	GOIATUBA	BJ10400402	BOM JESUS DE GOIAS	14/11/2019 14:49	18/11/2019 19:20	14/11/2019 21:16	14/11/2019 22:45	1,48	94	138,83	CHI
201911368285	ITUMBIARA	BJ10400402	BOM JESUS DE GOIAS	14/11/2019 14:49	18/11/2019 19:20	14/11/2019 21:16	14/11/2019 22:45	1,48	71	104,86	CHI
201911368285	QUIRINOPOLIS	BJ10400402	BOM JESUS DE GOIAS	14/11/2019 14:49	18/11/2019 19:20	14/11/2019 21:16	14/11/2019 22:45	1,48	6	8,86	CHI
201911368285	BOM JESUS DE GOIAS	BJ10400744	BOM JESUS DE GOIAS	14/11/2019 14:49	18/11/2019 19:20	14/11/2019 21:16	14/11/2019 22:46	1,49	64	95,52	CHI
201911368285	GOIATUBA	BJ10400744	BOM JESUS DE GOIAS	14/11/2019 14:49	18/11/2019 19:20	14/11/2019 21:16	14/11/2019 22:46	1,49	9	13,43	CHI
201911368285	ITUMBIARA	BJ13095694	BOM JESUS DE GOIAS	14/11/2019 14:49	18/11/2019 19:20	14/11/2019 17:44	15/11/2019 18:50	25,11	1	25,11	CHI
201911368285	BOM JESUS DE GOIAS	BJ12208130	BOM JESUS DE GOIAS	14/11/2019 14:49	18/11/2019 19:20	14/11/2019 14:56	15/11/2019 19:58	29,03	6	174,20	CHI
201911368285	BOM JESUS DE GOIAS	BJ12208038	BOM JESUS DE GOIAS	14/11/2019 14:49	18/11/2019 19:20	14/11/2019 19:48	17/11/2019 10:44	62,95	10	629,46	CHI
201911368285	BOM JESUS DE GOIAS	BJ12208038	BOM JESUS DE GOIAS	14/11/2019 14:49	18/11/2019 19:20	14/11/2019 19:48	17/11/2019 11:06	63,31	19	1202,95	CHI
201911368285	BOM JESUS DE GOIAS	BJ12208038	BOM JESUS DE GOIAS	14/11/2019 14:49	18/11/2019 19:20	14/11/2019 19:48	18/11/2019 19:20	95,55	11	1051,02	CHI
201911368286	CATALAO	10023855809	CATALAO S1	14/11/2019 17:01	15/11/2019 17:03	14/11/2019 17:01	15/11/2019 17:03	24,03	1	24,03	CHI
201911368289	CATALAO	10023855809	CATALAO S1	14/11/2019 17:01	15/11/2019 17:03	14/11/2019 17:01	15/11/2019 17:03	24,03	1	24,03	CHI
201911368290	CATALAO	9580012938	CATALAO S1	14/11/2019 18:29	15/11/2019 17:03	14/11/2019 18:29	15/11/2019 17:03	22,56	1	22,56	CHI
201911368291	CATALAO	10010929418	CATALAO S1	14/11/2019 19:26	15/11/2019 17:03	14/11/2019 19:26	15/11/2019 17:03	21,61	1	21,61	CHI
201911368292	CATALAO	9580011417	CATALAO S1	15/11/2019 08:55	15/11/2019 17:03	15/11/2019 08:55	15/11/2019 17:03	8,12	1	8,12	CHI
201911368293	CATALAO	9580011351	CATALAO S1	15/11/2019 09:04	15/11/2019 17:03	15/11/2019 09:04	15/11/2019 17:03	7,99	1	7,99	CHI
201911368294	CATALAO	9580011170	CATALAO S1	15/11/2019 12:04	15/11/2019 17:03	15/11/2019 12:04	15/11/2019 17:03	4,98	1	4,98	CHI
201911368295	CATALAO	9580009290	CATALAO S1	15/11/2019 12:23	15/11/2019 17:03	15/11/2019 12:23	15/11/2019 17:03	4,66	1	4,66	CHI
201911368296	CATALAO	9580002428	CATALAO S1	15/11/2019 13:38	15/11/2019 17:03	15/11/2019 13:38	15/11/2019 17:03	3,42	1	3,42	CHI
201911368297	CATALAO	9580010164	CATALAO S1	15/11/2019 15:30	15/11/2019 17:03	15/11/2019 15:30	15/11/2019 17:03	1,55	1	1,55	CHI
201911368298	CATALAO	9580005879	CATALAO S1	15/11/2019 15:53	15/11/2019 17:03	15/11/2019 15:53	15/11/2019 17:03	1,16	1	1,16	CHI
201911368299	CATALAO	9580013300	CATALAO S1	15/11/2019 16:29	15/11/2019 17:03	15/11/2019 16:29	15/11/2019 17:03	0,56	1	0,56	CHI
201911368310	APARECIDA DE GOIANIA	200126805	INDEPENDENCIA S2	18/11/2019 18:22	19/11/2019 17:36	18/11/2019 18:22	19/11/2019 17:36	23,22	1	23,22	CHI
201911368311	CATALAO	CT12009669	CATALAO S1	14/11/2019 08:47	14/11/2019 10:57	14/11/2019 08:47	14/11/2019 10:57	2,16	2	4,32	CHI
201911368320	OURO VERDE DE GOIAS	OV12009055	NEROPOLIS S2	16/11/2019 13:31	16/11/2019 16:28	16/11/2019 13:31	16/11/2019 16:28	2,94	21	61,80	CHI

201911368350	LUZIANIA	LZ12383044	CRISTALINA S2	15/11/2019 16:19	17/11/2019 15:14	15/11/2019 16:19	16/11/2019 09:43	17,40	42	730,72	CHI
201911368350	CRISTALINA	LZ12383044	CRISTALINA S2	15/11/2019 16:19	17/11/2019 15:14	15/11/2019 16:19	17/11/2019 14:46	46,46	11	511,07	CHI
201911368350	LUZIANIA	LZ12383044	CRISTALINA S2	15/11/2019 16:19	17/11/2019 15:14	15/11/2019 16:19	17/11/2019 14:46	46,46	5	232,30	CHI
201911368350	CRISTALINA	LZ12383044	CRISTALINA S2	15/11/2019 16:19	17/11/2019 15:14	15/11/2019 16:19	17/11/2019 15:14	46,92	10	469,18	CHI
201911368350	LUZIANIA	LZ12383044	CRISTALINA S2	15/11/2019 16:19	17/11/2019 15:14	15/11/2019 16:19	17/11/2019 15:14	46,92	56	2627,40	CHI
2019111400086	ABADIANIA	19801	ALEXANIA	14/11/2019 19:52	14/11/2019 19:55	14/11/2019 19:52	14/11/2019 19:55	0,05	4	0,20	CHI
2019111400086	ALEXANIA	19801	ALEXANIA	14/11/2019 19:52	14/11/2019 19:55	14/11/2019 19:52	14/11/2019 19:55	0,05	3985	199,25	CHI
2019111400086	ALEXANIA	36501	ALEXANIA	14/11/2019 19:52	14/11/2019 19:55	14/11/2019 19:52	14/11/2019 19:55	0,05	399	19,95	CHI
2019111400086	ALEXANIA	19802	ALEXANIA	14/11/2019 19:52	14/11/2019 19:55	14/11/2019 19:52	14/11/2019 19:55	0,05	1665	83,25	CHI
2019111400086	ALEXANIA	36502	ALEXANIA	14/11/2019 19:52	14/11/2019 19:55	14/11/2019 19:52	14/11/2019 19:55	0,05	65	3,25	CHI
2019111400086	ALEXANIA	19803	ALEXANIA	14/11/2019 19:52	14/11/2019 19:55	14/11/2019 19:52	14/11/2019 19:55	0,05	4725	236,25	CHI
2019111400086	ALEXANIA	36503	ALEXANIA	14/11/2019 19:52	14/11/2019 19:55	14/11/2019 19:52	14/11/2019 19:55	0,05	743	37,15	CHI
2019111400086	ALEXANIA	03195114	ALEXANIA	14/11/2019 19:52	14/11/2019 19:55	14/11/2019 19:52	14/11/2019 19:55	0,05	38	1,90	CHI
2019111400086	ALEXANIA	03195114	ALEXANIA	14/11/2019 19:52	14/11/2019 19:55	14/11/2019 19:52	14/11/2019 19:55	0,05	3	0,15	CHI
2019111400086	ALEXANIA	03195114	ALEXANIA	14/11/2019 19:52	14/11/2019 19:55	14/11/2019 19:52	14/11/2019 19:55	0,05	283	14,15	CHI
2019111400086	ALEXANIA	03195114	ALEXANIA	14/11/2019 19:52	14/11/2019 19:55	14/11/2019 19:52	14/11/2019 19:55	0,05	26	1,30	CHI
2019111400086	BARRO ALTO	36501	ALEXANIA	14/11/2019 19:52	14/11/2019 19:55	14/11/2019 19:52	14/11/2019 19:55	0,05	2	0,10	CHI
2019111400086	CORUMBA DE GOIAS	19801	ALEXANIA	14/11/2019 19:52	14/11/2019 19:55	14/11/2019 19:52	14/11/2019 19:55	0,05	121	6,05	CHI
2019111400086	CORUMBA DE GOIAS	16802	ALEXANIA	14/11/2019 19:52	14/11/2019 19:55	14/11/2019 19:52	14/11/2019 19:55	0,05	13	0,65	CHI
2019111400086	CORUMBA DE GOIAS	19802	ALEXANIA	14/11/2019 19:52	14/11/2019 19:55	14/11/2019 19:52	14/11/2019 19:55	0,05	7	0,35	CHI
2019111400086	CORUMBA DE GOIAS	03195114	ALEXANIA	14/11/2019 19:52	14/11/2019 19:55	14/11/2019 19:52	14/11/2019 19:55	0,05	15	0,75	CHI
2019111400086	JARAGUA	19801	ALEXANIA	14/11/2019 19:52	14/11/2019 19:55	14/11/2019 19:52	14/11/2019 19:55	0,05	74	3,70	CHI
2019111400086	SANTO ANTONIO DO DESCOBERTO	36501	ALEXANIA	14/11/2019 19:52	14/11/2019 19:55	14/11/2019 19:52	14/11/2019 19:55	0,05	1	0,05	CHI
2019111400086	SANTO ANTONIO DO DESCOBERTO	16802	ALEXANIA	14/11/2019 19:52	14/11/2019 19:55	14/11/2019 19:52	14/11/2019 19:55	0,05	12331	616,55	CHI
2019111400086	SANTO ANTONIO DO DESCOBERTO	19802	ALEXANIA	14/11/2019 19:52	14/11/2019 19:55	14/11/2019 19:52	14/11/2019 19:55	0,05	4	0,20	CHI
2019111400086	SANTO ANTONIO DO DESCOBERTO	36502	ALEXANIA	14/11/2019 19:52	14/11/2019 19:55	14/11/2019 19:52	14/11/2019 19:55	0,05	179	8,95	CHI
2019111400086	SANTO ANTONIO DO DESCOBERTO	19803	ALEXANIA	14/11/2019 19:52	14/11/2019 19:55	14/11/2019 19:52	14/11/2019 19:55	0,05	1	0,05	CHI
2019111400086	SANTO ANTONIO DO DESCOBERTO	03195114	ALEXANIA	14/11/2019 19:52	14/11/2019 19:55	14/11/2019 19:52	14/11/2019 19:55	0,05	34	1,70	CHI
2019111400086	COCALZINHO DE GOIAS	05745114	COCALZINHO	14/11/2019 19:52	14/11/2019 19:55	14/11/2019 19:52	14/11/2019 19:55	0,05	3304	165,20	CHI
2019111400086	COCALZINHO DE GOIAS	05745114	COCALZINHO	14/11/2019 19:52	14/11/2019 19:55	14/11/2019 19:52	14/11/2019 19:55	0,05	1624	81,20	CHI
2019111400086	CORUMBA DE GOIAS	05745114	COCALZINHO	14/11/2019 19:52	14/11/2019 19:55	14/11/2019 19:52	14/11/2019 19:55	0,05	18	0,90	CHI
2019111400086	CORUMBA DE GOIAS	05745114	COCALZINHO	14/11/2019 19:52	14/11/2019 19:55	14/11/2019 19:52	14/11/2019 19:55	0,05	312	15,60	CHI
2019111400086	PADRE BERNARDO	05745114	COCALZINHO	14/11/2019 19:52	14/11/2019 19:55	14/11/2019 19:52	14/11/2019 19:55	0,05	1	0,05	CHI

2019111400086	PIRENOPOLIS	05745114	COCALZINHO	14/11/2019 19:52	14/11/2019 19:55	14/11/2019 19:52	14/11/2019 19:55	0,05	34	1,70	CHI
2019111400086	PIRENOPOLIS	05745114	COCALZINHO	14/11/2019 19:52	14/11/2019 19:55	14/11/2019 19:52	14/11/2019 19:55	0,05	49	2,45	CHI
2019111400086	VILA PROPICIO	05745114	COCALZINHO	14/11/2019 19:52	14/11/2019 19:55	14/11/2019 19:52	14/11/2019 19:55	0,05	1	0,05	CHI
2019111400086	ABADIANIA	00400604	CORUMBA	14/11/2019 19:52	14/11/2019 19:55	14/11/2019 19:52	14/11/2019 19:55	0,05	87	4,35	CHI
2019111400086	ABADIANIA	20404	CORUMBA	14/11/2019 19:52	14/11/2019 19:55	14/11/2019 19:52	14/11/2019 19:55	0,05	587	29,35	CHI
2019111400086	ALEXANIA	32401	CORUMBA	14/11/2019 19:52	14/11/2019 19:55	14/11/2019 19:52	14/11/2019 19:55	0,05	850	42,50	CHI
2019111400086	ANAPOLIS	20402	CORUMBA	14/11/2019 19:52	14/11/2019 19:55	14/11/2019 19:52	14/11/2019 19:55	0,05	1	0,05	CHI
2019111400086	CORUMBA DE GOIAS	32401	CORUMBA	14/11/2019 19:52	14/11/2019 19:55	14/11/2019 19:52	14/11/2019 19:55	0,05	342	17,10	CHI
2019111400086	CORUMBA DE GOIAS	00400604	CORUMBA	14/11/2019 19:52	14/11/2019 19:55	14/11/2019 19:52	14/11/2019 19:55	0,05	3339	166,95	CHI
2019111400086	CORUMBA DE GOIAS	20404	CORUMBA	14/11/2019 19:52	14/11/2019 19:55	14/11/2019 19:52	14/11/2019 19:55	0,05	37	1,85	CHI
2019111400086	CORUMBA DE GOIAS	00400604	CORUMBA	14/11/2019 19:52	14/11/2019 19:55	14/11/2019 19:52	14/11/2019 19:55	0,05	256	12,80	CHI
2019111400086	GOIANESIA	20402	CORUMBA	14/11/2019 19:52	14/11/2019 19:55	14/11/2019 19:52	14/11/2019 19:55	0,05	11	0,55	CHI
2019111400086	ITAUCU	20403	CORUMBA	14/11/2019 19:52	14/11/2019 19:55	14/11/2019 19:52	14/11/2019 19:55	0,05	1	0,05	CHI
2019111400086	JARAGUA	20402	CORUMBA	14/11/2019 19:52	14/11/2019 19:55	14/11/2019 19:52	14/11/2019 19:55	0,05	17	0,85	CHI
2019111400086	PIRENOPOLIS	20401	CORUMBA	14/11/2019 19:52	14/11/2019 19:55	14/11/2019 19:52	14/11/2019 19:55	0,05	2542	127,10	CHI
2019111400086	PIRENOPOLIS	20402	CORUMBA	14/11/2019 19:52	14/11/2019 19:55	14/11/2019 19:52	14/11/2019 19:55	0,05	3567	178,35	CHI
2019111400086	PIRENOPOLIS	20403	CORUMBA	14/11/2019 19:52	14/11/2019 19:55	14/11/2019 19:52	14/11/2019 19:55	0,05	4142	207,10	CHI
2019111400086	PIRENOPOLIS	20404	CORUMBA	14/11/2019 19:52	14/11/2019 19:55	14/11/2019 19:52	14/11/2019 19:55	0,05	602	30,10	CHI
2019111400086	PIRENOPOLIS	00400604	CORUMBA	14/11/2019 19:52	14/11/2019 19:55	14/11/2019 19:52	14/11/2019 19:55	0,05	121	6,05	CHI
2019111400086	SAO FRANCISCO DE GOIAS	20402	CORUMBA	14/11/2019 19:52	14/11/2019 19:55	14/11/2019 19:52	14/11/2019 19:55	0,05	2	0,10	CHI
2019111400086	VILA PROPICIO	20402	CORUMBA	14/11/2019 19:52	14/11/2019 19:55	14/11/2019 19:52	14/11/2019 19:55	0,05	16	0,80	CHI
2019111500030	BELA VISTA DE GOIAS	52401	CRISTIANOPOLIS	14/11/2019 23:39	15/11/2019 02:55	14/11/2019 23:39	15/11/2019 02:55	3,27	83	271,13	CHI
2019111500030	BELA VISTA DE GOIAS	00440414	CRISTIANOPOLIS	14/11/2019 23:39	15/11/2019 02:55	14/11/2019 23:39	15/11/2019 02:55	3,27	1	3,27	CHI
2019111500030	CRISTIANOPOLIS	52401	CRISTIANOPOLIS	14/11/2019 23:39	15/11/2019 02:55	14/11/2019 23:39	15/11/2019 02:55	3,27	21	68,60	CHI
2019111500030	CRISTIANOPOLIS	00440414	CRISTIANOPOLIS	14/11/2019 23:39	15/11/2019 02:55	14/11/2019 23:39	15/11/2019 02:55	3,27	1	3,27	CHI
2019111500030	SAO MIGUEL DO ARAGUAIA	52402	CRISTIANOPOLIS	14/11/2019 23:39	15/11/2019 02:55	14/11/2019 23:39	15/11/2019 02:55	3,27	1	3,27	CHI
2019111500030	SAO MIGUEL DO PASSA QUATRO	52401	CRISTIANOPOLIS	14/11/2019 23:39	15/11/2019 02:55	14/11/2019 23:39	15/11/2019 02:55	3,27	275	898,33	CHI
2019111500030	SAO MIGUEL DO PASSA QUATRO	52402	CRISTIANOPOLIS	14/11/2019 23:39	15/11/2019 02:55	14/11/2019 23:39	15/11/2019 02:55	3,27	1472	4808,53	CHI
2019111500030	VIANOPOLIS	52401	CRISTIANOPOLIS	14/11/2019 23:39	15/11/2019 02:55	14/11/2019 23:39	15/11/2019 02:55	3,27	3	9,80	CHI
2019111500030	VIANOPOLIS	52402	CRISTIANOPOLIS	14/11/2019 23:39	15/11/2019 02:55	14/11/2019 23:39	15/11/2019 02:55	3,27	37	120,87	CHI
2019111500074	CAMPO ALEGRE DE GOIAS	02250424	CAMPO ALEGRE DE GOIAS	15/11/2019 16:54	15/11/2019 17:31	15/11/2019 16:54	15/11/2019 17:31	0,62	92	56,73	CHI
2019111500102	GOIATUBA	00730214	GOIATUBA S2	14/11/2019 23:06	15/11/2019 00:11	14/11/2019 23:06	15/11/2019 00:11	1,08	1	1,08	CHI
2019111600032	CALDAS NOVAS	00320244	CALDAS NOVAS S1	16/11/2019 20:48	16/11/2019 20:53	16/11/2019 20:48	16/11/2019 20:53	0,08	8391	699,25	CHI

2019111600032	CALDAS NOVAS	00320424	CALDAS NOVAS S1	16/11/2019 20:48	16/11/2019 20:53	16/11/2019 20:48	16/11/2019 20:53	0,08	34	2,83	CHI
2019111600032	CALDAS NOVAS	00320434	CALDAS NOVAS S1	16/11/2019 20:48	16/11/2019 20:53	16/11/2019 20:48	16/11/2019 20:53	0,08	293	24,42	CHI
2019111600032	RIO QUENTE	00320424	CALDAS NOVAS S1	16/11/2019 20:48	16/11/2019 20:53	16/11/2019 20:48	16/11/2019 20:53	0,08	42	3,50	CHI
2019111600032	SANTA CRUZ DE GOIAS	00320244	CALDAS NOVAS S1	16/11/2019 20:48	16/11/2019 20:53	16/11/2019 20:48	16/11/2019 20:53	0,08	102	8,50	CHI
2019111600059	ALTO HORIZONTE	24901	SANTA TEREZINHA	16/11/2019 16:21	16/11/2019 16:25	16/11/2019 16:21	16/11/2019 16:25	0,07	9	0,60	CHI
2019111600059	ALTO HORIZONTE	34001	SANTA TEREZINHA	16/11/2019 16:21	16/11/2019 16:25	16/11/2019 16:21	16/11/2019 16:25	0,07	13	0,87	CHI
2019111600059	ALTO HORIZONTE	34002	SANTA TEREZINHA	16/11/2019 16:21	16/11/2019 16:25	16/11/2019 16:21	16/11/2019 16:25	0,07	58	3,87	CHI
2019111600059	CAMPOS VERDES	24901	SANTA TEREZINHA	16/11/2019 16:21	16/11/2019 16:25	16/11/2019 16:21	16/11/2019 16:25	0,07	2002	133,47	CHI
2019111600059	CAMPOS VERDES	24902	SANTA TEREZINHA	16/11/2019 16:21	16/11/2019 16:25	16/11/2019 16:21	16/11/2019 16:25	0,07	47	3,13	CHI
2019111600059	CAMPOS VERDES	34002	SANTA TEREZINHA	16/11/2019 16:21	16/11/2019 16:25	16/11/2019 16:21	16/11/2019 16:25	0,07	8	0,53	CHI
2019111600059	CAMPOS VERDES	01730414	SANTA TEREZINHA	16/11/2019 16:21	16/11/2019 16:25	16/11/2019 16:21	16/11/2019 16:25	0,07	1	0,07	CHI
2019111600059	CAMPOS VERDES	01730444	SANTA TEREZINHA	16/11/2019 16:21	16/11/2019 16:25	16/11/2019 16:21	16/11/2019 16:25	0,07	67	4,47	CHI
2019111600059	CRIXAS	01730414	SANTA TEREZINHA	16/11/2019 16:21	16/11/2019 16:25	16/11/2019 16:21	16/11/2019 16:25	0,07	146	9,73	CHI
2019111600059	CRIXAS	01730424	SANTA TEREZINHA	16/11/2019 16:21	16/11/2019 16:25	16/11/2019 16:21	16/11/2019 16:25	0,07	255	17,00	CHI
2019111600059	CRIXAS	01730454	SANTA TEREZINHA	16/11/2019 16:21	16/11/2019 16:25	16/11/2019 16:21	16/11/2019 16:25	0,07	312	20,80	CHI
2019111600059	GUARINOS	01730454	SANTA TEREZINHA	16/11/2019 16:21	16/11/2019 16:25	16/11/2019 16:21	16/11/2019 16:25	0,07	1190	79,33	CHI
2019111600059	HIDROLINA	01730454	SANTA TEREZINHA	16/11/2019 16:21	16/11/2019 16:25	16/11/2019 16:21	16/11/2019 16:25	0,07	17	1,13	CHI
2019111600059	ITAPACI	01730454	SANTA TEREZINHA	16/11/2019 16:21	16/11/2019 16:25	16/11/2019 16:21	16/11/2019 16:25	0,07	6	0,40	CHI
2019111600059	MARA ROSA	24901	SANTA TEREZINHA	16/11/2019 16:21	16/11/2019 16:25	16/11/2019 16:21	16/11/2019 16:25	0,07	68	4,53	CHI
2019111600059	MARA ROSA	01730414	SANTA TEREZINHA	16/11/2019 16:21	16/11/2019 16:25	16/11/2019 16:21	16/11/2019 16:25	0,07	76	5,07	CHI
2019111600059	NOVA IGUACU DE GOIAS	34001	SANTA TEREZINHA	16/11/2019 16:21	16/11/2019 16:25	16/11/2019 16:21	16/11/2019 16:25	0,07	816	54,40	CHI
2019111600059	NOVA IGUACU DE GOIAS	34002	SANTA TEREZINHA	16/11/2019 16:21	16/11/2019 16:25	16/11/2019 16:21	16/11/2019 16:25	0,07	362	24,13	CHI
2019111600059	NOVA IGUACU DE GOIAS	01730434	SANTA TEREZINHA	16/11/2019 16:21	16/11/2019 16:25	16/11/2019 16:21	16/11/2019 16:25	0,07	1	0,07	CHI
2019111600059	PILAR DE GOIAS	24901	SANTA TEREZINHA	16/11/2019 16:21	16/11/2019 16:25	16/11/2019 16:21	16/11/2019 16:25	0,07	6	0,40	CHI
2019111600059	PILAR DE GOIAS	34001	SANTA TEREZINHA	16/11/2019 16:21	16/11/2019 16:25	16/11/2019 16:21	16/11/2019 16:25	0,07	169	11,27	CHI
2019111600059	PILAR DE GOIAS	34002	SANTA TEREZINHA	16/11/2019 16:21	16/11/2019 16:25	16/11/2019 16:21	16/11/2019 16:25	0,07	1	0,07	CHI
2019111600059	PILAR DE GOIAS	01730434	SANTA TEREZINHA	16/11/2019 16:21	16/11/2019 16:25	16/11/2019 16:21	16/11/2019 16:25	0,07	11	0,73	CHI
2019111600059	PILAR DE GOIAS	01730454	SANTA TEREZINHA	16/11/2019 16:21	16/11/2019 16:25	16/11/2019 16:21	16/11/2019 16:25	0,07	246	16,40	CHI
2019111600059	SANTA TEREZINHA DE GOIAS	01730214	SANTA TEREZINHA	16/11/2019 16:21	16/11/2019 16:25	16/11/2019 16:21	16/11/2019 16:25	0,07	3178	211,87	CHI
2019111600059	SANTA TEREZINHA DE GOIAS	24901	SANTA TEREZINHA	16/11/2019 16:21	16/11/2019 16:25	16/11/2019 16:21	16/11/2019 16:25	0,07	48	3,20	CHI
2019111600059	SANTA TEREZINHA DE GOIAS	34001	SANTA TEREZINHA	16/11/2019 16:21	16/11/2019 16:25	16/11/2019 16:21	16/11/2019 16:25	0,07	62	4,13	CHI
2019111600059	SANTA TEREZINHA DE GOIAS	01730414	SANTA TEREZINHA	16/11/2019 16:21	16/11/2019 16:25	16/11/2019 16:21	16/11/2019 16:25	0,07	124	8,27	CHI
2019111600059	SANTA TEREZINHA DE GOIAS	01730424	SANTA TEREZINHA	16/11/2019 16:21	16/11/2019 16:25	16/11/2019 16:21	16/11/2019 16:25	0,07	3	0,20	CHI

2019111600059	SANTA TEREZINHA DE GOIAS	01730434	SANTA TEREZINHA	16/11/2019 16:21	16/11/2019 16:25	16/11/2019 16:21	16/11/2019 16:25	0,07	148	9,87	CHI
2019111600059	SANTA TEREZINHA DE GOIAS	01730444	SANTA TEREZINHA	16/11/2019 16:21	16/11/2019 16:25	16/11/2019 16:21	16/11/2019 16:25	0,07	529	35,27	CHI
2019111600059	SANTA TEREZINHA DE GOIAS	01730454	SANTA TEREZINHA	16/11/2019 16:21	16/11/2019 16:25	16/11/2019 16:21	16/11/2019 16:25	0,07	662	44,13	CHI
2019111600059	UIRAPURU	01730414	SANTA TEREZINHA	16/11/2019 16:21	16/11/2019 16:25	16/11/2019 16:21	16/11/2019 16:25	0,07	983	65,53	CHI
2019111600059	UIRAPURU	01730444	SANTA TEREZINHA	16/11/2019 16:21	16/11/2019 16:25	16/11/2019 16:21	16/11/2019 16:25	0,07	56	3,73	CHI
2019111600059	URUACU	01730454	SANTA TEREZINHA	16/11/2019 16:21	16/11/2019 16:25	16/11/2019 16:21	16/11/2019 16:25	0,07	4	0,27	CHI
2019111600080	SAO DOMINGOS	02090214	SAO DOMINGOS	16/11/2019 18:37	16/11/2019 18:46	16/11/2019 18:37	16/11/2019 18:46	0,15	2368	355,20	CHI
2019111600081	GUARANI DE GOIAS	02090424	SAO DOMINGOS	16/11/2019 18:37	16/11/2019 18:45	16/11/2019 18:37	16/11/2019 18:45	0,13	149	19,87	CHI
2019111600081	MONTE ALEGRE DE GOIAS	02090424	SAO DOMINGOS	16/11/2019 18:37	16/11/2019 18:45	16/11/2019 18:37	16/11/2019 18:45	0,13	2	0,27	CHI
2019111600081	NOVA ROMA	02090424	SAO DOMINGOS	16/11/2019 18:37	16/11/2019 18:45	16/11/2019 18:37	16/11/2019 18:45	0,13	3	0,40	CHI
2019111600081	SAO DOMINGOS	02090424	SAO DOMINGOS	16/11/2019 18:37	16/11/2019 18:45	16/11/2019 18:37	16/11/2019 18:45	0,13	1152	153,60	CHI
2019111700028	HIDROLANDIA	36302	PIRACANJUBA	17/11/2019 07:39	17/11/2019 07:42	17/11/2019 07:39	17/11/2019 07:42	0,05	15	0,75	CHI
2019111700028	PIRACANJUBA	36302	PIRACANJUBA	17/11/2019 07:39	17/11/2019 07:42	17/11/2019 07:39	17/11/2019 07:42	0,05	137	6,85	CHI
2019111700028	PROFESSOR JAMIL SAFADY	36302	PIRACANJUBA	17/11/2019 07:39	17/11/2019 07:42	17/11/2019 07:39	17/11/2019 07:42	0,05	13	0,65	CHI
2019111700028	CROMINIA	36301	ROCHEDO	17/11/2019 07:39	17/11/2019 07:42	17/11/2019 07:39	17/11/2019 07:42	0,05	41	2,05	CHI
2019111700028	CROMINIA	36302	ROCHEDO	17/11/2019 07:39	17/11/2019 07:42	17/11/2019 07:39	17/11/2019 07:42	0,05	3	0,15	CHI
2019111700028	PIRACANJUBA	01620514	ROCHEDO	17/11/2019 07:39	17/11/2019 07:42	17/11/2019 07:39	17/11/2019 07:42	0,05	48	2,40	CHI
2019111700028	PIRACANJUBA	36302	ROCHEDO	17/11/2019 07:39	17/11/2019 07:42	17/11/2019 07:39	17/11/2019 07:42	0,05	273	13,65	CHI
2019111700028	PIRACANJUBA	01620514	ROCHEDO	17/11/2019 07:39	17/11/2019 07:42	17/11/2019 07:39	17/11/2019 07:42	0,05	309	15,45	CHI
2019111700028	PROFESSOR JAMIL SAFADY	01620514	ROCHEDO	17/11/2019 07:39	17/11/2019 07:42	17/11/2019 07:39	17/11/2019 07:42	0,05	25	1,25	CHI
2019111700028	PROFESSOR JAMIL SAFADY	36301	ROCHEDO	17/11/2019 07:39	17/11/2019 07:42	17/11/2019 07:39	17/11/2019 07:42	0,05	827	41,35	CHI
2019111700028	PROFESSOR JAMIL SAFADY	36302	ROCHEDO	17/11/2019 07:39	17/11/2019 07:42	17/11/2019 07:39	17/11/2019 07:42	0,05	642	32,10	CHI
2019111700064	AMARALINA	05630424	NOVA CRIXAS	17/11/2019 10:57	17/11/2019 11:00	17/11/2019 10:57	17/11/2019 11:00	0,05	70	3,50	CHI
2019111700064	CRIXAS	05630424	NOVA CRIXAS	17/11/2019 10:57	17/11/2019 11:00	17/11/2019 10:57	17/11/2019 11:00	0,05	22	1,10	CHI
2019111700064	MARA ROSA	05630424	NOVA CRIXAS	17/11/2019 10:57	17/11/2019 11:00	17/11/2019 10:57	17/11/2019 11:00	0,05	39	1,95	CHI
2019111700064	MUNDO NOVO DE GOIAS	15901	NOVA CRIXAS	17/11/2019 10:57	17/11/2019 11:00	17/11/2019 10:57	17/11/2019 11:00	0,05	1859	92,95	CHI
2019111700064	MUNDO NOVO DE GOIAS	05630424	NOVA CRIXAS	17/11/2019 10:57	17/11/2019 11:00	17/11/2019 10:57	17/11/2019 11:00	0,05	797	39,85	CHI
2019111700064	NOVA CRIXAS	05630424	NOVA CRIXAS	17/11/2019 10:57	17/11/2019 11:00	17/11/2019 10:57	17/11/2019 11:00	0,05	1256	62,80	CHI
2019111700064	SANTA TEREZINHA DE GOIAS	05630424	NOVA CRIXAS	17/11/2019 10:57	17/11/2019 11:00	17/11/2019 10:57	17/11/2019 11:00	0,05	1	0,05	CHI
2019111700064	SAO MIGUEL DO ARAGUAIA	05630424	NOVA CRIXAS	17/11/2019 10:57	17/11/2019 11:00	17/11/2019 10:57	17/11/2019 11:00	0,05	21	1,05	CHI
2019111700064	UIRAPURU	05630424	NOVA CRIXAS	17/11/2019 10:57	17/11/2019 11:00	17/11/2019 10:57	17/11/2019 11:00	0,05	308	15,40	CHI
2019111900021	MONTIVIDIU	05700414	MONTIVIDIU T	19/11/2019 17:43	19/11/2019 17:54	19/11/2019 17:43	19/11/2019 17:54	0,18	2	0,37	CHI
2019111900021	RIO VERDE	05700414	MONTIVIDIU T	19/11/2019 17:43	19/11/2019 17:54	19/11/2019 17:43	19/11/2019 17:54	0,18	80	14,67	CHI

2019111900021	RIO VERDE	05700414	MONTIVIDIU T	19/11/2019 17:43	19/11/2019 17:54	19/11/2019 17:43	19/11/2019 17:54	0,18	22	4,03	CHI
2019111900039	HIDROLANDIA	36302	PIRACANJUBA	19/11/2019 14:11	19/11/2019 14:15	19/11/2019 14:11	19/11/2019 14:15	0,07	15	1,00	CHI
2019111900039	PIRACANJUBA	36302	PIRACANJUBA	19/11/2019 14:11	19/11/2019 14:15	19/11/2019 14:11	19/11/2019 14:15	0,07	137	9,13	CHI
2019111900039	PROFESSOR JAMIL SAFADY	36302	PIRACANJUBA	19/11/2019 14:11	19/11/2019 14:15	19/11/2019 14:11	19/11/2019 14:15	0,07	13	0,87	CHI
2019111900039	CROMINIA	36301	ROCHEDO	19/11/2019 14:11	19/11/2019 14:15	19/11/2019 14:11	19/11/2019 14:15	0,07	41	2,73	CHI
2019111900039	CROMINIA	36302	ROCHEDO	19/11/2019 14:11	19/11/2019 14:15	19/11/2019 14:11	19/11/2019 14:15	0,07	3	0,20	CHI
2019111900039	HIDROLANDIA	36302	ROCHEDO	19/11/2019 14:11	19/11/2019 14:15	19/11/2019 14:11	19/11/2019 14:15	0,07	9	0,60	CHI
2019111900039	PIRACANJUBA	01620514	ROCHEDO	19/11/2019 14:11	19/11/2019 14:15	19/11/2019 14:11	19/11/2019 14:15	0,07	48	3,20	CHI
2019111900039	PIRACANJUBA	36302	ROCHEDO	19/11/2019 14:11	19/11/2019 14:15	19/11/2019 14:11	19/11/2019 14:15	0,07	213	14,20	CHI
2019111900039	PIRACANJUBA	01620514	ROCHEDO	19/11/2019 14:11	19/11/2019 14:15	19/11/2019 14:11	19/11/2019 14:15	0,07	309	20,60	CHI
2019111900039	PROFESSOR JAMIL SAFADY	01620514	ROCHEDO	19/11/2019 14:11	19/11/2019 14:15	19/11/2019 14:11	19/11/2019 14:15	0,07	25	1,67	CHI
2019111900039	PROFESSOR JAMIL SAFADY	36301	ROCHEDO	19/11/2019 14:11	19/11/2019 14:15	19/11/2019 14:11	19/11/2019 14:15	0,07	827	55,13	CHI
2019111900039	PROFESSOR JAMIL SAFADY	36302	ROCHEDO	19/11/2019 14:11	19/11/2019 14:15	19/11/2019 14:11	19/11/2019 14:15	0,07	642	42,80	CHI
2019111900047	ORIZONA	01480414	PIRES DO RIO S2	19/11/2019 16:09	19/11/2019 16:20	19/11/2019 16:09	19/11/2019 16:20	0,18	2	0,37	CHI
2019111900047	PIRES DO RIO	01480414	PIRES DO RIO S2	19/11/2019 16:09	19/11/2019 16:20	19/11/2019 16:09	19/11/2019 16:20	0,18	10	1,83	CHI
2019111900047	URUTAI	01480414	PIRES DO RIO S2	19/11/2019 16:09	19/11/2019 16:20	19/11/2019 16:09	19/11/2019 16:20	0,18	61	11,18	CHI
2019111900049	LUZIANIA	18802	PIRES DO RIO S2	19/11/2019 16:09	19/11/2019 16:18	19/11/2019 16:09	19/11/2019 16:18	0,15	2	0,30	CHI
2019111900049	ORIZONA	18801	PIRES DO RIO S2	19/11/2019 16:09	19/11/2019 16:18	19/11/2019 16:09	19/11/2019 16:18	0,15	903	135,45	CHI
2019111900049	ORIZONA	18802	PIRES DO RIO S2	19/11/2019 16:09	19/11/2019 16:18	19/11/2019 16:09	19/11/2019 16:18	0,15	2408	361,20	CHI
2019111900049	ORIZONA	18803	PIRES DO RIO S2	19/11/2019 16:09	19/11/2019 16:18	19/11/2019 16:09	19/11/2019 16:18	0,15	3074	461,10	CHI
2019111900049	ORIZONA	01480434	PIRES DO RIO S2	19/11/2019 16:09	19/11/2019 16:18	19/11/2019 16:09	19/11/2019 16:18	0,15	102	15,30	CHI
2019111900049	PIRES DO RIO	18801	PIRES DO RIO S2	19/11/2019 16:09	19/11/2019 16:18	19/11/2019 16:09	19/11/2019 16:18	0,15	77	11,55	CHI
2019111900049	PIRES DO RIO	01480434	PIRES DO RIO S2	19/11/2019 16:09	19/11/2019 16:18	19/11/2019 16:09	19/11/2019 16:18	0,15	31	4,65	CHI
2019111900049	SAO MIGUEL DO PASSA QUATRO	18801	PIRES DO RIO S2	19/11/2019 16:09	19/11/2019 16:18	19/11/2019 16:09	19/11/2019 16:18	0,15	1	0,15	CHI
2019111900049	VIANOPOLIS	18801	PIRES DO RIO S2	19/11/2019 16:09	19/11/2019 16:18	19/11/2019 16:09	19/11/2019 16:18	0,15	81	12,15	CHI
2019111900049	VIANOPOLIS	18803	PIRES DO RIO S2	19/11/2019 16:09	19/11/2019 16:18	19/11/2019 16:09	19/11/2019 16:18	0,15	143	21,45	CHI
2019111900055	ORIZONA	01480414	PIRES DO RIO S2	19/11/2019 16:27	19/11/2019 16:36	19/11/2019 16:27	19/11/2019 16:36	0,15	2	0,30	CHI
2019111900055	PIRES DO RIO	01480414	PIRES DO RIO S2	19/11/2019 16:27	19/11/2019 16:36	19/11/2019 16:27	19/11/2019 16:36	0,15	10	1,50	CHI
2019111900055	URUTAI	01480414	PIRES DO RIO S2	19/11/2019 16:27	19/11/2019 16:36	19/11/2019 16:27	19/11/2019 16:36	0,15	61	9,15	CHI
2019111900087	APARECIDA DE GOIANIA	00360434	CEPAIGO S2	19/11/2019 08:09	19/11/2019 08:12	19/11/2019 08:09	19/11/2019 08:12	0,05	6	0,30	CHI
2019111900087	ARAGOIANIA	22002	CEPAIGO S2	19/11/2019 08:09	19/11/2019 08:12	19/11/2019 08:09	19/11/2019 08:12	0,05	13	0,65	CHI
2019111900087	BELA VISTA DE GOIAS	22001	CEPAIGO S2	19/11/2019 08:09	19/11/2019 08:12	19/11/2019 08:09	19/11/2019 08:12	0,05	9	0,45	CHI
2019111900087	HIDROLANDIA	22001	CEPAIGO S2	19/11/2019 08:09	19/11/2019 08:12	19/11/2019 08:09	19/11/2019 08:12	0,05	4309	215,45	CHI

2019111900087	HIDROLANDIA	22002	CEPAIGO S2	19/11/2019 08:09	19/11/2019 08:12	19/11/2019 08:09	19/11/2019 08:12	0,05	1975	98,75	CHI
2019111900087	HIDROLANDIA	22001	CEPAIGO S2	19/11/2019 08:09	19/11/2019 08:12	19/11/2019 08:09	19/11/2019 08:12	0,05	356	17,80	CHI
2019111900087	HIDROLANDIA	22003	CEPAIGO S2	19/11/2019 08:09	19/11/2019 08:12	19/11/2019 08:09	19/11/2019 08:12	0,05	559	27,95	CHI
2019111900087	HIDROLANDIA	00360434	CEPAIGO S2	19/11/2019 08:09	19/11/2019 08:12	19/11/2019 08:09	19/11/2019 08:12	0,05	13	0,65	CHI
2019111900087	PIRACANJUBA	22001	CEPAIGO S2	19/11/2019 08:09	19/11/2019 08:12	19/11/2019 08:09	19/11/2019 08:12	0,05	4	0,20	CHI
2019111900087	PROFESSOR JAMIL SAFADY	22001	CEPAIGO S2	19/11/2019 08:09	19/11/2019 08:12	19/11/2019 08:09	19/11/2019 08:12	0,05	1	0,05	CHI
2019111900089	ABADIANIA	00050414	ANAPOLIS UNIVERSITARIO S1	19/11/2019 09:21	19/11/2019 09:25	19/11/2019 09:21	19/11/2019 09:25	0,07	22	1,47	CHI
2019111900089	ANAPOLIS	00050414	ANAPOLIS UNIVERSITARIO S1	19/11/2019 09:21	19/11/2019 09:25	19/11/2019 09:21	19/11/2019 09:25	0,07	63	4,20	CHI
2019111900098	APARECIDA DE GOIANIA	00360234	CEPAIGO S1	19/11/2019 13:14	19/11/2019 13:34	19/11/2019 13:14	19/11/2019 13:34	0,33	1316	438,67	CHI
2019111900098	HIDROLANDIA	00360234	CEPAIGO S1	19/11/2019 13:14	19/11/2019 13:34	19/11/2019 13:14	19/11/2019 13:34	0,33	559	186,33	CHI
2019111900115	APARECIDA DE GOIANIA	03440244	ANHANGUERA	19/11/2019 16:09	19/11/2019 16:30	19/11/2019 16:09	19/11/2019 16:30	0,35	2661	931,35	CHI
2019111900115	APARECIDA DE GOIANIA	03440254	ANHANGUERA	19/11/2019 16:09	19/11/2019 16:30	19/11/2019 16:09	19/11/2019 16:30	0,35	7676	2686,60	CHI
2019111900115	APARECIDA DE GOIANIA	03440264	ANHANGUERA	19/11/2019 16:09	19/11/2019 16:30	19/11/2019 16:09	19/11/2019 16:30	0,35	6991	2446,85	CHI
2019111900115	HIDROLANDIA	03440264	ANHANGUERA	19/11/2019 16:09	19/11/2019 16:30	19/11/2019 16:09	19/11/2019 16:30	0,35	1998	699,30	CHI
2019111900124	BELA VISTA DE GOIAS	04982118	SENADOR CANEDO	19/11/2019 16:09	19/11/2019 16:18	19/11/2019 16:09	19/11/2019 16:18	0,15	11	1,65	CHI
2019111900124	BELA VISTA DE GOIAS	04986114	SENADOR CANEDO	19/11/2019 16:09	19/11/2019 16:18	19/11/2019 16:09	19/11/2019 16:18	0,15	14	2,10	CHI
2019111900124	CALDAZINHA	04982118	SENADOR CANEDO	19/11/2019 16:09	19/11/2019 16:18	19/11/2019 16:09	19/11/2019 16:18	0,15	37	5,55	CHI
2019111900124	CALDAZINHA	04986114	SENADOR CANEDO	19/11/2019 16:09	19/11/2019 16:18	19/11/2019 16:09	19/11/2019 16:18	0,15	39	5,85	CHI
2019111900124	CALDAZINHA	04982118	SENADOR CANEDO	19/11/2019 16:09	19/11/2019 16:18	19/11/2019 16:09	19/11/2019 16:18	0,15	24	3,60	CHI
2019111900124	CALDAZINHA	04986114	SENADOR CANEDO	19/11/2019 16:09	19/11/2019 16:18	19/11/2019 16:09	19/11/2019 16:18	0,15	34	5,10	CHI
2019111900124	GOIANIA	04982118	SENADOR CANEDO	19/11/2019 16:09	19/11/2019 16:18	19/11/2019 16:09	19/11/2019 16:18	0,15	2407	361,05	CHI
2019111900124	GOIANIA	04986114	SENADOR CANEDO	19/11/2019 16:09	19/11/2019 16:18	19/11/2019 16:09	19/11/2019 16:18	0,15	1461	219,15	CHI
2019111900124	GOIANIA	04982118	SENADOR CANEDO	19/11/2019 16:09	19/11/2019 16:18	19/11/2019 16:09	19/11/2019 16:18	0,15	1	0,15	CHI
2019111900124	GOIANIA	04986114	SENADOR CANEDO	19/11/2019 16:09	19/11/2019 16:18	19/11/2019 16:09	19/11/2019 16:18	0,15	7	1,05	CHI
2019111900124	SENADOR CANEDO	04982118	SENADOR CANEDO	19/11/2019 16:09	19/11/2019 16:18	19/11/2019 16:09	19/11/2019 16:18	0,15	1780	267,00	CHI
2019111900124	SENADOR CANEDO	04986114	SENADOR CANEDO	19/11/2019 16:09	19/11/2019 16:18	19/11/2019 16:09	19/11/2019 16:18	0,15	809	121,35	CHI
2019111900124	SENADOR CANEDO	04982118	SENADOR CANEDO	19/11/2019 16:09	19/11/2019 16:18	19/11/2019 16:09	19/11/2019 16:18	0,15	5783	867,45	CHI
2019111900124	SENADOR CANEDO	04986114	SENADOR CANEDO	19/11/2019 16:09	19/11/2019 16:18	19/11/2019 16:09	19/11/2019 16:18	0,15	6237	935,55	CHI
2019111900124	SENADOR CANEDO	04982118	SENADOR CANEDO	19/11/2019 16:09	19/11/2019 16:18	19/11/2019 16:09	19/11/2019 16:18	0,15	5171	775,65	CHI
2019111900124	SENADOR CANEDO	04986114	SENADOR CANEDO	19/11/2019 16:09	19/11/2019 16:18	19/11/2019 16:09	19/11/2019 16:18	0,15	4135	620,25	CHI
2019111900124	SENADOR CANEDO	04982118	SENADOR CANEDO	19/11/2019 16:09	19/11/2019 16:18	19/11/2019 16:09	19/11/2019 16:18	0,15	3900	585,00	CHI
2019111900124	SENADOR CANEDO	04986114	SENADOR CANEDO	19/11/2019 16:09	19/11/2019 16:18	19/11/2019 16:09	19/11/2019 16:18	0,15	3226	483,90	CHI
2019111900124	SENADOR CANEDO	04982118	SENADOR CANEDO	19/11/2019 16:09	19/11/2019 16:18	19/11/2019 16:09	19/11/2019 16:18	0,15	3969	595,35	CHI

2019111900124	SENADOR CANEDO	04986114	SENADOR CANEDO	19/11/2019 16:09	19/11/2019 16:18	19/11/2019 16:09	19/11/2019 16:18	0,15	5776	866,40	CHI
2019111900124	SENADOR CANEDO	04982118	SENADOR CANEDO	19/11/2019 16:09	19/11/2019 16:18	19/11/2019 16:09	19/11/2019 16:18	0,15	1819	272,85	CHI
2019111900124	SENADOR CANEDO	04986114	SENADOR CANEDO	19/11/2019 16:09	19/11/2019 16:18	19/11/2019 16:09	19/11/2019 16:18	0,15	1737	260,55	CHI
2019111900127	ABADIANIA	31001	DAIA S2	19/11/2019 16:09	19/11/2019 16:12	19/11/2019 16:09	19/11/2019 16:12	0,05	4	0,20	CHI
2019111900127	ABADIANIA	57301	DAIA S2	19/11/2019 16:09	19/11/2019 16:12	19/11/2019 16:09	19/11/2019 16:12	0,05	382	19,10	CHI
2019111900127	ABADIANIA	57202	DAIA S2	19/11/2019 16:09	19/11/2019 16:12	19/11/2019 16:09	19/11/2019 16:12	0,05	2	0,10	CHI
2019111900127	ABADIANIA	57302	DAIA S2	19/11/2019 16:09	19/11/2019 16:12	19/11/2019 16:09	19/11/2019 16:12	0,05	180	9,00	CHI
2019111900127	ANAPOLIS	31001	DAIA S2	19/11/2019 16:09	19/11/2019 16:12	19/11/2019 16:09	19/11/2019 16:12	0,05	4	0,20	CHI
2019111900127	ANAPOLIS	38801	DAIA S2	19/11/2019 16:09	19/11/2019 16:12	19/11/2019 16:09	19/11/2019 16:12	0,05	1	0,05	CHI
2019111900127	ANAPOLIS	00030618	DAIA S2	19/11/2019 16:09	19/11/2019 16:12	19/11/2019 16:09	19/11/2019 16:12	0,05	17	0,85	CHI
2019111900127	ANAPOLIS	00030618	DAIA S2	19/11/2019 16:09	19/11/2019 16:12	19/11/2019 16:09	19/11/2019 16:12	0,05	1	0,05	CHI
2019111900127	BELA VISTA DE GOIAS	10701	DAIA S2	19/11/2019 16:09	19/11/2019 16:12	19/11/2019 16:09	19/11/2019 16:12	0,05	1	0,05	CHI
2019111900127	BELA VISTA DE GOIAS	31001	DAIA S2	19/11/2019 16:09	19/11/2019 16:12	19/11/2019 16:09	19/11/2019 16:12	0,05	1	0,05	CHI
2019111900127	BELA VISTA DE GOIAS	10702	DAIA S2	19/11/2019 16:09	19/11/2019 16:12	19/11/2019 16:09	19/11/2019 16:12	0,05	8	0,40	CHI
2019111900127	BONFINOPOLIS	33801	DAIA S2	19/11/2019 16:09	19/11/2019 16:12	19/11/2019 16:09	19/11/2019 16:12	0,05	51	2,55	CHI
2019111900127	BONFINOPOLIS	33832	DAIA S2	19/11/2019 16:09	19/11/2019 16:12	19/11/2019 16:09	19/11/2019 16:12	0,05	1	0,05	CHI
2019111900127	CALDAZINHA	10701	DAIA S2	19/11/2019 16:09	19/11/2019 16:12	19/11/2019 16:09	19/11/2019 16:12	0,05	67	3,35	CHI
2019111900127	GAMELEIRA DE GOIAS	10701	DAIA S2	19/11/2019 16:09	19/11/2019 16:12	19/11/2019 16:09	19/11/2019 16:12	0,05	24	1,20	CHI
2019111900127	GAMELEIRA DE GOIAS	31001	DAIA S2	19/11/2019 16:09	19/11/2019 16:12	19/11/2019 16:09	19/11/2019 16:12	0,05	980	49,00	CHI
2019111900127	GAMELEIRA DE GOIAS	33801	DAIA S2	19/11/2019 16:09	19/11/2019 16:12	19/11/2019 16:09	19/11/2019 16:12	0,05	2	0,10	CHI
2019111900127	GAMELEIRA DE GOIAS	57202	DAIA S2	19/11/2019 16:09	19/11/2019 16:12	19/11/2019 16:09	19/11/2019 16:12	0,05	141	7,05	CHI
2019111900127	GAMELEIRA DE GOIAS	57302	DAIA S2	19/11/2019 16:09	19/11/2019 16:12	19/11/2019 16:09	19/11/2019 16:12	0,05	1	0,05	CHI
2019111900127	GAMELEIRA DE GOIAS	00030618	DAIA S2	19/11/2019 16:09	19/11/2019 16:12	19/11/2019 16:09	19/11/2019 16:12	0,05	228	11,40	CHI
2019111900127	GOIANAPOLIS	33801	DAIA S2	19/11/2019 16:09	19/11/2019 16:12	19/11/2019 16:09	19/11/2019 16:12	0,05	3530	176,50	CHI
2019111900127	GOIANAPOLIS	38801	DAIA S2	19/11/2019 16:09	19/11/2019 16:12	19/11/2019 16:09	19/11/2019 16:12	0,05	2	0,10	CHI
2019111900127	GOIANAPOLIS	33802	DAIA S2	19/11/2019 16:09	19/11/2019 16:12	19/11/2019 16:09	19/11/2019 16:12	0,05	1039	51,95	CHI
2019111900127	GOIANAPOLIS	38802	DAIA S2	19/11/2019 16:09	19/11/2019 16:12	19/11/2019 16:09	19/11/2019 16:12	0,05	332	16,60	CHI
2019111900127	GOIANAPOLIS	00030618	DAIA S2	19/11/2019 16:09	19/11/2019 16:12	19/11/2019 16:09	19/11/2019 16:12	0,05	2	0,10	CHI
2019111900127	GOIANAPOLIS	33832	DAIA S2	19/11/2019 16:09	19/11/2019 16:12	19/11/2019 16:09	19/11/2019 16:12	0,05	3	0,15	CHI
2019111900127	GOIANIA	38802	DAIA S2	19/11/2019 16:09	19/11/2019 16:12	19/11/2019 16:09	19/11/2019 16:12	0,05	1	0,05	CHI
2019111900127	LEOPOLDO DE BULHOES	10701	DAIA S2	19/11/2019 16:09	19/11/2019 16:12	19/11/2019 16:09	19/11/2019 16:12	0,05	1051	52,55	CHI
2019111900127	LEOPOLDO DE BULHOES	33801	DAIA S2	19/11/2019 16:09	19/11/2019 16:12	19/11/2019 16:09	19/11/2019 16:12	0,05	597	29,85	CHI
2019111900127	LEOPOLDO DE BULHOES	10702	DAIA S2	19/11/2019 16:09	19/11/2019 16:12	19/11/2019 16:09	19/11/2019 16:12	0,05	1840	92,00	CHI

2019111900127	LEOPOLDO DE BULHOES	33802	DAIA S2	19/11/2019 16:09	19/11/2019 16:12	19/11/2019 16:09	19/11/2019 16:12	0,05	510	25,50	CHI
2019111900127	LEOPOLDO DE BULHOES	00030618	DAIA S2	19/11/2019 16:09	19/11/2019 16:12	19/11/2019 16:09	19/11/2019 16:12	0,05	21	1,05	CHI
2019111900127	LEOPOLDO DE BULHOES	00030618	DAIA S2	19/11/2019 16:09	19/11/2019 16:12	19/11/2019 16:09	19/11/2019 16:12	0,05	1	0,05	CHI
2019111900127	NEROPOLIS	38801	DAIA S2	19/11/2019 16:09	19/11/2019 16:12	19/11/2019 16:09	19/11/2019 16:12	0,05	41	2,05	CHI
2019111900127	NEROPOLIS	38802	DAIA S2	19/11/2019 16:09	19/11/2019 16:12	19/11/2019 16:09	19/11/2019 16:12	0,05	2	0,10	CHI
2019111900127	SILVANIA	10701	DAIA S2	19/11/2019 16:09	19/11/2019 16:12	19/11/2019 16:09	19/11/2019 16:12	0,05	305	15,25	CHI
2019111900127	SILVANIA	31001	DAIA S2	19/11/2019 16:09	19/11/2019 16:12	19/11/2019 16:09	19/11/2019 16:12	0,05	341	17,05	CHI
2019111900127	SILVANIA	10702	DAIA S2	19/11/2019 16:09	19/11/2019 16:12	19/11/2019 16:09	19/11/2019 16:12	0,05	245	12,25	CHI
2019111900127	SILVANIA	00030618	DAIA S2	19/11/2019 16:09	19/11/2019 16:12	19/11/2019 16:09	19/11/2019 16:12	0,05	19	0,95	CHI
2019111900127	TEREZOPOLIS DE GOIAS	33801	DAIA S2	19/11/2019 16:09	19/11/2019 16:12	19/11/2019 16:09	19/11/2019 16:12	0,05	46	2,30	CHI
2019111900127	TEREZOPOLIS DE GOIAS	38801	DAIA S2	19/11/2019 16:09	19/11/2019 16:12	19/11/2019 16:09	19/11/2019 16:12	0,05	2252	112,60	CHI
2019111900127	TEREZOPOLIS DE GOIAS	38802	DAIA S2	19/11/2019 16:09	19/11/2019 16:12	19/11/2019 16:09	19/11/2019 16:12	0,05	693	34,65	CHI
2019111900127	TEREZOPOLIS DE GOIAS	33832	DAIA S2	19/11/2019 16:09	19/11/2019 16:12	19/11/2019 16:09	19/11/2019 16:12	0,05	2	0,10	CHI
2019111900127	ANAPOLIS	02370605	NEROPOLIS S1	19/11/2019 16:09	19/11/2019 16:12	19/11/2019 16:09	19/11/2019 16:12	0,05	3	0,15	CHI
2019111900127	CAMPO LIMPO	02370605	NEROPOLIS S1	19/11/2019 16:09	19/11/2019 16:12	19/11/2019 16:09	19/11/2019 16:12	0,05	135	6,75	CHI
2019111900178	ALVORADA DO NORTE	00015124	IACIARA S2	19/11/2019 15:48	19/11/2019 15:52	19/11/2019 15:48	19/11/2019 15:52	0,07	1997	133,13	CHI
2019111900178	ALVORADA DO NORTE	00015124	IACIARA S2	19/11/2019 15:48	19/11/2019 15:52	19/11/2019 15:48	19/11/2019 15:52	0,07	1158	77,20	CHI
2019111900178	ALVORADA DO NORTE	00015124	IACIARA S2	19/11/2019 15:48	19/11/2019 15:52	19/11/2019 15:48	19/11/2019 15:52	0,07	3	0,20	CHI
2019111900178	BURITINOPOLIS	00015124	IACIARA S2	19/11/2019 15:48	19/11/2019 15:52	19/11/2019 15:48	19/11/2019 15:52	0,07	1030	68,67	CHI
2019111900178	BURITINOPOLIS	49901	IACIARA S2	19/11/2019 15:48	19/11/2019 15:52	19/11/2019 15:48	19/11/2019 15:52	0,07	441	29,40	CHI
2019111900178	DAMIANOPOLIS	11101	IACIARA S2	19/11/2019 15:48	19/11/2019 15:52	19/11/2019 15:48	19/11/2019 15:52	0,07	130	8,67	CHI
2019111900178	DAMIANOPOLIS	49902	IACIARA S2	19/11/2019 15:48	19/11/2019 15:52	19/11/2019 15:48	19/11/2019 15:52	0,07	1502	100,13	CHI
2019111900178	MAMBAI	49901	IACIARA S2	19/11/2019 15:48	19/11/2019 15:52	19/11/2019 15:48	19/11/2019 15:52	0,07	2861	190,73	CHI
2019111900178	MAMBAI	49902	IACIARA S2	19/11/2019 15:48	19/11/2019 15:52	19/11/2019 15:48	19/11/2019 15:52	0,07	83	5,53	CHI
2019111900178	POSSE	00015124	IACIARA S2	19/11/2019 15:48	19/11/2019 15:52	19/11/2019 15:48	19/11/2019 15:52	0,07	105	7,00	CHI
2019111900178	POSSE	00015124	IACIARA S2	19/11/2019 15:48	19/11/2019 15:52	19/11/2019 15:48	19/11/2019 15:52	0,07	81	5,40	CHI
2019111900178	SIMOLANDIA	00015124	IACIARA S2	19/11/2019 15:48	19/11/2019 15:52	19/11/2019 15:48	19/11/2019 15:52	0,07	2124	141,60	CHI
2019111900178	SIMOLANDIA	00015124	IACIARA S2	19/11/2019 15:48	19/11/2019 15:52	19/11/2019 15:48	19/11/2019 15:52	0,07	2	0,13	CHI
2019111900178	SIMOLANDIA	00015124	IACIARA S2	19/11/2019 15:48	19/11/2019 15:52	19/11/2019 15:48	19/11/2019 15:52	0,07	247	16,47	CHI
2019111900178	SITIO D ABADIA	11101	IACIARA S2	19/11/2019 15:48	19/11/2019 15:52	19/11/2019 15:48	19/11/2019 15:52	0,07	375	25,00	CHI
2019111900178	SITIO D ABADIA	42901	IACIARA S2	19/11/2019 15:48	19/11/2019 15:52	19/11/2019 15:48	19/11/2019 15:52	0,07	91	6,07	CHI
2019111900178	SITIO D ABADIA	49901	IACIARA S2	19/11/2019 15:48	19/11/2019 15:52	19/11/2019 15:48	19/11/2019 15:52	0,07	1	0,07	CHI
2019111900178	SITIO D ABADIA	42902	IACIARA S2	19/11/2019 15:48	19/11/2019 15:52	19/11/2019 15:48	19/11/2019 15:52	0,07	479	31,93	CHI

2019111900178	VILA BOA	18901	IACIARA S2	19/11/2019 15:48	19/11/2019 15:52	19/11/2019 15:48	19/11/2019 15:52	0,07	1357	90,47	CHI
2019111900179	CABECEIRAS	22101	ITUIQUIRA	19/11/2019 15:48	19/11/2019 15:53	19/11/2019 15:48	19/11/2019 15:53	0,08	2898	241,50	CHI
2019111900179	CABECEIRAS	03740424	ITUIQUIRA	19/11/2019 15:48	19/11/2019 15:53	19/11/2019 15:48	19/11/2019 15:53	0,08	48	4,00	CHI
2019111900179	CABECEIRAS	03740434	ITUIQUIRA	19/11/2019 15:48	19/11/2019 15:53	19/11/2019 15:48	19/11/2019 15:53	0,08	198	16,50	CHI
2019111900179	CABECEIRAS	22134	ITUIQUIRA	19/11/2019 15:48	19/11/2019 15:53	19/11/2019 15:48	19/11/2019 15:53	0,08	23	1,92	CHI
2019111900179	CABECEIRAS	03740444	ITUIQUIRA	19/11/2019 15:48	19/11/2019 15:53	19/11/2019 15:48	19/11/2019 15:53	0,08	142	11,83	CHI
2019111900179	CABECEIRAS	03740454	ITUIQUIRA	19/11/2019 15:48	19/11/2019 15:53	19/11/2019 15:48	19/11/2019 15:53	0,08	40	3,33	CHI
2019111900179	DISTRITO FEDERAL	22101	ITUIQUIRA	19/11/2019 15:48	19/11/2019 15:53	19/11/2019 15:48	19/11/2019 15:53	0,08	1	0,08	CHI
2019111900179	DISTRITO FEDERAL	03740414	ITUIQUIRA	19/11/2019 15:48	19/11/2019 15:53	19/11/2019 15:48	19/11/2019 15:53	0,08	2	0,17	CHI
2019111900179	DISTRITO FEDERAL	22134	ITUIQUIRA	19/11/2019 15:48	19/11/2019 15:53	19/11/2019 15:48	19/11/2019 15:53	0,08	1	0,08	CHI
2019111900179	DISTRITO FEDERAL	03740454	ITUIQUIRA	19/11/2019 15:48	19/11/2019 15:53	19/11/2019 15:48	19/11/2019 15:53	0,08	1	0,08	CHI
2019111900179	FLORES DE GOIAS	25901	ITUIQUIRA	19/11/2019 15:48	19/11/2019 15:53	19/11/2019 15:48	19/11/2019 15:53	0,08	3	0,25	CHI
2019111900179	FORMOSA	25901	ITUIQUIRA	19/11/2019 15:48	19/11/2019 15:53	19/11/2019 15:48	19/11/2019 15:53	0,08	571	47,58	CHI
2019111900179	FORMOSA	28201	ITUIQUIRA	19/11/2019 15:48	19/11/2019 15:53	19/11/2019 15:48	19/11/2019 15:53	0,08	740	61,67	CHI
2019111900179	FORMOSA	03740214	ITUIQUIRA	19/11/2019 15:48	19/11/2019 15:53	19/11/2019 15:48	19/11/2019 15:53	0,08	11616	968,00	CHI
2019111900179	FORMOSA	03740224	ITUIQUIRA	19/11/2019 15:48	19/11/2019 15:53	19/11/2019 15:48	19/11/2019 15:53	0,08	15379	1281,58	CHI
2019111900179	FORMOSA	03742134	ITUIQUIRA	19/11/2019 15:48	19/11/2019 15:53	19/11/2019 15:48	19/11/2019 15:53	0,08	14609	1217,42	CHI
2019111900179	FORMOSA	03740414	ITUIQUIRA	19/11/2019 15:48	19/11/2019 15:53	19/11/2019 15:48	19/11/2019 15:53	0,08	33	2,75	CHI
2019111900179	FORMOSA	03740424	ITUIQUIRA	19/11/2019 15:48	19/11/2019 15:53	19/11/2019 15:48	19/11/2019 15:53	0,08	6	0,50	CHI
2019111900179	FORMOSA	03740434	ITUIQUIRA	19/11/2019 15:48	19/11/2019 15:53	19/11/2019 15:48	19/11/2019 15:53	0,08	2	0,17	CHI
2019111900179	FORMOSA	03740444	ITUIQUIRA	19/11/2019 15:48	19/11/2019 15:53	19/11/2019 15:48	19/11/2019 15:53	0,08	31	2,58	CHI
2019111900179	FORMOSA	03740454	ITUIQUIRA	19/11/2019 15:48	19/11/2019 15:53	19/11/2019 15:48	19/11/2019 15:53	0,08	2388	199,00	CHI
2019111900179	ITARUMA	03742134	ITUIQUIRA	19/11/2019 15:48	19/11/2019 15:53	19/11/2019 15:48	19/11/2019 15:53	0,08	3	0,25	CHI
2019111900179	SAO JOAO D ALIANCA	25901	ITUIQUIRA	19/11/2019 15:48	19/11/2019 15:53	19/11/2019 15:48	19/11/2019 15:53	0,08	225	18,75	CHI
2019111900179	VILA BOA	25901	ITUIQUIRA	19/11/2019 15:48	19/11/2019 15:53	19/11/2019 15:48	19/11/2019 15:53	0,08	6	0,50	CHI
2019111900179	VILA BOA	03740454	ITUIQUIRA	19/11/2019 15:48	19/11/2019 15:53	19/11/2019 15:48	19/11/2019 15:53	0,08	203	16,92	CHI
2019112000008	RIO VERDE	02450414	CABRIUVA S2	20/11/2019 15:08	20/11/2019 15:11	20/11/2019 15:08	20/11/2019 15:11	0,05	80	4,00	CHI
2019112000037	ARENOPOLIS	00160503	ARENOPOLIS	20/11/2019 13:33	20/11/2019 13:36	20/11/2019 13:33	20/11/2019 13:36	0,05	1309	65,45	CHI
2019112000037	ARENOPOLIS	00160503	ARENOPOLIS	20/11/2019 13:33	20/11/2019 13:36	20/11/2019 13:33	20/11/2019 13:36	0,05	223	11,15	CHI
2019112000037	ARENOPOLIS	00160503	ARENOPOLIS	20/11/2019 13:33	20/11/2019 13:36	20/11/2019 13:33	20/11/2019 13:36	0,05	19	0,95	CHI
2019112000037	DIORAMA	00160503	ARENOPOLIS	20/11/2019 13:33	20/11/2019 13:36	20/11/2019 13:33	20/11/2019 13:36	0,05	165	8,25	CHI
2019112000037	DIORAMA	00160503	ARENOPOLIS	20/11/2019 13:33	20/11/2019 13:36	20/11/2019 13:33	20/11/2019 13:36	0,05	12	0,60	CHI
2019112000037	IPORA	00160503	ARENOPOLIS	20/11/2019 13:33	20/11/2019 13:36	20/11/2019 13:33	20/11/2019 13:36	0,05	157	7,85	CHI

2019112000037	IVOLANDIA	00160503	ARENOPOLIS	20/11/2019 13:33	20/11/2019 13:36	20/11/2019 13:33	20/11/2019 13:36	0,05	83	4,15	CHI
2019112000037	MONTES CLAROS DE GOIAS	00160503	ARENOPOLIS	20/11/2019 13:33	20/11/2019 13:36	20/11/2019 13:33	20/11/2019 13:36	0,05	39	1,95	CHI
2019112000037	MONTES CLAROS DE GOIAS	00160503	ARENOPOLIS	20/11/2019 13:33	20/11/2019 13:36	20/11/2019 13:33	20/11/2019 13:36	0,05	24	1,20	CHI
2019112000037	PALESTINA DE GOIAS	00160503	ARENOPOLIS	20/11/2019 13:33	20/11/2019 13:36	20/11/2019 13:33	20/11/2019 13:36	0,05	50	2,50	CHI
2019112000037	PALESTINA DE GOIAS	00160503	ARENOPOLIS	20/11/2019 13:33	20/11/2019 13:36	20/11/2019 13:33	20/11/2019 13:36	0,05	7	0,35	CHI
2019112000037	PIRANHAS	00160503	ARENOPOLIS	20/11/2019 13:33	20/11/2019 13:36	20/11/2019 13:33	20/11/2019 13:36	0,05	25	1,25	CHI
2019112000037	PIRANHAS	00160503	ARENOPOLIS	20/11/2019 13:33	20/11/2019 13:36	20/11/2019 13:33	20/11/2019 13:36	0,05	43	2,15	CHI
2019112000038	PIRANHAS	05560524	ARENOPOLIS	20/11/2019 13:33	20/11/2019 13:37	20/11/2019 13:33	20/11/2019 13:37	0,07	24	1,60	CHI
2019112000038	ARENOPOLIS	05560524	PIRANHAS	20/11/2019 13:33	20/11/2019 13:37	20/11/2019 13:33	20/11/2019 13:37	0,07	11	0,73	CHI
2019112000038	BOM JARDIM DE GOIAS	05560524	PIRANHAS	20/11/2019 13:33	20/11/2019 13:37	20/11/2019 13:33	20/11/2019 13:37	0,07	18	1,20	CHI
2019112000038	CAIAPONIA	05560524	PIRANHAS	20/11/2019 13:33	20/11/2019 13:37	20/11/2019 13:33	20/11/2019 13:37	0,07	1	0,07	CHI
2019112000038	CAIAPONIA	05560524	PIRANHAS	20/11/2019 13:33	20/11/2019 13:37	20/11/2019 13:33	20/11/2019 13:37	0,07	71	4,73	CHI
2019112000038	PIRANHAS	05560524	PIRANHAS	20/11/2019 13:33	20/11/2019 13:37	20/11/2019 13:33	20/11/2019 13:37	0,07	2098	139,87	CHI
2019112000038	PIRANHAS	05560524	PIRANHAS	20/11/2019 13:33	20/11/2019 13:37	20/11/2019 13:33	20/11/2019 13:37	0,07	3123	208,20	CHI
2019112000038	PIRANHAS	05560524	PIRANHAS	20/11/2019 13:33	20/11/2019 13:37	20/11/2019 13:33	20/11/2019 13:37	0,07	33	2,20	CHI
2019112000038	PIRANHAS	05560524	PIRANHAS	20/11/2019 13:33	20/11/2019 13:37	20/11/2019 13:33	20/11/2019 13:37	0,07	2	0,13	CHI
2019112000039	ARAGARCAS	00110504	ARAGARCAS	20/11/2019 13:33	20/11/2019 13:41	20/11/2019 13:33	20/11/2019 13:41	0,13	4558	607,73	CHI
2019112000039	ARAGARCAS	00110504	ARAGARCAS	20/11/2019 13:33	20/11/2019 13:41	20/11/2019 13:33	20/11/2019 13:41	0,13	3235	431,33	CHI
2019112000039	BOM JARDIM DE GOIAS	00110504	ARAGARCAS	20/11/2019 13:33	20/11/2019 13:41	20/11/2019 13:33	20/11/2019 13:41	0,13	37	4,93	CHI
2019112000039	ARAGARCAS	00240406	BOM JARDIM	20/11/2019 13:33	20/11/2019 13:41	20/11/2019 13:33	20/11/2019 13:41	0,13	58	7,73	CHI
2019112000039	ARAGARCAS	00240518	BOM JARDIM	20/11/2019 13:33	20/11/2019 13:41	20/11/2019 13:33	20/11/2019 13:41	0,13	57	7,60	CHI
2019112000039	BALIZA	00240406	BOM JARDIM	20/11/2019 13:33	20/11/2019 13:41	20/11/2019 13:33	20/11/2019 13:41	0,13	123	16,40	CHI
2019112000039	BALIZA	00240518	BOM JARDIM	20/11/2019 13:33	20/11/2019 13:41	20/11/2019 13:33	20/11/2019 13:41	0,13	146	19,47	CHI
2019112000039	BOM JARDIM DE GOIAS	00240406	BOM JARDIM	20/11/2019 13:33	20/11/2019 13:41	20/11/2019 13:33	20/11/2019 13:41	0,13	1324	176,53	CHI
2019112000039	BOM JARDIM DE GOIAS	00240518	BOM JARDIM	20/11/2019 13:33	20/11/2019 13:41	20/11/2019 13:33	20/11/2019 13:41	0,13	2491	332,13	CHI
2019112000039	PIRANHAS	00240406	BOM JARDIM	20/11/2019 13:33	20/11/2019 13:41	20/11/2019 13:33	20/11/2019 13:41	0,13	21	2,80	CHI
2019112000039	PIRANHAS	00240518	BOM JARDIM	20/11/2019 13:33	20/11/2019 13:41	20/11/2019 13:33	20/11/2019 13:41	0,13	18	2,40	CHI

Plotagem das Ocorrências conforme a Espacialização das Chuvas

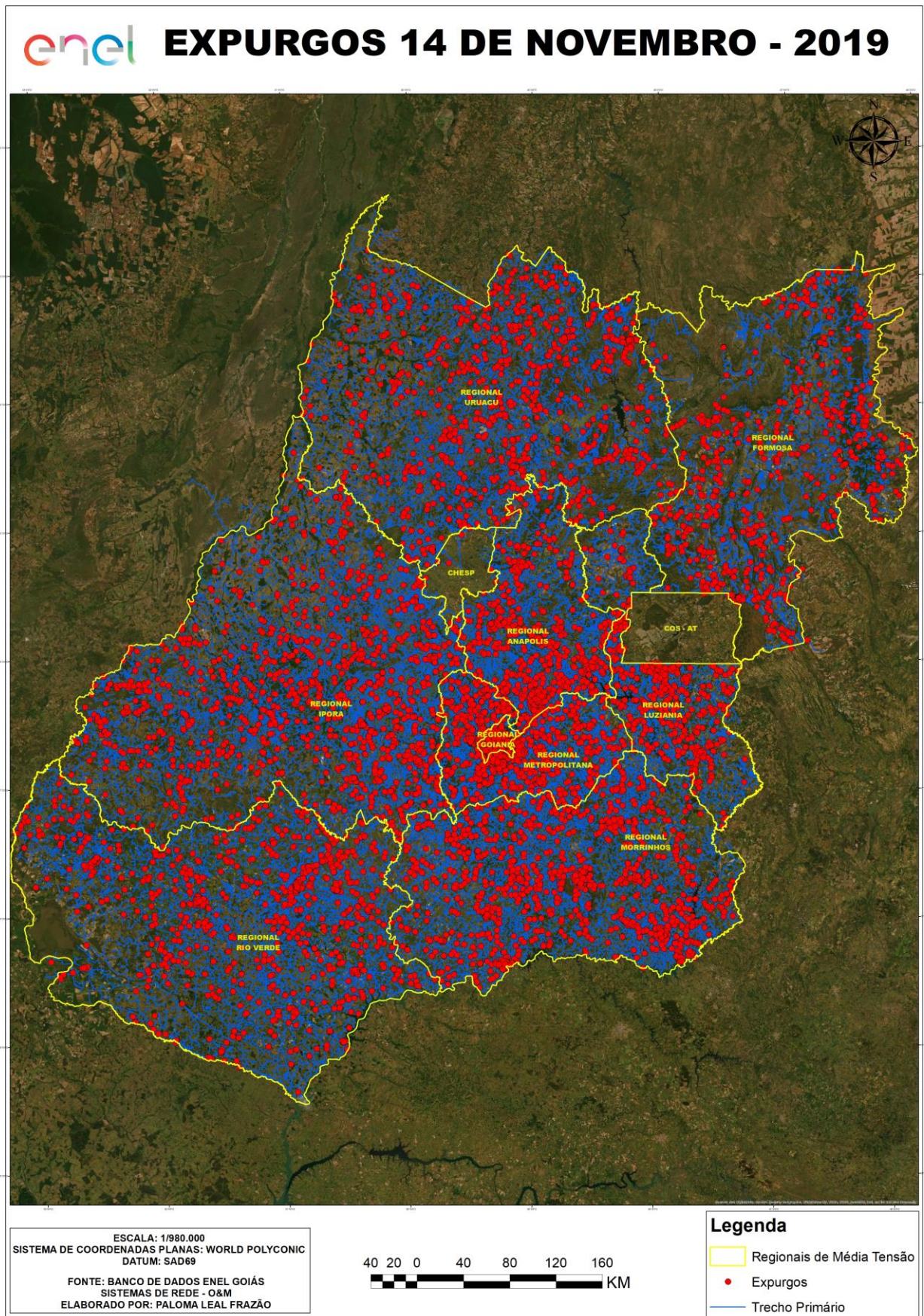

Diagramas Unifilares

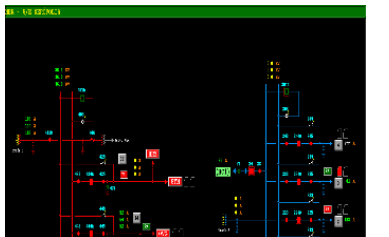
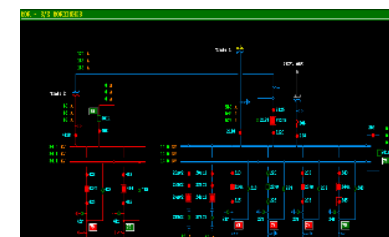
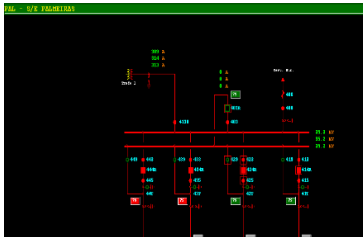
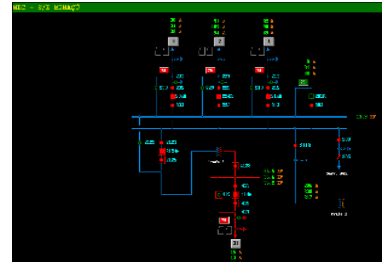
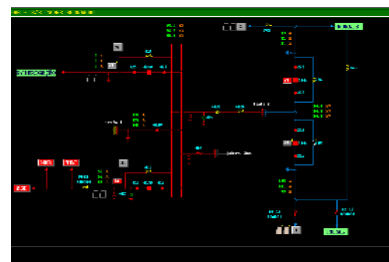
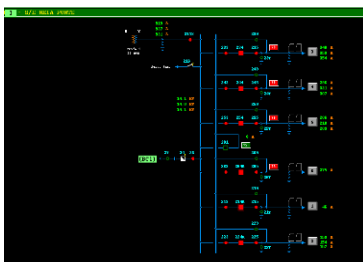
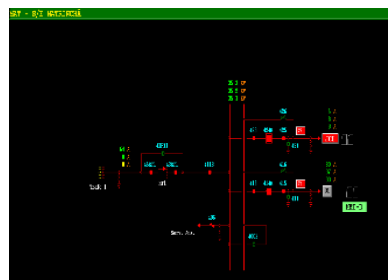
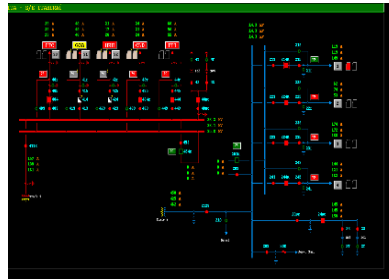
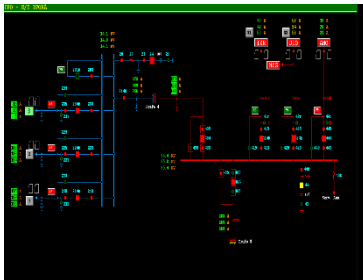
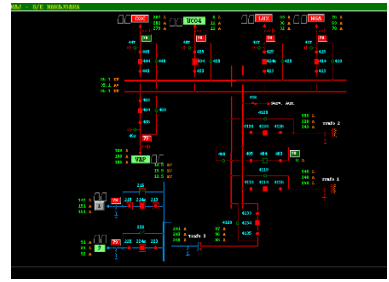
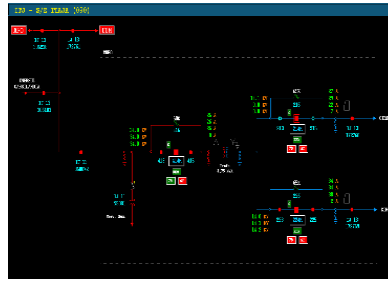
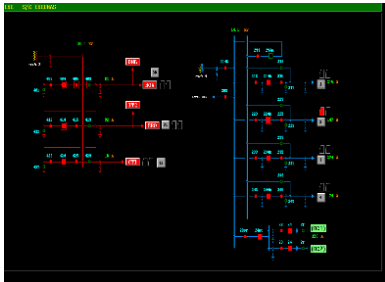
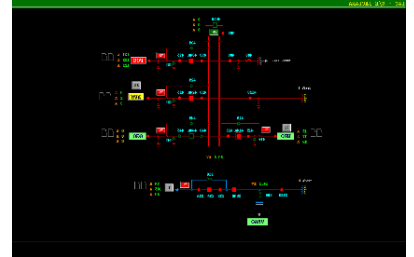
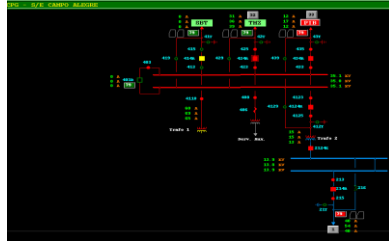
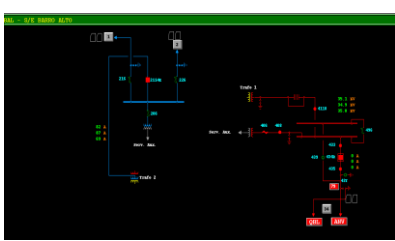
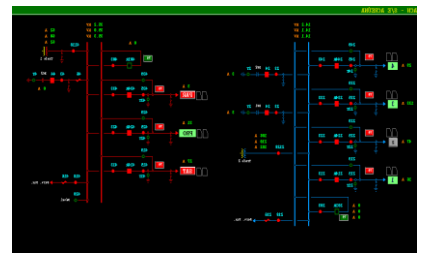
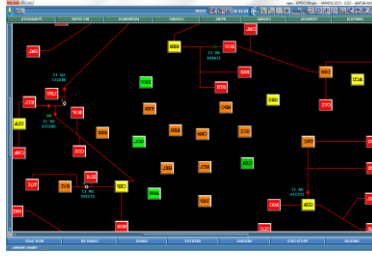
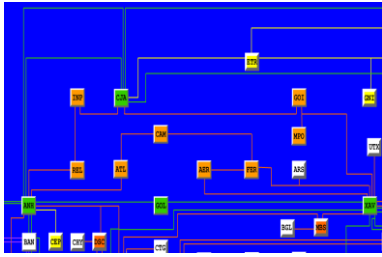

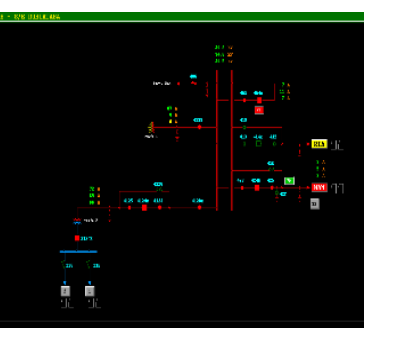
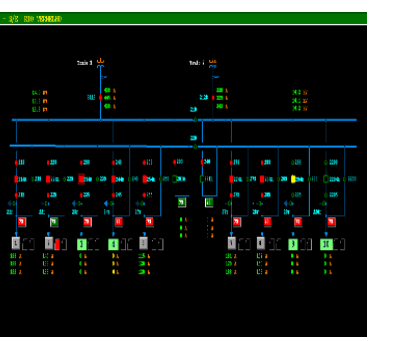
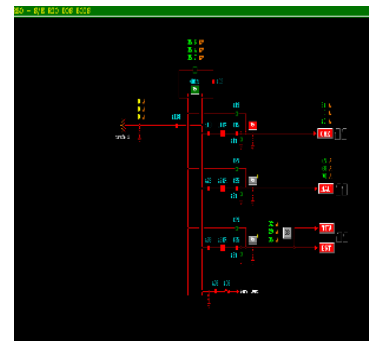
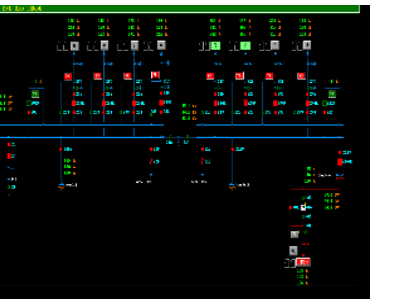
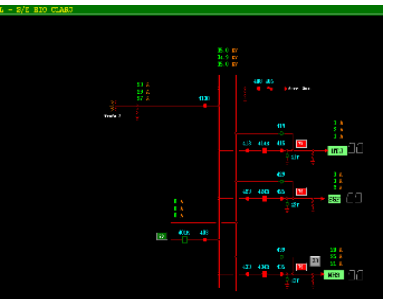
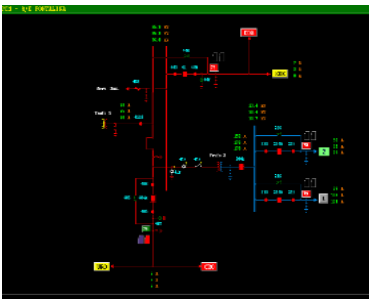
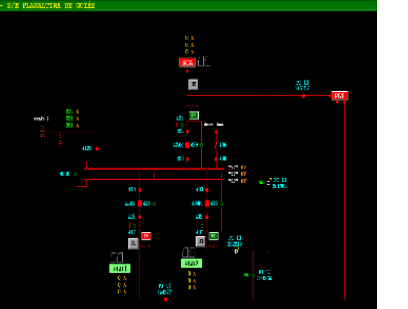
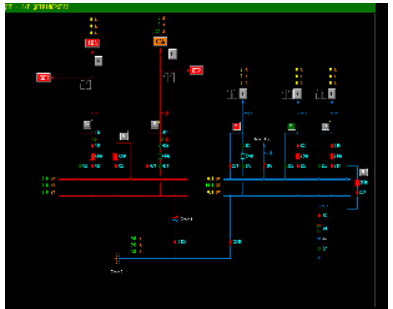
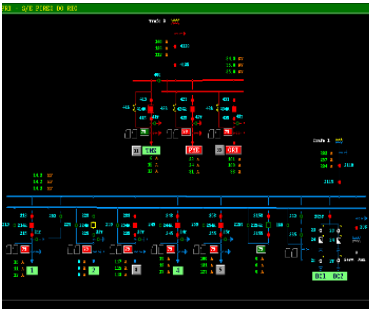
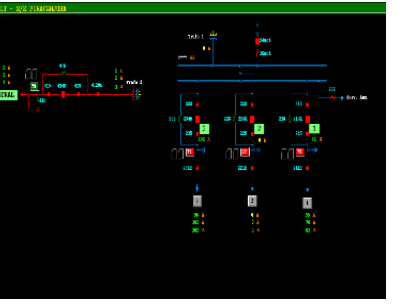
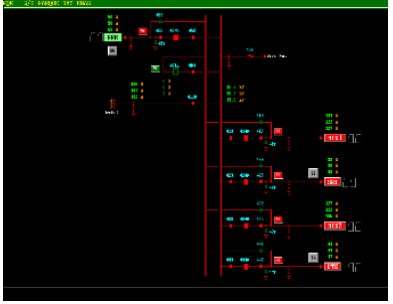
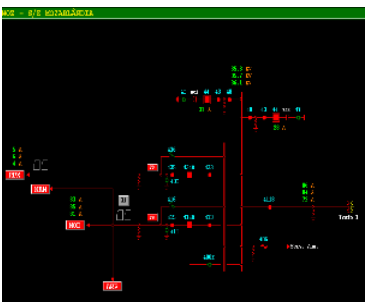
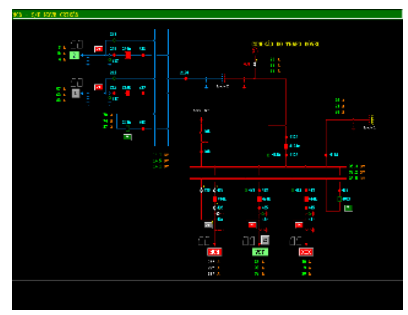

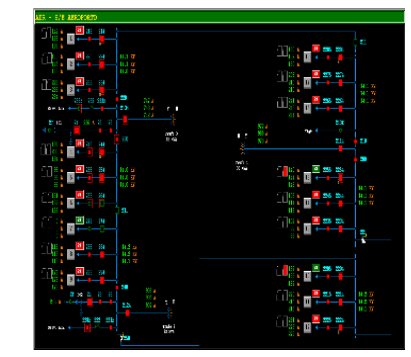
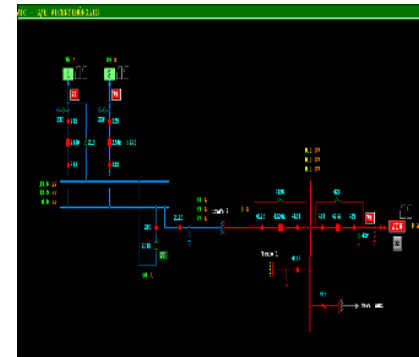
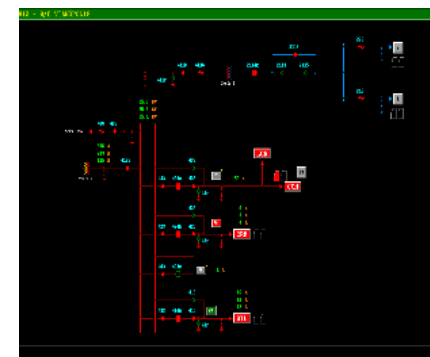
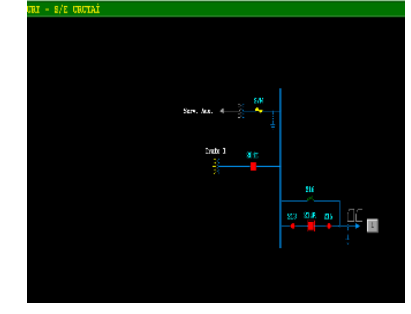
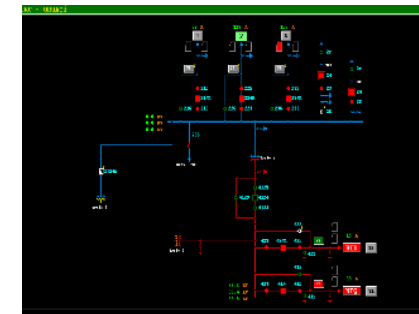
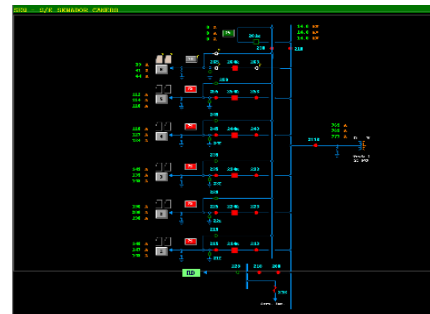
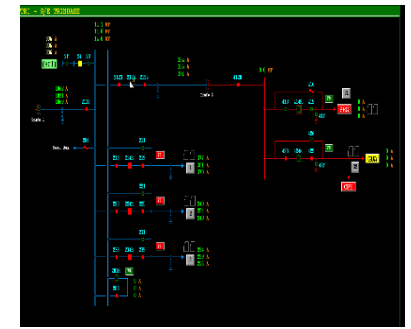
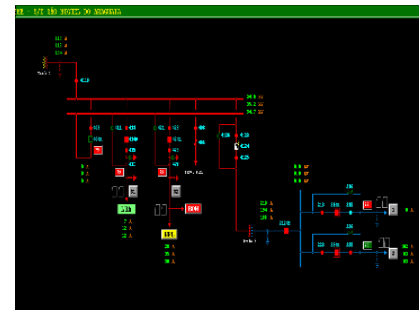
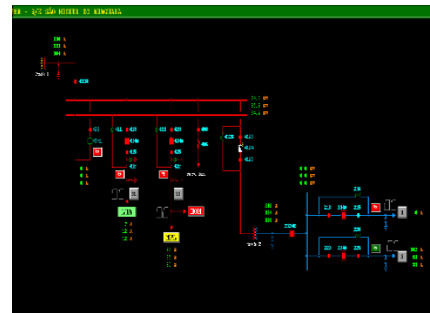
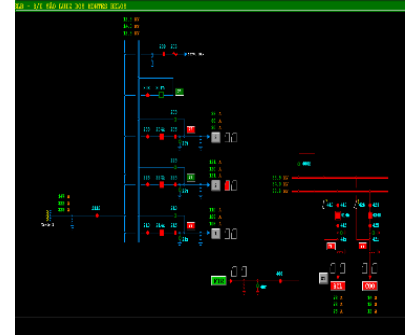
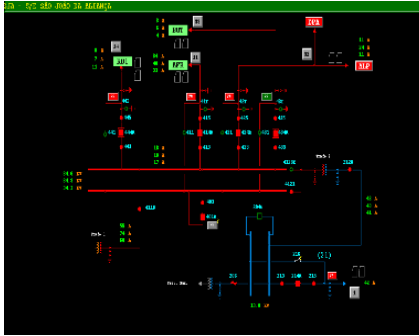
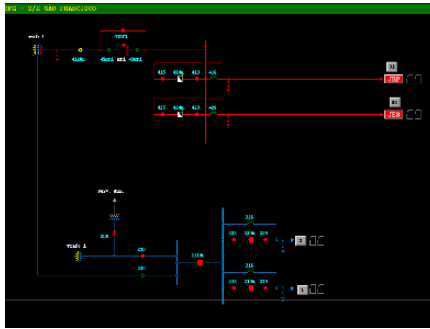
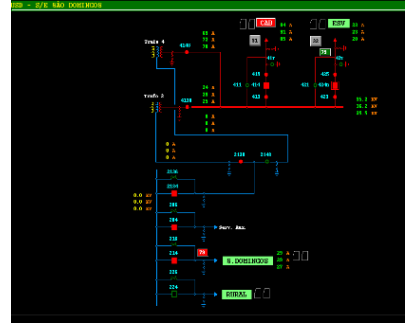
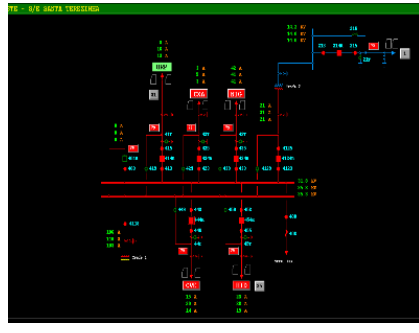
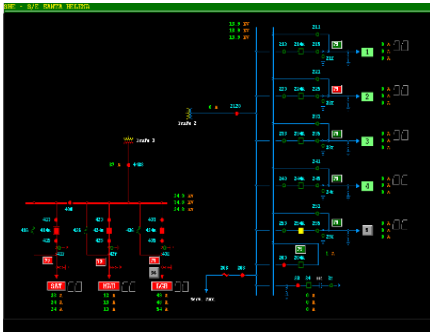

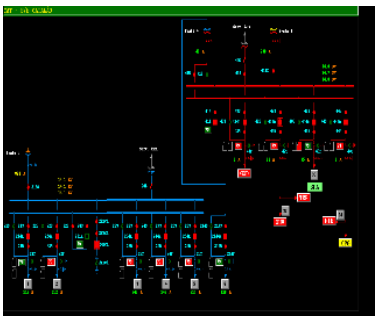
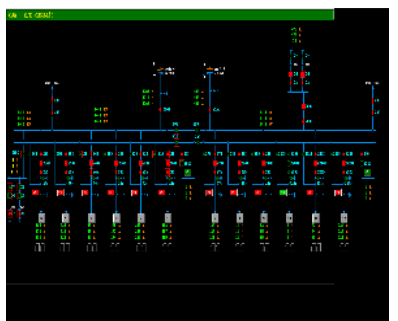
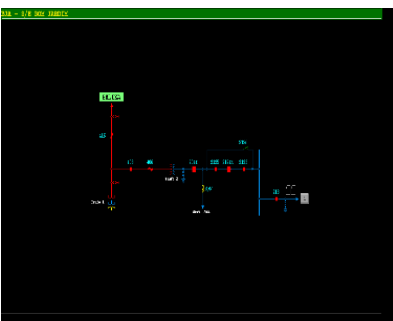
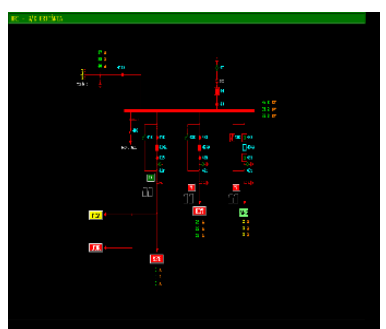
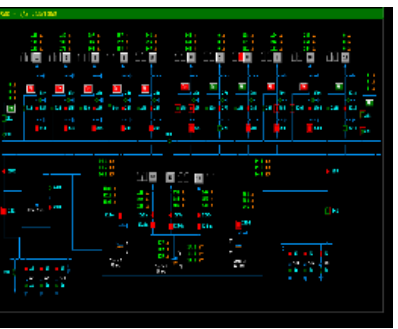
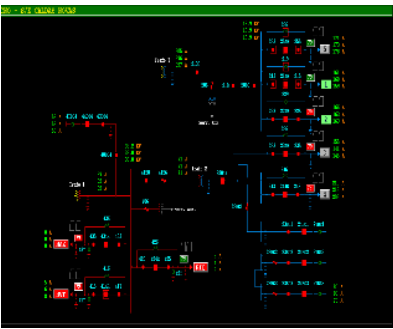
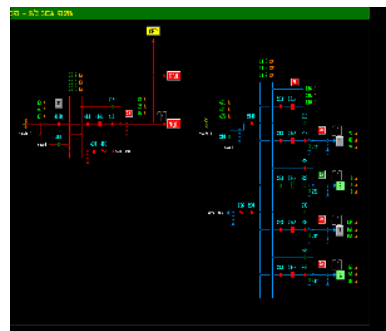
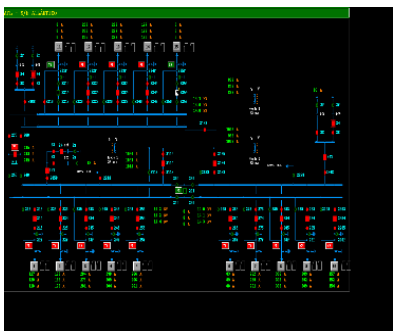
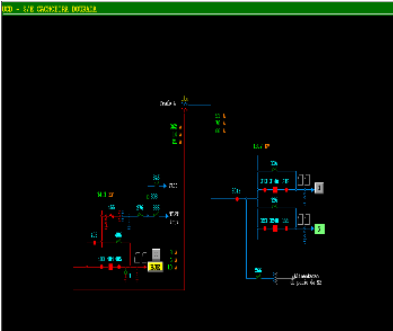
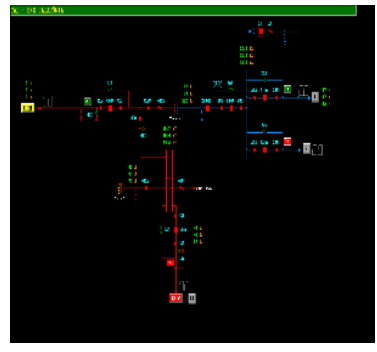
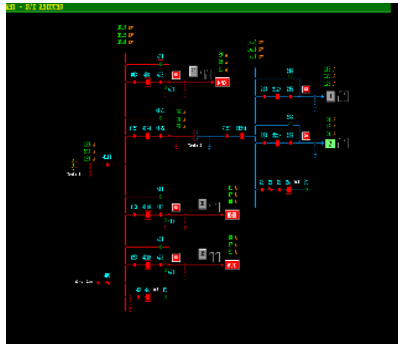
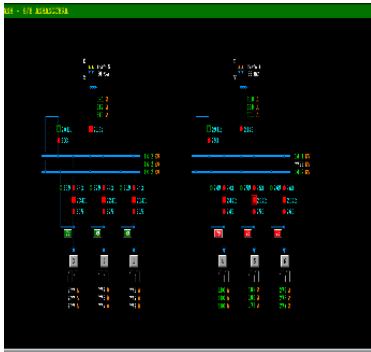
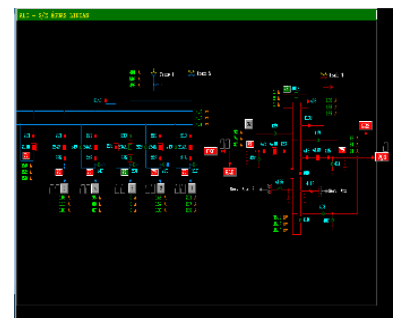
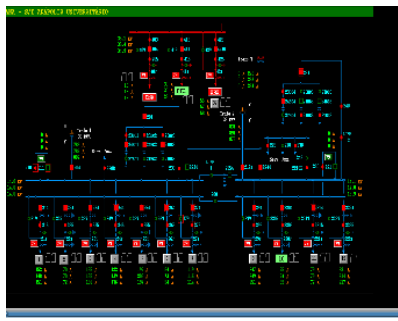
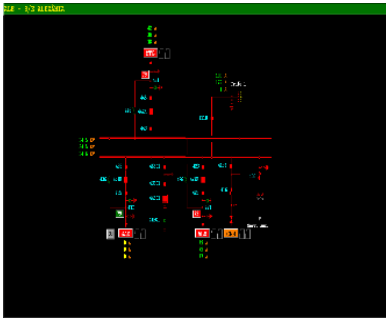

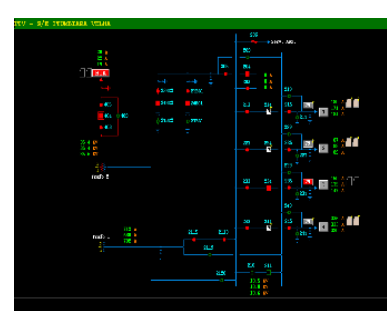
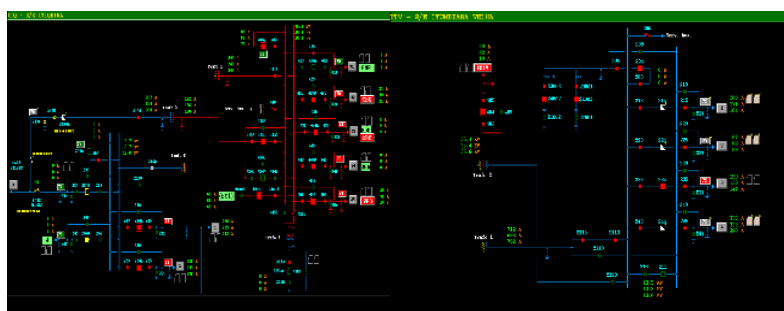
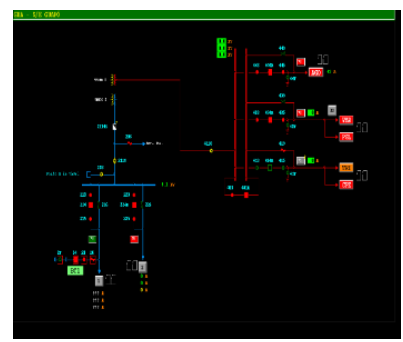
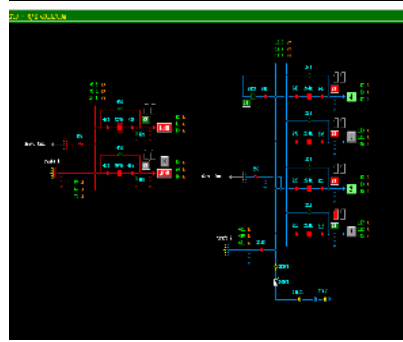
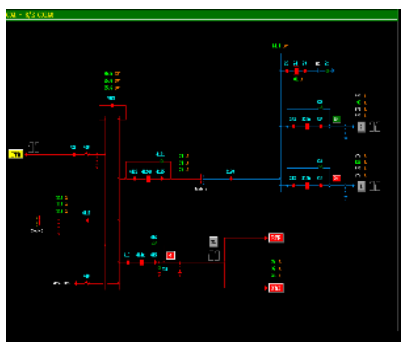
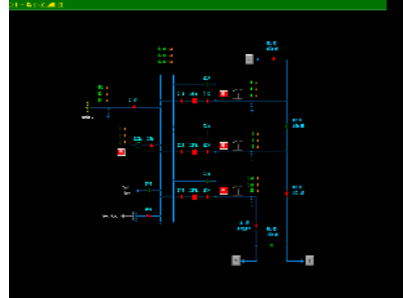
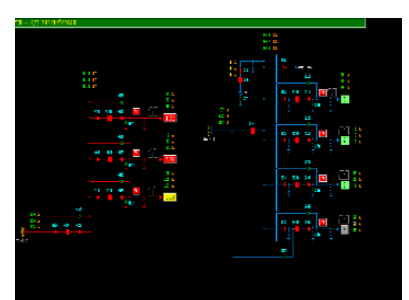
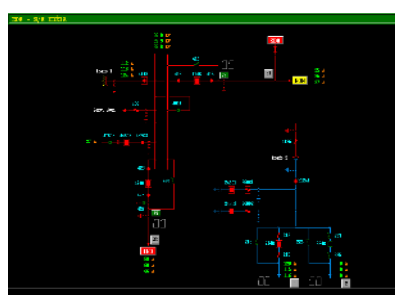
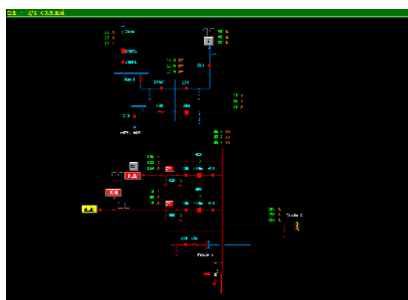
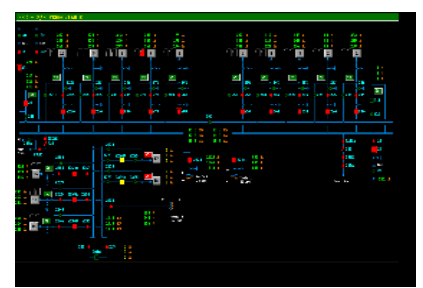
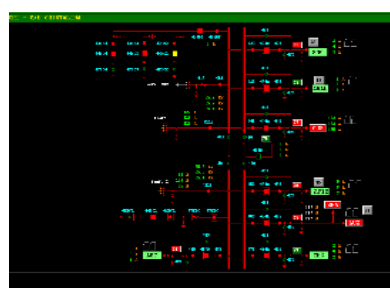
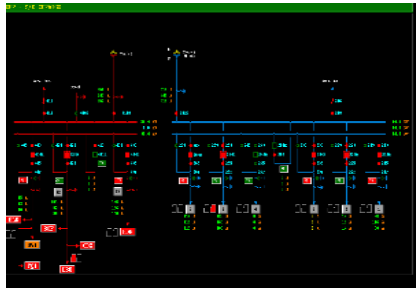
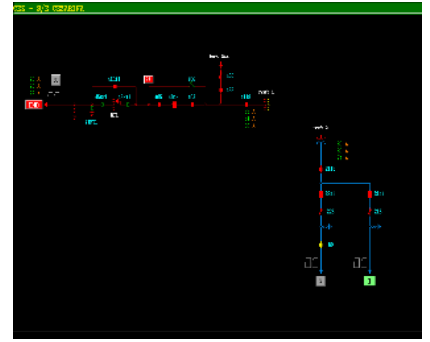
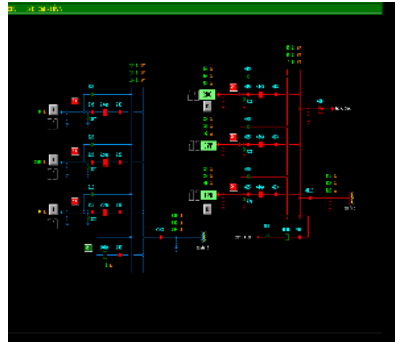
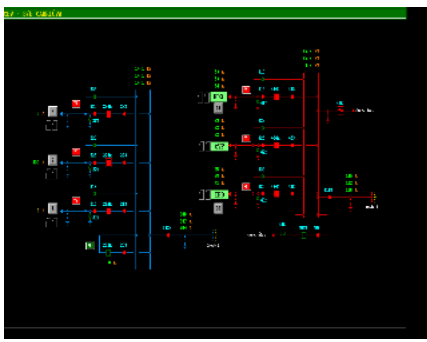

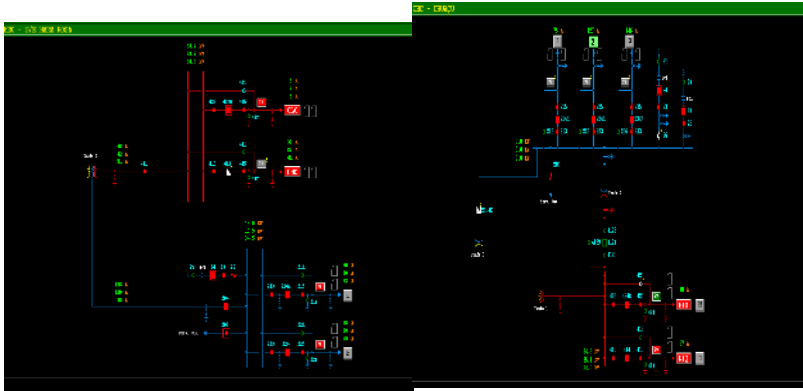
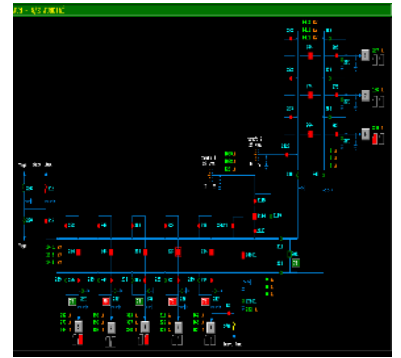
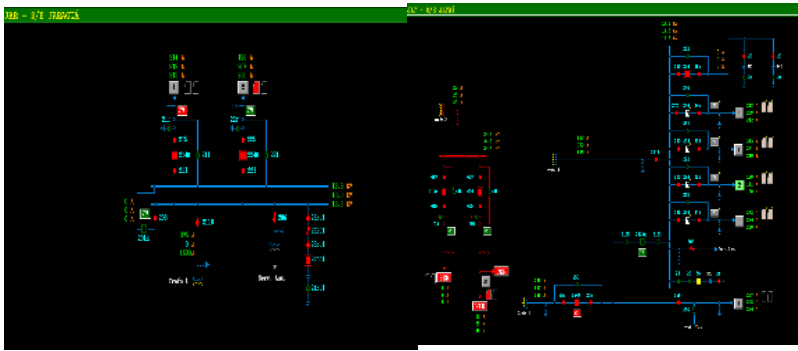

DEMAIS EVIDÊNCIAS

DADOS TÉCNICO - OPERACIONAIS ENEL GO

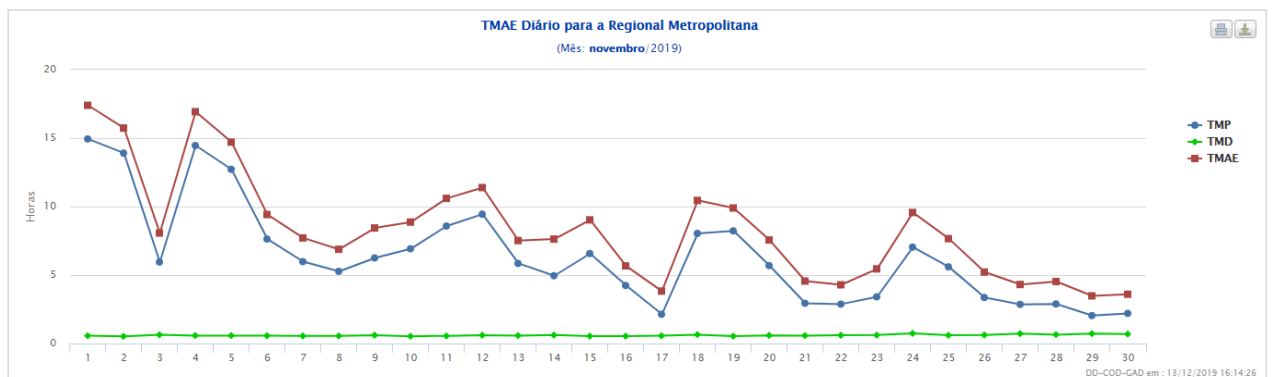
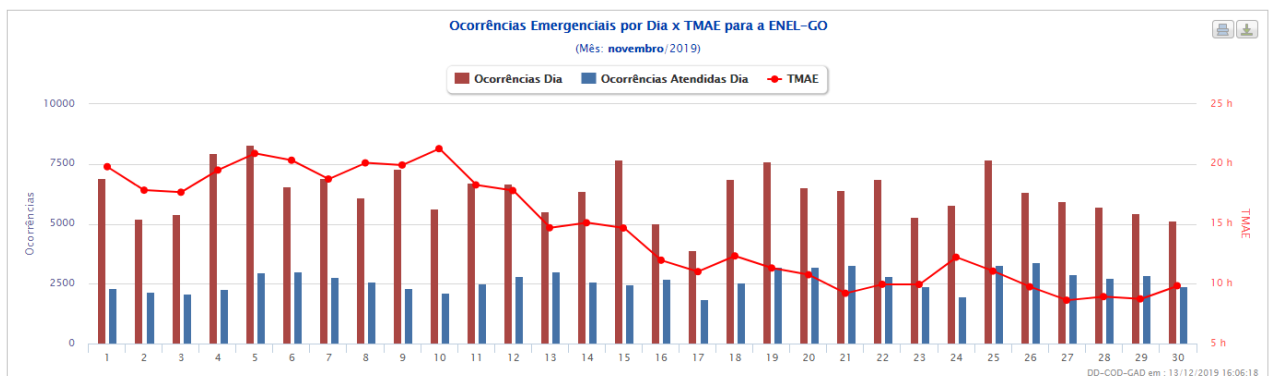
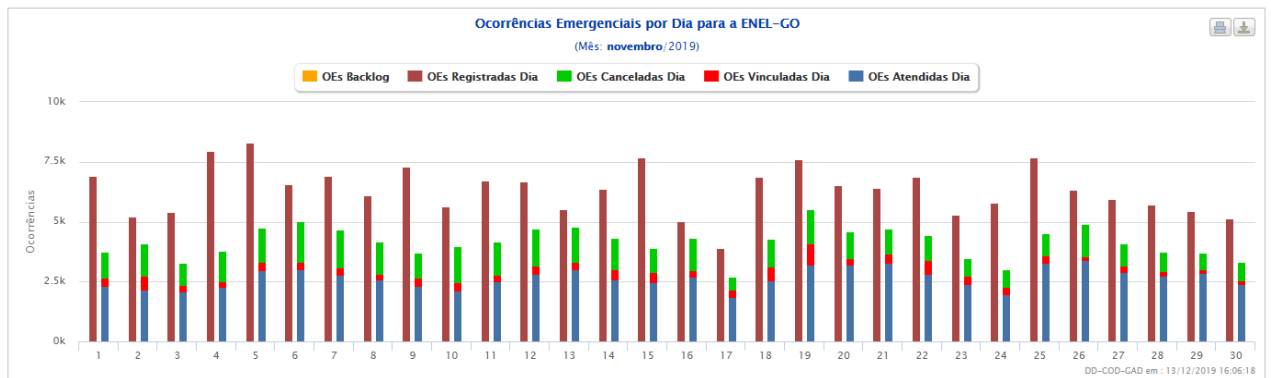
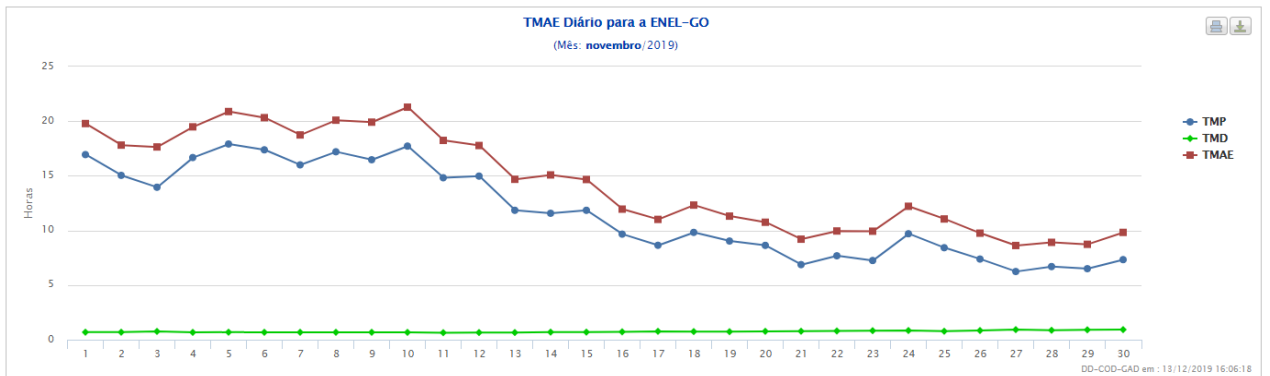

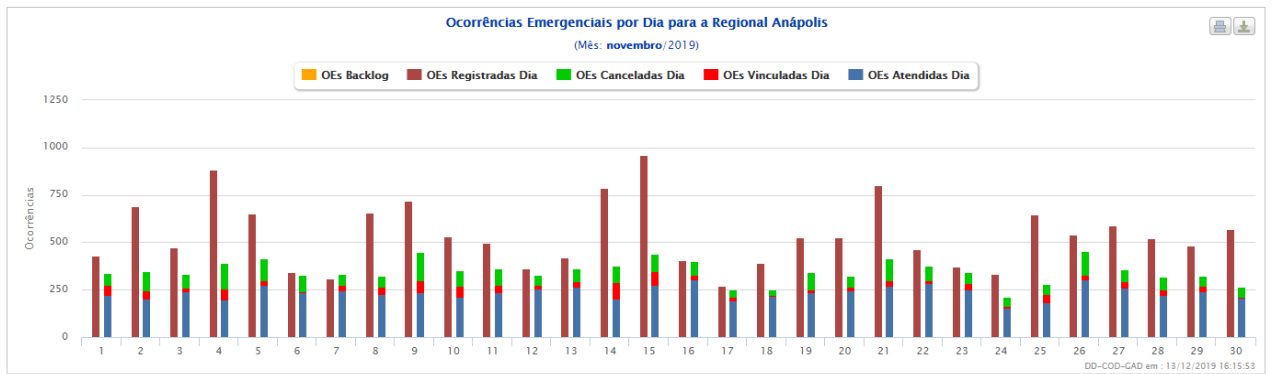
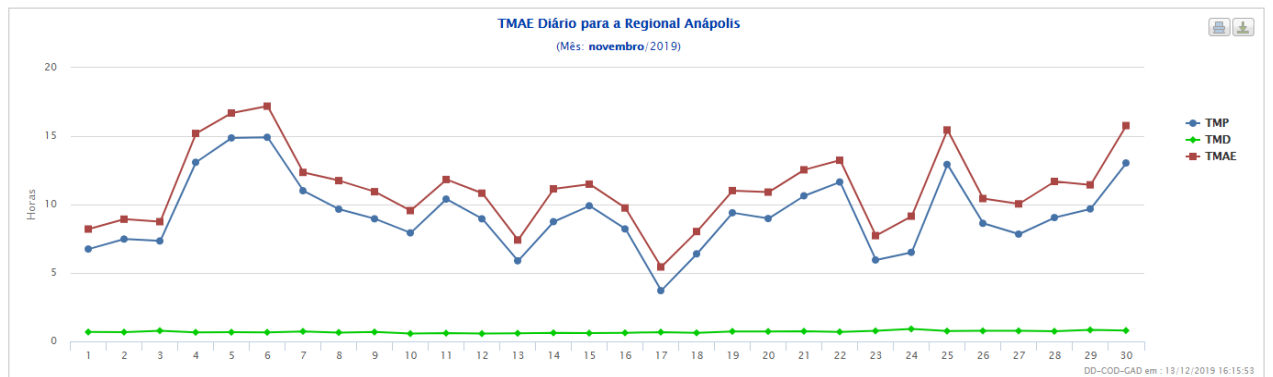
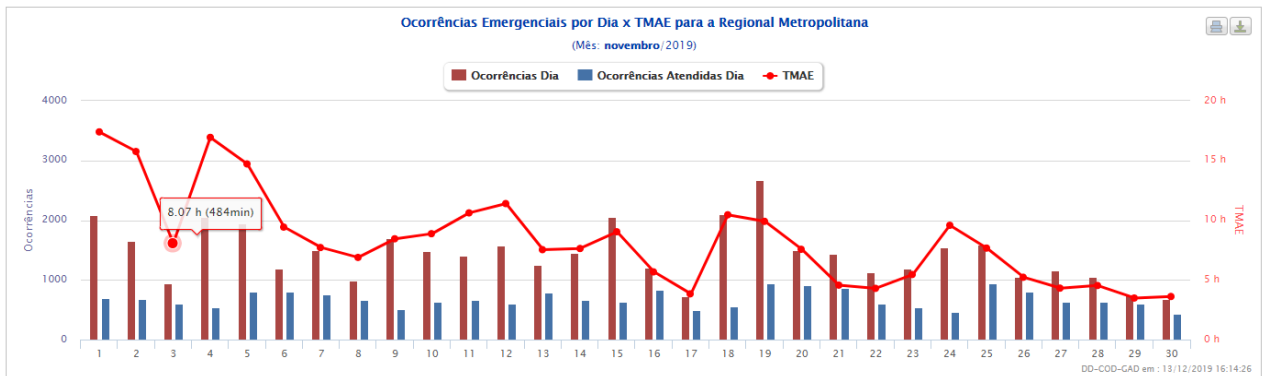
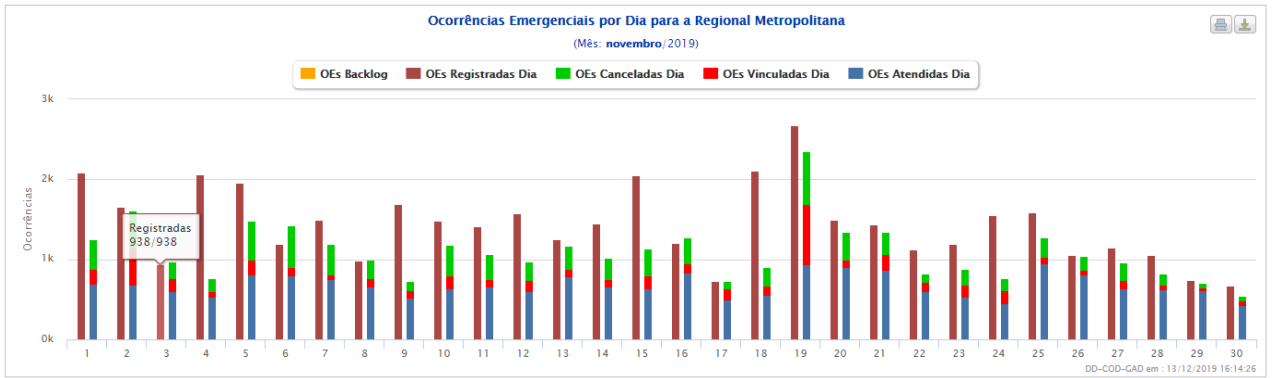

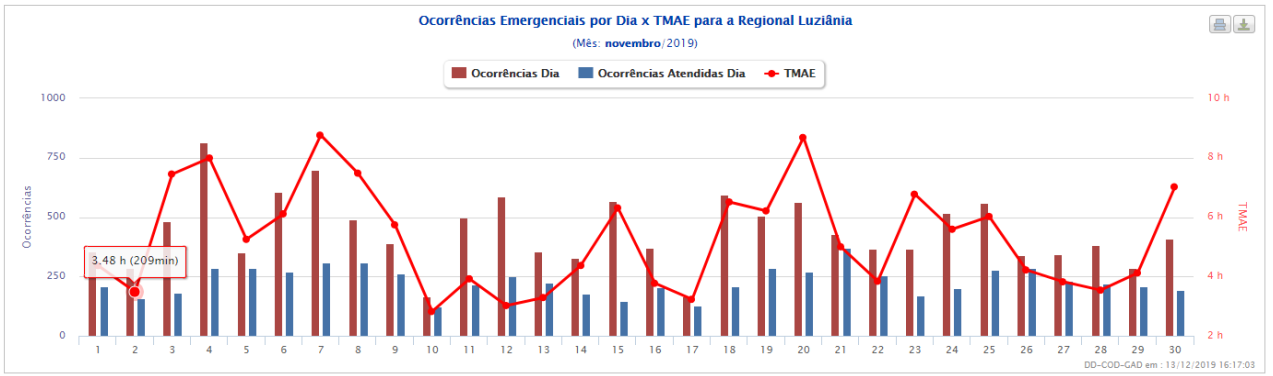
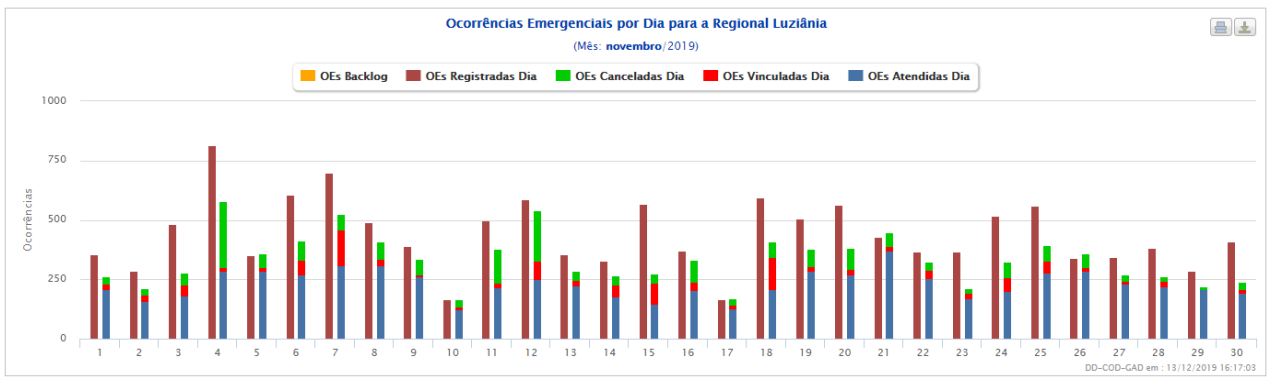
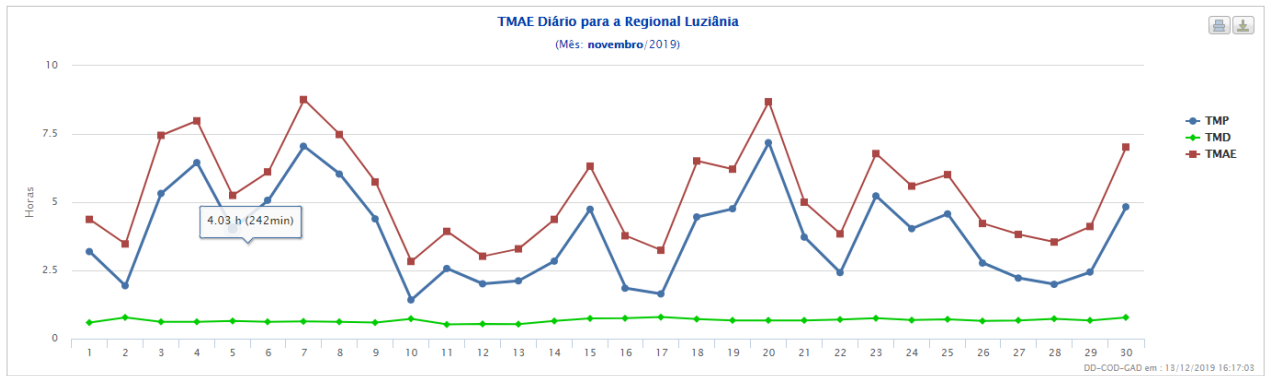
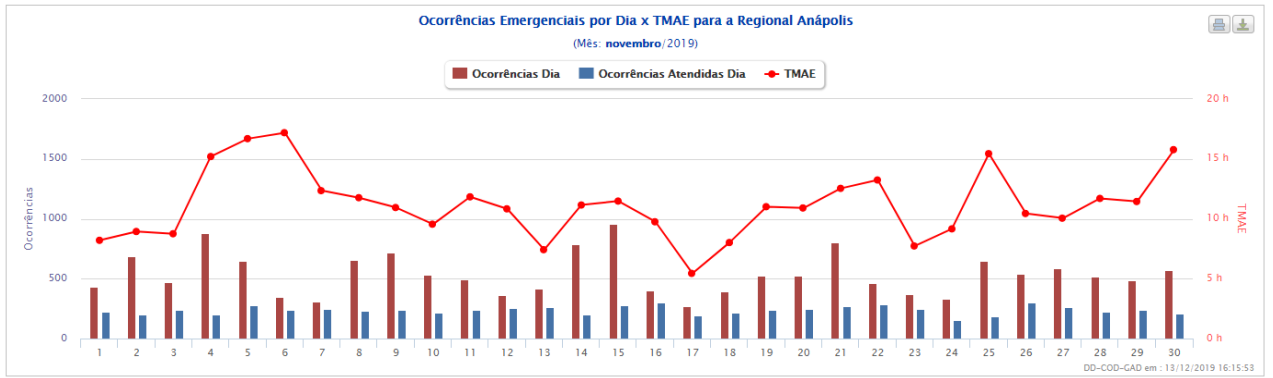

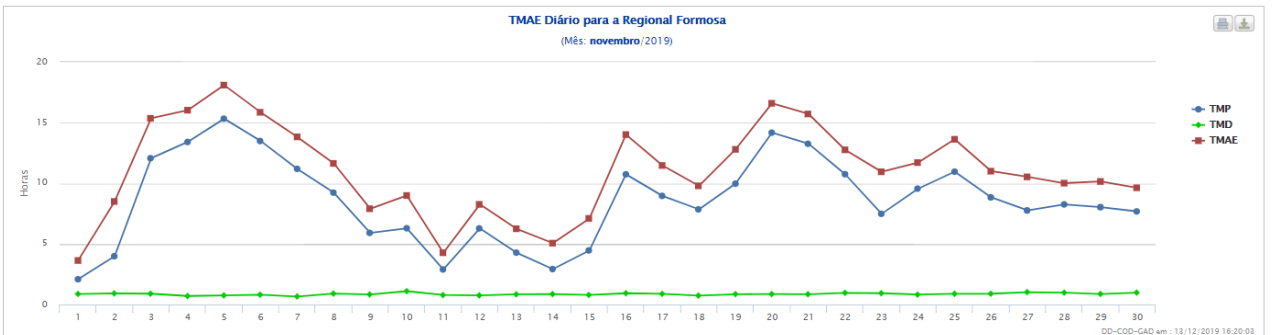
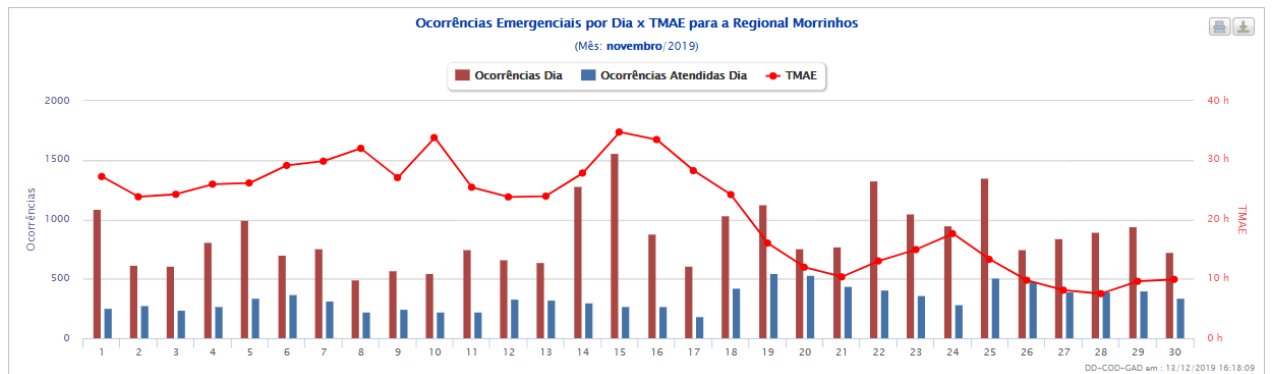
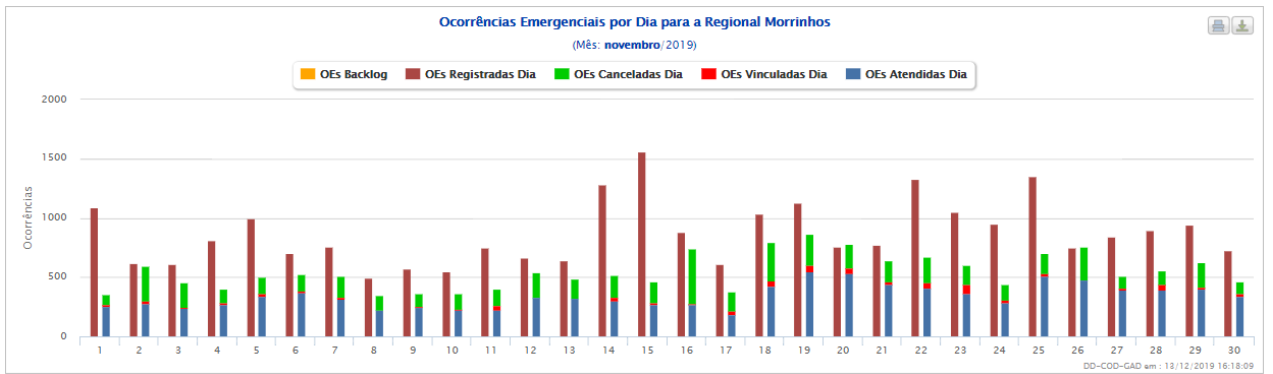
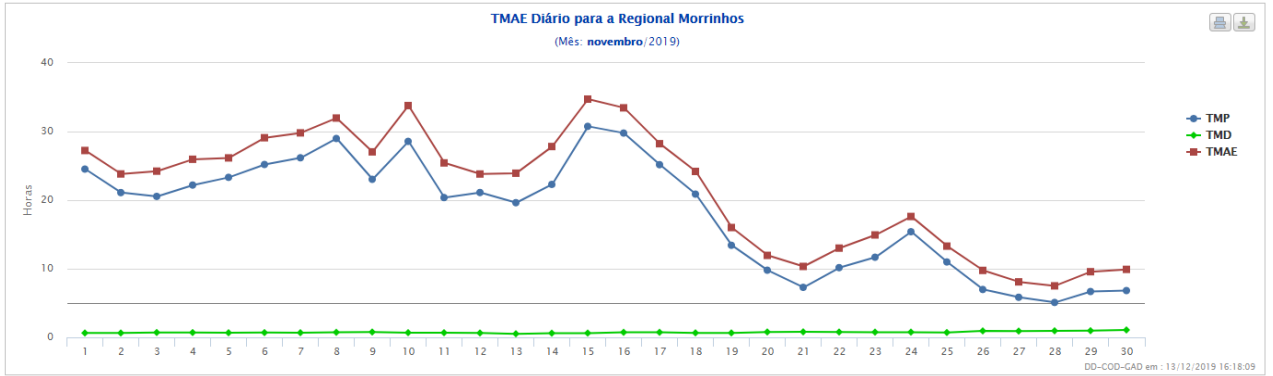

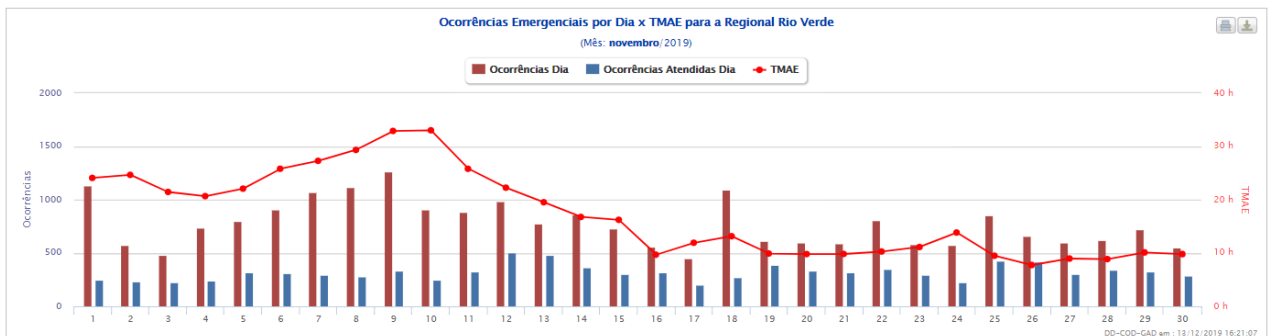
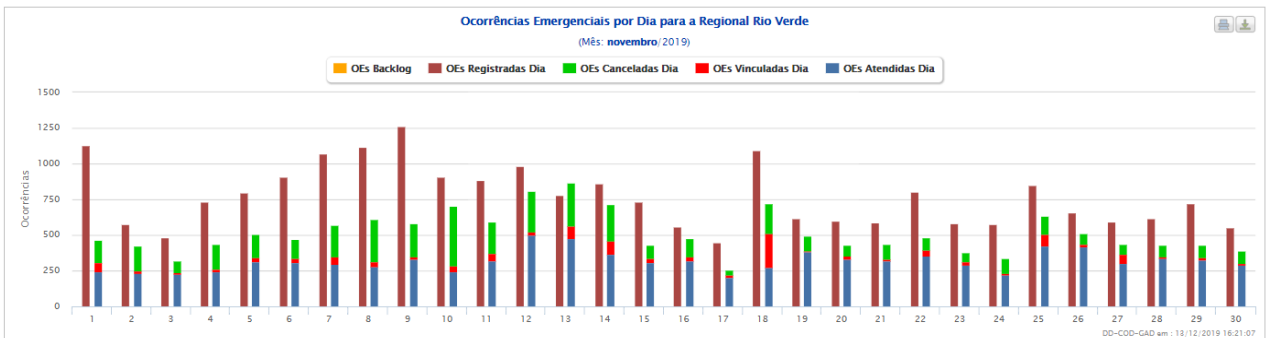
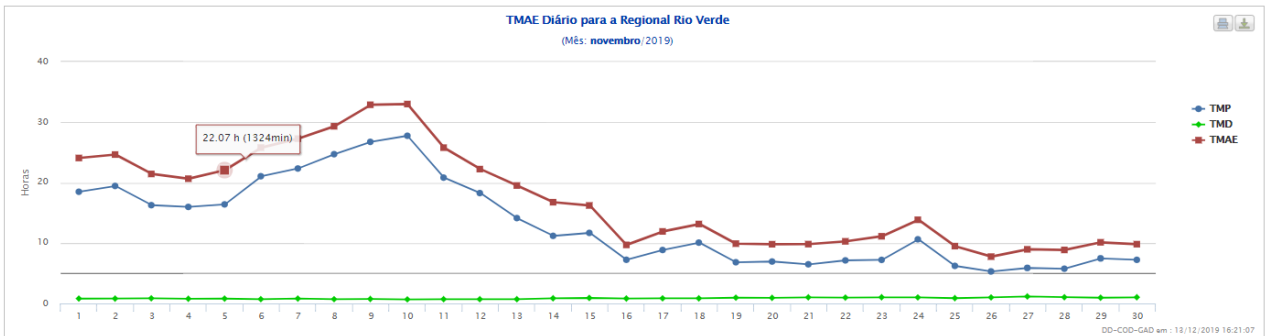
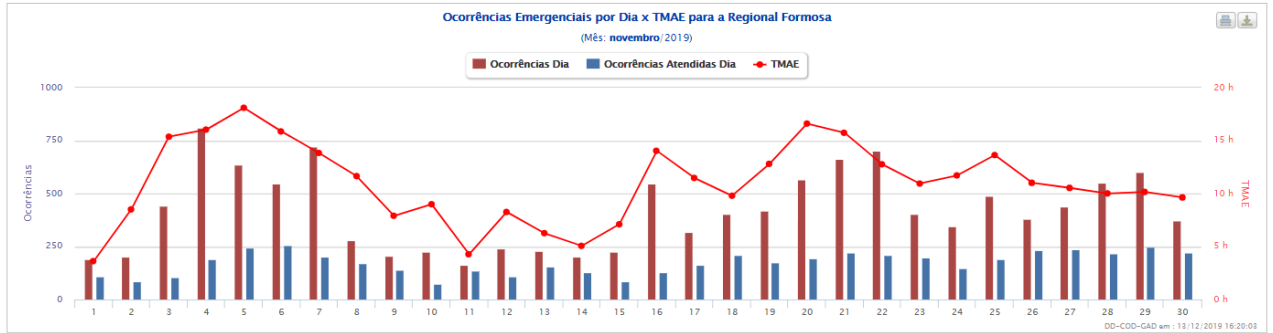
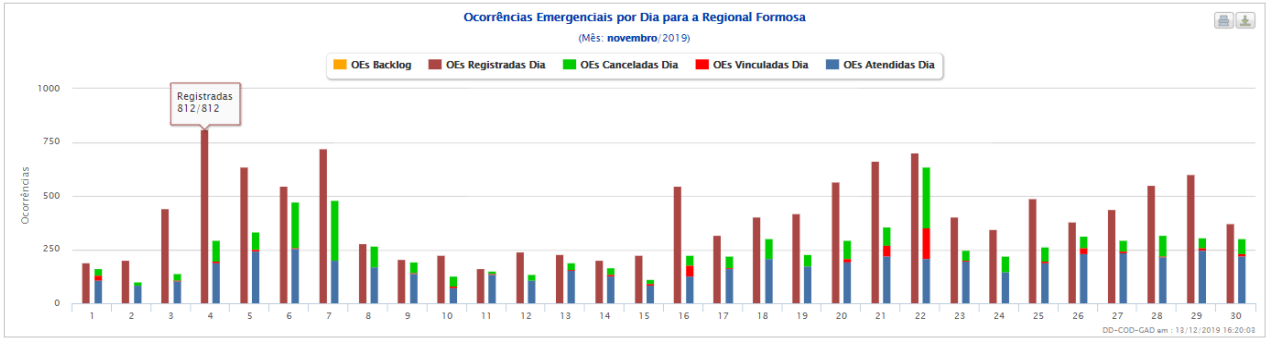

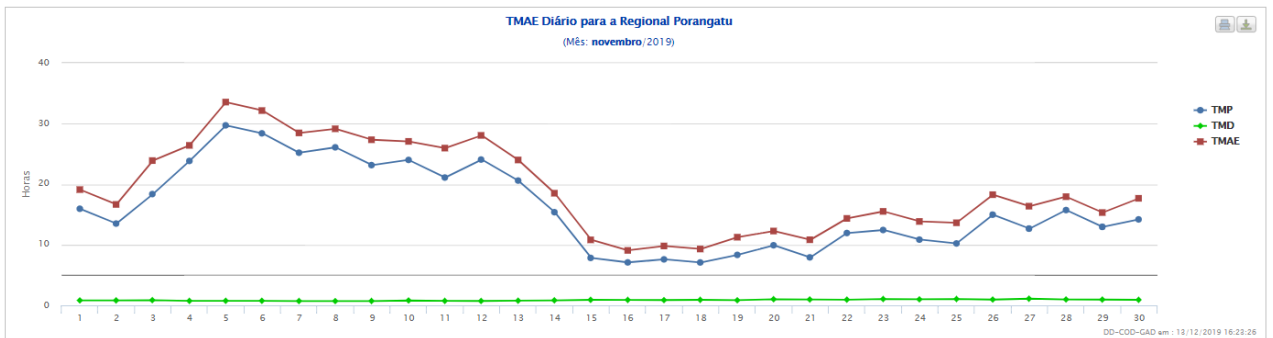
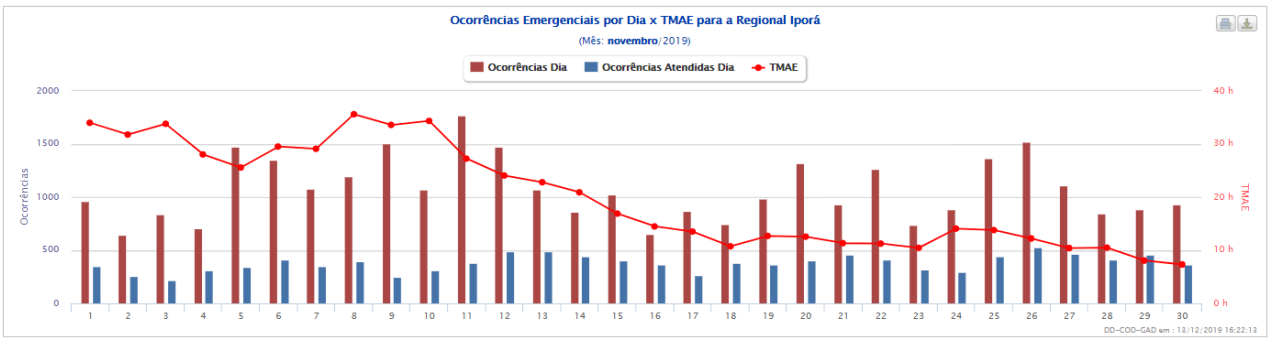
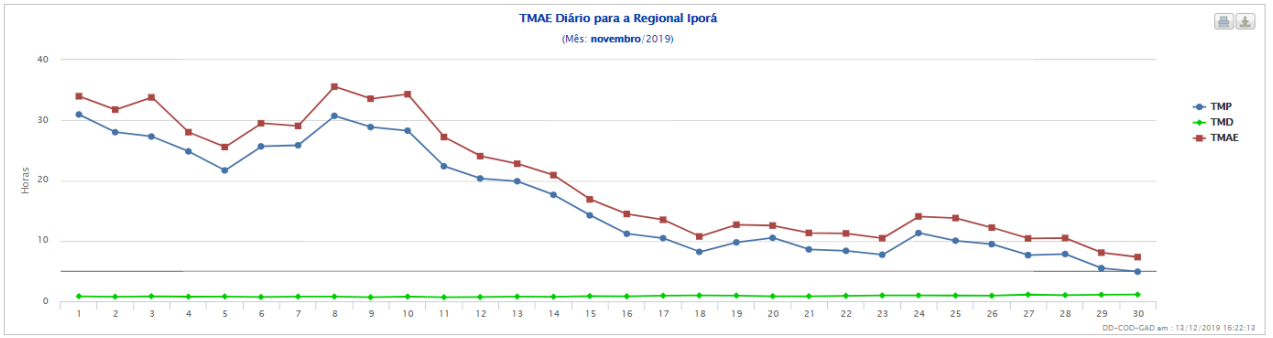

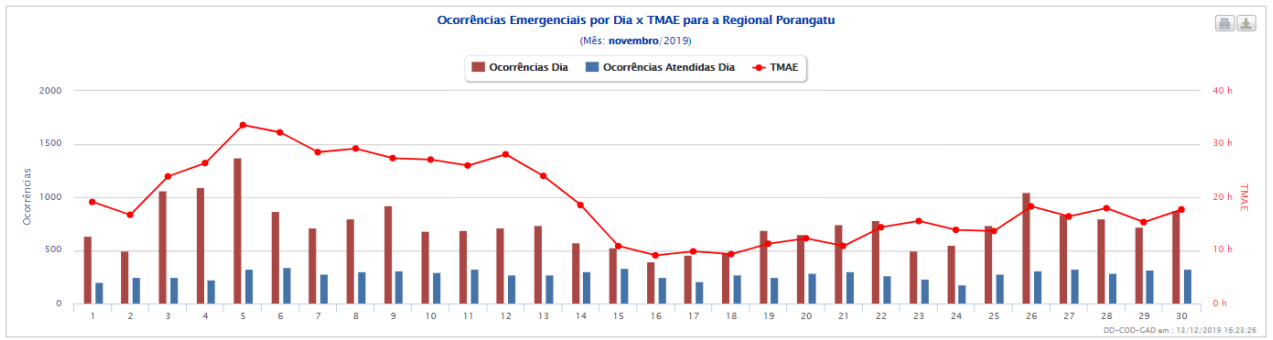

CLIMATEMPO

**Laudo Meteorológico de Evento Climático -
CELG Distribuição S.A. - 14 a 20 de novembro
de 2019**

São Paulo, SP, Brasil

Dezembro de 2019

Sumário

1	ANÁLISE DE EVENTO METEOROLÓGICO	2
1.1	Descrição do Evento.....	2
1.2	Abrangência do Evento	6
2	CLASSIFICAÇÃO COBRADE	29
3	RESUMO DO EVENTO	30
4	REFERÊNCIAS.....	36

1 Análise de Evento Meteorológico

1.1 Descrição do Evento

Na figura a seguir é apresentada a área de concessão da CELG Distribuição, dividida em regiões, a serem analisadas neste relatório.



Figura 1 – Regiões de Goiás atendidas pela CELG Distribuição.

Áreas de instabilidade organizadas pela presença de uma frente fria predominaram as condições do tempo sobre o estado de Goiás entre a manhã do dia 14 e a madrugada do dia 20 de novembro de 2019.

Nas Figuras 2 e 3 são apresentadas as descargas atmosféricas nuvem-solo (raios) e nuvem-nuvem detectadas pelo sistema Earth Networks. Entre as 06h30 do dia 14 e 02h30 do dia 21 de novembro foram registrados 55156 raios nuvem-solo e 92806 descargas nuvem-nuvem sobre a área da CELG Distribuição em Goiás.

Na tabela 1 são apresentados os valores de rajada de vento iguais ou maiores a 50 km/h registradas nas estações meteorológicas do Instituto Nacional de Meteorologia (INMET) representativas da região de interesse. O maior valor de rajada registrado foi de 104,8 km/h, classificado como tempestade violenta pela escala Beaufort.

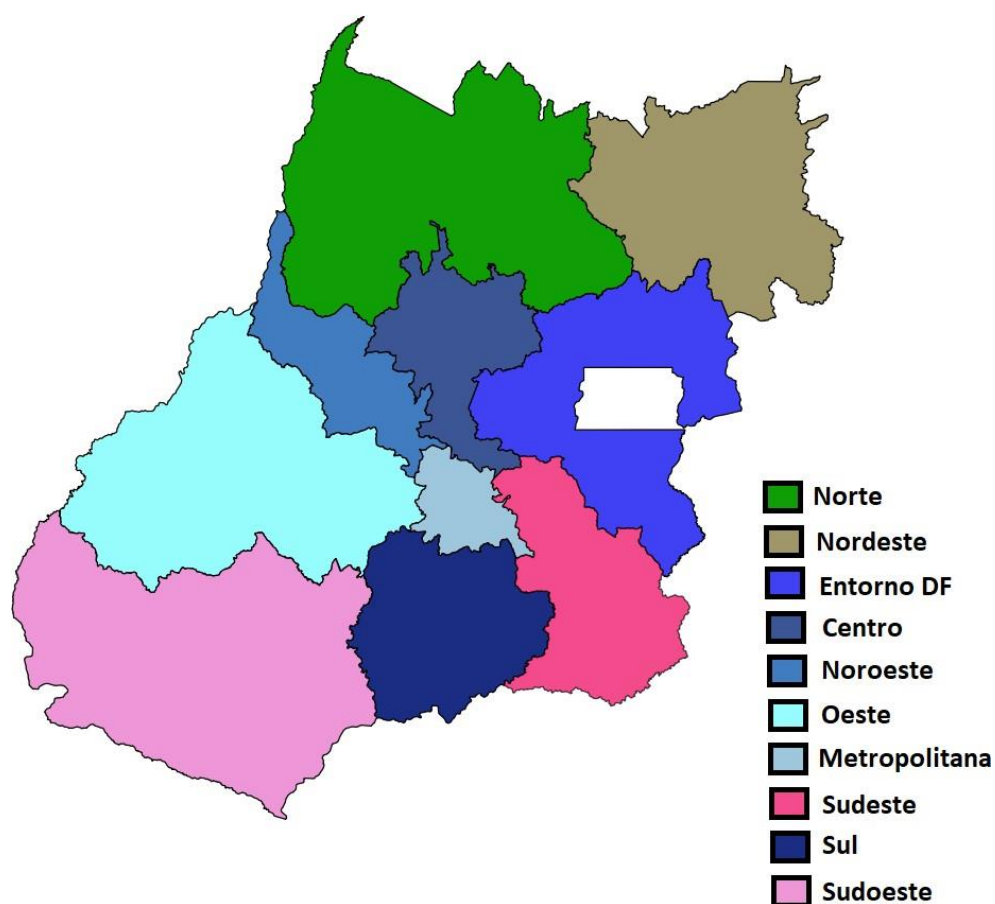
Tabela 1 –Rajadas de vento maiores ou iguais a 50 km/h registradas pelo INMET no dia 11 de novembro de 2019. Segundo a escala Beaufort, ventos entre 50 e 61 km/h são classificados como vento forte, entre 62 e 74 km/h como ventania, entre 75 e 88 km/h como ventania forte e entre 89 e 102 km/h como tempestade e entre 103 a 117 km/h como tempestade violenta.

Estação	Horário	Rajada (km/h)
Aragarças	Entre 14h e 15h do dia 15/11/2019	51.5
Catalão	Entre 16h e 17h do dia 15/11/2019	58.7
Catalão	Entre 17h e 18h do dia 15/11/2019	58.7
Goianésia	Entre 17h e 18h do dia 15/11/2019	50.4
Goiânia	Entre 15h e 16h do dia 14/11/2019	75.2
Goiânia	Entre 16h e 17h do dia 14/11/2019	61.2
Itumbiara	Entre 16h e 17h do dia 14/11/2019	104.8
Itumbiara	Entre 14h e 15h do dia 15/11/2019	52.2
Itumbiara	Entre 13h e 14h do dia 18/11/2019	49.7
Jataí	Entre 13h e 14h do dia 15/11/2019	50.4
Jataí	Entre 15h e 16h do dia 20/11/2019	50.4
Mineiros	Entre 12h e 13h do dia 17/11/2019	58.3
Mineiros	Entre 13h e 14h do dia 17/11/2019	58.3
Monte Alegre de Goiás	Entre 17h e 18h do dia 17/11/2019	50.0
Monte Alegre de Goiás	Entre 15h e 16h do dia 19/11/2019	49.7
Morrinhos	Entre 14h e 15h do dia 15/11/2019	73.1
Morrinhos	Entre 15h e 16h do dia 15/11/2019	73.1
Pires do Rio	Entre 13h e 14h do dia 14/11/2019	60.8
Posse	Entre 12h e 13h do dia 14/11/2019	72.7
Posse	Entre 13h e 14h do dia 14/11/2019	72.7
Rio Verde	Entre 17h e 18h do dia 15/11/2019	60.5
Rio Verde	Entre 18h e 19h do dia 15/11/2019	60.5
São Simão	Entre 17h e 18h do dia 14/11/2019	69.5
São Simão	Entre 12h e 13h do dia 15/11/2019	70.6
São Simão	Entre 18h e 19h do dia 18/11/2019	53.6



Figura 2 – Descargas atmosféricas nuvem-solo (em preto) detectadas pelo sistema Earth Networks entre 06h30 do dia 14 e 02h30 do dia 21 de novembro de 2019 sobre a área de concessão da CELG Distribuição.



Figura 3 –Descargas atmosféricas nuvem-nuvem (em vermelho) detectadas pelo sistema Earth Networks entre 06h30 do dia 14 e 02h30 do dia 21 de novembro de 2019 sobre a área de concessão da CELG Distribuição.

1.2 Abrangência do Evento

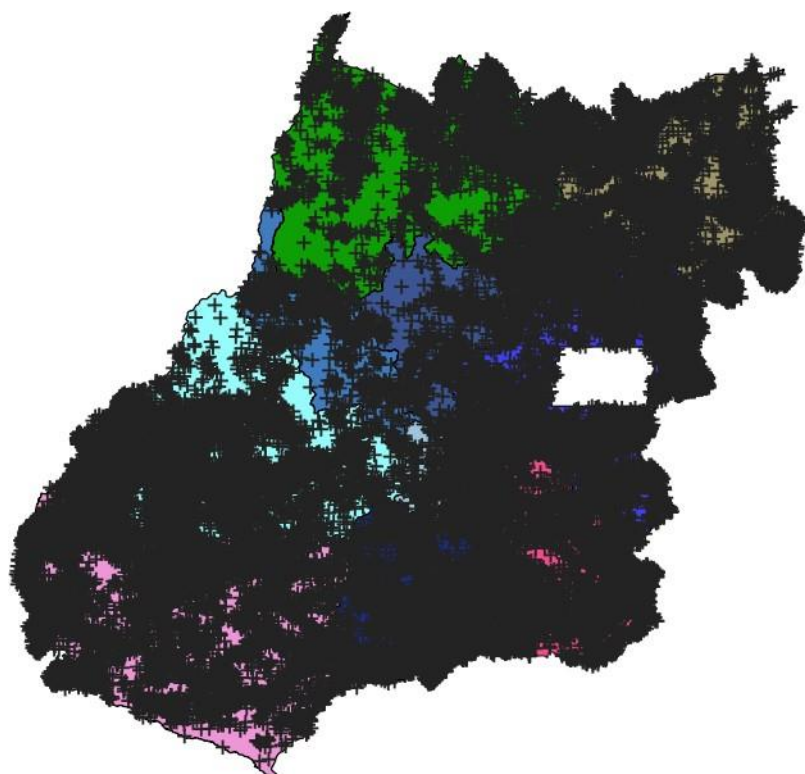
A seguir são apresentadas as imagens realçadas do satélite GOES-16 entre as 13h00 do dia 14 e 05h00 do dia 21 de novembro de 2019. Os tons em vermelho e preto indicam a presença de nuvens de grande desenvolvimento vertical, geralmente associadas à ocorrência de tempo severo.

13h00 - 14 de novembro de 2019

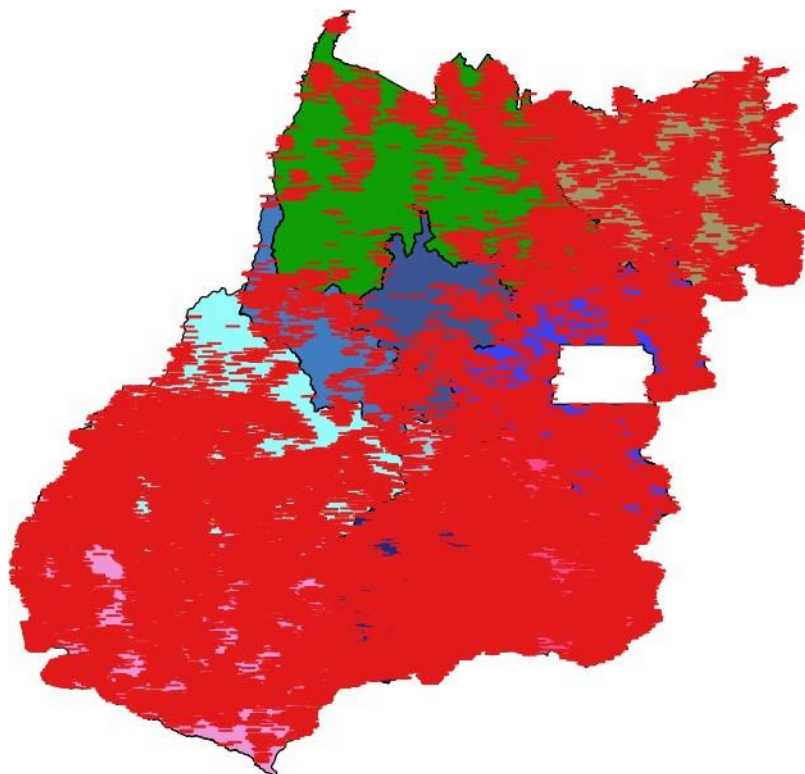

Figura 4 –Imagens realçadas do satélite GOES-16 das 13h00 do dia 14 de novembro de 2019.
FONTE: Cptec/INPE.

17h00 - 14 de novembro de 2019

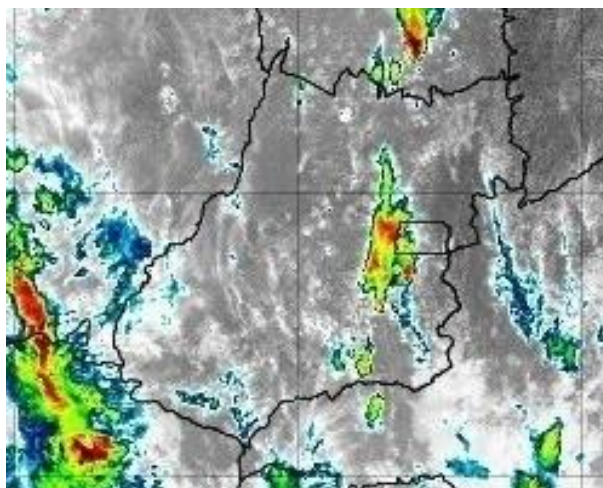

Figura 5 –Imagens realçadas do satélite GOES-16 das 17h00 do dia 14 de novembro de 2019.
FONTE: Cptec/INPE.

21h00 - 14 de novembro de 2019

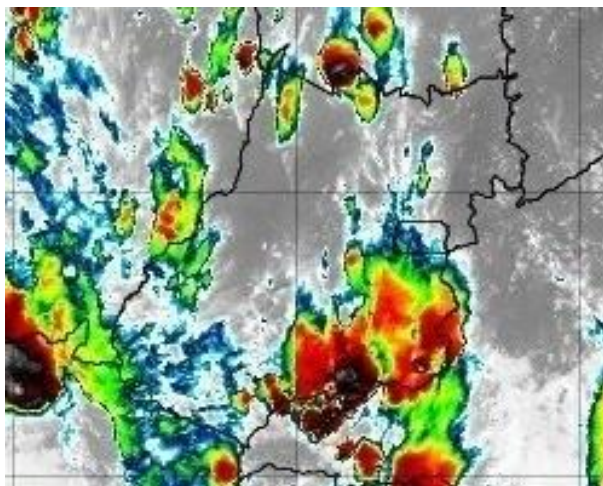

Figura 6 –Imagens realçadas do satélite GOES-16 das 21h00 do dia 14 de novembro de 2019.
FONTE: Cptec/INPE.

01h00 - 15 de novembro de 2019

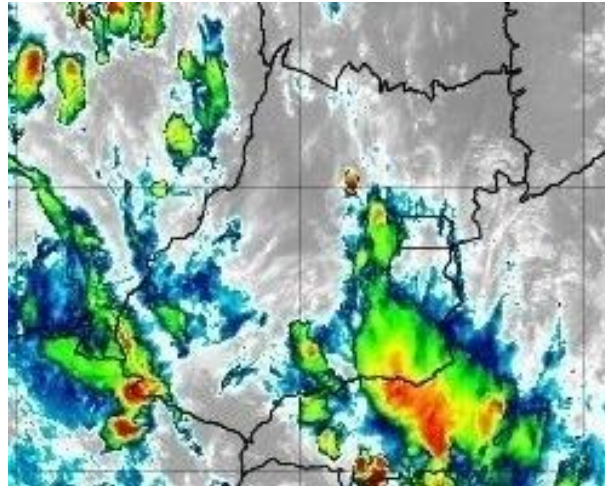

Figura 7 –Imagens realçadas do satélite GOES-16 das 01h00 do dia 15 de novembro de 2019.
FONTE: Cptec/INPE.

05h00 - 15 de novembro de 2019

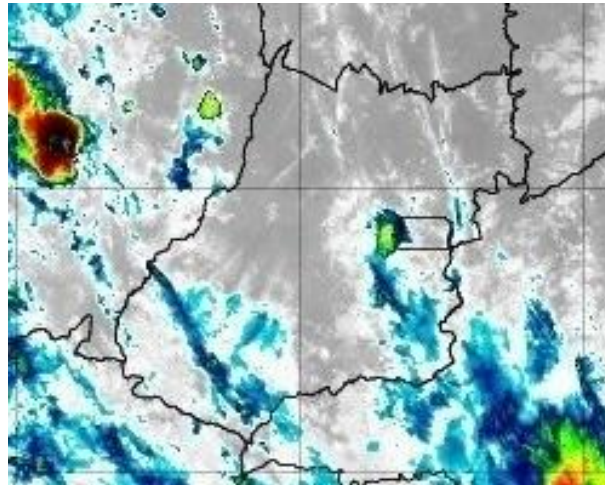

Figura 8 –Imagens realçadas do satélite GOES-16 das 05h00 do dia 15 de novembro de 2019. FONTE: Cptec/INPE.

09h00 - 15 de novembro de 2019



Figura 9 –Imagens realçadas do satélite GOES-16 das 09h00 do dia 15 de novembro de 2019. FONTE: Cptec/INPE.

13h00 - 15 de novembro de 2019

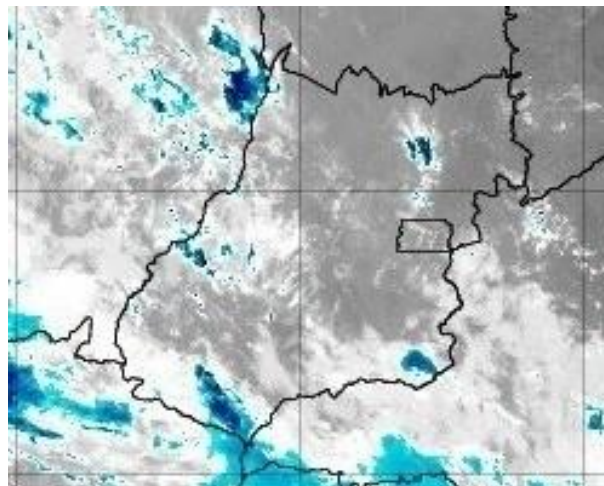

Figura 10 –Imagens realçadas do satélite GOES-16 das 13h00 do dia 15 de novembro de 2019.
FONTE: Cptec/INPE.

17h00 - 15 de novembro de 2019

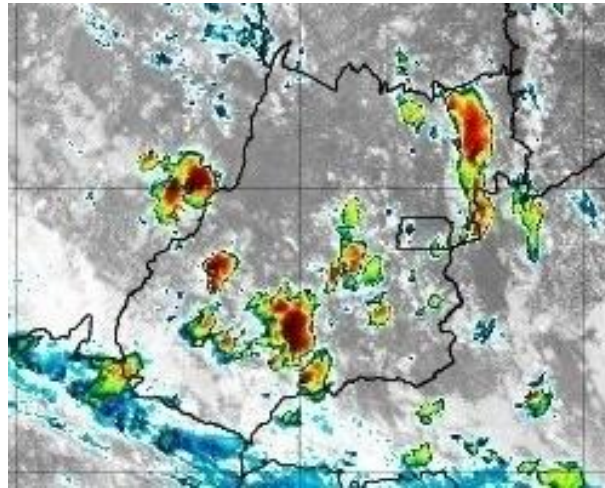

Figura 11 –Imagens realçadas do satélite GOES-16 das 17h00 do dia 15 de novembro de 2019.
FONTE: Cptec/INPE.

21h00 - 15 de novembro de 2019

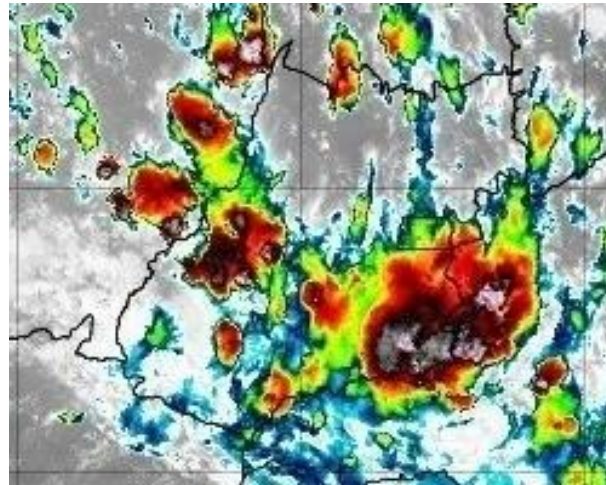

Figura 12 –Imagens realçadas do satélite GOES-16 das 21h00 do dia 15 de novembro de 2019.
FONTE: Cptec/INPE.

01h00 - 16 de novembro de 2019

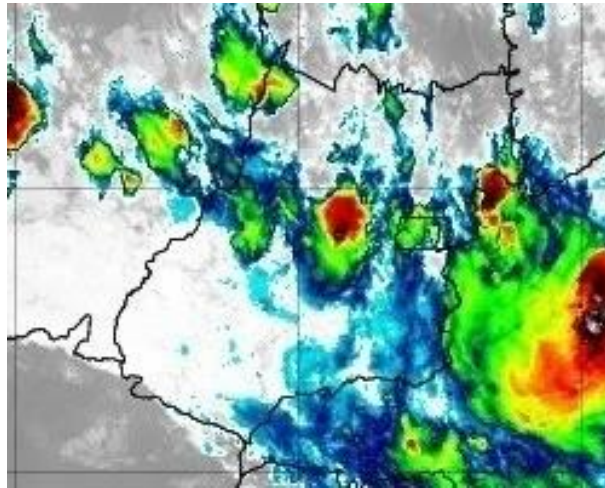

Figura 13 –Imagens realçadas do satélite GOES-16 das 01h00 do dia 16 de novembro de 2019.
FONTE: Cptec/INPE.

01h00 - 16 de novembro de 2019

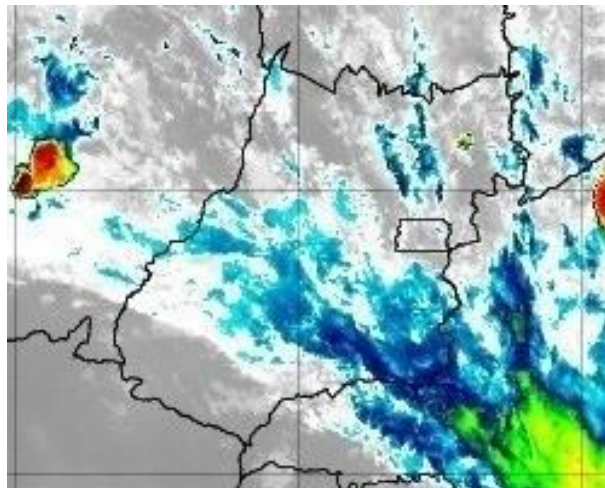

Figura 14 –Imagens realçadas do satélite GOES-16 das 01h00 do dia 16 de novembro de 2019. FONTE: Cptec/INPE.

05h00 - 16 de novembro de 2019

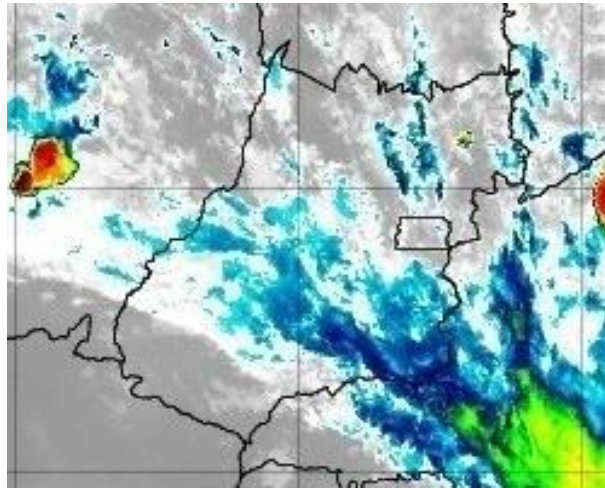

Figura 15 –Imagens realçadas do satélite GOES-16 das 05h00 do dia 16 de novembro de 2019. FONTE: Cptec/INPE.

09h00 - 16 de novembro de 2019

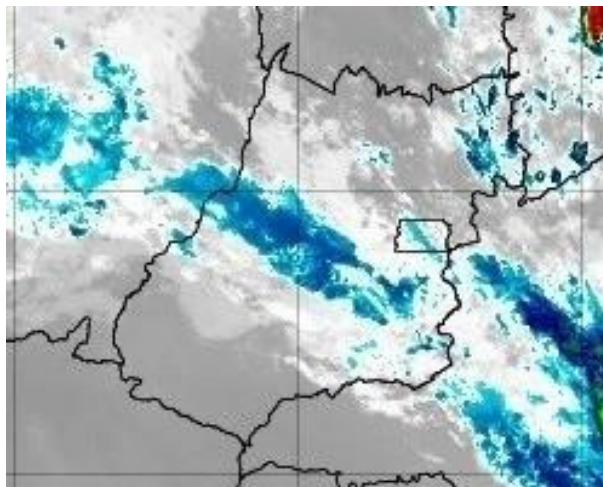

Figura 16 –Imagens realçadas do satélite GOES-16 das 09h00 do dia 16 de novembro de 2019. FONTE: Cptec/INPE.

13h00 - 16 de novembro de 2019

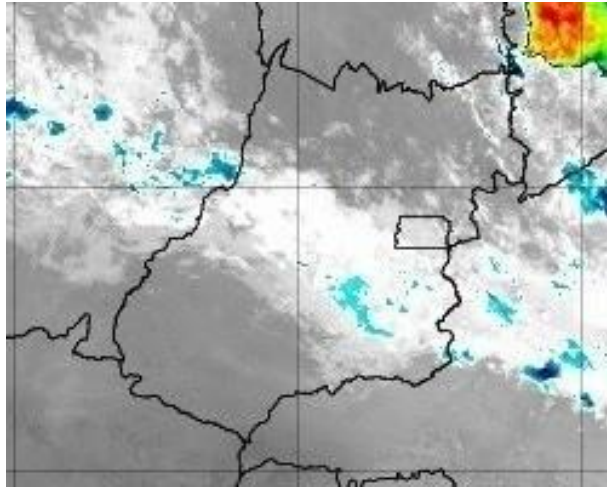

Figura 17 –Imagens realçadas do satélite GOES-16 das 13h00 do dia 16 de novembro de 2019. FONTE: Cptec/INPE.

17h00 - 16 de novembro de 2019

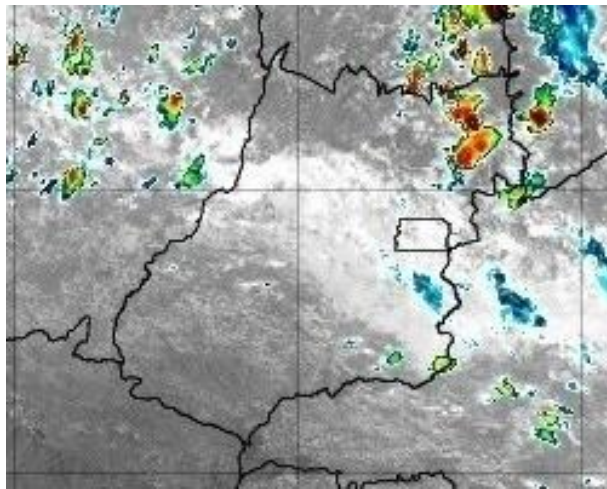

Figura 18 –Imagens realçadas do satélite GOES-16 das 17h00 do dia 16 de novembro de 2019.
FONTE: Cptec/INPE.

21h00 - 16 de novembro de 2019

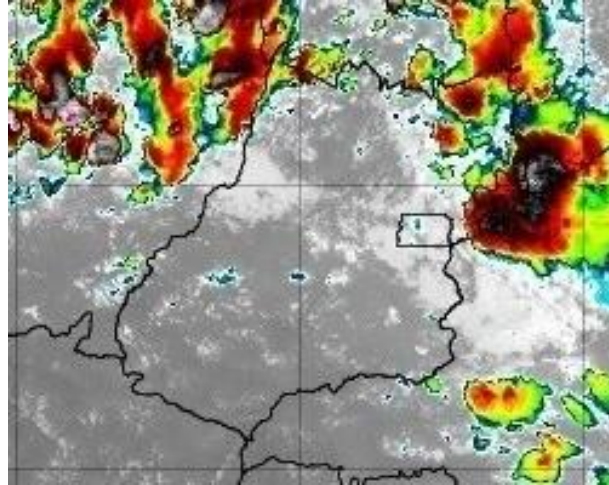

Figura 19 –Imagens realçadas do satélite GOES-16 das 21h00 do dia 16 de novembro de 2019.
FONTE: Cptec/INPE.

01h00 - 17 de novembro de 2019

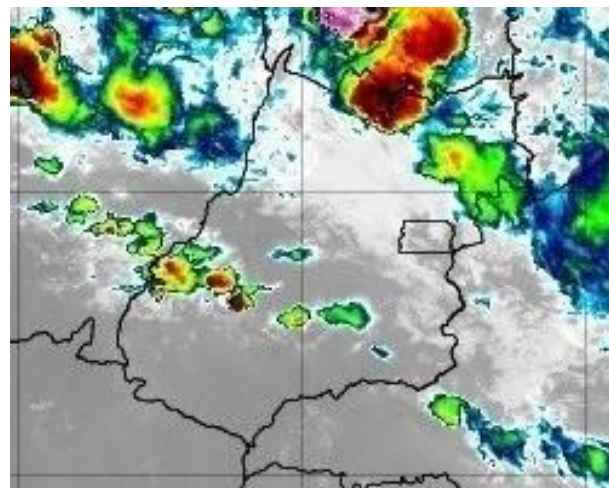

Figura 20 –Imagens realçadas do satélite GOES-16 das 01h00 do dia 17 de novembro de 2019. FONTE: Cptec/INPE.

01h00 - 17 de novembro de 2019

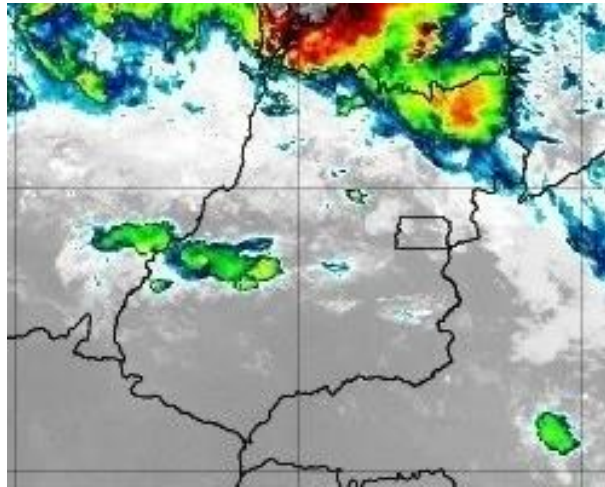

Figura 21 –Imagens realçadas do satélite GOES-16 das 01h00 do dia 17 de novembro de 2019. FONTE: Cptec/INPE.

05h00 - 17 de novembro de 2019

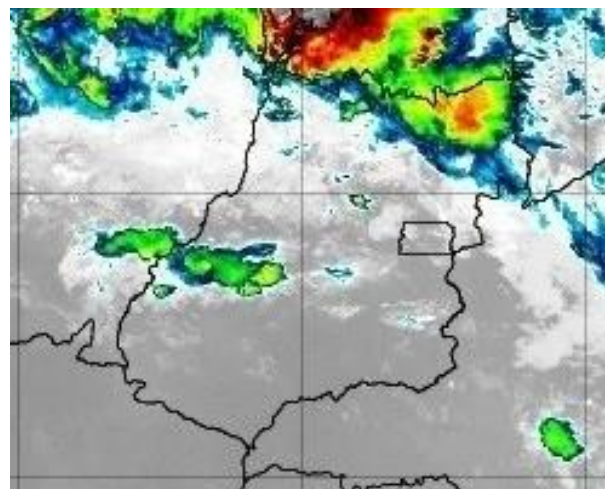

Figura 22 –Imagens realçadas do satélite GOES-16 das 05h00 do dia 17 de novembro de 2019. FONTE: Cptec/INPE.

09h00 - 17 de novembro de 2019



Figura 23 –Imagens realçadas do satélite GOES-16 das 09h00 do dia 17 de novembro de 2019. FONTE: Cptec/INPE.

13h00 - 17 de novembro de 2019

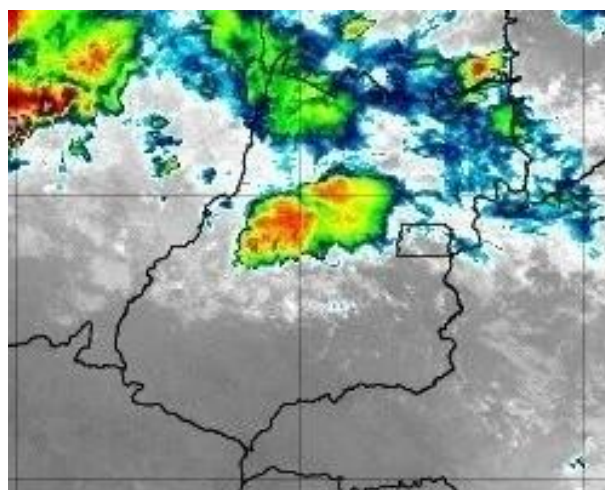

Figura 24 –Imagens realçadas do satélite GOES-16 das 13h00 do dia 17 de novembro de 2019.
FONTE: Cptec/INPE.

17h00 - 17 de novembro de 2019

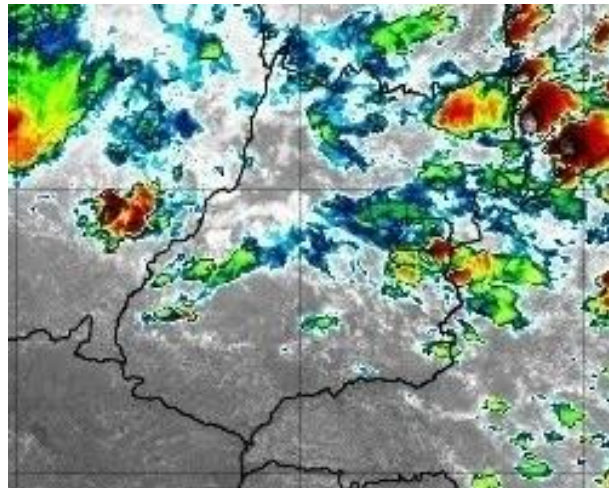

Figura 25 –Imagens realçadas do satélite GOES-16 das 17h00 do dia 17 de novembro de 2019.
FONTE: Cptec/INPE.

21h00 - 17 de novembro de 2019



Figura 26 –Imagens realçadas do satélite GOES-16 das 21h00 do dia 17 de novembro de 2019.
FONTE: Cptec/INPE.

01h00 - 18 de novembro de 2019

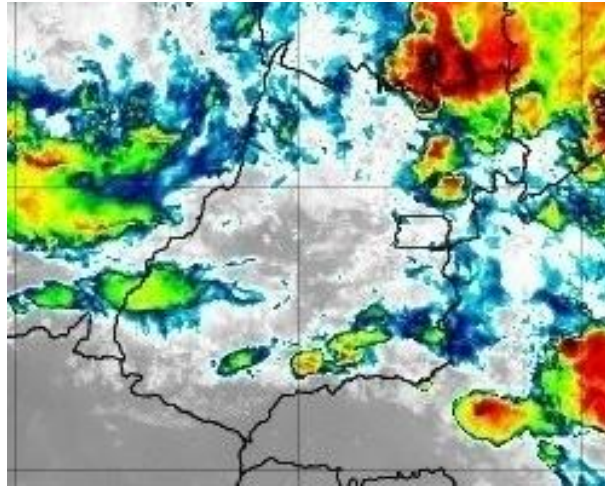

Figura 27 –Imagens realçadas do satélite GOES-16 das 01h00 do dia 18 de novembro de 2019. FONTE:
Cptec/INPE.

01h00 - 18 de novembro de 2019

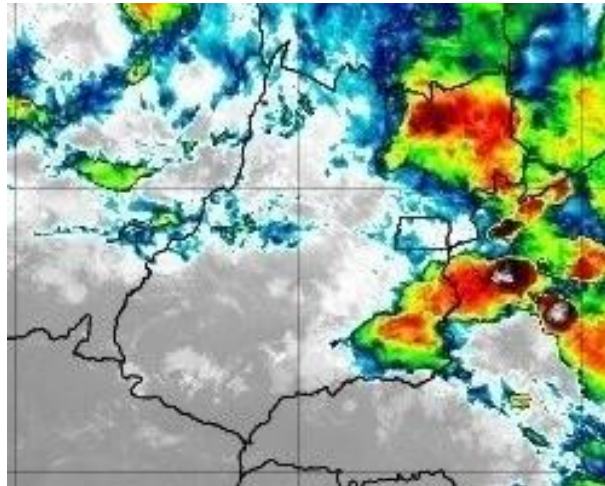

Figura 28 –Imagens realçadas do satélite GOES-16 das 01h00 do dia 18 de novembro de 2019. FONTE: Cptec/INPE.

05h00 - 18 de novembro de 2019

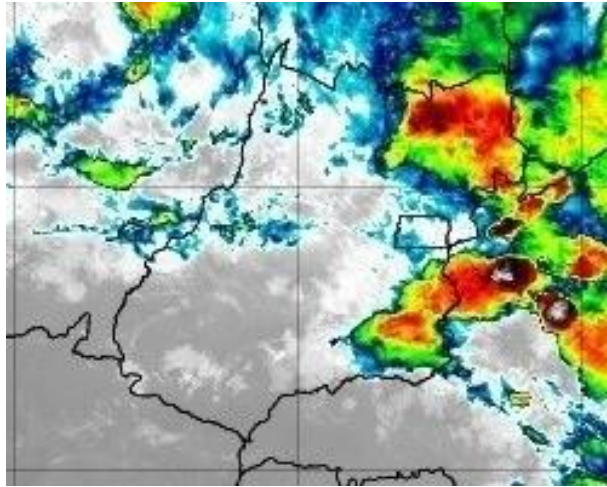

Figura 29 –Imagens realçadas do satélite GOES-16 das 05h00 do dia 18 de novembro de 2019. FONTE: Cptec/INPE.

09h00 - 18 de novembro de 2019

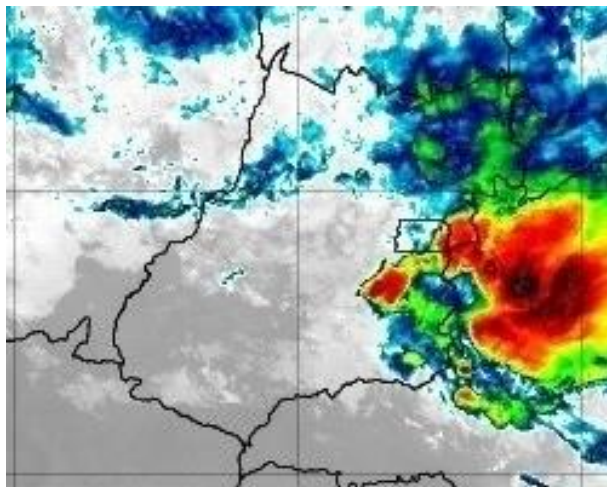

Figura 30 –Imagens realçadas do satélite GOES-16 das 09h00 do dia 18 de novembro de 2019. FONTE: Cptec/INPE.

13h00 - 18 de novembro de 2019

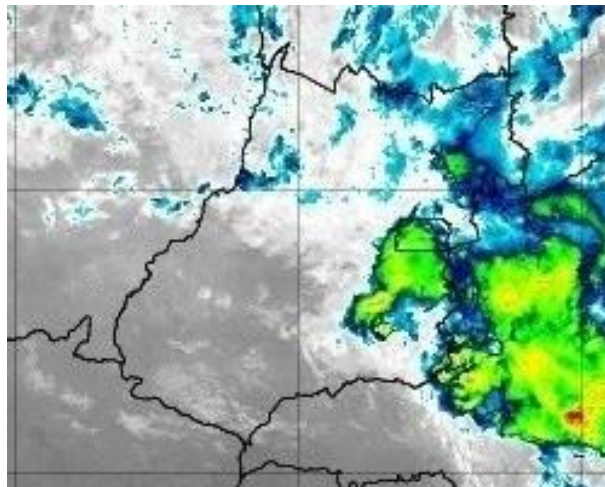

Figura 31 –Imagens realçadas do satélite GOES-16 das 13h00 do dia 18 de novembro de 2019. FONTE: Cptec/INPE.

17h00 - 18 de novembro de 2019

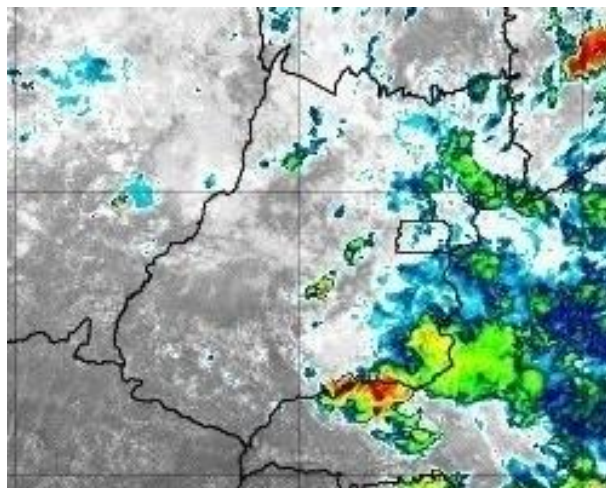

Figura 32 –Imagens realçadas do satélite GOES-16 das 17h00 do dia 18 de novembro de 2019.
FONTE: Cptec/INPE.

21h00 - 18 de novembro de 2019

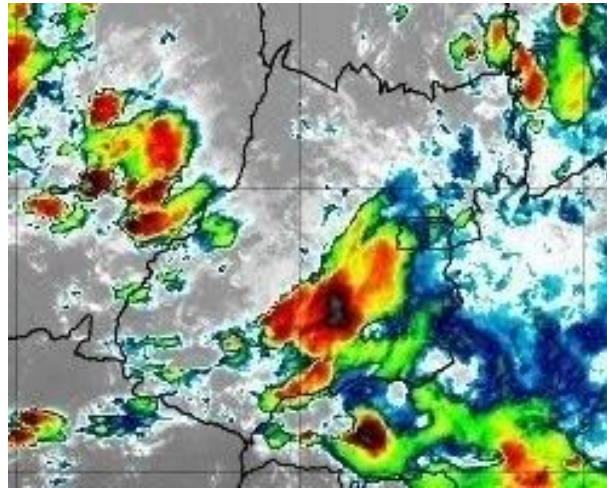

Figura 33 –Imagens realçadas do satélite GOES-16 das 21h00 do dia 18 de novembro de 2019. FONTE:
Cptec/INPE.

01h00 - 19 de novembro de 2019

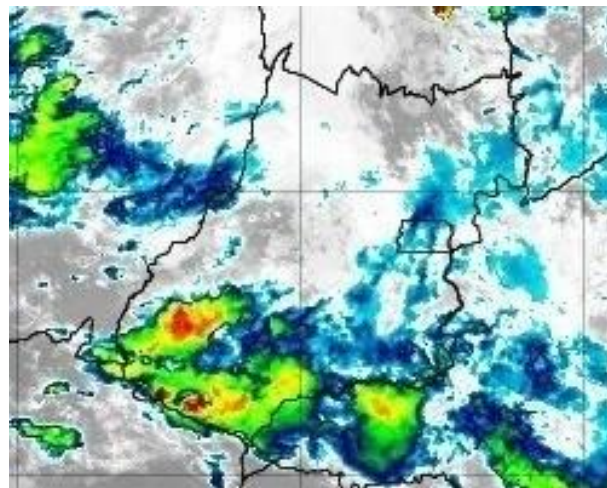

Figura 34 –Imagens realçadas do satélite GOES-16 das 01h00 do dia 19 de novembro de 2019. FONTE: Cptec/INPE.

01h00 - 19 de novembro de 2019

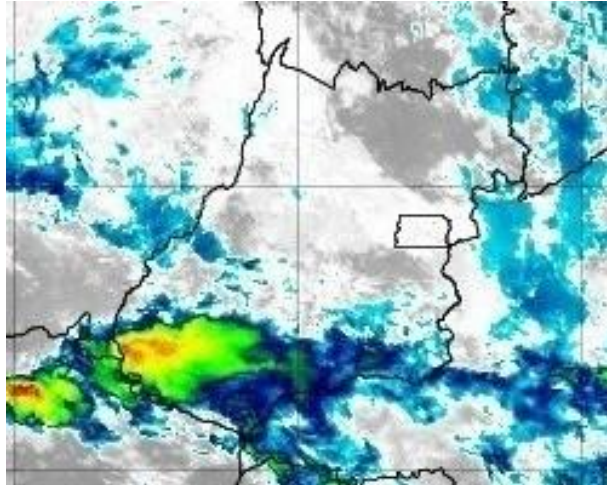

Figura 35 –Imagens realçadas do satélite GOES-16 das 01h00 do dia 19 de novembro de 2019. FONTE: Cptec/INPE.

05h00 - 19 de novembro de 2019

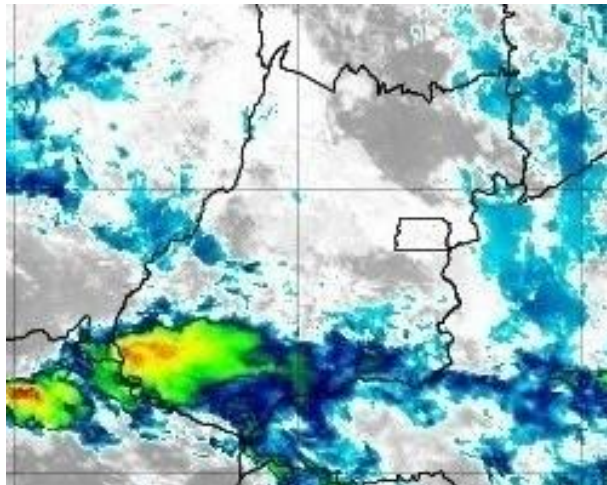

Figura 36 –Imagens realçadas do satélite GOES-16 das 05h00 do dia 19 de novembro de 2019. FONTE: Cptec/INPE.

09h00 - 19 de novembro de 2019

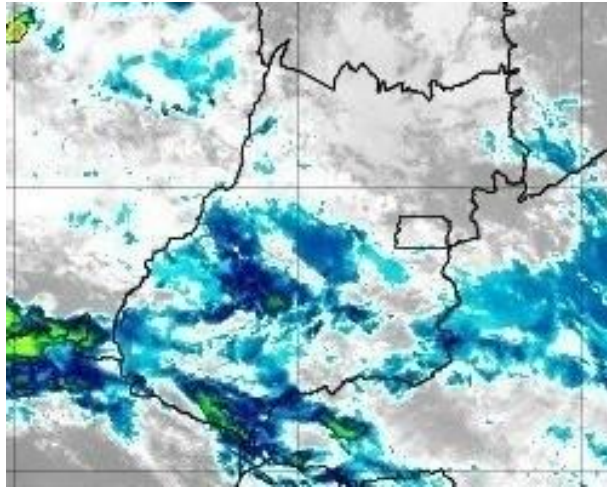

Figura 37 –Imagens realçadas do satélite GOES-16 das 09h00 do dia 19 de novembro de 2019. FONTE: Cptec/INPE.

13h00 - 19 de novembro de 2019

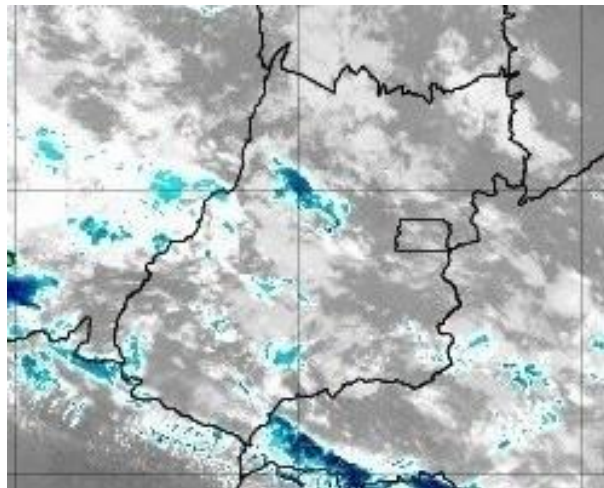

Figura 38 –Imagens realçadas do satélite GOES-16 das 13h00 do dia 19 de novembro de 2019. FONTE: Cptec/INPE.

17h00 - 19 de novembro de 2019

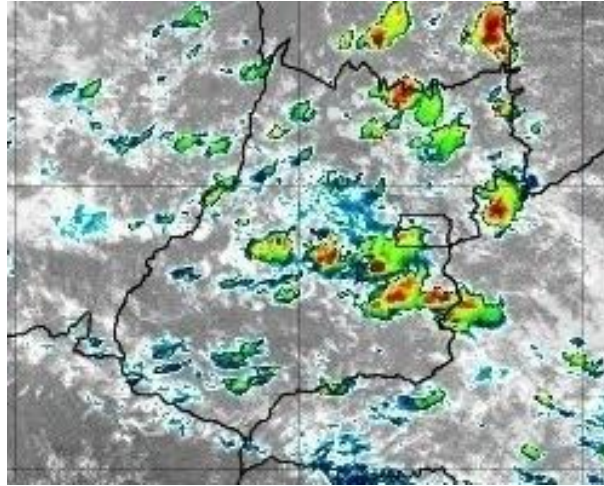

Figura 39 –Imagens realçadas do satélite GOES-16 das 17h00 do dia 19 de novembro de 2019. FONTE: Cptec/INPE.

21h00 - 19 de novembro de 2019

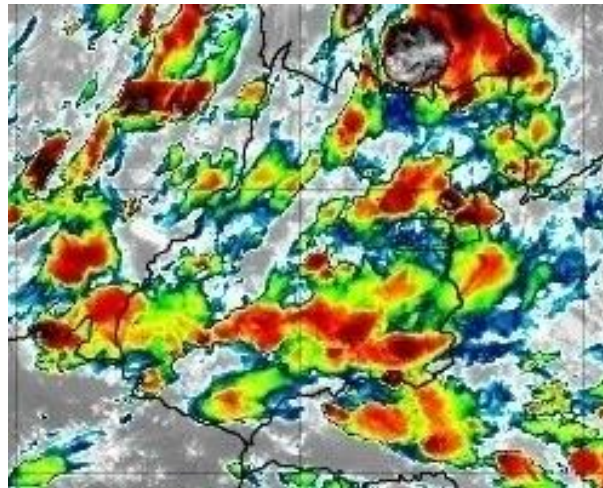

Figura 40 –Imagens realçadas do satélite GOES-16 das 21h00 do dia 19 de novembro de 2019. FONTE: Cptec/INPE.

01h00 - 20 de novembro de 2019

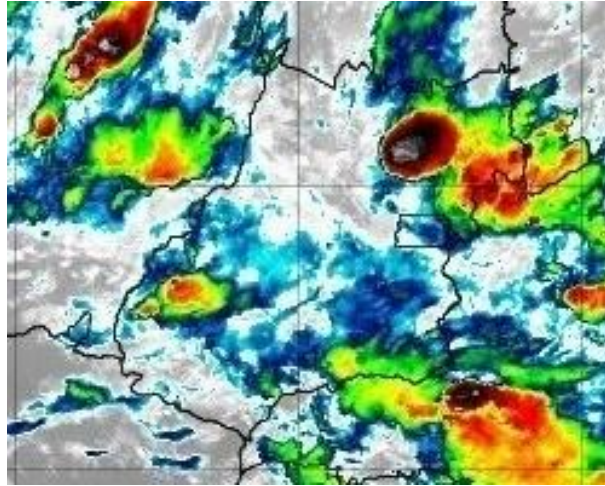

Figura 41 –Imagens realçadas do satélite GOES-16 das 01h00 do dia 20 de novembro de 2019. FONTE: Cptec/INPE.

01h00 - 20 de novembro de 2019

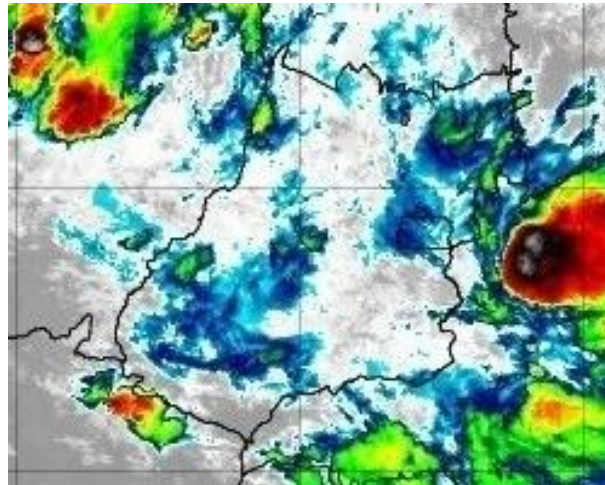

Figura 42 –Imagens realçadas do satélite GOES-16 das 01h00 do dia 20 de novembro de 2019. FONTE: Cptec/INPE.

05h00 - 20 de novembro de 2019

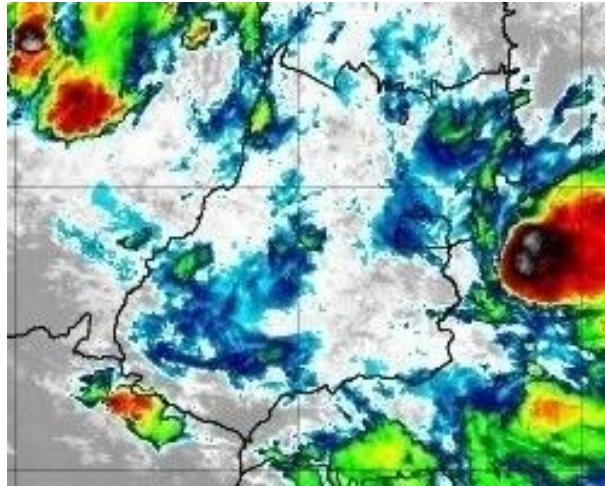

Figura 43 –Imagens realçadas do satélite GOES-16 das 05h00 do dia 20 de novembro de 2019. FONTE: Cptec/INPE.

09h00 - 20 de novembro de 2019

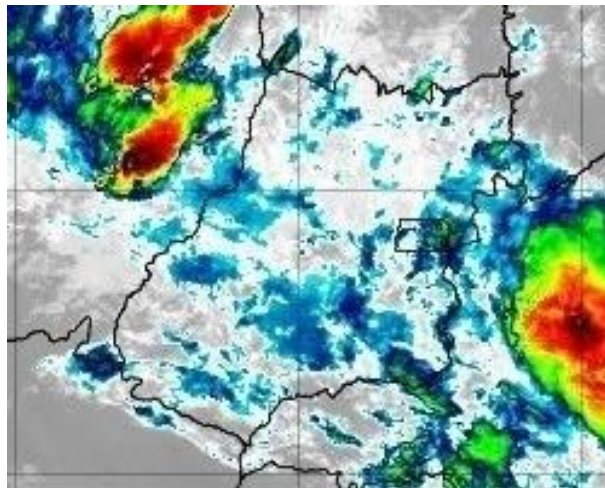

Figura 44 –Imagens realçadas do satélite GOES-16 das 09h00 do dia 20 de novembro de 2019. FONTE: Cptec/INPE.

13h00 - 20 de novembro de 2019

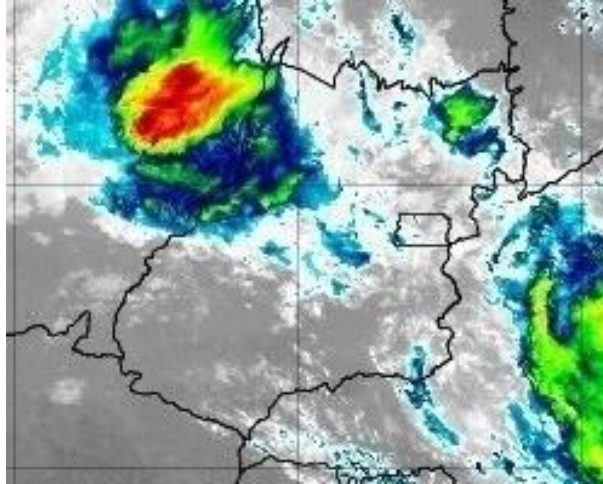

Figura 45 –Imagens realçadas do satélite GOES-16 das 13h00 do dia 20 de novembro de 2019. FONTE: Cptec/INPE.

17h00 - 20 de novembro de 2019

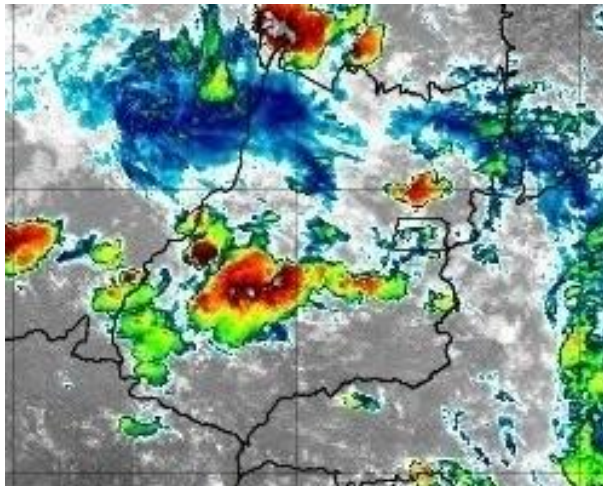

Figura 46 –Imagens realçadas do satélite GOES-16 das 17h00 do dia 20 de novembro de 2019. FONTE: Cptec/INPE.

21h00 - 20 de novembro de 2019

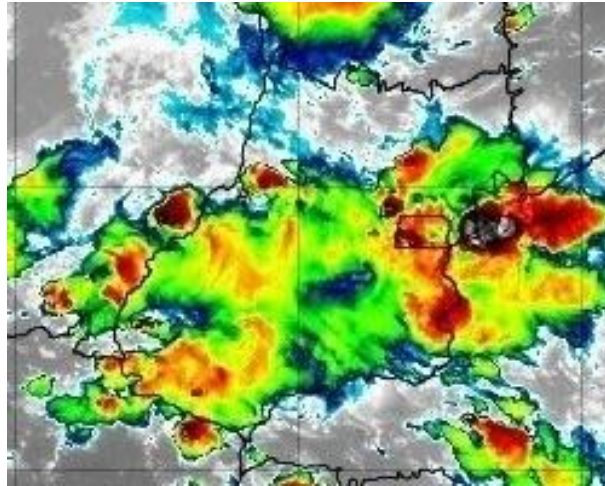

Figura 47 –Imagens realçadas do satélite GOES-16 das 21h00 do dia 20 de novembro de 2019. FONTE: Cptec/INPE.

01h00 - 21 de novembro de 2019

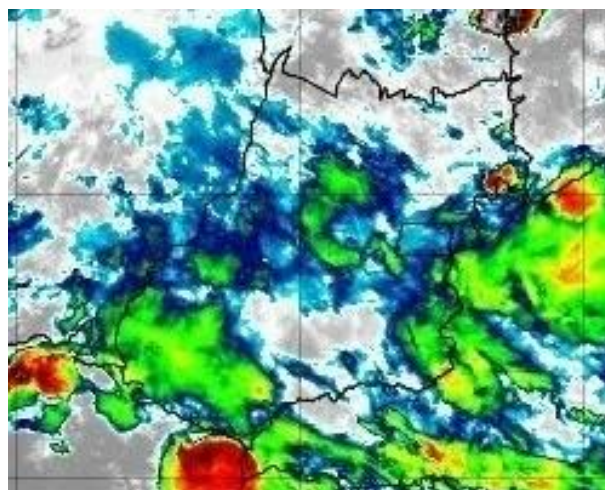

Figura 48 –Imagens realçadas do satélite GOES-16 das 01h00 do dia 21 de novembro de 2019. FONTE: Cptec/INPE.

05h00 - 21 de novembro de 2019

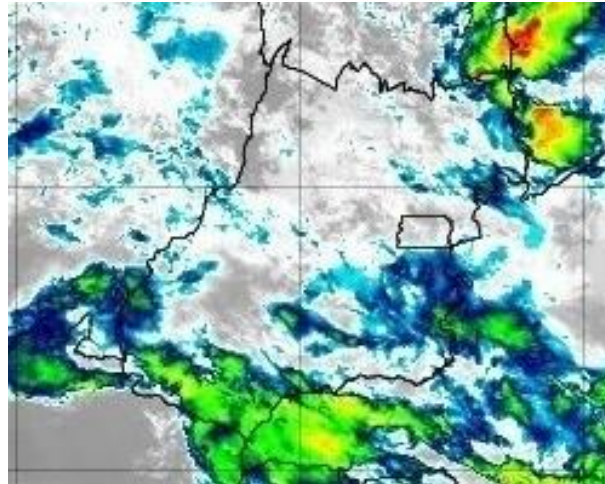

Figura 49 –Imagens realçadas do satélite GOES-16 das 05h00 do dia 21 de novembro de 2019. FONTE: Cptec/INPE.

2 Classificação COBRADE

O COBRADE (Classificação e Codificação Brasileira de Desastres) foi criado com o intuito de adequar a classificação brasileira à classificação utilizada pela ONU na classificação de desastres e nivelar o país aos demais organismos de gestão de desastres do mundo.

Baseados nos dados analisados nos itens anteriores, podemos classificar o evento ocorrido na CELG Distribuição como Tempestades - Vendaval (Código 1.3.2.1.5), Tempestade de raios (Código 1.3.2.1.2) e Granizo (Código 1.3.2.1.3).

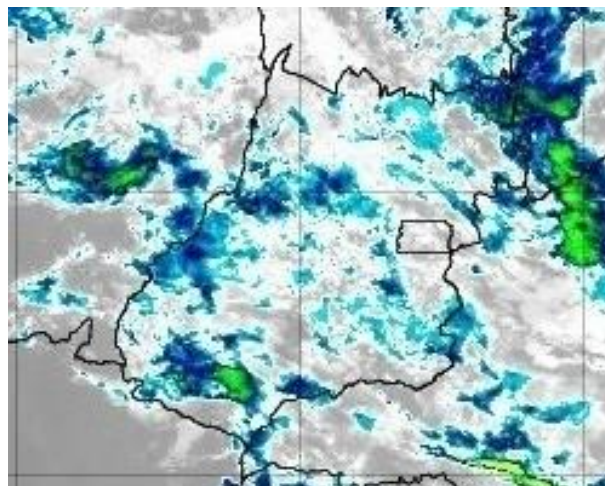
3 Resumo do Evento

Um corredor de umidade organizado pela presença de uma frente fria favoreceu a formação de áreas de instabilidade sobre o estado de Goiás entre a manhã do dia 14 de novembro e a madrugada do dia 21 de novembro de 2019.

Entre as 06h30 do dia 14 e 02h30 do dia 21 de novembro o sistema de detecção da Earth Networks registrou 147962 descargas atmosféricas sobre a área de concessão da CELG Distribuição Goiás, sendo que 55156 foram raios nuvem-solo.

A estação de Itumbiara do INMET registrou rajadas de vento de aproximadamente 104,8 km/h entre as 16h00 e 17h00 do dia 14 de novembro, vento classificado como tempestade violenta pela escala Beaufort, com potencial para arrancar árvores e provocar estragos generalizados em construções. Veículos de imprensa relataram que uma fábrica no município teve o telhado arrancado devido aos ventos intensos na região.

Tabela 2 – Resumo do evento Região Sudoeste

Número/Código do Evento	
Número/Código do Relatório	
Descrição	Forte deslocamento de uma massa de ar em uma região. Tempestade com intensa atividade elétrica no interior das nuvens, com grande desenvolvimento vertical. Precipitação de pedaços irregulares de gelo.
Código COBRADE	1.3.2.1.5 - Tempestades-Vendaval, 1.3.2.1.2 - Tempestade de raios e 1.3.2.1.3 - Granizo
Hora início do evento	13h00 do dia 14 de novembro de 2019
Hora de fim do evento	00h30 do dia 21 de novembro de 2019
Abrangência	Região Sudoeste da CELG Distribuição S.A.

Tabela 3 – Resumo do evento Região Sul

Número/Código do Evento	
Número/Código do Relatório	
Descrição	Forte deslocamento de uma massa de ar em uma região. Tempestade com intensa atividade elétrica no interior das nuvens, com grande desenvolvimento vertical. Precipitação de pedaços irregulares de gelo.
Código COBRADE	1.3.2.1.5 - Tempestades-Vendaval, 1.3.2.1.2 - Tempestade de raios e 1.3.2.1.3 - Granizo
Hora início do evento	09h00 do dia 14 de novembro de 2019
Hora de fim do evento	16h30 do dia 20 de novembro de 2019
Abrangência	Região Sul da CELG Distribuição S.A.

Tabela 4 – Resumo do evento Região Sudeste

Número/Código do Evento	
Número/Código do Relatório	
Descrição	Forte deslocamento de uma massa de ar em uma região. Tempestade com intensa atividade elétrica no interior das nuvens, com grande desenvolvimento vertical. Precipitação de pedaços irregulares de gelo.
Código COBRADE	1.3.2.1.5 - Tempestades-Vendaval, 1.3.2.1.2 - Tempestade de raios e 1.3.2.1.3 - Granizo
Hora início do evento	06h30 do dia 14 de novembro de 2019
Hora de fim do evento	22h00 do dia 20 de novembro de 2019
Abrangência	Região Sudeste da CELG Distribuição S.A.

Tabela 5 – Resumo do evento Região Metropolitana

Número/Código do Evento	
Número/Código do Relatório	
Descrição	Forte deslocamento de uma massa de ar em uma região. Tempestade com intensa atividade elétrica no interior das nuvens, com grande desenvolvimento vertical. Precipitação de pedaços irregulares de gelo.
Código COBRADE	1.3.2.1.5 - Tempestades-Vendaval, 1.3.2.1.2 - Tempestade de raios e 1.3.2.1.3 - Granizo
Hora início do evento	12h30 do dia 14 de novembro de 2019
Hora de fim do evento	16h00 do dia 20 de novembro de 2019
Abrangência	Região Metropolitana da CELG Distribuição S.A.

Tabela 6 – Resumo do evento Região Oeste

Número/Código do Evento	
Número/Código do Relatório	
Descrição	Forte deslocamento de uma massa de ar em uma região. Tempestade com intensa atividade elétrica no interior das nuvens, com grande desenvolvimento vertical. Precipitação de pedaços irregulares de gelo.
Código COBRADE	1.3.2.1.5 - Tempestades-Vendaval, 1.3.2.1.2 - Tempestade de raios e 1.3.2.1.3 - Granizo
Hora início do evento	14h00 do dia 14 de novembro de 2019
Hora de fim do evento	17h30 do dia 20 de novembro de 2019
Abrangência	Região Oeste da CELG Distribuição S.A.

Tabela 7 – Resumo do evento Região EDF

Número/Código do Evento	
Número/Código do Relatório	
Descrição	Forte deslocamento de uma massa de ar em uma região. Tempestade com intensa atividade elétrica no interior das nuvens, com grande desenvolvimento vertical. Precipitação de pedaços irregulares de gelo.
Código COBRADE	1.3.2.1.5 - Tempestades-Vendaval, 1.3.2.1.2 - Tempestade de raios e 1.3.2.1.3 - Granizo
Hora início do evento	10h30 do dia 14 de novembro de 2019
Hora de fim do evento	20h00 do dia 20 de novembro de 2019
Abrangência	Região EDF da CELG Distribuição S.A.

Tabela 8 – Resumo do evento Região Centro

Número/Código do Evento	
Número/Código do Relatório	
Descrição	Forte deslocamento de uma massa de ar em uma região. Tempestade com intensa atividade elétrica no interior das nuvens, com grande desenvolvimento vertical. Precipitação de pedaços irregulares de gelo.
Código COBRADE	1.3.2.1.5 - Tempestades-Vendaval, 1.3.2.1.2 - Tempestade de raios e 1.3.2.1.3 - Granizo
Hora início do evento	12h00 do dia 14 de novembro de 2019
Hora de fim do evento	18h30 do dia 20 de novembro de 2019
Abrangência	Região Centro da CELG Distribuição S.A.

Tabela 9 – Resumo do evento Região Noroeste

Número/Código do Evento	
Número/Código do Relatório	
Descrição	Forte deslocamento de uma massa de ar em uma região. Tempestade com intensa atividade elétrica no interior das nuvens, com grande desenvolvimento vertical. Precipitação de pedaços irregulares de gelo.
Código COBRADE	1.3.2.1.5 - Tempestades-Vendaval, 1.3.2.1.2 - Tempestade de raios e 1.3.2.1.3 - Granizo
Hora início do evento	04h00 do dia 15 de novembro de 2019
Hora de fim do evento	18h30 do dia 20 de novembro de 2019
Abrangência	Região Noroeste da CELG Distribuição S.A.

Tabela 10 – Resumo do evento Região Norte

Número/Código do Evento	
Número/Código do Relatório	
Descrição	Forte deslocamento de uma massa de ar em uma região. Tempestade com intensa atividade elétrica no interior das nuvens, com grande desenvolvimento vertical. Precipitação de pedaços irregulares de gelo.
Código COBRADE	1.3.2.1.5 - Tempestades-Vendaval, 1.3.2.1.2 - Tempestade de raios e 1.3.2.1.3 - Granizo
Hora início do evento	11h00 do dia 14 de novembro de 2019
Hora de fim do evento	19h00 do dia 20 de novembro de 2019
Abrangência	Região Norte da CELG Distribuição S.A.

Tabela 11 – Resumo do evento Região Nordeste

Número/Código do Evento	
Número/Código do Relatório	
Descrição	Forte deslocamento de uma massa de ar em uma região. Tempestade com intensa atividade elétrica no interior das nuvens, com grande desenvolvimento vertical. Precipitação de pedaços irregulares de gelo.
Código COBRADE	1.3.2.1.5 - Tempestades-Vendaval, 1.3.2.1.2 - Tempestade de raios e 1.3.2.1.3 - Granizo
Hora início do evento	13h00 do dia 14 de novembro de 2019
Hora de fim do evento	02h30 do dia 21 de novembro de 2019
Abrangência	Região Nordeste da CELG Distribuição S.A.

4 Referências

- RMetS Royal Meteorological Society – Beaufort Scale - <https://www.rmets.org/weather-and-climate/observing/beaufort-scale>
- Instituto Nacional de Meteorologia (INMET) - <http://www.inmet.gov.br>
- Cptec/INPE- <https://www.cptec.inpe.br/>
- Meteorology Glossary - American Meteorological Society - <http://glossary.ametsoc.org/>

Anexos

A.1 Carta Sinótica



Figura A1 - Carta sinótica para as 1200Z do dia 14 de novembro de 2019 (09h00 do dia 14 de novembro de 2019, hora local. FONTE:CPTEC).



Figura A2 - Carta sinótica da Marinha do Brasil para as 1200Z do dia 15 de novembro de 2019 (09h00 do dia 15 de novembro de 2019, hora local). FONTE:CPTEC).

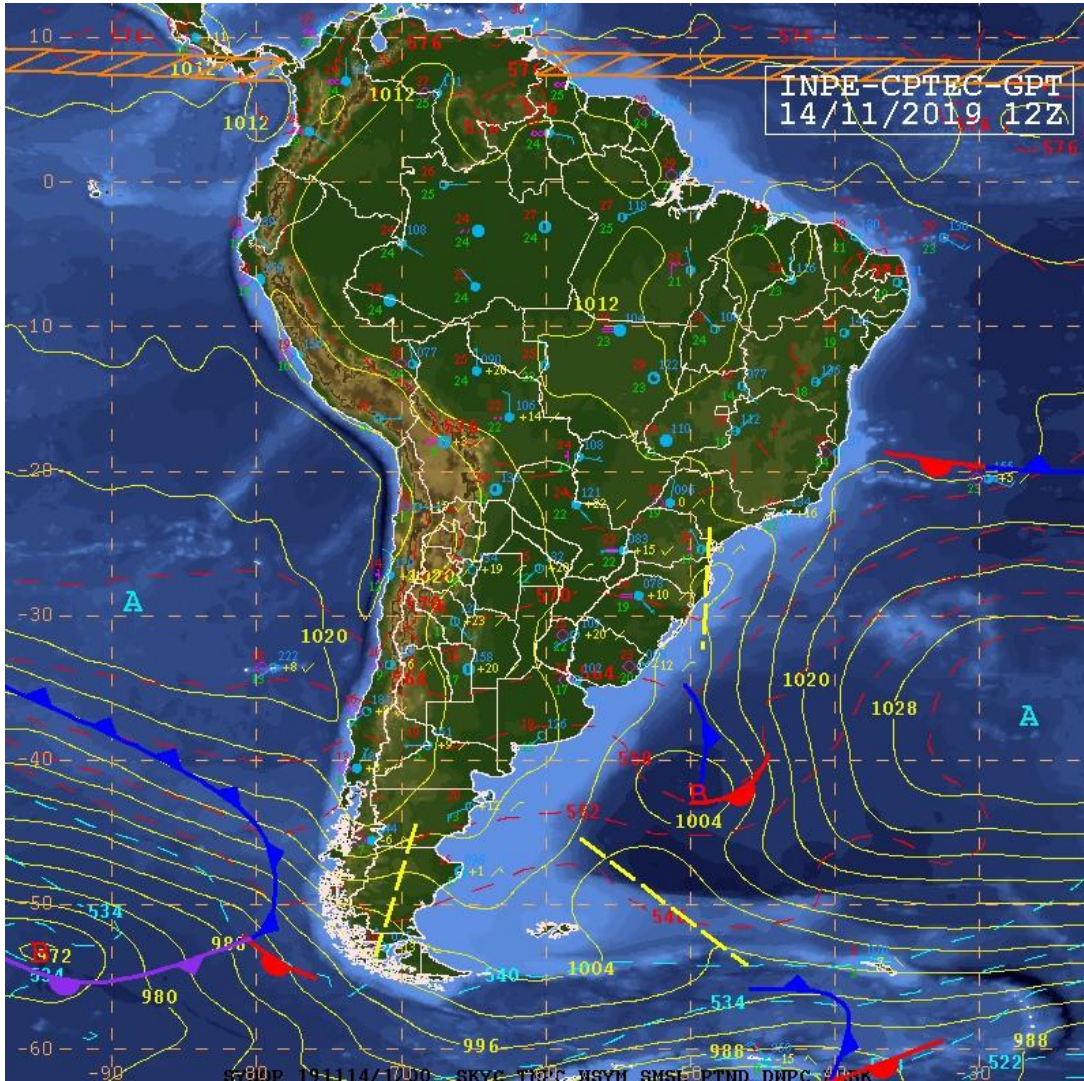

Figura A3 - Carta sinótica da Marinha do Brasil para as 1200Z do dia 16 de novembro de 2019 (09h00 do dia 16 de novembro de 2019, hora local). FONTE:CPTEC).

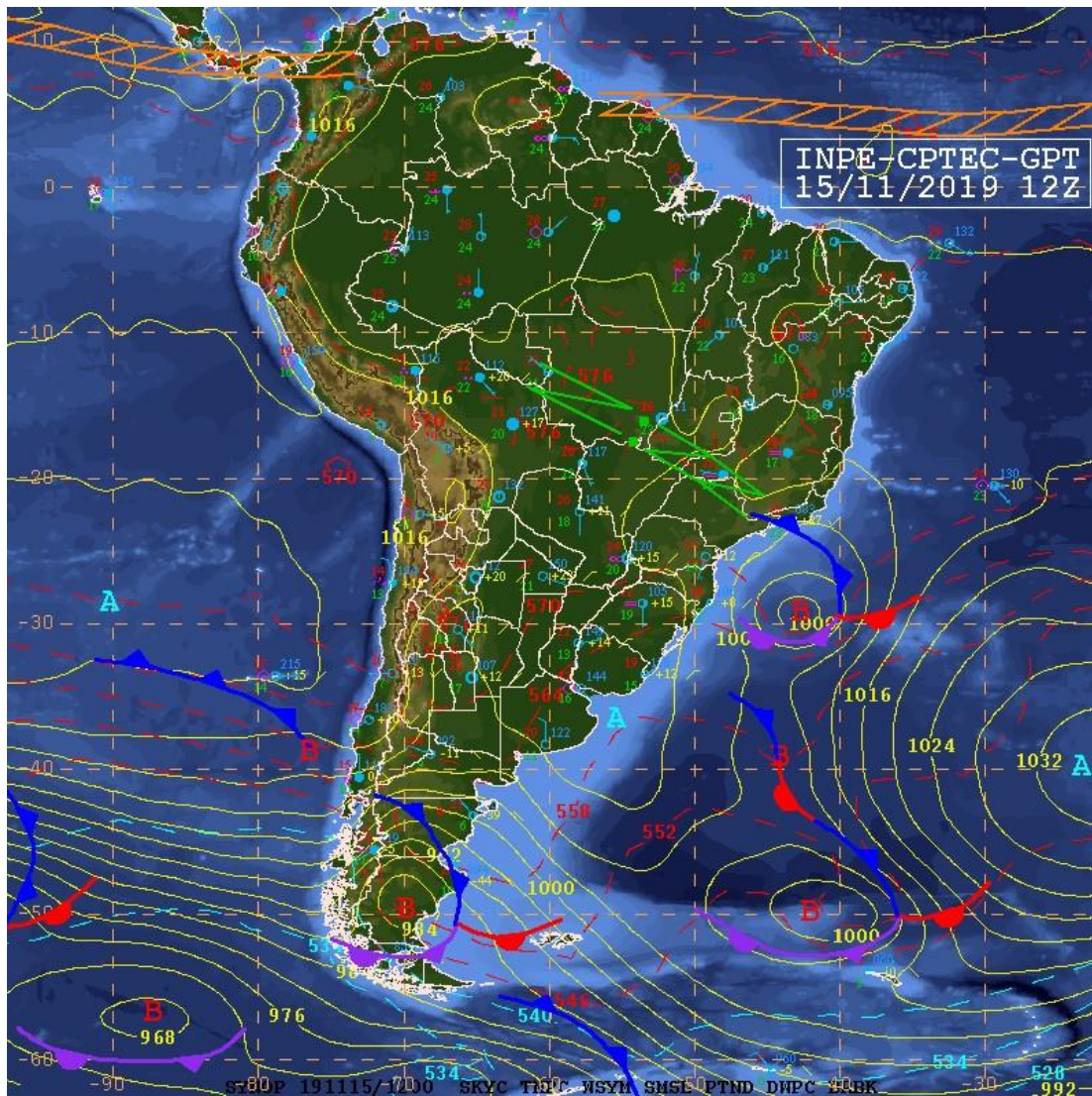

Figura A4 - Carta sinótica da Marinha do Brasil para as 1200Z do dia 17 de novembro de 2019 (09h00 do dia 17 de novembro de 2019, hora local). FONTE:CPTEC).

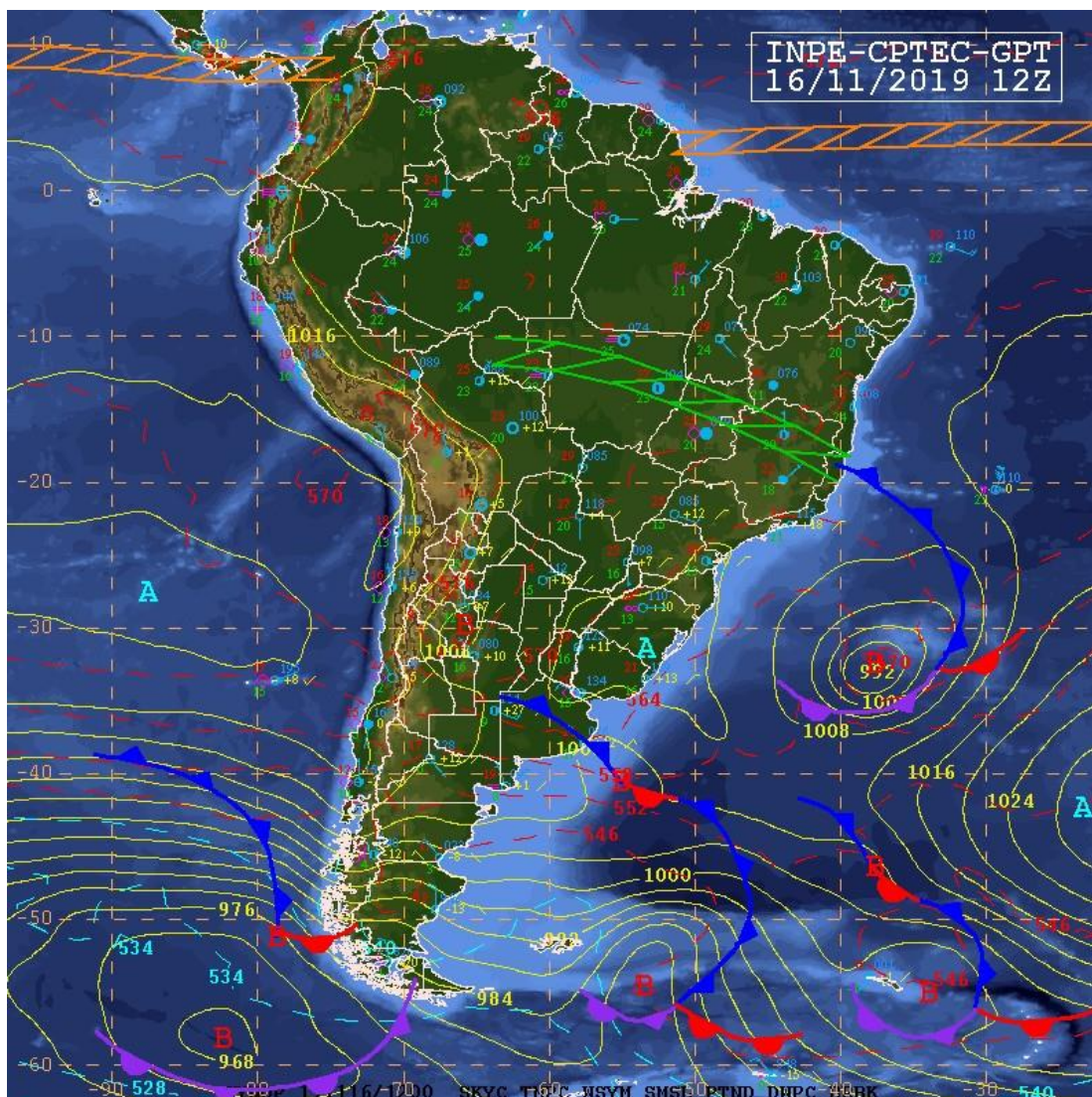

Figura A5 - Carta sinótica da Marinha do Brasil para as 1200Z do dia 18 de novembro de 2019 (09h00 do dia 18 de novembro de 2019, hora local). FONTE:CPTEC).

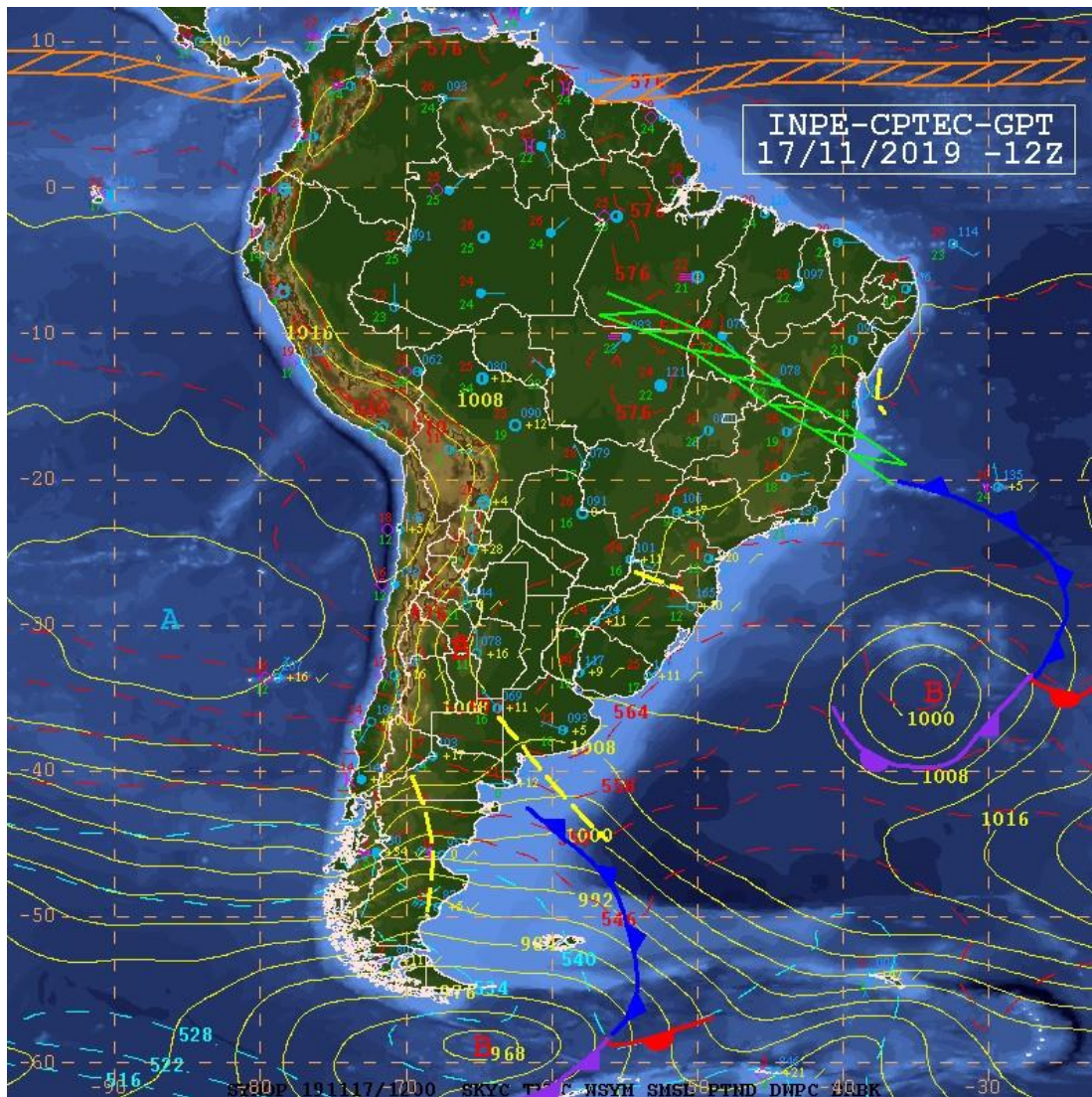

Figura A6 - Carta sinótica da Marinha do Brasil para as 1200Z do dia 19 de novembro de 2019 (09h00 do dia 19 de novembro de 2019, hora local). FONTE:CPTEC).

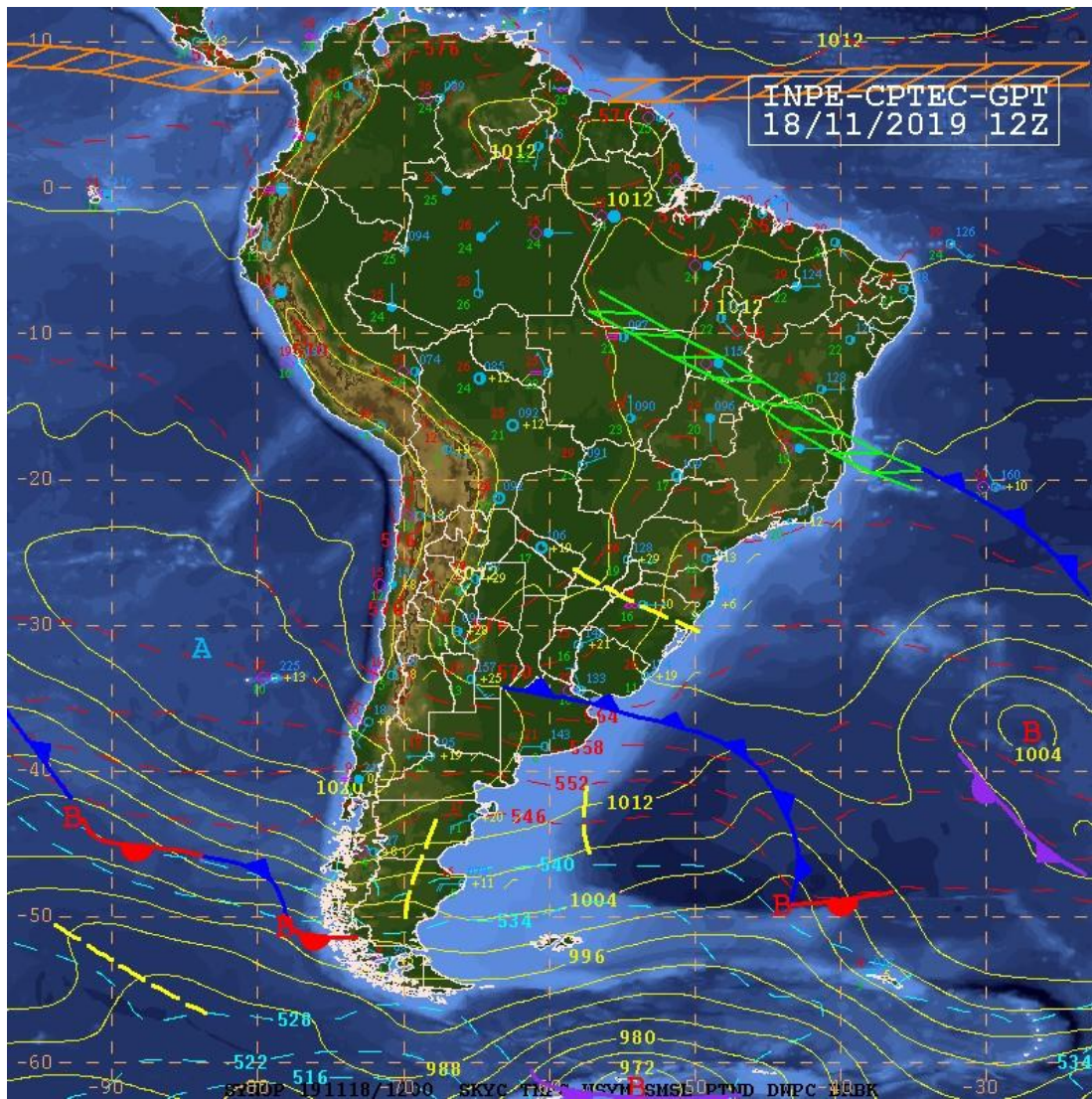

Figura A7 - Carta sinótica da Marinha do Brasil para as 1200Z do dia 20 de novembro de 2019 (09h00 do dia 20 de novembro de 2019, hora local. FONTE:CPTEC).

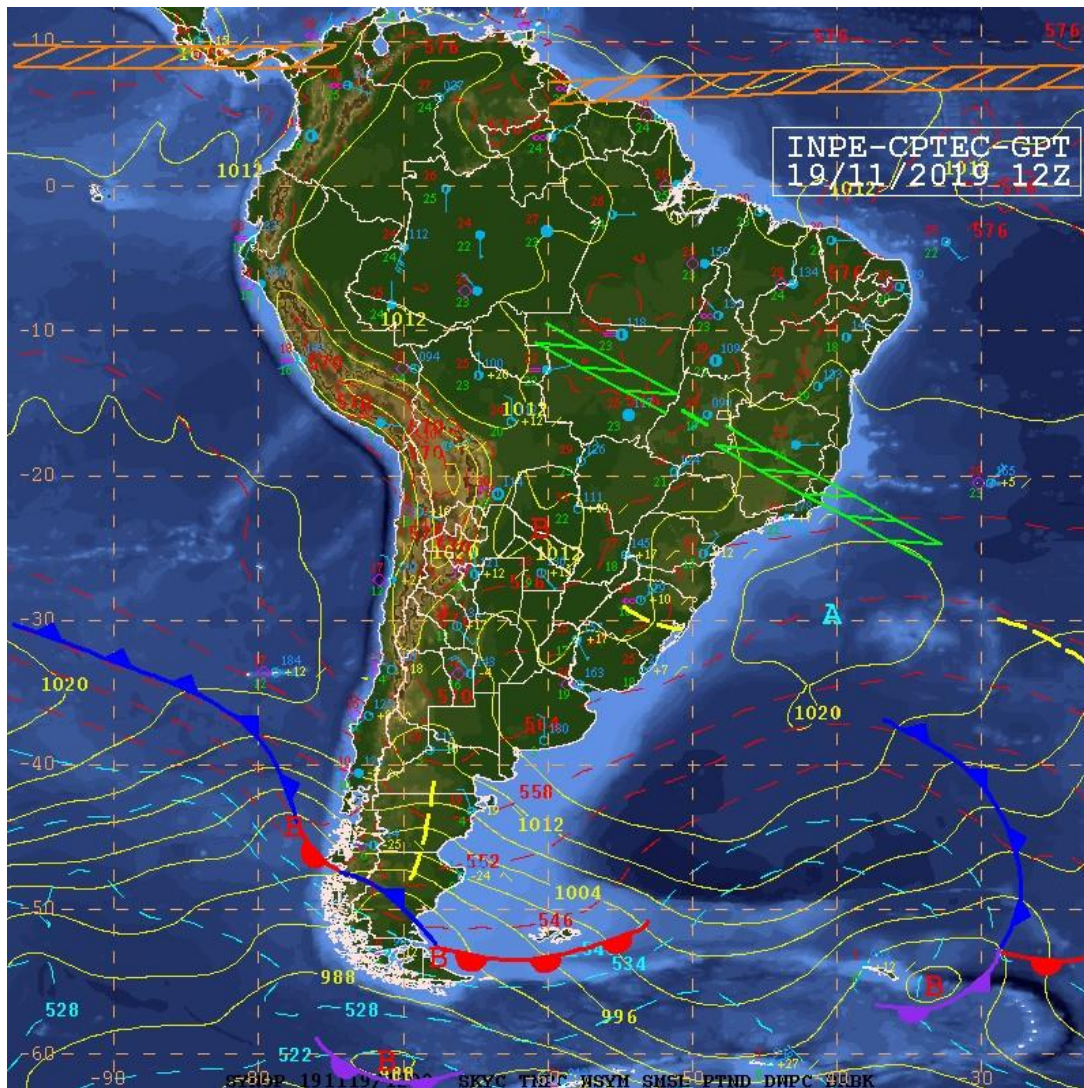

Figura A8 - Legenda das cartas sinóticas apresentadas acima. FONTE:CPTEC

A.2 Notícias relacionadas

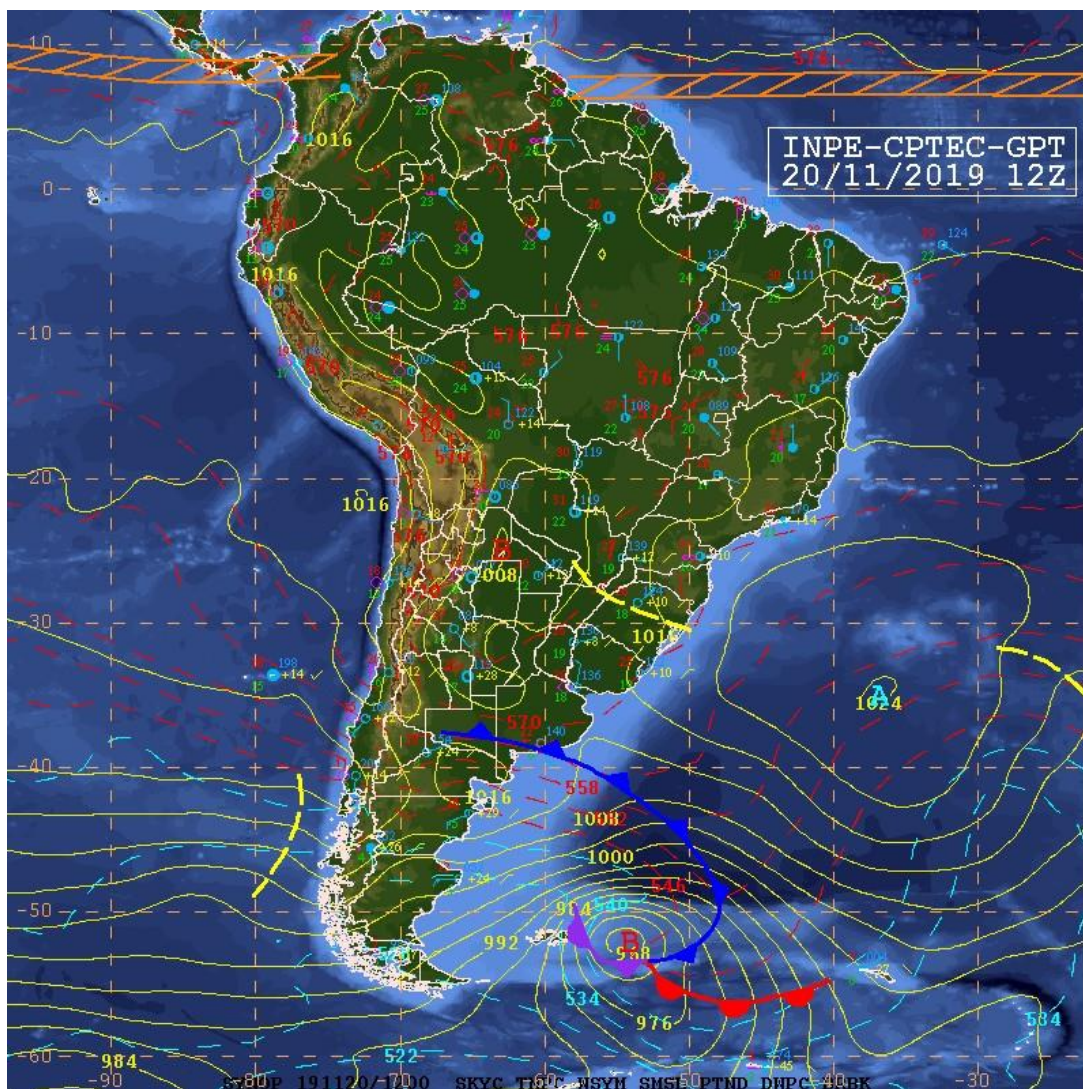
- Temporal arranca telhado de fábrica e deixa dois funcionários feridos, em Itumbiara

<https://g1.globo.com/go/goias/noticia/2019/11/15/temporal-arranca-telhado-de-fabrica-e-deixa-dois-funcionarios-feridos-em-itumbiara.ghtml>

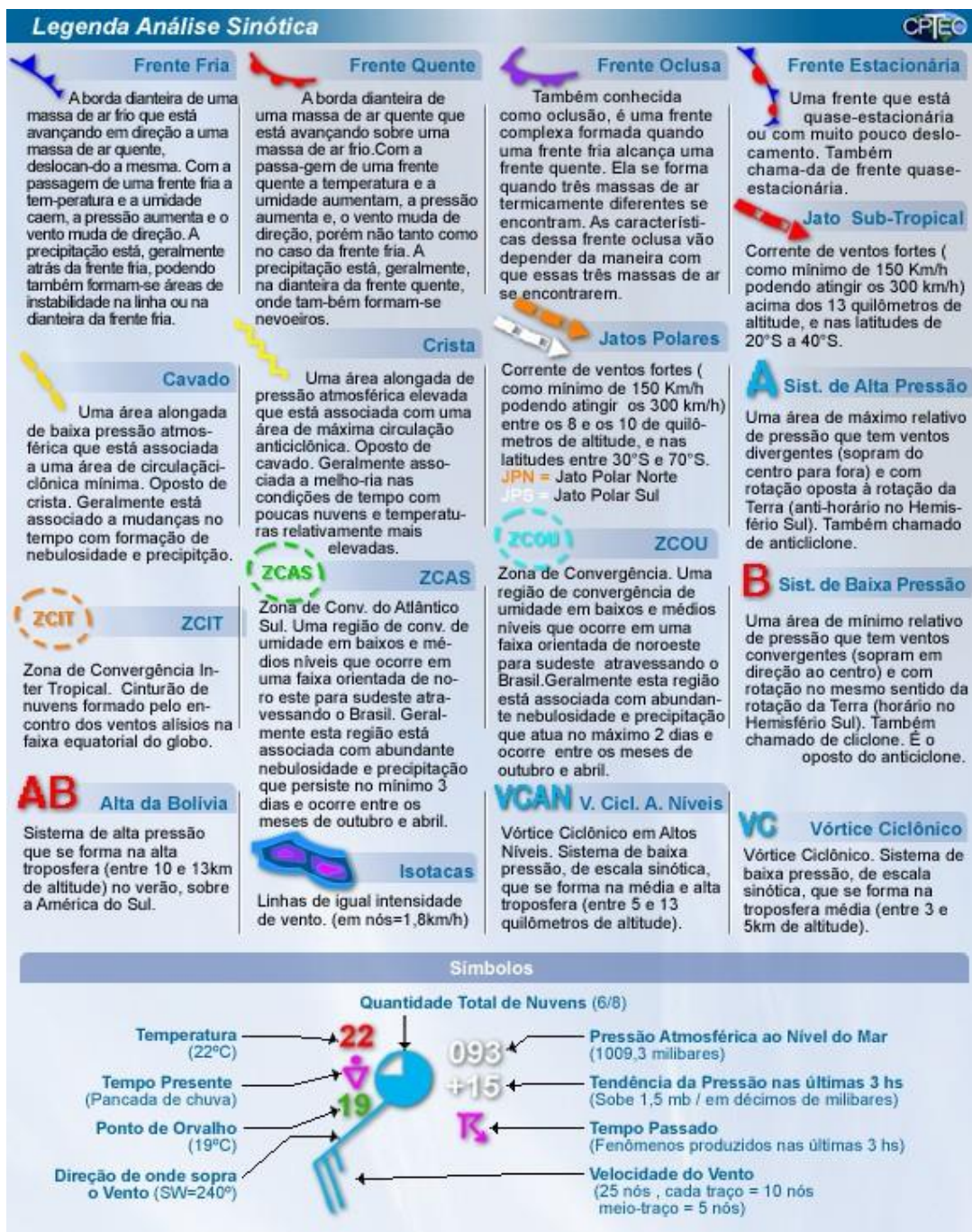
- Chuva com vento forte derruba árvores e até o teto de um galpão em Goiás

<https://globoplay.globo.com/v/8088745/>

- Cobertura de galpão industrial desaba durante temporal em Itumbiara

<https://www.aredacao.com.br/noticias/126432/cobertura-de-galpao-industrial-desaba-durante-temporal-em-itumbiara>

- Forte chuva destelha galpões e derruba barracão de empresa, em Itumbiara

<https://diaonline.com.br/2019/11/15/forte-chuva-destelha-galpoes-e-derruba-barracao-de-empresa-em-itumbiara/?utm>

- Enxurrada arrasta mulher e carro durante temporal em Quirinópolis; vídeo

<https://g1.globo.com/go/goias/noticia/2019/11/19/enxurrada-arrasta-mulher-e-carro-durante-temporal-em-quirinopolis-video.ghtml>

- Motociclista morre eletrocutado ao tentar fugir da chuva e segurar em poste em Goiânia - Jornal O Popular

<https://www.opopular.com.br/noticias/cidades/motociclista-morre-eletrocutado-ao-tentar-fugir-da-chuva-e-segurar-em-poste-em-goiânia-1.1933672>

- Chove granizo em Goiânia e trânsito fica complicado - Jornal O Popular

<https://www.opopular.com.br/noticias/cidades/chove-granizo-em-goiânia-e-trânsito-fica-complicado-1.1936466>

- Chuva de granizo e árvores caídas atingem Goiânia

<https://www.opopular.com.br/noticias/cidades/chuva-de-granizo-e-árvores-caídas-atingem-goiânia-1.1936864>

Bianca Lobo Silva

Meteorologista

CREA 5063840461

Dados do INMET – UMIDADE RELATIVA e CHUVA ACUMULADA

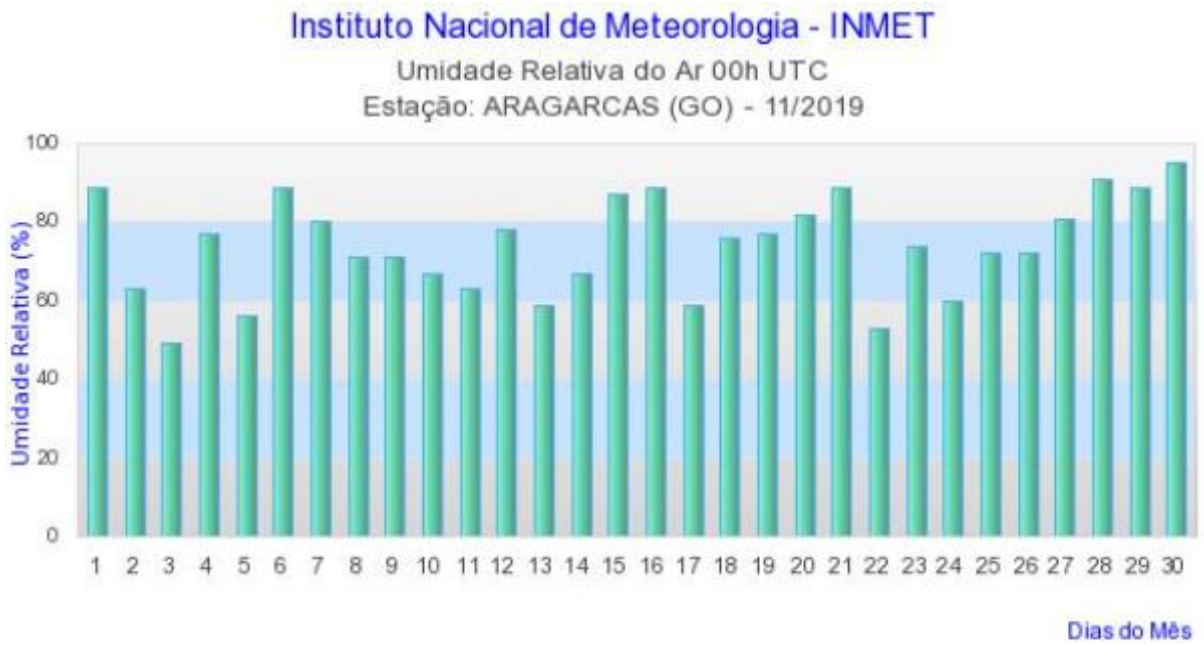

Instituto Nacional de Meteorologia - INMET

Umidade Relativa do Ar 00h UTC
Estação: CATALAO (GO) - 11/2019

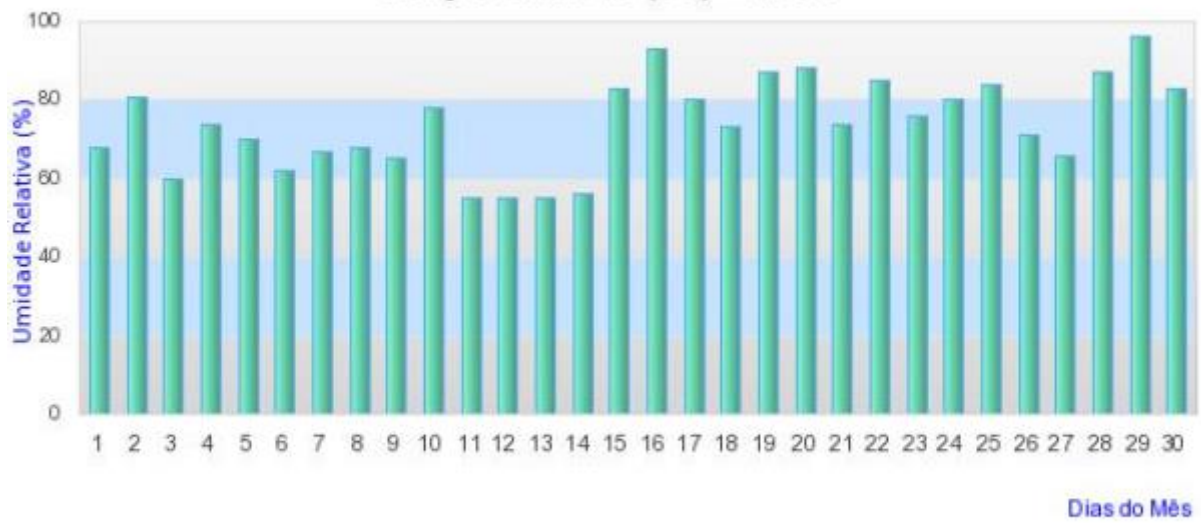

Instituto Nacional de Meteorologia - INMET

Chuva Acumulada 24h
Estação: CATALAO - 11/2019



Instituto Nacional de Meteorologia - INMET

Umidade Relativa do Ar 00h UTC
Estação: IPAMERI (GO) - 11/2019

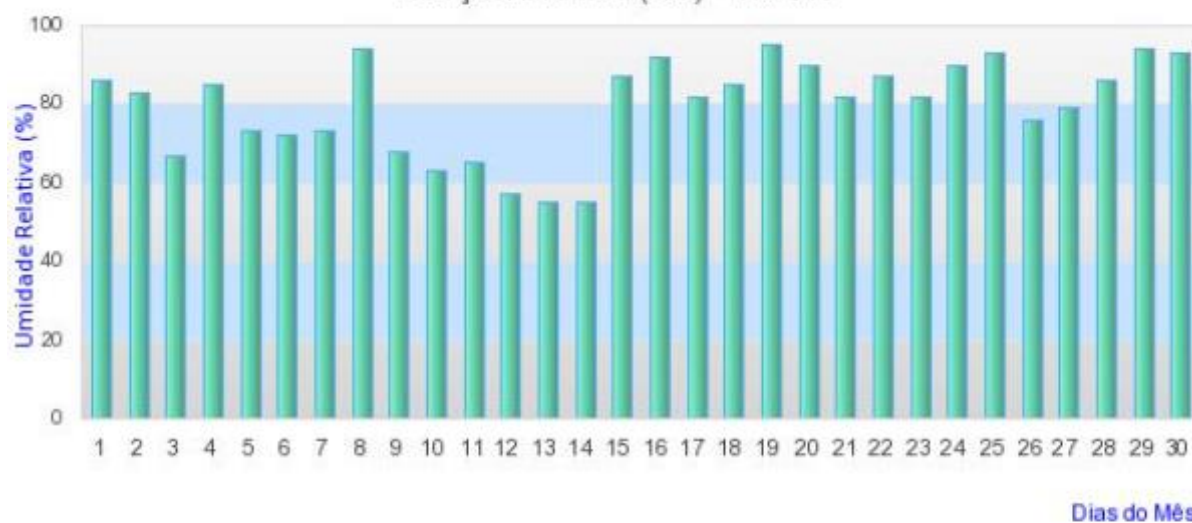

Instituto Nacional de Meteorologia - INMET

Chuva Acumulada 24h
Estação: IPAMERI - 11/2019

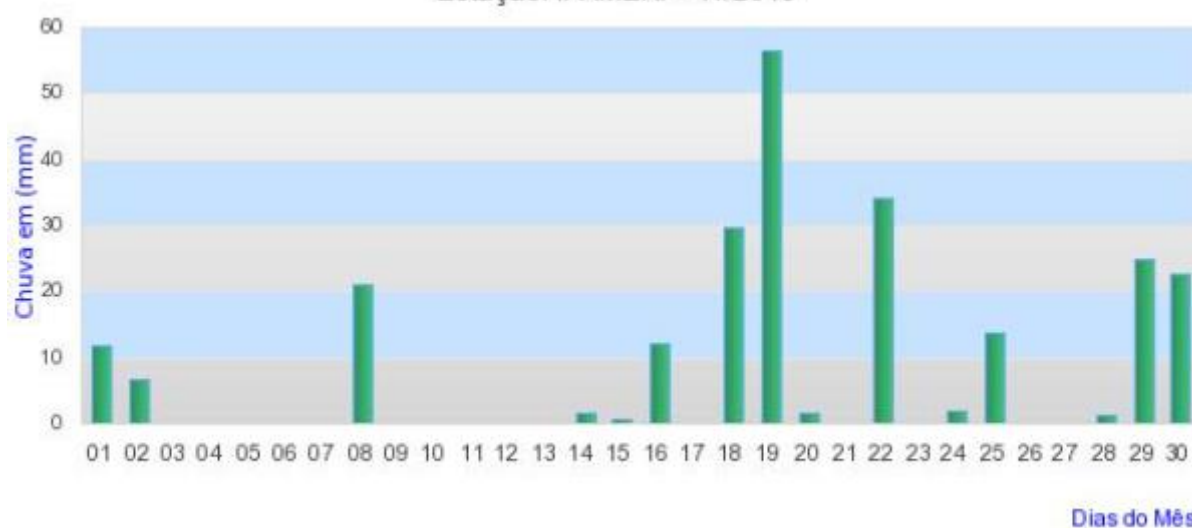

Instituto Nacional de Meteorologia - INMET

Umidade Relativa do Ar 00h UTC
Estação: RIO VERDE (GO) - 11/2019

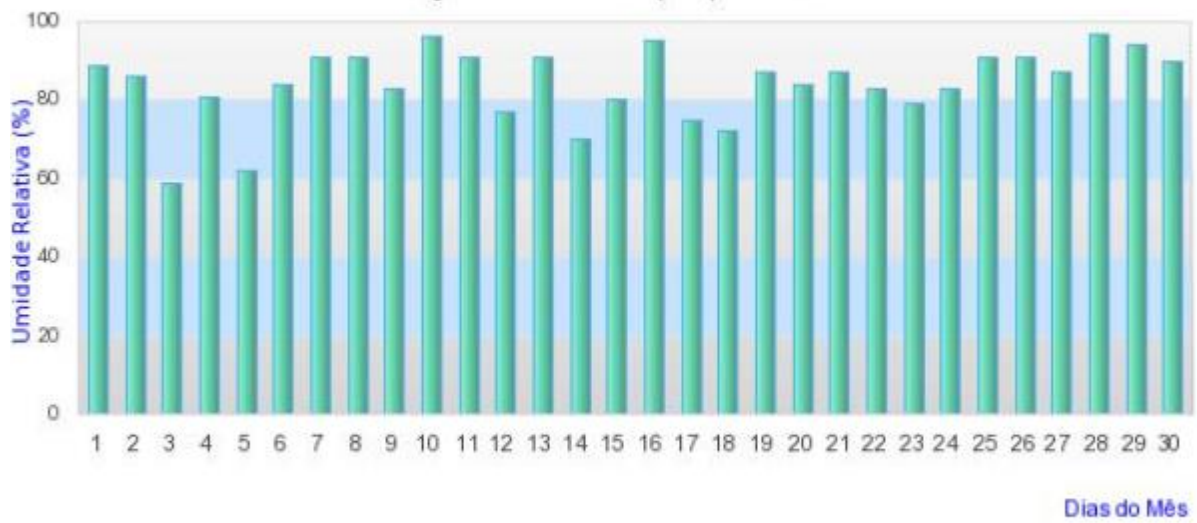

Instituto Nacional de Meteorologia - INMET

Chuva Acumulada 24h
Estação: RIO VERDE - 11/2019



Abadia de Goiás - Estação Abadia de Goiás - Novembro de 2019

Para ver os dados horários clique no dia desejado

Dia	Precip.	Prec.Acum.	Vel. Vent. (m/s)	Dir. Vent.	Umid. Relat. AR (Max) %	Umid. Relat. AR (Min) %	Umid. Relat. AR (Média)%	Temp. Max. °C Dia	Temp. Min. °C Dia	Temp. Med. °C do Ar	Temp. 09.00h	Temp. 21.00h	Ponto orvalho	Razao Mistura	Radiação Solar Diária MJ/m ²
1	8.80	8.80	2.3	NO	87.0	31.0	53	32.5	19.6	25.64	28.3	23.9	-	-	18.5
2	0.00	8.80	2.5	SE	92.0	37.0	56.7	31.6	19.0	25.32	26.4	24.8	-	-	19.7
3	0.00	8.80	2.8	N	82.0	40.0	63.7	29.9	20.5	24.42	25.1	23.3	-	-	19.5
4	12.20	21.00	2.1	N	91.0	33.0	65.7	33.1	19.8	24.9	28.4	21.6	-	-	19.1
5	5.20	26.20	1.9	NO	90.0	41.0	68.7	31.6	20.0	25.28	28	23.4	-	-	14.1
6	0.00	26.20	2.0	NO	87.0	47.0	70.2	29.4	20.4	23.92	23.6	23.1	-	-	14.6
7	0.00	26.20	1.9	SE	95.0	44.0	63	31.6	19.6	24.76	25.6	23.5	-	-	16.5
8	0.00	26.20	2.6	SO	92.0	59.0	73.2	28.3	20.7	23.88	22.8	23.8	-	-	12.3
9	16.40	42.60	3.2	SE	90.0	31.0	66.2	34.6	20.1	24.6	28.1	20.1	-	-	19.1
10	0.00	42.60	1.8	SO	96.0	35.0	61.5	32.5	19.1	24.96	26	23.6	-	-	18.8
11	1.00	43.60	2.3	NO	84.0	38.0	60.7	33.1	20.9	25.32	28.4	22.1	-	-	18
12	0.00	43.60	2.5	O	88.0	32.0	52.2	33.3	20.6	26.52	26.1	26.3	-	-	18.1
13	0.00	43.60	2.3	N	87.0	29.0	43	33.2	19.7	27.14	27.6	27.6	-	-	18.9
14	0.00	43.60	1.7	NO	89.0	40.0	59.2	31.1	20.4	25.78	27.8	24.8	-	-	15.2
15	11.40	55.00	1.6	NO	96.0	47.0	79.5	30.1	19.8	23.72	27.9	20.4	-	-	12.8
16	0.20	55.20	1.2	N	98.0	57.0	75.7	28.3	20.0	23.12	22.3	22.5	-	-	12
17	0.20	55.40	2.0	NO	95.0	59.0	76.7	28.6	20.0	24.14	25.3	23.4	-	-	13.4
18	12.60	68.00	2.1	L	95.0	60.0	88	26.8	19.2	21.72	22.6	20	-	-	7.1
19	1.00	69.00	1.6	L	97.0	52.0	85	28.3	19.7	22.74	23.9	20.9	-	-	10.5
20	0.00	69.00	1.9	L	94.0	51.0	82	28.0	20.0	22.98	25.3	20.8	-	-	8.6
21	0.00	69.00	2.5	SE	97.0	44.0	64.5	29.0	19.1	23.52	24.9	22.3	-	-	18.2
22	0.00	69.00	2.9	L	97.0	46.0	64	29.1	18.3	23.78	24.3	23.6	-	-	15.8
23	4.40	73.40	2.1	NO	95.0	44.0	73	29.4	20.0	23.96	27	21.7	-	-	8.2
24	48.00	121.40	2.3	N	97.0	44.0	77.2	30.3	18.9	22.78	25.1	19.8	-	-	16.7
25	0.40	121.80	2.2	NO	97.0	52.0	75	29.0	19.6	23.74	24.1	23	-	-	15.9
26	0.00	121.80	1.9	L	91.0	52.0	69.7	29.8	19.4	24.58	26.5	23.6	-	-	18.3
27	7.60	129.40	1.9	L	97.0	69.0	82.2	26.3	20.1	23.14	25.1	22.1	-	-	10.2
28	15.60	145.00	1.9	NO	98.0	75.0	90.5	25.1	20.0	22.2	23.9	21	-	-	5.8
29	8.00	153.00	1.9	NO	97.0	67.0	89	27.1	20.0	22.74	22.6	22	-	-	12.1
30	9.80	162.80	1.5	L	97.0	67.0	80	26.5	20.7	23.06	25.9	21.1	-	-	7.6

Aragarças - Estação Estação Hidro Aragarças - GO - ANA - Novembro de 2019

Para ver os dados horários clique no dia desejado

Dia	Precip.	Prec.Acum.	Sensor Pressão min	Sensor Pressão max	Sensor Pressão media	Nível Régua	CodifEixo	Vazão min (m3/s)	Vazão max (m3/s)	Vazão media (m3/s)
1	0.00	0.00	0.95	0.99	1.0	0.99	0.45	0.00	0.00	0.00
2	0.00	0.00	0.99	1.06	1.0	1.06	0.45	0.00	0.00	0.00
3	3.80	3.80	1.06	1.09	1.1	1.09	0.45	0.00	0.00	0.00
4	0.00	3.80	1.09	1.11	1.1	1.11	0.45	0.00	0.00	0.00
5	0.00	3.80	1.06	1.09	1.1	1.09	0.45	0.00	0.00	0.00
6	3.20	7.00	1.06	1.07	1.1	1.07	0.45	0.00	0.00	0.00
7	44.00	51.00	1.04	1.06	1.1	1.06	0.45	0.00	0.00	0.00
8	9.20	60.20	1.05	1.06	1.1	1.06	0.45	0.00	0.00	0.00
9	0.00	60.20	1.06	1.08	1.1	1.08	0.45	0.00	0.00	0.00
10	7.20	67.40	1.08	1.1	1.1	1.1	0.45	0.00	0.00	0.00
11	0.20	67.60	1.09	1.1	1.1	1.1	0.45	0.00	0.00	0.00
12	0.00	67.60	0	1.2	1.1	1.2	0.49	0.00	0.00	0.00
13	-122.80	-55.20	1.19	1.22	1.2	1.22	0.49	0.00	0.00	0.00
14	0.00	-55.20	1.18	1.19	1.2	1.19	0.49	0.00	0.00	0.00
15	8.20	-47.00	1.18	1.19	1.2	1.19	0.49	0.00	0.00	0.00
16	0.20	-46.80	1.16	1.18	1.2	1.18	0.49	0.00	0.00	0.00
17	0.00	-46.80	1.13	1.16	1.1	1.16	0.49	0.00	0.00	0.00
18	0.00	-46.80	1.13	1.14	1.1	1.14	0.49	0.00	0.00	0.00
19	16.40	-30.40	1.14	1.21	1.2	1.21	0.49	0.00	0.00	0.00
20	2.60	-27.80	1.21	1.24	1.2	1.24	0.49	0.00	0.00	0.00
21	0.20	-27.60	1.23	1.26	1.2	1.26	0.49	0.00	0.00	0.00
22	0.00	-27.60	1.26	1.32	1.3	1.32	0.49	0.00	0.00	0.00
23	0.00	-27.60	1.27	1.29	1.3	1.29	0.49	0.00	0.00	0.00
24	0.00	-27.60	1.29	1.32	1.3	1.32	0.49	0.00	0.00	0.00
25	0.00	-27.60	1.26	1.33	1.3	1.33	0.49	0.00	0.00	0.00
26	0.00	-27.60	1.2	1.27	1.2	1.27	0.49	0.00	0.00	0.00
27	34.00	6.40	1.21	1.77	1.4	1.77	0.49	0.00	0.00	0.00
28	0.80	7.20	1.73	1.77	1.8	1.77	0.49	0.00	0.00	0.00
29	0.00	7.20	1.73	1.84	1.8	1.84	0.49	0.00	0.00	0.00
30	0.20	7.40	1.82	2.06	1.9	2.06	0.49	0.00	0.00	0.00

Cidade de Goiás - Estação Estação Hidro Cid. Goiás Montante - GO - ANA - Novembro de 2019

Para ver os dados horários clique no dia desejado

Dia	Precip.	Prec. Acum.	Sensor Pressão min	Sensor Pressão max	Sensor Pressão media	Nível Régua	CodifEixo	Vazão min (m3/s)	Vazão max (m3/s)	Vazão media (m3/s)
1	0.00	0.00	0.2	0.21	0.2	0.21	-0.17	0.00	0.00	0.00
2	2.20	2.20	0.19	0.2	0.2	0.2	-0.17	0.00	0.00	0.00
3	0.20	2.40	0.19	0.21	0.2	0.21	-0.17	0.00	0.00	0.00
4	0.00	2.40	0.19	0.2	0.2	0.2	-0.17	0.00	0.00	0.00
5	5.20	7.60	0.19	0.75	0.2	0.75	-0.17	0.00	0.00	0.00
6	0.00	7.60	0.23	0.58	0.3	0.58	-0.17	0.00	0.00	0.00
7	0.00	7.60	0	0.23	0.2	0.23	-0.17	0.00	0.00	0.00
8	-145.40	-137.80	0.19	0.21	0.2	0.21	-0.17	0.00	0.00	0.00
9	7.40	-130.40	0.19	0.2	0.2	0.2	-0.17	0.00	0.00	0.00
10	0.00	-130.40	0.18	0.19	0.2	0.19	-0.17	0.00	0.00	0.00
11	1.80	-128.60	0.18	0.2	0.2	0.2	-0.17	0.00	0.00	0.00
12	1.00	-127.60	0.19	0.2	0.2	0.2	-0.17	0.00	0.00	0.00
13	0.20	-127.40	0.18	0.19	0.2	0.19	-0.17	0.00	0.00	0.00
14	0.00	-127.40	0.17	0.18	0.2	0.18	-0.17	0.00	0.00	0.00
15	7.80	-119.60	0.17	0.18	0.2	0.18	-0.17	0.00	0.00	0.00
16	0.00	-119.60	0.17	0.18	0.2	0.18	-0.17	0.00	0.00	0.00
17	3.20	-116.40	0.17	0.18	0.2	0.18	-0.17	0.00	0.00	0.00
18	0.00	-116.40	0.18	0.18	0.2	0.18	-0.17	0.00	0.00	0.00
19	0.20	-116.20	0.18	0.18	0.2	0.18	-0.17	0.00	0.00	0.00
20	1.80	-114.40	0.18	0.19	0.2	0.19	-0.17	0.00	0.00	0.00
21	0.00	-114.40	0.19	0.19	0.2	0.19	-0.17	0.00	0.00	0.00
22	0.80	-113.60	0.19	0.19	0.2	0.19	-0.17	0.00	0.00	0.00
23	0.00	-113.60	0.19	0.21	0.2	0.21	-0.17	0.00	0.00	0.00
24	2.80	-110.80	0.18	0.22	0.2	0.22	-0.17	0.00	0.00	0.00
25	7.20	-103.60	0.22	0.91	0.3	0.91	-0.17	0.00	0.00	0.00
26	0.00	-103.60	0.26	0.69	0.4	0.69	-0.17	0.00	0.00	0.00
27	9.20	-94.40	0.25	0.97	0.4	0.97	-0.17	0.00	0.00	0.00
28	11.80	-82.60	0.27	0.44	0.3	0.44	-0.17	0.00	0.00	0.00
29	0.20	-82.40	0.24	0.27	0.3	0.27	-0.17	0.00	0.00	0.00
30	0.00	-82.40	0.22	0.24	0.2	0.24	-0.17	0.00	0.00	0.00

Goiania - Estação CELG Estação Autodromo - Novembro de 2019

Para ver os dados horários clique no dia desejado

Dia	Precip.	Prec. Acum.	Vel. Vent. (m/s)	Dir. Vent.	Umid. Relat. AR (Max) %	Umid. Relat. AR (Min) %	Umid. Relat. AR (Média) %	Temp. Max. °C Dia	Temp. Min. °C Dia	Temp. Med. °C do Ar	Temp. 09:00h	Temp. 21:00h	Ponto orvalho	Razao Mistura
1	3.60	3.60	1.8	N	86.0	33.0	61.2	33.4	20.4	25.32	28.2	22.3	17.86667	14.0069
2	0.00	3.60	2.1	SE	84.0	37.0	51.7	32.8	20.7	26.94	26.6	27.3	17.31250	13.5417
3	0.00	3.60	2.1	N	81.0	44.0	66.5	30.6	22.1	25.32	24.7	24.6	18.16250	14.3611
4	0.40	4.00	2.1	N	88.0	33.0	57	33.8	21.6	26.66	28.3	24.8	18.09583	14.3472
5	1.40	5.40	1.5	N	87.0	34.0	63.7	33.6	20.1	25.5	27.4	23.2	18.52083	14.6597
6	0.00	5.40	1.9	N	86.0	43.0	66	31.5	21.5	25.62	23.5	25.8	19.12083	15.2847
7	0.00	5.40	1.9	SE	90.0	47.0	65.7	32.0	21.0	25.64	27	24.1	19.21250	15.1736
8	0.00	5.40	2.2	S	86.0	61.0	71.7	28.7	22.1	24.96	22.8	25.6	19.80417	15.9444
9	1.00	6.40	3.0	L	83.0	32.0	52.2	34.9	23.0	27.76	29.5	25.7	17.93333	14.1389
10	0.60	7.00	2.0	S	90.0	34.0	57.7	33.8	20.1	25.68	25.5	24.5	17.71667	13.8472
11	0.00	7.00	2.3	S	82.0	31.0	52.7	35.1	20.6	27.04	28.1	25.7	17.20000	13.4931
12	0.00	7.00	2.0	S	81.0	26.0	47.7	35.3	21.5	27.84	27	27.7	17.06667	13.3750
13	0.00	7.00	3.0	N	77.0	25.0	36.5	34.8	21.4	29.08	29.4	29.9	14.86250	11.7431
14	11.80	18.80	1.9	N	93.0	40.0	68.5	32.6	18.9	25.4	28.3	23.6	18.51667	14.7500
15	30.80	49.60	1.6	N	100.0	44.0	83.2	31.0	20.2	23.76	27.2	20.2	19.10000	15.3611
16	0.00	49.60	1.0	L	100.0	58.0	75.5	28.2	20.1	23.86	23	24	20.00417	16.2083
17	2.80	52.40	2.0	N	94.0	51.0	74.5	30.7	20.4	25.02	25.4	24.3	19.75000	15.7986
18	22.60	75.00	2.1	N	100.0	62.0	84.5	27.2	18.0	21.52	22	20.2	19.30833	15.3681
19	1.40	76.40	1.3	L	100.0	58.0	85.7	28.3	19.4	22.88	25.1	20.8	19.79167	15.8819
20	0.20	76.60	1.4	N	95.0	50.0	81	29.4	20.0	23.66	25.1	21.9	19.08750	15.1319
21	0.00	76.60	2.0	N	96.0	50.0	67	29.8	19.2	24.06	24.9	23.2	18.54583	14.7083
22	5.00	81.60	2.5	S	99.0	48.0	67	29.4	19.3	24.3	24.4	24.2	18.79583	14.9514
23	7.80	89.40	1.4	N	91.0	47.0	79.5	30.6	21.7	24.88	27.7	22.2	19.48750	15.3958
24	5.00	94.40	2.2	N	98.0	43.0	75.7	31.3	20.2	23.98	27	20.7	19.22917	15.3333
25	0.40	94.80	1.7	N	97.0	53.0	83.2	29.5	19.8	23.96	23.9	23.3	19.62917	15.6667
26	0.00	94.80	2.0	N	95.0	55.0	68.7	30.0	20.2	25.3	26.1	25.1	19.84583	15.9444
27	41.20	136.00	1.5	L	98.0	77.0	89	25.3	20.9	23.06	25.3	21.9	20.91250	17.1597
28	3.60	139.60	2.4	N	99.0	64.0	88.7	28.3	21.1	23.1	23.9	21.1	20.77500	16.9653
29	1.60	141.20	2.1	N	99.0	56.0	79.2	29.5	21.1	24.46	23.7	24	20.87917	17.0833
30	1.40	142.60	1.8	S	97.0	67.0	82.2	28.1	21.5	24.12	25.6	22.7	21.03333	17.0903

Anapolis - Estação CELG Estação Anapolis - Novembro de 2019

Para ver os dados horários clique no dia desejado

Dia	Precip.	Prec.Acum.	Vel. Vent. (m/s)	Dir. Vent.	Umid. Relat. AR (Max) %	Umid. Relat. AR (Min) %	Umid. Relat. AR (Média)%	Temp. Max. °C Dia	Temp. Min. °C Dia	Temp. Med. °C do Ar	Temp. 09:00h	Temp. 21:00h	Ponto orvalho	Razao Mistura
1	0.40	0.40	1.5	N	72.0	35.0	57	31.7	22.0	25.88	26.7	24.5	15.73333	12.7014
2	8.00	8.40	1.7	L	82.0	39.0	62	31.5	19.8	24.6	24.3	23.7	17.02917	13.7917
3	0.00	8.40	1.9	N	87.0	57.0	71.5	26.3	19.3	22.6	21.6	22.9	17.43333	14.1181
4	0.00	8.40	1.7	N	86.0	41.0	66.2	30.7	19.9	24.22	26.5	22	17.23333	13.9236
5	0.00	8.40	1.3	N	86.0	48.0	70.5	29.0	19.2	24.2	25.8	23.5	15.26667	14.0764
6	0.00	8.40	1.5	SE	94.0	52.0	64.2	28.4	19.9	24.18	23	24.8	17.72500	14.4167
7	0.00	8.40	1.6	L	86.0	50.0	61	28.6	20.4	24.66	25.5	24.4	18.02083	14.7986
8	0.00	8.40	1.8	S	87.0	58.0	71.2	28.8	20.3	24.04	22.1	24.5	18.72083	15.3333
9	0.00	8.40	2.2	L	87.0	32.0	57.2	32.6	20.3	25.58	26	24.5	16.80833	13.6250
10	0.20	8.60	1.7	O	88.0	42.0	57.2	30.7	19.7	25.16	26	24.7	16.57083	13.2708
11	3.20	11.80	1.9	O	69.0	30.0	53.7	32.8	21.7	26.16	28.1	24.1	15.79167	12.8681
12	0.00	11.80	2.2	SO	76.0	31.0	47	32.5	22.0	26.78	26	26.7	15.81667	12.7569
13	0.00	11.80	2.2	N	64.0	30.0	42.5	31.7	21.4	26.58	26.6	26.6	13.87500	11.2778
14	22.60	34.40	1.6	O	98.0	42.0	77.5	30.9	17.2	21.52	25.1	17.2	17.57500	14.3264
15	13.20	47.60	1.5	SO	98.0	53.0	83.2	28.3	19.0	22.36	25.7	19.4	18.50000	15.0833
16	1.80	49.40	0.7	SO	98.0	65.0	74	25.4	19.0	22.38	22.3	22.6	18.46667	15.1250
17	0.00	49.40	1.6	N	88.0	57.0	70	27.9	20.4	23.82	24.8	23	18.75000	15.4583
18	16.20	65.60	1.5	L	100.0	68.0	93.7	25.3	18.6	21.08	21.3	20.1	18.70833	15.3681
19	5.40	71.00	0.9	L	100.0	60.0	89.7	26.5	18.7	21.86	21.5	21.3	19.27083	15.9097
20	16.60	87.60	1.5	L	100.0	59.0	90.5	27.1	18.6	21.3	23.2	18.8	18.91667	15.5139
21	8.40	96.00	1.6	L	99.0	59.0	88.2	26.9	17.8	21.48	22.7	20	18.28333	14.9097
22	0.00	96.00	1.7	N	100.0	53.0	70.5	27.1	17.9	22.48	20.2	23.6	17.77917	14.3819
23	2.80	98.80	1.3	O	88.0	49.0	80.2	29.1	20.1	23.46	25.9	21.1	17.81667	14.4167
24	5.80	104.60	1.3	O	97.0	67.0	84.7	26.8	19.4	21.68	22.6	19.8	18.76250	15.3750
25	5.20	109.80	1.1	L	100.0	56.0	83	27.6	18.5	22.78	24.4	21.7	19.07500	15.5833
26	18.40	128.20	1.5	N	99.0	64.0	87.5	27.3	18.1	22.44	23.2	21.8	19.03333	15.7431
27	8.20	136.40	1.5	N	100.0	70.0	82.5	25.5	18.3	22.14	22.3	22.3	19.44583	16.0833
28	0.00	136.40	2.2	N	98.0	67.0	78.7	25.8	20.1	22.8	23.3	22.4	19.27500	15.8750
29	0.80	137.20	1.3	O	97.0	57.0	77.5	28.6	19.1	23.08	22.1	22.8	19.40417	15.9931
30	14.20	151.40	1.5	L	100.0	54.0	90.7	29.4	19.8	22.84	25.2	19.9	19.83333	16.4722

Goiania - Estação CELG Estação Aerodromo Goiania - Novembro de 2019

Para ver os dados horários clique no dia desejado

Dia	Precip.	Prec.Acum.	Vel. Vent. (m/s)	Dir. Vent.	Umid. Relat. AR (Max) %	Umid. Relat. AR (Min) %	Umid. Relat. AR (Média)%	Temp. Max. °C Dia	Temp. Min. °C Dia	Temp. Med. °C do Ar	Temp. 09:00h	Temp. 21:00h	Ponto orvalho	Razao Mistura
1	1.00	1.00	1.9	SO	85.0	32.0	57.7	33.7	20.8	26.02	28	23.8	17.57083	-
2	0.40	1.40	2.4	SE	86.0	35.0	50.7	33.2	20.5	27.08	26.1	27.8	17.27917	-
3	0.00	1.40	2.8	NO	79.0	48.0	61.5	29.3	21.6	25.42	24.8	25.7	17.73333	-
4	16.40	17.80	1.7	N	89.0	34.0	63	33.4	20.9	25.54	27.8	22.8	18.19167	-
5	0.00	17.80	1.7	NO	90.0	46.0	64.2	31.4	20.4	25.56	26.8	24.6	18.91667	-
6	0.00	17.80	1.8	N	92.0	43.0	67	30.6	20.4	24.68	24	24.2	19.10833	-
7	17.00	34.80	1.6	SE	91.0	43.0	68	33.0	20.2	24.84	25	23	19.25833	-
8	0.00	34.80	2.2	S	93.0	63.0	72	28.4	21.4	24.96	23.2	25.9	19.88750	-
9	9.80	44.60	2.4	SE	84.0	34.0	63	33.8	21.7	25.62	28.4	22.1	18.47083	-
10	0.00	44.60	1.7	SO	89.0	37.0	56	32.6	20.6	25.9	25.3	25.5	18.18750	-
11	0.00	44.60	2.1	S	81.0	32.0	58.2	33.9	21.1	26.02	27.7	23.7	17.78750	-
12	0.00	44.60	2.4	SO	80.0	32.0	51.2	33.8	22.1	26.73	27	26.8	17.65417	-
13	0.00	44.60	2.2	N	77.0	30.0	46.2	33.2	21.8	27.74	26.7	28.5	16.36667	-
14	0.00	44.60	1.8	SO	76.0	43.0	61.2	32.1	22.9	26.66	26.9	25.7	18.30833	-
15	25.00	69.60	1.6	S	99.0	48.0	78.5	30.5	20.7	24.04	27.6	20.7	18.84167	-
16	0.40	70.00	0.9	N	100.0	60.0	74	27.6	20.4	23.82	22.5	24.3	19.75000	-
17	6.60	76.60	1.9	N	93.0	58.0	75.5	29.1	20.6	24.44	24.9	23.8	19.77083	-
18	69.80	146.40	2.2	N	100.0	63.0	91	26.8	19.2	21.68	23.2	19.6	19.32917	-
19	1.00	147.40	1.3	L	97.0	60.0	76	27.8	20.2	23.82	25.5	22.8	19.87083	-
20	5.20	152.60	1.5	L	92.0	57.0	86.5	28.2	20.9	23.62	25.4	21.8	19.57500	-
21	0.00	152.60	2.0	SE	98.0	53.0	68.7	29.5	19.6	23.76	23.9	22.9	18.60417	-
22	0.00	152.60	2.7	N	96.0	49.0	64	28.6	19.9	24.78	24.4	25.5	18.40833	-
23	0.60	153.20	2.0	NO	87.0	43.0	75	30.3	21.6	24.68	26.9	22.3	18.99583	-
24	12.80	166.00	2.7	NO	99.0	46.0	78.2	30.4	20.2	23.76	26.4	20.9	19.27917	-
25	1.40	167.40	1.8	N	98.0	56.0	76.5	28.9	20.2	24.1	25	23.2	19.84583	-
26	3.80	171.20	1.9	N	89.0	59.0	74.5	28.8	20.5	24.68	25.3	24.4	19.52917	-
27	6.80	178.00	2.1	N	98.0	61.0	73.5	28.5	21.0	24.56	25.5	23.9	20.38750	-
28	5.60	183.60	2.5	N	100.0	67.0	90.2	27.6	20.4	23.02	24.1	21.5	20.93333	-
29	0.00	183.60	1.8	NO	100.0	63.0	78.7	29.2	20.6	24.28	22.8	24.4	20.95000	-
30	0.00	183.60	2.1	N	95.0	66.0	81	28.0	21.9	24.26	26.2	22.6	21.03333	-

Aparecida de Goiania - Estação CELG Estação Aparecida de Goiania - Novembro de 2019

Para ver os dados horários clique no dia desejado

Dia	Precip.	Prec.Acum.	Vel. Vent. (m/s)	Dir. Vent.	Umid. Relat. AR (Max) %	Umid. Relat. AR (Min) %	Umid. Relat. AR (Média)%	Temp. Max. °C Dia	Temp. Min. °C Dia	Temp. Med. °C do Ar	Temp. 09:00h	Temp. 21:00h	Ponto orvalho	Razao Mistura
1	6.40	6.40	1.0	S	84.0	33.0	62.2	33.5	20.6	24.72	27.9	20.8	17.03333	13.4514
2	0.00	6.40	1.1	S	85.0	37.0	53	32.5	20.1	26.46	25.7	27	17.22917	13.6736
3	0.00	6.40	1.4	N	71.0	45.0	60.2	30.4	21.7	25.46	25.6	24.8	17.47500	13.8194
4	1.80	8.20	1.3	N	79.0	33.0	59.2	34.0	22.2	26.44	27.8	24.1	17.80000	14.1736
5	0.20	8.40	1.0	N	82.0	36.0	62.7	33.8	21.1	25.84	27.3	23.5	18.37917	14.6597
6	0.00	8.40	1.0	NO	79.0	42.0	63.5	31.1	21.9	25.66	24.5	25.4	18.46250	14.6667
7	0.00	8.40	0.9	S	82.0	46.0	60.5	31.4	21.6	26.14	25.1	26.3	18.81250	15.1667
8	0.00	8.40	0.9	SE	85.0	60.0	70.7	28.7	21.2	24.9	22.6	26	19.22083	15.5694
9	0.20	8.60	1.5	L	78.0	30.0	53	34.9	22.9	27.1	28.3	24.7	17.51250	13.7639
10	0.00	8.60	0.9	S	83.0	35.0	56	33.5	20.7	26.26	25.5	25.8	17.59583	13.9583
11	2.60	11.20	0.9	S	76.0	36.0	56	34.0	21.9	26.7	28.6	24.5	17.75417	14.1250
12	2.60	13.80	0.9	S	81.0	30.0	50.5	34.8	21.3	27.76	27.3	27.7	17.34583	13.8333
13	0.00	13.80	2.1	N	76.0	27.0	37.5	33.8	21.3	28.86	28.6	30.3	15.21667	12.0764
14	0.00	13.80	1.0	N	75.0	39.0	59	33.6	22.5	26.7	28.4	24.5	17.94167	14.2847
15	4.40	18.20	0.8	NO	89.0	45.0	73.7	31.2	21.1	24.5	27.6	21.3	18.34583	14.7361
16	0.40	18.60	0.7	N	94.0	58.0	72.5	27.8	20.7	24.32	22.9	25.1	19.59583	15.9583
17	0.00	18.60	1.1	NO	85.0	50.0	65	30.8	21.3	25.62	25.4	25.3	19.14583	15.5417
18	20.60	39.20	1.5	SE	94.0	58.0	80.7	27.9	18.8	21.62	22	19.7	18.47500	14.7500
19	7.00	46.20	0.8	SO	95.0	57.0	85.7	29.2	19.8	22.94	24.3	20.7	19.39167	15.5000
20	0.00	46.20	1.2	N	93.0	49.0	79	29.8	20.0	23.7	25.3	21.7	18.91667	15.1667
21	0.00	46.20	1.4	L	91.0	47.0	63.5	29.6	19.3	24.18	24.2	23.9	18.05417	14.3819
22	3.00	49.20	1.5	S	93.0	51.0	70.7	29.2	19.0	23.72	23.6	23.4	18.49167	14.8264
23	6.00	55.20	0.7	N	85.0	49.0	74.7	29.8	22.2	24.76	27.2	22.3	18.88333	15.1597
24	9.80	65.00	1.1	NO	93.0	44.0	74.7	31.7	20.1	23.84	26.4	20.5	18.91667	15.0833
25	2.00	67.00	1.0	N	94.0	53.0	78.5	31.2	19.7	24.18	22.8	23.6	19.67500	15.9583
26	0.40	67.40	1.2	N	84.0	54.0	71.5	29.9	20.6	25.32	25.9	25.1	19.51667	15.9097
27	6.20	73.60	1.0	SE	94.0	74.0	83.7	25.6	20.6	23.56	24.2	23.7	20.60833	16.8264
28	13.20	86.80	1.1	N	94.0	71.0	90.2	26.8	21.2	22.9	23.7	21.4	20.51667	16.9167
29	3.20	90.00	1.1	NO	96.0	59.0	80	29.7	21.0	24.02	23.2	23.1	20.69583	17.0000
30	1.20	91.20	0.8	SE	95.0	79.0	85.5	26.5	21.2	23.7	24.6	23.1	20.87917	17.1319

Bela Vista - Estação CELG Estação Bela Vista - Novembro de 2019

Para ver os dados horários clique no dia desejado

Dia	Precip.	Prec.Acum.	Vel. Vent. (m/s)	Dir. Vent.	Umid. Relat. AR (Max) %	Umid. Relat. AR (Min) %	Umid. Relat. AR (Média)%	Temp. Max. °C Dia	Temp. Min. °C Dia	Temp. Med. °C do Ar	Temp. 09:00h	Temp. 21:00h	Ponto orvalho	Razao Mistura
7	0.00	0.00	2.0	L	67.0	55.0	-	29.6	23.1	-	-	24.7	18.33000	14.7600
8	0.20	0.20	1.4	S	94.0	61.0	73.5	28.4	20.6	24.22	23.1	24.5	19.62500	16.0208
9	0.00	0.20	3.1	L	88.0	28.0	52.5	35.3	21.8	27.54	29	25.8	17.65000	14.0069
10	9.60	9.80	1.5	SO	97.0	39.0	65	33.4	19.1	24.8	26.1	22.7	18.78750	15.0000
11	0.00	9.80	1.4	S	88.0	37.0	57.5	33.7	20.3	26.4	27.8	25.1	18.26250	14.4653
12	0.00	9.80	1.5	SO	89.0	30.0	49.7	35.2	20.1	27.22	26.8	27	17.17083	13.5000
13	0.00	9.80	2.5	L	76.0	27.0	37.2	34.3	21.1	28.48	29.4	28.8	14.76250	11.7153
14	1.20	11.00	1.7	NO	86.0	46.0	66.2	31.5	21.8	25.52	27.5	23.4	18.55000	14.8611
15	17.00	28.00	1.3	O	100.0	54.0	91.7	29.5	19.3	22.94	25.9	20	19.66667	15.7431
16	0.00	28.00	1.0	L	100.0	59.0	79.2	27.9	19.7	23.1	22.7	22.6	19.72500	15.9167
17	0.00	28.00	1.6	N	97.0	48.0	71.7	31.2	19.6	24.4	26	22.6	19.51250	15.7500
18	45.00	73.00	2.0	L	100.0	75.0	92.7	25.1	19.0	20.38	19	19.4	19.51667	15.7083
19	2.00	75.00	1.3	L	98.0	64.0	89	27.6	19.6	22.48	25.4	19.9	19.30417	15.5000
20	6.00	81.00	1.7	L	98.0	53.0	85.2	29.6	19.6	23.08	25	20.6	19.01667	15.0556
21	0.00	81.00	1.9	L	97.0	52.0	69	29.5	18.5	23.7	25.5	22.5	18.67500	14.9514
22	7.00	88.00	1.9	L	100.0	55.0	75.2	28.0	17.7	22.94	23.4	22.8	19.27500	15.4097
23	0.40	88.40	1.2	NO	98.0	57.0	75	28.3	20.8	23.98	26.4	22.2	19.42917	15.6319
24	29.40	117.80	1.7	O	100.0	54.0	81.5	30.3	19.3	22.86	25.5	19.6	19.51667	15.8264
25	19.60	137.40	1.8	N	100.0	50.0	80.7	30.3	18.9	22.7	23.9	20.2	19.83750	16.0486
26	16.80	154.20	1.9	L	100.0	56.0	82	30.1	19.6	23.38	25.4	20.9	20.33750	16.6944
27	6.80	161.00	1.4	L	100.0	71.0	87.7	26.8	19.7	23.08	24.1	22.4	20.81250	17.0833
28	0.80	161.80	1.7	NO	100.0	70.0	90	27.4	20.4	22.94	22.9	22	20.88750	17.1319
29	4.60	166.40	1.5	N	100.0	63.0	85.7	29.1	20.5	22.86	22.7	21	20.82917	17.1181
30	4.00	170.40	1.4	L	100.0	75.0	90.5	27.2	20.5	22.7	23.8	21	20.75833	17.0903

Goiania - Estação CELG Estação Goiania 2 - Novembro de 2019

Para ver os dados horários clique no dia desejado

Dia	Precip.	Prec.Acum.	Vel. Vent. (m/s)	Dir. Vent.	Umid. Relat. AR (Max) %	Umid. Relat. AR (Min) %	Umid. Relat. AR (Média)%	Temp. Max. °C Dia	Temp. Min. °C Dia	Temp. Med. °C do Ar	Temp. 09:00h	Temp. 21:00h	Ponto orvalho	Razao Mistura
1	0.00	0.00	0.5	NO	98.0	31.0	57.7	34.8	19.0	26.04	29	23.7	18.03750	14.2847
2	0.60	0.60	0.7	SE	97.0	39.0	56.2	34.0	19.7	26.56	28.1	25.5	18.25417	14.2500
3	0.00	0.60	0.7	N	81.0	41.0	65.7	30.9	21.7	25.56	26	24.6	18.49583	14.4514
4	1.80	2.40	0.5	NO	95.0	33.0	60.5	34.9	20.7	26.5	29.5	23.7	18.94583	15.0417
5	2.60	5.00	0.5	NO	99.0	39.0	68.5	33.6	19.4	25.7	28.7	23.4	19.69583	15.6667
6	0.00	5.00	0.6	NO	96.0	43.0	69.5	32.0	20.5	25.32	25.5	24.3	19.92500	15.9931
7	0.00	5.00	0.6	SE	98.0	44.0	73.5	33.2	20.5	24.96	28.3	21.4	19.97083	15.9306
8	0.00	5.00	0.7	SE	94.0	61.0	76.5	29.4	20.5	24.26	23.8	23.8	20.37083	16.5278
9	8.60	13.60	0.9	SE	93.0	30.0	63.7	36.0	20.8	26.02	30.5	21.4	18.98333	15.0903
10	0.60	14.20	0.5	NO	100.0	35.0	62.7	34.1	19.9	25.66	26.9	23.7	18.85833	14.8750
11	0.00	14.20	0.8	NO	98.0	33.0	59.5	35.6	19.5	26.28	28.3	24	18.67083	14.7222
12	0.00	14.20	0.7	SE	82.0	29.0	56.7	35.7	22.3	27.34	27.7	25.5	18.29583	14.5347
13	0.00	14.20	0.9	NO	95.0	28.0	-	34.2	19.4	-	29.5	-	16.57391	13.0000
14	4.60	18.80	0.7	NO	91.0	40.0	63.7	33.7	21.0	26.42	28.8	24.3	19.51667	15.6181
15	14.40	33.20	0.6	O	100.0	48.0	85	30.9	20.1	24.02	28.1	20.5	20.11667	16.1944
16	0.40	33.60	0.3	NO	100.0	55.0	84	29.2	20.4	23.3	21.9	22.5	20.64167	16.7917
17	0.00	33.60	0.7	NO	100.0	46.0	76.2	31.0	19.7	24.84	26.3	23.6	20.46667	16.5417
18	29.80	63.40	0.7	SE	100.0	62.0	89.7	28.0	19.2	22.32	24.6	19.9	20.01667	16.0486
19	0.60	64.00	0.4	L	100.0	66.0	83	28.3	19.6	23.56	25.7	22.1	20.70000	16.7083
20	15.80	79.80	0.4	NO	100.0	57.0	93.5	29.3	19.5	23.32	26.4	20.7	20.42500	16.3333
21	0.00	79.80	0.7	SE	100.0	52.0	77.5	30.2	19.2	23.38	24.7	21.4	19.60417	15.6250
22	6.20	86.00	0.8	NO	100.0	51.0	72.2	29.9	19.4	24.08	25.7	22.7	19.60417	15.6597
23	0.00	86.00	0.5	NO	99.0	47.0	78.5	31.2	20.6	24.68	28.2	21.7	20.11250	16.0000
24	6.40	92.40	0.8	NO	100.0	39.0	78.2	32.2	19.3	24.04	27.3	20.7	19.73333	15.7500
25	0.60	93.00	0.4	NO	100.0	61.0	76.7	29.1	19.6	24.28	25.9	23.4	20.53750	16.6736
26	0.00	93.00	0.6	NO	99.0	55.0	76	30.6	19.5	25	26.7	24.1	20.37917	16.4028
27	17.20	110.20	0.4	SE	100.0	71.0	90	27.9	20.9	23.74	26.1	21.9	21.55000	17.7014
28	11.20	121.40	0.7	NO	100.0	62.0	91.5	29.2	20.5	23.38	25.8	20.7	21.32083	17.4236
29	2.60	124.00	0.5	NO	100.0	61.0	92.5	29.5	20.3	23.94	23.7	23.1	21.51250	17.6597
30	0.00	124.00	0.7	O	100.0	65.0	82	29.6	21.5	24.72	27.3	22.6	21.72917	17.8403

Senador Canedo - Estação CELG Estação Senador Canedo - Novembro de 2019

Para ver os dados horários clique no dia desejado

Dia	Precip.	Prec.Acum.	Vel. Vent. (m/s)	Dir. Vent.	Umid. Relat. AR (Max) %	Umid. Relat. AR (Min) %	Umid. Relat. AR (Média)%	Temp. Max. °C Dia	Temp. Min. °C Dia	Temp. Med. °C do Ar	Temp. 09:00h	Temp. 21:00h	Ponto orvalho	Razao Mistura
7	0.00	0.00	1.4	N	62.0	50.0	-	30.9	25.5	-	-	25.8	18.45833	14.7816
8	0.00	0.00	1.5	SO	90.0	59.0	74.2	27.6	21.2	24.28	21.8	25.4	19.62500	16.0278
9	1.00	1.00	2.1	L	83.0	33.0	57.2	34.2	22.2	27.02	28.5	25.1	17.72500	14.1319
10	2.40	3.40	1.2	S	91.0	37.0	57.5	32.7	20.0	25.44	25.3	24.6	17.76250	14.1458
11	0.00	3.40	1.3	NO	77.0	29.0	55	34.4	21.5	26.66	27.8	24.8	16.87500	13.6111
12	0.00	3.40	1.3	S	81.0	27.0	51	34.7	21.7	27.2	26.2	26.7	16.93333	13.4236
13	0.00	3.40	2.6	N	65.0	27.0	37.7	34.1	23.1	28.74	28.9	28.8	14.39167	11.4097
14	1.80	5.20	1.3	SO	81.0	43.0	67	31.9	22.7	26	27.6	23.9	18.36250	14.5903
15	11.80	17.00	0.9	SO	100.0	44.0	83.2	31.0	19.7	23.6	27.7	19.8	18.76250	15.1458
16	0.40	17.40	0.7	L	100.0	59.0	74.7	27.4	19.5	23.56	22.5	24.2	19.45833	15.7986
17	0.00	17.40	1.5	N	88.0	55.0	73.5	29.7	20.9	24.56	24.8	23.7	19.44167	15.8264
18	18.20	35.60	1.4	L	99.0	63.0	87.7	26.9	18.9	21	20.2	19.5	19.20833	15.5000
19	1.20	36.80	1.1	SO	94.0	63.0	83.7	26.5	20.2	22.74	26.2	20.4	19.45000	15.7153
20	15.40	52.20	1.5	SE	97.0	55.0	87.5	28.6	18.9	22.9	25.4	20.8	19.06250	15.2639
21	0.00	52.20	1.5	L	99.0	48.0	69	29.1	18.6	23.54	24.8	22.6	18.46250	14.9097
22	7.00	59.20	1.9	N	100.0	52.0	70	28.7	18.7	23.62	24.1	23.3	18.78750	15.0417
23	0.80	60.00	0.9	N	85.0	50.0	75.5	30.7	21.6	24.88	26.5	22.8	18.93333	15.1736
24	9.20	69.20	1.7	N	100.0	44.0	79.5	31.1	19.4	23.22	25.4	20.1	19.12500	15.5764
25	0.20	69.40	1.2	L	99.0	55.0	80	29.9	19.4	23.74	23.2	23.1	19.60833	15.8681
26	6.00	75.40	1.4	N	94.0	58.0	82	28.7	20.2	24.1	25.2	23.2	19.85833	16.2847
27	4.00	79.40	1.3	SO	99.0	74.0	90.7	25.7	20.4	23.22	24.6	22.7	20.85000	17.1250
28	3.60	83.00	1.7	N	100.0	63.0	88.2	28.1	20.2	22.78	24.2	20.7	20.64583	16.8333
29	0.80	83.80	1.6	N	99.0	61.0	82.7	29.2	20.4	23.46	22.7	22.5	20.78750	17.1250
30	0.00	83.80	1.5	L	94.0	62.0	83.5	28.6	21.4	23.78	25.7	21.6	20.71667	17.0903

Goiânia - Estação Estação Hidro Goiânia Jusante - GO - ANA - Novembro de 2019

[Para ver os dados horários clique no dia desejado](#)

Dia	Precip.	Prec. Acum.	Sensor Pressão min	Sensor Pressão max	Sensor Pressão media	Nível Régua	CodifEixo	Vazão min (m3/s)	Vazão max (m3/s)	Vazão media (m3/s)
1	2.20	2.20	0.88	1.1	0.9	1.1	6.25	0.00	0.00	0.00
2	0.00	2.20	0.87	1.1	0.9	1.1	6.25	0.00	0.00	0.00
3	0.00	2.20	0.88	0.91	0.9	0.91	6.25	0.00	0.00	0.00
4	0.20	2.40	0.84	0.97	0.9	0.97	6.25	0.00	0.00	0.00
5	1.80	4.20	0.89	1.09	1.0	1.09	6.25	0.00	0.00	0.00
6	0.60	4.80	0.88	0.93	0.9	0.93	6.25	0.00	0.00	0.00
7	0.00	4.80	0.9	1.26	0.9	1.26	6.25	0.00	0.00	0.00
8	0.00	4.80	0.87	1.22	0.9	1.22	6.25	0.00	0.00	0.00
9	0.00	4.80	0.86	1.13	0.9	1.13	6.25	0.00	0.00	0.00
10	0.00	4.80	0.88	1.36	1.0	1.36	6.25	0.00	0.00	0.00
11	0.00	4.80	0.84	0.94	0.9	0.94	6.25	0.00	0.00	0.00
12	0.00	4.80	0.88	0.9	0.9	0.9	6.25	0.00	0.00	0.00
13	0.00	4.80	0.88	0.91	0.9	0.91	6.25	0.00	0.00	0.00
14	15.00	19.80	0.88	1.18	0.9	1.18	6.25	0.00	0.00	0.00
15	36.80	56.60	0.87	3.03	1.2	3.03	6.25	0.00	0.00	0.00
16	0.40	57.00	0.92	2.83	1.2	2.83	6.25	0.00	0.00	0.00
17	0.00	57.00	0.95	1.12	1.1	1.12	6.25	0.00	0.00	0.00
18	23.80	80.80	0.95	3.25	1.4	3.25	6.25	0.00	0.00	0.00
19	0.00	80.80	1.09	2.49	1.3	2.49	6.25	0.00	0.00	0.00
20	17.20	98.00	1.08	2.06	1.3	2.06	6.25	0.00	0.00	0.00
21	0.20	98.20	0.91	1.17	1.1	1.17	6.25	0.00	0.00	0.00
22	-177.60	-79.40	0.9	1.03	0.9	1.03	6.25	0.00	0.00	0.00
23	0.40	-79.00	0.88	0.96	0.9	0.96	6.25	0.00	0.00	0.00
24	9.20	-69.80	0.89	1.55	0.9	1.55	6.25	0.00	0.00	0.00
25	1.20	-68.60	0.98	1.58	1.2	1.58	6.25	0.00	0.00	0.00
26	0.20	-68.40	0.94	1.22	1.0	1.22	6.25	0.00	0.00	0.00
27	41.40	-27.00	0.92	1.77	1.2	1.77	6.25	0.00	0.00	0.00
28	5.20	-21.80	0.92	1.37	1.0	1.37	6.25	0.00	0.00	0.00
29	0.20	-21.60	0.95	1.45	1.1	1.45	6.25	0.00	0.00	0.00
30	0.20	-21.40	0.95	1.17	1.0	1.17	6.25	0.00	0.00	0.00

Goiânia - Estação Estação Hidro Goiânia Montante - GO - ANA - Novembro de 2019

[Para ver os dados horários clique no dia desejado](#)

Dia	Precip.	Prec. Acum.	Sensor Pressão min	Sensor Pressão max	Sensor Pressão media	Nível Régua	CodifEixo	Vazão min (m3/s)	Vazão max (m3/s)	Vazão media (m3/s)
1	2.40	2.40	1.1	1.48	1.3	1.48	6.71	0.00	0.00	0.00
2	1.40	3.80	1.18	1.62	1.3	1.62	6.71	0.00	0.00	0.00
3	0.00	3.80	1.06	1.49	1.3	1.49	6.71	0.00	0.00	0.00
4	2.80	6.60	0.95	1.52	1.4	1.52	6.71	0.00	0.00	0.00
5	0.20	6.80	0.91	1.51	1.3	1.51	6.71	0.00	0.00	0.00
6	0.00	6.80	1.01	1.45	1.3	1.45	6.71	0.00	0.00	0.00
7	7.60	14.40	0.91	1.46	1.3	1.46	6.71	0.00	0.00	0.00
8	0.00	14.40	0.9	1.47	1.3	1.47	6.71	0.00	0.00	0.00
9	14.60	29.00	0.93	1.43	1.2	1.43	6.71	0.00	0.00	0.00
10	0.00	29.00	0.92	1.42	1.2	1.42	6.71	0.00	0.00	0.00
11	0.00	29.00	0.91	1.35	1.2	1.35	6.71	0.00	0.00	0.00
12	0.00	29.00	1.06	1.33	1.2	1.33	6.71	0.00	0.00	0.00
13	0.00	29.00	0.98	1.43	1.2	1.43	6.71	0.00	0.00	0.00
14	0.00	29.00	0.98	1.4	1.2	1.4	6.71	0.00	0.00	0.00
15	23.20	52.20	1.03	2.07	1.3	2.07	6.71	0.00	0.00	0.00
16	0.60	52.80	1.03	1.5	1.3	1.5	6.71	0.00	0.00	0.00
17	0.00	52.80	1.09	1.53	1.3	1.53	6.71	0.00	0.00	0.00
18	37.00	89.80	1.1	2.45	1.5	2.45	6.71	0.00	0.00	0.00
19	2.60	92.40	0.94	1.38	1.1	1.38	6.71	0.00	0.00	0.00
20	11.20	103.60	1	1.39	1.1	1.39	6.71	0.00	0.00	0.00
21	0.00	103.60	0	1.63	1.4	1.63	7.17	0.00	0.00	0.00
22	-152.20	-48.60	1.4	1.55	1.5	1.55	7.17	0.00	0.00	0.00
23	0.00	-48.60	1.33	1.45	1.4	1.45	7.17	0.00	0.00	0.00
24	4.20	-44.40	1.33	1.51	1.4	1.51	7.17	0.00	0.00	0.00
25	0.00	-44.40	1.38	1.5	1.4	1.5	7.17	0.00	0.00	0.00
26	0.00	-44.40	1.46	1.58	1.5	1.58	7.17	0.00	0.00	0.00
27	6.80	-37.60	1.54	1.69	1.6	1.69	7.17	0.00	0.00	0.00
28	24.00	-13.60	1.49	1.74	1.6	1.74	7.17	0.00	0.00	0.00
29	1.40	-12.20	1.44	1.59	1.5	1.59	7.17	0.00	0.00	0.00
30	0.00	-12.20	1.42	1.56	1.5	1.56	7.17	0.00	0.00	0.00

Goiânia - Estação Heliponto Goiânia - Novembro de 2019

Para ver os dados horários clique no dia desejado

Dia	Precip.	Prec. Acum.	Vel. Vent. (m/s)	Dir. Vent.	Umid. Relat. AR (Max) %	Umid. Relat. AR (Min) %	Umid. Relat. AR (Média)%	Temp. Max. °C Dia	Temp. Min. °C Dia	Temp. Med. °C do Ar	Temp. 09:00h	Temp. 21:00h	Ponto orvalho	Razao Mistura	Radiação Solar Diária MJ/m²
1	0.00	0.00	1.9	SE	81.0	30.0	54	33.1	21.9	26.22	28.9	23.6	-	-	15.6
2	0.00	0.00	1.8	SE	85.0	32.0	47.2	33.3	21.1	27.54	26.5	28.4	-	-	20.3
3	0.00	0.00	1.5	N	76.0	39.0	60.2	29.5	22.4	25.76	25.3	25.8	-	-	15.2
4	0.60	0.60	1.4	L	81.0	28.0	56.5	33.8	23.0	26.68	28.8	23.9	-	-	19.3
5	8.80	9.40	1.4	NO	82.0	36.0	62.5	32.3	22.0	26.12	27.3	24.5	-	-	14.8
6	0.00	9.40	1.7	NO	89.0	38.0	63.7	31.1	21.5	25.62	24.5	25.5	-	-	15.7
7	0.00	9.40	1.4	SE	88.0	43.0	63.7	31.9	22.4	25.94	26.4	24.5	-	-	15.8
8	0.00	9.40	2.0	SE	90.0	60.0	70.2	28.4	21.9	25.2	22.9	26.4	-	-	9.9
9	0.00	9.40	2.4	SE	74.0	25.0	53.5	35.6	23.6	26.94	28.3	23.6	-	-	20.2
10	0.00	9.40	1.7	SE	85.0	32.0	48.7	32.8	21.7	26.84	26.1	26.8	-	-	21
11	0.00	9.40	2.0	NO	80.0	28.0	50	34.1	22.5	27.12	27.8	25.6	-	-	18.4
12	0.00	9.40	1.7	S	78.0	24.0	44.7	34.8	22.8	28.06	27.1	27.8	-	-	17.6
13	0.00	9.40	1.5	N	72.0	23.0	36	33.6	23.1	28.5	28	28.9	-	-	20.2
14	3.80	13.20	1.7	NO	74.0	36.0	59.5	32.3	23.6	27.1	29.8	24.9	-	-	17.7
15	31.00	44.20	1.6	SE	99.0	43.0	76.5	30.3	20.7	24.28	28.6	20.9	-	-	13.9
16	0.60	44.80	0.8	L	99.0	53.0	73	29.3	20.8	24.62	22.8	25.1	-	-	9.1
17	0.00	44.80	1.5	N	95.0	47.0	70.7	30.4	21.6	25.22	24.9	24.6	-	-	16.4
18	17.60	62.40	1.8	SE	100.0	57.0	87.2	27.5	19.6	22.24	23.3	20.4	-	-	12.5
19	0.20	62.60	1.4	SE	97.0	58.0	80.7	28.0	20.8	23.6	25.6	21.8	-	-	10.7
20	23.00	85.60	1.4	SE	96.0	51.0	85.5	29.1	20.6	23.72	25.9	21.5	-	-	9.8
21	0.00	85.60	1.5	SE	100.0	43.0	66.2	30.4	19.7	24.26	24.4	23.4	-	-	19.3
22	3.60	89.20	1.7	L	99.0	44.0	64.7	29.1	19.5	24.64	24	25.3	-	-	16.4
23	0.60	89.80	1.3	NO	88.0	46.0	70.2	29.5	22.5	25.26	27.3	23.5	-	-	12.5
24	5.60	95.40	1.8	NO	99.0	36.0	76.5	30.9	20.4	23.92	25.1	21.6	-	-	19.1
25	2.00	97.40	1.4	SE	99.0	55.0	78.5	28.8	20.3	24.24	24.9	23.6	-	-	14.1
26	0.00	97.40	1.4	L	89.0	52.0	69	29.4	21.1	25.16	26.1	24.6	-	-	15.7
27	16.00	113.40	1.4	SE	98.0	71.0	85.5	27.1	21.6	24.2	25.1	23.6	-	-	10.2
28	10.20	123.60	1.8	NO	99.0	62.0	91	27.8	20.7	23.26	24.8	21.5	-	-	9.1
29	7.00	130.60	1.4	NO	100.0	60.0	86.2	28.4	21.1	24.02	22.4	24.1	-	-	13.6
30	1.60	132.20	1.6	SE	99.0	68.0	79.5	27.6	22.1	24.52	27.1	22.9	-	-	12.1

Palmeiras de Goiás - Estação Palmeiras de Goiás - Novembro de 2019

Para ver os dados horários clique no dia desejado

Dia	Precip.	Prec. Acum.	Vel. Vent. (m/s)	Dir. Vent.	Umid. Relat. AR (Max) %	Umid. Relat. AR (Min) %	Umid. Relat. AR (Média)%	Temp. Max. °C Dia	Temp. Min. °C Dia	Temp. Med. °C do Ar	Temp. 09:00h	Temp. 21:00h	Ponto orvalho	Razao Mistura	Radiação Solar Diária MJ/m²
1	0.00	0.00	2.5	S	96.0	34.0	60	35.3	21.3	26.9	27.7	25.1	-	-	21.8
2	0.00	0.00	2.9	SO	96.0	34.0	50.5	34.3	20.5	27.78	27.9	28.1	-	-	-
3	1.20	1.20	2.3	SO	90.0	48.0	69.7	30.1	22.0	25.66	26.8	24.7	-	-	-
4	0.00	1.20	3.0	S	90.0	32.0	57.2	34.6	22.8	27.72	29	26.1	-	-	-
5	14.80	16.00	2.4	SO	100.0	32.0	76.2	35.4	22.3	25.94	27.2	22.4	-	-	-
6	0.20	16.20	1.1	S	100.0	43.0	80.5	32.6	21.2	25.22	23.3	24.5	-	-	-
7	0.00	16.20	1.8	S	100.0	40.0	62.7	34.1	20.9	27.08	27	26.7	-	-	-
8	0.00	16.20	2.8	SO	100.0	48.0	63	32.6	21.6	26.48	24.4	26.9	-	-	-
9	39.60	55.80	1.8	S	100.0	35.0	74	34.7	19.8	24.94	29.6	20.3	-	-	-
10	0.20	56.00	2.3	S	100.0	39.0	66	33.9	19.8	26.32	24.9	26.5	-	-	-
11	18.00	74.00	2.2	S	100.0	31.0	75	35.9	22.2	26.22	28	22.5	-	-	-
12	1.40	75.40	1.8	SO	100.0	41.0	71.2	34.6	21.5	26.02	24.8	24.6	-	-	-
13	0.00	75.40	0.9	S	100.0	36.0	55	34.4	22.0	27.94	26.7	28.3	-	-	-
14	0.00	75.40	1.1	S	92.0	35.0	52.2	34.7	22.3	28.48	28.2	28.6	-	-	-
15	24.20	99.60	2.7	L	100.0	47.0	84.2	31.8	21.0	24.7	27.7	21.5	-	-	-
16	0.20	99.80	1.1	L	100.0	52.0	80.2	30.3	21.2	25.1	23.4	25.3	-	-	-
17	9.40	109.20	1.3	L	100.0	57.0	74.5	30.7	20.8	25.22	25.8	24.4	-	-	-
18	2.20	111.40	1.4	SO	100.0	54.0	92.5	30.1	21.4	24.12	25.7	21.7	-	-	-
19	0.20	111.60	0.6	O	100.0	56.0	90	29.5	20.6	23.84	24.5	22.3	-	-	-
20	1.80	113.40	1.1	SO	100.0	41.0	92	31.9	21.1	24.68	26.4	22	-	-	-
21	0.20	113.60	1.2	S	100.0	42.0	64.2	32.0	20.3	25.58	25.4	25.1	-	-	-
22	18.40	132.00	1.9	S	100.0	54.0	73.7	30.0	19.3	24.96	25.3	25.1	-	-	-
23	2.40	134.40	3.4	O	100.0	47.0	87	32.9	22.6	25.98	27.8	23.3	-	-	-
24	2.20	136.60	1.7	S	100.0	46.0	86	32.8	21.8	24.94	26.1	22	-	-	-
25	3.40	140.00	1.5	SO	100.0	59.0	88.7	31.0	20.0	24.36	25.4	22.7	-	-	-
26	0.00	140.00	0.8	O	100.0	59.0	72.5	30.8	21.1	25.76	26.5	25.2	-	-	-
27	5.80	145.80	1.3	L	100.0	77.0	93.5	27.7	21.8	24.7	26.2	23.9	-	-	-
28	9.80	155.60	0.9	S	100.0	58.0	81.5	29.2	20.6	24.92	25	24.9	-	-	-
29	2.40	158.00	1.9	O	100.0	63.0	89.7	30.8	22.0	24.96	24.6	23.7	-	-	-
30	1.40	159.40	0.7	L	100.0	76.0	98.5	28.4	22.6	24.52	26.2	22.7	-	-	-

Parauna - Estação Estação Hidro Ponte Rodagem - GO - ANA - Novembro de 2019

[Para ver os dados horários clique no dia desejado](#)

Dia	Precip.	Prec. Acum.	Sensor Pressão min	Sensor Pressão max	Sensor Pressão média	Nível Régua	CodifEixo	Vazão min (m3/s)	Vazão max (m3/s)	Vazão média (m3/s)
1	0.00	0.00	0.57	1.17	0.8	1.17	42.69	0.00	0.00	0.00
2	0.00	0.00	0.6	1.01	0.7	1.01	42.69	0.00	0.00	0.00
3	0.00	0.00	0.59	1.06	0.7	1.06	42.69	0.00	0.00	0.00
4	0.00	0.00	0.61	1.2	0.8	1.2	42.69	0.00	0.00	0.00
5	1.80	1.80	0.65	1.15	0.8	1.15	42.69	0.00	0.00	0.00
6	9.40	11.20	0.66	1.07	0.8	1.07	42.69	0.00	0.00	0.00
7	0.40	11.60	0.63	1.12	0.8	1.12	42.69	0.00	0.00	0.00
8	6.60	18.20	0.71	1.34	0.8	1.34	42.69	0.00	0.00	0.00
9	13.20	31.40	0.68	1.26	0.8	1.26	42.69	0.00	0.00	0.00
10	0.20	31.60	0.65	1.28	0.8	1.28	42.69	0.00	0.00	0.00
11	8.60	40.20	0.7	1.33	0.8	1.33	42.69	0.00	0.00	0.00
12	0.20	40.40	0.68	1.23	0.8	1.23	42.69	0.00	0.00	0.00
13	0.00	40.40	0.68	1.17	0.8	1.17	42.69	0.00	0.00	0.00
14	3.00	43.40	0.66	1.09	0.8	1.09	42.69	0.00	0.00	0.00
15	2.00	45.40	0	1.18	0.8	1.18	42.99	0.00	0.00	0.00
16	-89.20	-43.80	0.89	1.33	1.1	1.33	42.99	0.00	0.00	0.00
17	4.40	-39.40	0.92	1.36	1.1	1.36	42.99	0.00	0.00	0.00
18	49.80	10.40	0.92	1.26	1.1	1.26	42.99	0.00	0.00	0.00
19	3.80	14.20	0.91	1.41	1.1	1.41	42.99	0.00	0.00	0.00
20	0.20	14.40	0.9	1.55	1.1	1.55	42.99	0.00	0.00	0.00
21	0.00	14.40	0.93	1.46	1.1	1.46	42.99	0.00	0.00	0.00
22	0.00	14.40	0.91	1.29	1.1	1.29	42.99	0.00	0.00	0.00
23	4.40	18.80	0.95	1.53	1.1	1.53	42.99	0.00	0.00	0.00
24	12.40	31.20	1	1.58	1.1	1.58	42.99	0.00	0.00	0.00
25	8.40	39.60	1	1.49	1.1	1.49	42.99	0.00	0.00	0.00
26	0.20	39.80	1	1.56	1.2	1.56	42.99	0.00	0.00	0.00
27	9.00	48.80	1.03	1.45	1.2	1.45	42.99	0.00	0.00	0.00
28	6.40	55.20	1.04	1.47	1.2	1.47	42.99	0.00	0.00	0.00
29	7.60	62.80	1.06	1.65	1.2	1.65	42.99	0.00	0.00	0.00
30	1.20	64.00	1.06	1.56	1.2	1.56	42.99	0.00	0.00	0.00

Anapolis - Estação Estação Hidro Ribeirão Antas - GO - ANA - Novembro de 2019

[Para ver os dados horários clique no dia desejado](#)

Dia	Precip.	Prec. Acum.	Sensor Pressão min	Sensor Pressão max	Sensor Pressão média	Nível Régua	CodifEixo	Vazão min (m3/s)	Vazão max (m3/s)	Vazão média (m3/s)
1	0.00	0.00	0.29	0.31	0.3	-	-	0.00	0.00	0.00
2	0.40	0.40	0.29	0.71	0.3	-	-	0.00	0.00	0.00
3	0.20	0.60	0.29	0.35	0.3	-	-	0.00	0.00	0.00
4	3.00	3.60	0.29	1.07	0.4	-	-	0.00	0.00	0.00
5	0.20	3.80	0.3	0.38	0.3	-	-	0.00	0.00	0.00
6	0.00	3.80	0.29	0.31	0.3	-	-	0.00	0.00	0.00
7	0.00	3.80	0.29	0.31	0.3	-	-	0.00	0.00	0.00
8	0.00	3.80	0.29	0.31	0.3	-	-	0.00	0.00	0.00
9	0.00	3.80	0.29	0.31	0.3	-	-	0.00	0.00	0.00
10	14.60	18.40	0.29	1.27	0.4	-	-	0.00	0.00	0.00
11	0.00	18.40	0.29	0.32	0.3	-	-	0.00	0.00	0.00
12	0.00	18.40	0.29	0.31	0.3	-	-	0.00	0.00	0.00
13	0.00	18.40	0.29	0.31	0.3	-	-	0.00	0.00	0.00
14	58.40	76.80	0.28	1.47	0.5	-	-	0.00	0.00	0.00
15	5.20	82.00	0.31	0.9	0.4	-	-	0.00	0.00	0.00
16	0.40	82.40	0.3	0.39	0.3	-	-	0.00	0.00	0.00
17	1.20	83.60	0.3	0.33	0.3	-	-	0.00	0.00	0.00
18	13.00	96.60	0.3	0.56	0.3	-	-	0.00	0.00	0.00
19	3.40	100.00	0.31	0.34	0.3	-	-	0.00	0.00	0.00
20	31.60	131.60	0.3	1	0.3	-	-	0.00	0.00	0.00
21	3.20	134.80	0.3	0.69	0.3	-	-	0.00	0.00	0.00
22	0.20	135.00	0.3	0.32	0.3	-	-	0.00	0.00	0.00
23	4.60	139.60	0.3	0.43	0.3	-	-	0.00	0.00	0.00
24	2.60	142.20	0.3	0.41	0.3	-	-	0.00	0.00	0.00
25	1.60	143.80	0.31	0.98	0.4	-	-	0.00	0.00	0.00
26	27.40	171.20	0.31	1.41	0.4	-	-	0.00	0.00	0.00
27	11.20	182.40	0.32	0.85	0.4	-	-	0.00	0.00	0.00
28	0.00	182.40	0.31	0.33	0.3	-	-	0.00	0.00	0.00
29	3.20	185.60	0.31	0.39	0.3	-	-	0.00	0.00	0.00
30	8.20	193.80	0.31	0.94	0.4	-	-	0.00	0.00	0.00

Pirenópolis - Estação Estação Hidro Rio das Almas Montante - GO - ANA - Novembro de 2019

Para ver os dados horários clique no dia desejado

Dia	Precip.	Prec.Acum.	Sensor Pressão min	Sensor Pressão max	Sensor Pressão media	Nível Régua	CodifEixo	Vazão min (m3/s)	Vazão max (m3/s)	Vazão media (m3/s)
1	0.00	0.00	0	0	0.0	-	-	0.00	0.00	0.00
2	3.40	3.40	0	0	0.0	-	-	0.00	0.00	0.00
3	0.20	3.60	0	0	0.0	-	-	0.00	0.00	0.00
4	0.00	3.60	0	0	0.0	-	-	0.00	0.00	0.00
5	0.00	3.60	0	0.23	0.1	-	-	0.00	0.00	0.00
6	3.60	7.20	0.2	0.24	0.2	-	-	0.00	0.00	0.00
7	0.00	7.20	0.21	0.25	0.2	-	-	0.00	0.00	0.00
8	0.00	7.20	0.21	0.25	0.2	-	-	0.00	0.00	0.00
9	0.00	7.20	0.21	0.25	0.2	-	-	0.00	0.00	0.00
10	0.00	7.20	0.22	0.27	0.2	-	-	0.00	0.00	0.00
11	2.40	9.60	0.23	0.27	0.3	-	-	0.00	0.00	0.00
12	0.20	9.80	0.22	0.27	0.3	-	-	0.00	0.00	0.00
13	0.00	9.80	0.21	0.25	0.2	-	-	0.00	0.00	0.00
14	7.00	16.80	0	0.23	0.1	-	-	0.00	0.00	0.00
15	2.80	19.60	0	0.04	0.0	-	-	0.00	0.00	0.00
16	0.20	19.80	0	0.06	0.0	-	-	0.00	0.00	0.00
17	0.00	19.80	0	0	0.0	-	-	0.00	0.00	0.00
18	15.60	35.40	0	0	0.0	-	-	0.00	0.00	0.00
19	15.40	50.80	0	0.22	0.1	-	-	0.00	0.00	0.00
20	2.20	53.00	0	0.22	0.1	-	-	0.00	0.00	0.00
21	10.00	63.00	0	0.04	0.0	-	-	0.00	0.00	0.00
22	3.20	66.20	0	0	0.0	-	-	0.00	0.00	0.00
23	0.00	66.20	0	0	0.0	-	-	0.00	0.00	0.00
24	0.00	66.20	0	0	0.0	-	-	0.00	0.00	0.00
25	34.80	101.00	0	0	0.0	-	-	0.00	0.00	0.00
26	0.20	101.20	0	0	0.0	-	-	0.00	0.00	0.00
27	1.80	103.00	0	0	0.0	-	-	0.00	0.00	0.00
28	5.60	108.60	0	0	0.0	-	-	0.00	0.00	0.00
29	2.20	110.80	0	0	0.0	-	-	0.00	0.00	0.00
30	0.00	110.80	0	0	0.0	-	-	0.00	0.00	0.00

Santa Isabel - Estação Usina Codora - Santa Isabel - Novembro de 2019

Para ver os dados horários clique no dia desejado

Dia	Precip.	Prec.Acum.	Vel. Vent. (m/s)	Dir. Vent.	Umid. Relat. AR (Max) %	Umid. Relat. AR (Min) %	Umid. Relat. AR (Média) %	Temp. Max. °C Dia	Temp. Min. °C Dia	Temp. Med. °C do Ar	Temp. 09:00h	Temp. 21:00h	Ponto orvalho	Razao Mistura	Radiação Solar Diária MJ/m²
1	0.00	0.00	2.0	SO	77.0	26.0	47.7	35.8	21.0	27.42	29.1	25.6	-	-	17.4
2	0.00	0.00	2.7	SO	73.0	33.0	48	34.7	22.9	28.3	29.3	27.3	-	-	16.7
3	12.40	12.40	2.5	L	98.0	41.0	61.7	31.1	20.2	25.16	24.5	25	-	-	17
4	9.40	21.80	2.7	SO	97.0	37.0	79.2	33.7	20.2	25.14	28.6	21.6	-	-	17.6
5	21.80	43.60	1.8	S	100.0	35.0	80.2	34.5	20.6	25.28	26.5	22.4	-	-	16.7
6	0.00	43.60	1.9	L	100.0	38.0	67.5	33.3	21.0	25.66	23	25.5	-	-	16.1
7	0.00	43.60	2.3	SO	90.0	47.0	68.7	32.2	22.0	26.48	28.6	24.8	-	-	16.4
8	0.00	43.60	3.2	SO	93.0	43.0	57.5	32.8	21.8	27.4	26.8	27.8	-	-	19.7
9	0.00	43.60	2.9	S	88.0	34.0	56.2	35.6	20.3	26.62	30	23.6	-	-	20
10	0.00	43.60	2.0	SO	92.0	38.0	65	34.0	20.7	26.36	29.5	23.8	-	-	17.3
11	0.00	43.60	2.4	SO	77.0	31.0	53.7	35.6	22.3	27.56	29.3	25.3	-	-	16.5
12	0.00	43.60	2.2	SO	82.0	26.0	-	36.2	22.4	29.4	30.6	28.9	-	-	17.9
13	0.00	43.60	2.7	SO	81.0	32.0	-	33.7	23.1	28.12	30.6	26.6	-	-	21
14	37.80	81.40	2.5	SO	100.0	32.0	59.2	35.3	19.8	26.76	29.5	24.6	-	-	21.8
15	0.00	81.40	2.3	NO	88.0	36.0	55.5	34.8	22.4	27.9	29.1	26.6	-	-	20.8
16	0.00	81.40	1.4	SO	94.0	44.0	57.5	31.6	21.5	26.82	27.4	26.8	-	-	14.5
17	29.00	110.40	2.0	L	100.0	60.0	76	28.3	21.0	24.2	22.1	24.8	-	-	8.9
18	0.80	111.20	2.2	S	98.0	48.0	67.7	30.9	20.6	25.04	23.1	25.3	-	-	16.9
19	0.20	111.40	1.9	SO	90.0	45.0	70.7	32.2	22.4	25.94	28.1	23.5	-	-	14.8
20	0.00	111.40	1.9	N	96.0	49.0	64.7	30.0	20.9	24.9	25.6	24	-	-	10
21	0.00	111.40	2.3	SE	87.0	36.0	62.7	32.0	21.7	25.68	27.1	23.8	-	-	19.3
22	0.00	111.40	1.7	SO	99.0	45.0	63	31.0	21.0	25.4	24.8	25.1	-	-	14.8
23	0.00	111.40	1.5	SO	88.0	45.0	61.7	31.3	22.4	26.58	26	26.6	-	-	9.6
24	0.00	111.40	1.8	S	89.0	50.0	75.7	30.5	22.3	25.38	26.9	23.6	-	-	11.2
25	2.40	113.80	2.0	SO	97.0	43.0	74.2	32.8	20.4	24.58	26.9	21.4	-	-	15.8
26	12.60	126.40	1.8	L	100.0	47.0	86.7	31.5	20.4	24.78	25.8	23.1	-	-	14.7
27	4.00	130.40	2.4	L	100.0	56.0	84.2	28.6	20.3	23.52	22.1	23.3	-	-	14.8
28	9.40	139.80	2.4	L	100.0	74.0	88.5	25.9	20.9	23.14	22.3	23.3	-	-	8.9
29	3.00	142.80	1.9	NO	100.0	51.0	73.7	32.1	20.7	25.7	25.5	25.1	-	-	21.9
30	0.00	142.80	2.1	L	98.0	46.0	80.7	33.0	21.9	25.8	27.9	23.1	-	-	15.5

Aparecida de Goiânia - Estação Estação Hidro Rib. Sto. Antônio - GO - ANA - Novembro de 2019

Para ver os dados horários clique no dia desejado

Dia	Precip.	Prec.Acum.	Sensor Pressão min	Sensor Pressão max	Sensor Pressão media	Nível Régua	CodifEixo	Vazão min (m3/s)	Vazão max (m3/s)	Vazão media (m3/s)
1	2.00	2.00	0.54	1	0.6	-	-	0.00	0.00	0.00
2	0.60	2.60	0.52	0.81	0.6	-	-	0.00	0.00	0.00
3	0.00	2.60	0.51	0.54	0.5	-	-	0.00	0.00	0.00
4	0.00	2.60	0.51	0.92	0.6	-	-	0.00	0.00	0.00
5	0.20	2.80	0.54	0.69	0.6	-	-	0.00	0.00	0.00
6	0.00	2.80	0.53	0.56	0.5	-	-	0.00	0.00	0.00
7	0.00	2.80	0.53	0.55	0.5	-	-	0.00	0.00	0.00
8	0.00	2.80	0.53	0.55	0.5	-	-	0.00	0.00	0.00
9	0.20	3.00	0.53	0.57	0.5	-	-	0.00	0.00	0.00
10	0.20	3.20	0.52	0.57	0.5	-	-	0.00	0.00	0.00
11	0.00	3.20	0.53	0.71	0.6	-	-	0.00	0.00	0.00
12	0.00	3.20	0.52	0.56	0.5	-	-	0.00	0.00	0.00
13	0.00	3.20	0.52	0.56	0.5	-	-	0.00	0.00	0.00
14	0.00	3.20	0.52	0.55	0.5	-	-	0.00	0.00	0.00
15	12.80	16.00	0.52	1.52	0.6	-	-	0.00	0.00	0.00
16	0.40	16.40	0.65	0.78	0.7	-	-	0.00	0.00	0.00
17	0.00	16.40	0.65	0.67	0.7	-	-	0.00	0.00	0.00
18	28.00	44.40	0.64	4.55	1.0	-	-	0.00	0.00	0.00
19	5.20	49.60	0.73	0.92	0.8	-	-	0.00	0.00	0.00
20	0.40	50.00	0.66	0.72	0.7	-	-	0.00	0.00	0.00
21	0.00	50.00	0.64	0.68	0.7	-	-	0.00	0.00	0.00
22	2.40	52.40	0.64	0.75	0.7	-	-	0.00	0.00	0.00
23	2.00	54.40	0.64	0.88	0.7	-	-	0.00	0.00	0.00
24	39.60	94.00	0.64	3.3	0.9	-	-	0.00	0.00	0.00
25	8.60	102.60	0.74	1.86	0.8	-	-	0.00	0.00	0.00
26	1.20	103.80	0.7	0.82	0.7	-	-	0.00	0.00	0.00
27	16.80	120.60	0.68	0.95	0.8	-	-	0.00	0.00	0.00
28	7.20	127.80	0.66	1.4	0.8	-	-	0.00	0.00	0.00
29	0.40	128.20	0.66	0.87	0.7	-	-	0.00	0.00	0.00
30	1.80	130.00	0.67	0.92	0.7	-	-	0.00	0.00	0.00

Morrinhos - Estação Usina CEM - Morrinhos - Novembro de 2019

Para ver os dados horários clique no dia desejado

Dia	Precip.	Prec.Acum.	Vel. Vent. (m/s)	Dir. Vent.	Umid. Relat. AR (Max) %	Umid. Relat. AR (Min) %	Umid. Relat. AR (Média)%	Temp. Max. °C Dia	Temp. Min. °C Dia	Temp. Med. °C do Ar	Temp. 09:00h	Temp. 21:00h	Ponto orvalho	Razao Mistura	Radiação Solar Diária MJ/m²
1	9.40	9.40	3.2	L	94.0	43.0	65	31.3	20.2	24.96	28.3	22.5	-	-	14.4
2	0.00	9.40	2.1	L	89.0	43.0	61	31.6	19.3	25.26	24.8	25.3	-	-	20.7
3	0.80	10.20	4.1	L	91.0	50.0	75.2	30.1	20.8	24.1	25.4	22.1	-	-	20
4	0.00	10.20	2.7	N	94.0	49.0	66.7	30.5	20.7	25.3	28.3	23.5	-	-	14.4
5	0.00	10.20	3.1	N	91.0	41.0	71.5	32.5	21.0	25.36	26.3	23.5	-	-	18
6	0.00	10.20	2.5	N	100.0	54.0	77.5	30.9	21.0	24.84	26.1	23.1	-	-	19.4
7	0.00	10.20	2.6	L	100.0	40.0	61.7	32.5	20.0	25.66	26	24.9	-	-	18.6
8	0.00	10.20	2.9	S	100.0	53.0	69	30.5	19.9	24.2	22.6	24	-	-	15.6
9	13.20	23.40	3.2	L	100.0	37.0	64.7	33.1	20.2	24.86	27.6	21.7	-	-	17.7
10	6.80	30.20	2.2	S	100.0	55.0	85	30.9	19.4	23.46	24.6	21.2	-	-	16.6
11	17.60	47.80	2.6	S	93.0	39.0	63.2	33.1	19.8	25.44	25.1	24.6	-	-	18.7
12	1.00	48.80	2.5	S	96.0	42.0	61	33.3	21.0	26.68	24.9	27.1	-	-	22.8
13	0.00	48.80	4.3	L	77.0	37.0	48	32.3	21.6	27.32	26.1	28.3	-	-	20.1
14	4.20	53.00	2.1	S	100.0	55.0	86.2	29.8	20.4	24.06	27.1	21.5	-	-	14.3
15	18.60	71.60	2.1	O	100.0	61.0	92	27.9	19.5	22.24	23.8	20	-	-	11.9
16	0.00	71.60	2.3	L	100.0	74.0	85	26.4	19.3	22.86	22.6	23	-	-	13
17	0.60	72.20	2.5	N	100.0	47.0	75.2	31.1	19.6	24.42	26.6	22.4	-	-	17.8
18	11.40	83.60	4.1	N	100.0	69.0	94.2	25.8	19.8	21.76	22.6	20.3	-	-	11.4
19	3.00	86.60	2.8	L	100.0	59.0	90.5	28.3	19.0	21.66	22.6	19.2	-	-	14.1
20	0.00	86.60	3.1	L	100.0	55.0	79.2	29.3	18.8	22.98	24.8	21	-	-	20.5
21	0.00	86.60	2.6	L	100.0	51.0	69.5	29.8	19.1	24.32	24.5	24.1	-	-	18.7
22	33.00	119.60	4.1	L	100.0	63.0	89.7	28.0	17.5	22.8	23.3	22.6	-	-	16.9
23	3.00	122.60	3.1	N	100.0	64.0	83.5	27.5	20.3	23.64	25.4	22.5	-	-	14.9
24	0.00	122.60	3.3	N	100.0	59.0	84	28.5	19.6	23.1	24.4	21.5	-	-	14.3
25	23.20	145.80	2.6	N	100.0	57.0	86	30.1	19.4	23.78	26.4	21.5	-	-	16.1
26	0.40	146.20	3.0	L	100.0	63.0	87.7	28.6	20.2	24.18	24.9	23.6	-	-	16.9
27	4.80	151.00	3.7	N	100.0	79.0	100	26.6	20.2	22.32	22.4	21.2	-	-	10.1
28	0.80	151.80	3.0	N	100.0	72.0	91.7	28.1	20.3	23.16	23.6	21.9	-	-	15
29	2.00	153.80	2.6	L	100.0	78.0	94.5	27.1	21.1	23.26	23.3	22.4	-	-	12.6
30	1.20	155.00	3.5	N	100.0	65.0	92.7	28.4	20.4	23.12	22.8	22	-	-	11.2

Bom Jesus de Goiás - Estação Usina Goiás - Bom Jesus de Goiás - Novembro de 2019

Para ver os dados horários clique no dia desejado

Dia	Precip.	Prec.Acum.	Vel. Vent. (m/s)	Dir. Vent.	Umid. Relat. AR (Max) %	Umid. Relat. AR (Min) %	Umid. Relat. AR (Média)%	Temp. Max. °C Dia	Temp. Min. °C Dia	Temp. Med. °C do Ar	Temp. 09:00h	Temp. 21:00h	Ponto orvalho	Razao Mistura	Radiação Solar Diária MJ/m²
1	0.00	0.00	3.4	L	78.0	35.0	61.7	33.1	21.9	25.92	29	22.8	-	-	14.9
2	0.00	0.00	2.7	L	90.0	30.0	50.2	33.8	19.8	26.76	25.6	27.3	-	-	19.9
3	11.00	11.00	4.8	L	100.0	39.0	66.2	31.5	18.9	24.44	28	21.9	-	-	16.8
4	0.00	11.00	2.8	L	84.0	40.0	63.2	32.7	22.1	26.28	26.4	25.1	-	-	19.5
5	0.00	11.00	3.1	L	82.0	35.0	59	33.6	21.8	26.76	28.6	24.9	-	-	17.3
6	0.20	11.20	3.0	S	90.0	50.0	73	31.1	21.8	24.82	26.6	22.3	-	-	17.5
7	0.20	11.40	2.7	S	100.0	35.0	63.5	33.8	20.5	26.12	27.1	24.6	-	-	17.2
8	0.00	11.40	3.2	S	100.0	42.0	66.7	29.9	19.5	23.62	21.7	23.5	-	-	13.2
9	8.20	19.60	3.8	SE	97.0	37.0	73.7	33.0	21.1	25.42	28	22.5	-	-	13.1
10	1.80	21.40	3.0	S	100.0	41.0	64.5	32.1	19.7	25.06	24.3	24.6	-	-	18.2
11	0.00	21.40	3.4	S	89.0	31.0	56.7	34.0	21.3	26.48	26.1	25.5	-	-	15.8
12	0.00	21.40	3.5	SO	93.0	36.0	54	33.1	21.6	27.58	26	28.6	-	-	19.5
13	0.00	21.40	5.1	SE	71.0	33.0	49.7	33.2	24.6	27.82	29.1	26.1	-	-	17.4
14	2.60	24.00	3.3	S	94.0	39.0	74	32.3	21.7	24.76	25.6	22.1	-	-	15.2
15	7.80	31.80	2.3	O	100.0	53.0	91	29.1	19.8	22.8	25.5	19.8	-	-	10.2
16	0.20	32.00	2.0	NO	100.0	45.0	69.7	30.9	19.6	24.16	23.1	23.6	-	-	16.8
17	0.00	32.00	2.4	L	92.0	41.0	60.7	31.9	20.6	26.24	27.5	25.6	-	-	20
18	5.00	37.00	3.4	N	95.0	60.0	83.2	27.8	20.9	23.18	24.6	21.3	-	-	12.4
19	10.20	47.20	3.0	L	97.0	53.0	84.7	29.5	19.3	22.2	23.6	19.3	-	-	11.6
20	0.00	47.20	2.8	L	91.0	45.0	67.5	30.4	19.5	24.12	26.1	22.3	-	-	16.9
21	1.00	48.20	3.4	L	92.0	40.0	66.2	31.6	20.2	24.12	25.6	21.6	-	-	18.5
22	10.60	58.80	4.5	L	98.0	57.0	78	28.6	17.1	23	24.1	22.6	-	-	17.2
23	2.00	60.80	2.2	NO	86.0	48.0	71.7	30.4	21.9	25.56	26.9	24.3	-	-	15.3
24	2.20	63.00	3.3	SO	99.0	56.0	75.7	29.1	20.8	23.42	23.6	21.8	-	-	11.9
25	11.60	74.60	2.5	L	100.0	50.0	87.7	30.9	20.0	24.02	25.6	21.8	-	-	16
26	0.00	74.60	2.8	L	100.0	53.0	77	29.9	21.0	24.72	25.1	23.8	-	-	14.3
27	13.60	88.20	3.2	L	100.0	73.0	97.7	27.3	19.9	22.8	23.4	21.7	-	-	8.7
28	30.60	118.80	2.3	NO	100.0	63.0	94	28.3	20.3	22.92	22.8	21.6	-	-	11.8
29	21.00	139.80	1.8	NO	100.0	71.0	98.2	26.3	20.7	23.14	21.5	23.6	-	-	5.3
30	0.60	140.40	2.6	N	100.0	69.0	85.7	26.8	20.4	23.06	24.1	22	-	-	10.9

Santa Helena de Goiás - Estação Usina Santa Helena - Santa Helena - Novembro de 2019

Para ver os dados horários clique no dia desejado

Dia	Precip.	Prec.Acum.	Vel. Vent. (m/s)	Dir. Vent.	Umid. Relat. AR (Max) %	Umid. Relat. AR (Min) %	Umid. Relat. AR (Média)%	Temp. Max. °C Dia	Temp. Min. °C Dia	Temp. Med. °C do Ar	Temp. 09:00h	Temp. 21:00h	Ponto orvalho	Razao Mistura	Radiação Solar Diária MJ/m²
1	3.40	3.40	1.5	NO	89.0	36.0	67.7	34.6	22.3	27.28	30.3	24.6	-	-	11.8
2	0.20	3.60	1.3	L	99.0	27.0	57.7	36.0	20.6	27.26	26.9	26.4	-	-	18.4
3	6.80	10.40	1.9	N	96.0	46.0	83	31.6	23.4	26.88	29.8	24.8	-	-	12.6
4	0.00	10.40	1.3	N	100.0	32.0	47	34.7	21.9	28.58	29.1	28.6	-	-	14.3
5	1.80	12.20	1.8	NO	100.0	39.0	84.5	34.2	21.9	26.68	29.1	24.1	-	-	10.2
6	0.20	12.40	1.6	NO	100.0	45.0	75.7	33.6	23.0	26.54	26.9	24.6	-	-	15.6
7	0.00	12.40	1.4	O	100.0	39.0	62	34.8	21.9	27.62	27.6	26.9	-	-	16.9
8	20.80	33.20	1.5	SE	100.0	63.0	91	28.4	20.9	23.8	22.1	23.8	-	-	8.5
9	30.80	64.00	1.5	N	100.0	39.0	73.7	34.3	20.1	25.44	28.6	22.1	-	-	15.7
10	0.00	64.00	1.0	L	100.0	48.0	73.7	32.8	21.1	25.8	25.1	25	-	-	14.9
11	4.60	68.60	1.9	SE	100.0	34.0	69.7	35.1	22.1	26.36	29	22.8	-	-	18.2
12	1.00	69.60	1.4	O	98.0	63.0	83.7	30.1	22.0	25.66	24	26.1	-	-	6.1
13	0.00	69.60	1.7	N	95.0	36.0	57	34.2	23.9	28.48	29.1	27.6	-	-	16.5
14	0.00	69.60	1.1	SE	100.0	38.0	71.5	34.3	22.4	26.5	26.6	24.6	-	-	13.4
15	28.20	97.80	1.3	N	100.0	53.0	92	30.6	20.7	24.24	28.1	20.9	-	-	7.8
16	0.00	97.80	1.0	O	100.0	46.0	81	32.0	20.5	25.32	25.9	24.1	-	-	17.8
17	0.00	97.80	1.3	N	100.0	42.0	62.2	32.2	20.7	26.58	27.8	26.1	-	-	18.6
18	3.40	101.20	2.1	N	100.0	44.0	83	32.0	21.6	24.76	27	21.6	-	-	16.8
19	0.20	101.40	1.4	N	100.0	50.0	79.7	31.1	21.6	24.98	25.6	23.3	-	-	11
20	0.00	101.40	1.4	N	100.0	43.0	73.5	32.5	21.4	25.64	27.1	23.6	-	-	13.9
21	0.40	101.80	1.2	SE	100.0	37.0	67	33.6	20.5	25.64	27.3	23.4	-	-	17.1
22	0.00	101.80	1.5	N	100.0	43.0	74.5	32.2	20.4	25.3	25.3	24.3	-	-	16.1
23	2.60	104.40	1.2	NO	99.0	47.0	82.2	31.8	22.0	26.38	29.3	24.4	-	-	9.3
24	0.20	104.60	1.2	N	100.0	51.0	80.5	31.6	22.1	25.72	27.1	23.9	-	-	10.9
25	0.00	104.60	1.3	O	100.0	59.0	92.5	31.3	21.7	25.58	27.1	23.9	-	-	8.6
26	0.00	104.60	1.4	N	100.0	49.0	76.2	32.0	21.7	26.7	26.6	26.6	-	-	15.2
27	33.80	138.40	2.2	N	100.0	56.0	85	31.6	22.1	25.48	28.1	22.8	-	-	13.1
28	29.40	167.80	1.1	NO	100.0	67.0	100	29.8	21.7	24.06	23.6	22.6	-	-	7.9
29	0.60	168.40	1.2	N	100.0	64.0	92	29.1	22.3	25.22	24.1	25.3	-	-	12.7
30	8.00	176.40	1.7	N	100.0	52.0	89	32.5	21.8	24.88	25.3	22.4	-	-	9.9

Maurilândia - Estação Usina Vale do Verdão - Maurilândia - Novembro de 2019

Para ver os dados horários clique no dia desejado

Dia	Precip.	Prec.Acum.	Vel. Vent (m/s)	Dir. Vent.	Umid. Relat. AR (Max) %	Umid. Relat. AR (Min) %	Umid. Relat. AR (Média)%	Temp. Max. °C Dia	Temp. Min. °C Dia	Temp. Med. °C do Ar	Temp. 09:00h	Temp. 21:00h	Ponto orvalho	Razao Mistura	Radiação Solar Diária MJ/m²
1	4.20	4.20	2.5	N	0.0	0.0	0	-10.0	-10.0	-10	-10	-10	-	-	14.9
2	0.20	4.40	1.9	SE	0.0	0.0	0	-10.0	-10.0	-10	-10	-10	-	-	18.9
3	0.00	4.40	2.8	O	0.0	0.0	0	-10.0	-10.0	-10	-10	-10	-	-	17.4
4	0.00	4.40	1.9	NO	0.0	0.0	0	-10.0	-10.0	-10	-10	-10	-	-	17
5	0.00	4.40	2.1	NO	0.0	0.0	0	-10.0	-10.0	-10	-10	-10	-	-	11.9
6	0.40	4.80	2.3	NO	0.0	0.0	0	-10.0	-10.0	-10	-10	-10	-	-	17.6
7	9.20	14.00	1.7	L	0.0	0.0	0	-10.0	-10.0	-10	-10	-10	-	-	16.9
8	1.80	15.80	2.0	SE	0.0	0.0	0	-10.0	-10.0	-10	-10	-10	-	-	7.2
9	14.20	30.00	2.0	SO	0.0	0.0	0	-10.0	-10.0	-10	-10	-10	-	-	15
10	0.60	30.60	1.8	L	0.0	0.0	0	-10.0	-10.0	-10	-10	-10	-	-	16.8
11	22.80	53.40	2.8	SE	0.0	0.0	0	-10.0	-10.0	-10	-10	-10	-	-	19.2
12	0.00	53.40	3.1	S	0.0	0.0	0	-10.0	-10.0	-10	-10	-10	-	-	10.6
13	0.00	53.40	3.0	S	0.0	0.0	0	-10.0	-10.0	-10	-10	-10	-	-	14.1
14	2.00	55.40	2.1	S	0.0	0.0	0	-10.0	-10.0	-10	-10	-10	-	-	13.5
15	14.00	69.40	1.5	S	0.0	0.0	0	-10.0	-10.0	-10	-10	-10	-	-	9.6
16	1.20	70.60	1.3	O	0.0	0.0	0	-10.0	-10.0	-10	-10	-10	-	-	13.5
17	0.00	70.60	2.0	NO	0.0	0.0	0	-10.0	-10.0	-10	-10	-10	-	-	17
18	5.00	75.60	2.6	NO	0.0	0.0	0	-10.0	-10.0	-10	-10	-10	-	-	14.6
19	0.00	75.60	1.5	NO	0.0	0.0	0	-10.0	-10.0	-10	-10	-10	-	-	12.9
20	0.00	75.60	1.8	NO	0.0	0.0	0	-10.0	-10.0	-10	-10	-10	-	-	14.3
21	18.80	94.40	2.0	L	0.0	0.0	0	-10.0	-10.0	-10	-10	-10	-	-	16
22	3.20	97.60	1.9	NO	1.0	0.0	0	-10.0	-10.0	-10	-10	-10	-	-	15.4
23	0.00	97.60	1.9	NO	4.0	0.0	0.5	-10.0	-10.0	-10	-10	-10	-	-	14.3
24	3.60	101.20	2.0	S	4.0	0.0	1.2	-10.0	-10.0	-10	-10	-10	-	-	7.8
25	0.40	101.60	1.6	NO	2.0	0.0	0.2	-10.0	-10.0	-10	-10	-10	-	-	11.4
26	2.20	103.80	1.6	NO	2.0	0.0	0.5	-10.0	-10.0	-10	-10	-10	-	-	13.1
27	56.20	160.00	2.5	N	1.0	0.0	0	-10.0	-10.0	-10	-10	-10	-	-	7.7
28	10.20	170.20	1.4	NO	4.0	0.0	2	-10.0	-10.0	-10	-10	-10	-	-	10.5
29	9.60	179.80	1.2	NO	4.0	0.0	1.5	-10.0	-10.0	-10	-10	-10	-	-	9.8
30	45.20	225.00	2.2	NO	5.0	0.0	1.7	-10.0	-10.0	-10	-10	-10	-	-	9.4

Estacao : Usina Codora - Santa Isabel

Data : 14 de Novembro de 2019

Município : Santa Isabel

Hora LOCAL	Precip.	Prec.Acum.	Vel. Vento (m/s)	Dir. Vento	Vel.Rajada Vento (m/s)	Dir.Rajada Vento	Umid. Relat. AR (%)	Temperatura do ar (C)	Ponto Orvalho	Razao Mistura	Radiação Solar Acum. MJ/m²
00:00	0.00	0.00	2.7	SO	3.9	SO	77.0	24.4			-
01:00	0.00	0.00	2.4	SO	4.3	SO	80.0	23.8			-
02:00	0.00	0.00	2.1	SO	3.4	SO	80.0	23.1			-
03:00	0.00	0.00	1.7	SO	3.4	SO	79.0	23.3			-
04:00	0.00	0.00	1.9	S	3.3	SO	81.0	23.3			-
05:00	0.00	0.00	2.1	S	3.6	S	81.0	23.4			-
06:00	0.00	0.00	0.8	N	9.4	O	88.0	22.1			-
07:00	0.00	0.00	1.4	SO	10.8	S	78.0	24.4			0.4
08:00	0.00	0.00	1.6	S	2.6	S	65.0	26.9			1.1
09:00	0.00	0.00	1.5	O	15.5	O	52.0	29.5			1.9
10:00	0.00	0.00	1.6	NO	5.4	O	48.0	31.1			2.4
11:00	0.00	0.00	1.9	NO	6.7	N	41.0	32.7			2.8
12:00	0.00	0.00	2.3	O	6.8	O	36.0	33.8			3.2
13:00	0.00	0.00	2.3	NO	7.2	NO	35.0	34.6			2.2
14:00	0.00	0.00	3.4	N	8.4	N	32.0	35.3			2.3
15:00	0.00	0.00	2.6	N	6.5	NE	35.0	34.6			2.1
16:00	0.00	0.00	4.0	NO	17.9	NO	33.0	35.2			1.9
17:00	1.80	1.60	4.7	N	14.0	O	62.0	28.6			1.1
18:00	29.20	30.80	6.0	L	31.2	NE	100.0	19.8			0.4
19:00	7.00	37.80	3.5	S	18.1	L	80.0	23.1			-
20:00	0.00	37.80	2.9	SO	4.7	S	71.0	24.6			-
21:00	0.00	37.80	3.5	L	8.4	NE	75.0	24.6			-
22:00	0.00	37.80	2.7	SE	8.9	L	63.0	25.6			-
23:00	0.00	37.80	1.2	NO	4.7	SO	75.0	24.6			-

<https://g1.globo.com/go/goias/noticia/2019/11/15/temporal-arranca-telhado-de-fabrica-e-deixa-dois-funcionarios-feridos-em-itumbiara.ghtml>

Temporal arranca telhado de fábrica e deixa dois funcionários feridos, em Itumbiara

Chuva também fez com que motos fossem arrastadas pela correnteza da água e causou a quedas de árvores. Instituto Nacional de Meteorologia alerta a população para ventos fortes até o início da tarde deste sábado.

Por Rafael Oliveira, G1 GO

15/11/2019 11h49 - Atualizado há 4 semanas



<https://globoplay.globo.com/v/8088745/>

Globo Novelas Séries Cinema Infantil Mais ▾

#Jo

JA GOIÂNIA

JA 2ª Edição >

Chuva com vento forte derruba árvores e até o teto de um galpão em Goiás

28 seg Exibição em 14 Nov 2019

Cerca de sete árvores caíram em Goiânia.

<https://www.aredacao.com.br/noticias/126432/cobertura-de-galpao-industrial-desaba-durante-temporal-em-itumbiara>

ar a redação



CAPA ÚLTIMAS CULTURA OPINIÃO NEGÓCIOS ESPORTE NOITE E DIA VÍDEO

HOME / NOTÍCIAS

CHUVA FORTE

Cobertura de galpão industrial desaba durante temporal em Itumbiara

Dois funcionários tiveram ferimentos leves

15.11.19 - 14:47

Share 46



(FOTO: DIVULGAÇÃO/BOMBEIROS)

<https://g1.globo.com/go/goias/noticia/2019/11/19/enxurrada-arrasta-mulher-e-carro-durante-temporal-em-quirinopolis-video.ghtml>

G1

GOIÁS

Enxurrada arrasta mulher e carro durante temporal em Quirinópolis; vídeo

Imagens mostram mulher tentando interromper que carro se mova, mas não consegue. Em seguida, ela também cai e é levada pela água. Apesar do susto, ninguém se feriu.

Por Silvío Túlio, G1 GO

19/11/2019 14h25 - Atualizado há 3 semanas

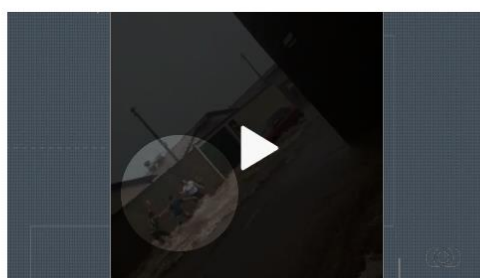

<https://www.opopular.com.br/noticias/cidades/motociclista-morre-eletrocutado-ao-tentar-fugir-da-chuva-e-segurar-em-poste-em-goi%C3%A2nia-1.1933672?usarChave=true>

O Popular 62 99995 2795 BUSCAR 2 ALEXANDRE X

CAPA POLÍTICA ECONOMIA MUNDO **CIDADES** ESPORTE MAGAZINE LUDOVICA OPINIÃO ESPECIAIS VÍDEOS INFOMERCIAL GUIA

Vandré Abreu
vandre.abreu@opopular.com.br

CIDADES

Motociclista morre eletrocutado ao tentar fugir da chuva e segurar em poste em Goiânia

Para atravessar a Avenida 87, que no momento do acidente estava alagada, homem subiu com a moto no passeio e sofreu uma descarga elétrica ao segurar em estrutura metálica

15/11/2019 - 19:45



O motociclista tentou desviar da água na via passando pela calçada (Foto: Douglas Schinatto)

Atualizada às 22:40 desta sexta-feira (15)*

<https://www.opopular.com.br/noticias/cidades/chove-granizo-em-goi%C3%A2nia-e-tr%C3%A2nsito-fica-complicado-1.1936466?usarChave=true>

O Popular 62 99995 2795 BUSCAR 1 ALEXANDRE X ANU

CAPA POLÍTICA ECONOMIA MUNDO **CIDADES** ESPORTE MAGAZINE LUDOVICA OPINIÃO ESPECIAIS VÍDEOS INFOMERCIAL GUIAS

Ivânia Cavalcanti
Juan Meloni

CIDADES

Chove granizo em Goiânia e trânsito fica complicado

A enxurrada tomou conta da via e gerou congestionamento no local

20/11/2019 - 13:50



(Foto: Fabio Lima)

Atualizada às 14h45.

Uma chuva de granizo, no início da tarde desta quarta-feira (20), surpreendeu os motoristas que trafegavam pela Avenida Anhanguera, na região Central de Goiânia. A enxurrada tomou conta da via e gerou congestionamento no local. Há registro de



MUNICÍPIO DE CALDAS NOVAS

DECRETO Nº 1.774/2019

DE 31 DE OUTUBRO DE 2019.

**“DECLARA SITUAÇÃO DE EMERGÊNCIA EM
RAZÃO DO TEMPORAL (ANTICLONE), NAS
ÁREAS DO MUNICÍPIO DE CALDAS NOVAS,
AFETADAS PELAS CHUVAS”**

O PREFEITO DO MUNICÍPIO DE CALDAS NOVAS, Estado de Goiás, no uso da competência e das atribuições que lhe conferem as Constituições da República e do Estado de Goiás, bem como a Lei Orgânica Municipal, e

CONSIDERANDO o caos instalado no Município em razão das chuvas acompanhadas das fortíssimas correntes de ventos na tarde do dia 27 (vinte e sete) de outubro de 2019, mais precisamente por volta das 16h (dezesesseis horas);

CONSIDERANDO o registro de índice pluviométrico muito superior ao habitual, com fortíssimas correntes de ventos, causando inúmeros prejuízos humanos e materiais ao município, em residências, em estabelecimentos comerciais, prédios, equipamentos públicos e hospitais;

CONSIDERANDO que as intempéries acarretaram uma série de problemas e danos em diversas regiões rurais, com a ocorrência de grande número de queda de árvores nas redes elétricas; o que causou diversas perdas, partindo cabos elétricos;

CONSIDERANDO ainda, os danos causados na zona urbana do município, como danos às calçadas, destelhamento de residências, destruição de fachadas de prédios comerciais e públicos;

CONSIDERANDO por fim que, de acordo com os serviços de meteorologia a cidade de Caldas Novas foi atingida por um anticiclone, com chuva de granizo, com ventos de mais de 100km/h, causando danos em vários bairros e assustando toda a população e os turistas.

DECRETA:

Art. 1º. Fica Decretada situação de emergência e estado de calamidade pública no município entre os dias 27 de outubro de 2019 à 15 de novembro de 2019.

Art. 2º. Autoriza-se a mobilização de todos os órgãos municipais para atuarem sob a coordenação do Órgão Municipal de Proteção e Defesa Civil, nas ações de resposta aos danos e reabilitação do cenário e reconstrução.

Art. 3º. Este Decreto entrará em vigor na data de sua publicação, para que surta todos os seus jurídicos e legais efeitos.

Cumpra-se e Publique-se.

GABINETE DO PREFEITO DE CALDAS NOVAS-GO, aos trinta e um dias do mês de outubro de 2019.

EVANDO MAGAL ABADIA CORREIA SILVA
Prefeito de Caldas Novas/GO