

## Resumo Executivo

O Presente Relatório tem como objetivo a incorporação de informações que sejam relevantes para que se possa fazer a devida associação aos dados contidos no corpo do documento objeto da classificação de Situação de Emergência caracterizada pelo Módulo 8 do Prodist, que tem como foco o impacto do evento sobre determinada rede geelétrica e cuja denominação é definida como CHI (Consumidor hora interrompido). O parâmetro para enquadramento nesta classificação de expurgo tem como premissa inicial o limite de Consumidor hora interrompido definido pela fórmula descrita no Módulo 01 do Prodist (Revisão - 10), acrescido de todos os outros informes e dados listados no Módulo 08 (Revisão 10) do Prodist. Este enquadramento se apresenta na maioria das vezes em condições climáticas adversas com severidade dos fatores inerentes a situação, caracterizado na maioria dos casos por fortes ventos e chuvas de grande intensidade e continuidade.

Entre o dia 25/11/2019 – Segunda-feira – e a madrugada do dia 26/11/2019 – Terça-feira – O calor e a umidade favoreceram a formação de nuvens de tempestade que avançaram sobre o estado e ajudou na formação de áreas de instabilidade sobre as Regiões da Enel Distribuição Goiás.

Entre as 10h00 do dia 25 e 04h30 do dia 25 de novembro de 2019 tivemos, em todo o Estado de Goiás, a incidências de 68.148 descargas atmosféricas (22.403 raios nuvem-solo e 45.745 descargas nuvem-nuvem) sobre a região, o que causou grande instabilidade na rede.

Conforme informações do Climatempo Meteorologia, o Instituto Nacional de Meteorologia (INMET) detectou rajadas de vento acima de 50km/h durante o período. A máxima rajada registrada foi de 64,8km/h entre as 12h e 13h do dia 25 de novembro, sendo esse vento classificado como ventania pela escala Beaufort.

Os maiores acumulados de chuva registrados pelo INMET foram em Rio Verde, entre 13h00 e 14h00, com um total de 32,0mm. Segundo o INMET, chuvas com taxas superiores à 7,6mm são consideradas chuvas fortes.

**Temporal arranca cobertura de posto de combustíveis em Itaguaru: 'Coisa de louco'** - Segundo o dono do estabelecimento, que é o prefeito da cidade, o teto 'deu um nó' após ser destruído por ventania e causou prejuízo estimado de R\$ 300 mil. Apesar dos estragos, ninguém se feriu. Acesso em: <https://g1.globo.com/go/goias/noticia/2019/11/26/temporal-arranca-cobertura-de-posto-de-combustiveis-do-prefeito-de-itaguaru-coisa-de-louco.ghtml>

**Chuva de granizo causa estragos em posto de gasolina de Itaguaru** - Esta é a segunda chuva forte que causa prejuízo na cidade em 15 dias. Acesso em: <https://www.emaisgoias.com.br/chuva-de-granizo-causa-estragos-em-posto-de-gasolina-de-itaguaru/>.

## Relatório de Ocorrências do período

Em todo o Estado de Goiás verificou-se também que a intensidade da chuva e dos ventos danificaram a rede de distribuição de energia elétrica em diversos pontos, registrando aproximadamente 175 mil clientes com interrupção no fornecimento de energia elétrica devido a eventos relacionados ao temporal.

Para otimizar o volume de atendimentos e reduzir os tempos de interrupção foram mobilizados os recursos extras da empresa que aumentou o contingente em relação a situação normal de operação. O acompanhamento da quantidade de equipes e o Tempo Médio de Atendimento podem ser consultados na Pág.02 do Relatório em anexo.

O impacto e severidade do evento estão relatados em artigos de mídia, como fotos e reportagens que demonstram os danos na Rede de Distribuição, oriundos dos eventos climáticos no período. Eventos estes que afetaram 174.997 consumidores com CHI de 575.144,45 superior ao de 482.391,86 estabelecido como limite para definição de Situação de Emergência, conforme resumo das informações obrigatórias.

Empresa		ENEL DISTRIBUIÇÃO GOIÁS				
Código do Relatório		CHI-026 - ENEL DISTRIBUIÇÃO GOIÁS				
Evento:		TEMPORAL NA AREA DE CONCESSÃO DA ENEL DISTRIBUIÇÃO GOIAS				
Código COBRADE:		1.3.2.1.2, 1.3.2.1.4 e 1.3.2.1.5	Data Inicio	25/11/2019	Hora início	10h
Código do Evento:		CHI-026-ENEL GO	Data Término	26/11/2019	Hora Término	08h59
Valor CHI (Limite e Real)		482.391,86	575.144,45			
Código do Decreto (Se Houver):						
Quantidade de Interrupções (Evento)		1941				
Início 1ª Incidência (Data e Hora)		25/11/2019 10:16		Subestações Atingidas		
		ABADIANA / ABC / ACREUNA / ADELANDIA / AEROPORTO / AGUAS LINDAS / ALEXANIA / ALMERINDONOPOLIS / ALOANDIA / ALPHAVILLE / ALTO BURITI / ALTO PARAISO DE GOIAS / ALVORADA DO NORTE / AMERICANO DO BRASIL / AMORINOPOLIS / ANAPOLIS UNIVERSITARIA / ANHANGUERA / ANICUNS / ANTONIO DO VITTO / APARECIDA DO RIO DOCE / ARACU / ARAGARCAS / ARAGOIANIA / ARAGUAPAZ / ARENOPOLIS / ARUANA / ASA BRANCA / ATLANTICO / AURILANDIA / AVELINOPOLIS / BACURI (RIO VERDE) / BARBOSELANDIA / BARCELONA / BARREIRO (PORANGATU) / BARRO ALTO / BELA VISTA (TRANSMISSAO) / BOA VISTA / BOM JARDIM / BOM JESUS DE GOIAS / BONFINOPOLIS / BONOPOLIS / BRAZABRANTES / BRITANIA / BRITANIA (TRANSMISSAO) / BURITI ALEGRE / BURITI DE GOIAS / CABECEIRAS / CABRIUVA (RIO VERDE) / CACHOEIRA ALTA / CACHOEIRA NOVA / CACHOEIRINHA (ITARUMA) / CACU / CAIAPONIA / CALCILANDIA / CALDAS NOVAS / CAMPESTRE / CAMPINAS / CAMPINORTE / CAMPO ALEGRE DE GOIAS / CAMPO LIMPO DE GOIAS / CAMPOS BELOS / CAMPOS VERDES / CARAIBAS / CARAJAS / CATALAO / CATURAI / CEBRASA FABRICA DA AMBEV / CEPALGO / CEZARINA / CHAPADA DO CEU / CIDADE ECLETICA / CIDADE OCIDENTAL / COCALZINHO / COLINACU / CORREGO DO OURO / CORUMBA / CORUMBAIBA / CRISTALINA / CRISTALINA TRANSMISSAO / CRISTIANOPOLIS / CRIXAS / CROMINIA / CUMARI / DAIA - ANAPOLIS / DAMOLANDIA / DESFECHO / DESTILARIA BRASIL CENTRAL / DIORAMA / DORCELINO PEIXOTO DE MORAES / DOVERLANDIA / EDEALINA / EDEIA / ENERSUL / ESTANIFERA / ESTRELA DO NORTE / FAINA / FERROVIARIO / FIRMINOPOLIS / FLORES DE GOIAS / FORMIGA / FORMOSO / GAMELEIRA / GIRASSOL / GOIANAPOLIS / GOIANESIA / GOIANIA LESTE / GOIANIRA / GOIAS / GOIATUBA / GOYA / HEITORAI / HIDROLANDIA / HIDROLINA / IACIARA / INDEPENDENCIA / INDIARA / INHUMAS / IPAMERI / IPEGUARI / IPORA / ISRAELANDIA / ITABERAI / ITAGUARU / ITAJA / ITAPACI / ITAPIRAPUA / ITAPURANGA / ITAPURANGA (TRANSMISSAO) / ITARUMA / ITAUCU / ITIQUIRA (FORMOSA) / ITUMBIARA NOVA / ITUMBIARA VELHA / JACILANDIA / JANDAIA / JARAGUA / JATAI / JAUPACI / JESUPOLIS / JOVIANIA / JUNDIAI / JUSCELANDIA / JUSSARA / LAGES / LAGOA DA SERRA / LAGOA DO BAUZINHO (RIO VERDE) / LUZIANIA / MAIRIPOTABA / MAMBAI / MARA ROSA / MARAJOARA / MARZAGAO / MATRINCHA / MAURILANDIA / MEIA PONTE / MINACU / MINEIROS / MOIPORA / MONTE ALEGRE / MONTES CLAROS DE GOIAS / MONTIVIDIU T / MORRINHOS / MORRO AGUDO / MOSSAMEDES / MOZARLANDIA / MOZARLANDIA (TRANSMISSAO) / MUTUNOPOLIS / NAVESLANDIA ( JATAI ) / NAZARIO / NEROPOLIS / NIQUELANDIA / NOVA AMERICA / NOVA CRIXAS (TRANSMISSAO) / NOVA IGUACU / NOVA VENEZA / NOVO BRASIL / NOVO GAMA / NOVO PLANALTO / OLHOS DAGUA / OLOANA / ORIZONA / OUIDOR / PACAEMBU (NOVO GAMA) / PADRE BERNARDO / PALESTINA / PALMEIRAS DE GOIAS / PAMPLONA / PANAMA / PARANA / PARANAIGUARA / PARAUNA SE ALTA TENSAO / PARQUE DAS EMAS (MINEIROS) / PARQUE DAS NACOES / PEROLANDIA / PETROLINA / PILAR / PILOANDIA / PIRACANJUBA / PIRANHAS T / PIRENOPOLIS / PIRES BELO / PIRES DO RIO / PLANALTINA / PLANALTINA (TRANSMISSAO) / PLANALTO / PONTALINA / PORANGATU / PORTELANDIA / PROFESSOR JAMIL / QUEBRA LINHA / QUIRINOPOLIS / REAL / RIO CLARO JATAI MONTIVIDIU / RIO DO PEIXE / RIO PRETO / RIO VERDE / RIO VERMELHO / RIVERLANDIA (RIO VERDE) / ROCHEDO (UEH) / RUBIATABA / SANCLERLANDIA / SANTA FE DE GOIAS / SANTA HELENA / SANTA ROSA / SANTA ROSA DE GOIAS / SANTA ROSA DO MEIA PONTE / SANTA TEREZINHA / SANTA TEREZINHA / SANTO ANTONIO DA BARRA / SANTO ANTONIO DO DESCOBERTO / SAO BARTOLOMEU / SAO DOMINGOS / SAO FRANCISCO DE GOIAS / SAO JOAO D ALIANCA / SAO JOAO DA PARAUNA / SAO LUIZ DOS MONTES BELOS / SAO MIGUEL DO ARAGUAIA / SAO MIGUEL DO PASSA QUATRO / SENADOR CANEDO TRANSMISSAO / SERRA AZUL (JATAI) / SERRA DE CALDAS / SERRANOPOLIS / SILVANIA / SOUZALANDIA / SUCURI / TAQUARAL / TEREZOPOLIS / TRES BARRAS / TRINDADE / TUCUNARE / TURVANIA / URU / URUACU / USINA DE ACUCAR DE GOIANESIA / VALPARAISO / VARJAO / VENDA SECA / VIANOPOLIS / VICENTINOPOLIS / VILA PROPICIO / XAVANTES / XIXA / ZELANDIA				
Início Ultima Incidência (Data e Hora)		26/11/2019 08:59		Municípios Atingidos		
Média de Duração das Incidências (h)		12,25				
Duração da Incidência mais longa (h)		89,04				
Total de Clientes afetados		174.997				

		/ GAMELEIRA DE GOIAS / GOIANAPOLIS / GOIANESIA / GOIANIA / GOIANIRA / GOIAS / GOIATUBA / GOUVELANDIA / GUARAITA / GUARANI DE GOIAS / GUARINOS / HEITORAI / HIDROLANDIA / HIDROLINA / IACIARA / INDIARA / INHUMAS / IPAMERI / IPIRANGA DE GOIAS / IPORA / ISRAELANDIA / ITABERAI / ITAGUARI / ITAGUARU / ITAJA / ITAPACI / ITAPIRAPUA / ITAPURANGA / ITARUMA / ITAUCU / ITUMBIARA / IVOLANDIA / JANDAIA / JARAGUA / JATAI / JAUPACI / JESUPOLIS / JOVIANIA / JUSSARA / LAGOA SANTA / LEOPOLDO DE BULHOES / LUZIANIA / MAIRIPOTABA / MAMBAI / MARA ROSA / MATRINCHA / MAURILANDIA / MIMOSO DE GOIAS / MINACU / MINEIROS / MOIPORA / MONTE ALEGRE DE GOIAS / MONTES CLAROS DE GOIAS / MONTIVIDIU / MONTIVIDIU DO NORTE / MORRINHOS / MORRO AGUDO DE GOIAS / MOSSAMEDES / MOZARLANDIA / MUNDO NOVO DE GOIAS / MUTUNOPOLIS / NAZARIO / NEROPOLIS / NIQUELANDIA / NOVA AMERICA / NOVA CRIXAS / NOVA GLORIA / NOVA IGUACU DE GOIAS / NOVA ROMA / NOVA VENEZA / NOVO BRASIL / NOVO GAMA / NOVO PLANALTO / ORIZONA / OUVIDOR / PADRE BERNARDO / PALESTINA DE GOIAS / PALMEIRAS DE GOIAS / PALMINOPOLIS / PANAMA / PARANAIGUARA / PARAUNA / PEROLANDIA / PETROLINA DE GOIAS / PILAR DE GOIAS / PIRACANJUBA / PIRANHAS / PIRENOPOLIS / PIRES DO RIO / PLANALTINA / PONTALINA / PORANGATU / PORTELANDIA / POSSE / PROFESSOR JAMIL SAFADY / QUIRINOPOLIS / RIO QUENTE / RIO VERDE / RUBIATABA / SANCLERLANDIA / SANTA CRUZ DE GOIAS / SANTA FE DE GOIAS / SANTA HELENA DE GOIAS / SANTA RITA DO NOVO DESTINO / SANTA ROSA DE GOIAS / SANTA TEREZA DE GOIAS / SANTA TEREZINHA DE GOIAS / SANTO ANTONIO DA BARRA / SANTO ANTONIO DO DESCOBERTO / SAO DOMINGOS / SAO FRANCISCO DE GOIAS / SAO JOAO D ALIANCA / SAO JOAO DA PARAUNA / SAO LUIS DE MONTES BELOS / SAO LUIZ DO NORTE / SAO MIGUEL DO ARAGUAIA / SAO MIGUEL DO PASSA QUATRO / SAO PATRICIO / SAO SIMAO / SENADOR CANEDO / SERRANOPOLIS / SILVANIA / SIMOLANDIA / TAQUARAL DE GOIAS / TERESINA DE GOIAS / TEREZOPOLIS DE GOIAS / TRINDADE / TROMBAS / TURVANIA / UIRAPURU / URUACU / URUANA / URUTAI / VALPARAISO DE GOIAS / VARJAO / VIANOPOLIS / VICENTINOPOLIS / VILA BOA / VILA PROPICIO
--	--	---

<b>DANOS CAUSADOS</b>			
<b>Equipamentos Danificado</b>	<b>Importância para o Sistema</b>	<b>Local</b>	<b>Quantidade</b>
Disjuntor/Religador Operado	Proteção do Alimentador	Área de Concessão	59
Chaves Fusíveis Operada	Proteção de Ramais de Alimentadores	Área de Concessão	685
Transformador Operado	Proteção do Transformador	Área de Concessão	423

<b>Relato técnico sobre a Intervenção realizada em Goiânia e Região Metropolitana</b>			
<b>Informações sobre Equipes</b>	25/11	26/11	
<b>Quantidade Usual</b>	600	600	turmas
<b>Quantidade Adicional</b>	188	204	turmas
<b>Quantidade Total</b>	788	804	turmas
<b>Tempos Médios</b>			
<b>Preparação</b>	8,36	7,38	Horas
<b>Deslocamento</b>	0,78	0,84	Horas
<b>Execução</b>	1,89	1,53	Horas
<b>TMAE</b>	11,04	9,75	Horas

### **Principais Dificuldades Encontradas:**

Chuvas com ventos fortes provocaram muitos pontos de alagamento e enxurrada, trânsito impedido por vários semáforos desligados dificultando a chegada ao atendimento das ocorrências emergenciais. Em determinadas regiões, decorrente dos fortes ventos, houve o tombamento de árvores nas estruturas de alimentação de média tensão, danos em ramais de ligação dos clientes, impedimentos de acesso e atolamentos em estradas rurais.

<b>Empresa</b>	ENEL DISTRIBUIÇÃO GOIAS		
<b>Valor CHI (Limite e Real)</b>	<b>482.391,86</b>		<b>575.144,45</b>

DOC ORIGEM	MIUNICIPIO	EQP_ORIGEM	CONJUNTO	INI_OCORRENC	FIM_OCORRENC	DT_INI_EVENTO	DT_FIM_EVENTO	DURAÇ	UC INT	CHI	EXPURGO
201911324465	CALDAS NOVAS	CN12139717LD	CALDAS NOVAS S2	25/11/2019 13:14	25/11/2019 14:06	25/11/2019 13:14	25/11/2019 14:06	0,85	1502	1280,04	CHI
201911324465	PIRACANJUBA	CN12139717LD	CALDAS NOVAS S2	25/11/2019 13:14	25/11/2019 14:06	25/11/2019 13:14	25/11/2019 14:06	0,85	2	1,70	CHI
201911325699	PIRES DO RIO	PR12000019	PIRES DO RIO S1	25/11/2019 12:25	25/11/2019 18:48	25/11/2019 12:25	25/11/2019 18:48	6,37	82	522,61	CHI
201911325881	CALDAS NOVAS	760114985	CALDAS NOVAS S2	25/11/2019 11:13	25/11/2019 12:57	25/11/2019 11:13	25/11/2019 12:57	1,72	1	1,72	CHI
201911327835	NOVA CRIXAS	NA12325050	NOVA CRIXAS	25/11/2019 11:23	25/11/2019 11:53	25/11/2019 07:23	25/11/2019 11:53	4,49	1	4,49	CHI
201911328488	RIO VERDE	RV12074677	CACHOEIRA ALTA	25/11/2019 11:13	25/11/2019 16:38	25/11/2019 11:13	25/11/2019 16:38	5,42	1	5,42	CHI
201911328492	ANAPOLIS	AN13370412	ANAPOLIS UNIVERSITARIO S1	25/11/2019 11:16	26/11/2019 19:50	25/11/2019 11:16	25/11/2019 17:30	6,22	263	1636,01	CHI
201911328492	ABADIANIA	AN13376523	ANAPOLIS UNIVERSITARIO S1	25/11/2019 11:16	26/11/2019 19:50	25/11/2019 11:16	25/11/2019 18:03	6,78	6	40,70	CHI
201911328492	ANAPOLIS	AN13376523	ANAPOLIS UNIVERSITARIO S1	25/11/2019 11:16	26/11/2019 19:50	25/11/2019 11:16	25/11/2019 18:03	6,78	52	352,70	CHI
201911328492	GAMELEIRA DE GOIAS	AN13376523	ANAPOLIS UNIVERSITARIO S1	25/11/2019 11:16	26/11/2019 19:50	25/11/2019 11:16	25/11/2019 18:03	6,78	5	33,91	CHI
201911328492	ABADIANIA	AN13382470	ANAPOLIS UNIVERSITARIO S1	25/11/2019 11:16	26/11/2019 19:50	25/11/2019 11:16	25/11/2019 18:59	7,72	124	956,87	CHI
201911328492	GAMELEIRA DE GOIAS	AN13382470	ANAPOLIS UNIVERSITARIO S1	25/11/2019 11:16	26/11/2019 19:50	25/11/2019 11:16	25/11/2019 18:59	7,72	26	200,63	CHI
201911328492	ANAPOLIS	AN13394333	ANAPOLIS UNIVERSITARIO S1	25/11/2019 11:16	26/11/2019 19:50	25/11/2019 11:16	26/11/2019 15:24	28,12	48	1349,79	CHI
201911328492	ABADIANIA	AA12401980	ANAPOLIS UNIVERSITARIO S1	25/11/2019 11:16	26/11/2019 19:50	25/11/2019 11:16	26/11/2019 19:50	32,55	1	32,55	CHI
201911329118	ISRAELANDIA	IS11187461	IPORA	25/11/2019 19:35	25/11/2019 22:39	25/11/2019 19:35	25/11/2019 22:39	3,07	50	153,25	CHI
201911329198	FAZENDA NOVA	FN21295317	BRITANIA	25/11/2019 10:16	26/11/2019 13:53	25/11/2019 10:16	26/11/2019 13:53	27,61	1	27,61	CHI
201911329256	JANDAIA	10016215727	PALMEIRAS	25/11/2019 10:24	25/11/2019 12:16	25/11/2019 10:24	25/11/2019 12:16	1,87	1	1,87	CHI
201911329289	CAIAPONIA	930012999	CAIAPONIA	25/11/2019 10:30	26/11/2019 08:24	25/11/2019 10:30	26/11/2019 08:24	21,90	1	21,90	CHI
201911329290	PORTELANDIA	PW12302970	PARQUE DAS EMAS	25/11/2019 10:30	25/11/2019 18:25	25/11/2019 10:30	25/11/2019 18:25	7,92	4	31,66	CHI
201911329294	PLANALTINA	9450000584	SAO JOAO D ALIANCA	25/11/2019 10:31	25/11/2019 12:40	25/11/2019 10:31	25/11/2019 12:40	2,14	1	2,14	CHI
201911329295	PORANGATU	PO21217375	PORANGATU	25/11/2019 10:32	25/11/2019 17:20	25/11/2019 10:32	25/11/2019 17:20	6,80	1	6,80	CHI
201911329298	LUZIANIA	120382040	RIO VERMELHO	25/11/2019 10:32	25/11/2019 13:24	25/11/2019 10:32	25/11/2019 13:24	2,85	1	2,85	CHI
201911329309	SANTA HELENA DE GOIAS	400066014	IPEGUARI	25/11/2019 10:34	25/11/2019 12:34	25/11/2019 10:34	25/11/2019 12:34	1,99	1	1,99	CHI
201911329316	CRISTALINA	KR21321839	PAMPLONA	25/11/2019 10:35	25/11/2019 12:35	25/11/2019 10:35	25/11/2019 12:35	2,00	1	2,00	CHI
201911329328	ANAPOLIS	AN11000224	JUNDIAI S1	25/11/2019 10:36	25/11/2019 16:20	25/11/2019 10:36	25/11/2019 16:20	5,72	79	451,99	CHI
201911329339	CIDADE OCIDENTAL	LZ21037903	MARAJOARA	25/11/2019 10:38	25/11/2019 21:40	25/11/2019 10:38	25/11/2019 21:40	11,02	2	22,05	CHI
201911329348	PARAUNA	980021753	PARAUNA	25/11/2019 10:39	25/11/2019 20:54	25/11/2019 10:39	25/11/2019 20:54	10,25	1	10,25	CHI
201911329354	MONTES CLAROS DE GOIAS	ME21187638	IPORA	25/11/2019 10:40	26/11/2019 12:20	25/11/2019 10:40	26/11/2019 12:20	25,67	1	25,67	CHI
201911329359	SANTA RITA DO NOVO DESTINO	DF12377521	BARRO ALTO	25/11/2019 10:42	27/11/2019 13:57	25/11/2019 10:42	27/11/2019 13:57	51,24	23	1178,58	CHI
201911329361	CAMPINORTE	CR21168813	MARA ROSA	25/11/2019 10:42	25/11/2019 20:38	25/11/2019 10:42	25/11/2019 20:38	9,92	1	9,92	CHI
201911329394	ANAPOLIS	AN11056411	JUNDIAI S1	25/11/2019 10:35	25/11/2019 11:56	25/11/2019 10:35	25/11/2019 11:56	1,34	109	146,42	CHI
201911329397	RIO VERDE	630106514	CABRIUVA S1	25/11/2019 10:48	25/11/2019 14:39	25/11/2019 10:48	25/11/2019 14:39	3,84	1	3,84	CHI

201911329414	ALTO PARAISO DE GOIAS	BF12204703	FLORES DE GOIAS	25/11/2019 10:50	25/11/2019 15:37	25/11/2019 10:50	25/11/2019 15:37	4,77	1	4,77	CHI
201911329416	NIQUELANDIA	04560224	BARRO ALTO	25/11/2019 10:43	25/11/2019 18:14	25/11/2019 10:43	25/11/2019 12:54	2,18	997	2174,84	CHI
201911329416	VILA PROPICIO	04560224	BARRO ALTO	25/11/2019 10:43	25/11/2019 18:14	25/11/2019 10:43	25/11/2019 12:54	2,18	32	69,80	CHI
201911329416	MIMOSO DE GOIAS	04560224	BARRO ALTO	25/11/2019 10:43	25/11/2019 18:14	25/11/2019 12:55	25/11/2019 15:16	2,35	4	9,40	CHI
201911329416	NIQUELANDIA	04560224	BARRO ALTO	25/11/2019 10:43	25/11/2019 18:14	25/11/2019 12:55	25/11/2019 15:16	2,35	318	747,30	CHI
201911329416	VILA PROPICIO	04560224	BARRO ALTO	25/11/2019 10:43	25/11/2019 18:14	25/11/2019 12:55	25/11/2019 15:16	2,35	32	75,20	CHI
201911329416	NIQUELANDIA	NQ13212750	BARRO ALTO	25/11/2019 10:43	25/11/2019 18:14	25/11/2019 12:55	25/11/2019 17:37	4,71	621	2922,15	CHI
201911329416	NIQUELANDIA	NQ12197531LD	BARRO ALTO	25/11/2019 10:43	25/11/2019 18:14	25/11/2019 12:55	25/11/2019 18:14	5,32	85	452,20	CHI
201911329421	NAZARIO	440007197	ANICUNS	25/11/2019 10:51	25/11/2019 15:25	25/11/2019 10:51	25/11/2019 15:25	4,56	1	4,56	CHI
201911329429	SAO LUIS DE MONTES BELOS	10016875158	SAO LUIZ DOS MONTES BELOS	25/11/2019 10:53	25/11/2019 17:06	25/11/2019 10:53	25/11/2019 17:06	6,22	1	6,22	CHI
201911329438	COLINAS DO SUL	TI11037455	NIQUELANDIA SUBTRANSMISSAO	25/11/2019 10:56	25/11/2019 12:25	25/11/2019 10:56	25/11/2019 12:25	1,48	112	165,39	CHI
201911329439	ACREUNA	2440008583	ACREUNA	25/11/2019 10:56	25/11/2019 16:08	25/11/2019 10:56	25/11/2019 16:08	5,20	1	5,20	CHI
201911329446	AMARALINA	LC12278479	MARA ROSA	25/11/2019 10:57	25/11/2019 14:59	25/11/2019 10:57	25/11/2019 14:59	4,03	1	4,03	CHI
201911329447	SAO MIGUEL DO ARAGUAIA	SM21192286	SAO MIGUEL DO ARAGUAIA	25/11/2019 10:57	26/11/2019 18:55	25/11/2019 10:57	26/11/2019 18:55	31,97	1	31,97	CHI
201911329451	JUSSARA	JR21217106	JUSSARA	25/11/2019 10:58	26/11/2019 11:09	25/11/2019 10:58	26/11/2019 11:09	24,17	1	24,17	CHI
201911329461	GOIATUBA	10020436961	GOIATUBA S2	25/11/2019 11:01	25/11/2019 12:21	25/11/2019 11:01	25/11/2019 12:21	1,33	1	1,33	CHI
201911329462	SANTO ANTONIO DO DESCOBERTO	SN21338441	MARAJOARA	25/11/2019 11:01	25/11/2019 15:19	25/11/2019 11:01	25/11/2019 15:19	4,29	1	4,29	CHI
201911329473	TERESINA DE GOIAS	TE11047977	FLORES DE GOIAS	25/11/2019 10:49	25/11/2019 16:20	25/11/2019 10:49	25/11/2019 16:20	5,50	133	731,94	CHI
201911329476	MATRINCHA	4380000176	MATRINCHA	25/11/2019 11:04	26/11/2019 06:40	25/11/2019 11:04	26/11/2019 06:40	19,60	1	19,60	CHI
201911329480	BALIZA	BM12390150	BOM JARDIM	25/11/2019 11:05	25/11/2019 14:26	25/11/2019 11:05	25/11/2019 14:26	3,36	52	174,81	CHI
201911329480	BOM JARDIM DE GOIAS	BM12390150	BOM JARDIM	25/11/2019 11:05	25/11/2019 14:26	25/11/2019 11:05	25/11/2019 14:26	3,36	9	30,26	CHI
201911329483	PALMEIRAS DE GOIAS	PL21010889	PALMEIRAS	25/11/2019 11:05	26/11/2019 15:47	25/11/2019 11:05	26/11/2019 15:47	28,69	1	28,69	CHI
201911329490	PONTALINA	JV12208107	GOIATUBA S1	25/11/2019 11:07	26/11/2019 10:10	25/11/2019 11:07	26/11/2019 10:10	23,05	4	92,20	CHI
201911329497	PIRENOPOLIS	220017438	CORUMBA	25/11/2019 11:07	25/11/2019 13:50	25/11/2019 11:07	25/11/2019 13:50	2,70	1	2,70	CHI
201911329516	SANTA HELENA DE GOIAS	400036186	IPEGUARI	25/11/2019 11:10	25/11/2019 17:10	25/11/2019 11:10	25/11/2019 17:10	6,00	1	6,00	CHI
201911329519	CAMPO ALEGRE DE GOIAS	CM21164111	CAMPO ALEGRE DE GOIAS	25/11/2019 11:09	25/11/2019 15:04	25/11/2019 11:09	25/11/2019 15:04	3,90	1	3,90	CHI
201911329527	AGUA FRIA DE GOIAS	TL21067459	SAO JOAO D ALIANCA	25/11/2019 11:12	27/11/2019 08:46	25/11/2019 11:12	27/11/2019 08:46	45,56	1	45,56	CHI
201911329532	GOUVELANDIA	GB21303123	QUIRINOPOLIS	25/11/2019 11:12	25/11/2019 15:18	25/11/2019 11:12	25/11/2019 15:18	4,09	3	12,27	CHI
201911329534	CALDAS NOVAS	CN12106305	CALDAS NOVAS S2	25/11/2019 11:13	25/11/2019 18:10	25/11/2019 11:13	25/11/2019 18:10	6,93	103	714,16	CHI
201911329538	PLANALTINA	PI12085617RE	PLANALTINA	25/11/2019 10:52	25/11/2019 16:27	25/11/2019 10:52	25/11/2019 16:27	5,58	388	2163,64	CHI
201911329572	PILAR DE GOIAS	GG12245205	SANTA TEREZINHA	25/11/2019 11:19	26/11/2019 09:35	25/11/2019 11:19	26/11/2019 09:35	22,26	15	333,90	CHI
201911329576	ALEXANIA	AX12402007	ALEXANIA	25/11/2019 11:20	25/11/2019 15:53	25/11/2019 11:20	25/11/2019 15:53	4,55	16	72,77	CHI
201911329580	MONTIVIDIU DO NORTE	MX12270942	PORANGATU	25/11/2019 11:20	26/11/2019 10:19	25/11/2019 11:20	26/11/2019 10:19	22,97	49	1125,60	CHI

201911329589	JANDAIA	JD12005515	PALMEIRAS	25/11/2019 11:19	25/11/2019 15:20	25/11/2019 11:19	25/11/2019 15:20	4,02	7	28,16	CHI
201911329604	COCALZINHO DE GOIAS	ZN21247649	COCALZINHO	25/11/2019 11:24	25/11/2019 14:58	25/11/2019 11:24	25/11/2019 14:58	3,55	1	3,55	CHI
201911329605	JAUPACI	1280011686	IPORA	25/11/2019 11:24	26/11/2019 10:32	25/11/2019 11:24	26/11/2019 10:32	23,12	1	23,12	CHI
201911329608	ANAPOLIS	10017294248	JUNDIAI S2	25/11/2019 11:25	25/11/2019 16:46	25/11/2019 11:25	25/11/2019 16:46	5,34	1	5,34	CHI
201911329609	CRISTALINA	KR11276497	CRISTALINA S2	25/11/2019 11:25	26/11/2019 08:07	25/11/2019 11:25	26/11/2019 08:07	20,68	1	20,68	CHI
201911329612	LUZIANIA	LZ12261755RE	MARAJOARA	25/11/2019 11:27	25/11/2019 15:19	25/11/2019 11:27	25/11/2019 15:19	3,86	31	119,63	CHI
201911329617	RIO VERDE	RV12190439	CACHOEIRA ALTA	25/11/2019 11:28	25/11/2019 17:53	25/11/2019 11:28	25/11/2019 17:53	6,41	2	12,81	CHI
201911329620	FAZENDA NOVA	FN12113973	IPORA	25/11/2019 11:29	28/11/2019 20:41	25/11/2019 11:29	27/11/2019 19:59	56,50	7	395,49	CHI
201911329620	FAZENDA NOVA	FN12113973	IPORA	25/11/2019 11:29	28/11/2019 20:41	25/11/2019 11:29	28/11/2019 20:41	81,21	3	243,63	CHI
201911329620	ISRAELANDIA	FN12113973	IPORA	25/11/2019 11:29	28/11/2019 20:41	25/11/2019 11:29	28/11/2019 20:41	81,21	2	162,42	CHI
201911329620	FAZENDA NOVA	FN12113973	IPORA	25/11/2019 11:29	28/11/2019 20:41	28/11/2019 18:30	28/11/2019 20:41	2,18	7	15,28	CHI
201911329623	CRISTALINA	KR21351945	CRISTALINA S1	25/11/2019 11:29	25/11/2019 15:36	25/11/2019 11:29	25/11/2019 15:36	4,11	2	8,22	CHI
201911329627	PARAUNA	PU21028675	PARAUNA	25/11/2019 11:30	25/11/2019 21:22	25/11/2019 11:30	25/11/2019 21:22	9,87	1	9,87	CHI
201911329632	ALTO PARAISO DE GOIAS	BF21231947	FLORES DE GOIAS	25/11/2019 11:31	25/11/2019 21:21	25/11/2019 11:31	25/11/2019 21:21	9,82	1	9,82	CHI
201911329643	MONTIVIDIU	MV21399761	MONTIVIDIU T	25/11/2019 11:33	26/11/2019 12:50	25/11/2019 11:33	26/11/2019 12:50	25,27	0	0,00	CHI
201911329650	AGUAS LINDAS DE GOIAS	4830095971	AGUAS LINDAS DE GOIAS S1	25/11/2019 11:34	25/11/2019 12:37	25/11/2019 11:34	25/11/2019 12:37	1,04	1	1,04	CHI
201911329672	CATALAO	CT21042382	CATALAO S1	25/11/2019 11:36	25/11/2019 15:46	25/11/2019 11:36	25/11/2019 15:46	4,17	1	4,17	CHI
201911329678	CAIAPONIA	PH12221148	PIRANHAS	25/11/2019 11:37	25/11/2019 18:12	25/11/2019 11:37	25/11/2019 18:12	6,57	3	19,72	CHI
201911329685	JATAI	290081476	JATAI S2	25/11/2019 11:39	25/11/2019 16:23	25/11/2019 11:39	25/11/2019 16:23	4,72	1	4,72	CHI
201911329686	NIQUELANDIA	2750096152	URUACU	25/11/2019 11:40	26/11/2019 04:56	25/11/2019 11:40	26/11/2019 04:56	17,26	1	17,26	CHI
201911329690	MORRINHOS	GT21188847	GOIATUBA S2	25/11/2019 11:40	25/11/2019 14:38	25/11/2019 11:40	25/11/2019 14:38	2,96	1	2,96	CHI
201911329697	CRISTALINA	KR21171567	CRISTALINA S2	25/11/2019 11:42	26/11/2019 12:21	25/11/2019 11:42	26/11/2019 12:21	24,64	1	24,64	CHI
201911329698	SANTO ANTONIO DO DESCOBERTO	10003910758	AGUAS LINDAS DE GOIAS S2	25/11/2019 11:42	25/11/2019 16:45	25/11/2019 11:42	25/11/2019 16:45	5,05	1	5,05	CHI
201911329704	COCALZINHO DE GOIAS	1200006206	COCALZINHO	25/11/2019 11:43	25/11/2019 14:14	25/11/2019 11:43	25/11/2019 14:14	2,51	1	2,51	CHI
201911329717	CACHOEIRA DE GOIAS	CG12087363	FIRMINOPOLIS S2	25/11/2019 11:45	25/11/2019 15:41	25/11/2019 11:45	25/11/2019 15:41	3,93	19	74,71	CHI
201911329719	CIDADE OCIDENTAL	DH12376173	MARAJOARA	25/11/2019 11:45	25/11/2019 18:10	25/11/2019 11:45	25/11/2019 18:10	6,41	3	19,24	CHI
201911329730	ITAPIRAPUA	IU12292875	MATRINCHA	25/11/2019 11:48	25/11/2019 16:50	25/11/2019 11:48	25/11/2019 16:50	5,03	1	5,03	CHI
201911329739	JATAI	JT12306444	JATAI S3	25/11/2019 11:50	25/11/2019 18:52	25/11/2019 11:50	25/11/2019 18:52	7,03	6	42,16	CHI
201911329740	DIORAMA	DI21193436	IPORA	25/11/2019 11:50	25/11/2019 18:29	25/11/2019 11:50	25/11/2019 18:29	6,64	1	6,64	CHI
201911329742	MORRINHOS	MR21399301	MORRINHOS	25/11/2019 11:50	25/11/2019 13:30	25/11/2019 11:50	25/11/2019 13:30	1,66	2	3,32	CHI
201911329746	RIO VERDE	RV21152706	QUIRINOPOLIS	25/11/2019 11:51	26/11/2019 10:00	25/11/2019 11:51	26/11/2019 10:00	22,14	1	22,14	CHI
201911329753	CRIXAS	UP12171176	SANTA TEREZINHA	25/11/2019 10:37	25/11/2019 18:38	25/11/2019 10:37	25/11/2019 18:38	8,02	12	96,20	CHI
201911329753	UIRAPURU	UP12171176	SANTA TEREZINHA	25/11/2019 10:37	25/11/2019 18:38	25/11/2019 10:37	25/11/2019 18:38	8,02	11	88,18	CHI

201911329755	IVOLANDIA	MO12165608	IPORA	25/11/2019 11:01	25/11/2019 17:10	25/11/2019 11:01	25/11/2019 17:10	6,15	17	104,52	CHI
201911329755	MOIPORA	MO12165608	IPORA	25/11/2019 11:01	25/11/2019 17:10	25/11/2019 11:01	25/11/2019 17:10	6,15	1	6,15	CHI
201911329756	RIO VERDE	RV21246816	RIO VERDE S1	25/11/2019 11:53	25/11/2019 18:01	25/11/2019 11:53	25/11/2019 18:01	6,12	1	6,12	CHI
201911329763	PADRE BERNARDO	2760014170	PADRE BERNARDO	25/11/2019 11:55	25/11/2019 20:54	25/11/2019 11:55	25/11/2019 20:54	8,99	1	8,99	CHI
201911329769	URUACU	UR21325229	URUACU	25/11/2019 11:57	25/11/2019 18:24	25/11/2019 11:57	25/11/2019 18:24	6,44	1	6,44	CHI
201911329775	FAINA	MP12096007	MATRINCHA	25/11/2019 11:32	26/11/2019 08:40	25/11/2019 11:32	26/11/2019 08:40	21,13	8	169,06	CHI
201911329802	PALMEIRAS DE GOIAS	PL21194016	PALMEIRAS	25/11/2019 12:04	26/11/2019 14:25	25/11/2019 12:04	26/11/2019 14:25	26,34	1	26,34	CHI
201911329805	AGUAS LINDAS DE GOIAS	4830369219	AGUAS LINDAS DE GOIAS S1	25/11/2019 12:05	25/11/2019 13:33	25/11/2019 12:05	25/11/2019 13:33	1,46	1	1,46	CHI
201911329818	NOVA GLORIA	NG12181407	RUBIATABA	25/11/2019 12:07	25/11/2019 17:40	25/11/2019 12:07	25/11/2019 17:40	5,54	6	33,23	CHI
201911329822	MARA ROSA	MQ12240635	SANTA TEREZINHA	25/11/2019 12:08	26/11/2019 13:35	25/11/2019 12:08	26/11/2019 13:35	25,44	1	25,44	CHI
201911329831	PORANGATU	PO12391670	PORANGATU	25/11/2019 12:09	26/11/2019 15:10	25/11/2019 12:09	26/11/2019 15:10	27,01	4	108,04	CHI
201911329838	OUVIDOR	OU21267002	CATALAO S1	25/11/2019 12:10	25/11/2019 21:58	25/11/2019 12:10	25/11/2019 21:58	9,79	1	9,79	CHI
201911329850	QUIRINOPOLIS	QI21103416	QUIRINOPOLIS	25/11/2019 12:12	25/11/2019 17:47	25/11/2019 12:12	25/11/2019 17:47	5,57	1	5,57	CHI
201911329856	FORMOSA	FA21157355	SAO JOAO D ALIANCA	25/11/2019 12:13	25/11/2019 17:41	25/11/2019 12:13	25/11/2019 17:41	5,45	1	5,45	CHI
201911329873	MINACU	IH21192402	MINACU	25/11/2019 12:17	25/11/2019 16:38	25/11/2019 12:17	25/11/2019 16:38	4,34	2	8,68	CHI
201911329878	JUSSARA	JR12019332	JUSSARA	25/11/2019 12:18	26/11/2019 12:00	25/11/2019 12:18	26/11/2019 12:00	23,70	13	308,11	CHI
201911329880	MATRINCHA	MP21274449	MATRINCHA	25/11/2019 12:18	26/11/2019 09:50	25/11/2019 12:18	26/11/2019 09:50	21,52	1	21,52	CHI
201911329884	PONTALINA	PK12047065	PONTALINA	25/11/2019 11:43	25/11/2019 17:17	25/11/2019 11:43	25/11/2019 17:17	5,57	10	55,69	CHI
201911329891	JATAI	JT21267769	JATAI S1	25/11/2019 12:20	26/11/2019 11:41	25/11/2019 12:20	26/11/2019 11:41	23,34	1	23,34	CHI
201911329904	IPORA	IR11000015	IPORA	25/11/2019 13:42	25/11/2019 15:20	25/11/2019 13:42	25/11/2019 15:20	1,62	82	133,18	CHI
201911329910	JATAI	JT10378104	JATAI S2	25/11/2019 13:06	26/11/2019 15:48	25/11/2019 13:06	25/11/2019 14:20	1,23	41	50,34	CHI
201911329910	JATAI	JT10378104	JATAI S2	25/11/2019 13:06	26/11/2019 15:48	25/11/2019 13:06	25/11/2019 15:10	2,06	13	26,79	CHI
201911329910	JATAI	JT10378104	JATAI S2	25/11/2019 13:06	26/11/2019 15:48	25/11/2019 13:06	25/11/2019 15:50	2,73	101	276,18	CHI
201911329910	RIO VERDE	JT10378104	JATAI S2	25/11/2019 13:06	26/11/2019 15:48	25/11/2019 13:06	25/11/2019 15:50	2,73	30	82,03	CHI
201911329910	JATAI	JT10400674	JATAI S2	25/11/2019 13:06	26/11/2019 15:48	25/11/2019 13:06	25/11/2019 16:04	2,97	130	385,92	CHI
201911329910	RIO VERDE	JT10400674	JATAI S2	25/11/2019 13:06	26/11/2019 15:48	25/11/2019 13:06	25/11/2019 16:04	2,97	1	2,97	CHI
201911329910	JATAI	JT10378104	JATAI S2	25/11/2019 13:06	26/11/2019 15:48	25/11/2019 13:06	25/11/2019 16:04	2,97	47	139,56	CHI
201911329910	JATAI	JT10378104	JATAI S2	25/11/2019 13:06	26/11/2019 15:48	25/11/2019 16:17	26/11/2019 00:26	8,16	25	203,94	CHI
201911329910	JATAI	JT13378128	JATAI S2	25/11/2019 13:06	26/11/2019 15:48	25/11/2019 16:17	26/11/2019 14:58	22,69	260	5900,27	CHI
201911329910	RIO VERDE	JT13378128	JATAI S2	25/11/2019 13:06	26/11/2019 15:48	25/11/2019 16:17	26/11/2019 14:58	22,69	31	703,49	CHI
201911329910	JATAI	JT10400675	JATAI S2	25/11/2019 13:06	26/11/2019 15:48	25/11/2019 16:17	26/11/2019 15:48	23,52	48	1128,76	CHI
201911329921	ALTO HORIZONTE	03400406	SANTA TEREZINHA	25/11/2019 13:21	25/11/2019 17:08	25/11/2019 13:21	25/11/2019 15:59	2,63	2295	6045,41	CHI
201911329921	CAMPOS VERDES	03400406	SANTA TEREZINHA	25/11/2019 13:21	25/11/2019 17:08	25/11/2019 13:21	25/11/2019 15:59	2,63	8	21,07	CHI



201911329921	NOVA IGUACU DE GOIAS	03400406	SANTA TEREZINHA	25/11/2019 13:21	25/11/2019 17:08	25/11/2019 13:21	25/11/2019 15:59	2,63	363	956,20	CHI
201911329921	PILAR DE GOIAS	03400406	SANTA TEREZINHA	25/11/2019 13:21	25/11/2019 17:08	25/11/2019 13:21	25/11/2019 15:59	2,63	1	2,63	CHI
201911329921	ALTO HORIZONTE	03404114	SANTA TEREZINHA	25/11/2019 13:21	25/11/2019 17:08	25/11/2019 16:34	25/11/2019 16:59	0,43	2294	987,69	CHI
201911329921	CAMPOS VERDES	03404114	SANTA TEREZINHA	25/11/2019 13:21	25/11/2019 17:08	25/11/2019 16:34	25/11/2019 16:59	0,43	8	3,44	CHI
201911329921	NOVA IGUACU DE GOIAS	03404114	SANTA TEREZINHA	25/11/2019 13:21	25/11/2019 17:08	25/11/2019 16:34	25/11/2019 16:59	0,43	363	156,29	CHI
201911329921	PILAR DE GOIAS	03404114	SANTA TEREZINHA	25/11/2019 13:21	25/11/2019 17:08	25/11/2019 16:34	25/11/2019 16:59	0,43	1	0,43	CHI
201911329921	SANTA TEREZINHA DE GOIAS	NH13341294	SANTA TEREZINHA	25/11/2019 13:21	25/11/2019 17:08	25/11/2019 13:21	25/11/2019 17:07	3,76	1	3,76	CHI
201911329921	ALTO HORIZONTE	NH13341294	SANTA TEREZINHA	25/11/2019 13:21	25/11/2019 17:08	25/11/2019 13:21	25/11/2019 17:08	3,78	13	49,10	CHI
201911329921	NOVA IGUACU DE GOIAS	NH13341294	SANTA TEREZINHA	25/11/2019 13:21	25/11/2019 17:08	25/11/2019 13:21	25/11/2019 17:08	3,78	816	3081,76	CHI
201911329921	PILAR DE GOIAS	NH13341294	SANTA TEREZINHA	25/11/2019 13:21	25/11/2019 17:08	25/11/2019 13:21	25/11/2019 17:08	3,78	169	638,26	CHI
201911329921	SANTA TEREZINHA DE GOIAS	NH13341294	SANTA TEREZINHA	25/11/2019 13:21	25/11/2019 17:08	25/11/2019 13:21	25/11/2019 17:08	3,78	61	230,38	CHI
201911329925	ITAJA	IJ21096117	ITAJA S2	25/11/2019 12:11	25/11/2019 15:03	25/11/2019 12:11	25/11/2019 15:03	2,85	1	2,85	CHI
201911329933	INHUMAS	IN21218043	INHUMAS S1	25/11/2019 14:00	25/11/2019 14:11	25/11/2019 14:00	25/11/2019 14:11	0,18	1	0,18	CHI
201911329938	RIO VERDE	O1600224	RIO VERDE S2	25/11/2019 13:37	25/11/2019 20:15	25/11/2019 13:37	25/11/2019 13:42	0,09	3853	347,84	CHI
201911329938	RIO VERDE	RV16407781	RIO VERDE S2	25/11/2019 13:37	25/11/2019 20:15	25/11/2019 13:37	25/11/2019 13:45	0,13	2057	271,41	CHI
201911329938	RIO VERDE	RV16408210	RIO VERDE S2	25/11/2019 13:37	25/11/2019 20:15	25/11/2019 13:37	25/11/2019 13:47	0,17	2316	398,87	CHI
201911329938	RIO VERDE	RV16406925	RIO VERDE S2	25/11/2019 13:37	25/11/2019 20:15	25/11/2019 13:37	25/11/2019 13:50	0,22	28	6,27	CHI
201911329938	RIO VERDE	RV16402444	RIO VERDE S2	25/11/2019 13:37	25/11/2019 20:15	25/11/2019 13:37	25/11/2019 13:52	0,25	1012	254,69	CHI
201911329938	RIO VERDE	RV16406923	RIO VERDE S2	25/11/2019 13:37	25/11/2019 20:15	25/11/2019 13:37	25/11/2019 16:35	2,96	1006	2982,23	CHI
201911329938	RIO VERDE	RV16406923	RIO VERDE S2	25/11/2019 13:37	25/11/2019 20:15	25/11/2019 13:37	25/11/2019 16:49	3,21	1351	4329,96	CHI
201911329938	RIO VERDE	RV16406923	RIO VERDE S2	25/11/2019 13:37	25/11/2019 20:15	25/11/2019 16:50	25/11/2019 16:58	0,14	1351	195,52	CHI
201911329938	RIO VERDE	RV16406925	RIO VERDE S2	25/11/2019 13:37	25/11/2019 20:15	25/11/2019 17:35	25/11/2019 18:50	1,25	1351	1692,50	CHI
201911329938	RIO VERDE	RV16406925	RIO VERDE S2	25/11/2019 13:37	25/11/2019 20:15	25/11/2019 17:47	25/11/2019 18:50	1,04	2046	2135,80	CHI
201911329938	RIO VERDE	RV12241409	RIO VERDE S2	25/11/2019 13:37	25/11/2019 20:15	25/11/2019 16:50	25/11/2019 20:15	3,43	99	339,32	CHI
201911329940	BARRO ALTO	BA10400377	GOIANESIA S1	25/11/2019 14:17	27/11/2019 21:00	25/11/2019 14:17	26/11/2019 18:35	28,31	1	28,31	CHI
201911329940	BARRO ALTO	BA13267338	GOIANESIA S1	25/11/2019 14:17	27/11/2019 21:00	25/11/2019 14:17	27/11/2019 21:00	54,71	4	218,85	CHI
201911329952	CRISTALINA	KR11287426	CRISTALINA S1	25/11/2019 14:59	25/11/2019 16:42	25/11/2019 14:59	25/11/2019 16:42	1,71	5	8,53	CHI
201911329956	PIRACANJUBA	PJ12000060RE	PIRACANJUBA	25/11/2019 12:50	25/11/2019 20:57	25/11/2019 12:50	25/11/2019 20:57	8,12	81	657,54	CHI
201911329968	LUZIANIA	120163330	RIO VERMELHO	25/11/2019 15:31	25/11/2019 18:18	25/11/2019 15:31	25/11/2019 18:18	2,77	1	2,77	CHI
201911329973	ANAPOLIS	AN10404062	DAIA S1	25/11/2019 15:26	26/11/2019 00:27	25/11/2019 15:30	25/11/2019 15:43	0,22	380	82,44	CHI
201911329973	ANAPOLIS	AN10384922	DAIA S1	25/11/2019 15:26	26/11/2019 00:27	25/11/2019 15:26	25/11/2019 16:57	1,52	34	51,68	CHI
201911329973	ANAPOLIS	AN13382481	DAIA S1	25/11/2019 15:26	26/11/2019 00:27	25/11/2019 15:26	25/11/2019 18:55	3,48	14	48,75	CHI
201911329973	LEOPOLDO DE BULHOES	AN13382481	DAIA S1	25/11/2019 15:26	26/11/2019 00:27	25/11/2019 15:26	25/11/2019 18:55	3,48	30	104,47	CHI

201911329973	LEOPOLDO DE BULHOES	LB12057538	DAIA S1	25/11/2019 15:26	26/11/2019 00:27	25/11/2019 15:26	25/11/2019 19:33	4,12	11	45,30	CHI
201911329973	SILVANIA	LB12057538	DAIA S1	25/11/2019 15:26	26/11/2019 00:27	25/11/2019 15:26	25/11/2019 19:33	4,12	23	94,73	CHI
201911329973	LEOPOLDO DE BULHOES	LB12000624	DAIA S1	25/11/2019 15:26	26/11/2019 00:27	25/11/2019 15:26	25/11/2019 19:50	4,40	32	140,80	CHI
201911329973	ANAPOLIS	AN13086507	DAIA S1	25/11/2019 15:26	26/11/2019 00:27	25/11/2019 18:18	25/11/2019 21:15	2,97	4	11,86	CHI
201911329973	ANAPOLIS	AN10404060	DAIA S1	25/11/2019 15:26	26/11/2019 00:27	25/11/2019 16:07	26/11/2019 00:27	8,34	18	150,04	CHI
201911329979	MAIRIPOTABA	MI12320285	PONTALINA	25/11/2019 11:07	26/11/2019 17:09	25/11/2019 11:07	26/11/2019 17:09	30,04	3	90,11	CHI
201911329980	CRISTALINA	03460434	PAMPLONA	25/11/2019 15:45	25/11/2019 20:46	25/11/2019 15:45	25/11/2019 20:46	5,02	205	1029,84	CHI
201911329980	DISTRITO FEDERAL	03460434	PAMPLONA	25/11/2019 15:45	25/11/2019 20:46	25/11/2019 15:45	25/11/2019 20:46	5,02	4	20,09	CHI
201911329980	LUZIANIA	03460434	PAMPLONA	25/11/2019 15:45	25/11/2019 20:46	25/11/2019 15:45	25/11/2019 20:46	5,02	2	10,05	CHI
201911329981	BARRO ALTO	BA11256950	GOIANESIA S1	25/11/2019 15:57	26/11/2019 17:30	25/11/2019 15:57	26/11/2019 17:30	25,54	1	25,54	CHI
201911329990	ITARUMA	IM10394710	CACHOEIRA ALTA	25/11/2019 15:45	26/11/2019 18:03	25/11/2019 15:45	25/11/2019 20:42	4,95	86	425,82	CHI
201911329990	JATAI	IM10394710	CACHOEIRA ALTA	25/11/2019 15:45	26/11/2019 18:03	25/11/2019 15:45	25/11/2019 20:42	4,95	12	59,42	CHI
201911329990	ITARUMA	IM10394710	CACHOEIRA ALTA	25/11/2019 15:45	26/11/2019 18:03	25/11/2019 21:26	25/11/2019 22:03	0,61	86	52,75	CHI
201911329990	JATAI	IM10394710	CACHOEIRA ALTA	25/11/2019 15:45	26/11/2019 18:03	25/11/2019 21:26	25/11/2019 22:03	0,61	12	7,36	CHI
201911329990	ITARUMA	IM10394710	CACHOEIRA ALTA	25/11/2019 15:45	26/11/2019 18:03	25/11/2019 22:10	25/11/2019 23:51	1,69	86	145,65	CHI
201911329990	JATAI	IM10394710	CACHOEIRA ALTA	25/11/2019 15:45	26/11/2019 18:03	25/11/2019 22:10	25/11/2019 23:51	1,69	12	20,32	CHI
201911329990	ITARUMA	IM13248369	CACHOEIRA ALTA	25/11/2019 15:45	26/11/2019 18:03	25/11/2019 15:45	26/11/2019 16:46	25,02	9	225,21	CHI
201911329990	ITARUMA	IM13107436	CACHOEIRA ALTA	25/11/2019 15:45	26/11/2019 18:03	25/11/2019 15:45	26/11/2019 18:03	26,31	28	736,57	CHI
201911329990	SERRANOPOLIS	IM13107436	CACHOEIRA ALTA	25/11/2019 15:45	26/11/2019 18:03	25/11/2019 15:45	26/11/2019 18:03	26,31	49	1289,00	CHI
201911329991	MONTES CLAROS DE GOIAS	ME10400383	IPORA	25/11/2019 15:06	27/11/2019 18:20	25/11/2019 15:06	27/11/2019 13:15	46,14	11	507,54	CHI
201911329991	MONTES CLAROS DE GOIAS	ME12207822	IPORA	25/11/2019 15:06	27/11/2019 18:20	25/11/2019 15:06	27/11/2019 17:10	50,07	28	1401,91	CHI
201911329991	MONTES CLAROS DE GOIAS	ME12132529	IPORA	25/11/2019 15:06	27/11/2019 18:20	25/11/2019 23:12	27/11/2019 18:20	43,14	30	1294,27	CHI
201911329994	ITAJA	IJ12200623	ITAJA S2	25/11/2019 14:40	26/11/2019 10:49	25/11/2019 14:40	26/11/2019 10:49	20,14	1	20,14	CHI
201911329998	SANTA TEREZINHA DE GOIAS	O1730214	SANTA TEREZINHA	25/11/2019 16:23	26/11/2019 19:27	25/11/2019 16:23	25/11/2019 18:04	1,69	3178	5356,70	CHI
201911329998	SANTA TEREZINHA DE GOIAS	SG12391336	SANTA TEREZINHA	25/11/2019 16:23	26/11/2019 19:27	26/11/2019 16:50	26/11/2019 19:27	2,61	9	23,53	CHI
201911330001	CATALAO	CT21389991	CATALAO S1	25/11/2019 12:22	25/11/2019 17:44	25/11/2019 12:22	25/11/2019 17:44	5,37	2	10,73	CHI
201911330005	ALTO PARAISO DE GOIAS	BF21129910	FLORES DE GOIAS	25/11/2019 12:23	25/11/2019 17:36	25/11/2019 12:23	25/11/2019 17:36	5,21	1	5,21	CHI
201911330011	FORMOSA	FA11046850	ITUIQUIRA	25/11/2019 11:15	25/11/2019 17:51	25/11/2019 11:15	25/11/2019 17:51	6,59	200	1318,06	CHI
201911330013	BRITANIA	IU12020119	MATRINCHA	25/11/2019 11:15	25/11/2019 17:20	25/11/2019 11:15	25/11/2019 17:20	6,07	6	36,42	CHI
201911330013	ITAPIRAPUA	IU12020119	MATRINCHA	25/11/2019 11:15	25/11/2019 17:20	25/11/2019 11:15	25/11/2019 17:20	6,07	43	261,00	CHI
201911330018	LUZIANIA	10029241888	MARAJOARA	25/11/2019 12:25	26/11/2019 09:54	25/11/2019 12:25	26/11/2019 09:54	21,47	1	21,47	CHI
201911330019	PORANGATU	PO12360153	PORANGATU	25/11/2019 11:51	25/11/2019 18:39	25/11/2019 11:51	25/11/2019 18:39	6,79	3	20,36	CHI
201911330022	IPAMERI	IP21100362	CRISTALINA S2	25/11/2019 12:26	26/11/2019 04:56	25/11/2019 12:26	26/11/2019 04:56	16,49	1	16,49	CHI

201911330025	RIO VERDE	RV21068339	MONTIVIDIU T	25/11/2019 12:27	26/11/2019 09:20	25/11/2019 12:27	26/11/2019 09:20	20,87	1	20,87	CHI
201911330030	DOVERLANDIA	DV21124068	CAIAPONIA	25/11/2019 12:28	25/11/2019 17:45	25/11/2019 12:28	25/11/2019 17:45	5,27	1	5,27	CHI
201911330032	MINEIROS	MY21358851	PARQUE DAS EMAS	25/11/2019 12:28	25/11/2019 17:14	25/11/2019 12:28	25/11/2019 17:14	4,75	1	4,75	CHI
201911330045	VALPARAISO DE GOIAS	2860279850	PACAEMBU S2	25/11/2019 12:32	25/11/2019 13:49	25/11/2019 12:32	25/11/2019 13:49	1,28	1	1,28	CHI
201911330046	CALDAS NOVAS	MG21056728	VILA CORUMBA	25/11/2019 12:32	26/11/2019 11:13	25/11/2019 12:32	26/11/2019 11:13	22,67	1	22,67	CHI
201911330051	JATAI	290337586	JATAI S2	25/11/2019 12:33	26/11/2019 10:29	25/11/2019 12:33	26/11/2019 10:29	21,93	1	21,93	CHI
201911330057	PIRES DO RIO	PR11000022	PIRES DO RIO S1	25/11/2019 12:12	25/11/2019 20:47	25/11/2019 12:12	25/11/2019 20:47	8,58	185	1587,61	CHI
201911330063	GUARINOS	IW12330115	ITAPACI	25/11/2019 11:47	25/11/2019 13:52	25/11/2019 11:47	25/11/2019 13:52	2,07	7	14,47	CHI
201911330063	ITAPACI	IW12330115	ITAPACI	25/11/2019 11:47	25/11/2019 13:52	25/11/2019 11:47	25/11/2019 13:52	2,07	115	237,76	CHI
201911330063	PILAR DE GOIAS	IW12330115	ITAPACI	25/11/2019 11:47	25/11/2019 13:52	25/11/2019 11:47	25/11/2019 13:52	2,07	1	2,07	CHI
201911330069	ALTO HORIZONTE	AJ21070403	SANTA TEREZINHA	25/11/2019 12:35	25/11/2019 18:38	25/11/2019 12:35	25/11/2019 18:38	6,04	1	6,04	CHI
201911330076	CRISTALINA	KR21097543	CRISTALINA S1	25/11/2019 12:35	25/11/2019 17:49	25/11/2019 12:35	25/11/2019 17:49	5,22	1	5,22	CHI
201911330080	SANTA TEREZINHA DE GOIAS	SG12237481	SANTA TEREZINHA	25/11/2019 12:36	25/11/2019 14:42	25/11/2019 12:36	25/11/2019 14:42	2,09	14	29,22	CHI
201911330089	ALTO PARAISO DE GOIAS	BF21129911	FLORES DE GOIAS	25/11/2019 12:38	25/11/2019 22:16	25/11/2019 12:38	25/11/2019 22:16	9,62	1	9,62	CHI
201911330091	GOIAS	GS12093357	MATRINCHA	25/11/2019 12:39	25/11/2019 18:30	25/11/2019 12:39	25/11/2019 18:30	5,84	7	40,88	CHI
201911330092	NOVO GAMA	4990014018	PACAEMBU S1	25/11/2019 12:39	25/11/2019 15:50	25/11/2019 12:39	25/11/2019 15:50	3,17	1	3,17	CHI
201911330097	INDIARA	PL12205902	EDEIA	25/11/2019 12:41	25/11/2019 18:50	25/11/2019 12:41	25/11/2019 18:50	6,15	5	30,73	CHI
201911330097	PALMEIRAS DE GOIAS	PL12205902	EDEIA	25/11/2019 12:41	25/11/2019 18:50	25/11/2019 12:41	25/11/2019 18:50	6,15	1	6,15	CHI
201911330098	GUARANI DE GOIAS	1580001972	IACIARA S1	25/11/2019 12:41	25/11/2019 13:40	25/11/2019 12:41	25/11/2019 13:40	0,98	1	0,98	CHI
201911330114	ORIZONA	3950000183	PIRES DO RIO S2	25/11/2019 12:45	26/11/2019 12:42	25/11/2019 12:45	26/11/2019 12:42	23,95	1	23,95	CHI
201911330115	CAIAPONIA	CP12075059	CAIAPONIA	25/11/2019 12:19	25/11/2019 15:52	25/11/2019 12:19	25/11/2019 15:52	3,53	84	296,85	CHI
201911330116	PARAUNA	PU12081329	PARAUNA	25/11/2019 15:43	25/11/2019 18:10	25/11/2019 15:43	25/11/2019 18:10	2,45	46	112,92	CHI
201911330130	ITABERAI	IB21234920	ITABERAI S1	25/11/2019 12:48	26/11/2019 11:12	25/11/2019 12:48	26/11/2019 11:12	22,40	1	22,40	CHI
201911330132	MAURILANDIA	ML12205446LD	SANTA HELENA S1	25/11/2019 12:48	26/11/2019 21:00	25/11/2019 12:48	26/11/2019 21:00	32,20	4	128,79	CHI
201911330132	MAURILANDIA	ML12205446LD	SANTA HELENA S1	25/11/2019 12:48	26/11/2019 21:00	26/11/2019 19:45	26/11/2019 21:00	1,24	1	1,24	CHI
201911330136	GOIANESIA	GE12326325	GOIANESIA S2	25/11/2019 11:33	26/11/2019 10:55	25/11/2019 11:33	26/11/2019 10:55	23,36	6	140,19	CHI
201911330140	IPAMERI	IP12041051	IPAMERI	25/11/2019 12:49	25/11/2019 16:02	25/11/2019 12:49	25/11/2019 16:02	3,21	7	22,48	CHI
201911330151	RIO VERDE	RV12092821	MONTIVIDIU T	25/11/2019 12:50	25/11/2019 19:12	25/11/2019 12:50	25/11/2019 19:12	6,36	11	69,91	CHI
201911330164	NIQUELANDIA	10011986563	NIQUELANDIA SUBTRANSMISSAO	25/11/2019 12:54	26/11/2019 11:30	25/11/2019 12:54	26/11/2019 11:30	22,60	1	22,60	CHI
201911330186	ALEXANIA	AX12114206	ALEXANIA	25/11/2019 12:44	25/11/2019 20:57	25/11/2019 12:44	25/11/2019 20:57	8,21	99	812,93	CHI
201911330187	TAQUARAL DE GOIAS	TQ12250793	ITABERAI S1	25/11/2019 12:56	25/11/2019 17:48	25/11/2019 12:56	25/11/2019 17:48	4,85	11	53,39	CHI
201911330197	ALEXANIA	AX10404067	CORUMBA	25/11/2019 12:54	26/11/2019 16:50	25/11/2019 12:54	25/11/2019 15:11	2,28	76	173,09	CHI
201911330197	CORUMBA DE GOIAS	AX10404067	CORUMBA	25/11/2019 12:54	26/11/2019 16:50	25/11/2019 12:54	25/11/2019 15:11	2,28	56	127,54	CHI

201911330197	ALEXANIA	AX10404067	CORUMBA	25/11/2019 12:54	26/11/2019 16:50	25/11/2019 15:17	25/11/2019 15:24	0,12	76	9,04	CHI
201911330197	CORUMBA DE GOIAS	AX10404067	CORUMBA	25/11/2019 12:54	26/11/2019 16:50	25/11/2019 15:17	25/11/2019 15:24	0,12	56	6,66	CHI
201911330197	ALEXANIA	AX10404067	CORUMBA	25/11/2019 12:54	26/11/2019 16:50	25/11/2019 17:08	25/11/2019 17:15	0,11	76	8,25	CHI
201911330197	CORUMBA DE GOIAS	AX10404067	CORUMBA	25/11/2019 12:54	26/11/2019 16:50	25/11/2019 17:08	25/11/2019 17:15	0,11	56	6,08	CHI
201911330197	ALEXANIA	AX10404067	CORUMBA	25/11/2019 12:54	26/11/2019 16:50	25/11/2019 19:28	25/11/2019 19:35	0,12	76	8,76	CHI
201911330197	CORUMBA DE GOIAS	AX10404067	CORUMBA	25/11/2019 12:54	26/11/2019 16:50	25/11/2019 19:28	25/11/2019 19:35	0,12	56	6,46	CHI
201911330197	ALEXANIA	AX13311909	CORUMBA	25/11/2019 12:54	26/11/2019 16:50	25/11/2019 12:54	26/11/2019 11:22	22,45	6	134,72	CHI
201911330197	CORUMBA DE GOIAS	AX13311909	CORUMBA	25/11/2019 12:54	26/11/2019 16:50	25/11/2019 12:54	26/11/2019 11:22	22,45	13	291,89	CHI
201911330197	ALEXANIA	AX10404067	CORUMBA	25/11/2019 12:54	26/11/2019 16:50	26/11/2019 11:23	26/11/2019 11:43	0,33	76	25,04	CHI
201911330197	CORUMBA DE GOIAS	AX10404067	CORUMBA	25/11/2019 12:54	26/11/2019 16:50	26/11/2019 11:23	26/11/2019 11:43	0,33	56	18,45	CHI
201911330197	CORUMBA DE GOIAS	AX13311909	CORUMBA	25/11/2019 12:54	26/11/2019 16:50	25/11/2019 12:54	26/11/2019 16:50	27,92	277	7733,84	CHI
201911330197	CORUMBA DE GOIAS	AX13311909	CORUMBA	25/11/2019 12:54	26/11/2019 16:50	25/11/2019 17:08	26/11/2019 16:50	23,69	1	23,69	CHI
201911330197	ALEXANIA	AX13311909	CORUMBA	25/11/2019 12:54	26/11/2019 16:50	26/11/2019 11:23	26/11/2019 16:50	5,43	6	32,61	CHI
201911330197	CORUMBA DE GOIAS	AX13311909	CORUMBA	25/11/2019 12:54	26/11/2019 16:50	26/11/2019 11:23	26/11/2019 16:50	5,43	13	70,65	CHI
201911330199	ALTO PARAISO DE GOIAS	BF21048007	SAO JOAO D ALIANCA	25/11/2019 12:59	25/11/2019 20:15	25/11/2019 12:59	25/11/2019 20:15	7,26	1	7,26	CHI
201911330201	VALPARAISO DE GOIAS	10011713907	PACAEMBU S2	25/11/2019 12:59	25/11/2019 18:41	25/11/2019 12:59	25/11/2019 18:41	5,69	1	5,69	CHI
201911330204	IPAMERI	IP12031357	IPAMERI	25/11/2019 12:59	26/11/2019 11:53	25/11/2019 12:59	26/11/2019 11:53	22,89	2	45,78	CHI
201911330209	NOVA ROMA	ND21255177	IACIARA S2	25/11/2019 13:01	25/11/2019 16:02	25/11/2019 13:01	25/11/2019 16:02	3,02	1	3,02	CHI
201911330210	BARRO ALTO	BA21000064	BARRO ALTO	25/11/2019 13:01	27/11/2019 09:38	25/11/2019 13:01	27/11/2019 09:38	44,61	1	44,61	CHI
201911330216	JATAI	JT21182041	JATAI S1	25/11/2019 13:02	26/11/2019 16:41	25/11/2019 13:02	26/11/2019 16:41	27,64	1	27,64	CHI
201911330222	CALDAS NOVAS	CN21186166	SERRA DE CALDAS	25/11/2019 13:03	26/11/2019 10:53	25/11/2019 13:03	26/11/2019 10:53	21,82	2	43,65	CHI
201911330238	GOIAS	IB12210550	ITABERAI S1	25/11/2019 12:06	25/11/2019 15:25	25/11/2019 12:06	25/11/2019 15:25	3,31	3	9,92	CHI
201911330238	ITABERAI	IB12210550	ITABERAI S1	25/11/2019 12:06	25/11/2019 15:25	25/11/2019 12:06	25/11/2019 15:25	3,31	35	115,69	CHI
201911330240	ARAGUAPAZ	AZ12010440	MOZARLANDIA	25/11/2019 13:07	26/11/2019 14:03	25/11/2019 13:07	26/11/2019 07:13	18,11	15	271,59	CHI
201911330240	ARAGUAPAZ	AZ12010440	MOZARLANDIA	25/11/2019 13:07	26/11/2019 14:03	26/11/2019 07:23	26/11/2019 14:03	6,67	15	99,98	CHI
201911330248	ABADIANIA	AA11308961	DAIA S2	25/11/2019 13:09	25/11/2019 22:34	25/11/2019 13:09	25/11/2019 22:34	9,41	17	159,97	CHI
201911330262	SANTO ANTONIO DO DESCOBERTO	SN21037173	MARAJOARA	25/11/2019 13:12	25/11/2019 16:49	25/11/2019 13:12	25/11/2019 16:49	3,61	1	3,61	CHI
201911330266	JATAI	JT12210006	JATAI S1	25/11/2019 13:12	25/11/2019 15:10	25/11/2019 13:12	25/11/2019 15:10	1,96	2	3,91	CHI
201911330268	AGUAS LINDAS DE GOIAS	10011892429	AGUAS LINDAS DE GOIAS S1	25/11/2019 13:13	25/11/2019 14:34	25/11/2019 13:13	25/11/2019 14:34	1,35	1	1,35	CHI
201911330284	URUACU	UR12181375	URUACU	25/11/2019 13:15	25/11/2019 21:13	25/11/2019 13:15	25/11/2019 21:13	7,96	2	15,92	CHI
201911330299	LUZIANIA	LZ21209584	MARAJOARA	25/11/2019 13:18	25/11/2019 17:05	25/11/2019 13:18	25/11/2019 17:05	3,78	1	3,78	CHI
201911330318	ITUMBIARA	IT21305367	ITUMBIARA NOVA	25/11/2019 13:22	25/11/2019 17:02	25/11/2019 13:22	25/11/2019 17:02	3,67	1	3,67	CHI
201911330319	PIRENOPOLIS	220049762	CORUMBA	25/11/2019 13:22	26/11/2019 11:10	25/11/2019 13:22	26/11/2019 11:10	21,79	1	21,79	CHI

201911330332	CAVALCANTE	BF12047986	FLORES DE GOIAS	25/11/2019 13:25	25/11/2019 17:21	25/11/2019 13:25	25/11/2019 17:21	3,92	2	7,84	CHI
201911330335	SERRANOPOLIS	MY21241833	CHAPADAO DO CEU	25/11/2019 13:27	26/11/2019 09:53	25/11/2019 13:27	26/11/2019 09:53	20,43	1	20,43	CHI
201911330339	ABADIANIA	AA12221425	ANAPOLIS UNIVERSITARIO S1	25/11/2019 12:37	25/11/2019 20:08	25/11/2019 12:37	25/11/2019 20:08	7,52	45	338,20	CHI
201911330339	GAMELEIRA DE GOIAS	AA12221425	ANAPOLIS UNIVERSITARIO S1	25/11/2019 12:37	25/11/2019 20:08	25/11/2019 12:37	25/11/2019 20:08	7,52	1	7,52	CHI
201911330342	CATALAO	CT12149150	CATALAO S1	25/11/2019 13:28	25/11/2019 18:11	25/11/2019 13:28	25/11/2019 18:11	4,71	3	14,14	CHI
201911330346	PALESTINA DE GOIAS	PY12268539	PALESTINA	25/11/2019 13:29	26/11/2019 08:41	25/11/2019 13:29	26/11/2019 08:41	19,19	5	95,96	CHI
201911330360	TRINDADE	TR11393094	TRINDADE	25/11/2019 13:31	26/11/2019 11:43	25/11/2019 13:31	26/11/2019 11:43	22,20	19	421,75	CHI
201911330364	ANICUNS	TV21095726	FIRMINOPOLIS S2	25/11/2019 13:31	25/11/2019 16:11	25/11/2019 13:31	25/11/2019 16:11	2,67	1	2,67	CHI
201911330369	GOIANESIA	GE12352313	GOIANESIA S1	25/11/2019 13:32	26/11/2019 14:59	25/11/2019 13:32	26/11/2019 14:59	25,45	24	610,77	CHI
201911330369	SAO LUIZ DO NORTE	GE12352313	GOIANESIA S1	25/11/2019 13:32	26/11/2019 14:59	25/11/2019 13:32	26/11/2019 14:59	25,45	21	534,43	CHI
201911330372	ANICUNS	NZ12003882	ANICUNS	25/11/2019 13:27	25/11/2019 16:27	25/11/2019 13:27	25/11/2019 16:27	3,00	145	434,72	CHI
201911330372	NAZARIO	NZ12003882	ANICUNS	25/11/2019 13:27	25/11/2019 16:27	25/11/2019 13:27	25/11/2019 16:27	3,00	147	440,71	CHI
201911330372	PALMEIRAS DE GOIAS	NZ12003882	ANICUNS	25/11/2019 13:27	25/11/2019 16:27	25/11/2019 13:27	25/11/2019 16:27	3,00	3	8,99	CHI
201911330372	TURVANIA	NZ12003882	ANICUNS	25/11/2019 13:27	25/11/2019 16:27	25/11/2019 13:27	25/11/2019 16:27	3,00	48	143,91	CHI
201911330374	MARA ROSA	MQ21220765	MARA ROSA	25/11/2019 13:33	26/11/2019 11:09	25/11/2019 13:33	26/11/2019 11:09	21,60	1	21,60	CHI
201911330375	ALTO PARAISO DE GOIAS	BF21375517	FLORES DE GOIAS	25/11/2019 13:33	25/11/2019 20:54	25/11/2019 13:33	25/11/2019 20:54	7,35	1	7,35	CHI
201911330376	LUZIANIA	10005996188	MARAJOARA	25/11/2019 13:33	25/11/2019 17:19	25/11/2019 13:33	25/11/2019 17:19	3,76	1	3,76	CHI
201911330377	PLANALTINA	10004683593	PLANALTINA	25/11/2019 13:33	26/11/2019 14:56	25/11/2019 13:33	26/11/2019 14:56	25,38	1	25,38	CHI
201911330378	GOIANIA	13012253	CAMPINAS S1	25/11/2019 13:33	25/11/2019 17:24	25/11/2019 13:33	25/11/2019 17:24	3,84	1	3,84	CHI
201911330382	ANAPOLIS	AN12258715	JUNDIAI S1	25/11/2019 13:34	25/11/2019 22:05	25/11/2019 13:34	25/11/2019 22:05	8,51	49	416,98	CHI
201911330388	VALPARAISO DE GOIAS	3350052986	PACAEMBU S2	25/11/2019 13:35	26/11/2019 10:59	25/11/2019 13:35	26/11/2019 10:59	21,40	1	21,40	CHI
201911330401	CAIAPONIA	CP12390177	CAIAPONIA	25/11/2019 13:37	27/11/2019 22:10	25/11/2019 13:37	27/11/2019 22:10	56,56	6	339,34	CHI
201911330408	GUARANI DE GOIAS	SD12192246	SAO DOMINGOS	25/11/2019 13:09	25/11/2019 15:26	25/11/2019 13:09	25/11/2019 15:26	2,27	3	6,80	CHI
201911330408	SAO DOMINGOS	SD12192246	SAO DOMINGOS	25/11/2019 13:09	25/11/2019 15:26	25/11/2019 13:09	25/11/2019 15:26	2,27	10	22,68	CHI
201911330411	GOIANIA	AP21198394	CEPAIGO S1	25/11/2019 13:38	25/11/2019 16:23	25/11/2019 13:38	25/11/2019 16:23	2,74	1	2,74	CHI
201911330415	ITAUCU	IX21113965	INHUMAS S1	25/11/2019 13:38	25/11/2019 18:51	25/11/2019 13:38	25/11/2019 18:51	5,22	2	10,44	CHI
201911330418	ITUMBIARA	BG21066350	ALTO BURITI	25/11/2019 13:39	26/11/2019 20:55	25/11/2019 13:39	26/11/2019 20:55	31,27	1	31,27	CHI
201911330449	ITUMBIARA	IT21000237	ITUMBIARA NOVA	25/11/2019 13:42	25/11/2019 17:28	25/11/2019 13:42	25/11/2019 17:28	3,76	1	3,76	CHI
201911330463	JATAI	JT11182100	JATAI S2	25/11/2019 12:33	25/11/2019 16:45	25/11/2019 12:33	25/11/2019 16:45	4,18	130	543,87	CHI
201911330468	RIO VERDE	RV12093121	RIO VERDE S2	25/11/2019 13:44	25/11/2019 17:24	25/11/2019 13:44	25/11/2019 17:24	3,67	129	473,93	CHI
201911330469	ALTO PARAISO DE GOIAS	BF21163462	FLORES DE GOIAS	25/11/2019 13:44	25/11/2019 22:39	25/11/2019 13:44	25/11/2019 22:39	8,91	1	8,91	CHI
201911330472	CASTELANDIA	ML32191806	RIO DOS BOIS	25/11/2019 10:51	26/11/2019 08:31	25/11/2019 10:51	26/11/2019 08:31	21,67	20	433,42	CHI
201911330472	MAURILANDIA	ML32191806	RIO DOS BOIS	25/11/2019 10:51	26/11/2019 08:31	25/11/2019 10:51	26/11/2019 08:31	21,67	72	1560,30	CHI

201911330472	RIO VERDE	ML32191806	RIO DOS BOIS	25/11/2019 10:51	26/11/2019 08:31	25/11/2019 10:51	26/11/2019 08:31	21,67	22	476,76	CHI
201911330473	ITABERAÍ	IB21158831	ITABERAÍ S1	25/11/2019 13:45	25/11/2019 18:10	25/11/2019 13:45	25/11/2019 18:10	4,42	1	4,42	CHI
201911330474	MORRINHOS	MR12000183	MORRINHOS	25/11/2019 13:45	26/11/2019 01:26	25/11/2019 13:45	26/11/2019 01:26	11,68	7	81,76	CHI
201911330508	LUZIANIA	LZ21153846	MARAJÓARA	25/11/2019 13:48	25/11/2019 17:26	25/11/2019 13:48	25/11/2019 17:26	3,63	2	7,27	CHI
201911330513	RIO VERDE	RV12260132	CABRIÚVA S2	25/11/2019 13:48	25/11/2019 16:24	25/11/2019 13:48	25/11/2019 16:24	2,60	19	49,42	CHI
201911330526	ITAPURANGA	IK11000007	ITAPURANGA	25/11/2019 16:47	25/11/2019 18:30	25/11/2019 16:47	25/11/2019 18:30	1,71	142	242,39	CHI
201911330527	ALTO PARAISO DE GOIAS	BF21361347	NIQUELANDIA SUBTRANSMISSAO	25/11/2019 13:49	26/11/2019 10:01	25/11/2019 13:49	26/11/2019 10:01	20,20	1	20,20	CHI
201911330533	SAO LUIS DE MONTES BELOS	SL11158902	SAO LUIZ DOS MONTES BELOS	25/11/2019 13:06	25/11/2019 18:31	25/11/2019 13:06	25/11/2019 18:31	5,42	167	905,88	CHI
201911330535	APARECIDA DE GOIANIA	AP11241338	INDEPENDENCIA S1	25/11/2019 13:50	26/11/2019 13:02	26/11/2019 11:26	26/11/2019 13:02	1,59	179	284,91	CHI
201911330543	PARANAIGUARA	PC12000018	CACHOEIRA ALTA	25/11/2019 13:51	25/11/2019 18:12	25/11/2019 13:51	25/11/2019 18:12	4,35	1	4,35	CHI
201911330543	SAO SIMAO	PC12000018	CACHOEIRA ALTA	25/11/2019 13:51	25/11/2019 18:12	25/11/2019 13:51	25/11/2019 18:12	4,35	5	21,73	CHI
201911330548	ORIZONA	2060029989	PIRES DO RIO S2	25/11/2019 13:51	26/11/2019 10:27	25/11/2019 13:51	26/11/2019 10:27	20,59	1	20,59	CHI
201911330554	COLINAS DO SUL	TI11037457	NIQUELANDIA SUBTRANSMISSAO	25/11/2019 13:46	26/11/2019 01:23	25/11/2019 13:46	26/11/2019 01:23	11,60	80	928,09	CHI
201911330555	FORMOSA	FA11233621	SAO JOAO D ALIANCA	25/11/2019 13:52	26/11/2019 11:59	25/11/2019 13:52	26/11/2019 11:59	22,10	1	22,10	CHI
201911330559	DISTRITO FEDERAL	NJ12283924	MARAJÓARA	25/11/2019 13:49	25/11/2019 15:44	25/11/2019 13:49	25/11/2019 15:44	1,91	4	7,62	CHI
201911330559	NOVO GAMA	NJ12283924	MARAJÓARA	25/11/2019 13:49	25/11/2019 15:44	25/11/2019 13:49	25/11/2019 15:44	1,91	32	60,97	CHI
201911330559	SANTO ANTONIO DO DESCOBERTO	NJ12283924	MARAJÓARA	25/11/2019 13:49	25/11/2019 15:44	25/11/2019 13:49	25/11/2019 15:44	1,91	163	310,56	CHI
201911330567	MINACU	10016346716	MINACU	25/11/2019 13:53	25/11/2019 16:44	25/11/2019 13:53	25/11/2019 16:44	2,83	1	2,83	CHI
201911330571	TURVANIA	1220008993	FIRMINOPOLIS S2	25/11/2019 13:54	25/11/2019 17:27	25/11/2019 13:54	25/11/2019 17:27	3,55	1	3,55	CHI
201911330576	PETROLINA DE GOIAS	PG12200842	SAO FRANCISCO DE GOIAS	25/11/2019 13:56	26/11/2019 02:17	25/11/2019 13:56	26/11/2019 02:17	12,35	2	24,70	CHI
201911330580	PARANAIGUARA	QI12279808	QUIRINOPOLIS	25/11/2019 13:56	25/11/2019 16:06	25/11/2019 13:56	25/11/2019 16:06	2,16	44	95,11	CHI
201911330580	QUIRINOPOLIS	QI12279808	QUIRINOPOLIS	25/11/2019 13:56	25/11/2019 16:06	25/11/2019 13:56	25/11/2019 16:06	2,16	64	138,35	CHI
201911330587	APARECIDA DE GOIANIA	AP12402133	INDEPENDENCIA S2	25/11/2019 13:48	25/11/2019 16:00	25/11/2019 13:48	25/11/2019 16:00	2,20	559	1227,16	CHI
201911330591	FLORES DE GOIAS	FB21293606	FLORES DE GOIAS	25/11/2019 13:58	26/11/2019 19:04	25/11/2019 13:58	26/11/2019 19:04	29,10	1	29,10	CHI
201911330595	GOIANIA	15257400	CARAJAS S1	25/11/2019 13:59	25/11/2019 18:53	25/11/2019 13:59	25/11/2019 18:53	4,90	1	4,90	CHI
201911330597	CAMPO ALEGRE DE GOIAS	CM21103634	CAMPO ALEGRE DE GOIAS	25/11/2019 13:59	25/11/2019 17:32	25/11/2019 13:59	25/11/2019 17:32	3,54	2	7,08	CHI
201911330598	GOIANIA	10017233044	GOIANIA LESTE S2	25/11/2019 13:59	25/11/2019 18:00	25/11/2019 13:59	25/11/2019 18:00	4,00	1	4,00	CHI
201911330599	LUZIANIA	10014008759	MARAJÓARA	25/11/2019 13:59	25/11/2019 16:31	25/11/2019 13:59	25/11/2019 16:31	2,52	1	2,52	CHI
201911330601	JATAI	JT12306448	JATAI S1	25/11/2019 13:49	25/11/2019 17:00	25/11/2019 13:49	25/11/2019 17:00	3,18	16	50,87	CHI
201911330604	MONTE ALEGRE DE GOIAS	MA12357827	SAO DOMINGOS	25/11/2019 14:00	25/11/2019 17:42	25/11/2019 14:00	25/11/2019 17:42	3,70	2	7,40	CHI
201911330605	RIO VERDE	RV12018184	RIO VERDE S2	25/11/2019 14:00	25/11/2019 15:51	25/11/2019 14:00	25/11/2019 15:51	1,85	11	20,32	CHI
201911330606	PIRENOPOLIS	PV21144043	CORUMBA	25/11/2019 14:00	25/11/2019 17:57	25/11/2019 14:00	25/11/2019 17:57	3,95	1	3,95	CHI
201911330608	PIRES DO RIO	PR21000017	PIRES DO RIO S1	25/11/2019 14:00	25/11/2019 23:52	25/11/2019 14:00	25/11/2019 23:52	9,85	4	39,41	CHI

201911330618	PETROLINA DE GOIAS	PG21281380	PETROLINA	25/11/2019 14:02	26/11/2019 10:15	25/11/2019 14:02	26/11/2019 10:15	20,21	1	20,21	CHI
201911330619	ALEXANIA	AX12398552	ALEXANIA	25/11/2019 13:55	26/11/2019 17:48	25/11/2019 13:55	26/11/2019 17:48	27,87	5	139,35	CHI
201911330623	AGUA FRIA DE GOIAS	TL21211514	SAO JOAO D ALIANCA	25/11/2019 14:02	26/11/2019 15:48	25/11/2019 14:02	26/11/2019 15:48	25,77	1	25,77	CHI
201911330635	PLANALTINA	PI12321745	PLANALTINA	25/11/2019 14:03	26/11/2019 14:34	25/11/2019 14:03	26/11/2019 14:34	24,50	4	98,01	CHI
201911330642	PONTALINA	PK11000002	PONTALINA	25/11/2019 12:11	25/11/2019 18:18	25/11/2019 12:11	25/11/2019 18:18	6,11	56	342,04	CHI
201911330652	CAIAPONIA	CP12354302	CAIAPONIA	25/11/2019 14:00	26/11/2019 09:34	25/11/2019 14:00	26/11/2019 09:34	19,57	16	313,04	CHI
201911330654	AMORINOPOLIS	AM12079563	IPORA	25/11/2019 14:06	26/11/2019 10:15	25/11/2019 14:06	26/11/2019 10:15	20,14	3	60,43	CHI
201911330665	MOSSAMEDES	MD21091061	FIRMINOPOLIS S2	25/11/2019 14:08	25/11/2019 16:00	25/11/2019 14:08	25/11/2019 16:00	1,88	1	1,88	CHI
201911330667	RIO VERDE	RV12260111	RIO VERDE S2	25/11/2019 14:08	25/11/2019 18:15	25/11/2019 14:08	25/11/2019 18:15	4,11	1	4,11	CHI
201911330669	GOIANIA	GN11002836	XAVANTES	25/11/2019 13:41	25/11/2019 15:30	25/11/2019 13:41	25/11/2019 15:30	1,80	32	57,76	CHI
201911330677	GOIANIA	10015107734	ATLANTICO S3	25/11/2019 14:09	25/11/2019 17:24	25/11/2019 14:09	25/11/2019 17:24	3,24	1	3,24	CHI
201911330701	QUIRINOPOLIS	80149108	QUIRINOPOLIS	25/11/2019 14:09	25/11/2019 15:37	25/11/2019 14:09	25/11/2019 15:37	1,45	1	1,45	CHI
201911330801	PIRACANJUBA	PJ21228164	CALDAS NOVAS S1	25/11/2019 14:09	26/11/2019 16:15	25/11/2019 14:09	26/11/2019 16:15	26,09	1	26,09	CHI
201911330804	ORIZONA	OZ21195135	PIRES DO RIO S2	25/11/2019 14:10	26/11/2019 17:15	25/11/2019 14:10	26/11/2019 17:15	27,08	1	27,08	CHI
201911330806	ITAPIRAPUA	IU12055120	MATRINCHA	25/11/2019 13:21	26/11/2019 19:06	25/11/2019 13:21	26/11/2019 19:06	29,75	5	148,77	CHI
201911330809	BURITI DE GOIAS	1660001265	FIRMINOPOLIS S2	25/11/2019 14:10	26/11/2019 08:11	25/11/2019 14:10	26/11/2019 08:11	18,01	1	18,01	CHI
201911330810	NOVO GAMA	LZ21206570	MARAJOARA	25/11/2019 14:10	25/11/2019 18:30	25/11/2019 14:10	25/11/2019 18:30	4,32	2	8,64	CHI
201911330813	BELA VISTA DE GOIAS	BV32063026	BELA VISTA S1	25/11/2019 14:12	25/11/2019 20:09	25/11/2019 14:12	25/11/2019 18:56	4,73	69	326,31	CHI
201911330813	BELA VISTA DE GOIAS	BV12402719	BELA VISTA S1	25/11/2019 14:12	25/11/2019 20:09	25/11/2019 18:56	25/11/2019 20:09	1,23	98	120,35	CHI
201911330814	ITABERAI	IB21251050	ANICUNS	25/11/2019 14:10	26/11/2019 10:01	25/11/2019 14:10	26/11/2019 10:01	19,85	1	19,85	CHI
201911330816	GOIANIA	GN12001527	GOYA S1	25/11/2019 13:57	25/11/2019 18:31	25/11/2019 13:57	25/11/2019 17:06	3,14	52	163,34	CHI
201911330816	GOIANIA	GN12391588LD	GOYA S1	25/11/2019 13:57	25/11/2019 18:31	25/11/2019 13:57	25/11/2019 18:31	4,56	9	41,05	CHI
201911330824	PLANALTINA	PI12262312	PLANALTINA	25/11/2019 12:21	26/11/2019 10:57	25/11/2019 12:21	26/11/2019 10:57	22,60	10	225,98	CHI
201911330827	LUZIANIA	LZ11216264	MARAJOARA	25/11/2019 14:12	25/11/2019 15:51	25/11/2019 14:12	25/11/2019 15:51	1,65	117	192,63	CHI
201911330833	CORREGO DO OURO	CO12055677	SAO LUIZ DOS MONTES BELOS	25/11/2019 12:44	25/11/2019 19:27	25/11/2019 12:44	25/11/2019 19:27	6,71	15	100,70	CHI
201911330833	MOIPORA	CO12055677	SAO LUIZ DOS MONTES BELOS	25/11/2019 12:44	25/11/2019 19:27	25/11/2019 12:44	25/11/2019 19:27	6,71	2	13,43	CHI
201911330835	JANDAIA	JD21226946	PALMEIRAS	25/11/2019 14:13	26/11/2019 12:10	25/11/2019 14:13	26/11/2019 12:10	21,96	1	21,96	CHI
201911330836	GOIANIA	GN12137199	GOIANIA LESTE S2	25/11/2019 14:13	25/11/2019 15:50	25/11/2019 14:13	25/11/2019 15:50	1,61	74	119,08	CHI
201911330844	CRISTALINA	KR12376152	CRISTALINA S1	25/11/2019 14:14	26/11/2019 17:14	25/11/2019 14:14	26/11/2019 17:14	26,99	3	80,98	CHI
201911330846	PALMEIRAS DE GOIAS	PL11158607	PALMEIRAS	25/11/2019 14:16	25/11/2019 18:24	25/11/2019 14:16	25/11/2019 18:24	4,13	148	611,08	CHI
201911330855	CORUMBA DE GOIAS	CB21171924	CORUMBA	25/11/2019 14:15	25/11/2019 23:51	25/11/2019 14:15	25/11/2019 23:51	9,59	1	9,59	CHI
201911330862	NAZARIO	NZ11005214	ANICUNS	25/11/2019 14:16	26/11/2019 10:10	25/11/2019 14:16	26/11/2019 10:10	19,91	99	1971,34	CHI
201911330867	GOIANIA	GN12173001	CAMPINAS S1	25/11/2019 14:10	25/11/2019 17:44	25/11/2019 14:10	25/11/2019 17:44	3,56	127	451,84	CHI

201911330868	DOVERLANDIA	DV12171957	CAIAPONIA	25/11/2019 12:30	27/11/2019 19:58	25/11/2019 12:30	25/11/2019 18:28	5,96	20	119,22	CHI
201911330868	DOVERLANDIA	DV12171957	CAIAPONIA	25/11/2019 12:30	27/11/2019 19:58	25/11/2019 12:30	27/11/2019 19:58	55,47	4	221,87	CHI
201911330875	PALMEIRAS DE GOIAS	590070370	PALMEIRAS	25/11/2019 14:17	25/11/2019 17:46	25/11/2019 14:17	25/11/2019 17:46	3,48	1	3,48	CHI
201911330882	SANTA HELENA DE GOIAS	SH11246704	RIO VERDE S1	25/11/2019 14:17	25/11/2019 16:28	25/11/2019 14:17	25/11/2019 16:28	2,17	1	2,17	CHI
201911330883	ALTO PARAISO DE GOIAS	3870001614	FLORES DE GOIAS	25/11/2019 14:17	26/11/2019 17:00	25/11/2019 14:17	26/11/2019 17:00	26,70	1	26,70	CHI
201911330900	ALTO PARAISO DE GOIAS	BF21228726	FLORES DE GOIAS	25/11/2019 14:19	25/11/2019 21:37	25/11/2019 14:19	25/11/2019 21:37	7,29	1	7,29	CHI
201911330905	JAUPACI	JP21212533	IPORA	25/11/2019 14:20	26/11/2019 07:40	25/11/2019 14:20	26/11/2019 07:40	17,33	2	34,66	CHI
201911330909	GOIANIA	GN21044108	GOYA S1	25/11/2019 14:20	25/11/2019 15:47	25/11/2019 14:20	25/11/2019 15:47	1,44	1	1,44	CHI
201911330910	SERRANOPOLIS	SX12324757	CHAPADAO DO CEU	25/11/2019 14:20	25/11/2019 19:56	25/11/2019 14:20	25/11/2019 19:56	5,60	2	11,19	CHI
201911330922	ALOANDIA	AD12394185	GOIATUBA S1	25/11/2019 14:21	26/11/2019 11:42	25/11/2019 14:21	26/11/2019 11:42	21,34	3	64,01	CHI
201911330922	JOVIANIA	AD12394185	GOIATUBA S1	25/11/2019 14:21	26/11/2019 11:42	25/11/2019 14:21	26/11/2019 11:42	21,34	2	42,67	CHI
201911330923	CRISTALINA	KR12087952	CRISTALINA S2	25/11/2019 11:33	25/11/2019 16:14	25/11/2019 11:33	25/11/2019 16:14	4,67	1	4,67	CHI
201911330929	SAO JOAO D ALIANCA	JL12211635	SAO JOAO D ALIANCA	25/11/2019 13:53	25/11/2019 16:50	25/11/2019 13:53	25/11/2019 16:50	2,94	215	631,38	CHI
201911330932	ITAUCU	IX21134421	INHUMAS S1	25/11/2019 14:22	25/11/2019 16:59	25/11/2019 14:22	25/11/2019 16:59	2,61	2	5,22	CHI
201911330942	ALEXANIA	AX12000041	ALEXANIA	25/11/2019 13:09	25/11/2019 19:38	25/11/2019 13:09	25/11/2019 19:38	6,48	86	556,92	CHI
201911330943	CATALAO	CT21042525	CATALAO S1	25/11/2019 14:25	25/11/2019 20:28	25/11/2019 14:25	25/11/2019 20:28	6,04	1	6,04	CHI
201911330944	PIRACANJUBA	PJ21154671	PIRACANJUBA	25/11/2019 14:25	27/11/2019 16:40	25/11/2019 14:25	27/11/2019 16:05	49,66	1	49,66	CHI
201911330944	PIRACANJUBA	PJ12025097	PIRACANJUBA	25/11/2019 14:25	27/11/2019 16:40	27/11/2019 13:18	27/11/2019 16:40	3,37	5	16,83	CHI
201911330955	SANTO ANTONIO DA BARRA	2270014929	ACREUNA	25/11/2019 14:26	25/11/2019 16:58	25/11/2019 14:26	25/11/2019 16:58	2,55	1	2,55	CHI
201911330958	RIO VERDE	630515244	RIO VERDE S1	25/11/2019 14:26	25/11/2019 17:07	25/11/2019 14:26	25/11/2019 17:07	2,68	1	2,68	CHI
201911330959	ALTO PARAISO DE GOIAS	BF12218456	NIQUELANDIA SUBTRANSMISSAO	25/11/2019 14:26	25/11/2019 18:21	25/11/2019 14:26	25/11/2019 18:21	3,92	5	19,60	CHI
201911330960	INHUMAS	IN21148011	INHUMAS S1	25/11/2019 14:26	26/11/2019 10:30	25/11/2019 14:26	26/11/2019 10:30	20,07	2	40,15	CHI
201911330971	CHAPADAO DO CEU	DJ12365007	CHAPADAO DO CEU	25/11/2019 14:27	25/11/2019 19:24	25/11/2019 14:27	25/11/2019 19:24	4,94	7	34,55	CHI
201911330971	MINEIROS	DJ12365007	CHAPADAO DO CEU	25/11/2019 14:27	25/11/2019 19:24	25/11/2019 14:27	25/11/2019 19:24	4,94	3	14,81	CHI
201911330975	PIRES DO RIO	PR21319029	PIRES DO RIO S1	25/11/2019 14:20	26/11/2019 16:23	25/11/2019 14:20	26/11/2019 16:23	26,05	1	26,05	CHI
201911330977	ITAPURANGA	IK21186760	ITAPURANGA	25/11/2019 14:28	25/11/2019 17:38	25/11/2019 14:28	25/11/2019 17:38	3,16	1	3,16	CHI
201911330991	ALTO PARAISO DE GOIAS	BF21342373	FLORES DE GOIAS	25/11/2019 14:29	25/11/2019 17:16	25/11/2019 14:29	25/11/2019 17:16	2,78	1	2,78	CHI
201911330992	NOVA CRIXAS	NA12220366	MOZARLANDIA	25/11/2019 14:13	25/11/2019 18:35	25/11/2019 14:13	25/11/2019 18:35	4,36	6	26,15	CHI
201911330993	GOIANIA	11313328	CAMPINAS S1	25/11/2019 14:30	25/11/2019 18:46	25/11/2019 14:30	25/11/2019 18:46	4,26	1	4,26	CHI
201911330998	CALDAS NOVAS	CN12180276	CALDAS NOVAS S1	25/11/2019 13:41	25/11/2019 19:29	25/11/2019 13:41	25/11/2019 19:29	5,79	6	34,76	CHI
201911330998	SANTA CRUZ DE GOIAS	CN12180276	CALDAS NOVAS S1	25/11/2019 13:41	25/11/2019 19:29	25/11/2019 13:41	25/11/2019 19:29	5,79	52	301,25	CHI
201911330999	RIO VERDE	BZ12295804LD	ACREUNA	25/11/2019 14:30	25/11/2019 19:14	25/11/2019 14:30	25/11/2019 19:14	4,72	24	113,38	CHI
201911330999	SANTA HELENA DE GOIAS	BZ12295804LD	ACREUNA	25/11/2019 14:30	25/11/2019 19:14	25/11/2019 14:30	25/11/2019 19:14	4,72	5	23,62	CHI



201911330999	SANTO ANTONIO DA BARRA	BZ12295804LD	ACREUNA	25/11/2019 14:30	25/11/2019 19:14	25/11/2019 14:30	25/11/2019 19:14	4,72	44	207,86	CHI
201911331003	ESTRELA DO NORTE	ET12036513	MARA ROSA	25/11/2019 12:21	26/11/2019 16:57	25/11/2019 12:21	26/11/2019 16:57	28,60	3	85,81	CHI
201911331003	FORMOSO	ET12036513	MARA ROSA	25/11/2019 12:21	26/11/2019 16:57	25/11/2019 12:21	26/11/2019 16:57	28,60	1	28,60	CHI
201911331003	MARA ROSA	ET12036513	MARA ROSA	25/11/2019 12:21	26/11/2019 16:57	25/11/2019 12:21	26/11/2019 16:57	28,60	6	171,62	CHI
201911331005	ITAJA	IJ12057626	ITAJA S2	25/11/2019 14:31	25/11/2019 15:33	25/11/2019 14:31	25/11/2019 15:33	1,02	20	20,38	CHI
201911331005	LAGOA SANTA	IJ12057626	ITAJA S2	25/11/2019 14:31	25/11/2019 15:33	25/11/2019 14:31	25/11/2019 15:33	1,02	5	5,10	CHI
201911331010	NEROPOLIS	NR11008341	NEROPOLIS S2	25/11/2019 14:32	25/11/2019 17:00	25/11/2019 14:32	25/11/2019 17:00	2,45	120	294,10	CHI
201911331013	PIRACANJUBA	PJ12263257	CALDAS NOVAS S1	25/11/2019 14:27	25/11/2019 20:55	25/11/2019 14:27	25/11/2019 20:55	6,48	7	45,33	CHI
201911331029	GOIANIA	10019880802	XAVANTES	25/11/2019 14:35	25/11/2019 20:11	25/11/2019 14:35	25/11/2019 20:11	5,59	1	5,59	CHI
201911331038	PALMEIRAS DE GOIAS	10004207066	PALMEIRAS	25/11/2019 14:37	26/11/2019 11:35	25/11/2019 14:37	26/11/2019 11:35	20,97	1	20,97	CHI
201911331039	LUZIANIA	120203170	RIO VERMELHO	25/11/2019 14:37	25/11/2019 20:37	25/11/2019 14:37	25/11/2019 20:37	6,00	1	6,00	CHI
201911331040	SERRANOPOLIS	SX12268627	JATAI S1	25/11/2019 14:37	25/11/2019 19:59	25/11/2019 14:37	25/11/2019 19:59	5,36	3	16,09	CHI
201911331041	IPAMERI	IP21167003	IPAMERI	25/11/2019 14:37	26/11/2019 09:21	25/11/2019 14:37	26/11/2019 09:21	18,73	1	18,73	CHI
201911331045	GUARANI DE GOIAS	GY12267998	IACIARA S1	25/11/2019 14:37	25/11/2019 16:50	25/11/2019 14:37	25/11/2019 16:50	2,20	15	33,06	CHI
201911331046	GOIANIA	10312304	CAMPINAS S1	25/11/2019 14:37	25/11/2019 16:55	25/11/2019 14:37	25/11/2019 16:55	2,29	1	2,29	CHI
201911331056	TRINDADE	TR11049497	GOYA S1	25/11/2019 14:38	25/11/2019 20:35	25/11/2019 14:38	25/11/2019 20:35	5,94	74	439,25	CHI
201911331060	APARECIDA DE GOIANIA	16832620	INDEPENDENCIA S2	25/11/2019 14:39	25/11/2019 17:00	25/11/2019 14:39	25/11/2019 17:00	2,34	1	2,34	CHI
201911331063	AGUA FRIA DE GOIAS	TL21342506	SAO JOAO D ALIANCA	25/11/2019 14:39	26/11/2019 11:49	25/11/2019 14:39	26/11/2019 11:49	21,16	1	21,16	CHI
201911331067	SERRANOPOLIS	DJ12194822	CHAPADAO DO CEU	25/11/2019 14:40	25/11/2019 18:28	25/11/2019 14:40	25/11/2019 18:28	3,80	1	3,80	CHI
201911331073	RIO VERDE	RV12260123	CABRIUVA S1	25/11/2019 14:40	25/11/2019 22:07	25/11/2019 14:40	25/11/2019 20:28	5,79	17	98,50	CHI
201911331073	RIO VERDE	RV12260123	CABRIUVA S1	25/11/2019 14:40	25/11/2019 22:07	25/11/2019 20:29	25/11/2019 22:07	1,63	17	27,77	CHI
201911331076	SILVANIA	SV21284638	VIANOPOLIS	25/11/2019 14:40	26/11/2019 15:38	25/11/2019 14:40	26/11/2019 15:38	24,95	1	24,95	CHI
201911331079	CAIAPONIA	CP12248981	CAIAPONIA	25/11/2019 14:41	27/11/2019 07:25	25/11/2019 14:41	27/11/2019 07:25	40,73	8	325,83	CHI
201911331083	AGUAS LINDAS DE GOIAS	4830095971	AGUAS LINDAS DE GOIAS S1	25/11/2019 14:41	25/11/2019 16:09	25/11/2019 14:41	25/11/2019 16:09	1,46	1	1,46	CHI
201911331084	MONTIVIDIU	MV12230886	MONTIVIDIU T	25/11/2019 14:41	25/11/2019 18:15	25/11/2019 14:41	25/11/2019 18:15	3,55	9	31,96	CHI
201911331084	RIO VERDE	MV12230886	MONTIVIDIU T	25/11/2019 14:41	25/11/2019 18:15	25/11/2019 14:41	25/11/2019 18:15	3,55	39	138,50	CHI
201911331085	MINEIROS	MY21341157	PARQUE DAS EMAS	25/11/2019 14:42	25/11/2019 21:22	25/11/2019 14:42	25/11/2019 21:22	6,67	1	6,67	CHI
201911331086	GOIANESIA	GE12357151	GOIANESIA S1	25/11/2019 14:42	26/11/2019 19:30	25/11/2019 14:42	26/11/2019 19:30	28,80	1	28,80	CHI
201911331087	ANAPOLIS	10002017197	JUNDIAI S2	25/11/2019 14:42	25/11/2019 18:01	25/11/2019 14:42	25/11/2019 18:01	3,32	1	3,32	CHI
201911331092	ALTO PARAISO DE GOIAS	BF10400692	FLORES DE GOIAS	25/11/2019 12:39	26/11/2019 17:31	25/11/2019 12:39	25/11/2019 19:20	6,68	211	1409,25	CHI
201911331092	SAO JOAO D ALIANCA	BF10400692	FLORES DE GOIAS	25/11/2019 12:39	26/11/2019 17:31	25/11/2019 12:39	25/11/2019 19:20	6,68	2	13,36	CHI
201911331092	ALTO PARAISO DE GOIAS	BF10400692	FLORES DE GOIAS	25/11/2019 12:39	26/11/2019 17:31	25/11/2019 12:39	26/11/2019 17:31	28,88	3	86,63	CHI
201911331092	ALTO PARAISO DE GOIAS	BF13000001	FLORES DE GOIAS	25/11/2019 12:39	26/11/2019 17:31	26/11/2019 12:06	26/11/2019 17:31	5,43	197	1069,82	CHI

201911331092	SAO JOAO D ALIANCA	BF13000001	FLORES DE GOIAS	25/11/2019 12:39	26/11/2019 17:31	26/11/2019 12:06	26/11/2019 17:31	5,43	2	10,86	CHI
201911331094	BONFINOPOLIS	920001932	CEPAIGO S2	25/11/2019 14:42	25/11/2019 19:21	25/11/2019 14:42	25/11/2019 19:21	4,64	1	4,64	CHI
201911331095	ANICUNS	AC12404424	ANICUNS	25/11/2019 14:07	26/11/2019 13:54	25/11/2019 14:07	26/11/2019 13:54	23,78	13	309,17	CHI
201911331096	ALTO PARAISO DE GOIAS	BF21144675	NIQUELANDIA SUBTRANSMISSAO	25/11/2019 14:42	25/11/2019 16:20	25/11/2019 14:42	25/11/2019 16:20	1,62	1	1,62	CHI
201911331102	RIO VERDE	630258466	RIO VERDE S2	25/11/2019 14:43	26/11/2019 03:43	25/11/2019 14:43	26/11/2019 03:43	13,01	1	13,01	CHI
201911331103	SANTA RITA DO NOVO DESTINO	BA21210765	GOIANESIA S1	25/11/2019 14:43	26/11/2019 14:54	25/11/2019 14:43	26/11/2019 14:54	24,18	3	72,54	CHI
201911331106	JUSSARA	JR21292918	JUSSARA	25/11/2019 14:43	26/11/2019 10:02	25/11/2019 14:43	26/11/2019 10:02	19,32	1	19,32	CHI
201911331107	CATURAI	CK11207484	INHUMAS S1	25/11/2019 14:43	25/11/2019 16:41	25/11/2019 14:43	25/11/2019 16:41	1,95	101	197,40	CHI
201911331108	TRINDADE	TR31029036	TRINDADE	25/11/2019 14:43	26/11/2019 12:19	25/11/2019 14:43	26/11/2019 12:19	21,59	1	21,59	CHI
201911331111	ALTO PARAISO DE GOIAS	BF21386162	FLORES DE GOIAS	25/11/2019 14:44	25/11/2019 21:13	25/11/2019 14:44	25/11/2019 21:13	6,48	1	6,48	CHI
201911331112	CALDAS NOVAS	CN12246675	SERRA DE CALDAS	25/11/2019 14:44	26/11/2019 12:26	25/11/2019 14:44	26/11/2019 12:26	21,70	4	86,78	CHI
201911331115	SANTA HELENA DE GOIAS	400089294	IPEGUARI	25/11/2019 14:44	25/11/2019 17:30	25/11/2019 14:44	25/11/2019 17:30	2,77	1	2,77	CHI
201911331127	LUZIANIA	LZ12203332	VIANOPOLIS	25/11/2019 14:46	26/11/2019 09:05	25/11/2019 14:46	26/11/2019 09:05	18,31	10	183,14	CHI
201911331129	COCALZINHO DE GOIAS	ZN11137322	AGUAS LINDAS DE GOIAS S2	25/11/2019 16:35	25/11/2019 18:44	25/11/2019 16:35	25/11/2019 18:44	2,14	126	269,43	CHI
201911331132	PADRE BERNARDO	PB11375255	PADRE BERNARDO	25/11/2019 14:47	26/11/2019 09:30	25/11/2019 14:47	26/11/2019 09:30	18,72	12	224,63	CHI
201911331143	LUZIANIA	LZ12314021	MARAJOARA	25/11/2019 14:48	25/11/2019 15:50	25/11/2019 14:48	25/11/2019 15:50	1,02	10	10,25	CHI
201911331145	CAVALCANTE	TI12162624	NIQUELANDIA SUBTRANSMISSAO	25/11/2019 14:48	26/11/2019 11:09	25/11/2019 14:48	26/11/2019 11:09	20,34	29	589,88	CHI
201911331145	COLINAS DO SUL	TI12162624	NIQUELANDIA SUBTRANSMISSAO	25/11/2019 14:48	26/11/2019 11:09	25/11/2019 14:48	26/11/2019 11:09	20,34	6	122,04	CHI
201911331148	INHUMAS	IN12403335	INHUMAS S2	25/11/2019 14:48	25/11/2019 17:55	25/11/2019 14:48	25/11/2019 17:55	3,10	21	65,18	CHI
201911331149	BRAZABRANTES	BR12031470	NEROPOLIS S1	25/11/2019 14:24	25/11/2019 17:46	25/11/2019 14:24	25/11/2019 17:46	3,36	9	30,26	CHI
201911331150	SAO MIGUEL DO ARAGUAIA	10010318001	SAO MIGUEL DO ARAGUAIA	25/11/2019 14:48	26/11/2019 15:30	25/11/2019 14:48	26/11/2019 15:30	24,69	1	24,69	CHI
201911331151	MARA ROSA	MQ12262455	MARA ROSA	25/11/2019 14:49	26/11/2019 15:05	25/11/2019 14:49	26/11/2019 15:05	24,26	3	72,79	CHI
201911331165	GOIANIA	GN21051004	SENADOR CANEDO	25/11/2019 14:50	25/11/2019 17:07	25/11/2019 14:50	25/11/2019 17:07	2,28	3	6,84	CHI
201911331166	SENADOR CANEDO	SW11098421	GOIANIA LESTE S1	25/11/2019 14:50	26/11/2019 00:16	25/11/2019 14:50	26/11/2019 00:16	9,43	157	1480,20	CHI
201911331170	FORMOSO	FO12189559	MARA ROSA	25/11/2019 14:51	26/11/2019 12:14	25/11/2019 14:51	26/11/2019 12:14	21,38	2	42,76	CHI
201911331171	GOIANIA	GN11199060	CAMPINAS S2	25/11/2019 14:35	25/11/2019 17:23	25/11/2019 14:35	25/11/2019 17:23	2,79	124	345,79	CHI
201911331176	TRINDADE	TR11168681	GOYA S2	25/11/2019 14:11	26/11/2019 03:55	25/11/2019 14:11	26/11/2019 03:55	13,73	41	562,86	CHI
201911331185	CRISTALINA	KR11376948	CRISTALINA S2	25/11/2019 14:52	26/11/2019 09:08	25/11/2019 14:52	26/11/2019 09:08	18,25	1	18,25	CHI
201911331191	MINACU	4020043001	MINACU	25/11/2019 14:53	26/11/2019 00:24	25/11/2019 14:53	26/11/2019 00:24	9,51	1	9,51	CHI
201911331199	GOIATUBA	140027520	GOIATUBA S2	25/11/2019 14:54	25/11/2019 16:19	25/11/2019 14:54	25/11/2019 16:19	1,40	1	1,40	CHI
201911331200	RIO VERDE	RV12020006	CABRIUVA S1	25/11/2019 14:39	25/11/2019 22:53	25/11/2019 14:39	25/11/2019 22:53	8,22	5	41,09	CHI
201911331202	MORRINHOS	MR21268862	GOIATUBA S2	25/11/2019 14:55	26/11/2019 08:58	25/11/2019 14:55	26/11/2019 08:58	18,05	1	18,05	CHI
201911331203	BELA VISTA DE GOIAS	BV21200311	BELA VISTA S2	25/11/2019 14:55	25/11/2019 23:40	25/11/2019 14:55	25/11/2019 23:40	8,74	1	8,74	CHI

201911331204	RIO VERDE	RV12237206	CABRIUVA S2	25/11/2019 14:52	25/11/2019 18:05	25/11/2019 14:52	25/11/2019 18:05	3,21	6	19,29	CHI
201911331206	ALTO PARAISO DE GOIAS	BF12349123	FLORES DE GOIAS	25/11/2019 14:13	25/11/2019 19:35	25/11/2019 14:13	25/11/2019 19:35	5,37	4	21,47	CHI
201911331206	SAO JOAO D ALIANCA	BF12349123	FLORES DE GOIAS	25/11/2019 14:13	25/11/2019 19:35	25/11/2019 14:13	25/11/2019 19:35	5,37	3	16,10	CHI
201911331209	PILAR DE GOIAS	GG12128447	SANTA TEREZINHA	25/11/2019 14:56	26/11/2019 19:00	25/11/2019 14:56	26/11/2019 19:00	28,06	39	1094,47	CHI
201911331210	GAMELEIRA DE GOIAS	GL21270343	DAIA S2	25/11/2019 14:56	25/11/2019 18:11	25/11/2019 14:56	25/11/2019 18:11	3,24	2	6,49	CHI
201911331216	ANAPOLIS	AN21297748	ANAPOLIS UNIVERSITARIO S1	25/11/2019 14:57	26/11/2019 14:19	25/11/2019 14:57	26/11/2019 14:19	23,36	1	23,36	CHI
201911331219	GOIANIA	GN11082032	REAL S1	25/11/2019 14:50	25/11/2019 17:45	25/11/2019 14:50	25/11/2019 17:45	2,92	158	460,75	CHI
201911331220	GOIANIA	10144985	CAMPINAS S2	25/11/2019 14:57	25/11/2019 16:22	25/11/2019 14:57	25/11/2019 16:22	1,41	1	1,41	CHI
201911331223	PIRES DO RIO	PR11000027	PIRES DO RIO S1	25/11/2019 14:44	26/11/2019 08:30	25/11/2019 14:44	26/11/2019 08:30	17,77	56	995,01	CHI
201911331224	HIDROLANDIA	HD12000305	CEPAIGO S2	25/11/2019 13:42	26/11/2019 08:47	25/11/2019 13:42	26/11/2019 08:47	19,07	6	114,41	CHI
201911331226	DOVERLANDIA	DV21188462	CAIAPONIA	25/11/2019 14:58	25/11/2019 20:25	25/11/2019 14:58	25/11/2019 20:25	5,44	1	5,44	CHI
201911331229	RIO VERDE	RV12154021	MONTIVIDIU T	25/11/2019 14:58	26/11/2019 15:30	25/11/2019 14:58	26/11/2019 11:12	20,22	3	60,67	CHI
201911331229	RIO VERDE	RV12154021	MONTIVIDIU T	25/11/2019 14:58	26/11/2019 15:30	26/11/2019 11:13	26/11/2019 15:30	4,28	3	12,85	CHI
201911331236	IACIARA	IA21317962	IACIARA S1	25/11/2019 15:00	25/11/2019 17:33	25/11/2019 15:00	25/11/2019 17:33	2,55	2	5,10	CHI
201911331243	HIDROLANDIA	HD12000188	INDEPENDENCIA S1	25/11/2019 15:01	25/11/2019 19:18	25/11/2019 15:01	25/11/2019 19:18	4,28	1	4,28	CHI
201911331259	COLINAS DO SUL	TI12396760	MINACU	25/11/2019 13:35	26/11/2019 07:27	25/11/2019 13:35	26/11/2019 07:27	17,86	12	214,27	CHI
201911331259	NIQUELANDIA	TI12396760	MINACU	25/11/2019 13:35	26/11/2019 07:27	25/11/2019 13:35	26/11/2019 07:27	17,86	1	17,86	CHI
201911331268	JANDAIA	EU12000110	ACREUNA	25/11/2019 15:02	25/11/2019 22:57	25/11/2019 15:02	25/11/2019 22:57	7,91	1	7,91	CHI
201911331268	PARAUNA	EU12000110	ACREUNA	25/11/2019 15:02	25/11/2019 22:57	25/11/2019 15:02	25/11/2019 22:57	7,91	11	87,06	CHI
201911331273	AGUA FRIA DE GOIAS	TL21206257	SAO JOAO D ALIANCA	25/11/2019 15:02	25/11/2019 18:33	25/11/2019 15:02	25/11/2019 18:33	3,52	1	3,52	CHI
201911331279	IPORA	730038397	IPORA	25/11/2019 15:03	25/11/2019 19:20	25/11/2019 15:03	25/11/2019 19:20	4,30	1	4,30	CHI
201911331286	ALTO PARAISO DE GOIAS	BF21249281	NIQUELANDIA SUBTRANSMISSAO	25/11/2019 15:03	25/11/2019 18:03	25/11/2019 15:03	25/11/2019 18:03	2,99	2	5,98	CHI
201911331292	PADRE BERNARDO	PB12377293	PADRE BERNARDO	25/11/2019 15:03	25/11/2019 16:52	25/11/2019 15:03	25/11/2019 16:52	1,80	12	21,65	CHI
201911331300	AGUA FRIA DE GOIAS	TL21344127	SAO JOAO D ALIANCA	25/11/2019 15:04	26/11/2019 14:21	25/11/2019 15:04	26/11/2019 14:21	23,28	1	23,28	CHI
201911331302	GOIANIA	12663323	AEROPORTO S3	25/11/2019 15:04	25/11/2019 17:14	25/11/2019 15:04	25/11/2019 17:14	2,17	1	2,17	CHI
201911331305	IPAMERI	IP12404728	IPAMERI	25/11/2019 12:56	25/11/2019 16:23	25/11/2019 12:56	25/11/2019 16:23	3,44	10	34,43	CHI
201911331308	PIRACANJUBA	PJ21196481	PIRACANJUBA	25/11/2019 15:06	26/11/2019 23:44	25/11/2019 15:06	26/11/2019 23:44	32,63	2	65,26	CHI
201911331311	CORUMBAIBA	CI12263343	VILA CORUMBA	25/11/2019 15:06	26/11/2019 16:23	25/11/2019 15:06	26/11/2019 16:23	25,27	4	101,10	CHI
201911331313	BRAZABRANTES	GR21016118	NEROPOLIS S1	25/11/2019 15:06	26/11/2019 11:23	25/11/2019 15:06	26/11/2019 11:23	20,27	1	20,27	CHI
201911331315	INHUMAS	IN12000227	INHUMAS S2	25/11/2019 14:44	25/11/2019 18:55	25/11/2019 14:44	25/11/2019 18:55	4,18	115	481,05	CHI
201911331317	RUBIATABA	RB12194747	RUBIATABA	25/11/2019 13:39	25/11/2019 20:58	25/11/2019 13:39	25/11/2019 20:58	7,31	12	87,78	CHI
201911331320	GOIANIA	GN11214748	CARAJAS S2	25/11/2019 14:59	25/11/2019 17:30	25/11/2019 14:59	25/11/2019 17:30	2,51	30	75,19	CHI
201911331322	CALDAZINHA	10001295398	CEPAIGO S2	25/11/2019 15:08	26/11/2019 17:49	25/11/2019 15:08	26/11/2019 17:49	26,68	1	26,68	CHI

201911331323	MINACU	IH21208341	MINACU	25/11/2019 15:08	25/11/2019 20:40	25/11/2019 15:08	25/11/2019 20:40	5,52	2	11,05	CHI
201911331334	MAIRIPOTABA	MI12000231	PONTALINA	25/11/2019 14:39	26/11/2019 16:57	25/11/2019 14:39	26/11/2019 16:57	26,29	1	26,29	CHI
201911331334	PROFESSOR JAMIL SAFADY	MI12000231	PONTALINA	25/11/2019 14:39	26/11/2019 16:57	25/11/2019 14:39	26/11/2019 16:57	26,29	14	368,10	CHI
201911331335	FORMOSA	FA12395906	FLORES DE GOIAS	25/11/2019 15:10	26/11/2019 19:17	25/11/2019 15:10	26/11/2019 19:17	28,13	27	759,50	CHI
201911331346	CAIAPONIA	CP12193478	CAIAPONIA	25/11/2019 14:21	25/11/2019 16:10	25/11/2019 14:21	25/11/2019 16:10	1,83	97	177,54	CHI
201911331362	ARENOPOLIS	PH12201801	PIRANHAS	25/11/2019 14:28	25/11/2019 18:09	25/11/2019 14:28	25/11/2019 18:09	3,69	1	3,69	CHI
201911331362	PIRANHAS	PH12201801	PIRANHAS	25/11/2019 14:28	25/11/2019 18:09	25/11/2019 14:28	25/11/2019 18:09	3,69	12	44,28	CHI
201911331369	SANTA TEREZA DE GOIAS	SE12288750	PORANGATU	25/11/2019 15:13	26/11/2019 18:15	25/11/2019 15:13	26/11/2019 18:15	27,02	4	108,09	CHI
201911331371	MUNDO NOVO DE GOIAS	MH12262550	NOVA CRIXAS	25/11/2019 14:15	26/11/2019 02:02	25/11/2019 14:15	26/11/2019 02:02	11,80	6	70,77	CHI
201911331376	ANAPOLIS	AN11198704	JUNDIAI S2	25/11/2019 15:14	25/11/2019 16:31	25/11/2019 15:14	25/11/2019 16:31	1,28	127	162,31	CHI
201911331385	BALIZA	BH12334576	BOM JARDIM	25/11/2019 15:12	25/11/2019 18:23	25/11/2019 15:12	25/11/2019 18:23	3,17	2	6,33	CHI
201911331386	GOIANESIA	550098860	GOIANESIA S2	25/11/2019 15:15	25/11/2019 20:16	25/11/2019 15:15	25/11/2019 20:16	5,01	1	5,01	CHI
201911331389	GOIANESIA	GE21234248	GOIANESIA S1	25/11/2019 15:16	27/11/2019 20:32	25/11/2019 15:16	27/11/2019 20:32	53,25	1	53,25	CHI
201911331390	GOIANIA	14597044	ATLANTICO S1	25/11/2019 15:17	25/11/2019 18:47	25/11/2019 15:17	25/11/2019 18:47	3,50	1	3,50	CHI
201911331392	GOIANESIA	GE12000085	GOIANESIA S2	25/11/2019 14:42	27/11/2019 13:23	25/11/2019 14:42	26/11/2019 18:21	27,65	67	1852,72	CHI
201911331392	GOIANESIA	GE12000085	GOIANESIA S2	25/11/2019 14:42	27/11/2019 13:23	26/11/2019 18:22	27/11/2019 12:51	18,50	67	1239,24	CHI
201911331392	GOIANESIA	GE12000233	GOIANESIA S2	25/11/2019 14:42	27/11/2019 13:23	25/11/2019 14:42	27/11/2019 13:23	46,68	23	1073,56	CHI
201911331394	CRISTALINA	KR12351414	PAMPLONA	25/11/2019 15:17	26/11/2019 12:48	25/11/2019 15:17	26/11/2019 12:48	21,52	5	107,60	CHI
201911331395	ANICUNS	AC21000078	ANICUNS	25/11/2019 15:17	26/11/2019 11:57	25/11/2019 15:17	26/11/2019 11:57	20,67	1	20,67	CHI
201911331399	FLORES DE GOIAS	FB12252148	FLORES DE GOIAS	25/11/2019 15:17	25/11/2019 22:54	25/11/2019 15:17	25/11/2019 22:54	7,61	9	68,45	CHI
201911331413	CAIAPONIA	930036920	CAIAPONIA	25/11/2019 15:18	26/11/2019 09:59	25/11/2019 15:18	26/11/2019 09:59	18,68	1	18,68	CHI
201911331417	PLANALTINA	PI12149010	PLANALTINA	25/11/2019 14:32	25/11/2019 17:28	25/11/2019 14:32	25/11/2019 17:28	2,92	171	500,08	CHI
201911331421	CATALAO	1990173590	CATALAO S2	25/11/2019 15:19	26/11/2019 16:12	25/11/2019 15:19	26/11/2019 16:12	24,88	1	24,88	CHI
201911331426	MAMBAI	MB11189300	IACIARA S2	25/11/2019 15:19	25/11/2019 17:19	25/11/2019 15:19	25/11/2019 17:19	1,98	3	5,95	CHI
201911331439	CALDAS NOVAS	760035842	CALDAS NOVAS S1	25/11/2019 15:21	26/11/2019 12:29	25/11/2019 15:21	26/11/2019 12:29	21,14	1	21,14	CHI
201911331441	ANICUNS	910054502	ANICUNS	25/11/2019 15:21	25/11/2019 16:35	25/11/2019 15:21	25/11/2019 16:35	1,24	1	1,24	CHI
201911331442	VALPARAISO DE GOIAS	VA11171651	MARAJOARA	25/11/2019 15:21	25/11/2019 18:27	25/11/2019 15:21	25/11/2019 18:27	3,09	41	126,56	CHI
201911331449	GOIANIA	10009032817	FERROVIARIO S1	25/11/2019 15:23	25/11/2019 17:52	25/11/2019 15:23	25/11/2019 17:52	2,49	1	2,49	CHI
201911331470	GOIANESIA	GE12115125	GOIANESIA S2	25/11/2019 15:25	25/11/2019 17:35	25/11/2019 15:25	25/11/2019 17:35	2,16	10	21,64	CHI
201911331512	APARECIDA DE GOIANIA	200284230	ANHANGUERA	25/11/2019 15:26	25/11/2019 20:17	25/11/2019 15:26	25/11/2019 20:17	4,84	1	4,84	CHI
201911331513	NIQUELANDIA	NQ12374575	NIQUELANDIA SUBTRANSMISSAO	25/11/2019 15:22	25/11/2019 17:00	25/11/2019 15:22	25/11/2019 17:00	1,63	12	19,54	CHI
201911331515	ABADIANIA	AA12388855	DAIA S2	25/11/2019 13:17	26/11/2019 17:03	25/11/2019 13:17	26/11/2019 17:03	27,75	16	444,01	CHI
201911331515	GAMELEIRA DE GOIAS	AA12388855	DAIA S2	25/11/2019 13:17	26/11/2019 17:03	25/11/2019 13:17	26/11/2019 17:03	27,75	1	27,75	CHI

201911331519	JATAI	JT12234311	JATAI S2	25/11/2019 15:18	25/11/2019 17:20	25/11/2019 15:18	25/11/2019 17:20	2,04	36	73,41	CHI
201911331528	VILA PROPICIO	NP21344907	BARRO ALTO	25/11/2019 15:29	25/11/2019 19:58	25/11/2019 15:29	25/11/2019 19:58	4,47	1	4,47	CHI
201911331532	GOIANESIA	GE12379116	GOIANESIA S2	25/11/2019 15:13	25/11/2019 18:31	25/11/2019 15:13	25/11/2019 18:31	3,30	99	326,40	CHI
201911331533	GOIAS	GS21259623	ITABERAI S1	25/11/2019 15:30	25/11/2019 18:20	25/11/2019 15:30	25/11/2019 18:20	2,84	1	2,84	CHI
201911331543	ITUMBIARA	BG12384533	ITUMBIARA VELHA S2	25/11/2019 15:31	26/11/2019 08:17	25/11/2019 15:31	26/11/2019 08:17	16,76	30	502,89	CHI
201911331549	PARAUNA	PU21295867	ACREUNA	25/11/2019 15:32	25/11/2019 20:45	25/11/2019 15:32	25/11/2019 20:45	5,22	1	5,22	CHI
201911331553	HIDROLINA	HL21293489	SANTA TEREZINHA	25/11/2019 15:32	26/11/2019 11:03	25/11/2019 15:32	26/11/2019 11:03	19,50	1	19,50	CHI
201911331556	NOVO BRASIL	NB21020214	JUSSARA	25/11/2019 12:44	26/11/2019 09:15	25/11/2019 12:44	26/11/2019 09:15	20,52	1	20,52	CHI
201911331575	PLANALTINA	PI12262264	PLANALTINA	25/11/2019 15:34	26/11/2019 16:47	25/11/2019 15:34	26/11/2019 16:47	25,21	1	25,21	CHI
201911331577	ORIZONA	OZ21152147	PIRES DO RIO S2	25/11/2019 15:35	26/11/2019 11:28	25/11/2019 15:35	26/11/2019 11:28	19,89	1	19,89	CHI
201911331595	HIDROLINA	GG21210158	URUACU	25/11/2019 15:37	26/11/2019 14:40	25/11/2019 15:37	26/11/2019 14:40	23,05	1	23,05	CHI
201911331596	CALDAS NOVAS	CN12404748	CALDAS NOVAS S1	25/11/2019 15:24	25/11/2019 17:50	25/11/2019 15:24	25/11/2019 17:50	2,43	6	14,60	CHI
201911331596	RIO QUENTE	CN12404748	CALDAS NOVAS S1	25/11/2019 15:24	25/11/2019 17:50	25/11/2019 15:24	25/11/2019 17:50	2,43	40	97,30	CHI
201911331600	PLANALTINA	2960152676	PLANALTINA	25/11/2019 15:37	26/11/2019 11:27	25/11/2019 15:37	26/11/2019 11:27	19,82	1	19,82	CHI
201911331610	RIO VERDE	RV12260642	RIO VERDE S1	25/11/2019 14:38	25/11/2019 17:54	25/11/2019 14:38	25/11/2019 17:54	3,26	25	81,42	CHI
201911331613	PALMEIRAS DE GOIAS	PL12143287	PALMEIRAS	25/11/2019 15:39	26/11/2019 16:40	25/11/2019 15:39	26/11/2019 16:40	25,01	39	975,44	CHI
201911331614	TRINDADE	TR11158289	GOYA S2	25/11/2019 14:44	25/11/2019 17:08	25/11/2019 14:44	25/11/2019 17:08	2,39	70	167,57	CHI
201911331618	APARECIDA DE GOIANIA	AP11378264	ANHANGUERA	25/11/2019 15:39	26/11/2019 03:05	25/11/2019 15:39	26/11/2019 03:05	11,42	115	1313,11	CHI
201911331619	NEROPOLIS	NR11140814	NEROPOLIS S2	25/11/2019 14:56	25/11/2019 20:13	25/11/2019 14:56	25/11/2019 20:13	5,27	159	837,84	CHI
201911331620	LUZIANIA	LZ21183988	CRISTALINA S2	25/11/2019 15:40	26/11/2019 11:10	25/11/2019 15:40	26/11/2019 11:10	19,50	1	19,50	CHI
201911331623	PONTALINA	PK21186010	PONTALINA	25/11/2019 15:40	26/11/2019 10:30	25/11/2019 15:40	26/11/2019 10:30	18,83	1	18,83	CHI
201911331625	PALMEIRAS DE GOIAS	PL21027655	PALMEIRAS	25/11/2019 15:35	26/11/2019 12:05	25/11/2019 15:35	26/11/2019 12:05	20,50	2	40,99	CHI
201911331626	AGUA FRIA DE GOIAS	TL12206197	SAO JOAO D ALIANCA	25/11/2019 15:10	26/11/2019 10:26	25/11/2019 15:10	26/11/2019 10:26	19,25	9	173,29	CHI
201911331628	JATAI	JT11348899	JATAI S3	25/11/2019 15:41	25/11/2019 18:10	25/11/2019 15:41	25/11/2019 18:10	2,48	54	133,87	CHI
201911331631	PIRANHAS	PH11260022	PIRANHAS	25/11/2019 15:40	26/11/2019 09:55	25/11/2019 15:40	26/11/2019 09:55	18,24	70	1277,09	CHI
201911331637	ITABERAI	IB21310538	ITABERAI S2	25/11/2019 15:41	25/11/2019 19:34	25/11/2019 15:41	25/11/2019 19:34	3,87	1	3,87	CHI
201911331638	MARA ROSA	MQ12286000	MARA ROSA	25/11/2019 14:32	25/11/2019 22:16	25/11/2019 14:32	25/11/2019 20:18	5,78	12	69,32	CHI
201911331638	MARA ROSA	CR12056108LD	MARA ROSA	25/11/2019 14:32	25/11/2019 22:16	25/11/2019 14:32	25/11/2019 21:34	7,05	95	669,43	CHI
201911331638	CAMPINORTE	MQ12051921LD	MARA ROSA	25/11/2019 14:32	25/11/2019 22:16	25/11/2019 14:32	25/11/2019 22:16	7,75	1	7,75	CHI
201911331638	MARA ROSA	MQ12051921LD	MARA ROSA	25/11/2019 14:32	25/11/2019 22:16	25/11/2019 14:32	25/11/2019 22:16	7,75	3	23,24	CHI
201911331639	GOIANESIA	GE11259022	GOIANESIA S2	25/11/2019 15:20	26/11/2019 00:45	25/11/2019 15:20	26/11/2019 00:45	9,41	70	658,76	CHI
201911331650	PIRENOPOLIS	PV12115149	GOIANESIA S1	25/11/2019 11:47	25/11/2019 18:58	25/11/2019 11:47	25/11/2019 18:58	7,17	3	21,50	CHI
201911331650	VILA PROPICIO	PV12115149	GOIANESIA S1	25/11/2019 11:47	25/11/2019 18:58	25/11/2019 11:47	25/11/2019 18:58	7,17	2	14,34	CHI

201911331652	FAZENDA NOVA	JR12033556	BRITANIA	25/11/2019 15:01	26/11/2019 13:19	25/11/2019 15:01	26/11/2019 13:19	22,30	9	200,73	CHI
201911331652	JUSSARA	JR12033556	BRITANIA	25/11/2019 15:01	26/11/2019 13:19	25/11/2019 15:01	26/11/2019 13:19	22,30	161	3590,93	CHI
201911331659	ANAPOLIS	AN11012274	ANAPOLIS UNIVERSITARIO S2	25/11/2019 15:39	25/11/2019 16:50	25/11/2019 15:39	25/11/2019 16:50	1,18	13	15,30	CHI
201911331660	CAIAPONIA	CP11020865	CAIAPONIA	25/11/2019 14:14	25/11/2019 17:54	25/11/2019 14:14	25/11/2019 17:54	3,67	114	418,48	CHI
201911331661	VALPARAISO DE GOIAS	VA11169073	PACAEMBU S1	25/11/2019 15:45	25/11/2019 16:15	25/11/2019 15:45	25/11/2019 16:15	0,51	114	57,67	CHI
201911331668	IPORA	730038154	IPORA	25/11/2019 15:45	26/11/2019 12:21	25/11/2019 15:45	26/11/2019 12:21	20,60	1	20,60	CHI
201911331669	RIO VERDE	RV12338538	MONTIVIDIU T	25/11/2019 15:45	28/11/2019 18:26	25/11/2019 15:45	26/11/2019 16:05	24,34	3	73,01	CHI
201911331669	RIO VERDE	8319767	MONTIVIDIU T	25/11/2019 15:45	28/11/2019 18:26	25/11/2019 15:45	27/11/2019 13:00	45,25	1	45,25	CHI
201911331669	RIO VERDE	8316937	MONTIVIDIU T	25/11/2019 15:45	28/11/2019 18:26	25/11/2019 15:45	28/11/2019 18:26	74,67	1	74,67	CHI
201911331671	MAMBAI	MB12302923	IACIARA S2	25/11/2019 15:45	25/11/2019 20:38	25/11/2019 15:45	25/11/2019 20:38	4,87	27	131,42	CHI
201911331673	AGUA FRIA DE GOIAS	TL12356260	SAO JOAO D ALIANCA	25/11/2019 15:46	26/11/2019 17:09	25/11/2019 15:46	26/11/2019 17:09	25,38	19	482,20	CHI
201911331674	GOIANIA	GN11214570	GOIANIA LESTE S2	25/11/2019 15:11	25/11/2019 18:37	25/11/2019 15:11	25/11/2019 18:37	3,43	78	267,50	CHI
201911331676	HIDROLINA	HL12380749	SANTA TEREZINHA	25/11/2019 15:46	25/11/2019 21:20	25/11/2019 15:46	25/11/2019 21:20	5,56	8	44,45	CHI
201911331676	PILAR DE GOIAS	HL12380749	SANTA TEREZINHA	25/11/2019 15:46	25/11/2019 21:20	25/11/2019 15:46	25/11/2019 21:20	5,56	1	5,56	CHI
201911331677	PANAMA	PX12166412	GOIATUBA S1	25/11/2019 15:46	25/11/2019 21:02	25/11/2019 15:46	25/11/2019 21:02	5,26	8	42,05	CHI
201911331678	PALMEIRAS DE GOIAS	590019089	PALMEIRAS	25/11/2019 15:46	26/11/2019 13:40	25/11/2019 15:46	26/11/2019 13:40	21,89	1	21,89	CHI
201911331681	GOIANIA	GN11000930	CAMPINAS S2	25/11/2019 15:47	25/11/2019 17:23	25/11/2019 15:47	25/11/2019 17:23	1,60	43	68,81	CHI
201911331683	GOIANIA	GN11000724	GOIANIA LESTE S2	25/11/2019 15:47	25/11/2019 19:23	25/11/2019 15:47	25/11/2019 19:23	3,60	179	644,35	CHI
201911331695	HIDROLANDIA	HD21373631	CEPAIGO S2	25/11/2019 15:49	25/11/2019 20:19	25/11/2019 15:49	25/11/2019 20:19	4,51	1	4,51	CHI
201911331708	BELA VISTA DE GOIAS	HD12017462LD	CEPAIGO S2	25/11/2019 15:51	26/11/2019 17:57	25/11/2019 15:51	26/11/2019 17:57	26,10	1	26,10	CHI
201911331708	HIDROLANDIA	HD12017462LD	CEPAIGO S2	25/11/2019 15:51	26/11/2019 17:57	25/11/2019 15:51	26/11/2019 17:57	26,10	12	313,16	CHI
201911331708	BELA VISTA DE GOIAS	02200234	CEPAIGO S2	25/11/2019 15:51	26/11/2019 17:57	26/11/2019 17:44	26/11/2019 17:57	0,22	8	1,72	CHI
201911331708	HIDROLANDIA	02200234	CEPAIGO S2	25/11/2019 15:51	26/11/2019 17:57	26/11/2019 17:44	26/11/2019 17:57	0,22	873	187,94	CHI
201911331710	PIRENOPOLIS	220050776	CORUMBA	25/11/2019 15:51	26/11/2019 07:39	25/11/2019 15:51	26/11/2019 07:39	15,79	1	15,79	CHI
201911331711	BELA VISTA DE GOIAS	BV21209154	BELA VISTA S1	25/11/2019 15:51	25/11/2019 19:30	25/11/2019 15:51	25/11/2019 19:30	3,64	2	7,28	CHI
201911331722	JUSSARA	JR11009928	JUSSARA	25/11/2019 15:52	25/11/2019 21:24	25/11/2019 15:52	25/11/2019 21:24	5,53	63	348,50	CHI
201911331731	INHUMAS	IN21098349	INHUMAS S2	25/11/2019 15:53	26/11/2019 14:00	25/11/2019 15:53	26/11/2019 14:00	22,12	1	22,12	CHI
201911331732	MORRINHOS	MR21041955	GOIATUBA S2	25/11/2019 15:53	26/11/2019 10:23	25/11/2019 15:53	26/11/2019 10:23	18,49	1	18,49	CHI
201911331737	JATAI	JT12274032	JATAI S2	25/11/2019 15:44	25/11/2019 17:09	25/11/2019 15:44	25/11/2019 17:09	1,40	10	14,05	CHI
201911331738	CACU	CC12078926	CACHOEIRA ALTA	25/11/2019 15:41	26/11/2019 10:19	25/11/2019 15:41	26/11/2019 10:19	18,62	7	130,36	CHI
201911331741	GOIANIA	GN11097718	ATLANTICO S3	25/11/2019 15:02	25/11/2019 19:30	25/11/2019 15:02	25/11/2019 19:30	4,45	32	142,43	CHI
201911331743	GOIANESIA	GE12352312	GOIANESIA S2	25/11/2019 15:07	26/11/2019 18:07	25/11/2019 15:07	26/11/2019 18:07	26,99	20	539,82	CHI
201911331747	CAIAPONIA	CP11334931	CAIAPONIA	25/11/2019 15:55	25/11/2019 18:28	25/11/2019 15:55	25/11/2019 18:28	2,55	120	305,50	CHI

201911331752	AGUAS LINDAS DE GOIAS	LA11347936	AGUAS LINDAS DE GOIAS S2	25/11/2019 15:56	25/11/2019 18:32	25/11/2019 15:56	25/11/2019 18:32	2,59	144	372,52	CHI
201911331757	DOVERLANDIA	DV12123974	CAIAPONIA	25/11/2019 15:57	26/11/2019 07:53	25/11/2019 15:57	26/11/2019 07:53	15,93	12	191,19	CHI
201911331760	MORRINHOS	MR21120860	MORRINHOS	25/11/2019 15:57	26/11/2019 11:22	25/11/2019 15:57	26/11/2019 11:22	19,41	1	19,41	CHI
201911331777	PIRENOPOLIS	SF12017628	SAO FRANCISCO DE GOIAS	25/11/2019 15:59	25/11/2019 21:54	25/11/2019 15:59	25/11/2019 21:54	5,91	4	23,66	CHI
201911331777	SAO FRANCISCO DE GOIAS	SF12017628	SAO FRANCISCO DE GOIAS	25/11/2019 15:59	25/11/2019 21:54	25/11/2019 15:59	25/11/2019 21:54	5,91	8	47,32	CHI
201911331790	CATALAO	CT21266292	CATALAO S1	25/11/2019 16:00	25/11/2019 20:39	25/11/2019 16:00	25/11/2019 20:39	4,64	1	4,64	CHI
201911331794	TRINDADE	14534563	GOYA S2	25/11/2019 16:01	25/11/2019 20:53	25/11/2019 16:01	25/11/2019 20:53	4,87	1	4,87	CHI
201911331804	SANTA CRUZ DE GOIAS	CF32057682	CRISTIANOPOLIS	25/11/2019 16:02	25/11/2019 18:04	25/11/2019 16:02	25/11/2019 18:04	2,03	1	2,03	CHI
201911331806	LUZIANIA	10022439135	RIO VERMELHO	25/11/2019 16:02	25/11/2019 19:17	25/11/2019 16:02	25/11/2019 19:17	3,24	1	3,24	CHI
201911331809	BOM JESUS DE GOIAS	BJ12222267	BOM JESUS DE GOIAS	25/11/2019 16:02	25/11/2019 22:08	25/11/2019 16:02	25/11/2019 22:08	6,08	3	18,25	CHI
201911331810	CRIXAS	UP12233001	SANTA TEREZINHA	25/11/2019 15:34	25/11/2019 21:53	25/11/2019 15:34	25/11/2019 21:53	6,31	5	31,53	CHI
201911331810	UIRAPURU	UP12233001	SANTA TEREZINHA	25/11/2019 15:34	25/11/2019 21:53	25/11/2019 15:34	25/11/2019 21:53	6,31	44	277,49	CHI
201911331818	SILVANIA	SV12205353	VIANOPOLIS	25/11/2019 15:09	26/11/2019 10:25	25/11/2019 15:09	26/11/2019 10:25	19,26	7	134,85	CHI
201911331822	JATAI	JT12205194	JATAI S1	25/11/2019 15:53	25/11/2019 19:25	25/11/2019 15:53	25/11/2019 19:25	3,52	7	24,66	CHI
201911331826	SANTO ANTONIO DO DESCOBERTO	SN21249216	MARAJOARA	25/11/2019 16:04	25/11/2019 21:30	25/11/2019 16:04	25/11/2019 21:30	5,42	1	5,42	CHI
201911331829	GOIANIA	17437120	GOYA S1	25/11/2019 16:05	25/11/2019 18:46	25/11/2019 16:05	25/11/2019 18:46	2,67	1	2,67	CHI
201911331830	PALMINOPOLIS	RP12156223	FIRMINOPOLIS S2	25/11/2019 16:05	25/11/2019 19:40	25/11/2019 16:05	25/11/2019 19:40	3,59	2	7,18	CHI
201911331830	SAO JOAO DA PARAUNA	RP12156223	FIRMINOPOLIS S2	25/11/2019 16:05	25/11/2019 19:40	25/11/2019 16:05	25/11/2019 19:40	3,59	27	96,87	CHI
201911331833	CRISTALINA	KR21184844	CRISTALINA S1	25/11/2019 16:05	26/11/2019 13:41	25/11/2019 16:05	26/11/2019 13:41	21,58	1	21,58	CHI
201911331835	BELA VISTA DE GOIAS	BV12000046	CEPAIGO S2	25/11/2019 15:57	25/11/2019 21:57	25/11/2019 15:57	25/11/2019 21:57	5,98	30	179,53	CHI
201911331838	CATALAO	CT21380522	CATALAO S2	25/11/2019 16:06	25/11/2019 23:00	25/11/2019 16:06	25/11/2019 23:00	6,90	1	6,90	CHI
201911331840	ORIZONA	OZZ1155583	VIANOPOLIS	25/11/2019 16:06	26/11/2019 10:05	25/11/2019 16:06	26/11/2019 10:05	17,99	2	35,98	CHI
201911331844	MORRINHOS	MR12171699RE	MORRINHOS	25/11/2019 14:26	25/11/2019 18:52	25/11/2019 14:26	25/11/2019 18:52	4,43	26	115,24	CHI
201911331844	PONTALINA	MR12171699RE	MORRINHOS	25/11/2019 14:26	25/11/2019 18:52	25/11/2019 14:26	25/11/2019 18:52	4,43	5	22,16	CHI
201911331848	SERRANOPOLIS	DJ12136090	CHAPADAO DO CEU	25/11/2019 16:07	25/11/2019 16:48	25/11/2019 16:07	25/11/2019 16:48	0,68	2	1,37	CHI
201911331851	PIRANHAS	PH12342187	PIRANHAS	25/11/2019 16:01	25/11/2019 19:09	25/11/2019 16:01	25/11/2019 19:09	3,14	2	6,27	CHI
201911331853	PIRES DO RIO	PR12000095	PIRES DO RIO S1	25/11/2019 13:35	25/11/2019 17:57	25/11/2019 13:35	25/11/2019 17:57	4,37	18	78,60	CHI
201911331853	URUTAI	PR12000095	PIRES DO RIO S1	25/11/2019 13:35	25/11/2019 17:57	25/11/2019 13:35	25/11/2019 17:57	4,37	13	56,77	CHI
201911331854	LUZIANIA	120061661	RIO VERMELHO	25/11/2019 16:08	25/11/2019 23:24	25/11/2019 16:08	25/11/2019 23:24	7,26	1	7,26	CHI
201911331855	ARAGUAPAZ	AZ12219983	GOIAS	25/11/2019 16:08	25/11/2019 18:30	25/11/2019 16:08	25/11/2019 18:30	2,36	2	4,73	CHI
201911331857	CRISTALINA	KR12210364	CRISTALINA S2	25/11/2019 16:08	25/11/2019 18:55	25/11/2019 16:08	25/11/2019 18:55	2,77	2	5,54	CHI
201911331861	AGUA FRIA DE GOIAS	PI12048041	SAO JOAO D ALIANCA	25/11/2019 16:09	26/11/2019 15:00	25/11/2019 16:09	26/11/2019 15:00	22,84	14	319,74	CHI
201911331862	ALEXANIA	2790002521	CORUMBA	25/11/2019 16:09	25/11/2019 18:25	25/11/2019 16:09	25/11/2019 18:25	2,25	1	2,25	CHI

201911331863	CAIAPONIA	CP12395452	PALESTINA	25/11/2019 16:09	26/11/2019 11:45	25/11/2019 16:09	26/11/2019 11:45	19,59	28	548,43	CHI
201911331866	BELA VISTA DE GOIAS	BV21156519	SENADOR CANEDO	25/11/2019 16:10	26/11/2019 01:58	25/11/2019 16:10	26/11/2019 01:58	9,80	1	9,80	CHI
201911331870	HIDROLINA	HL21372467	SANTA TEREZINHA	25/11/2019 16:10	26/11/2019 21:12	25/11/2019 16:10	26/11/2019 21:12	29,03	1	29,03	CHI
201911331873	NOVO GAMA	LZ12372231	PACAEMBU S1	25/11/2019 13:45	25/11/2019 17:41	25/11/2019 13:45	25/11/2019 17:41	3,92	9	35,32	CHI
201911331875	GOIANIA	GN11164378	CARAJAS S1	25/11/2019 15:59	25/11/2019 20:14	25/11/2019 15:59	25/11/2019 20:14	4,24	129	546,64	CHI
201911331886	PLANALTINA	PI12056840	PLANALTINA	25/11/2019 13:32	25/11/2019 17:04	25/11/2019 13:32	25/11/2019 17:04	3,52	1264	4452,09	CHI
201911331889	CRISTALINA	KR21089576	PAMPLONA	25/11/2019 16:12	25/11/2019 21:49	25/11/2019 16:12	25/11/2019 21:49	5,61	2	11,21	CHI
201911331905	GOIANIA	10203266	AEROPORTO S1	25/11/2019 16:13	25/11/2019 17:55	25/11/2019 16:13	25/11/2019 17:55	1,68	1	1,68	CHI
201911331913	CAMPOS VERDES	VD21200588	SANTA TEREZINHA	25/11/2019 16:15	26/11/2019 16:26	25/11/2019 16:15	26/11/2019 16:26	24,18	1	24,18	CHI
201911331915	APARECIDA DE GOIANIA	AP11180186	ANHANGUERA	25/11/2019 16:15	25/11/2019 22:59	25/11/2019 16:15	25/11/2019 22:59	6,72	57	382,87	CHI
201911331917	GOIANESIA	550201026	GOIANESIA S2	25/11/2019 16:16	26/11/2019 17:51	25/11/2019 16:16	26/11/2019 17:51	25,58	1	25,58	CHI
201911331925	ANAPOLIS	AN21267926	ANAPOLIS UNIVERSITARIO S2	25/11/2019 16:16	26/11/2019 16:34	25/11/2019 16:16	26/11/2019 16:34	24,29	1	24,29	CHI
201911331928	ANICUNS	AC12000046	ANICUNS	25/11/2019 13:57	26/11/2019 07:45	25/11/2019 13:57	26/11/2019 07:45	17,81	7	124,64	CHI
201911331941	ITUMBIRA	IT21134682	BOM JESUS DE GOIAS	25/11/2019 16:18	27/11/2019 00:00	25/11/2019 16:18	27/11/2019 00:00	31,69	1	31,69	CHI
201911331943	AGUAS LINDAS DE GOIAS	LA11164944	AGUAS LINDAS DE GOIAS S1	25/11/2019 16:18	25/11/2019 17:40	25/11/2019 16:18	25/11/2019 17:40	1,35	203	274,61	CHI
201911331946	AVELINOPOLIS	AV11101334	ANICUNS	25/11/2019 16:16	25/11/2019 19:32	25/11/2019 16:16	25/11/2019 19:32	3,26	90	293,45	CHI
201911331953	SAO DOMINGOS	SD12035858	SAO DOMINGOS	25/11/2019 15:03	25/11/2019 18:03	25/11/2019 15:03	25/11/2019 18:03	2,99	904	2698,69	CHI
201911331959	ANICUNS	AC12391422	ANICUNS	25/11/2019 15:17	25/11/2019 20:25	25/11/2019 15:17	25/11/2019 20:25	5,13	4	20,54	CHI
201911331964	CRISTALINA	KR12110413	CRISTALINA S2	25/11/2019 16:20	26/11/2019 13:36	25/11/2019 16:20	26/11/2019 13:36	21,26	6	127,54	CHI
201911331965	ANAPOLIS	LB12078506	DAIA S2	25/11/2019 16:19	26/11/2019 11:05	25/11/2019 16:19	26/11/2019 11:05	18,76	8	150,10	CHI
201911331965	LEOPOLDO DE BULHOES	LB12078506	DAIA S2	25/11/2019 16:19	26/11/2019 11:05	25/11/2019 16:19	26/11/2019 11:05	18,76	6	112,57	CHI
201911331972	CROMINIA	CQ11000019	PONTALINA	25/11/2019 15:37	26/11/2019 10:47	25/11/2019 15:37	26/11/2019 10:47	19,16	146	2797,68	CHI
201911331979	CORUMBA DE GOIAS	CB12382369	CORUMBA	25/11/2019 16:22	26/11/2019 19:54	25/11/2019 16:22	26/11/2019 19:54	27,53	5	137,64	CHI
201911331981	CARMO DO RIO VERDE	IK12220480	ITAPURANGA	25/11/2019 16:10	26/11/2019 19:17	25/11/2019 16:10	26/11/2019 19:17	27,10	27	731,78	CHI
201911331982	ITAPACI	IW21079707	ITAPACI	25/11/2019 16:21	25/11/2019 18:39	25/11/2019 16:21	25/11/2019 18:39	2,29	1	2,29	CHI
201911331985	CRISTALINA	KR21013476	PAMPLONA	25/11/2019 16:23	26/11/2019 09:22	25/11/2019 16:23	26/11/2019 09:22	16,99	1	16,99	CHI
201911331995	PIRES DO RIO	PR11195157	PIRES DO RIO S1	25/11/2019 13:43	25/11/2019 23:17	25/11/2019 13:43	25/11/2019 23:17	9,55	32	305,76	CHI
201911332001	JUSSARA	JR12250546	BRITANIA	25/11/2019 16:24	26/11/2019 14:50	25/11/2019 16:24	26/11/2019 14:50	22,43	81	1816,65	CHI
201911332003	BRITANIA	BT12257311	BRITANIA	25/11/2019 12:05	25/11/2019 21:06	25/11/2019 12:05	25/11/2019 21:06	9,01	3	27,03	CHI
201911332003	JUSSARA	BT12257311	BRITANIA	25/11/2019 12:05	25/11/2019 21:06	25/11/2019 12:05	25/11/2019 21:06	9,01	2	18,02	CHI
201911332004	SANTA HELENA DE GOIAS	SH11246703	RIO VERDE S1	25/11/2019 16:24	25/11/2019 19:19	25/11/2019 16:24	25/11/2019 19:19	2,91	1	2,91	CHI
201911332011	ARACU	AV21272357	ANICUNS	25/11/2019 16:25	26/11/2019 10:00	25/11/2019 16:25	26/11/2019 10:00	17,59	1	17,59	CHI
201911332012	ARENOPOLIS	1920005952	ARENOPOLIS	25/11/2019 16:25	26/11/2019 09:24	25/11/2019 16:25	26/11/2019 09:24	16,98	1	16,98	CHI



201911332016	ITUMBIARA	10015813949	ITUMBIARA VELHA S1	25/11/2019 16:25	25/11/2019 17:35	25/11/2019 16:25	25/11/2019 17:35	1,16	1	1,16	CHI
201911332020	GOIANIA	10564421	REAL S2	25/11/2019 16:26	25/11/2019 20:56	25/11/2019 16:26	25/11/2019 20:56	4,50	1	4,50	CHI
201911332023	PLANALTINA	2960112757	PLANALTINA	25/11/2019 16:26	26/11/2019 09:36	25/11/2019 16:26	26/11/2019 09:36	17,16	1	17,16	CHI
201911332030	AGUAS LINDAS DE GOIAS	LA12149052	AGUAS LINDAS DE GOIAS S1	25/11/2019 17:56	25/11/2019 18:20	25/11/2019 17:56	25/11/2019 18:20	0,39	276	107,10	CHI
201911332034	GOIANIA	GN11137207	GOIANIA LESTE S2	25/11/2019 16:00	25/11/2019 18:06	25/11/2019 16:00	25/11/2019 18:06	2,09	74	154,82	CHI
201911332036	MORRINHOS	MR12395643	GOIATUBA S1	25/11/2019 15:02	25/11/2019 22:15	25/11/2019 15:02	25/11/2019 22:15	7,20	226	1627,39	CHI
201911332041	MINACU	IH12202490	MINACU	25/11/2019 16:28	26/11/2019 02:59	25/11/2019 16:28	26/11/2019 02:59	10,52	3	31,55	CHI
201911332052	QUIRINOPOLIS	QI31207158	SANTA HELENA S1	25/11/2019 16:28	25/11/2019 22:52	25/11/2019 16:28	25/11/2019 22:52	6,39	1	6,39	CHI
201911332053	GOIANIA	GN11217588	AEROPORTO S2	25/11/2019 20:41	25/11/2019 21:00	25/11/2019 20:41	25/11/2019 21:00	0,33	12	3,96	CHI
201911332054	TURVANIA	TV21299139	FIRMINOPOLIS S2	25/11/2019 16:28	25/11/2019 18:28	25/11/2019 16:28	25/11/2019 18:28	2,00	1	2,00	CHI
201911332055	COCALZINHO DE GOIAS	6090000974	COCALZINHO	25/11/2019 16:28	25/11/2019 19:12	25/11/2019 16:28	25/11/2019 19:12	2,72	1	2,72	CHI
201911332078	INHUMAS	IN21051498	ARACU	25/11/2019 16:31	26/11/2019 10:51	25/11/2019 16:31	26/11/2019 10:51	18,32	2	36,64	CHI
201911332084	CRISTALINA	03940214	CRISTALINA S2	25/11/2019 15:12	25/11/2019 19:08	25/11/2019 15:12	25/11/2019 19:08	3,92	235	921,13	CHI
201911332085	QUIRINOPOLIS	80051236	QUIRINOPOLIS	25/11/2019 16:32	25/11/2019 18:10	25/11/2019 16:32	25/11/2019 18:10	1,64	1	1,64	CHI
201911332088	LUZIANIA	LZ11216264	MARAJOARA	25/11/2019 16:28	25/11/2019 17:47	25/11/2019 16:28	25/11/2019 17:47	1,32	117	153,86	CHI
201911332095	TRINDADE	TR12185497	GOYA S1	25/11/2019 14:47	26/11/2019 03:12	25/11/2019 14:47	26/11/2019 03:12	12,41	99	1228,20	CHI
201911332097	SANTA TEREZINHA DE GOIAS	SG12392297	SANTA TEREZINHA	25/11/2019 16:12	26/11/2019 18:48	25/11/2019 16:12	26/11/2019 18:48	26,59	7	186,12	CHI
201911332098	ITABERAI	IB21235763	ITABERAI S2	25/11/2019 16:33	25/11/2019 21:07	25/11/2019 16:33	25/11/2019 21:07	4,56	1	4,56	CHI
201911332100	INHUMAS	DL21332021	INHUMAS S1	25/11/2019 16:33	26/11/2019 11:30	25/11/2019 16:33	26/11/2019 11:30	18,94	1	18,94	CHI
201911332111	GOIANIA	GN11002662	ATLANTICO S3	25/11/2019 16:45	25/11/2019 18:35	25/11/2019 16:45	25/11/2019 18:35	1,83	103	188,12	CHI
201911332112	MAIRIPOTABA	MI21000417	PONTALINA	25/11/2019 16:34	26/11/2019 15:02	25/11/2019 16:34	26/11/2019 15:02	22,46	1	22,46	CHI
201911332114	PORANGATU	PO12350109	PORANGATU	25/11/2019 14:57	26/11/2019 16:00	25/11/2019 14:57	26/11/2019 16:00	25,05	11	275,52	CHI
201911332117	PALMEIRAS DE GOIAS	PL12000111	PALMEIRAS	25/11/2019 13:30	25/11/2019 21:20	25/11/2019 13:30	25/11/2019 21:20	7,83	4	31,33	CHI
201911332126	ITUMBIARA	IT12347446	ITUMBIARA VELHA S1	25/11/2019 16:36	25/11/2019 19:51	25/11/2019 16:36	25/11/2019 19:51	3,25	89	289,00	CHI
201911332130	ITAPIRAPUA	IU12018785	MATRINCHA	25/11/2019 14:27	26/11/2019 17:55	25/11/2019 14:27	26/11/2019 17:55	27,46	83	2278,93	CHI
201911332131	PLANALTINA	PI21245170	SAO JOAO D ALIANCA	25/11/2019 16:37	26/11/2019 20:51	25/11/2019 16:37	26/11/2019 20:51	28,23	1	28,23	CHI
201911332136	DIVINOPOLIS DE GOIAS	GH12211204	SAO DOMINGOS	25/11/2019 16:37	25/11/2019 21:27	25/11/2019 16:37	25/11/2019 21:27	4,82	12	57,88	CHI
201911332137	APARECIDA DE GOIANIA	200068015	INDEPENDENCIA S1	25/11/2019 16:37	25/11/2019 18:02	25/11/2019 16:37	25/11/2019 18:02	1,41	1	1,41	CHI
201911332140	CRISTALINA	KR21245989	CRISTALINA S2	25/11/2019 16:37	25/11/2019 18:25	25/11/2019 16:37	25/11/2019 18:25	1,79	1	1,79	CHI
201911332155	CAMPOS VERDES	VD12253107	SANTA TEREZINHA	25/11/2019 16:32	26/11/2019 17:09	25/11/2019 16:32	26/11/2019 17:09	24,60	4	98,41	CHI
201911332159	CRISTALINA	KR12228591LD	CRISTALINA S1	25/11/2019 16:33	25/11/2019 23:13	25/11/2019 16:33	25/11/2019 23:13	6,67	69	460,15	CHI
201911332163	SAO JOAO D ALIANCA	JL12383345	SAO JOAO D ALIANCA	25/11/2019 16:39	26/11/2019 13:35	25/11/2019 16:39	26/11/2019 13:35	20,92	5	104,60	CHI
201911332168	SANTA ROSA DE GOIAS	SR12346425	INHUMAS S1	25/11/2019 14:10	26/11/2019 14:08	25/11/2019 14:10	26/11/2019 14:08	23,96	3	71,88	CHI

201911332168	TAQUARAL DE GOIAS	SR12346425	INHUMAS S1	25/11/2019 14:10	26/11/2019 14:08	25/11/2019 14:10	26/11/2019 14:08	23,96	4	95,85	CHI
201911332170	GOIANAPOLIS	GP12000087	DAIA S2	25/11/2019 16:41	26/11/2019 09:55	25/11/2019 16:41	26/11/2019 09:55	17,24	8	137,96	CHI
201911332170	TEREZOPOLIS DE GOIAS	GP12000087	DAIA S2	25/11/2019 16:41	26/11/2019 09:55	25/11/2019 16:41	26/11/2019 09:55	17,24	9	155,20	CHI
201911332187	ABADIANIA	AN12360334	ANAPOLIS UNIVERSITARIO S2	25/11/2019 15:31	25/11/2019 18:50	25/11/2019 15:31	25/11/2019 18:50	3,31	94	310,85	CHI
201911332187	ANAPOLIS	AN12360334	ANAPOLIS UNIVERSITARIO S2	25/11/2019 15:31	25/11/2019 18:50	25/11/2019 15:31	25/11/2019 18:50	3,31	407	1345,93	CHI
201911332188	CRISTALINA	KR11171669	PAMPLONA	25/11/2019 16:44	26/11/2019 10:11	25/11/2019 16:44	26/11/2019 10:11	17,46	5	87,31	CHI
201911332194	CABECEIRAS	CW12052029	ITUIQUIRA	25/11/2019 16:15	25/11/2019 22:28	25/11/2019 16:15	25/11/2019 22:28	6,21	6	37,27	CHI
201911332199	LUZIANIA	LZ21192949	MARAJOARA	25/11/2019 16:45	26/11/2019 08:49	25/11/2019 16:45	26/11/2019 08:49	16,07	1	16,07	CHI
201911332200	RIO VERDE	RV21106382	RIO VERDE S1	25/11/2019 16:50	26/11/2019 15:45	25/11/2019 16:50	26/11/2019 15:45	22,91	1	22,91	CHI
201911332206	PONTALINA	7776611	GOIATUBA S1	25/11/2019 16:42	28/11/2019 16:59	25/11/2019 16:42	28/11/2019 16:59	72,28	3	216,85	CHI
201911332210	PIRENOPOLIS	PV11198350	CORUMBA	25/11/2019 16:47	25/11/2019 20:44	25/11/2019 16:47	25/11/2019 20:44	3,94	48	189,28	CHI
201911332228	CRISTIANOPOLIS	7948235	CRISTIANOPOLIS	25/11/2019 17:31	27/11/2019 14:12	25/11/2019 17:31	27/11/2019 14:12	44,67	1	44,67	CHI
201911332235	GOIAS	03234118	ITAPURANGA	25/11/2019 17:39	26/11/2019 13:43	25/11/2019 17:41	25/11/2019 17:49	0,14	76	10,66	CHI
201911332235	HEITORAI	03234118	ITAPURANGA	25/11/2019 17:39	26/11/2019 13:43	25/11/2019 17:41	25/11/2019 17:49	0,14	1436	201,44	CHI
201911332235	HEITORAI	03234118	ITAPURANGA	25/11/2019 17:39	26/11/2019 13:43	25/11/2019 17:41	25/11/2019 17:49	0,14	168	23,57	CHI
201911332235	HEITORAI	HE10400387	ITAPURANGA	25/11/2019 17:39	26/11/2019 13:43	25/11/2019 17:41	25/11/2019 17:49	0,14	32	4,49	CHI
201911332235	ITAGUARU	03234118	ITAPURANGA	25/11/2019 17:39	26/11/2019 13:43	25/11/2019 17:41	25/11/2019 17:49	0,14	55	7,72	CHI
201911332235	ITAPURANGA	03234118	ITAPURANGA	25/11/2019 17:39	26/11/2019 13:43	25/11/2019 17:41	25/11/2019 17:49	0,14	75	10,52	CHI
201911332235	ITAPURANGA	03234118	ITAPURANGA	25/11/2019 17:39	26/11/2019 13:43	25/11/2019 17:41	25/11/2019 17:49	0,14	83	11,64	CHI
201911332235	ITAPURANGA	HE10400387	ITAPURANGA	25/11/2019 17:39	26/11/2019 13:43	25/11/2019 17:41	25/11/2019 17:49	0,14	185	25,95	CHI
201911332235	URUANA	03234118	ITAPURANGA	25/11/2019 17:39	26/11/2019 13:43	25/11/2019 17:41	25/11/2019 17:49	0,14	1	0,14	CHI
201911332235	ARAGUAPAZ	03234118	ITAPURANGA	25/11/2019 17:39	26/11/2019 13:43	25/11/2019 17:41	25/11/2019 17:57	0,27	3	0,81	CHI
201911332235	FAINA	03234118	ITAPURANGA	25/11/2019 17:39	26/11/2019 13:43	25/11/2019 17:41	25/11/2019 17:57	0,27	15	4,04	CHI
201911332235	ITAPURANGA	03234118	ITAPURANGA	25/11/2019 17:39	26/11/2019 13:43	25/11/2019 17:41	25/11/2019 17:57	0,27	38	10,24	CHI
201911332235	ITAPURANGA	IK10395420	ITAPURANGA	25/11/2019 17:39	26/11/2019 13:43	25/11/2019 17:41	25/11/2019 17:57	0,27	6	1,62	CHI
201911332235	MORRO AGUDO DE GOIAS	03234118	ITAPURANGA	25/11/2019 17:39	26/11/2019 13:43	25/11/2019 17:41	25/11/2019 17:57	0,27	1306	351,89	CHI
201911332235	MORRO AGUDO DE GOIAS	IK10395420	ITAPURANGA	25/11/2019 17:39	26/11/2019 13:43	25/11/2019 17:41	25/11/2019 17:57	0,27	9	2,42	CHI
201911332235	RUBIATABA	03234118	ITAPURANGA	25/11/2019 17:39	26/11/2019 13:43	25/11/2019 17:41	25/11/2019 17:57	0,27	12	3,23	CHI
201911332235	CARMO DO RIO VERDE	HE10400387	ITAPURANGA	25/11/2019 17:39	26/11/2019 13:43	25/11/2019 17:39	25/11/2019 18:06	0,45	84	37,82	CHI
201911332235	FAINA	HE10400387	ITAPURANGA	25/11/2019 17:39	26/11/2019 13:43	25/11/2019 17:39	25/11/2019 18:06	0,45	262	117,97	CHI
201911332235	GOIAS	HE10400387	ITAPURANGA	25/11/2019 17:39	26/11/2019 13:43	25/11/2019 17:39	25/11/2019 18:06	0,45	30	13,51	CHI
201911332235	GUARAITA	HE10400387	ITAPURANGA	25/11/2019 17:39	26/11/2019 13:43	25/11/2019 17:39	25/11/2019 18:06	0,45	7	3,15	CHI
201911332235	GUARAITA	HE10400387	ITAPURANGA	25/11/2019 17:39	26/11/2019 13:43	25/11/2019 17:39	25/11/2019 18:06	0,45	1148	516,92	CHI

201911332235	ITAPURANGA	HE10400387	ITAPURANGA	25/11/2019 17:39	26/11/2019 13:43	25/11/2019 17:39	25/11/2019 18:06	0,45	6235	2807,48	CHI
201911332235	ITAPURANGA	HE10400387	ITAPURANGA	25/11/2019 17:39	26/11/2019 13:43	25/11/2019 17:39	25/11/2019 18:06	0,45	1416	637,59	CHI
201911332235	ITAPURANGA	HE10400387	ITAPURANGA	25/11/2019 17:39	26/11/2019 13:43	25/11/2019 17:39	25/11/2019 18:06	0,45	1619	729,00	CHI
201911332235	MORRO AGUDO DE GOIAS	HE10400387	ITAPURANGA	25/11/2019 17:39	26/11/2019 13:43	25/11/2019 17:39	25/11/2019 18:06	0,45	13	5,85	CHI
201911332235	SAO PATRICIO	HE10400387	ITAPURANGA	25/11/2019 17:39	26/11/2019 13:43	25/11/2019 17:39	25/11/2019 18:06	0,45	2	0,90	CHI
201911332235	ARAGUAPAZ	HE10400387	ITAPURANGA	25/11/2019 17:39	26/11/2019 13:43	25/11/2019 18:01	25/11/2019 18:06	0,07	3	0,21	CHI
201911332235	FAINA	HE10400387	ITAPURANGA	25/11/2019 17:39	26/11/2019 13:43	25/11/2019 18:01	25/11/2019 18:06	0,07	15	1,07	CHI
201911332235	GOIAS	HE10400387	ITAPURANGA	25/11/2019 17:39	26/11/2019 13:43	25/11/2019 18:01	25/11/2019 18:06	0,07	76	5,40	CHI
201911332235	HEITORAI	HE10400387	ITAPURANGA	25/11/2019 17:39	26/11/2019 13:43	25/11/2019 18:01	25/11/2019 18:06	0,07	1436	102,12	CHI
201911332235	HEITORAI	HE10400387	ITAPURANGA	25/11/2019 17:39	26/11/2019 13:43	25/11/2019 18:01	25/11/2019 18:06	0,07	168	11,95	CHI
201911332235	HEITORAI	HE10400387	ITAPURANGA	25/11/2019 17:39	26/11/2019 13:43	25/11/2019 18:01	25/11/2019 18:06	0,07	32	2,28	CHI
201911332235	ITAGUARU	HE10400387	ITAPURANGA	25/11/2019 17:39	26/11/2019 13:43	25/11/2019 18:01	25/11/2019 18:06	0,07	55	3,91	CHI
201911332235	ITAPURANGA	HE10400387	ITAPURANGA	25/11/2019 17:39	26/11/2019 13:43	25/11/2019 18:01	25/11/2019 18:06	0,07	75	5,33	CHI
201911332235	ITAPURANGA	HE10400387	ITAPURANGA	25/11/2019 17:39	26/11/2019 13:43	25/11/2019 18:01	25/11/2019 18:06	0,07	38	2,70	CHI
201911332235	ITAPURANGA	HE10400387	ITAPURANGA	25/11/2019 17:39	26/11/2019 13:43	25/11/2019 18:01	25/11/2019 18:06	0,07	83	5,90	CHI
201911332235	ITAPURANGA	HE10400387	ITAPURANGA	25/11/2019 17:39	26/11/2019 13:43	25/11/2019 18:01	25/11/2019 18:06	0,07	191	13,58	CHI
201911332235	MORRO AGUDO DE GOIAS	HE10400387	ITAPURANGA	25/11/2019 17:39	26/11/2019 13:43	25/11/2019 18:01	25/11/2019 18:06	0,07	1305	92,80	CHI
201911332235	MORRO AGUDO DE GOIAS	HE10400387	ITAPURANGA	25/11/2019 17:39	26/11/2019 13:43	25/11/2019 18:01	25/11/2019 18:06	0,07	9	0,64	CHI
201911332235	RUBIATABA	HE10400387	ITAPURANGA	25/11/2019 17:39	26/11/2019 13:43	25/11/2019 18:01	25/11/2019 18:06	0,07	12	0,85	CHI
201911332235	URUANA	HE10400387	ITAPURANGA	25/11/2019 17:39	26/11/2019 13:43	25/11/2019 18:01	25/11/2019 18:06	0,07	1	0,07	CHI
201911332235	ITAPURANGA	00930234	ITAPURANGA	25/11/2019 17:39	26/11/2019 13:43	25/11/2019 17:39	25/11/2019 18:23	0,74	3384	2511,68	CHI
201911332235	ARAGUAPAZ	HE10400387	ITAPURANGA	25/11/2019 17:39	26/11/2019 13:43	25/11/2019 19:17	25/11/2019 19:21	0,07	3	0,20	CHI
201911332235	FAINA	HE10400387	ITAPURANGA	25/11/2019 17:39	26/11/2019 13:43	25/11/2019 19:17	25/11/2019 19:21	0,07	15	1,02	CHI
201911332235	GOIAS	HE10400387	ITAPURANGA	25/11/2019 17:39	26/11/2019 13:43	25/11/2019 19:17	25/11/2019 19:21	0,07	76	5,17	CHI
201911332235	HEITORAI	HE10400387	ITAPURANGA	25/11/2019 17:39	26/11/2019 13:43	25/11/2019 19:17	25/11/2019 19:21	0,07	1436	97,73	CHI
201911332235	HEITORAI	HE10400387	ITAPURANGA	25/11/2019 17:39	26/11/2019 13:43	25/11/2019 19:17	25/11/2019 19:21	0,07	168	11,43	CHI
201911332235	HEITORAI	HE10400387	ITAPURANGA	25/11/2019 17:39	26/11/2019 13:43	25/11/2019 19:17	25/11/2019 19:21	0,07	32	2,18	CHI
201911332235	ITAGUARU	HE10400387	ITAPURANGA	25/11/2019 17:39	26/11/2019 13:43	25/11/2019 19:17	25/11/2019 19:21	0,07	55	3,74	CHI
201911332235	ITAPURANGA	HE10400387	ITAPURANGA	25/11/2019 17:39	26/11/2019 13:43	25/11/2019 19:17	25/11/2019 19:21	0,07	75	5,10	CHI
201911332235	ITAPURANGA	HE10400387	ITAPURANGA	25/11/2019 17:39	26/11/2019 13:43	25/11/2019 19:17	25/11/2019 19:21	0,07	38	2,59	CHI
201911332235	ITAPURANGA	HE10400387	ITAPURANGA	25/11/2019 17:39	26/11/2019 13:43	25/11/2019 19:17	25/11/2019 19:21	0,07	83	5,65	CHI
201911332235	ITAPURANGA	HE10400387	ITAPURANGA	25/11/2019 17:39	26/11/2019 13:43	25/11/2019 19:17	25/11/2019 19:21	0,07	191	13,00	CHI
201911332235	MORRO AGUDO DE GOIAS	HE10400387	ITAPURANGA	25/11/2019 17:39	26/11/2019 13:43	25/11/2019 19:17	25/11/2019 19:21	0,07	1304	88,74	CHI

201911332235	MORRO AGUDO DE GOIAS	HE10400387	ITAPURANGA	25/11/2019 17:39	26/11/2019 13:43	25/11/2019 19:17	25/11/2019 19:21	0,07	9	0,61	CHI
201911332235	RUBIATABA	HE10400387	ITAPURANGA	25/11/2019 17:39	26/11/2019 13:43	25/11/2019 19:17	25/11/2019 19:21	0,07	12	0,82	CHI
201911332235	URUANA	HE10400387	ITAPURANGA	25/11/2019 17:39	26/11/2019 13:43	25/11/2019 19:17	25/11/2019 19:21	0,07	1	0,07	CHI
201911332235	FAINA	HE10400387	ITAPURANGA	25/11/2019 17:39	26/11/2019 13:43	25/11/2019 19:17	25/11/2019 19:35	0,29	262	76,42	CHI
201911332235	GOIAS	HE10400387	ITAPURANGA	25/11/2019 17:39	26/11/2019 13:43	25/11/2019 19:17	25/11/2019 19:35	0,29	30	8,75	CHI
201911332235	GUARAITA	HE10400387	ITAPURANGA	25/11/2019 17:39	26/11/2019 13:43	25/11/2019 19:17	25/11/2019 19:35	0,29	1130	329,58	CHI
201911332235	ITAPURANGA	HE10400387	ITAPURANGA	25/11/2019 17:39	26/11/2019 13:43	25/11/2019 19:17	25/11/2019 19:35	0,29	529	154,29	CHI
201911332235	ITAPURANGA	HE10400387	ITAPURANGA	25/11/2019 17:39	26/11/2019 13:43	25/11/2019 19:17	25/11/2019 19:35	0,29	1409	410,96	CHI
201911332235	CARMO DO RIO VERDE	00930244	ITAPURANGA	25/11/2019 17:39	26/11/2019 13:43	25/11/2019 18:10	25/11/2019 19:49	1,64	48	78,79	CHI
201911332235	ITAPURANGA	00930244	ITAPURANGA	25/11/2019 17:39	26/11/2019 13:43	25/11/2019 18:10	25/11/2019 19:49	1,64	702	1152,26	CHI
201911332235	ITAPURANGA	HE10400387	ITAPURANGA	25/11/2019 17:39	26/11/2019 13:43	25/11/2019 19:17	25/11/2019 19:59	0,69	1019	704,81	CHI
201911332235	ITAPURANGA	IK16410196	ITAPURANGA	25/11/2019 17:39	26/11/2019 13:43	25/11/2019 18:10	25/11/2019 21:15	3,09	5264	16248,21	CHI
201911332235	ITAPURANGA	IK16408576	ITAPURANGA	25/11/2019 17:39	26/11/2019 13:43	25/11/2019 19:17	25/11/2019 21:52	2,58	2507	6459,01	CHI
201911332235	ITAPURANGA	IK10400623	ITAPURANGA	25/11/2019 17:39	26/11/2019 13:43	25/11/2019 18:10	25/11/2019 22:05	3,91	195	762,40	CHI
201911332235	CARMO DO RIO VERDE	IK10395414	ITAPURANGA	25/11/2019 17:39	26/11/2019 13:43	25/11/2019 18:10	25/11/2019 22:07	3,94	36	141,95	CHI
201911332235	ITAPURANGA	IK10395414	ITAPURANGA	25/11/2019 17:39	26/11/2019 13:43	25/11/2019 18:10	25/11/2019 22:07	3,94	721	2842,94	CHI
201911332235	MORRO AGUDO DE GOIAS	IK10395414	ITAPURANGA	25/11/2019 17:39	26/11/2019 13:43	25/11/2019 18:10	25/11/2019 22:07	3,94	13	51,26	CHI
201911332235	SAO PATRICIO	IK10395414	ITAPURANGA	25/11/2019 17:39	26/11/2019 13:43	25/11/2019 18:10	25/11/2019 22:07	3,94	2	7,89	CHI
201911332235	GUARAITA	IK10396063	ITAPURANGA	25/11/2019 17:39	26/11/2019 13:43	25/11/2019 18:10	25/11/2019 22:10	4,00	7	27,97	CHI
201911332235	ITAPURANGA	IK10396063	ITAPURANGA	25/11/2019 17:39	26/11/2019 13:43	25/11/2019 18:10	25/11/2019 22:10	4,00	443	1770,15	CHI
201911332235	ITAPURANGA	IK16408580	ITAPURANGA	25/11/2019 17:39	26/11/2019 13:43	25/11/2019 21:34	25/11/2019 23:43	2,15	2153	4634,93	CHI
201911332235	GOIAS	00880424	ITAPURANGA	25/11/2019 17:39	26/11/2019 13:43	26/11/2019 13:39	26/11/2019 13:43	0,06	76	4,58	CHI
201911332235	HEITORAI	00880424	ITAPURANGA	25/11/2019 17:39	26/11/2019 13:43	26/11/2019 13:39	26/11/2019 13:43	0,06	1435	86,50	CHI
201911332235	HEITORAI	00880424	ITAPURANGA	25/11/2019 17:39	26/11/2019 13:43	26/11/2019 13:39	26/11/2019 13:43	0,06	168	10,13	CHI
201911332235	HEITORAI	IK10395419	ITAPURANGA	25/11/2019 17:39	26/11/2019 13:43	26/11/2019 13:39	26/11/2019 13:43	0,06	32	1,93	CHI
201911332235	ITAGUARU	00880424	ITAPURANGA	25/11/2019 17:39	26/11/2019 13:43	26/11/2019 13:39	26/11/2019 13:43	0,06	55	3,32	CHI
201911332235	ITAPURANGA	00880424	ITAPURANGA	25/11/2019 17:39	26/11/2019 13:43	26/11/2019 13:39	26/11/2019 13:43	0,06	75	4,52	CHI
201911332235	ITAPURANGA	00880424	ITAPURANGA	25/11/2019 17:39	26/11/2019 13:43	26/11/2019 13:39	26/11/2019 13:43	0,06	83	5,00	CHI
201911332235	ITAPURANGA	IK10395419	ITAPURANGA	25/11/2019 17:39	26/11/2019 13:43	26/11/2019 13:39	26/11/2019 13:43	0,06	175	10,55	CHI
201911332235	URUANA	00880424	ITAPURANGA	25/11/2019 17:39	26/11/2019 13:43	26/11/2019 13:39	26/11/2019 13:43	0,06	1	0,06	CHI
201911332253	HIDROLANDIA	01510404	PIRACANJUBA	25/11/2019 17:59	25/11/2019 22:01	25/11/2019 17:59	25/11/2019 20:51	2,88	15	43,19	CHI
201911332253	PIRACANJUBA	01510404	PIRACANJUBA	25/11/2019 17:59	25/11/2019 22:01	25/11/2019 17:59	25/11/2019 20:51	2,88	136	391,57	CHI
201911332253	PROFESSOR JAMIL SAFADY	01510404	PIRACANJUBA	25/11/2019 17:59	25/11/2019 22:01	25/11/2019 17:59	25/11/2019 20:51	2,88	13	37,43	CHI

201911332253	CROMINIA	01510404	ROCHEDO	25/11/2019 17:59	25/11/2019 22:01	25/11/2019 17:59	25/11/2019 20:51	2,88	41	118,05	CHI
201911332253	CROMINIA	01510404	ROCHEDO	25/11/2019 17:59	25/11/2019 22:01	25/11/2019 17:59	25/11/2019 20:51	2,88	3	8,64	CHI
201911332253	HIDROLANDIA	01510404	ROCHEDO	25/11/2019 17:59	25/11/2019 22:01	25/11/2019 17:59	25/11/2019 20:51	2,88	9	25,91	CHI
201911332253	PIRACANJUBA	01510404	ROCHEDO	25/11/2019 17:59	25/11/2019 22:01	25/11/2019 17:59	25/11/2019 20:51	2,88	281	809,05	CHI
201911332253	PIRACANJUBA	01510404	ROCHEDO	25/11/2019 17:59	25/11/2019 22:01	25/11/2019 17:59	25/11/2019 20:51	2,88	1	2,88	CHI
201911332253	PROFESSOR JAMIL SAFADY	01510404	ROCHEDO	25/11/2019 17:59	25/11/2019 22:01	25/11/2019 17:59	25/11/2019 20:51	2,88	825	2375,31	CHI
201911332253	PROFESSOR JAMIL SAFADY	01510404	ROCHEDO	25/11/2019 17:59	25/11/2019 22:01	25/11/2019 17:59	25/11/2019 20:51	2,88	642	1848,43	CHI
201911332253	PROFESSOR JAMIL SAFADY	01510404	ROCHEDO	25/11/2019 17:59	25/11/2019 22:01	25/11/2019 17:59	25/11/2019 20:51	2,88	6	17,28	CHI
201911332253	CEZARINA	01510404	PONTALINA	25/11/2019 17:59	25/11/2019 22:01	25/11/2019 17:59	25/11/2019 22:01	4,04	40	161,51	CHI
201911332253	CROMINIA	01510404	PONTALINA	25/11/2019 17:59	25/11/2019 22:01	25/11/2019 17:59	25/11/2019 22:01	4,04	1583	6391,80	CHI
201911332253	CROMINIA	01510404	PONTALINA	25/11/2019 17:59	25/11/2019 22:01	25/11/2019 17:59	25/11/2019 22:01	4,04	20	80,76	CHI
201911332253	CROMINIA	01510404	PONTALINA	25/11/2019 17:59	25/11/2019 22:01	25/11/2019 17:59	25/11/2019 22:01	4,04	18	72,68	CHI
201911332253	CROMINIA	PJ10401415	PONTALINA	25/11/2019 17:59	25/11/2019 22:01	25/11/2019 17:59	25/11/2019 22:01	4,04	37	149,40	CHI
201911332253	CROMINIA	01510404	PONTALINA	25/11/2019 17:59	25/11/2019 22:01	25/11/2019 17:59	25/11/2019 22:01	4,04	12	48,45	CHI
201911332253	CROMINIA	01510404	PONTALINA	25/11/2019 17:59	25/11/2019 22:01	25/11/2019 17:59	25/11/2019 22:01	4,04	9	36,34	CHI
201911332253	HIDROLANDIA	01510404	PONTALINA	25/11/2019 17:59	25/11/2019 22:01	25/11/2019 17:59	25/11/2019 22:01	4,04	145	585,48	CHI
201911332253	HIDROLANDIA	01510404	PONTALINA	25/11/2019 17:59	25/11/2019 22:01	25/11/2019 17:59	25/11/2019 22:01	4,04	74	298,80	CHI
201911332253	HIDROLANDIA	01510404	PONTALINA	25/11/2019 17:59	25/11/2019 22:01	25/11/2019 17:59	25/11/2019 22:01	4,04	3	12,11	CHI
201911332253	MAIRIPOTABA	01510404	PONTALINA	25/11/2019 17:59	25/11/2019 22:01	25/11/2019 17:59	25/11/2019 22:01	4,04	47	189,78	CHI
201911332253	MAIRIPOTABA	01510404	PONTALINA	25/11/2019 17:59	25/11/2019 22:01	25/11/2019 17:59	25/11/2019 22:01	4,04	778	3141,39	CHI
201911332253	MAIRIPOTABA	01510404	PONTALINA	25/11/2019 17:59	25/11/2019 22:01	25/11/2019 17:59	25/11/2019 22:01	4,04	352	1421,30	CHI
201911332253	MAIRIPOTABA	PJ10401415	PONTALINA	25/11/2019 17:59	25/11/2019 22:01	25/11/2019 17:59	25/11/2019 22:01	4,04	8	32,30	CHI
201911332253	MAIRIPOTABA	01510404	PONTALINA	25/11/2019 17:59	25/11/2019 22:01	25/11/2019 17:59	25/11/2019 22:01	4,04	2	8,08	CHI
201911332253	MAIRIPOTABA	01510404	PONTALINA	25/11/2019 17:59	25/11/2019 22:01	25/11/2019 17:59	25/11/2019 22:01	4,04	3	12,11	CHI
201911332253	PONTALINA	01510404	PONTALINA	25/11/2019 17:59	25/11/2019 22:01	25/11/2019 17:59	25/11/2019 22:01	4,04	16	64,60	CHI
201911332253	PONTALINA	01510404	PONTALINA	25/11/2019 17:59	25/11/2019 22:01	25/11/2019 17:59	25/11/2019 22:01	4,04	3	12,11	CHI
201911332253	PONTALINA	01510404	PONTALINA	25/11/2019 17:59	25/11/2019 22:01	25/11/2019 17:59	25/11/2019 22:01	4,04	61	246,30	CHI
201911332253	PROFESSOR JAMIL SAFADY	PJ10401415	PONTALINA	25/11/2019 17:59	25/11/2019 22:01	25/11/2019 17:59	25/11/2019 22:01	4,04	44	177,66	CHI
201911332266	URUACU	UR12280291	SANTA TEREZINHA	25/11/2019 13:41	28/11/2019 01:19	25/11/2019 13:41	27/11/2019 01:49	36,13	1	36,13	CHI
201911332266	URUACU	UR12280291	SANTA TEREZINHA	25/11/2019 13:41	28/11/2019 01:19	27/11/2019 15:13	27/11/2019 21:28	6,26	1	6,26	CHI
201911332266	URUACU	UR21269014	SANTA TEREZINHA	25/11/2019 13:41	28/11/2019 01:19	25/11/2019 13:41	28/11/2019 00:53	59,21	1	59,21	CHI
201911332266	PILAR DE GOIAS	GG21387929	SANTA TEREZINHA	25/11/2019 13:41	28/11/2019 01:19	25/11/2019 13:41	28/11/2019 01:19	59,64	1	59,64	CHI
201911332267	PILAR DE GOIAS	GG12341672	SANTA TEREZINHA	25/11/2019 16:59	26/11/2019 18:02	25/11/2019 16:59	26/11/2019 18:02	25,05	2	50,09	CHI

201911332280	CAMPO ALEGRE DE GOIAS	CM10397305	CAMPO ALEGRE DE GOIAS	25/11/2019 20:12	27/11/2019 12:22	25/11/2019 20:12	26/11/2019 08:07	11,92	12	143,00	CHI
201911332280	CAMPO ALEGRE DE GOIAS	CM10397305	CAMPO ALEGRE DE GOIAS	25/11/2019 20:12	27/11/2019 12:22	25/11/2019 20:12	26/11/2019 08:10	11,96	9	107,60	CHI
201911332280	CAMPO ALEGRE DE GOIAS	CM10397305	CAMPO ALEGRE DE GOIAS	25/11/2019 20:12	27/11/2019 12:22	25/11/2019 20:12	26/11/2019 09:39	13,45	24	322,75	CHI
201911332280	CATALAO	CM10397305	CAMPO ALEGRE DE GOIAS	25/11/2019 20:12	27/11/2019 12:22	25/11/2019 20:12	26/11/2019 09:39	13,45	1	13,45	CHI
201911332280	CAMPO ALEGRE DE GOIAS	CM10397305	CAMPO ALEGRE DE GOIAS	25/11/2019 20:12	27/11/2019 12:22	25/11/2019 20:12	26/11/2019 11:00	14,79	31	458,58	CHI
201911332280	CATALAO	CM10397305	CAMPO ALEGRE DE GOIAS	25/11/2019 20:12	27/11/2019 12:22	25/11/2019 20:12	26/11/2019 11:00	14,79	17	251,48	CHI
201911332280	DISTRITO FEDERAL	CM10397305	CAMPO ALEGRE DE GOIAS	25/11/2019 20:12	27/11/2019 12:22	25/11/2019 20:12	26/11/2019 11:00	14,79	1	14,79	CHI
201911332280	CAMPO ALEGRE DE GOIAS	CM10397305	CAMPO ALEGRE DE GOIAS	25/11/2019 20:12	27/11/2019 12:22	25/11/2019 20:12	26/11/2019 12:40	16,46	33	543,15	CHI
201911332280	CATALAO	CM10397305	CAMPO ALEGRE DE GOIAS	25/11/2019 20:12	27/11/2019 12:22	25/11/2019 20:12	26/11/2019 12:40	16,46	3	49,38	CHI
201911332280	IPAMERI	CM10397305	CAMPO ALEGRE DE GOIAS	25/11/2019 20:12	27/11/2019 12:22	25/11/2019 20:12	26/11/2019 12:40	16,46	11	181,05	CHI
201911332280	CAMPO ALEGRE DE GOIAS	CM10397305	CAMPO ALEGRE DE GOIAS	25/11/2019 20:12	27/11/2019 12:22	26/11/2019 14:07	26/11/2019 15:56	1,82	76	138,13	CHI
201911332280	CATALAO	CM10397305	CAMPO ALEGRE DE GOIAS	25/11/2019 20:12	27/11/2019 12:22	26/11/2019 14:07	26/11/2019 15:56	1,82	18	32,72	CHI
201911332280	DISTRITO FEDERAL	CM10397305	CAMPO ALEGRE DE GOIAS	25/11/2019 20:12	27/11/2019 12:22	26/11/2019 14:07	26/11/2019 15:56	1,82	1	1,82	CHI
201911332280	CAMPO ALEGRE DE GOIAS	CM10397305	CAMPO ALEGRE DE GOIAS	25/11/2019 20:12	27/11/2019 12:22	26/11/2019 14:07	26/11/2019 16:48	2,68	29	77,70	CHI
201911332280	IPAMERI	CM10397305	CAMPO ALEGRE DE GOIAS	25/11/2019 20:12	27/11/2019 12:22	26/11/2019 14:07	26/11/2019 16:48	2,68	11	29,47	CHI
201911332280	CAMPO ALEGRE DE GOIAS	CM10397305	CAMPO ALEGRE DE GOIAS	25/11/2019 20:12	27/11/2019 12:22	25/11/2019 20:12	27/11/2019 09:17	37,08	14	519,18	CHI
201911332280	IPAMERI	CM10397305	CAMPO ALEGRE DE GOIAS	25/11/2019 20:12	27/11/2019 12:22	25/11/2019 20:12	27/11/2019 09:17	37,08	1	37,08	CHI
201911332280	CAMPO ALEGRE DE GOIAS	CM10397305	CAMPO ALEGRE DE GOIAS	25/11/2019 20:12	27/11/2019 12:22	26/11/2019 14:07	27/11/2019 12:22	22,25	4	88,99	CHI
201911332280	CATALAO	CM10397305	CAMPO ALEGRE DE GOIAS	25/11/2019 20:12	27/11/2019 12:22	26/11/2019 14:07	27/11/2019 12:22	22,25	3	66,74	CHI
201911332282	MIMOSO DE GOIAS	MJ12071970	PADRE BERNARDO	25/11/2019 16:59	26/11/2019 00:09	25/11/2019 16:59	26/11/2019 00:09	7,16	23	164,64	CHI
201911332294	SAO JOAO D ALIANCA	JL11211488	SAO JOAO D ALIANCA	25/11/2019 18:02	26/11/2019 00:33	25/11/2019 18:02	26/11/2019 00:33	6,52	94	612,46	CHI
201911332295	PARAUNA	PU10404071	PARAUNA	25/11/2019 21:24	26/11/2019 03:58	25/11/2019 21:24	26/11/2019 01:14	3,84	15	57,58	CHI
201911332295	PARAUNA	PU12061373LD	PARAUNA	25/11/2019 21:24	26/11/2019 03:58	25/11/2019 21:24	26/11/2019 03:58	6,56	106	695,57	CHI
201911332306	PLANALTINA	PI12211506	SAO JOAO D ALIANCA	25/11/2019 16:45	26/11/2019 12:05	25/11/2019 16:45	26/11/2019 12:05	19,34	1	19,34	CHI
201911332307	APARECIDA DE GOIANIA	AP12075580	CEPAIGO S1	25/11/2019 16:45	26/11/2019 18:31	25/11/2019 16:45	25/11/2019 19:19	2,56	4	10,23	CHI
201911332307	APARECIDA DE GOIANIA	AP12402747LD	CEPAIGO S1	25/11/2019 16:45	26/11/2019 18:31	25/11/2019 16:45	26/11/2019 18:31	25,76	15	386,36	CHI
201911332308	DIVINOPOLIS DE GOIAS	GH12253952	SAO DOMINGOS	25/11/2019 16:45	26/11/2019 11:05	25/11/2019 16:45	26/11/2019 11:05	18,32	4	73,29	CHI
201911332310	CRISTALINA	KR21240980	CRISTALINA S1	25/11/2019 16:45	26/11/2019 15:02	25/11/2019 16:45	26/11/2019 15:02	22,27	1	22,27	CHI
201911332314	BONOPOLIS	BX12321724	SAO MIGUEL DO ARAGUAIA	25/11/2019 16:45	25/11/2019 19:45	25/11/2019 16:45	25/11/2019 19:45	2,99	5	14,93	CHI
201911332324	IPAMERI	IP12311773	IPAMERI	25/11/2019 16:47	26/11/2019 10:59	25/11/2019 16:47	26/11/2019 10:59	18,19	1	18,19	CHI
201911332325	ANAPOLIS	AN21270306	ANAPOLIS UNIVERSITARIO S2	25/11/2019 16:47	26/11/2019 17:49	25/11/2019 16:47	26/11/2019 17:49	25,03	1	25,03	CHI
201911332330	PIRACANJUBA	PJ21025032	PIRACANJUBA	25/11/2019 16:48	26/11/2019 19:03	25/11/2019 16:48	26/11/2019 19:03	26,24	1	26,24	CHI
201911332333	GOIANIA	10002031882	FERROVIARIO S3	25/11/2019 16:48	25/11/2019 19:49	25/11/2019 16:48	25/11/2019 19:49	3,02	1	3,02	CHI

201911332339	APARECIDA DE GOIANIA	14986164	INDEPENDENCIA S2	25/11/2019 16:48	25/11/2019 17:19	25/11/2019 16:48	25/11/2019 17:19	0,50	1	0,50	CHI
201911332342	ITUMBIARA	BJ21208136	CACHOEIRA DOURADA	25/11/2019 16:49	26/11/2019 12:58	25/11/2019 16:49	26/11/2019 12:58	20,15	2	40,30	CHI
201911332345	ORIZONA	OZ12216210	PIRES DO RIO S2	25/11/2019 16:49	26/11/2019 16:26	25/11/2019 16:49	26/11/2019 16:26	23,62	9	212,57	CHI
201911332345	PIRES DO RIO	OZ12216210	PIRES DO RIO S2	25/11/2019 16:49	26/11/2019 16:26	25/11/2019 16:49	26/11/2019 16:26	23,62	10	236,18	CHI
201911332348	ANAPOLIS	AN12261159	ANAPOLIS UNIVERSITARIO S1	25/11/2019 13:01	26/11/2019 12:50	25/11/2019 13:01	26/11/2019 12:50	23,81	6	142,83	CHI
201911332355	EDEIA	10028657070	EDEIA	25/11/2019 16:50	26/11/2019 11:07	25/11/2019 16:50	26/11/2019 11:07	18,28	1	18,28	CHI
201911332360	MORRINHOS	MR12320268	MORRINHOS	25/11/2019 16:50	26/11/2019 09:20	25/11/2019 16:50	26/11/2019 09:20	16,50	4	65,98	CHI
201911332362	GOIANIA	GN11056160	GOIANIA LESTE S2	25/11/2019 16:48	25/11/2019 20:45	25/11/2019 16:48	25/11/2019 20:45	3,94	214	842,80	CHI
201911332363	TURVANIA	TV12259061	FIRMINOPOLIS S2	25/11/2019 16:50	26/11/2019 01:31	25/11/2019 16:50	26/11/2019 01:31	8,68	8	69,48	CHI
201911332365	AGUA FRIA DE GOIAS	PI12067431	SAO JOAO D ALIANCA	25/11/2019 16:50	27/11/2019 15:03	25/11/2019 16:50	27/11/2019 15:03	46,20	12	554,43	CHI
201911332366	ACREUNA	3330004548	ACREUNA	25/11/2019 16:50	25/11/2019 22:00	25/11/2019 16:50	25/11/2019 22:00	5,16	1	5,16	CHI
201911332367	BRITANIA	BT12210599	BRITANIA	25/11/2019 15:54	25/11/2019 18:29	25/11/2019 15:54	25/11/2019 18:29	2,57	699	1799,34	CHI
201911332367	JUSSARA	BT12210599	BRITANIA	25/11/2019 15:54	25/11/2019 18:29	25/11/2019 15:54	25/11/2019 18:29	2,57	49	126,13	CHI
201911332369	JATAI	JT12219384RE	JATAI S3	25/11/2019 15:23	25/11/2019 18:12	25/11/2019 15:23	25/11/2019 18:12	2,80	28	78,42	CHI
201911332370	SAO DOMINGOS	SD12302841	SAO DOMINGOS	25/11/2019 16:51	25/11/2019 19:17	25/11/2019 16:51	25/11/2019 19:17	2,43	43	104,42	CHI
201911332374	CAMPINORTE	CR12398061	CAMPINORTE	25/11/2019 16:41	25/11/2019 20:47	25/11/2019 16:41	25/11/2019 20:47	4,09	3	12,26	CHI
201911332374	URUACU	CR12398061	CAMPINORTE	25/11/2019 16:41	25/11/2019 20:47	25/11/2019 16:41	25/11/2019 20:47	4,09	5	20,44	CHI
201911332383	JARAGUA	JA12353232	GOIANESIA S2	25/11/2019 16:06	26/11/2019 11:20	25/11/2019 16:06	26/11/2019 11:20	19,24	31	596,53	CHI
201911332386	NAZARIO	NZ31167182	ANICUNS	25/11/2019 16:53	26/11/2019 14:18	25/11/2019 16:53	26/11/2019 14:18	21,43	1	21,43	CHI
201911332388	RIO VERDE	RV11226368	MONTIVIDIU T	25/11/2019 16:53	26/11/2019 10:15	25/11/2019 16:53	26/11/2019 10:15	17,36	1	17,36	CHI
201911332389	RIO VERDE	RV12326780	CABRIUVA S1	25/11/2019 16:26	25/11/2019 20:00	25/11/2019 16:26	25/11/2019 20:00	3,56	46	163,71	CHI
201911332393	SILVANIA	SV21284619	VIANOPOLIS	25/11/2019 16:53	26/11/2019 19:40	25/11/2019 16:53	26/11/2019 19:40	26,77	1	26,77	CHI
201911332414	ARENOPOLIS	AY21100364	ARENOPOLIS	25/11/2019 16:55	26/11/2019 11:40	25/11/2019 16:55	26/11/2019 11:40	18,74	1	18,74	CHI
201911332416	BELA VISTA DE GOIAS	BV21000047	BELA VISTA S1	25/11/2019 16:55	26/11/2019 14:48	25/11/2019 16:55	26/11/2019 14:48	21,87	3	65,60	CHI
201911332437	GAMELEIRA DE GOIAS	3830003399	DAIA S2	25/11/2019 16:58	26/11/2019 11:24	25/11/2019 16:58	26/11/2019 11:24	18,43	1	18,43	CHI
201911332477	CALDAS NOVAS	CN11066112	CALDAS NOVAS S2	25/11/2019 16:59	25/11/2019 23:31	25/11/2019 16:59	25/11/2019 23:31	6,53	68	444,17	CHI
201911332481	MIMOSO DE GOIAS	MJ12305276	PADRE BERNARDO	25/11/2019 17:33	25/11/2019 21:38	25/11/2019 17:33	25/11/2019 21:38	4,09	7	28,63	CHI
201911332489	COCALZINHO DE GOIAS	PB10400401	PADRE BERNARDO	25/11/2019 17:01	25/11/2019 19:13	25/11/2019 17:01	25/11/2019 19:13	2,21	41	90,51	CHI
201911332489	DISTRITO FEDERAL	PB10400401	PADRE BERNARDO	25/11/2019 17:01	25/11/2019 19:13	25/11/2019 17:01	25/11/2019 19:13	2,21	4	8,83	CHI
201911332489	ITARUMA	PB10400401	PADRE BERNARDO	25/11/2019 17:01	25/11/2019 19:13	25/11/2019 17:01	25/11/2019 19:13	2,21	1	2,21	CHI
201911332489	PADRE BERNARDO	PB10400401	PADRE BERNARDO	25/11/2019 17:01	25/11/2019 19:13	25/11/2019 17:01	25/11/2019 19:13	2,21	3480	7682,10	CHI
201911332489	PADRE BERNARDO	PB10400401	PADRE BERNARDO	25/11/2019 17:01	25/11/2019 19:13	25/11/2019 17:01	25/11/2019 19:13	2,21	1151	2540,83	CHI
201911332489	PLANALTINA	PB10400401	PADRE BERNARDO	25/11/2019 17:01	25/11/2019 19:13	25/11/2019 17:01	25/11/2019 19:13	2,21	3	6,62	CHI

201911332490	CAMPO ALEGRE DE GOIAS	CM12215704	CAMPO ALEGRE DE GOIAS	25/11/2019 12:05	26/11/2019 16:50	25/11/2019 12:05	26/11/2019 16:50	28,75	3	86,24	CHI
201911332493	URUACU	CR12271956	MARA ROSA	25/11/2019 17:01	26/11/2019 00:05	25/11/2019 17:01	26/11/2019 00:05	7,06	2	14,12	CHI
201911332500	CRISTALINA	KR21805420	CRISTALINA S1	25/11/2019 17:01	25/11/2019 19:59	25/11/2019 17:01	25/11/2019 19:59	2,96	1	2,96	CHI
201911332507	SAO DOMINGOS	SD21195978	SAO DOMINGOS	25/11/2019 17:03	26/11/2019 10:02	25/11/2019 17:03	26/11/2019 10:02	16,98	1	16,98	CHI
201911332510	INHUMAS	CK21380296	INHUMAS S1	25/11/2019 17:03	26/11/2019 11:48	25/11/2019 17:03	26/11/2019 11:48	18,74	2	37,48	CHI
201911332512	RIO VERDE	RV11093029	RIO VERDE S1	25/11/2019 14:01	26/11/2019 02:09	25/11/2019 14:01	26/11/2019 02:09	12,13	168	2037,79	CHI
201911332515	ALEXANIA	AX12071776	ALEXANIA	25/11/2019 17:00	26/11/2019 15:31	25/11/2019 17:00	26/11/2019 15:31	22,51	14	315,12	CHI
201911332518	PLANALTINA	PI12117128	SAO JOAO D ALIANCA	25/11/2019 15:41	26/11/2019 13:21	25/11/2019 15:41	26/11/2019 13:21	21,66	9	194,91	CHI
201911332525	CHAPADAO DO CEU	10005570830	CHAPADAO DO CEU	25/11/2019 17:04	26/11/2019 09:17	25/11/2019 17:04	26/11/2019 09:17	16,20	1	16,20	CHI
201911332527	GOIANESIA	GE12000204	GOIANESIA S2	25/11/2019 15:44	27/11/2019 08:41	25/11/2019 15:44	27/11/2019 08:41	40,94	4	163,76	CHI
201911332539	ARENOPOLIS	AY12245925	ARENOPOLIS	25/11/2019 17:07	26/11/2019 10:45	25/11/2019 17:07	26/11/2019 10:45	17,63	3	52,88	CHI
201911332540	PIRACANJUBA	PJ12084826	PIRACANJUBA	25/11/2019 17:07	26/11/2019 23:44	25/11/2019 17:07	26/11/2019 23:44	30,61	9	275,48	CHI
201911332543	APARECIDA DE GOIANIA	AP21007572	CEPAIGO S1	25/11/2019 17:07	26/11/2019 09:41	25/11/2019 17:07	26/11/2019 09:41	16,56	2	33,11	CHI
201911332548	RIO VERDE	RV12230885	CABRIUVA S1	25/11/2019 15:29	25/11/2019 22:40	25/11/2019 15:29	25/11/2019 22:40	7,17	5	35,86	CHI
201911332551	NIQUELANDIA	NQ12234274	NIQUELANDIA SUBTRANSMISSAO	25/11/2019 17:09	26/11/2019 16:52	25/11/2019 17:09	26/11/2019 16:52	23,71	9	213,41	CHI
201911332555	GOIANIA	11224125	XAVANTES	25/11/2019 17:09	25/11/2019 20:27	25/11/2019 17:09	25/11/2019 20:27	3,29	1	3,29	CHI
201911332559	ANAPOLIS	10012200580	JUNDIAI S1	25/11/2019 17:10	26/11/2019 07:25	25/11/2019 17:10	26/11/2019 07:25	14,24	1	14,24	CHI
201911332561	MOIPIORA	MO21015665	IPORA	26/11/2019 06:05	26/11/2019 12:25	26/11/2019 06:05	26/11/2019 12:25	6,34	1	6,34	CHI
201911332568	TRINDADE	40238301	TRINDADE	25/11/2019 17:11	25/11/2019 21:38	25/11/2019 17:11	25/11/2019 21:38	4,44	1	4,44	CHI
201911332570	CAIAPONIA	DV12023480	CAIAPONIA	25/11/2019 15:38	25/11/2019 21:10	25/11/2019 15:38	25/11/2019 21:10	5,53	148	818,40	CHI
201911332570	DOVERLANDIA	DV12023480	CAIAPONIA	25/11/2019 15:38	25/11/2019 21:10	25/11/2019 15:38	25/11/2019 21:10	5,53	11	60,83	CHI
201911332570	PIRANHAS	DV12023480	CAIAPONIA	25/11/2019 15:38	25/11/2019 21:10	25/11/2019 15:38	25/11/2019 21:10	5,53	76	420,26	CHI
201911332572	ANAPOLIS	20526222	JUNDIAI S1	25/11/2019 17:12	25/11/2019 19:13	25/11/2019 17:12	25/11/2019 19:13	2,02	1	2,02	CHI
201911332583	BELA VISTA DE GOIAS	BV12291753	BELA VISTA S1	25/11/2019 16:54	25/11/2019 18:13	25/11/2019 16:54	25/11/2019 18:13	1,31	85	111,52	CHI
201911332597	PIRENOPOLIS	PV11272979	CORUMBA	25/11/2019 16:38	25/11/2019 22:39	25/11/2019 16:38	25/11/2019 22:39	6,01	57	342,49	CHI
201911332608	GOIANIA	GN12222920	ATLANTICO S2	25/11/2019 15:09	25/11/2019 19:38	25/11/2019 15:09	25/11/2019 19:38	4,48	201	900,42	CHI
201911332610	FORMOSA	2920007914	ITUIQUIRA	25/11/2019 17:15	26/11/2019 09:48	25/11/2019 17:15	26/11/2019 09:48	16,54	1	16,54	CHI
201911332613	ALTO PARAISO DE GOIAS	BF21392369	FLORES DE GOIAS	25/11/2019 17:21	25/11/2019 18:02	25/11/2019 17:21	25/11/2019 18:02	0,68	1	0,68	CHI
201911332616	ITAPURANGA	IK12300342	ITAPURANGA	25/11/2019 16:52	26/11/2019 09:07	25/11/2019 16:52	26/11/2019 09:07	16,25	38	617,44	CHI
201911332621	FAZENDA NOVA	IS12381080	IPORA	25/11/2019 17:16	26/11/2019 10:30	25/11/2019 17:16	26/11/2019 10:30	17,23	9	155,08	CHI
201911332621	ISRAELANDIA	IS12381080	IPORA	25/11/2019 17:16	26/11/2019 10:30	25/11/2019 17:16	26/11/2019 10:30	17,23	2	34,46	CHI
201911332622	CALDAS NOVAS	CN11393846	SERRA DE CALDAS	25/11/2019 16:49	25/11/2019 19:04	25/11/2019 16:49	25/11/2019 19:04	2,24	50	111,85	CHI
201911332639	JARAGUA	JA12059983	JARAGUA	25/11/2019 15:30	25/11/2019 19:49	25/11/2019 15:30	25/11/2019 19:49	4,30	89	383,12	CHI



201911332640	CAIAPONIA	930034636	CAIAPONIA	25/11/2019 17:18	26/11/2019 12:12	25/11/2019 17:18	26/11/2019 12:12	18,90	1	18,90	CHI
201911332641	PIRES DO RIO	PR11020461	PIRES DO RIO S1	25/11/2019 17:04	26/11/2019 14:38	25/11/2019 17:04	26/11/2019 14:38	21,56	91	1962,16	CHI
201911332646	BALIZA	BM12390150	BOM JARDIM	25/11/2019 17:19	26/11/2019 06:32	25/11/2019 17:19	26/11/2019 06:32	13,21	52	687,06	CHI
201911332646	BOM JARDIM DE GOIAS	BM12390150	BOM JARDIM	25/11/2019 17:19	26/11/2019 06:32	25/11/2019 17:19	26/11/2019 06:32	13,21	9	118,91	CHI
201911332649	GOIANIA	10000538165	CAMPINAS S2	25/11/2019 17:19	25/11/2019 20:01	25/11/2019 17:19	25/11/2019 20:01	2,69	1	2,69	CHI
201911332655	DIVINOPOLIS DE GOIAS	2570005132	SAO DOMINGOS	25/11/2019 17:19	25/11/2019 23:34	25/11/2019 17:19	25/11/2019 23:34	6,24	1	6,24	CHI
201911332658	APARECIDA DE GOIANIA	13035514	INDEPENDENCIA S2	25/11/2019 17:19	25/11/2019 19:27	25/11/2019 17:19	25/11/2019 19:27	2,12	1	2,12	CHI
201911332659	BARRO ALTO	GE12115071	GOIANESIA S1	25/11/2019 14:48	26/11/2019 02:34	25/11/2019 14:48	26/11/2019 02:34	11,76	2	23,53	CHI
201911332659	GOIANESIA	GE12115071	GOIANESIA S1	25/11/2019 14:48	26/11/2019 02:34	25/11/2019 14:48	26/11/2019 02:34	11,76	10	117,63	CHI
201911332665	APARECIDA DE GOIANIA	13750630	INDEPENDENCIA S1	25/11/2019 17:20	26/11/2019 21:32	25/11/2019 17:20	26/11/2019 21:32	28,19	1	28,19	CHI
201911332670	SANTA HELENA DE GOIAS	400013046	IPEGUARI	25/11/2019 17:21	26/11/2019 07:45	25/11/2019 17:21	26/11/2019 07:45	14,40	1	14,40	CHI
201911332679	ALTO PARAISO DE GOIAS	BF12105397	SAO JOAO D ALIANCA	25/11/2019 16:36	25/11/2019 19:10	25/11/2019 16:36	25/11/2019 19:10	2,56	209	534,63	CHI
201911332680	JATAI	290109346	JATAI S2	25/11/2019 17:22	26/11/2019 14:12	25/11/2019 17:22	26/11/2019 14:12	20,83	1	20,83	CHI
201911332682	BARRO ALTO	BA21345791	GOIANESIA S1	25/11/2019 17:22	27/11/2019 21:32	25/11/2019 17:22	27/11/2019 21:32	52,15	1	52,15	CHI
201911332686	GOIANIA	14045631	XAVANTES	25/11/2019 17:23	25/11/2019 22:07	25/11/2019 17:23	25/11/2019 22:07	4,73	1	4,73	CHI
201911332687	INHUMAS	IN11168392	INHUMAS S2	25/11/2019 14:46	25/11/2019 18:04	25/11/2019 14:46	25/11/2019 18:04	3,31	78	258,46	CHI
201911332690	GOIANIRA	GR21015723	INHUMAS S1	25/11/2019 17:23	26/11/2019 11:39	25/11/2019 17:23	26/11/2019 11:39	18,26	1	18,26	CHI
201911332698	GOIANIA	14331147	CARAJAS S2	25/11/2019 17:24	25/11/2019 19:58	25/11/2019 17:24	25/11/2019 19:58	2,56	1	2,56	CHI
201911332707	CRIXAS	CX12284412	SERRA DO OURO	25/11/2019 16:21	25/11/2019 19:39	25/11/2019 16:21	25/11/2019 19:39	3,29	70	230,47	CHI
201911332714	MINEIROS	MY21322113	PARQUE DAS EMAS	25/11/2019 17:27	26/11/2019 11:34	25/11/2019 17:27	26/11/2019 11:34	18,11	1	18,11	CHI
201911332716	PETROLINA DE GOIAS	PG12015781	PETROLINA	25/11/2019 16:35	26/11/2019 04:04	25/11/2019 16:35	26/11/2019 04:04	11,47	24	275,35	CHI
201911332719	PIRES DO RIO	PR11195088	PIRES DO RIO S1	25/11/2019 13:23	25/11/2019 21:40	25/11/2019 13:23	25/11/2019 21:40	8,29	106	879,12	CHI
201911332721	PIRACANJUBA	PJ21030031	CRISTIANOPOLIS	25/11/2019 17:28	26/11/2019 17:00	25/11/2019 17:28	26/11/2019 17:00	23,52	1	23,52	CHI
201911332727	MUNDO NOVO DE GOIAS	MH12391952	NOVA CRIXAS	25/11/2019 16:04	26/11/2019 13:22	25/11/2019 16:04	26/11/2019 13:22	21,29	29	617,27	CHI
201911332731	ARAGUAPAZ	FC12299833	GOIAS	25/11/2019 17:30	25/11/2019 18:34	25/11/2019 17:30	25/11/2019 18:34	1,06	16	16,94	CHI
201911332731	FAINA	FC12299833	GOIAS	25/11/2019 17:30	25/11/2019 18:34	25/11/2019 17:30	25/11/2019 18:34	1,06	9	9,53	CHI
201911332735	NOVO GAMA	NJ11283925	MARAJOARA	25/11/2019 17:30	25/11/2019 20:30	25/11/2019 17:30	25/11/2019 20:30	2,99	32	95,65	CHI
201911332739	DOVERLANDIA	DV11253347	CAIAPONIA	25/11/2019 17:16	26/11/2019 16:13	25/11/2019 17:16	26/11/2019 16:13	22,95	1	22,95	CHI
201911332745	AGUA FRIA DE GOIAS	PI12048039	SAO JOAO D ALIANCA	25/11/2019 15:23	26/11/2019 14:57	25/11/2019 15:23	26/11/2019 14:57	23,56	44	1036,69	CHI
201911332746	ORIZONA	OZ21143503	VIANOPOLIS	25/11/2019 17:32	26/11/2019 10:16	25/11/2019 17:32	26/11/2019 10:16	16,73	1	16,73	CHI
201911332747	GOIAS	IK12250614	ITAPURANGA	25/11/2019 17:25	26/11/2019 07:27	25/11/2019 17:25	26/11/2019 07:27	14,04	2	28,07	CHI
201911332747	GUARAITA	IK12250614	ITAPURANGA	25/11/2019 17:25	26/11/2019 07:27	25/11/2019 17:25	26/11/2019 07:27	14,04	18	252,67	CHI
201911332747	ITAPURANGA	IK12250614	ITAPURANGA	25/11/2019 17:25	26/11/2019 07:27	25/11/2019 17:25	26/11/2019 07:27	14,04	23	322,86	CHI

201911332748	VICENTINOPOLIS	VI21269126	VICENTINOPOLIS	25/11/2019 17:32	26/11/2019 13:00	25/11/2019 17:32	26/11/2019 13:00	19,45	1	19,45	CHI
201911332752	CACHOEIRA DOURADA	3280007493	CACHOEIRA DOURADA	25/11/2019 17:33	26/11/2019 16:25	25/11/2019 17:33	26/11/2019 16:25	22,86	1	22,86	CHI
201911332755	ANAPOLIS	AN12388770	ANAPOLIS UNIVERSITARIO S2	25/11/2019 17:33	26/11/2019 09:21	25/11/2019 17:33	26/11/2019 09:21	15,79	1	15,79	CHI
201911332756	ANAPOLIS	AN11072945	JUNDIAI S1	25/11/2019 16:26	25/11/2019 21:47	25/11/2019 16:26	25/11/2019 21:47	5,34	119	635,06	CHI
201911332772	CAMPOS BELOS	820002732	SAO DOMINGOS	25/11/2019 17:34	25/11/2019 18:52	25/11/2019 17:34	25/11/2019 18:52	1,29	1	1,29	CHI
201911332774	APARECIDA DE GOIANIA	14930870	INDEPENDENCIA S2	25/11/2019 17:34	25/11/2019 23:05	25/11/2019 17:34	25/11/2019 23:05	5,50	1	5,50	CHI
201911332775	SILVANIA	SV11241014	VIANOPOLIS	25/11/2019 17:16	26/11/2019 07:39	25/11/2019 17:16	26/11/2019 07:39	14,38	142	2041,88	CHI
201911332778	CRISTALINA	KR11032618	PAMPLONA	25/11/2019 17:12	25/11/2019 21:25	25/11/2019 17:12	25/11/2019 21:25	4,20	65	273,04	CHI
201911332783	DOVERLANDIA	DV12223236	CAIAPONIA	25/11/2019 17:36	26/11/2019 10:11	25/11/2019 17:36	26/11/2019 10:11	16,57	15	248,57	CHI
201911332786	GUARINOS	GF12164878	SANTA TEREZINHA	25/11/2019 14:06	27/11/2019 19:29	25/11/2019 14:06	26/11/2019 11:51	21,75	10	217,48	CHI
201911332786	GUARINOS	GF12164878	SANTA TEREZINHA	25/11/2019 14:06	27/11/2019 19:29	25/11/2019 14:06	27/11/2019 18:48	52,70	45	2371,36	CHI
201911332786	GUARINOS	GF12164878	SANTA TEREZINHA	25/11/2019 14:06	27/11/2019 19:29	25/11/2019 14:06	27/11/2019 19:29	53,38	2	106,76	CHI
201911332789	AGUA FRIA DE GOIAS	TL12193668	SAO JOAO D ALIANCA	25/11/2019 17:37	27/11/2019 15:52	25/11/2019 17:37	27/11/2019 15:52	46,25	3	138,74	CHI
201911332793	CRIXAS	CX12286780	RUBIATABA	25/11/2019 17:37	26/11/2019 16:14	25/11/2019 17:37	26/11/2019 16:14	22,60	9	203,44	CHI
201911332797	ITAUCU	IX21293429	INHUMAS S1	25/11/2019 17:37	26/11/2019 11:33	25/11/2019 17:37	26/11/2019 11:33	17,92	2	35,83	CHI
201911332799	ISRAELANDIA	IS12184272	IPORA	25/11/2019 17:38	26/11/2019 13:50	25/11/2019 17:38	26/11/2019 13:50	20,20	6	121,19	CHI
201911332801	NAZARIO	NZ21000052	ANICUNS	25/11/2019 17:38	26/11/2019 11:33	25/11/2019 17:38	26/11/2019 11:33	17,92	1	17,92	CHI
201911332803	BELA VISTA DE GOIAS	BV10406910	BELA VISTA S1	25/11/2019 17:38	25/11/2019 22:12	25/11/2019 17:38	25/11/2019 22:12	4,57	1259	5753,28	CHI
201911332803	BELA VISTA DE GOIAS	BV10406910	BELA VISTA S1	25/11/2019 17:38	25/11/2019 22:12	25/11/2019 21:21	25/11/2019 22:12	0,84	1895	1596,54	CHI
201911332803	BELA VISTA DE GOIAS	BV11188884	BELA VISTA S1	25/11/2019 17:38	25/11/2019 22:12	25/11/2019 17:38	25/11/2019 22:12	4,58	43	196,84	CHI
201911332810	ABADIANIA	AA31004380	ANAPOLIS UNIVERSITARIO S2	25/11/2019 17:38	26/11/2019 14:06	25/11/2019 17:38	26/11/2019 14:06	20,45	1	20,45	CHI
201911332818	APARECIDA DE GOIANIA	AP11234807	INDEPENDENCIA S1	25/11/2019 17:19	26/11/2019 12:18	25/11/2019 17:19	26/11/2019 12:18	18,98	75	1423,21	CHI
201911332819	COCALZINHO DE GOIAS	ZN21130706	COCALZINHO	25/11/2019 17:39	25/11/2019 20:50	25/11/2019 17:39	25/11/2019 20:50	3,17	1	3,17	CHI
201911332821	SILVANIA	SV21319703	DAIA S2	25/11/2019 17:40	26/11/2019 09:21	25/11/2019 17:40	26/11/2019 09:21	15,68	1	15,68	CHI
201911332823	NOVA CRIXAS	NA21209002	NOVA CRIXAS	25/11/2019 17:40	26/11/2019 17:08	25/11/2019 17:40	26/11/2019 17:08	23,46	1	23,46	CHI
201911332834	SANTA TEREZINHA DE GOIAS	SG21210194	SANTA TEREZINHA	25/11/2019 17:41	27/11/2019 08:20	25/11/2019 17:41	27/11/2019 08:20	38,66	1	38,66	CHI
201911332835	ANICUNS	AC21158660	ANICUNS	25/11/2019 17:41	26/11/2019 10:50	25/11/2019 17:41	26/11/2019 10:50	17,15	1	17,15	CHI
201911332836	JARAGUA	JA12297448	JARAGUA	25/11/2019 13:31	25/11/2019 21:03	25/11/2019 13:31	25/11/2019 21:03	7,52	159	1196,25	CHI
201911332836	PIRENOPOLIS	JA12297448	JARAGUA	25/11/2019 13:31	25/11/2019 21:03	25/11/2019 13:31	25/11/2019 21:03	7,52	36	270,85	CHI
201911332839	PALMEIRAS DE GOIAS	PL12398710	PALMEIRAS	25/11/2019 17:41	26/11/2019 11:07	25/11/2019 17:41	26/11/2019 11:07	17,44	21	366,15	CHI
201911332842	CACHOEIRA DOURADA	CD12000311	CACHOEIRA DOURADA	25/11/2019 17:39	25/11/2019 20:47	25/11/2019 17:39	25/11/2019 20:47	3,12	6	18,74	CHI
201911332849	CRISTALINA	KR21230250	CRISTALINA S2	25/11/2019 18:52	26/11/2019 09:33	25/11/2019 18:52	26/11/2019 09:33	14,67	1	14,67	CHI
201911332850	JATAI	JT12337012	JATAI S2	25/11/2019 17:04	25/11/2019 22:00	25/11/2019 17:04	25/11/2019 22:00	4,93	128	630,47	CHI

201911332860	GOIANIA	GN11323132	AEROPORTO S2	25/11/2019 16:06	25/11/2019 18:58	25/11/2019 16:06	25/11/2019 18:58	2,85	35	99,84	CHI
201911332864	AMORINOPOLIS	AM21000021	IPORA	25/11/2019 17:43	26/11/2019 12:50	25/11/2019 17:43	26/11/2019 12:50	19,11	1	19,11	CHI
201911332866	BALIZA	BH12331338	CAIAPONIA	25/11/2019 16:29	26/11/2019 10:38	25/11/2019 16:29	26/11/2019 10:38	18,14	80	1451,38	CHI
201911332879	GOUVELANDIA	QI21000127	QUIRINOPOLIS	25/11/2019 17:44	25/11/2019 19:03	25/11/2019 17:44	25/11/2019 19:03	1,30	2	2,60	CHI
201911332881	RIO VERDE	RV21190357	CABRIUVA S2	25/11/2019 17:44	26/11/2019 09:31	25/11/2019 17:44	26/11/2019 09:31	15,77	1	15,77	CHI
201911332883	SANTA TEREZINHA DE GOIAS	SG11181030	SANTA TEREZINHA	25/11/2019 17:45	26/11/2019 05:45	25/11/2019 17:45	26/11/2019 05:45	12,01	155	1861,25	CHI
201911332896	ABADIANIA	AN12001083	ANAPOLIS UNIVERSITARIO S2	25/11/2019 15:36	26/11/2019 13:03	25/11/2019 15:36	26/11/2019 13:03	21,44	30	643,15	CHI
201911332903	CALDAS NOVAS	10002633220	CALDAS NOVAS S2	25/11/2019 17:46	26/11/2019 10:30	25/11/2019 17:46	26/11/2019 10:30	16,73	1	16,73	CHI
201911332904	NOVO BRASIL	NB12396240	JUSSARA	25/11/2019 16:48	26/11/2019 11:15	25/11/2019 16:48	26/11/2019 11:15	18,44	10	184,39	CHI
201911332915	GOIANESIA	GE12115053	GOIANESIA S2	25/11/2019 17:47	27/11/2019 07:51	25/11/2019 17:47	27/11/2019 07:51	38,06	1	38,06	CHI
201911332928	BURITINOPOLIS	MB12314303	IACIARA S2	25/11/2019 17:48	25/11/2019 19:44	25/11/2019 17:48	25/11/2019 19:44	1,93	2	3,86	CHI
201911332928	MAMBAI	MB12314303	IACIARA S2	25/11/2019 17:48	25/11/2019 19:44	25/11/2019 17:48	25/11/2019 19:44	1,93	3	5,79	CHI
201911332941	SANTA HELENA DE GOIAS	400128690	IPEGUARI	25/11/2019 17:49	26/11/2019 00:04	25/11/2019 17:49	26/11/2019 00:04	6,25	1	6,25	CHI
201911332944	CAIAPONIA	CP12245300	CAIAPONIA	25/11/2019 16:17	26/11/2019 09:48	25/11/2019 16:17	26/11/2019 09:48	17,51	38	665,40	CHI
201911332945	GOIANESIA	550044711	GOIANESIA S1	25/11/2019 17:49	26/11/2019 04:47	25/11/2019 17:49	26/11/2019 04:47	10,96	1	10,96	CHI
201911332954	GOIANESIA	JA12297408	GOIANESIA S2	25/11/2019 17:50	26/11/2019 11:58	25/11/2019 17:50	26/11/2019 11:58	18,14	1	18,14	CHI
201911332954	JARAGUA	JA12297408	GOIANESIA S2	25/11/2019 17:50	26/11/2019 11:58	25/11/2019 17:50	26/11/2019 11:58	18,14	13	235,78	CHI
201911332961	APARECIDA DE GOIANIA	10002670834	INDEPENDENCIA S2	25/11/2019 17:51	25/11/2019 21:39	25/11/2019 17:51	25/11/2019 21:39	3,79	1	3,79	CHI
201911332969	IPORA	IR12014480	IPORA	25/11/2019 17:45	25/11/2019 18:40	25/11/2019 17:45	25/11/2019 18:40	0,90	14	12,61	CHI
201911332972	AMARALINA	LC12278480	MARA ROSA	25/11/2019 17:52	26/11/2019 11:00	25/11/2019 17:52	26/11/2019 11:00	17,13	3	51,39	CHI
201911332976	CAIAPONIA	CP12354549	CAIAPONIA	25/11/2019 13:09	26/11/2019 09:13	25/11/2019 13:09	26/11/2019 09:13	20,05	12	240,64	CHI
201911332979	NOVO BRASIL	NB12396244	JUSSARA	25/11/2019 17:49	26/11/2019 08:40	25/11/2019 17:49	26/11/2019 08:40	14,86	5	74,28	CHI
201911332983	RIO VERDE	RV21136256	MONTIVIDIU T	25/11/2019 17:53	26/11/2019 10:44	25/11/2019 17:53	26/11/2019 10:44	16,84	1	16,84	CHI
201911332985	AMORINOPOLIS	AM12000005	IPORA	25/11/2019 13:30	25/11/2019 22:54	25/11/2019 13:30	25/11/2019 22:54	9,38	31	290,93	CHI
201911332985	IVOLANDIA	AM12000005	IPORA	25/11/2019 13:30	25/11/2019 22:54	25/11/2019 13:30	25/11/2019 22:54	9,38	2	18,77	CHI
201911332987	MOSSAMEDES	MD12024152	FIRMINOPOLIS S2	25/11/2019 10:59	25/11/2019 19:40	25/11/2019 10:59	25/11/2019 19:40	8,67	109	945,51	CHI
201911332987	SANCLERLANDIA	MD12024152	FIRMINOPOLIS S2	25/11/2019 10:59	25/11/2019 19:40	25/11/2019 10:59	25/11/2019 19:40	8,67	8	69,40	CHI
201911332993	DOVERLANDIA	DV12212855	CAIAPONIA	25/11/2019 17:54	26/11/2019 13:39	25/11/2019 17:54	26/11/2019 13:39	19,73	6	118,41	CHI
201911332995	ARAGOIANIA	AO31060883	GUAPO S2	25/11/2019 17:54	26/11/2019 11:00	25/11/2019 17:54	26/11/2019 11:00	17,10	1	17,10	CHI
201911332996	IPORA	IR12033222	IPORA	25/11/2019 17:55	26/11/2019 14:11	25/11/2019 17:55	26/11/2019 14:11	20,27	4	81,06	CHI
201911333013	CEZARINA	CZ12323632	CEZARINA	25/11/2019 17:56	26/11/2019 17:09	25/11/2019 17:56	26/11/2019 17:09	23,22	4	92,88	CHI
201911333013	INDIARA	CZ12323632	CEZARINA	25/11/2019 17:56	26/11/2019 17:09	25/11/2019 17:56	26/11/2019 17:09	23,22	3	69,66	CHI
201911333015	IPAMERI	IP12071030	IPAMERI	25/11/2019 17:57	25/11/2019 20:05	25/11/2019 17:57	25/11/2019 20:05	2,13	2	4,26	CHI

201911333016	JARAGUA	JA12353235	GOIANESIA S2	25/11/2019 16:09	26/11/2019 12:40	25/11/2019 16:09	26/11/2019 12:40	20,51	16	328,21	CHI
201911333023	MOZARLANDIA	MZ11158815	MOZARLANDIA	25/11/2019 17:58	25/11/2019 20:24	25/11/2019 17:58	25/11/2019 20:24	2,43	15	36,43	CHI
201911333027	NIQUELANDIA	NQ12181047	URUACU	25/11/2019 16:57	26/11/2019 00:22	25/11/2019 16:57	26/11/2019 00:22	7,41	10	74,12	CHI
201911333029	GOIATUBA	GT12008236	BOM JESUS DE GOIAS	25/11/2019 13:10	26/11/2019 10:17	25/11/2019 13:10	26/11/2019 10:17	21,12	17	359,07	CHI
201911333033	CALDAS NOVAS	760069359	SERRA DE CALDAS	25/11/2019 17:59	26/11/2019 16:19	25/11/2019 17:59	26/11/2019 16:19	22,33	1	22,33	CHI
201911333040	SANTO ANTONIO DO DESCOBERTO	2210083236	AGUAS LINDAS DE GOIAS S2	25/11/2019 17:59	25/11/2019 19:58	25/11/2019 17:59	25/11/2019 19:58	1,97	1	1,97	CHI
201911333049	JATAI	JT12211164	JATAI S2	25/11/2019 18:00	26/11/2019 15:40	25/11/2019 18:00	26/11/2019 15:40	21,66	10	216,58	CHI
201911333056	CUMARI	CY21000305	CATALAO S1	25/11/2019 18:01	26/11/2019 11:29	25/11/2019 18:01	26/11/2019 11:29	17,46	1	17,46	CHI
201911333060	GOIAS	GS11274470	GOIAS	25/11/2019 18:02	27/11/2019 11:29	25/11/2019 18:02	27/11/2019 11:29	41,45	5	207,27	CHI
201911333062	PADRE BERNARDO	PB12382236	PADRE BERNARDO	25/11/2019 18:02	26/11/2019 07:51	25/11/2019 18:02	26/11/2019 07:51	13,80	7	96,63	CHI
201911333070	MONTIVIDIU	MV21260840	MONTIVIDIU T	25/11/2019 18:03	26/11/2019 12:55	25/11/2019 18:03	26/11/2019 12:55	18,86	1	18,86	CHI
201911333078	NOVA VENEZA	NV11202315	INHUMAS S1	25/11/2019 15:03	25/11/2019 22:18	25/11/2019 15:03	25/11/2019 22:18	7,24	28	202,86	CHI
201911333079	INDIARA	PL21029696	EDEIA	25/11/2019 18:04	26/11/2019 11:45	25/11/2019 18:04	26/11/2019 11:45	17,68	1	17,68	CHI
201911333084	BRAZABRANTES	BR21132772	NEROPOLIS S1	25/11/2019 18:04	26/11/2019 13:59	25/11/2019 18:04	26/11/2019 13:59	19,90	1	19,90	CHI
201911333092	NOVO BRASIL	NB12047598	JUSSARA	25/11/2019 17:16	26/11/2019 10:00	25/11/2019 17:16	26/11/2019 10:00	16,73	13	217,44	CHI
201911333096	ITARUMA	IM21239560	CACHOEIRA ALTA	25/11/2019 18:17	25/11/2019 19:20	25/11/2019 18:17	25/11/2019 19:20	1,05	2	2,09	CHI
201911333097	VILA PROPICIO	PV12073537	GOIANESIA S1	25/11/2019 18:06	26/11/2019 17:03	25/11/2019 18:06	26/11/2019 17:03	22,94	5	114,68	CHI
201911333102	BOM JESUS DE GOIAS	BJ12000333	BOM JESUS DE GOIAS	25/11/2019 18:07	25/11/2019 23:15	25/11/2019 18:07	25/11/2019 23:15	5,12	4	20,50	CHI
201911333107	SAO JOAO D ALIANCA	JL12325730	SAO JOAO D ALIANCA	25/11/2019 18:08	26/11/2019 16:42	25/11/2019 18:08	26/11/2019 16:42	22,57	13	293,36	CHI
201911333111	APARECIDA DE GOIANIA	10018350621	INDEPENDENCIA S1	25/11/2019 18:08	25/11/2019 20:11	25/11/2019 18:08	25/11/2019 20:11	2,04	1	2,04	CHI
201911333113	PIRACANJUBA	PJ21029245	CRISTIANOPOLIS	25/11/2019 18:08	26/11/2019 17:23	25/11/2019 18:08	26/11/2019 17:23	23,24	1	23,24	CHI
201911333122	PLANALTINA	PI12101089	PLANALTINA	25/11/2019 18:09	25/11/2019 20:24	25/11/2019 18:09	25/11/2019 20:24	2,24	1	2,24	CHI
201911333123	DOVERLANDIA	DV12395475	CAIAPONIA	25/11/2019 17:11	26/11/2019 08:50	25/11/2019 17:11	26/11/2019 08:50	15,65	11	172,12	CHI
201911333129	LUZIANIA	LZ12162291	CRISTALINA S1	25/11/2019 16:01	25/11/2019 23:35	25/11/2019 16:01	25/11/2019 23:35	7,56	15	113,37	CHI
201911333135	APARECIDA DE GOIANIA	AP12147249	ATLANTICO S2	25/11/2019 17:42	25/11/2019 20:26	25/11/2019 17:42	25/11/2019 20:26	2,72	323	877,84	CHI
201911333137	IPAMERI	580065650	IPAMERI	25/11/2019 18:11	26/11/2019 08:15	25/11/2019 18:11	26/11/2019 08:15	14,06	1	14,06	CHI
201911333140	CRISTIANOPOLIS	CF12309628	CRISTIANOPOLIS	25/11/2019 18:00	26/11/2019 12:01	25/11/2019 18:00	26/11/2019 12:01	18,03	3	54,09	CHI
201911333141	NIQUELANDIA	NQ21291041	BARRO ALTO	25/11/2019 18:11	26/11/2019 01:55	25/11/2019 18:11	26/11/2019 01:55	7,72	1	7,72	CHI
201911333152	APARECIDA DE GOIANIA	10000313317	ATLANTICO S3	25/11/2019 18:12	25/11/2019 20:57	25/11/2019 18:12	25/11/2019 20:57	2,75	1	2,75	CHI
201911333153	JUSSARA	1290078856	JUSSARA	25/11/2019 18:12	26/11/2019 13:30	25/11/2019 18:12	26/11/2019 13:30	19,31	1	19,31	CHI
201911333155	ITARUMA	CC12000108	CACHOEIRA ALTA	25/11/2019 18:12	28/11/2019 22:08	25/11/2019 18:12	26/11/2019 11:41	17,48	9	157,34	CHI
201911333155	ITARUMA	CC12000108	CACHOEIRA ALTA	25/11/2019 18:12	28/11/2019 22:08	25/11/2019 18:12	27/11/2019 02:59	32,78	5	163,92	CHI
201911333155	ITARUMA	CC12000108	CACHOEIRA ALTA	25/11/2019 18:12	28/11/2019 22:08	28/11/2019 12:42	28/11/2019 13:12	0,49	13	6,43	CHI

201911333155	ITARUMA	CC12000108	CACHOEIRA ALTA	25/11/2019 18:12	28/11/2019 22:08	25/11/2019 18:12	28/11/2019 22:08	75,93	5	379,66	CHI
201911333157	PLANALTINA	PI12129929	PLANALTINA	25/11/2019 16:28	26/11/2019 16:33	25/11/2019 16:28	26/11/2019 16:33	24,08	32	770,54	CHI
201911333158	JARAGUA	JA21157782	JARAGUA	25/11/2019 18:12	26/11/2019 14:34	25/11/2019 18:12	26/11/2019 14:34	20,35	1	20,35	CHI
201911333161	JUSSARA	JR11101627	JUSSARA	25/11/2019 17:20	25/11/2019 20:51	25/11/2019 17:20	25/11/2019 20:51	3,52	62	217,95	CHI
201911333170	EDEALINA	ED21249776	EDEIA	25/11/2019 18:14	26/11/2019 16:23	25/11/2019 18:14	26/11/2019 16:23	22,15	1	22,15	CHI
201911333172	SANTA HELENA DE GOIAS	400003480	IPEGUARI	25/11/2019 18:14	25/11/2019 21:02	25/11/2019 18:14	25/11/2019 21:02	2,80	1	2,80	CHI
201911333175	SILVANIA	SV21129587	JUNDIAI S1	25/11/2019 18:14	26/11/2019 00:08	25/11/2019 18:14	26/11/2019 00:08	5,89	1	5,89	CHI
201911333178	BURITINOPOLIS	MB12344322RE	IACIARA S2	25/11/2019 18:10	25/11/2019 20:38	25/11/2019 18:10	25/11/2019 20:38	2,45	30	73,64	CHI
201911333178	MAMBAI	MB12344322RE	IACIARA S2	25/11/2019 18:10	25/11/2019 20:38	25/11/2019 18:10	25/11/2019 20:38	2,45	104	255,29	CHI
201911333181	CALDAS NOVAS	MG21000353	VILA CORUMBA	25/11/2019 18:15	26/11/2019 11:59	25/11/2019 18:15	26/11/2019 11:59	17,73	1	17,73	CHI
201911333196	HIDROLINA	HL21317005	SANTA TEREZINHA	25/11/2019 18:17	26/11/2019 10:02	25/11/2019 18:17	26/11/2019 10:02	15,74	1	15,74	CHI
201911333198	ANICUNS	AC12259100	ANICUNS	25/11/2019 17:23	26/11/2019 09:09	25/11/2019 17:23	26/11/2019 09:09	15,76	14	220,68	CHI
201911333201	DISTRITO FEDERAL	PI21195990	PLANALTINA	25/11/2019 18:17	25/11/2019 23:51	25/11/2019 18:17	25/11/2019 23:51	5,55	1	5,55	CHI
201911333206	NOVO BRASIL	NB11020195	JUSSARA	25/11/2019 17:31	26/11/2019 06:51	25/11/2019 17:31	26/11/2019 06:51	13,33	126	1679,16	CHI
201911333215	JOVIANIA	AD12394182	GOIATUBA S1	25/11/2019 16:42	26/11/2019 18:30	25/11/2019 16:42	26/11/2019 18:30	25,80	6	154,81	CHI
201911333215	PONTALINA	AD12394182	GOIATUBA S1	25/11/2019 16:42	26/11/2019 18:30	25/11/2019 16:42	26/11/2019 18:30	25,80	33	851,45	CHI
201911333218	ITABERAI	IB12220127	ITABERAI S1	25/11/2019 17:55	26/11/2019 10:32	25/11/2019 17:55	26/11/2019 10:32	16,61	286	4749,74	CHI
201911333224	SANTA TEREZINHA DE GOIAS	SG12213220	SANTA TEREZINHA	25/11/2019 17:14	27/11/2019 12:34	25/11/2019 17:14	26/11/2019 22:23	29,15	25	728,81	CHI
201911333224	SANTA TEREZINHA DE GOIAS	SG12213220	SANTA TEREZINHA	25/11/2019 17:14	27/11/2019 12:34	26/11/2019 22:24	27/11/2019 11:36	13,21	25	330,24	CHI
201911333224	SANTA TEREZINHA DE GOIAS	SG12197521LD	SANTA TEREZINHA	25/11/2019 17:14	27/11/2019 12:34	25/11/2019 17:14	27/11/2019 12:34	43,32	22	953,13	CHI
201911333227	ARUANA	AK12028880	BRITANIA	25/11/2019 18:20	26/11/2019 09:25	25/11/2019 18:20	26/11/2019 09:25	15,07	12	180,88	CHI
201911333227	BRITANIA	AK12028880	BRITANIA	25/11/2019 18:20	26/11/2019 09:25	25/11/2019 18:20	26/11/2019 09:25	15,07	1	15,07	CHI
201911333239	SENADOR CANEDO	190053458	SENADOR CANEDO	25/11/2019 18:21	25/11/2019 22:46	25/11/2019 18:21	25/11/2019 22:46	4,41	1	4,41	CHI
201911333243	MOZARLANDIA	MZ12063703	MOZARLANDIA	25/11/2019 18:22	27/11/2019 14:21	25/11/2019 18:22	27/11/2019 14:21	43,98	10	439,76	CHI
201911333245	CRISTALINA	KR11266420	CRISTALINA S2	25/11/2019 18:22	26/11/2019 09:57	25/11/2019 18:22	26/11/2019 09:57	15,57	2	31,14	CHI
201911333247	ITAPURANGA	IK21322513	ITAPURANGA	25/11/2019 18:10	26/11/2019 01:40	25/11/2019 18:10	26/11/2019 01:40	7,49	1	7,49	CHI
201911333289	FORMOSA	7681466	ITUIQUIRA	25/11/2019 18:24	26/11/2019 18:45	25/11/2019 18:24	26/11/2019 18:45	24,34	15	365,03	CHI
201911333295	CACU	CC12097088	CACHOEIRA ALTA	25/11/2019 18:25	26/11/2019 12:35	25/11/2019 18:25	26/11/2019 12:35	18,16	9	163,41	CHI
201911333303	CRISTALINA	KR21248322	CRISTALINA S2	25/11/2019 18:26	26/11/2019 10:48	25/11/2019 18:26	26/11/2019 10:48	16,36	1	16,36	CHI
201911333322	CRISTALINA	KR12352836	CRISTALINA S1	25/11/2019 18:21	25/11/2019 21:42	25/11/2019 18:21	25/11/2019 21:42	3,35	4	13,40	CHI
201911333328	ITUMBIARA	IT21293318	CACHOEIRA DOURADA	25/11/2019 18:28	26/11/2019 11:11	25/11/2019 18:28	26/11/2019 11:11	16,72	1	16,72	CHI
201911333336	GOIANIA	10008738040	GOYA S1	25/11/2019 18:28	25/11/2019 20:44	25/11/2019 18:28	25/11/2019 20:44	2,25	1	2,25	CHI
201911333341	SERRANOPOLIS	SX12166082	JATAI S1	25/11/2019 18:29	26/11/2019 09:14	25/11/2019 18:29	26/11/2019 09:14	14,75	19	280,22	CHI

201911333349	MAMBAI	MB12190551	IACIARA S2	25/11/2019 18:29	25/11/2019 23:49	25/11/2019 18:29	25/11/2019 23:49	5,33	3	15,98	CHI
201911333352	JATAI	JT12196245	JATAI S1	25/11/2019 18:30	26/11/2019 08:43	25/11/2019 18:30	26/11/2019 08:43	14,21	3	42,64	CHI
201911333358	CRIXAS	CX12380748	SERRA DO OURO	25/11/2019 16:56	25/11/2019 19:54	25/11/2019 16:56	25/11/2019 19:54	2,96	26	76,83	CHI
201911333360	CAIAPONIA	CP12204879	PIRANHAS	25/11/2019 18:29	26/11/2019 10:43	25/11/2019 18:29	26/11/2019 10:43	16,22	16	259,49	CHI
201911333362	RIO VERDE	10003362947	RIO VERDE S2	25/11/2019 18:30	26/11/2019 01:02	25/11/2019 18:30	26/11/2019 01:02	6,53	1	6,53	CHI
201911333366	CRISTALINA	KR12383029	CRISTALINA S2	25/11/2019 16:26	26/11/2019 11:50	25/11/2019 16:26	26/11/2019 11:50	19,40	5	96,99	CHI
201911333367	IPORA	IR12222975	IPORA	25/11/2019 16:24	26/11/2019 07:10	25/11/2019 16:24	26/11/2019 07:10	14,76	22	324,74	CHI
201911333367	IPORA	IR12222975	IPORA	25/11/2019 16:24	26/11/2019 07:10	25/11/2019 16:24	26/11/2019 07:10	14,76	44	649,46	CHI
201911333367	IVOLANDIA	IR12222975	IPORA	25/11/2019 16:24	26/11/2019 07:10	25/11/2019 16:24	26/11/2019 07:10	14,76	6	88,56	CHI
201911333367	MOIPORA	IR12222975	IPORA	25/11/2019 16:24	26/11/2019 07:10	25/11/2019 16:24	26/11/2019 07:10	14,76	20	295,21	CHI
201911333368	JATAI	JT12334255	JATAI S1	25/11/2019 18:31	26/11/2019 11:28	25/11/2019 18:31	26/11/2019 11:28	16,94	1	16,94	CHI
201911333369	ALTO PARAISO DE GOIAS	BF21129910	FLORES DE GOIAS	25/11/2019 18:31	26/11/2019 11:30	25/11/2019 18:31	26/11/2019 11:30	16,98	1	16,98	CHI
201911333370	ITABERAI	IB12107133	ITABERAI S1	25/11/2019 18:31	26/11/2019 09:42	25/11/2019 18:31	26/11/2019 09:42	15,18	1	15,18	CHI
201911333371	SAO LUIS DE MONTES BELOS	SL12006949	SAO LUIZ DOS MONTES BELOS	25/11/2019 18:10	25/11/2019 20:27	25/11/2019 18:10	25/11/2019 20:27	2,28	41	93,39	CHI
201911333375	GOIANESIA	GE12000111	GOIANESIA S1	25/11/2019 15:49	26/11/2019 17:31	25/11/2019 15:49	26/11/2019 17:31	25,68	1	25,68	CHI
201911333375	SANTA RITA DO NOVO DESTINO	GE12000111	GOIANESIA S1	25/11/2019 15:49	26/11/2019 17:31	25/11/2019 15:49	26/11/2019 17:31	25,68	8	205,47	CHI
201911333376	SANTA HELENA DE GOIAS	SH21306316	IPEGUARI	25/11/2019 18:31	26/11/2019 11:17	25/11/2019 18:31	26/11/2019 11:17	16,76	1	16,76	CHI
201911333377	PARANAIGUARA	2230016034	CACHOEIRA ALTA	25/11/2019 18:31	25/11/2019 22:21	25/11/2019 18:31	25/11/2019 22:21	3,82	1	3,82	CHI
201911333380	BOM JARDIM DE GOIAS	BM21155812	BOM JARDIM	25/11/2019 18:32	26/11/2019 11:22	25/11/2019 18:32	26/11/2019 11:22	16,82	1	16,82	CHI
201911333382	CORREGO DO OURO	CO12000058	FIRMINOPOLIS S2	25/11/2019 16:50	26/11/2019 13:50	25/11/2019 16:50	26/11/2019 00:02	7,20	3	21,61	CHI
201911333382	FAZENDA NOVA	CO12000058	FIRMINOPOLIS S2	25/11/2019 16:50	26/11/2019 13:50	25/11/2019 16:50	26/11/2019 13:50	21,00	27	566,99	CHI
201911333382	BURITI DE GOIAS	CO12000058	FIRMINOPOLIS S2	25/11/2019 16:50	26/11/2019 13:50	26/11/2019 08:58	26/11/2019 13:50	4,87	31	150,86	CHI
201911333382	CORREGO DO OURO	CO12000058	FIRMINOPOLIS S2	25/11/2019 16:50	26/11/2019 13:50	26/11/2019 08:58	26/11/2019 13:50	4,87	140	681,29	CHI
201911333382	FAZENDA NOVA	CO12000058	FIRMINOPOLIS S2	25/11/2019 16:50	26/11/2019 13:50	26/11/2019 08:58	26/11/2019 13:50	4,87	11	53,53	CHI
201911333386	CAMPINORTE	CR12247060	PORANGATU	25/11/2019 18:33	26/11/2019 10:25	25/11/2019 18:33	26/11/2019 10:25	15,86	9	142,76	CHI
201911333388	ITABERAI	IB12079203	ITABERAI S1	25/11/2019 17:35	26/11/2019 07:07	25/11/2019 17:35	26/11/2019 07:07	13,52	24	324,55	CHI
201911333394	DOVERLANDIA	DV12354650	CAIAPONIA	25/11/2019 18:07	27/11/2019 19:58	25/11/2019 18:07	27/11/2019 19:58	49,85	55	2741,70	CHI
201911333397	ITAPIRAPUA	IU12188141	MATRINCHA	25/11/2019 18:34	27/11/2019 10:08	25/11/2019 18:34	27/11/2019 10:08	39,57	3	118,70	CHI
201911333407	PIRANHAS	PH11157888	PIRANHAS	25/11/2019 15:34	26/11/2019 08:00	25/11/2019 15:34	26/11/2019 08:00	16,42	161	2643,49	CHI
201911333409	NIQUELANDIA	NQ12325258	SAO JOAO D ALIANCA	25/11/2019 18:34	26/11/2019 20:46	25/11/2019 18:34	26/11/2019 20:46	26,19	3	78,56	CHI
201911333410	SAO MIGUEL DO PASSA QUATRO	SQ12130588	CRISTIANOPOLIS	25/11/2019 18:34	26/11/2019 13:00	25/11/2019 18:34	26/11/2019 13:00	18,42	6	110,51	CHI
201911333414	URUACU	CR21155990	CAMPINORTE	25/11/2019 18:35	25/11/2019 21:37	25/11/2019 18:35	25/11/2019 21:37	3,03	1	3,03	CHI
201911333418	APARECIDA DE GOIANIA	AP11004898	REAL S1	25/11/2019 18:35	26/11/2019 17:50	25/11/2019 18:35	26/11/2019 17:50	23,25	58	1348,60	CHI

201911333424	CRIXAS	CX12390328	SANTA TEREZINHA	25/11/2019 18:36	26/11/2019 21:50	25/11/2019 18:36	26/11/2019 21:50	27,22	31	843,79	CHI
201911333437	JATAI	JT12000085	JATAI S3	25/11/2019 18:02	25/11/2019 19:25	25/11/2019 18:02	25/11/2019 19:25	1,39	1416	1971,39	CHI
201911333446	DOVERLANDIA	DV12217563	CAIAPONIA	25/11/2019 16:15	27/11/2019 18:01	25/11/2019 16:15	26/11/2019 10:18	18,05	15	270,69	CHI
201911333446	DOVERLANDIA	DV12139918LD	CAIAPONIA	25/11/2019 16:15	27/11/2019 18:01	25/11/2019 16:15	27/11/2019 15:37	47,37	2	94,74	CHI
201911333446	DOVERLANDIA	DV12342581	CAIAPONIA	25/11/2019 16:15	27/11/2019 18:01	27/11/2019 15:36	27/11/2019 15:49	0,23	7	1,59	CHI
201911333446	DOVERLANDIA	DV12259464LD	CAIAPONIA	25/11/2019 16:15	27/11/2019 18:01	25/11/2019 16:15	27/11/2019 17:51	49,61	53	2629,12	CHI
201911333446	DOVERLANDIA	DV12381099LD	CAIAPONIA	25/11/2019 16:15	27/11/2019 18:01	25/11/2019 16:15	27/11/2019 18:01	49,77	58	2886,93	CHI
201911333451	CRISTALINA	KR12389576	CRISTALINA S2	25/11/2019 16:45	26/11/2019 19:55	25/11/2019 16:45	26/11/2019 01:45	8,99	2	17,98	CHI
201911333451	CRISTALINA	KR12389576	CRISTALINA S2	25/11/2019 16:45	26/11/2019 19:55	25/11/2019 23:10	26/11/2019 01:45	2,58	19	48,98	CHI
201911333451	CRISTALINA	KR12389576	CRISTALINA S2	25/11/2019 16:45	26/11/2019 19:55	25/11/2019 16:45	26/11/2019 19:55	27,15	6	162,92	CHI
201911333451	CRISTALINA	KR12389576	CRISTALINA S2	25/11/2019 16:45	26/11/2019 19:55	25/11/2019 23:10	26/11/2019 19:55	20,74	12	248,89	CHI
201911333451	CRISTALINA	KR12389576	CRISTALINA S2	25/11/2019 16:45	26/11/2019 19:55	26/11/2019 01:50	26/11/2019 19:55	18,08	21	379,66	CHI
201911333463	AMORINOPOLIS	AM12390135	IPORA	25/11/2019 16:37	25/11/2019 23:32	25/11/2019 16:37	25/11/2019 23:32	6,91	7	48,40	CHI
201911333463	IVOLANDIA	AM12390135	IPORA	25/11/2019 16:37	25/11/2019 23:32	25/11/2019 16:37	25/11/2019 23:32	6,91	68	470,13	CHI
201911333465	TROMBAS	TB12156807	PORANGATU	25/11/2019 18:34	25/11/2019 20:54	25/11/2019 18:34	25/11/2019 20:54	2,33	71	165,45	CHI
201911333466	SAO MIGUEL DO ARAGUAIA	SM10396890	SAO MIGUEL DO ARAGUAIA	25/11/2019 18:40	27/11/2019 20:14	25/11/2019 18:40	26/11/2019 12:18	17,63	46	811,01	CHI
201911333466	SAO MIGUEL DO ARAGUAIA	SM12013034LD	SAO MIGUEL DO ARAGUAIA	25/11/2019 18:40	27/11/2019 20:14	25/11/2019 18:40	26/11/2019 12:40	18,00	18	324,03	CHI
201911333466	SAO MIGUEL DO ARAGUAIA	SM10396890	SAO MIGUEL DO ARAGUAIA	25/11/2019 18:40	27/11/2019 20:14	25/11/2019 18:40	26/11/2019 14:44	20,08	10	200,78	CHI
201911333466	BONOPOLIS	SM10396890	SAO MIGUEL DO ARAGUAIA	25/11/2019 18:40	27/11/2019 20:14	25/11/2019 18:40	26/11/2019 22:23	27,71	82	2272,52	CHI
201911333466	SAO MIGUEL DO ARAGUAIA	SM10396890	SAO MIGUEL DO ARAGUAIA	25/11/2019 18:40	27/11/2019 20:14	25/11/2019 18:40	26/11/2019 22:23	27,71	37	1025,40	CHI
201911333466	SAO MIGUEL DO ARAGUAIA	SM10396890	SAO MIGUEL DO ARAGUAIA	25/11/2019 18:40	27/11/2019 20:14	26/11/2019 22:43	27/11/2019 08:15	9,55	46	439,24	CHI
201911333466	SAO MIGUEL DO ARAGUAIA	SM12013034LD	SAO MIGUEL DO ARAGUAIA	25/11/2019 18:40	27/11/2019 20:14	26/11/2019 22:43	27/11/2019 09:04	10,36	19	196,86	CHI
201911333466	SAO MIGUEL DO ARAGUAIA	SM10396890	SAO MIGUEL DO ARAGUAIA	25/11/2019 18:40	27/11/2019 20:14	27/11/2019 09:10	27/11/2019 10:02	0,86	46	39,50	CHI
201911333466	BONOPOLIS	SM10396890	SAO MIGUEL DO ARAGUAIA	25/11/2019 18:40	27/11/2019 20:14	25/11/2019 18:40	27/11/2019 11:27	40,79	24	979,02	CHI
201911333466	BONOPOLIS	SM10396890	SAO MIGUEL DO ARAGUAIA	25/11/2019 18:40	27/11/2019 20:14	26/11/2019 22:43	27/11/2019 11:27	12,75	82	1045,14	CHI
201911333466	SAO MIGUEL DO ARAGUAIA	SM10396890	SAO MIGUEL DO ARAGUAIA	25/11/2019 18:40	27/11/2019 20:14	26/11/2019 22:43	27/11/2019 11:27	12,75	47	599,04	CHI
201911333466	SAO MIGUEL DO ARAGUAIA	SM12013034LD	SAO MIGUEL DO ARAGUAIA	25/11/2019 18:40	27/11/2019 20:14	27/11/2019 09:10	27/11/2019 13:37	4,44	8	35,53	CHI
201911333466	SAO MIGUEL DO ARAGUAIA	SM13375324	SAO MIGUEL DO ARAGUAIA	25/11/2019 18:40	27/11/2019 20:14	27/11/2019 09:10	27/11/2019 20:14	11,07	11	121,77	CHI
201911333473	NOVO BRASIL	NB11076351	JUSSARA	25/11/2019 18:39	26/11/2019 04:58	25/11/2019 18:39	26/11/2019 04:58	10,30	179	1844,20	CHI
201911333484	CIDADE OCIDENTAL	2680119697	MARAJOARA	25/11/2019 18:42	25/11/2019 20:51	25/11/2019 18:42	25/11/2019 20:51	2,15	1	2,15	CHI
201911333491	AURILANDIA	AI12003841	SAO LUIZ DOS MONTES BELOS	25/11/2019 18:42	26/11/2019 15:13	25/11/2019 18:42	26/11/2019 15:13	20,52	7	143,61	CHI
201911333493	RIO VERDE	RV12260606	CABRIUVA S1	25/11/2019 16:48	26/11/2019 00:17	25/11/2019 16:48	26/11/2019 00:17	7,48	4	29,91	CHI
201911333511	ITABERAI	IB12220126	ITABERAI S1	25/11/2019 18:29	26/11/2019 10:10	25/11/2019 18:29	26/11/2019 10:10	15,68	5	78,39	CHI

201911333525	SANTA TEREZINHA DE GOIAS	SG12090800LD	SANTA TEREZINHA	25/11/2019 18:45	26/11/2019 19:40	26/11/2019 16:01	26/11/2019 19:20	3,32	1	3,32	CHI
201911333525	SANTA TEREZINHA DE GOIAS	SG21294685	SANTA TEREZINHA	25/11/2019 18:45	26/11/2019 19:40	25/11/2019 18:45	26/11/2019 19:40	24,91	1	24,91	CHI
201911333526	GOIANIA	14218719	CARAJAS S2	25/11/2019 18:45	25/11/2019 21:40	25/11/2019 18:45	25/11/2019 21:40	2,90	1	2,90	CHI
201911333527	INDIARA	IY21037482	ACREUNA	25/11/2019 18:45	26/11/2019 14:52	25/11/2019 18:45	26/11/2019 14:52	20,10	1	20,10	CHI
201911333529	CATALAO	CT21266977	CATALAO S1	25/11/2019 18:45	26/11/2019 00:01	25/11/2019 18:45	26/11/2019 00:01	5,25	1	5,25	CHI
201911333530	NOVO GAMA	LZ21000091	PACAEMBU S1	25/11/2019 18:45	26/11/2019 08:24	25/11/2019 18:45	26/11/2019 08:24	13,63	1	13,63	CHI
201911333531	VALPARAISO DE GOIAS	2860101695	PACAEMBU S1	25/11/2019 18:45	25/11/2019 23:56	25/11/2019 18:45	25/11/2019 23:56	5,17	1	5,17	CHI
201911333547	IVOLANDIA	IV11053372	IPORA	25/11/2019 18:46	26/11/2019 18:05	25/11/2019 18:46	26/11/2019 18:05	23,32	22	512,98	CHI
201911333552	GOIAS	GS13390113	ITABERAI S1	25/11/2019 18:30	26/11/2019 15:35	25/11/2019 18:30	26/11/2019 15:35	21,07	82	1728,08	CHI
201911333552	GOIAS	GS13390113	ITABERAI S1	25/11/2019 18:30	26/11/2019 15:35	26/11/2019 15:09	26/11/2019 15:35	0,43	8	3,47	CHI
201911333560	FLORES DE GOIAS	10010182827	FLORES DE GOIAS	25/11/2019 18:48	26/11/2019 19:08	25/11/2019 18:48	26/11/2019 19:08	24,34	1	24,34	CHI
201911333562	CAIAPONIA	CP12200873	PALESTINA	25/11/2019 18:48	26/11/2019 11:40	25/11/2019 18:48	26/11/2019 11:40	16,86	54	910,45	CHI
201911333563	PARAUNA	PU12205940	PARAUNA	25/11/2019 18:48	26/11/2019 11:36	25/11/2019 18:48	26/11/2019 11:36	16,79	6	100,75	CHI
201911333568	SANTA TEREZINHA DE GOIAS	SG11000018	SANTA TEREZINHA	25/11/2019 18:36	26/11/2019 02:53	25/11/2019 18:36	26/11/2019 02:53	8,27	102	843,77	CHI
201911333575	BURITINOPOLIS	BQ11190584	IACIARA S2	25/11/2019 18:49	25/11/2019 22:36	25/11/2019 18:49	25/11/2019 22:36	3,77	8	30,19	CHI
201911333576	GOIATUBA	GT21088633	GOIATUBA S2	25/11/2019 18:49	26/11/2019 00:16	25/11/2019 18:49	26/11/2019 00:16	5,44	1	5,44	CHI
201911333579	ANAPOLIS	AN13384814	ANAPOLIS UNIVERSITARIO S2	25/11/2019 19:04	26/11/2019 02:27	25/11/2019 19:04	25/11/2019 21:39	2,58	312	803,83	CHI
201911333579	ANAPOLIS	AN13000410	ANAPOLIS UNIVERSITARIO S2	25/11/2019 19:04	26/11/2019 02:27	25/11/2019 19:04	26/11/2019 01:00	5,93	123	728,95	CHI
201911333579	CAMPO LIMPO	AN13000410	ANAPOLIS UNIVERSITARIO S2	25/11/2019 19:04	26/11/2019 02:27	25/11/2019 19:04	26/11/2019 01:00	5,93	7	41,48	CHI
201911333579	ANAPOLIS	AN13240521	ANAPOLIS UNIVERSITARIO S2	25/11/2019 19:04	26/11/2019 02:27	25/11/2019 19:04	26/11/2019 01:14	6,17	415	2561,47	CHI
201911333579	ANAPOLIS	AN12273408RE	ANAPOLIS UNIVERSITARIO S2	25/11/2019 19:04	26/11/2019 02:27	25/11/2019 22:01	26/11/2019 01:39	3,63	71	257,91	CHI
201911333579	PIRENOPOLIS	AN12273408RE	ANAPOLIS UNIVERSITARIO S2	25/11/2019 19:04	26/11/2019 02:27	25/11/2019 22:01	26/11/2019 01:39	3,63	52	188,89	CHI
201911333579	ANAPOLIS	AN10404178	ANAPOLIS UNIVERSITARIO S2	25/11/2019 19:04	26/11/2019 02:27	25/11/2019 19:04	26/11/2019 02:27	7,38	134	988,73	CHI
201911333579	ANAPOLIS	AN10404178	ANAPOLIS UNIVERSITARIO S2	25/11/2019 19:04	26/11/2019 02:27	25/11/2019 23:20	26/11/2019 02:27	3,11	46	143,02	CHI
201911333579	PIRENOPOLIS	AN10404178	ANAPOLIS UNIVERSITARIO S2	25/11/2019 19:04	26/11/2019 02:27	25/11/2019 23:20	26/11/2019 02:27	3,11	15	46,64	CHI
201911333582	MINEIROS	MY12149301	PARQUE DAS EMAS	25/11/2019 17:29	26/11/2019 16:16	25/11/2019 17:29	26/11/2019 16:16	22,78	17	387,22	CHI
201911333582	PEROLANDIA	MY12149301	PARQUE DAS EMAS	25/11/2019 17:29	26/11/2019 16:16	25/11/2019 17:29	26/11/2019 16:16	22,78	1	22,78	CHI
201911333583	ALOANDIA	AD12108925	GOIATUBA S1	25/11/2019 18:05	26/11/2019 13:55	25/11/2019 18:05	26/11/2019 13:55	19,83	6	118,99	CHI
201911333583	MORRINHOS	AD12108925	GOIATUBA S1	25/11/2019 18:05	26/11/2019 13:55	25/11/2019 18:05	26/11/2019 13:55	19,83	2	39,66	CHI
201911333587	PARAUNA	PU12361895	PARAUNA	25/11/2019 18:51	26/11/2019 12:49	25/11/2019 18:51	26/11/2019 12:49	17,97	1	17,97	CHI
201911333591	GOIANIA	10861166	GOIANIA LESTE S3	25/11/2019 18:51	25/11/2019 22:57	25/11/2019 18:51	25/11/2019 22:57	4,11	1	4,11	CHI
201911333594	ITAGUARU	IC11154617	ITABERAI S1	25/11/2019 18:30	26/11/2019 09:03	25/11/2019 18:30	26/11/2019 09:03	14,55	155	2255,08	CHI
201911333595	GOIANIA	14193802	MEIA PONTE	25/11/2019 18:51	25/11/2019 20:55	25/11/2019 18:51	25/11/2019 20:55	2,05	1	2,05	CHI



201911333597	FORMOSA	2920006466	ITIQUEIRA	25/11/2019 18:51	26/11/2019 18:42	25/11/2019 18:51	26/11/2019 18:42	23,85	1	23,85	CHI
201911333598	ABADIANIA	CB12272931	CORUMBA	25/11/2019 15:09	26/11/2019 15:42	25/11/2019 15:09	26/11/2019 15:42	24,54	1	24,54	CHI
201911333598	CORUMBA DE GOIAS	CB12272931	CORUMBA	25/11/2019 15:09	26/11/2019 15:42	25/11/2019 15:09	26/11/2019 15:42	24,54	50	1226,88	CHI
201911333611	ITUMBUIARA	BJ12392125	BOM JESUS DE GOIAS	25/11/2019 15:17	26/11/2019 23:29	25/11/2019 15:17	26/11/2019 23:29	32,19	4	128,75	CHI
201911333613	APARECIDA DE GOIANIA	AP11067636	ATLANTICO S2	25/11/2019 18:51	25/11/2019 21:16	25/11/2019 18:51	25/11/2019 21:16	2,41	183	441,89	CHI
201911333615	APARECIDA DE GOIANIA	200267796	CEPAIGO S1	25/11/2019 18:54	26/11/2019 08:58	25/11/2019 18:54	26/11/2019 08:58	14,06	1	14,06	CHI
201911333618	CATALAO	10001804462	CATALAO S2	25/11/2019 18:54	25/11/2019 20:30	25/11/2019 18:54	25/11/2019 20:30	1,59	1	1,59	CHI
201911333621	PIRES DO RIO	PR12255837	PIRES DO RIO S1	25/11/2019 17:01	26/11/2019 10:36	25/11/2019 17:01	26/11/2019 10:36	17,59	33	580,36	CHI
201911333628	COCALZINHO DE GOIAS	NP12402058	GOIANESIA S1	25/11/2019 16:38	26/11/2019 14:04	25/11/2019 16:38	26/11/2019 14:04	21,42	1	21,42	CHI
201911333628	PADRE BERNARDO	NP12402058	GOIANESIA S1	25/11/2019 16:38	26/11/2019 14:04	25/11/2019 16:38	26/11/2019 14:04	21,42	10	214,23	CHI
201911333628	VILA PROPICIO	NP12402058	GOIANESIA S1	25/11/2019 16:38	26/11/2019 14:04	25/11/2019 16:38	26/11/2019 14:04	21,42	94	2013,77	CHI
201911333631	INHUMAS	IX12016404	INHUMAS S1	25/11/2019 16:36	25/11/2019 20:49	25/11/2019 16:36	25/11/2019 20:49	4,21	1	4,21	CHI
201911333631	ITAUCU	IX12016404	INHUMAS S1	25/11/2019 16:36	25/11/2019 20:49	25/11/2019 16:36	25/11/2019 20:49	4,21	4	16,86	CHI
201911333651	TRINDADE	40243321	TRINDADE	25/11/2019 18:58	25/11/2019 23:43	25/11/2019 18:58	25/11/2019 23:43	4,74	1	4,74	CHI
201911333654	JESUPOLIS	JE21222093	SAO FRANCISCO DE GOIAS	25/11/2019 18:59	26/11/2019 10:02	25/11/2019 18:59	26/11/2019 10:02	15,05	2	30,10	CHI
201911333656	PARAUNA	PU12034828	ACREUNA	25/11/2019 14:23	26/11/2019 20:33	25/11/2019 14:23	26/11/2019 20:33	30,18	14	422,49	CHI
201911333658	JATAI	JT12210133	JATAI S1	25/11/2019 18:46	26/11/2019 10:37	25/11/2019 18:46	26/11/2019 10:37	15,85	5	79,23	CHI
201911333665	QUIRINOPOLIS	8054058	QUIRINOPOLIS	25/11/2019 18:59	26/11/2019 08:03	25/11/2019 18:59	26/11/2019 08:03	13,06	2	26,11	CHI
201911333672	ANAPOLIS	AN11000499	JUNDIAI S1	25/11/2019 18:47	25/11/2019 21:18	25/11/2019 18:47	25/11/2019 21:18	2,51	149	373,66	CHI
201911333679	BARRO ALTO	7587669	GOIANESIA S1	25/11/2019 15:51	27/11/2019 17:57	25/11/2019 15:51	27/11/2019 17:57	50,09	7	350,65	CHI
201911333690	IACIARA	1550024283	IACIARA S1	25/11/2019 19:02	25/11/2019 20:58	25/11/2019 19:02	25/11/2019 20:58	1,93	1	1,93	CHI
201911333694	CAIAPONIA	CP12076264	MONTIVIDIU T	25/11/2019 16:50	26/11/2019 07:50	25/11/2019 16:50	26/11/2019 07:50	15,01	78	1171,13	CHI
201911333694	JATAI	CP12076264	MONTIVIDIU T	25/11/2019 16:50	26/11/2019 07:50	25/11/2019 16:50	26/11/2019 07:50	15,01	7	105,10	CHI
201911333694	MONTIVIDIU	CP12076264	MONTIVIDIU T	25/11/2019 16:50	26/11/2019 07:50	25/11/2019 16:50	26/11/2019 07:50	15,01	2	30,03	CHI
201911333694	RIO VERDE	CP12076264	MONTIVIDIU T	25/11/2019 16:50	26/11/2019 07:50	25/11/2019 16:50	26/11/2019 07:50	15,01	12	180,17	CHI
201911333700	JUSSARA	JR21054018	JUSSARA	25/11/2019 19:03	26/11/2019 15:30	25/11/2019 19:03	26/11/2019 15:30	20,45	2	40,90	CHI
201911333704	CRISTALINA	KR12087952	CRISTALINA S2	25/11/2019 16:44	26/11/2019 09:52	25/11/2019 16:44	26/11/2019 09:52	17,12	16	273,88	CHI
201911333714	BOM JESUS DE GOIAS	1250013644	BOM JESUS DE GOIAS	25/11/2019 19:19	26/11/2019 11:54	25/11/2019 19:19	26/11/2019 11:54	16,58	1	16,58	CHI
201911333715	MORRINHOS	MR21028759	MORRINHOS	25/11/2019 19:04	26/11/2019 09:00	25/11/2019 19:04	26/11/2019 09:00	13,94	1	13,94	CHI
201911333718	ITAGUARU	IC11274196	ITABERAI S1	25/11/2019 18:44	26/11/2019 16:49	25/11/2019 18:44	26/11/2019 16:49	22,07	53	1169,74	CHI
201911333719	JATAI	JT12219503	JATAI S3	25/11/2019 15:39	25/11/2019 23:30	25/11/2019 15:39	25/11/2019 23:30	7,84	5	39,18	CHI
201911333720	APARECIDA DE GOIANIA	13139368	INDEPENDENCIA S2	25/11/2019 19:05	26/11/2019 01:13	25/11/2019 19:05	26/11/2019 01:13	6,13	1	6,13	CHI
201911333721	GOIANIA	12860785	XAVANTES	25/11/2019 19:05	25/11/2019 21:55	25/11/2019 19:05	25/11/2019 21:55	2,83	1	2,83	CHI

201911333723	SAO JOAO D ALIANCA	JL21255808	SAO JOAO D ALIANCA	25/11/2019 19:05	26/11/2019 15:31	25/11/2019 19:05	26/11/2019 15:31	20,44	1	20,44	CHI
201911333724	BONOPOLIS	BX10403942	SAO MIGUEL DO ARAGUAIA	25/11/2019 19:24	26/11/2019 14:01	25/11/2019 19:24	25/11/2019 21:41	2,29	12	27,53	CHI
201911333724	AMARALINA	LC13051072	SAO MIGUEL DO ARAGUAIA	25/11/2019 19:24	26/11/2019 14:01	25/11/2019 19:24	26/11/2019 01:03	5,66	80	453,18	CHI
201911333724	AMARALINA	LC12270112	SAO MIGUEL DO ARAGUAIA	25/11/2019 19:24	26/11/2019 14:01	25/11/2019 19:24	26/11/2019 01:48	6,40	62	397,04	CHI
201911333724	AMARALINA	LC12182475	SAO MIGUEL DO ARAGUAIA	25/11/2019 19:24	26/11/2019 14:01	25/11/2019 19:24	26/11/2019 10:19	14,93	37	552,30	CHI
201911333724	AMARALINA	LC13315123	SAO MIGUEL DO ARAGUAIA	25/11/2019 19:24	26/11/2019 14:01	25/11/2019 19:24	26/11/2019 13:04	17,68	12	212,12	CHI
201911333724	AMARALINA	LC12262759	SAO MIGUEL DO ARAGUAIA	25/11/2019 19:24	26/11/2019 14:01	25/11/2019 19:24	26/11/2019 13:28	18,07	15	271,08	CHI
201911333724	AMARALINA	BX12391938	SAO MIGUEL DO ARAGUAIA	25/11/2019 19:24	26/11/2019 14:01	25/11/2019 19:24	26/11/2019 14:01	18,62	13	242,05	CHI
201911333727	SENADOR CANEDO	SW12047580	CEPAIGO S1	25/11/2019 19:06	26/11/2019 00:27	25/11/2019 19:06	26/11/2019 00:27	5,35	1	5,35	CHI
201911333743	APARECIDA DE GOIANIA	10027334633	INDEPENDENCIA S1	25/11/2019 19:07	25/11/2019 21:42	25/11/2019 19:07	25/11/2019 21:42	2,58	1	2,58	CHI
201911333746	PARAUNA	PU12186452	FIRMINOPOLIS S2	25/11/2019 19:07	27/11/2019 00:26	25/11/2019 19:07	27/11/2019 00:26	29,31	2	58,62	CHI
201911333747	PIRACANJUBA	PJ21263251	CALDAS NOVAS S1	25/11/2019 19:07	26/11/2019 14:20	25/11/2019 19:07	26/11/2019 14:20	19,21	1	19,21	CHI
201911333754	NOVA AMERICA	RB12320982	RUBIATABA	25/11/2019 19:08	26/11/2019 16:24	25/11/2019 19:08	26/11/2019 16:24	21,26	3	63,79	CHI
201911333754	RUBIATABA	RB12320982	RUBIATABA	25/11/2019 19:08	26/11/2019 16:24	25/11/2019 19:08	26/11/2019 16:24	21,26	23	489,06	CHI
201911333758	APARECIDA DE GOIANIA	10007561120	INDEPENDENCIA S2	25/11/2019 19:08	25/11/2019 22:29	25/11/2019 19:08	25/11/2019 22:29	3,34	1	3,34	CHI
201911333759	BRITANIA	BT12274251	BRITANIA	25/11/2019 19:08	26/11/2019 13:20	25/11/2019 19:08	26/11/2019 13:20	18,19	10	181,92	CHI
201911333761	PIRENOPOLIS	PV21084551	SAO FRANCISCO DE GOIAS	25/11/2019 19:08	27/11/2019 07:49	25/11/2019 19:08	27/11/2019 07:49	36,67	1	36,67	CHI
201911333769	DIVINOPOLIS DE GOIAS	GH12208671	SAO DOMINGOS	25/11/2019 17:14	25/11/2019 20:23	25/11/2019 17:14	25/11/2019 20:23	3,14	518	1625,37	CHI
201911333770	CACU	CC21074339	CACHOEIRA ALTA	25/11/2019 19:09	26/11/2019 11:09	25/11/2019 19:09	26/11/2019 11:09	15,98	1	15,98	CHI
201911333781	MORRINHOS	MR12360057	MORRINHOS	25/11/2019 19:10	26/11/2019 01:12	25/11/2019 19:10	26/11/2019 01:12	6,02	8	48,15	CHI
201911333788	MARA ROSA	MU12172596	MARA ROSA	25/11/2019 18:26	26/11/2019 09:55	25/11/2019 18:26	26/11/2019 09:55	15,47	27	417,62	CHI
201911333788	MUTUNOPOLIS	MU12172596	MARA ROSA	25/11/2019 18:26	26/11/2019 09:55	25/11/2019 18:26	26/11/2019 09:55	15,47	2	30,93	CHI
201911333792	ITAPURANGA	IK11051548	ITAPURANGA	25/11/2019 15:01	26/11/2019 02:28	25/11/2019 15:01	26/11/2019 02:28	11,44	165	1887,42	CHI
201911333794	APARECIDA DE GOIANIA	13883197	REAL S1	25/11/2019 19:13	26/11/2019 00:07	25/11/2019 19:13	26/11/2019 00:07	4,89	1	4,89	CHI
201911333797	GOIANIA	GN11002614	GOIANIA LESTE S1	25/11/2019 19:03	25/11/2019 21:22	25/11/2019 19:03	25/11/2019 21:22	2,32	45	104,51	CHI
201911333804	APARECIDA DE GOIANIA	16009538	INDEPENDENCIA S2	25/11/2019 19:15	25/11/2019 22:04	25/11/2019 19:15	25/11/2019 22:04	2,82	1	2,82	CHI
201911333809	SAO LUIS DE MONTES BELOS	SL11000016	SAO LUIZ DOS MONTES BELOS	25/11/2019 19:15	25/11/2019 21:40	25/11/2019 19:15	25/11/2019 21:40	2,40	101	242,82	CHI
201911333816	CRIXAS	NM12027453	RUBIATABA	25/11/2019 18:59	26/11/2019 02:35	25/11/2019 18:59	26/11/2019 02:35	7,59	6	45,53	CHI
201911333816	ITAPACI	NM12027453	RUBIATABA	25/11/2019 18:59	26/11/2019 02:35	25/11/2019 18:59	26/11/2019 02:35	7,59	2	15,18	CHI
201911333816	NOVA AMERICA	NM12027453	RUBIATABA	25/11/2019 18:59	26/11/2019 02:35	25/11/2019 18:59	26/11/2019 02:35	7,59	9	68,30	CHI
201911333824	JATAI	290100665	JATAI S3	25/11/2019 19:17	26/11/2019 11:53	25/11/2019 19:17	26/11/2019 11:53	16,59	1	16,59	CHI
201911333826	GOIAS	GS12332675	GOIAS	25/11/2019 19:18	26/11/2019 16:48	25/11/2019 19:18	26/11/2019 16:48	21,50	2	43,00	CHI
201911333830	PORANGATU	TB12208457	PORANGATU	25/11/2019 16:32	27/11/2019 15:08	25/11/2019 16:32	26/11/2019 16:18	23,78	1	23,78	CHI

201911333830	TROMBAS	TB12208457	PORANGATU	25/11/2019 16:32	27/11/2019 15:08	25/11/2019 16:32	26/11/2019 16:18	23,78	16	380,47	CHI
201911333830	PORANGATU	TB12208457	PORANGATU	25/11/2019 16:32	27/11/2019 15:08	26/11/2019 16:19	27/11/2019 15:08	22,83	1	22,83	CHI
201911333830	TROMBAS	TB12208457	PORANGATU	25/11/2019 16:32	27/11/2019 15:08	26/11/2019 16:19	27/11/2019 15:08	22,83	16	365,25	CHI
201911333834	AMARALINA	MU12335306	MARA ROSA	25/11/2019 19:11	26/11/2019 07:57	25/11/2019 19:11	26/11/2019 07:57	12,76	12	153,12	CHI
201911333839	APARECIDA DE GOIANIA	AP11150297	INDEPENDENCIA S2	25/11/2019 16:56	25/11/2019 22:04	25/11/2019 16:56	25/11/2019 22:04	5,13	23	117,94	CHI
201911333842	BOM JESUS DE GOIAS	BJ21310062	BOM JESUS DE GOIAS	25/11/2019 19:20	26/11/2019 00:07	25/11/2019 19:20	26/11/2019 00:07	4,77	1	4,77	CHI
201911333846	RIO VERDE	RV12260102	RIO VERDE S2	25/11/2019 18:20	26/11/2019 08:13	25/11/2019 18:20	26/11/2019 08:13	13,88	4	55,53	CHI
201911333848	MINEIROS	MY12278368	PARQUE DAS EMAS	25/11/2019 19:22	26/11/2019 15:50	25/11/2019 19:22	26/11/2019 15:50	20,46	13	266,04	CHI
201911333848	SERRANOPOLIS	MY12278368	PARQUE DAS EMAS	25/11/2019 19:22	26/11/2019 15:50	25/11/2019 19:22	26/11/2019 15:50	20,46	7	143,25	CHI
201911333849	NOVA IGUACU DE GOIAS	NH12048720	SANTA TEREZINHA	25/11/2019 18:35	25/11/2019 21:41	25/11/2019 18:35	25/11/2019 21:41	3,09	37	114,50	CHI
201911333852	PIRACANJUBA	PJ12249833	PIRACANJUBA	25/11/2019 18:59	26/11/2019 14:05	25/11/2019 18:59	26/11/2019 14:05	19,09	81	1546,15	CHI
201911333855	PIRES DO RIO	PR21000045	PIRES DO RIO S1	25/11/2019 19:22	25/11/2019 23:00	25/11/2019 19:22	25/11/2019 23:00	3,62	1	3,62	CHI
201911333860	SANTA HELENA DE GOIAS	400148845	IPEGUARI	25/11/2019 19:23	26/11/2019 09:03	25/11/2019 19:23	26/11/2019 09:03	13,67	1	13,67	CHI
201911333862	VALPARAISO DE GOIAS	VA11276307	MARAOARA	25/11/2019 18:47	26/11/2019 00:26	25/11/2019 18:47	26/11/2019 00:26	5,65	9	50,85	CHI
201911333863	ACREUNA	2440055007	ACREUNA	25/11/2019 19:24	25/11/2019 23:43	25/11/2019 19:24	25/11/2019 23:43	4,33	1	4,33	CHI
201911333864	BONOPOLIS	BX21168232	SAO MIGUEL DO ARAGUAIA	25/11/2019 19:24	26/11/2019 18:00	25/11/2019 19:24	26/11/2019 18:00	22,61	1	22,61	CHI
201911333871	ADELANDIA	DN12259109	ANICUNS	25/11/2019 19:25	26/11/2019 16:50	25/11/2019 19:25	26/11/2019 16:50	21,42	6	128,53	CHI
201911333886	DOVERLANDIA	DV12212770	CAIAPONIA	25/11/2019 18:07	26/11/2019 15:35	25/11/2019 18:07	26/11/2019 15:35	21,45	5	107,26	CHI
201911333889	CAIAPONIA	CP12119577	CAIAPONIA	25/11/2019 16:04	26/11/2019 07:14	25/11/2019 16:04	26/11/2019 07:14	15,16	65	985,36	CHI
201911333889	DOVERLANDIA	CP12119577	CAIAPONIA	25/11/2019 16:04	26/11/2019 07:14	25/11/2019 16:04	26/11/2019 07:14	15,16	7	106,12	CHI
201911333898	MONTIVIDIU	2840004234	MONTIVIDIU T	25/11/2019 19:30	25/11/2019 23:42	25/11/2019 19:30	25/11/2019 23:42	4,22	1	4,22	CHI
201911333899	SAO LUIS DE MONTES BELOS	SL21220270	SAO LUIZ DOS MONTES BELOS	25/11/2019 19:30	25/11/2019 22:15	25/11/2019 19:30	25/11/2019 22:15	2,75	1	2,75	CHI
201911333902	JESUPOLIS	JE21314989	SAO FRANCISCO DE GOIAS	25/11/2019 19:30	26/11/2019 11:16	25/11/2019 19:30	26/11/2019 11:16	15,76	1	15,76	CHI
201911333904	EDEIA	1120031567	EDEIA	25/11/2019 19:31	26/11/2019 10:11	25/11/2019 19:31	26/11/2019 10:11	14,66	1	14,66	CHI
201911333907	PIRENOPOLIS	PV12302191	CORUMBA	25/11/2019 17:27	26/11/2019 09:59	25/11/2019 17:27	26/11/2019 09:59	16,52	24	396,57	CHI
201911333909	GOIAS	IB12210550	ITABERAI S1	25/11/2019 19:32	26/11/2019 07:34	25/11/2019 19:32	26/11/2019 07:34	12,03	3	36,09	CHI
201911333909	ITABERAI	IB12210550	ITABERAI S1	25/11/2019 19:32	26/11/2019 07:34	25/11/2019 19:32	26/11/2019 07:34	12,03	35	421,06	CHI
201911333914	ITAGUARU	IC11159957	ITABERAI S1	25/11/2019 18:09	26/11/2019 11:29	25/11/2019 18:09	26/11/2019 11:29	17,34	47	814,78	CHI
201911333919	GOIANIA	12051147	REAL S1	25/11/2019 19:33	25/11/2019 21:35	25/11/2019 19:33	25/11/2019 21:35	2,02	1	2,02	CHI
201911333921	GOIANIA	17229327	FERROVIARIO S3	25/11/2019 19:34	25/11/2019 23:22	25/11/2019 19:34	25/11/2019 23:22	3,80	1	3,80	CHI
201911333926	ITAGUARI	IC12219941	ITABERAI S1	25/11/2019 12:34	26/11/2019 17:45	25/11/2019 12:34	26/11/2019 17:45	29,18	31	904,47	CHI
201911333926	ITAGUARU	IC12219941	ITABERAI S1	25/11/2019 12:34	26/11/2019 17:45	25/11/2019 12:34	26/11/2019 17:45	29,18	21	612,70	CHI
201911333928	APARECIDA DE GOIANIA	10020733770	INDEPENDENCIA S1	25/11/2019 19:35	25/11/2019 23:37	25/11/2019 19:35	25/11/2019 23:37	4,02	1	4,02	CHI

201911333929	AMORINOPOLIS	AM12133498	IPORA	25/11/2019 18:14	25/11/2019 22:07	25/11/2019 18:14	25/11/2019 22:07	3,88	180	698,20	CHI
201911333930	ANICUNS	AC12189632	ANICUNS	25/11/2019 19:07	26/11/2019 11:46	25/11/2019 19:07	26/11/2019 11:46	16,64	6	99,84	CHI
201911333934	BOM JARDIM DE GOIAS	BM12243912	BOM JARDIM	25/11/2019 18:29	26/11/2019 09:15	25/11/2019 18:29	26/11/2019 09:15	14,76	11	162,36	CHI
201911333934	PIRANHAS	BM12243912	BOM JARDIM	25/11/2019 18:29	26/11/2019 09:15	25/11/2019 18:29	26/11/2019 09:15	14,76	9	132,84	CHI
201911333939	PLANALTINA	10022091953	PLANALTINA	25/11/2019 19:38	26/11/2019 16:15	25/11/2019 19:38	26/11/2019 16:15	20,62	1	20,62	CHI
201911333952	DOVERLANDIA	DV12221021	CAIAPONIA	25/11/2019 19:18	26/11/2019 06:02	25/11/2019 19:18	26/11/2019 06:02	10,72	22	235,81	CHI
201911333955	CRIXAS	CX10394718	SERRA DO OURO	25/11/2019 19:54	26/11/2019 17:15	25/11/2019 19:54	25/11/2019 23:25	3,51	88	308,68	CHI
201911333955	CRIXAS	CX12132683LD	SERRA DO OURO	25/11/2019 19:54	26/11/2019 17:15	25/11/2019 19:54	26/11/2019 02:30	6,61	75	495,38	CHI
201911333955	CRIXAS	CX10394718	SERRA DO OURO	25/11/2019 19:54	26/11/2019 17:15	25/11/2019 19:54	26/11/2019 10:27	14,55	21	305,56	CHI
201911333955	CRIXAS	CX12181440LD	SERRA DO OURO	25/11/2019 19:54	26/11/2019 17:15	25/11/2019 19:54	26/11/2019 17:15	21,34	36	768,31	CHI
201911333955	NOVA CRIXAS	CX12181440LD	SERRA DO OURO	25/11/2019 19:54	26/11/2019 17:15	25/11/2019 19:54	26/11/2019 17:15	21,34	6	128,05	CHI
201911333955	CRIXAS	CX12181440LD	SERRA DO OURO	25/11/2019 19:54	26/11/2019 17:15	25/11/2019 19:56	26/11/2019 17:15	21,32	1	21,32	CHI
201911333961	MINACU	IH12341446	MINACU	25/11/2019 19:53	26/11/2019 01:24	25/11/2019 19:53	26/11/2019 01:24	5,51	36	198,30	CHI
201911333963	MATRINCHA	MP12274451	MATRINCHA	25/11/2019 19:41	27/11/2019 14:34	25/11/2019 19:41	27/11/2019 14:34	42,88	5	214,39	CHI
201911333964	AGUA FRIA DE GOIAS	TL12205638	SAO JOAO D ALIANCA	25/11/2019 19:41	26/11/2019 14:19	25/11/2019 19:41	26/11/2019 14:19	18,62	11	204,83	CHI
201911333966	SILVANIA	SV12161557	DAIA S2	25/11/2019 17:33	26/11/2019 00:16	25/11/2019 17:33	26/11/2019 00:16	6,70	11	73,74	CHI
201911333967	ITAGUARU	IC12219942	ITABERAI S1	25/11/2019 18:37	26/11/2019 16:36	25/11/2019 18:37	26/11/2019 15:20	20,72	56	1160,12	CHI
201911333967	ITAGUARU	IC11219943	ITABERAI S1	25/11/2019 18:37	26/11/2019 16:36	25/11/2019 18:37	26/11/2019 16:36	21,99	40	879,76	CHI
201911333977	ARUANA	AK11376419	ARUANA	25/11/2019 19:43	26/11/2019 10:08	25/11/2019 19:43	26/11/2019 10:08	14,41	54	778,05	CHI
201911333982	ALTO HORIZONTE	AJ12143571	MARA ROSA	25/11/2019 19:44	26/11/2019 11:42	25/11/2019 19:44	26/11/2019 11:42	15,97	36	574,78	CHI
201911333982	MARA ROSA	AJ12143571	MARA ROSA	25/11/2019 19:44	26/11/2019 11:42	25/11/2019 19:44	26/11/2019 11:42	15,97	6	95,80	CHI
201911333982	NOVA IGUACU DE GOIAS	AJ12143571	MARA ROSA	25/11/2019 19:44	26/11/2019 11:42	25/11/2019 19:44	26/11/2019 11:42	15,97	12	191,59	CHI
201911333986	BRITANIA	BT12396220	BRITANIA	25/11/2019 19:24	26/11/2019 21:05	25/11/2019 19:24	26/11/2019 21:05	25,68	2	51,35	CHI
201911333986	JUSSARA	BT12396220	BRITANIA	25/11/2019 19:24	26/11/2019 21:05	25/11/2019 19:24	26/11/2019 21:05	25,68	9	231,08	CHI
201911333991	ITABERAI	IB11227149	ITABERAI S1	25/11/2019 18:19	26/11/2019 08:54	25/11/2019 18:19	26/11/2019 08:54	14,58	1	14,58	CHI
201911333995	FORMOSO	FO12328885	PORANGATU	25/11/2019 19:46	26/11/2019 12:12	25/11/2019 19:46	26/11/2019 12:12	16,43	4	65,72	CHI
201911333995	SANTA TEREZA DE GOIAS	FO12328885	PORANGATU	25/11/2019 19:46	26/11/2019 12:12	25/11/2019 19:46	26/11/2019 12:12	16,43	12	197,17	CHI
201911333997	JATAI	10005378301	JATAI S2	25/11/2019 19:46	26/11/2019 09:09	25/11/2019 19:46	26/11/2019 09:09	13,38	1	13,38	CHI
201911334012	GOIANESIA	10020423606	GOIANESIA S2	25/11/2019 19:49	27/11/2019 11:51	25/11/2019 19:49	27/11/2019 11:51	40,03	1	40,03	CHI
201911334014	ITABERAI	HE21099453	ITABERAI S1	25/11/2019 19:49	26/11/2019 11:42	25/11/2019 19:49	26/11/2019 11:42	15,88	2	31,75	CHI
201911334019	MINEIROS	MY21301843	PARQUE DAS EMAS	25/11/2019 19:50	26/11/2019 02:18	25/11/2019 19:50	26/11/2019 02:18	6,45	1	6,45	CHI
201911334020	VILA PROPICIO	NP21235907	GOIANESIA S1	25/11/2019 19:51	26/11/2019 17:41	25/11/2019 19:51	26/11/2019 17:41	21,83	1	21,83	CHI
201911334021	SAO JOAO D ALIANCA	JL12383340	SAO JOAO D ALIANCA	25/11/2019 11:11	25/11/2019 23:37	25/11/2019 11:11	25/11/2019 23:37	12,43	76	944,51	CHI

201911334023	GOIANIRA	390064154	GOIANIRA	25/11/2019 19:51	26/11/2019 13:25	25/11/2019 19:51	26/11/2019 13:25	17,56	1	17,56	CHI
201911334024	JESUPOLIS	SF21163922	SAO FRANCISCO DE GOIAS	25/11/2019 19:51	26/11/2019 12:16	25/11/2019 19:51	26/11/2019 12:16	16,41	1	16,41	CHI
201911334025	ITUMBIARA	IT21294950	ITUMBIARA NOVA	25/11/2019 19:51	26/11/2019 09:55	25/11/2019 19:51	26/11/2019 09:55	14,05	1	14,05	CHI
201911334033	INHUMAS	IN11051564	INHUMAS S2	25/11/2019 19:43	25/11/2019 22:10	25/11/2019 19:43	25/11/2019 22:10	2,45	71	173,65	CHI
201911334034	CAIAPONIA	CP12068509	IPORA	25/11/2019 18:03	26/11/2019 08:37	25/11/2019 18:03	26/11/2019 08:37	14,57	2	29,13	CHI
201911334034	IVOLANDIA	CP12068509	IPORA	25/11/2019 18:03	26/11/2019 08:37	25/11/2019 18:03	26/11/2019 08:37	14,57	2	29,13	CHI
201911334037	IPAMERI	IP21000069	IPAMERI	25/11/2019 19:53	25/11/2019 23:38	25/11/2019 19:53	25/11/2019 23:38	3,74	1	3,74	CHI
201911334041	PIRACANJUBA	PJ12105720	PIRACANJUBA	25/11/2019 19:54	26/11/2019 20:31	25/11/2019 19:54	26/11/2019 20:31	24,61	4	98,43	CHI
201911334045	ANAPOLIS	20623902	JUNDIAI S1	25/11/2019 19:55	26/11/2019 00:04	25/11/2019 19:55	26/11/2019 00:04	4,15	1	4,15	CHI
201911334061	NOVA CRIXAS	NA12381800	NOVA CRIXAS	25/11/2019 19:58	26/11/2019 15:45	25/11/2019 19:58	26/11/2019 15:45	19,78	2	39,56	CHI
201911334065	MATRINCHA	MP21065004	MATRINCHA	25/11/2019 19:59	27/11/2019 07:41	25/11/2019 19:59	27/11/2019 07:41	35,70	1	35,70	CHI
201911334066	CAIAPONIA	CP12390147	CAIAPONIA	25/11/2019 19:59	26/11/2019 13:25	25/11/2019 19:59	26/11/2019 13:25	17,44	8	139,54	CHI
201911334072	LEOPOLDO DE BULHOES	LB31089096	DAIA S1	25/11/2019 20:01	26/11/2019 09:54	25/11/2019 20:01	26/11/2019 09:54	13,88	1	13,88	CHI
201911334084	MINACU	IH12129795	MINACU	25/11/2019 18:10	26/11/2019 02:47	25/11/2019 18:10	26/11/2019 02:47	8,61	32	275,67	CHI
201911334085	GOIANIA	GN11203708	INDEPENDENCIA S2	25/11/2019 19:58	25/11/2019 21:12	25/11/2019 19:58	25/11/2019 21:12	1,22	113	137,70	CHI
201911334102	CAIAPONIA	DV12332038	CAIAPONIA	25/11/2019 17:15	26/11/2019 19:35	25/11/2019 17:15	26/11/2019 19:35	26,33	21	553,00	CHI
201911334102	DOVERLANDIA	DV12332038	CAIAPONIA	25/11/2019 17:15	26/11/2019 19:35	25/11/2019 17:15	26/11/2019 19:35	26,33	28	737,33	CHI
201911334109	DOVERLANDIA	MY13209660	PARQUE DAS EMAS	25/11/2019 20:16	29/11/2019 13:18	25/11/2019 20:16	29/11/2019 13:18	89,05	7	623,32	CHI
201911334116	RIO VERDE	RV21189213	MONTIVIDIU T	25/11/2019 20:07	26/11/2019 10:32	25/11/2019 20:07	26/11/2019 10:32	14,40	1	14,40	CHI
201911334117	JATAI	290056640	JATAI S2	25/11/2019 20:07	26/11/2019 11:30	25/11/2019 20:07	26/11/2019 11:30	15,37	1	15,37	CHI
201911334118	ORIZONA	OZ12079953	VIANOPOLIS	25/11/2019 18:09	26/11/2019 17:02	25/11/2019 18:09	26/11/2019 17:02	22,88	4	91,51	CHI
201911334118	VIANOPOLIS	OZ12079953	VIANOPOLIS	25/11/2019 18:09	26/11/2019 17:02	25/11/2019 18:09	26/11/2019 17:02	22,88	12	274,52	CHI
201911334125	COCALZINHO DE GOIAS	ZN12258524RE	COCALZINHO	25/11/2019 11:47	26/11/2019 18:30	25/11/2019 11:47	26/11/2019 18:30	30,71	55	1689,02	CHI
201911334130	LEOPOLDO DE BULHOES	LB21311949	DAIA S1	25/11/2019 20:09	26/11/2019 10:23	25/11/2019 20:09	26/11/2019 10:23	14,22	1	14,22	CHI
201911334134	ITAPURANGA	IK12300385	ITAPURANGA	25/11/2019 19:12	26/11/2019 10:24	25/11/2019 19:12	26/11/2019 08:13	13,02	6	78,12	CHI
201911334134	ITAPURANGA	IK12300385	ITAPURANGA	25/11/2019 19:12	26/11/2019 10:24	25/11/2019 19:12	26/11/2019 10:24	15,21	1	15,21	CHI
201911334136	SANTA HELENA DE GOIAS	400063050	IPEGUARI	25/11/2019 20:10	25/11/2019 23:21	25/11/2019 20:10	25/11/2019 23:21	3,18	1	3,18	CHI
201911334138	QUIRINOPOLIS	QI12112129	QUIRINOPOLIS	25/11/2019 20:10	26/11/2019 02:53	25/11/2019 20:10	26/11/2019 02:53	6,70	4	26,80	CHI
201911334141	BARRO ALTO	BA21089725	GOIANESIA S1	25/11/2019 20:11	26/11/2019 14:38	25/11/2019 20:11	26/11/2019 14:38	18,44	2	36,87	CHI
201911334144	ITABERAI	HE21307647	ITABERAI S1	25/11/2019 20:12	26/11/2019 11:21	25/11/2019 20:12	26/11/2019 11:21	15,14	1	15,14	CHI
201911334145	RUBIATABA	780028510	RUBIATABA	25/11/2019 20:12	26/11/2019 00:08	25/11/2019 20:12	26/11/2019 00:08	3,94	1	3,94	CHI
201911334147	PIRES DO RIO	PR12344710	PIRES DO RIO S1	25/11/2019 20:13	26/11/2019 13:23	25/11/2019 20:13	26/11/2019 13:23	17,16	2	34,33	CHI
201911334148	CRIXAS	CX12392063	SANTA TEREZINHA	25/11/2019 20:13	26/11/2019 14:40	25/11/2019 20:13	26/11/2019 14:40	18,44	28	516,31	CHI

201911334148	ITAPACI	CX12392063	SANTA TEREZINHA	25/11/2019 20:13	26/11/2019 14:40	25/11/2019 20:13	26/11/2019 14:40	18,44	4	73,76	CHI
201911334153	SANTO ANTONIO DO DESCOBERTO	2210177050	ALEXANIA	25/11/2019 20:15	26/11/2019 00:34	25/11/2019 20:15	26/11/2019 00:34	4,30	1	4,30	CHI
201911334155	JARAGUA	10015506795	JARAGUA	25/11/2019 20:16	26/11/2019 16:09	25/11/2019 20:16	26/11/2019 16:09	19,87	1	19,87	CHI
201911334156	MOSSAMEDES	MD12300425	FIRMINOPOLIS S2	25/11/2019 19:44	26/11/2019 08:49	25/11/2019 19:44	26/11/2019 08:49	13,07	5	65,36	CHI
201911334159	MINEIROS	MY12358869	PARQUE DAS EMAS	25/11/2019 20:13	27/11/2019 10:00	27/11/2019 02:33	27/11/2019 10:00	7,45	14	104,26	CHI
201911334170	ITABERAI	IB11000038	ITABERAI S2	25/11/2019 18:41	25/11/2019 23:44	25/11/2019 18:41	25/11/2019 23:44	5,05	112	565,29	CHI
201911334177	CUMARI	CY12306655	CATALAO S1	25/11/2019 20:20	26/11/2019 07:55	25/11/2019 20:20	26/11/2019 07:55	11,57	72	833,36	CHI
201911334184	ACREUNA	EU21260859	ACREUNA	25/11/2019 20:22	26/11/2019 08:15	25/11/2019 20:22	26/11/2019 08:15	11,88	2	23,76	CHI
201911334186	PORANGATU	PO12220862	PORANGATU	25/11/2019 19:48	26/11/2019 18:10	25/11/2019 19:48	26/11/2019 18:10	22,37	4	89,46	CHI
201911334187	RIO VERDE	RV12260134	CABRIUVA S1	25/11/2019 20:23	26/11/2019 11:44	25/11/2019 20:23	26/11/2019 11:44	15,34	8	122,72	CHI
201911334191	IPORA	10001154662	IPORA	25/11/2019 20:24	26/11/2019 15:22	25/11/2019 20:24	26/11/2019 15:22	18,96	1	18,96	CHI
201911334192	AMORINOPOLIS	AM12259501	IPORA	25/11/2019 18:59	26/11/2019 00:14	25/11/2019 18:59	26/11/2019 00:14	5,24	6	31,46	CHI
201911334196	HEITORAI	HE12310804	ITABERAI S1	25/11/2019 19:48	26/11/2019 11:05	25/11/2019 19:48	26/11/2019 11:05	15,28	20	305,58	CHI
201911334196	ITABERAI	HE12310804	ITABERAI S1	25/11/2019 19:48	26/11/2019 11:05	25/11/2019 19:48	26/11/2019 11:05	15,28	1	15,28	CHI
201911334199	QUIRINOPOLIS	QI12244963	CACHOEIRA ALTA	25/11/2019 20:26	26/11/2019 09:10	25/11/2019 20:26	26/11/2019 09:10	12,72	3	38,17	CHI
201911334202	GOIAS	MD12062634	ITABERAI S1	26/11/2019 06:43	26/11/2019 11:01	26/11/2019 06:43	26/11/2019 11:01	4,29	7	30,05	CHI
201911334202	ITABERAI	MD12062634	ITABERAI S1	26/11/2019 06:43	26/11/2019 11:01	26/11/2019 06:43	26/11/2019 11:01	4,29	4	17,17	CHI
201911334202	MOSSAMEDES	MD12062634	ITABERAI S1	26/11/2019 06:43	26/11/2019 11:01	26/11/2019 06:43	26/11/2019 11:01	4,29	196	841,33	CHI
201911334211	RUBIATABA	RB12000022	RUBIATABA	26/11/2019 08:55	27/11/2019 17:00	26/11/2019 08:55	27/11/2019 17:00	32,08	7	224,54	CHI
201911334212	PLANALTINA	PI12100878	PLANALTINA	25/11/2019 18:47	26/11/2019 04:09	25/11/2019 18:47	26/11/2019 04:09	9,37	23	215,40	CHI
201911334223	GUARINOS	01490224	URUACU	25/11/2019 19:24	26/11/2019 01:06	25/11/2019 19:24	26/11/2019 01:04	5,65	10	56,52	CHI
201911334223	ITAPACI	01490224	URUACU	25/11/2019 19:24	26/11/2019 01:06	25/11/2019 19:24	26/11/2019 01:04	5,65	2	11,30	CHI
201911334223	PILAR DE GOIAS	01490224	URUACU	25/11/2019 19:24	26/11/2019 01:06	25/11/2019 19:24	26/11/2019 01:04	5,65	429	2424,57	CHI
201911334223	SANTA TEREZINHA DE GOIAS	01490224	URUACU	25/11/2019 19:24	26/11/2019 01:06	25/11/2019 19:24	26/11/2019 01:04	5,65	1	5,65	CHI
201911334223	PILAR DE GOIAS	01490214	URUACU	25/11/2019 19:24	26/11/2019 01:06	25/11/2019 19:24	26/11/2019 01:06	5,69	29	165,15	CHI
201911334234	CRIXAS	RB12170307	RUBIATABA	25/11/2019 18:48	26/11/2019 15:23	25/11/2019 18:48	26/11/2019 15:23	20,58	1	20,58	CHI
201911334234	NOVA AMERICA	RB12170307	RUBIATABA	25/11/2019 18:48	26/11/2019 15:23	25/11/2019 18:48	26/11/2019 15:23	20,58	19	390,98	CHI
201911334234	RUBIATABA	RB12170307	RUBIATABA	25/11/2019 18:48	26/11/2019 15:23	25/11/2019 18:48	26/11/2019 15:23	20,58	57	1172,95	CHI
201911334236	VIANOPOLIS	VN12127632	VIANOPOLIS	25/11/2019 20:35	26/11/2019 13:26	25/11/2019 20:35	26/11/2019 13:26	16,84	30	505,10	CHI
201911334238	ABADIA DE GOIAS	5584288504	CARAJAS S1	25/11/2019 20:36	26/11/2019 11:40	25/11/2019 20:36	26/11/2019 11:40	15,07	1	15,07	CHI
201911334246	RUBIATABA	RB21312121	RUBIATABA	25/11/2019 20:38	27/11/2019 10:51	25/11/2019 20:38	27/11/2019 10:51	38,21	1	38,21	CHI
201911334258	CAIAPONIA	CP12207985	CAIAPONIA	25/11/2019 19:31	26/11/2019 00:15	25/11/2019 19:31	26/11/2019 00:15	4,73	231	1092,69	CHI
201911334261	PONTALINA	PK12047240	PONTALINA	25/11/2019 15:26	27/11/2019 11:31	25/11/2019 15:26	27/11/2019 11:31	44,07	2	88,15	CHI

201911334285	RIO VERDE	630040114	RIO VERDE S1	25/11/2019 20:45	26/11/2019 09:29	25/11/2019 20:45	26/11/2019 09:29	12,74	1	12,74	CHI
201911334290	BOM JARDIM DE GOIAS	BM12205302	BOM JARDIM	25/11/2019 19:37	26/11/2019 09:52	25/11/2019 19:37	26/11/2019 09:52	14,25	9	128,22	CHI
201911334293	APARECIDA DE GOIANIA	15861831	INDEPENDENCIA S1	25/11/2019 20:45	26/11/2019 01:37	25/11/2019 20:45	26/11/2019 01:37	4,85	1	4,85	CHI
201911334312	CABECEIRAS	10002455313	ITUIQUIRA	25/11/2019 20:49	26/11/2019 14:30	25/11/2019 20:49	26/11/2019 14:30	17,69	1	17,69	CHI
201911334318	PILAR DE GOIAS	GG21340119	SANTA TEREZINHA	25/11/2019 20:50	26/11/2019 18:42	25/11/2019 20:50	26/11/2019 18:42	21,85	1	21,85	CHI
201911334320	PIRES DO RIO	460094075	PIRES DO RIO S1	25/11/2019 20:51	25/11/2019 21:50	25/11/2019 20:51	25/11/2019 21:50	0,99	1	0,99	CHI
201911334324	ITAGUARU	IC11159958	ITABERAI S1	25/11/2019 18:47	27/11/2019 12:18	25/11/2019 18:47	27/11/2019 12:18	41,50	43	1784,61	CHI
201911334326	DOVERLANDIA	DV11253351	CAIAPONIA	25/11/2019 20:52	26/11/2019 16:45	25/11/2019 20:52	26/11/2019 16:45	19,87	1	19,87	CHI
201911334327	GOIANIA	14432080	XAVANTES	25/11/2019 20:52	25/11/2019 23:30	25/11/2019 20:52	25/11/2019 23:30	2,62	1	2,62	CHI
201911334351	ITAJA	IJ12202625	ITAJA S2	25/11/2019 20:58	29/11/2019 15:15	26/11/2019 12:11	26/11/2019 16:55	4,75	16	75,94	CHI
201911334351	ITAJA	IJ13205157	ITAJA S2	25/11/2019 20:58	29/11/2019 15:15	26/11/2019 12:11	26/11/2019 18:51	6,68	5	33,39	CHI
201911334351	ITAJA	IJ13241715	ITAJA S2	25/11/2019 20:58	29/11/2019 15:15	26/11/2019 12:11	27/11/2019 14:17	26,11	1	26,11	CHI
201911334351	APORE	AE13241809	ITAJA S2	25/11/2019 20:58	29/11/2019 15:15	26/11/2019 12:11	28/11/2019 18:04	53,89	2	107,77	CHI
201911334351	APORE	AE13241823	ITAJA S2	25/11/2019 20:58	29/11/2019 15:15	26/11/2019 12:11	29/11/2019 12:11	72,00	1	72,00	CHI
201911334351	APORE	IM10401499	ITAJA S2	25/11/2019 20:58	29/11/2019 15:15	29/11/2019 12:12	29/11/2019 12:31	0,31	2	0,61	CHI
201911334351	ITAJA	IM10401499	ITAJA S2	25/11/2019 20:58	29/11/2019 15:15	29/11/2019 12:12	29/11/2019 12:31	0,31	68	20,89	CHI
201911334351	ITARUMA	IM10401499	ITAJA S2	25/11/2019 20:58	29/11/2019 15:15	29/11/2019 12:12	29/11/2019 12:31	0,31	99	30,42	CHI
201911334351	APORE	AE13241823	ITAJA S2	25/11/2019 20:58	29/11/2019 15:15	29/11/2019 12:12	29/11/2019 13:40	1,46	1	1,46	CHI
201911334351	APORE	AE12340774	ITAJA S2	25/11/2019 20:58	29/11/2019 15:15	29/11/2019 12:12	29/11/2019 15:15	3,04	1	3,04	CHI
201911334371	ABADIANIA	AA21350812	ANAPOLIS UNIVERSITARIO S1	25/11/2019 21:04	27/11/2019 16:01	25/11/2019 21:04	27/11/2019 16:01	42,96	1	42,96	CHI
201911334393	CATALAO	1990136671	CATALAO S2	25/11/2019 21:11	26/11/2019 00:01	25/11/2019 21:11	26/11/2019 00:01	2,83	1	2,83	CHI
201911334397	SENADOR CANEDO	SW11270547	CEPAIGO S2	25/11/2019 19:59	25/11/2019 23:47	25/11/2019 19:59	25/11/2019 23:47	3,79	14	53,11	CHI
201911334399	GOIANIA	GN12087621	ATLANTICO S1	25/11/2019 20:55	25/11/2019 22:31	25/11/2019 20:55	25/11/2019 22:31	1,59	38	60,47	CHI
201911334401	PORANGATU	PO12297105	PORANGATU	25/11/2019 21:07	26/11/2019 11:40	25/11/2019 21:07	26/11/2019 11:40	14,56	10	145,62	CHI
201911334416	ARAGOIANIA	AO11132422	GUAPU S2	25/11/2019 18:54	27/11/2019 12:20	25/11/2019 18:54	27/11/2019 12:20	41,43	23	952,93	CHI
201911334418	AMARALINA	MU12391981	MARA ROSA	25/11/2019 21:19	26/11/2019 20:25	25/11/2019 21:19	26/11/2019 20:25	23,09	5	115,44	CHI
201911334418	MUTUNOPOLIS	MU12391981	MARA ROSA	25/11/2019 21:19	26/11/2019 20:25	25/11/2019 21:19	26/11/2019 20:25	23,09	5	115,44	CHI
201911334420	SAO JOAO D ALIANCA	3840001168	SAO JOAO D ALIANCA	25/11/2019 17:22	26/11/2019 00:37	25/11/2019 17:22	26/11/2019 00:37	7,23	1	7,23	CHI
201911334432	FIRMINOPOLIS	FR12391442	FIRMINOPOLIS S2	25/11/2019 20:39	26/11/2019 13:53	25/11/2019 20:39	26/11/2019 13:53	17,23	65	1120,13	CHI
201911334432	SAO JOAO DA PARAUNA	FR12391442	FIRMINOPOLIS S2	25/11/2019 20:39	26/11/2019 13:53	25/11/2019 20:39	26/11/2019 13:53	17,23	71	1223,53	CHI
201911334436	MINEIROS	MY12347799	PARQUE DAS EMAS	25/11/2019 21:29	26/11/2019 11:27	25/11/2019 21:29	26/11/2019 11:27	13,96	6	83,77	CHI
201911334440	MORRINHOS	MR21373957	MORRINHOS	25/11/2019 21:30	26/11/2019 11:52	25/11/2019 21:30	26/11/2019 11:52	14,37	1	14,37	CHI
201911334446	MORRO AGUDO DE GOIAS	RB12156092	RUBIATABA	25/11/2019 21:30	27/11/2019 15:24	25/11/2019 21:30	27/11/2019 15:24	41,90	10	418,96	CHI

201911334448	ITAPIRAPUA	1420009683	MATRINCHA	25/11/2019 21:33	26/11/2019 08:17	25/11/2019 21:33	26/11/2019 08:17	10,73	1	10,73	CHI
201911334459	ARENOPOLIS	AY12000051	ARENOPOLIS	25/11/2019 21:37	26/11/2019 15:59	25/11/2019 21:37	26/11/2019 15:59	18,36	4	73,46	CHI
201911334459	DIORAMA	AY12000051	ARENOPOLIS	25/11/2019 21:37	26/11/2019 15:59	25/11/2019 21:37	26/11/2019 15:59	18,36	2	36,73	CHI
201911334466	PLANALTINA	10003740640	PLANALTINA	25/11/2019 21:38	26/11/2019 12:05	25/11/2019 21:38	26/11/2019 12:05	14,44	1	14,44	CHI
201911334473	SANTA HELENA DE GOIAS	10015602727	IPEGUARI	25/11/2019 21:40	26/11/2019 10:00	25/11/2019 21:40	26/11/2019 10:00	12,32	1	12,32	CHI
201911334474	PLANALTINA	PI12214338	PLANALTINA	25/11/2019 14:48	26/11/2019 19:26	25/11/2019 14:48	26/11/2019 19:26	28,63	12	343,51	CHI
201911334480	ITABERAI	IB12220379	ITABERAI S1	25/11/2019 18:19	26/11/2019 09:42	25/11/2019 18:19	26/11/2019 08:15	13,92	123	1712,77	CHI
201911334480	ITABERAI	IB12220379	ITABERAI S1	25/11/2019 18:19	26/11/2019 09:42	25/11/2019 18:19	26/11/2019 09:42	15,38	3	46,13	CHI
201911334499	PORANGATU	PO12020578	PORANGATU	25/11/2019 21:48	26/11/2019 11:11	25/11/2019 21:48	26/11/2019 11:11	13,38	23	307,78	CHI
201911334531	PALMEIRAS DE GOIAS	PL21197890	PALMEIRAS	25/11/2019 16:21	26/11/2019 15:26	25/11/2019 16:21	26/11/2019 15:26	23,08	1	23,08	CHI
201911334609	ARENOPOLIS	AY12087158	ARENOPOLIS	25/11/2019 21:53	26/11/2019 14:43	25/11/2019 21:53	26/11/2019 14:43	16,82	10	168,21	CHI
201911334610	ANICUNS	910010304	ANICUNS	25/11/2019 21:54	26/11/2019 08:01	25/11/2019 21:54	26/11/2019 08:01	10,11	1	10,11	CHI
201911334615	SAO LUIS DE MONTES BELOS	2930001258	FIRMINOPOLIS S2	25/11/2019 21:57	26/11/2019 12:15	25/11/2019 21:57	26/11/2019 12:15	14,30	1	14,30	CHI
201911334616	JANDAIA	JD12021345	PALMEIRAS	25/11/2019 18:47	26/11/2019 09:55	25/11/2019 18:47	26/11/2019 09:55	15,14	3	45,41	CHI
201911334619	CRISTALINA	KR21170440	CRISTALINA S2	25/11/2019 12:08	26/11/2019 11:16	25/11/2019 12:08	26/11/2019 11:16	23,13	1	23,13	CHI
201911334626	NOVA IGUACU DE GOIAS	UR12000054	CAMPINORTE	25/11/2019 22:02	26/11/2019 00:39	25/11/2019 22:02	26/11/2019 00:39	2,61	15	39,17	CHI
201911334626	URUACU	UR12000054	CAMPINORTE	25/11/2019 22:02	26/11/2019 00:39	25/11/2019 22:02	26/11/2019 00:39	2,61	90	235,05	CHI
201911334631	CORUMBA DE GOIAS	CB21297778	CORUMBA	25/11/2019 22:05	26/11/2019 08:30	25/11/2019 22:05	26/11/2019 08:30	10,42	1	10,42	CHI
201911334634	GOIAS	IB12000044	ITABERAI S2	25/11/2019 22:06	26/11/2019 11:57	25/11/2019 22:06	26/11/2019 11:57	13,85	1	13,85	CHI
201911334634	ITABERAI	IB12000044	ITABERAI S2	25/11/2019 22:06	26/11/2019 11:57	25/11/2019 22:06	26/11/2019 11:57	13,85	7	96,93	CHI
201911334642	PONTALINA	PK12182928	PONTALINA	25/11/2019 20:04	26/11/2019 15:09	25/11/2019 20:04	26/11/2019 15:09	19,08	15	286,18	CHI
201911334655	NIQUELANDIA	NQ12088704	URUACU	25/11/2019 22:15	26/11/2019 14:30	25/11/2019 22:15	26/11/2019 10:13	11,97	2	23,93	CHI
201911334655	NIQUELANDIA	NQ12088704	URUACU	25/11/2019 22:15	26/11/2019 14:30	26/11/2019 12:00	26/11/2019 14:30	2,50	21	52,52	CHI
201911334657	NOVA CRIXAS	MH10400727	NOVA CRIXAS	25/11/2019 22:15	26/11/2019 18:18	25/11/2019 22:15	26/11/2019 08:29	10,25	223	2284,82	CHI
201911334657	NOVA CRIXAS	NA13313424	NOVA CRIXAS	25/11/2019 22:15	26/11/2019 18:18	25/11/2019 22:15	26/11/2019 10:36	12,36	778	9617,81	CHI
201911334657	NOVA CRIXAS	NA11208315	NOVA CRIXAS	25/11/2019 22:15	26/11/2019 18:18	25/11/2019 22:15	26/11/2019 18:18	20,05	57	1142,83	CHI
201911334662	ARACU	AR11194857	ARACU	25/11/2019 17:24	25/11/2019 23:50	25/11/2019 17:24	25/11/2019 23:50	6,42	58	372,33	CHI
201911334666	FLORES DE GOIAS	FB21320594	FLORES DE GOIAS	25/11/2019 22:19	26/11/2019 14:00	25/11/2019 22:19	26/11/2019 14:00	15,68	1	15,68	CHI
201911334668	FORMOSA	FB21242854	FLORES DE GOIAS	25/11/2019 22:20	26/11/2019 14:12	25/11/2019 22:20	26/11/2019 14:12	15,87	2	31,74	CHI
201911334670	ADELANDIA	SL12019453	FIRMINOPOLIS S2	25/11/2019 19:16	26/11/2019 13:10	25/11/2019 19:16	26/11/2019 13:10	17,89	45	804,99	CHI
201911334670	MOSSAMEDES	SL12019453	FIRMINOPOLIS S2	25/11/2019 19:16	26/11/2019 13:10	25/11/2019 19:16	26/11/2019 13:10	17,89	5	89,44	CHI
201911334670	SANCLERLANDIA	SL12019453	FIRMINOPOLIS S2	25/11/2019 19:16	26/11/2019 13:10	25/11/2019 19:16	26/11/2019 13:10	17,89	30	536,66	CHI
201911334670	SAO LUIS DE MONTES BELOS	SL12019453	FIRMINOPOLIS S2	25/11/2019 19:16	26/11/2019 13:10	25/11/2019 19:16	26/11/2019 13:10	17,89	14	250,44	CHI



201911334674	MOSSAMEDES	MD12020754	ITABERAI S2	25/11/2019 22:23	27/11/2019 08:14	25/11/2019 22:23	27/11/2019 08:14	33,84	7	236,90	CHI
201911334676	ITABERAI	IB21259651	ITABERAI S2	25/11/2019 22:24	26/11/2019 20:59	25/11/2019 22:24	26/11/2019 20:59	22,58	1	22,58	CHI
201911334690	ITAPACI	100033611	ITAPACI	25/11/2019 22:30	26/11/2019 02:27	25/11/2019 22:30	26/11/2019 02:27	3,94	1	3,94	CHI
201911334699	CRIXAS	MZ12055650	MOZARLANDIA	26/11/2019 06:37	26/11/2019 15:20	26/11/2019 06:37	26/11/2019 15:20	8,71	76	662,02	CHI
201911334699	MOZARLANDIA	MZ12055650	MOZARLANDIA	26/11/2019 06:37	26/11/2019 15:20	26/11/2019 06:37	26/11/2019 15:20	8,71	5	43,55	CHI
201911334699	NOVA CRIXAS	MZ12055650	MOZARLANDIA	26/11/2019 06:37	26/11/2019 15:20	26/11/2019 06:37	26/11/2019 15:20	8,71	28	243,90	CHI
201911334703	DOVERLANDIA	DV12138540	CAIAPONIA	25/11/2019 18:06	26/11/2019 10:52	25/11/2019 18:06	26/11/2019 10:52	16,76	9	150,82	CHI
201911334709	RUBIATABA	10001453660	RUBIATABA	25/11/2019 22:45	26/11/2019 12:32	25/11/2019 22:45	26/11/2019 12:32	13,77	1	13,77	CHI
201911334710	FORMOSA	610189104	ITIQUEIRA	25/11/2019 22:46	26/11/2019 02:56	25/11/2019 22:46	26/11/2019 02:56	4,17	1	4,17	CHI
201911334723	IPORA	730089101	IPORA	25/11/2019 22:54	26/11/2019 09:30	25/11/2019 22:54	26/11/2019 09:30	10,60	1	10,60	CHI
201911334729	ALTO PARAISO DE GOIAS	BF12264707	FLORES DE GOIAS	25/11/2019 20:34	26/11/2019 08:53	25/11/2019 20:34	26/11/2019 08:53	12,32	21	258,80	CHI
201911334760	CAIAPONIA	CP12193479	CAIAPONIA	25/11/2019 23:14	26/11/2019 11:00	25/11/2019 23:14	26/11/2019 11:00	11,76	34	400,01	CHI
201911334769	FIRMINOPOLIS	FR12063120	FIRMINOPOLIS S1	26/11/2019 05:46	26/11/2019 11:13	26/11/2019 05:46	26/11/2019 11:13	5,44	1	5,44	CHI
201911334770	CAMPINORTE	CR12398067	CAMPINORTE	25/11/2019 23:26	26/11/2019 10:02	25/11/2019 23:26	26/11/2019 10:02	10,59	9	95,28	CHI
201911334770	URUACU	CR12398067	CAMPINORTE	25/11/2019 23:26	26/11/2019 10:02	25/11/2019 23:26	26/11/2019 10:02	10,59	1	10,59	CHI
201911334793	SAO LUIS DE MONTES BELOS	10002848552	SAO LUIZ DOS MONTES BELOS	25/11/2019 23:51	26/11/2019 10:41	25/11/2019 23:51	26/11/2019 10:41	10,83	1	10,83	CHI
201911334795	CRIXAS	00450214	SERRA DO OURO	25/11/2019 23:54	26/11/2019 20:24	26/11/2019 10:39	26/11/2019 10:57	0,30	4374	1319,49	CHI
201911334795	CRIXAS	CX12070410LD	SERRA DO OURO	25/11/2019 23:54	26/11/2019 20:24	25/11/2019 23:54	26/11/2019 20:24	20,49	373	7643,70	CHI
201911334795	NOVA ROMA	CX12070410LD	SERRA DO OURO	25/11/2019 23:54	26/11/2019 20:24	25/11/2019 23:54	26/11/2019 20:24	20,49	1	20,49	CHI
201911334795	PORANGATU	CX12070410LD	SERRA DO OURO	25/11/2019 23:54	26/11/2019 20:24	25/11/2019 23:54	26/11/2019 20:24	20,49	1	20,49	CHI
201911334795	CRIXAS	CX12070410LD	SERRA DO OURO	25/11/2019 23:54	26/11/2019 20:24	26/11/2019 10:39	26/11/2019 20:24	9,75	2	19,50	CHI
201911334800	ITABERAI	50044965	ITABERAI S2	26/11/2019 00:07	26/11/2019 18:11	26/11/2019 00:07	26/11/2019 18:11	18,05	1	18,05	CHI
201911334801	GOIANESIA	GE12376588	GOIANESIA S2	25/11/2019 19:55	26/11/2019 09:51	25/11/2019 19:55	26/11/2019 09:51	13,93	8	111,41	CHI
201911334801	VILA PROPICIO	GE12376588	GOIANESIA S2	25/11/2019 19:55	26/11/2019 09:51	25/11/2019 19:55	26/11/2019 09:51	13,93	2	27,85	CHI
201911334805	AMORINOPOLIS	AM12123963	IPORA	26/11/2019 00:23	26/11/2019 11:55	26/11/2019 00:23	26/11/2019 11:55	11,52	10	115,22	CHI
201911334805	IVOLANDIA	AM12123963	IPORA	26/11/2019 00:23	26/11/2019 11:55	26/11/2019 00:23	26/11/2019 11:55	11,52	9	103,70	CHI
201911334815	NOVA CRIXAS	SM10406657	SAO MIGUEL DO ARAGUAIA	26/11/2019 00:37	26/11/2019 11:57	26/11/2019 00:37	26/11/2019 02:39	2,05	1	2,05	CHI
201911334815	SAO MIGUEL DO ARAGUAIA	SM10406657	SAO MIGUEL DO ARAGUAIA	26/11/2019 00:37	26/11/2019 11:57	26/11/2019 00:37	26/11/2019 02:39	2,05	281	575,11	CHI
201911334815	NOVA CRIXAS	SM10406657	SAO MIGUEL DO ARAGUAIA	26/11/2019 00:37	26/11/2019 11:57	26/11/2019 02:48	26/11/2019 03:03	0,26	1	0,26	CHI
201911334815	SAO MIGUEL DO ARAGUAIA	SM10406657	SAO MIGUEL DO ARAGUAIA	26/11/2019 00:37	26/11/2019 11:57	26/11/2019 02:48	26/11/2019 03:03	0,26	281	71,89	CHI
201911334815	SAO MIGUEL DO ARAGUAIA	SM13086462	SAO MIGUEL DO ARAGUAIA	26/11/2019 00:37	26/11/2019 11:57	26/11/2019 00:37	26/11/2019 04:47	4,18	28	116,92	CHI
201911334815	SAO MIGUEL DO ARAGUAIA	SM12086469	SAO MIGUEL DO ARAGUAIA	26/11/2019 00:37	26/11/2019 11:57	26/11/2019 00:37	26/11/2019 10:24	9,79	471	4609,39	CHI
201911334815	SAO MIGUEL DO ARAGUAIA	SM13334392	SAO MIGUEL DO ARAGUAIA	26/11/2019 00:37	26/11/2019 11:57	26/11/2019 00:37	26/11/2019 11:57	11,34	248	2811,91	CHI

201911334821	BURITINOPOLIS	04990216	IACIARA S2	26/11/2019 01:13	26/11/2019 02:27	26/11/2019 01:13	26/11/2019 02:27	1,22	393	480,99	CHI
201911334821	MAMBAI	04990216	IACIARA S2	26/11/2019 01:13	26/11/2019 02:27	26/11/2019 01:13	26/11/2019 02:27	1,22	2526	3091,54	CHI
201911334823	ANAPOLIS	AN12285251	ANAPOLIS UNIVERSITARIO S2	25/11/2019 16:28	27/11/2019 15:49	25/11/2019 16:28	26/11/2019 04:10	11,69	11	128,57	CHI
201911334823	ANAPOLIS	AN12297706	ANAPOLIS UNIVERSITARIO S2	25/11/2019 16:28	27/11/2019 15:49	26/11/2019 20:22	26/11/2019 20:33	0,19	2	0,38	CHI
201911334823	ANAPOLIS	AN12221398	ANAPOLIS UNIVERSITARIO S2	25/11/2019 16:28	27/11/2019 15:49	25/11/2019 16:28	27/11/2019 01:24	32,92	2	65,84	CHI
201911334823	PIRENOPOLIS	AN12221398	ANAPOLIS UNIVERSITARIO S2	25/11/2019 16:28	27/11/2019 15:49	25/11/2019 16:28	27/11/2019 01:24	32,92	5	164,61	CHI
201911334823	ABADIANIA	AN12221398	ANAPOLIS UNIVERSITARIO S2	25/11/2019 16:28	27/11/2019 15:49	25/11/2019 16:28	27/11/2019 15:49	47,34	17	804,78	CHI
201911334823	PIRENOPOLIS	AN12221398	ANAPOLIS UNIVERSITARIO S2	25/11/2019 16:28	27/11/2019 15:49	25/11/2019 16:28	27/11/2019 15:49	47,34	7	331,38	CHI
201911334823	PIRENOPOLIS	AN12221398	ANAPOLIS UNIVERSITARIO S2	25/11/2019 16:28	27/11/2019 15:49	26/11/2019 15:18	27/11/2019 15:49	24,52	1	24,52	CHI
201911334823	ANAPOLIS	AN12221398	ANAPOLIS UNIVERSITARIO S2	25/11/2019 16:28	27/11/2019 15:49	27/11/2019 01:25	27/11/2019 15:49	14,40	2	28,80	CHI
201911334823	PIRENOPOLIS	AN12221398	ANAPOLIS UNIVERSITARIO S2	25/11/2019 16:28	27/11/2019 15:49	27/11/2019 01:25	27/11/2019 15:49	14,40	5	72,01	CHI
201911334824	MINACU	IH11311576	MINACU	26/11/2019 01:26	26/11/2019 07:13	26/11/2019 01:26	26/11/2019 07:13	5,78	104	601,41	CHI
201911334831	IACIARA	IA12262079	IACIARA S1	26/11/2019 01:43	26/11/2019 08:31	26/11/2019 01:43	26/11/2019 08:31	6,80	21	142,79	CHI
201911334849	CAIAPONIA	CP12238699	PALESTINA	26/11/2019 02:45	26/11/2019 12:35	26/11/2019 02:45	26/11/2019 12:35	9,82	8	78,60	CHI
201911334856	SAO MIGUEL DO ARAGUAIA	830027180	SAO MIGUEL DO ARAGUAIA	26/11/2019 03:02	26/11/2019 19:53	26/11/2019 03:02	26/11/2019 19:53	16,84	1	16,84	CHI
201911334864	FORMOSA	FA12404372	ITIQUEIRA	26/11/2019 03:31	26/11/2019 09:17	26/11/2019 03:31	26/11/2019 09:17	5,76	167	962,01	CHI
201911334865	PORANGATU	840025774	PORANGATU	26/11/2019 03:37	26/11/2019 09:21	26/11/2019 03:37	26/11/2019 09:21	5,73	1	5,73	CHI
201911334877	ALVORADA DO NORTE	BQ12180925RE	IACIARA S2	26/11/2019 04:03	26/11/2019 08:12	26/11/2019 04:03	26/11/2019 08:12	4,14	1	4,14	CHI
201911334877	BURITINOPOLIS	BQ12180925RE	IACIARA S2	26/11/2019 04:03	26/11/2019 08:12	26/11/2019 04:03	26/11/2019 08:12	4,14	149	616,69	CHI
201911334887	MOSSAMEDES	MD12120930	ITABERAI S2	26/11/2019 04:04	26/11/2019 13:43	26/11/2019 04:04	26/11/2019 13:43	9,65	11	106,14	CHI
201911334891	MINACU	IH12088797	MINACU	26/11/2019 04:25	26/11/2019 08:42	26/11/2019 04:25	26/11/2019 08:42	4,27	164	701,05	CHI
201911334897	MOZARLANDIA	MZ12057146	MOZARLANDIA	26/11/2019 05:54	26/11/2019 18:57	26/11/2019 05:54	26/11/2019 18:57	13,04	6	78,23	CHI
201911334897	NOVA CRIXAS	MZ12057146	MOZARLANDIA	26/11/2019 05:54	26/11/2019 18:57	26/11/2019 05:54	26/11/2019 18:57	13,04	32	417,24	CHI
201911334907	ALEXANIA	AX12295588	ALEXANIA	25/11/2019 13:30	26/11/2019 16:21	25/11/2019 13:30	26/11/2019 16:21	26,85	10	268,50	CHI
201911334940	MOSSAMEDES	MD12188234	FIRMINOPOLIS S2	26/11/2019 06:11	26/11/2019 08:53	26/11/2019 06:11	26/11/2019 08:53	2,70	34	91,71	CHI
201911334988	MONTES CLAROS DE GOIAS	ME21138694	IPORA	26/11/2019 07:58	26/11/2019 15:10	26/11/2019 07:58	26/11/2019 15:10	7,20	1	7,20	CHI
201911335001	MORRINHOS	MR12117392	GOIATUBA S1	25/11/2019 16:39	26/11/2019 11:42	25/11/2019 16:39	26/11/2019 11:42	19,04	11	209,44	CHI
201911335007	MONTES CLAROS DE GOIAS	ME12212902	IPORA	26/11/2019 04:51	26/11/2019 20:10	26/11/2019 04:51	26/11/2019 20:10	15,32	10	153,24	CHI
201911335009	AMARALINA	LC12189854	MARA ROSA	26/11/2019 04:51	26/11/2019 13:35	26/11/2019 04:51	26/11/2019 13:35	8,72	7	61,05	CHI
201911335009	MARA ROSA	LC12189854	MARA ROSA	26/11/2019 04:51	26/11/2019 13:35	26/11/2019 04:51	26/11/2019 13:35	8,72	2	17,44	CHI
201911335014	CRIXAS	NM12025397LD	RUBIATABA	26/11/2019 04:58	26/11/2019 17:08	26/11/2019 04:58	26/11/2019 17:08	12,17	25	304,25	CHI
201911335014	GUARINOS	NM12025397LD	RUBIATABA	26/11/2019 04:58	26/11/2019 17:08	26/11/2019 04:58	26/11/2019 17:08	12,17	11	133,87	CHI
201911335014	ITAPACI	NM12025397LD	RUBIATABA	26/11/2019 04:58	26/11/2019 17:08	26/11/2019 04:58	26/11/2019 17:08	12,17	107	1302,19	CHI

201911335014	NOVA AMERICA	NM12025397LD	RUBIATABA	26/11/2019 04:58	26/11/2019 17:08	26/11/2019 04:58	26/11/2019 17:08	12,17	25	304,25	CHI
201911335016	AMORINOPOLIS	IV12390141	IPORA	26/11/2019 04:56	26/11/2019 06:52	26/11/2019 04:56	26/11/2019 06:52	1,93	5	9,66	CHI
201911335016	IVOLANDIA	IV12390141	IPORA	26/11/2019 04:56	26/11/2019 06:52	26/11/2019 04:56	26/11/2019 06:52	1,93	60	115,88	CHI
201911335018	VILA BOA	FA12102763	ITIQUEIRA	26/11/2019 05:00	26/11/2019 16:23	26/11/2019 05:00	26/11/2019 16:23	11,38	1	11,38	CHI
201911335022	VARJAO	VJ12402740	GUAPO S2	25/11/2019 19:41	26/11/2019 10:24	25/11/2019 19:41	26/11/2019 10:24	14,71	8	117,64	CHI
201911335033	ARAGUAPAZ	FC12071270	GOIAS	26/11/2019 05:13	26/11/2019 18:07	26/11/2019 05:13	26/11/2019 18:07	12,89	4	51,55	CHI
201911335033	FAINA	FC12071270	GOIAS	26/11/2019 05:13	26/11/2019 18:07	26/11/2019 05:13	26/11/2019 18:07	12,89	3	38,66	CHI
201911335034	LUZIANIA	LZ12072245	VIANOPOLIS	25/11/2019 17:40	26/11/2019 08:31	25/11/2019 17:40	26/11/2019 08:31	14,84	11	163,23	CHI
201911335048	URUACU	UR21156423	CAMPINORTE	26/11/2019 05:21	26/11/2019 10:52	26/11/2019 05:21	26/11/2019 10:52	5,51	1	5,51	CHI
201911335053	URUACU	UR12364104	URUACU	26/11/2019 05:22	26/11/2019 08:56	26/11/2019 05:22	26/11/2019 08:56	3,56	87	309,31	CHI
201911335055	ITAPIRAPUA	IU12030155	JUSSARA	26/11/2019 05:23	26/11/2019 09:28	26/11/2019 05:23	26/11/2019 09:28	4,07	42	171,10	CHI
201911335055	NOVO BRASIL	IU12030155	JUSSARA	26/11/2019 05:23	26/11/2019 09:28	26/11/2019 05:23	26/11/2019 09:28	4,07	1	4,07	CHI
201911335062	FORMOSO	TB12051886	PORANGATU	26/11/2019 05:26	26/11/2019 19:20	26/11/2019 05:26	26/11/2019 19:20	13,89	2	27,78	CHI
201911335062	TROMBAS	TB12051886	PORANGATU	26/11/2019 05:26	26/11/2019 19:20	26/11/2019 05:26	26/11/2019 19:20	13,89	24	333,38	CHI
201911335072	PORANGATU	PO12020580	PORANGATU	26/11/2019 05:33	26/11/2019 12:32	26/11/2019 05:33	26/11/2019 12:32	6,99	66	461,45	CHI
201911335080	MUNDO NOVO DE GOIAS	MH12357676	NOVA CRIXAS	26/11/2019 05:37	26/11/2019 15:20	26/11/2019 05:37	26/11/2019 15:20	9,72	24	233,25	CHI
201911335091	ITAPURANGA	IK12220544	ITAPURANGA	26/11/2019 05:44	26/11/2019 08:21	26/11/2019 05:44	26/11/2019 08:21	2,61	27	70,57	CHI
201911335096	URUACU	UR12291129	CAMPINORTE	26/11/2019 05:46	26/11/2019 07:28	26/11/2019 05:46	26/11/2019 07:28	1,69	1	1,69	CHI
201911335097	NIQUELANDIA	NQ12398045	URUACU	26/11/2019 05:46	26/11/2019 08:48	26/11/2019 05:46	26/11/2019 08:48	3,03	11	33,30	CHI
201911335109	NIQUELANDIA	NQ12237500	URUACU	26/11/2019 05:47	26/11/2019 10:45	26/11/2019 05:47	26/11/2019 10:45	4,95	2	9,90	CHI
201911335118	FORMOSA	FA12218285	SAO JOAO D ALIANCA	26/11/2019 05:50	26/11/2019 16:55	26/11/2019 05:50	26/11/2019 16:55	11,07	6	66,41	CHI
201911335123	URUACU	UR121268550	URUACU	26/11/2019 05:53	26/11/2019 13:14	26/11/2019 05:53	26/11/2019 13:14	7,35	1	7,35	CHI
201911335124	FAINA	FC12147790	GOIAS	26/11/2019 05:53	26/11/2019 11:15	26/11/2019 05:53	26/11/2019 11:15	5,36	5	26,81	CHI
201911335125	FORMOSA	FA12242853LD	FLORES DE GOIAS	26/11/2019 05:53	29/11/2019 02:15	26/11/2019 05:53	29/11/2019 02:15	68,36	2	136,72	CHI
201911335125	SAO JOAO D ALIANCA	FA12242853LD	FLORES DE GOIAS	26/11/2019 05:53	29/11/2019 02:15	26/11/2019 05:53	29/11/2019 02:15	68,36	5	341,80	CHI
201911335131	PORANGATU	PO12297140	PORANGATU	26/11/2019 05:54	26/11/2019 11:40	26/11/2019 05:54	26/11/2019 11:40	5,77	14	80,71	CHI
201911335131	SANTA TEREZA DE GOIAS	PO12297140	PORANGATU	26/11/2019 05:54	26/11/2019 11:40	26/11/2019 05:54	26/11/2019 11:40	5,77	11	63,42	CHI
201911335131	TROMBAS	PO12297140	PORANGATU	26/11/2019 05:54	26/11/2019 11:40	26/11/2019 05:54	26/11/2019 11:40	5,77	154	887,85	CHI
201911335137	ARENOPOLIS	AY12345509	ARENOPOLIS	26/11/2019 04:07	26/11/2019 11:07	26/11/2019 04:07	26/11/2019 11:07	6,99	9	62,87	CHI
201911335140	BONOPOLIS	013604126	NOVO PLANALTO	26/11/2019 05:21	26/11/2019 08:19	26/11/2019 05:21	26/11/2019 08:19	2,97	54	160,21	CHI
201911335140	NOVO PLANALTO	013604126	NOVO PLANALTO	26/11/2019 05:21	26/11/2019 08:19	26/11/2019 05:21	26/11/2019 08:19	2,97	500	1483,47	CHI
201911335140	NOVO PLANALTO	013604126	NOVO PLANALTO	26/11/2019 05:21	26/11/2019 08:19	26/11/2019 05:21	26/11/2019 08:19	2,97	565	1676,32	CHI
201911335140	PORANGATU	013604126	NOVO PLANALTO	26/11/2019 05:21	26/11/2019 08:19	26/11/2019 05:21	26/11/2019 08:19	2,97	237	703,17	CHI

201911335155	TURVANIA	TV12005720	FIRMINOPOLIS S2	26/11/2019 06:05	26/11/2019 08:30	26/11/2019 06:05	26/11/2019 08:30	2,41	13	31,30	CHI
201911335157	IPIRANGA DE GOIAS	RB12194284	RUBIATABA	25/11/2019 19:25	27/11/2019 00:37	25/11/2019 19:25	27/11/2019 00:37	29,20	4	116,78	CHI
201911335172	GUARINOS	GG12318446	URUACU	25/11/2019 19:24	26/11/2019 12:00	25/11/2019 19:24	26/11/2019 12:00	16,58	1	16,58	CHI
201911335172	PILAR DE GOIAS	GG12318446	URUACU	25/11/2019 19:24	26/11/2019 12:00	25/11/2019 19:24	26/11/2019 12:00	16,58	111	1840,90	CHI
201911335172	SANTA TEREZINHA DE GOIAS	GG12318446	URUACU	25/11/2019 19:24	26/11/2019 12:00	25/11/2019 19:24	26/11/2019 12:00	16,58	3	49,75	CHI
201911335172	PILAR DE GOIAS	GG12318446	URUACU	25/11/2019 19:24	26/11/2019 12:00	25/11/2019 19:28	26/11/2019 12:00	16,52	1	16,52	CHI
201911335172	SANTA TEREZINHA DE GOIAS	GG12318446	URUACU	25/11/2019 19:24	26/11/2019 12:00	25/11/2019 19:28	26/11/2019 12:00	16,52	1	16,52	CHI
201911335176	FAINA	FC12299792	GOIAS	25/11/2019 21:19	26/11/2019 11:51	25/11/2019 21:19	26/11/2019 11:51	14,52	52	755,11	CHI
201911335183	ALTO PARAISO DE GOIAS	ND12302636	IACIARA S2	26/11/2019 06:12	26/11/2019 11:27	26/11/2019 06:12	26/11/2019 11:27	5,24	18	94,24	CHI
201911335183	NOVA ROMA	ND12302636	IACIARA S2	26/11/2019 06:12	26/11/2019 11:27	26/11/2019 06:12	26/11/2019 11:27	5,24	96	502,61	CHI
201911335183	SAO JOAO D ALIANCA	ND12302636	IACIARA S2	26/11/2019 06:12	26/11/2019 11:27	26/11/2019 06:12	26/11/2019 11:27	5,24	12	62,83	CHI
201911335184	GOIAS	IB12022205	ITABERAI S2	25/11/2019 18:38	26/11/2019 08:57	25/11/2019 18:38	26/11/2019 08:57	14,30	40	572,12	CHI
201911335184	ITABERAI	IB12022205	ITABERAI S2	25/11/2019 18:38	26/11/2019 08:57	25/11/2019 18:38	26/11/2019 08:57	14,30	14	200,24	CHI
201911335195	MINACU	IH21230459	MINACU	26/11/2019 06:14	26/11/2019 10:15	26/11/2019 06:14	26/11/2019 10:15	4,00	1	4,00	CHI
201911335212	FORMOSO	FO12321783	PORANGATU	26/11/2019 06:18	26/11/2019 20:05	26/11/2019 06:18	26/11/2019 20:05	13,77	3	41,32	CHI
201911335220	BURITINOPOLIS	MB12344322RE	IACIARA S2	25/11/2019 21:24	26/11/2019 08:21	25/11/2019 21:24	26/11/2019 08:21	10,94	30	328,10	CHI
201911335220	MAMBAI	MB12344322RE	IACIARA S2	25/11/2019 21:24	26/11/2019 08:21	25/11/2019 21:24	26/11/2019 08:21	10,94	131	1432,70	CHI
201911335228	MARA ROSA	MQ12086247	MARA ROSA	25/11/2019 22:18	26/11/2019 13:19	25/11/2019 22:18	26/11/2019 13:19	15,01	7	105,04	CHI
201911335237	MOSSAMEDES	MD12024167	FIRMINOPOLIS S2	26/11/2019 03:50	26/11/2019 08:28	26/11/2019 03:50	26/11/2019 08:28	4,62	46	212,71	CHI
201911335237	SANCLERLANDIA	MD12024167	FIRMINOPOLIS S2	26/11/2019 03:50	26/11/2019 08:28	26/11/2019 03:50	26/11/2019 08:28	4,62	7	32,37	CHI
201911335243	CEZARINA	CZ12072974	CEZARINA	26/11/2019 05:33	26/11/2019 15:12	26/11/2019 05:33	26/11/2019 15:12	9,66	6	57,96	CHI
201911335243	INDIARA	CZ12072974	CEZARINA	26/11/2019 05:33	26/11/2019 15:12	26/11/2019 05:33	26/11/2019 15:12	9,66	9	86,94	CHI
201911335248	AMORINOPOLIS	AM12000005	IPORA	26/11/2019 02:59	26/11/2019 09:50	26/11/2019 02:59	26/11/2019 09:50	6,83	32	218,68	CHI
201911335248	IVOLANDIA	AM12000005	IPORA	26/11/2019 02:59	26/11/2019 09:50	26/11/2019 02:59	26/11/2019 09:50	6,83	2	13,67	CHI
201911335259	URUACU	CR12271956	MARA ROSA	26/11/2019 06:25	26/11/2019 23:18	26/11/2019 06:25	26/11/2019 23:18	16,87	2	33,74	CHI
201911335260	FAINA	FC12299779	MATRINCHA	25/11/2019 22:48	28/11/2019 17:12	25/11/2019 22:48	27/11/2019 19:02	44,23	10	442,29	CHI
201911335260	FAINA	MP13062750	MATRINCHA	25/11/2019 22:48	28/11/2019 17:12	25/11/2019 22:48	27/11/2019 21:45	46,94	2	93,88	CHI
201911335260	MATRINCHA	MP13062750	MATRINCHA	25/11/2019 22:48	28/11/2019 17:12	25/11/2019 22:48	27/11/2019 21:45	46,94	23	1079,59	CHI
201911335260	FAINA	FC12299779	MATRINCHA	25/11/2019 22:48	28/11/2019 17:12	27/11/2019 21:52	27/11/2019 22:36	0,74	10	7,36	CHI
201911335260	FAINA	MP13062750	MATRINCHA	25/11/2019 22:48	28/11/2019 17:12	27/11/2019 21:52	28/11/2019 16:08	18,26	2	36,51	CHI
201911335260	MATRINCHA	MP13062750	MATRINCHA	25/11/2019 22:48	28/11/2019 17:12	27/11/2019 21:52	28/11/2019 16:08	18,26	23	419,91	CHI
201911335260	FAINA	MP12239999	MATRINCHA	25/11/2019 22:48	28/11/2019 17:12	25/11/2019 22:48	28/11/2019 17:00	66,20	3	198,60	CHI
201911335260	MATRINCHA	MP12198012	MATRINCHA	25/11/2019 22:48	28/11/2019 17:12	25/11/2019 22:48	28/11/2019 17:12	66,39	15	995,85	CHI

201911335266	SAO MIGUEL DO ARAGUAIA	SM12017268	SAO MIGUEL DO ARAGUAIA	25/11/2019 20:03	26/11/2019 21:45	25/11/2019 20:03	26/11/2019 21:45	25,68	9	231,16	CHI
201911335276	GOIAS	GS12076722	GOIAS	26/11/2019 06:19	26/11/2019 12:49	26/11/2019 06:19	26/11/2019 12:49	6,50	14	90,96	CHI
201911335281	AURILANDIA	CG12382596	FIRMINOPOLIS S2	26/11/2019 05:49	26/11/2019 13:53	26/11/2019 05:49	26/11/2019 13:53	8,07	24	193,71	CHI
201911335281	CACHOEIRA DE GOIAS	CG12382596	FIRMINOPOLIS S2	26/11/2019 05:49	26/11/2019 13:53	26/11/2019 05:49	26/11/2019 13:53	8,07	2	16,14	CHI
201911335281	MOIPORA	CG12382596	FIRMINOPOLIS S2	26/11/2019 05:49	26/11/2019 13:53	26/11/2019 05:49	26/11/2019 13:53	8,07	1	8,07	CHI
201911335290	HIDROLINA	HL12190112	URUACU	26/11/2019 06:33	27/11/2019 09:45	26/11/2019 06:33	27/11/2019 09:45	27,19	5	135,96	CHI
201911335290	PILAR DE GOIAS	HL12190112	URUACU	26/11/2019 06:33	27/11/2019 09:45	26/11/2019 06:33	27/11/2019 09:45	27,19	1	27,19	CHI
201911335301	NOVO PLANALTO	TA12139159	NOVO PLANALTO	26/11/2019 05:36	26/11/2019 10:01	26/11/2019 05:36	26/11/2019 10:01	4,41	8	35,25	CHI
201911335301	PORANGATU	TA12139159	NOVO PLANALTO	26/11/2019 05:36	26/11/2019 10:01	26/11/2019 05:36	26/11/2019 10:01	4,41	13	57,28	CHI
201911335314	FAZENDA NOVA	FN12396225	JUSSARA	26/11/2019 06:37	26/11/2019 15:47	26/11/2019 06:37	26/11/2019 15:47	9,15	10	91,53	CHI
201911335320	HIDROLINA	HL121375486	SANTA TEREZINHA	26/11/2019 06:38	27/11/2019 11:27	26/11/2019 06:38	27/11/2019 11:27	28,81	1	28,81	CHI
201911335321	CRIXAS	CX12380748	SERRA DO OURO	26/11/2019 06:21	26/11/2019 10:18	26/11/2019 06:21	26/11/2019 10:18	3,95	26	102,71	CHI
201911335326	PALMEIRAS DE GOIAS	PL12194014	PALMEIRAS	26/11/2019 03:56	26/11/2019 10:25	26/11/2019 03:56	26/11/2019 10:25	6,49	60	389,48	CHI
201911335367	CARMO DO RIO VERDE	IK12311305	ITAPURANGA	26/11/2019 05:22	26/11/2019 05:27	26/11/2019 05:22	26/11/2019 05:27	0,08	27	2,27	CHI
201911335367	ITAPURANGA	IK12311305	ITAPURANGA	26/11/2019 05:22	26/11/2019 05:27	26/11/2019 05:22	26/11/2019 05:27	0,08	120	10,07	CHI
201911335373	ARUANA	AK12250808	ARUANA	26/11/2019 06:47	26/11/2019 11:55	26/11/2019 06:47	26/11/2019 11:55	5,13	4	20,51	CHI
201911335376	MARA ROSA	MQ12390474	MARA ROSA	26/11/2019 06:47	26/11/2019 15:03	26/11/2019 06:47	26/11/2019 15:03	8,26	5	41,29	CHI
201911335385	NOVA CRIXAS	NA12197190	NOVA CRIXAS	26/11/2019 06:07	27/11/2019 00:34	26/11/2019 06:07	27/11/2019 00:05	17,95	110	1975,05	CHI
201911335385	NOVA CRIXAS	NA12132792	NOVA CRIXAS	26/11/2019 06:07	27/11/2019 00:34	26/11/2019 06:07	27/11/2019 00:34	18,44	33	608,51	CHI
201911335389	FORMOSA	FA12242845	ITIQUEIRA	26/11/2019 06:50	26/11/2019 11:55	26/11/2019 06:50	26/11/2019 11:55	5,08	4	20,31	CHI
201911335398	DIVINOPOLIS DE GOIAS	GH12256132	SAO DOMINGOS	25/11/2019 19:23	26/11/2019 10:25	25/11/2019 19:23	26/11/2019 10:25	15,03	18	270,56	CHI
201911335403	ESTRELA DO NORTE	MQ12150566	MARA ROSA	26/11/2019 06:52	26/11/2019 14:05	26/11/2019 06:52	26/11/2019 14:05	7,22	7	50,51	CHI
201911335403	MARA ROSA	MQ12150566	MARA ROSA	26/11/2019 06:52	26/11/2019 14:05	26/11/2019 06:52	26/11/2019 14:05	7,22	7	50,51	CHI
201911335431	AMARALINA	LC12308828	MARA ROSA	26/11/2019 06:55	26/11/2019 16:29	26/11/2019 06:55	26/11/2019 16:29	9,55	2	19,11	CHI
201911335431	MARA ROSA	LC12308828	MARA ROSA	26/11/2019 06:55	26/11/2019 16:29	26/11/2019 06:55	26/11/2019 16:29	9,55	1	9,55	CHI
201911335433	GOIAS	GS12220498	GOIAS	26/11/2019 06:55	26/11/2019 11:00	26/11/2019 06:55	26/11/2019 11:00	4,08	46	187,68	CHI
201911335446	GOIAS	GS12250582	GOIAS	25/11/2019 20:52	26/11/2019 20:05	25/11/2019 20:52	26/11/2019 20:05	23,21	10	232,09	CHI
201911335448	UIRAPURU	UP12243590	NOVA CRIXAS	26/11/2019 06:35	27/11/2019 17:10	26/11/2019 06:35	27/11/2019 17:10	34,57	5	172,86	CHI
201911335453	IPORA	IR12091419	IPORA	26/11/2019 06:59	26/11/2019 15:41	26/11/2019 06:59	26/11/2019 15:41	8,69	1	8,69	CHI
201911335461	NAZARIO	NZ1238194	ANICUNS	26/11/2019 07:00	26/11/2019 17:17	26/11/2019 07:00	26/11/2019 17:17	10,29	1	10,29	CHI
201911335466	FAZENDA NOVA	FN12060710	IPORA	26/11/2019 07:00	26/11/2019 14:15	26/11/2019 07:00	26/11/2019 14:15	7,25	48	348,20	CHI
201911335471	CABECEIRAS	CW12108845	ITIQUEIRA	26/11/2019 06:15	26/11/2019 23:41	26/11/2019 06:15	26/11/2019 23:41	17,42	11	191,66	CHI
201911335473	SAO JOAO D ALIANCA	3840014096	SAO JOAO D ALIANCA	26/11/2019 07:01	27/11/2019 00:53	26/11/2019 07:01	27/11/2019 00:53	17,86	1	17,86	CHI

201911335475	FORMOSO	FO12143711	MARA ROSA	26/11/2019 06:33	26/11/2019 09:11	26/11/2019 06:33	26/11/2019 09:11	2,63	22	57,88	CHI
201911335482	PARAUNA	PU12248129	PARAUNA	26/11/2019 07:02	26/11/2019 12:15	26/11/2019 07:02	26/11/2019 12:15	5,22	4	20,87	CHI
201911335484	IPORA	IR12014024	IPORA	26/11/2019 04:25	26/11/2019 08:41	26/11/2019 04:25	26/11/2019 08:41	4,25	17	72,33	CHI
201911335493	URUACU	UR21292592	URUACU	26/11/2019 07:04	26/11/2019 08:28	26/11/2019 07:04	26/11/2019 08:28	1,40	2	2,79	CHI
201911335505	CABECEIRAS	CW21243116	ITUIQUIRA	26/11/2019 07:05	26/11/2019 13:38	26/11/2019 07:05	26/11/2019 13:38	6,54	1	6,54	CHI
201911335512	GUARINOS	GG12203705	URUACU	26/11/2019 07:06	26/11/2019 16:25	26/11/2019 07:06	26/11/2019 13:10	6,05	10	60,55	CHI
201911335512	ITAPACI	GG12203705	URUACU	26/11/2019 07:06	26/11/2019 16:25	26/11/2019 07:06	26/11/2019 13:10	6,05	2	12,11	CHI
201911335512	PILAR DE GOIAS	GG12203705	URUACU	26/11/2019 07:06	26/11/2019 16:25	26/11/2019 07:06	26/11/2019 13:10	6,05	19	115,04	CHI
201911335512	SANTA TEREZINHA DE GOIAS	GG12203705	URUACU	26/11/2019 07:06	26/11/2019 16:25	26/11/2019 07:06	26/11/2019 13:10	6,05	1	6,05	CHI
201911335512	PILAR DE GOIAS	GG21201675	URUACU	26/11/2019 07:06	26/11/2019 16:25	26/11/2019 07:06	26/11/2019 16:25	9,31	1	9,31	CHI
201911335518	CAMPO LIMPO	AN12267847	NEROPOLIS S1	25/11/2019 19:33	26/11/2019 11:21	25/11/2019 19:33	26/11/2019 11:21	15,79	63	994,89	CHI
201911335519	HIDROLINA	HL21000012	SANTA TEREZINHA	26/11/2019 07:08	27/11/2019 12:50	26/11/2019 07:08	27/11/2019 12:50	29,70	1	29,70	CHI
201911335524	RUBIATABA	RB21110462	RUBIATABA	26/11/2019 07:08	27/11/2019 21:24	26/11/2019 07:08	27/11/2019 21:24	38,25	2	76,51	CHI
201911335526	JANDAIA	JD21091194	PALMEIRAS	26/11/2019 07:09	26/11/2019 16:24	26/11/2019 07:09	26/11/2019 16:24	9,25	2	18,49	CHI
201911335545	FAINA	FC12220907	GOIAS	25/11/2019 20:38	26/11/2019 10:15	25/11/2019 20:38	26/11/2019 10:15	13,61	11	149,71	CHI
201911335557	POSSE	PS21195914	IACIARA S1	26/11/2019 07:12	26/11/2019 10:38	26/11/2019 07:12	26/11/2019 10:38	3,43	1	3,43	CHI
201911335563	CERES	RB12363545	RUBIATABA	26/11/2019 06:21	27/11/2019 12:34	26/11/2019 06:21	27/11/2019 12:34	30,21	7	211,44	CHI
201911335569	ALTO PARAISO DE GOIAS	BF21163462	FLORES DE GOIAS	26/11/2019 07:13	26/11/2019 12:30	26/11/2019 07:13	26/11/2019 12:30	5,28	1	5,28	CHI
201911335574	PORANGATU	PO11262733	PORANGATU	26/11/2019 07:14	26/11/2019 11:37	26/11/2019 07:14	26/11/2019 11:37	4,38	118	517,20	CHI
201911335587	IVOLANDIA	AM21000016	IPORA	26/11/2019 07:15	26/11/2019 12:14	26/11/2019 07:15	26/11/2019 12:14	4,97	1	4,97	CHI
201911335589	PARAUNA	PU12212975	PARAUNA	26/11/2019 04:46	26/11/2019 08:55	26/11/2019 04:46	26/11/2019 08:55	4,15	154	639,14	CHI
201911335612	MARA ROSA	MQ12318474	SANTA TEREZINHA	26/11/2019 07:19	27/11/2019 14:10	26/11/2019 07:19	27/11/2019 14:10	30,85	6	185,08	CHI
201911335615	IPIRANGA DE GOIAS	780032871	RUBIATABA	26/11/2019 07:20	27/11/2019 23:29	26/11/2019 07:20	27/11/2019 23:29	40,14	1	40,14	CHI
201911335631	FORMOSO	FO12060936	PORANGATU	26/11/2019 07:23	26/11/2019 18:15	26/11/2019 07:23	26/11/2019 18:15	10,86	4	43,43	CHI
201911335631	SANTA TEREZA DE GOIAS	FO12060936	PORANGATU	26/11/2019 07:23	26/11/2019 18:15	26/11/2019 07:23	26/11/2019 18:15	10,86	32	347,44	CHI
201911335636	SAO MIGUEL DO ARAGUAIA	SM11216322	SAO MIGUEL DO ARAGUAIA	26/11/2019 07:18	26/11/2019 15:12	26/11/2019 07:18	26/11/2019 15:12	7,90	141	1113,82	CHI
201911335643	PARAUNA	PU21239462	PARAUNA	26/11/2019 07:25	26/11/2019 20:09	26/11/2019 07:25	26/11/2019 20:09	12,73	1	12,73	CHI
201911335644	PALMEIRAS DE GOIAS	PL21247726	PALMEIRAS	26/11/2019 07:25	27/11/2019 10:05	26/11/2019 07:25	27/11/2019 10:05	26,66	1	26,66	CHI
201911335655	VILA BOA	VB12320614	IACIARA S2	26/11/2019 07:27	27/11/2019 08:17	26/11/2019 07:27	27/11/2019 08:17	24,82	5	124,12	CHI
201911335659	CAIAPONIA	CP21020909	CAIAPONIA	26/11/2019 07:27	27/11/2019 05:59	26/11/2019 07:27	27/11/2019 05:59	22,52	1	22,52	CHI
201911335668	URUACU	UR12003395	URUACU	26/11/2019 07:28	26/11/2019 11:20	26/11/2019 07:28	26/11/2019 11:20	3,86	8	30,87	CHI
201911335673	NOVA CRIXAS	NA12087039	NOVA CRIXAS	26/11/2019 03:44	26/11/2019 12:25	26/11/2019 03:44	26/11/2019 12:25	8,67	4	34,68	CHI
201911335706	DIORAMA	19690650	IPORA	26/11/2019 07:31	26/11/2019 11:59	26/11/2019 07:31	26/11/2019 11:59	4,45	15	66,77	CHI

201911335712	GOIAS	GS12274362	GOIAS	26/11/2019 05:07	26/11/2019 11:10	26/11/2019 05:07	26/11/2019 11:10	6,05	7	42,33	CHI
201911335713	MOSSAMEDES	MD12024495	ITABERAI S2	26/11/2019 07:32	26/11/2019 11:16	26/11/2019 07:32	26/11/2019 11:16	3,73	14	52,21	CHI
201911335719	PALMINOPOLIS	RP12156223	FIRMINOPOLIS S2	26/11/2019 03:59	26/11/2019 09:45	26/11/2019 03:59	26/11/2019 09:45	5,76	2	11,51	CHI
201911335719	SAO JOAO DA PARAUNA	RP12156223	FIRMINOPOLIS S2	26/11/2019 03:59	26/11/2019 09:45	26/11/2019 03:59	26/11/2019 09:45	5,76	27	155,39	CHI
201911335735	PORANGATU	PO12349237	MARA ROSA	26/11/2019 07:31	26/11/2019 13:50	26/11/2019 07:31	26/11/2019 13:50	6,32	18	113,69	CHI
201911335741	MINACU	IH12230340	MINACU	26/11/2019 07:35	26/11/2019 12:37	26/11/2019 07:35	26/11/2019 12:37	5,03	12	60,35	CHI
201911335744	MINACU	TB12256991	PORANGATU	26/11/2019 06:33	26/11/2019 17:10	26/11/2019 06:33	26/11/2019 17:10	10,61	12	127,32	CHI
201911335744	TROMBAS	TB12256991	PORANGATU	26/11/2019 06:33	26/11/2019 17:10	26/11/2019 06:33	26/11/2019 17:10	10,61	22	233,42	CHI
201911335751	SERRANOPOLIS	SX12260526	JATAI S1	25/11/2019 19:53	26/11/2019 10:06	25/11/2019 19:53	26/11/2019 10:06	14,20	10	142,02	CHI
201911335762	CAVALCANTE	CJ12346073	MINACU	25/11/2019 21:16	26/11/2019 23:08	25/11/2019 21:16	26/11/2019 23:08	25,85	181	4679,60	CHI
201911335777	AGUA FRIA DE GOIAS	TL121216326	SAO JOAO D ALIANCA	26/11/2019 07:42	26/11/2019 12:27	26/11/2019 07:42	26/11/2019 12:27	4,74	1	4,74	CHI
201911335806	AGUA FRIA DE GOIAS	TL12264641	SAO JOAO D ALIANCA	26/11/2019 07:36	26/11/2019 13:12	26/11/2019 07:36	26/11/2019 13:12	5,58	12	67,02	CHI
201911335817	ITABERAI	IB12108139	ITABERAI S1	26/11/2019 05:43	26/11/2019 09:17	26/11/2019 05:43	26/11/2019 09:17	3,57	6	21,40	CHI
201911335820	ITAPIRAPUA	IU12020125	MATRINCHA	26/11/2019 07:12	27/11/2019 12:52	26/11/2019 07:12	27/11/2019 12:52	29,67	15	444,99	CHI
201911335823	MONTES CLAROS DE GOIAS	ME12139989	IPORA	26/11/2019 06:38	26/11/2019 20:07	26/11/2019 06:38	26/11/2019 20:07	13,48	64	862,60	CHI
201911335825	PORANGATU	840047691	PORANGATU	26/11/2019 07:41	26/11/2019 09:59	26/11/2019 07:41	26/11/2019 09:59	2,29	1	2,29	CHI
201911335832	AMARALINA	MU12391672	MARA ROSA	26/11/2019 04:32	26/11/2019 08:48	26/11/2019 04:32	26/11/2019 08:48	4,26	101	430,23	CHI
201911335832	MUTUNOPOLIS	MU12391672	MARA ROSA	26/11/2019 04:32	26/11/2019 08:48	26/11/2019 04:32	26/11/2019 08:48	4,26	7	29,82	CHI
201911335836	NOVA IGUACU DE GOIAS	NH12048720	SANTA TEREZINHA	26/11/2019 06:39	27/11/2019 11:36	26/11/2019 06:39	26/11/2019 19:20	12,67	10	126,75	CHI
201911335836	NOVA IGUACU DE GOIAS	NH12181043LD	SANTA TEREZINHA	26/11/2019 06:39	27/11/2019 11:36	26/11/2019 06:39	27/11/2019 11:36	28,96	25	723,93	CHI
201911335838	ITAPURANGA	IK21289410	ITAPURANGA	26/11/2019 07:43	27/11/2019 15:08	26/11/2019 07:43	27/11/2019 15:08	31,41	1	31,41	CHI
201911335840	MINACU	IH21192454	MINACU	26/11/2019 07:43	26/11/2019 10:57	26/11/2019 07:43	26/11/2019 10:57	3,23	1	3,23	CHI
201911335859	CAIAPONIA	CP12155495	CAIAPONIA	25/11/2019 23:37	26/11/2019 09:35	25/11/2019 23:37	26/11/2019 09:35	9,95	9	89,58	CHI
201911335860	ITABERAI	IB12206924	ITABERAI S2	25/11/2019 22:13	27/11/2019 07:30	25/11/2019 22:13	27/11/2019 07:30	33,28	7	232,96	CHI
201911335871	SAO JOAO D ALIANCA	JL12218393	SAO JOAO D ALIANCA	26/11/2019 06:54	26/11/2019 11:50	26/11/2019 06:54	26/11/2019 11:50	4,92	88	433,08	CHI
201911335876	MIMOSO DE GOIAS	NQ12371855	BARRO ALTO	25/11/2019 19:59	27/11/2019 12:01	25/11/2019 19:59	26/11/2019 16:49	20,82	4	83,29	CHI
201911335876	NIQUELANDIA	NQ12371855	BARRO ALTO	25/11/2019 19:59	27/11/2019 12:01	25/11/2019 19:59	26/11/2019 16:49	20,82	74	1540,80	CHI
201911335876	MIMOSO DE GOIAS	NQ12371855	BARRO ALTO	25/11/2019 19:59	27/11/2019 12:01	26/11/2019 16:50	27/11/2019 00:12	7,38	4	29,52	CHI
201911335876	NIQUELANDIA	NQ12371855	BARRO ALTO	25/11/2019 19:59	27/11/2019 12:01	26/11/2019 16:50	27/11/2019 00:12	7,38	66	487,15	CHI
201911335876	NIQUELANDIA	NQ13083002	BARRO ALTO	25/11/2019 19:59	27/11/2019 12:01	25/11/2019 19:59	27/11/2019 01:09	29,17	169	4929,68	CHI
201911335876	NIQUELANDIA	NQ21317673	BARRO ALTO	25/11/2019 19:59	27/11/2019 12:01	26/11/2019 16:50	27/11/2019 06:06	13,27	3	39,81	CHI
201911335876	NIQUELANDIA	NQ21317676	BARRO ALTO	25/11/2019 19:59	27/11/2019 12:01	26/11/2019 16:50	27/11/2019 06:41	13,86	5	69,28	CHI
201911335876	MIMOSO DE GOIAS	NQ12371855	BARRO ALTO	25/11/2019 19:59	27/11/2019 12:01	27/11/2019 07:17	27/11/2019 12:01	4,72	4	18,89	CHI

201911335876	NIQUELANDIA	NQ12371855	BARRO ALTO	25/11/2019 19:59	27/11/2019 12:01	27/11/2019 07:17	27/11/2019 12:01	4,72	242	1142,85	CHI
201911335876	NIQUELANDIA	NQ12371855	BARRO ALTO	25/11/2019 19:59	27/11/2019 12:01	27/11/2019 07:30	27/11/2019 12:01	4,51	1	4,51	CHI
201911335888	IVOLANDIA	IV12231159	IPORA	26/11/2019 05:46	26/11/2019 11:40	26/11/2019 05:46	26/11/2019 11:40	5,89	2	11,78	CHI
201911335895	MUTUNOPOLIS	MU12357192	MARA ROSA	26/11/2019 07:48	27/11/2019 12:56	26/11/2019 07:48	27/11/2019 12:56	29,14	2	58,28	CHI
201911335909	ITABERAI	IB21108190	ITABERAI S1	26/11/2019 07:49	27/11/2019 12:34	26/11/2019 07:49	27/11/2019 12:34	28,74	1	28,74	CHI
201911335916	GUARANI DE GOIAS	GY12257673	IACIARA S1	26/11/2019 02:41	26/11/2019 09:07	26/11/2019 02:41	26/11/2019 09:07	6,42	95	609,90	CHI
201911335916	IACIARA	GY12257673	IACIARA S1	26/11/2019 02:41	26/11/2019 09:07	26/11/2019 02:41	26/11/2019 09:07	6,42	5	32,10	CHI
201911335918	NIQUELANDIA	NQ21092989	URUACU	26/11/2019 07:50	26/11/2019 19:41	26/11/2019 07:50	26/11/2019 19:41	11,86	1	11,86	CHI
201911335926	PIRANHAS	PH12256780	PIRANHAS	26/11/2019 07:51	27/11/2019 08:27	26/11/2019 07:51	27/11/2019 08:27	24,60	5	122,99	CHI
201911335927	AMARALINA	LC12248963	MARA ROSA	26/11/2019 02:57	26/11/2019 12:19	26/11/2019 02:57	26/11/2019 12:19	9,37	22	206,04	CHI
201911335934	JANDAIA	JD21008649	PALMEIRAS	26/11/2019 07:51	26/11/2019 15:18	26/11/2019 07:51	26/11/2019 15:18	7,45	1	7,45	CHI
201911335937	PALMEIRAS DE GOIAS	04880406	PALMEIRAS	26/11/2019 06:51	26/11/2019 09:48	26/11/2019 06:51	26/11/2019 09:44	2,89	138	398,82	CHI
201911335937	CEZARINA	PL13260014	PALMEIRAS	26/11/2019 06:51	26/11/2019 09:48	26/11/2019 06:51	26/11/2019 09:48	2,96	5	14,80	CHI
201911335937	INDIARA	PL13260014	PALMEIRAS	26/11/2019 06:51	26/11/2019 09:48	26/11/2019 06:51	26/11/2019 09:48	2,96	3	8,88	CHI
201911335937	PALMEIRAS DE GOIAS	PL13260014	PALMEIRAS	26/11/2019 06:51	26/11/2019 09:48	26/11/2019 06:51	26/11/2019 09:48	2,96	395	1169,53	CHI
201911335944	NIQUELANDIA	NQ21210217	URUACU	26/11/2019 07:52	26/11/2019 16:05	26/11/2019 07:52	26/11/2019 16:05	8,22	2	16,45	CHI
201911335948	BRITANIA	BT12378880	BRITANIA	26/11/2019 07:51	27/11/2019 06:15	26/11/2019 07:51	27/11/2019 06:15	22,40	4	89,58	CHI
201911335966	SAO DOMINGOS	SD21257605	SAO DOMINGOS	26/11/2019 07:54	26/11/2019 11:40	26/11/2019 07:54	26/11/2019 11:40	3,76	1	3,76	CHI
201911335968	MINACU	IH12245137	MINACU	26/11/2019 07:54	26/11/2019 16:26	26/11/2019 07:54	26/11/2019 16:26	8,52	1	8,52	CHI
201911335969	MOZARLANDIA	MZ12057111	MOZARLANDIA	26/11/2019 07:54	26/11/2019 16:21	26/11/2019 07:54	26/11/2019 16:21	8,44	2	16,87	CHI
201911335974	POSSE	PS12143770	IACIARA S2	26/11/2019 05:13	26/11/2019 09:57	26/11/2019 05:13	26/11/2019 09:57	4,73	108	511,20	CHI
201911335975	ITAPIRAPUA	IU12259711	MATRINCHA	26/11/2019 05:25	26/11/2019 10:25	26/11/2019 05:25	26/11/2019 10:25	4,98	5	24,92	CHI
201911335985	POSSE	PS12375543	IACIARA S2	26/11/2019 07:56	26/11/2019 11:53	26/11/2019 07:56	26/11/2019 11:53	3,94	8	31,53	CHI
201911335995	MONTE ALEGRE DE GOIAS	7980000078	SAO DOMINGOS	26/11/2019 07:57	26/11/2019 11:50	26/11/2019 07:57	26/11/2019 11:50	3,87	1	3,87	CHI
201911336021	POSSE	PS12132043	IACIARA S2	26/11/2019 04:20	26/11/2019 11:11	26/11/2019 04:20	26/11/2019 11:11	6,84	37	252,94	CHI
201911336028	CAMPINORTE	CR12051895	MARA ROSA	26/11/2019 08:01	27/11/2019 12:08	26/11/2019 08:01	27/11/2019 12:08	28,11	17	477,93	CHI
201911336028	NOVA IGUACU DE GOIAS	CR12051895	MARA ROSA	26/11/2019 08:01	27/11/2019 12:08	26/11/2019 08:01	27/11/2019 12:08	28,11	15	421,70	CHI
201911336029	ITAPACI	IW12201625	ITAPACI	26/11/2019 08:01	27/11/2019 01:11	26/11/2019 08:01	27/11/2019 01:11	17,16	7	120,15	CHI
201911336029	PILAR DE GOIAS	IW12201625	ITAPACI	26/11/2019 08:01	27/11/2019 01:11	26/11/2019 08:01	27/11/2019 01:11	17,16	21	360,44	CHI
201911336038	BOM JARDIM DE GOIAS	BM21123533	BOM JARDIM	26/11/2019 08:01	26/11/2019 10:30	26/11/2019 08:01	26/11/2019 10:30	2,47	1	2,47	CHI
201911336044	GUARINOS	SG12363548	SANTA TEREZINHA	26/11/2019 06:31	27/11/2019 17:23	26/11/2019 06:31	27/11/2019 16:23	33,86	1	33,86	CHI
201911336044	GUARINOS	SG12363548	SANTA TEREZINHA	26/11/2019 06:31	27/11/2019 17:23	26/11/2019 06:31	27/11/2019 16:58	34,44	1	34,44	CHI
201911336044	GUARINOS	SG12363548	SANTA TEREZINHA	26/11/2019 06:31	27/11/2019 17:23	26/11/2019 06:31	27/11/2019 17:23	34,86	1	34,86	CHI



201911336053	ITAGUARI	IC21217198	ITABERAÍ S1	26/11/2019 08:03	27/11/2019 15:00	26/11/2019 08:03	27/11/2019 15:00	30,94	2	61,88	CHI
201911336060	SANTA TEREZINHA DE GOIAS	SG12243431	SANTA TEREZINHA	26/11/2019 08:04	27/11/2019 15:30	26/11/2019 08:04	27/11/2019 15:30	31,43	3	94,30	CHI
201911336065	JUSSARA	JR12023506	IPORA	26/11/2019 07:06	26/11/2019 20:12	26/11/2019 07:06	26/11/2019 20:12	13,11	7	91,80	CHI
201911336067	CRIXAS	SG12291238	SANTA TEREZINHA	26/11/2019 08:04	28/11/2019 18:20	26/11/2019 08:04	28/11/2019 18:20	58,27	1	58,27	CHI
201911336084	RUBIATABA	RB21003289	RUBIATABA	26/11/2019 08:06	27/11/2019 16:27	26/11/2019 08:06	27/11/2019 16:27	32,35	2	64,70	CHI
201911336087	CAMPOS BELOS	CH12325631	SAO DOMINGOS	26/11/2019 08:06	26/11/2019 11:51	26/11/2019 08:06	26/11/2019 11:51	3,75	1	3,75	CHI
201911336097	GOIAS	GS12087523	GOIAS	25/11/2019 21:00	26/11/2019 11:33	25/11/2019 21:00	26/11/2019 11:33	14,55	67	974,78	CHI
201911336101	GUARAÍTA	IK12300356	ITAPURANGA	26/11/2019 07:01	26/11/2019 10:17	26/11/2019 07:01	26/11/2019 10:17	3,27	36	117,84	CHI
201911336101	ITAPURANGA	IK12300356	ITAPURANGA	26/11/2019 07:01	26/11/2019 10:17	26/11/2019 07:01	26/11/2019 10:17	3,27	82	268,41	CHI
201911336112	FAINA	FC12299793	GOIAS	26/11/2019 07:28	27/11/2019 11:23	26/11/2019 07:28	27/11/2019 11:23	27,91	4	111,63	CHI
201911336122	CABECEIRAS	CW12194580	ITIQUEIRA	26/11/2019 08:08	27/11/2019 11:50	26/11/2019 08:08	27/11/2019 11:50	27,71	2	55,41	CHI
201911336133	FORMOSA	FA21279955	ITIQUEIRA	26/11/2019 08:09	26/11/2019 12:02	26/11/2019 08:09	26/11/2019 12:02	3,88	2	7,75	CHI
201911336141	MONTIVÍDIU DO NORTE	MX12182380	PORANGATU	26/11/2019 08:09	26/11/2019 23:35	26/11/2019 08:09	26/11/2019 21:56	13,78	1	13,78	CHI
201911336141	MONTIVÍDIU DO NORTE	MX12182380	PORANGATU	26/11/2019 08:09	26/11/2019 23:35	26/11/2019 21:57	26/11/2019 23:35	1,63	1	1,63	CHI
201911336147	BOM JARDIM DE GOIAS	BM12155682	BOM JARDIM	26/11/2019 07:47	26/11/2019 14:43	26/11/2019 07:47	26/11/2019 14:43	6,93	14	97,07	CHI
201911336147	PIRANHAS	BM12155682	BOM JARDIM	26/11/2019 07:47	26/11/2019 14:43	26/11/2019 07:47	26/11/2019 14:43	6,93	4	27,73	CHI
201911336156	ALTO PARAISO DE GOIAS	BF12105397	SAO JOAO D ALIANCA	25/11/2019 21:26	26/11/2019 10:03	25/11/2019 21:26	26/11/2019 10:03	12,61	209	2636,01	CHI
201911336158	GOIAS	GS12071258	GOIAS	26/11/2019 06:14	26/11/2019 14:39	26/11/2019 06:14	26/11/2019 14:39	8,40	91	764,65	CHI
201911336167	AMORINOPOLIS	AM21000015	IPORA	26/11/2019 08:12	26/11/2019 13:35	26/11/2019 08:12	26/11/2019 13:35	5,38	1	5,38	CHI
201911336177	SANCLERLANDIA	1210008868	FIRMINOPOLIS S2	26/11/2019 08:13	26/11/2019 11:51	26/11/2019 08:13	26/11/2019 11:51	3,64	1	3,64	CHI
201911336178	SIMOLANDIA	10011694228	IACIARA S2	26/11/2019 08:13	26/11/2019 10:04	26/11/2019 08:13	26/11/2019 10:04	1,84	1	1,84	CHI
201911336181	RUBIATABA	780030849	RUBIATABA	26/11/2019 08:13	27/11/2019 15:50	26/11/2019 08:13	27/11/2019 15:50	31,62	1	31,62	CHI
201911336184	PILAR DE GOIAS	GG21318444	URUACU	26/11/2019 08:13	27/11/2019 15:28	26/11/2019 08:13	27/11/2019 15:28	31,24	6	187,42	CHI
201911336186	DOVERLANDIA	DV12209145	CAIAPONIA	26/11/2019 08:13	28/11/2019 10:07	26/11/2019 08:13	28/11/2019 10:07	49,90	1	49,90	CHI
201911336220	CAIAPONIA	CP12119577	CAIAPONIA	26/11/2019 07:29	26/11/2019 11:49	26/11/2019 07:29	26/11/2019 11:49	4,33	66	285,72	CHI
201911336220	DOVERLANDIA	CP12119577	CAIAPONIA	26/11/2019 07:29	26/11/2019 11:49	26/11/2019 07:29	26/11/2019 11:49	4,33	7	30,30	CHI
201911336221	SAO MIGUEL DO ARAGUAIA	SM12235205	SAO MIGUEL DO ARAGUAIA	26/11/2019 08:15	26/11/2019 15:20	26/11/2019 08:15	26/11/2019 15:20	7,07	9	63,62	CHI
201911336225	FAINA	FC12299839	GOIAS	26/11/2019 07:24	27/11/2019 11:43	26/11/2019 07:24	27/11/2019 11:43	28,31	13	368,02	CHI
201911336240	ANICUNS	AC12031058	ANICUNS	26/11/2019 06:20	26/11/2019 11:19	26/11/2019 06:20	26/11/2019 11:19	4,98	5	24,90	CHI
201911336255	ANICUNS	AC21159715	FIRMINOPOLIS S2	26/11/2019 08:16	26/11/2019 16:30	26/11/2019 08:16	26/11/2019 16:30	8,23	1	8,23	CHI
201911336273	MOIPORA	MO32259058	SAO LUIZ DOS MONTES BELOS	26/11/2019 08:20	26/11/2019 15:23	26/11/2019 08:20	26/11/2019 15:23	7,04	5	35,19	CHI
201911336286	ARUANA	AK12210601	MOZARLANDIA	26/11/2019 08:21	27/11/2019 16:46	26/11/2019 08:21	27/11/2019 16:46	32,40	5	162,02	CHI
201911336289	PARAUNA	PU12388915	PARAUNA	26/11/2019 08:21	26/11/2019 12:08	26/11/2019 08:21	26/11/2019 12:08	3,77	3	11,30	CHI

201911336297	CRIXAS	CX12226949	SANTA TEREZINHA	26/11/2019 06:24	27/11/2019 06:25	26/11/2019 06:24	27/11/2019 06:25	24,02	11	264,17	CHI
201911336301	ARAGARCAS	1820036112	ARAGARCAS	26/11/2019 08:23	26/11/2019 17:10	26/11/2019 08:23	26/11/2019 17:10	8,79	1	8,79	CHI
201911336305	HIDROLINA	HL12000023	SANTA TEREZINHA	26/11/2019 06:03	26/11/2019 15:59	26/11/2019 06:03	26/11/2019 15:59	9,93	2	19,85	CHI
201911336310	SAO MIGUEL DO ARAGUAIA	SM12291166	SAO MIGUEL DO ARAGUAIA	26/11/2019 07:27	27/11/2019 02:30	26/11/2019 07:27	27/11/2019 02:30	19,04	8	152,28	CHI
201911336312	MOSSAMEDES	MD12020737	ITABERAI S2	26/11/2019 07:09	26/11/2019 11:26	26/11/2019 07:09	26/11/2019 11:26	4,27	6	25,61	CHI
201911336317	NOVA CRIXAS	NA12220366	MOZARLANDIA	26/11/2019 07:26	27/11/2019 17:09	26/11/2019 07:26	27/11/2019 17:09	33,71	6	202,24	CHI
201911336325	FLORES DE GOIAS	FB12287910LD	IACIARA S2	26/11/2019 05:54	26/11/2019 11:06	26/11/2019 05:54	26/11/2019 11:06	5,19	3	15,56	CHI
201911336331	FIRMINOPOLIS	SL12004026	SAO LUIZ DOS MONTES BELOS	26/11/2019 06:56	26/11/2019 11:50	26/11/2019 06:56	26/11/2019 11:50	4,89	91	444,91	CHI
201911336331	SAO LUIS DE MONTES BELOS	SL12004026	SAO LUIZ DOS MONTES BELOS	26/11/2019 06:56	26/11/2019 11:50	26/11/2019 06:56	26/11/2019 11:50	4,89	93	454,69	CHI
201911336337	TROMBAS	TB12345570	PORANGATU	26/11/2019 08:26	29/11/2019 13:54	26/11/2019 08:26	28/11/2019 16:17	55,85	5	279,25	CHI
201911336337	TROMBAS	TB12345570	PORANGATU	26/11/2019 08:26	29/11/2019 13:54	26/11/2019 08:26	29/11/2019 12:59	76,55	5	382,73	CHI
201911336337	TROMBAS	TB12345570	PORANGATU	26/11/2019 08:26	29/11/2019 13:54	26/11/2019 08:26	29/11/2019 13:54	77,45	4	309,82	CHI
201911336350	IACIARA	IA12253250	IACIARA S1	26/11/2019 05:17	26/11/2019 10:19	26/11/2019 05:17	26/11/2019 10:19	5,02	7	35,15	CHI
201911336353	AMARALINA	MU12335335	MARA ROSA	26/11/2019 08:28	26/11/2019 15:20	26/11/2019 08:28	26/11/2019 15:20	6,86	4	27,42	CHI
201911336379	FORMOSA	FA32058452	SAO JOAO D ALIANCA	26/11/2019 08:30	26/11/2019 11:16	26/11/2019 08:30	26/11/2019 11:16	2,75	10	27,55	CHI
201911336380	GOIAS	GS21242477	ITAPURANGA	26/11/2019 08:30	27/11/2019 19:57	26/11/2019 08:30	27/11/2019 19:57	35,44	1	35,44	CHI
201911336383	PORANGATU	PO11354485	NOVO PLANALTO	26/11/2019 08:31	26/11/2019 19:42	26/11/2019 08:31	26/11/2019 19:42	11,19	2	22,37	CHI
201911336384	CABECEIRAS	CW12262301	ITIQUEIRA	26/11/2019 05:49	26/11/2019 23:27	26/11/2019 05:49	26/11/2019 23:27	17,63	43	758,16	CHI
201911336384	DISTRITO FEDERAL	CW12262301	ITIQUEIRA	26/11/2019 05:49	26/11/2019 23:27	26/11/2019 05:49	26/11/2019 23:27	17,63	1	17,63	CHI
201911336386	SANTA TEREZINHA DE GOIAS	SG12314431	SANTA TEREZINHA	26/11/2019 08:31	28/11/2019 08:37	26/11/2019 08:31	28/11/2019 08:37	48,09	3	144,28	CHI
201911336390	AMARALINA	MU12384286	MARA ROSA	26/11/2019 06:05	26/11/2019 11:05	26/11/2019 06:05	26/11/2019 11:05	4,99	3	14,97	CHI
201911336390	MUTUNOPOLIS	MU12384286	MARA ROSA	26/11/2019 06:05	26/11/2019 11:05	26/11/2019 06:05	26/11/2019 11:05	4,99	1	4,99	CHI
201911336397	NIQUELANDIA	NQ12318497	NIQUELANDIA SUBTRANSMISSAO	26/11/2019 08:59	26/11/2019 09:46	26/11/2019 08:59	26/11/2019 09:46	0,78	2	1,56	CHI
201911336402	CABECEIRAS	CW12052029	ITIQUEIRA	26/11/2019 08:27	27/11/2019 11:26	26/11/2019 08:27	27/11/2019 11:26	26,97	8	215,79	CHI
201911336433	MONTIVIDIU DO NORTE	MX12203423	PORANGATU	26/11/2019 06:53	26/11/2019 11:13	26/11/2019 06:53	26/11/2019 11:13	4,33	16	69,29	CHI
201911336441	JUSSARA	JR11292879	JUSSARA	26/11/2019 08:35	26/11/2019 17:01	26/11/2019 08:35	26/11/2019 17:01	8,42	42	353,62	CHI
201911336454	SAO MIGUEL DO ARAGUAIA	SM12000065	SAO MIGUEL DO ARAGUAIA	26/11/2019 06:15	26/11/2019 14:30	26/11/2019 06:15	26/11/2019 14:30	8,24	24	197,78	CHI
201911336457	SAO MIGUEL DO ARAGUAIA	SM12252458	SAO MIGUEL DO ARAGUAIA	26/11/2019 08:37	27/11/2019 13:34	26/11/2019 08:37	27/11/2019 13:34	28,94	5	144,70	CHI
201911336463	AMORINOPOLIS	AM12354612	IPORA	26/11/2019 08:38	27/11/2019 06:13	26/11/2019 08:38	27/11/2019 06:13	21,58	2	43,16	CHI
201911336466	DOVERLANDIA	DV12342596	CAIAPONIA	26/11/2019 08:38	27/11/2019 07:48	26/11/2019 08:38	27/11/2019 07:48	23,16	1	23,16	CHI
201911336475	NIQUELANDIA	2750064011	NIQUELANDIA SUBTRANSMISSAO	26/11/2019 08:39	26/11/2019 17:02	26/11/2019 08:39	26/11/2019 17:02	8,38	1	8,38	CHI
201911336485	MONTES CLAROS DE GOIAS	ME12161605	IPORA	26/11/2019 07:40	27/11/2019 07:30	26/11/2019 07:40	27/11/2019 07:30	23,82	4	95,30	CHI
201911336489	SAO JOAO D ALIANCA	JL11130018	SAO JOAO D ALIANCA	26/11/2019 08:40	26/11/2019 18:03	26/11/2019 08:40	26/11/2019 18:03	9,39	6	56,33	CHI

201911336493	ITABERAÍ	IB12000016	ITABERAÍ S2	26/11/2019 06:57	26/11/2019 14:14	26/11/2019 06:57	26/11/2019 14:14	7,28	162	1179,90	CHI
201911336522	BRITANIA	BT21009717	BRITANIA	26/11/2019 08:42	27/11/2019 11:22	26/11/2019 08:42	27/11/2019 11:22	26,65	1	26,65	CHI
201911336526	AGUA FRIA DE GOIAS	TL21321479	SAO JOAO D ALIANCA	26/11/2019 08:42	26/11/2019 18:09	26/11/2019 08:42	26/11/2019 18:09	9,43	1	9,43	CHI
201911336533	SANTA FE DE GOIAS	RN12009764	BRITANIA	26/11/2019 04:51	27/11/2019 07:16	26/11/2019 04:51	27/11/2019 07:16	26,42	6	158,50	CHI
201911336536	SANTA TEREZA DE GOIAS	SE12390457	MARA ROSA	26/11/2019 08:00	26/11/2019 23:28	26/11/2019 08:00	26/11/2019 23:28	15,45	4	61,81	CHI
201911336544	MONTIVIDIU DO NORTE	MX12203429	PORANGATU	26/11/2019 08:45	27/11/2019 09:28	26/11/2019 08:45	27/11/2019 09:28	24,72	24	593,17	CHI
201911336553	CAMPOS VERDES	VD21236352	SANTA TEREZINHA	26/11/2019 08:45	28/11/2019 12:52	26/11/2019 08:45	28/11/2019 12:52	52,11	1	52,11	CHI
201911336564	BONOPOLIS	PO12394943	MARA ROSA	26/11/2019 06:34	27/11/2019 10:52	26/11/2019 06:34	27/11/2019 10:52	28,29	2	56,58	CHI
201911336564	PORANGATU	PO12394943	MARA ROSA	26/11/2019 06:34	27/11/2019 10:52	26/11/2019 06:34	27/11/2019 10:52	28,29	10	282,92	CHI
201911336577	BRITANIA	BT12289912	BRITANIA	26/11/2019 08:48	26/11/2019 13:06	26/11/2019 08:48	26/11/2019 13:06	4,29	3	12,87	CHI
201911336587	NOVO PLANALTO	SM12020677	SAO MIGUEL DO ARAGUAIA	26/11/2019 05:10	26/11/2019 12:41	26/11/2019 05:10	26/11/2019 12:41	7,50	7	52,50	CHI
201911336587	SAO MIGUEL DO ARAGUAIA	SM12020677	SAO MIGUEL DO ARAGUAIA	26/11/2019 05:10	26/11/2019 12:41	26/11/2019 05:10	26/11/2019 12:41	7,50	37	277,52	CHI
201911336597	CAMPINACU	UC12300538	PORANGATU	26/11/2019 08:49	27/11/2019 13:36	26/11/2019 08:49	27/11/2019 13:36	28,77	15	431,51	CHI
201911336610	SANTA TEREZINHA DE GOIAS	SG12048775	SANTA TEREZINHA	26/11/2019 06:35	27/11/2019 16:30	26/11/2019 06:35	27/11/2019 16:30	33,90	9	305,12	CHI
201911336612	MOSSAMEDES	MD12060620	ITABERAÍ S2	25/11/2019 21:49	26/11/2019 12:29	25/11/2019 21:49	26/11/2019 12:29	14,66	10	146,64	CHI
201911336617	AGUA FRIA DE GOIAS	TL21403165	SAO JOAO D ALIANCA	26/11/2019 08:51	26/11/2019 15:08	26/11/2019 08:51	26/11/2019 15:08	6,27	1	6,27	CHI
201911336621	AURILANDIA	00170416	FIRMINOPOLIS S2	26/11/2019 07:51	26/11/2019 13:53	26/11/2019 07:51	26/11/2019 13:53	6,03	1570	9461,87	CHI
201911336621	CACHOEIRA DE GOIAS	00170416	FIRMINOPOLIS S2	26/11/2019 07:51	26/11/2019 13:53	26/11/2019 07:51	26/11/2019 13:53	6,03	783	4718,88	CHI
201911336621	FIRMINOPOLIS	00170416	FIRMINOPOLIS S2	26/11/2019 07:51	26/11/2019 13:53	26/11/2019 07:51	26/11/2019 13:53	6,03	47	283,25	CHI
201911336621	PARAUNA	00170416	FIRMINOPOLIS S2	26/11/2019 07:51	26/11/2019 13:53	26/11/2019 07:51	26/11/2019 13:53	6,03	32	192,85	CHI
201911336628	IPORA	730036534	IPORA	26/11/2019 08:52	26/11/2019 14:30	26/11/2019 08:52	26/11/2019 14:30	5,62	1	5,62	CHI
201911336652	MARA ROSA	MQ12031345	MARA ROSA	25/11/2019 22:07	26/11/2019 13:41	25/11/2019 22:07	26/11/2019 13:41	15,56	5	77,78	CHI
201911336654	SAO MIGUEL DO ARAGUAIA	SM12208506	SAO MIGUEL DO ARAGUAIA	26/11/2019 08:13	27/11/2019 01:58	26/11/2019 08:13	27/11/2019 01:58	17,75	9	159,71	CHI
201911336657	NIQUELANDIA	NQ12280419	NIQUELANDIA SUBTRANSMISSAO	26/11/2019 05:59	26/11/2019 11:26	26/11/2019 05:59	26/11/2019 11:26	5,45	64	348,71	CHI
201911336669	AGUA FRIA DE GOIAS	TL12279981	SAO JOAO D ALIANCA	26/11/2019 08:57	26/11/2019 18:00	26/11/2019 08:57	26/11/2019 18:00	9,04	41	370,55	CHI
201911336715	AMARALINA	LC12230319	NOVA CRIXAS	26/11/2019 08:09	26/11/2019 20:44	26/11/2019 08:09	26/11/2019 20:44	12,58	3	37,74	CHI
201911336717	NOVO PLANALTO	TA12354470	NOVO PLANALTO	26/11/2019 07:24	26/11/2019 10:40	26/11/2019 07:24	26/11/2019 10:40	3,26	15	48,95	CHI
201911336796	AMARALINA	MH12362454	NOVA CRIXAS	26/11/2019 06:13	26/11/2019 13:02	26/11/2019 06:13	26/11/2019 13:02	6,80	1	6,80	CHI
201911336796	MUNDO NOVO DE GOIAS	MH12362454	NOVA CRIXAS	26/11/2019 06:13	26/11/2019 13:02	26/11/2019 06:13	26/11/2019 13:02	6,80	137	932,13	CHI
201911336797	AMARALINA	MU12384317	MARA ROSA	26/11/2019 05:30	26/11/2019 16:25	26/11/2019 05:30	26/11/2019 16:25	10,90	4	43,61	CHI
201911336797	MUTUNOPOLIS	MU12384317	MARA ROSA	26/11/2019 05:30	26/11/2019 16:25	26/11/2019 05:30	26/11/2019 16:25	10,90	20	218,07	CHI
201911336830	CRIXAS	MZ12055628	MOZARLANDIA	26/11/2019 05:36	26/11/2019 18:15	26/11/2019 05:36	26/11/2019 18:15	12,66	26	329,07	CHI
201911336830	MOZARLANDIA	MZ12055628	MOZARLANDIA	26/11/2019 05:36	26/11/2019 18:15	26/11/2019 05:36	26/11/2019 18:15	12,66	38	480,94	CHI

201911336855	NOVO PLANALTO	TA12293689	SAO MIGUEL DO ARAGUAIA	26/11/2019 08:14	26/11/2019 14:17	26/11/2019 08:14	26/11/2019 14:17	6,04	10	60,41	CHI
201911336986	AGUA FRIA DE GOIAS	TL12067444	SAO JOAO D ALIANCA	26/11/2019 07:12	26/11/2019 12:52	26/11/2019 07:12	26/11/2019 12:52	5,66	1	5,66	CHI
201911336986	MIMOSO DE GOIAS	TL12067444	SAO JOAO D ALIANCA	26/11/2019 07:12	26/11/2019 12:52	26/11/2019 07:12	26/11/2019 12:52	5,66	17	96,19	CHI
201911337005	SAO MIGUEL DO ARAGUAIA	SM12253876	SAO MIGUEL DO ARAGUAIA	26/11/2019 07:34	27/11/2019 04:19	26/11/2019 07:34	27/11/2019 04:19	20,74	3	62,21	CHI
201911337037	SANCLERLANDIA	SC12005463	SAO LUIZ DOS MONTES BELOS	26/11/2019 07:31	26/11/2019 11:54	26/11/2019 07:31	26/11/2019 11:54	4,38	11	48,22	CHI
201911337037	SAO LUIS DE MONTES BELOS	SC12005463	SAO LUIZ DOS MONTES BELOS	26/11/2019 07:31	26/11/2019 11:54	26/11/2019 07:31	26/11/2019 11:54	4,38	19	83,28	CHI
201911337058	PORANGATU	PO12208614	PORANGATU	26/11/2019 08:05	26/11/2019 16:51	26/11/2019 08:05	26/11/2019 16:51	8,76	9	78,85	CHI
201911337084	PALMEIRAS DE GOIAS	PL21308584	PALMEIRAS	26/11/2019 06:51	26/11/2019 14:48	26/11/2019 06:51	26/11/2019 14:48	7,95	1	7,95	CHI
201911337091	ESTRELA DO NORTE	ET12143710	MARA ROSA	26/11/2019 08:32	27/11/2019 01:29	26/11/2019 08:32	27/11/2019 01:29	16,94	4	67,74	CHI
201911337091	SANTA TEREZA DE GOIAS	ET12143710	MARA ROSA	26/11/2019 08:32	27/11/2019 01:29	26/11/2019 08:32	27/11/2019 01:29	16,94	4	67,74	CHI
201911337094	PALESTINA DE GOIAS	PY12023472	PALESTINA	26/11/2019 08:59	27/11/2019 00:18	26/11/2019 08:59	27/11/2019 00:18	15,31	8	122,46	CHI
201911337114	ARAGARCAS	AG11354634	ARAGARCAS	26/11/2019 07:55	26/11/2019 12:13	26/11/2019 07:55	26/11/2019 12:13	4,29	85	364,60	CHI
201911337120	HIDROLINA	HL12068284	URUACU	26/11/2019 08:29	27/11/2019 00:30	26/11/2019 08:29	27/11/2019 00:30	16,00	22	352,02	CHI
201911337159	PALMEIRAS DE GOIAS	PL11276989	PALMEIRAS	26/11/2019 06:51	26/11/2019 20:45	26/11/2019 06:51	26/11/2019 20:45	13,91	1	13,91	CHI
201911337185	BONOPOLIS	TA12263013	NOVO PLANALTO	26/11/2019 08:36	26/11/2019 15:40	26/11/2019 08:36	26/11/2019 15:40	7,06	31	219,00	CHI
201911337219	MONTIVIDIU DO NORTE	MX12192265	PORANGATU	26/11/2019 08:39	26/11/2019 13:51	26/11/2019 08:39	26/11/2019 13:51	5,19	63	327,14	CHI
201911337243	ANICUNS	AC12212648	ANICUNS	26/11/2019 04:06	26/11/2019 18:57	26/11/2019 04:06	26/11/2019 18:57	14,85	1	14,85	CHI
201911337294	CAIAPONIA	CP12251347	CAIAPONIA	26/11/2019 08:03	27/11/2019 09:40	26/11/2019 08:03	27/11/2019 09:40	25,61	7	179,29	CHI
201911337309	FORMOSO	FO12392284	PORANGATU	26/11/2019 06:42	26/11/2019 13:33	26/11/2019 06:42	26/11/2019 13:33	6,84	13	88,87	CHI
201911337309	SANTA TEREZA DE GOIAS	FO12392284	PORANGATU	26/11/2019 06:42	26/11/2019 13:33	26/11/2019 06:42	26/11/2019 13:33	6,84	5	34,18	CHI
201911337324	JATAI	JT21196077	JATAI S1	25/11/2019 17:57	26/11/2019 13:08	25/11/2019 17:57	26/11/2019 13:08	19,17	1	19,17	CHI
201911337328	HIDROLINA	HL12292474	URUACU	26/11/2019 04:10	27/11/2019 02:03	26/11/2019 04:10	27/11/2019 02:03	21,88	7	153,14	CHI
201911337392	ITAPACI	IW12079629	ITAPACI	26/11/2019 08:50	26/11/2019 14:50	26/11/2019 08:50	26/11/2019 14:50	6,00	3	18,00	CHI
201911337412	MOSSAMEDES	MD12066158	FIRMINOPOLIS S2	26/11/2019 07:44	26/11/2019 13:21	26/11/2019 07:44	26/11/2019 13:21	5,60	19	106,47	CHI
201911337497	ANICUNS	AC12323460	ANICUNS	26/11/2019 07:09	26/11/2019 15:20	26/11/2019 07:09	26/11/2019 15:20	8,17	7	57,21	CHI
201911337497	TURVANIA	AC12323460	ANICUNS	26/11/2019 07:09	26/11/2019 15:20	26/11/2019 07:09	26/11/2019 15:20	8,17	3	24,52	CHI
201911337560	CABECEIRAS	FA12302845	ITUIQUIRA	26/11/2019 07:32	26/11/2019 12:46	26/11/2019 07:32	26/11/2019 12:46	5,23	14	73,24	CHI
201911337560	FORMOSA	FA12302845	ITUIQUIRA	26/11/2019 07:32	26/11/2019 12:46	26/11/2019 07:32	26/11/2019 12:46	5,23	18	94,17	CHI
201911337680	FAINA	FC12038664LD	GOIAS	26/11/2019 07:12	27/11/2019 08:59	26/11/2019 07:12	27/11/2019 08:59	25,77	10	257,68	CHI
201911337736	SANTA TEREZINHA DE GOIAS	SG12380710	SANTA TEREZINHA	26/11/2019 08:14	27/11/2019 10:50	26/11/2019 08:14	27/11/2019 10:50	26,59	7	186,14	CHI
201911337743	CRIXAS	CX12252911	SANTA TEREZINHA	26/11/2019 08:04	27/11/2019 10:40	26/11/2019 08:04	27/11/2019 10:40	26,60	13	345,79	CHI
201911337844	DOVERLANDIA	DV12207928	CAIAPONIA	26/11/2019 05:39	26/11/2019 19:48	26/11/2019 05:39	26/11/2019 19:48	14,15	6	84,87	CHI
201911337922	MONTIVIDIU DO NORTE	MX12192270	PORANGATU	26/11/2019 08:15	27/11/2019 13:42	26/11/2019 08:15	27/11/2019 13:42	29,44	104	3061,38	CHI

201911337954	CAIAPONIA	PH12187421	CAIAPONIA	26/11/2019 07:36	27/11/2019 08:45	26/11/2019 07:36	27/11/2019 08:45	25,14	4	100,58	CHI
201911337954	PIRANHAS	PH12187421	CAIAPONIA	26/11/2019 07:36	27/11/2019 08:45	26/11/2019 07:36	27/11/2019 08:45	25,14	1	25,14	CHI
201911337965	CRIXAS	CX12405291	SANTA TEREZINHA	26/11/2019 06:24	27/11/2019 10:48	26/11/2019 06:24	27/11/2019 10:48	28,41	89	2528,22	CHI
201911337971	ITABERAI	IB12272618	ITABERAI S1	26/11/2019 07:43	27/11/2019 22:40	26/11/2019 07:43	27/11/2019 22:40	38,95	24	934,73	CHI
201911337991	ITAGUARU	IC11169748	ITABERAI S1	26/11/2019 08:15	27/11/2019 14:30	26/11/2019 08:15	27/11/2019 14:30	30,24	94	2842,59	CHI
201911338045	MIMOSO DE GOIAS	MJ12282532	PADRE BERNARDO	25/11/2019 18:29	26/11/2019 13:10	25/11/2019 18:29	26/11/2019 13:10	18,68	2	37,36	CHI
201911338070	MOIPIORA	MO12004152	SAO LUIZ DOS MONTES BELOS	26/11/2019 08:55	26/11/2019 17:51	26/11/2019 08:55	26/11/2019 17:51	8,93	5	44,63	CHI
201911338108	CAIAPONIA	PH12390191	CAIAPONIA	26/11/2019 04:42	28/11/2019 13:57	26/11/2019 04:42	26/11/2019 18:20	13,64	2	27,29	CHI
201911338108	PIRANHAS	PH12390191	CAIAPONIA	26/11/2019 04:42	28/11/2019 13:57	26/11/2019 04:42	26/11/2019 18:20	13,64	7	95,51	CHI
201911338108	CAIAPONIA	PH12390191	CAIAPONIA	26/11/2019 04:42	28/11/2019 13:57	26/11/2019 18:21	28/11/2019 13:57	43,60	2	87,21	CHI
201911338108	PIRANHAS	PH12390191	CAIAPONIA	26/11/2019 04:42	28/11/2019 13:57	26/11/2019 18:21	28/11/2019 13:57	43,60	7	305,23	CHI
201911338221	FAINA	FC12061005	GOIAS	26/11/2019 05:29	26/11/2019 18:11	26/11/2019 05:29	26/11/2019 18:11	12,69	23	291,78	CHI
201911338280	GOIAS	GS12070348	GOIAS	26/11/2019 06:36	26/11/2019 19:13	26/11/2019 06:36	26/11/2019 19:13	12,61	6	75,65	CHI
201911338404	SAO JOAO D ALIANCA	JL12324141	SAO JOAO D ALIANCA	26/11/2019 08:11	26/11/2019 16:35	26/11/2019 08:11	26/11/2019 16:35	8,40	4	33,59	CHI
201911338422	SAO MIGUEL DO ARAGUAIA	SM12020623	SAO MIGUEL DO ARAGUAIA	26/11/2019 07:39	27/11/2019 09:05	26/11/2019 07:39	27/11/2019 09:05	25,43	6	152,60	CHI
201911338740	SAO MIGUEL DO ARAGUAIA	SM12211095	SAO MIGUEL DO ARAGUAIA	26/11/2019 06:10	26/11/2019 16:41	26/11/2019 06:10	26/11/2019 16:41	10,52	131	1377,68	CHI
201911338839	CORREGO DO OURO	03690216	IPORA	26/11/2019 08:02	26/11/2019 16:17	26/11/2019 14:44	26/11/2019 16:17	1,55	3	4,66	CHI
201911338839	FAZENDA NOVA	03690216	IPORA	26/11/2019 08:02	26/11/2019 16:17	26/11/2019 14:44	26/11/2019 16:17	1,55	122	189,44	CHI
201911338839	ISRAELANDIA	03690216	IPORA	26/11/2019 08:02	26/11/2019 16:17	26/11/2019 14:44	26/11/2019 16:17	1,55	12	18,63	CHI
201911339029	ANICUNS	AC21278671	FIRMINOPOLIS S2	26/11/2019 08:19	26/11/2019 15:38	26/11/2019 08:19	26/11/2019 15:38	7,32	1	7,32	CHI
201911339165	MOIPIORA	MO12223030	IPORA	25/11/2019 17:11	26/11/2019 20:01	25/11/2019 17:11	26/11/2019 20:01	26,83	4	107,33	CHI
201911339289	IVOLANDIA	1560008560	ARENOPOLIS	26/11/2019 04:01	27/11/2019 02:30	26/11/2019 04:01	27/11/2019 02:30	22,49	1	22,49	CHI
201911339513	TROMBAS	TB12202552	PORANGATU	26/11/2019 06:17	26/11/2019 19:54	26/11/2019 06:17	26/11/2019 19:54	13,60	3	40,81	CHI
201911339536	CAIAPONIA	PY12040163	PALESTINA	26/11/2019 08:57	26/11/2019 21:29	26/11/2019 08:57	26/11/2019 21:29	12,53	43	538,85	CHI
201911339536	PALESTINA DE GOIAS	PY12040163	PALESTINA	26/11/2019 08:57	26/11/2019 21:29	26/11/2019 08:57	26/11/2019 21:29	12,53	102	1278,20	CHI
201911339748	APARECIDA DE GOIANIA	10027256802	INDEPENDENCIA S1	25/11/2019 13:50	26/11/2019 11:26	25/11/2019 13:50	26/11/2019 11:26	21,60	1	21,60	CHI
201911340293	FAZENDA NOVA	FN12082059	IPORA	26/11/2019 07:11	27/11/2019 17:48	26/11/2019 07:11	27/11/2019 17:48	34,61	6	207,66	CHI
201911340550	BARRO ALTO	BA12210722	GOIANESIA S1	25/11/2019 16:30	27/11/2019 13:20	25/11/2019 16:30	27/11/2019 13:20	44,83	3	134,50	CHI
201911341436	RUBIATABA	RB12197854	RUBIATABA	26/11/2019 06:29	27/11/2019 04:27	26/11/2019 06:29	27/11/2019 04:27	21,96	10	219,56	CHI
201911345568	PALMEIRAS DE GOIAS	TV21095707	FIRMINOPOLIS S2	26/11/2019 08:06	27/11/2019 16:27	26/11/2019 08:06	27/11/2019 16:27	32,35	1	32,35	CHI
201911347238	DOVERLANDIA	MY12036563	PARQUE DAS EMAS	25/11/2019 20:16	28/11/2019 21:13	25/11/2019 20:16	28/11/2019 21:13	72,95	5	364,75	CHI
201911368073	ARUANA	AK12404527	MOZARLANDIA	25/11/2019 15:59	28/11/2019 20:54	25/11/2019 15:59	26/11/2019 16:34	24,58	5	122,92	CHI
201911368073	ARUANA	AK12404527	MOZARLANDIA	25/11/2019 15:59	28/11/2019 20:54	25/11/2019 15:59	26/11/2019 18:11	26,20	4	104,80	CHI

201911368073	ARUANA	AK12404527	MOZARLANDIA	25/11/2019 15:59	28/11/2019 20:54	25/11/2019 15:59	26/11/2019 19:39	27,67	21	581,00	CHI
201911368073	ARUANA	AK12311285LD	MOZARLANDIA	25/11/2019 15:59	28/11/2019 20:54	26/11/2019 19:48	27/11/2019 21:15	25,45	16	407,20	CHI
201911368073	ARUANA	AK12311285LD	MOZARLANDIA	25/11/2019 15:59	28/11/2019 20:54	26/11/2019 19:48	28/11/2019 11:42	39,90	5	199,50	CHI
201911368073	ARUANA	AK12404527	MOZARLANDIA	25/11/2019 15:59	28/11/2019 20:54	25/11/2019 15:59	28/11/2019 20:54	76,93	4	307,73	CHI
201911368193	ITAJA	IJ12200688	ITAJA S2	25/11/2019 11:17	25/11/2019 14:22	25/11/2019 11:17	25/11/2019 14:22	3,08	4	12,33	CHI
201911368195	GUARAITA	GK12299411	ITAPURANGA	25/11/2019 18:21	26/11/2019 13:21	25/11/2019 18:21	26/11/2019 13:21	19,00	19	360,99	CHI
201911368199	NOVO PLANALTO	TA12293622	SAO MIGUEL DO ARAGUAIA	26/11/2019 08:37	26/11/2019 13:50	26/11/2019 08:37	26/11/2019 13:50	5,21	19	99,04	CHI
201911368268	GOIANIA	GN12347548	REAL S1	25/11/2019 17:40	25/11/2019 22:20	25/11/2019 17:40	25/11/2019 22:20	4,66	110	513,00	CHI
201911368268	GOIANIA	GN12347548	REAL S1	25/11/2019 17:40	25/11/2019 22:20	25/11/2019 21:10	25/11/2019 22:20	1,17	136	158,70	CHI
2019112500106	BARRO ALTO	00180518	BARRO ALTO	25/11/2019 14:11	25/11/2019 14:17	25/11/2019 14:11	25/11/2019 14:17	0,10	1244	124,40	CHI
2019112500106	BARRO ALTO	00180518	BARRO ALTO	25/11/2019 14:11	25/11/2019 14:17	25/11/2019 14:11	25/11/2019 14:17	0,10	2115	211,50	CHI
2019112500106	BARRO ALTO	56102	BARRO ALTO	25/11/2019 14:11	25/11/2019 14:17	25/11/2019 14:11	25/11/2019 14:17	0,10	24	2,40	CHI
2019112500106	BARRO ALTO	00180518	BARRO ALTO	25/11/2019 14:11	25/11/2019 14:17	25/11/2019 14:11	25/11/2019 14:17	0,10	2	0,20	CHI
2019112500106	GOIANESIA	56102	BARRO ALTO	25/11/2019 14:11	25/11/2019 14:17	25/11/2019 14:11	25/11/2019 14:17	0,10	4	0,40	CHI
2019112500106	HIDROLINA	00180518	BARRO ALTO	25/11/2019 14:11	25/11/2019 14:17	25/11/2019 14:11	25/11/2019 14:17	0,10	1	0,10	CHI
2019112500106	HIDROLINA	56101	BARRO ALTO	25/11/2019 14:11	25/11/2019 14:17	25/11/2019 14:11	25/11/2019 14:17	0,10	1	0,10	CHI
2019112500106	MIMOSO DE GOIAS	45601	BARRO ALTO	25/11/2019 14:11	25/11/2019 14:17	25/11/2019 14:11	25/11/2019 14:17	0,10	11	1,10	CHI
2019112500106	NIQUELANDIA	00180518	BARRO ALTO	25/11/2019 14:11	25/11/2019 14:17	25/11/2019 14:11	25/11/2019 14:17	0,10	107	10,70	CHI
2019112500106	NIQUELANDIA	45601	BARRO ALTO	25/11/2019 14:11	25/11/2019 14:17	25/11/2019 14:11	25/11/2019 14:17	0,10	175	17,50	CHI
2019112500106	NIQUELANDIA	00180518	BARRO ALTO	25/11/2019 14:11	25/11/2019 14:17	25/11/2019 14:11	25/11/2019 14:17	0,10	2	0,20	CHI
2019112500106	SANTA RITA DO NOVO DESTINO	00180518	BARRO ALTO	25/11/2019 14:11	25/11/2019 14:17	25/11/2019 14:11	25/11/2019 14:17	0,10	470	47,00	CHI
2019112500106	SANTA RITA DO NOVO DESTINO	56102	BARRO ALTO	25/11/2019 14:11	25/11/2019 14:17	25/11/2019 14:11	25/11/2019 14:17	0,10	213	21,30	CHI
2019112500106	SANTA RITA DO NOVO DESTINO	00180518	BARRO ALTO	25/11/2019 14:11	25/11/2019 14:17	25/11/2019 14:11	25/11/2019 14:17	0,10	7	0,70	CHI
2019112500106	SAO LUIZ DO NORTE	00180518	BARRO ALTO	25/11/2019 14:11	25/11/2019 14:17	25/11/2019 14:11	25/11/2019 14:17	0,10	34	3,40	CHI
2019112500106	SAO LUIZ DO NORTE	56101	BARRO ALTO	25/11/2019 14:11	25/11/2019 14:17	25/11/2019 14:11	25/11/2019 14:17	0,10	96	9,60	CHI
2019112500106	SAO LUIZ DO NORTE	56102	BARRO ALTO	25/11/2019 14:11	25/11/2019 14:17	25/11/2019 14:11	25/11/2019 14:17	0,10	14	1,40	CHI
2019112500106	SAO LUIZ DO NORTE	00180518	BARRO ALTO	25/11/2019 14:11	25/11/2019 14:17	25/11/2019 14:11	25/11/2019 14:17	0,10	2	0,20	CHI
2019112500106	VILA PROPICIO	45601	BARRO ALTO	25/11/2019 14:11	25/11/2019 14:17	25/11/2019 14:11	25/11/2019 14:17	0,10	49	4,90	CHI
2019112500106	VILA PROPICIO	00180518	BARRO ALTO	25/11/2019 14:11	25/11/2019 14:17	25/11/2019 14:11	25/11/2019 14:17	0,10	24	2,40	CHI
2019112500106	VILA PROPICIO	00180518	BARRO ALTO	25/11/2019 14:11	25/11/2019 14:17	25/11/2019 14:11	25/11/2019 14:17	0,10	1	0,10	CHI
2019112500106	CAMPINORTE	01800503	CAMPINORTE	25/11/2019 14:11	25/11/2019 14:17	25/11/2019 14:11	25/11/2019 14:17	0,10	10	1,00	CHI
2019112500106	NOVA IGUACU DE GOIAS	01800503	CAMPINORTE	25/11/2019 14:11	25/11/2019 14:17	25/11/2019 14:11	25/11/2019 14:17	0,10	15	1,50	CHI
2019112500106	URUACU	01800503	CAMPINORTE	25/11/2019 14:11	25/11/2019 14:17	25/11/2019 14:11	25/11/2019 14:17	0,10	102	10,20	CHI

2019112500106	BARRO ALTO	01805114	URUACU	25/11/2019 14:11	25/11/2019 14:17	25/11/2019 14:11	25/11/2019 14:17	0,10	1	0,10	CHI
2019112500106	CAMPINORTE	01800503	URUACU	25/11/2019 14:11	25/11/2019 14:17	25/11/2019 14:11	25/11/2019 14:17	0,10	13	1,30	CHI
2019112500106	CAMPINORTE	01805114	URUACU	25/11/2019 14:11	25/11/2019 14:17	25/11/2019 14:11	25/11/2019 14:17	0,10	10	1,00	CHI
2019112500106	GUARINOS	14902	URUACU	25/11/2019 14:11	25/11/2019 14:17	25/11/2019 14:11	25/11/2019 14:17	0,10	11	1,10	CHI
2019112500106	HIDROLINA	07901	URUACU	25/11/2019 14:11	25/11/2019 14:17	25/11/2019 14:11	25/11/2019 14:17	0,10	1256	125,60	CHI
2019112500106	HIDROLINA	01800503	URUACU	25/11/2019 14:11	25/11/2019 14:17	25/11/2019 14:11	25/11/2019 14:17	0,10	15	1,50	CHI
2019112500106	HIDROLINA	07931	URUACU	25/11/2019 14:11	25/11/2019 14:17	25/11/2019 14:11	25/11/2019 14:17	0,10	110	11,00	CHI
2019112500106	HIDROLINA	01800503	URUACU	25/11/2019 14:11	25/11/2019 14:17	25/11/2019 14:11	25/11/2019 14:17	0,10	141	14,10	CHI
2019112500106	HIDROLINA	01805114	URUACU	25/11/2019 14:11	25/11/2019 14:17	25/11/2019 14:11	25/11/2019 14:17	0,10	51	5,10	CHI
2019112500106	ITAPACI	14902	URUACU	25/11/2019 14:11	25/11/2019 14:17	25/11/2019 14:11	25/11/2019 14:17	0,10	2	0,20	CHI
2019112500106	MARA ROSA	01805114	URUACU	25/11/2019 14:11	25/11/2019 14:17	25/11/2019 14:11	25/11/2019 14:17	0,10	1	0,10	CHI
2019112500106	NIQUELANDIA	01800503	URUACU	25/11/2019 14:11	25/11/2019 14:17	25/11/2019 14:11	25/11/2019 14:17	0,10	1080	108,00	CHI
2019112500106	NIQUELANDIA	01805114	URUACU	25/11/2019 14:11	25/11/2019 14:17	25/11/2019 14:11	25/11/2019 14:17	0,10	1115	111,50	CHI
2019112500106	NOVA IGUACU DE GOIAS	01800503	URUACU	25/11/2019 14:11	25/11/2019 14:17	25/11/2019 14:11	25/11/2019 14:17	0,10	20	2,00	CHI
2019112500106	PILAR DE GOIAS	14901	URUACU	25/11/2019 14:11	25/11/2019 14:17	25/11/2019 14:11	25/11/2019 14:17	0,10	55	5,50	CHI
2019112500106	PILAR DE GOIAS	14902	URUACU	25/11/2019 14:11	25/11/2019 14:17	25/11/2019 14:11	25/11/2019 14:17	0,10	696	69,60	CHI
2019112500106	PILAR DE GOIAS	01800503	URUACU	25/11/2019 14:11	25/11/2019 14:17	25/11/2019 14:11	25/11/2019 14:17	0,10	1	0,10	CHI
2019112500106	PILAR DE GOIAS	07931	URUACU	25/11/2019 14:11	25/11/2019 14:17	25/11/2019 14:11	25/11/2019 14:17	0,10	42	4,20	CHI
2019112500106	PILAR DE GOIAS	01800503	URUACU	25/11/2019 14:11	25/11/2019 14:17	25/11/2019 14:11	25/11/2019 14:17	0,10	17	1,70	CHI
2019112500106	PILAR DE GOIAS	01805114	URUACU	25/11/2019 14:11	25/11/2019 14:17	25/11/2019 14:11	25/11/2019 14:17	0,10	11	1,10	CHI
2019112500106	SANTA TEREZINHA DE GOIAS	14902	URUACU	25/11/2019 14:11	25/11/2019 14:17	25/11/2019 14:11	25/11/2019 14:17	0,10	5	0,50	CHI
2019112500106	URUACU	01800503	URUACU	25/11/2019 14:11	25/11/2019 14:17	25/11/2019 14:11	25/11/2019 14:17	0,10	1782	178,20	CHI
2019112500106	URUACU	01800503	URUACU	25/11/2019 14:11	25/11/2019 14:17	25/11/2019 14:11	25/11/2019 14:17	0,10	7633	763,30	CHI
2019112500106	URUACU	01800503	URUACU	25/11/2019 14:11	25/11/2019 14:17	25/11/2019 14:11	25/11/2019 14:17	0,10	7889	788,90	CHI
2019112500106	URUACU	01800503	URUACU	25/11/2019 14:11	25/11/2019 14:17	25/11/2019 14:11	25/11/2019 14:17	0,10	283	28,30	CHI
2019112500106	URUACU	01805114	URUACU	25/11/2019 14:11	25/11/2019 14:17	25/11/2019 14:11	25/11/2019 14:17	0,10	318	31,80	CHI
2019112500106	URUACU	01800503	URUACU	25/11/2019 14:11	25/11/2019 14:17	25/11/2019 14:11	25/11/2019 14:17	0,10	214	21,40	CHI
2019112500106	URUACU	01805114	URUACU	25/11/2019 14:11	25/11/2019 14:17	25/11/2019 14:11	25/11/2019 14:17	0,10	124	12,40	CHI



## Plotagem das Ocorrências conforme a Espacialização das Chuvas

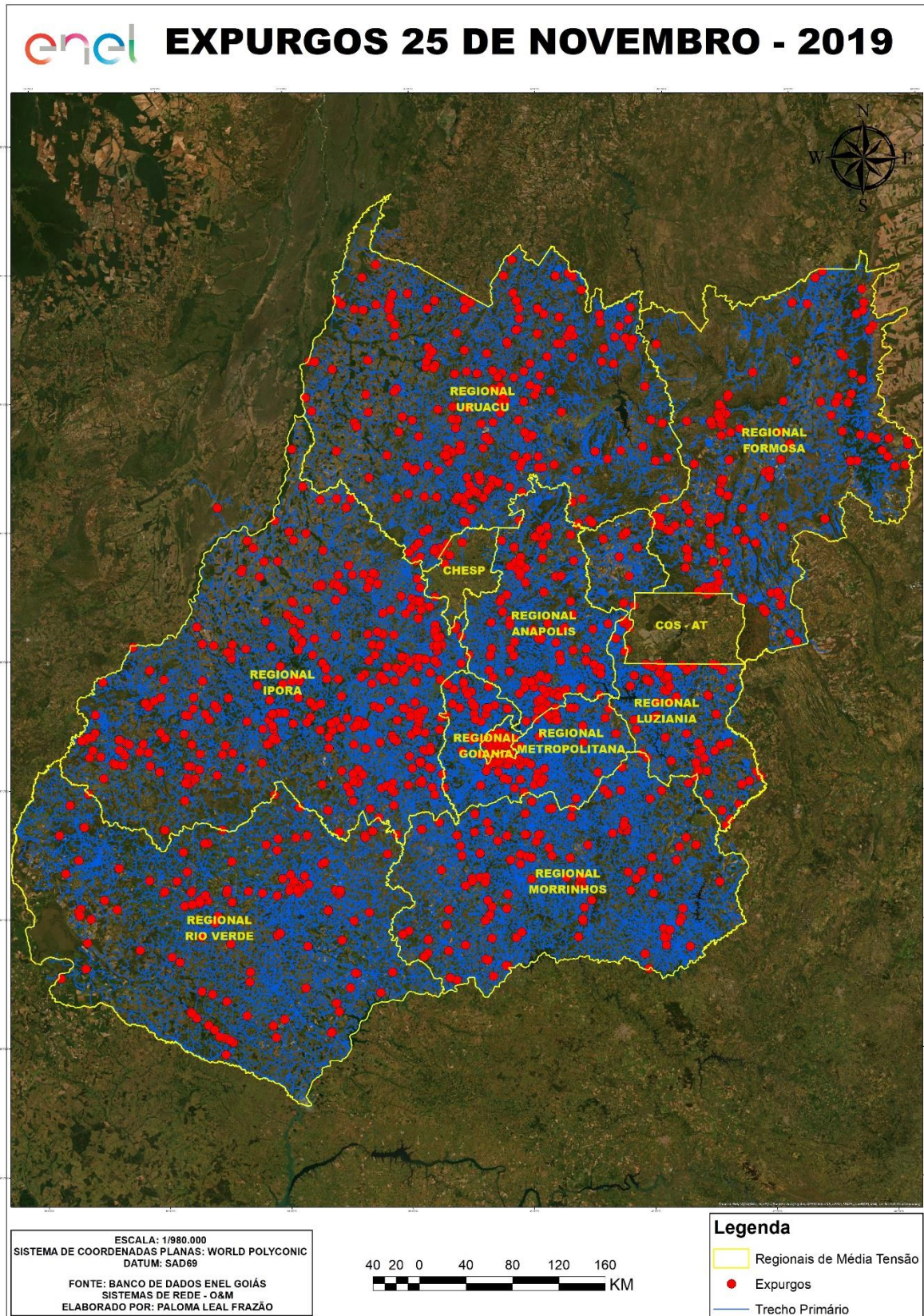





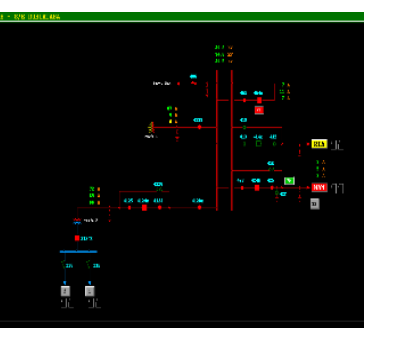
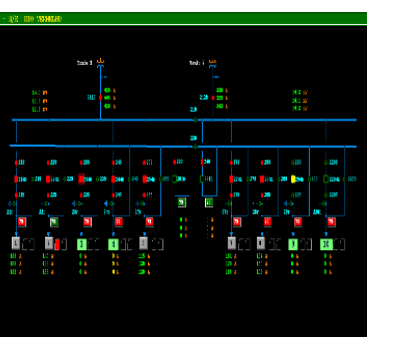
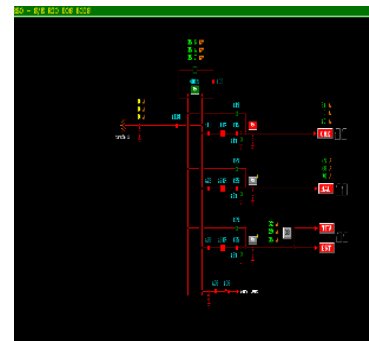
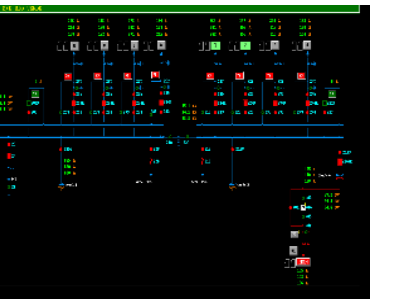
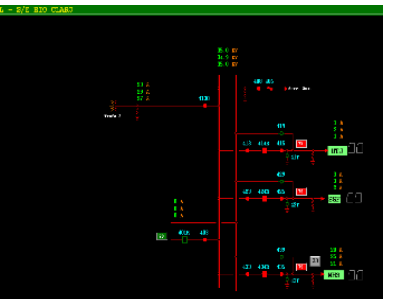
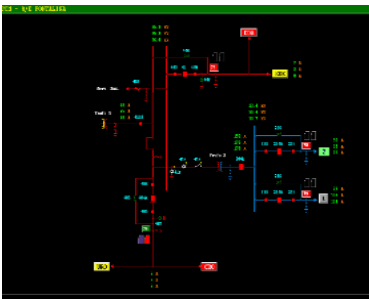
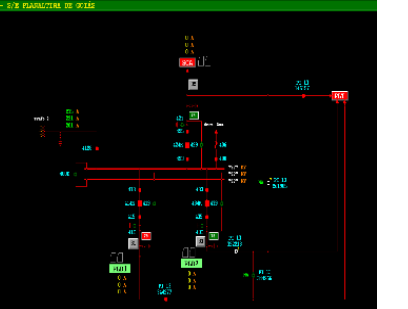
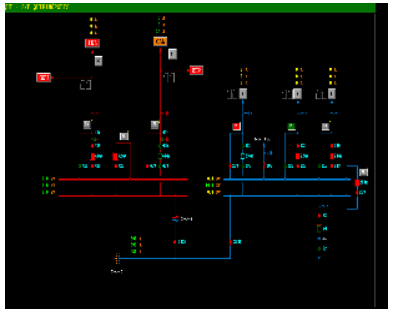
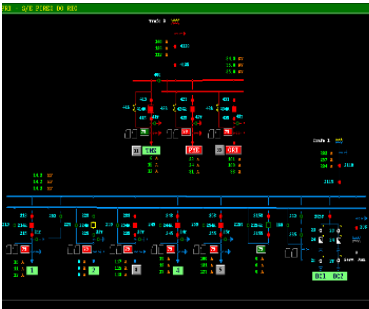
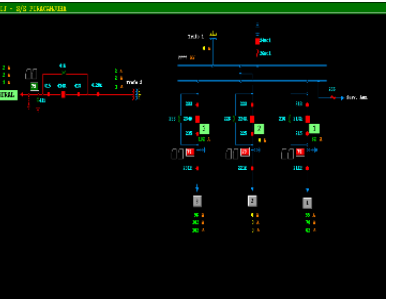
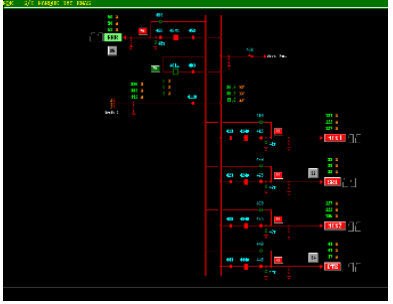
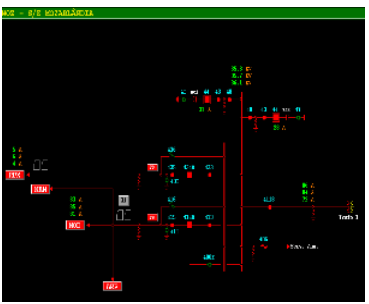
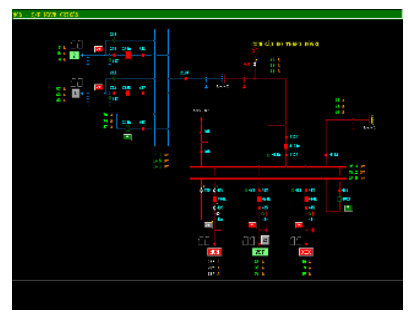

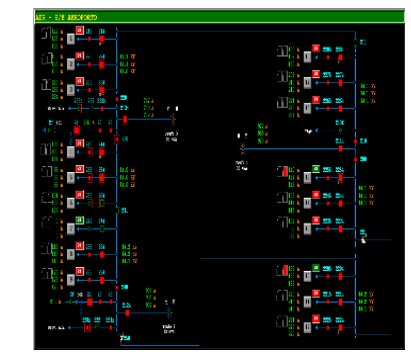
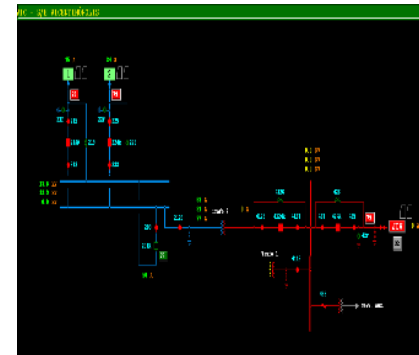
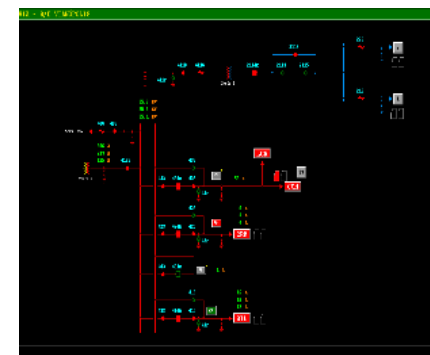
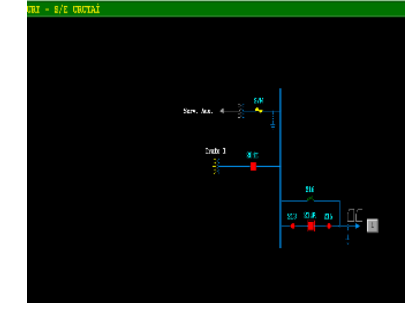
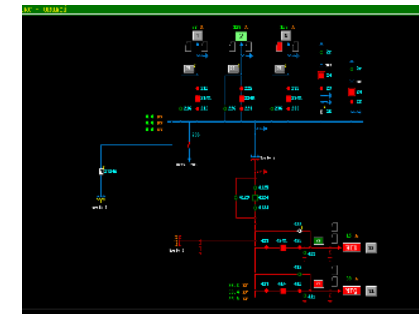
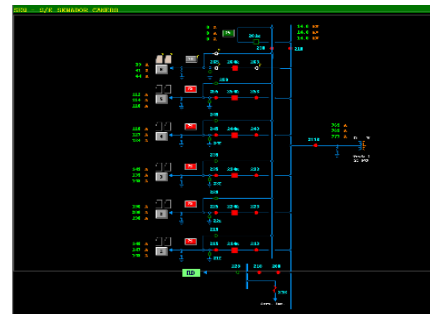
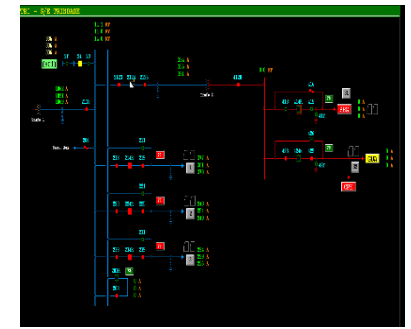
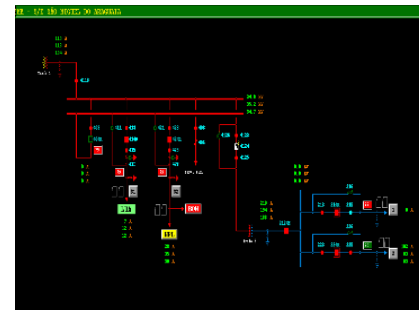
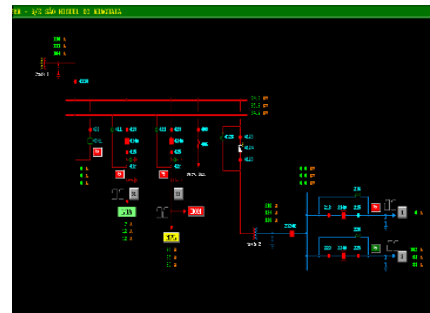
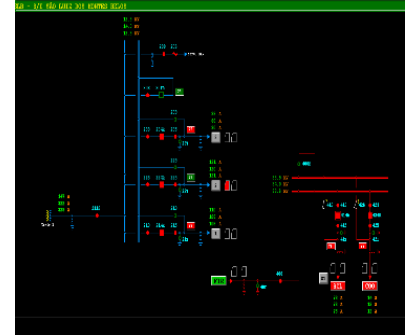
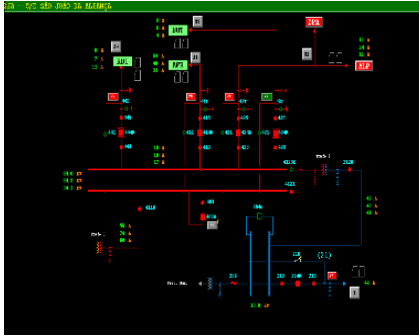
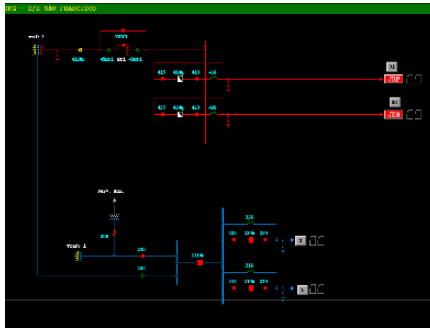
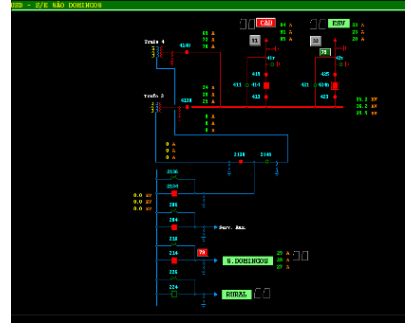
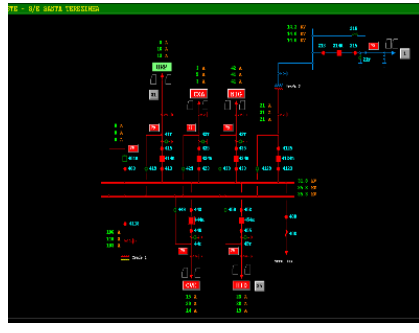
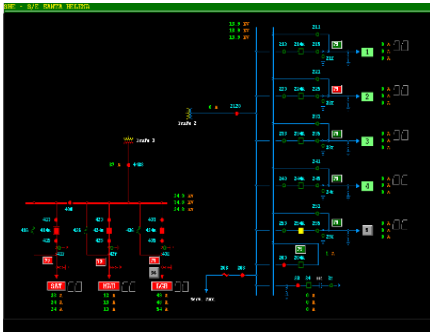

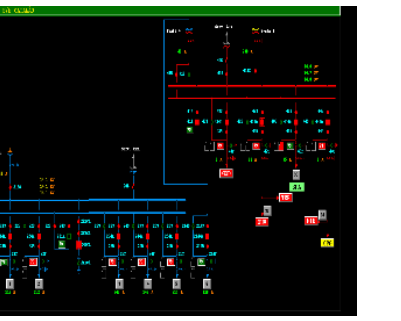
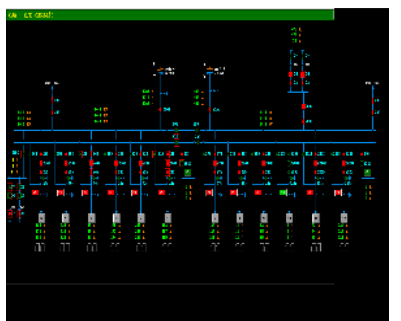
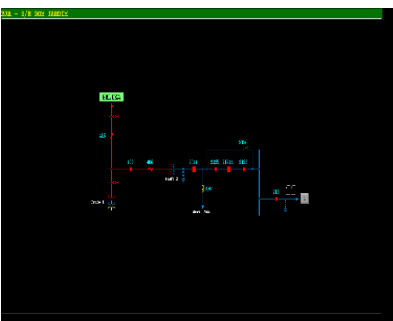
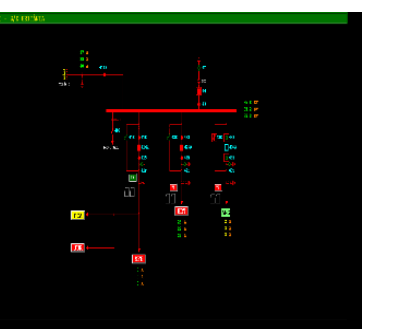
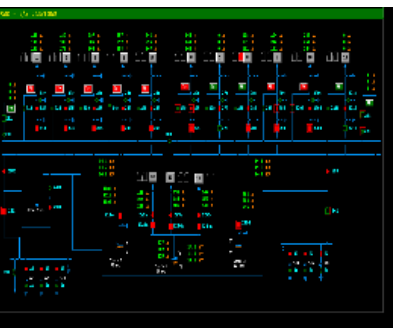
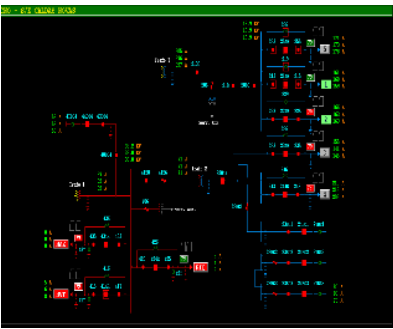
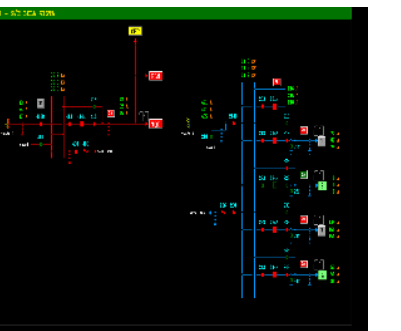
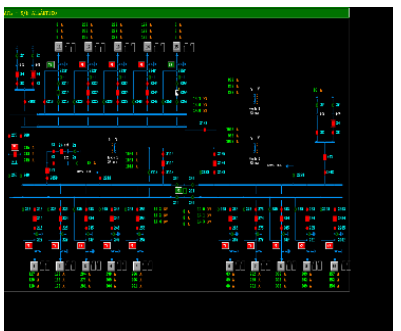
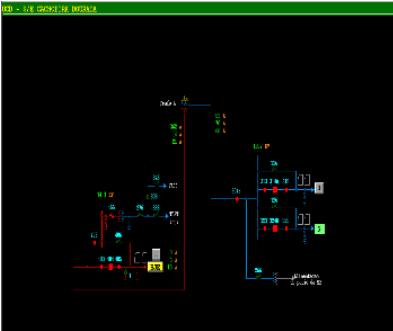
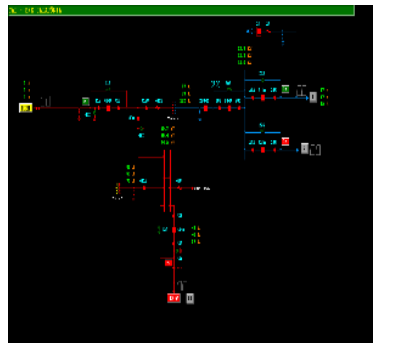
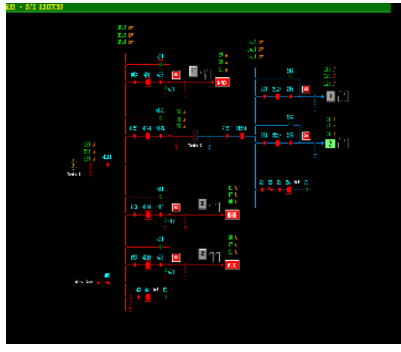
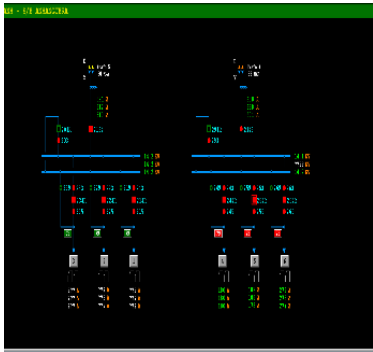
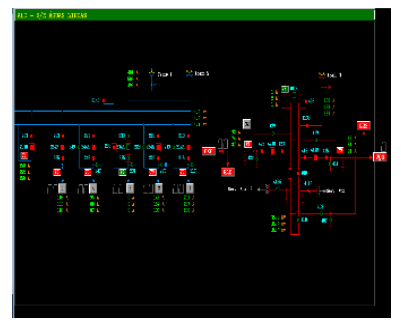
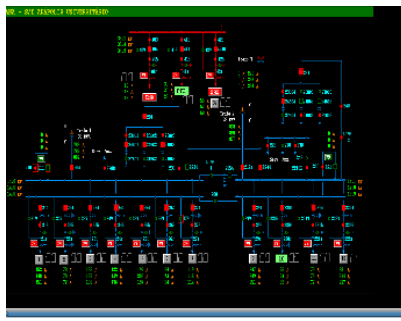
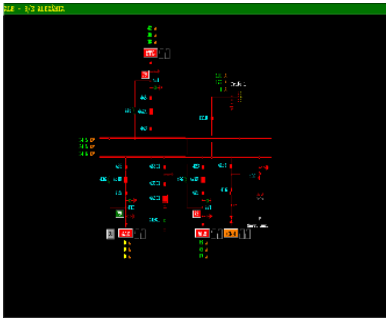

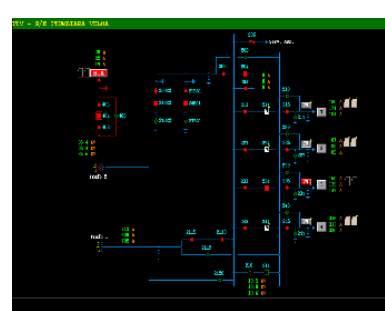
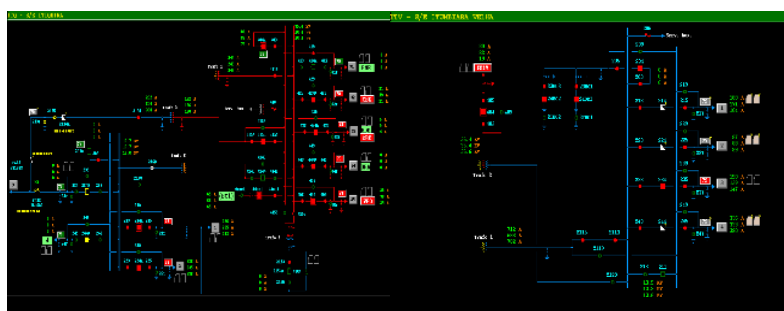
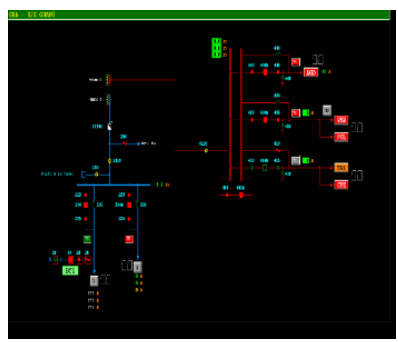
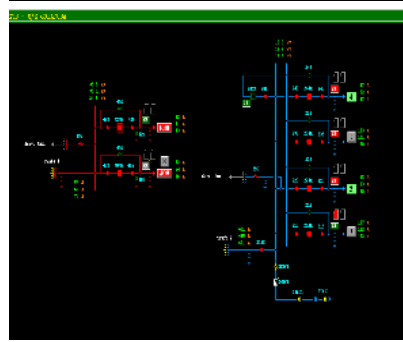
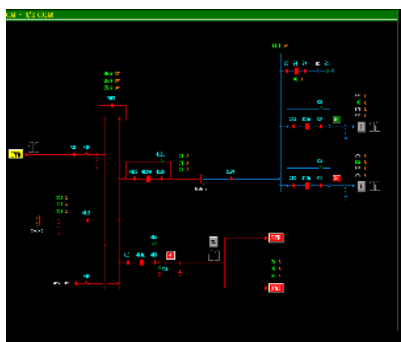
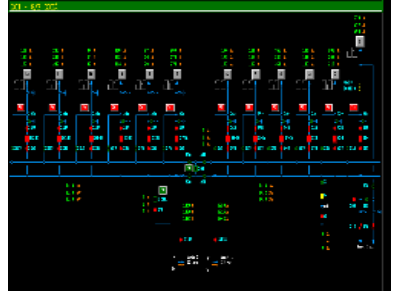
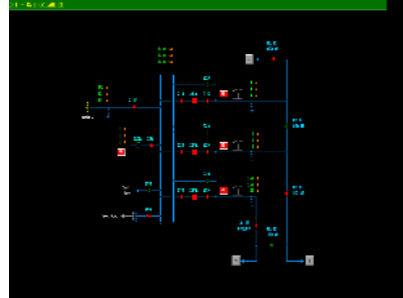
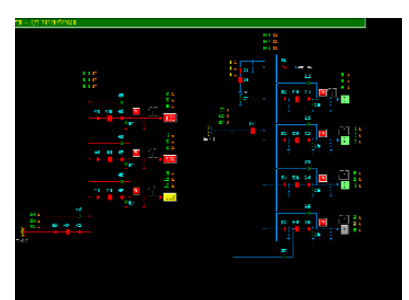
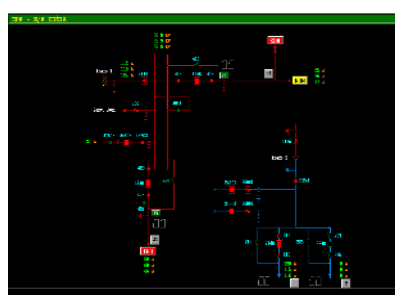
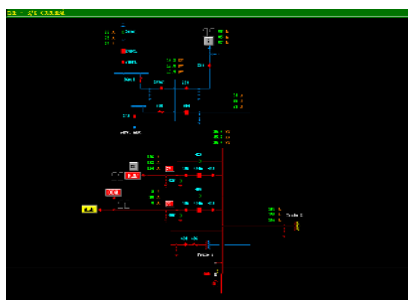
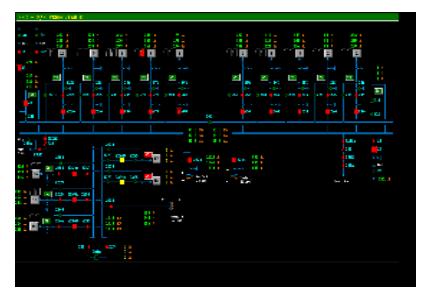
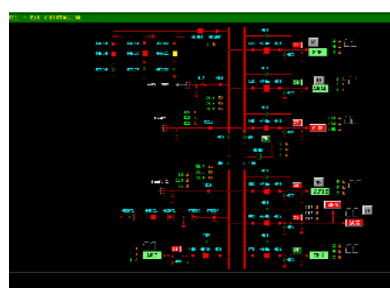
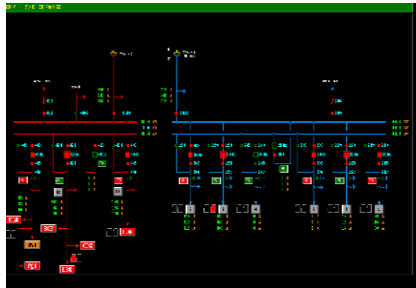
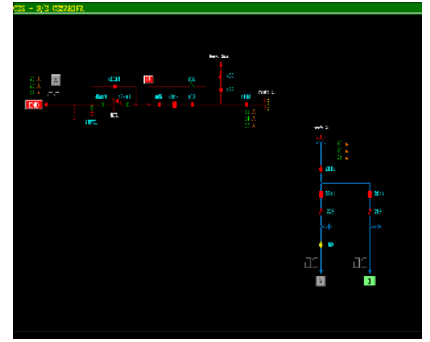
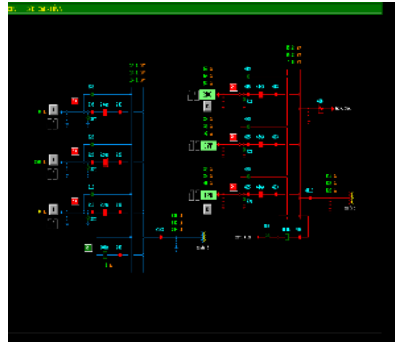
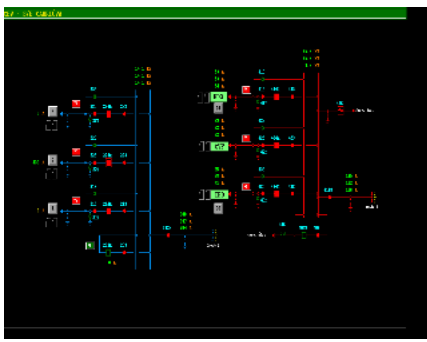

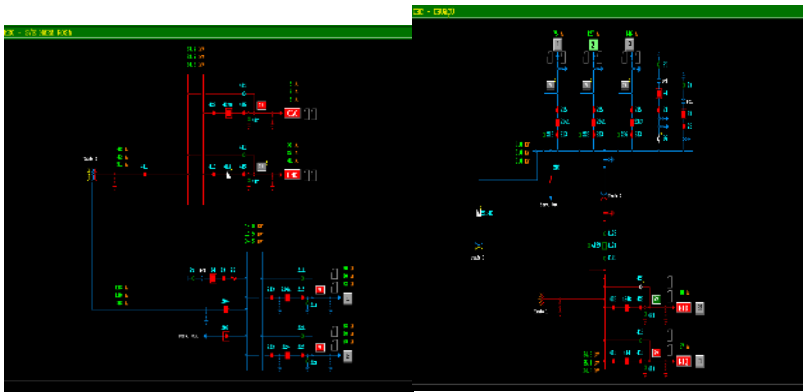
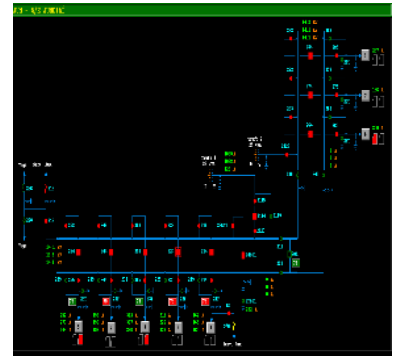
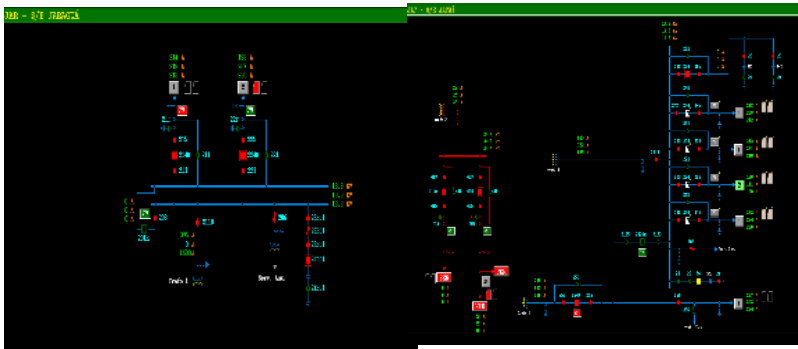

## DEMAIS EVIDÊNCIAS

### DADOS TÉCNICO - OPERACIONAIS ENEL GO

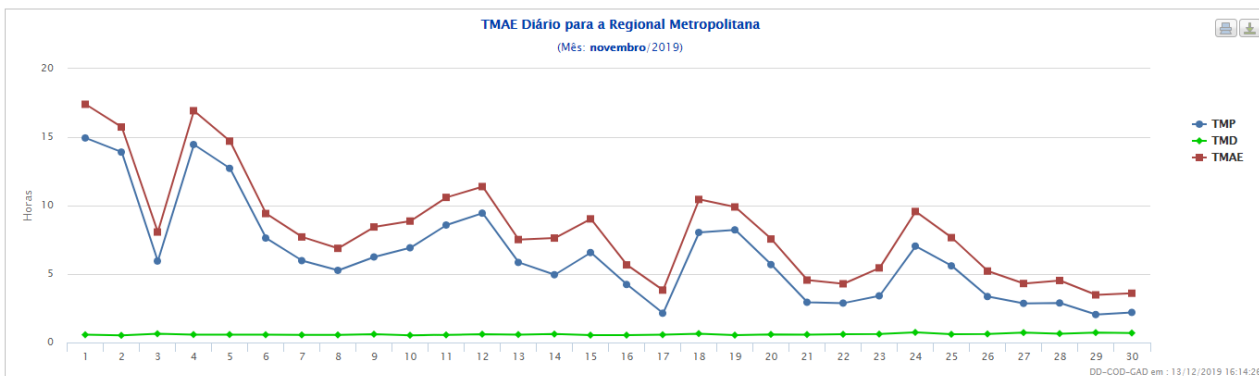
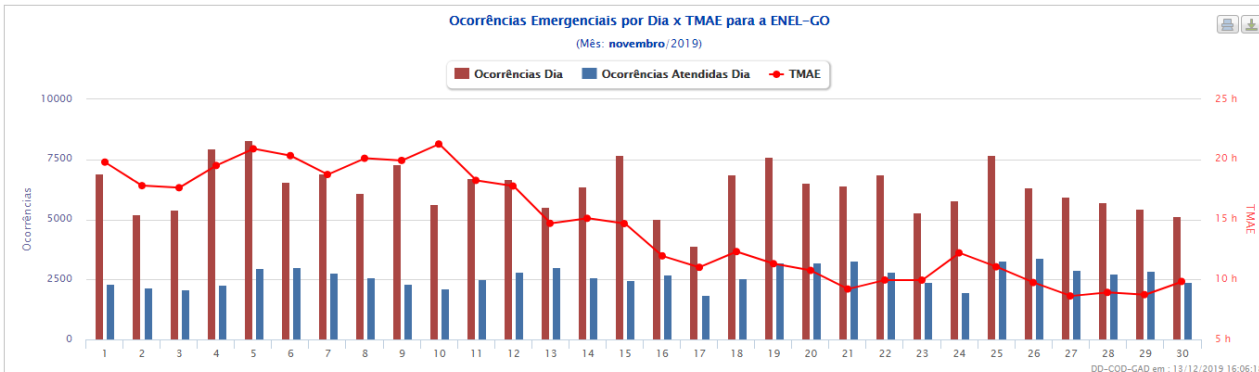
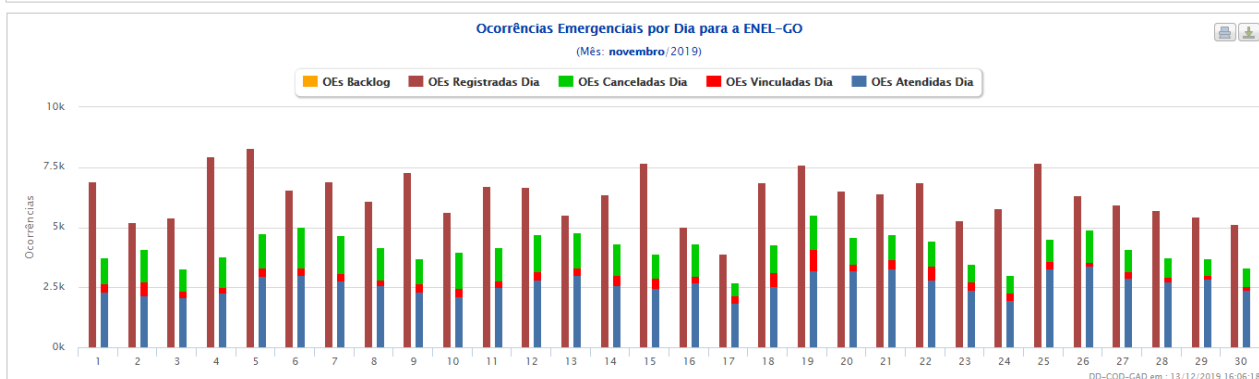
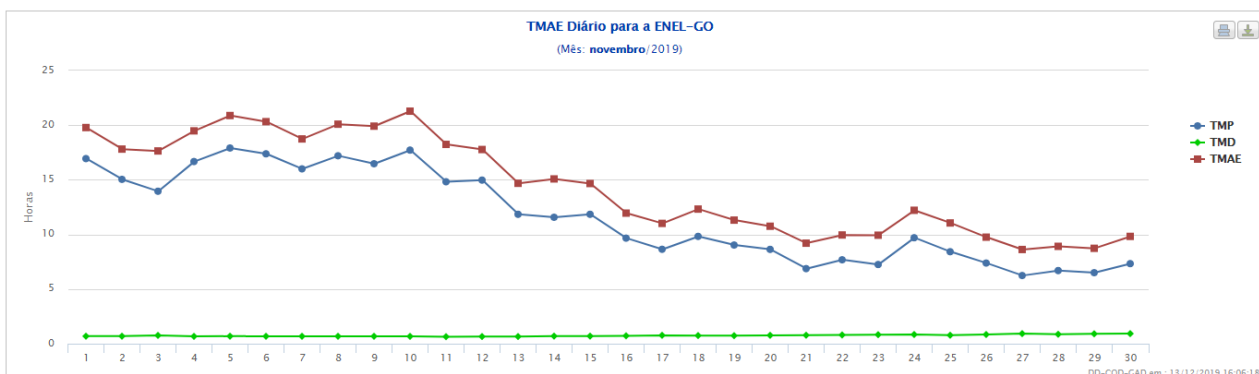

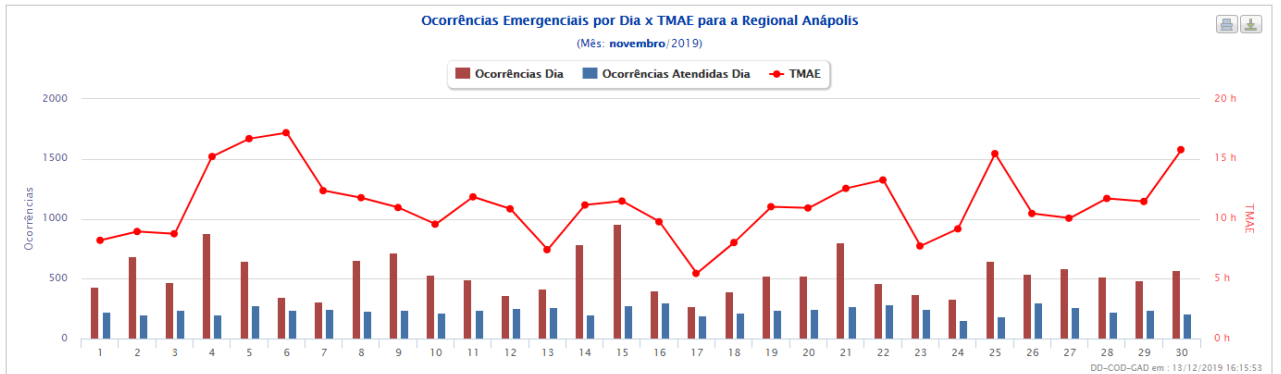
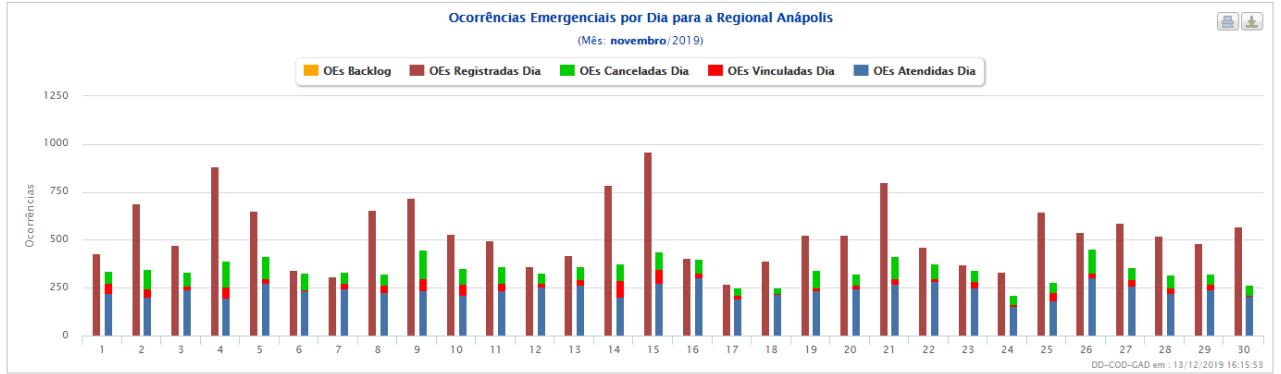
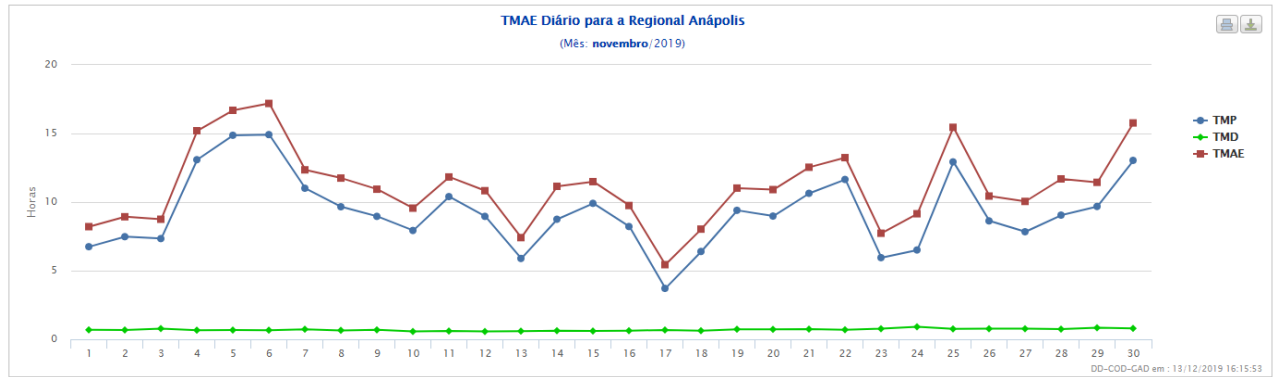
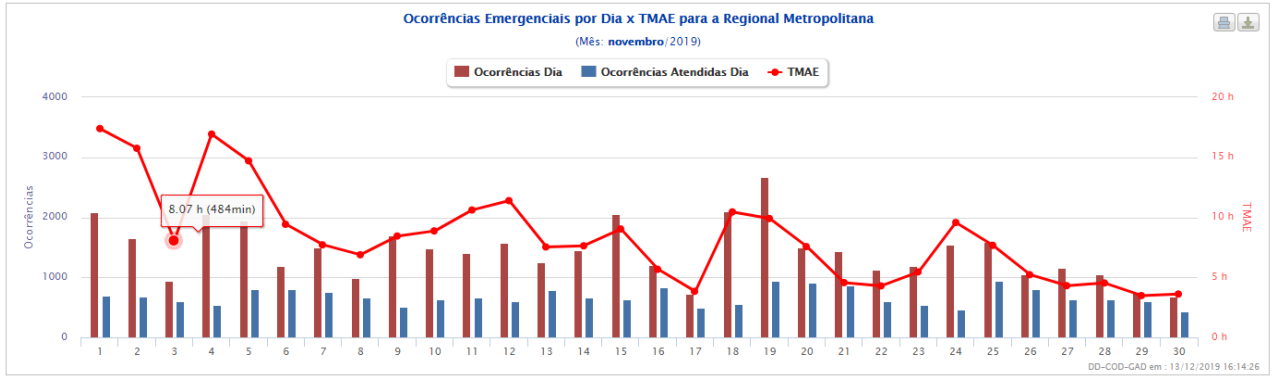
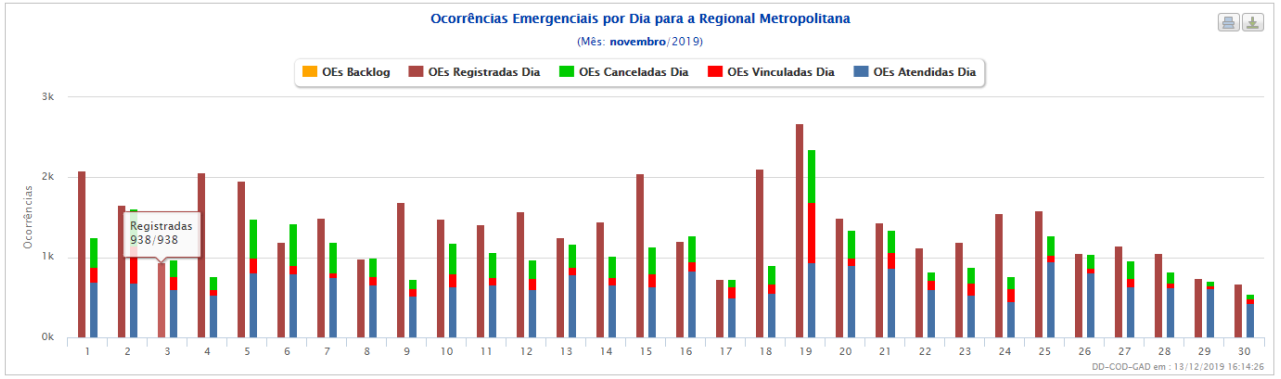



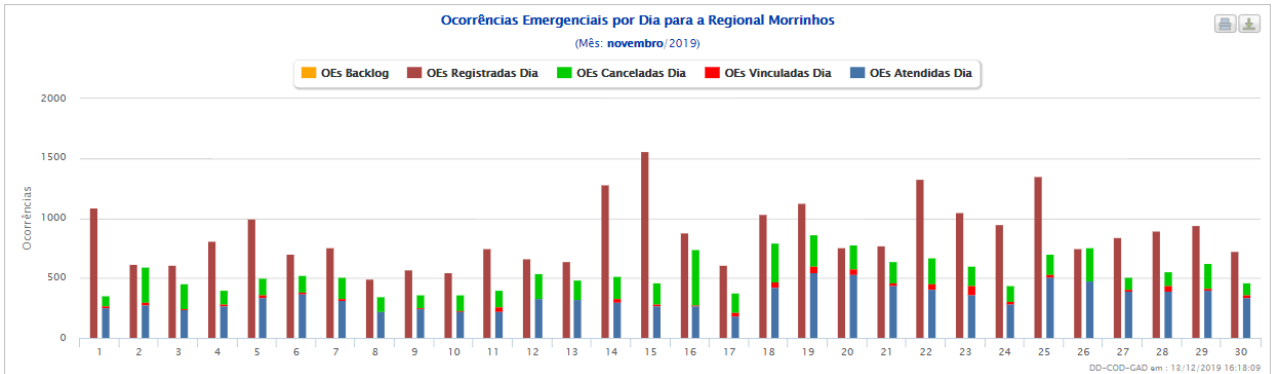
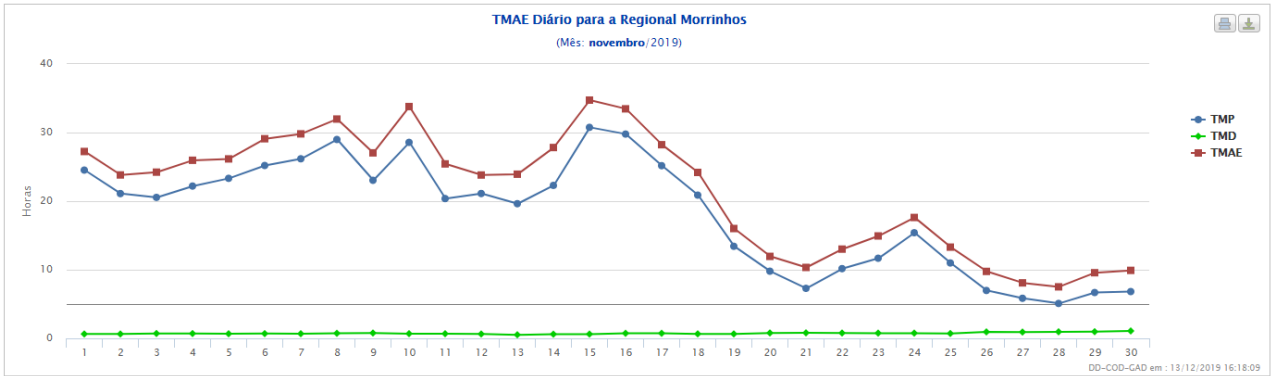
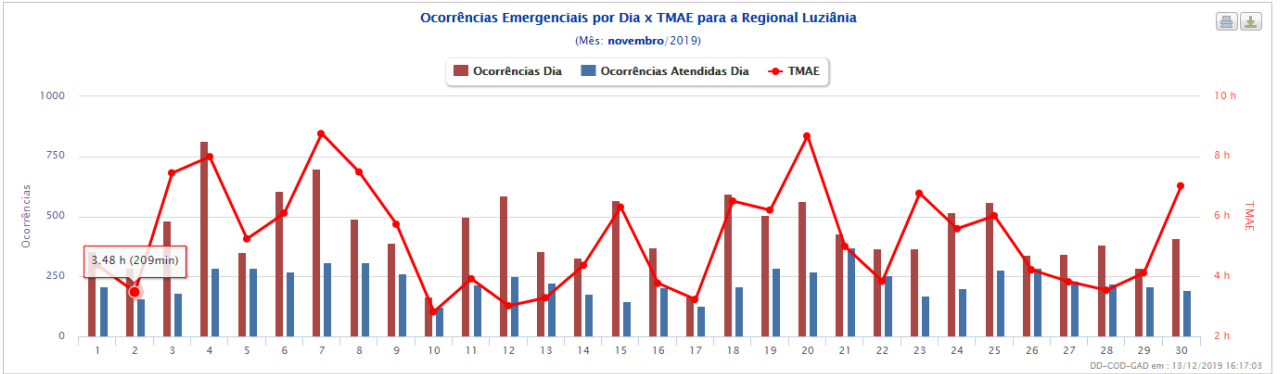
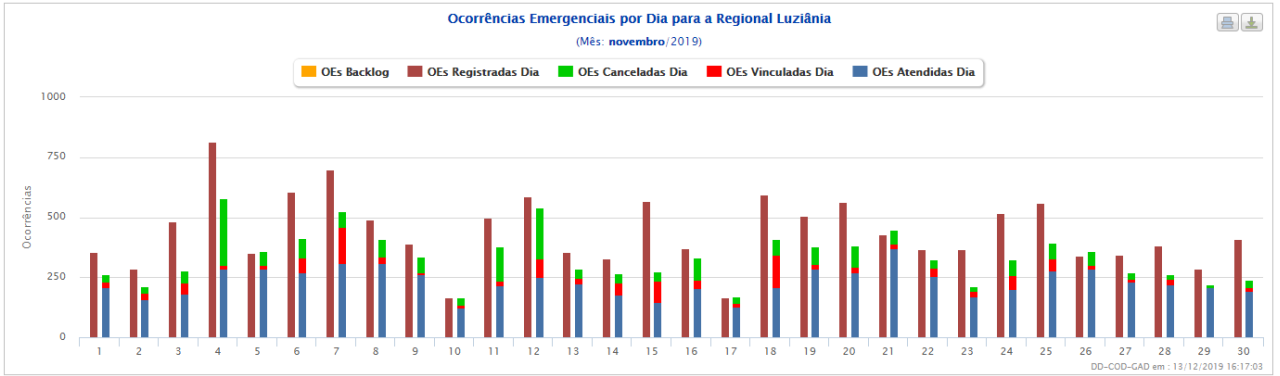
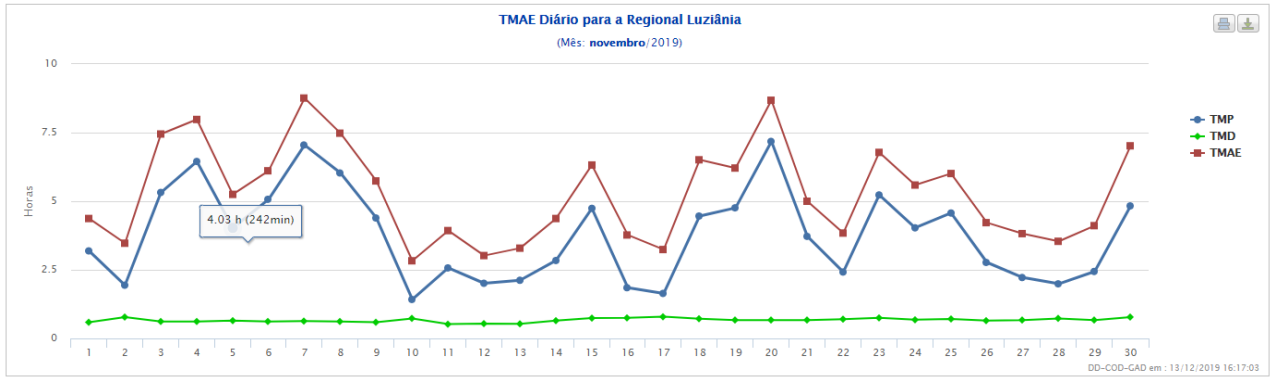

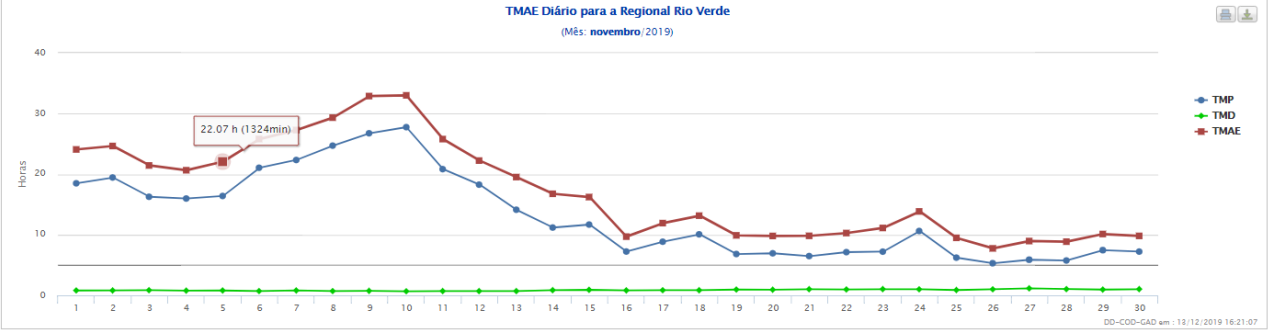
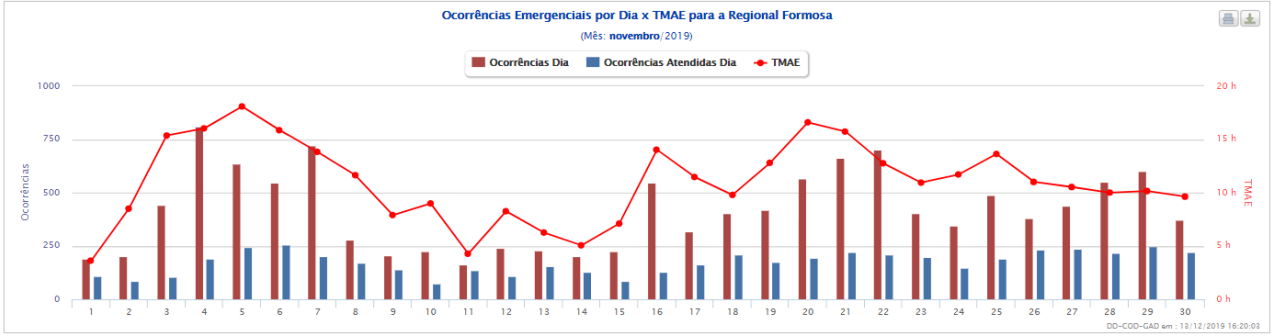
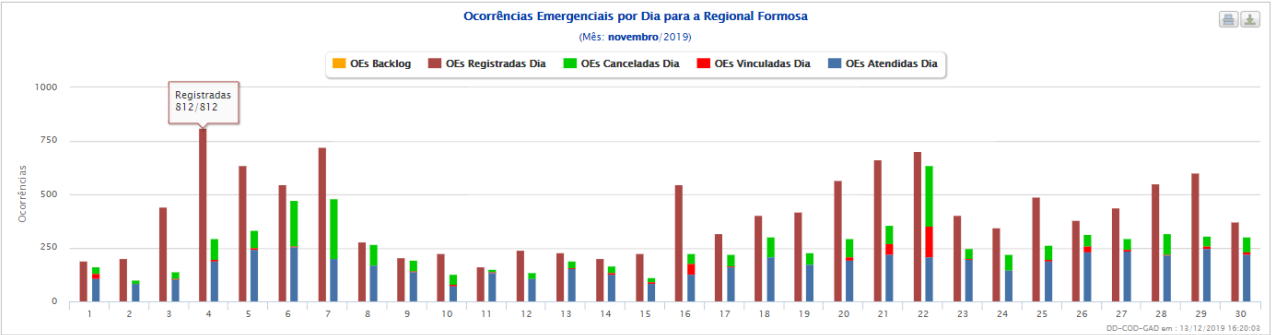
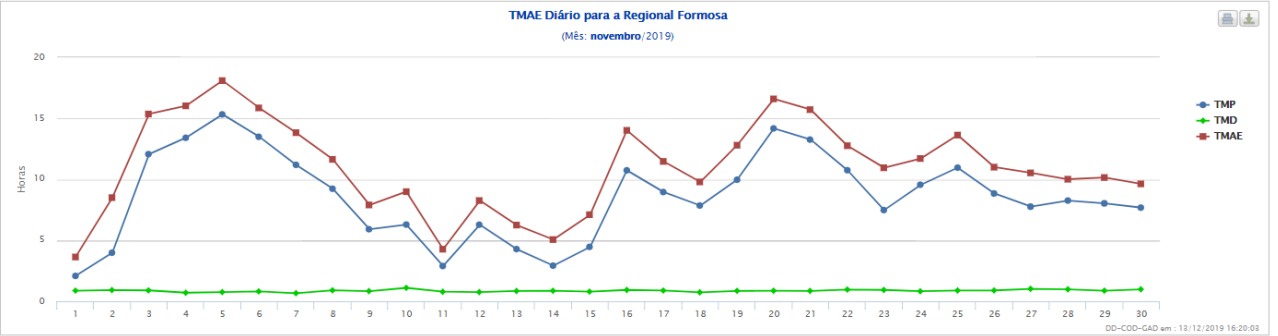
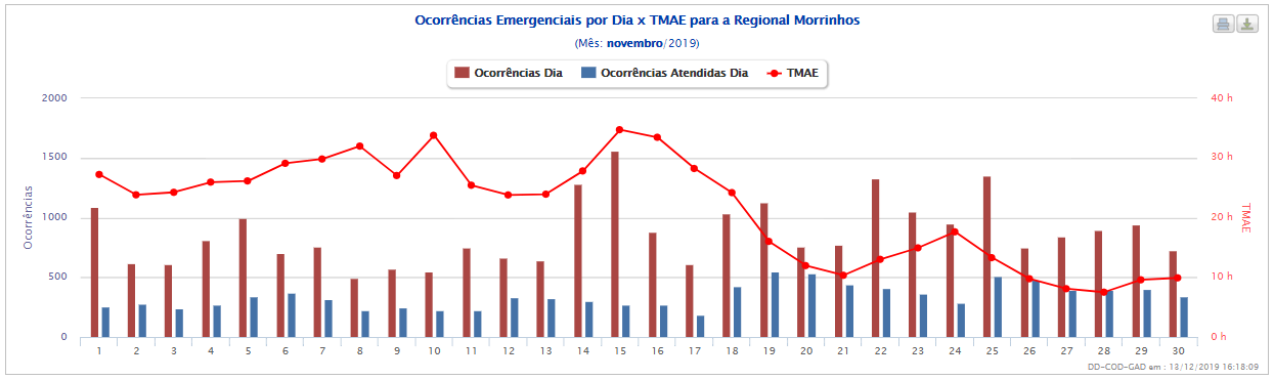

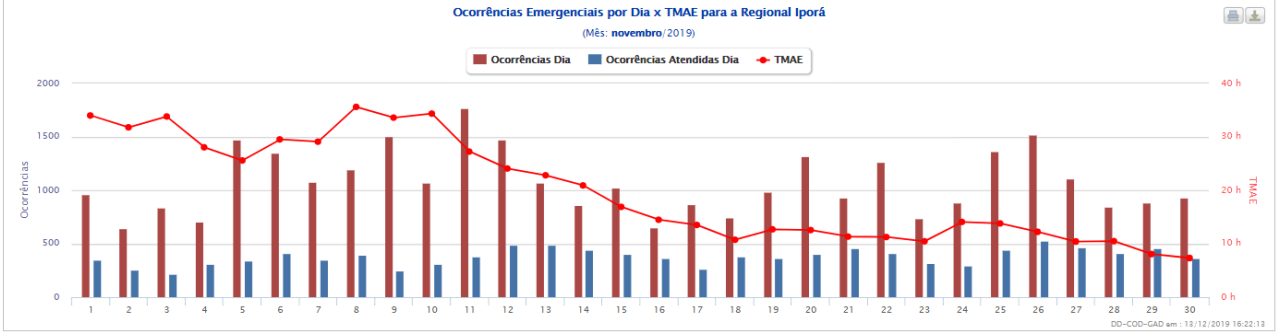
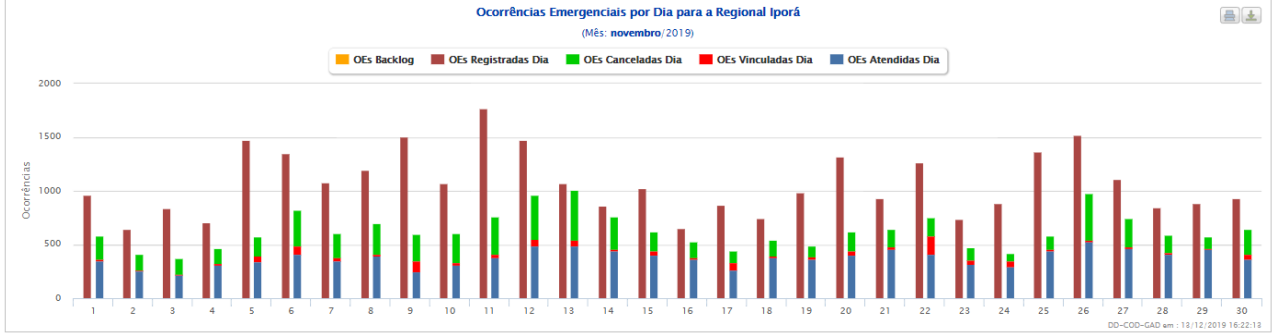
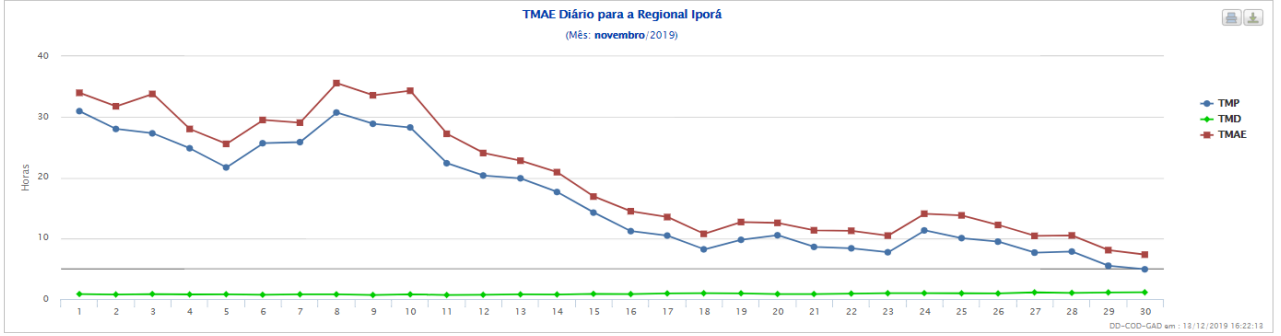
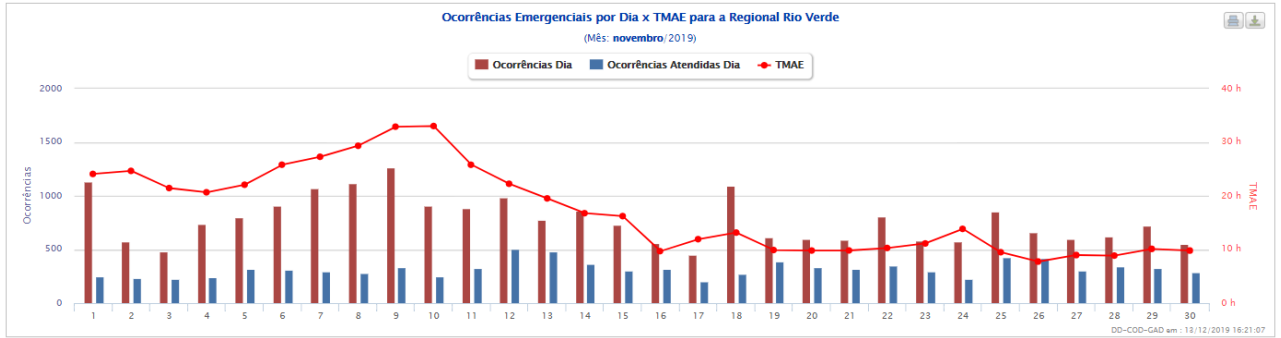
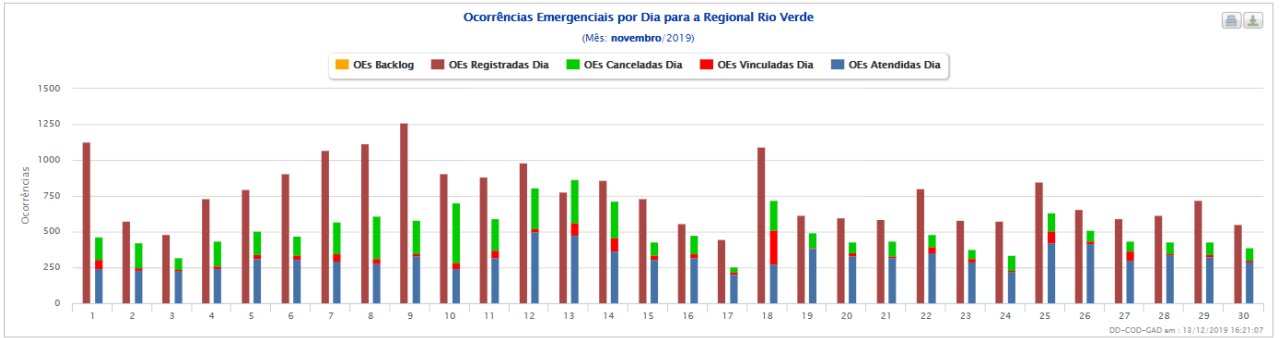

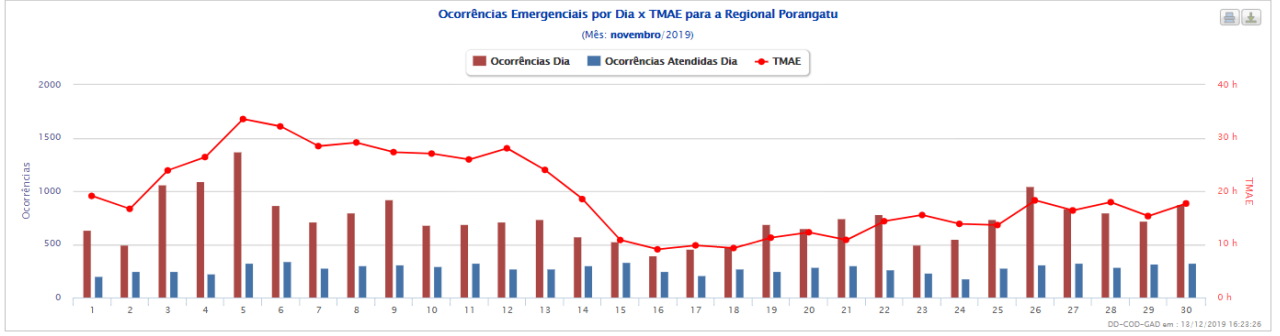
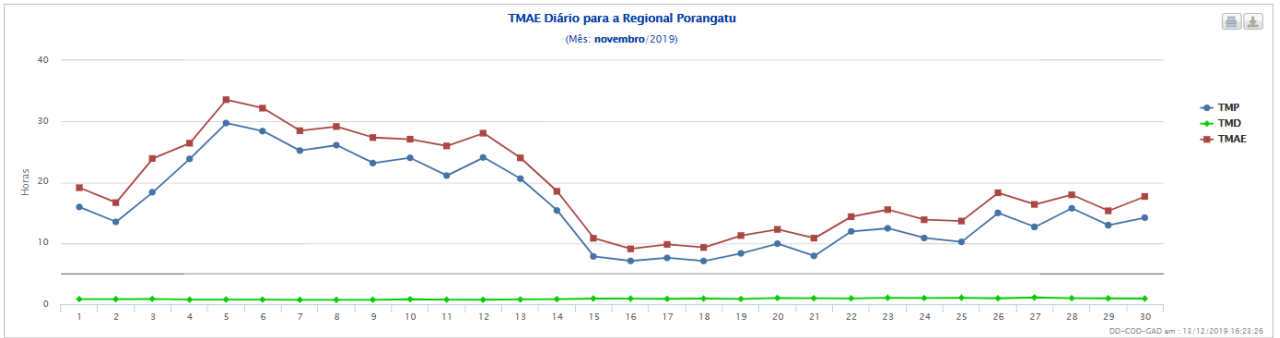

CLIMATEMPO

**Laudo Meteorológico de Evento Climático -  
CELG Distribuição S.A. - 25 de novembro de  
2019**

São Paulo, SP, Brasil

Dezembro de 2019

## Sumário

<b>1</b>	<b>ANÁLISE DE EVENTO METEOROLÓGICO .....</b>	<b>2</b>
<b>1.1</b>	<b>Descrição do Evento.....</b>	<b>2</b>
<b>1.2</b>	<b>Abrangência do Evento .....</b>	<b>5</b>
<b>2</b>	<b>CLASSIFICAÇÃO COBRADE .....</b>	<b>9</b>
<b>3</b>	<b>RESUMO DO EVENTO .....</b>	<b>10</b>
<b>4</b>	<b>REFERÊNCIAS.....</b>	<b>16</b>

# 1 Análise de Evento Meteorológico

## 1.1 Descrição do Evento

Na figura a seguir é apresentada a área de concessão da CELG Distribuição, dividida em regiões, a serem analisadas neste relatório.



Figura 1 – Regiões de Goiás atendidas pela CELG Distribuição.

Áreas de instabilidade associadas ao calor e a umidade favoreceram a formação de nuvens de tempestade que avançaram sobre o estado de Goiás entre os dias 25 e 26 de novembro de 2019.

Nas Figuras 2 e 3 são apresentadas as descargas atmosféricas nuvem-solo (raios) e nuvem-nuvem detectadas pelo sistema Earth Networks. Entre as 10h00 do dia 25 e 04h30 do dia 26 de novembro foram registrados 22403 raios nuvem-solo e 45745 descargas nuvem-nuvem sobre a área da CELG Distribuição em Goiás.

O Instituto Nacional de Meteorologia (INMET) registrou rajadas de vento de aproximadamente 64,8 km/h em Caiapônia entre as 12h e 13h do dia 25 de novembro, vento classificado como ventania pela escala Beaufort. Estações do INMET representativas

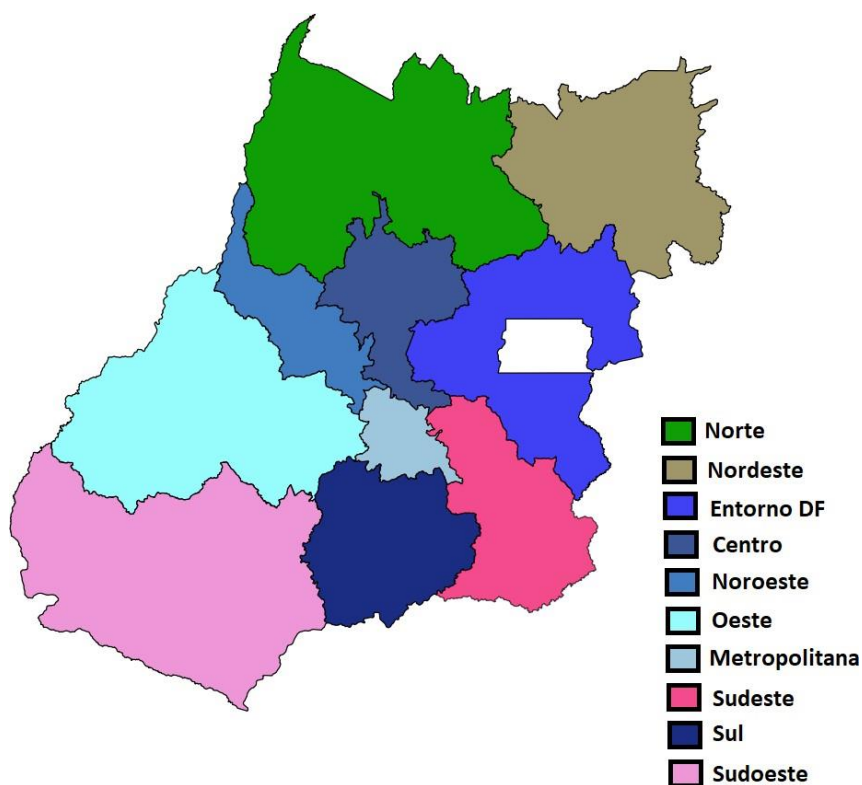
da área de concessão da CELG Distribuição Goiás registraram chuva forte ( Segundo a American Meteorological Society - Sociedade Meteorológica Americana -, chuvas com taxa entre 2,5mm a 7,6 mm por hora são consideradas moderadas e aquelas com taxa superior a 7,6 mm por hora são consideradas chuva forte). Na tabela 2 são apresentados os registros de acumulados horários superiores a 7,6 mm.

Tabela 1 –Rajadas de vento maiores ou iguais a 50 km/h registradas pelo INMET. Segundo a escala Beaufort, ventos entre 62 e 74 km/h são classificados como ventania.

Estação	Horário	Rajada (km/h)
Caiaopônia	Entre 12h e 13h do dia 25/11/2019	64.8



Figura 2 –Descargas atmosféricas nuvem-solo (em preto) detectadas pelo sistema Earth Networks entre 10h00 do dia 25 e 04h30 do dia 26 de novembro de 2019 sobre a área de concessão da CELG Distribuição.



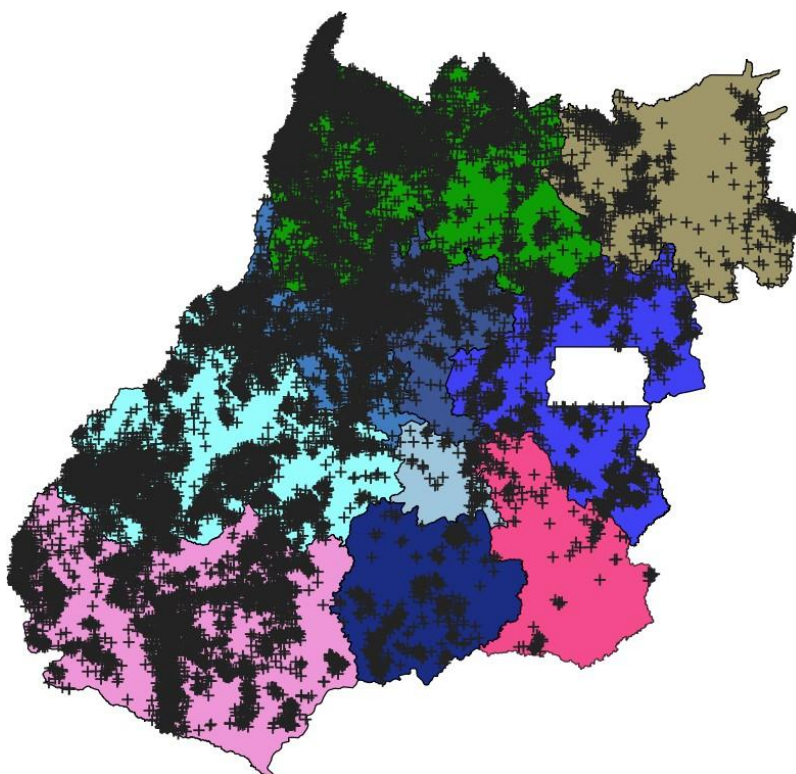

Figura 3 –Descargas atmosféricas nuvem-nuvem (em vermelho) detectadas pelo sistema Earth Networks entre 10h00 do dia 25 e 04h30 do dia 26 de novembro de 2019 sobre a área de concessão da CELG Distribuição.

Tabela 2 – Acumulado horário de chuva registrada pelo INMET.

Estação	Horário	Precipitação (mm)
Alto Araguaia	Entre 20h e 21h do dia 25/11/2019	15.2
Caiapônia	Entre 12h e 13h do dia 25/11/2019	25.0
Caiapônia	Entre 18h e 19h do dia 25/11/2019	10.8
Caiapônia	Entre 19h e 20h do dia 25/11/2019	8.8
Cristalina	Entre 15h e 16h do dia 25/11/2019	8.4
Goiânia	Entre 14h e 15h do dia 25/11/2019	8.0
Itumbiara	Entre 13h e 14h do dia 25/11/2019	9.8
Rio Verde	Entre 11h e 12h do dia 25/11/2019	10.4
Rio Verde	Entre 13h e 14h do dia 25/11/2019	32.0

## 1.2 Abrangência do Evento

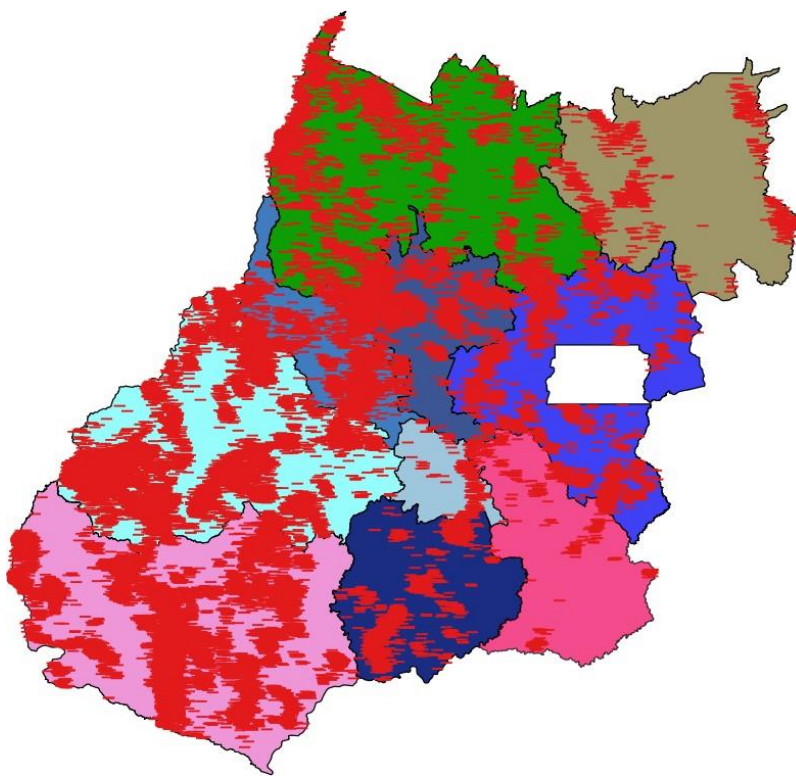
A seguir são apresentadas as imagens realçadas do satélite GOES-16 entre as 13h00 do dia 25 e 03h00 do dia 26 de novembro de 2019. Os tons em vermelho e preto indicam a presença de nuvens de grande desenvolvimento vertical, geralmente associadas à ocorrência de tempo severo.

13h00 - 25 de novembro de 2019



Figura 4 –Imagens realçadas do satélite GOES-16 das 13h00 do dia 25 de novembro de 2019. FONTE: Cptec/INPE.

15h00 - 25 de novembro de 2019

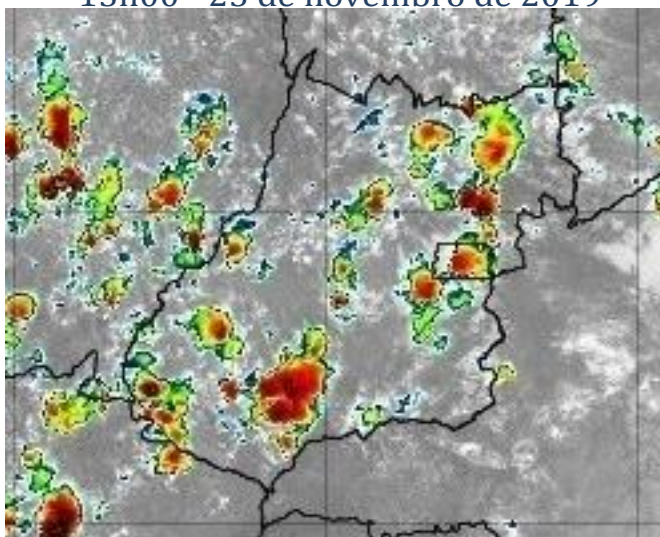

Figura 5 –Imagens realçadas do satélite GOES-16 das 15h00 do dia 25 de novembro de 2019. FONTE: Cptec/INPE.

17h00 - 25 de novembro de 2019

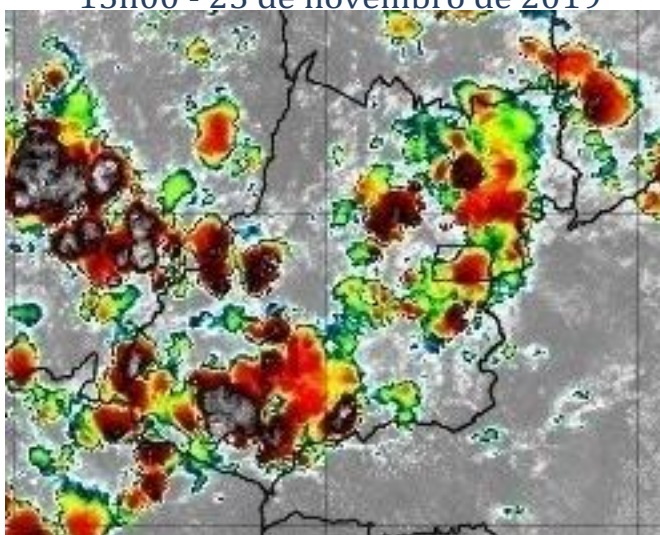

Figura 6 –Imagens realçadas do satélite GOES-16 das 17h00 do dia 25 de novembro de 2019.  
FONTE: Cptec/INPE.

19h00 - 25 de novembro de 2019



Figura 7 –Imagens realçadas do satélite GOES-16 das 19h00 do dia 25 de novembro de 2019.  
FONTE: Cptec/INPE.

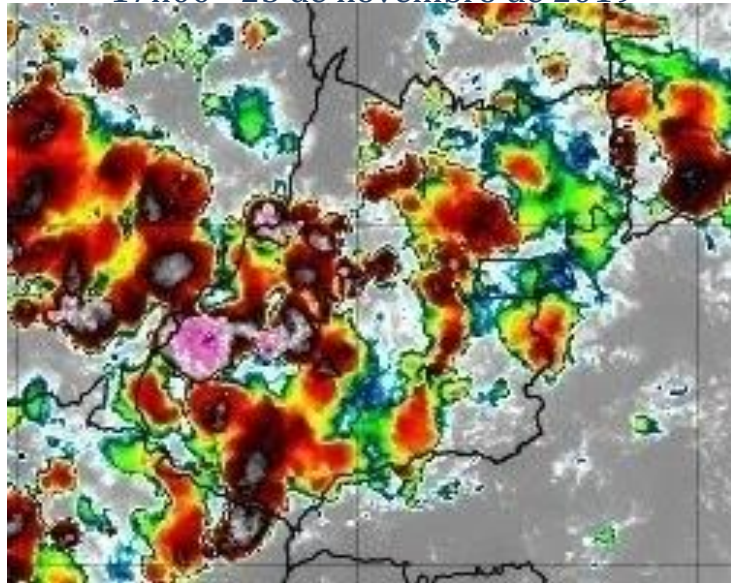

21h00 - 25 de novembro de 2019

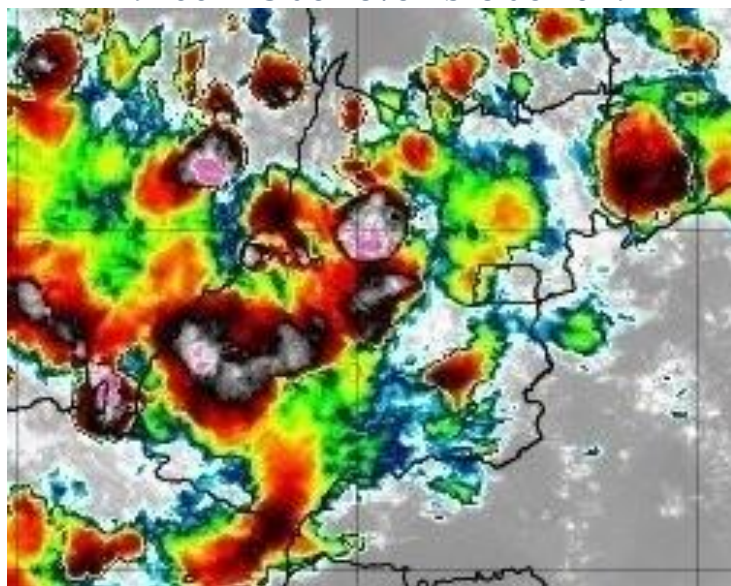

Figura 8 –Imagens realçadas do satélite GOES-16 das 21h00 do dia 25 de novembro de 2019. FONTE: Cptec/INPE.

23h00 - 25 de novembro de 2019

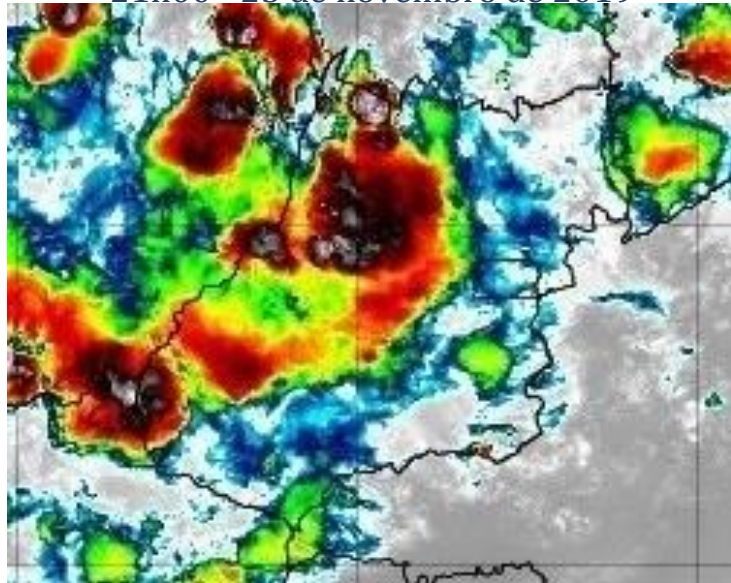

Figura 9 –Imagens realçadas do satélite GOES-16 das 23h00 do dia 25 de novembro de 2019. FONTE: Cptec/INPE.

01h00 - 26 de novembro de 2019

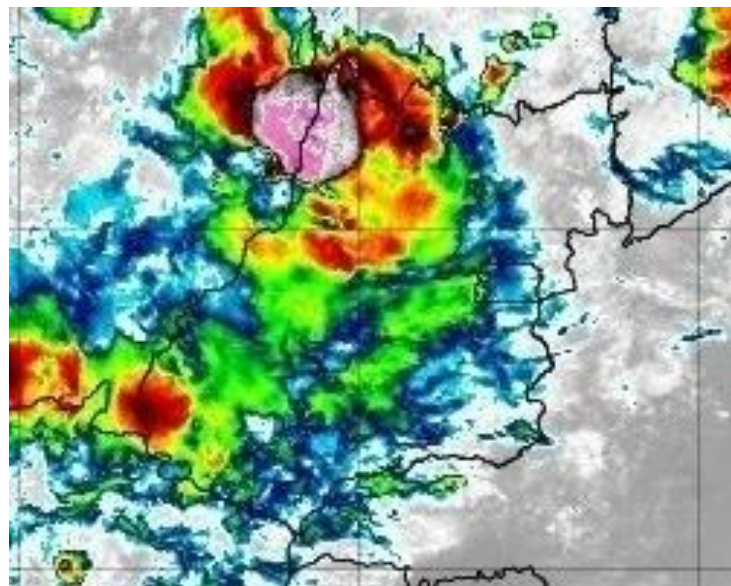

Figura 10 –Imagens realçadas do satélite GOES-16 das 01h00 do dia 26 de novembro de 2019. FONTE: Cptec/INPE.

03h00 - 26 de novembro de 2019



Figura 11 –Imagens realçadas do satélite GOES-16 das 03h00 do dia 26 de novembro de 2019. FONTE: Cptec/INPE.

## 2 Classificação COBRADE

O COBRADE (Classificação e Codificação Brasileira de Desastres) foi criado com o intuito de adequar a classificação brasileira à classificação utilizada pela ONU na classificação de desastres e nivelar o país aos demais organismos de gestão de desastres do mundo.

Baseados nos dados analisados nos itens anteriores, podemos classificar o evento ocorrido na CELG Distribuição como Tempestades - Vendaval (Código 1.3.2.1.5), Tempestade de raios (Código 1.3.2.1.2) e Chuvas intensas (Código 1.3.2.1.4).

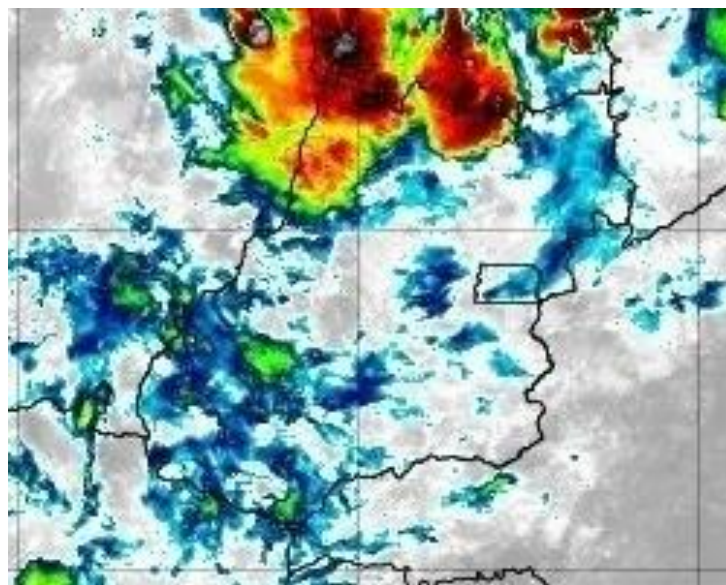
### 3 Resumo do Evento

Nuvens de tempestade, do tipo Cumulonimbus, formadas pelo ar quente e úmido favoreceram a ocorrência de raios, rajadas de vento e chuva forte sobre a área de concessão da CELG Distribuição Goiás entre os dias 25 e 26 de novembro de 2019.

O sistema de detecção da EarthNetworks registrou 68148 descargas atmosféricas sobre a área de concessão da CELG Distribuição entre as 10h00 do dia 25 e as 04h30 do dia 26 de novembro de 2019. O INMET registrou chuva forte em estações representativas da região de interesse durante a tarde e a noite do dia 25 de novembro.

Tabela 3 – Resumo do evento Região Sudoeste

Número/Código do Evento	
Número/Código do Relatório	
Descrição	Forte deslocamento de uma massa de ar em uma região. Tempestade com intensa atividade elétrica no interior das nuvens, com grande desenvolvimento vertical. Chuvas com acumulados significativos.
Código COBRADE	1.3.2.1.5 - Tempestades, Vendaval e 1.3.2.1.2 - Tempestade de raios e 1.3.2.1.4 - Chuvas intensas
Hora início do evento	10h30 do dia 25 de novembro de 2019
Hora de fim do evento	22h00 do dia 26 de novembro de 2019
Abrangência	Região Sudoeste da CELG Distribuição S.A.

Tabela 4 – Resumo do evento Região Sul

Número/Código do Evento	
Número/Código do Relatório	
Descrição	Forte deslocamento de uma massa de ar em uma região. Tempestade com intensa atividade elétrica no interior das nuvens, com grande desenvolvimento vertical. Chuvas com acumulados significativos.
Código COBRADE	1.3.2.1.5 - Tempestades, Vendaval e 1.3.2.1.2 - Tempestade de raios e 1.3.2.1.4 - Chuvas intensas
Hora início do evento	11h00 do dia 25 de novembro de 2019
Hora de fim do evento	18h30 do dia 25 de novembro de 2019
Abrangência	Região Sul da CELG Distribuição S.A.

Tabela 5 – Resumo do evento Região Sudeste

Número/Código do Evento	
Número/Código do Relatório	
Descrição	Forte deslocamento de uma massa de ar em uma região. Tempestade com intensa atividade elétrica no interior das nuvens, com grande desenvolvimento vertical. Chuvas com acumulados significativos.
Código COBRADE	1.3.2.1.5 - Tempestades, Vendaval e 1.3.2.1.2 - Tempestade de raios e 1.3.2.1.4 - Chuvas intensas
Hora início do evento	11h00 do dia 25 de novembro de 2019
Hora de fim do evento	21h30 do dia 25 de novembro de 2019
Abrangência	Região Sudeste da CELG Distribuição S.A.



Tabela 6 – Resumo do evento Região Metropolitana

Número/Código do Evento	
Número/Código do Relatório	
Descrição	Forte deslocamento de uma massa de ar em uma região. Tempestade com intensa atividade elétrica no interior das nuvens, com grande desenvolvimento vertical. Chuvas com acumulados significativos.
Código COBRADE	1.3.2.1.5 - Tempestades, Vendaval e 1.3.2.1.2 - Tempestade de raios e 1.3.2.1.4 - Chuvas intensas
Hora início do evento	13h30 do dia 25 de novembro de 2019
Hora de fim do evento	21h00 do dia 25 de novembro de 2019
Abrangência	Região Metropolitana da CELG Distribuição S.A.

Tabela 7 – Resumo do evento Região Oeste

Número/Código do Evento	
Número/Código do Relatório	
Descrição	Forte deslocamento de uma massa de ar em uma região. Tempestade com intensa atividade elétrica no interior das nuvens, com grande desenvolvimento vertical. Chuvas com acumulados significativos.
Código COBRADE	1.3.2.1.5 - Tempestades, Vendaval e 1.3.2.1.2 - Tempestade de raios e 1.3.2.1.4 - Chuvas intensas
Hora início do evento	10h00 do dia 25 de novembro de 2019
Hora de fim do evento	22h30 do dia 25 de novembro de 2019
Abrangência	Região Oeste da CELG Distribuição S.A.

Tabela 8 – Resumo do evento Região EDF

Número/Código do Evento	
Número/Código do Relatório	
Descrição	Forte deslocamento de uma massa de ar em uma região. Tempestade com intensa atividade elétrica no interior das nuvens, com grande desenvolvimento vertical. Chuvas com acumulados significativos.
Código COBRADE	1.3.2.1.5 - Tempestades, Vendaval e 1.3.2.1.2 - Tempestade de raios e 1.3.2.1.4 - Chuvas intensas
Hora início do evento	10h30 do dia 25 de novembro de 2019
Hora de fim do evento	19h00 do dia 25 de novembro de 2019
Abrangência	Região EDF da CELG Distribuição S.A.

Tabela 9 – Resumo do evento Região Centro

Número/Código do Evento	
Número/Código do Relatório	
Descrição	Forte deslocamento de uma massa de ar em uma região. Tempestade com intensa atividade elétrica no interior das nuvens, com grande desenvolvimento vertical. Chuvas com acumulados significativos.
Código COBRADE	1.3.2.1.5 - Tempestades, Vendaval e 1.3.2.1.2 - Tempestade de raios e 1.3.2.1.4 - Chuvas intensas
Hora início do evento	10h30 do dia 25 de novembro de 2019
Hora de fim do evento	23h00 do dia 25 de novembro de 2019
Abrangência	Região Centro da CELG Distribuição S.A.

Tabela 10 – Resumo do evento Região Noroeste

Número/Código do Evento	
Número/Código do Relatório	
Descrição	Forte deslocamento de uma massa de ar em uma região. Tempestade com intensa atividade elétrica no interior das nuvens, com grande desenvolvimento vertical. Chuvas com acumulados significativos.
Código COBRADE	1.3.2.1.5 - Tempestades, Vendaval e 1.3.2.1.2 - Tempestade de raios e 1.3.2.1.4 - Chuvas intensas
Hora início do evento	11h00 do dia 25 de novembro de 2019
Hora de fim do evento	01h30 do dia 26 de novembro de 2019
Abrangência	Região Noroeste da CELG Distribuição S.A.

Tabela 11 – Resumo do evento Região Norte

Número/Código do Evento	
Número/Código do Relatório	
Descrição	Forte deslocamento de uma massa de ar em uma região. Tempestade com intensa atividade elétrica no interior das nuvens, com grande desenvolvimento vertical. Chuvas com acumulados significativos.
Código COBRADE	1.3.2.1.5 - Tempestades, Vendaval e 1.3.2.1.2 - Tempestade de raios e 1.3.2.1.4 - Chuvas intensas
Hora início do evento	10h30 do dia 25 de novembro de 2019
Hora de fim do evento	04h00 do dia 26 de novembro de 2019
Abrangência	Região Norte da CELG Distribuição S.A.

Tabela 12 – Resumo do evento Região Nordeste

Número/Código do Evento	
Número/Código do Relatório	
Descrição	Forte deslocamento de uma massa de ar em uma região. Tempestade com intensa atividade elétrica no interior das nuvens, com grande desenvolvimento vertical. Chuvas com acumulados significativos.
Código COBRADE	1.3.2.1.5 - Tempestades, Vendaval e 1.3.2.1.2 - Tempestade de raios e 1.3.2.1.4 - Chuvas intensas
Hora início do evento	10h30 do dia 25 de novembro de 2019
Hora de fim do evento	05h00 do dia 26 de novembro de 2019
Abrangência	Região Nordeste da CELG Distribuição S.A.

#### 4 Referências

- RMetS Royal Meteorological Society – Beaufort Scale - <https://www.rmets.org/weather-and-climate/observing/beaufort-scale>

- Instituto Nacional de Meteorologia (INMET) - <http://www.inmet.gov.br>

- Cptec/INPE- <https://www.cptec.inpe.br/>

- Centro de Hidrografia da Marinha do Brasil - <https://www.marinha.mil.br/chm/>

- Meteorology Glossary - American Meteorological Society -  
<http://glossary.ametsoc.org/>

Anexos

A.1 Carta Sinótica

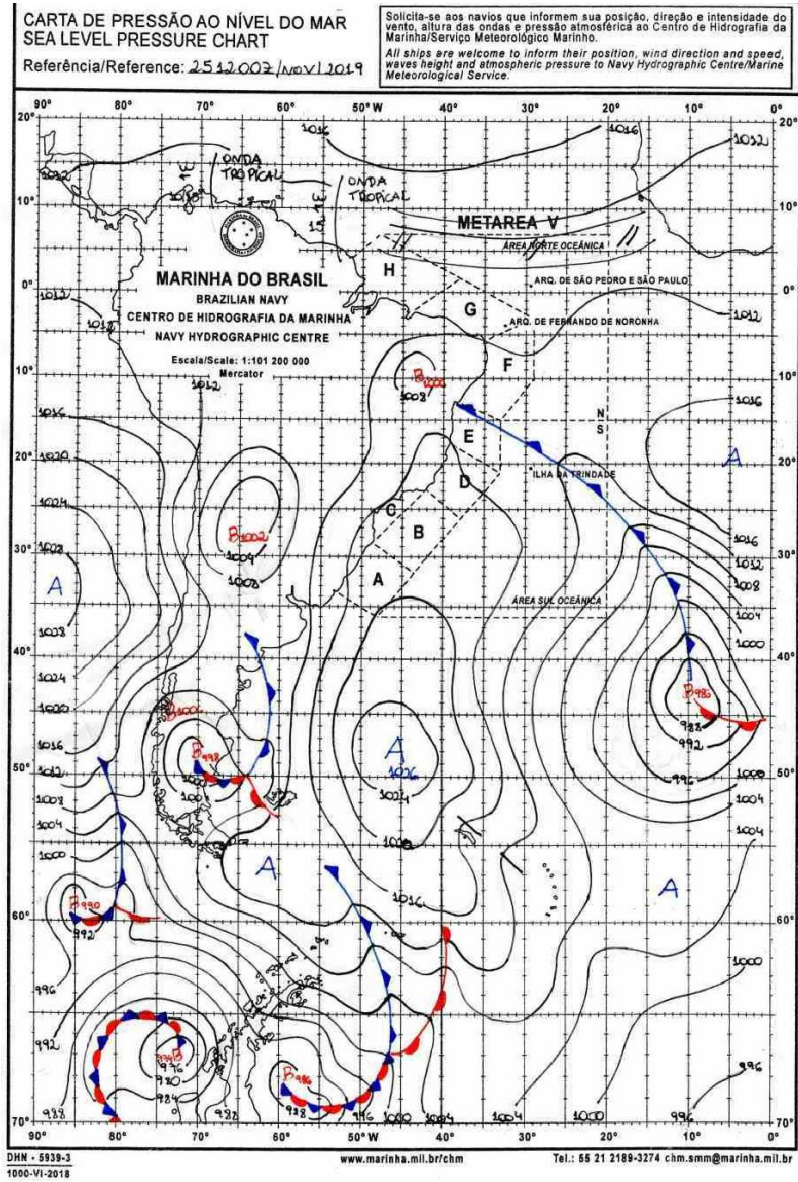

LEGENDA			
	Frente Fria	<b>A</b>	Alta Pressão
	Frente Quente	<b>B</b>	Baixa Pressão
	Instabilidade		Zona de Convergência

Figura A1 - Carta sinótica para as 1200Z do dia 25 de novembro de 2019 (09h00 do dia 25 de novembro de 2019, hora local. FONTE:Marinha do Brasil).



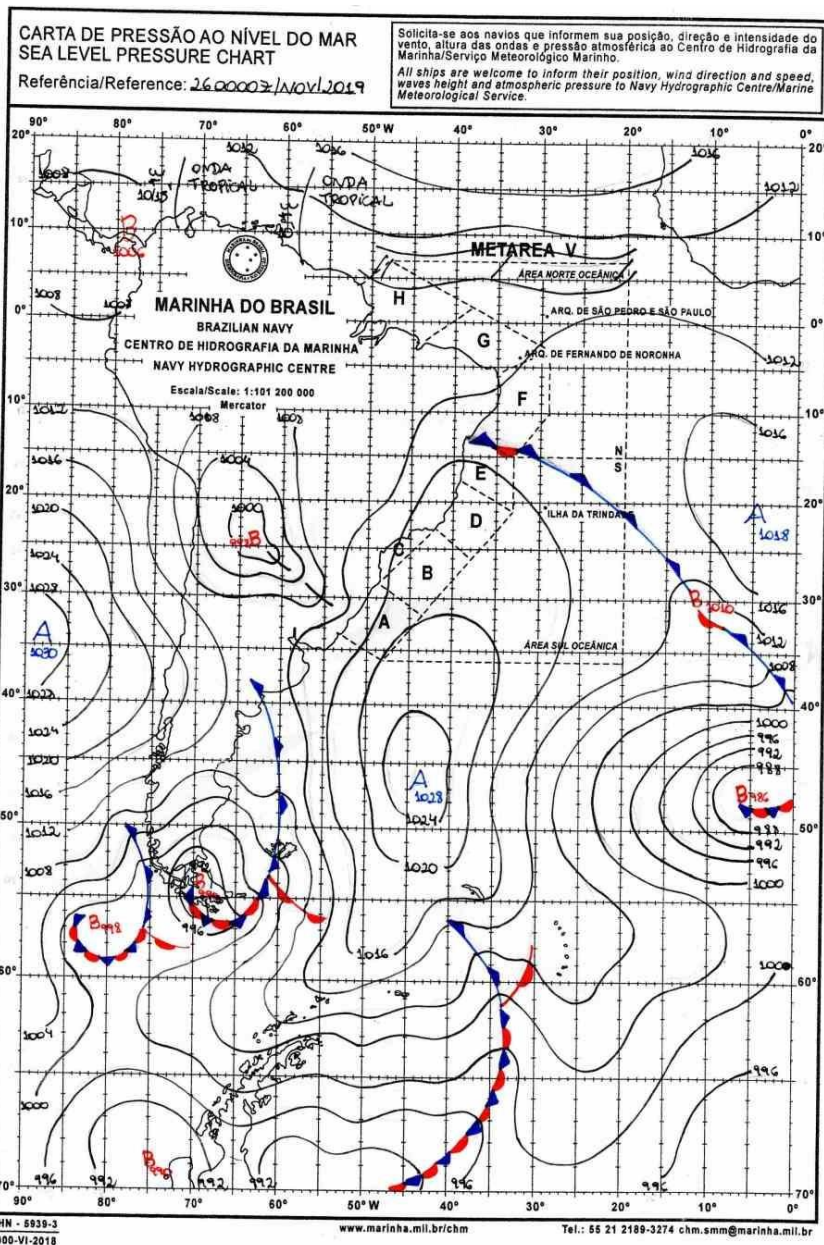

LEGENDA			
	Frente Fria	<b>A</b>	Alta Pressão
	Frente Quente	<b>B</b>	Baixa Pressão
	Instabilidade		Zona de Convergência

Figura A2 - Carta sinótica da Marinha do Brasil para as 0000Z do dia 26 de novembro de 2019 (21h00 do dia 25 de novembro de 2019, hora local. FONTE:CPTEC).

## A.2 Notícias relacionadas

- Temporal arranca cobertura de posto de combustíveis em Itaguaru: 'Coisa de louco'

<https://g1.globo.com/go/goias/noticia/2019/11/26/temporal-arranca-cobertura-de-posto-de-combustiveis-do-prefeito-de-itaguaru-coisa-de-louco.ghtml>

- Chuva de granizo causa estragos em posto de gasolina de Itaguaru

<https://www.emaisgoias.com.br/chuva-de-granizo-causa-estragos-em-posto-de-gasolina-de-itaguaru/>

Bianca Lobo Silva  
Meteorologista CREA  
5063840461



## Instituto Nacional de Meteorologia - INMET

Umidade Relativa do Ar 00h UTC  
Estação: IPAMERI (GO) - 11/2019

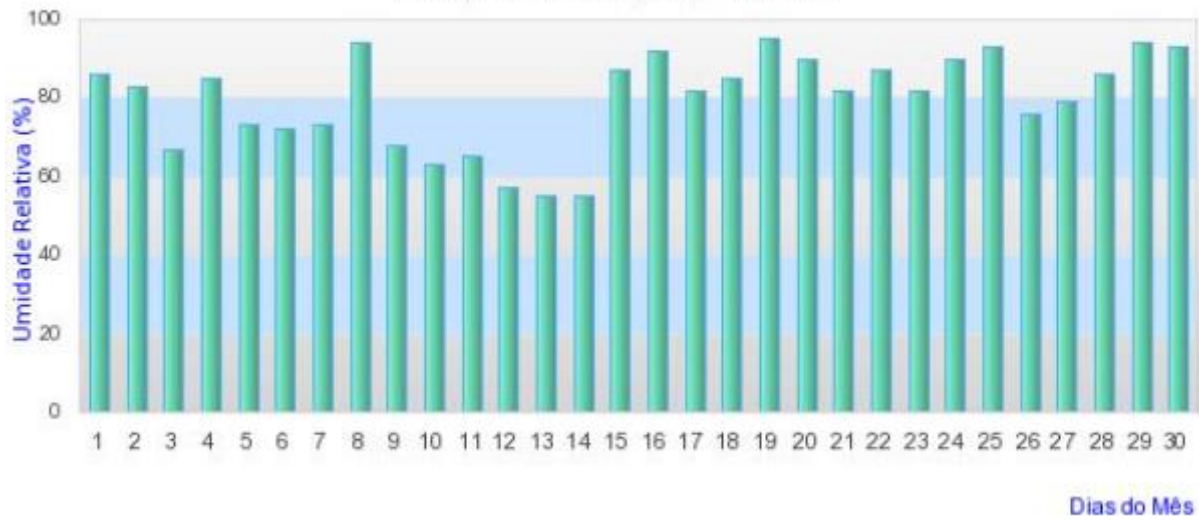

## Instituto Nacional de Meteorologia - INMET

Chuva Acumulada 24h  
Estação: IPAMERI - 11/2019

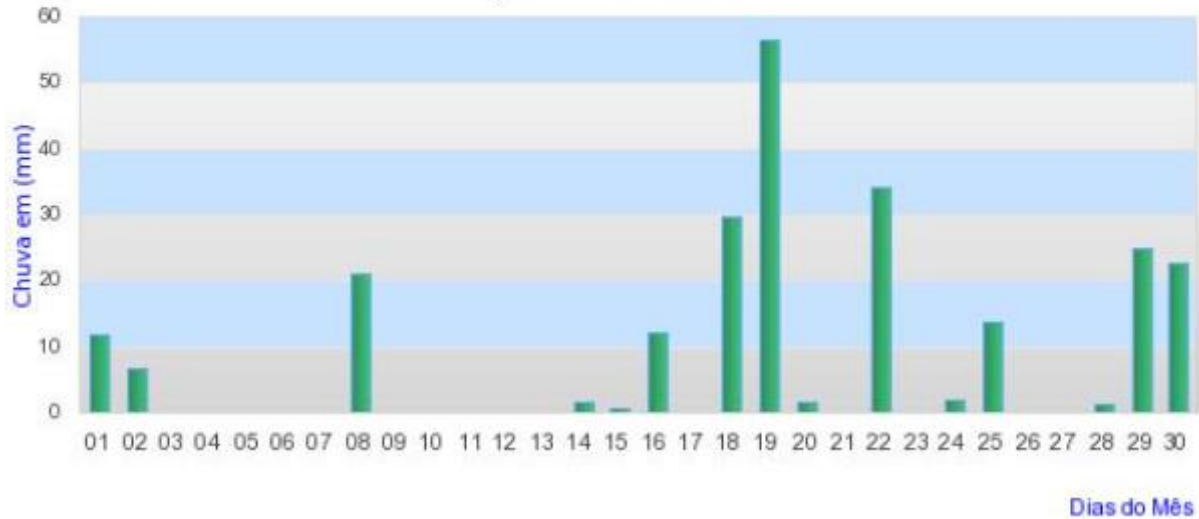

## Instituto Nacional de Meteorologia - INMET

Umidade Relativa do Ar 00h UTC  
Estação: FORMOSA (GO) - 11/2019

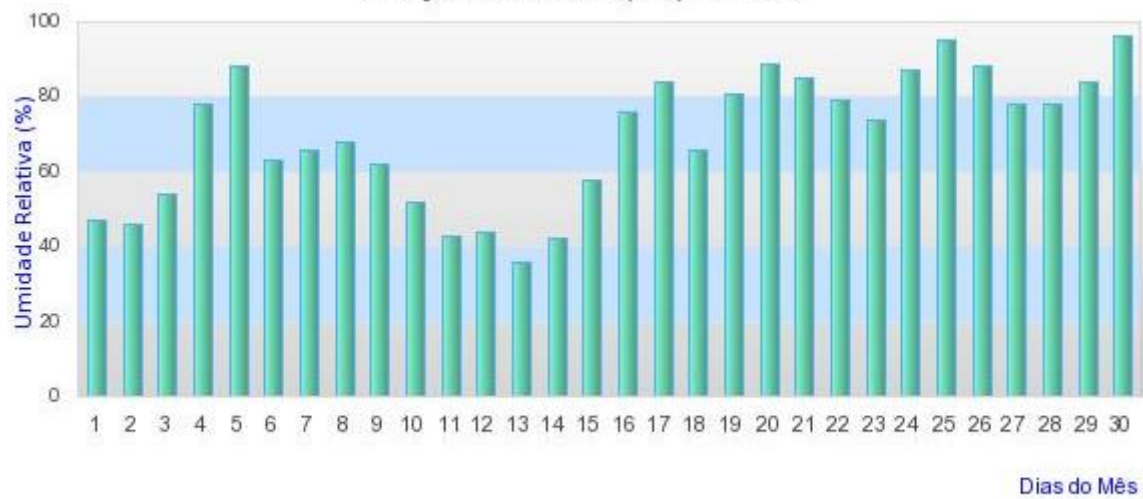

## Instituto Nacional de Meteorologia - INMET

Chuva Acumulada 24h  
Estação: FORMOSA - 11/2019

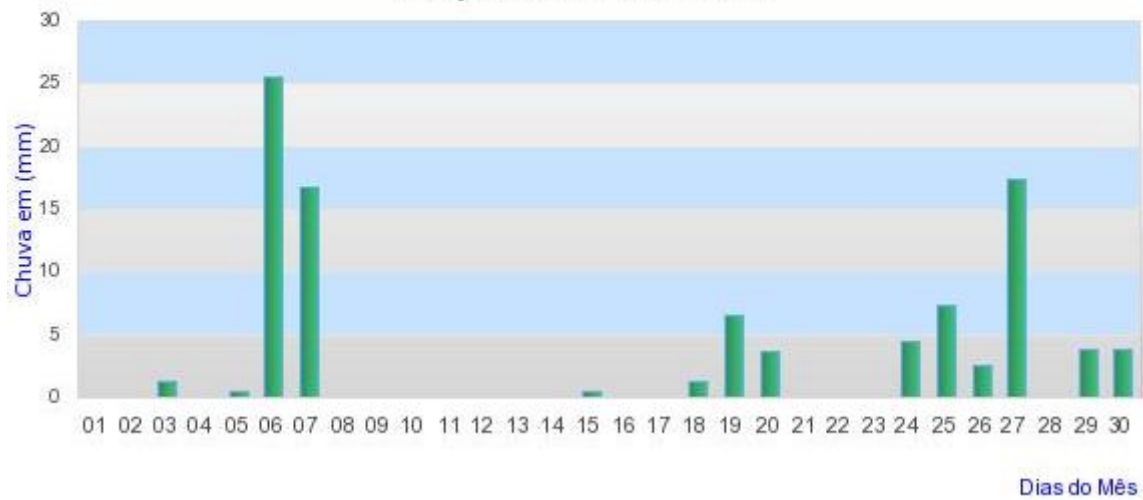

## Instituto Nacional de Meteorologia - INMET

Umidade Relativa do Ar 00h UTC

Estação: GOIANIA (GO) - 11/2019

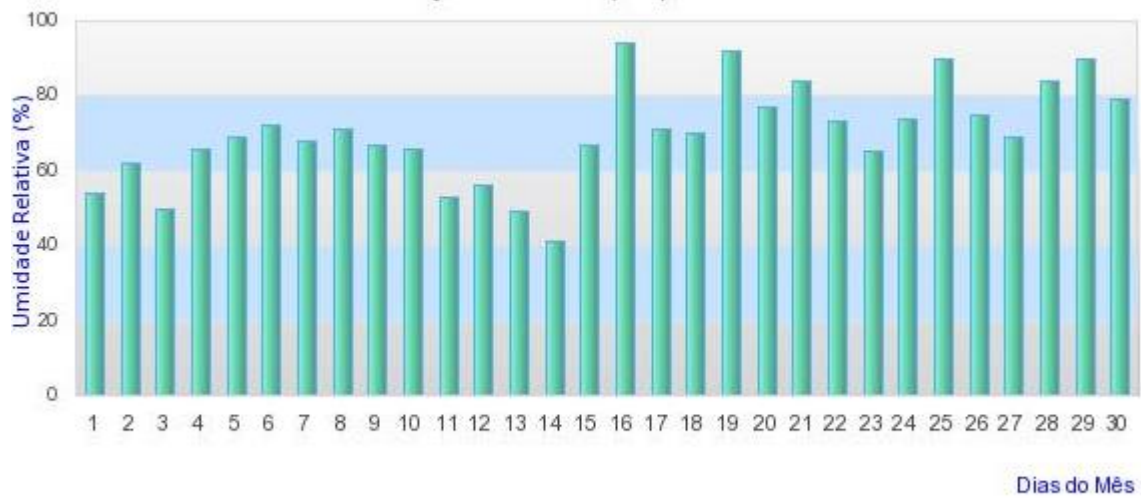

## Instituto Nacional de Meteorologia - INMET

Chuva Acumulada 24h

Estação: GOIANIA - 11/2019

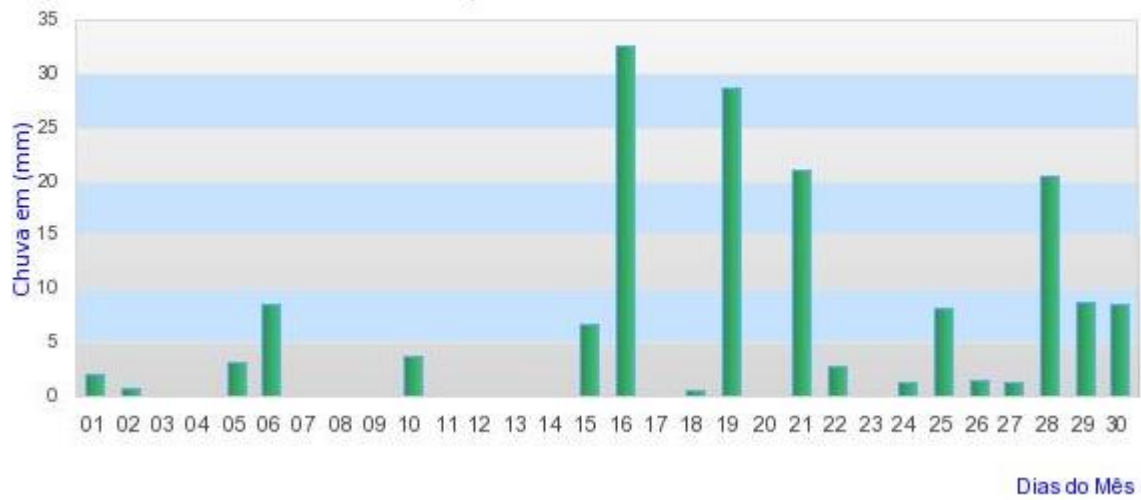

Cidade de Goiás - Estação Estação Hidro Cid. Goiás Montante - GO - ANA - Novembro de 2019

Para ver os dados horários clique no dia desejado

Dia	Precip.	Prec.Acum.	Sensor Pressão min	Sensor Pressão max	Sensor Pressão media	Nível Régua	CodifEixo	Vazão min (m3/s)	Vazão max (m3/s)	Vazão media (m3/s)
<a href="#">1</a>	0.00	0.00	0.2	0.21	0.2	0.21	-0.17	0.00	0.00	0.00
<a href="#">2</a>	2.20	2.20	0.19	0.2	0.2	0.2	-0.17	0.00	0.00	0.00
<a href="#">3</a>	0.20	2.40	0.19	0.21	0.2	0.21	-0.17	0.00	0.00	0.00
<a href="#">4</a>	0.00	2.40	0.19	0.2	0.2	0.2	-0.17	0.00	0.00	0.00
<a href="#">5</a>	5.20	7.60	0.19	0.75	0.2	0.75	-0.17	0.00	0.00	0.00
<a href="#">6</a>	0.00	7.60	0.23	0.58	0.3	0.58	-0.17	0.00	0.00	0.00
<a href="#">7</a>	0.00	7.60	0	0.23	0.2	0.23	-0.17	0.00	0.00	0.00
<a href="#">8</a>	-145.40	-137.80	0.19	0.21	0.2	0.21	-0.17	0.00	0.00	0.00
<a href="#">9</a>	7.40	-130.40	0.19	0.2	0.2	0.2	-0.17	0.00	0.00	0.00
<a href="#">10</a>	0.00	-130.40	0.18	0.19	0.2	0.19	-0.17	0.00	0.00	0.00
<a href="#">11</a>	1.80	-128.60	0.18	0.2	0.2	0.2	-0.17	0.00	0.00	0.00
<a href="#">12</a>	1.00	-127.60	0.19	0.2	0.2	0.2	-0.17	0.00	0.00	0.00
<a href="#">13</a>	0.20	-127.40	0.18	0.19	0.2	0.19	-0.17	0.00	0.00	0.00
<a href="#">14</a>	0.00	-127.40	0.17	0.18	0.2	0.18	-0.17	0.00	0.00	0.00
<a href="#">15</a>	7.80	-119.60	0.17	0.18	0.2	0.18	-0.17	0.00	0.00	0.00
<a href="#">16</a>	0.00	-119.60	0.17	0.18	0.2	0.18	-0.17	0.00	0.00	0.00
<a href="#">17</a>	3.20	-116.40	0.17	0.18	0.2	0.18	-0.17	0.00	0.00	0.00
<a href="#">18</a>	0.00	-116.40	0.18	0.18	0.2	0.18	-0.17	0.00	0.00	0.00
<a href="#">19</a>	0.20	-116.20	0.18	0.18	0.2	0.18	-0.17	0.00	0.00	0.00
<a href="#">20</a>	1.80	-114.40	0.18	0.19	0.2	0.19	-0.17	0.00	0.00	0.00
<a href="#">21</a>	0.00	-114.40	0.19	0.19	0.2	0.19	-0.17	0.00	0.00	0.00
<a href="#">22</a>	0.80	-113.60	0.19	0.19	0.2	0.19	-0.17	0.00	0.00	0.00
<a href="#">23</a>	0.00	-113.60	0.19	0.21	0.2	0.21	-0.17	0.00	0.00	0.00
<a href="#">24</a>	2.80	-110.80	0.18	0.22	0.2	0.22	-0.17	0.00	0.00	0.00
<a href="#">25</a>	7.20	-103.60	0.22	0.91	0.3	0.91	-0.17	0.00	0.00	0.00
<a href="#">26</a>	0.00	-103.60	0.26	0.69	0.4	0.69	-0.17	0.00	0.00	0.00
<a href="#">27</a>	9.20	-94.40	0.25	0.97	0.4	0.97	-0.17	0.00	0.00	0.00
<a href="#">28</a>	11.80	-82.60	0.27	0.44	0.3	0.44	-0.17	0.00	0.00	0.00
<a href="#">29</a>	0.20	-82.40	0.24	0.27	0.3	0.27	-0.17	0.00	0.00	0.00
<a href="#">30</a>	0.00	-82.40	0.22	0.24	0.2	0.24	-0.17	0.00	0.00	0.00

Anapolis - Estação CELG Estação Anapolis - Novembro de 2019

Para ver os dados horários clique no dia desejado

Dia	Precip.	Prec.Acum.	Vel. Vent. (m/s)	Dir. Vent.	Umid. Relat. AR (Max) %	Umid. Relat. AR (Min) %	Umid. Relat. AR (Média) %	Temp. Max. °C Dia	Temp. Min. °C Dia	Temp. Med. °C do Ar	Temp. 09:00h	Temp. 21:00h	Ponto orvalho	Razao Mistura
<a href="#">1</a>	0.40	0.40	1.5	N	72.0	35.0	57	31.7	22.0	25.88	26.7	24.5	15.73333	12.7014
<a href="#">2</a>	8.00	8.40	1.7	L	82.0	39.0	62	31.5	19.8	24.6	24.3	23.7	17.02917	13.7917
<a href="#">3</a>	0.00	8.40	1.9	N	87.0	57.0	71.5	26.3	19.3	22.6	21.6	22.9	17.43333	14.1181
<a href="#">4</a>	0.00	8.40	1.7	N	86.0	41.0	66.2	30.7	19.9	24.22	26.5	22	17.23333	13.9236
<a href="#">5</a>	0.00	8.40	1.3	N	86.0	48.0	70.5	29.0	19.2	24.2	25.8	23.5	17.26667	14.0764
<a href="#">6</a>	0.00	8.40	1.5	SE	94.0	52.0	64.2	28.4	19.9	24.18	23	24.8	17.72500	14.4167
<a href="#">7</a>	0.00	8.40	1.6	L	86.0	50.0	61	28.6	20.4	24.66	25.5	24.4	18.02083	14.7986
<a href="#">8</a>	0.00	8.40	1.8	S	87.0	58.0	71.2	28.8	20.3	24.04	22.1	24.5	18.72083	15.3333
<a href="#">9</a>	0.00	8.40	2.2	L	87.0	32.0	57.2	32.6	20.3	25.58	26	24.5	16.80833	13.6250
<a href="#">10</a>	0.20	8.60	1.7	O	88.0	42.0	57.2	30.7	19.7	25.16	26	24.7	16.57083	13.2708
<a href="#">11</a>	3.20	11.80	1.9	O	69.0	30.0	53.7	32.8	21.7	26.16	28.1	24.1	15.79167	12.8681
<a href="#">12</a>	0.00	11.80	2.2	SO	76.0	31.0	47	32.5	22.0	26.78	26	26.7	15.81667	12.7569
<a href="#">13</a>	0.00	11.80	2.2	N	64.0	30.0	42.5	31.7	21.4	26.58	26.6	26.6	13.87500	11.2778
<a href="#">14</a>	22.60	34.40	1.6	O	98.0	42.0	77.5	30.9	17.2	21.52	25.1	17.2	17.57500	14.3264
<a href="#">15</a>	13.20	47.60	1.5	SO	98.0	53.0	83.2	28.3	19.0	22.36	25.7	19.4	18.50000	15.0833
<a href="#">16</a>	1.80	49.40	0.7	SO	98.0	65.0	74	25.4	19.0	22.38	22.3	22.6	18.46667	15.1250
<a href="#">17</a>	0.00	49.40	1.6	N	88.0	57.0	70	27.9	20.4	23.82	24.8	23	18.75000	15.4583
<a href="#">18</a>	16.20	65.60	1.5	L	100.0	68.0	93.7	25.3	18.6	21.08	21.3	20.1	18.70833	15.3681
<a href="#">19</a>	5.40	71.00	0.9	L	100.0	60.0	89.7	26.5	18.7	21.86	21.5	21.3	19.27083	15.9097
<a href="#">20</a>	16.60	87.60	1.5	L	100.0	59.0	90.5	27.1	18.6	21.3	23.2	18.8	18.91667	15.5139
<a href="#">21</a>	8.40	96.00	1.6	L	99.0	59.0	88.2	26.9	17.8	21.48	22.7	20	18.28333	14.9097
<a href="#">22</a>	0.00	96.00	1.7	N	100.0	53.0	70.5	27.1	17.9	22.48	20.2	23.6	17.77917	14.3819
<a href="#">23</a>	2.80	98.80	1.3	O	88.0	49.0	80.2	29.1	20.1	23.46	25.9	21.1	17.81667	14.4167
<a href="#">24</a>	5.80	104.60	1.3	O	97.0	67.0	84.7	26.8	19.4	21.68	22.6	19.8	18.76250	15.3750
<a href="#">25</a>	5.20	109.80	1.1	L	100.0	56.0	83	27.6	18.5	22.78	24.4	21.7	19.07500	15.5833
<a href="#">26</a>	18.40	128.20	1.5	N	99.0	64.0	87.5	27.3	18.1	22.44	23.2	21.8	19.03333	15.7431
<a href="#">27</a>	8.20	136.40	1.5	N	100.0	70.0	82.5	25.5	18.3	22.14	22.3	22.3	19.44583	16.0833
<a href="#">28</a>	0.00	136.40	2.2	N	98.0	67.0	78.7	25.8	20.1	22.8	23.3	22.4	19.27500	15.8750
<a href="#">29</a>	0.80	137.20	1.3	O	97.0	57.0	77.5	28.6	19.1	23.08	22.1	22.8	19.40417	15.9931
<a href="#">30</a>	14.20	151.40	1.5	L	100.0	54.0	90.7	29.4	19.8	22.84	25.2	19.9	19.83333	16.4722

Bela Vista - Estação CELG Estação Bela Vista - Novembro de 2019  
 Para ver os dados horários clique no dia desejado

Dia	Precip.	Prec. Acum.	Vel. Vent. (m/s)	Dir. Vent.	Umid. Relat. AR (Max) %	Umid. Relat. AR (Min) %	Umid. Relat. AR (Média)%	Temp. Max. °C Dia	Temp. Min. °C Dia	Temp. Med. °C do Ar	Temp. 09:00h	Temp. 21:00h	Ponto orvalho	Razao Mistura
<a href="#">7</a>	0.00	0.00	2.0	L	67.0	55.0	-	29.6	23.1	-	-	24.7	18.33000	14.7600
<a href="#">8</a>	0.20	0.20	1.4	S	94.0	61.0	73.5	28.4	20.6	24.22	23.1	24.5	19.62500	16.0208
<a href="#">9</a>	0.00	0.20	3.1	L	88.0	28.0	52.5	35.3	21.8	27.54	29	25.8	17.65000	14.0069
<a href="#">10</a>	9.60	9.80	1.5	SO	97.0	39.0	65	33.4	19.1	24.8	26.1	22.7	18.78750	15.0000
<a href="#">11</a>	0.00	9.80	1.4	S	88.0	37.0	57.5	33.7	20.3	26.4	27.8	25.1	18.26250	14.4653
<a href="#">12</a>	0.00	9.80	1.5	SO	89.0	30.0	49.7	35.2	20.1	27.22	26.8	27	17.17083	13.5000
<a href="#">13</a>	0.00	9.80	2.5	L	76.0	27.0	37.2	34.3	21.1	28.48	29.4	28.8	14.76250	11.7153
<a href="#">14</a>	1.20	11.00	1.7	NO	86.0	46.0	66.2	31.5	21.8	25.52	27.5	23.4	18.55000	14.8611
<a href="#">15</a>	17.00	28.00	1.3	O	100.0	54.0	91.7	29.5	19.3	22.94	25.9	20	19.66667	15.7431
<a href="#">16</a>	0.00	28.00	1.0	L	100.0	59.0	79.2	27.9	19.7	23.1	22.7	22.6	19.72500	15.9167
<a href="#">17</a>	0.00	28.00	1.6	N	97.0	48.0	71.7	31.2	19.6	24.4	26	22.6	19.51250	15.7500
<a href="#">18</a>	45.00	73.00	2.0	L	100.0	75.0	92.7	25.1	19.0	20.38	19	19.4	19.51667	15.7083
<a href="#">19</a>	2.00	75.00	1.3	L	98.0	64.0	89	27.6	19.6	22.48	25.4	19.9	19.30417	15.5000
<a href="#">20</a>	6.00	81.00	1.7	L	98.0	53.0	85.2	29.6	19.6	23.08	25	20.6	19.01667	15.0556
<a href="#">21</a>	0.00	81.00	1.9	L	97.0	52.0	69	29.5	18.5	23.7	25.5	22.5	18.67500	14.9514
<a href="#">22</a>	7.00	88.00	1.9	L	100.0	55.0	75.2	28.0	17.7	22.94	23.4	22.8	19.27500	15.4097
<a href="#">23</a>	0.40	88.40	1.2	NO	98.0	57.0	75	28.3	20.8	23.98	26.4	22.2	19.42917	15.6319
<a href="#">24</a>	29.40	117.80	1.7	O	100.0	54.0	81.5	30.3	19.3	22.86	25.5	19.6	19.51667	15.8264
<a href="#">25</a>	19.60	137.40	1.8	N	100.0	50.0	80.7	30.3	18.9	22.7	23.9	20.2	19.83750	16.0486
<a href="#">26</a>	16.80	154.20	1.9	L	100.0	56.0	82	30.1	19.6	23.38	25.4	20.9	20.33750	16.6944
<a href="#">27</a>	6.80	161.00	1.4	L	100.0	71.0	87.7	26.8	19.7	23.08	24.1	22.4	20.81250	17.0833
<a href="#">28</a>	0.80	161.80	1.7	NO	100.0	70.0	90	27.4	20.4	22.94	22.9	22	20.88750	17.1319
<a href="#">29</a>	4.60	166.40	1.5	N	100.0	63.0	85.7	29.1	20.5	22.86	22.7	21	20.82917	17.1181
<a href="#">30</a>	4.00	170.40	1.4	L	100.0	75.0	90.5	27.2	20.5	22.7	23.8	21	20.75833	17.0903

Matrinchã - Estação Estação Hidro Matrinchã - GO - ANA - Novembro de 2019  
 Para ver os dados horários clique no dia desejado

Dia	Precip.	Prec. Acum.	Sensor Pressão min	Sensor Pressão max	Sensor Pressão media	Nível Régua	CodifEixo	Vazão min (m3/s)	Vazão max (m3/s)	Vazão media (m3/s)
<a href="#">1</a>	0.00	0.00	0.17	0.22	0.2	0.22	6.74	0.00	0.00	0.00
<a href="#">2</a>	0.00	0.00	0.18	0.21	0.2	0.21	6.74	0.00	0.00	0.00
<a href="#">3</a>	0.00	0.00	0.15	0.18	0.2	0.18	6.74	0.00	0.00	0.00
<a href="#">4</a>	0.00	0.00	0.12	0.15	0.1	0.15	6.74	0.00	0.00	0.00
<a href="#">5</a>	29.60	29.60	0.1	0.15	0.1	0.15	6.74	0.00	0.00	0.00
<a href="#">6</a>	0.00	29.60	0	0.14	0.1	0.14	6.74	0.00	0.00	0.00
<a href="#">7</a>	-134.40	-104.80	0.06	0.09	0.1	0.09	6.74	0.00	0.00	0.00
<a href="#">8</a>	0.00	-104.80	0.06	0.1	0.1	0.1	6.74	0.00	0.00	0.00
<a href="#">9</a>	0.00	-104.80	0.1	0.17	0.1	0.17	6.74	0.00	0.00	0.00
<a href="#">10</a>	0.00	-104.80	0.09	0.14	0.1	0.14	6.74	0.00	0.00	0.00
<a href="#">11</a>	0.00	-104.80	0.07	0.1	0.1	0.1	6.74	0.00	0.00	0.00
<a href="#">12</a>	0.00	-104.80	0.07	0.09	0.1	0.09	6.74	0.00	0.00	0.00
<a href="#">13</a>	2.60	-102.20	0.09	0.17	0.1	0.17	6.74	0.00	0.00	0.00
<a href="#">14</a>	0.00	-102.20	0.13	0.16	0.1	0.16	6.74	0.00	0.00	0.00
<a href="#">15</a>	0.00	-102.20	0.1	0.13	0.1	0.13	6.74	0.00	0.00	0.00
<a href="#">16</a>	0.00	-102.20	0.09	0.16	0.1	0.16	6.74	0.00	0.00	0.00
<a href="#">17</a>	4.40	-97.80	0.13	0.16	0.1	0.16	6.74	0.00	0.00	0.00
<a href="#">18</a>	0.00	-97.80	0.1	0.13	0.1	0.13	6.74	0.00	0.00	0.00
<a href="#">19</a>	0.00	-97.80	0.08	0.1	0.1	0.1	6.74	0.00	0.00	0.00
<a href="#">20</a>	1.20	-96.60	0.08	0.09	0.1	0.09	6.74	0.00	0.00	0.00
<a href="#">21</a>	0.00	-96.60	0.09	0.1	0.1	0.1	6.74	0.00	0.00	0.00
<a href="#">22</a>	22.80	-73.80	0.09	0.12	0.1	0.12	6.74	0.00	0.00	0.00
<a href="#">23</a>	0.00	-73.80	0.12	0.21	0.2	0.21	6.74	0.00	0.00	0.00
<a href="#">24</a>	0.40	-73.40	0.17	0.21	0.2	0.21	6.74	0.00	0.00	0.00
<a href="#">25</a>	8.80	-64.60	0.15	0.18	0.2	0.18	6.74	0.00	0.00	0.00
<a href="#">26</a>	4.20	-60.40	0.15	0.21	0.2	0.21	6.74	0.00	0.00	0.00
<a href="#">27</a>	20.20	-40.20	0.19	0.35	0.2	0.35	6.74	0.00	0.00	0.00
<a href="#">28</a>	25.00	-15.20	0.33	0.37	0.4	0.37	6.74	0.00	0.00	0.00
<a href="#">29</a>	0.40	-14.80	0.32	0.39	0.4	0.39	6.74	0.00	0.00	0.00
<a href="#">30</a>	0.00	-14.80	0.31	0.41	0.4	0.41	6.74	0.00	0.00	0.00



Nova Crixas - Estação Estação Hidro Bandeirantes - GO - ANA - Novembro de 2019

Para ver os dados horários clique no dia desejado

Dia	Precip.	Prec.Acum.	Sensor Pressão min	Sensor Pressão max	Sensor Pressão media	Nível Régua	CodifEixo	Vazão min (m3/s)	Vazão max (m3/s)	Vazão media (m3/s)
<a href="#">1</a>	0.00	0.00	3.84	3.87	3.9	3.87	2.78	0.00	0.00	0.00
<a href="#">2</a>	0.00	0.00	3.8	3.84	3.8	3.84	2.78	0.00	0.00	0.00
<a href="#">3</a>	46.60	46.60	3.8	3.82	3.8	3.82	2.78	0.00	0.00	0.00
<a href="#">4</a>	0.00	46.60	3.76	3.81	3.8	3.81	2.78	0.00	0.00	0.00
<a href="#">5</a>	49.60	96.20	3.74	3.83	3.8	3.83	2.78	0.00	0.00	0.00
<a href="#">6</a>	21.00	117.20	3.81	3.85	3.8	3.85	2.78	0.00	0.00	0.00
<a href="#">7</a>	0.00	117.20	0	3.83	3.7	3.83	2.78	0.00	0.00	0.00
<a href="#">8</a>	-226.80	-109.60	3.83	3.87	3.8	3.87	2.78	0.00	0.00	0.00
<a href="#">9</a>	1.00	-108.60	3.86	3.88	3.9	3.88	2.78	0.00	0.00	0.00
<a href="#">10</a>	0.00	-108.60	3.83	3.86	3.8	3.86	2.78	0.00	0.00	0.00
<a href="#">11</a>	0.00	-108.60	3.81	3.83	3.8	3.83	2.78	0.00	0.00	0.00
<a href="#">12</a>	10.60	-98.00	3.79	3.81	3.8	3.81	2.78	0.00	0.00	0.00
<a href="#">13</a>	21.00	-77.00	3.79	3.85	3.8	3.85	2.78	0.00	0.00	0.00
<a href="#">14</a>	0.00	-77.00	3.84	3.85	3.8	3.85	2.78	0.00	0.00	0.00
<a href="#">15</a>	6.40	-70.60	3.84	3.87	3.8	3.87	2.78	0.00	0.00	0.00
<a href="#">16</a>	0.00	-70.60	3.87	3.93	3.9	3.93	2.78	0.00	0.00	0.00
<a href="#">17</a>	6.80	-63.80	3.92	4	4.0	4	2.78	0.00	0.00	0.00
<a href="#">18</a>	0.20	-63.60	4	4.02	4.0	4.02	2.78	0.00	0.00	0.00
<a href="#">19</a>	0.00	-63.60	3.99	4.02	4.0	4.02	2.78	0.00	0.00	0.00
<a href="#">20</a>	0.00	-63.60	3.98	4	4.0	4	2.78	0.00	0.00	0.00
<a href="#">21</a>	0.00	-63.60	3.95	3.98	4.0	3.98	2.78	0.00	0.00	0.00
<a href="#">22</a>	0.00	-63.60	3.91	3.95	3.9	3.95	2.78	0.00	0.00	0.00
<a href="#">23</a>	0.00	-63.60	3.9	3.93	3.9	3.93	2.78	0.00	0.00	0.00
<a href="#">24</a>	1.00	-62.60	3.93	4	4.0	4	2.78	0.00	0.00	0.00
<a href="#">25</a>	73.80	11.20	4	4.1	4.0	4.1	2.78	0.00	0.00	0.00
<a href="#">26</a>	4.40	15.60	4.04	4.1	4.1	4.1	2.78	0.00	0.00	0.00
<a href="#">27</a>	33.60	49.20	4.03	4.1	4.1	4.1	2.78	0.00	0.00	0.00
<a href="#">28</a>	37.40	86.60	4.09	4.16	4.1	4.16	2.78	0.00	0.00	0.00
<a href="#">29</a>	0.00	86.60	4.13	4.16	4.1	4.16	2.78	0.00	0.00	0.00
<a href="#">30</a>	19.60	106.20	4.12	4.14	4.1	4.14	2.78	0.00	0.00	0.00

Palmeiras de Goiás - Estação Palmeiras de Goiás - Novembro de 2019

Para ver os dados horários clique no dia desejado

Dia	Precip.	Prec.Acum.	Vel. Vent. (m/s)	Dir. Vent.	Umid. Relat. AR (Max) %	Umid. Relat. AR (Min) %	Umid. Relat. AR (Média) %	Temp. Max. °C Dia	Temp. Min. °C Dia	Temp. Med. °C do Ar	Temp. 09:00h	Temp. 21:00h	Ponto orvalho	Razao Mistura	Radiação Solar Diária MJ/m²
<a href="#">1</a>	0.00	0.00	2.5	S	96.0	34.0	60	35.3	21.3	26.9	27.7	25.1	-	-	21.8
<a href="#">2</a>	0.00	0.00	2.9	SO	96.0	34.0	50.5	34.3	20.5	27.78	27.9	28.1	-	-	-
<a href="#">3</a>	1.20	1.20	2.3	SO	90.0	48.0	69.7	30.1	22.0	25.66	26.8	24.7	-	-	-
<a href="#">4</a>	0.00	1.20	3.0	S	90.0	32.0	57.2	34.6	22.8	27.72	29	26.1	-	-	-
<a href="#">5</a>	14.80	16.00	2.4	SO	100.0	32.0	76.2	35.4	22.3	25.94	27.2	22.4	-	-	-
<a href="#">6</a>	0.20	16.20	1.1	S	100.0	43.0	80.5	32.6	21.2	25.22	23.3	24.5	-	-	-
<a href="#">7</a>	0.00	16.20	1.8	S	100.0	40.0	62.7	34.1	20.9	27.08	27	26.7	-	-	-
<a href="#">8</a>	0.00	16.20	2.8	SO	100.0	48.0	63	32.6	21.6	26.48	24.4	26.9	-	-	-
<a href="#">9</a>	39.60	55.80	1.8	S	100.0	35.0	74	34.7	19.8	24.94	29.6	20.3	-	-	-
<a href="#">10</a>	0.20	56.00	2.3	S	100.0	39.0	66	33.9	19.8	26.32	24.9	26.5	-	-	-
<a href="#">11</a>	18.00	74.00	2.2	S	100.0	31.0	75	35.9	22.2	26.22	28	22.5	-	-	-
<a href="#">12</a>	1.40	75.40	1.8	SO	100.0	41.0	71.2	34.6	21.5	26.02	24.8	24.6	-	-	-
<a href="#">13</a>	0.00	75.40	0.9	S	100.0	36.0	55	34.4	22.0	27.94	26.7	28.3	-	-	-
<a href="#">14</a>	0.00	75.40	1.1	S	92.0	35.0	52.2	34.7	22.3	28.48	28.6	28.6	-	-	-
<a href="#">15</a>	24.20	99.60	2.7	L	100.0	47.0	84.2	31.8	21.0	24.7	27.7	21.5	-	-	-
<a href="#">16</a>	0.20	99.80	1.1	L	100.0	52.0	80.2	30.3	21.2	25.1	23.4	25.3	-	-	-
<a href="#">17</a>	9.40	109.20	1.3	L	100.0	57.0	74.5	30.7	20.8	25.22	25.8	24.4	-	-	-
<a href="#">18</a>	2.20	111.40	1.4	SO	100.0	54.0	92.5	30.1	21.4	24.12	25.7	21.7	-	-	-
<a href="#">19</a>	0.20	111.60	0.6	O	100.0	56.0	90	29.5	20.6	23.84	24.5	22.3	-	-	-
<a href="#">20</a>	1.80	113.40	1.1	SO	100.0	41.0	92	31.9	21.1	24.68	26.4	22	-	-	-
<a href="#">21</a>	0.20	113.60	1.2	S	100.0	42.0	64.2	32.0	20.3	25.58	25.4	25.1	-	-	-
<a href="#">22</a>	18.40	132.00	1.9	S	100.0	54.0	73.7	30.0	19.3	24.96	25.3	25.1	-	-	-
<a href="#">23</a>	2.40	134.40	3.4	O	100.0	47.0	87	32.9	22.6	25.98	27.8	23.3	-	-	-
<a href="#">24</a>	2.20	136.60	1.7	S	100.0	46.0	86	32.8	21.8	24.94	26.1	22	-	-	-
<a href="#">25</a>	3.40	140.00	1.5	SO	100.0	59.0	88.7	31.0	20.0	24.36	25.4	22.7	-	-	-
<a href="#">26</a>	0.00	140.00	0.8	O	100.0	59.0	72.5	30.8	21.1	25.76	26.5	25.2	-	-	-
<a href="#">27</a>	5.80	145.80	1.3	L	100.0	77.0	93.5	27.7	21.8	24.7	26.2	23.9	-	-	-
<a href="#">28</a>	9.80	155.60	0.9	S	100.0	58.0	81.5	29.2	20.6	24.92	25	24.9	-	-	-
<a href="#">29</a>	2.40	158.00	1.9	O	100.0	63.0	89.7	30.8	22.0	24.96	24.6	23.7	-	-	-
<a href="#">30</a>	1.40	159.40	0.7	L	100.0	76.0	98.5	28.4	22.6	24.52	26.2	22.7	-	-	-

Parauna - Estação Estação Hidro Ponte Rodagem - GO - ANA - Novembro de 2019

[Para ver os dados horários clique no dia desejado](#)

Dia	Precip.	Prec. Acum.	Sensor Pressão min	Sensor Pressão max	Sensor Pressão média	Nível Régua	CodifEixo	Vazão min (m3/s)	Vazão max (m3/s)	Vazão média (m3/s)
<a href="#">1</a>	0.00	0.00	0.57	1.17	0.8	1.17	42.69	0.00	0.00	0.00
<a href="#">2</a>	0.00	0.00	0.6	1.01	0.7	1.01	42.69	0.00	0.00	0.00
<a href="#">3</a>	0.00	0.00	0.59	1.06	0.7	1.06	42.69	0.00	0.00	0.00
<a href="#">4</a>	0.00	0.00	0.61	1.2	0.8	1.2	42.69	0.00	0.00	0.00
<a href="#">5</a>	1.80	1.80	0.65	1.15	0.8	1.15	42.69	0.00	0.00	0.00
<a href="#">6</a>	9.40	11.20	0.66	1.07	0.8	1.07	42.69	0.00	0.00	0.00
<a href="#">7</a>	0.40	11.60	0.63	1.12	0.8	1.12	42.69	0.00	0.00	0.00
<a href="#">8</a>	6.60	18.20	0.71	1.34	0.8	1.34	42.69	0.00	0.00	0.00
<a href="#">9</a>	13.20	31.40	0.68	1.26	0.8	1.26	42.69	0.00	0.00	0.00
<a href="#">10</a>	0.20	31.60	0.65	1.28	0.8	1.28	42.69	0.00	0.00	0.00
<a href="#">11</a>	8.60	40.20	0.7	1.33	0.8	1.33	42.69	0.00	0.00	0.00
<a href="#">12</a>	0.20	40.40	0.68	1.23	0.8	1.23	42.69	0.00	0.00	0.00
<a href="#">13</a>	0.00	40.40	0.68	1.17	0.8	1.17	42.69	0.00	0.00	0.00
<a href="#">14</a>	3.00	43.40	0.66	1.09	0.8	1.09	42.69	0.00	0.00	0.00
<a href="#">15</a>	2.00	45.40	0	1.18	0.8	1.18	42.99	0.00	0.00	0.00
<a href="#">16</a>	-89.20	-43.80	0.89	1.33	1.1	1.33	42.99	0.00	0.00	0.00
<a href="#">17</a>	4.40	-39.40	0.92	1.36	1.1	1.36	42.99	0.00	0.00	0.00
<a href="#">18</a>	49.80	10.40	0.92	1.26	1.1	1.26	42.99	0.00	0.00	0.00
<a href="#">19</a>	3.80	14.20	0.91	1.41	1.1	1.41	42.99	0.00	0.00	0.00
<a href="#">20</a>	0.20	14.40	0.9	1.55	1.1	1.55	42.99	0.00	0.00	0.00
<a href="#">21</a>	0.00	14.40	0.93	1.46	1.1	1.46	42.99	0.00	0.00	0.00
<a href="#">22</a>	0.00	14.40	0.91	1.29	1.1	1.29	42.99	0.00	0.00	0.00
<a href="#">23</a>	4.40	18.80	0.95	1.53	1.1	1.53	42.99	0.00	0.00	0.00
<a href="#">24</a>	12.40	31.20	1	1.58	1.1	1.58	42.99	0.00	0.00	0.00
<a href="#">25</a>	8.40	39.60	1	1.49	1.1	1.49	42.99	0.00	0.00	0.00
<a href="#">26</a>	0.20	39.80	1	1.56	1.2	1.56	42.99	0.00	0.00	0.00
<a href="#">27</a>	9.00	48.80	1.03	1.45	1.2	1.45	42.99	0.00	0.00	0.00
<a href="#">28</a>	6.40	55.20	1.04	1.47	1.2	1.47	42.99	0.00	0.00	0.00
<a href="#">29</a>	7.60	62.80	1.06	1.65	1.2	1.65	42.99	0.00	0.00	0.00
<a href="#">30</a>	1.20	64.00	1.06	1.56	1.2	1.56	42.99	0.00	0.00	0.00

Pirenópolis - Estação Estação Hidro Rio das Almas Montante - GO - ANA - Novembro de 2019

[Para ver os dados horários clique no dia desejado](#)

Dia	Precip.	Prec. Acum.	Sensor Pressão min	Sensor Pressão max	Sensor Pressão média	Nível Régua	CodifEixo	Vazão min (m3/s)	Vazão max (m3/s)	Vazão média (m3/s)
<a href="#">1</a>	0.00	0.00	0	0	0.0	-	-	0.00	0.00	0.00
<a href="#">2</a>	3.40	3.40	0	0	0.0	-	-	0.00	0.00	0.00
<a href="#">3</a>	0.20	3.60	0	0	0.0	-	-	0.00	0.00	0.00
<a href="#">4</a>	0.00	3.60	0	0	0.0	-	-	0.00	0.00	0.00
<a href="#">5</a>	0.00	3.60	0	0.23	0.1	-	-	0.00	0.00	0.00
<a href="#">6</a>	3.60	7.20	0.2	0.24	0.2	-	-	0.00	0.00	0.00
<a href="#">7</a>	0.00	7.20	0.21	0.25	0.2	-	-	0.00	0.00	0.00
<a href="#">8</a>	0.00	7.20	0.21	0.25	0.2	-	-	0.00	0.00	0.00
<a href="#">9</a>	0.00	7.20	0.21	0.25	0.2	-	-	0.00	0.00	0.00
<a href="#">10</a>	0.00	7.20	0.22	0.27	0.2	-	-	0.00	0.00	0.00
<a href="#">11</a>	2.40	9.60	0.23	0.27	0.3	-	-	0.00	0.00	0.00
<a href="#">12</a>	0.20	9.80	0.22	0.27	0.3	-	-	0.00	0.00	0.00
<a href="#">13</a>	0.00	9.80	0.21	0.25	0.2	-	-	0.00	0.00	0.00
<a href="#">14</a>	7.00	16.80	0	0.23	0.1	-	-	0.00	0.00	0.00
<a href="#">15</a>	2.80	19.60	0	0.04	0.0	-	-	0.00	0.00	0.00
<a href="#">16</a>	0.20	19.80	0	0.06	0.0	-	-	0.00	0.00	0.00
<a href="#">17</a>	0.00	19.80	0	0	0.0	-	-	0.00	0.00	0.00
<a href="#">18</a>	15.60	35.40	0	0	0.0	-	-	0.00	0.00	0.00
<a href="#">19</a>	15.40	50.80	0	0.22	0.1	-	-	0.00	0.00	0.00
<a href="#">20</a>	2.20	53.00	0	0.22	0.1	-	-	0.00	0.00	0.00
<a href="#">21</a>	10.00	63.00	0	0.04	0.0	-	-	0.00	0.00	0.00
<a href="#">22</a>	3.20	66.20	0	0	0.0	-	-	0.00	0.00	0.00
<a href="#">23</a>	0.00	66.20	0	0	0.0	-	-	0.00	0.00	0.00
<a href="#">24</a>	0.00	66.20	0	0	0.0	-	-	0.00	0.00	0.00
<a href="#">25</a>	34.80	101.00	0	0	0.0	-	-	0.00	0.00	0.00
<a href="#">26</a>	0.20	101.20	0	0	0.0	-	-	0.00	0.00	0.00
<a href="#">27</a>	1.80	103.00	0	0	0.0	-	-	0.00	0.00	0.00
<a href="#">28</a>	5.60	108.60	0	0	0.0	-	-	0.00	0.00	0.00
<a href="#">29</a>	2.20	110.80	0	0	0.0	-	-	0.00	0.00	0.00
<a href="#">30</a>	0.00	110.80	0	0	0.0	-	-	0.00	0.00	0.00

Aparecida de Goiânia - Estação Estação Hidro Rib. Sto. Antônio - GO - ANA - Novembro de 2019

Para ver os dados horários clique no dia desejado

Dia	Precip.	Prec.Acum.	Sensor Pressão min	Sensor Pressão max	Sensor Pressão media	Nível Régua	CodifEixo	Vazão min (m3/s)	Vazão max (m3/s)	Vazão media (m3/s)
<a href="#">1</a>	2.00	2.00	0.54	1	0.6	-	-	0.00	0.00	0.00
<a href="#">2</a>	0.60	2.60	0.52	0.81	0.6	-	-	0.00	0.00	0.00
<a href="#">3</a>	0.00	2.60	0.51	0.54	0.5	-	-	0.00	0.00	0.00
<a href="#">4</a>	0.00	2.60	0.51	0.92	0.6	-	-	0.00	0.00	0.00
<a href="#">5</a>	0.20	2.80	0.54	0.69	0.6	-	-	0.00	0.00	0.00
<a href="#">6</a>	0.00	2.80	0.53	0.56	0.5	-	-	0.00	0.00	0.00
<a href="#">7</a>	0.00	2.80	0.53	0.55	0.5	-	-	0.00	0.00	0.00
<a href="#">8</a>	0.00	2.80	0.53	0.55	0.5	-	-	0.00	0.00	0.00
<a href="#">9</a>	0.20	3.00	0.53	0.57	0.5	-	-	0.00	0.00	0.00
<a href="#">10</a>	0.20	3.20	0.52	0.57	0.5	-	-	0.00	0.00	0.00
<a href="#">11</a>	0.00	3.20	0.53	0.71	0.6	-	-	0.00	0.00	0.00
<a href="#">12</a>	0.00	3.20	0.52	0.56	0.5	-	-	0.00	0.00	0.00
<a href="#">13</a>	0.00	3.20	0.52	0.56	0.5	-	-	0.00	0.00	0.00
<a href="#">14</a>	0.00	3.20	0.52	0.55	0.5	-	-	0.00	0.00	0.00
<a href="#">15</a>	12.80	16.00	0.52	1.52	0.6	-	-	0.00	0.00	0.00
<a href="#">16</a>	0.40	16.40	0.65	0.78	0.7	-	-	0.00	0.00	0.00
<a href="#">17</a>	0.00	16.40	0.65	0.67	0.7	-	-	0.00	0.00	0.00
<a href="#">18</a>	28.00	44.40	0.64	4.55	1.0	-	-	0.00	0.00	0.00
<a href="#">19</a>	5.20	49.60	0.73	0.92	0.8	-	-	0.00	0.00	0.00
<a href="#">20</a>	0.40	50.00	0.66	0.72	0.7	-	-	0.00	0.00	0.00
<a href="#">21</a>	0.00	50.00	0.64	0.68	0.7	-	-	0.00	0.00	0.00
<a href="#">22</a>	2.40	52.40	0.64	0.75	0.7	-	-	0.00	0.00	0.00
<a href="#">23</a>	2.00	54.40	0.64	0.88	0.7	-	-	0.00	0.00	0.00
<a href="#">24</a>	39.60	94.00	0.64	3.3	0.9	-	-	0.00	0.00	0.00
<a href="#">25</a>	8.60	102.60	0.74	1.86	0.8	-	-	0.00	0.00	0.00
<a href="#">26</a>	1.20	103.80	0.7	0.82	0.7	-	-	0.00	0.00	0.00
<a href="#">27</a>	16.80	120.60	0.68	0.95	0.8	-	-	0.00	0.00	0.00
<a href="#">28</a>	7.20	127.80	0.66	1.4	0.8	-	-	0.00	0.00	0.00
<a href="#">29</a>	0.40	128.20	0.66	0.87	0.7	-	-	0.00	0.00	0.00
<a href="#">30</a>	1.80	130.00	0.67	0.92	0.7	-	-	0.00	0.00	0.00

Morrinhos - Estação Usina CEM - Morrinhos - Novembro de 2019

Para ver os dados horários clique no dia desejado

Dia	Precip.	Prec.Acum.	Vel. Vent. (m/s)	Dir. Vent.	Umid. Relat. AR (Max) %	Umid. Relat. AR (Min) %	Umid. Relat. AR (Média)%	Temp. Max. °C Dia	Temp. Min. °C Dia	Temp. Med. °C do Ar	Temp. 09:00h	Temp. 21:00h	Ponto orvalho	Razao Mistura	Radiação Solar Diária MJ/m²
<a href="#">1</a>	9.40	9.40	3.2	L	94.0	43.0	65	31.3	20.2	24.96	28.3	22.5	-	-	14.4
<a href="#">2</a>	0.00	9.40	2.1	L	89.0	43.0	61	31.6	19.3	25.26	24.8	25.3	-	-	20.7
<a href="#">3</a>	0.80	10.20	4.1	L	91.0	50.0	75.2	30.1	20.8	24.1	25.4	22.1	-	-	20
<a href="#">4</a>	0.00	10.20	2.7	N	94.0	49.0	66.7	30.5	20.7	25.3	28.3	23.5	-	-	14.4
<a href="#">5</a>	0.00	10.20	3.1	N	91.0	41.0	71.5	32.5	21.0	25.36	26.3	23.5	-	-	18
<a href="#">6</a>	0.00	10.20	2.5	N	100.0	54.0	77.5	30.9	21.0	24.84	26.1	23.1	-	-	19.4
<a href="#">7</a>	0.00	10.20	2.6	L	100.0	40.0	61.7	32.5	20.0	25.66	26	24.9	-	-	18.6
<a href="#">8</a>	0.00	10.20	2.9	S	100.0	53.0	69	30.5	19.9	24.2	22.6	24	-	-	15.6
<a href="#">9</a>	13.20	23.40	3.2	L	100.0	37.0	64.7	33.1	20.2	24.86	27.6	21.7	-	-	17.7
<a href="#">10</a>	6.80	30.20	2.2	S	100.0	55.0	85	30.9	19.4	23.46	24.6	21.2	-	-	16.6
<a href="#">11</a>	17.60	47.80	2.6	S	93.0	39.0	63.2	33.1	19.8	25.44	25.1	24.6	-	-	18.7
<a href="#">12</a>	1.00	48.80	2.5	S	96.0	42.0	61	33.3	21.0	26.68	24.9	27.1	-	-	22.8
<a href="#">13</a>	0.00	48.80	4.3	L	77.0	37.0	48	32.3	21.6	27.32	26.1	28.3	-	-	20.1
<a href="#">14</a>	4.20	53.00	2.1	S	100.0	55.0	86.2	29.8	20.4	24.06	27.1	21.5	-	-	14.3
<a href="#">15</a>	18.60	71.60	2.1	O	100.0	61.0	92	27.9	19.5	22.24	23.8	20	-	-	11.9
<a href="#">16</a>	0.00	71.60	2.3	L	100.0	74.0	85	26.4	19.3	22.86	22.6	23	-	-	13
<a href="#">17</a>	0.60	72.20	2.5	N	100.0	47.0	75.2	31.1	19.6	24.42	26.6	22.4	-	-	17.8
<a href="#">18</a>	11.40	83.60	4.1	N	100.0	69.0	94.2	25.8	19.8	21.76	22.6	20.3	-	-	11.4
<a href="#">19</a>	3.00	86.60	2.8	L	100.0	59.0	90.5	28.3	19.0	21.66	22.6	19.2	-	-	14.1
<a href="#">20</a>	0.00	86.60	3.1	L	100.0	55.0	79.2	29.3	18.8	22.98	24.8	21	-	-	20.5
<a href="#">21</a>	0.00	86.60	2.6	L	100.0	51.0	69.5	29.8	19.1	24.32	24.5	24.1	-	-	18.7
<a href="#">22</a>	33.00	119.60	4.1	L	100.0	63.0	89.7	28.0	17.5	22.8	23.3	22.6	-	-	16.9
<a href="#">23</a>	3.00	122.60	3.1	N	100.0	64.0	83.5	27.5	20.3	23.64	25.4	22.5	-	-	14.9
<a href="#">24</a>	0.00	122.60	3.3	N	100.0	59.0	84	28.5	19.6	23.1	24.4	21.5	-	-	14.3
<a href="#">25</a>	23.20	145.80	2.6	N	100.0	57.0	86	30.1	19.4	23.78	26.4	21.5	-	-	16.1
<a href="#">26</a>	0.40	146.20	3.0	L	100.0	63.0	87.7	28.6	20.2	24.18	24.9	23.6	-	-	16.9
<a href="#">27</a>	4.80	151.00	3.7	N	100.0	79.0	100	26.6	20.2	22.32	22.4	21.2	-	-	10.1
<a href="#">28</a>	0.80	151.80	3.0	N	100.0	72.0	91.7	28.1	20.3	23.16	23.6	21.9	-	-	15
<a href="#">29</a>	2.00	153.80	2.6	L	100.0	78.0	94.5	27.1	21.1	23.26	23.3	22.4	-	-	12.6
<a href="#">30</a>	1.20	155.00	3.5	N	100.0	65.0	92.7	28.4	20.4	23.12	22.8	22	-	-	11.2



## Bom Jesus de Goiás - Estação Usina Goiás - Bom Jesus de Goiás - Novembro de 2019

Para ver os dados horários clique no dia desejado

Dia	Precip.	Prec. Acum.	Vel. Vent. (m/s)	Dir. Vent.	Umid. Relat. AR (Max) %	Umid. Relat. AR (Min) %	Umid. Relat. AR (Média)%	Temp. Max. °C Dia	Temp. Min. °C Dia	Temp. Med. °C do Ar	Temp. 09:00h	Temp. 21:00h	Ponto orvalho	Razao Mistura	Radiação Solar Diária MJ/m²
<a href="#">1</a>	0.00	0.00	3.4	L	78.0	35.0	61.7	33.1	21.9	25.92	29	22.8	-	-	14.9
<a href="#">2</a>	0.00	0.00	2.7	L	90.0	30.0	50.2	33.8	19.8	26.76	25.6	27.3	-	-	19.9
<a href="#">3</a>	11.00	11.00	4.8	L	100.0	39.0	66.2	31.5	18.9	24.44	28	21.9	-	-	16.8
<a href="#">4</a>	0.00	11.00	2.8	L	84.0	40.0	63.2	32.7	22.1	26.28	26.4	25.1	-	-	19.5
<a href="#">5</a>	0.00	11.00	3.1	L	82.0	35.0	59	33.6	21.8	26.76	28.6	24.9	-	-	17.3
<a href="#">6</a>	0.20	11.20	3.0	S	90.0	50.0	73	31.1	21.8	24.82	26.6	22.3	-	-	17.5
<a href="#">7</a>	0.20	11.40	2.7	S	100.0	35.0	63.5	33.8	20.5	26.12	27.1	24.6	-	-	17.2
<a href="#">8</a>	0.00	11.40	3.2	S	100.0	42.0	66.7	29.9	19.5	23.62	21.7	23.5	-	-	13.2
<a href="#">9</a>	8.20	19.60	3.8	SE	97.0	37.0	73.7	33.0	21.1	25.42	28	22.5	-	-	13.1
<a href="#">10</a>	1.80	21.40	3.0	S	100.0	41.0	64.5	32.1	19.7	25.06	24.3	24.6	-	-	18.2
<a href="#">11</a>	0.00	21.40	3.4	S	89.0	31.0	56.7	34.0	21.3	26.48	26.1	25.5	-	-	15.8
<a href="#">12</a>	0.00	21.40	3.5	SO	93.0	36.0	54	33.1	21.6	27.58	26	28.6	-	-	19.5
<a href="#">13</a>	0.00	21.40	5.1	SE	71.0	33.0	49.7	33.2	24.6	27.82	29.1	26.1	-	-	17.4
<a href="#">14</a>	2.60	24.00	3.3	S	94.0	39.0	74	32.3	21.7	24.76	25.6	22.1	-	-	15.2
<a href="#">15</a>	7.80	31.80	2.3	O	100.0	53.0	91	29.1	19.8	22.8	25.5	19.8	-	-	10.2
<a href="#">16</a>	0.20	32.00	2.0	NO	100.0	45.0	69.7	30.9	19.6	24.16	23.1	23.6	-	-	16.8
<a href="#">17</a>	0.00	32.00	2.4	L	92.0	41.0	60.7	31.9	20.6	26.24	27.5	25.6	-	-	20
<a href="#">18</a>	5.00	37.00	3.4	N	95.0	60.0	83.2	27.8	20.9	23.18	24.6	21.3	-	-	12.4
<a href="#">19</a>	10.20	47.20	3.0	L	97.0	53.0	84.7	29.5	19.3	22.2	23.6	19.3	-	-	11.6
<a href="#">20</a>	0.00	47.20	2.8	L	91.0	45.0	67.5	30.4	19.5	24.12	26.1	22.3	-	-	16.9
<a href="#">21</a>	1.00	48.20	3.4	L	92.0	40.0	66.2	31.6	20.2	24.12	25.6	21.6	-	-	18.5
<a href="#">22</a>	10.60	58.80	4.5	L	98.0	57.0	78	28.6	17.1	23	24.1	22.6	-	-	17.2
<a href="#">23</a>	2.00	60.80	2.2	NO	86.0	48.0	71.7	30.4	21.9	25.56	26.9	24.3	-	-	15.3
<a href="#">24</a>	2.20	63.00	3.3	SO	99.0	56.0	75.7	29.1	20.8	23.42	23.6	21.8	-	-	11.9
<a href="#">25</a>	11.60	74.60	2.5	L	100.0	50.0	87.7	30.9	20.0	24.02	25.6	21.8	-	-	16
<a href="#">26</a>	0.00	74.60	2.8	L	100.0	53.0	77	29.9	21.0	24.72	25.1	23.8	-	-	14.3
<a href="#">27</a>	13.60	88.20	3.2	L	100.0	73.0	97.7	27.3	19.9	22.8	23.4	21.7	-	-	8.7
<a href="#">28</a>	30.60	118.80	2.3	NO	100.0	63.0	94	28.3	20.3	22.92	22.8	21.6	-	-	11.8
<a href="#">29</a>	21.00	139.80	1.8	NO	100.0	71.0	98.2	26.3	20.7	23.14	21.5	23.6	-	-	5.3
<a href="#">30</a>	0.60	140.40	2.6	N	100.0	69.0	85.7	26.8	20.4	23.06	24.1	22	-	-	10.9

## NOTÍCIAS RELACIONADAS

<https://g1.globo.com/go/goias/noticia/2019/11/26/temporal-arranca-cobertura-de-posto-de-combustiveis-do-prefeito-de-itaguaru-coisa-de-louco.shtml>

GOIÁS

# Temporal arranca cobertura de posto de combustíveis em Itaguaru: 'Coisa de louco'

Segundo o dono do estabelecimento, que é o prefeito da cidade, o teto 'deu um nó' após ser destruído por ventania e causou prejuízo estimado de R\$ 300 mil. Apesar dos estragos, ninguém se feriu.

Por **Silvio Túlio**

26/11/2019 09h13 | Atualizado há um mês

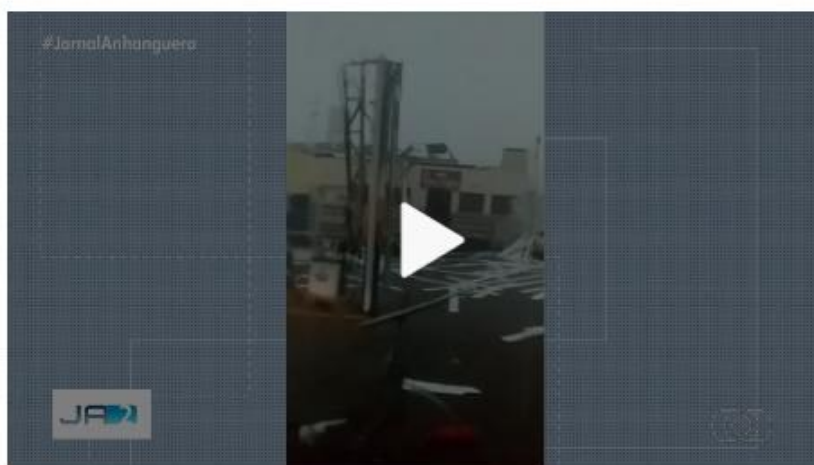

Cobertura de posto de gasolina foi arrancado por temporal, em Itaguaru

<https://g1.globo.com/go/goias/noticia/2019/11/26/temporal-arranca-cobertura-de-posto-de-combustiveis-do-prefeito-de-itaguaru-coisa-de-louco.shtml>

O TEMPO FECHOU...

# Chuva de granizo causa estragos em posto de gasolina de Itaguaru

Esta é a segunda chuva forte que causa prejuízo na cidade em 15 dias



Francisco Costa

Do

Mais

Goias

|

Em:

25/11/2019

às

19:45:45

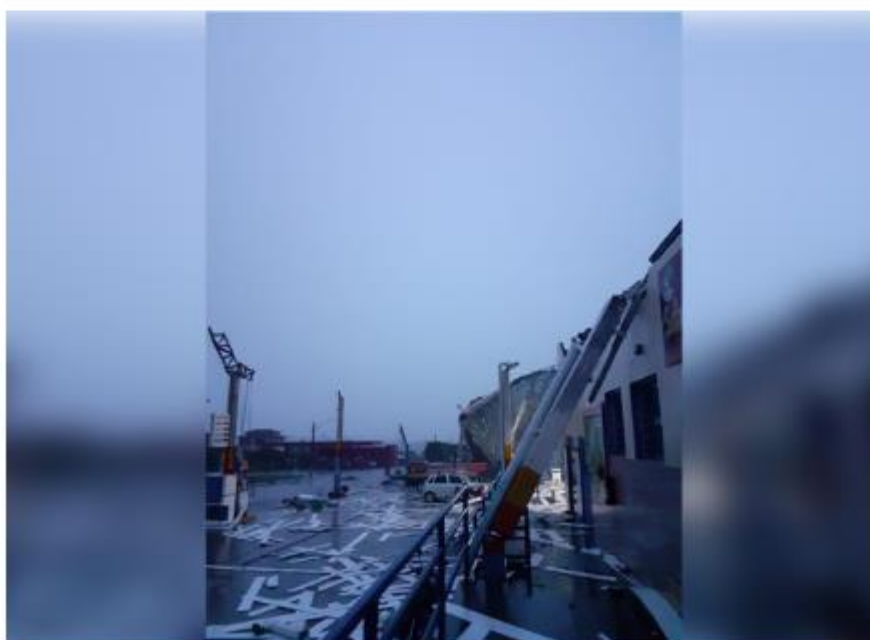

(Foto: Reprodução)