

## Resumo Executivo

O Presente Relatório tem como objetivo a incorporação de informações que sejam relevantes para que se possa fazer a devida associação aos dados contidos no corpo do documento objeto da classificação de Situação de Emergência caracterizada pelo Módulo 8 do Prodist, que tem como foco o impacto do evento sobre determinada rede geelétrica e cuja denominação é definida como CHI (Consumidor hora interrompido). O parâmetro para enquadramento nesta classificação de expurgo tem como premissa inicial o limite de Consumidor hora interrompido definido pela fórmula descrita no Módulo 01 do Prodist (Revisão - 10), acrescido de todos os outros informes e dados listados no Módulo 08 (Revisão 10) do Prodist. Este enquadramento se apresenta na maioria das vezes em condições climáticas adversas com severidade dos fatores inerentes a situação, caracterizado na maioria dos casos por fortes ventos e chuvas de grande intensidade e continuidade.

Entre o dia 27/11/2019 – Quarta-feira – e a madrugada do dia 01/12/2019 – Domingo – A presença de uma frente fria favoreceu a organização de um corredor de umidade sobre o estado e ajudou na formação de áreas de instabilidade sobre as Regiões da Enel Distribuição Goiás.

Entre as 09h50 do dia 27 de novembro e 03h00 do dia 01 de dezembro de 2019 tivemos, em todo o Estado de Goiás, a incidências de 65.659 descargas atmosféricas (27.166 raios nuvem-solo e 38.493 descargas nuvem-nuvem) sobre a região, o que causou grande instabilidade na rede.

Conforme informações do Climatempo Meteorologia, o Instituto Nacional de Meteorologia (INMET) detectou rajadas de vento acima de 50km/h durante o período. A máxima rajada registrada foi de 77,0km/h entre as 13h e 14h e entre 14h e 15h do dia 30 de novembro, em Goianésia, sendo esse vento classificado como ventania forte pela escala Beaufort.

Os maiores acumulados de chuva registrados pelo INMET foram em Rio Verde, entre 19h00 e 20h00, do dia 27/11/2019, totalizando 41.6mm de chuva. Segundo o INMET, chuvas com taxas superiores à 7,6mm são consideradas chuvas fortes.

**Asfalto cede durante chuva e 'engole' carros na GO-206, em Itarumã-** Motoristas tiveram apenas escoriações. Pista está interditada nos dois sentidos. Acesso em:

<https://g1.globo.com/go/goias/transito/noticia/2019/11/29/asfalto-cede-durante-chuva-e-engole-carros-na-go-206-em-itaruma.ghtml>

**Asfalto cede durante chuva e 'engole' carros no Goiás -** Acesso em: <http://informatudodf.com.br/2019/11/29/asfalto-cede-durante-chuva-e-engole-carros-no-goias/>.

## Relatório de Ocorrências do período

Em todo o Estado de Goiás verificou-se também que a intensidade da chuva e dos ventos danificaram a rede de distribuição de energia elétrica em diversos pontos, registrando aproximadamente 400 mil clientes com interrupção no fornecimento de energia elétrica devido a eventos relacionados ao temporal.

Para otimizar o volume de atendimentos e reduzir os tempos de interrupção foram mobilizados os recursos extras da empresa que aumentou o contingente em relação a situação normal de operação. O acompanhamento da quantidade de equipes e o Tempo Médio de Atendimento podem ser consultados na Pág.02 do Relatório em anexo.

O impacto e severidade do evento estão relatados em artigos de mídia, como fotos e reportagens que demonstram os danos na Rede de Distribuição, oriundos dos eventos climáticos no período. Eventos estes que afetaram 400.970 consumidores com CHI de 1.447.577,21 superior ao de 482.391,86 estabelecido como limite para definição de Situação de Emergência, conforme resumo das informações obrigatórias.

Empresa		ENEL DISTRIBUIÇÃO GOIÁS							
Código do Relatório		CHI-027 - ENEL DISTRIBUIÇÃO GOIÁS							
Evento:		TEMPORAL NA AREA DE CONCESSÃO DA ENEL DISTRIBUIÇÃO GOIAS							
Código COBRADE:		1.3.1.1.2, 1.3.1.1.4 e 1.3.1.1.5	Data Início	27/11/2019	Hora início	09h30m			
Código do Evento:		CHI-027-ENEL GO	Data Término	01/12/2019	Hora Término	08h59m			
Valor CHI (Limite e Real)		482.391,86	1.447.577,21						
Código do Decreto (Se Houver):									
Quantidade de Interrupções (Evento)		6786							
Início 1ª Incidência (Data e Hora)		27/11/2019 09:35		<b>Subestações Atingidas</b> ABADIANA / ABC / ACREUNA / ADELANDIA / AEROPORTO / AGUA LIMPA (MARZAGAO) / AGUAS LINDAS / ALEXANIA / ALEXANIA TRANSMISSAO / ALMERINDONOPOLIS / ALOANDIA / ALPHAVILLE / ALTO BURITI / ALTO PARAISO DE GOIAS / ALVORADA DO NORTE / AMERICANO DO BRASIL / AMORINOPOLIS / ANAPOLIS UNIVERSITARIA / ANHANGUERA / ANICUNS / ANTONIO DO VITTO / APARECIDA DO RIO DOCE / APORE / ARACU / ARAGARCAS / ARAGOIANIA / ARAGUAPAZ / ARARAS / AREIAS / ARENOPOLIS / ARUANA / ARUANA (TRANSMISSAO) / ASA BRANCA / ATLANTICO / AURILANDIA / AVELINOPOLIS / BACURI (RIO VERDE) / BARBOSELANDIA / BARCELONA / BARREIRO (PORANGATU) / BARRO ALTO / BELA VISTA (TRANSMISSAO) / BOA VISTA / BOM JARDIM / BOM JESUS DE GOIAS / BONFINOPOLIS / BONITO / BONOPOLIS / BRAZABRANTES / BRITANIA / BRITANIA (TRANSMISSAO) / BURITI ALEGRE / BURITI DE GOIAS / CABECEIRAS / CABRIUVA (RIO VERDE) / CACHOEIRA ALTA / CACHOEIRA DOURADA / CACHOEIRA NOVA / CACHOEIRINHA (ITARUMA) / CACU / CAIAPONIA / CALDAS NOVAS / CALDAZINHA / CAMPESTRE / CAMPINAS / CAMPINORTE / CAMPO ALEGRE DE GOIAS / CAMPO LIMPO DE GOIAS / CAMPO NOVO / CAMPOS BELOS / CAMPOS VERDES / CARAIBAS / CARAJAS / CASTELANDIA / CATALAO / CATURAI / CEBRASA FABRICA DA AMBEV / CEMAT/BALIZA / CEPALGO / CEZARINA / CHAPADAO DO CEU / CIDADE OCIDENTAL / COCALZINHO / COLINACU / CORREGO DO OURO / CORUMBA / CORUMBAIBA / CRISTALINA / CRISTALINA TRANSMISSAO / CRISTIANOPOLIS / CRIXAS / CROMINIA / CUMARI / DAIA - ANAPOLIS / DAMOLANDIA / DAVINOPOLIS / DESFECHO / DESTILARIA BRASIL CENTRAL / DIMIC / DIORAMA / DORCELINO PEIXOTO DE MORAES / DOVERLANDIA / EDEALINA / EDEIA / ENERSUL / ESTANIFERA / ESTRELA DO NORTE / FAINA / FAZENDA CANADA / FAZENDA NOVA / FERROVIARIO / FIRMINOPOLIS / FLORES DE GOIAS / FORMIGA / FORMOSO / FRONTEIRA / GAMELEIRA / GIRASSOL / GOIANAPOLIS / GOIANDIRA / GOIANESIA / GOIANIA LESTE / GOIANIRA / GOIAS / GOIATUBA / GOUVERLANDIA / GOYA / GUAPO / HEITORAI / HIDROLANDIA / HIDROLINA / IACIARA / INACIOLANDIA / INDEPENDENCIA / INDIARA / INHUMAS / IPAMERI / IPEGUARI / IPORA / ISRAELANDIA / ITABERAI / ITAGUARI / ITAGUARU / ITAJA / ITAPACI / ITAPACI (TRANSMISSAO) / ITAPIRAPUA / ITAPURANGA / ITAPURANGA (TRANSMISSAO) / ITARUMA / ITAUCU / ITIQUIRA (FORMOSA) / ITUMBIARA NOVA / ITUMBIARA VELHA / JACILANDIA / JANDAIA / JARAGUA / JARANAPOLIS / JATAI / JAUPACI / JESUPOLIS / JOVIANIA / JUNDIAI / JURUMIRIM / JUSCELANDIA / JUSSARA / LAGES / LAGOA DA SERRA / LAGOA DO BAUZINHO (RIO VERDE) / LEOPOLDO DE BULHOES / LUZIANIA / LUZIANIA INDUSTRIAL / MAIRIPOTABA / MAMBAI / MARA ROSA / MARAJOARA / MARCIANOPOLIS / MARIAPOLIS (PADRE BERNARDO) / MARZAGAO / MATO GRANDE / MATRINCHA / MAURILANDIA / MEIA PONTE / MINACU / MINEIROS / MOIPORA / MONTE ALEGRE / MONTES CLAROS DE GOIAS / MONTIVIDIU T / MORRINHOS / MORRO AGUDO / MOSSAMEDES / MOZARLANDIA / MOZARLANDIA (TRANSMISSAO) / MUNDO NOVO DE GOIAS / MUTUNOPOLIS / NAVESLANDIA ( JATAI ) / NAZARIO / NEROPOLIS / NIQUELANDIA / NOVA AMERICA / NOVA AURORA / NOVA CRIXAS (TRANSMISSAO) / NOVA IGUAQU / NOVA PONTE / NOVA VENEZA / NOVO BRASIL / NOVO GAMA / NOVO PLANALTO / OLHOS D'AGUA / OLOANA / ORIZONA / OURO VERDE DE GOIAS / OUIDOR / PACAEMBU (NOVO GAMA) / PADRE BERNARDO / PALESTINA / PALMEIRAS / PALMEIRAS DE GOIAS / PALMELO / PALMINOPOLIS / PAMPLONA / PANAMA / PARANA / PARANAIBA / PARANAIGUARA / PARAUNA SE ALTA TENSÃO / PARQUE DAS EMAS (MINEIROS) / PARQUE DAS NACOES / PEROLANDIA / PETROLINA / PILAR / PILOANDIA / PIRACANJUBA / PIRANHAS T / PIRENOPOLIS / PIRES BELO / PIRES DO RIO / PLANALTINA / PLANALTINA (TRANSMISSAO) / PLANALTO / PONTALINA / PORANGATU / PORTEIRAO / PORTELANDIA / PORTO SAO SIMAO / POSSE / POSSELANDIA / PROFESSOR JAMIL / QUEBRA LINHA / QUIRINOPOLIS / REAL / RETIRO / GOIAS / RIO CLARO JATAI MONTIVIDIU / RIO DO PEIXE / RIO DOS BOIS (MAURILANDIA) / RIO PRETO / RIO QUENTE / RIO VERDE / RIO VERMELHO / RIVERLANDIA (RIO VERDE) / ROCHEDO (UEH) / RUBIATABA / SANCLERLANDIA / SANTA BARBARA / SANTA FE DE GOIAS / SANTA HELENA / SANTA RITA DO ARAGUAIA / SANTA ROSA / SANTA ROSA DE GOIAS / SANTA ROSA DO MEIA PONTE / SANTA TEREZA DE GOIAS / SANTA TEREZINHA / SANTO ANTONIO DA BARRA / SANTO ANTONIO DE GOIAS / SANTO ANTONIO DO DESCOBERTO / SAO BARTOLOMEU / SAO DOMINGOS / SAO FRANCISCO DE GOIAS / SAO JOAO D ALIANCA / SAO JOAO DA PARAUNA / SAO JUDAS TADEU / SAO LUIZ DOS MONTES BELOS / SAO MIGUEL DO ARAGUAIA / SAO MIGUEL DO PASSA QUATRO / SAO SIMAO / SENADOR CANEDO TRANSMISSAO / SERRA AZUL (JATAI) / SERRA DE CALDAS / SERRANOPOLIS / SILVANIA / SITIO DABADIA / SOUZALANDIA / SUCURI / TAIOBA / TAQUARI / TEREZOPOLIS / TERRA VERMELHA / TRAJANOPOLIS (PADRE BERNARDO) / TRES BARRAS / TRES RANCHOS / TRINDADE / TUCUNARE / TURVANIA / TURVELANDIA / URU / URUACU / URUTAI / USINA DE ACUCAR DE GOIANESIA / USINA MAMBAI / VARJAO / VENDA SECA / VIANOPOLIS / VICENTINOPOLIS / VILA BOA / VILA CORUMBA / VILA PROPICIO / XAVANTES / XIXA / ZELANDIA					
Início Última Incidência (Data e Hora)		01/12/2019 08:59					<b>Municípios Atingidos</b> ABADIA DE GOIAS / ABADIANA / ACREUNA / ADELANDIA / AGUA FRIA DE GOIAS / AGUA LIMPA / AGUAS LINDAS DE GOIAS / ALEXANIA / ALOANDIA / ALTO HORIZONTE / ALTO PARAISO DE GOIAS / ALVORADA DO NORTE / AMARALINA / AMERICANO DO BRASIL / AMORINOPOLIS / ANAPOLIS / ANHANGUERA / ANICUNS / APARECIDA DE GOIANIA / APARECIDA DO RIO DOCE / APORE / ARACU / ARAGARCAS / ARAGOIANIA / ARAGUAPAZ / ARENOPOLIS / ARUANA / AURILANDIA / AVELINOPOLIS / BALIZA / BARRO ALTO / BELA VISTA DE GOIAS / BOM JARDIM DE GOIAS / BOM JESUS DE GOIAS / BONFINOPOLIS / BONOPOLIS / BRAZABRANTES / BRITANIA / BURITI ALEGRE / BURITI DE GOIAS / BURITINOPOLIS / CABECEIRAS / CACHOEIRA ALTA / CACHOEIRA DE GOIAS		
Média de Duração das Incidências (h)		9,54							
Duração da Incidência mais longa (h)		88,51							
Total de Clientes afetados		400.970							

			CACHOEIRA DOURADA / CACU / CAIAPONIA / CALDAS NOVAS / CALDAZINHA / CAMPESTRE DE GOIAS / CAMPINACU / CAMPINORTE / CAMPO ALEGRE DE GOIAS / CAMPO LIMPO / CAMPOS BELOS / CAMPOS VERDES / CARMO DO RIO VERDE / CASTELANDIA / CATALAO / CATURAI / CAVALCANTE / CERES / CEZARINA / CHAPADAO DO CEU / CIDADE OCIDENTAL / COCALZINHO DE GOIAS / COLINAS DO SUL / CORREGO DO OURO / CORUMBA DE GOIAS / CORUMBAIBA / CRISTALINA / CRISTIANOPOLIS / CRIXAS / CROMINIA / CUMARI / DAMIANOPOLIS / DAMOLANDIA / DAVINOPOLIS / DIORAMA / DISTRITO FEDERAL / DIVINOPOLIS DE GOIAS / DOVERLANDIA / EDEALINA / EDEIA / ESTRELA DO NORTE / FAINA / FAZENDA NOVA / FIRMINOPOLIS / FLORES DE GOIAS / FORMOSA / FORMOSO / GAMELEIRA DE GOIAS / GOIANAPOLIS / GOIANDIRA / GOIANESIA / GOIANIA / GOIANIRA / GOIAS / GOIATUBA / GOUVELANDIA / GUAPO / GUARAITA / GUARANI DE GOIAS / GUARINOS / HEITORAI / HIDROLANDIA / HIDROLINA / IACIARA / INACIOLANDIA / INDIARA / INHUMAS / IPAMERI / IPIRANGA DE GOIAS / IPORA / ISRAELANDIA / ITABERAI / ITAGUARI / ITAGUARU / ITAJA / ITAPACI / ITAPIRAPUA / ITAPURANGA / ITARUMA / ITAUCU / ITUMBIARA / IVOLANDIA / JANDAIA / JARAGUA / JATAI / JAUPACI / JESUPOLIS / JOVIANIA / JUSSARA / LAGOA SANTA / LEOPOLDO DE BULHOES / LUZIANIA / MAIRIPOTABA / MAMBAI / MARA ROSA / MARZAGAO / MATRINCHA / MAURILANDIA / MIMOSO DE GOIAS / MINACU / MINEIROS / MOIPORA / MONTE ALEGRE DE GOIAS / MONTES CLAROS DE GOIAS / MONTIVIDIU / MONTIVIDIU DO NORTE / MORRINHOS / MORRO AGUDO DE GOIAS / MOSSAMEDES / MOZARLANDIA / MUNDO NOVO DE GOIAS / MUTUNOPOLIS / NAZARIO / NEROPOLIS / NIQUELANDIA / NOVA AMERICA / NOVA AURORA / NOVA CRIXAS / NOVA GLORIA / NOVA IGUAQU DE GOIAS / NOVA ROMA / NOVA VENEZA / NOVO BRASIL / NOVO GAMA / NOVO PLANALTO / ORIZONA / OURO VERDE DE GOIAS / OUVIDOR / PADRE BERNARDO / PALESTINA DE GOIAS / PALMEIRAS DE GOIAS / PALMELO / PALMINOPOLIS / PANAMA / PARANAIGUARA / PARAUNA / PEROLANDIA / PETROLINA DE GOIAS / PILAR DE GOIAS / PIRACANJUBA / PIRANHAS / PIRENOPOLIS / PIRES DO RIO / PLANALTINA / PONTALINA / PORANGATU / PORTEIRAO / PORTELANDIA / POSSE / PROFESSOR JAMIL SAFADY / QUIRINOPOLIS / RIO QUENTE / RIO VERDE / RUBIATABA / SANCLERLANDIA / SANTA BARBARA DE GOIAS / SANTA CRUZ DE GOIAS / SANTA FE DE GOIAS / SANTA HELENA DE GOIAS / SANTA ISABEL / SANTA RITA DO ARAGUAIA / SANTA RITA DO NOVO DESTINO / SANTA ROSA DE GOIAS / SANTA TEREZA DE GOIAS / SANTA TEREZINHA DE GOIAS / SANTO ANTONIO DA BARRA / SANTO ANTONIO DE GOIAS / SANTO ANTONIO DO DESCOBERTO / SAO DOMINGOS / SAO FRANCISCO DE GOIAS / SAO JOAO D ALIANCA / SAO JOAO DA PARAUNA / SAO LUIS DE MONTES BELOS / SAO LUIZ DO NORTE / SAO MIGUEL DO ARAGUAIA / SAO MIGUEL DO PASSA QUATRO / SAO PATRICIO / SAO SIMAO / SENADOR CANEDO / SERRANOPOLIS / SILVANIA / SIMOLANDIA / SITIO D ABADIA / TAQUARAL DE GOIAS / TERESINA DE GOIAS / TEREZOPOLIS DE GOIAS / TRES RANCHOS / TRINDADE / TROMBAS / TURVANIA / TURVELANDIA / UIRAPURU / URUACU / URUANA / URUTAI / VALPARAISO DE GOIAS / VARJAO / VIANOPOLIS / VICENTINOPOLIS / VILA BOA / VILA PROPICIO
--	--	--	---

<b>DANOS CAUSADOS</b>			
<b>Equipamentos Danificado</b>	<b>Importância para o Sistema</b>	<b>Local</b>	<b>Quantidade</b>
Disjuntor/Religador Operado	Proteção do Alimentador	Área de Concessão	165
Chaves Fusíveis Operada	Proteção de Ramais de Alimentadores	Área de Concessão	2097
Transformador Operado	Proteção do Transformador	Área de Concessão	1535

Relato técnico sobre a Intervenção realizada em Goiânia e Região Metropolitana						
Informações sobre Equipes	27/11	28/11	29/11	30/11	01/12	
Quantidade Usual	600	600	600	600	600	turmas
Quantidade Adicional	165	156	161	158	152	turmas
Quantidade Total	765	756	761	758	752	turmas
Tempos Médios						
Preparação	6,25	6,70	6,50	7,37	8,33	Horas
Deslocamento	0,92	0,88	0,9	0,92	0,87	Horas
Execução	1,50	1,37	1,37	1,69	1,55	Horas
TMAE	8,67	8,95	8,77	9,98	10,75	Horas

### Principais Dificuldades Encontradas:

Chuvas com ventos fortes provocaram muitos pontos de alagamento e enxurrada, trânsito impedido por vários semáforos desligados dificultando a chegada ao atendimento das ocorrências emergenciais. Em determinadas regiões, decorrente dos fortes ventos, houve o tombamento de árvores nas estruturas de alimentação de média tensão, danos em ramais de ligação dos clientes, impedimentos de acesso e atolamentos em estradas rurais.

Empresa	ENEL DISTRIBUIÇÃO GOIAS		
Valor CHI (Limite e Real)	<b>482.391,86</b>		<b>1.447.577,21</b>



DOC ORIGEM	MIUNICIPIO	EQP_ORIGEM	CONJUNTO	INI_OCORRENC	FIM_OCORRENC	DT_INI_EVENTO	DT_FIM_EVENTO	DURAÇ	UC INT	CHI	EXPURGO
2019126	HEITORAI	HE11000003	ITAPURANGA	01/12/2019 00:10	01/12/2019 09:25	01/12/2019 00:10	01/12/2019 09:25	9,25	88	814,44	CHI
20191219	PORANGATU	PO12192371	PORANGATU	01/12/2019 00:32	01/12/2019 14:00	01/12/2019 00:32	01/12/2019 14:00	13,46	12	161,54	CHI
20191234	ARAGUAPAZ	AZ12327535	GOIAS	01/12/2019 00:55	01/12/2019 15:14	01/12/2019 00:55	01/12/2019 15:14	14,31	1	14,31	CHI
20191243	NOVA CRIXAS	NA12334349	NOVA CRIXAS	01/12/2019 01:06	01/12/2019 11:59	01/12/2019 01:06	01/12/2019 11:59	10,87	85	924,28	CHI
20191245	NOVA CRIXAS	NA12181524	NOVA CRIXAS	01/12/2019 01:08	02/12/2019 00:50	01/12/2019 01:08	02/12/2019 00:50	23,70	2	47,41	CHI
20191260	PORANGATU	PO12208614	PORANGATU	01/12/2019 02:03	01/12/2019 18:46	01/12/2019 02:03	01/12/2019 18:46	16,70	8	133,62	CHI
20191261	RIO VERDE	RV11246853	RIO VERDE S1	01/12/2019 01:08	01/12/2019 06:30	01/12/2019 01:08	01/12/2019 06:30	5,36	135	724,05	CHI
20191262	SANTA TEREZINHA DE GOIAS	SG21210185	SANTA TEREZINHA	01/12/2019 02:16	01/12/2019 13:30	01/12/2019 02:16	01/12/2019 13:30	11,24	1	11,24	CHI
20191264	BURITI DE GOIAS	1680007935	FIRMINOPOLIS S2	01/12/2019 02:24	01/12/2019 08:26	01/12/2019 02:24	01/12/2019 08:26	6,02	1	6,02	CHI
20191276	IPORA	IR12381025	IPORA	30/11/2019 21:48	01/12/2019 06:34	30/11/2019 21:48	01/12/2019 06:34	8,76	11	96,39	CHI
20191288	MOZARLANDIA	MZ12060053	MOZARLANDIA	01/12/2019 03:44	02/12/2019 10:38	01/12/2019 03:44	02/12/2019 10:38	30,89	1	30,89	CHI
20191290	AMERICANO DO BRASIL	KB12031452	ANICUNS	01/12/2019 03:48	01/12/2019 09:06	01/12/2019 03:48	01/12/2019 09:06	5,30	9	47,69	CHI
20191290	ANICUNS	KB12031452	ANICUNS	01/12/2019 03:48	01/12/2019 09:06	01/12/2019 03:48	01/12/2019 09:06	5,30	23	121,87	CHI
20191293	ARUANA	AK21228475	BRITANIA	01/12/2019 04:07	01/12/2019 14:09	01/12/2019 04:07	01/12/2019 14:09	10,02	1	10,02	CHI
20191295	ARUANA	AK12183184	BRITANIA	01/12/2019 04:09	01/12/2019 14:51	01/12/2019 04:09	01/12/2019 14:51	10,69	13	138,93	CHI
201912131	SERRANOPOLIS	SX12296496	JATAI S1	01/12/2019 06:16	01/12/2019 14:27	01/12/2019 06:16	01/12/2019 14:27	8,17	143	1167,91	CHI
201912201	ARAGUAPAZ	AZ12041362	MOZARLANDIA	01/12/2019 04:21	01/12/2019 11:04	01/12/2019 04:21	01/12/2019 11:04	6,70	24	160,90	CHI
201912207	FORMOSO	FO12145406	PORANGATU	30/11/2019 16:35	02/12/2019 02:31	30/11/2019 16:35	02/12/2019 02:31	33,94	70	2375,68	CHI
201912215	JAUPACI	01650214	BRITANIA	01/12/2019 04:50	01/12/2019 07:57	01/12/2019 04:50	01/12/2019 07:57	3,11	2	6,23	CHI
201912215	SANTA FE DE GOIAS	01650214	BRITANIA	01/12/2019 04:50	01/12/2019 07:57	01/12/2019 04:50	01/12/2019 07:57	3,11	412	1283,27	CHI
201912215	FAZENDA NOVA	01650214	BRITANIA	01/12/2019 04:50	01/12/2019 07:57	01/12/2019 04:50	01/12/2019 07:57	3,11	209	650,98	CHI
201912215	JUSSARA	01650214	BRITANIA	01/12/2019 04:50	01/12/2019 07:57	01/12/2019 04:50	01/12/2019 07:57	3,11	346	1077,69	CHI
201912216	IVOLANDIA	AM12390135	IPORA	01/12/2019 04:50	02/12/2019 07:36	01/12/2019 04:50	01/12/2019 11:19	6,48	8	51,82	CHI
201912216	AMORINOPOLIS	AM12390135	IPORA	01/12/2019 04:50	02/12/2019 07:36	01/12/2019 04:50	01/12/2019 11:19	6,48	2	12,96	CHI
201912216	IVOLANDIA	AM12390135	IPORA	01/12/2019 04:50	02/12/2019 07:36	01/12/2019 11:22	01/12/2019 23:14	11,88	8	95,01	CHI
201912216	AMORINOPOLIS	AM12390135	IPORA	01/12/2019 04:50	02/12/2019 07:36	01/12/2019 11:22	01/12/2019 23:14	11,88	2	23,75	CHI
201912216	IVOLANDIA	IV12390141	IPORA	01/12/2019 04:50	02/12/2019 07:36	01/12/2019 04:50	02/12/2019 07:36	26,76	60	1605,78	CHI
201912216	AMORINOPOLIS	IV12390141	IPORA	01/12/2019 04:50	02/12/2019 07:36	01/12/2019 04:50	02/12/2019 07:36	26,76	6	160,58	CHI
201912228	MONTIVIDIU	MV12340904	MONTIVIDIU T	01/12/2019 04:59	01/12/2019 09:00	01/12/2019 04:59	01/12/2019 09:00	4,01	18	72,24	CHI
201912228	CAIAPONIA	MV12340904	MONTIVIDIU T	01/12/2019 04:59	01/12/2019 09:00	01/12/2019 04:59	01/12/2019 09:00	4,01	1	4,01	CHI
201912240	MARA ROSA	MQ12338191	SANTA TEREZINHA	01/12/2019 05:13	02/12/2019 09:21	01/12/2019 05:13	02/12/2019 09:21	28,13	3	84,38	CHI
201912262	ITABERAI	IB12336400	ITABERAI S2	01/12/2019 05:31	01/12/2019 07:43	01/12/2019 05:31	01/12/2019 07:43	2,19	17	37,29	CHI

201912269	SAO LUIS DE MONTES BELOS	SL12125617	FIRMINOPOLIS S1	01/12/2019 04:27	01/12/2019 08:18	01/12/2019 04:27	01/12/2019 08:18	3,84	52	199,82	CHI
201912269	TURVANIA	SL12125617	FIRMINOPOLIS S1	01/12/2019 04:27	01/12/2019 08:18	01/12/2019 04:27	01/12/2019 08:18	3,84	8	30,74	CHI
201912269	FIRMINOPOLIS	SL12125617	FIRMINOPOLIS S1	01/12/2019 04:27	01/12/2019 08:18	01/12/2019 04:27	01/12/2019 08:18	3,84	17	65,33	CHI
201912280	TAQUARAL DE GOIAS	TQ12025622	ITABERAI S1	01/12/2019 05:40	01/12/2019 09:30	01/12/2019 05:40	01/12/2019 09:30	3,83	34	130,05	CHI
201912280	ITABERAI	TQ12025622	ITABERAI S1	01/12/2019 05:40	01/12/2019 09:30	01/12/2019 05:40	01/12/2019 09:30	3,83	3	11,48	CHI
201912282	IPORA	IR21139417	IPORA	01/12/2019 05:40	01/12/2019 07:19	01/12/2019 05:40	01/12/2019 07:19	1,63	1	1,63	CHI
201912289	BURITI DE GOIAS	CO12376358	FIRMINOPOLIS S2	01/12/2019 05:43	01/12/2019 09:09	01/12/2019 05:43	01/12/2019 09:09	3,42	30	102,74	CHI
201912289	CORREGO DO OURO	CO12376358	FIRMINOPOLIS S2	01/12/2019 05:43	01/12/2019 09:09	01/12/2019 05:43	01/12/2019 09:09	3,42	21	71,92	CHI
201912292	MARA ROSA	MQ12125574	MARA ROSA	01/12/2019 05:46	01/12/2019 09:09	01/12/2019 05:46	01/12/2019 09:09	3,38	13	43,92	CHI
201912298	BOM JARDIM DE GOIAS	BM11231854	BOM JARDIM	01/12/2019 05:48	01/12/2019 08:07	01/12/2019 05:48	01/12/2019 08:07	2,30	1	2,30	CHI
201912307	RIO VERDE	RV12260693	CABRIUVA S1	01/12/2019 05:53	01/12/2019 10:55	01/12/2019 05:53	01/12/2019 10:55	5,03	9	45,28	CHI
201912328	FAZENDA NOVA	FN12292871	IPORA	30/11/2019 19:43	01/12/2019 11:05	30/11/2019 19:43	01/12/2019 11:05	15,36	34	522,32	CHI
201912343	PEROLANDIA	DP21346701	JATAI S1	01/12/2019 06:05	01/12/2019 11:18	01/12/2019 06:05	01/12/2019 11:18	5,21	1	5,21	CHI
201912345	ARAGUAPAZ	AZZ1042943	MOZARLANDIA	01/12/2019 06:05	01/12/2019 11:59	01/12/2019 06:05	01/12/2019 11:59	5,89	1	5,89	CHI
201912358	FAINA	FC11299832	GOIAS	01/12/2019 06:09	01/12/2019 16:00	01/12/2019 06:09	01/12/2019 16:00	9,83	68	668,78	CHI
201912359	ARENOPOLIS	AY12390170	ARENOPOLIS	01/12/2019 06:10	01/12/2019 15:20	01/12/2019 06:10	01/12/2019 15:20	9,17	7	64,16	CHI
201912361	PONTALINA	PK12249930	PONTALINA	30/11/2019 21:43	01/12/2019 08:31	30/11/2019 21:43	01/12/2019 08:31	10,79	8	86,30	CHI
201912375	PALMEIRAS DE GOIAS	PL12086232	PALMEIRAS	01/12/2019 02:46	01/12/2019 08:20	01/12/2019 02:46	01/12/2019 08:20	5,58	6	33,45	CHI
201912377	ITAPIRAPUA	IU12087963	MATRINCHA	01/12/2019 04:21	01/12/2019 09:13	01/12/2019 04:21	01/12/2019 09:13	4,86	40	194,40	CHI
201912381	ITAPIRAPUA	IU12030113	MATRINCHA	01/12/2019 06:15	04/12/2019 01:50	01/12/2019 06:15	01/12/2019 16:16	10,01	6	60,04	CHI
201912381	ITAPIRAPUA	IU12250541LD	MATRINCHA	01/12/2019 06:15	04/12/2019 01:50	01/12/2019 06:15	04/12/2019 00:36	66,34	2	132,68	CHI
201912381	ITAPIRAPUA	IU12189999	MATRINCHA	01/12/2019 06:15	04/12/2019 01:50	01/12/2019 06:15	04/12/2019 01:50	67,57	3	202,72	CHI
201912382	MATRINCHA	MP12183061	MOZARLANDIA	01/12/2019 06:16	01/12/2019 11:00	01/12/2019 06:16	01/12/2019 11:00	4,73	27	127,77	CHI
201912382	ARUANA	MP12183061	MOZARLANDIA	01/12/2019 06:16	01/12/2019 11:00	01/12/2019 06:16	01/12/2019 11:00	4,73	7	33,13	CHI
201912387	SERRANOPOLIS	SX21216742	JATAI S1	30/11/2019 20:19	01/12/2019 10:21	30/11/2019 20:19	01/12/2019 10:21	14,03	1	14,03	CHI
201912388	PIRACANJUBA	PJ12082235	MORRINHOS	30/11/2019 18:07	02/12/2019 16:40	30/11/2019 18:07	02/12/2019 10:22	40,25	10	402,54	CHI
201912388	PIRACANJUBA	PJ12082235	MORRINHOS	30/11/2019 18:07	02/12/2019 16:40	02/12/2019 10:22	02/12/2019 12:15	1,89	6	11,31	CHI
201912388	PIRACANJUBA	PJ32088831	MORRINHOS	30/11/2019 18:07	02/12/2019 16:40	30/11/2019 18:07	02/12/2019 13:34	43,45	2	86,90	CHI
201912388	PIRACANJUBA	7925669	MORRINHOS	30/11/2019 18:07	02/12/2019 16:40	02/12/2019 10:22	02/12/2019 16:40	6,31	4	25,22	CHI
201912389	SANTA TEREZINHA DE GOIAS	SG21129902	SANTA TEREZINHA	01/12/2019 06:17	01/12/2019 14:00	01/12/2019 06:17	01/12/2019 14:00	7,72	1	7,72	CHI
201912396	JATAI	SX12013892	JATAI S1	01/12/2019 05:52	01/12/2019 08:36	01/12/2019 05:52	01/12/2019 08:36	2,73	14	38,21	CHI
201912396	SERRANOPOLIS	SX12013892	JATAI S1	01/12/2019 05:52	01/12/2019 08:36	01/12/2019 05:52	01/12/2019 08:36	2,73	141	384,85	CHI
201912399	ISRAELANDIA	MO12402985	IPORA	01/12/2019 06:21	01/12/2019 12:49	01/12/2019 06:21	01/12/2019 12:49	6,46	2	12,93	CHI

201912399	MOIPORA	MO12402985	IPORA	01/12/2019 06:21	01/12/2019 12:49	01/12/2019 06:21	01/12/2019 12:49	6,46	15	96,97	CHI
201912403	ITAPIRAPUA	IU12259711	MATRINCHA	01/12/2019 06:22	01/12/2019 11:40	01/12/2019 06:22	01/12/2019 11:40	5,29	5	26,45	CHI
201912408	RIO VERDE	SH12271532	IPEGUARI	30/11/2019 21:04	01/12/2019 08:35	30/11/2019 21:04	01/12/2019 08:35	11,50	1	11,50	CHI
201912408	SANTA HELENA DE GOIAS	SH12271532	IPEGUARI	30/11/2019 21:04	01/12/2019 08:35	30/11/2019 21:04	01/12/2019 08:35	11,50	23	264,60	CHI
201912409	CACU	CC21191644	CACHOEIRA ALTA	30/11/2019 18:40	02/12/2019 09:35	30/11/2019 18:40	02/12/2019 09:35	38,91	1	38,91	CHI
201912415	ITAGUARU	IC12036344	ITAPURANGA	01/12/2019 06:02	01/12/2019 22:51	01/12/2019 06:02	01/12/2019 22:51	16,82	3	50,45	CHI
201912415	ITAPURANGA	IC12036344	ITAPURANGA	01/12/2019 06:02	01/12/2019 22:51	01/12/2019 06:02	01/12/2019 22:51	16,82	73	1227,54	CHI
201912415	HEITORAI	IC12036344	ITAPURANGA	01/12/2019 06:02	01/12/2019 22:51	01/12/2019 06:02	01/12/2019 22:51	16,82	3	50,45	CHI
201912416	BALIZA	BH12343730	BOM JARDIM	01/12/2019 06:27	01/12/2019 09:30	01/12/2019 06:27	01/12/2019 09:30	3,04	8	24,35	CHI
201912417	MINEIROS	MY12166292	CHAPADAO DO CEU	01/12/2019 06:27	01/12/2019 15:49	01/12/2019 06:27	01/12/2019 15:49	9,37	5	46,85	CHI
201912417	SERRANOPOLIS	MY12166292	CHAPADAO DO CEU	01/12/2019 06:27	01/12/2019 15:49	01/12/2019 06:27	01/12/2019 15:49	9,37	3	28,11	CHI
201912422	JATAI	JT12302009LD	JATAI S1	01/12/2019 06:28	01/12/2019 17:00	01/12/2019 06:28	01/12/2019 17:00	10,53	10	105,29	CHI
201912428	GOIAS	GS12234111	GOIAS	01/12/2019 05:59	01/12/2019 11:44	01/12/2019 05:59	01/12/2019 11:44	5,76	51	293,68	CHI
201912432	ANICUNS	AC12304607	FIRMINOPOLIS S2	01/12/2019 06:31	01/12/2019 15:00	01/12/2019 06:31	01/12/2019 15:00	8,48	3	25,44	CHI
201912443	PORANGATU	PO12350110	PORANGATU	01/12/2019 06:20	02/12/2019 18:11	01/12/2019 06:20	02/12/2019 18:11	35,84	17	609,28	CHI
201912450	RIO VERDE	630059445	RIO VERDE S1	01/12/2019 06:35	01/12/2019 13:25	01/12/2019 06:35	01/12/2019 13:25	6,83	1	6,83	CHI
201912455	SAO LUIS DE MONTES BELOS	SL12206033	SAO LUIZ DOS MONTES BELOS	01/12/2019 06:36	01/12/2019 08:44	01/12/2019 06:36	01/12/2019 08:44	2,12	13	27,54	CHI
201912460	MARA ROSA	MQ12072578	MARA ROSA	30/11/2019 23:10	01/12/2019 08:27	30/11/2019 23:10	01/12/2019 08:27	9,27	6	55,64	CHI
201912468	UIRAPURU	UP12181466	SANTA TEREZINHA	30/11/2019 16:12	02/12/2019 11:20	30/11/2019 16:12	02/12/2019 11:20	43,13	9	388,14	CHI
201912475	ITAPURANGA	IK21298438	ITAPURANGA	01/12/2019 06:42	01/12/2019 14:30	01/12/2019 06:42	01/12/2019 14:30	7,79	2	15,58	CHI
201912476	ITAPACI	IW12123102	ITAPACI	01/12/2019 05:47	02/12/2019 11:10	01/12/2019 05:47	02/12/2019 11:10	29,38	11	323,15	CHI
201912485	SAO LUIS DE MONTES BELOS	SL21180320	FIRMINOPOLIS S2	01/12/2019 06:45	01/12/2019 09:22	01/12/2019 06:45	01/12/2019 09:22	2,61	1	2,61	CHI
201912489	ARENOPOLIS	AY12070195	ARENOPOLIS	01/12/2019 08:57	02/12/2019 10:33	01/12/2019 08:57	02/12/2019 10:33	25,59	10	255,87	CHI
201912489	MONTES CLAROS DE GOIAS	AY12070195	ARENOPOLIS	01/12/2019 08:57	02/12/2019 10:33	01/12/2019 08:57	02/12/2019 10:33	25,59	25	639,68	CHI
201912489	DIORAMA	AY12070195	ARENOPOLIS	01/12/2019 08:57	02/12/2019 10:33	01/12/2019 08:57	02/12/2019 10:33	25,59	3	76,76	CHI
201912515	FAINA	GS12042217	GOIAS	01/12/2019 05:35	01/12/2019 11:56	01/12/2019 05:35	01/12/2019 11:56	6,35	71	450,61	CHI
201912526	ITABERAI	IB12078567	ITABERAI S1	01/12/2019 06:55	01/12/2019 10:20	01/12/2019 06:55	01/12/2019 10:20	3,41	9	30,72	CHI
201912526	ITAUCU	IB12078567	ITABERAI S1	01/12/2019 06:55	01/12/2019 10:20	01/12/2019 06:55	01/12/2019 10:20	3,41	1	3,41	CHI
201912534	ITAPIRAPUA	JR12087418	JUSSARA	01/12/2019 03:48	01/12/2019 08:00	01/12/2019 03:48	01/12/2019 08:00	4,21	1	4,21	CHI
201912534	JUSSARA	JR12087418	JUSSARA	01/12/2019 03:48	01/12/2019 08:00	01/12/2019 03:48	01/12/2019 08:00	4,21	11	46,27	CHI
201912545	RIO VERDE	RV12228296	MONTIVIDIU T	01/12/2019 06:50	01/12/2019 10:40	01/12/2019 06:50	01/12/2019 10:40	3,82	7	26,73	CHI
201912546	URUACU	CR12410914	MARA ROSA	01/12/2019 06:33	02/12/2019 21:23	01/12/2019 06:33	01/12/2019 17:25	10,87	11	119,60	CHI
201912546	URUACU	CR12410914	MARA ROSA	01/12/2019 06:33	02/12/2019 21:23	02/12/2019 17:38	02/12/2019 17:53	0,25	12	2,99	CHI

201912546	URUACU	UR21247233	MARA ROSA	01/12/2019 06:33	02/12/2019 21:23	01/12/2019 06:33	02/12/2019 20:34	38,02	1	38,02	CHI
201912546	URUACU	UR21243290	MARA ROSA	01/12/2019 06:33	02/12/2019 21:23	01/12/2019 06:33	02/12/2019 21:00	38,46	1	38,46	CHI
201912546	URUACU	UR21247237	MARA ROSA	01/12/2019 06:33	02/12/2019 21:23	01/12/2019 06:33	02/12/2019 21:23	38,84	1	38,84	CHI
201912554	MINEIROS	MY12246680	SANTA RITA DO ARAGUAIA	01/12/2019 07:02	01/12/2019 14:11	01/12/2019 07:02	01/12/2019 14:11	7,14	6	42,85	CHI
201912556	APARECIDA DO RIO DOCE	RV12136254	CACHOEIRA ALTA	01/12/2019 07:03	01/12/2019 10:10	01/12/2019 07:03	01/12/2019 10:10	3,11	5	15,56	CHI
201912556	JATAI	RV12136254	CACHOEIRA ALTA	01/12/2019 07:03	01/12/2019 10:10	01/12/2019 07:03	01/12/2019 10:10	3,11	1	3,11	CHI
201912556	RIO VERDE	RV12136254	CACHOEIRA ALTA	01/12/2019 07:03	01/12/2019 10:10	01/12/2019 07:03	01/12/2019 10:10	3,11	18	56,02	CHI
201912570	BONOPOLIS	BX12391936	SAO MIGUEL DO ARAGUAIA	30/11/2019 23:19	01/12/2019 13:35	30/11/2019 23:19	01/12/2019 13:35	14,25	29	413,35	CHI
201912585	ISRAELANDIA	IS12184272	IPORA	01/12/2019 07:10	01/12/2019 11:30	01/12/2019 07:10	01/12/2019 11:30	4,32	6	25,94	CHI
201912603	GUARINOS	SG21049816	SANTA TEREZINHA	01/12/2019 07:13	02/12/2019 21:34	01/12/2019 07:13	02/12/2019 21:34	38,33	1	38,33	CHI
201912626	GOIAS	GS12056682	GOIAS	01/12/2019 07:00	01/12/2019 08:46	01/12/2019 07:00	01/12/2019 08:46	1,77	7	12,36	CHI
201912628	SANTA TEREZINHA DE GOIAS	SG12048775	SANTA TEREZINHA	01/12/2019 07:20	02/12/2019 17:40	01/12/2019 07:20	02/12/2019 17:40	34,33	10	343,34	CHI
201912629	BONOPOLIS	BX12079321	SAO MIGUEL DO ARAGUAIA	01/12/2019 05:25	01/12/2019 11:23	01/12/2019 05:25	01/12/2019 11:23	5,97	58	346,08	CHI
201912630	MORRO AGUDO DE GOIAS	MS12376423	ITAPURANGA	01/12/2019 07:20	01/12/2019 13:58	01/12/2019 07:20	01/12/2019 13:58	6,63	6	39,77	CHI
201912637	PEROLANDIA	JT1142780	JATAI S1	01/12/2019 07:21	01/12/2019 12:25	01/12/2019 07:21	01/12/2019 12:25	5,06	1	5,06	CHI
201912653	CAMPINACU	UC12236229	PORANGATU	01/12/2019 07:11	01/12/2019 09:21	01/12/2019 07:11	01/12/2019 09:21	2,16	28	60,47	CHI
201912654	GOIAS	GS12378886	MATRINCHA	01/12/2019 07:23	01/12/2019 11:17	01/12/2019 07:23	01/12/2019 11:17	3,90	4	15,58	CHI
201912668	SANTA HELENA DE GOIAS	SH12296008	IPEGUARI	01/12/2019 07:26	01/12/2019 14:48	01/12/2019 07:26	01/12/2019 14:48	7,35	14	102,93	CHI
201912668	SANTA HELENA DE GOIAS	SH12296008	IPEGUARI	01/12/2019 07:26	01/12/2019 14:48	01/12/2019 11:00	01/12/2019 14:48	3,80	24	91,21	CHI
201912670	CRIXAS	MZ12055628	MOZARLANDIA	01/12/2019 06:57	01/12/2019 16:11	01/12/2019 06:57	01/12/2019 16:11	9,23	26	239,94	CHI
201912670	MOZARLANDIA	MZ12055628	MOZARLANDIA	01/12/2019 06:57	01/12/2019 16:11	01/12/2019 06:57	01/12/2019 16:11	9,23	37	341,46	CHI
201912671	JUSSARA	JR12160972	BRITANIA	01/12/2019 07:27	01/12/2019 15:18	01/12/2019 07:27	01/12/2019 15:18	7,86	4	31,44	CHI
201912673	RIO VERDE	RV12260656	RIO VERDE S1	01/12/2019 07:27	02/12/2019 15:50	01/12/2019 07:27	02/12/2019 15:50	32,38	2	64,75	CHI
201912673	RIO VERDE	RV12260656	RIO VERDE S1	01/12/2019 07:27	02/12/2019 15:50	02/12/2019 08:35	02/12/2019 15:50	7,24	8	57,95	CHI
201912674	MONTIVIDIU DO NORTE	MX12391987	PORANGATU	30/11/2019 20:57	02/12/2019 00:09	30/11/2019 20:57	02/12/2019 00:09	27,18	18	489,33	CHI
201912695	SAO SIMAO	SO12226534	CACHOEIRA ALTA	30/11/2019 19:54	01/12/2019 12:00	30/11/2019 19:54	01/12/2019 12:00	16,09	23	369,98	CHI
201912697	FIRMINOPOLIS	FR21283562	FIRMINOPOLIS S2	01/12/2019 07:33	01/12/2019 11:03	01/12/2019 07:33	01/12/2019 11:03	3,50	1	3,50	CHI
201912700	MUNDO NOVO DE GOIAS	NA12041162	NOVA CRIXAS	30/11/2019 22:47	01/12/2019 11:04	30/11/2019 22:47	01/12/2019 11:04	12,27	37	454,12	CHI
201912700	NOVA CRIXAS	NA12041162	NOVA CRIXAS	30/11/2019 22:47	01/12/2019 11:04	30/11/2019 22:47	01/12/2019 11:04	12,27	29	355,93	CHI
201912702	PALESTINA DE GOIAS	PY21116728	PALESTINA	01/12/2019 07:33	01/12/2019 11:11	01/12/2019 07:33	01/12/2019 11:11	3,62	1	3,62	CHI
201912705	PALMINOPOLIS	1340011521	PALMEIRAS	01/12/2019 07:34	01/12/2019 10:13	01/12/2019 07:34	01/12/2019 10:13	2,64	1	2,64	CHI
201912724	CACHOEIRA DE GOIAS	CG21171029	FIRMINOPOLIS S2	01/12/2019 07:37	01/12/2019 14:15	01/12/2019 07:37	01/12/2019 14:15	6,64	1	6,64	CHI
201912729	MINEIROS	MY12358901	PARQUE DAS EMAS	01/12/2019 07:40	01/12/2019 20:58	01/12/2019 07:40	01/12/2019 20:58	13,29	53	704,18	CHI

201912729	SANTA RITA DO ARAGUAIA	MY12358901	PARQUE DAS EMAS	01/12/2019 07:40	01/12/2019 20:58	01/12/2019 07:40	01/12/2019 20:58	13,29	2	26,57	CHI
201912737	MORRO AGUDO DE GOIAS	RB12156092	RUBIATABA	01/12/2019 06:54	02/12/2019 11:00	01/12/2019 06:54	02/12/2019 11:00	28,10	10	280,98	CHI
201912748	MINACU	10020079204	MINACU	01/12/2019 07:41	01/12/2019 11:23	01/12/2019 07:41	01/12/2019 11:23	3,69	1	3,69	CHI
201912755	CAIAPONIA	CP12254646	JATAI S1	01/12/2019 07:43	01/12/2019 17:15	01/12/2019 07:43	01/12/2019 17:15	9,52	5	47,62	CHI
201912758	NIQUELANDIA	NQ12210926	NIQUELANDIA SUBTRANSMISSAO	01/12/2019 07:43	01/12/2019 11:33	01/12/2019 07:43	01/12/2019 11:33	3,82	7	26,75	CHI
201912764	INDIARA	IY12406245	ACREUNA	01/12/2019 07:44	01/12/2019 11:33	01/12/2019 07:44	01/12/2019 11:33	3,82	3	11,46	CHI
201912766	JATAI	JT12228519	JATAI S1	01/12/2019 07:44	01/12/2019 13:25	01/12/2019 07:44	01/12/2019 13:25	5,67	4	22,69	CHI
201912773	JAUPACI	IR12091410	IPORA	01/12/2019 07:46	01/12/2019 08:45	01/12/2019 07:46	01/12/2019 08:45	0,98	5	4,91	CHI
201912773	DIORAMA	IR12091410	IPORA	01/12/2019 07:46	01/12/2019 08:45	01/12/2019 07:46	01/12/2019 08:45	0,98	10	9,83	CHI
201912773	IPORA	IR12091410	IPORA	01/12/2019 07:46	01/12/2019 08:45	01/12/2019 07:46	01/12/2019 08:45	0,98	7	6,88	CHI
201912783	CAMPINORTE	CR21101004	CAMPINORTE	01/12/2019 07:48	02/12/2019 10:23	01/12/2019 07:48	02/12/2019 10:23	26,58	1	26,58	CHI
201912787	AURILANDIA	AI12383536	FIRMINOPOLIS S2	01/12/2019 07:48	02/12/2019 15:00	01/12/2019 07:48	02/12/2019 15:00	31,19	4	124,76	CHI
201912790	AMARALINA	LC12215796	MARA ROSA	01/12/2019 04:14	01/12/2019 20:12	01/12/2019 04:14	01/12/2019 20:12	15,95	13	207,41	CHI
201912792	MATRINCHA	AK12157596	MOZARLANDIA	01/12/2019 07:49	01/12/2019 18:14	01/12/2019 07:49	01/12/2019 18:14	10,41	1	10,41	CHI
201912797	NOVA CRIXAS	NA12228222	MOZARLANDIA	30/11/2019 20:59	02/12/2019 00:03	30/11/2019 20:59	02/12/2019 00:03	27,06	7	189,43	CHI
201912827	NIQUELANDIA	NQ12255460	NIQUELANDIA SUBTRANSMISSAO	01/12/2019 07:55	02/12/2019 02:35	01/12/2019 07:55	02/12/2019 02:35	18,65	2	37,30	CHI
201912828	JANDAIA	JD21308608	PALMEIRAS	01/12/2019 07:56	01/12/2019 10:00	01/12/2019 07:56	01/12/2019 10:00	2,08	1	2,08	CHI
201912831	AURILANDIA	1010008034	FIRMINOPOLIS S2	01/12/2019 07:56	01/12/2019 10:28	01/12/2019 07:56	01/12/2019 10:28	2,53	1	2,53	CHI
201912835	MOZARLANDIA	MZ11158815	MOZARLANDIA	01/12/2019 07:57	01/12/2019 18:36	01/12/2019 07:57	01/12/2019 18:36	10,65	15	159,72	CHI
201912839	JUSSARA	JR12341198	JUSSARA	01/12/2019 06:11	01/12/2019 15:15	01/12/2019 06:11	01/12/2019 15:15	9,07	7	63,46	CHI
201912841	NOVA IGUACU DE GOIAS	NH12202119	CAMPINORTE	01/12/2019 07:32	02/12/2019 16:56	01/12/2019 07:32	02/12/2019 16:56	33,40	8	267,18	CHI
201912851	GOIAS	GS12162488	GOIAS	01/12/2019 07:59	01/12/2019 17:55	01/12/2019 07:59	01/12/2019 17:55	9,94	6	59,62	CHI
201912854	MINEIROS	MY12054714	PARQUE DAS EMAS	01/12/2019 07:59	02/12/2019 10:11	01/12/2019 07:59	02/12/2019 10:11	26,19	3	78,57	CHI
201912856	TURVANIA	TV12026469	FIRMINOPOLIS S1	01/12/2019 07:54	01/12/2019 09:40	01/12/2019 07:54	01/12/2019 09:40	1,77	7	12,41	CHI
201912859	DOVERLANDIA	DV12235070	PARQUE DAS EMAS	01/12/2019 08:00	01/12/2019 10:59	01/12/2019 08:00	01/12/2019 10:59	2,97	5	14,84	CHI
201912863	FAZENDA NOVA	FN21232159	BRITANIA	01/12/2019 08:01	01/12/2019 16:50	01/12/2019 08:01	01/12/2019 16:50	8,81	1	8,81	CHI
201912870	BONOPOLIS	PO21189508	NOVO PLANALTO	01/12/2019 08:02	01/12/2019 16:12	01/12/2019 08:02	01/12/2019 16:12	8,16	1	8,16	CHI
201912874	NIQUELANDIA	NQ12265691	URUACU	01/12/2019 08:03	02/12/2019 14:45	01/12/2019 08:03	02/12/2019 14:45	30,70	16	491,26	CHI
201912879	CORREGO DO OURO	CO12062738	FIRMINOPOLIS S2	01/12/2019 08:04	01/12/2019 10:20	01/12/2019 08:04	01/12/2019 10:20	2,26	4	9,05	CHI
201912883	CACU	CA12384078	CACHOEIRA ALTA	01/12/2019 06:28	01/12/2019 16:55	01/12/2019 06:28	01/12/2019 16:55	10,44	1	10,44	CHI
201912883	CACHOEIRA ALTA	CA12384078	CACHOEIRA ALTA	01/12/2019 06:28	01/12/2019 16:55	01/12/2019 06:28	01/12/2019 16:55	10,44	8	83,51	CHI
201912897	PALMEIRAS DE GOIAS	PL12304469	PALMEIRAS	01/12/2019 06:27	01/12/2019 09:20	01/12/2019 06:27	01/12/2019 09:20	2,88	3	8,64	CHI
201912905	ADELANDIA	DN21304562	FIRMINOPOLIS S2	01/12/2019 08:08	01/12/2019 12:51	01/12/2019 08:08	01/12/2019 12:51	4,71	1	4,71	CHI

201912909	BOM JARDIM DE GOIAS	BM12065619	BOM JARDIM	01/12/2019 08:09	01/12/2019 13:59	01/12/2019 08:09	01/12/2019 13:59	5,83	1	5,83	CHI
201912912	MAURILANDIA	ML32085705	RIO DOS BOIS	01/12/2019 08:09	01/12/2019 17:18	01/12/2019 08:09	01/12/2019 17:18	9,15	1	9,15	CHI
201912926	ITABERAI	IB21217052	ITABERAI S2	01/12/2019 08:11	01/12/2019 10:00	01/12/2019 08:11	01/12/2019 10:00	1,81	1	1,81	CHI
201912930	BONOPOLIS	PO21103382	SAO MIGUEL DO ARAGUAIA	01/12/2019 08:11	01/12/2019 17:21	01/12/2019 08:11	01/12/2019 17:21	9,15	1	9,15	CHI
201912938	JATAI	290148935	JATAI S2	01/12/2019 08:13	01/12/2019 16:54	01/12/2019 08:13	01/12/2019 16:54	8,69	1	8,69	CHI
201912943	PARANAIGUARA	PC12000129	CACHOEIRA ALTA	01/12/2019 08:13	01/12/2019 11:50	01/12/2019 08:13	01/12/2019 11:50	3,61	24	86,63	CHI
201912961	CRIXAS	UP12248237	SANTA TEREZINHA	01/12/2019 08:16	02/12/2019 15:21	01/12/2019 08:16	02/12/2019 15:21	31,07	2	62,14	CHI
201912961	UIRAPURU	UP12248237	SANTA TEREZINHA	01/12/2019 08:16	02/12/2019 15:21	01/12/2019 08:16	02/12/2019 15:21	31,07	2	62,14	CHI
201912964	GUARINOS	GF12051406	SANTA TEREZINHA	01/12/2019 07:31	02/12/2019 17:06	01/12/2019 07:31	02/12/2019 17:06	33,57	9	302,14	CHI
201912964	SANTA TEREZINHA DE GOIAS	GF12051406	SANTA TEREZINHA	01/12/2019 07:31	02/12/2019 17:06	01/12/2019 07:31	02/12/2019 17:06	33,57	4	134,28	CHI
201912967	RIO VERDE	RV12384584	SANTA HELENA S1	01/12/2019 08:17	01/12/2019 13:10	01/12/2019 08:17	01/12/2019 13:10	4,87	22	107,12	CHI
201912967	SANTA HELENA DE GOIAS	RV12384584	SANTA HELENA S1	01/12/2019 08:17	01/12/2019 13:10	01/12/2019 08:17	01/12/2019 13:10	4,87	1	4,87	CHI
201912973	PALMEIRAS DE GOIAS	PL21000024	PALMEIRAS	01/12/2019 08:18	01/12/2019 11:35	01/12/2019 08:18	01/12/2019 11:35	3,28	1	3,28	CHI
201912974	RUBIATABA	RB12290996	RUBIATABA	01/12/2019 05:27	02/12/2019 09:55	01/12/2019 05:27	02/12/2019 09:55	28,46	9	256,15	CHI
201912975	FIRMINOPOLIS	FR12013010	FIRMINOPOLIS S1	01/12/2019 08:19	01/12/2019 10:15	01/12/2019 08:19	01/12/2019 10:15	1,93	4	7,74	CHI
201912994	NOVA CRIXAS	NA12091638	NOVA CRIXAS	01/12/2019 05:58	01/12/2019 23:45	01/12/2019 05:58	01/12/2019 23:45	17,78	9	160,05	CHI
2019121002	MONTES CLAROS DE GOIAS	ME21144414	IPORA	01/12/2019 08:25	01/12/2019 19:25	01/12/2019 08:25	01/12/2019 19:25	11,00	1	11,00	CHI
2019121004	ITAGUARU	HE12300137	ITAPURANGA	01/12/2019 07:34	01/12/2019 12:26	01/12/2019 07:34	01/12/2019 12:26	4,87	12	58,44	CHI
2019121004	HEITORAI	HE12300137	ITAPURANGA	01/12/2019 07:34	01/12/2019 12:26	01/12/2019 07:34	01/12/2019 12:26	4,87	78	379,86	CHI
2019121013	ITAGUARI	IC12219941	ITABERAI S1	01/12/2019 05:22	01/12/2019 21:56	01/12/2019 05:22	01/12/2019 21:56	16,56	31	513,42	CHI
2019121013	ITAGUARU	IC12219941	ITABERAI S1	01/12/2019 05:22	01/12/2019 21:56	01/12/2019 05:22	01/12/2019 21:56	16,56	21	347,80	CHI
2019121019	PARAUNA	PU12396131	MONTIVIDIU T	01/12/2019 08:27	01/12/2019 10:15	01/12/2019 08:27	01/12/2019 10:15	1,79	9	16,11	CHI
2019121027	JUSSARA	JR12198907	BRITANIA	01/12/2019 08:01	02/12/2019 08:26	01/12/2019 08:01	02/12/2019 08:26	24,40	36	878,54	CHI
2019121030	CRIXAS	CX21364261	SANTA TEREZINHA	01/12/2019 08:29	02/12/2019 17:39	01/12/2019 08:29	02/12/2019 17:39	33,17	1	33,17	CHI
2019121032	DOVERLANDIA	DV12138540	CAIAPONIA	01/12/2019 08:29	01/12/2019 17:36	01/12/2019 08:29	01/12/2019 17:36	9,11	9	81,98	CHI
2019121037	BALIZA	BH12381003	BOM JARDIM	01/12/2019 06:45	01/12/2019 11:13	01/12/2019 06:45	01/12/2019 11:13	4,45	23	102,46	CHI
2019121038	QUIRINOPOLIS	QI21350063	QUIRINOPOLIS	01/12/2019 08:30	01/12/2019 14:00	01/12/2019 08:30	01/12/2019 14:00	5,50	1	5,50	CHI
2019121043	CAMPOS VERDES	VD12201662	SANTA TEREZINHA	01/12/2019 08:30	02/12/2019 23:17	01/12/2019 08:30	02/12/2019 23:17	38,77	5	193,87	CHI
2019121044	BRITANIA	BT21009922	BRITANIA	01/12/2019 08:30	01/12/2019 13:46	01/12/2019 08:30	01/12/2019 13:46	5,26	1	5,26	CHI
2019121050	NIQUELANDIA	NQ12235366	NIQUELANDIA SUBTRANSMISSAO	01/12/2019 08:00	02/12/2019 07:30	01/12/2019 08:00	02/12/2019 07:30	23,49	3	70,46	CHI
2019121055	MUTUNOPOLIS	MU12391658	MARA ROSA	30/11/2019 23:20	01/12/2019 19:35	30/11/2019 23:20	01/12/2019 19:35	20,25	34	688,38	CHI
2019121062	SAO LUIS DE MONTES BELOS	SL21156471	FIRMINOPOLIS S1	01/12/2019 08:33	01/12/2019 10:36	01/12/2019 08:33	01/12/2019 10:36	2,04	1	2,04	CHI
2019121065	CRIXAS	CX12235697	SERRA DO OURO	01/12/2019 06:54	02/12/2019 18:08	01/12/2019 06:54	02/12/2019 18:08	35,22	49	1725,94	CHI

2019121066	JATAI	JT12210133	JATAI S1	01/12/2019 08:34	01/12/2019 13:41	01/12/2019 08:34	01/12/2019 13:41	5,11	5	25,57	CHI
2019121075	FAZENDA NOVA	1080023103	BRITANIA	01/12/2019 08:35	01/12/2019 18:26	01/12/2019 08:35	01/12/2019 18:26	9,84	1	9,84	CHI
2019121081	COLINAS DO SUL	TI21295045	MINACU	01/12/2019 08:36	02/12/2019 07:44	01/12/2019 08:36	02/12/2019 07:44	23,12	1	23,12	CHI
2019121085	ITARUMA	8770907	ITAJA S2	01/12/2019 08:36	01/12/2019 11:50	01/12/2019 08:36	01/12/2019 11:50	3,23	2	6,45	CHI
2019121086	RIO VERDE	RV12214125	RIO VERDE S1	01/12/2019 08:37	01/12/2019 16:35	01/12/2019 08:37	01/12/2019 16:35	7,96	13	103,51	CHI
2019121089	CAMPOS VERDES	VD12054418	SANTA TEREZINHA	01/12/2019 07:58	03/12/2019 08:05	01/12/2019 07:58	03/12/2019 08:05	48,11	6	288,67	CHI
2019121093	MINEIROS	MY12244759	PARQUE DAS EMAS	01/12/2019 08:38	01/12/2019 15:19	01/12/2019 08:38	01/12/2019 15:19	6,67	6	40,03	CHI
2019121099	AURILANDIA	AI12377179	FIRMINOPOLIS S2	01/12/2019 07:43	01/12/2019 10:15	01/12/2019 07:43	01/12/2019 10:15	2,54	3	7,63	CHI
2019121108	PARAUNA	PU21148162	PARAUNA	30/11/2019 22:36	01/12/2019 11:55	30/11/2019 22:36	01/12/2019 11:55	13,31	2	26,61	CHI
2019121109	PARAUNA	PU12198702	PARAUNA	01/12/2019 07:05	01/12/2019 10:27	01/12/2019 07:05	01/12/2019 10:27	3,35	2	6,70	CHI
2019121110	PARAUNA	PU21103326	PARAUNA	01/12/2019 07:24	01/12/2019 13:57	01/12/2019 07:24	01/12/2019 13:57	6,56	1	6,56	CHI
2019121116	QUIRINOPOLIS	QI12052484	QUIRINOPOLIS	01/12/2019 08:23	01/12/2019 14:45	01/12/2019 08:23	01/12/2019 14:45	6,37	11	70,02	CHI
2019121117	RIO VERDE	630343366	RIO VERDE S2	01/12/2019 08:43	01/12/2019 11:30	01/12/2019 08:43	01/12/2019 11:30	2,79	1	2,79	CHI
2019121118	IPORA	IR12070218	IPORA	01/12/2019 08:43	01/12/2019 18:39	01/12/2019 08:43	01/12/2019 18:39	9,94	2	19,87	CHI
2019121123	AMARALINA	LC12270203	SAO MIGUEL DO ARAGUAIA	01/12/2019 07:35	01/12/2019 10:35	01/12/2019 07:35	01/12/2019 10:35	2,99	9	26,87	CHI
2019121125	MAURILANDIA	RV12026877	RIO DOS BOIS	01/12/2019 08:13	01/12/2019 20:16	01/12/2019 08:13	01/12/2019 20:16	12,04	11	132,45	CHI
2019121125	MAURILANDIA	ML12303327	RIO DOS BOIS	01/12/2019 08:13	01/12/2019 20:16	01/12/2019 08:13	01/12/2019 20:16	12,04	9	108,36	CHI
2019121125	MAURILANDIA	ML12303327	RIO DOS BOIS	01/12/2019 08:13	01/12/2019 20:16	01/12/2019 14:35	01/12/2019 20:16	5,69	6	34,12	CHI
2019121128	IVOLANDIA	PU12090442	MONTIVIDIU T	01/12/2019 08:43	01/12/2019 21:25	01/12/2019 08:43	01/12/2019 21:25	12,70	22	279,42	CHI
2019121128	PARAUNA	PU12090442	MONTIVIDIU T	01/12/2019 08:43	01/12/2019 21:25	01/12/2019 08:43	01/12/2019 21:25	12,70	49	622,35	CHI
2019121129	JATAI	JT12226459	JATAI S1	01/12/2019 08:44	01/12/2019 16:54	01/12/2019 08:44	01/12/2019 16:54	8,16	2	16,31	CHI
2019121132	PORTELANDIA	PW21226543	PARQUE DAS EMAS	01/12/2019 08:45	02/12/2019 12:24	01/12/2019 08:45	02/12/2019 12:24	27,65	1	27,65	CHI
2019121140	QUIRINOPOLIS	QI21315188	QUIRINOPOLIS	01/12/2019 08:45	01/12/2019 15:31	01/12/2019 08:45	01/12/2019 15:31	6,76	1	6,76	CHI
2019121155	RIO VERDE	RV11228295	MONTIVIDIU T	01/12/2019 08:48	01/12/2019 13:05	01/12/2019 08:48	01/12/2019 13:05	4,27	1	4,27	CHI
2019121156	PARAUNA	PU12244168	PARAUNA	01/12/2019 08:48	01/12/2019 10:00	01/12/2019 08:48	01/12/2019 10:00	1,20	1	1,20	CHI
2019121168	GOIAS	GS12274242	MATRINCHA	01/12/2019 08:50	01/12/2019 10:05	01/12/2019 08:50	01/12/2019 10:05	1,24	92	114,44	CHI
2019121170	CAIAPONIA	CP12200875	CAIAPONIA	01/12/2019 08:31	01/12/2019 13:45	01/12/2019 08:31	01/12/2019 13:45	5,23	9	47,09	CHI
2019121175	PALMEIRAS DE GOIAS	PL12395109	PALMEIRAS	01/12/2019 08:51	01/12/2019 13:15	01/12/2019 08:51	01/12/2019 13:15	4,40	6	26,38	CHI
2019121192	URUACU	UR21350236	URUACU	01/12/2019 08:55	01/12/2019 12:15	01/12/2019 08:55	01/12/2019 12:15	3,32	5	16,62	CHI
2019121193	ITAPIRAPUA	IU21018851	MATRINCHA	01/12/2019 08:55	01/12/2019 11:30	01/12/2019 08:55	01/12/2019 11:30	2,57	1	2,57	CHI
2019121194	GOIAS	GS21148816	GOIAS	01/12/2019 08:55	01/12/2019 10:03	01/12/2019 08:55	01/12/2019 10:03	1,12	1	1,12	CHI
2019121202	JATAI	JT21260352	JATAI S1	01/12/2019 08:57	01/12/2019 13:59	01/12/2019 08:57	01/12/2019 13:59	5,03	2	10,05	CHI
2019121205	FORMOSO	FO12285186	PORANGATU	30/11/2019 22:37	01/12/2019 11:08	30/11/2019 22:37	01/12/2019 11:08	12,51	8	100,07	CHI

2019121212	SANTA HELENA DE GOIAS	SH12296172	IPEGUARI	01/12/2019 07:13	01/12/2019 09:55	01/12/2019 07:13	01/12/2019 09:55	2,70	51	137,63	CHI
2019121214	AURILANDIA	AI21000012	FIRMINOPOLIS S2	01/12/2019 08:58	01/12/2019 10:50	01/12/2019 08:58	01/12/2019 10:50	1,87	1	1,87	CHI
2019121220	NIQUELANDIA	NQ12265772	NIQUELANDIA SUBTRANSMISSAO	01/12/2019 08:59	02/12/2019 21:34	01/12/2019 08:59	02/12/2019 21:34	36,57	3	109,70	CHI
2019121234	NOVA CRIXAS	NA12213190	MOZARLANDIA	01/12/2019 06:01	01/12/2019 23:27	01/12/2019 06:01	01/12/2019 23:27	17,42	23	400,64	CHI
2019121263	NOVA CRIXAS	NA12151310	MOZARLANDIA	01/12/2019 08:44	02/12/2019 14:11	01/12/2019 08:44	02/12/2019 14:11	29,44	6	176,64	CHI
2019121322	ESTRELA DO NORTE	ET12136395	MARA ROSA	01/12/2019 06:20	01/12/2019 22:32	01/12/2019 06:20	01/12/2019 22:32	16,19	11	178,08	CHI
2019121322	MARA ROSA	ET12136395	MARA ROSA	01/12/2019 06:20	01/12/2019 22:32	01/12/2019 06:20	01/12/2019 22:32	16,19	8	129,51	CHI
2019121345	UIRAPURU	UP12392295	SANTA TEREZINHA	30/11/2019 22:40	01/12/2019 16:27	30/11/2019 22:40	01/12/2019 16:27	17,78	5	88,92	CHI
2019121365	CRIXAS	CX12248236	SERRA DO OURO	01/12/2019 08:10	02/12/2019 14:30	01/12/2019 08:10	02/12/2019 14:30	30,32	6	181,91	CHI
2019121369	TURVELANDIA	SH12301062	RIO DOS BOIS	01/12/2019 07:14	01/12/2019 14:40	01/12/2019 07:14	01/12/2019 14:40	7,42	3	22,27	CHI
2019121369	SANTA HELENA DE GOIAS	SH12301062	RIO DOS BOIS	01/12/2019 07:14	01/12/2019 14:40	01/12/2019 07:14	01/12/2019 14:40	7,42	3	22,27	CHI
2019121496	PORANGATU	PO12391649	PORANGATU	01/12/2019 07:23	01/12/2019 21:31	01/12/2019 07:23	01/12/2019 21:31	14,12	4	56,47	CHI
2019121501	NOVA AMERICA	NM12087557	RUBIATABA	01/12/2019 07:40	02/12/2019 11:11	01/12/2019 07:40	02/12/2019 11:11	27,52	3	82,56	CHI
2019121508	CRIXAS	CX12239577	SANTA TEREZINHA	01/12/2019 08:02	02/12/2019 03:47	01/12/2019 08:02	02/12/2019 03:47	19,74	16	315,81	CHI
2019121599	BALIZA	BH12331395	CAIAPONIA	01/12/2019 07:49	01/12/2019 19:31	01/12/2019 07:49	01/12/2019 19:31	11,69	70	818,51	CHI
2019121608	PORANGATU	PO12282160	PORANGATU	01/12/2019 05:38	01/12/2019 17:36	01/12/2019 05:38	01/12/2019 17:36	11,95	11	131,47	CHI
2019121769	URUACU	UR12210932	URUACU	30/11/2019 18:09	01/12/2019 19:00	30/11/2019 18:09	01/12/2019 19:00	24,84	29	720,30	CHI
2019121769	NOVA IGUACU DE GOIAS	UR12210932	URUACU	30/11/2019 18:09	01/12/2019 19:00	30/11/2019 18:09	01/12/2019 19:00	24,84	20	496,76	CHI
2019121769	PILAR DE GOIAS	UR12210932	URUACU	30/11/2019 18:09	01/12/2019 19:00	30/11/2019 18:09	01/12/2019 19:00	24,84	1	24,84	CHI
2019121784	MOZARLANDIA	MZ21238767	MOZARLANDIA	01/12/2019 07:58	02/12/2019 11:40	01/12/2019 07:58	02/12/2019 11:40	27,71	1	27,71	CHI
2019121812	INACIOLANDIA	ID32128272	QUIRINOPOLIS	01/12/2019 08:29	01/12/2019 17:02	01/12/2019 08:29	01/12/2019 17:02	8,54	8	68,35	CHI
2019121870	PORANGATU	PO12256448	NOVO PLANALTO	01/12/2019 08:35	02/12/2019 11:17	01/12/2019 08:35	02/12/2019 11:17	26,69	8	213,49	CHI
2019121889	MOZARLANDIA	MZ12245804	MOZARLANDIA	01/12/2019 07:11	01/12/2019 18:10	01/12/2019 07:11	01/12/2019 18:10	10,97	2	21,94	CHI
2019121913	FAINA	FC12038664	GOIAS	01/12/2019 08:28	01/12/2019 16:30	01/12/2019 08:28	01/12/2019 16:30	8,03	10	80,26	CHI
2019121936	HEITORAI	HE12220534	ITAPURANGA	01/12/2019 08:29	01/12/2019 16:14	01/12/2019 08:29	01/12/2019 16:14	7,76	6	46,58	CHI
2019122036	VILA PROPICIO	10029675063	GOIANESIA S1	30/11/2019 07:08	01/12/2019 15:56	30/11/2019 07:08	01/12/2019 15:56	32,80	1	32,80	CHI
2019122169	JATAI	IM12234538	CACHOEIRA ALTA	01/12/2019 06:21	01/12/2019 15:26	01/12/2019 06:21	01/12/2019 15:26	9,07	20	181,48	CHI
2019122169	ITARUMA	IM12234538	CACHOEIRA ALTA	01/12/2019 06:21	01/12/2019 15:26	01/12/2019 06:21	01/12/2019 15:26	9,07	34	308,51	CHI
2019122169	CACU	IM12234538	CACHOEIRA ALTA	01/12/2019 06:21	01/12/2019 15:26	01/12/2019 06:21	01/12/2019 15:26	9,07	60	544,43	CHI
2019122263	ITAGUARI	IC12035368	ITABERAI S1	01/12/2019 04:43	01/12/2019 21:01	01/12/2019 04:43	01/12/2019 21:01	16,30	27	440,04	CHI
2019122263	JARAGUA	IC12035368	ITABERAI S1	01/12/2019 04:43	01/12/2019 21:01	01/12/2019 04:43	01/12/2019 21:01	16,30	8	130,38	CHI
2019122351	NIQUELANDIA	TI12239430	MINACU	01/12/2019 07:48	01/12/2019 19:17	01/12/2019 07:48	01/12/2019 19:17	11,48	1	11,48	CHI
2019122351	COLINAS DO SUL	TI12239430	MINACU	01/12/2019 07:48	01/12/2019 19:17	01/12/2019 07:48	01/12/2019 19:17	11,48	26	298,50	CHI



2019122399	BALIZA	BH12390192	CAIAPONIA	01/12/2019 07:53	01/12/2019 18:12	01/12/2019 07:53	01/12/2019 18:12	10,31	11	113,38	CHI
2019122632	RUBIATABA	RB12232743	RUBIATABA	01/12/2019 08:32	02/12/2019 13:38	01/12/2019 08:32	02/12/2019 13:38	29,08	2	58,17	CHI
2019122824	RIO VERDE	RV12326911	MONTIVIDIU T	01/12/2019 07:48	01/12/2019 20:12	01/12/2019 07:48	01/12/2019 20:12	12,40	4	49,58	CHI
2019122912	SANTA TEREZINHA DE GOIAS	SG12287593	SANTA TEREZINHA	01/12/2019 07:09	02/12/2019 09:34	01/12/2019 07:09	02/12/2019 09:34	26,41	2	52,82	CHI
2019123182	VILA PROPICIO	NP21307139	BARRO ALTO	30/11/2019 14:45	02/12/2019 16:55	30/11/2019 14:45	02/12/2019 16:55	50,15	1	50,15	CHI
2019123548	SANTA TEREZINHA DE GOIAS	SG12213220	SANTA TEREZINHA	01/12/2019 06:27	03/12/2019 01:27	01/12/2019 06:27	03/12/2019 01:27	42,99	47	2020,54	CHI
2019123851	CAMPINORTE	CR12094178	CAMPINORTE	01/12/2019 06:50	02/12/2019 02:07	01/12/2019 06:50	02/12/2019 02:07	19,28	11	212,04	CHI
2019123858	MINACU	CR12234938	PORANGATU	01/12/2019 08:12	02/12/2019 11:47	01/12/2019 08:12	02/12/2019 11:47	27,58	42	1158,50	CHI
2019123858	CAMPINORTE	CR12234938	PORANGATU	01/12/2019 08:12	02/12/2019 11:47	01/12/2019 08:12	02/12/2019 11:47	27,58	19	524,08	CHI
2019123963	MINEIROS	MY12332631	PARQUE DAS EMAS	01/12/2019 07:38	01/12/2019 21:18	01/12/2019 07:38	01/12/2019 21:18	13,66	7	95,61	CHI
2019124023	JUSSARA	1290062551	BRITANIA	01/12/2019 08:06	02/12/2019 11:10	01/12/2019 08:06	02/12/2019 11:10	27,06	1	27,06	CHI
2019124253	MONTIVIDIU DO NORTE	MX12187847	PORANGATU	01/12/2019 06:53	01/12/2019 22:28	01/12/2019 06:53	01/12/2019 22:28	15,58	29	451,78	CHI
2019126968	CRIXAS	CX21181634	SERRA DO OURO	30/11/2019 19:29	02/12/2019 10:41	30/11/2019 19:29	02/12/2019 10:41	39,20	1	39,20	CHI
201911338616	GOIANESIA	GE21401942	GOIANESIA S2	28/11/2019 07:25	28/11/2019 10:11	28/11/2019 07:25	28/11/2019 10:11	2,77	1	2,77	CHI
201911340238	SANTA FE DE GOIAS	RN12324624	BRITANIA	27/11/2019 13:14	27/11/2019 18:01	27/11/2019 13:14	27/11/2019 18:01	4,79	4	19,16	CHI
201911341388	BOM JARDIM DE GOIAS	BM10396904	BOM JARDIM	27/11/2019 09:57	27/11/2019 14:52	27/11/2019 09:57	27/11/2019 13:28	3,52	160	563,60	CHI
201911341388	BOM JARDIM DE GOIAS	BM10396904	BOM JARDIM	27/11/2019 09:57	27/11/2019 14:52	27/11/2019 09:57	27/11/2019 14:52	4,92	125	615,56	CHI
201911341388	BALIZA	BM10396904	BOM JARDIM	27/11/2019 09:57	27/11/2019 14:52	27/11/2019 09:57	27/11/2019 14:52	4,92	53	261,00	CHI
201911341388	PIRANHAS	BM13334770	BOM JARDIM	27/11/2019 09:57	27/11/2019 14:52	27/11/2019 12:13	27/11/2019 14:52	2,65	4	10,61	CHI
201911341388	BOM JARDIM DE GOIAS	BM13334770	BOM JARDIM	27/11/2019 09:57	27/11/2019 14:52	27/11/2019 12:13	27/11/2019 14:52	2,65	7	18,57	CHI
201911343216	JANDAIA	JD21314906	PALMEIRAS	27/11/2019 09:48	27/11/2019 19:00	27/11/2019 09:48	27/11/2019 19:00	9,19	1	9,19	CHI
201911343218	MATRINCHA	MP21073651	MATRINCHA	27/11/2019 09:49	27/11/2019 12:40	27/11/2019 09:49	27/11/2019 12:40	2,85	1	2,85	CHI
201911343225	ISRAELANDIA	IS21188918	IPORA	27/11/2019 09:50	27/11/2019 11:19	27/11/2019 09:50	27/11/2019 11:19	1,48	1	1,48	CHI
201911343236	AMERICANO DO BRASIL	KB21188608	ANICUNS	27/11/2019 09:47	27/11/2019 17:03	27/11/2019 09:47	27/11/2019 17:03	7,27	1	7,27	CHI
201911343405	JANDAIA	PL21189958	PALMEIRAS	27/11/2019 09:57	27/11/2019 10:55	27/11/2019 09:57	27/11/2019 10:55	0,97	2	1,94	CHI
201911343419	MINEIROS	MY21336364	PARQUE DAS EMAS	27/11/2019 10:00	27/11/2019 14:59	27/11/2019 10:00	27/11/2019 14:59	4,98	1	4,98	CHI
201911343428	CACU	CC21271253	CACHOEIRA ALTA	27/11/2019 10:01	28/11/2019 12:44	27/11/2019 10:01	28/11/2019 12:44	26,70	1	26,70	CHI
201911343434	GOIAS	GS12162481	GOIAS	27/11/2019 09:50	27/11/2019 18:05	27/11/2019 09:50	27/11/2019 18:05	8,24	10	82,41	CHI
201911343444	AURILANDIA	AI21048683	FIRMINOPOLIS S2	27/11/2019 10:04	27/11/2019 13:20	27/11/2019 10:04	27/11/2019 13:20	3,26	1	3,26	CHI
201911343448	BOM JARDIM DE GOIAS	1880019570	BOM JARDIM	27/11/2019 10:04	27/11/2019 13:50	27/11/2019 10:04	27/11/2019 13:50	3,77	1	3,77	CHI
201911343461	ARAGARCAS	AG21234267	ARAGARCAS	27/11/2019 10:06	27/11/2019 12:22	27/11/2019 10:06	27/11/2019 12:22	2,25	1	2,25	CHI
201911343483	BRITANIA	BT12106205	BRITANIA	28/11/2019 21:13	30/11/2019 12:12	28/11/2019 21:14	29/11/2019 18:12	20,97	1	20,97	CHI
201911343483	BRITANIA	BT12106207	BRITANIA	28/11/2019 21:13	30/11/2019 12:12	28/11/2019 21:13	30/11/2019 12:12	38,97	8	311,78	CHI

201911343495	QUIRINOPOLIS	10018281875	QUIRINOPOLIS	27/11/2019 10:13	27/11/2019 12:23	27/11/2019 10:13	27/11/2019 12:23	2,16	1	2,16	CHI
201911343520	MINEIROS	MY21210132	PARQUE DAS EMAS	27/11/2019 10:18	28/11/2019 11:50	27/11/2019 10:18	28/11/2019 11:50	25,52	1	25,52	CHI
201911343526	PALESTINA DE GOIAS	PY12395436	PALESTINA	27/11/2019 10:19	27/11/2019 19:57	27/11/2019 10:19	27/11/2019 19:57	9,62	5	48,09	CHI
201911343606	BALIZA	BH12238881	BOM JARDIM	27/11/2019 10:24	27/11/2019 19:41	27/11/2019 10:24	27/11/2019 19:41	9,27	1	9,27	CHI
201911343709	RIO VERDE	MV12126908	MONTIVIDIU T	27/11/2019 10:26	27/11/2019 16:43	27/11/2019 10:26	27/11/2019 16:43	6,28	1	6,28	CHI
201911343709	MONTIVIDIU	MV12126908	MONTIVIDIU T	27/11/2019 10:26	27/11/2019 16:43	27/11/2019 10:26	27/11/2019 16:43	6,28	4	25,12	CHI
201911343710	IPORA	IR21289225	IPORA	27/11/2019 10:26	27/11/2019 15:11	27/11/2019 10:26	27/11/2019 15:11	4,75	1	4,75	CHI
201911343739	CACHOEIRA DE GOIAS	CG21171029	FIRMINOPOLIS S2	27/11/2019 10:30	28/11/2019 09:15	27/11/2019 10:30	28/11/2019 09:15	22,75	1	22,75	CHI
201911343746	QUIRINOPOLIS	QI21226697	SANTA HELENA S1	27/11/2019 10:31	27/11/2019 12:47	27/11/2019 10:31	27/11/2019 12:47	2,25	2	4,51	CHI
201911343754	MOSSAMEDES	MD21157128	ITABERAI S2	27/11/2019 10:32	27/11/2019 11:45	27/11/2019 10:32	27/11/2019 11:45	1,21	1	1,21	CHI
201911343761	SANTO ANTONIO DO DESCOBERTO	7595769	ALEXANIA	27/11/2019 12:17	28/11/2019 17:18	27/11/2019 12:17	28/11/2019 17:18	29,01	1	29,01	CHI
201911343761	BARRO ALTO	7595769	ALEXANIA	27/11/2019 12:17	28/11/2019 17:18	27/11/2019 12:17	28/11/2019 17:18	29,01	2	58,03	CHI
201911343761	ALEXANIA	7595769	ALEXANIA	27/11/2019 12:17	28/11/2019 17:18	27/11/2019 12:17	28/11/2019 17:18	29,01	376	10909,43	CHI
201911343761	ALEXANIA	03650214	ALEXANIA	27/11/2019 12:17	28/11/2019 17:18	27/11/2019 18:35	28/11/2019 17:18	22,71	8	181,67	CHI
201911343763	CACHOEIRA ALTA	CA12193930LD	CACHOEIRA ALTA	28/11/2019 19:50	29/11/2019 02:30	28/11/2019 19:50	29/11/2019 02:30	6,66	1	6,66	CHI
201911343767	JATAI	JT21387369	MONTIVIDIU T	27/11/2019 10:35	27/11/2019 13:31	27/11/2019 10:35	27/11/2019 13:31	2,92	1	2,92	CHI
201911343775	APARECIDA DE GOIANIA	13609233	INDEPENDENCIA S1	27/11/2019 10:37	27/11/2019 13:30	27/11/2019 10:37	27/11/2019 13:30	2,88	1	2,88	CHI
201911343782	GOIANIA	16749418	MEIA PONTE	27/11/2019 10:38	27/11/2019 11:51	27/11/2019 10:38	27/11/2019 11:51	1,21	1	1,21	CHI
201911343784	GOIANIA	10002947798	MEIA PONTE	27/11/2019 10:39	27/11/2019 11:40	27/11/2019 10:39	27/11/2019 11:40	1,01	1	1,01	CHI
201911343811	ITAPURANGA	IK11061595	ITAPURANGA	27/11/2019 11:01	27/11/2019 13:18	27/11/2019 11:01	27/11/2019 13:18	2,28	152	345,97	CHI
201911343833	APARECIDA DE GOIANIA	10005057556	CARAJAS S1	27/11/2019 11:58	27/11/2019 13:58	27/11/2019 11:58	27/11/2019 13:58	1,99	1	1,99	CHI
201911343895	RIO VERDE	RV11360957	RIO VERDE S2	27/11/2019 16:14	28/11/2019 00:40	27/11/2019 16:14	28/11/2019 00:40	8,45	115	971,27	CHI
201911343901	PALMEIRAS DE GOIAS	PL11215478	PALMEIRAS	27/11/2019 10:42	27/11/2019 11:48	27/11/2019 10:42	27/11/2019 11:48	1,09	137	150,01	CHI
201911344003	SAO FRANCISCO DE GOIAS	SF12319863	SAO FRANCISCO DE GOIAS	27/11/2019 12:07	27/11/2019 13:41	27/11/2019 12:07	27/11/2019 13:41	1,56	7	10,94	CHI
201911344014	RIO VERDE	630020681	RIO VERDE S1	27/11/2019 10:48	27/11/2019 13:33	27/11/2019 10:48	27/11/2019 13:33	2,76	1	2,76	CHI
201911344016	CACHOEIRA DE GOIAS	CG12391526	FIRMINOPOLIS S2	27/11/2019 10:13	27/11/2019 15:18	27/11/2019 10:13	27/11/2019 15:18	5,07	11	55,76	CHI
201911344016	PARAUNA	CG12391526	FIRMINOPOLIS S2	27/11/2019 10:13	27/11/2019 15:18	27/11/2019 10:13	27/11/2019 15:18	5,07	32	162,22	CHI
201911344016	AURILANDIA	CG12391526	FIRMINOPOLIS S2	27/11/2019 10:13	27/11/2019 15:18	27/11/2019 10:13	27/11/2019 15:18	5,07	2	10,14	CHI
201911344017	QUIRINOPOLIS	QI31249039	QUIRINOPOLIS	27/11/2019 10:48	27/11/2019 13:01	27/11/2019 10:48	27/11/2019 13:01	2,21	1	2,21	CHI
201911344104	GOIANIA	16431352	GOIANIA LESTE S1	27/11/2019 10:52	27/11/2019 11:56	27/11/2019 10:52	27/11/2019 11:56	1,06	1	1,06	CHI
201911344108	SAO JOAO DA PARAUNA	RP21299211	FIRMINOPOLIS S2	27/11/2019 10:52	27/11/2019 14:14	27/11/2019 10:52	27/11/2019 14:14	3,35	1	3,35	CHI
201911344116	GOIANIA	11776237	REAL S1	27/11/2019 10:55	27/11/2019 17:24	27/11/2019 10:55	27/11/2019 17:24	6,48	1	6,48	CHI
201911344126	QUIRINOPOLIS	RV12029069	SANTA HELENA S1	27/11/2019 10:57	28/11/2019 17:45	27/11/2019 10:57	28/11/2019 17:45	30,80	3	92,40	CHI

201911344126	RIO VERDE	RV12029069	SANTA HELENA S1	27/11/2019 10:57	28/11/2019 17:45	28/11/2019 13:43	28/11/2019 17:45	4,05	3	12,14	CHI
201911344126	QUIRINOPOLIS	RV12029069	SANTA HELENA S1	27/11/2019 10:57	28/11/2019 17:45	28/11/2019 13:43	28/11/2019 17:45	4,05	1	4,05	CHI
201911344130	JATAI	JT12378176	JATAI S1	27/11/2019 10:58	27/11/2019 13:46	27/11/2019 10:58	27/11/2019 13:46	2,79	2	5,59	CHI
201911344141	GOIANIA	10014702914	CAMPINAS S2	27/11/2019 11:00	27/11/2019 13:32	27/11/2019 11:00	27/11/2019 13:32	2,52	1	2,52	CHI
201911344145	PETROLINA DE GOIAS	SR21073299	INHUMAS S1	27/11/2019 11:01	27/11/2019 20:58	27/11/2019 11:01	27/11/2019 20:58	9,94	1	9,94	CHI
201911344155	BELA VISTA DE GOIAS	BV21020408	BELA VISTA S2	27/11/2019 11:04	27/11/2019 15:09	27/11/2019 11:04	27/11/2019 15:09	4,07	1	4,07	CHI
201911344160	CATALAO	CT21216967	CATALAO S2	27/11/2019 11:06	27/11/2019 12:30	27/11/2019 11:06	27/11/2019 12:30	1,40	1	1,40	CHI
201911344169	GOIANIA	12563213	ATLANTICO S3	27/11/2019 11:07	27/11/2019 13:24	27/11/2019 11:07	27/11/2019 13:24	2,27	1	2,27	CHI
201911344191	BRITANIA	BT12009771	BRITANIA	27/11/2019 11:12	27/11/2019 22:00	27/11/2019 11:12	27/11/2019 22:00	10,81	18	194,54	CHI
201911344192	SERRANOPOLIS	DJ12164061	CHAPADAO DO CEU	27/11/2019 11:12	27/11/2019 14:55	27/11/2019 11:12	27/11/2019 14:55	3,71	2	7,41	CHI
201911344193	ACREUNA	EU12355036	ACREUNA	27/11/2019 11:12	27/11/2019 14:20	27/11/2019 11:12	27/11/2019 14:20	3,14	1	3,14	CHI
201911344198	CATALAO	1990168313	CATALAO S2	27/11/2019 11:13	27/11/2019 14:18	27/11/2019 11:13	27/11/2019 14:18	3,07	1	3,07	CHI
201911344205	CALDAS NOVAS	CN12110086	SERRA DE CALDAS	27/11/2019 11:14	27/11/2019 16:13	27/11/2019 11:14	27/11/2019 16:13	4,97	16	79,48	CHI
201911344207	PIRES DO RIO	460081780	PIRES DO RIO S1	27/11/2019 11:15	27/11/2019 14:29	27/11/2019 11:15	27/11/2019 14:29	3,23	1	3,23	CHI
201911344208	GOIATUBA	GT21048514	GOIATUBA S2	27/11/2019 11:15	27/11/2019 16:33	27/11/2019 11:15	27/11/2019 16:33	5,30	1	5,30	CHI
201911344210	MOSSAMEDES	MD21089238	ITABERAIS S2	27/11/2019 11:16	27/11/2019 15:24	27/11/2019 11:16	27/11/2019 15:24	4,13	1	4,13	CHI
201911344215	ITUMBIARA	IT21000334	ITUMBIARA NOVA	27/11/2019 11:12	27/11/2019 14:00	27/11/2019 11:12	27/11/2019 14:00	2,79	2	5,59	CHI
201911344222	CATALAO	CT12333388	CATALAO S1	27/11/2019 11:20	27/11/2019 20:25	27/11/2019 11:20	27/11/2019 20:25	9,07	1	9,07	CHI
201911344224	PIRACANJUBA	PJ21040032	PIRACANJUBA	27/11/2019 11:21	27/11/2019 15:35	27/11/2019 11:21	27/11/2019 15:35	4,23	1	4,23	CHI
201911344242	CAIAPONIA	10006626058	PIRANHAS	27/11/2019 11:23	27/11/2019 17:45	27/11/2019 11:23	27/11/2019 17:45	6,37	1	6,37	CHI
201911344252	RIO VERDE	630517216	CABRIUVA S1	27/11/2019 11:25	27/11/2019 16:02	27/11/2019 11:25	27/11/2019 16:02	4,61	1	4,61	CHI
201911344258	PARAUNA	PU21312314	MONTIVIDIU T	27/11/2019 11:26	27/11/2019 22:25	27/11/2019 11:26	27/11/2019 22:25	10,97	1	10,97	CHI
201911344263	GOIANIRA	GR32104345	GOIANIRA	27/11/2019 11:27	27/11/2019 15:52	27/11/2019 11:27	27/11/2019 15:52	4,41	2	8,82	CHI
201911344265	INDIARA	2710028974	EDEIA	27/11/2019 11:27	27/11/2019 17:18	27/11/2019 11:27	27/11/2019 17:18	5,86	1	5,86	CHI
201911344269	GOIAS	GS12378882	MATRINCHA	27/11/2019 10:28	27/11/2019 17:31	27/11/2019 10:28	27/11/2019 17:31	7,04	7	49,29	CHI
201911344271	JATAI	JT12248447	JATAI S2	27/11/2019 11:28	27/11/2019 13:29	27/11/2019 11:28	27/11/2019 13:29	2,01	7	14,04	CHI
201911344274	CALDAZINHA	2340008792	CEPAIGO S2	27/11/2019 11:28	27/11/2019 20:24	27/11/2019 11:28	27/11/2019 20:24	8,92	1	8,92	CHI
201911344276	GOIANIA	14811625	INDEPENDENCIA S2	27/11/2019 11:30	27/11/2019 17:12	27/11/2019 11:30	27/11/2019 17:12	5,70	1	5,70	CHI
201911344277	MINEIROS	1390148364	PARQUE DAS EMAS	27/11/2019 11:30	27/11/2019 15:42	27/11/2019 11:30	27/11/2019 15:42	4,19	1	4,19	CHI
201911344279	PONTALINA	ED12223495	PONTALINA	27/11/2019 11:31	27/11/2019 14:55	27/11/2019 11:31	27/11/2019 14:55	3,41	2	6,82	CHI
201911344279	EDEALINA	ED12223495	PONTALINA	27/11/2019 11:31	27/11/2019 14:55	27/11/2019 11:31	27/11/2019 14:55	3,41	4	13,64	CHI
201911344290	JATAI	JT21000150	JATAI S2	27/11/2019 11:33	27/11/2019 13:55	27/11/2019 11:33	27/11/2019 13:55	2,35	1	2,35	CHI
201911344294	GOIANIA	10020786253	CARAJAS S1	27/11/2019 11:34	27/11/2019 15:33	27/11/2019 11:34	27/11/2019 15:33	3,97	1	3,97	CHI

201911344306	SAO SIMAO	PC12000018	CACHOEIRA ALTA	27/11/2019 11:12	28/11/2019 12:05	27/11/2019 11:12	28/11/2019 12:05	24,88	10	248,80	CHI
201911344306	PARANAIGUARA	PC12000018	CACHOEIRA ALTA	27/11/2019 11:12	28/11/2019 12:05	27/11/2019 11:12	28/11/2019 12:05	24,88	33	821,03	CHI
201911344306	CACHOEIRA ALTA	PC12000018	CACHOEIRA ALTA	27/11/2019 11:12	28/11/2019 12:05	27/11/2019 11:12	28/11/2019 12:05	24,88	8	199,04	CHI
201911344312	NOVA CRIXAS	NA11354868	NOVA CRIXAS	27/11/2019 11:37	28/11/2019 13:28	27/11/2019 11:37	28/11/2019 13:28	25,84	1	25,84	CHI
201911344313	GOIANIA	GN11265182	ATLANTICO S2	27/11/2019 10:47	27/11/2019 14:40	27/11/2019 10:47	27/11/2019 14:40	3,88	53	205,54	CHI
201911344319	NIQUELANDIA	NQ11307765	NIQUELANDIA SUBTRANSMISSAO	27/11/2019 11:38	27/11/2019 22:35	27/11/2019 11:38	27/11/2019 22:35	10,94	59	645,69	CHI
201911344326	PEROLANDIA	DP21346701	JATAI S1	27/11/2019 12:06	27/11/2019 12:12	27/11/2019 12:06	27/11/2019 12:12	0,10	1	0,10	CHI
201911344336	CAMPO ALEGRE DE GOIAS	CM21071196	CAMPO ALEGRE DE GOIAS	27/11/2019 11:41	27/11/2019 16:08	27/11/2019 11:41	27/11/2019 16:08	4,45	1	4,45	CHI
201911344339	CATALAO	CT21231783	CATALAO S1	27/11/2019 11:41	27/11/2019 15:13	27/11/2019 11:41	27/11/2019 15:13	3,52	1	3,52	CHI
201911344365	CACHOEIRA DOURADA	130003992	CACHOEIRA DOURADA	27/11/2019 11:47	27/11/2019 13:47	27/11/2019 11:47	27/11/2019 13:47	1,99	1	1,99	CHI
201911344366	INDIARA	2710002705	EDEIA	27/11/2019 11:49	27/11/2019 15:23	27/11/2019 11:49	27/11/2019 15:23	3,57	1	3,57	CHI
201911344370	PALMEIRAS DE GOIAS	10001301622	PALMEIRAS	27/11/2019 11:50	27/11/2019 16:57	27/11/2019 11:50	27/11/2019 16:57	5,12	1	5,12	CHI
201911344382	LUZIANIA	LZ12370715	VIANOPOLIS	27/11/2019 11:53	27/11/2019 21:28	27/11/2019 11:53	27/11/2019 21:28	9,58	1	9,58	CHI
201911344383	NOVA CRIXAS	NA12057172	MOZARLANDIA	27/11/2019 09:35	28/11/2019 15:10	27/11/2019 09:35	28/11/2019 15:10	29,58	22	650,71	CHI
201911344402	VICENTINOPOLIS	1970011248	VICENTINOPOLIS	27/11/2019 11:56	27/11/2019 16:46	27/11/2019 11:56	27/11/2019 16:46	4,83	1	4,83	CHI
201911344403	SAO MIGUEL DO ARAGUAIA	SM12083960	SAO MIGUEL DO ARAGUAIA	27/11/2019 11:56	28/11/2019 12:10	27/11/2019 11:56	28/11/2019 12:10	24,22	5	121,11	CHI
201911344405	APARECIDA DE GOIANIA	10007510711	ANHANGUERA	27/11/2019 11:57	27/11/2019 14:44	27/11/2019 11:57	27/11/2019 14:44	2,79	1	2,79	CHI
201911344422	JANDAIA	JD12008638	PALMEIRAS	27/11/2019 11:54	27/11/2019 19:00	27/11/2019 11:54	27/11/2019 19:00	7,09	131	928,83	CHI
201911344422	PALESTINA DE GOIAS	JD12008638	PALMEIRAS	27/11/2019 11:54	27/11/2019 19:00	27/11/2019 11:54	27/11/2019 19:00	7,09	1	7,09	CHI
201911344422	PALMEIRAS DE GOIAS	JD12008638	PALMEIRAS	27/11/2019 11:54	27/11/2019 19:00	27/11/2019 11:54	27/11/2019 19:00	7,09	97	687,76	CHI
201911344422	PALMINOPOLIS	JD12008638	PALMEIRAS	27/11/2019 11:54	27/11/2019 19:00	27/11/2019 11:54	27/11/2019 19:00	7,09	14	99,26	CHI
201911344427	AGUA FRIA DE GOIAS	TL21204651	SAO JOAO D ALIANCA	27/11/2019 12:00	28/11/2019 12:26	27/11/2019 12:00	28/11/2019 12:26	24,44	1	24,44	CHI
201911344438	SAO LUIS DE MONTES BELOS	500122064	SAO LUIZ DOS MONTES BELOS	27/11/2019 12:02	27/11/2019 16:17	27/11/2019 12:02	27/11/2019 16:17	4,26	1	4,26	CHI
201911344447	IVOLANDIA	IV21231150	IPORA	27/11/2019 12:03	27/11/2019 17:32	27/11/2019 12:03	27/11/2019 17:32	5,48	1	5,48	CHI
201911344450	GOIANIA	GN12222920	ATLANTICO S2	27/11/2019 12:03	27/11/2019 13:48	27/11/2019 12:03	27/11/2019 13:48	1,74	148	256,86	CHI
201911344452	ITABERAI	19623684	ITABERAI S1	27/11/2019 12:04	27/11/2019 17:57	27/11/2019 12:04	27/11/2019 17:57	5,88	1	5,88	CHI
201911344463	SANTA FE DE GOIAS	RN12397579	BRITANIA	27/11/2019 12:05	27/11/2019 20:04	27/11/2019 12:05	27/11/2019 20:04	7,99	1	7,99	CHI
201911344464	NIQUELANDIA	NQ21128484	NIQUELANDIA SUBTRANSMISSAO	27/11/2019 12:05	28/11/2019 09:03	27/11/2019 12:05	28/11/2019 09:03	20,95	1	20,95	CHI
201911344465	JATAI	JT12207203	JATAI S1	27/11/2019 12:06	28/11/2019 13:44	27/11/2019 12:06	28/11/2019 13:44	25,64	5	128,19	CHI
201911344465	JATAI	JT12207203	JATAI S1	27/11/2019 12:06	28/11/2019 13:44	28/11/2019 11:43	28/11/2019 13:44	2,02	18	36,33	CHI
201911344470	HIDROLINA	HL21157014	URUACU	27/11/2019 12:07	28/11/2019 22:24	27/11/2019 12:07	28/11/2019 22:24	34,28	1	34,28	CHI
201911344474	AGUA FRIA DE GOIAS	TL12255433	SAO JOAO D ALIANCA	27/11/2019 12:08	29/11/2019 13:06	27/11/2019 12:08	29/11/2019 13:06	48,97	1	48,97	CHI
201911344491	GOIANIA	16240601	GOYA S2	27/11/2019 12:11	27/11/2019 16:46	27/11/2019 12:11	27/11/2019 16:46	4,58	1	4,58	CHI

201911344494	GOIANIA	11022796	FERROVIARIO S3	27/11/2019 12:12	27/11/2019 14:24	27/11/2019 12:12	27/11/2019 14:24	2,20	1	2,20	CHI
201911344496	PANAMA	IT21304238	ITUMBIARA NOVA	27/11/2019 12:12	27/11/2019 15:50	27/11/2019 12:12	27/11/2019 15:50	3,62	1	3,62	CHI
201911344506	FAINA	FC21156331	GOIAS	27/11/2019 12:13	28/11/2019 10:44	27/11/2019 12:13	28/11/2019 10:44	22,51	1	22,51	CHI
201911344508	ALTO PARAISO DE GOIAS	BF21222892	FLORES DE GOIAS	27/11/2019 12:13	27/11/2019 15:08	27/11/2019 12:13	27/11/2019 15:08	2,92	2	5,83	CHI
201911344517	JUSSARA	JR12220050	JUSSARA	27/11/2019 12:15	27/11/2019 16:15	27/11/2019 12:15	27/11/2019 16:15	4,00	2	7,99	CHI
201911344538	GOIANIA	GN10400444	CARAJAS S2	27/11/2019 12:11	27/11/2019 13:45	27/11/2019 12:11	27/11/2019 12:46	0,58	7068	4079,81	CHI
201911344538	GOIANIA	GN10385817	CARAJAS S2	27/11/2019 12:11	27/11/2019 13:45	27/11/2019 13:42	27/11/2019 13:45	0,05	6780	344,65	CHI
201911344549	ARAGARCAS	1820054606	ARAGARCAS	27/11/2019 12:19	27/11/2019 19:51	27/11/2019 12:19	27/11/2019 19:51	7,53	1	7,53	CHI
201911344550	GOIANIA	10021146878	GOYA S2	27/11/2019 12:19	27/11/2019 16:36	27/11/2019 12:19	27/11/2019 16:36	4,28	1	4,28	CHI
201911344558	PORANGATU	PO12349237	MARA ROSA	27/11/2019 12:15	27/11/2019 16:23	27/11/2019 12:15	27/11/2019 16:23	4,12	18	74,18	CHI
201911344561	ARAGOIANIA	AO32097662	GUAPO S2	27/11/2019 12:21	27/11/2019 21:53	27/11/2019 12:21	27/11/2019 21:53	9,53	4	38,12	CHI
201911344561	VARJAO	AO32097662	GUAPO S2	27/11/2019 12:21	27/11/2019 21:53	27/11/2019 12:21	27/11/2019 21:53	9,53	5	47,65	CHI
201911344568	SAO DOMINGOS	SD12344090	SAO DOMINGOS	27/11/2019 12:22	28/11/2019 14:42	27/11/2019 12:22	28/11/2019 14:42	26,33	3	79,00	CHI
201911344575	PORANGATU	PO12240727	PORANGATU	27/11/2019 12:22	28/11/2019 00:10	27/11/2019 12:22	28/11/2019 00:10	11,79	1	11,79	CHI
201911344587	BOM JESUS DE GOIAS	GB13000028	QUIRINOPOLIS	27/11/2019 13:51	27/11/2019 17:20	27/11/2019 13:51	27/11/2019 17:20	3,48	69	240,27	CHI
201911344587	INACIOLANDIA	GB13000028	QUIRINOPOLIS	27/11/2019 13:51	27/11/2019 17:20	27/11/2019 13:51	27/11/2019 17:20	3,48	2656	9248,78	CHI
201911344587	ITUMBIARA	GB13000028	QUIRINOPOLIS	27/11/2019 13:51	27/11/2019 17:20	27/11/2019 13:51	27/11/2019 17:20	3,48	8	27,86	CHI
201911344600	GOIANIA	15822229	INDEPENDENCIA S1	27/11/2019 12:25	27/11/2019 18:23	27/11/2019 12:25	27/11/2019 18:23	5,95	1	5,95	CHI
201911344603	APARECIDA DE GOIANIA	12299285	INDEPENDENCIA S2	27/11/2019 12:26	27/11/2019 16:05	27/11/2019 12:26	27/11/2019 16:05	3,64	1	3,64	CHI
201911344628	PORANGATU	PO12230420	NOVO PLANALTO	27/11/2019 12:29	27/11/2019 23:23	27/11/2019 12:29	27/11/2019 23:23	10,89	3	32,66	CHI
201911344637	ITUMBIARA	IT21309023	ITUMBIARA VELHA S2	27/11/2019 12:30	28/11/2019 11:24	27/11/2019 12:30	28/11/2019 11:24	22,88	1	22,88	CHI
201911344643	TRES RANCHOS	TH21165233	CATALAO S1	27/11/2019 12:31	27/11/2019 16:12	27/11/2019 12:31	27/11/2019 16:12	3,67	4	14,67	CHI
201911344648	CRISTIANOPOLIS	CF21107267	CRISTIANOPOLIS	27/11/2019 12:32	28/11/2019 08:46	27/11/2019 12:32	28/11/2019 08:46	20,22	1	20,22	CHI
201911344649	GOIANIA	13015874	CARAJAS S1	27/11/2019 12:32	27/11/2019 15:51	27/11/2019 12:32	27/11/2019 15:51	3,31	1	3,31	CHI
201911344657	PARAUNA	PU21228099	PARAUNA	27/11/2019 12:33	27/11/2019 19:18	27/11/2019 12:33	27/11/2019 19:18	6,75	2	13,51	CHI
201911344666	BURITINOPOLIS	MB12314303	IACIARA S2	27/11/2019 12:34	27/11/2019 14:42	27/11/2019 12:34	27/11/2019 14:42	2,12	2	4,24	CHI
201911344666	MAMBAI	MB12314303	IACIARA S2	27/11/2019 12:34	27/11/2019 14:42	27/11/2019 12:34	27/11/2019 14:42	2,12	3	6,36	CHI
201911344687	MARA ROSA	6199704	MARA ROSA	27/11/2019 12:38	28/11/2019 09:16	27/11/2019 12:38	28/11/2019 09:16	20,63	1	20,63	CHI
201911344711	SAO FRANCISCO DE GOIAS	SF12389750	SAO FRANCISCO DE GOIAS	27/11/2019 12:45	27/11/2019 15:55	27/11/2019 12:45	27/11/2019 15:55	3,16	14	44,24	CHI
201911344712	INDIARA	CZ12072974	CEZARINA	27/11/2019 11:13	27/11/2019 14:39	27/11/2019 11:13	27/11/2019 14:39	3,42	9	30,79	CHI
201911344712	CEZARINA	CZ12072974	CEZARINA	27/11/2019 11:13	27/11/2019 14:39	27/11/2019 11:13	27/11/2019 14:39	3,42	6	20,53	CHI
201911344713	PIRENOPOLIS	PV21062020	SAO FRANCISCO DE GOIAS	27/11/2019 12:41	27/11/2019 18:25	27/11/2019 12:41	27/11/2019 18:25	5,73	2	11,45	CHI
201911344716	ANAPOLIS	20094851	JUNDIAI S2	27/11/2019 12:41	27/11/2019 23:04	27/11/2019 12:41	27/11/2019 23:04	10,37	1	10,37	CHI

201911344717	FORMOSO	FO12189559	MARA ROSA	27/11/2019 12:41	28/11/2019 11:30	27/11/2019 12:41	28/11/2019 11:30	22,81	2	45,62	CHI
201911344730	BURITI ALEGRE	BG21000115	ITUMBIARA VELHA S2	27/11/2019 12:43	28/11/2019 09:47	27/11/2019 12:43	28/11/2019 09:47	21,07	1	21,07	CHI
201911344738	GOIANIA	00582254	AEROPORTO S3	27/11/2019 12:39	27/11/2019 13:41	27/11/2019 12:39	27/11/2019 12:43	0,06	1989	122,10	CHI
201911344738	GOIANIA	00582254	GOIANIA LESTE S1	27/11/2019 12:39	27/11/2019 13:41	27/11/2019 12:39	27/11/2019 12:44	0,08	70	5,56	CHI
201911344738	GOIANIA	00582254	GOIANIA LESTE S3	27/11/2019 12:39	27/11/2019 13:41	27/11/2019 12:39	27/11/2019 12:44	0,08	663	52,67	CHI
201911344738	GOIANIA	00582254	GOIANIA LESTE S3	27/11/2019 12:39	27/11/2019 13:41	27/11/2019 12:39	27/11/2019 13:41	1,03	663	684,18	CHI
201911344742	CAMPO ALEGRE DE GOIAS	CM21294570	CAMPO ALEGRE DE GOIAS	27/11/2019 12:45	27/11/2019 15:37	27/11/2019 12:45	27/11/2019 15:37	2,86	1	2,86	CHI
201911344746	GOIANIA	GN11040729	AEROPORTO S1	27/11/2019 12:45	27/11/2019 14:16	27/11/2019 12:45	27/11/2019 14:16	1,52	28	42,51	CHI
201911344751	SERRANOPOLIS	SX21216600	JATAI S1	27/11/2019 12:46	28/11/2019 11:09	27/11/2019 12:46	28/11/2019 11:09	22,37	1	22,37	CHI
201911344756	APARECIDA DE GOIANIA	12380702	REAL S1	27/11/2019 12:47	27/11/2019 18:08	27/11/2019 12:47	27/11/2019 18:08	5,34	1	5,34	CHI
201911344769	IPORA	IR21014429	IPORA	27/11/2019 12:50	27/11/2019 15:57	27/11/2019 12:50	27/11/2019 15:57	3,13	1	3,13	CHI
201911344774	CALDAZINHA	2340003071	CEPAIGO S2	27/11/2019 12:51	27/11/2019 20:26	27/11/2019 12:51	27/11/2019 20:26	7,58	1	7,58	CHI
201911344776	DIVINOPOLIS DE GOIAS	GH12211210	SAO DOMINGOS	27/11/2019 12:51	27/11/2019 13:16	27/11/2019 12:51	27/11/2019 13:16	0,41	17	7,05	CHI
201911344777	MINACU	IH11052676	MINACU	27/11/2019 12:33	27/11/2019 15:11	27/11/2019 12:33	27/11/2019 15:11	2,62	126	330,72	CHI
201911344798	BELA VISTA DE GOIAS	BV12208886	BELA VISTA S1	27/11/2019 12:55	28/11/2019 19:36	27/11/2019 12:55	28/11/2019 19:36	30,70	48	1473,47	CHI
201911344798	BELA VISTA DE GOIAS	BV12208886	BELA VISTA S1	27/11/2019 12:55	28/11/2019 19:36	28/11/2019 17:38	28/11/2019 19:36	1,97	15	29,60	CHI
201911344801	LUZIANIA	LZ12370748	RIO VERMELHO	27/11/2019 15:50	27/11/2019 17:24	27/11/2019 15:50	27/11/2019 17:24	1,56	107	166,89	CHI
201911344810	ANAPOLIS	AN12000034	ANAPOLIS UNIVERSITARIO S2	27/11/2019 12:57	27/11/2019 15:26	27/11/2019 12:57	27/11/2019 15:26	2,48	83	205,77	CHI
201911344812	NOVO BRASIL	6340049	JUSSARA	27/11/2019 12:57	28/11/2019 23:25	27/11/2019 12:57	28/11/2019 23:25	34,45	1	34,45	CHI
201911344813	PETROLINA DE GOIAS	PV12062894	SAO FRANCISCO DE GOIAS	27/11/2019 12:46	27/11/2019 16:35	27/11/2019 12:46	27/11/2019 16:35	3,81	3	11,44	CHI
201911344813	PIRENOPOLIS	PV12062894	SAO FRANCISCO DE GOIAS	27/11/2019 12:46	27/11/2019 16:35	27/11/2019 12:46	27/11/2019 16:35	3,81	21	80,07	CHI
201911344815	BOM JESUS DE GOIAS	10003305595	BOM JESUS DE GOIAS	27/11/2019 12:57	27/11/2019 14:58	27/11/2019 12:57	27/11/2019 14:58	2,01	1	2,01	CHI
201911344822	VILA PROPICIO	9290001403	GOIANESIA S1	27/11/2019 12:59	29/11/2019 13:45	27/11/2019 12:59	29/11/2019 13:45	48,76	1	48,76	CHI
201911344826	DIORAMA	DI12066071	ARENOPOLIS	27/11/2019 13:00	28/11/2019 07:16	27/11/2019 13:00	28/11/2019 07:16	18,27	28	511,43	CHI
201911344833	IVOLANDIA	IV21165814	IPORA	27/11/2019 13:00	27/11/2019 18:41	27/11/2019 13:00	27/11/2019 18:41	5,67	1	5,67	CHI
201911344836	MUTUNOPOLIS	MU12086727	MARA ROSA	27/11/2019 13:01	27/11/2019 17:10	27/11/2019 13:01	27/11/2019 17:10	4,14	1	4,14	CHI
201911344841	GAMELEIRA DE GOIAS	SV21093668	DAIA S2	27/11/2019 13:02	27/11/2019 18:30	27/11/2019 13:02	27/11/2019 18:30	5,45	1	5,45	CHI
201911344842	LUZIANIA	LZ12203332	VIANOPOLIS	27/11/2019 13:02	28/11/2019 09:09	27/11/2019 13:02	28/11/2019 09:09	20,10	15	301,55	CHI
201911344848	AMERICANO DO BRASIL	KB21322829	ANICUNS	27/11/2019 13:04	27/11/2019 18:31	27/11/2019 13:04	27/11/2019 18:31	5,46	1	5,46	CHI
201911344850	PALMEIRAS DE GOIAS	PL11276948	PALMEIRAS	27/11/2019 13:04	27/11/2019 14:43	27/11/2019 13:04	27/11/2019 14:43	1,65	1	1,65	CHI
201911344856	NOVA ROMA	ND11160043	IACIARA S2	27/11/2019 12:57	27/11/2019 16:40	27/11/2019 12:57	27/11/2019 16:40	3,72	9	33,45	CHI
201911344857	PETROLINA DE GOIAS	PG21036108	PETROLINA	27/11/2019 13:05	27/11/2019 21:45	27/11/2019 13:05	27/11/2019 21:45	8,66	1	8,66	CHI
201911344858	PORANGATU	PO21315429	NOVO PLANALTO	27/11/2019 13:05	27/11/2019 18:29	27/11/2019 13:05	27/11/2019 18:29	5,39	1	5,39	CHI

201911344860	CATALAO	CT12316116	CATALAO S1	27/11/2019 13:06	27/11/2019 15:18	27/11/2019 13:06	27/11/2019 15:18	2,20	4	8,78	CHI
201911344873	SENADOR CANEDO	190053446	SENADOR CANEDO	27/11/2019 13:07	27/11/2019 14:26	27/11/2019 13:07	27/11/2019 14:26	1,31	1	1,31	CHI
201911344879	SANTA CRUZ DE GOIAS	CN12180276	CALDAS NOVAS S1	27/11/2019 13:08	27/11/2019 23:43	27/11/2019 13:08	27/11/2019 23:43	10,58	52	550,00	CHI
201911344879	CALDAS NOVAS	CN12180276	CALDAS NOVAS S1	27/11/2019 13:08	27/11/2019 23:43	27/11/2019 13:08	27/11/2019 23:43	10,58	6	63,46	CHI
201911344886	JATAI	10024763371	JATAI S2	27/11/2019 13:09	27/11/2019 16:30	27/11/2019 13:09	27/11/2019 16:30	3,34	1	3,34	CHI
201911344888	GOIANIA	GN12329375	AEROPORTO S2	27/11/2019 13:10	27/11/2019 17:29	27/11/2019 13:10	27/11/2019 17:29	4,32	109	470,37	CHI
201911344895	PORANGATU	PO12020611	NOVO PLANALTO	27/11/2019 13:11	27/11/2019 20:15	27/11/2019 13:11	27/11/2019 20:15	7,07	8	56,53	CHI
201911344903	RUBIATABA	RB12273121	RUBIATABA	27/11/2019 13:13	27/11/2019 23:42	27/11/2019 21:59	27/11/2019 23:34	1,59	115	182,47	CHI
201911344903	RUBIATABA	RB11273187	RUBIATABA	27/11/2019 13:13	27/11/2019 23:42	27/11/2019 13:13	27/11/2019 23:42	10,49	34	356,56	CHI
201911344907	JATAI	JT12092386	JATAI S1	27/11/2019 13:13	29/11/2019 11:53	27/11/2019 13:13	28/11/2019 08:48	19,58	10	195,79	CHI
201911344907	SERRANOPOLIS	JT12092386	JATAI S1	27/11/2019 13:13	29/11/2019 11:53	27/11/2019 13:13	28/11/2019 08:48	19,58	4	78,32	CHI
201911344907	JATAI	JT12092386	JATAI S1	27/11/2019 13:13	29/11/2019 11:53	27/11/2019 13:13	28/11/2019 13:17	24,06	32	770,05	CHI
201911344907	JATAI	JT12092386	JATAI S1	27/11/2019 13:13	29/11/2019 11:53	28/11/2019 08:49	28/11/2019 13:17	4,48	10	44,77	CHI
201911344907	SERRANOPOLIS	JT12092386	JATAI S1	27/11/2019 13:13	29/11/2019 11:53	28/11/2019 08:49	28/11/2019 13:17	4,48	4	17,91	CHI
201911344907	SERRANOPOLIS	JT12092386	JATAI S1	27/11/2019 13:13	29/11/2019 11:53	28/11/2019 13:18	29/11/2019 11:53	22,60	4	90,40	CHI
201911344907	JATAI	JT12092386	JATAI S1	27/11/2019 13:13	29/11/2019 11:53	28/11/2019 13:18	29/11/2019 11:53	22,60	44	994,38	CHI
201911344911	APARECIDA DE GOIANIA	AP11124432	ANHANGUERA	27/11/2019 13:14	27/11/2019 14:33	27/11/2019 13:14	27/11/2019 14:33	1,32	250	328,82	CHI
201911344915	RIO VERDE	RV21205437	MONTIVIDIU T	27/11/2019 13:14	27/11/2019 15:12	27/11/2019 13:14	27/11/2019 15:12	1,97	13	25,61	CHI
201911344916	PEROLANDIA	DP12194926	PARQUE DAS EMAS	27/11/2019 12:01	27/11/2019 16:28	27/11/2019 12:01	27/11/2019 16:28	4,45	2	8,89	CHI
201911344930	BARRO ALTO	BA21000034	BARRO ALTO	27/11/2019 13:17	28/11/2019 16:19	27/11/2019 13:17	28/11/2019 16:19	27,03	1	27,03	CHI
201911344945	IPORA	IR12079742	IPORA	27/11/2019 13:20	28/11/2019 10:39	27/11/2019 13:20	28/11/2019 10:39	21,33	38	810,51	CHI
201911344945	IVOLANDIA	IR12079742	IPORA	27/11/2019 13:20	28/11/2019 10:39	27/11/2019 13:20	28/11/2019 10:39	21,33	12	255,95	CHI
201911344949	CALDAS NOVAS	CN11040987	SERRA DE CALDAS	27/11/2019 13:09	28/11/2019 12:00	27/11/2019 13:09	28/11/2019 12:00	22,85	67	1530,91	CHI
201911344956	FORMOSA	FA12325470	ITUIQUIRA	27/11/2019 13:22	28/11/2019 11:45	27/11/2019 13:22	28/11/2019 11:45	22,39	1	22,39	CHI
201911344959	GOIANIA	11167014	ATLANTICO S1	27/11/2019 13:22	27/11/2019 18:16	27/11/2019 13:22	27/11/2019 18:16	4,90	1	4,90	CHI
201911344961	ITUMBIARA	690171602	ITUMBIARA VELHA S1	27/11/2019 13:22	27/11/2019 16:23	27/11/2019 13:22	27/11/2019 16:23	3,01	1	3,01	CHI
201911344967	SERRANOPOLIS	SX12268627	JATAI S1	27/11/2019 13:23	28/11/2019 13:17	27/11/2019 13:23	28/11/2019 13:17	23,89	3	71,68	CHI
201911344971	RIO VERDE	630142579	RIO VERDE S1	27/11/2019 13:22	27/11/2019 15:15	27/11/2019 13:22	27/11/2019 15:15	1,87	1	1,87	CHI
201911344972	QUIRINOPOLIS	QI21101729	QUIRINOPOLIS	27/11/2019 13:24	28/11/2019 08:25	27/11/2019 13:24	28/11/2019 08:25	19,01	1	19,01	CHI
201911344976	JARAGUA	70063448	JARAGUA	27/11/2019 13:25	27/11/2019 15:12	27/11/2019 13:25	27/11/2019 15:12	1,77	1	1,77	CHI
201911344979	MARA ROSA	MQ21125501	MARA ROSA	27/11/2019 13:26	28/11/2019 11:40	27/11/2019 13:26	28/11/2019 11:40	22,23	1	22,23	CHI
201911344985	PIRES DO RIO	460110822	PIRES DO RIO S1	27/11/2019 13:27	28/11/2019 08:35	27/11/2019 13:27	28/11/2019 08:35	19,13	1	19,13	CHI
201911345004	SENADOR CANEDO	SW11092252	SENADOR CANEDO	27/11/2019 13:31	27/11/2019 15:23	27/11/2019 13:31	27/11/2019 15:23	1,86	114	212,17	CHI

201911345006	QUIRINOPOLIS	QI21296581	QUIRINOPOLIS	27/11/2019 13:31	28/11/2019 05:20	27/11/2019 13:31	28/11/2019 05:20	15,81	4	63,23	CHI
201911345010	CALDAS NOVAS	CN12139717LD	CALDAS NOVAS S2	27/11/2019 12:05	27/11/2019 15:23	27/11/2019 12:05	27/11/2019 15:23	3,30	1565	5158,41	CHI
201911345010	PIRACANJUBA	CN12139717LD	CALDAS NOVAS S2	27/11/2019 12:05	27/11/2019 15:23	27/11/2019 12:05	27/11/2019 15:23	3,30	2	6,59	CHI
201911345012	PIRES DO RIO	460047735	PIRES DO RIO S1	27/11/2019 13:31	28/11/2019 08:22	27/11/2019 13:31	28/11/2019 08:22	18,84	1	18,84	CHI
201911345025	VIANOPOLIS	510030737	VIANOPOLIS	27/11/2019 13:32	28/11/2019 07:48	27/11/2019 13:32	28/11/2019 07:48	18,26	1	18,26	CHI
201911345037	CACHOEIRA DE GOIAS	CG21158955	FIRMINOPOLIS S2	27/11/2019 13:33	27/11/2019 16:20	27/11/2019 13:33	27/11/2019 16:20	2,78	1	2,78	CHI
201911345091	GUARANI DE GOIAS	1580011539	IACIARA S2	27/11/2019 13:41	28/11/2019 12:20	27/11/2019 13:41	28/11/2019 12:20	22,65	1	22,65	CHI
201911345106	QUIRINOPOLIS	QI21000278	QUIRINOPOLIS	27/11/2019 13:44	28/11/2019 10:45	27/11/2019 13:44	28/11/2019 10:45	21,01	1	21,01	CHI
201911345111	SAO DOMINGOS	SD12389176	SAO DOMINGOS	27/11/2019 13:45	27/11/2019 14:34	27/11/2019 13:45	27/11/2019 14:34	0,81	7	5,69	CHI
201911345113	VILA PROPICIO	PV12396658	GOIANESIA S1	27/11/2019 13:45	29/11/2019 09:11	27/11/2019 13:45	29/11/2019 09:11	43,45	15	651,69	CHI
201911345114	ORIZONA	OZ21207568	VIANOPOLIS	27/11/2019 12:51	27/11/2019 22:12	27/11/2019 12:51	27/11/2019 22:12	9,35	1	9,35	CHI
201911345127	ISRAELANDIA	IS12015600	IPORA	27/11/2019 13:47	27/11/2019 17:48	27/11/2019 13:47	27/11/2019 17:48	4,02	2	8,05	CHI
201911345129	PADRE BERNARDO	PB12275505	PADRE BERNARDO	27/11/2019 13:47	27/11/2019 20:20	27/11/2019 13:47	27/11/2019 20:20	6,54	3	19,62	CHI
201911345133	AGUA FRIA DE GOIAS	TL21244590	SAO JOAO D ALIANCA	27/11/2019 13:48	27/11/2019 16:21	27/11/2019 13:48	27/11/2019 16:21	2,55	1	2,55	CHI
201911345144	PORANGATU	PO12349234	MARA ROSA	27/11/2019 13:48	27/11/2019 15:53	27/11/2019 13:48	27/11/2019 15:53	2,07	16	33,19	CHI
201911345151	SANTA HELENA DE GOIAS	SH21000135	IPEGUARI	27/11/2019 13:50	27/11/2019 23:56	27/11/2019 13:50	27/11/2019 23:56	10,10	1	10,10	CHI
201911345157	LUZIANIA	10004799613	RIO VERMELHO	27/11/2019 13:50	27/11/2019 16:21	27/11/2019 13:50	27/11/2019 16:21	2,52	1	2,52	CHI
201911345164	JATAI	JT121216767	JATAI S1	27/11/2019 13:51	27/11/2019 17:34	27/11/2019 13:51	27/11/2019 17:34	3,71	1	3,71	CHI
201911345179	VIANOPOLIS	2060034330	PIRES DO RIO S2	27/11/2019 13:53	27/11/2019 19:32	27/11/2019 13:53	27/11/2019 19:32	5,67	1	5,67	CHI
201911345188	SILVANIA	SV12385027	VIANOPOLIS	27/11/2019 13:55	27/11/2019 16:47	27/11/2019 13:55	27/11/2019 16:47	2,86	1	2,86	CHI
201911345189	CABECEIRAS	CW21264717	ITIQUEIRA	27/11/2019 13:55	27/11/2019 15:50	27/11/2019 13:55	27/11/2019 15:50	1,91	1	1,91	CHI
201911345192	ITAPACI	IW12197514	ITAPACI	27/11/2019 12:54	27/11/2019 19:20	27/11/2019 12:54	27/11/2019 19:20	6,43	121	778,13	CHI
201911345193	ITABERAI	50082516	ITABERAI S2	27/11/2019 13:56	27/11/2019 15:24	27/11/2019 13:56	27/11/2019 15:24	1,46	1	1,46	CHI
201911345210	CALDAS NOVAS	CN12186163	CALDAS NOVAS S2	27/11/2019 14:00	27/11/2019 15:29	27/11/2019 14:00	27/11/2019 15:29	1,48	39	57,81	CHI
201911345221	APARECIDA DE GOIANIA	13899533	INDEPENDENCIA S2	27/11/2019 14:02	27/11/2019 15:48	27/11/2019 14:02	27/11/2019 15:48	1,76	1	1,76	CHI
201911345222	GOIANIA	GN11211338	CARAJAS S2	27/11/2019 13:30	27/11/2019 14:33	27/11/2019 13:30	27/11/2019 14:33	1,04	121	126,04	CHI
201911345224	APARECIDA DE GOIANIA	AP11132701	ANHANGUERA	27/11/2019 14:03	27/11/2019 15:59	27/11/2019 14:03	27/11/2019 15:59	1,93	15	28,95	CHI
201911345225	ARAGOIANIA	AO32000019	GUAPO S2	27/11/2019 12:54	27/11/2019 16:54	27/11/2019 12:54	27/11/2019 16:54	3,99	15	59,86	CHI
201911345228	LUZIANIA	120174893	RIO VERMELHO	27/11/2019 14:03	27/11/2019 17:12	27/11/2019 14:03	27/11/2019 17:12	3,14	1	3,14	CHI
201911345231	ANAPOLIS	AN21091588	ANAPOLIS UNIVERSITARIO S1	27/11/2019 14:04	27/11/2019 18:20	27/11/2019 14:04	27/11/2019 18:20	4,26	1	4,26	CHI
201911345232	ITUMBIARA	IT12304246	ITUMBIARA NOVA	27/11/2019 14:04	27/11/2019 15:20	27/11/2019 14:04	27/11/2019 15:20	1,26	3	3,78	CHI
201911345248	SAO DOMINGOS	SD12128037	SAO DOMINGOS	27/11/2019 12:56	28/11/2019 12:11	27/11/2019 12:56	28/11/2019 12:11	23,25	4	92,98	CHI
201911345251	JATAI	JT12260426	JATAI S1	27/11/2019 13:04	27/11/2019 15:30	27/11/2019 13:04	27/11/2019 15:30	2,42	117	283,04	CHI



201911345257	RIO VERDE	RV21098539	MONTIVIDIU T	27/11/2019 14:08	27/11/2019 19:06	27/11/2019 14:08	27/11/2019 19:06	4,96	1	4,96	CHI
201911345258	PONTALINA	03130406	VICENTINOPOLIS	27/11/2019 13:35	28/11/2019 17:30	27/11/2019 13:35	27/11/2019 17:17	3,70	1	3,70	CHI
201911345258	VICENTINOPOLIS	03130406	VICENTINOPOLIS	27/11/2019 13:35	28/11/2019 17:30	27/11/2019 13:35	27/11/2019 18:45	5,16	13	67,03	CHI
201911345258	PONTALINA	03130406	VICENTINOPOLIS	27/11/2019 13:35	28/11/2019 17:30	27/11/2019 13:35	27/11/2019 18:45	5,16	114	587,80	CHI
201911345258	PONTALINA	03130214	VICENTINOPOLIS	27/11/2019 13:35	28/11/2019 17:30	28/11/2019 08:48	28/11/2019 09:00	0,21	114	23,91	CHI
201911345258	VICENTINOPOLIS	03130214	VICENTINOPOLIS	27/11/2019 13:35	28/11/2019 17:30	28/11/2019 08:48	28/11/2019 09:00	0,21	13	2,73	CHI
201911345258	PONTALINA	03130406	VICENTINOPOLIS	27/11/2019 13:35	28/11/2019 17:30	27/11/2019 13:35	28/11/2019 09:54	20,32	1	20,32	CHI
201911345258	VICENTINOPOLIS	03130214	VICENTINOPOLIS	27/11/2019 13:35	28/11/2019 17:30	28/11/2019 09:55	28/11/2019 10:34	0,66	13	8,64	CHI
201911345258	PONTALINA	03130214	VICENTINOPOLIS	27/11/2019 13:35	28/11/2019 17:30	28/11/2019 09:55	28/11/2019 10:34	0,66	114	75,78	CHI
201911345258	PONTALINA	03130406	VICENTINOPOLIS	27/11/2019 13:35	28/11/2019 17:30	27/11/2019 13:35	28/11/2019 17:30	27,92	59	1647,08	CHI
201911345258	PONTALINA	PK13120767	VICENTINOPOLIS	27/11/2019 13:35	28/11/2019 17:30	27/11/2019 17:27	28/11/2019 17:30	24,05	1	24,05	CHI
201911345258	PONTALINA	PK13120767	VICENTINOPOLIS	27/11/2019 13:35	28/11/2019 17:30	28/11/2019 08:48	28/11/2019 17:30	8,71	1	8,71	CHI
201911345258	PONTALINA	PK13120767	VICENTINOPOLIS	27/11/2019 13:35	28/11/2019 17:30	28/11/2019 09:55	28/11/2019 17:30	7,59	1	7,59	CHI
201911345259	SENADOR CANEDO	SW12002156	SENADOR CANEDO	27/11/2019 14:08	27/11/2019 19:56	27/11/2019 14:08	27/11/2019 19:56	5,80	4	23,21	CHI
201911345271	MONTE ALEGRE DE GOIAS	MA12105998	SAO DOMINGOS	27/11/2019 14:10	27/11/2019 22:13	27/11/2019 14:10	27/11/2019 22:13	8,05	15	120,70	CHI
201911345277	MINEIROS	PW12219564	PARQUE DAS EMAS	27/11/2019 14:10	29/11/2019 14:32	27/11/2019 14:10	29/11/2019 14:32	48,35	7	338,47	CHI
201911345277	PORTELANDIA	PW12219564	PARQUE DAS EMAS	27/11/2019 14:10	29/11/2019 14:32	27/11/2019 14:10	29/11/2019 14:32	48,35	11	531,89	CHI
201911345277	PORTELANDIA	PW12219564	PARQUE DAS EMAS	27/11/2019 14:10	29/11/2019 14:32	29/11/2019 10:21	29/11/2019 14:32	4,17	1	4,17	CHI
201911345279	QUIRINOPOLIS	GB31134426	QUIRINOPOLIS	27/11/2019 14:10	27/11/2019 18:22	27/11/2019 14:10	27/11/2019 18:22	4,18	1	4,18	CHI
201911345280	PIRENOPOLIS	PV21302207	CORUMBA	27/11/2019 14:11	27/11/2019 15:30	27/11/2019 14:11	27/11/2019 15:30	1,31	1	1,31	CHI
201911345282	APARECIDA DE GOIANIA	17325298	INDEPENDENCIA S2	27/11/2019 14:12	27/11/2019 15:40	27/11/2019 14:12	27/11/2019 15:40	1,46	1	1,46	CHI
201911345286	URUACU	UR21146989	URUACU	27/11/2019 14:12	27/11/2019 16:12	27/11/2019 14:12	27/11/2019 16:12	1,98	2	3,97	CHI
201911345288	VILA PROPICIO	GE12376588	GOIANESIA S2	27/11/2019 14:02	27/11/2019 17:00	27/11/2019 14:02	27/11/2019 17:00	2,97	2	5,93	CHI
201911345288	GOIANESIA	GE12376588	GOIANESIA S2	27/11/2019 14:02	27/11/2019 17:00	27/11/2019 14:02	27/11/2019 17:00	2,97	8	23,73	CHI
201911345290	SENADOR CANEDO	10004189408	CEPAIGO S2	27/11/2019 14:13	27/11/2019 20:23	27/11/2019 14:13	27/11/2019 20:23	6,16	1	6,16	CHI
201911345295	GOIAS	GS12220495	ITABERAI S1	27/11/2019 14:12	27/11/2019 15:17	27/11/2019 14:12	27/11/2019 15:17	1,07	2	2,14	CHI
201911345297	CALDAS NOVAS	CN21311852	RIO QUENTE	27/11/2019 14:14	27/11/2019 18:21	27/11/2019 14:14	27/11/2019 18:21	4,11	1	4,11	CHI
201911345298	MORRINHOS	MR12000166	MORRINHOS	27/11/2019 14:14	27/11/2019 16:28	27/11/2019 14:14	27/11/2019 16:28	2,23	5	11,13	CHI
201911345306	CALDAS NOVAS	CN21182871	SERRA DE CALDAS	27/11/2019 14:16	27/11/2019 23:00	27/11/2019 14:16	27/11/2019 23:00	8,72	1	8,72	CHI
201911345307	NOVA AURORA	NE21082764	CATALAO S1	27/11/2019 14:17	27/11/2019 16:37	27/11/2019 14:17	27/11/2019 16:37	2,33	1	2,33	CHI
201911345308	RIO VERDE	630150242	RIO VERDE S2	27/11/2019 14:17	27/11/2019 15:26	27/11/2019 14:17	27/11/2019 15:26	1,16	1	1,16	CHI
201911345309	CUMARI	CT21216984	CATALAO S2	27/11/2019 14:17	27/11/2019 21:04	27/11/2019 14:17	27/11/2019 21:04	6,77	1	6,77	CHI
201911345324	IVOLANDIA	IR21140095	IPORA	27/11/2019 14:18	28/11/2019 14:30	27/11/2019 14:18	28/11/2019 14:30	24,19	1	24,19	CHI

201911345325	EDEALINA	ED11044339	PONTALINA	27/11/2019 14:18	27/11/2019 19:01	27/11/2019 14:18	27/11/2019 19:01	4,72	290	1370,01	CHI
201911345328	FORMOSA	610285610	ITUIQUIRA	27/11/2019 14:19	27/11/2019 17:49	27/11/2019 14:19	27/11/2019 17:49	3,49	1	3,49	CHI
201911345335	GOIANIA	15684234	GOIANIA LESTE S3	27/11/2019 14:21	27/11/2019 17:00	27/11/2019 14:21	27/11/2019 17:00	2,65	1	2,65	CHI
201911345344	GAMELEIRA DE GOIAS	3820000948	DAIA S2	27/11/2019 14:22	28/11/2019 11:00	27/11/2019 14:22	28/11/2019 11:00	20,62	1	20,62	CHI
201911345350	ORIZONA	OZ12318935	PIRES DO RIO S2	27/11/2019 14:23	27/11/2019 19:40	27/11/2019 14:23	27/11/2019 19:40	5,27	2	10,54	CHI
201911345351	MONTE ALEGRE DE GOIAS	MA12233174	SAO DOMINGOS	27/11/2019 12:25	27/11/2019 17:35	27/11/2019 12:25	27/11/2019 17:35	5,16	17	87,77	CHI
201911345356	SAO JOAO D ALIANCA	JL12117446	SAO JOAO D ALIANCA	27/11/2019 14:24	28/11/2019 09:05	27/11/2019 14:24	28/11/2019 09:05	18,67	23	429,45	CHI
201911345356	AGUA FRIA DE GOIAS	JL12117446	SAO JOAO D ALIANCA	27/11/2019 14:24	28/11/2019 09:05	27/11/2019 14:24	28/11/2019 09:05	18,67	19	354,77	CHI
201911345359	IVOLANDIA	IV21231255	ARENOPOLIS	27/11/2019 14:25	28/11/2019 12:20	27/11/2019 14:25	28/11/2019 12:20	21,91	1	21,91	CHI
201911345365	AMORINOPOLIS	AM12193439	IPORA	27/11/2019 11:35	27/11/2019 15:20	27/11/2019 11:35	27/11/2019 15:20	3,75	14	52,46	CHI
201911345373	ITUMBIARA	CD12000179	CACHOEIRA DOURADA	27/11/2019 14:28	27/11/2019 21:00	27/11/2019 14:28	27/11/2019 20:40	6,20	5	31,02	CHI
201911345373	CACHOEIRA DOURADA	CD12000179	CACHOEIRA DOURADA	27/11/2019 14:28	27/11/2019 21:00	27/11/2019 14:28	27/11/2019 20:40	6,20	3	18,61	CHI
201911345373	CACHOEIRA DOURADA	CD12000181	CACHOEIRA DOURADA	27/11/2019 14:28	27/11/2019 21:00	27/11/2019 14:28	27/11/2019 21:00	6,55	1	6,55	CHI
201911345376	SAO SIMAO	2240010132	CACHOEIRA ALTA	27/11/2019 14:28	27/11/2019 16:08	27/11/2019 14:28	27/11/2019 16:08	1,66	1	1,66	CHI
201911345377	GOIANIA	10012192293	CAMPINAS S2	27/11/2019 14:28	27/11/2019 15:44	27/11/2019 14:28	27/11/2019 15:44	1,27	1	1,27	CHI
201911345381	PETROLINA DE GOIAS	10020267019	PETROLINA	27/11/2019 14:29	27/11/2019 16:10	27/11/2019 14:29	27/11/2019 16:10	1,69	1	1,69	CHI
201911345382	CALDAS NOVAS	CN21103280	RIO QUENTE	27/11/2019 14:29	27/11/2019 18:47	27/11/2019 14:29	27/11/2019 18:47	4,30	1	4,30	CHI
201911345384	PIRENOPOLIS	PV21171449	CORUMBA	27/11/2019 14:29	27/11/2019 17:11	27/11/2019 14:29	27/11/2019 17:11	2,69	5	13,43	CHI
201911345385	GOIANIA	12410007	GOYA S2	27/11/2019 14:29	27/11/2019 17:23	27/11/2019 14:29	27/11/2019 17:23	2,89	1	2,89	CHI
201911345386	BELA VISTA DE GOIAS	BV12086489	CEPAIGO S2	27/11/2019 14:28	28/11/2019 08:30	27/11/2019 14:28	28/11/2019 08:30	18,02	13	234,22	CHI
201911345390	JESUPOLIS	JE21269000	SAO FRANCISCO DE GOIAS	27/11/2019 14:31	27/11/2019 15:50	27/11/2019 14:31	27/11/2019 15:50	1,31	1	1,31	CHI
201911345392	POSSE	1480044997	IACIARA S2	27/11/2019 14:31	27/11/2019 18:15	27/11/2019 14:31	27/11/2019 18:15	3,73	1	3,73	CHI
201911345400	NIQUELANDIA	NQ12378056	NIQUELANDIA SUBTRANSMISSAO	27/11/2019 12:35	28/11/2019 09:06	27/11/2019 12:35	28/11/2019 09:06	20,51	5	102,54	CHI
201911345408	LUZIANIA	LZ12013828	VIANOPOLIS	27/11/2019 14:32	27/11/2019 18:57	27/11/2019 14:32	27/11/2019 18:57	4,41	7	30,90	CHI
201911345409	SITIO D ABADIA	PS12236912	IACIARA S2	27/11/2019 14:34	27/11/2019 18:12	27/11/2019 14:34	27/11/2019 18:12	3,62	2	7,24	CHI
201911345410	GOIANIA	10011700902	XAVANTES	27/11/2019 14:34	27/11/2019 17:10	27/11/2019 14:34	27/11/2019 17:10	2,59	1	2,59	CHI
201911345411	TERESINA DE GOIAS	TE21237596	FLORES DE GOIAS	27/11/2019 14:34	27/11/2019 16:53	27/11/2019 14:34	27/11/2019 16:53	2,30	1	2,30	CHI
201911345416	ALEXANIA	AX21071321	ALEXANIA	27/11/2019 14:36	27/11/2019 16:37	27/11/2019 14:36	27/11/2019 16:37	2,01	1	2,01	CHI
201911345417	PALMEIRAS DE GOIAS	NZ12233489	ANICUNS	27/11/2019 14:36	27/11/2019 16:13	27/11/2019 14:36	27/11/2019 16:13	1,61	3	4,82	CHI
201911345417	NAZARIO	NZ12233489	ANICUNS	27/11/2019 14:36	27/11/2019 16:13	27/11/2019 14:36	27/11/2019 16:13	1,61	40	64,27	CHI
201911345419	NEROPOLIS	NR21322371	NEROPOLIS S2	27/11/2019 14:36	27/11/2019 16:31	27/11/2019 14:36	27/11/2019 16:31	1,90	1	1,90	CHI
201911345421	CALDAS NOVAS	CN12363765	CALDAS NOVAS S1	27/11/2019 14:37	27/11/2019 18:00	27/11/2019 14:37	27/11/2019 18:00	3,38	18	60,87	CHI
201911345423	ITUMBIARA	IT12257075	ITUMBIARA NOVA	27/11/2019 14:38	27/11/2019 17:29	27/11/2019 14:38	27/11/2019 17:29	2,85	22	62,68	CHI

201911345425	MINACU	IH21320940	MINACU	27/11/2019 14:38	27/11/2019 23:37	27/11/2019 14:38	27/11/2019 23:37	8,98	1	8,98	CHI
201911345428	INHUMAS	30092619	INHUMAS S2	27/11/2019 14:38	27/11/2019 16:41	27/11/2019 14:38	27/11/2019 16:41	2,04	1	2,04	CHI
201911345433	ALEXANIA	AX12048218	ALEXANIA	27/11/2019 13:35	27/11/2019 15:56	27/11/2019 13:35	27/11/2019 15:56	2,34	3	7,01	CHI
201911345434	HIDROLANDIA	10009540499	CEPAIGO S2	27/11/2019 14:39	27/11/2019 17:57	27/11/2019 14:39	27/11/2019 17:57	3,29	1	3,29	CHI
201911345439	CALDAS NOVAS	CN11163580	CALDAS NOVAS S2	27/11/2019 14:13	27/11/2019 17:04	27/11/2019 14:13	27/11/2019 17:04	2,84	32	90,90	CHI
201911345444	ITAPURANGA	IK21286234	ITAPURANGA	27/11/2019 14:40	28/11/2019 12:08	27/11/2019 14:40	28/11/2019 12:08	21,45	1	21,45	CHI
201911345452	RUBIATABA	RB12029016LD	RUBIATABA	27/11/2019 12:01	28/11/2019 14:18	27/11/2019 12:01	28/11/2019 14:18	26,27	15	394,07	CHI
201911345459	GOIATUBA	CL12295951	RIO DOS BOIS	27/11/2019 12:47	27/11/2019 17:10	27/11/2019 12:47	27/11/2019 17:10	4,37	10	43,73	CHI
201911345465	GOIATUBA	GT12041937	GOIATUBA S2	27/11/2019 14:44	27/11/2019 20:30	27/11/2019 14:44	27/11/2019 20:30	5,78	2	11,56	CHI
201911345466	SANTA TEREZINHA DE GOIAS	SG21194939	SANTA TEREZINHA	27/11/2019 14:43	28/11/2019 11:40	27/11/2019 14:43	28/11/2019 11:40	20,95	2	41,89	CHI
201911345467	SAO LUIS DE MONTES BELOS	SL21003701	SAO LUIZ DOS MONTES BELOS	27/11/2019 14:43	27/11/2019 16:47	27/11/2019 14:43	27/11/2019 16:47	2,06	1	2,06	CHI
201911345468	PIRES DO RIO	PR12319028	PIRES DO RIO S1	27/11/2019 14:41	27/11/2019 18:41	27/11/2019 14:41	27/11/2019 18:41	4,00	13	52,04	CHI
201911345470	INHUMAS	10019008617	INHUMAS S2	27/11/2019 14:44	27/11/2019 18:00	27/11/2019 14:44	27/11/2019 18:00	3,27	1	3,27	CHI
201911345476	CRIXAS	CX12405291	SANTA TEREZINHA	27/11/2019 13:16	27/11/2019 21:45	27/11/2019 13:16	27/11/2019 21:45	8,47	90	762,08	CHI
201911345477	SANTA HELENA DE GOIAS	400137434	SANTA HELENA S1	27/11/2019 14:45	27/11/2019 16:10	27/11/2019 14:45	27/11/2019 16:10	1,41	1	1,41	CHI
201911345478	MUNDO NOVO DE GOIAS	MH11269078	NOVA CRIXAS	27/11/2019 14:45	28/11/2019 00:44	27/11/2019 14:45	28/11/2019 00:44	9,97	1	9,97	CHI
201911345488	CATURAI	CK12039223	ARACU	27/11/2019 14:47	27/11/2019 17:26	27/11/2019 14:47	27/11/2019 17:26	2,64	7	18,46	CHI
201911345512	JUSSARA	JR12349229	BRITANIA	27/11/2019 14:39	27/11/2019 15:12	27/11/2019 14:39	27/11/2019 15:12	0,54	2	1,08	CHI
201911345518	IVOLANDIA	IV12334658	IPORA	27/11/2019 14:29	27/11/2019 15:45	27/11/2019 14:29	27/11/2019 15:45	1,25	1	1,25	CHI
201911345537	FAINA	FC12278266	GOIAS	27/11/2019 11:53	27/11/2019 17:42	27/11/2019 11:53	27/11/2019 17:42	5,81	7	40,66	CHI
201911345543	PIRANHAS	05560214	PIRANHAS	27/11/2019 15:57	27/11/2019 22:19	27/11/2019 15:57	27/11/2019 17:40	1,73	1646	2844,84	CHI
201911345543	ARENOPOLIS	05560214	PIRANHAS	27/11/2019 15:57	27/11/2019 22:19	27/11/2019 15:57	27/11/2019 17:40	1,73	10	17,28	CHI
201911345543	PIRANHAS	05560214	PIRANHAS	27/11/2019 15:57	27/11/2019 22:19	27/11/2019 19:14	27/11/2019 19:17	0,06	1646	98,30	CHI
201911345543	ARENOPOLIS	05560214	PIRANHAS	27/11/2019 15:57	27/11/2019 22:19	27/11/2019 19:14	27/11/2019 19:17	0,06	10	0,60	CHI
201911345543	PIRANHAS	05560214	PIRANHAS	27/11/2019 15:57	27/11/2019 22:19	27/11/2019 15:57	27/11/2019 22:19	6,36	489	3112,48	CHI
201911345543	BOM JARDIM DE GOIAS	05560214	PIRANHAS	27/11/2019 15:57	27/11/2019 22:19	27/11/2019 15:57	27/11/2019 22:19	6,36	16	101,84	CHI
201911345543	ARENOPOLIS	05560214	PIRANHAS	27/11/2019 15:57	27/11/2019 22:19	27/11/2019 15:57	27/11/2019 22:19	6,36	1	6,36	CHI
201911345543	PIRANHAS	PH12243872LD	PIRANHAS	27/11/2019 15:57	27/11/2019 22:19	27/11/2019 19:06	27/11/2019 22:19	3,21	2	6,43	CHI
201911345543	BOM JARDIM DE GOIAS	PH12243872LD	PIRANHAS	27/11/2019 15:57	27/11/2019 22:19	27/11/2019 19:06	27/11/2019 22:19	3,21	2	6,43	CHI
201911345544	GOIANIA	GN11093391	MEIA PONTE	27/11/2019 16:07	27/11/2019 20:18	27/11/2019 16:07	27/11/2019 20:18	4,18	99	413,38	CHI
201911345547	CAMPO ALEGRE DE GOIAS	02250424	CAMPO ALEGRE DE GOIAS	27/11/2019 15:54	27/11/2019 16:14	27/11/2019 15:54	27/11/2019 16:08	0,24	147	35,57	CHI
201911345547	CAMPO ALEGRE DE GOIAS	02250424	CAMPO ALEGRE DE GOIAS	27/11/2019 15:54	27/11/2019 16:14	27/11/2019 15:54	27/11/2019 16:08	0,23	2	0,47	CHI
201911345547	CATALAO	02250424	CAMPO ALEGRE DE GOIAS	27/11/2019 15:54	27/11/2019 16:14	27/11/2019 15:54	27/11/2019 16:14	0,34	20	6,76	CHI

201911345547	IPAMERI	02250424	CAMPO ALEGRE DE GOIAS	27/11/2019 15:54	27/11/2019 16:14	27/11/2019 15:54	27/11/2019 16:14	0,34	12	4,05	CHI
201911345547	DISTRITO FEDERAL	02250424	CAMPO ALEGRE DE GOIAS	27/11/2019 15:54	27/11/2019 16:14	27/11/2019 15:54	27/11/2019 16:14	0,34	1	0,34	CHI
201911345547	CAMPO ALEGRE DE GOIAS	02250424	CAMPO ALEGRE DE GOIAS	27/11/2019 15:54	27/11/2019 16:14	27/11/2019 15:54	27/11/2019 16:14	0,34	115	38,84	CHI
201911345554	SAO DOMINGOS	SD12345873	SAO DOMINGOS	27/11/2019 13:13	27/11/2019 20:38	27/11/2019 13:13	27/11/2019 20:38	7,40	2	14,80	CHI
201911345556	SAO DOMINGOS	SD12160018	SAO DOMINGOS	27/11/2019 16:43	27/11/2019 21:07	27/11/2019 16:43	27/11/2019 21:07	4,40	3	13,19	CHI
201911345557	PIRENOPOLIS	PV10395367	CORUMBA	27/11/2019 16:59	28/11/2019 17:38	27/11/2019 16:59	27/11/2019 18:12	1,22	44	53,53	CHI
201911345557	JARAGUA	PV12000071LD	CORUMBA	27/11/2019 16:59	28/11/2019 17:38	27/11/2019 16:59	27/11/2019 18:31	1,53	13	19,85	CHI
201911345557	PIRENOPOLIS	PV12000071LD	CORUMBA	27/11/2019 16:59	28/11/2019 17:38	27/11/2019 16:59	27/11/2019 18:31	1,53	318	485,57	CHI
201911345557	PIRENOPOLIS	PV13382375	CORUMBA	27/11/2019 16:59	28/11/2019 17:38	27/11/2019 16:59	27/11/2019 18:45	1,76	289	507,76	CHI
201911345557	SAO FRANCISCO DE GOIAS	PV13382375	CORUMBA	27/11/2019 16:59	28/11/2019 17:38	27/11/2019 16:59	27/11/2019 18:45	1,76	2	3,51	CHI
201911345557	JARAGUA	PV10395367	CORUMBA	27/11/2019 16:59	28/11/2019 17:38	27/11/2019 18:45	27/11/2019 19:01	0,27	13	3,47	CHI
201911345557	PIRENOPOLIS	PV10395367	CORUMBA	27/11/2019 16:59	28/11/2019 17:38	27/11/2019 18:45	27/11/2019 19:01	0,27	361	96,37	CHI
201911345557	JARAGUA	PV10395367	CORUMBA	27/11/2019 16:59	28/11/2019 17:38	27/11/2019 20:28	27/11/2019 20:43	0,24	13	3,07	CHI
201911345557	PIRENOPOLIS	PV10395367	CORUMBA	27/11/2019 16:59	28/11/2019 17:38	27/11/2019 20:28	27/11/2019 20:43	0,24	361	85,34	CHI
201911345557	PIRENOPOLIS	PV10395367	CORUMBA	27/11/2019 16:59	28/11/2019 17:38	27/11/2019 22:53	28/11/2019 10:03	11,16	362	4040,93	CHI
201911345557	JARAGUA	PV10395367	CORUMBA	27/11/2019 16:59	28/11/2019 17:38	27/11/2019 22:53	28/11/2019 10:03	11,16	13	145,12	CHI
201911345557	PIRENOPOLIS	PV13382375	CORUMBA	27/11/2019 16:59	28/11/2019 17:38	27/11/2019 20:28	28/11/2019 14:43	18,25	18	328,47	CHI
201911345557	PIRENOPOLIS	PV12056014	CORUMBA	27/11/2019 16:59	28/11/2019 17:38	27/11/2019 20:28	28/11/2019 16:41	20,21	45	909,50	CHI
201911345557	PIRENOPOLIS	PV12017586	CORUMBA	27/11/2019 16:59	28/11/2019 17:38	27/11/2019 20:28	28/11/2019 17:03	20,58	56	1152,32	CHI
201911345557	PIRENOPOLIS	PV12355148	CORUMBA	27/11/2019 16:59	28/11/2019 17:38	27/11/2019 20:28	28/11/2019 17:38	21,16	25	528,94	CHI
201911345565	SAO SIMAO	SO10394738	CACHOEIRA ALTA	27/11/2019 17:09	27/11/2019 22:58	27/11/2019 17:09	27/11/2019 18:56	1,79	8	14,29	CHI
201911345565	CACU	SO13071430	CACHOEIRA ALTA	27/11/2019 17:09	27/11/2019 22:58	27/11/2019 17:09	27/11/2019 20:32	3,37	89	300,10	CHI
201911345565	SAO SIMAO	SO13071430	CACHOEIRA ALTA	27/11/2019 17:09	27/11/2019 22:58	27/11/2019 17:09	27/11/2019 20:32	3,37	13	43,84	CHI
201911345565	CACHOEIRA ALTA	SO13071430	CACHOEIRA ALTA	27/11/2019 17:09	27/11/2019 22:58	27/11/2019 17:09	27/11/2019 20:32	3,37	6	20,23	CHI
201911345565	CACU	CC13360544	CACHOEIRA ALTA	27/11/2019 17:09	27/11/2019 22:58	27/11/2019 17:09	27/11/2019 22:17	5,14	3	15,41	CHI
201911345565	CACU	CC13071437	CACHOEIRA ALTA	27/11/2019 17:09	27/11/2019 22:58	27/11/2019 17:09	27/11/2019 22:58	5,81	7	40,64	CHI
201911345572	JATAI	JT10378104	JATAI S2	27/11/2019 17:24	28/11/2019 10:16	27/11/2019 17:24	27/11/2019 21:19	3,92	54	211,57	CHI
201911345572	RIO VERDE	JT10378104	JATAI S2	27/11/2019 17:24	28/11/2019 10:16	27/11/2019 17:24	28/11/2019 07:19	13,91	1	13,91	CHI
201911345572	JATAI	JT10378104	JATAI S2	27/11/2019 17:24	28/11/2019 10:16	27/11/2019 17:24	28/11/2019 07:19	13,91	161	2239,33	CHI
201911345572	JATAI	JT10378104	JATAI S2	27/11/2019 17:24	28/11/2019 10:16	27/11/2019 17:24	28/11/2019 07:33	14,14	48	678,84	CHI
201911345572	JATAI	JT10378104	JATAI S2	27/11/2019 17:24	28/11/2019 10:16	27/11/2019 17:24	28/11/2019 09:30	16,10	21	338,02	CHI
201911345572	JATAI	JT10378104	JATAI S2	27/11/2019 17:24	28/11/2019 10:16	27/11/2019 17:24	28/11/2019 10:16	16,86	49	826,02	CHI
201911345572	RIO VERDE	JT10378104	JATAI S2	27/11/2019 17:24	28/11/2019 10:16	27/11/2019 17:24	28/11/2019 10:16	16,86	30	505,73	CHI

201911345573	RUBIATABA	RB10394723	RUBIATABA	27/11/2019 17:46	30/11/2019 13:19	27/11/2019 17:46	27/11/2019 21:42	3,93	131	514,90	CHI
201911345573	RUBIATABA	RB10394723	RUBIATABA	27/11/2019 17:46	30/11/2019 13:19	28/11/2019 01:13	28/11/2019 02:06	0,88	132	115,65	CHI
201911345573	MORRO AGUDO DE GOIAS	MS13325146	RUBIATABA	27/11/2019 17:46	30/11/2019 13:19	27/11/2019 17:46	28/11/2019 03:55	10,14	14	141,99	CHI
201911345573	RUBIATABA	MS13325146	RUBIATABA	27/11/2019 17:46	30/11/2019 13:19	27/11/2019 17:46	28/11/2019 03:55	10,14	143	1450,34	CHI
201911345573	RUBIATABA	RB12372516	RUBIATABA	27/11/2019 17:46	30/11/2019 13:19	27/11/2019 17:46	29/11/2019 02:17	32,51	310	10078,79	CHI
201911345573	NOVA AMERICA	RB12372516	RUBIATABA	27/11/2019 17:46	30/11/2019 13:19	27/11/2019 17:46	29/11/2019 02:17	32,51	22	715,27	CHI
201911345573	CRIXAS	RB12372516	RUBIATABA	27/11/2019 17:46	30/11/2019 13:19	27/11/2019 17:46	29/11/2019 02:17	32,51	1	32,51	CHI
201911345573	MORRO AGUDO DE GOIAS	MS10400601	RUBIATABA	27/11/2019 17:46	30/11/2019 13:19	29/11/2019 07:26	29/11/2019 07:30	0,08	14	1,15	CHI
201911345573	CRIXAS	MS10400601	RUBIATABA	27/11/2019 17:46	30/11/2019 13:19	29/11/2019 07:26	29/11/2019 07:30	0,08	1	0,08	CHI
201911345573	RUBIATABA	MS10400601	RUBIATABA	27/11/2019 17:46	30/11/2019 13:19	29/11/2019 07:26	29/11/2019 07:30	0,08	466	38,19	CHI
201911345573	NOVA AMERICA	MS10400601	RUBIATABA	27/11/2019 17:46	30/11/2019 13:19	29/11/2019 07:26	29/11/2019 07:30	0,08	22	1,80	CHI
201911345573	ARAGUAPAZ	MS10400601	RUBIATABA	27/11/2019 17:46	30/11/2019 13:19	29/11/2019 07:26	29/11/2019 07:30	0,08	1	0,08	CHI
201911345573	ARAGUAPAZ	MS10400601	ITAPURANGA	27/11/2019 17:46	30/11/2019 13:19	29/11/2019 07:26	29/11/2019 07:30	0,08	3	0,25	CHI
201911345573	MORRO AGUDO DE GOIAS	MS10400601	ITAPURANGA	27/11/2019 17:46	30/11/2019 13:19	29/11/2019 07:26	29/11/2019 07:30	0,08	38	3,11	CHI
201911345573	FAINA	MS10400601	ITAPURANGA	27/11/2019 17:46	30/11/2019 13:19	29/11/2019 07:26	29/11/2019 07:30	0,08	7	0,57	CHI
201911345573	RUBIATABA	MS10400601	ITAPURANGA	27/11/2019 17:46	30/11/2019 13:19	29/11/2019 07:26	29/11/2019 07:30	0,08	10	0,82	CHI
201911345573	RUBIATABA	RB10394723	RUBIATABA	27/11/2019 17:46	30/11/2019 13:19	28/11/2019 23:47	30/11/2019 13:19	37,54	137	5143,40	CHI
201911345575	RIO VERDE	10002727747	CABRIUVA S1	27/11/2019 18:04	28/11/2019 08:20	27/11/2019 18:04	28/11/2019 08:20	14,27	1	14,27	CHI
201911345583	SANTA TEREZINHA DE GOIAS	01730434	SANTA TEREZINHA	27/11/2019 18:55	29/11/2019 20:18	27/11/2019 18:55	27/11/2019 22:02	3,13	35	109,38	CHI
201911345583	PILAR DE GOIAS	SG13141180	SANTA TEREZINHA	27/11/2019 18:55	29/11/2019 20:18	27/11/2019 18:55	28/11/2019 04:16	9,34	11	102,79	CHI
201911345583	SANTA TEREZINHA DE GOIAS	SG13141180	SANTA TEREZINHA	27/11/2019 18:55	29/11/2019 20:18	27/11/2019 18:55	28/11/2019 04:16	9,34	106	990,54	CHI
201911345583	PILAR DE GOIAS	01730434	SANTA TEREZINHA	27/11/2019 18:55	29/11/2019 20:18	28/11/2019 04:26	28/11/2019 04:39	0,21	11	2,31	CHI
201911345583	SANTA TEREZINHA DE GOIAS	01730434	SANTA TEREZINHA	27/11/2019 18:55	29/11/2019 20:18	28/11/2019 04:26	28/11/2019 04:39	0,21	141	29,61	CHI
201911345583	NOVA IGUACU DE GOIAS	NH13141173	SANTA TEREZINHA	27/11/2019 18:55	29/11/2019 20:18	27/11/2019 18:55	28/11/2019 06:45	11,84	1	11,84	CHI
201911345583	ALTO HORIZONTE	01730434	SANTA TEREZINHA	27/11/2019 18:55	29/11/2019 20:18	27/11/2019 18:55	28/11/2019 08:11	13,26	13	172,40	CHI
201911345583	NOVA IGUACU DE GOIAS	01730434	SANTA TEREZINHA	27/11/2019 18:55	29/11/2019 20:18	27/11/2019 18:55	28/11/2019 08:11	13,26	816	10821,29	CHI
201911345583	SANTA TEREZINHA DE GOIAS	01730434	SANTA TEREZINHA	27/11/2019 18:55	29/11/2019 20:18	27/11/2019 18:55	28/11/2019 08:11	13,26	62	822,21	CHI
201911345583	PILAR DE GOIAS	01730434	SANTA TEREZINHA	27/11/2019 18:55	29/11/2019 20:18	27/11/2019 18:55	28/11/2019 08:11	13,26	166	2201,39	CHI
201911345583	CAMPOS VERDES	01730434	SANTA TEREZINHA	27/11/2019 18:55	29/11/2019 20:18	27/11/2019 18:55	28/11/2019 08:12	13,29	8	106,28	CHI
201911345583	ALTO HORIZONTE	01730434	SANTA TEREZINHA	27/11/2019 18:55	29/11/2019 20:18	27/11/2019 18:55	28/11/2019 08:12	13,29	2296	30502,36	CHI
201911345583	PILAR DE GOIAS	01730434	SANTA TEREZINHA	27/11/2019 18:55	29/11/2019 20:18	27/11/2019 18:55	28/11/2019 08:12	13,29	1	13,29	CHI
201911345583	NOVA IGUACU DE GOIAS	01730434	SANTA TEREZINHA	27/11/2019 18:55	29/11/2019 20:18	27/11/2019 18:55	28/11/2019 08:12	13,29	362	4809,17	CHI
201911345583	NOVA IGUACU DE GOIAS	NH13341295	SANTA TEREZINHA	27/11/2019 18:55	29/11/2019 20:18	28/11/2019 04:26	28/11/2019 08:12	3,76	1	3,76	CHI

201911345583	NOVA IGUACU DE GOIAS	03400224	SANTA TEREZINHA	27/11/2019 18:55	29/11/2019 20:18	28/11/2019 08:14	28/11/2019 08:20	0,09	126	11,37	CHI
201911345583	CAMPOS VERDES	NH16410907	SANTA TEREZINHA	27/11/2019 18:55	29/11/2019 20:18	28/11/2019 08:14	28/11/2019 09:46	1,53	8	12,25	CHI
201911345583	ALTO HORIZONTE	NH16410907	SANTA TEREZINHA	27/11/2019 18:55	29/11/2019 20:18	28/11/2019 08:14	28/11/2019 09:46	1,53	58	88,79	CHI
201911345583	NOVA IGUACU DE GOIAS	NH16410907	SANTA TEREZINHA	27/11/2019 18:55	29/11/2019 20:18	28/11/2019 08:14	28/11/2019 09:46	1,53	235	359,75	CHI
201911345583	PILAR DE GOIAS	NH16410907	SANTA TEREZINHA	27/11/2019 18:55	29/11/2019 20:18	28/11/2019 08:14	28/11/2019 09:46	1,53	1	1,53	CHI
201911345583	ALTO HORIZONTE	MQ10400799	SANTA TEREZINHA	27/11/2019 18:55	29/11/2019 20:18	28/11/2019 08:14	28/11/2019 13:16	5,02	2209	11088,57	CHI
201911345583	ALTO HORIZONTE	AJ12213250	SANTA TEREZINHA	27/11/2019 18:55	29/11/2019 20:18	28/11/2019 19:27	28/11/2019 23:50	4,38	2156	9450,47	CHI
201911345583	ALTO HORIZONTE	MQ13023848	SANTA TEREZINHA	27/11/2019 18:55	29/11/2019 20:18	28/11/2019 08:14	29/11/2019 17:50	33,59	29	974,01	CHI
201911345583	NOVA IGUACU DE GOIAS	MQ13023848	SANTA TEREZINHA	27/11/2019 18:55	29/11/2019 20:18	28/11/2019 08:14	29/11/2019 17:50	33,59	2	67,17	CHI
201911345583	ALTO HORIZONTE	AJ13321037	SANTA TEREZINHA	27/11/2019 18:55	29/11/2019 20:18	29/11/2019 19:01	29/11/2019 19:13	0,20	1774	351,84	CHI
201911345583	ALTO HORIZONTE	AJ16408540	SANTA TEREZINHA	27/11/2019 18:55	29/11/2019 20:18	29/11/2019 20:12	29/11/2019 20:18	0,09	435	39,51	CHI
201911345584	CAMPO ALEGRE DE GOIAS	02250424	CAMPO ALEGRE DE GOIAS	27/11/2019 19:07	28/11/2019 16:19	27/11/2019 19:07	27/11/2019 22:35	3,48	78	271,31	CHI
201911345584	CAMPO ALEGRE DE GOIAS	02250424	CAMPO ALEGRE DE GOIAS	27/11/2019 19:07	28/11/2019 16:19	27/11/2019 19:07	28/11/2019 11:55	16,81	43	723,02	CHI
201911345584	CAMPO ALEGRE DE GOIAS	CM13266893	CAMPO ALEGRE DE GOIAS	27/11/2019 19:07	28/11/2019 16:19	27/11/2019 19:07	28/11/2019 11:55	16,81	131	2202,69	CHI
201911345584	CATALAO	CM13266893	CAMPO ALEGRE DE GOIAS	27/11/2019 19:07	28/11/2019 16:19	27/11/2019 19:07	28/11/2019 11:55	16,81	21	353,10	CHI
201911345584	IPAMERI	CM13266893	CAMPO ALEGRE DE GOIAS	27/11/2019 19:07	28/11/2019 16:19	27/11/2019 19:07	28/11/2019 11:55	16,81	12	201,77	CHI
201911345584	DISTRITO FEDERAL	CM13266893	CAMPO ALEGRE DE GOIAS	27/11/2019 19:07	28/11/2019 16:19	27/11/2019 19:07	28/11/2019 11:55	16,81	1	16,81	CHI
201911345584	CAMPO ALEGRE DE GOIAS	02250424	CAMPO ALEGRE DE GOIAS	27/11/2019 19:07	28/11/2019 16:19	27/11/2019 19:07	28/11/2019 16:19	21,21	29	615,23	CHI
201911345585	CACU	CC10394735	CACHOEIRA ALTA	27/11/2019 19:22	28/11/2019 21:36	27/11/2019 19:22	28/11/2019 00:31	5,15	63	324,70	CHI
201911345585	CACU	CC10394735	CACHOEIRA ALTA	27/11/2019 19:22	28/11/2019 21:36	27/11/2019 19:22	28/11/2019 21:36	26,24	93	2439,88	CHI
201911345585	ITARUMA	CC10394735	CACHOEIRA ALTA	27/11/2019 19:22	28/11/2019 21:36	27/11/2019 19:22	28/11/2019 21:36	26,24	35	918,23	CHI
201911345590	MINEIROS	MY10396070	PARQUE DAS EMAS	27/11/2019 19:57	29/11/2019 22:58	27/11/2019 19:57	27/11/2019 21:43	1,76	43	75,80	CHI
201911345590	MINEIROS	MY10396070	PARQUE DAS EMAS	27/11/2019 19:57	29/11/2019 22:58	27/11/2019 19:57	28/11/2019 01:19	5,35	34	182,03	CHI
201911345590	MINEIROS	MY10396070	PARQUE DAS EMAS	27/11/2019 19:57	29/11/2019 22:58	28/11/2019 21:26	28/11/2019 21:40	0,23	77	17,99	CHI
201911345590	MINEIROS	MY10396070	PARQUE DAS EMAS	27/11/2019 19:57	29/11/2019 22:58	27/11/2019 19:57	29/11/2019 01:04	29,11	24	698,67	CHI
201911345590	MINEIROS	MY10396070	PARQUE DAS EMAS	27/11/2019 19:57	29/11/2019 22:58	29/11/2019 01:05	29/11/2019 04:50	3,77	77	289,97	CHI
201911345590	MINEIROS	MY10396070	PARQUE DAS EMAS	27/11/2019 19:57	29/11/2019 22:58	29/11/2019 11:18	29/11/2019 11:48	0,50	77	38,37	CHI
201911345590	MINEIROS	MY10396070	PARQUE DAS EMAS	27/11/2019 19:57	29/11/2019 22:58	29/11/2019 14:57	29/11/2019 15:21	0,41	77	31,27	CHI
201911345590	MINEIROS	MY10396070	PARQUE DAS EMAS	27/11/2019 19:57	29/11/2019 22:58	27/11/2019 19:57	29/11/2019 16:20	44,37	13	576,84	CHI
201911345590	MINEIROS	MY13324361	PARQUE DAS EMAS	27/11/2019 19:57	29/11/2019 22:58	29/11/2019 01:05	29/11/2019 17:17	16,21	3	48,64	CHI
201911345590	MINEIROS	MY13324463	PARQUE DAS EMAS	27/11/2019 19:57	29/11/2019 22:58	29/11/2019 01:05	29/11/2019 22:58	21,89	18	393,97	CHI
201911345590	SERRANOPOLIS	MY10396070	PARQUE DAS EMAS	27/11/2019 19:57	29/11/2019 22:58	27/11/2019 19:57	29/11/2019 22:58	51,01	7	357,05	CHI
201911345590	MINEIROS	MY10396070	PARQUE DAS EMAS	27/11/2019 19:57	29/11/2019 22:58	27/11/2019 19:57	29/11/2019 22:58	51,01	13	663,10	CHI

201911345590	MINEIROS	MY13324497	PARQUE DAS EMAS	27/11/2019 19:57	29/11/2019 22:58	29/11/2019 17:38	29/11/2019 22:58	5,33	16	85,22	CHI
201911345590	MINEIROS	MY12324392	PARQUE DAS EMAS	27/11/2019 19:57	29/11/2019 22:58	29/11/2019 01:05	29/11/2019 22:58	21,90	3	65,70	CHI
201911345591	BALIZA	BH12331363	BOM JARDIM	27/11/2019 20:03	27/11/2019 20:08	27/11/2019 20:03	27/11/2019 20:08	0,07	2	0,14	CHI
201911345618	NOVA AURORA	NE12042356	CATALAO S1	27/11/2019 14:53	27/11/2019 17:37	27/11/2019 14:53	27/11/2019 17:37	2,73	3	8,19	CHI
201911345619	CALDAS NOVAS	CN12213871	CALDAS NOVAS S1	27/11/2019 14:53	27/11/2019 18:02	27/11/2019 14:53	27/11/2019 18:02	3,16	5	15,78	CHI
201911345630	CAMPOS BELOS	CH11204736	SAO DOMINGOS	27/11/2019 14:55	27/11/2019 18:50	27/11/2019 14:55	27/11/2019 18:50	3,91	89	347,99	CHI
201911345631	FAINA	MS12220561	ITAPURANGA	27/11/2019 13:49	28/11/2019 11:35	27/11/2019 13:49	28/11/2019 11:35	21,76	10	217,59	CHI
201911345637	PETROLINA DE GOIAS	01450224	PETROLINA	27/11/2019 14:56	27/11/2019 15:16	27/11/2019 14:56	27/11/2019 15:16	0,33	1530	505,75	CHI
201911345637	SAO FRANCISCO DE GOIAS	01450224	PETROLINA	27/11/2019 14:56	27/11/2019 15:16	27/11/2019 14:56	27/11/2019 15:16	0,33	34	11,24	CHI
201911345639	JATAI	10018764892	JATAI S3	27/11/2019 14:57	27/11/2019 17:00	27/11/2019 14:57	27/11/2019 17:00	2,06	1	2,06	CHI
201911345652	CRISTIANOPOLIS	CF21127023	CRISTIANOPOLIS	27/11/2019 15:00	27/11/2019 18:35	27/11/2019 15:00	27/11/2019 18:35	3,58	1	3,58	CHI
201911345695	RIO VERDE	RV12260579	RIO VERDE S1	27/11/2019 15:02	27/11/2019 17:34	27/11/2019 15:02	27/11/2019 17:34	2,54	16	40,64	CHI
201911345699	GOUVELANDIA	GB12116524	QUIRINOPOLIS	27/11/2019 15:03	27/11/2019 22:27	27/11/2019 15:03	27/11/2019 22:27	7,40	4	29,60	CHI
201911345699	QUIRINOPOLIS	GB12116524	QUIRINOPOLIS	27/11/2019 15:03	27/11/2019 22:27	27/11/2019 15:03	27/11/2019 22:27	7,40	7	51,80	CHI
201911345703	SAO FRANCISCO DE GOIAS	SF12008967	SAO FRANCISCO DE GOIAS	27/11/2019 12:33	27/11/2019 17:13	27/11/2019 12:33	27/11/2019 17:13	4,65	19	88,44	CHI
201911345714	SENADOR CANEDO	SW12329397	SENADOR CANEDO	27/11/2019 15:05	27/11/2019 17:10	27/11/2019 15:05	27/11/2019 17:10	2,08	393	815,48	CHI
201911345731	JATAI	JT12182083	JATAI S1	27/11/2019 15:07	27/11/2019 20:25	27/11/2019 15:07	27/11/2019 20:25	5,28	3	15,85	CHI
201911345732	GUARINOS	IW12201636	ITAPACI	27/11/2019 14:40	27/11/2019 18:17	27/11/2019 14:40	27/11/2019 17:02	2,38	7	16,66	CHI
201911345732	ITAPACI	IW12201636	ITAPACI	27/11/2019 14:40	27/11/2019 18:17	27/11/2019 14:40	27/11/2019 17:02	2,38	134	318,99	CHI
201911345732	PILAR DE GOIAS	IW12201636	ITAPACI	27/11/2019 14:40	27/11/2019 18:17	27/11/2019 14:40	27/11/2019 17:02	2,38	1	2,38	CHI
201911345732	ITAPACI	IW12201636	ITAPACI	27/11/2019 14:40	27/11/2019 18:17	27/11/2019 14:40	27/11/2019 18:17	3,62	110	398,54	CHI
201911345738	MARA ROSA	10012459800	MARA ROSA	27/11/2019 15:09	28/11/2019 11:34	27/11/2019 15:09	28/11/2019 11:34	20,42	1	20,42	CHI
201911345743	SANTA FE DE GOIAS	RN12250624	BRITANIA	27/11/2019 15:09	27/11/2019 17:59	27/11/2019 15:09	27/11/2019 17:59	2,82	3	8,47	CHI
201911345744	NIQUELANDIA	NQ12371855	BARRO ALTO	27/11/2019 12:08	27/11/2019 22:46	27/11/2019 12:08	27/11/2019 22:46	10,62	243	2580,86	CHI
201911345744	MIMOSO DE GOIAS	NQ12371855	BARRO ALTO	27/11/2019 12:08	27/11/2019 22:46	27/11/2019 12:08	27/11/2019 22:46	10,62	4	42,48	CHI
201911345745	CALDAS NOVAS	CN11163542	CALDAS NOVAS S2	27/11/2019 14:06	27/11/2019 17:11	27/11/2019 14:06	27/11/2019 17:11	3,07	53	162,84	CHI
201911345758	GOIANIA	11543310	GOIANIA LESTE S3	27/11/2019 15:11	27/11/2019 17:04	27/11/2019 15:11	27/11/2019 17:04	1,88	1	1,88	CHI
201911345766	GOIANESIA	GE21229534	GOIANESIA S2	27/11/2019 15:14	28/11/2019 16:03	27/11/2019 15:14	28/11/2019 16:03	24,81	1	24,81	CHI
201911345773	QUIRINOPOLIS	QI11306199	QUIRINOPOLIS	27/11/2019 15:14	27/11/2019 16:49	27/11/2019 15:14	27/11/2019 16:49	1,57	32	50,28	CHI
201911345778	CALDAZINHA	BO12400523	CEPAIGO S2	27/11/2019 14:38	27/11/2019 17:15	27/11/2019 14:38	27/11/2019 17:15	2,61	2	5,22	CHI
201911345778	LEOPOLDO DE BULHOES	BO12400523	CEPAIGO S2	27/11/2019 14:38	27/11/2019 17:15	27/11/2019 14:38	27/11/2019 17:15	2,61	32	83,49	CHI
201911345779	SENADOR CANEDO	20293885	SENADOR CANEDO	27/11/2019 15:15	27/11/2019 19:07	27/11/2019 15:15	27/11/2019 19:07	3,86	2	7,73	CHI
201911345780	SENADOR CANEDO	SW12094891	SENADOR CANEDO	27/11/2019 15:15	27/11/2019 19:13	27/11/2019 15:15	27/11/2019 19:13	3,96	7	27,71	CHI

201911345782	NIQUELANDIA	NQ21255075	URUACU	27/11/2019 15:15	28/11/2019 15:33	27/11/2019 15:15	28/11/2019 15:33	24,29	1	24,29	CHI
201911345787	SILVANIA	SV21146437	DAIA S2	27/11/2019 15:16	28/11/2019 16:37	27/11/2019 15:16	28/11/2019 16:37	25,34	1	25,34	CHI
201911345788	SENADOR CANEDO	10030245778	SENADOR CANEDO	27/11/2019 15:16	27/11/2019 17:39	27/11/2019 15:16	27/11/2019 17:39	2,37	1	2,37	CHI
201911345789	COLINAS DO SUL	TI12232369RE	MINACU	27/11/2019 14:44	27/11/2019 20:32	27/11/2019 14:44	27/11/2019 20:32	5,79	13	75,33	CHI
201911345789	CAVALCANTE	TI12232369RE	MINACU	27/11/2019 14:44	27/11/2019 20:32	27/11/2019 14:44	27/11/2019 20:32	5,79	3	17,38	CHI
201911345791	SILVANIA	SV21079295	VIANOPOLIS	27/11/2019 15:17	28/11/2019 12:02	27/11/2019 15:17	28/11/2019 12:02	20,74	1	20,74	CHI
201911345793	HIDROLANDIA	HD31142616	CEPAIGO S2	27/11/2019 15:17	27/11/2019 18:15	27/11/2019 15:17	27/11/2019 18:15	2,96	2	5,92	CHI
201911345796	MORRINHOS	MR21212733	GOIATUBA S1	27/11/2019 15:17	27/11/2019 16:40	27/11/2019 15:17	27/11/2019 16:40	1,39	1	1,39	CHI
201911345799	APARECIDA DE GOIANIA	14933240	CARAJAS S1	27/11/2019 15:18	27/11/2019 17:51	27/11/2019 15:18	27/11/2019 17:51	2,55	1	2,55	CHI
201911345801	UIRAPURU	UP12297236	SANTA TEREZINHA	27/11/2019 15:18	28/11/2019 16:50	27/11/2019 15:18	28/11/2019 16:50	25,54	1	25,54	CHI
201911345811	MINEIROS	MY12260468	PARQUE DAS EMAS	27/11/2019 15:20	27/11/2019 18:37	27/11/2019 15:20	27/11/2019 18:37	3,28	5	16,41	CHI
201911345812	APARECIDA DE GOIANIA	11072568	ANHANGUERA	27/11/2019 15:20	27/11/2019 16:37	27/11/2019 15:20	27/11/2019 16:37	1,27	1	1,27	CHI
201911345815	NIQUELANDIA	6306820	NIQUELANDIA SUBTRANSMISSAO	27/11/2019 15:21	28/11/2019 22:09	27/11/2019 15:21	28/11/2019 22:09	30,81	4	123,22	CHI
201911345817	COCALZINHO DE GOIAS	1200021645	COCALZINHO	27/11/2019 15:21	27/11/2019 19:38	27/11/2019 15:21	27/11/2019 19:38	4,27	1	4,27	CHI
201911345827	GOIANIA	GN12001720	FERROVIARIO S3	27/11/2019 15:22	27/11/2019 15:55	27/11/2019 15:22	27/11/2019 15:55	0,54	2	1,07	CHI
201911345833	MONTE ALEGRE DE GOIAS	MA21202245	SAO DOMINGOS	27/11/2019 15:25	28/11/2019 12:01	27/11/2019 15:25	28/11/2019 12:01	20,60	1	20,60	CHI
201911345834	ARACU	AR21228341	ARACU	27/11/2019 15:25	27/11/2019 18:29	27/11/2019 15:25	27/11/2019 18:29	3,06	2	6,12	CHI
201911345836	IPORA	730091879	IPORA	27/11/2019 15:25	27/11/2019 17:08	27/11/2019 15:25	27/11/2019 17:08	1,71	1	1,71	CHI
201911345846	ABADIA DE GOIAS	LG21202850	INDEPENDENCIA S2	27/11/2019 15:27	27/11/2019 17:44	27/11/2019 15:27	27/11/2019 17:44	2,28	1	2,28	CHI
201911345848	RIO VERDE	RV21104918	CABRIUVA S1	27/11/2019 15:15	27/11/2019 15:26	27/11/2019 15:15	27/11/2019 15:26	0,18	1	0,18	CHI
201911345859	COCALZINHO DE GOIAS	PB21219627	AGUAS LINDAS DE GOIAS S2	27/11/2019 15:29	27/11/2019 20:01	27/11/2019 15:29	27/11/2019 20:01	4,53	1	4,53	CHI
201911345861	GOIATUBA	GT12044903	GOIATUBA S2	27/11/2019 15:29	27/11/2019 18:20	27/11/2019 15:29	27/11/2019 18:20	2,85	8	22,82	CHI
201911345861	MORRINHOS	GT12044903	GOIATUBA S2	27/11/2019 15:29	27/11/2019 18:20	27/11/2019 15:29	27/11/2019 18:20	2,85	3	8,56	CHI
201911345866	JATAI	SX12264387	JATAI S1	27/11/2019 15:30	28/11/2019 12:19	27/11/2019 15:30	28/11/2019 12:19	20,81	7	145,70	CHI
201911345866	SERRANOPOLIS	SX12264387	JATAI S1	27/11/2019 15:30	28/11/2019 12:19	27/11/2019 15:30	28/11/2019 12:19	20,81	22	457,91	CHI
201911345868	PORANGATU	840093858	PORANGATU	27/11/2019 15:30	27/11/2019 17:20	27/11/2019 15:30	27/11/2019 17:20	1,83	1	1,83	CHI
201911345875	PALMEIRAS DE GOIAS	PL12398710	PALMEIRAS	27/11/2019 15:31	27/11/2019 18:12	27/11/2019 15:31	27/11/2019 18:12	2,68	21	56,28	CHI
201911345877	PALMINOPOLIS	PP12072422	PALMEIRAS	27/11/2019 15:32	28/11/2019 12:35	27/11/2019 15:32	28/11/2019 12:35	21,04	3	63,12	CHI
201911345878	PORTELANDIA	PW12151599	PARQUE DAS EMAS	27/11/2019 15:19	27/11/2019 20:16	27/11/2019 15:19	27/11/2019 20:16	4,95	5	24,74	CHI
201911345881	JATAI	JT12219384RE	JATAI S3	27/11/2019 15:33	28/11/2019 10:52	27/11/2019 15:33	28/11/2019 09:07	17,56	10	175,56	CHI
201911345881	JATAI	JT12219384RE	JATAI S3	27/11/2019 15:33	28/11/2019 10:52	27/11/2019 22:43	28/11/2019 09:07	10,38	1	10,38	CHI
201911345881	JATAI	JT12219384RE	JATAI S3	27/11/2019 15:33	28/11/2019 10:52	27/11/2019 15:33	28/11/2019 10:20	18,78	15	281,73	CHI
201911345881	JATAI	JT12219384RE	JATAI S3	27/11/2019 15:33	28/11/2019 10:52	27/11/2019 15:33	28/11/2019 10:52	19,31	3	57,93	CHI



201911345882	ABADIANIA	AA12388792	DAIA S2	27/11/2019 15:33	28/11/2019 14:00	27/11/2019 15:33	28/11/2019 14:00	22,44	2	44,87	CHI
201911345885	CRISTALINA	KR21261101	CRISTALINA S2	27/11/2019 15:34	27/11/2019 16:57	27/11/2019 15:34	27/11/2019 16:57	1,38	1	1,38	CHI
201911345888	GOIAS	GS21059821	ITABERAÍ S1	27/11/2019 15:33	27/11/2019 15:37	27/11/2019 15:33	27/11/2019 15:37	0,07	1	0,07	CHI
201911345890	SAO DOMINGOS	SD12344106	SAO DOMINGOS	27/11/2019 15:07	27/11/2019 17:20	27/11/2019 15:07	27/11/2019 17:20	2,20	6	13,22	CHI
201911345897	FAZENDA NOVA	FN12250945	IPORA	27/11/2019 15:36	28/11/2019 14:06	27/11/2019 15:36	28/11/2019 14:06	22,50	26	585,02	CHI
201911345908	SAO DOMINGOS	SD12398397	SAO DOMINGOS	27/11/2019 15:38	27/11/2019 21:00	27/11/2019 15:38	27/11/2019 21:00	5,36	6	32,18	CHI
201911345910	PARAUNA	PU12248129	PARAUNA	27/11/2019 15:39	28/11/2019 14:07	27/11/2019 15:39	28/11/2019 14:07	22,47	4	89,86	CHI
201911345911	GOIANIA	GN11000865	GOIANIA LESTE S3	27/11/2019 15:28	27/11/2019 22:18	27/11/2019 15:28	27/11/2019 22:18	6,83	80	546,64	CHI
201911345914	CEZARINA	CZ12000034	CEZARINA	27/11/2019 15:22	27/11/2019 23:08	27/11/2019 15:22	27/11/2019 23:08	7,76	21	162,93	CHI
201911345914	INDIARA	CZ12000034	CEZARINA	27/11/2019 15:22	27/11/2019 23:08	27/11/2019 15:22	27/11/2019 23:08	7,76	9	69,83	CHI
201911345923	ACREUNA	EU21260916	ACREUNA	27/11/2019 15:42	28/11/2019 08:30	27/11/2019 15:42	28/11/2019 08:30	16,80	1	16,80	CHI
201911345939	ITUMBIARA	IT21293056	PARANAIBA	27/11/2019 15:44	27/11/2019 17:00	27/11/2019 15:44	27/11/2019 17:00	1,26	2	2,52	CHI
201911345941	ANAPOLIS	Z1064131	ANAPOLIS UNIVERSITARIO S1	27/11/2019 15:44	27/11/2019 20:15	27/11/2019 15:44	27/11/2019 20:15	4,50	1	4,50	CHI
201911345944	ALTO PARAISO DE GOIAS	BF11102304	FLORES DE GOIAS	27/11/2019 15:45	27/11/2019 17:59	27/11/2019 15:45	27/11/2019 17:59	2,23	87	193,94	CHI
201911345946	GOIANIA	14582132	XAVANTES	27/11/2019 15:45	27/11/2019 17:09	27/11/2019 15:45	27/11/2019 17:09	1,39	1	1,39	CHI
201911345956	ITUMBIARA	BG12000084	ITUMBIARA VELHA S2	27/11/2019 15:46	27/11/2019 22:02	27/11/2019 15:46	27/11/2019 22:02	6,26	3	18,79	CHI
201911345957	SAO JOAO D ALIANCA	JL11130018	SAO JOAO D ALIANCA	27/11/2019 15:47	27/11/2019 19:45	27/11/2019 15:47	27/11/2019 19:45	3,96	6	23,79	CHI
201911345959	IACIARA	IA12302910	IACIARA S1	28/11/2019 17:09	28/11/2019 17:31	28/11/2019 17:09	28/11/2019 17:31	0,35	10	3,51	CHI
201911345960	SAO LUIZ DO NORTE	GE12382134	BARRO ALTO	27/11/2019 12:08	28/11/2019 16:27	27/11/2019 12:08	28/11/2019 16:27	28,31	5	141,57	CHI
201911345960	HIDROLINA	GE12382134	BARRO ALTO	27/11/2019 12:08	28/11/2019 16:27	27/11/2019 12:08	28/11/2019 16:27	28,31	1	28,31	CHI
201911345961	RIO VERDE	RV12135950	CABRIUVA S2	27/11/2019 15:47	28/11/2019 17:00	27/11/2019 15:47	28/11/2019 17:00	25,22	20	504,50	CHI
201911345963	CAMPINACU	UC21314765	PORANGATU	27/11/2019 15:49	28/11/2019 08:31	27/11/2019 15:49	28/11/2019 08:31	16,70	1	16,70	CHI
201911345969	PORANGATU	PO21265746	PORANGATU	27/11/2019 15:50	27/11/2019 19:16	27/11/2019 15:50	27/11/2019 19:16	3,44	1	3,44	CHI
201911345975	ITAPACI	IW11282034	ITAPACI	27/11/2019 12:51	28/11/2019 03:22	27/11/2019 12:51	28/11/2019 03:22	14,52	85	1233,80	CHI
201911345979	CEZARINA	CZ21314873	CEZARINA	27/11/2019 15:52	28/11/2019 15:35	27/11/2019 15:52	28/11/2019 15:35	23,71	2	47,42	CHI
201911345982	ANICUNS	AC12391423	ANICUNS	27/11/2019 15:35	27/11/2019 21:00	27/11/2019 15:35	27/11/2019 21:00	5,40	17	91,85	CHI
201911345988	BOM JESUS DE GOIAS	IT12352670	CACHOEIRA DOURADA	27/11/2019 15:54	27/11/2019 19:35	27/11/2019 15:54	27/11/2019 19:35	3,68	2	7,37	CHI
201911345988	ITUMBIARA	IT12352670	CACHOEIRA DOURADA	27/11/2019 15:54	27/11/2019 19:35	27/11/2019 15:54	27/11/2019 19:35	3,68	5	18,42	CHI
201911346005	SAO JOAO D ALIANCA	JL12146125	SAO JOAO D ALIANCA	27/11/2019 15:56	27/11/2019 20:39	27/11/2019 15:56	27/11/2019 20:39	4,70	3	14,11	CHI
201911346007	ALTO PARAISO DE GOIAS	BF21325484	SAO JOAO D ALIANCA	27/11/2019 15:57	27/11/2019 17:00	27/11/2019 15:57	27/11/2019 17:00	1,05	1	1,05	CHI
201911346011	CAMPESTRE DE GOIAS	GC12050512	TRINDADE	27/11/2019 14:52	27/11/2019 17:15	27/11/2019 14:52	27/11/2019 17:15	2,38	9	21,41	CHI
201911346018	GOIAS	GS21183458	GOIAS	27/11/2019 15:59	27/11/2019 19:00	27/11/2019 15:59	27/11/2019 19:00	3,02	1	3,02	CHI
201911346020	ITARUMA	IM21138075	CACHOEIRA ALTA	27/11/2019 15:59	28/11/2019 18:26	27/11/2019 15:59	28/11/2019 18:26	26,44	1	26,44	CHI

201911346021	PARAUNA	PU21000021	PARAUNA	27/11/2019 15:59	27/11/2019 19:33	27/11/2019 15:59	27/11/2019 19:33	3,56	1	3,56	CHI
201911346033	SANTO ANTONIO DO DESCOBERTO	SN11168731	ALEXANIA	27/11/2019 15:14	27/11/2019 21:55	27/11/2019 15:14	27/11/2019 21:07	5,89	45	264,86	CHI
201911346033	SANTO ANTONIO DO DESCOBERTO	SN11168729	ALEXANIA	27/11/2019 15:14	27/11/2019 21:55	27/11/2019 15:14	27/11/2019 21:55	6,69	75	501,73	CHI
201911346036	NOVA ROMA	ND12235288	IACIARA S2	27/11/2019 16:03	28/11/2019 22:15	27/11/2019 16:03	28/11/2019 21:56	29,87	1	29,87	CHI
201911346036	NOVA ROMA	ND12235288	IACIARA S2	27/11/2019 16:03	28/11/2019 22:15	28/11/2019 22:08	28/11/2019 22:15	0,12	1	0,12	CHI
201911346038	JATAI	JT12211164	JATAI S2	27/11/2019 16:03	27/11/2019 19:17	27/11/2019 16:03	27/11/2019 19:17	3,22	9	28,95	CHI
201911346050	MOZARLANDIA	MZ21058542	MOZARLANDIA	27/11/2019 16:05	28/11/2019 16:20	27/11/2019 16:05	28/11/2019 16:20	24,24	1	24,24	CHI
201911346056	PIRENOPOLIS	PV21385773	CORUMBA	27/11/2019 13:11	27/11/2019 19:55	27/11/2019 13:11	27/11/2019 19:55	6,73	4	26,91	CHI
201911346060	PIRES DO RIO	10019279785	PIRES DO RIO S1	27/11/2019 16:06	28/11/2019 09:20	27/11/2019 16:06	28/11/2019 09:20	17,22	1	17,22	CHI
201911346063	MAMBAI	MB11046226	IACIARA S2	27/11/2019 16:06	27/11/2019 18:28	27/11/2019 16:06	27/11/2019 18:28	2,35	145	340,83	CHI
201911346067	PETROLINA DE GOIAS	PG21111259	PETROLINA	27/11/2019 16:07	27/11/2019 20:29	27/11/2019 16:07	27/11/2019 20:29	4,35	1	4,35	CHI
201911346074	ITAPIRAPUA	IU21206876	MATRINCHA	27/11/2019 16:10	28/11/2019 15:40	27/11/2019 16:10	28/11/2019 15:40	23,50	1	23,50	CHI
201911346081	PIRACANJUBA	PJ21120808	PIRACANJUBA	27/11/2019 16:11	27/11/2019 20:14	27/11/2019 16:11	27/11/2019 20:14	4,04	1	4,04	CHI
201911346100	INHUMAS	IN21066359	INHUMAS S2	27/11/2019 16:14	27/11/2019 19:10	27/11/2019 16:14	27/11/2019 19:10	2,93	1	2,93	CHI
201911346101	NEROPOLIS	NR11000001	NEROPOLIS S2	27/11/2019 16:12	27/11/2019 17:26	27/11/2019 16:12	27/11/2019 17:26	1,23	173	213,27	CHI
201911346104	PIRENOPOLIS	AN12000433	ANAPOLIS UNIVERSITARIO S2	27/11/2019 16:14	27/11/2019 18:53	27/11/2019 16:14	27/11/2019 18:53	2,64	10	26,44	CHI
201911346104	ANAPOLIS	AN12000433	ANAPOLIS UNIVERSITARIO S2	27/11/2019 16:14	27/11/2019 18:53	27/11/2019 16:14	27/11/2019 18:53	2,64	18	47,60	CHI
201911346109	ITABERAI	50017081	ITABERAI S2	27/11/2019 16:15	28/11/2019 10:39	27/11/2019 16:15	28/11/2019 10:39	18,39	1	18,39	CHI
201911346110	ITABERAI	IB21154777	ITABERAI S1	27/11/2019 12:04	27/11/2019 19:15	27/11/2019 12:04	27/11/2019 19:15	7,18	2	14,36	CHI
201911346113	CAMPINORTE	CR12161155	MARA ROSA	27/11/2019 14:49	27/11/2019 18:41	27/11/2019 14:49	27/11/2019 18:41	3,85	4	15,40	CHI
201911346113	MARA ROSA	CR12161155	MARA ROSA	27/11/2019 14:49	27/11/2019 18:41	27/11/2019 14:49	27/11/2019 18:41	3,85	5	19,25	CHI
201911346118	NIQUELANDIA	NQ12391958	NIQUELANDIA SUBTRANSMISSAO	27/11/2019 16:16	28/11/2019 12:14	27/11/2019 16:16	28/11/2019 12:14	19,95	20	399,01	CHI
201911346125	ANAPOLIS	AN21261154	ANAPOLIS UNIVERSITARIO S1	28/11/2019 10:45	28/11/2019 11:20	28/11/2019 10:45	28/11/2019 11:20	0,58	1	0,58	CHI
201911346127	JARAGUA	JA11205770	JARAGUA	27/11/2019 15:31	27/11/2019 17:51	27/11/2019 15:31	27/11/2019 17:51	2,33	51	118,86	CHI
201911346128	CRIXAS	CX21181329	SERRA DO OURO	27/11/2019 16:20	28/11/2019 21:41	27/11/2019 16:20	28/11/2019 21:41	29,35	1	29,35	CHI
201911346133	GOIANIA	10973930	FERROVIARIO S3	27/11/2019 16:21	27/11/2019 18:16	27/11/2019 16:21	27/11/2019 18:16	1,91	1	1,91	CHI
201911346140	BALIZA	BH11330940	CAIAPONIA	27/11/2019 16:23	28/11/2019 12:58	27/11/2019 16:23	28/11/2019 12:58	20,57	1	20,57	CHI
201911346145	CATALAO	1990058040	CATALAO S2	27/11/2019 16:24	27/11/2019 18:28	27/11/2019 16:24	27/11/2019 18:28	2,06	1	2,06	CHI
201911346150	QUIRINOPOLIS	80118690	QUIRINOPOLIS	27/11/2019 16:26	27/11/2019 23:54	27/11/2019 16:26	27/11/2019 23:54	7,46	1	7,46	CHI
201911346153	GOIANIA	14933160	CARAJAS S2	27/11/2019 16:28	27/11/2019 19:08	27/11/2019 16:28	27/11/2019 19:08	2,66	1	2,66	CHI
201911346155	AGUA FRIA DE GOIAS	TL21322494	SAO JOAO D ALIANCA	27/11/2019 16:28	28/11/2019 13:58	27/11/2019 16:28	28/11/2019 13:58	21,50	3	64,50	CHI
201911346158	NEROPOLIS	NR12000010	NEROPOLIS S2	27/11/2019 16:27	27/11/2019 20:38	27/11/2019 16:27	27/11/2019 20:38	4,18	3	12,54	CHI
201911346166	NOVA IGUACU DE GOIAS	NH12094070	CAMPINORTE	27/11/2019 14:03	28/11/2019 14:37	27/11/2019 14:03	28/11/2019 14:37	24,56	5	122,78	CHI

201911346167	NOVA IGUACU DE GOIAS	CX12134501	RUBIATABA	27/11/2019 14:24	28/11/2019 04:13	27/11/2019 14:24	28/11/2019 04:13	13,81	1	13,81	CHI
201911346167	CRIXAS	CX12134501	RUBIATABA	27/11/2019 14:24	28/11/2019 04:13	27/11/2019 14:24	28/11/2019 04:13	13,81	57	787,20	CHI
201911346170	VARJAO	VJ32066174	GUAPO S2	27/11/2019 16:13	28/11/2019 02:03	27/11/2019 16:13	28/11/2019 02:03	9,82	7	68,76	CHI
201911346175	LUZIANIA	3200047985	MARAJOARA	27/11/2019 16:32	27/11/2019 17:53	27/11/2019 16:32	27/11/2019 17:53	1,34	1	1,34	CHI
201911346187	PALMINOPOLIS	PP12308385LD	PALMEIRAS	27/11/2019 16:34	28/11/2019 12:12	27/11/2019 16:34	28/11/2019 12:12	19,62	48	941,73	CHI
201911346187	PALMINOPOLIS	PP12308385LD	PALMEIRAS	27/11/2019 16:34	28/11/2019 12:12	28/11/2019 01:50	28/11/2019 12:12	10,37	2	20,73	CHI
201911346191	NAZARIO	NZ21349296	ANICUNS	27/11/2019 16:35	28/11/2019 08:12	27/11/2019 16:35	28/11/2019 08:12	15,61	1	15,61	CHI
201911346192	JATAI	10014077556	JATAI S2	27/11/2019 16:35	27/11/2019 17:34	27/11/2019 16:35	27/11/2019 17:34	0,98	1	0,98	CHI
201911346203	PALMEIRAS DE GOIAS	PL12026608	PALMEIRAS	27/11/2019 13:10	27/11/2019 19:02	27/11/2019 13:10	27/11/2019 19:02	5,85	8	46,80	CHI
201911346204	FORMOSO	FO21322540	PORANGATU	27/11/2019 16:36	28/11/2019 12:46	27/11/2019 16:36	28/11/2019 12:46	20,16	1	20,16	CHI
201911346208	ITUMBIARA	IT12316758	ITUMBIARA NOVA	27/11/2019 16:37	27/11/2019 18:25	27/11/2019 16:37	27/11/2019 18:25	1,80	2	3,61	CHI
201911346213	JATAI	JT12209803	JATAI S3	27/11/2019 16:06	27/11/2019 18:03	27/11/2019 16:06	27/11/2019 18:03	1,93	24	46,43	CHI
201911346220	PIRACANJUBA	60006470	PIRACANJUBA	27/11/2019 16:39	28/11/2019 07:48	27/11/2019 16:39	28/11/2019 07:48	15,14	1	15,14	CHI
201911346226	SAO JOAO D ALIANCA	JL21048018	SAO JOAO D ALIANCA	27/11/2019 16:40	28/11/2019 15:20	27/11/2019 16:40	28/11/2019 15:20	22,67	1	22,67	CHI
201911346244	RIO VERDE	SH12273765	SANTA HELENA S1	27/11/2019 16:42	28/11/2019 13:15	27/11/2019 16:42	28/11/2019 13:15	20,54	3	61,63	CHI
201911346244	SANTA HELENA DE GOIAS	SH12273765	SANTA HELENA S1	27/11/2019 16:42	28/11/2019 13:15	27/11/2019 16:42	28/11/2019 13:15	20,54	15	308,17	CHI
201911346246	MOZARLANDIA	AZ12326098LD	MOZARLANDIA	27/11/2019 16:42	30/11/2019 16:55	27/11/2019 16:42	30/11/2019 16:55	72,21	1	72,21	CHI
201911346251	JUSSARA	JR21320018	BRITANIA	27/11/2019 16:43	28/11/2019 10:30	27/11/2019 16:43	28/11/2019 10:30	17,77	1	17,77	CHI
201911346252	PORANGATU	TA12114216	NOVO PLANALTO	27/11/2019 16:43	29/11/2019 05:58	27/11/2019 16:43	28/11/2019 11:36	18,87	4	75,48	CHI
201911346252	PORANGATU	PO21320751	NOVO PLANALTO	27/11/2019 16:43	29/11/2019 05:58	27/11/2019 16:43	29/11/2019 05:58	37,25	1	37,25	CHI
201911346256	PALMINOPOLIS	PP21007012	PALMEIRAS	27/11/2019 16:44	27/11/2019 21:38	27/11/2019 16:44	27/11/2019 21:38	4,89	1	4,89	CHI
201911346262	CIDADE OCIDENTAL	DH12383019	MARAJOARA	27/11/2019 16:45	27/11/2019 18:46	27/11/2019 16:45	27/11/2019 18:46	2,00	30	60,10	CHI
201911346266	TRINDADE	10016031863	TRINDADE	27/11/2019 16:46	27/11/2019 18:56	27/11/2019 16:46	27/11/2019 18:56	2,17	1	2,17	CHI
201911346269	SAO JOAO D ALIANCA	JL12383338	SAO JOAO D ALIANCA	27/11/2019 16:13	27/11/2019 19:13	27/11/2019 16:13	27/11/2019 19:13	3,00	39	116,84	CHI
201911346272	NIQUELANDIA	NQ12262802	NIQUELANDIA SUBTRANSMISSAO	27/11/2019 16:47	28/11/2019 22:52	27/11/2019 16:47	28/11/2019 22:52	30,08	6	180,49	CHI
201911346274	SAO DOMINGOS	SD12344108	SAO DOMINGOS	27/11/2019 16:47	28/11/2019 10:31	27/11/2019 16:47	28/11/2019 10:31	17,73	2	35,45	CHI
201911346277	MATRINCHA	4370001202	MATRINCHA	27/11/2019 16:47	28/11/2019 11:20	27/11/2019 16:47	28/11/2019 11:20	18,53	1	18,53	CHI
201911346280	PLANALTINA	PI11204753	PLANALTINA	27/11/2019 16:48	27/11/2019 21:33	27/11/2019 16:48	27/11/2019 21:33	4,75	19	90,30	CHI
201911346281	ITUMBIARA	BG12000097	ITUMBIARA VELHA S2	27/11/2019 15:18	27/11/2019 18:30	27/11/2019 15:18	27/11/2019 18:30	3,19	8	25,49	CHI
201911346283	MOSSAMEDES	MD12024167	FIRMINOPOLIS S2	27/11/2019 16:35	27/11/2019 20:47	27/11/2019 16:35	27/11/2019 20:47	4,19	46	192,88	CHI
201911346283	SANCLERLANDIA	MD12024167	FIRMINOPOLIS S2	27/11/2019 16:35	27/11/2019 20:47	27/11/2019 16:35	27/11/2019 20:47	4,19	7	29,35	CHI
201911346290	SANTO ANTONIO DO DESCOBERTO	05410224	MARAJOARA	27/11/2019 16:27	28/11/2019 16:28	27/11/2019 16:27	27/11/2019 19:00	2,54	75	190,50	CHI
201911346290	DISTRITO FEDERAL	SN13078131	MARAJOARA	27/11/2019 16:27	28/11/2019 16:28	27/11/2019 16:27	27/11/2019 20:14	3,79	49	185,64	CHI

201911346290	SANTO ANTONIO DO DESCOBERTO	SN13078131	MARAJOARA	27/11/2019 16:27	28/11/2019 16:28	27/11/2019 16:27	27/11/2019 20:14	3,79	691	2617,93	CHI
201911346290	NOVO GAMA	SN12248690LD	MARAJOARA	27/11/2019 16:27	28/11/2019 16:28	27/11/2019 16:27	28/11/2019 16:28	24,01	9	216,12	CHI
201911346290	SANTO ANTONIO DO DESCOBERTO	SN12248690LD	MARAJOARA	27/11/2019 16:27	28/11/2019 16:28	27/11/2019 16:27	28/11/2019 16:28	24,01	56	1344,78	CHI
201911346291	FORMOSA	FA12309111	ITUIQUIRA	27/11/2019 16:48	27/11/2019 21:42	27/11/2019 16:48	27/11/2019 21:42	4,88	4	19,53	CHI
201911346302	IPORA	10019408259	IPORA	27/11/2019 16:50	28/11/2019 09:45	27/11/2019 16:50	28/11/2019 09:45	16,92	1	16,92	CHI
201911346309	PALESTINA DE GOIAS	PY12011439	PALESTINA	27/11/2019 16:29	27/11/2019 23:19	27/11/2019 16:29	27/11/2019 23:19	6,83	24	163,98	CHI
201911346309	CAIAPONIA	PY12011439	PALESTINA	27/11/2019 16:29	27/11/2019 23:19	27/11/2019 16:29	27/11/2019 23:19	6,83	91	621,76	CHI
201911346310	GOIANIRA	GR11234823	GOIANIRA	27/11/2019 16:51	27/11/2019 21:40	27/11/2019 16:51	27/11/2019 21:40	4,81	43	206,71	CHI
201911346312	CRIXAS	CX12394450	SERRA DO OURO	27/11/2019 16:52	28/11/2019 18:40	27/11/2019 16:52	28/11/2019 18:40	25,80	13	335,36	CHI
201911346326	NIQUELANDIA	TI12396760	MINACU	27/11/2019 16:54	27/11/2019 23:51	27/11/2019 16:54	27/11/2019 23:51	6,94	1	6,94	CHI
201911346326	COLINAS DO SUL	TI12396760	MINACU	27/11/2019 16:54	27/11/2019 23:51	27/11/2019 16:54	27/11/2019 23:51	6,94	12	83,22	CHI
201911346329	NOVO GAMA	10024552621	PACAEMBU S1	27/11/2019 16:55	27/11/2019 21:06	27/11/2019 16:55	27/11/2019 21:06	4,17	1	4,17	CHI
201911346330	RIO VERDE	RV12000192	RIO VERDE S1	27/11/2019 16:55	27/11/2019 23:00	27/11/2019 16:55	27/11/2019 23:00	6,07	20	121,36	CHI
201911346344	CALDAS NOVAS	CN12363988	CALDAS NOVAS S2	27/11/2019 17:01	28/11/2019 09:10	27/11/2019 17:01	28/11/2019 09:10	16,14	11	177,59	CHI
201911346355	PORANGATU	PO12048413	PORANGATU	27/11/2019 17:03	28/11/2019 09:14	27/11/2019 17:03	28/11/2019 09:14	16,17	7	113,19	CHI
201911346356	IPAMERI	IP12071429	PIRES DO RIO S2	27/11/2019 17:03	28/11/2019 17:48	27/11/2019 17:03	28/11/2019 17:48	24,73	2	49,47	CHI
201911346357	ORIZONA	2060039119	PIRES DO RIO S2	27/11/2019 17:03	27/11/2019 19:43	27/11/2019 17:03	27/11/2019 19:43	2,65	1	2,65	CHI
201911346361	ARUANA	AK12183185	BRITANIA	27/11/2019 15:40	28/11/2019 07:46	27/11/2019 15:40	28/11/2019 07:46	16,10	3	48,29	CHI
201911346365	PETROLINA DE GOIAS	320002044	PETROLINA	27/11/2019 17:05	27/11/2019 19:07	27/11/2019 17:05	27/11/2019 19:07	2,02	1	2,02	CHI
201911346366	GOIAS	IU12073753	MATRINCHA	27/11/2019 16:41	28/11/2019 17:20	27/11/2019 16:41	28/11/2019 17:20	24,67	18	443,98	CHI
201911346366	ITAPIRAPUA	IU12073753	MATRINCHA	27/11/2019 16:41	28/11/2019 17:20	27/11/2019 16:41	28/11/2019 17:20	24,67	6	147,99	CHI
201911346371	PALMEIRAS DE GOIAS	PL12085247	PALMEIRAS	27/11/2019 17:07	27/11/2019 18:55	27/11/2019 17:07	27/11/2019 18:55	1,80	9	16,22	CHI
201911346372	NOVA CRIXAS	NA12381800	NOVA CRIXAS	27/11/2019 17:07	28/11/2019 13:06	27/11/2019 17:07	28/11/2019 13:06	19,98	2	39,96	CHI
201911346377	CAMPINORTE	CR12051914	MARA ROSA	27/11/2019 17:08	28/11/2019 11:23	27/11/2019 17:08	28/11/2019 11:23	18,25	2	36,50	CHI
201911346379	APARECIDA DE GOIANIA	AP11205658	ANHANGUERA	27/11/2019 17:08	27/11/2019 22:20	27/11/2019 17:08	27/11/2019 22:20	5,19	101	524,61	CHI
201911346384	LUZIANIA	LZ11253462	VIANOPOLIS	27/11/2019 17:09	28/11/2019 09:12	27/11/2019 17:09	28/11/2019 09:12	16,04	1	16,04	CHI
201911346386	AGUAS LINDAS DE GOIAS	4830255597	AGUAS LINDAS DE GOIAS S1	27/11/2019 17:09	27/11/2019 18:38	27/11/2019 17:09	27/11/2019 18:38	1,47	1	1,47	CHI
201911346391	IPORA	730116153	IPORA	27/11/2019 17:10	28/11/2019 21:30	27/11/2019 17:10	28/11/2019 21:30	28,32	1	28,32	CHI
201911346394	COCALZINHO DE GOIAS	ZN21302483	COCALZINHO	27/11/2019 17:11	27/11/2019 21:27	27/11/2019 17:11	27/11/2019 21:27	4,26	1	4,26	CHI
201911346397	SANTO ANTONIO DO DESCOBERTO	2210138225	AGUAS LINDAS DE GOIAS S2	27/11/2019 17:11	27/11/2019 18:50	27/11/2019 17:11	27/11/2019 18:50	1,64	1	1,64	CHI
201911346401	ANAPOLIS	10026813490	ANAPOLIS UNIVERSITARIO S2	27/11/2019 17:11	28/11/2019 06:19	27/11/2019 17:11	28/11/2019 06:19	13,12	1	13,12	CHI
201911346408	PORTEIRAO	GT12030782	RIO DOS BOIS	27/11/2019 17:13	28/11/2019 10:08	27/11/2019 17:13	28/11/2019 10:08	16,92	4	67,68	CHI
201911346408	GOIATUBA	GT12030782	RIO DOS BOIS	27/11/2019 17:13	28/11/2019 10:08	27/11/2019 17:13	28/11/2019 10:08	16,92	1	16,92	CHI

201911346408	PORTEIRAO	GT12030782	RIO DOS BOIS	27/11/2019 17:13	28/11/2019 10:08	27/11/2019 17:13	28/11/2019 10:08	16,92	3	50,76	CHI
201911346408	GOIATUBA	GT12030782	RIO DOS BOIS	27/11/2019 17:13	28/11/2019 10:08	27/11/2019 17:13	28/11/2019 10:08	16,92	18	304,55	CHI
201911346411	MONTE ALEGRE DE GOIAS	MA21282313	SAO DOMINGOS	27/11/2019 17:14	28/11/2019 12:13	27/11/2019 17:14	28/11/2019 12:13	18,98	1	18,98	CHI
201911346413	URUACU	UR21212339	URUACU	27/11/2019 17:14	28/11/2019 08:54	27/11/2019 17:14	28/11/2019 08:54	15,67	1	15,67	CHI
201911346415	ANAPOLIS	20535946	JUNDIAI S2	27/11/2019 17:14	28/11/2019 04:09	27/11/2019 17:14	28/11/2019 04:09	10,91	1	10,91	CHI
201911346416	NIQUELANDIA	NQ11243529	BARRO ALTO	27/11/2019 17:15	28/11/2019 02:30	27/11/2019 17:15	28/11/2019 02:30	9,25	126	1165,22	CHI
201911346424	PALMINOPOLIS	PP21053899	PALMEIRAS	27/11/2019 17:16	27/11/2019 20:34	27/11/2019 17:16	27/11/2019 20:34	3,30	1	3,30	CHI
201911346425	ANAPOLIS	21181585	JUNDIAI S1	27/11/2019 17:16	28/11/2019 04:28	27/11/2019 17:16	28/11/2019 04:28	11,19	1	11,19	CHI
201911346426	RIO VERDE	RV12214125	RIO VERDE S1	27/11/2019 17:16	27/11/2019 22:00	27/11/2019 17:16	27/11/2019 22:00	4,73	13	61,45	CHI
201911346431	ARACU	AR21278781	ARACU	27/11/2019 17:17	27/11/2019 22:34	27/11/2019 17:17	27/11/2019 22:34	5,28	1	5,28	CHI
201911346433	BOM JESUS DE GOIAS	BJ12226866	RIO DOS BOIS	27/11/2019 17:17	28/11/2019 20:45	27/11/2019 17:17	28/11/2019 20:45	27,47	5	137,34	CHI
201911346433	GOIATUBA	BJ12226866	RIO DOS BOIS	27/11/2019 17:17	28/11/2019 20:45	27/11/2019 17:17	28/11/2019 20:45	27,47	1	27,47	CHI
201911346440	ARUANA	04940406	ARUANA	27/11/2019 13:47	28/11/2019 09:39	27/11/2019 13:47	28/11/2019 09:39	19,85	59	1171,25	CHI
201911346444	PALMEIRAS DE GOIAS	590072663	PALMEIRAS	27/11/2019 17:19	27/11/2019 20:39	27/11/2019 17:19	27/11/2019 20:39	3,33	1	3,33	CHI
201911346445	BOM JESUS DE GOIAS	BJ12256996	BOM JESUS DE GOIAS	27/11/2019 17:19	28/11/2019 08:48	27/11/2019 17:19	27/11/2019 23:33	6,22	14	87,11	CHI
201911346445	GOIATUBA	BJ12256996	BOM JESUS DE GOIAS	27/11/2019 17:19	28/11/2019 08:48	27/11/2019 17:19	27/11/2019 23:33	6,22	39	242,66	CHI
201911346445	GOIATUBA	BJ12256996	BOM JESUS DE GOIAS	27/11/2019 17:19	28/11/2019 08:48	27/11/2019 17:19	28/11/2019 08:48	15,47	13	201,14	CHI
201911346448	SANTA HELENA DE GOIAS	SH12279545	IPEGUARI	27/11/2019 17:13	27/11/2019 19:19	27/11/2019 17:13	27/11/2019 19:19	2,11	10	21,05	CHI
201911346464	APARECIDA DE GOIANIA	10030132833	INDEPENDENCIA S2	27/11/2019 17:22	27/11/2019 19:52	27/11/2019 17:22	27/11/2019 19:52	2,49	1	2,49	CHI
201911346473	CACHOEIRA ALTA	RV12227747	QUIRINOPOLIS	27/11/2019 17:21	28/11/2019 11:30	27/11/2019 17:21	28/11/2019 11:30	18,14	7	127,00	CHI
201911346473	RIO VERDE	RV12227747	QUIRINOPOLIS	27/11/2019 17:21	28/11/2019 11:30	27/11/2019 17:21	28/11/2019 11:30	18,14	3	54,43	CHI
201911346475	FAZENDA NOVA	FN21009968	IPORA	27/11/2019 17:25	28/11/2019 12:33	27/11/2019 17:25	28/11/2019 12:33	19,13	1	19,13	CHI
201911346477	IPORA	IR21065123	IPORA	27/11/2019 17:25	28/11/2019 10:19	27/11/2019 17:25	28/11/2019 10:19	16,89	1	16,89	CHI
201911346485	ITAJA	IJ12226574	ITAJA S2	27/11/2019 17:26	27/11/2019 19:01	27/11/2019 17:26	27/11/2019 19:01	1,57	8	12,58	CHI
201911346498	IACIARA	IA11039967	IACIARA S1	27/11/2019 17:29	28/11/2019 01:33	27/11/2019 17:29	28/11/2019 01:33	8,06	132	1064,21	CHI
201911346507	DISTRITO FEDERAL	NJ12290513	MARAJOARA	27/11/2019 17:31	27/11/2019 19:52	27/11/2019 17:31	27/11/2019 19:52	2,35	10	23,47	CHI
201911346510	GOIANIA	10017092823	REAL S2	27/11/2019 17:32	27/11/2019 19:14	27/11/2019 17:32	27/11/2019 19:14	1,70	1	1,70	CHI
201911346519	SAO LUIS DE MONTES BELOS	500086953	SAO LUIZ DOS MONTES BELOS	27/11/2019 17:33	28/11/2019 11:28	27/11/2019 17:33	28/11/2019 11:28	17,92	1	17,92	CHI
201911346527	GOIAS	GS12061668	ITABERAI S1	28/11/2019 05:58	28/11/2019 08:20	28/11/2019 05:58	28/11/2019 08:20	2,36	18	42,52	CHI
201911346528	GOIANIA	GN12001875	FERROVIARIO S3	27/11/2019 17:32	27/11/2019 19:00	27/11/2019 17:32	27/11/2019 19:00	1,46	324	471,96	CHI
201911346541	TRES RANCHOS	TH12068478	CATALAO S1	27/11/2019 17:16	27/11/2019 19:30	27/11/2019 17:16	27/11/2019 19:30	2,22	13	28,83	CHI
201911346542	ITAGUARI	770004430	ITABERAI S1	27/11/2019 17:38	28/11/2019 17:53	27/11/2019 17:38	28/11/2019 17:53	24,26	1	24,26	CHI
201911346559	CRIXAS	CX11056776	SERRA DO OURO	27/11/2019 15:55	27/11/2019 23:57	27/11/2019 15:55	27/11/2019 23:57	8,03	132	1060,33	CHI

201911346564	ITABERAÍ	19615773	ITABERAÍ S2	27/11/2019 17:03	27/11/2019 19:31	27/11/2019 17:03	27/11/2019 19:31	2,45	359	880,35	CHI
201911346574	PARANAÍGUARA	QJ21306099	QUIRINÓPOLIS	27/11/2019 17:44	28/11/2019 09:30	27/11/2019 17:44	28/11/2019 09:30	15,76	1	15,76	CHI
201911346575	PONTALINA	JV12218123	GOIATUBA S1	27/11/2019 17:44	27/11/2019 21:56	27/11/2019 17:44	27/11/2019 21:56	4,19	5	20,97	CHI
201911346580	MONTES CLAROS DE GOIÁS	ME11091495	IPORA	27/11/2019 16:32	28/11/2019 07:26	27/11/2019 16:32	28/11/2019 07:26	14,89	88	1310,52	CHI
201911346582	JOVIANIA	570009273	GOIATUBA S1	27/11/2019 17:46	27/11/2019 23:22	27/11/2019 17:46	27/11/2019 23:22	5,59	1	5,59	CHI
201911346585	CATALAO	CT21288037	CATALAO S1	27/11/2019 15:43	28/11/2019 18:04	27/11/2019 15:43	28/11/2019 18:04	26,34	1	26,34	CHI
201911346589	PALMINÓPOLIS	1340005235	PALMEIRAS	27/11/2019 17:47	28/11/2019 10:32	27/11/2019 17:47	28/11/2019 10:32	16,75	1	16,75	CHI
201911346597	BOM JARDIM DE GOIÁS	BM12065611	BOM JARDIM	27/11/2019 17:48	27/11/2019 19:44	27/11/2019 17:48	27/11/2019 19:44	1,92	3	5,77	CHI
201911346602	CAMPO LIMPO	AN12258222	NERÓPOLIS S1	27/11/2019 16:32	28/11/2019 11:56	27/11/2019 16:32	28/11/2019 11:56	19,39	34	659,35	CHI
201911346602	ANAPÓLIS	AN12258222	NERÓPOLIS S1	27/11/2019 16:32	28/11/2019 11:56	27/11/2019 16:32	28/11/2019 11:56	19,39	16	310,28	CHI
201911346606	POSSE	PS11164544	IACIARA S2	27/11/2019 17:50	28/11/2019 15:37	27/11/2019 17:50	28/11/2019 15:37	21,78	9	196,00	CHI
201911346607	AGUAS LINDAS DE GOIÁS	4830186861	AGUAS LINDAS DE GOIÁS S1	27/11/2019 17:50	27/11/2019 18:51	27/11/2019 17:50	27/11/2019 18:51	1,01	1	1,01	CHI
201911346616	JUSSARA	JR12008751	BRITANIA	27/11/2019 17:52	28/11/2019 20:16	27/11/2019 17:52	28/11/2019 20:16	26,40	2	52,80	CHI
201911346621	PLANALTINA	PI11146248	PLANALTINA	27/11/2019 17:36	27/11/2019 19:00	27/11/2019 17:36	27/11/2019 19:00	1,38	401	555,27	CHI
201911346623	CRISTALINA	KR11000017	CRISTALINA S1	27/11/2019 17:20	27/11/2019 20:08	27/11/2019 17:20	27/11/2019 20:08	2,79	55	153,69	CHI
201911346632	SANTA BARBARA DE GOIÁS	1030012869	TRINDADE	27/11/2019 17:55	27/11/2019 20:31	27/11/2019 17:55	27/11/2019 20:31	2,60	1	2,60	CHI
201911346636	MOZARLANDIA	MZ21055665	MOZARLANDIA	27/11/2019 17:55	28/11/2019 16:52	27/11/2019 17:55	28/11/2019 16:52	22,95	1	22,95	CHI
201911346638	PALMEIRAS DE GOIÁS	PL12000053	PALMEIRAS	27/11/2019 17:54	27/11/2019 20:01	27/11/2019 17:54	27/11/2019 20:01	2,12	39	82,56	CHI
201911346903	COCALZINHO DE GOIÁS	ZN12351596	COCALZINHO	27/11/2019 17:57	27/11/2019 20:53	27/11/2019 17:57	27/11/2019 20:53	2,93	2	5,86	CHI
201911346908	CORREGO DO OURO	CO12308374	FIRMINÓPOLIS S2	27/11/2019 17:58	27/11/2019 22:45	27/11/2019 17:58	27/11/2019 22:45	4,79	24	114,96	CHI
201911346917	APARECIDA DE GOIANIA	AP21000043	CEPAIGO S1	27/11/2019 18:00	27/11/2019 20:23	27/11/2019 18:00	27/11/2019 20:23	2,38	1	2,38	CHI
201911346919	CIDADE OCIDENTAL	2680138217	MARAJÓARA	27/11/2019 18:00	27/11/2019 19:52	27/11/2019 18:00	27/11/2019 19:52	1,86	1	1,86	CHI
201911346920	PORANGATU	PO12100815	NOVO PLANALTO	27/11/2019 18:00	29/11/2019 03:46	27/11/2019 18:00	29/11/2019 03:46	33,76	3	101,27	CHI
201911346921	MIMOSO DE GOIÁS	10011702921	PADRE BERNARDO	27/11/2019 18:00	27/11/2019 19:46	27/11/2019 18:00	27/11/2019 19:46	1,76	1	1,76	CHI
201911346922	MINEIROS	MY12296303	PARQUE DAS EMAS	27/11/2019 18:01	28/11/2019 09:46	27/11/2019 18:01	28/11/2019 09:46	15,75	3	47,25	CHI
201911346923	SAO LUIS DE MONTES BELOS	DN21282418	FIRMINÓPOLIS S1	27/11/2019 18:01	27/11/2019 19:45	27/11/2019 18:01	27/11/2019 19:45	1,75	1	1,75	CHI
201911346924	JATAI	JT12000167	JATAI S1	27/11/2019 16:55	27/11/2019 23:50	27/11/2019 16:55	27/11/2019 23:50	6,91	25	172,87	CHI
201911346928	FORMOSA	FA12395983	FLORES DE GOIÁS	27/11/2019 17:12	29/11/2019 05:30	27/11/2019 17:12	29/11/2019 05:30	36,28	98	3555,90	CHI
201911346929	AURILANDIA	AI12073526	FIRMINÓPOLIS S2	27/11/2019 18:02	27/11/2019 22:37	27/11/2019 18:02	27/11/2019 22:37	4,58	13	59,54	CHI
201911346929	CACHOEIRA DE GOIÁS	AI12073526	FIRMINÓPOLIS S2	27/11/2019 18:02	27/11/2019 22:37	27/11/2019 18:02	27/11/2019 22:37	4,58	2	9,16	CHI
201911346934	CAMPINACU	UC11139121	PORANGATU	27/11/2019 18:03	28/11/2019 11:06	27/11/2019 18:03	28/11/2019 11:06	17,05	22	375,02	CHI
201911346937	PIRACANJUBA	10000928753	CALDAS NOVAS S1	27/11/2019 18:04	28/11/2019 15:45	27/11/2019 18:04	28/11/2019 15:45	21,69	1	21,69	CHI
201911346941	ARAGARCAS	1820027391	ARAGARCAS	27/11/2019 18:04	28/11/2019 07:38	27/11/2019 18:04	28/11/2019 07:38	13,55	1	13,55	CHI

201911346944	TRINDADE	TR12052092	TRINDADE	27/11/2019 18:05	27/11/2019 23:53	27/11/2019 18:05	27/11/2019 23:53	5,79	10	57,95	CHI
201911346946	PONTALINA	PK21068160	PONTALINA	27/11/2019 18:05	28/11/2019 11:20	27/11/2019 18:05	28/11/2019 11:20	17,25	1	17,25	CHI
201911346954	FORMOSA	610267474	ITUIQUIRA	27/11/2019 18:06	28/11/2019 06:37	27/11/2019 18:06	28/11/2019 06:37	12,50	1	12,50	CHI
201911346962	BONOPOLIS	BX12263039	SAO MIGUEL DO ARAGUAIA	27/11/2019 18:08	27/11/2019 22:15	27/11/2019 18:08	27/11/2019 22:15	4,12	96	395,44	CHI
201911346970	JATAI	JT12378114	JATAI S3	27/11/2019 17:42	28/11/2019 13:30	27/11/2019 17:42	28/11/2019 13:30	19,79	5	98,94	CHI
201911346971	CALDAS NOVAS	MR12392164	MORRINHOS	27/11/2019 16:31	27/11/2019 20:47	27/11/2019 16:31	27/11/2019 20:47	4,25	1	4,25	CHI
201911346971	RIO QUENTE	MR12392164	MORRINHOS	27/11/2019 16:31	27/11/2019 20:47	27/11/2019 16:31	27/11/2019 20:47	4,25	18	76,56	CHI
201911346971	MORRINHOS	MR12392164	MORRINHOS	27/11/2019 16:31	27/11/2019 20:47	27/11/2019 16:31	27/11/2019 20:47	4,25	29	123,35	CHI
201911346972	NOVO GAMA	LZ21230085	PACAEMBU S1	27/11/2019 18:10	27/11/2019 21:42	27/11/2019 18:10	27/11/2019 21:42	3,52	1	3,52	CHI
201911346975	CAMPINACU	IH21250144	MINACU	27/11/2019 18:11	28/11/2019 11:28	27/11/2019 18:11	28/11/2019 11:28	17,28	1	17,28	CHI
201911346976	CATALAO	CT21278942	CATALAO S1	27/11/2019 18:11	28/11/2019 09:57	27/11/2019 18:11	28/11/2019 09:57	15,76	1	15,76	CHI
201911346993	ANAPOLIS	20679725	JUNDIAI S1	27/11/2019 18:16	27/11/2019 21:32	27/11/2019 18:16	27/11/2019 21:32	3,26	1	3,26	CHI
201911346994	GOIANIA	GN11000874	FERROVIARIO S2	27/11/2019 18:16	27/11/2019 22:07	27/11/2019 18:16	27/11/2019 22:07	3,85	45	173,07	CHI
201911346996	BRAZABRANTES	BR11013957	INHUMAS S2	27/11/2019 17:33	27/11/2019 19:46	27/11/2019 17:33	27/11/2019 19:46	2,21	25	55,21	CHI
201911346997	SANTO ANTONIO DO DESCOBERTO	2210091051	AGUAS LINDAS DE GOIAS S2	27/11/2019 18:16	28/11/2019 08:54	27/11/2019 18:16	28/11/2019 08:54	14,62	1	14,62	CHI
201911346998	ANAPOLIS	20660327	DAIA S1	27/11/2019 18:17	28/11/2019 12:18	27/11/2019 18:17	28/11/2019 12:18	18,02	1	18,02	CHI
201911347000	RIO VERDE	RV21260264	RIO VERDE S1	27/11/2019 18:17	28/11/2019 07:56	27/11/2019 18:17	28/11/2019 07:56	13,65	1	13,65	CHI
201911347005	JATAI	JT12182032RE	JATAI S3	27/11/2019 16:33	28/11/2019 08:48	27/11/2019 16:33	28/11/2019 08:48	16,25	5	81,25	CHI
201911347006	GOIANIA	GN12162224	CARAJAS S2	27/11/2019 17:56	27/11/2019 19:50	27/11/2019 17:56	27/11/2019 19:50	1,90	192	364,75	CHI
201911347007	SIMOLANDIA	1940015240	IACIARA S2	27/11/2019 18:19	27/11/2019 22:03	27/11/2019 18:19	27/11/2019 22:03	3,73	1	3,73	CHI
201911347008	SAO JOAO D ALIANCA	FB12248238	FLORES DE GOIAS	27/11/2019 17:14	28/11/2019 19:39	27/11/2019 17:14	28/11/2019 19:39	26,41	8	211,28	CHI
201911347008	FLORES DE GOIAS	FB12248238	FLORES DE GOIAS	27/11/2019 17:14	28/11/2019 19:39	27/11/2019 17:14	28/11/2019 19:39	26,41	94	2482,49	CHI
201911347010	INDIARA	IY12301628	ACREUNA	27/11/2019 18:19	28/11/2019 22:25	27/11/2019 18:19	28/11/2019 22:25	28,09	1	28,09	CHI
201911347012	BELA VISTA DE GOIAS	BV21058339	BELA VISTA S1	27/11/2019 18:19	28/11/2019 18:50	27/11/2019 18:19	28/11/2019 18:50	24,50	1	24,50	CHI
201911347014	IVOLANDIA	IV21015652	IPORA	27/11/2019 18:20	27/11/2019 23:26	27/11/2019 18:20	27/11/2019 23:26	5,09	1	5,09	CHI
201911347015	CRISTALINA	KR12090782	PAMPLONA	27/11/2019 18:20	27/11/2019 20:34	27/11/2019 18:20	27/11/2019 20:34	2,22	7	15,57	CHI
201911347018	FLORES DE GOIAS	FB10401475	FLORES DE GOIAS	27/11/2019 17:35	28/11/2019 23:48	27/11/2019 17:35	27/11/2019 20:37	3,04	21	63,79	CHI
201911347018	FLORES DE GOIAS	FB10401475	FLORES DE GOIAS	27/11/2019 17:35	28/11/2019 23:48	27/11/2019 17:35	28/11/2019 00:40	7,08	17	120,44	CHI
201911347018	ALVORADA DO NORTE	FB10401475	FLORES DE GOIAS	27/11/2019 17:35	28/11/2019 23:48	27/11/2019 17:35	28/11/2019 00:40	7,08	18	127,52	CHI
201911347018	IACIARA	FB12068785LD	FLORES DE GOIAS	27/11/2019 17:35	28/11/2019 23:48	27/11/2019 17:35	28/11/2019 16:30	22,91	11	251,99	CHI
201911347018	ALVORADA DO NORTE	FB12068785LD	FLORES DE GOIAS	27/11/2019 17:35	28/11/2019 23:48	27/11/2019 17:35	28/11/2019 16:30	22,91	26	595,60	CHI
201911347018	POSSE	AQ12257608	FLORES DE GOIAS	27/11/2019 17:35	28/11/2019 23:48	27/11/2019 17:35	28/11/2019 21:26	27,86	1	27,86	CHI
201911347018	IACIARA	AQ12257608	FLORES DE GOIAS	27/11/2019 17:35	28/11/2019 23:48	27/11/2019 17:35	28/11/2019 21:26	27,86	4	111,43	CHI

201911347018	ALVORADA DO NORTE	AQ12257608	FLORES DE GOIAS	27/11/2019 17:35	28/11/2019 23:48	27/11/2019 17:35	28/11/2019 21:26	27,86	10	278,56	CHI
201911347018	POSSE	PS12297255LD	FLORES DE GOIAS	27/11/2019 17:35	28/11/2019 23:48	27/11/2019 17:35	28/11/2019 23:48	30,21	1	30,21	CHI
201911347021	GOIAS	GS12037507	GOIAS	27/11/2019 18:21	28/11/2019 17:21	27/11/2019 18:21	28/11/2019 17:21	22,98	4	91,94	CHI
201911347023	QUIRINOPOLIS	10005870958	QUIRINOPOLIS	27/11/2019 18:22	28/11/2019 03:32	27/11/2019 18:22	28/11/2019 03:32	9,16	1	9,16	CHI
201911347033	SAO LUIS DE MONTES BELOS	SL21226440	FIRMINOPOLIS S2	27/11/2019 18:25	27/11/2019 20:03	27/11/2019 18:25	27/11/2019 20:03	1,64	1	1,64	CHI
201911347042	CAMPOS VERDES	VD12145521	SANTA TEREZINHA	27/11/2019 17:55	28/11/2019 03:40	27/11/2019 17:55	28/11/2019 03:40	9,74	2	19,49	CHI
201911347042	SANTA TEREZINHA DE GOIAS	VD12145521	SANTA TEREZINHA	27/11/2019 17:55	28/11/2019 03:40	27/11/2019 17:55	28/11/2019 03:40	9,74	27	263,09	CHI
201911347043	SAO JOAO D ALIANCA	JL21261867	SAO JOAO D ALIANCA	27/11/2019 18:27	28/11/2019 15:38	27/11/2019 18:27	28/11/2019 15:38	21,18	2	42,36	CHI
201911347045	ITARUMA	IM12205220	ITAJA S2	27/11/2019 18:06	28/11/2019 11:46	27/11/2019 18:06	28/11/2019 11:46	17,67	9	159,00	CHI
201911347046	AURILANDIA	CG12153727	FIRMINOPOLIS S2	27/11/2019 18:27	28/11/2019 10:45	27/11/2019 18:27	28/11/2019 10:45	16,29	3	48,88	CHI
201911347046	CACHOEIRA DE GOIAS	CG12153727	FIRMINOPOLIS S2	27/11/2019 18:27	28/11/2019 10:45	27/11/2019 18:27	28/11/2019 10:45	16,29	1	16,29	CHI
201911347050	PLANALTINA	10026493371	PLANALTINA	27/11/2019 18:28	27/11/2019 22:33	27/11/2019 18:28	27/11/2019 22:33	4,07	1	4,07	CHI
201911347055	ANAPOLIS	20153272	JUNDIAI S2	27/11/2019 18:29	28/11/2019 07:00	27/11/2019 18:29	28/11/2019 07:00	12,51	1	12,51	CHI
201911347056	VIANOPOLIS	VN12068287	VIANOPOLIS	27/11/2019 17:48	28/11/2019 08:28	27/11/2019 17:48	28/11/2019 08:28	14,66	4	58,64	CHI
201911347057	APORE	AE21274121	ITAJA S1	27/11/2019 18:29	28/11/2019 16:29	27/11/2019 18:29	28/11/2019 16:29	21,99	1	21,99	CHI
201911347061	JUSSARA	JR12022269	BRITANIA	27/11/2019 18:11	28/11/2019 09:03	27/11/2019 18:11	28/11/2019 09:03	14,87	30	446,04	CHI
201911347061	MONTES CLAROS DE GOIAS	JR12022269	BRITANIA	27/11/2019 18:11	28/11/2019 09:03	27/11/2019 18:11	28/11/2019 09:03	14,87	257	3821,09	CHI
201911347072	BELA VISTA DE GOIAS	BV31072166	BELA VISTA S1	27/11/2019 18:32	28/11/2019 10:44	27/11/2019 18:32	28/11/2019 10:44	16,19	1	16,19	CHI
201911347076	APARECIDA DE GOIANIA	14137446	INDEPENDENCIA S2	27/11/2019 18:33	27/11/2019 19:42	27/11/2019 18:33	27/11/2019 19:42	1,15	1	1,15	CHI
201911347083	ANAPOLIS	AN11215239	DAIA S1	27/11/2019 16:50	27/11/2019 20:23	27/11/2019 16:50	27/11/2019 20:23	3,54	321	1134,74	CHI
201911347084	MARA ROSA	MQ12291951	MARA ROSA	27/11/2019 18:36	28/11/2019 14:06	27/11/2019 18:36	28/11/2019 14:06	19,49	1	19,49	CHI
201911347085	IVOLANDIA	1560010608	IPORA	27/11/2019 18:37	28/11/2019 10:33	27/11/2019 18:37	28/11/2019 10:33	15,93	1	15,93	CHI
201911347086	ARAGOIANIA	LG21209227	INDEPENDENCIA S2	27/11/2019 18:37	28/11/2019 05:31	27/11/2019 18:37	28/11/2019 05:31	10,91	1	10,91	CHI
201911347091	HIDROLANDIA	HD12007492	PONTALINA	27/11/2019 18:38	28/11/2019 12:48	27/11/2019 18:38	28/11/2019 12:48	18,16	10	181,61	CHI
201911347108	SANTA HELENA DE GOIAS	SH11000043	IPEGUARI	27/11/2019 18:40	27/11/2019 22:34	27/11/2019 18:40	27/11/2019 22:34	3,89	51	198,18	CHI
201911347110	AVELINOPOLIS	990009087	ANICUNS	27/11/2019 18:42	28/11/2019 01:38	27/11/2019 18:42	28/11/2019 01:38	6,93	1	6,93	CHI
201911347112	PIRENOPOLIS	PV12056026	CORUMBA	27/11/2019 16:59	29/11/2019 08:58	27/11/2019 16:59	29/11/2019 08:58	39,97	9	359,72	CHI
201911347116	MONTES CLAROS DE GOIAS	ME12207822	IPORA	27/11/2019 18:43	28/11/2019 10:12	27/11/2019 18:43	28/11/2019 10:12	15,47	14	216,56	CHI
201911347122	GOUVELANDIA	QI21155909	QUIRINOPOLIS	27/11/2019 18:44	28/11/2019 16:42	27/11/2019 18:44	28/11/2019 16:42	21,95	2	43,91	CHI
201911347128	RIO VERDE	10012854563	RIO VERDE S2	27/11/2019 18:46	28/11/2019 09:51	27/11/2019 18:46	28/11/2019 09:51	15,08	1	15,08	CHI
201911347129	CATALAO	1990307945	CATALAO S2	27/11/2019 18:46	27/11/2019 22:59	27/11/2019 18:46	27/11/2019 22:59	4,21	1	4,21	CHI
201911347131	JARAGUA	JA12283464	JARAGUA	27/11/2019 17:56	27/11/2019 20:26	27/11/2019 17:56	27/11/2019 20:26	2,50	13	32,47	CHI
201911347136	GOIANIA	10013150470	ATLANTICO S2	27/11/2019 18:46	27/11/2019 20:07	27/11/2019 18:46	27/11/2019 20:07	1,33	1	1,33	CHI



201911347150	NIQUELANDIA	2750057638	NIQUELANDIA SUBTRANSMISSAO	27/11/2019 18:49	28/11/2019 20:26	27/11/2019 18:49	28/11/2019 20:26	25,61	1	25,61	CHI
201911347154	SAO FRANCISCO DE GOIAS	10023725816	SAO FRANCISCO DE GOIAS	27/11/2019 18:49	27/11/2019 21:51	27/11/2019 18:49	27/11/2019 21:51	3,02	1	3,02	CHI
201911347159	URUACU	640134567	URUACU	27/11/2019 18:50	27/11/2019 21:25	27/11/2019 18:50	27/11/2019 21:25	2,58	1	2,58	CHI
201911347161	ITAPURANGA	IK11051549	ITAPURANGA	27/11/2019 18:42	28/11/2019 07:20	27/11/2019 18:42	28/11/2019 07:20	12,63	197	2487,67	CHI
201911347163	PIRENOPOLIS	PV21171302	CORUMBA	27/11/2019 18:50	29/11/2019 07:59	27/11/2019 18:50	29/11/2019 07:59	37,14	2	74,28	CHI
201911347168	SANCLERLANDIA	1210031799	FIRMINOPOLIS S2	27/11/2019 18:52	28/11/2019 00:23	27/11/2019 18:52	28/11/2019 00:23	5,52	1	5,52	CHI
201911347170	ITUMBIARA	IT12097341	ITUMBIARA VELHA S1	27/11/2019 18:52	27/11/2019 23:58	27/11/2019 18:52	27/11/2019 23:58	5,10	2	10,19	CHI
201911347176	IPORA	10011055691	IPORA	27/11/2019 18:53	27/11/2019 20:09	27/11/2019 18:53	27/11/2019 20:09	1,28	1	1,28	CHI
201911347181	CAMPINORTE	CR12190203	MARA ROSA	27/11/2019 17:32	28/11/2019 18:26	27/11/2019 17:32	28/11/2019 18:26	24,89	2	49,77	CHI
201911347183	IVOLANDIA	IV12231193	ARENOPOLIS	27/11/2019 17:48	28/11/2019 09:30	27/11/2019 17:48	28/11/2019 09:30	15,71	9	141,37	CHI
201911347183	PALESTINA DE GOIAS	IV12231193	ARENOPOLIS	27/11/2019 17:48	28/11/2019 09:30	27/11/2019 17:48	28/11/2019 09:30	15,71	13	204,20	CHI
201911347185	ABADIANIA	AA21291793	ANAPOLIS UNIVERSITARIO S2	27/11/2019 18:54	28/11/2019 16:28	27/11/2019 18:54	28/11/2019 16:28	21,55	1	21,55	CHI
201911347186	FORMOSA	CW21184632	ITUIQUIRA	27/11/2019 18:54	28/11/2019 09:23	27/11/2019 18:54	28/11/2019 09:23	14,48	1	14,48	CHI
201911347187	BARRO ALTO	BA21000036	BARRO ALTO	27/11/2019 18:54	28/11/2019 16:44	27/11/2019 18:54	28/11/2019 16:44	21,82	1	21,82	CHI
201911347199	ITUMBIARA	IT21263963	PARANAIBA	27/11/2019 18:56	28/11/2019 12:20	27/11/2019 18:56	28/11/2019 12:20	17,39	1	17,39	CHI
201911347200	IPORA	IR12024576	ARENOPOLIS	27/11/2019 18:54	28/11/2019 08:59	27/11/2019 18:54	28/11/2019 08:59	14,07	3	42,21	CHI
201911347201	VALPARAISO DE GOIAS	10006156566	PACAEMBU S1	27/11/2019 18:56	28/11/2019 00:02	27/11/2019 18:56	28/11/2019 00:02	5,09	1	5,09	CHI
201911347207	ITAPACI	SZ12243712	ITAPACI	27/11/2019 18:49	28/11/2019 19:43	27/11/2019 18:49	28/11/2019 19:43	24,89	3	74,68	CHI
201911347207	SAO LUIZ DO NORTE	SZ12243712	ITAPACI	27/11/2019 18:49	28/11/2019 19:43	27/11/2019 18:49	28/11/2019 19:43	24,89	12	298,72	CHI
201911347212	BRITANIA	2110002986	BRITANIA	27/11/2019 18:59	28/11/2019 08:41	27/11/2019 18:59	28/11/2019 08:41	13,70	1	13,70	CHI
201911347213	ITUMBIARA	IT21000157	PARANAIBA	27/11/2019 18:59	27/11/2019 20:26	27/11/2019 18:59	27/11/2019 20:26	1,45	2	2,89	CHI
201911347214	FIRMINOPOLIS	FR21283580	FIRMINOPOLIS S1	27/11/2019 18:59	27/11/2019 23:18	27/11/2019 18:59	27/11/2019 23:18	4,32	1	4,32	CHI
201911347215	NIQUELANDIA	NQ12364084	URUACU	27/11/2019 18:59	28/11/2019 12:14	27/11/2019 18:59	28/11/2019 12:14	17,24	4	68,97	CHI
201911347217	PARAUNA	PU12081329	PARAUNA	27/11/2019 18:59	28/11/2019 07:44	27/11/2019 18:59	28/11/2019 07:44	12,73	46	585,80	CHI
201911347219	HIDROLANDIA	HD12321570	INDEPENDENCIA S1	27/11/2019 20:09	28/11/2019 10:20	27/11/2019 20:09	28/11/2019 10:20	14,18	7	99,27	CHI
201911347231	GOIANIA	17251771	GOYA S1	27/11/2019 19:02	27/11/2019 22:43	27/11/2019 19:02	27/11/2019 22:43	3,68	1	3,68	CHI
201911347238	DOVERLANDIA	MY12036563	PARQUE DAS EMAS	27/11/2019 19:03	28/11/2019 21:13	27/11/2019 19:03	28/11/2019 21:13	26,17	58	1517,59	CHI
201911347241	CRIXAS	CX12321023	SANTA TEREZINHA	27/11/2019 19:03	29/11/2019 02:07	27/11/2019 19:03	29/11/2019 02:07	31,06	11	341,68	CHI
201911347243	TEREZOPOLIS DE GOIAS	1370007120	DAIA S2	27/11/2019 19:03	28/11/2019 03:09	27/11/2019 19:03	28/11/2019 03:09	8,09	1	8,09	CHI
201911347247	SAO MIGUEL DO ARAGUAIA	SM21000037	SAO MIGUEL DO ARAGUAIA	27/11/2019 19:03	28/11/2019 04:56	27/11/2019 19:03	28/11/2019 04:56	9,87	1	9,87	CHI
201911347249	GOIANIA	GN11244737	ATLANTICO S2	27/11/2019 19:04	27/11/2019 21:53	27/11/2019 19:04	27/11/2019 21:53	2,81	17	47,82	CHI
201911347253	ITUMBIARA	690012603	ITUMBIARA VELHA S1	27/11/2019 19:05	28/11/2019 09:22	27/11/2019 19:05	28/11/2019 09:22	14,28	1	14,28	CHI
201911347256	CALDAS NOVAS	760018583	CALDAS NOVAS S2	27/11/2019 19:05	27/11/2019 22:39	27/11/2019 19:05	27/11/2019 22:39	3,56	1	3,56	CHI

201911347259	MAIRIPOTABA	MI12000430	PONTALINA	27/11/2019 18:38	28/11/2019 08:45	27/11/2019 18:38	28/11/2019 08:45	14,10	4	56,41	CHI
201911347261	NOVA AMERICA	NM12363582	RUBIATABA	27/11/2019 19:07	28/11/2019 14:20	27/11/2019 19:07	28/11/2019 14:20	19,23	3	57,68	CHI
201911347264	FORMOSA	FA11085464	ITUIQUIRA	27/11/2019 19:08	28/11/2019 13:00	27/11/2019 19:08	28/11/2019 13:00	17,86	2	35,73	CHI
201911347269	SENADOR CANEDO	SW11384961	SENADOR CANEDO	27/11/2019 19:04	27/11/2019 20:48	27/11/2019 19:04	27/11/2019 20:48	1,72	174	299,28	CHI
201911347273	MONTIVIDIU	MV21267617	MONTIVIDIU T	27/11/2019 19:10	27/11/2019 20:50	27/11/2019 19:10	27/11/2019 20:50	1,66	3	4,98	CHI
201911347274	GOIANIA	GN11247748	GOYA S2	27/11/2019 19:03	27/11/2019 20:52	27/11/2019 19:03	27/11/2019 20:52	1,80	91	163,88	CHI
201911347278	LUZIANIA	LZ12230126	MARAJOARA	27/11/2019 19:12	27/11/2019 23:04	27/11/2019 19:12	27/11/2019 23:04	3,88	150	581,83	CHI
201911347280	CATALAO	10002551533	CATALAO S2	27/11/2019 19:12	28/11/2019 01:09	27/11/2019 19:12	28/11/2019 01:09	5,95	1	5,95	CHI
201911347281	JATAI	JT12274032	JATAI S2	27/11/2019 18:46	28/11/2019 09:25	27/11/2019 18:46	28/11/2019 09:25	14,65	10	146,49	CHI
201911347283	PILAR DE GOIAS	GG12214355	URUACU	27/11/2019 19:12	29/11/2019 00:10	27/11/2019 19:12	29/11/2019 00:10	28,96	1	28,96	CHI
201911347285	CIDADE OCIDENTAL	10023410769	MARAJOARA	27/11/2019 19:13	27/11/2019 20:54	27/11/2019 19:13	27/11/2019 20:54	1,67	1	1,67	CHI
201911347287	BARRO ALTO	10015302413	BARRO ALTO	27/11/2019 19:13	28/11/2019 18:48	27/11/2019 19:13	28/11/2019 18:48	23,57	1	23,57	CHI
201911347293	GOIANIA	GN11002810	GOYA S2	27/11/2019 19:14	27/11/2019 20:21	27/11/2019 19:14	27/11/2019 20:21	1,11	143	159,17	CHI
201911347294	MONTES CLAROS DE GOIAS	ME21039667	IPORA	27/11/2019 19:15	28/11/2019 14:27	27/11/2019 19:15	28/11/2019 14:27	19,21	1	19,21	CHI
201911347295	GOIANIA	13630611	CARAJAS S1	27/11/2019 19:15	27/11/2019 20:40	27/11/2019 19:15	27/11/2019 20:40	1,40	1	1,40	CHI
201911347296	CRISTALINA	KR12087954	CRISTALINA S2	27/11/2019 19:15	27/11/2019 21:32	27/11/2019 19:15	27/11/2019 21:32	2,27	3	6,81	CHI
201911347297	APARECIDA DE GOIANIA	12362438	INDEPENDENCIA S2	27/11/2019 19:16	27/11/2019 20:37	27/11/2019 19:16	27/11/2019 20:37	1,34	1	1,34	CHI
201911347300	URUACU	20119953	URUACU	27/11/2019 19:17	28/11/2019 11:53	27/11/2019 19:17	28/11/2019 11:53	16,59	2	33,18	CHI
201911347305	ALTO PARAISO DE GOIAS	BF11130060	FLORES DE GOIAS	27/11/2019 18:56	27/11/2019 22:20	27/11/2019 18:56	27/11/2019 22:20	3,39	123	416,76	CHI
201911347307	PARAUNA	PU21034029	FIRMINOPOLIS S2	27/11/2019 19:19	28/11/2019 12:30	27/11/2019 19:19	28/11/2019 12:30	17,18	1	17,18	CHI
201911347322	VILA PROPICIO	GE12376588	GOIANESIA S2	27/11/2019 18:49	28/11/2019 16:35	27/11/2019 18:49	28/11/2019 16:35	21,76	2	43,52	CHI
201911347322	GOIANESIA	GE12376588	GOIANESIA S2	27/11/2019 18:49	28/11/2019 16:35	27/11/2019 18:49	28/11/2019 16:35	21,76	8	174,07	CHI
201911347325	ABADIANIA	AA21123839	DAIA S2	27/11/2019 19:24	28/11/2019 11:37	27/11/2019 19:24	28/11/2019 11:37	16,21	1	16,21	CHI
201911347330	GOIANIA	GN11162013	FERROVIARIO S3	27/11/2019 19:03	27/11/2019 20:44	27/11/2019 19:03	27/11/2019 20:44	1,67	70	117,06	CHI
201911347335	BOM JARDIM DE GOIAS	BM12064234	BOM JARDIM	27/11/2019 17:44	28/11/2019 06:00	27/11/2019 17:44	28/11/2019 06:00	12,27	4	49,07	CHI
201911347336	GOIAS	GS12234099	GOIAS	27/11/2019 19:27	28/11/2019 17:20	27/11/2019 19:27	28/11/2019 17:20	21,89	3	65,66	CHI
201911347346	BELA VISTA DE GOIAS	BV31037982	BELA VISTA S1	27/11/2019 19:29	28/11/2019 15:05	27/11/2019 19:29	28/11/2019 15:05	19,59	1	19,59	CHI
201911347358	IPAMERI	1060100591	PIRES DO RIO S2	27/11/2019 19:32	28/11/2019 12:42	27/11/2019 19:32	28/11/2019 12:42	17,15	1	17,15	CHI
201911347363	EDEIA	EA12060898	EDEIA	27/11/2019 19:34	28/11/2019 10:57	27/11/2019 19:34	28/11/2019 10:57	15,38	4	61,52	CHI
201911347364	ALEXANIA	AX31121618	ALEXANIA	27/11/2019 19:34	28/11/2019 07:08	27/11/2019 19:34	28/11/2019 07:08	11,56	2	23,11	CHI
201911347366	FAZENDA NOVA	FN12220464	JUSSARA	27/11/2019 19:30	28/11/2019 09:00	27/11/2019 19:30	28/11/2019 09:00	13,50	29	391,59	CHI
201911347368	PORANGATU	PO12349237	MARA ROSA	27/11/2019 19:35	28/11/2019 09:22	27/11/2019 19:35	28/11/2019 09:22	13,77	18	247,89	CHI
201911347369	CEZARINA	CZ12271995	GUAPO S2	28/11/2019 06:27	29/11/2019 11:48	28/11/2019 06:27	29/11/2019 11:48	29,35	25	733,82	CHI

201911347374	PORANGATU	PO12391933	MARA ROSA	27/11/2019 14:56	28/11/2019 08:14	27/11/2019 14:56	28/11/2019 08:14	17,29	5	86,45	CHI
201911347375	MINACU	IH12189548	MINACU	27/11/2019 19:14	28/11/2019 03:49	27/11/2019 19:14	28/11/2019 03:49	8,58	4	34,30	CHI
201911347378	ALTO PARAISO DE GOIAS	BF12072316	SAO JOAO D ALIANCA	27/11/2019 19:39	28/11/2019 13:22	27/11/2019 19:39	28/11/2019 13:22	17,72	7	124,01	CHI
201911347378	ALTO PARAISO DE GOIAS	BF12072316	SAO JOAO D ALIANCA	27/11/2019 19:39	28/11/2019 13:22	28/11/2019 08:45	28/11/2019 13:22	4,62	3	13,87	CHI
201911347392	MONTIVIDIU DO NORTE	MX12377673	PORANGATU	27/11/2019 19:42	28/11/2019 12:12	27/11/2019 19:42	28/11/2019 12:12	16,49	1	16,49	CHI
201911347393	ARUANA	AK21307436	ARUANA	27/11/2019 19:42	29/11/2019 11:10	27/11/2019 19:42	29/11/2019 11:10	39,46	2	78,91	CHI
201911347397	APARECIDA DE GOIANIA	12720732	REAL S1	27/11/2019 19:43	27/11/2019 21:32	27/11/2019 19:43	27/11/2019 21:32	1,81	1	1,81	CHI
201911347404	AGUAS LINDAS DE GOIAS	4830390531	AGUAS LINDAS DE GOIAS S1	27/11/2019 19:44	27/11/2019 22:17	27/11/2019 19:44	27/11/2019 22:17	2,55	1	2,55	CHI
201911347408	SILVANIA	10007379593	VIANOPOLIS	27/11/2019 19:44	28/11/2019 09:44	27/11/2019 19:44	28/11/2019 09:44	14,00	1	14,00	CHI
201911347409	ITABERAI	IB11206916	ITABERAI S2	27/11/2019 19:41	27/11/2019 20:36	27/11/2019 19:41	27/11/2019 20:36	0,90	157	142,08	CHI
201911347412	FAINA	FC21284740	GOIAS	27/11/2019 19:45	28/11/2019 14:53	27/11/2019 19:45	28/11/2019 14:53	19,12	2	38,25	CHI
201911347414	VALPARAISO DE GOIAS	VA12163163	PACAEMBU S1	27/11/2019 19:45	27/11/2019 21:45	27/11/2019 19:45	27/11/2019 21:45	1,99	157	312,12	CHI
201911347423	BELA VISTA DE GOIAS	BV11000112	CEPAIGO S2	27/11/2019 19:48	28/11/2019 11:09	27/11/2019 19:48	28/11/2019 11:09	15,34	10	153,42	CHI
201911347432	SAO LUIZ DO NORTE	3090000530	ITAPACI	27/11/2019 19:52	29/11/2019 00:09	27/11/2019 19:52	29/11/2019 00:09	28,28	1	28,28	CHI
201911347435	AGUA FRIA DE GOIAS	4440003115	SAO JOAO D ALIANCA	27/11/2019 19:52	28/11/2019 15:28	27/11/2019 19:52	28/11/2019 15:28	19,60	1	19,60	CHI
201911347436	CALDAS NOVAS	CN12231992	CALDAS NOVAS S1	27/11/2019 19:52	28/11/2019 09:45	27/11/2019 19:52	28/11/2019 09:45	13,87	84	1164,94	CHI
201911347437	APARECIDA DE GOIANIA	10148577	REAL S1	27/11/2019 19:53	27/11/2019 21:26	27/11/2019 19:53	27/11/2019 21:26	1,55	1	1,55	CHI
201911347447	PIRES DO RIO	PR11333135	PIRES DO RIO S1	27/11/2019 19:57	28/11/2019 08:29	27/11/2019 19:57	28/11/2019 08:29	12,53	3	37,60	CHI
201911347448	GOIANIA	GN11169355	GOYA S1	27/11/2019 18:47	28/11/2019 01:16	27/11/2019 18:47	28/11/2019 01:16	6,47	246	1591,55	CHI
201911347452	JAUPACI	1280002284	IPORA	27/11/2019 19:58	28/11/2019 11:29	27/11/2019 19:58	28/11/2019 11:29	15,52	1	15,52	CHI
201911347453	MOSSAMEDES	1310002463	FIRMINOPOLIS S2	27/11/2019 19:58	27/11/2019 23:50	27/11/2019 19:58	27/11/2019 23:50	3,85	1	3,85	CHI
201911347454	LUZIANIA	LZ21172150	VIANOPOLIS	27/11/2019 19:59	28/11/2019 02:37	27/11/2019 19:59	28/11/2019 02:37	6,63	2	13,26	CHI
201911347466	PARAUNA	PU21228099	PARAUNA	27/11/2019 20:01	28/11/2019 01:24	27/11/2019 20:01	28/11/2019 01:24	5,38	2	10,77	CHI
201911347468	GOIANIA	GN11001457	GOYA S1	27/11/2019 20:01	27/11/2019 21:25	27/11/2019 20:01	27/11/2019 21:25	1,38	115	159,24	CHI
201911347475	GOIANIA	14335610	CARAJAS S2	27/11/2019 20:03	27/11/2019 22:11	27/11/2019 20:03	27/11/2019 22:11	2,13	1	2,13	CHI
201911347482	SENADOR CANEDO	SW11092646	SENADOR CANEDO	27/11/2019 20:07	27/11/2019 22:02	27/11/2019 20:07	27/11/2019 22:02	1,91	137	261,59	CHI
201911347488	CEZARINA	CZ12259266	CEZARINA	27/11/2019 20:08	28/11/2019 16:40	27/11/2019 20:08	28/11/2019 16:40	20,54	6	123,22	CHI
201911347491	FORMOSA	10002618565	ITIQUEIRA	27/11/2019 20:08	28/11/2019 11:33	27/11/2019 20:08	28/11/2019 11:33	15,41	0	0,00	CHI
201911347497	PIRENOPOLIS	PV21376562	CORUMBA	27/11/2019 20:11	29/11/2019 10:10	27/11/2019 20:11	29/11/2019 10:10	37,97	3	113,92	CHI
201911347500	APARECIDA DE GOIANIA	200531347	ANHANGUERA	27/11/2019 20:12	27/11/2019 22:02	27/11/2019 20:12	27/11/2019 22:02	1,83	1	1,83	CHI
201911347502	JATAI	JT21164213	JATAI S1	27/11/2019 20:12	28/11/2019 11:37	27/11/2019 20:12	28/11/2019 11:37	15,41	1	15,41	CHI
201911347503	MUNDO NOVO DE GOIAS	NA12035650	NOVA CRIXAS	27/11/2019 19:50	29/11/2019 09:35	27/11/2019 19:50	29/11/2019 09:35	37,73	8	301,87	CHI
201911347503	NOVA CRIXAS	NA12035650	NOVA CRIXAS	27/11/2019 19:50	29/11/2019 09:35	27/11/2019 19:50	29/11/2019 09:35	37,73	24	905,62	CHI

201911347504	MIMOSO DE GOIAS	MJ12313927	PADRE BERNARDO	27/11/2019 20:13	27/11/2019 22:35	27/11/2019 20:13	27/11/2019 22:35	2,36	18	42,42	CHI
201911347508	MINEIROS	MY12244166	PARQUE DAS EMAS	27/11/2019 20:14	28/11/2019 09:45	27/11/2019 20:14	28/11/2019 09:45	13,51	1	13,51	CHI
201911347513	SAO MIGUEL DO ARAGUAIA	SM13375324	SAO MIGUEL DO ARAGUAIA	27/11/2019 20:16	30/11/2019 18:11	27/11/2019 20:16	28/11/2019 14:26	18,17	8	145,34	CHI
201911347513	SAO MIGUEL DO ARAGUAIA	SM10396890	SAO MIGUEL DO ARAGUAIA	27/11/2019 20:16	30/11/2019 18:11	28/11/2019 14:26	28/11/2019 16:20	1,89	76	143,94	CHI
201911347513	BONOPOLIS	SM10396890	SAO MIGUEL DO ARAGUAIA	27/11/2019 20:16	30/11/2019 18:11	28/11/2019 14:26	28/11/2019 16:20	1,89	106	200,75	CHI
201911347513	SAO MIGUEL DO ARAGUAIA	SM10396890	SAO MIGUEL DO ARAGUAIA	27/11/2019 20:16	30/11/2019 18:11	28/11/2019 20:21	28/11/2019 23:20	2,99	66	197,17	CHI
201911347513	BONOPOLIS	SM10396890	SAO MIGUEL DO ARAGUAIA	27/11/2019 20:16	30/11/2019 18:11	28/11/2019 20:21	28/11/2019 23:20	2,99	106	316,67	CHI
201911347513	SAO MIGUEL DO ARAGUAIA	SM12013034LD	SAO MIGUEL DO ARAGUAIA	27/11/2019 20:16	30/11/2019 18:11	28/11/2019 20:21	29/11/2019 11:23	15,04	8	120,31	CHI
201911347513	SAO MIGUEL DO ARAGUAIA	SM13375324	SAO MIGUEL DO ARAGUAIA	27/11/2019 20:16	30/11/2019 18:11	28/11/2019 15:15	29/11/2019 11:58	20,71	8	165,68	CHI
201911347513	SAO MIGUEL DO ARAGUAIA	SM10396890	SAO MIGUEL DO ARAGUAIA	27/11/2019 20:16	30/11/2019 18:11	29/11/2019 12:58	29/11/2019 19:08	6,17	92	567,90	CHI
201911347513	BONOPOLIS	SM10396890	SAO MIGUEL DO ARAGUAIA	27/11/2019 20:16	30/11/2019 18:11	29/11/2019 12:58	29/11/2019 19:08	6,17	104	641,97	CHI
201911347513	SAO MIGUEL DO ARAGUAIA	SM13375324	SAO MIGUEL DO ARAGUAIA	27/11/2019 20:16	30/11/2019 18:11	29/11/2019 12:58	30/11/2019 13:34	24,60	8	196,77	CHI
201911347513	SAO MIGUEL DO ARAGUAIA	SM12013061LD	SAO MIGUEL DO ARAGUAIA	27/11/2019 20:16	30/11/2019 18:11	27/11/2019 20:16	30/11/2019 18:11	69,92	1	69,92	CHI
201911347513	SAO MIGUEL DO ARAGUAIA	SM10396890	SAO MIGUEL DO ARAGUAIA	27/11/2019 20:16	30/11/2019 18:11	27/11/2019 20:16	30/11/2019 18:11	69,92	2	139,85	CHI
201911347513	SAO MIGUEL DO ARAGUAIA	SM10396890	SAO MIGUEL DO ARAGUAIA	27/11/2019 20:16	30/11/2019 18:11	30/11/2019 15:57	30/11/2019 18:11	2,24	108	242,43	CHI
201911347513	BONOPOLIS	SM10396890	SAO MIGUEL DO ARAGUAIA	27/11/2019 20:16	30/11/2019 18:11	30/11/2019 15:57	30/11/2019 18:11	2,24	105	235,70	CHI
201911347522	AGUAS LINDAS DE GOIAS	4830142961	AGUAS LINDAS DE GOIAS S1	27/11/2019 20:20	27/11/2019 21:51	27/11/2019 20:20	27/11/2019 21:51	1,51	1	1,51	CHI
201911347532	JATAI	JT12209803	JATAI S3	27/11/2019 18:40	28/11/2019 10:00	27/11/2019 18:40	28/11/2019 10:00	15,34	24	368,19	CHI
201911347535	CIDADE OCIDENTAL	DH21305305	MARAJOARA	27/11/2019 20:26	28/11/2019 08:37	27/11/2019 20:26	28/11/2019 08:37	12,18	1	12,18	CHI
201911347536	GOIANIA	15012141	CARAJAS S1	27/11/2019 20:27	28/11/2019 01:40	27/11/2019 20:27	28/11/2019 01:40	5,21	1	5,21	CHI
201911347540	CACHOEIRA ALTA	RV12051482	CACHOEIRA ALTA	27/11/2019 20:28	28/11/2019 09:48	27/11/2019 20:28	28/11/2019 09:48	13,32	3	39,96	CHI
201911347540	RIO VERDE	RV12051482	CACHOEIRA ALTA	27/11/2019 20:28	28/11/2019 09:48	27/11/2019 20:28	28/11/2019 09:48	13,32	4	53,28	CHI
201911347541	JANDAIA	JD21159007	PALMEIRAS	27/11/2019 20:29	28/11/2019 07:50	27/11/2019 20:29	28/11/2019 07:50	11,35	1	11,35	CHI
201911347545	CATALAO	CT21160934	CATALAO S1	27/11/2019 20:31	28/11/2019 09:05	27/11/2019 20:31	28/11/2019 09:05	12,56	1	12,56	CHI
201911347546	CAIAPONIA	CP12354285	CAIAPONIA	28/11/2019 07:10	28/11/2019 09:46	28/11/2019 07:10	28/11/2019 09:46	2,61	12	31,36	CHI
201911347548	FAINA	FC12310647	GOIAS	27/11/2019 20:33	28/11/2019 19:34	27/11/2019 20:33	28/11/2019 19:34	23,01	3	69,02	CHI
201911347552	MORRINHOS	MR12033194	MORRINHOS	27/11/2019 20:25	28/11/2019 07:50	27/11/2019 20:25	28/11/2019 07:50	11,41	15	171,20	CHI
201911347554	POSSE	PS12204605	IACIARA S2	27/11/2019 20:35	27/11/2019 23:37	27/11/2019 20:35	27/11/2019 23:37	3,03	277	838,62	CHI
201911347559	PORANGATU	PO12192315	PORANGATU	27/11/2019 20:36	28/11/2019 14:47	27/11/2019 20:36	28/11/2019 14:47	18,19	19	345,57	CHI
201911347563	ALTO PARAISO DE GOIAS	ND12302635	IACIARA S2	27/11/2019 20:38	28/11/2019 14:06	27/11/2019 20:38	28/11/2019 14:06	17,46	18	314,34	CHI
201911347563	NOVA ROMA	ND12302635	IACIARA S2	27/11/2019 20:38	28/11/2019 14:06	27/11/2019 20:38	28/11/2019 14:06	17,46	121	2113,06	CHI
201911347563	SAO JOAO D ALIANCA	ND12302635	IACIARA S2	27/11/2019 20:38	28/11/2019 14:06	27/11/2019 20:38	28/11/2019 14:06	17,46	27	471,51	CHI
201911347567	ITUMBIARA	690220273	ITUMBIARA NOVA	27/11/2019 20:38	27/11/2019 23:54	27/11/2019 20:38	27/11/2019 23:54	3,27	1	3,27	CHI

201911347571	QUIRINOPOLIS	QI12089047	QUIRINOPOLIS	27/11/2019 20:39	28/11/2019 13:10	27/11/2019 20:39	28/11/2019 13:10	16,51	9	148,55	CHI
201911347573	GOIANIA	GN11268058	GOYA S1	27/11/2019 20:36	27/11/2019 22:31	27/11/2019 20:36	27/11/2019 22:31	1,91	133	253,99	CHI
201911347576	GOIANIA	GN11001949	CAMPINAS S3	27/11/2019 20:39	28/11/2019 05:29	27/11/2019 20:39	28/11/2019 05:29	8,83	86	759,50	CHI
201911347586	MONTES CLAROS DE GOIAS	ME12204928	IPORA	27/11/2019 20:44	28/11/2019 15:10	27/11/2019 20:44	28/11/2019 15:10	18,43	5	92,17	CHI
201911347589	SANTA FE DE GOIAS	RN21199811	BRITANIA	28/11/2019 08:45	28/11/2019 18:13	28/11/2019 08:45	28/11/2019 18:13	9,45	1	9,45	CHI
201911347592	IPORA	IR21014482	IPORA	27/11/2019 20:46	28/11/2019 10:40	27/11/2019 20:46	28/11/2019 10:40	13,90	2	27,79	CHI
201911347597	PLANALTINA	2960217660	PLANALTINA	27/11/2019 20:46	28/11/2019 01:43	27/11/2019 20:46	28/11/2019 01:43	4,94	1	4,94	CHI
201911347604	RIO VERDE	RV21150174	MONTIVIDIU T	27/11/2019 20:15	27/11/2019 23:20	27/11/2019 20:15	27/11/2019 23:20	3,07	1	3,07	CHI
201911347605	CAMPO ALEGRE DE GOIAS	04760224	CATALAO S1	27/11/2019 16:45	28/11/2019 13:32	27/11/2019 16:45	27/11/2019 22:30	5,75	1	5,75	CHI
201911347605	CATALAO	04760224	CATALAO S1	27/11/2019 16:45	28/11/2019 13:32	27/11/2019 16:45	27/11/2019 22:30	5,75	215	1236,13	CHI
201911347605	CATALAO	CT13287033	CATALAO S1	27/11/2019 16:45	28/11/2019 13:32	27/11/2019 16:45	28/11/2019 13:32	20,79	342	7110,09	CHI
201911347605	CAMPO ALEGRE DE GOIAS	CT13287033	CATALAO S1	27/11/2019 16:45	28/11/2019 13:32	27/11/2019 16:45	28/11/2019 13:32	20,79	1	20,79	CHI
201911347677	GOIANDIRA	00340434	CATALAO S1	28/11/2019 01:54	28/11/2019 11:33	28/11/2019 01:54	28/11/2019 03:48	1,91	556	1059,80	CHI
201911347677	CATALAO	00340434	CATALAO S1	28/11/2019 01:54	28/11/2019 11:33	28/11/2019 01:54	28/11/2019 03:48	1,91	30	57,18	CHI
201911347677	CATALAO	00340434	CATALAO S1	28/11/2019 01:54	28/11/2019 11:33	28/11/2019 01:54	28/11/2019 03:48	1,91	40	76,24	CHI
201911347677	GOIANDIRA	00340434	CATALAO S1	28/11/2019 01:54	28/11/2019 11:33	28/11/2019 01:54	28/11/2019 03:48	1,91	2157	4111,48	CHI
201911347677	IPAMERI	00340434	CATALAO S1	28/11/2019 01:54	28/11/2019 11:33	28/11/2019 01:54	28/11/2019 03:48	1,91	7	13,34	CHI
201911347677	GOIANDIRA	00340434	CATALAO S1	28/11/2019 01:54	28/11/2019 11:33	28/11/2019 01:54	28/11/2019 03:48	1,91	28	53,37	CHI
201911347677	NOVA AURORA	00340434	CATALAO S1	28/11/2019 01:54	28/11/2019 11:33	28/11/2019 01:54	28/11/2019 03:48	1,91	15	28,59	CHI
201911347677	GOIANDIRA	00340434	CATALAO S1	28/11/2019 01:54	28/11/2019 11:33	28/11/2019 04:03	28/11/2019 04:12	0,15	28	4,13	CHI
201911347677	CATALAO	00340434	CATALAO S1	28/11/2019 01:54	28/11/2019 11:33	28/11/2019 04:03	28/11/2019 04:12	0,15	40	5,90	CHI
201911347677	CATALAO	00340434	CATALAO S1	28/11/2019 01:54	28/11/2019 11:33	28/11/2019 04:03	28/11/2019 04:12	0,15	30	4,42	CHI
201911347677	GOIANDIRA	00340434	CATALAO S1	28/11/2019 01:54	28/11/2019 11:33	28/11/2019 04:03	28/11/2019 04:12	0,15	2156	318,01	CHI
201911347677	GOIANDIRA	00340434	CATALAO S1	28/11/2019 01:54	28/11/2019 11:33	28/11/2019 04:03	28/11/2019 04:12	0,15	556	82,01	CHI
201911347677	IPAMERI	00340434	CATALAO S1	28/11/2019 01:54	28/11/2019 11:33	28/11/2019 04:03	28/11/2019 04:12	0,15	7	1,03	CHI
201911347677	NOVA AURORA	00340434	CATALAO S1	28/11/2019 01:54	28/11/2019 11:33	28/11/2019 04:03	28/11/2019 04:12	0,15	15	2,21	CHI
201911347677	CUMARI	00340434	CATALAO S1	28/11/2019 01:54	28/11/2019 11:33	28/11/2019 01:54	28/11/2019 04:22	2,47	313	773,89	CHI
201911347677	CORUMBAIBA	00340434	CATALAO S1	28/11/2019 01:54	28/11/2019 11:33	28/11/2019 01:54	28/11/2019 04:22	2,47	4	9,89	CHI
201911347677	CUMARI	GD13231562	CATALAO S1	28/11/2019 01:54	28/11/2019 11:33	28/11/2019 01:54	28/11/2019 04:22	2,47	5	12,36	CHI
201911347677	GOIANDIRA	GD13231562	CATALAO S1	28/11/2019 01:54	28/11/2019 11:33	28/11/2019 01:54	28/11/2019 04:22	2,47	35	86,54	CHI
201911347677	CUMARI	00340434	CATALAO S1	28/11/2019 01:54	28/11/2019 11:33	28/11/2019 01:54	28/11/2019 04:22	2,47	1208	2986,78	CHI
201911347677	GOIANDIRA	00340434	CATALAO S1	28/11/2019 01:54	28/11/2019 11:33	28/11/2019 01:54	28/11/2019 04:22	2,47	13	32,14	CHI
201911347677	NOVA AURORA	00340434	CATALAO S1	28/11/2019 01:54	28/11/2019 11:33	28/11/2019 01:54	28/11/2019 04:22	2,47	1	2,47	CHI

201911347677	ANHANGUERA	00340434	CATALAO S1	28/11/2019 01:54	28/11/2019 11:33	28/11/2019 01:54	28/11/2019 04:22	2,47	574	1419,21	CHI
201911347677	CATALAO	00340434	CATALAO S1	28/11/2019 01:54	28/11/2019 11:33	28/11/2019 07:57	28/11/2019 08:04	0,12	30	3,67	CHI
201911347677	ANHANGUERA	00340434	CATALAO S1	28/11/2019 01:54	28/11/2019 11:33	28/11/2019 07:57	28/11/2019 08:04	0,12	574	70,16	CHI
201911347677	GOIANDIRA	00340434	CATALAO S1	28/11/2019 01:54	28/11/2019 11:33	28/11/2019 07:57	28/11/2019 08:04	0,12	13	1,59	CHI
201911347677	CUMARI	00340434	CATALAO S1	28/11/2019 01:54	28/11/2019 11:33	28/11/2019 07:57	28/11/2019 08:04	0,12	1208	147,64	CHI
201911347677	CUMARI	00340434	CATALAO S1	28/11/2019 01:54	28/11/2019 11:33	28/11/2019 07:57	28/11/2019 08:04	0,12	5	0,61	CHI
201911347677	IPAMERI	00340434	CATALAO S1	28/11/2019 01:54	28/11/2019 11:33	28/11/2019 07:57	28/11/2019 08:04	0,12	7	0,86	CHI
201911347677	GOIANDIRA	00340434	CATALAO S1	28/11/2019 01:54	28/11/2019 11:33	28/11/2019 07:57	28/11/2019 08:04	0,12	35	4,28	CHI
201911347677	GOIANDIRA	00340434	CATALAO S1	28/11/2019 01:54	28/11/2019 11:33	28/11/2019 07:57	28/11/2019 08:04	0,12	504	61,60	CHI
201911347677	CUMARI	00340434	CATALAO S1	28/11/2019 01:54	28/11/2019 11:33	28/11/2019 07:57	28/11/2019 08:04	0,12	312	38,13	CHI
201911347677	GOIANDIRA	00340434	CATALAO S1	28/11/2019 01:54	28/11/2019 11:33	28/11/2019 07:57	28/11/2019 08:04	0,12	2157	263,63	CHI
201911347677	NOVA AURORA	00340434	CATALAO S1	28/11/2019 01:54	28/11/2019 11:33	28/11/2019 07:57	28/11/2019 08:04	0,12	1	0,12	CHI
201911347677	CATALAO	00340434	CATALAO S1	28/11/2019 01:54	28/11/2019 11:33	28/11/2019 07:57	28/11/2019 08:04	0,12	40	4,89	CHI
201911347677	CORUMBAIBA	00340434	CATALAO S1	28/11/2019 01:54	28/11/2019 11:33	28/11/2019 07:57	28/11/2019 08:04	0,12	4	0,49	CHI
201911347677	GOIANDIRA	00340434	CATALAO S1	28/11/2019 01:54	28/11/2019 11:33	28/11/2019 07:57	28/11/2019 08:04	0,12	28	3,42	CHI
201911347677	GOIANDIRA	00340434	CATALAO S1	28/11/2019 01:54	28/11/2019 11:33	28/11/2019 01:54	28/11/2019 11:33	9,65	7	67,56	CHI
201911347677	CORUMBAIBA	00340434	CATALAO S1	28/11/2019 01:54	28/11/2019 11:33	28/11/2019 01:54	28/11/2019 11:33	9,65	137	1322,16	CHI
201911347677	MORRINHOS	00340434	CATALAO S1	28/11/2019 01:54	28/11/2019 11:33	28/11/2019 01:54	28/11/2019 11:33	9,65	1	9,65	CHI
201911347677	IPAMERI	00340434	CATALAO S1	28/11/2019 01:54	28/11/2019 11:33	28/11/2019 01:54	28/11/2019 11:33	9,65	15	144,76	CHI
201911347677	NOVA AURORA	GD13147715	CATALAO S1	28/11/2019 01:54	28/11/2019 11:33	28/11/2019 01:54	28/11/2019 11:33	9,65	3	28,95	CHI
201911347677	NOVA AURORA	00340434	CATALAO S1	28/11/2019 01:54	28/11/2019 11:33	28/11/2019 01:54	28/11/2019 11:33	9,65	1112	10731,73	CHI
201911347677	NOVA AURORA	00340434	CATALAO S1	28/11/2019 01:54	28/11/2019 11:33	28/11/2019 01:54	28/11/2019 11:33	9,65	13	125,46	CHI
201911347680	CALDAS NOVAS	CN10408437	CALDAS NOVAS S1	28/11/2019 03:18	28/11/2019 12:22	28/11/2019 03:18	28/11/2019 12:22	9,07	178	1614,61	CHI
201911347680	SANTA CRUZ DE GOIAS	CN10408437	CALDAS NOVAS S1	28/11/2019 03:18	28/11/2019 12:22	28/11/2019 03:18	28/11/2019 12:22	9,07	102	925,22	CHI
201911347684	ARAGARCAS	AG10396201	ARAGARCAS	28/11/2019 03:45	28/11/2019 09:01	28/11/2019 03:45	28/11/2019 08:36	4,85	151	732,69	CHI
201911347684	ARAGARCAS	AG12031032LD	ARAGARCAS	28/11/2019 03:45	28/11/2019 09:01	28/11/2019 03:45	28/11/2019 09:01	5,28	26	137,21	CHI
201911347695	ANAPOLIS	AN21328556	ANAPOLIS UNIVERSITARIO S2	28/11/2019 07:24	28/11/2019 12:26	28/11/2019 07:24	28/11/2019 12:26	5,03	1	5,03	CHI
201911347696	GUARINOS	01630414	ITAPACI	28/11/2019 07:20	29/11/2019 22:14	28/11/2019 07:20	28/11/2019 09:06	1,77	19	33,64	CHI
201911347696	ITAPACI	01630414	ITAPACI	28/11/2019 07:20	29/11/2019 22:14	28/11/2019 07:20	28/11/2019 09:06	1,77	177	313,39	CHI
201911347696	NOVA GLORIA	01630414	ITAPACI	28/11/2019 07:20	29/11/2019 22:14	28/11/2019 07:20	28/11/2019 09:06	1,77	1	1,77	CHI
201911347696	RUBIATABA	01630414	RUBIATABA	28/11/2019 07:20	29/11/2019 22:14	28/11/2019 07:20	28/11/2019 11:06	3,76	130	489,12	CHI
201911347696	IPIRANGA DE GOIAS	01630414	RUBIATABA	28/11/2019 07:20	29/11/2019 22:14	28/11/2019 07:20	28/11/2019 11:06	3,76	3	11,29	CHI
201911347696	ITAPACI	01630414	RUBIATABA	28/11/2019 07:20	29/11/2019 22:14	28/11/2019 07:20	28/11/2019 11:06	3,76	10	37,62	CHI

201911347696	RUBIATABA	IW13146314	RUBIATABA	28/11/2019 07:20	29/11/2019 22:14	28/11/2019 07:20	28/11/2019 13:13	5,88	2	11,77	CHI
201911347696	NOVA GLORIA	IW13146314	RUBIATABA	28/11/2019 07:20	29/11/2019 22:14	28/11/2019 07:20	28/11/2019 13:13	5,88	76	447,13	CHI
201911347696	IPIRANGA DE GOIAS	IW13146314	RUBIATABA	28/11/2019 07:20	29/11/2019 22:14	28/11/2019 07:20	28/11/2019 13:13	5,88	2	11,77	CHI
201911347696	CERES	IW13146314	RUBIATABA	28/11/2019 07:20	29/11/2019 22:14	28/11/2019 07:20	28/11/2019 13:13	5,88	1	5,88	CHI
201911347696	IPIRANGA DE GOIAS	RB13272934	RUBIATABA	28/11/2019 07:20	29/11/2019 22:14	28/11/2019 07:20	29/11/2019 12:37	29,29	28	820,01	CHI
201911347696	CERES	RA13241557	RUBIATABA	28/11/2019 07:20	29/11/2019 22:14	28/11/2019 07:20	29/11/2019 22:10	38,83	19	737,77	CHI
201911347696	IPIRANGA DE GOIAS	RA13241557	RUBIATABA	28/11/2019 07:20	29/11/2019 22:14	28/11/2019 07:20	29/11/2019 22:10	38,83	6	232,98	CHI
201911347696	IPIRANGA DE GOIAS	RB13095552	RUBIATABA	28/11/2019 07:20	29/11/2019 22:14	28/11/2019 07:20	29/11/2019 22:14	38,89	7	272,25	CHI
201911347703	PARAUNA	PU11233900	PARAUNA	27/11/2019 20:48	28/11/2019 10:35	27/11/2019 20:48	28/11/2019 10:35	13,78	1	13,78	CHI
201911347704	NOVA CRIXAS	NA11201735	NOVA CRIXAS	27/11/2019 19:45	28/11/2019 00:45	27/11/2019 19:45	28/11/2019 00:45	5,00	108	540,09	CHI
201911347715	JATAI	JT12182089	JATAI S1	27/11/2019 20:53	28/11/2019 15:42	27/11/2019 20:53	28/11/2019 15:42	18,80	9	169,21	CHI
201911347716	IVOLANDIA	IV12015642	IPORA	27/11/2019 20:54	28/11/2019 12:20	27/11/2019 20:54	28/11/2019 12:20	15,42	1	15,42	CHI
201911347719	RIO VERDE	630243610	CABRIUVA S1	27/11/2019 20:57	28/11/2019 03:50	27/11/2019 20:57	28/11/2019 03:50	6,89	1	6,89	CHI
201911347720	POSSE	PS12302648	IACIARA S2	27/11/2019 20:57	28/11/2019 11:46	27/11/2019 20:57	28/11/2019 11:46	14,80	4	59,21	CHI
201911347734	GOIANIA	16117890	ATLANTICO S2	27/11/2019 21:02	27/11/2019 22:53	27/11/2019 21:02	27/11/2019 22:53	1,84	1	1,84	CHI
201911347735	NAZARIO	NZ21040407	ANICUNS	27/11/2019 21:03	28/11/2019 10:31	27/11/2019 21:03	28/11/2019 10:31	13,47	1	13,47	CHI
201911347738	GOIANIA	11977127	FERROVIARIO S1	27/11/2019 21:04	27/11/2019 22:32	27/11/2019 21:04	27/11/2019 22:32	1,45	1	1,45	CHI
201911347741	TRES RANCHOS	7161448	CATALAO S1	27/11/2019 21:06	28/11/2019 15:26	27/11/2019 21:06	28/11/2019 15:26	18,33	2	36,67	CHI
201911347742	GOIANIA	GN11213733	GOYA S1	27/11/2019 20:38	27/11/2019 23:11	27/11/2019 20:38	27/11/2019 23:11	2,55	263	670,14	CHI
201911347743	TRINDADE	TR11258430	TRINDADE	27/11/2019 21:06	28/11/2019 03:15	27/11/2019 21:06	28/11/2019 03:15	6,16	26	160,05	CHI
201911347744	SAO LUIS DE MONTES BELOS	FR12215326	FIRMINOPOLIS S1	27/11/2019 21:07	28/11/2019 15:05	27/11/2019 21:07	28/11/2019 15:05	17,96	2	35,93	CHI
201911347748	CAMPESTRE DE GOIAS	GC11197478	TRINDADE	27/11/2019 21:08	28/11/2019 09:05	27/11/2019 21:08	28/11/2019 09:05	11,96	50	598,14	CHI
201911347754	ITUMBIARA	IT21304244	ITUMBIARA NOVA	27/11/2019 21:10	28/11/2019 07:43	27/11/2019 21:10	28/11/2019 07:43	10,55	1	10,55	CHI
201911347756	SILVANIA	SV12349987	VIANOPOLIS	27/11/2019 20:59	28/11/2019 04:08	27/11/2019 20:59	28/11/2019 04:08	7,14	94	671,60	CHI
201911347757	ANAPOLIS	AN11186982	ANAPOLIS UNIVERSITARIO S2	27/11/2019 21:05	27/11/2019 22:27	27/11/2019 21:05	27/11/2019 22:27	1,36	87	118,01	CHI
201911347761	SILVANIA	SV11090102	VIANOPOLIS	27/11/2019 21:01	28/11/2019 01:01	27/11/2019 21:01	28/11/2019 01:01	3,99	204	814,92	CHI
201911347764	QUIRINOPOLIS	QI21036056	QUIRINOPOLIS	27/11/2019 21:14	28/11/2019 09:01	27/11/2019 21:14	28/11/2019 09:01	11,77	1	11,77	CHI
201911347780	ITAPACI	IW12275237	ITAPACI	27/11/2019 21:23	28/11/2019 23:57	27/11/2019 21:23	28/11/2019 23:57	26,55	3	79,66	CHI
201911347791	TROMBAS	TB12208457	PORANGATU	27/11/2019 21:08	27/11/2019 22:44	27/11/2019 21:08	27/11/2019 22:44	1,59	16	25,48	CHI
201911347791	PORANGATU	TB12208457	PORANGATU	27/11/2019 21:08	27/11/2019 22:44	27/11/2019 21:08	27/11/2019 22:44	1,59	1	1,59	CHI
201911347794	MORRINHOS	MR12211124	MORRINHOS	27/11/2019 21:29	28/11/2019 10:36	27/11/2019 21:29	28/11/2019 10:36	13,11	2	26,23	CHI
201911347797	VILA PROPICIO	PV12252676	BARRO ALTO	27/11/2019 21:30	28/11/2019 16:10	27/11/2019 21:30	28/11/2019 16:10	18,66	24	447,82	CHI
201911347807	EDEIA	IY12010954	EDEIA	27/11/2019 21:31	28/11/2019 14:09	27/11/2019 21:31	28/11/2019 10:15	12,73	5	63,63	CHI

201911347807	INDIARA	IY12010954	EDEIA	27/11/2019 21:31	28/11/2019 14:09	27/11/2019 21:31	28/11/2019 10:15	12,73	20	254,54	CHI
201911347807	INDIARA	IY12010954	EDEIA	27/11/2019 21:31	28/11/2019 14:09	27/11/2019 21:31	28/11/2019 14:09	16,64	26	432,55	CHI
201911347807	INDIARA	IY12010954	EDEIA	27/11/2019 21:31	28/11/2019 14:09	28/11/2019 13:44	28/11/2019 14:09	0,43	20	8,52	CHI
201911347807	EDEIA	IY12010954	EDEIA	27/11/2019 21:31	28/11/2019 14:09	28/11/2019 13:44	28/11/2019 14:09	0,43	5	2,13	CHI
201911347809	ITUMBIARA	690337346	ITUMBIARA NOVA	27/11/2019 21:38	27/11/2019 22:30	27/11/2019 21:38	27/11/2019 22:30	0,88	1	0,88	CHI
201911347814	TRINDADE	TR11110907	GOYA S2	27/11/2019 21:20	28/11/2019 00:12	27/11/2019 21:20	28/11/2019 00:12	2,86	166	474,39	CHI
201911347815	CALDAZINHA	DE21250027	CEPAIGO S2	27/11/2019 12:40	28/11/2019 11:53	27/11/2019 12:40	28/11/2019 11:53	23,21	2	46,41	CHI
201911347818	GOIANIA	10971180	FERROVIARIO S3	27/11/2019 21:41	27/11/2019 23:57	27/11/2019 21:41	27/11/2019 23:57	2,26	1	2,26	CHI
201911347819	ALEXANIA	AX12393199	ALEXANIA	27/11/2019 20:47	28/11/2019 01:35	27/11/2019 20:47	28/11/2019 01:35	4,79	256	1225,32	CHI
201911347822	ANAPOLIS	AN12270406	ANAPOLIS UNIVERSITARIO S2	27/11/2019 21:43	28/11/2019 11:30	27/11/2019 21:43	28/11/2019 11:30	13,78	6	82,65	CHI
201911347837	MONTIVIDIU	2840036442	MONTIVIDIU T	27/11/2019 21:56	28/11/2019 08:38	27/11/2019 21:56	28/11/2019 08:38	10,71	1	10,71	CHI
201911347842	LUZIANIA	120282252	RIO VERMELHO	27/11/2019 21:59	28/11/2019 02:16	27/11/2019 21:59	28/11/2019 02:16	4,27	1	4,27	CHI
201911347844	ITAPIRAPUA	IU12020119	MATRINCHA	27/11/2019 22:01	28/11/2019 16:37	27/11/2019 22:01	28/11/2019 15:18	17,27	28	483,66	CHI
201911347844	BRITANIA	IU12020119	MATRINCHA	27/11/2019 22:01	28/11/2019 16:37	27/11/2019 22:01	28/11/2019 15:18	17,27	6	103,64	CHI
201911347844	ITAPIRAPUA	IU12020125	MATRINCHA	27/11/2019 22:01	28/11/2019 16:37	27/11/2019 22:01	28/11/2019 16:37	18,60	15	278,93	CHI
201911347848	IPAMERI	IP12234084	URUTAI	27/11/2019 22:03	28/11/2019 11:54	27/11/2019 22:03	28/11/2019 11:54	13,84	6	83,04	CHI
201911347851	CIDADE OCIDENTAL	DH12330711	MARAJOARA	27/11/2019 20:10	27/11/2019 23:58	27/11/2019 20:10	27/11/2019 23:58	3,79	45	170,68	CHI
201911347856	GOIANIA	14199221	ATLANTICO S3	27/11/2019 22:11	27/11/2019 23:22	27/11/2019 22:11	27/11/2019 23:22	1,17	1	1,17	CHI
201911347858	EDEIA	EA12105005	VICENTINOPOLIS	27/11/2019 22:13	28/11/2019 18:52	27/11/2019 22:13	28/11/2019 18:52	20,65	4	82,58	CHI
201911347858	EDEALINA	EA12105005	VICENTINOPOLIS	27/11/2019 22:13	28/11/2019 18:52	27/11/2019 22:13	28/11/2019 18:52	20,65	3	61,94	CHI
201911347861	GOIANIA	16885995	GOIANIA LESTE S2	27/11/2019 22:15	28/11/2019 01:13	27/11/2019 22:15	28/11/2019 01:13	2,96	1	2,96	CHI
201911347867	ANAPOLIS	AN12000193RE	ANAPOLIS UNIVERSITARIO S2	27/11/2019 21:40	28/11/2019 07:33	27/11/2019 21:40	28/11/2019 07:33	9,87	11	108,62	CHI
201911347877	JUSSARA	JR12118236	JUSSARA	27/11/2019 22:30	28/11/2019 15:15	27/11/2019 22:30	28/11/2019 15:15	16,75	4	67,01	CHI
201911347878	PONTALINA	210023030	PONTALINA	27/11/2019 22:33	28/11/2019 10:04	27/11/2019 22:33	28/11/2019 10:04	11,53	1	11,53	CHI
201911347884	CACU	CC12322236	CACHOEIRA ALTA	27/11/2019 22:36	28/11/2019 13:05	27/11/2019 22:36	28/11/2019 13:05	14,48	1	14,48	CHI
201911347888	GOIANIA	10017282304	FERROVIARIO S2	27/11/2019 22:41	28/11/2019 01:41	27/11/2019 22:41	28/11/2019 01:41	3,00	1	3,00	CHI
201911347902	GOIANIA	10000091918	CAMPINAS S1	27/11/2019 22:53	28/11/2019 00:31	27/11/2019 22:53	28/11/2019 00:31	1,63	1	1,63	CHI
201911347903	ANAPOLIS	AN11000183	JUNDIAI S1	27/11/2019 22:41	28/11/2019 01:13	27/11/2019 22:41	28/11/2019 01:13	2,52	145	365,88	CHI
201911347905	CORUMBAIBA	CI21234688	VILA CORUMBA	27/11/2019 22:55	28/11/2019 11:00	27/11/2019 22:55	28/11/2019 11:00	12,07	1	12,07	CHI
201911347906	MARA ROSA	MQ21220890	MARA ROSA	27/11/2019 22:56	28/11/2019 15:42	27/11/2019 22:56	28/11/2019 15:42	16,75	1	16,75	CHI
201911347907	PALMINOPOLIS	1340010012	PALMEIRAS	27/11/2019 22:56	28/11/2019 13:21	27/11/2019 22:56	28/11/2019 13:21	14,41	1	14,41	CHI
201911347908	PARAUNA	PU21186068	PARAUNA	27/11/2019 22:57	28/11/2019 07:47	27/11/2019 22:57	28/11/2019 07:47	8,83	1	8,83	CHI
201911347913	NIQUELANDIA	NQ12262848	URUACU	27/11/2019 22:59	28/11/2019 12:20	27/11/2019 22:59	28/11/2019 12:20	13,34	1	13,34	CHI



201911347927	GOIANIA	11737335	REAL S1	27/11/2019 23:19	28/11/2019 01:34	27/11/2019 23:19	28/11/2019 01:34	2,24	1	2,24	CHI
201911347929	EDEIA	EA21182595	VICENTINOPOLIS	27/11/2019 23:21	28/11/2019 13:58	27/11/2019 23:21	28/11/2019 13:58	14,61	1	14,61	CHI
201911347935	MORRINHOS	MR12058833	MORRINHOS	27/11/2019 23:18	28/11/2019 09:50	27/11/2019 23:18	28/11/2019 09:50	10,53	4	42,12	CHI
201911347939	CAMPOS VERDES	VD12390494	SANTA TEREZINHA	27/11/2019 23:28	28/11/2019 17:21	27/11/2019 23:28	28/11/2019 17:21	17,88	1	17,88	CHI
201911347939	ALTO HORIZONTE	VD12390494	SANTA TEREZINHA	27/11/2019 23:28	28/11/2019 17:21	27/11/2019 23:28	28/11/2019 17:21	17,88	9	160,91	CHI
201911347939	MARA ROSA	VD12390494	SANTA TEREZINHA	27/11/2019 23:28	28/11/2019 17:21	27/11/2019 23:28	28/11/2019 17:21	17,88	66	1179,97	CHI
201911347940	NOVA IGUACU DE GOIAS	UR12210932	URUACU	27/11/2019 16:41	28/11/2019 13:30	27/11/2019 16:41	28/11/2019 13:30	20,81	20	416,11	CHI
201911347940	PILAR DE GOIAS	UR12210932	URUACU	27/11/2019 16:41	28/11/2019 13:30	27/11/2019 16:41	28/11/2019 13:30	20,81	1	20,81	CHI
201911347940	URUACU	UR12210932	URUACU	27/11/2019 16:41	28/11/2019 13:30	27/11/2019 16:41	28/11/2019 13:30	20,81	30	624,17	CHI
201911347950	QUIRINOPOLIS	QI21227798	QUIRINOPOLIS	27/11/2019 23:36	28/11/2019 08:09	27/11/2019 23:36	28/11/2019 08:09	8,54	2	17,07	CHI
201911347951	SAO MIGUEL DO ARAGUAIA	4650001561	SAO MIGUEL DO ARAGUAIA	27/11/2019 23:39	29/11/2019 06:20	27/11/2019 23:39	29/11/2019 06:20	30,68	1	30,68	CHI
201911347955	CATALAO	CT12195296	CATALAO S2	27/11/2019 23:43	28/11/2019 01:51	27/11/2019 23:43	28/11/2019 01:51	2,13	214	455,94	CHI
201911347956	FORMOSO	ET12391916	MARA ROSA	27/11/2019 23:45	28/11/2019 12:57	27/11/2019 23:45	28/11/2019 12:57	13,20	26	343,19	CHI
201911347959	APARECIDA DE GOIANIA	200230360	ANHANGUERA	27/11/2019 23:50	28/11/2019 00:55	27/11/2019 23:50	28/11/2019 00:55	1,08	1	1,08	CHI
201911347960	ANAPOLIS	AN21357394	ANAPOLIS UNIVERSITARIO S2	27/11/2019 23:53	28/11/2019 09:47	27/11/2019 23:53	28/11/2019 09:47	9,90	1	9,90	CHI
201911347964	PALESTINA DE GOIAS	PY12040163	PALESTINA	28/11/2019 03:52	28/11/2019 11:23	28/11/2019 03:52	28/11/2019 11:23	7,52	101	759,32	CHI
201911347964	CAIAPONIA	PY12040163	PALESTINA	28/11/2019 03:52	28/11/2019 11:23	28/11/2019 03:52	28/11/2019 11:23	7,52	43	323,28	CHI
201911348001	PORTEIRAO	CL12295997	RIO DOS BOIS	27/11/2019 22:22	28/11/2019 10:30	27/11/2019 22:22	28/11/2019 10:30	12,14	1	12,14	CHI
201911348001	GOIATUBA	CL12295997	RIO DOS BOIS	27/11/2019 22:22	28/11/2019 10:30	27/11/2019 22:22	28/11/2019 10:30	12,14	17	206,33	CHI
201911348202	JATAI	290159118	JATAI S3	28/11/2019 00:13	28/11/2019 05:02	28/11/2019 00:13	28/11/2019 05:02	4,82	1	4,82	CHI
201911348207	ITAPIRAPUA	IU12030113	MATRINCHA	28/11/2019 00:39	28/11/2019 11:40	28/11/2019 00:39	28/11/2019 11:40	11,01	11	121,14	CHI
201911348209	SENADOR CANEDO	SW12094891	SENADOR CANEDO	28/11/2019 01:03	28/11/2019 08:55	28/11/2019 01:03	28/11/2019 08:55	7,86	7	55,01	CHI
201911348213	JATAI	JT12384002	JATAI S2	27/11/2019 23:26	28/11/2019 06:10	27/11/2019 23:26	28/11/2019 06:10	6,74	99	666,96	CHI
201911348219	ITUMBIARA	CD12000007RE	CACHOEIRA DOURADA	28/11/2019 02:22	28/11/2019 08:39	28/11/2019 02:22	28/11/2019 08:39	6,27	27	169,27	CHI
201911348219	CACHOEIRA DOURADA	CD12000007RE	CACHOEIRA DOURADA	28/11/2019 02:22	28/11/2019 08:39	28/11/2019 02:22	28/11/2019 08:39	6,27	27	169,27	CHI
201911348221	MINEIROS	MY12209668	PARQUE DAS EMAS	28/11/2019 02:37	28/11/2019 08:19	28/11/2019 02:37	28/11/2019 08:19	5,69	88	500,50	CHI
201911348222	CAIAPONIA	CP12238699	PALESTINA	28/11/2019 02:39	28/11/2019 06:43	28/11/2019 02:39	28/11/2019 06:43	4,07	8	32,52	CHI
201911348224	BELA VISTA DE GOIAS	BV12000030	BELA VISTA S1	28/11/2019 03:05	28/11/2019 12:30	28/11/2019 03:05	28/11/2019 12:30	9,42	13	122,43	CHI
201911348224	HIDROLANDIA	BV12000030	BELA VISTA S1	28/11/2019 03:05	28/11/2019 12:30	28/11/2019 03:05	28/11/2019 12:30	9,42	1	9,42	CHI
201911348224	PIRACANJUBA	BV12000030	BELA VISTA S1	28/11/2019 03:05	28/11/2019 12:30	28/11/2019 03:05	28/11/2019 12:30	9,42	2	18,83	CHI
201911348229	FORMOSA	FA32042639	ITUIQUIRA	28/11/2019 03:12	28/11/2019 12:03	28/11/2019 03:12	28/11/2019 12:03	8,84	19	167,87	CHI
201911348230	BELA VISTA DE GOIAS	BV21373992	BELA VISTA S1	28/11/2019 03:20	28/11/2019 09:26	28/11/2019 03:20	28/11/2019 09:26	6,10	1	6,10	CHI
201911348233	NIQUELANDIA	NQ12311494	BARRO ALTO	28/11/2019 03:23	28/11/2019 21:42	28/11/2019 03:23	28/11/2019 21:42	18,30	18	329,48	CHI

201911348234	SAO MIGUEL DO ARAGUAIA	SM12239670	SAO MIGUEL DO ARAGUAIA	28/11/2019 03:27	28/11/2019 14:00	28/11/2019 03:27	28/11/2019 14:00	10,55	11	116,05	CHI
201911348235	URUACU	UR21268550	URUACU	28/11/2019 03:31	28/11/2019 10:38	28/11/2019 03:31	28/11/2019 10:38	7,11	1	7,11	CHI
201911348243	SANTA CRUZ DE GOIAS	BC12023183	CRISTIANOPOLIS	28/11/2019 04:01	28/11/2019 21:26	28/11/2019 04:01	28/11/2019 17:23	13,36	3	40,09	CHI
201911348243	SANTA CRUZ DE GOIAS	BC13300743	CRISTIANOPOLIS	28/11/2019 04:01	28/11/2019 21:26	28/11/2019 04:01	28/11/2019 21:26	17,41	40	696,53	CHI
201911348250	HEITORAI	HE12310819	ITAPURANGA	28/11/2019 09:16	28/11/2019 12:52	28/11/2019 09:16	28/11/2019 12:52	3,59	10	35,85	CHI
201911348250	ITAGUARU	HE12310819	ITAPURANGA	28/11/2019 09:16	28/11/2019 12:52	28/11/2019 09:16	28/11/2019 12:52	3,59	11	39,44	CHI
201911348253	SAO JOAO DA PARAUNA	FR12391442	FIRMINOPOLIS S2	28/11/2019 04:25	28/11/2019 08:40	28/11/2019 04:25	28/11/2019 08:40	4,25	71	301,55	CHI
201911348253	FIRMINOPOLIS	FR12391442	FIRMINOPOLIS S2	28/11/2019 04:25	28/11/2019 08:40	28/11/2019 04:25	28/11/2019 08:40	4,25	65	276,07	CHI
201911348257	MOSSAMEDES	MD12066158	FIRMINOPOLIS S2	28/11/2019 04:46	28/11/2019 08:29	28/11/2019 04:46	28/11/2019 08:29	3,70	20	74,05	CHI
201911348258	SILVANIA	SV12063570	VIANOPOLIS	28/11/2019 04:50	28/11/2019 13:06	28/11/2019 04:50	28/11/2019 13:06	8,26	4	33,06	CHI
201911348259	MUNDO NOVO DE GOIAS	MH12058014	NOVA CRIXAS	28/11/2019 04:50	29/11/2019 12:50	28/11/2019 04:50	29/11/2019 12:50	31,99	1	31,99	CHI
201911348261	NOVA CRIXAS	NA12126913	NOVA CRIXAS	28/11/2019 04:54	30/11/2019 15:40	28/11/2019 04:54	30/11/2019 15:40	58,75	5	293,76	CHI
201911348261	CRIXAS	NA12126913	NOVA CRIXAS	28/11/2019 04:54	30/11/2019 15:40	28/11/2019 04:54	30/11/2019 15:40	58,75	1	58,75	CHI
201911348269	RIO VERDE	RV12371578	RIO VERDE S1	28/11/2019 05:06	28/11/2019 20:42	28/11/2019 05:06	28/11/2019 20:42	15,60	3	46,81	CHI
201911348269	RIO VERDE	RV12371578	RIO VERDE S1	28/11/2019 05:06	28/11/2019 20:42	28/11/2019 16:06	28/11/2019 20:42	4,61	89	409,92	CHI
201911348273	IPAMERI	IP12017029	IPAMERI	28/11/2019 05:13	28/11/2019 11:10	28/11/2019 05:13	28/11/2019 11:10	5,96	15	89,42	CHI
201911348274	NOVA CRIXAS	NA11354860	NOVA CRIXAS	28/11/2019 05:13	28/11/2019 14:05	28/11/2019 05:13	28/11/2019 14:05	8,85	1	8,85	CHI
201911348275	MUTUNOPOLIS	MU12087485	MARA ROSA	28/11/2019 05:14	28/11/2019 15:00	28/11/2019 05:14	28/11/2019 15:00	9,77	5	48,86	CHI
201911348275	AMARALINA	MU12087485	MARA ROSA	28/11/2019 05:14	28/11/2019 15:00	28/11/2019 05:14	28/11/2019 15:00	9,77	5	48,86	CHI
201911348275	MUTUNOPOLIS	MU12087485	MARA ROSA	28/11/2019 05:14	28/11/2019 15:00	28/11/2019 05:14	28/11/2019 15:00	9,77	6	58,63	CHI
201911348280	CRISTALINA	KR12273424	CRISTALINA S2	28/11/2019 05:17	28/11/2019 11:11	28/11/2019 05:17	28/11/2019 11:11	5,89	16	94,28	CHI
201911348281	DOVERLANDIA	DV21303675	PARQUE DAS EMAS	28/11/2019 05:18	28/11/2019 23:40	28/11/2019 05:18	28/11/2019 23:40	18,36	1	18,36	CHI
201911348286	MORRINHOS	MR12035910	MORRINHOS	28/11/2019 05:20	28/11/2019 10:15	28/11/2019 05:20	28/11/2019 10:15	4,92	6	29,50	CHI
201911348291	AGUA LIMPA	AL21000273	VILA CORUMBA	28/11/2019 05:26	28/11/2019 12:40	28/11/2019 05:26	28/11/2019 12:40	7,23	1	7,23	CHI
201911348296	PIRENOPOLIS	PV12302405	SAO FRANCISCO DE GOIAS	27/11/2019 18:21	28/11/2019 16:14	27/11/2019 18:21	28/11/2019 16:14	21,88	60	1312,60	CHI
201911348296	PETROLINA DE GOIAS	PV12302405	SAO FRANCISCO DE GOIAS	27/11/2019 18:21	28/11/2019 16:14	27/11/2019 18:21	28/11/2019 16:14	21,88	5	109,38	CHI
201911348296	SAO FRANCISCO DE GOIAS	PV12302405	SAO FRANCISCO DE GOIAS	27/11/2019 18:21	28/11/2019 16:14	27/11/2019 18:21	28/11/2019 16:14	21,88	19	415,66	CHI
201911348297	MINACU	IH12052624	MINACU	28/11/2019 05:30	28/11/2019 08:32	28/11/2019 05:30	28/11/2019 08:32	3,02	16	48,39	CHI
201911348298	EDEIA	ED12007552	PONTALINA	28/11/2019 02:05	28/11/2019 13:35	28/11/2019 02:05	28/11/2019 13:35	11,49	1	11,49	CHI
201911348298	EDEALINA	ED12007552	PONTALINA	28/11/2019 02:05	28/11/2019 13:35	28/11/2019 02:05	28/11/2019 13:35	11,49	7	80,44	CHI
201911348301	CORUMBAIBA	CI21283278	VILA CORUMBA	28/11/2019 05:34	28/11/2019 11:44	28/11/2019 05:34	28/11/2019 11:44	6,16	1	6,16	CHI
201911348302	GAMELEIRA DE GOIAS	SV12027617	DAIA S2	28/11/2019 05:34	28/11/2019 09:51	28/11/2019 05:34	28/11/2019 09:51	4,27	2	8,55	CHI
201911348304	MORRINHOS	MR12223453	GOIATUBA S1	28/11/2019 05:35	28/11/2019 09:07	28/11/2019 05:35	28/11/2019 09:07	3,53	35	123,46	CHI

201911348308	GOIANDIRA	GD12043082	CATALAO S1	28/11/2019 05:37	28/11/2019 11:40	28/11/2019 05:37	28/11/2019 11:40	6,05	52	314,66	CHI
201911348308	NOVA AURORA	GD12043082	CATALAO S1	28/11/2019 05:37	28/11/2019 11:40	28/11/2019 05:37	28/11/2019 11:40	6,05	15	90,77	CHI
201911348312	URUTAI	PR12080258RE	URUTAI	28/11/2019 05:37	28/11/2019 15:50	28/11/2019 05:37	28/11/2019 15:50	10,20	62	632,43	CHI
201911348312	PIRES DO RIO	PR12080258RE	URUTAI	28/11/2019 05:37	28/11/2019 15:50	28/11/2019 05:37	28/11/2019 15:50	10,20	8	81,60	CHI
201911348313	TROMBAS	TB12208457	PORANGATU	28/11/2019 05:39	28/11/2019 10:42	28/11/2019 05:39	28/11/2019 10:42	5,05	16	80,83	CHI
201911348313	PORANGATU	TB12208457	PORANGATU	28/11/2019 05:39	28/11/2019 10:42	28/11/2019 05:39	28/11/2019 10:42	5,05	1	5,05	CHI
201911348314	TURVELANDIA	TD12303745	RIO DOS BOIS	28/11/2019 05:39	28/11/2019 14:06	28/11/2019 05:39	28/11/2019 14:06	8,44	2	16,88	CHI
201911348321	AURILANDIA	AI12377179	FIRMINOPOLIS S2	28/11/2019 05:40	28/11/2019 17:31	28/11/2019 05:40	28/11/2019 17:31	11,83	4	47,34	CHI
201911348328	ITAPIRAPUA	IU12142823	MATRINCHA	28/11/2019 05:42	29/11/2019 11:15	28/11/2019 05:42	29/11/2019 11:15	29,54	3	88,63	CHI
201911348329	VICENTINOPOLIS	VI12047269	VICENTINOPOLIS	28/11/2019 05:42	28/11/2019 14:04	28/11/2019 05:42	28/11/2019 14:04	8,35	4	33,40	CHI
201911348332	CALDAS NOVAS	IP12153045	IPAMERI	28/11/2019 05:44	28/11/2019 10:09	28/11/2019 05:44	28/11/2019 10:09	4,41	7	30,88	CHI
201911348332	IPAMERI	IP12153045	IPAMERI	28/11/2019 05:44	28/11/2019 10:09	28/11/2019 05:44	28/11/2019 10:09	4,41	32	141,18	CHI
201911348335	JANDAIA	JD12008635	PALMEIRAS	28/11/2019 03:50	28/11/2019 13:35	28/11/2019 03:50	28/11/2019 13:35	9,74	12	116,92	CHI
201911348339	ITAPIRAPUA	JR12087418	JUSSARA	28/11/2019 05:20	28/11/2019 16:42	28/11/2019 05:20	28/11/2019 16:42	11,37	1	11,37	CHI
201911348339	JUSSARA	JR12087418	JUSSARA	28/11/2019 05:20	28/11/2019 16:42	28/11/2019 05:20	28/11/2019 16:42	11,37	11	125,04	CHI
201911348342	TRINDADE	40110436	TRINDADE	28/11/2019 05:46	28/11/2019 09:32	28/11/2019 05:46	28/11/2019 09:32	3,76	1	3,76	CHI
201911348344	JATAI	JT21189500	JATAI S1	28/11/2019 05:47	28/11/2019 17:37	28/11/2019 05:47	28/11/2019 17:37	11,83	1	11,83	CHI
201911348347	GOIANIA	00590254	FERROVIARIO S1	28/11/2019 05:39	28/11/2019 12:30	28/11/2019 05:39	28/11/2019 06:23	0,74	840	621,13	CHI
201911348347	GOIANIA	00590254	FERROVIARIO S1	28/11/2019 05:39	28/11/2019 12:30	28/11/2019 05:39	28/11/2019 06:45	1,10	574	629,01	CHI
201911348347	GOIANIA	GN16404312	FERROVIARIO S1	28/11/2019 05:39	28/11/2019 12:30	28/11/2019 06:27	28/11/2019 07:20	0,89	467	413,55	CHI
201911348347	GOIANIA	GN16403895	FERROVIARIO S1	28/11/2019 05:39	28/11/2019 12:30	28/11/2019 06:27	28/11/2019 07:38	1,18	62	73,09	CHI
201911348347	GOIANIA	GN13000096	FERROVIARIO S1	28/11/2019 05:39	28/11/2019 12:30	28/11/2019 06:27	28/11/2019 08:53	2,43	221	537,09	CHI
201911348347	GOIANIA	GN12000471	FERROVIARIO S1	28/11/2019 05:39	28/11/2019 12:30	28/11/2019 06:27	28/11/2019 12:15	5,80	51	295,72	CHI
201911348347	GOIANIA	GN21343169	FERROVIARIO S1	28/11/2019 05:39	28/11/2019 12:30	28/11/2019 06:27	28/11/2019 12:19	5,87	1	5,87	CHI
201911348347	GOIANIA	GN11000878	FERROVIARIO S1	28/11/2019 05:39	28/11/2019 12:30	28/11/2019 06:27	28/11/2019 12:20	5,88	6	35,31	CHI
201911348347	GOIANIA	GN11041813	FERROVIARIO S1	28/11/2019 05:39	28/11/2019 12:30	28/11/2019 06:27	28/11/2019 12:29	6,03	31	186,86	CHI
201911348347	GOIANIA	GN21356769	FERROVIARIO S1	28/11/2019 05:39	28/11/2019 12:30	28/11/2019 06:27	28/11/2019 12:30	6,06	1	6,06	CHI
201911348350	GUARAITA	GK12234058	ITAPURANGA	28/11/2019 05:14	28/11/2019 23:01	28/11/2019 05:14	28/11/2019 23:01	17,77	8	142,20	CHI
201911348353	JATAI	SX12139578	JATAI S1	28/11/2019 05:50	28/11/2019 09:11	28/11/2019 05:50	28/11/2019 09:11	3,34	14	46,72	CHI
201911348353	SERRANOPOLIS	SX12139578	JATAI S1	28/11/2019 05:50	28/11/2019 09:11	28/11/2019 05:50	28/11/2019 09:11	3,34	33	110,14	CHI
201911348359	PIRACANJUBA	PJ12011464	MORRINHOS	28/11/2019 05:35	30/11/2019 16:44	28/11/2019 05:35	28/11/2019 16:15	10,67	8	85,38	CHI
201911348359	PIRACANJUBA	PJ13264039	MORRINHOS	28/11/2019 05:35	30/11/2019 16:44	29/11/2019 23:43	30/11/2019 04:20	4,63	32	148,09	CHI
201911348359	PIRACANJUBA	PJ12011464	MORRINHOS	28/11/2019 05:35	30/11/2019 16:44	28/11/2019 05:35	30/11/2019 16:44	59,15	28	1656,24	CHI

201911348359	PIRACANJUBA	PJ12011464	MORRINHOS	28/11/2019 05:35	30/11/2019 16:44	28/11/2019 16:16	30/11/2019 16:44	48,46	8	387,70	CHI
201911348364	PONTALINA	PK12218118	GOIATUBA S1	28/11/2019 04:05	28/11/2019 11:00	28/11/2019 04:05	28/11/2019 11:00	6,92	3	20,75	CHI
201911348365	NOVO BRASIL	NB12120651LD	MATRINCHA	28/11/2019 05:56	28/11/2019 19:15	28/11/2019 05:56	28/11/2019 19:15	13,32	22	293,00	CHI
201911348368	GOIANIA	10025426271	FERROVIARIO S2	28/11/2019 05:57	28/11/2019 11:30	28/11/2019 05:57	28/11/2019 11:30	5,56	1	5,56	CHI
201911348370	ITAPIRAPUA	IU12121437	MATRINCHA	28/11/2019 05:28	28/11/2019 18:10	28/11/2019 05:28	28/11/2019 18:10	12,71	16	203,40	CHI
201911348382	MORRINHOS	MR12098617	MORRINHOS	28/11/2019 06:01	28/11/2019 12:03	28/11/2019 06:01	28/11/2019 12:03	6,03	5	30,16	CHI
201911348383	CUMARI	2000007606	CATALAO S1	28/11/2019 06:01	28/11/2019 12:59	28/11/2019 06:01	28/11/2019 12:59	6,97	1	6,97	CHI
201911348391	GUAPO	GA12054272	GUAPO S2	28/11/2019 06:02	28/11/2019 08:02	28/11/2019 06:02	28/11/2019 08:02	2,00	2	4,00	CHI
201911348391	VARJAO	GA12054272	GUAPO S2	28/11/2019 06:02	28/11/2019 08:02	28/11/2019 06:02	28/11/2019 08:02	2,00	9	18,02	CHI
201911348393	PALMEIRAS DE GOIAS	PL12000058	PALMEIRAS	28/11/2019 06:02	28/11/2019 10:11	28/11/2019 06:02	28/11/2019 10:11	4,13	6	24,81	CHI
201911348399	FAINA	FC12227862	GOIAS	28/11/2019 06:04	28/11/2019 15:39	28/11/2019 06:04	28/11/2019 12:55	6,84	5	34,19	CHI
201911348399	FAINA	FC12227864LD	GOIAS	28/11/2019 06:04	28/11/2019 15:39	28/11/2019 06:04	28/11/2019 15:39	9,58	6	57,50	CHI
201911348401	GOIATUBA	GT12048509	GOIATUBA S2	28/11/2019 06:06	28/11/2019 09:48	28/11/2019 06:06	28/11/2019 09:48	3,69	2	7,38	CHI
201911348403	CACHOEIRA ALTA	RV21112429	CACHOEIRA ALTA	28/11/2019 06:07	28/11/2019 15:19	28/11/2019 06:07	28/11/2019 15:19	9,19	1	9,19	CHI
201911348405	MONTES CLAROS DE GOIAS	ME21223058	IPORA	28/11/2019 06:07	28/11/2019 16:44	28/11/2019 06:07	28/11/2019 16:44	10,61	1	10,61	CHI
201911348414	LAGOA SANTA	IJ12063067	ITAJA S2	28/11/2019 05:43	28/11/2019 08:09	28/11/2019 05:43	28/11/2019 08:09	2,43	12	29,19	CHI
201911348414	ITAJA	IJ12063067	ITAJA S2	28/11/2019 05:43	28/11/2019 08:09	28/11/2019 05:43	28/11/2019 08:09	2,43	3	7,30	CHI
201911348417	CACU	CA12080196	CACHOEIRA ALTA	28/11/2019 04:30	28/11/2019 16:24	28/11/2019 04:30	28/11/2019 16:24	11,89	7	83,26	CHI
201911348422	SAO FRANCISCO DE GOIAS	SF12389750	SAO FRANCISCO DE GOIAS	28/11/2019 06:10	28/11/2019 09:32	28/11/2019 06:10	28/11/2019 09:32	3,35	14	46,94	CHI
201911348423	MORRINHOS	MR12128621RE	MORRINHOS	27/11/2019 20:28	28/11/2019 07:50	27/11/2019 20:28	28/11/2019 07:50	11,37	40	454,82	CHI
201911348423	PIRACANJUBA	MR12128621RE	MORRINHOS	27/11/2019 20:28	28/11/2019 07:50	27/11/2019 20:28	28/11/2019 07:50	11,37	2	22,74	CHI
201911348425	PONTALINA	PK12010178	PONTALINA	28/11/2019 04:24	28/11/2019 08:29	28/11/2019 04:24	28/11/2019 08:29	4,08	19	77,53	CHI
201911348425	MAIRIPOTABA	PK12010178	PONTALINA	28/11/2019 04:24	28/11/2019 08:29	28/11/2019 04:24	28/11/2019 08:29	4,08	10	40,80	CHI
201911348428	GOIATUBA	GT12044924	GOIATUBA S2	28/11/2019 06:12	28/11/2019 10:30	28/11/2019 06:12	28/11/2019 10:30	4,30	3	12,90	CHI
201911348428	MORRINHOS	GT12044924	GOIATUBA S2	28/11/2019 06:12	28/11/2019 10:30	28/11/2019 06:12	28/11/2019 10:30	4,30	3	12,90	CHI
201911348432	ITARUMA	IM12371217	CACHOEIRA ALTA	28/11/2019 05:49	28/11/2019 14:38	28/11/2019 05:49	28/11/2019 14:38	8,80	8	70,42	CHI
201911348432	CACU	IM12371217	CACHOEIRA ALTA	28/11/2019 05:49	28/11/2019 14:38	28/11/2019 05:49	28/11/2019 14:38	8,80	31	272,88	CHI
201911348433	URUACU	UR12364104	URUACU	28/11/2019 06:13	28/11/2019 08:55	28/11/2019 06:13	28/11/2019 08:55	2,69	81	218,23	CHI
201911348444	CRISTALINA	KR12153067	CRISTALINA S2	28/11/2019 06:15	28/11/2019 10:16	28/11/2019 06:15	28/11/2019 10:16	4,00	3	12,00	CHI
201911348449	CACU	CC12205166	CACHOEIRA ALTA	28/11/2019 06:16	28/11/2019 11:37	28/11/2019 06:16	28/11/2019 11:37	5,34	7	37,38	CHI
201911348455	SAO MIGUEL DO ARAGUAIA	SM12013036	SAO MIGUEL DO ARAGUAIA	28/11/2019 06:17	29/11/2019 09:51	28/11/2019 06:17	29/11/2019 09:51	27,57	22	606,63	CHI
201911348461	INDIARA	IY21371646	EDEIA	28/11/2019 06:18	28/11/2019 08:30	28/11/2019 06:18	28/11/2019 08:30	2,20	2	4,41	CHI
201911348462	BOM JARDIM DE GOIAS	BM12212797	BOM JARDIM	28/11/2019 06:18	29/11/2019 07:04	28/11/2019 06:18	29/11/2019 07:04	24,75	86	2128,79	CHI

201911348462	PIRANHAS	BM12212797	BOM JARDIM	28/11/2019 06:18	29/11/2019 07:04	28/11/2019 06:18	29/11/2019 07:04	24,75	2	49,51	CHI
201911348464	IACIARA	GY12465246	IACIARA S1	28/11/2019 06:18	28/11/2019 11:41	28/11/2019 06:18	28/11/2019 11:41	5,37	3	16,10	CHI
201911348464	GUARANI DE GOIAS	GY12465246	IACIARA S1	28/11/2019 06:18	28/11/2019 11:41	28/11/2019 06:18	28/11/2019 11:41	5,37	13	69,77	CHI
201911348468	APARECIDA DO RIO DOCE	JT12211312	JATAI S1	28/11/2019 06:04	28/11/2019 16:18	28/11/2019 06:04	28/11/2019 16:18	10,23	2	20,46	CHI
201911348468	JATAI	JT12211312	JATAI S1	28/11/2019 06:04	28/11/2019 16:18	28/11/2019 06:04	28/11/2019 16:18	10,23	1	10,23	CHI
201911348477	IPAMERI	IP12242608	IPAMERI	28/11/2019 06:21	28/11/2019 12:10	28/11/2019 06:21	28/11/2019 12:10	5,81	5	29,03	CHI
201911348480	BURITINOPOLIS	MB12314303	IACIARA S2	28/11/2019 06:22	28/11/2019 08:43	28/11/2019 06:22	28/11/2019 08:43	2,34	2	4,68	CHI
201911348480	MAMBAI	MB12314303	IACIARA S2	28/11/2019 06:22	28/11/2019 08:43	28/11/2019 06:22	28/11/2019 08:43	2,34	3	7,02	CHI
201911348489	VILA PROPICIO	PV21252636	BARRO ALTO	28/11/2019 06:24	29/11/2019 04:04	28/11/2019 06:24	29/11/2019 04:04	21,65	1	21,65	CHI
201911348492	ITUMBIARA	CD12000306	CACHOEIRA DOURADA	28/11/2019 06:24	28/11/2019 13:07	28/11/2019 06:24	28/11/2019 13:07	6,71	4	26,83	CHI
201911348492	CACHOEIRA DOURADA	CD12000306	CACHOEIRA DOURADA	28/11/2019 06:24	28/11/2019 13:07	28/11/2019 06:24	28/11/2019 13:07	6,71	1	6,71	CHI
201911348495	OURO VERDE DE GOIAS	AN12084813	NEROPOLIS S1	27/11/2019 22:50	28/11/2019 11:04	27/11/2019 22:50	28/11/2019 11:04	12,22	1	12,22	CHI
201911348495	CAMPO LIMPO	AN12084813	NEROPOLIS S1	27/11/2019 22:50	28/11/2019 11:04	27/11/2019 22:50	28/11/2019 11:04	12,22	64	781,99	CHI
201911348505	GOIATUBA	BJ21000125	BOM JESUS DE GOIAS	28/11/2019 06:29	28/11/2019 10:25	28/11/2019 06:29	28/11/2019 10:25	3,93	1	3,93	CHI
201911348508	TURVANIA	TV12102334	FIRMINOPOLIS S2	28/11/2019 06:30	28/11/2019 09:27	28/11/2019 06:30	28/11/2019 09:27	2,95	5	14,76	CHI
201911348509	MORRINHOS	MR12000008	MORRINHOS	28/11/2019 05:04	28/11/2019 08:24	28/11/2019 05:04	28/11/2019 08:24	3,32	796	2646,48	CHI
201911348510	IPAMERI	UT12027069RE	URUTAI	28/11/2019 05:39	28/11/2019 10:25	28/11/2019 05:39	28/11/2019 10:25	4,75	26	123,55	CHI
201911348510	URUTAI	UT12027069RE	URUTAI	28/11/2019 05:39	28/11/2019 10:25	28/11/2019 05:39	28/11/2019 10:25	4,75	47	223,34	CHI
201911348512	JUSSARA	JR12124817	BRITANIA	28/11/2019 00:48	28/11/2019 15:15	28/11/2019 00:48	28/11/2019 15:15	14,43	11	158,78	CHI
201911348516	MOZARLANDIA	MZ12051179	MOZARLANDIA	28/11/2019 06:28	28/11/2019 17:13	28/11/2019 06:28	28/11/2019 17:13	10,73	15	161,01	CHI
201911348526	CEZARINA	CZ12228898	CEZARINA	28/11/2019 06:34	29/11/2019 08:40	28/11/2019 06:34	29/11/2019 08:40	26,09	7	182,60	CHI
201911348528	IACIARA	IA12361389	IACIARA S2	28/11/2019 06:35	28/11/2019 11:21	28/11/2019 06:35	28/11/2019 11:21	4,77	41	195,43	CHI
201911348528	FLORES DE GOIAS	IA12361389	IACIARA S2	28/11/2019 06:35	28/11/2019 11:21	28/11/2019 06:35	28/11/2019 11:21	4,77	1	4,77	CHI
201911348530	CASTELANDIA	CL21384573	RIO DOS BOIS	28/11/2019 06:35	28/11/2019 09:37	28/11/2019 06:35	28/11/2019 09:37	3,02	1	3,02	CHI
201911348533	CAIAPONIA	CP12245754	CAIAPONIA	28/11/2019 15:38	29/11/2019 08:46	28/11/2019 15:38	29/11/2019 08:46	17,14	4	68,55	CHI
201911348533	DOVERLANDIA	CP12245754	CAIAPONIA	28/11/2019 15:38	29/11/2019 08:46	28/11/2019 15:38	29/11/2019 08:46	17,14	1	17,14	CHI
201911348534	RUBIATABA	RB12003316	RUBIATABA	28/11/2019 06:36	29/11/2019 10:00	28/11/2019 06:36	29/11/2019 10:00	27,40	45	1233,00	CHI
201911348536	JATAI	JT121241771	JATAI S1	28/11/2019 06:36	28/11/2019 17:30	28/11/2019 06:36	28/11/2019 17:30	10,91	1	10,91	CHI
201911348538	GOIAS	GS21310659	GOIAS	28/11/2019 06:36	29/11/2019 11:25	28/11/2019 06:36	29/11/2019 11:25	28,82	1	28,82	CHI
201911348545	NIQUELANDIA	NQ21359825	URUACU	28/11/2019 06:37	28/11/2019 12:55	28/11/2019 06:37	28/11/2019 12:55	6,29	2	12,57	CHI
201911348548	PALESTINA DE GOIAS	CP12207858	PALESTINA	28/11/2019 06:38	28/11/2019 09:32	28/11/2019 06:38	28/11/2019 09:32	2,89	1	2,89	CHI
201911348548	CAIAPONIA	CP12207858	PALESTINA	28/11/2019 06:38	28/11/2019 09:32	28/11/2019 06:38	28/11/2019 09:32	2,89	16	46,23	CHI
201911348549	CALDAS NOVAS	760210056	SERRA DE CALDAS	28/11/2019 06:38	28/11/2019 11:34	28/11/2019 06:38	28/11/2019 11:34	4,92	1	4,92	CHI

201911348550	PORANGATU	PO12390358	PORANGATU	28/11/2019 06:21	28/11/2019 17:35	28/11/2019 06:21	28/11/2019 17:35	11,23	7	78,64	CHI
201911348551	BALIZA	BH12380942	BOM JARDIM	28/11/2019 06:39	28/11/2019 13:50	28/11/2019 06:39	28/11/2019 13:50	7,18	7	50,28	CHI
201911348555	VICENTINOPOLIS	JV12000028	GOIATUBA S1	28/11/2019 06:39	28/11/2019 12:43	28/11/2019 06:39	28/11/2019 12:43	6,06	3	18,17	CHI
201911348555	JOVIANIA	JV12000028	GOIATUBA S1	28/11/2019 06:39	28/11/2019 12:43	28/11/2019 06:39	28/11/2019 12:43	6,06	12	72,66	CHI
201911348555	GOIATUBA	JV12000028	GOIATUBA S1	28/11/2019 06:39	28/11/2019 12:43	28/11/2019 06:39	28/11/2019 12:43	6,06	9	54,50	CHI
201911348559	CAIAPONIA	CP12245718	CAIAPONIA	28/11/2019 06:40	28/11/2019 12:44	28/11/2019 06:40	28/11/2019 12:44	6,06	2	12,12	CHI
201911348561	NIQUELANDIA	NQ12213063	BARRO ALTO	28/11/2019 06:42	28/11/2019 16:44	28/11/2019 06:42	28/11/2019 16:44	10,03	1	10,03	CHI
201911348561	VILA PROPICIO	NQ12213063	BARRO ALTO	28/11/2019 06:42	28/11/2019 16:44	28/11/2019 06:42	28/11/2019 16:44	10,03	10	100,26	CHI
201911348561	MIMOSO DE GOIAS	NQ12213063	BARRO ALTO	28/11/2019 06:42	28/11/2019 16:44	28/11/2019 06:42	28/11/2019 16:44	10,03	11	110,28	CHI
201911348563	PROFESSOR JAMIL SAFADY	JS21000113	ROCHEDO	28/11/2019 06:43	28/11/2019 10:16	28/11/2019 06:43	28/11/2019 10:16	3,54	2	7,08	CHI
201911348573	MARA ROSA	AJ12404037	MARA ROSA	28/11/2019 03:13	29/11/2019 00:32	28/11/2019 03:13	29/11/2019 00:32	21,30	6	127,83	CHI
201911348573	NOVA IGUACU DE GOIAS	AJ12404037	MARA ROSA	28/11/2019 03:13	29/11/2019 00:32	28/11/2019 03:13	29/11/2019 00:32	21,30	12	255,65	CHI
201911348573	ALTO HORIZONTE	AJ12404037	MARA ROSA	28/11/2019 03:13	29/11/2019 00:32	28/11/2019 03:13	29/11/2019 00:32	21,30	36	766,96	CHI
201911348575	BONOPOLIS	01710424	SAO MIGUEL DO ARAGUAIA	28/11/2019 06:45	28/11/2019 13:32	28/11/2019 06:45	28/11/2019 07:28	0,72	284	204,16	CHI
201911348575	PORANGATU	01710424	SAO MIGUEL DO ARAGUAIA	28/11/2019 06:45	28/11/2019 13:32	28/11/2019 06:45	28/11/2019 07:28	0,72	1	0,72	CHI
201911348575	BONOPOLIS	01710424	SAO MIGUEL DO ARAGUAIA	28/11/2019 06:45	28/11/2019 13:32	28/11/2019 06:45	28/11/2019 08:03	1,31	721	946,51	CHI
201911348575	BONOPOLIS	BX12263039	SAO MIGUEL DO ARAGUAIA	28/11/2019 06:45	28/11/2019 13:32	28/11/2019 08:04	28/11/2019 08:48	0,74	96	70,96	CHI
201911348575	SAO MIGUEL DO ARAGUAIA	SM10400363	SAO MIGUEL DO ARAGUAIA	28/11/2019 06:45	28/11/2019 13:32	28/11/2019 06:45	28/11/2019 08:53	2,14	175	373,97	CHI
201911348575	NOVO PLANALTO	SM10400363	SAO MIGUEL DO ARAGUAIA	28/11/2019 06:45	28/11/2019 13:32	28/11/2019 06:45	28/11/2019 08:53	2,14	33	70,52	CHI
201911348575	SAO MIGUEL DO ARAGUAIA	SM10400363	SAO MIGUEL DO ARAGUAIA	28/11/2019 06:45	28/11/2019 13:32	28/11/2019 06:45	28/11/2019 09:47	3,04	26	78,98	CHI
201911348575	NOVO PLANALTO	SM10400363	SAO MIGUEL DO ARAGUAIA	28/11/2019 06:45	28/11/2019 13:32	28/11/2019 06:45	28/11/2019 09:47	3,04	15	45,56	CHI
201911348575	BONOPOLIS	SM10400363	SAO MIGUEL DO ARAGUAIA	28/11/2019 06:45	28/11/2019 13:32	28/11/2019 06:45	28/11/2019 09:47	3,04	3	9,11	CHI
201911348575	PORANGATU	BX10403948	SAO MIGUEL DO ARAGUAIA	28/11/2019 06:45	28/11/2019 13:32	28/11/2019 09:47	28/11/2019 09:50	0,06	1	0,06	CHI
201911348575	BONOPOLIS	BX10403948	SAO MIGUEL DO ARAGUAIA	28/11/2019 06:45	28/11/2019 13:32	28/11/2019 09:47	28/11/2019 09:50	0,06	721	40,06	CHI
201911348575	BONOPOLIS	BX10403948	SAO MIGUEL DO ARAGUAIA	28/11/2019 06:45	28/11/2019 13:32	28/11/2019 09:47	28/11/2019 09:50	0,06	284	15,78	CHI
201911348575	BONOPOLIS	SM10400363	SAO MIGUEL DO ARAGUAIA	28/11/2019 06:45	28/11/2019 13:32	28/11/2019 06:45	28/11/2019 11:44	4,99	10	49,93	CHI
201911348575	BONOPOLIS	SM10400363	SAO MIGUEL DO ARAGUAIA	28/11/2019 06:45	28/11/2019 13:32	28/11/2019 06:45	28/11/2019 12:15	5,50	7	38,51	CHI
201911348575	BONOPOLIS	BX13262653	SAO MIGUEL DO ARAGUAIA	28/11/2019 06:45	28/11/2019 13:32	28/11/2019 12:59	28/11/2019 13:25	0,44	721	314,84	CHI
201911348575	BONOPOLIS	01710424	SAO MIGUEL DO ARAGUAIA	28/11/2019 06:45	28/11/2019 13:32	28/11/2019 06:45	28/11/2019 13:32	6,79	12	81,50	CHI
201911348575	AMARALINA	01710424	SAO MIGUEL DO ARAGUAIA	28/11/2019 06:45	28/11/2019 13:32	28/11/2019 06:45	28/11/2019 13:32	6,79	205	1392,35	CHI
201911348577	RUBIATABA	NM12194294	RUBIATABA	28/11/2019 06:48	28/11/2019 17:35	28/11/2019 06:48	28/11/2019 17:35	10,78	8	86,25	CHI
201911348577	CRIXAS	NM12194294	RUBIATABA	28/11/2019 06:48	28/11/2019 17:35	28/11/2019 06:48	28/11/2019 17:35	10,78	1	10,78	CHI
201911348577	NOVA AMERICA	NM12194294	RUBIATABA	28/11/2019 06:48	28/11/2019 17:35	28/11/2019 06:48	28/11/2019 17:35	10,78	157	1692,68	CHI

201911348579	PONTALINA	PK21284876	PONTALINA	28/11/2019 06:48	28/11/2019 17:30	28/11/2019 06:48	28/11/2019 17:30	10,71	1	10,71	CHI
201911348588	MARA ROSA	MQ12208421	MARA ROSA	28/11/2019 06:50	28/11/2019 10:30	28/11/2019 06:50	28/11/2019 10:30	3,66	15	54,85	CHI
201911348590	CARMO DO RIO VERDE	IK12311305	ITAPURANGA	28/11/2019 06:16	28/11/2019 08:26	28/11/2019 06:16	28/11/2019 08:26	2,16	27	58,27	CHI
201911348590	ITAPURANGA	IK12311305	ITAPURANGA	28/11/2019 06:16	28/11/2019 08:26	28/11/2019 06:16	28/11/2019 08:26	2,16	120	258,97	CHI
201911348593	GOIANIA	15410687	GOYA S2	28/11/2019 06:52	28/11/2019 08:36	28/11/2019 06:52	28/11/2019 08:36	1,73	1	1,73	CHI
201911348596	DIORAMA	DI21139441	IPORA	28/11/2019 06:53	29/11/2019 07:27	28/11/2019 06:53	29/11/2019 07:27	24,55	1	24,55	CHI
201911348597	GOIANESIA	GE12353258	GOIANESIA S2	27/11/2019 22:29	28/11/2019 10:31	27/11/2019 22:29	28/11/2019 10:31	12,02	119	1430,94	CHI
201911348598	JAUPACI	JP12035039	IPORA	27/11/2019 20:46	28/11/2019 10:38	27/11/2019 20:46	28/11/2019 10:38	13,87	13	180,26	CHI
201911348605	PORTEIRAO	CL21305978	RIO DOS BOIS	28/11/2019 06:54	28/11/2019 13:14	28/11/2019 06:54	28/11/2019 13:14	6,32	1	6,32	CHI
201911348611	VIANOPOLIS	510016388	VIANOPOLIS	28/11/2019 06:55	28/11/2019 20:19	28/11/2019 06:55	28/11/2019 20:19	13,39	1	13,39	CHI
201911348627	SANTA RITA DO ARAGUAIA	SU13377949	SANTA RITA DO ARAGUAIA	28/11/2019 07:55	28/11/2019 08:11	28/11/2019 07:55	28/11/2019 08:10	0,25	2007	492,83	CHI
201911348627	MINEIROS	SU13377949	SANTA RITA DO ARAGUAIA	28/11/2019 07:55	28/11/2019 08:11	28/11/2019 07:55	28/11/2019 08:10	0,25	31	7,61	CHI
201911348627	SANTA RITA DO ARAGUAIA	SU13377948	SANTA RITA DO ARAGUAIA	28/11/2019 07:55	28/11/2019 08:11	28/11/2019 08:05	28/11/2019 08:11	0,11	1181	130,89	CHI
201911348627	MINEIROS	SU13377948	SANTA RITA DO ARAGUAIA	28/11/2019 07:55	28/11/2019 08:11	28/11/2019 08:05	28/11/2019 08:11	0,11	11	1,22	CHI
201911348627	BURITINOPOLIS	SU13377948	SANTA RITA DO ARAGUAIA	28/11/2019 07:55	28/11/2019 08:11	28/11/2019 08:05	28/11/2019 08:11	0,11	1	0,11	CHI
201911348628	ITABERAI	IB12227143	ITABERAI S1	28/11/2019 06:58	28/11/2019 09:36	28/11/2019 06:58	28/11/2019 09:36	2,62	38	99,71	CHI
201911348632	ANAPOLIS	AN12285314	ANAPOLIS UNIVERSITARIO S2	28/11/2019 06:59	28/11/2019 14:57	28/11/2019 06:59	28/11/2019 14:57	7,96	4	31,84	CHI
201911348643	PARAUNA	RV12301719	ACREUNA	28/11/2019 07:02	28/11/2019 11:30	28/11/2019 07:02	28/11/2019 11:30	4,47	17	75,92	CHI
201911348643	SANTO ANTONIO DA BARRA	RV12301719	ACREUNA	28/11/2019 07:02	28/11/2019 11:30	28/11/2019 07:02	28/11/2019 11:30	4,47	3	13,40	CHI
201911348644	CRISTALINA	KR12417561	CRISTALINA S2	28/11/2019 07:02	28/11/2019 11:08	28/11/2019 07:02	28/11/2019 11:08	4,10	4	16,39	CHI
201911348647	GOIANIRA	GR21146886	GOIANIRA	28/11/2019 07:02	28/11/2019 11:02	28/11/2019 07:02	28/11/2019 11:02	3,99	1	3,99	CHI
201911348651	OUVIDOR	OU12077703	CATALAO S1	28/11/2019 07:02	28/11/2019 20:30	28/11/2019 07:02	28/11/2019 20:30	13,45	24	322,81	CHI
201911348656	CAMPINORTE	CR12053035	MARA ROSA	28/11/2019 05:17	28/11/2019 17:30	28/11/2019 05:17	28/11/2019 17:30	12,22	4	48,90	CHI
201911348658	MORRINHOS	MR12000273	MORRINHOS	28/11/2019 07:03	28/11/2019 09:32	28/11/2019 07:03	28/11/2019 09:32	2,47	9	22,23	CHI
201911348663	GAMELEIRA DE GOIAS	SV12056396	DAIA S2	28/11/2019 06:17	28/11/2019 10:07	28/11/2019 06:17	28/11/2019 10:07	3,82	102	389,70	CHI
201911348663	SILVANIA	SV12056396	DAIA S2	28/11/2019 06:17	28/11/2019 10:07	28/11/2019 06:17	28/11/2019 10:07	3,82	1	3,82	CHI
201911348670	AGUA LIMPA	AL12257000	VILA CORUMBA	28/11/2019 07:05	28/11/2019 11:40	28/11/2019 07:05	28/11/2019 11:40	4,59	88	403,80	CHI
201911348686	ITABERAI	IB21234920	ITABERAI S1	28/11/2019 07:07	28/11/2019 15:02	28/11/2019 07:07	28/11/2019 15:02	7,91	1	7,91	CHI
201911348687	CATALAO	CT21231774	CATALAO S1	28/11/2019 07:07	28/11/2019 09:20	28/11/2019 07:07	28/11/2019 09:20	2,21	1	2,21	CHI
201911348689	POSSE	PS12124656	IACIARA S2	28/11/2019 06:54	28/11/2019 10:26	28/11/2019 06:54	28/11/2019 10:26	3,52	20	70,50	CHI
201911348698	CORUMBAIBA	CI12110161	VILA CORUMBA	28/11/2019 05:58	28/11/2019 10:24	28/11/2019 05:58	28/11/2019 10:24	4,42	42	185,77	CHI
201911348703	TURVELANDIA	TD21207234	RIO DOS BOIS	28/11/2019 07:12	28/11/2019 09:10	28/11/2019 07:12	28/11/2019 09:10	1,97	1	1,97	CHI
201911348704	MINACU	IH12334428LD	MINACU	28/11/2019 07:12	28/11/2019 09:58	28/11/2019 07:12	28/11/2019 09:58	2,75	179	493,10	CHI

201911348705	GOIANIA	GN12159972	GOIANIA LESTE S3	28/11/2019 07:13	28/11/2019 11:33	28/11/2019 07:13	28/11/2019 11:33	4,32	212	915,49	CHI
201911348709	IACIARA	IA12206170	IACIARA S1	28/11/2019 05:46	28/11/2019 09:35	28/11/2019 05:46	28/11/2019 09:35	3,81	80	305,02	CHI
201911348711	NOVA IGUACU DE GOIAS	NH21070610	CAMPINORTE	28/11/2019 07:14	28/11/2019 15:06	28/11/2019 07:14	28/11/2019 15:06	7,86	1	7,86	CHI
201911348715	RIO VERDE	RV12260156	RIO VERDE S1	28/11/2019 07:15	28/11/2019 09:08	28/11/2019 07:15	28/11/2019 09:08	1,89	1	1,89	CHI
201911348717	RIO VERDE	RV12271289	CABRIUVA S2	28/11/2019 04:18	28/11/2019 10:32	28/11/2019 04:18	28/11/2019 10:32	6,23	39	243,09	CHI
201911348720	CACU	CC12295769	CACHOEIRA ALTA	28/11/2019 07:06	29/11/2019 17:35	28/11/2019 07:06	29/11/2019 17:35	34,47	6	206,84	CHI
201911348720	CACU	CC13348178	CACHOEIRA ALTA	28/11/2019 07:06	29/11/2019 17:35	28/11/2019 16:10	29/11/2019 17:35	25,42	1	25,42	CHI
201911348724	MUTUNOPOLIS	MU12391658	MARA ROSA	28/11/2019 07:16	28/11/2019 14:11	28/11/2019 07:16	28/11/2019 14:11	6,91	34	234,80	CHI
201911348731	SENADOR CANEDO	SW12323510	CEPAIGO S2	28/11/2019 07:17	28/11/2019 14:02	28/11/2019 07:17	28/11/2019 14:02	6,75	2	13,50	CHI
201911348734	RUBIATABA	RB21228850	RUBIATABA	28/11/2019 07:17	29/11/2019 11:33	28/11/2019 07:17	29/11/2019 11:33	28,26	1	28,26	CHI
201911348735	ITABERAI	IB21078391	ITABERAI S1	28/11/2019 07:17	28/11/2019 11:04	28/11/2019 07:17	28/11/2019 11:04	3,77	1	3,77	CHI
201911348747	QUIRINOPOLIS	QI12113302	QUIRINOPOLIS	28/11/2019 07:18	28/11/2019 09:43	28/11/2019 07:18	28/11/2019 09:43	2,40	8	19,23	CHI
201911348748	CATALAO	10028322620	CATALAO S2	28/11/2019 07:18	28/11/2019 13:24	28/11/2019 07:18	28/11/2019 13:24	6,09	1	6,09	CHI
201911348750	GOIANIA	12516247	GOIANIA LESTE S2	28/11/2019 07:18	28/11/2019 10:02	28/11/2019 07:18	28/11/2019 10:02	2,72	1	2,72	CHI
201911348751	ITABERAI	IB12016899	INHUMAS S1	28/11/2019 05:03	28/11/2019 09:11	28/11/2019 05:03	28/11/2019 09:11	4,13	30	123,80	CHI
201911348755	ITABERAI	IB21360504	ITABERAI S1	28/11/2019 07:19	28/11/2019 11:59	28/11/2019 07:19	28/11/2019 11:59	4,65	1	4,65	CHI
201911348763	MONTE ALEGRE DE GOIAS	MA12211597	SAO DOMINGOS	28/11/2019 07:20	28/11/2019 10:45	28/11/2019 07:20	28/11/2019 10:45	3,40	10	34,01	CHI
201911348774	MINACU	10014708785	MINACU	28/11/2019 07:23	28/11/2019 12:19	28/11/2019 07:23	28/11/2019 12:19	4,93	1	4,93	CHI
201911348778	CRISTALINA	KR21304811	CRISTALINA S2	28/11/2019 07:23	28/11/2019 16:39	28/11/2019 07:23	28/11/2019 16:39	9,25	1	9,25	CHI
201911348783	URUACU	UR21221679	URUACU	28/11/2019 06:39	28/11/2019 09:18	28/11/2019 06:39	28/11/2019 09:18	2,63	6	15,81	CHI
201911348784	MINEIROS	MY13303668	PARQUE DAS EMAS	28/11/2019 09:42	28/11/2019 11:46	28/11/2019 09:42	28/11/2019 11:46	2,08	11	22,84	CHI
201911348788	TURVELANDIA	TD21027430	RIO DOS BOIS	28/11/2019 07:25	28/11/2019 10:51	28/11/2019 07:25	28/11/2019 10:51	3,44	1	3,44	CHI
201911348789	QUIRINOPOLIS	QI12279632	QUIRINOPOLIS	27/11/2019 20:23	28/11/2019 10:31	27/11/2019 20:23	28/11/2019 10:31	14,12	2	28,25	CHI
201911348789	RIO VERDE	QI12279632	QUIRINOPOLIS	27/11/2019 20:23	28/11/2019 10:31	27/11/2019 20:23	28/11/2019 10:31	14,12	30	423,69	CHI
201911348795	MINEIROS	MY12195521	PARQUE DAS EMAS	28/11/2019 07:25	28/11/2019 13:40	28/11/2019 07:25	28/11/2019 13:40	6,24	6	37,44	CHI
201911348797	BELA VISTA DE GOIAS	BV21152547	BELA VISTA S1	28/11/2019 07:26	28/11/2019 11:31	28/11/2019 07:26	28/11/2019 11:31	4,08	1	4,08	CHI
201911348803	ITUMBIARA	IT12257075	ITUMBIARA NOVA	28/11/2019 07:27	28/11/2019 08:30	28/11/2019 07:27	28/11/2019 08:30	1,04	22	22,79	CHI
201911348804	JARAGUA	JA12035642	JARAGUA	28/11/2019 07:27	29/11/2019 15:15	28/11/2019 07:27	28/11/2019 13:16	5,81	5	29,07	CHI
201911348804	JARAGUA	JA12035642	JARAGUA	28/11/2019 07:27	29/11/2019 15:15	28/11/2019 10:15	28/11/2019 13:16	3,03	2	6,06	CHI
201911348804	JARAGUA	JA12035642	JARAGUA	28/11/2019 07:27	29/11/2019 15:15	29/11/2019 09:38	29/11/2019 10:33	0,93	7	6,48	CHI
201911348804	JARAGUA	JA12035642	JARAGUA	28/11/2019 07:27	29/11/2019 15:15	28/11/2019 07:27	29/11/2019 14:42	31,24	3	93,71	CHI
201911348804	JARAGUA	JA12034846	JARAGUA	28/11/2019 07:27	29/11/2019 15:15	28/11/2019 10:15	29/11/2019 14:42	28,45	1	28,45	CHI
201911348804	JARAGUA	JA12035642	JARAGUA	28/11/2019 07:27	29/11/2019 15:15	28/11/2019 07:27	29/11/2019 15:15	31,79	7	222,53	CHI



201911348809	UIRAPURU	UP12181272	SANTA TEREZINHA	27/11/2019 14:36	30/11/2019 00:52	27/11/2019 14:36	29/11/2019 12:46	46,18	3	138,54	CHI
201911348809	UIRAPURU	UP12181271LD	SANTA TEREZINHA	27/11/2019 14:36	30/11/2019 00:52	27/11/2019 14:36	29/11/2019 23:10	56,58	2	113,16	CHI
201911348809	UIRAPURU	UP21287440	SANTA TEREZINHA	27/11/2019 14:36	30/11/2019 00:52	29/11/2019 13:40	30/11/2019 00:24	10,74	1	10,74	CHI
201911348809	UIRAPURU	UP21181268	SANTA TEREZINHA	27/11/2019 14:36	30/11/2019 00:52	29/11/2019 13:10	30/11/2019 00:52	11,71	2	23,42	CHI
201911348811	SAO DOMINGOS	SD21345874	SAO DOMINGOS	28/11/2019 07:28	28/11/2019 13:48	28/11/2019 07:28	28/11/2019 13:48	6,32	1	6,32	CHI
201911348813	HIDROLANDIA	HD21031837	CEPAIGO S2	28/11/2019 07:29	28/11/2019 11:10	28/11/2019 07:29	28/11/2019 11:10	3,69	1	3,69	CHI
201911348815	LUZIANIA	05650416	MARAJOARA	28/11/2019 07:04	28/11/2019 12:11	28/11/2019 07:04	28/11/2019 12:11	5,10	652	3325,92	CHI
201911348822	GOIANIA	GN12162224	CARAJAS S2	28/11/2019 07:30	28/11/2019 08:55	28/11/2019 07:30	28/11/2019 08:55	1,40	192	269,12	CHI
201911348824	GOIAS	GS12206887	GOIAS	28/11/2019 06:21	29/11/2019 10:31	28/11/2019 06:21	29/11/2019 10:31	28,17	22	619,65	CHI
201911348827	PARAUNA	PU12361861	PARAUNA	28/11/2019 07:31	28/11/2019 14:41	28/11/2019 07:31	28/11/2019 14:41	7,17	5	35,87	CHI
201911348837	CORUMBAIBA	CI2000463RE	VILA CORUMBA	27/11/2019 23:36	28/11/2019 10:41	27/11/2019 23:36	28/11/2019 10:41	11,07	125	1384,13	CHI
201911348841	MONTIVIDIU	MV12303377LD	MONTIVIDIU T	28/11/2019 07:33	28/11/2019 11:25	28/11/2019 07:33	28/11/2019 11:25	3,87	25	96,65	CHI
201911348841	RIO VERDE	MV12303377LD	MONTIVIDIU T	28/11/2019 07:33	28/11/2019 11:25	28/11/2019 07:33	28/11/2019 11:25	3,87	5	19,33	CHI
201911348846	PARAUNA	PU21305730	ACREUNA	28/11/2019 07:34	28/11/2019 10:30	28/11/2019 07:34	28/11/2019 10:30	2,93	1	2,93	CHI
201911348848	HIDROLANDIA	180050163	CEPAIGO S2	28/11/2019 07:34	28/11/2019 11:10	28/11/2019 07:34	28/11/2019 11:10	3,60	1	3,60	CHI
201911348850	GOIANIRA	GR11275477	MEIA PONTE	28/11/2019 05:37	28/11/2019 10:21	28/11/2019 05:37	28/11/2019 10:21	4,72	127	599,23	CHI
201911348854	MUNDO NOVO DE GOIAS	MH12357676	NOVA CRIXAS	27/11/2019 23:25	28/11/2019 00:00	27/11/2019 23:25	28/11/2019 00:00	0,57	24	13,66	CHI
201911348855	QUIRINOPOLIS	QI21155908	QUIRINOPOLIS	28/11/2019 07:34	28/11/2019 14:55	28/11/2019 07:34	28/11/2019 14:55	7,34	1	7,34	CHI
201911348857	CACU	CC12241667	CACHOEIRA ALTA	28/11/2019 07:34	28/11/2019 14:15	28/11/2019 07:34	28/11/2019 14:15	6,67	2	13,34	CHI
201911348858	BRITANIA	7122286	BRITANIA	28/11/2019 07:34	28/11/2019 13:45	28/11/2019 07:34	28/11/2019 13:45	6,17	6	37,00	CHI
201911348859	PORANGATU	PO21315429	NOVO PLANALTO	28/11/2019 07:35	28/11/2019 19:11	28/11/2019 07:35	28/11/2019 19:11	11,60	1	11,60	CHI
201911348864	ITAPURANGA	IK21326002	ITAPURANGA	28/11/2019 07:36	28/11/2019 11:20	28/11/2019 07:36	28/11/2019 11:20	3,73	1	3,73	CHI
201911348867	JATAI	JT11083453	JATAI S2	28/11/2019 07:36	28/11/2019 10:30	28/11/2019 07:36	28/11/2019 10:30	2,90	1	2,90	CHI
201911348868	JAUPACI	IS12070211	IPORA	28/11/2019 03:45	28/11/2019 12:50	28/11/2019 03:45	28/11/2019 12:50	9,08	3	27,23	CHI
201911348868	ISRAELANDIA	IS12070211	IPORA	28/11/2019 03:45	28/11/2019 12:50	28/11/2019 03:45	28/11/2019 12:50	9,08	29	263,20	CHI
201911348873	EDEIA	EA12000030	PONTALINA	28/11/2019 06:01	28/11/2019 11:49	28/11/2019 06:01	28/11/2019 11:49	5,79	9	52,07	CHI
201911348875	CRIXAS	CX12102899	SERRA DO OURO	28/11/2019 05:29	28/11/2019 16:40	28/11/2019 05:29	28/11/2019 16:40	11,18	62	693,02	CHI
201911348878	INDIARA	IY12170319	EDEIA	28/11/2019 07:37	28/11/2019 10:00	28/11/2019 07:37	28/11/2019 10:00	2,38	5	11,91	CHI
201911348878	PALMEIRAS DE GOIAS	IY12170319	EDEIA	28/11/2019 07:37	28/11/2019 10:00	28/11/2019 07:37	28/11/2019 10:00	2,38	6	14,29	CHI
201911348879	CAMPO ALEGRE DE GOIAS	7920000347	CAMPO ALEGRE DE GOIAS	28/11/2019 07:37	28/11/2019 13:19	28/11/2019 07:37	28/11/2019 13:19	5,69	1	5,69	CHI
201911348883	NIQUELANDIA	NQ12181068	URUACU	28/11/2019 06:56	28/11/2019 16:09	28/11/2019 06:56	28/11/2019 16:09	9,21	102	939,70	CHI
201911348892	GOIANIA	GN12098425	CEPAIGO S1	28/11/2019 06:01	28/11/2019 10:51	28/11/2019 06:01	28/11/2019 10:51	4,83	117	564,88	CHI
201911348928	AGUAS LINDAS DE GOIAS	04190214	AGUAS LINDAS DE GOIAS S2	28/11/2019 08:05	30/11/2019 00:42	28/11/2019 12:11	28/11/2019 12:18	0,13	3	0,39	CHI

201911348928	CORUMBA DE GOIAS	04190214	AGUAS LINDAS DE GOIAS S2	28/11/2019 08:05	30/11/2019 00:42	28/11/2019 12:11	28/11/2019 12:18	0,13	7	0,91	CHI
201911348928	COCALZINHO DE GOIAS	04190214	AGUAS LINDAS DE GOIAS S2	28/11/2019 08:05	30/11/2019 00:42	28/11/2019 12:11	28/11/2019 12:18	0,13	186	24,28	CHI
201911348928	SANTO ANTONIO DO DESCOBERTO	04190214	AGUAS LINDAS DE GOIAS S2	28/11/2019 08:05	30/11/2019 00:42	28/11/2019 12:11	28/11/2019 12:18	0,13	98	12,79	CHI
201911348928	COCALZINHO DE GOIAS	ZN10271882	COCALZINHO	28/11/2019 08:05	30/11/2019 00:42	28/11/2019 08:05	28/11/2019 14:23	6,31	76	479,33	CHI
201911348928	CORUMBA DE GOIAS	ZN10271882	COCALZINHO	28/11/2019 08:05	30/11/2019 00:42	28/11/2019 08:05	28/11/2019 14:23	6,31	174	1097,41	CHI
201911348928	COCALZINHO DE GOIAS	ZN10398171	AGUAS LINDAS DE GOIAS S2	28/11/2019 08:05	30/11/2019 00:42	28/11/2019 12:32	28/11/2019 14:37	2,08	1	2,08	CHI
201911348928	CORUMBA DE GOIAS	ZN13018209	COCALZINHO	28/11/2019 08:05	30/11/2019 00:42	28/11/2019 08:05	28/11/2019 17:02	8,95	60	537,08	CHI
201911348928	COCALZINHO DE GOIAS	ZN13018209	COCALZINHO	28/11/2019 08:05	30/11/2019 00:42	28/11/2019 08:05	28/11/2019 17:02	8,95	14	125,32	CHI
201911348928	COCALZINHO DE GOIAS	ZN12290933LD	AGUAS LINDAS DE GOIAS S2	28/11/2019 08:05	30/11/2019 00:42	28/11/2019 12:32	28/11/2019 17:41	5,15	154	792,50	CHI
201911348928	AGUAS LINDAS DE GOIAS	ZN12290933LD	AGUAS LINDAS DE GOIAS S2	28/11/2019 08:05	30/11/2019 00:42	28/11/2019 12:32	28/11/2019 17:41	5,15	3	15,44	CHI
201911348928	SANTO ANTONIO DO DESCOBERTO	ZN12290933LD	AGUAS LINDAS DE GOIAS S2	28/11/2019 08:05	30/11/2019 00:42	28/11/2019 12:32	28/11/2019 17:41	5,15	98	504,32	CHI
201911348928	CORUMBA DE GOIAS	ZN12290933LD	AGUAS LINDAS DE GOIAS S2	28/11/2019 08:05	30/11/2019 00:42	28/11/2019 12:32	28/11/2019 17:41	5,15	7	36,02	CHI
201911348928	COCALZINHO DE GOIAS	ZN13248662	COCALZINHO	28/11/2019 08:05	30/11/2019 00:42	28/11/2019 08:05	28/11/2019 18:15	10,17	508	5165,23	CHI
201911348928	COCALZINHO DE GOIAS	ZN10271882	COCALZINHO	28/11/2019 08:05	30/11/2019 00:42	28/11/2019 19:40	28/11/2019 20:05	0,42	90	37,52	CHI
201911348928	CORUMBA DE GOIAS	ZN10271882	COCALZINHO	28/11/2019 08:05	30/11/2019 00:42	28/11/2019 19:40	28/11/2019 20:05	0,42	234	97,56	CHI
201911348928	COCALZINHO DE GOIAS	04190214	AGUAS LINDAS DE GOIAS S2	28/11/2019 08:05	30/11/2019 00:42	28/11/2019 20:45	28/11/2019 20:58	0,22	31	6,68	CHI
201911348928	COCALZINHO DE GOIAS	04190214	COCALZINHO	28/11/2019 08:05	30/11/2019 00:42	28/11/2019 20:45	28/11/2019 20:58	0,22	508	109,50	CHI
201911348928	CORUMBA DE GOIAS	ZN13018210	COCALZINHO	28/11/2019 08:05	30/11/2019 00:42	28/11/2019 08:05	28/11/2019 21:31	13,44	76	1021,65	CHI
201911348928	COCALZINHO DE GOIAS	ZN13018210	COCALZINHO	28/11/2019 08:05	30/11/2019 00:42	28/11/2019 08:05	28/11/2019 21:31	13,44	285	3831,19	CHI
201911348928	COCALZINHO DE GOIAS	ZN12290933LD	AGUAS LINDAS DE GOIAS S2	28/11/2019 08:05	30/11/2019 00:42	28/11/2019 12:32	28/11/2019 22:17	9,75	1	9,75	CHI
201911348928	COCALZINHO DE GOIAS	ZN12290933LD	AGUAS LINDAS DE GOIAS S2	28/11/2019 08:05	30/11/2019 00:42	28/11/2019 18:29	28/11/2019 22:17	3,81	14	53,30	CHI
201911348928	AGUAS LINDAS DE GOIAS	ZN12290933LD	AGUAS LINDAS DE GOIAS S2	28/11/2019 08:05	30/11/2019 00:42	28/11/2019 18:29	28/11/2019 23:34	5,08	3	15,25	CHI
201911348928	COCALZINHO DE GOIAS	ZN12290933LD	AGUAS LINDAS DE GOIAS S2	28/11/2019 08:05	30/11/2019 00:42	28/11/2019 18:29	28/11/2019 23:34	5,08	42	213,52	CHI
201911348928	COCALZINHO DE GOIAS	ZN12290933LD	AGUAS LINDAS DE GOIAS S2	28/11/2019 08:05	30/11/2019 00:42	28/11/2019 18:29	29/11/2019 01:06	6,63	14	92,81	CHI
201911348928	SANTO ANTONIO DO DESCOBERTO	ZN12290933LD	AGUAS LINDAS DE GOIAS S2	28/11/2019 08:05	30/11/2019 00:42	28/11/2019 18:29	29/11/2019 01:06	6,63	17	112,70	CHI
201911348928	CORUMBA DE GOIAS	ZN12290933LD	AGUAS LINDAS DE GOIAS S2	28/11/2019 08:05	30/11/2019 00:42	28/11/2019 18:29	29/11/2019 03:23	8,91	2	17,83	CHI
201911348928	COCALZINHO DE GOIAS	ZN12290933LD	AGUAS LINDAS DE GOIAS S2	28/11/2019 08:05	30/11/2019 00:42	28/11/2019 18:29	29/11/2019 03:23	8,91	42	374,37	CHI
201911348928	COCALZINHO DE GOIAS	04190214	AGUAS LINDAS DE GOIAS S2	28/11/2019 08:05	30/11/2019 00:42	29/11/2019 04:01	29/11/2019 04:07	0,10	30	3,00	CHI
201911348928	AGUAS LINDAS DE GOIAS	ZN10398171	AGUAS LINDAS DE GOIAS S2	28/11/2019 08:05	30/11/2019 00:42	29/11/2019 04:01	29/11/2019 04:10	0,15	3	0,44	CHI
201911348928	COCALZINHO DE GOIAS	ZN10398171	AGUAS LINDAS DE GOIAS S2	28/11/2019 08:05	30/11/2019 00:42	29/11/2019 04:01	29/11/2019 04:10	0,15	114	16,63	CHI
201911348928	CORUMBA DE GOIAS	ZN10398171	AGUAS LINDAS DE GOIAS S2	28/11/2019 08:05	30/11/2019 00:42	29/11/2019 04:01	29/11/2019 04:10	0,15	2	0,29	CHI
201911348928	SANTO ANTONIO DO DESCOBERTO	ZN10398171	AGUAS LINDAS DE GOIAS S2	28/11/2019 08:05	30/11/2019 00:42	29/11/2019 04:01	29/11/2019 04:10	0,15	17	2,48	CHI
201911348928	COCALZINHO DE GOIAS	ZN10398171	COCALZINHO	28/11/2019 08:05	30/11/2019 00:42	29/11/2019 04:01	29/11/2019 04:10	0,15	508	74,08	CHI

201911348928	COCALZINHO DE GOIAS	04190214	AGUAS LINDAS DE GOIAS S2	28/11/2019 08:05	30/11/2019 00:42	29/11/2019 04:12	29/11/2019 04:16	0,06	30	1,79	CHI
201911348928	AGUAS LINDAS DE GOIAS	04190214	AGUAS LINDAS DE GOIAS S2	28/11/2019 08:05	30/11/2019 00:42	29/11/2019 04:12	29/11/2019 04:30	0,31	3	0,92	CHI
201911348928	COCALZINHO DE GOIAS	04190214	AGUAS LINDAS DE GOIAS S2	28/11/2019 08:05	30/11/2019 00:42	29/11/2019 04:12	29/11/2019 04:30	0,31	72	22,02	CHI
201911348928	SANTO ANTONIO DO DESCOBERTO	04190214	AGUAS LINDAS DE GOIAS S2	28/11/2019 08:05	30/11/2019 00:42	29/11/2019 04:12	29/11/2019 04:30	0,31	17	5,20	CHI
201911348928	COCALZINHO DE GOIAS	04190214	COCALZINHO	28/11/2019 08:05	30/11/2019 00:42	29/11/2019 04:12	29/11/2019 04:30	0,31	508	155,36	CHI
201911348928	COCALZINHO DE GOIAS	04190214	AGUAS LINDAS DE GOIAS S2	28/11/2019 08:05	30/11/2019 00:42	29/11/2019 09:15	29/11/2019 09:18	0,06	30	1,67	CHI
201911348928	AGUAS LINDAS DE GOIAS	ZN10398171	AGUAS LINDAS DE GOIAS S2	28/11/2019 08:05	30/11/2019 00:42	29/11/2019 09:15	29/11/2019 09:23	0,13	3	0,38	CHI
201911348928	COCALZINHO DE GOIAS	ZN10398171	AGUAS LINDAS DE GOIAS S2	28/11/2019 08:05	30/11/2019 00:42	29/11/2019 09:15	29/11/2019 09:23	0,13	72	9,02	CHI
201911348928	SANTO ANTONIO DO DESCOBERTO	ZN10398171	AGUAS LINDAS DE GOIAS S2	28/11/2019 08:05	30/11/2019 00:42	29/11/2019 09:15	29/11/2019 09:23	0,13	17	2,13	CHI
201911348928	COCALZINHO DE GOIAS	ZN10398171	COCALZINHO	28/11/2019 08:05	30/11/2019 00:42	29/11/2019 09:15	29/11/2019 09:23	0,13	508	63,64	CHI
201911348928	COCALZINHO DE GOIAS	ZN12313683LD	AGUAS LINDAS DE GOIAS S2	28/11/2019 08:05	30/11/2019 00:42	29/11/2019 04:12	29/11/2019 11:32	7,33	33	242,00	CHI
201911348928	CORUMBA DE GOIAS	ZN12313683LD	AGUAS LINDAS DE GOIAS S2	28/11/2019 08:05	30/11/2019 00:42	29/11/2019 04:12	29/11/2019 11:32	7,33	2	14,67	CHI
201911348928	COCALZINHO DE GOIAS	ZN13018210	COCALZINHO	28/11/2019 08:05	30/11/2019 00:42	28/11/2019 08:05	29/11/2019 15:12	31,12	1	31,12	CHI
201911348928	CORUMBA DE GOIAS	ZN13018210	COCALZINHO	28/11/2019 08:05	30/11/2019 00:42	28/11/2019 08:05	29/11/2019 15:36	31,52	1	31,52	CHI
201911348928	COCALZINHO DE GOIAS	ZN12313683LD	AGUAS LINDAS DE GOIAS S2	28/11/2019 08:05	30/11/2019 00:42	29/11/2019 04:12	29/11/2019 16:23	12,18	9	109,60	CHI
201911348928	AGUAS LINDAS DE GOIAS	04190214	AGUAS LINDAS DE GOIAS S2	28/11/2019 08:05	30/11/2019 00:42	29/11/2019 16:50	29/11/2019 17:07	0,29	3	0,86	CHI
201911348928	COCALZINHO DE GOIAS	04190214	AGUAS LINDAS DE GOIAS S2	28/11/2019 08:05	30/11/2019 00:42	29/11/2019 16:50	29/11/2019 17:07	0,29	144	41,44	CHI
201911348928	CORUMBA DE GOIAS	04190214	AGUAS LINDAS DE GOIAS S2	28/11/2019 08:05	30/11/2019 00:42	29/11/2019 16:50	29/11/2019 17:07	0,29	2	0,58	CHI
201911348928	SANTO ANTONIO DO DESCOBERTO	04190214	AGUAS LINDAS DE GOIAS S2	28/11/2019 08:05	30/11/2019 00:42	29/11/2019 16:50	29/11/2019 17:07	0,29	17	4,89	CHI
201911348928	COCALZINHO DE GOIAS	04190214	COCALZINHO	28/11/2019 08:05	30/11/2019 00:42	29/11/2019 16:50	29/11/2019 17:07	0,29	508	146,19	CHI
201911348928	COCALZINHO DE GOIAS	ZN12290914LD	AGUAS LINDAS DE GOIAS S2	28/11/2019 08:05	30/11/2019 00:42	28/11/2019 18:29	29/11/2019 20:34	26,09	12	313,08	CHI
201911348928	SANTO ANTONIO DO DESCOBERTO	ZN12290914LD	AGUAS LINDAS DE GOIAS S2	28/11/2019 08:05	30/11/2019 00:42	28/11/2019 18:29	29/11/2019 20:34	26,09	1	26,09	CHI
201911348928	COCALZINHO DE GOIAS	ZN12290914LD	AGUAS LINDAS DE GOIAS S2	28/11/2019 08:05	30/11/2019 00:42	28/11/2019 18:29	29/11/2019 20:46	26,29	5	131,45	CHI
201911348928	CORUMBA DE GOIAS	ZN12290914LD	AGUAS LINDAS DE GOIAS S2	28/11/2019 08:05	30/11/2019 00:42	28/11/2019 18:29	29/11/2019 20:46	26,29	5	131,45	CHI
201911348928	COCALZINHO DE GOIAS	ZN12290914LD	AGUAS LINDAS DE GOIAS S2	28/11/2019 08:05	30/11/2019 00:42	28/11/2019 18:29	29/11/2019 20:58	26,48	14	370,74	CHI
201911348928	SANTO ANTONIO DO DESCOBERTO	ZN12290914LD	AGUAS LINDAS DE GOIAS S2	28/11/2019 08:05	30/11/2019 00:42	28/11/2019 18:29	29/11/2019 20:58	26,48	66	1747,75	CHI
201911348928	AGUAS LINDAS DE GOIAS	04190214	AGUAS LINDAS DE GOIAS S2	28/11/2019 08:05	30/11/2019 00:42	29/11/2019 20:59	29/11/2019 21:36	0,60	3	1,80	CHI
201911348928	CORUMBA DE GOIAS	04190214	AGUAS LINDAS DE GOIAS S2	28/11/2019 08:05	30/11/2019 00:42	29/11/2019 20:59	29/11/2019 21:36	0,60	7	4,20	CHI
201911348928	SANTO ANTONIO DO DESCOBERTO	04190214	AGUAS LINDAS DE GOIAS S2	28/11/2019 08:05	30/11/2019 00:42	29/11/2019 20:59	29/11/2019 21:36	0,60	18	10,81	CHI
201911348928	COCALZINHO DE GOIAS	04190214	AGUAS LINDAS DE GOIAS S2	28/11/2019 08:05	30/11/2019 00:42	29/11/2019 20:59	29/11/2019 21:36	0,60	161	96,69	CHI
201911348928	COCALZINHO DE GOIAS	04190214	COCALZINHO	28/11/2019 08:05	30/11/2019 00:42	29/11/2019 20:59	29/11/2019 21:36	0,60	508	305,08	CHI
201911348928	COCALZINHO DE GOIAS	ZN12290914LD	AGUAS LINDAS DE GOIAS S2	28/11/2019 08:05	30/11/2019 00:42	28/11/2019 18:29	29/11/2019 21:49	27,33	5	136,66	CHI
201911348928	SANTO ANTONIO DO DESCOBERTO	ZN12290914LD	AGUAS LINDAS DE GOIAS S2	28/11/2019 08:05	30/11/2019 00:42	28/11/2019 18:29	29/11/2019 21:49	27,33	14	382,64	CHI

201911348928	COCALZINHO DE GOIAS	ZN12290914LD	AGUAS LINDAS DE GOIAS S2	28/11/2019 08:05	30/11/2019 00:42	28/11/2019 18:29	29/11/2019 22:09	27,67	6	166,05	CHI
201911348928	COCALZINHO DE GOIAS	ZN12290914LD	AGUAS LINDAS DE GOIAS S2	28/11/2019 08:05	30/11/2019 00:42	29/11/2019 04:01	29/11/2019 22:09	18,14	1	18,14	CHI
201911348928	COCALZINHO DE GOIAS	04190214	COCALZINHO	28/11/2019 08:05	30/11/2019 00:42	29/11/2019 23:29	29/11/2019 23:52	0,37	508	189,51	CHI
201911348928	AGUAS LINDAS DE GOIAS	04190214	AGUAS LINDAS DE GOIAS S2	28/11/2019 08:05	30/11/2019 00:42	29/11/2019 23:29	29/11/2019 23:53	0,40	3	1,20	CHI
201911348928	COCALZINHO DE GOIAS	04190214	AGUAS LINDAS DE GOIAS S2	28/11/2019 08:05	30/11/2019 00:42	29/11/2019 23:29	29/11/2019 23:53	0,40	143	57,08	CHI
201911348928	CORUMBA DE GOIAS	04190214	AGUAS LINDAS DE GOIAS S2	28/11/2019 08:05	30/11/2019 00:42	29/11/2019 23:29	29/11/2019 23:53	0,40	7	2,79	CHI
201911348928	SANTO ANTONIO DO DESCOBERTO	04190214	AGUAS LINDAS DE GOIAS S2	28/11/2019 08:05	30/11/2019 00:42	29/11/2019 23:29	29/11/2019 23:53	0,40	32	12,77	CHI
201911348928	COCALZINHO DE GOIAS	ZN12357357	AGUAS LINDAS DE GOIAS S2	28/11/2019 08:05	30/11/2019 00:42	29/11/2019 20:59	30/11/2019 00:42	3,70	14	51,83	CHI
201911348928	SANTO ANTONIO DO DESCOBERTO	ZN12357357	AGUAS LINDAS DE GOIAS S2	28/11/2019 08:05	30/11/2019 00:42	29/11/2019 20:59	30/11/2019 00:42	3,70	66	244,36	CHI
201911348928	COCALZINHO DE GOIAS	ZN10398171	AGUAS LINDAS DE GOIAS S2	28/11/2019 08:05	30/11/2019 00:42	30/11/2019 00:37	30/11/2019 00:42	0,08	143	11,92	CHI
201911348928	AGUAS LINDAS DE GOIAS	ZN10398171	AGUAS LINDAS DE GOIAS S2	28/11/2019 08:05	30/11/2019 00:42	30/11/2019 00:37	30/11/2019 00:42	0,08	3	0,25	CHI
201911348928	SANTO ANTONIO DO DESCOBERTO	ZN10398171	AGUAS LINDAS DE GOIAS S2	28/11/2019 08:05	30/11/2019 00:42	30/11/2019 00:37	30/11/2019 00:42	0,08	32	2,67	CHI
201911348928	CORUMBA DE GOIAS	ZN10398171	AGUAS LINDAS DE GOIAS S2	28/11/2019 08:05	30/11/2019 00:42	30/11/2019 00:37	30/11/2019 00:42	0,08	7	0,58	CHI
201911348970	JAUPACI	1280000950	IPORA	28/11/2019 09:49	28/11/2019 10:35	28/11/2019 09:49	28/11/2019 10:35	0,76	1	0,76	CHI
201911348975	CALDAS NOVAS	04890244	SERRA DE CALDAS	28/11/2019 09:59	28/11/2019 13:29	28/11/2019 09:59	28/11/2019 10:56	0,96	986	947,93	CHI
201911348975	CALDAS NOVAS	04890244	SERRA DE CALDAS	28/11/2019 09:59	28/11/2019 13:29	28/11/2019 10:01	28/11/2019 10:56	0,92	105	96,19	CHI
201911348975	CALDAS NOVAS	04890244	SERRA DE CALDAS	28/11/2019 09:59	28/11/2019 13:29	28/11/2019 09:59	28/11/2019 12:03	2,07	2793	5790,04	CHI
201911348975	CALDAS NOVAS	CN13213809	SERRA DE CALDAS	28/11/2019 09:59	28/11/2019 13:29	28/11/2019 10:01	28/11/2019 12:03	2,03	187	379,19	CHI
201911348975	CALDAS NOVAS	CN16404234	SERRA DE CALDAS	28/11/2019 09:59	28/11/2019 13:29	28/11/2019 09:59	28/11/2019 12:08	2,15	1040	2233,98	CHI
201911348975	CALDAS NOVAS	CN13213882	CALDAS NOVAS S1	28/11/2019 09:59	28/11/2019 13:29	28/11/2019 09:59	28/11/2019 12:46	2,79	1817	5077,51	CHI
201911348975	CALDAS NOVAS	04890244	SERRA DE CALDAS	28/11/2019 09:59	28/11/2019 13:29	28/11/2019 09:59	28/11/2019 13:29	3,50	867	3034,74	CHI
201911348975	CALDAS NOVAS	CN13000006	SERRA DE CALDAS	28/11/2019 09:59	28/11/2019 13:29	28/11/2019 10:01	28/11/2019 13:29	3,46	364	1257,62	CHI
201911348977	PORANGATU	PO12192371	PORANGATU	27/11/2019 22:49	28/11/2019 23:17	27/11/2019 22:49	28/11/2019 23:17	24,47	12	293,60	CHI
201911348991	ITAPURANGA	IK11061594	ITAPURANGA	28/11/2019 10:54	28/11/2019 13:00	28/11/2019 10:54	28/11/2019 13:00	2,10	48	100,77	CHI
201911348992	LUZIANIA	LZ12261767	CRISTALINA S2	28/11/2019 10:48	28/11/2019 12:41	28/11/2019 10:48	28/11/2019 12:41	1,88	12	22,59	CHI
201911349003	SANTA HELENA DE GOIAS	SH12267725	SANTA HELENA S1	28/11/2019 07:39	28/11/2019 10:50	28/11/2019 07:39	28/11/2019 10:50	3,17	4	12,69	CHI
201911349012	DIVINOPOLIS DE GOIAS	GH12253952	SAO DOMINGOS	28/11/2019 07:41	28/11/2019 16:05	28/11/2019 07:41	28/11/2019 16:05	8,39	4	33,57	CHI
201911349014	APARECIDA DE GOIANIA	AP12004611	REAL S1	28/11/2019 07:38	28/11/2019 09:30	28/11/2019 07:38	28/11/2019 09:30	1,86	1394	2592,45	CHI
201911349015	MAURILANDIA	ML12303542	RIO DOS BOIS	28/11/2019 07:14	28/11/2019 11:13	28/11/2019 07:14	28/11/2019 11:13	3,97	15	59,59	CHI
201911349015	CASTELANDIA	ML12303542	RIO DOS BOIS	28/11/2019 07:14	28/11/2019 11:13	28/11/2019 07:14	28/11/2019 11:13	3,97	5	19,86	CHI
201911349019	NIQUELANDIA	BA12035658	BARRO ALTO	28/11/2019 07:42	29/11/2019 10:41	28/11/2019 07:42	29/11/2019 10:41	26,97	4	107,88	CHI
201911349019	BARRO ALTO	BA12035658	BARRO ALTO	28/11/2019 07:42	29/11/2019 10:41	28/11/2019 07:42	29/11/2019 10:41	26,97	11	296,67	CHI
201911349021	CATALAO	CT21314771	CATALAO S1	28/11/2019 07:42	28/11/2019 10:33	28/11/2019 07:42	28/11/2019 10:33	2,83	1	2,83	CHI

201911349024	ACREUNA	EU12114599	ACREUNA	28/11/2019 07:43	28/11/2019 15:40	28/11/2019 07:43	28/11/2019 15:40	7,96	6	47,74	CHI
201911349031	NIQUELANDIA	NQ21142236	SAO JOAO D ALIANCA	28/11/2019 07:44	28/11/2019 12:35	28/11/2019 07:44	28/11/2019 12:35	4,85	2	9,69	CHI
201911349033	BARRO ALTO	BA21000019	BARRO ALTO	28/11/2019 07:44	28/11/2019 17:31	28/11/2019 07:44	28/11/2019 17:31	9,77	1	9,77	CHI
201911349047	GUARINOS	GF12181361	SANTA TEREZINHA	28/11/2019 07:46	29/11/2019 11:20	28/11/2019 07:46	29/11/2019 11:20	27,56	1	27,56	CHI
201911349049	SANTA ISABEL	GE12000139	GOIANESIA S1	28/11/2019 06:29	28/11/2019 17:47	28/11/2019 06:29	28/11/2019 17:47	11,30	14	158,20	CHI
201911349052	TURVELANDIA	SH12271563	IPEGUARI	28/11/2019 06:27	28/11/2019 22:38	28/11/2019 06:27	28/11/2019 22:38	16,18	3	48,54	CHI
201911349052	SANTA HELENA DE GOIAS	SH12271563	IPEGUARI	28/11/2019 06:27	28/11/2019 22:38	28/11/2019 06:27	28/11/2019 22:38	16,18	5	80,90	CHI
201911349052	TURVELANDIA	SH12271563	IPEGUARI	28/11/2019 06:27	28/11/2019 22:38	28/11/2019 16:43	28/11/2019 22:38	5,91	9	53,22	CHI
201911349052	SANTA HELENA DE GOIAS	SH12271563	IPEGUARI	28/11/2019 06:27	28/11/2019 22:38	28/11/2019 16:43	28/11/2019 22:38	5,91	11	65,05	CHI
201911349055	SAO DOMINGOS	SD12317855	SAO DOMINGOS	28/11/2019 07:47	28/11/2019 18:59	28/11/2019 07:47	28/11/2019 18:59	11,19	2	22,38	CHI
201911349062	ESTRELA DO NORTE	2420005060	MARA ROSA	28/11/2019 07:48	28/11/2019 19:43	28/11/2019 07:48	28/11/2019 19:43	11,91	1	11,91	CHI
201911349076	GOIATUBA	GT121283879	GOIATUBA S1	28/11/2019 07:49	28/11/2019 13:32	28/11/2019 07:49	28/11/2019 13:32	5,71	1	5,71	CHI
201911349078	URUACU	UR12201756	URUACU	28/11/2019 07:50	28/11/2019 10:12	28/11/2019 07:50	28/11/2019 10:12	2,36	2	4,73	CHI
201911349079	PALMEIRAS DE GOIAS	590044126	PALMEIRAS	28/11/2019 07:50	28/11/2019 12:32	28/11/2019 07:50	28/11/2019 12:32	4,71	1	4,71	CHI
201911349081	TURVANIA	TV12259061	FIRMINOPOLIS S2	28/11/2019 07:50	28/11/2019 11:35	28/11/2019 07:50	28/11/2019 11:35	3,75	8	29,98	CHI
201911349082	BOM JESUS DE GOIAS	1250054713	BOM JESUS DE GOIAS	28/11/2019 07:50	28/11/2019 10:46	28/11/2019 07:50	28/11/2019 10:46	2,92	1	2,92	CHI
201911349084	SANTO ANTONIO DO DESCOBERTO	SN12314046	MARAJOARA	27/11/2019 23:42	28/11/2019 10:23	27/11/2019 23:42	28/11/2019 10:23	10,68	27	288,31	CHI
201911349085	PIRENOPOLIS	PV12334671	CORUMBA	28/11/2019 06:44	29/11/2019 10:12	28/11/2019 06:44	29/11/2019 10:12	27,46	26	714,09	CHI
201911349091	INACIOLANDIA	ID12306349	CACHOEIRA DOURADA	28/11/2019 07:30	28/11/2019 18:01	28/11/2019 07:30	28/11/2019 18:01	10,53	83	873,67	CHI
201911349098	PADRE BERNARDO	2760052273	PADRE BERNARDO	28/11/2019 07:54	28/11/2019 10:34	28/11/2019 07:54	28/11/2019 10:34	2,67	1	2,67	CHI
201911349100	POSSE	PS12344418	IACIARA S1	28/11/2019 07:55	28/11/2019 15:59	28/11/2019 07:55	28/11/2019 15:59	8,06	41	330,57	CHI
201911349102	URUACU	UR12339121	MARA ROSA	28/11/2019 05:40	29/11/2019 14:12	28/11/2019 05:40	29/11/2019 14:12	32,52	7	227,65	CHI
201911349106	PARAUNA	SA21000110	ACREUNA	28/11/2019 07:56	28/11/2019 16:15	28/11/2019 07:56	28/11/2019 16:15	8,31	1	8,31	CHI
201911349112	APARECIDA DE GOIANIA	AP11161915	INDEPENDENCIA S2	28/11/2019 10:18	28/11/2019 12:34	28/11/2019 10:18	28/11/2019 12:34	2,26	58	130,85	CHI
201911349115	ITAPURANGA	IK12300232	ITAPURANGA	28/11/2019 07:57	29/11/2019 11:04	28/11/2019 07:57	29/11/2019 11:04	27,11	13	352,45	CHI
201911349118	BOM JESUS DE GOIAS	BJ21208190	BOM JESUS DE GOIAS	28/11/2019 07:58	28/11/2019 14:30	28/11/2019 07:58	28/11/2019 14:30	6,53	1	6,53	CHI
201911349129	NOVA CRIXAS	SM12089299	SAO MIGUEL DO ARAGUAIA	28/11/2019 07:59	28/11/2019 16:55	28/11/2019 07:59	28/11/2019 16:55	8,92	1	8,92	CHI
201911349129	SAO MIGUEL DO ARAGUAIA	SM12089299	SAO MIGUEL DO ARAGUAIA	28/11/2019 07:59	28/11/2019 16:55	28/11/2019 07:59	28/11/2019 16:55	8,92	90	803,02	CHI
201911349132	GUARANI DE GOIAS	GY21242612	SAO DOMINGOS	28/11/2019 08:00	28/11/2019 17:39	28/11/2019 08:00	28/11/2019 17:39	9,65	1	9,65	CHI
201911349133	POSSE	PS12195703	IACIARA S2	28/11/2019 07:56	28/11/2019 10:31	28/11/2019 07:56	28/11/2019 10:31	2,57	6	15,42	CHI
201911349137	PARANAIGUARA	PC12193843	QUIRINOPOLIS	28/11/2019 08:01	28/11/2019 18:38	28/11/2019 08:01	28/11/2019 18:38	10,61	1	10,61	CHI
201911349138	MUTUNOPOLIS	MU12391672	MARA ROSA	28/11/2019 06:10	28/11/2019 10:26	28/11/2019 06:10	28/11/2019 10:26	4,26	7	29,81	CHI
201911349138	AMARALINA	MU12391672	MARA ROSA	28/11/2019 06:10	28/11/2019 10:26	28/11/2019 06:10	28/11/2019 10:26	4,26	101	430,18	CHI

201911349142	MOSSAMEDES	MD21183226	FIRMINOPOLIS S2	27/11/2019 22:52	28/11/2019 10:58	27/11/2019 22:52	28/11/2019 10:58	12,10	1	12,10	CHI
201911349151	RIO VERDE	RV21322222	RIO VERDE S1	28/11/2019 08:02	28/11/2019 09:34	28/11/2019 08:02	28/11/2019 09:34	1,52	1	1,52	CHI
201911349163	ITAGUARU	IC12376461	ITABERAI S1	28/11/2019 06:55	28/11/2019 11:09	28/11/2019 06:55	28/11/2019 11:09	4,22	47	198,22	CHI
201911349163	HEITORAI	IC12376461	ITABERAI S1	28/11/2019 06:55	28/11/2019 11:09	28/11/2019 06:55	28/11/2019 11:09	4,22	7	29,52	CHI
201911349164	MONTE ALEGRE DE GOIAS	MA12240202	SAO DOMINGOS	28/11/2019 07:32	28/11/2019 15:32	28/11/2019 07:32	28/11/2019 15:32	7,99	3	23,96	CHI
201911349168	JATAI	JT12219503	JATAI S3	28/11/2019 08:04	28/11/2019 11:03	28/11/2019 08:04	28/11/2019 11:03	2,97	5	14,87	CHI
201911349184	PORANGATU	PO12208558	PORANGATU	28/11/2019 06:57	28/11/2019 17:30	28/11/2019 06:57	28/11/2019 17:30	10,54	14	147,61	CHI
201911349186	FLORES DE GOIAS	FB12257743	FLORES DE GOIAS	28/11/2019 05:56	28/11/2019 17:01	28/11/2019 05:56	28/11/2019 17:01	11,07	7	77,48	CHI
201911349187	PORANGATU	PO12050740	PORANGATU	28/11/2019 08:05	28/11/2019 15:49	28/11/2019 08:05	28/11/2019 15:49	7,72	4	30,89	CHI
201911349190	BALIZA	BH12343730	BOM JARDIM	28/11/2019 05:41	28/11/2019 11:48	28/11/2019 05:41	28/11/2019 11:48	6,10	8	48,81	CHI
201911349199	ANAPOLIS	AN11084673	ANAPOLIS UNIVERSITARIO S2	28/11/2019 06:34	28/11/2019 10:52	28/11/2019 06:34	28/11/2019 10:52	4,29	39	167,12	CHI
201911349202	CAIAPONIA	CP21071225	CAIAPONIA	28/11/2019 08:07	29/11/2019 09:05	28/11/2019 08:07	29/11/2019 09:05	24,96	1	24,96	CHI
201911349204	CAMPINACU	IH12360453	MINACU	28/11/2019 07:47	28/11/2019 15:19	28/11/2019 07:47	28/11/2019 15:19	7,52	5	37,59	CHI
201911349204	MINACU	IH12360453	MINACU	28/11/2019 07:47	28/11/2019 15:19	28/11/2019 07:47	28/11/2019 15:19	7,52	72	541,34	CHI
201911349205	CRIXAS	CX12405291	SANTA TEREZINHA	28/11/2019 00:02	28/11/2019 17:21	28/11/2019 00:02	28/11/2019 17:21	17,31	90	1557,95	CHI
201911349207	SANTA ROSA DE GOIAS	SR21019094	INHUMAS S1	28/11/2019 08:07	28/11/2019 17:55	28/11/2019 08:07	28/11/2019 17:55	9,79	1	9,79	CHI
201911349208	PIRANHAS	PH21024569	ARENOPOLIS	28/11/2019 08:07	28/11/2019 14:43	28/11/2019 08:07	28/11/2019 14:43	6,60	1	6,60	CHI
201911349210	FIRMINOPOLIS	900022061	FIRMINOPOLIS S1	28/11/2019 08:07	28/11/2019 13:36	28/11/2019 08:07	28/11/2019 13:36	5,47	1	5,47	CHI
201911349211	SAO MIGUEL DO ARAGUAIA	SM12192361	SAO MIGUEL DO ARAGUAIA	28/11/2019 07:57	28/11/2019 12:10	28/11/2019 07:57	28/11/2019 12:10	4,21	169	711,49	CHI
201911349212	FAZENDA NOVA	FN11292868	BRITANIA	28/11/2019 08:07	29/11/2019 07:13	28/11/2019 08:07	29/11/2019 07:13	23,09	6	138,53	CHI
201911349302	RIO VERDE	630097203	RIO VERDE S2	28/11/2019 08:08	28/11/2019 12:09	28/11/2019 08:08	28/11/2019 12:09	4,01	1	4,01	CHI
201911349311	GOIANIA	11114320	GOIANIA LESTE S3	28/11/2019 08:09	28/11/2019 10:00	28/11/2019 08:09	28/11/2019 10:00	1,85	1	1,85	CHI
201911349314	PORANGATU	PO12090602	MARA ROSA	28/11/2019 08:09	28/11/2019 12:09	28/11/2019 08:09	28/11/2019 12:09	4,00	65	259,75	CHI
201911349314	BONOPOLIS	PO12090602	MARA ROSA	28/11/2019 08:09	28/11/2019 12:09	28/11/2019 08:09	28/11/2019 12:09	4,00	2	7,99	CHI
201911349315	PONTALINA	PK12047217	PONTALINA	28/11/2019 08:06	28/11/2019 09:20	28/11/2019 08:06	28/11/2019 09:20	1,22	78	94,92	CHI
201911349326	ITABERAI	IB12250758	ITABERAI S1	28/11/2019 07:11	28/11/2019 10:17	28/11/2019 07:11	28/11/2019 10:17	3,10	5	15,50	CHI
201911349334	SANTA HELENA DE GOIAS	SH21296060	IPEGUARI	28/11/2019 08:11	28/11/2019 10:55	28/11/2019 08:11	28/11/2019 10:55	2,73	2	5,46	CHI
201911349341	JATAI	JT12196090	JATAI S2	28/11/2019 07:20	28/11/2019 10:28	28/11/2019 07:20	28/11/2019 10:28	3,12	12	37,49	CHI
201911349343	GUARINOS	SG12291237	SANTA TEREZINHA	28/11/2019 04:11	29/11/2019 04:10	28/11/2019 04:11	29/11/2019 04:10	23,97	6	143,80	CHI
201911349343	CRIXAS	SG12291237	SANTA TEREZINHA	28/11/2019 04:11	29/11/2019 04:10	28/11/2019 04:11	29/11/2019 04:10	23,97	13	311,58	CHI
201911349346	IPORA	IR12070218	IPORA	28/11/2019 08:12	28/11/2019 13:10	28/11/2019 08:12	28/11/2019 13:10	4,98	2	9,95	CHI
201911349347	PORANGATU	PO21246515	PORANGATU	28/11/2019 08:12	28/11/2019 11:00	28/11/2019 08:12	28/11/2019 11:00	2,78	6	16,71	CHI
201911349351	QUIRINOPOLIS	80008290	QUIRINOPOLIS	28/11/2019 08:13	28/11/2019 11:24	28/11/2019 08:13	28/11/2019 11:24	3,18	1	3,18	CHI

201911349359	CACHOEIRA DOURADA	CD21000340	CACHOEIRA DOURADA	28/11/2019 08:14	28/11/2019 11:55	28/11/2019 08:14	28/11/2019 11:55	3,70	1	3,70	CHI
201911349361	CAMPO ALEGRE DE GOIAS	CM12192738RE	CAMPO ALEGRE DE GOIAS	28/11/2019 06:57	28/11/2019 12:20	28/11/2019 06:57	28/11/2019 12:20	5,38	6	32,26	CHI
201911349366	BURITI DE GOIAS	10018383350	FIRMINOPOLIS S2	28/11/2019 08:14	28/11/2019 11:38	28/11/2019 08:14	28/11/2019 11:38	3,39	1	3,39	CHI
201911349368	MINACU	4020003684	MINACU	28/11/2019 08:15	28/11/2019 15:56	28/11/2019 08:15	28/11/2019 15:56	7,68	1	7,68	CHI
201911349370	CALDAS NOVAS	760383522	SERRA DE CALDAS	28/11/2019 08:15	28/11/2019 12:45	28/11/2019 08:15	28/11/2019 12:45	4,49	1	4,49	CHI
201911349373	CATALAO	CT21166721	CATALAO S1	28/11/2019 08:15	28/11/2019 17:23	28/11/2019 08:15	28/11/2019 17:23	9,12	2	18,24	CHI
201911349379	MONTIVIDIU	2840037240	MONTIVIDIU T	28/11/2019 08:16	28/11/2019 11:03	28/11/2019 08:16	28/11/2019 11:03	2,78	1	2,78	CHI
201911349381	NAZARIO	NZ21299088	ANICUNS	28/11/2019 08:17	28/11/2019 09:40	28/11/2019 08:17	28/11/2019 09:40	1,38	0	0,00	CHI
201911349382	PIRANHAS	PH21118133	ARENOPOLIS	28/11/2019 08:17	28/11/2019 17:30	28/11/2019 08:17	28/11/2019 17:30	9,23	1	9,23	CHI
201911349402	SAO LUIZ DO NORTE	SZ11336113	BARRO ALTO	28/11/2019 08:20	28/11/2019 17:00	28/11/2019 08:20	28/11/2019 17:00	8,66	1	8,66	CHI
201911349406	CAMPOS BELOS	CH21317862	SAO DOMINGOS	28/11/2019 08:24	28/11/2019 09:39	28/11/2019 08:24	28/11/2019 09:39	1,25	2	2,50	CHI
201911349503	BARRO ALTO	BA12382485	BARRO ALTO	28/11/2019 06:46	28/11/2019 21:21	28/11/2019 06:46	28/11/2019 21:21	14,58	9	131,19	CHI
201911349504	NIQUELANDIA	NQ13243450	NIQUELANDIA SUBTRANSMISSAO	28/11/2019 07:25	28/11/2019 17:28	28/11/2019 07:25	28/11/2019 17:28	10,04	43	431,80	CHI
201911349505	PIRACANJUBA	PJ21199406	PIRACANJUBA	28/11/2019 08:21	28/11/2019 10:17	28/11/2019 08:21	28/11/2019 10:17	1,93	1	1,93	CHI
201911349510	CATALAO	CT21250468	CATALAO S1	28/11/2019 08:21	28/11/2019 12:09	28/11/2019 08:21	28/11/2019 12:09	3,79	1	3,79	CHI
201911349512	CATALAO	1990143237	CATALAO S2	28/11/2019 08:22	28/11/2019 10:50	28/11/2019 08:22	28/11/2019 10:50	2,47	1	2,47	CHI
201911349514	ANAPOLIS	10018156736	ANAPOLIS UNIVERSITARIO S2	28/11/2019 08:22	28/11/2019 11:47	28/11/2019 08:22	28/11/2019 11:47	3,41	1	3,41	CHI
201911349518	CACHOEIRA ALTA	1090000161	CACHOEIRA ALTA	28/11/2019 08:22	28/11/2019 17:05	28/11/2019 08:22	28/11/2019 17:05	8,70	1	8,70	CHI
201911349523	PALMEIRAS DE GOIAS	PL12000240	PALMEIRAS	28/11/2019 04:05	28/11/2019 10:58	28/11/2019 04:05	28/11/2019 10:58	6,88	5	34,41	CHI
201911349525	PARAUNA	980045290	PARAUNA	28/11/2019 08:23	28/11/2019 11:06	28/11/2019 08:23	28/11/2019 11:06	2,73	1	2,73	CHI
201911349526	SAO JOAO D ALIANCA	JL12257606	SAO JOAO D ALIANCA	28/11/2019 08:23	30/11/2019 09:09	28/11/2019 08:23	30/11/2019 09:09	48,76	81	3949,65	CHI
201911349526	ALTO PARAISO DE GOIAS	JL12257606	SAO JOAO D ALIANCA	28/11/2019 08:23	30/11/2019 09:09	28/11/2019 08:23	30/11/2019 09:09	48,76	2	97,52	CHI
201911349533	SAO SIMAO	SO21216658	CACHOEIRA ALTA	28/11/2019 08:24	28/11/2019 13:22	28/11/2019 08:24	28/11/2019 13:22	4,98	1	4,98	CHI
201911349550	COLINAS DO SUL	TI12232369RE	MINACU	28/11/2019 07:22	28/11/2019 11:07	28/11/2019 07:22	28/11/2019 11:07	3,74	13	48,56	CHI
201911349550	CAVALCANTE	TI12232369RE	MINACU	28/11/2019 07:22	28/11/2019 11:07	28/11/2019 07:22	28/11/2019 11:07	3,74	3	11,21	CHI
201911349553	PORANGATU	PO12365598	PORANGATU	28/11/2019 06:14	28/11/2019 11:58	28/11/2019 06:14	28/11/2019 11:58	5,73	8	45,83	CHI
201911349555	PIRANHAS	PH21201987	ARENOPOLIS	28/11/2019 08:27	28/11/2019 13:46	28/11/2019 08:27	28/11/2019 13:46	5,31	1	5,31	CHI
201911349557	SIMOLANDIA	SA21344394	IACIARA S2	28/11/2019 08:27	28/11/2019 10:16	28/11/2019 08:27	28/11/2019 10:16	1,81	1	1,81	CHI
201911349566	PIRENOPOLIS	PV21185525	CORUMBA	28/11/2019 08:29	28/11/2019 13:11	28/11/2019 08:29	28/11/2019 13:11	4,69	2	9,38	CHI
201911349573	MONTE ALEGRE DE GOIAS	MA12212699	SAO DOMINGOS	28/11/2019 08:31	28/11/2019 11:19	28/11/2019 08:31	28/11/2019 11:19	2,79	63	176,03	CHI
201911349575	SAO DOMINGOS	SD21344089	SAO DOMINGOS	28/11/2019 08:31	28/11/2019 13:04	28/11/2019 08:31	28/11/2019 13:04	4,54	1	4,54	CHI
201911349581	URUACU	640093772	URUACU	28/11/2019 08:32	28/11/2019 15:01	28/11/2019 08:32	28/11/2019 15:01	6,48	1	6,48	CHI
201911349582	PIRACANJUBA	PJ12263257	CALDAS NOVAS S1	28/11/2019 08:09	28/11/2019 10:35	28/11/2019 08:09	28/11/2019 10:35	2,43	8	19,43	CHI

201911349592	NIQUELANDIA	NQ12232353	NIQUELANDIA SUBTRANSMISSAO	28/11/2019 08:32	28/11/2019 19:10	28/11/2019 08:32	28/11/2019 19:10	10,63	1	10,63	CHI
201911349594	GOIATUBA	BJ21000092	BOM JESUS DE GOIAS	28/11/2019 08:33	28/11/2019 11:39	28/11/2019 08:33	28/11/2019 11:39	3,10	1	3,10	CHI
201911349597	IPORA	AM12060715	IPORA	28/11/2019 05:52	28/11/2019 10:10	28/11/2019 05:52	28/11/2019 10:10	4,29	4	17,16	CHI
201911349597	AMORINOPOLIS	AM12060715	IPORA	28/11/2019 05:52	28/11/2019 10:10	28/11/2019 05:52	28/11/2019 10:10	4,29	22	94,40	CHI
201911349703	NIQUELANDIA	NQ12256380	NIQUELANDIA SUBTRANSMISSAO	28/11/2019 08:33	28/11/2019 13:05	28/11/2019 08:33	28/11/2019 13:05	4,52	12	54,28	CHI
201911349704	GOIAS	GS12274373	GOIAS	27/11/2019 23:29	28/11/2019 10:55	27/11/2019 23:29	28/11/2019 10:55	11,43	12	137,18	CHI
201911349712	PLANALTINA	10023852052	PLANALTINA	28/11/2019 08:34	28/11/2019 11:20	28/11/2019 08:34	28/11/2019 11:20	2,78	1	2,78	CHI
201911349716	MINEIROS	MY21358859	PARQUE DAS EMAS	28/11/2019 08:34	28/11/2019 12:39	28/11/2019 08:34	28/11/2019 12:39	4,07	1	4,07	CHI
201911349717	JATAI	JT11379634	JATAI S2	28/11/2019 08:34	28/11/2019 14:38	28/11/2019 08:34	28/11/2019 14:38	6,05	4	24,21	CHI
201911349723	NIQUELANDIA	NQ21318507	NIQUELANDIA SUBTRANSMISSAO	28/11/2019 08:35	29/11/2019 06:02	28/11/2019 08:35	29/11/2019 06:02	21,44	1	21,44	CHI
201911349726	ITAPURANGA	IK12071747	ITAPURANGA	28/11/2019 06:35	29/11/2019 10:16	28/11/2019 06:35	29/11/2019 10:16	27,68	53	1467,26	CHI
201911349727	ITUMBIARA	IT11000156	ITUMBIARA VELHA S1	28/11/2019 08:35	28/11/2019 10:54	28/11/2019 08:35	28/11/2019 10:54	2,31	175	404,49	CHI
201911349747	GOIANDIRA	2010023840	CATALAO S1	28/11/2019 08:37	28/11/2019 14:13	28/11/2019 08:37	28/11/2019 14:13	5,60	1	5,60	CHI
201911349751	RIO VERDE	RV21093126	RIO VERDE S1	28/11/2019 08:38	28/11/2019 17:55	28/11/2019 08:38	28/11/2019 17:50	9,20	1	9,20	CHI
201911349751	RIO VERDE	RV12093125	RIO VERDE S1	28/11/2019 08:38	28/11/2019 17:55	28/11/2019 16:41	28/11/2019 17:55	1,23	4	4,93	CHI
201911349770	PADRE BERNARDO	2760040362	PADRE BERNARDO	28/11/2019 08:40	28/11/2019 11:58	28/11/2019 08:40	28/11/2019 11:58	3,30	1	3,30	CHI
201911349777	PIRES DO RIO	460082802	PIRES DO RIO S2	28/11/2019 08:40	28/11/2019 15:15	28/11/2019 08:40	28/11/2019 15:15	6,59	1	6,59	CHI
201911349780	GOIANIA	11862555	REAL S1	28/11/2019 08:40	28/11/2019 10:16	28/11/2019 08:40	28/11/2019 10:16	1,59	1	1,59	CHI
201911349781	GOIAS	GS12068548	MATRINCHA	28/11/2019 06:09	28/11/2019 14:28	28/11/2019 06:09	28/11/2019 14:28	8,31	41	340,51	CHI
201911349788	IPORA	730120041	IPORA	28/11/2019 08:42	28/11/2019 11:50	28/11/2019 08:42	28/11/2019 11:50	3,15	1	3,15	CHI
201911349789	TRINDADE	TR32052849	TRINDADE	28/11/2019 14:51	28/11/2019 15:44	28/11/2019 14:51	28/11/2019 15:44	0,88	11	9,69	CHI
201911349808	INHUMAS	30186407	INHUMAS S2	28/11/2019 08:46	28/11/2019 14:55	28/11/2019 08:46	28/11/2019 14:55	6,15	1	6,15	CHI
201911349819	CRIXAS	CX12380748	SERRA DO OURO	28/11/2019 07:48	30/11/2019 03:28	28/11/2019 07:48	30/11/2019 03:28	43,66	26	1135,17	CHI
201911349822	FORMOSA	FA12248883	ITUIQUIRA	28/11/2019 07:38	28/11/2019 13:41	28/11/2019 07:38	28/11/2019 13:41	6,05	18	108,86	CHI
201911349901	MAURILANDIA	1040014644	RIO DOS BOIS	28/11/2019 08:47	28/11/2019 12:56	28/11/2019 08:47	28/11/2019 12:56	4,14	1	4,14	CHI
201911349902	CORUMBA DE GOIAS	CB21171994	CORUMBA	28/11/2019 08:47	29/11/2019 10:39	28/11/2019 08:47	29/11/2019 10:39	25,85	1	25,85	CHI
201911349905	JATAI	JT12105239	JATAI S1	28/11/2019 06:37	28/11/2019 14:33	28/11/2019 06:37	28/11/2019 14:33	7,92	3	23,76	CHI
201911349907	AMARALINA	LC12278479	MARA ROSA	28/11/2019 08:48	28/11/2019 22:43	28/11/2019 08:48	28/11/2019 22:43	13,92	1	13,92	CHI
201911349919	MOZARLANDIA	MZ12157802	MOZARLANDIA	28/11/2019 08:49	28/11/2019 16:23	28/11/2019 08:49	28/11/2019 16:23	7,56	3	22,67	CHI
201911349928	FAZENDA NOVA	2290002441	IPORA	28/11/2019 08:51	29/11/2019 10:45	28/11/2019 08:51	29/11/2019 10:45	25,89	1	25,89	CHI
201911349929	EDEIA	1120009458	EDEIA	28/11/2019 08:49	28/11/2019 12:02	28/11/2019 08:49	28/11/2019 12:02	3,22	1	3,22	CHI
201911349932	CRISTALINA	KR12230266	PAMPLONA	28/11/2019 08:52	28/11/2019 11:45	28/11/2019 08:52	28/11/2019 11:45	2,88	7	20,16	CHI
201911349936	FORMOSA	FA11053613	ITUIQUIRA	28/11/2019 08:53	28/11/2019 10:17	28/11/2019 08:53	28/11/2019 10:17	1,39	290	404,47	CHI



201911349938	QUIRINOPOLIS	QI31049538	QUIRINOPOLIS	28/11/2019 08:53	28/11/2019 10:36	28/11/2019 08:53	28/11/2019 10:36	1,71	1	1,71	CHI
201911349944	PIRENOPOLIS	ZN21259006	COCALZINHO	28/11/2019 08:53	29/11/2019 14:49	28/11/2019 08:53	29/11/2019 14:49	29,92	1	29,92	CHI
201911349956	RUBIATABA	RB12401680	RUBIATABA	28/11/2019 07:20	29/11/2019 16:24	28/11/2019 07:20	29/11/2019 16:24	33,06	4	132,23	CHI
201911349958	GAMELEIRA DE GOIAS	SV21236994	DAIA S2	28/11/2019 08:54	28/11/2019 15:59	28/11/2019 08:54	28/11/2019 15:59	7,07	4	28,27	CHI
201911349966	ITAPIRAPUA	IU12378860	MATRINCHA	28/11/2019 05:20	28/11/2019 17:07	28/11/2019 05:20	28/11/2019 17:07	11,77	71	835,89	CHI
201911349967	GAMELEIRA DE GOIAS	AN11273412	DAIA S1	28/11/2019 08:55	28/11/2019 15:09	28/11/2019 08:55	28/11/2019 15:09	6,24	31	193,39	CHI
201911349973	DAMOLANDIA	DL21280550	INHUMAS S1	28/11/2019 08:56	28/11/2019 12:54	28/11/2019 08:56	28/11/2019 12:54	3,96	1	3,96	CHI
201911349974	NOVO BRASIL	NB12396223	JUSSARA	28/11/2019 08:09	29/11/2019 10:19	28/11/2019 08:09	29/11/2019 10:19	26,15	4	104,62	CHI
201911349975	GOIANIA	12497290	GOIANIA LESTE S1	28/11/2019 08:56	28/11/2019 13:22	28/11/2019 08:56	28/11/2019 13:22	4,42	1	4,42	CHI
201911349976	CACHOEIRA DOURADA	CD21222515	CACHOEIRA DOURADA	28/11/2019 08:57	28/11/2019 12:07	28/11/2019 08:57	28/11/2019 12:07	3,17	2	6,33	CHI
201911349978	PIRACANJUBA	PJ12000213	PIRACANJUBA	27/11/2019 17:22	29/11/2019 13:43	27/11/2019 17:22	29/11/2019 13:43	44,35	5	221,75	CHI
201911349983	ARAGARCAS	1820053304	ARAGARCAS	28/11/2019 08:57	28/11/2019 13:25	28/11/2019 08:57	28/11/2019 13:25	4,47	1	4,47	CHI
201911349985	ARUANA	AK12250804	ARUANA	28/11/2019 07:09	28/11/2019 14:11	28/11/2019 07:09	28/11/2019 14:11	7,02	31	217,57	CHI
201911349987	ARUANA	AK11281048	ARUANA	28/11/2019 07:04	28/11/2019 12:07	28/11/2019 07:04	28/11/2019 12:07	5,04	65	327,74	CHI
201911349991	ITUMBIARA	IT21122335	ITUMBIARA NOVA	28/11/2019 08:58	28/11/2019 10:27	28/11/2019 08:58	28/11/2019 10:27	1,48	1	1,48	CHI
201911349992	ITAUCU	110006215	INHUMAS S1	28/11/2019 08:58	28/11/2019 21:09	28/11/2019 08:58	28/11/2019 21:09	12,19	1	12,19	CHI
201911349993	UIRAPURU	UP12244464	NOVA CRIXAS	28/11/2019 08:07	29/11/2019 14:25	28/11/2019 08:07	29/11/2019 14:25	30,31	24	727,35	CHI
201911349997	NIQUELANDIA	NQ12314130	NIQUELANDIA SUBTRANSMISSAO	28/11/2019 08:49	28/11/2019 13:45	28/11/2019 08:49	28/11/2019 13:45	4,93	12	59,19	CHI
201911349998	GOIATUBA	GT21222540	GOIATUBA S1	28/11/2019 08:59	28/11/2019 16:47	28/11/2019 08:59	28/11/2019 16:47	7,81	1	7,81	CHI
201911350001	ITAPURANGA	170101599	ITAPURANGA	28/11/2019 08:59	28/11/2019 14:35	28/11/2019 08:59	28/11/2019 14:35	5,59	1	5,59	CHI
201911350005	JATAI	10000473071	JATAI S2	28/11/2019 09:00	28/11/2019 13:44	28/11/2019 09:00	28/11/2019 13:44	4,73	1	4,73	CHI
201911350008	QUIRINOPOLIS	QI21134272	QUIRINOPOLIS	28/11/2019 09:00	28/11/2019 12:50	28/11/2019 09:00	28/11/2019 12:50	3,83	1	3,83	CHI
201911350011	PIRACANJUBA	PJ12249794	CALDAS NOVAS S1	28/11/2019 09:01	28/11/2019 13:27	28/11/2019 09:01	28/11/2019 13:27	4,43	2	8,86	CHI
201911350013	LUZIANIA	3200104889	MARAJOARA	28/11/2019 09:01	28/11/2019 10:35	28/11/2019 09:01	28/11/2019 10:35	1,56	1	1,56	CHI
201911350016	AGUAS LINDAS DE GOIAS	4830427335	AGUAS LINDAS DE GOIAS S2	28/11/2019 09:01	28/11/2019 12:27	28/11/2019 09:01	28/11/2019 12:27	3,42	1	3,42	CHI
201911350019	URUACU	640124781	URUACU	28/11/2019 09:01	28/11/2019 11:37	28/11/2019 09:01	28/11/2019 11:37	2,59	1	2,59	CHI
201911350020	INDIARA	IY12056554	EDEIA	28/11/2019 09:01	28/11/2019 19:11	28/11/2019 09:01	28/11/2019 19:11	10,16	1	10,16	CHI
201911350022	ITAPIRAPUA	IU12020174	JUSSARA	28/11/2019 06:20	28/11/2019 16:21	28/11/2019 06:20	28/11/2019 16:21	10,01	5	50,06	CHI
201911350029	RIO VERDE	10002944748	RIO VERDE S1	28/11/2019 09:03	28/11/2019 12:35	28/11/2019 09:03	28/11/2019 12:35	3,52	1	3,52	CHI
201911350031	ESTRELA DO NORTE	ET21265525	MARA ROSA	28/11/2019 09:04	29/11/2019 15:50	28/11/2019 09:04	29/11/2019 15:50	30,76	1	30,76	CHI
201911350035	HEITORAI	HE12310804	ITABERAI S1	28/11/2019 09:04	28/11/2019 17:36	28/11/2019 09:04	28/11/2019 17:36	8,52	20	170,40	CHI
201911350035	ITABERAI	HE12310804	ITABERAI S1	28/11/2019 09:04	28/11/2019 17:36	28/11/2019 09:04	28/11/2019 17:36	8,52	1	8,52	CHI
201911350038	NOVO GAMA	4990063339	PACAEMBU S1	28/11/2019 09:05	28/11/2019 10:27	28/11/2019 09:05	28/11/2019 10:27	1,37	1	1,37	CHI

201911350045	ANICUNS	AC12391420	ANICUNS	28/11/2019 08:42	28/11/2019 10:29	28/11/2019 08:42	28/11/2019 10:29	1,79	322	576,56	CHI
201911350050	SANTA RITA DO NOVO DESTINO	GE21000332	BARRO ALTO	28/11/2019 09:07	29/11/2019 15:32	28/11/2019 09:07	29/11/2019 15:32	30,42	1	30,42	CHI
201911350051	GOIAS	8528161	GOIAS	28/11/2019 09:07	28/11/2019 13:06	28/11/2019 09:07	28/11/2019 13:06	3,99	2	7,97	CHI
201911350057	GUARANI DE GOIAS	GY12276037	IACIARA S1	29/11/2019 07:04	29/11/2019 13:17	29/11/2019 07:04	29/11/2019 13:17	6,21	77	478,26	CHI
201911350073	SANTA HELENA DE GOIAS	SH21023817	RIO DOS BOIS	28/11/2019 09:09	28/11/2019 12:30	28/11/2019 09:09	28/11/2019 12:30	3,34	1	3,34	CHI
201911350074	INHUMAS	30172093	INHUMAS S2	28/11/2019 09:09	28/11/2019 16:42	28/11/2019 09:09	28/11/2019 16:42	7,54	1	7,54	CHI
201911350077	NIQUELANDIA	2750020159	NIQUELANDIA SUBTRANSMISSAO	28/11/2019 09:09	28/11/2019 14:20	28/11/2019 09:09	28/11/2019 14:20	5,17	0	0,00	CHI
201911350080	URUACU	UR12182465	URUACU	28/11/2019 09:10	29/11/2019 13:10	28/11/2019 09:10	29/11/2019 13:10	28,00	6	167,98	CHI
201911350084	MONTIVIDIU	MV21135917	MONTIVIDIU T	28/11/2019 09:10	28/11/2019 18:10	28/11/2019 09:10	28/11/2019 18:10	8,99	1	8,99	CHI
201911350085	NEROPOLIS	NR12356423	NEROPOLIS S2	28/11/2019 09:10	28/11/2019 10:55	28/11/2019 09:10	28/11/2019 10:55	1,74	8	13,92	CHI
201911350091	ITABERAI	HE12310524	ITABERAI S1	28/11/2019 09:11	28/11/2019 18:51	28/11/2019 09:11	28/11/2019 18:51	9,66	3	28,97	CHI
201911350099	CASTELANDIA	DM21240424	RIO DOS BOIS	28/11/2019 09:13	28/11/2019 17:12	28/11/2019 09:13	28/11/2019 17:12	7,98	1	7,98	CHI
201911350104	URUACU	UR21339116	URUACU	28/11/2019 09:14	29/11/2019 11:41	28/11/2019 09:14	29/11/2019 11:41	26,46	1	26,46	CHI
201911350111	VARJAO	VJ21180482	GUAPO S2	28/11/2019 09:15	28/11/2019 11:50	28/11/2019 09:15	28/11/2019 11:50	2,58	1	2,58	CHI
201911350123	PORANGATU	PO12208396	PORANGATU	28/11/2019 09:16	28/11/2019 15:28	28/11/2019 09:16	28/11/2019 15:28	6,20	1	6,20	CHI
201911350126	NIQUELANDIA	2750068790	NIQUELANDIA SUBTRANSMISSAO	28/11/2019 09:16	28/11/2019 14:52	28/11/2019 09:16	28/11/2019 14:52	5,59	1	5,59	CHI
201911350129	CATALAO	CT12250357RE	CATALAO S1	28/11/2019 09:17	28/11/2019 16:53	28/11/2019 09:17	28/11/2019 16:53	7,61	12	91,34	CHI
201911350129	TRES RANCHOS	CT12250357RE	CATALAO S1	28/11/2019 09:17	28/11/2019 16:53	28/11/2019 09:17	28/11/2019 16:53	7,61	1	7,61	CHI
201911350141	PALMEIRAS DE GOIAS	PL21026609	PALMEIRAS	28/11/2019 09:19	28/11/2019 11:58	28/11/2019 09:19	28/11/2019 11:58	2,66	1	2,66	CHI
201911350142	FORMOSA	FA31211602	ITUIQUIRA	28/11/2019 09:19	28/11/2019 12:19	28/11/2019 09:19	28/11/2019 12:19	3,01	1	3,01	CHI
201911350149	PLANALTINA	2960253468	PLANALTINA	28/11/2019 09:20	28/11/2019 14:50	28/11/2019 09:20	28/11/2019 14:50	5,51	1	5,51	CHI
201911350150	PILAR DE GOIAS	GG12262898	SANTA TEREZINHA	28/11/2019 09:20	29/11/2019 18:29	28/11/2019 09:20	29/11/2019 18:29	33,15	2	66,29	CHI
201911350161	FAINA	FC12038664LD	GOIAS	28/11/2019 07:09	28/11/2019 16:57	28/11/2019 07:09	28/11/2019 16:57	9,79	10	97,92	CHI
201911350163	NIQUELANDIA	20095782	URUACU	28/11/2019 09:22	28/11/2019 13:18	28/11/2019 09:22	28/11/2019 13:18	3,93	4	15,71	CHI
201911350164	GOIANIA	10030602309	FERROVIARIO S3	28/11/2019 09:22	28/11/2019 13:04	28/11/2019 09:22	28/11/2019 13:04	3,69	0	0,00	CHI
201911350166	VICENTINOPOLIS	VI12028470	VICENTINOPOLIS	28/11/2019 09:22	28/11/2019 14:55	28/11/2019 09:22	28/11/2019 14:55	5,55	2	11,10	CHI
201911350168	PORANGATU	PO12202569	PORANGATU	28/11/2019 09:22	29/11/2019 15:50	28/11/2019 09:22	29/11/2019 15:50	30,45	6	182,73	CHI
201911350169	GOIANIA	GN12372441	GOIANIA LESTE S2	28/11/2019 09:22	28/11/2019 15:06	28/11/2019 09:22	28/11/2019 15:06	5,72	98	560,51	CHI
201911350173	URUACU	10017516860	URUACU	28/11/2019 09:23	28/11/2019 18:54	28/11/2019 09:23	28/11/2019 18:54	9,51	1	9,51	CHI
201911350180	SAO LUIS DE MONTES BELOS	SL21061318	SAO LUIZ DOS MONTES BELOS	28/11/2019 09:25	29/11/2019 18:14	28/11/2019 09:25	29/11/2019 18:14	32,82	1	32,82	CHI
201911350182	ACREUNA	EU11031192	ACREUNA	28/11/2019 09:25	28/11/2019 12:40	28/11/2019 09:25	28/11/2019 12:40	3,26	112	364,62	CHI
201911350189	CRISTALINA	KR12237804	CRISTALINA S1	28/11/2019 09:26	28/11/2019 11:32	28/11/2019 09:26	28/11/2019 11:32	2,10	6	12,59	CHI
201911350190	ANICUNS	AC12189632	ANICUNS	28/11/2019 09:05	28/11/2019 14:05	28/11/2019 09:05	28/11/2019 14:05	5,00	6	30,00	CHI

201911350195	CRISTALINA	1060039191	CRISTALINA S1	28/11/2019 09:26	28/11/2019 11:19	28/11/2019 09:26	28/11/2019 11:19	1,88	1	1,88	CHI
201911350206	PILAR DE GOIAS	GG12325151	SANTA TEREZINHA	28/11/2019 09:28	29/11/2019 15:45	28/11/2019 09:28	29/11/2019 15:45	30,28	6	181,67	CHI
201911350210	NIQUELANDIA	NQ12236697	NIQUELANDIA SUBTRANSMISSAO	28/11/2019 09:28	29/11/2019 09:53	28/11/2019 09:28	29/11/2019 09:53	24,41	4	97,63	CHI
201911350211	JUSSARA	JR12118238	JUSSARA	28/11/2019 09:28	29/11/2019 07:53	28/11/2019 09:28	29/11/2019 07:53	22,40	1	22,40	CHI
201911350212	NOVA AMERICA	NM12235977	RUBIATABA	28/11/2019 07:32	29/11/2019 13:30	28/11/2019 07:32	29/11/2019 13:30	29,97	5	149,83	CHI
201911350213	JATAI	JT12196099	JATAI S1	28/11/2019 09:28	28/11/2019 15:25	28/11/2019 09:28	28/11/2019 15:25	5,94	2	11,87	CHI
201911350219	COCALZINHO DE GOIAS	ZN12297780	COCALZINHO	28/11/2019 08:24	28/11/2019 22:02	28/11/2019 08:24	28/11/2019 22:02	13,62	9	122,59	CHI
201911350226	GOIAS	GS12073673	MATRINCHA	28/11/2019 09:10	29/11/2019 12:55	28/11/2019 09:10	29/11/2019 12:55	27,74	10	277,35	CHI
201911350227	VIANOPOLIS	510026620	VIANOPOLIS	28/11/2019 09:31	28/11/2019 20:06	28/11/2019 09:31	28/11/2019 20:06	10,58	1	10,58	CHI
201911350234	PIRANHAS	PH12223156	PIRANHAS	28/11/2019 09:32	28/11/2019 17:47	28/11/2019 09:32	28/11/2019 17:47	8,24	7	57,69	CHI
201911350236	PIRACANJUBA	PJ21199398	PIRACANJUBA	28/11/2019 09:32	28/11/2019 19:30	28/11/2019 09:32	28/11/2019 19:30	9,95	1	9,95	CHI
201911350238	FORMOSA	FA11397069	ITIQUEIRA	29/11/2019 14:50	29/11/2019 21:44	29/11/2019 14:50	29/11/2019 21:44	6,89	1	6,89	CHI
201911350256	FAINA	FC11198853	ITAPURANGA	28/11/2019 08:09	28/11/2019 17:45	28/11/2019 08:09	28/11/2019 17:45	9,60	88	845,09	CHI
201911350257	HEITORAI	HE12099418	ITAPURANGA	28/11/2019 06:18	28/11/2019 19:29	28/11/2019 06:18	28/11/2019 19:29	13,18	38	500,77	CHI
201911350259	GUARAITA	GK21299358	ITAPURANGA	28/11/2019 09:35	28/11/2019 12:21	28/11/2019 09:35	28/11/2019 12:21	2,76	1	2,76	CHI
201911350268	CALDAS NOVAS	760189092	SERRA DE CALDAS	28/11/2019 09:36	28/11/2019 10:28	28/11/2019 09:36	28/11/2019 10:28	0,87	1	0,87	CHI
201911350269	GOIAS	GS12336540	GOIAS	28/11/2019 07:26	28/11/2019 15:40	28/11/2019 07:26	28/11/2019 15:40	8,22	8	65,79	CHI
201911350283	POSSE	PS12318355	IACIARA S2	28/11/2019 09:39	28/11/2019 11:31	28/11/2019 09:39	28/11/2019 11:31	1,86	1	1,86	CHI
201911350284	PIRENOPOLIS	PV12360338RE	CORUMBA	28/11/2019 08:55	28/11/2019 11:38	28/11/2019 08:55	28/11/2019 11:38	2,71	93	252,44	CHI
201911350287	NIQUELANDIA	2750049757	NIQUELANDIA SUBTRANSMISSAO	28/11/2019 09:39	28/11/2019 15:47	28/11/2019 09:39	28/11/2019 15:47	6,12	1	6,12	CHI
201911350288	CALDAS NOVAS	760118784	SERRA DE CALDAS	28/11/2019 09:39	28/11/2019 18:31	28/11/2019 09:39	28/11/2019 18:31	8,85	1	8,85	CHI
201911350294	CRIXAS	2490033718	SERRA DO OURO	28/11/2019 09:41	29/11/2019 13:44	28/11/2019 09:41	29/11/2019 13:44	28,05	1	28,05	CHI
201911350296	HIDROLANDIA	HD12383437	CEPAIGO S2	28/11/2019 09:42	28/11/2019 13:57	28/11/2019 09:42	28/11/2019 13:57	4,25	2	8,50	CHI
201911350308	PIRES DO RIO	OZ12022847	PIRES DO RIO S2	28/11/2019 09:43	28/11/2019 15:58	28/11/2019 09:43	28/11/2019 15:58	6,24	8	49,88	CHI
201911350310	VILA PROPICIO	PV21074934	GOIANESIA S1	28/11/2019 09:44	29/11/2019 08:05	28/11/2019 09:44	29/11/2019 08:05	22,36	1	22,36	CHI
201911350312	SAO MIGUEL DO ARAGUAIA	SM12211095	SAO MIGUEL DO ARAGUAIA	28/11/2019 08:38	28/11/2019 18:30	28/11/2019 08:38	28/11/2019 18:30	9,87	131	1292,53	CHI
201911350322	ARAGARCAS	1820063103	ARAGARCAS	28/11/2019 09:45	28/11/2019 16:19	28/11/2019 09:45	28/11/2019 16:19	6,55	1	6,55	CHI
201911350323	SANTA BARBARA DE GOIAS	SB12000156	TRINDADE	28/11/2019 09:45	28/11/2019 12:32	28/11/2019 09:45	28/11/2019 12:32	2,77	10	27,70	CHI
201911350328	SAO LUIS DE MONTES BELOS	500072917	SAO LUIZ DOS MONTES BELOS	28/11/2019 09:46	28/11/2019 15:19	28/11/2019 09:46	28/11/2019 15:19	5,54	0	0,00	CHI
201911350330	ANAPOLIS	20831936	ANAPOLIS UNIVERSITARIO S1	28/11/2019 09:46	28/11/2019 11:11	28/11/2019 09:46	28/11/2019 11:11	1,40	1	1,40	CHI
201911350332	LEOPOLDO DE BULHOES	LB12000004	DAIA S2	28/11/2019 08:52	28/11/2019 11:41	28/11/2019 08:52	28/11/2019 11:41	2,82	347	978,83	CHI
201911350333	BURITI DE GOIAS	BS21300405	FIRMINOPOLIS S2	28/11/2019 09:47	28/11/2019 14:28	28/11/2019 09:47	28/11/2019 14:28	4,68	1	4,68	CHI
201911350334	MINACU	4020016060	MINACU	28/11/2019 09:47	28/11/2019 21:44	28/11/2019 09:47	28/11/2019 21:44	11,94	1	11,94	CHI

201911350336	MUNDO NOVO DE GOIAS	MH12274898	NOVA CRIXAS	28/11/2019 08:38	30/11/2019 01:49	28/11/2019 08:38	30/11/2019 01:49	41,17	3	123,51	CHI
201911350344	SAO FRANCISCO DE GOIAS	SF21074638	SAO FRANCISCO DE GOIAS	28/11/2019 09:52	28/11/2019 10:43	28/11/2019 09:52	28/11/2019 10:43	0,85	2	1,70	CHI
201911350348	BARRO ALTO	7587669	GOIANESIA S1	28/11/2019 09:51	29/11/2019 12:15	28/11/2019 09:51	29/11/2019 12:15	26,40	7	184,82	CHI
201911350349	GOIANIA	13238693	CAMPINAS S2	28/11/2019 09:51	28/11/2019 15:24	28/11/2019 09:51	28/11/2019 15:24	5,54	1	5,54	CHI
201911350363	MINACU	IH21338797	MINACU	28/11/2019 09:50	29/11/2019 00:08	28/11/2019 09:50	29/11/2019 00:08	14,29	2	28,58	CHI
201911350369	RIO VERDE	10004444645	RIO VERDE S1	28/11/2019 09:52	28/11/2019 12:22	28/11/2019 09:52	28/11/2019 12:22	2,50	1	2,50	CHI
201911350371	ITUMBIARA	10027847789	ITUMBIARA NOVA	28/11/2019 09:52	28/11/2019 15:19	28/11/2019 09:52	28/11/2019 15:19	5,44	1	5,44	CHI
201911350380	MONTE ALEGRE DE GOIAS	MA21253176	SAO DOMINGOS	28/11/2019 09:54	28/11/2019 20:00	28/11/2019 09:54	28/11/2019 20:00	10,09	1	10,09	CHI
201911350382	GOIANIA	14737449	CARAJAS S1	28/11/2019 09:55	28/11/2019 14:51	28/11/2019 09:55	28/11/2019 14:51	4,93	1	4,93	CHI
201911350383	MAIRIPOTABA	MI12000430	PONTALINA	28/11/2019 09:55	28/11/2019 17:12	28/11/2019 09:55	28/11/2019 15:17	5,38	3	16,14	CHI
201911350383	MAIRIPOTABA	MI12000433	PONTALINA	28/11/2019 09:55	28/11/2019 17:12	28/11/2019 09:55	28/11/2019 17:12	7,29	1	7,29	CHI
201911350387	CAIAPONIA	CP12097751	CAIAPONIA	28/11/2019 09:05	28/11/2019 17:25	28/11/2019 09:05	28/11/2019 17:25	8,33	100	832,86	CHI
201911350396	MOIPORA	1450003180	IPORA	28/11/2019 09:58	29/11/2019 11:26	28/11/2019 09:58	29/11/2019 11:26	25,46	1	25,46	CHI
201911350398	BALIZA	DV21137080	CAIAPONIA	28/11/2019 09:58	29/11/2019 08:51	28/11/2019 09:58	29/11/2019 08:51	22,88	1	22,88	CHI
201911350403	MINEIROS	MY12209668	PARQUE DAS EMAS	28/11/2019 09:01	28/11/2019 17:40	28/11/2019 09:01	28/11/2019 17:40	8,65	89	769,90	CHI
201911350404	SAO JOAO D ALIANCA	JL11242658	SAO JOAO D ALIANCA	28/11/2019 09:59	28/11/2019 21:48	28/11/2019 09:59	28/11/2019 21:48	11,80	1	11,80	CHI
201911350408	SAO LUIS DE MONTES BELOS	500115059	SAO LUIZ DOS MONTES BELOS	28/11/2019 10:00	28/11/2019 11:50	28/11/2019 10:00	28/11/2019 11:50	1,83	1	1,83	CHI
201911350409	CRIXAS	CX21150744	SANTA TEREZINHA	28/11/2019 09:55	01/12/2019 23:20	28/11/2019 09:55	01/12/2019 23:20	85,41	1	85,41	CHI
201911350446	GOIATUBA	GT31044948	GOIATUBA S2	28/11/2019 10:05	28/11/2019 10:49	28/11/2019 10:05	28/11/2019 10:49	0,72	1	0,72	CHI
201911350447	SAO DOMINGOS	GY21344068	SAO DOMINGOS	28/11/2019 08:07	28/11/2019 14:45	28/11/2019 08:07	28/11/2019 14:45	6,63	1	6,63	CHI
201911350452	BARRO ALTO	BA21342222	GOIANESIA S1	28/11/2019 10:07	29/11/2019 12:55	28/11/2019 10:07	29/11/2019 12:55	26,79	1	26,79	CHI
201911350460	JATAI	290342351	JATAI S1	28/11/2019 10:03	28/11/2019 14:27	28/11/2019 10:03	28/11/2019 14:27	4,38	1	4,38	CHI
201911350468	GOIANIA	10506184	GOIANIA LESTE S1	28/11/2019 10:05	28/11/2019 13:05	28/11/2019 10:05	28/11/2019 13:05	3,01	1	3,01	CHI
201911350470	CAMPINORTE	CR12266635	MARA ROSA	28/11/2019 09:54	28/11/2019 19:16	28/11/2019 09:54	28/11/2019 19:16	9,37	6	56,20	CHI
201911350471	NAZARIO	NZ12003986	ANICUNS	28/11/2019 08:26	28/11/2019 11:19	28/11/2019 08:26	28/11/2019 11:19	2,88	5	14,41	CHI
201911350476	BOM JESUS DE GOIAS	BJ12316132	BOM JESUS DE GOIAS	28/11/2019 10:08	28/11/2019 21:45	28/11/2019 10:08	28/11/2019 21:45	11,61	1	11,61	CHI
201911350485	MINACU	IH21236051	MINACU	28/11/2019 10:09	29/11/2019 08:04	28/11/2019 10:09	29/11/2019 08:04	21,91	1	21,91	CHI
201911350486	GOIAS	GS21059821	ITABERAÍ S1	28/11/2019 10:09	28/11/2019 12:08	28/11/2019 10:09	28/11/2019 12:08	1,98	1	1,98	CHI
201911350492	LUZIANIA	LZ12203332	VIANOPOLIS	28/11/2019 10:10	28/11/2019 11:53	28/11/2019 10:10	28/11/2019 11:53	1,70	10	17,03	CHI
201911350501	AMERICANO DO BRASIL	1410019825	ANICUNS	28/11/2019 10:11	28/11/2019 15:00	28/11/2019 10:11	28/11/2019 15:00	4,81	1	4,81	CHI
201911350506	PIRENOPOLIS	AN21221543	ANAPOLIS UNIVERSITARIO S2	28/11/2019 10:11	28/11/2019 17:23	28/11/2019 10:11	28/11/2019 17:23	7,19	1	7,19	CHI
201911350513	GOIANIA	10637394	AEROPORTO S2	28/11/2019 10:13	28/11/2019 12:03	28/11/2019 10:13	28/11/2019 12:03	1,83	1	1,83	CHI
201911350514	GOIANIA	13326636	FERROVIARIO S2	28/11/2019 10:14	28/11/2019 14:26	28/11/2019 10:14	28/11/2019 14:26	4,19	1	4,19	CHI

201911350518	ALTO PARAISO DE GOIAS	10022845354	NIQUELANDIA SUBTRANSMISSAO	28/11/2019 10:15	28/11/2019 16:27	28/11/2019 10:15	28/11/2019 16:27	6,19	1	6,19	CHI
201911350524	PIRACANJUBA	PJ21060895	PIRACANJUBA	28/11/2019 10:17	28/11/2019 14:23	28/11/2019 10:17	28/11/2019 14:23	4,09	1	4,09	CHI
201911350526	RIO VERDE	RV21213395	MONTIVIDIU T	28/11/2019 10:18	28/11/2019 12:25	28/11/2019 10:18	28/11/2019 12:25	2,10	1	2,10	CHI
201911350527	MONTES CLAROS DE GOIAS	ME21183237	BRITANIA	28/11/2019 10:18	28/11/2019 20:38	28/11/2019 10:18	28/11/2019 20:38	10,32	1	10,32	CHI
201911350530	GOIANIA	17073832	AEROPORTO S1	28/11/2019 10:19	28/11/2019 11:58	28/11/2019 10:19	28/11/2019 11:58	1,64	1	1,64	CHI
201911350534	CALDAS NOVAS	IP21223574	IPAMERI	28/11/2019 10:10	28/11/2019 19:14	28/11/2019 10:10	28/11/2019 19:14	9,06	1	9,06	CHI
201911350538	SANTO ANTONIO DO DESCOBERTO	SN11151467	ALEXANIA	28/11/2019 10:12	28/11/2019 12:03	28/11/2019 10:12	28/11/2019 12:03	1,84	185	339,78	CHI
201911350601	CRIXAS	CX12145539	RUBIATABA	28/11/2019 10:13	30/11/2019 01:36	28/11/2019 10:13	30/11/2019 01:36	39,38	19	748,21	CHI
201911350606	CALDAS NOVAS	760189092	SERRA DE CALDAS	28/11/2019 10:29	28/11/2019 17:18	28/11/2019 10:29	28/11/2019 17:18	6,80	1	6,80	CHI
201911350607	ANAPOLIS	AN11412733	DAIA S1	28/11/2019 10:15	28/11/2019 23:26	28/11/2019 10:15	28/11/2019 23:26	13,17	3	39,51	CHI
201911350709	GAMELEIRA DE GOIAS	SV12278872	DAIA S2	28/11/2019 10:23	28/11/2019 15:16	28/11/2019 10:23	28/11/2019 15:16	4,87	4	19,49	CHI
201911350805	QUIRINOPOLIS	QI21279792	QUIRINOPOLIS	28/11/2019 10:26	29/11/2019 09:24	28/11/2019 10:26	29/11/2019 09:24	22,97	1	22,97	CHI
201911350820	PARAUNA	EU21000136	ACREUNA	28/11/2019 10:21	28/11/2019 15:05	28/11/2019 10:21	28/11/2019 15:05	4,74	1	4,74	CHI
201911350904	VILA PROPICIO	GE11321379	GOIANESIA S2	28/11/2019 10:27	29/11/2019 11:09	28/11/2019 10:27	29/11/2019 11:09	24,69	1	24,69	CHI
201911350908	ABADIA DE GOIAS	5583732410	CARAJAS S1	28/11/2019 10:28	28/11/2019 13:14	28/11/2019 10:28	28/11/2019 13:14	2,76	1	2,76	CHI
201911350914	INDIARA	IY21312430	CEZARINA	28/11/2019 10:29	29/11/2019 11:30	28/11/2019 10:29	29/11/2019 11:30	25,02	1	25,02	CHI
201911350915	JATAI	JT21348498	JATAI S1	28/11/2019 10:30	28/11/2019 12:49	28/11/2019 10:30	28/11/2019 12:49	2,32	1	2,32	CHI
201911350916	GUARANI DE GOIAS	GY12268029	IACIARA S1	28/11/2019 09:03	28/11/2019 17:50	28/11/2019 09:03	28/11/2019 17:50	8,78	6	52,66	CHI
201911350922	ITUMBIARA	10016942831	ITUMBIARA VELHA S1	28/11/2019 10:31	28/11/2019 12:20	28/11/2019 10:31	28/11/2019 12:20	1,81	0	0,00	CHI
201911350925	RUBIATABA	RB12132695	RUBIATABA	28/11/2019 06:21	29/11/2019 09:23	28/11/2019 06:21	29/11/2019 09:23	27,03	107	2892,12	CHI
201911350926	PARAUNA	RP21102349	PARAUNA	28/11/2019 10:32	28/11/2019 15:21	28/11/2019 10:32	28/11/2019 12:38	2,11	1	2,11	CHI
201911350926	PARAUNA	PU12083901LD	PARAUNA	28/11/2019 10:32	28/11/2019 15:21	28/11/2019 12:38	28/11/2019 15:21	2,72	21	57,05	CHI
201911350927	VALPARAISO DE GOIAS	10004116389	PACAEMBU S2	28/11/2019 10:32	28/11/2019 12:36	28/11/2019 10:32	28/11/2019 12:36	2,06	1	2,06	CHI
201911350930	SENADOR CANEDO	10020400665	SENADOR CANEDO	28/11/2019 10:33	28/11/2019 12:24	28/11/2019 10:33	28/11/2019 12:24	1,86	1	1,86	CHI
201911350931	NIQUELANDIA	2750073504	NIQUELANDIA SUBTRANSMISSAO	28/11/2019 10:33	28/11/2019 17:30	28/11/2019 10:33	28/11/2019 17:30	6,94	1	6,94	CHI
201911350935	CRISTALINA	1060090226	CRISTALINA S1	28/11/2019 10:34	28/11/2019 12:26	28/11/2019 10:34	28/11/2019 12:26	1,85	1	1,85	CHI
201911350936	JOVIANIA	570015236	GOIATUBA S1	28/11/2019 10:35	28/11/2019 12:30	28/11/2019 10:35	28/11/2019 12:30	1,92	1	1,92	CHI
201911350938	POSSE	PS21352155	IACIARA S2	28/11/2019 10:35	28/11/2019 16:54	28/11/2019 10:35	28/11/2019 16:54	6,31	1	6,31	CHI
201911350939	URUACU	640110113	URUACU	28/11/2019 10:35	28/11/2019 20:19	28/11/2019 10:35	28/11/2019 20:19	9,73	1	9,73	CHI
201911350947	PORANGATU	PO21254787	MARA ROSA	28/11/2019 10:36	29/11/2019 10:55	28/11/2019 10:36	29/11/2019 10:55	24,30	1	24,30	CHI
201911350956	PIRENOPOLIS	220075852	CORUMBA	28/11/2019 10:37	29/11/2019 19:21	28/11/2019 10:37	29/11/2019 19:21	32,72	1	32,72	CHI
201911350957	ANAPOLIS	AN12204075LD	ANAPOLIS UNIVERSITARIO S2	29/11/2019 13:36	29/11/2019 13:42	29/11/2019 13:36	29/11/2019 13:42	0,09	176	16,23	CHI
201911350959	ITUMBIARA	IT21290329	CACHOEIRA DOURADA	28/11/2019 10:21	28/11/2019 13:35	28/11/2019 10:21	28/11/2019 13:35	3,22	1	3,22	CHI

201911350961	ITAJA	IJ12226574	ITAJA S2	28/11/2019 08:07	28/11/2019 12:43	28/11/2019 08:07	28/11/2019 12:43	4,60	8	36,76	CHI
201911350969	URUACU	CR21190038	CAMPINORTE	28/11/2019 10:39	29/11/2019 12:50	28/11/2019 10:39	29/11/2019 12:50	26,19	3	78,58	CHI
201911350974	DIORAMA	DI21063467	IPORA	28/11/2019 10:39	28/11/2019 18:36	28/11/2019 10:39	28/11/2019 18:36	7,94	1	7,94	CHI
201911350978	SAO FRANCISCO DE GOIAS	SF21021320	SAO FRANCISCO DE GOIAS	28/11/2019 10:40	28/11/2019 11:29	28/11/2019 10:40	28/11/2019 11:29	0,81	1	0,81	CHI
201911350980	PARAUNA	PU12090442	MONTIVIDIU T	28/11/2019 10:40	28/11/2019 17:23	28/11/2019 10:40	28/11/2019 17:23	6,71	48	322,23	CHI
201911350980	IVOLANDIA	PU12090442	MONTIVIDIU T	28/11/2019 10:40	28/11/2019 17:23	28/11/2019 10:40	28/11/2019 17:23	6,71	22	147,69	CHI
201911350981	LUZIANIA	10011087003	MARAJOARA	28/11/2019 10:41	28/11/2019 13:03	28/11/2019 10:41	28/11/2019 13:03	2,37	1	2,37	CHI
201911350985	QUIRINOPOLIS	QI21101234	QUIRINOPOLIS	28/11/2019 10:42	28/11/2019 14:03	28/11/2019 10:42	28/11/2019 14:03	3,35	1	3,35	CHI
201911350988	RIO VERDE	RV12227884	MONTIVIDIU T	28/11/2019 10:42	28/11/2019 15:19	28/11/2019 10:42	28/11/2019 15:19	4,61	7	32,27	CHI
201911350998	MUTUNOPOLIS	MU12170091	MARA ROSA	28/11/2019 10:44	28/11/2019 18:30	28/11/2019 10:44	28/11/2019 18:30	7,77	18	139,79	CHI
201911351000	FORMOSA	TL21344153	SAO JOAO D ALIANCA	28/11/2019 10:45	29/11/2019 15:46	28/11/2019 10:45	29/11/2019 15:46	29,02	1	29,02	CHI
201911351004	IPAMERI	IP21344644	IPAMERI	28/11/2019 10:45	28/11/2019 16:59	28/11/2019 10:45	28/11/2019 16:59	6,22	1	6,22	CHI
201911351006	PONTALINA	AD21108885	GOIATUBA S1	28/11/2019 10:46	28/11/2019 16:45	28/11/2019 10:46	28/11/2019 16:45	5,98	1	5,98	CHI
201911351017	SAO DOMINGOS	SD12170547	SAO DOMINGOS	28/11/2019 10:47	28/11/2019 21:58	28/11/2019 10:47	28/11/2019 21:58	11,17	13	145,27	CHI
201911351018	PADRE BERNARDO	PB12249192	PADRE BERNARDO	28/11/2019 10:47	28/11/2019 12:19	28/11/2019 10:47	28/11/2019 12:19	1,52	20	30,46	CHI
201911351024	JARAGUA	JA11273168	JARAGUA	28/11/2019 10:48	28/11/2019 11:44	28/11/2019 10:48	28/11/2019 11:44	0,93	103	96,02	CHI
201911351030	ANAPOLIS	AN11000302	ANAPOLIS UNIVERSITARIO S2	28/11/2019 10:49	28/11/2019 19:20	28/11/2019 10:49	28/11/2019 12:02	1,21	143	173,47	CHI
201911351030	ANAPOLIS	AN11000302	ANAPOLIS UNIVERSITARIO S2	28/11/2019 10:49	28/11/2019 19:20	28/11/2019 12:37	28/11/2019 19:20	6,71	143	959,93	CHI
201911351033	GOIANIA	GN21227550	CEPAIGO S1	28/11/2019 10:49	28/11/2019 13:18	28/11/2019 10:49	28/11/2019 13:18	2,48	4	9,91	CHI
201911351036	CROMINIA	520008509	PONTALINA	28/11/2019 10:50	28/11/2019 14:10	28/11/2019 10:50	28/11/2019 14:10	3,33	1	3,33	CHI
201911351037	SAO MIGUEL DO PASSA QUATRO	SQ21212539	BELA VISTA S2	28/11/2019 10:50	28/11/2019 17:39	28/11/2019 10:50	28/11/2019 17:39	6,81	1	6,81	CHI
201911351039	PORANGATU	PO12102901	PORANGATU	28/11/2019 10:50	29/11/2019 11:51	28/11/2019 10:50	29/11/2019 11:51	25,01	3	75,03	CHI
201911351041	ANAPOLIS	AN11326397	JUNDIAI S2	28/11/2019 10:50	28/11/2019 12:24	28/11/2019 10:50	28/11/2019 12:24	1,56	50	78,03	CHI
201911351044	URUACU	UR21131404	MARA ROSA	28/11/2019 10:43	29/11/2019 15:35	28/11/2019 10:43	29/11/2019 15:35	28,87	1	28,87	CHI
201911351046	NOVA ROMA	ND12164550	IACIARA S2	28/11/2019 10:28	28/11/2019 15:48	28/11/2019 10:28	28/11/2019 15:48	5,33	217	1156,13	CHI
201911351046	MONTE ALEGRE DE GOIAS	ND12164550	IACIARA S2	28/11/2019 10:28	28/11/2019 15:48	28/11/2019 10:28	28/11/2019 15:48	5,33	1	5,33	CHI
201911351047	BURITINOPOLIS	MB12361385	IACIARA S2	28/11/2019 10:51	28/11/2019 12:11	28/11/2019 10:51	28/11/2019 12:11	1,33	18	23,91	CHI
201911351050	GOIAS	GS12021598	GOIAS	28/11/2019 09:30	29/11/2019 11:00	28/11/2019 09:30	29/11/2019 11:00	25,50	5	127,49	CHI
201911351051	NIQUELANDIA	2750116000	NIQUELANDIA SUBTRANSMISSAO	28/11/2019 10:51	28/11/2019 17:05	28/11/2019 10:51	28/11/2019 17:05	6,22	1	6,22	CHI
201911351054	RIO VERDE	RV12000198	RIO VERDE S1	28/11/2019 10:53	29/11/2019 08:39	28/11/2019 10:53	29/11/2019 08:39	21,77	1	21,77	CHI
201911351056	MONTE ALEGRE DE GOIAS	MA12261947	SAO DOMINGOS	28/11/2019 09:24	28/11/2019 19:17	28/11/2019 09:24	28/11/2019 19:17	9,87	7	69,12	CHI
201911351057	PALMEIRAS DE GOIAS	PL21381359	PALMEIRAS	28/11/2019 10:53	28/11/2019 14:45	28/11/2019 10:53	28/11/2019 14:45	3,87	1	3,87	CHI
201911351058	APARECIDA DE GOIANIA	10005941952	INDEPENDENCIA S2	28/11/2019 10:53	28/11/2019 12:57	28/11/2019 10:53	28/11/2019 12:57	2,06	1	2,06	CHI

201911351061	GUAPO	GA21011347	GUAPO S2	28/11/2019 10:54	28/11/2019 14:40	28/11/2019 10:54	28/11/2019 14:40	3,77	1	3,77	CHI
201911351063	GOIANESIA	GE12000016	GOIANESIA S2	28/11/2019 10:27	28/11/2019 16:56	28/11/2019 10:27	28/11/2019 16:56	6,48	8	51,81	CHI
201911351063	VILA PROPICIO	GE12000016	GOIANESIA S2	28/11/2019 10:27	28/11/2019 16:56	28/11/2019 10:27	28/11/2019 16:56	6,48	5	32,38	CHI
201911351064	CATALAO	IO12131003	CATALAO S1	28/11/2019 10:54	28/11/2019 14:47	28/11/2019 10:54	28/11/2019 14:47	3,88	2	7,76	CHI
201911351080	POSSE	PS12257688	IACIARA S2	28/11/2019 10:23	28/11/2019 15:10	28/11/2019 10:23	28/11/2019 15:10	4,77	21	100,23	CHI
201911351091	GOIANIA	10640629	AEROPORTO S2	28/11/2019 11:00	28/11/2019 15:28	28/11/2019 11:00	28/11/2019 15:28	4,45	1	4,45	CHI
201911351092	CORUMBAIBA	CI21000498	VILA CORUMBA	28/11/2019 11:00	28/11/2019 13:59	28/11/2019 11:00	28/11/2019 13:59	2,97	1	2,97	CHI
201911351106	ACREUNA	EU12200726	ACREUNA	28/11/2019 11:20	28/11/2019 14:55	28/11/2019 11:20	28/11/2019 14:55	3,59	1	3,59	CHI
201911351106	TURVELANDIA	EU12200726	ACREUNA	28/11/2019 11:20	28/11/2019 14:55	28/11/2019 11:20	28/11/2019 14:55	3,59	3	10,77	CHI
201911351110	JARAGUA	JA21059960	JARAGUA	28/11/2019 11:05	28/11/2019 20:10	28/11/2019 11:05	28/11/2019 20:10	9,09	1	9,09	CHI
201911351111	CALDAS NOVAS	CN12311850	RIO QUENTE	28/11/2019 11:06	28/11/2019 16:48	28/11/2019 11:06	28/11/2019 16:48	5,70	3	17,11	CHI
201911351111	MORRINHOS	CN12311850	RIO QUENTE	28/11/2019 11:06	28/11/2019 16:48	28/11/2019 11:06	28/11/2019 16:48	5,70	3	17,11	CHI
201911351118	ITAJA	IJ12162692	ITAJA S2	28/11/2019 10:54	28/11/2019 22:29	28/11/2019 10:54	28/11/2019 22:29	11,58	6	69,46	CHI
201911351134	DISTRITO FEDERAL	NJ21209509	MARAJOARA	28/11/2019 10:59	28/11/2019 12:17	28/11/2019 10:59	28/11/2019 12:17	1,29	3	3,86	CHI
201911351135	PIRACANJUBA	PJ12263070	PIRACANJUBA	28/11/2019 10:59	28/11/2019 15:45	28/11/2019 10:59	28/11/2019 15:45	4,75	4	19,01	CHI
201911351137	JARAGUA	II12025632	ITABERAI S1	28/11/2019 10:59	28/11/2019 17:44	28/11/2019 10:59	28/11/2019 17:44	6,73	2	13,47	CHI
201911351137	ITAGUARI	II12025632	ITABERAI S1	28/11/2019 10:59	28/11/2019 17:44	28/11/2019 10:59	28/11/2019 17:44	6,73	14	94,28	CHI
201911351138	PIRES DO RIO	PR10408498	PIRES DO RIO S1	28/11/2019 10:58	28/11/2019 20:58	28/11/2019 10:58	28/11/2019 20:58	9,99	60	599,30	CHI
201911351139	SAO MIGUEL DO PASSA QUATRO	SQ12328170	BELA VISTA S2	28/11/2019 11:00	29/11/2019 09:37	28/11/2019 11:00	29/11/2019 09:37	22,62	1	22,62	CHI
201911351141	ITAGUARI	II12170252	ITABERAI S1	28/11/2019 11:07	28/11/2019 19:22	28/11/2019 11:07	28/11/2019 19:22	8,24	5	41,22	CHI
201911351145	IACIARA	IA21218690	IACIARA S2	28/11/2019 11:08	28/11/2019 21:09	28/11/2019 11:08	28/11/2019 21:09	10,02	1	10,02	CHI
201911351149	VICENTINOPOLIS	VI11064595	VICENTINOPOLIS	28/11/2019 11:08	28/11/2019 18:23	28/11/2019 11:08	28/11/2019 18:23	7,25	141	1022,21	CHI
201911351150	MUTUNOPOLIS	MU21000002	MARA ROSA	28/11/2019 11:09	29/11/2019 11:13	28/11/2019 11:09	29/11/2019 11:13	24,06	1	24,06	CHI
201911351162	MINACU	IH12396733LD	MINACU	28/11/2019 11:13	29/11/2019 04:42	28/11/2019 19:10	29/11/2019 04:42	9,52	132	1256,53	CHI
201911351162	MINACU	IH11297047	MINACU	28/11/2019 11:13	29/11/2019 04:42	28/11/2019 11:13	29/11/2019 04:42	17,49	3	52,48	CHI
201911351168	CALDAS NOVAS	CN12139717LD	CALDAS NOVAS S2	28/11/2019 11:14	28/11/2019 12:54	28/11/2019 11:14	28/11/2019 12:54	1,66	1552	2574,16	CHI
201911351168	PIRACANJUBA	CN12139717LD	CALDAS NOVAS S2	28/11/2019 11:14	28/11/2019 12:54	28/11/2019 11:14	28/11/2019 12:54	1,66	2	3,32	CHI
201911351171	SAO MIGUEL DO ARAGUAIA	SM12334360	SAO MIGUEL DO ARAGUAIA	28/11/2019 07:18	28/11/2019 20:45	28/11/2019 07:18	28/11/2019 20:45	13,44	113	1518,31	CHI
201911351172	FORMOSA	10005671483	ITIQUEIRA	28/11/2019 11:14	28/11/2019 14:09	28/11/2019 11:14	28/11/2019 14:09	2,92	1	2,92	CHI
201911351181	GOIANIA	10742360	CAMPINAS S1	28/11/2019 11:16	28/11/2019 13:10	28/11/2019 11:16	28/11/2019 13:10	1,89	1	1,89	CHI
201911351185	CACHOEIRA ALTA	CA12025059	CACHOEIRA ALTA	28/11/2019 11:16	28/11/2019 13:56	28/11/2019 11:16	28/11/2019 13:56	2,65	3	7,96	CHI
201911351188	NIQUELANDIA	NQ12362992	URUACU	28/11/2019 11:17	28/11/2019 17:43	28/11/2019 11:17	28/11/2019 17:43	6,43	371	2383,88	CHI
201911351192	MAURILANDIA	ML21360631	RIO DOS BOIS	28/11/2019 11:17	28/11/2019 16:00	28/11/2019 11:17	28/11/2019 16:00	4,71	1	4,71	CHI

201911351198	RIO VERDE	RV21280525	CABRIUVA S2	28/11/2019 11:18	28/11/2019 15:02	28/11/2019 11:18	28/11/2019 15:02	3,73	1	3,73	CHI
201911351206	MONTE ALEGRE DE GOIAS	MA12282250	SAO DOMINGOS	28/11/2019 09:09	28/11/2019 16:42	28/11/2019 09:09	28/11/2019 16:42	7,55	3	22,64	CHI
201911351216	NOVA CRIXAS	NA12392031	NOVA CRIXAS	28/11/2019 08:50	28/11/2019 18:11	28/11/2019 08:50	28/11/2019 18:11	9,34	345	3222,59	CHI
201911351219	RIO VERDE	RV21085768	SANTA HELENA S1	28/11/2019 11:21	29/11/2019 09:27	28/11/2019 11:21	29/11/2019 09:27	22,10	1	22,10	CHI
201911351227	JATAI	JT21184237	JATAI S1	28/11/2019 11:22	28/11/2019 16:20	28/11/2019 11:22	28/11/2019 16:20	4,95	1	4,95	CHI
201911351228	NIQUELANDIA	2750116643	NIQUELANDIA SUBTRANSMISSAO	28/11/2019 11:22	28/11/2019 16:18	28/11/2019 11:22	28/11/2019 16:18	4,92	1	4,92	CHI
201911351235	SANTA HELENA DE GOIAS	400115931	IPEGUARI	28/11/2019 11:23	28/11/2019 14:10	28/11/2019 11:23	28/11/2019 14:10	2,78	1	2,78	CHI
201911351236	VICENTINOPOLIS	VI21263849	VICENTINOPOLIS	28/11/2019 11:23	28/11/2019 16:47	28/11/2019 11:23	28/11/2019 16:47	5,39	1	5,39	CHI
201911351244	CHAPADAO DO CEU	DJ12219559LD	CHAPADAO DO CEU	29/11/2019 09:09	30/11/2019 11:46	29/11/2019 09:09	30/11/2019 11:46	26,62	4	106,48	CHI
201911351249	HIDROLANDIA	PJ12000117	PIRACANJUBA	28/11/2019 10:55	29/11/2019 19:40	28/11/2019 10:55	28/11/2019 19:30	8,57	7	59,99	CHI
201911351249	PIRACANJUBA	PJ12000117	PIRACANJUBA	28/11/2019 10:55	29/11/2019 19:40	28/11/2019 10:55	28/11/2019 19:30	8,57	56	479,92	CHI
201911351249	PIRACANJUBA	PJ13000015	PIRACANJUBA	28/11/2019 10:55	29/11/2019 19:40	28/11/2019 10:55	29/11/2019 10:32	23,61	18	425,00	CHI
201911351249	PIRACANJUBA	PJ13000016	PIRACANJUBA	28/11/2019 10:55	29/11/2019 19:40	28/11/2019 21:19	29/11/2019 12:53	15,56	20	311,29	CHI
201911351249	CROMINIA	01620424	ROCHEDO	28/11/2019 10:55	29/11/2019 19:40	29/11/2019 15:00	29/11/2019 15:04	0,07	41	2,68	CHI
201911351249	HIDROLANDIA	01620424	ROCHEDO	28/11/2019 10:55	29/11/2019 19:40	29/11/2019 15:00	29/11/2019 15:04	0,07	8	0,52	CHI
201911351249	PIRACANJUBA	01620424	ROCHEDO	28/11/2019 10:55	29/11/2019 19:40	29/11/2019 15:00	29/11/2019 15:04	0,07	1	0,07	CHI
201911351249	PROFESSOR JAMIL SAFADY	01620424	ROCHEDO	28/11/2019 10:55	29/11/2019 19:40	29/11/2019 15:00	29/11/2019 15:04	0,07	6	0,39	CHI
201911351249	PROFESSOR JAMIL SAFADY	01620424	ROCHEDO	28/11/2019 10:55	29/11/2019 19:40	29/11/2019 15:00	29/11/2019 15:04	0,07	642	41,91	CHI
201911351249	PIRACANJUBA	01620424	ROCHEDO	28/11/2019 10:55	29/11/2019 19:40	29/11/2019 15:00	29/11/2019 15:04	0,07	281	18,34	CHI
201911351249	CROMINIA	01620424	ROCHEDO	28/11/2019 10:55	29/11/2019 19:40	29/11/2019 15:00	29/11/2019 15:04	0,07	3	0,20	CHI
201911351249	PROFESSOR JAMIL SAFADY	01620424	ROCHEDO	28/11/2019 10:55	29/11/2019 19:40	29/11/2019 15:00	29/11/2019 15:04	0,07	827	53,98	CHI
201911351249	PIRACANJUBA	PJ13263475	PIRACANJUBA	28/11/2019 10:55	29/11/2019 19:40	28/11/2019 21:19	29/11/2019 15:37	18,29	3	54,87	CHI
201911351249	HIDROLANDIA	PJ12000117	PIRACANJUBA	28/11/2019 10:55	29/11/2019 19:40	29/11/2019 15:00	29/11/2019 15:57	0,94	8	7,53	CHI
201911351249	PIRACANJUBA	PJ12000117	PIRACANJUBA	28/11/2019 10:55	29/11/2019 19:40	29/11/2019 15:00	29/11/2019 15:57	0,94	62	58,33	CHI
201911351249	PROFESSOR JAMIL SAFADY	PJ12000117	PIRACANJUBA	28/11/2019 10:55	29/11/2019 19:40	29/11/2019 15:00	29/11/2019 15:57	0,94	13	12,23	CHI
201911351249	PIRACANJUBA	PJ12000097	PIRACANJUBA	28/11/2019 10:55	29/11/2019 19:40	28/11/2019 21:19	29/11/2019 18:56	21,61	19	410,53	CHI
201911351249	HIDROLANDIA	PJ12000097	PIRACANJUBA	28/11/2019 10:55	29/11/2019 19:40	28/11/2019 21:19	29/11/2019 19:40	22,35	7	156,42	CHI
201911351249	PIRACANJUBA	PJ12000097	PIRACANJUBA	28/11/2019 10:55	29/11/2019 19:40	28/11/2019 21:19	29/11/2019 19:40	22,35	15	335,20	CHI
201911351252	AGUAS LINDAS DE GOIAS	XX27767048	AGUAS LINDAS DE GOIAS S1	28/11/2019 10:55	28/11/2019 16:50	28/11/2019 10:55	28/11/2019 16:50	5,91	1927	11387,50	CHI
201911351255	APARECIDA DE GOIANIA	200218281	INDEPENDENCIA S1	28/11/2019 11:24	28/11/2019 14:17	28/11/2019 11:24	28/11/2019 14:17	2,87	1	2,87	CHI
201911351258	SAO JOAO D ALIANCA	JL12144660	SAO JOAO D ALIANCA	28/11/2019 11:25	29/11/2019 12:43	28/11/2019 11:25	29/11/2019 12:43	25,29	1	25,29	CHI
201911351263	MUNDO NOVO DE GOIAS	MH12274702	NOVA CRIXAS	28/11/2019 07:24	29/11/2019 14:30	28/11/2019 07:24	29/11/2019 14:30	31,10	44	1368,28	CHI
201911351267	DIVINOPOLIS DE GOIAS	GH21254499	SAO DOMINGOS	28/11/2019 11:27	29/11/2019 15:33	28/11/2019 11:27	29/11/2019 15:33	28,09	2	56,18	CHI



201911351268	COLINAS DO SUL	TI12397518	NIQUELANDIA SUBTRANSMISSAO	28/11/2019 11:27	29/11/2019 11:53	28/11/2019 11:27	29/11/2019 11:53	24,42	4	97,70	CHI
201911351268	NIQUELANDIA	TI12397518	NIQUELANDIA SUBTRANSMISSAO	28/11/2019 11:27	29/11/2019 11:53	28/11/2019 11:27	29/11/2019 11:53	24,42	124	3028,63	CHI
201911351272	ALEXANIA	AX21000071	MARAJOARA	28/11/2019 11:28	29/11/2019 11:42	28/11/2019 11:28	29/11/2019 11:42	24,23	2	48,46	CHI
201911351279	JATAI	10016227920	JATAI S2	28/11/2019 11:29	28/11/2019 16:55	28/11/2019 11:29	28/11/2019 16:55	5,42	1	5,42	CHI
201911351280	GOIANIA	13909927	CAMPINAS S2	28/11/2019 11:30	28/11/2019 15:48	28/11/2019 11:30	28/11/2019 15:48	4,30	1	4,30	CHI
201911351281	ARUANA	AK12198048	ARUANA	28/11/2019 11:30	28/11/2019 15:28	28/11/2019 11:30	28/11/2019 15:28	3,96	2	7,93	CHI
201911351284	MATRINCHA	MP21194510	MATRINCHA	28/11/2019 11:30	29/11/2019 16:02	28/11/2019 11:30	29/11/2019 16:02	28,54	1	28,54	CHI
201911351288	PEROLANDIA	2370009397	JATAI S1	28/11/2019 11:31	29/11/2019 09:46	28/11/2019 11:31	29/11/2019 09:46	22,26	1	22,26	CHI
201911351291	JATAI	10020584308	JATAI S1	28/11/2019 11:31	29/11/2019 11:31	28/11/2019 11:31	29/11/2019 11:31	23,99	1	23,99	CHI
201911351296	QUIRINOPOLIS	QI31049543	QUIRINOPOLIS	28/11/2019 11:32	28/11/2019 14:56	28/11/2019 11:32	28/11/2019 14:56	3,39	2	6,78	CHI
201911351297	ITAPURANGA	IK12299288	ITAPURANGA	28/11/2019 07:53	28/11/2019 21:06	28/11/2019 07:53	28/11/2019 21:06	13,20	6	79,22	CHI
201911351297	FAINA	IK12299288	ITAPURANGA	28/11/2019 07:53	28/11/2019 21:06	28/11/2019 07:53	28/11/2019 21:06	13,20	10	132,04	CHI
201911351304	LUZIANIA	LZ11206669	MARAJOARA	28/11/2019 11:33	28/11/2019 13:27	28/11/2019 11:33	28/11/2019 13:27	1,89	22	41,48	CHI
201911351305	TROMBAS	TB12288317	PORANGATU	28/11/2019 11:33	28/11/2019 21:06	28/11/2019 11:33	28/11/2019 21:06	9,53	6	57,21	CHI
201911351307	FORMOSO	FO12200415	MARA ROSA	28/11/2019 09:40	28/11/2019 21:07	28/11/2019 09:40	28/11/2019 21:07	11,44	18	205,95	CHI
201911351309	GOIANIA	11300140	CARAJAS S2	28/11/2019 11:34	28/11/2019 16:57	28/11/2019 11:34	28/11/2019 16:57	5,38	1	5,38	CHI
201911351310	GOIANDIRA	CT21267153	CATALAO S1	28/11/2019 11:34	29/11/2019 09:06	28/11/2019 11:34	29/11/2019 09:06	21,52	1	21,52	CHI
201911351313	PALMEIRAS DE GOIAS	590021795	PALMEIRAS	28/11/2019 11:34	28/11/2019 15:49	28/11/2019 11:34	28/11/2019 15:49	4,25	1	4,25	CHI
201911351320	VILA PROPICIO	PV12086528	GOIANESIA S1	28/11/2019 08:40	28/11/2019 17:56	28/11/2019 08:40	28/11/2019 17:56	9,25	18	166,58	CHI
201911351321	PIRES DO RIO	PR12083164LD	PIRES DO RIO S1	28/11/2019 11:36	28/11/2019 23:53	28/11/2019 11:36	28/11/2019 23:53	12,28	6	73,70	CHI
201911351321	SANTA CRUZ DE GOIAS	PR12083164LD	PIRES DO RIO S1	28/11/2019 11:36	28/11/2019 23:53	28/11/2019 19:55	28/11/2019 23:53	3,97	1	3,97	CHI
201911351321	URUTAI	PR12083164LD	PIRES DO RIO S1	28/11/2019 11:36	28/11/2019 23:53	28/11/2019 19:55	28/11/2019 23:53	3,97	1	3,97	CHI
201911351321	PIRES DO RIO	PR12083164LD	PIRES DO RIO S1	28/11/2019 11:36	28/11/2019 23:53	28/11/2019 19:55	28/11/2019 23:53	3,97	63	249,90	CHI
201911351329	ALEXANIA	AX12211852	ALEXANIA	28/11/2019 10:25	29/11/2019 19:15	28/11/2019 10:25	29/11/2019 19:15	32,82	15	492,30	CHI
201911351337	SAO DOMINGOS	SD12302841	SAO DOMINGOS	28/11/2019 10:48	28/11/2019 17:21	28/11/2019 10:48	28/11/2019 17:21	6,55	4	26,19	CHI
201911351349	SANTA TEREZINHA DE GOIAS	2480015720	SANTA TEREZINHA	28/11/2019 11:43	28/11/2019 17:20	28/11/2019 11:43	28/11/2019 17:20	5,63	1	5,63	CHI
201911351352	JATAI	290346782	JATAI S2	28/11/2019 11:43	28/11/2019 14:59	28/11/2019 11:43	28/11/2019 14:59	3,26	1	3,26	CHI
201911351360	IACIARA	IA12206170	IACIARA S1	28/11/2019 11:29	28/11/2019 13:56	28/11/2019 11:29	28/11/2019 13:56	2,45	80	195,87	CHI
201911351361	ITUMBIARA	690197007	ITUMBIARA VELHA S1	28/11/2019 11:44	28/11/2019 13:18	28/11/2019 11:44	28/11/2019 13:18	1,56	1	1,56	CHI
201911351370	VILA PROPICIO	NP12384850	GOIANESIA S1	28/11/2019 11:45	29/11/2019 10:03	28/11/2019 11:45	29/11/2019 10:03	22,30	5	111,49	CHI
201911351374	SIMOLANDIA	1940006305	IACIARA S2	28/11/2019 11:45	28/11/2019 15:54	28/11/2019 11:45	28/11/2019 15:54	4,14	1	4,14	CHI
201911351377	FORMOSA	FA12253080	ITUIQUIRA	28/11/2019 11:40	29/11/2019 10:46	28/11/2019 11:40	29/11/2019 10:46	23,10	3	69,30	CHI
201911351380	MINACU	IH12230363	MINACU	28/11/2019 07:21	28/11/2019 20:22	28/11/2019 07:21	28/11/2019 20:22	13,01	6	78,05	CHI

201911351381	LUZIANIA	LZ12390021	PIRES DO RIO S2	28/11/2019 11:03	28/11/2019 20:51	28/11/2019 11:03	28/11/2019 20:51	9,79	18	176,19	CHI
201911351384	ANAPOLIS	GL10395380	DAIA S2	28/11/2019 11:48	29/11/2019 21:23	29/11/2019 00:46	29/11/2019 01:00	0,24	4	0,95	CHI
201911351384	GAMELEIRA DE GOIAS	GL10395380	DAIA S2	28/11/2019 11:48	29/11/2019 21:23	29/11/2019 00:46	29/11/2019 01:00	0,24	177	42,09	CHI
201911351384	ABADIANIA	GL10395380	DAIA S2	28/11/2019 11:48	29/11/2019 21:23	29/11/2019 00:46	29/11/2019 01:00	0,24	4	0,95	CHI
201911351384	GAMELEIRA DE GOIAS	SV12056396	DAIA S2	28/11/2019 11:48	29/11/2019 21:23	28/11/2019 11:48	29/11/2019 12:58	25,18	46	1158,20	CHI
201911351384	GAMELEIRA DE GOIAS	SV12056396	DAIA S2	28/11/2019 11:48	29/11/2019 21:23	28/11/2019 11:48	29/11/2019 21:23	33,59	56	1880,87	CHI
201911351384	SILVANIA	SV12056396	DAIA S2	28/11/2019 11:48	29/11/2019 21:23	28/11/2019 11:48	29/11/2019 21:23	33,59	1	33,59	CHI
201911351384	GAMELEIRA DE GOIAS	SV12056396	DAIA S2	28/11/2019 11:48	29/11/2019 21:23	29/11/2019 17:37	29/11/2019 21:23	3,77	46	173,50	CHI
201911351388	SAO JOAO D ALIANCA	3840027029	SAO JOAO D ALIANCA	28/11/2019 11:50	28/11/2019 19:04	28/11/2019 11:50	28/11/2019 19:04	7,25	1	7,25	CHI
201911351394	HIDROLANDIA	HD12046375	INDEPENDENCIA S1	28/11/2019 10:47	28/11/2019 14:22	28/11/2019 10:47	28/11/2019 14:22	3,57	4	14,29	CHI
201911351397	QUIRINOPOLIS	QI21113293	QUIRINOPOLIS	28/11/2019 11:51	28/11/2019 15:26	28/11/2019 11:51	28/11/2019 15:26	3,57	1	3,57	CHI
201911351402	JATAI	SX12139578	JATAI S1	28/11/2019 11:52	28/11/2019 17:32	28/11/2019 11:52	28/11/2019 17:32	5,65	14	79,12	CHI
201911351402	SERRANOPOLIS	SX12139578	JATAI S1	28/11/2019 11:52	28/11/2019 17:32	28/11/2019 11:52	28/11/2019 17:32	5,65	33	186,49	CHI
201911351403	MORRINHOS	MR21252193	MORRINHOS	28/11/2019 11:53	28/11/2019 15:40	28/11/2019 11:53	28/11/2019 15:40	3,79	1	3,79	CHI
201911351404	GOIANIA	10016898263	CARAJAS S2	28/11/2019 11:53	28/11/2019 22:03	28/11/2019 11:53	28/11/2019 22:03	10,16	1	10,16	CHI
201911351406	NOVO GAMA	2900064138	MARAJOARA	28/11/2019 11:53	28/11/2019 13:42	28/11/2019 11:53	28/11/2019 13:42	1,81	1	1,81	CHI
201911351416	DOVERLANDIA	DV12138335	CAIAPONIA	28/11/2019 11:55	28/11/2019 15:50	28/11/2019 11:55	28/11/2019 15:50	3,91	37	144,68	CHI
201911351427	SENADOR CANEDO	SW11094938	SENADOR CANEDO	28/11/2019 11:47	28/11/2019 16:03	28/11/2019 11:47	28/11/2019 16:03	4,26	160	681,11	CHI
201911351429	NIQUELANDIA	NQ12039296	BARRO ALTO	28/11/2019 11:54	28/11/2019 18:43	28/11/2019 11:54	28/11/2019 18:43	6,80	89	605,55	CHI
201911351431	APARECIDA DE GOIANIA	17344440	INDEPENDENCIA S1	28/11/2019 11:58	28/11/2019 15:39	28/11/2019 11:58	28/11/2019 15:39	3,68	1	3,68	CHI
201911351434	ALEXANIA	AX11393201	ALEXANIA	28/11/2019 08:57	29/11/2019 15:51	28/11/2019 08:57	29/11/2019 15:51	30,89	90	2779,92	CHI
201911351439	ITAUCU	AR12104723	ARACU	28/11/2019 10:40	28/11/2019 19:51	28/11/2019 10:40	28/11/2019 19:51	9,18	9	82,59	CHI
201911351439	ARACU	AR12104723	ARACU	28/11/2019 10:40	28/11/2019 19:51	28/11/2019 10:40	28/11/2019 19:51	9,18	22	201,89	CHI
201911351471	GUARINOS	GF12164878	SANTA TEREZINHA	29/11/2019 12:42	29/11/2019 22:26	29/11/2019 12:42	29/11/2019 22:26	9,73	57	554,47	CHI
201911351474	PONTALINA	PK21108796	VICENTINOPOLIS	28/11/2019 12:04	28/11/2019 17:42	28/11/2019 12:04	28/11/2019 17:42	5,63	1	5,63	CHI
201911351479	BARRO ALTO	BA21237503	BARRO ALTO	28/11/2019 12:05	28/11/2019 20:44	28/11/2019 12:05	28/11/2019 20:44	8,65	1	8,65	CHI
201911351485	MONTIVIDIU	2840023897	MONTIVIDIU T	28/11/2019 12:06	28/11/2019 14:40	28/11/2019 12:06	28/11/2019 14:40	2,57	1	2,57	CHI
201911351486	TRINDADE	40225288	TRINDADE	28/11/2019 12:07	28/11/2019 18:24	28/11/2019 12:07	28/11/2019 18:24	6,29	1	6,29	CHI
201911351488	NOVA ROMA	5600000071	IACIARA S2	28/11/2019 12:07	29/11/2019 11:11	28/11/2019 12:07	29/11/2019 11:11	23,06	1	23,06	CHI
201911351489	EDEIA	EA12308046	EDEIA	28/11/2019 12:07	28/11/2019 13:55	28/11/2019 12:07	28/11/2019 13:55	1,79	1	1,79	CHI
201911351490	AGUAS LINDAS DE GOIAS	LA11148936	AGUAS LINDAS DE GOIAS S1	28/11/2019 12:07	28/11/2019 18:59	28/11/2019 12:07	28/11/2019 18:59	6,86	23	157,68	CHI
201911351497	MORRO AGUDO DE GOIAS	MS21185028	ITAPURANGA	28/11/2019 12:09	29/11/2019 11:25	28/11/2019 12:09	29/11/2019 11:25	23,26	1	23,26	CHI
201911351499	POSSE	PS11156242	IACIARA S2	28/11/2019 12:10	28/11/2019 17:49	28/11/2019 12:10	28/11/2019 17:49	5,64	8	45,16	CHI

201911351500	SANTO ANTONIO DO DESCOBERTO	SN11164922	ALEXANIA	28/11/2019 17:38	28/11/2019 18:23	28/11/2019 17:38	28/11/2019 18:23	0,75	56	42,02	CHI
201911351502	FLORES DE GOIAS	FB11257718	FLORES DE GOIAS	28/11/2019 12:05	28/11/2019 17:16	28/11/2019 12:05	28/11/2019 17:16	5,17	48	248,08	CHI
201911351513	ANAPOLIS	AN21370360	ANAPOLIS UNIVERSITARIO S2	28/11/2019 12:29	28/11/2019 12:41	28/11/2019 12:29	28/11/2019 12:41	0,19	1	0,19	CHI
201911351520	CAVALCANTE	20105026	MINACU	28/11/2019 12:59	28/11/2019 17:58	28/11/2019 12:59	28/11/2019 17:58	4,98	1	4,98	CHI
201911351523	SAO DOMINGOS	SD21269706	SAO DOMINGOS	28/11/2019 10:06	28/11/2019 15:41	28/11/2019 10:06	28/11/2019 15:41	5,58	1	5,58	CHI
201911351524	ALEXANIA	AX10406647	ALEXANIA	28/11/2019 13:21	29/11/2019 12:26	28/11/2019 13:21	29/11/2019 12:09	22,80	9	205,17	CHI
201911351524	ALEXANIA	AX13286094	ALEXANIA	28/11/2019 13:21	29/11/2019 12:26	28/11/2019 13:21	29/11/2019 12:26	23,08	2	46,16	CHI
201911351536	SAO DOMINGOS	GH12211203	SAO DOMINGOS	28/11/2019 13:30	28/11/2019 18:15	28/11/2019 13:30	28/11/2019 18:15	4,74	61	288,89	CHI
201911351536	DIVINOPOLIS DE GOIAS	GH12211203	SAO DOMINGOS	28/11/2019 13:30	28/11/2019 18:15	28/11/2019 13:30	28/11/2019 18:15	4,74	37	175,23	CHI
201911351542	INDIARA	IY12010954	EDEIA	28/11/2019 14:17	29/11/2019 19:28	28/11/2019 14:17	29/11/2019 19:24	29,12	7	203,82	CHI
201911351542	EDEIA	IY12010954	EDEIA	28/11/2019 14:17	29/11/2019 19:28	29/11/2019 19:25	29/11/2019 19:28	0,06	5	0,30	CHI
201911351542	INDIARA	IY12010954	EDEIA	28/11/2019 14:17	29/11/2019 19:28	29/11/2019 19:25	29/11/2019 19:28	0,06	46	2,72	CHI
201911351547	PIRACANJUBA	PJ13293373	CALDAS NOVAS S1	28/11/2019 19:32	28/11/2019 22:19	28/11/2019 19:32	28/11/2019 22:19	2,78	22	61,24	CHI
201911351547	SANTA CRUZ DE GOIAS	PJ13293373	CALDAS NOVAS S1	28/11/2019 19:32	28/11/2019 22:19	28/11/2019 19:32	28/11/2019 22:19	2,78	1	2,78	CHI
201911351555	MINEIROS	1390118580	PARQUE DAS EMAS	28/11/2019 14:59	29/11/2019 10:15	28/11/2019 14:59	29/11/2019 10:15	19,27	1	19,27	CHI
201911351592	IVOLANDIA	IV12402910	IPORA	28/11/2019 08:50	28/11/2019 21:04	28/11/2019 08:50	28/11/2019 21:04	12,23	7	85,58	CHI
201911351601	CACHOEIRA DE GOIAS	CG12018660	FIRMINOPOLIS S2	28/11/2019 10:26	28/11/2019 16:23	28/11/2019 10:26	28/11/2019 16:23	5,94	29	172,16	CHI
201911351602	MONTE ALEGRE DE GOIAS	MA12130286	SAO DOMINGOS	28/11/2019 10:22	28/11/2019 17:27	28/11/2019 10:22	28/11/2019 17:27	7,08	4	28,33	CHI
201911351607	ITARUMA	IM21219273	ITAJA S2	28/11/2019 12:42	28/11/2019 18:25	28/11/2019 12:42	28/11/2019 18:25	5,71	1	5,71	CHI
201911351608	RIO VERDE	630198380	RIO VERDE S1	28/11/2019 12:11	28/11/2019 15:05	28/11/2019 12:11	28/11/2019 15:05	2,91	1	2,91	CHI
201911351619	PROFESSOR JAMIL SAFADY	JS12000038	PONTALINA	28/11/2019 12:12	28/11/2019 16:47	28/11/2019 12:12	28/11/2019 16:47	4,58	1	4,58	CHI
201911351629	GUAPO	GA21238909	GUAPO S1	28/11/2019 12:14	28/11/2019 15:24	28/11/2019 12:14	28/11/2019 15:24	3,17	2	6,35	CHI
201911351634	IVOLANDIA	IV12162553	IPORA	28/11/2019 06:57	29/11/2019 07:52	28/11/2019 06:57	29/11/2019 07:52	24,91	7	174,34	CHI
201911351644	GOIANIA	GN11002039	CAMPINAS S3	28/11/2019 11:08	28/11/2019 13:20	28/11/2019 11:08	28/11/2019 13:20	2,19	73	159,91	CHI
201911351647	MAIRIPOTABA	MI21000457	PONTALINA	28/11/2019 12:18	29/11/2019 08:26	28/11/2019 12:18	29/11/2019 08:26	20,12	2	40,24	CHI
201911351652	NOVO PLANALTO	TA12243601	NOVO PLANALTO	28/11/2019 10:57	28/11/2019 16:12	28/11/2019 10:57	28/11/2019 16:12	5,24	39	204,39	CHI
201911351659	JAUPACI	JP21184764	IPORA	28/11/2019 12:21	28/11/2019 23:17	28/11/2019 12:21	28/11/2019 23:17	10,93	1	10,93	CHI
201911351663	CAMPINORTE	CR12068033	MARA ROSA	28/11/2019 12:21	29/11/2019 18:06	28/11/2019 12:21	29/11/2019 18:06	29,74	2	59,49	CHI
201911351664	APARECIDA DE GOIANIA	AP12041820	INDEPENDENCIA S2	28/11/2019 12:02	29/11/2019 02:05	28/11/2019 12:02	28/11/2019 20:05	8,05	405	3260,36	CHI
201911351664	APARECIDA DE GOIANIA	AP12041820	INDEPENDENCIA S2	28/11/2019 12:02	29/11/2019 02:05	28/11/2019 20:06	29/11/2019 02:05	5,98	405	2423,25	CHI
201911351668	QUIRINOPOLIS	QI12054841	QUIRINOPOLIS	28/11/2019 12:22	28/11/2019 17:23	28/11/2019 12:22	28/11/2019 17:23	5,01	17	85,16	CHI
201911351668	PARANAIGUARA	QI12054841	QUIRINOPOLIS	28/11/2019 12:22	28/11/2019 17:23	28/11/2019 12:22	28/11/2019 17:23	5,01	2	10,02	CHI
201911351675	MINEIROS	1390060485	PARQUE DAS EMAS	28/11/2019 12:24	28/11/2019 14:42	28/11/2019 12:24	28/11/2019 14:42	2,30	1	2,30	CHI

201911351676	MONTE ALEGRE DE GOIAS	MA12252663	SAO DOMINGOS	28/11/2019 12:25	28/11/2019 18:48	28/11/2019 12:25	28/11/2019 18:48	6,37	4	25,49	CHI
201911351677	JUSSARA	10008528282	JUSSARA	28/11/2019 12:25	29/11/2019 16:42	28/11/2019 12:25	29/11/2019 16:42	28,27	1	28,27	CHI
201911351683	PANAMA	PX12257095	PARANAIBA	28/11/2019 12:26	28/11/2019 15:06	28/11/2019 12:26	28/11/2019 15:06	2,65	3	7,96	CHI
201911351687	SANTA TEREZINHA DE GOIAS	2480023662	SANTA TEREZINHA	28/11/2019 12:27	28/11/2019 16:13	28/11/2019 12:27	28/11/2019 16:13	3,78	1	3,78	CHI
201911351691	PIRANHAS	PH12079515	PIRANHAS	28/11/2019 12:27	28/11/2019 15:30	28/11/2019 12:27	28/11/2019 15:30	3,04	14	42,53	CHI
201911351692	JATAI	290149769	JATAI S1	28/11/2019 12:27	29/11/2019 20:22	28/11/2019 12:27	29/11/2019 20:22	31,91	1	31,91	CHI
201911351703	VIANOPOLIS	10001565212	VIANOPOLIS	28/11/2019 12:29	29/11/2019 06:30	28/11/2019 12:29	29/11/2019 06:30	18,02	1	18,02	CHI
201911351704	AGUAS LINDAS DE GOIAS	LA11162896	AGUAS LINDAS DE GOIAS S2	28/11/2019 11:57	28/11/2019 13:51	28/11/2019 11:57	28/11/2019 13:51	1,90	38	72,19	CHI
201911351707	GOIANIA	GN11165055	ATLANTICO S1	28/11/2019 12:07	28/11/2019 17:35	28/11/2019 12:07	28/11/2019 17:35	5,45	111	605,47	CHI
201911351711	JAUPACI	JP12235888	IPORA	28/11/2019 12:31	29/11/2019 12:25	28/11/2019 12:31	29/11/2019 12:25	23,89	3	71,68	CHI
201911351715	GOIANIA	GN11039643	FERROVIARIO S3	29/11/2019 11:00	29/11/2019 13:02	29/11/2019 11:00	29/11/2019 13:02	2,03	151	306,53	CHI
201911351721	ANAPOLIS	20303361	JUNDIAI S1	28/11/2019 12:32	28/11/2019 14:02	28/11/2019 12:32	28/11/2019 14:02	1,48	1	1,48	CHI
201911351723	INDIARA	IY21371646	EDEIA	28/11/2019 12:33	29/11/2019 11:00	28/11/2019 12:33	29/11/2019 11:00	22,46	2	44,92	CHI
201911351726	ITUMBIARA	690050562	ITUMBIARA VELHA S1	28/11/2019 12:33	28/11/2019 16:17	28/11/2019 12:33	28/11/2019 16:17	3,74	1	3,74	CHI
201911351736	PALMEIRAS DE GOIAS	10009396010	PALMEIRAS	28/11/2019 12:33	28/11/2019 15:53	28/11/2019 12:33	28/11/2019 15:53	3,33	1	3,33	CHI
201911351740	SAO LUIS DE MONTES BELOS	SL12259053	SAO LUIZ DOS MONTES BELOS	28/11/2019 12:34	28/11/2019 16:24	28/11/2019 12:34	28/11/2019 16:24	3,82	3	11,46	CHI
201911351744	SANTO ANTONIO DO DESCOBERTO	SN21285252	MARAJOARA	28/11/2019 12:35	28/11/2019 15:19	28/11/2019 12:35	28/11/2019 15:19	2,72	1	2,72	CHI
201911351746	CAMPO ALEGRE DE GOIAS	CM12127512	CAMPO ALEGRE DE GOIAS	28/11/2019 10:19	28/11/2019 22:43	28/11/2019 10:19	28/11/2019 22:43	12,39	3	37,16	CHI
201911351747	LUZIANIA	3200258017	MARAJOARA	28/11/2019 12:35	28/11/2019 14:32	28/11/2019 12:35	28/11/2019 14:32	1,94	1	1,94	CHI
201911351748	MAIRIPOTABA	MI21130517	PONTALINA	28/11/2019 12:35	28/11/2019 14:34	28/11/2019 12:35	28/11/2019 14:34	1,97	2	3,93	CHI
201911351763	SAO MIGUEL DO ARAGUAIA	SM12276195	SAO MIGUEL DO ARAGUAIA	28/11/2019 12:26	29/11/2019 13:29	28/11/2019 12:26	29/11/2019 13:29	25,04	8	200,32	CHI
201911351765	LUZIANIA	120339950	RIO VERMELHO	28/11/2019 12:38	28/11/2019 15:28	28/11/2019 12:38	28/11/2019 15:28	2,85	1	2,85	CHI
201911351766	ALTO PARAISO DE GOIAS	BF12364990	SAO JOAO D ALIANCA	28/11/2019 10:54	28/11/2019 16:22	28/11/2019 10:54	28/11/2019 16:22	5,46	16	87,42	CHI
201911351767	BURITINOPOLIS	MB12314303	IACIARA S2	28/11/2019 09:12	28/11/2019 18:12	28/11/2019 09:12	28/11/2019 18:12	9,00	2	17,99	CHI
201911351767	MAMBAI	MB12314303	IACIARA S2	28/11/2019 09:12	28/11/2019 18:12	28/11/2019 09:12	28/11/2019 18:12	9,00	3	26,99	CHI
201911351774	SENADOR CANEDO	SW11340695	CEPAIGO S1	28/11/2019 12:39	28/11/2019 14:42	28/11/2019 12:39	28/11/2019 14:42	2,04	9	18,35	CHI
201911351775	ANAPOLIS	AN11101503	ANAPOLIS UNIVERSITARIO S2	28/11/2019 12:10	28/11/2019 17:54	28/11/2019 12:10	28/11/2019 17:54	5,72	139	794,77	CHI
201911351782	ITABERAÍ	IB12272618	ITABERAÍ S1	28/11/2019 06:14	28/11/2019 14:35	28/11/2019 06:14	28/11/2019 14:35	8,35	21	175,32	CHI
201911351796	RIO VERDE	10003048274	RIO VERDE S2	28/11/2019 12:41	28/11/2019 15:24	28/11/2019 12:41	28/11/2019 15:24	2,70	1	2,70	CHI
201911351803	IPAMERI	IP12071421	IPAMERI	28/11/2019 12:43	28/11/2019 16:24	28/11/2019 12:43	28/11/2019 16:24	3,67	3	11,01	CHI
201911351804	SAO JOAO DA PARAUNA	RP21156229	FIRMINOPOLIS S2	28/11/2019 12:43	28/11/2019 19:41	28/11/2019 12:43	28/11/2019 19:41	6,95	2	13,90	CHI
201911351807	AURILANDIA	AI21006810	SAO LUIZ DOS MONTES BELOS	28/11/2019 12:44	29/11/2019 09:50	28/11/2019 12:44	29/11/2019 09:50	21,10	1	21,10	CHI
201911351818	LEOPOLDO DE BULHOES	LB12267902	DAIA S2	28/11/2019 12:45	28/11/2019 17:09	28/11/2019 12:45	28/11/2019 17:09	4,39	1	4,39	CHI

201911351818	SILVANIA	LB12267902	DAIA S2	28/11/2019 12:45	28/11/2019 17:09	28/11/2019 12:45	28/11/2019 17:09	4,39	111	487,11	CHI
201911351819	SANCLERLANDIA	1610001336	FIRMINOPOLIS S2	28/11/2019 12:46	28/11/2019 16:23	28/11/2019 12:46	28/11/2019 16:23	3,61	1	3,61	CHI
201911351821	CAMPOS BELOS	CH21232264	SAO DOMINGOS	28/11/2019 12:46	28/11/2019 16:50	28/11/2019 12:46	28/11/2019 16:50	4,06	1	4,06	CHI
201911351822	ANAPOLIS	AN11000183	JUNDIAI S1	28/11/2019 12:46	28/11/2019 17:43	28/11/2019 12:46	28/11/2019 17:43	4,94	145	716,42	CHI
201911351823	GUAPO	GA31098716	GUAPO S2	28/11/2019 12:46	28/11/2019 17:06	28/11/2019 12:46	28/11/2019 17:06	4,32	1	4,32	CHI
201911351825	MORRINHOS	MR12000008	MORRINHOS	28/11/2019 12:20	28/11/2019 13:40	28/11/2019 12:20	28/11/2019 13:40	1,32	796	1052,49	CHI
201911351831	GOIANIA	GN11003103	CAMPINAS S3	28/11/2019 12:32	28/11/2019 16:12	28/11/2019 12:32	28/11/2019 16:12	3,65	59	215,46	CHI
201911351833	PIRACANJUBA	PJ12212194	PIRACANJUBA	28/11/2019 12:47	29/11/2019 11:08	28/11/2019 12:47	29/11/2019 11:08	22,33	19	424,36	CHI
201911351833	PIRACANJUBA	PJ12249833	PIRACANJUBA	28/11/2019 12:47	29/11/2019 11:08	28/11/2019 12:48	29/11/2019 11:08	22,33	62	1384,68	CHI
201911351836	LUZIANIA	LZ12353712	VIANOPOLIS	28/11/2019 12:48	28/11/2019 14:45	28/11/2019 12:48	28/11/2019 14:45	1,95	30	58,48	CHI
201911351838	PALMEIRAS DE GOIAS	PL12205902	EDEIA	28/11/2019 12:48	28/11/2019 15:48	28/11/2019 12:48	28/11/2019 15:48	3,00	1	3,00	CHI
201911351838	INDIARA	PL12205902	EDEIA	28/11/2019 12:48	28/11/2019 15:48	28/11/2019 12:48	28/11/2019 15:48	3,00	6	18,01	CHI
201911351848	CAMPO LIMPO	AN21357369	NEROPOLIS S1	28/11/2019 12:49	29/11/2019 11:10	28/11/2019 12:49	29/11/2019 11:10	22,34	3	67,01	CHI
201911351855	LUZIANIA	KR12330533	CRISTALINA S1	28/11/2019 12:37	28/11/2019 15:17	28/11/2019 12:37	28/11/2019 15:17	2,65	8	21,22	CHI
201911351855	IPAMERI	KR12330533	CRISTALINA S1	28/11/2019 12:37	28/11/2019 15:17	28/11/2019 12:37	28/11/2019 15:17	2,65	1	2,65	CHI
201911351855	CRISTALINA	KR12330533	CRISTALINA S1	28/11/2019 12:37	28/11/2019 15:17	28/11/2019 12:37	28/11/2019 15:17	2,65	34	90,18	CHI
201911351861	GOIANESIA	GE21229513	GOIANESIA S2	28/11/2019 12:51	28/11/2019 19:01	28/11/2019 12:51	28/11/2019 19:01	6,16	1	6,16	CHI
201911351863	ITAPURANGA	GS12198785	GOIAS	28/11/2019 07:15	28/11/2019 14:53	28/11/2019 07:15	28/11/2019 14:53	7,62	2	15,25	CHI
201911351863	GOIAS	GS12198785	GOIAS	28/11/2019 07:15	28/11/2019 14:53	28/11/2019 07:15	28/11/2019 14:53	7,62	8	60,99	CHI
201911351863	GUARAITA	GS12198785	GOIAS	28/11/2019 07:15	28/11/2019 14:53	28/11/2019 07:15	28/11/2019 14:53	7,62	2	15,25	CHI
201911351864	MONTE ALEGRE DE GOIAS	MA21265610	SAO DOMINGOS	28/11/2019 12:51	28/11/2019 19:12	28/11/2019 12:51	28/11/2019 19:12	6,34	1	6,34	CHI
201911351868	QUIRINOPOLIS	GB12402317LD	QUIRINOPOLIS	28/11/2019 10:24	28/11/2019 16:51	28/11/2019 10:24	28/11/2019 16:51	6,45	5	32,23	CHI
201911351868	GOUVELANDIA	GB12402317LD	QUIRINOPOLIS	28/11/2019 10:24	28/11/2019 16:51	28/11/2019 10:24	28/11/2019 16:51	6,45	23	148,27	CHI
201911351870	NOVO BRASIL	NB12378883	JUSSARA	28/11/2019 09:23	29/11/2019 12:05	28/11/2019 09:23	29/11/2019 12:05	26,70	5	133,51	CHI
201911351874	PALMINOPOLIS	PP21259848	PALMEIRAS	28/11/2019 12:53	28/11/2019 17:30	28/11/2019 12:53	28/11/2019 17:30	4,62	2	9,24	CHI
201911351875	ANAPOLIS	AN11090382	ANAPOLIS UNIVERSITARIO S1	28/11/2019 12:11	28/11/2019 15:07	28/11/2019 12:11	28/11/2019 15:07	2,92	171	499,27	CHI
201911351877	PIRENOPOLIS	PV21096782	ANAPOLIS UNIVERSITARIO S2	28/11/2019 12:53	28/11/2019 19:02	28/11/2019 12:53	28/11/2019 19:02	6,13	1	6,13	CHI
201911351882	FAINA	FC12250731	GOIAS	28/11/2019 12:54	28/11/2019 18:31	28/11/2019 12:54	28/11/2019 18:31	5,61	2	11,21	CHI
201911351884	GOIANIA	11089090	REAL S1	28/11/2019 12:55	28/11/2019 14:43	28/11/2019 12:55	28/11/2019 14:43	1,79	1	1,79	CHI
201911351894	LUZIANIA	LZ12203332	VIANOPOLIS	28/11/2019 12:57	28/11/2019 15:08	28/11/2019 12:57	28/11/2019 15:08	2,18	10	21,77	CHI
201911351901	NEROPOLIS	NR11169182	NEROPOLIS S2	28/11/2019 12:58	28/11/2019 15:30	28/11/2019 12:58	28/11/2019 15:30	2,54	124	314,79	CHI
201911351909	URUACU	CR12410914	MARA ROSA	28/11/2019 06:19	29/11/2019 00:37	28/11/2019 06:19	29/11/2019 00:37	18,29	16	292,69	CHI
201911351916	CALDAS NOVAS	CN12139717LD	CALDAS NOVAS S2	28/11/2019 13:01	28/11/2019 15:24	28/11/2019 13:01	28/11/2019 15:24	2,38	1571	3741,16	CHI

201911351916	PIRACANJUBA	CN12139717LD	CALDAS NOVAS S2	28/11/2019 13:01	28/11/2019 15:24	28/11/2019 13:01	28/11/2019 15:24	2,38	2	4,76	CHI
201911351917	ANAPOLIS	AN11000852	ANAPOLIS UNIVERSITARIO S2	28/11/2019 12:50	28/11/2019 17:15	28/11/2019 12:50	28/11/2019 17:15	4,41	28	123,53	CHI
201911351921	SANTA TEREZINHA DE GOIAS	2480007887	SANTA TEREZINHA	28/11/2019 13:01	28/11/2019 18:33	28/11/2019 13:01	28/11/2019 18:33	5,53	1	5,53	CHI
201911351927	VICENTINOPOLIS	VI12071025	VICENTINOPOLIS	28/11/2019 11:47	28/11/2019 13:23	28/11/2019 11:47	28/11/2019 13:23	1,59	409	650,20	CHI
201911351934	AVELINOPOLIS	990001805	ANICUNS	28/11/2019 13:05	28/11/2019 15:24	28/11/2019 13:05	28/11/2019 15:24	2,33	1	2,33	CHI
201911351938	ANAPOLIS	10002841000	JUNDIAI S2	28/11/2019 13:05	28/11/2019 16:46	28/11/2019 13:05	28/11/2019 16:46	3,67	1	3,67	CHI
201911351946	ITAGUARI	770008926	ITABERAI S1	28/11/2019 13:07	28/11/2019 20:26	28/11/2019 13:07	28/11/2019 20:26	7,31	1	7,31	CHI
201911351948	ITAPACI	IW12081354	ITAPACI	28/11/2019 10:44	28/11/2019 20:15	28/11/2019 10:44	28/11/2019 20:15	9,51	5	47,53	CHI
201911351950	PLANALTINA	PI12325588	SAO JOAO D ALIANCA	28/11/2019 10:47	29/11/2019 10:23	28/11/2019 10:47	29/11/2019 10:23	23,59	103	2430,28	CHI
201911351950	AGUA FRIA DE GOIAS	PI12325588	SAO JOAO D ALIANCA	28/11/2019 10:47	29/11/2019 10:23	28/11/2019 10:47	29/11/2019 10:23	23,59	1	23,59	CHI
201911351951	ORIZONA	OZ12143757	PIRES DO RIO S2	28/11/2019 13:08	28/11/2019 16:06	28/11/2019 13:08	28/11/2019 16:06	2,96	38	112,56	CHI
201911351953	VILA PROPICIO	BA12210749	GOIANESIA S1	28/11/2019 12:54	29/11/2019 04:13	28/11/2019 12:54	29/11/2019 04:13	15,31	3	45,93	CHI
201911351954	TEREZOPOLIS DE GOIAS	TJ11203378	DAIA S2	28/11/2019 12:39	28/11/2019 16:30	28/11/2019 12:39	28/11/2019 16:30	3,84	167	641,37	CHI
201911351959	FORMOSO	FO21297035	MARA ROSA	28/11/2019 13:10	29/11/2019 20:02	28/11/2019 13:10	29/11/2019 20:02	30,87	0	0,00	CHI
201911351963	ARAGUAPAZ	AZ12070035	GOIAS	28/11/2019 13:10	28/11/2019 19:28	28/11/2019 13:10	28/11/2019 19:28	6,29	4	25,16	CHI
201911351966	ITAPURANGA	IK21113431	ITAPURANGA	28/11/2019 13:10	29/11/2019 09:06	28/11/2019 13:10	29/11/2019 09:06	19,92	1	19,92	CHI
201911351970	CRISTALINA	KR12087954	CRISTALINA S2	28/11/2019 13:11	28/11/2019 16:39	28/11/2019 13:11	28/11/2019 16:39	3,45	2	6,91	CHI
201911351974	GUAPO	GA21127978	GUAPO S1	28/11/2019 13:12	28/11/2019 19:26	28/11/2019 13:12	28/11/2019 19:26	6,22	1	6,22	CHI
201911351978	LUZIANIA	10029927356	MARAJOARA	28/11/2019 13:12	28/11/2019 18:39	28/11/2019 13:12	28/11/2019 18:39	5,43	1	5,43	CHI
201911351980	GOIANIA	10807706	GOIANIA LESTE S1	28/11/2019 13:13	28/11/2019 16:20	28/11/2019 13:13	28/11/2019 16:20	3,11	1	3,11	CHI
201911351981	APARECIDA DE GOIANIA	10027639515	INDEPENDENCIA S1	28/11/2019 13:13	28/11/2019 16:44	28/11/2019 13:13	28/11/2019 16:44	3,52	1	3,52	CHI
201911352006	ITAPIRAPUA	IU12060536	MATRINCHA	28/11/2019 13:15	28/11/2019 16:52	28/11/2019 13:15	28/11/2019 16:52	3,61	11	39,73	CHI
201911352006	GOIAS	IU12060536	MATRINCHA	28/11/2019 13:15	28/11/2019 16:52	28/11/2019 13:15	28/11/2019 16:52	3,61	1	3,61	CHI
201911352006	ITAPIRAPUA	IU12060536	MATRINCHA	28/11/2019 13:15	28/11/2019 16:52	28/11/2019 13:15	28/11/2019 16:52	3,61	5	18,06	CHI
201911352010	PLANALTINA	PI21218354	PLANALTINA	28/11/2019 13:16	28/11/2019 18:46	28/11/2019 13:16	28/11/2019 18:46	5,49	1	5,49	CHI
201911352013	CRIXAS	CX12287951	SERRA DO OURO	28/11/2019 10:35	29/11/2019 23:18	28/11/2019 10:35	29/11/2019 23:18	36,71	4	146,84	CHI
201911352019	URUACU	CR21051929	MARA ROSA	28/11/2019 13:18	29/11/2019 16:03	28/11/2019 13:18	29/11/2019 16:03	26,74	1	26,74	CHI
201911352024	FAINA	MS12036227	ITAPURANGA	28/11/2019 13:17	29/11/2019 16:32	28/11/2019 13:17	29/11/2019 16:32	27,25	2	54,49	CHI
201911352024	MORRO AGUDO DE GOIAS	MS12036227	ITAPURANGA	28/11/2019 13:17	29/11/2019 16:32	28/11/2019 13:17	29/11/2019 16:32	27,25	6	163,47	CHI
201911352026	ITAUCU	PV17246847	CORUMBA	28/11/2019 11:04	29/11/2019 12:07	28/11/2019 11:04	29/11/2019 12:07	25,05	1	25,05	CHI
201911352026	PIRENOPOLIS	PV17246847	CORUMBA	28/11/2019 11:04	29/11/2019 12:07	28/11/2019 11:04	29/11/2019 12:07	25,05	71	1778,55	CHI
201911352029	RIO VERDE	630133610	RIO VERDE S2	28/11/2019 13:20	29/11/2019 00:40	28/11/2019 13:20	29/11/2019 00:40	11,34	1	11,34	CHI
201911352030	MINACU	IH12348010	MINACU	28/11/2019 13:20	28/11/2019 21:57	28/11/2019 13:20	28/11/2019 21:57	8,61	4	34,44	CHI

201911352032	AMERICANO DO BRASIL	1410015881	ANICUNS	28/11/2019 13:21	28/11/2019 14:42	28/11/2019 13:21	28/11/2019 14:42	1,36	1	1,36	CHI
201911352036	BONOPOLIS	BX12202542	SAO MIGUEL DO ARAGUAIA	28/11/2019 13:06	30/11/2019 01:06	28/11/2019 13:06	28/11/2019 22:27	9,35	17	158,95	CHI
201911352036	PORANGATU	BX12202542	SAO MIGUEL DO ARAGUAIA	28/11/2019 13:06	30/11/2019 01:06	28/11/2019 13:06	30/11/2019 01:06	35,99	1	35,99	CHI
201911352036	BONOPOLIS	BX12202542	SAO MIGUEL DO ARAGUAIA	28/11/2019 13:06	30/11/2019 01:06	28/11/2019 13:06	30/11/2019 01:06	35,99	38	1367,76	CHI
201911352036	BONOPOLIS	BX12202542	SAO MIGUEL DO ARAGUAIA	28/11/2019 13:06	30/11/2019 01:06	28/11/2019 22:28	30/11/2019 01:06	26,64	17	452,91	CHI
201911352041	PLANALTINA	2960147152	PLANALTINA	28/11/2019 13:22	28/11/2019 17:40	28/11/2019 13:22	28/11/2019 17:40	4,31	1	4,31	CHI
201911352044	JATAI	JT12000085	JATAI S3	28/11/2019 13:22	28/11/2019 15:16	28/11/2019 13:22	28/11/2019 15:16	1,89	1416	2678,99	CHI
201911352056	CATALAO	GD12039654	CATALAO S1	28/11/2019 13:24	28/11/2019 17:01	28/11/2019 13:24	28/11/2019 17:01	3,62	4	14,46	CHI
201911352056	GOIANDIRA	GD12039654	CATALAO S1	28/11/2019 13:24	28/11/2019 17:01	28/11/2019 13:24	28/11/2019 17:01	3,62	6	21,69	CHI
201911352057	GOIANIA	15822229	INDEPENDENCIA S1	28/11/2019 13:24	28/11/2019 20:48	28/11/2019 13:24	28/11/2019 20:48	7,39	1	7,39	CHI
201911352058	GUAPO	TR21000203	GUAPO S1	28/11/2019 13:25	28/11/2019 16:27	28/11/2019 13:25	28/11/2019 16:27	3,02	1	3,02	CHI
201911352059	GOIANDIRA	00540424	CATALAO S1	28/11/2019 13:25	28/11/2019 16:58	28/11/2019 13:25	28/11/2019 16:58	3,54	35	123,90	CHI
201911352059	CUMARI	00540424	CATALAO S1	28/11/2019 13:25	28/11/2019 16:58	28/11/2019 13:25	28/11/2019 16:58	3,54	5	17,70	CHI
201911352065	EDEIA	EA12084049	VICENTINOPOLIS	28/11/2019 06:16	28/11/2019 15:51	28/11/2019 06:16	28/11/2019 15:51	9,58	2	19,15	CHI
201911352069	CATALAO	CT12127882	CATALAO S1	28/11/2019 13:27	29/11/2019 02:24	28/11/2019 13:27	29/11/2019 02:24	12,95	17	220,10	CHI
201911352078	PORANGATU	PO12394943	MARA ROSA	28/11/2019 13:27	29/11/2019 11:56	28/11/2019 13:27	29/11/2019 11:56	22,48	10	224,82	CHI
201911352078	BONOPOLIS	PO12394943	MARA ROSA	28/11/2019 13:27	29/11/2019 11:56	28/11/2019 13:27	29/11/2019 11:56	22,48	2	44,96	CHI
201911352081	GOIANIA	GN11293516	INDEPENDENCIA S2	28/11/2019 12:21	28/11/2019 18:24	28/11/2019 12:21	28/11/2019 18:24	6,05	87	526,64	CHI
201911352087	SENADOR CANEDO	10008229048	SENADOR CANEDO	28/11/2019 13:28	28/11/2019 17:50	28/11/2019 13:28	28/11/2019 17:50	4,35	1	4,35	CHI
201911352090	ITAGUARU	JA12328472	JARAGUA	28/11/2019 13:29	29/11/2019 18:10	28/11/2019 13:29	29/11/2019 18:10	28,68	17	487,58	CHI
201911352090	JARAGUA	JA12328472	JARAGUA	28/11/2019 13:29	29/11/2019 18:10	28/11/2019 13:29	29/11/2019 18:10	28,68	1	28,68	CHI
201911352092	GOIAS	GS12220498	GOIAS	28/11/2019 13:29	28/11/2019 17:40	28/11/2019 13:29	28/11/2019 17:40	4,18	46	192,22	CHI
201911352093	GOIANIA	GN12326216	FERROVIARIO S1	28/11/2019 12:33	28/11/2019 15:06	28/11/2019 12:33	28/11/2019 15:06	2,55	253	644,10	CHI
201911352105	VARJAO	VJ21358040	GUAPO S2	28/11/2019 13:31	28/11/2019 17:30	28/11/2019 13:31	28/11/2019 17:30	3,98	1	3,98	CHI
201911352106	GOIANESIA	550118470	GOIANESIA S2	28/11/2019 13:31	28/11/2019 17:15	28/11/2019 13:31	28/11/2019 17:15	3,72	1	3,72	CHI
201911352115	APARECIDA DE GOIANIA	AP11329209	INDEPENDENCIA S2	28/11/2019 13:32	28/11/2019 16:15	28/11/2019 13:32	28/11/2019 16:15	2,71	53	143,62	CHI
201911352116	VILA PROPICIO	NP21221436	GOIANESIA S1	28/11/2019 13:32	29/11/2019 09:25	28/11/2019 13:32	29/11/2019 09:25	19,87	1	19,87	CHI
201911352121	ARAGOIANIA	AO32097617	GUAPO S2	28/11/2019 13:33	28/11/2019 18:16	28/11/2019 13:33	28/11/2019 18:16	4,72	1	4,72	CHI
201911352127	GOIAS	GS21063244	GOIAS	28/11/2019 13:33	28/11/2019 18:35	28/11/2019 13:33	28/11/2019 18:35	5,02	1	5,02	CHI
201911352129	MONTE ALEGRE DE GOIAS	MA12302753	SAO DOMINGOS	28/11/2019 12:11	28/11/2019 17:04	28/11/2019 12:11	28/11/2019 17:04	4,87	36	175,33	CHI
201911352132	IPAMERI	IP12247905	CRISTALINA S2	28/11/2019 13:16	28/11/2019 19:30	28/11/2019 13:16	28/11/2019 19:30	6,22	8	49,74	CHI
201911352134	SANTA HELENA DE GOIAS	SH12370214	SANTA HELENA S1	28/11/2019 13:34	28/11/2019 17:00	28/11/2019 13:34	28/11/2019 17:00	3,43	1	3,43	CHI
201911352150	MONTE ALEGRE DE GOIAS	MA12130278	SAO DOMINGOS	28/11/2019 10:40	28/11/2019 17:31	28/11/2019 10:40	28/11/2019 17:31	6,84	6	41,05	CHI

201911352153	JARAGUA	JA21353389	GOIANESIA S2	28/11/2019 13:37	29/11/2019 10:45	28/11/2019 13:37	29/11/2019 10:45	21,13	1	21,13	CHI
201911352156	GOIANAPOLIS	GP21188812	GOIANIA LESTE S2	28/11/2019 13:37	28/11/2019 20:54	28/11/2019 13:37	28/11/2019 20:54	7,28	1	7,28	CHI
201911352163	HIDROLANDIA	HD12366272	CEPAIGO S2	28/11/2019 13:38	28/11/2019 15:00	28/11/2019 13:38	28/11/2019 15:00	1,36	7	9,50	CHI
201911352168	TRINDADE	10020420437	MEIA PONTE	28/11/2019 13:39	28/11/2019 18:10	28/11/2019 13:39	28/11/2019 18:10	4,53	1	4,53	CHI
201911352172	ANHANGUERA	AH11000072	CATALAO S1	28/11/2019 13:21	28/11/2019 18:05	28/11/2019 13:21	28/11/2019 18:05	4,72	99	467,03	CHI
201911352173	CATALAO	CT11186684	CATALAO S2	28/11/2019 13:34	28/11/2019 14:20	28/11/2019 13:34	28/11/2019 14:20	0,76	127	96,24	CHI
201911352174	ITARUMA	IM12107442	CACHOEIRA ALTA	28/11/2019 13:39	30/11/2019 11:31	28/11/2019 13:39	29/11/2019 17:38	27,99	5	139,94	CHI
201911352174	ITARUMA	IM12107442	CACHOEIRA ALTA	28/11/2019 13:39	30/11/2019 11:31	28/11/2019 13:39	29/11/2019 19:32	29,89	30	896,66	CHI
201911352174	ITARUMA	IM12107442	CACHOEIRA ALTA	28/11/2019 13:39	30/11/2019 11:31	28/11/2019 13:39	30/11/2019 11:31	45,86	6	275,19	CHI
201911352176	ANAPOLIS	20600562	ANAPOLIS UNIVERSITARIO S2	28/11/2019 13:40	28/11/2019 14:39	28/11/2019 13:40	28/11/2019 14:39	0,97	1	0,97	CHI
201911352177	ITARUMA	IM12107406	CACHOEIRA ALTA	28/11/2019 13:40	30/11/2019 09:42	28/11/2019 13:40	30/11/2019 09:42	44,04	17	748,65	CHI
201911352180	BOM JARDIM DE GOIAS	BM21064177	BOM JARDIM	28/11/2019 13:41	28/11/2019 17:52	28/11/2019 13:41	28/11/2019 17:52	4,17	1	4,17	CHI
201911352183	CRISTALINA	KR21237899	CRISTALINA S1	28/11/2019 13:41	28/11/2019 19:02	28/11/2019 13:41	28/11/2019 19:02	5,34	1	5,34	CHI
201911352186	LUZIANIA	LZ21304819	MARAJOARA	28/11/2019 13:41	28/11/2019 15:25	28/11/2019 13:41	28/11/2019 15:25	1,72	1	1,72	CHI
201911352202	SAO DOMINGOS	SD12389125	SAO DOMINGOS	28/11/2019 13:44	29/11/2019 13:35	28/11/2019 13:44	29/11/2019 13:35	23,84	33	786,67	CHI
201911352208	LUZIANIA	LZ12041471	RIO VERMELHO	28/11/2019 13:45	28/11/2019 16:50	28/11/2019 13:45	28/11/2019 16:50	3,09	11	33,99	CHI
201911352216	PLANALTINA	2960143766	PLANALTINA	28/11/2019 13:46	28/11/2019 19:19	28/11/2019 13:46	28/11/2019 19:19	5,55	1	5,55	CHI
201911352226	HIDROLANDIA	BV12079678	BELA VISTA S1	28/11/2019 13:32	28/11/2019 15:40	28/11/2019 13:32	28/11/2019 15:40	2,13	1	2,13	CHI
201911352226	BELA VISTA DE GOIAS	BV12079678	BELA VISTA S1	28/11/2019 13:32	28/11/2019 15:40	28/11/2019 13:32	28/11/2019 15:40	2,13	124	264,19	CHI
201911352244	ADELANDIA	DN12021716	ANICUNS	28/11/2019 12:20	28/11/2019 17:23	28/11/2019 12:20	28/11/2019 17:23	5,05	8	40,36	CHI
201911352246	GOIANAPOLIS	GP11135901	DAIA S2	28/11/2019 13:48	28/11/2019 19:15	28/11/2019 13:48	28/11/2019 19:15	5,44	68	369,84	CHI
201911352250	VICENTINOPOLIS	VI12071025	VICENTINOPOLIS	28/11/2019 13:49	28/11/2019 14:15	28/11/2019 13:49	28/11/2019 14:15	0,44	409	181,32	CHI
201911352255	AGUA FRIA DE GOIAS	TL12164659	SAO JOAO D ALIANCA	28/11/2019 10:14	28/11/2019 17:13	28/11/2019 10:14	28/11/2019 17:13	6,97	44	306,61	CHI
201911352265	IPAMERI	IP12153045	IPAMERI	28/11/2019 13:50	28/11/2019 19:14	28/11/2019 13:50	28/11/2019 19:14	5,39	32	172,41	CHI
201911352265	CALDAS NOVAS	IP12153045	IPAMERI	28/11/2019 13:50	28/11/2019 19:14	28/11/2019 13:50	28/11/2019 19:14	5,39	5	26,94	CHI
201911352272	PLANALTINA	PI11043450	PLANALTINA	28/11/2019 13:21	28/11/2019 15:31	28/11/2019 13:21	28/11/2019 15:31	2,16	96	207,28	CHI
201911352274	CRISTALINA	KR12039306	CRISTALINA S1	28/11/2019 13:51	28/11/2019 16:57	28/11/2019 13:51	28/11/2019 16:57	3,08	2	6,17	CHI
201911352279	PARAUNA	980045575	ACREUNA	28/11/2019 13:52	28/11/2019 17:48	28/11/2019 13:52	28/11/2019 17:48	3,93	1	3,93	CHI
201911352283	SAO JOAO D ALIANCA	JL12383338	SAO JOAO D ALIANCA	28/11/2019 13:45	28/11/2019 19:50	28/11/2019 13:45	28/11/2019 19:50	6,08	39	237,16	CHI
201911352291	ANICUNS	10011611284	ANICUNS	28/11/2019 13:54	28/11/2019 16:12	28/11/2019 13:54	28/11/2019 16:12	2,30	1	2,30	CHI
201911352293	GOIANDIRA	CT12130960RE	CATALAO S2	28/11/2019 13:46	28/11/2019 20:16	28/11/2019 13:46	28/11/2019 20:16	6,50	5	32,51	CHI
201911352293	CUMARI	CT12130960RE	CATALAO S2	28/11/2019 13:46	28/11/2019 20:16	28/11/2019 13:46	28/11/2019 20:16	6,50	202	1313,56	CHI
201911352293	CATALAO	CT12130960RE	CATALAO S2	28/11/2019 13:46	28/11/2019 20:16	28/11/2019 13:46	28/11/2019 20:16	6,50	89	578,75	CHI



201911352297	LUZIANIA	120066920	RIO VERMELHO	28/11/2019 13:55	28/11/2019 17:35	28/11/2019 13:55	28/11/2019 17:35	3,66	1	3,66	CHI
201911352299	NIQUELANDIA	NQ12088704	URUACU	28/11/2019 11:43	28/11/2019 17:15	28/11/2019 11:43	28/11/2019 17:15	5,53	21	116,09	CHI
201911352301	GOIAS	GS12250582	GOIAS	28/11/2019 13:19	29/11/2019 16:23	28/11/2019 13:19	29/11/2019 16:23	27,05	10	270,54	CHI
201911352303	ITUMBARA	IT21284395	PARANAIBA	28/11/2019 13:55	28/11/2019 15:40	28/11/2019 13:55	28/11/2019 15:40	1,74	1	1,74	CHI
201911352306	PADRE BERNARDO	9980020677	PADRE BERNARDO	28/11/2019 13:55	28/11/2019 18:08	28/11/2019 13:55	28/11/2019 18:08	4,20	1	4,20	CHI
201911352317	GOIATUBA	CL12295937	RIO DOS BOIS	28/11/2019 13:57	28/11/2019 18:56	28/11/2019 13:57	28/11/2019 18:56	5,00	3	14,99	CHI
201911352317	PORTEIRAO	CL12295937	RIO DOS BOIS	28/11/2019 13:57	28/11/2019 18:56	28/11/2019 13:57	28/11/2019 18:56	5,00	1	5,00	CHI
201911352335	GOIANIA	15808622	CARAJAS S1	28/11/2019 13:59	28/11/2019 17:30	28/11/2019 13:59	28/11/2019 17:30	3,50	1	3,50	CHI
201911352336	URUACU	UR12221685	URUACU	28/11/2019 12:02	28/11/2019 15:56	28/11/2019 12:02	28/11/2019 15:56	3,89	20	77,79	CHI
201911352337	PIRENOPOLIS	PV12360338RE	CORUMBA	28/11/2019 12:20	28/11/2019 18:31	28/11/2019 12:20	28/11/2019 18:31	6,17	91	561,92	CHI
201911352339	PADRE BERNARDO	PB11192960	PADRE BERNARDO	28/11/2019 13:50	28/11/2019 16:27	28/11/2019 13:50	28/11/2019 16:27	2,61	150	391,92	CHI
201911352348	QUIRINOPOLIS	QI21207138	QUIRINOPOLIS	28/11/2019 14:01	29/11/2019 11:58	28/11/2019 14:01	29/11/2019 11:58	21,94	1	21,94	CHI
201911352349	APARECIDA DE GOIANIA	200051751	ANHANGUERA	28/11/2019 14:01	28/11/2019 15:19	28/11/2019 14:01	28/11/2019 15:19	1,29	1	1,29	CHI
201911352352	NIQUELANDIA	10009416224	NIQUELANDIA SUBTRANSMISSAO	28/11/2019 14:01	29/11/2019 09:07	28/11/2019 14:01	29/11/2019 09:07	19,09	1	19,09	CHI
201911352353	ANAPOLIS	20247254	ANAPOLIS UNIVERSITARIO S2	28/11/2019 14:02	28/11/2019 16:04	28/11/2019 14:02	28/11/2019 16:04	2,03	1	2,03	CHI
201911352359	RIO VERDE	RV21267689	CABRIUVA S2	28/11/2019 14:02	28/11/2019 15:40	28/11/2019 14:02	28/11/2019 15:40	1,62	1	1,62	CHI
201911352363	SAO MIGUEL DO ARAGUAIA	SM21357409	SAO MIGUEL DO ARAGUAIA	28/11/2019 14:04	29/11/2019 12:21	28/11/2019 14:04	29/11/2019 12:21	22,28	1	22,28	CHI
201911352365	PORANGATU	840121714	PORANGATU	28/11/2019 14:04	29/11/2019 11:30	28/11/2019 14:04	29/11/2019 11:30	21,43	1	21,43	CHI
201911352370	LUZIANIA	3200201068	RIO VERMELHO	28/11/2019 14:04	28/11/2019 17:01	28/11/2019 14:04	28/11/2019 17:01	2,94	1	2,94	CHI
201911352375	MONTES CLAROS DE GOIAS	ME21160287	IPORA	28/11/2019 14:05	28/11/2019 21:54	28/11/2019 14:05	28/11/2019 21:54	7,81	1	7,81	CHI
201911352380	TROMBAS	TB12372648	PORANGATU	28/11/2019 13:57	28/11/2019 22:05	28/11/2019 13:57	28/11/2019 22:05	8,13	67	544,58	CHI
201911352380	FORMOSO	TB12372648	PORANGATU	28/11/2019 13:57	28/11/2019 22:05	28/11/2019 13:57	28/11/2019 22:05	8,13	1	8,13	CHI
201911352381	ARAGOIANIA	AO31097641	GUAPO S2	28/11/2019 14:05	28/11/2019 19:28	28/11/2019 14:05	28/11/2019 19:28	5,37	2	10,74	CHI
201911352383	ANAPOLIS	AN11135790	ANAPOLIS UNIVERSITARIO S1	28/11/2019 14:06	28/11/2019 18:01	28/11/2019 14:06	28/11/2019 18:01	3,91	74	289,34	CHI
201911352385	IPAMERI	IP12100702	CRISTALINA S2	28/11/2019 14:06	28/11/2019 17:06	28/11/2019 14:06	28/11/2019 17:06	2,98	1	2,98	CHI
201911352385	CRISTALINA	IP12100702	CRISTALINA S2	28/11/2019 14:06	28/11/2019 17:06	28/11/2019 14:06	28/11/2019 17:06	2,98	1	2,98	CHI
201911352386	BELA VISTA DE GOIAS	BV21324941	BELA VISTA S2	28/11/2019 14:07	28/11/2019 16:17	28/11/2019 14:07	28/11/2019 16:17	2,17	2	4,33	CHI
201911352390	ANAPOLIS	20827398	ANAPOLIS UNIVERSITARIO S2	28/11/2019 14:08	28/11/2019 15:12	28/11/2019 14:08	28/11/2019 15:12	1,06	1	1,06	CHI
201911352395	GOUVELANDIA	GB12116577	QUIRINOPOLIS	28/11/2019 13:55	28/11/2019 16:06	28/11/2019 13:55	28/11/2019 16:06	2,18	35	76,38	CHI
201911352395	QUIRINOPOLIS	GB12116577	QUIRINOPOLIS	28/11/2019 13:55	28/11/2019 16:06	28/11/2019 13:55	28/11/2019 16:06	2,18	13	28,37	CHI
201911352398	PIRES DO RIO	PR12263172	PIRES DO RIO S2	28/11/2019 14:09	28/11/2019 17:25	28/11/2019 14:09	28/11/2019 17:25	3,27	9	29,40	CHI
201911352401	LUZIANIA	LZ12000220	RIO VERMELHO	28/11/2019 14:09	28/11/2019 16:45	28/11/2019 14:09	28/11/2019 16:45	2,59	70	181,09	CHI
201911352410	CATALAO	CT11078243	CATALAO S2	28/11/2019 14:10	28/11/2019 17:30	28/11/2019 14:10	28/11/2019 17:30	3,33	86	286,45	CHI

201911352411	SILVANIA	SV12143185	VIANOPOLIS	28/11/2019 14:10	28/11/2019 16:43	28/11/2019 14:10	28/11/2019 16:43	2,55	12	30,55	CHI
201911352412	CATALAO	IP12157299RE	IPAMERI	28/11/2019 13:19	28/11/2019 15:23	28/11/2019 13:19	28/11/2019 15:23	2,06	7	14,44	CHI
201911352412	GOIANDIRA	IP12157299RE	IPAMERI	28/11/2019 13:19	28/11/2019 15:23	28/11/2019 13:19	28/11/2019 15:23	2,06	15	30,94	CHI
201911352412	IPAMERI	IP12157299RE	IPAMERI	28/11/2019 13:19	28/11/2019 15:23	28/11/2019 13:19	28/11/2019 15:23	2,06	53	109,33	CHI
201911352416	ORIZONA	OZ12101919	PIRES DO RIO S2	28/11/2019 14:08	28/11/2019 18:31	28/11/2019 14:08	28/11/2019 18:31	4,38	9	39,40	CHI
201911352425	SAO MIGUEL DO ARAGUAIA	SM12372634	SAO MIGUEL DO ARAGUAIA	28/11/2019 13:41	29/11/2019 09:33	28/11/2019 13:41	29/11/2019 09:33	19,87	23	456,93	CHI
201911352429	PETROLINA DE GOIAS	PG21031551	PETROLINA	28/11/2019 09:51	28/11/2019 20:02	28/11/2019 09:51	28/11/2019 20:02	10,17	1	10,17	CHI
201911352432	CRISTALINA	KR21330175	CRISTALINA S1	28/11/2019 14:13	28/11/2019 20:12	28/11/2019 14:13	28/11/2019 20:12	5,98	1	5,98	CHI
201911352436	IACIARA	IA12244056	IACIARA S1	28/11/2019 11:53	28/11/2019 22:59	28/11/2019 11:53	28/11/2019 22:59	11,10	3	33,29	CHI
201911352444	FORMOSA	610154310	PLANALTINA	28/11/2019 14:14	29/11/2019 09:41	28/11/2019 14:14	29/11/2019 09:41	19,45	1	19,45	CHI
201911352451	SANTA HELENA DE GOIAS	SH12301407	SANTA HELENA S1	28/11/2019 14:14	28/11/2019 17:40	28/11/2019 14:14	28/11/2019 17:40	3,42	10	34,17	CHI
201911352451	RIO VERDE	SH12301407	SANTA HELENA S1	28/11/2019 14:14	28/11/2019 17:40	28/11/2019 14:14	28/11/2019 17:40	3,42	3	10,25	CHI
201911352453	ITAGUARU	HE12041333	ITAPURANGA	28/11/2019 14:14	29/11/2019 08:54	28/11/2019 14:14	29/11/2019 08:54	18,66	1	18,66	CHI
201911352455	JATAI	JT12209803	JATAI S3	28/11/2019 14:10	28/11/2019 17:46	28/11/2019 14:10	28/11/2019 17:46	3,59	24	86,22	CHI
201911352459	GOIATUBA	GT12008236	BOM JESUS DE GOIAS	28/11/2019 14:16	28/11/2019 17:19	28/11/2019 14:16	28/11/2019 17:19	3,05	17	51,83	CHI
201911352466	QUIRINOPOLIS	QI12234619	QUIRINOPOLIS	28/11/2019 14:17	29/11/2019 10:01	28/11/2019 14:17	29/11/2019 10:01	19,73	3	59,20	CHI
201911352469	PETROLINA DE GOIAS	PG21101825	PETROLINA	28/11/2019 14:17	29/11/2019 11:24	28/11/2019 14:17	29/11/2019 11:24	21,10	1	21,10	CHI
201911352471	CALDAS NOVAS	760313775	CALDAS NOVAS S1	28/11/2019 14:18	28/11/2019 17:59	28/11/2019 14:18	28/11/2019 17:59	3,68	1	3,68	CHI
201911352473	GOIAS	GS21021055	GOIAS	28/11/2019 14:18	29/11/2019 18:08	28/11/2019 14:18	29/11/2019 18:08	27,82	1	27,82	CHI
201911352487	CRISTALINA	IP12165527	CRISTALINA S1	28/11/2019 13:32	28/11/2019 15:10	28/11/2019 13:32	28/11/2019 15:10	1,62	14	22,64	CHI
201911352497	VILA PROPICIO	PV13185501	GOIANESIA S1	28/11/2019 13:06	29/11/2019 09:11	28/11/2019 13:06	29/11/2019 09:11	20,09	151	3032,96	CHI
201911352497	COCALZINHO DE GOIAS	PV13185501	GOIANESIA S1	28/11/2019 13:06	29/11/2019 09:11	28/11/2019 13:06	29/11/2019 09:11	20,09	255	5121,89	CHI
201911352499	AGUAS LINDAS DE GOIAS	4830319228	AGUAS LINDAS DE GOIAS S1	28/11/2019 14:22	28/11/2019 20:49	28/11/2019 14:22	28/11/2019 20:49	6,44	1	6,44	CHI
201911352500	ANAPOLIS	AN12082525	ANAPOLIS UNIVERSITARIO S2	28/11/2019 14:16	28/11/2019 16:27	28/11/2019 14:16	28/11/2019 16:27	2,18	32	69,71	CHI
201911352502	PETROLINA DE GOIAS	PG21388598	PETROLINA	28/11/2019 14:23	28/11/2019 19:23	28/11/2019 14:23	28/11/2019 19:23	5,00	3	14,99	CHI
201911352506	PORANGATU	PO11227209	PORANGATU	28/11/2019 14:24	29/11/2019 11:19	28/11/2019 14:24	29/11/2019 11:19	20,91	1	20,91	CHI
201911352514	GOIANIA	16082771	CAMPINAS S2	28/11/2019 14:25	28/11/2019 16:44	28/11/2019 14:25	28/11/2019 16:44	2,32	1	2,32	CHI
201911352517	AMARALINA	8093419	SAO MIGUEL DO ARAGUAIA	28/11/2019 14:18	29/11/2019 11:38	28/11/2019 14:18	29/11/2019 11:38	21,32	219	4669,26	CHI
201911352517	BONOPOLIS	8093419	SAO MIGUEL DO ARAGUAIA	28/11/2019 14:18	29/11/2019 11:38	28/11/2019 14:18	29/11/2019 11:38	21,32	11	234,53	CHI
201911352518	ITARUMA	8732442	CACHOEIRA ALTA	28/11/2019 07:04	28/11/2019 15:38	28/11/2019 07:04	28/11/2019 15:38	8,56	16	137,01	CHI
201911352518	ITAJA	8732442	CACHOEIRA ALTA	28/11/2019 07:04	28/11/2019 15:38	28/11/2019 07:04	28/11/2019 15:38	8,56	11	94,19	CHI
201911352524	PALMINOPOLIS	PP21390944	PALMEIRAS	28/11/2019 14:25	28/11/2019 17:55	28/11/2019 14:25	28/11/2019 17:55	3,50	1	3,50	CHI
201911352530	FORMOSO	2410011166	PORANGATU	28/11/2019 14:26	28/11/2019 19:35	28/11/2019 14:26	28/11/2019 19:35	5,15	1	5,15	CHI

201911352531	SANTA CRUZ DE GOIAS	PR12051693	PIRES DO RIO S2	28/11/2019 13:21	28/11/2019 16:26	28/11/2019 13:21	28/11/2019 16:26	3,09	2	6,17	CHI
201911352531	PIRES DO RIO	PR12051693	PIRES DO RIO S2	28/11/2019 13:21	28/11/2019 16:26	28/11/2019 13:21	28/11/2019 16:26	3,09	13	40,11	CHI
201911352534	MINEIROS	MY21226598	PARQUE DAS EMAS	28/11/2019 14:27	29/11/2019 10:30	28/11/2019 14:27	29/11/2019 10:30	20,04	2	40,08	CHI
201911352549	LUZIANIA	LZ12040417	RIO VERMELHO	28/11/2019 12:44	28/11/2019 17:11	28/11/2019 12:44	28/11/2019 17:11	4,44	15	66,57	CHI
201911352550	NEROPOLIS	NR11008341	NEROPOLIS S2	28/11/2019 13:38	28/11/2019 19:50	28/11/2019 13:38	28/11/2019 19:50	6,19	120	742,77	CHI
201911352556	GOIANESIA	GE12382867	GOIANESIA S1	28/11/2019 05:33	28/11/2019 18:42	28/11/2019 05:33	28/11/2019 18:42	13,14	4	52,57	CHI
201911352559	ALTO PARAISO DE GOIAS	BF21231958	FLORES DE GOIAS	28/11/2019 14:31	28/11/2019 18:52	28/11/2019 14:31	28/11/2019 18:52	4,35	1	4,35	CHI
201911352564	CAMPINORTE	CR11257436	PORANGATU	28/11/2019 14:32	28/11/2019 22:05	28/11/2019 14:32	28/11/2019 22:05	7,55	1	7,55	CHI
201911352565	RIO VERDE	630126458	RIO VERDE S1	28/11/2019 14:32	28/11/2019 18:00	28/11/2019 14:32	28/11/2019 18:00	3,46	1	3,46	CHI
201911352569	GOIANIA	11162958	GOYA S2	28/11/2019 14:34	28/11/2019 16:06	28/11/2019 14:34	28/11/2019 16:06	1,53	1	1,53	CHI
201911352579	JUSSARA	03210424	BRITANIA	28/11/2019 14:10	29/11/2019 01:55	28/11/2019 14:10	28/11/2019 14:15	0,08	49	4,08	CHI
201911352579	JUSSARA	03210424	BRITANIA	28/11/2019 14:10	29/11/2019 01:55	28/11/2019 14:10	28/11/2019 14:15	0,08	24	2,00	CHI
201911352579	ITAPIRAPUA	03210424	BRITANIA	28/11/2019 14:10	29/11/2019 01:55	28/11/2019 14:10	28/11/2019 14:15	0,08	2	0,17	CHI
201911352579	ARUANA	03210424	BRITANIA	28/11/2019 14:10	29/11/2019 01:55	28/11/2019 14:10	28/11/2019 14:15	0,08	23	1,92	CHI
201911352579	BRITANIA	03210424	BRITANIA	28/11/2019 14:10	29/11/2019 01:55	28/11/2019 14:10	28/11/2019 14:15	0,08	1905	158,75	CHI
201911352579	BRITANIA	03210424	BRITANIA	28/11/2019 14:10	29/11/2019 01:55	28/11/2019 14:10	28/11/2019 14:15	0,08	1353	112,75	CHI
201911352579	BRITANIA	03210424	BRITANIA	28/11/2019 14:10	29/11/2019 01:55	28/11/2019 14:10	28/11/2019 16:40	2,51	11	27,61	CHI
201911352579	BRITANIA	03210424	BRITANIA	28/11/2019 14:10	29/11/2019 01:55	28/11/2019 14:10	28/11/2019 16:40	2,51	12	30,12	CHI
201911352579	ARUANA	03210424	BRITANIA	28/11/2019 14:10	29/11/2019 01:55	28/11/2019 14:10	28/11/2019 16:40	2,51	13	32,63	CHI
201911352579	ARUANA	03210424	BRITANIA	28/11/2019 14:10	29/11/2019 01:55	28/11/2019 14:10	28/11/2019 17:01	2,86	15	42,97	CHI
201911352579	ARUANA	03210424	BRITANIA	28/11/2019 14:10	29/11/2019 01:55	28/11/2019 14:10	28/11/2019 17:11	3,02	10	30,21	CHI
201911352579	BRITANIA	03210424	BRITANIA	28/11/2019 14:10	29/11/2019 01:55	28/11/2019 14:10	28/11/2019 17:11	3,02	7	21,14	CHI
201911352579	ARUANA	AK10400388	BRITANIA	28/11/2019 14:10	29/11/2019 01:55	28/11/2019 17:02	28/11/2019 17:56	0,91	5	4,53	CHI
201911352579	ARUANA	AK13341255	BRITANIA	28/11/2019 14:10	29/11/2019 01:55	28/11/2019 17:02	29/11/2019 01:13	8,18	10	81,79	CHI
201911352579	ARUANA	BT13080946	BRITANIA	28/11/2019 14:10	29/11/2019 01:55	29/11/2019 01:46	29/11/2019 01:55	0,16	15	2,34	CHI
201911352581	ABADIA DE GOIAS	GN12062083	CARAJAS S1	28/11/2019 14:35	28/11/2019 21:27	28/11/2019 14:35	28/11/2019 21:27	6,86	4	27,44	CHI
201911352584	GOIANIRA	GR21016123	GOIANIRA	28/11/2019 14:35	28/11/2019 20:24	28/11/2019 14:35	28/11/2019 20:24	5,81	1	5,81	CHI
201911352588	CORUMBAIBA	CI12107485	VILA CORUMBA	28/11/2019 12:52	28/11/2019 18:52	28/11/2019 12:52	28/11/2019 18:52	5,99	19	113,78	CHI
201911352611	BRITANIA	BT12013469	BRITANIA	28/11/2019 08:01	29/11/2019 20:19	28/11/2019 08:01	29/11/2019 20:19	36,29	3	108,87	CHI
201911352612	IPAMERI	IP21017012	IPAMERI	28/11/2019 14:41	28/11/2019 16:45	28/11/2019 14:41	28/11/2019 16:45	2,05	1	2,05	CHI
201911352620	PIRES DO RIO	BC21221792	PIRES DO RIO S2	28/11/2019 14:44	29/11/2019 05:00	28/11/2019 14:44	29/11/2019 05:00	14,27	1	14,27	CHI
201911352623	CAMPINORTE	UC12283781	MARA ROSA	28/11/2019 14:44	29/11/2019 20:17	28/11/2019 14:44	29/11/2019 20:17	29,55	1	29,55	CHI
201911352623	CAMPINACU	UC12283781	MARA ROSA	28/11/2019 14:44	29/11/2019 20:17	28/11/2019 14:44	29/11/2019 20:17	29,55	8	236,37	CHI

201911352630	VILA BOA	FA21042037	ITUIQUIRA	28/11/2019 14:45	29/11/2019 11:25	28/11/2019 14:45	29/11/2019 11:25	20,67	1	20,67	CHI
201911352633	ITARUMA	IM21016194	CACHOEIRA ALTA	28/11/2019 14:45	29/11/2019 10:18	28/11/2019 14:45	29/11/2019 10:18	19,54	1	19,54	CHI
201911352634	DAVINOPOLIS	IO12074295	CATALAO S1	28/11/2019 13:35	29/11/2019 12:48	28/11/2019 13:35	29/11/2019 12:48	23,23	18	418,07	CHI
201911352638	RIO VERDE	10017291532	RIO VERDE S1	28/11/2019 14:46	28/11/2019 18:20	28/11/2019 14:46	28/11/2019 18:20	3,55	1	3,55	CHI
201911352639	ANICUNS	AC12076714	ANICUNS	28/11/2019 14:46	28/11/2019 21:40	28/11/2019 14:46	28/11/2019 21:40	6,90	51	351,89	CHI
201911352644	MOSSAMEDES	MD21318808	ITABERAÍ S2	28/11/2019 14:47	28/11/2019 18:25	28/11/2019 14:47	28/11/2019 18:25	3,63	1	3,63	CHI
201911352651	PALMINOPOLIS	PP21019885	PALMEIRAS	28/11/2019 14:48	28/11/2019 18:20	28/11/2019 14:48	28/11/2019 18:20	3,53	1	3,53	CHI
201911352653	MONTE ALEGRE DE GOIAS	MA12282303	SAO DOMINGOS	28/11/2019 14:48	28/11/2019 18:02	28/11/2019 14:48	28/11/2019 18:02	3,22	11	35,42	CHI
201911352662	ALEXANIA	AX21319808	ALEXANIA	28/11/2019 14:50	29/11/2019 16:56	28/11/2019 14:50	29/11/2019 16:56	26,09	1	26,09	CHI
201911352667	CRISTALINA	KR21330523	CRISTALINA S2	28/11/2019 14:51	29/11/2019 07:57	28/11/2019 14:51	29/11/2019 07:57	17,09	1	17,09	CHI
201911352672	PIRANHAS	PH21281569	PIRANHAS	28/11/2019 14:51	28/11/2019 18:30	28/11/2019 14:51	28/11/2019 18:30	3,65	1	3,65	CHI
201911352674	CAMPINACU	UC12265729	PORANGATU	28/11/2019 14:26	28/11/2019 20:57	28/11/2019 14:26	28/11/2019 20:57	6,52	26	169,46	CHI
201911352677	DAMIANOPOLIS	DA21256702	IACIARA S2	28/11/2019 14:53	28/11/2019 20:24	28/11/2019 14:53	28/11/2019 20:24	5,50	1	5,50	CHI
201911352680	NOVO GAMA	NJ11128866	PACAEMBU S1	28/11/2019 14:54	28/11/2019 17:46	28/11/2019 14:54	28/11/2019 17:46	2,86	47	134,59	CHI
201911352688	CATALAO	CT12042349	CATALAO S1	28/11/2019 14:20	28/11/2019 23:57	28/11/2019 14:20	28/11/2019 23:57	9,61	22	211,39	CHI
201911352690	GOIANESIA	GE12000223	GOIANESIA S2	28/11/2019 11:49	29/11/2019 16:26	28/11/2019 11:49	29/11/2019 16:26	28,61	37	1058,46	CHI
201911352691	PORANGATU	840143527	PORANGATU	28/11/2019 14:55	29/11/2019 10:01	28/11/2019 14:55	29/11/2019 10:01	19,09	1	19,09	CHI
201911352698	SAO DOMINGOS	SD21205419	SAO DOMINGOS	28/11/2019 14:57	29/11/2019 16:10	28/11/2019 14:57	29/11/2019 16:10	25,21	1	25,21	CHI
201911352703	COLINAS DO SUL	TI11197667	NIQUELANDIA SUBTRANSMISSAO	28/11/2019 14:56	28/11/2019 20:50	28/11/2019 14:56	28/11/2019 20:50	5,89	144	847,60	CHI
201911352704	FLORES DE GOIAS	FB21262022	FLORES DE GOIAS	28/11/2019 14:58	29/11/2019 12:49	28/11/2019 14:58	29/11/2019 12:49	21,86	2	43,71	CHI
201911352720	GOIAS	GS12215791	ITAPURANGA	28/11/2019 15:00	29/11/2019 17:27	28/11/2019 15:00	29/11/2019 17:27	26,44	1	26,44	CHI
201911352720	FAINA	GS12215791	ITAPURANGA	28/11/2019 15:00	29/11/2019 17:27	28/11/2019 15:00	29/11/2019 17:27	26,44	2	52,88	CHI
201911352722	DIVINOPOLIS DE GOIAS	GH12269345	SAO DOMINGOS	28/11/2019 12:39	28/11/2019 19:51	28/11/2019 12:39	28/11/2019 19:51	7,19	36	258,84	CHI
201911352723	BURITI ALEGRE	10005653930	ALTO BURITI	28/11/2019 15:00	28/11/2019 17:50	28/11/2019 15:00	28/11/2019 17:50	2,82	1	2,82	CHI
201911352732	PIRACANJUBA	PJ21109700	CALDAS NOVAS S1	28/11/2019 15:02	28/11/2019 17:15	28/11/2019 15:02	28/11/2019 17:15	2,22	1	2,22	CHI
201911352738	CACHOEIRA DOURADA	CD21000305	CACHOEIRA DOURADA	28/11/2019 15:03	28/11/2019 18:00	28/11/2019 15:03	28/11/2019 18:00	2,94	1	2,94	CHI
201911352748	CAMPOS VERDES	VD12238510	SANTA TEREZINHA	28/11/2019 13:24	29/11/2019 14:20	28/11/2019 13:24	29/11/2019 14:20	24,93	6	149,55	CHI
201911352750	FORMOSA	FA12228227	SAO JOAO D ALIANCA	28/11/2019 07:30	29/11/2019 11:49	28/11/2019 07:30	29/11/2019 11:49	28,30	11	311,32	CHI
201911352759	IVOLANDIA	IV21097771	IPORA	28/11/2019 15:07	28/11/2019 19:09	28/11/2019 15:07	28/11/2019 19:09	4,02	1	4,02	CHI
201911352765	SILVANIA	660007095	VIANOPOLIS	28/11/2019 15:08	28/11/2019 16:42	28/11/2019 15:08	28/11/2019 16:42	1,56	1	1,56	CHI
201911352766	ANAPOLIS	20237881	JUNDIAI S2	28/11/2019 15:08	28/11/2019 16:29	28/11/2019 15:08	28/11/2019 16:29	1,34	1	1,34	CHI
201911352770	PIRES DO RIO	460106004	PIRES DO RIO S1	28/11/2019 15:09	28/11/2019 21:58	28/11/2019 15:09	28/11/2019 21:58	6,81	1	6,81	CHI
201911352772	CACU	IM12371217	CACHOEIRA ALTA	28/11/2019 15:09	28/11/2019 20:38	28/11/2019 15:09	28/11/2019 20:38	5,47	31	169,66	CHI

201911352772	ITARUMA	IM12371217	CACHOEIRA ALTA	28/11/2019 15:09	28/11/2019 20:38	28/11/2019 15:09	28/11/2019 20:38	5,47	8	43,78	CHI
201911352773	ACREUNA	2440048933	ACREUNA	28/11/2019 15:09	28/11/2019 16:51	28/11/2019 15:09	28/11/2019 16:51	1,70	1	1,70	CHI
201911352776	IPAMERI	IP21275916	URUTAI	28/11/2019 15:09	29/11/2019 16:58	28/11/2019 15:09	29/11/2019 16:58	25,81	1	25,81	CHI
201911352779	TRINDADE	TR11321106	TRINDADE	28/11/2019 12:47	28/11/2019 19:07	28/11/2019 12:47	28/11/2019 19:07	6,33	79	500,18	CHI
201911352782	POSSE	PS21160036	IACIARA S2	28/11/2019 15:10	28/11/2019 16:51	28/11/2019 15:10	28/11/2019 16:51	1,68	1	1,68	CHI
201911352783	MINACU	IH11207708	MINACU	28/11/2019 15:10	28/11/2019 22:45	28/11/2019 15:10	28/11/2019 22:45	7,58	2	15,16	CHI
201911352785	SANTA TEREZA DE GOIAS	SE21240768	PORANGATU	28/11/2019 15:10	29/11/2019 10:30	28/11/2019 15:10	29/11/2019 10:30	19,33	1	19,33	CHI
201911352786	LEOPOLDO DE BULHOES	870023676	DAIA S2	28/11/2019 15:10	29/11/2019 09:28	28/11/2019 15:10	29/11/2019 09:28	18,29	1	18,29	CHI
201911352787	ITAPURANGA	IK12311323	ITAPURANGA	28/11/2019 15:10	28/11/2019 17:10	28/11/2019 15:10	28/11/2019 17:10	2,00	7	13,98	CHI
201911352789	BELA VISTA DE GOIAS	240004577	BELA VISTA S1	28/11/2019 15:10	28/11/2019 16:49	28/11/2019 15:10	28/11/2019 16:49	1,64	1	1,64	CHI
201911352792	LUZIANIA	LZ21261113	MARAJOARA	28/11/2019 15:11	28/11/2019 18:41	28/11/2019 15:11	28/11/2019 18:41	3,49	1	3,49	CHI
201911352793	SAO LUIS DE MONTES BELOS	500019897	SAO LUIZ DOS MONTES BELOS	28/11/2019 15:11	28/11/2019 19:15	28/11/2019 15:11	28/11/2019 19:15	4,07	1	4,07	CHI
201911352795	SAO MIGUEL DO ARAGUAIA	SM12351125	SAO MIGUEL DO ARAGUAIA	28/11/2019 14:46	28/11/2019 22:30	28/11/2019 14:46	28/11/2019 22:30	7,73	5	38,67	CHI
201911352800	MONTES CLAROS DE GOIAS	3060000485	IPORA	28/11/2019 15:12	29/11/2019 09:16	28/11/2019 15:12	29/11/2019 09:16	18,06	1	18,06	CHI
201911352814	APARECIDA DE GOIANIA	11964315	ATLANTICO S2	28/11/2019 15:15	28/11/2019 16:36	28/11/2019 15:15	28/11/2019 16:36	1,34	1	1,34	CHI
201911352819	NOVA IGUACU DE GOIAS	NH21361808	CAMPINORTE	28/11/2019 15:16	29/11/2019 14:03	28/11/2019 15:16	29/11/2019 14:03	22,78	1	22,78	CHI
201911352820	SANTA TEREZA DE GOIAS	SE12262714	PORANGATU	28/11/2019 15:16	29/11/2019 01:45	28/11/2019 15:16	29/11/2019 01:45	10,48	13	136,27	CHI
201911352821	TURVELANDIA	03050224	RIO DOS BOIS	28/11/2019 15:12	29/11/2019 12:20	28/11/2019 15:12	28/11/2019 15:56	0,74	425	313,32	CHI
201911352821	TURVELANDIA	03050224	RIO DOS BOIS	28/11/2019 15:12	29/11/2019 12:20	28/11/2019 16:42	28/11/2019 16:47	0,08	425	33,06	CHI
201911352821	TURVELANDIA	03050224	RIO DOS BOIS	28/11/2019 15:12	29/11/2019 12:20	28/11/2019 15:12	28/11/2019 17:50	2,62	597	1565,30	CHI
201911352821	PORTEIRAO	03050224	RIO DOS BOIS	28/11/2019 15:12	29/11/2019 12:20	28/11/2019 15:12	28/11/2019 18:09	2,94	1	2,94	CHI
201911352821	TURVELANDIA	03050224	RIO DOS BOIS	28/11/2019 15:12	29/11/2019 12:20	28/11/2019 15:12	28/11/2019 18:09	2,94	171	502,55	CHI
201911352821	SANTA HELENA DE GOIAS	03050224	RIO DOS BOIS	28/11/2019 15:12	29/11/2019 12:20	28/11/2019 15:12	28/11/2019 18:09	2,94	18	52,90	CHI
201911352821	ACREUNA	03050224	RIO DOS BOIS	28/11/2019 15:12	29/11/2019 12:20	28/11/2019 15:12	28/11/2019 18:09	2,94	24	70,53	CHI
201911352821	TURVELANDIA	03050224	RIO DOS BOIS	28/11/2019 15:12	29/11/2019 12:20	28/11/2019 15:12	28/11/2019 18:10	2,96	65	192,11	CHI
201911352821	TURVELANDIA	03050224	RIO DOS BOIS	28/11/2019 15:12	29/11/2019 12:20	28/11/2019 15:12	29/11/2019 12:20	21,13	13	274,70	CHI
201911352824	ABADIA DE GOIAS	AO12007317	INDEPENDENCIA S2	28/11/2019 15:16	29/11/2019 08:05	28/11/2019 15:16	29/11/2019 08:05	16,81	2	33,62	CHI
201911352825	GOIANESIA	GE12373995	GOIANESIA S2	28/11/2019 07:29	28/11/2019 16:54	28/11/2019 07:29	28/11/2019 16:54	9,40	18	169,26	CHI
201911352830	MONTIVIDIU DO NORTE	MX21153524	PORANGATU	28/11/2019 15:17	29/11/2019 11:22	28/11/2019 15:17	29/11/2019 11:22	20,08	1	20,08	CHI
201911352838	CAMPINACU	UC12055175	PORANGATU	28/11/2019 14:47	28/11/2019 22:06	28/11/2019 14:47	28/11/2019 22:06	7,31	17	124,33	CHI
201911352846	FLORES DE GOIAS	FB21334129	FLORES DE GOIAS	28/11/2019 15:19	29/11/2019 11:52	28/11/2019 15:19	29/11/2019 11:52	20,54	1	20,54	CHI
201911352848	ANAPOLIS	AN12360334	ANAPOLIS UNIVERSITARIO S2	28/11/2019 12:49	28/11/2019 17:54	28/11/2019 12:49	28/11/2019 17:54	5,08	275	1397,15	CHI
201911352848	ABADIANIA	AN12360334	ANAPOLIS UNIVERSITARIO S2	28/11/2019 12:49	28/11/2019 17:54	28/11/2019 12:49	28/11/2019 17:54	5,08	10	50,81	CHI

201911352854	PALMINOPOLIS	PP21053917	PALMEIRAS	28/11/2019 15:20	28/11/2019 19:42	28/11/2019 15:20	28/11/2019 19:42	4,36	1	4,36	CHI
201911352865	CALDAS NOVAS	760408531	CALDAS NOVAS S2	28/11/2019 15:22	28/11/2019 17:12	28/11/2019 15:22	28/11/2019 17:12	1,83	1	1,83	CHI
201911352883	MINACU	IH21248587	MINACU	28/11/2019 15:25	29/11/2019 09:50	28/11/2019 15:25	29/11/2019 09:50	18,40	1	18,40	CHI
201911352884	RIO VERDE	RV11230851	RIO VERDE S2	29/11/2019 08:10	29/11/2019 11:05	29/11/2019 08:10	29/11/2019 11:05	2,92	89	259,90	CHI
201911352890	GOIANIA	GN11203807	CARAJAS S2	28/11/2019 15:27	28/11/2019 16:49	28/11/2019 15:27	28/11/2019 16:49	1,36	156	212,77	CHI
201911352891	FAINA	FC12199793	GOIAS	28/11/2019 15:27	29/11/2019 12:16	28/11/2019 15:27	29/11/2019 12:16	20,81	17	353,83	CHI
201911352899	SANTA TEREZINHA DE GOIAS	VD21251086	SANTA TEREZINHA	28/11/2019 15:28	29/11/2019 14:35	28/11/2019 15:28	29/11/2019 14:35	23,10	1	23,10	CHI
201911352900	GOIANIA	11859969	CAMPINAS S3	28/11/2019 15:28	28/11/2019 16:47	28/11/2019 15:28	28/11/2019 16:47	1,30	1	1,30	CHI
201911352906	SAO DOMINGOS	SD12161808	SAO DOMINGOS	28/11/2019 15:01	28/11/2019 17:39	28/11/2019 15:01	28/11/2019 17:39	2,62	28	73,34	CHI
201911352911	INHUMAS	30135801	INHUMAS S2	28/11/2019 15:30	29/11/2019 07:09	28/11/2019 15:30	29/11/2019 07:09	15,63	1	15,63	CHI
201911352913	GOIANIA	GN11000878	FERROVIARIO S1	28/11/2019 15:31	28/11/2019 23:07	28/11/2019 15:31	28/11/2019 23:07	7,60	6	45,60	CHI
201911352915	ITABERAI	IB12220379	ITABERAI S1	28/11/2019 15:31	28/11/2019 17:22	28/11/2019 15:31	28/11/2019 17:22	1,85	147	272,24	CHI
201911352922	CATALAO	CT21274688	CATALAO S1	28/11/2019 15:32	28/11/2019 18:40	28/11/2019 15:32	28/11/2019 18:40	3,12	1	3,12	CHI
201911352930	PALMEIRAS DE GOIAS	590083326	PALMEIRAS	28/11/2019 15:34	28/11/2019 17:13	28/11/2019 15:34	28/11/2019 17:13	1,66	1	1,66	CHI
201911352933	ORIZONA	OZ12105272	PIRES DO RIO S2	28/11/2019 14:38	29/11/2019 07:38	28/11/2019 14:38	29/11/2019 07:38	17,00	33	560,96	CHI
201911352933	VIANOPOLIS	OZ12105272	PIRES DO RIO S2	28/11/2019 14:38	29/11/2019 07:38	28/11/2019 14:38	29/11/2019 07:38	17,00	4	68,00	CHI
201911352940	APARECIDA DE GOIANIA	AP11076553	INDEPENDENCIA S2	28/11/2019 15:19	28/11/2019 17:22	28/11/2019 15:19	28/11/2019 17:22	2,05	123	251,95	CHI
201911352947	MONTIVIDIU DO NORTE	MX12187846	PORANGATU	28/11/2019 11:58	28/11/2019 18:29	28/11/2019 11:58	28/11/2019 18:29	6,52	8	52,13	CHI
201911352959	BELA VISTA DE GOIAS	BV12020406	BELA VISTA S2	28/11/2019 15:40	29/11/2019 13:30	28/11/2019 15:40	29/11/2019 13:30	21,83	11	240,12	CHI
201911352961	MONTIVIDIU	MV21085658	MONTIVIDIU T	28/11/2019 15:41	28/11/2019 19:54	28/11/2019 15:41	28/11/2019 19:54	4,22	1	4,22	CHI
201911352963	JATAI	JT13136007	JATAI S2	28/11/2019 17:16	29/11/2019 17:09	28/11/2019 17:16	28/11/2019 19:04	1,81	31	56,18	CHI
201911352963	JATAI	JT10378104	JATAI S2	28/11/2019 17:16	29/11/2019 17:09	28/11/2019 19:05	28/11/2019 19:10	0,08	54	4,50	CHI
201911352963	JATAI	JT13136007	JATAI S2	28/11/2019 17:16	29/11/2019 17:09	28/11/2019 19:05	28/11/2019 19:38	0,56	31	17,34	CHI
201911352963	JATAI	JT10378104	JATAI S2	28/11/2019 17:16	29/11/2019 17:09	28/11/2019 19:39	28/11/2019 20:00	0,34	54	18,54	CHI
201911352963	JATAI	JT13136007	JATAI S2	28/11/2019 17:16	29/11/2019 17:09	28/11/2019 17:16	28/11/2019 20:02	2,77	69	190,92	CHI
201911352963	RIO VERDE	JT13136007	JATAI S2	28/11/2019 17:16	29/11/2019 17:09	28/11/2019 17:16	28/11/2019 20:02	2,77	28	77,47	CHI
201911352963	JATAI	JT13136007	JATAI S2	28/11/2019 17:16	29/11/2019 17:09	28/11/2019 19:39	28/11/2019 20:02	0,38	30	11,31	CHI
201911352963	JATAI	JT13136007	JATAI S2	28/11/2019 17:16	29/11/2019 17:09	28/11/2019 17:16	28/11/2019 20:31	3,25	130	423,04	CHI
201911352963	RIO VERDE	JT13136007	JATAI S2	28/11/2019 17:16	29/11/2019 17:09	28/11/2019 17:16	28/11/2019 20:31	3,25	1	3,25	CHI
201911352963	JATAI	JT13136007	JATAI S2	28/11/2019 17:16	29/11/2019 17:09	28/11/2019 17:16	28/11/2019 20:40	3,40	48	163,21	CHI
201911352963	JATAI	JT13136018	JATAI S2	28/11/2019 17:16	29/11/2019 17:09	29/11/2019 11:52	29/11/2019 16:34	4,70	11	51,67	CHI
201911352963	JATAI	JT13136016	JATAI S2	28/11/2019 17:16	29/11/2019 17:09	28/11/2019 19:39	29/11/2019 17:09	21,50	1	21,50	CHI
201911352970	MONTE ALEGRE DE GOIAS	MA21290216	SAO DOMINGOS	28/11/2019 15:42	28/11/2019 19:03	28/11/2019 15:42	28/11/2019 19:03	3,34	1	3,34	CHI

201911352971	PADRE BERNARDO	3160001244	PADRE BERNARDO	28/11/2019 15:42	28/11/2019 16:26	28/11/2019 15:42	28/11/2019 16:26	0,72	1	0,72	CHI
201911352982	PALMINOPOLIS	PP21308392	PALMEIRAS	28/11/2019 15:45	28/11/2019 21:45	28/11/2019 15:45	28/11/2019 21:45	5,99	2	11,98	CHI
201911352983	CATALAO	10015588350	CATALAO S2	28/11/2019 15:45	28/11/2019 18:17	28/11/2019 15:45	28/11/2019 18:17	2,52	1	2,52	CHI
201911352984	CRISTIANOPOLIS	CF12265545	CRISTIANOPOLIS	28/11/2019 15:33	29/11/2019 11:37	28/11/2019 15:33	29/11/2019 11:37	20,05	19	381,03	CHI
201911353003	VARJAO	7396986	GUAPO S2	28/11/2019 15:49	29/11/2019 03:00	28/11/2019 15:49	29/11/2019 03:00	11,17	6	67,00	CHI
201911353009	SAO MIGUEL DO ARAGUAIA	SM12143671	SAO MIGUEL DO ARAGUAIA	28/11/2019 13:45	28/11/2019 20:01	28/11/2019 13:45	28/11/2019 20:01	6,25	261	1631,90	CHI
201911353011	TEREZOPOLIS DE GOIAS	GP12011844	JUNDIAI S1	28/11/2019 13:59	28/11/2019 19:14	28/11/2019 13:59	28/11/2019 19:14	5,24	16	83,91	CHI
201911353027	GOIANESIA	GE11328284	GOIANESIA S1	28/11/2019 13:46	28/11/2019 17:24	28/11/2019 13:46	28/11/2019 17:24	3,62	47	170,10	CHI
201911353029	SANTA HELENA DE GOIAS	400050031	IPEGUARI	28/11/2019 15:55	28/11/2019 19:40	28/11/2019 15:55	28/11/2019 19:40	3,75	1	3,75	CHI
201911353030	SAO JOAO D ALIANCA	JL21048018	SAO JOAO D ALIANCA	28/11/2019 15:55	29/11/2019 18:56	28/11/2019 15:55	29/11/2019 18:56	27,01	1	27,01	CHI
201911353036	BELA VISTA DE GOIAS	240086600	BELA VISTA S1	28/11/2019 15:55	28/11/2019 18:05	28/11/2019 15:55	28/11/2019 18:05	2,16	1	2,16	CHI
201911353037	RIO VERDE	RV12327004	RIO VERDE S2	28/11/2019 15:55	28/11/2019 18:11	28/11/2019 15:55	28/11/2019 18:11	2,25	4	9,00	CHI
201911353041	RIO VERDE	10007820370	RIO VERDE S1	28/11/2019 15:56	29/11/2019 08:41	28/11/2019 15:56	29/11/2019 08:41	16,74	1	16,74	CHI
201911353048	RIO VERDE	630132409	RIO VERDE S1	28/11/2019 15:58	29/11/2019 10:11	28/11/2019 15:58	29/11/2019 10:11	18,21	1	18,21	CHI
201911353051	GOIANIA	10363774	CAMPINAS S1	28/11/2019 15:58	28/11/2019 18:22	28/11/2019 15:58	28/11/2019 18:22	2,40	1	2,40	CHI
201911353053	PEROLANDIA	JT12226497	PARQUE DAS EMAS	28/11/2019 15:53	28/11/2019 19:10	28/11/2019 15:53	28/11/2019 19:10	3,28	18	59,00	CHI
201911353053	MINEIROS	JT12226497	PARQUE DAS EMAS	28/11/2019 15:53	28/11/2019 19:10	28/11/2019 15:53	28/11/2019 19:10	3,28	1	3,28	CHI
201911353053	JATAI	JT12226497	PARQUE DAS EMAS	28/11/2019 15:53	28/11/2019 19:10	28/11/2019 15:53	28/11/2019 19:10	3,28	23	75,39	CHI
201911353060	CRISTALINA	KR12276359	CRISTALINA S2	28/11/2019 15:47	28/11/2019 19:01	28/11/2019 15:47	28/11/2019 19:01	3,23	19	61,41	CHI
201911353061	SAO LUIS DE MONTES BELOS	10002520654	SAO LUIZ DOS MONTES BELOS	28/11/2019 15:59	28/11/2019 18:43	28/11/2019 15:59	28/11/2019 18:43	2,73	1	2,73	CHI
201911353063	TURVANIA	TV12259071	FIRMINOPOLIS S2	28/11/2019 15:59	28/11/2019 20:01	28/11/2019 15:59	28/11/2019 20:01	4,04	6	24,25	CHI
201911353064	COLINAS DO SUL	TI12266452	MINACU	28/11/2019 15:39	29/11/2019 13:08	28/11/2019 15:39	29/11/2019 13:08	21,48	6	128,87	CHI
201911353069	CRISTALINA	KR21339712	CRISTALINA S1	28/11/2019 16:01	28/11/2019 17:34	28/11/2019 16:01	28/11/2019 17:34	1,55	1	1,55	CHI
201911353070	CATALAO	9580003901	CATALAO S1	28/11/2019 16:01	29/11/2019 09:23	28/11/2019 16:01	29/11/2019 09:23	17,37	1	17,37	CHI
201911353072	NOVO GAMA	NJ21041448	PACAEMBU S1	28/11/2019 16:01	28/11/2019 19:43	28/11/2019 16:01	28/11/2019 19:43	3,69	3	11,06	CHI
201911353073	GOUVELANDIA	QI12326803	QUIRINOPOLIS	28/11/2019 16:01	28/11/2019 18:18	28/11/2019 16:01	28/11/2019 18:18	2,27	2	4,54	CHI
201911353082	CAMPOS BELOS	CH12242796	SAO DOMINGOS	28/11/2019 15:58	28/11/2019 17:53	28/11/2019 15:58	28/11/2019 17:53	1,91	8	15,26	CHI
201911353089	PLANALTINA	2960235491	PLANALTINA	28/11/2019 16:05	28/11/2019 18:03	28/11/2019 16:05	28/11/2019 18:03	1,95	1	1,95	CHI
201911353098	PIRACANJUBA	PJ11153419	PIRACANJUBA	28/11/2019 16:08	29/11/2019 13:14	28/11/2019 16:08	29/11/2019 13:14	21,09	10	210,90	CHI
201911353099	GOIATUBA	BJ21000094	BOM JESUS DE GOIAS	28/11/2019 16:08	28/11/2019 18:22	28/11/2019 16:08	28/11/2019 18:22	2,22	1	2,22	CHI
201911353108	FORMOSA	FA32042639	ITIQUEIRA	28/11/2019 13:27	29/11/2019 09:43	28/11/2019 13:27	29/11/2019 09:43	20,26	13	263,39	CHI
201911353115	JATAI	JT21234455	JATAI S1	28/11/2019 16:12	28/11/2019 18:12	28/11/2019 16:12	28/11/2019 18:12	2,00	1	2,00	CHI
201911353121	URUACU	640093693	URUACU	28/11/2019 16:14	29/11/2019 11:40	28/11/2019 16:14	29/11/2019 11:40	19,43	1	19,43	CHI

201911353125	URUTAI	460116850	URUTAI	28/11/2019 15:53	28/11/2019 23:08	28/11/2019 15:53	28/11/2019 23:08	7,25	1	7,25	CHI
201911353127	PADRE BERNARDO	10016534261	PADRE BERNARDO	28/11/2019 16:15	28/11/2019 19:23	28/11/2019 16:15	28/11/2019 19:23	3,13	1	3,13	CHI
201911353134	PALMEIRAS DE GOIAS	PL21088493	PALMEIRAS	28/11/2019 16:16	29/11/2019 08:15	28/11/2019 16:16	29/11/2019 08:15	15,99	1	15,99	CHI
201911353135	HIDROLANDIA	HD31194943	INDEPENDENCIA S1	28/11/2019 16:16	28/11/2019 19:45	28/11/2019 16:16	28/11/2019 19:45	3,47	1	3,47	CHI
201911353143	CRISTIANOPOLIS	CF21300858	CRISTIANOPOLIS	28/11/2019 16:19	29/11/2019 12:27	28/11/2019 16:19	29/11/2019 12:27	20,13	1	20,13	CHI
201911353146	VILA PROPICIO	NP12402058	GOIANESIA S1	28/11/2019 08:08	29/11/2019 09:38	28/11/2019 08:08	29/11/2019 09:38	25,48	93	2370,00	CHI
201911353146	PADRE BERNARDO	NP12402058	GOIANESIA S1	28/11/2019 08:08	29/11/2019 09:38	28/11/2019 08:08	29/11/2019 09:38	25,48	10	254,84	CHI
201911353146	COCALZINHO DE GOIAS	NP12402058	GOIANESIA S1	28/11/2019 08:08	29/11/2019 09:38	28/11/2019 08:08	29/11/2019 09:38	25,48	1	25,48	CHI
201911353147	CAMPINACU	UC12239750	PORANGATU	28/11/2019 16:19	28/11/2019 21:40	28/11/2019 16:19	28/11/2019 21:40	5,34	5	26,68	CHI
201911353148	DOVERLANDIA	PW12374317	PARQUE DAS EMAS	28/11/2019 13:23	29/11/2019 14:44	28/11/2019 13:23	29/11/2019 14:44	25,35	1	25,35	CHI
201911353148	CAIAPONIA	PW12374317	PARQUE DAS EMAS	28/11/2019 13:23	29/11/2019 14:44	28/11/2019 13:23	29/11/2019 14:44	25,35	1	25,35	CHI
201911353148	PORTELANDIA	PW12374317	PARQUE DAS EMAS	28/11/2019 13:23	29/11/2019 14:44	28/11/2019 13:23	29/11/2019 14:44	25,35	7	177,43	CHI
201911353148	MINEIROS	PW12374317	PARQUE DAS EMAS	28/11/2019 13:23	29/11/2019 14:44	28/11/2019 13:23	29/11/2019 14:44	25,35	6	152,08	CHI
201911353148	PEROLANDIA	PW12374317	PARQUE DAS EMAS	28/11/2019 13:23	29/11/2019 14:44	28/11/2019 13:23	29/11/2019 14:44	25,35	2	50,69	CHI
201911353152	GOIANIA	10002314892	GOIANIA LESTE S1	28/11/2019 16:22	28/11/2019 17:42	28/11/2019 16:22	28/11/2019 17:42	1,33	1	1,33	CHI
201911353158	CORUMBAIBA	CI21298741	VILA CORUMBA	28/11/2019 16:23	28/11/2019 19:26	28/11/2019 16:23	28/11/2019 19:26	3,04	13	39,48	CHI
201911353162	MONTIVIDIU DO NORTE	MX11203483	PORANGATU	28/11/2019 16:24	29/11/2019 13:11	28/11/2019 16:24	29/11/2019 13:11	20,77	3	62,31	CHI
201911353167	INHUMAS	IN12098348	INHUMAS S2	28/11/2019 14:21	28/11/2019 18:12	28/11/2019 14:21	28/11/2019 18:12	3,83	6	23,00	CHI
201911353168	RIO VERDE	RV21412028	CABRIUVA S2	28/11/2019 16:26	29/11/2019 08:26	28/11/2019 16:26	29/11/2019 08:26	15,99	1	15,99	CHI
201911353174	NOVA ROMA	ND12302636	IACIARA S2	28/11/2019 15:41	28/11/2019 19:55	28/11/2019 15:41	28/11/2019 19:55	4,22	96	405,49	CHI
201911353174	ALTO PARAISO DE GOIAS	ND12302636	IACIARA S2	28/11/2019 15:41	28/11/2019 19:55	28/11/2019 15:41	28/11/2019 19:55	4,22	18	76,03	CHI
201911353174	SAO JOAO D ALIANCA	ND12302636	IACIARA S2	28/11/2019 15:41	28/11/2019 19:55	28/11/2019 15:41	28/11/2019 19:55	4,22	12	50,69	CHI
201911353178	ITUMBIARA	690089697	ITUMBIARA NOVA	28/11/2019 16:28	28/11/2019 18:25	28/11/2019 16:28	28/11/2019 18:25	1,94	1	1,94	CHI
201911353184	CALDAS NOVAS	CN21226652	CALDAS NOVAS S1	28/11/2019 16:29	28/11/2019 19:07	28/11/2019 16:29	28/11/2019 19:07	2,62	1	2,62	CHI
201911353198	DOVERLANDIA	DV12297286	CAIAPONIA	28/11/2019 16:29	28/11/2019 16:42	28/11/2019 16:29	28/11/2019 16:42	0,21	1	0,21	CHI
201911353206	ORIZONA	OZ12404726	PIRES DO RIO S1	28/11/2019 16:30	29/11/2019 09:20	28/11/2019 16:30	29/11/2019 09:20	16,83	9	151,51	CHI
201911353208	GOIANIA	10710814	CAMPINAS S3	28/11/2019 16:30	28/11/2019 17:25	28/11/2019 16:30	28/11/2019 17:25	0,91	1	0,91	CHI
201911353209	INHUMAS	10000211786	INHUMAS S2	28/11/2019 16:30	29/11/2019 07:53	28/11/2019 16:30	29/11/2019 07:53	15,37	1	15,37	CHI
201911353211	VILA PROPICIO	GE12247163	GOIANESIA S2	28/11/2019 12:50	29/11/2019 08:47	28/11/2019 12:50	29/11/2019 08:47	19,96	8	159,65	CHI
201911353212	GOIATUBA	BJ21030814	RIO DOS BOIS	28/11/2019 16:31	29/11/2019 11:56	28/11/2019 16:31	29/11/2019 11:56	19,41	1	19,41	CHI
201911353214	PARAUNA	PU12391518	PARAUNA	28/11/2019 16:31	28/11/2019 19:04	28/11/2019 16:31	28/11/2019 19:04	2,55	24	61,29	CHI
201911353216	SAO MIGUEL DO ARAGUAIA	SM12252091	SAO MIGUEL DO ARAGUAIA	28/11/2019 16:07	28/11/2019 23:30	28/11/2019 16:07	28/11/2019 23:30	7,38	61	450,32	CHI
201911353218	NOVA ROMA	ND12208720	IACIARA S2	28/11/2019 13:12	28/11/2019 19:14	28/11/2019 13:12	28/11/2019 19:14	6,03	5	30,13	CHI



201911353220	TRINDADE	TR12323750	TRINDADE	28/11/2019 16:32	29/11/2019 00:25	28/11/2019 16:32	29/11/2019 00:25	7,88	2	15,77	CHI
201911353220	AVELINOPOLIS	01760414	TRINDADE	28/11/2019 16:32	29/11/2019 00:25	29/11/2019 00:15	29/11/2019 00:25	0,18	10	1,76	CHI
201911353220	SANTA BARBARA DE GOIAS	01760414	TRINDADE	28/11/2019 16:32	29/11/2019 00:25	29/11/2019 00:15	29/11/2019 00:25	0,18	1136	200,38	CHI
201911353220	SANTA BARBARA DE GOIAS	01760414	TRINDADE	28/11/2019 16:32	29/11/2019 00:25	29/11/2019 00:15	29/11/2019 00:25	0,18	14	2,47	CHI
201911353220	SANTA BARBARA DE GOIAS	01760414	TRINDADE	28/11/2019 16:32	29/11/2019 00:25	29/11/2019 00:15	29/11/2019 00:25	0,18	1340	236,36	CHI
201911353220	NAZARIO	01760414	TRINDADE	28/11/2019 16:32	29/11/2019 00:25	29/11/2019 00:15	29/11/2019 00:25	0,18	11	1,94	CHI
201911353220	TRINDADE	01760414	TRINDADE	28/11/2019 16:32	29/11/2019 00:25	29/11/2019 00:15	29/11/2019 00:25	0,18	3	0,53	CHI
201911353220	TRINDADE	01760414	TRINDADE	28/11/2019 16:32	29/11/2019 00:25	29/11/2019 00:15	29/11/2019 00:25	0,18	8	1,41	CHI
201911353222	CAMPO LIMPO	960021899	NEROPOLIS S1	28/11/2019 16:33	29/11/2019 08:40	28/11/2019 16:33	29/11/2019 08:40	16,12	1	16,12	CHI
201911353230	DOVERLANDIA	DV12217563	CAIAPONIA	28/11/2019 16:35	29/11/2019 09:53	28/11/2019 16:35	29/11/2019 09:53	17,29	128	2213,37	CHI
201911353236	GAMELEIRA DE GOIAS	AN11273366	DAIA S1	28/11/2019 12:36	28/11/2019 18:50	28/11/2019 12:36	28/11/2019 18:50	6,23	23	143,21	CHI
201911353239	SAO DOMINGOS	SD12067690	IACIARA S2	28/11/2019 16:36	29/11/2019 11:01	28/11/2019 16:36	29/11/2019 11:01	18,41	2	36,82	CHI
201911353239	NOVA ROMA	SD12067690	IACIARA S2	28/11/2019 16:36	29/11/2019 11:01	28/11/2019 16:36	29/11/2019 11:01	18,41	1	18,41	CHI
201911353240	ORIZONA	PR12333485	PIRES DO RIO S2	28/11/2019 16:11	28/11/2019 19:17	28/11/2019 16:11	28/11/2019 19:17	3,10	5	15,49	CHI
201911353240	PIRES DO RIO	PR12333485	PIRES DO RIO S2	28/11/2019 16:11	28/11/2019 19:17	28/11/2019 16:11	28/11/2019 19:17	3,10	5	15,49	CHI
201911353241	LUZIANIA	LZ12070127RE	MARAJOARA	28/11/2019 16:36	28/11/2019 18:35	28/11/2019 16:36	28/11/2019 18:35	1,99	15	29,86	CHI
201911353246	CATALAO	CT12266779	CATALAO S1	28/11/2019 16:37	28/11/2019 17:33	28/11/2019 16:37	28/11/2019 17:33	0,93	1	0,93	CHI
201911353250	CACU	CC12080194LD	CACHOEIRA ALTA	28/11/2019 16:38	29/11/2019 11:26	28/11/2019 16:38	29/11/2019 11:26	18,80	2	37,60	CHI
201911353254	BOM JESUS DE GOIAS	BJ12389738	BOM JESUS DE GOIAS	28/11/2019 16:39	29/11/2019 17:36	28/11/2019 16:39	29/11/2019 11:10	18,52	6	111,11	CHI
201911353254	GOIATUBA	BJ12389738	BOM JESUS DE GOIAS	28/11/2019 16:39	29/11/2019 17:36	28/11/2019 16:39	29/11/2019 11:10	18,52	5	92,59	CHI
201911353254	BOM JESUS DE GOIAS	BJ12389738	BOM JESUS DE GOIAS	28/11/2019 16:39	29/11/2019 17:36	28/11/2019 16:39	29/11/2019 17:36	24,95	1	24,95	CHI
201911353260	VARJAO	VJ31089525	GUAPO S2	28/11/2019 16:40	29/11/2019 04:19	28/11/2019 16:40	29/11/2019 04:19	11,65	2	23,30	CHI
201911353263	IPAMERI	NE12035437	CATALAO S1	28/11/2019 15:44	28/11/2019 18:20	28/11/2019 15:44	28/11/2019 18:20	2,60	1	2,60	CHI
201911353263	NOVA AURORA	NE12035437	CATALAO S1	28/11/2019 15:44	28/11/2019 18:20	28/11/2019 15:44	28/11/2019 18:20	2,60	25	64,88	CHI
201911353265	CORUMBAIBA	CI12377064	CATALAO S1	28/11/2019 16:18	29/11/2019 08:15	28/11/2019 16:18	29/11/2019 08:15	15,93	12	191,22	CHI
201911353271	NIQUELANDIA	NQ11353783	URUACU	28/11/2019 16:42	29/11/2019 09:32	28/11/2019 16:42	29/11/2019 09:32	16,84	1	16,84	CHI
201911353277	GOIANIA	10009160378	GOIANIA LESTE S3	28/11/2019 16:44	28/11/2019 18:39	28/11/2019 16:44	28/11/2019 18:39	1,91	1	1,91	CHI
201911353278	AGUA FRIA DE GOIAS	TL21067536	SAO JOAO D ALIANCA	28/11/2019 16:44	29/11/2019 09:54	28/11/2019 16:44	29/11/2019 09:54	17,16	2	34,31	CHI
201911353286	GOIANIA	11055716	XAVANTES	28/11/2019 16:45	28/11/2019 17:52	28/11/2019 16:45	28/11/2019 17:52	1,12	1	1,12	CHI
201911353291	GAMELEIRA DE GOIAS	GL12319531	DAIA S2	28/11/2019 16:47	29/11/2019 13:04	28/11/2019 16:47	29/11/2019 13:04	20,28	5	101,41	CHI
201911353293	TROMBAS	TB12185404	PORANGATU	28/11/2019 13:28	29/11/2019 00:07	28/11/2019 13:28	29/11/2019 00:07	10,65	3	31,94	CHI
201911353298	JATAI	JT21166064	JATAI S3	28/11/2019 16:48	28/11/2019 18:00	28/11/2019 16:48	28/11/2019 18:00	1,20	2	2,39	CHI
201911353302	ITAPURANGA	IK12310899	ITAPURANGA	28/11/2019 14:34	28/11/2019 16:49	28/11/2019 14:34	28/11/2019 16:49	2,24	16	35,91	CHI

201911353307	GOIANIA	GN11000970	CAMPINAS S1	28/11/2019 16:49	28/11/2019 19:05	28/11/2019 16:49	28/11/2019 19:05	2,26	195	441,57	CHI
201911353308	BELA VISTA DE GOIAS	BV12011067	BELA VISTA S1	28/11/2019 16:49	28/11/2019 18:20	28/11/2019 16:49	28/11/2019 18:20	1,51	29	43,90	CHI
201911353309	CIDADE OCIDENTAL	DH12401738	MARAOARA	28/11/2019 16:16	28/11/2019 18:12	28/11/2019 16:16	28/11/2019 18:12	1,93	612	1180,31	CHI
201911353312	CAMPO LIMPO	AN21258900	JUNDIAI S1	28/11/2019 16:49	29/11/2019 07:25	28/11/2019 16:49	29/11/2019 07:25	14,59	1	14,59	CHI
201911353315	GOIANIA	GN12001482	GOIANIA LESTE S2	28/11/2019 16:50	28/11/2019 17:39	28/11/2019 16:50	28/11/2019 17:39	0,81	780	633,53	CHI
201911353316	ANAPOLIS	20933230	JUNDIAI S1	28/11/2019 16:50	28/11/2019 17:46	28/11/2019 16:50	28/11/2019 17:46	0,93	1	0,93	CHI
201911353320	RIO VERDE	RV12260723	RIO VERDE S1	28/11/2019 16:51	29/11/2019 00:19	28/11/2019 16:51	29/11/2019 00:19	7,47	29	216,52	CHI
201911353320	SANTA HELENA DE GOIAS	RV12260723	RIO VERDE S1	28/11/2019 16:51	29/11/2019 00:19	28/11/2019 16:51	29/11/2019 00:19	7,47	11	82,13	CHI
201911353326	TURVELANDIA	SH12301062	RIO DOS BOIS	28/11/2019 16:52	29/11/2019 10:39	28/11/2019 16:52	29/11/2019 10:39	17,78	3	53,35	CHI
201911353326	SANTA HELENA DE GOIAS	SH12301062	RIO DOS BOIS	28/11/2019 16:52	29/11/2019 10:39	28/11/2019 16:52	29/11/2019 10:39	17,78	3	53,35	CHI
201911353335	AGUA LIMPA	AL12075701	VILA CORUMBA	28/11/2019 16:54	28/11/2019 23:06	28/11/2019 16:54	28/11/2019 23:06	6,20	5	30,99	CHI
201911353337	APARECIDA DE GOIANIA	10011639340	INDEPENDENCIA S1	28/11/2019 16:54	28/11/2019 19:12	28/11/2019 16:54	28/11/2019 19:12	2,31	1	2,31	CHI
201911353340	PANAMA	GT21050606	GOIATUBA S1	28/11/2019 16:55	28/11/2019 18:04	28/11/2019 16:55	28/11/2019 18:04	1,15	1	1,15	CHI
201911353341	JATAI	JT12210133	JATAI S1	28/11/2019 16:30	29/11/2019 18:48	28/11/2019 16:30	29/11/2019 18:48	26,30	5	131,48	CHI
201911353359	JOVIANIA	JV21050281	GOIATUBA S1	28/11/2019 17:00	28/11/2019 22:17	28/11/2019 17:00	28/11/2019 22:17	5,28	1	5,28	CHI
201911353363	ITUMBIARA	IT21309023	ITUMBIARA VELHA S2	28/11/2019 17:00	29/11/2019 09:29	28/11/2019 17:00	29/11/2019 09:29	16,47	1	16,47	CHI
201911353381	IPAMERI	UT12027074	URUTAI	28/11/2019 14:45	28/11/2019 19:11	28/11/2019 14:45	28/11/2019 19:11	4,43	43	190,41	CHI
201911353381	URUTAI	UT12027074	URUTAI	28/11/2019 14:45	28/11/2019 19:11	28/11/2019 14:45	28/11/2019 19:11	4,43	9	39,85	CHI
201911353383	CAIAPONIA	CP12244220	CAIAPONIA	28/11/2019 17:02	29/11/2019 11:03	28/11/2019 17:02	29/11/2019 11:03	18,02	10	180,21	CHI
201911353385	FORMOSA	FA12000078	ITUIQUIRA	28/11/2019 17:04	28/11/2019 18:12	28/11/2019 17:04	28/11/2019 18:12	1,12	1	1,12	CHI
201911353386	CIDADE OCIDENTAL	2680111844	MARAOARA	28/11/2019 17:04	28/11/2019 20:58	28/11/2019 17:04	28/11/2019 20:58	3,89	1	3,89	CHI
201911353388	PIRANHAS	PH21134384	PIRANHAS	28/11/2019 17:05	29/11/2019 10:27	28/11/2019 17:05	29/11/2019 10:27	17,37	1	17,37	CHI
201911353391	SAO MIGUEL DO ARAGUAIA	830029801	SAO MIGUEL DO ARAGUAIA	28/11/2019 17:05	29/11/2019 12:16	28/11/2019 17:05	29/11/2019 12:16	19,18	1	19,18	CHI
201911353409	ALTO PARAISO DE GOIAS	BF21047995	FLORES DE GOIAS	28/11/2019 17:07	28/11/2019 19:21	28/11/2019 17:07	28/11/2019 19:21	2,23	2	4,45	CHI
201911353411	FAINA	FC21203431	GOIAS	28/11/2019 17:07	29/11/2019 13:53	28/11/2019 17:07	29/11/2019 13:53	20,76	1	20,76	CHI
201911353416	CATALAO	CT12149150	CATALAO S1	28/11/2019 16:15	29/11/2019 13:22	28/11/2019 16:15	29/11/2019 13:22	21,11	3	63,32	CHI
201911353417	SERRANOPOLIS	JT12241839	JATAI S1	28/11/2019 17:08	29/11/2019 10:18	28/11/2019 17:08	29/11/2019 10:18	17,15	1	17,15	CHI
201911353423	LUZIANIA	LZ12383068	VIANOPOLIS	28/11/2019 17:09	28/11/2019 20:57	28/11/2019 17:09	28/11/2019 20:57	3,79	1	3,79	CHI
201911353429	CATALAO	CT21265215	CATALAO S1	28/11/2019 17:10	28/11/2019 19:12	28/11/2019 17:10	28/11/2019 19:12	2,03	1	2,03	CHI
201911353430	FIRMINOPOLIS	AI21332077	FIRMINOPOLIS S2	28/11/2019 17:10	28/11/2019 18:58	28/11/2019 17:10	28/11/2019 18:58	1,81	1	1,81	CHI
201911353434	CAMPO ALEGRE DE GOIAS	CM12077272	CAMPO ALEGRE DE GOIAS	28/11/2019 17:10	29/11/2019 06:58	28/11/2019 17:10	29/11/2019 06:58	13,79	8	110,30	CHI
201911353442	PIRES DO RIO	PR11344696	PIRES DO RIO S1	28/11/2019 17:11	28/11/2019 20:42	28/11/2019 17:11	28/11/2019 20:42	3,51	23	80,70	CHI
201911353445	NIQUELANDIA	NQ12262921	BARRO ALTO	28/11/2019 09:47	28/11/2019 19:19	28/11/2019 09:47	28/11/2019 19:19	9,52	5	47,61	CHI

201911353448	MINACU	CR11254427	PORANGATU	28/11/2019 17:12	28/11/2019 22:55	28/11/2019 17:12	28/11/2019 22:55	5,72	1	5,72	CHI
201911353460	NIQUELANDIA	NQ12239432	URUACU	28/11/2019 17:06	29/11/2019 01:33	28/11/2019 17:06	29/11/2019 01:33	8,44	19	160,37	CHI
201911353479	SANCLERLANDIA	MD12206498	FIRMINOPOLIS S2	28/11/2019 17:14	28/11/2019 20:24	28/11/2019 17:14	28/11/2019 20:24	3,17	7	22,17	CHI
201911353479	MOSSAMEDES	MD12206498	FIRMINOPOLIS S2	28/11/2019 17:14	28/11/2019 20:24	28/11/2019 17:14	28/11/2019 20:24	3,17	44	139,38	CHI
201911353480	LUZIANIA	10001212263	MARAJOARA	28/11/2019 17:17	28/11/2019 19:31	28/11/2019 17:17	28/11/2019 19:31	2,23	1	2,23	CHI
201911353485	NOVO GAMA	NJ11376146	PACAEMBU S1	28/11/2019 16:40	28/11/2019 18:34	28/11/2019 16:40	28/11/2019 18:34	1,89	95	179,37	CHI
201911353491	ANAPOLIS	21362970	ANAPOLIS UNIVERSITARIO S1	28/11/2019 17:19	28/11/2019 18:40	28/11/2019 17:19	28/11/2019 18:40	1,34	1	1,34	CHI
201911353492	TRINDADE	40269668	GOYA S1	28/11/2019 17:20	28/11/2019 20:39	28/11/2019 17:20	28/11/2019 20:39	3,31	1	3,31	CHI
201911353495	RIO VERDE	RV21240536	MONTIVIDIU T	28/11/2019 17:20	29/11/2019 08:31	28/11/2019 17:20	29/11/2019 08:31	15,18	1	15,18	CHI
201911353497	BURITI ALEGRE	BG12249831	ITUMBIARA VELHA S2	28/11/2019 17:21	28/11/2019 21:20	28/11/2019 17:21	28/11/2019 21:20	3,99	2	7,98	CHI
201911353500	GOIANIA	11644126	GOIANIA LESTE S1	28/11/2019 17:21	28/11/2019 19:04	28/11/2019 17:21	28/11/2019 19:04	1,71	1	1,71	CHI
201911353514	INACIOLANDIA	ID21018105	QUIRINOPOLIS	28/11/2019 18:03	28/11/2019 19:07	28/11/2019 18:03	28/11/2019 19:07	1,05	1	1,05	CHI
201911353536	SAO MIGUEL DO ARAGUAIA	SM10388763	SAO MIGUEL DO ARAGUAIA	28/11/2019 20:49	02/12/2019 12:18	28/11/2019 20:49	28/11/2019 21:46	0,94	47	44,18	CHI
201911353536	SAO MIGUEL DO ARAGUAIA	SM10388763	SAO MIGUEL DO ARAGUAIA	28/11/2019 20:49	02/12/2019 12:18	29/11/2019 01:02	29/11/2019 01:16	0,23	47	10,71	CHI
201911353536	SAO MIGUEL DO ARAGUAIA	SM10388763	SAO MIGUEL DO ARAGUAIA	28/11/2019 20:49	02/12/2019 12:18	28/11/2019 20:49	29/11/2019 03:24	6,59	6	39,53	CHI
201911353536	SAO MIGUEL DO ARAGUAIA	SM10388763	SAO MIGUEL DO ARAGUAIA	28/11/2019 20:49	02/12/2019 12:18	29/11/2019 12:57	29/11/2019 13:18	0,35	53	18,58	CHI
201911353536	SAO MIGUEL DO ARAGUAIA	SM10388763	SAO MIGUEL DO ARAGUAIA	28/11/2019 20:49	02/12/2019 12:18	30/11/2019 01:23	30/11/2019 01:31	0,14	53	7,23	CHI
201911353536	SAO MIGUEL DO ARAGUAIA	SM10388763	SAO MIGUEL DO ARAGUAIA	28/11/2019 20:49	02/12/2019 12:18	28/11/2019 20:49	30/11/2019 08:16	35,46	56	1985,53	CHI
201911353536	SAO MIGUEL DO ARAGUAIA	SM10388763	SAO MIGUEL DO ARAGUAIA	28/11/2019 20:49	02/12/2019 12:18	30/11/2019 08:17	30/11/2019 08:31	0,23	53	12,38	CHI
201911353536	SAO MIGUEL DO ARAGUAIA	SM10388763	SAO MIGUEL DO ARAGUAIA	28/11/2019 20:49	02/12/2019 12:18	30/11/2019 10:13	30/11/2019 10:29	0,27	53	14,30	CHI
201911353536	SAO MIGUEL DO ARAGUAIA	SM10388763	SAO MIGUEL DO ARAGUAIA	28/11/2019 20:49	02/12/2019 12:18	28/11/2019 20:49	30/11/2019 11:18	38,49	125	4810,80	CHI
201911353536	SAO MIGUEL DO ARAGUAIA	SM13182440	SAO MIGUEL DO ARAGUAIA	28/11/2019 20:49	02/12/2019 12:18	30/11/2019 08:17	30/11/2019 11:18	3,03	24	72,73	CHI
201911353536	SAO MIGUEL DO ARAGUAIA	SM10388763	SAO MIGUEL DO ARAGUAIA	28/11/2019 20:49	02/12/2019 12:18	30/11/2019 08:17	30/11/2019 11:18	3,03	20	60,61	CHI
201911353536	SAO MIGUEL DO ARAGUAIA	SM13182440	SAO MIGUEL DO ARAGUAIA	28/11/2019 20:49	02/12/2019 12:18	30/11/2019 08:17	30/11/2019 11:28	3,19	1	3,19	CHI
201911353536	SAO MIGUEL DO ARAGUAIA	SM10388763	SAO MIGUEL DO ARAGUAIA	28/11/2019 20:49	02/12/2019 12:18	28/11/2019 20:49	30/11/2019 12:31	39,70	79	3135,93	CHI
201911353536	SAO MIGUEL DO ARAGUAIA	SM10388763	SAO MIGUEL DO ARAGUAIA	28/11/2019 20:49	02/12/2019 12:18	28/11/2019 20:49	30/11/2019 12:43	39,90	12	478,83	CHI
201911353536	SAO MIGUEL DO ARAGUAIA	SM10404183	SAO MIGUEL DO ARAGUAIA	28/11/2019 20:49	02/12/2019 12:18	30/11/2019 11:53	30/11/2019 12:44	0,85	107	90,92	CHI
201911353536	SAO MIGUEL DO ARAGUAIA	SM12031421	SAO MIGUEL DO ARAGUAIA	28/11/2019 20:49	02/12/2019 12:18	30/11/2019 11:53	30/11/2019 15:00	3,12	17	53,11	CHI
201911353536	SAO MIGUEL DO ARAGUAIA	SM12013063LD	SAO MIGUEL DO ARAGUAIA	28/11/2019 20:49	02/12/2019 12:18	30/11/2019 08:17	02/12/2019 12:18	52,03	11	572,36	CHI
201911353541	SILVANIA	SV11241014	VIANOPOLIS	28/11/2019 21:11	29/11/2019 05:15	28/11/2019 21:11	29/11/2019 05:15	8,05	142	1143,26	CHI
201911353561	PIRES DO RIO	PR21000082	PIRES DO RIO S1	29/11/2019 04:56	29/11/2019 15:59	29/11/2019 04:56	29/11/2019 15:59	11,05	2	22,09	CHI
201911353562	PORANGATU	TA12114216	NOVO PLANALTO	29/11/2019 06:00	29/11/2019 11:14	29/11/2019 06:00	29/11/2019 11:14	5,23	5	26,15	CHI
201911353602	PALMEIRAS DE GOIAS	PL21026500	PALMEIRAS	28/11/2019 17:22	29/11/2019 10:00	28/11/2019 17:22	29/11/2019 10:00	16,65	1	16,65	CHI

201911353610	NIQUELANDIA	NQ21213019	NIQUELANDIA SUBTRANSMISSAO	28/11/2019 17:24	29/11/2019 12:05	28/11/2019 17:24	29/11/2019 12:05	18,68	1	18,68	CHI
201911353611	GOIANESIA	GE12384171	GOIANESIA S2	28/11/2019 16:09	28/11/2019 19:58	28/11/2019 16:09	28/11/2019 19:58	3,81	1	3,81	CHI
201911353611	VILA PROPICIO	GE12384171	GOIANESIA S2	28/11/2019 16:09	28/11/2019 19:58	28/11/2019 16:09	28/11/2019 19:58	3,81	2	7,63	CHI
201911353612	VILA PROPICIO	NP21293994	GOIANESIA S1	28/11/2019 17:24	29/11/2019 12:00	28/11/2019 17:24	29/11/2019 12:00	18,60	1	18,60	CHI
201911353613	MONTES CLAROS DE GOIAS	ME12091498	IPORA	28/11/2019 10:02	29/11/2019 06:12	28/11/2019 10:02	29/11/2019 06:12	20,15	2	40,31	CHI
201911353615	CORUMBAIBA	CI12000467	VILA CORUMBA	28/11/2019 17:24	29/11/2019 10:40	28/11/2019 17:24	29/11/2019 10:40	17,26	11	189,84	CHI
201911353617	CORUMBAIBA	CI12263342	VILA CORUMBA	28/11/2019 16:32	28/11/2019 21:40	28/11/2019 16:32	28/11/2019 21:40	5,12	386	1976,64	CHI
201911353619	JARAGUA	JA12070670	JARAGUA	28/11/2019 12:40	30/11/2019 19:13	28/11/2019 12:40	30/11/2019 19:13	54,55	9	490,93	CHI
201911353620	SENADOR CANEDO	SW11092646	SENADOR CANEDO	28/11/2019 17:25	29/11/2019 00:02	28/11/2019 17:25	29/11/2019 00:02	6,61	137	905,53	CHI
201911353625	PILAR DE GOIAS	IW12170008	ITAPACI	28/11/2019 17:27	29/11/2019 14:20	28/11/2019 17:27	29/11/2019 14:20	20,88	2	41,76	CHI
201911353625	ITAPACI	IW12170008	ITAPACI	28/11/2019 17:27	29/11/2019 14:20	28/11/2019 17:27	29/11/2019 14:20	20,88	4	83,51	CHI
201911353626	ANICUNS	AC11379771	ANICUNS	28/11/2019 17:27	28/11/2019 18:30	28/11/2019 17:27	28/11/2019 18:30	1,05	43	45,05	CHI
201911353627	CACU	CC12226533	CACHOEIRA ALTA	28/11/2019 17:27	28/11/2019 20:29	28/11/2019 17:27	28/11/2019 20:29	3,02	9	27,21	CHI
201911353636	COLINAS DO SUL	TI21289883	MINACU	28/11/2019 17:28	29/11/2019 19:12	28/11/2019 17:28	29/11/2019 19:12	25,72	1	25,72	CHI
201911353648	PALESTINA DE GOIAS	IR12188430	IPORA	28/11/2019 17:12	28/11/2019 19:42	28/11/2019 17:12	28/11/2019 19:42	2,49	44	109,71	CHI
201911353648	IVOLANDIA	IR12188430	IPORA	28/11/2019 17:12	28/11/2019 19:42	28/11/2019 17:12	28/11/2019 19:42	2,49	140	349,07	CHI
201911353648	IPORA	IR12188430	IPORA	28/11/2019 17:12	28/11/2019 19:42	28/11/2019 17:12	28/11/2019 19:42	2,49	116	289,23	CHI
201911353648	AMORINOPOLIS	IR12188430	IPORA	28/11/2019 17:12	28/11/2019 19:42	28/11/2019 17:12	28/11/2019 19:42	2,49	84	209,44	CHI
201911353654	PALMINOPOLIS	PP21168182	PALMEIRAS	28/11/2019 17:31	28/11/2019 22:50	28/11/2019 17:31	28/11/2019 22:50	5,31	1	5,31	CHI
201911353657	PALMEIRAS DE GOIAS	PL12000032	PALMEIRAS	28/11/2019 16:14	30/11/2019 00:37	28/11/2019 16:14	30/11/2019 00:37	32,38	6	194,27	CHI
201911353658	VILA BOA	VB12265366	ITUIQUIRA	28/11/2019 17:32	29/11/2019 09:07	28/11/2019 17:32	29/11/2019 09:07	15,58	40	623,04	CHI
201911353665	COLINAS DO SUL	TI12196809	NIQUELANDIA SUBTRANSMISSAO	28/11/2019 17:33	30/11/2019 01:21	28/11/2019 17:33	30/11/2019 01:21	31,79	2	63,59	CHI
201911353666	GOIANIA	12278397	FERROVIARIO S1	28/11/2019 17:33	29/11/2019 02:34	28/11/2019 17:33	29/11/2019 02:34	9,01	1	9,01	CHI
201911353672	GOIANIA	10517601	GOIANIA LESTE S1	28/11/2019 17:34	28/11/2019 19:26	28/11/2019 17:34	28/11/2019 19:26	1,86	1	1,86	CHI
201911353673	IPAMERI	IP12036044	URUTAI	28/11/2019 17:30	28/11/2019 21:26	28/11/2019 17:30	28/11/2019 21:26	3,93	10	39,32	CHI
201911353675	MINEIROS	MY21244157	PARQUE DAS EMAS	28/11/2019 17:34	29/11/2019 12:00	28/11/2019 17:34	29/11/2019 12:00	18,42	1	18,42	CHI
201911353680	GOIAS	GS12336536	GOIAS	28/11/2019 16:41	28/11/2019 18:15	28/11/2019 16:41	28/11/2019 18:15	1,58	9	14,21	CHI
201911353685	SAO JOAO DA PARAUNA	RP21026464	FIRMINOPOLIS S2	28/11/2019 17:37	28/11/2019 20:25	28/11/2019 17:37	28/11/2019 20:25	2,80	1	2,80	CHI
201911353694	RIO VERDE	630574601	RIO VERDE S2	28/11/2019 17:39	29/11/2019 08:20	28/11/2019 17:39	29/11/2019 08:20	14,68	1	14,68	CHI
201911353695	MONTIVIDIU DO NORTE	MX11361994	PORANGATU	28/11/2019 17:39	29/11/2019 12:20	28/11/2019 17:39	29/11/2019 12:20	18,67	1	18,67	CHI
201911353699	NIQUELANDIA	NQ12265772	NIQUELANDIA SUBTRANSMISSAO	28/11/2019 17:40	29/11/2019 11:23	28/11/2019 17:40	29/11/2019 11:23	17,70	3	53,10	CHI
201911353703	BELA VISTA DE GOIAS	BV21244201	BELA VISTA S1	28/11/2019 17:41	28/11/2019 22:52	28/11/2019 17:41	28/11/2019 22:52	5,17	1	5,17	CHI
201911353704	IPORA	IR12014019	IPORA	28/11/2019 17:41	28/11/2019 22:43	28/11/2019 17:41	28/11/2019 22:43	5,02	3	15,07	CHI

201911353706	ANAPOLIS	AN11000363	ANAPOLIS UNIVERSITARIO S2	28/11/2019 17:41	28/11/2019 20:23	28/11/2019 17:41	28/11/2019 20:23	2,68	35	93,93	CHI
201911353709	ITAGUARU	IC12045481	ITABERAI S1	28/11/2019 11:58	28/11/2019 21:24	28/11/2019 11:58	28/11/2019 21:24	9,43	1	9,43	CHI
201911353709	ITAGUARI	IC12045481	ITABERAI S1	28/11/2019 11:58	28/11/2019 21:24	28/11/2019 11:58	28/11/2019 21:24	9,43	5	47,14	CHI
201911353718	MONTIVIDIU	MV21240398	MONTIVIDIU T	28/11/2019 17:44	29/11/2019 08:45	28/11/2019 17:44	29/11/2019 08:45	15,01	1	15,01	CHI
201911353734	VICENTINOPOLIS	VI12047297	VICENTINOPOLIS	28/11/2019 17:48	28/11/2019 21:30	28/11/2019 17:48	28/11/2019 21:30	3,70	5	18,48	CHI
201911353739	RIO QUENTE	RQ21316157	VILA CORUMBA	28/11/2019 17:49	29/11/2019 10:05	28/11/2019 17:49	29/11/2019 10:05	16,25	1	16,25	CHI
201911353743	CRISTALINA	KR12305010	PAMPLONA	28/11/2019 17:50	28/11/2019 19:20	28/11/2019 17:50	28/11/2019 19:20	1,50	20	29,91	CHI
201911353745	CUMARI	CY12306730RE	CATALAO S1	28/11/2019 17:50	29/11/2019 11:20	28/11/2019 17:50	29/11/2019 11:20	17,49	132	2308,13	CHI
201911353748	APARECIDA DE GOIANIA	15551003	INDEPENDENCIA S2	28/11/2019 17:51	28/11/2019 19:46	28/11/2019 17:51	28/11/2019 19:46	1,91	1	1,91	CHI
201911353756	ORIZONA	OZ12022985	PIRES DO RIO S2	28/11/2019 17:03	29/11/2019 11:40	28/11/2019 17:03	29/11/2019 11:40	18,61	5	93,06	CHI
201911353761	QUIRINOPOLIS	QI32052820	QUIRINOPOLIS	28/11/2019 17:53	28/11/2019 20:46	28/11/2019 17:53	28/11/2019 20:46	2,88	35	100,87	CHI
201911353766	CAMPO ALEGRE DE GOIAS	CM12338745	CAMPO ALEGRE DE GOIAS	28/11/2019 15:26	29/11/2019 10:42	28/11/2019 15:26	29/11/2019 10:42	19,26	6	115,55	CHI
201911353769	HIDROLANDIA	180000883	CEPAIGO S2	28/11/2019 17:54	29/11/2019 07:58	28/11/2019 17:54	29/11/2019 07:58	14,05	1	14,05	CHI
201911353780	CEZARINA	10007610830	EDEIA	28/11/2019 17:56	29/11/2019 16:22	28/11/2019 17:56	29/11/2019 16:22	22,44	1	22,44	CHI
201911353781	AMARALINA	MQ12390465	MARA ROSA	28/11/2019 17:56	29/11/2019 01:48	28/11/2019 17:56	29/11/2019 01:48	7,85	278	2182,38	CHI
201911353781	MARA ROSA	MQ12390465	MARA ROSA	28/11/2019 17:56	29/11/2019 01:48	28/11/2019 17:56	29/11/2019 01:48	7,85	86	675,12	CHI
201911353782	PALESTINA DE GOIAS	PY21198177	ARENOPOLIS	28/11/2019 17:57	29/11/2019 09:43	28/11/2019 17:57	29/11/2019 09:43	15,76	1	15,76	CHI
201911353786	SILVANIA	AN12285354	JUNDIAI S1	28/11/2019 17:51	28/11/2019 20:26	28/11/2019 17:51	28/11/2019 20:26	2,57	20	51,44	CHI
201911353786	GAMELEIRA DE GOIAS	AN12285354	JUNDIAI S1	28/11/2019 17:51	28/11/2019 20:26	28/11/2019 17:51	28/11/2019 20:26	2,57	9	23,15	CHI
201911353793	PONTALINA	PK12161220	VICENTINOPOLIS	28/11/2019 17:58	28/11/2019 23:33	28/11/2019 17:58	28/11/2019 23:33	5,58	2	11,16	CHI
201911353794	RIO VERDE	RV21098552	MONTIVIDIU T	28/11/2019 17:58	29/11/2019 13:31	28/11/2019 17:58	29/11/2019 13:31	19,54	1	19,54	CHI
201911353799	CAVALCANTE	10000234042	FLORES DE GOIAS	28/11/2019 17:59	28/11/2019 20:55	28/11/2019 17:59	28/11/2019 20:55	2,93	1	2,93	CHI
201911353824	LUZIANIA	LZ21041502	VIANOPOLIS	28/11/2019 18:04	28/11/2019 22:39	28/11/2019 18:04	28/11/2019 22:39	4,58	1	4,58	CHI
201911353825	MONTIVIDIU	MV12029219	MONTIVIDIU T	28/11/2019 17:25	28/11/2019 20:10	28/11/2019 17:25	28/11/2019 20:10	2,75	235	645,53	CHI
201911353825	RIO VERDE	MV12029219	MONTIVIDIU T	28/11/2019 17:25	28/11/2019 20:10	28/11/2019 17:25	28/11/2019 20:10	2,75	1	2,75	CHI
201911353828	GOIANIA	10280819	CAMPINAS S2	28/11/2019 18:04	28/11/2019 20:36	28/11/2019 18:04	28/11/2019 20:36	2,53	1	2,53	CHI
201911353829	PALMEIRAS DE GOIAS	PL31132066	PALMEIRAS	28/11/2019 18:05	28/11/2019 23:56	28/11/2019 18:05	28/11/2019 23:56	5,85	1	5,85	CHI
201911353830	PIRENOPOLIS	PV21000709	ANAPOLIS UNIVERSITARIO S2	28/11/2019 18:05	29/11/2019 12:27	28/11/2019 18:05	29/11/2019 12:27	18,36	1	18,36	CHI
201911353833	RIO VERDE	RV12111052	CABRIUVA S2	28/11/2019 17:46	29/11/2019 13:26	28/11/2019 17:46	29/11/2019 13:22	19,59	23	450,59	CHI
201911353833	RIO VERDE	RV12111052	CABRIUVA S2	28/11/2019 17:46	29/11/2019 13:26	28/11/2019 17:46	29/11/2019 13:26	19,66	6	117,95	CHI
201911353834	ARUANA	2380003057	ARUANA	28/11/2019 18:05	29/11/2019 09:16	28/11/2019 18:05	29/11/2019 09:16	15,17	1	15,17	CHI
201911353838	RIO VERDE	4100000833	SANTA HELENA S1	28/11/2019 18:06	29/11/2019 10:46	28/11/2019 18:06	29/11/2019 10:46	16,66	1	16,66	CHI
201911353841	SAO SIMAO	SO21224177	CACHOEIRA ALTA	28/11/2019 18:07	28/11/2019 21:37	28/11/2019 18:07	28/11/2019 21:37	3,49	1	3,49	CHI

201911353842	URUACU	UR21202001	URUACU	28/11/2019 18:08	29/11/2019 11:38	28/11/2019 18:08	29/11/2019 11:38	17,50	2	34,99	CHI
201911353843	AURILANDIA	AI12377187	FIRMINOPOLIS S2	28/11/2019 18:08	28/11/2019 21:48	28/11/2019 18:08	28/11/2019 21:48	3,66	12	43,97	CHI
201911353846	ANAPOLIS	AN11201219	ANAPOLIS UNIVERSITARIO S2	28/11/2019 13:51	28/11/2019 20:05	28/11/2019 13:51	28/11/2019 20:05	6,22	39	242,56	CHI
201911353858	PIRACANJUBA	60039942	PIRACANJUBA	28/11/2019 18:12	29/11/2019 19:43	28/11/2019 18:12	29/11/2019 19:43	25,51	1	25,51	CHI
201911353860	RIO VERDE	RV21230814	MONTIVIDIU T	28/11/2019 18:12	29/11/2019 12:13	28/11/2019 18:12	29/11/2019 12:13	18,00	1	18,00	CHI
201911353862	GOIANIA	11366205	CARAJAS S1	28/11/2019 18:13	28/11/2019 19:11	28/11/2019 18:13	28/11/2019 19:11	0,96	1	0,96	CHI
201911353865	CATALAO	CT12195296	CATALAO S2	28/11/2019 18:14	28/11/2019 19:21	28/11/2019 18:14	28/11/2019 19:21	1,11	214	237,42	CHI
201911353866	CAMPINACU	UC12300538	PORANGATU	28/11/2019 13:23	29/11/2019 11:03	28/11/2019 13:23	29/11/2019 11:03	21,66	14	303,24	CHI
201911353879	CACU	CC11241768	CACHOEIRA ALTA	28/11/2019 18:18	29/11/2019 11:49	28/11/2019 18:18	29/11/2019 11:49	17,52	1	17,52	CHI
201911353880	GOIANDIRA	CY21071489	CATALAO S1	28/11/2019 18:18	29/11/2019 08:22	28/11/2019 18:18	29/11/2019 08:22	14,06	1	14,06	CHI
201911353885	VILA PROPICIO	NQ21256618	BARRO ALTO	28/11/2019 18:18	29/11/2019 14:21	28/11/2019 18:18	29/11/2019 14:21	20,04	1	20,04	CHI
201911353892	BELA VISTA DE GOIAS	BV12185857	CEPAIGO S2	28/11/2019 18:19	28/11/2019 20:00	28/11/2019 18:19	28/11/2019 20:00	1,67	3	5,01	CHI
201911353894	GOIANAPOLIS	GP12351033	DAIA S2	28/11/2019 18:20	28/11/2019 20:20	28/11/2019 18:20	28/11/2019 20:20	2,00	17	33,98	CHI
201911353898	PALMEIRAS DE GOIAS	PL12398710	PALMEIRAS	28/11/2019 17:17	29/11/2019 11:22	28/11/2019 17:17	29/11/2019 11:22	18,07	21	379,49	CHI
201911353899	GOIANIA	GN11001887	GOIANIA LESTE S2	28/11/2019 18:20	28/11/2019 19:55	28/11/2019 18:20	28/11/2019 19:55	1,58	108	170,34	CHI
201911353902	ALVORADA DO NORTE	SI12248880	IACIARA S2	28/11/2019 18:20	30/11/2019 09:12	28/11/2019 18:20	30/11/2019 09:12	38,86	3	116,57	CHI
201911353906	GOIANIA	13501343	MEIA PONTE	28/11/2019 18:20	28/11/2019 22:33	28/11/2019 18:20	28/11/2019 22:33	4,22	1	4,22	CHI
201911353914	ANAPOLIS	AN11072062	ANAPOLIS UNIVERSITARIO S2	28/11/2019 18:19	28/11/2019 19:28	28/11/2019 18:19	28/11/2019 19:28	1,14	46	52,27	CHI
201911353923	MONTE ALEGRE DE GOIAS	MA12240197	SAO DOMINGOS	28/11/2019 18:19	28/11/2019 22:07	28/11/2019 18:19	28/11/2019 22:07	3,80	10	37,96	CHI
201911353925	SANTO ANTONIO DO DESCOBERTO	2210101536	AGUAS LINDAS DE GOIAS S2	28/11/2019 18:24	28/11/2019 20:30	28/11/2019 18:24	28/11/2019 20:30	2,10	1	2,10	CHI
201911353926	GOIANIA	13245612	ATLANTICO S2	28/11/2019 18:24	28/11/2019 22:13	28/11/2019 18:24	28/11/2019 22:13	3,81	1	3,81	CHI
201911353928	GOIANESIA	550181751	GOIANESIA S2	28/11/2019 18:24	29/11/2019 10:44	28/11/2019 18:24	29/11/2019 10:44	16,33	1	16,33	CHI
201911353929	RIO VERDE	RV12018224	CABRIUVA S2	28/11/2019 17:47	29/11/2019 07:37	28/11/2019 17:47	29/11/2019 07:37	13,82	7	96,77	CHI
201911353933	CALDAS NOVAS	760250418	SERRA DE CALDAS	28/11/2019 18:25	28/11/2019 20:55	28/11/2019 18:25	28/11/2019 20:55	2,51	1	2,51	CHI
201911353934	MARZAGAO	MG11212680	VILA CORUMBA	28/11/2019 18:25	29/11/2019 09:45	28/11/2019 18:25	29/11/2019 09:45	15,33	71	1088,53	CHI
201911353939	JARAGUA	JA21273410	JARAGUA	28/11/2019 18:25	30/11/2019 02:33	28/11/2019 18:25	30/11/2019 02:33	32,12	6	192,72	CHI
201911353945	CALDAS NOVAS	CN11246583	SERRA DE CALDAS	28/11/2019 16:55	28/11/2019 20:47	28/11/2019 16:55	28/11/2019 20:47	3,86	93	359,11	CHI
201911353946	FORMOSA	FA21255321	ITIQUEIRA	28/11/2019 18:27	30/11/2019 01:02	28/11/2019 18:27	30/11/2019 01:02	30,58	1	30,58	CHI
201911353949	PIRENOPOLIS	PV21144043	CORUMBA	28/11/2019 18:27	29/11/2019 17:11	28/11/2019 18:27	29/11/2019 17:11	22,72	1	22,72	CHI
201911353951	CIDADE OCIDENTAL	10015279748	MARAJOARA	28/11/2019 18:28	28/11/2019 21:58	28/11/2019 18:28	28/11/2019 21:58	3,50	1	3,50	CHI
201911353952	GUAPO	710021471	GUAPO S1	28/11/2019 18:28	28/11/2019 21:22	28/11/2019 18:28	28/11/2019 21:22	2,90	1	2,90	CHI
201911353953	NIQUELANDIA	NQ12280419	NIQUELANDIA SUBTRANSMISSAO	28/11/2019 07:25	29/11/2019 01:29	28/11/2019 07:25	29/11/2019 01:29	18,06	12	216,70	CHI
201911353953	NIQUELANDIA	NQ12280419	NIQUELANDIA SUBTRANSMISSAO	28/11/2019 07:25	29/11/2019 01:29	28/11/2019 16:09	29/11/2019 01:29	9,32	52	484,58	CHI

201911353972	PLANALTINA	PI21195962	SAO JOAO D ALIANCA	28/11/2019 18:31	29/11/2019 13:37	28/11/2019 18:31	29/11/2019 13:37	19,09	3	57,27	CHI
201911353974	GOIATUBA	CL21295953	RIO DOS BOIS	28/11/2019 18:32	28/11/2019 23:40	28/11/2019 18:32	28/11/2019 23:40	5,13	1	5,13	CHI
201911353977	ITUMBIARA	IT11000029	ITUMBIARA VELHA S1	28/11/2019 18:32	29/11/2019 12:37	28/11/2019 18:32	29/11/2019 12:37	18,08	146	2639,23	CHI
201911353985	MORRINHOS	MR21021168	MORRINHOS	28/11/2019 18:33	29/11/2019 07:40	28/11/2019 18:33	29/11/2019 07:40	13,12	1	13,12	CHI
201911354005	CAMPO ALEGRE DE GOIAS	CM12281443	CAMPO ALEGRE DE GOIAS	28/11/2019 18:35	29/11/2019 10:05	28/11/2019 18:35	29/11/2019 10:05	15,49	13	201,32	CHI
201911354005	IPAMERI	CM12281443	CAMPO ALEGRE DE GOIAS	28/11/2019 18:35	29/11/2019 10:05	28/11/2019 18:35	29/11/2019 10:05	15,49	1	15,49	CHI
201911354012	GOIANIA	GN11180081	XAVANTES	28/11/2019 18:37	28/11/2019 20:59	28/11/2019 18:37	28/11/2019 20:59	2,36	136	320,70	CHI
201911354013	NIQUELANDIA	NQ12375652	URUACU	28/11/2019 18:32	29/11/2019 19:45	28/11/2019 18:32	29/11/2019 19:45	25,21	210	5293,92	CHI
201911354017	MONTE ALEGRE DE GOIAS	MA21146876	SAO DOMINGOS	28/11/2019 18:38	29/11/2019 11:13	28/11/2019 18:38	29/11/2019 11:13	16,58	1	16,58	CHI
201911354022	GOIANIA	GN12087621	ATLANTICO S1	28/11/2019 18:39	28/11/2019 21:48	28/11/2019 18:39	28/11/2019 21:48	3,15	38	119,67	CHI
201911354039	CRISTALINA	KR11170185	CRISTALINA S2	28/11/2019 18:41	29/11/2019 09:33	28/11/2019 18:41	29/11/2019 09:33	14,86	2	29,71	CHI
201911354040	CACHOEIRA DOURADA	CD12000044	CACHOEIRA DOURADA	29/11/2019 08:06	29/11/2019 09:00	29/11/2019 08:06	29/11/2019 09:00	0,90	11	9,90	CHI
201911354045	ALEXANIA	AX12221403	ALEXANIA	28/11/2019 17:49	29/11/2019 07:53	28/11/2019 17:49	29/11/2019 07:53	14,05	119	1672,15	CHI
201911354047	LUZIANIA	120277505	RIO VERMELHO	28/11/2019 18:42	29/11/2019 00:44	28/11/2019 18:42	29/11/2019 00:44	6,03	1	6,03	CHI
201911354056	TRINDADE	40088080	TRINDADE	28/11/2019 18:43	28/11/2019 21:33	28/11/2019 18:43	28/11/2019 21:33	2,82	1	2,82	CHI
201911354064	ITABERAÍ	IB12310510	ITABERAÍ S2	28/11/2019 18:44	29/11/2019 09:22	28/11/2019 18:44	29/11/2019 09:22	14,62	1	14,62	CHI
201911354065	FLORES DE GOIAS	FB12302811	FLORES DE GOIAS	28/11/2019 15:47	28/11/2019 20:44	28/11/2019 15:47	28/11/2019 20:44	4,94	72	355,34	CHI
201911354069	NOVA AMERICA	NM21184698	RUBIATABA	28/11/2019 18:45	28/11/2019 19:01	28/11/2019 18:45	28/11/2019 19:01	0,26	1	0,26	CHI
201911354074	INHUMAS	IN12012230	INHUMAS S2	28/11/2019 17:43	28/11/2019 20:16	28/11/2019 17:43	28/11/2019 20:16	2,54	284	721,75	CHI
201911354075	CORUMBAIBA	CI12025121	VILA CORUMBA	28/11/2019 18:45	29/11/2019 10:26	28/11/2019 18:45	29/11/2019 10:26	15,67	31	485,75	CHI
201911354079	SAO LUIS DE MONTES BELOS	SL12003839	SAO LUIZ DOS MONTES BELOS	28/11/2019 18:46	29/11/2019 00:49	28/11/2019 18:46	29/11/2019 00:49	6,04	7	42,25	CHI
201911354079	AURILANDIA	SL12003839	SAO LUIZ DOS MONTES BELOS	28/11/2019 18:46	29/11/2019 00:49	28/11/2019 18:46	29/11/2019 00:49	6,04	15	90,54	CHI
201911354081	CAIAPONIA	CP12303513	MONTIVIDIU T	28/11/2019 18:47	29/11/2019 11:35	28/11/2019 18:47	29/11/2019 11:35	16,80	21	352,71	CHI
201911354088	ITABERAÍ	IB12379742	ITABERAÍ S2	28/11/2019 16:55	28/11/2019 20:02	28/11/2019 16:55	28/11/2019 20:02	3,11	185	575,66	CHI
201911354090	FORMOSA	FA12041996	ITUIQUIRA	28/11/2019 18:39	28/11/2019 21:04	28/11/2019 18:39	28/11/2019 21:04	2,40	407	977,25	CHI
201911354105	SAO DOMINGOS	SD12346473	SAO DOMINGOS	28/11/2019 17:43	29/11/2019 09:14	28/11/2019 17:43	29/11/2019 09:14	15,50	24	372,04	CHI
201911354112	ARUANA	AK12250806	MOZARLANDIA	28/11/2019 18:54	29/11/2019 17:15	28/11/2019 18:54	29/11/2019 17:15	22,35	4	89,40	CHI
201911354117	BURITI DE GOIAS	SC13308356	FIRMINOPOLIS S2	29/11/2019 16:50	29/11/2019 23:10	29/11/2019 16:50	29/11/2019 23:10	6,33	3	19,00	CHI
201911354117	SANCLERLANDIA	SC13308356	FIRMINOPOLIS S2	29/11/2019 16:50	29/11/2019 23:10	29/11/2019 16:50	29/11/2019 23:10	6,33	29	183,67	CHI
201911354117	SAO LUIS DE MONTES BELOS	SC13308356	FIRMINOPOLIS S2	29/11/2019 16:50	29/11/2019 23:10	29/11/2019 16:50	29/11/2019 23:10	6,33	48	304,01	CHI
201911354121	JARAGUA	JA1238928	JARAGUA	28/11/2019 18:55	29/11/2019 12:53	28/11/2019 18:55	29/11/2019 12:53	17,95	1	17,95	CHI
201911354126	GOIANIA	10881451	GOIANIA LESTE S2	28/11/2019 18:56	28/11/2019 21:20	28/11/2019 18:56	28/11/2019 21:20	2,39	1	2,39	CHI
201911354135	CRISTALINA	KR12230274	CRISTALINA S2	28/11/2019 18:08	29/11/2019 08:46	28/11/2019 18:08	29/11/2019 08:46	14,62	8	116,99	CHI

201911354136	PORANGATU	PO12022073	PORANGATU	29/11/2019 11:48	29/11/2019 23:39	29/11/2019 11:48	29/11/2019 23:39	11,84	43	509,00	CHI
201911354137	SAO LUIS DE MONTES BELOS	SL31167217	SAO LUIZ DOS MONTES BELOS	28/11/2019 18:58	28/11/2019 21:10	28/11/2019 18:58	28/11/2019 21:10	2,21	2	4,42	CHI
201911354140	BONFINOPOLIS	BO11329165	CEPAIGO S2	28/11/2019 18:51	29/11/2019 00:33	28/11/2019 18:51	29/11/2019 00:33	5,70	117	666,48	CHI
201911354141	ALEXANIA	480093945	ALEXANIA	28/11/2019 18:58	29/11/2019 20:58	28/11/2019 18:58	29/11/2019 20:58	25,99	1	25,99	CHI
201911354152	LUZIANIA	OZ21114865	PIRES DO RIO S2	28/11/2019 19:00	29/11/2019 11:58	28/11/2019 19:00	29/11/2019 11:58	16,96	1	16,96	CHI
201911354161	FORMOSA	FA11341524	ITIQUEIRA	28/11/2019 17:55	28/11/2019 21:02	28/11/2019 17:55	28/11/2019 21:02	3,11	90	280,35	CHI
201911354165	QUIRINOPOLIS	QI21296547	QUIRINOPOLIS	28/11/2019 19:02	29/11/2019 08:13	28/11/2019 19:02	29/11/2019 08:13	13,18	1	13,18	CHI
201911354171	CIDADE OCIDENTAL	DH11128724	MARAJOARA	28/11/2019 19:04	28/11/2019 21:47	28/11/2019 19:04	28/11/2019 21:47	2,71	14	38,01	CHI
201911354174	GOIANIA	16872010	REAL S2	28/11/2019 19:04	29/11/2019 01:01	28/11/2019 19:04	29/11/2019 01:01	5,94	1	5,94	CHI
201911354175	QUIRINOPOLIS	QI12000040	QUIRINOPOLIS	28/11/2019 18:55	29/11/2019 20:58	28/11/2019 18:55	28/11/2019 22:44	3,81	84	320,37	CHI
201911354175	QUIRINOPOLIS	QI12000040	QUIRINOPOLIS	28/11/2019 18:55	29/11/2019 20:58	28/11/2019 18:55	29/11/2019 20:58	26,05	7	182,34	CHI
201911354182	ANAPOLIS	20691245	DAIA S1	28/11/2019 19:07	28/11/2019 21:50	28/11/2019 19:07	28/11/2019 21:50	2,71	1	2,71	CHI
201911354184	GOIANIA	GN11167716	FERROVIARIO S2	28/11/2019 18:19	28/11/2019 23:36	28/11/2019 18:19	28/11/2019 23:36	5,28	76	401,30	CHI
201911354186	HIDROLANDIA	HD12321570	INDEPENDENCIA S1	28/11/2019 19:07	29/11/2019 09:16	28/11/2019 19:07	29/11/2019 09:16	14,14	7	98,96	CHI
201911354195	MARA ROSA	MQ21125501	MARA ROSA	28/11/2019 19:09	29/11/2019 15:50	28/11/2019 19:09	29/11/2019 15:50	20,67	1	20,67	CHI
201911354203	CRISTALINA	KR21219727	CRISTALINA S1	28/11/2019 19:11	29/11/2019 11:01	28/11/2019 19:11	29/11/2019 11:01	15,83	1	15,83	CHI
201911354210	ITUMBIAIRA	IT21034468	CACHOEIRA DOURADA	28/11/2019 19:12	29/11/2019 08:28	28/11/2019 19:12	29/11/2019 08:28	13,26	2	26,53	CHI
201911354214	CATALAO	CT12166743RE	CATALAO S1	28/11/2019 15:13	29/11/2019 10:59	28/11/2019 15:13	29/11/2019 10:59	19,76	33	652,20	CHI
201911354219	TRES RANCHOS	TH21103421	CATALAO S1	28/11/2019 19:14	29/11/2019 17:30	28/11/2019 19:14	29/11/2019 17:30	22,26	1	22,26	CHI
201911354221	CRISTALINA	KR12276359	CRISTALINA S2	28/11/2019 19:15	29/11/2019 01:05	28/11/2019 19:15	29/11/2019 01:05	5,83	19	110,70	CHI
201911354224	BALIZA	BH12142110	BOM JARDIM	28/11/2019 19:00	28/11/2019 23:45	28/11/2019 19:00	28/11/2019 23:45	4,75	84	398,88	CHI
201911354226	AGUAS LINDAS DE GOIAS	LA11133126	AGUAS LINDAS DE GOIAS S2	28/11/2019 19:16	28/11/2019 20:12	28/11/2019 19:16	28/11/2019 20:12	0,92	51	46,76	CHI
201911354227	RIO VERDE	RV21191973	JATAI S2	28/11/2019 19:17	29/11/2019 08:52	28/11/2019 19:17	29/11/2019 08:52	13,58	1	13,58	CHI
201911354228	BALIZA	BH12343730	BOM JARDIM	28/11/2019 19:17	29/11/2019 15:50	28/11/2019 19:17	29/11/2019 15:50	20,55	8	164,37	CHI
201911354235	TRINDADE	12321655	GOYA S2	28/11/2019 19:19	29/11/2019 05:47	28/11/2019 19:19	29/11/2019 05:47	10,46	1	10,46	CHI
201911354241	MOZARLANDIA	MZ12055650	MOZARLANDIA	28/11/2019 18:41	29/11/2019 11:32	28/11/2019 18:41	29/11/2019 11:32	16,84	5	84,18	CHI
201911354241	NOVA CRIXAS	MZ12055650	MOZARLANDIA	28/11/2019 18:41	29/11/2019 11:32	28/11/2019 18:41	29/11/2019 11:32	16,84	28	471,43	CHI
201911354241	CRIXAS	MZ12055650	MOZARLANDIA	28/11/2019 18:41	29/11/2019 11:32	28/11/2019 18:41	29/11/2019 11:32	16,84	76	1279,59	CHI
201911354245	INHUMAS	IN12326287	INHUMAS S2	28/11/2019 19:18	29/11/2019 15:17	28/11/2019 19:18	29/11/2019 15:17	19,97	9	179,75	CHI
201911354249	FAINA	IK12300247	ITAPURANGA	28/11/2019 07:31	29/11/2019 07:42	28/11/2019 07:31	29/11/2019 07:42	24,18	24	580,37	CHI
201911354249	ITAPURANGA	IK12300247	ITAPURANGA	28/11/2019 07:31	29/11/2019 07:42	28/11/2019 07:31	29/11/2019 07:42	24,18	7	169,28	CHI
201911354255	GOIANESIA	GE12328285	GOIANESIA S1	28/11/2019 17:27	29/11/2019 11:07	28/11/2019 17:27	29/11/2019 11:07	17,65	76	1341,57	CHI
201911354256	APARECIDA DE GOIANIA	10015706727	ANHANGUERA	28/11/2019 19:23	28/11/2019 21:45	28/11/2019 19:23	28/11/2019 21:45	2,36	1	2,36	CHI



201911354259	PALMEIRAS DE GOIAS	PL21147515	ANICUNS	28/11/2019 19:23	29/11/2019 08:25	28/11/2019 19:23	29/11/2019 08:25	13,03	1	13,03	CHI
201911354260	CATALAO	1990105200	CATALAO S2	28/11/2019 19:23	29/11/2019 08:14	28/11/2019 19:23	29/11/2019 08:14	12,83	1	12,83	CHI
201911354264	PIRES DO RIO	PR21309164	PIRES DO RIO S1	28/11/2019 19:24	29/11/2019 12:36	28/11/2019 19:24	29/11/2019 12:36	17,19	1	17,19	CHI
201911354266	SAO MIGUEL DO ARAGUAIA	SM12393998	SAO MIGUEL DO ARAGUAIA	28/11/2019 19:25	29/11/2019 11:05	28/11/2019 19:25	29/11/2019 11:05	15,66	9	140,92	CHI
201911354272	URUTAI	600014678	URUTAI	28/11/2019 19:27	28/11/2019 20:59	28/11/2019 19:27	28/11/2019 20:59	1,54	1	1,54	CHI
201911354274	GOIAS	GS12310471	ITABERAÍ S1	28/11/2019 19:28	29/11/2019 09:43	28/11/2019 19:28	29/11/2019 09:43	14,25	2	28,50	CHI
201911354277	QUIRINOPOLIS	QI32007538	QUIRINOPOLIS	28/11/2019 18:47	29/11/2019 12:21	28/11/2019 18:47	29/11/2019 12:21	17,56	40	702,37	CHI
201911354278	GOIANIA	10519105	GOIANIA LESTE S2	28/11/2019 19:29	28/11/2019 23:26	28/11/2019 19:29	28/11/2019 23:26	3,93	1	3,93	CHI
201911354281	GOIANIA	GN11000462	AEROPORTO S1	28/11/2019 19:30	29/11/2019 00:13	28/11/2019 19:30	29/11/2019 00:13	4,71	89	419,07	CHI
201911354282	FORMOSA	FA12085474	ITUIQUIRA	28/11/2019 19:30	29/11/2019 22:00	28/11/2019 19:30	29/11/2019 22:00	26,49	29	768,18	CHI
201911354291	INHUMAS	IN21066359	INHUMAS S2	28/11/2019 19:32	29/11/2019 11:27	28/11/2019 19:32	29/11/2019 11:27	15,90	1	15,90	CHI
201911354297	SAO SIMAO	2240054500	CACHOEIRA ALTA	28/11/2019 19:34	29/11/2019 09:36	28/11/2019 19:34	29/11/2019 09:36	14,03	1	14,03	CHI
201911354300	ALVORADA DO NORTE	FB12044974RE	IACIARA S2	28/11/2019 19:05	28/11/2019 21:29	28/11/2019 19:05	28/11/2019 21:29	2,40	280	671,92	CHI
201911354300	SITIO D ABADIA	FB12044974RE	IACIARA S2	28/11/2019 19:05	28/11/2019 21:29	28/11/2019 19:05	28/11/2019 21:29	2,40	138	331,16	CHI
201911354300	FLORES DE GOIAS	FB12044974RE	IACIARA S2	28/11/2019 19:05	28/11/2019 21:29	28/11/2019 19:05	28/11/2019 21:29	2,40	693	1663,01	CHI
201911354300	SIMOLANDIA	FB12044974RE	IACIARA S2	28/11/2019 19:05	28/11/2019 21:29	28/11/2019 19:05	28/11/2019 21:29	2,40	1	2,40	CHI
201911354300	VILA BOA	FB12044974RE	IACIARA S2	28/11/2019 19:05	28/11/2019 21:29	28/11/2019 19:05	28/11/2019 21:29	2,40	60	143,98	CHI
201911354304	FORMOSA	610272974	ITUIQUIRA	28/11/2019 19:36	29/11/2019 00:02	28/11/2019 19:36	29/11/2019 00:02	4,43	1	4,43	CHI
201911354306	GOIANIA	GN12002332	CAMPINAS S1	28/11/2019 19:17	28/11/2019 21:33	28/11/2019 19:17	28/11/2019 21:33	2,26	112	252,81	CHI
201911354309	VALPARAISO DE GOIAS	3350060806	PACAEMBU S1	28/11/2019 19:37	28/11/2019 21:30	28/11/2019 19:37	28/11/2019 21:30	1,88	1	1,88	CHI
201911354313	ANICUNS	AC12000090	ANICUNS	28/11/2019 19:37	28/11/2019 21:46	28/11/2019 19:37	28/11/2019 21:46	2,14	2	4,28	CHI
201911354317	SANTA ISABEL	GE21205715	GOIANESIA S1	28/11/2019 19:38	29/11/2019 11:56	28/11/2019 19:38	29/11/2019 11:56	16,30	2	32,59	CHI
201911354320	PIRENOPOLIS	PV12360338RE	CORUMBA	28/11/2019 18:54	29/11/2019 18:11	28/11/2019 18:54	29/11/2019 18:11	23,27	93	2164,01	CHI
201911354322	TRINDADE	10002965311	TRINDADE	28/11/2019 19:39	28/11/2019 22:50	28/11/2019 19:39	28/11/2019 22:50	3,18	1	3,18	CHI
201911354325	URUACU	20119953	URUACU	28/11/2019 19:39	29/11/2019 10:37	28/11/2019 19:39	29/11/2019 10:37	14,95	2	29,90	CHI
201911354331	LUZIANIA	120118518	RIO VERMELHO	28/11/2019 19:41	28/11/2019 20:52	28/11/2019 19:41	28/11/2019 20:52	1,19	1	1,19	CHI
201911354335	APARECIDA DE GOIANIA	200209498	INDEPENDENCIA S2	28/11/2019 19:42	29/11/2019 01:28	28/11/2019 19:42	29/11/2019 01:28	5,76	1	5,76	CHI
201911354337	FLORES DE GOIAS	FB12249653	FLORES DE GOIAS	28/11/2019 15:27	29/11/2019 02:25	28/11/2019 15:27	29/11/2019 02:25	10,96	153	1677,18	CHI
201911354341	PIRACANJUBA	PJ11323918	PIRACANJUBA	28/11/2019 19:07	28/11/2019 22:45	28/11/2019 19:07	28/11/2019 22:45	3,62	69	249,84	CHI
201911354342	AURILANDIA	AI12232979	FIRMINOPOLIS S2	28/11/2019 19:42	29/11/2019 01:35	28/11/2019 19:42	29/11/2019 01:35	5,87	5	29,36	CHI
201911354344	RIO VERDE	RV21191966	MONTVIDIU T	28/11/2019 19:42	29/11/2019 08:34	28/11/2019 19:42	29/11/2019 08:34	12,85	1	12,85	CHI
201911354347	ESTRELA DO NORTE	ET12088710	MARA ROSA	28/11/2019 19:43	29/11/2019 14:01	28/11/2019 19:43	29/11/2019 14:01	18,30	3	54,91	CHI
201911354349	TRINDADE	10000345685	TRINDADE	28/11/2019 19:43	28/11/2019 22:00	28/11/2019 19:43	28/11/2019 22:00	2,28	1	2,28	CHI

201911354350	BOM JESUS DE GOIAS	10030364114	BOM JESUS DE GOIAS	28/11/2019 19:43	28/11/2019 23:39	28/11/2019 19:43	28/11/2019 23:39	3,93	1	3,93	CHI
201911354352	APARECIDA DE GOIANIA	AP11078462	INDEPENDENCIA S2	28/11/2019 19:19	28/11/2019 21:33	28/11/2019 19:19	28/11/2019 21:33	2,22	170	377,49	CHI
201911354356	RUBIATABA	RB21144553	RUBIATABA	28/11/2019 19:47	29/11/2019 18:21	28/11/2019 19:47	29/11/2019 18:21	22,56	1	22,56	CHI
201911354357	SANTA CRUZ DE GOIAS	PR12051693	PIRES DO RIO S2	29/11/2019 01:12	29/11/2019 15:09	29/11/2019 01:12	29/11/2019 15:09	13,94	2	27,88	CHI
201911354357	PIRES DO RIO	PR12051693	PIRES DO RIO S2	29/11/2019 01:12	29/11/2019 15:09	29/11/2019 01:12	29/11/2019 15:09	13,94	13	181,21	CHI
201911354367	LEOPOLDO DE BULHOES	LB21125722	DAIA S2	28/11/2019 19:49	29/11/2019 15:19	28/11/2019 19:49	29/11/2019 15:19	19,49	1	19,49	CHI
201911354370	MARZAGAO	MG11000046	VILA CORUMBA	28/11/2019 19:50	28/11/2019 22:15	28/11/2019 19:50	28/11/2019 22:15	2,42	75	181,25	CHI
201911354374	PORANGATU	PO12391647	NOVO PLANALTO	28/11/2019 19:51	29/11/2019 14:30	28/11/2019 19:51	29/11/2019 14:30	18,64	25	466,12	CHI
201911354375	NOVA IGUACU DE GOIAS	NH12374720	URUACU	28/11/2019 16:36	29/11/2019 12:25	28/11/2019 16:36	29/11/2019 12:25	19,81	7	138,69	CHI
201911354384	BURITI ALEGRE	BG21316688	ITUMBIARA VELHA S2	28/11/2019 19:52	28/11/2019 21:19	28/11/2019 19:52	28/11/2019 21:19	1,44	1	1,44	CHI
201911354387	VIANOPOLIS	VN12194266	VIANOPOLIS	28/11/2019 19:53	29/11/2019 10:00	28/11/2019 19:53	29/11/2019 10:00	14,11	5	70,56	CHI
201911354405	PORANGATU	PO12192315	PORANGATU	28/11/2019 19:55	29/11/2019 09:40	28/11/2019 19:55	29/11/2019 09:40	13,74	19	260,98	CHI
201911354416	FORMOSA	FA12053601RE	ITUIQUIRA	28/11/2019 19:05	28/11/2019 23:23	28/11/2019 19:05	28/11/2019 23:23	4,29	34	145,83	CHI
201911354419	RIO VERDE	RV12106546	CABRIUVA S2	28/11/2019 18:38	28/11/2019 23:15	28/11/2019 18:38	28/11/2019 23:15	4,61	10	46,11	CHI
201911354422	NOVA CRIXAS	NA12349203	NOVA CRIXAS	28/11/2019 19:59	29/11/2019 09:45	28/11/2019 19:59	29/11/2019 09:45	13,76	4	55,04	CHI
201911354428	ITAPIRAPUA	1420011124	MATRINCHA	28/11/2019 20:02	29/11/2019 09:20	28/11/2019 20:02	29/11/2019 09:20	13,30	1	13,30	CHI
201911354430	APARECIDA DE GOIANIA	10004929088	INDEPENDENCIA S2	28/11/2019 20:02	28/11/2019 23:54	28/11/2019 20:02	28/11/2019 23:54	3,85	1	3,85	CHI
201911354432	AGUA LIMPA	AL21263207	VILA CORUMBA	28/11/2019 20:03	28/11/2019 23:54	28/11/2019 20:03	28/11/2019 23:54	3,84	1	3,84	CHI
201911354437	CORUMBAIBA	CI12149233	VILA CORUMBA	28/11/2019 20:05	29/11/2019 09:30	28/11/2019 20:05	29/11/2019 09:30	13,41	7	93,86	CHI
201911354439	JATAI	JT12209803	JATAI S3	28/11/2019 20:04	29/11/2019 14:00	28/11/2019 20:04	29/11/2019 13:24	17,35	17	294,92	CHI
201911354439	JATAI	JT12209804LD	JATAI S3	28/11/2019 20:04	29/11/2019 14:00	28/11/2019 20:04	29/11/2019 14:00	17,94	7	125,56	CHI
201911354456	RIO VERDE	RV21279862	CABRIUVA S2	28/11/2019 20:10	29/11/2019 10:50	28/11/2019 20:10	29/11/2019 10:50	14,66	1	14,66	CHI
201911354458	ANAPOLIS	AN11130801	JUNDIAI S2	28/11/2019 20:05	28/11/2019 21:13	28/11/2019 20:05	28/11/2019 21:13	1,13	126	142,24	CHI
201911354460	MONTE ALEGRE DE GOIAS	MA12405181	SAO DOMINGOS	28/11/2019 20:10	29/11/2019 15:44	28/11/2019 20:10	29/11/2019 15:44	19,55	4	78,21	CHI
201911354469	SAO MIGUEL DO ARAGUAIA	10002090919	SAO MIGUEL DO ARAGUAIA	28/11/2019 20:14	29/11/2019 11:29	28/11/2019 20:14	29/11/2019 11:29	15,24	1	15,24	CHI
201911354480	GOIANIA	12871588	GOIANIA LESTE S3	28/11/2019 20:16	28/11/2019 22:04	28/11/2019 20:16	28/11/2019 22:04	1,78	1	1,78	CHI
201911354483	RIO VERDE	MV12260796	MONTIVIDIU T	28/11/2019 20:17	29/11/2019 09:40	28/11/2019 20:17	29/11/2019 09:40	13,38	2	26,75	CHI
201911354483	MONTIVIDIU	MV12260796	MONTIVIDIU T	28/11/2019 20:17	29/11/2019 09:40	28/11/2019 20:17	29/11/2019 09:40	13,38	2	26,75	CHI
201911354484	ITABERAI	IB12300320	ITABERAI S2	28/11/2019 20:18	28/11/2019 23:18	28/11/2019 20:18	28/11/2019 23:18	3,00	21	62,98	CHI
201911354490	MARA ROSA	LC12308828	MARA ROSA	28/11/2019 20:20	29/11/2019 14:43	28/11/2019 20:20	29/11/2019 14:43	18,38	1	18,38	CHI
201911354490	AMARALINA	LC12308828	MARA ROSA	28/11/2019 20:20	29/11/2019 14:43	28/11/2019 20:20	29/11/2019 14:43	18,38	2	36,76	CHI
201911354503	ARAGARCAS	1820037244	ARAGARCAS	28/11/2019 20:22	28/11/2019 22:32	28/11/2019 20:22	28/11/2019 22:32	2,16	1	2,16	CHI
201911354504	SAO MIGUEL DO PASSA QUATRO	BV21060457	CRISTIANOPOLIS	28/11/2019 20:22	29/11/2019 10:13	28/11/2019 20:22	29/11/2019 10:13	13,84	1	13,84	CHI

201911354506	ITUMBIARA	690200444	ITUMBIARA NOVA	28/11/2019 20:22	28/11/2019 21:26	28/11/2019 20:22	28/11/2019 21:26	1,05	1	1,05	CHI
201911354510	GOIATUBA	GT21295921	RIO DOS BOIS	28/11/2019 20:24	28/11/2019 23:25	28/11/2019 20:24	28/11/2019 23:25	3,01	1	3,01	CHI
201911354525	GOIANIA	GN11001224	GOIANIA LESTE S1	28/11/2019 20:10	29/11/2019 01:54	28/11/2019 20:10	29/11/2019 01:54	5,73	60	344,02	CHI
201911354528	GOIATUBA	10019179918	GOIATUBA S2	28/11/2019 20:30	29/11/2019 09:16	28/11/2019 20:30	29/11/2019 09:16	12,78	1	12,78	CHI
201911354535	INHUMAS	10014724829	INHUMAS S2	28/11/2019 17:04	29/11/2019 01:14	28/11/2019 17:04	29/11/2019 01:14	8,16	1	8,16	CHI
201911354537	MONTE ALEGRE DE GOIAS	MA12290214	SAO DOMINGOS	28/11/2019 17:54	28/11/2019 22:58	28/11/2019 17:54	28/11/2019 22:58	5,06	12	60,74	CHI
201911354540	GOIANIRA	390088237	GOIANIRA	28/11/2019 20:32	29/11/2019 07:07	28/11/2019 20:32	29/11/2019 07:07	10,57	1	10,57	CHI
201911354541	MAMBAI	1570015986	IACIARA S2	28/11/2019 20:33	28/11/2019 21:58	28/11/2019 20:33	28/11/2019 21:58	1,41	1	1,41	CHI
201911354550	NOVA AURORA	CI12000451	VILA CORUMBA	28/11/2019 20:37	29/11/2019 08:55	28/11/2019 20:37	29/11/2019 08:55	12,30	7	86,10	CHI
201911354550	CORUMBAIBA	CI12000451	VILA CORUMBA	28/11/2019 20:37	29/11/2019 08:55	28/11/2019 20:37	29/11/2019 08:55	12,30	7	86,10	CHI
201911354555	SANTA HELENA DE GOIAS	400142960	IPEGUARI	28/11/2019 20:38	28/11/2019 23:54	28/11/2019 20:38	28/11/2019 23:54	3,27	1	3,27	CHI
201911354558	POSSE	1480059885	IACIARA S2	28/11/2019 20:39	28/11/2019 21:56	28/11/2019 20:39	28/11/2019 21:56	1,28	1	1,28	CHI
201911354563	ARUANA	AK11051861	ARUANA	28/11/2019 17:52	29/11/2019 00:13	28/11/2019 17:52	29/11/2019 00:13	6,34	44	278,80	CHI
201911354569	PORANGATU	PO12137591	PORANGATU	28/11/2019 20:42	29/11/2019 17:30	28/11/2019 20:42	29/11/2019 17:30	20,80	3	62,40	CHI
201911354571	CATALAO	CT21266272	CATALAO S1	28/11/2019 20:43	29/11/2019 10:15	28/11/2019 20:43	29/11/2019 10:15	13,53	1	13,53	CHI
201911354583	PIRENOPOLIS	PV21297713	CORUMBA	28/11/2019 20:45	29/11/2019 15:43	28/11/2019 20:45	29/11/2019 15:43	18,95	1	18,95	CHI
201911354586	GOIANIA	GN11053056	GOYA S1	28/11/2019 20:40	28/11/2019 22:25	28/11/2019 20:40	28/11/2019 22:25	1,74	145	252,78	CHI
201911354594	ITUMBIARA	690405054	ITUMBIARA VELHA S1	28/11/2019 20:49	28/11/2019 23:26	28/11/2019 20:49	28/11/2019 23:26	2,61	1	2,61	CHI
201911354596	ARUANA	2380027372	ARUANA	28/11/2019 20:50	29/11/2019 10:01	28/11/2019 20:50	29/11/2019 10:01	13,17	1	13,17	CHI
201911354597	SAO MIGUEL DO ARAGUAIA	830020718	SAO MIGUEL DO ARAGUAIA	28/11/2019 20:52	29/11/2019 14:05	28/11/2019 20:52	29/11/2019 14:05	17,21	1	17,21	CHI
201911354601	CIDADE OCIDENTAL	2680044673	MARAJOARA	28/11/2019 20:53	28/11/2019 22:35	28/11/2019 20:53	28/11/2019 22:35	1,69	1	1,69	CHI
201911354603	GOIANIA	15656410	ATLANTICO S1	28/11/2019 20:54	29/11/2019 00:06	28/11/2019 20:54	29/11/2019 00:06	3,19	1	3,19	CHI
201911354604	GOIANIA	12475166	REAL S2	28/11/2019 20:54	29/11/2019 01:51	28/11/2019 20:54	29/11/2019 01:51	4,94	1	4,94	CHI
201911354607	GOIAS	GS12021038	GOIAS	28/11/2019 20:55	29/11/2019 14:14	28/11/2019 20:55	29/11/2019 14:14	17,30	2	34,61	CHI
201911354617	URUTAI	UT11000152	URUTAI	28/11/2019 20:56	29/11/2019 00:19	28/11/2019 20:56	29/11/2019 00:19	3,37	232	781,45	CHI
201911354621	PALMEIRAS DE GOIAS	PL12000113	PALMEIRAS	28/11/2019 21:00	29/11/2019 11:34	28/11/2019 21:00	29/11/2019 11:34	14,56	1	14,56	CHI
201911354629	SILVANIA	660064881	VIANOPOLIS	28/11/2019 21:05	29/11/2019 09:06	28/11/2019 21:05	29/11/2019 09:06	12,00	1	12,00	CHI
201911354634	POSSE	PS12212366	IACIARA S1	28/11/2019 21:07	29/11/2019 12:30	28/11/2019 21:07	29/11/2019 12:30	15,37	37	568,67	CHI
201911354641	OUIDOR	OU21154886	CATALAO S1	28/11/2019 21:09	29/11/2019 18:00	28/11/2019 21:09	29/11/2019 18:00	20,85	1	20,85	CHI
201911354649	LUZIANIA	LZ11253505	VIANOPOLIS	28/11/2019 21:11	29/11/2019 01:34	28/11/2019 21:11	29/11/2019 01:34	4,38	2	8,75	CHI
201911354665	PEROLANDIA	DP21182169	PARQUE DAS EMAS	28/11/2019 21:14	29/11/2019 16:10	28/11/2019 21:14	29/11/2019 16:10	18,92	1	18,92	CHI
201911354667	PLANALTINA	PI11070762	PLANALTINA	28/11/2019 21:06	28/11/2019 22:19	28/11/2019 21:06	28/11/2019 22:19	1,22	168	204,26	CHI
201911354671	APARECIDA DE GOIANIA	10024665892	ANHANGUERA	28/11/2019 21:16	28/11/2019 23:01	28/11/2019 21:16	28/11/2019 23:01	1,74	1	1,74	CHI

201911354673	SAO DOMINGOS	SD21375465	SAO DOMINGOS	28/11/2019 21:17	29/11/2019 16:53	28/11/2019 21:17	29/11/2019 16:53	19,59	1	19,59	CHI
201911354676	GOIANIRA	10010434702	GOIANIRA	28/11/2019 21:17	29/11/2019 08:28	28/11/2019 21:17	29/11/2019 08:28	11,17	1	11,17	CHI
201911354677	GOIANIA	11041468	GOYA S2	28/11/2019 21:18	28/11/2019 23:58	28/11/2019 21:18	28/11/2019 23:58	2,66	1	2,66	CHI
201911354688	CATALAO	CT21281725	CATALAO S1	28/11/2019 21:27	29/11/2019 11:39	28/11/2019 21:27	29/11/2019 11:39	14,20	1	14,20	CHI
201911354689	RUBIATABA	780072601	RUBIATABA	28/11/2019 21:27	29/11/2019 21:55	28/11/2019 21:27	29/11/2019 21:55	24,48	1	24,48	CHI
201911354707	ISRAELANDIA	IS12089375	IPORA	28/11/2019 21:41	29/11/2019 08:14	28/11/2019 21:41	29/11/2019 08:14	10,54	18	189,79	CHI
201911354709	PLANALTINA	2960176358	PLANALTINA	28/11/2019 21:42	28/11/2019 23:32	28/11/2019 21:42	28/11/2019 23:32	1,83	1	1,83	CHI
201911354712	SANTO ANTONIO DO DESCOBERTO	10003765685	ALEXANIA	28/11/2019 21:45	29/11/2019 07:10	28/11/2019 21:45	29/11/2019 07:10	9,42	1	9,42	CHI
201911354714	BRAZABRANTES	BR12013941	INHUMAS S2	28/11/2019 18:43	28/11/2019 23:25	28/11/2019 18:43	28/11/2019 23:25	4,69	216	1012,38	CHI
201911354715	ITARUMA	IM12058060	CACHOEIRA ALTA	28/11/2019 21:46	30/11/2019 09:21	28/11/2019 21:46	30/11/2019 09:21	35,59	1	35,59	CHI
201911354715	ITARUMA	IM12058060	CACHOEIRA ALTA	28/11/2019 21:46	30/11/2019 09:21	30/11/2019 08:02	30/11/2019 09:21	1,33	2	2,66	CHI
201911354719	APARECIDA DE GOIANIA	10018481912	INDEPENDENCIA S1	28/11/2019 21:49	29/11/2019 00:29	28/11/2019 21:49	29/11/2019 00:29	2,67	1	2,67	CHI
201911354720	IPAMERI	IP12071433	IPAMERI	28/11/2019 19:52	29/11/2019 09:13	28/11/2019 19:52	29/11/2019 09:13	13,35	4	53,38	CHI
201911354722	IPORA	10024471290	IPORA	28/11/2019 21:50	28/11/2019 23:49	28/11/2019 21:50	28/11/2019 23:49	1,98	1	1,98	CHI
201911354724	ABADIANIA	AN21339489	ANAPOLIS UNIVERSITARIO S2	28/11/2019 21:51	29/11/2019 12:03	28/11/2019 21:51	29/11/2019 12:03	14,20	1	14,20	CHI
201911354726	LUZIANIA	LZ21041422	RIO VERMELHO	28/11/2019 21:55	28/11/2019 23:49	28/11/2019 21:55	28/11/2019 23:49	1,88	1	1,88	CHI
201911354727	FAZENDA NOVA	FN12390148	IPORA	28/11/2019 21:56	29/11/2019 10:20	28/11/2019 21:56	29/11/2019 10:20	12,40	3	37,19	CHI
201911354727	ISRAELANDIA	FN12390148	IPORA	28/11/2019 21:56	29/11/2019 10:20	28/11/2019 21:56	29/11/2019 10:20	12,40	10	123,96	CHI
201911354728	MONTIVIDIU	2840030919	MONTIVIDIU T	28/11/2019 21:57	29/11/2019 00:20	28/11/2019 21:57	29/11/2019 00:20	2,38	1	2,38	CHI
201911354730	RIO VERDE	RV12315683	SANTA HELENA S1	28/11/2019 22:00	30/11/2019 12:00	29/11/2019 18:53	30/11/2019 11:31	16,63	1	16,63	CHI
201911354730	RIO VERDE	6396029	SANTA HELENA S1	28/11/2019 22:00	30/11/2019 12:00	28/11/2019 22:00	30/11/2019 12:00	38,01	6	228,05	CHI
201911354730	MAURILANDIA	6396029	SANTA HELENA S1	28/11/2019 22:00	30/11/2019 12:00	28/11/2019 22:00	30/11/2019 12:00	38,01	4	152,03	CHI
201911354732	ITABERAI	IB12124898	ITABERAI S2	28/11/2019 20:23	29/11/2019 01:10	28/11/2019 20:23	29/11/2019 01:10	4,77	185	883,02	CHI
201911354734	CATALAO	CT12266940	CATALAO S1	28/11/2019 22:03	29/11/2019 10:30	28/11/2019 22:03	29/11/2019 10:30	12,43	2	24,87	CHI
201911354738	NOVO GAMA	2900061927	MARAJOARA	28/11/2019 22:07	29/11/2019 02:02	28/11/2019 22:07	29/11/2019 02:02	3,92	1	3,92	CHI
201911354740	GOIANIA	10922398	FERROVIARIO S2	28/11/2019 22:07	29/11/2019 00:10	28/11/2019 22:07	29/11/2019 00:10	2,04	1	2,04	CHI
201911354743	VALPARAISO DE GOIAS	3350011856	PACAEMBU S2	28/11/2019 22:11	28/11/2019 23:25	28/11/2019 22:11	28/11/2019 23:25	1,23	1	1,23	CHI
201911354744	MOZARLANDIA	410003293	MOZARLANDIA	28/11/2019 22:12	29/11/2019 08:56	28/11/2019 22:12	29/11/2019 08:56	10,75	1	10,75	CHI
201911354750	TERESINA DE GOIAS	TE12237605RE	FLORES DE GOIAS	28/11/2019 22:07	29/11/2019 08:56	28/11/2019 22:07	29/11/2019 08:56	10,80	212	2290,54	CHI
201911354750	NOVA ROMA	TE12237605RE	FLORES DE GOIAS	28/11/2019 22:07	29/11/2019 08:56	28/11/2019 22:07	29/11/2019 08:56	10,80	32	345,74	CHI
201911354754	APARECIDA DE GOIANIA	10000372402	INDEPENDENCIA S2	28/11/2019 22:17	29/11/2019 00:29	28/11/2019 22:17	29/11/2019 00:29	2,20	1	2,20	CHI
201911354759	GOIANESIA	GE21134030	GOIANESIA S2	28/11/2019 22:23	29/11/2019 14:27	28/11/2019 22:23	29/11/2019 14:27	16,06	1	16,06	CHI
201911354761	ITAPIRAPUA	IU12121437	MATRINCHA	28/11/2019 21:06	29/11/2019 11:00	28/11/2019 21:06	29/11/2019 11:00	13,89	16	222,18	CHI

201911354768	INHUMAS	30098117	INHUMAS S2	28/11/2019 22:31	29/11/2019 07:37	28/11/2019 22:31	29/11/2019 07:37	9,10	1	9,10	CHI
201911354769	GOIANIA	14163536	MEIA PONTE	28/11/2019 22:31	29/11/2019 03:46	28/11/2019 22:31	29/11/2019 03:46	5,24	1	5,24	CHI
201911354771	IPORA	730091170	IPORA	28/11/2019 22:32	29/11/2019 07:19	28/11/2019 22:32	29/11/2019 07:19	8,77	1	8,77	CHI
201911354772	GOIANIA	GN11292155	GOYA S2	28/11/2019 22:30	29/11/2019 00:26	28/11/2019 22:30	29/11/2019 00:26	1,92	198	381,04	CHI
201911354778	ANICUNS	AC21000094	ANICUNS	28/11/2019 22:37	29/11/2019 09:42	28/11/2019 22:37	29/11/2019 09:42	11,08	1	11,08	CHI
201911354780	GOIANIA	10614746	AEROPORTO S2	28/11/2019 22:42	29/11/2019 01:09	28/11/2019 22:42	29/11/2019 01:09	2,44	1	2,44	CHI
201911354784	NOVO BRASIL	NB12396240	JUSSARA	28/11/2019 21:17	29/11/2019 00:47	28/11/2019 21:17	29/11/2019 00:47	3,49	10	34,88	CHI
201911354796	TRINDADE	40316397	TRINDADE	28/11/2019 23:03	29/11/2019 07:18	28/11/2019 23:03	29/11/2019 07:18	8,25	1	8,25	CHI
201911354797	POSSE	PS21143800	IACIARA S2	28/11/2019 20:54	29/11/2019 09:37	28/11/2019 20:54	29/11/2019 09:37	12,70	1	12,70	CHI
201911354799	GOIANIA	GN21001528	MEIA PONTE	28/11/2019 23:07	29/11/2019 01:45	28/11/2019 23:07	29/11/2019 01:45	2,63	1	2,63	CHI
201911354800	ITUMBIARA	10020394002	ITUMBIARA VELHA S1	28/11/2019 23:09	29/11/2019 07:29	28/11/2019 23:09	29/11/2019 07:29	8,32	1	8,32	CHI
201911354806	ANAPOLIS	AN11412733	DAIA S1	28/11/2019 23:57	29/11/2019 01:21	28/11/2019 23:57	29/11/2019 01:21	1,39	3	4,17	CHI
201911354814	INACIOLANDIA	ID32128272	QUIRINOPOLIS	29/11/2019 00:28	29/11/2019 10:14	29/11/2019 00:28	29/11/2019 10:14	9,76	8	78,04	CHI
201911354815	GOIANIA	14860910	CAMPINAS S2	29/11/2019 00:30	29/11/2019 01:58	29/11/2019 00:30	29/11/2019 01:58	1,47	1	1,47	CHI
201911354817	SANTA TEREZINHA DE GOIAS	SG11034165	SANTA TEREZINHA	28/11/2019 22:20	29/11/2019 08:20	28/11/2019 22:20	29/11/2019 08:20	10,01	195	1951,30	CHI
201911354821	LUZIANIA	LZ11199548	MARAJOARA	29/11/2019 00:32	29/11/2019 02:13	29/11/2019 00:32	29/11/2019 02:13	1,67	361	602,37	CHI
201911354824	AURILANDIA	AI12377187	FIRMINOPOLIS S2	29/11/2019 00:38	29/11/2019 10:00	29/11/2019 00:38	29/11/2019 10:00	9,36	12	112,36	CHI
201911354829	RIO VERDE	10018683116	RIO VERDE S1	29/11/2019 00:45	29/11/2019 10:24	29/11/2019 00:45	29/11/2019 10:24	9,64	1	9,64	CHI
201911354832	TRINDADE	TR12311261	TRINDADE	29/11/2019 00:50	29/11/2019 03:59	29/11/2019 00:50	29/11/2019 03:59	3,15	233	733,50	CHI
201911354833	PORANGATU	PO12182396	PORANGATU	29/11/2019 00:51	29/11/2019 11:55	29/11/2019 00:51	29/11/2019 11:55	11,05	28	309,52	CHI
201911354834	IACIARA	IA12262079	IACIARA S1	29/11/2019 00:53	29/11/2019 07:41	29/11/2019 00:53	29/11/2019 07:41	6,79	21	142,58	CHI
201911354836	RIO VERDE	RV10406662	RIO VERDE S2	29/11/2019 00:47	29/11/2019 00:50	29/11/2019 00:47	29/11/2019 00:50	0,06	9	0,54	CHI
201911354848	INHUMAS	IN11012237	INHUMAS S2	28/11/2019 17:32	29/11/2019 08:12	28/11/2019 17:32	29/11/2019 08:12	14,66	78	1143,29	CHI
201911354851	ALEXANIA	AX12379444	ALEXANIA	29/11/2019 01:18	29/11/2019 20:19	29/11/2019 01:18	29/11/2019 20:19	19,01	4	76,03	CHI
201911354860	RIO VERDE	BZ12295804LD	ACREUNA	29/11/2019 01:59	29/11/2019 07:44	29/11/2019 01:59	29/11/2019 07:44	5,74	2	11,49	CHI
201911354860	SANTO ANTONIO DA BARRA	BZ12295804LD	ACREUNA	29/11/2019 01:59	29/11/2019 07:44	29/11/2019 01:59	29/11/2019 07:44	5,74	14	80,40	CHI
201911354862	RIO VERDE	RV10394866	RIO VERDE S2	29/11/2019 01:56	29/11/2019 20:18	29/11/2019 01:58	29/11/2019 12:03	10,09	1	10,09	CHI
201911354862	RIO VERDE	RV10394866	RIO VERDE S2	29/11/2019 01:56	29/11/2019 20:18	29/11/2019 01:58	29/11/2019 12:40	10,70	19	203,35	CHI
201911354862	RIO VERDE	RV10394866	RIO VERDE S2	29/11/2019 01:56	29/11/2019 20:18	29/11/2019 12:49	29/11/2019 12:55	0,10	20	1,92	CHI
201911354862	RIO VERDE	RV10406662	RIO VERDE S2	29/11/2019 01:56	29/11/2019 20:18	29/11/2019 01:56	29/11/2019 20:18	18,37	9	165,29	CHI
201911354866	SENADOR CANEDO	10009119009	SENADOR CANEDO	29/11/2019 02:25	29/11/2019 10:26	29/11/2019 02:25	29/11/2019 10:26	8,01	1	8,01	CHI
201911354868	PALMEIRAS DE GOIAS	PL12276902	PALMEIRAS	29/11/2019 00:30	29/11/2019 08:18	29/11/2019 00:30	29/11/2019 08:18	7,80	67	522,56	CHI
201911354871	PETROLINA DE GOIAS	01450224	PETROLINA	29/11/2019 00:38	29/11/2019 05:00	29/11/2019 00:38	29/11/2019 05:00	4,35	1529	6653,70	CHI

201911354871	SAO FRANCISCO DE GOIAS	01450224	PETROLINA	29/11/2019 00:38	29/11/2019 05:00	29/11/2019 00:38	29/11/2019 05:00	4,35	33	143,60	CHI
201911354873	TROMBAS	TB12185306	PORANGATU	29/11/2019 02:59	29/11/2019 10:33	29/11/2019 02:59	29/11/2019 10:33	7,55	10	75,52	CHI
201911354873	FORMOSO	TB12185306	PORANGATU	29/11/2019 02:59	29/11/2019 10:33	29/11/2019 02:59	29/11/2019 10:33	7,55	1	7,55	CHI
201911354881	MORRINHOS	MR21064833	GOIATUBA S1	29/11/2019 03:32	29/11/2019 09:55	29/11/2019 03:32	29/11/2019 09:55	6,38	1	6,38	CHI
201911354883	APARECIDA DE GOIANIA	AP11127735	ANHANGUERA	29/11/2019 03:05	29/11/2019 08:17	29/11/2019 03:05	29/11/2019 08:17	5,20	102	530,60	CHI
201911354887	ITAPIRAPUA	IU12030113	MATRINCHA	29/11/2019 03:43	29/11/2019 12:47	29/11/2019 03:43	29/11/2019 12:47	9,07	11	99,74	CHI
201911354891	JUSSARA	JR12019326	JUSSARA	29/11/2019 04:04	29/11/2019 11:12	29/11/2019 04:04	29/11/2019 11:12	7,12	1	7,12	CHI
201911354895	BALIZA	BH12334522	BOM JARDIM	29/11/2019 04:05	29/11/2019 15:17	29/11/2019 04:05	29/11/2019 15:17	11,19	15	167,89	CHI
201911354905	SAO JOAO D ALIANCA	BF21264780	NIQUELANDIA SUBTRANSMISSAO	29/11/2019 04:40	30/11/2019 17:33	29/11/2019 04:40	30/11/2019 17:33	36,89	1	36,89	CHI
201911354909	JUSSARA	JR12259541	JUSSARA	29/11/2019 04:48	29/11/2019 15:23	29/11/2019 04:48	29/11/2019 15:23	10,57	7	74,01	CHI
201911354911	DIORAMA	DI12354638	IPORA	29/11/2019 04:50	29/11/2019 09:20	29/11/2019 04:50	29/11/2019 09:20	4,50	4	17,98	CHI
201911354914	MOIPIORA	MO12374883	IPORA	29/11/2019 04:54	29/11/2019 12:38	29/11/2019 04:54	29/11/2019 12:38	7,72	1	7,72	CHI
201911354915	ITAPIRAPUA	IU12341192	JUSSARA	29/11/2019 04:55	29/11/2019 12:07	29/11/2019 04:55	29/11/2019 12:07	7,20	9	64,78	CHI
201911354924	IPAMERI	IP12376252	CRISTALINA S2	28/11/2019 20:57	29/11/2019 11:21	28/11/2019 20:57	29/11/2019 11:21	14,39	17	244,58	CHI
201911354927	GOIATUBA	140044413	GOIATUBA S2	29/11/2019 05:10	29/11/2019 09:02	29/11/2019 05:10	29/11/2019 09:02	3,86	1	3,86	CHI
201911354930	AGUA FRIA DE GOIAS	TL121234004	SAO JOAO D ALIANCA	29/11/2019 05:11	29/11/2019 21:51	29/11/2019 05:11	29/11/2019 21:51	16,66	1	16,66	CHI
201911354938	PADRE BERNARDO	PB12382939	PADRE BERNARDO	29/11/2019 05:15	29/11/2019 07:35	29/11/2019 05:15	29/11/2019 07:35	2,33	6	13,95	CHI
201911354939	SAO LUIS DE MONTES BELOS	SL12019284	SAO LUIZ DOS MONTES BELOS	29/11/2019 03:07	29/11/2019 09:02	29/11/2019 03:07	29/11/2019 09:02	5,90	56	330,56	CHI
201911354939	SANCLERLANDIA	SL12019284	SAO LUIZ DOS MONTES BELOS	29/11/2019 03:07	29/11/2019 09:02	29/11/2019 03:07	29/11/2019 09:02	5,90	28	165,28	CHI
201911354940	GOIANDIRA	GD12340044	CATALAO S1	29/11/2019 05:17	29/11/2019 11:06	29/11/2019 05:17	29/11/2019 11:06	5,82	1	5,82	CHI
201911354945	PALMINOPOLIS	PP12008241	PALMEIRAS	29/11/2019 05:22	29/11/2019 15:25	29/11/2019 05:22	29/11/2019 15:25	10,05	22	221,01	CHI
201911354946	CUMARI	CY12287056	CATALAO S1	28/11/2019 20:22	29/11/2019 07:25	28/11/2019 20:22	29/11/2019 07:25	11,04	4	44,17	CHI
201911354951	MARA ROSA	MQ12390474	MARA ROSA	29/11/2019 05:23	29/11/2019 14:50	29/11/2019 05:23	29/11/2019 14:50	9,44	5	47,22	CHI
201911354957	RIO QUENTE	RQ12392077	VILA CORUMBA	29/11/2019 05:26	29/11/2019 11:32	29/11/2019 05:26	29/11/2019 11:32	6,08	7	42,59	CHI
201911354958	DOVERLANDIA	DV12324390	PARQUE DAS EMAS	29/11/2019 05:26	29/11/2019 13:37	29/11/2019 05:26	29/11/2019 13:37	8,17	11	89,84	CHI
201911354961	PIRES DO RIO	PR21100004	PIRES DO RIO S2	29/11/2019 05:29	29/11/2019 20:08	29/11/2019 05:29	29/11/2019 20:08	14,65	1	14,65	CHI
201911354963	URUACU	UR12364104	URUACU	28/11/2019 22:36	30/11/2019 09:47	28/11/2019 22:36	29/11/2019 10:01	11,42	67	765,10	CHI
201911354963	URUACU	UR12221685	URUACU	28/11/2019 22:36	30/11/2019 09:47	28/11/2019 22:36	29/11/2019 12:52	14,26	13	185,38	CHI
201911354963	URUACU	UR12364104	URUACU	28/11/2019 22:36	30/11/2019 09:47	29/11/2019 12:28	29/11/2019 12:52	0,39	67	26,15	CHI
201911354963	URUACU	UR12221685	URUACU	28/11/2019 22:36	30/11/2019 09:47	29/11/2019 13:31	29/11/2019 21:33	8,03	13	104,43	CHI
201911354963	URUACU	UR12364104	URUACU	28/11/2019 22:36	30/11/2019 09:47	29/11/2019 21:34	29/11/2019 21:52	0,31	67	20,83	CHI
201911354963	URUACU	UR12221685	URUACU	28/11/2019 22:36	30/11/2019 09:47	29/11/2019 21:34	30/11/2019 09:40	12,11	13	157,39	CHI
201911354963	URUACU	UR12229602LD	URUACU	28/11/2019 22:36	30/11/2019 09:47	28/11/2019 22:36	30/11/2019 09:47	35,18	7	246,23	CHI

201911354968	TURVANIA	TV12005582	FIRMINOPOLIS S2	29/11/2019 05:33	29/11/2019 08:59	29/11/2019 05:33	29/11/2019 08:59	3,42	49	167,77	CHI
201911354972	MAIRIPOTABA	MI12166303	PONTALINA	29/11/2019 05:34	29/11/2019 09:20	29/11/2019 05:34	29/11/2019 09:20	3,76	1	3,76	CHI
201911354972	PONTALINA	MI12166303	PONTALINA	29/11/2019 05:34	29/11/2019 09:20	29/11/2019 05:34	29/11/2019 09:20	3,76	3	11,29	CHI
201911354973	ORIZONA	OZ12114511	PIRES DO RIO S2	29/11/2019 05:35	29/11/2019 08:49	29/11/2019 05:35	29/11/2019 08:49	3,23	13	41,94	CHI
201911354976	PONTALINA	PK21083359	PONTALINA	29/11/2019 05:38	29/11/2019 10:17	29/11/2019 05:38	29/11/2019 10:17	4,65	1	4,65	CHI
201911354978	CAIAPONIA	CP12254646	JATAI S1	28/11/2019 17:51	29/11/2019 10:43	28/11/2019 17:51	29/11/2019 10:43	16,86	5	84,28	CHI
201911354984	JATAI	04070214	JATAI S1	29/11/2019 05:40	29/11/2019 22:01	29/11/2019 05:40	29/11/2019 12:25	6,75	151	1019,25	CHI
201911354984	JATAI	04070214	JATAI S1	29/11/2019 05:40	29/11/2019 22:01	29/11/2019 05:40	29/11/2019 13:28	7,80	25	195,05	CHI
201911354984	JATAI	JT13214393	JATAI S1	29/11/2019 05:40	29/11/2019 22:01	29/11/2019 10:50	29/11/2019 13:28	2,63	26	68,41	CHI
201911354984	JATAI	04070214	JATAI S1	29/11/2019 05:40	29/11/2019 22:01	29/11/2019 05:40	29/11/2019 15:41	10,02	23	230,56	CHI
201911354984	APARECIDA DO RIO DOCE	04070214	JATAI S1	29/11/2019 05:40	29/11/2019 22:01	29/11/2019 05:40	29/11/2019 15:41	10,02	1	10,02	CHI
201911354984	JATAI	04070214	JATAI S1	29/11/2019 05:40	29/11/2019 22:01	29/11/2019 15:50	29/11/2019 16:51	1,02	203	206,27	CHI
201911354984	APARECIDA DO RIO DOCE	04070214	JATAI S1	29/11/2019 05:40	29/11/2019 22:01	29/11/2019 05:40	29/11/2019 22:01	16,36	68	1112,23	CHI
201911354984	JATAI	04070214	JATAI S1	29/11/2019 05:40	29/11/2019 22:01	29/11/2019 05:40	29/11/2019 22:01	16,36	68	1112,23	CHI
201911354984	APARECIDA DO RIO DOCE	JT13365070	JATAI S1	29/11/2019 05:40	29/11/2019 22:01	29/11/2019 15:50	29/11/2019 22:01	6,19	1	6,19	CHI
201911354984	JATAI	JT13365070	JATAI S1	29/11/2019 05:40	29/11/2019 22:01	29/11/2019 15:50	29/11/2019 22:01	6,19	23	142,33	CHI
201911354985	PONTALINA	PK21161144	VICENTINOPOLIS	29/11/2019 05:40	29/11/2019 17:43	29/11/2019 05:40	29/11/2019 17:43	12,05	1	12,05	CHI
201911354986	EDEIA	EA12068777	EDEIA	29/11/2019 04:57	29/11/2019 10:40	29/11/2019 04:57	29/11/2019 10:40	5,71	198	1130,97	CHI
201911354987	IVOLANDIA	IV21139344	IPORA	29/11/2019 05:40	29/11/2019 17:52	29/11/2019 05:40	29/11/2019 17:52	12,19	1	12,19	CHI
201911354989	GOIANIA	GN11271037	XAVANTES	29/11/2019 05:42	29/11/2019 07:32	29/11/2019 05:42	29/11/2019 07:32	1,83	112	205,15	CHI
201911354994	CRIXAS	UP12171811	SANTA TEREZINHA	29/11/2019 05:44	29/11/2019 10:20	29/11/2019 05:44	29/11/2019 10:20	4,59	6	27,53	CHI
201911354994	UIRAPURU	UP12171811	SANTA TEREZINHA	29/11/2019 05:44	29/11/2019 10:20	29/11/2019 05:44	29/11/2019 10:20	4,59	31	142,23	CHI
201911354998	GOIANIRA	CK12015717	INHUMAS S1	29/11/2019 05:46	29/11/2019 12:12	29/11/2019 05:46	29/11/2019 12:12	6,42	42	269,73	CHI
201911354998	TRINDADE	CK12015717	INHUMAS S1	29/11/2019 05:46	29/11/2019 12:12	29/11/2019 05:46	29/11/2019 12:12	6,42	68	436,71	CHI
201911355000	GOIANESIA	GE12379116	GOIANESIA S2	28/11/2019 22:54	29/11/2019 08:49	28/11/2019 22:54	29/11/2019 08:49	9,90	99	980,18	CHI
201911355004	FLORES DE GOIAS	FB12344172LD	FLORES DE GOIAS	29/11/2019 05:49	29/11/2019 16:09	29/11/2019 05:49	29/11/2019 14:18	8,47	2	16,95	CHI
201911355004	FLORES DE GOIAS	FB12344172LD	FLORES DE GOIAS	29/11/2019 05:49	29/11/2019 16:09	29/11/2019 05:49	29/11/2019 16:09	10,32	2	20,65	CHI
201911355007	PIRES DO RIO	PR21000070	PIRES DO RIO S1	29/11/2019 05:50	30/11/2019 00:40	29/11/2019 05:50	30/11/2019 00:40	18,82	1	18,82	CHI
201911355011	PONTALINA	MI12038832	PONTALINA	29/11/2019 05:51	29/11/2019 11:00	29/11/2019 05:51	29/11/2019 11:00	5,14	10	51,40	CHI
201911355012	GOUVELANDIA	GB12402317LD	QUIRINOPOLIS	29/11/2019 05:51	29/11/2019 11:54	29/11/2019 05:51	29/11/2019 11:54	6,04	18	108,68	CHI
201911355012	QUIRINOPOLIS	GB12402317LD	QUIRINOPOLIS	29/11/2019 05:51	29/11/2019 11:54	29/11/2019 05:51	29/11/2019 11:54	6,04	5	30,19	CHI
201911355015	CATALAO	CT12042349	CATALAO S1	29/11/2019 05:52	29/11/2019 11:56	29/11/2019 05:52	29/11/2019 11:56	6,06	22	133,28	CHI
201911355016	INDIARA	IY12391438	EDEIA	29/11/2019 05:52	29/11/2019 08:01	29/11/2019 05:52	29/11/2019 08:01	2,15	15	32,19	CHI

201911355016	PALMEIRAS DE GOIAS	IY12391438	EDEIA	29/11/2019 05:52	29/11/2019 08:01	29/11/2019 05:52	29/11/2019 08:01	2,15	1	2,15	CHI
201911355017	VALPARAISO DE GOIAS	VA12199513	PACAEMBU S1	29/11/2019 02:50	29/11/2019 07:48	29/11/2019 02:50	29/11/2019 07:48	4,95	297	1470,81	CHI
201911355018	MUTUNOPOLIS	MU12269538	MARA ROSA	28/11/2019 20:15	29/11/2019 10:00	28/11/2019 20:15	29/11/2019 10:00	13,74	49	673,34	CHI
201911355018	AMARALINA	MU12269538	MARA ROSA	28/11/2019 20:15	29/11/2019 10:00	28/11/2019 20:15	29/11/2019 10:00	13,74	40	549,67	CHI
201911355021	MORRINHOS	MR12000355	MORRINHOS	29/11/2019 05:53	29/11/2019 08:35	29/11/2019 05:53	29/11/2019 08:35	2,70	6	16,19	CHI
201911355026	MONTES CLAROS DE GOIAS	ME12155653	IPORA	29/11/2019 05:30	29/11/2019 17:27	29/11/2019 05:30	29/11/2019 17:27	11,94	37	441,86	CHI
201911355029	CUMARI	CY12000515	CATALAO S1	29/11/2019 05:55	29/11/2019 11:41	29/11/2019 05:55	29/11/2019 11:41	5,76	13	74,92	CHI
201911355039	DIORAMA	DI12063472	IPORA	29/11/2019 05:58	29/11/2019 11:10	29/11/2019 05:58	29/11/2019 11:10	5,20	1	5,20	CHI
201911355043	PORANGATU	PO12012430	PORANGATU	28/11/2019 19:02	29/11/2019 12:35	28/11/2019 19:02	29/11/2019 12:35	17,56	3	52,68	CHI
201911355046	IPAMERI	IP12404721	IPAMERI	29/11/2019 06:00	29/11/2019 11:51	29/11/2019 06:00	29/11/2019 11:51	5,85	4	23,40	CHI
201911355061	PORANGATU	PO12391666	PORANGATU	29/11/2019 06:02	29/11/2019 18:55	29/11/2019 06:02	29/11/2019 18:55	12,87	15	193,11	CHI
201911355063	PORANGATU	PO12390358	PORANGATU	29/11/2019 05:48	29/11/2019 10:00	29/11/2019 05:48	29/11/2019 10:00	4,20	7	29,39	CHI
201911355064	RIO VERDE	RV12260117	CABRIUVA S1	29/11/2019 06:03	29/11/2019 07:48	29/11/2019 06:03	29/11/2019 07:48	1,75	16	27,99	CHI
201911355066	RIO VERDE	10013128963	RIO VERDE S1	29/11/2019 06:04	29/11/2019 07:33	29/11/2019 06:04	29/11/2019 07:33	1,48	1	1,48	CHI
201911355070	GOUVELANDIA	QI21155909	QUIRINOPOLIS	29/11/2019 06:04	29/11/2019 19:13	29/11/2019 06:04	29/11/2019 19:13	13,14	2	26,28	CHI
201911355075	BARRO ALTO	BA21161175	GOIANESIA S1	29/11/2019 06:05	30/11/2019 12:52	29/11/2019 06:05	30/11/2019 12:52	30,77	1	30,77	CHI
201911355078	PLANALTINA	PI12066045	PLANALTINA	29/11/2019 06:05	29/11/2019 09:20	29/11/2019 06:05	29/11/2019 09:20	3,24	9	29,12	CHI
201911355081	CARMO DO RIO VERDE	IK12311305	ITAPURANGA	29/11/2019 04:17	29/11/2019 07:56	29/11/2019 04:17	29/11/2019 07:56	3,64	27	98,36	CHI
201911355081	ITAPURANGA	IK12311305	ITAPURANGA	29/11/2019 04:17	29/11/2019 07:56	29/11/2019 04:17	29/11/2019 07:56	3,64	118	429,85	CHI
201911355082	CALDAS NOVAS	CN12409034	CALDAS NOVAS S1	29/11/2019 05:45	29/11/2019 11:31	29/11/2019 05:45	29/11/2019 11:31	5,75	1	5,75	CHI
201911355082	SANTA CRUZ DE GOIAS	CN12409034	CALDAS NOVAS S1	29/11/2019 05:45	29/11/2019 11:31	29/11/2019 05:45	29/11/2019 11:31	5,75	16	92,08	CHI
201911355085	PROFESSOR JAMIL SAFADY	PJ12078744	ROCHEDO	29/11/2019 06:07	29/11/2019 11:45	29/11/2019 06:07	29/11/2019 11:45	5,63	4	22,51	CHI
201911355088	EDEIA	EA21044521	EDEIA	29/11/2019 06:08	29/11/2019 17:45	29/11/2019 06:08	29/11/2019 17:44	11,60	1	11,60	CHI
201911355088	EDEIA	EA10394609	EDEIA	29/11/2019 06:08	29/11/2019 17:45	29/11/2019 15:29	29/11/2019 17:45	2,27	8	18,14	CHI
201911355090	PORANGATU	PO12403391	PORANGATU	29/11/2019 04:01	29/11/2019 09:17	29/11/2019 04:01	29/11/2019 09:17	5,26	31	163,09	CHI
201911355094	GOIANIA	GN11162013	FERROVIARIO S3	29/11/2019 06:10	29/11/2019 07:45	29/11/2019 06:10	29/11/2019 07:35	1,41	70	98,93	CHI
201911355094	GOIANIA	GN12001875	FERROVIARIO S3	29/11/2019 06:10	29/11/2019 07:45	29/11/2019 06:10	29/11/2019 07:45	1,59	254	402,73	CHI
201911355099	QUIRINOPOLIS	QI12065837	CACHOEIRA ALTA	29/11/2019 06:11	29/11/2019 10:45	29/11/2019 06:11	29/11/2019 10:45	4,56	11	50,19	CHI
201911355105	ORIZONA	OZ21189414	PIRES DO RIO S2	29/11/2019 06:13	29/11/2019 14:30	29/11/2019 06:13	29/11/2019 14:30	8,27	1	8,27	CHI
201911355109	SANTA RITA DO NOVO DESTINO	BA12163300	BARRO ALTO	29/11/2019 05:59	29/11/2019 16:58	29/11/2019 05:59	29/11/2019 16:58	10,98	20	219,60	CHI
201911355114	IPAMERI	IP21242326	PIRES DO RIO S2	29/11/2019 06:15	29/11/2019 20:39	29/11/2019 06:15	29/11/2019 20:39	14,41	1	14,41	CHI
201911355120	IPORA	IR12172534	IPORA	29/11/2019 06:17	30/11/2019 09:48	29/11/2019 06:17	30/11/2019 09:48	27,53	9	247,73	CHI
201911355120	IVOLANDIA	IR12172534	IPORA	29/11/2019 06:17	30/11/2019 09:48	29/11/2019 06:17	30/11/2019 09:48	27,53	1	27,53	CHI



201911355122	CRIXAS	CX12221599	SANTA TEREZINHA	29/11/2019 05:33	29/11/2019 17:22	29/11/2019 05:33	29/11/2019 17:22	11,81	19	224,46	CHI
201911355122	SANTA TEREZINHA DE GOIAS	CX12221599	SANTA TEREZINHA	29/11/2019 05:33	29/11/2019 17:22	29/11/2019 05:33	29/11/2019 17:22	11,81	1	11,81	CHI
201911355131	FORMOSA	FA21106955	ITIQUEIRA	29/11/2019 06:18	29/11/2019 12:28	29/11/2019 06:18	29/11/2019 12:28	6,16	1	6,16	CHI
201911355136	AGUAS LINDAS DE GOIAS	10027671028	AGUAS LINDAS DE GOIAS S2	29/11/2019 06:19	29/11/2019 07:43	29/11/2019 06:19	29/11/2019 07:43	1,39	1	1,39	CHI
201911355140	ANICUNS	AC12307109	FIRMINOPOLIS S2	29/11/2019 05:24	29/11/2019 07:52	29/11/2019 05:24	29/11/2019 07:52	2,45	11	26,99	CHI
201911355142	GOIANIA	10009674223	CARAJAS S1	29/11/2019 06:20	29/11/2019 08:15	29/11/2019 06:20	29/11/2019 08:15	1,91	1	1,91	CHI
201911355146	ITUMBIARA	690367636	PARANAIBA	29/11/2019 06:21	29/11/2019 07:53	29/11/2019 06:21	29/11/2019 07:53	1,53	1	1,53	CHI
201911355153	PEROLANDIA	DP12209129	JATAI S1	29/11/2019 06:22	29/11/2019 14:01	29/11/2019 06:22	29/11/2019 14:01	7,64	7	53,48	CHI
201911355155	DIORAMA	DI12066071	ARENOPOLIS	29/11/2019 03:39	29/11/2019 10:30	29/11/2019 03:39	29/11/2019 10:30	6,85	28	191,71	CHI
201911355156	CAMPOS BELOS	CH12000001	SAO DOMINGOS	29/11/2019 05:04	29/11/2019 08:28	29/11/2019 05:04	29/11/2019 08:28	3,38	42	142,14	CHI
201911355163	CAMPOS VERDES	VD12181203	SANTA TEREZINHA	29/11/2019 06:26	30/11/2019 04:12	29/11/2019 06:26	30/11/2019 04:12	21,76	12	261,11	CHI
201911355164	CABECEIRAS	CW10395425	ITIQUEIRA	29/11/2019 06:18	29/11/2019 12:20	29/11/2019 06:18	29/11/2019 06:24	0,11	46	4,92	CHI
201911355164	FORMOSA	CW10395425	ITIQUEIRA	29/11/2019 06:18	29/11/2019 12:20	29/11/2019 06:18	29/11/2019 06:24	0,11	4	0,43	CHI
201911355164	CABECEIRAS	CW10395425	ITIQUEIRA	29/11/2019 06:18	29/11/2019 12:20	29/11/2019 06:25	29/11/2019 12:15	5,85	46	268,90	CHI
201911355164	FORMOSA	CW10395425	ITIQUEIRA	29/11/2019 06:18	29/11/2019 12:20	29/11/2019 06:25	29/11/2019 12:15	5,85	4	23,38	CHI
201911355164	FORMOSA	CW10395425	ITIQUEIRA	29/11/2019 06:18	29/11/2019 12:20	29/11/2019 06:18	29/11/2019 12:20	6,04	16	96,66	CHI
201911355164	CABECEIRAS	CW10395425	ITIQUEIRA	29/11/2019 06:18	29/11/2019 12:20	29/11/2019 06:18	29/11/2019 12:20	6,04	70	422,90	CHI
201911355169	CATALAO	CT21192621	CATALAO S1	29/11/2019 06:27	29/11/2019 15:44	29/11/2019 06:27	29/11/2019 15:44	9,28	1	9,28	CHI
201911355170	SENADOR CANEDO	SW11235049	SENADOR CANEDO	29/11/2019 06:27	29/11/2019 08:12	29/11/2019 06:27	29/11/2019 08:12	1,75	24	42,00	CHI
201911355171	NIQUELANDIA	NQ12262921	BARRO ALTO	29/11/2019 06:18	29/11/2019 12:37	29/11/2019 06:18	29/11/2019 12:37	6,31	5	31,53	CHI
201911355174	MONTE ALEGRE DE GOIAS	MA12252206	SAO DOMINGOS	29/11/2019 06:28	29/11/2019 17:51	29/11/2019 06:28	29/11/2019 17:51	11,37	5	56,87	CHI
201911355175	CATALAO	CT21166721	CATALAO S1	29/11/2019 06:28	29/11/2019 09:52	29/11/2019 06:28	29/11/2019 09:52	3,39	2	6,78	CHI
201911355178	MONTES CLAROS DE GOIAS	AY12349671	IPORA	29/11/2019 06:14	29/11/2019 17:16	29/11/2019 06:14	29/11/2019 17:16	11,02	1	11,02	CHI
201911355178	ARENOPOLIS	AY12349671	IPORA	29/11/2019 06:14	29/11/2019 17:16	29/11/2019 06:14	29/11/2019 17:16	11,02	2	22,05	CHI
201911355181	NOVA CRIXAS	NA21359770	NOVA CRIXAS	29/11/2019 06:29	29/11/2019 12:55	29/11/2019 06:29	29/11/2019 12:20	5,85	1	5,85	CHI
201911355181	NOVA CRIXAS	NA21386616	NOVA CRIXAS	29/11/2019 06:29	29/11/2019 12:55	29/11/2019 06:29	29/11/2019 12:55	6,43	1	6,43	CHI
201911355188	CALDAS NOVAS	CN11207278	SERRA DE CALDAS	29/11/2019 06:32	29/11/2019 08:40	29/11/2019 06:32	29/11/2019 08:40	2,13	1	2,13	CHI
201911355191	BONOPOLIS	BX12168214	SAO MIGUEL DO ARAGUAIA	29/11/2019 04:52	29/11/2019 15:01	29/11/2019 04:52	29/11/2019 15:01	10,15	122	1237,96	CHI
201911355197	SANTA RITA DO ARAGUAIA	MY12034227	PARQUE DAS EMAS	29/11/2019 06:35	29/11/2019 11:43	29/11/2019 06:35	29/11/2019 11:43	5,13	2	10,26	CHI
201911355197	MINEIROS	MY12034227	PARQUE DAS EMAS	29/11/2019 06:35	29/11/2019 11:43	29/11/2019 06:35	29/11/2019 11:43	5,13	30	153,94	CHI
201911355200	JUSSARA	BT12396220	BRITANIA	29/11/2019 06:36	29/11/2019 11:21	29/11/2019 06:36	29/11/2019 11:21	4,75	8	37,97	CHI
201911355200	BRITANIA	BT12396220	BRITANIA	29/11/2019 06:36	29/11/2019 11:21	29/11/2019 06:36	29/11/2019 11:21	4,75	1	4,75	CHI
201911355208	ITABERAÍ	IB21095591	ITABERAÍ S2	29/11/2019 06:37	29/11/2019 09:12	29/11/2019 06:37	29/11/2019 09:12	2,58	1	2,58	CHI

201911355212	JATAI	JT12260426	JATAI S1	29/11/2019 06:19	29/11/2019 10:59	29/11/2019 06:19	29/11/2019 10:59	4,66	117	545,19	CHI
201911355213	PORANGATU	MU12192418	MARA ROSA	29/11/2019 06:38	29/11/2019 14:55	29/11/2019 06:38	29/11/2019 14:55	8,28	1	8,28	CHI
201911355213	AMARALINA	MU12192418	MARA ROSA	29/11/2019 06:38	29/11/2019 14:55	29/11/2019 06:38	29/11/2019 14:55	8,28	2	16,56	CHI
201911355217	VILA PROPICIO	NP12188681	GOIANESIA S1	29/11/2019 06:38	29/11/2019 15:37	29/11/2019 06:38	29/11/2019 15:37	8,97	87	780,29	CHI
201911355221	ALEXANIA	AX12351026	ALEXANIA	28/11/2019 22:14	29/11/2019 10:52	28/11/2019 22:14	29/11/2019 10:52	12,62	77	971,63	CHI
201911355225	URUTAI	UT21382048	PIRES DO RIO S2	29/11/2019 06:40	29/11/2019 21:11	29/11/2019 06:40	29/11/2019 21:11	14,51	1	14,51	CHI
201911355236	CRISTALINA	KR12025841	PAMPLONA	29/11/2019 06:42	29/11/2019 12:18	29/11/2019 06:42	29/11/2019 12:18	5,60	3	16,80	CHI
201911355237	JATAI	SX12139578	JATAI S1	28/11/2019 19:14	29/11/2019 10:50	28/11/2019 19:14	29/11/2019 10:50	15,59	14	218,32	CHI
201911355237	SERRANOPOLIS	SX12139578	JATAI S1	28/11/2019 19:14	29/11/2019 10:50	28/11/2019 19:14	29/11/2019 10:50	15,59	30	467,83	CHI
201911355239	CAMPINACU	UC12265668	PORANGATU	29/11/2019 06:42	30/11/2019 00:14	29/11/2019 06:42	30/11/2019 00:14	17,52	4	70,09	CHI
201911355240	GOIANIA	GN12001007	GOYA S2	29/11/2019 06:42	29/11/2019 12:23	29/11/2019 06:42	29/11/2019 10:34	3,87	121	468,10	CHI
201911355240	GOIANIA	GN12040322LD	GOYA S2	29/11/2019 06:42	29/11/2019 12:23	29/11/2019 06:42	29/11/2019 12:23	5,67	77	436,74	CHI
201911355246	GOIAS	GS12172048	GOIAS	29/11/2019 06:18	29/11/2019 12:24	29/11/2019 06:18	29/11/2019 12:24	6,09	14	85,24	CHI
201911355250	SAO DOMINGOS	SD12218814	SAO DOMINGOS	29/11/2019 06:45	29/11/2019 12:02	29/11/2019 06:45	29/11/2019 12:02	5,27	7	36,90	CHI
201911355252	ARUANA	AK21201046	MOZARLANDIA	29/11/2019 06:46	29/11/2019 19:20	29/11/2019 06:46	29/11/2019 19:20	12,57	1	12,57	CHI
201911355254	ITAPIRAPUA	GS12092203	MATRINCHA	29/11/2019 06:46	29/11/2019 11:18	29/11/2019 06:46	29/11/2019 11:18	4,52	8	36,18	CHI
201911355254	GOIAS	GS12092203	MATRINCHA	29/11/2019 06:46	29/11/2019 11:18	29/11/2019 06:46	29/11/2019 11:18	4,52	4	18,09	CHI
201911355255	SANTA CRUZ DE GOIAS	CN21204469	CALDAS NOVAS S1	29/11/2019 06:46	29/11/2019 13:49	29/11/2019 06:46	29/11/2019 13:49	7,04	1	7,04	CHI
201911355256	GUARAITA	IK12364707	ITAPURANGA	29/11/2019 06:43	29/11/2019 09:20	29/11/2019 06:43	29/11/2019 09:20	2,60	6	15,61	CHI
201911355256	ITAPURANGA	IK12364707	ITAPURANGA	29/11/2019 06:43	29/11/2019 09:20	29/11/2019 06:43	29/11/2019 09:20	2,60	11	28,62	CHI
201911355257	CAMPINORTE	CR12101054	CAMPINORTE	29/11/2019 06:16	29/11/2019 12:19	29/11/2019 06:16	29/11/2019 12:19	6,04	6	36,23	CHI
201911355260	MOSSAMEDES	MD21249343	ITABERAI S2	29/11/2019 06:47	29/11/2019 11:17	29/11/2019 06:47	29/11/2019 11:17	4,49	1	4,49	CHI
201911355266	MINEIROS	MY11347885	PARQUE DAS EMAS	29/11/2019 06:49	30/11/2019 11:29	29/11/2019 06:49	30/11/2019 11:29	28,66	1	28,66	CHI
201911355269	NIQUELANDIA	10029989521	NIQUELANDIA SUBTRANSMISSAO	29/11/2019 06:50	29/11/2019 17:12	29/11/2019 06:50	29/11/2019 17:12	10,36	1	10,36	CHI
201911355274	FORMOSA	FA12383260	ITIQUEIRA	29/11/2019 06:51	01/12/2019 23:40	29/11/2019 06:51	01/12/2019 10:15	51,40	5	256,99	CHI
201911355274	FORMOSA	FA12383260	ITIQUEIRA	29/11/2019 06:51	01/12/2019 23:40	01/12/2019 10:15	01/12/2019 12:42	2,45	4	9,79	CHI
201911355274	FORMOSA	FA12325436	ITIQUEIRA	29/11/2019 06:51	01/12/2019 23:40	01/12/2019 10:15	01/12/2019 17:37	7,37	1	7,37	CHI
201911355274	FORMOSA	FA12383260	ITIQUEIRA	29/11/2019 06:51	01/12/2019 23:40	29/11/2019 06:51	01/12/2019 22:08	63,28	13	822,63	CHI
201911355274	FORMOSA	FA12383260	ITIQUEIRA	29/11/2019 06:51	01/12/2019 23:40	29/11/2019 06:51	01/12/2019 22:56	64,08	3	192,24	CHI
201911355274	FORMOSA	FA12383260	ITIQUEIRA	29/11/2019 06:51	01/12/2019 23:40	29/11/2019 06:51	01/12/2019 23:40	64,83	1	64,83	CHI
201911355274	FORMOSA	FA12383260	ITIQUEIRA	29/11/2019 06:51	01/12/2019 23:40	29/11/2019 06:51	01/12/2019 23:40	64,83	1	64,83	CHI
201911355276	CACU	CC12322236	CACHOEIRA ALTA	29/11/2019 06:51	30/11/2019 13:17	29/11/2019 06:51	30/11/2019 13:17	30,42	1	30,42	CHI
201911355277	ITUMBIARA	IT11166329	PARANAIBA	29/11/2019 06:51	29/11/2019 11:37	29/11/2019 06:51	29/11/2019 11:37	4,76	3	14,27	CHI

201911355279	CASTELANDIA	DM21240424	RIO DOS BOIS	29/11/2019 06:48	29/11/2019 10:43	29/11/2019 06:48	29/11/2019 10:43	3,92	1	3,92	CHI
201911355280	VILA BOA	FA12278155	ITIQUEIRA	29/11/2019 06:14	29/11/2019 10:39	29/11/2019 06:14	29/11/2019 10:39	4,40	4	17,62	CHI
201911355280	FORMOSA	FA12278155	ITIQUEIRA	29/11/2019 06:14	29/11/2019 10:39	29/11/2019 06:14	29/11/2019 10:39	4,40	32	140,93	CHI
201911355282	MUTUNOPOLIS	MU12354546	MARA ROSA	29/11/2019 06:53	29/11/2019 17:05	29/11/2019 06:53	29/11/2019 17:05	10,21	6	61,26	CHI
201911355285	BONOPOLIS	BX12246493	SAO MIGUEL DO ARAGUAIA	29/11/2019 06:53	29/11/2019 16:30	29/11/2019 06:53	29/11/2019 16:30	9,61	4	38,45	CHI
201911355289	NIQUELANDIA	NQ12171080	BARRO ALTO	29/11/2019 05:39	29/11/2019 11:08	29/11/2019 05:39	29/11/2019 11:08	5,47	11	60,18	CHI
201911355296	MONTIVIDIU	MV12214244	MONTIVIDIU T	29/11/2019 06:55	29/11/2019 12:12	29/11/2019 06:55	29/11/2019 12:12	5,27	15	79,12	CHI
201911355296	RIO VERDE	MV12214244	MONTIVIDIU T	29/11/2019 06:55	29/11/2019 12:12	29/11/2019 06:55	29/11/2019 12:12	5,27	2	10,55	CHI
201911355297	CACHOEIRA ALTA	CA12015352	CACHOEIRA ALTA	29/11/2019 05:04	29/11/2019 10:35	29/11/2019 05:04	29/11/2019 10:35	5,52	40	220,87	CHI
201911355298	GOIANIA	GN11130314	REAL S2	29/11/2019 06:57	29/11/2019 11:40	29/11/2019 06:57	29/11/2019 11:40	4,72	51	240,56	CHI
201911355304	PONTALINA	ED21292972	PONTALINA	29/11/2019 06:59	29/11/2019 09:38	29/11/2019 06:59	29/11/2019 09:38	2,65	1	2,65	CHI
201911355308	SANTA RITA DO NOVO DESTINO	BA12156230	BARRO ALTO	29/11/2019 01:43	29/11/2019 17:40	29/11/2019 01:43	29/11/2019 17:40	15,94	8	127,52	CHI
201911355308	BARRO ALTO	BA12156230	BARRO ALTO	29/11/2019 01:43	29/11/2019 17:40	29/11/2019 01:43	29/11/2019 17:40	15,94	2	31,88	CHI
201911355314	NAZARIO	NZ12003986	ANICUNS	29/11/2019 07:01	29/11/2019 10:00	29/11/2019 07:01	29/11/2019 10:00	2,98	5	14,92	CHI
201911355317	CORUMBAIBA	CI12107485	VILA CORUMBA	29/11/2019 07:02	29/11/2019 11:20	29/11/2019 07:02	29/11/2019 11:20	4,30	19	81,64	CHI
201911355318	CACHOEIRA ALTA	CA12078938	CACHOEIRA ALTA	29/11/2019 07:02	29/11/2019 11:53	29/11/2019 07:02	29/11/2019 11:53	4,84	4	19,36	CHI
201911355321	MONTES CLAROS DE GOIAS	ME12207822	IPORA	29/11/2019 03:36	29/11/2019 11:10	29/11/2019 03:36	29/11/2019 11:10	7,55	16	120,81	CHI
201911355324	JARAGUA	JA12382495RE	JARAGUA	29/11/2019 02:35	29/11/2019 15:13	29/11/2019 02:35	29/11/2019 15:13	12,62	119	1501,68	CHI
201911355324	PIRENOPOLIS	JA12382495RE	JARAGUA	29/11/2019 02:35	29/11/2019 15:13	29/11/2019 02:35	29/11/2019 15:13	12,62	86	1085,25	CHI
201911355325	IPORA	IR12065120	IPORA	29/11/2019 06:44	29/11/2019 09:36	29/11/2019 06:44	29/11/2019 09:36	2,85	7	19,96	CHI
201911355330	SAO JOAO D ALIANCA	JL12218486	SAO JOAO D ALIANCA	29/11/2019 07:05	29/11/2019 16:32	29/11/2019 07:05	29/11/2019 16:32	9,44	1	9,44	CHI
201911355335	EDEIA	EA12043985	EDEIA	29/11/2019 06:36	29/11/2019 11:10	29/11/2019 06:36	29/11/2019 11:10	4,55	5	22,77	CHI
201911355337	ITABERAI	AC12306940	ANICUNS	29/11/2019 06:26	29/11/2019 08:15	29/11/2019 06:26	29/11/2019 08:15	1,80	2	3,60	CHI
201911355337	ANICUNS	AC12306940	ANICUNS	29/11/2019 06:26	29/11/2019 08:15	29/11/2019 06:26	29/11/2019 08:15	1,80	35	63,06	CHI
201911355340	ANAPOLIS	AN11000119	JUNDIAI S2	29/11/2019 09:27	29/11/2019 10:47	29/11/2019 09:27	29/11/2019 10:47	1,32	137	180,84	CHI
201911355341	MARA ROSA	VD12201669	SANTA TEREZINHA	29/11/2019 07:06	29/11/2019 17:20	29/11/2019 07:06	29/11/2019 17:20	10,22	2	20,44	CHI
201911355346	BOM JARDIM DE GOIAS	BM21188444	BOM JARDIM	29/11/2019 07:07	29/11/2019 09:37	29/11/2019 07:07	29/11/2019 09:37	2,49	1	2,49	CHI
201911355350	PADRE BERNARDO	PB12347929	PADRE BERNARDO	29/11/2019 07:08	29/11/2019 09:33	29/11/2019 07:08	29/11/2019 09:33	2,42	6	14,50	CHI
201911355351	GOIANIA	GN12051055	CAMPINAS S2	29/11/2019 07:08	29/11/2019 08:35	29/11/2019 07:08	29/11/2019 08:35	1,44	92	132,94	CHI
201911355357	SANTA HELENA DE GOIAS	SH12214104	ACREUNA	29/11/2019 09:20	29/11/2019 12:19	29/11/2019 09:20	29/11/2019 12:19	2,97	4	11,88	CHI
201911355362	PALMEIRAS DE GOIAS	PL12051263	FIRMINOPOLIS S2	29/11/2019 07:10	29/11/2019 09:29	29/11/2019 07:10	29/11/2019 09:29	2,31	3	6,94	CHI
201911355368	RIO VERDE	RV12106375	CABRIUVA S2	29/11/2019 07:10	29/11/2019 11:54	29/11/2019 07:10	29/11/2019 11:54	4,72	17	80,27	CHI
201911355374	NIQUELANDIA	10004950630	BARRO ALTO	29/11/2019 07:11	29/11/2019 15:51	29/11/2019 07:11	29/11/2019 15:51	8,66	1	8,66	CHI

201911355375	INDIARA	JD12304491	PALMEIRAS	29/11/2019 07:11	29/11/2019 11:01	29/11/2019 07:11	29/11/2019 11:01	3,83	77	294,80	CHI
201911355375	JANDAIA	JD12304491	PALMEIRAS	29/11/2019 07:11	29/11/2019 11:01	29/11/2019 07:11	29/11/2019 11:01	3,83	2	7,66	CHI
201911355377	CACU	CC12338616	CACHOEIRA ALTA	29/11/2019 06:09	29/11/2019 15:30	29/11/2019 06:09	29/11/2019 15:30	9,36	32	299,54	CHI
201911355383	SAO FRANCISCO DE GOIAS	SF12389750	SAO FRANCISCO DE GOIAS	29/11/2019 06:42	29/11/2019 19:15	29/11/2019 06:42	29/11/2019 19:15	12,54	14	175,61	CHI
201911355385	MINEIROS	MY12209668	PARQUE DAS EMAS	28/11/2019 22:46	29/11/2019 08:40	28/11/2019 22:46	29/11/2019 08:40	9,91	88	871,79	CHI
201911355387	CORUMBAIBA	CI21000537	VILA CORUMBA	29/11/2019 07:13	29/11/2019 14:33	29/11/2019 07:13	29/11/2019 14:33	7,32	1	7,32	CHI
201911355388	MAURILANDIA	ML21046723	RIO DOS BOIS	29/11/2019 07:13	29/11/2019 14:13	29/11/2019 07:13	29/11/2019 14:13	6,99	1	6,99	CHI
201911355389	CASTELANDIA	RV12026920	RIO DOS BOIS	29/11/2019 07:13	29/11/2019 09:42	29/11/2019 07:13	29/11/2019 09:42	2,48	4	9,93	CHI
201911355395	ALTO PARAISO DE GOIAS	3870000361	SAO JOAO D ALIANCA	29/11/2019 07:15	30/11/2019 11:04	29/11/2019 07:15	30/11/2019 11:04	27,82	1	27,82	CHI
201911355399	BURITINOPOLIS	BQ12149627	IACIARA S2	29/11/2019 06:46	29/11/2019 09:00	29/11/2019 06:46	29/11/2019 09:00	2,23	118	262,94	CHI
201911355409	SANTA CRUZ DE GOIAS	BC21215994	CALDAS NOVAS S1	29/11/2019 07:18	29/11/2019 12:56	29/11/2019 07:18	29/11/2019 12:56	5,63	1	5,63	CHI
201911355412	BOM JARDIM DE GOIAS	BM12335382	BOM JARDIM	29/11/2019 07:18	29/11/2019 10:45	29/11/2019 07:18	29/11/2019 10:45	3,44	5	17,22	CHI
201911355413	SAO JOAO DA PARAUNA	RP12391404	FIRMINOPOLIS S2	29/11/2019 07:15	29/11/2019 18:03	29/11/2019 07:15	29/11/2019 18:03	10,80	5	53,98	CHI
201911355414	GOIAS	GS12217745	MATRINCHA	29/11/2019 07:05	29/11/2019 17:30	29/11/2019 07:05	29/11/2019 17:30	10,43	3	31,28	CHI
201911355419	FORMOSA	FA21265685	ITUIQUIRA	29/11/2019 07:19	29/11/2019 15:38	29/11/2019 07:19	29/11/2019 15:38	8,31	1	8,31	CHI
201911355424	ABADIANIA	CB12089823	ALEXANIA	29/11/2019 07:20	29/11/2019 09:28	29/11/2019 07:20	29/11/2019 09:28	2,13	4	8,51	CHI
201911355424	CORUMBA DE GOIAS	CB12089823	ALEXANIA	29/11/2019 07:20	29/11/2019 09:28	29/11/2019 07:20	29/11/2019 09:28	2,13	11	23,41	CHI
201911355432	MARA ROSA	AJ12143571	MARA ROSA	29/11/2019 04:52	29/11/2019 09:55	29/11/2019 04:52	29/11/2019 09:55	5,04	6	30,25	CHI
201911355432	NOVA IGUACU DE GOIAS	AJ12143571	MARA ROSA	29/11/2019 04:52	29/11/2019 09:55	29/11/2019 04:52	29/11/2019 09:55	5,04	12	60,49	CHI
201911355432	ALTO HORIZONTE	AJ12143571	MARA ROSA	29/11/2019 04:52	29/11/2019 09:55	29/11/2019 04:52	29/11/2019 09:55	5,04	37	186,52	CHI
201911355434	RIO VERDE	RV12301218	SANTA HELENA S1	29/11/2019 01:37	29/11/2019 10:58	29/11/2019 01:37	29/11/2019 10:58	9,36	18	168,50	CHI
201911355434	QUIRINOPOLIS	RV12301218	SANTA HELENA S1	29/11/2019 01:37	29/11/2019 10:58	29/11/2019 01:37	29/11/2019 10:58	9,36	37	346,35	CHI
201911355441	MINEIROS	MY12043894	PARQUE DAS EMAS	29/11/2019 06:07	29/11/2019 18:29	29/11/2019 06:07	29/11/2019 18:29	12,35	100	1235,44	CHI
201911355443	MARA ROSA	MQ12140366	SANTA TEREZINHA	29/11/2019 07:22	29/11/2019 17:01	29/11/2019 07:22	29/11/2019 17:01	9,64	40	385,59	CHI
201911355444	ITUMBIARA	IT12257075	ITUMBIARA NOVA	29/11/2019 07:24	29/11/2019 09:05	29/11/2019 07:24	29/11/2019 09:05	1,68	22	36,98	CHI
201911355446	PONTALINA	PK12080060	PONTALINA	29/11/2019 06:01	29/11/2019 08:39	29/11/2019 06:01	29/11/2019 08:39	2,63	28	73,59	CHI
201911355447	PARAUNA	PU12233300	PARAUNA	29/11/2019 07:25	29/11/2019 20:40	29/11/2019 07:25	29/11/2019 20:40	13,26	4	53,04	CHI
201911355449	ITAPURANGA	IK12364740	ITAPURANGA	29/11/2019 07:21	29/11/2019 11:11	29/11/2019 07:21	29/11/2019 11:11	3,82	12	45,88	CHI
201911355449	MORRO AGUDO DE GOIAS	IK12364740	ITAPURANGA	29/11/2019 07:21	29/11/2019 11:11	29/11/2019 07:21	29/11/2019 11:11	3,82	14	53,53	CHI
201911355454	GUAPO	VJ12061544	GUAPO S2	29/11/2019 07:26	29/11/2019 13:50	29/11/2019 07:26	29/11/2019 13:50	6,39	1	6,39	CHI
201911355454	VARJAO	VJ12061544	GUAPO S2	29/11/2019 07:26	29/11/2019 13:50	29/11/2019 07:26	29/11/2019 13:50	6,39	19	121,34	CHI
201911355455	JATAI	CP12191771	MONTIVIDIU T	28/11/2019 19:25	29/11/2019 14:15	28/11/2019 19:25	29/11/2019 14:15	18,83	6	113,00	CHI
201911355455	RIO VERDE	CP12191771	MONTIVIDIU T	28/11/2019 19:25	29/11/2019 14:15	28/11/2019 19:25	29/11/2019 14:15	18,83	9	169,51	CHI

201911355455	CAIAPONIA	CP12191771	MONTIVIDIU T	28/11/2019 19:25	29/11/2019 14:15	28/11/2019 19:25	29/11/2019 14:15	18,83	10	188,34	CHI
201911355456	MORRINHOS	MR12349822	MORRINHOS	29/11/2019 07:29	29/11/2019 10:29	29/11/2019 07:29	29/11/2019 10:29	3,01	15	45,18	CHI
201911355458	APARECIDA DE GOIANIA	AP21197893	CEPAIGO S1	29/11/2019 07:29	29/11/2019 09:02	29/11/2019 07:29	29/11/2019 09:02	1,55	2	3,09	CHI
201911355460	ITUMBIARA	IT11143848	ITUMBIARA VELHA S1	29/11/2019 07:30	29/11/2019 09:39	29/11/2019 07:30	29/11/2019 09:39	2,14	121	259,38	CHI
201911355461	MINACU	IH12242031	MINACU	29/11/2019 07:30	29/11/2019 15:32	29/11/2019 07:30	29/11/2019 15:32	8,03	4	32,13	CHI
201911355462	CACHOEIRA ALTA	CA21196108	CACHOEIRA ALTA	29/11/2019 07:30	29/11/2019 17:20	29/11/2019 07:30	29/11/2019 17:20	9,82	1	9,82	CHI
201911355465	LUZIANIA	LZ12219702	PIRES DO RIO S2	29/11/2019 07:31	29/11/2019 16:06	29/11/2019 07:31	29/11/2019 16:06	8,58	3	25,74	CHI
201911355471	MINACU	IH12360453	MINACU	29/11/2019 05:29	29/11/2019 10:18	29/11/2019 05:29	29/11/2019 10:18	4,81	72	346,34	CHI
201911355471	CAMPINACU	IH12360453	MINACU	29/11/2019 05:29	29/11/2019 10:18	29/11/2019 05:29	29/11/2019 10:18	4,81	5	24,05	CHI
201911355475	TRINDADE	TR12006367	GUAPO S1	29/11/2019 07:32	29/11/2019 11:10	29/11/2019 07:32	29/11/2019 11:10	3,62	5	18,09	CHI
201911355475	GUAPO	TR12006367	GUAPO S1	29/11/2019 07:32	29/11/2019 11:10	29/11/2019 07:32	29/11/2019 11:10	3,62	33	119,40	CHI
201911355476	POSSE	PS12122519	IACIARA S2	29/11/2019 06:36	29/11/2019 16:29	29/11/2019 06:36	29/11/2019 16:29	9,87	10	98,71	CHI
201911355480	GOIANIA	10275873	CAMPINAS S2	29/11/2019 07:33	29/11/2019 12:31	29/11/2019 07:33	29/11/2019 12:31	4,95	1	4,95	CHI
201911355482	URUTAI	UT12027074	URUTAI	29/11/2019 07:20	29/11/2019 11:05	29/11/2019 07:20	29/11/2019 11:05	3,74	9	33,62	CHI
201911355482	IPAMERI	UT12027074	URUTAI	29/11/2019 07:20	29/11/2019 11:05	29/11/2019 07:20	29/11/2019 11:05	3,74	43	160,65	CHI
201911355488	NIQUELANDIA	NQ12292625	NIQUELANDIA SUBTRANSMISSAO	29/11/2019 07:35	29/11/2019 14:04	29/11/2019 07:35	29/11/2019 14:04	6,48	10	64,82	CHI
201911355489	ARUANA	AK21066587	ARUANA	29/11/2019 07:35	29/11/2019 12:32	29/11/2019 07:35	29/11/2019 12:32	4,95	1	4,95	CHI
201911355491	MONTIVIDIU	MV12267718	MONTIVIDIU T	29/11/2019 07:35	29/11/2019 13:01	29/11/2019 07:35	29/11/2019 13:01	5,42	14	75,93	CHI
201911355491	RIO VERDE	MV12267718	MONTIVIDIU T	29/11/2019 07:35	29/11/2019 13:01	29/11/2019 07:35	29/11/2019 13:01	5,42	1	5,42	CHI
201911355505	GOIANIA	11553248	CAMPINAS S2	29/11/2019 07:36	29/11/2019 10:18	29/11/2019 07:36	29/11/2019 10:18	2,69	1	2,69	CHI
201911355510	GOIANIA	14988926	GOYA S2	29/11/2019 07:37	29/11/2019 09:35	29/11/2019 07:37	29/11/2019 09:35	1,96	1	1,96	CHI
201911355515	CERES	RB21003297	RUBIATABA	29/11/2019 07:37	30/11/2019 09:30	29/11/2019 07:37	30/11/2019 09:30	25,87	1	25,87	CHI
201911355523	GOIANIA	GN12267333	CEPAIGO S1	29/11/2019 07:38	29/11/2019 09:34	29/11/2019 07:38	29/11/2019 09:34	1,92	24	46,19	CHI
201911355524	MONTE ALEGRE DE GOIAS	MA12130278	SAO DOMINGOS	28/11/2019 20:23	29/11/2019 09:07	28/11/2019 20:23	29/11/2019 09:07	12,73	6	76,36	CHI
201911355525	FORMOSA	FA12261997	ITUIQUIRA	29/11/2019 07:38	29/11/2019 10:39	29/11/2019 07:38	29/11/2019 10:39	3,00	32	96,04	CHI
201911355527	IVOLANDIA	IV12231193	ARENOPOLIS	29/11/2019 07:39	29/11/2019 12:20	29/11/2019 07:39	29/11/2019 12:20	4,68	9	42,14	CHI
201911355527	PALESTINA DE GOIAS	IV12231193	ARENOPOLIS	29/11/2019 07:39	29/11/2019 12:20	29/11/2019 07:39	29/11/2019 12:20	4,68	12	56,19	CHI
201911355528	IPORA	IR12038307	IPORA	29/11/2019 06:39	29/11/2019 11:40	29/11/2019 06:39	29/11/2019 11:40	5,02	52	261,07	CHI
201911355532	MARA ROSA	MQ12187776	MARA ROSA	29/11/2019 06:41	29/11/2019 18:01	29/11/2019 06:41	29/11/2019 18:01	11,33	2	22,67	CHI
201911355533	IPORA	IR12381025	IPORA	29/11/2019 06:42	29/11/2019 09:20	29/11/2019 06:42	29/11/2019 09:20	2,63	12	31,57	CHI
201911355535	FIRMINOPOLIS	FR21096822	FIRMINOPOLIS S1	29/11/2019 07:39	29/11/2019 09:26	29/11/2019 07:39	29/11/2019 09:26	1,79	1	1,79	CHI
201911355538	SANTO ANTONIO DO DESCOBERTO	8206429	MARAJOARA	29/11/2019 07:39	29/11/2019 10:05	29/11/2019 07:39	29/11/2019 10:05	2,42	677	1640,78	CHI
201911355538	DISTRITO FEDERAL	8206429	MARAJOARA	29/11/2019 07:39	29/11/2019 10:05	29/11/2019 07:39	29/11/2019 10:05	2,42	48	116,33	CHI

201911355541	CIDADE OCIDENTAL	10005219866	MARAJOARA	29/11/2019 07:40	29/11/2019 16:22	29/11/2019 07:40	29/11/2019 16:22	8,69	1	8,69	CHI
201911355544	GOIANESIA	GE21000239	GOIANESIA S2	29/11/2019 07:40	29/11/2019 15:59	29/11/2019 07:40	29/11/2019 15:59	8,31	1	8,31	CHI
201911355545	BRITANIA	IU12020119	MATRINCHA	29/11/2019 07:25	29/11/2019 15:40	29/11/2019 07:25	29/11/2019 15:40	8,25	6	49,49	CHI
201911355545	ITAPIRAPUA	IU12020119	MATRINCHA	29/11/2019 07:25	29/11/2019 15:40	29/11/2019 07:25	29/11/2019 15:40	8,25	43	354,65	CHI
201911355552	BALIZA	BM12396126	BOM JARDIM	29/11/2019 06:42	29/11/2019 17:36	29/11/2019 06:42	29/11/2019 17:36	10,90	1	10,90	CHI
201911355552	BOM JARDIM DE GOIAS	BM12396126	BOM JARDIM	29/11/2019 06:42	29/11/2019 17:36	29/11/2019 06:42	29/11/2019 17:36	10,90	16	174,40	CHI
201911355554	BALIZA	BH12142110	BOM JARDIM	29/11/2019 05:57	29/11/2019 09:53	29/11/2019 05:57	29/11/2019 09:53	3,93	68	267,32	CHI
201911355559	CAMPOS VERDES	VD12257334	SANTA TEREZINHA	29/11/2019 07:18	30/11/2019 03:17	29/11/2019 07:18	30/11/2019 03:17	19,98	6	119,90	CHI
201911355562	CACHOEIRA ALTA	CA21196107	CACHOEIRA ALTA	29/11/2019 07:43	29/11/2019 16:54	29/11/2019 07:43	29/11/2019 16:54	9,18	1	9,18	CHI
201911355564	SAO LUIS DE MONTES BELOS	SL12006949	SAO LUIZ DOS MONTES BELOS	29/11/2019 06:00	29/11/2019 09:09	29/11/2019 06:00	29/11/2019 09:09	3,14	41	128,74	CHI
201911355566	ITAGUARU	IC12300399	ITABERAI S1	29/11/2019 07:43	29/11/2019 16:33	29/11/2019 07:43	29/11/2019 16:33	8,82	1	8,82	CHI
201911355566	ITAGUARI	IC12300399	ITABERAI S1	29/11/2019 07:43	29/11/2019 16:33	29/11/2019 07:43	29/11/2019 16:33	8,82	8	70,56	CHI
201911355572	CRIXAS	CX12134501	RUBIATABA	29/11/2019 06:28	29/11/2019 15:21	29/11/2019 06:28	29/11/2019 15:21	8,87	57	505,49	CHI
201911355572	NOVA IGUACU DE GOIAS	CX12134501	RUBIATABA	29/11/2019 06:28	29/11/2019 15:21	29/11/2019 06:28	29/11/2019 15:21	8,87	1	8,87	CHI
201911355579	JUSSARA	1290066817	JUSSARA	29/11/2019 07:44	29/11/2019 17:56	29/11/2019 07:44	29/11/2019 17:56	10,19	1	10,19	CHI
201911355583	SANTA TEREZINHA DE GOIAS	SG11048646	SANTA TEREZINHA	29/11/2019 06:25	29/11/2019 09:10	29/11/2019 06:25	29/11/2019 09:10	2,75	189	520,01	CHI
201911355584	ARENOPOLIS	AY21100364	ARENOPOLIS	29/11/2019 07:44	29/11/2019 17:00	29/11/2019 07:44	29/11/2019 11:30	3,75	1	3,75	CHI
201911355584	ARENOPOLIS	AY21100364	ARENOPOLIS	29/11/2019 07:44	29/11/2019 17:00	29/11/2019 15:10	29/11/2019 17:00	1,82	1	1,82	CHI
201911355587	MONTES CLAROS DE GOIAS	ME12088929	IPORA	29/11/2019 07:45	29/11/2019 12:20	29/11/2019 07:45	29/11/2019 12:20	4,58	4	18,34	CHI
201911355595	ARUANA	AK21220351	MOZARLANDIA	29/11/2019 07:46	29/11/2019 18:50	29/11/2019 07:46	29/11/2019 18:50	11,06	1	11,06	CHI
201911355596	PIRENOPOLIS	PV12065968LD	ANAPOLIS UNIVERSITARIO S2	29/11/2019 07:46	29/11/2019 19:30	29/11/2019 07:46	29/11/2019 19:30	11,73	8	93,83	CHI
201911355596	ABADIANIA	PV12065968LD	ANAPOLIS UNIVERSITARIO S2	29/11/2019 07:46	29/11/2019 19:30	29/11/2019 07:46	29/11/2019 19:30	11,73	1	11,73	CHI
201911355607	ARENOPOLIS	AY12259445	IPORA	29/11/2019 07:47	29/11/2019 18:42	29/11/2019 07:47	29/11/2019 18:42	10,91	5	54,56	CHI
201911355607	PIRANHAS	AY12259445	IPORA	29/11/2019 07:47	29/11/2019 18:42	29/11/2019 07:47	29/11/2019 18:42	10,91	1	10,91	CHI
201911355610	SILVANIA	SV12011158	DAIA S2	29/11/2019 04:04	29/11/2019 09:22	29/11/2019 04:04	29/11/2019 09:22	5,29	17	90,00	CHI
201911355614	ANAPOLIS	AN12339396	JUNDIAI S2	29/11/2019 07:09	29/11/2019 09:01	29/11/2019 07:09	29/11/2019 09:01	1,85	921	1706,66	CHI
201911355615	RIO VERDE	RV21020007	MONTVIDIU T	29/11/2019 07:48	29/11/2019 16:00	29/11/2019 07:48	29/11/2019 16:00	8,19	1	8,19	CHI
201911355618	LEOPOLDO DE BULHOES	LB12321544	DAIA S2	29/11/2019 07:48	29/11/2019 11:41	29/11/2019 07:48	29/11/2019 11:41	3,87	2	7,74	CHI
201911355619	NOVA CRIXAS	SM12099600	SAO MIGUEL DO ARAGUAIA	29/11/2019 07:47	29/11/2019 18:00	29/11/2019 07:47	29/11/2019 17:20	9,55	1	9,55	CHI
201911355619	SAO MIGUEL DO ARAGUAIA	SM12099600	SAO MIGUEL DO ARAGUAIA	29/11/2019 07:47	29/11/2019 18:00	29/11/2019 07:47	29/11/2019 17:20	9,55	82	782,71	CHI
201911355619	SAO MIGUEL DO ARAGUAIA	SM21334351	SAO MIGUEL DO ARAGUAIA	29/11/2019 07:47	29/11/2019 18:00	29/11/2019 07:47	29/11/2019 18:00	10,21	1	10,21	CHI
201911355621	PARAUNA	PU21226341	MONTVIDIU T	29/11/2019 07:49	29/11/2019 12:40	29/11/2019 07:49	29/11/2019 12:40	4,86	1	4,86	CHI
201911355625	NIQUELANDIA	NQ21372206	NIQUELANDIA SUBTRANSMISSAO	29/11/2019 07:49	30/11/2019 08:04	29/11/2019 07:49	30/11/2019 08:04	24,25	2	48,49	CHI

201911355626	NIQUELANDIA	NQ12314128	NIQUELANDIA SUBTRANSMISSAO	29/11/2019 07:49	30/11/2019 06:25	29/11/2019 07:49	30/11/2019 06:25	22,60	2	45,19	CHI
201911355628	GOIANIA	10922386	FERROVIARIO S2	29/11/2019 07:49	29/11/2019 10:09	29/11/2019 07:49	29/11/2019 10:09	2,33	1	2,33	CHI
201911355630	SAO LUIS DE MONTES BELOS	SL21259188	SAO LUIZ DOS MONTES BELOS	29/11/2019 07:49	29/11/2019 11:34	29/11/2019 07:49	29/11/2019 11:34	3,74	1	3,74	CHI
201911355641	FIRMINOPOLIS	FR12391442	FIRMINOPOLIS S2	29/11/2019 07:36	29/11/2019 10:56	29/11/2019 07:36	29/11/2019 10:56	3,33	65	216,45	CHI
201911355641	SAO JOAO DA PARAUNA	FR12391442	FIRMINOPOLIS S2	29/11/2019 07:36	29/11/2019 10:56	29/11/2019 07:36	29/11/2019 10:56	3,33	71	236,43	CHI
201911355648	CAMPINACU	UC12269887	MARA ROSA	29/11/2019 07:51	30/11/2019 08:22	29/11/2019 07:51	30/11/2019 08:22	24,51	8	196,06	CHI
201911355650	SANTA RITA DO NOVO DESTINO	DF12382140	BARRO ALTO	29/11/2019 06:58	29/11/2019 14:46	29/11/2019 06:58	29/11/2019 14:46	7,80	15	116,96	CHI
201911355655	FORMOSA	FA21164592	ITUIQUIRA	29/11/2019 07:52	29/11/2019 09:56	29/11/2019 07:52	29/11/2019 09:56	2,06	1	2,06	CHI
201911355658	PARANAIGUARA	PC12060518	QUIRINOPOLIS	29/11/2019 05:00	29/11/2019 14:35	29/11/2019 05:00	29/11/2019 14:35	9,58	5	47,89	CHI
201911355660	MARA ROSA	AJ12210309	MARA ROSA	29/11/2019 04:46	29/11/2019 11:22	29/11/2019 04:46	29/11/2019 11:22	6,59	3	19,77	CHI
201911355660	ALTO HORIZONTE	AJ12210309	MARA ROSA	29/11/2019 04:46	29/11/2019 11:22	29/11/2019 04:46	29/11/2019 11:22	6,59	18	118,62	CHI
201911355661	POSSE	PS21123499	IACIARA S2	29/11/2019 07:53	29/11/2019 21:34	29/11/2019 07:53	29/11/2019 21:34	13,68	1	13,68	CHI
201911355663	CROMINIA	CQ12000245	PONTALINA	29/11/2019 07:09	29/11/2019 10:06	29/11/2019 07:09	29/11/2019 10:06	2,95	9	26,53	CHI
201911355666	RUBIATABA	RB12303953	RUBIATABA	29/11/2019 06:33	29/11/2019 19:21	29/11/2019 06:33	29/11/2019 19:21	12,79	3	38,38	CHI
201911355670	INHUMAS	IN21000500	INHUMAS S2	29/11/2019 07:55	29/11/2019 09:21	29/11/2019 07:55	29/11/2019 09:21	1,43	2	2,87	CHI
201911355675	ISRAELANDIA	IS21289306	IPORA	29/11/2019 07:55	29/11/2019 17:50	29/11/2019 07:55	29/11/2019 17:50	9,90	1	9,90	CHI
201911355680	CACU	CC12202700	CACHOEIRA ALTA	29/11/2019 06:00	29/11/2019 12:06	29/11/2019 06:00	29/11/2019 12:06	6,09	16	97,51	CHI
201911355690	INDIARA	JD12323638	ACREUNA	29/11/2019 05:52	29/11/2019 16:02	29/11/2019 05:52	29/11/2019 16:02	10,16	3	30,49	CHI
201911355690	JANDAIA	JD12323638	ACREUNA	29/11/2019 05:52	29/11/2019 16:02	29/11/2019 05:52	29/11/2019 16:02	10,16	11	111,80	CHI
201911355691	CRIXAS	CX12162721	SANTA TEREZINHA	29/11/2019 07:35	30/11/2019 12:49	29/11/2019 07:35	30/11/2019 12:49	29,24	5	146,18	CHI
201911355692	POSSE	IA12262096	IACIARA S1	29/11/2019 06:04	29/11/2019 09:30	29/11/2019 06:04	29/11/2019 09:30	3,42	1	3,42	CHI
201911355692	IACIARA	IA12262096	IACIARA S1	29/11/2019 06:04	29/11/2019 09:30	29/11/2019 06:04	29/11/2019 09:30	3,42	4	13,69	CHI
201911355695	ITUMBIARA	IT12399537	PARANAIBA	29/11/2019 07:57	29/11/2019 12:17	29/11/2019 07:57	29/11/2019 12:17	4,32	5	21,59	CHI
201911355697	RIO VERDE	RV12076265	CABRIUVA S2	29/11/2019 07:58	29/11/2019 23:25	29/11/2019 07:58	29/11/2019 23:25	15,44	2	30,89	CHI
201911355702	INDIARA	IY21010917	EDEIA	29/11/2019 05:52	29/11/2019 15:17	29/11/2019 05:52	29/11/2019 15:17	9,41	1	9,41	CHI
201911355711	BELA VISTA DE GOIAS	BV12066384	BELA VISTA S2	29/11/2019 06:25	29/11/2019 10:48	29/11/2019 06:25	29/11/2019 10:48	4,37	31	135,55	CHI
201911355715	PIRANHAS	PH12381052	PIRANHAS	29/11/2019 08:00	29/11/2019 14:13	29/11/2019 08:00	29/11/2019 14:13	6,21	7	43,48	CHI
201911355718	MONTIVIDIU	RV12384572B	MONTIVIDIU T	29/11/2019 08:01	29/11/2019 12:34	29/11/2019 08:01	29/11/2019 12:34	4,54	18	81,74	CHI
201911355730	FORMOSA	FA12000035	ITUIQUIRA	29/11/2019 07:46	29/11/2019 09:45	29/11/2019 07:46	29/11/2019 09:45	1,97	131	258,51	CHI
201911355731	FORMOSA	FA12395906	FLORES DE GOIAS	29/11/2019 08:03	30/11/2019 18:52	29/11/2019 08:03	30/11/2019 18:52	34,81	27	939,89	CHI
201911355732	PLANALTINA	10026496605	PLANALTINA	29/11/2019 08:03	29/11/2019 15:42	29/11/2019 08:03	29/11/2019 15:42	7,65	1	7,65	CHI
201911355739	PORTEIRAO	CL12306027	RIO DOS BOIS	29/11/2019 08:04	29/11/2019 12:24	29/11/2019 08:04	29/11/2019 12:24	4,33	3	13,00	CHI
201911355739	MAURILANDIA	CL12306027	RIO DOS BOIS	29/11/2019 08:04	29/11/2019 12:24	29/11/2019 08:04	29/11/2019 12:24	4,33	4	17,33	CHI

201911355742	NOVA CRIXAS	NA12220366	MOZARLANDIA	29/11/2019 06:32	29/11/2019 14:33	29/11/2019 06:32	29/11/2019 14:33	8,01	6	48,03	CHI
201911355746	GOIANIA	GN12133833	GOIANIA LESTE S3	29/11/2019 08:04	29/11/2019 09:30	29/11/2019 08:04	29/11/2019 09:30	1,42	6	8,52	CHI
201911355751	SANTO ANTONIO DO DESCOBERTO	SN12376791	MARAJOARA	29/11/2019 08:05	29/11/2019 12:44	29/11/2019 08:05	29/11/2019 12:44	4,65	2	9,30	CHI
201911355752	SAO SIMAO	PC21000068	CACHOEIRA ALTA	29/11/2019 08:05	29/11/2019 10:00	29/11/2019 08:05	29/11/2019 10:00	1,91	2	3,83	CHI
201911355754	SANTA RITA DO NOVO DESTINO	DF21287217	BARRO ALTO	29/11/2019 08:05	29/11/2019 17:51	29/11/2019 08:05	29/11/2019 17:51	9,76	1	9,76	CHI
201911355763	PIRENOPOLIS	PV21238137	CORUMBA	29/11/2019 08:05	29/11/2019 11:12	29/11/2019 08:05	29/11/2019 11:12	3,10	1	3,10	CHI
201911355765	AGUA FRIA DE GOIAS	4140000522	SAO JOAO D ALIANCA	29/11/2019 08:05	29/11/2019 12:42	29/11/2019 08:05	29/11/2019 12:42	4,60	1	4,60	CHI
201911355770	MOZARLANDIA	MZ12220221	MOZARLANDIA	29/11/2019 08:06	29/11/2019 18:23	29/11/2019 08:06	29/11/2019 18:23	10,28	1	10,28	CHI
201911355771	URUACU	UR21327253	MARA ROSA	29/11/2019 08:06	29/11/2019 15:14	29/11/2019 08:06	29/11/2019 15:14	7,13	1	7,13	CHI
201911355774	SANTA HELENA DE GOIAS	400001925	IPEGUARI	29/11/2019 08:06	29/11/2019 13:15	29/11/2019 08:06	29/11/2019 13:15	5,15	1	5,15	CHI
201911355775	ALEXANIA	AX21071322	ALEXANIA	29/11/2019 08:06	29/11/2019 18:50	29/11/2019 08:06	29/11/2019 18:50	10,72	1	10,72	CHI
201911355778	PETROLINA DE GOIAS	PG12025388	SAO FRANCISCO DE GOIAS	29/11/2019 05:23	29/11/2019 10:45	29/11/2019 05:23	29/11/2019 10:45	5,36	10	53,64	CHI
201911355778	PIRENOPOLIS	PG12025388	SAO FRANCISCO DE GOIAS	29/11/2019 05:23	29/11/2019 10:45	29/11/2019 05:23	29/11/2019 10:45	5,36	39	209,21	CHI
201911355780	GOIANIA	14900038	MEIA PONTE	29/11/2019 08:06	29/11/2019 09:50	29/11/2019 08:06	29/11/2019 09:50	1,72	1	1,72	CHI
201911355783	GOIAS	GS21299710	GOIAS	29/11/2019 08:07	29/11/2019 17:10	29/11/2019 08:07	29/11/2019 17:10	9,05	1	9,05	CHI
201911355800	NOVO GAMA	LZ21000066	PACAEMBU S1	29/11/2019 08:08	29/11/2019 09:27	29/11/2019 08:08	29/11/2019 09:27	1,31	1	1,31	CHI
201911355802	ALTO PARAISO DE GOIAS	BF12196490	NIQUELANDIA SUBTRANSMISSAO	29/11/2019 08:08	29/11/2019 12:09	29/11/2019 08:08	29/11/2019 12:09	4,01	9	36,06	CHI
201911355803	FORMOSA	610290721	ITUIQUIRA	29/11/2019 08:08	29/11/2019 10:12	29/11/2019 08:08	29/11/2019 10:12	2,06	1	2,06	CHI
201911355812	ANAPOLIS	20458666	JUNDIAI S1	29/11/2019 08:09	29/11/2019 17:20	29/11/2019 08:09	29/11/2019 17:20	9,19	1	9,19	CHI
201911355818	ORIZONA	OZ12300573	PIRES DO RIO S2	29/11/2019 07:12	29/11/2019 15:37	29/11/2019 07:12	29/11/2019 15:37	8,41	8	67,30	CHI
201911355819	CORUMBA DE GOIAS	260021635	CORUMBA	29/11/2019 08:10	29/11/2019 17:13	29/11/2019 08:10	29/11/2019 17:13	9,05	1	9,05	CHI
201911355821	PARANAIGUARA	PC12295754	CACHOEIRA ALTA	29/11/2019 08:10	29/11/2019 22:41	29/11/2019 08:10	29/11/2019 22:41	14,52	3	43,55	CHI
201911355822	MINACU	IH12181712	MINACU	29/11/2019 05:54	29/11/2019 10:57	29/11/2019 05:54	29/11/2019 10:57	5,05	75	378,77	CHI
201911355824	PIRANHAS	PH12349758	PIRANHAS	29/11/2019 08:10	30/11/2019 13:02	29/11/2019 08:10	30/11/2019 13:02	28,86	1	28,86	CHI
201911355825	ALTO HORIZONTE	20556299	MARA ROSA	29/11/2019 08:10	01/12/2019 07:38	29/11/2019 08:10	01/12/2019 07:38	47,46	1	47,46	CHI
201911355826	GOIATUBA	GT21190879	GOIATUBA S2	29/11/2019 08:10	29/11/2019 10:01	29/11/2019 08:10	29/11/2019 10:01	1,84	2	3,67	CHI
201911355827	ITUMBIARA	CD21046741	CACHOEIRA DOURADA	29/11/2019 08:10	29/11/2019 10:20	29/11/2019 08:10	29/11/2019 10:20	2,15	1	2,15	CHI
201911355831	TAQUARAL DE GOIAS	TQ12025614	ITABERAÍ S1	29/11/2019 04:16	29/11/2019 16:30	29/11/2019 04:16	29/11/2019 16:30	12,23	52	636,03	CHI
201911355834	AGUA FRIA DE GOIAS	TL12337518	SAO JOAO D ALIANCA	29/11/2019 08:11	29/11/2019 14:17	29/11/2019 08:11	29/11/2019 14:17	6,11	1	6,11	CHI
201911355837	SAO MIGUEL DO ARAGUAIA	SM12334418	SAO MIGUEL DO ARAGUAIA	29/11/2019 08:11	30/11/2019 18:00	29/11/2019 08:11	30/11/2019 18:00	33,80	16	540,85	CHI
201911355838	MUTUNOPOLIS	MU12127951	MARA ROSA	29/11/2019 08:11	29/11/2019 15:26	29/11/2019 08:11	29/11/2019 15:26	7,23	4	28,94	CHI
201911355842	MATRINCHA	MP11292810	MATRINCHA	29/11/2019 07:19	29/11/2019 15:31	29/11/2019 07:19	29/11/2019 15:31	8,20	38	311,62	CHI
201911355843	CORUMBAIBA	CI12035404	VILA CORUMBA	29/11/2019 08:12	29/11/2019 14:49	29/11/2019 08:12	29/11/2019 14:49	6,61	84	554,94	CHI



201911355846	ITAPIRAPUA	IU21071453	MATRINCHA	29/11/2019 08:13	29/11/2019 18:00	29/11/2019 08:13	29/11/2019 18:00	9,78	1	9,78	CHI
201911355850	LUZIANIA	10008210630	RIO VERMELHO	29/11/2019 08:13	29/11/2019 10:46	29/11/2019 08:13	29/11/2019 10:46	2,54	1	2,54	CHI
201911355852	AGUA FRIA DE GOIAS	TL21204694	SAO JOAO D ALIANCA	29/11/2019 08:14	29/11/2019 16:50	29/11/2019 08:14	29/11/2019 16:50	8,61	1	8,61	CHI
201911355856	FORMOSA	610089651	ITUIQUIRA	29/11/2019 08:14	29/11/2019 11:45	29/11/2019 08:14	29/11/2019 11:45	3,52	1	3,52	CHI
201911355858	MONTE ALEGRE DE GOIAS	MA21242464	SAO DOMINGOS	29/11/2019 08:14	29/11/2019 18:30	29/11/2019 08:14	29/11/2019 18:30	10,25	1	10,25	CHI
201911355861	PIRES DO RIO	PR10408498	PIRES DO RIO S1	29/11/2019 08:15	30/11/2019 10:25	29/11/2019 08:15	30/11/2019 10:25	26,17	3	78,52	CHI
201911355861	PIRES DO RIO	PR10408498	PIRES DO RIO S1	29/11/2019 08:15	30/11/2019 10:25	30/11/2019 10:08	30/11/2019 10:25	0,28	56	15,49	CHI
201911355862	IPAMERI	IP21275915	URUTAI	29/11/2019 08:15	29/11/2019 17:01	29/11/2019 08:15	29/11/2019 17:01	8,78	1	8,78	CHI
201911355863	PIRACANJUBA	PJ12097886	BELA VISTA S1	29/11/2019 08:15	29/11/2019 14:32	29/11/2019 08:15	29/11/2019 14:32	6,28	6	37,69	CHI
201911355865	OURO VERDE DE GOIAS	OV12115017	NEROPOLIS S1	29/11/2019 07:36	29/11/2019 10:23	29/11/2019 07:36	29/11/2019 10:23	2,77	9	24,95	CHI
201911355866	GUARINOS	GF21280928	URUACU	29/11/2019 08:15	30/11/2019 08:30	29/11/2019 08:15	30/11/2019 08:30	24,24	1	24,24	CHI
201911355867	CAMPINORTE	CR21190032	MARA ROSA	29/11/2019 08:15	30/11/2019 05:07	29/11/2019 08:15	30/11/2019 05:07	20,86	1	20,86	CHI
201911355868	NOVA CRIXAS	NA12300441	MOZARLANDIA	29/11/2019 08:15	29/11/2019 16:17	29/11/2019 08:15	29/11/2019 16:17	8,02	4	32,09	CHI
201911355870	OURO VERDE DE GOIAS	OV12319823	NEROPOLIS S1	29/11/2019 06:59	29/11/2019 09:56	29/11/2019 06:59	29/11/2019 09:56	2,95	23	67,74	CHI
201911355876	MORRO AGUDO DE GOIAS	IK12250599	ITAPURANGA	29/11/2019 07:03	30/11/2019 14:00	29/11/2019 07:03	30/11/2019 14:00	30,94	5	154,71	CHI
201911355876	ITAPURANGA	IK12250599	ITAPURANGA	29/11/2019 07:03	30/11/2019 14:00	29/11/2019 07:03	30/11/2019 14:00	30,94	16	495,06	CHI
201911355876	SAO PATRICIO	IK12250599	ITAPURANGA	29/11/2019 07:03	30/11/2019 14:00	29/11/2019 07:03	30/11/2019 14:00	30,94	2	61,88	CHI
201911355879	BOM JESUS DE GOIAS	BJ12305385	BOM JESUS DE GOIAS	29/11/2019 08:15	29/11/2019 12:21	29/11/2019 08:15	29/11/2019 12:21	4,09	7	28,62	CHI
201911355880	INHUMAS	IN21200037	INHUMAS S2	29/11/2019 08:17	29/11/2019 11:30	29/11/2019 08:17	29/11/2019 11:30	3,21	1	3,21	CHI
201911355882	ANAPOLIS	AN11000231	JUNDIAI S1	29/11/2019 08:17	29/11/2019 12:42	29/11/2019 08:17	29/11/2019 12:42	4,41	131	578,07	CHI
201911355887	MIMOSO DE GOIAS	MJ12288360	PADRE BERNARDO	29/11/2019 08:17	29/11/2019 10:19	29/11/2019 08:17	29/11/2019 10:19	2,02	1	2,02	CHI
201911355894	FLORES DE GOIAS	3480001310	FLORES DE GOIAS	29/11/2019 08:19	29/11/2019 16:45	29/11/2019 08:19	29/11/2019 16:45	8,43	1	8,43	CHI
201911355897	CRIXAS	CX11399895	RUBIATABA	29/11/2019 08:19	30/11/2019 11:32	29/11/2019 08:19	30/11/2019 11:32	27,21	1	27,21	CHI
201911355907	HIDROLANDIA	HD31092157	CEPAIGO S2	29/11/2019 08:20	29/11/2019 11:18	29/11/2019 08:20	29/11/2019 11:18	2,96	1	2,96	CHI
201911355908	AGUA FRIA DE GOIAS	TL21169881	SAO JOAO D ALIANCA	29/11/2019 08:20	29/11/2019 22:34	29/11/2019 08:20	29/11/2019 22:34	14,22	2	28,45	CHI
201911355912	RIO VERDE	630555760	CABRIUVA S1	29/11/2019 08:20	29/11/2019 10:30	29/11/2019 08:20	29/11/2019 10:30	2,15	1	2,15	CHI
201911355920	BARRO ALTO	BA12382485	BARRO ALTO	29/11/2019 08:09	29/11/2019 20:35	29/11/2019 08:09	29/11/2019 20:35	12,42	9	111,78	CHI
201911355927	MINEIROS	MY21394784	PARQUE DAS EMAS	29/11/2019 08:22	30/11/2019 08:43	29/11/2019 08:22	30/11/2019 08:43	24,33	1	24,33	CHI
201911355929	URUTAI	UT12027071	URUTAI	29/11/2019 08:23	29/11/2019 12:43	29/11/2019 08:23	29/11/2019 12:43	4,35	3	13,04	CHI
201911355930	GOIANIA	GN11189917	CARAJAS S1	29/11/2019 08:23	29/11/2019 09:38	29/11/2019 08:23	29/11/2019 09:38	1,25	86	107,24	CHI
201911355934	BOM JESUS DE GOIAS	BJ12208036RE	BOM JESUS DE GOIAS	29/11/2019 08:23	29/11/2019 18:28	29/11/2019 08:23	29/11/2019 18:28	10,08	3	30,23	CHI
201911355934	GOIATUBA	BJ12208036RE	BOM JESUS DE GOIAS	29/11/2019 08:23	29/11/2019 18:28	29/11/2019 08:23	29/11/2019 18:28	10,08	2	20,15	CHI
201911355938	SAO DOMINGOS	GY12160070	IACIARA S1	29/11/2019 08:23	29/11/2019 17:49	29/11/2019 08:23	29/11/2019 17:49	9,42	1	9,42	CHI

201911355938	IACIARA	GY12160070	IACIARA S1	29/11/2019 08:23	29/11/2019 17:49	29/11/2019 08:23	29/11/2019 17:49	9,42	2	18,84	CHI
201911355938	GUARANI DE GOIAS	GY12160070	IACIARA S1	29/11/2019 08:23	29/11/2019 17:49	29/11/2019 08:23	29/11/2019 17:49	9,42	2	18,84	CHI
201911355939	MINEIROS	MY21193787	PARQUE DAS EMAS	29/11/2019 08:23	30/11/2019 09:07	29/11/2019 08:23	30/11/2019 09:07	24,72	1	24,72	CHI
201911355940	ITAPACI	100046253	ITAPACI	29/11/2019 08:23	29/11/2019 18:25	29/11/2019 08:23	29/11/2019 18:25	10,02	1	10,02	CHI
201911355943	PARANAIGUARA	PC12193843	QUIRINOPOLIS	29/11/2019 08:24	29/11/2019 12:35	29/11/2019 08:24	29/11/2019 12:35	4,19	1	4,19	CHI
201911355949	PALMEIRAS DE GOIAS	6378541	PALMEIRAS	29/11/2019 08:14	29/11/2019 09:40	29/11/2019 08:14	29/11/2019 09:40	1,42	891	1263,98	CHI
201911355950	SANTA FE DE GOIAS	RN12362415	BRITANIA	29/11/2019 07:38	29/11/2019 13:54	29/11/2019 07:38	29/11/2019 13:54	6,27	18	112,91	CHI
201911355955	IPAMERI	IP21266939	IPAMERI	29/11/2019 08:26	29/11/2019 16:35	29/11/2019 08:26	29/11/2019 16:35	8,16	1	8,16	CHI
201911355960	ITABERAI	IB21000141	ITABERAI S2	29/11/2019 08:27	29/11/2019 12:47	29/11/2019 08:27	29/11/2019 12:47	4,33	3	12,99	CHI
201911355962	CRIXAS	CX21075605	RUBIATABA	29/11/2019 08:27	30/11/2019 11:59	29/11/2019 08:27	30/11/2019 11:59	27,53	1	27,53	CHI
201911355963	BRITANIA	BT13249637	BRITANIA	29/11/2019 14:07	29/11/2019 22:07	29/11/2019 18:51	29/11/2019 21:56	3,09	7	21,61	CHI
201911355963	JUSSARA	BT13249637	BRITANIA	29/11/2019 14:07	29/11/2019 22:07	29/11/2019 18:51	29/11/2019 21:56	3,09	48	148,17	CHI
201911355963	BRITANIA	BT12249634LD	BRITANIA	29/11/2019 14:07	29/11/2019 22:07	29/11/2019 14:07	29/11/2019 22:07	7,99	97	775,51	CHI
201911355963	BRITANIA	BT12249634LD	BRITANIA	29/11/2019 14:07	29/11/2019 22:07	29/11/2019 18:51	29/11/2019 22:07	3,26	1	3,26	CHI
201911355965	VICENTINOPOLIS	10029830735	VICENTINOPOLIS	29/11/2019 08:27	29/11/2019 12:20	29/11/2019 08:27	29/11/2019 12:20	3,89	1	3,89	CHI
201911355966	RIO VERDE	RV21105880	ACREUNA	29/11/2019 08:27	29/11/2019 10:45	29/11/2019 08:27	29/11/2019 10:45	2,29	1	2,29	CHI
201911355969	CALDAS NOVAS	CN21142360	SERRA DE CALDAS	29/11/2019 08:27	29/11/2019 09:30	29/11/2019 08:27	29/11/2019 09:30	1,04	1	1,04	CHI
201911355974	GOIANIA	GN12000621	CAMPINAS S2	29/11/2019 07:41	29/11/2019 10:23	29/11/2019 07:41	29/11/2019 09:31	1,83	74	135,32	CHI
201911355974	GOIANIA	GN11000946	CAMPINAS S2	29/11/2019 07:41	29/11/2019 10:23	29/11/2019 07:41	29/11/2019 10:23	2,69	53	142,83	CHI
201911355976	DOVERLANDIA	DV12354650	CAIAPONIA	29/11/2019 08:15	30/11/2019 13:09	29/11/2019 08:15	29/11/2019 14:36	6,34	102	646,51	CHI
201911355976	DOVERLANDIA	DV12354650	CAIAPONIA	29/11/2019 08:15	30/11/2019 13:09	29/11/2019 08:15	30/11/2019 13:09	28,90	8	231,17	CHI
201911355976	DOVERLANDIA	DV12354650	CAIAPONIA	29/11/2019 08:15	30/11/2019 13:09	30/11/2019 11:12	30/11/2019 13:09	1,95	103	201,22	CHI
201911355979	ABADIANIA	AN21229828	ANAPOLIS UNIVERSITARIO S2	29/11/2019 08:29	29/11/2019 13:01	29/11/2019 08:29	29/11/2019 13:01	4,53	1	4,53	CHI
201911355983	GOUVELANDIA	GB21338583	QUIRINOPOLIS	29/11/2019 08:29	29/11/2019 22:07	29/11/2019 08:29	29/11/2019 22:07	13,62	4	54,49	CHI
201911355988	IACIARA	IA21317946	IACIARA S1	29/11/2019 08:30	29/11/2019 15:49	29/11/2019 08:30	29/11/2019 15:49	7,31	1	7,31	CHI
201911355990	ARENOPOLIS	AY21000007	ARENOPOLIS	29/11/2019 08:30	29/11/2019 14:56	29/11/2019 08:30	29/11/2019 14:56	6,43	1	6,43	CHI
201911355999	CATALAO	CT11215495	CATALAO S1	29/11/2019 08:30	29/11/2019 14:10	29/11/2019 08:30	29/11/2019 14:10	5,65	172	971,90	CHI
201911356059	APARECIDA DE GOIANIA	AP11317630	INDEPENDENCIA S1	29/11/2019 09:37	29/11/2019 10:38	29/11/2019 09:37	29/11/2019 10:38	1,01	72	72,36	CHI
201911356082	CATALAO	CT21250350	CATALAO S1	29/11/2019 10:48	29/11/2019 15:49	29/11/2019 10:48	29/11/2019 15:49	5,01	1	5,01	CHI
201911356099	QUIRINOPOLIS	QI11018002	QUIRINOPOLIS	29/11/2019 11:46	30/11/2019 00:14	29/11/2019 11:46	30/11/2019 00:14	12,45	155	1929,97	CHI
201911356105	PIRENOPOLIS	PV21086594	CORUMBA	29/11/2019 08:31	29/11/2019 18:50	29/11/2019 08:31	29/11/2019 18:50	10,30	1	10,30	CHI
201911356106	FIRMINOPOLIS	FR12096826	FIRMINOPOLIS S1	29/11/2019 08:31	29/11/2019 12:46	29/11/2019 08:31	29/11/2019 12:46	4,23	1	4,23	CHI
201911356115	CACHOEIRA DOURADA	10012400228	CACHOEIRA DOURADA	29/11/2019 08:32	29/11/2019 10:54	29/11/2019 08:32	29/11/2019 10:54	2,37	1	2,37	CHI

201911356116	PIRES DO RIO	PR21186743	PIRES DO RIO S1	29/11/2019 08:33	29/11/2019 13:13	29/11/2019 08:33	29/11/2019 13:13	4,67	1	4,67	CHI
201911356120	QUIRINOPOLIS	QJ21203850	QUIRINOPOLIS	29/11/2019 08:33	29/11/2019 11:13	29/11/2019 08:33	29/11/2019 11:13	2,66	1	2,66	CHI
201911356124	BOM JESUS DE GOIAS	BJ21000335	BOM JESUS DE GOIAS	29/11/2019 08:34	29/11/2019 13:54	29/11/2019 08:34	29/11/2019 13:54	5,33	2	10,66	CHI
201911356130	MATRINCHA	MP12183061	MOZARLANDIA	29/11/2019 06:47	30/11/2019 00:07	29/11/2019 06:47	30/11/2019 00:07	17,32	27	467,61	CHI
201911356130	ARUANA	MP12183061	MOZARLANDIA	29/11/2019 06:47	30/11/2019 00:07	29/11/2019 06:47	30/11/2019 00:07	17,32	8	138,55	CHI
201911356133	ITUMBIARA	IT21122349	PARANAIBA	29/11/2019 08:34	29/11/2019 12:46	29/11/2019 08:34	29/11/2019 12:46	4,20	1	4,20	CHI
201911356134	ARUANA	AK12404549	MOZARLANDIA	29/11/2019 08:35	29/11/2019 11:46	29/11/2019 08:35	29/11/2019 11:46	3,18	9	28,64	CHI
201911356137	ACREUNA	EU12246788	ACREUNA	29/11/2019 08:36	29/11/2019 14:50	29/11/2019 08:36	29/11/2019 14:50	6,23	3	18,69	CHI
201911356138	SAO MIGUEL DO ARAGUAIA	830087114	SAO MIGUEL DO ARAGUAIA	29/11/2019 08:36	29/11/2019 15:38	29/11/2019 08:36	29/11/2019 15:38	7,03	1	7,03	CHI
201911356140	ARENOPOLIS	AY12105959	ARENOPOLIS	29/11/2019 06:26	29/11/2019 14:09	29/11/2019 06:26	29/11/2019 14:09	7,71	2	15,43	CHI
201911356140	PIRANHAS	AY12105959	ARENOPOLIS	29/11/2019 06:26	29/11/2019 14:09	29/11/2019 06:26	29/11/2019 14:09	7,71	1	7,71	CHI
201911356142	NOVA ROMA	ND21218881	IACIARA S2	29/11/2019 08:36	29/11/2019 15:50	29/11/2019 08:36	29/11/2019 15:50	7,22	1	7,22	CHI
201911356147	IPORA	IR21014429	IPORA	29/11/2019 08:37	29/11/2019 10:21	29/11/2019 08:37	29/11/2019 10:21	1,73	1	1,73	CHI
201911356155	SITIO D ABADIA	FB11278023	IACIARA S2	29/11/2019 08:38	30/11/2019 11:37	29/11/2019 08:38	30/11/2019 11:37	26,98	1	26,98	CHI
201911356156	IACIARA	IA12206170	IACIARA S1	29/11/2019 06:36	29/11/2019 11:19	29/11/2019 06:36	29/11/2019 11:19	4,71	80	376,73	CHI
201911356167	SAO LUIS DE MONTES BELOS	SL32145916	SAO LUIZ DOS MONTES BELOS	29/11/2019 08:09	29/11/2019 10:11	29/11/2019 08:09	29/11/2019 10:11	2,03	7	14,18	CHI
201911356168	JATAI	290276860	JATAI S2	29/11/2019 08:39	29/11/2019 11:34	29/11/2019 08:39	29/11/2019 11:34	2,90	1	2,90	CHI
201911356177	GOIANESIA	550128475	GOIANESIA S2	29/11/2019 08:40	29/11/2019 13:40	29/11/2019 08:40	29/11/2019 13:40	4,99	1	4,99	CHI
201911356185	ORIZONA	OZ12000353	PIRES DO RIO S1	29/11/2019 07:35	29/11/2019 10:37	29/11/2019 07:35	29/11/2019 10:37	3,04	34	103,26	CHI
201911356186	GOIAS	GS12250577	GOIAS	29/11/2019 07:42	29/11/2019 16:43	29/11/2019 07:42	29/11/2019 16:43	9,01	9	81,10	CHI
201911356188	SAO LUIS DE MONTES BELOS	FR12111635	FIRMINOPOLIS S1	29/11/2019 08:42	29/11/2019 11:25	29/11/2019 08:42	29/11/2019 11:25	2,71	2	5,42	CHI
201911356190	GOIANIA	16743210	XAVANTES	29/11/2019 08:42	29/11/2019 10:39	29/11/2019 08:42	29/11/2019 10:39	1,94	1	1,94	CHI
201911356192	FORMOSA	FA31211602	ITUIQUIRA	29/11/2019 08:42	29/11/2019 14:39	29/11/2019 08:42	29/11/2019 14:39	5,94	1	5,94	CHI
201911356197	APARECIDA DE GOIANIA	AP21150472	INDEPENDENCIA S2	29/11/2019 08:39	29/11/2019 16:16	29/11/2019 08:39	29/11/2019 16:16	7,61	3	22,83	CHI
201911356200	MINACU	IH12088797	MINACU	29/11/2019 08:43	29/11/2019 15:02	29/11/2019 08:43	29/11/2019 15:02	6,30	164	1033,25	CHI
201911356202	ORIZONA	2060041709	PIRES DO RIO S2	29/11/2019 08:44	30/11/2019 16:11	29/11/2019 08:44	30/11/2019 16:11	31,45	1	31,45	CHI
201911356218	CORUMBAIBA	560004667	VILA CORUMBA	29/11/2019 08:45	29/11/2019 11:46	29/11/2019 08:45	29/11/2019 11:46	3,02	1	3,02	CHI
201911356224	RIO QUENTE	CN10396194	VILA CORUMBA	29/11/2019 08:07	01/12/2019 16:04	29/11/2019 12:47	29/11/2019 12:50	0,05	4	0,22	CHI
201911356224	MORRINHOS	CN10396194	VILA CORUMBA	29/11/2019 08:07	01/12/2019 16:04	29/11/2019 12:47	29/11/2019 12:50	0,05	55	3,02	CHI
201911356224	MARZAGAO	CN10396194	VILA CORUMBA	29/11/2019 08:07	01/12/2019 16:04	29/11/2019 12:47	29/11/2019 12:50	0,05	36	1,98	CHI
201911356224	MARZAGAO	CN10396194	VILA CORUMBA	29/11/2019 08:07	01/12/2019 16:04	29/11/2019 12:47	29/11/2019 12:50	0,05	8	0,44	CHI
201911356224	MARZAGAO	CN10396194	VILA CORUMBA	29/11/2019 08:07	01/12/2019 16:04	29/11/2019 12:47	29/11/2019 12:50	0,05	1071	58,90	CHI
201911356224	CALDAS NOVAS	CN10396194	VILA CORUMBA	29/11/2019 08:07	01/12/2019 16:04	29/11/2019 12:47	29/11/2019 12:50	0,05	20	1,10	CHI

201911356224	MARZAGAO	CN10396194	VILA CORUMBA	29/11/2019 08:07	01/12/2019 16:04	29/11/2019 12:47	29/11/2019 12:50	0,05	4	0,22	CHI
201911356224	MORRINHOS	CN10396194	VILA CORUMBA	29/11/2019 08:07	01/12/2019 16:04	29/11/2019 12:47	29/11/2019 12:50	0,05	2	0,11	CHI
201911356224	AGUA LIMPA	CN10396194	VILA CORUMBA	29/11/2019 08:07	01/12/2019 16:04	29/11/2019 12:47	29/11/2019 12:50	0,05	134	7,37	CHI
201911356224	CORUMBAIBA	CN10396194	VILA CORUMBA	29/11/2019 08:07	01/12/2019 16:04	29/11/2019 12:47	29/11/2019 12:50	0,05	38	2,09	CHI
201911356224	CALDAS NOVAS	CN10396194	VILA CORUMBA	29/11/2019 08:07	01/12/2019 16:04	29/11/2019 12:47	29/11/2019 12:50	0,05	6	0,33	CHI
201911356224	AGUA LIMPA	CN10396194	VILA CORUMBA	29/11/2019 08:07	01/12/2019 16:04	29/11/2019 12:47	29/11/2019 12:50	0,05	16	0,88	CHI
201911356224	BURITI ALEGRE	CN10396194	VILA CORUMBA	29/11/2019 08:07	01/12/2019 16:04	29/11/2019 12:47	29/11/2019 12:50	0,05	3	0,16	CHI
201911356224	AGUA LIMPA	CN10396194	VILA CORUMBA	29/11/2019 08:07	01/12/2019 16:04	29/11/2019 12:47	29/11/2019 12:50	0,05	8	0,44	CHI
201911356224	AGUA LIMPA	CN10396194	VILA CORUMBA	29/11/2019 08:07	01/12/2019 16:04	29/11/2019 12:47	29/11/2019 12:50	0,05	831	45,70	CHI
201911356224	MARZAGAO	CN10396194	VILA CORUMBA	29/11/2019 08:07	01/12/2019 16:04	29/11/2019 12:47	29/11/2019 15:12	2,41	38	91,65	CHI
201911356224	CALDAS NOVAS	CN10396194	VILA CORUMBA	29/11/2019 08:07	01/12/2019 16:04	29/11/2019 12:47	29/11/2019 15:12	2,41	15	36,18	CHI
201911356224	CALDAS NOVAS	CN10396194	VILA CORUMBA	29/11/2019 08:07	01/12/2019 16:04	29/11/2019 12:47	29/11/2019 15:53	3,10	31	96,10	CHI
201911356224	CALDAS NOVAS	CN13400584B	VILA CORUMBA	29/11/2019 08:07	01/12/2019 16:04	29/11/2019 16:06	29/11/2019 16:17	0,18	20	3,66	CHI
201911356224	CALDAS NOVAS	CN12000066LD	VILA CORUMBA	29/11/2019 08:07	01/12/2019 16:04	29/11/2019 12:47	29/11/2019 16:54	4,11	22	90,53	CHI
201911356224	CALDAS NOVAS	CN10396194	VILA CORUMBA	29/11/2019 08:07	01/12/2019 16:04	29/11/2019 16:55	29/11/2019 17:11	0,27	31	8,34	CHI
201911356224	CALDAS NOVAS	CN12000066LD	VILA CORUMBA	29/11/2019 08:07	01/12/2019 16:04	29/11/2019 16:55	29/11/2019 20:43	3,82	5	19,08	CHI
201911356224	CALDAS NOVAS	CN10396194	VILA CORUMBA	29/11/2019 08:07	01/12/2019 16:04	29/11/2019 21:39	29/11/2019 21:45	0,10	32	3,16	CHI
201911356224	CALDAS NOVAS	CN10396194	VILA CORUMBA	29/11/2019 08:07	01/12/2019 16:04	30/11/2019 20:13	30/11/2019 21:19	1,09	32	34,84	CHI
201911356224	CALDAS NOVAS	CN12000066LD	VILA CORUMBA	29/11/2019 08:07	01/12/2019 16:04	29/11/2019 16:55	01/12/2019 08:48	39,89	17	678,05	CHI
201911356224	CALDAS NOVAS	CN12000066LD	VILA CORUMBA	29/11/2019 08:07	01/12/2019 16:04	29/11/2019 20:44	01/12/2019 08:48	36,07	3	108,21	CHI
201911356224	CALDAS NOVAS	CN10396194	VILA CORUMBA	29/11/2019 08:07	01/12/2019 16:04	01/12/2019 08:48	01/12/2019 09:20	0,54	33	17,69	CHI
201911356224	CALDAS NOVAS	CN12000066LD	VILA CORUMBA	29/11/2019 08:07	01/12/2019 16:04	29/11/2019 20:44	01/12/2019 15:57	43,23	2	86,46	CHI
201911356224	CALDAS NOVAS	CN12000066LD	VILA CORUMBA	29/11/2019 08:07	01/12/2019 16:04	01/12/2019 08:48	01/12/2019 15:57	7,16	20	143,25	CHI
201911356224	RIO QUENTE	CN10396194	VILA CORUMBA	29/11/2019 08:07	01/12/2019 16:04	29/11/2019 08:07	01/12/2019 16:04	55,94	17	950,98	CHI
201911356224	RIO QUENTE	CN10396194	VILA CORUMBA	29/11/2019 08:07	01/12/2019 16:04	29/11/2019 12:47	01/12/2019 16:04	51,28	93	4769,40	CHI
201911356224	AGUA LIMPA	CN10396194	VILA CORUMBA	29/11/2019 08:07	01/12/2019 16:04	29/11/2019 12:47	01/12/2019 16:04	51,28	16	820,54	CHI
201911356224	MORRINHOS	CN10396194	VILA CORUMBA	29/11/2019 08:07	01/12/2019 16:04	29/11/2019 12:47	01/12/2019 16:04	51,28	5	256,42	CHI
201911356224	CALDAS NOVAS	CN10396194	VILA CORUMBA	29/11/2019 08:07	01/12/2019 16:04	29/11/2019 12:47	01/12/2019 16:04	51,28	3	153,85	CHI
201911356224	RIO QUENTE	RQ13122104	VILA CORUMBA	29/11/2019 08:07	01/12/2019 16:04	29/11/2019 15:05	01/12/2019 16:04	48,98	1	48,98	CHI
201911356229	GUAPO	710028763	GUAPO S1	29/11/2019 08:47	29/11/2019 11:15	29/11/2019 08:47	29/11/2019 11:15	2,47	1	2,47	CHI
201911356231	APARECIDA DE GOIANIA	13139058	REAL S1	29/11/2019 08:45	29/11/2019 10:10	29/11/2019 08:45	29/11/2019 10:10	1,40	1	1,40	CHI
201911356237	MINACU	IH12337406	MINACU	29/11/2019 08:48	29/11/2019 13:48	29/11/2019 08:48	29/11/2019 13:48	5,00	40	199,89	CHI
201911356243	CACHOEIRA DOURADA	CD21000162	CACHOEIRA DOURADA	29/11/2019 08:48	29/11/2019 20:28	29/11/2019 08:48	29/11/2019 20:28	11,66	1	11,66	CHI

201911356246	GOIANDIRA	CT12042362	CATALAO S1	29/11/2019 08:49	29/11/2019 09:20	29/11/2019 08:49	29/11/2019 09:20	0,53	1	0,53	CHI
201911356246	CATALAO	CT12042362	CATALAO S1	29/11/2019 08:49	29/11/2019 09:20	29/11/2019 08:49	29/11/2019 09:20	0,53	1	0,53	CHI
201911356248	JATAI	SX12264387	JATAI S1	29/11/2019 08:49	29/11/2019 17:09	29/11/2019 08:49	29/11/2019 17:09	8,33	7	58,29	CHI
201911356248	SERRANOPOLIS	SX12264387	JATAI S1	29/11/2019 08:49	29/11/2019 17:09	29/11/2019 08:49	29/11/2019 17:09	8,33	22	183,20	CHI
201911356259	JARAGUA	JA21354160	JARAGUA	29/11/2019 08:50	29/11/2019 16:58	29/11/2019 08:50	29/11/2019 16:58	8,12	1	8,12	CHI
201911356261	URUTAI	UT21207644	URUTAI	29/11/2019 08:41	29/11/2019 12:28	29/11/2019 08:41	29/11/2019 12:28	3,77	2	7,55	CHI
201911356266	CRIXAS	2490037116	SANTA TEREZINHA	29/11/2019 08:51	01/12/2019 00:16	29/11/2019 08:51	01/12/2019 00:16	39,41	1	39,41	CHI
201911356267	RIO VERDE	RV12098479	RIO VERDE S1	29/11/2019 08:51	29/11/2019 11:46	29/11/2019 08:51	29/11/2019 11:46	2,90	7	20,33	CHI
201911356272	MONTIVIDIU	MV21260821	MONTIVIDIU T	29/11/2019 08:52	29/11/2019 21:15	29/11/2019 08:52	29/11/2019 21:15	12,38	1	12,38	CHI
201911356274	BOM JESUS DE GOIAS	BJ21257012	BOM JESUS DE GOIAS	29/11/2019 08:53	29/11/2019 19:35	29/11/2019 08:53	29/11/2019 19:35	10,70	1	10,70	CHI
201911356280	PIRENOPOLIS	PV12062894	SAO FRANCISCO DE GOIAS	29/11/2019 08:54	29/11/2019 14:31	29/11/2019 08:54	29/11/2019 14:31	5,61	21	117,84	CHI
201911356280	PETROLINA DE GOIAS	PV12062894	SAO FRANCISCO DE GOIAS	29/11/2019 08:54	29/11/2019 14:31	29/11/2019 08:54	29/11/2019 14:31	5,61	3	16,83	CHI
201911356287	ABADIANIA	AA21021505	ANAPOLIS UNIVERSITARIO S1	29/11/2019 08:54	29/11/2019 14:32	29/11/2019 08:54	29/11/2019 14:32	5,62	1	5,62	CHI
201911356288	ITAPIRAPUA	IU12016406	MATRINCHA	29/11/2019 08:46	29/11/2019 16:20	29/11/2019 08:46	29/11/2019 16:20	7,56	12	90,66	CHI
201911356294	GOIANESIA	GE12092175	GOIANESIA S1	29/11/2019 08:06	29/11/2019 19:19	29/11/2019 08:06	29/11/2019 19:19	11,21	3	33,62	CHI
201911356295	GOIANESIA	GE12358979	GOIANESIA S2	29/11/2019 05:23	29/11/2019 13:16	29/11/2019 05:23	29/11/2019 13:16	7,87	4	31,49	CHI
201911356295	VILA PROPICIO	GE12358979	GOIANESIA S2	29/11/2019 05:23	29/11/2019 13:16	29/11/2019 05:23	29/11/2019 13:16	7,87	8	62,98	CHI
201911356299	CACHOEIRA DOURADA	CD21060785	CACHOEIRA DOURADA	29/11/2019 08:56	29/11/2019 17:10	29/11/2019 08:56	29/11/2019 17:10	8,22	1	8,22	CHI
201911356303	PLANALTINA	2960183065	PLANALTINA	29/11/2019 08:57	29/11/2019 12:16	29/11/2019 08:57	29/11/2019 12:16	3,31	1	3,31	CHI
201911356311	PIRANHAS	PH21201829	PIRANHAS	29/11/2019 08:58	29/11/2019 11:30	29/11/2019 08:58	29/11/2019 11:30	2,52	1	2,52	CHI
201911356315	JATAI	JT12182034	JATAI S2	29/11/2019 08:13	29/11/2019 09:55	29/11/2019 08:13	29/11/2019 09:55	1,69	125	211,77	CHI
201911356318	MONTIVIDIU	MV21144769	MONTIVIDIU T	29/11/2019 08:59	29/11/2019 13:36	29/11/2019 08:59	29/11/2019 13:36	4,61	1	4,61	CHI
201911356325	GOIANIA	12154775	INDEPENDENCIA S2	29/11/2019 08:59	29/11/2019 10:44	29/11/2019 08:59	29/11/2019 10:44	1,74	1	1,74	CHI
201911356327	APARECIDA DE GOIANIA	AP12000047	CEPAIGO S1	29/11/2019 08:59	29/11/2019 12:38	29/11/2019 08:59	29/11/2019 12:38	3,64	53	192,79	CHI
201911356327	HIDROLANDIA	AP12000047	CEPAIGO S1	29/11/2019 08:59	29/11/2019 12:38	29/11/2019 08:59	29/11/2019 12:38	3,64	4	14,55	CHI
201911356329	RIO VERDE	RV12340876	MONTIVIDIU T	29/11/2019 08:59	29/11/2019 11:03	29/11/2019 08:59	29/11/2019 11:03	2,07	5	10,35	CHI
201911356330	CATALAO	10005076372	CATALAO S2	29/11/2019 09:00	29/11/2019 10:45	29/11/2019 09:00	29/11/2019 10:45	1,77	1	1,77	CHI
201911356331	ANAPOLIS	AN11000262	ANAPOLIS UNIVERSITARIO S2	29/11/2019 08:30	29/11/2019 10:35	29/11/2019 08:30	29/11/2019 10:35	2,07	141	292,34	CHI
201911356333	MONTE ALEGRE DE GOIAS	GH12074067	SAO DOMINGOS	29/11/2019 08:16	29/11/2019 13:50	29/11/2019 08:16	29/11/2019 13:50	5,56	15	83,47	CHI
201911356333	SAO DOMINGOS	GH12074067	SAO DOMINGOS	29/11/2019 08:16	29/11/2019 13:50	29/11/2019 08:16	29/11/2019 13:50	5,56	1	5,56	CHI
201911356333	DIVINOPOLIS DE GOIAS	GH12074067	SAO DOMINGOS	29/11/2019 08:16	29/11/2019 13:50	29/11/2019 08:16	29/11/2019 13:50	5,56	363	2020,09	CHI
201911356337	LEOPOLDO DE BULHOES	870004931	DAIA S2	29/11/2019 09:00	29/11/2019 10:22	29/11/2019 09:00	29/11/2019 10:22	1,37	1	1,37	CHI
201911356345	ITUMBIARA	IT21232623	ITUMBIARA VELHA S2	29/11/2019 09:02	29/11/2019 11:16	29/11/2019 09:02	29/11/2019 11:16	2,23	2	4,46	CHI

201911356349	CACU	00270434	CACHOEIRA ALTA	29/11/2019 08:56	29/11/2019 21:23	29/11/2019 08:56	29/11/2019 12:03	3,12	2	6,25	CHI
201911356349	CACHOEIRA ALTA	00270434	CACHOEIRA ALTA	29/11/2019 08:56	29/11/2019 21:23	29/11/2019 08:56	29/11/2019 12:03	3,12	7	21,86	CHI
201911356349	CACU	00270434	CACHOEIRA ALTA	29/11/2019 08:56	29/11/2019 21:23	29/11/2019 13:07	29/11/2019 13:11	0,07	2	0,14	CHI
201911356349	CACHOEIRA ALTA	00270434	CACHOEIRA ALTA	29/11/2019 08:56	29/11/2019 21:23	29/11/2019 13:07	29/11/2019 13:11	0,07	7	0,50	CHI
201911356349	CACU	IM13164248	CACHOEIRA ALTA	29/11/2019 08:56	29/11/2019 21:23	29/11/2019 08:56	29/11/2019 14:23	5,46	1	5,46	CHI
201911356349	ITAJA	00270434	CACHOEIRA ALTA	29/11/2019 08:56	29/11/2019 21:23	29/11/2019 08:56	29/11/2019 18:19	9,38	2	18,77	CHI
201911356349	ITARUMA	00270434	CACHOEIRA ALTA	29/11/2019 08:56	29/11/2019 21:23	29/11/2019 08:56	29/11/2019 18:19	9,38	79	741,37	CHI
201911356349	LAGOA SANTA	00270434	CACHOEIRA ALTA	29/11/2019 08:56	29/11/2019 21:23	29/11/2019 08:56	29/11/2019 18:19	9,38	62	581,84	CHI
201911356349	ITAJA	00270434	CACHOEIRA ALTA	29/11/2019 08:56	29/11/2019 21:23	29/11/2019 08:56	29/11/2019 18:19	9,38	78	731,99	CHI
201911356349	ITAJA	00270434	CACHOEIRA ALTA	29/11/2019 08:56	29/11/2019 21:23	29/11/2019 08:56	29/11/2019 18:19	9,38	8	75,08	CHI
201911356349	ITARUMA	00270434	CACHOEIRA ALTA	29/11/2019 08:56	29/11/2019 21:23	29/11/2019 08:56	29/11/2019 18:19	9,38	129	1210,59	CHI
201911356349	CACU	00270434	CACHOEIRA ALTA	29/11/2019 08:56	29/11/2019 21:23	29/11/2019 08:56	29/11/2019 18:19	9,38	4	37,54	CHI
201911356349	ITAJA	00270434	CACHOEIRA ALTA	29/11/2019 08:56	29/11/2019 21:23	29/11/2019 08:56	29/11/2019 18:19	9,38	31	290,92	CHI
201911356349	ITARUMA	00270434	CACHOEIRA ALTA	29/11/2019 08:56	29/11/2019 21:23	29/11/2019 08:56	29/11/2019 18:19	9,38	42	394,15	CHI
201911356349	LAGOA SANTA	00270434	CACHOEIRA ALTA	29/11/2019 08:56	29/11/2019 21:23	29/11/2019 08:56	29/11/2019 21:19	12,38	4	49,54	CHI
201911356349	ITARUMA	00270434	CACHOEIRA ALTA	29/11/2019 08:56	29/11/2019 21:23	29/11/2019 08:56	29/11/2019 21:19	12,38	5	61,92	CHI
201911356349	ITAJA	00270434	CACHOEIRA ALTA	29/11/2019 08:56	29/11/2019 21:23	29/11/2019 08:56	29/11/2019 21:19	12,38	24	297,23	CHI
201911356349	LAGOA SANTA	IJ12200624	CACHOEIRA ALTA	29/11/2019 08:56	29/11/2019 21:23	29/11/2019 08:56	29/11/2019 21:23	12,46	10	124,58	CHI
201911356349	ITAJA	IJ12200624	CACHOEIRA ALTA	29/11/2019 08:56	29/11/2019 21:23	29/11/2019 08:56	29/11/2019 21:23	12,46	15	186,87	CHI
201911356349	ITARUMA	IJ12200624	CACHOEIRA ALTA	29/11/2019 08:56	29/11/2019 21:23	29/11/2019 08:56	29/11/2019 21:23	12,46	1	12,46	CHI
201911356354	RIO VERDE	630519651	RIO VERDE S1	29/11/2019 09:03	29/11/2019 11:30	29/11/2019 09:03	29/11/2019 11:30	2,44	1	2,44	CHI
201911356355	FIRMINOPOLIS	FR12096828	FIRMINOPOLIS S1	29/11/2019 08:58	29/11/2019 12:26	29/11/2019 08:58	29/11/2019 12:26	3,47	8	27,73	CHI
201911356357	URUACU	640004714	URUACU	29/11/2019 09:04	29/11/2019 10:17	29/11/2019 09:04	29/11/2019 10:17	1,21	1	1,21	CHI
201911356359	POSSE	PS21237076	IACIARA S2	29/11/2019 09:05	29/11/2019 17:13	29/11/2019 09:05	29/11/2019 17:13	8,13	1	8,13	CHI
201911356365	NOVA ROMA	SD12115759LD	SAO DOMINGOS	29/11/2019 08:13	29/11/2019 12:02	29/11/2019 08:13	29/11/2019 12:02	3,81	3	11,44	CHI
201911356365	MONTE ALEGRE DE GOIAS	SD12115759LD	SAO DOMINGOS	29/11/2019 08:13	29/11/2019 12:02	29/11/2019 08:13	29/11/2019 12:02	3,81	2	7,63	CHI
201911356365	SAO DOMINGOS	SD12115759LD	SAO DOMINGOS	29/11/2019 08:13	29/11/2019 12:02	29/11/2019 08:13	29/11/2019 12:02	3,81	76	289,92	CHI
201911356366	ITAPIRAPUA	IU21022148	MATRINCHA	29/11/2019 09:06	29/11/2019 13:28	29/11/2019 09:06	29/11/2019 13:28	4,37	1	4,37	CHI
201911356367	ARUANA	04300216	MOZARLANDIA	29/11/2019 07:20	29/11/2019 19:04	29/11/2019 07:20	29/11/2019 19:04	11,73	8	93,83	CHI
201911356367	NOVA CRIXAS	04300216	MOZARLANDIA	29/11/2019 07:20	29/11/2019 19:04	29/11/2019 07:20	29/11/2019 19:04	11,73	1	11,73	CHI
201911356367	MOZARLANDIA	04300216	MOZARLANDIA	29/11/2019 07:20	29/11/2019 19:04	29/11/2019 07:20	29/11/2019 19:04	11,73	73	856,19	CHI
201911356381	MINEIROS	MY12209668	PARQUE DAS EMAS	29/11/2019 09:08	30/11/2019 08:45	29/11/2019 09:08	30/11/2019 08:45	23,61	89	2100,92	CHI
201911356390	GOIANDIRA	GD21276196	CATALAO S1	29/11/2019 09:10	29/11/2019 11:02	29/11/2019 09:10	29/11/2019 11:02	1,87	1	1,87	CHI

201911356391	MOIPORA	MO12130217	IPORA	29/11/2019 09:10	29/11/2019 21:48	29/11/2019 09:10	29/11/2019 21:48	12,62	5	63,11	CHI
201911356395	DOVERLANDIA	DV12334957	PARQUE DAS EMAS	29/11/2019 07:13	01/12/2019 09:00	29/11/2019 07:13	01/12/2019 09:00	49,78	6	298,68	CHI
201911356398	JATAI	JT12336920	JATAI S1	29/11/2019 08:44	29/11/2019 10:44	29/11/2019 08:44	29/11/2019 10:44	1,99	10	19,90	CHI
201911356399	RIO VERDE	RV11279526	RIO VERDE S1	29/11/2019 08:02	29/11/2019 11:38	29/11/2019 08:02	29/11/2019 11:38	3,60	102	367,03	CHI
201911356401	ANAPOLIS	21181056	ANAPOLIS UNIVERSITARIO S2	29/11/2019 09:11	29/11/2019 15:49	29/11/2019 09:11	29/11/2019 15:49	6,62	1	6,62	CHI
201911356410	SAO DOMINGOS	4950000240	SAO DOMINGOS	29/11/2019 09:12	29/11/2019 16:09	29/11/2019 09:12	29/11/2019 16:09	6,94	1	6,94	CHI
201911356412	GOIAS	GS12188167	MATRINCHA	29/11/2019 07:57	29/11/2019 15:40	29/11/2019 07:57	29/11/2019 15:40	7,72	18	139,02	CHI
201911356426	BELA VISTA DE GOIAS	LB12270662	DAIA S2	29/11/2019 08:49	29/11/2019 13:17	29/11/2019 08:49	29/11/2019 13:17	4,46	1	4,46	CHI
201911356426	CALDAZINHA	LB12270662	DAIA S2	29/11/2019 08:49	29/11/2019 13:17	29/11/2019 08:49	29/11/2019 13:17	4,46	65	289,63	CHI
201911356426	LEOPOLDO DE BULHOES	LB12270662	DAIA S2	29/11/2019 08:49	29/11/2019 13:17	29/11/2019 08:49	29/11/2019 13:17	4,46	5	22,28	CHI
201911356426	SILVANIA	LB12270662	DAIA S2	29/11/2019 08:49	29/11/2019 13:17	29/11/2019 08:49	29/11/2019 13:17	4,46	59	262,89	CHI
201911356427	FORMOSA	FA12242845	ITIQUEIRA	29/11/2019 07:52	29/11/2019 15:48	29/11/2019 07:52	29/11/2019 15:48	7,92	4	31,67	CHI
201911356429	CEZARINA	CZ21295366	GUAPO S2	29/11/2019 09:15	29/11/2019 16:25	29/11/2019 09:15	29/11/2019 16:25	7,17	2	14,34	CHI
201911356434	SENADOR CANEDO	190155127	SENADOR CANEDO	29/11/2019 09:15	29/11/2019 17:13	29/11/2019 09:15	29/11/2019 17:13	7,96	1	7,96	CHI
201911356437	AMARALINA	LC21288771	MARA ROSA	29/11/2019 09:16	30/11/2019 07:40	29/11/2019 09:16	30/11/2019 07:40	22,39	1	22,39	CHI
201911356438	MARA ROSA	MQ12140367	MARA ROSA	29/11/2019 05:59	29/11/2019 14:51	29/11/2019 05:59	29/11/2019 14:51	8,85	56	495,79	CHI
201911356440	PARAUNA	EU21000192	ACREUNA	29/11/2019 09:16	29/11/2019 15:45	29/11/2019 09:16	29/11/2019 15:45	6,47	1	6,47	CHI
201911356444	CORUMBAIBA	CI12025149	VILA CORUMBA	29/11/2019 09:17	29/11/2019 16:10	29/11/2019 09:17	29/11/2019 16:10	6,88	12	82,52	CHI
201911356451	INHUMAS	IN21025206	INHUMAS S2	29/11/2019 09:18	29/11/2019 19:05	29/11/2019 09:18	29/11/2019 19:05	9,77	2	19,54	CHI
201911356455	RIO VERDE	RV12065038	RIO VERDE S1	29/11/2019 09:03	29/11/2019 11:11	29/11/2019 09:03	29/11/2019 11:11	2,14	3	6,41	CHI
201911356463	URUACU	HL12003223	SANTA TEREZINHA	29/11/2019 07:15	29/11/2019 20:03	29/11/2019 07:15	29/11/2019 20:03	12,79	4	51,15	CHI
201911356463	PILAR DE GOIAS	HL12003223	SANTA TEREZINHA	29/11/2019 07:15	29/11/2019 20:03	29/11/2019 07:15	29/11/2019 20:03	12,79	49	626,60	CHI
201911356463	HIDROLINA	HL12003223	SANTA TEREZINHA	29/11/2019 07:15	29/11/2019 20:03	29/11/2019 07:15	29/11/2019 20:03	12,79	1	12,79	CHI
201911356464	VILA PROPICIO	NP11232981	GOIANESIA S1	29/11/2019 09:20	29/11/2019 16:23	29/11/2019 09:20	29/11/2019 16:23	7,04	2	14,08	CHI
201911356465	MONTIVIDIU	MV12085651	MONTIVIDIU T	29/11/2019 09:19	29/11/2019 11:10	29/11/2019 09:19	29/11/2019 11:10	1,85	13	24,00	CHI
201911356465	RIO VERDE	MV12085651	MONTIVIDIU T	29/11/2019 09:19	29/11/2019 11:10	29/11/2019 09:19	29/11/2019 11:10	1,85	5	9,23	CHI
201911356467	IACIARA	IA12218688	IACIARA S2	29/11/2019 09:20	29/11/2019 15:38	29/11/2019 09:20	29/11/2019 15:38	6,29	3	18,86	CHI
201911356469	HEITORAI	HE21307641	ITABERAÍ S1	29/11/2019 09:21	29/11/2019 15:25	29/11/2019 09:21	29/11/2019 15:25	6,06	1	6,06	CHI
201911356472	PLANALTINA	10015888728	PLANALTINA	29/11/2019 09:21	29/11/2019 11:22	29/11/2019 09:21	29/11/2019 11:22	2,02	1	2,02	CHI
201911356474	ARENOPOLIS	AY12103482	ARENOPOLIS	29/11/2019 06:37	29/11/2019 15:05	29/11/2019 06:37	29/11/2019 15:05	8,46	11	93,10	CHI
201911356474	DIORAMA	AY12103482	ARENOPOLIS	29/11/2019 06:37	29/11/2019 15:05	29/11/2019 06:37	29/11/2019 15:05	8,46	9	76,18	CHI
201911356475	TRINDADE	40272485	TRINDADE	29/11/2019 09:20	29/11/2019 10:44	29/11/2019 09:20	29/11/2019 10:44	1,38	1	1,38	CHI
201911356476	MINEIROS	1390030031	PARQUE DAS EMAS	29/11/2019 09:21	29/11/2019 17:20	29/11/2019 09:21	29/11/2019 17:20	7,97	1	7,97	CHI

201911356482	AURILANDIA	CG12382596	FIRMINOPOLIS S2	29/11/2019 00:45	29/11/2019 11:32	29/11/2019 00:45	29/11/2019 11:32	10,78	24	258,60	CHI
201911356482	CACHOEIRA DE GOIAS	CG12382596	FIRMINOPOLIS S2	29/11/2019 00:45	29/11/2019 11:32	29/11/2019 00:45	29/11/2019 11:32	10,78	2	21,55	CHI
201911356482	MOIPORA	CG12382596	FIRMINOPOLIS S2	29/11/2019 00:45	29/11/2019 11:32	29/11/2019 00:45	29/11/2019 11:32	10,78	1	10,78	CHI
201911356487	FLORES DE GOIAS	FB12085509	FLORES DE GOIAS	29/11/2019 09:22	29/11/2019 16:09	29/11/2019 09:22	29/11/2019 16:09	6,77	4	27,07	CHI
201911356492	SENADOR CANEDO	10029775114	SENADOR CANEDO	29/11/2019 09:22	29/11/2019 11:19	29/11/2019 09:22	29/11/2019 11:19	1,95	1	1,95	CHI
201911356493	ITUMBIARA	690056760	ITUMBIARA VELHA S1	29/11/2019 09:23	29/11/2019 10:50	29/11/2019 09:23	29/11/2019 10:50	1,44	1	1,44	CHI
201911356494	ITABERAI	IB21337302	ITABERAI S1	29/11/2019 09:23	29/11/2019 14:12	29/11/2019 09:23	29/11/2019 14:12	4,80	1	4,80	CHI
201911356507	MONTIVIDIU	MV21075508	MONTIVIDIU T	29/11/2019 09:26	29/11/2019 17:49	29/11/2019 09:26	29/11/2019 17:49	8,38	1	8,38	CHI
201911356516	CAMPO ALEGRE DE GOIAS	CT12166855	CATALAO S1	29/11/2019 09:26	29/11/2019 17:46	29/11/2019 09:26	29/11/2019 17:46	8,32	1	8,32	CHI
201911356516	CATALAO	CT12166855	CATALAO S1	29/11/2019 09:26	29/11/2019 17:46	29/11/2019 09:26	29/11/2019 17:46	8,32	2	16,64	CHI
201911356521	PIRACANJUBA	PJ12412508	CRISTIANOPOLIS	29/11/2019 07:48	29/11/2019 12:40	29/11/2019 07:48	29/11/2019 12:40	4,86	12	58,27	CHI
201911356529	URUTAI	UT12-417470	PIRES DO RIO S2	29/11/2019 09:25	29/11/2019 20:50	29/11/2019 09:25	29/11/2019 20:50	11,41	2	22,83	CHI
201911356534	JATAI	JT12398520	JATAI S1	29/11/2019 09:28	29/11/2019 12:43	29/11/2019 09:28	29/11/2019 12:43	3,24	9	29,12	CHI
201911356535	ITABERAI	IB12379742	ITABERAI S2	29/11/2019 07:22	29/11/2019 10:22	29/11/2019 07:22	29/11/2019 10:22	2,99	189	565,74	CHI
201911356540	GOIANIA	10347483	CAMPINAS S1	29/11/2019 09:29	29/11/2019 12:15	29/11/2019 09:29	29/11/2019 12:15	2,75	1	2,75	CHI
201911356541	CAIAPONIA	PH12341859	PIRANHAS	29/11/2019 09:29	29/11/2019 12:24	29/11/2019 09:29	29/11/2019 12:24	2,91	7	20,35	CHI
201911356547	MORRINHOS	MR12032249	MORRINHOS	29/11/2019 09:30	29/11/2019 16:36	29/11/2019 09:30	29/11/2019 16:36	7,09	14	99,27	CHI
201911356552	SANTA HELENA DE GOIAS	SH12279531	IPEGUARI	29/11/2019 09:30	29/11/2019 15:30	29/11/2019 09:30	29/11/2019 15:30	5,99	3	17,98	CHI
201911356609	RIO VERDE	10011584210	RIO VERDE S1	29/11/2019 09:32	29/11/2019 12:59	29/11/2019 09:32	29/11/2019 12:59	3,43	1	3,43	CHI
201911356610	SAO DOMINGOS	SD12262409	SAO DOMINGOS	29/11/2019 07:13	29/11/2019 12:29	29/11/2019 07:13	29/11/2019 12:29	5,26	70	368,26	CHI
201911356610	GUARANI DE GOIAS	SD12262409	SAO DOMINGOS	29/11/2019 07:13	29/11/2019 12:29	29/11/2019 07:13	29/11/2019 12:29	5,26	3	15,78	CHI
201911356617	MONTIVIDIU	MV12214245	MONTIVIDIU T	29/11/2019 09:34	29/11/2019 14:01	29/11/2019 09:34	29/11/2019 14:01	4,44	14	62,15	CHI
201911356620	VARJAO	VJ31066180	GUAPO S2	29/11/2019 09:35	29/11/2019 16:42	29/11/2019 09:35	29/11/2019 16:42	7,12	1	7,12	CHI
201911356626	SENADOR CANEDO	SW31060066	GOIANIA LESTE S1	29/11/2019 09:35	29/11/2019 13:36	29/11/2019 09:35	29/11/2019 13:36	4,01	2	8,01	CHI
201911356628	ARUANA	10010764290	ARUANA	29/11/2019 09:35	29/11/2019 11:36	29/11/2019 09:35	29/11/2019 11:36	2,00	1	2,00	CHI
201911356630	ANICUNS	AC12391525	FIRMINOPOLIS S2	29/11/2019 09:26	29/11/2019 16:07	29/11/2019 09:26	29/11/2019 16:07	6,68	3	20,03	CHI
201911356632	CROMINIA	520001126	PONTALINA	29/11/2019 09:37	29/11/2019 10:34	29/11/2019 09:37	29/11/2019 10:34	0,95	1	0,95	CHI
201911356633	GOIANIA	11277968	CAMPINAS S3	29/11/2019 09:37	29/11/2019 11:52	29/11/2019 09:37	29/11/2019 11:52	2,25	1	2,25	CHI
201911356635	SAO LUIZ DO NORTE	DF21272180	BARRO ALTO	29/11/2019 09:37	29/11/2019 16:28	29/11/2019 09:37	29/11/2019 16:28	6,84	1	6,84	CHI
201911356636	CAMPO ALEGRE DE GOIAS	CM12338749	CAMPO ALEGRE DE GOIAS	29/11/2019 09:37	29/11/2019 12:35	29/11/2019 09:37	29/11/2019 12:35	2,96	2	5,92	CHI
201911356648	PIRANHAS	BM12212797	BOM JARDIM	29/11/2019 14:01	29/11/2019 17:41	29/11/2019 14:01	29/11/2019 17:41	3,67	2	7,35	CHI
201911356648	BOM JARDIM DE GOIAS	BM12212797	BOM JARDIM	29/11/2019 14:01	29/11/2019 17:41	29/11/2019 14:01	29/11/2019 17:41	3,67	87	319,56	CHI
201911356652	MORRO AGUDO DE GOIAS	RB12126565	RUBIATABA	29/11/2019 06:20	29/11/2019 17:10	29/11/2019 06:20	29/11/2019 17:10	10,82	4	43,29	CHI



201911356652	RUBIATABA	RB12126565	RUBIATABA	29/11/2019 06:20	29/11/2019 17:10	29/11/2019 06:20	29/11/2019 17:10	10,82	57	616,95	CHI
201911356660	CRIXAS	CX12163274	SANTA TEREZINHA	29/11/2019 06:00	30/11/2019 16:06	29/11/2019 06:00	30/11/2019 16:06	34,08	6	204,51	CHI
201911356661	LUZIANIA	7740003449	PIRES DO RIO S2	29/11/2019 09:41	30/11/2019 12:50	29/11/2019 09:41	30/11/2019 12:50	27,15	1	27,15	CHI
201911356664	CACHOEIRA DE GOIAS	AI12126017	FIRMINOPOLIS S2	29/11/2019 09:39	29/11/2019 13:30	29/11/2019 09:39	29/11/2019 13:30	3,83	4	15,34	CHI
201911356664	AURILANDIA	AI12126017	FIRMINOPOLIS S2	29/11/2019 09:39	29/11/2019 13:30	29/11/2019 09:39	29/11/2019 13:30	3,83	5	19,17	CHI
201911356668	GOIANDIRA	GD12400840	CATALAO S1	29/11/2019 09:41	29/11/2019 10:02	29/11/2019 09:41	29/11/2019 10:02	0,34	3	1,01	CHI
201911356670	PORANGATU	840030381	PORANGATU	29/11/2019 09:42	29/11/2019 16:22	29/11/2019 09:42	29/11/2019 16:22	6,65	1	6,65	CHI
201911356672	CAMPINACU	IH12250126	MINACU	29/11/2019 08:54	29/11/2019 11:48	29/11/2019 08:54	29/11/2019 11:48	2,88	9	25,96	CHI
201911356683	AGUAS LINDAS DE GOIAS	4830114394	AGUAS LINDAS DE GOIAS S1	29/11/2019 09:44	29/11/2019 10:33	29/11/2019 09:44	29/11/2019 10:33	0,80	1	0,80	CHI
201911356687	FIRMINOPOLIS	FR12000056	FIRMINOPOLIS S1	29/11/2019 09:22	29/11/2019 12:22	29/11/2019 09:22	29/11/2019 12:22	3,00	20	60,00	CHI
201911356692	FORMOSA	FA12376643	ITIQUEIRA	29/11/2019 08:45	29/11/2019 14:51	29/11/2019 08:45	29/11/2019 12:33	3,79	81	307,22	CHI
201911356692	FORMOSA	FA12376643	ITIQUEIRA	29/11/2019 08:45	29/11/2019 14:51	29/11/2019 08:45	29/11/2019 14:51	6,09	18	109,67	CHI
201911356696	URUACU	UR12266043	URUACU	29/11/2019 09:41	29/11/2019 14:51	29/11/2019 09:41	29/11/2019 14:51	5,15	16	82,41	CHI
201911356700	DIVINOPOLIS DE GOIAS	GH121255349	SAO DOMINGOS	29/11/2019 09:46	30/11/2019 19:37	29/11/2019 09:46	30/11/2019 19:37	33,84	1	33,84	CHI
201911356702	APARECIDA DE GOIANIA	10017334576	REAL S1	29/11/2019 09:46	29/11/2019 11:08	29/11/2019 09:46	29/11/2019 11:08	1,35	1	1,35	CHI
201911356704	MORRINHOS	MR21190901	GOIATUBA S2	29/11/2019 09:47	29/11/2019 13:35	29/11/2019 09:47	29/11/2019 13:35	3,79	1	3,79	CHI
201911356706	COCALZINHO DE GOIAS	ZN12344978	COCALZINHO	29/11/2019 09:47	29/11/2019 13:23	29/11/2019 09:47	29/11/2019 13:23	3,59	2	7,18	CHI
201911356711	LUZIANIA	LZ12313554	VIANOPOLIS	29/11/2019 09:48	29/11/2019 13:41	29/11/2019 09:48	29/11/2019 13:41	3,88	13	50,39	CHI
201911356712	RUBIATABA	780000020	RUBIATABA	29/11/2019 09:48	30/11/2019 10:57	29/11/2019 09:48	30/11/2019 10:57	25,14	1	25,14	CHI
201911356718	GOIANIA	12509632	GOIANIA LESTE S3	29/11/2019 09:49	29/11/2019 10:52	29/11/2019 09:49	29/11/2019 10:52	1,05	1	1,05	CHI
201911356719	DISTRITO FEDERAL	SN21314003	MARAJOARA	29/11/2019 09:49	29/11/2019 11:58	29/11/2019 09:49	29/11/2019 11:58	2,14	1	2,14	CHI
201911356725	TRES RANCHOS	TH121266789	CATALAO S1	29/11/2019 09:50	29/11/2019 18:05	29/11/2019 09:50	29/11/2019 18:05	8,25	1	8,25	CHI
201911356726	PIRENOPOLIS	PV21221471	CORUMBA	29/11/2019 09:50	30/11/2019 17:49	29/11/2019 09:50	30/11/2019 17:49	31,97	1	31,97	CHI
201911356727	IACIARA	1550017680	IACIARA S1	29/11/2019 09:50	29/11/2019 11:33	29/11/2019 09:50	29/11/2019 11:33	1,71	1	1,71	CHI
201911356731	NOVA ROMA	ND21360133	IACIARA S2	29/11/2019 09:50	29/11/2019 17:30	29/11/2019 09:50	29/11/2019 17:30	7,65	1	7,65	CHI
201911356736	ITABERAI	50070241	ITABERAI S2	29/11/2019 09:51	29/11/2019 12:13	29/11/2019 09:51	29/11/2019 12:13	2,36	1	2,36	CHI
201911356742	SANTA TEREZINHA DE GOIAS	SG11034165	SANTA TEREZINHA	29/11/2019 09:27	29/11/2019 11:54	29/11/2019 09:27	29/11/2019 11:54	2,45	195	477,48	CHI
201911356747	EDEIA	1120004140	EDEIA	29/11/2019 09:52	29/11/2019 11:01	29/11/2019 09:52	29/11/2019 11:01	1,13	1	1,13	CHI
201911356748	MINEIROS	MY11274022	PARQUE DAS EMAS	29/11/2019 09:53	29/11/2019 12:30	29/11/2019 09:53	29/11/2019 12:30	2,61	54	141,16	CHI
201911356754	MUTUNOPOLIS	MU12395764	MARA ROSA	29/11/2019 08:42	29/11/2019 18:01	29/11/2019 08:42	29/11/2019 18:01	9,31	9	83,75	CHI
201911356757	ITAPIRAPUA	IU21073756	MATRINCHA	29/11/2019 09:54	29/11/2019 18:50	29/11/2019 09:54	29/11/2019 18:50	8,93	1	8,93	CHI
201911356764	SAO DOMINGOS	SD121224217	SAO DOMINGOS	29/11/2019 09:55	29/11/2019 15:51	29/11/2019 09:55	29/11/2019 15:51	5,92	2	11,84	CHI
201911356767	PADRE BERNARDO	PB12376761	PADRE BERNARDO	29/11/2019 09:56	29/11/2019 11:30	29/11/2019 09:56	29/11/2019 11:30	1,56	5	7,78	CHI

201911356767	VILA PROPICIO	PB12376761	PADRE BERNARDO	29/11/2019 09:56	29/11/2019 11:30	29/11/2019 09:56	29/11/2019 11:30	1,56	1	1,56	CHI
201911356779	COLINAS DO SUL	TI21266443	MINACU	29/11/2019 09:58	30/11/2019 10:18	29/11/2019 09:58	30/11/2019 10:18	24,33	1	24,33	CHI
201911356781	FIRMINOPOLIS	FR12079136	FIRMINOPOLIS S1	29/11/2019 09:58	29/11/2019 13:40	29/11/2019 09:58	29/11/2019 13:40	3,69	2	7,38	CHI
201911356783	CAMPO ALEGRE DE GOIAS	CM12192738RE	CAMPO ALEGRE DE GOIAS	29/11/2019 07:32	29/11/2019 14:28	29/11/2019 07:32	29/11/2019 14:28	6,93	48	332,41	CHI
201911356784	FORMOSA	610230748	ITUIQUIRA	29/11/2019 09:59	29/11/2019 14:29	29/11/2019 09:59	29/11/2019 14:29	4,49	1	4,49	CHI
201911356787	SANTA CRUZ DE GOIAS	PR12337227	PIRES DO RIO S1	29/11/2019 09:19	29/11/2019 12:30	29/11/2019 09:19	29/11/2019 12:30	3,18	1	3,18	CHI
201911356787	URUTAI	PR12337227	PIRES DO RIO S1	29/11/2019 09:19	29/11/2019 12:30	29/11/2019 09:19	29/11/2019 12:30	3,18	1	3,18	CHI
201911356787	PIRES DO RIO	PR12337227	PIRES DO RIO S1	29/11/2019 09:19	29/11/2019 12:30	29/11/2019 09:19	29/11/2019 12:30	3,18	39	124,06	CHI
201911356788	PLANALTINA	TL12320532	SAO JOAO D ALIANCA	29/11/2019 09:59	29/11/2019 17:30	29/11/2019 09:59	29/11/2019 17:30	7,50	5	37,51	CHI
201911356789	NIQUELANDIA	NQ12265691	URUACU	29/11/2019 08:43	29/11/2019 21:58	29/11/2019 08:43	29/11/2019 21:58	13,24	17	225,02	CHI
201911356794	JARAGUA	II12217087	ITABERAI S1	29/11/2019 05:39	29/11/2019 12:47	29/11/2019 05:39	29/11/2019 12:47	7,13	92	655,60	CHI
201911356794	ITAGUARI	II12217087	ITABERAI S1	29/11/2019 05:39	29/11/2019 12:47	29/11/2019 05:39	29/11/2019 12:47	7,13	32	228,04	CHI
201911356794	TAQUARAL DE GOIAS	II12217087	ITABERAI S1	29/11/2019 05:39	29/11/2019 12:47	29/11/2019 05:39	29/11/2019 12:47	7,13	8	57,01	CHI
201911356797	ITUMBIARA	IT12198546	ITUMBIARA NOVA	29/11/2019 08:55	29/11/2019 11:20	29/11/2019 08:55	29/11/2019 11:20	2,40	136	326,66	CHI
201911356801	ARAGUAPAZ	AZ11210556	MOZARLANDIA	29/11/2019 09:35	29/11/2019 12:08	29/11/2019 09:35	29/11/2019 12:08	2,55	77	196,26	CHI
201911356802	FORMOSA	FA11341482	ITUIQUIRA	29/11/2019 18:36	29/11/2019 19:58	29/11/2019 18:36	29/11/2019 19:58	1,36	90	122,30	CHI
201911356804	SANTA CRUZ DE GOIAS	BC21231768	PIRES DO RIO S2	29/11/2019 10:03	29/11/2019 13:52	29/11/2019 10:03	29/11/2019 13:52	3,81	1	3,81	CHI
201911356805	SANTO ANTONIO DO DESCOBERTO	10003488630	ALEXANIA	29/11/2019 10:03	29/11/2019 11:29	29/11/2019 10:03	29/11/2019 11:29	1,43	1	1,43	CHI
201911356807	IPAMERI	IP12403326	PIRES DO RIO S2	29/11/2019 10:03	29/11/2019 15:40	29/11/2019 10:03	29/11/2019 15:40	5,61	3	16,82	CHI
201911356811	APARECIDA DE GOIANIA	AP11161915	INDEPENDENCIA S2	29/11/2019 10:03	29/11/2019 19:28	29/11/2019 10:03	29/11/2019 19:28	9,42	58	546,07	CHI
201911356820	VILA BOA	VB11270062	ITUIQUIRA	29/11/2019 10:05	29/11/2019 17:00	29/11/2019 10:05	29/11/2019 17:00	6,92	2	13,83	CHI
201911356821	MAIRIPOTABA	MI21109292	PONTALINA	29/11/2019 10:06	29/11/2019 13:17	29/11/2019 10:06	29/11/2019 13:17	3,18	1	3,18	CHI
201911356823	TURVELANDIA	EA12263286	RIO DOS BOIS	29/11/2019 10:06	29/11/2019 19:24	29/11/2019 10:06	29/11/2019 19:24	9,29	12	111,48	CHI
201911356823	EDEIA	EA12263286	RIO DOS BOIS	29/11/2019 10:06	29/11/2019 19:24	29/11/2019 10:06	29/11/2019 19:24	9,29	2	18,58	CHI
201911356824	SANTA BARBARA DE GOIAS	1030007692	TRINDADE	29/11/2019 10:06	29/11/2019 12:31	29/11/2019 10:06	29/11/2019 12:31	2,41	1	2,41	CHI
201911356825	JARAGUA	JA12000213	JARAGUA	29/11/2019 06:16	29/11/2019 14:32	29/11/2019 06:16	29/11/2019 14:32	8,26	3	24,79	CHI
201911356826	GOIANIA	10814255	GOIANIA LESTE S1	29/11/2019 10:06	29/11/2019 12:07	29/11/2019 10:06	29/11/2019 12:07	2,00	1	2,00	CHI
201911356827	NOVA AMERICA	NM12184696	RUBIATABA	29/11/2019 07:50	29/11/2019 14:15	29/11/2019 07:50	29/11/2019 14:15	6,41	7	44,89	CHI
201911356832	PARANAIGUARA	2230028530	CACHOEIRA ALTA	29/11/2019 10:07	30/11/2019 11:48	29/11/2019 10:07	30/11/2019 11:48	25,68	1	25,68	CHI
201911356838	ITAUCU	IX21102104	INHUMAS S1	29/11/2019 10:08	29/11/2019 16:58	29/11/2019 10:08	29/11/2019 16:58	6,83	1	6,83	CHI
201911356839	ITUMBIARA	IT12352729	ITUMBIARA VELHA S1	29/11/2019 10:08	29/11/2019 17:22	29/11/2019 10:08	29/11/2019 17:22	7,23	35	253,07	CHI
201911356841	FORMOSA	FA11361303	ITUIQUIRA	29/11/2019 10:08	29/11/2019 11:19	29/11/2019 10:08	29/11/2019 11:19	1,18	37	43,54	CHI
201911356842	PARAUNA	980011700	PARAUNA	29/11/2019 10:08	29/11/2019 12:54	29/11/2019 10:08	29/11/2019 12:54	2,77	1	2,77	CHI

201911356846	RIO VERDE	RV12271283	CABRIUVA S2	29/11/2019 08:42	29/11/2019 13:15	29/11/2019 08:42	29/11/2019 13:15	4,55	19	86,47	CHI
201911356904	CRISTALINA	KR21165521	CRISTALINA S2	29/11/2019 10:10	29/11/2019 14:04	29/11/2019 10:10	29/11/2019 14:04	3,89	1	3,89	CHI
201911356907	CAMPOS BELOS	CH21320565	SAO DOMINGOS	29/11/2019 10:10	29/11/2019 16:21	29/11/2019 10:10	29/11/2019 16:21	6,17	1	6,17	CHI
201911357001	VILA PROPICIO	NP21235916	GOIANESIA S1	29/11/2019 10:11	29/11/2019 16:11	29/11/2019 10:11	29/11/2019 16:11	6,00	1	6,00	CHI
201911357003	GOIATUBA	BJ21000094	BOM JESUS DE GOIAS	29/11/2019 10:11	29/11/2019 21:16	29/11/2019 10:11	29/11/2019 21:16	11,09	1	11,09	CHI
201911357207	PORANGATU	10022731316	PORANGATU	29/11/2019 10:12	29/11/2019 16:31	29/11/2019 10:12	29/11/2019 16:31	6,30	1	6,30	CHI
201911357210	AGUA FRIA DE GOIAS	TL21350079	SAO JOAO D ALIANCA	29/11/2019 10:13	29/11/2019 16:38	29/11/2019 10:13	29/11/2019 16:38	6,40	1	6,40	CHI
201911357211	FORMOSA	610208123	ITUIQUIRA	29/11/2019 10:14	29/11/2019 12:18	29/11/2019 10:14	29/11/2019 12:18	2,07	1	2,07	CHI
201911357214	NIQUELANDIA	NQ21359236	NIQUELANDIA SUBTRANSMISSAO	29/11/2019 10:15	30/11/2019 08:49	29/11/2019 10:15	30/11/2019 08:49	22,56	1	22,56	CHI
201911357217	PONTALINA	PK21088491	VICENTINOPOLIS	29/11/2019 10:16	29/11/2019 14:30	29/11/2019 10:16	29/11/2019 14:30	4,23	1	4,23	CHI
201911357221	APARECIDA DE GOIANIA	10025751040	INDEPENDENCIA S1	29/11/2019 10:16	29/11/2019 11:36	29/11/2019 10:16	29/11/2019 11:36	1,32	1	1,32	CHI
201911357224	FAINA	MP21083971	MATRINCHA	29/11/2019 10:17	29/11/2019 16:23	29/11/2019 10:17	29/11/2019 16:23	6,10	1	6,10	CHI
201911357228	QUIRINOPOLIS	80051765	QUIRINOPOLIS	29/11/2019 10:18	29/11/2019 11:04	29/11/2019 10:18	29/11/2019 11:04	0,77	1	0,77	CHI
201911357230	CIDADE OCIDENTAL	DH12313967	MARAJOARA	29/11/2019 10:18	29/11/2019 12:56	29/11/2019 10:18	29/11/2019 12:56	2,63	1	2,63	CHI
201911357233	CACHOEIRA DOURADA	CD11352705	CACHOEIRA DOURADA	29/11/2019 10:18	29/11/2019 13:03	29/11/2019 10:18	29/11/2019 13:03	2,75	85	233,37	CHI
201911357240	PALESTINA DE GOIAS	930027322	PALESTINA	29/11/2019 10:20	29/11/2019 13:20	29/11/2019 10:20	29/11/2019 13:20	3,01	1	3,01	CHI
201911357243	LUZIANIA	LZ21348414	MARAJOARA	29/11/2019 10:08	29/11/2019 11:39	29/11/2019 10:08	29/11/2019 11:39	1,51	1	1,51	CHI
201911357245	BRAZABRANTES	BR11101109	NEROPOLIS S1	29/11/2019 10:20	29/11/2019 12:37	29/11/2019 10:20	29/11/2019 12:37	2,29	60	137,25	CHI
201911357254	LUZIANIA	LZ11290535	MARAJOARA	29/11/2019 10:21	29/11/2019 11:11	29/11/2019 10:21	29/11/2019 11:11	0,82	26	21,29	CHI
201911357257	VALPARAISO DE GOIAS	2860022000	PACAEMBU S1	29/11/2019 10:22	29/11/2019 18:52	29/11/2019 10:22	29/11/2019 18:52	8,49	1	8,49	CHI
201911357261	IPAMERI	IP12071421	IPAMERI	29/11/2019 10:23	29/11/2019 17:29	29/11/2019 10:23	29/11/2019 17:29	7,10	3	21,30	CHI
201911357264	CORUMBA DE GOIAS	CB21191475	CORUMBA	29/11/2019 10:23	29/11/2019 16:35	29/11/2019 10:23	29/11/2019 16:35	6,19	2	12,38	CHI
201911357267	ISRAELANDIA	IS12089375	IPORA	29/11/2019 09:00	29/11/2019 13:32	29/11/2019 09:00	29/11/2019 13:32	4,52	18	81,39	CHI
201911357274	NIQUELANDIA	NQ12262783	URUACU	29/11/2019 07:41	29/11/2019 19:36	29/11/2019 07:41	29/11/2019 19:36	11,91	2	23,82	CHI
201911357284	GOIANIA	10011493958	ATLANTICO S3	29/11/2019 10:27	29/11/2019 13:15	29/11/2019 10:27	29/11/2019 13:15	2,79	1	2,79	CHI
201911357289	ITAPACI	IW21335695	ITAPACI	29/11/2019 10:28	30/11/2019 10:30	29/11/2019 10:28	30/11/2019 10:30	24,02	1	24,02	CHI
201911357292	JUSSARA	JR21020187	JUSSARA	29/11/2019 10:29	29/11/2019 21:45	29/11/2019 10:29	29/11/2019 21:45	11,27	1	11,27	CHI
201911357293	ANICUNS	AC21159712	ANICUNS	29/11/2019 10:29	29/11/2019 15:48	29/11/2019 10:29	29/11/2019 15:48	5,32	1	5,32	CHI
201911357295	NIQUELANDIA	NQ12335416	BARRO ALTO	29/11/2019 10:29	29/11/2019 13:56	29/11/2019 10:29	29/11/2019 13:56	3,45	10	34,46	CHI
201911357297	RIO VERDE	630146688	RIO VERDE S1	29/11/2019 10:29	29/11/2019 12:06	29/11/2019 10:29	29/11/2019 12:06	1,61	1	1,61	CHI
201911357300	PIRES DO RIO	PR12000076	PIRES DO RIO S1	29/11/2019 10:29	29/11/2019 17:43	29/11/2019 10:29	29/11/2019 17:43	7,22	2	14,44	CHI
201911357301	MONTE ALEGRE DE GOIAS	MA21352885	SAO DOMINGOS	29/11/2019 10:29	29/11/2019 16:25	29/11/2019 10:29	29/11/2019 16:25	5,92	1	5,92	CHI
201911357303	ANAPOLIS	AN11000241	ANAPOLIS UNIVERSITARIO S1	29/11/2019 10:24	30/11/2019 09:30	29/11/2019 10:24	30/11/2019 09:30	23,09	135	3116,55	CHI

201911357309	LUZIANIA	LZ12375907	VIANOPOLIS	29/11/2019 10:31	29/11/2019 15:36	29/11/2019 10:31	29/11/2019 15:36	5,07	2	10,13	CHI
201911357318	VALPARAISO DE GOIAS	VA12199513	PACAEMBU S1	29/11/2019 09:42	29/11/2019 11:31	29/11/2019 09:42	29/11/2019 11:31	1,80	297	535,59	CHI
201911357324	FIRMINOPOLIS	900015858	FIRMINOPOLIS S1	29/11/2019 10:34	29/11/2019 11:48	29/11/2019 10:34	29/11/2019 11:48	1,24	1	1,24	CHI
201911357327	CATALAO	1990201146	CATALAO S2	29/11/2019 10:35	29/11/2019 17:26	29/11/2019 10:35	29/11/2019 17:26	6,86	1	6,86	CHI
201911357330	CRISTALINA	IP21147561	CRISTALINA S1	29/11/2019 10:35	29/11/2019 12:30	29/11/2019 10:35	29/11/2019 12:30	1,91	1	1,91	CHI
201911357339	ANICUNS	AC21259987	ANICUNS	29/11/2019 10:37	29/11/2019 19:34	29/11/2019 10:37	29/11/2019 19:34	8,95	1	8,95	CHI
201911357340	CAMPOS BELOS	CH12000017	SAO DOMINGOS	29/11/2019 09:45	29/11/2019 13:29	29/11/2019 09:45	29/11/2019 13:29	3,72	7	26,05	CHI
201911357342	PALMEIRAS DE GOIAS	PL21085267	PALMEIRAS	29/11/2019 10:38	29/11/2019 12:59	29/11/2019 10:38	29/11/2019 12:59	2,35	1	2,35	CHI
201911357344	NOVA ROMA	ND12051336	IACIARA S2	29/11/2019 06:26	29/11/2019 12:35	29/11/2019 06:26	29/11/2019 12:35	6,14	5	30,68	CHI
201911357345	INHUMAS	30133660	INHUMAS S2	29/11/2019 10:39	29/11/2019 14:48	29/11/2019 10:39	29/11/2019 14:48	4,16	1	4,16	CHI
201911357354	GOIAS	90061871	GOIAS	29/11/2019 10:40	29/11/2019 18:52	29/11/2019 10:40	29/11/2019 18:52	8,19	1	8,19	CHI
201911357357	DIVINOPOLIS DE GOIAS	GH11272659	SAO DOMINGOS	29/11/2019 10:42	30/11/2019 13:57	29/11/2019 10:42	30/11/2019 13:57	27,24	1	27,24	CHI
201911357365	VIANOPOLIS	VN21289086	VIANOPOLIS	29/11/2019 10:43	29/11/2019 15:08	29/11/2019 10:43	29/11/2019 15:08	4,40	1	4,40	CHI
201911357367	DIVINOPOLIS DE GOIAS	GH12389051	SAO DOMINGOS	29/11/2019 10:38	30/11/2019 10:06	29/11/2019 10:38	30/11/2019 10:06	23,47	23	539,71	CHI
201911357368	JARAGUA	JA21158318	JARAGUA	29/11/2019 10:44	30/11/2019 16:08	29/11/2019 10:44	30/11/2019 16:08	29,39	2	58,78	CHI
201911357370	PLANALTINA	PI21229580	SAO JOAO D ALIANCA	29/11/2019 10:44	29/11/2019 19:50	29/11/2019 10:44	29/11/2019 19:50	9,08	1	9,08	CHI
201911357373	ITAGUARI	IC12035368	ITABERAI S1	29/11/2019 04:58	29/11/2019 14:03	29/11/2019 04:58	29/11/2019 14:03	9,08	27	245,17	CHI
201911357373	JARAGUA	IC12035368	ITABERAI S1	29/11/2019 04:58	29/11/2019 14:03	29/11/2019 04:58	29/11/2019 14:03	9,08	8	72,64	CHI
201911357378	CAIAPONIA	CP21354367	CAIAPONIA	29/11/2019 10:46	29/11/2019 15:20	29/11/2019 10:46	29/11/2019 15:20	4,55	1	4,55	CHI
201911357379	NEROPOLIS	NR11104451	NEROPOLIS S2	29/11/2019 10:47	29/11/2019 12:14	29/11/2019 10:47	29/11/2019 12:14	1,44	18	25,99	CHI
201911357384	BOM JESUS DE GOIAS	BJ21218246	BOM JESUS DE GOIAS	29/11/2019 10:47	29/11/2019 12:42	29/11/2019 10:47	29/11/2019 12:42	1,90	1	1,90	CHI
201911357385	GUARINOS	GF12051406	SANTA TEREZINHA	29/11/2019 10:48	29/11/2019 15:57	29/11/2019 10:48	29/11/2019 15:57	5,15	9	46,36	CHI
201911357385	SANTA TEREZINHA DE GOIAS	GF12051406	SANTA TEREZINHA	29/11/2019 10:48	29/11/2019 15:57	29/11/2019 10:48	29/11/2019 15:57	5,15	3	15,45	CHI
201911357388	VILA PROPICIO	NP21235946	GOIANESIA S2	29/11/2019 10:49	29/11/2019 17:05	29/11/2019 10:49	29/11/2019 17:05	6,26	1	6,26	CHI
201911357392	GOIANIA	16200664	CARAJAS S1	29/11/2019 10:49	29/11/2019 16:51	29/11/2019 10:49	29/11/2019 16:51	6,03	1	6,03	CHI
201911357393	COCALZINHO DE GOIAS	ZN12338822	COCALZINHO	29/11/2019 09:31	30/11/2019 19:19	29/11/2019 09:31	30/11/2019 19:19	33,79	7	236,55	CHI
201911357399	CRISTALINA	KR11376948	CRISTALINA S2	29/11/2019 10:51	29/11/2019 16:42	29/11/2019 10:51	29/11/2019 16:42	5,85	1	5,85	CHI
201911357405	ANAPOLIS	AN12000688	JUNDIAI S1	29/11/2019 09:01	29/11/2019 12:42	29/11/2019 09:01	29/11/2019 12:42	3,68	289	1064,16	CHI
201911357419	NOVO PLANALTO	SM12328903	SAO MIGUEL DO ARAGUAIA	29/11/2019 08:42	30/11/2019 12:02	29/11/2019 08:42	30/11/2019 12:02	27,32	10	273,24	CHI
201911357425	GOIANIA	11079484	ATLANTICO S2	29/11/2019 10:55	29/11/2019 15:40	29/11/2019 10:55	29/11/2019 15:40	4,74	1	4,74	CHI
201911357429	CORUMBA DE GOIAS	CB12384883	CORUMBA	29/11/2019 17:00	29/11/2019 18:45	29/11/2019 17:00	29/11/2019 18:45	1,75	2	3,50	CHI
201911357430	RIO VERDE	SH12301407	SANTA HELENA S1	29/11/2019 10:51	29/11/2019 15:42	29/11/2019 10:51	29/11/2019 15:42	4,86	3	14,57	CHI
201911357430	SANTA HELENA DE GOIAS	SH12301407	SANTA HELENA S1	29/11/2019 10:51	29/11/2019 15:42	29/11/2019 10:51	29/11/2019 15:42	4,86	10	48,57	CHI

201911357431	CUMARI	CY12064048	CATALAO S2	29/11/2019 10:57	29/11/2019 13:36	29/11/2019 10:57	29/11/2019 13:36	2,65	3	7,95	CHI
201911357431	CATALAO	CY12064048	CATALAO S2	29/11/2019 10:57	29/11/2019 13:36	29/11/2019 10:57	29/11/2019 13:36	2,65	3	7,95	CHI
201911357435	CALDAS NOVAS	CN12200060RE	CALDAS NOVAS S2	29/11/2019 10:57	29/11/2019 16:07	29/11/2019 10:57	29/11/2019 16:07	5,17	137	707,91	CHI
201911357435	PIRACANJUBA	CN12200060RE	CALDAS NOVAS S2	29/11/2019 10:57	29/11/2019 16:07	29/11/2019 10:57	29/11/2019 16:07	5,17	2	10,33	CHI
201911357437	CATALAO	1990202497	CATALAO S2	29/11/2019 10:58	29/11/2019 15:05	29/11/2019 10:58	29/11/2019 15:05	4,11	1	4,11	CHI
201911357438	GOIANIA	17470006	XAVANTES	29/11/2019 10:58	29/11/2019 11:51	29/11/2019 10:58	29/11/2019 11:51	0,88	1	0,88	CHI
201911357449	SAO DOMINGOS	SD12302841	SAO DOMINGOS	29/11/2019 11:00	29/11/2019 21:38	29/11/2019 11:00	29/11/2019 21:38	10,63	45	478,36	CHI
201911357453	SAO DOMINGOS	GY21332262	SAO DOMINGOS	29/11/2019 11:01	30/11/2019 10:04	29/11/2019 11:01	30/11/2019 10:04	23,03	1	23,03	CHI
201911357457	NOVO GAMA	LZ21206564	PACAEMBU S1	29/11/2019 11:03	29/11/2019 13:56	29/11/2019 11:03	29/11/2019 13:56	2,88	1	2,88	CHI
201911357476	PORANGATU	840048981	PORANGATU	29/11/2019 11:07	29/11/2019 17:35	29/11/2019 11:07	29/11/2019 17:35	6,46	1	6,46	CHI
201911357479	SAO JOAO D ALIANCA	JL11218462	SAO JOAO D ALIANCA	29/11/2019 11:08	29/11/2019 20:55	29/11/2019 11:08	29/11/2019 20:55	9,78	3	29,34	CHI
201911357482	SANTA HELENA DE GOIAS	SH12279533	IPEGUARI	29/11/2019 09:30	29/11/2019 14:45	29/11/2019 09:30	29/11/2019 14:45	5,24	32	167,72	CHI
201911357488	QUIRINOPOLIS	QI12070710	CACHOEIRA ALTA	29/11/2019 11:09	30/11/2019 15:41	29/11/2019 11:09	30/11/2019 15:41	28,52	8	228,15	CHI
201911357498	EDEIA	EA11257914	EDEIA	29/11/2019 11:12	29/11/2019 19:30	29/11/2019 11:12	29/11/2019 19:06	7,90	51	403,14	CHI
201911357498	EDEIA	EA12068777	EDEIA	29/11/2019 11:12	29/11/2019 19:30	29/11/2019 19:07	29/11/2019 19:30	0,39	15	5,85	CHI
201911357499	APARECIDA DE GOIANIA	13927590	ANHANGUERA	29/11/2019 11:12	29/11/2019 12:30	29/11/2019 11:12	29/11/2019 12:30	1,29	1	1,29	CHI
201911357500	NIQUELANDIA	NQ12235112	URUACU	29/11/2019 11:12	30/11/2019 02:38	29/11/2019 11:12	30/11/2019 02:38	15,43	11	169,70	CHI
201911357505	SANTA TEREZINHA DE GOIAS	SG12390506	SANTA TEREZINHA	29/11/2019 09:28	29/11/2019 19:59	29/11/2019 09:28	29/11/2019 19:59	10,52	49	515,25	CHI
201911357505	PILAR DE GOIAS	SG12390506	SANTA TEREZINHA	29/11/2019 09:28	29/11/2019 19:59	29/11/2019 09:28	29/11/2019 19:59	10,52	3	31,55	CHI
201911357510	SAO MIGUEL DO ARAGUAIA	SM12245701	SAO MIGUEL DO ARAGUAIA	29/11/2019 09:17	29/11/2019 13:55	29/11/2019 09:17	29/11/2019 13:55	4,62	7	32,35	CHI
201911357512	ARAGOIANIA	AO31087604	GUAPO S2	29/11/2019 11:15	29/11/2019 13:00	29/11/2019 11:15	29/11/2019 13:00	1,75	3	5,25	CHI
201911357536	NOVA CRIXAS	NA12320912	NOVA CRIXAS	29/11/2019 07:14	01/12/2019 09:22	29/11/2019 07:14	01/12/2019 09:22	50,13	2	100,26	CHI
201911357538	MARA ROSA	MQ21338228	MARA ROSA	29/11/2019 11:20	30/11/2019 09:14	29/11/2019 11:20	30/11/2019 09:14	21,88	1	21,88	CHI
201911357540	PALMINOPOLIS	PP21391020	PALMEIRAS	29/11/2019 11:21	29/11/2019 14:30	29/11/2019 11:21	29/11/2019 14:30	3,14	1	3,14	CHI
201911357546	INHUMAS	IX12016404	INHUMAS S1	29/11/2019 11:22	29/11/2019 19:04	29/11/2019 11:22	29/11/2019 19:04	7,69	1	7,69	CHI
201911357546	ITAUCU	IX12016404	INHUMAS S1	29/11/2019 11:22	29/11/2019 19:04	29/11/2019 11:22	29/11/2019 19:04	7,69	4	30,75	CHI
201911357550	AGUAS LINDAS DE GOIAS	4830227115	AGUAS LINDAS DE GOIAS S1	29/11/2019 11:23	29/11/2019 12:21	29/11/2019 11:23	29/11/2019 12:21	0,96	1	0,96	CHI
201911357554	PORTELANDIA	PW12301806	PARQUE DAS EMAS	29/11/2019 11:24	30/11/2019 10:30	29/11/2019 11:24	30/11/2019 10:30	23,09	4	92,38	CHI
201911357555	RIO VERDE	RV21249080	CABRIUVA S2	29/11/2019 11:24	29/11/2019 14:59	29/11/2019 11:24	29/11/2019 14:59	3,58	1	3,58	CHI
201911357566	URUACU	640060377	URUACU	29/11/2019 11:27	29/11/2019 16:32	29/11/2019 11:27	29/11/2019 16:32	5,08	1	5,08	CHI
201911357569	CAIAPONIA	MV13305749	MONTIVIDIU T	29/11/2019 11:19	30/11/2019 13:20	29/11/2019 11:19	29/11/2019 19:10	7,84	35	274,46	CHI
201911357569	PARAUNA	MV13305749	MONTIVIDIU T	29/11/2019 11:19	30/11/2019 13:20	29/11/2019 11:19	29/11/2019 19:10	7,84	88	690,07	CHI
201911357569	IVOLANDIA	MV13305749	MONTIVIDIU T	29/11/2019 11:19	30/11/2019 13:20	29/11/2019 11:19	29/11/2019 19:10	7,84	29	227,41	CHI

201911357569	MONTIVIDIU	MV13305749	MONTIVIDIU T	29/11/2019 11:19	30/11/2019 13:20	29/11/2019 11:19	29/11/2019 19:10	7,84	23	180,36	CHI
201911357569	RIO VERDE	MV13305749	MONTIVIDIU T	29/11/2019 11:19	30/11/2019 13:20	29/11/2019 11:19	29/11/2019 19:10	7,84	1	7,84	CHI
201911357569	RIO VERDE	RV10400619	MONTIVIDIU T	29/11/2019 11:19	30/11/2019 13:20	29/11/2019 11:19	29/11/2019 23:15	11,92	23	274,27	CHI
201911357569	PARAUNA	RV10400619	MONTIVIDIU T	29/11/2019 11:19	30/11/2019 13:20	29/11/2019 11:19	29/11/2019 23:15	11,92	2	23,85	CHI
201911357569	PARAUNA	RV10400619	MONTIVIDIU T	29/11/2019 11:19	30/11/2019 13:20	29/11/2019 11:19	30/11/2019 13:20	26,01	54	1404,46	CHI
201911357569	RIO VERDE	RV10400619	MONTIVIDIU T	29/11/2019 11:19	30/11/2019 13:20	29/11/2019 11:19	30/11/2019 13:20	26,01	112	2912,96	CHI
201911357571	RIO VERDE	RV21260752	RIO VERDE S1	29/11/2019 11:28	29/11/2019 14:45	29/11/2019 11:28	29/11/2019 14:45	3,28	1	3,28	CHI
201911357578	CAMPOS VERDES	UP10398079	SANTA TEREZINHA	29/11/2019 11:15	29/11/2019 11:21	29/11/2019 11:15	29/11/2019 11:21	0,11	1	0,11	CHI
201911357578	MARA ROSA	UP10398079	SANTA TEREZINHA	29/11/2019 11:15	29/11/2019 11:21	29/11/2019 11:15	29/11/2019 11:21	0,11	76	8,47	CHI
201911357578	SANTA TEREZINHA DE GOIAS	UP10398079	SANTA TEREZINHA	29/11/2019 11:15	29/11/2019 11:21	29/11/2019 11:15	29/11/2019 11:21	0,11	116	12,92	CHI
201911357578	UIRAPURU	UP10398079	SANTA TEREZINHA	29/11/2019 11:15	29/11/2019 11:21	29/11/2019 11:15	29/11/2019 11:21	0,11	18	2,01	CHI
201911357582	IPAMERI	IP12112265RE	CAMPO ALEGRE DE GOIAS	29/11/2019 11:28	30/11/2019 13:53	29/11/2019 11:28	30/11/2019 13:53	26,41	30	792,17	CHI
201911357587	PALESTINA DE GOIAS	PY12354642	PALESTINA	29/11/2019 11:28	29/11/2019 17:40	29/11/2019 11:28	29/11/2019 17:40	6,19	11	68,09	CHI
201911357587	CAIAPONIA	PY12354642	PALESTINA	29/11/2019 11:28	29/11/2019 17:40	29/11/2019 11:28	29/11/2019 17:40	6,19	18	111,42	CHI
201911357589	ANAPOLIS	AN11068145	ANAPOLIS UNIVERSITARIO S2	29/11/2019 11:27	29/11/2019 12:59	29/11/2019 11:27	29/11/2019 12:59	1,53	199	304,41	CHI
201911357599	GOIANESIA	550019091	GOIANESIA S2	29/11/2019 11:32	29/11/2019 13:40	29/11/2019 11:32	29/11/2019 13:40	2,14	1	2,14	CHI
201911357607	RUBIATABA	RB12003316	RUBIATABA	29/11/2019 11:33	29/11/2019 18:04	29/11/2019 11:33	29/11/2019 18:04	6,51	45	292,83	CHI
201911357608	MOIPIORA	CO12079990	SAO LUIZ DOS MONTES BELOS	29/11/2019 10:27	29/11/2019 15:45	29/11/2019 10:27	29/11/2019 15:45	5,30	2	10,59	CHI
201911357608	CORREGO DO OURO	CO12079990	SAO LUIZ DOS MONTES BELOS	29/11/2019 10:27	29/11/2019 15:45	29/11/2019 10:27	29/11/2019 15:45	5,30	35	185,39	CHI
201911357610	MINEIROS	MY10401496	PARQUE DAS EMAS	29/11/2019 11:30	30/11/2019 21:12	29/11/2019 11:30	29/11/2019 20:48	9,31	17	158,29	CHI
201911357610	MINEIROS	MY13311798	PARQUE DAS EMAS	29/11/2019 11:30	30/11/2019 21:12	29/11/2019 11:30	30/11/2019 21:12	33,70	5	168,48	CHI
201911357612	INDIARA	IY12312450	CEZARINA	29/11/2019 11:34	29/11/2019 20:33	29/11/2019 11:34	29/11/2019 20:33	8,98	27	242,47	CHI
201911357614	NIQUELANDIA	10023970535	NIQUELANDIA SUBTRANSMISSAO	29/11/2019 11:35	30/11/2019 00:48	29/11/2019 11:35	30/11/2019 00:48	13,22	1	13,22	CHI
201911357615	CAVALCANTE	CJ12239935	FLORES DE GOIAS	29/11/2019 11:35	29/11/2019 14:53	29/11/2019 11:35	29/11/2019 14:53	3,29	121	398,19	CHI
201911357616	QUIRINOPOLIS	10024114594	QUIRINOPOLIS	29/11/2019 11:35	30/11/2019 09:03	29/11/2019 11:35	30/11/2019 09:03	21,45	1	21,45	CHI
201911357619	PIRES DO RIO	460116599	PIRES DO RIO S1	29/11/2019 11:36	29/11/2019 15:49	29/11/2019 11:36	29/11/2019 15:49	4,22	1	4,22	CHI
201911357623	MARA ROSA	2260007412	MARA ROSA	29/11/2019 11:36	29/11/2019 18:58	29/11/2019 11:36	29/11/2019 18:58	7,36	1	7,36	CHI
201911357626	COCALZINHO DE GOIAS	ZN11315330	GOIANESIA S1	29/11/2019 11:36	30/11/2019 11:02	29/11/2019 11:36	30/11/2019 11:02	23,43	1	23,43	CHI
201911357634	MINACU	IH12230531	MINACU	29/11/2019 11:38	30/11/2019 11:27	29/11/2019 11:38	30/11/2019 11:27	23,81	4	95,22	CHI
201911357635	APARECIDA DE GOIANIA	10010884015	ANHANGUERA	29/11/2019 11:39	29/11/2019 13:38	29/11/2019 11:39	29/11/2019 13:38	1,98	1	1,98	CHI
201911357637	SAO SIMAO	SO12261031	CACHOEIRA ALTA	29/11/2019 11:39	30/11/2019 09:54	29/11/2019 11:39	30/11/2019 09:54	22,24	2	44,48	CHI
201911357638	PARAUNA	PU21159276	PARAUNA	29/11/2019 11:39	29/11/2019 22:20	29/11/2019 11:39	29/11/2019 22:20	10,68	1	10,68	CHI
201911357639	AGUAS LINDAS DE GOIAS	4830223626	AGUAS LINDAS DE GOIAS S1	29/11/2019 11:40	29/11/2019 13:39	29/11/2019 11:40	29/11/2019 13:39	1,98	1	1,98	CHI

201911357643	CRISTALINA	KR21133628	CRISTALINA S2	29/11/2019 11:40	29/11/2019 16:36	29/11/2019 11:40	29/11/2019 16:36	4,93	1	4,93	CHI
201911357644	PILAR DE GOIAS	GG21138220	SANTA TEREZINHA	29/11/2019 11:40	01/12/2019 14:31	29/11/2019 11:40	01/12/2019 14:31	50,84	1	50,84	CHI
201911357647	CATALAO	OU21152795	CATALAO S1	29/11/2019 11:40	29/11/2019 16:52	29/11/2019 11:40	29/11/2019 16:52	5,19	1	5,19	CHI
201911357653	CAIAPONIA	CP11020859	CAIAPONIA	29/11/2019 11:41	29/11/2019 15:20	29/11/2019 11:41	29/11/2019 15:20	3,64	111	403,55	CHI
201911357657	CIDADE OCIDENTAL	03890214	MARAJOARA	29/11/2019 11:42	29/11/2019 15:10	29/11/2019 11:42	29/11/2019 15:10	3,46	120	415,17	CHI
201911357657	CRISTALINA	03890214	MARAJOARA	29/11/2019 11:42	29/11/2019 15:10	29/11/2019 11:42	29/11/2019 15:10	3,46	33	114,17	CHI
201911357657	LUZIANIA	03890214	MARAJOARA	29/11/2019 11:42	29/11/2019 15:10	29/11/2019 11:42	29/11/2019 15:10	3,46	163	563,93	CHI
201911357662	GOIANIA	13547756	GOIANIA LESTE S3	29/11/2019 11:43	29/11/2019 12:55	29/11/2019 11:43	29/11/2019 12:55	1,21	1	1,21	CHI
201911357672	PILAR DE GOIAS	GG12245205	SANTA TEREZINHA	29/11/2019 10:17	30/11/2019 08:55	29/11/2019 10:17	30/11/2019 08:55	22,62	15	339,32	CHI
201911357673	URUACU	UR12186974	MARA ROSA	29/11/2019 11:30	29/11/2019 15:53	29/11/2019 11:30	29/11/2019 15:53	4,38	31	135,81	CHI
201911357681	ALEXANIA	AX21000141	ALEXANIA	29/11/2019 11:47	29/11/2019 22:16	29/11/2019 11:47	29/11/2019 22:16	10,48	2	20,96	CHI
201911357684	CATALAO	9580011430	CATALAO S1	29/11/2019 11:47	30/11/2019 16:53	29/11/2019 11:47	30/11/2019 16:53	29,10	1	29,10	CHI
201911357687	GOIANIA	12911290	MEIA PONTE	29/11/2019 11:48	29/11/2019 13:25	29/11/2019 11:48	29/11/2019 13:25	1,61	1	1,61	CHI
201911357693	RIO VERDE	RV12074513	RIO VERDE S1	29/11/2019 09:19	29/11/2019 11:51	29/11/2019 09:19	29/11/2019 11:51	2,54	1	2,54	CHI
201911357696	GOIAS	GS12378886	MATRINCHA	29/11/2019 05:50	29/11/2019 14:39	29/11/2019 05:50	29/11/2019 14:39	8,80	4	35,21	CHI
201911357707	ITUMBIARA	IT11000137	ITUMBIARA NOVA	29/11/2019 11:49	29/11/2019 13:52	29/11/2019 11:49	29/11/2019 13:52	2,04	100	203,89	CHI
201911357729	BARRO ALTO	BA12342218	GOIANESIA S1	29/11/2019 13:46	29/11/2019 14:12	29/11/2019 13:46	29/11/2019 14:12	0,43	3	1,30	CHI
201911357754	NOVA CRIXAS	NA12377684LD	NOVA CRIXAS	29/11/2019 15:51	30/11/2019 08:53	29/11/2019 15:51	30/11/2019 08:21	16,50	95	1567,26	CHI
201911357754	NOVA CRIXAS	NA12391973	NOVA CRIXAS	29/11/2019 15:51	30/11/2019 08:53	29/11/2019 15:53	30/11/2019 08:53	17,00	15	255,00	CHI
201911357774	PLANALTINA	PI11164618	PLANALTINA	29/11/2019 16:15	29/11/2019 18:50	29/11/2019 16:15	29/11/2019 18:50	2,59	78	201,65	CHI
201911357789	ITAPACI	IW21405389	ITAPACI	29/11/2019 10:04	30/11/2019 11:04	29/11/2019 10:04	30/11/2019 11:04	25,01	1	25,01	CHI
201911357790	GOIANIA	GN11157952	GOIANIA LESTE S3	29/11/2019 16:49	29/11/2019 17:53	29/11/2019 16:49	29/11/2019 17:53	1,07	17	18,12	CHI
201911357798	BALIZA	BH12358780	BOM JARDIM	29/11/2019 06:53	30/11/2019 07:43	29/11/2019 06:53	30/11/2019 07:43	24,82	19	471,59	CHI
201911357803	CACU	CC12080194LD	CACHOEIRA ALTA	29/11/2019 11:51	01/12/2019 15:45	29/11/2019 11:51	29/11/2019 11:59	0,14	2	0,28	CHI
201911357803	QUIRINOPOLIS	CC10394736	CACHOEIRA ALTA	29/11/2019 11:51	01/12/2019 15:45	30/11/2019 21:20	01/12/2019 15:40	18,34	1	18,34	CHI
201911357803	CACU	CC10394736	CACHOEIRA ALTA	29/11/2019 11:51	01/12/2019 15:45	30/11/2019 21:20	01/12/2019 15:40	18,34	393	7206,42	CHI
201911357803	CACU	CC13306262	CACHOEIRA ALTA	29/11/2019 11:51	01/12/2019 15:45	29/11/2019 12:08	01/12/2019 15:45	51,61	2	103,23	CHI
201911357803	CACU	CC13306262	CACHOEIRA ALTA	29/11/2019 11:51	01/12/2019 15:45	30/11/2019 21:20	01/12/2019 15:45	18,42	61	1123,47	CHI
201911357803	CACU	CC13306262	CACHOEIRA ALTA	29/11/2019 11:51	01/12/2019 15:45	01/12/2019 15:28	01/12/2019 15:45	0,29	8	2,29	CHI
201911357806	BELA VISTA DE GOIAS	BV21116268	BELA VISTA S1	29/11/2019 11:51	29/11/2019 15:39	29/11/2019 11:51	29/11/2019 15:39	3,79	1	3,79	CHI
201911357811	SAO JOAO D ALIANCA	JL21344260	SAO JOAO D ALIANCA	29/11/2019 11:52	29/11/2019 14:16	29/11/2019 11:52	29/11/2019 14:16	2,39	1	2,39	CHI
201911357813	PALMEIRAS DE GOIAS	10020544730	PALMEIRAS	29/11/2019 11:52	29/11/2019 14:47	29/11/2019 11:52	29/11/2019 14:47	2,91	1	2,91	CHI
201911357814	MONTIVIDIU	MV21007829	MONTIVIDIU T	29/11/2019 11:53	30/11/2019 08:52	29/11/2019 11:53	30/11/2019 08:52	21,00	1	21,00	CHI

201911357817	SANTA HELENA DE GOIAS	SH12391801	IPEGUARI	29/11/2019 11:54	29/11/2019 15:00	29/11/2019 11:54	29/11/2019 15:00	3,09	1	3,09	CHI
201911357822	ANAPOLIS	20526659	JUNDIAI S2	29/11/2019 11:55	29/11/2019 14:07	29/11/2019 11:55	29/11/2019 14:07	2,19	1	2,19	CHI
201911357826	PORTEIRAO	BJ21309804	RIO DOS BOIS	29/11/2019 11:56	30/11/2019 09:36	29/11/2019 11:56	30/11/2019 09:36	21,66	1	21,66	CHI
201911357828	CUMARI	CY11215559	CATALAO S1	29/11/2019 11:47	29/11/2019 13:30	29/11/2019 11:47	29/11/2019 13:30	1,72	116	199,52	CHI
201911357833	ITABERAI	IB12336256	ITABERAI S1	29/11/2019 11:59	29/11/2019 13:54	29/11/2019 11:59	29/11/2019 13:54	1,91	7	13,38	CHI
201911357839	PANAMA	PX21028945	PARANAIBA	29/11/2019 12:01	29/11/2019 18:36	29/11/2019 12:01	29/11/2019 18:35	6,57	2	13,13	CHI
201911357839	GOIATUBA	PX12304288	PARANAIBA	29/11/2019 12:01	29/11/2019 18:36	29/11/2019 15:49	29/11/2019 18:36	2,78	4	11,12	CHI
201911357839	PANAMA	PX12304288	PARANAIBA	29/11/2019 12:01	29/11/2019 18:36	29/11/2019 15:49	29/11/2019 18:36	2,78	1	2,78	CHI
201911357840	QUIRINOPOLIS	PC12100483	QUIRINOPOLIS	29/11/2019 09:35	29/11/2019 17:09	29/11/2019 09:35	29/11/2019 17:09	7,56	1	7,56	CHI
201911357840	PARANAIGUARA	PC12100483	QUIRINOPOLIS	29/11/2019 09:35	29/11/2019 17:09	29/11/2019 09:35	29/11/2019 17:09	7,56	9	68,07	CHI
201911357850	SANTA FE DE GOIAS	RN12090835	BRITANIA	29/11/2019 07:19	30/11/2019 00:50	29/11/2019 07:19	30/11/2019 00:50	17,51	6	105,08	CHI
201911357852	QUIRINOPOLIS	QI12370013	CACHOEIRA ALTA	29/11/2019 12:05	29/11/2019 17:00	29/11/2019 12:05	29/11/2019 17:00	4,91	4	19,64	CHI
201911357859	GOIANDIRA	2010009284	CATALAO S1	29/11/2019 12:07	29/11/2019 16:42	29/11/2019 12:07	29/11/2019 16:42	4,58	1	4,58	CHI
201911357864	ITAPURANGA	IK12300342	ITAPURANGA	29/11/2019 12:09	30/11/2019 17:38	29/11/2019 12:09	30/11/2019 17:38	29,48	2	58,97	CHI
201911357864	ITAPURANGA	IK12300342	ITAPURANGA	29/11/2019 12:09	30/11/2019 17:38	30/11/2019 12:24	30/11/2019 17:38	5,23	36	188,38	CHI
201911357865	JUSSARA	JR12038166	BRITANIA	29/11/2019 10:09	29/11/2019 20:04	29/11/2019 10:09	29/11/2019 20:04	9,91	5	49,55	CHI
201911357873	DISTRITO FEDERAL	2900047074	MARAJOARA	29/11/2019 12:10	29/11/2019 16:44	29/11/2019 12:10	29/11/2019 16:44	4,55	1	4,55	CHI
201911357879	CRISTALINA	10011595904	PAMPLONA	29/11/2019 12:12	29/11/2019 19:20	29/11/2019 12:12	29/11/2019 19:20	7,12	1	7,12	CHI
201911357881	GOIANIA	16367327	GOYA S2	29/11/2019 12:13	29/11/2019 20:02	29/11/2019 12:13	29/11/2019 20:02	7,81	1	7,81	CHI
201911357888	FORMOSA	FA11395008	FLORES DE GOIAS	29/11/2019 12:14	29/11/2019 18:38	29/11/2019 12:14	29/11/2019 18:38	6,40	1	6,40	CHI
201911357894	CALDAS NOVAS	760194579	SERRA DE CALDAS	29/11/2019 12:16	29/11/2019 17:46	29/11/2019 12:16	29/11/2019 17:46	5,51	1	5,51	CHI
201911357895	JATAI	JT12182190	JATAI S1	29/11/2019 10:40	29/11/2019 14:10	29/11/2019 10:40	29/11/2019 14:10	3,49	24	83,81	CHI
201911357897	CAIAPONIA	CP21223231	MONTIVIDIU T	29/11/2019 12:16	30/11/2019 18:03	29/11/2019 12:16	30/11/2019 18:03	29,78	1	29,78	CHI
201911357898	INHUMAS	IN11012223	INHUMAS S2	29/11/2019 12:16	29/11/2019 13:31	29/11/2019 12:16	29/11/2019 13:31	1,25	182	228,26	CHI
201911357900	PONTALINA	PK21050331	GOIATUBA S1	29/11/2019 12:16	29/11/2019 14:45	29/11/2019 12:16	29/11/2019 14:45	2,47	1	2,47	CHI
201911357904	ANAPOLIS	AN12297708	ANAPOLIS UNIVERSITARIO S2	29/11/2019 12:17	29/11/2019 20:39	29/11/2019 12:17	29/11/2019 20:39	8,36	10	83,59	CHI
201911357906	CATALAO	CT12162904	CATALAO S1	29/11/2019 12:17	30/11/2019 11:21	29/11/2019 12:17	30/11/2019 11:21	23,05	9	207,48	CHI
201911357921	FORMOSA	FA12394153	ITUIQUIRA	29/11/2019 12:21	29/11/2019 14:51	29/11/2019 12:21	29/11/2019 14:51	2,50	1	2,50	CHI
201911357925	ANICUNS	AC21278671	FIRMINOPOLIS S2	29/11/2019 12:21	29/11/2019 19:10	29/11/2019 12:21	29/11/2019 19:10	6,82	1	6,82	CHI
201911357928	CATALAO	CT21266334	CATALAO S1	29/11/2019 12:22	29/11/2019 22:16	29/11/2019 12:22	29/11/2019 22:16	9,90	1	9,90	CHI
201911357935	ITAPIRAPUA	IU12095446	MATRINCHA	29/11/2019 07:38	29/11/2019 11:35	29/11/2019 07:38	29/11/2019 11:35	3,94	9	35,43	CHI
201911357938	AMERICANO DO BRASIL	KB21322812	ANICUNS	29/11/2019 12:23	29/11/2019 16:13	29/11/2019 12:23	29/11/2019 16:13	3,83	1	3,83	CHI
201911357939	CORUMBAIBA	IP12337197	IPAMERI	29/11/2019 12:23	29/11/2019 19:11	29/11/2019 12:23	29/11/2019 19:11	6,80	3	20,39	CHI



201911357939	IPAMERI	IP12337197	IPAMERI	29/11/2019 12:23	29/11/2019 19:11	29/11/2019 12:23	29/11/2019 19:11	6,80	9	61,16	CHI
201911357959	PALMELO	10003030324	PIRES DO RIO S2	29/11/2019 12:27	29/11/2019 15:00	29/11/2019 12:27	29/11/2019 15:00	2,54	1	2,54	CHI
201911357960	SANTA HELENA DE GOIAS	SH12295844	IPEGUARI	29/11/2019 12:26	29/11/2019 16:44	29/11/2019 12:26	29/11/2019 16:44	4,30	17	73,03	CHI
201911357961	QUIRINOPOLIS	QI21279592	QUIRINOPOLIS	29/11/2019 12:28	29/11/2019 16:45	29/11/2019 12:28	29/11/2019 16:45	4,27	2	8,55	CHI
201911357962	FORMOSA	FA11383285	ITIQUEIRA	29/11/2019 12:28	29/11/2019 13:28	29/11/2019 12:28	29/11/2019 13:28	0,99	145	143,19	CHI
201911357972	GOIANDIRA	CY21081496	CATALAO S1	29/11/2019 12:31	29/11/2019 15:38	29/11/2019 12:31	29/11/2019 15:38	3,12	1	3,12	CHI
201911357975	GOIANIA	GN11002043	CAMPINAS S1	29/11/2019 12:31	29/11/2019 15:59	29/11/2019 12:31	29/11/2019 15:59	3,45	58	200,36	CHI
201911357979	CRISTALINA	KR21219637	PAMPLONA	29/11/2019 12:32	29/11/2019 16:33	29/11/2019 12:32	29/11/2019 16:33	4,01	1	4,01	CHI
201911357984	LUZIANIA	3200005759	MARAJOARA	29/11/2019 12:33	29/11/2019 16:35	29/11/2019 12:33	29/11/2019 16:35	4,03	1	4,03	CHI
201911357997	CALDAS NOVAS	CN12075111	SERRA DE CALDAS	29/11/2019 12:35	29/11/2019 15:42	29/11/2019 12:35	29/11/2019 15:42	3,10	21	65,16	CHI
201911357998	SAO JOAO D ALIANCA	JL21264866	SAO JOAO D ALIANCA	29/11/2019 12:36	29/11/2019 14:54	29/11/2019 12:36	29/11/2019 14:54	2,29	1	2,29	CHI
201911358000	GOIANIA	GN12162224	CARAJAS S2	29/11/2019 12:32	29/11/2019 14:38	29/11/2019 12:32	29/11/2019 14:38	2,10	192	403,04	CHI
201911358004	AGUAS LINDAS DE GOIAS	10015570230	AGUAS LINDAS DE GOIAS S1	29/11/2019 12:38	29/11/2019 14:03	29/11/2019 12:38	29/11/2019 14:03	1,41	1	1,41	CHI
201911358008	MONTIVIDIU	RV12384572B	MONTIVIDIU T	29/11/2019 12:38	29/11/2019 16:05	29/11/2019 12:38	29/11/2019 16:05	3,44	18	61,88	CHI
201911358009	MONTE ALEGRE DE GOIAS	MA12315143	SAO DOMINGOS	29/11/2019 06:39	29/11/2019 17:18	29/11/2019 06:39	29/11/2019 17:18	10,64	5	53,19	CHI
201911358011	RIO VERDE	RV21023921	RIO VERDE S2	29/11/2019 12:39	30/11/2019 07:41	29/11/2019 12:39	30/11/2019 07:41	19,04	1	19,04	CHI
201911358013	PLANALTINA	2960014711	PLANALTINA	29/11/2019 12:40	29/11/2019 14:12	29/11/2019 12:40	29/11/2019 14:12	1,53	1	1,53	CHI
201911358014	CAMPINACU	IH12250126	MINACU	29/11/2019 12:38	29/11/2019 22:40	29/11/2019 12:38	29/11/2019 22:40	10,02	9	90,21	CHI
201911358015	SAO DOMINGOS	SD12384774	SAO DOMINGOS	29/11/2019 10:28	29/11/2019 15:45	29/11/2019 10:28	29/11/2019 15:45	5,27	40	210,96	CHI
201911358018	DOVERLANDIA	DV21229586	CAIAPONIA	29/11/2019 12:41	30/11/2019 15:22	29/11/2019 12:41	30/11/2019 15:22	26,67	1	26,67	CHI
201911358019	PIRENOPOLIS	PV12000119	CORUMBA	29/11/2019 11:20	29/11/2019 14:51	29/11/2019 11:20	29/11/2019 14:51	3,51	4	14,05	CHI
201911358034	CABECEIRAS	CW21150380	ITIQUEIRA	29/11/2019 12:44	30/11/2019 16:28	29/11/2019 12:44	30/11/2019 16:28	27,72	1	27,72	CHI
201911358036	PIRES DO RIO	PR12000080	PIRES DO RIO S1	29/11/2019 11:55	30/11/2019 00:19	29/11/2019 11:55	30/11/2019 00:19	12,38	10	123,85	CHI
201911358038	SAO MIGUEL DO ARAGUAIA	SM21262463	SAO MIGUEL DO ARAGUAIA	29/11/2019 12:45	30/11/2019 13:36	29/11/2019 12:45	30/11/2019 13:36	24,84	1	24,84	CHI
201911358042	CRISTIANOPOLIS	10030150815	CRISTIANOPOLIS	29/11/2019 12:46	29/11/2019 16:15	29/11/2019 12:46	29/11/2019 16:15	3,48	1	3,48	CHI
201911358051	LUZIANIA	LZ21330566	MARAJOARA	29/11/2019 12:46	29/11/2019 22:38	29/11/2019 12:46	29/11/2019 22:38	9,85	2	19,70	CHI
201911358059	RIO VERDE	RV21384356	CACHOEIRA ALTA	29/11/2019 12:47	30/11/2019 04:49	29/11/2019 12:47	30/11/2019 04:49	16,02	2	32,05	CHI
201911358060	NIQUELANDIA	NQ21197554	URUACU	29/11/2019 12:47	30/11/2019 08:55	29/11/2019 12:47	30/11/2019 08:55	20,14	1	20,14	CHI
201911358063	ABADIANIA	350002060	ANAPOLIS UNIVERSITARIO S1	29/11/2019 12:48	29/11/2019 16:42	29/11/2019 12:48	29/11/2019 16:42	3,90	1	3,90	CHI
201911358072	PONTALINA	PK12293405	VICENTINOPOLIS	29/11/2019 12:51	29/11/2019 20:08	29/11/2019 12:51	29/11/2019 20:08	7,28	3	21,84	CHI
201911358074	PIRACANJUBA	PJ12249833	PIRACANJUBA	29/11/2019 11:25	29/11/2019 15:40	29/11/2019 11:25	29/11/2019 15:40	4,25	81	344,36	CHI
201911358077	RIO VERDE	10000812054	RIO VERDE S2	29/11/2019 12:52	29/11/2019 16:30	29/11/2019 12:52	29/11/2019 16:30	3,64	1	3,64	CHI
201911358088	PETROLINA DE GOIAS	PG12090243	PETROLINA	29/11/2019 08:29	29/11/2019 17:17	29/11/2019 08:29	29/11/2019 17:17	8,79	9	79,07	CHI

201911358095	PIRENOPOLIS	PV12334636	CORUMBA	29/11/2019 12:56	29/11/2019 18:07	29/11/2019 12:56	29/11/2019 18:07	5,17	13	67,19	CHI
201911358116	APARECIDA DE GOIANIA	AP21080230	CEPAIGO S1	29/11/2019 13:01	29/11/2019 14:34	29/11/2019 13:01	29/11/2019 14:34	1,55	1	1,55	CHI
201911358120	ISRAELANDIA	FN12390152	IPORA	29/11/2019 07:47	29/11/2019 15:41	29/11/2019 07:47	29/11/2019 15:41	7,89	2	15,78	CHI
201911358120	FAZENDA NOVA	FN12390152	IPORA	29/11/2019 07:47	29/11/2019 15:41	29/11/2019 07:47	29/11/2019 15:41	7,89	12	94,68	CHI
201911358124	ALTO PARAISO DE GOIAS	BF21386162	FLORES DE GOIAS	29/11/2019 13:03	29/11/2019 16:23	29/11/2019 13:03	29/11/2019 16:23	3,32	1	3,32	CHI
201911358132	VALPARAISO DE GOIAS	2860020981	PACAEMBU S2	29/11/2019 13:06	29/11/2019 17:56	29/11/2019 13:06	29/11/2019 17:56	4,83	1	4,83	CHI
201911358142	ANICUNS	AC11379771	ANICUNS	29/11/2019 13:08	29/11/2019 14:47	29/11/2019 13:08	29/11/2019 14:47	1,64	43	70,39	CHI
201911358147	INACIOLANDIA	IT12025051	CACHOEIRA DOURADA	29/11/2019 13:11	30/11/2019 08:59	29/11/2019 13:11	30/11/2019 08:59	19,79	5	98,95	CHI
201911358149	URUTAI	UT12300665	URUTAI	29/11/2019 13:12	29/11/2019 19:43	29/11/2019 13:12	29/11/2019 19:43	6,51	2	13,02	CHI
201911358150	CAMPOS VERDES	3790030464	SANTA TEREZINHA	29/11/2019 13:12	30/11/2019 14:35	29/11/2019 13:12	30/11/2019 14:35	25,38	1	25,38	CHI
201911358153	MONTE ALEGRE DE GOIAS	MA12130277	SAO DOMINGOS	29/11/2019 13:12	29/11/2019 18:42	29/11/2019 13:12	29/11/2019 18:42	5,49	3	16,47	CHI
201911358154	BURITI ALEGRE	BG21372807	ITUMBIARA VELHA S2	29/11/2019 13:12	30/11/2019 13:21	29/11/2019 13:12	30/11/2019 12:54	23,69	1	23,69	CHI
201911358154	BURITI ALEGRE	BG12363927	ITUMBIARA VELHA S2	29/11/2019 13:12	30/11/2019 13:21	30/11/2019 10:46	30/11/2019 13:21	2,59	1	2,59	CHI
201911358156	COLINAS DO SUL	9700005087	NIQUELANDIA SUBTRANSMISSAO	29/11/2019 13:13	30/11/2019 12:07	29/11/2019 13:13	30/11/2019 12:07	22,89	1	22,89	CHI
201911358164	VICENTINOPOLIS	VI11064595	VICENTINOPOLIS	29/11/2019 13:12	29/11/2019 15:57	29/11/2019 13:12	29/11/2019 15:35	2,39	141	336,32	CHI
201911358164	VICENTINOPOLIS	VI12071025	VICENTINOPOLIS	29/11/2019 13:12	29/11/2019 15:57	29/11/2019 15:46	29/11/2019 15:57	0,18	550	100,07	CHI
201911358169	GAMELEIRA DE GOIAS	SV12278872	DAIA S2	29/11/2019 13:15	29/11/2019 17:57	29/11/2019 13:15	29/11/2019 17:57	4,69	38	178,26	CHI
201911358170	CRISTALINA	KR21165510	CRISTALINA S2	29/11/2019 13:16	29/11/2019 14:43	29/11/2019 13:16	29/11/2019 14:43	1,45	1	1,45	CHI
201911358175	ITABERAI	10021542323	ITABERAI S2	29/11/2019 13:18	29/11/2019 20:59	29/11/2019 13:18	29/11/2019 20:59	7,68	1	7,68	CHI
201911358182	GOIANIA	14903994	CARAJAS S1	29/11/2019 13:19	29/11/2019 17:30	29/11/2019 13:19	29/11/2019 17:30	4,18	1	4,18	CHI
201911358192	OUVIDOR	OU12042459	CATALAO S1	29/11/2019 13:20	29/11/2019 20:15	29/11/2019 13:20	29/11/2019 20:15	6,91	3	20,73	CHI
201911358194	HIDROLANDIA	HD21006267	INDEPENDENCIA S1	29/11/2019 13:20	29/11/2019 16:36	29/11/2019 13:20	29/11/2019 16:36	3,26	4	13,04	CHI
201911358203	JUSSARA	JR12349229	BRITANIA	29/11/2019 13:20	29/11/2019 22:04	29/11/2019 13:20	29/11/2019 22:04	8,72	2	17,43	CHI
201911358207	PIRES DO RIO	460013180	PIRES DO RIO S1	29/11/2019 13:21	30/11/2019 00:25	29/11/2019 13:21	30/11/2019 00:25	11,06	1	11,06	CHI
201911358214	CRISTALINA	3490011312	PAMPLONA	29/11/2019 13:22	29/11/2019 18:55	29/11/2019 13:22	29/11/2019 18:55	5,55	1	5,55	CHI
201911358216	LUZIANIA	3200094460	MARAJOARA	29/11/2019 13:22	29/11/2019 18:51	29/11/2019 13:22	29/11/2019 18:51	5,47	1	5,47	CHI
201911358219	RIO VERDE	4090003510	SANTA HELENA S1	29/11/2019 13:23	30/11/2019 09:09	29/11/2019 13:23	30/11/2019 09:09	19,78	1	19,78	CHI
201911358220	RIO VERDE	630347621	RIO VERDE S2	29/11/2019 13:23	30/11/2019 09:27	29/11/2019 13:23	30/11/2019 09:27	20,07	1	20,07	CHI
201911358223	ITABERAI	IB12300320	ITABERAI S2	29/11/2019 13:24	30/11/2019 09:57	29/11/2019 13:24	30/11/2019 09:57	20,55	21	431,58	CHI
201911358228	SIMOLANDIA	10024763177	IACIARA S2	29/11/2019 13:24	30/11/2019 11:43	29/11/2019 13:24	30/11/2019 11:43	22,31	1	22,31	CHI
201911358229	CRISTALINA	KR11276434	CRISTALINA S2	29/11/2019 13:25	29/11/2019 17:47	29/11/2019 13:25	29/11/2019 17:47	4,37	1	4,37	CHI
201911358254	VILA PROPICIO	PV12396674	GOIANESIA S1	29/11/2019 13:28	29/11/2019 20:17	29/11/2019 13:28	29/11/2019 20:17	6,80	9	61,24	CHI
201911358260	ITAPURANGA	IK12299287	ITAPURANGA	29/11/2019 13:28	29/11/2019 15:33	29/11/2019 13:28	29/11/2019 15:33	2,07	13	26,88	CHI

201911358279	ITUMBIARA	690313627	PARANAIBA	29/11/2019 13:30	29/11/2019 20:40	29/11/2019 13:30	29/11/2019 20:40	7,16	1	7,16	CHI
201911358282	CAVALCANTE	CJ21404477	MINACU	29/11/2019 13:31	01/12/2019 11:14	29/11/2019 13:31	01/12/2019 11:14	45,70	1	45,70	CHI
201911358283	ANAPOLIS	AN21353201	ANAPOLIS UNIVERSITARIO S2	29/11/2019 13:32	29/11/2019 17:26	29/11/2019 13:32	29/11/2019 17:26	3,90	1	3,90	CHI
201911358294	ITAPIRAPUA	IU12142832	MATRINCHA	29/11/2019 13:35	29/11/2019 20:30	29/11/2019 13:35	29/11/2019 20:30	6,92	4	27,68	CHI
201911358303	FORMOSA	610188770	ITUIQUIRA	29/11/2019 13:35	29/11/2019 16:13	29/11/2019 13:35	29/11/2019 16:13	2,62	1	2,62	CHI
201911358306	TURVELANDIA	TD21308797	RIO DOS BOIS	29/11/2019 13:36	29/11/2019 20:10	29/11/2019 13:36	29/11/2019 20:10	6,56	1	6,56	CHI
201911358309	MINACU	IH11202463	MINACU	29/11/2019 13:26	29/11/2019 22:11	29/11/2019 13:26	29/11/2019 22:11	8,74	14	122,33	CHI
201911358312	MINACU	IH12208345	MINACU	29/11/2019 08:32	30/11/2019 00:51	29/11/2019 08:32	30/11/2019 00:51	16,31	49	799,24	CHI
201911358312	MINACU	IH12208345	MINACU	29/11/2019 08:32	30/11/2019 00:51	29/11/2019 08:32	30/11/2019 00:51	16,31	47	766,61	CHI
201911358313	NOVA IGUACU DE GOIAS	NH12086291	CAMPINORTE	29/11/2019 12:33	29/11/2019 15:33	29/11/2019 12:33	29/11/2019 15:33	2,99	4	11,96	CHI
201911358317	AGUAS LINDAS DE GOIAS	4830467199	AGUAS LINDAS DE GOIAS S1	29/11/2019 13:37	29/11/2019 17:04	29/11/2019 13:37	29/11/2019 17:04	3,44	1	3,44	CHI
201911358320	MONTE ALEGRE DE GOIAS	MA12211609	SAO DOMINGOS	29/11/2019 13:38	29/11/2019 20:33	29/11/2019 13:38	29/11/2019 20:33	6,92	7	48,42	CHI
201911358320	CAMPOS BELOS	MA12211609	SAO DOMINGOS	29/11/2019 13:38	29/11/2019 20:33	29/11/2019 13:38	29/11/2019 20:33	6,92	8	55,33	CHI
201911358327	VICENTINOPOLIS	1970017111	VICENTINOPOLIS	29/11/2019 13:38	29/11/2019 16:46	29/11/2019 13:38	29/11/2019 16:46	3,12	1	3,12	CHI
201911358329	GOIATUBA	GT21000014	BOM JESUS DE GOIAS	29/11/2019 13:38	29/11/2019 19:12	29/11/2019 13:38	29/11/2019 19:12	5,55	1	5,55	CHI
201911358333	PIRENOPOLIS	220081931	CORUMBA	29/11/2019 13:39	29/11/2019 16:30	29/11/2019 13:39	29/11/2019 16:30	2,85	1	2,85	CHI
201911358334	MINEIROS	1390054370	PARQUE DAS EMAS	29/11/2019 13:39	29/11/2019 15:24	29/11/2019 13:39	29/11/2019 15:24	1,74	1	1,74	CHI
201911358349	CATALAO	CT21266251	CATALAO S1	29/11/2019 13:41	29/11/2019 16:20	29/11/2019 13:41	29/11/2019 16:20	2,64	2	5,29	CHI
201911358354	APARECIDA DE GOIANIA	10036568	REAL S2	29/11/2019 13:41	29/11/2019 21:17	29/11/2019 13:41	29/11/2019 21:17	7,59	1	7,59	CHI
201911358357	PONTALINA	PK11000005	PONTALINA	29/11/2019 13:42	29/11/2019 16:39	29/11/2019 13:42	29/11/2019 16:39	2,94	85	249,81	CHI
201911358358	CRISTALINA	KR21230268	CRISTALINA S2	29/11/2019 13:42	29/11/2019 17:16	29/11/2019 13:42	29/11/2019 17:16	3,56	1	3,56	CHI
201911358361	IPAMERI	IP12079464	CAMPO ALEGRE DE GOIAS	29/11/2019 13:39	30/11/2019 10:30	29/11/2019 13:39	30/11/2019 10:30	20,84	4	83,35	CHI
201911358364	PIRANHAS	1930020937	PIRANHAS	29/11/2019 13:44	29/11/2019 16:14	29/11/2019 13:44	29/11/2019 16:14	2,50	1	2,50	CHI
201911358377	URUTAI	UT21115670	URUTAI	29/11/2019 13:47	29/11/2019 17:34	29/11/2019 13:47	29/11/2019 17:34	3,80	1	3,80	CHI
201911358378	CRISTALINA	KR12164788	PAMPLONA	29/11/2019 07:58	29/11/2019 16:25	29/11/2019 07:58	29/11/2019 16:25	8,44	20	168,73	CHI
201911358381	QUIRINOPOLIS	QI12279793	QUIRINOPOLIS	29/11/2019 13:48	29/11/2019 15:50	29/11/2019 13:48	29/11/2019 15:50	2,05	5	10,23	CHI
201911358384	AGUAS LINDAS DE GOIAS	4830024496	AGUAS LINDAS DE GOIAS S1	29/11/2019 13:48	29/11/2019 16:13	29/11/2019 13:48	29/11/2019 16:13	2,41	1	2,41	CHI
201911358385	SAO MIGUEL DO ARAGUAIA	SM11245680	SAO MIGUEL DO ARAGUAIA	29/11/2019 13:48	29/11/2019 14:47	29/11/2019 13:48	29/11/2019 14:47	0,97	1	0,97	CHI
201911358387	BARRO ALTO	BA12064541	BARRO ALTO	29/11/2019 09:29	29/11/2019 18:23	29/11/2019 09:29	29/11/2019 18:23	8,89	2	17,77	CHI
201911358388	MINACU	4020071902	MINACU	29/11/2019 13:49	30/11/2019 08:05	29/11/2019 13:49	30/11/2019 08:05	18,26	1	18,26	CHI
201911358392	CORUMBAIBA	AL12263113	VILA CORUMBA	29/11/2019 11:22	29/11/2019 18:26	29/11/2019 11:22	29/11/2019 18:26	7,06	1	7,06	CHI
201911358392	AGUA LIMPA	AL12263113	VILA CORUMBA	29/11/2019 11:22	29/11/2019 18:26	29/11/2019 11:22	29/11/2019 18:26	7,06	31	218,87	CHI
201911358404	BURITINOPOLIS	MB12314303	IACIARA S2	29/11/2019 12:00	30/11/2019 09:38	29/11/2019 12:00	30/11/2019 09:38	21,63	2	43,26	CHI

201911358404	MAMBAI	MB12314303	IACIARA S2	29/11/2019 12:00	30/11/2019 09:38	29/11/2019 12:00	30/11/2019 09:38	21,63	3	64,89	CHI
201911358410	BELA VISTA DE GOIAS	BV21207503	BELA VISTA S1	29/11/2019 13:52	29/11/2019 16:49	29/11/2019 13:52	29/11/2019 16:49	2,95	1	2,95	CHI
201911358414	CAMPO ALEGRE DE GOIAS	7920000542	CAMPO ALEGRE DE GOIAS	29/11/2019 13:52	30/11/2019 11:11	29/11/2019 13:52	30/11/2019 11:11	21,32	1	21,32	CHI
201911358417	JATAI	10012316898	JATAI S2	29/11/2019 13:54	30/11/2019 11:55	29/11/2019 13:54	30/11/2019 11:55	22,01	1	22,01	CHI
201911358421	NOVO BRASIL	NB12047598	JUSSARA	29/11/2019 12:06	29/11/2019 18:45	29/11/2019 12:06	29/11/2019 18:45	6,65	13	86,41	CHI
201911358423	JANDAIA	IY12205924	EDEIA	29/11/2019 13:55	29/11/2019 19:24	29/11/2019 13:55	29/11/2019 17:00	3,07	1	3,07	CHI
201911358423	INDIARA	IY12205924	EDEIA	29/11/2019 13:55	29/11/2019 19:24	29/11/2019 13:55	29/11/2019 17:00	3,07	383	1176,87	CHI
201911358423	INDIARA	IY12205924	EDEIA	29/11/2019 13:55	29/11/2019 19:24	29/11/2019 13:55	29/11/2019 19:24	5,47	39	213,51	CHI
201911358423	EDEIA	IY12205924	EDEIA	29/11/2019 13:55	29/11/2019 19:24	29/11/2019 13:55	29/11/2019 19:24	5,47	5	27,37	CHI
201911358442	GOUVELANDIA	QI12000160	QUIRINOPOLIS	29/11/2019 13:26	29/11/2019 15:21	29/11/2019 13:26	29/11/2019 15:21	1,90	23	43,78	CHI
201911358443	ITAUCU	IX21322441	INHUMAS S1	29/11/2019 13:59	29/11/2019 18:10	29/11/2019 13:59	29/11/2019 18:10	4,17	1	4,17	CHI
201911358451	VILA PROPICIO	PV21080994	GOIANESIA S1	29/11/2019 14:00	30/11/2019 04:06	29/11/2019 14:00	30/11/2019 04:06	14,09	2	28,17	CHI
201911358453	AGUAS LINDAS DE GOIAS	4830364301	AGUAS LINDAS DE GOIAS S1	29/11/2019 14:01	29/11/2019 15:41	29/11/2019 14:01	29/11/2019 15:41	1,66	1	1,66	CHI
201911358459	ACREUNA	EU21317014	ACREUNA	29/11/2019 14:01	29/11/2019 15:31	29/11/2019 14:01	29/11/2019 15:31	1,49	1	1,49	CHI
201911358465	MINACU	IH12334428LD	MINACU	29/11/2019 13:25	29/11/2019 18:29	29/11/2019 13:25	29/11/2019 18:29	5,07	74	374,81	CHI
201911358465	MINACU	IH12334428LD	MINACU	29/11/2019 13:25	29/11/2019 18:29	29/11/2019 13:25	29/11/2019 18:29	5,06	68	344,40	CHI
201911358466	FLORES DE GOIAS	FB12258043	FLORES DE GOIAS	29/11/2019 14:02	29/11/2019 18:12	29/11/2019 14:02	29/11/2019 18:12	4,16	3	12,48	CHI
201911358467	GOIANESIA	GE21222822	GOIANESIA S2	29/11/2019 14:02	29/11/2019 18:41	29/11/2019 14:02	29/11/2019 18:41	4,64	1	4,64	CHI
201911358468	FAZENDA NOVA	FN12251355	IPORA	29/11/2019 12:11	29/11/2019 18:10	29/11/2019 12:11	29/11/2019 18:10	5,99	4	23,97	CHI
201911358469	RIO VERDE	RV12297883	MONTIVIDIU T	29/11/2019 13:14	29/11/2019 19:10	29/11/2019 13:14	29/11/2019 19:10	5,93	14	83,03	CHI
201911358471	ALEXANIA	AX21066464	ALEXANIA	29/11/2019 14:02	30/11/2019 16:11	29/11/2019 14:02	30/11/2019 16:11	26,14	2	52,28	CHI
201911358472	MOZARLANDIA	410018302	MOZARLANDIA	29/11/2019 14:02	29/11/2019 17:36	29/11/2019 14:02	29/11/2019 17:36	3,57	1	3,57	CHI
201911358474	SAO MIGUEL DO ARAGUAIA	SM21282158	SAO MIGUEL DO ARAGUAIA	29/11/2019 14:02	30/11/2019 16:00	29/11/2019 14:02	30/11/2019 16:00	25,95	1	25,95	CHI
201911358481	MONTE ALEGRE DE GOIAS	MA12290214	SAO DOMINGOS	29/11/2019 13:39	29/11/2019 17:51	29/11/2019 13:39	29/11/2019 17:51	4,18	12	50,21	CHI
201911358488	GUAPO	TR12006367	GUAPO S1	29/11/2019 14:05	29/11/2019 19:20	29/11/2019 14:05	29/11/2019 19:20	5,24	38	198,95	CHI
201911358488	TRINDADE	TR12006367	GUAPO S1	29/11/2019 14:05	29/11/2019 19:20	29/11/2019 14:05	29/11/2019 19:20	5,24	3	15,71	CHI
201911358498	CABECEIRAS	CW21157369	ITUIQUIRA	29/11/2019 14:07	30/11/2019 22:51	29/11/2019 14:07	30/11/2019 22:51	32,73	2	65,45	CHI
201911358500	PARAUNA	PU12289841	PARAUNA	29/11/2019 11:17	30/11/2019 08:28	29/11/2019 11:17	30/11/2019 08:28	21,17	9	190,55	CHI
201911358507	QUIRINOPOLIS	QI12054920	QUIRINOPOLIS	29/11/2019 14:09	30/11/2019 08:31	29/11/2019 14:09	30/11/2019 08:31	18,37	2	36,73	CHI
201911358508	PALMEIRAS DE GOIAS	10012117038	PALMEIRAS	29/11/2019 14:09	29/11/2019 15:23	29/11/2019 14:09	29/11/2019 15:23	1,24	1	1,24	CHI
201911358509	GOIATUBA	GT12363916	BOM JESUS DE GOIAS	29/11/2019 14:09	29/11/2019 17:30	29/11/2019 14:09	29/11/2019 17:30	3,34	2	6,68	CHI
201911358513	ARUANA	10012839220	ARUANA	29/11/2019 14:10	29/11/2019 16:50	29/11/2019 14:10	29/11/2019 16:50	2,67	1	2,67	CHI
201911358515	ITARUMA	CA12402274	CACHOEIRA ALTA	29/11/2019 13:40	29/11/2019 17:13	29/11/2019 13:40	29/11/2019 17:13	3,55	7	24,83	CHI

201911358515	CACU	CA12402274	CACHOEIRA ALTA	29/11/2019 13:40	29/11/2019 17:13	29/11/2019 13:40	29/11/2019 17:13	3,55	52	184,48	CHI
201911358515	CACHOEIRA ALTA	CA12402274	CACHOEIRA ALTA	29/11/2019 13:40	29/11/2019 17:13	29/11/2019 13:40	29/11/2019 17:13	3,55	85	301,56	CHI
201911358516	TROMBAS	TB12337372	PORANGATU	29/11/2019 14:10	29/11/2019 20:12	29/11/2019 14:10	29/11/2019 20:12	6,02	1	6,02	CHI
201911358526	SAO JOAO D ALIANCA	10011941241	SAO JOAO D ALIANCA	29/11/2019 14:12	30/11/2019 01:41	29/11/2019 14:12	30/11/2019 01:41	11,48	1	11,48	CHI
201911358529	SANTA RITA DO ARAGUAIA	2130016486	SANTA RITA DO ARAGUAIA	29/11/2019 14:14	29/11/2019 19:07	29/11/2019 14:14	29/11/2019 19:07	4,87	1	4,87	CHI
201911358545	GOIANIA	GN21002662	NEROPOLIS S2	29/11/2019 14:17	29/11/2019 16:10	29/11/2019 14:17	29/11/2019 16:10	1,87	2	3,74	CHI
201911358548	IPORA	IR21187400	IPORA	29/11/2019 14:18	29/11/2019 16:08	29/11/2019 14:18	29/11/2019 16:08	1,83	1	1,83	CHI
201911358549	ORIZONA	OZ12083185	PIRES DO RIO S1	29/11/2019 14:18	29/11/2019 17:20	29/11/2019 14:18	29/11/2019 17:20	3,03	2	6,07	CHI
201911358550	MUTUNOPOLIS	MU12257886	MARA ROSA	29/11/2019 11:05	29/11/2019 16:48	29/11/2019 11:05	29/11/2019 16:48	5,71	1	5,71	CHI
201911358550	AMARALINA	MU12257886	MARA ROSA	29/11/2019 11:05	29/11/2019 16:48	29/11/2019 11:05	29/11/2019 16:48	5,71	36	205,44	CHI
201911358556	CAIAPONIA	CP12260792	MONTIVIDIU T	29/11/2019 06:07	29/11/2019 16:29	29/11/2019 06:07	29/11/2019 16:29	10,35	3	31,06	CHI
201911358556	MONTIVIDIU	CP12260792	MONTIVIDIU T	29/11/2019 06:07	29/11/2019 16:29	29/11/2019 06:07	29/11/2019 16:29	10,35	3	31,06	CHI
201911358560	INDIARA	2710018452	EDEIA	29/11/2019 14:19	29/11/2019 18:31	29/11/2019 14:19	29/11/2019 18:31	4,20	1	4,20	CHI
201911358563	SAO JOAO D ALIANCA	3840007006	SAO JOAO D ALIANCA	29/11/2019 14:20	30/11/2019 11:19	29/11/2019 14:20	30/11/2019 11:19	20,97	1	20,97	CHI
201911358564	PADRE BERNARDO	9980020975	PADRE BERNARDO	29/11/2019 14:20	29/11/2019 15:43	29/11/2019 14:20	29/11/2019 15:43	1,37	1	1,37	CHI
201911358565	RIO VERDE	630435339	RIO VERDE S2	29/11/2019 14:20	29/11/2019 19:25	29/11/2019 14:20	29/11/2019 19:25	5,07	1	5,07	CHI
201911358575	COCALZINHO DE GOIAS	ZN21297809	COCALZINHO	29/11/2019 14:21	30/11/2019 14:15	29/11/2019 14:21	30/11/2019 14:15	23,89	1	23,89	CHI
201911358583	VILA BOA	02590204	ITIQUEIRA	29/11/2019 09:06	29/11/2019 15:48	29/11/2019 09:06	29/11/2019 15:48	6,69	6	40,13	CHI
201911358583	FORMOSA	02590204	ITIQUEIRA	29/11/2019 09:06	29/11/2019 15:48	29/11/2019 09:06	29/11/2019 15:48	6,69	484	3237,42	CHI
201911358583	FLORES DE GOIAS	02590204	ITIQUEIRA	29/11/2019 09:06	29/11/2019 15:48	29/11/2019 09:06	29/11/2019 15:48	6,69	2	13,38	CHI
201911358583	SAO JOAO D ALIANCA	02590204	ITIQUEIRA	29/11/2019 09:06	29/11/2019 15:48	29/11/2019 09:06	29/11/2019 15:48	6,69	225	1505,00	CHI
201911358584	PALMINOPOLIS	PP12197365	PALMEIRAS	29/11/2019 14:23	29/11/2019 17:30	29/11/2019 14:23	29/11/2019 17:30	3,11	19	59,07	CHI
201911358586	ITUMBIARA	IT21122349	PARANAIBA	29/11/2019 14:24	29/11/2019 16:10	29/11/2019 14:24	29/11/2019 16:10	1,76	1	1,76	CHI
201911358591	ITUMBIARA	CD12097345RE	CACHOEIRA DOURADA	29/11/2019 14:24	29/11/2019 23:52	29/11/2019 14:24	29/11/2019 23:52	9,46	9	85,17	CHI
201911358593	NOVA IGUACU DE GOIAS	NH12270877	CAMPINORTE	29/11/2019 14:24	29/11/2019 17:57	29/11/2019 14:24	29/11/2019 17:57	3,54	5	17,70	CHI
201911358602	GOIANIA	10139163	ATLANTICO S3	29/11/2019 14:27	29/11/2019 19:37	29/11/2019 14:27	29/11/2019 19:37	5,17	1	5,17	CHI
201911358603	MONTIVIDIU	MV12267743	MONTIVIDIU T	29/11/2019 14:27	29/11/2019 19:48	29/11/2019 14:27	29/11/2019 19:48	5,35	1	5,35	CHI
201911358605	CABECEIRAS	CW21245491	ITIQUEIRA	29/11/2019 14:27	30/11/2019 15:00	29/11/2019 14:27	30/11/2019 15:00	24,54	1	24,54	CHI
201911358606	CORREGO DO OURO	CO12028902	SAO LUIZ DOS MONTES BELOS	29/11/2019 14:27	29/11/2019 19:30	29/11/2019 14:27	29/11/2019 19:30	5,06	54	273,08	CHI
201911358607	CAIAPONIA	CP12253985	CAIAPONIA	29/11/2019 13:20	29/11/2019 20:12	29/11/2019 13:20	29/11/2019 20:12	6,85	41	280,88	CHI
201911358616	CORUMBAIBA	CI12263785	VILA CORUMBA	29/11/2019 14:29	29/11/2019 22:00	29/11/2019 14:29	29/11/2019 22:00	7,53	1	7,53	CHI
201911358617	MATRINCHA	MP12199954	MATRINCHA	29/11/2019 14:29	29/11/2019 22:57	29/11/2019 14:29	29/11/2019 22:57	8,46	4	33,86	CHI
201911358636	RIO VERDE	10008316730	CABRIUVA S1	29/11/2019 14:32	29/11/2019 18:38	29/11/2019 14:32	29/11/2019 18:38	4,11	1	4,11	CHI

201911358637	DOVERLANDIA	MY12219258	PARQUE DAS EMAS	29/11/2019 14:32	30/11/2019 21:18	29/11/2019 14:32	30/11/2019 21:18	30,76	18	553,76	CHI
201911358645	URUACU	UR12325185	URUACU	29/11/2019 08:00	30/11/2019 08:45	29/11/2019 08:00	30/11/2019 08:45	24,75	24	593,93	CHI
201911358645	PILAR DE GOIAS	UR12325185	URUACU	29/11/2019 08:00	30/11/2019 08:45	29/11/2019 08:00	30/11/2019 08:45	24,75	1	24,75	CHI
201911358650	AGUAS LINDAS DE GOIAS	4830192174	AGUAS LINDAS DE GOIAS S1	29/11/2019 14:34	29/11/2019 16:40	29/11/2019 14:34	29/11/2019 16:40	2,10	1	2,10	CHI
201911358651	PALMEIRAS DE GOIAS	CZ12011083	CEZARINA	29/11/2019 14:34	30/11/2019 11:20	29/11/2019 14:34	30/11/2019 11:20	20,77	2	41,53	CHI
201911358659	MINACU	IH12026971	MINACU	29/11/2019 13:22	29/11/2019 15:56	29/11/2019 13:22	29/11/2019 15:56	2,56	1122	2874,19	CHI
201911358660	MONTE ALEGRE DE GOIAS	MA12302753	SAO DOMINGOS	29/11/2019 06:57	29/11/2019 16:25	29/11/2019 06:57	29/11/2019 16:25	9,46	26	246,06	CHI
201911358662	PORANGATU	PO12391676	NOVO PLANALTO	29/11/2019 09:09	29/11/2019 17:16	29/11/2019 09:09	29/11/2019 17:16	8,11	5	40,55	CHI
201911358665	SAO DOMINGOS	SD12389176	SAO DOMINGOS	29/11/2019 14:36	29/11/2019 15:18	29/11/2019 14:36	29/11/2019 15:18	0,69	7	4,82	CHI
201911358667	PARAUNA	PU13008049	PARAUNA	29/11/2019 14:36	29/11/2019 23:09	29/11/2019 18:06	29/11/2019 22:18	4,20	1	4,20	CHI
201911358667	PARAUNA	PU10404071	PARAUNA	29/11/2019 14:36	29/11/2019 23:09	29/11/2019 14:36	29/11/2019 23:09	8,56	125	1069,93	CHI
201911358670	ACREUNA	EU21271616	ACREUNA	29/11/2019 14:38	29/11/2019 17:47	29/11/2019 14:38	29/11/2019 17:47	3,15	1	3,15	CHI
201911358672	JATAI	290330919	JATAI S2	29/11/2019 14:38	29/11/2019 16:47	29/11/2019 14:38	29/11/2019 16:47	2,14	1	2,14	CHI
201911358674	RIO VERDE	630505184	RIO VERDE S2	29/11/2019 14:38	29/11/2019 17:13	29/11/2019 14:38	29/11/2019 17:13	2,59	1	2,59	CHI
201911358675	PLANALTINA	PI21218353	PLANALTINA	29/11/2019 14:38	30/11/2019 10:12	29/11/2019 14:38	30/11/2019 10:12	19,55	1	19,55	CHI
201911358683	FAINA	FC12219921	GOIAS	29/11/2019 11:45	29/11/2019 15:46	29/11/2019 11:45	29/11/2019 15:46	4,01	4	16,05	CHI
201911358684	CRISTALINA	KR11170188	CRISTALINA S1	29/11/2019 14:40	29/11/2019 16:23	29/11/2019 14:40	29/11/2019 16:23	1,71	18	30,86	CHI
201911358700	MONTIVIDIU	MV12267718	MONTIVIDIU T	29/11/2019 14:41	29/11/2019 17:02	29/11/2019 14:41	29/11/2019 17:02	2,34	14	32,76	CHI
201911358700	RIO VERDE	MV12267718	MONTIVIDIU T	29/11/2019 14:41	29/11/2019 17:02	29/11/2019 14:41	29/11/2019 17:02	2,34	1	2,34	CHI
201911358701	ANAPOLIS	AN11019594	ANAPOLIS UNIVERSITARIO S2	29/11/2019 13:26	29/11/2019 15:53	29/11/2019 13:26	29/11/2019 15:53	2,44	38	92,83	CHI
201911358702	ALTO PARAISO DE GOIAS	ND12302635	IACIARA S2	29/11/2019 14:31	29/11/2019 16:42	29/11/2019 14:31	29/11/2019 16:42	2,17	18	39,15	CHI
201911358702	NOVA ROMA	ND12302635	IACIARA S2	29/11/2019 14:31	29/11/2019 16:42	29/11/2019 14:31	29/11/2019 16:42	2,17	120	260,97	CHI
201911358702	SAO JOAO D ALIANCA	ND12302635	IACIARA S2	29/11/2019 14:31	29/11/2019 16:42	29/11/2019 14:31	29/11/2019 16:42	2,17	27	58,72	CHI
201911358706	COCALZINHO DE GOIAS	ZN21345247	COCALZINHO	29/11/2019 14:41	30/11/2019 12:18	29/11/2019 14:41	30/11/2019 12:18	21,61	1	21,61	CHI
201911358711	CATALAO	CT11000040	CATALAO S2	29/11/2019 14:13	29/11/2019 20:10	29/11/2019 14:13	29/11/2019 20:10	5,95	44	261,76	CHI
201911358712	PALMEIRAS DE GOIAS	PL21000126	PALMEIRAS	29/11/2019 14:43	29/11/2019 21:45	29/11/2019 14:43	29/11/2019 21:45	7,03	1	7,03	CHI
201911358715	NOVA IGUACU DE GOIAS	NH21333052	URUACU	29/11/2019 14:44	30/11/2019 12:07	29/11/2019 14:44	30/11/2019 12:07	21,38	1	21,38	CHI
201911358722	COCALZINHO DE GOIAS	ZN12327436	GOIANESIA S1	29/11/2019 13:25	30/11/2019 12:12	29/11/2019 13:25	30/11/2019 12:12	22,77	14	318,75	CHI
201911358724	NOVO BRASIL	1460005998	JUSSARA	29/11/2019 14:45	29/11/2019 19:20	29/11/2019 14:45	29/11/2019 19:20	4,59	1	4,59	CHI
201911358726	NOVA CRIXAS	8570013762	NOVA CRIXAS	29/11/2019 14:46	30/11/2019 15:58	29/11/2019 14:46	30/11/2019 15:58	25,21	1	25,21	CHI
201911358731	PIRES DO RIO	PR12215590	PIRES DO RIO S1	29/11/2019 14:47	29/11/2019 17:50	29/11/2019 14:47	29/11/2019 17:50	3,06	12	36,70	CHI
201911358742	NIQUELANDIA	NQ12181071	NIQUELANDIA SUBTRANSMISSAO	29/11/2019 14:08	29/11/2019 22:40	29/11/2019 14:08	29/11/2019 22:40	8,53	16	136,51	CHI
201911358743	ITABERAÍ	IB21364832	ITABERAÍ S1	29/11/2019 14:49	29/11/2019 20:36	29/11/2019 14:49	29/11/2019 20:36	5,78	1	5,78	CHI

201911358747	MINACU	IH11325949	MINACU	29/11/2019 14:49	30/11/2019 02:46	29/11/2019 14:49	30/11/2019 02:46	11,94	1	11,94	CHI
201911358750	JUSSARA	JR12011813	BRITANIA	29/11/2019 12:55	30/11/2019 11:02	29/11/2019 12:55	30/11/2019 11:02	22,11	29	641,15	CHI
201911358751	CALDAS NOVAS	760340249	SERRA DE CALDAS	29/11/2019 14:49	30/11/2019 20:55	29/11/2019 14:49	30/11/2019 20:55	30,09	1	30,09	CHI
201911358752	NEROPOLIS	NR11104451	NEROPOLIS S2	29/11/2019 14:50	29/11/2019 18:21	29/11/2019 14:50	29/11/2019 18:21	3,51	18	63,24	CHI
201911358756	SAO MIGUEL DO ARAGUAIA	SM11276055	SAO MIGUEL DO ARAGUAIA	29/11/2019 14:50	30/11/2019 12:33	29/11/2019 14:50	30/11/2019 12:33	21,70	1	21,70	CHI
201911358759	PIRES DO RIO	10022088723	PIRES DO RIO S2	29/11/2019 14:50	30/11/2019 10:46	29/11/2019 14:50	30/11/2019 10:46	19,92	1	19,92	CHI
201911358763	LUZIANIA	LZ21001352	RIO VERMELHO	29/11/2019 14:51	29/11/2019 18:07	29/11/2019 14:51	29/11/2019 18:07	3,26	1	3,26	CHI
201911358766	QUIRINOPOLIS	QI12279590	QUIRINOPOLIS	29/11/2019 14:52	29/11/2019 18:15	29/11/2019 14:52	29/11/2019 18:15	3,38	7	23,67	CHI
201911358771	PIRACANJUBA	PJ21000177	PIRACANJUBA	29/11/2019 14:53	29/11/2019 15:59	29/11/2019 14:53	29/11/2019 15:59	1,10	2	2,19	CHI
201911358785	ARAGARCAS	10003888841	ARAGARCAS	29/11/2019 14:54	29/11/2019 17:18	29/11/2019 14:54	29/11/2019 17:18	2,40	1	2,40	CHI
201911358790	LUZIANIA	LZ12390021	PIRES DO RIO S2	29/11/2019 14:38	30/11/2019 12:46	29/11/2019 14:38	30/11/2019 12:46	22,14	18	398,48	CHI
201911358796	ITUMBIARA	690239403	ITUMBIARA NOVA	29/11/2019 14:55	29/11/2019 18:05	29/11/2019 14:55	29/11/2019 18:05	3,17	1	3,17	CHI
201911358800	SANTA RITA DO ARAGUAIA	SU12188580	SANTA RITA DO ARAGUAIA	29/11/2019 14:56	30/11/2019 10:27	29/11/2019 14:56	30/11/2019 10:27	19,51	1	19,51	CHI
201911358802	LUZIANIA	10012080100	RIO VERMELHO	29/11/2019 14:56	29/11/2019 16:27	29/11/2019 14:56	29/11/2019 16:27	1,51	1	1,51	CHI
201911358803	NIQUELANDIA	NQ12262919	NIQUELANDIA SUBTRANSMISSAO	29/11/2019 07:49	29/11/2019 15:31	29/11/2019 07:49	29/11/2019 15:31	7,69	10	76,90	CHI
201911358807	CRISTIANOPOLIS	CF21306782	CRISTIANOPOLIS	29/11/2019 14:58	30/11/2019 12:16	29/11/2019 14:58	30/11/2019 12:00	21,03	2	42,07	CHI
201911358807	CRISTIANOPOLIS	CF12309062	CRISTIANOPOLIS	29/11/2019 14:58	30/11/2019 12:16	30/11/2019 09:42	30/11/2019 12:16	2,58	4	10,31	CHI
201911358811	CORUMBAIBA	CI12131032	VILA CORUMBA	29/11/2019 14:58	01/12/2019 16:43	29/11/2019 14:58	01/12/2019 15:55	48,96	6	293,73	CHI
201911358811	CORUMBAIBA	CI12131032	VILA CORUMBA	29/11/2019 14:58	01/12/2019 16:43	29/11/2019 14:58	01/12/2019 16:14	49,26	6	295,58	CHI
201911358811	CORUMBAIBA	CI12149233	VILA CORUMBA	29/11/2019 14:58	01/12/2019 16:43	29/11/2019 14:58	01/12/2019 16:43	49,75	8	398,00	CHI
201911358812	MINACU	IH11151069	MINACU	29/11/2019 13:21	29/11/2019 22:13	29/11/2019 13:21	29/11/2019 22:13	8,87	37	328,05	CHI
201911358814	SANTA TEREZINHA DE GOIAS	VD21251083	SANTA TEREZINHA	29/11/2019 14:59	30/11/2019 11:05	29/11/2019 14:59	30/11/2019 11:05	20,10	1	20,10	CHI
201911358817	NOVA CRIXAS	MZ12055650	MOZARLANDIA	29/11/2019 13:38	30/11/2019 20:08	29/11/2019 13:38	30/11/2019 12:45	23,12	2	46,24	CHI
201911358817	NOVA CRIXAS	MZ12055650	MOZARLANDIA	29/11/2019 13:38	30/11/2019 20:08	30/11/2019 11:10	30/11/2019 12:45	1,58	10	15,82	CHI
201911358817	MOZARLANDIA	MZ12055650	MOZARLANDIA	29/11/2019 13:38	30/11/2019 20:08	29/11/2019 13:38	30/11/2019 17:21	27,72	2	55,44	CHI
201911358817	NOVA CRIXAS	MZ12055650	MOZARLANDIA	29/11/2019 13:38	30/11/2019 20:08	29/11/2019 13:38	30/11/2019 17:21	27,72	12	332,62	CHI
201911358817	MOZARLANDIA	MZ12150974LD	MOZARLANDIA	29/11/2019 13:38	30/11/2019 20:08	29/11/2019 13:38	30/11/2019 20:08	30,50	3	91,49	CHI
201911358817	NOVA CRIXAS	MZ12150974LD	MOZARLANDIA	29/11/2019 13:38	30/11/2019 20:08	29/11/2019 13:38	30/11/2019 20:08	30,50	4	121,99	CHI
201911358817	CRIXAS	MZ12150974LD	MOZARLANDIA	29/11/2019 13:38	30/11/2019 20:08	29/11/2019 13:38	30/11/2019 20:08	30,50	76	2317,83	CHI
201911358822	ITAPURANGA	IK12299324	ITAPURANGA	29/11/2019 15:00	29/11/2019 20:32	29/11/2019 15:00	29/11/2019 20:32	5,52	3	16,56	CHI
201911358823	CATALAO	CT21317612	CATALAO S1	29/11/2019 15:00	30/11/2019 10:32	29/11/2019 15:00	30/11/2019 10:32	19,52	1	19,52	CHI
201911358824	MINEIROS	1390021984	PARQUE DAS EMAS	29/11/2019 15:00	30/11/2019 11:57	29/11/2019 15:00	30/11/2019 11:57	20,94	1	20,94	CHI
201911358826	NIQUELANDIA	2750087436	NIQUELANDIA SUBTRANSMISSAO	29/11/2019 15:01	30/11/2019 02:52	29/11/2019 15:01	30/11/2019 02:52	11,84	1	11,84	CHI

201911358838	QUIRINOPOLIS	QI21359391	QUIRINOPOLIS	29/11/2019 15:04	29/11/2019 17:29	29/11/2019 15:04	29/11/2019 17:29	2,41	2	4,83	CHI
201911358840	QUIRINOPOLIS	QI21009003	QUIRINOPOLIS	29/11/2019 15:04	29/11/2019 17:05	29/11/2019 15:04	29/11/2019 17:05	2,00	2	4,01	CHI
201911358843	FORMOSA	FA12245346	ITIQUEIRA	29/11/2019 15:05	30/11/2019 10:35	29/11/2019 15:05	30/11/2019 10:35	19,50	3	58,49	CHI
201911358844	JATAI	JT21036547	JATAI S1	29/11/2019 15:05	29/11/2019 20:53	29/11/2019 15:05	29/11/2019 20:53	5,80	1	5,80	CHI
201911358848	PARAUNA	RP12304543	FIRMINOPOLIS S2	29/11/2019 15:05	30/11/2019 14:35	29/11/2019 15:05	30/11/2019 06:05	14,99	2	29,97	CHI
201911358848	AURILANDIA	PU13299202	FIRMINOPOLIS S2	29/11/2019 15:05	30/11/2019 14:35	29/11/2019 15:05	30/11/2019 13:46	22,67	3	68,01	CHI
201911358848	PARAUNA	PU13299202	FIRMINOPOLIS S2	29/11/2019 15:05	30/11/2019 14:35	29/11/2019 15:05	30/11/2019 13:46	22,67	6	136,03	CHI
201911358848	PARAUNA	PU12010292	FIRMINOPOLIS S2	29/11/2019 15:05	30/11/2019 14:35	29/11/2019 15:05	30/11/2019 14:35	23,50	27	634,48	CHI
201911358853	IPIRANGA DE GOIAS	RB12194284	RUBIATABA	29/11/2019 15:06	30/11/2019 16:50	29/11/2019 15:06	30/11/2019 16:50	25,72	9	231,49	CHI
201911358854	CATALAO	1990136324	CATALAO S2	29/11/2019 15:06	29/11/2019 17:55	29/11/2019 15:06	29/11/2019 17:55	2,80	1	2,80	CHI
201911358855	ITAUCU	IX11000009	INHUMAS S1	29/11/2019 15:06	29/11/2019 23:45	29/11/2019 15:06	29/11/2019 23:45	8,64	121	1045,07	CHI
201911358859	MONTE ALEGRE DE GOIAS	MA21236740	SAO DOMINGOS	29/11/2019 15:07	30/11/2019 10:44	29/11/2019 15:07	30/11/2019 10:44	19,61	1	19,61	CHI
201911358860	TEREZOPOLIS DE GOIAS	TJ21186931	JUNDIAI S1	29/11/2019 15:07	29/11/2019 16:25	29/11/2019 15:07	29/11/2019 16:25	1,30	1	1,30	CHI
201911358861	BURITI ALEGRE	BG21090572	ITUMBIARA VELHA S2	29/11/2019 15:07	30/11/2019 17:10	29/11/2019 15:07	30/11/2019 17:10	26,04	1	26,04	CHI
201911358865	IPORA	IR21212938	IPORA	29/11/2019 15:07	29/11/2019 18:50	29/11/2019 15:07	29/11/2019 18:50	3,70	2	7,41	CHI
201911358870	GOIANIA	GN12162224	CARAJAS S2	29/11/2019 14:53	29/11/2019 16:59	29/11/2019 14:53	29/11/2019 16:59	2,08	192	400,16	CHI
201911358871	NIQUELANDIA	2750113083	NIQUELANDIA SUBTRANSMISSAO	29/11/2019 15:08	30/11/2019 13:09	29/11/2019 15:08	30/11/2019 13:09	22,01	1	22,01	CHI
201911358873	ALEXANIA	10006949124	ALEXANIA	29/11/2019 15:08	29/11/2019 20:40	29/11/2019 15:08	29/11/2019 20:40	5,53	1	5,53	CHI
201911358874	NIQUELANDIA	NQ12317176	NIQUELANDIA SUBTRANSMISSAO	29/11/2019 12:16	29/11/2019 23:13	29/11/2019 12:16	29/11/2019 23:13	10,94	75	820,23	CHI
201911358875	GOIAS	IK12250721	GOIAS	29/11/2019 15:07	29/11/2019 18:27	29/11/2019 18:00	29/11/2019 18:26	0,43	7	2,99	CHI
201911358875	ITABERAI	IK12250721	GOIAS	29/11/2019 15:07	29/11/2019 18:27	29/11/2019 18:00	29/11/2019 18:26	0,43	2	0,85	CHI
201911358875	ITAPURANGA	IK12250721	GOIAS	29/11/2019 15:07	29/11/2019 18:27	29/11/2019 18:00	29/11/2019 18:26	0,43	2	0,85	CHI
201911358875	GOIAS	IK12250721	GOIAS	29/11/2019 15:07	29/11/2019 18:27	29/11/2019 15:07	29/11/2019 18:27	3,34	6	20,04	CHI
201911358875	ITAPURANGA	IK12250721	GOIAS	29/11/2019 15:07	29/11/2019 18:27	29/11/2019 15:07	29/11/2019 18:27	3,34	1	3,34	CHI
201911358875	GOIAS	8051070	GOIAS	29/11/2019 15:07	29/11/2019 18:27	29/11/2019 15:07	29/11/2019 18:27	3,34	1	3,34	CHI
201911358876	VILA PROPICIO	PV12396676	GOIANESIA S1	29/11/2019 15:09	30/11/2019 03:33	29/11/2019 15:09	30/11/2019 03:33	12,39	26	322,20	CHI
201911358878	VILA PROPICIO	NP21298238	GOIANESIA S1	29/11/2019 15:09	29/11/2019 19:17	29/11/2019 15:09	29/11/2019 19:17	4,12	2	8,24	CHI
201911358889	PORANGATU	PO12241996	PORANGATU	29/11/2019 11:38	29/11/2019 16:28	29/11/2019 11:38	29/11/2019 16:28	4,83	81	391,07	CHI
201911358891	GOIANIA	15514407	CARAJAS S1	29/11/2019 15:12	29/11/2019 18:23	29/11/2019 15:12	29/11/2019 18:23	3,18	1	3,18	CHI
201911358895	LUZIANIA	10025458491	RIO VERMELHO	29/11/2019 15:13	29/11/2019 17:04	29/11/2019 15:13	29/11/2019 17:04	1,84	1	1,84	CHI
201911358905	SANTA FE DE GOIAS	RN12159290LD	BRITANIA	29/11/2019 15:15	30/11/2019 13:16	29/11/2019 15:15	30/11/2019 08:42	17,44	19	331,38	CHI
201911358905	ITAPIRAPUA	RN12159290LD	BRITANIA	29/11/2019 15:15	30/11/2019 13:16	29/11/2019 15:15	30/11/2019 08:42	17,44	2	34,88	CHI
201911358905	SANTA FE DE GOIAS	RN12159290LD	BRITANIA	29/11/2019 15:15	30/11/2019 13:16	30/11/2019 09:23	30/11/2019 13:16	3,88	19	73,63	CHI



201911358905	ITAPIRAPUA	RN12159290LD	BRITANIA	29/11/2019 15:15	30/11/2019 13:16	30/11/2019 09:23	30/11/2019 13:16	3,88	2	7,75	CHI
201911358909	FORMOSA	FA12228227	SAO JOAO D ALIANCA	30/11/2019 06:19	30/11/2019 13:29	30/11/2019 06:19	30/11/2019 13:29	7,15	11	78,67	CHI
201911358913	ITUMBIARA	690152905	ITUMBIARA VELHA S1	29/11/2019 15:16	29/11/2019 16:28	29/11/2019 15:16	29/11/2019 16:28	1,21	1	1,21	CHI
201911358914	ALEXANIA	AX12000104	CORUMBA	29/11/2019 06:58	29/11/2019 18:56	29/11/2019 06:58	29/11/2019 18:56	11,96	49	586,23	CHI
201911358920	PIRACANJUBA	PJ12263455	PIRACANJUBA	29/11/2019 15:17	29/11/2019 17:39	29/11/2019 15:17	29/11/2019 17:39	2,36	8	18,86	CHI
201911358923	AGUA FRIA DE GOIAS	TL21322494	SAO JOAO D ALIANCA	29/11/2019 15:18	01/12/2019 09:28	29/11/2019 15:18	01/12/2019 09:28	42,16	3	126,48	CHI
201911358924	MORRINHOS	150013954	MORRINHOS	29/11/2019 15:18	29/11/2019 18:50	29/11/2019 15:18	29/11/2019 18:50	3,53	1	3,53	CHI
201911358929	AGUA FRIA DE GOIAS	PI21039175	SAO JOAO D ALIANCA	29/11/2019 15:19	29/11/2019 23:14	29/11/2019 15:19	29/11/2019 23:14	7,91	1	7,91	CHI
201911358934	GOIATUBA	140051077	GOIATUBA S2	29/11/2019 15:20	29/11/2019 16:55	29/11/2019 15:20	29/11/2019 16:55	1,58	1	1,58	CHI
201911358935	DIORAMA	DI12066071	ARENOPOLIS	29/11/2019 15:20	29/11/2019 21:12	29/11/2019 15:20	29/11/2019 21:12	5,86	28	164,03	CHI
201911358937	OUVIDOR	OU12390000	CATALAO S1	29/11/2019 15:20	29/11/2019 16:41	29/11/2019 15:20	29/11/2019 16:41	1,34	5	6,70	CHI
201911358939	ITAPURANGA	IK21386578	ITAPURANGA	29/11/2019 15:21	29/11/2019 22:56	29/11/2019 15:21	29/11/2019 22:56	7,58	2	15,16	CHI
201911358943	JATAI	290220749	JATAI S2	29/11/2019 15:21	29/11/2019 17:26	29/11/2019 15:21	29/11/2019 17:26	2,07	1	2,07	CHI
201911358961	PEROLANDIA	JT21152154	JATAI S1	29/11/2019 15:24	29/11/2019 17:10	29/11/2019 15:24	29/11/2019 17:10	1,76	1	1,76	CHI
201911358966	ITABERAI	IB21300086	ITABERAI S2	29/11/2019 15:24	29/11/2019 17:10	29/11/2019 15:24	29/11/2019 17:10	1,75	1	1,75	CHI
201911358968	ITUMBIARA	690189801	PARANAIBA	29/11/2019 15:25	29/11/2019 18:21	29/11/2019 15:25	29/11/2019 18:21	2,93	1	2,93	CHI
201911358976	INDIARA	10002975031	EDEIA	29/11/2019 15:26	29/11/2019 17:19	29/11/2019 15:26	29/11/2019 17:19	1,89	1	1,89	CHI
201911358977	GOIANIA	10016961895	CARAJAS S2	29/11/2019 15:26	29/11/2019 18:23	29/11/2019 15:26	29/11/2019 18:23	2,95	1	2,95	CHI
201911358980	MUNDO NOVO DE GOIAS	MH12318486	NOVA CRIXAS	29/11/2019 09:46	30/11/2019 12:12	29/11/2019 09:46	30/11/2019 12:12	26,43	45	1189,15	CHI
201911358986	ANAPOLIS	AN11288615	JUNDIAI S2	29/11/2019 15:28	29/11/2019 16:51	29/11/2019 15:28	29/11/2019 16:51	1,37	32	43,99	CHI
201911358989	GOIANIA	GN21001211	FERROVIARIO S1	29/11/2019 15:28	29/11/2019 19:04	29/11/2019 15:28	29/11/2019 19:04	3,59	1	3,59	CHI
201911358990	ANAPOLIS	10029189797	ANAPOLIS UNIVERSITARIO S2	29/11/2019 15:28	29/11/2019 16:31	29/11/2019 15:28	29/11/2019 16:31	1,03	1	1,03	CHI
201911358993	PALMEIRAS DE GOIAS	PL12308381	PALMEIRAS	29/11/2019 15:29	29/11/2019 19:23	29/11/2019 15:29	29/11/2019 19:23	3,90	18	70,11	CHI
201911358994	ITAPURANGA	IK12234789	ITAPURANGA	29/11/2019 15:29	30/11/2019 11:48	29/11/2019 15:29	30/11/2019 11:48	20,31	6	121,83	CHI
201911359005	MONTE ALEGRE DE GOIAS	MA12233174	SAO DOMINGOS	29/11/2019 13:49	29/11/2019 18:27	29/11/2019 13:49	29/11/2019 18:27	4,62	17	78,58	CHI
201911359018	GOIANIA	GN11043359	XAVANTES	29/11/2019 15:35	29/11/2019 16:51	29/11/2019 15:35	29/11/2019 16:51	1,27	93	117,72	CHI
201911359023	MONTIVIDIU	MV12054334	MONTIVIDIU T	29/11/2019 14:41	30/11/2019 13:10	29/11/2019 14:41	30/11/2019 13:10	22,48	4	89,93	CHI
201911359028	PIRENOPOLIS	PV21354783	CORUMBA	29/11/2019 15:37	30/11/2019 21:04	29/11/2019 15:37	30/11/2019 21:04	29,44	2	58,88	CHI
201911359031	NOVA ROMA	ND21391128	IACIARA S2	29/11/2019 15:38	29/11/2019 19:01	29/11/2019 15:38	29/11/2019 19:01	3,37	1	3,37	CHI
201911359036	CORUMBAIBA	CI12000451	VILA CORUMBA	29/11/2019 09:23	30/11/2019 18:22	29/11/2019 09:23	29/11/2019 16:57	7,55	8	60,44	CHI
201911359036	NOVA AURORA	CI12000451	VILA CORUMBA	29/11/2019 09:23	30/11/2019 18:22	29/11/2019 09:23	29/11/2019 16:57	7,55	6	45,33	CHI
201911359036	NOVA AURORA	CI12000495LD	VILA CORUMBA	29/11/2019 09:23	30/11/2019 18:22	29/11/2019 09:23	30/11/2019 18:22	32,97	1	32,97	CHI
201911359036	NOVA AURORA	CI12000495LD	VILA CORUMBA	29/11/2019 09:23	30/11/2019 18:22	30/11/2019 17:02	30/11/2019 18:22	1,33	5	6,66	CHI

201911359036	CORUMBAIBA	CI12000495LD	VILA CORUMBA	29/11/2019 09:23	30/11/2019 18:22	30/11/2019 17:02	30/11/2019 18:22	1,33	1	1,33	CHI
201911359047	ORIZONA	OZ10300885	PIRES DO RIO S2	29/11/2019 15:38	29/11/2019 22:52	29/11/2019 15:38	29/11/2019 16:51	1,22	136	165,66	CHI
201911359047	ORIZONA	OZ13215727	PIRES DO RIO S2	29/11/2019 15:38	29/11/2019 22:52	29/11/2019 15:38	29/11/2019 22:15	6,61	56	370,00	CHI
201911359047	ORIZONA	OZ12319027LD	PIRES DO RIO S2	29/11/2019 15:38	29/11/2019 22:52	29/11/2019 15:38	29/11/2019 22:52	7,23	304	2197,33	CHI
201911359047	ORIZONA	OZ12319027LD	PIRES DO RIO S2	29/11/2019 15:38	29/11/2019 22:52	29/11/2019 18:58	29/11/2019 22:52	3,89	10	38,91	CHI
201911359051	HIDROLANDIA	HD21010536	CEPAIGO S2	29/11/2019 15:43	29/11/2019 18:55	29/11/2019 15:43	29/11/2019 18:55	3,19	1	3,19	CHI
201911359054	PIRANHAS	PH21278438	PIRANHAS	29/11/2019 15:43	29/11/2019 19:12	29/11/2019 15:43	29/11/2019 19:12	3,47	1	3,47	CHI
201911359061	CORUMBAIBA	CI12363786	VILA CORUMBA	29/11/2019 12:08	29/11/2019 22:58	29/11/2019 12:08	29/11/2019 22:58	10,82	18	194,80	CHI
201911359062	CASTELANDIA	CL21384573	RIO DOS BOIS	29/11/2019 15:45	30/11/2019 12:19	29/11/2019 15:45	30/11/2019 12:19	20,56	1	20,56	CHI
201911359065	ITAPURANGA	IK12300186	ITAPURANGA	29/11/2019 15:25	30/11/2019 10:31	29/11/2019 15:25	29/11/2019 17:48	2,38	39	92,90	CHI
201911359065	ITAPURANGA	IK12300186	ITAPURANGA	29/11/2019 15:25	30/11/2019 10:31	29/11/2019 17:49	30/11/2019 10:31	16,70	39	651,33	CHI
201911359072	FLORES DE GOIAS	FB12255043	FLORES DE GOIAS	29/11/2019 12:26	30/11/2019 19:50	29/11/2019 12:26	30/11/2019 19:48	31,37	31	972,42	CHI
201911359072	FLORES DE GOIAS	FB11255041	FLORES DE GOIAS	29/11/2019 12:26	30/11/2019 19:50	29/11/2019 12:26	30/11/2019 19:50	31,41	8	251,27	CHI
201911359085	PORANGATU	PO21289308	PORANGATU	29/11/2019 15:50	30/11/2019 03:34	29/11/2019 15:50	30/11/2019 03:34	11,72	1	11,72	CHI
201911359087	GOIANIA	10005808462	ATLANTICO S3	29/11/2019 15:50	29/11/2019 19:55	29/11/2019 15:50	29/11/2019 19:55	4,07	0	0,00	CHI
201911359092	ITAPIRAPUA	IU12259757	MATRINCHA	29/11/2019 15:51	29/11/2019 18:34	29/11/2019 15:51	29/11/2019 18:34	2,71	25	67,78	CHI
201911359092	SANTA FE DE GOIAS	IU12259757	MATRINCHA	29/11/2019 15:51	29/11/2019 18:34	29/11/2019 15:51	29/11/2019 18:34	2,71	12	32,54	CHI
201911359093	PORANGATU	PO12391933	MARA ROSA	29/11/2019 15:52	29/11/2019 18:45	29/11/2019 15:52	29/11/2019 18:45	2,88	5	14,41	CHI
201911359098	MINACU	IH11202453	MINACU	29/11/2019 13:25	29/11/2019 17:51	29/11/2019 13:25	29/11/2019 17:51	4,43	36	159,36	CHI
201911359099	IACIARA	IA21218689	IACIARA S2	29/11/2019 15:53	29/11/2019 17:19	29/11/2019 15:53	29/11/2019 17:19	1,43	1	1,43	CHI
201911359106	GOIANIA	GN11247739	XAVANTES	29/11/2019 15:53	29/11/2019 18:52	29/11/2019 15:53	29/11/2019 18:52	2,97	72	213,94	CHI
201911359113	NOVO PLANALTO	TA12391926	SAO MIGUEL DO ARAGUAIA	29/11/2019 14:19	29/11/2019 23:34	29/11/2019 14:19	29/11/2019 23:34	9,24	18	166,26	CHI
201911359117	ALTO PARAISO DE GOIAS	BF12244571	SAO JOAO D ALIANCA	29/11/2019 15:47	29/11/2019 18:50	29/11/2019 15:47	29/11/2019 18:50	3,04	25	76,10	CHI
201911359119	SAO DOMINGOS	SD12211512	SAO DOMINGOS	29/11/2019 15:56	30/11/2019 21:27	29/11/2019 15:56	30/11/2019 21:27	29,51	10	295,10	CHI
201911359123	JATAI	JT21056260	JATAI S2	29/11/2019 15:56	29/11/2019 19:28	29/11/2019 15:56	29/11/2019 19:28	3,52	2	7,04	CHI
201911359125	COCALZINHO DE GOIAS	ZN11315371	GOIANESIA S1	29/11/2019 15:57	30/11/2019 11:43	29/11/2019 15:57	30/11/2019 11:43	19,76	1	19,76	CHI
201911359126	ALTO PARAISO DE GOIAS	BF11364983	SAO JOAO D ALIANCA	29/11/2019 15:57	29/11/2019 19:48	29/11/2019 15:57	29/11/2019 19:48	3,84	1	3,84	CHI
201911359128	AMORINOPOLIS	AM12007749	IPORA	29/11/2019 15:57	29/11/2019 23:53	29/11/2019 15:57	29/11/2019 23:53	7,92	3	23,75	CHI
201911359133	SAO DOMINGOS	SD21262221	SAO DOMINGOS	29/11/2019 15:59	30/11/2019 11:42	29/11/2019 15:59	30/11/2019 11:42	19,70	1	19,70	CHI
201911359134	SANTA RITA DO NOVO DESTINO	BA12068485	BARRO ALTO	29/11/2019 15:30	29/11/2019 17:46	29/11/2019 15:30	29/11/2019 17:46	2,26	32	72,40	CHI
201911359134	BARRO ALTO	BA12068485	BARRO ALTO	29/11/2019 15:30	29/11/2019 17:46	29/11/2019 15:30	29/11/2019 17:46	2,26	1	2,26	CHI
201911359137	COCALZINHO DE GOIAS	ZN12295667	COCALZINHO	29/11/2019 11:00	30/11/2019 17:21	29/11/2019 11:00	30/11/2019 17:21	30,35	13	394,51	CHI
201911359139	POSSE	10008855950	IACIARA S2	29/11/2019 16:01	30/11/2019 07:11	29/11/2019 16:01	30/11/2019 07:11	15,16	1	15,16	CHI

201911359140	CATALAO	CT11000074	CATALAO S2	29/11/2019 16:01	29/11/2019 17:09	29/11/2019 16:01	29/11/2019 17:09	1,14	67	76,14	CHI
201911359143	CALDAS NOVAS	CN21207637	CALDAS NOVAS S1	29/11/2019 16:01	29/11/2019 18:41	29/11/2019 16:01	29/11/2019 18:41	2,67	1	2,67	CHI
201911359144	PLANALTINA	PI11136679	PLANALTINA	29/11/2019 16:01	29/11/2019 17:14	29/11/2019 16:01	29/11/2019 17:14	1,21	79	95,41	CHI
201911359145	NOVO PLANALTO	TA12139137	NOVO PLANALTO	29/11/2019 13:39	30/11/2019 01:09	29/11/2019 13:39	30/11/2019 01:09	11,48	3	34,45	CHI
201911359148	MONTE ALEGRE DE GOIAS	MA12071357	SAO DOMINGOS	29/11/2019 13:40	29/11/2019 19:28	29/11/2019 13:40	29/11/2019 19:28	5,79	68	393,68	CHI
201911359151	NIQUELANDIA	2750019558	NIQUELANDIA SUBTRANSMISSAO	29/11/2019 16:02	30/11/2019 08:04	29/11/2019 16:02	30/11/2019 08:04	16,02	1	16,02	CHI
201911359156	COCALZINHO DE GOIAS	CB12051789	GOIANESIA S1	29/11/2019 12:43	30/11/2019 20:37	29/11/2019 12:43	30/11/2019 20:37	31,90	6	191,37	CHI
201911359163	RIO VERDE	630576257	CABRIUVA S1	29/11/2019 16:05	29/11/2019 19:30	29/11/2019 16:05	29/11/2019 19:30	3,42	1	3,42	CHI
201911359166	QUIRINOPOLIS	QI11000055	QUIRINOPOLIS	29/11/2019 14:18	29/11/2019 20:10	29/11/2019 14:18	29/11/2019 20:10	5,86	45	263,50	CHI
201911359181	BRITANIA	10010551067	BRITANIA	29/11/2019 16:08	30/11/2019 10:28	29/11/2019 16:08	30/11/2019 10:28	18,32	1	18,32	CHI
201911359183	PARAUNA	PU12205943	PARAUNA	29/11/2019 16:09	30/11/2019 11:48	29/11/2019 16:09	30/11/2019 11:48	19,65	24	471,58	CHI
201911359183	JANDAIA	PU12205943	PARAUNA	29/11/2019 16:09	30/11/2019 11:48	29/11/2019 16:09	30/11/2019 11:48	19,65	3	58,95	CHI
201911359186	GOIANIA	GN11000337	GOIANIA LESTE S3	29/11/2019 15:43	29/11/2019 17:11	29/11/2019 15:43	29/11/2019 17:11	1,46	69	100,93	CHI
201911359188	JATAI	JT12296503	JATAI S1	29/11/2019 13:33	30/11/2019 08:14	29/11/2019 13:33	30/11/2019 08:14	18,68	8	149,41	CHI
201911359188	PEROLANDIA	JT12296503	JATAI S1	29/11/2019 13:33	30/11/2019 08:14	29/11/2019 13:33	30/11/2019 08:14	18,68	3	56,03	CHI
201911359193	VALPARAISO DE GOIAS	2860114343	PACAEMBU S1	29/11/2019 16:10	29/11/2019 19:31	29/11/2019 16:10	29/11/2019 19:31	3,34	1	3,34	CHI
201911359197	BONOPOLIS	BX12334612	SAO MIGUEL DO ARAGUAIA	29/11/2019 16:11	30/11/2019 13:00	29/11/2019 16:11	30/11/2019 13:00	20,81	2	41,62	CHI
201911359198	CHAPADAO DO CEU	DJ21241806	CHAPADAO DO CEU	29/11/2019 16:11	30/11/2019 13:52	29/11/2019 16:11	30/11/2019 13:52	21,68	1	21,68	CHI
201911359199	ITUMBIARA	690191753	ITUMBIARA NOVA	29/11/2019 16:11	29/11/2019 18:23	29/11/2019 16:11	29/11/2019 18:23	2,19	1	2,19	CHI
201911359203	LUZIANIA	LZ21161338	VIANOPOLIS	29/11/2019 16:11	29/11/2019 19:00	29/11/2019 16:11	29/11/2019 19:00	2,80	1	2,80	CHI
201911359205	GOIANIRA	GR21016123	GOIANIRA	29/11/2019 16:12	29/11/2019 18:00	29/11/2019 16:12	29/11/2019 18:00	1,79	1	1,79	CHI
201911359206	AGUAS LINDAS DE GOIAS	4830031270	AGUAS LINDAS DE GOIAS S1	29/11/2019 16:12	29/11/2019 17:28	29/11/2019 16:12	29/11/2019 17:28	1,26	1	1,26	CHI
201911359207	SILVANIA	SV21284619	VIANOPOLIS	29/11/2019 16:12	30/11/2019 17:18	29/11/2019 16:12	30/11/2019 17:18	25,10	1	25,10	CHI
201911359208	ITABERAI	IB12379749	ITABERAI S2	29/11/2019 16:12	29/11/2019 18:43	29/11/2019 16:12	29/11/2019 18:43	2,50	7	17,53	CHI
201911359210	PLANALTINA	PI11070762	PLANALTINA	29/11/2019 16:13	29/11/2019 19:03	29/11/2019 16:13	29/11/2019 19:03	2,82	168	474,41	CHI
201911359212	CRIXAS	CX12391852	RUBIATABA	28/11/2019 09:07	30/11/2019 00:15	28/11/2019 09:07	30/11/2019 00:15	39,13	21	821,69	CHI
201911359215	GOIANIA	GN12220948	MEIA PONTE	29/11/2019 16:14	29/11/2019 23:54	29/11/2019 16:14	29/11/2019 23:54	7,66	160	1225,87	CHI
201911359223	ARAGARCAS	AG11000013	ARAGARCAS	29/11/2019 16:15	29/11/2019 19:18	29/11/2019 16:15	29/11/2019 19:18	3,04	116	352,19	CHI
201911359238	MINACU	IH21187808	MINACU	29/11/2019 16:19	30/11/2019 08:37	29/11/2019 16:19	30/11/2019 08:37	16,30	1	16,30	CHI
201911359250	CAMPOS BELOS	CH12243118	SAO DOMINGOS	29/11/2019 15:03	30/11/2019 08:06	29/11/2019 15:03	30/11/2019 08:06	17,05	6	102,30	CHI
201911359250	MONTE ALEGRE DE GOIAS	CH12243118	SAO DOMINGOS	29/11/2019 15:03	30/11/2019 08:06	29/11/2019 15:03	30/11/2019 08:06	17,05	3	51,15	CHI
201911359257	CAMPINORTE	10005801468	CAMPINORTE	29/11/2019 16:25	30/11/2019 09:32	29/11/2019 16:25	30/11/2019 09:32	17,11	1	17,11	CHI
201911359258	VIANOPOLIS	10028710884	VIANOPOLIS	29/11/2019 16:25	29/11/2019 18:54	29/11/2019 16:25	29/11/2019 18:54	2,48	1	2,48	CHI

201911359266	AURILANDIA	AI21287135	FIRMINOPOLIS S2	29/11/2019 16:26	29/11/2019 17:50	29/11/2019 16:26	29/11/2019 17:50	1,40	1	1,40	CHI
201911359270	CUMARI	AH21130936	CATALAO S1	29/11/2019 16:27	30/11/2019 09:27	29/11/2019 16:27	30/11/2019 09:27	17,00	1	17,00	CHI
201911359271	SANTO ANTONIO DA BARRA	BZ21136109	ACREUNA	29/11/2019 16:29	30/11/2019 10:11	29/11/2019 16:29	30/11/2019 10:11	17,70	1	17,70	CHI
201911359274	OURO VERDE DE GOIAS	NR21282638	NEROPOLIS S2	29/11/2019 16:29	29/11/2019 22:49	29/11/2019 16:29	29/11/2019 22:49	6,33	1	6,33	CHI
201911359279	JATAI	JT12159407	JATAI S1	29/11/2019 16:30	30/11/2019 09:22	29/11/2019 16:30	30/11/2019 09:22	16,86	3	50,57	CHI
201911359281	ORIZONA	03600224	VIANOPOLIS	29/11/2019 16:19	30/11/2019 16:35	29/11/2019 16:19	29/11/2019 16:26	0,12	58	7,01	CHI
201911359281	SILVANIA	03600224	VIANOPOLIS	29/11/2019 16:19	30/11/2019 16:35	29/11/2019 16:19	29/11/2019 16:26	0,12	5	0,60	CHI
201911359281	VIANOPOLIS	03600224	VIANOPOLIS	29/11/2019 16:19	30/11/2019 16:35	29/11/2019 16:19	29/11/2019 16:26	0,12	225	27,19	CHI
201911359281	MORRINHOS	03600224	VIANOPOLIS	29/11/2019 16:19	30/11/2019 16:35	29/11/2019 16:19	29/11/2019 16:26	0,12	1	0,12	CHI
201911359281	VIANOPOLIS	VN10403993	VIANOPOLIS	29/11/2019 16:19	30/11/2019 16:35	29/11/2019 16:19	29/11/2019 17:35	1,27	285	361,63	CHI
201911359281	ORIZONA	VN13200161	VIANOPOLIS	29/11/2019 16:19	30/11/2019 16:35	29/11/2019 16:19	29/11/2019 17:35	1,27	38	48,22	CHI
201911359281	VIANOPOLIS	VN13200161	VIANOPOLIS	29/11/2019 16:19	30/11/2019 16:35	29/11/2019 16:19	29/11/2019 17:35	1,27	144	182,72	CHI
201911359281	VIANOPOLIS	03600224	VIANOPOLIS	29/11/2019 16:19	30/11/2019 16:35	29/11/2019 16:27	29/11/2019 17:35	1,14	225	256,38	CHI
201911359281	ORIZONA	03600224	VIANOPOLIS	29/11/2019 16:19	30/11/2019 16:35	29/11/2019 16:27	29/11/2019 17:35	1,14	58	66,09	CHI
201911359281	SILVANIA	03600224	VIANOPOLIS	29/11/2019 16:19	30/11/2019 16:35	29/11/2019 16:27	29/11/2019 17:35	1,14	5	5,70	CHI
201911359281	MORRINHOS	03600224	VIANOPOLIS	29/11/2019 16:19	30/11/2019 16:35	29/11/2019 16:27	29/11/2019 17:35	1,14	1	1,14	CHI
201911359281	ORIZONA	03600226	VIANOPOLIS	29/11/2019 16:19	30/11/2019 16:35	29/11/2019 17:36	29/11/2019 18:50	1,23	45	55,16	CHI
201911359281	VIANOPOLIS	03600226	VIANOPOLIS	29/11/2019 16:19	30/11/2019 16:35	29/11/2019 17:36	29/11/2019 18:50	1,23	310	380,01	CHI
201911359281	VIANOPOLIS	03600224	VIANOPOLIS	29/11/2019 16:19	30/11/2019 16:35	29/11/2019 19:33	29/11/2019 20:03	0,50	311	155,50	CHI
201911359281	ORIZONA	03600224	VIANOPOLIS	29/11/2019 16:19	30/11/2019 16:35	29/11/2019 19:33	29/11/2019 20:03	0,50	45	22,50	CHI
201911359281	VIANOPOLIS	VN13200254	VIANOPOLIS	29/11/2019 16:19	30/11/2019 16:35	29/11/2019 17:36	30/11/2019 04:50	11,23	292	3277,94	CHI
201911359281	ORIZONA	VN13103017	VIANOPOLIS	29/11/2019 16:19	30/11/2019 16:35	29/11/2019 17:36	30/11/2019 05:36	12,01	51	612,41	CHI
201911359281	SILVANIA	VN13103017	VIANOPOLIS	29/11/2019 16:19	30/11/2019 16:35	29/11/2019 17:36	30/11/2019 05:36	12,01	5	60,04	CHI
201911359281	VIANOPOLIS	VN13103017	VIANOPOLIS	29/11/2019 16:19	30/11/2019 16:35	29/11/2019 17:36	30/11/2019 05:36	12,01	53	636,43	CHI
201911359281	MORRINHOS	VN13103017	VIANOPOLIS	29/11/2019 16:19	30/11/2019 16:35	29/11/2019 17:36	30/11/2019 05:36	12,01	1	12,01	CHI
201911359281	VIANOPOLIS	03600224	VIANOPOLIS	29/11/2019 16:19	30/11/2019 16:35	29/11/2019 20:04	30/11/2019 08:21	12,29	8	98,31	CHI
201911359281	VIANOPOLIS	03600224	VIANOPOLIS	29/11/2019 16:19	30/11/2019 16:35	29/11/2019 20:04	30/11/2019 10:41	14,63	303	4433,31	CHI
201911359281	ORIZONA	03600224	VIANOPOLIS	29/11/2019 16:19	30/11/2019 16:35	29/11/2019 20:04	30/11/2019 10:41	14,63	45	658,41	CHI
201911359281	ORIZONA	VN13014629	VIANOPOLIS	29/11/2019 16:19	30/11/2019 16:35	30/11/2019 16:14	30/11/2019 16:35	0,35	51	18,05	CHI
201911359281	SILVANIA	VN13014629	VIANOPOLIS	29/11/2019 16:19	30/11/2019 16:35	30/11/2019 16:14	30/11/2019 16:35	0,35	5	1,77	CHI
201911359281	MORRINHOS	VN13014629	VIANOPOLIS	29/11/2019 16:19	30/11/2019 16:35	30/11/2019 16:14	30/11/2019 16:35	0,35	1	0,35	CHI
201911359281	VIANOPOLIS	VN13014629	VIANOPOLIS	29/11/2019 16:19	30/11/2019 16:35	30/11/2019 16:14	30/11/2019 16:35	0,35	345	122,09	CHI
201911359291	GOIANIA	GN11001984	ATLANTICO S1	29/11/2019 16:32	29/11/2019 18:40	29/11/2019 16:32	29/11/2019 18:40	2,13	108	229,71	CHI

201911359296	ITUMBIARA	IT12273924	ITUMBIARA VELHA S2	29/11/2019 16:16	29/11/2019 19:00	29/11/2019 16:16	29/11/2019 19:00	2,73	5	13,63	CHI
201911359299	GOIANDIRA	CT12266142RE	CATALAO S1	29/11/2019 13:00	29/11/2019 17:52	29/11/2019 13:00	29/11/2019 17:52	4,86	43	208,87	CHI
201911359299	CATALAO	CT12266142RE	CATALAO S1	29/11/2019 13:00	29/11/2019 17:52	29/11/2019 13:00	29/11/2019 17:52	4,86	107	519,75	CHI
201911359301	BELA VISTA DE GOIAS	BV12185857	CEPAIGO S2	29/11/2019 16:34	29/11/2019 19:20	29/11/2019 16:34	29/11/2019 19:20	2,77	3	8,30	CHI
201911359303	PARANAIGUARA	2230041491	CACHOEIRA ALTA	29/11/2019 16:34	30/11/2019 13:06	29/11/2019 16:34	30/11/2019 13:06	20,53	1	20,53	CHI
201911359305	CACHOEIRA ALTA	CA21200031	CACHOEIRA ALTA	29/11/2019 16:34	29/11/2019 23:09	29/11/2019 16:34	29/11/2019 23:09	6,57	1	6,57	CHI
201911359313	GOIANIA	GN12338047	FERROVIARIO S3	29/11/2019 16:30	29/11/2019 18:04	29/11/2019 16:30	29/11/2019 18:04	1,56	801	1248,23	CHI
201911359314	SERRANOPOLIS	SX12390596	JATAI S1	29/11/2019 15:08	30/11/2019 08:02	29/11/2019 15:08	30/11/2019 08:02	16,89	33	557,21	CHI
201911359319	PORANGATU	PO12265495	PORANGATU	29/11/2019 16:37	29/11/2019 23:50	29/11/2019 16:37	29/11/2019 23:50	7,20	1	7,20	CHI
201911359323	ALTO PARAISO DE GOIAS	3870003313	FLORES DE GOIAS	29/11/2019 16:38	29/11/2019 17:49	29/11/2019 16:38	29/11/2019 17:49	1,17	1	1,17	CHI
201911359338	FORMOSA	FA12204761	ITUIQUIRA	29/11/2019 16:41	30/11/2019 19:07	29/11/2019 16:41	30/11/2019 19:07	26,43	49	1295,12	CHI
201911359340	CORUMBAIBA	CI21402578	CATALAO S1	29/11/2019 16:41	30/11/2019 10:10	29/11/2019 16:41	30/11/2019 10:10	17,49	1	17,49	CHI
201911359343	CATALAO	CT21165281	CATALAO S1	29/11/2019 16:41	30/11/2019 10:18	29/11/2019 16:41	30/11/2019 10:18	17,61	1	17,61	CHI
201911359354	SANTO ANTONIO DE GOIAS	1360001132	NEROPOLIS S1	29/11/2019 16:43	29/11/2019 19:19	29/11/2019 16:43	29/11/2019 19:19	2,60	1	2,60	CHI
201911359361	LUZIANIA	LZ12203332	VIANOPOLIS	29/11/2019 16:44	29/11/2019 21:25	29/11/2019 16:44	29/11/2019 21:25	4,68	10	46,78	CHI
201911359363	PIRACANJUBA	PJ21283728	ROCHEDO	29/11/2019 16:44	29/11/2019 20:25	29/11/2019 16:44	29/11/2019 20:25	3,67	2	7,34	CHI
201911359370	GOIANAPOLIS	GP12000087	DAIA S2	29/11/2019 16:46	30/11/2019 14:53	29/11/2019 16:46	30/11/2019 14:53	22,10	3	66,30	CHI
201911359373	GOIANIA	13652461	ATLANTICO S1	29/11/2019 16:48	29/11/2019 19:05	29/11/2019 16:48	29/11/2019 19:05	2,28	1	2,28	CHI
201911359376	PIRACANJUBA	PJ12223377	ROCHEDO	29/11/2019 16:48	30/11/2019 14:50	29/11/2019 20:27	30/11/2019 14:40	18,22	5	91,08	CHI
201911359376	PIRACANJUBA	PJ12233807	MORRINHOS	29/11/2019 16:48	30/11/2019 14:50	29/11/2019 16:48	30/11/2019 14:50	22,03	2	44,06	CHI
201911359376	PIRACANJUBA	PJ12233807	ROCHEDO	29/11/2019 16:48	30/11/2019 14:50	29/11/2019 16:48	30/11/2019 14:50	22,03	8	176,24	CHI
201911359378	NOVO BRASIL	NB12396240	JUSSARA	29/11/2019 16:49	29/11/2019 21:16	29/11/2019 16:49	29/11/2019 21:16	4,44	10	44,42	CHI
201911359380	PEROLANDIA	MY13348945	PARQUE DAS EMAS	29/11/2019 06:10	30/11/2019 19:19	30/11/2019 11:36	30/11/2019 19:18	7,70	2	15,40	CHI
201911359380	PEROLANDIA	7144588	PARQUE DAS EMAS	29/11/2019 06:10	30/11/2019 19:19	29/11/2019 06:10	30/11/2019 19:19	37,14	14	519,93	CHI
201911359380	PORTELANDIA	7144588	PARQUE DAS EMAS	29/11/2019 06:10	30/11/2019 19:19	29/11/2019 06:10	30/11/2019 19:19	37,14	1	37,14	CHI
201911359380	MINEIROS	7144588	PARQUE DAS EMAS	29/11/2019 06:10	30/11/2019 19:19	29/11/2019 06:10	30/11/2019 19:19	37,14	20	742,76	CHI
201911359384	NOVA CRIXAS	NA12208598	NOVA CRIXAS	29/11/2019 16:50	30/11/2019 10:10	29/11/2019 16:50	30/11/2019 10:10	17,32	1	17,32	CHI
201911359386	LUZIANIA	LZ21349005	RIO VERMELHO	29/11/2019 16:51	29/11/2019 20:28	29/11/2019 16:51	29/11/2019 20:28	3,61	1	3,61	CHI
201911359389	SILVANIA	SV12389456	VIANOPOLIS	29/11/2019 16:50	30/11/2019 09:35	29/11/2019 16:50	30/11/2019 09:35	16,75	108	1808,79	CHI
201911359395	SANTO ANTONIO DA BARRA	BZ12303298	ACREUNA	29/11/2019 16:53	30/11/2019 00:25	29/11/2019 16:53	30/11/2019 00:25	7,52	1	7,52	CHI
201911359404	GOIANIA	14034001	MEIA PONTE	29/11/2019 16:55	29/11/2019 19:41	29/11/2019 16:55	29/11/2019 19:41	2,76	1	2,76	CHI
201911359405	PLANALTINA	2960095152	PLANALTINA	29/11/2019 16:55	29/11/2019 18:40	29/11/2019 16:55	29/11/2019 18:40	1,74	1	1,74	CHI
201911359406	ARUANA	AK21016453	BRITANIA	29/11/2019 16:55	29/11/2019 18:22	29/11/2019 16:55	29/11/2019 18:22	1,44	1	1,44	CHI

201911359409	MUNDO NOVO DE GOIAS	MH21252118	NOVA CRIXAS	29/11/2019 16:56	30/11/2019 11:56	29/11/2019 16:56	30/11/2019 11:56	18,99	1	18,99	CHI
201911359411	FORMOSA	FA11000042	ITIQUEIRA	29/11/2019 23:24	30/11/2019 00:09	29/11/2019 23:24	30/11/2019 00:09	0,74	140	102,98	CHI
201911359419	APARECIDA DE GOIANIA	AP11004859	ATLANTICO S1	29/11/2019 16:59	29/11/2019 19:12	29/11/2019 16:59	29/11/2019 19:12	2,21	153	338,26	CHI
201911359420	NOVA VENEZA	NV12010103	INHUMAS S1	29/11/2019 16:43	29/11/2019 18:27	29/11/2019 16:43	29/11/2019 18:27	1,72	2	3,44	CHI
201911359422	LUZIANIA	LZ21070107	MARAJOARA	29/11/2019 16:59	29/11/2019 19:25	29/11/2019 16:59	29/11/2019 19:25	2,42	1	2,42	CHI
201911359424	GAMELEIRA DE GOIAS	LB12000008	DAIA S2	29/11/2019 16:33	29/11/2019 19:32	29/11/2019 16:33	29/11/2019 19:32	2,98	15	44,72	CHI
201911359424	LEOPOLDO DE BULHOES	LB12000008	DAIA S2	29/11/2019 16:33	29/11/2019 19:32	29/11/2019 16:33	29/11/2019 19:32	2,98	152	453,17	CHI
201911359424	SILVANIA	LB12000008	DAIA S2	29/11/2019 16:33	29/11/2019 19:32	29/11/2019 16:33	29/11/2019 19:32	2,98	91	271,31	CHI
201911359425	PALMEIRAS DE GOIAS	PL12398710	PALMEIRAS	29/11/2019 16:58	29/11/2019 19:20	29/11/2019 16:58	29/11/2019 19:20	2,36	21	49,55	CHI
201911359430	POSSE	SA12195795	IACIARA S2	29/11/2019 10:18	29/11/2019 22:43	29/11/2019 10:18	29/11/2019 22:43	12,41	5	62,07	CHI
201911359439	CAIAPONIA	CP12191771	MONTIVIDIU T	29/11/2019 15:30	30/11/2019 09:41	29/11/2019 15:30	30/11/2019 09:41	18,17	10	181,70	CHI
201911359439	JATAI	CP12191771	MONTIVIDIU T	29/11/2019 15:30	30/11/2019 09:41	29/11/2019 15:30	30/11/2019 09:41	18,17	7	127,19	CHI
201911359439	RIO VERDE	CP12191771	MONTIVIDIU T	29/11/2019 15:30	30/11/2019 09:41	29/11/2019 15:30	30/11/2019 09:41	18,17	9	163,53	CHI
201911359441	MINEIROS	MY12114029	PARQUE DAS EMAS	29/11/2019 15:25	30/11/2019 09:22	29/11/2019 15:25	30/11/2019 09:22	17,94	7	125,59	CHI
201911359446	CAMPO ALEGRE DE GOIAS	1160006330	CAMPO ALEGRE DE GOIAS	29/11/2019 17:04	30/11/2019 17:58	29/11/2019 17:04	30/11/2019 17:58	24,90	1	24,90	CHI
201911359447	APARECIDA DE GOIANIA	14379594	ANHANGUERA	29/11/2019 17:04	29/11/2019 18:50	29/11/2019 17:04	29/11/2019 18:50	1,75	1	1,75	CHI
201911359451	GOIATUBA	CL21295953	RIO DOS BOIS	29/11/2019 17:06	30/11/2019 08:30	29/11/2019 17:06	30/11/2019 08:30	15,40	1	15,40	CHI
201911359452	IACIARA	IA12206170	IACIARA S1	29/11/2019 13:23	29/11/2019 19:37	29/11/2019 13:23	29/11/2019 19:37	6,23	80	498,76	CHI
201911359454	LUZIANIA	LZ11184656	RIO VERMELHO	29/11/2019 17:06	29/11/2019 19:11	29/11/2019 17:06	29/11/2019 19:11	2,08	43	89,46	CHI
201911359457	FAINA	FC11378219	GOIAS	29/11/2019 17:06	29/11/2019 21:11	29/11/2019 17:06	29/11/2019 21:11	4,08	1	4,08	CHI
201911359461	MINEIROS	MY21303792	PARQUE DAS EMAS	29/11/2019 17:06	30/11/2019 12:35	29/11/2019 17:06	30/11/2019 12:35	19,47	1	19,47	CHI
201911359469	JATAI	290205578	JATAI S2	29/11/2019 17:07	29/11/2019 18:30	29/11/2019 17:07	29/11/2019 18:30	1,39	1	1,39	CHI
201911359473	PEROLANDIA	DP12209129	JATAI S1	29/11/2019 17:09	29/11/2019 21:37	29/11/2019 17:09	29/11/2019 21:37	4,46	7	31,23	CHI
201911359477	GOIANESIA	GE21202174	GOIANESIA S2	29/11/2019 17:10	01/12/2019 21:15	29/11/2019 17:10	01/12/2019 21:15	52,08	3	156,25	CHI
201911359479	PIRACANJUBA	PJ12025290	PIRACANJUBA	29/11/2019 17:10	29/11/2019 22:49	29/11/2019 17:10	29/11/2019 22:49	5,64	19	107,23	CHI
201911359481	GOIAS	90091541	GOIAS	29/11/2019 17:11	29/11/2019 20:58	29/11/2019 17:11	29/11/2019 20:58	3,78	1	3,78	CHI
201911359487	FORMOSA	610159756	ITIQUEIRA	29/11/2019 17:12	29/11/2019 18:35	29/11/2019 17:12	29/11/2019 18:35	1,37	1	1,37	CHI
201911359490	INHUMAS	IN31066334	INHUMAS S2	29/11/2019 17:13	30/11/2019 15:42	29/11/2019 17:13	30/11/2019 15:42	22,48	1	22,48	CHI
201911359492	CAMPO ALEGRE DE GOIAS	CM12192738RE	CAMPO ALEGRE DE GOIAS	29/11/2019 16:42	30/11/2019 07:37	29/11/2019 16:42	30/11/2019 07:37	14,91	47	700,55	CHI
201911359498	BURITI DE GOIAS	BS10404254	FIRMINOPOLIS S2	29/11/2019 17:15	29/11/2019 21:52	29/11/2019 17:15	29/11/2019 21:52	4,63	1	4,63	CHI
201911359498	SAO LUIS DE MONTES BELOS	BS10404254	FIRMINOPOLIS S2	29/11/2019 17:15	29/11/2019 21:52	29/11/2019 19:10	29/11/2019 21:52	2,71	4	10,82	CHI
201911359498	SANCLERLANDIA	BS10404254	FIRMINOPOLIS S2	29/11/2019 17:15	29/11/2019 21:52	29/11/2019 19:10	29/11/2019 21:52	2,71	55	148,81	CHI
201911359498	BURITI DE GOIAS	BS10404254	FIRMINOPOLIS S2	29/11/2019 17:15	29/11/2019 21:52	29/11/2019 19:10	29/11/2019 21:52	2,71	24	64,93	CHI

201911359499	DOVERLANDIA	10010885321	CAIAPONIA	29/11/2019 17:15	30/11/2019 16:10	29/11/2019 17:15	30/11/2019 16:10	22,91	1	22,91	CHI
201911359513	GOIANESIA	SZ12034200	ITAPACI	29/11/2019 10:58	30/11/2019 09:08	29/11/2019 10:58	30/11/2019 09:08	22,15	1	22,15	CHI
201911359513	SAO LUIZ DO NORTE	SZ12034200	ITAPACI	29/11/2019 10:58	30/11/2019 09:08	29/11/2019 10:58	30/11/2019 09:08	22,15	3	66,46	CHI
201911359527	MUNDO NOVO DE GOIAS	MH21321055	NOVA CRIXAS	29/11/2019 17:22	30/11/2019 11:20	29/11/2019 17:22	30/11/2019 11:20	17,96	1	17,96	CHI
201911359528	CORUMBA DE GOIAS	CB11215166	CORUMBA	29/11/2019 15:54	29/11/2019 20:26	29/11/2019 15:54	29/11/2019 20:26	4,52	75	339,02	CHI
201911359529	GOIANIA	12640050	CAMPINAS S2	29/11/2019 17:23	29/11/2019 19:18	29/11/2019 17:23	29/11/2019 19:18	1,91	1	1,91	CHI
201911359530	MINEIROS	MY12360756	PARQUE DAS EMAS	29/11/2019 17:24	30/11/2019 11:36	29/11/2019 17:24	30/11/2019 11:36	18,20	5	90,98	CHI
201911359531	INDIARA	2710048500	EDEIA	29/11/2019 17:24	30/11/2019 01:37	29/11/2019 17:24	30/11/2019 01:37	8,22	1	8,22	CHI
201911359534	ITUMBIARA	690007516	ITUMBIARA VELHA S1	29/11/2019 17:24	29/11/2019 19:37	29/11/2019 17:24	29/11/2019 19:37	2,20	1	2,20	CHI
201911359541	BELA VISTA DE GOIAS	BV21020431	BELA VISTA S2	29/11/2019 17:27	29/11/2019 21:08	29/11/2019 17:27	29/11/2019 21:08	3,67	1	3,67	CHI
201911359542	CAMPOS BELOS	MA12261978	SAO DOMINGOS	29/11/2019 12:22	29/11/2019 19:57	29/11/2019 12:22	29/11/2019 19:57	7,57	21	159,03	CHI
201911359542	MONTE ALEGRE DE GOIAS	MA12261978	SAO DOMINGOS	29/11/2019 12:22	29/11/2019 19:57	29/11/2019 12:22	29/11/2019 19:57	7,57	36	272,62	CHI
201911359543	PIRENOPOLIS	PV21000709	ANAPOLIS UNIVERSITARIO S2	29/11/2019 17:28	30/11/2019 11:15	29/11/2019 17:28	30/11/2019 11:15	17,78	1	17,78	CHI
201911359544	RIO VERDE	10006067652	RIO VERDE S1	29/11/2019 17:28	30/11/2019 10:22	29/11/2019 17:28	30/11/2019 10:22	16,90	1	16,90	CHI
201911359547	GOIANESIA	GE21401948	GOIANESIA S1	29/11/2019 17:29	30/11/2019 19:40	29/11/2019 17:29	30/11/2019 19:40	26,18	1	26,18	CHI
201911359552	FORMOSA	FA32042639	ITUIQUIRA	29/11/2019 17:19	30/11/2019 09:19	29/11/2019 17:19	30/11/2019 09:19	15,99	12	191,88	CHI
201911359559	FORMOSA	FA12404381	ITUIQUIRA	29/11/2019 17:33	30/11/2019 11:41	29/11/2019 17:33	30/11/2019 11:41	18,13	4	72,53	CHI
201911359561	VARJAO	VJ21315897	GUAPO S2	29/11/2019 17:33	29/11/2019 22:09	29/11/2019 17:33	29/11/2019 22:09	4,60	1	4,60	CHI
201911359562	CRISTALINA	KR12168488	CRISTALINA S1	29/11/2019 17:33	29/11/2019 20:05	29/11/2019 17:33	29/11/2019 20:05	2,53	32	80,88	CHI
201911359562	LUZIANIA	KR12168488	CRISTALINA S1	29/11/2019 17:33	29/11/2019 20:05	29/11/2019 17:33	29/11/2019 20:05	2,53	1	2,53	CHI
201911359566	GOIANIA	13622950	XAVANTES	29/11/2019 17:34	29/11/2019 19:00	29/11/2019 17:34	29/11/2019 19:00	1,43	1	1,43	CHI
201911359568	MONTE ALEGRE DE GOIAS	MA12130278	SAO DOMINGOS	29/11/2019 16:00	29/11/2019 19:55	29/11/2019 16:00	29/11/2019 19:55	3,91	5	19,53	CHI
201911359573	GOIANIA	GN11002637	FERROVIARIO S3	29/11/2019 17:35	29/11/2019 19:24	29/11/2019 17:35	29/11/2019 19:24	1,81	62	111,96	CHI
201911359577	AGUA LIMPA	AL21238076	VILA CORUMBA	29/11/2019 17:36	30/11/2019 14:28	29/11/2019 17:36	30/11/2019 14:28	20,86	1	20,86	CHI
201911359584	QUIRINOPOLIS	QI12065828	CACHOEIRA ALTA	29/11/2019 17:37	30/11/2019 19:31	29/11/2019 17:37	30/11/2019 19:31	25,89	1	25,89	CHI
201911359586	CRISTALINA	KR21163732	CRISTALINA S2	29/11/2019 17:37	30/11/2019 04:58	29/11/2019 17:37	30/11/2019 04:58	11,33	1	11,33	CHI
201911359593	BURITI ALEGRE	BG12000121	GOIATUBA S2	29/11/2019 17:40	30/11/2019 22:03	29/11/2019 17:40	30/11/2019 22:03	28,38	14	397,31	CHI
201911359593	GOIATUBA	BG12000121	GOIATUBA S2	29/11/2019 17:40	30/11/2019 22:03	29/11/2019 17:40	30/11/2019 22:03	28,38	1	28,38	CHI
201911359595	FIRMINOPOLIS	SL21309564	SAO LUIZ DOS MONTES BELOS	29/11/2019 17:41	29/11/2019 19:58	29/11/2019 17:41	29/11/2019 19:58	2,28	1	2,28	CHI
201911359597	RIO VERDE	RV12301246	MONTVIDIU T	29/11/2019 15:49	30/11/2019 01:00	29/11/2019 15:49	30/11/2019 01:00	9,17	14	128,38	CHI
201911359599	MONTES CLAROS DE GOIAS	ME21353754	IPORA	29/11/2019 17:41	29/11/2019 19:31	29/11/2019 17:41	29/11/2019 19:31	1,82	1	1,82	CHI
201911359600	ITUMBIARA	05210214	CACHOEIRA DOURADA	29/11/2019 17:37	30/11/2019 12:19	29/11/2019 17:37	29/11/2019 23:05	5,46	80	436,67	CHI
201911359600	BOM JESUS DE GOIAS	05210214	CACHOEIRA DOURADA	29/11/2019 17:37	30/11/2019 12:19	29/11/2019 17:37	29/11/2019 23:05	5,46	3	16,37	CHI

201911359600	GOIATUBA	IT12033089LD	CACHOEIRA DOURADA	29/11/2019 17:37	30/11/2019 12:19	29/11/2019 17:37	30/11/2019 12:19	18,70	7	130,88	CHI
201911359600	ITUMBIARA	IT12033089LD	CACHOEIRA DOURADA	29/11/2019 17:37	30/11/2019 12:19	29/11/2019 17:37	30/11/2019 12:19	18,70	92	1720,17	CHI
201911359600	PANAMA	IT12033089LD	CACHOEIRA DOURADA	29/11/2019 17:37	30/11/2019 12:19	29/11/2019 17:37	30/11/2019 12:19	18,70	19	355,25	CHI
201911359600	BOM JESUS DE GOIAS	IT12033089LD	CACHOEIRA DOURADA	29/11/2019 17:37	30/11/2019 12:19	29/11/2019 17:37	30/11/2019 12:19	18,70	29	542,23	CHI
201911359600	ITUMBIARA	05210214	CACHOEIRA DOURADA	29/11/2019 17:37	30/11/2019 12:19	29/11/2019 17:37	30/11/2019 12:19	18,70	12	224,37	CHI
201911359600	BOM JESUS DE GOIAS	05210214	CACHOEIRA DOURADA	29/11/2019 17:37	30/11/2019 12:19	29/11/2019 17:37	30/11/2019 12:19	18,70	1	18,70	CHI
201911359607	IPORA	IR21070234	IPORA	29/11/2019 17:44	30/11/2019 01:53	29/11/2019 17:44	30/11/2019 01:53	8,14	2	16,27	CHI
201911359609	MINACU	IH12192447	MINACU	29/11/2019 17:44	30/11/2019 15:47	29/11/2019 17:44	30/11/2019 15:47	22,04	24	529,07	CHI
201911359609	CAMPINACU	IH12192447	MINACU	29/11/2019 17:44	30/11/2019 15:47	29/11/2019 17:44	30/11/2019 15:47	22,04	5	110,22	CHI
201911359610	SAO FRANCISCO DE GOIAS	SF12211807	SAO FRANCISCO DE GOIAS	29/11/2019 08:29	29/11/2019 21:42	29/11/2019 08:29	29/11/2019 21:42	13,20	4	52,82	CHI
201911359611	LUZIANIA	LZ21000271	RIO VERMELHO	29/11/2019 17:45	30/11/2019 00:01	29/11/2019 17:45	30/11/2019 00:01	6,26	1	6,26	CHI
201911359614	PLANALTINA	PI12196961	PLANALTINA	29/11/2019 08:30	30/11/2019 11:02	29/11/2019 08:30	30/11/2019 11:02	26,53	26	689,73	CHI
201911359625	PIRENOPOLIS	PV21000078	CORUMBA	29/11/2019 17:49	29/11/2019 19:55	29/11/2019 17:49	29/11/2019 19:55	2,10	1	2,10	CHI
201911359626	SILVANIA	660051862	VIANOPOLIS	29/11/2019 17:49	30/11/2019 10:00	29/11/2019 17:49	30/11/2019 10:00	16,19	1	16,19	CHI
201911359627	LEOPOLDO DE BULHOES	LB12321544	DAIA S2	29/11/2019 17:21	30/11/2019 09:06	29/11/2019 17:21	30/11/2019 09:06	15,75	2	31,50	CHI
201911359630	PIRENOPOLIS	PV21135421	JARAGUA	29/11/2019 17:50	30/11/2019 15:07	29/11/2019 17:50	30/11/2019 15:07	21,27	2	42,55	CHI
201911359633	JATAI	290344517	JATAI S3	29/11/2019 17:51	30/11/2019 00:36	29/11/2019 17:51	30/11/2019 00:36	6,75	1	6,75	CHI
201911359643	ABADIANIA	AA12390220	ANAPOLIS UNIVERSITARIO S1	29/11/2019 17:52	30/11/2019 12:58	29/11/2019 17:52	30/11/2019 12:58	19,09	1	19,09	CHI
201911359644	CABECEIRAS	CW12287236	ITIQUEIRA	29/11/2019 17:48	30/11/2019 15:15	29/11/2019 17:48	30/11/2019 15:15	21,44	17	364,55	CHI
201911359649	RIO VERDE	10002774761	RIO VERDE S1	29/11/2019 17:53	30/11/2019 09:00	29/11/2019 17:53	30/11/2019 09:00	15,11	1	15,11	CHI
201911359650	CABECEIRAS	CW12262301	ITIQUEIRA	29/11/2019 15:42	30/11/2019 13:14	29/11/2019 15:42	30/11/2019 13:14	21,52	43	925,35	CHI
201911359650	DISTRITO FEDERAL	CW12262301	ITIQUEIRA	29/11/2019 15:42	30/11/2019 13:14	29/11/2019 15:42	30/11/2019 13:14	21,52	1	21,52	CHI
201911359654	ANAPOLIS	AN11189908	JUNDIAI S1	29/11/2019 17:54	30/11/2019 06:10	29/11/2019 17:54	30/11/2019 06:10	12,27	67	822,03	CHI
201911359662	BELA VISTA DE GOIAS	BV21238105	BELA VISTA S2	29/11/2019 17:56	30/11/2019 07:58	29/11/2019 17:56	30/11/2019 07:58	14,02	1	14,02	CHI
201911359664	PALMEIRAS DE GOIAS	PL21161866	PALMEIRAS	29/11/2019 17:57	29/11/2019 22:50	29/11/2019 17:57	29/11/2019 22:50	4,89	1	4,89	CHI
201911359666	GUARANI DE GOIAS	GY12268482	SAO DOMINGOS	29/11/2019 14:53	29/11/2019 22:32	29/11/2019 14:53	29/11/2019 22:32	7,64	22	168,12	CHI
201911359672	LUZIANIA	120334173	RIO VERMELHO	29/11/2019 17:59	29/11/2019 20:32	29/11/2019 17:59	29/11/2019 20:32	2,55	1	2,55	CHI
201911359675	CASTELANDIA	CL21284365	RIO DOS BOIS	29/11/2019 17:59	30/11/2019 12:55	29/11/2019 17:59	30/11/2019 12:55	18,93	1	18,93	CHI
201911359679	AMARALINA	MU11335320	MARA ROSA	29/11/2019 17:59	30/11/2019 13:05	29/11/2019 17:59	30/11/2019 13:05	19,09	1	19,09	CHI
201911359680	ANAPOLIS	AN11008996	ANAPOLIS UNIVERSITARIO S1	29/11/2019 18:00	29/11/2019 21:20	29/11/2019 18:00	29/11/2019 21:20	3,35	85	284,68	CHI
201911359683	SERRANOPOLIS	MY21241655	CHAPADAO DO CEU	29/11/2019 18:00	30/11/2019 14:20	29/11/2019 18:00	30/11/2019 14:20	20,32	1	20,32	CHI
201911359684	ITABERAI	AR12384485	ARACU	29/11/2019 17:20	29/11/2019 23:36	29/11/2019 17:20	29/11/2019 23:36	6,25	6	37,52	CHI
201911359684	ANICUNS	AR12384485	ARACU	29/11/2019 17:20	29/11/2019 23:36	29/11/2019 17:20	29/11/2019 23:36	6,25	10	62,54	CHI



201911359684	ARACU	AR12384485	ARACU	29/11/2019 17:20	29/11/2019 23:36	29/11/2019 17:20	29/11/2019 23:36	6,25	1	6,25	CHI
201911359686	GOIANIA	17090556	REAL S1	29/11/2019 18:01	29/11/2019 20:04	29/11/2019 18:01	29/11/2019 20:04	2,04	1	2,04	CHI
201911359688	ORIZONA	10000694442	PIRES DO RIO S2	29/11/2019 18:02	30/11/2019 11:23	29/11/2019 18:02	30/11/2019 11:23	17,34	1	17,34	CHI
201911359692	ANAPOLIS	20518225	ANAPOLIS UNIVERSITARIO S1	29/11/2019 18:03	30/11/2019 10:34	29/11/2019 18:03	30/11/2019 10:34	16,51	1	16,51	CHI
201911359698	NOVA AMERICA	NM21235994	RUBIATABA	29/11/2019 18:04	30/11/2019 16:05	29/11/2019 18:04	30/11/2019 16:05	22,01	2	44,02	CHI
201911359700	FLORES DE GOIAS	FB11277875	IACIARA S2	29/11/2019 18:05	30/11/2019 12:01	29/11/2019 18:05	30/11/2019 12:01	17,93	1	17,93	CHI
201911359712	RIO VERDE	RV12000198	RIO VERDE S1	29/11/2019 18:28	30/11/2019 15:45	29/11/2019 18:28	30/11/2019 15:45	21,28	1	21,28	CHI
201911359727	RIO VERDE	RV12271286	CABRIUVA S2	29/11/2019 19:51	29/11/2019 22:00	29/11/2019 19:51	29/11/2019 22:00	2,14	2	4,28	CHI
201911359728	PIRACANJUBA	PJ12000097	PIRACANJUBA	29/11/2019 20:14	30/11/2019 19:25	29/11/2019 20:14	30/11/2019 14:40	18,42	19	350,00	CHI
201911359728	HIDROLANDIA	PJ13039987	PIRACANJUBA	29/11/2019 20:14	30/11/2019 19:25	29/11/2019 20:14	30/11/2019 19:25	23,17	7	162,21	CHI
201911359728	PIRACANJUBA	PJ13039987	PIRACANJUBA	29/11/2019 20:14	30/11/2019 19:25	29/11/2019 20:14	30/11/2019 19:25	23,17	15	347,59	CHI
201911359743	ITAPACI	10022263681	ITAPACI	29/11/2019 10:38	30/11/2019 00:55	29/11/2019 10:38	30/11/2019 00:55	14,27	1	14,27	CHI
201911359802	FORMOSA	CW12381542	ITUIQUIRA	29/11/2019 15:29	30/11/2019 10:17	29/11/2019 15:29	30/11/2019 10:17	18,80	2	37,59	CHI
201911359802	CABECEIRAS	CW12381542	ITUIQUIRA	29/11/2019 15:29	30/11/2019 10:17	29/11/2019 15:29	30/11/2019 10:17	18,80	53	996,19	CHI
201911359803	GOIANIA	14881512	GOIANIA LESTE S3	29/11/2019 18:06	29/11/2019 20:46	29/11/2019 18:06	29/11/2019 20:46	2,67	1	2,67	CHI
201911359804	AURILANDIA	AI21361886	FIRMINOPOLIS S2	29/11/2019 18:06	29/11/2019 20:37	29/11/2019 18:06	29/11/2019 20:37	2,51	1	2,51	CHI
201911359813	LUZIANIA	LZ21156995	MARAJOARA	29/11/2019 18:08	29/11/2019 21:38	29/11/2019 18:08	29/11/2019 21:38	3,49	2	6,97	CHI
201911359816	JATAI	290281751	JATAI S2	29/11/2019 18:09	30/11/2019 08:59	29/11/2019 18:09	30/11/2019 08:59	14,83	1	14,83	CHI
201911359817	IPORA	IR11000021	IPORA	29/11/2019 18:09	30/11/2019 02:35	29/11/2019 18:09	30/11/2019 02:35	8,44	60	506,22	CHI
201911359818	CUMARI	2000007930	CATALAO S1	29/11/2019 18:09	29/11/2019 20:20	29/11/2019 18:09	29/11/2019 20:20	2,17	1	2,17	CHI
201911359819	LEOPOLDO DE BULHOES	LB21378022	DAIA S2	29/11/2019 18:09	30/11/2019 09:51	29/11/2019 18:09	30/11/2019 09:51	15,69	1	15,69	CHI
201911359822	JARAGUA	7278118	ITABERAI S1	29/11/2019 18:09	29/11/2019 20:59	29/11/2019 18:09	29/11/2019 20:59	2,82	1	2,82	CHI
201911359822	ITAGUARI	7278118	ITABERAI S1	29/11/2019 18:09	29/11/2019 20:59	29/11/2019 18:09	29/11/2019 20:59	2,82	5	14,09	CHI
201911359823	IPORA	IR12358519	IPORA	29/11/2019 18:10	29/11/2019 20:09	29/11/2019 18:10	29/11/2019 20:09	1,98	12	23,79	CHI
201911359823	IVOLANDIA	IR12358519	IPORA	29/11/2019 18:10	29/11/2019 20:09	29/11/2019 18:10	29/11/2019 20:09	1,98	2	3,96	CHI
201911359824	GOIANIA	12475166	REAL S2	29/11/2019 18:10	29/11/2019 22:06	29/11/2019 18:10	29/11/2019 22:06	3,93	1	3,93	CHI
201911359826	ANAPOLIS	20958729	ANAPOLIS UNIVERSITARIO S2	29/11/2019 18:10	30/11/2019 13:25	29/11/2019 18:10	30/11/2019 13:25	19,24	1	19,24	CHI
201911359829	PARAUNA	PU12009706	IPORA	29/11/2019 18:10	30/11/2019 08:17	29/11/2019 18:10	30/11/2019 08:17	14,10	3	42,30	CHI
201911359829	CACHOEIRA DE GOIAS	PU12009706	IPORA	29/11/2019 18:10	30/11/2019 08:17	29/11/2019 18:10	30/11/2019 08:17	14,10	5	70,50	CHI
201911359832	CUMARI	2000018793	CATALAO S1	29/11/2019 18:11	30/11/2019 20:37	29/11/2019 18:11	30/11/2019 20:37	26,43	1	26,43	CHI
201911359836	CATALAO	CT21278418	CATALAO S1	29/11/2019 18:12	30/11/2019 11:58	29/11/2019 18:12	30/11/2019 11:58	17,77	1	17,77	CHI
201911359837	CATURAI	IN21117364	ARACU	29/11/2019 18:12	29/11/2019 20:23	29/11/2019 18:12	29/11/2019 20:23	2,18	2	4,36	CHI
201911359848	PARANAIGUARA	PC12389640	CACHOEIRA ALTA	29/11/2019 16:32	30/11/2019 17:51	29/11/2019 16:32	30/11/2019 17:51	25,32	23	582,26	CHI

201911359848	CACHOEIRA ALTA	PC12389640	CACHOEIRA ALTA	29/11/2019 16:32	30/11/2019 17:51	29/11/2019 16:32	30/11/2019 17:51	25,32	2	50,63	CHI
201911359849	LUZIANIA	KR12163676	PAMPLONA	29/11/2019 17:47	29/11/2019 20:30	29/11/2019 17:47	29/11/2019 20:30	2,71	2	5,43	CHI
201911359849	DISTRITO FEDERAL	KR12163676	PAMPLONA	29/11/2019 17:47	29/11/2019 20:30	29/11/2019 17:47	29/11/2019 20:30	2,71	4	10,85	CHI
201911359849	CRISTALINA	KR12163676	PAMPLONA	29/11/2019 17:47	29/11/2019 20:30	29/11/2019 17:47	29/11/2019 20:30	2,71	26	70,54	CHI
201911359850	FAZENDA NOVA	NB12099378	JUSSARA	29/11/2019 18:15	30/11/2019 07:10	29/11/2019 18:15	30/11/2019 07:10	12,90	3	38,70	CHI
201911359850	NOVO BRASIL	NB12099378	JUSSARA	29/11/2019 18:15	30/11/2019 07:10	29/11/2019 18:15	30/11/2019 07:10	12,90	1	12,90	CHI
201911359851	PIRES DO RIO	PR21300718	PIRES DO RIO S1	29/11/2019 18:16	30/11/2019 13:29	29/11/2019 18:16	30/11/2019 13:29	19,22	1	19,22	CHI
201911359859	GOIANIA	10023877543	MEIA PONTE	29/11/2019 18:18	30/11/2019 01:30	29/11/2019 18:18	30/11/2019 01:30	7,19	1	7,19	CHI
201911359861	SAO LUIS DE MONTES BELOS	SL21144878	SAO LUIZ DOS MONTES BELOS	29/11/2019 18:18	29/11/2019 21:06	29/11/2019 18:18	29/11/2019 21:06	2,79	3	8,36	CHI
201911359863	FORMOSA	FA21053565	ITUIQUIRA	29/11/2019 18:18	30/11/2019 17:22	29/11/2019 18:18	30/11/2019 17:22	23,05	1	23,05	CHI
201911359865	JATAI	JT21334228	JATAI S1	29/11/2019 18:19	30/11/2019 09:18	29/11/2019 18:19	30/11/2019 09:18	14,98	1	14,98	CHI
201911359866	PALESTINA DE GOIAS	PY21139314	ARENOPOLIS	29/11/2019 18:19	30/11/2019 08:32	29/11/2019 18:19	30/11/2019 08:32	14,21	1	14,21	CHI
201911359872	CACHOEIRA ALTA	QI12119881	QUIRINOPOLIS	29/11/2019 17:47	30/11/2019 09:26	29/11/2019 17:47	30/11/2019 09:26	15,64	6	93,85	CHI
201911359872	QUIRINOPOLIS	QI12119881	QUIRINOPOLIS	29/11/2019 17:47	30/11/2019 09:26	29/11/2019 17:47	30/11/2019 09:26	15,64	18	281,55	CHI
201911359873	GUAPO	GA12400521	GUAPO S1	29/11/2019 18:22	29/11/2019 21:50	29/11/2019 18:22	29/11/2019 21:50	3,46	13	45,02	CHI
201911359877	LUZIANIA	LZ12115952	MARAJOARA	29/11/2019 17:32	29/11/2019 19:33	29/11/2019 17:32	29/11/2019 19:33	2,00	11	22,01	CHI
201911359881	CAVALCANTE	CJ21163395	FLORES DE GOIAS	29/11/2019 18:24	30/11/2019 12:01	29/11/2019 18:24	30/11/2019 12:01	17,61	1	17,61	CHI
201911359886	SAO DOMINGOS	SD12348628	SAO DOMINGOS	29/11/2019 17:54	30/11/2019 11:25	29/11/2019 17:54	30/11/2019 11:25	17,50	14	245,01	CHI
201911359887	COCALZINHO DE GOIAS	ZN11326566	GOIANESIA S1	29/11/2019 18:24	30/11/2019 12:43	29/11/2019 18:24	30/11/2019 12:43	18,30	14	256,22	CHI
201911359888	AGUAS LINDAS DE GOIAS	4830144477	AGUAS LINDAS DE GOIAS S1	29/11/2019 18:25	29/11/2019 19:49	29/11/2019 18:25	29/11/2019 19:49	1,40	1	1,40	CHI
201911359889	VIANOPOLIS	OZ12084921RE	PIRES DO RIO S2	29/11/2019 17:04	30/11/2019 10:24	29/11/2019 17:04	30/11/2019 10:24	17,33	17	294,64	CHI
201911359889	ORIZONA	OZ12084921RE	PIRES DO RIO S2	29/11/2019 17:04	30/11/2019 10:24	29/11/2019 17:04	30/11/2019 10:24	17,33	111	1923,82	CHI
201911359890	AGUA FRIA DE GOIAS	TL12320523	SAO JOAO D ALIANCA	29/11/2019 07:50	29/11/2019 21:51	29/11/2019 07:50	29/11/2019 21:51	14,00	11	154,01	CHI
201911359899	RIO VERDE	RV12260251	RIO VERDE S1	29/11/2019 18:18	29/11/2019 23:48	29/11/2019 18:18	29/11/2019 23:48	5,49	16	87,80	CHI
201911359903	CRISTALINA	KR12170191	CRISTALINA S1	29/11/2019 17:49	29/11/2019 22:24	29/11/2019 17:49	29/11/2019 22:24	4,58	57	261,09	CHI
201911359908	PEROLANDIA	MY12212678	PARQUE DAS EMAS	29/11/2019 18:27	01/12/2019 14:57	29/11/2019 18:27	30/11/2019 17:42	23,25	3	69,76	CHI
201911359908	MINEIROS	MY12301837	PARQUE DAS EMAS	29/11/2019 18:27	01/12/2019 14:57	01/12/2019 08:13	01/12/2019 09:40	1,44	1	1,44	CHI
201911359908	PEROLANDIA	MY12212678	PARQUE DAS EMAS	29/11/2019 18:27	01/12/2019 14:57	30/11/2019 17:43	01/12/2019 14:52	21,15	2	42,30	CHI
201911359908	PEROLANDIA	MY12347907LD	PARQUE DAS EMAS	29/11/2019 18:27	01/12/2019 14:57	30/11/2019 17:43	01/12/2019 14:57	21,24	1	21,24	CHI
201911359912	ITAGUARI	10002344236	ITABERAI S1	29/11/2019 18:27	29/11/2019 19:14	29/11/2019 18:27	29/11/2019 19:14	0,77	1	0,77	CHI
201911359920	RIO VERDE	RV12260603	CABRIUVA S1	29/11/2019 15:33	30/11/2019 10:46	29/11/2019 15:33	30/11/2019 10:46	19,21	5	96,05	CHI
201911359921	CACHOEIRA DOURADA	130014631	CACHOEIRA DOURADA	29/11/2019 18:30	29/11/2019 22:58	29/11/2019 18:30	29/11/2019 22:58	4,46	1	4,46	CHI
201911359927	SANTA TEREZA DE GOIAS	FO12392284	PORANGATU	29/11/2019 17:46	29/11/2019 21:45	29/11/2019 17:46	29/11/2019 21:45	3,98	5	19,91	CHI

201911359927	FORMOSO	FO12392284	PORANGATU	29/11/2019 17:46	29/11/2019 21:45	29/11/2019 17:46	29/11/2019 21:45	3,98	13	51,75	CHI
201911359931	IPORA	IR21065123	IPORA	29/11/2019 18:32	29/11/2019 22:00	29/11/2019 18:32	29/11/2019 22:00	3,47	1	3,47	CHI
201911359933	ANHANGUERA	1980004113	CATALAO S1	29/11/2019 18:33	30/11/2019 09:07	29/11/2019 18:33	30/11/2019 09:07	14,58	1	14,58	CHI
201911359934	IPAMERI	IP21385741	CRISTALINA S2	29/11/2019 18:33	30/11/2019 09:22	29/11/2019 18:33	30/11/2019 09:22	14,81	1	14,81	CHI
201911359935	NOVO BRASIL	NB12216880	JUSSARA	29/11/2019 18:33	30/11/2019 12:44	29/11/2019 18:33	30/11/2019 12:44	18,19	2	36,38	CHI
201911359937	GOIANIA	10000062489	CAMPINAS S2	29/11/2019 18:34	29/11/2019 20:19	29/11/2019 18:34	29/11/2019 20:19	1,75	1	1,75	CHI
201911359940	URUACU	CR12410914	MARA ROSA	29/11/2019 18:36	30/11/2019 01:20	29/11/2019 18:36	30/11/2019 01:20	6,73	16	107,67	CHI
201911359944	SANTO ANTONIO DO DESCOBERTO	SN12330527	MARAJOARA	29/11/2019 18:37	29/11/2019 21:40	29/11/2019 18:37	29/11/2019 21:40	3,05	3	9,15	CHI
201911359946	ALEXANIA	AX12384864	ALEXANIA	29/11/2019 18:34	30/11/2019 11:47	29/11/2019 18:34	30/11/2019 11:47	17,20	74	1272,86	CHI
201911359948	NOVA ROMA	IA12180523	IACIARA S2	29/11/2019 18:37	29/11/2019 19:51	29/11/2019 18:37	29/11/2019 19:51	1,22	3	3,66	CHI
201911359951	DOVERLANDIA	CP12389843	CAIAPONIA	29/11/2019 18:38	30/11/2019 10:34	29/11/2019 18:38	30/11/2019 10:34	15,93	7	111,48	CHI
201911359952	PIRANHAS	1930020937	PIRANHAS	29/11/2019 18:38	29/11/2019 21:50	29/11/2019 18:38	29/11/2019 21:50	3,19	1	3,19	CHI
201911359954	VILA BOA	10024924561	IACIARA S2	29/11/2019 18:38	30/11/2019 15:48	29/11/2019 18:38	30/11/2019 15:48	21,15	1	21,15	CHI
201911359962	IPORA	AM12402911	IPORA	29/11/2019 17:51	29/11/2019 22:12	29/11/2019 17:51	29/11/2019 22:12	4,35	45	195,59	CHI
201911359967	BONFINOPOLIS	LB21038944	CEPAIGO S2	29/11/2019 18:40	30/11/2019 13:47	29/11/2019 18:40	30/11/2019 13:47	19,11	2	38,21	CHI
201911359970	GOIANIA	11323802	AEROPORTO S1	29/11/2019 18:41	29/11/2019 20:41	29/11/2019 18:41	29/11/2019 20:41	2,00	1	2,00	CHI
201911359971	LUZIANIA	10016769234	RIO VERMELHO	29/11/2019 18:41	29/11/2019 21:04	29/11/2019 18:41	29/11/2019 21:04	2,38	1	2,38	CHI
201911359973	AGUA LIMPA	AL12245823	VILA CORUMBA	29/11/2019 18:41	01/12/2019 19:49	29/11/2019 18:41	01/12/2019 19:49	49,13	1	49,13	CHI
201911359975	SENADOR CANEDO	10004611878	SENADOR CANEDO	29/11/2019 18:42	29/11/2019 23:07	29/11/2019 18:42	29/11/2019 23:07	4,41	1	4,41	CHI
201911359976	ORIZONA	OZ21111530	PIRES DO RIO S2	29/11/2019 18:42	30/11/2019 08:20	29/11/2019 18:42	30/11/2019 08:20	13,62	1	13,62	CHI
201911359977	SITIO D ABADIA	SI11099840	IACIARA S2	29/11/2019 11:40	30/11/2019 02:06	29/11/2019 11:40	30/11/2019 02:06	14,43	149	2149,74	CHI
201911359978	LUZIANIA	LZ11261472	RIO VERMELHO	29/11/2019 18:43	30/11/2019 07:54	29/11/2019 18:43	30/11/2019 07:54	13,18	40	527,18	CHI
201911359988	AGUAS LINDAS DE GOIAS	LA11108704	AGUAS LINDAS DE GOIAS S1	29/11/2019 18:45	29/11/2019 20:10	29/11/2019 18:45	29/11/2019 20:10	1,42	87	123,13	CHI
201911359989	MINACU	4020024602	MINACU	29/11/2019 18:45	30/11/2019 20:57	29/11/2019 18:45	30/11/2019 20:57	26,19	1	26,19	CHI
201911359991	FORMOSA	610252823	ITIQUEIRA	29/11/2019 18:45	29/11/2019 21:29	29/11/2019 18:45	29/11/2019 21:29	2,72	1	2,72	CHI
201911359997	CABECEIRAS	CW21146045	ITIQUEIRA	29/11/2019 18:47	01/12/2019 10:50	29/11/2019 18:47	01/12/2019 10:50	40,05	1	40,05	CHI
201911360000	CRISTALINA	KR21261534	CRISTALINA S1	29/11/2019 18:47	30/11/2019 08:11	29/11/2019 18:47	30/11/2019 08:11	13,39	1	13,39	CHI
201911360001	LUZIANIA	LZ21247958	CRISTALINA S2	29/11/2019 18:47	30/11/2019 10:12	29/11/2019 18:47	30/11/2019 10:12	15,41	1	15,41	CHI
201911360003	FORMOSA	FA21124659	ITIQUEIRA	29/11/2019 18:47	30/11/2019 15:19	29/11/2019 18:47	30/11/2019 15:19	20,53	4	82,12	CHI
201911360005	PARAUNA	PU12213493	PARAUNA	30/11/2019 10:38	30/11/2019 11:50	30/11/2019 10:38	30/11/2019 11:50	1,20	4	4,80	CHI
201911360009	APARECIDA DE GOIANIA	16543750	INDEPENDENCIA S1	29/11/2019 18:48	29/11/2019 19:51	29/11/2019 18:48	29/11/2019 19:51	1,03	1	1,03	CHI
201911360016	FORMOSA	FA21403581	SAO JOAO D ALIANCA	29/11/2019 18:50	30/11/2019 10:40	29/11/2019 18:50	30/11/2019 10:40	15,83	1	15,83	CHI
201911360032	FORMOSA	FA12261997	ITIQUEIRA	29/11/2019 13:45	30/11/2019 11:46	29/11/2019 13:45	30/11/2019 08:44	18,97	33	626,07	CHI

201911360032	VILA BOA	FA12261997	ITIQUEIRA	29/11/2019 13:45	30/11/2019 11:46	29/11/2019 13:45	30/11/2019 11:46	22,00	4	88,02	CHI
201911360032	FORMOSA	FA12261997	ITIQUEIRA	29/11/2019 13:45	30/11/2019 11:46	29/11/2019 13:45	30/11/2019 11:46	22,00	30	660,14	CHI
201911360033	VILA PROPICIO	PV21074934	GOIANESIA S1	29/11/2019 18:54	30/11/2019 15:07	29/11/2019 18:54	30/11/2019 15:07	20,22	1	20,22	CHI
201911360034	LUZIANIA	3200032441	MARAJOARA	29/11/2019 18:54	29/11/2019 19:50	29/11/2019 18:54	29/11/2019 19:50	0,92	1	0,92	CHI
201911360036	ITUMBIARA	BG21000052	PARANAIBA	29/11/2019 18:54	29/11/2019 22:08	29/11/2019 18:54	29/11/2019 22:08	3,22	1	3,22	CHI
201911360040	CORUMBAIBA	CI21098627	VILA CORUMBA	29/11/2019 18:55	30/11/2019 14:50	29/11/2019 18:55	30/11/2019 14:50	19,91	1	19,91	CHI
201911360046	ITAPACI	IW12308199	ITAPACI	29/11/2019 10:32	30/11/2019 10:33	29/11/2019 10:32	30/11/2019 10:33	24,01	6	144,06	CHI
201911360047	APARECIDA DE GOIANIA	AP11000071	CEPAIGO S1	29/11/2019 18:57	29/11/2019 21:37	29/11/2019 18:57	29/11/2019 21:37	2,66	1	2,66	CHI
201911360051	GOIANDIRA	CT12075551	CATALAO S1	29/11/2019 18:57	29/11/2019 21:08	29/11/2019 18:57	29/11/2019 21:08	2,17	2	4,34	CHI
201911360053	SANTA HELENA DE GOIAS	SH21131537	SANTA HELENA S1	29/11/2019 18:57	30/11/2019 09:30	29/11/2019 18:57	30/11/2019 09:30	14,53	1	14,53	CHI
201911360055	CACHOEIRA ALTA	CA12196169	CACHOEIRA ALTA	29/11/2019 18:58	30/11/2019 20:50	29/11/2019 18:58	30/11/2019 20:50	25,86	5	129,31	CHI
201911360061	ANAPOLIS	20978080	ANAPOLIS UNIVERSITARIO S2	29/11/2019 18:59	30/11/2019 12:31	29/11/2019 18:59	30/11/2019 12:31	17,53	1	17,53	CHI
201911360070	APARECIDA DE GOIANIA	10003328072	INDEPENDENCIA S2	29/11/2019 19:00	29/11/2019 20:05	29/11/2019 19:00	29/11/2019 20:05	1,07	1	1,07	CHI
201911360078	INDIARA	10010737349	EDEIA	29/11/2019 19:01	30/11/2019 00:19	29/11/2019 19:01	30/11/2019 00:19	5,30	1	5,30	CHI
201911360094	GOIANESIA	GE12000085	GOIANESIA S2	29/11/2019 18:46	30/11/2019 10:44	29/11/2019 18:46	30/11/2019 10:44	15,96	90	1436,83	CHI
201911360097	GAMELEIRA DE GOIAS	SV12382110	JUNDIAI S1	29/11/2019 17:32	30/11/2019 11:04	29/11/2019 17:32	30/11/2019 11:04	17,53	2	35,06	CHI
201911360097	ANAPOLIS	SV12382110	JUNDIAI S1	29/11/2019 17:32	30/11/2019 11:04	29/11/2019 17:32	30/11/2019 11:04	17,53	39	683,64	CHI
201911360106	INHUMAS	IN21066359	INHUMAS S2	29/11/2019 19:05	30/11/2019 12:09	29/11/2019 19:05	30/11/2019 12:09	17,06	1	17,06	CHI
201911360110	SANTA BARBARA DE GOIAS	SB12299229	TRINDADE	29/11/2019 19:05	29/11/2019 20:55	29/11/2019 19:05	29/11/2019 20:55	1,82	21	38,21	CHI
201911360121	SANTA RITA DO ARAGUAIA	MY12241641	PARQUE DAS EMAS	29/11/2019 14:31	30/11/2019 23:03	29/11/2019 14:31	30/11/2019 23:03	32,53	2	65,06	CHI
201911360121	MINEIROS	MY12241641	PARQUE DAS EMAS	29/11/2019 14:31	30/11/2019 23:03	29/11/2019 14:31	30/11/2019 23:03	32,53	3	97,60	CHI
201911360139	SAO DOMINGOS	SD12254355	SAO DOMINGOS	29/11/2019 18:39	30/11/2019 09:16	29/11/2019 18:39	30/11/2019 09:16	14,61	9	131,49	CHI
201911360142	CRISTALINA	KR12090782	PAMPLONA	29/11/2019 19:09	30/11/2019 11:24	29/11/2019 19:09	30/11/2019 11:24	16,23	7	113,64	CHI
201911360155	CAMPO ALEGRE DE GOIAS	1160014600	CAMPO ALEGRE DE GOIAS	29/11/2019 19:12	30/11/2019 17:55	29/11/2019 19:12	30/11/2019 17:55	22,71	1	22,71	CHI
201911360170	SANTO ANTONIO DO DESCOBERTO	SN12085981	MARAJOARA	29/11/2019 19:15	29/11/2019 22:10	29/11/2019 19:15	29/11/2019 22:10	2,91	25	72,74	CHI
201911360177	GOIANIA	10115122	CAMPINAS S1	29/11/2019 19:16	29/11/2019 20:27	29/11/2019 19:16	29/11/2019 20:27	1,18	1	1,18	CHI
201911360183	GUAPO	GA31098737	GUAPO S1	29/11/2019 18:22	30/11/2019 12:13	29/11/2019 18:22	30/11/2019 12:13	17,86	1	17,86	CHI
201911360191	CATALAO	CT21228824	CAMPO ALEGRE DE GOIAS	29/11/2019 19:18	30/11/2019 07:48	29/11/2019 19:18	30/11/2019 07:48	12,49	1	12,49	CHI
201911360192	PIRES DO RIO	10029884940	PIRES DO RIO S1	29/11/2019 19:18	30/11/2019 02:45	29/11/2019 19:18	30/11/2019 02:45	7,44	1	7,44	CHI
201911360199	PADRE BERNARDO	ZN12302505RE	COCALZINHO	29/11/2019 19:20	30/11/2019 20:02	29/11/2019 19:20	30/11/2019 20:02	24,69	1	24,69	CHI
201911360199	COCALZINHO DE GOIAS	ZN12302505RE	COCALZINHO	29/11/2019 19:20	30/11/2019 20:02	29/11/2019 19:20	30/11/2019 20:02	24,69	38	938,39	CHI
201911360200	CORUMBA DE GOIAS	CB12382361	CORUMBA	29/11/2019 19:05	30/11/2019 08:14	29/11/2019 19:05	30/11/2019 08:14	13,13	5	65,67	CHI
201911360201	LUZIANIA	3200201755	MARAJOARA	29/11/2019 19:20	29/11/2019 20:26	29/11/2019 19:20	29/11/2019 20:26	1,09	1	1,09	CHI

201911360202	IPORA	10018520071	IPORA	29/11/2019 19:20	29/11/2019 22:54	29/11/2019 19:20	29/11/2019 22:54	3,57	1	3,57	CHI
201911360209	MOZARLANDIA	410035490	MOZARLANDIA	29/11/2019 19:20	29/11/2019 21:49	29/11/2019 19:20	29/11/2019 21:49	2,47	1	2,47	CHI
201911360219	MORRINHOS	MR12273673	MORRINHOS	29/11/2019 19:22	30/11/2019 10:27	29/11/2019 19:22	30/11/2019 10:27	15,08	3	45,25	CHI
201911360226	GOIANIA	14690263	MEIA PONTE	29/11/2019 19:22	29/11/2019 20:59	29/11/2019 19:22	29/11/2019 20:59	1,61	1	1,61	CHI
201911360233	GOIANESIA	GE12382867	GOIANESIA S1	29/11/2019 19:00	30/11/2019 18:14	29/11/2019 19:00	30/11/2019 18:14	23,23	4	92,93	CHI
201911360248	NAZARIO	10025713610	ANICUNS	29/11/2019 19:26	29/11/2019 22:45	29/11/2019 19:26	29/11/2019 22:45	3,31	1	3,31	CHI
201911360249	PIRACANJUBA	PJ12293360	PIRACANJUBA	29/11/2019 19:26	03/12/2019 00:10	29/11/2019 19:26	30/11/2019 13:05	17,64	3	52,92	CHI
201911360249	PIRACANJUBA	PJ12293360	PIRACANJUBA	29/11/2019 19:26	03/12/2019 00:10	29/11/2019 19:26	30/11/2019 15:54	20,47	3	61,40	CHI
201911360249	PIRACANJUBA	PJ12293360	PIRACANJUBA	29/11/2019 19:26	03/12/2019 00:10	30/11/2019 19:31	01/12/2019 13:40	18,15	3	54,44	CHI
201911360249	PIRACANJUBA	PJ12293360	PIRACANJUBA	29/11/2019 19:26	03/12/2019 00:10	29/11/2019 19:26	02/12/2019 00:50	53,40	7	373,80	CHI
201911360249	PIRACANJUBA	PJ13139516	PIRACANJUBA	29/11/2019 19:26	03/12/2019 00:10	30/11/2019 19:31	02/12/2019 00:50	29,31	1	29,31	CHI
201911360249	PIRACANJUBA	PJ12293360	PIRACANJUBA	29/11/2019 19:26	03/12/2019 00:10	29/11/2019 19:26	02/12/2019 23:53	76,44	1	76,44	CHI
201911360249	PIRACANJUBA	PJ13139516	PIRACANJUBA	29/11/2019 19:26	03/12/2019 00:10	30/11/2019 19:31	02/12/2019 23:53	52,35	1	52,35	CHI
201911360249	PIRACANJUBA	PJ21139506	PIRACANJUBA	29/11/2019 19:26	03/12/2019 00:10	30/11/2019 19:31	02/12/2019 23:55	52,39	1	52,39	CHI
201911360249	PIRACANJUBA	PJ13139516	PIRACANJUBA	29/11/2019 19:26	03/12/2019 00:10	02/12/2019 19:46	03/12/2019 00:10	4,41	9	39,72	CHI
201911360249	PIRACANJUBA	PJ13139516	PIRACANJUBA	29/11/2019 19:26	03/12/2019 00:10	02/12/2019 23:53	03/12/2019 00:10	0,29	2	0,57	CHI
201911360250	FLORES DE GOIAS	3480016209	FLORES DE GOIAS	29/11/2019 19:26	30/11/2019 18:54	29/11/2019 19:26	30/11/2019 18:54	23,45	1	23,45	CHI
201911360258	GOIANIA	16574114	GOYA S2	29/11/2019 19:27	29/11/2019 22:56	29/11/2019 19:27	29/11/2019 22:56	3,47	1	3,47	CHI
201911360265	MORRINHOS	MR32056682	MORRINHOS	29/11/2019 19:29	30/11/2019 09:12	29/11/2019 19:29	30/11/2019 09:12	13,72	2	27,43	CHI
201911360267	JANDAIA	JD21024181	PALMEIRAS	29/11/2019 19:29	30/11/2019 08:35	29/11/2019 19:29	30/11/2019 08:35	13,10	1	13,10	CHI
201911360272	CRISTALINA	KR12087954	CRISTALINA S2	29/11/2019 19:29	29/11/2019 21:12	29/11/2019 19:29	29/11/2019 21:12	1,71	3	5,12	CHI
201911360284	LUZIANIA	LZ12261608	VIANOPOLIS	29/11/2019 19:32	30/11/2019 11:54	29/11/2019 19:32	30/11/2019 11:24	15,86	27	428,35	CHI
201911360284	LUZIANIA	LZ13335850	VIANOPOLIS	29/11/2019 19:32	30/11/2019 11:54	29/11/2019 19:32	30/11/2019 11:54	16,36	42	687,30	CHI
201911360289	JATAI	10003594430	JATAI S2	29/11/2019 19:32	30/11/2019 07:36	29/11/2019 19:32	30/11/2019 07:36	12,06	1	12,06	CHI
201911360292	SAO DOMINGOS	8680006727	SAO DOMINGOS	29/11/2019 19:34	01/12/2019 11:07	29/11/2019 19:34	01/12/2019 11:07	39,55	1	39,55	CHI
201911360296	SANTA RITA DO NOVO DESTINO	BA12068485	BARRO ALTO	29/11/2019 19:11	30/11/2019 20:22	29/11/2019 19:11	30/11/2019 20:22	25,18	32	805,75	CHI
201911360296	BARRO ALTO	BA12068485	BARRO ALTO	29/11/2019 19:11	30/11/2019 20:22	29/11/2019 19:11	30/11/2019 20:22	25,18	1	25,18	CHI
201911360299	SANTO ANTONIO DO DESCOBERTO	2210015188	ALEXANIA	29/11/2019 19:35	29/11/2019 23:39	29/11/2019 19:35	29/11/2019 23:39	4,07	1	4,07	CHI
201911360302	UIRAPURU	UP12248237	SANTA TEREZINHA	29/11/2019 19:35	30/11/2019 11:20	29/11/2019 19:35	30/11/2019 11:20	15,74	3	47,22	CHI
201911360302	CRIXAS	UP12248237	SANTA TEREZINHA	29/11/2019 19:35	30/11/2019 11:20	29/11/2019 19:35	30/11/2019 11:20	15,74	2	31,48	CHI
201911360309	DIVINOPOLIS DE GOIAS	GH12254508	SAO DOMINGOS	29/11/2019 16:06	30/11/2019 20:03	29/11/2019 16:06	30/11/2019 20:03	27,94	8	223,49	CHI
201911360313	NOVO BRASIL	NB12396241	JUSSARA	29/11/2019 16:48	29/11/2019 23:54	29/11/2019 16:48	29/11/2019 23:54	7,10	5	35,49	CHI
201911360316	JOVIANIA	AD12394182	GOIATUBA S1	29/11/2019 19:02	29/11/2019 22:50	29/11/2019 19:02	29/11/2019 22:50	3,80	6	22,78	CHI

201911360316	PONTALINA	AD12394182	GOIATUBA S1	29/11/2019 19:02	29/11/2019 22:50	29/11/2019 19:02	29/11/2019 22:50	3,80	33	125,28	CHI
201911360319	PLANALTINA	PI11164618	PLANALTINA	29/11/2019 19:38	30/11/2019 02:33	29/11/2019 19:38	30/11/2019 02:33	6,91	78	539,35	CHI
201911360328	MONTIVIDIU	2840021013	MONTIVIDIU T	29/11/2019 19:39	30/11/2019 15:08	29/11/2019 19:39	30/11/2019 15:08	19,48	1	19,48	CHI
201911360332	CRIXAS	CX21132161	SERRA DO OURO	29/11/2019 19:40	01/12/2019 01:30	29/11/2019 19:40	01/12/2019 01:30	29,83	1	29,83	CHI
201911360348	ANAPOLIS	AN11086508	NEROPOLIS S1	29/11/2019 19:03	29/11/2019 21:30	29/11/2019 19:03	29/11/2019 21:30	2,44	176	429,54	CHI
201911360350	ANICUNS	AC21248920	ANICUNS	29/11/2019 19:42	29/11/2019 20:57	29/11/2019 19:42	29/11/2019 20:57	1,25	1	1,25	CHI
201911360357	CRISTALINA	KR11033835	CRISTALINA S1	29/11/2019 19:44	29/11/2019 20:28	29/11/2019 19:44	29/11/2019 20:28	0,73	52	37,73	CHI
201911360358	GOIANIA	14362399	CARAJAS S1	29/11/2019 19:45	29/11/2019 21:42	29/11/2019 19:45	29/11/2019 21:42	1,95	1	1,95	CHI
201911360368	PALESTINA DE GOIAS	PY12396111LD	PALESTINA	29/11/2019 19:47	30/11/2019 14:28	29/11/2019 19:47	30/11/2019 14:28	18,67	12	224,08	CHI
201911360368	CAIAPONIA	PY12396111LD	PALESTINA	29/11/2019 19:47	30/11/2019 14:28	29/11/2019 19:47	30/11/2019 14:28	18,67	18	336,11	CHI
201911360369	MINEIROS	MY11095199	PARQUE DAS EMAS	29/11/2019 19:40	29/11/2019 22:57	29/11/2019 19:40	29/11/2019 22:57	3,28	194	635,62	CHI
201911360371	ITAPACI	IW12267460	ITAPACI	29/11/2019 19:48	01/12/2019 10:59	29/11/2019 19:48	01/12/2019 10:59	39,18	8	313,44	CHI
201911360372	MONTES CLAROS DE GOIAS	ME12390172	IPORA	29/11/2019 19:46	29/11/2019 23:03	29/11/2019 19:46	29/11/2019 23:03	3,27	30	98,15	CHI
201911360378	CORUMBAIBA	CI12060348	VILA CORUMBA	29/11/2019 16:50	30/11/2019 15:47	29/11/2019 16:50	30/11/2019 15:47	22,97	20	459,30	CHI
201911360381	ANAPOLIS	10007502085	JUNDIAI S2	29/11/2019 19:50	30/11/2019 11:43	29/11/2019 19:50	30/11/2019 11:43	15,87	1	15,87	CHI
201911360389	ABADIANIA	AA21146375	DAIA S2	29/11/2019 19:54	30/11/2019 10:37	29/11/2019 19:54	30/11/2019 10:37	14,71	1	14,71	CHI
201911360392	CORUMBA DE GOIAS	CB21319204	CORUMBA	29/11/2019 19:55	30/11/2019 17:48	29/11/2019 19:55	30/11/2019 17:48	21,88	1	21,88	CHI
201911360399	GOIANIA	10935393	FERROVIARIO S2	29/11/2019 19:58	29/11/2019 21:43	29/11/2019 19:58	29/11/2019 21:43	1,75	1	1,75	CHI
201911360407	JATAI	JT21264413	JATAI S1	29/11/2019 20:01	30/11/2019 09:30	29/11/2019 20:01	30/11/2019 09:30	13,48	1	13,48	CHI
201911360409	GOIAS	GS12217234	MATRINCHA	29/11/2019 20:02	30/11/2019 08:42	29/11/2019 20:02	30/11/2019 08:42	12,67	82	1039,05	CHI
201911360409	ITAPIRAPUA	GS12217234	MATRINCHA	29/11/2019 20:02	30/11/2019 08:42	29/11/2019 20:02	30/11/2019 08:42	12,67	1	12,67	CHI
201911360409	NOVO BRASIL	GS12217234	MATRINCHA	29/11/2019 20:02	30/11/2019 08:42	29/11/2019 20:02	30/11/2019 08:42	12,67	36	456,17	CHI
201911360411	PORANGATU	PO12253874	PORANGATU	29/11/2019 20:03	30/11/2019 12:40	29/11/2019 20:03	30/11/2019 12:40	16,61	3	49,83	CHI
201911360418	AGUAS LINDAS DE GOIAS	LA12207456	AGUAS LINDAS DE GOIAS S1	29/11/2019 20:00	29/11/2019 21:30	29/11/2019 20:00	29/11/2019 21:30	1,50	567	848,45	CHI
201911360420	GOIANIA	13886538	GOYA S2	29/11/2019 20:08	29/11/2019 21:42	29/11/2019 20:08	29/11/2019 21:42	1,56	1	1,56	CHI
201911360421	CATALAO	CM10397305	CAMPO ALEGRE DE GOIAS	29/11/2019 20:08	01/12/2019 00:00	29/11/2019 20:08	01/12/2019 00:00	27,87	21	585,22	CHI
201911360421	IPAMERI	CM10397305	CAMPO ALEGRE DE GOIAS	29/11/2019 20:08	01/12/2019 00:00	29/11/2019 20:08	01/12/2019 00:00	27,87	12	334,41	CHI
201911360421	DISTRITO FEDERAL	CM10397305	CAMPO ALEGRE DE GOIAS	29/11/2019 20:08	01/12/2019 00:00	29/11/2019 20:08	01/12/2019 00:00	27,87	1	27,87	CHI
201911360421	CAMPO ALEGRE DE GOIAS	CM10397305	CAMPO ALEGRE DE GOIAS	29/11/2019 20:08	01/12/2019 00:00	29/11/2019 20:08	01/12/2019 00:00	27,87	127	3539,17	CHI
201911360421	CAMPO ALEGRE DE GOIAS	CM10397305	CAMPO ALEGRE DE GOIAS	29/11/2019 20:08	01/12/2019 00:00	30/11/2019 20:05	01/12/2019 00:00	3,91	2	7,82	CHI
201911360425	CAIAPONIA	PH21170783	PIRANHAS	29/11/2019 20:09	30/11/2019 10:50	29/11/2019 20:09	30/11/2019 10:50	14,68	1	14,68	CHI
201911360432	BONFINOPOLIS	SW21270670	CEPAIGO S2	29/11/2019 20:11	30/11/2019 00:46	29/11/2019 20:11	30/11/2019 00:46	4,57	1	4,57	CHI
201911360434	APARECIDA DE GOIANIA	200287345	ANHANGUERA	29/11/2019 20:12	29/11/2019 22:28	29/11/2019 20:12	29/11/2019 22:28	2,26	1	2,26	CHI

201911360436	SAO LUIS DE MONTES BELOS	SL12076410	SAO LUIZ DOS MONTES BELOS	29/11/2019 20:14	29/11/2019 23:00	29/11/2019 20:14	29/11/2019 23:00	2,76	34	93,68	CHI
201911360437	MORRO AGUDO DE GOIAS	MS21157487	ITAPURANGA	29/11/2019 20:14	30/11/2019 08:36	29/11/2019 20:14	30/11/2019 08:36	12,35	1	12,35	CHI
201911360440	SERRANOPOLIS	SX12260461	JATAI S1	29/11/2019 20:15	30/11/2019 09:15	29/11/2019 20:15	30/11/2019 09:15	12,99	4	51,95	CHI
201911360447	GOIANIA	10133987	FERROVIARIO S1	29/11/2019 20:19	29/11/2019 22:58	29/11/2019 20:19	29/11/2019 22:58	2,64	1	2,64	CHI
201911360452	PADRE BERNARDO	PB12377293	PADRE BERNARDO	29/11/2019 20:20	29/11/2019 22:23	29/11/2019 20:20	29/11/2019 22:23	2,04	12	24,49	CHI
201911360454	SANTO ANTONIO DO DESCOBERTO	SN21068714	ALEXANIA	29/11/2019 20:22	30/11/2019 16:21	29/11/2019 20:22	30/11/2019 16:21	19,98	2	39,97	CHI
201911360458	GOIANIA	10935502	FERROVIARIO S1	29/11/2019 20:23	29/11/2019 22:24	29/11/2019 20:23	29/11/2019 22:24	2,01	1	2,01	CHI
201911360465	CABECEIRAS	860022705	ITUIQUIRA	29/11/2019 20:24	30/11/2019 13:10	29/11/2019 20:24	30/11/2019 13:10	16,76	1	16,76	CHI
201911360466	LUZIANIA	LZ21276306	VIANOPOLIS	29/11/2019 20:25	30/11/2019 10:50	29/11/2019 20:25	30/11/2019 10:50	14,43	1	14,43	CHI
201911360468	NOVO BRASIL	NB12047598	JUSSARA	29/11/2019 20:19	30/11/2019 00:55	29/11/2019 20:19	30/11/2019 00:55	4,59	13	59,71	CHI
201911360470	CAIAPONIA	CP12303513	MONTIVIDIU T	29/11/2019 17:01	30/11/2019 07:55	29/11/2019 17:01	30/11/2019 07:55	14,91	21	313,17	CHI
201911360475	PIRES DO RIO	PR12000096RE	PIRES DO RIO S1	29/11/2019 20:28	30/11/2019 09:57	29/11/2019 20:28	30/11/2019 09:57	13,48	21	283,07	CHI
201911360475	PALMELO	PR12000096RE	PIRES DO RIO S1	29/11/2019 20:28	30/11/2019 09:57	29/11/2019 20:28	30/11/2019 09:57	13,48	6	80,88	CHI
201911360479	APARECIDA DE GOIANIA	13860884	REAL S2	29/11/2019 20:29	29/11/2019 22:38	29/11/2019 20:29	29/11/2019 22:38	2,14	1	2,14	CHI
201911360486	IPAMERI	IP21376073	IPAMERI	29/11/2019 20:33	30/11/2019 17:52	29/11/2019 20:33	30/11/2019 17:52	21,31	1	21,31	CHI
201911360489	GOIAS	GS21170836	GOIAS	29/11/2019 20:34	29/11/2019 22:55	29/11/2019 20:34	29/11/2019 22:55	2,34	1	2,34	CHI
201911360494	SANTA CRUZ DE GOIAS	BC12110028RE	PIRES DO RIO S2	29/11/2019 20:29	30/11/2019 12:00	29/11/2019 20:29	30/11/2019 12:00	15,51	19	294,77	CHI
201911360495	PLANALTINA	PI12344175	SAO JOAO D ALIANCA	29/11/2019 11:18	30/11/2019 14:03	29/11/2019 11:18	30/11/2019 14:03	26,76	23	615,37	CHI
201911360497	GOIANIA	10029935812	XAVANTES	29/11/2019 20:36	29/11/2019 23:59	29/11/2019 20:36	29/11/2019 23:59	3,39	1	3,39	CHI
201911360499	MINACU	IH11207732	MINACU	29/11/2019 20:37	30/11/2019 12:22	29/11/2019 20:37	30/11/2019 12:22	15,73	2	31,47	CHI
201911360501	BALIZA	BH12380942	BOM JARDIM	29/11/2019 20:39	29/11/2019 22:06	29/11/2019 20:39	29/11/2019 22:06	1,44	7	10,08	CHI
201911360503	ITUMBIARA	10023302885	ITUMBIARA NOVA	29/11/2019 20:40	30/11/2019 01:43	29/11/2019 20:40	30/11/2019 01:43	5,06	1	5,06	CHI
201911360504	ALEXANIA	AX12221351	ALEXANIA	29/11/2019 18:29	29/11/2019 22:41	29/11/2019 18:29	29/11/2019 22:41	4,19	144	604,00	CHI
201911360507	MINACU	IH12220680	MINACU	29/11/2019 16:24	30/11/2019 02:04	29/11/2019 16:24	30/11/2019 02:04	9,67	13	125,67	CHI
201911360509	ANICUNS	AC12075338	FIRMINOPOLIS S2	29/11/2019 20:29	29/11/2019 22:10	29/11/2019 20:29	29/11/2019 22:10	1,67	15	25,04	CHI
201911360511	GOIANIA	GN11199192	ATLANTICO S3	29/11/2019 20:33	29/11/2019 21:54	29/11/2019 20:33	29/11/2019 21:54	1,34	122	163,68	CHI
201911360513	GOIANIA	12066242	GOIANIA LESTE S1	29/11/2019 20:44	29/11/2019 22:47	29/11/2019 20:44	29/11/2019 22:47	2,05	1	2,05	CHI
201911360514	GOIANIA	15005574	NEROPOLIS S2	29/11/2019 20:44	30/11/2019 01:10	29/11/2019 20:44	30/11/2019 01:10	4,42	1	4,42	CHI
201911360517	ITUMBIARA	1250038800	BOM JESUS DE GOIAS	29/11/2019 20:46	29/11/2019 22:36	29/11/2019 20:46	29/11/2019 22:36	1,83	1	1,83	CHI
201911360518	FAZENDA NOVA	FN12229882	FIRMINOPOLIS S2	29/11/2019 20:46	30/11/2019 10:26	29/11/2019 20:46	30/11/2019 10:26	13,65	2	27,31	CHI
201911360531	VARJAO	VJ121162451	GUAPO S2	29/11/2019 20:50	30/11/2019 10:54	29/11/2019 20:50	30/11/2019 10:54	14,06	2	28,12	CHI
201911360532	ITUMBIARA	IT21293037	PARANAIBA	29/11/2019 20:50	30/11/2019 07:45	29/11/2019 20:50	30/11/2019 07:45	10,91	1	10,91	CHI
201911360545	ITAPURANGA	IK11051549	ITAPURANGA	29/11/2019 20:49	30/11/2019 06:33	29/11/2019 20:49	30/11/2019 06:33	9,72	197	1914,68	CHI

201911360548	AMARALINA	LC11270110	SAO MIGUEL DO ARAGUAIA	29/11/2019 20:55	30/11/2019 12:49	29/11/2019 20:55	30/11/2019 12:49	15,89	1	15,89	CHI
201911360550	ANAPOLIS	21032040	JUNDIAI S1	29/11/2019 20:55	30/11/2019 08:58	29/11/2019 20:55	30/11/2019 08:58	12,04	1	12,04	CHI
201911360560	ITUMBIARA	1250044380	BOM JESUS DE GOIAS	29/11/2019 20:58	29/11/2019 23:50	29/11/2019 20:58	29/11/2019 23:50	2,87	1	2,87	CHI
201911360567	MONTE ALEGRE DE GOIAS	MA21284424	SAO DOMINGOS	29/11/2019 21:03	30/11/2019 09:55	29/11/2019 21:03	30/11/2019 09:55	12,87	1	12,87	CHI
201911360569	RIO VERDE	630217658	RIO VERDE S1	29/11/2019 21:03	30/11/2019 10:30	29/11/2019 21:03	30/11/2019 10:30	13,45	1	13,45	CHI
201911360593	PIRENOPOLIS	PV21273360	CORUMBA	29/11/2019 21:11	30/11/2019 19:54	29/11/2019 21:11	30/11/2019 19:54	22,70	1	22,70	CHI
201911360598	ITAPIRAPUA	IU21142840	MATRINCHA	29/11/2019 21:13	30/11/2019 03:22	29/11/2019 21:13	30/11/2019 03:22	6,14	1	6,14	CHI
201911360599	PIRENOPOLIS	PV12381258	CORUMBA	29/11/2019 21:13	30/11/2019 14:32	29/11/2019 21:13	30/11/2019 14:32	17,30	7	121,13	CHI
201911360606	GOIANIA	GN11002778	ATLANTICO S3	29/11/2019 21:16	29/11/2019 23:33	29/11/2019 21:16	29/11/2019 23:33	2,28	148	337,65	CHI
201911360607	GOUVELANDIA	QI12000157	QUIRINOPOLIS	29/11/2019 18:16	29/11/2019 22:36	29/11/2019 18:16	29/11/2019 22:36	4,33	10	43,29	CHI
201911360609	ORIZONA	OZ12114531	PIRES DO RIO S2	29/11/2019 13:39	30/11/2019 11:30	29/11/2019 13:39	30/11/2019 11:30	21,85	25	546,31	CHI
201911360611	GOIANIRA	GR12011978	NEROPOLIS S1	29/11/2019 21:20	30/11/2019 00:20	29/11/2019 21:20	30/11/2019 00:20	2,99	5	14,96	CHI
201911360614	PIRACANJUBA	PJ12000126	PIRACANJUBA	29/11/2019 21:20	30/11/2019 13:50	29/11/2019 21:20	30/11/2019 13:50	16,49	2	32,98	CHI
201911360615	HIDROLANDIA	HD21007664	PONTALINA	29/11/2019 21:21	30/11/2019 12:20	29/11/2019 21:21	30/11/2019 12:20	14,99	1	14,99	CHI
201911360620	SAO DOMINGOS	SD12317864	SAO DOMINGOS	29/11/2019 21:23	30/11/2019 10:20	29/11/2019 21:23	30/11/2019 10:20	12,94	33	427,05	CHI
201911360621	ARAGARCAS	BM12204860	BOM JARDIM	29/11/2019 21:24	29/11/2019 22:39	29/11/2019 21:24	29/11/2019 22:39	1,25	1	1,25	CHI
201911360621	BOM JARDIM DE GOIAS	BM12204860	BOM JARDIM	29/11/2019 21:24	29/11/2019 22:39	29/11/2019 21:24	29/11/2019 22:39	1,25	7	8,74	CHI
201911360623	BOM JESUS DE GOIAS	BJ12392126	BOM JESUS DE GOIAS	29/11/2019 21:24	30/11/2019 09:04	29/11/2019 21:24	30/11/2019 09:04	11,65	137	1596,58	CHI
201911360629	CALDAS NOVAS	CN12162992	SERRA DE CALDAS	29/11/2019 19:41	30/11/2019 09:28	29/11/2019 19:41	30/11/2019 09:28	13,77	771	10617,95	CHI
201911360632	CATURAI	GR31004765	TRINDADE	29/11/2019 21:27	30/11/2019 13:37	29/11/2019 21:27	30/11/2019 13:37	16,17	1	16,17	CHI
201911360633	PIRACANJUBA	PJ12009149	PIRACANJUBA	30/11/2019 07:25	01/12/2019 10:30	30/11/2019 07:25	01/12/2019 10:30	27,08	1	27,08	CHI
201911360634	GOIATUBA	BJ12000013	BOM JESUS DE GOIAS	30/11/2019 06:05	30/11/2019 07:31	30/11/2019 06:05	30/11/2019 07:31	1,43	4	5,71	CHI
201911360634	BOM JESUS DE GOIAS	BJ12000013	BOM JESUS DE GOIAS	30/11/2019 06:05	30/11/2019 07:31	30/11/2019 06:05	30/11/2019 07:31	1,43	25	35,68	CHI
201911360640	GOIANIA	14873321	CARAJAS S1	29/11/2019 21:30	29/11/2019 23:05	29/11/2019 21:30	29/11/2019 23:05	1,58	1	1,58	CHI
201911360644	ISRAELANDIA	IS12089375	IPORA	29/11/2019 18:50	30/11/2019 10:31	29/11/2019 18:50	30/11/2019 10:31	15,69	18	282,48	CHI
201911360648	GOUVELANDIA	QI21000143	QUIRINOPOLIS	29/11/2019 21:31	29/11/2019 23:50	29/11/2019 21:31	29/11/2019 23:50	2,31	1	2,31	CHI
201911360651	PIRES DO RIO	PR12255829	PIRES DO RIO S1	29/11/2019 12:34	30/11/2019 08:28	29/11/2019 12:34	30/11/2019 08:28	19,89	8	159,11	CHI
201911360654	FORMOSA	FA11000001	ITUIQUIRA	29/11/2019 20:34	30/11/2019 00:00	29/11/2019 20:34	30/11/2019 00:00	3,42	166	567,67	CHI
201911360658	BRITANIA	IU12025065	MATRINCHA	29/11/2019 20:07	30/11/2019 02:19	29/11/2019 20:07	30/11/2019 02:19	6,20	6	37,18	CHI
201911360658	ITAPIRAPUA	IU12025065	MATRINCHA	29/11/2019 20:07	30/11/2019 02:19	29/11/2019 20:07	30/11/2019 02:19	6,20	15	92,94	CHI
201911360663	ANAPOLIS	10015012172	ANAPOLIS UNIVERSITARIO S2	29/11/2019 21:39	30/11/2019 08:45	29/11/2019 21:39	30/11/2019 08:45	11,09	1	11,09	CHI
201911360664	AGUAS LINDAS DE GOIAS	LA11189840	AGUAS LINDAS DE GOIAS S1	29/11/2019 21:39	29/11/2019 22:52	29/11/2019 21:39	29/11/2019 22:52	1,21	217	261,49	CHI
201911360668	LUZIANIA	LZ12336007	RIO VERMELHO	29/11/2019 20:55	03/12/2019 13:26	29/11/2019 20:55	30/11/2019 08:58	12,05	7	84,33	CHI



201911360668	LUZIANIA	LZ13066521	RIO VERMELHO	29/11/2019 20:55	03/12/2019 13:26	29/11/2019 20:55	30/11/2019 11:05	14,16	35	495,57	CHI
201911360668	LUZIANIA	LZ12067375LD	RIO VERMELHO	29/11/2019 20:55	03/12/2019 13:26	29/11/2019 20:55	30/11/2019 19:30	22,57	12	270,89	CHI
201911360668	LUZIANIA	LZ12067375LD	RIO VERMELHO	29/11/2019 20:55	03/12/2019 13:26	29/11/2019 20:55	02/12/2019 19:20	70,41	24	1689,94	CHI
201911360668	LUZIANIA	LZ12067375LD	RIO VERMELHO	29/11/2019 20:55	03/12/2019 13:26	02/12/2019 18:35	02/12/2019 19:20	0,76	12	9,06	CHI
201911360668	LUZIANIA	20520440	RIO VERMELHO	29/11/2019 20:55	03/12/2019 13:26	29/11/2019 20:55	03/12/2019 13:26	88,51	7	619,57	CHI
201911360670	PIRACANJUBA	PJ21221030	PIRACANJUBA	29/11/2019 21:41	30/11/2019 11:35	29/11/2019 21:41	30/11/2019 11:35	13,90	2	27,79	CHI
201911360673	MORRINHOS	MR12000077RE	MORRINHOS	30/11/2019 08:38	30/11/2019 13:08	30/11/2019 11:38	30/11/2019 13:04	1,43	91	130,16	CHI
201911360673	MORRINHOS	MR12223465	MORRINHOS	30/11/2019 08:38	30/11/2019 13:08	30/11/2019 08:38	30/11/2019 13:08	4,49	10	44,87	CHI
201911360675	PALMEIRAS DE GOIAS	10028625305	PALMEIRAS	29/11/2019 21:45	30/11/2019 00:03	29/11/2019 21:45	30/11/2019 00:03	2,31	1	2,31	CHI
201911360679	CRIXAS	CX21166553	SANTA TEREZINHA	29/11/2019 21:46	01/12/2019 11:53	29/11/2019 21:46	01/12/2019 11:53	38,11	1	38,11	CHI
201911360681	GOUVELANDIA	GB12000209	QUIRINOPOLIS	29/11/2019 20:27	29/11/2019 23:09	29/11/2019 20:27	29/11/2019 23:09	2,68	29	77,83	CHI
201911360681	QUIRINOPOLIS	GB12000209	QUIRINOPOLIS	29/11/2019 20:27	29/11/2019 23:09	29/11/2019 20:27	29/11/2019 23:09	2,68	83	222,76	CHI
201911360702	URUTAI	UT21227140	URUTAI	29/11/2019 22:00	30/11/2019 10:19	29/11/2019 22:00	30/11/2019 10:19	12,31	1	12,31	CHI
201911360705	INDIARA	CZ12308499	CEZARINA	29/11/2019 21:40	30/11/2019 08:34	29/11/2019 21:40	30/11/2019 08:34	10,89	10	108,90	CHI
201911360705	CEZARINA	CZ12308499	CEZARINA	29/11/2019 21:40	30/11/2019 08:34	29/11/2019 21:40	30/11/2019 08:34	10,89	2	21,78	CHI
201911360708	MUTUNOPOLIS	MU12141105	MARA ROSA	29/11/2019 22:12	30/11/2019 17:34	29/11/2019 22:12	30/11/2019 17:34	19,38	25	484,51	CHI
201911360717	GOIANIA	14774744	MEIA PONTE	29/11/2019 22:22	30/11/2019 00:22	29/11/2019 22:22	30/11/2019 00:22	1,99	1	1,99	CHI
201911360719	PIRENOPOLIS	PV12360338RE	CORUMBA	29/11/2019 19:57	30/11/2019 14:31	29/11/2019 19:57	30/11/2019 14:31	18,57	93	1726,67	CHI
201911360720	APORE	AE12168304	ITAJA S2	29/11/2019 17:04	30/11/2019 10:34	29/11/2019 17:04	30/11/2019 10:34	17,48	9	157,36	CHI
201911360721	FAZENDA NOVA	FN11246059	IPORA	29/11/2019 22:25	30/11/2019 08:20	29/11/2019 22:25	30/11/2019 08:20	9,92	2	19,84	CHI
201911360723	PORANGATU	PO12202569	PORANGATU	29/11/2019 22:27	30/11/2019 18:05	29/11/2019 22:27	30/11/2019 18:05	19,64	6	117,82	CHI
201911360735	FORMOSA	FA12383392	ITIQUEIRA	29/11/2019 22:29	30/11/2019 10:25	29/11/2019 22:29	30/11/2019 10:25	11,92	1	11,92	CHI
201911360735	DISTRITO FEDERAL	FA12383392	ITIQUEIRA	29/11/2019 22:29	30/11/2019 10:25	29/11/2019 22:29	30/11/2019 10:25	11,92	2	23,85	CHI
201911360737	QUIRINOPOLIS	QI21126451	QUIRINOPOLIS	29/11/2019 22:30	30/11/2019 05:13	29/11/2019 22:30	30/11/2019 05:13	6,71	1	6,71	CHI
201911360738	ARAGUAPAZ	MS21157477	ITAPURANGA	29/11/2019 22:31	30/11/2019 11:43	29/11/2019 22:31	30/11/2019 11:43	13,19	1	13,19	CHI
201911360740	IPIRANGA DE GOIAS	RB13191286	RUBIATABA	29/11/2019 22:33	01/12/2019 13:50	29/11/2019 22:33	01/12/2019 13:50	39,27	7	274,91	CHI
201911360743	SANTO ANTONIO DO DESCOBERTO	SN21330429	MARAJOARA	29/11/2019 22:34	30/11/2019 00:12	29/11/2019 22:34	30/11/2019 00:12	1,63	1	1,63	CHI
201911360744	CRISTALINA	KR11170180	CRISTALINA S2	29/11/2019 22:34	30/11/2019 02:53	29/11/2019 22:34	30/11/2019 02:53	4,31	12	51,68	CHI
201911360745	SANTA HELENA DE GOIAS	SH12271561	IPEGUARI	29/11/2019 22:27	30/11/2019 10:50	29/11/2019 22:27	30/11/2019 10:50	12,38	11	136,16	CHI
201911360750	AGUAS LINDAS DE GOIAS	LA11219648	AGUAS LINDAS DE GOIAS S2	29/11/2019 22:41	30/11/2019 07:54	29/11/2019 22:41	30/11/2019 00:10	1,50	14	20,97	CHI
201911360750	AGUAS LINDAS DE GOIAS	LA12219645	AGUAS LINDAS DE GOIAS S2	29/11/2019 22:41	30/11/2019 07:54	29/11/2019 22:41	30/11/2019 07:54	9,23	17	156,88	CHI
201911360751	VILA PROPICIO	NP12255982	GOIANESIA S1	29/11/2019 22:42	01/12/2019 11:37	29/11/2019 22:42	01/12/2019 10:51	36,13	5	180,67	CHI
201911360751	PIRENOPOLIS	NP12255982	GOIANESIA S1	29/11/2019 22:42	01/12/2019 11:37	29/11/2019 22:42	01/12/2019 10:51	36,13	1	36,13	CHI

201911360751	VILA PROPICIO	NP12255982	GOIANESIA S1	29/11/2019 22:42	01/12/2019 11:37	29/11/2019 22:42	01/12/2019 11:37	36,90	3	110,70	CHI
201911360753	ANAPOLIS	AN11101812	ANAPOLIS UNIVERSITARIO S2	29/11/2019 22:14	30/11/2019 03:14	29/11/2019 22:14	30/11/2019 03:14	4,99	115	573,56	CHI
201911360758	AMARALINA	LC12270203	SAO MIGUEL DO ARAGUAIA	29/11/2019 20:20	30/11/2019 11:31	29/11/2019 20:20	30/11/2019 11:31	15,18	9	136,59	CHI
201911360759	SAO MIGUEL DO ARAGUAIA	SM12220658	SAO MIGUEL DO ARAGUAIA	29/11/2019 22:54	30/11/2019 09:50	29/11/2019 22:54	30/11/2019 09:50	10,92	4	43,69	CHI
201911360761	ANAPOLIS	AN11003272	JUNDIAI S1	29/11/2019 22:22	30/11/2019 02:11	29/11/2019 22:22	30/11/2019 02:11	3,81	138	526,12	CHI
201911360762	DOVERLANDIA	DV21193359	CAIAPONIA	29/11/2019 22:56	30/11/2019 16:07	29/11/2019 22:56	30/11/2019 16:07	17,18	1	17,18	CHI
201911360764	CRISTALINA	KR21000012	CRISTALINA S2	29/11/2019 22:57	30/11/2019 02:07	29/11/2019 22:57	30/11/2019 02:07	3,16	3	9,49	CHI
201911360766	PONTALINA	PK12080054	PONTALINA	29/11/2019 20:19	30/11/2019 09:42	29/11/2019 20:19	30/11/2019 09:42	13,37	95	1269,99	CHI
201911360767	CARMO DO RIO VERDE	IK21286664	ITAPURANGA	29/11/2019 22:58	30/11/2019 10:20	29/11/2019 22:58	30/11/2019 10:20	11,37	1	11,37	CHI
201911360768	SANTO ANTONIO DO DESCOBERTO	SN12379433	ALEXANIA	29/11/2019 20:35	30/11/2019 07:57	29/11/2019 20:35	30/11/2019 07:57	11,35	24	272,48	CHI
201911360775	RIO VERDE	RV21380699	RIO VERDE S2	29/11/2019 23:06	30/11/2019 09:14	29/11/2019 23:06	30/11/2019 09:14	10,13	1	10,13	CHI
201911360779	FORMOSA	FA11131872	ITIQUEIRA	29/11/2019 21:07	30/11/2019 00:53	29/11/2019 21:07	30/11/2019 00:53	3,77	156	587,64	CHI
201911360782	APARECIDA DE GOIANIA	12481932	REAL S1	29/11/2019 23:16	30/11/2019 00:32	29/11/2019 23:16	30/11/2019 00:32	1,26	1	1,26	CHI
201911360783	PIRANHAS	PH12204991	PIRANHAS	29/11/2019 23:22	30/11/2019 07:03	29/11/2019 23:22	30/11/2019 07:03	7,68	4	30,72	CHI
201911360786	INHUMAS	IN12326219	INHUMAS S2	29/11/2019 23:27	30/11/2019 10:53	29/11/2019 23:27	30/11/2019 10:53	11,43	6	68,57	CHI
201911360793	IPORA	IR12381025	IPORA	29/11/2019 17:59	30/11/2019 03:05	29/11/2019 17:59	30/11/2019 03:05	9,10	12	109,15	CHI
201911360799	ARUANA	AK11220042	ARUANA	29/11/2019 23:02	30/11/2019 09:05	29/11/2019 23:02	30/11/2019 09:05	10,04	23	231,00	CHI
201911360801	CATALAO	CT12195296	CATALAO S2	29/11/2019 23:41	30/11/2019 01:38	29/11/2019 23:41	30/11/2019 01:38	1,95	214	416,82	CHI
201911360804	DIORAMA	AY12000051	ARENOPOLIS	29/11/2019 20:47	30/11/2019 06:24	29/11/2019 20:47	30/11/2019 06:24	9,61	2	19,23	CHI
201911360804	ARENOPOLIS	AY12000051	ARENOPOLIS	29/11/2019 20:47	30/11/2019 06:24	29/11/2019 20:47	30/11/2019 06:24	9,61	4	38,45	CHI
201911360807	LUZIANIA	120302056	RIO VERMELHO	29/11/2019 23:48	30/11/2019 01:29	29/11/2019 23:48	30/11/2019 01:29	1,67	1	1,67	CHI
201911360809	SANTO ANTONIO DO DESCOBERTO	ZN12383330	ALEXANIA	29/11/2019 23:53	30/11/2019 10:40	29/11/2019 23:53	30/11/2019 10:40	10,78	1	10,78	CHI
201911360812	GOIAS	GS12071232	GOIAS	30/11/2019 00:02	30/11/2019 09:04	30/11/2019 00:02	30/11/2019 09:04	9,02	39	351,89	CHI
201911360813	ALEXANIA	10006001333	ALEXANIA	30/11/2019 00:08	30/11/2019 19:18	30/11/2019 00:08	30/11/2019 19:18	19,16	1	19,16	CHI
201911360820	FORMOSA	FA12359113	ITIQUEIRA	29/11/2019 20:06	30/11/2019 10:51	29/11/2019 20:06	30/11/2019 10:51	14,74	12	176,87	CHI
201911360822	SAO LUIS DE MONTES BELOS	SL11006845	SAO LUIZ DOS MONTES BELOS	30/11/2019 00:35	30/11/2019 02:14	30/11/2019 00:35	30/11/2019 02:14	1,65	182	300,35	CHI
201911360823	GOIANIA	GN11001732	FERROVIARIO S2	30/11/2019 01:30	30/11/2019 01:52	30/11/2019 01:30	30/11/2019 01:52	0,36	121	43,09	CHI
201911360824	MINEIROS	MY21324394	PARQUE DAS EMAS	29/11/2019 22:59	30/11/2019 14:00	29/11/2019 22:59	30/11/2019 13:20	14,35	1	14,35	CHI
201911360824	MINEIROS	MY21324393	PARQUE DAS EMAS	29/11/2019 22:59	30/11/2019 14:00	29/11/2019 22:59	30/11/2019 13:40	14,69	1	14,69	CHI
201911360824	MINEIROS	MY21305761	PARQUE DAS EMAS	29/11/2019 22:59	30/11/2019 14:00	29/11/2019 22:59	30/11/2019 14:00	15,02	1	15,02	CHI
201911360829	DIORAMA	DI12066071	ARENOPOLIS	30/11/2019 05:58	30/11/2019 08:22	30/11/2019 05:58	30/11/2019 08:22	2,39	28	66,81	CHI
201911360832	MINACU	10020111191	MINACU	30/11/2019 01:01	30/11/2019 18:20	30/11/2019 01:01	30/11/2019 18:20	17,31	1	17,31	CHI
201911360838	NOVA CRIXAS	NA21315083	NOVA CRIXAS	30/11/2019 01:18	01/12/2019 17:54	30/11/2019 01:18	01/12/2019 17:54	40,60	3	121,80	CHI

201911360841	QUIRINOPOLIS	QI13303243	QUIRINOPOLIS	30/11/2019 01:43	01/12/2019 13:19	01/12/2019 11:06	01/12/2019 13:19	2,21	13	28,76	CHI
201911360841	QUIRINOPOLIS	RV32073779	QUIRINOPOLIS	30/11/2019 01:43	01/12/2019 13:19	30/11/2019 01:43	01/12/2019 13:19	35,59	1	35,59	CHI
201911360841	RIO VERDE	RV32073779	QUIRINOPOLIS	30/11/2019 01:43	01/12/2019 13:19	30/11/2019 01:43	01/12/2019 13:19	35,59	31	1103,14	CHI
201911360843	NOVO BRASIL	NB12396240	JUSSARA	30/11/2019 01:54	30/11/2019 10:59	30/11/2019 01:54	30/11/2019 10:59	9,08	10	90,78	CHI
201911360849	MONTES CLAROS DE GOIAS	10007804480	IPORA	30/11/2019 02:22	30/11/2019 06:34	30/11/2019 02:22	30/11/2019 06:34	4,19	1	4,19	CHI
201911360856	MORRO AGUDO DE GOIAS	MS12335823	ITAPURANGA	30/11/2019 02:45	30/11/2019 09:41	30/11/2019 02:45	30/11/2019 09:41	6,92	2	13,84	CHI
201911360857	ITABERAI	00880214	ITABERAI S2	30/11/2019 02:46	30/11/2019 11:00	30/11/2019 02:46	30/11/2019 03:31	0,76	648	491,04	CHI
201911360857	GOIAS	IB10403932	ITABERAI S2	30/11/2019 02:46	30/11/2019 11:00	30/11/2019 03:46	30/11/2019 03:52	0,11	107	11,92	CHI
201911360857	ITABERAI	IB10403932	ITABERAI S2	30/11/2019 02:46	30/11/2019 11:00	30/11/2019 03:46	30/11/2019 03:52	0,11	1532	170,65	CHI
201911360857	MOSSAMEDES	IB10403932	ITABERAI S2	30/11/2019 02:46	30/11/2019 11:00	30/11/2019 03:46	30/11/2019 03:52	0,11	250	27,85	CHI
201911360857	ITABERAI	00880214	ITABERAI S2	30/11/2019 02:46	30/11/2019 11:00	30/11/2019 02:46	30/11/2019 05:00	2,23	275	613,56	CHI
201911360857	ITABERAI	00880214	ITABERAI S2	30/11/2019 02:46	30/11/2019 11:00	30/11/2019 02:46	30/11/2019 05:08	2,37	225	532,94	CHI
201911360857	ITABERAI	IB13000004	ITABERAI S2	30/11/2019 02:46	30/11/2019 11:00	30/11/2019 05:19	30/11/2019 05:22	0,06	819	46,86	CHI
201911360857	ITABERAI	IB13000014	ITABERAI S2	30/11/2019 02:46	30/11/2019 11:00	30/11/2019 04:43	30/11/2019 07:12	2,48	953	2362,91	CHI
201911360857	GOIAS	IB12000022	ITABERAI S2	30/11/2019 02:46	30/11/2019 11:00	30/11/2019 04:43	30/11/2019 11:00	6,28	107	671,84	CHI
201911360857	ITABERAI	IB12000022	ITABERAI S2	30/11/2019 02:46	30/11/2019 11:00	30/11/2019 04:43	30/11/2019 11:00	6,28	260	1632,51	CHI
201911360857	MOSSAMEDES	IB12000022	ITABERAI S2	30/11/2019 02:46	30/11/2019 11:00	30/11/2019 04:43	30/11/2019 11:00	6,28	250	1569,72	CHI
201911360880	GOIAS	GK12220543	ITAPURANGA	29/11/2019 23:11	30/11/2019 12:34	29/11/2019 23:11	30/11/2019 12:34	13,37	11	147,06	CHI
201911360880	GUARAITA	GK12220543	ITAPURANGA	29/11/2019 23:11	30/11/2019 12:34	29/11/2019 23:11	30/11/2019 12:34	13,37	22	294,12	CHI
201911360884	IPORA	IR12207857	IPORA	30/11/2019 04:15	30/11/2019 06:46	30/11/2019 04:15	30/11/2019 06:46	2,51	12	30,16	CHI
201911360885	PORANGATU	PO12192371	PORANGATU	30/11/2019 04:20	30/11/2019 23:37	30/11/2019 04:20	30/11/2019 23:37	19,28	12	231,37	CHI
201911360888	JARAGUA	JA12278873	JARAGUA	30/11/2019 04:26	30/11/2019 08:02	30/11/2019 04:26	30/11/2019 08:02	3,59	15	53,90	CHI
201911360899	GUAPO	GA21232813	GUAPO S1	30/11/2019 04:38	30/11/2019 12:36	30/11/2019 04:38	30/11/2019 12:36	7,96	1	7,96	CHI
201911360908	MORRINHOS	01240424	MORRINHOS	30/11/2019 04:23	30/11/2019 09:28	30/11/2019 04:23	30/11/2019 07:00	2,62	10	26,19	CHI
201911360908	MAIRIPOTABA	01240424	MORRINHOS	30/11/2019 04:23	30/11/2019 09:28	30/11/2019 04:23	30/11/2019 07:42	3,32	12	39,79	CHI
201911360908	PONTALINA	01240424	MORRINHOS	30/11/2019 04:23	30/11/2019 09:28	30/11/2019 04:23	30/11/2019 07:42	3,32	15	49,74	CHI
201911360908	MORRINHOS	01240424	MORRINHOS	30/11/2019 04:23	30/11/2019 09:28	30/11/2019 04:23	30/11/2019 07:42	3,32	192	636,69	CHI
201911360908	MORRINHOS	01240424	MORRINHOS	30/11/2019 04:23	30/11/2019 09:28	30/11/2019 04:23	30/11/2019 07:42	3,32	13	43,11	CHI
201911360908	PIRACANJUBA	01240424	MORRINHOS	30/11/2019 04:23	30/11/2019 09:28	30/11/2019 04:23	30/11/2019 07:42	3,32	79	261,97	CHI
201911360908	MORRINHOS	01240424	MORRINHOS	30/11/2019 04:23	30/11/2019 09:28	30/11/2019 04:23	30/11/2019 08:04	3,67	4	14,69	CHI
201911360908	CALDAS NOVAS	01240424	MORRINHOS	30/11/2019 04:23	30/11/2019 09:28	30/11/2019 04:23	30/11/2019 08:28	4,07	7	28,50	CHI
201911360908	MORRINHOS	01240424	MORRINHOS	30/11/2019 04:23	30/11/2019 09:28	30/11/2019 04:23	30/11/2019 08:28	4,07	1	4,07	CHI
201911360908	PIRACANJUBA	01240424	MORRINHOS	30/11/2019 04:23	30/11/2019 09:28	30/11/2019 04:23	30/11/2019 08:28	4,07	89	362,33	CHI

201911360908	MORRINHOS	01240424	MORRINHOS	30/11/2019 04:23	30/11/2019 09:28	30/11/2019 04:23	30/11/2019 08:28	4,07	23	93,64	CHI
201911360908	MORRINHOS	01240424	MORRINHOS	30/11/2019 04:23	30/11/2019 09:28	30/11/2019 04:23	30/11/2019 08:46	4,37	1	4,37	CHI
201911360908	PIRACANJUBA	01240424	MORRINHOS	30/11/2019 04:23	30/11/2019 09:28	30/11/2019 04:23	30/11/2019 09:28	5,08	3	15,25	CHI
201911360908	MORRINHOS	01240424	MORRINHOS	30/11/2019 04:23	30/11/2019 09:28	30/11/2019 04:23	30/11/2019 09:28	5,08	4	20,33	CHI
201911360924	ITUMBIARA	IT21046767	ITUMBIARA NOVA	30/11/2019 07:52	30/11/2019 13:04	30/11/2019 07:52	30/11/2019 13:04	5,19	1	5,19	CHI
201911360930	RIO VERDE	RV21104920	SANTA HELENA S1	30/11/2019 08:10	30/11/2019 09:31	30/11/2019 08:10	30/11/2019 09:31	1,34	1	1,34	CHI
201911360931	SAO JOAO D ALIANCA	JL21363970	SAO JOAO D ALIANCA	30/11/2019 08:11	30/11/2019 16:35	30/11/2019 08:11	30/11/2019 16:35	8,40	1	8,40	CHI
201911360949	CAVALCANTE	740013816	FLORES DE GOIAS	30/11/2019 10:14	30/11/2019 11:43	30/11/2019 10:14	30/11/2019 11:43	1,48	1	1,48	CHI
201911360958	BOM JESUS DE GOIAS	BJ11097222	BOM JESUS DE GOIAS	30/11/2019 11:07	30/11/2019 15:26	30/11/2019 11:07	30/11/2019 15:26	4,30	162	697,10	CHI
201911360964	TERESINA DE GOIAS	TE11281551	FLORES DE GOIAS	30/11/2019 11:57	30/11/2019 16:18	30/11/2019 11:57	30/11/2019 16:18	4,34	1	4,34	CHI
201911360965	PARAUNA	PU12233886	PARAUNA	30/11/2019 12:18	30/11/2019 12:46	30/11/2019 12:18	30/11/2019 12:46	0,46	19	8,77	CHI
201911360983	SANTA TEREZINHA DE GOIAS	SG11082956	SANTA TEREZINHA	30/11/2019 15:03	30/11/2019 18:26	30/11/2019 15:03	30/11/2019 18:26	3,38	144	487,20	CHI
201911360985	CRISTALINA	KR10400360	PAMPLONA	30/11/2019 14:25	01/12/2019 12:14	30/11/2019 14:25	30/11/2019 15:57	1,53	85	129,65	CHI
201911360985	CRISTALINA	KR10400355	PAMPLONA	30/11/2019 14:25	01/12/2019 12:14	30/11/2019 14:25	30/11/2019 17:01	2,60	2	5,20	CHI
201911360985	CRISTALINA	KR10400355	PAMPLONA	30/11/2019 14:25	01/12/2019 12:14	30/11/2019 14:25	30/11/2019 19:18	4,89	12	58,66	CHI
201911360985	CRISTALINA	KR10400355	PAMPLONA	30/11/2019 14:25	01/12/2019 12:14	30/11/2019 14:25	01/12/2019 12:14	21,82	13	283,64	CHI
201911360991	SERRANOPOLIS	DJ21365094	CHAPADAO DO CEU	30/11/2019 15:15	30/11/2019 16:40	30/11/2019 15:15	30/11/2019 16:40	1,42	1	1,42	CHI
201911360994	SAO MIGUEL DO ARAGUAIA	SM21359906	SAO MIGUEL DO ARAGUAIA	30/11/2019 11:53	30/11/2019 15:00	30/11/2019 11:53	30/11/2019 15:00	3,13	1	3,13	CHI
201911360999	ABADIANIA	AA13000007	CORUMBA	30/11/2019 15:33	01/12/2019 13:42	30/11/2019 15:33	30/11/2019 23:04	7,51	84	630,89	CHI
201911360999	CORUMBA DE GOIAS	AA13000007	CORUMBA	30/11/2019 15:33	01/12/2019 13:42	30/11/2019 15:33	30/11/2019 23:04	7,51	128	961,35	CHI
201911360999	CORUMBA DE GOIAS	CB13000003	CORUMBA	30/11/2019 15:33	01/12/2019 13:42	01/12/2019 09:12	01/12/2019 09:57	0,74	34	25,28	CHI
201911360999	CORUMBA DE GOIAS	CB10395375	CORUMBA	30/11/2019 15:33	01/12/2019 13:42	30/11/2019 15:33	01/12/2019 13:42	22,14	181	4007,79	CHI
201911360999	ABADIANIA	CB10395375	CORUMBA	30/11/2019 15:33	01/12/2019 13:42	30/11/2019 15:33	01/12/2019 13:42	22,14	3	66,43	CHI
201911361002	ANICUNS	AC12075338	FIRMINOPOLIS S2	30/11/2019 04:40	30/11/2019 08:46	30/11/2019 04:40	30/11/2019 08:46	4,10	16	65,53	CHI
201911361012	ALEXANIA	AX21255933	ALEXANIA	30/11/2019 04:52	30/11/2019 12:11	30/11/2019 04:52	30/11/2019 12:11	7,31	4	29,24	CHI
201911361013	PORANGATU	PO12390255	PORANGATU	30/11/2019 02:04	30/11/2019 10:40	30/11/2019 02:04	30/11/2019 10:40	8,59	4	34,35	CHI
201911361014	URUACU	MQ12181177	MARA ROSA	30/11/2019 04:54	30/11/2019 10:40	30/11/2019 04:54	30/11/2019 10:40	5,76	1	5,76	CHI
201911361014	ALTO HORIZONTE	MQ12181177	MARA ROSA	30/11/2019 04:54	30/11/2019 10:40	30/11/2019 04:54	30/11/2019 10:40	5,76	3	17,29	CHI
201911361014	MARA ROSA	MQ12181177	MARA ROSA	30/11/2019 04:54	30/11/2019 10:40	30/11/2019 04:54	30/11/2019 10:40	5,76	28	161,38	CHI
201911361022	MIMOSO DE GOIAS	MJ12305277	PADRE BERNARDO	30/11/2019 05:11	30/11/2019 08:30	30/11/2019 05:11	30/11/2019 08:30	3,30	16	52,85	CHI
201911361026	PORANGATU	PO12104347	PORANGATU	30/11/2019 05:16	30/11/2019 08:40	30/11/2019 05:16	30/11/2019 08:40	3,39	8	27,11	CHI
201911361028	MATRINCHA	MP12199954	MATRINCHA	30/11/2019 05:18	30/11/2019 12:30	30/11/2019 05:18	30/11/2019 12:30	7,19	4	28,75	CHI
201911361032	NOVO PLANALTO	TA12121348	SAO MIGUEL DO ARAGUAIA	30/11/2019 05:19	30/11/2019 12:38	30/11/2019 05:19	30/11/2019 12:38	7,31	38	277,86	CHI

201911361035	MARA ROSA	MQ12338191	SANTA TEREZINHA	30/11/2019 05:23	30/11/2019 16:28	30/11/2019 05:23	30/11/2019 16:28	11,08	3	33,24	CHI
201911361038	URUTAI	PR12080258RE	URUTAI	30/11/2019 03:47	30/11/2019 08:47	30/11/2019 03:47	30/11/2019 08:47	5,00	56	279,89	CHI
201911361038	PIRES DO RIO	PR12080258RE	URUTAI	30/11/2019 03:47	30/11/2019 08:47	30/11/2019 03:47	30/11/2019 08:47	5,00	8	39,98	CHI
201911361040	APORE	SX12153265	JATAI S1	30/11/2019 05:27	30/11/2019 21:53	30/11/2019 05:27	30/11/2019 21:53	16,43	7	115,02	CHI
201911361040	ITARUMA	SX12153265	JATAI S1	30/11/2019 05:27	30/11/2019 21:53	30/11/2019 05:27	30/11/2019 21:53	16,43	1	16,43	CHI
201911361040	SERRANOPOLIS	SX12153265	JATAI S1	30/11/2019 05:27	30/11/2019 21:53	30/11/2019 05:27	30/11/2019 21:53	16,43	4	65,73	CHI
201911361045	PORTELANDIA	PW21200601	PARQUE DAS EMAS	30/11/2019 05:30	30/11/2019 17:38	30/11/2019 05:30	30/11/2019 17:38	12,13	1	12,13	CHI
201911361046	PORANGATU	PO12136349	NOVO PLANALTO	30/11/2019 05:30	30/11/2019 15:30	30/11/2019 05:30	30/11/2019 15:30	10,00	23	230,02	CHI
201911361050	FORMOSA	FA12262114	ITUIQUIRA	30/11/2019 05:31	30/11/2019 12:19	30/11/2019 05:31	30/11/2019 12:19	6,78	6	40,71	CHI
201911361052	ESTRELA DO NORTE	ET12012492	MARA ROSA	30/11/2019 05:32	30/11/2019 09:09	30/11/2019 05:32	30/11/2019 09:09	3,60	8	28,82	CHI
201911361057	PORANGATU	PO12027986	PORANGATU	30/11/2019 05:36	01/12/2019 08:13	30/11/2019 05:36	01/12/2019 08:13	26,61	3	79,83	CHI
201911361059	ITAPURANGA	IK12220545	ITAPURANGA	30/11/2019 03:46	30/11/2019 08:50	30/11/2019 03:46	30/11/2019 08:50	5,07	51	258,47	CHI
201911361065	CRISTALINA	KR12087954	CRISTALINA S2	30/11/2019 05:39	30/11/2019 09:28	30/11/2019 05:39	30/11/2019 09:28	3,82	3	11,45	CHI
201911361066	JANDAIA	JD12314913	PALMEIRAS	29/11/2019 21:31	30/11/2019 10:15	29/11/2019 21:31	30/11/2019 10:15	12,73	17	216,47	CHI
201911361067	DAMOLANDIA	DL12021273	INHUMAS S1	30/11/2019 05:39	30/11/2019 11:09	30/11/2019 05:39	30/11/2019 11:09	5,49	8	43,95	CHI
201911361067	INHUMAS	DL12021273	INHUMAS S1	30/11/2019 05:39	30/11/2019 11:09	30/11/2019 05:39	30/11/2019 11:09	5,49	3	16,48	CHI
201911361073	TROMBAS	TB12181734	PORANGATU	30/11/2019 05:41	30/11/2019 21:29	30/11/2019 05:41	30/11/2019 21:29	15,80	10	157,96	CHI
201911361074	MORRINHOS	150160379	GOIATUBA S1	30/11/2019 05:41	30/11/2019 14:20	30/11/2019 05:41	30/11/2019 14:20	8,65	1	8,65	CHI
201911361079	FORMOSA	610106442	ITUIQUIRA	30/11/2019 05:42	30/11/2019 10:13	30/11/2019 05:42	30/11/2019 10:13	4,51	1	4,51	CHI
201911361082	BOM JARDIM DE GOIAS	BH12207585	BOM JARDIM	30/11/2019 05:43	30/11/2019 10:34	30/11/2019 05:43	30/11/2019 10:34	4,84	1	4,84	CHI
201911361082	BALIZA	BH12207585	BOM JARDIM	30/11/2019 05:43	30/11/2019 10:34	30/11/2019 05:43	30/11/2019 10:34	4,84	6	29,04	CHI
201911361083	MUTUNOPOLIS	MU12172596	MARA ROSA	30/11/2019 05:22	30/11/2019 08:43	30/11/2019 05:22	30/11/2019 08:43	3,33	2	6,67	CHI
201911361083	MARA ROSA	MU12172596	MARA ROSA	30/11/2019 05:22	30/11/2019 08:43	30/11/2019 05:22	30/11/2019 08:43	3,33	28	93,36	CHI
201911361084	ANICUNS	AC12020469	ANICUNS	30/11/2019 05:43	30/11/2019 08:48	30/11/2019 05:43	30/11/2019 08:48	3,09	19	58,62	CHI
201911361085	CIDADE OCIDENTAL	LZ21313540	MARAJOARA	30/11/2019 05:44	30/11/2019 08:31	30/11/2019 05:44	30/11/2019 08:31	2,78	1	2,78	CHI
201911361086	POSSE	PS12195977	IACIARA S1	30/11/2019 05:44	30/11/2019 11:19	30/11/2019 05:44	30/11/2019 11:19	5,58	1	5,58	CHI
201911361086	IACIARA	PS12195977	IACIARA S1	30/11/2019 05:44	30/11/2019 11:19	30/11/2019 05:44	30/11/2019 11:19	5,58	85	474,39	CHI
201911361101	MORRINHOS	MR12000324	MORRINHOS	30/11/2019 05:49	30/11/2019 10:29	30/11/2019 05:49	30/11/2019 10:29	4,65	4	18,61	CHI
201911361106	ITAPIRAPUA	IU12030113	MATRINCHA	30/11/2019 05:52	30/11/2019 18:57	30/11/2019 05:52	30/11/2019 12:33	6,68	6	40,08	CHI
201911361106	ITAPIRAPUA	IU12250541LD	MATRINCHA	30/11/2019 05:52	30/11/2019 18:57	30/11/2019 05:52	30/11/2019 18:57	13,08	5	65,38	CHI
201911361107	PARAUNA	PU12194221	ACREUNA	30/11/2019 05:53	30/11/2019 10:25	30/11/2019 05:53	30/11/2019 10:25	4,53	34	153,90	CHI
201911361110	NOVA CRIXAS	NA12091628	NOVA CRIXAS	30/11/2019 05:53	30/11/2019 17:20	30/11/2019 05:53	30/11/2019 17:20	11,44	16	182,99	CHI
201911361111	OUIDOR	IO12281489RE	CATALAO S1	30/11/2019 05:54	30/11/2019 20:30	30/11/2019 05:54	30/11/2019 17:06	11,21	30	336,33	CHI

201911361111	TRES RANCHOS	IO12281489RE	CATALAO S1	30/11/2019 05:54	30/11/2019 20:30	30/11/2019 05:54	30/11/2019 17:06	11,21	1	11,21	CHI
201911361111	DAVINOPOLIS	IO12281489RE	CATALAO S1	30/11/2019 05:54	30/11/2019 20:30	30/11/2019 05:54	30/11/2019 17:06	11,21	7	78,48	CHI
201911361111	OUIDOR	IO12281489RE	CATALAO S1	30/11/2019 05:54	30/11/2019 20:30	30/11/2019 05:54	30/11/2019 20:30	14,60	8	116,80	CHI
201911361112	URUACU	CR12410914	MARA ROSA	30/11/2019 05:55	30/11/2019 11:00	30/11/2019 05:55	30/11/2019 11:00	5,08	16	81,32	CHI
201911361115	GOIANIA	GN11012784	FERROVIARIO S1	30/11/2019 05:51	30/11/2019 07:20	30/11/2019 05:51	30/11/2019 07:20	1,47	81	119,34	CHI
201911361117	CAMPO ALEGRE DE GOIAS	IP21086059	CAMPO ALEGRE DE GOIAS	30/11/2019 05:57	30/11/2019 12:00	30/11/2019 05:57	30/11/2019 12:00	6,06	1	6,06	CHI
201911361127	CORUMBAIBA	CI12392158	VILA CORUMBA	30/11/2019 06:00	30/11/2019 14:18	30/11/2019 06:00	30/11/2019 14:18	8,30	10	82,95	CHI
201911361130	CEZARINA	CZ12000020	CEZARINA	30/11/2019 06:01	30/11/2019 13:03	30/11/2019 06:01	30/11/2019 13:03	7,04	1	7,04	CHI
201911361130	VARJAO	CZ12000020	CEZARINA	30/11/2019 06:01	30/11/2019 13:03	30/11/2019 06:01	30/11/2019 13:03	7,04	4	28,15	CHI
201911361131	PIRACANJUBA	PJ12039733	PIRACANJUBA	30/11/2019 05:44	30/11/2019 13:20	30/11/2019 05:44	30/11/2019 13:20	7,59	28	212,47	CHI
201911361134	ITABERAI	IB21022007	ITABERAI S2	30/11/2019 06:03	30/11/2019 12:05	30/11/2019 06:03	30/11/2019 12:05	6,03	2	12,06	CHI
201911361138	UIRAPURU	UP12243509	SANTA TEREZINHA	30/11/2019 06:04	30/11/2019 22:26	30/11/2019 06:04	30/11/2019 22:26	16,35	25	408,81	CHI
201911361139	BOM JESUS DE GOIAS	BJ12305385	BOM JESUS DE GOIAS	30/11/2019 06:04	30/11/2019 12:17	30/11/2019 06:04	30/11/2019 12:17	6,20	6	37,20	CHI
201911361145	PORANGATU	TB12208457	PORANGATU	30/11/2019 05:19	30/11/2019 10:56	30/11/2019 05:19	30/11/2019 10:56	5,61	1	5,61	CHI
201911361145	TROMBAS	TB12208457	PORANGATU	30/11/2019 05:19	30/11/2019 10:56	30/11/2019 05:19	30/11/2019 10:56	5,61	16	89,71	CHI
201911361148	NOVA IGUACU DE GOIAS	AJ12143571	MARA ROSA	30/11/2019 04:59	30/11/2019 11:55	30/11/2019 04:59	30/11/2019 11:55	6,92	12	83,07	CHI
201911361148	MARA ROSA	AJ12143571	MARA ROSA	30/11/2019 04:59	30/11/2019 11:55	30/11/2019 04:59	30/11/2019 11:55	6,92	6	41,54	CHI
201911361148	ALTO HORIZONTE	AJ12143571	MARA ROSA	30/11/2019 04:59	30/11/2019 11:55	30/11/2019 04:59	30/11/2019 11:55	6,92	36	249,21	CHI
201911361154	ARUANA	AK12250808	ARUANA	30/11/2019 06:09	30/11/2019 11:13	30/11/2019 06:09	30/11/2019 11:13	5,06	4	20,24	CHI
201911361162	MORRINHOS	MR12075101	MORRINHOS	30/11/2019 05:51	30/11/2019 13:18	30/11/2019 05:51	30/11/2019 13:18	7,44	44	327,30	CHI
201911361167	AMARALINA	LC12270751	SAO MIGUEL DO ARAGUAIA	30/11/2019 06:13	01/12/2019 08:05	30/11/2019 06:13	01/12/2019 08:05	25,87	3	77,60	CHI
201911361170	ITUMBIARA	IT21208195	CACHOEIRA DOURADA	30/11/2019 06:13	30/11/2019 09:40	30/11/2019 06:13	30/11/2019 09:40	3,45	1	3,45	CHI
201911361175	GOIAS	GS21217179	GOIAS	30/11/2019 06:13	30/11/2019 09:45	30/11/2019 06:13	30/11/2019 09:45	3,52	1	3,52	CHI
201911361183	PORANGATU	TA12114216	NOVO PLANALTO	30/11/2019 06:15	30/11/2019 14:09	30/11/2019 06:15	30/11/2019 14:09	7,89	6	47,32	CHI
201911361186	IVOLANDIA	IV12334659	IPORA	30/11/2019 06:17	30/11/2019 12:56	30/11/2019 06:17	30/11/2019 12:56	6,64	2	13,28	CHI
201911361187	ANAPOLIS	AN11101812	ANAPOLIS UNIVERSITARIO S2	30/11/2019 06:17	30/11/2019 10:54	30/11/2019 06:17	30/11/2019 10:54	4,61	115	529,64	CHI
201911361189	JARAGUA	JA21148833	JARAGUA	30/11/2019 06:18	30/11/2019 09:19	30/11/2019 06:18	30/11/2019 09:19	3,02	1	3,02	CHI
201911361192	BALIZA	BH12343730	BOM JARDIM	30/11/2019 06:18	30/11/2019 23:55	30/11/2019 06:18	30/11/2019 23:55	17,60	8	140,83	CHI
201911361194	MAMBAI	MB11046226	IACIARA S2	30/11/2019 06:18	30/11/2019 09:28	30/11/2019 06:18	30/11/2019 09:28	3,15	145	456,95	CHI
201911361201	CALDAS NOVAS	CN12075111	SERRA DE CALDAS	30/11/2019 06:20	30/11/2019 08:51	30/11/2019 06:20	30/11/2019 08:51	2,50	21	52,60	CHI
201911361202	NIQUELANDIA	NQ12265691	URUACU	30/11/2019 06:20	30/11/2019 14:22	30/11/2019 06:20	30/11/2019 14:22	8,02	17	136,29	CHI
201911361204	CACHOEIRA ALTA	QI12279622	QUIRINOPOLIS	30/11/2019 05:35	30/11/2019 10:14	30/11/2019 05:35	30/11/2019 10:14	4,64	14	64,97	CHI
201911361213	GOIANESIA	GE12353258	GOIANESIA S2	30/11/2019 00:23	30/11/2019 09:30	30/11/2019 00:23	30/11/2019 09:30	9,11	163	1484,39	CHI

201911361213	VILA PROPICIO	GE12353258	GOIANESIA S2	30/11/2019 00:23	30/11/2019 09:30	30/11/2019 00:23	30/11/2019 09:30	9,11	18	163,92	CHI
201911361214	PIRACANJUBA	PJ12082187	PIRACANJUBA	30/11/2019 05:30	30/11/2019 12:20	30/11/2019 05:30	30/11/2019 12:20	6,83	11	75,13	CHI
201911361215	QUIRINOPOLIS	QI12189166	CACHOEIRA ALTA	30/11/2019 06:26	30/11/2019 19:07	30/11/2019 06:26	30/11/2019 19:07	12,67	2	25,34	CHI
201911361215	CACHOEIRA ALTA	QI12189166	CACHOEIRA ALTA	30/11/2019 06:26	30/11/2019 19:07	30/11/2019 06:26	30/11/2019 19:07	12,67	2	25,34	CHI
201911361217	FORMOSA	FA11085457	ITUIQUIRA	30/11/2019 06:27	30/11/2019 16:09	30/11/2019 06:27	30/11/2019 16:09	9,69	3	29,06	CHI
201911361225	ARAGUAPAZ	AZ12193702	GOIAS	30/11/2019 06:32	30/11/2019 09:00	30/11/2019 06:32	30/11/2019 09:00	2,46	2	4,92	CHI
201911361235	NOVA ROMA	8720005467	IACIARA S2	30/11/2019 06:35	30/11/2019 18:20	30/11/2019 06:35	30/11/2019 18:20	11,75	1	11,75	CHI
201911361240	TURVELANDIA	TD12025721	RIO DOS BOIS	30/11/2019 06:07	30/11/2019 12:02	30/11/2019 06:07	30/11/2019 12:02	5,91	19	112,28	CHI
201911361240	ACREUNA	TD12025721	RIO DOS BOIS	30/11/2019 06:07	30/11/2019 12:02	30/11/2019 06:07	30/11/2019 12:02	5,91	18	106,38	CHI
201911361240	TURVELANDIA	TD12025721	RIO DOS BOIS	30/11/2019 06:07	30/11/2019 12:02	30/11/2019 11:16	30/11/2019 12:02	0,76	15	11,42	CHI
201911361240	ACREUNA	TD12025721	RIO DOS BOIS	30/11/2019 06:07	30/11/2019 12:02	30/11/2019 11:16	30/11/2019 12:02	0,76	2	1,52	CHI
201911361245	GOIANESIA	GE12000180	GOIANESIA S2	29/11/2019 21:03	30/11/2019 18:58	29/11/2019 21:03	30/11/2019 18:58	21,90	20	438,08	CHI
201911361246	SAO DOMINGOS	SD12192249	SAO DOMINGOS	30/11/2019 02:38	30/11/2019 12:56	30/11/2019 02:38	30/11/2019 12:56	10,29	11	113,21	CHI
201911361249	PORANGATU	TB12262770	PORANGATU	30/11/2019 06:41	30/11/2019 10:02	30/11/2019 06:41	30/11/2019 10:02	3,35	1	3,35	CHI
201911361249	SANTA TEREZA DE GOIAS	TB12262770	PORANGATU	30/11/2019 06:41	30/11/2019 10:02	30/11/2019 06:41	30/11/2019 10:02	3,35	5	16,75	CHI
201911361249	TROMBAS	TB12262770	PORANGATU	30/11/2019 06:41	30/11/2019 10:02	30/11/2019 06:41	30/11/2019 10:02	3,35	13	43,54	CHI
201911361252	MONTE ALEGRE DE GOIAS	MA21127987	SAO DOMINGOS	30/11/2019 06:43	30/11/2019 11:35	30/11/2019 06:43	30/11/2019 11:35	4,86	1	4,86	CHI
201911361253	BONOPOLIS	BX12079321	SAO MIGUEL DO ARAGUAIA	29/11/2019 23:50	30/11/2019 10:29	29/11/2019 23:50	30/11/2019 10:29	10,64	58	617,35	CHI
201911361260	ITABERAI	IB21373127	ITABERAI S1	30/11/2019 06:49	30/11/2019 14:13	30/11/2019 06:49	30/11/2019 14:13	7,39	1	7,39	CHI
201911361261	CATALAO	CT21215629	CATALAO S1	30/11/2019 06:50	30/11/2019 07:51	30/11/2019 06:50	30/11/2019 07:51	1,00	2	2,01	CHI
201911361262	NEROPOLIS	NR21065489	NEROPOLIS S2	30/11/2019 06:51	30/11/2019 11:20	30/11/2019 06:51	30/11/2019 11:20	4,48	3	13,43	CHI
201911361270	CORUMBAIBA	CI21266195	VILA CORUMBA	30/11/2019 06:57	30/11/2019 12:47	30/11/2019 06:57	30/11/2019 12:47	5,82	1	5,82	CHI
201911361272	CATALAO	CT21195445	CATALAO S1	30/11/2019 06:58	30/11/2019 09:33	30/11/2019 06:58	30/11/2019 09:33	2,58	1	2,58	CHI
201911361277	IACIARA	IA12302910	IACIARA S1	30/11/2019 06:59	30/11/2019 15:37	30/11/2019 06:59	30/11/2019 11:42	4,71	2	9,41	CHI
201911361277	IACIARA	IA12132462LD	IACIARA S1	30/11/2019 06:59	30/11/2019 15:37	30/11/2019 06:59	30/11/2019 15:37	8,63	9	77,63	CHI
201911361278	NIQUELANDIA	NQ12171084	BARRO ALTO	30/11/2019 06:14	30/11/2019 11:30	30/11/2019 06:14	30/11/2019 11:30	5,26	43	225,99	CHI
201911361282	PONTALINA	PK12263503	PONTALINA	30/11/2019 06:04	30/11/2019 15:01	30/11/2019 06:04	30/11/2019 15:01	8,94	15	134,08	CHI
201911361284	CRIXAS	CX12158232	SERRA DO OURO	30/11/2019 07:02	01/12/2019 16:06	30/11/2019 07:02	01/12/2019 16:06	33,07	5	165,33	CHI
201911361285	SAO JOAO DA PARAUNA	RP12391404	FIRMINOPOLIS S2	30/11/2019 07:02	30/11/2019 10:18	30/11/2019 07:02	30/11/2019 10:18	3,26	5	16,30	CHI
201911361290	BELA VISTA DE GOIAS	BV12079678	BELA VISTA S1	30/11/2019 07:02	30/11/2019 09:48	30/11/2019 07:02	30/11/2019 09:48	2,75	122	336,08	CHI
201911361290	HIDROLANDIA	BV12079678	BELA VISTA S1	30/11/2019 07:02	30/11/2019 09:48	30/11/2019 07:02	30/11/2019 09:48	2,75	1	2,75	CHI
201911361291	NIQUELANDIA	NQ10406903	BARRO ALTO	30/11/2019 02:23	30/11/2019 08:40	30/11/2019 02:23	30/11/2019 08:40	6,27	593	3718,44	CHI
201911361292	DAVINOPOLIS	IO12363432	CATALAO S1	30/11/2019 07:03	30/11/2019 09:52	30/11/2019 07:03	30/11/2019 09:52	2,81	22	61,83	CHI

201911361292	OUVIDOR	IO12363432	CATALAO S1	30/11/2019 07:03	30/11/2019 09:52	30/11/2019 07:03	30/11/2019 09:52	2,81	16	44,96	CHI
201911361293	BALIZA	BH12060671	BOM JARDIM	30/11/2019 07:03	30/11/2019 09:15	30/11/2019 07:03	30/11/2019 09:15	2,21	6	13,23	CHI
201911361294	ITARUMA	CC12384080	CACHOEIRA ALTA	30/11/2019 05:16	30/11/2019 15:31	30/11/2019 05:16	30/11/2019 15:31	10,25	3	30,74	CHI
201911361294	CACU	CC12384080	CACHOEIRA ALTA	30/11/2019 05:16	30/11/2019 15:31	30/11/2019 05:16	30/11/2019 15:31	10,25	5	51,23	CHI
201911361297	NEROPOLIS	NR21277028	NEROPOLIS S2	30/11/2019 07:04	30/11/2019 10:06	30/11/2019 07:04	30/11/2019 10:06	3,03	1	3,03	CHI
201911361306	OUVIDOR	OU12063777	CATALAO S1	30/11/2019 07:05	30/11/2019 13:54	30/11/2019 07:05	30/11/2019 13:54	6,83	1	6,83	CHI
201911361310	PARANAIGUARA	6517034	QUIRINOPOLIS	30/11/2019 07:02	01/12/2019 11:00	30/11/2019 07:02	01/12/2019 11:00	27,96	1	27,96	CHI
201911361317	ITAGUARU	HE12041333	ITAPURANGA	30/11/2019 07:06	30/11/2019 10:03	30/11/2019 07:06	30/11/2019 10:03	2,93	1	2,93	CHI
201911361318	PORANGATU	PO21088719	PORANGATU	30/11/2019 07:07	30/11/2019 11:15	30/11/2019 07:07	30/11/2019 11:15	4,12	1	4,12	CHI
201911361324	VILA PROPICIO	NP12403817	GOIANESIA S1	30/11/2019 07:08	01/12/2019 12:29	30/11/2019 07:08	01/12/2019 12:29	29,35	1	29,35	CHI
201911361325	NOVA CRIXAS	NA12334349	NOVA CRIXAS	30/11/2019 05:42	30/11/2019 12:33	30/11/2019 05:42	30/11/2019 12:33	6,85	82	561,68	CHI
201911361328	PIRENOPOLIS	PV12084565	CORUMBA	30/11/2019 05:16	30/11/2019 10:25	30/11/2019 05:16	30/11/2019 10:25	5,14	10	51,45	CHI
201911361330	MUTUNOPOLIS	MU21000011	MARA ROSA	30/11/2019 07:09	30/11/2019 14:04	30/11/2019 07:09	30/11/2019 14:04	6,91	1	6,91	CHI
201911361341	TURVANIA	TV12005223	FIRMINOPOLIS S2	30/11/2019 07:12	30/11/2019 08:35	30/11/2019 07:12	30/11/2019 08:35	1,39	5	6,94	CHI
201911361342	DOVERLANDIA	DV12381096	CAIAPONIA	30/11/2019 07:12	30/11/2019 12:24	30/11/2019 07:12	30/11/2019 12:24	5,19	2	10,38	CHI
201911361344	GOUVELANDIA	GB12000209	QUIRINOPOLIS	30/11/2019 07:12	30/11/2019 10:12	30/11/2019 07:12	30/11/2019 10:12	2,99	29	86,58	CHI
201911361344	QUIRINOPOLIS	GB12000209	QUIRINOPOLIS	30/11/2019 07:12	30/11/2019 10:12	30/11/2019 07:12	30/11/2019 10:12	2,99	84	250,79	CHI
201911361345	PORANGATU	PO12350110	PORANGATU	30/11/2019 05:58	30/11/2019 11:40	30/11/2019 05:58	30/11/2019 11:40	5,69	17	96,67	CHI
201911361346	MOZARLANDIA	MZ12057110	MOZARLANDIA	30/11/2019 07:13	30/11/2019 11:53	30/11/2019 07:13	30/11/2019 11:53	4,66	5	23,31	CHI
201911361349	PADRE BERNARDO	PB12344764	PADRE BERNARDO	30/11/2019 07:13	30/11/2019 11:13	30/11/2019 07:13	30/11/2019 11:13	3,99	8	31,92	CHI
201911361352	GOIANIA	10712951	ATLANTICO S3	30/11/2019 07:13	30/11/2019 09:38	30/11/2019 07:13	30/11/2019 09:38	2,40	1	2,40	CHI
201911361355	RIO VERDE	RV12260643	CABRIUVA S2	30/11/2019 05:47	30/11/2019 10:25	30/11/2019 05:47	30/11/2019 10:25	4,62	8	36,99	CHI
201911361357	CRISTALINA	KR21351945	CRISTALINA S1	30/11/2019 07:15	30/11/2019 11:50	30/11/2019 07:15	30/11/2019 11:50	4,58	2	9,15	CHI
201911361361	APORE	AE21107341	ITAJA S1	30/11/2019 07:17	30/11/2019 09:03	30/11/2019 07:17	30/11/2019 09:03	1,77	1	1,77	CHI
201911361368	ITAPURANGA	IK12250728	ITAPURANGA	30/11/2019 07:19	30/11/2019 12:12	30/11/2019 07:19	30/11/2019 12:12	4,87	26	126,72	CHI
201911361376	UIRAPURU	UP12244464	NOVA CRIXAS	30/11/2019 04:38	01/12/2019 00:40	30/11/2019 04:38	01/12/2019 00:40	20,03	24	480,78	CHI
201911361377	MOIPORA	SL13194836	SAO LUIZ DOS MONTES BELOS	30/11/2019 07:17	30/11/2019 13:05	30/11/2019 07:17	30/11/2019 09:30	2,21	28	61,81	CHI
201911361377	SANCLERLANDIA	SL13194836	SAO LUIZ DOS MONTES BELOS	30/11/2019 07:17	30/11/2019 13:05	30/11/2019 07:17	30/11/2019 09:30	2,21	35	77,26	CHI
201911361377	SAO LUIS DE MONTES BELOS	SL13194836	SAO LUIZ DOS MONTES BELOS	30/11/2019 07:17	30/11/2019 13:05	30/11/2019 07:17	30/11/2019 09:30	2,21	726	1602,65	CHI
201911361377	AURILANDIA	SL13194836	SAO LUIZ DOS MONTES BELOS	30/11/2019 07:17	30/11/2019 13:05	30/11/2019 07:17	30/11/2019 09:30	2,21	32	70,64	CHI
201911361377	FIRMINOPOLIS	SL13194836	SAO LUIZ DOS MONTES BELOS	30/11/2019 07:17	30/11/2019 13:05	30/11/2019 07:17	30/11/2019 09:30	2,21	109	240,62	CHI
201911361377	CORREGO DO OURO	SL13194836	SAO LUIZ DOS MONTES BELOS	30/11/2019 07:17	30/11/2019 13:05	30/11/2019 07:17	30/11/2019 09:30	2,21	326	719,65	CHI
201911361377	SAO LUIS DE MONTES BELOS	SL10394730	SAO LUIZ DOS MONTES BELOS	30/11/2019 07:17	30/11/2019 13:05	30/11/2019 09:26	30/11/2019 13:05	3,65	34	124,14	CHI



201911361381	PIRACANJUBA	PJ12212150RE	PIRACANJUBA	30/11/2019 05:06	30/11/2019 10:30	30/11/2019 05:06	30/11/2019 10:30	5,40	66	356,14	CHI
201911361385	GOIAS	GS21297350	MATRINCHA	30/11/2019 07:26	30/11/2019 10:53	30/11/2019 07:26	30/11/2019 10:53	3,46	2	6,92	CHI
201911361390	BONOPOLIS	BX12364681	SAO MIGUEL DO ARAGUAIA	30/11/2019 07:27	30/11/2019 19:03	30/11/2019 07:27	30/11/2019 19:03	11,59	4	46,37	CHI
201911361394	GUARANI DE GOIAS	GY12393812	IACIARA S1	30/11/2019 07:27	30/11/2019 12:30	30/11/2019 07:27	30/11/2019 12:30	5,04	22	110,91	CHI
201911361395	PIRES DO RIO	PR12337189RE	PIRES DO RIO S1	29/11/2019 21:48	30/11/2019 12:36	29/11/2019 21:48	30/11/2019 12:36	14,79	35	517,78	CHI
201911361395	SANTA CRUZ DE GOIAS	PR12337189RE	PIRES DO RIO S1	29/11/2019 21:48	30/11/2019 12:36	29/11/2019 21:48	30/11/2019 12:36	14,79	1	14,79	CHI
201911361395	URUTAI	PR12337189RE	PIRES DO RIO S1	29/11/2019 21:48	30/11/2019 12:36	29/11/2019 21:48	30/11/2019 12:36	14,79	1	14,79	CHI
201911361400	TRINDADE	TR12326279	TRINDADE	30/11/2019 07:28	30/11/2019 10:30	30/11/2019 07:28	30/11/2019 10:30	3,04	4	12,16	CHI
201911361401	COLINAS DO SUL	TIZ1196831	NIQUELANDIA SUBTRANSMISSAO	30/11/2019 07:28	30/11/2019 14:39	30/11/2019 07:28	30/11/2019 14:39	7,18	1	7,18	CHI
201911361413	SANTO ANTONIO DO DESCOBERTO	SN12382252	ALEXANIA	29/11/2019 21:33	30/11/2019 11:05	29/11/2019 21:33	30/11/2019 11:05	13,52	10	135,21	CHI
201911361414	FAINA	FC12147794	GOIAS	30/11/2019 07:30	30/11/2019 10:35	30/11/2019 07:30	30/11/2019 10:35	3,08	52	159,96	CHI
201911361417	CAMPINORTE	CR12291123	MARA ROSA	30/11/2019 06:17	30/11/2019 16:54	30/11/2019 06:17	30/11/2019 16:54	10,62	25	265,44	CHI
201911361419	LUZIANIA	LZ12000098	RIO VERMELHO	30/11/2019 07:32	30/11/2019 09:54	30/11/2019 07:32	30/11/2019 09:54	2,36	3	7,08	CHI
201911361426	URUACU	UC12237456	MARA ROSA	30/11/2019 05:43	30/11/2019 09:22	30/11/2019 05:43	30/11/2019 09:22	3,65	5	18,25	CHI
201911361426	CAMPINACU	UC12237456	MARA ROSA	30/11/2019 05:43	30/11/2019 09:22	30/11/2019 05:43	30/11/2019 09:22	3,65	7	25,55	CHI
201911361429	CRISTALINA	KR12304816	CRISTALINA S2	30/11/2019 06:15	30/11/2019 10:39	30/11/2019 06:15	30/11/2019 10:39	4,39	15	65,80	CHI
201911361433	ARAGARCAS	AG12188251	ARAGARCAS	30/11/2019 07:13	30/11/2019 10:04	30/11/2019 07:13	30/11/2019 10:04	2,84	53	150,76	CHI
201911361439	CABECEIRAS	CW12052029	ITUIQUIRA	30/11/2019 07:33	30/11/2019 13:39	30/11/2019 07:33	30/11/2019 13:39	6,10	7	42,67	CHI
201911361445	ANAPOLIS	AN11167570	ANAPOLIS UNIVERSITARIO S2	30/11/2019 07:36	30/11/2019 09:26	30/11/2019 07:36	30/11/2019 09:26	1,82	87	158,61	CHI
201911361448	BRITANIA	04750224	MATRINCHA	30/11/2019 06:12	30/11/2019 10:10	30/11/2019 06:12	30/11/2019 10:10	3,96	6	23,73	CHI
201911361448	ITAPIRAPUA	04750224	MATRINCHA	30/11/2019 06:12	30/11/2019 10:10	30/11/2019 06:12	30/11/2019 10:10	3,96	92	363,91	CHI
201911361449	MORRINHOS	MR11372888	MORRINHOS	30/11/2019 05:42	30/11/2019 09:20	30/11/2019 05:42	30/11/2019 09:20	3,63	59	214,10	CHI
201911361451	FORMOSA	FA11131890	ITUIQUIRA	30/11/2019 05:57	30/11/2019 09:11	30/11/2019 05:57	30/11/2019 09:11	3,22	78	251,27	CHI
201911361455	GOIANIA	15678581	GOIANIA LESTE S1	30/11/2019 07:37	30/11/2019 09:31	30/11/2019 07:37	30/11/2019 09:31	1,90	1	1,90	CHI
201911361456	GUARANI DE GOIAS	GY12268482	SAO DOMINGOS	30/11/2019 06:13	30/11/2019 10:47	30/11/2019 06:13	30/11/2019 10:47	4,56	22	100,31	CHI
201911361457	PALMELO	PZ11000143	PIRES DO RIO S2	30/11/2019 07:30	30/11/2019 08:30	30/11/2019 07:30	30/11/2019 08:30	1,01	115	116,31	CHI
201911361464	LUZIANIA	LZ12304995	VIANOPOLIS	30/11/2019 04:23	30/11/2019 10:38	30/11/2019 04:23	30/11/2019 10:38	6,23	8	49,88	CHI
201911361464	ORIZONA	LZ12304995	VIANOPOLIS	30/11/2019 04:23	30/11/2019 10:38	30/11/2019 04:23	30/11/2019 10:38	6,23	89	554,87	CHI
201911361474	IPAMERI	IP12376252	CRISTALINA S2	30/11/2019 07:19	01/12/2019 14:41	30/11/2019 07:19	01/12/2019 14:41	31,37	17	533,21	CHI
201911361480	PORANGATU	PO12371059	PORANGATU	30/11/2019 07:42	30/11/2019 09:12	30/11/2019 07:42	30/11/2019 09:12	1,49	44	65,61	CHI
201911361482	NOVA CRIXAS	NA12197190	NOVA CRIXAS	30/11/2019 07:42	01/12/2019 17:26	30/11/2019 07:42	01/12/2019 17:26	33,72	92	3102,39	CHI
201911361482	NOVA CRIXAS	NA12197190	NOVA CRIXAS	30/11/2019 07:42	01/12/2019 17:26	01/12/2019 15:45	01/12/2019 17:26	1,67	48	80,20	CHI
201911361486	MOZARLANDIA	MZ12330409	MOZARLANDIA	30/11/2019 07:43	30/11/2019 16:01	30/11/2019 07:43	30/11/2019 16:01	8,30	1	8,30	CHI

201911361490	SENADOR CANEDO	SW12213758	CEPAIGO S1	30/11/2019 07:45	30/11/2019 09:13	30/11/2019 07:45	30/11/2019 09:13	1,45	40	58,09	CHI
201911361497	VILA PROPICIO	NP21221360	GOIANESIA S1	30/11/2019 07:48	01/12/2019 13:01	30/11/2019 07:48	01/12/2019 13:01	29,21	1	29,21	CHI
201911361501	PORANGATU	PO12354489	NOVO PLANALTO	30/11/2019 07:50	30/11/2019 11:11	30/11/2019 07:50	30/11/2019 11:11	3,34	10	33,44	CHI
201911361508	ALTO HORIZONTE	AJ21086205	SANTA TEREZINHA	30/11/2019 07:51	30/11/2019 13:48	30/11/2019 07:51	30/11/2019 13:48	5,95	1	5,95	CHI
201911361513	PADRE BERNARDO	PB11377259	PADRE BERNARDO	30/11/2019 07:53	30/11/2019 12:48	30/11/2019 07:53	30/11/2019 12:48	4,91	58	284,83	CHI
201911361516	LEOPOLDO DE BULHOES	LB12382739	DAIA S2	30/11/2019 07:53	30/11/2019 17:00	30/11/2019 07:53	30/11/2019 17:00	9,10	2	18,20	CHI
201911361517	JATAI	SX12264387	JATAI S1	29/11/2019 19:57	30/11/2019 20:08	29/11/2019 19:57	30/11/2019 20:08	24,18	7	169,24	CHI
201911361517	SERRANOPOLIS	SX12264387	JATAI S1	29/11/2019 19:57	30/11/2019 20:08	29/11/2019 19:57	30/11/2019 20:08	24,18	22	531,90	CHI
201911361518	BELA VISTA DE GOIAS	BV21207372	BELA VISTA S1	30/11/2019 07:54	01/12/2019 09:54	30/11/2019 07:54	01/12/2019 09:54	25,99	2	51,98	CHI
201911361519	CAMPINACU	UC12265668	PORANGATU	30/11/2019 07:55	30/11/2019 15:15	30/11/2019 07:55	30/11/2019 15:15	7,34	3	22,02	CHI
201911361521	ARUANA	AK11376430	ARUANA	30/11/2019 07:56	30/11/2019 09:33	30/11/2019 07:56	30/11/2019 09:33	1,61	29	46,59	CHI
201911361522	IPAMERI	IP21013343	URUTAI	30/11/2019 07:56	30/11/2019 11:06	30/11/2019 07:56	30/11/2019 11:06	3,16	1	3,16	CHI
201911361523	JATAI	JT21296399	JATAI S1	30/11/2019 07:56	30/11/2019 09:49	30/11/2019 07:56	30/11/2019 09:49	1,87	1	1,87	CHI
201911361530	CALDAS NOVAS	PJ12223314RE	CALDAS NOVAS S1	30/11/2019 10:02	01/12/2019 11:40	30/11/2019 10:02	01/12/2019 11:40	25,63	5	128,16	CHI
201911361530	PIRACANJUBA	PJ12223314RE	CALDAS NOVAS S1	30/11/2019 10:02	01/12/2019 11:40	30/11/2019 10:02	01/12/2019 11:40	25,63	32	820,20	CHI
201911361530	SANTA CRUZ DE GOIAS	PJ12223314RE	CALDAS NOVAS S1	30/11/2019 10:02	01/12/2019 11:40	30/11/2019 10:02	01/12/2019 11:40	25,63	1	25,63	CHI
201911361531	CEZARINA	IY12010392	EDEIA	30/11/2019 07:57	30/11/2019 12:29	30/11/2019 07:57	30/11/2019 11:30	3,54	5	17,70	CHI
201911361531	INDIARA	IY12010392	EDEIA	30/11/2019 07:57	30/11/2019 12:29	30/11/2019 07:57	30/11/2019 11:30	3,54	7	24,79	CHI
201911361531	CEZARINA	IY12010801	EDEIA	30/11/2019 07:57	30/11/2019 12:29	30/11/2019 12:24	30/11/2019 12:29	0,09	1	0,09	CHI
201911361535	GAMELEIRA DE GOIAS	GL12326247	DAIA S2	30/11/2019 07:58	30/11/2019 09:52	30/11/2019 07:58	30/11/2019 09:52	1,90	5	9,50	CHI
201911361541	SANTO ANTONIO DO DESCOBERTO	SN12351246	ALEXANIA	29/11/2019 20:52	30/11/2019 11:37	29/11/2019 20:52	30/11/2019 11:37	14,74	17	250,50	CHI
201911361543	ITAPURANGA	IK12300245	ITAPURANGA	30/11/2019 07:38	30/11/2019 14:26	30/11/2019 07:38	30/11/2019 14:26	6,80	29	197,22	CHI
201911361545	PORANGATU	PO12020578	PORANGATU	30/11/2019 04:51	02/12/2019 13:29	30/11/2019 04:51	30/11/2019 18:28	13,62	4	54,48	CHI
201911361545	PORANGATU	PO13375469	PORANGATU	30/11/2019 04:51	02/12/2019 13:29	30/11/2019 04:51	30/11/2019 19:18	14,44	9	130,00	CHI
201911361545	PORANGATU	PO12020578	PORANGATU	30/11/2019 04:51	02/12/2019 13:29	30/11/2019 04:51	30/11/2019 22:42	17,85	7	124,98	CHI
201911361545	PORANGATU	PO12020578	PORANGATU	30/11/2019 04:51	02/12/2019 13:29	30/11/2019 21:41	30/11/2019 22:42	1,02	13	13,23	CHI
201911361545	PORANGATU	PO12020578	PORANGATU	30/11/2019 04:51	02/12/2019 13:29	01/12/2019 18:00	01/12/2019 19:48	1,81	20	36,26	CHI
201911361545	PORANGATU	PO12020578	PORANGATU	30/11/2019 04:51	02/12/2019 13:29	30/11/2019 04:51	02/12/2019 13:29	56,63	3	169,89	CHI
201911361545	PORANGATU	PO12020578	PORANGATU	30/11/2019 04:51	02/12/2019 13:29	02/12/2019 10:35	02/12/2019 13:29	2,90	20	58,02	CHI
201911361548	ITABERAI	10014414919	ITABERAI S2	30/11/2019 07:21	30/11/2019 10:52	30/11/2019 07:21	30/11/2019 10:52	3,52	1	3,52	CHI
201911361549	MUTUNOPOLIS	MU12390125	MARA ROSA	30/11/2019 08:00	30/11/2019 10:25	30/11/2019 08:00	30/11/2019 10:25	2,41	3	7,22	CHI
201911361549	AMARALINA	MU12390125	MARA ROSA	30/11/2019 08:00	30/11/2019 10:25	30/11/2019 08:00	30/11/2019 10:25	2,41	1	2,41	CHI
201911361550	BOM JESUS DE GOIAS	BJ12222571	BOM JESUS DE GOIAS	30/11/2019 05:38	30/11/2019 11:05	30/11/2019 05:38	30/11/2019 11:05	5,44	162	881,37	CHI

201911361558	GOIANIA	10018748854	FERROVIARIO S2	30/11/2019 08:01	30/11/2019 09:22	30/11/2019 08:01	30/11/2019 09:22	1,35	1	1,35	CHI
201911361561	PIRENOPOLIS	PV12034069	CORUMBA	30/11/2019 08:02	30/11/2019 10:12	30/11/2019 08:02	30/11/2019 10:12	2,16	65	140,54	CHI
201911361566	CACHOEIRA ALTA	CA12200034	CACHOEIRA ALTA	30/11/2019 08:02	01/12/2019 09:43	30/11/2019 08:02	01/12/2019 09:43	25,67	3	77,02	CHI
201911361569	URUANA	UA12078282	JARAGUA	30/11/2019 05:29	30/11/2019 11:42	30/11/2019 05:29	30/11/2019 11:42	6,21	8	49,71	CHI
201911361569	JARAGUA	UA12078282	JARAGUA	30/11/2019 05:29	30/11/2019 11:42	30/11/2019 05:29	30/11/2019 11:42	6,21	2	12,43	CHI
201911361573	ALTO HORIZONTE	AJ12317686	SANTA TEREZINHA	30/11/2019 08:02	01/12/2019 10:49	30/11/2019 08:02	01/12/2019 10:49	26,77	1	26,77	CHI
201911361576	MUNDO NOVO DE GOIAS	MH11269406	NOVA CRIXAS	30/11/2019 08:03	30/11/2019 19:25	30/11/2019 08:03	30/11/2019 19:25	11,36	1	11,36	CHI
201911361581	SAO JOAO D ALIANCA	JL12321185	SAO JOAO D ALIANCA	30/11/2019 08:03	01/12/2019 12:40	30/11/2019 08:03	01/12/2019 12:40	28,61	5	143,04	CHI
201911361582	SAO MIGUEL DO PASSA QUATRO	SQ21116225	CRISTIANOPOLIS	30/11/2019 08:03	30/11/2019 12:01	30/11/2019 08:03	30/11/2019 12:01	3,96	1	3,96	CHI
201911361584	MONTES CLAROS DE GOIAS	ME12091498	IPORA	30/11/2019 08:03	30/11/2019 10:40	30/11/2019 08:03	30/11/2019 10:40	2,61	2	5,21	CHI
201911361589	SANTA ROSA DE GOIAS	SR21019094	INHUMAS S1	30/11/2019 08:04	30/11/2019 18:20	30/11/2019 08:04	30/11/2019 18:20	10,27	1	10,27	CHI
201911361590	CUMARI	CY21071486	CATALAO S1	30/11/2019 08:04	30/11/2019 11:24	30/11/2019 08:04	30/11/2019 11:24	3,32	1	3,32	CHI
201911361592	CALDAS NOVAS	10007199498	SERRA DE CALDAS	30/11/2019 08:04	01/12/2019 09:24	30/11/2019 08:04	01/12/2019 09:24	25,33	1	25,33	CHI
201911361593	MUNDO NOVO DE GOIAS	8276217	NOVA CRIXAS	30/11/2019 08:04	01/12/2019 11:40	30/11/2019 08:04	01/12/2019 11:40	27,58	2	55,17	CHI
201911361597	IPORA	IR21069082	IPORA	30/11/2019 08:05	30/11/2019 09:23	30/11/2019 08:05	30/11/2019 09:23	1,29	1	1,29	CHI
201911361600	INDIARA	IY12391429	EDEIA	30/11/2019 08:05	30/11/2019 16:24	30/11/2019 08:05	30/11/2019 16:24	8,31	6	49,83	CHI
201911361601	GOIANIA	12400087	ATLANTICO S1	30/11/2019 08:05	30/11/2019 09:12	30/11/2019 08:05	30/11/2019 09:12	1,10	1	1,10	CHI
201911361603	IPAMERI	IP21133581	CRISTALINA S2	30/11/2019 08:06	30/11/2019 17:45	30/11/2019 08:06	30/11/2019 17:45	9,65	1	9,65	CHI
201911361606	BRAZABRANTES	BR12238978	NEROPOLIS S1	30/11/2019 08:06	30/11/2019 09:56	30/11/2019 08:06	30/11/2019 09:56	1,82	9	16,39	CHI
201911361607	MINEIROS	MY12371631	PARQUE DAS EMAS	30/11/2019 08:06	30/11/2019 18:13	30/11/2019 08:06	30/11/2019 18:13	10,10	2	20,20	CHI
201911361610	PALMEIRAS DE GOIAS	PL12000049	PALMEIRAS	30/11/2019 05:47	30/11/2019 10:40	30/11/2019 05:47	30/11/2019 10:40	4,87	27	131,57	CHI
201911361610	JANDAIA	PL12000049	PALMEIRAS	30/11/2019 05:47	30/11/2019 10:40	30/11/2019 05:47	30/11/2019 10:40	4,87	8	38,98	CHI
201911361610	PALESTINA DE GOIAS	PL12000049	PALMEIRAS	30/11/2019 05:47	30/11/2019 10:40	30/11/2019 05:47	30/11/2019 10:40	4,87	1	4,87	CHI
201911361615	PORTELANDIA	PW21117567	PARQUE DAS EMAS	29/11/2019 11:24	30/11/2019 11:41	29/11/2019 11:24	30/11/2019 11:41	24,28	1	24,28	CHI
201911361620	PORANGATU	PO21139186	PORANGATU	30/11/2019 08:08	01/12/2019 10:31	30/11/2019 08:08	01/12/2019 10:31	26,38	1	26,38	CHI
201911361621	GOIANIA	13393789	FERROVIARIO S1	30/11/2019 08:08	30/11/2019 09:12	30/11/2019 08:08	30/11/2019 09:12	1,06	1	1,06	CHI
201911361627	PILAR DE GOIAS	NH12202110	SANTA TEREZINHA	30/11/2019 07:10	30/11/2019 11:28	30/11/2019 07:10	30/11/2019 11:28	4,30	9	38,67	CHI
201911361627	SANTA TEREZINHA DE GOIAS	NH12202110	SANTA TEREZINHA	30/11/2019 07:10	30/11/2019 11:28	30/11/2019 07:10	30/11/2019 11:28	4,30	23	98,81	CHI
201911361627	ALTO HORIZONTE	NH12202110	SANTA TEREZINHA	30/11/2019 07:10	30/11/2019 11:28	30/11/2019 07:10	30/11/2019 11:28	4,30	13	55,85	CHI
201911361632	BURITINOPOLIS	BQ12190586	IACIARA S2	30/11/2019 06:33	30/11/2019 10:10	30/11/2019 06:33	30/11/2019 10:10	3,60	13	46,86	CHI
201911361634	CALDAS NOVAS	CN11066111	CALDAS NOVAS S2	30/11/2019 07:04	30/11/2019 09:52	30/11/2019 07:04	30/11/2019 09:52	2,78	101	281,14	CHI
201911361636	GAMELEIRA DE GOIAS	SV21093698	DAIA S2	30/11/2019 08:10	30/11/2019 11:17	30/11/2019 08:10	30/11/2019 11:17	3,11	1	3,11	CHI
201911361637	SAO MIGUEL DO PASSA QUATRO	SQ12355286	CRISTIANOPOLIS	30/11/2019 08:10	30/11/2019 11:24	30/11/2019 08:10	30/11/2019 11:24	3,22	1	3,22	CHI

201911361638	VARJAO	VJ32089969	GUAPO S2	30/11/2019 08:09	30/11/2019 09:59	30/11/2019 08:09	30/11/2019 09:59	1,82	3	5,47	CHI
201911361639	PIRACANJUBA	PJ21000141	PIRACANJUBA	30/11/2019 08:11	30/11/2019 13:20	30/11/2019 08:11	30/11/2019 13:20	5,15	4	20,59	CHI
201911361650	GOIANIA	AP21002093	REAL S1	30/11/2019 08:13	30/11/2019 12:00	30/11/2019 08:13	30/11/2019 12:00	3,78	1	3,78	CHI
201911361652	CAMPOS VERDES	VD12390493	SANTA TEREZINHA	30/11/2019 08:13	02/12/2019 13:26	30/11/2019 08:13	02/12/2019 03:21	43,13	11	474,39	CHI
201911361652	MARA ROSA	VD12390493	SANTA TEREZINHA	30/11/2019 08:13	02/12/2019 13:26	30/11/2019 08:13	02/12/2019 03:21	43,13	2	86,25	CHI
201911361652	CAMPOS VERDES	VD12390493	SANTA TEREZINHA	30/11/2019 08:13	02/12/2019 13:26	02/12/2019 03:21	02/12/2019 13:26	10,08	11	110,91	CHI
201911361652	MARA ROSA	VD12390493	SANTA TEREZINHA	30/11/2019 08:13	02/12/2019 13:26	02/12/2019 03:21	02/12/2019 13:26	10,08	2	20,17	CHI
201911361656	LUZIANIA	LZ21261580	CRISTALINA S2	30/11/2019 08:14	30/11/2019 14:00	30/11/2019 08:14	30/11/2019 14:00	5,76	1	5,76	CHI
201911361657	MONTES CLAROS DE GOIAS	ME12088949	IPORA	30/11/2019 08:14	30/11/2019 11:12	30/11/2019 08:14	30/11/2019 11:12	2,96	49	145,03	CHI
201911361661	JATAI	JT12354973	JATAI S1	30/11/2019 07:20	30/11/2019 10:06	30/11/2019 07:20	30/11/2019 10:06	2,75	35	96,28	CHI
201911361663	APORE	AE12112889	ITAJA S1	30/11/2019 08:16	01/12/2019 15:18	30/11/2019 08:16	01/12/2019 15:18	31,03	4	124,13	CHI
201911361665	VIANOPOLIS	OZ21186229	PIRES DO RIO S2	30/11/2019 08:16	30/11/2019 11:00	30/11/2019 08:16	30/11/2019 11:00	2,73	1	2,73	CHI
201911361669	ITABERAI	IB11336406	ITABERAI S2	30/11/2019 08:17	30/11/2019 09:46	30/11/2019 08:17	30/11/2019 09:46	1,47	27	39,77	CHI
201911361670	CATALAO	1990079675	CATALAO S2	30/11/2019 08:17	30/11/2019 08:40	30/11/2019 08:17	30/11/2019 08:40	0,38	1	0,38	CHI
201911361672	ITUMBIARA	IT12263732	CACHOEIRA DOURADA	30/11/2019 08:18	30/11/2019 10:32	30/11/2019 08:18	30/11/2019 10:32	2,23	3	6,68	CHI
201911361673	MONTE ALEGRE DE GOIAS	CH12383357	SAO DOMINGOS	30/11/2019 08:18	30/11/2019 10:05	30/11/2019 08:18	30/11/2019 10:05	1,77	1	1,77	CHI
201911361673	CAMPOS BELOS	CH12383357	SAO DOMINGOS	30/11/2019 08:18	30/11/2019 10:05	30/11/2019 08:18	30/11/2019 10:05	1,77	1	1,77	CHI
201911361676	PIRENOPOLIS	PV12119640RE	CORUMBA	30/11/2019 05:00	30/11/2019 21:33	30/11/2019 05:00	30/11/2019 21:33	16,54	89	1471,71	CHI
201911361681	ITABERAI	10025848826	ITABERAI S2	30/11/2019 08:19	30/11/2019 12:23	30/11/2019 08:19	30/11/2019 12:23	4,07	1	4,07	CHI
201911361682	MUNDO NOVO DE GOIAS	MH12297074	NOVA CRIXAS	30/11/2019 08:20	01/12/2019 08:40	30/11/2019 08:20	01/12/2019 08:40	24,33	3	72,98	CHI
201911361687	PARANAIGUARA	2230027019	CACHOEIRA ALTA	30/11/2019 08:21	30/11/2019 12:55	30/11/2019 08:21	30/11/2019 12:55	4,56	1	4,56	CHI
201911361689	PIRANHAS	PH12381017	PIRANHAS	30/11/2019 08:21	30/11/2019 13:06	30/11/2019 08:21	30/11/2019 11:45	3,40	12	40,80	CHI
201911361689	PIRANHAS	PH11273660	PIRANHAS	30/11/2019 08:21	30/11/2019 13:06	30/11/2019 11:56	30/11/2019 13:06	1,18	1	1,18	CHI
201911361690	AGUA LIMPA	430004898	VILA CORUMBA	30/11/2019 08:22	30/11/2019 10:20	30/11/2019 08:22	30/11/2019 10:20	1,96	1	1,96	CHI
201911361691	ITAGUARI	IC21035361	ITABERAI S1	30/11/2019 08:22	30/11/2019 13:05	30/11/2019 08:22	30/11/2019 13:05	4,71	2	9,41	CHI
201911361694	GOIANIA	17217751	ATLANTICO S2	30/11/2019 08:23	30/11/2019 10:54	30/11/2019 08:23	30/11/2019 10:54	2,51	1	2,51	CHI
201911361699	FORMOSA	610229000	ITUIQUIRA	30/11/2019 08:24	30/11/2019 11:57	30/11/2019 08:24	30/11/2019 11:57	3,55	1	3,55	CHI
201911361703	CROMINIA	MI21109300	PONTALINA	30/11/2019 08:25	30/11/2019 11:02	30/11/2019 08:25	30/11/2019 11:02	2,61	2	5,23	CHI
201911361707	CATALAO	CT12266100	CATALAO S1	30/11/2019 08:25	30/11/2019 09:39	30/11/2019 08:25	30/11/2019 09:39	1,23	17	20,90	CHI
201911361710	MUTUNOPOLIS	ET12000004	MARA ROSA	30/11/2019 07:37	30/11/2019 09:55	30/11/2019 07:37	30/11/2019 09:55	2,30	3	6,89	CHI
201911361710	AMARALINA	ET12000004	MARA ROSA	30/11/2019 07:37	30/11/2019 09:55	30/11/2019 07:37	30/11/2019 09:55	2,30	6	13,77	CHI
201911361718	MUTUNOPOLIS	MU12244469	MARA ROSA	30/11/2019 08:26	30/11/2019 12:50	30/11/2019 08:26	30/11/2019 12:50	4,39	3	13,18	CHI
201911361720	AMORINOPOLIS	AM12079563	IPORA	30/11/2019 08:26	30/11/2019 10:50	30/11/2019 08:26	30/11/2019 10:50	2,39	3	7,17	CHI

201911361726	RIO VERDE	RV12106375	CABRIUVA S2	30/11/2019 06:48	30/11/2019 13:38	30/11/2019 06:48	30/11/2019 13:38	6,84	17	116,35	CHI
201911361728	CATALAO	CT21358259	CATALAO S1	30/11/2019 08:27	30/11/2019 09:01	30/11/2019 08:27	30/11/2019 09:01	0,57	1	0,57	CHI
201911361731	ORIZONA	IP21213682	PIRES DO RIO S2	30/11/2019 08:27	01/12/2019 16:17	30/11/2019 08:27	01/12/2019 16:17	31,83	1	31,83	CHI
201911361733	JANDAIA	JD12055081	PALMEIRAS	30/11/2019 07:46	30/11/2019 11:15	30/11/2019 07:46	30/11/2019 11:15	3,49	10	34,87	CHI
201911361734	SAO MIGUEL DO ARAGUAIA	SM12334361	SAO MIGUEL DO ARAGUAIA	30/11/2019 01:00	30/11/2019 20:17	30/11/2019 01:00	30/11/2019 20:17	19,28	4	77,13	CHI
201911361736	BONOPOLIS	BX12364670	SAO MIGUEL DO ARAGUAIA	30/11/2019 08:12	30/11/2019 17:17	30/11/2019 08:12	30/11/2019 17:17	9,08	2	18,17	CHI
201911361739	CACHOEIRA ALTA	CA21306120	CACHOEIRA ALTA	30/11/2019 08:29	30/11/2019 15:30	30/11/2019 08:29	30/11/2019 15:30	7,01	1	7,01	CHI
201911361740	FORMOSA	FA11000035	ITUIQUIRA	30/11/2019 08:26	30/11/2019 11:34	30/11/2019 08:26	30/11/2019 11:34	3,13	118	368,82	CHI
201911361742	DAVINOPOLIS	IO21332211	CATALAO S1	30/11/2019 08:29	30/11/2019 10:45	30/11/2019 08:29	30/11/2019 10:45	2,26	1	2,26	CHI
201911361743	ANAPOLIS	2090000242	NEROPOLIS S1	30/11/2019 08:29	30/11/2019 14:20	30/11/2019 08:29	30/11/2019 14:20	5,83	1	5,83	CHI
201911361746	BELA VISTA DE GOIAS	BV21381616	BELA VISTA S1	30/11/2019 08:30	30/11/2019 10:54	30/11/2019 08:30	30/11/2019 10:54	2,39	1	2,39	CHI
201911361750	VICENTINOPOLIS	10011347102	VICENTINOPOLIS	30/11/2019 08:31	30/11/2019 10:09	30/11/2019 08:31	30/11/2019 10:09	1,64	0	0,00	CHI
201911361755	ALTO HORIZONTE	9640004126	SANTA TEREZINHA	30/11/2019 08:32	02/12/2019 12:15	30/11/2019 08:32	02/12/2019 12:15	51,71	1	51,71	CHI
201911361756	FORMOSA	FA12071048	ITUIQUIRA	30/11/2019 08:30	30/11/2019 17:06	30/11/2019 08:30	30/11/2019 17:06	8,59	14	120,32	CHI
201911361757	SAO DOMINGOS	GH21211231	SAO DOMINGOS	30/11/2019 08:32	30/11/2019 14:22	30/11/2019 08:32	30/11/2019 14:22	5,83	1	5,83	CHI
201911361765	LUZIANIA	LZ21000492	MARAJOARA	30/11/2019 08:33	30/11/2019 13:50	30/11/2019 08:33	30/11/2019 13:50	5,29	1	5,29	CHI
201911361768	POSSE	IA12035179	IACIARA S2	30/11/2019 08:33	30/11/2019 12:51	30/11/2019 08:33	30/11/2019 12:51	4,29	7	30,06	CHI
201911361769	CRISTALINA	KR12304869	CRISTALINA S2	30/11/2019 08:01	30/11/2019 11:48	30/11/2019 08:01	30/11/2019 11:48	3,77	15	56,61	CHI
201911361773	AMARALINA	LC21262772	NOVA CRIXAS	30/11/2019 08:33	01/12/2019 09:43	30/11/2019 08:33	01/12/2019 09:43	25,15	2	50,31	CHI
201911361776	CEZARINA	CZ12314870	CEZARINA	30/11/2019 04:42	30/11/2019 09:55	30/11/2019 04:42	30/11/2019 09:55	5,21	21	109,46	CHI
201911361778	PIRACANJUBA	PJ12249827	PIRACANJUBA	30/11/2019 08:18	01/12/2019 13:00	30/11/2019 08:18	01/12/2019 13:00	28,70	30	860,99	CHI
201911361780	IACIARA	IA12302810	FLORES DE GOIAS	30/11/2019 08:34	30/11/2019 15:54	30/11/2019 08:34	30/11/2019 15:54	7,32	3	21,96	CHI
201911361783	NOVA CRIXAS	NA12354854	NOVA CRIXAS	29/11/2019 23:56	30/11/2019 11:36	29/11/2019 23:56	30/11/2019 11:36	11,66	9	104,92	CHI
201911361787	SERRANOPOLIS	JT21241840	JATAI S1	30/11/2019 08:35	30/11/2019 16:29	30/11/2019 08:35	30/11/2019 16:29	7,90	1	7,90	CHI
201911361788	SERRANOPOLIS	SX12390576	JATAI S1	30/11/2019 08:35	30/11/2019 12:36	30/11/2019 08:35	30/11/2019 12:36	4,01	9	36,09	CHI
201911361792	SANTA HELENA DE GOIAS	SH12279533	IPEGUARI	30/11/2019 05:53	30/11/2019 11:55	30/11/2019 05:53	30/11/2019 11:55	6,02	32	192,77	CHI
201911361803	PALMEIRAS DE GOIAS	PL12093996	PALMEIRAS	30/11/2019 08:37	30/11/2019 12:30	30/11/2019 08:37	30/11/2019 12:30	3,88	1	3,88	CHI
201911361807	VILA PROPICIO	NP12196266	GOIANESIA S1	30/11/2019 06:12	01/12/2019 09:18	30/11/2019 06:12	01/12/2019 09:18	27,09	22	595,91	CHI
201911361810	LAGOA SANTA	IJ12226575	CACHOEIRA ALTA	30/11/2019 08:38	30/11/2019 23:48	30/11/2019 08:38	30/11/2019 23:48	15,16	12	181,92	CHI
201911361810	ITAJA	IJ12226575	CACHOEIRA ALTA	30/11/2019 08:38	30/11/2019 23:48	30/11/2019 08:38	30/11/2019 23:48	15,16	2	30,32	CHI
201911361812	COCALZINHO DE GOIAS	ZN12258078	COCALZINHO	30/11/2019 07:53	30/11/2019 12:00	30/11/2019 07:53	30/11/2019 12:00	4,12	56	230,50	CHI
201911361814	PIRACANJUBA	60034853	PIRACANJUBA	30/11/2019 08:39	30/11/2019 21:32	30/11/2019 08:39	30/11/2019 21:32	12,89	1	12,89	CHI
201911361815	CUMARI	CY21071483	CATALAO S1	30/11/2019 08:39	30/11/2019 13:20	30/11/2019 08:39	30/11/2019 13:20	4,68	1	4,68	CHI

201911361819	MARA ROSA	MQ12338220	MARA ROSA	30/11/2019 08:39	01/12/2019 00:52	30/11/2019 08:39	01/12/2019 00:52	16,21	2	32,42	CHI
201911361820	CAMPOS BELOS	CH12302834	SAO DOMINGOS	30/11/2019 08:39	30/11/2019 10:52	30/11/2019 08:39	30/11/2019 10:52	2,21	8	17,68	CHI
201911361821	CATALAO	CT12134367	CATALAO S1	30/11/2019 08:39	30/11/2019 11:10	30/11/2019 08:39	30/11/2019 11:10	2,51	11	27,64	CHI
201911361827	PLANALTINA	TL12381390	SAO JOAO D ALIANCA	30/11/2019 08:35	30/11/2019 12:45	30/11/2019 08:35	30/11/2019 12:45	4,15	20	83,07	CHI
201911361827	AGUA FRIA DE GOIAS	TL12381390	SAO JOAO D ALIANCA	30/11/2019 08:35	30/11/2019 12:45	30/11/2019 08:35	30/11/2019 12:45	4,15	3	12,46	CHI
201911361828	ITAGUARU	IC12336553	ITABERAI S1	30/11/2019 08:40	30/11/2019 11:44	30/11/2019 08:40	30/11/2019 11:44	3,07	4	12,26	CHI
201911361837	CACHOEIRA ALTA	CA12279740	CACHOEIRA ALTA	30/11/2019 08:12	30/11/2019 13:27	30/11/2019 08:12	30/11/2019 13:27	5,25	5	26,23	CHI
201911361847	PALESTINA DE GOIAS	PY12121107	PALESTINA	30/11/2019 08:43	30/11/2019 12:21	30/11/2019 08:43	30/11/2019 12:21	3,63	34	123,45	CHI
201911361847	CAIAPONIA	PY12121107	PALESTINA	30/11/2019 08:43	30/11/2019 12:21	30/11/2019 08:43	30/11/2019 12:21	3,63	49	177,91	CHI
201911361848	CAIAPONIA	CP12296476	JATAI S1	30/11/2019 05:17	30/11/2019 18:15	30/11/2019 05:17	30/11/2019 18:15	12,97	7	90,76	CHI
201911361849	ANAPOLIS	21233937	JUNDIAI S2	30/11/2019 08:44	30/11/2019 11:37	30/11/2019 08:44	30/11/2019 11:37	2,89	1	2,89	CHI
201911361851	NEROPOLIS	160065770	NEROPOLIS S2	30/11/2019 08:44	30/11/2019 16:58	30/11/2019 08:44	30/11/2019 16:58	8,22	1	8,22	CHI
201911361852	FORMOSA	FA31042636	ITUIQUIRA	30/11/2019 08:45	30/11/2019 11:42	30/11/2019 08:45	30/11/2019 11:42	2,95	1	2,95	CHI
201911361858	MONTES CLAROS DE GOIAS	ME12023516	IPORA	30/11/2019 08:43	30/11/2019 12:03	30/11/2019 08:43	30/11/2019 12:03	3,33	4	13,32	CHI
201911361862	FORMOSA	FA12404372	ITUIQUIRA	30/11/2019 05:57	30/11/2019 09:46	30/11/2019 05:57	30/11/2019 09:46	3,81	140	533,24	CHI
201911361867	CAIAPONIA	CP11292018	CAIAPONIA	30/11/2019 08:49	30/11/2019 22:14	30/11/2019 08:49	30/11/2019 22:14	13,40	1	13,40	CHI
201911361873	GOIANIA	GN11372181	FERROVIARIO S2	30/11/2019 08:23	30/11/2019 10:57	30/11/2019 08:23	30/11/2019 10:57	2,56	285	729,92	CHI
201911361875	GUAPO	GA21238360	GUAPO S1	30/11/2019 08:51	30/11/2019 11:27	30/11/2019 08:51	30/11/2019 11:27	2,60	2	5,21	CHI
201911361877	JATAI	JT12302009LD	JATAI S1	30/11/2019 08:51	30/11/2019 11:47	30/11/2019 08:51	30/11/2019 11:47	2,93	9	26,34	CHI
201911361878	ITUMBIARA	10014434260	ITUMBIARA NOVA	30/11/2019 08:51	01/12/2019 19:06	30/11/2019 08:51	01/12/2019 19:06	34,26	1	34,26	CHI
201911361882	CABECEIRAS	CW12108845	ITUIQUIRA	30/11/2019 07:34	30/11/2019 16:28	30/11/2019 07:34	30/11/2019 16:28	8,89	11	97,75	CHI
201911361886	CRISTALINA	KR21261534	CRISTALINA S1	30/11/2019 08:52	30/11/2019 10:32	30/11/2019 08:52	30/11/2019 10:32	1,65	1	1,65	CHI
201911361887	JATAI	290346083	JATAI S2	30/11/2019 08:52	30/11/2019 11:15	30/11/2019 08:52	30/11/2019 11:15	2,37	1	2,37	CHI
201911361892	ITAPURANGA	IK12299350	ITAPURANGA	30/11/2019 08:12	30/11/2019 11:00	30/11/2019 08:12	30/11/2019 11:00	2,81	13	36,53	CHI
201911361895	PIRACANJUBA	PJ12025290	PIRACANJUBA	30/11/2019 08:54	30/11/2019 17:00	30/11/2019 08:54	30/11/2019 17:00	8,10	19	153,86	CHI
201911361896	MONTES CLAROS DE GOIAS	ME12231233	IPORA	30/11/2019 08:54	30/11/2019 16:07	30/11/2019 08:54	30/11/2019 16:07	7,22	3	21,67	CHI
201911361898	DAVINOPOLIS	IO21071465	CATALAO S1	30/11/2019 08:54	30/11/2019 14:45	30/11/2019 08:54	30/11/2019 14:45	5,85	2	11,71	CHI
201911361899	PLANALTINA	PI11164618	PLANALTINA	30/11/2019 05:55	30/11/2019 16:21	30/11/2019 05:55	30/11/2019 16:21	10,42	78	812,59	CHI
201911361901	MINACU	IH21230434	MINACU	30/11/2019 08:55	30/11/2019 19:28	30/11/2019 08:55	30/11/2019 19:28	10,56	1	10,56	CHI
201911361902	GOIANIA	12566421	ATLANTICO S1	30/11/2019 08:55	30/11/2019 11:36	30/11/2019 08:55	30/11/2019 11:36	2,68	1	2,68	CHI
201911361903	NOVA CRIXAS	NA12228222	MOZARLANDIA	30/11/2019 06:51	30/11/2019 17:40	30/11/2019 06:51	30/11/2019 17:40	10,81	7	75,64	CHI
201911361908	SERRANOPOLIS	SX12182120	JATAI S1	30/11/2019 08:56	30/11/2019 11:01	30/11/2019 08:56	30/11/2019 11:01	2,08	16	33,33	CHI
201911361912	ANAPOLIS	21180258	JUNDIAI S1	30/11/2019 08:56	30/11/2019 11:03	30/11/2019 08:56	30/11/2019 11:03	2,11	1	2,11	CHI

201911361913	CORUMBA DE GOIAS	CB21155952	CORUMBA	30/11/2019 08:56	30/11/2019 15:22	30/11/2019 08:56	30/11/2019 15:22	6,43	1	6,43	CHI
201911361914	PADRE BERNARDO	PB11382977	PADRE BERNARDO	30/11/2019 08:56	30/11/2019 17:11	30/11/2019 08:56	30/11/2019 17:11	8,25	21	173,15	CHI
201911361918	PORANGATU	840041251	PORANGATU	30/11/2019 08:57	30/11/2019 10:43	30/11/2019 08:57	30/11/2019 10:43	1,77	1	1,77	CHI
201911361921	BOM JESUS DE GOIAS	BJ21000051	BOM JESUS DE GOIAS	30/11/2019 08:58	30/11/2019 12:23	30/11/2019 08:58	30/11/2019 12:23	3,41	1	3,41	CHI
201911361922	NOVA ROMA	ND21318553	IACIARA S2	30/11/2019 08:58	30/11/2019 13:19	30/11/2019 08:58	30/11/2019 13:19	4,34	1	4,34	CHI
201911361925	ITAJA	IJ21155322	ITAJA S2	30/11/2019 08:59	01/12/2019 02:16	30/11/2019 08:59	01/12/2019 02:16	17,28	1	17,28	CHI
201911361928	CRISTALINA	KR21248617	CRISTALINA S2	30/11/2019 08:59	30/11/2019 19:10	30/11/2019 08:59	30/11/2019 19:10	10,17	1	10,17	CHI
201911361930	PORANGATU	PO12394943	MARA ROSA	30/11/2019 09:00	30/11/2019 13:45	30/11/2019 09:00	30/11/2019 13:45	4,74	8	37,96	CHI
201911361930	BONOPOLIS	PO12394943	MARA ROSA	30/11/2019 09:00	30/11/2019 13:45	30/11/2019 09:00	30/11/2019 13:45	4,74	2	9,49	CHI
201911361937	JATAI	JT12219503	JATAI S3	30/11/2019 08:21	30/11/2019 10:50	30/11/2019 08:21	30/11/2019 10:50	2,47	5	12,37	CHI
201911361938	GOIANIA	10028910891	ATLANTICO S3	30/11/2019 09:01	30/11/2019 09:40	30/11/2019 09:01	30/11/2019 09:40	0,64	1	0,64	CHI
201911361940	APARECIDA DE GOIANIA	16844506	ATLANTICO S1	30/11/2019 09:02	30/11/2019 11:00	30/11/2019 09:02	30/11/2019 11:00	1,96	1	1,96	CHI
201911361941	SANTA RITA DO ARAGUAIA	SU12301950	SANTA RITA DO ARAGUAIA	30/11/2019 07:05	30/11/2019 12:00	30/11/2019 07:05	30/11/2019 12:00	4,90	21	102,91	CHI
201911361941	BURITINOPOLIS	SU12301950	SANTA RITA DO ARAGUAIA	30/11/2019 07:05	30/11/2019 12:00	30/11/2019 07:05	30/11/2019 12:00	4,90	1	4,90	CHI
201911361942	NOVA ROMA	6550000344	IACIARA S2	30/11/2019 09:02	30/11/2019 12:19	30/11/2019 09:02	30/11/2019 12:19	3,28	1	3,28	CHI
201911361943	AGUAS LINDAS DE GOIAS	4830328217	AGUAS LINDAS DE GOIAS S1	30/11/2019 09:02	30/11/2019 11:26	30/11/2019 09:02	30/11/2019 11:26	2,39	1	2,39	CHI
201911361945	CORUMBA DE GOIAS	CB21297657	CORUMBA	30/11/2019 09:02	30/11/2019 17:25	30/11/2019 09:02	30/11/2019 17:25	8,37	2	16,74	CHI
201911361946	VILA PROPICIO	NP12298198	GOIANESIA S1	30/11/2019 09:02	01/12/2019 11:37	30/11/2019 09:02	01/12/2019 11:37	26,57	1	26,57	CHI
201911361947	GOIAS	GS12310466	ITABERAÍ S1	30/11/2019 05:42	30/11/2019 10:00	30/11/2019 05:42	30/11/2019 10:00	4,29	3	12,88	CHI
201911361954	PORANGATU	PO12020945	PORANGATU	30/11/2019 09:03	01/12/2019 00:34	30/11/2019 09:03	01/12/2019 00:34	15,51	6	93,05	CHI
201911361955	MINEIROS	1390103393	PARQUE DAS EMAS	30/11/2019 09:03	30/11/2019 18:45	30/11/2019 09:03	30/11/2019 18:45	9,69	1	9,69	CHI
201911361961	MINACU	IH21220737	MINACU	30/11/2019 09:04	30/11/2019 23:28	30/11/2019 09:04	30/11/2019 23:28	14,39	1	14,39	CHI
201911361967	IVOLANDIA	IV21138482	IPORA	30/11/2019 09:05	30/11/2019 11:45	30/11/2019 09:05	30/11/2019 11:45	2,67	1	2,67	CHI
201911361970	BARRO ALTO	BA12210734	BARRO ALTO	30/11/2019 09:05	01/12/2019 19:57	30/11/2019 09:05	01/12/2019 19:57	34,86	4	139,45	CHI
201911361974	PORANGATU	PO12208614	PORANGATU	30/11/2019 08:27	30/11/2019 12:36	30/11/2019 08:27	30/11/2019 12:36	4,14	9	37,28	CHI
201911361983	MOSSAMEDES	KB12079150	ANICUNS	30/11/2019 07:06	30/11/2019 12:10	30/11/2019 07:06	30/11/2019 12:10	5,08	7	35,53	CHI
201911361989	IPORA	IR21187400	IPORA	30/11/2019 09:09	30/11/2019 10:48	30/11/2019 09:09	30/11/2019 10:48	1,65	1	1,65	CHI
201911361993	GOIANDIRA	CY21081496	CATALAO S1	30/11/2019 09:09	30/11/2019 17:18	30/11/2019 09:09	30/11/2019 17:18	8,16	1	8,16	CHI
201911361995	SAO JOAO D ALIANCA	JL12051344	SAO JOAO D ALIANCA	30/11/2019 09:10	01/12/2019 17:13	30/11/2019 09:10	01/12/2019 08:07	22,95	1	22,95	CHI
201911361995	SAO JOAO D ALIANCA	JL12051344	SAO JOAO D ALIANCA	30/11/2019 09:10	01/12/2019 17:13	01/12/2019 08:07	01/12/2019 17:13	9,11	1	9,11	CHI
201911362000	GUARANI DE GOIAS	GY21271762	IACIARA S1	30/11/2019 09:11	30/11/2019 11:47	30/11/2019 09:11	30/11/2019 11:47	2,59	1	2,59	CHI
201911362003	MONTE ALEGRE DE GOIAS	MA21262252	SAO DOMINGOS	30/11/2019 09:11	30/11/2019 12:30	30/11/2019 09:11	30/11/2019 12:30	3,31	1	3,31	CHI
201911362005	MARA ROSA	ET12391906	MARA ROSA	30/11/2019 07:42	30/11/2019 18:01	30/11/2019 07:42	30/11/2019 18:01	10,30	10	103,00	CHI

201911362008	IVOLANDIA	IV21139345	IPORA	30/11/2019 09:11	30/11/2019 12:43	30/11/2019 09:11	30/11/2019 12:43	3,52	1	3,52	CHI
201911362010	NIQUELANDIA	NQ12270128RE	SAO JOAO D ALIANCA	30/11/2019 08:34	30/11/2019 14:10	30/11/2019 08:34	30/11/2019 14:10	5,59	18	100,62	CHI
201911362010	AGUA FRIA DE GOIAS	NQ12270128RE	SAO JOAO D ALIANCA	30/11/2019 08:34	30/11/2019 14:10	30/11/2019 08:34	30/11/2019 14:10	5,59	70	391,32	CHI
201911362015	TURVELANDIA	TD12025685	RIO DOS BOIS	30/11/2019 02:00	30/11/2019 12:32	30/11/2019 02:00	30/11/2019 12:32	10,54	29	305,70	CHI
201911362016	GOIAS	GS12250875	GOIAS	30/11/2019 09:14	30/11/2019 11:39	30/11/2019 09:14	30/11/2019 11:39	2,42	3	7,26	CHI
201911362019	CRISTALINA	KR21261077	CRISTALINA S1	30/11/2019 09:14	30/11/2019 13:49	30/11/2019 09:14	30/11/2019 13:49	4,57	1	4,57	CHI
201911362020	MORRINHOS	AD12108925	GOIATUBA S1	30/11/2019 08:46	30/11/2019 11:00	30/11/2019 08:46	30/11/2019 11:00	2,22	2	4,43	CHI
201911362020	ALOANDIA	AD12108925	GOIATUBA S1	30/11/2019 08:46	30/11/2019 11:00	30/11/2019 08:46	30/11/2019 11:00	2,22	6	13,30	CHI
201911362024	QUIRINOPOLIS	QI21319948	QUIRINOPOLIS	30/11/2019 09:15	30/11/2019 11:38	30/11/2019 09:15	30/11/2019 11:38	2,38	1	2,38	CHI
201911362027	CEZARINA	CZ21373400	GUAPO S2	30/11/2019 09:16	30/11/2019 12:00	30/11/2019 09:16	30/11/2019 12:00	2,73	1	2,73	CHI
201911362028	RIO VERDE	RV21260746	CABRIUVA S1	30/11/2019 09:16	30/11/2019 11:46	30/11/2019 09:16	30/11/2019 11:46	2,49	1	2,49	CHI
201911362029	CACU	CC21073775	CACHOEIRA ALTA	30/11/2019 09:15	30/11/2019 10:46	30/11/2019 09:15	30/11/2019 10:46	1,50	1	1,50	CHI
201911362034	SANTA RITA DO NOVO DESTINO	GE12374628	BARRO ALTO	30/11/2019 07:58	30/11/2019 16:10	30/11/2019 07:58	30/11/2019 16:10	8,19	26	213,01	CHI
201911362041	SAO DOMINGOS	SD12389176	SAO DOMINGOS	30/11/2019 09:19	01/12/2019 11:43	30/11/2019 09:19	30/11/2019 15:37	6,31	6	37,85	CHI
201911362041	SAO DOMINGOS	SD12389176	SAO DOMINGOS	30/11/2019 09:19	01/12/2019 11:43	30/11/2019 09:19	01/12/2019 08:25	23,10	1	23,10	CHI
201911362041	SAO DOMINGOS	SD11389131	SAO DOMINGOS	30/11/2019 09:19	01/12/2019 11:43	01/12/2019 08:25	01/12/2019 11:43	3,31	1	3,31	CHI
201911362043	RIO VERDE	10007808281	RIO VERDE S2	30/11/2019 09:19	30/11/2019 11:49	30/11/2019 09:19	30/11/2019 11:49	2,50	1	2,50	CHI
201911362044	CAMPINACU	UC12280055	MARA ROSA	30/11/2019 09:19	30/11/2019 12:19	30/11/2019 09:19	30/11/2019 12:19	2,99	12	35,85	CHI
201911362046	CALDAS NOVAS	CN21166963	CALDAS NOVAS S1	30/11/2019 09:19	30/11/2019 14:10	30/11/2019 09:19	30/11/2019 14:10	4,85	1	4,85	CHI
201911362051	CABECEIRAS	CW21224216	ITUIQUIRA	30/11/2019 09:21	02/12/2019 19:24	30/11/2019 09:21	02/12/2019 19:24	58,04	1	58,04	CHI
201911362054	PILAR DE GOIAS	UR12280291	SANTA TEREZINHA	30/11/2019 09:21	03/12/2019 15:40	30/11/2019 09:21	03/12/2019 15:40	78,31	1	78,31	CHI
201911362054	URUACU	UR12280291	SANTA TEREZINHA	30/11/2019 09:21	03/12/2019 15:40	30/11/2019 09:21	03/12/2019 15:40	78,31	2	156,62	CHI
201911362055	CAMPINACU	UC21283690	MARA ROSA	30/11/2019 09:21	01/12/2019 12:01	30/11/2019 09:21	01/12/2019 12:01	26,65	1	26,65	CHI
201911362056	GOIANIA	16424050	CARAJAS S1	30/11/2019 09:22	30/11/2019 10:02	30/11/2019 09:22	30/11/2019 10:02	0,67	1	0,67	CHI
201911362058	TRINDADE	TR21272902	TRINDADE	30/11/2019 09:22	30/11/2019 15:25	30/11/2019 09:22	30/11/2019 15:25	6,06	1	6,06	CHI
201911362063	PIRACANJUBA	PJ21074788	PIRACANJUBA	30/11/2019 09:22	30/11/2019 15:41	30/11/2019 09:22	30/11/2019 15:41	6,31	4	25,24	CHI
201911362073	ALTO PARAISO DE GOIAS	BF21170630	FLORES DE GOIAS	30/11/2019 09:24	30/11/2019 21:54	30/11/2019 09:24	30/11/2019 21:54	12,49	1	12,49	CHI
201911362074	TROMBAS	TB12345570	PORANGATU	30/11/2019 09:24	02/12/2019 16:30	30/11/2019 09:24	01/12/2019 21:08	35,74	12	428,88	CHI
201911362074	TROMBAS	TB11318375	PORANGATU	30/11/2019 09:24	02/12/2019 16:30	01/12/2019 21:08	02/12/2019 15:31	18,37	1	18,37	CHI
201911362074	TROMBAS	TB21185294	PORANGATU	30/11/2019 09:24	02/12/2019 16:30	01/12/2019 21:08	02/12/2019 15:58	18,82	1	18,82	CHI
201911362074	TROMBAS	TB11337384	PORANGATU	30/11/2019 09:24	02/12/2019 16:30	01/12/2019 21:08	02/12/2019 16:19	19,17	1	19,17	CHI
201911362074	TROMBAS	TB12345570	PORANGATU	30/11/2019 09:24	02/12/2019 16:30	30/11/2019 09:24	02/12/2019 16:30	55,09	4	220,38	CHI
201911362074	TROMBAS	TB12345570	PORANGATU	30/11/2019 09:24	02/12/2019 16:30	01/12/2019 21:08	02/12/2019 16:30	19,35	9	174,19	CHI



201911362077	FLORES DE GOIAS	FB12320627	FLORES DE GOIAS	30/11/2019 05:18	30/11/2019 14:54	30/11/2019 05:18	30/11/2019 14:54	9,59	27	258,92	CHI
201911362078	RIO VERDE	RV11234447	CABRIUVA S1	30/11/2019 09:01	30/11/2019 14:00	30/11/2019 09:01	30/11/2019 14:00	4,98	110	547,25	CHI
201911362080	PLANALTINA	PI12355773	PLANALTINA	30/11/2019 09:05	30/11/2019 12:15	30/11/2019 09:05	30/11/2019 12:15	3,16	45	142,37	CHI
201911362081	CUMARI	CY12000321	CATALAO S1	30/11/2019 09:21	30/11/2019 16:00	30/11/2019 09:21	30/11/2019 16:00	6,64	3	19,91	CHI
201911362085	MONTE ALEGRE DE GOIAS	MA12405583	SAO DOMINGOS	30/11/2019 09:26	30/11/2019 14:54	30/11/2019 09:26	30/11/2019 14:54	5,46	1	5,46	CHI
201911362086	INHUMAS	IN32066302	INHUMAS S2	30/11/2019 09:26	30/11/2019 17:57	30/11/2019 09:26	30/11/2019 17:57	8,51	2	17,02	CHI
201911362088	GOIAS	GS12282276	GOIAS	30/11/2019 09:26	30/11/2019 12:15	30/11/2019 09:26	30/11/2019 12:15	2,80	1	2,80	CHI
201911362091	APARECIDA DE GOIANIA	AP21000320	CEPAIGO S1	30/11/2019 09:28	30/11/2019 12:51	30/11/2019 09:28	30/11/2019 12:51	3,38	2	6,76	CHI
201911362094	SANTA HELENA DE GOIAS	01660424	SANTA HELENA S1	30/11/2019 09:21	02/12/2019 21:43	30/11/2019 09:21	30/11/2019 11:22	2,02	11	22,25	CHI
201911362094	MAURILANDIA	SH13191770	SANTA HELENA S1	30/11/2019 09:21	02/12/2019 21:43	30/11/2019 09:21	30/11/2019 13:50	4,47	1	4,47	CHI
201911362094	SANTA HELENA DE GOIAS	SH13191770	SANTA HELENA S1	30/11/2019 09:21	02/12/2019 21:43	30/11/2019 09:21	30/11/2019 13:50	4,47	8	35,79	CHI
201911362094	MAURILANDIA	ML13085669	SANTA HELENA S1	30/11/2019 09:21	02/12/2019 21:43	30/11/2019 09:21	02/12/2019 19:44	58,38	4	233,53	CHI
201911362094	MAURILANDIA	01660424	SANTA HELENA S1	30/11/2019 09:21	02/12/2019 21:43	02/12/2019 19:44	02/12/2019 19:52	0,14	1	0,14	CHI
201911362094	SANTA HELENA DE GOIAS	01660424	SANTA HELENA S1	30/11/2019 09:21	02/12/2019 21:43	02/12/2019 19:44	02/12/2019 19:52	0,14	19	2,59	CHI
201911362094	MAURILANDIA	ML13085669	SANTA HELENA S1	30/11/2019 09:21	02/12/2019 21:43	02/12/2019 19:44	02/12/2019 21:43	1,98	4	7,90	CHI
201911362095	SANTA BARBARA DE GOIAS	SB12289687	TRINDADE	30/11/2019 09:28	30/11/2019 17:07	30/11/2019 09:28	30/11/2019 17:07	7,64	1	7,64	CHI
201911362096	SAO JOAO DA PARAUNA	RP12099242	FIRMINOPOLIS S2	30/11/2019 09:28	30/11/2019 12:42	30/11/2019 09:28	30/11/2019 12:42	3,22	3	9,66	CHI
201911362101	JATAI	10002686706	JATAI S3	30/11/2019 09:29	01/12/2019 09:24	30/11/2019 09:29	01/12/2019 09:24	23,92	1	23,92	CHI
201911362103	MUTUNOPOLIS	MU12391658	MARA ROSA	30/11/2019 07:23	30/11/2019 15:52	30/11/2019 07:23	30/11/2019 15:52	8,48	34	288,16	CHI
201911362108	GOIANIA	11662189	REAL S1	30/11/2019 09:30	30/11/2019 10:33	30/11/2019 09:30	30/11/2019 10:33	1,04	1	1,04	CHI
201911362109	LUZIANIA	120289581	RIO VERMELHO	30/11/2019 09:31	30/11/2019 11:40	30/11/2019 09:31	30/11/2019 11:40	2,15	1	2,15	CHI
201911362111	PIRACANJUBA	PJ12043108	PIRACANJUBA	29/11/2019 23:03	30/11/2019 10:50	29/11/2019 23:03	30/11/2019 10:50	11,78	12	141,40	CHI
201911362112	PIRACANJUBA	PJ12045336	PIRACANJUBA	30/11/2019 07:30	30/11/2019 14:33	30/11/2019 07:30	30/11/2019 14:33	7,04	19	133,80	CHI
201911362122	VALPARAISO DE GOIAS	2860029303	PACAEMBU S2	30/11/2019 09:32	30/11/2019 11:54	30/11/2019 09:32	30/11/2019 11:54	2,36	1	2,36	CHI
201911362124	SILVANIA	SV21085394	VIANOPOLIS	30/11/2019 09:32	30/11/2019 17:40	30/11/2019 09:32	30/11/2019 17:40	8,13	1	8,13	CHI
201911362127	IPAMERI	IP12159928	CRISTALINA S2	30/11/2019 09:14	30/11/2019 15:00	30/11/2019 09:14	30/11/2019 15:00	5,76	5	28,79	CHI
201911362128	CATALAO	CT12061132	CATALAO S1	30/11/2019 08:02	30/11/2019 15:54	30/11/2019 08:02	30/11/2019 15:54	7,86	63	495,20	CHI
201911362133	NIQUELANDIA	NQ12235660	NIQUELANDIA SUBTRANSMISSAO	30/11/2019 09:28	30/11/2019 15:58	30/11/2019 09:28	30/11/2019 15:58	6,50	158	1026,74	CHI
201911362137	CAMPO ALEGRE DE GOIAS	1160005993	CAMPO ALEGRE DE GOIAS	30/11/2019 07:45	01/12/2019 11:36	30/11/2019 07:45	01/12/2019 11:36	27,85	1	27,85	CHI
201911362138	COCALZINHO DE GOIAS	ZN21302473	COCALZINHO	30/11/2019 09:33	02/12/2019 17:44	30/11/2019 09:33	02/12/2019 17:44	56,17	1	56,17	CHI
201911362142	HEITORAI	HE12032357LD	ITAPURANGA	30/11/2019 07:36	01/12/2019 13:28	30/11/2019 07:36	01/12/2019 13:28	29,85	6	179,12	CHI
201911362142	GOIAS	HE12032357LD	ITAPURANGA	30/11/2019 07:36	01/12/2019 13:28	30/11/2019 07:36	01/12/2019 13:28	29,85	9	268,68	CHI
201911362142	GOIAS	HE12032357LD	ITAPURANGA	30/11/2019 07:36	01/12/2019 13:28	01/12/2019 10:02	01/12/2019 13:28	3,43	3	10,28	CHI

201911362143	ITAPURANGA	170071765	ITAPURANGA	30/11/2019 09:34	30/11/2019 12:43	30/11/2019 09:34	30/11/2019 12:43	3,15	1	3,15	CHI
201911362144	AMARALINA	BX12391938	SAO MIGUEL DO ARAGUAIA	30/11/2019 07:42	30/11/2019 12:21	30/11/2019 07:42	30/11/2019 12:21	4,64	13	60,37	CHI
201911362145	MONTES CLAROS DE GOIAS	ME12334885	IPORA	30/11/2019 09:34	30/11/2019 19:35	30/11/2019 09:34	30/11/2019 19:35	10,02	272	2725,44	CHI
201911362146	GOIANIA	11041067	GOYA S2	30/11/2019 09:34	30/11/2019 11:41	30/11/2019 09:34	30/11/2019 11:41	2,10	1	2,10	CHI
201911362149	GOIATUBA	CL21295953	RIO DOS BOIS	30/11/2019 09:35	30/11/2019 12:50	30/11/2019 09:35	30/11/2019 12:50	3,25	1	3,25	CHI
201911362150	CATALAO	CT21215629	CATALAO S1	30/11/2019 09:35	30/11/2019 11:00	30/11/2019 09:35	30/11/2019 11:00	1,42	2	2,83	CHI
201911362151	FORMOSA	FA12278155	ITUIQUIRA	30/11/2019 06:10	30/11/2019 11:46	30/11/2019 06:10	30/11/2019 11:46	5,59	2	11,18	CHI
201911362154	NOVA CRIXAS	NA12087039	NOVA CRIXAS	30/11/2019 07:09	30/11/2019 11:30	30/11/2019 07:09	30/11/2019 11:30	4,34	4	17,37	CHI
201911362158	SANTA FE DE GOIAS	RN21378804	BRITANIA	30/11/2019 09:37	30/11/2019 16:22	30/11/2019 09:37	30/11/2019 16:22	6,74	1	6,74	CHI
201911362161	ANICUNS	AC21268362	ANICUNS	30/11/2019 09:38	30/11/2019 11:30	30/11/2019 09:38	30/11/2019 11:30	1,87	1	1,87	CHI
201911362165	INHUMAS	IX21000038	INHUMAS S1	30/11/2019 09:38	30/11/2019 15:30	30/11/2019 09:38	30/11/2019 15:30	5,85	1	5,85	CHI
201911362166	GOIANIA	13834629	AEROPORTO S3	30/11/2019 09:39	30/11/2019 14:55	30/11/2019 09:39	30/11/2019 14:55	5,25	1	5,25	CHI
201911362168	PALESTINA DE GOIAS	PY12021357	PALESTINA	30/11/2019 09:39	30/11/2019 13:00	30/11/2019 09:39	30/11/2019 13:00	3,34	2	6,69	CHI
201911362168	CAIAPONIA	PY12021357	PALESTINA	30/11/2019 09:39	30/11/2019 13:00	30/11/2019 09:39	30/11/2019 13:00	3,34	39	130,45	CHI
201911362178	PIRENOPOLIS	PV12319630	SAO FRANCISCO DE GOIAS	30/11/2019 07:38	30/11/2019 12:27	30/11/2019 07:38	30/11/2019 12:27	4,82	5	24,08	CHI
201911362184	RIO VERDE	MV10400640	MONTIVIDIU T	30/11/2019 09:37	30/11/2019 19:37	30/11/2019 09:37	30/11/2019 11:34	1,95	39	76,13	CHI
201911362184	MONTIVIDIU	MV10400640	MONTIVIDIU T	30/11/2019 09:37	30/11/2019 19:37	30/11/2019 09:37	30/11/2019 11:34	1,95	46	89,79	CHI
201911362184	CAIAPONIA	MV10400640	MONTIVIDIU T	30/11/2019 09:37	30/11/2019 19:37	30/11/2019 09:37	30/11/2019 11:34	1,95	29	56,61	CHI
201911362184	RIO VERDE	MV10400640	MONTIVIDIU T	30/11/2019 09:37	30/11/2019 19:37	30/11/2019 09:37	30/11/2019 12:50	3,21	11	35,29	CHI
201911362184	MONTIVIDIU	MV10400640	MONTIVIDIU T	30/11/2019 09:37	30/11/2019 19:37	30/11/2019 09:37	30/11/2019 12:50	3,21	5	16,04	CHI
201911362184	PARAUNA	MV10400640	MONTIVIDIU T	30/11/2019 09:37	30/11/2019 19:37	30/11/2019 09:37	30/11/2019 18:10	8,55	32	273,53	CHI
201911362184	RIO VERDE	MV10400640	MONTIVIDIU T	30/11/2019 09:37	30/11/2019 19:37	30/11/2019 09:37	30/11/2019 18:10	8,55	1	8,55	CHI
201911362184	MONTIVIDIU	MV10400640	MONTIVIDIU T	30/11/2019 09:37	30/11/2019 19:37	30/11/2019 09:37	30/11/2019 18:10	8,55	8	68,38	CHI
201911362184	MONTIVIDIU	MV10400640	MONTIVIDIU T	30/11/2019 09:37	30/11/2019 19:37	30/11/2019 09:37	30/11/2019 19:11	9,56	15	143,40	CHI
201911362184	PARAUNA	MV10400640	MONTIVIDIU T	30/11/2019 09:37	30/11/2019 19:37	30/11/2019 09:37	30/11/2019 19:11	9,56	57	544,94	CHI
201911362184	IVOLANDIA	MV10400640	MONTIVIDIU T	30/11/2019 09:37	30/11/2019 19:37	30/11/2019 09:37	30/11/2019 19:11	9,56	29	277,25	CHI
201911362184	CAIAPONIA	MV10400640	MONTIVIDIU T	30/11/2019 09:37	30/11/2019 19:37	30/11/2019 09:37	30/11/2019 19:11	9,56	35	334,61	CHI
201911362184	MONTIVIDIU	MV10400640	MONTIVIDIU T	30/11/2019 09:37	30/11/2019 19:37	30/11/2019 09:37	30/11/2019 19:37	10,00	11	109,95	CHI
201911362186	MUTUNOPOLIS	MU12129783	MARA ROSA	30/11/2019 07:18	01/12/2019 14:15	30/11/2019 07:18	01/12/2019 14:15	30,95	9	278,54	CHI
201911362189	AGUAS LINDAS DE GOIAS	LA11149058	AGUAS LINDAS DE GOIAS S1	30/11/2019 09:43	30/11/2019 11:06	30/11/2019 09:43	30/11/2019 11:06	1,37	149	204,83	CHI
201911362197	CUMARI	CY21165169	CATALAO S1	30/11/2019 09:44	30/11/2019 18:14	30/11/2019 09:44	30/11/2019 18:14	8,49	1	8,49	CHI
201911362198	SANTA TEREZINHA DE GOIAS	SG21253040	SANTA TEREZINHA	30/11/2019 09:45	02/12/2019 11:15	30/11/2019 09:45	02/12/2019 11:15	49,50	1	49,50	CHI
201911362203	PIRANHAS	PH21051611	PIRANHAS	30/11/2019 09:45	30/11/2019 15:35	30/11/2019 09:45	30/11/2019 15:35	5,82	1	5,82	CHI

201911362208	SENADOR CANEDO	SW12193555	SENADOR CANEDO	30/11/2019 09:35	30/11/2019 11:11	30/11/2019 09:35	30/11/2019 11:11	1,59	353	562,05	CHI
201911362212	CRISTALINA	KR10406671	CRISTALINA S2	30/11/2019 09:44	01/12/2019 14:45	30/11/2019 09:44	30/11/2019 09:52	0,14	248	34,24	CHI
201911362212	CRISTALINA	KR10406671	CRISTALINA S2	30/11/2019 09:44	01/12/2019 14:45	30/11/2019 09:54	30/11/2019 15:46	5,86	3	17,57	CHI
201911362212	CRISTALINA	KR13352453	CRISTALINA S2	30/11/2019 09:44	01/12/2019 14:45	30/11/2019 09:54	01/12/2019 14:45	28,85	241	6951,98	CHI
201911362212	CRISTALINA	KR10406671	CRISTALINA S2	30/11/2019 09:44	01/12/2019 14:45	30/11/2019 09:54	01/12/2019 14:45	28,85	4	115,39	CHI
201911362217	ANAPOLIS	10014574479	JUNDIAI S1	30/11/2019 09:49	01/12/2019 13:24	30/11/2019 09:49	01/12/2019 13:24	27,57	1	27,57	CHI
201911362220	SAO DOMINGOS	SD21224217	SAO DOMINGOS	30/11/2019 09:51	30/11/2019 13:12	30/11/2019 09:51	30/11/2019 13:12	3,35	2	6,70	CHI
201911362226	CORREGO DO OURO	CO12319967	FIRMINOPOLIS S2	30/11/2019 09:51	30/11/2019 12:20	30/11/2019 09:51	30/11/2019 12:20	2,49	4	9,95	CHI
201911362232	SANTO ANTONIO DO DESCOBERTO	SN21313985	ALEXANIA	30/11/2019 09:53	30/11/2019 14:57	30/11/2019 09:53	30/11/2019 14:57	5,06	1	5,06	CHI
201911362234	NIQUELANDIA	10006737127	URUACU	30/11/2019 09:53	30/11/2019 10:49	30/11/2019 09:53	30/11/2019 10:49	0,93	1	0,93	CHI
201911362236	RIO VERDE	RV21326917	RIO VERDE S2	30/11/2019 09:53	30/11/2019 12:06	30/11/2019 09:53	30/11/2019 12:06	2,21	1	2,21	CHI
201911362237	NIQUELANDIA	NQ12335416	BARRO ALTO	30/11/2019 09:53	30/11/2019 15:21	30/11/2019 09:53	30/11/2019 15:21	5,46	10	54,56	CHI
201911362240	MORRINHOS	MR21212729	MORRINHOS	30/11/2019 09:55	30/11/2019 12:42	30/11/2019 09:55	30/11/2019 12:42	2,78	1	2,78	CHI
201911362241	GOIANESIA	GE21000120	GOIANESIA S1	30/11/2019 09:55	01/12/2019 10:29	30/11/2019 09:55	01/12/2019 10:29	24,56	1	24,56	CHI
201911362242	MINEIROS	1390113520	PARQUE DAS EMAS	30/11/2019 09:55	30/11/2019 13:57	30/11/2019 09:55	30/11/2019 13:57	4,02	1	4,02	CHI
201911362246	PALMEIRAS DE GOIAS	PL12390266	PALMEIRAS	30/11/2019 09:56	30/11/2019 14:25	30/11/2019 09:56	30/11/2019 14:25	4,48	5	22,41	CHI
201911362250	ITUMBIARA	IT21097342	ITUMBIARA VELHA S1	30/11/2019 09:56	30/11/2019 11:50	30/11/2019 09:56	30/11/2019 11:50	1,89	1	1,89	CHI
201911362253	GOIANIA	GN11240463	FERROVIARIO S1	30/11/2019 09:57	30/11/2019 12:33	30/11/2019 09:57	30/11/2019 12:33	2,59	171	442,75	CHI
201911362254	PIRENOPOLIS	PV11000010	CORUMBA	30/11/2019 09:57	30/11/2019 12:03	30/11/2019 09:57	30/11/2019 12:03	2,09	90	187,67	CHI
201911362255	BELA VISTA DE GOIAS	10005798360	BELA VISTA S1	30/11/2019 09:58	30/11/2019 13:07	30/11/2019 09:58	30/11/2019 13:07	3,15	1	3,15	CHI
201911362256	RIO VERDE	RV12301246	MONTVIDIU T	30/11/2019 09:48	30/11/2019 13:53	30/11/2019 09:48	30/11/2019 13:53	4,08	14	57,08	CHI
201911362260	URUACU	UR12322790	MARA ROSA	30/11/2019 09:58	01/12/2019 12:50	30/11/2019 09:58	01/12/2019 12:50	26,85	1	26,85	CHI
201911362263	ITABERAI	IB21000063	ITABERAI S2	30/11/2019 09:59	30/11/2019 14:05	30/11/2019 09:59	30/11/2019 14:05	4,10	1	4,10	CHI
201911362268	APARECIDA DE GOIANIA	11836817	ATLANTICO S3	30/11/2019 10:00	30/11/2019 11:22	30/11/2019 10:00	30/11/2019 11:22	1,35	1	1,35	CHI
201911362269	RIO VERDE	10004379894	RIO VERDE S1	30/11/2019 10:01	30/11/2019 11:45	30/11/2019 10:01	30/11/2019 11:45	1,74	1	1,74	CHI
201911362270	GOIANIA	16144508	MEIA PONTE	30/11/2019 10:01	30/11/2019 11:28	30/11/2019 10:01	30/11/2019 11:28	1,44	1	1,44	CHI
201911362271	SAO MIGUEL DO ARAGUAIA	SM12334360	SAO MIGUEL DO ARAGUAIA	30/11/2019 07:58	30/11/2019 19:18	30/11/2019 07:58	30/11/2019 19:18	11,33	113	1279,79	CHI
201911362273	ANAPOLIS	2080001146	ANAPOLIS UNIVERSITARIO S1	30/11/2019 10:01	30/11/2019 14:23	30/11/2019 10:01	30/11/2019 14:23	4,35	1	4,35	CHI
201911362274	SANTA HELENA DE GOIAS	SH12038291	RIO DOS BOIS	30/11/2019 07:58	30/11/2019 12:10	30/11/2019 07:58	30/11/2019 12:10	4,19	6	25,16	CHI
201911362274	TURVELANDIA	SH12038291	RIO DOS BOIS	30/11/2019 07:58	30/11/2019 12:10	30/11/2019 07:58	30/11/2019 12:10	4,19	5	20,97	CHI
201911362279	PIRENOPOLIS	PV21286506	SAO FRANCISCO DE GOIAS	30/11/2019 10:03	01/12/2019 16:14	30/11/2019 10:03	01/12/2019 16:14	30,18	1	30,18	CHI
201911362284	ITUMBIARA	10023898990	PARANAIBA	30/11/2019 10:04	30/11/2019 12:31	30/11/2019 10:04	30/11/2019 12:31	2,44	1	2,44	CHI
201911362287	BONOPOLIS	BX12262762	SAO MIGUEL DO ARAGUAIA	30/11/2019 08:03	30/11/2019 18:03	30/11/2019 08:03	30/11/2019 18:03	10,00	5	49,98	CHI

201911362288	ALTO PARAISO DE GOIAS	BF12365234	SAO JOAO D ALIANCA	30/11/2019 09:31	30/11/2019 19:48	30/11/2019 09:31	30/11/2019 19:48	10,27	9	92,40	CHI
201911362294	JARAGUA	JA21017405	JARAGUA	30/11/2019 10:07	30/11/2019 12:40	30/11/2019 10:07	30/11/2019 12:40	2,55	1	2,55	CHI
201911362302	CALDAS NOVAS	760257840	SERRA DE CALDAS	30/11/2019 10:10	30/11/2019 12:15	30/11/2019 10:10	30/11/2019 12:15	2,08	1	2,08	CHI
201911362305	SANTO ANTONIO DO DESCOBERTO	SN21308908	ALEXANIA	30/11/2019 08:44	30/11/2019 13:05	30/11/2019 08:44	30/11/2019 13:05	4,34	1	4,34	CHI
201911362308	AGUA FRIA DE GOIAS	TL12164607	SAO JOAO D ALIANCA	30/11/2019 09:03	30/11/2019 14:29	30/11/2019 09:03	30/11/2019 14:29	5,42	17	92,10	CHI
201911362311	ANICUNS	AC21278671	FIRMINOPOLIS S2	30/11/2019 10:12	30/11/2019 13:23	30/11/2019 10:12	30/11/2019 13:23	3,19	1	3,19	CHI
201911362315	SAO FRANCISCO DE GOIAS	SF12319829	SAO FRANCISCO DE GOIAS	30/11/2019 09:32	30/11/2019 11:28	30/11/2019 09:32	30/11/2019 11:28	1,92	19	36,47	CHI
201911362318	CATALAO	1990094883	CATALAO S2	30/11/2019 10:14	30/11/2019 12:52	30/11/2019 10:14	30/11/2019 12:52	2,62	1	2,62	CHI
201911362325	PIRANHAS	BM12253665	BOM JARDIM	30/11/2019 10:15	30/11/2019 14:22	30/11/2019 10:15	30/11/2019 14:22	4,11	2	8,23	CHI
201911362325	BOM JARDIM DE GOIAS	BM12253665	BOM JARDIM	30/11/2019 10:15	30/11/2019 14:22	30/11/2019 10:15	30/11/2019 14:22	4,11	3	12,34	CHI
201911362326	URUACU	UR12201756	URUACU	30/11/2019 10:16	01/12/2019 11:25	30/11/2019 10:16	01/12/2019 11:25	25,15	3	75,44	CHI
201911362330	GOIANIA	GN11187579	FERROVIARIO S3	30/11/2019 10:16	30/11/2019 12:20	30/11/2019 10:16	30/11/2019 12:20	2,05	27	55,44	CHI
201911362332	PALESTINA DE GOIAS	PY12023466	PALESTINA	30/11/2019 10:03	30/11/2019 14:25	30/11/2019 10:03	30/11/2019 14:25	4,38	4	17,51	CHI
201911362339	SANCLERLANDIA	10003656703	FIRMINOPOLIS S2	30/11/2019 10:19	30/11/2019 12:04	30/11/2019 10:19	30/11/2019 12:04	1,74	1	1,74	CHI
201911362346	BURITI ALEGRE	MR12041248	GOIATUBA S2	30/11/2019 09:40	01/12/2019 19:12	30/11/2019 09:40	01/12/2019 19:12	33,53	3	100,59	CHI
201911362346	GOIATUBA	MR12041248	GOIATUBA S2	30/11/2019 09:40	01/12/2019 19:12	30/11/2019 09:40	01/12/2019 19:12	33,53	1	33,53	CHI
201911362348	RUBIATABA	780026093	RUBIATABA	30/11/2019 10:22	30/11/2019 12:18	30/11/2019 10:22	30/11/2019 12:18	1,92	1	1,92	CHI
201911362356	MOZARLANDIA	MZ12158752	MOZARLANDIA	30/11/2019 10:24	30/11/2019 18:05	30/11/2019 10:24	30/11/2019 18:05	7,67	1	7,67	CHI
201911362356	NOVA CRIXAS	MZ12158752	MOZARLANDIA	30/11/2019 10:24	30/11/2019 18:05	30/11/2019 10:24	30/11/2019 18:05	7,67	1	7,67	CHI
201911362360	ITAPACI	2160004401	RUBIATABA	30/11/2019 10:26	30/11/2019 14:26	30/11/2019 10:26	30/11/2019 14:26	4,00	1	4,00	CHI
201911362365	BELA VISTA DE GOIAS	BV12242097	BELA VISTA S1	30/11/2019 10:27	30/11/2019 13:01	30/11/2019 10:27	30/11/2019 13:01	2,55	10	25,54	CHI
201911362370	BARRO ALTO	BA21342222	GOIANESIA S1	30/11/2019 10:28	01/12/2019 13:10	30/11/2019 10:28	01/12/2019 13:10	26,69	1	26,69	CHI
201911362371	GOIANIA	11704986	CAMPINAS S2	30/11/2019 10:28	30/11/2019 12:59	30/11/2019 10:28	30/11/2019 12:59	2,50	1	2,50	CHI
201911362377	CRISTALINA	KR12209473	CRISTALINA S2	30/11/2019 09:04	30/11/2019 12:44	30/11/2019 09:04	30/11/2019 12:44	3,66	6	21,97	CHI
201911362378	APORE	AE12219493	ITAJA S1	30/11/2019 10:30	01/12/2019 11:30	30/11/2019 10:30	01/12/2019 11:30	24,99	3	74,96	CHI
201911362380	ALTO PARAISO DE GOIAS	BF21386162	FLORES DE GOIAS	30/11/2019 10:30	01/12/2019 07:51	30/11/2019 10:30	01/12/2019 07:51	21,33	1	21,33	CHI
201911362381	GOIANDIRA	1050001282	CATALAO S1	30/11/2019 10:31	30/11/2019 12:45	30/11/2019 10:31	30/11/2019 12:45	2,25	1	2,25	CHI
201911362382	CAIAPONIA	CP21374803	PALESTINA	30/11/2019 10:32	30/11/2019 19:25	30/11/2019 10:32	30/11/2019 19:25	8,88	1	8,88	CHI
201911362389	PALMELO	10010907538	PIRES DO RIO S2	30/11/2019 08:48	30/11/2019 16:24	30/11/2019 08:48	30/11/2019 16:24	7,60	1	7,60	CHI
201911362392	VILA PROPICIO	PV21396639	GOIANESIA S1	30/11/2019 10:34	02/12/2019 01:19	30/11/2019 10:34	02/12/2019 01:19	38,74	1	38,74	CHI
201911362396	GAMELEIRA DE GOIAS	AA12258344	ANAPOLIS UNIVERSITARIO S1	30/11/2019 10:04	30/11/2019 14:30	30/11/2019 10:04	30/11/2019 14:30	4,42	9	39,81	CHI
201911362396	ABADIANIA	AA12258344	ANAPOLIS UNIVERSITARIO S1	30/11/2019 10:04	30/11/2019 14:30	30/11/2019 10:04	30/11/2019 14:30	4,42	93	411,37	CHI
201911362397	ANAPOLIS	AN11000473	JUNDIAI S2	30/11/2019 10:34	30/11/2019 11:44	30/11/2019 10:34	30/11/2019 11:44	1,16	45	51,98	CHI

201911362400	FORMOSA	FA11269915	ITUIQUIRA	30/11/2019 10:36	30/11/2019 19:12	30/11/2019 10:36	30/11/2019 19:12	8,60	1	8,60	CHI
201911362401	PROFESSOR JAMIL SAFADY	7590042	ROCHEDO	30/11/2019 10:36	30/11/2019 18:33	30/11/2019 10:36	30/11/2019 16:20	5,73	1	5,73	CHI
201911362401	PROFESSOR JAMIL SAFADY	JS21317530	ROCHEDO	30/11/2019 10:36	30/11/2019 18:33	30/11/2019 15:59	30/11/2019 18:33	2,56	1	2,56	CHI
201911362402	SAO JOAO D ALIANCA	JL21295133	SAO JOAO D ALIANCA	30/11/2019 10:36	30/11/2019 18:02	30/11/2019 10:36	30/11/2019 18:02	7,43	1	7,43	CHI
201911362407	CAVALCANTE	CJ12319290	MINACU	30/11/2019 08:13	01/12/2019 10:33	30/11/2019 08:13	01/12/2019 10:33	26,32	11	289,55	CHI
201911362408	HIDROLANDIA	HD12000269	CEPAIGO S1	30/11/2019 10:37	30/11/2019 13:20	30/11/2019 10:37	30/11/2019 13:20	2,71	116	313,94	CHI
201911362416	GOIANIA	10011741005	ATLANTICO S2	30/11/2019 10:39	30/11/2019 12:51	30/11/2019 10:39	30/11/2019 12:51	2,19	1	2,19	CHI
201911362427	TEREZOPOLIS DE GOIAS	TJ11254542	DAIA S2	30/11/2019 10:41	30/11/2019 11:59	30/11/2019 10:41	30/11/2019 11:59	1,29	9	11,60	CHI
201911362428	PARAUNA	PU12096380	ACREUNA	30/11/2019 10:41	30/11/2019 15:57	30/11/2019 10:41	30/11/2019 15:57	5,25	2	10,51	CHI
201911362431	PIRENOPOLIS	PV21319720	SAO FRANCISCO DE GOIAS	30/11/2019 10:42	30/11/2019 15:06	30/11/2019 10:42	30/11/2019 15:06	4,39	1	4,39	CHI
201911362432	EDEALINA	00500414	EDEIA	30/11/2019 10:31	30/11/2019 10:37	30/11/2019 10:31	30/11/2019 10:36	0,07	3	0,22	CHI
201911362432	EDEIA	00500414	EDEIA	30/11/2019 10:31	30/11/2019 10:37	30/11/2019 10:31	30/11/2019 10:36	0,07	11	0,81	CHI
201911362432	PONTALINA	00500414	PONTALINA	30/11/2019 10:31	30/11/2019 10:37	30/11/2019 10:31	30/11/2019 10:37	0,09	22	2,08	CHI
201911362432	INDIARA	00500414	PONTALINA	30/11/2019 10:31	30/11/2019 10:37	30/11/2019 10:31	30/11/2019 10:37	0,09	2	0,19	CHI
201911362432	EDEIA	00500414	PONTALINA	30/11/2019 10:31	30/11/2019 10:37	30/11/2019 10:31	30/11/2019 10:37	0,09	130	12,31	CHI
201911362432	CEZARINA	00500414	PONTALINA	30/11/2019 10:31	30/11/2019 10:37	30/11/2019 10:31	30/11/2019 10:37	0,09	4	0,38	CHI
201911362432	EDEALINA	00500414	PONTALINA	30/11/2019 10:31	30/11/2019 10:37	30/11/2019 10:31	30/11/2019 10:37	0,09	1999	189,35	CHI
201911362432	EDEALINA	00410214	PONTALINA	30/11/2019 10:31	30/11/2019 10:37	30/11/2019 10:34	30/11/2019 10:37	0,06	1	0,06	CHI
201911362438	LUZIANIA	LZ12383017	PAMPLONA	30/11/2019 10:44	30/11/2019 13:21	30/11/2019 10:44	30/11/2019 13:21	2,61	3	7,82	CHI
201911362439	SANTA RITA DO ARAGUAIA	SU12202821LD	SANTA RITA DO ARAGUAIA	30/11/2019 10:44	01/12/2019 11:03	30/11/2019 10:44	01/12/2019 11:03	24,30	1	24,30	CHI
201911362441	PARAUNA	PU21387511	PARAUNA	30/11/2019 10:44	30/11/2019 14:56	30/11/2019 10:44	30/11/2019 14:56	4,20	1	4,20	CHI
201911362442	MORRINHOS	MR21000157	MORRINHOS	30/11/2019 10:45	30/11/2019 11:55	30/11/2019 10:45	30/11/2019 11:55	1,16	1	1,16	CHI
201911362443	JATAI	JT21316315	JATAI S1	30/11/2019 08:51	30/11/2019 12:57	30/11/2019 08:51	30/11/2019 12:57	4,09	1	4,09	CHI
201911362448	GOIANESIA	GE12253807	GOIANESIA S2	30/11/2019 09:42	30/11/2019 13:10	30/11/2019 09:42	30/11/2019 13:10	3,45	7	24,17	CHI
201911362449	PORANGATU	PO12050744	PORANGATU	30/11/2019 10:46	30/11/2019 21:50	30/11/2019 10:46	30/11/2019 21:50	11,06	4	44,23	CHI
201911362450	RUBIATABA	RB12126565	RUBIATABA	30/11/2019 10:46	30/11/2019 12:00	30/11/2019 10:46	30/11/2019 12:00	1,23	57	70,00	CHI
201911362450	MORRO AGUDO DE GOIAS	RB12126565	RUBIATABA	30/11/2019 10:46	30/11/2019 12:00	30/11/2019 10:46	30/11/2019 12:00	1,23	4	4,91	CHI
201911362451	HIDROLANDIA	HD21357250	CEPAIGO S2	30/11/2019 10:46	30/11/2019 13:41	30/11/2019 10:46	30/11/2019 13:41	2,90	1	2,90	CHI
201911362462	JATAI	JT12214347	JATAI S2	30/11/2019 09:03	30/11/2019 12:29	30/11/2019 09:03	30/11/2019 12:29	3,43	12	41,15	CHI
201911362465	QUIRINOPOLIS	QI12091057	QUIRINOPOLIS	30/11/2019 10:50	30/11/2019 13:37	30/11/2019 10:50	30/11/2019 13:37	2,77	4	11,10	CHI
201911362471	CRISTALINA	KR21165510	CRISTALINA S2	30/11/2019 10:51	01/12/2019 09:57	30/11/2019 10:51	01/12/2019 09:57	23,10	1	23,10	CHI
201911362474	AGUA FRIA DE GOIAS	TL12279981	SAO JOAO D ALIANCA	30/11/2019 10:51	30/11/2019 15:13	30/11/2019 10:51	30/11/2019 15:13	4,36	41	178,70	CHI
201911362475	ARACU	AR11194857	ARACU	30/11/2019 10:52	30/11/2019 16:04	30/11/2019 10:52	30/11/2019 16:04	5,20	58	301,54	CHI

201911362482	MARA ROSA	MQ12140367	MARA ROSA	30/11/2019 07:20	30/11/2019 17:18	30/11/2019 07:20	30/11/2019 17:18	9,96	56	557,70	CHI
201911362488	GOIANIA	11308590	XAVANTES	30/11/2019 10:54	30/11/2019 14:01	30/11/2019 10:54	30/11/2019 14:01	3,13	1	3,13	CHI
201911362489	ORIZONA	OZ21335564	VIANOPOLIS	30/11/2019 10:40	30/11/2019 12:53	30/11/2019 10:40	30/11/2019 12:53	2,20	1	2,20	CHI
201911362491	JUSSARA	JR12396219	BRITANIA	30/11/2019 10:54	30/11/2019 12:29	30/11/2019 10:54	30/11/2019 12:29	1,58	3	4,75	CHI
201911362495	NOVA VENEZA	OV32125977LD	NEROPOLIS S2	30/11/2019 10:55	30/11/2019 17:00	30/11/2019 10:55	30/11/2019 17:00	6,07	6	36,44	CHI
201911362497	CORREGO DO OURO	CO21003688	SAO LUIZ DOS MONTES BELOS	30/11/2019 07:17	30/11/2019 16:08	30/11/2019 07:17	30/11/2019 16:08	8,84	1	8,84	CHI
201911362498	ITUMBIARA	10026166079	PARANAIBA	30/11/2019 10:56	30/11/2019 12:15	30/11/2019 10:56	30/11/2019 12:15	1,32	1	1,32	CHI
201911362501	ALTO PARAISO DE GOIAS	BF21361347	NIQUELANDIA SUBTRANSMISSAO	30/11/2019 10:58	01/12/2019 10:10	30/11/2019 10:58	01/12/2019 10:10	23,20	1	23,20	CHI
201911362505	LUZIANIA	LZ21133915	MARAJOARA	30/11/2019 10:58	30/11/2019 15:12	30/11/2019 10:58	30/11/2019 15:12	4,22	1	4,22	CHI
201911362506	ALTO PARAISO DE GOIAS	BF21170211	FLORES DE GOIAS	30/11/2019 10:59	01/12/2019 09:52	30/11/2019 10:59	01/12/2019 09:52	22,88	1	22,88	CHI
201911362519	FIRMINOPOLIS	FR21081384	FIRMINOPOLIS S1	30/11/2019 11:03	30/11/2019 20:53	30/11/2019 11:03	30/11/2019 20:33	9,50	1	9,50	CHI
201911362519	FIRMINOPOLIS	FR12096828	FIRMINOPOLIS S1	30/11/2019 11:03	30/11/2019 20:53	30/11/2019 17:57	30/11/2019 20:53	2,94	7	20,57	CHI
201911362523	SILVANIA	660051862	VIANOPOLIS	30/11/2019 11:05	30/11/2019 12:26	30/11/2019 11:05	30/11/2019 12:26	1,36	1	1,36	CHI
201911362528	TRINDADE	40284025	TRINDADE	30/11/2019 11:07	30/11/2019 18:42	30/11/2019 11:07	30/11/2019 18:42	7,60	1	7,60	CHI
201911362530	ITABERAI	IB12310505	ITABERAI S2	30/11/2019 11:07	30/11/2019 15:20	30/11/2019 11:07	30/11/2019 15:20	4,21	74	311,40	CHI
201911362531	EDEIA	EA12000039	EDEIA	30/11/2019 11:08	30/11/2019 13:57	30/11/2019 11:08	30/11/2019 13:57	2,81	19	53,44	CHI
201911362535	DIVINOPOLIS DE GOIAS	GH21344136	SAO DOMINGOS	30/11/2019 11:08	01/12/2019 10:40	30/11/2019 11:08	01/12/2019 10:40	23,52	2	47,05	CHI
201911362537	ITUMBIARA	IT21046645	PARANAIBA	30/11/2019 11:09	30/11/2019 14:05	30/11/2019 11:09	30/11/2019 14:05	2,93	2	5,86	CHI
201911362544	NOVA VENEZA	OV21011581	NEROPOLIS S2	30/11/2019 11:11	30/11/2019 19:00	30/11/2019 11:11	30/11/2019 19:00	7,80	1	7,80	CHI
201911362545	COCALZINHO DE GOIAS	ZN12302491	COCALZINHO	30/11/2019 09:12	01/12/2019 10:07	30/11/2019 09:12	01/12/2019 10:07	24,90	17	423,34	CHI
201911362551	JATAI	JT21334251	JATAI S1	30/11/2019 11:13	30/11/2019 14:25	30/11/2019 11:13	30/11/2019 14:25	3,19	1	3,19	CHI
201911362553	VALPARAISO DE GOIAS	3350107100	PACAEMBU S1	30/11/2019 11:13	30/11/2019 15:39	30/11/2019 11:13	30/11/2019 15:39	4,43	1	4,43	CHI
201911362555	VIANOPOLIS	VN21374403	VIANOPOLIS	30/11/2019 11:14	30/11/2019 22:10	30/11/2019 11:14	30/11/2019 22:10	10,93	1	10,93	CHI
201911362556	UIRAPURU	SG12181444	SANTA TEREZINHA	30/11/2019 08:08	02/12/2019 23:50	02/12/2019 23:22	02/12/2019 23:50	0,47	2	0,93	CHI
201911362556	SANTA TEREZINHA DE GOIAS	SG12181444	SANTA TEREZINHA	30/11/2019 08:08	02/12/2019 23:50	02/12/2019 23:22	02/12/2019 23:50	0,47	1	0,47	CHI
201911362559	PIRES DO RIO	460085165	PIRES DO RIO S1	30/11/2019 11:15	01/12/2019 08:29	30/11/2019 11:15	01/12/2019 08:29	21,23	1	21,23	CHI
201911362571	INHUMAS	30079214	INHUMAS S1	30/11/2019 11:18	30/11/2019 18:24	30/11/2019 11:18	30/11/2019 18:24	7,09	1	7,09	CHI
201911362572	AURILANDIA	AI12003841	SAO LUIZ DOS MONTES BELOS	30/11/2019 11:18	30/11/2019 16:41	30/11/2019 11:18	30/11/2019 16:41	5,39	7	37,70	CHI
201911362578	TROMBAS	TB21337375	PORANGATU	30/11/2019 11:19	01/12/2019 12:58	30/11/2019 11:19	01/12/2019 12:58	25,65	1	25,65	CHI
201911362579	PLANALTINA	PI12262312	PLANALTINA	30/11/2019 11:19	30/11/2019 15:36	30/11/2019 11:19	30/11/2019 15:36	4,29	7	30,04	CHI
201911362580	SANTO ANTONIO DE GOIAS	1360008916	NEROPOLIS S1	30/11/2019 11:19	30/11/2019 14:32	30/11/2019 11:19	30/11/2019 14:32	3,21	1	3,21	CHI
201911362585	PIRACANJUBA	PJ21078735	PIRACANJUBA	30/11/2019 11:20	01/12/2019 07:48	30/11/2019 11:20	01/12/2019 07:48	20,46	2	40,93	CHI
201911362588	GOIANIA	GN12087621	ATLANTICO S1	30/11/2019 11:20	30/11/2019 15:49	30/11/2019 11:20	30/11/2019 15:49	4,48	38	170,18	CHI

201911362589	DOVERLANDIA	CP12119577	CAIAPONIA	30/11/2019 09:00	30/11/2019 16:00	30/11/2019 09:00	30/11/2019 16:00	6,99	6	41,92	CHI
201911362589	CAIAPONIA	CP12119577	CAIAPONIA	30/11/2019 09:00	30/11/2019 16:00	30/11/2019 09:00	30/11/2019 16:00	6,99	65	454,19	CHI
201911362594	EDEIA	EA21044475	EDEIA	30/11/2019 11:22	30/11/2019 13:20	30/11/2019 11:22	30/11/2019 13:20	1,97	2	3,93	CHI
201911362599	BOM JARDIM DE GOIAS	BM21064177	BOM JARDIM	30/11/2019 11:24	30/11/2019 16:10	30/11/2019 11:24	30/11/2019 16:10	4,77	1	4,77	CHI
201911362603	EDEIA	EA12394399	EDEIA	30/11/2019 11:24	30/11/2019 13:58	30/11/2019 11:24	30/11/2019 13:58	2,55	49	125,09	CHI
201911362605	CATALAO	CT12061266	CATALAO S1	30/11/2019 11:25	30/11/2019 21:04	30/11/2019 11:25	30/11/2019 21:04	9,66	3	28,97	CHI
201911362607	COCALZINHO DE GOIAS	LA21185376	AGUAS LINDAS DE GOIAS S1	30/11/2019 11:25	30/11/2019 13:54	30/11/2019 11:25	30/11/2019 13:54	2,48	1	2,48	CHI
201911362609	LUZIANIA	LZ21209533	MARAJOARA	30/11/2019 11:25	01/12/2019 07:50	30/11/2019 11:25	01/12/2019 07:50	20,40	1	20,40	CHI
201911362610	PONTALINA	PK12080063	PONTALINA	30/11/2019 10:36	30/11/2019 13:47	30/11/2019 10:36	30/11/2019 13:47	3,17	38	120,65	CHI
201911362615	AGUAS LINDAS DE GOIAS	10014801998	AGUAS LINDAS DE GOIAS S1	30/11/2019 11:27	30/11/2019 15:51	30/11/2019 11:27	30/11/2019 15:51	4,39	1	4,39	CHI
201911362616	CATALAO	1990017773	CATALAO S2	30/11/2019 11:27	30/11/2019 14:09	30/11/2019 11:27	30/11/2019 14:09	2,70	1	2,70	CHI
201911362619	CACU	CC12027354	CACHOEIRA ALTA	30/11/2019 08:44	30/11/2019 16:15	30/11/2019 08:44	30/11/2019 16:15	7,50	6	45,03	CHI
201911362620	RIO VERDE	RV21346018	RIO VERDE S1	30/11/2019 15:45	30/11/2019 16:19	30/11/2019 15:45	30/11/2019 16:19	0,58	1	0,58	CHI
201911362622	FORMOSA	7194099	ITUIQUIRA	30/11/2019 11:16	30/11/2019 13:12	30/11/2019 11:16	30/11/2019 13:12	1,92	22	42,20	CHI
201911362631	MINACU	IH12088797	MINACU	30/11/2019 10:19	30/11/2019 16:27	30/11/2019 10:19	30/11/2019 16:27	6,13	164	1005,87	CHI
201911362632	PIRENOPOLIS	220061452	CORUMBA	30/11/2019 11:29	30/11/2019 16:51	30/11/2019 11:29	30/11/2019 16:51	5,35	1	5,35	CHI
201911362637	ALEXANIA	AX21370363	ALEXANIA	30/11/2019 11:30	30/11/2019 18:45	30/11/2019 11:30	30/11/2019 18:45	7,24	1	7,24	CHI
201911362646	MONTE ALEGRE DE GOIAS	MA21150385	SAO DOMINGOS	30/11/2019 11:33	30/11/2019 14:19	30/11/2019 11:33	30/11/2019 14:19	2,77	1	2,77	CHI
201911362651	GOIANIA	GN12222920	ATLANTICO S2	30/11/2019 11:13	30/11/2019 12:15	30/11/2019 11:13	30/11/2019 12:15	1,03	201	207,20	CHI
201911362652	PEROLANDIA	JT12209712	JATAI S1	30/11/2019 11:34	30/11/2019 23:39	30/11/2019 11:34	30/11/2019 23:39	12,07	9	108,66	CHI
201911362652	JATAI	JT12209712	JATAI S1	30/11/2019 11:34	30/11/2019 23:39	30/11/2019 11:34	30/11/2019 23:39	12,07	109	1315,96	CHI
201911362653	CALDAS NOVAS	CN12392080	CALDAS NOVAS S2	30/11/2019 11:34	30/11/2019 15:10	30/11/2019 11:34	30/11/2019 15:10	3,59	17	60,97	CHI
201911362655	GOIANIA	16672161	CARAJAS S1	30/11/2019 11:35	30/11/2019 12:36	30/11/2019 11:35	30/11/2019 12:36	1,01	1	1,01	CHI
201911362656	MOSSAMEDES	MD21268861	ITABERAI S2	30/11/2019 11:36	30/11/2019 14:22	30/11/2019 11:36	30/11/2019 14:22	2,77	1	2,77	CHI
201911362657	RIO VERDE	RV11000026	RIO VERDE S2	30/11/2019 15:54	30/11/2019 17:00	30/11/2019 15:54	30/11/2019 17:00	1,10	151	166,14	CHI
201911362660	SAO DOMINGOS	SD12170576	SAO DOMINGOS	30/11/2019 05:39	30/11/2019 18:50	30/11/2019 05:39	30/11/2019 18:50	13,17	36	474,28	CHI
201911362663	COCALZINHO DE GOIAS	ZN12375219	AGUAS LINDAS DE GOIAS S2	30/11/2019 11:38	30/11/2019 15:02	30/11/2019 11:38	30/11/2019 15:02	3,40	25	84,98	CHI
201911362666	TRINDADE	TR12323217	TRINDADE	30/11/2019 11:31	30/11/2019 22:20	30/11/2019 11:31	30/11/2019 22:20	10,82	3	32,45	CHI
201911362666	SANTA BARBARA DE GOIAS	TR12323217	TRINDADE	30/11/2019 11:31	30/11/2019 22:20	30/11/2019 11:31	30/11/2019 22:20	10,82	7	75,71	CHI
201911362669	URUACU	UR12243278	MARA ROSA	30/11/2019 10:50	01/12/2019 09:40	30/11/2019 10:50	01/12/2019 09:40	22,82	15	342,28	CHI
201911362669	CAMPINORTE	UR12243278	MARA ROSA	30/11/2019 10:50	01/12/2019 09:40	30/11/2019 10:50	01/12/2019 09:40	22,82	7	159,73	CHI
201911362672	CATALAO	CT12266108	CATALAO S1	30/11/2019 11:40	30/11/2019 16:54	30/11/2019 11:40	30/11/2019 16:54	5,23	8	41,85	CHI
201911362673	ORIZONA	OZ21160201	VIANOPOLIS	30/11/2019 11:40	30/11/2019 13:47	30/11/2019 11:40	30/11/2019 13:47	2,11	2	4,22	CHI

201911362678	ACREUNA	EU12271441	ACREUNA	30/11/2019 11:41	30/11/2019 13:41	30/11/2019 11:41	30/11/2019 13:41	1,98	266	527,79	CHI
201911362683	LUZIANIA	LZ21219589	CRISTALINA S2	30/11/2019 11:44	01/12/2019 12:06	30/11/2019 11:44	01/12/2019 12:06	24,36	2	48,73	CHI
201911362686	CATALAO	IP21157422	IPAMERI	30/11/2019 11:44	30/11/2019 13:38	30/11/2019 11:44	30/11/2019 13:38	1,89	1	1,89	CHI
201911362687	URUACU	UR21231332	MARA ROSA	30/11/2019 11:45	01/12/2019 10:14	30/11/2019 11:45	01/12/2019 10:14	22,48	1	22,48	CHI
201911362688	GOIANIRA	390085832	MEIA PONTE	30/11/2019 11:45	30/11/2019 15:28	30/11/2019 11:45	30/11/2019 15:28	3,70	1	3,70	CHI
201911362693	COCALZINHO DE GOIAS	ZN21201315	COCALZINHO	30/11/2019 11:47	01/12/2019 10:49	30/11/2019 11:47	01/12/2019 10:49	23,03	1	23,03	CHI
201911362695	URUACU	UR12395652	URUACU	30/11/2019 10:45	30/11/2019 16:20	30/11/2019 10:45	30/11/2019 16:20	5,57	19	105,87	CHI
201911362699	QUIRINOPOLIS	QI21101769	QUIRINOPOLIS	30/11/2019 11:48	30/11/2019 14:30	30/11/2019 11:48	30/11/2019 14:30	2,69	0	0,00	CHI
201911362700	TRINDADE	40237758	TRINDADE	30/11/2019 11:48	30/11/2019 19:01	30/11/2019 11:48	30/11/2019 19:01	7,21	1	7,21	CHI
201911362704	BELA VISTA DE GOIAS	BV12000027	BELA VISTA S1	30/11/2019 11:49	30/11/2019 14:01	30/11/2019 11:49	30/11/2019 14:01	2,19	18	39,45	CHI
201911362706	ALTO PARAISO DE GOIAS	BF12375518	FLORES DE GOIAS	30/11/2019 11:02	30/11/2019 21:06	30/11/2019 11:02	30/11/2019 21:06	10,07	4	40,26	CHI
201911362708	MINACU	IH12396740	MINACU	30/11/2019 11:34	30/11/2019 21:07	30/11/2019 11:34	30/11/2019 21:07	9,55	83	792,33	CHI
201911362711	MINEIROS	MY12278368	PARQUE DAS EMAS	30/11/2019 09:18	30/11/2019 13:51	30/11/2019 09:18	30/11/2019 13:51	4,55	13	59,10	CHI
201911362711	SERRANOPOLIS	MY12278368	PARQUE DAS EMAS	30/11/2019 09:18	30/11/2019 13:51	30/11/2019 09:18	30/11/2019 13:51	4,55	7	31,82	CHI
201911362712	ARUANA	AK12310710	ARUANA	30/11/2019 11:51	30/11/2019 14:17	30/11/2019 11:51	30/11/2019 14:17	2,42	21	50,88	CHI
201911362713	GOIANIA	17237130	GOYA S1	30/11/2019 11:52	30/11/2019 15:58	30/11/2019 11:52	30/11/2019 15:58	4,10	1	4,10	CHI
201911362714	MORRINHOS	150050483	MORRINHOS	30/11/2019 11:52	30/11/2019 17:09	30/11/2019 11:52	30/11/2019 17:09	5,28	1	5,28	CHI
201911362719	DIVINOPOLIS DE GOIAS	GH12211210	SAO DOMINGOS	30/11/2019 11:53	30/11/2019 18:41	30/11/2019 11:53	30/11/2019 18:41	6,80	17	115,63	CHI
201911362727	FORMOSA	PI12122031	PLANALTINA	30/11/2019 11:40	30/11/2019 13:17	30/11/2019 11:40	30/11/2019 13:17	1,60	3	4,81	CHI
201911362728	PIRACANJUBA	PJ21000029	CALDAS NOVAS S1	30/11/2019 11:54	30/11/2019 15:01	30/11/2019 11:54	30/11/2019 15:01	3,12	1	3,12	CHI
201911362732	DAMIANOPOLIS	SI12295432	IACIARA S2	30/11/2019 11:50	30/11/2019 12:51	30/11/2019 11:50	30/11/2019 12:51	1,01	9	9,05	CHI
201911362733	ALEXANIA	AX12185636	ALEXANIA	30/11/2019 11:55	01/12/2019 11:26	30/11/2019 11:55	01/12/2019 11:26	23,51	1	23,51	CHI
201911362741	PORANGATU	PO12241996	PORANGATU	30/11/2019 11:56	30/11/2019 16:04	30/11/2019 11:56	30/11/2019 16:04	4,12	81	333,61	CHI
201911362744	VARJAO	O3320226	GUAPO S2	30/11/2019 11:58	30/11/2019 13:18	30/11/2019 11:58	30/11/2019 13:18	1,33	196	261,06	CHI
201911362744	GUAPO	O3320226	GUAPO S2	30/11/2019 11:58	30/11/2019 13:18	30/11/2019 11:58	30/11/2019 13:18	1,33	119	158,50	CHI
201911362748	FAINA	FC12274422	GOIAS	30/11/2019 11:58	30/11/2019 14:44	30/11/2019 11:58	30/11/2019 14:44	2,75	54	148,74	CHI
201911362753	MORRINHOS	MR21000338	MORRINHOS	30/11/2019 12:00	30/11/2019 14:46	30/11/2019 12:00	30/11/2019 14:46	2,76	1	2,76	CHI
201911362756	CATALAO	CT12130972	CATALAO S2	30/11/2019 11:58	30/11/2019 16:36	30/11/2019 11:58	30/11/2019 16:36	4,63	27	124,98	CHI
201911362756	CUMARI	CT12130972	CATALAO S2	30/11/2019 11:58	30/11/2019 16:36	30/11/2019 11:58	30/11/2019 16:36	4,63	1	4,63	CHI
201911362761	GOUVELANDIA	O1560234	QUIRINOPOLIS	30/11/2019 12:00	01/12/2019 12:34	30/11/2019 12:00	30/11/2019 15:26	3,44	99	340,72	CHI
201911362761	QUIRINOPOLIS	O1560234	QUIRINOPOLIS	30/11/2019 12:00	01/12/2019 12:34	30/11/2019 12:00	30/11/2019 15:26	3,44	13	44,74	CHI
201911362761	GOUVELANDIA	O1560234	QUIRINOPOLIS	30/11/2019 12:00	01/12/2019 12:34	30/11/2019 12:00	30/11/2019 15:54	3,91	215	841,13	CHI
201911362761	CASTELANDIA	O1560234	QUIRINOPOLIS	30/11/2019 12:00	01/12/2019 12:34	30/11/2019 12:00	30/11/2019 15:54	3,91	20	78,24	CHI



201911362761	RIO VERDE	01560234	QUIRINOPOLIS	30/11/2019 12:00	01/12/2019 12:34	30/11/2019 12:00	30/11/2019 15:54	3,91	1	3,91	CHI
201911362761	QUIRINOPOLIS	01560234	QUIRINOPOLIS	30/11/2019 12:00	01/12/2019 12:34	30/11/2019 12:00	30/11/2019 15:54	3,91	609	2382,54	CHI
201911362761	GOUVELANDIA	GB10402438	QUIRINOPOLIS	30/11/2019 12:00	01/12/2019 12:34	30/11/2019 13:54	30/11/2019 15:54	2,01	1	2,01	CHI
201911362761	QUIRINOPOLIS	01560234	QUIRINOPOLIS	30/11/2019 12:00	01/12/2019 12:34	30/11/2019 12:00	30/11/2019 21:42	9,71	130	1261,76	CHI
201911362761	QUIRINOPOLIS	01560234	QUIRINOPOLIS	30/11/2019 12:00	01/12/2019 12:34	30/11/2019 13:54	30/11/2019 21:42	7,80	15	117,05	CHI
201911362761	QUIRINOPOLIS	01560234	QUIRINOPOLIS	30/11/2019 12:00	01/12/2019 12:34	30/11/2019 12:00	01/12/2019 11:58	23,98	6	143,86	CHI
201911362761	GOUVELANDIA	QI13000025	QUIRINOPOLIS	30/11/2019 12:00	01/12/2019 12:34	01/12/2019 12:29	01/12/2019 12:34	0,09	214	18,49	CHI
201911362761	RIO VERDE	QI13000025	QUIRINOPOLIS	30/11/2019 12:00	01/12/2019 12:34	01/12/2019 12:29	01/12/2019 12:34	0,09	1	0,09	CHI
201911362761	CASTELANDIA	QI13000025	QUIRINOPOLIS	30/11/2019 12:00	01/12/2019 12:34	01/12/2019 12:29	01/12/2019 12:34	0,09	19	1,64	CHI
201911362761	QUIRINOPOLIS	QI13000025	QUIRINOPOLIS	30/11/2019 12:00	01/12/2019 12:34	01/12/2019 12:29	01/12/2019 12:34	0,09	613	52,96	CHI
201911362763	SERRANOPOLIS	3000009496	JATAI S1	30/11/2019 12:03	01/12/2019 09:50	30/11/2019 12:03	01/12/2019 09:50	21,77	1	21,77	CHI
201911362765	GOIANIA	13816329	XAVANTES	30/11/2019 12:04	30/11/2019 14:24	30/11/2019 12:04	30/11/2019 14:24	2,32	1	2,32	CHI
201911362772	APARECIDA DE GOIANIA	14493792	REAL S1	30/11/2019 12:05	30/11/2019 14:55	30/11/2019 12:05	30/11/2019 14:55	2,83	1	2,83	CHI
201911362776	RIO VERDE	630561989	RIO VERDE S1	30/11/2019 12:06	30/11/2019 15:59	30/11/2019 12:06	30/11/2019 15:59	3,88	1	3,88	CHI
201911362777	TRINDADE	TR11002505	TRINDADE	30/11/2019 11:42	30/11/2019 17:01	30/11/2019 11:42	30/11/2019 17:01	5,31	194	1029,55	CHI
201911362782	ALEXANIA	AX31061865	ALEXANIA	30/11/2019 12:07	30/11/2019 20:34	30/11/2019 12:07	30/11/2019 20:34	8,44	1	8,44	CHI
201911362784	CAIAPONIA	CP21190335	CAIAPONIA	30/11/2019 12:07	01/12/2019 13:28	30/11/2019 12:07	01/12/2019 13:28	25,34	1	25,34	CHI
201911362789	LUZIANIA	LZ12330544	MARAJOARA	30/11/2019 12:08	30/11/2019 18:15	30/11/2019 12:08	30/11/2019 18:15	6,11	8	48,90	CHI
201911362790	RIO VERDE	RV12000136	RIO VERDE S2	30/11/2019 12:08	30/11/2019 15:30	30/11/2019 12:08	30/11/2019 15:30	3,38	145	489,42	CHI
201911362792	GOIANIA	15592560	GOYA S2	30/11/2019 12:09	30/11/2019 12:47	30/11/2019 12:09	30/11/2019 12:47	0,62	1	0,62	CHI
201911362795	GOIANIA	10008549689	ATLANTICO S1	30/11/2019 12:11	30/11/2019 14:57	30/11/2019 12:11	30/11/2019 14:57	2,77	1	2,77	CHI
201911362797	MARZAGAO	970002506	VILA CORUMBA	30/11/2019 12:11	30/11/2019 14:55	30/11/2019 12:11	30/11/2019 14:55	2,74	1	2,74	CHI
201911362803	TURVELANDIA	EU12100587	RIO DOS BOIS	30/11/2019 12:13	01/12/2019 00:05	30/11/2019 12:13	01/12/2019 00:05	11,86	1	11,86	CHI
201911362811	BONOPOLIS	BX12198529	NOVO PLANALTO	30/11/2019 12:16	30/11/2019 23:06	30/11/2019 12:16	30/11/2019 23:06	10,83	1	10,83	CHI
201911362813	LUZIANIA	LZ12203332	VIANOPOLIS	30/11/2019 12:16	30/11/2019 14:20	30/11/2019 12:16	30/11/2019 14:20	2,06	10	20,59	CHI
201911362815	APARECIDA DE GOIANIA	AP11167785	INDEPENDENCIA S2	30/11/2019 12:08	30/11/2019 13:53	30/11/2019 12:08	30/11/2019 13:53	1,75	175	306,10	CHI
201911362820	ITARUMA	IM12107440	CACHOEIRA ALTA	30/11/2019 10:26	30/11/2019 14:41	30/11/2019 10:26	30/11/2019 13:35	3,14	6	18,87	CHI
201911362820	ITARUMA	IM11370120	CACHOEIRA ALTA	30/11/2019 10:26	30/11/2019 14:41	30/11/2019 10:26	30/11/2019 14:41	4,25	56	237,88	CHI
201911362822	SAO MIGUEL DO ARAGUAIA	830064126	SAO MIGUEL DO ARAGUAIA	30/11/2019 12:19	01/12/2019 02:45	30/11/2019 12:19	01/12/2019 02:45	14,45	1	14,45	CHI
201911362824	SENADOR CANEDO	10002163010	GOIANIA LESTE S1	30/11/2019 12:19	30/11/2019 15:34	30/11/2019 12:19	30/11/2019 15:34	3,24	1	3,24	CHI
201911362825	APARECIDA DE GOIANIA	AP11224134	INDEPENDENCIA S1	30/11/2019 12:13	30/11/2019 14:14	30/11/2019 12:13	30/11/2019 14:14	2,00	171	342,52	CHI
201911362827	GOIANDIRA	GD12215681	CATALAO S1	30/11/2019 11:56	01/12/2019 10:27	30/11/2019 11:56	01/12/2019 10:27	22,51	4	90,05	CHI
201911362830	GOIANIA	15030106	NEROPOLIS S2	30/11/2019 12:20	30/11/2019 13:53	30/11/2019 12:20	30/11/2019 13:53	1,54	1	1,54	CHI

201911362833	CEZARINA	IY12010391	EDEIA	30/11/2019 12:21	30/11/2019 18:35	30/11/2019 12:21	30/11/2019 18:35	6,25	3	18,74	CHI
201911362833	INDIARA	IY12010391	EDEIA	30/11/2019 12:21	30/11/2019 18:35	30/11/2019 12:21	30/11/2019 18:35	6,25	1	6,25	CHI
201911362840	PIRES DO RIO	460013180	PIRES DO RIO S1	30/11/2019 12:23	30/11/2019 15:35	30/11/2019 12:23	30/11/2019 15:35	3,21	1	3,21	CHI
201911362844	DIVINOPOLIS DE GOIAS	GH12383359	SAO DOMINGOS	30/11/2019 12:24	01/12/2019 11:47	30/11/2019 12:24	01/12/2019 11:47	23,38	7	163,66	CHI
201911362845	TRINDADE	TR12071529	TRINDADE	30/11/2019 11:18	30/11/2019 14:30	30/11/2019 11:18	30/11/2019 14:30	3,19	89	283,56	CHI
201911362847	SANTA TEREZA DE GOIAS	FO12328885	PORANGATU	30/11/2019 12:24	30/11/2019 21:19	30/11/2019 12:24	30/11/2019 21:19	8,91	12	106,86	CHI
201911362847	FORMOSO	FO12328885	PORANGATU	30/11/2019 12:24	30/11/2019 21:19	30/11/2019 12:24	30/11/2019 21:19	8,91	4	35,62	CHI
201911362852	ARAGUAPAZ	AZ12193702	GOIAS	30/11/2019 12:25	01/12/2019 01:08	30/11/2019 12:25	01/12/2019 01:08	12,71	2	25,42	CHI
201911362853	MOSSAMEDES	MD21198264	ITABERAI S2	30/11/2019 12:25	30/11/2019 14:10	30/11/2019 12:25	30/11/2019 14:10	1,74	1	1,74	CHI
201911362855	ITAPACI	IW12282269	ITAPACI	30/11/2019 12:18	30/11/2019 20:12	30/11/2019 12:18	30/11/2019 20:12	7,90	7	55,27	CHI
201911362858	PORANGATU	04950224	SAO MIGUEL DO ARAGUAIA	30/11/2019 12:22	30/11/2019 12:42	30/11/2019 12:22	30/11/2019 12:42	0,34	1	0,34	CHI
201911362858	BONOPOLIS	04950224	SAO MIGUEL DO ARAGUAIA	30/11/2019 12:22	30/11/2019 12:42	30/11/2019 12:22	30/11/2019 12:42	0,34	538	182,47	CHI
201911362859	TRINDADE	TR11104720	TRINDADE	30/11/2019 12:02	30/11/2019 15:22	30/11/2019 12:02	30/11/2019 15:22	3,34	87	290,56	CHI
201911362860	EDEALINA	ED12007679	PONTALINA	30/11/2019 12:24	30/11/2019 14:41	30/11/2019 12:24	30/11/2019 14:41	2,27	16	36,32	CHI
201911362863	RIO VERDE	630354261	CABRIUVA S2	30/11/2019 12:28	02/12/2019 00:06	30/11/2019 12:28	02/12/2019 00:06	35,63	1	35,63	CHI
201911362869	GAMELEIRA DE GOIAS	CL21361816	ANAPOLIS UNIVERSITARIO S1	30/11/2019 10:04	30/11/2019 17:48	30/11/2019 10:04	30/11/2019 17:48	7,73	1	7,73	CHI
201911362870	ITAJA	IJ12359424	CACHOEIRA ALTA	30/11/2019 12:31	01/12/2019 11:35	30/11/2019 12:31	01/12/2019 11:35	23,06	2	46,13	CHI
201911362871	BALIZA	BH21360376	BOM JARDIM	30/11/2019 12:31	30/11/2019 16:55	30/11/2019 12:31	30/11/2019 16:55	4,40	1	4,40	CHI
201911362873	AGUA FRIA DE GOIAS	TL12394165	SAO JOAO D ALIANCA	30/11/2019 12:31	30/11/2019 16:39	30/11/2019 12:31	30/11/2019 16:39	4,13	18	74,28	CHI
201911362875	BRITANIA	IU12025071	MATRINCHA	30/11/2019 12:31	30/11/2019 16:20	30/11/2019 12:31	30/11/2019 16:20	3,81	6	22,84	CHI
201911362875	ITAPIRAPUA	IU12025071	MATRINCHA	30/11/2019 12:31	30/11/2019 16:20	30/11/2019 12:31	30/11/2019 16:20	3,81	8	30,46	CHI
201911362876	ARENOPOLIS	AY12156761	ARENOPOLIS	30/11/2019 12:32	30/11/2019 16:25	30/11/2019 12:32	30/11/2019 16:25	3,88	5	19,41	CHI
201911362879	AGUA FRIA DE GOIAS	TL12067535	SAO JOAO D ALIANCA	30/11/2019 12:32	30/11/2019 18:05	30/11/2019 12:32	30/11/2019 18:05	5,56	7	38,90	CHI
201911362880	ITABERAI	50010852	ITABERAI S2	30/11/2019 12:32	30/11/2019 15:17	30/11/2019 12:32	30/11/2019 15:17	2,74	1	2,74	CHI
201911362884	SAO DOMINGOS	SD12384774	SAO DOMINGOS	30/11/2019 12:32	30/11/2019 16:15	30/11/2019 12:32	30/11/2019 16:15	3,70	40	148,08	CHI
201911362890	NIQUELANDIA	NQ12378065	NIQUELANDIA SUBTRANSMISSAO	30/11/2019 12:33	30/11/2019 16:24	30/11/2019 12:33	30/11/2019 16:24	3,84	3	11,52	CHI
201911362897	MONTE ALEGRE DE GOIAS	MA21218649	SAO DOMINGOS	30/11/2019 12:36	30/11/2019 18:02	30/11/2019 12:36	30/11/2019 18:02	5,43	3	16,30	CHI
201911362900	ITAPIRAPUA	IU12142895	MATRINCHA	30/11/2019 12:06	30/11/2019 14:15	30/11/2019 12:06	30/11/2019 14:15	2,15	7	15,04	CHI
201911362904	ABADIANIA	AA12413713	DAIA S2	30/11/2019 11:18	30/11/2019 18:08	30/11/2019 11:18	30/11/2019 18:08	6,83	50	341,50	CHI
201911362907	MONTE ALEGRE DE GOIAS	MA21252207	SAO DOMINGOS	30/11/2019 12:38	30/11/2019 16:32	30/11/2019 12:38	30/11/2019 16:32	3,90	1	3,90	CHI
201911362910	PORANGATU	PO12020611	NOVO PLANALTO	30/11/2019 10:57	30/11/2019 15:14	30/11/2019 10:57	30/11/2019 15:14	4,28	8	34,25	CHI
201911362913	AGUA FRIA DE GOIAS	TL12264641	SAO JOAO D ALIANCA	30/11/2019 12:39	30/11/2019 18:03	30/11/2019 12:39	30/11/2019 18:03	5,40	12	64,77	CHI
201911362914	URUACU	UR21314220	URUACU	30/11/2019 12:39	01/12/2019 09:56	30/11/2019 12:39	01/12/2019 09:56	21,28	1	21,28	CHI

201911362916	PALMEIRAS DE GOIAS	NZ12233489	ANICUNS	30/11/2019 12:37	30/11/2019 15:21	30/11/2019 12:37	30/11/2019 15:21	2,73	3	8,19	CHI
201911362916	NAZARIO	NZ12233489	ANICUNS	30/11/2019 12:37	30/11/2019 15:21	30/11/2019 12:37	30/11/2019 15:21	2,73	40	109,27	CHI
201911362925	CRISTALINA	KR12228876	CRISTALINA S2	30/11/2019 10:50	30/11/2019 15:32	30/11/2019 10:50	30/11/2019 15:32	4,68	10	46,85	CHI
201911362927	PIRES DO RIO	PR21100250	PIRES DO RIO S1	30/11/2019 12:42	01/12/2019 16:24	30/11/2019 12:42	01/12/2019 16:24	27,71	2	55,42	CHI
201911362933	ARAGOIANIA	680040389	GUAPO S2	30/11/2019 12:43	30/11/2019 16:46	30/11/2019 12:43	30/11/2019 16:46	4,04	1	4,04	CHI
201911362934	PIRES DO RIO	PR21172807	PIRES DO RIO S1	30/11/2019 12:43	30/11/2019 17:40	30/11/2019 12:43	30/11/2019 17:40	4,94	1	4,94	CHI
201911362942	CERES	RB12363545	RUBIATABA	30/11/2019 09:49	02/12/2019 10:10	30/11/2019 09:49	02/12/2019 10:10	48,34	7	338,41	CHI
201911362946	JUSSARA	JR12120986	BRITANIA	30/11/2019 12:46	30/11/2019 23:58	30/11/2019 12:46	30/11/2019 23:58	11,19	3	33,56	CHI
201911362947	GOIANESIA	GE12379116	GOIANESIA S2	30/11/2019 12:32	30/11/2019 16:56	30/11/2019 12:32	30/11/2019 16:56	4,39	99	434,50	CHI
201911362949	POSSE	PS21143797	IACIARA S1	30/11/2019 12:47	30/11/2019 16:46	30/11/2019 12:47	30/11/2019 16:46	3,98	1	3,98	CHI
201911362951	LUZIANIA	10013915337	RIO VERMELHO	30/11/2019 12:48	30/11/2019 15:53	30/11/2019 12:48	30/11/2019 15:53	3,09	1	3,09	CHI
201911362955	DAVINOPOLIS	OU12077558	CATALAO S1	30/11/2019 12:48	30/11/2019 20:58	30/11/2019 12:48	30/11/2019 20:58	8,15	10	81,53	CHI
201911362955	OUVIDOR	OU12077558	CATALAO S1	30/11/2019 12:48	30/11/2019 20:58	30/11/2019 12:48	30/11/2019 20:58	8,15	201	1638,71	CHI
201911362957	TROMBAS	TB12256991	PORANGATU	30/11/2019 12:50	30/11/2019 20:04	30/11/2019 12:50	30/11/2019 20:04	7,23	22	159,10	CHI
201911362957	MINACU	TB12256991	PORANGATU	30/11/2019 12:50	30/11/2019 20:04	30/11/2019 12:50	30/11/2019 20:04	7,23	12	86,78	CHI
201911362961	MINACU	CR12234938	PORANGATU	30/11/2019 12:45	30/11/2019 16:47	30/11/2019 12:45	30/11/2019 16:47	4,03	42	169,14	CHI
201911362961	CAMPINORTE	CR12234938	PORANGATU	30/11/2019 12:45	30/11/2019 16:47	30/11/2019 12:45	30/11/2019 16:47	4,03	19	76,52	CHI
201911362974	GOIANIA	14172902	GOIANIA LESTE S2	30/11/2019 12:52	30/11/2019 15:23	30/11/2019 12:52	30/11/2019 15:23	2,50	1	2,50	CHI
201911362976	AGUAS LINDAS DE GOIAS	10011590295	AGUAS LINDAS DE GOIAS S1	30/11/2019 12:53	30/11/2019 14:20	30/11/2019 12:53	30/11/2019 14:20	1,44	0	0,00	CHI
201911362979	URUACU	UR16405016	URUACU	30/11/2019 12:48	30/11/2019 18:32	30/11/2019 14:29	30/11/2019 14:52	0,37	839	313,93	CHI
201911362979	URUACU	UR16410033	URUACU	30/11/2019 12:48	30/11/2019 18:32	30/11/2019 14:29	30/11/2019 14:55	0,43	1589	685,04	CHI
201911362979	URUACU	UR13220585	URUACU	30/11/2019 12:48	30/11/2019 18:32	30/11/2019 12:48	30/11/2019 16:17	3,49	1807	6305,43	CHI
201911362979	URUACU	UR13220584	URUACU	30/11/2019 12:48	30/11/2019 18:32	30/11/2019 14:29	30/11/2019 18:32	4,05	1	4,05	CHI
201911362980	BELA VISTA DE GOIAS	BV12201455	BELA VISTA S2	30/11/2019 12:07	30/11/2019 15:51	30/11/2019 12:07	30/11/2019 15:51	3,73	7	26,12	CHI
201911362982	SANTA RITA DO NOVO DESTINO	BA12156230	BARRO ALTO	30/11/2019 12:54	02/12/2019 05:27	30/11/2019 12:54	02/12/2019 05:27	40,54	13	527,06	CHI
201911362982	BARRO ALTO	BA12156230	BARRO ALTO	30/11/2019 12:54	02/12/2019 05:27	30/11/2019 12:54	02/12/2019 05:27	40,54	2	81,09	CHI
201911362985	MONTES CLAROS DE GOIAS	ME12395480	IPORA	30/11/2019 12:55	30/11/2019 14:38	30/11/2019 12:55	30/11/2019 14:38	1,72	5	8,60	CHI
201911362992	MINACU	IH12220633	MINACU	30/11/2019 08:03	30/11/2019 22:40	30/11/2019 08:03	30/11/2019 22:40	14,61	21	306,78	CHI
201911362994	SAO JOAO D ALIANCA	JL12257606	SAO JOAO D ALIANCA	30/11/2019 12:53	30/11/2019 21:25	30/11/2019 12:53	30/11/2019 21:25	8,52	81	690,50	CHI
201911362994	ALTO PARAISO DE GOIAS	JL12257606	SAO JOAO D ALIANCA	30/11/2019 12:53	30/11/2019 21:25	30/11/2019 12:53	30/11/2019 21:25	8,52	2	17,05	CHI
201911362998	ANICUNS	AC12259103	FIRMINOPOLIS S2	30/11/2019 12:57	30/11/2019 15:15	30/11/2019 12:57	30/11/2019 15:15	2,31	19	43,84	CHI
201911363000	DISTRITO FEDERAL	SN12237830	MARAJOARA	30/11/2019 09:14	30/11/2019 14:17	30/11/2019 09:14	30/11/2019 14:17	5,04	3	15,11	CHI
201911363000	SANTO ANTONIO DO DESCOBERTO	SN12237830	MARAJOARA	30/11/2019 09:14	30/11/2019 14:17	30/11/2019 09:14	30/11/2019 14:17	5,04	23	115,85	CHI

201911363001	POSSE	PS21132019	IACIARA S2	30/11/2019 12:59	30/11/2019 16:15	30/11/2019 12:59	30/11/2019 16:15	3,26	1	3,26	CHI
201911363002	PIRACANJUBA	PJ21263512	PIRACANJUBA	30/11/2019 13:00	01/12/2019 09:21	30/11/2019 13:00	01/12/2019 09:21	20,35	1	20,35	CHI
201911363008	GUARINOS	IW12330115	ITAPACI	30/11/2019 09:42	30/11/2019 16:36	30/11/2019 09:42	30/11/2019 16:36	6,89	7	48,22	CHI
201911363008	ITAPACI	IW12330115	ITAPACI	30/11/2019 09:42	30/11/2019 16:36	30/11/2019 09:42	30/11/2019 16:36	6,89	107	737,08	CHI
201911363008	PILAR DE GOIAS	IW12330115	ITAPACI	30/11/2019 09:42	30/11/2019 16:36	30/11/2019 09:42	30/11/2019 16:36	6,89	1	6,89	CHI
201911363015	JATAI	JT12336920	JATAI S1	30/11/2019 09:06	30/11/2019 23:40	30/11/2019 09:06	30/11/2019 23:40	14,55	8	116,44	CHI
201911363015	JATAI	JT12336920	JATAI S1	30/11/2019 09:06	30/11/2019 23:40	30/11/2019 13:58	30/11/2019 23:40	9,70	2	19,39	CHI
201911363017	BOM JESUS DE GOIAS	BJ21122265	CACHOEIRA DOURADA	30/11/2019 13:02	30/11/2019 18:40	30/11/2019 13:02	30/11/2019 18:40	5,62	1	5,62	CHI
201911363101	CATALAO	CT21063931	CATALAO S1	30/11/2019 13:03	30/11/2019 14:58	30/11/2019 13:03	30/11/2019 14:58	1,92	1	1,92	CHI
201911363108	URUACU	CR21181311	MARA ROSA	30/11/2019 13:03	02/12/2019 19:24	30/11/2019 13:03	02/12/2019 19:24	54,34	27	1467,21	CHI
201911363111	AGUA LIMPA	AL12391494RE	VILA CORUMBA	30/11/2019 12:35	30/11/2019 18:40	30/11/2019 12:35	30/11/2019 18:40	6,08	16	97,23	CHI
201911363116	ITAPIRAPUA	IU12016406	MATRINCHA	30/11/2019 13:05	30/11/2019 14:56	30/11/2019 13:05	30/11/2019 14:56	1,85	12	22,22	CHI
201911363117	HIDROLANDIA	HD21000274	CEPAIGO S2	30/11/2019 13:05	30/11/2019 17:29	30/11/2019 13:05	30/11/2019 17:29	4,40	1	4,40	CHI
201911363118	TRINDADE	16931932	GOYA S2	30/11/2019 13:05	30/11/2019 21:54	30/11/2019 13:05	30/11/2019 21:54	8,82	1	8,82	CHI
201911363123	SANTO ANTONIO DE GOIAS	GR12002133	NEROPOLIS S1	30/11/2019 13:06	30/11/2019 18:57	30/11/2019 13:06	30/11/2019 18:57	5,85	3	17,54	CHI
201911363126	APARECIDA DE GOIANIA	16376778	INDEPENDENCIA S2	30/11/2019 13:06	30/11/2019 14:42	30/11/2019 13:06	30/11/2019 14:42	1,58	0	0,00	CHI
201911363133	FORMOSA	610319504	ITUIQUIRA	30/11/2019 13:08	30/11/2019 17:00	30/11/2019 13:08	30/11/2019 17:00	3,87	1	3,87	CHI
201911363134	SANTA TEREZINHA DE GOIAS	SG12181455	SANTA TEREZINHA	30/11/2019 12:52	02/12/2019 12:00	30/11/2019 12:52	02/12/2019 12:00	47,12	17	801,10	CHI
201911363135	VILA PROPICIO	NP21284925	GOIANESIA S1	30/11/2019 13:09	02/12/2019 02:44	30/11/2019 13:09	02/12/2019 02:44	37,58	1	37,58	CHI
201911363138	MINEIROS	MY11348110	PARQUE DAS EMAS	30/11/2019 13:09	30/11/2019 15:47	30/11/2019 13:09	30/11/2019 15:47	2,62	1	2,62	CHI
201911363145	BALIZA	BH12060671	BOM JARDIM	30/11/2019 13:10	30/11/2019 18:28	30/11/2019 13:10	30/11/2019 18:28	5,30	6	31,83	CHI
201911363152	PIRACANJUBA	PJ21000039	CALDAS NOVAS S1	30/11/2019 13:13	30/11/2019 15:35	30/11/2019 13:13	30/11/2019 15:35	2,36	1	2,36	CHI
201911363158	CAMPINORTE	CR12285376	CAMPINORTE	30/11/2019 12:46	30/11/2019 20:58	30/11/2019 12:46	30/11/2019 20:58	8,19	6	49,14	CHI
201911363159	PORANGATU	PO12256448	NOVO PLANALTO	30/11/2019 09:57	30/11/2019 23:57	30/11/2019 09:57	30/11/2019 23:57	13,99	8	111,95	CHI
201911363166	TURVANIA	TV12259071	FIRMINOPOLIS S2	30/11/2019 13:17	30/11/2019 15:08	30/11/2019 13:17	30/11/2019 15:08	1,86	6	11,14	CHI
201911363169	CHAPADAO DO CEU	DJ12164750	CHAPADAO DO CEU	30/11/2019 13:17	30/11/2019 15:06	30/11/2019 13:17	30/11/2019 15:06	1,82	38	69,23	CHI
201911363176	PIRENOPOLIS	PV21000016	CORUMBA	30/11/2019 13:18	01/12/2019 17:20	30/11/2019 13:18	01/12/2019 17:20	28,03	2	56,05	CHI
201911363180	SAO JOAO D ALIANCA	JL12117446	SAO JOAO D ALIANCA	30/11/2019 13:18	30/11/2019 16:29	30/11/2019 13:18	30/11/2019 16:29	3,17	25	79,29	CHI
201911363180	AGUA FRIA DE GOIAS	JL12117446	SAO JOAO D ALIANCA	30/11/2019 13:18	30/11/2019 16:29	30/11/2019 13:18	30/11/2019 16:29	3,17	19	60,26	CHI
201911363184	ARACU	AV12272362	ANICUNS	30/11/2019 13:20	30/11/2019 14:27	30/11/2019 13:20	30/11/2019 14:27	1,12	4	4,47	CHI
201911363184	ITABERAI	AV12272362	ANICUNS	30/11/2019 13:20	30/11/2019 14:27	30/11/2019 13:20	30/11/2019 14:27	1,12	17	19,00	CHI
201911363185	URUACU	UC12237456	MARA ROSA	30/11/2019 10:56	01/12/2019 10:59	30/11/2019 10:56	01/12/2019 10:59	24,04	5	120,20	CHI
201911363185	CAMPINACU	UC12237456	MARA ROSA	30/11/2019 10:56	01/12/2019 10:59	30/11/2019 10:56	01/12/2019 10:59	24,04	7	168,27	CHI

201911363188	CROMINIA	520008212	PONTALINA	30/11/2019 13:20	01/12/2019 10:27	30/11/2019 13:20	01/12/2019 10:27	21,12	1	21,12	CHI
201911363189	MOSSAMEDES	MD11274191	FIRMINOPOLIS S2	30/11/2019 12:42	30/11/2019 19:11	30/11/2019 12:42	30/11/2019 19:11	6,47	86	556,54	CHI
201911363193	NIQUELANDIA	NQ12316271	BARRO ALTO	30/11/2019 13:21	30/11/2019 20:23	30/11/2019 13:21	30/11/2019 20:23	7,03	3	21,09	CHI
201911363196	APORE	00100414	ITAJA S1	30/11/2019 13:20	01/12/2019 15:47	30/11/2019 13:20	30/11/2019 15:19	1,99	5	9,94	CHI
201911363196	SERRANOPOLIS	AE13311589	ITAJA S1	30/11/2019 13:20	01/12/2019 15:47	30/11/2019 13:20	30/11/2019 16:29	3,15	44	138,49	CHI
201911363196	APORE	AE13311589	ITAJA S1	30/11/2019 13:20	01/12/2019 15:47	30/11/2019 13:20	30/11/2019 16:29	3,15	92	289,57	CHI
201911363196	APORE	00100414	ITAJA S1	30/11/2019 13:20	01/12/2019 15:47	30/11/2019 15:20	30/11/2019 16:53	1,56	1	1,56	CHI
201911363196	APORE	00100414	ITAJA S1	30/11/2019 13:20	01/12/2019 15:47	30/11/2019 20:33	30/11/2019 20:38	0,09	1	0,09	CHI
201911363196	APORE	AE13311580	ITAJA S1	30/11/2019 13:20	01/12/2019 15:47	30/11/2019 15:20	01/12/2019 08:55	17,57	2	35,15	CHI
201911363196	APORE	AE13311580	ITAJA S1	30/11/2019 13:20	01/12/2019 15:47	30/11/2019 15:20	01/12/2019 09:45	18,42	1	18,42	CHI
201911363196	APORE	AE13311582	ITAJA S1	30/11/2019 13:20	01/12/2019 15:47	30/11/2019 13:20	01/12/2019 10:35	21,24	2	42,49	CHI
201911363196	APORE	AE13311582	ITAJA S1	30/11/2019 13:20	01/12/2019 15:47	30/11/2019 15:20	01/12/2019 10:35	19,24	1	19,24	CHI
201911363196	SERRANOPOLIS	AE13254716	ITAJA S1	30/11/2019 13:20	01/12/2019 15:47	01/12/2019 15:35	01/12/2019 15:47	0,20	46	9,20	CHI
201911363196	APORE	AE13254716	ITAJA S1	30/11/2019 13:20	01/12/2019 15:47	01/12/2019 15:35	01/12/2019 15:47	0,20	91	18,20	CHI
201911363203	GOIATUBA	140055990	GOIATUBA S2	30/11/2019 13:23	01/12/2019 09:52	30/11/2019 13:23	01/12/2019 09:52	20,49	1	20,49	CHI
201911363205	ARAGOIANIA	HD12000186	CEPAIGO S2	30/11/2019 13:23	30/11/2019 18:00	30/11/2019 13:23	30/11/2019 18:00	4,61	13	59,91	CHI
201911363205	HIDROLANDIA	HD12000186	CEPAIGO S2	30/11/2019 13:23	30/11/2019 18:00	30/11/2019 13:23	30/11/2019 18:00	4,61	10	46,08	CHI
201911363206	PARANAIGUARA	PC12295754	CACHOEIRA ALTA	30/11/2019 13:23	01/12/2019 09:25	30/11/2019 13:23	01/12/2019 09:25	20,02	3	60,06	CHI
201911363207	SAO MIGUEL DO ARAGUAIA	SM21282205	SAO MIGUEL DO ARAGUAIA	30/11/2019 13:23	30/11/2019 20:59	30/11/2019 13:23	30/11/2019 20:59	7,59	1	7,59	CHI
201911363212	CALDAS NOVAS	760006982	SERRA DE CALDAS	30/11/2019 13:24	30/11/2019 16:47	30/11/2019 13:24	30/11/2019 16:47	3,39	1	3,39	CHI
201911363218	URUACU	UR12325208	URUACU	30/11/2019 13:25	01/12/2019 13:07	30/11/2019 13:25	01/12/2019 13:07	23,70	2	47,39	CHI
201911363219	SANTA HELENA DE GOIAS	SH21301724	ACREUNA	30/11/2019 13:25	30/11/2019 15:07	30/11/2019 13:25	30/11/2019 15:07	1,69	3	5,08	CHI
201911363222	ANAPOLIS	AN12351048	JUNDIAI S1	30/11/2019 12:20	30/11/2019 16:46	30/11/2019 12:20	30/11/2019 16:46	4,43	17	75,28	CHI
201911363223	URUACU	UR12056774	URUACU	30/11/2019 13:10	30/11/2019 14:32	30/11/2019 13:10	30/11/2019 14:32	1,37	284	387,74	CHI
201911363225	NOVA CRIXAS	05630224	NOVA CRIXAS	30/11/2019 13:25	30/11/2019 21:06	30/11/2019 13:25	30/11/2019 14:30	1,10	29	31,81	CHI
201911363225	NOVA CRIXAS	NA13294704	NOVA CRIXAS	30/11/2019 13:25	30/11/2019 21:06	30/11/2019 13:25	30/11/2019 15:40	2,25	6	13,49	CHI
201911363225	NOVA CRIXAS	NA13073596	NOVA CRIXAS	30/11/2019 13:25	30/11/2019 21:06	30/11/2019 13:25	30/11/2019 21:06	7,68	3	23,04	CHI
201911363235	GOIANIA	14334306	CARAJAS S2	30/11/2019 13:28	30/11/2019 16:56	30/11/2019 13:28	30/11/2019 16:56	3,46	1	3,46	CHI
201911363238	SANTO ANTONIO DO DESCOBERTO	SN21308908	ALEXANIA	30/11/2019 13:28	01/12/2019 10:33	30/11/2019 13:28	01/12/2019 10:33	21,07	1	21,07	CHI
201911363240	GOIAS	IU12060536	MATRINCHA	30/11/2019 12:30	30/11/2019 16:00	30/11/2019 12:30	30/11/2019 16:00	3,51	1	3,51	CHI
201911363240	ITAPIRAPUA	IU12060536	MATRINCHA	30/11/2019 12:30	30/11/2019 16:00	30/11/2019 12:30	30/11/2019 16:00	3,51	16	56,19	CHI
201911363241	PLANALTINA	PI12049937	PLANALTINA	30/11/2019 13:00	30/11/2019 15:23	30/11/2019 13:00	30/11/2019 15:23	2,38	281	668,70	CHI
201911363242	GOIATUBA	GT12000051LD	GOIATUBA S2	30/11/2019 13:23	30/11/2019 18:52	30/11/2019 13:23	30/11/2019 18:52	5,48	1254	6875,40	CHI

201911363242	GOIATUBA	GT12000051LD	GOIATUBA S1	30/11/2019 13:23	30/11/2019 18:52	30/11/2019 13:23	30/11/2019 18:52	5,48	5	27,41	CHI
201911363247	PLANALTINA	00070214	PADRE BERNARDO	30/11/2019 13:19	30/11/2019 15:48	30/11/2019 13:19	30/11/2019 15:48	2,49	65	162,03	CHI
201911363247	PADRE BERNARDO	00070214	PADRE BERNARDO	30/11/2019 13:19	30/11/2019 15:48	30/11/2019 13:19	30/11/2019 15:48	2,49	1352	3370,24	CHI
201911363251	CALDAS NOVAS	CN12200060RE	CALDAS NOVAS S2	30/11/2019 13:27	30/11/2019 15:33	30/11/2019 13:27	30/11/2019 15:33	2,09	120	251,13	CHI
201911363251	PIRACANJUBA	CN12200060RE	CALDAS NOVAS S2	30/11/2019 13:27	30/11/2019 15:33	30/11/2019 13:27	30/11/2019 15:33	2,09	1	2,09	CHI
201911363253	DOVERLANDIA	DV12212846	CAIAPONIA	30/11/2019 13:15	30/11/2019 15:12	30/11/2019 13:15	30/11/2019 15:12	1,95	22	42,88	CHI
201911363256	GOIATUBA	140126247	GOIATUBA S2	30/11/2019 13:32	01/12/2019 09:00	30/11/2019 13:32	01/12/2019 09:00	19,47	1	19,47	CHI
201911363259	SANCLERLANDIA	SC12005400	FIRMINOPOLIS S2	30/11/2019 12:57	30/11/2019 14:52	30/11/2019 12:57	30/11/2019 14:52	1,90	42	79,93	CHI
201911363259	SAO LUIS DE MONTES BELOS	SC12005400	FIRMINOPOLIS S2	30/11/2019 12:57	30/11/2019 14:52	30/11/2019 12:57	30/11/2019 14:52	1,90	2	3,81	CHI
201911363260	JATAI	JT12104620	JATAI S1	30/11/2019 13:32	30/11/2019 17:10	30/11/2019 13:32	30/11/2019 17:10	3,63	7	25,38	CHI
201911363262	FORMOSA	FA21233563	ITIQUEIRA	30/11/2019 13:33	01/12/2019 13:17	30/11/2019 13:33	01/12/2019 13:17	23,73	1	23,73	CHI
201911363271	AGUA LIMPA	AL12075701	VILA CORUMBA	30/11/2019 07:15	30/11/2019 17:50	30/11/2019 07:15	30/11/2019 17:50	10,58	5	52,91	CHI
201911363280	JATAI	JT21141708	JATAI S1	30/11/2019 13:35	01/12/2019 12:27	30/11/2019 13:35	01/12/2019 12:27	22,86	1	22,86	CHI
201911363284	MOSSAMEDES	MD21304797	ANICUNS	30/11/2019 13:36	30/11/2019 18:10	30/11/2019 13:36	30/11/2019 18:10	4,57	1	4,57	CHI
201911363285	BARRO ALTO	BA12210736	GOIANESIA S1	30/11/2019 13:37	02/12/2019 14:15	30/11/2019 13:37	02/12/2019 14:15	48,63	20	972,65	CHI
201911363286	ITABERAI	IB12220379	ITABERAI S1	30/11/2019 13:33	30/11/2019 16:30	30/11/2019 13:33	30/11/2019 16:30	2,94	146	428,83	CHI
201911363289	MORRINHOS	MR21120711	MORRINHOS	30/11/2019 13:37	30/11/2019 15:47	30/11/2019 13:37	30/11/2019 15:47	2,16	1	2,16	CHI
201911363290	TRINDADE	TR12266490	TRINDADE	30/11/2019 11:55	30/11/2019 15:58	30/11/2019 11:55	30/11/2019 15:58	4,04	185	746,53	CHI
201911363291	FAZENDA NOVA	1080027704	IPORA	30/11/2019 13:37	30/11/2019 16:58	30/11/2019 13:37	30/11/2019 16:58	3,35	1	3,35	CHI
201911363294	HIDROLANDIA	HD12007423	CEPAIGO S2	30/11/2019 12:33	30/11/2019 16:08	30/11/2019 12:33	30/11/2019 16:08	3,58	4	14,30	CHI
201911363295	ORIZONA	01880214	PIRES DO RIO S2	30/11/2019 13:34	30/11/2019 22:06	30/11/2019 13:34	30/11/2019 14:35	1,01	429	431,86	CHI
201911363295	SAO MIGUEL DO PASSA QUATRO	01880214	PIRES DO RIO S2	30/11/2019 13:34	30/11/2019 22:06	30/11/2019 13:34	30/11/2019 22:06	8,52	2	17,05	CHI
201911363295	PIRES DO RIO	01880214	PIRES DO RIO S2	30/11/2019 13:34	30/11/2019 22:06	30/11/2019 13:34	30/11/2019 22:06	8,52	77	656,38	CHI
201911363295	ORIZONA	01880214	PIRES DO RIO S2	30/11/2019 13:34	30/11/2019 22:06	30/11/2019 13:34	30/11/2019 22:06	8,52	508	4330,42	CHI
201911363295	VIANOPOLIS	01880214	PIRES DO RIO S2	30/11/2019 13:34	30/11/2019 22:06	30/11/2019 13:34	30/11/2019 22:06	8,52	79	673,43	CHI
201911363299	PILAR DE GOIAS	GG12320964	URUACU	30/11/2019 13:38	01/12/2019 01:16	30/11/2019 13:38	01/12/2019 01:16	11,62	7	81,32	CHI
201911363302	ITABERAI	IB12210550	ITABERAI S1	30/11/2019 13:39	30/11/2019 15:08	30/11/2019 13:39	30/11/2019 15:08	1,48	4	5,92	CHI
201911363306	NOVO GAMA	2460188736	PACAEMBU S1	30/11/2019 13:39	30/11/2019 15:04	30/11/2019 13:39	30/11/2019 15:04	1,40	1	1,40	CHI
201911363310	CORUMBA DE GOIAS	CB12146615	CORUMBA	30/11/2019 08:43	01/12/2019 13:58	30/11/2019 08:43	01/12/2019 13:58	29,25	38	1111,42	CHI
201911363311	CAMPINORTE	CR12093167	CAMPINORTE	30/11/2019 12:38	30/11/2019 20:00	30/11/2019 12:38	30/11/2019 20:00	7,36	26	191,48	CHI
201911363311	NOVA IGUACU DE GOIAS	CR12093167	CAMPINORTE	30/11/2019 12:38	30/11/2019 20:00	30/11/2019 12:38	30/11/2019 20:00	7,36	4	29,46	CHI
201911363312	CAMPINACU	UC12055175	PORANGATU	30/11/2019 13:39	30/11/2019 15:17	30/11/2019 13:39	30/11/2019 15:17	1,63	17	27,71	CHI
201911363315	URUACU	UR12003416	URUACU	30/11/2019 13:40	01/12/2019 07:46	30/11/2019 13:40	01/12/2019 07:46	18,08	1	18,08	CHI

201911363328	CORUMBAIBA	CI11117136	VILA CORUMBA	30/11/2019 13:43	01/12/2019 16:20	30/11/2019 13:43	01/12/2019 16:20	26,62	19	505,81	CHI
201911363329	JATAI	290301348	JATAI S1	30/11/2019 13:44	01/12/2019 11:01	30/11/2019 13:44	01/12/2019 11:01	21,29	1	21,29	CHI
201911363333	ITAGUARU	II12300111	ITABERAI S1	30/11/2019 13:44	01/12/2019 20:27	30/11/2019 13:44	01/12/2019 20:27	30,71	1	30,71	CHI
201911363333	ITAGUARI	II12300111	ITABERAI S1	30/11/2019 13:44	01/12/2019 20:27	30/11/2019 13:44	01/12/2019 20:27	30,71	8	245,65	CHI
201911363333	ITAGUARI	II12300111	ITABERAI S1	30/11/2019 13:44	01/12/2019 20:27	01/12/2019 17:55	01/12/2019 20:27	2,53	15	37,91	CHI
201911363334	VIANOPOLIS	VN12282733	VIANOPOLIS	30/11/2019 13:43	30/11/2019 15:27	30/11/2019 13:43	30/11/2019 15:27	1,74	11	19,14	CHI
201911363335	MINACU	IH12230510	MINACU	30/11/2019 13:44	01/12/2019 00:27	30/11/2019 13:44	01/12/2019 00:27	10,71	1	10,71	CHI
201911363337	RUBIATABA	RB21000009	RUBIATABA	30/11/2019 13:44	02/12/2019 21:55	30/11/2019 13:44	02/12/2019 21:55	56,18	1	56,18	CHI
201911363339	INHUMAS	30027690	INHUMAS S2	30/11/2019 13:45	30/11/2019 16:04	30/11/2019 13:45	30/11/2019 16:04	2,32	1	2,32	CHI
201911363341	ANAPOLIS	20187361	JUNDIAI S2	30/11/2019 13:45	01/12/2019 05:39	30/11/2019 13:45	01/12/2019 05:39	15,89	1	15,89	CHI
201911363342	PLANALTINA	PI11131815	PLANALTINA	30/11/2019 12:38	30/11/2019 14:48	30/11/2019 12:38	30/11/2019 14:48	2,17	193	418,11	CHI
201911363345	SANTA ROSA DE GOIAS	SR21117272	INHUMAS S1	30/11/2019 13:46	30/11/2019 18:55	30/11/2019 13:46	30/11/2019 18:55	5,14	2	10,29	CHI
201911363351	NIQUELANDIA	NQ21348685	BARRO ALTO	30/11/2019 13:47	01/12/2019 03:34	30/11/2019 13:47	01/12/2019 03:34	13,78	1	13,78	CHI
201911363353	VILA PROPICIO	03620214	GOIANESIA S1	30/11/2019 13:38	30/11/2019 17:16	30/11/2019 13:38	30/11/2019 17:06	3,46	538	1861,78	CHI
201911363353	GOIANESIA	03620214	GOIANESIA S1	30/11/2019 13:38	30/11/2019 17:16	30/11/2019 13:38	30/11/2019 17:06	3,46	113	391,04	CHI
201911363353	BARRO ALTO	03620214	GOIANESIA S1	30/11/2019 13:38	30/11/2019 17:16	30/11/2019 13:38	30/11/2019 17:06	3,46	70	242,24	CHI
201911363353	VILA PROPICIO	03620214	GOIANESIA S1	30/11/2019 13:38	30/11/2019 17:16	30/11/2019 13:38	30/11/2019 17:16	3,64	27	98,35	CHI
201911363353	COCALZINHO DE GOIAS	PV13335013	GOIANESIA S1	30/11/2019 13:38	30/11/2019 17:16	30/11/2019 13:38	30/11/2019 17:16	3,64	1	3,64	CHI
201911363353	VILA PROPICIO	PV13335013	GOIANESIA S1	30/11/2019 13:38	30/11/2019 17:16	30/11/2019 13:38	30/11/2019 17:16	3,64	337	1227,52	CHI
201911363353	PADRE BERNARDO	PV13335013	GOIANESIA S1	30/11/2019 13:38	30/11/2019 17:16	30/11/2019 13:38	30/11/2019 17:16	3,64	10	36,43	CHI
201911363355	ORIZONA	OZ21000313	PIRES DO RIO S2	30/11/2019 13:47	30/11/2019 15:41	30/11/2019 13:47	30/11/2019 15:41	1,89	1	1,89	CHI
201911363358	ALEXANIA	AX12211846	ALEXANIA	30/11/2019 12:44	30/11/2019 16:19	30/11/2019 12:44	30/11/2019 16:19	3,57	77	274,65	CHI
201911363361	APARECIDA DE GOIANIA	10001052274	INDEPENDENCIA S1	30/11/2019 13:49	30/11/2019 16:51	30/11/2019 13:49	30/11/2019 16:51	3,02	1	3,02	CHI
201911363363	JATAI	10012256593	JATAI S2	30/11/2019 13:49	30/11/2019 16:09	30/11/2019 13:49	30/11/2019 16:09	2,32	1	2,32	CHI
201911363366	PORANGATU	PO12192255	PORANGATU	30/11/2019 13:35	30/11/2019 19:54	30/11/2019 13:35	30/11/2019 19:54	6,31	59	372,06	CHI
201911363372	DOVERLANDIA	DV12171957	CAIAPONIA	30/11/2019 13:50	30/11/2019 17:15	30/11/2019 13:50	30/11/2019 17:15	3,41	24	81,73	CHI
201911363373	CRIXAS	CX11108001	SERRA DO OURO	30/11/2019 12:39	30/11/2019 16:10	30/11/2019 12:39	30/11/2019 16:10	3,50	191	669,30	CHI
201911363376	SAO JOAO D ALIANCA	JL12262352	SAO JOAO D ALIANCA	30/11/2019 08:08	30/11/2019 22:12	30/11/2019 08:08	30/11/2019 22:12	14,06	107	1503,94	CHI
201911363376	AGUA FRIA DE GOIAS	JL12262352	SAO JOAO D ALIANCA	30/11/2019 08:08	30/11/2019 22:12	30/11/2019 08:08	30/11/2019 22:12	14,06	6	84,33	CHI
201911363381	LUZIANIA	LZ12000543	MARAJOARA	30/11/2019 12:32	30/11/2019 15:37	30/11/2019 12:32	30/11/2019 15:37	3,08	39	119,97	CHI
201911363385	ALEXANIA	AX12071776	ALEXANIA	30/11/2019 12:54	30/11/2019 14:42	30/11/2019 12:54	30/11/2019 14:42	1,79	14	25,05	CHI
201911363389	PADRE BERNARDO	PB13383679B	PADRE BERNARDO	30/11/2019 15:09	30/11/2019 18:48	30/11/2019 15:09	30/11/2019 18:48	3,65	662	2415,93	CHI
201911363389	COCALZINHO DE GOIAS	PB13383679B	PADRE BERNARDO	30/11/2019 15:09	30/11/2019 18:48	30/11/2019 15:09	30/11/2019 18:48	3,65	32	116,78	CHI

201911363389	DISTRITO FEDERAL	PB13383679B	PADRE BERNARDO	30/11/2019 15:09	30/11/2019 18:48	30/11/2019 15:09	30/11/2019 18:48	3,65	3	10,95	CHI
201911363398	PLANALTINA	PI11063082	PLANALTINA	30/11/2019 12:37	30/11/2019 15:52	30/11/2019 12:37	30/11/2019 15:52	3,24	262	849,90	CHI
201911363401	ITUMBIARA	IT12033777	CACHOEIRA DOURADA	30/11/2019 13:56	30/11/2019 17:09	30/11/2019 13:56	30/11/2019 17:09	3,21	13	41,79	CHI
201911363403	POSSE	PS21251260	IACIARA S2	30/11/2019 13:56	30/11/2019 17:40	30/11/2019 13:56	30/11/2019 17:40	3,73	1	3,73	CHI
201911363405	CAMPINACU	UC12236229	PORANGATU	30/11/2019 12:51	01/12/2019 04:20	30/11/2019 12:51	01/12/2019 04:20	15,48	27	417,84	CHI
201911363406	PIRES DO RIO	OZ12017062	PIRES DO RIO S2	30/11/2019 13:57	01/12/2019 09:03	30/11/2019 13:57	01/12/2019 09:03	19,10	1	19,10	CHI
201911363406	ORIZONA	OZ12017062	PIRES DO RIO S2	30/11/2019 13:57	01/12/2019 09:03	30/11/2019 13:57	01/12/2019 09:03	19,10	9	171,87	CHI
201911363408	TRINDADE	TR11381314	TRINDADE	30/11/2019 13:01	30/11/2019 19:20	30/11/2019 13:01	30/11/2019 19:20	6,30	71	447,34	CHI
201911363411	SAO FRANCISCO DE GOIAS	SF12297998	SAO FRANCISCO DE GOIAS	30/11/2019 13:56	30/11/2019 16:35	30/11/2019 13:56	30/11/2019 16:35	2,65	88	233,13	CHI
201911363412	FORMOSA	FA11269944	ITUIQUIRA	30/11/2019 13:58	30/11/2019 21:33	30/11/2019 13:58	30/11/2019 21:33	7,58	1	7,58	CHI
201911363413	ANAPOLIS	AN11000017	ANAPOLIS UNIVERSITARIO S2	30/11/2019 13:58	30/11/2019 14:52	30/11/2019 13:58	30/11/2019 14:52	0,89	138	123,32	CHI
201911363417	CRISTALINA	KR10400684	CRISTALINA S1	30/11/2019 13:55	01/12/2019 10:51	30/11/2019 13:55	30/11/2019 18:45	4,83	66	318,63	CHI
201911363417	IPAMERI	KR10400684	CRISTALINA S1	30/11/2019 13:55	01/12/2019 10:51	30/11/2019 13:55	30/11/2019 18:45	4,83	1	4,83	CHI
201911363417	LUZIANIA	KR10400684	CRISTALINA S1	30/11/2019 13:55	01/12/2019 10:51	30/11/2019 13:55	30/11/2019 18:45	4,83	8	38,62	CHI
201911363417	IPAMERI	KR10370643	CRISTALINA S1	30/11/2019 13:55	01/12/2019 10:51	30/11/2019 18:50	30/11/2019 19:15	0,42	1234	513,14	CHI
201911363417	CRISTALINA	KR10370643	CRISTALINA S1	30/11/2019 13:55	01/12/2019 10:51	30/11/2019 18:50	30/11/2019 19:15	0,42	27	11,23	CHI
201911363417	CRISTALINA	KR10400684	CRISTALINA S1	30/11/2019 13:55	01/12/2019 10:51	30/11/2019 18:50	30/11/2019 19:17	0,44	66	29,28	CHI
201911363417	IPAMERI	KR10400684	CRISTALINA S1	30/11/2019 13:55	01/12/2019 10:51	30/11/2019 18:50	30/11/2019 19:17	0,44	1	0,44	CHI
201911363417	LUZIANIA	KR10400684	CRISTALINA S1	30/11/2019 13:55	01/12/2019 10:51	30/11/2019 18:50	30/11/2019 19:17	0,44	8	3,55	CHI
201911363417	CRISTALINA	KR10370643	CRISTALINA S1	30/11/2019 13:55	01/12/2019 10:51	30/11/2019 21:27	30/11/2019 21:34	0,11	27	3,00	CHI
201911363417	IPAMERI	KR10370643	CRISTALINA S1	30/11/2019 13:55	01/12/2019 10:51	30/11/2019 21:27	30/11/2019 21:34	0,11	1234	137,11	CHI
201911363417	CRISTALINA	KR10400684	CRISTALINA S1	30/11/2019 13:55	01/12/2019 10:51	30/11/2019 19:18	01/12/2019 02:32	7,23	41	296,27	CHI
201911363417	LUZIANIA	KR10400684	CRISTALINA S1	30/11/2019 13:55	01/12/2019 10:51	30/11/2019 19:18	01/12/2019 02:32	7,23	8	57,81	CHI
201911363417	IPAMERI	KR10400684	CRISTALINA S1	30/11/2019 13:55	01/12/2019 10:51	30/11/2019 19:18	01/12/2019 02:32	7,23	1	7,23	CHI
201911363417	CRISTALINA	KR10370643	CRISTALINA S1	30/11/2019 13:55	01/12/2019 10:51	01/12/2019 02:32	01/12/2019 02:42	0,16	27	4,28	CHI
201911363417	IPAMERI	KR10370643	CRISTALINA S1	30/11/2019 13:55	01/12/2019 10:51	01/12/2019 02:32	01/12/2019 02:42	0,16	1236	196,04	CHI
201911363417	CRISTALINA	KR10400684	CRISTALINA S1	30/11/2019 13:55	01/12/2019 10:51	01/12/2019 02:32	01/12/2019 10:39	8,12	40	324,76	CHI
201911363417	IPAMERI	KR10400684	CRISTALINA S1	30/11/2019 13:55	01/12/2019 10:51	01/12/2019 02:32	01/12/2019 10:39	8,12	1	8,12	CHI
201911363417	LUZIANIA	KR10400684	CRISTALINA S1	30/11/2019 13:55	01/12/2019 10:51	01/12/2019 02:32	01/12/2019 10:39	8,12	8	64,95	CHI
201911363417	CRISTALINA	KR10400684	CRISTALINA S1	30/11/2019 13:55	01/12/2019 10:51	30/11/2019 13:55	01/12/2019 10:51	20,93	134	2804,58	CHI
201911363417	LUZIANIA	KR10400684	CRISTALINA S1	30/11/2019 13:55	01/12/2019 10:51	30/11/2019 13:55	01/12/2019 10:51	20,93	29	606,96	CHI
201911363417	CRISTALINA	KR10400684	CRISTALINA S1	30/11/2019 13:55	01/12/2019 10:51	30/11/2019 19:18	01/12/2019 10:51	15,54	25	388,62	CHI
201911363425	PLANALTINA	PI12099216	PLANALTINA	30/11/2019 13:17	30/11/2019 17:57	30/11/2019 13:17	30/11/2019 17:57	4,66	155	722,73	CHI



201911363425	PADRE BERNARDO	PI12099216	PLANALTINA	30/11/2019 13:17	30/11/2019 17:57	30/11/2019 13:17	30/11/2019 17:57	4,66	14	65,28	CHI
201911363428	URUACU	UR21202149	URUACU	30/11/2019 14:00	01/12/2019 12:56	30/11/2019 14:00	01/12/2019 12:56	22,93	2	45,87	CHI
201911363430	PALMEIRAS DE GOIAS	10004949569	PALMEIRAS	30/11/2019 14:00	30/11/2019 16:41	30/11/2019 14:00	30/11/2019 16:41	2,68	1	2,68	CHI
201911363436	CORREGO DO OURO	CO12319967	FIRMINOPOLIS S2	30/11/2019 14:01	01/12/2019 00:31	30/11/2019 14:01	01/12/2019 00:31	10,49	4	41,95	CHI
201911363438	CAIAPONIA	CP12377302	JATAI S1	30/11/2019 14:01	30/11/2019 18:13	30/11/2019 14:01	30/11/2019 18:13	4,19	1	4,19	CHI
201911363440	ORIZONA	OZ12022880RE	PIRES DO RIO S2	30/11/2019 13:28	30/11/2019 18:06	30/11/2019 13:28	30/11/2019 18:06	4,63	58	268,73	CHI
201911363449	FORMOSO	FO12151052	PORANGATU	30/11/2019 14:02	30/11/2019 19:03	30/11/2019 14:02	30/11/2019 19:03	5,00	6	30,02	CHI
201911363453	IPAMERI	IP12095243	IPAMERI	30/11/2019 13:59	30/11/2019 19:30	30/11/2019 13:59	30/11/2019 19:30	5,50	7	38,52	CHI
201911363456	ISRAELANDIA	IS12381080	IPORA	30/11/2019 14:03	30/11/2019 21:51	30/11/2019 14:03	30/11/2019 21:51	7,79	2	15,59	CHI
201911363456	FAZENDA NOVA	IS12381080	IPORA	30/11/2019 14:03	30/11/2019 21:51	30/11/2019 14:03	30/11/2019 21:51	7,79	9	70,14	CHI
201911363458	GOIANIA	GN11291440	INDEPENDENCIA S2	30/11/2019 14:03	30/11/2019 18:31	30/11/2019 14:03	30/11/2019 18:31	4,46	106	472,67	CHI
201911363459	ARAGOIANIA	AO32000019	GUAPU S2	30/11/2019 13:21	30/11/2019 19:51	30/11/2019 13:21	30/11/2019 19:51	6,51	11	71,56	CHI
201911363463	SAO JOAO DA PARAUNA	RP12156223	FIRMINOPOLIS S2	30/11/2019 14:04	30/11/2019 20:50	30/11/2019 14:04	30/11/2019 18:02	3,98	15	59,71	CHI
201911363463	PALMINOPOLIS	RP13259185	FIRMINOPOLIS S2	30/11/2019 14:04	30/11/2019 20:50	30/11/2019 14:04	30/11/2019 20:50	6,77	2	13,54	CHI
201911363463	SAO JOAO DA PARAUNA	RP13259185	FIRMINOPOLIS S2	30/11/2019 14:04	30/11/2019 20:50	30/11/2019 14:04	30/11/2019 20:50	6,77	10	67,69	CHI
201911363464	EDEIA	EA12182675	EDEIA	30/11/2019 13:03	30/11/2019 19:55	30/11/2019 13:03	30/11/2019 19:55	6,86	4	27,46	CHI
201911363471	ITAPURANGA	IK21206798	ITAPURANGA	30/11/2019 14:05	30/11/2019 15:09	30/11/2019 14:05	30/11/2019 15:09	1,07	1	1,07	CHI
201911363480	MINEIROS	MY12114018	PARQUE DAS EMAS	30/11/2019 13:52	30/11/2019 17:40	30/11/2019 13:52	30/11/2019 17:40	3,79	47	178,33	CHI
201911363486	MAIRIPOTABA	PK12079815	PONTALINA	30/11/2019 11:03	30/11/2019 17:35	30/11/2019 11:03	30/11/2019 17:35	6,53	12	78,34	CHI
201911363488	UIRAPURU	UP12392059	SANTA TEREZINHA	30/11/2019 14:06	01/12/2019 16:10	30/11/2019 14:06	01/12/2019 16:10	26,06	3	78,19	CHI
201911363494	ITAPIRAPUA	3270005797	MATRINCHA	30/11/2019 14:06	30/11/2019 17:10	30/11/2019 14:06	30/11/2019 17:10	3,05	1	3,05	CHI
201911363500	TEREZOPOLIS DE GOIAS	TJ12197112	DAIA S2	30/11/2019 14:07	30/11/2019 16:45	30/11/2019 14:07	30/11/2019 16:45	2,62	11	28,87	CHI
201911363510	ANAPOLIS	AN12000089	ANAPOLIS UNIVERSITARIO S2	30/11/2019 13:56	30/11/2019 17:20	30/11/2019 13:56	30/11/2019 17:20	3,40	576	1958,40	CHI
201911363511	ARACU	AR21019621	ARACU	30/11/2019 14:09	30/11/2019 23:13	30/11/2019 14:09	30/11/2019 23:13	9,06	2	18,12	CHI
201911363516	VIANOPOLIS	OZ12084915RE	PIRES DO RIO S2	30/11/2019 07:27	30/11/2019 17:12	30/11/2019 07:27	30/11/2019 17:12	9,74	36	350,65	CHI
201911363516	ORIZONA	OZ12084915RE	PIRES DO RIO S2	30/11/2019 07:27	30/11/2019 17:12	30/11/2019 07:27	30/11/2019 17:12	9,74	3	29,22	CHI
201911363522	CRIXAS	GF12146937	SANTA TEREZINHA	30/11/2019 14:12	01/12/2019 23:20	30/11/2019 14:12	01/12/2019 03:55	13,73	79	1084,36	CHI
201911363522	GUARINOS	GF12146937	SANTA TEREZINHA	30/11/2019 14:12	01/12/2019 23:20	30/11/2019 14:12	01/12/2019 03:55	13,73	12	164,71	CHI
201911363522	GUARINOS	GF12146937	SANTA TEREZINHA	30/11/2019 14:12	01/12/2019 23:20	01/12/2019 03:55	01/12/2019 11:00	7,07	12	84,88	CHI
201911363522	CRIXAS	GF12146937	SANTA TEREZINHA	30/11/2019 14:12	01/12/2019 23:20	01/12/2019 03:55	01/12/2019 11:00	7,07	18	127,32	CHI
201911363522	GUARINOS	GF12146937	SANTA TEREZINHA	30/11/2019 14:12	01/12/2019 23:20	01/12/2019 11:02	01/12/2019 20:30	9,48	12	113,74	CHI
201911363522	CRIXAS	GF12146937	SANTA TEREZINHA	30/11/2019 14:12	01/12/2019 23:20	01/12/2019 11:02	01/12/2019 20:30	9,48	18	170,61	CHI
201911363522	CRIXAS	CX13243677	SANTA TEREZINHA	30/11/2019 14:12	01/12/2019 23:20	01/12/2019 03:55	01/12/2019 21:56	18,02	61	1099,08	CHI

201911363522	CRIXAS	GF12146937	SANTA TEREZINHA	30/11/2019 14:12	01/12/2019 23:20	30/11/2019 14:12	01/12/2019 23:20	33,14	156	5169,84	CHI
201911363532	ANAPOLIS	AN16404273	ANAPOLIS UNIVERSITARIO S2	30/11/2019 13:56	30/11/2019 14:46	30/11/2019 13:56	30/11/2019 14:00	0,08	1914	157,37	CHI
201911363532	ANAPOLIS	00052224	ANAPOLIS UNIVERSITARIO S2	30/11/2019 13:56	30/11/2019 14:46	30/11/2019 13:56	30/11/2019 14:43	0,78	2717	2128,32	CHI
201911363532	ANAPOLIS	AN16407073	ANAPOLIS UNIVERSITARIO S2	30/11/2019 13:56	30/11/2019 14:46	30/11/2019 13:56	30/11/2019 14:46	0,84	8401	7033,50	CHI
201911363534	LUZIANIA	LZ12059634	CRISTALINA S2	30/11/2019 13:59	30/11/2019 18:35	30/11/2019 13:59	30/11/2019 18:35	4,58	17	77,92	CHI
201911363544	ALTO HORIZONTE	03400224	SANTA TEREZINHA	30/11/2019 14:13	01/12/2019 15:49	01/12/2019 15:46	01/12/2019 15:49	0,05	58	3,14	CHI
201911363544	CAMPOS VERDES	03400224	SANTA TEREZINHA	30/11/2019 14:13	01/12/2019 15:49	01/12/2019 15:46	01/12/2019 15:49	0,05	8	0,43	CHI
201911363544	NOVA IGUACU DE GOIAS	03400224	SANTA TEREZINHA	30/11/2019 14:13	01/12/2019 15:49	01/12/2019 15:46	01/12/2019 15:49	0,05	325	17,60	CHI
201911363544	PILAR DE GOIAS	03400224	SANTA TEREZINHA	30/11/2019 14:13	01/12/2019 15:49	01/12/2019 15:46	01/12/2019 15:49	0,05	1	0,05	CHI
201911363552	BARRO ALTO	BA21144531	BARRO ALTO	30/11/2019 14:15	02/12/2019 12:19	30/11/2019 14:15	02/12/2019 12:19	46,05	2	92,11	CHI
201911363561	URUACU	UR12317135	URUACU	30/11/2019 13:32	01/12/2019 03:25	30/11/2019 13:32	01/12/2019 03:25	13,88	11	152,65	CHI
201911363565	BURITINOPOLIS	BQ12149628	IACIARA S2	30/11/2019 12:16	30/11/2019 15:35	30/11/2019 12:16	30/11/2019 15:35	3,32	36	119,34	CHI
201911363570	COCALZINHO DE GOIAS	ZN12084617	AGUAS LINDAS DE GOIAS S2	30/11/2019 14:18	30/11/2019 16:55	30/11/2019 14:18	30/11/2019 16:55	2,62	27	70,64	CHI
201911363574	BARRO ALTO	10015302413	BARRO ALTO	30/11/2019 14:18	30/11/2019 21:52	30/11/2019 14:18	30/11/2019 21:52	7,56	1	7,56	CHI
201911363578	PONTALINA	JV12223261	GOIATUBA S1	30/11/2019 14:20	01/12/2019 18:29	30/11/2019 14:20	01/12/2019 18:29	28,16	2	56,31	CHI
201911363590	AURILANDIA	AI21194098	FIRMINOPOLIS S2	30/11/2019 14:20	30/11/2019 16:53	30/11/2019 14:20	30/11/2019 16:53	2,55	1	2,55	CHI
201911363602	PIRACANJUBA	PJ21182660	MORRINHOS	30/11/2019 14:22	01/12/2019 11:16	30/11/2019 14:22	01/12/2019 11:16	20,89	1	20,89	CHI
201911363605	SANTA HELENA DE GOIAS	SH12295844	IPEGUARI	30/11/2019 14:23	01/12/2019 14:27	30/11/2019 14:23	01/12/2019 14:27	24,06	17	409,03	CHI
201911363606	PORANGATU	PO12028736	PORANGATU	30/11/2019 14:18	30/11/2019 18:20	30/11/2019 14:18	30/11/2019 18:20	4,03	4	16,13	CHI
201911363611	GOIANIA	GN11272079	XAVANTES	30/11/2019 14:24	30/11/2019 17:25	30/11/2019 14:24	30/11/2019 17:25	3,00	24	72,04	CHI
201911363616	GOIANIA	GN11148303	MEIA PONTE	30/11/2019 14:25	30/11/2019 17:09	30/11/2019 14:25	30/11/2019 17:09	2,73	131	357,01	CHI
201911363625	URUACU	UR12201700	URUACU	30/11/2019 14:05	01/12/2019 01:08	30/11/2019 14:05	01/12/2019 01:08	11,04	41	452,54	CHI
201911363628	PIRACANJUBA	PJ12076794	MORRINHOS	30/11/2019 14:27	01/12/2019 15:20	30/11/2019 14:27	01/12/2019 15:20	24,87	3	74,62	CHI
201911363629	LUZIANIA	LZ11373754	MARAJOARA	30/11/2019 14:27	30/11/2019 17:47	30/11/2019 14:27	30/11/2019 17:47	3,32	31	102,95	CHI
201911363633	EDEIA	EA12000039	EDEIA	30/11/2019 14:05	30/11/2019 17:47	30/11/2019 14:05	30/11/2019 17:47	3,70	20	73,92	CHI
201911363635	AGUAS LINDAS DE GOIAS	LA12382901	AGUAS LINDAS DE GOIAS S1	30/11/2019 14:25	30/11/2019 16:33	30/11/2019 14:25	30/11/2019 16:33	2,12	31	65,79	CHI
201911363635	SANTO ANTONIO DO DESCOBERTO	LA12382901	AGUAS LINDAS DE GOIAS S1	30/11/2019 14:25	30/11/2019 16:33	30/11/2019 14:25	30/11/2019 16:33	2,12	1	2,12	CHI
201911363637	VILA PROPICIO	NQ12233554	BARRO ALTO	30/11/2019 14:28	01/12/2019 00:00	30/11/2019 14:28	01/12/2019 00:00	9,52	11	104,71	CHI
201911363637	NIQUELANDIA	NQ12233554	BARRO ALTO	30/11/2019 14:28	01/12/2019 00:00	30/11/2019 14:28	01/12/2019 00:00	9,52	2	19,04	CHI
201911363640	PIRACANJUBA	MR12000241	MORRINHOS	30/11/2019 09:38	02/12/2019 13:29	30/11/2019 09:38	30/11/2019 19:50	10,19	4	40,77	CHI
201911363640	PIRACANJUBA	PJ21153454	MORRINHOS	30/11/2019 09:38	02/12/2019 13:29	30/11/2019 09:38	02/12/2019 13:04	51,44	1	51,44	CHI
201911363640	PIRACANJUBA	PJ21010544	MORRINHOS	30/11/2019 09:38	02/12/2019 13:29	30/11/2019 09:38	02/12/2019 13:29	51,85	1	51,85	CHI
201911363642	BARRO ALTO	BA21181759	BARRO ALTO	30/11/2019 14:29	02/12/2019 15:29	30/11/2019 14:29	02/12/2019 15:29	48,99	1	48,99	CHI

201911363643	GOIATUBA	CL21295998	RIO DOS BOIS	30/11/2019 14:29	01/12/2019 12:00	01/12/2019 11:50	01/12/2019 11:55	0,08	1	0,08	CHI
201911363643	GOIATUBA	CL12295997	RIO DOS BOIS	30/11/2019 14:29	01/12/2019 12:00	30/11/2019 14:29	01/12/2019 12:00	21,51	17	365,74	CHI
201911363643	PORTEIRAO	CL12295997	RIO DOS BOIS	30/11/2019 14:29	01/12/2019 12:00	30/11/2019 14:29	01/12/2019 12:00	21,51	1	21,51	CHI
201911363645	ANAPOLIS	AN11288615	JUNDIAI S2	30/11/2019 14:30	30/11/2019 16:08	30/11/2019 14:30	30/11/2019 16:08	1,63	32	52,12	CHI
201911363648	ARAGOIANIA	AO11159963	GUAPO S2	30/11/2019 13:25	30/11/2019 15:59	30/11/2019 13:25	30/11/2019 15:59	2,56	98	251,37	CHI
201911363649	SANTA RITA DO ARAGUAIA	SU12184124	SANTA RITA DO ARAGUAIA	30/11/2019 14:30	30/11/2019 18:36	30/11/2019 14:30	30/11/2019 18:36	4,09	1	4,09	CHI
201911363659	ARACU	AV12241063	ANICUNS	30/11/2019 14:32	30/11/2019 17:14	30/11/2019 14:32	30/11/2019 17:14	2,70	1	2,70	CHI
201911363659	AVELINOPOLIS	AV12241063	ANICUNS	30/11/2019 14:32	30/11/2019 17:14	30/11/2019 14:32	30/11/2019 17:14	2,70	1	2,70	CHI
201911363661	SANTO ANTONIO DA BARRA	BZ12240570	ACREUNA	30/11/2019 14:32	30/11/2019 17:25	30/11/2019 14:32	30/11/2019 17:25	2,87	4	11,47	CHI
201911363664	SANTA TEREZINHA DE GOIAS	SG21087953	SANTA TEREZINHA	30/11/2019 14:33	01/12/2019 12:15	30/11/2019 14:33	01/12/2019 12:15	21,71	1	21,71	CHI
201911363669	ANAPOLIS	AN11135790	ANAPOLIS UNIVERSITARIO S1	30/11/2019 14:18	30/11/2019 16:36	30/11/2019 14:18	30/11/2019 16:36	2,29	74	169,28	CHI
201911363671	PLANALTINA	PI12218356	PLANALTINA	30/11/2019 13:03	30/11/2019 17:54	30/11/2019 13:03	30/11/2019 17:54	4,85	29	140,53	CHI
201911363674	TROMBAS	TB12202556	PORANGATU	30/11/2019 14:34	02/12/2019 04:52	30/11/2019 14:34	02/12/2019 04:52	38,30	2	76,60	CHI
201911363675	CATALAO	CT12250354	CATALAO S1	30/11/2019 14:34	01/12/2019 12:42	30/11/2019 14:34	01/12/2019 12:42	22,14	8	177,15	CHI
201911363675	CATALAO	CT12250354	CATALAO S1	30/11/2019 14:34	01/12/2019 12:42	01/12/2019 11:01	01/12/2019 12:42	1,68	9	15,15	CHI
201911363680	CEZARINA	CZ12314870	CEZARINA	30/11/2019 14:04	30/11/2019 16:12	30/11/2019 14:04	30/11/2019 16:12	2,13	22	46,86	CHI
201911363683	PORANGATU	PO12363572	PORANGATU	30/11/2019 11:39	01/12/2019 19:13	30/11/2019 11:39	01/12/2019 19:13	31,56	9	284,05	CHI
201911363684	PIRENOPOLIS	PV21297609	CORUMBA	30/11/2019 14:35	01/12/2019 21:11	30/11/2019 14:35	01/12/2019 21:11	30,59	1	30,59	CHI
201911363685	ITAPIRAPUA	IU21137834	MATRINCHA	30/11/2019 14:36	30/11/2019 16:25	30/11/2019 14:36	30/11/2019 16:25	1,82	1	1,82	CHI
201911363696	VALPARAISO DE GOIAS	2860179179	PACAEMBU S1	30/11/2019 14:39	01/12/2019 18:34	30/11/2019 14:39	01/12/2019 18:34	27,91	1	27,91	CHI
201911363701	UIRAPURU	UP12181272	SANTA TEREZINHA	30/11/2019 10:27	30/11/2019 21:21	30/11/2019 10:27	30/11/2019 21:21	10,90	5	54,48	CHI
201911363715	ANAPOLIS	10001339743	JUNDIAI S2	30/11/2019 14:41	30/11/2019 16:54	30/11/2019 14:41	30/11/2019 16:54	2,20	1	2,20	CHI
201911363718	SAO JOAO D ALIANCA	JL12106845	SAO JOAO D ALIANCA	30/11/2019 14:42	01/12/2019 00:45	30/11/2019 14:42	01/12/2019 00:45	10,04	15	150,65	CHI
201911363719	ORIZONA	OZ21022894	PIRES DO RIO S2	30/11/2019 14:42	01/12/2019 10:57	30/11/2019 14:42	01/12/2019 10:57	20,24	2	40,49	CHI
201911363722	CEZARINA	10007278673	CEZARINA	30/11/2019 14:42	30/11/2019 23:39	30/11/2019 14:42	30/11/2019 23:39	8,93	1	8,93	CHI
201911363724	ANAPOLIS	21377121	ANAPOLIS UNIVERSITARIO S1	30/11/2019 14:43	01/12/2019 02:45	30/11/2019 14:43	01/12/2019 02:45	12,04	1	12,04	CHI
201911363732	MAIRIPOTABA	MI12000430	PONTALINA	30/11/2019 14:44	01/12/2019 10:59	30/11/2019 14:44	01/12/2019 10:59	20,24	4	80,94	CHI
201911363739	URUACU	UR12232450	URUACU	30/11/2019 14:27	01/12/2019 12:42	30/11/2019 14:27	01/12/2019 12:42	22,24	8	177,95	CHI
201911363741	RIO VERDE	RV12260129	CABRIUVA S1	30/11/2019 14:46	30/11/2019 17:55	30/11/2019 14:46	30/11/2019 17:55	3,15	2	6,30	CHI
201911363743	RIO VERDE	630511913	RIO VERDE S1	30/11/2019 14:46	30/11/2019 17:15	30/11/2019 14:46	30/11/2019 17:15	2,48	1	2,48	CHI
201911363744	ORIZONA	OZ12114517	PIRES DO RIO S2	30/11/2019 14:33	30/11/2019 23:08	30/11/2019 14:33	30/11/2019 23:08	8,58	23	197,29	CHI
201911363745	OUVIDOR	OU21061206	CATALAO S1	30/11/2019 14:46	30/11/2019 17:26	30/11/2019 14:46	30/11/2019 17:26	2,66	1	2,66	CHI
201911363747	GAMELEIRA DE GOIAS	SV12278872	DAIA S2	30/11/2019 14:16	30/11/2019 17:37	30/11/2019 14:16	30/11/2019 17:37	3,35	38	127,34	CHI

201911363756	GOIANAPOLIS	GP11180129	DAIA S2	30/11/2019 12:35	30/11/2019 15:58	30/11/2019 12:35	30/11/2019 15:58	3,38	87	294,33	CHI
201911363762	LUZIANIA	LZ21128852	MARAJOARA	30/11/2019 14:50	30/11/2019 16:55	30/11/2019 14:50	30/11/2019 16:55	2,08	1	2,08	CHI
201911363769	CATALAO	CT12149194	CATALAO S1	30/11/2019 13:47	30/11/2019 18:23	30/11/2019 13:47	30/11/2019 18:23	4,60	7	32,20	CHI
201911363770	PIRES DO RIO	PR21153246	PIRES DO RIO S1	30/11/2019 14:10	30/11/2019 22:54	30/11/2019 14:10	30/11/2019 22:54	8,73	2	17,46	CHI
201911363778	GUARINOS	SG12000052	SANTA TEREZINHA	30/11/2019 12:31	30/11/2019 22:00	30/11/2019 12:31	30/11/2019 22:00	9,49	263	2495,43	CHI
201911363778	SANTA TEREZINHA DE GOIAS	SG12000052	SANTA TEREZINHA	30/11/2019 12:31	30/11/2019 22:00	30/11/2019 12:31	30/11/2019 22:00	9,49	5	47,44	CHI
201911363778	CRIXAS	SG12000052	SANTA TEREZINHA	30/11/2019 12:31	30/11/2019 22:00	30/11/2019 12:31	30/11/2019 22:00	9,49	13	123,35	CHI
201911363781	ITAPURANGA	IK12299882	ITAPURANGA	30/11/2019 14:53	30/11/2019 18:04	30/11/2019 14:53	30/11/2019 18:04	3,18	10	31,77	CHI
201911363782	IPORA	IR12259868	ARENOPOLIS	30/11/2019 14:53	30/11/2019 16:43	30/11/2019 14:53	30/11/2019 16:43	1,83	15	27,40	CHI
201911363784	MINEIROS	MY11217018	PARQUE DAS EMAS	30/11/2019 14:53	30/11/2019 16:37	30/11/2019 14:53	30/11/2019 16:37	1,72	121	208,22	CHI
201911363785	CRISTALINA	KR11170511	CRISTALINA S2	30/11/2019 14:53	01/12/2019 11:12	30/11/2019 14:53	01/12/2019 11:12	20,30	1	20,30	CHI
201911363786	ANAPOLIS	2100001353	JUNDIAI S1	30/11/2019 14:53	30/11/2019 16:40	30/11/2019 14:53	30/11/2019 16:40	1,77	1	1,77	CHI
201911363790	JATAI	290046865	JATAI S2	30/11/2019 14:55	01/12/2019 13:48	30/11/2019 14:55	01/12/2019 13:48	22,88	1	22,88	CHI
201911363794	CATALAO	CT12229928	CATALAO S2	30/11/2019 14:56	01/12/2019 10:34	30/11/2019 14:56	01/12/2019 10:34	19,63	1	19,63	CHI
201911363800	RIO VERDE	RV12159300	CABRIUVA S2	30/11/2019 14:56	30/11/2019 19:10	30/11/2019 14:56	30/11/2019 19:10	4,22	11	46,40	CHI
201911363801	VALPARAISO DE GOIAS	2860307420	PACAEMBU S2	30/11/2019 14:56	30/11/2019 22:27	30/11/2019 14:56	30/11/2019 22:27	7,50	1	7,50	CHI
201911363803	PIRENOPOLIS	PV12244370	COCALZINHO	30/11/2019 14:57	01/12/2019 15:14	30/11/2019 14:57	01/12/2019 15:14	24,28	12	291,39	CHI
201911363805	CRIXAS	CX12236026	SERRA DO OURO	30/11/2019 14:57	30/11/2019 19:40	30/11/2019 14:57	30/11/2019 19:40	4,71	7	32,95	CHI
201911363806	ANAPOLIS	AN11072062	ANAPOLIS UNIVERSITARIO S2	30/11/2019 14:05	30/11/2019 17:31	30/11/2019 14:05	30/11/2019 17:31	3,43	46	157,72	CHI
201911363815	CATALAO	CT21063865	CATALAO S1	30/11/2019 14:59	01/12/2019 10:48	30/11/2019 14:59	01/12/2019 10:48	19,82	1	19,82	CHI
201911363816	SANTA TEREZINHA DE GOIAS	SG12237481	SANTA TEREZINHA	30/11/2019 14:41	01/12/2019 01:52	30/11/2019 14:41	01/12/2019 01:52	11,17	14	156,39	CHI
201911363819	GOIANESIA	GE21317817	GOIANESIA S2	30/11/2019 14:59	01/12/2019 12:52	30/11/2019 14:59	01/12/2019 12:52	21,87	1	21,87	CHI
201911363823	MORRINHOS	MR21288146	MORRINHOS	30/11/2019 15:00	30/11/2019 18:30	30/11/2019 15:00	30/11/2019 18:30	3,50	2	7,00	CHI
201911363824	GOIATUBA	GT21315860	GOIATUBA S1	30/11/2019 15:01	30/11/2019 17:28	30/11/2019 15:01	30/11/2019 17:28	2,44	1	2,44	CHI
201911363826	CAIAPONIA	CP12160847	PALESTINA	30/11/2019 14:15	30/11/2019 18:01	30/11/2019 14:15	30/11/2019 18:01	3,75	26	97,51	CHI
201911363828	PORANGATU	PO12265821	PORANGATU	30/11/2019 15:01	01/12/2019 11:14	30/11/2019 15:01	01/12/2019 11:14	20,20	5	101,02	CHI
201911363834	SAO LUIS DE MONTES BELOS	SL21019517	SAO LUIZ DOS MONTES BELOS	30/11/2019 15:02	30/11/2019 17:46	30/11/2019 15:02	30/11/2019 17:46	2,74	1	2,74	CHI
201911363844	ABADIANIA	AN10396190	ANAPOLIS UNIVERSITARIO S2	30/11/2019 14:48	30/11/2019 21:18	30/11/2019 14:48	30/11/2019 21:18	6,50	95	617,34	CHI
201911363844	ANAPOLIS	AN10396190	ANAPOLIS UNIVERSITARIO S2	30/11/2019 14:48	30/11/2019 21:18	30/11/2019 14:48	30/11/2019 21:18	6,50	405	2631,83	CHI
201911363844	ANAPOLIS	AN10396190	ANAPOLIS UNIVERSITARIO S2	30/11/2019 14:48	30/11/2019 21:18	30/11/2019 21:09	30/11/2019 21:18	0,16	577	90,72	CHI
201911363848	PALMEIRAS DE GOIAS	PL11276916	PALMEIRAS	30/11/2019 15:03	30/11/2019 17:13	30/11/2019 15:03	30/11/2019 17:13	2,17	1	2,17	CHI
201911363849	SANTA TEREZINHA DE GOIAS	SG11034165	SANTA TEREZINHA	30/11/2019 14:27	01/12/2019 12:20	30/11/2019 14:27	01/12/2019 12:20	21,87	195	4264,22	CHI
201911363850	SERRANOPOLIS	SX12296514	JATAI S1	30/11/2019 14:28	30/11/2019 18:38	30/11/2019 14:28	30/11/2019 18:38	4,16	23	95,65	CHI

201911363853	VILA PROPICIO	NP21235760	GOIANESIA S1	30/11/2019 15:03	02/12/2019 13:10	30/11/2019 15:03	02/12/2019 13:10	46,11	1	46,11	CHI
201911363858	JARAGUA	JA12038937	ITABERAI S1	30/11/2019 15:04	30/11/2019 20:13	30/11/2019 15:04	30/11/2019 20:13	5,13	6	30,81	CHI
201911363858	ITAGUARU	JA12038937	ITABERAI S1	30/11/2019 15:04	30/11/2019 20:13	30/11/2019 15:04	30/11/2019 20:13	5,13	1	5,13	CHI
201911363858	ITAGUARI	JA12038937	ITABERAI S1	30/11/2019 15:04	30/11/2019 20:13	30/11/2019 15:04	30/11/2019 20:13	5,13	3	15,40	CHI
201911363862	BOM JESUS DE GOIAS	1250047368	BOM JESUS DE GOIAS	30/11/2019 15:05	30/11/2019 18:45	30/11/2019 15:05	30/11/2019 18:45	3,66	1	3,66	CHI
201911363863	MORRINHOS	MR11223398	MORRINHOS	30/11/2019 15:05	30/11/2019 17:02	30/11/2019 15:05	30/11/2019 17:02	1,94	124	240,73	CHI
201911363865	ANAPOLIS	AN21297729	ANAPOLIS UNIVERSITARIO S1	30/11/2019 15:06	30/11/2019 18:02	30/11/2019 15:06	30/11/2019 18:02	2,93	1	2,93	CHI
201911363870	GOIAS	GS21203876	ITABERAI S2	30/11/2019 15:07	30/11/2019 17:14	30/11/2019 15:07	30/11/2019 17:14	2,13	3	6,39	CHI
201911363878	MONTIVIDIU DO NORTE	MX12203423	PORANGATU	30/11/2019 15:07	01/12/2019 21:59	30/11/2019 15:07	01/12/2019 21:59	30,87	16	493,87	CHI
201911363880	RIO VERDE	RV21024220	RIO VERDE S1	30/11/2019 15:08	30/11/2019 18:36	30/11/2019 15:08	30/11/2019 18:36	3,46	2	6,91	CHI
201911363882	RIO VERDE	RV12123367	RIO VERDE S1	30/11/2019 15:09	30/11/2019 16:02	30/11/2019 15:09	30/11/2019 16:02	0,89	67	59,33	CHI
201911363893	GOIANESIA	GE12376533	GOIANESIA S1	30/11/2019 07:05	01/12/2019 00:13	30/11/2019 07:05	01/12/2019 00:13	17,13	88	1507,05	CHI
201911363895	ACREUNA	TD12301229	RIO DOS BOIS	30/11/2019 15:05	30/11/2019 21:09	30/11/2019 15:05	30/11/2019 21:09	6,07	5	30,33	CHI
201911363902	BALIZA	BH21361729	BOM JARDIM	30/11/2019 15:13	30/11/2019 18:16	30/11/2019 15:13	30/11/2019 18:16	3,05	1	3,05	CHI
201911363903	OUVIDOR	OU12077703	CATALAO S1	30/11/2019 15:13	30/11/2019 22:09	30/11/2019 15:13	30/11/2019 22:09	6,93	24	166,32	CHI
201911363907	SANTA TEREZINHA DE GOIAS	SG12213220	SANTA TEREZINHA	30/11/2019 13:37	30/11/2019 23:20	30/11/2019 13:37	30/11/2019 23:20	9,71	47	456,58	CHI
201911363912	QUIRINOPOLIS	QI21203844	QUIRINOPOLIS	30/11/2019 15:14	01/12/2019 20:24	30/11/2019 15:14	01/12/2019 20:24	29,16	1	29,16	CHI
201911363921	CRISTALINA	KR12133610	CRISTALINA S2	30/11/2019 15:16	01/12/2019 11:10	30/11/2019 15:16	01/12/2019 11:10	19,89	12	238,64	CHI
201911363924	GAMELEIRA DE GOIAS	AN12312044	JUNDIAI S1	30/11/2019 14:20	30/11/2019 17:31	30/11/2019 14:20	30/11/2019 17:31	3,17	15	47,54	CHI
201911363924	ANAPOLIS	AN12312044	JUNDIAI S1	30/11/2019 14:20	30/11/2019 17:31	30/11/2019 14:20	30/11/2019 17:31	3,17	18	57,05	CHI
201911363929	SERRANOPOLIS	SX12296496	JATAI S1	30/11/2019 13:59	30/11/2019 19:22	30/11/2019 13:59	30/11/2019 19:22	5,38	141	757,99	CHI
201911363934	MINEIROS	MY12278397	PARQUE DAS EMAS	30/11/2019 14:40	30/11/2019 21:37	30/11/2019 14:40	30/11/2019 21:37	6,95	5	34,74	CHI
201911363934	SERRANOPOLIS	MY12278397	PARQUE DAS EMAS	30/11/2019 14:40	30/11/2019 21:37	30/11/2019 14:40	30/11/2019 21:37	6,95	6	41,69	CHI
201911363937	CRISTALINA	KR11383043	CRISTALINA S1	30/11/2019 15:19	30/11/2019 16:45	30/11/2019 15:19	30/11/2019 16:45	1,43	7	10,00	CHI
201911363945	NIQUELANDIA	NQ12353780LD	URUACU	30/11/2019 15:19	30/11/2019 15:49	30/11/2019 15:19	30/11/2019 15:49	0,50	12	5,96	CHI
201911363946	AGUAS LINDAS DE GOIAS	4830391687	AGUAS LINDAS DE GOIAS S2	30/11/2019 15:19	30/11/2019 18:02	30/11/2019 15:19	30/11/2019 18:02	2,70	1	2,70	CHI
201911363963	CALDAS NOVAS	CN21100152	VILA CORUMBA	30/11/2019 15:21	01/12/2019 10:23	30/11/2019 15:21	01/12/2019 10:23	19,02	1	19,02	CHI
201911363965	MORRINHOS	MR31132356	GOIATUBA S1	30/11/2019 15:22	01/12/2019 10:20	30/11/2019 15:22	01/12/2019 10:20	18,96	1	18,96	CHI
201911363966	SERRANOPOLIS	SX21318781	JATAI S1	30/11/2019 15:23	01/12/2019 10:48	30/11/2019 15:23	01/12/2019 10:48	19,41	2	38,83	CHI
201911363975	ANAPOLIS	20102367	JUNDIAI S2	30/11/2019 15:24	01/12/2019 13:36	30/11/2019 15:24	01/12/2019 13:36	22,20	1	22,20	CHI
201911363978	ANAPOLIS	10004560653	JUNDIAI S1	30/11/2019 15:24	01/12/2019 09:10	30/11/2019 15:24	01/12/2019 09:10	17,76	1	17,76	CHI
201911363988	IPORA	730094170	IPORA	30/11/2019 15:26	30/11/2019 18:02	30/11/2019 15:26	30/11/2019 18:02	2,59	1	2,59	CHI
201911363991	AGUA FRIA DE GOIAS	MJ12320111	PADRE BERNARDO	30/11/2019 15:26	01/12/2019 00:37	30/11/2019 15:26	01/12/2019 00:37	9,18	9	82,60	CHI

201911363994	PIRENOPOLIS	PV12086031	CORUMBA	30/11/2019 15:14	30/11/2019 22:41	30/11/2019 15:14	30/11/2019 22:41	7,45	22	163,81	CHI
201911363996	SAO MIGUEL DO ARAGUAIA	SM12228636	SAO MIGUEL DO ARAGUAIA	30/11/2019 15:27	01/12/2019 09:35	30/11/2019 15:27	01/12/2019 09:35	18,12	56	1014,83	CHI
201911364000	SAO MIGUEL DO ARAGUAIA	SM21020632	SAO MIGUEL DO ARAGUAIA	30/11/2019 15:28	01/12/2019 12:55	30/11/2019 15:28	01/12/2019 12:55	21,45	1	21,45	CHI
201911364001	SANTA RITA DO NOVO DESTINO	DF12215093	GOIANESIA S1	30/11/2019 15:28	01/12/2019 12:10	30/11/2019 15:28	01/12/2019 12:10	20,70	2	41,39	CHI
201911364004	MARZAGAO	970001990	VILA CORUMBA	30/11/2019 15:29	30/11/2019 21:55	30/11/2019 15:29	30/11/2019 21:55	6,42	1	6,42	CHI
201911364011	JUSSARA	BT12396220	BRITANIA	30/11/2019 15:30	01/12/2019 23:10	30/11/2019 15:30	01/12/2019 23:10	31,68	9	285,10	CHI
201911364011	BRITANIA	BT12396220	BRITANIA	30/11/2019 15:30	01/12/2019 23:10	30/11/2019 15:30	01/12/2019 23:10	31,68	2	63,36	CHI
201911364012	SAO FRANCISCO DE GOIAS	SF12000177	SAO FRANCISCO DE GOIAS	30/11/2019 15:28	30/11/2019 17:29	30/11/2019 15:28	30/11/2019 17:29	2,01	4	8,04	CHI
201911364013	NIQUELANDIA	NQ21056789	URUACU	30/11/2019 15:30	01/12/2019 02:30	30/11/2019 15:30	01/12/2019 01:28	9,97	1	9,97	CHI
201911364013	NIQUELANDIA	NQ12056788	URUACU	30/11/2019 15:30	01/12/2019 02:30	30/11/2019 15:30	01/12/2019 02:30	11,00	89	978,95	CHI
201911364014	CORREGO DO OURO	CO12000058	FIRMINOPOLIS S2	30/11/2019 15:30	30/11/2019 18:28	30/11/2019 15:30	30/11/2019 18:28	2,97	141	418,14	CHI
201911364014	BURITI DE GOIAS	CO12000058	FIRMINOPOLIS S2	30/11/2019 15:30	30/11/2019 18:28	30/11/2019 15:30	30/11/2019 18:28	2,97	31	91,93	CHI
201911364014	FAZENDA NOVA	CO12000058	FIRMINOPOLIS S2	30/11/2019 15:30	30/11/2019 18:28	30/11/2019 15:30	30/11/2019 18:28	2,97	38	112,69	CHI
201911364017	CABECEIRAS	CW12342434	ITUIQUIRA	30/11/2019 11:14	30/11/2019 18:10	30/11/2019 11:14	30/11/2019 18:10	6,93	6	41,58	CHI
201911364018	SAO MIGUEL DO ARAGUAIA	SM12245706	SAO MIGUEL DO ARAGUAIA	30/11/2019 15:31	01/12/2019 02:14	30/11/2019 15:31	01/12/2019 02:14	10,71	10	107,13	CHI
201911364018	NOVO PLANALTO	SM12245706	SAO MIGUEL DO ARAGUAIA	30/11/2019 15:31	01/12/2019 02:14	30/11/2019 15:31	01/12/2019 02:14	10,71	26	278,54	CHI
201911364027	CRIXAS	CX12276573	SANTA TEREZINHA	30/11/2019 14:41	02/12/2019 14:53	30/11/2019 14:41	02/12/2019 14:53	48,19	9	433,74	CHI
201911364032	CRISTALINA	1060038472	CRISTALINA S1	30/11/2019 15:33	30/11/2019 17:23	30/11/2019 15:33	30/11/2019 17:23	1,83	1	1,83	CHI
201911364034	PIRES DO RIO	460039611	PIRES DO RIO S1	30/11/2019 15:33	30/11/2019 23:48	30/11/2019 15:33	30/11/2019 23:48	8,24	1	8,24	CHI
201911364037	SANTA TEREZINHA DE GOIAS	SG11049778	SANTA TEREZINHA	30/11/2019 14:34	01/12/2019 11:00	30/11/2019 14:34	01/12/2019 11:00	20,44	123	2514,09	CHI
201911364038	LUZIANIA	120340562	RIO VERMELHO	30/11/2019 15:34	30/11/2019 17:53	30/11/2019 15:34	30/11/2019 17:53	2,32	1	2,32	CHI
201911364050	RUBIATABA	RB12070858	RUBIATABA	30/11/2019 15:33	01/12/2019 19:05	30/11/2019 15:33	01/12/2019 01:31	9,96	19	189,29	CHI
201911364050	RUBIATABA	RB12070858	RUBIATABA	30/11/2019 15:33	01/12/2019 19:05	30/11/2019 15:33	01/12/2019 19:05	27,53	19	523,01	CHI
201911364051	URUACU	UR11237494	URUACU	30/11/2019 15:36	01/12/2019 12:37	30/11/2019 15:36	01/12/2019 12:37	21,01	5	105,06	CHI
201911364052	APORE	IJ12131593	ITAJA S2	30/11/2019 15:36	01/12/2019 03:21	30/11/2019 15:36	01/12/2019 03:21	11,75	1	11,75	CHI
201911364052	ITAJA	IJ12131593	ITAJA S2	30/11/2019 15:36	01/12/2019 03:21	30/11/2019 15:36	01/12/2019 03:21	11,75	10	117,46	CHI
201911364054	PIRENOPOLIS	PV21403572	CORUMBA	30/11/2019 15:36	30/11/2019 18:04	30/11/2019 15:36	30/11/2019 18:04	2,46	1	2,46	CHI
201911364055	MIMOSO DE GOIAS	NQ12251264	BARRO ALTO	30/11/2019 15:36	01/12/2019 15:42	30/11/2019 15:36	01/12/2019 15:42	24,09	8	192,73	CHI
201911364055	VILA PROPICIO	NQ12251264	BARRO ALTO	30/11/2019 15:36	01/12/2019 15:42	30/11/2019 15:36	01/12/2019 15:42	24,09	1	24,09	CHI
201911364058	CAMPESTRE DE GOIAS	GC12000278	TRINDADE	30/11/2019 11:58	30/11/2019 18:08	30/11/2019 11:58	30/11/2019 18:08	6,16	9	55,43	CHI
201911364069	ABADIANIA	AA21319833	DAIA S2	30/11/2019 15:38	30/11/2019 18:45	30/11/2019 15:38	30/11/2019 18:45	3,11	6	18,67	CHI
201911364075	PIRENOPOLIS	PV21123793	CORUMBA	30/11/2019 15:38	01/12/2019 17:04	30/11/2019 15:38	01/12/2019 17:04	25,44	3	76,31	CHI
201911364089	COCALZINHO DE GOIAS	ZN21302468	COCALZINHO	30/11/2019 15:41	01/12/2019 15:01	30/11/2019 15:41	01/12/2019 15:01	23,32	2	46,64	CHI

201911364100	FAZENDA NOVA	FN12042812	JUSSARA	30/11/2019 15:33	30/11/2019 17:37	30/11/2019 15:33	30/11/2019 17:37	2,06	10	20,59	CHI
201911364104	NOVA CRIXAS	NA12213190	MOZARLANDIA	30/11/2019 15:10	30/11/2019 23:19	30/11/2019 15:10	30/11/2019 23:19	8,14	23	187,23	CHI
201911364108	ANICUNS	AR12019251	ARACU	30/11/2019 13:40	30/11/2019 18:12	30/11/2019 13:40	30/11/2019 18:12	4,52	69	311,86	CHI
201911364108	ITABERAI	AR12019251	ARACU	30/11/2019 13:40	30/11/2019 18:12	30/11/2019 13:40	30/11/2019 18:12	4,52	39	176,27	CHI
201911364108	ARACU	AR12019251	ARACU	30/11/2019 13:40	30/11/2019 18:12	30/11/2019 13:40	30/11/2019 18:12	4,52	12	54,24	CHI
201911364109	BONOPOLIS	BX12321724	SAO MIGUEL DO ARAGUAIA	30/11/2019 15:33	30/11/2019 21:40	30/11/2019 15:33	30/11/2019 21:40	6,11	5	30,57	CHI
201911364116	LUZIANIA	LZ21168113	CRISTALINA S2	30/11/2019 15:46	30/11/2019 19:43	30/11/2019 15:46	30/11/2019 19:43	3,95	3	11,85	CHI
201911364119	SAO JOAO D ALIANCA	JL12207449	SAO JOAO D ALIANCA	30/11/2019 15:46	02/12/2019 00:07	30/11/2019 15:46	02/12/2019 00:07	32,34	2	64,69	CHI
201911364128	JATAI	00270444	CACHOEIRA ALTA	30/11/2019 15:43	01/12/2019 22:24	30/11/2019 15:43	30/11/2019 21:55	6,20	32	198,40	CHI
201911364128	ITARUMA	00270444	CACHOEIRA ALTA	30/11/2019 15:43	01/12/2019 22:24	30/11/2019 15:43	30/11/2019 21:55	6,20	2229	13819,80	CHI
201911364128	SERRANOPOLIS	00270444	CACHOEIRA ALTA	30/11/2019 15:43	01/12/2019 22:24	30/11/2019 15:43	30/11/2019 21:55	6,20	49	303,80	CHI
201911364128	ITARUMA	00270444	CACHOEIRA ALTA	30/11/2019 15:43	01/12/2019 22:24	30/11/2019 15:43	30/11/2019 21:55	6,20	111	688,20	CHI
201911364128	ITAJA	00270444	CACHOEIRA ALTA	30/11/2019 15:43	01/12/2019 22:24	30/11/2019 15:43	30/11/2019 21:55	6,20	19	117,80	CHI
201911364128	CACU	00270444	CACHOEIRA ALTA	30/11/2019 15:43	01/12/2019 22:24	30/11/2019 15:43	30/11/2019 21:55	6,20	60	372,00	CHI
201911364128	ITARUMA	IM13082117	ITAJA S2	30/11/2019 15:43	01/12/2019 22:24	30/11/2019 15:43	30/11/2019 21:55	6,20	96	595,20	CHI
201911364128	ITAJA	IM13082117	ITAJA S2	30/11/2019 15:43	01/12/2019 22:24	30/11/2019 15:43	30/11/2019 21:55	6,20	66	409,20	CHI
201911364128	APORE	IM13082117	ITAJA S2	30/11/2019 15:43	01/12/2019 22:24	30/11/2019 15:43	30/11/2019 21:55	6,20	3	18,60	CHI
201911364128	ITARUMA	00270444	CACHOEIRA ALTA	30/11/2019 15:43	01/12/2019 22:24	30/11/2019 17:44	30/11/2019 21:55	4,18	22	91,95	CHI
201911364128	CACU	00270444	CACHOEIRA ALTA	30/11/2019 15:43	01/12/2019 22:24	30/11/2019 15:43	30/11/2019 23:14	7,52	50	376,08	CHI
201911364128	CACHOEIRA ALTA	00270444	CACHOEIRA ALTA	30/11/2019 15:43	01/12/2019 22:24	30/11/2019 15:43	30/11/2019 23:14	7,52	15	112,83	CHI
201911364128	CACU	00270444	CACHOEIRA ALTA	30/11/2019 15:43	01/12/2019 22:24	30/11/2019 15:43	01/12/2019 00:09	8,45	90	760,15	CHI
201911364128	ITARUMA	00270444	CACHOEIRA ALTA	30/11/2019 15:43	01/12/2019 22:24	30/11/2019 15:43	01/12/2019 00:09	8,45	13	109,80	CHI
201911364128	CACU	IM13360893	CACHOEIRA ALTA	30/11/2019 15:43	01/12/2019 22:24	30/11/2019 18:40	01/12/2019 00:09	5,49	9	49,40	CHI
201911364128	CACU	00270444	CACHOEIRA ALTA	30/11/2019 15:43	01/12/2019 22:24	30/11/2019 23:15	01/12/2019 20:21	21,10	31	654,09	CHI
201911364128	CACHOEIRA ALTA	00270444	CACHOEIRA ALTA	30/11/2019 15:43	01/12/2019 22:24	30/11/2019 23:15	01/12/2019 20:21	21,10	16	337,60	CHI
201911364128	CACU	CC13082114	CACHOEIRA ALTA	30/11/2019 15:43	01/12/2019 22:24	30/11/2019 23:15	01/12/2019 20:33	21,30	19	404,64	CHI
201911364128	ITARUMA	8770950	ITAJA S2	30/11/2019 15:43	01/12/2019 22:24	30/11/2019 15:43	01/12/2019 22:24	30,68	3	92,05	CHI
201911364129	FORMOSA	FA12072574LD	ITUIQUIRA	30/11/2019 12:47	01/12/2019 12:30	30/11/2019 12:47	01/12/2019 12:02	23,26	46	1069,83	CHI
201911364129	FORMOSA	FA12072574LD	ITUIQUIRA	30/11/2019 12:47	01/12/2019 12:30	01/12/2019 12:02	01/12/2019 12:30	0,46	46	21,04	CHI
201911364132	BOM JARDIM DE GOIAS	BM12065619	BOM JARDIM	30/11/2019 15:49	30/11/2019 19:01	30/11/2019 15:49	30/11/2019 19:01	3,20	1	3,20	CHI
201911364133	COCALZINHO DE GOIAS	ZN12297780	COCALZINHO	30/11/2019 14:56	01/12/2019 09:17	30/11/2019 14:56	01/12/2019 09:17	18,34	9	165,09	CHI
201911364139	CRISTALINA	KR12163740	CRISTALINA S2	30/11/2019 15:50	01/12/2019 08:59	30/11/2019 15:50	01/12/2019 08:59	17,15	8	137,20	CHI
201911364140	PALMEIRAS DE GOIAS	PL12092541	PALMEIRAS	30/11/2019 15:45	30/11/2019 18:05	30/11/2019 15:45	30/11/2019 18:05	2,33	7	16,33	CHI

201911364143	PLANALTINA	PI12355773	PLANALTINA	30/11/2019 15:21	30/11/2019 19:11	30/11/2019 15:21	30/11/2019 19:11	3,82	48	183,53	CHI
201911364147	IPORA	730018350	IPORA	30/11/2019 15:51	30/11/2019 17:05	30/11/2019 15:51	30/11/2019 17:05	1,23	1	1,23	CHI
201911364154	CRISTALINA	KR12209473	CRISTALINA S2	30/11/2019 15:52	01/12/2019 15:07	30/11/2019 15:52	01/12/2019 15:07	23,24	6	139,45	CHI
201911364165	ANAPOLIS	AN21297537	ANAPOLIS UNIVERSITARIO S2	30/11/2019 15:53	01/12/2019 13:16	30/11/2019 15:53	01/12/2019 13:16	21,37	1	21,37	CHI
201911364166	MOZARLANDIA	MZ12065623	MOZARLANDIA	30/11/2019 15:53	30/11/2019 20:25	30/11/2019 15:53	30/11/2019 20:25	4,52	14	63,31	CHI
201911364170	ANAPOLIS	AN11000433	JUNDIAI S1	30/11/2019 14:26	01/12/2019 00:34	30/11/2019 14:26	01/12/2019 00:34	10,12	162	1639,31	CHI
201911364172	TRES RANCHOS	TH12149178	CATALAO S1	30/11/2019 15:54	01/12/2019 11:05	30/11/2019 15:54	01/12/2019 11:05	19,18	13	249,31	CHI
201911364173	FAZENDA NOVA	FN21250946	IPORA	30/11/2019 15:54	01/12/2019 11:40	30/11/2019 15:54	01/12/2019 11:40	19,76	1	19,76	CHI
201911364174	SILVANIA	SV21078648	DAIA S2	30/11/2019 15:54	30/11/2019 17:48	30/11/2019 15:54	30/11/2019 17:48	1,89	2	3,78	CHI
201911364175	DISTRITO FEDERAL	SN12237830	MARAJOARA	30/11/2019 15:55	01/12/2019 18:20	30/11/2019 15:55	01/12/2019 18:20	26,42	3	79,25	CHI
201911364175	SANTO ANTONIO DO DESCOBERTO	SN12237830	MARAJOARA	30/11/2019 15:55	01/12/2019 18:20	30/11/2019 15:55	01/12/2019 18:20	26,42	24	633,98	CHI
201911364179	URUACU	UR11237478	URUACU	30/11/2019 15:56	30/11/2019 20:03	30/11/2019 15:56	30/11/2019 20:03	4,10	265	1086,57	CHI
201911364180	URUACU	UR21317788	URUACU	30/11/2019 15:57	01/12/2019 15:53	30/11/2019 15:57	01/12/2019 15:53	23,93	1	23,93	CHI
201911364181	SANTA TEREZINHA DE GOIAS	SG12030743	SANTA TEREZINHA	30/11/2019 15:57	30/11/2019 20:20	30/11/2019 15:57	30/11/2019 20:20	4,38	114	499,13	CHI
201911364187	ITAPURANGA	IK12308896	ITAPURANGA	30/11/2019 15:58	30/11/2019 19:51	30/11/2019 15:58	30/11/2019 19:51	3,88	1	3,88	CHI
201911364202	SANTA HELENA DE GOIAS	SH12029901	IPEGUARI	30/11/2019 14:59	30/11/2019 15:50	30/11/2019 14:59	30/11/2019 15:50	0,84	1	0,84	CHI
201911364204	CAMPOS VERDES	SG12202098	SANTA TEREZINHA	30/11/2019 13:59	30/11/2019 18:16	30/11/2019 13:59	30/11/2019 18:16	4,28	40	171,22	CHI
201911364204	SANTA TEREZINHA DE GOIAS	SG12202098	SANTA TEREZINHA	30/11/2019 13:59	30/11/2019 18:16	30/11/2019 13:59	30/11/2019 18:16	4,28	133	569,31	CHI
201911364204	UIRAPURU	SG12202098	SANTA TEREZINHA	30/11/2019 13:59	30/11/2019 18:16	30/11/2019 13:59	30/11/2019 18:16	4,28	56	239,71	CHI
201911364223	SAO SIMAO	PC12000018	CACHOEIRA ALTA	30/11/2019 14:03	01/12/2019 09:25	30/11/2019 14:03	01/12/2019 09:25	19,37	10	193,67	CHI
201911364223	PARANAIGUARA	PC12000018	CACHOEIRA ALTA	30/11/2019 14:03	01/12/2019 09:25	30/11/2019 14:03	01/12/2019 09:25	19,37	30	581,00	CHI
201911364223	CACHOEIRA ALTA	PC12000018	CACHOEIRA ALTA	30/11/2019 14:03	01/12/2019 09:25	30/11/2019 14:03	01/12/2019 09:25	19,37	8	154,93	CHI
201911364235	SAO JOAO D ALIANCA	10011898567	SAO JOAO D ALIANCA	30/11/2019 13:51	01/12/2019 08:55	30/11/2019 13:51	01/12/2019 08:55	19,06	1	19,06	CHI
201911364236	SAO JOAO D ALIANCA	JL21255803	SAO JOAO D ALIANCA	30/11/2019 14:34	02/12/2019 10:42	30/11/2019 14:34	02/12/2019 10:42	44,15	2	88,29	CHI
201911364247	ITAPURANGA	IK21299766	ITAPURANGA	30/11/2019 15:58	01/12/2019 09:45	30/11/2019 15:58	01/12/2019 09:45	17,78	2	35,56	CHI
201911364253	MUNDO NOVO DE GOIAS	MH12274988	NOVA CRIXAS	30/11/2019 15:16	01/12/2019 14:10	30/11/2019 15:16	01/12/2019 14:10	22,90	3	68,69	CHI
201911364254	MUNDO NOVO DE GOIAS	MH11269437	NOVA CRIXAS	30/11/2019 17:45	30/11/2019 22:19	30/11/2019 17:45	30/11/2019 22:19	4,56	1	4,56	CHI
201911364257	MUNDO NOVO DE GOIAS	MH12274895	NOVA CRIXAS	30/11/2019 19:08	30/11/2019 21:25	30/11/2019 19:08	30/11/2019 21:25	2,27	15	34,11	CHI
201911364272	ANAPOLIS	AN12096781	ANAPOLIS UNIVERSITARIO S2	30/11/2019 15:06	01/12/2019 11:44	30/11/2019 15:06	01/12/2019 11:44	20,62	13	268,04	CHI
201911364303	MINEIROS	MY21126177	PARQUE DAS EMAS	30/11/2019 16:01	01/12/2019 16:43	30/11/2019 16:01	01/12/2019 16:43	24,69	1	24,69	CHI
201911364304	NIQUELANDIA	NQ12254342	NIQUELANDIA SUBTRANSMISSAO	30/11/2019 16:01	30/11/2019 20:44	30/11/2019 16:01	30/11/2019 20:44	4,71	1	4,71	CHI
201911364307	ITARUMA	IM21370019	CACHOEIRA ALTA	30/11/2019 16:02	01/12/2019 09:45	30/11/2019 16:02	01/12/2019 09:45	17,72	1	17,72	CHI
201911364308	CACU	CC12000095	CACHOEIRA ALTA	30/11/2019 16:02	30/11/2019 19:35	30/11/2019 16:02	30/11/2019 19:35	3,55	24	85,11	CHI



201911364311	COCALZINHO DE GOIAS	ZN12067369	AGUAS LINDAS DE GOIAS S1	30/11/2019 15:59	30/11/2019 19:46	30/11/2019 15:59	30/11/2019 19:46	3,78	25	94,53	CHI
201911364317	URUACU	UR11243707	URUACU	30/11/2019 16:03	30/11/2019 23:00	30/11/2019 16:03	30/11/2019 23:00	6,94	86	596,74	CHI
201911364318	NIQUELANDIA	NQ12264219	BARRO ALTO	30/11/2019 16:03	01/12/2019 01:47	30/11/2019 16:03	01/12/2019 01:47	9,72	1	9,72	CHI
201911364321	ALTO PARAISO DE GOIAS	BF21224076	SAO JOAO D ALIANCA	30/11/2019 16:04	30/11/2019 20:19	30/11/2019 16:04	30/11/2019 20:19	4,25	1	4,25	CHI
201911364324	IPAMERI	IP12071421	IPAMERI	30/11/2019 16:04	30/11/2019 22:18	30/11/2019 16:04	30/11/2019 22:18	6,23	3	18,68	CHI
201911364325	GOIANESIA	GE12000058	GOIANESIA S2	30/11/2019 15:02	30/11/2019 23:15	30/11/2019 15:02	30/11/2019 23:15	8,20	202	1656,51	CHI
201911364329	CATALAO	10027476950	CATALAO S2	30/11/2019 16:04	30/11/2019 17:22	30/11/2019 16:04	30/11/2019 17:22	1,29	1	1,29	CHI
201911364330	ALVORADA DO NORTE	AQ12131772	IACIARA S2	30/11/2019 15:43	30/11/2019 17:49	30/11/2019 15:43	30/11/2019 17:49	2,09	116	242,76	CHI
201911364330	SIMOLANDIA	AQ12131772	IACIARA S2	30/11/2019 15:43	30/11/2019 17:49	30/11/2019 15:43	30/11/2019 17:49	2,09	1	2,09	CHI
201911364331	ALEXANIA	AX12374685	CORUMBA	30/11/2019 15:48	30/11/2019 19:55	30/11/2019 15:48	30/11/2019 19:55	4,11	36	147,91	CHI
201911364333	BALIZA	BH12356956	BOM JARDIM	30/11/2019 16:05	30/11/2019 19:53	30/11/2019 16:05	30/11/2019 19:53	3,80	2	7,60	CHI
201911364336	MIMOSO DE GOIAS	MJ12376711	PADRE BERNARDO	30/11/2019 15:11	01/12/2019 14:21	01/12/2019 05:42	01/12/2019 07:27	1,77	291	513,86	CHI
201911364336	MIMOSO DE GOIAS	MJ12377232	PADRE BERNARDO	30/11/2019 15:11	01/12/2019 14:21	30/11/2019 15:11	01/12/2019 14:21	23,16	15	347,46	CHI
201911364339	PALMINOPOLIS	PL12019884	PALMEIRAS	30/11/2019 16:07	30/11/2019 18:37	30/11/2019 16:07	30/11/2019 18:37	2,50	1	2,50	CHI
201911364340	URUACU	UR12341275	URUACU	30/11/2019 13:38	01/12/2019 11:22	30/11/2019 13:38	01/12/2019 11:22	21,72	7	152,05	CHI
201911364342	URUACU	UR12082989	URUACU	30/11/2019 16:07	01/12/2019 12:00	30/11/2019 16:07	01/12/2019 12:00	19,88	5	99,40	CHI
201911364355	PARAUNA	PU11233921	MONTIVIDIU T	30/11/2019 16:10	30/11/2019 19:42	30/11/2019 16:10	30/11/2019 19:42	3,54	1	3,54	CHI
201911364359	CALDAS NOVAS	10003647020	CALDAS NOVAS S1	30/11/2019 16:11	30/11/2019 21:12	30/11/2019 16:11	30/11/2019 21:12	5,02	1	5,02	CHI
201911364366	AURILANDIA	AI12377187	FIRMINOPOLIS S2	30/11/2019 16:12	30/11/2019 20:35	30/11/2019 16:12	30/11/2019 20:35	4,39	12	52,65	CHI
201911364367	ANICUNS	AC12382567	ANICUNS	30/11/2019 15:27	30/11/2019 17:35	30/11/2019 15:27	30/11/2019 17:35	2,14	831	1776,49	CHI
201911364378	PIRANHAS	PH12243813	PIRANHAS	30/11/2019 16:13	30/11/2019 20:00	30/11/2019 16:13	30/11/2019 20:00	3,78	7	26,44	CHI
201911364387	CRIXAS	CX12202067	SERRA DO OURO	30/11/2019 16:15	03/12/2019 00:58	30/11/2019 16:15	03/12/2019 00:58	56,72	1	56,72	CHI
201911364390	ALEXANIA	AX11155171	ALEXANIA	30/11/2019 15:56	30/11/2019 17:03	30/11/2019 15:56	30/11/2019 17:03	1,10	35	38,58	CHI
201911364393	ANAPOLIS	20944822	JUNDIAI S1	30/11/2019 16:16	30/11/2019 18:26	30/11/2019 16:16	30/11/2019 18:26	2,17	1	2,17	CHI
201911364396	TRINDADE	TR11230639	TRINDADE	30/11/2019 11:32	30/11/2019 17:24	30/11/2019 11:32	30/11/2019 17:24	5,86	86	503,84	CHI
201911364399	BALIZA	BH12061407	BOM JARDIM	30/11/2019 16:17	30/11/2019 21:32	30/11/2019 16:17	30/11/2019 21:32	5,25	30	157,41	CHI
201911364401	MINACU	IH21182330	MINACU	30/11/2019 16:17	01/12/2019 00:56	30/11/2019 16:17	01/12/2019 00:56	8,65	1	8,65	CHI
201911364405	JATAI	JT21234417	JATAI S1	30/11/2019 16:17	01/12/2019 10:25	30/11/2019 16:17	01/12/2019 10:25	18,12	1	18,12	CHI
201911364407	SAO LUIS DE MONTES BELOS	SC12005400	FIRMINOPOLIS S2	30/11/2019 16:17	30/11/2019 20:47	30/11/2019 16:17	30/11/2019 20:47	4,48	2	8,97	CHI
201911364407	SANCLERLANDIA	SC12005400	FIRMINOPOLIS S2	30/11/2019 16:17	30/11/2019 20:47	30/11/2019 16:17	30/11/2019 20:47	4,48	42	188,31	CHI
201911364413	PLANALTINA	PI12325516	PLANALTINA	30/11/2019 16:18	30/11/2019 18:37	30/11/2019 16:18	30/11/2019 18:37	2,31	9	20,77	CHI
201911364414	BONOPOLIS	BX12389769	SAO MIGUEL DO ARAGUAIA	30/11/2019 16:19	30/11/2019 20:47	30/11/2019 16:19	30/11/2019 20:47	4,47	2	8,93	CHI
201911364416	NIQUELANDIA	NQ12210926	NIQUELANDIA SUBTRANSMISSAO	30/11/2019 14:51	30/11/2019 19:02	30/11/2019 14:51	30/11/2019 19:02	4,18	7	29,24	CHI

201911364420	ITAPURANGA	IK12299970	GOIAS	30/11/2019 13:10	01/12/2019 00:00	30/11/2019 13:10	01/12/2019 00:00	10,82	3	32,46	CHI
201911364420	ITABERAI	IK12299970	GOIAS	30/11/2019 13:10	01/12/2019 00:00	30/11/2019 13:10	01/12/2019 00:00	10,82	2	21,64	CHI
201911364420	HEITORAI	IK12299970	GOIAS	30/11/2019 13:10	01/12/2019 00:00	30/11/2019 13:10	01/12/2019 00:00	10,82	29	313,77	CHI
201911364420	GOIAS	IK12299970	GOIAS	30/11/2019 13:10	01/12/2019 00:00	30/11/2019 13:10	01/12/2019 00:00	10,82	24	259,67	CHI
201911364423	TURVANIA	TV12058371	FIRMINOPOLIS S2	30/11/2019 16:20	30/11/2019 21:00	30/11/2019 16:20	30/11/2019 21:00	4,66	6	27,99	CHI
201911364424	CACHOEIRA DOURADA	CD21033407	CACHOEIRA DOURADA	30/11/2019 16:20	30/11/2019 18:09	30/11/2019 16:20	30/11/2019 18:09	1,81	2	3,62	CHI
201911364429	VILA PROPICIO	GE12000009RE	GOIANESIA S2	30/11/2019 10:17	02/12/2019 20:32	30/11/2019 10:17	01/12/2019 14:04	27,77	8	222,19	CHI
201911364429	GOIANESIA	GE12000009RE	GOIANESIA S2	30/11/2019 10:17	02/12/2019 20:32	30/11/2019 10:17	01/12/2019 14:04	27,77	42	1166,50	CHI
201911364429	GOIANESIA	GE12000009RE	GOIANESIA S2	30/11/2019 10:17	02/12/2019 20:32	01/12/2019 14:04	02/12/2019 17:20	27,27	22	599,99	CHI
201911364429	VILA PROPICIO	GE12000009RE	GOIANESIA S2	30/11/2019 10:17	02/12/2019 20:32	01/12/2019 14:04	02/12/2019 17:20	27,27	2	54,54	CHI
201911364429	GOIANESIA	GE12384167	GOIANESIA S2	30/11/2019 10:17	02/12/2019 20:32	01/12/2019 14:04	02/12/2019 20:32	30,48	20	609,59	CHI
201911364429	VILA PROPICIO	GE12384167	GOIANESIA S2	30/11/2019 10:17	02/12/2019 20:32	01/12/2019 14:04	02/12/2019 20:32	30,48	6	182,88	CHI
201911364432	FAINA	FC12199793	GOIAS	30/11/2019 16:21	30/11/2019 21:51	30/11/2019 16:21	30/11/2019 21:51	5,50	17	93,44	CHI
201911364438	CAMPO LIMPO	AN12265111	ANAPOLIS UNIVERSITARIO S2	30/11/2019 16:03	01/12/2019 09:48	30/11/2019 16:03	01/12/2019 09:48	17,74	6	106,44	CHI
201911364440	MOZARLANDIA	MZ12063703	MOZARLANDIA	30/11/2019 14:04	30/11/2019 21:05	30/11/2019 14:04	30/11/2019 21:05	7,00	9	63,02	CHI
201911364441	PALMEIRAS DE GOIAS	PL12049487	PALMEIRAS	30/11/2019 16:12	30/11/2019 19:00	30/11/2019 16:12	30/11/2019 19:00	2,79	17	47,41	CHI
201911364444	RIO VERDE	RV21271581	CABRIUVA S2	30/11/2019 16:24	01/12/2019 09:21	30/11/2019 16:24	01/12/2019 09:21	16,95	1	16,95	CHI
201911364450	ANAPOLIS	AN12262491	ANAPOLIS UNIVERSITARIO S1	30/11/2019 16:13	30/11/2019 18:45	30/11/2019 16:13	30/11/2019 18:45	2,52	39	98,36	CHI
201911364458	SANTA HELENA DE GOIAS	10021539845	IPEGUARI	30/11/2019 16:26	01/12/2019 09:27	30/11/2019 16:26	01/12/2019 09:27	17,02	1	17,02	CHI
201911364460	ALEXANIA	SN12382967	MARAJOARA	30/11/2019 16:24	01/12/2019 09:27	30/11/2019 16:24	01/12/2019 09:27	17,04	1	17,04	CHI
201911364460	SANTO ANTONIO DO DESCOBERTO	SN12382967	MARAJOARA	30/11/2019 16:24	01/12/2019 09:27	30/11/2019 16:24	01/12/2019 09:27	17,04	15	255,56	CHI
201911364461	SANTA TEREZINHA DE GOIAS	SG11034164	SANTA TEREZINHA	30/11/2019 15:29	30/11/2019 16:59	30/11/2019 15:29	30/11/2019 16:59	1,49	101	150,24	CHI
201911364462	AGUA FRIA DE GOIAS	NQ12140180	SAO JOAO D ALIANCA	30/11/2019 16:26	01/12/2019 14:32	30/11/2019 16:26	01/12/2019 14:32	22,09	2	44,17	CHI
201911364469	RIO VERDE	RV21287975	RIO VERDE S1	30/11/2019 16:27	30/11/2019 19:55	30/11/2019 16:27	30/11/2019 19:55	3,45	1	3,45	CHI
201911364473	CACHOEIRA DOURADA	CD21166462	CACHOEIRA DOURADA	30/11/2019 16:28	30/11/2019 19:23	30/11/2019 16:28	30/11/2019 19:23	2,91	1	2,91	CHI
201911364475	AGUAS LINDAS DE GOIAS	LA11375285	AGUAS LINDAS DE GOIAS S1	30/11/2019 16:24	30/11/2019 17:50	30/11/2019 16:24	30/11/2019 17:50	1,42	138	196,08	CHI
201911364477	TROMBAS	TB12137675	PORANGATU	30/11/2019 12:48	30/11/2019 22:30	30/11/2019 12:48	30/11/2019 22:30	9,69	8	77,52	CHI
201911364501	MATRINCHA	MP21235839	MATRINCHA	30/11/2019 16:30	30/11/2019 20:35	30/11/2019 16:30	30/11/2019 20:35	4,08	4	16,30	CHI
201911364603	ITABERAI	IB12066172	ITABERAI S1	30/11/2019 16:30	30/11/2019 19:46	30/11/2019 16:30	30/11/2019 19:46	3,27	13	42,47	CHI
201911364604	MONTIVIDIU DO NORTE	MX12187847	PORANGATU	30/11/2019 12:05	01/12/2019 02:19	30/11/2019 12:05	01/12/2019 02:19	14,23	29	412,53	CHI
201911364702	ITAPURANGA	IK12220328	ITAPURANGA	30/11/2019 16:31	30/11/2019 21:15	30/11/2019 16:31	30/11/2019 21:15	4,73	230	1086,81	CHI
201911364706	CACHOEIRA ALTA	CA12349527	CACHOEIRA ALTA	30/11/2019 16:32	02/12/2019 02:35	30/11/2019 16:32	02/12/2019 02:35	34,05	2	68,09	CHI
201911364801	ITARUMA	CC12000108	CACHOEIRA ALTA	30/11/2019 16:32	01/12/2019 19:36	30/11/2019 16:32	01/12/2019 19:36	27,05	19	514,04	CHI

201911365002	AGUAS LINDAS DE GOIAS	10006633372	AGUAS LINDAS DE GOIAS S1	30/11/2019 16:33	30/11/2019 18:23	30/11/2019 16:33	30/11/2019 18:23	1,83	1	1,83	CHI
201911365003	ANAPOLIS	AN12285315	ANAPOLIS UNIVERSITARIO S2	30/11/2019 16:29	01/12/2019 00:51	30/11/2019 16:29	01/12/2019 00:51	8,37	21	175,80	CHI
201911365209	JATAI	JT12219384RE	JATAI S3	30/11/2019 16:34	01/12/2019 09:30	30/11/2019 16:34	01/12/2019 07:03	14,47	28	405,20	CHI
201911365209	JATAI	JT12219384RE	JATAI S3	30/11/2019 16:34	01/12/2019 09:30	01/12/2019 07:04	01/12/2019 08:20	1,27	14	17,79	CHI
201911365209	JATAI	JT13383927	JATAI S3	30/11/2019 16:34	01/12/2019 09:30	01/12/2019 07:04	01/12/2019 09:30	2,44	15	36,58	CHI
201911365402	FORMOSA	FA12395181	FLORES DE GOIAS	30/11/2019 16:35	30/11/2019 21:36	30/11/2019 16:35	30/11/2019 21:36	5,01	8	40,05	CHI
201911365411	DAVINOPOLIS	IO12085164	CATALAO S1	30/11/2019 16:36	01/12/2019 08:23	30/11/2019 16:36	01/12/2019 08:23	15,77	6	94,64	CHI
201911365411	OUVIDOR	IO12085164	CATALAO S1	30/11/2019 16:36	01/12/2019 08:23	30/11/2019 16:36	01/12/2019 08:23	15,77	5	78,86	CHI
201911365415	ANAPOLIS	AN11077945	ANAPOLIS UNIVERSITARIO S2	30/11/2019 14:52	01/12/2019 04:47	30/11/2019 14:52	01/12/2019 04:47	13,90	33	458,81	CHI
201911365416	ALEXANIA	AX21318552	ALEXANIA	30/11/2019 16:37	30/11/2019 18:10	30/11/2019 16:37	30/11/2019 18:10	1,55	1	1,55	CHI
201911365419	FLORES DE GOIAS	3480014572	FLORES DE GOIAS	30/11/2019 16:37	01/12/2019 10:04	30/11/2019 16:37	01/12/2019 10:04	17,44	1	17,44	CHI
201911365422	CRIXAS	CX11088757	SERRA DO OURO	30/11/2019 16:38	03/12/2019 14:52	30/11/2019 16:38	03/12/2019 14:52	70,23	125	8779,03	CHI
201911365426	PIRACANJUBA	PJ21099022	PIRACANJUBA	30/11/2019 16:38	01/12/2019 09:35	30/11/2019 16:38	01/12/2019 09:35	16,94	2	33,87	CHI
201911365428	PIRENOPOLIS	PV21185572	CORUMBA	30/11/2019 16:39	01/12/2019 15:53	30/11/2019 16:39	01/12/2019 15:53	23,23	2	46,45	CHI
201911365429	PADRE BERNARDO	PB12255487	PADRE BERNARDO	30/11/2019 16:39	30/11/2019 20:16	30/11/2019 16:39	30/11/2019 20:16	3,61	4	14,43	CHI
201911365430	CRIXAS	CX12325183	RUBIATABA	30/11/2019 16:39	02/12/2019 10:12	30/11/2019 16:39	02/12/2019 10:12	41,54	29	1204,67	CHI
201911365432	SAO LUIS DE MONTES BELOS	500083060	SAO LUIZ DOS MONTES BELOS	30/11/2019 16:40	30/11/2019 19:38	30/11/2019 16:40	30/11/2019 19:38	2,98	1	2,98	CHI
201911365436	CATALAO	1990043504	CATALAO S2	30/11/2019 16:40	01/12/2019 00:11	30/11/2019 16:40	01/12/2019 00:11	7,50	1	7,50	CHI
201911365437	GUARANI DE GOIAS	GY12255279	IACIARA S1	30/11/2019 16:40	30/11/2019 18:14	30/11/2019 16:40	30/11/2019 18:14	1,55	13	20,20	CHI
201911365443	CALDAS NOVAS	MG12120777	VILA CORUMBA	30/11/2019 16:41	01/12/2019 15:45	30/11/2019 16:41	01/12/2019 15:45	23,07	1	23,07	CHI
201911365443	MARZAGAO	MG12120777	VILA CORUMBA	30/11/2019 16:41	01/12/2019 15:45	30/11/2019 16:41	01/12/2019 15:45	23,07	2	46,13	CHI
201911365443	RIO QUENTE	MG12120777	VILA CORUMBA	30/11/2019 16:41	01/12/2019 15:45	30/11/2019 16:41	01/12/2019 15:45	23,07	1	23,07	CHI
201911365451	RUBIATABA	RB21062084	RUBIATABA	30/11/2019 16:42	02/12/2019 11:58	30/11/2019 16:42	02/12/2019 11:58	43,25	1	43,25	CHI
201911365453	PADRE BERNARDO	PB12169086	PADRE BERNARDO	30/11/2019 16:43	30/11/2019 21:46	30/11/2019 16:43	30/11/2019 21:46	5,04	3	15,12	CHI
201911365457	TURVANIA	TV12259061	FIRMINOPOLIS S2	30/11/2019 16:45	30/11/2019 17:59	30/11/2019 16:45	30/11/2019 17:59	1,24	8	9,89	CHI
201911365462	QUIRINOPOLIS	QI21381437	QUIRINOPOLIS	30/11/2019 16:45	30/11/2019 23:22	30/11/2019 16:45	30/11/2019 23:22	6,61	1	6,61	CHI
201911365466	PIRENOPOLIS	PV12017586	CORUMBA	30/11/2019 15:37	30/11/2019 18:19	30/11/2019 15:37	30/11/2019 18:19	2,70	56	150,97	CHI
201911365467	MOZARLANDIA	MZ12055655	MOZARLANDIA	30/11/2019 16:47	01/12/2019 07:02	30/11/2019 16:47	01/12/2019 07:02	14,24	2	28,48	CHI
201911365477	NIQUELANDIA	4760001427	NIQUELANDIA SUBTRANSMISSAO	30/11/2019 16:49	30/11/2019 20:05	30/11/2019 16:49	30/11/2019 20:05	3,26	1	3,26	CHI
201911365482	NOVA IGUACU DE GOIAS	NH12048720	SANTA TEREZINHA	30/11/2019 16:36	02/12/2019 18:19	30/11/2019 16:36	02/12/2019 18:19	49,71	37	1839,16	CHI
201911365485	ITAPURANGA	FC12160891	GOIAS	01/12/2019 06:35	01/12/2019 10:46	01/12/2019 06:35	01/12/2019 10:46	4,17	2	8,34	CHI
201911365485	MORRO AGUDO DE GOIAS	FC12160891	GOIAS	01/12/2019 06:35	01/12/2019 10:46	01/12/2019 06:35	01/12/2019 10:46	4,17	2	8,34	CHI
201911365485	FAINA	FC12160891	GOIAS	01/12/2019 06:35	01/12/2019 10:46	01/12/2019 06:35	01/12/2019 10:46	4,17	14	58,38	CHI

201911365501	ORIZONA	OZ12114508	PIRES DO RIO S2	30/11/2019 14:41	01/12/2019 10:09	30/11/2019 14:41	01/12/2019 10:09	19,47	12	233,62	CHI
201911365901	PIRENOPOLIS	JA12000001	JARAGUA	30/11/2019 16:30	30/11/2019 18:00	30/11/2019 16:30	30/11/2019 18:00	1,49	55	81,77	CHI
201911365901	JARAGUA	JA12000001	JARAGUA	30/11/2019 16:30	30/11/2019 18:00	30/11/2019 16:30	30/11/2019 18:00	1,49	373	554,53	CHI
201911366002	NIQUELANDIA	NQ12117625	BARRO ALTO	30/11/2019 14:39	30/11/2019 22:57	30/11/2019 14:39	30/11/2019 22:57	8,30	5	41,48	CHI
201911366003	SAO FRANCISCO DE GOIAS	SF12319829	SAO FRANCISCO DE GOIAS	30/11/2019 16:55	30/11/2019 20:50	30/11/2019 16:55	30/11/2019 20:50	3,91	20	78,20	CHI
201911366013	BARRO ALTO	BA21169968	BARRO ALTO	30/11/2019 16:56	02/12/2019 15:54	30/11/2019 16:56	02/12/2019 15:54	46,96	1	46,96	CHI
201911366104	CRISTALINA	KR12163676	PAMPLONA	30/11/2019 16:29	30/11/2019 20:16	30/11/2019 16:29	30/11/2019 20:16	3,77	24	90,45	CHI
201911366104	LUZIANIA	KR12163676	PAMPLONA	30/11/2019 16:29	30/11/2019 20:16	30/11/2019 16:29	30/11/2019 20:16	3,77	2	7,54	CHI
201911366104	DISTRITO FEDERAL	KR12163676	PAMPLONA	30/11/2019 16:29	30/11/2019 20:16	30/11/2019 16:29	30/11/2019 20:16	3,77	4	15,07	CHI
201911366127	GOIAS	IU12060535	MATRINCHA	30/11/2019 16:58	30/11/2019 18:21	30/11/2019 16:58	30/11/2019 18:21	1,39	1	1,39	CHI
201911366127	ITAPIRAPUA	IU12060535	MATRINCHA	30/11/2019 16:58	30/11/2019 18:21	30/11/2019 16:58	30/11/2019 18:21	1,39	11	15,29	CHI
201911366128	FORMOSA	FA11270036	ITUIQUIRA	30/11/2019 16:58	30/11/2019 21:58	30/11/2019 16:58	30/11/2019 21:58	4,99	1	4,99	CHI
201911366134	CALDAS NOVAS	CN12075111	SERRA DE CALDAS	30/11/2019 16:19	30/11/2019 19:40	30/11/2019 16:19	30/11/2019 19:40	3,35	21	70,37	CHI
201911366139	MOZARLANDIA	MZ12055646	MOZARLANDIA	30/11/2019 16:59	01/12/2019 08:18	30/11/2019 16:59	01/12/2019 08:18	15,30	3	45,91	CHI
201911366143	MINEIROS	1390118580	PARQUE DAS EMAS	30/11/2019 17:00	30/11/2019 17:54	30/11/2019 17:00	30/11/2019 17:54	0,90	1	0,90	CHI
201911366148	DIORAMA	DI13231244	ARENOPOLIS	30/11/2019 17:01	01/12/2019 17:49	30/11/2019 17:01	01/12/2019 17:49	24,80	28	694,44	CHI
201911366148	DIORAMA	DI13231244	ARENOPOLIS	30/11/2019 17:01	01/12/2019 17:49	01/12/2019 12:03	01/12/2019 17:49	5,78	55	317,66	CHI
201911366148	MONTES CLAROS DE GOIAS	DI13231244	ARENOPOLIS	30/11/2019 17:01	01/12/2019 17:49	01/12/2019 12:03	01/12/2019 17:49	5,78	31	179,04	CHI
201911366151	QUIRINOPOLIS	QI21326601	CACHOEIRA ALTA	30/11/2019 17:02	01/12/2019 11:10	30/11/2019 17:02	01/12/2019 11:10	18,12	1	18,12	CHI
201911366154	FAINA	FC11220259	GOIAS	30/11/2019 16:53	30/11/2019 18:23	30/11/2019 16:53	30/11/2019 18:23	1,48	68	100,94	CHI
201911366160	AGUAS LINDAS DE GOIAS	LA11108725	AGUAS LINDAS DE GOIAS S1	30/11/2019 16:40	30/11/2019 18:58	30/11/2019 16:40	30/11/2019 18:58	2,30	119	273,11	CHI
201911366165	BARRO ALTO	BA12382485	BARRO ALTO	30/11/2019 10:37	01/12/2019 11:59	30/11/2019 10:37	01/12/2019 11:59	25,35	9	228,19	CHI
201911366170	COCALZINHO DE GOIAS	ZN12302364	COCALZINHO	30/11/2019 15:38	01/12/2019 09:13	30/11/2019 15:38	01/12/2019 09:13	17,57	9	158,12	CHI
201911366176	GOUVELANDIA	GB12207219	QUIRINOPOLIS	30/11/2019 17:06	30/11/2019 19:04	30/11/2019 17:06	30/11/2019 19:04	1,96	1	1,96	CHI
201911366177	JATAI	290176177	JATAI S2	30/11/2019 17:06	01/12/2019 10:48	30/11/2019 17:06	01/12/2019 10:48	17,70	1	17,70	CHI
201911366181	COCALZINHO DE GOIAS	ZN21295712	COCALZINHO	30/11/2019 17:07	02/12/2019 21:10	30/11/2019 17:07	02/12/2019 21:10	52,06	1	52,06	CHI
201911366191	LUZIANIA	120100149	RIO VERMELHO	30/11/2019 17:07	30/11/2019 18:48	30/11/2019 17:07	30/11/2019 18:48	1,67	1	1,67	CHI
201911366192	SAO MIGUEL DO ARAGUAIA	SM12220886	SAO MIGUEL DO ARAGUAIA	30/11/2019 14:45	01/12/2019 02:44	30/11/2019 14:45	01/12/2019 02:44	11,98	17	203,67	CHI
201911366196	JARAGUA	JA12090006	JARAGUA	30/11/2019 17:08	01/12/2019 05:20	30/11/2019 17:08	01/12/2019 05:20	12,19	17	207,31	CHI
201911366197	FAINA	FC21396453	ITAPURANGA	30/11/2019 17:08	01/12/2019 10:41	30/11/2019 17:08	01/12/2019 10:41	17,54	1	17,54	CHI
201911366200	CABECEIRAS	CW21194600	ITUIQUIRA	30/11/2019 17:09	01/12/2019 08:30	30/11/2019 17:09	01/12/2019 08:30	15,35	1	15,35	CHI
201911366223	CRISTALINA	1060048271	CRISTALINA S1	30/11/2019 17:14	30/11/2019 17:49	30/11/2019 17:14	30/11/2019 17:49	0,58	1	0,58	CHI
201911366225	CATALAO	CT21295474	CAMPO ALEGRE DE GOIAS	30/11/2019 17:14	01/12/2019 10:40	30/11/2019 17:14	01/12/2019 10:40	17,43	1	17,43	CHI

201911366228	BOM JESUS DE GOIAS	10001494951	BOM JESUS DE GOIAS	30/11/2019 17:14	30/11/2019 20:00	30/11/2019 17:14	30/11/2019 20:00	2,75	1	2,75	CHI
201911366232	BOM JESUS DE GOIAS	10000632706	BOM JESUS DE GOIAS	30/11/2019 17:15	30/11/2019 23:04	30/11/2019 17:15	30/11/2019 23:04	5,81	1	5,81	CHI
201911366237	RIO VERDE	PU12305779	MONTIVIDIU T	30/11/2019 16:48	30/11/2019 19:40	30/11/2019 16:48	30/11/2019 19:40	2,86	113	323,31	CHI
201911366244	DOVERLANDIA	MY12219553	PARQUE DAS EMAS	30/11/2019 17:17	30/11/2019 20:30	30/11/2019 17:17	30/11/2019 20:30	3,21	43	138,21	CHI
201911366246	COCALZINHO DE GOIAS	CB12089828	AGUAS LINDAS DE GOIAS S2	30/11/2019 17:17	01/12/2019 10:56	30/11/2019 17:17	01/12/2019 10:56	17,64	6	105,84	CHI
201911366251	AGUAS LINDAS DE GOIAS	10018628573	AGUAS LINDAS DE GOIAS S2	30/11/2019 17:17	30/11/2019 23:41	30/11/2019 17:17	30/11/2019 23:41	6,39	1	6,39	CHI
201911366254	ANAPOLIS	20115702	JUNDIAI S2	30/11/2019 17:18	01/12/2019 14:36	30/11/2019 17:18	01/12/2019 14:36	21,30	1	21,30	CHI
201911366255	BOM JESUS DE GOIAS	10001804446	BOM JESUS DE GOIAS	30/11/2019 17:18	30/11/2019 21:36	30/11/2019 17:18	30/11/2019 21:36	4,29	1	4,29	CHI
201911366259	COCALZINHO DE GOIAS	CB21102097	AGUAS LINDAS DE GOIAS S2	30/11/2019 17:19	30/11/2019 20:43	30/11/2019 17:19	30/11/2019 20:43	3,39	1	3,39	CHI
201911366266	MORRINHOS	MR12402502	GOIATUBA S1	30/11/2019 13:07	01/12/2019 09:19	30/11/2019 13:07	01/12/2019 09:19	20,19	8	161,51	CHI
201911366269	SAO FRANCISCO DE GOIAS	10014356714	SAO FRANCISCO DE GOIAS	30/11/2019 17:20	30/11/2019 19:52	30/11/2019 17:20	30/11/2019 19:52	2,53	1	2,53	CHI
201911366279	NOVA AMERICA	NM12052447	RUBIATABA	30/11/2019 15:23	01/12/2019 03:36	30/11/2019 15:23	01/12/2019 03:36	12,22	14	171,03	CHI
201911366288	VILA PROPICIO	NP12231823	GOIANESIA S1	30/11/2019 17:22	02/12/2019 13:10	30/11/2019 17:22	02/12/2019 13:10	43,79	17	744,45	CHI
201911366289	CRISTALINA	KR12348534	PAMPLONA	30/11/2019 16:02	30/11/2019 21:41	30/11/2019 16:02	30/11/2019 21:41	5,65	5	28,23	CHI
201911366308	LUZIANIA	LZ21000523	MARAJOARA	30/11/2019 17:24	30/11/2019 21:08	30/11/2019 17:24	30/11/2019 21:08	3,73	1	3,73	CHI
201911366312	GOIANDIRA	GD12160906	CATALAO S1	30/11/2019 17:04	30/11/2019 19:41	30/11/2019 17:04	30/11/2019 19:41	2,61	15	39,15	CHI
201911366338	ARUANA	AK21096000	MOZARLANDIA	30/11/2019 17:26	30/11/2019 19:21	30/11/2019 17:26	30/11/2019 19:21	1,91	1	1,91	CHI
201911366347	VICENTINOPOLIS	VI12329055	VICENTINOPOLIS	30/11/2019 17:26	01/12/2019 09:24	30/11/2019 17:26	01/12/2019 09:24	15,96	24	382,93	CHI
201911366347	GOIATUBA	VI12329055	VICENTINOPOLIS	30/11/2019 17:26	01/12/2019 09:24	30/11/2019 17:26	01/12/2019 09:24	15,96	12	191,47	CHI
201911366361	JATAI	10029240377	JATAI S2	30/11/2019 17:27	01/12/2019 11:28	30/11/2019 17:27	01/12/2019 11:28	18,00	1	18,00	CHI
201911366366	SAO DOMINGOS	SD11046278	SAO DOMINGOS	30/11/2019 16:59	01/12/2019 00:35	30/11/2019 16:59	01/12/2019 00:35	7,60	87	660,77	CHI
201911366379	FAINA	MP12096007	MATRINCHA	30/11/2019 17:15	01/12/2019 06:38	30/11/2019 17:15	01/12/2019 06:38	13,38	8	107,07	CHI
201911366392	AGUA FRIA DE GOIAS	TL21180519	SAO JOAO D ALIANCA	30/11/2019 17:30	02/12/2019 11:23	30/11/2019 17:30	02/12/2019 11:23	41,89	1	41,89	CHI
201911366396	CIDADE OCIDENTAL	DH12391861	MARAJOARA	30/11/2019 14:01	30/11/2019 19:13	30/11/2019 14:01	30/11/2019 19:13	5,19	15	77,79	CHI
201911366398	INDIARA	IY12233349	CEZARINA	30/11/2019 17:31	01/12/2019 08:25	30/11/2019 17:31	01/12/2019 08:25	14,89	5	74,46	CHI
201911366399	URUACU	UR21136491	URUACU	30/11/2019 17:31	01/12/2019 19:45	30/11/2019 17:31	01/12/2019 19:45	26,23	1	26,23	CHI
201911366401	JARAGUA	JA12353235	GOIANESIA S2	30/11/2019 14:40	01/12/2019 17:53	30/11/2019 14:40	01/12/2019 00:05	9,41	13	122,37	CHI
201911366401	GOIANESIA	JA12353235	GOIANESIA S2	30/11/2019 14:40	01/12/2019 17:53	30/11/2019 14:40	01/12/2019 00:05	9,41	1	9,41	CHI
201911366401	JARAGUA	JA12353235	GOIANESIA S2	30/11/2019 14:40	01/12/2019 17:53	30/11/2019 14:40	01/12/2019 00:05	9,41	16	150,61	CHI
201911366401	JARAGUA	JA12353235	GOIANESIA S2	30/11/2019 14:40	01/12/2019 17:53	01/12/2019 00:05	01/12/2019 17:19	17,23	16	275,73	CHI
201911366401	JARAGUA	JA12297408	GOIANESIA S2	30/11/2019 14:40	01/12/2019 17:53	01/12/2019 00:05	01/12/2019 17:53	17,79	13	231,32	CHI
201911366401	GOIANESIA	JA12297408	GOIANESIA S2	30/11/2019 14:40	01/12/2019 17:53	01/12/2019 00:05	01/12/2019 17:53	17,79	1	17,79	CHI
201911366404	AURILANDIA	CG12391526	FIRMINOPOLIS S2	30/11/2019 17:32	30/11/2019 21:10	30/11/2019 17:32	30/11/2019 21:10	3,64	2	7,28	CHI

201911366404	CACHOEIRA DE GOIAS	CG12391526	FIRMINOPOLIS S2	30/11/2019 17:32	30/11/2019 21:10	30/11/2019 17:32	30/11/2019 21:10	3,64	11	40,03	CHI
201911366404	PARAUNA	CG12391526	FIRMINOPOLIS S2	30/11/2019 17:32	30/11/2019 21:10	30/11/2019 17:32	30/11/2019 21:10	3,64	32	116,44	CHI
201911366409	NOVA AMERICA	NM12077844	RUBIATABA	30/11/2019 17:15	30/11/2019 20:13	30/11/2019 17:15	30/11/2019 20:13	2,95	22	64,93	CHI
201911366413	NIQUELANDIA	NQ12362139	NIQUELANDIA SUBTRANSMISSAO	30/11/2019 17:33	01/12/2019 09:12	30/11/2019 17:33	01/12/2019 09:12	15,64	9	140,80	CHI
201911366414	GOIAS	GS12220477	GOIAS	30/11/2019 17:33	01/12/2019 09:50	30/11/2019 17:33	01/12/2019 09:50	16,28	11	179,05	CHI
201911366417	UIRAPURU	UP11253360	NOVA CRIXAS	30/11/2019 17:35	02/12/2019 16:53	30/11/2019 17:35	02/12/2019 16:53	47,30	1	47,30	CHI
201911366419	RUBIATABA	RB12194289	RUBIATABA	30/11/2019 17:09	01/12/2019 02:27	30/11/2019 17:09	01/12/2019 02:27	9,29	6	55,75	CHI
201911366421	CALDAS NOVAS	CN12363765	CALDAS NOVAS S1	30/11/2019 17:25	01/12/2019 09:12	30/11/2019 17:25	01/12/2019 09:12	15,78	18	284,10	CHI
201911366426	MORRO AGUDO DE GOIAS	MS12335823	ITAPURANGA	30/11/2019 17:06	01/12/2019 09:43	30/11/2019 17:06	01/12/2019 09:43	16,60	2	33,20	CHI
201911366436	BARRO ALTO	BA21210701	GOIANESIA S1	30/11/2019 17:38	02/12/2019 19:00	30/11/2019 17:38	02/12/2019 19:00	49,36	1	49,36	CHI
201911366438	TURVANIA	TV12005582	FIRMINOPOLIS S2	30/11/2019 17:38	30/11/2019 19:00	30/11/2019 17:38	30/11/2019 19:00	1,36	43	58,54	CHI
201911366448	CORUMBA DE GOIAS	CB12302322	ANAPOLIS UNIVERSITARIO S1	30/11/2019 17:17	01/12/2019 10:46	30/11/2019 17:17	01/12/2019 10:46	17,47	19	331,99	CHI
201911366459	MOZARLANDIA	MZ12055622	MOZARLANDIA	30/11/2019 17:42	01/12/2019 09:21	30/11/2019 17:42	01/12/2019 09:21	15,64	1	15,64	CHI
201911366460	CATALAO	CT21267115	CATALAO S1	30/11/2019 17:42	01/12/2019 08:08	30/11/2019 17:42	01/12/2019 08:08	14,42	1	14,42	CHI
201911366461	SANTO ANTONIO DO DESCOBERTO	2210177050	ALEXANIA	30/11/2019 17:43	30/11/2019 20:08	30/11/2019 17:43	30/11/2019 20:08	2,42	1	2,42	CHI
201911366462	GOIAS	GS12070358	GOIAS	30/11/2019 17:43	01/12/2019 14:10	30/11/2019 17:43	01/12/2019 14:10	20,44	11	224,84	CHI
201911366464	URUTAI	UT13352297	URUTAI	30/11/2019 16:30	01/12/2019 03:00	30/11/2019 16:30	01/12/2019 03:00	10,49	57	598,12	CHI
201911366464	IPAMERI	UT13352297	URUTAI	30/11/2019 16:30	01/12/2019 03:00	30/11/2019 16:30	01/12/2019 03:00	10,49	34	356,77	CHI
201911366477	COCALZINHO DE GOIAS	ZN12389400	AGUAS LINDAS DE GOIAS S2	30/11/2019 14:34	30/11/2019 20:02	30/11/2019 14:34	30/11/2019 20:02	5,46	103	562,41	CHI
201911366477	PADRE BERNARDO	ZN12389400	AGUAS LINDAS DE GOIAS S2	30/11/2019 14:34	30/11/2019 20:02	30/11/2019 14:34	30/11/2019 20:02	5,46	4	21,84	CHI
201911366482	DAVINOPOLIS	2950000776	CATALAO S1	30/11/2019 17:45	01/12/2019 09:04	30/11/2019 17:45	01/12/2019 09:04	15,30	1	15,30	CHI
201911366484	PORANGATU	PO21079733	PORANGATU	30/11/2019 17:46	02/12/2019 17:21	30/11/2019 17:46	02/12/2019 17:21	47,58	1	47,58	CHI
201911366488	GOIAS	GS11274470	GOIAS	30/11/2019 17:46	01/12/2019 14:27	30/11/2019 17:46	01/12/2019 14:27	20,67	5	103,34	CHI
201911366489	ALEXANIA	480071962	ALEXANIA	30/11/2019 17:46	30/11/2019 23:18	30/11/2019 17:46	30/11/2019 23:18	5,52	1	5,52	CHI
201911366491	MONTES CLAROS DE GOIAS	ME12038971	IPORA	30/11/2019 16:55	01/12/2019 21:23	30/11/2019 16:55	01/12/2019 13:23	20,46	21	429,68	CHI
201911366491	MONTES CLAROS DE GOIAS	ME12038971	IPORA	30/11/2019 16:55	01/12/2019 21:23	01/12/2019 13:23	01/12/2019 21:23	8,00	21	167,97	CHI
201911366493	CROMINIA	520004012	PONTALINA	30/11/2019 17:47	01/12/2019 11:30	30/11/2019 17:47	01/12/2019 11:30	17,72	1	17,72	CHI
201911366494	CACHOEIRA ALTA	CA21154436	CACHOEIRA ALTA	30/11/2019 17:47	01/12/2019 12:00	30/11/2019 17:47	01/12/2019 12:00	18,20	1	18,20	CHI
201911366498	GOIAS	GS11162398	GOIAS	30/11/2019 17:48	01/12/2019 09:58	30/11/2019 17:48	01/12/2019 09:58	16,16	1	16,16	CHI
201911366504	CORUMBA DE GOIAS	CB21094722	ALEXANIA	30/11/2019 17:48	01/12/2019 12:32	30/11/2019 17:48	01/12/2019 12:32	18,72	2	37,43	CHI
201911366511	ANAPOLIS	AN12221522	JUNDIAI S2	30/11/2019 17:48	01/12/2019 15:22	30/11/2019 17:48	01/12/2019 15:22	21,57	5	107,83	CHI
201911366512	RUBIATABA	RB12354231	RUBIATABA	30/11/2019 17:49	01/12/2019 16:20	30/11/2019 17:49	01/12/2019 16:20	22,51	1	22,51	CHI
201911366518	JARAGUA	JA21282500	JARAGUA	30/11/2019 17:50	30/11/2019 19:30	30/11/2019 17:50	30/11/2019 19:30	1,66	1	1,66	CHI

201911366525	RIO VERDE	630059445	RIO VERDE S1	30/11/2019 17:51	30/11/2019 22:50	30/11/2019 17:51	30/11/2019 22:50	4,97	1	4,97	CHI
201911366539	PIRES DO RIO	PR12064876RE	PIRES DO RIO S1	30/11/2019 14:17	30/11/2019 22:54	30/11/2019 14:17	30/11/2019 22:54	8,61	31	266,77	CHI
201911366543	CRIXAS	CX12134501	RUBIATABA	30/11/2019 17:07	01/12/2019 01:16	30/11/2019 17:07	01/12/2019 01:16	8,14	57	464,04	CHI
201911366543	NOVA IGUACU DE GOIAS	CX12134501	RUBIATABA	30/11/2019 17:07	01/12/2019 01:16	30/11/2019 17:07	01/12/2019 01:16	8,14	1	8,14	CHI
201911366549	CAMPOS VERDES	VD12049791	SANTA TEREZINHA	30/11/2019 15:20	30/11/2019 23:50	30/11/2019 15:20	30/11/2019 23:50	8,49	18	152,85	CHI
201911366562	PORANGATU	PO12170950	PORANGATU	30/11/2019 13:24	01/12/2019 01:56	30/11/2019 13:24	01/12/2019 01:56	12,53	2	25,06	CHI
201911366566	FAINA	2580000040	GOIAS	30/11/2019 18:01	01/12/2019 09:11	30/11/2019 18:01	01/12/2019 09:11	15,15	1	15,15	CHI
201911366568	AVELINOPOLIS	AV21241073	ANICUNS	30/11/2019 18:01	30/11/2019 19:47	30/11/2019 18:01	30/11/2019 19:47	1,76	1	1,76	CHI
201911366576	IPORA	IR21159119	IPORA	30/11/2019 18:03	30/11/2019 19:39	30/11/2019 18:03	30/11/2019 19:39	1,60	1	1,60	CHI
201911366579	MOZARLANDIA	MZ12055642	MOZARLANDIA	30/11/2019 18:03	01/12/2019 10:03	30/11/2019 18:03	01/12/2019 10:03	15,99	1	15,99	CHI
201911366580	ANAPOLIS	AN11000100	ANAPOLIS UNIVERSITARIO S2	30/11/2019 16:48	30/11/2019 23:30	30/11/2019 16:48	30/11/2019 23:15	6,46	23	148,53	CHI
201911366580	ANAPOLIS	AN12000105	ANAPOLIS UNIVERSITARIO S2	30/11/2019 16:48	30/11/2019 23:30	30/11/2019 16:48	30/11/2019 23:30	6,70	23	154,18	CHI
201911366581	BONOPOLIS	BX12079316	SAO MIGUEL DO ARAGUAIA	30/11/2019 15:19	30/11/2019 20:30	30/11/2019 15:19	30/11/2019 20:30	5,18	8	41,44	CHI
201911366588	MUNDO NOVO DE GOIAS	4240032570	NOVA CRIXAS	30/11/2019 18:04	01/12/2019 13:51	30/11/2019 18:04	01/12/2019 13:51	19,77	1	19,77	CHI
201911366589	PEROLANDIA	DP12194926	PARQUE DAS EMAS	30/11/2019 18:04	30/11/2019 21:30	30/11/2019 18:04	30/11/2019 21:30	3,42	2	6,84	CHI
201911366595	SANTA RITA DO NOVO DESTINO	BA12163300	BARRO ALTO	30/11/2019 13:00	01/12/2019 11:34	30/11/2019 13:00	01/12/2019 11:34	22,55	11	248,09	CHI
201911366599	AURILANDIA	RP12304543	FIRMINOPOLIS S2	01/12/2019 06:11	01/12/2019 09:27	01/12/2019 06:11	01/12/2019 09:27	3,26	3	9,77	CHI
201911366599	PARAUNA	RP12304543	FIRMINOPOLIS S2	01/12/2019 06:11	01/12/2019 09:27	01/12/2019 06:11	01/12/2019 09:27	3,26	35	114,02	CHI
201911366606	PIRES DO RIO	460051969	PIRES DO RIO S1	30/11/2019 18:08	30/11/2019 21:00	30/11/2019 18:08	30/11/2019 21:00	2,86	1	2,86	CHI
201911366609	ISRAELANDIA	IS21184710	IPORA	30/11/2019 18:10	01/12/2019 02:55	30/11/2019 18:10	01/12/2019 02:55	8,75	1	8,75	CHI
201911366611	RUBIATABA	780003706	RUBIATABA	30/11/2019 18:10	02/12/2019 10:20	30/11/2019 18:10	02/12/2019 10:20	40,18	1	40,18	CHI
201911366625	GUARAITA	IK12300356	ITAPURANGA	30/11/2019 16:27	30/11/2019 23:23	30/11/2019 16:27	30/11/2019 23:23	6,92	36	249,15	CHI
201911366625	ITAPURANGA	IK12300356	ITAPURANGA	30/11/2019 16:27	30/11/2019 23:23	30/11/2019 16:27	30/11/2019 23:23	6,92	82	567,51	CHI
201911366628	SAO MIGUEL DO PASSA QUATRO	SQ21074851	CRISTIANOPOLIS	30/11/2019 18:13	01/12/2019 07:47	30/11/2019 18:13	01/12/2019 07:47	13,56	1	13,56	CHI
201911366629	ACREUNA	EU21160745	ACREUNA	30/11/2019 18:14	30/11/2019 22:33	30/11/2019 18:14	30/11/2019 22:33	4,32	1	4,32	CHI
201911366633	ITAGUARU	IC12219965	ITABERAI S1	30/11/2019 18:00	01/12/2019 14:15	30/11/2019 18:00	01/12/2019 14:15	20,24	8	161,91	CHI
201911366634	CRISTALINA	KR12068384	PAMPLONA	30/11/2019 14:39	01/12/2019 17:53	30/11/2019 14:39	01/12/2019 17:53	27,22	28	762,28	CHI
201911366635	CRIXAS	CX12226949	SANTA TEREZINHA	30/11/2019 15:27	02/12/2019 12:37	30/11/2019 15:27	02/12/2019 12:37	45,17	10	451,68	CHI
201911366636	GOIAS	GS21145500	GOIAS	30/11/2019 18:15	01/12/2019 16:07	30/11/2019 18:15	01/12/2019 16:07	21,87	1	21,87	CHI
201911366649	ANAPOLIS	AN11129355	JUNDIAI S1	30/11/2019 15:00	01/12/2019 01:15	30/11/2019 15:00	01/12/2019 01:15	10,23	63	644,79	CHI
201911366652	MOZARLANDIA	MZ21181580	MOZARLANDIA	30/11/2019 18:20	01/12/2019 10:43	30/11/2019 18:20	01/12/2019 10:43	16,38	1	16,38	CHI
201911366653	BURITI ALEGRE	BG21285859	ITUMBIARA VELHA S2	30/11/2019 18:21	01/12/2019 11:50	30/11/2019 18:21	01/12/2019 11:50	17,48	1	17,48	CHI
201911366657	PIRES DO RIO	460073771	PIRES DO RIO S1	30/11/2019 18:22	01/12/2019 07:14	30/11/2019 18:22	01/12/2019 07:14	12,86	1	12,86	CHI

201911366660	GOIAS	GS12065878	MATRINCHA	30/11/2019 18:22	01/12/2019 08:38	30/11/2019 18:22	01/12/2019 08:38	14,26	1	14,26	CHI
201911366670	RUBIATABA	RB12194366	RUBIATABA	30/11/2019 16:32	01/12/2019 05:32	30/11/2019 16:32	01/12/2019 05:32	12,99	8	103,90	CHI
201911366672	CRISTALINA	KR12383072	CRISTALINA S2	30/11/2019 15:28	02/12/2019 01:31	30/11/2019 15:28	02/12/2019 01:31	34,05	18	612,82	CHI
201911366675	TURVELANDIA	SH12271563	IPEGUARI	30/11/2019 18:26	01/12/2019 07:20	30/11/2019 18:26	01/12/2019 07:20	12,90	9	116,06	CHI
201911366675	SANTA HELENA DE GOIAS	SH12271563	IPEGUARI	30/11/2019 18:26	01/12/2019 07:20	30/11/2019 18:26	01/12/2019 07:20	12,90	28	361,08	CHI
201911366684	CAMPOS VERDES	VD21291246	SANTA TEREZINHA	30/11/2019 18:28	01/12/2019 12:50	30/11/2019 18:28	01/12/2019 12:50	18,38	1	18,38	CHI
201911366685	ARUANA	AK21066580	ARUANA	30/11/2019 18:28	30/11/2019 21:22	30/11/2019 18:28	30/11/2019 21:22	2,90	1	2,90	CHI
201911366694	IPORA	IR21060743	IPORA	30/11/2019 18:29	30/11/2019 22:07	30/11/2019 18:29	30/11/2019 22:07	3,63	1	3,63	CHI
201911366695	IPAMERI	580060445	IPAMERI	30/11/2019 18:29	30/11/2019 20:46	30/11/2019 18:29	30/11/2019 20:46	2,27	1	2,27	CHI
201911366696	NOVO BRASIL	NB12020225	JUSSARA	30/11/2019 18:29	01/12/2019 08:30	30/11/2019 18:29	01/12/2019 08:30	14,01	40	560,26	CHI
201911366696	FAZENDA NOVA	NB12020225	JUSSARA	30/11/2019 18:29	01/12/2019 08:30	30/11/2019 18:29	01/12/2019 08:30	14,01	38	532,24	CHI
201911366696	JUSSARA	NB12020225	JUSSARA	30/11/2019 18:29	01/12/2019 08:30	30/11/2019 18:29	01/12/2019 08:30	14,01	1	14,01	CHI
201911366701	COCALZINHO DE GOIAS	CB12028344	COCALZINHO	30/11/2019 17:40	01/12/2019 22:25	30/11/2019 17:40	01/12/2019 22:25	28,74	4	114,98	CHI
201911366707	ITAPIRAPUA	IU12142895	MATRINCHA	30/11/2019 18:31	01/12/2019 08:54	30/11/2019 18:31	01/12/2019 08:54	14,38	7	100,66	CHI
201911366711	OUVIDOR	OU21250300	CATALAO S1	30/11/2019 18:32	01/12/2019 10:00	30/11/2019 18:32	01/12/2019 10:00	15,47	1	15,47	CHI
201911366715	AMORINOPOLIS	AM12000028	IPORA	30/11/2019 18:31	01/12/2019 00:54	30/11/2019 18:31	01/12/2019 00:54	6,38	4	25,51	CHI
201911366718	ALTO PARAISO DE GOIAS	BF12170287	NIQUELANDIA SUBTRANSMISSAO	30/11/2019 11:56	01/12/2019 08:39	30/11/2019 11:56	01/12/2019 08:39	20,71	11	227,79	CHI
201911366727	JANDAIA	JD12083934	PALMEIRAS	30/11/2019 17:53	30/11/2019 22:52	30/11/2019 17:53	30/11/2019 22:52	4,97	13	64,66	CHI
201911366745	GOIAS	GS12162491	GOIAS	30/11/2019 18:00	01/12/2019 08:26	30/11/2019 18:00	01/12/2019 08:26	14,43	53	764,92	CHI
201911366759	JATAI	JT11037070	JATAI S2	30/11/2019 18:10	30/11/2019 23:45	30/11/2019 18:10	30/11/2019 23:45	5,58	175	976,99	CHI
201911366773	MINEIROS	MY21296367	PARQUE DAS EMAS	30/11/2019 18:43	01/12/2019 15:06	30/11/2019 18:43	01/12/2019 15:06	20,38	1	20,38	CHI
201911366775	PARANAIGUARA	PC21000118	QUIRINOPOLIS	30/11/2019 18:43	01/12/2019 15:30	30/11/2019 18:43	01/12/2019 15:30	20,77	1	20,77	CHI
201911366784	JUSSARA	JR12124817	BRITANIA	30/11/2019 18:44	01/12/2019 09:19	30/11/2019 18:44	01/12/2019 09:19	14,58	11	160,36	CHI
201911366785	GOIAS	GS12319412	ITAPURANGA	30/11/2019 17:44	01/12/2019 13:24	30/11/2019 17:44	01/12/2019 13:24	19,65	7	137,58	CHI
201911366798	SAO MIGUEL DO ARAGUAIA	SM11292376	SAO MIGUEL DO ARAGUAIA	30/11/2019 16:37	30/11/2019 21:30	30/11/2019 16:37	30/11/2019 21:30	4,87	40	194,90	CHI
201911366802	URUACU	UR12245232	URUACU	30/11/2019 14:06	01/12/2019 08:52	30/11/2019 14:06	01/12/2019 08:52	18,76	33	619,03	CHI
201911366806	RUBIATABA	780017444	RUBIATABA	30/11/2019 18:50	02/12/2019 14:20	30/11/2019 18:50	02/12/2019 14:20	43,50	1	43,50	CHI
201911366819	SAO MIGUEL DO ARAGUAIA	SM11038061	SAO MIGUEL DO ARAGUAIA	30/11/2019 18:53	01/12/2019 19:32	30/11/2019 18:53	01/12/2019 19:32	24,64	6	147,85	CHI
201911366820	PARAUNA	05760414	PARAUNA	30/11/2019 18:49	01/12/2019 19:25	30/11/2019 18:49	30/11/2019 20:20	1,53	41	62,54	CHI
201911366820	JANDAIA	05760414	PARAUNA	30/11/2019 18:49	01/12/2019 19:25	30/11/2019 18:49	30/11/2019 21:53	3,06	3	9,18	CHI
201911366820	PARAUNA	05760414	PARAUNA	30/11/2019 18:49	01/12/2019 19:25	30/11/2019 18:49	30/11/2019 21:53	3,06	34	104,04	CHI
201911366820	PARAUNA	05760414	PARAUNA	30/11/2019 18:49	01/12/2019 19:25	30/11/2019 18:49	30/11/2019 23:40	4,84	14	67,81	CHI
201911366820	PARAUNA	05760414	PARAUNA	30/11/2019 18:49	01/12/2019 19:25	30/11/2019 18:49	01/12/2019 01:17	6,47	20	129,48	CHI



201911366820	PARAUNA	05760414	PARAUNA	30/11/2019 18:49	01/12/2019 19:25	30/11/2019 18:49	01/12/2019 02:42	7,88	78	614,38	CHI
201911366820	PARAUNA	05760414	PARAUNA	30/11/2019 18:49	01/12/2019 19:25	30/11/2019 18:49	01/12/2019 02:55	8,09	10	80,93	CHI
201911366820	PARAUNA	05760414	PARAUNA	30/11/2019 18:49	01/12/2019 19:25	30/11/2019 18:49	01/12/2019 03:10	8,34	23	191,90	CHI
201911366820	RIO VERDE	05760414	PARAUNA	30/11/2019 18:49	01/12/2019 19:25	30/11/2019 18:49	01/12/2019 03:10	8,34	2	16,69	CHI
201911366820	PARAUNA	05760414	PARAUNA	30/11/2019 18:49	01/12/2019 19:25	30/11/2019 18:49	01/12/2019 19:25	24,59	19	467,27	CHI
201911366821	SAO MIGUEL DO ARAGUAIA	SM21013041	SAO MIGUEL DO ARAGUAIA	30/11/2019 18:53	01/12/2019 19:00	30/11/2019 18:53	01/12/2019 19:00	24,11	1	24,11	CHI
201911366822	ITUMBIARA	690390180	ITUMBIARA VELHA S1	30/11/2019 18:54	30/11/2019 23:17	30/11/2019 18:54	30/11/2019 23:17	4,37	1	4,37	CHI
201911366826	CACHOEIRA ALTA	CA11000003	CACHOEIRA ALTA	30/11/2019 18:51	30/11/2019 23:12	30/11/2019 18:51	30/11/2019 23:12	4,35	98	425,81	CHI
201911366828	PORANGATU	PO12390257	PORANGATU	30/11/2019 11:54	01/12/2019 03:15	30/11/2019 11:54	01/12/2019 03:15	15,35	4	61,39	CHI
201911366834	BRITANIA	BT12005387	BRITANIA	30/11/2019 18:57	01/12/2019 06:41	30/11/2019 18:57	01/12/2019 06:41	11,72	1	11,72	CHI
201911366838	ACREUNA	00080244	ACREUNA	30/11/2019 18:59	01/12/2019 13:52	30/11/2019 18:59	30/11/2019 19:29	0,51	38	19,44	CHI
201911366838	ACREUNA	EU13000008	ACREUNA	30/11/2019 18:59	01/12/2019 13:52	30/11/2019 18:59	30/11/2019 20:18	1,32	45	59,36	CHI
201911366838	ACREUNA	EU13088659	ACREUNA	30/11/2019 18:59	01/12/2019 13:52	30/11/2019 18:59	30/11/2019 21:27	2,48	477	1181,77	CHI
201911366838	EDEIA	EU12045047LD	ACREUNA	30/11/2019 18:59	01/12/2019 13:52	30/11/2019 18:59	01/12/2019 13:25	18,44	13	239,72	CHI
201911366838	TURVANIA	EU12045047LD	ACREUNA	30/11/2019 18:59	01/12/2019 13:52	30/11/2019 18:59	01/12/2019 13:25	18,44	1	18,44	CHI
201911366838	ACREUNA	EU12045047LD	ACREUNA	30/11/2019 18:59	01/12/2019 13:52	30/11/2019 18:59	01/12/2019 13:25	18,44	26	479,45	CHI
201911366838	TURVELANDIA	EU12045047LD	ACREUNA	30/11/2019 18:59	01/12/2019 13:52	30/11/2019 18:59	01/12/2019 13:25	18,44	28	516,33	CHI
201911366838	ACREUNA	8590648	ACREUNA	30/11/2019 18:59	01/12/2019 13:52	30/11/2019 18:59	01/12/2019 13:52	18,88	1	18,88	CHI
201911366860	BOM JESUS DE GOIAS	1250049274	BOM JESUS DE GOIAS	30/11/2019 19:02	01/12/2019 07:46	30/11/2019 19:02	01/12/2019 07:46	12,72	1	12,72	CHI
201911366863	JANDAIA	JD12030352	PALMEIRAS	30/11/2019 19:03	01/12/2019 07:54	30/11/2019 19:03	01/12/2019 07:54	12,84	15	192,67	CHI
201911366866	SAO MIGUEL DO ARAGUAIA	SM12252091	SAO MIGUEL DO ARAGUAIA	30/11/2019 17:20	30/11/2019 23:11	30/11/2019 17:20	30/11/2019 23:11	5,85	61	356,77	CHI
201911366884	RIO VERDE	630151799	RIO VERDE S1	30/11/2019 19:07	01/12/2019 07:44	30/11/2019 19:07	01/12/2019 07:44	12,63	1	12,63	CHI
201911366885	GOUVELANDIA	GB12000209	QUIRINOPOLIS	30/11/2019 19:07	30/11/2019 20:40	30/11/2019 19:07	30/11/2019 20:40	1,54	28	43,24	CHI
201911366885	QUIRINOPOLIS	GB12000209	QUIRINOPOLIS	30/11/2019 19:07	30/11/2019 20:40	30/11/2019 19:07	30/11/2019 20:40	1,54	84	129,71	CHI
201911366900	JATAI	290160753	JATAI S3	30/11/2019 19:09	01/12/2019 12:03	30/11/2019 19:09	01/12/2019 12:03	16,89	1	16,89	CHI
201911366910	PILAR DE GOIAS	3050002655	URUACU	30/11/2019 19:10	02/12/2019 12:36	30/11/2019 19:10	02/12/2019 12:36	41,43	1	41,43	CHI
201911366913	JATAI	JT12219503	JATAI S3	30/11/2019 16:31	01/12/2019 10:04	30/11/2019 16:31	01/12/2019 10:04	17,54	5	87,69	CHI
201911366928	RUBIATABA	RB11282271	RUBIATABA	30/11/2019 19:14	02/12/2019 18:22	02/12/2019 17:55	02/12/2019 18:22	0,45	18	8,17	CHI
201911366934	ITAPURANGA	IK11220251	ITAPURANGA	30/11/2019 16:14	30/11/2019 21:57	30/11/2019 16:14	30/11/2019 21:57	5,70	97	553,33	CHI
201911366939	NOVO BRASIL	NB11020195	JUSSARA	30/11/2019 18:52	01/12/2019 07:08	30/11/2019 18:52	01/12/2019 07:08	12,26	126	1545,15	CHI
201911366943	JATAI	290338402	JATAI S2	30/11/2019 19:16	01/12/2019 10:28	30/11/2019 19:16	01/12/2019 10:28	15,19	1	15,19	CHI
201911366944	NIQUELANDIA	2750069975	NIQUELANDIA SUBTRANSMISSAO	30/11/2019 19:16	01/12/2019 14:48	30/11/2019 19:16	01/12/2019 14:48	19,52	1	19,52	CHI
201911366951	CORUMBA DE GOIAS	CB12327779	CORUMBA	30/11/2019 17:48	01/12/2019 17:08	30/11/2019 17:48	01/12/2019 17:08	23,33	7	163,30	CHI

201911367010	JATAI	290336090	JATAI S2	30/11/2019 19:20	01/12/2019 09:21	30/11/2019 19:20	01/12/2019 09:21	14,00	1	14,00	CHI
201911367012	BRITANIA	8038871	MATRINCHA	30/11/2019 19:20	01/12/2019 09:17	30/11/2019 19:20	01/12/2019 09:17	13,94	6	83,63	CHI
201911367012	ITAPIRAPUA	8038871	MATRINCHA	30/11/2019 19:20	01/12/2019 09:17	30/11/2019 19:20	01/12/2019 09:17	13,94	13	181,20	CHI
201911367013	SANTA TEREZINHA DE GOIAS	SG12088386	SANTA TEREZINHA	30/11/2019 17:16	30/11/2019 20:45	30/11/2019 17:16	30/11/2019 20:45	3,48	81	281,63	CHI
201911367016	CATALAO	10019014765	CATALAO S1	30/11/2019 19:21	01/12/2019 03:34	30/11/2019 19:21	01/12/2019 03:34	8,21	1	8,21	CHI
201911367102	PARAUNA	PU21301179	ACREUNA	30/11/2019 19:24	01/12/2019 08:20	30/11/2019 19:24	01/12/2019 08:20	12,94	1	12,94	CHI
201911367201	PARAUNA	PU12244168	PARAUNA	30/11/2019 19:26	01/12/2019 08:30	30/11/2019 19:26	01/12/2019 08:30	13,06	1	13,06	CHI
201911367211	CRIXAS	CX21143324	SERRA DO OURO	30/11/2019 11:15	02/12/2019 09:25	30/11/2019 11:15	02/12/2019 09:25	46,15	1	46,15	CHI
201911367214	MUNDO NOVO DE GOIAS	MH11269091	NOVA CRIXAS	30/11/2019 19:29	01/12/2019 16:18	30/11/2019 19:29	01/12/2019 16:18	20,80	1	20,80	CHI
201911367215	CRIXAS	CX12322605	SERRA DO OURO	30/11/2019 19:01	01/12/2019 02:36	30/11/2019 19:01	01/12/2019 02:36	7,57	16	121,18	CHI
201911367216	DOVERLANDIA	DV12380883	CAIAPONIA	30/11/2019 19:31	01/12/2019 12:34	30/11/2019 19:31	01/12/2019 12:34	17,05	7	119,32	CHI
201911367217	ITAPIRAPUA	IU12095446	MATRINCHA	30/11/2019 18:30	30/11/2019 22:00	30/11/2019 18:30	30/11/2019 22:00	3,49	9	31,42	CHI
201911367227	RIO VERDE	630156827	RIO VERDE S1	30/11/2019 19:33	01/12/2019 09:34	30/11/2019 19:33	01/12/2019 09:34	14,01	1	14,01	CHI
201911367301	MUNDO NOVO DE GOIAS	MH12269469	NOVA CRIXAS	30/11/2019 18:07	30/11/2019 20:46	30/11/2019 18:07	30/11/2019 20:46	2,65	3	7,95	CHI
201911367302	ARAGARCAS	10004710175	ARAGARCAS	30/11/2019 19:38	30/11/2019 21:40	30/11/2019 19:38	30/11/2019 21:40	2,02	1	2,02	CHI
201911367314	NOVO BRASIL	NB12020253	JUSSARA	30/11/2019 19:42	01/12/2019 12:38	30/11/2019 19:42	01/12/2019 12:38	16,93	7	118,53	CHI
201911367322	MONTIVIDIU	RV21103168	MONTIVIDIU T	30/11/2019 19:43	30/11/2019 22:48	30/11/2019 19:43	30/11/2019 22:48	3,07	1	3,07	CHI
201911367325	CATALAO	CT11373674	CATALAO S2	30/11/2019 19:44	30/11/2019 23:27	30/11/2019 19:44	30/11/2019 23:27	3,71	10	37,07	CHI
201911367346	SERRANOPOLIS	SX21164179	JATAI S1	30/11/2019 19:48	01/12/2019 12:50	30/11/2019 19:48	01/12/2019 12:50	17,03	1	17,03	CHI
201911367349	FORMOSO	FO21270929	PORANGATU	30/11/2019 19:48	01/12/2019 17:25	30/11/2019 19:48	01/12/2019 17:25	21,60	1	21,60	CHI
201911367363	JAUPACI	IS12018686	IPORA	30/11/2019 19:52	01/12/2019 03:56	30/11/2019 19:52	01/12/2019 03:56	8,05	9	72,48	CHI
201911367363	ISRAELANDIA	IS12018686	IPORA	30/11/2019 19:52	01/12/2019 03:56	30/11/2019 19:52	01/12/2019 03:56	8,05	2	16,11	CHI
201911367365	CAIAPONIA	CP12241868	CAIAPONIA	30/11/2019 19:53	01/12/2019 06:57	30/11/2019 19:53	01/12/2019 06:57	11,06	6	66,35	CHI
201911367370	EDEIA	VI12352542	VICENTINOPOLIS	30/11/2019 19:53	01/12/2019 11:14	30/11/2019 19:53	01/12/2019 11:14	15,34	7	107,35	CHI
201911367370	VICENTINOPOLIS	VI12352542	VICENTINOPOLIS	30/11/2019 19:53	01/12/2019 11:14	30/11/2019 19:53	01/12/2019 11:14	15,34	14	214,70	CHI
201911367372	BONOPOLIS	BX21253254	SAO MIGUEL DO ARAGUAIA	30/11/2019 19:54	02/12/2019 08:17	30/11/2019 19:54	02/12/2019 08:17	36,38	1	36,38	CHI
201911367373	JAUPACI	JP12352497	IPORA	30/11/2019 19:54	01/12/2019 08:39	30/11/2019 19:54	01/12/2019 08:39	12,75	7	89,22	CHI
201911367376	MONTES CLAROS DE GOIAS	ME21353754	IPORA	30/11/2019 19:55	01/12/2019 14:18	30/11/2019 19:55	01/12/2019 14:18	18,38	1	18,38	CHI
201911367378	PIRENOPOLIS	PV12273236	SAO FRANCISCO DE GOIAS	30/11/2019 17:30	02/12/2019 09:14	30/11/2019 17:30	02/12/2019 09:14	39,73	13	516,54	CHI
201911367378	SAO FRANCISCO DE GOIAS	PV12273236	SAO FRANCISCO DE GOIAS	30/11/2019 17:30	02/12/2019 09:14	30/11/2019 17:30	02/12/2019 09:14	39,73	11	437,08	CHI
201911367388	RIO VERDE	630373802	RIO VERDE S1	30/11/2019 19:59	01/12/2019 09:25	30/11/2019 19:59	01/12/2019 09:25	13,43	1	13,43	CHI
201911367390	ITAPIRAPUA	IU12008889	MATRINCHA	30/11/2019 20:00	01/12/2019 09:17	30/11/2019 20:00	01/12/2019 09:17	13,29	9	119,57	CHI
201911367399	DISTRITO FEDERAL	CT10400690	CATALAO S1	30/11/2019 18:25	30/11/2019 23:26	30/11/2019 18:25	30/11/2019 22:40	4,25	1	4,25	CHI

201911367399	DAVINOPOLIS	CT10400690	CATALAO S1	30/11/2019 18:25	30/11/2019 23:26	30/11/2019 18:25	30/11/2019 22:40	4,25	6	25,49	CHI
201911367399	CATALAO	CT10400690	CATALAO S1	30/11/2019 18:25	30/11/2019 23:26	30/11/2019 18:25	30/11/2019 22:40	4,25	1514	6432,82	CHI
201911367399	CATALAO	CT10394223	CATALAO S1	30/11/2019 18:25	30/11/2019 23:26	30/11/2019 18:25	30/11/2019 23:26	5,01	25	125,31	CHI
201911367399	CAMPO ALEGRE DE GOIAS	CT10394223	CATALAO S1	30/11/2019 18:25	30/11/2019 23:26	30/11/2019 18:25	30/11/2019 23:26	5,01	1	5,01	CHI
201911367399	DAVINOPOLIS	CT10394223	CATALAO S1	30/11/2019 18:25	30/11/2019 23:26	30/11/2019 18:25	30/11/2019 23:26	5,01	6	30,07	CHI
201911367407	BOM JESUS DE GOIAS	BJ21222755	CACHOEIRA DOURADA	30/11/2019 20:04	01/12/2019 09:33	30/11/2019 20:04	01/12/2019 09:33	13,47	1	13,47	CHI
201911367409	CALDAS NOVAS	CN21110351	CALDAS NOVAS S2	30/11/2019 20:04	01/12/2019 12:00	30/11/2019 20:04	01/12/2019 12:00	15,92	1	15,92	CHI
201911367412	MOSSAMEDES	MD11274183	FIRMINOPOLIS S2	30/11/2019 20:06	30/11/2019 21:55	30/11/2019 20:06	30/11/2019 21:55	1,81	53	95,86	CHI
201911367413	CAMPINACU	UC12354229	MARA ROSA	30/11/2019 20:06	01/12/2019 12:52	30/11/2019 20:06	01/12/2019 12:52	16,76	16	268,14	CHI
201911367415	CATALAO	GD12027441	CATALAO S1	30/11/2019 20:07	01/12/2019 12:25	30/11/2019 20:07	01/12/2019 12:25	16,30	4	65,18	CHI
201911367415	GOIANDIRA	GD12027441	CATALAO S1	30/11/2019 20:07	01/12/2019 12:25	30/11/2019 20:07	01/12/2019 12:25	16,30	14	228,15	CHI
201911367417	SAO MIGUEL DO ARAGUAIA	SM12000063	SAO MIGUEL DO ARAGUAIA	30/11/2019 18:38	01/12/2019 00:57	30/11/2019 18:38	01/12/2019 00:57	6,33	36	227,92	CHI
201911367423	SANTA HELENA DE GOIAS	SH11000037	IPEGUARI	30/11/2019 19:28	01/12/2019 07:28	30/11/2019 19:28	01/12/2019 07:28	12,00	92	1103,72	CHI
201911367424	ACREUNA	EU11000008	ACREUNA	30/11/2019 19:19	01/12/2019 12:25	30/11/2019 19:19	01/12/2019 12:25	17,09	37	632,22	CHI
201911367426	PEROLANDIA	DP12210131	PARQUE DAS EMAS	30/11/2019 20:10	01/12/2019 20:15	30/11/2019 20:10	01/12/2019 20:15	24,07	5	120,34	CHI
201911367426	MINEIROS	DP12210131	PARQUE DAS EMAS	30/11/2019 20:10	01/12/2019 20:15	30/11/2019 20:10	01/12/2019 20:15	24,07	13	312,89	CHI
201911367426	PORTELANDIA	DP12210131	PARQUE DAS EMAS	30/11/2019 20:10	01/12/2019 20:15	30/11/2019 20:10	01/12/2019 20:15	24,07	1	24,07	CHI
201911367433	NIQUELANDIA	NQ21345198	URUACU	30/11/2019 20:14	01/12/2019 04:58	30/11/2019 20:14	01/12/2019 04:58	8,73	1	8,73	CHI
201911367434	INDIARA	IY21086864	EDEIA	30/11/2019 20:13	01/12/2019 17:23	30/11/2019 20:13	01/12/2019 17:23	21,17	1	21,17	CHI
201911367436	FAZENDA NOVA	FN12040966	JUSSARA	30/11/2019 19:57	01/12/2019 17:08	30/11/2019 19:57	01/12/2019 17:08	21,19	8	169,50	CHI
201911367447	EDEIA	00500414	EDEIA	30/11/2019 20:10	01/12/2019 14:40	30/11/2019 20:10	30/11/2019 20:14	0,07	10	0,68	CHI
201911367447	EDEIA	00500414	EDEIA	30/11/2019 20:10	01/12/2019 14:40	30/11/2019 20:10	30/11/2019 22:06	1,93	11	21,26	CHI
201911367447	EDEALINA	00500414	EDEIA	30/11/2019 20:10	01/12/2019 14:40	30/11/2019 20:10	30/11/2019 22:06	1,93	3	5,80	CHI
201911367447	PONTALINA	00500414	PONTALINA	30/11/2019 20:10	01/12/2019 14:40	30/11/2019 20:10	30/11/2019 22:06	1,93	22	42,51	CHI
201911367447	CEZARINA	00500414	PONTALINA	30/11/2019 20:10	01/12/2019 14:40	30/11/2019 20:10	30/11/2019 22:06	1,93	4	7,73	CHI
201911367447	EDEIA	00500414	PONTALINA	30/11/2019 20:10	01/12/2019 14:40	30/11/2019 20:10	30/11/2019 22:06	1,93	130	251,22	CHI
201911367447	INDIARA	00500414	PONTALINA	30/11/2019 20:10	01/12/2019 14:40	30/11/2019 20:10	30/11/2019 22:06	1,93	2	3,86	CHI
201911367447	EDEALINA	00500414	PONTALINA	30/11/2019 20:10	01/12/2019 14:40	30/11/2019 20:10	30/11/2019 22:06	1,93	2000	3865,00	CHI
201911367447	PONTALINA	01510444	PONTALINA	30/11/2019 20:10	01/12/2019 14:40	30/11/2019 21:48	30/11/2019 22:06	0,31	254	78,03	CHI
201911367447	EDEALINA	01510444	PONTALINA	30/11/2019 20:10	01/12/2019 14:40	30/11/2019 21:48	30/11/2019 22:06	0,31	28	8,60	CHI
201911367447	EDEIA	EA21394402	EDEIA	30/11/2019 20:10	01/12/2019 14:40	30/11/2019 20:15	01/12/2019 11:00	14,75	1	14,75	CHI
201911367447	EDEIA	00500414	EDEIA	30/11/2019 20:10	01/12/2019 14:40	30/11/2019 20:15	01/12/2019 14:40	18,41	9	165,69	CHI
201911367456	ITABERAÍ	IB11000005	ITABERAÍ S2	30/11/2019 18:35	30/11/2019 21:03	30/11/2019 18:35	30/11/2019 21:03	2,46	66	162,52	CHI

201911367461	MINEIROS	MY11066493	PARQUE DAS EMAS	30/11/2019 19:44	30/11/2019 22:30	30/11/2019 19:44	30/11/2019 22:30	2,76	172	474,62	CHI
201911367462	ACREUNA	2440067514	ACREUNA	30/11/2019 20:21	01/12/2019 21:22	30/11/2019 20:21	01/12/2019 21:22	25,01	1	25,01	CHI
201911367471	QUIRINOPOLIS	QI21191556	QUIRINOPOLIS	30/11/2019 20:23	01/12/2019 01:04	30/11/2019 20:23	01/12/2019 01:04	4,67	2	9,34	CHI
201911367486	MONTES CLAROS DE GOIAS	JR12022269	BRITANIA	30/11/2019 20:31	01/12/2019 09:59	30/11/2019 20:31	01/12/2019 09:59	13,47	257	3462,58	CHI
201911367486	JUSSARA	JR12022269	BRITANIA	30/11/2019 20:31	01/12/2019 09:59	30/11/2019 20:31	01/12/2019 09:59	13,47	30	404,19	CHI
201911367494	TRES RANCHOS	TH21160948	CATALAO S1	30/11/2019 20:34	01/12/2019 11:55	30/11/2019 20:34	01/12/2019 11:55	15,35	2	30,70	CHI
201911367500	JUSSARA	JR11023510	IPORA	30/11/2019 20:02	01/12/2019 12:00	30/11/2019 20:02	01/12/2019 12:00	15,96	56	893,98	CHI
201911367502	SAO MIGUEL DO ARAGUAIA	SM12013055	SAO MIGUEL DO ARAGUAIA	30/11/2019 20:38	02/12/2019 22:03	30/11/2019 20:38	02/12/2019 22:03	49,40	4	197,60	CHI
201911367503	ITAPIRAPUA	IU12341188	JUSSARA	30/11/2019 20:39	01/12/2019 09:39	30/11/2019 20:39	01/12/2019 09:39	13,00	6	77,98	CHI
201911367517	PORANGATU	PO12282160	PORANGATU	30/11/2019 20:29	30/11/2019 23:16	30/11/2019 20:29	30/11/2019 23:16	2,77	11	30,47	CHI
201911367520	CORREGO DO OURO	CO21005023	FIRMINOPOLIS S2	30/11/2019 20:46	01/12/2019 09:45	30/11/2019 20:46	01/12/2019 09:45	12,98	1	12,98	CHI
201911367536	MUNDO NOVO DE GOIAS	MH12391952	NOVA CRIXAS	30/11/2019 18:30	01/12/2019 10:10	30/11/2019 18:30	01/12/2019 10:10	15,66	29	454,23	CHI
201911367542	IPAMERI	IP12265555	CAMPO ALEGRE DE GOIAS	30/11/2019 18:06	01/12/2019 10:58	30/11/2019 18:06	01/12/2019 10:58	16,86	7	118,03	CHI
201911367708	NOVA CRIXAS	NA12311289	MOZARLANDIA	30/11/2019 20:55	01/12/2019 12:35	30/11/2019 20:55	01/12/2019 12:35	15,65	1	15,65	CHI
201911367803	JATAI	290220970	JATAI S2	30/11/2019 20:57	01/12/2019 11:50	30/11/2019 20:57	01/12/2019 11:50	14,88	1	14,88	CHI
201911367804	MOSSAMEDES	MD12000176	FIRMINOPOLIS S2	30/11/2019 20:53	30/11/2019 22:38	30/11/2019 20:53	30/11/2019 22:38	1,74	18	31,39	CHI
201911367805	INDIARA	IY12010924	PALMEIRAS	30/11/2019 20:57	01/12/2019 09:45	30/11/2019 20:57	01/12/2019 09:45	12,79	14	179,04	CHI
201911367805	JANDAIA	IY12010924	PALMEIRAS	30/11/2019 20:57	01/12/2019 09:45	30/11/2019 20:57	01/12/2019 09:45	12,79	1	12,79	CHI
201911367820	ANICUNS	AC12000067	ANICUNS	30/11/2019 20:39	30/11/2019 22:28	30/11/2019 20:39	30/11/2019 22:28	1,80	13	23,45	CHI
201911367833	NOVA AMERICA	NM21121742	RUBIATABA	30/11/2019 21:05	02/12/2019 12:42	30/11/2019 21:05	02/12/2019 12:42	39,61	1	39,61	CHI
201911367854	RIO VERDE	630250054	RIO VERDE S1	30/11/2019 21:15	01/12/2019 10:55	30/11/2019 21:15	01/12/2019 10:55	13,66	1	13,66	CHI
201911367856	NIQUELANDIA	NQ21213091	NIQUELANDIA SUBTRANSMISSAO	30/11/2019 21:15	01/12/2019 01:29	30/11/2019 21:15	01/12/2019 01:29	4,22	1	4,22	CHI
201911367861	IPAMERI	IP12000014	IPAMERI	30/11/2019 21:20	30/11/2019 23:03	30/11/2019 21:20	30/11/2019 23:03	1,71	20	34,25	CHI
201911367868	BRITANIA	BT12220341	BRITANIA	30/11/2019 21:24	01/12/2019 07:42	30/11/2019 21:24	01/12/2019 07:42	10,28	2	20,57	CHI
201911367870	GOIAS	GS12336536	GOIAS	30/11/2019 21:27	01/12/2019 10:34	30/11/2019 21:27	01/12/2019 10:34	13,11	9	118,02	CHI
201911367874	FAINA	GK12274573	ITAPURANGA	30/11/2019 21:28	01/12/2019 12:20	30/11/2019 21:28	01/12/2019 12:20	14,86	2	29,71	CHI
201911367878	FIRMINOPOLIS	AI12289759	FIRMINOPOLIS S2	30/11/2019 21:30	01/12/2019 00:13	30/11/2019 21:30	01/12/2019 00:13	2,71	1	2,71	CHI
201911367878	AURILANDIA	AI12289759	FIRMINOPOLIS S2	30/11/2019 21:30	01/12/2019 00:13	30/11/2019 21:30	01/12/2019 00:13	2,71	4	10,86	CHI
201911367886	URUTAI	UT11278551	URUTAI	30/11/2019 21:36	01/12/2019 10:30	30/11/2019 21:36	01/12/2019 10:30	12,89	32	412,60	CHI
201911367896	MATRINCHA	MP12010442	MOZARLANDIA	30/11/2019 21:42	01/12/2019 08:20	30/11/2019 21:42	01/12/2019 08:20	10,63	4	42,52	CHI
201911367902	PARAUNA	RV12048983	ACREUNA	30/11/2019 20:47	01/12/2019 09:00	30/11/2019 20:47	01/12/2019 09:00	12,21	28	341,79	CHI
201911367905	RIO VERDE	03390224	CACHOEIRA ALTA	30/11/2019 21:34	01/12/2019 02:09	30/11/2019 21:34	01/12/2019 00:57	3,38	166	561,77	CHI
201911367905	JATAI	03390224	CACHOEIRA ALTA	30/11/2019 21:34	01/12/2019 02:09	30/11/2019 21:34	01/12/2019 00:57	3,38	1	3,38	CHI

201911367905	CACHOEIRA ALTA	03390224	CACHOEIRA ALTA	30/11/2019 21:34	01/12/2019 02:09	30/11/2019 21:34	01/12/2019 00:57	3,38	3	10,15	CHI
201911367905	APARECIDA DO RIO DOCE	03390224	CACHOEIRA ALTA	30/11/2019 21:34	01/12/2019 02:09	30/11/2019 21:34	01/12/2019 00:57	3,38	529	1790,22	CHI
201911367905	APARECIDA DO RIO DOCE	03390224	CACHOEIRA ALTA	30/11/2019 21:34	01/12/2019 02:09	30/11/2019 21:34	01/12/2019 02:09	4,58	93	426,12	CHI
201911367912	MUNDO NOVO DE GOIAS	MH11269484	NOVA CRIXAS	30/11/2019 17:10	01/12/2019 17:31	30/11/2019 17:10	01/12/2019 17:31	24,35	1	24,35	CHI
201911367921	PIRES DO RIO	PR21051300	PIRES DO RIO S1	30/11/2019 21:52	01/12/2019 16:09	30/11/2019 21:52	01/12/2019 16:09	18,27	1	18,27	CHI
201911367922	ARENOPOLIS	AY12087158	ARENOPOLIS	30/11/2019 21:53	01/12/2019 12:48	30/11/2019 21:53	01/12/2019 12:48	14,90	10	149,02	CHI
201911367939	ITAPURANGA	10023069986	ITAPURANGA	30/11/2019 22:09	01/12/2019 10:33	30/11/2019 22:09	01/12/2019 10:33	12,39	1	12,39	CHI
201911367941	CEZARINA	1650024190	CEZARINA	30/11/2019 22:10	01/12/2019 08:16	30/11/2019 22:10	01/12/2019 08:16	10,11	1	10,11	CHI
201911367949	EDEIA	EA12000039	EDEIA	30/11/2019 18:51	01/12/2019 10:44	30/11/2019 18:51	01/12/2019 10:44	15,88	20	317,52	CHI
201911367950	CALDAS NOVAS	CN11263264	SERRA DE CALDAS	30/11/2019 22:17	01/12/2019 10:20	30/11/2019 22:17	01/12/2019 10:20	12,04	3	36,13	CHI
201911367951	JAUPACI	JP12349721	IPORA	30/11/2019 22:17	01/12/2019 07:16	30/11/2019 22:17	01/12/2019 07:16	8,97	7	62,78	CHI
201911367953	MINEIROS	MY12209668	PARQUE DAS EMAS	30/11/2019 22:12	01/12/2019 12:48	30/11/2019 22:12	01/12/2019 12:48	14,60	89	1299,05	CHI
201911367957	ITUMBIARA	IT12305607	ITUMBIARA NOVA	30/11/2019 22:25	02/12/2019 15:17	30/11/2019 22:25	01/12/2019 08:35	10,17	13	132,16	CHI
201911367957	ITUMBIARA	IT12305607	ITUMBIARA NOVA	30/11/2019 22:25	02/12/2019 15:17	01/12/2019 08:35	01/12/2019 11:10	2,57	3	7,71	CHI
201911367957	ITUMBIARA	IT12305607	ITUMBIARA NOVA	30/11/2019 22:25	02/12/2019 15:17	01/12/2019 18:40	01/12/2019 20:43	2,05	3	6,16	CHI
201911367957	ITUMBIARA	IT12305607	ITUMBIARA NOVA	30/11/2019 22:25	02/12/2019 15:17	01/12/2019 08:35	02/12/2019 10:50	26,23	5	131,17	CHI
201911367957	ITUMBIARA	IT12305607	ITUMBIARA NOVA	30/11/2019 22:25	02/12/2019 15:17	01/12/2019 08:35	02/12/2019 15:17	30,69	5	153,43	CHI
201911367957	ITUMBIARA	IT12305607	ITUMBIARA NOVA	30/11/2019 22:25	02/12/2019 15:17	02/12/2019 13:52	02/12/2019 15:17	1,42	8	11,33	CHI
201911367958	CAIAPONIA	CP11292001	CAIAPONIA	30/11/2019 22:27	01/12/2019 09:04	30/11/2019 22:27	01/12/2019 09:04	10,61	1	10,61	CHI
201911367963	SANTO ANTONIO DA BARRA	BZ21136108	ACREUNA	30/11/2019 22:28	01/12/2019 10:10	30/11/2019 22:28	01/12/2019 10:10	11,69	1	11,69	CHI
201911367964	URUACU	640099105	URUACU	30/11/2019 22:28	02/12/2019 00:45	30/11/2019 22:28	02/12/2019 00:45	26,27	1	26,27	CHI
201911367968	MUNDO NOVO DE GOIAS	NA21128439	NOVA CRIXAS	30/11/2019 22:32	01/12/2019 17:18	30/11/2019 22:32	01/12/2019 17:18	18,76	1	18,76	CHI
201911367973	BOM JESUS DE GOIAS	BJ12000046	BOM JESUS DE GOIAS	30/11/2019 22:37	02/12/2019 09:39	30/11/2019 22:37	02/12/2019 09:39	35,03	1	35,03	CHI
201911367988	ITUMBIARA	IT21027783	ITUMBIARA NOVA	30/11/2019 22:48	01/12/2019 07:30	30/11/2019 22:48	01/12/2019 07:30	8,69	1	8,69	CHI
201911367995	MARA ROSA	MQ21187784	MARA ROSA	30/11/2019 22:56	01/12/2019 10:30	30/11/2019 22:56	01/12/2019 10:30	11,56	2	23,12	CHI
201911367998	NOVA CRIXAS	NA12325050	MOZARLANDIA	01/12/2019 08:11	02/12/2019 15:26	01/12/2019 08:11	01/12/2019 12:39	4,47	2	8,94	CHI
201911367998	NOVA CRIXAS	NA12325050	NOVA CRIXAS	01/12/2019 08:11	02/12/2019 15:26	01/12/2019 08:11	01/12/2019 12:39	4,47	1	4,47	CHI
201911367998	NOVA CRIXAS	NA12022049	MOZARLANDIA	01/12/2019 08:11	02/12/2019 15:26	01/12/2019 08:11	01/12/2019 20:59	12,79	2	25,58	CHI
201911367998	NOVA CRIXAS	NA12058013	MOZARLANDIA	01/12/2019 08:11	02/12/2019 15:26	01/12/2019 08:11	01/12/2019 21:27	13,26	2	26,52	CHI
201911367998	NOVA CRIXAS	NA12022049	MOZARLANDIA	01/12/2019 08:11	02/12/2019 15:26	01/12/2019 08:11	02/12/2019 15:26	31,24	3	93,73	CHI
201911368007	TROMBAS	TB11288300	PORANGATU	30/11/2019 17:43	01/12/2019 01:04	30/11/2019 17:43	01/12/2019 01:04	7,34	1	7,34	CHI
201911368008	ORIZONA	OZ32052342	PIRES DO RIO S2	30/11/2019 23:14	01/12/2019 10:01	30/11/2019 23:14	01/12/2019 10:01	10,77	5	53,86	CHI
201911368017	EDEIA	EA12263332	VICENTINOPOLIS	30/11/2019 23:26	01/12/2019 11:00	30/11/2019 23:26	01/12/2019 11:00	11,56	22	254,28	CHI

201911368018	JUSSARA	JR12027532	BRITANIA	30/11/2019 23:29	01/12/2019 15:46	30/11/2019 23:29	01/12/2019 15:46	16,28	40	651,03	CHI
201911368019	PORANGATU	PO21290392	PORANGATU	30/11/2019 23:29	02/12/2019 09:19	30/11/2019 23:29	02/12/2019 09:19	33,82	1	33,82	CHI
201911368021	PIRACANJUBA	PJ12082228	CRISTIANOPOLIS	30/11/2019 15:02	01/12/2019 09:20	30/11/2019 15:02	01/12/2019 09:20	18,31	5	91,55	CHI
201911368023	ACREUNA	2440046663	ACREUNA	30/11/2019 23:33	01/12/2019 09:25	30/11/2019 23:33	01/12/2019 09:25	9,86	1	9,86	CHI
201911368029	NOVO BRASIL	NB12396240	JUSSARA	30/11/2019 23:40	01/12/2019 12:00	30/11/2019 23:40	01/12/2019 12:00	12,33	10	123,30	CHI
201911368030	SANTA FE DE GOIAS	RN21167344	BRITANIA	30/11/2019 23:51	01/12/2019 10:03	30/11/2019 23:51	01/12/2019 10:03	10,20	1	10,20	CHI
201911368190	ALVORADA DO NORTE	00010434	IACIARA S2	29/11/2019 11:40	30/11/2019 01:58	29/11/2019 11:40	29/11/2019 13:17	1,60	93	148,93	CHI
201911368190	SITIO D ABADIA	00010434	IACIARA S2	29/11/2019 11:40	30/11/2019 01:58	29/11/2019 11:40	29/11/2019 13:17	1,60	36	57,65	CHI
201911368190	SITIO D ABADIA	00010434	IACIARA S2	29/11/2019 11:40	30/11/2019 01:58	29/11/2019 11:40	29/11/2019 13:17	1,60	479	767,07	CHI
201911368190	BURITINOPOLIS	00010434	IACIARA S2	29/11/2019 11:40	30/11/2019 01:58	29/11/2019 11:40	29/11/2019 13:17	1,60	7	11,21	CHI
201911368190	SITIO D ABADIA	00010434	IACIARA S2	29/11/2019 11:40	30/11/2019 01:58	29/11/2019 11:40	29/11/2019 13:17	1,60	91	145,73	CHI
201911368190	ALVORADA DO NORTE	AQ13393810B	IACIARA S2	29/11/2019 11:40	30/11/2019 01:58	29/11/2019 11:40	29/11/2019 14:48	3,12	68	212,27	CHI
201911368190	BURITINOPOLIS	00010434	IACIARA S2	29/11/2019 11:40	30/11/2019 01:58	29/11/2019 16:07	29/11/2019 16:14	0,11	7	0,80	CHI
201911368190	ALVORADA DO NORTE	00010434	IACIARA S2	29/11/2019 11:40	30/11/2019 01:58	29/11/2019 16:07	29/11/2019 16:14	0,11	161	18,34	CHI
201911368190	SITIO D ABADIA	00010434	IACIARA S2	29/11/2019 11:40	30/11/2019 01:58	29/11/2019 16:07	29/11/2019 16:14	0,11	479	54,55	CHI
201911368190	SITIO D ABADIA	00010434	IACIARA S2	29/11/2019 11:40	30/11/2019 01:58	29/11/2019 16:07	29/11/2019 16:14	0,11	36	4,10	CHI
201911368190	SITIO D ABADIA	00010434	IACIARA S2	29/11/2019 11:40	30/11/2019 01:58	29/11/2019 16:07	29/11/2019 16:14	0,11	91	10,36	CHI
201911368190	ALVORADA DO NORTE	00010434	IACIARA S2	29/11/2019 11:40	30/11/2019 01:58	29/11/2019 17:26	29/11/2019 17:30	0,06	161	9,62	CHI
201911368190	BURITINOPOLIS	00010434	IACIARA S2	29/11/2019 11:40	30/11/2019 01:58	29/11/2019 17:26	29/11/2019 17:30	0,06	7	0,42	CHI
201911368190	SITIO D ABADIA	00010434	IACIARA S2	29/11/2019 11:40	30/11/2019 01:58	29/11/2019 17:26	29/11/2019 17:30	0,06	91	5,43	CHI
201911368190	SITIO D ABADIA	00010434	IACIARA S2	29/11/2019 11:40	30/11/2019 01:58	29/11/2019 17:26	29/11/2019 17:30	0,06	36	2,15	CHI
201911368190	SITIO D ABADIA	00010434	IACIARA S2	29/11/2019 11:40	30/11/2019 01:58	29/11/2019 17:26	29/11/2019 17:30	0,06	479	28,61	CHI
201911368190	ALVORADA DO NORTE	SI13268142	IACIARA S2	29/11/2019 11:40	30/11/2019 01:58	29/11/2019 11:40	30/11/2019 00:38	12,95	14	181,34	CHI
201911368190	DAMIANOPOLIS	SI13268142	IACIARA S2	29/11/2019 11:40	30/11/2019 01:58	29/11/2019 11:40	30/11/2019 00:38	12,95	2	25,91	CHI
201911368190	DAMIANOPOLIS	00010434	IACIARA S2	29/11/2019 11:40	30/11/2019 01:58	29/11/2019 11:40	30/11/2019 00:45	13,07	130	1698,78	CHI
201911368190	SITIO D ABADIA	00010434	IACIARA S2	29/11/2019 11:40	30/11/2019 01:58	29/11/2019 11:40	30/11/2019 00:45	13,07	228	2979,39	CHI
201911368190	DAMIANOPOLIS	SI13268142	IACIARA S2	29/11/2019 11:40	30/11/2019 01:58	29/11/2019 11:40	30/11/2019 01:02	13,36	1	13,36	CHI
201911368190	MAMBAI	DA13302880	IACIARA S2	29/11/2019 11:40	30/11/2019 01:58	29/11/2019 11:40	30/11/2019 01:02	13,36	17	227,20	CHI
201911368190	BURITINOPOLIS	MB13291535	IACIARA S2	29/11/2019 11:40	30/11/2019 01:58	29/11/2019 11:40	30/11/2019 01:55	14,23	441	6277,27	CHI
201911368190	MAMBAI	MB13291535	IACIARA S2	29/11/2019 11:40	30/11/2019 01:58	29/11/2019 11:40	30/11/2019 01:55	14,23	2861	40723,95	CHI
201911368190	SITIO D ABADIA	MB13291535	IACIARA S2	29/11/2019 11:40	30/11/2019 01:58	29/11/2019 11:40	30/11/2019 01:55	14,23	1	14,23	CHI
201911368190	DAMIANOPOLIS	MB13291536	IACIARA S2	29/11/2019 11:40	30/11/2019 01:58	29/11/2019 11:40	30/11/2019 01:58	14,29	1502	21470,26	CHI
201911368190	MAMBAI	MB13291536	IACIARA S2	29/11/2019 11:40	30/11/2019 01:58	29/11/2019 11:40	30/11/2019 01:58	14,29	83	1186,44	CHI

201911368197	FORMOSA	FB12384211	IACIARA S2	29/11/2019 13:20	29/11/2019 15:56	29/11/2019 13:20	29/11/2019 15:56	2,60	1	2,60	CHI
201911368197	FLORES DE GOIAS	FB12384211	IACIARA S2	29/11/2019 13:20	29/11/2019 15:56	29/11/2019 13:20	29/11/2019 15:56	2,60	124	322,92	CHI
201911368197	VILA BOA	FB12384211	IACIARA S2	29/11/2019 13:20	29/11/2019 15:56	29/11/2019 13:20	29/11/2019 15:56	2,60	4	10,42	CHI
201911368198	FLORES DE GOIAS	6730000711	IACIARA S2	28/11/2019 18:59	29/11/2019 13:20	28/11/2019 18:59	29/11/2019 13:20	18,35	1	18,35	CHI
201911368205	IPAMERI	IP12000086	IPAMERI	27/11/2019 15:36	28/11/2019 15:23	27/11/2019 15:36	28/11/2019 15:23	23,78	5	118,90	CHI
201911368209	SAO MIGUEL DO ARAGUAIA	SM12031421	SAO MIGUEL DO ARAGUAIA	28/11/2019 06:06	28/11/2019 17:31	28/11/2019 06:06	28/11/2019 17:31	11,42	18	205,61	CHI
201911368212	ITABERAI	IB12300044	ITABERAI S1	28/11/2019 06:13	28/11/2019 14:35	28/11/2019 06:13	28/11/2019 14:35	8,38	9	75,38	CHI
201911368213	FLORES DE GOIAS	FB12239102	IACIARA S2	28/11/2019 07:17	28/11/2019 18:38	28/11/2019 07:17	28/11/2019 18:38	11,34	19	215,38	CHI
201911368215	SITIO D ABADIA	FB12245566	IACIARA S2	28/11/2019 07:23	28/11/2019 12:58	28/11/2019 07:23	28/11/2019 12:58	5,57	38	211,67	CHI
201911368215	FLORES DE GOIAS	FB12245566	IACIARA S2	28/11/2019 07:23	28/11/2019 12:58	28/11/2019 07:23	28/11/2019 12:58	5,57	71	395,49	CHI
201911368216	ITUMBIARA	IT12263732	CACHOEIRA DOURADA	28/11/2019 08:49	28/11/2019 10:22	28/11/2019 08:49	28/11/2019 10:22	1,54	4	6,16	CHI
201911368221	POSSE	PS12262357	IACIARA S2	28/11/2019 20:54	28/11/2019 22:56	28/11/2019 20:54	28/11/2019 22:56	2,02	4	8,08	CHI
201911368222	FIRMINOPOLIS	FR12096824	FIRMINOPOLIS S1	29/11/2019 06:08	29/11/2019 08:46	29/11/2019 06:08	29/11/2019 08:46	2,64	7	18,47	CHI
201911368225	SAO FRANCISCO DE GOIAS	01450224	PETROLINA	28/11/2019 06:22	28/11/2019 14:41	28/11/2019 06:22	28/11/2019 09:16	2,89	34	98,36	CHI
201911368225	PETROLINA DE GOIAS	01450224	PETROLINA	28/11/2019 06:22	28/11/2019 14:41	28/11/2019 06:22	28/11/2019 09:16	2,89	1530	4426,38	CHI
201911368225	PETROLINA DE GOIAS	01450224	PETROLINA	28/11/2019 06:22	28/11/2019 14:41	28/11/2019 09:21	28/11/2019 09:27	0,10	1530	153,00	CHI
201911368225	SAO FRANCISCO DE GOIAS	01450224	PETROLINA	28/11/2019 06:22	28/11/2019 14:41	28/11/2019 09:21	28/11/2019 09:27	0,10	34	3,40	CHI
201911368225	SAO FRANCISCO DE GOIAS	01450224	PETROLINA	28/11/2019 06:22	28/11/2019 14:41	28/11/2019 09:42	28/11/2019 09:47	0,09	34	2,94	CHI
201911368225	PETROLINA DE GOIAS	01450224	PETROLINA	28/11/2019 06:22	28/11/2019 14:41	28/11/2019 09:42	28/11/2019 09:47	0,09	1530	132,17	CHI
201911368225	PETROLINA DE GOIAS	01450224	PETROLINA	28/11/2019 06:22	28/11/2019 14:41	28/11/2019 09:51	28/11/2019 09:57	0,10	1027	100,13	CHI
201911368225	PETROLINA DE GOIAS	01450224	PETROLINA	28/11/2019 06:22	28/11/2019 14:41	28/11/2019 10:05	28/11/2019 10:12	0,11	1027	113,54	CHI
201911368225	PETROLINA DE GOIAS	PG16411514	PETROLINA	28/11/2019 06:22	28/11/2019 14:41	28/11/2019 09:51	28/11/2019 13:58	4,11	57	234,11	CHI
201911368225	PETROLINA DE GOIAS	PG10390335	PETROLINA	28/11/2019 06:22	28/11/2019 14:41	28/11/2019 09:51	28/11/2019 14:12	4,34	215	933,28	CHI
201911368225	SAO FRANCISCO DE GOIAS	PG16411514	PETROLINA	28/11/2019 06:22	28/11/2019 14:41	28/11/2019 09:51	28/11/2019 14:41	4,83	34	164,30	CHI
201911368225	PETROLINA DE GOIAS	PG16411514	PETROLINA	28/11/2019 06:22	28/11/2019 14:41	28/11/2019 09:51	28/11/2019 14:41	4,83	230	1111,41	CHI
201911368232	EDEIA	EA12043985	EDEIA	29/11/2019 15:03	30/11/2019 16:12	29/11/2019 15:03	30/11/2019 16:12	25,16	5	125,82	CHI
201911368233	GUARANI DE GOIAS	10026992831	IACIARA S1	28/11/2019 09:07	29/11/2019 07:04	28/11/2019 09:07	29/11/2019 07:04	21,94	1	21,94	CHI
201911368238	FLORES DE GOIAS	FB12211535	IACIARA S2	29/11/2019 16:24	29/11/2019 22:27	29/11/2019 16:24	29/11/2019 22:27	6,04	53	320,36	CHI
201911368239	MORRINHOS	MR12236952	GOIATUBA S2	29/11/2019 17:54	30/11/2019 15:37	29/11/2019 17:54	30/11/2019 15:37	21,72	5	108,62	CHI
201911368240	CAMPO ALEGRE DE GOIAS	CM12203138	CAMPO ALEGRE DE GOIAS	29/11/2019 19:41	30/11/2019 18:03	29/11/2019 19:41	30/11/2019 18:03	22,36	6	134,17	CHI
201911368241	GOIATUBA	GT12000370	GOIATUBA S2	29/11/2019 20:28	30/11/2019 16:01	29/11/2019 20:28	30/11/2019 16:01	19,56	11	215,15	CHI
201911368277	ALTO HORIZONTE	03404114	SANTA TEREZINHA	27/11/2019 12:04	27/11/2019 15:00	27/11/2019 12:04	27/11/2019 15:00	2,93	13	38,14	CHI
201911368277	ALTO HORIZONTE	03404114	SANTA TEREZINHA	27/11/2019 12:04	27/11/2019 15:00	27/11/2019 12:04	27/11/2019 15:00	2,93	2296	6736,21	CHI

201911368277	NOVA IGUACU DE GOIAS	03404114	SANTA TEREZINHA	27/11/2019 12:04	27/11/2019 15:00	27/11/2019 12:04	27/11/2019 15:00	2,93	364	1067,94	CHI
201911368277	PILAR DE GOIAS	03404114	SANTA TEREZINHA	27/11/2019 12:04	27/11/2019 15:00	27/11/2019 12:04	27/11/2019 15:00	2,93	1	2,93	CHI
201911368277	NOVA IGUACU DE GOIAS	03404114	SANTA TEREZINHA	27/11/2019 12:04	27/11/2019 15:00	27/11/2019 12:04	27/11/2019 15:00	2,93	816	2394,05	CHI
201911368277	PILAR DE GOIAS	03404114	SANTA TEREZINHA	27/11/2019 12:04	27/11/2019 15:00	27/11/2019 12:04	27/11/2019 15:00	2,93	169	495,83	CHI
201911368277	CAMPOS VERDES	03404114	SANTA TEREZINHA	27/11/2019 12:04	27/11/2019 15:00	27/11/2019 12:04	27/11/2019 15:00	2,93	8	23,47	CHI
201911368277	SANTA TEREZINHA DE GOIAS	03404114	SANTA TEREZINHA	27/11/2019 12:04	27/11/2019 15:00	27/11/2019 12:04	27/11/2019 15:00	2,93	62	181,90	CHI
201911368306	MARA ROSA	2260039140	SANTA TEREZINHA	27/11/2019 11:37	27/11/2019 23:28	27/11/2019 11:37	27/11/2019 23:28	11,84	1	11,84	CHI
201911368319	AMARALINA	3590009121	SAO MIGUEL DO ARAGUAIA	28/11/2019 11:27	28/11/2019 14:18	28/11/2019 11:27	28/11/2019 14:18	2,86	1	2,86	CHI
201911368325	SANTA HELENA DE GOIAS	SH12271344LD	ACREUNA	29/11/2019 07:09	29/11/2019 11:12	29/11/2019 07:09	29/11/2019 11:12	4,04	24	96,99	CHI
201911368347	CABECEIRAS	03740434	ITIQUEIRA	28/11/2019 13:42	28/11/2019 19:55	28/11/2019 13:42	28/11/2019 15:35	1,88	27	50,78	CHI
201911368347	FORMOSA	03740434	ITIQUEIRA	28/11/2019 13:42	28/11/2019 19:55	28/11/2019 13:42	28/11/2019 15:35	1,88	2	3,76	CHI
201911368347	DISTRITO FEDERAL	03740434	ITIQUEIRA	28/11/2019 13:42	28/11/2019 19:55	28/11/2019 13:42	28/11/2019 15:35	1,88	1	1,88	CHI
201911368347	CABECEIRAS	03740434	ITIQUEIRA	28/11/2019 13:42	28/11/2019 19:55	28/11/2019 13:42	28/11/2019 15:35	1,88	24	45,14	CHI
201911368347	CABECEIRAS	03740434	ITIQUEIRA	28/11/2019 13:42	28/11/2019 19:55	28/11/2019 13:42	28/11/2019 19:55	6,22	172	1070,37	CHI
201911368347	DISTRITO FEDERAL	02210434	ITIQUEIRA	28/11/2019 13:42	28/11/2019 19:55	28/11/2019 19:29	28/11/2019 19:55	0,44	1	0,44	CHI
201911368347	CABECEIRAS	02210434	ITIQUEIRA	28/11/2019 13:42	28/11/2019 19:55	28/11/2019 19:29	28/11/2019 19:55	0,44	27	11,95	CHI
201911368347	FORMOSA	02210434	ITIQUEIRA	28/11/2019 13:42	28/11/2019 19:55	28/11/2019 19:29	28/11/2019 19:55	0,44	2	0,89	CHI
201911368347	CABECEIRAS	02210434	ITIQUEIRA	28/11/2019 13:42	28/11/2019 19:55	28/11/2019 19:29	28/11/2019 19:55	0,44	24	10,62	CHI
201912177733	FAINA	FC12307377	GOIAS	01/12/2019 08:56	01/12/2019 17:05	01/12/2019 08:56	01/12/2019 17:05	8,13	3	24,40	CHI
2019112800071	JUSSARA	02501	BRITANIA	28/11/2019 14:18	28/11/2019 14:21	28/11/2019 14:18	28/11/2019 14:21	0,05	49	2,45	CHI
2019112800071	JUSSARA	02502	BRITANIA	28/11/2019 14:18	28/11/2019 14:21	28/11/2019 14:18	28/11/2019 14:21	0,05	24	1,20	CHI
2019112800071	ITAPIRAPUA	02502	BRITANIA	28/11/2019 14:18	28/11/2019 14:21	28/11/2019 14:18	28/11/2019 14:21	0,05	2	0,10	CHI
2019112800071	BRITANIA	40501	BRITANIA	28/11/2019 14:18	28/11/2019 14:21	28/11/2019 14:18	28/11/2019 14:21	0,05	1	0,05	CHI
2019112800071	ARUANA	02502	BRITANIA	28/11/2019 14:18	28/11/2019 14:21	28/11/2019 14:18	28/11/2019 14:21	0,05	25	1,25	CHI
2019112800071	BRITANIA	02501	BRITANIA	28/11/2019 14:18	28/11/2019 14:21	28/11/2019 14:18	28/11/2019 14:21	0,05	1362	68,10	CHI
2019112800071	BRITANIA	02502	BRITANIA	28/11/2019 14:18	28/11/2019 14:21	28/11/2019 14:18	28/11/2019 14:21	0,05	1905	95,25	CHI
2019112800103	ITARUMA	03742134	ITIQUEIRA	28/11/2019 13:42	28/11/2019 13:56	28/11/2019 13:42	28/11/2019 13:56	0,23	3	0,70	CHI
2019112800103	FORMOSA	03742134	ITIQUEIRA	28/11/2019 13:42	28/11/2019 13:56	28/11/2019 13:42	28/11/2019 13:56	0,23	14609	3408,77	CHI
2019112900009	PORTEIRAO	26502	RIO DOS BOIS	29/11/2019 06:48	29/11/2019 06:52	29/11/2019 06:48	29/11/2019 06:52	0,07	1548	103,20	CHI
2019112900009	PORTEIRAO	23231	RIO DOS BOIS	29/11/2019 06:48	29/11/2019 06:52	29/11/2019 06:48	29/11/2019 06:52	0,07	4	0,27	CHI
2019112900009	MAURILANDIA	11302	RIO DOS BOIS	29/11/2019 06:48	29/11/2019 06:52	29/11/2019 06:48	29/11/2019 06:52	0,07	1582	105,47	CHI
2019112900009	GOIATUBA	23201	RIO DOS BOIS	29/11/2019 06:48	29/11/2019 06:52	29/11/2019 06:48	29/11/2019 06:52	0,07	20	1,33	CHI
2019112900009	TURVELANDIA	26502	RIO DOS BOIS	29/11/2019 06:48	29/11/2019 06:52	29/11/2019 06:48	29/11/2019 06:52	0,07	12	0,80	CHI



2019112900009	TURVELANDIA	30501	RIO DOS BOIS	29/11/2019 06:48	29/11/2019 06:52	29/11/2019 06:48	29/11/2019 06:52	0,07	535	35,67	CHI
2019112900009	TURVELANDIA	031706114	RIO DOS BOIS	29/11/2019 06:48	29/11/2019 06:52	29/11/2019 06:48	29/11/2019 06:52	0,07	83	5,53	CHI
2019112900009	CASTELANDIA	031706114	RIO DOS BOIS	29/11/2019 06:48	29/11/2019 06:52	29/11/2019 06:48	29/11/2019 06:52	0,07	2	0,13	CHI
2019112900009	RIO VERDE	11302	RIO DOS BOIS	29/11/2019 06:48	29/11/2019 06:52	29/11/2019 06:48	29/11/2019 06:52	0,07	22	1,47	CHI
2019112900009	VICENTINOPOLIS	26502	RIO DOS BOIS	29/11/2019 06:48	29/11/2019 06:52	29/11/2019 06:48	29/11/2019 06:52	0,07	4	0,27	CHI
2019112900009	SANTA HELENA DE GOIAS	031706114	RIO DOS BOIS	29/11/2019 06:48	29/11/2019 06:52	29/11/2019 06:48	29/11/2019 06:52	0,07	3	0,20	CHI
2019112900009	PORTEIRAO	26502	RIO DOS BOIS	29/11/2019 06:48	29/11/2019 06:52	29/11/2019 06:48	29/11/2019 06:52	0,07	39	2,60	CHI
2019112900009	TURVELANDIA	11302	RIO DOS BOIS	29/11/2019 06:48	29/11/2019 06:52	29/11/2019 06:48	29/11/2019 06:52	0,07	29	1,93	CHI
2019112900009	TURVELANDIA	11301	RIO DOS BOIS	29/11/2019 06:48	29/11/2019 06:52	29/11/2019 06:48	29/11/2019 06:52	0,07	3	0,20	CHI
2019112900009	SANTA HELENA DE GOIAS	11302	RIO DOS BOIS	29/11/2019 06:48	29/11/2019 06:52	29/11/2019 06:48	29/11/2019 06:52	0,07	48	3,20	CHI
2019112900009	SANTA HELENA DE GOIAS	30502	RIO DOS BOIS	29/11/2019 06:48	29/11/2019 06:52	29/11/2019 06:48	29/11/2019 06:52	0,07	18	1,20	CHI
2019112900009	PORTEIRAO	23201	RIO DOS BOIS	29/11/2019 06:48	29/11/2019 06:52	29/11/2019 06:48	29/11/2019 06:52	0,07	7	0,47	CHI
2019112900009	QUIRINOPOLIS	23201	RIO DOS BOIS	29/11/2019 06:48	29/11/2019 06:52	29/11/2019 06:48	29/11/2019 06:52	0,07	45	3,00	CHI
2019112900009	PORTEIRAO	36801	RIO DOS BOIS	29/11/2019 06:48	29/11/2019 06:52	29/11/2019 06:48	29/11/2019 06:52	0,07	2	0,13	CHI
2019112900009	PORTEIRAO	30502	RIO DOS BOIS	29/11/2019 06:48	29/11/2019 06:52	29/11/2019 06:48	29/11/2019 06:52	0,07	1	0,07	CHI
2019112900009	PORTEIRAO	26531	RIO DOS BOIS	29/11/2019 06:48	29/11/2019 06:52	29/11/2019 06:48	29/11/2019 06:52	0,07	5	0,33	CHI
2019112900009	MAURILANDIA	23201	RIO DOS BOIS	29/11/2019 06:48	29/11/2019 06:52	29/11/2019 06:48	29/11/2019 06:52	0,07	2	0,13	CHI
2019112900009	MAURILANDIA	031706114	RIO DOS BOIS	29/11/2019 06:48	29/11/2019 06:52	29/11/2019 06:48	29/11/2019 06:52	0,07	11	0,73	CHI
2019112900009	TURVELANDIA	30502	RIO DOS BOIS	29/11/2019 06:48	29/11/2019 06:52	29/11/2019 06:48	29/11/2019 06:52	0,07	1265	84,33	CHI
2019112900009	MAURILANDIA	11301	RIO DOS BOIS	29/11/2019 06:48	29/11/2019 06:52	29/11/2019 06:48	29/11/2019 06:52	0,07	2570	171,33	CHI
2019112900009	CASTELANDIA	23231	RIO DOS BOIS	29/11/2019 06:48	29/11/2019 06:52	29/11/2019 06:48	29/11/2019 06:52	0,07	1	0,07	CHI
2019112900009	GOIATUBA	36801	RIO DOS BOIS	29/11/2019 06:48	29/11/2019 06:52	29/11/2019 06:48	29/11/2019 06:52	0,07	390	26,00	CHI
2019112900009	GOIATUBA	23201	RIO DOS BOIS	29/11/2019 06:48	29/11/2019 06:52	29/11/2019 06:48	29/11/2019 06:52	0,07	19	1,27	CHI
2019112900009	MAURILANDIA	23231	RIO DOS BOIS	29/11/2019 06:48	29/11/2019 06:52	29/11/2019 06:48	29/11/2019 06:52	0,07	4	0,27	CHI
2019112900009	MAURILANDIA	031706114	RIO DOS BOIS	29/11/2019 06:48	29/11/2019 06:52	29/11/2019 06:48	29/11/2019 06:52	0,07	5	0,33	CHI
2019112900009	GOIATUBA	26502	RIO DOS BOIS	29/11/2019 06:48	29/11/2019 06:52	29/11/2019 06:48	29/11/2019 06:52	0,07	18	1,20	CHI
2019112900009	GOIATUBA	23231	RIO DOS BOIS	29/11/2019 06:48	29/11/2019 06:52	29/11/2019 06:48	29/11/2019 06:52	0,07	5	0,33	CHI
2019112900009	PORTEIRAO	11301	RIO DOS BOIS	29/11/2019 06:48	29/11/2019 06:52	29/11/2019 06:48	29/11/2019 06:52	0,07	28	1,87	CHI
2019112900009	PORTEIRAO	23201	RIO DOS BOIS	29/11/2019 06:48	29/11/2019 06:52	29/11/2019 06:48	29/11/2019 06:52	0,07	7	0,47	CHI
2019112900009	PORTEIRAO	031706114	RIO DOS BOIS	29/11/2019 06:48	29/11/2019 06:52	29/11/2019 06:48	29/11/2019 06:52	0,07	9	0,60	CHI
2019112900009	CASTELANDIA	23201	RIO DOS BOIS	29/11/2019 06:48	29/11/2019 06:52	29/11/2019 06:48	29/11/2019 06:52	0,07	1553	103,53	CHI
2019112900009	BOM JESUS DE GOIAS	23231	RIO DOS BOIS	29/11/2019 06:48	29/11/2019 06:52	29/11/2019 06:48	29/11/2019 06:52	0,07	5	0,33	CHI
2019112900009	BOM JESUS DE GOIAS	23201	RIO DOS BOIS	29/11/2019 06:48	29/11/2019 06:52	29/11/2019 06:48	29/11/2019 06:52	0,07	22	1,47	CHI

2019112900009	ACREUNA	26502	RIO DOS BOIS	29/11/2019 06:48	29/11/2019 06:52	29/11/2019 06:48	29/11/2019 06:52	0,07	14	0,93	CHI
2019112900009	ACREUNA	30502	RIO DOS BOIS	29/11/2019 06:48	29/11/2019 06:52	29/11/2019 06:48	29/11/2019 06:52	0,07	24	1,60	CHI
2019112900009	CASTELANDIA	11302	RIO DOS BOIS	29/11/2019 06:48	29/11/2019 06:52	29/11/2019 06:48	29/11/2019 06:52	0,07	25	1,67	CHI
2019112900009	EDEIA	26502	RIO DOS BOIS	29/11/2019 06:48	29/11/2019 06:52	29/11/2019 06:48	29/11/2019 06:52	0,07	50	3,33	CHI
2019112900087	GUARANI DE GOIAS	02090424	SAO DOMINGOS	29/11/2019 15:16	29/11/2019 15:19	29/11/2019 15:16	29/11/2019 15:19	0,05	127	6,35	CHI
2019112900087	NOVA ROMA	02090424	SAO DOMINGOS	29/11/2019 15:16	29/11/2019 15:19	29/11/2019 15:16	29/11/2019 15:19	0,05	3	0,15	CHI
2019112900087	MONTE ALEGRE DE GOIAS	02090424	SAO DOMINGOS	29/11/2019 15:16	29/11/2019 15:19	29/11/2019 15:16	29/11/2019 15:19	0,05	2	0,10	CHI
2019112900087	SAO DOMINGOS	02090424	SAO DOMINGOS	29/11/2019 15:16	29/11/2019 15:19	29/11/2019 15:16	29/11/2019 15:19	0,05	1108	55,40	CHI
2019113000095	RUBIATABA	46301	RUBIATABA	30/11/2019 16:09	30/11/2019 16:12	30/11/2019 16:09	30/11/2019 16:12	0,05	466	23,30	CHI
2019113000095	CRIXAS	46301	RUBIATABA	30/11/2019 16:09	30/11/2019 16:12	30/11/2019 16:09	30/11/2019 16:12	0,05	1	0,05	CHI
2019113000095	MORRO AGUDO DE GOIAS	46301	RUBIATABA	30/11/2019 16:09	30/11/2019 16:12	30/11/2019 16:09	30/11/2019 16:12	0,05	14	0,70	CHI
2019113000095	NOVA AMERICA	46301	RUBIATABA	30/11/2019 16:09	30/11/2019 16:12	30/11/2019 16:09	30/11/2019 16:12	0,05	22	1,10	CHI
2019113000095	ARAGUAPAZ	46301	RUBIATABA	30/11/2019 16:09	30/11/2019 16:12	30/11/2019 16:09	30/11/2019 16:12	0,05	1	0,05	CHI
2019113000095	ARAGUAPAZ	46301	ITAPURANGA	30/11/2019 16:09	30/11/2019 16:12	30/11/2019 16:09	30/11/2019 16:12	0,05	3	0,15	CHI
2019113000095	FAINA	46301	ITAPURANGA	30/11/2019 16:09	30/11/2019 16:12	30/11/2019 16:09	30/11/2019 16:12	0,05	18	0,90	CHI
2019113000095	ITAPURANGA	35301	ITAPURANGA	30/11/2019 16:09	30/11/2019 16:12	30/11/2019 16:09	30/11/2019 16:12	0,05	75	3,75	CHI
2019113000095	HEITORAI	35302	ITAPURANGA	30/11/2019 16:09	30/11/2019 16:12	30/11/2019 16:09	30/11/2019 16:12	0,05	162	8,10	CHI
2019113000095	MORRO AGUDO DE GOIAS	46301	ITAPURANGA	30/11/2019 16:09	30/11/2019 16:12	30/11/2019 16:09	30/11/2019 16:12	0,05	1306	65,30	CHI
2019113000095	URUANA	35301	ITAPURANGA	30/11/2019 16:09	30/11/2019 16:12	30/11/2019 16:09	30/11/2019 16:12	0,05	1	0,05	CHI
2019113000095	HEITORAI	03230414	ITAPURANGA	30/11/2019 16:09	30/11/2019 16:12	30/11/2019 16:09	30/11/2019 16:12	0,05	32	1,60	CHI
2019113000095	ITAPURANGA	46301	ITAPURANGA	30/11/2019 16:09	30/11/2019 16:12	30/11/2019 16:09	30/11/2019 16:12	0,05	38	1,90	CHI
2019113000095	HEITORAI	35301	ITAPURANGA	30/11/2019 16:09	30/11/2019 16:12	30/11/2019 16:09	30/11/2019 16:12	0,05	1436	71,80	CHI
2019113000095	ITAGUARU	35301	ITAPURANGA	30/11/2019 16:09	30/11/2019 16:12	30/11/2019 16:09	30/11/2019 16:12	0,05	54	2,70	CHI
2019113000095	ITAPURANGA	03230414	ITAPURANGA	30/11/2019 16:09	30/11/2019 16:12	30/11/2019 16:09	30/11/2019 16:12	0,05	193	9,65	CHI
2019113000095	ITAPURANGA	35302	ITAPURANGA	30/11/2019 16:09	30/11/2019 16:12	30/11/2019 16:09	30/11/2019 16:12	0,05	83	4,15	CHI
2019113000095	RUBIATABA	46301	ITAPURANGA	30/11/2019 16:09	30/11/2019 16:12	30/11/2019 16:09	30/11/2019 16:12	0,05	12	0,60	CHI
2019113000095	GOIAS	35302	ITAPURANGA	30/11/2019 16:09	30/11/2019 16:12	30/11/2019 16:09	30/11/2019 16:12	0,05	67	3,35	CHI
2019113000095	MORRO AGUDO DE GOIAS	03230414	ITAPURANGA	30/11/2019 16:09	30/11/2019 16:12	30/11/2019 16:09	30/11/2019 16:12	0,05	9	0,45	CHI
2019113000098	ARUANA	01401	ARUANA	30/11/2019 17:15	30/11/2019 17:29	30/11/2019 17:15	30/11/2019 17:29	0,23	2619	611,10	CHI
2019113000098	ARUANA	03205114	ARUANA	30/11/2019 17:15	30/11/2019 17:29	30/11/2019 17:15	30/11/2019 17:29	0,23	233	54,37	CHI
2019113000098	ARUANA	03205114	ARUANA	30/11/2019 17:15	30/11/2019 17:29	30/11/2019 17:15	30/11/2019 17:29	0,23	8	1,87	CHI
2019113000098	ARUANA	49401	ARUANA	30/11/2019 17:15	30/11/2019 17:29	30/11/2019 17:15	30/11/2019 17:29	0,23	60	14,00	CHI
2019113000098	ARUANA	01402	ARUANA	30/11/2019 17:15	30/11/2019 17:29	30/11/2019 17:15	30/11/2019 17:29	0,23	733	171,03	CHI

2019113000098	ARUANA	03205114	ARUANA	30/11/2019 17:15	30/11/2019 17:29	30/11/2019 17:15	30/11/2019 17:29	0,23	810	189,00	CHI
2019113000098	SANTA FE DE GOIAS	02705114	BRITANIA	30/11/2019 17:15	30/11/2019 17:29	30/11/2019 17:15	30/11/2019 17:29	0,23	21	4,90	CHI
2019113000098	JAUPACI	16501	BRITANIA	30/11/2019 17:15	30/11/2019 17:29	30/11/2019 17:15	30/11/2019 17:29	0,23	2	0,47	CHI
2019113000098	MONTES CLAROS DE GOIAS	38701	BRITANIA	30/11/2019 17:15	30/11/2019 17:29	30/11/2019 17:15	30/11/2019 17:29	0,23	414	96,60	CHI
2019113000098	FAZENDA NOVA	16501	BRITANIA	30/11/2019 17:15	30/11/2019 17:29	30/11/2019 17:15	30/11/2019 17:29	0,23	208	48,53	CHI
2019113000098	SANTA FE DE GOIAS	02705114	BRITANIA	30/11/2019 17:15	30/11/2019 17:29	30/11/2019 17:15	30/11/2019 17:29	0,23	72	16,80	CHI
2019113000098	BRITANIA	40501	BRITANIA	30/11/2019 17:15	30/11/2019 17:29	30/11/2019 17:15	30/11/2019 17:29	0,23	12	2,80	CHI
2019113000098	JUSSARA	16501	BRITANIA	30/11/2019 17:15	30/11/2019 17:29	30/11/2019 17:15	30/11/2019 17:29	0,23	347	80,97	CHI
2019113000098	JUSSARA	16502	BRITANIA	30/11/2019 17:15	30/11/2019 17:29	30/11/2019 17:15	30/11/2019 17:29	0,23	12	2,80	CHI
2019113000098	JUSSARA	02705114	BRITANIA	30/11/2019 17:15	30/11/2019 17:29	30/11/2019 17:15	30/11/2019 17:29	0,23	124	28,93	CHI
2019113000098	SANTA FE DE GOIAS	16501	BRITANIA	30/11/2019 17:15	30/11/2019 17:29	30/11/2019 17:15	30/11/2019 17:29	0,23	414	96,60	CHI
2019113000098	SANTA FE DE GOIAS	16502	BRITANIA	30/11/2019 17:15	30/11/2019 17:29	30/11/2019 17:15	30/11/2019 17:29	0,23	1678	391,53	CHI
2019113000098	SANTA FE DE GOIAS	02705114	BRITANIA	30/11/2019 17:15	30/11/2019 17:29	30/11/2019 17:15	30/11/2019 17:29	0,23	9	2,10	CHI
2019113000098	JUSSARA	02705114	BRITANIA	30/11/2019 17:15	30/11/2019 17:29	30/11/2019 17:15	30/11/2019 17:29	0,23	11	2,57	CHI
2019113000098	JUSSARA	03215114	BRITANIA	30/11/2019 17:15	30/11/2019 17:29	30/11/2019 17:15	30/11/2019 17:29	0,23	0	0,00	CHI
2019113000098	JUSSARA	02705114	BRITANIA	30/11/2019 17:15	30/11/2019 17:29	30/11/2019 17:15	30/11/2019 17:29	0,23	10	2,33	CHI
2019113000098	ITAPIRAPUA	02502	BRITANIA	30/11/2019 17:15	30/11/2019 17:29	30/11/2019 17:15	30/11/2019 17:29	0,23	2	0,47	CHI
2019113000098	JUSSARA	02501	BRITANIA	30/11/2019 17:15	30/11/2019 17:29	30/11/2019 17:15	30/11/2019 17:29	0,23	49	11,43	CHI
2019113000098	JUSSARA	02502	BRITANIA	30/11/2019 17:15	30/11/2019 17:29	30/11/2019 17:15	30/11/2019 17:29	0,23	15	3,50	CHI
2019113000098	JUSSARA	38701	BRITANIA	30/11/2019 17:15	30/11/2019 17:29	30/11/2019 17:15	30/11/2019 17:29	0,23	189	44,10	CHI
2019113000098	BRITANIA	02531	BRITANIA	30/11/2019 17:15	30/11/2019 17:29	30/11/2019 17:15	30/11/2019 17:29	0,23	19	4,43	CHI
2019113000098	BRITANIA	02705114	BRITANIA	30/11/2019 17:15	30/11/2019 17:29	30/11/2019 17:15	30/11/2019 17:29	0,23	12	2,80	CHI
2019113000098	ITAPIRAPUA	02705114	BRITANIA	30/11/2019 17:15	30/11/2019 17:29	30/11/2019 17:15	30/11/2019 17:29	0,23	2	0,47	CHI
2019113000098	BRITANIA	03215114	BRITANIA	30/11/2019 17:15	30/11/2019 17:29	30/11/2019 17:15	30/11/2019 17:29	0,23	45	10,50	CHI
2019113000098	BRITANIA	02501	BRITANIA	30/11/2019 17:15	30/11/2019 17:29	30/11/2019 17:15	30/11/2019 17:29	0,23	1242	289,80	CHI
2019113000098	BRITANIA	02502	BRITANIA	30/11/2019 17:15	30/11/2019 17:29	30/11/2019 17:15	30/11/2019 17:29	0,23	1903	444,03	CHI
2019113000098	ARUANA	02502	BRITANIA	30/11/2019 17:15	30/11/2019 17:29	30/11/2019 17:15	30/11/2019 17:29	0,23	25	5,83	CHI
2019113000098	BRITANIA	03215114	BRITANIA	30/11/2019 17:15	30/11/2019 17:29	30/11/2019 17:15	30/11/2019 17:29	0,23	11	2,57	CHI
2019113000098	ARUANA	02531	BRITANIA	30/11/2019 17:15	30/11/2019 17:29	30/11/2019 17:15	30/11/2019 17:29	0,23	38	8,87	CHI
2019113000098	ARAGUAPAZ	03295114	MATRINCHA	30/11/2019 17:15	30/11/2019 17:29	30/11/2019 17:15	30/11/2019 17:29	0,23	1	0,23	CHI
2019113000098	ARUANA	03295114	MATRINCHA	30/11/2019 17:15	30/11/2019 17:29	30/11/2019 17:15	30/11/2019 17:29	0,23	6	1,40	CHI
2019113000098	BRITANIA	47502	MATRINCHA	30/11/2019 17:15	30/11/2019 17:29	30/11/2019 17:15	30/11/2019 17:29	0,23	6	1,40	CHI
2019113000098	JUSSARA	47501	MATRINCHA	30/11/2019 17:15	30/11/2019 17:29	30/11/2019 17:15	30/11/2019 17:29	0,23	4	0,93	CHI

2019113000098	ITAPIRAPUA	09202	MATRINCHA	30/11/2019 17:15	30/11/2019 17:29	30/11/2019 17:15	30/11/2019 17:29	0,23	1390	324,33	CHI
2019113000098	GOIAS	09201	MATRINCHA	30/11/2019 17:15	30/11/2019 17:29	30/11/2019 17:15	30/11/2019 17:29	0,23	566	132,07	CHI
2019113000098	ITAPIRAPUA	03295114	MATRINCHA	30/11/2019 17:15	30/11/2019 17:29	30/11/2019 17:15	30/11/2019 17:29	0,23	140	32,67	CHI
2019113000098	GOIAS	03295114	MATRINCHA	30/11/2019 17:15	30/11/2019 17:29	30/11/2019 17:15	30/11/2019 17:29	0,23	428	99,87	CHI
2019113000098	FAINA	03295114	MATRINCHA	30/11/2019 17:15	30/11/2019 17:29	30/11/2019 17:15	30/11/2019 17:29	0,23	113	26,37	CHI
2019113000098	SANTA FE DE GOIAS	47501	MATRINCHA	30/11/2019 17:15	30/11/2019 17:29	30/11/2019 17:15	30/11/2019 17:29	0,23	11	2,57	CHI
2019113000098	ITAPIRAPUA	47501	MATRINCHA	30/11/2019 17:15	30/11/2019 17:29	30/11/2019 17:15	30/11/2019 17:29	0,23	426	99,40	CHI
2019113000098	ITAPIRAPUA	47502	MATRINCHA	30/11/2019 17:15	30/11/2019 17:29	30/11/2019 17:15	30/11/2019 17:29	0,23	92	21,47	CHI
2019113000098	ITAPIRAPUA	03295114	MATRINCHA	30/11/2019 17:15	30/11/2019 17:29	30/11/2019 17:15	30/11/2019 17:29	0,23	1	0,23	CHI
2019113000098	NOVO BRASIL	09201	MATRINCHA	30/11/2019 17:15	30/11/2019 17:29	30/11/2019 17:15	30/11/2019 17:29	0,23	36	8,40	CHI
2019113000098	ITAPIRAPUA	09201	MATRINCHA	30/11/2019 17:15	30/11/2019 17:29	30/11/2019 17:15	30/11/2019 17:29	0,23	1655	386,17	CHI
2019113000098	MATRINCHA	03295114	MATRINCHA	30/11/2019 17:15	30/11/2019 17:29	30/11/2019 17:15	30/11/2019 17:29	0,23	20	4,67	CHI
2019113000098	MATRINCHA	03295114	MATRINCHA	30/11/2019 17:15	30/11/2019 17:29	30/11/2019 17:15	30/11/2019 17:29	0,23	2226	519,40	CHI
2019113000098	NOVO BRASIL	01050224	JUSSARA	30/11/2019 17:15	30/11/2019 17:29	30/11/2019 17:15	30/11/2019 17:29	0,23	12	2,80	CHI
2019113000098	NOVO BRASIL	01050434	JUSSARA	30/11/2019 17:15	30/11/2019 17:29	30/11/2019 17:15	30/11/2019 17:29	0,23	121	28,23	CHI
2019113000098	FAZENDA NOVA	04801	JUSSARA	30/11/2019 17:15	30/11/2019 17:29	30/11/2019 17:15	30/11/2019 17:29	0,23	1399	326,43	CHI
2019113000098	FAZENDA NOVA	04802	JUSSARA	30/11/2019 17:15	30/11/2019 17:29	30/11/2019 17:15	30/11/2019 17:29	0,23	800	186,67	CHI
2019113000098	FAZENDA NOVA	13430	JUSSARA	30/11/2019 17:15	30/11/2019 17:29	30/11/2019 17:15	30/11/2019 17:29	0,23	47	10,97	CHI
2019113000098	FAZENDA NOVA	01050424	JUSSARA	30/11/2019 17:15	30/11/2019 17:29	30/11/2019 17:15	30/11/2019 17:29	0,23	6	1,40	CHI
2019113000098	NOVO BRASIL	13430	JUSSARA	30/11/2019 17:15	30/11/2019 17:29	30/11/2019 17:15	30/11/2019 17:29	0,23	50	11,67	CHI
2019113000098	NOVO BRASIL	13431	JUSSARA	30/11/2019 17:15	30/11/2019 17:29	30/11/2019 17:15	30/11/2019 17:29	0,23	26	6,07	CHI
2019113000098	SANTA FE DE GOIAS	01050424	JUSSARA	30/11/2019 17:15	30/11/2019 17:29	30/11/2019 17:15	30/11/2019 17:29	0,23	27	6,30	CHI
2019113000098	FAZENDA NOVA	13401	JUSSARA	30/11/2019 17:15	30/11/2019 17:29	30/11/2019 17:15	30/11/2019 17:29	0,23	100	23,33	CHI
2019113000098	NOVO BRASIL	13401	JUSSARA	30/11/2019 17:15	30/11/2019 17:29	30/11/2019 17:15	30/11/2019 17:29	0,23	496	115,73	CHI
2019113000098	JUSSARA	01050424	JUSSARA	30/11/2019 17:15	30/11/2019 17:29	30/11/2019 17:15	30/11/2019 17:29	0,23	174	40,60	CHI
2019113000098	JUSSARA	01050214	JUSSARA	30/11/2019 17:15	30/11/2019 17:29	30/11/2019 17:15	30/11/2019 17:29	0,23	5996	1399,07	CHI
2019113000098	NOVO BRASIL	13402	JUSSARA	30/11/2019 17:15	30/11/2019 17:29	30/11/2019 17:15	30/11/2019 17:29	0,23	1196	279,07	CHI
2019113000098	JUSSARA	01050224	JUSSARA	30/11/2019 17:15	30/11/2019 17:29	30/11/2019 17:15	30/11/2019 17:29	0,23	2342	546,47	CHI
2019113000098	ITAPIRAPUA	13401	JUSSARA	30/11/2019 17:15	30/11/2019 17:29	30/11/2019 17:15	30/11/2019 17:29	0,23	55	12,83	CHI
2019113000098	ITAPIRAPUA	01050224	JUSSARA	30/11/2019 17:15	30/11/2019 17:29	30/11/2019 17:15	30/11/2019 17:29	0,23	169	39,43	CHI
2019113000098	FAZENDA NOVA	01050434	JUSSARA	30/11/2019 17:15	30/11/2019 17:29	30/11/2019 17:15	30/11/2019 17:29	0,23	39	9,10	CHI
2019113000098	ITAPIRAPUA	13431	JUSSARA	30/11/2019 17:15	30/11/2019 17:29	30/11/2019 17:15	30/11/2019 17:29	0,23	27	6,30	CHI
2019113000098	JUSSARA	01050434	JUSSARA	30/11/2019 17:15	30/11/2019 17:29	30/11/2019 17:15	30/11/2019 17:29	0,23	109	25,43	CHI

2019113000117	CAMPINORTE	01800503	CAMPINORTE	30/11/2019 12:48	30/11/2019 12:53	30/11/2019 12:48	30/11/2019 12:53	0,08	10	0,83	CHI
2019113000117	VILA PROPICIO	00180518	BARRO ALTO	30/11/2019 12:48	30/11/2019 12:53	30/11/2019 12:48	30/11/2019 12:53	0,08	24	2,00	CHI
2019113000117	VILA PROPICIO	00180518	BARRO ALTO	30/11/2019 12:48	30/11/2019 12:53	30/11/2019 12:48	30/11/2019 12:53	0,08	1	0,08	CHI
2019113000117	SANTA RITA DO NOVO DESTINO	00180518	BARRO ALTO	30/11/2019 12:48	30/11/2019 12:53	30/11/2019 12:48	30/11/2019 12:53	0,08	462	38,50	CHI
2019113000117	SAO LUIZ DO NORTE	00180518	BARRO ALTO	30/11/2019 12:48	30/11/2019 12:53	30/11/2019 12:48	30/11/2019 12:53	0,08	2	0,17	CHI
2019113000117	NIQUELANDIA	45602	BARRO ALTO	30/11/2019 12:48	30/11/2019 12:53	30/11/2019 12:48	30/11/2019 12:53	0,08	1024	85,33	CHI
2019113000117	NIQUELANDIA	45601	BARRO ALTO	30/11/2019 12:48	30/11/2019 12:53	30/11/2019 12:48	30/11/2019 12:53	0,08	165	13,75	CHI
2019113000117	SANTA RITA DO NOVO DESTINO	00180518	BARRO ALTO	30/11/2019 12:48	30/11/2019 12:53	30/11/2019 12:48	30/11/2019 12:53	0,08	7	0,58	CHI
2019113000117	URUACU	01800503	CAMPINORTE	30/11/2019 12:48	30/11/2019 12:53	30/11/2019 12:48	30/11/2019 12:53	0,08	101	8,42	CHI
2019113000117	NOVA IGUACU DE GOIAS	01800503	CAMPINORTE	30/11/2019 12:48	30/11/2019 12:53	30/11/2019 12:48	30/11/2019 12:53	0,08	15	1,25	CHI
2019113000117	SANTA RITA DO NOVO DESTINO	56102	BARRO ALTO	30/11/2019 12:48	30/11/2019 12:53	30/11/2019 12:48	30/11/2019 12:53	0,08	187	15,58	CHI
2019113000117	VILA PROPICIO	45601	BARRO ALTO	30/11/2019 12:48	30/11/2019 12:53	30/11/2019 12:48	30/11/2019 12:53	0,08	49	4,08	CHI
2019113000117	VILA PROPICIO	45602	BARRO ALTO	30/11/2019 12:48	30/11/2019 12:53	30/11/2019 12:48	30/11/2019 12:53	0,08	32	2,67	CHI
2019113000117	NIQUELANDIA	00180518	BARRO ALTO	30/11/2019 12:48	30/11/2019 12:53	30/11/2019 12:48	30/11/2019 12:53	0,08	4	0,33	CHI
2019113000117	SAO LUIZ DO NORTE	00180518	BARRO ALTO	30/11/2019 12:48	30/11/2019 12:53	30/11/2019 12:48	30/11/2019 12:53	0,08	33	2,75	CHI
2019113000117	SAO LUIZ DO NORTE	56101	BARRO ALTO	30/11/2019 12:48	30/11/2019 12:53	30/11/2019 12:48	30/11/2019 12:53	0,08	96	8,00	CHI
2019113000117	SAO LUIZ DO NORTE	56102	BARRO ALTO	30/11/2019 12:48	30/11/2019 12:53	30/11/2019 12:48	30/11/2019 12:53	0,08	14	1,17	CHI
2019113000117	NIQUELANDIA	00180518	BARRO ALTO	30/11/2019 12:48	30/11/2019 12:53	30/11/2019 12:48	30/11/2019 12:53	0,08	118	9,83	CHI
2019113000117	GOIANESIA	56102	BARRO ALTO	30/11/2019 12:48	30/11/2019 12:53	30/11/2019 12:48	30/11/2019 12:53	0,08	4	0,33	CHI
2019113000117	HIDROLINA	00180518	BARRO ALTO	30/11/2019 12:48	30/11/2019 12:53	30/11/2019 12:48	30/11/2019 12:53	0,08	1	0,08	CHI
2019113000117	MIMOSO DE GOIAS	45602	BARRO ALTO	30/11/2019 12:48	30/11/2019 12:53	30/11/2019 12:48	30/11/2019 12:53	0,08	4	0,33	CHI
2019113000117	HIDROLINA	56101	BARRO ALTO	30/11/2019 12:48	30/11/2019 12:53	30/11/2019 12:48	30/11/2019 12:53	0,08	1	0,08	CHI
2019113000117	BARRO ALTO	00180518	BARRO ALTO	30/11/2019 12:48	30/11/2019 12:53	30/11/2019 12:48	30/11/2019 12:53	0,08	2	0,17	CHI
2019113000117	MIMOSO DE GOIAS	45601	BARRO ALTO	30/11/2019 12:48	30/11/2019 12:53	30/11/2019 12:48	30/11/2019 12:53	0,08	11	0,92	CHI
2019113000117	BARRO ALTO	00180518	BARRO ALTO	30/11/2019 12:48	30/11/2019 12:53	30/11/2019 12:48	30/11/2019 12:53	0,08	2257	188,08	CHI
2019113000117	BARRO ALTO	56102	BARRO ALTO	30/11/2019 12:48	30/11/2019 12:53	30/11/2019 12:48	30/11/2019 12:53	0,08	24	2,00	CHI
2019113000117	BARRO ALTO	00180518	BARRO ALTO	30/11/2019 12:48	30/11/2019 12:53	30/11/2019 12:48	30/11/2019 12:53	0,08	1243	103,58	CHI
2019113000117	BARRO ALTO	01805114	URUACU	30/11/2019 12:48	30/11/2019 12:53	30/11/2019 12:48	30/11/2019 12:53	0,08	1	0,08	CHI
2019113000117	HIDROLINA	01805114	URUACU	30/11/2019 12:48	30/11/2019 12:53	30/11/2019 12:48	30/11/2019 12:53	0,08	98	8,17	CHI
2019113000117	CAMPINORTE	01800503	URUACU	30/11/2019 12:48	30/11/2019 12:53	30/11/2019 12:48	30/11/2019 12:53	0,08	13	1,08	CHI
2019113000117	MARA ROSA	01800503	URUACU	30/11/2019 12:48	30/11/2019 12:53	30/11/2019 12:48	30/11/2019 12:53	0,08	1	0,08	CHI
2019113000117	CAMPINORTE	01805114	URUACU	30/11/2019 12:48	30/11/2019 12:53	30/11/2019 12:48	30/11/2019 12:53	0,08	10	0,83	CHI
2019113000117	GUARINOS	14902	URUACU	30/11/2019 12:48	30/11/2019 12:53	30/11/2019 12:48	30/11/2019 12:53	0,08	11	0,92	CHI

2019113000117	HIDROLINA	01800503	URUACU	30/11/2019 12:48	30/11/2019 12:53	30/11/2019 12:48	30/11/2019 12:53	0,08	15	1,25	CHI
2019113000117	HIDROLINA	01800503	URUACU	30/11/2019 12:48	30/11/2019 12:53	30/11/2019 12:48	30/11/2019 12:53	0,08	94	7,83	CHI
2019113000117	HIDROLINA	07931	URUACU	30/11/2019 12:48	30/11/2019 12:53	30/11/2019 12:48	30/11/2019 12:53	0,08	110	9,17	CHI
2019113000117	PILAR DE GOIAS	01805114	URUACU	30/11/2019 12:48	30/11/2019 12:53	30/11/2019 12:48	30/11/2019 12:53	0,08	17	1,42	CHI
2019113000117	SANTA TEREZINHA DE GOIAS	14902	URUACU	30/11/2019 12:48	30/11/2019 12:53	30/11/2019 12:48	30/11/2019 12:53	0,08	5	0,42	CHI
2019113000117	URUACU	01800503	URUACU	30/11/2019 12:48	30/11/2019 12:53	30/11/2019 12:48	30/11/2019 12:53	0,08	5825	485,42	CHI
2019113000117	URUACU	01800503	URUACU	30/11/2019 12:48	30/11/2019 12:53	30/11/2019 12:48	30/11/2019 12:53	0,08	302	25,17	CHI
2019113000117	PILAR DE GOIAS	14901	URUACU	30/11/2019 12:48	30/11/2019 12:53	30/11/2019 12:48	30/11/2019 12:53	0,08	55	4,58	CHI
2019113000117	PILAR DE GOIAS	14902	URUACU	30/11/2019 12:48	30/11/2019 12:53	30/11/2019 12:48	30/11/2019 12:53	0,08	696	58,00	CHI
2019113000117	PILAR DE GOIAS	07931	URUACU	30/11/2019 12:48	30/11/2019 12:53	30/11/2019 12:48	30/11/2019 12:53	0,08	42	3,50	CHI
2019113000117	PILAR DE GOIAS	01800503	URUACU	30/11/2019 12:48	30/11/2019 12:53	30/11/2019 12:48	30/11/2019 12:53	0,08	1	0,08	CHI
2019113000117	URUACU	01800503	URUACU	30/11/2019 12:48	30/11/2019 12:53	30/11/2019 12:48	30/11/2019 12:53	0,08	1782	148,50	CHI
2019113000117	NOVA IGUACU DE GOIAS	01800503	URUACU	30/11/2019 12:48	30/11/2019 12:53	30/11/2019 12:48	30/11/2019 12:53	0,08	20	1,67	CHI
2019113000117	URUACU	01800503	URUACU	30/11/2019 12:48	30/11/2019 12:53	30/11/2019 12:48	30/11/2019 12:53	0,08	7889	657,42	CHI
2019113000117	URUACU	01800503	URUACU	30/11/2019 12:48	30/11/2019 12:53	30/11/2019 12:48	30/11/2019 12:53	0,08	175	14,58	CHI
2019113000117	PILAR DE GOIAS	01800503	URUACU	30/11/2019 12:48	30/11/2019 12:53	30/11/2019 12:48	30/11/2019 12:53	0,08	11	0,92	CHI
2019113000117	URUACU	01805114	URUACU	30/11/2019 12:48	30/11/2019 12:53	30/11/2019 12:48	30/11/2019 12:53	0,08	295	24,58	CHI
2019113000117	HIDROLINA	07901	URUACU	30/11/2019 12:48	30/11/2019 12:53	30/11/2019 12:48	30/11/2019 12:53	0,08	1256	104,67	CHI
2019113000117	ITAPACI	14902	URUACU	30/11/2019 12:48	30/11/2019 12:53	30/11/2019 12:48	30/11/2019 12:53	0,08	2	0,17	CHI
2019113000117	URUACU	01805114	URUACU	30/11/2019 12:48	30/11/2019 12:53	30/11/2019 12:48	30/11/2019 12:53	0,08	146	12,17	CHI
2019113000117	NIQUELANDIA	01800503	URUACU	30/11/2019 12:48	30/11/2019 12:53	30/11/2019 12:48	30/11/2019 12:53	0,08	1108	92,33	CHI
2019113000117	NIQUELANDIA	01805114	URUACU	30/11/2019 12:48	30/11/2019 12:53	30/11/2019 12:48	30/11/2019 12:53	0,08	1069	89,08	CHI



# Plotagem das Ocorrências conforme a Espacialização das Chuvas

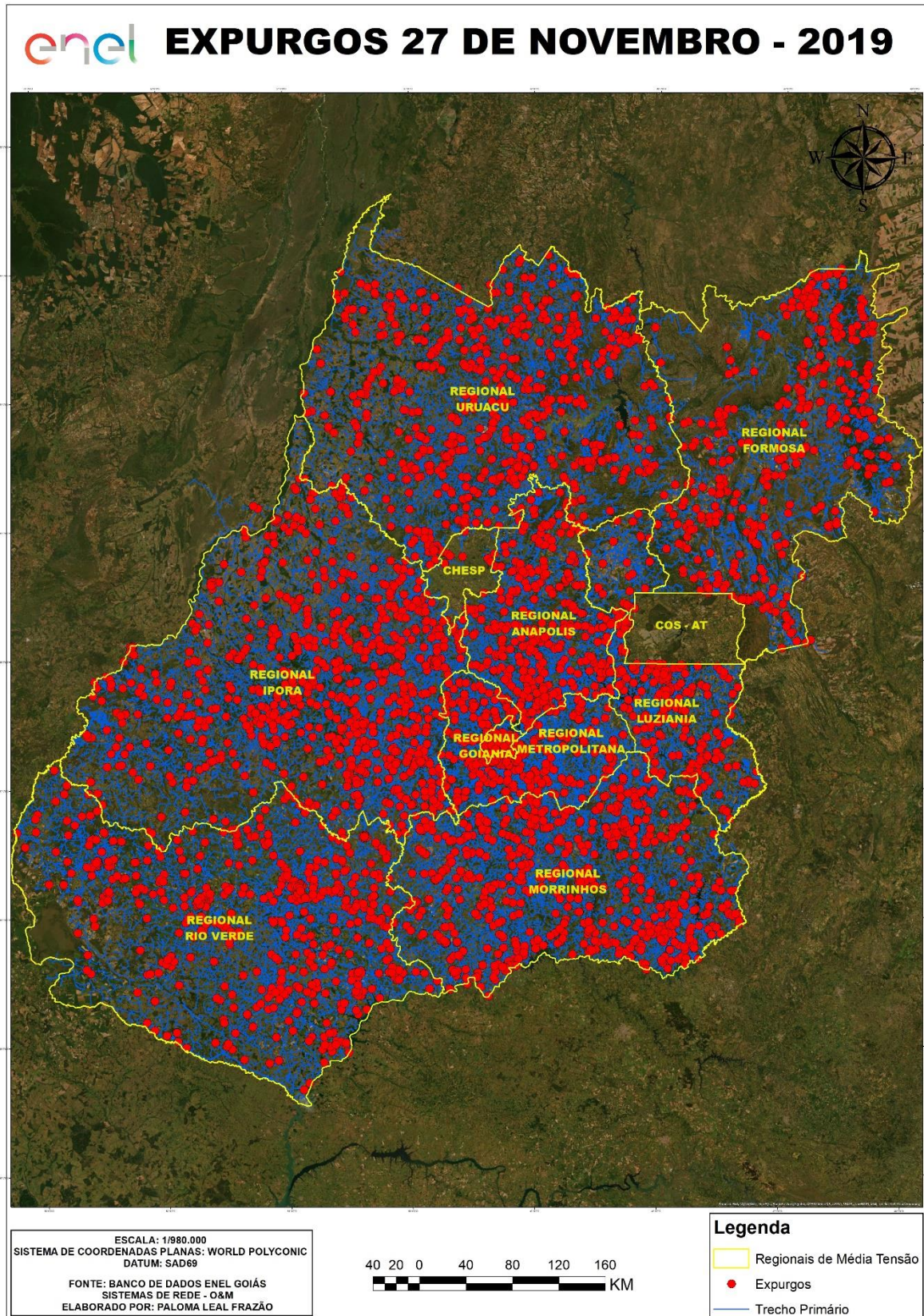





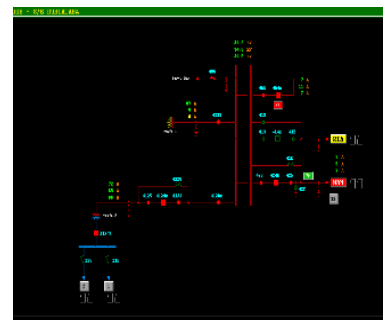
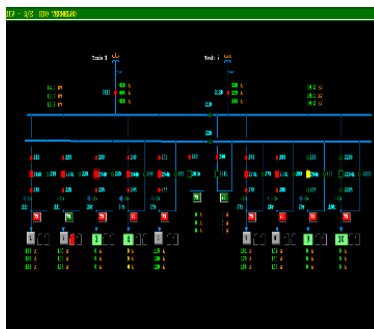
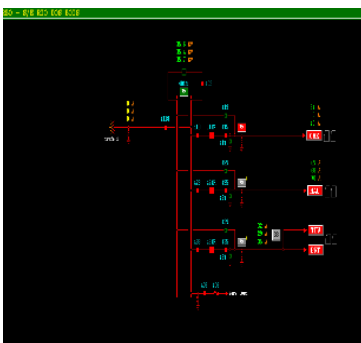
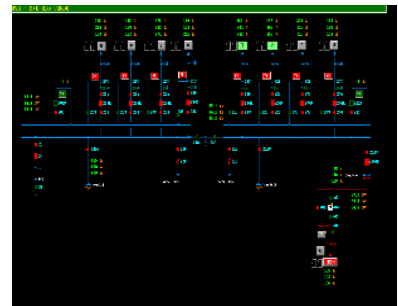
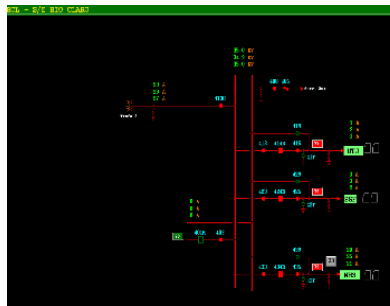
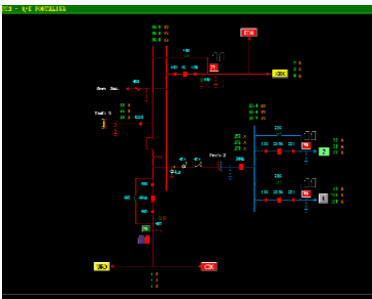
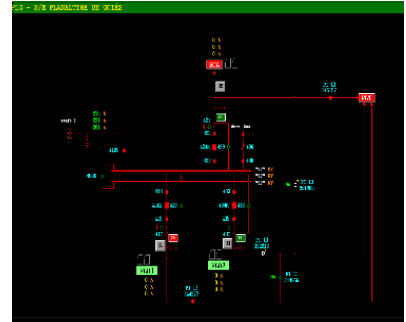
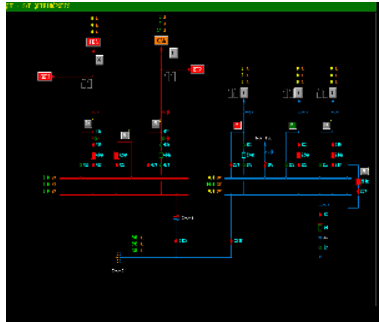
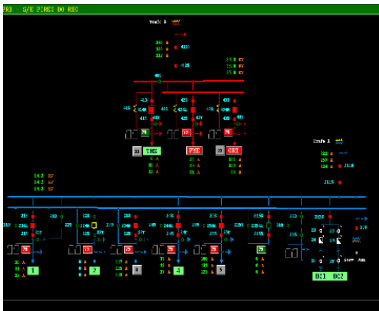
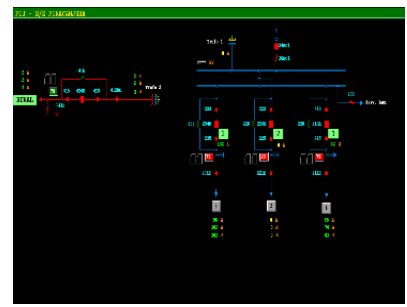
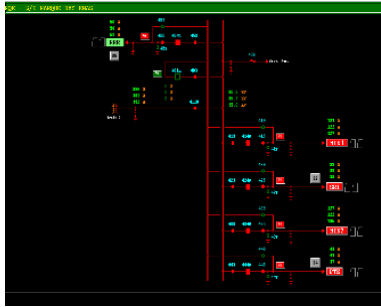
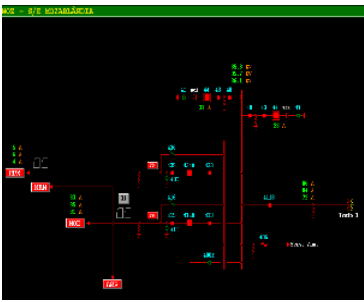
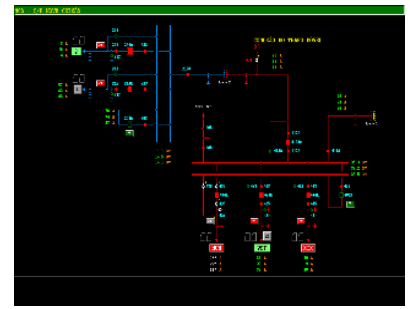
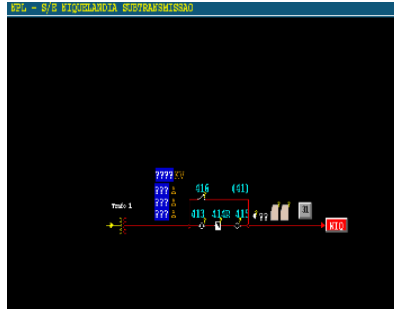

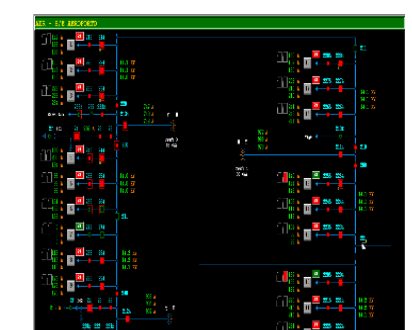
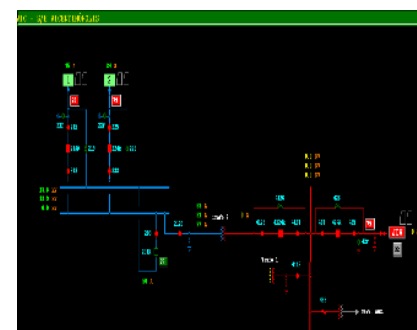
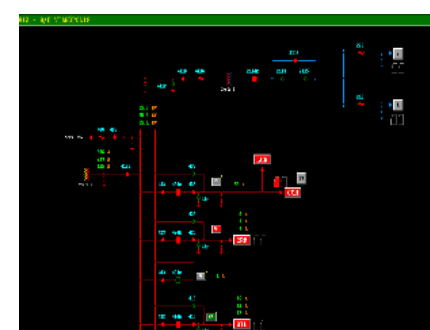
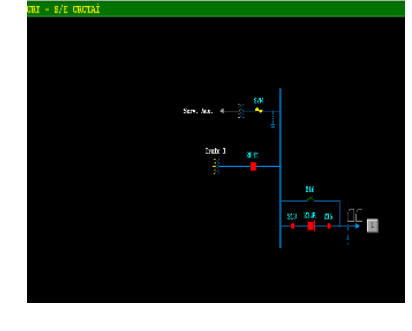
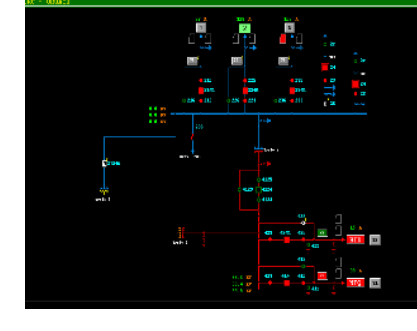
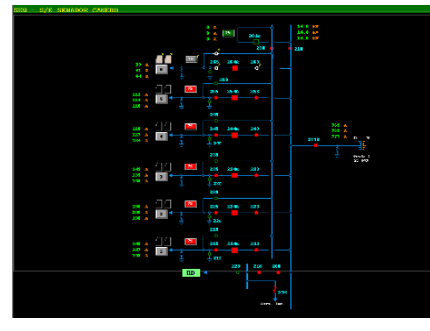
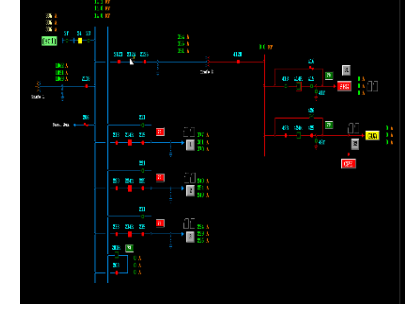
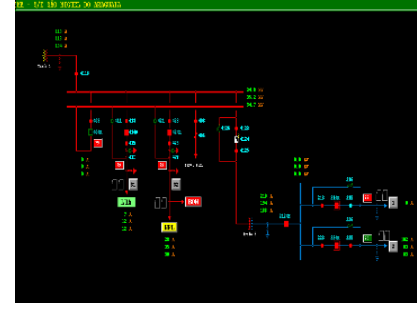
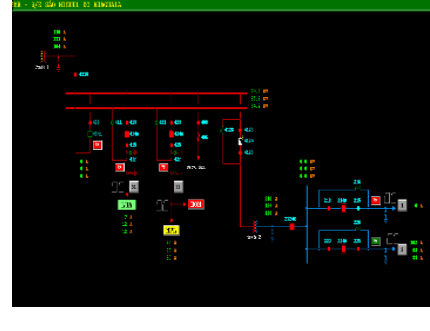
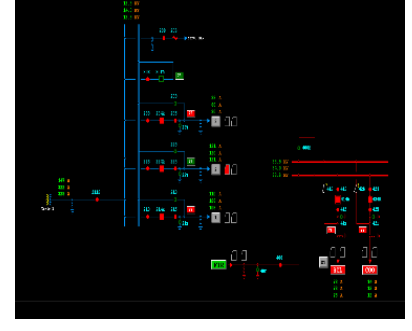
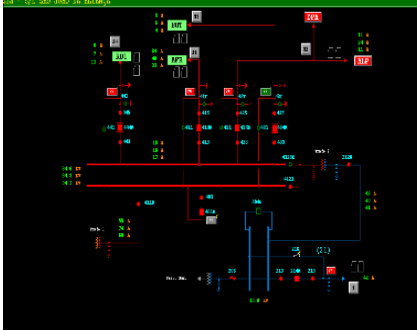
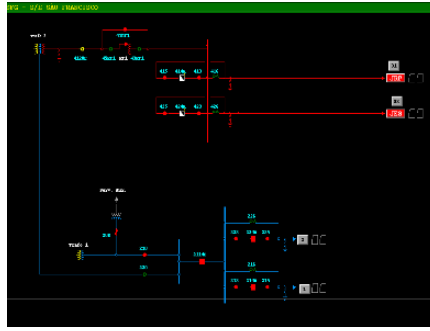
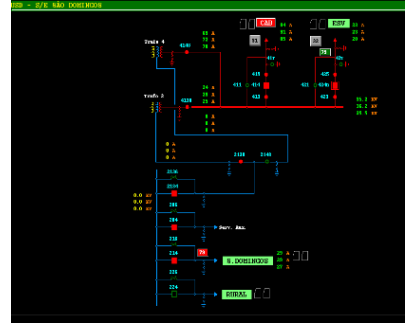
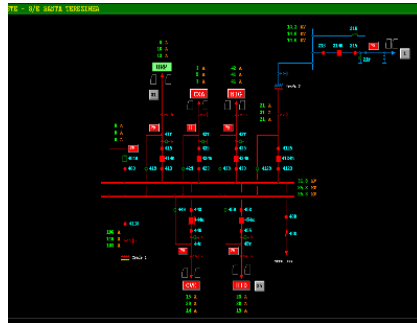
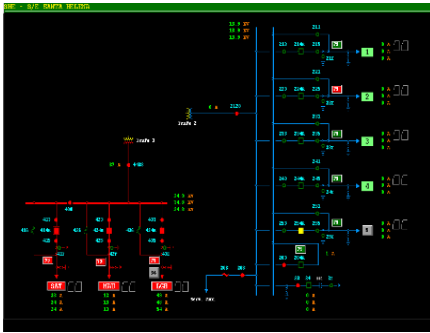

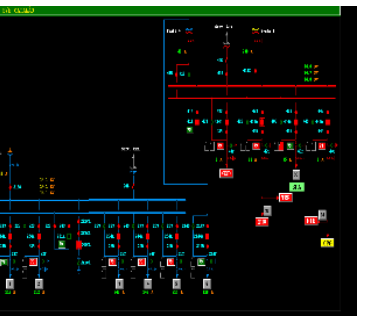
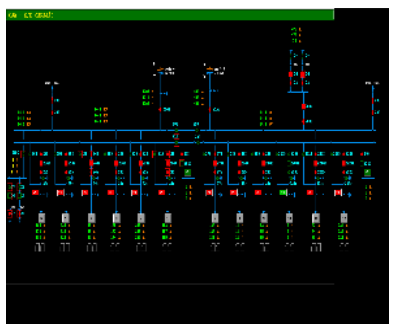
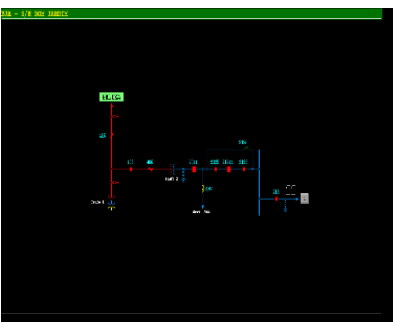
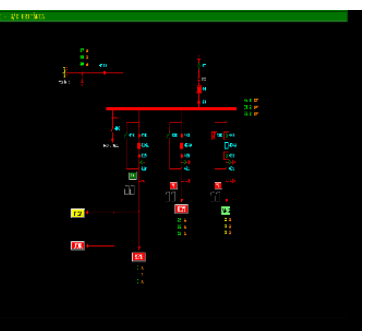
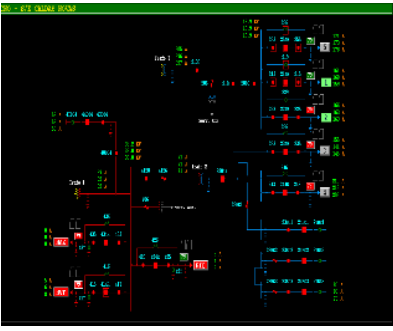
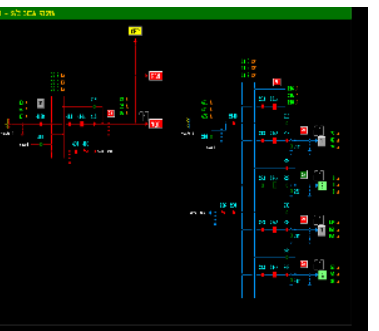
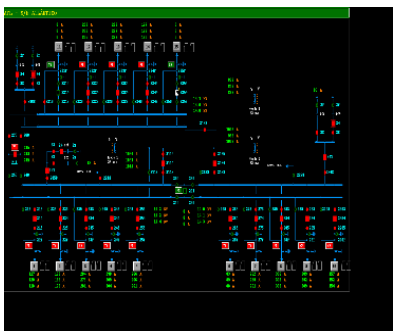
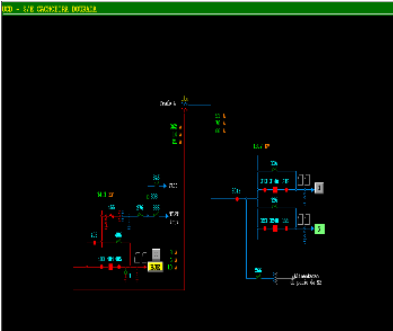
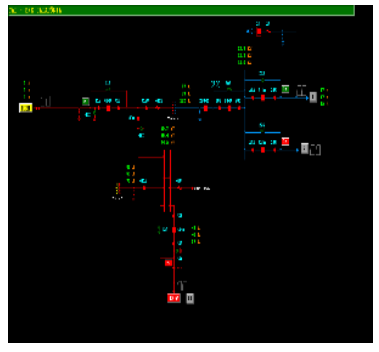
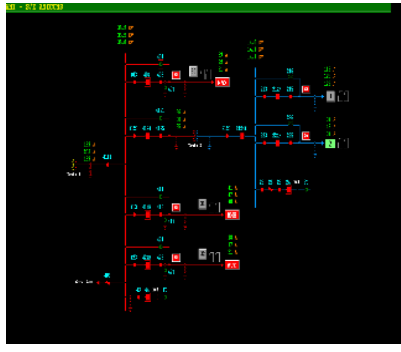
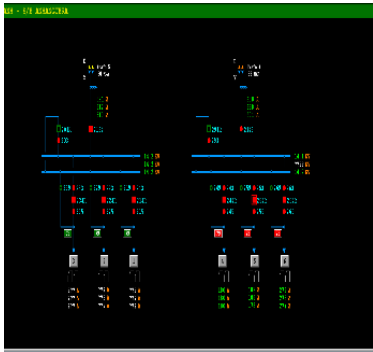
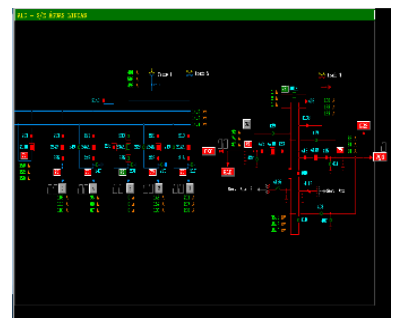
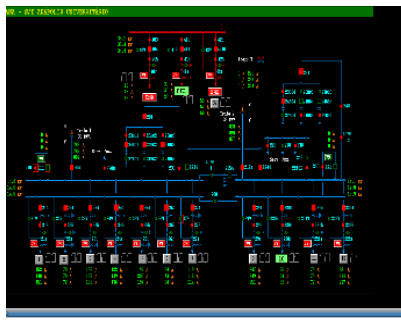
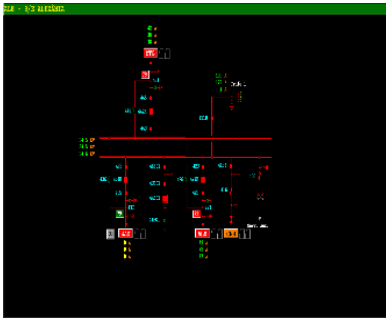

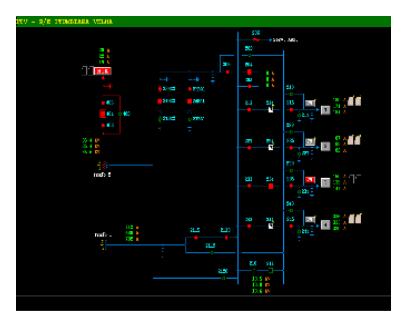
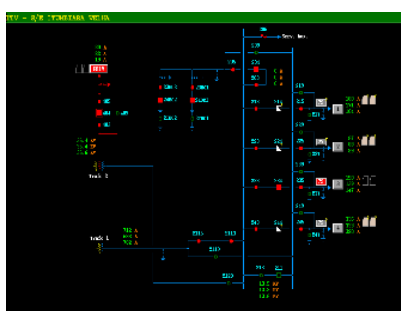
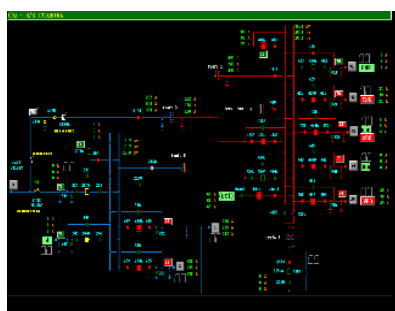
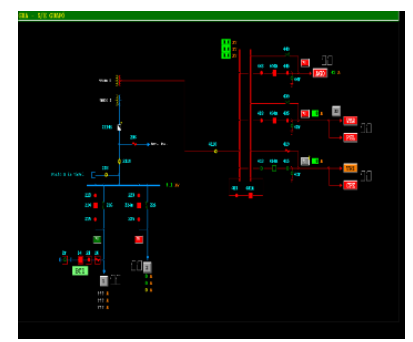
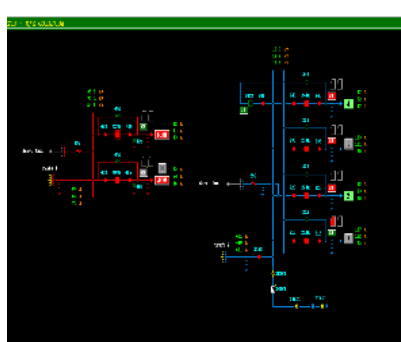
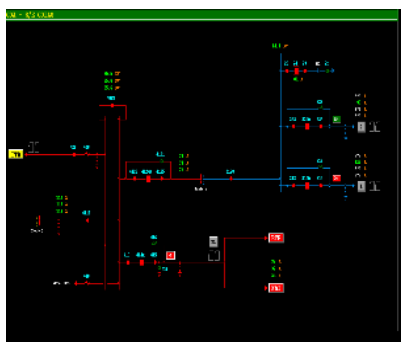
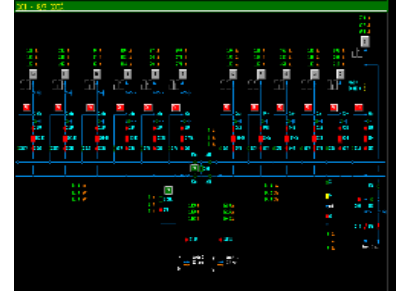
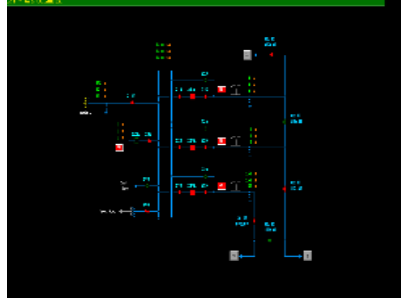
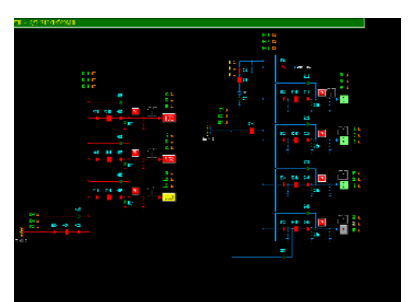
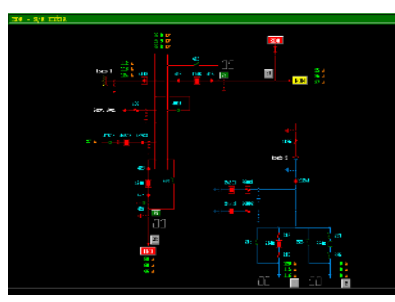
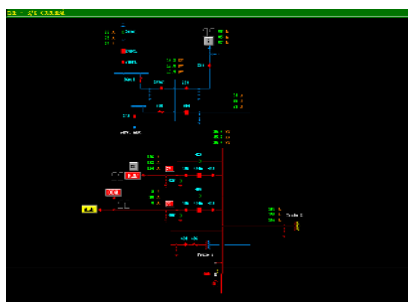
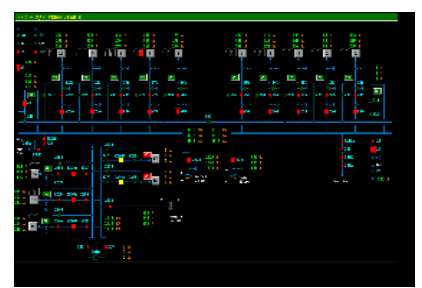
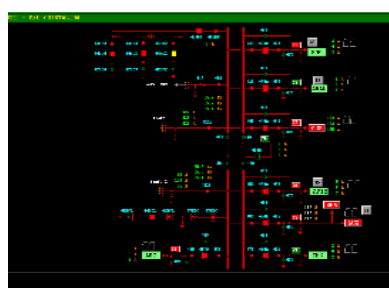
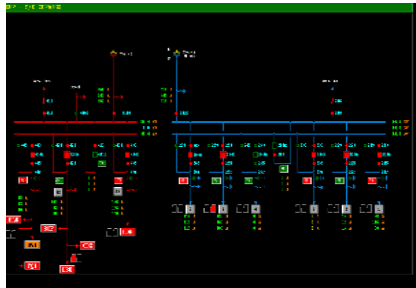
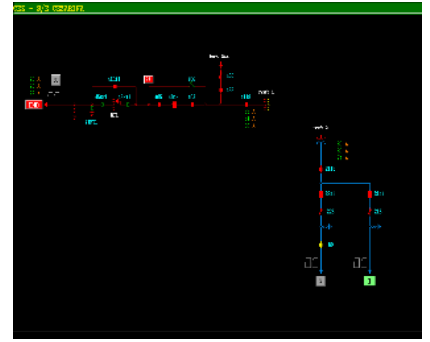
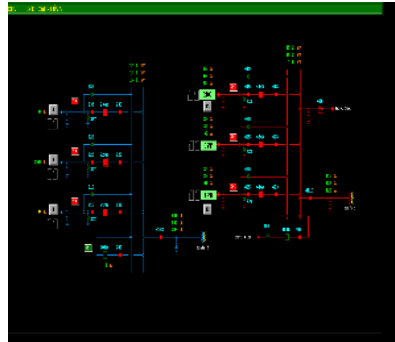
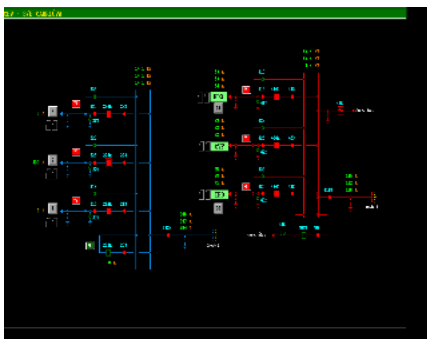



## DEMAIS EVIDÊNCIAS

### DADOS TÉCNICO - OPERACIONAIS ENEL GO

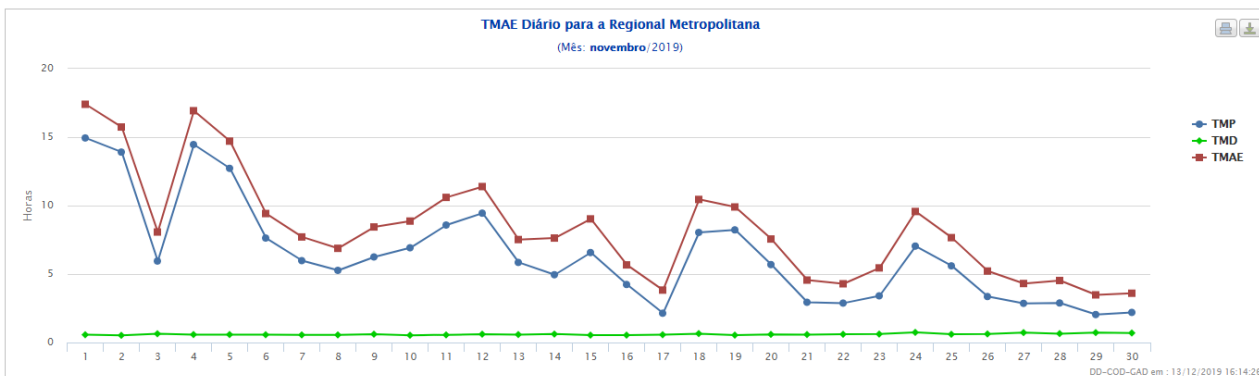
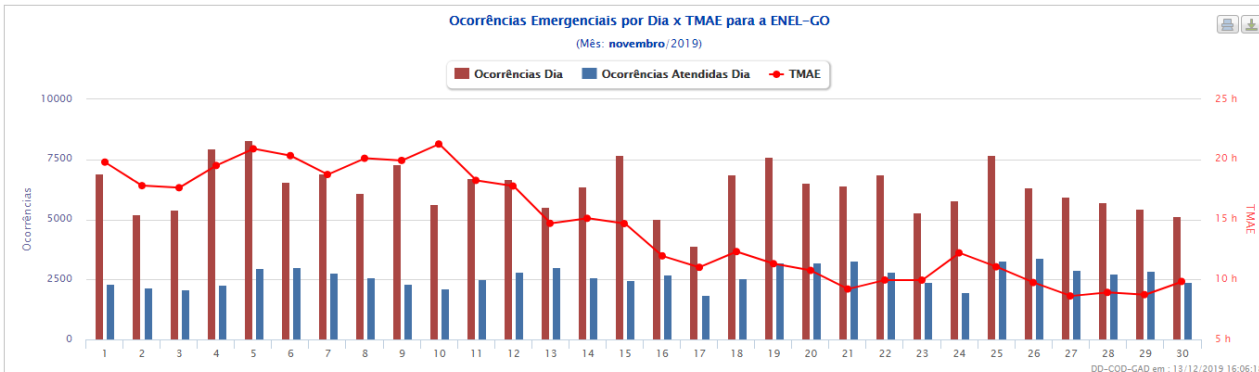
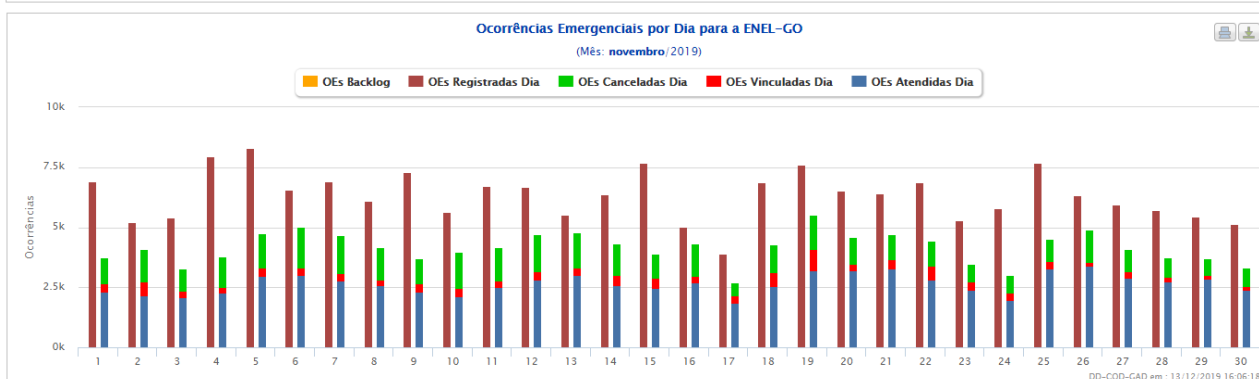
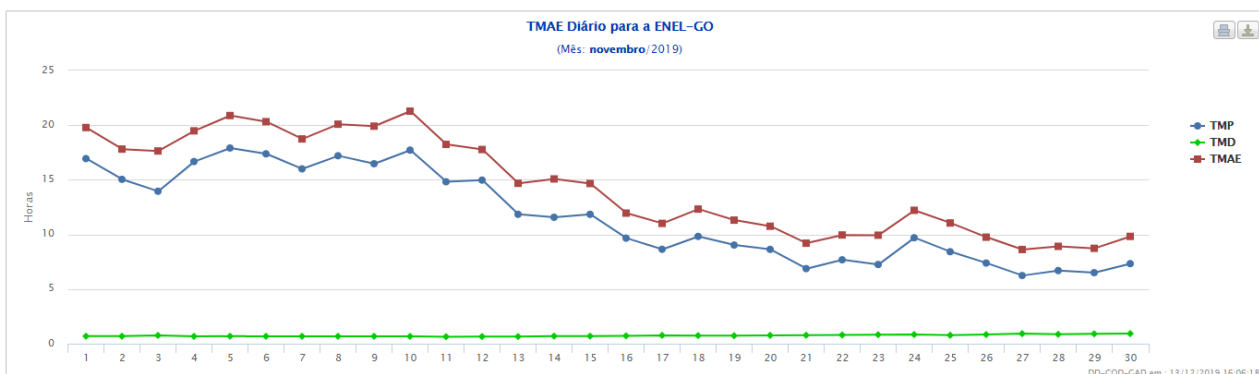

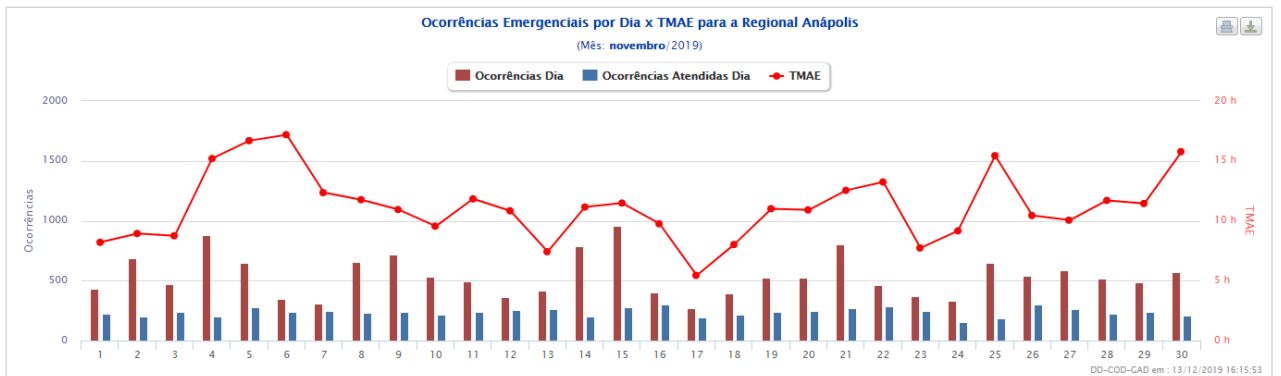
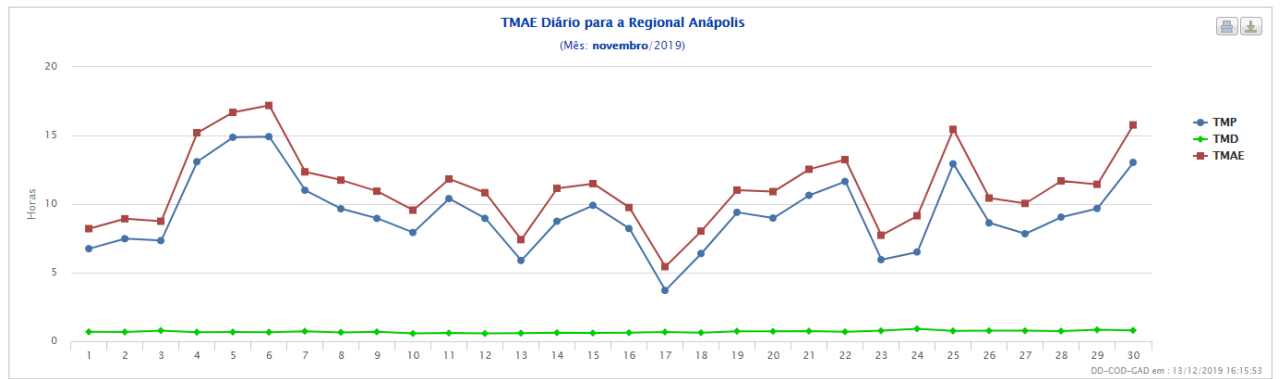
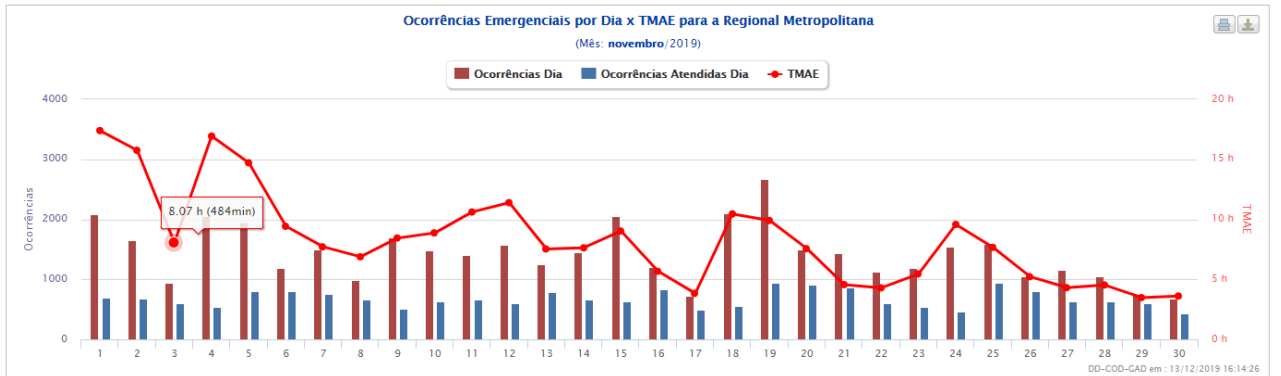
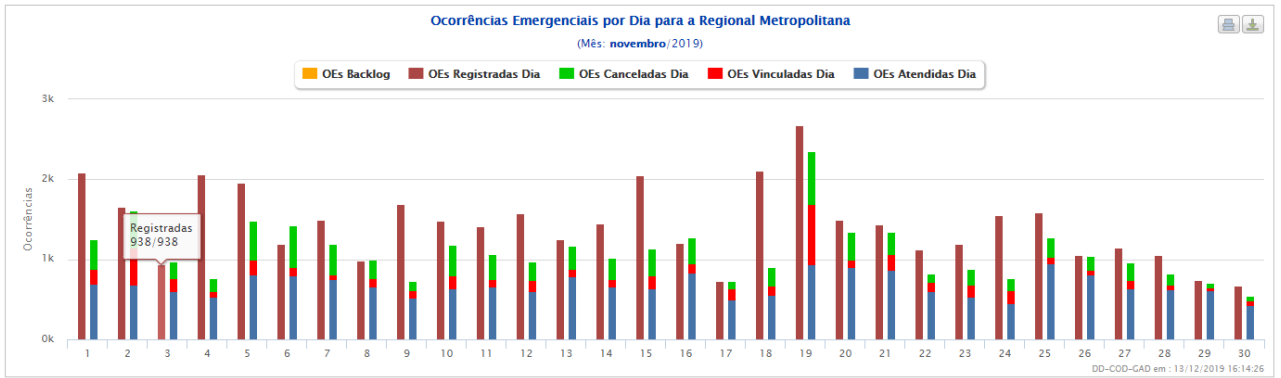

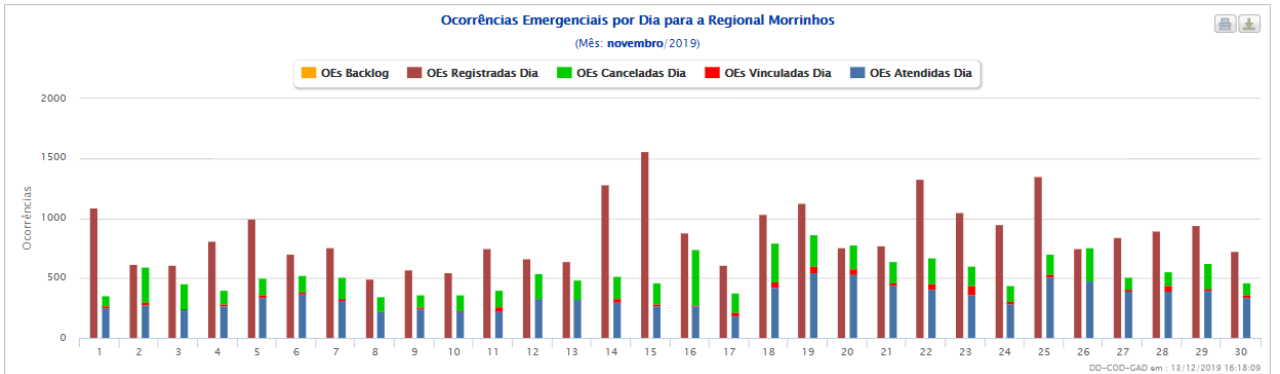
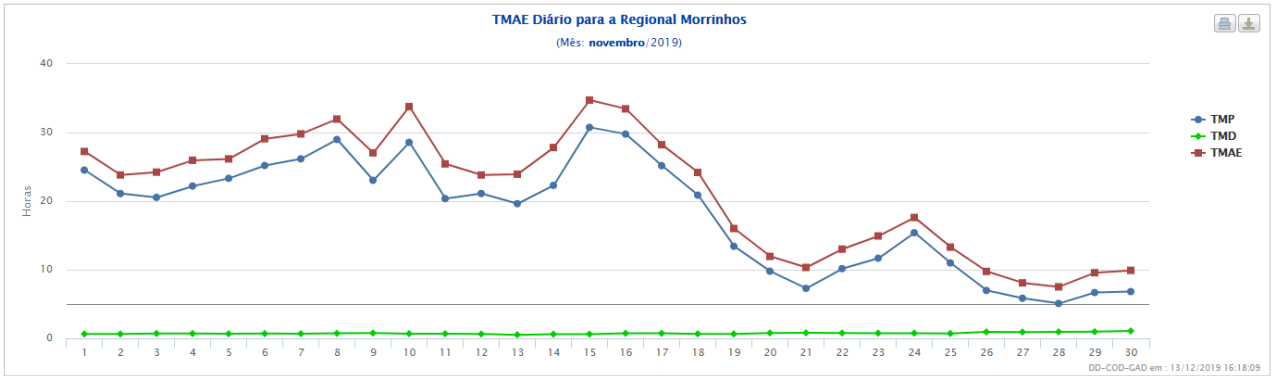
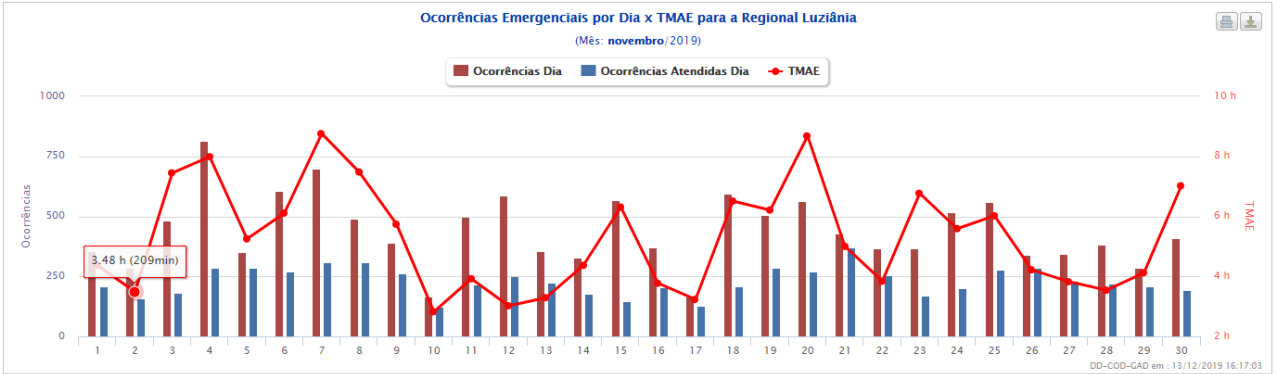
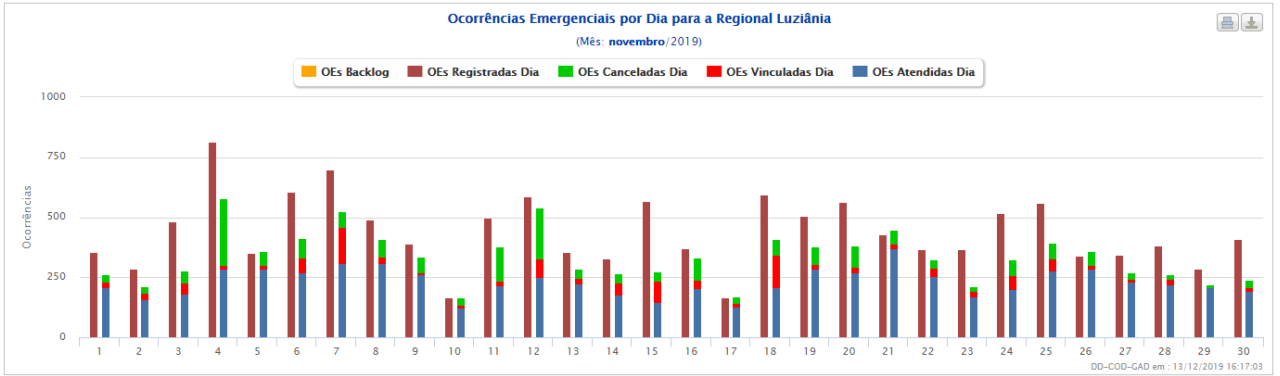
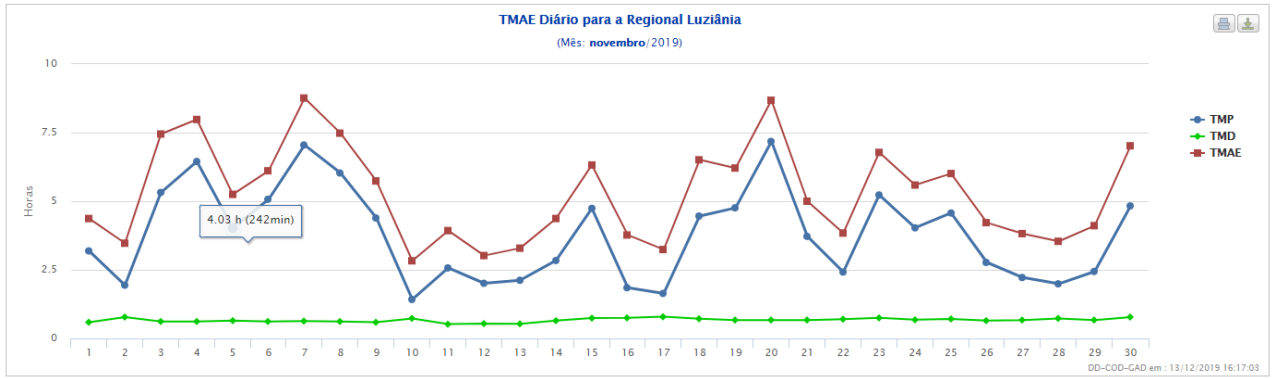



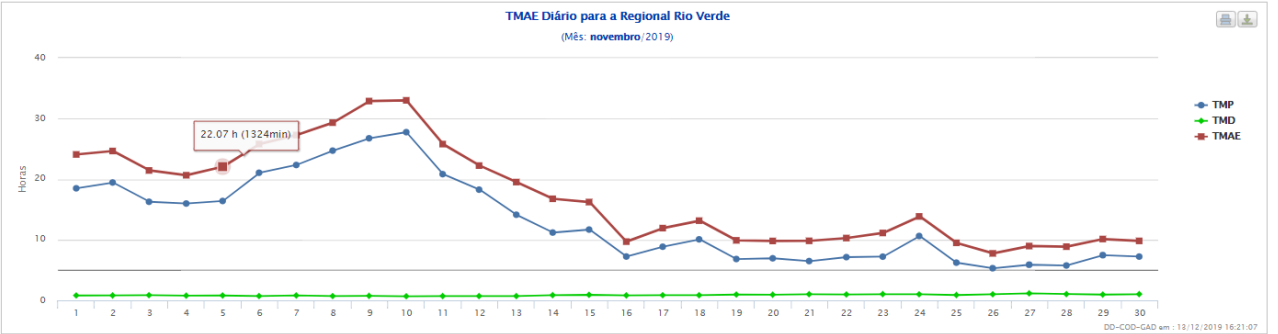
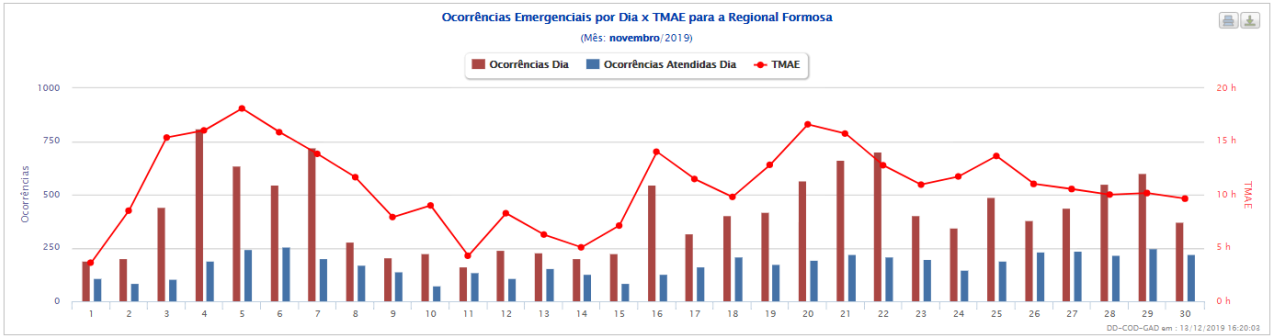
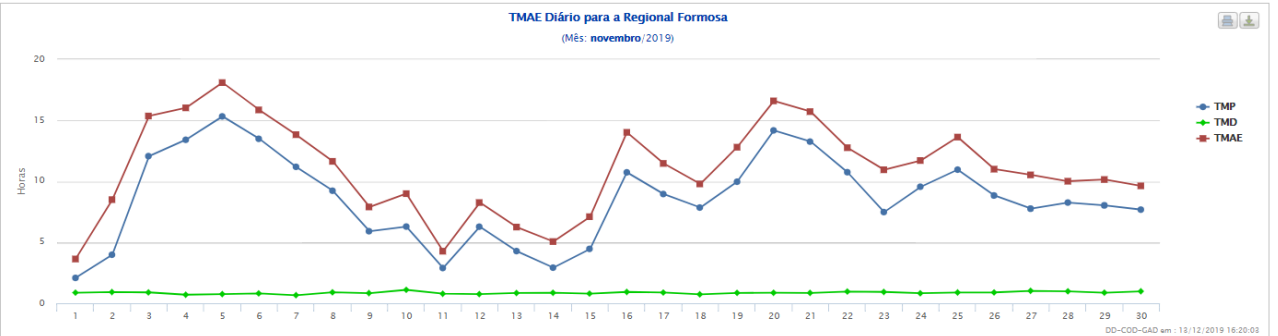
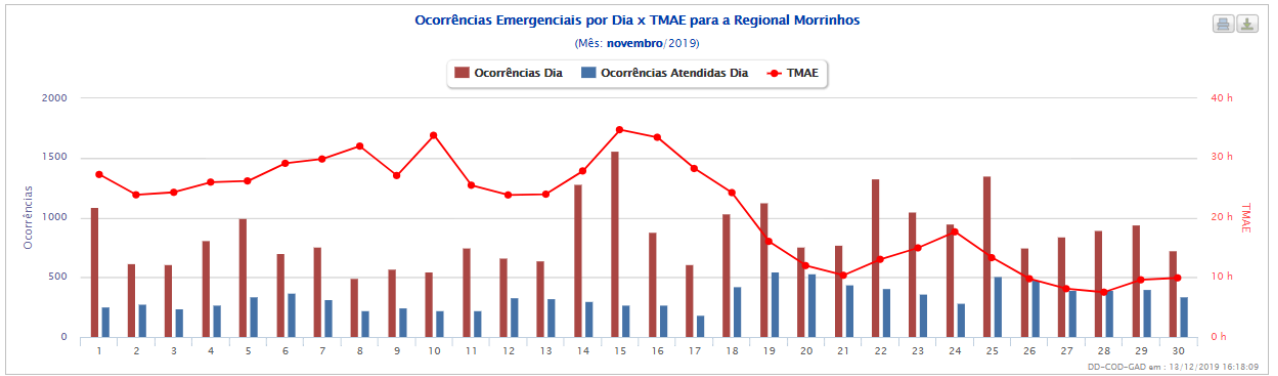

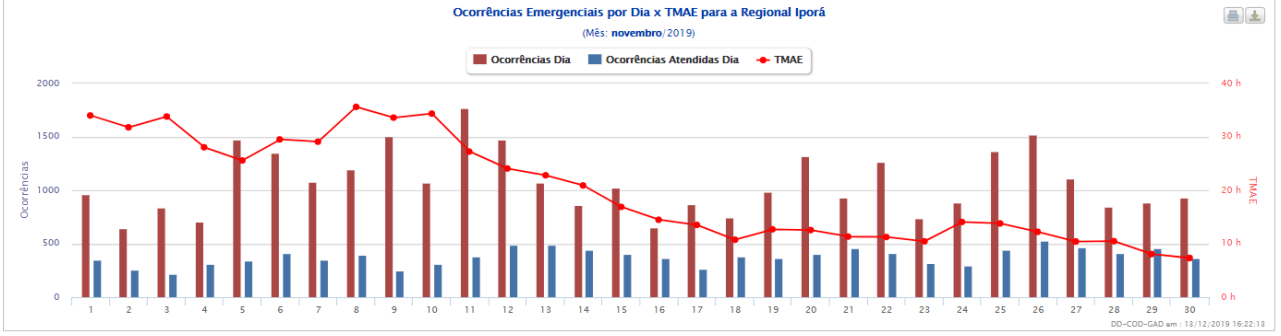
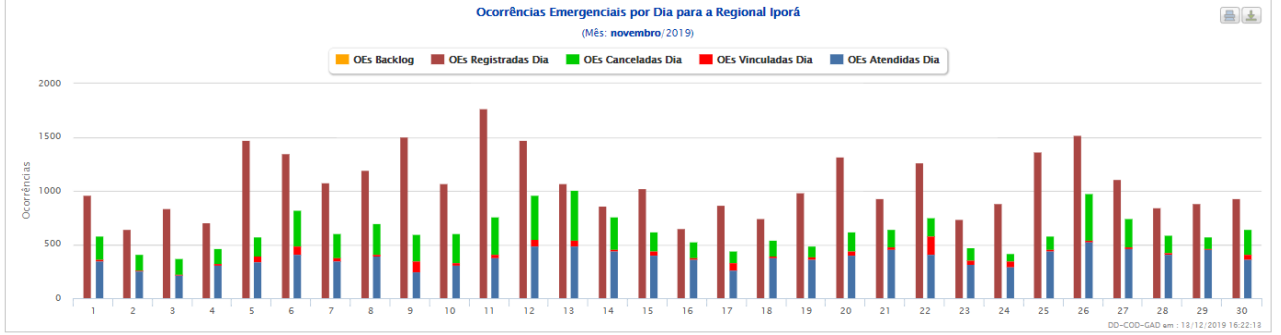
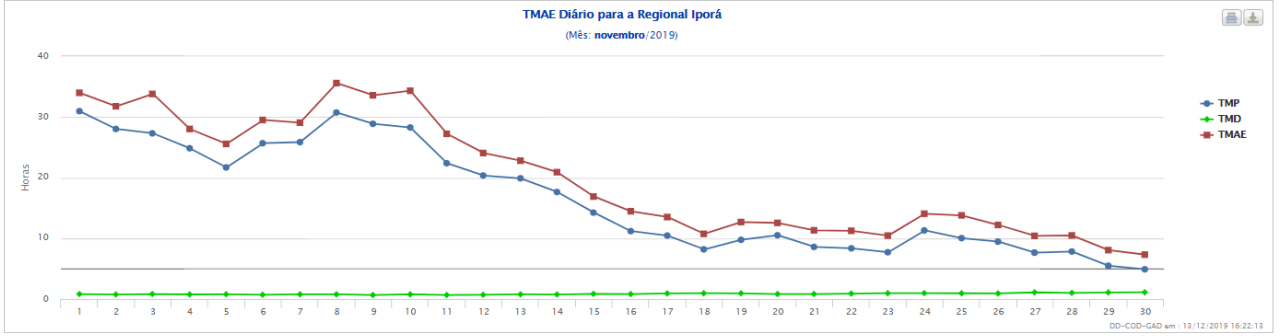
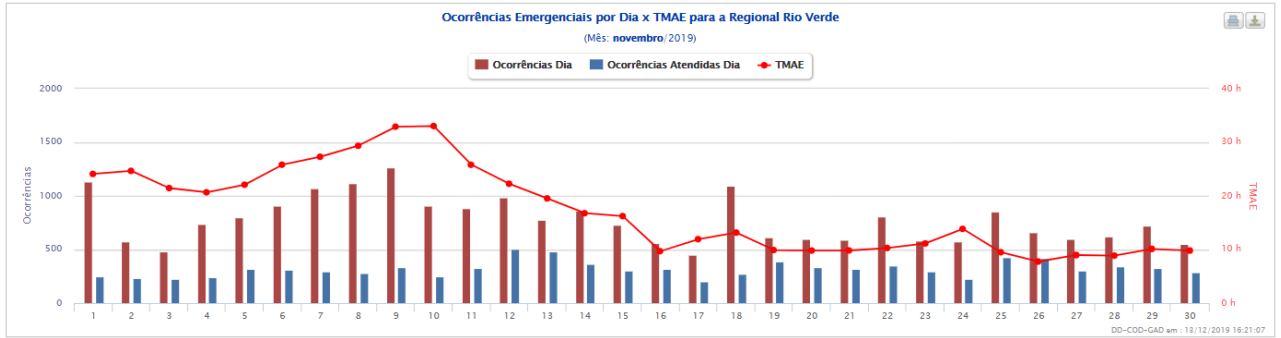
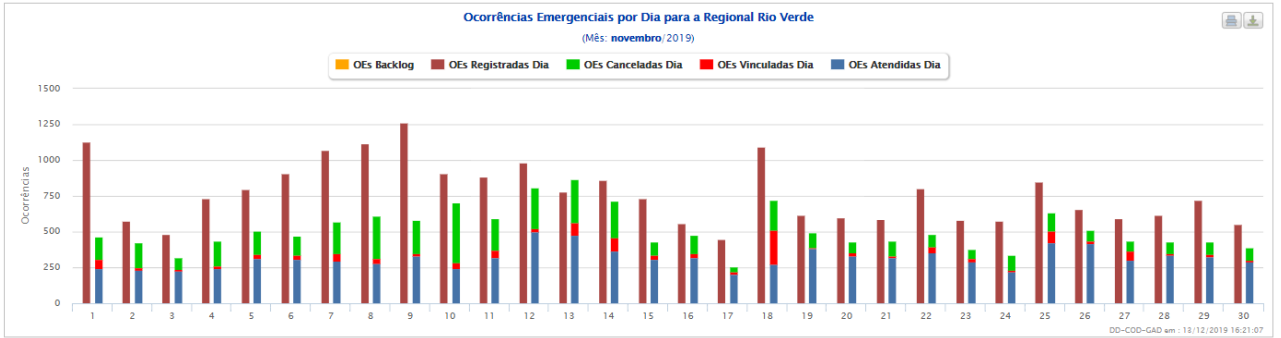

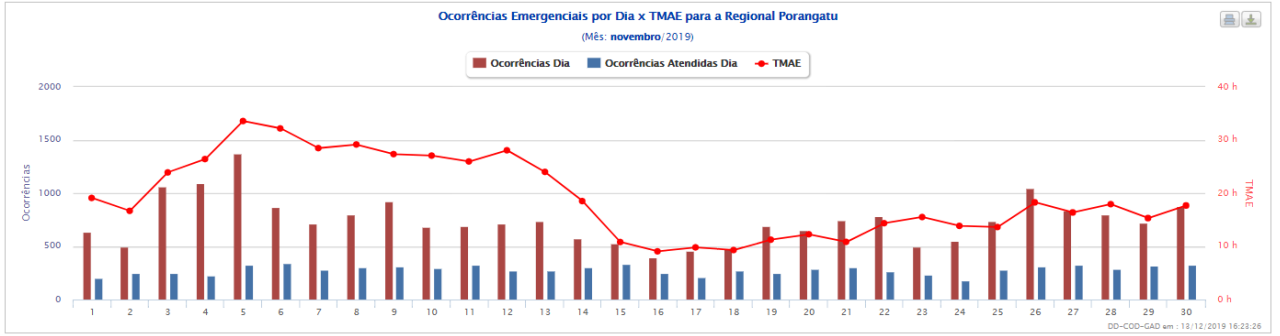
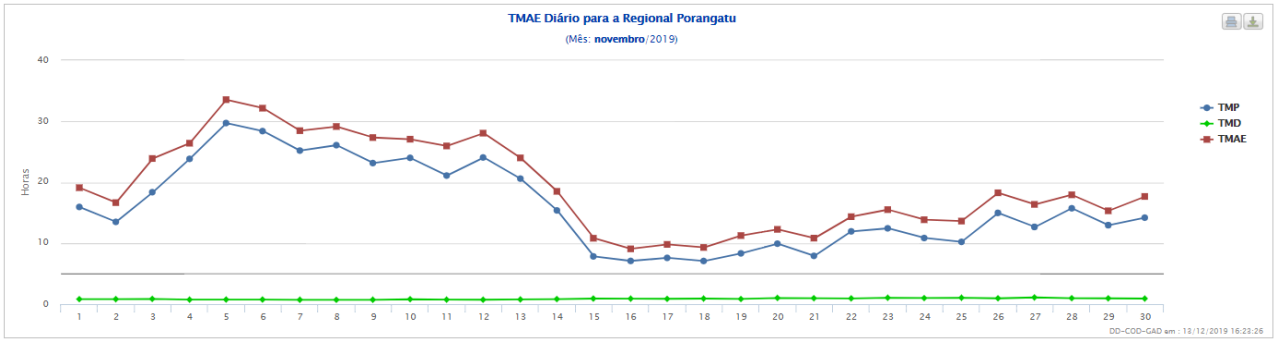

CLIMATEMPO

**Laudo Meteorológico de Evento Climático -  
CELG Distribuição S.A. - 27 a 01 de dezembro  
de 2019**

São Paulo, SP, Brasil

Dezembro de 2019

## Sumário

<b>1</b>	<b>ANÁLISE DE EVENTO METEOROLÓGICO .....</b>	<b>2</b>
<b>1.1</b>	<b>Descrição do Evento.....</b>	<b>2</b>
<b>1.2</b>	<b>Abrangência do Evento .....</b>	<b>6</b>
<b>2</b>	<b>CLASSIFICAÇÃO COBRADE .....</b>	<b>18</b>
<b>3</b>	<b>RESUMO DO EVENTO .....</b>	<b>19</b>
<b>4</b>	<b>REFERÊNCIAS.....</b>	<b>25</b>

# 1 Análise de Evento Meteorológico

## 1.1 Descrição do Evento

Na figura a seguir é apresentada a área de concessão da CELG Distribuição, dividida em regiões, a serem analisadas neste relatório.



Figura 1 – Regiões de Goiás atendidas pela CELG Distribuição.

A presença de uma frente fria favoreceu a organização de um corredor de umidade sobre o estado de Goiás entre o dia 27 e a madrugada do dia 01 de dezembro de 2019, mantendo as condições propícias a formação de nuvens de tempestade sobre a região durante o período.

Nas Figuras 2 e 3 são apresentadas as descargas atmosféricas nuvem-solo (raios) e nuvem-nuvem detectadas pelo sistema Earth Networks. Entre as 09h50 do dia 27 de novembro e 03h00 do dia 01 de dezembro foram registrados 27166 raios nuvem-solo e 38493 descargas nuvem-nuvem sobre a área da CELG Distribuição em Goiás.

Estações do Instituto Nacional de Meteorologia (INMET), representativas da área de concessão da CELG Distribuição Goiás, registraram chuva forte (segundo a American Meteorological Society - Sociedade Meteorológica Americana -), chuvas com taxa entre

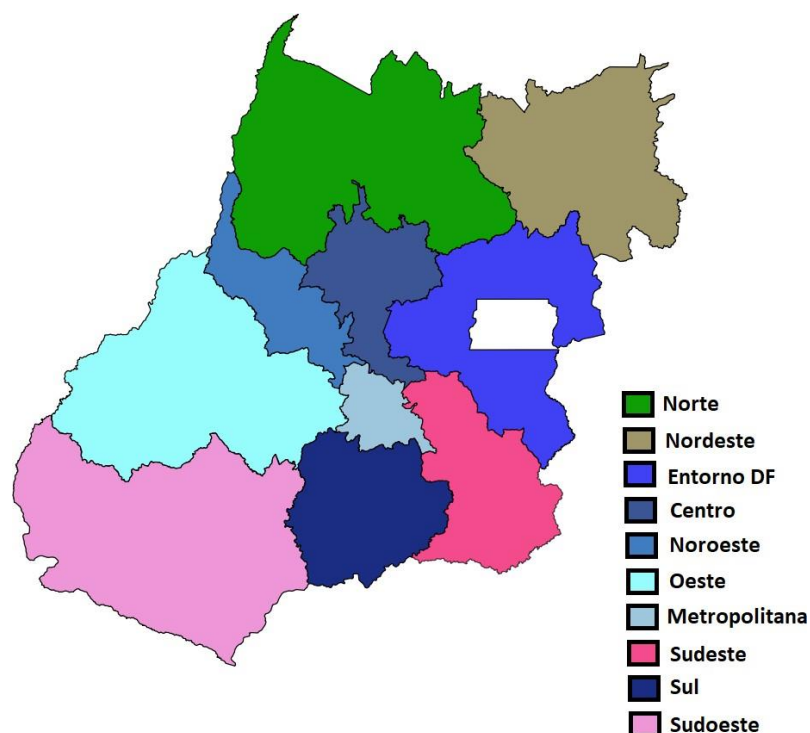
2,5mm a 7,6 mm por hora são consideradas moderadas e aquelas com taxa superior a 7,6 mm por hora são consideradas chuva forte). Na tabela 1 são apresentados os registros de acumulados horários superiores a 7,6 mm. O INMET também registrou rajadas de vento forte e ventania forte sobre a área de concessão da CELG Distribuição Goiás durante o período (tabela 2).



Figura 2 –Descargas atmosféricas nuvem-solo (em preto) detectadas pelo sistema Earth Networks entre 09h50 do dia 27 de novembro e 03h00 do dia 01 de dezembro de 2019 sobre a área de concessão da CELG Distribuição.



Figura 3 –Descargas atmosféricas nuvem-nuvem (em vermelho) detectadas pelo sistema Earth Networks entre 09h50 do dia 27 de novembro e 03h00 do dia 01 de dezembro de 2019 sobre a área de concessão da CELG Distribuição.

Tabela 1 –Acumulado horário de chuva registrada pelo INMET.

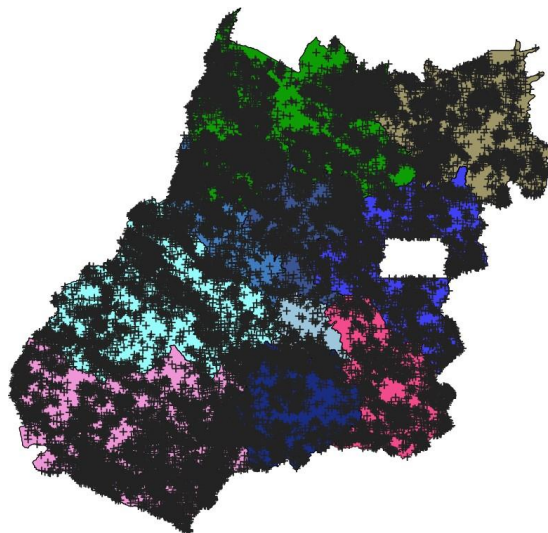
Estação	Horário	Precipitação (mm)
Alto Araguaia	Entre 13h e 14h do dia 27/11/2019	12.2
Alto Araguaia	Entre 12h e 13h do dia 28/11/2019	11.0
Alto Araguaia	Entre 14h e 15h do dia 29/11/2019	8.2
Alto Araguaia	Entre 13h e 14h do dia 30/11/2019	18.6
Aragarças	Entre 19h e 20h do dia 27/11/2019	20.6
Aragarças	Entre 20h e 21h do dia 27/11/2019	17.4
Caiapônia	Entre 10h e 11h do dia 29/11/2019	35.2
Caiapônia	Entre 16h e 17h do dia 30/11/2019	12.2
Caiapônia	Entre 18h e 19h do dia 30/11/2019	11.2
Catalão	Entre 22h e 23h do dia 27/11/2019	8.6
Catalão	Entre 23h e 0h do dia 28/11/2019	12.8
Catalão	Entre 22h e 23h do dia 29/11/2019	34.8
Catalão	Entre 10h e 11h do dia 30/11/2019	21.8
Catalão	Entre 17h e 18h do dia 30/11/2019	12.8
Cristalina	Entre 17h e 18h do dia 29/11/2019	12.4
Cristalina	Entre 21h e 22h do dia 29/11/2019	7.8
Goianésia	Entre 8h e 9h do dia 28/11/2019	13.0
Goianésia	Entre 13h e 14h do dia 30/11/2019	14.4
Goianésia	Entre 14h e 15h do dia 30/11/2019	8.6
Goiânia	Entre 18h e 19h do dia 28/11/2019	18.4
Itumbiara	Entre 14h e 15h do dia 27/11/2019	11.0
Itumbiara	Entre 17h e 18h do dia 28/11/2019	9.6
Itumbiara	Entre 5h e 6h do dia 29/11/2019	9.6
Jataí	Entre 3h e 4h do dia 29/11/2019	14.8
Jataí	Entre 4h e 5h do dia 29/11/2019	12.0
Mineiros	Entre 14h e 15h do dia 27/11/2019	21.2
Monte Alegre de Goiás	Entre 9h e 10h do dia 28/11/2019	8.0
Morrinhos	Entre 13h e 14h do dia 27/11/2019	11.2
Paraúna	Entre 22h e 23h do dia 27/11/2019	9.2
Paraúna	Entre 20h e 21h do dia 30/11/2019	15.8
Pires do Rio	Entre 13h e 14h do dia 30/11/2019	7.8
Rio Verde	Entre 18h e 19h do dia 27/11/2019	10.6
Rio Verde	Entre 19h e 20h do dia 27/11/2019	41.6
Silvânia	Entre 14h e 15h do dia 30/11/2019	10.6

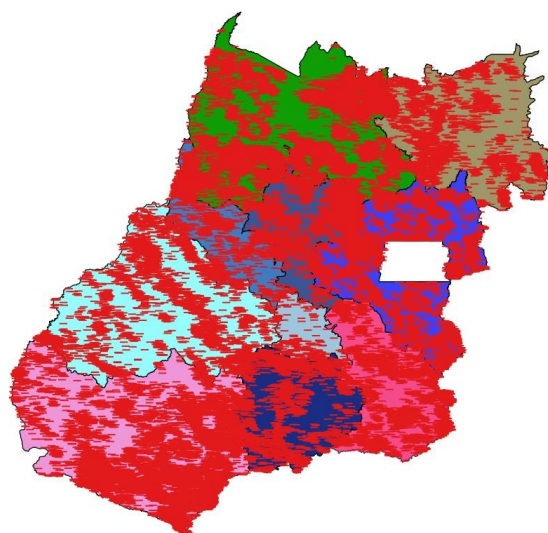

Tabela 2 –Rajadas de vento maiores ou iguais a 50 km/h registradas pelo INMET. Segundo a escala Beaufort, ventos entre 50 e 61 km/h são classificados como vento forte, entre 62 e 74 km/h como ventania e entre 75 e 88 km/h como ventania forte.

Estação	Horário	Rajada (km/h)
Goianésia	Entre 13h e 14h do dia 30/11/2019	77.0
Goianésia	Entre 14h e 15h do dia 30/11/2019	77.0
Luziânia	Entre 15h e 16h do dia 29/11/2019	52.6
São Simão	Entre 16h e 17h do dia 30/11/2019	56.2
São Simão	Entre 17h e 18h do dia 30/11/2019	56.2

## 1.2 Abrangência do Evento

A seguir são apresentadas as imagens realçadas do satélite GOES-16 entre as 13h00 do dia 27 de novembro e 05h00 do dia 01 de dezembro de 2019. Os tons em vermelho e preto indicam a presença de nuvens de grande desenvolvimento vertical, geralmente associadas à ocorrência de tempo severo.

13h00 - 27 de novembro de 2019



Figura 4 –Imagens realçadas do satélite GOES-16 das 13h00 do dia 27 de novembro de 2019.  
FONTE: Cptec/INPE.

17h00 - 27 de novembro de 2019

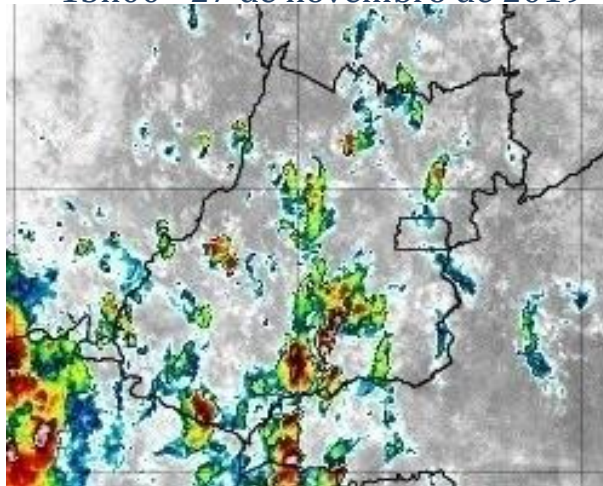

Figura 5 –Imagens realçadas do satélite GOES-16 das 17h00 do dia 27 de novembro de 2019.  
FONTE: Cptec/INPE.

21h00 - 27 de novembro de 2019

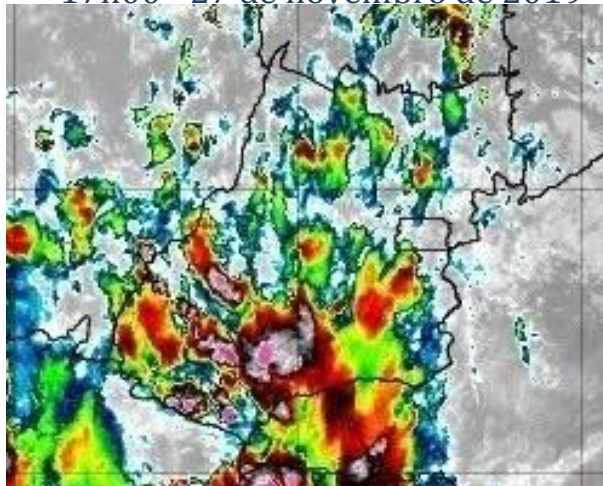

Figura 6 –Imagens realçadas do satélite GOES-16 das 21h00 do dia 27 de novembro de 2019. FONTE: Cptec/INPE.

01h00 - 28 de novembro de 2019



Figura 7 –Imagens realçadas do satélite GOES-16 das 01h00 do dia 28 de novembro de 2019. FONTE: Cptec/INPE.

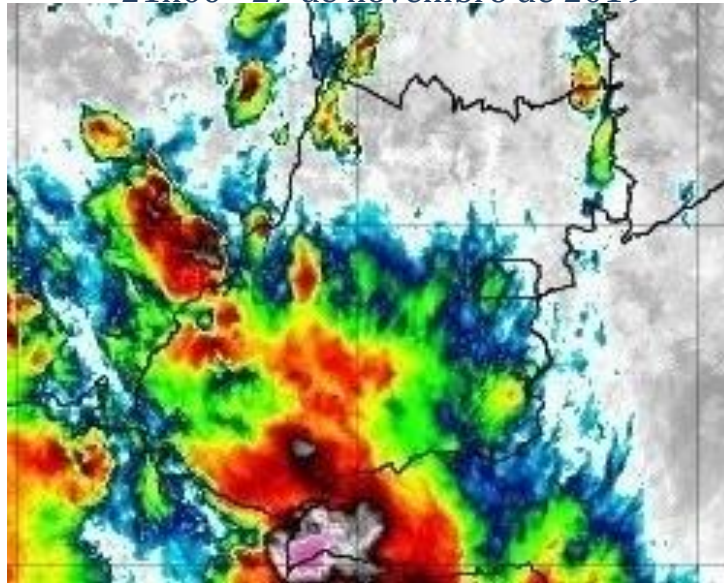

05h00 - 28 de novembro de 2019

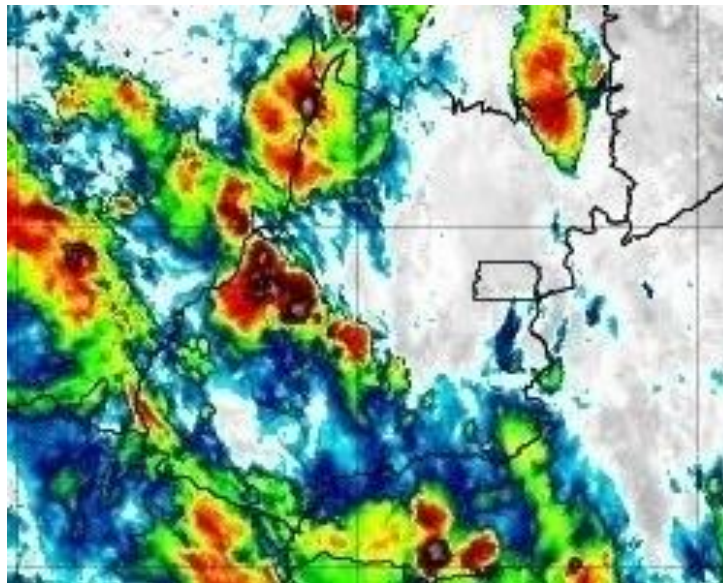

Figura 8 –Imagens realçadas do satélite GOES-16 das 05h00 do dia 28 de novembro de 2019. FONTE: Cptec/INPE.

09h00 - 28 de novembro de 2019

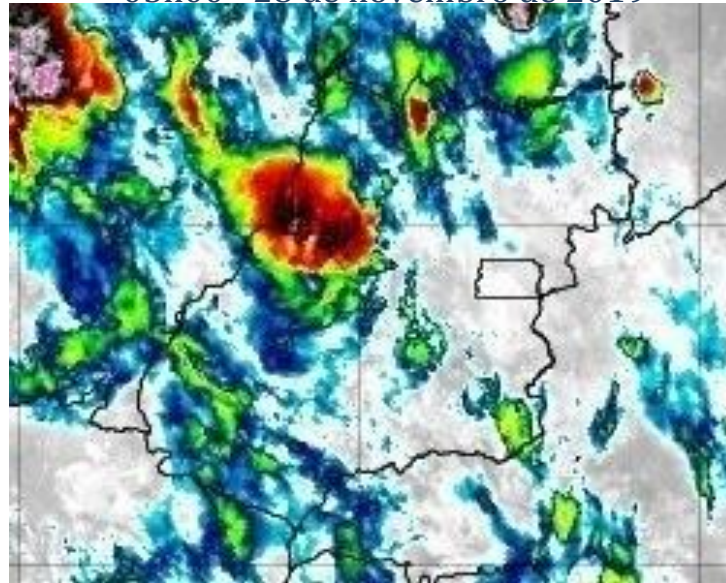

Figura 9 –Imagens realçadas do satélite GOES-16 das 09h00 do dia 28 de novembro de 2019. FONTE: Cptec/INPE.

13h00 - 28 de novembro de 2019

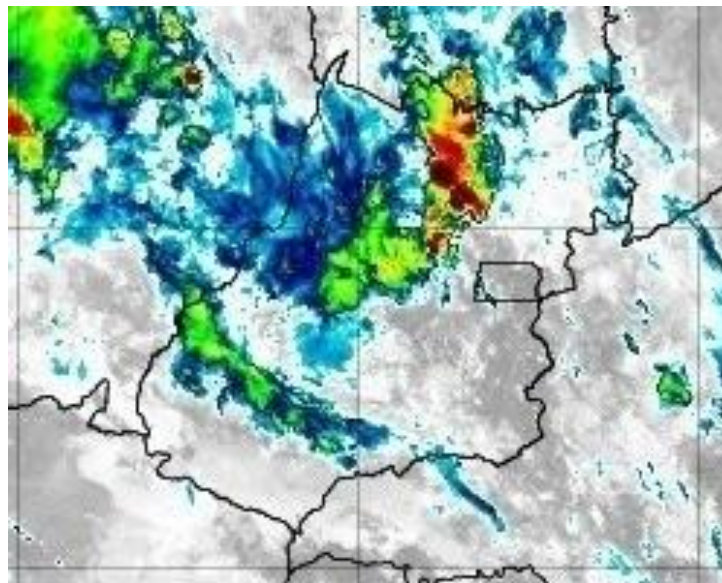

Figura 10 –Imagens realçadas do satélite GOES-16 das 13h00 do dia 28 de novembro de 2019. FONTE: Cptec/INPE.

17h00 - 28 de novembro de 2019



Figura 11 –Imagens realçadas do satélite GOES-16 das 17h00 do dia 28 de novembro de 2019. FONTE: Cptec/INPE.

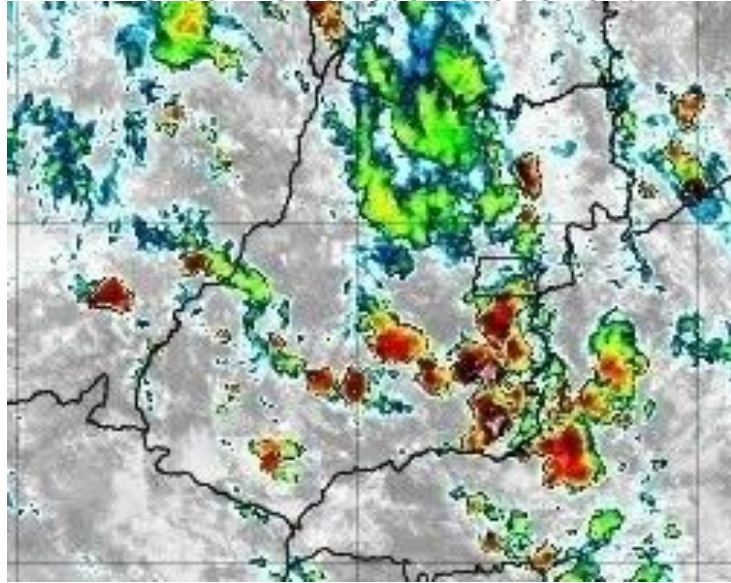

21h00 - 28 de novembro de 2019

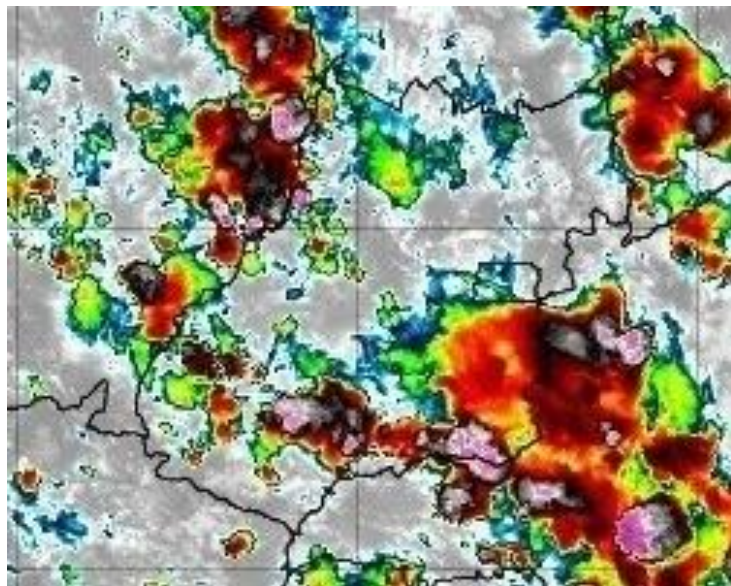

Figura 12 –Imagens realçadas do satélite GOES-16 das 21h00 do dia 28 de novembro de 2019. FONTE: Cptec/INPE.

01h00 - 29 de novembro de 2019

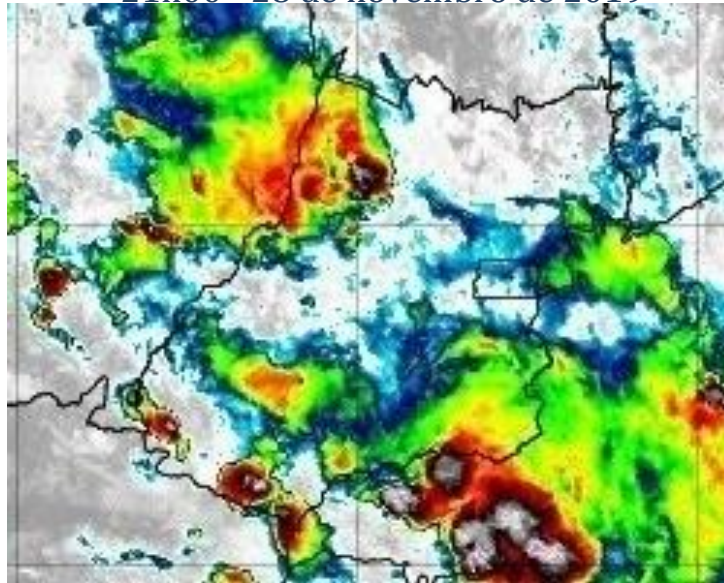

Figura 13 –Imagens realçadas do satélite GOES-16 das 01h00 do dia 29 de novembro de 2019. FONTE: Cptec/INPE.

05h00 - 29 de novembro de 2019

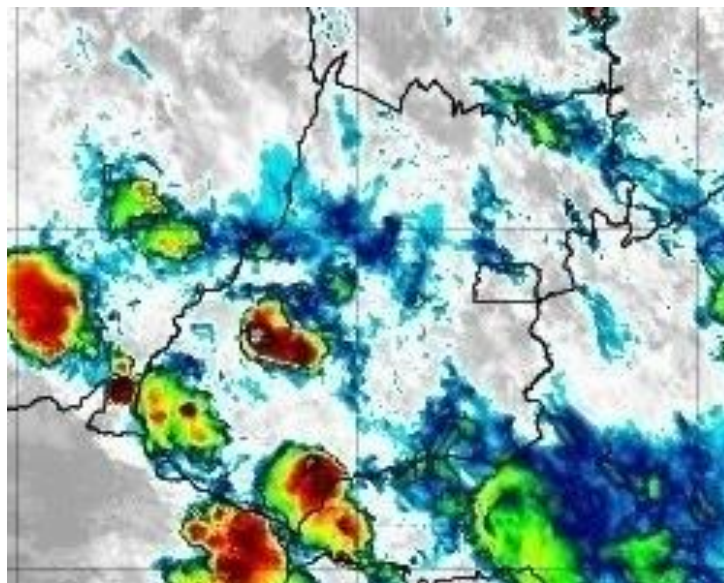

Figura 14 –Imagens realçadas do satélite GOES-16 das 05h00 do dia 29 de novembro de 2019. FONTE: Cptec/INPE.

09h00 - 29 de novembro de 2019



Figura 15 –Imagens realçadas do satélite GOES-16 das 09h00 do dia 29 de novembro de 2019. FONTE: Cptec/INPE.



13h00 - 29 de novembro de 2019



Figura 16 –Imagens realçadas do satélite GOES-16 das 13h00 do dia 29 de novembro de 2019. FONTE: Cptec/INPE.

17h00 - 29 de novembro de 2019



Figura 17 –Imagens realçadas do satélite GOES-16 das 17h00 do dia 29 de novembro de 2019. FONTE: Cptec/INPE.

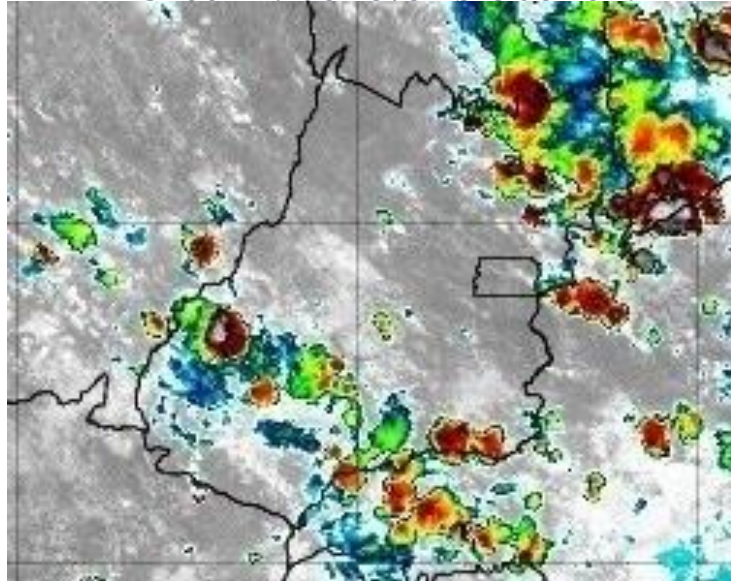

21h00 - 29 de novembro de 2019

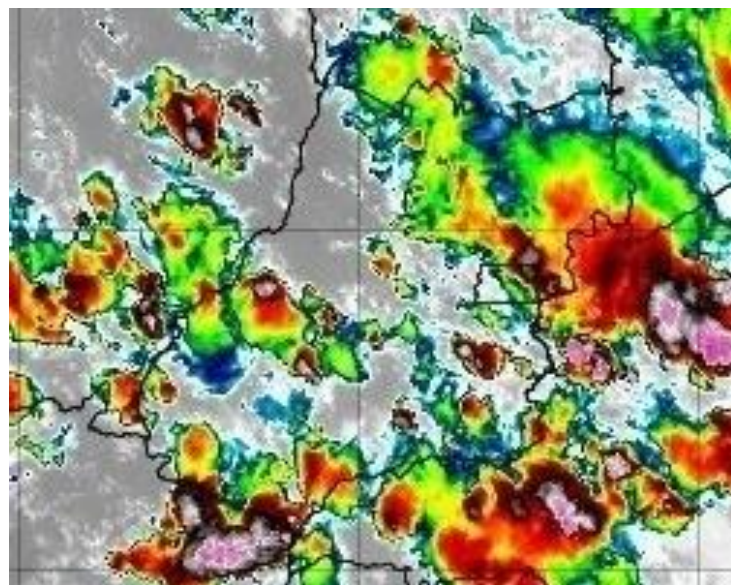

Figura 18 –Imagens realçadas do satélite GOES-16 das 21h00 do dia 29 de novembro de 2019. FONTE: Cptec/INPE.

01h00 - 30 de novembro de 2019

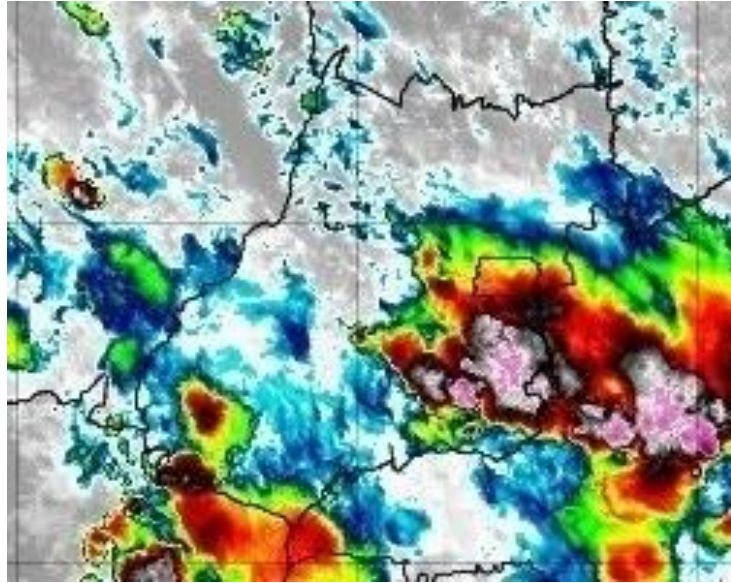

Figura 19 –Imagens realçadas do satélite GOES-16 das 01h00 do dia 30 de novembro de 2019. FONTE: Cptec/INPE.

05h00 - 30 de novembro de 2019

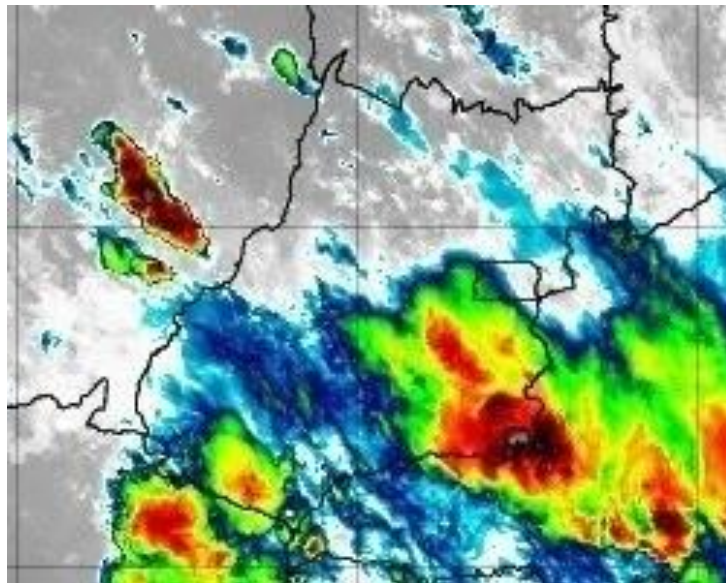

Figura 20 –Imagens realçadas do satélite GOES-16 das 05h00 do dia 30 de novembro de 2019. FONTE: Cptec/INPE.

09h00 - 30 de novembro de 2019



Figura 21 –Imagens realçadas do satélite GOES-16 das 09h00 do dia 30 de novembro de 2019. FONTE: Cptec/INPE.



13h00 - 30 de novembro de 2019



Figura 22 –Imagens realçadas do satélite GOES-16 das 13h00 do dia 30 de novembro de 2019. FONTE: Cptec/INPE.

17h00 - 30 de novembro de 2019

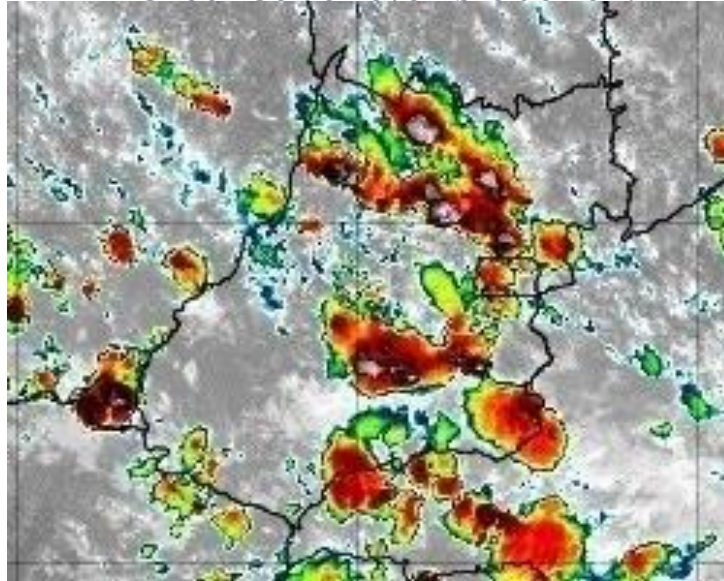

Figura 23 –Imagens realçadas do satélite GOES-16 das 17h00 do dia 30 de novembro de 2019. FONTE: Cptec/INPE.

21h00 - 30 de novembro de 2019

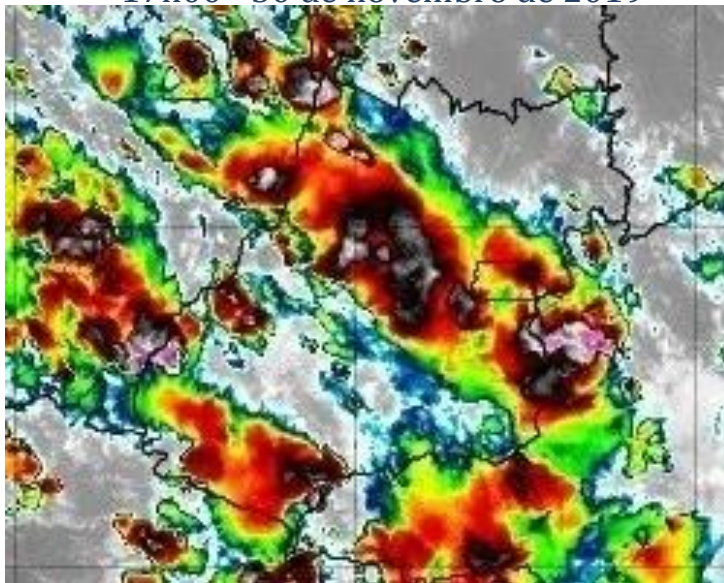

Figura 24 –Imagens realçadas do satélite GOES-16 das 21h00 do dia 30 de novembro de 2019. FONTE: Cptec/INPE.

01h00 - 01 de dezembro de  
2019

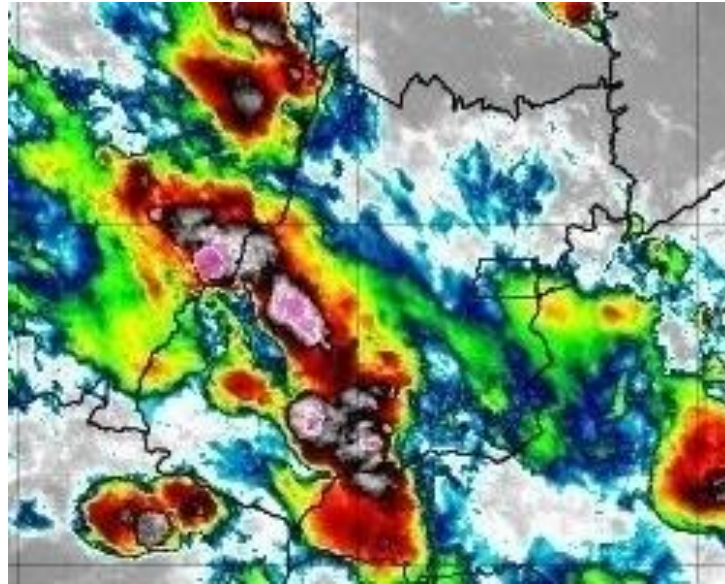

Figura 25 –Imagens realçadas do satélite GOES-16 das 01h00 do dia 01 de dezembro de 2019. FONTE: Cptec/INPE.

05h00 - 01 de dezembro de  
2019

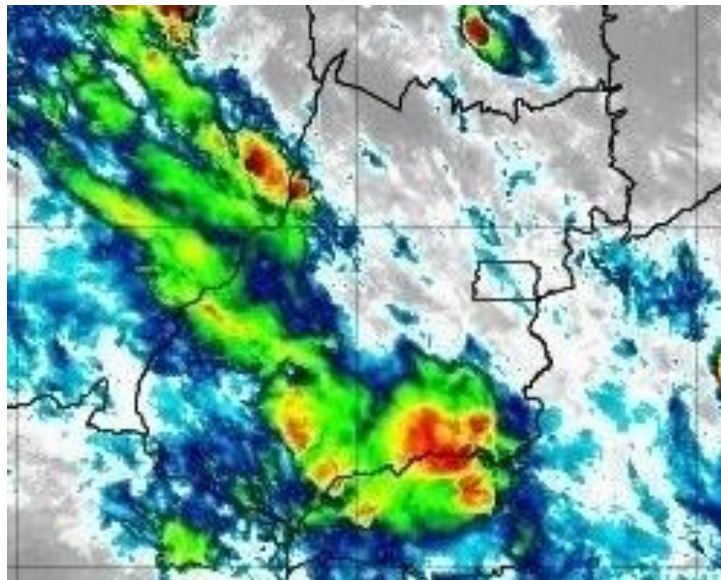

Figura 26 –Imagens realçadas do satélite GOES-16 das 05h00 do dia 01 de dezembro de 2019. FONTE: Cptec/INPE.

## 2 Classificação COBRADE

O COBRADE (Classificação e Codificação Brasileira de Desastres) foi criado com o intuito de adequar a classificação brasileira à classificação utilizada pela ONU na classificação de desastres e nivelar o país aos demais organismos de gestão de desastres do mundo.

Baseados nos dados analisados nos itens anteriores, podemos classificar o evento ocorrido na CELG Distribuição como Tempestades - Vendaval (Código 1.3.2.1.5), Tempestade de raios (Código 1.3.2.1.2) e Chuvas intensas (Código 1.3.2.1.4).

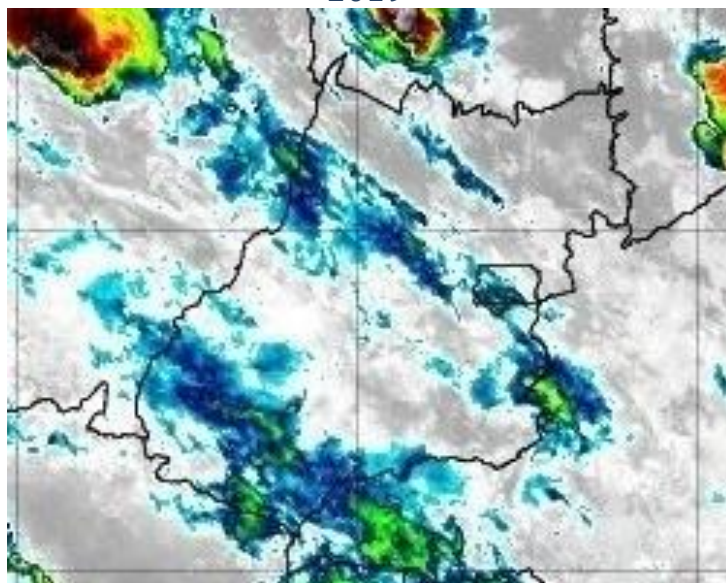
### 3 Resumo do Evento

O corredor de umidade associado à presença de uma frente fria na costa do país favoreceu a formação de nuvens de tempestade, do tipo Cumulonimbus, sobre o estado de Goiás entre a manhã do dia 27 de novembro e a madrugada do dia 01 de dezembro de 2019.

O INMET registrou chuva forte (com acumulado horário superior a 7,6 mm) em estações representativas da área de concessão da CELG Distribuição Goiás durante o evento. Rajadas de vento forte e ventania forte também foram registradas durante o período. A rajada máxima registrada foi de 77,0 km/h na estação de Goianésia. Entre as 09h50 do dia 27 de novembro e as 03h00 do dia 01 de dezembro de 2019 foram detectadas 65659 descargas atmosféricas sobre a região segundo a rede da Earth Networks.

Tabela 3 – Resumo do evento Região Sudoeste

Número/Código do Evento	
Número/Código do Relatório	
Descrição	Forte deslocamento de uma massa de ar em uma região. Tempestade com intensa atividade elétrica no interior das nuvens, com grande desenvolvimento vertical. Chuvas com acumulados significativos.
Código COBRADE	1.3.2.1.5 - Tempestades, Vendaval e 1.3.2.1.2 - Tempestade de raios e 1.3.2.1.4 - Chuvas intensas
Hora início do evento	10h00 do dia 27 de novembro de 2019
Hora de fim do evento	00h30 do dia 01 de dezembro de 2019
Abrangência	Região Sudoeste da CELG Distribuição S.A.



Tabela 4 – Resumo do evento Região Sul

Número/Código do Evento	
Número/Código do Relatório	
Descrição	Forte deslocamento de uma massa de ar em uma região. Tempestade com intensa atividade elétrica no interior das nuvens, com grande desenvolvimento vertical. Chuvas com acumulados significativos.
Código COBRADE	1.3.2.1.5 - Tempestades, Vendaval e 1.3.2.1.2 - Tempestade de raios e 1.3.2.1.4 - Chuvas intensas
Hora início do evento	11h00 do dia 27 de novembro de 2019
Hora de fim do evento	23h30 do dia 30 de novembro de 2019
Abrangência	Região Sul da CELG Distribuição S.A.

Tabela 5 – Resumo do evento Região Sudeste

Número/Código do Evento	
Número/Código do Relatório	
Descrição	Forte deslocamento de uma massa de ar em uma região. Tempestade com intensa atividade elétrica no interior das nuvens, com grande desenvolvimento vertical. Chuvas com acumulados significativos.
Código COBRADE	1.3.2.1.5 - Tempestades, Vendaval e 1.3.2.1.2 - Tempestade de raios e 1.3.2.1.4 - Chuvas intensas
Hora início do evento	11h30 do dia 27 de novembro de 2019
Hora de fim do evento	19h00 do dia 30 de novembro de 2019
Abrangência	Região Sudeste da CELG Distribuição S.A.



Tabela 6 – Resumo do evento Região Metropolitana

Número/Código do Evento	
Número/Código do Relatório	
Descrição	Forte deslocamento de uma massa de ar em uma região. Tempestade com intensa atividade elétrica no interior das nuvens, com grande desenvolvimento vertical. Chuvas com acumulados significativos.
Código COBRADE	1.3.2.1.5 - Tempestades, Vendaval e 1.3.2.1.2 - Tempestade de raios e 1.3.2.1.4 - Chuvas intensas
Hora início do evento	10h30 do dia 27 de novembro de 2019
Hora de fim do evento	14h30 do dia 30 de novembro de 2019
Abrangência	Região Metropolitana da CELG Distribuição S.A.

Tabela 7 – Resumo do evento Região Oeste

Número/Código do Evento	
Número/Código do Relatório	
Descrição	Forte deslocamento de uma massa de ar em uma região. Tempestade com intensa atividade elétrica no interior das nuvens, com grande desenvolvimento vertical. Chuvas com acumulados significativos.
Código COBRADE	1.3.2.1.5 - Tempestades, Vendaval e 1.3.2.1.2 - Tempestade de raios e 1.3.2.1.4 - Chuvas intensas
Hora início do evento	09h30 do dia 27 de novembro de 2019
Hora de fim do evento	22h00 do dia 30 de novembro de 2019
Abrangência	Região Oeste da CELG Distribuição S.A.

Tabela 8 – Resumo do evento Região EDF

Número/Código do Evento	
Número/Código do Relatório	
Descrição	Forte deslocamento de uma massa de ar em uma região. Tempestade com intensa atividade elétrica no interior das nuvens, com grande desenvolvimento vertical. Chuvas com acumulados significativos.
Código COBRADE	1.3.2.1.5 - Tempestades, Vendaval e 1.3.2.1.2 - Tempestade de raios e 1.3.2.1.4 - Chuvas intensas
Hora início do evento	12h30 do dia 27 de novembro de 2019
Hora de fim do evento	17h30 do dia 30 de novembro de 2019
Abrangência	Região EDF da CELG Distribuição S.A.

Tabela 9 – Resumo do evento Região Centro

Número/Código do Evento	
Número/Código do Relatório	
Descrição	Forte deslocamento de uma massa de ar em uma região. Tempestade com intensa atividade elétrica no interior das nuvens, com grande desenvolvimento vertical. Chuvas com acumulados significativos.
Código COBRADE	1.3.2.1.5 - Tempestades, Vendaval e 1.3.2.1.2 - Tempestade de raios e 1.3.2.1.4 - Chuvas intensas
Hora início do evento	12h00 do dia 27 de novembro de 2019
Hora de fim do evento	18h00 do dia 30 de novembro de 2019
Abrangência	Região Centro da CELG Distribuição S.A.

Tabela 10 – Resumo do evento Região Noroeste

Número/Código do Evento	
Número/Código do Relatório	
Descrição	Forte deslocamento de uma massa de ar em uma região. Tempestade com intensa atividade elétrica no interior das nuvens, com grande desenvolvimento vertical. Chuvas com acumulados significativos.
Código COBRADE	1.3.2.1.5 - Tempestades, Vendaval e 1.3.2.1.2 - Tempestade de raios e 1.3.2.1.4 - Chuvas intensas
Hora início do evento	11h00 do dia 27 de novembro de 2019
Hora de fim do evento	01h00 do dia 01 de dezembro de 2019
Abrangência	Região Noroeste da CELG Distribuição S.A.

Tabela 11 – Resumo do evento Região Norte

Número/Código do Evento	
Número/Código do Relatório	
Descrição	Forte deslocamento de uma massa de ar em uma região. Tempestade com intensa atividade elétrica no interior das nuvens, com grande desenvolvimento vertical. Chuvas com acumulados significativos.
Código COBRADE	1.3.2.1.5 - Tempestades, Vendaval e 1.3.2.1.2 - Tempestade de raios e 1.3.2.1.4 - Chuvas intensas
Hora início do evento	11h30 do dia 27 de novembro de 2019
Hora de fim do evento	03h00 do dia 01 de dezembro de 2019
Abrangência	Região Norte da CELG Distribuição S.A.

Tabela 12 – Resumo do evento Região Nordeste

Número/Código do Evento	
Número/Código do Relatório	
Descrição	Forte deslocamento de uma massa de ar em uma região. Tempestade com intensa atividade elétrica no interior das nuvens, com grande desenvolvimento vertical. Chuvas com acumulados significativos.
Código COBRADE	1.3.2.1.5 - Tempestades, Vendaval e 1.3.2.1.2 - Tempestade de raios e 1.3.2.1.4 - Chuvas intensas
Hora início do evento	12h00 do dia 27 de novembro de 2019
Hora de fim do evento	17h30 do dia 30 de novembro de 2019
Abrangência	Região Nordeste da CELG Distribuição S.A.

#### 4 Referências

- RMetS Royal Meteorological Society – Beaufort Scale - <https://www.rmets.org/weather-and-climate/observing/beaufort-scale>
- Instituto Nacional de Meteorologia (INMET) - <http://www.inmet.gov.br>
- Cptec/INPE- <https://www.cptec.inpe.br/>
- Centro de Hidrografia da Marinha do Brasil - <https://www.marinha.mil.br/chm/>
- Meteorology Glossary - American Meteorological Society - <http://glossary.ametsoc.org/>

Anexos

A.1 Carta Sinótica



Figura A1 - Carta sinótica para as 1200Z do dia 27 de novembro de 2019 (09h00 do dia 27 de novembro de 2019, hora local. FONTE: Marinha do Brasil).





Figura A2 - Carta sinótica da Marinha do Brasil para as 0000Z do dia 28 de novembro de 2019 (21h00 do dia 27 de novembro de 2019, hora local). FONTE: Marinha do Brasil).

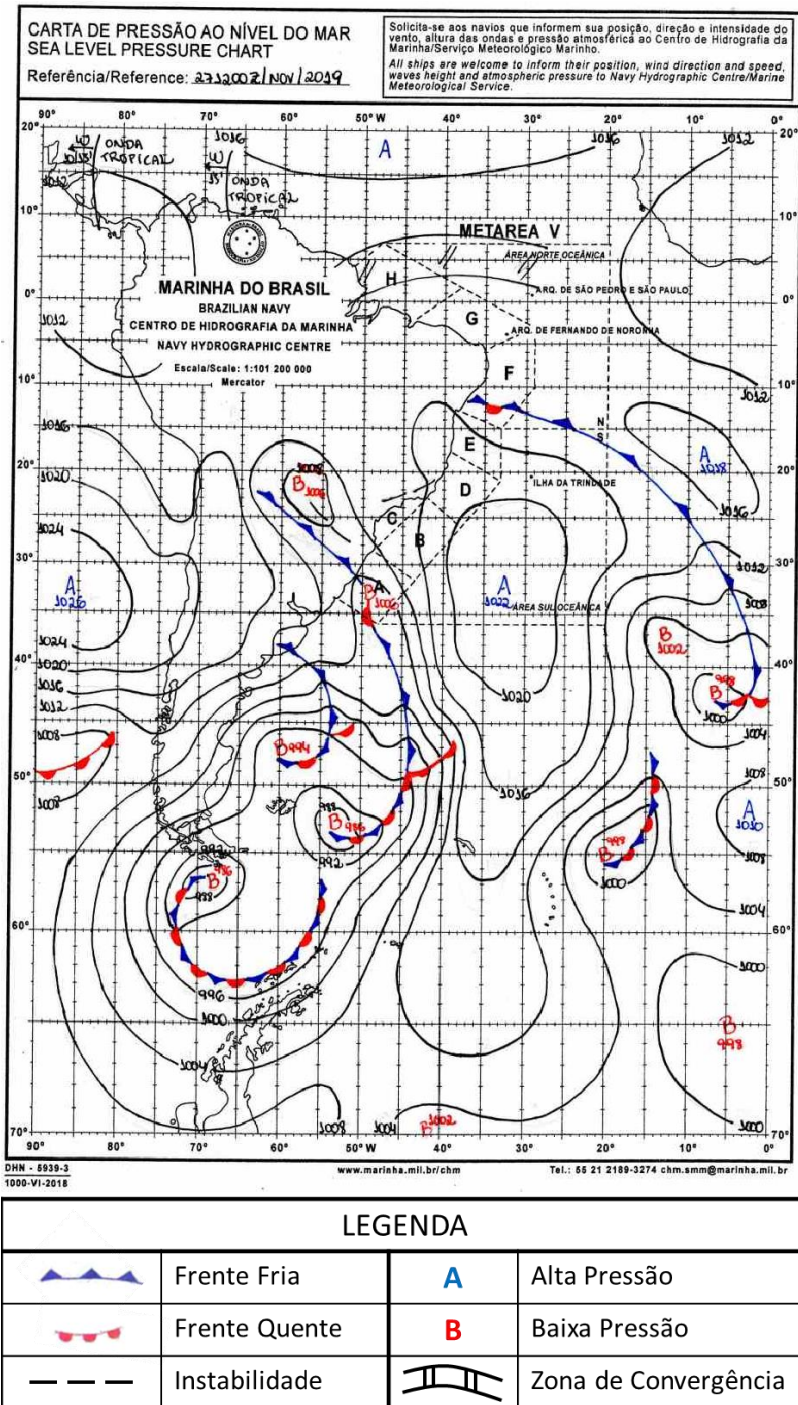

Figura A3 - Carta sinótica para as 1200Z do dia 28 de novembro de 2019 (09h00 do dia 28 de novembro de 2019, hora local. FONTE: Marinha do Brasil).



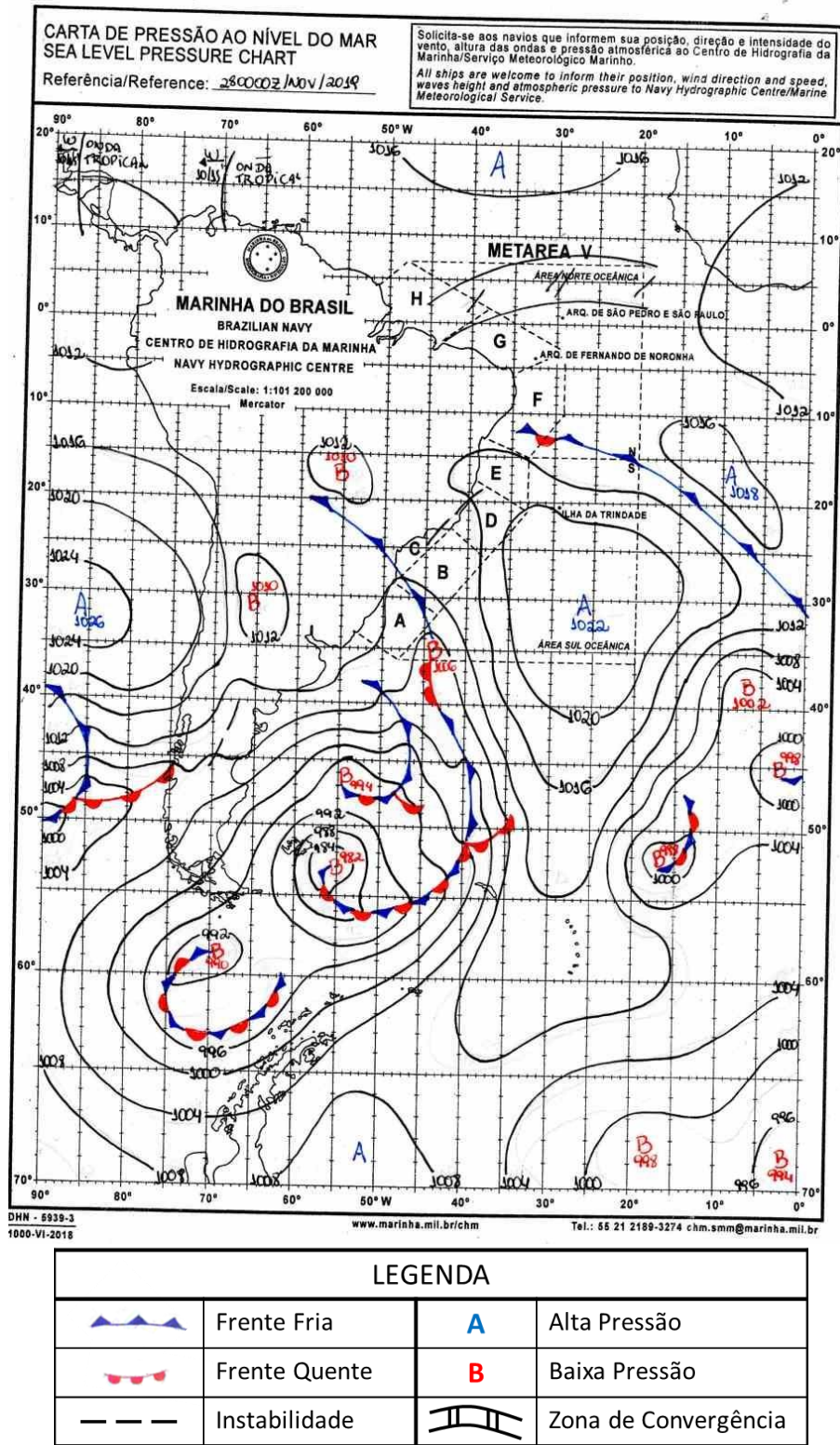

LEGENDA			
	Frente Fria	<b>A</b>	Alta Pressão
	Frente Quente	<b>B</b>	Baixa Pressão
	Instabilidade		Zona de Convergência

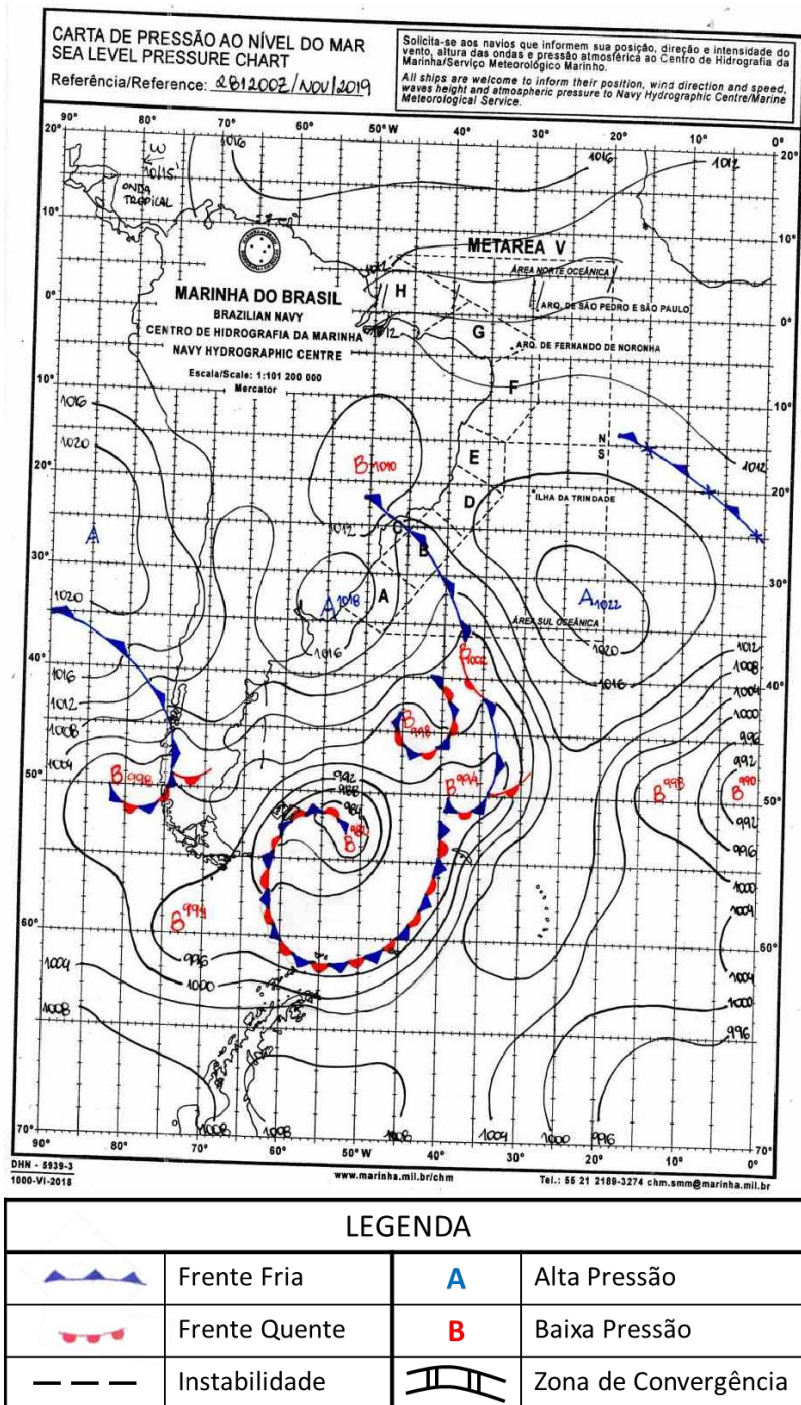
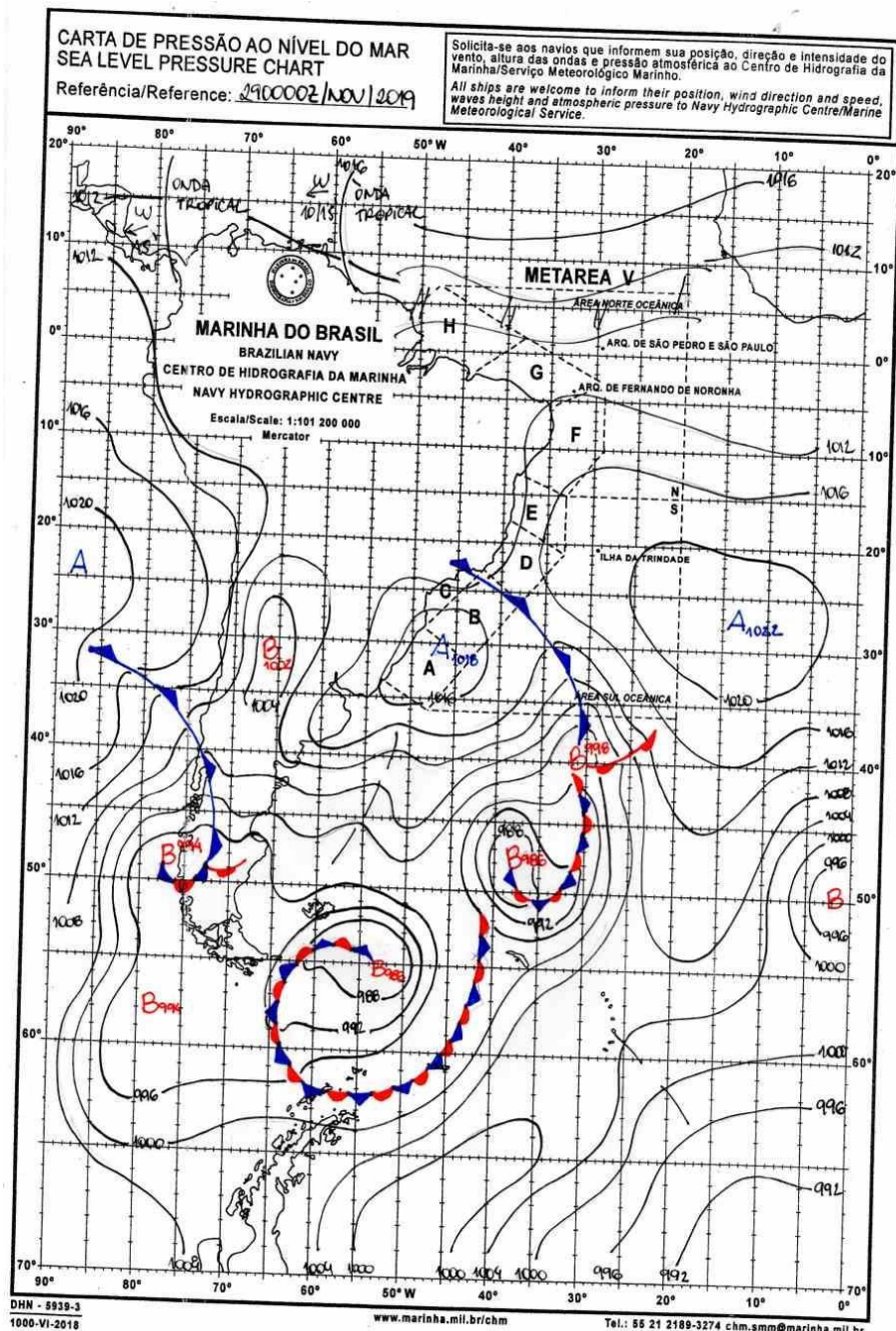
Figura A4 - Carta sinótica da Marinha do Brasil para as 0000Z do dia 29 de novembro de 2019 (21h00 do dia 28 de novembro de 2019, hora local. FONTE: Marinha do Brasil).



Figura A5 - Carta sinótica para as 1200Z do dia 29 de novembro de 2019 (09h00 do dia 29 de novembro de 2019, hora local. FONTE: Marinha do Brasil).



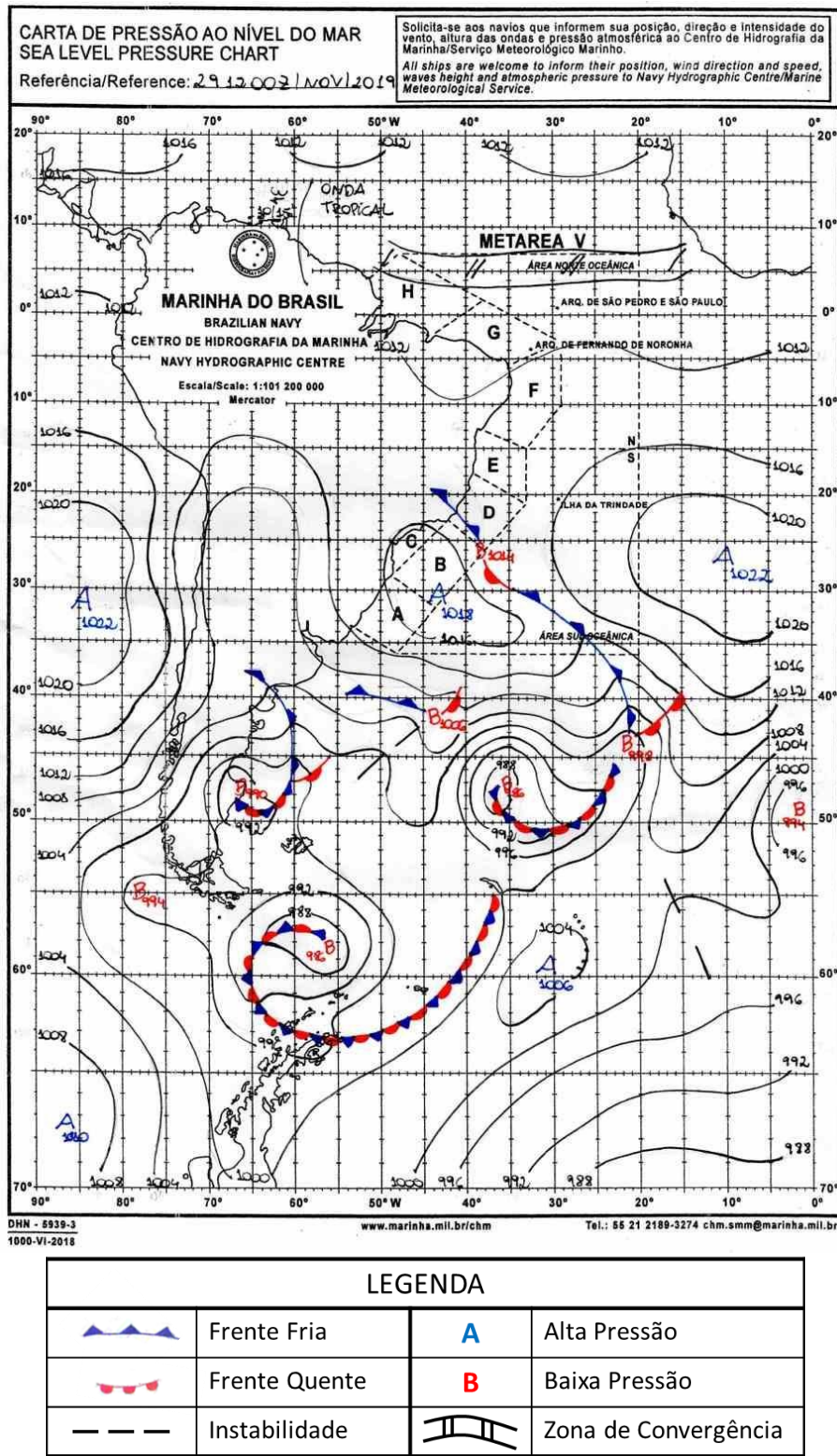
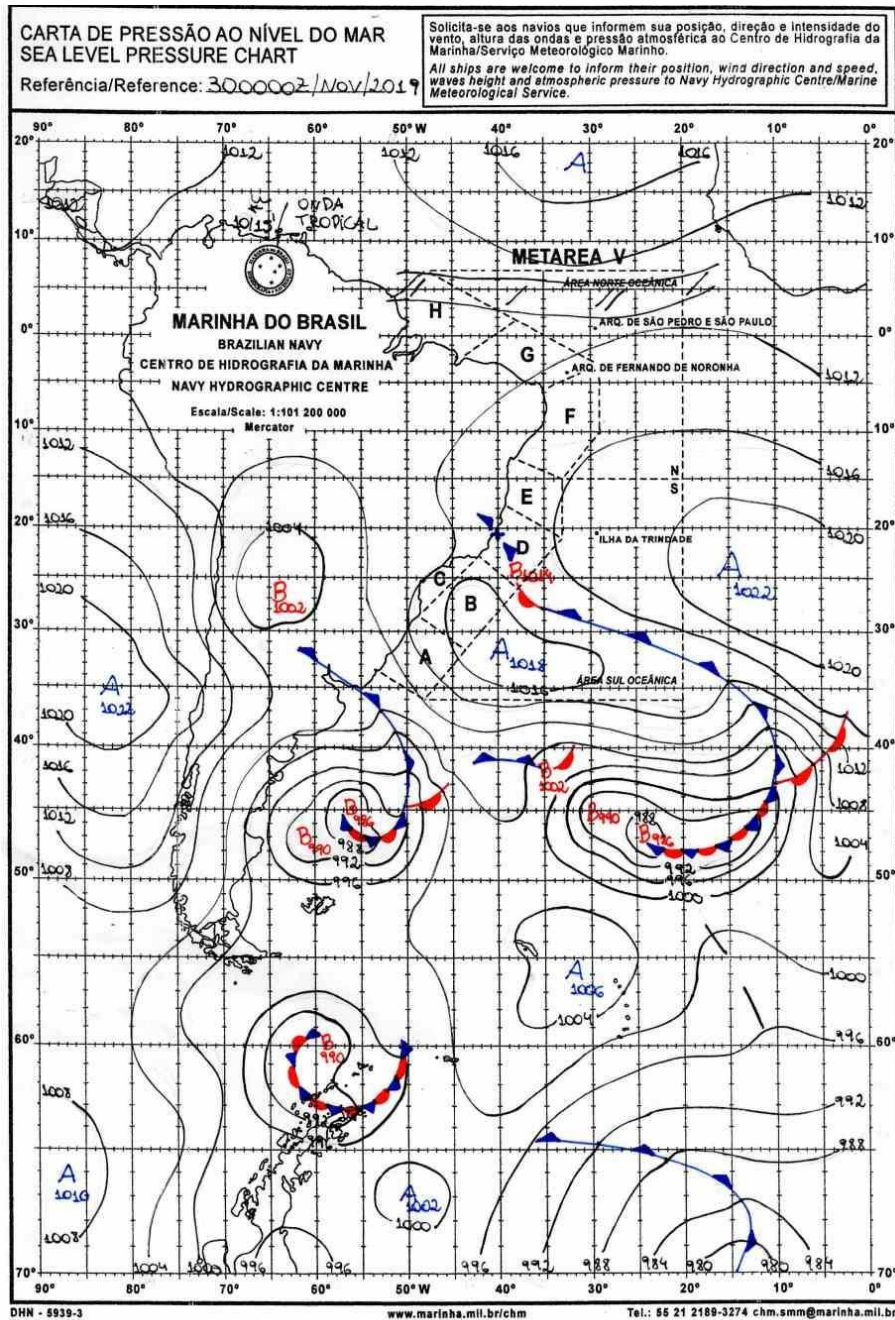

LEGENDA			
	Frente Fria	<b>A</b>	Alta Pressão
	Frente Quente	<b>B</b>	Baixa Pressão
	Instabilidade		Zona de Convergência

Figura A6 - Carta sinótica da Marinha do Brasil para as 0000Z do dia 30 de novembro de 2019 (21h00 do dia 29 de novembro de 2019, hora local. FONTE: Marinha do Brasil).

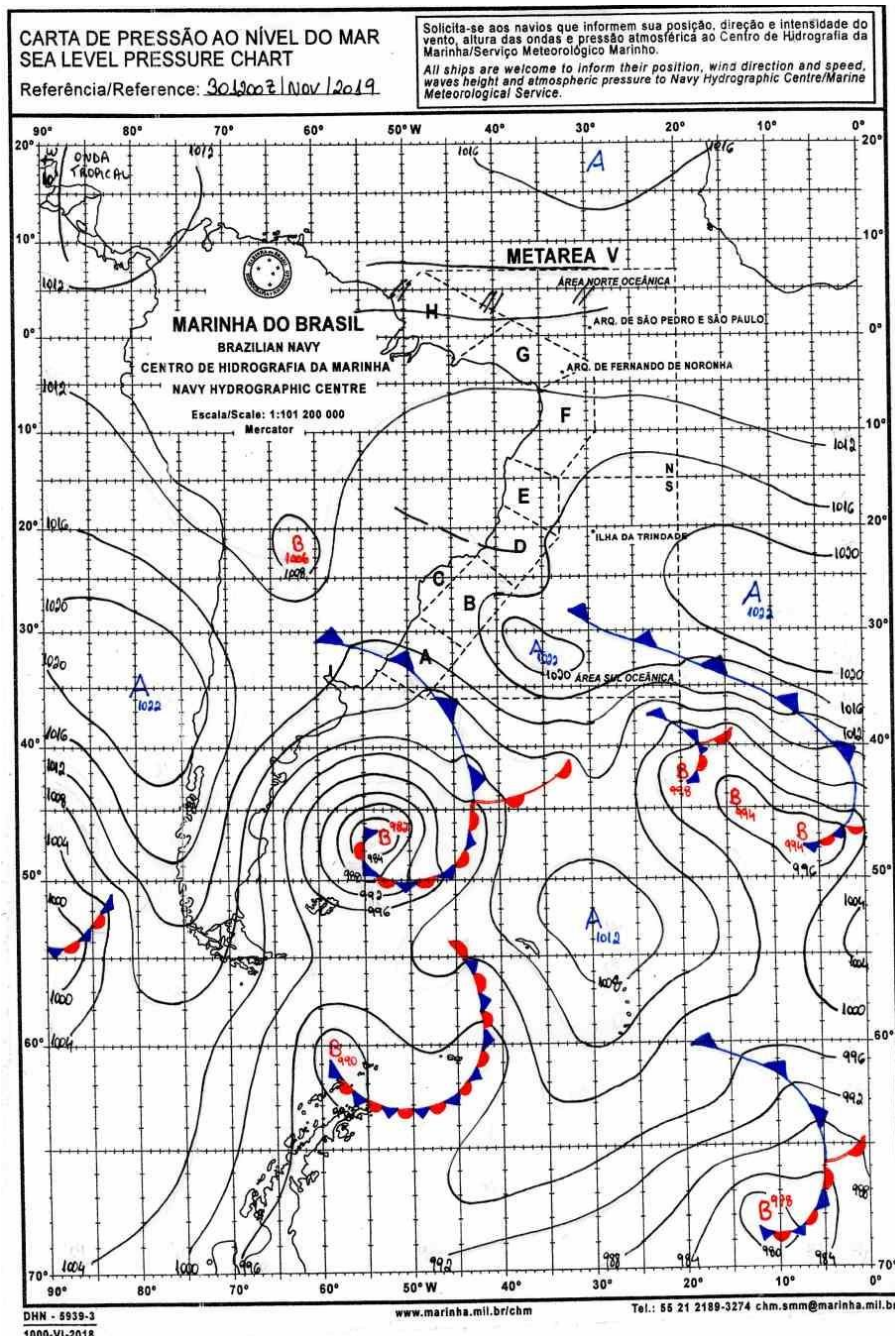

LEGENDA			
	Frente Fria	<b>A</b>	Alta Pressão
	Frente Quente	<b>B</b>	Baixa Pressão
	Instabilidade		Zona de Convergência

Figura A7 - Carta sinótica para as 1200Z do dia 30 de novembro de 2019 (09h00 do dia 30 de novembro de 2019, hora local. FONTE: Marinha do Brasil).





Figura A8 - Carta sinótica da Marinha do Brasil para as 0000Z do dia 01 de dezembro de 2019 (21h00 do dia 30 de novembro de 2019, hora local). FONTE: Marinha do Brasil).



Figura A7 - Carta sinótica para as 1200Z do dia 01 de dezembro de 2019 (09h00 do dia 01 de dezembro de 2019, hora local. FONTE: Marinha do Brasil).

## A.2 Notícias relacionadas

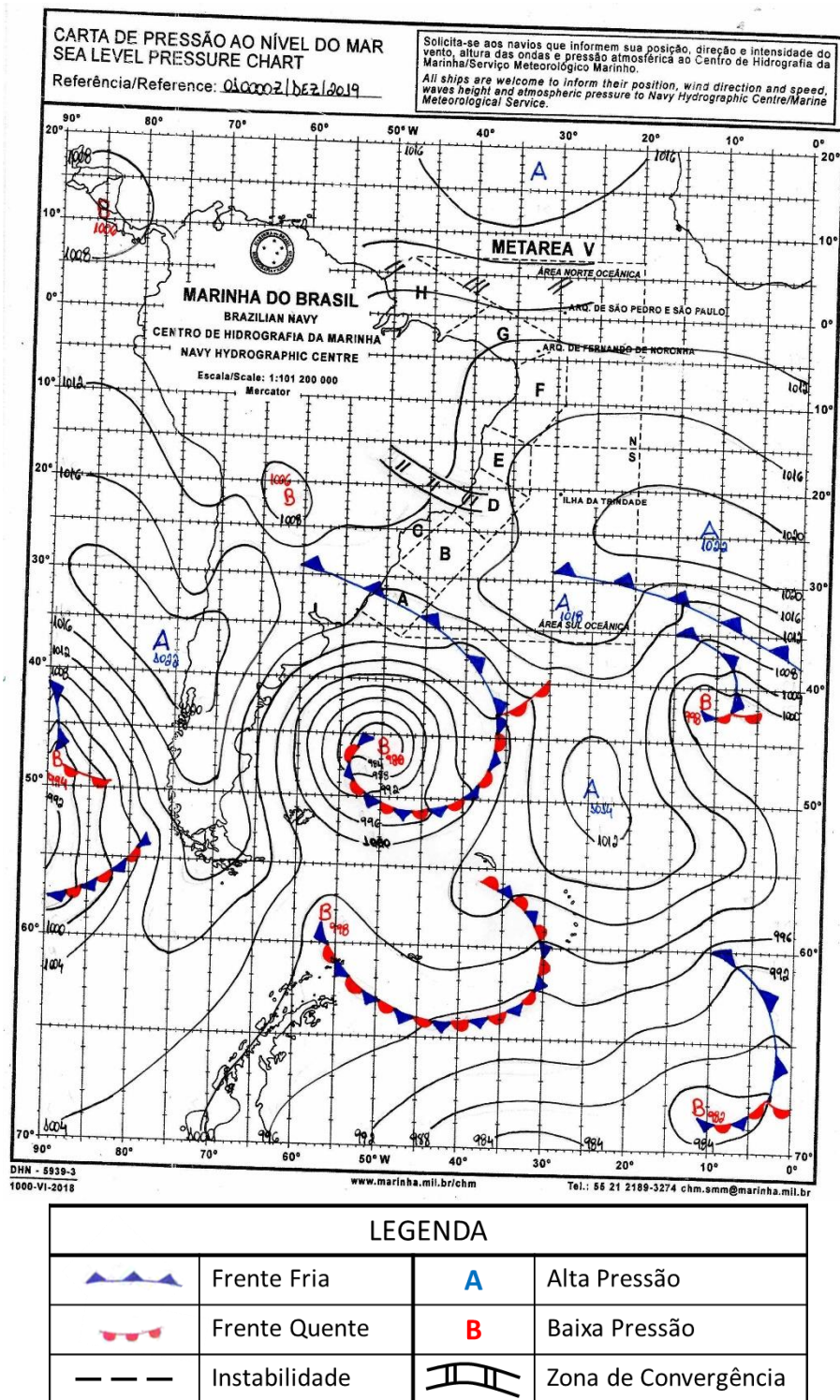
- Asfalto cede durante chuva e 'engole' carros na GO-206, em Itarumã

<https://g1.globo.com/go/goias/transito/noticia/2019/11/29/asfalto-cede-durante-chuva-e-engole-carros-na-go-206-em-itaruma.ghtml>

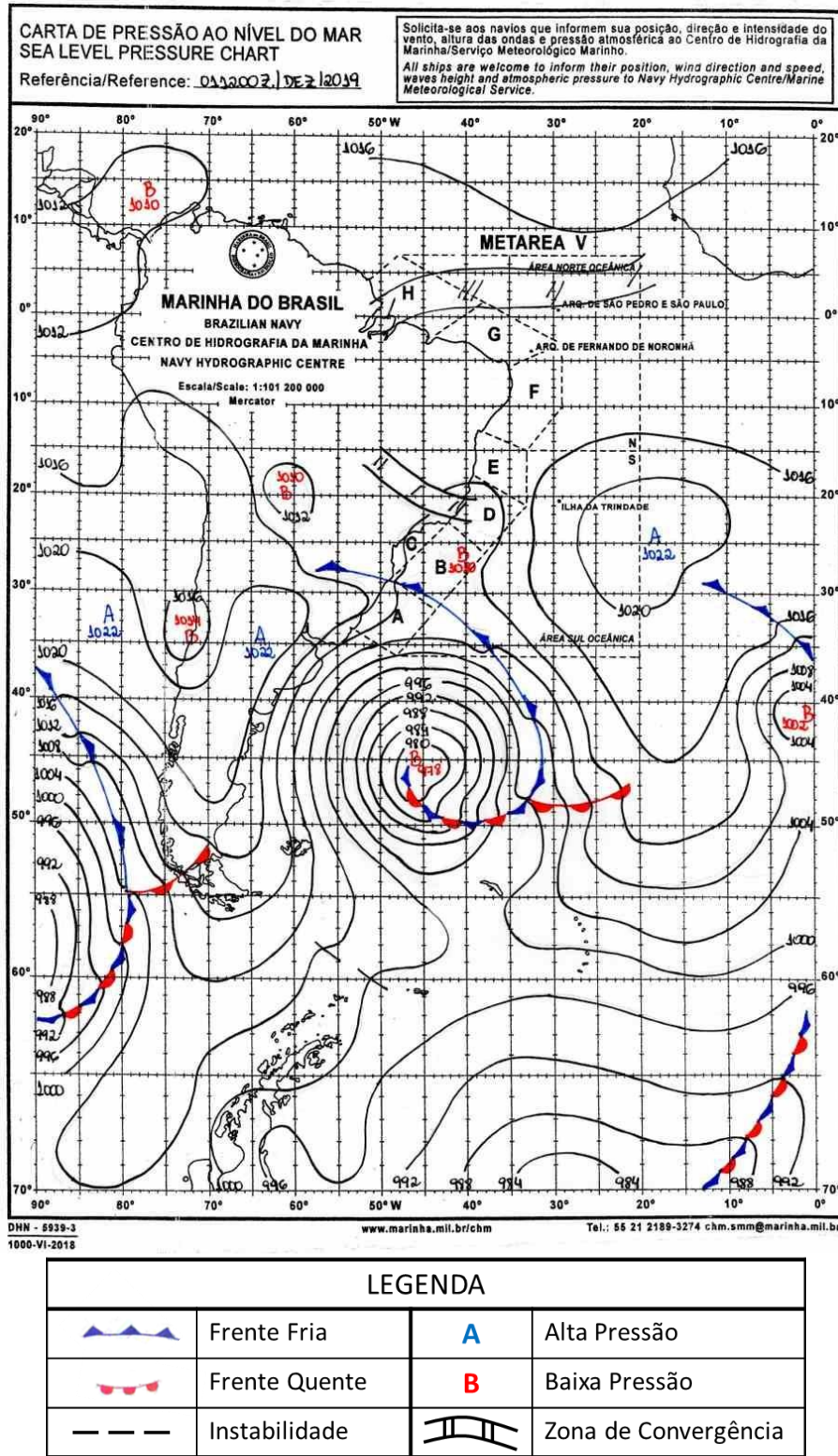
- Asfalto cede durante chuva e 'engole' carros no Goiás

<http://informatudof.com.br/2019/11/29/asfalto-cede-durante-chuva-e-engole-carros-no-goias/>

Bianca Lobo Silva

Meteorologista CREA

5063840461

## Instituto Nacional de Meteorologia - INMET

Umidade Relativa do Ar 00h UTC  
Estação: ARAGARCAS (GO) - 11/2019

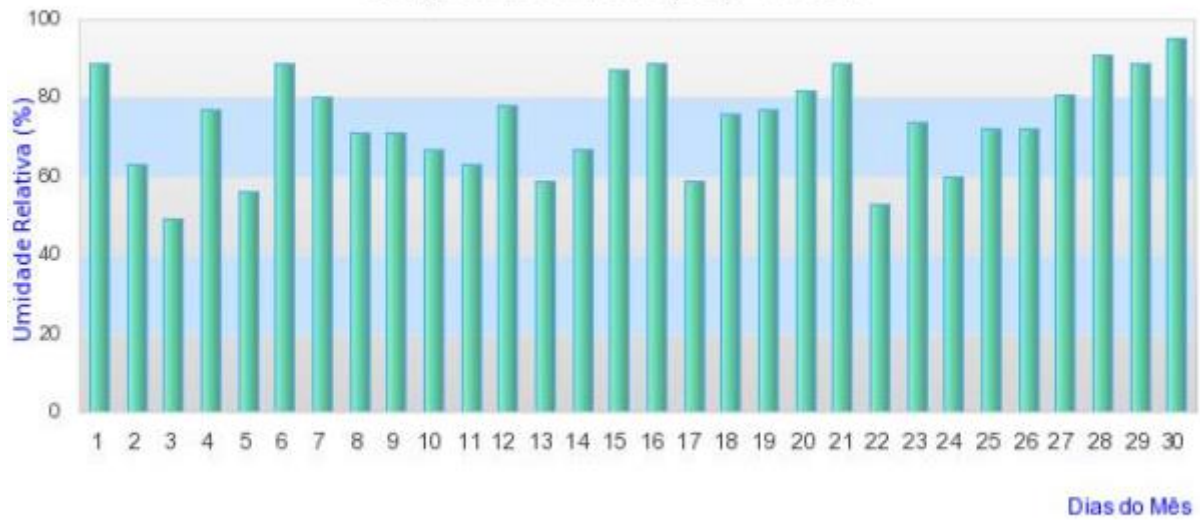

## Instituto Nacional de Meteorologia - INMET

Chuva Acumulada 24h  
Estação: ARAGARCAS - 11/2019

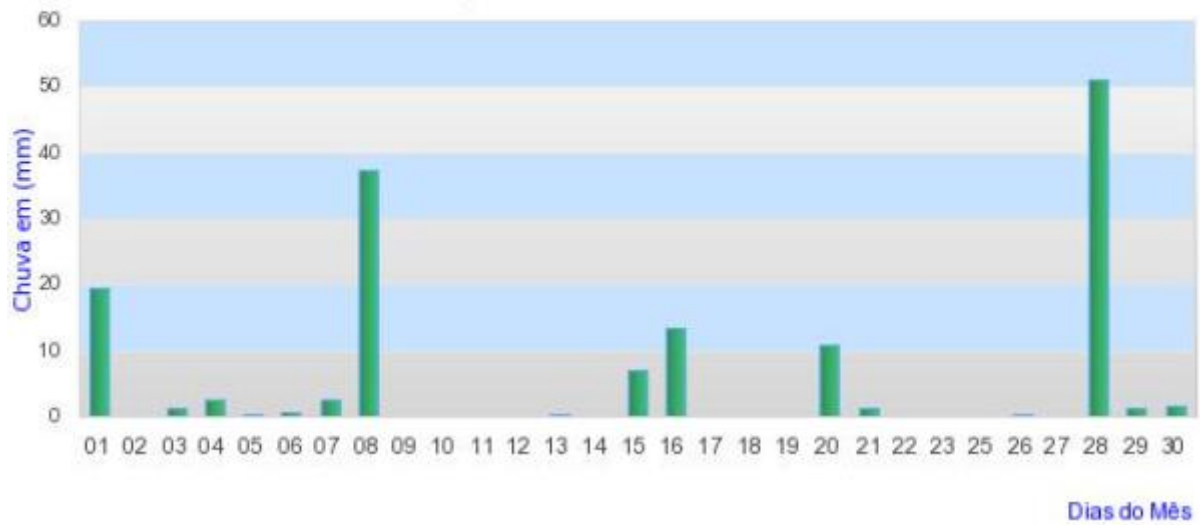



## Instituto Nacional de Meteorologia - INMET

Umidade Relativa do Ar 00h UTC  
Estação: CATALAO (GO) - 11/2019

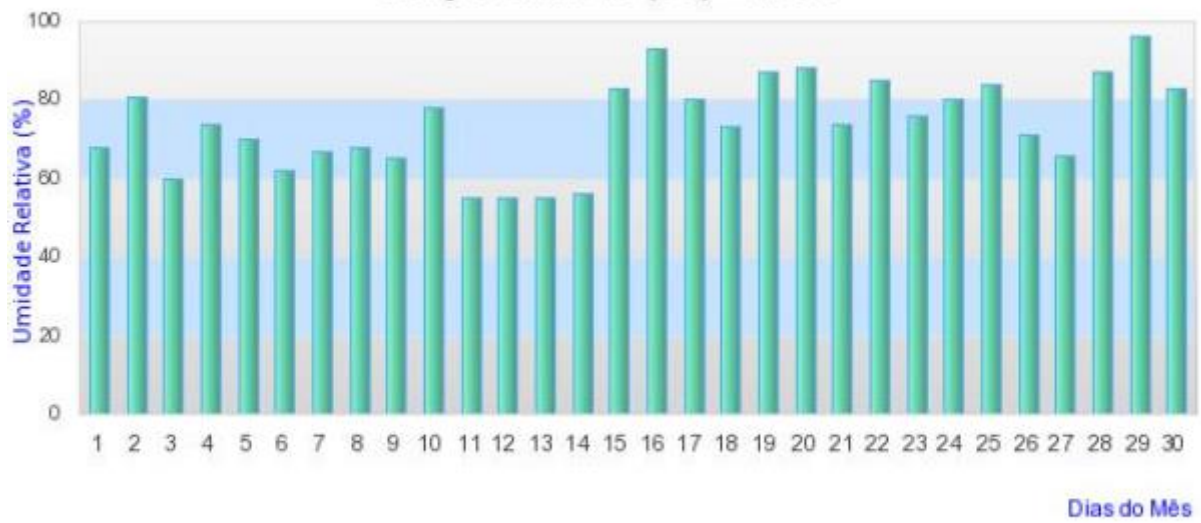

## Instituto Nacional de Meteorologia - INMET

Chuva Acumulada 24h  
Estação: CATALAO - 11/2019

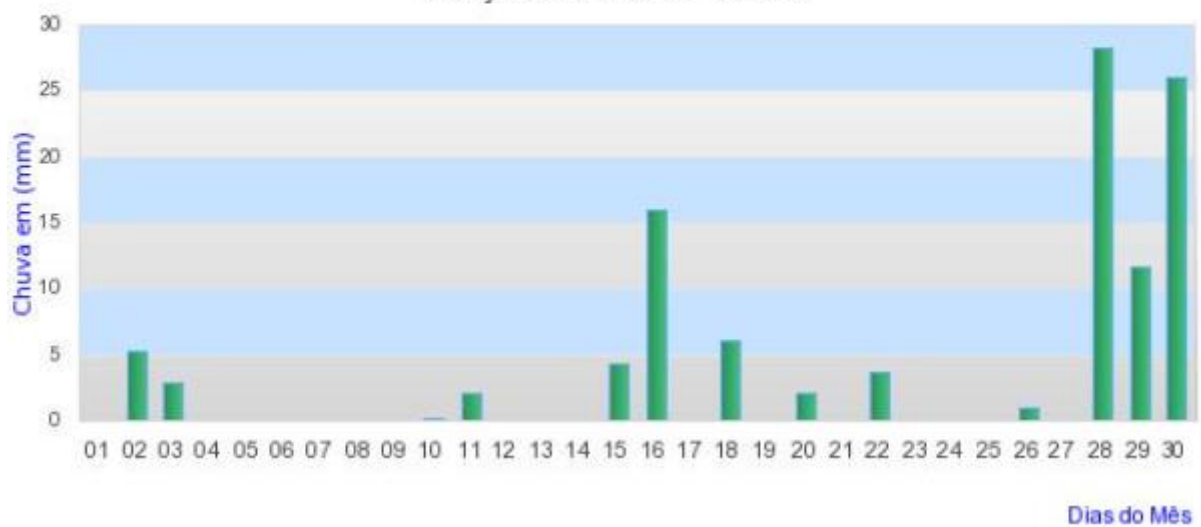

## Instituto Nacional de Meteorologia - INMET

Umidade Relativa do Ar 00h UTC  
Estação: FORMOSA (GO) - 11/2019

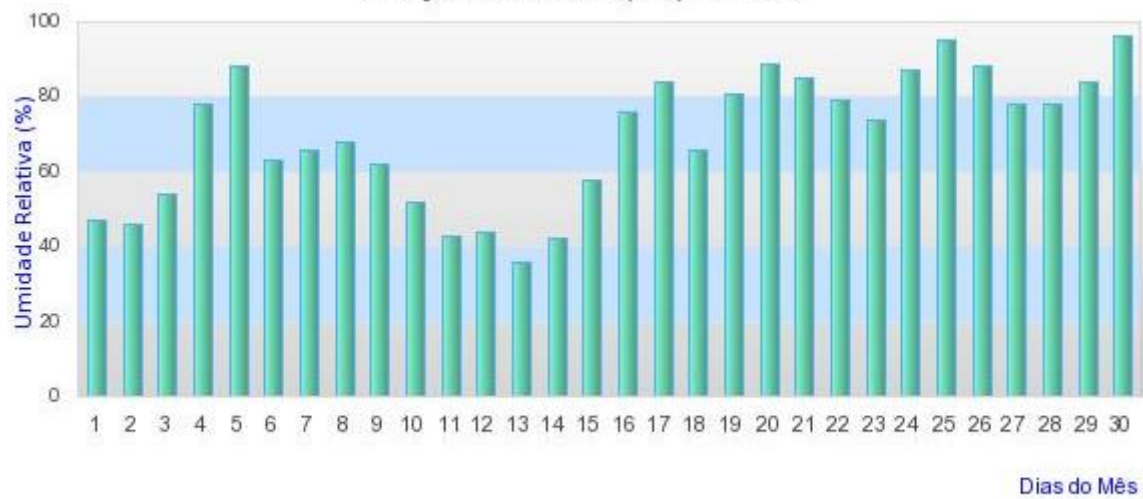

## Instituto Nacional de Meteorologia - INMET

Chuva Acumulada 24h  
Estação: FORMOSA - 11/2019

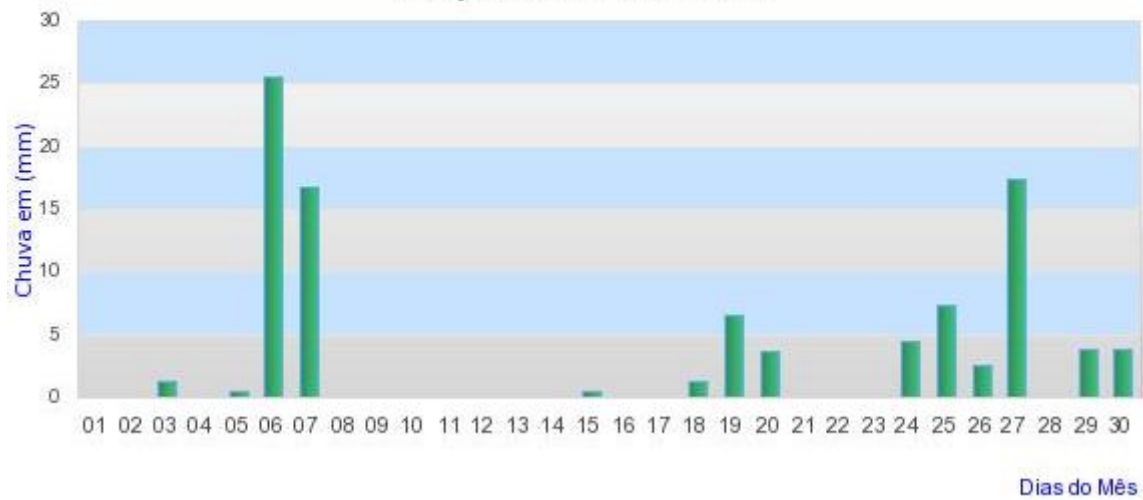

## Instituto Nacional de Meteorologia - INMET

Umidade Relativa do Ar 00h UTC  
Estação: GOIANIA (GO) - 11/2019

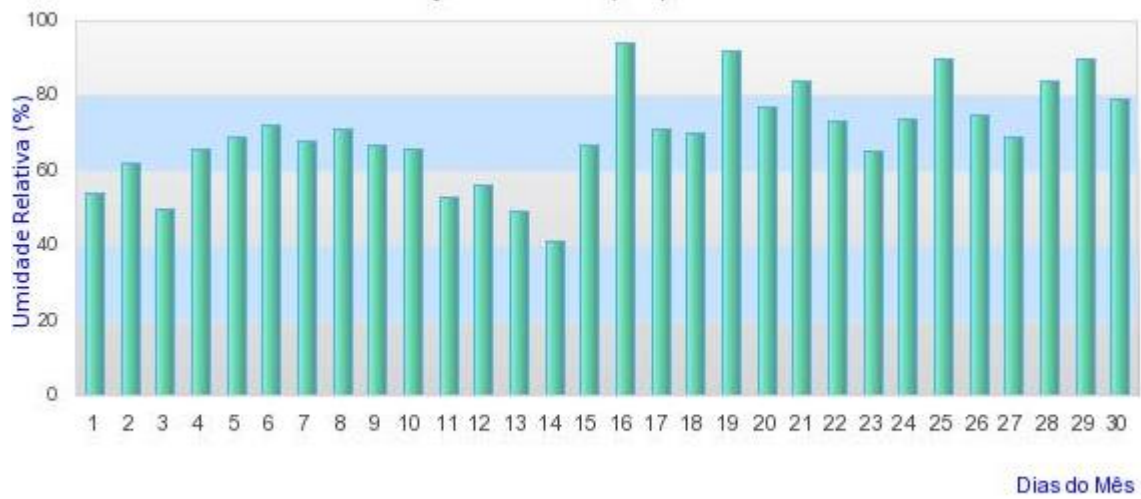

## Instituto Nacional de Meteorologia - INMET

Chuva Acumulada 24h  
Estação: GOIANIA - 11/2019

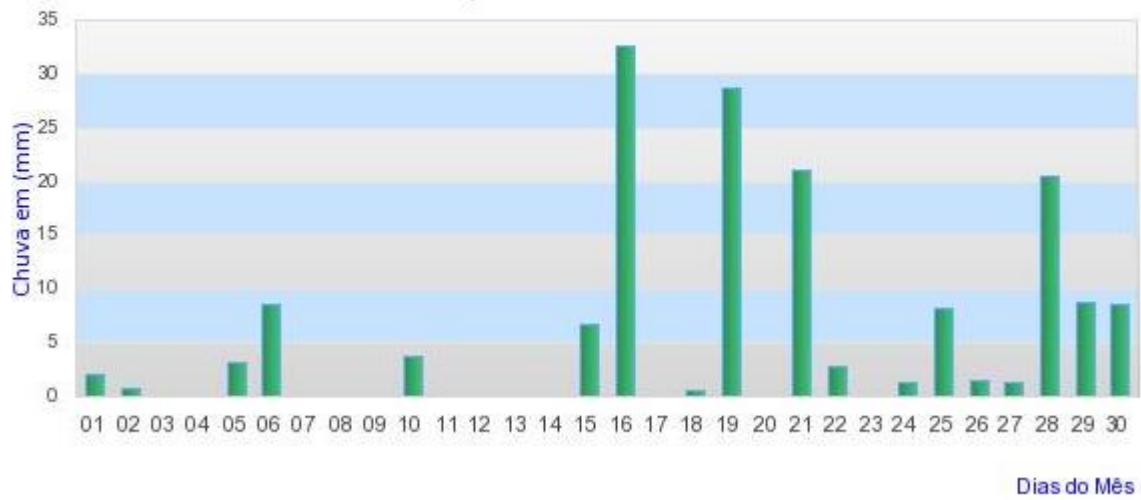

## Instituto Nacional de Meteorologia - INMET

Umidade Relativa do Ar 00h UTC

Estação: IPAMERI (GO) - 11/2019

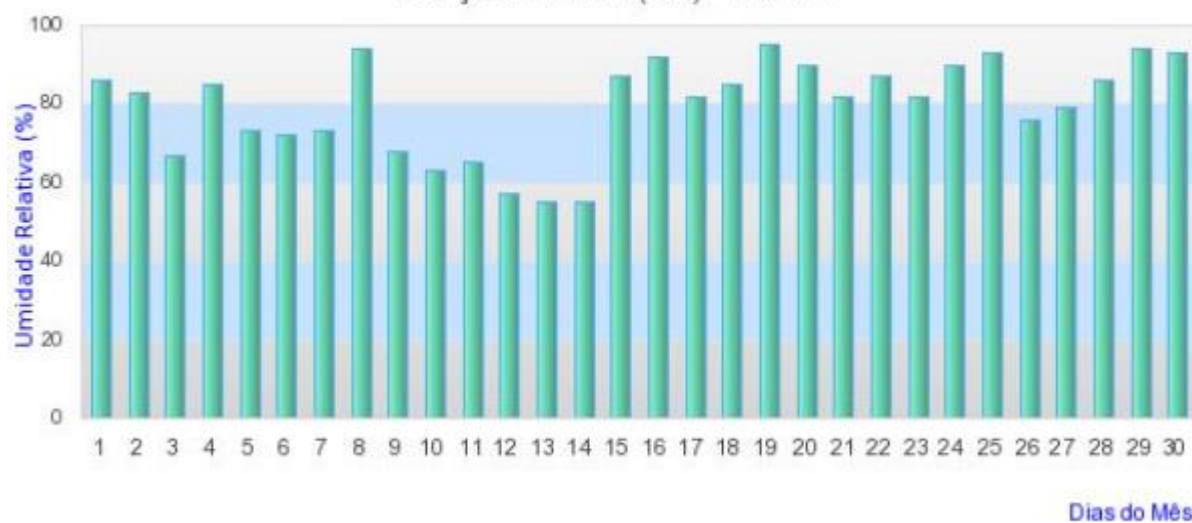

## Instituto Nacional de Meteorologia - INMET

Chuva Acumulada 24h

Estação: IPAMERI - 11/2019

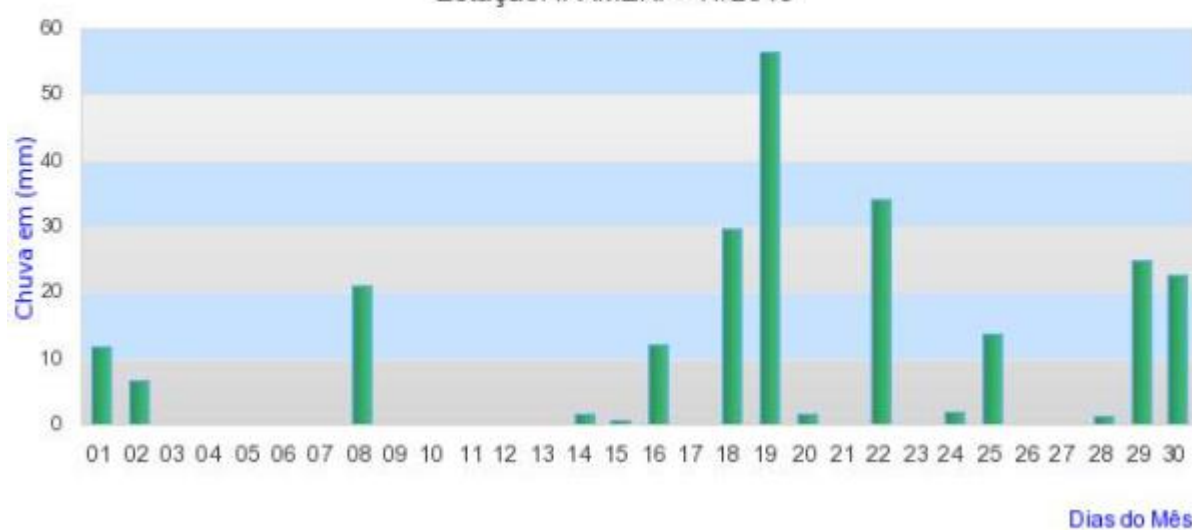

## Instituto Nacional de Meteorologia - INMET

Umidade Relativa do Ar 00h UTC

Estação: JATAI (GO) - 11/2019

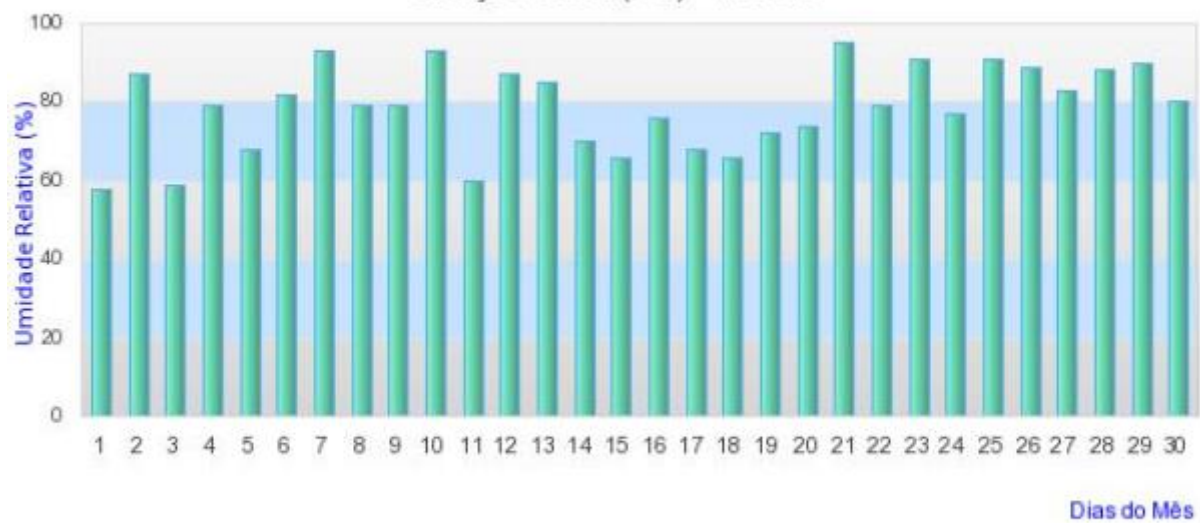

## Instituto Nacional de Meteorologia - INMET

Chuva Acumulada 24h

Estação: JATAI - 11/2019



## Instituto Nacional de Meteorologia - INMET

Umidade Relativa do Ar 00h UTC  
Estação: RIO VERDE (GO) - 11/2019

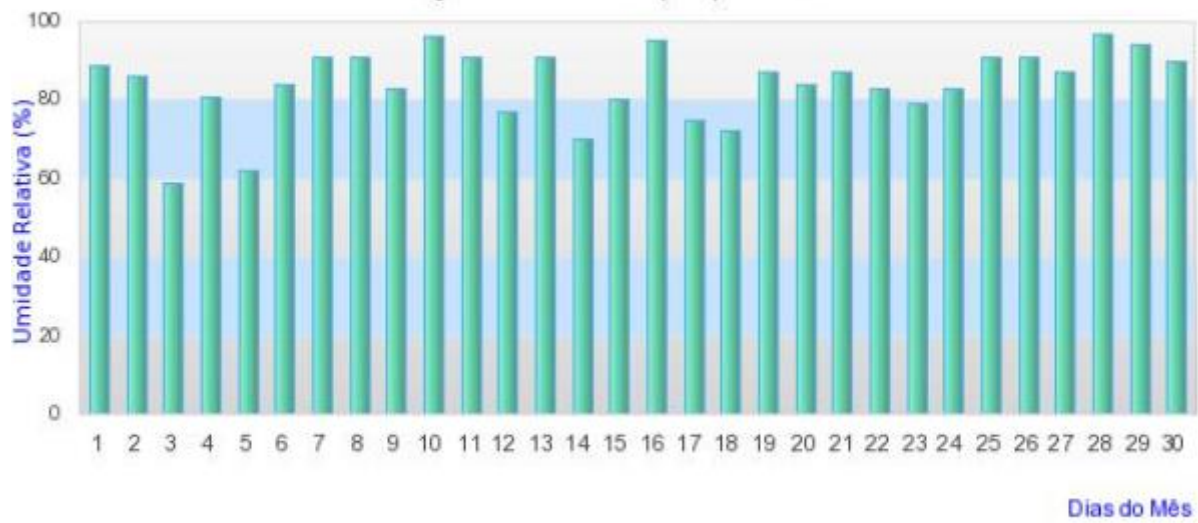

## Instituto Nacional de Meteorologia - INMET

Chuva Acumulada 24h  
Estação: RIO VERDE - 11/2019





## Instituto Nacional de Meteorologia - INMET

Umidade Relativa do Ar 00h UTC

Estação: POSSE (GO) - 11/2019

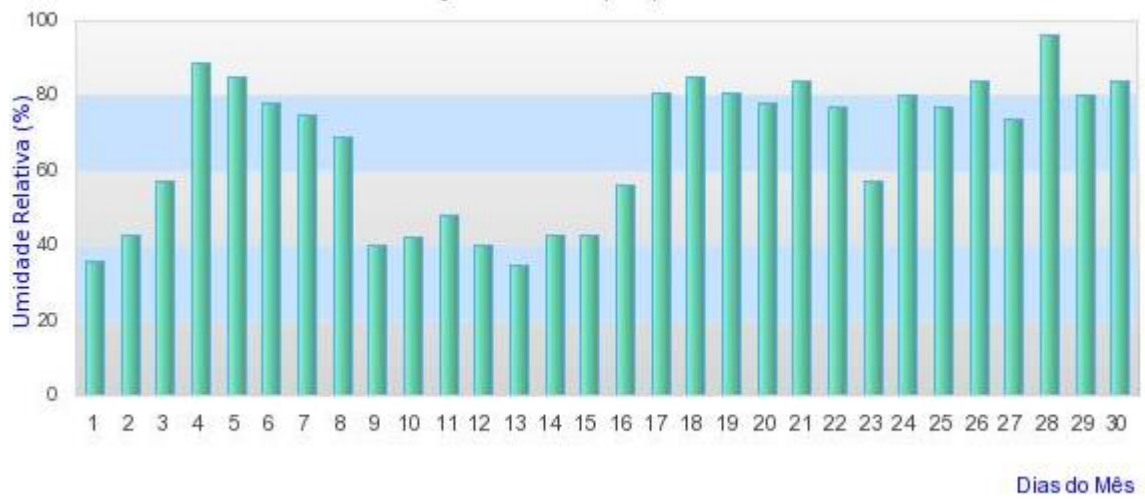

## Instituto Nacional de Meteorologia - INMET

Chuva Acumulada 24h

Estação: POSSE - 11/2019



Abadia de Goiás - Estação Abadia de Goiás - Novembro de 2019

Para ver os dados horários clique no dia desejado

Dia	Precip.	Prec.Acum.	Vel. Vent. (m/s)	Dir. Vent.	Umid. Relat. AR (Max) %	Umid. Relat. AR (Min) %	Umid. Relat. AR (Média)%	Temp. Max. °C Dia	Temp. Min. °C Dia	Temp. Med. °C do Ar	Temp. 09:00h	Temp. 21:00h	Ponto orvalho	Razao Mistura	Radiação Solar Diária MJ/m²
<a href="#">1</a>	8.80	8.80	2.3	NO	87.0	31.0	53	32.5	19.6	25.64	28.3	23.9	-	-	18.5
<a href="#">2</a>	0.00	8.80	2.5	SE	92.0	37.0	56.7	31.6	19.0	25.32	26.4	24.8	-	-	19.7
<a href="#">3</a>	0.00	8.80	2.8	N	82.0	40.0	63.7	29.9	20.5	24.42	25.1	23.3	-	-	19.5
<a href="#">4</a>	12.20	21.00	2.1	N	91.0	33.0	65.7	33.1	19.8	24.9	28.4	21.6	-	-	19.1
<a href="#">5</a>	5.20	26.20	1.9	NO	90.0	41.0	68.7	31.6	20.0	25.28	28	23.4	-	-	14.1
<a href="#">6</a>	0.00	26.20	2.0	NO	87.0	47.0	70.2	29.4	20.4	23.92	23.6	23.1	-	-	14.6
<a href="#">7</a>	0.00	26.20	1.9	SE	95.0	44.0	63	31.6	19.6	24.76	25.6	23.5	-	-	16.5
<a href="#">8</a>	0.00	26.20	2.6	SO	92.0	59.0	73.2	28.3	20.7	23.88	22.8	23.8	-	-	12.3
<a href="#">9</a>	16.40	42.60	3.2	SE	90.0	31.0	66.2	34.6	20.1	24.6	28.1	20.1	-	-	19.1
<a href="#">10</a>	0.00	42.60	1.8	SO	96.0	35.0	61.5	32.5	19.1	24.96	26	23.6	-	-	18.8
<a href="#">11</a>	1.00	43.60	2.3	NO	84.0	38.0	60.7	33.1	20.9	25.32	28.4	22.1	-	-	18
<a href="#">12</a>	0.00	43.60	2.5	O	88.0	32.0	52.2	33.3	20.6	26.52	26.1	26.3	-	-	18.1
<a href="#">13</a>	0.00	43.60	2.3	N	87.0	29.0	43	33.2	19.7	27.14	27.6	27.6	-	-	18.9
<a href="#">14</a>	0.00	43.60	1.7	NO	89.0	40.0	59.2	31.1	20.4	25.78	27.8	24.8	-	-	15.2
<a href="#">15</a>	11.40	55.00	1.6	NO	96.0	47.0	79.5	30.1	19.8	23.72	27.9	20.4	-	-	12.8
<a href="#">16</a>	0.20	55.20	1.2	N	98.0	57.0	75.7	28.3	20.0	23.12	22.3	22.5	-	-	12
<a href="#">17</a>	0.20	55.40	2.0	NO	95.0	59.0	76.7	28.6	20.0	24.14	25.3	23.4	-	-	13.4
<a href="#">18</a>	12.60	68.00	2.1	L	95.0	60.0	88	26.8	19.2	21.72	22.6	20	-	-	7.1
<a href="#">19</a>	1.00	69.00	1.6	L	97.0	52.0	85	28.3	19.7	22.74	23.9	20.9	-	-	10.5
<a href="#">20</a>	0.00	69.00	1.9	L	94.0	51.0	82	28.0	20.0	22.98	25.3	20.8	-	-	8.6
<a href="#">21</a>	0.00	69.00	2.5	SE	97.0	44.0	64.5	29.0	19.1	23.52	24.9	22.3	-	-	18.2
<a href="#">22</a>	0.00	69.00	2.9	L	97.0	46.0	64	29.1	18.3	23.78	24.3	23.6	-	-	15.8
<a href="#">23</a>	4.40	73.40	2.1	NO	95.0	44.0	73	29.4	20.0	23.96	27	21.7	-	-	8.2
<a href="#">24</a>	48.00	121.40	2.3	N	97.0	44.0	77.2	30.3	18.9	22.78	25.1	19.8	-	-	16.7
<a href="#">25</a>	0.40	121.80	2.2	NO	97.0	52.0	75	29.0	19.6	23.74	24.1	23	-	-	15.9
<a href="#">26</a>	0.00	121.80	1.9	L	91.0	52.0	69.7	29.8	19.4	24.58	26.5	23.6	-	-	18.3
<a href="#">27</a>	7.60	129.40	1.9	L	97.0	69.0	82.2	26.3	20.1	23.14	25.1	22.1	-	-	10.2
<a href="#">28</a>	15.60	145.00	1.9	NO	98.0	75.0	90.5	25.1	20.0	22.2	23.9	21	-	-	5.8
<a href="#">29</a>	8.00	153.00	1.9	NO	97.0	67.0	89	27.1	20.0	22.74	22.6	22	-	-	12.1
<a href="#">30</a>	9.80	162.80	1.5	L	97.0	67.0	80	26.5	20.7	23.06	25.9	21.1	-	-	7.6

Aragarças - Estação Estação Hidro Aragarças - GO - ANA - Novembro de 2019

Para ver os dados horários clique no dia desejado

Dia	Precip.	Prec.Acum.	Sensor Pressão min	Sensor Pressão max	Sensor Pressão media	Nível Régua	CodifExo	Vazão min (m3/s)	Vazão max (m3/s)	Vazão media (m3/s)
<a href="#">1</a>	0.00	0.00	0.95	0.99	1.0	0.99	0.45	0.00	0.00	0.00
<a href="#">2</a>	0.00	0.00	0.99	1.06	1.0	1.06	0.45	0.00	0.00	0.00
<a href="#">3</a>	3.80	3.80	1.06	1.09	1.1	1.09	0.45	0.00	0.00	0.00
<a href="#">4</a>	0.00	3.80	1.09	1.11	1.1	1.11	0.45	0.00	0.00	0.00
<a href="#">5</a>	0.00	3.80	1.06	1.09	1.1	1.09	0.45	0.00	0.00	0.00
<a href="#">6</a>	3.20	7.00	1.06	1.07	1.1	1.07	0.45	0.00	0.00	0.00
<a href="#">7</a>	44.00	51.00	1.04	1.06	1.1	1.06	0.45	0.00	0.00	0.00
<a href="#">8</a>	9.20	60.20	1.05	1.06	1.1	1.06	0.45	0.00	0.00	0.00
<a href="#">9</a>	0.00	60.20	1.06	1.08	1.1	1.08	0.45	0.00	0.00	0.00
<a href="#">10</a>	7.20	67.40	1.08	1.1	1.1	1.1	0.45	0.00	0.00	0.00
<a href="#">11</a>	0.20	67.60	1.09	1.1	1.1	1.1	0.45	0.00	0.00	0.00
<a href="#">12</a>	0.00	67.60	0	1.2	1.1	1.2	0.49	0.00	0.00	0.00
<a href="#">13</a>	-122.80	-55.20	1.19	1.22	1.2	1.22	0.49	0.00	0.00	0.00
<a href="#">14</a>	0.00	-55.20	1.18	1.19	1.2	1.19	0.49	0.00	0.00	0.00
<a href="#">15</a>	8.20	-47.00	1.18	1.19	1.2	1.19	0.49	0.00	0.00	0.00
<a href="#">16</a>	0.20	-46.80	1.16	1.18	1.2	1.18	0.49	0.00	0.00	0.00
<a href="#">17</a>	0.00	-46.80	1.13	1.16	1.1	1.16	0.49	0.00	0.00	0.00
<a href="#">18</a>	0.00	-46.80	1.13	1.14	1.1	1.14	0.49	0.00	0.00	0.00
<a href="#">19</a>	16.40	-30.40	1.14	1.21	1.2	1.21	0.49	0.00	0.00	0.00
<a href="#">20</a>	2.60	-27.80	1.21	1.24	1.2	1.24	0.49	0.00	0.00	0.00
<a href="#">21</a>	0.20	-27.60	1.23	1.26	1.2	1.26	0.49	0.00	0.00	0.00
<a href="#">22</a>	0.00	-27.60	1.26	1.32	1.3	1.32	0.49	0.00	0.00	0.00
<a href="#">23</a>	0.00	-27.60	1.27	1.29	1.3	1.29	0.49	0.00	0.00	0.00
<a href="#">24</a>	0.00	-27.60	1.29	1.32	1.3	1.32	0.49	0.00	0.00	0.00
<a href="#">25</a>	0.00	-27.60	1.26	1.33	1.3	1.33	0.49	0.00	0.00	0.00
<a href="#">26</a>	0.00	-27.60	1.2	1.27	1.2	1.27	0.49	0.00	0.00	0.00
<a href="#">27</a>	34.00	6.40	1.21	1.77	1.4	1.77	0.49	0.00	0.00	0.00
<a href="#">28</a>	0.80	7.20	1.73	1.77	1.8	1.77	0.49	0.00	0.00	0.00
<a href="#">29</a>	0.00	7.20	1.73	1.84	1.8	1.84	0.49	0.00	0.00	0.00
<a href="#">30</a>	0.20	7.40	1.82	2.06	1.9	2.06	0.49	0.00	0.00	0.00



## Aruanã - Estação Estação Hidro Aruanã - GO - ANA - Novembro de 2019

[Para ver os dados horários clique no dia desejado](#)

Dia	Precip.	Prec.Acum.	Sensor Pressão min	Sensor Pressão max	Sensor Pressão media	Nível Régua	CodifEixo	Vazão min (m3/s)	Vazão max (m3/s)	Vazão media (m3/s)
<a href="#">1</a>	0.00	0.00	1.49	1.53	1.5	1.53	0.97	0.00	0.00	0.00
<a href="#">2</a>	0.00	0.00	1.47	1.49	1.5	1.49	0.97	0.00	0.00	0.00
<a href="#">3</a>	0.20	0.20	1.47	1.51	1.5	1.51	0.97	0.00	0.00	0.00
<a href="#">4</a>	0.00	0.20	1.5	1.55	1.5	1.55	0.97	0.00	0.00	0.00
<a href="#">5</a>	14.20	14.40	1.55	1.6	1.6	1.6	0.97	0.00	0.00	0.00
<a href="#">6</a>	0.60	15.00	1.6	1.65	1.6	1.65	0.97	0.00	0.00	0.00
<a href="#">7</a>	0.00	15.00	1.61	1.65	1.6	1.65	0.97	0.00	0.00	0.00
<a href="#">8</a>	0.00	15.00	0	1.61	1.6	1.61	0.97	0.00	0.00	0.00
<a href="#">9</a>	-85.40	-70.40	1.55	1.57	1.6	1.57	0.97	0.00	0.00	0.00
<a href="#">10</a>	0.00	-70.40	1.55	1.55	1.5	1.55	0.97	0.00	0.00	0.00
<a href="#">11</a>	4.60	-65.80	1.55	1.57	1.6	1.57	0.97	0.00	0.00	0.00
<a href="#">12</a>	0.20	-65.60	1.56	1.59	1.6	1.59	0.97	0.00	0.00	0.00
<a href="#">13</a>	11.60	-54.00	1.58	1.65	1.6	1.65	0.97	0.00	0.00	0.00
<a href="#">14</a>	0.00	-54.00	1.66	1.8	1.7	1.8	0.97	0.00	0.00	0.00
<a href="#">15</a>	0.00	-54.00	1.8	1.84	1.8	1.84	0.97	0.00	0.00	0.00
<a href="#">16</a>	0.00	-54.00	1.8	1.83	1.8	1.83	0.97	0.00	0.00	0.00
<a href="#">17</a>	3.40	-50.60	1.76	1.8	1.8	1.8	0.97	0.00	0.00	0.00
<a href="#">18</a>	0.00	-50.60	1.75	1.76	1.8	1.76	0.97	0.00	0.00	0.00
<a href="#">19</a>	0.00	-50.60	1.67	1.75	1.7	1.75	0.97	0.00	0.00	0.00
<a href="#">20</a>	6.80	-43.80	1.65	1.67	1.7	1.67	0.97	0.00	0.00	0.00
<a href="#">21</a>	0.00	-43.80	1.66	1.75	1.7	1.75	0.97	0.00	0.00	0.00
<a href="#">22</a>	3.20	-40.60	1.76	1.86	1.8	1.86	0.97	0.00	0.00	0.00
<a href="#">23</a>	14.60	-26.00	1.82	1.86	1.8	1.86	0.97	0.00	0.00	0.00
<a href="#">24</a>	1.00	-25.00	1.81	1.85	1.8	1.85	0.97	0.00	0.00	0.00
<a href="#">25</a>	3.40	-21.60	1.85	1.91	1.9	1.91	0.97	0.00	0.00	0.00
<a href="#">26</a>	0.00	-21.60	1.88	1.91	1.9	1.91	0.97	0.00	0.00	0.00
<a href="#">27</a>	1.80	-19.80	1.86	1.88	1.9	1.88	0.97	0.00	0.00	0.00
<a href="#">28</a>	110.00	90.20	1.83	1.95	1.9	1.95	0.97	0.00	0.00	0.00
<a href="#">29</a>	1.00	91.20	1.82	1.89	1.8	1.89	0.97	0.00	0.00	0.00
<a href="#">30</a>	0.00	91.20	1.89	2.18	2.0	2.18	0.97	0.00	0.00	0.00

## Cidade de Goiás - Estação Estação Hidro Cid. Goiás Montante - GO - ANA - Novembro de 2019

[Para ver os dados horários clique no dia desejado](#)

Dia	Precip.	Prec.Acum.	Sensor Pressão min	Sensor Pressão max	Sensor Pressão media	Nível Régua	CodifEixo	Vazão min (m3/s)	Vazão max (m3/s)	Vazão media (m3/s)
<a href="#">1</a>	0.00	0.00	0.2	0.21	0.2	0.21	-0.17	0.00	0.00	0.00
<a href="#">2</a>	2.20	2.20	0.19	0.2	0.2	0.2	-0.17	0.00	0.00	0.00
<a href="#">3</a>	0.20	2.40	0.19	0.21	0.2	0.21	-0.17	0.00	0.00	0.00
<a href="#">4</a>	0.00	2.40	0.19	0.2	0.2	0.2	-0.17	0.00	0.00	0.00
<a href="#">5</a>	5.20	7.60	0.19	0.75	0.2	0.75	-0.17	0.00	0.00	0.00
<a href="#">6</a>	0.00	7.60	0.23	0.58	0.3	0.58	-0.17	0.00	0.00	0.00
<a href="#">7</a>	0.00	7.60	0	0.23	0.2	0.23	-0.17	0.00	0.00	0.00
<a href="#">8</a>	-145.40	-137.80	0.19	0.21	0.2	0.21	-0.17	0.00	0.00	0.00
<a href="#">9</a>	7.40	-130.40	0.19	0.2	0.2	0.2	-0.17	0.00	0.00	0.00
<a href="#">10</a>	0.00	-130.40	0.18	0.19	0.2	0.19	-0.17	0.00	0.00	0.00
<a href="#">11</a>	1.80	-128.60	0.18	0.2	0.2	0.2	-0.17	0.00	0.00	0.00
<a href="#">12</a>	1.00	-127.60	0.19	0.2	0.2	0.2	-0.17	0.00	0.00	0.00
<a href="#">13</a>	0.20	-127.40	0.18	0.19	0.2	0.19	-0.17	0.00	0.00	0.00
<a href="#">14</a>	0.00	-127.40	0.17	0.18	0.2	0.18	-0.17	0.00	0.00	0.00
<a href="#">15</a>	7.80	-119.60	0.17	0.18	0.2	0.18	-0.17	0.00	0.00	0.00
<a href="#">16</a>	0.00	-119.60	0.17	0.18	0.2	0.18	-0.17	0.00	0.00	0.00
<a href="#">17</a>	3.20	-116.40	0.17	0.18	0.2	0.18	-0.17	0.00	0.00	0.00
<a href="#">18</a>	0.00	-116.40	0.18	0.18	0.2	0.18	-0.17	0.00	0.00	0.00
<a href="#">19</a>	0.20	-116.20	0.18	0.18	0.2	0.18	-0.17	0.00	0.00	0.00
<a href="#">20</a>	1.80	-114.40	0.18	0.19	0.2	0.19	-0.17	0.00	0.00	0.00
<a href="#">21</a>	0.00	-114.40	0.19	0.19	0.2	0.19	-0.17	0.00	0.00	0.00
<a href="#">22</a>	0.80	-113.60	0.19	0.19	0.2	0.19	-0.17	0.00	0.00	0.00
<a href="#">23</a>	0.00	-113.60	0.19	0.21	0.2	0.21	-0.17	0.00	0.00	0.00
<a href="#">24</a>	2.80	-110.80	0.18	0.22	0.2	0.22	-0.17	0.00	0.00	0.00
<a href="#">25</a>	7.20	-103.60	0.22	0.91	0.3	0.91	-0.17	0.00	0.00	0.00
<a href="#">26</a>	0.00	-103.60	0.26	0.69	0.4	0.69	-0.17	0.00	0.00	0.00
<a href="#">27</a>	9.20	-94.40	0.25	0.97	0.4	0.97	-0.17	0.00	0.00	0.00
<a href="#">28</a>	11.80	-82.60	0.27	0.44	0.3	0.44	-0.17	0.00	0.00	0.00
<a href="#">29</a>	0.20	-82.40	0.24	0.27	0.3	0.27	-0.17	0.00	0.00	0.00
<a href="#">30</a>	0.00	-82.40	0.22	0.24	0.2	0.24	-0.17	0.00	0.00	0.00

## Goiania - Estação CELG Estação Autodromo - Novembro de 2019

Para ver os dados horários clique no dia desejado

Dia	Precip.	Prec.Acum.	Vel. Vent. (m/s)	Dir. Vent.	Umid. Relat. AR (Max) %	Umid. Relat. AR (Min) %	Umid. Relat. AR (Média)%	Temp. Max. °C Dia	Temp. Min. °C Dia	Temp. Med. °C do Ar	Temp. 09:00h	Temp. 21:00h	Ponto orvalho	Razao Mistura
<a href="#">1</a>	3.60	3.60	1.8	N	86.0	33.0	61.2	33.4	20.4	25.32	28.2	22.3	17.86667	14.0069
<a href="#">2</a>	0.00	3.60	2.1	SE	84.0	37.0	51.7	32.8	20.7	26.94	26.6	27.3	17.31250	13.5417
<a href="#">3</a>	0.00	3.60	2.1	N	81.0	44.0	66.5	30.6	22.1	25.32	24.7	24.6	18.16250	14.3611
<a href="#">4</a>	0.40	4.00	2.1	N	88.0	33.0	57	33.8	21.6	26.66	28.3	24.8	18.09583	14.3472
<a href="#">5</a>	1.40	5.40	1.5	N	87.0	34.0	63.7	33.6	20.1	25.5	27.4	23.2	18.52083	14.6597
<a href="#">6</a>	0.00	5.40	1.9	N	86.0	43.0	66	31.5	21.5	25.62	23.5	25.8	19.12083	15.2847
<a href="#">7</a>	0.00	5.40	1.9	SE	90.0	47.0	65.7	32.0	21.0	25.64	27	24.1	19.21250	15.1736
<a href="#">8</a>	0.00	5.40	2.2	S	86.0	61.0	71.7	28.7	22.1	24.96	22.8	25.6	19.80417	15.9444
<a href="#">9</a>	1.00	6.40	3.0	L	83.0	32.0	52.2	34.9	23.0	27.76	29.5	25.7	17.93333	14.1389
<a href="#">10</a>	0.60	7.00	2.0	S	90.0	34.0	57.7	33.8	20.1	25.68	25.5	24.5	17.71667	13.8472
<a href="#">11</a>	0.00	7.00	2.3	S	82.0	31.0	52.7	35.1	20.6	27.04	28.1	25.7	17.20000	13.4931
<a href="#">12</a>	0.00	7.00	2.0	S	81.0	26.0	47.7	35.3	21.5	27.84	27	27.7	17.06667	13.3750
<a href="#">13</a>	0.00	7.00	3.0	N	77.0	25.0	36.5	34.8	21.4	29.08	29.4	29.9	14.86250	11.7431
<a href="#">14</a>	11.80	18.80	1.9	N	93.0	40.0	68.5	32.6	18.9	25.4	28.3	23.6	18.51667	14.7500
<a href="#">15</a>	30.80	49.60	1.6	N	100.0	44.0	83.2	31.0	20.2	23.76	27.2	20.2	19.10000	15.3611
<a href="#">16</a>	0.00	49.60	1.0	L	100.0	58.0	75.5	28.2	20.1	23.86	23	24	20.00417	16.2083
<a href="#">17</a>	2.80	52.40	2.0	N	94.0	51.0	74.5	30.7	20.4	25.02	25.4	24.3	19.75000	15.7986
<a href="#">18</a>	22.60	75.00	2.1	N	100.0	62.0	84.5	27.2	18.0	21.52	22	20.2	19.30833	15.3681
<a href="#">19</a>	1.40	76.40	1.3	L	100.0	58.0	85.7	28.3	19.4	22.88	25.1	20.8	19.79167	15.8819
<a href="#">20</a>	0.20	76.60	1.4	N	95.0	50.0	81	29.4	20.0	23.66	25.1	21.9	19.08750	15.1319
<a href="#">21</a>	0.00	76.60	2.0	N	96.0	50.0	67	29.8	19.2	24.06	24.9	23.2	18.54583	14.7083
<a href="#">22</a>	5.00	81.60	2.5	S	99.0	48.0	67	29.4	19.3	24.3	24.4	24.2	18.79583	14.9514
<a href="#">23</a>	7.80	89.40	1.4	N	91.0	47.0	79.5	30.6	21.7	24.88	27.7	22.2	19.48750	15.3958
<a href="#">24</a>	5.00	94.40	2.2	N	98.0	43.0	75.7	31.3	20.2	23.98	27	20.7	19.22917	15.3333
<a href="#">25</a>	0.40	94.80	1.7	N	97.0	53.0	83.2	29.5	19.8	23.96	23.9	23.3	19.62917	15.6667
<a href="#">26</a>	0.00	94.80	2.0	N	95.0	55.0	68.7	30.0	20.2	25.3	26.1	25.1	19.84583	15.9444
<a href="#">27</a>	41.20	136.00	1.5	L	98.0	77.0	89	25.3	20.9	23.06	25.3	21.9	20.91250	17.1597
<a href="#">28</a>	3.60	139.60	2.4	N	99.0	64.0	88.7	28.3	21.1	23.1	23.9	21.1	20.77500	16.9653
<a href="#">29</a>	1.60	141.20	2.1	N	99.0	56.0	79.2	29.5	21.1	24.46	23.7	24	20.87917	17.0833
<a href="#">30</a>	1.40	142.60	1.8	S	97.0	67.0	82.2	28.1	21.5	24.12	25.6	22.7	21.03333	17.0903

## Anapolis - Estação CELG Estação Anapolis - Novembro de 2019

Para ver os dados horários clique no dia desejado

Dia	Precip.	Prec.Acum.	Vel. Vent. (m/s)	Dir. Vent.	Umid. Relat. AR (Max) %	Umid. Relat. AR (Min) %	Umid. Relat. AR (Média)%	Temp. Max. °C Dia	Temp. Min. °C Dia	Temp. Med. °C do Ar	Temp. 09:00h	Temp. 21:00h	Ponto orvalho	Razao Mistura
<a href="#">1</a>	0.40	0.40	1.5	N	72.0	35.0	57	31.7	22.0	25.88	26.7	24.5	15.73333	12.7014
<a href="#">2</a>	8.00	8.40	1.7	L	82.0	39.0	62	31.5	19.8	24.6	24.3	23.7	17.02917	13.7917
<a href="#">3</a>	0.00	8.40	1.9	N	87.0	57.0	71.5	26.3	19.3	22.6	21.6	22.9	17.43333	14.1181
<a href="#">4</a>	0.00	8.40	1.7	N	86.0	41.0	66.2	30.7	19.9	24.22	26.5	22	17.23333	13.9236
<a href="#">5</a>	0.00	8.40	1.3	N	86.0	48.0	70.5	29.0	19.2	24.2	25.8	23.5	17.26667	14.0764
<a href="#">6</a>	0.00	8.40	1.5	SE	94.0	52.0	64.2	28.4	19.9	24.18	23	24.8	17.72500	14.4167
<a href="#">7</a>	0.00	8.40	1.6	L	86.0	50.0	61	28.6	20.4	24.66	25.5	24.4	18.02083	14.7986
<a href="#">8</a>	0.00	8.40	1.8	S	87.0	58.0	71.2	28.8	20.3	24.04	22.1	24.5	18.72083	15.3333
<a href="#">9</a>	0.00	8.40	2.2	L	87.0	32.0	57.2	32.6	20.3	25.58	26	24.5	16.80833	13.6250
<a href="#">10</a>	0.20	8.60	1.7	O	88.0	42.0	57.2	30.7	19.7	25.16	26	24.7	16.57083	13.2708
<a href="#">11</a>	3.20	11.80	1.9	O	69.0	30.0	53.7	32.8	21.7	26.16	28.1	24.1	15.79167	12.8681
<a href="#">12</a>	0.00	11.80	2.2	SO	76.0	31.0	47	32.5	22.0	26.78	26	26.7	15.81667	12.7569
<a href="#">13</a>	0.00	11.80	2.2	N	64.0	30.0	42.5	31.7	21.4	26.58	26.6	26.6	13.87500	11.2778
<a href="#">14</a>	22.60	34.40	1.6	O	98.0	42.0	77.5	30.9	17.2	21.52	25.1	17.2	17.57500	14.3264
<a href="#">15</a>	13.20	47.60	1.5	SO	98.0	53.0	83.2	28.3	19.0	22.36	25.7	19.4	18.50000	15.0833
<a href="#">16</a>	1.80	49.40	0.7	SO	98.0	65.0	74	25.4	19.0	22.38	22.3	22.6	18.46667	15.1250
<a href="#">17</a>	0.00	49.40	1.6	N	88.0	57.0	70	27.9	20.4	23.82	24.8	23	18.75000	15.4583
<a href="#">18</a>	16.20	65.60	1.5	L	100.0	68.0	93.7	25.3	18.6	21.08	21.3	20.1	18.70833	15.3681
<a href="#">19</a>	5.40	71.00	0.9	L	100.0	60.0	89.7	26.5	18.7	21.86	21.5	21.3	19.27083	15.9097
<a href="#">20</a>	16.60	87.60	1.5	L	100.0	59.0	90.5	27.1	18.6	21.3	23.2	18.8	18.91667	15.5139
<a href="#">21</a>	8.40	96.00	1.6	L	99.0	59.0	88.2	26.9	17.8	21.48	22.7	20	18.28333	14.9097
<a href="#">22</a>	0.00	96.00	1.7	N	100.0	53.0	70.5	27.1	17.9	22.48	20.2	23.6	17.77917	14.3819
<a href="#">23</a>	2.80	98.80	1.3	O	88.0	49.0	80.2	29.1	20.1	23.46	25.9	21.1	17.81667	14.4167
<a href="#">24</a>	5.80	104.60	1.3	O	97.0	67.0	84.7	26.8	19.4	21.68	22.6	19.8	18.76250	15.3750
<a href="#">25</a>	5.20	109.80	1.1	L	100.0	56.0	83	27.6	18.5	22.78	24.4	21.7	19.07500	15.5833
<a href="#">26</a>	18.40	128.20	1.5	N	99.0	64.0	87.5	27.3	18.1	22.44	23.2	21.8	19.03333	15.7431
<a href="#">27</a>	8.20	136.40	1.5	N	100.0	70.0	82.5	25.5	18.3	22.14	22.3	22.3	19.44583	16.0833
<a href="#">28</a>	0.00	136.40	2.2	N	98.0	67.0	78.7	25.8	20.1	22.8	23.3	22.4	19.27500	15.8750
<a href="#">29</a>	0.80	137.20	1.3	O	97.0	57.0	77.5	28.6	19.1	23.08	22.1	22.8	19.40417	15.9931
<a href="#">30</a>	14.20	151.40	1.5	L	100.0	54.0	90.7	29.4	19.8	22.84	25.2	19.9	19.83333	16.4722

Goiania - Estação CELG Estação Aerodromo Goiania - Novembro de 2019  
 Para ver os dados horários clique no dia desejado

Dia	Precip.	Prec.Acum.	Vel. Vent. (m/s)	Dir. Vent.	Umid. Relat. AR (Max) %	Umid. Relat. AR (Min) %	Umid. Relat. AR (Média)%	Temp. Max. °C Dia	Temp. Min. °C Dia	Temp. Med. °C do Ar	Temp. 09:00h	Temp. 21:00h	Ponto orvalho	Razao Mistura
<a href="#">1</a>	1.00	1.00	1.9	SO	85.0	32.0	57.7	33.7	20.8	26.02	28	23.8	17.57083	-
<a href="#">2</a>	0.40	1.40	2.4	SE	86.0	35.0	50.7	33.2	20.5	27.08	26.1	27.8	17.27917	-
<a href="#">3</a>	0.00	1.40	2.8	NO	79.0	48.0	61.5	29.3	21.6	25.42	24.8	25.7	17.73333	-
<a href="#">4</a>	16.40	17.80	1.7	N	89.0	34.0	63	33.4	20.9	25.54	27.8	22.8	18.19167	-
<a href="#">5</a>	0.00	17.80	1.7	NO	90.0	46.0	64.2	31.4	20.4	25.56	26.8	24.6	18.91667	-
<a href="#">6</a>	0.00	17.80	1.8	N	92.0	43.0	67	30.6	20.4	24.68	24	24.2	19.10833	-
<a href="#">7</a>	17.00	34.80	1.6	SE	91.0	43.0	68	33.0	20.2	24.84	25	23	19.25833	-
<a href="#">8</a>	0.00	34.80	2.2	S	93.0	63.0	72	28.4	21.4	24.96	23.2	25.9	19.88750	-
<a href="#">9</a>	9.80	44.60	2.4	SE	84.0	34.0	63	33.8	21.7	25.62	28.4	22.1	18.47083	-
<a href="#">10</a>	0.00	44.60	1.7	SO	89.0	37.0	56	32.6	20.6	25.9	25.3	25.5	18.18750	-
<a href="#">11</a>	0.00	44.60	2.1	S	81.0	32.0	58.2	33.9	21.1	26.02	27.7	23.7	17.78750	-
<a href="#">12</a>	0.00	44.60	2.4	SO	80.0	32.0	51.2	33.8	22.1	27.3	27	26.8	17.65417	-
<a href="#">13</a>	0.00	44.60	2.2	N	77.0	30.0	46.2	33.2	21.8	27.74	26.7	28.5	16.36667	-
<a href="#">14</a>	0.00	44.60	1.8	SO	76.0	43.0	61.2	32.1	22.9	26.66	26.9	25.7	18.30833	-
<a href="#">15</a>	25.00	69.60	1.6	S	99.0	48.0	78.5	30.5	20.7	24.04	27.6	20.7	18.84167	-
<a href="#">16</a>	0.40	70.00	0.9	N	100.0	60.0	74	27.6	20.4	23.82	22.5	24.3	19.75000	-
<a href="#">17</a>	6.60	76.60	1.9	N	93.0	58.0	75.5	29.1	20.6	24.44	24.9	23.8	19.77083	-
<a href="#">18</a>	69.80	146.40	2.2	N	100.0	63.0	91	26.8	19.2	21.68	23.2	19.6	19.32917	-
<a href="#">19</a>	1.00	147.40	1.3	L	97.0	60.0	76	27.8	20.2	23.82	25.5	22.8	19.87083	-
<a href="#">20</a>	5.20	152.60	1.5	L	92.0	57.0	86.5	28.2	20.9	23.62	25.4	21.8	19.57500	-
<a href="#">21</a>	0.00	152.60	2.0	SE	98.0	53.0	68.7	29.5	19.6	23.76	23.9	22.9	18.60417	-
<a href="#">22</a>	0.00	152.60	2.7	N	96.0	49.0	64	28.6	19.9	24.78	24.4	25.5	18.40833	-
<a href="#">23</a>	0.60	153.20	2.0	NO	87.0	43.0	75	30.3	21.6	24.68	26.9	22.3	18.99583	-
<a href="#">24</a>	12.80	166.00	2.7	NO	99.0	46.0	78.2	30.4	20.2	23.76	26.4	20.9	19.27917	-
<a href="#">25</a>	1.40	167.40	1.8	N	98.0	56.0	76.5	28.9	20.2	24.1	25	23.2	19.84583	-
<a href="#">26</a>	3.80	171.20	1.9	N	89.0	59.0	74.5	28.8	20.5	24.68	25.3	24.4	19.52917	-
<a href="#">27</a>	6.80	178.00	2.1	N	98.0	61.0	73.5	28.5	21.0	24.56	25.5	23.9	20.38750	-
<a href="#">28</a>	5.60	183.60	2.5	N	100.0	67.0	90.2	27.6	20.4	23.02	24.1	21.5	20.93333	-
<a href="#">29</a>	0.00	183.60	1.8	NO	100.0	63.0	78.7	29.2	20.6	24.28	22.8	24.4	20.95000	-
<a href="#">30</a>	0.00	183.60	2.1	N	95.0	66.0	81	28.0	21.9	24.26	26.2	22.6	21.03333	-

Aparecida de Goiania - Estação CELG Estação Aparecida de Goiania - Novembro de 2019  
 Para ver os dados horários clique no dia desejado

Dia	Precip.	Prec.Acum.	Vel. Vent. (m/s)	Dir. Vent.	Umid. Relat. AR (Max) %	Umid. Relat. AR (Min) %	Umid. Relat. AR (Média)%	Temp. Max. °C Dia	Temp. Min. °C Dia	Temp. Med. °C do Ar	Temp. 09:00h	Temp. 21:00h	Ponto orvalho	Razao Mistura
<a href="#">1</a>	6.40	6.40	1.0	S	84.0	33.0	62.2	33.5	20.6	24.72	27.9	20.8	17.03333	13.4514
<a href="#">2</a>	0.00	6.40	1.1	S	85.0	37.0	53	32.5	20.1	26.46	25.7	27	17.22917	13.6736
<a href="#">3</a>	0.00	6.40	1.4	N	71.0	45.0	60.2	30.4	21.7	25.46	25.6	24.8	17.47500	13.8194
<a href="#">4</a>	1.80	8.20	1.3	N	79.0	33.0	59.2	34.0	22.2	26.44	27.8	24.1	17.80000	14.1736
<a href="#">5</a>	0.20	8.40	1.0	N	82.0	36.0	62.7	33.8	21.1	25.84	27.3	23.5	18.37917	14.6597
<a href="#">6</a>	0.00	8.40	1.0	NO	79.0	42.0	63.5	31.1	21.9	25.66	24.5	25.4	18.46250	14.6667
<a href="#">7</a>	0.00	8.40	0.9	S	82.0	46.0	60.5	31.4	21.6	26.14	25.1	26.3	18.81250	15.1667
<a href="#">8</a>	0.00	8.40	0.9	SE	85.0	60.0	70.7	28.7	21.2	24.9	22.6	26	19.22083	15.5694
<a href="#">9</a>	0.20	8.60	1.5	L	78.0	30.0	53	34.9	22.9	27.1	28.3	24.7	17.51250	13.7639
<a href="#">10</a>	0.00	8.60	0.9	S	83.0	35.0	56	33.5	20.7	26.26	25.5	25.8	17.59583	13.9583
<a href="#">11</a>	2.60	11.20	0.9	S	76.0	36.0	56	34.0	21.9	26.7	28.6	24.5	17.75417	14.1250
<a href="#">12</a>	2.60	13.80	0.9	S	81.0	30.0	50.5	34.8	21.3	27.76	27.3	27.7	17.34583	13.8333
<a href="#">13</a>	0.00	13.80	2.1	N	76.0	27.0	37.5	33.8	21.3	28.86	28.6	30.3	15.21667	12.0764
<a href="#">14</a>	0.00	13.80	1.0	N	75.0	39.0	59	33.6	22.5	26.7	28.4	24.5	17.94167	14.2847
<a href="#">15</a>	4.40	18.20	0.8	NO	89.0	45.0	73.7	31.2	21.1	24.5	27.6	21.3	18.34583	14.7361
<a href="#">16</a>	0.40	18.60	0.7	N	94.0	58.0	72.5	27.8	20.7	24.32	22.9	25.1	19.59583	15.9583
<a href="#">17</a>	0.00	18.60	1.1	NO	85.0	50.0	65	30.8	21.3	25.62	25.4	25.3	19.14583	15.5417
<a href="#">18</a>	20.60	39.20	1.5	SE	94.0	58.0	80.7	27.9	18.8	21.62	22	19.7	18.47500	14.7500
<a href="#">19</a>	7.00	46.20	0.8	SO	95.0	57.0	85.7	29.2	19.8	22.94	24.3	20.7	19.39167	15.5000
<a href="#">20</a>	0.00	46.20	1.2	N	93.0	49.0	79	29.8	20.0	23.7	25.3	21.7	18.91667	15.1667
<a href="#">21</a>	0.00	46.20	1.4	L	91.0	47.0	63.5	29.6	19.3	24.18	24.2	23.9	18.05417	14.3819
<a href="#">22</a>	3.00	49.20	1.5	S	93.0	51.0	70.7	29.2	19.0	23.72	23.6	23.4	18.49167	14.8264
<a href="#">23</a>	6.00	55.20	0.7	N	85.0	49.0	74.7	29.8	22.2	24.76	27.2	22.3	18.88333	15.1597
<a href="#">24</a>	9.80	65.00	1.1	NO	93.0	44.0	74.7	31.7	20.1	23.84	26.4	20.5	18.91667	15.0833
<a href="#">25</a>	2.00	67.00	1.0	N	94.0	53.0	78.5	31.2	19.7	24.18	22.8	23.6	19.67500	15.9583
<a href="#">26</a>	0.40	67.40	1.2	N	84.0	54.0	71.5	29.9	20.6	25.32	25.9	25.1	19.51667	15.9097
<a href="#">27</a>	6.20	73.60	1.0	SE	94.0	74.0	83.7	25.6	20.6	23.56	24.2	23.7	20.60833	16.8264
<a href="#">28</a>	13.20	86.80	1.1	N	94.0	71.0	90.2	26.8	21.2	22.9	23.7	21.4	20.51667	16.9167
<a href="#">29</a>	3.20	90.00	1.1	NO	96.0	59.0	80	29.7	21.0	24.02	23.2	23.1	20.69583	17.0000
<a href="#">30</a>	1.20	91.20	0.8	SE	95.0	79.0	85.5	26.5	21.2	23.7	24.6	23.1	20.87917	17.1319



Bela Vista - Estação CELG Estação Bela Vista - Novembro de 2019  
 Para ver os dados horários clique no dia desejado

Dia	Precip.	Prec. Acum.	Vel. Vent. (m/s)	Dir. Vent.	Umid. Relat. AR (Max) %	Umid. Relat. AR (Min) %	Umid. Relat. AR (Média)%	Temp. Max. °C Dia	Temp. Min. °C Dia	Temp. Med. °C do Ar	Temp. 09:00h	Temp. 21:00h	Ponto orvalho	Razao Mistura
<a href="#">7</a>	0.00	0.00	2.0	L	67.0	55.0	-	29.6	23.1	-	-	24.7	18.33000	14.7600
<a href="#">8</a>	0.20	0.20	1.4	S	94.0	61.0	73.5	28.4	20.6	24.22	23.1	24.5	19.62500	16.0208
<a href="#">9</a>	0.00	0.20	3.1	L	88.0	28.0	52.5	35.3	21.8	27.54	29	25.8	17.65000	14.0069
<a href="#">10</a>	9.60	9.80	1.5	SO	97.0	39.0	65	33.4	19.1	24.8	26.1	22.7	18.78750	15.0000
<a href="#">11</a>	0.00	9.80	1.4	S	88.0	37.0	57.5	33.7	20.3	26.4	27.8	25.1	18.26250	14.4653
<a href="#">12</a>	0.00	9.80	1.5	SO	89.0	30.0	49.7	35.2	20.1	27.22	26.8	27	17.17083	13.5000
<a href="#">13</a>	0.00	9.80	2.5	L	76.0	27.0	37.2	34.3	21.1	28.48	29.4	28.8	14.76250	11.7153
<a href="#">14</a>	1.20	11.00	1.7	NO	86.0	46.0	66.2	31.5	21.8	25.52	27.5	23.4	18.55000	14.8611
<a href="#">15</a>	17.00	28.00	1.3	O	100.0	54.0	91.7	29.5	19.3	22.94	25.9	20	19.66667	15.7431
<a href="#">16</a>	0.00	28.00	1.0	L	100.0	59.0	79.2	27.9	19.7	23.1	22.7	22.6	19.72500	15.9167
<a href="#">17</a>	0.00	28.00	1.6	N	97.0	48.0	71.7	31.2	19.6	24.4	26	22.6	19.51250	15.7500
<a href="#">18</a>	45.00	73.00	2.0	L	100.0	75.0	92.7	25.1	19.0	20.38	19	19.4	19.51667	15.7083
<a href="#">19</a>	2.00	75.00	1.3	L	98.0	64.0	89	27.6	19.6	22.48	25.4	19.9	19.30417	15.5000
<a href="#">20</a>	6.00	81.00	1.7	L	98.0	53.0	85.2	29.6	19.6	23.08	25	20.6	19.01667	15.0556
<a href="#">21</a>	0.00	81.00	1.9	L	97.0	52.0	69	29.5	18.5	23.7	25.5	22.5	18.67500	14.9514
<a href="#">22</a>	7.00	88.00	1.9	L	100.0	55.0	75.2	28.0	17.7	22.94	23.4	22.8	19.27500	15.4097
<a href="#">23</a>	0.40	88.40	1.2	NO	98.0	57.0	75	28.3	20.8	23.98	26.4	22.2	19.42917	15.6319
<a href="#">24</a>	29.40	117.80	1.7	O	100.0	54.0	81.5	30.3	19.3	22.86	25.5	19.6	19.51667	15.8264
<a href="#">25</a>	19.60	137.40	1.8	N	100.0	50.0	80.7	30.3	18.9	22.7	23.9	20.2	19.83750	16.0486
<a href="#">26</a>	16.80	154.20	1.9	L	100.0	56.0	82	30.1	19.6	23.38	25.4	20.9	20.33750	16.6944
<a href="#">27</a>	6.80	161.00	1.4	L	100.0	71.0	87.7	26.8	19.7	23.08	24.1	22.4	20.81250	17.0833
<a href="#">28</a>	0.80	161.80	1.7	NO	100.0	70.0	90	27.4	20.4	22.94	22.9	22	20.88750	17.1319
<a href="#">29</a>	4.60	166.40	1.5	N	100.0	63.0	85.7	29.1	20.5	22.86	22.7	21	20.82917	17.1181
<a href="#">30</a>	4.00	170.40	1.4	L	100.0	75.0	90.5	27.2	20.5	22.7	23.8	21	20.75833	17.0903

Araçu - Estação CELG Estação Emater Araçu - Novembro de 2019  
 Para ver os dados horários clique no dia desejado

Dia	Precip.	Prec. Acum.	Vel. Vent. (m/s)	Dir. Vent.	Umid. Relat. AR (Max) %	Umid. Relat. AR (Min) %	Umid. Relat. AR (Média)%	Temp. Max. °C Dia	Temp. Min. °C Dia	Temp. Med. °C do Ar	Temp. 09:00h	Temp. 21:00h	Ponto orvalho	Razao Mistura
<a href="#">1</a>	0.20	0.20	1.2	N	90.0	39.0	61.2	33.4	17.4	24.88	27	23.3	17.94583	14.0764
<a href="#">2</a>	0.00	0.20	1.3	SO	85.0	36.0	60.7	33.8	18.8	25.4	26.6	23.9	17.67083	13.8264
<a href="#">3</a>	0.00	0.20	2.0	N	83.0	51.0	69.2	29.6	20.8	24	24.4	22.6	18.37083	14.4583
<a href="#">4</a>	16.20	16.40	1.4	N	92.0	38.0	74.7	32.1	18.3	23.7	27.1	20.5	18.60417	14.6250
<a href="#">5</a>	2.40	18.80	1.3	N	95.0	51.0	81	31.7	19.5	24.24	24.2	22.9	20.14583	16.1667
<a href="#">6</a>	0.20	19.00	1.1	N	93.0	56.0	80.2	30.3	20.4	23.6	23.7	21.8	20.00000	16.0347
<a href="#">7</a>	4.80	23.80	1.1	N	94.0	49.0	77.2	32.2	18.6	23.48	24.4	21.1	19.55000	15.5903
<a href="#">8</a>	0.00	23.80	1.8	S	95.0	59.0	77.2	30.3	19.6	23.8	23.1	23	20.15833	16.1736
<a href="#">9</a>	0.00	23.80	1.5	N	93.0	34.0	62.5	34.1	19.3	26.64	27	26.4	18.82500	14.8333
<a href="#">10</a>	3.80	27.60	1.0	SO	90.0	42.0	81	32.8	18.4	23.9	25.1	21.6	18.98750	14.9931
<a href="#">11</a>	0.00	27.60	1.6	SO	92.0	39.0	69	33.9	19.9	25.56	26.2	23.9	19.36250	15.3681
<a href="#">12</a>	5.40	33.00	2.0	SO	90.0	37.0	73.7	34.5	21.0	24.5	23.6	21.7	19.52500	15.4722
<a href="#">13</a>	0.00	33.00	1.2	N	94.0	37.0	63.7	33.0	18.2	25.18	24.9	24.9	18.17917	14.4167
<a href="#">14</a>	0.00	33.00	1.2	N	89.0	42.0	64	32.9	18.9	25.22	26.1	24.1	18.53333	14.7014
<a href="#">15</a>	0.80	33.80	1.5	N	90.0	50.0	76.2	30.9	19.1	24.02	26.7	21.7	19.32083	15.4514
<a href="#">16</a>	1.20	35.00	0.6	N	94.0	58.0	79.7	28.7	19.9	22.74	22.5	21.3	19.63333	15.6042
<a href="#">17</a>	0.00	35.00	1.9	N	93.0	58.0	71.7	28.8	18.6	23.14	24.9	21.7	18.99583	15.2014
<a href="#">18</a>	0.20	35.20	1.8	N	89.0	61.0	80	28.3	20.1	23.14	24.7	21.3	19.28333	15.3681
<a href="#">19</a>	7.80	43.00	1.0	N	93.0	61.0	89.5	28.4	20.1	23.38	24.8	21.8	20.27500	16.4097
<a href="#">20</a>	0.60	43.60	0.7	NO	95.0	70.0	89.5	27.7	19.8	22.86	23.8	21.5	20.41667	16.4236
<a href="#">21</a>	0.60	44.20	0.9	SO	96.0	49.0	76	29.5	19.5	23.12	22.6	22	19.00000	15.0486
<a href="#">22</a>	0.00	44.20	2.0	N	91.0	56.0	73.2	28.5	19.0	23.18	22.8	22.8	18.95000	15.0764
<a href="#">23</a>	10.40	54.60	0.9	N	92.0	60.0	83	28.5	19.7	23.14	26.1	20.7	20.22083	16.2222
<a href="#">24</a>	13.80	68.40	0.9	N	96.0	61.0	86.2	29.2	18.8	22.54	25.7	19.5	19.52500	15.4931
<a href="#">25</a>	3.80	72.20	1.1	N	99.0	66.0	85.2	28.1	19.2	22.36	22.7	20.9	20.31250	16.5000
<a href="#">26</a>	0.00	72.20	1.3	N	94.0	58.0	80.2	30.3	19.8	24.06	24.8	22.7	20.34167	16.4444
<a href="#">27</a>	0.00	72.20	1.6	N	95.0	71.0	87	27.1	20.1	23.48	24.8	22.7	20.90833	16.8403
<a href="#">28</a>	5.40	77.60	1.7	N	96.0	75.0	88	26.6	20.5	23.24	24.7	22.2	21.12917	17.2083
<a href="#">29</a>	0.00	77.60	0.9	SO	96.0	65.0	83.2	28.5	20.3	23.64	23	23.2	21.29583	17.4167
<a href="#">30</a>	6.60	84.20	1.1	N	95.0	70.0	88.2	28.6	20.7	23.26	25.6	20.7	20.90833	17.0417

Goiania - Estação CELG Estação Goiania 2 - Novembro de 2019

Para ver os dados horários clique no dia desejado

Dia	Precip.	Prec.Acum.	Vel. Vent. (m/s)	Dir. Vent.	Umid. Relat. AR (Max) %	Umid. Relat. AR (Min) %	Umid. Relat. AR (Média)%	Temp. Max. °C Dia	Temp. Min. °C Dia	Temp. Med. °C do Ar	Temp. 09:00h	Temp. 21:00h	Ponto orvalho	Razao Mistura
<a href="#">1</a>	0.00	0.00	0.5	NO	98.0	31.0	57.7	34.8	19.0	26.04	29	23.7	18.03750	14.2847
<a href="#">2</a>	0.60	0.60	0.7	SE	97.0	39.0	56.2	34.0	19.7	26.56	28.1	25.5	18.25417	14.2500
<a href="#">3</a>	0.00	0.60	0.7	N	81.0	41.0	65.7	30.9	21.7	25.56	26	24.6	18.49583	14.4514
<a href="#">4</a>	1.80	2.40	0.5	NO	95.0	33.0	60.5	34.9	20.7	26.5	29.5	23.7	18.94583	15.0417
<a href="#">5</a>	2.60	5.00	0.5	NO	99.0	39.0	68.5	33.6	19.4	25.7	28.7	23.4	19.69583	15.6667
<a href="#">6</a>	0.00	5.00	0.6	NO	96.0	43.0	69.5	32.0	20.5	25.32	25.5	24.3	19.92500	15.9931
<a href="#">7</a>	0.00	5.00	0.6	SE	98.0	44.0	73.5	33.2	20.5	24.96	28.3	21.4	19.97083	15.9306
<a href="#">8</a>	0.00	5.00	0.7	SE	94.0	61.0	76.5	29.4	20.5	24.26	23.8	23.8	20.37083	16.5278
<a href="#">9</a>	8.60	13.60	0.9	SE	93.0	30.0	63.7	36.0	20.8	26.02	30.5	21.4	18.98333	15.0903
<a href="#">10</a>	0.60	14.20	0.5	NO	100.0	35.0	62.7	34.1	19.9	25.66	26.9	23.7	18.85833	14.8750
<a href="#">11</a>	0.00	14.20	0.8	NO	98.0	33.0	59.5	35.6	19.5	26.28	28.3	24	18.67083	14.7222
<a href="#">12</a>	0.00	14.20	0.7	SE	82.0	29.0	56.7	35.7	22.3	27.34	27.7	25.5	18.29583	14.5347
<a href="#">13</a>	0.00	14.20	0.9	NO	95.0	28.0	-	34.2	19.4	-	29.5	-	16.57391	13.0000
<a href="#">14</a>	4.60	18.80	0.7	NO	91.0	40.0	63.7	33.7	21.0	26.42	28.8	24.3	19.51667	15.6181
<a href="#">15</a>	14.40	33.20	0.6	O	100.0	48.0	85	30.9	20.1	24.02	28.1	20.5	20.11667	16.1944
<a href="#">16</a>	0.40	33.60	0.3	NO	100.0	55.0	84	29.2	20.4	23.3	21.9	22.5	20.64167	16.7917
<a href="#">17</a>	0.00	33.60	0.7	NO	100.0	46.0	76.2	31.0	19.7	24.84	26.3	23.6	20.46667	16.5417
<a href="#">18</a>	29.80	63.40	0.7	SE	100.0	62.0	89.7	28.0	19.2	22.32	24.6	19.9	20.01667	16.0486
<a href="#">19</a>	0.60	64.00	0.4	L	100.0	66.0	83	28.3	19.6	23.56	25.7	22.1	20.70000	16.7083
<a href="#">20</a>	15.80	79.80	0.4	NO	100.0	57.0	93.5	29.3	19.5	23.32	26.4	20.7	20.42500	16.3333
<a href="#">21</a>	0.00	79.80	0.7	SE	100.0	52.0	77.5	30.2	19.2	23.38	24.7	21.4	19.60417	15.6250
<a href="#">22</a>	6.20	86.00	0.8	NO	100.0	51.0	72.2	29.9	19.4	24.08	25.7	22.7	19.60417	15.6597
<a href="#">23</a>	0.00	86.00	0.5	NO	99.0	47.0	78.5	31.2	20.6	24.68	28.2	21.7	20.11250	16.0000
<a href="#">24</a>	6.40	92.40	0.8	NO	100.0	39.0	78.2	32.2	19.3	24.04	27.3	20.7	19.73333	15.7500
<a href="#">25</a>	0.60	93.00	0.4	NO	100.0	61.0	76.7	29.1	19.6	24.28	25.9	23.4	20.53750	16.6736
<a href="#">26</a>	0.00	93.00	0.6	NO	99.0	55.0	76	30.6	19.5	25	26.7	24.1	20.37917	16.4028
<a href="#">27</a>	17.20	110.20	0.4	SE	100.0	71.0	90	27.9	20.9	23.74	26.1	21.9	21.55000	17.7014
<a href="#">28</a>	11.20	121.40	0.7	NO	100.0	62.0	91.5	29.2	20.5	23.38	25.8	20.7	21.32083	17.4236
<a href="#">29</a>	2.60	124.00	0.5	NO	100.0	61.0	92.5	29.5	20.3	23.94	23.7	23.1	21.51250	17.6597
<a href="#">30</a>	0.00	124.00	0.7	O	100.0	65.0	82	29.6	21.5	24.72	27.3	22.6	21.72917	17.8403

Senador Canedo - Estação CELG Estação Senador Canedo - Novembro de 2019

Para ver os dados horários clique no dia desejado

Dia	Precip.	Prec.Acum.	Vel. Vent. (m/s)	Dir. Vent.	Umid. Relat. AR (Max) %	Umid. Relat. AR (Min) %	Umid. Relat. AR (Média)%	Temp. Max. °C Dia	Temp. Min. °C Dia	Temp. Med. °C do Ar	Temp. 09:00h	Temp. 21:00h	Ponto orvalho	Razao Mistura
<a href="#">7</a>	0.00	0.00	1.4	N	62.0	50.0	-	30.9	25.5	-	-	25.8	18.45833	14.7816
<a href="#">8</a>	0.00	0.00	1.5	SO	90.0	59.0	74.2	27.6	21.2	24.28	21.8	25.4	19.62500	16.0278
<a href="#">9</a>	1.00	1.00	2.1	L	83.0	33.0	57.2	34.2	22.2	27.02	28.5	25.1	17.72500	14.1319
<a href="#">10</a>	2.40	3.40	1.2	S	91.0	37.0	57.5	32.7	20.0	25.44	25.3	24.6	17.76250	14.1458
<a href="#">11</a>	0.00	3.40	1.3	NO	77.0	29.0	55	34.4	21.5	26.66	27.8	24.8	16.87500	13.6111
<a href="#">12</a>	0.00	3.40	1.3	S	81.0	27.0	51	34.7	21.7	27.2	26.2	26.7	16.93333	13.4236
<a href="#">13</a>	0.00	3.40	2.6	N	65.0	27.0	37.7	34.1	23.1	28.74	28.9	28.8	14.39167	11.4097
<a href="#">14</a>	1.80	5.20	1.3	SO	81.0	43.0	67	31.9	22.7	26	27.6	23.9	18.36250	14.5903
<a href="#">15</a>	11.80	17.00	0.9	SO	100.0	44.0	83.2	31.0	19.7	23.6	27.7	19.8	18.76250	15.1458
<a href="#">16</a>	0.40	17.40	0.7	L	100.0	59.0	74.7	27.4	19.5	23.56	22.5	24.2	19.45833	15.7986
<a href="#">17</a>	0.00	17.40	1.5	N	88.0	55.0	73.5	29.7	20.9	24.56	24.8	23.7	19.44167	15.8264
<a href="#">18</a>	18.20	35.60	1.4	L	99.0	63.0	87.7	26.9	18.9	21	20.2	19.5	19.20833	15.5000
<a href="#">19</a>	1.20	36.80	1.1	SO	94.0	63.0	83.7	26.5	20.2	22.74	26.2	20.4	19.45000	15.7153
<a href="#">20</a>	15.40	52.20	1.5	SE	97.0	55.0	87.5	28.6	18.9	22.9	25.4	20.8	19.06250	15.2639
<a href="#">21</a>	0.00	52.20	1.5	L	99.0	48.0	69	29.1	18.6	23.54	24.8	22.6	18.46250	14.9097
<a href="#">22</a>	7.00	59.20	1.9	N	100.0	52.0	70	28.7	18.7	23.62	24.1	23.3	18.78750	15.0417
<a href="#">23</a>	0.80	60.00	0.9	N	85.0	50.0	75.5	30.7	21.6	24.88	26.5	22.8	18.93333	15.1736
<a href="#">24</a>	9.20	69.20	1.7	N	100.0	44.0	79.5	31.1	19.4	23.22	25.4	20.1	19.12500	15.5764
<a href="#">25</a>	0.20	69.40	1.2	L	99.0	55.0	80	29.9	19.4	23.74	23.2	23.1	19.60833	15.8681
<a href="#">26</a>	6.00	75.40	1.4	N	94.0	58.0	82	28.7	20.2	24.1	25.2	23.2	19.85833	16.2847
<a href="#">27</a>	4.00	79.40	1.3	SO	99.0	74.0	90.7	25.7	20.4	23.22	24.6	22.7	20.85000	17.1250
<a href="#">28</a>	3.60	83.00	1.7	N	100.0	63.0	88.2	28.1	20.2	22.78	24.2	20.7	20.64583	16.8333
<a href="#">29</a>	0.80	83.80	1.6	N	99.0	61.0	82.7	29.2	20.4	23.46	22.7	22.5	20.78750	17.1250
<a href="#">30</a>	0.00	83.80	1.5	L	94.0	62.0	83.5	28.6	21.4	23.78	25.7	21.6	20.71667	17.0903

## Trindade - Estação CELG Estação Trindade - Novembro de 2019

Para ver os dados horários clique no dia desejado

Dia	Precip.	Prec.Acum.	Vel. Vent. (m/s)	Dir. Vent.	Umid. Relat. AR (Max) %	Umid. Relat. AR (Min) %	Umid. Relat. AR (Média)%	Temp. Max. °C Dia	Temp. Min. °C Dia	Temp. Med. °C do Ar	Temp. 09:00h	Temp. 21:00h	Ponto orvalho	Razao Mistura
<a href="#">11</a>	0.00	0.00	1.4	SO	85.0	73.0	-	24.5	22.4	-	-	23.6	19.27143	15.5789
<a href="#">12</a>	2.80	2.80	1.6	S	88.0	32.0	58.2	34.8	21.6	26.9	27.5	25.3	18.86667	15.1250
<a href="#">13</a>	0.00	2.80	2.2	N	86.0	33.0	50.5	33.5	21.2	27.7	25.8	29	17.63333	14.1944
<a href="#">14</a>	0.20	3.00	1.9	NO	81.0	43.0	54	31.7	22.8	27.28	27.9	27	18.52500	14.7569
<a href="#">15</a>	8.00	11.00	1.5	S	96.0	50.0	79.7	29.8	21.2	24.32	28	21.3	19.18333	15.5278
<a href="#">16</a>	0.00	11.00	0.9	L	99.0	57.0	70.7	28.4	20.8	24.52	23	25.2	19.88333	16.1250
<a href="#">17</a>	1.80	12.80	1.9	NO	88.0	56.0	73.2	29.2	21.7	25.16	24.9	25	19.85000	16.1250
<a href="#">18</a>	9.20	22.00	1.8	N	95.0	62.0	86	27.0	20.4	22.74	24.9	20.7	19.65833	15.8750
<a href="#">19</a>	1.40	23.40	1.6	SE	93.0	58.0	74.7	28.5	20.9	24	24.8	22.9	19.54583	15.6250
<a href="#">20</a>	4.00	27.40	1.7	L	92.0	51.0	84.2	29.9	21.3	24.1	26.1	21.6	19.39583	15.5000
<a href="#">21</a>	0.00	27.40	1.9	L	93.0	49.0	62	29.7	20.4	24.58	24.6	24.1	18.40000	14.6319
<a href="#">22</a>	0.00	27.40	2.7	N	95.0	48.0	64.2	29.1	19.5	24.82	24.9	25.3	18.52083	14.8264
<a href="#">23</a>	4.20	31.60	1.5	NO	89.0	51.0	81.5	29.9	21.7	24.52	27	22	19.49167	15.6597
<a href="#">24</a>	11.60	43.20	1.9	O	97.0	48.0	78.2	30.4	20.0	23.44	26	20.4	19.35833	15.6181
<a href="#">25</a>	1.60	44.80	1.6	L	98.0	55.0	77	29.7	20.3	24.18	25.1	22.9	20.17083	16.2569
<a href="#">26</a>	0.20	45.00	1.8	N	86.0	55.0	73.2	29.4	20.9	25.18	26.4	24.6	19.74167	16.0694
<a href="#">27</a>	2.60	47.60	2.5	N	94.0	61.0	74.5	28.2	21.4	24.84	25.6	24.5	20.51667	16.6736
<a href="#">28</a>	16.80	64.40	1.8	N	100.0	77.0	90.5	25.8	20.3	22.82	23.8	22.1	21.09167	17.4931
<a href="#">29</a>	8.60	73.00	1.6	NO	100.0	71.0	93.5	27.0	21.0	23.32	23	22.8	21.36667	17.7431
<a href="#">30</a>	1.20	74.20	1.6	L	98.0	65.0	80.7	28.5	20.9	23.74	26.5	21.4	21.13750	17.3056

## Goiânia - Estação Estação Hidro Goiânia Jusante - GO - ANA - Novembro de 2019

Para ver os dados horários clique no dia desejado

Dia	Precip.	Prec.Acum.	Sensor Pressão min	Sensor Pressão max	Sensor Pressão media	Nível Régua	CodifEixo	Vazão min (m3/s)	Vazão max (m3/s)	Vazão media (m3/s)
<a href="#">1</a>	2.20	2.20	0.88	1.1	0.9	1.1	6.25	0.00	0.00	0.00
<a href="#">2</a>	0.00	2.20	0.87	1.1	0.9	1.1	6.25	0.00	0.00	0.00
<a href="#">3</a>	0.00	2.20	0.88	0.91	0.9	0.91	6.25	0.00	0.00	0.00
<a href="#">4</a>	0.20	2.40	0.84	0.97	0.9	0.97	6.25	0.00	0.00	0.00
<a href="#">5</a>	1.80	4.20	0.89	1.09	1.0	1.09	6.25	0.00	0.00	0.00
<a href="#">6</a>	0.60	4.80	0.88	0.93	0.9	0.93	6.25	0.00	0.00	0.00
<a href="#">7</a>	0.00	4.80	0.9	1.26	0.9	1.26	6.25	0.00	0.00	0.00
<a href="#">8</a>	0.00	4.80	0.87	1.22	0.9	1.22	6.25	0.00	0.00	0.00
<a href="#">9</a>	0.00	4.80	0.86	1.13	0.9	1.13	6.25	0.00	0.00	0.00
<a href="#">10</a>	0.00	4.80	0.88	1.36	1.0	1.36	6.25	0.00	0.00	0.00
<a href="#">11</a>	0.00	4.80	0.84	0.94	0.9	0.94	6.25	0.00	0.00	0.00
<a href="#">12</a>	0.00	4.80	0.88	0.9	0.9	0.9	6.25	0.00	0.00	0.00
<a href="#">13</a>	0.00	4.80	0.88	0.91	0.9	0.91	6.25	0.00	0.00	0.00
<a href="#">14</a>	15.00	19.80	0.88	1.18	0.9	1.18	6.25	0.00	0.00	0.00
<a href="#">15</a>	36.80	56.60	0.87	3.03	1.2	3.03	6.25	0.00	0.00	0.00
<a href="#">16</a>	0.40	57.00	0.92	2.83	1.2	2.83	6.25	0.00	0.00	0.00
<a href="#">17</a>	0.00	57.00	0.95	1.12	1.1	1.12	6.25	0.00	0.00	0.00
<a href="#">18</a>	23.80	80.80	0.95	3.25	1.4	3.25	6.25	0.00	0.00	0.00
<a href="#">19</a>	0.00	80.80	1.09	2.49	1.3	2.49	6.25	0.00	0.00	0.00
<a href="#">20</a>	17.20	98.00	1.08	2.06	1.3	2.06	6.25	0.00	0.00	0.00
<a href="#">21</a>	0.20	98.20	0.91	1.17	1.1	1.17	6.25	0.00	0.00	0.00
<a href="#">22</a>	-177.60	-79.40	0.9	1.03	0.9	1.03	6.25	0.00	0.00	0.00
<a href="#">23</a>	0.40	-79.00	0.88	0.96	0.9	0.96	6.25	0.00	0.00	0.00
<a href="#">24</a>	9.20	-69.80	0.89	1.55	0.9	1.55	6.25	0.00	0.00	0.00
<a href="#">25</a>	1.20	-68.60	0.98	1.58	1.2	1.58	6.25	0.00	0.00	0.00
<a href="#">26</a>	0.20	-68.40	0.94	1.22	1.0	1.22	6.25	0.00	0.00	0.00
<a href="#">27</a>	41.40	-27.00	0.92	1.77	1.2	1.77	6.25	0.00	0.00	0.00
<a href="#">28</a>	5.20	-21.80	0.92	1.37	1.0	1.37	6.25	0.00	0.00	0.00
<a href="#">29</a>	0.20	-21.60	0.95	1.45	1.1	1.45	6.25	0.00	0.00	0.00
<a href="#">30</a>	0.20	-21.40	0.95	1.17	1.0	1.17	6.25	0.00	0.00	0.00

Goiânia - Estação Estação Hidro Goiânia Montante - GO - ANA - Novembro de 2019

Para ver os dados horários clique no dia desejado

Dia	Precip.	Prec.Acum.	Sensor Pressão min	Sensor Pressão max	Sensor Pressão media	Nível Régua	CodifEixo	Vazão min (m3/s)	Vazão max (m3/s)	Vazão media (m3/s)
<a href="#">1</a>	2.40	2.40	1.1	1.48	1.3	1.48	6.71	0.00	0.00	0.00
<a href="#">2</a>	1.40	3.80	1.18	1.62	1.3	1.62	6.71	0.00	0.00	0.00
<a href="#">3</a>	0.00	3.80	1.06	1.49	1.3	1.49	6.71	0.00	0.00	0.00
<a href="#">4</a>	2.80	6.60	0.95	1.52	1.4	1.52	6.71	0.00	0.00	0.00
<a href="#">5</a>	0.20	6.80	0.91	1.51	1.3	1.51	6.71	0.00	0.00	0.00
<a href="#">6</a>	0.00	6.80	1.01	1.45	1.3	1.45	6.71	0.00	0.00	0.00
<a href="#">7</a>	7.60	14.40	0.91	1.46	1.3	1.46	6.71	0.00	0.00	0.00
<a href="#">8</a>	0.00	14.40	0.9	1.47	1.3	1.47	6.71	0.00	0.00	0.00
<a href="#">9</a>	14.60	29.00	0.93	1.43	1.2	1.43	6.71	0.00	0.00	0.00
<a href="#">10</a>	0.00	29.00	0.92	1.42	1.2	1.42	6.71	0.00	0.00	0.00
<a href="#">11</a>	0.00	29.00	0.91	1.35	1.2	1.35	6.71	0.00	0.00	0.00
<a href="#">12</a>	0.00	29.00	1.06	1.33	1.2	1.33	6.71	0.00	0.00	0.00
<a href="#">13</a>	0.00	29.00	0.98	1.43	1.2	1.43	6.71	0.00	0.00	0.00
<a href="#">14</a>	0.00	29.00	0.98	1.4	1.2	1.4	6.71	0.00	0.00	0.00
<a href="#">15</a>	23.20	52.20	1.03	2.07	1.3	2.07	6.71	0.00	0.00	0.00
<a href="#">16</a>	0.60	52.80	1.03	1.5	1.3	1.5	6.71	0.00	0.00	0.00
<a href="#">17</a>	0.00	52.80	1.09	1.53	1.3	1.53	6.71	0.00	0.00	0.00
<a href="#">18</a>	37.00	89.80	1.1	2.45	1.5	2.45	6.71	0.00	0.00	0.00
<a href="#">19</a>	2.60	92.40	0.94	1.38	1.1	1.38	6.71	0.00	0.00	0.00
<a href="#">20</a>	11.20	103.60	1	1.39	1.1	1.39	6.71	0.00	0.00	0.00
<a href="#">21</a>	0.00	103.60	0	1.63	1.4	1.63	7.17	0.00	0.00	0.00
<a href="#">22</a>	-152.20	-48.60	1.4	1.55	1.5	1.55	7.17	0.00	0.00	0.00
<a href="#">23</a>	0.00	-48.60	1.33	1.45	1.4	1.45	7.17	0.00	0.00	0.00
<a href="#">24</a>	4.20	-44.40	1.33	1.51	1.4	1.51	7.17	0.00	0.00	0.00
<a href="#">25</a>	0.00	-44.40	1.38	1.5	1.4	1.5	7.17	0.00	0.00	0.00
<a href="#">26</a>	0.00	-44.40	1.46	1.58	1.5	1.58	7.17	0.00	0.00	0.00
<a href="#">27</a>	6.80	-37.60	1.54	1.69	1.6	1.69	7.17	0.00	0.00	0.00
<a href="#">28</a>	24.00	-13.60	1.49	1.74	1.6	1.74	7.17	0.00	0.00	0.00
<a href="#">29</a>	1.40	-12.20	1.44	1.59	1.5	1.59	7.17	0.00	0.00	0.00
<a href="#">30</a>	0.00	-12.20	1.42	1.56	1.5	1.56	7.17	0.00	0.00	0.00

Goiânia - Estação Heliponto Goiânia - Novembro de 2019

Para ver os dados horários clique no dia desejado

Dia	Precip.	Prec.Acum.	Vel. Vent. (m/s)	Dir. Vent.	Umid. Relat. AR (Max) %	Umid. Relat. AR (Min) %	Umid. Relat. AR (Média) %	Temp. Max. °C Dia	Temp. Min. °C Dia	Temp. Med. °C do Ar	Temp. 09:00h	Temp. 21:00h	Ponto orvalho	Razao Mistura	Radiação Solar Diária MJ/m²
<a href="#">1</a>	0.00	0.00	1.9	SE	81.0	30.0	54	33.1	21.9	26.22	28.9	23.6	-	-	15.6
<a href="#">2</a>	0.00	0.00	1.8	SE	85.0	32.0	47.2	33.3	21.1	27.54	26.5	28.4	-	-	20.3
<a href="#">3</a>	0.00	0.00	1.5	N	76.0	39.0	60.2	29.5	22.4	25.76	25.3	25.8	-	-	15.2
<a href="#">4</a>	0.60	0.60	1.4	L	81.0	28.0	56.5	33.8	23.0	26.68	28.8	23.9	-	-	19.3
<a href="#">5</a>	8.80	9.40	1.4	NO	82.0	36.0	62.5	32.3	22.0	26.12	27.3	24.5	-	-	14.8
<a href="#">6</a>	0.00	9.40	1.7	NO	89.0	38.0	63.7	31.1	21.5	25.62	24.5	25.5	-	-	15.7
<a href="#">7</a>	0.00	9.40	1.4	SE	88.0	43.0	63.7	31.9	22.4	25.94	26.4	24.5	-	-	15.8
<a href="#">8</a>	0.00	9.40	2.0	SE	90.0	60.0	70.2	28.4	21.9	25.2	22.9	26.4	-	-	9.9
<a href="#">9</a>	0.00	9.40	2.4	SE	74.0	25.0	53.5	35.6	23.6	26.94	28.3	23.6	-	-	20.2
<a href="#">10</a>	0.00	9.40	1.7	SE	85.0	32.0	48.7	32.8	21.7	26.84	26.1	26.8	-	-	21
<a href="#">11</a>	0.00	9.40	2.0	NO	80.0	28.0	50	34.1	22.5	27.12	27.8	25.6	-	-	18.4
<a href="#">12</a>	0.00	9.40	1.7	S	78.0	24.0	44.7	34.8	22.8	28.06	27.1	27.8	-	-	17.6
<a href="#">13</a>	0.00	9.40	1.5	N	72.0	23.0	36	33.6	23.1	28.5	28	28.9	-	-	20.2
<a href="#">14</a>	3.80	13.20	1.7	NO	74.0	36.0	59.5	32.3	23.6	27.1	29.8	24.9	-	-	17.7
<a href="#">15</a>	31.00	44.20	1.6	SE	99.0	43.0	76.5	30.3	20.7	24.28	28.6	20.9	-	-	13.9
<a href="#">16</a>	0.60	44.80	0.8	L	99.0	53.0	73	29.3	20.8	24.62	22.8	25.1	-	-	9.1
<a href="#">17</a>	0.00	44.80	1.5	N	95.0	47.0	70.7	30.4	21.6	25.22	24.9	24.6	-	-	16.4
<a href="#">18</a>	17.60	62.40	1.8	SE	100.0	57.0	87.2	27.5	19.6	22.24	23.3	20.4	-	-	12.5
<a href="#">19</a>	0.20	62.60	1.4	SE	97.0	58.0	80.7	28.0	20.8	23.6	25.6	21.8	-	-	10.7
<a href="#">20</a>	23.00	85.60	1.4	SE	96.0	51.0	85.5	29.1	20.6	23.72	25.9	21.5	-	-	9.8
<a href="#">21</a>	0.00	85.60	1.5	SE	100.0	43.0	66.2	30.4	19.7	24.26	24.4	23.4	-	-	19.3
<a href="#">22</a>	3.60	89.20	1.7	L	99.0	44.0	64.7	29.1	19.5	24.64	24	25.3	-	-	16.4
<a href="#">23</a>	0.60	89.80	1.3	NO	88.0	46.0	70.2	29.5	22.5	25.26	27.3	23.5	-	-	12.5
<a href="#">24</a>	5.60	95.40	1.8	NO	99.0	36.0	76.5	30.9	20.4	23.92	25.1	21.6	-	-	19.1
<a href="#">25</a>	2.00	97.40	1.4	SE	99.0	55.0	78.5	28.8	20.3	24.24	24.9	23.6	-	-	14.1
<a href="#">26</a>	0.00	97.40	1.4	L	89.0	52.0	69	29.4	21.1	25.16	26.1	24.6	-	-	15.7
<a href="#">27</a>	16.00	113.40	1.4	SE	98.0	71.0	85.5	27.1	21.6	24.2	25.1	23.6	-	-	10.2
<a href="#">28</a>	10.20	123.60	1.8	NO	99.0	62.0	91	27.8	20.7	23.26	24.8	21.5	-	-	9.1
<a href="#">29</a>	7.00	130.60	1.4	NO	100.0	60.0	86.2	28.4	21.1	24.02	22.4	24.1	-	-	13.6
<a href="#">30</a>	1.60	132.20	1.6	SE	99.0	68.0	79.5	27.6	22.1	24.52	27.1	22.9	-	-	12.1



Matrinchã - Estação Estação Hidro Matrinchã - GO - ANA - Novembro de 2019

Para ver os dados horários clique no dia desejado

Dia	Precip.	Prec.Acum.	Sensor Pressão min	Sensor Pressão max	Sensor Pressão media	Nível Régua	CodifEixo	Vazão min (m3/s)	Vazão max (m3/s)	Vazão media (m3/s)
<a href="#">1</a>	0.00	0.00	0.17	0.22	0.2	0.22	6.74	0.00	0.00	0.00
<a href="#">2</a>	0.00	0.00	0.18	0.21	0.2	0.21	6.74	0.00	0.00	0.00
<a href="#">3</a>	0.00	0.00	0.15	0.18	0.2	0.18	6.74	0.00	0.00	0.00
<a href="#">4</a>	0.00	0.00	0.12	0.15	0.1	0.15	6.74	0.00	0.00	0.00
<a href="#">5</a>	29.60	29.60	0.1	0.15	0.1	0.15	6.74	0.00	0.00	0.00
<a href="#">6</a>	0.00	29.60	0	0.14	0.1	0.14	6.74	0.00	0.00	0.00
<a href="#">7</a>	-134.40	-104.80	0.06	0.09	0.1	0.09	6.74	0.00	0.00	0.00
<a href="#">8</a>	0.00	-104.80	0.06	0.1	0.1	0.1	6.74	0.00	0.00	0.00
<a href="#">9</a>	0.00	-104.80	0.1	0.17	0.1	0.17	6.74	0.00	0.00	0.00
<a href="#">10</a>	0.00	-104.80	0.09	0.14	0.1	0.14	6.74	0.00	0.00	0.00
<a href="#">11</a>	0.00	-104.80	0.07	0.1	0.1	0.1	6.74	0.00	0.00	0.00
<a href="#">12</a>	0.00	-104.80	0.07	0.09	0.1	0.09	6.74	0.00	0.00	0.00
<a href="#">13</a>	2.60	-102.20	0.09	0.17	0.1	0.17	6.74	0.00	0.00	0.00
<a href="#">14</a>	0.00	-102.20	0.13	0.16	0.1	0.16	6.74	0.00	0.00	0.00
<a href="#">15</a>	0.00	-102.20	0.1	0.13	0.1	0.13	6.74	0.00	0.00	0.00
<a href="#">16</a>	0.00	-102.20	0.09	0.16	0.1	0.16	6.74	0.00	0.00	0.00
<a href="#">17</a>	4.40	-97.80	0.13	0.16	0.1	0.16	6.74	0.00	0.00	0.00
<a href="#">18</a>	0.00	-97.80	0.1	0.13	0.1	0.13	6.74	0.00	0.00	0.00
<a href="#">19</a>	0.00	-97.80	0.08	0.1	0.1	0.1	6.74	0.00	0.00	0.00
<a href="#">20</a>	1.20	-96.60	0.08	0.09	0.1	0.09	6.74	0.00	0.00	0.00
<a href="#">21</a>	0.00	-96.60	0.09	0.1	0.1	0.1	6.74	0.00	0.00	0.00
<a href="#">22</a>	22.80	-73.80	0.09	0.12	0.1	0.12	6.74	0.00	0.00	0.00
<a href="#">23</a>	0.00	-73.80	0.12	0.21	0.2	0.21	6.74	0.00	0.00	0.00
<a href="#">24</a>	0.40	-73.40	0.17	0.21	0.2	0.21	6.74	0.00	0.00	0.00
<a href="#">25</a>	8.80	-64.60	0.15	0.18	0.2	0.18	6.74	0.00	0.00	0.00
<a href="#">26</a>	4.20	-60.40	0.15	0.21	0.2	0.21	6.74	0.00	0.00	0.00
<a href="#">27</a>	20.20	-40.20	0.19	0.35	0.2	0.35	6.74	0.00	0.00	0.00
<a href="#">28</a>	25.00	-15.20	0.33	0.37	0.4	0.37	6.74	0.00	0.00	0.00
<a href="#">29</a>	0.40	-14.80	0.32	0.39	0.4	0.39	6.74	0.00	0.00	0.00
<a href="#">30</a>	0.00	-14.80	0.31	0.41	0.4	0.41	6.74	0.00	0.00	0.00

Nova Crixas - Estação Estação Hidro Bandeirantes - GO - ANA - Novembro de 2019

Para ver os dados horários clique no dia desejado

Dia	Precip.	Prec.Acum.	Sensor Pressão min	Sensor Pressão max	Sensor Pressão media	Nível Régua	CodifEixo	Vazão min (m3/s)	Vazão max (m3/s)	Vazão media (m3/s)
<a href="#">1</a>	0.00	0.00	3.84	3.87	3.9	3.87	2.78	0.00	0.00	0.00
<a href="#">2</a>	0.00	0.00	3.8	3.84	3.8	3.84	2.78	0.00	0.00	0.00
<a href="#">3</a>	46.60	46.60	3.8	3.82	3.8	3.82	2.78	0.00	0.00	0.00
<a href="#">4</a>	0.00	46.60	3.76	3.81	3.8	3.81	2.78	0.00	0.00	0.00
<a href="#">5</a>	49.60	96.20	3.74	3.83	3.8	3.83	2.78	0.00	0.00	0.00
<a href="#">6</a>	21.00	117.20	3.81	3.85	3.8	3.85	2.78	0.00	0.00	0.00
<a href="#">7</a>	0.00	117.20	0	3.83	3.7	3.83	2.78	0.00	0.00	0.00
<a href="#">8</a>	-226.80	-109.60	3.83	3.87	3.8	3.87	2.78	0.00	0.00	0.00
<a href="#">9</a>	1.00	-108.60	3.86	3.88	3.9	3.88	2.78	0.00	0.00	0.00
<a href="#">10</a>	0.00	-108.60	3.83	3.86	3.8	3.86	2.78	0.00	0.00	0.00
<a href="#">11</a>	0.00	-108.60	3.81	3.83	3.8	3.83	2.78	0.00	0.00	0.00
<a href="#">12</a>	10.60	-98.00	3.79	3.81	3.8	3.81	2.78	0.00	0.00	0.00
<a href="#">13</a>	21.00	-77.00	3.79	3.85	3.8	3.85	2.78	0.00	0.00	0.00
<a href="#">14</a>	0.00	-77.00	3.84	3.85	3.8	3.85	2.78	0.00	0.00	0.00
<a href="#">15</a>	6.40	-70.60	3.84	3.87	3.8	3.87	2.78	0.00	0.00	0.00
<a href="#">16</a>	0.00	-70.60	3.87	3.93	3.9	3.93	2.78	0.00	0.00	0.00
<a href="#">17</a>	6.80	-63.80	3.92	4	4.0	4	2.78	0.00	0.00	0.00
<a href="#">18</a>	0.20	-63.60	4	4.02	4.0	4.02	2.78	0.00	0.00	0.00
<a href="#">19</a>	0.00	-63.60	3.99	4.02	4.0	4.02	2.78	0.00	0.00	0.00
<a href="#">20</a>	0.00	-63.60	3.98	4	4.0	4	2.78	0.00	0.00	0.00
<a href="#">21</a>	0.00	-63.60	3.95	3.98	4.0	3.98	2.78	0.00	0.00	0.00
<a href="#">22</a>	0.00	-63.60	3.91	3.95	3.9	3.95	2.78	0.00	0.00	0.00
<a href="#">23</a>	0.00	-63.60	3.9	3.93	3.9	3.93	2.78	0.00	0.00	0.00
<a href="#">24</a>	1.00	-62.60	3.93	4	4.0	4	2.78	0.00	0.00	0.00
<a href="#">25</a>	73.80	11.20	4	4.1	4.0	4.1	2.78	0.00	0.00	0.00
<a href="#">26</a>	4.40	15.60	4.04	4.1	4.1	4.1	2.78	0.00	0.00	0.00
<a href="#">27</a>	33.60	49.20	4.03	4.1	4.1	4.1	2.78	0.00	0.00	0.00
<a href="#">28</a>	37.40	86.60	4.09	4.16	4.1	4.16	2.78	0.00	0.00	0.00
<a href="#">29</a>	0.00	86.60	4.13	4.16	4.1	4.16	2.78	0.00	0.00	0.00
<a href="#">30</a>	19.60	106.20	4.12	4.14	4.1	4.14	2.78	0.00	0.00	0.00



Palmeiras de Goiás - Estação Palmeiras de Goiás - Novembro de 2019

[Para ver os dados horários clique no dia desejado](#)

Dia	Precip.	Prec. Acum.	Vel. Vent. (m/s)	Dir. Vent.	Umid. Relat. AR (Max) %	Umid. Relat. AR (Min) %	Umid. Relat. AR (Média)%	Temp. Max. °C Dia	Temp. Min. °C Dia	Temp. Med. °C do Ar	Temp. 09:00h	Temp. 21:00h	Ponto orvalho	Razao Mistura	Radiação Solar Diária MJ/m²
1	0.00	0.00	2.5	S	96.0	34.0	60	35.3	21.3	26.9	27.7	25.1	-	-	21.8
2	0.00	0.00	2.9	SO	96.0	34.0	50.5	34.3	20.5	27.78	27.9	28.1	-	-	-
3	1.20	1.20	2.3	SO	90.0	48.0	69.7	30.1	22.0	25.66	26.8	24.7	-	-	-
4	0.00	1.20	3.0	S	90.0	32.0	57.2	34.6	22.8	27.72	29	26.1	-	-	-
5	14.80	16.00	2.4	SO	100.0	32.0	76.2	35.4	22.3	25.94	27.2	22.4	-	-	-
6	0.20	16.20	1.1	S	100.0	43.0	80.5	32.6	21.2	25.22	23.3	24.5	-	-	-
7	0.00	16.20	1.8	S	100.0	40.0	62.7	34.1	20.9	27.08	27	26.7	-	-	-
8	0.00	16.20	2.8	SO	100.0	48.0	63	32.6	21.6	26.48	24.4	26.9	-	-	-
9	39.60	55.80	1.8	S	100.0	35.0	74	34.7	19.8	24.94	29.6	20.3	-	-	-
10	0.20	56.00	2.3	S	100.0	39.0	66	33.9	19.8	26.32	24.9	26.5	-	-	-
11	18.00	74.00	2.2	S	100.0	31.0	75	35.9	22.2	26.22	28	22.5	-	-	-
12	1.40	75.40	1.8	SO	100.0	41.0	71.2	34.6	21.5	26.02	24.8	24.6	-	-	-
13	0.00	75.40	0.9	S	100.0	36.0	55	34.4	22.0	27.94	26.7	28.3	-	-	-
14	0.00	75.40	1.1	S	92.0	35.0	52.2	34.7	22.3	28.48	28.2	28.6	-	-	-
15	24.20	99.60	2.7	L	100.0	47.0	84.2	31.8	21.0	24.7	27.7	21.5	-	-	-
16	0.20	99.80	1.1	L	100.0	52.0	80.2	30.3	21.2	25.1	23.4	25.3	-	-	-
17	9.40	109.20	1.3	L	100.0	57.0	74.5	30.7	20.8	25.22	25.8	24.4	-	-	-
18	2.20	111.40	1.4	SO	100.0	54.0	92.5	30.1	21.4	24.12	25.7	21.7	-	-	-
19	0.20	111.60	0.6	O	100.0	56.0	90	29.5	20.6	23.84	24.5	22.3	-	-	-
20	1.80	113.40	1.1	SO	100.0	41.0	92	31.9	21.1	24.68	26.4	22	-	-	-
21	0.20	113.60	1.2	S	100.0	42.0	64.2	32.0	20.3	25.58	25.4	25.1	-	-	-
22	18.40	132.00	1.9	S	100.0	54.0	73.7	30.0	19.3	24.96	25.3	25.1	-	-	-
23	2.40	134.40	3.4	O	100.0	47.0	87	32.9	22.6	25.98	27.8	23.3	-	-	-
24	2.20	136.60	1.7	S	100.0	46.0	86	32.8	21.8	24.94	26.1	22	-	-	-
25	3.40	140.00	1.5	SO	100.0	59.0	88.7	31.0	20.0	24.36	25.4	22.7	-	-	-
26	0.00	140.00	0.8	O	100.0	59.0	72.5	30.8	21.1	25.76	26.5	25.2	-	-	-
27	5.80	145.80	1.3	L	100.0	77.0	93.5	27.7	21.8	24.7	26.2	23.9	-	-	-
28	9.80	155.60	0.9	S	100.0	58.0	81.5	29.2	20.6	24.92	25	24.9	-	-	-
29	2.40	158.00	1.9	O	100.0	63.0	89.7	30.8	22.0	24.96	24.6	23.7	-	-	-
30	1.40	159.40	0.7	L	100.0	76.0	98.5	28.4	22.6	24.52	26.2	22.7	-	-	-

Parauna - Estação Estação Hidro Ponte Rodagem - GO - ANA - Novembro de 2019

[Para ver os dados horários clique no dia desejado](#)

Dia	Precip.	Prec. Acum.	Sensor Pressão min	Sensor Pressão max	Sensor Pressão media	Nível Régua	CodifEixo	Vazão min (m3/s)	Vazão max (m3/s)	Vazão media (m3/s)
1	0.00	0.00	0.57	1.17	0.8	1.17	42.69	0.00	0.00	0.00
2	0.00	0.00	0.6	1.01	0.7	1.01	42.69	0.00	0.00	0.00
3	0.00	0.00	0.59	1.06	0.7	1.06	42.69	0.00	0.00	0.00
4	0.00	0.00	0.61	1.2	0.8	1.2	42.69	0.00	0.00	0.00
5	1.80	1.80	0.65	1.15	0.8	1.15	42.69	0.00	0.00	0.00
6	9.40	11.20	0.66	1.07	0.8	1.07	42.69	0.00	0.00	0.00
7	0.40	11.60	0.63	1.12	0.8	1.12	42.69	0.00	0.00	0.00
8	6.60	18.20	0.71	1.34	0.8	1.34	42.69	0.00	0.00	0.00
9	13.20	31.40	0.68	1.26	0.8	1.26	42.69	0.00	0.00	0.00
10	0.20	31.60	0.65	1.28	0.8	1.28	42.69	0.00	0.00	0.00
11	8.60	40.20	0.7	1.33	0.8	1.33	42.69	0.00	0.00	0.00
12	0.20	40.40	0.68	1.23	0.8	1.23	42.69	0.00	0.00	0.00
13	0.00	40.40	0.68	1.17	0.8	1.17	42.69	0.00	0.00	0.00
14	3.00	43.40	0.66	1.09	0.8	1.09	42.69	0.00	0.00	0.00
15	2.00	45.40	0	1.18	0.8	1.18	42.99	0.00	0.00	0.00
16	-89.20	-43.80	0.89	1.33	1.1	1.33	42.99	0.00	0.00	0.00
17	4.40	-39.40	0.92	1.36	1.1	1.36	42.99	0.00	0.00	0.00
18	49.80	10.40	0.92	1.26	1.1	1.26	42.99	0.00	0.00	0.00
19	3.80	14.20	0.91	1.41	1.1	1.41	42.99	0.00	0.00	0.00
20	0.20	14.40	0.9	1.55	1.1	1.55	42.99	0.00	0.00	0.00
21	0.00	14.40	0.93	1.46	1.1	1.46	42.99	0.00	0.00	0.00
22	0.00	14.40	0.91	1.29	1.1	1.29	42.99	0.00	0.00	0.00
23	4.40	18.80	0.95	1.53	1.1	1.53	42.99	0.00	0.00	0.00
24	12.40	31.20	1	1.58	1.1	1.58	42.99	0.00	0.00	0.00
25	8.40	39.60	1	1.49	1.1	1.49	42.99	0.00	0.00	0.00
26	0.20	39.80	1	1.56	1.2	1.56	42.99	0.00	0.00	0.00
27	9.00	48.80	1.03	1.45	1.2	1.45	42.99	0.00	0.00	0.00
28	6.40	55.20	1.04	1.47	1.2	1.47	42.99	0.00	0.00	0.00
29	7.60	62.80	1.06	1.65	1.2	1.65	42.99	0.00	0.00	0.00
30	1.20	64.00	1.06	1.56	1.2	1.56	42.99	0.00	0.00	0.00

## Anapolis - Estação Estação Hidro Ribeirão Antas - GO - ANA - Novembro de 2019

Para ver os dados horários clique no dia desejado

Dia	Precip.	Prec.Acum.	Sensor Pressão min	Sensor Pressão max	Sensor Pressão media	Nível Régua	CodifEixo	Vazão min (m3/s)	Vazão max (m3/s)	Vazão media (m3/s)
<a href="#">1</a>	0.00	0.00	0.29	0.31	0.3	-	-	0.00	0.00	0.00
<a href="#">2</a>	0.40	0.40	0.29	0.71	0.3	-	-	0.00	0.00	0.00
<a href="#">3</a>	0.20	0.60	0.29	0.35	0.3	-	-	0.00	0.00	0.00
<a href="#">4</a>	3.00	3.60	0.29	1.07	0.4	-	-	0.00	0.00	0.00
<a href="#">5</a>	0.20	3.80	0.3	0.38	0.3	-	-	0.00	0.00	0.00
<a href="#">6</a>	0.00	3.80	0.29	0.31	0.3	-	-	0.00	0.00	0.00
<a href="#">7</a>	0.00	3.80	0.29	0.31	0.3	-	-	0.00	0.00	0.00
<a href="#">8</a>	0.00	3.80	0.29	0.31	0.3	-	-	0.00	0.00	0.00
<a href="#">9</a>	0.00	3.80	0.29	0.31	0.3	-	-	0.00	0.00	0.00
<a href="#">10</a>	14.60	18.40	0.29	1.27	0.4	-	-	0.00	0.00	0.00
<a href="#">11</a>	0.00	18.40	0.29	0.32	0.3	-	-	0.00	0.00	0.00
<a href="#">12</a>	0.00	18.40	0.29	0.31	0.3	-	-	0.00	0.00	0.00
<a href="#">13</a>	0.00	18.40	0.29	0.31	0.3	-	-	0.00	0.00	0.00
<a href="#">14</a>	58.40	76.80	0.28	1.47	0.5	-	-	0.00	0.00	0.00
<a href="#">15</a>	5.20	82.00	0.31	0.9	0.4	-	-	0.00	0.00	0.00
<a href="#">16</a>	0.40	82.40	0.3	0.39	0.3	-	-	0.00	0.00	0.00
<a href="#">17</a>	1.20	83.60	0.3	0.33	0.3	-	-	0.00	0.00	0.00
<a href="#">18</a>	13.00	96.60	0.3	0.56	0.3	-	-	0.00	0.00	0.00
<a href="#">19</a>	3.40	100.00	0.31	0.34	0.3	-	-	0.00	0.00	0.00
<a href="#">20</a>	31.60	131.60	0.3	1	0.3	-	-	0.00	0.00	0.00
<a href="#">21</a>	3.20	134.80	0.3	0.69	0.3	-	-	0.00	0.00	0.00
<a href="#">22</a>	0.20	135.00	0.3	0.32	0.3	-	-	0.00	0.00	0.00
<a href="#">23</a>	4.60	139.60	0.3	0.43	0.3	-	-	0.00	0.00	0.00
<a href="#">24</a>	2.60	142.20	0.3	0.41	0.3	-	-	0.00	0.00	0.00
<a href="#">25</a>	1.60	143.80	0.31	0.98	0.4	-	-	0.00	0.00	0.00
<a href="#">26</a>	27.40	171.20	0.31	1.41	0.4	-	-	0.00	0.00	0.00
<a href="#">27</a>	11.20	182.40	0.32	0.85	0.4	-	-	0.00	0.00	0.00
<a href="#">28</a>	0.00	182.40	0.31	0.33	0.3	-	-	0.00	0.00	0.00
<a href="#">29</a>	3.20	185.60	0.31	0.39	0.3	-	-	0.00	0.00	0.00
<a href="#">30</a>	8.20	193.80	0.31	0.94	0.4	-	-	0.00	0.00	0.00

## Pirenópolis - Estação Estação Hidro Rio das Almas Montante - GO - ANA - Novembro de 2019

Para ver os dados horários clique no dia desejado

Dia	Precip.	Prec.Acum.	Sensor Pressão min	Sensor Pressão max	Sensor Pressão media	Nível Régua	CodifEixo	Vazão min (m3/s)	Vazão max (m3/s)	Vazão media (m3/s)
<a href="#">1</a>	0.00	0.00	0	0	0.0	-	-	0.00	0.00	0.00
<a href="#">2</a>	3.40	3.40	0	0	0.0	-	-	0.00	0.00	0.00
<a href="#">3</a>	0.20	3.60	0	0	0.0	-	-	0.00	0.00	0.00
<a href="#">4</a>	0.00	3.60	0	0	0.0	-	-	0.00	0.00	0.00
<a href="#">5</a>	0.00	3.60	0	0.23	0.1	-	-	0.00	0.00	0.00
<a href="#">6</a>	3.60	7.20	0.2	0.24	0.2	-	-	0.00	0.00	0.00
<a href="#">7</a>	0.00	7.20	0.21	0.25	0.2	-	-	0.00	0.00	0.00
<a href="#">8</a>	0.00	7.20	0.21	0.25	0.2	-	-	0.00	0.00	0.00
<a href="#">9</a>	0.00	7.20	0.21	0.25	0.2	-	-	0.00	0.00	0.00
<a href="#">10</a>	0.00	7.20	0.22	0.27	0.2	-	-	0.00	0.00	0.00
<a href="#">11</a>	2.40	9.60	0.23	0.27	0.3	-	-	0.00	0.00	0.00
<a href="#">12</a>	0.20	9.80	0.22	0.27	0.3	-	-	0.00	0.00	0.00
<a href="#">13</a>	0.00	9.80	0.21	0.25	0.2	-	-	0.00	0.00	0.00
<a href="#">14</a>	7.00	16.80	0	0.23	0.1	-	-	0.00	0.00	0.00
<a href="#">15</a>	2.80	19.60	0	0.04	0.0	-	-	0.00	0.00	0.00
<a href="#">16</a>	0.20	19.80	0	0.06	0.0	-	-	0.00	0.00	0.00
<a href="#">17</a>	0.00	19.80	0	0	0.0	-	-	0.00	0.00	0.00
<a href="#">18</a>	15.60	35.40	0	0	0.0	-	-	0.00	0.00	0.00
<a href="#">19</a>	15.40	50.80	0	0.22	0.1	-	-	0.00	0.00	0.00
<a href="#">20</a>	2.20	53.00	0	0.22	0.1	-	-	0.00	0.00	0.00
<a href="#">21</a>	10.00	63.00	0	0.04	0.0	-	-	0.00	0.00	0.00
<a href="#">22</a>	3.20	66.20	0	0	0.0	-	-	0.00	0.00	0.00
<a href="#">23</a>	0.00	66.20	0	0	0.0	-	-	0.00	0.00	0.00
<a href="#">24</a>	0.00	66.20	0	0	0.0	-	-	0.00	0.00	0.00
<a href="#">25</a>	34.80	101.00	0	0	0.0	-	-	0.00	0.00	0.00
<a href="#">26</a>	0.20	101.20	0	0	0.0	-	-	0.00	0.00	0.00
<a href="#">27</a>	1.80	103.00	0	0	0.0	-	-	0.00	0.00	0.00
<a href="#">28</a>	5.60	108.60	0	0	0.0	-	-	0.00	0.00	0.00
<a href="#">29</a>	2.20	110.80	0	0	0.0	-	-	0.00	0.00	0.00
<a href="#">30</a>	0.00	110.80	0	0	0.0	-	-	0.00	0.00	0.00

Santa Isabel - Estação Usina Codora - Santa Isabel - Novembro de 2019

Para ver os dados horários clique no dia desejado

Dia	Precip.	Prec.Acum.	Vel. Vent. (m/s)	Dir. Vent.	Umid. Relat. AR (Max) %	Umid. Relat. AR (Min) %	Umid. Relat. AR (Média)%	Temp. Max. °C Dia	Temp. Min. °C Dia	Temp. Med. °C do Ar	Temp. 09:00h	Temp. 21:00h	Ponto orvalho	Razao Mistura	Radiação Solar Diária MJ/m²
<a href="#">1</a>	0.00	0.00	2.0	SO	77.0	26.0	47.7	35.8	21.0	27.42	29.1	25.6	-	-	17.4
<a href="#">2</a>	0.00	0.00	2.7	SO	73.0	33.0	48	34.7	22.9	28.3	29.3	27.3	-	-	16.7
<a href="#">3</a>	12.40	12.40	2.5	L	98.0	41.0	61.7	31.1	20.2	25.16	24.5	25	-	-	17
<a href="#">4</a>	9.40	21.80	2.7	SO	97.0	37.0	79.2	33.7	20.2	25.14	28.6	21.6	-	-	17.6
<a href="#">5</a>	21.80	43.60	1.8	S	100.0	35.0	80.2	34.5	20.6	25.28	26.5	22.4	-	-	16.7
<a href="#">6</a>	0.00	43.60	1.9	L	100.0	38.0	67.5	33.3	21.0	25.66	23	25.5	-	-	16.1
<a href="#">7</a>	0.00	43.60	2.3	SO	90.0	47.0	68.7	32.2	22.0	26.48	28.6	24.8	-	-	16.4
<a href="#">8</a>	0.00	43.60	3.2	SO	93.0	43.0	57.5	32.8	21.8	27.4	26.8	27.8	-	-	19.7
<a href="#">9</a>	0.00	43.60	2.9	S	88.0	34.0	56.2	35.6	20.3	26.62	30	23.6	-	-	20
<a href="#">10</a>	0.00	43.60	2.0	SO	92.0	38.0	65	34.0	20.7	26.36	29.5	23.8	-	-	17.3
<a href="#">11</a>	0.00	43.60	2.4	SO	77.0	31.0	53.7	35.6	22.3	27.56	29.3	25.3	-	-	16.5
<a href="#">12</a>	0.00	43.60	2.2	SO	82.0	26.0	-	36.2	22.4	29.4	30.6	28.9	-	-	17.9
<a href="#">13</a>	0.00	43.60	2.7	SO	81.0	32.0	-	33.7	23.1	28.12	30.6	26.6	-	-	21
<a href="#">14</a>	37.80	81.40	2.5	SO	100.0	32.0	59.2	35.3	19.8	26.76	29.5	24.6	-	-	21.8
<a href="#">15</a>	0.00	81.40	2.3	NO	88.0	36.0	55.5	34.8	22.4	27.9	29.1	26.6	-	-	20.8
<a href="#">16</a>	0.00	81.40	1.4	SO	94.0	44.0	57.5	31.6	21.5	26.82	27.4	26.8	-	-	14.5
<a href="#">17</a>	29.00	110.40	2.0	L	100.0	60.0	76	28.3	21.0	24.2	22.1	24.8	-	-	8.9
<a href="#">18</a>	0.80	111.20	2.2	S	98.0	48.0	67.7	30.9	20.6	25.04	23.1	25.3	-	-	16.9
<a href="#">19</a>	0.20	111.40	1.9	SO	90.0	45.0	70.7	32.2	22.4	25.94	28.1	23.5	-	-	14.8
<a href="#">20</a>	0.00	111.40	1.9	N	96.0	49.0	64.7	30.0	20.9	24.9	25.6	24	-	-	10
<a href="#">21</a>	0.00	111.40	2.3	SE	87.0	36.0	62.7	32.0	21.7	25.68	27.1	23.8	-	-	19.3
<a href="#">22</a>	0.00	111.40	1.7	SO	99.0	45.0	63	31.0	21.0	25.4	24.8	25.1	-	-	14.8
<a href="#">23</a>	0.00	111.40	1.5	SO	88.0	45.0	61.7	31.3	22.4	26.58	26	26.6	-	-	9.6
<a href="#">24</a>	0.00	111.40	1.8	S	89.0	50.0	75.7	30.5	22.3	25.38	26.9	23.6	-	-	11.2
<a href="#">25</a>	2.40	113.80	2.0	SO	97.0	43.0	74.2	32.8	20.4	24.58	26.9	21.4	-	-	15.8
<a href="#">26</a>	12.60	126.40	1.8	L	100.0	47.0	86.7	31.5	20.4	24.78	25.8	23.1	-	-	14.7
<a href="#">27</a>	4.00	130.40	2.4	L	100.0	56.0	84.2	28.6	20.3	23.52	22.1	23.3	-	-	14.8
<a href="#">28</a>	9.40	139.80	2.4	L	100.0	74.0	88.5	25.9	20.9	23.14	22.3	23.3	-	-	8.9
<a href="#">29</a>	3.00	142.80	1.9	NO	100.0	51.0	73.7	32.1	20.7	25.7	25.5	25.1	-	-	21.9
<a href="#">30</a>	0.00	142.80	2.1	L	98.0	46.0	80.7	33.0	21.9	25.8	27.9	23.1	-	-	15.5

Aparecida de Goiânia - Estação Estação Hidro Rib. Sto. Antônio - GO - ANA - Novembro de 2019

Para ver os dados horários clique no dia desejado

Dia	Precip.	Prec.Acum.	Sensor Pressão min	Sensor Pressão max	Sensor Pressão media	Nível Régua	CodifEixo	Vazão min (m3/s)	Vazão max (m3/s)	Vazão media (m3/s)
<a href="#">1</a>	2.00	2.00	0.54	1	0.6	-	-	0.00	0.00	0.00
<a href="#">2</a>	0.60	2.60	0.52	0.81	0.6	-	-	0.00	0.00	0.00
<a href="#">3</a>	0.00	2.60	0.51	0.54	0.5	-	-	0.00	0.00	0.00
<a href="#">4</a>	0.00	2.60	0.51	0.92	0.6	-	-	0.00	0.00	0.00
<a href="#">5</a>	0.20	2.80	0.54	0.69	0.6	-	-	0.00	0.00	0.00
<a href="#">6</a>	0.00	2.80	0.53	0.56	0.5	-	-	0.00	0.00	0.00
<a href="#">7</a>	0.00	2.80	0.53	0.55	0.5	-	-	0.00	0.00	0.00
<a href="#">8</a>	0.00	2.80	0.53	0.55	0.5	-	-	0.00	0.00	0.00
<a href="#">9</a>	0.20	3.00	0.53	0.57	0.5	-	-	0.00	0.00	0.00
<a href="#">10</a>	0.20	3.20	0.52	0.57	0.5	-	-	0.00	0.00	0.00
<a href="#">11</a>	0.00	3.20	0.53	0.71	0.6	-	-	0.00	0.00	0.00
<a href="#">12</a>	0.00	3.20	0.52	0.56	0.5	-	-	0.00	0.00	0.00
<a href="#">13</a>	0.00	3.20	0.52	0.56	0.5	-	-	0.00	0.00	0.00
<a href="#">14</a>	0.00	3.20	0.52	0.55	0.5	-	-	0.00	0.00	0.00
<a href="#">15</a>	12.80	16.00	0.52	1.52	0.6	-	-	0.00	0.00	0.00
<a href="#">16</a>	0.40	16.40	0.65	0.78	0.7	-	-	0.00	0.00	0.00
<a href="#">17</a>	0.00	16.40	0.65	0.67	0.7	-	-	0.00	0.00	0.00
<a href="#">18</a>	28.00	44.40	0.64	4.55	1.0	-	-	0.00	0.00	0.00
<a href="#">19</a>	5.20	49.60	0.73	0.92	0.8	-	-	0.00	0.00	0.00
<a href="#">20</a>	0.40	50.00	0.66	0.72	0.7	-	-	0.00	0.00	0.00
<a href="#">21</a>	0.00	50.00	0.64	0.68	0.7	-	-	0.00	0.00	0.00
<a href="#">22</a>	2.40	52.40	0.64	0.75	0.7	-	-	0.00	0.00	0.00
<a href="#">23</a>	2.00	54.40	0.64	0.88	0.7	-	-	0.00	0.00	0.00
<a href="#">24</a>	39.60	94.00	0.64	3.3	0.9	-	-	0.00	0.00	0.00
<a href="#">25</a>	8.60	102.60	0.74	1.86	0.8	-	-	0.00	0.00	0.00
<a href="#">26</a>	1.20	103.80	0.7	0.82	0.7	-	-	0.00	0.00	0.00
<a href="#">27</a>	16.80	120.60	0.68	0.95	0.8	-	-	0.00	0.00	0.00
<a href="#">28</a>	7.20	127.80	0.66	1.4	0.8	-	-	0.00	0.00	0.00
<a href="#">29</a>	0.40	128.20	0.66	0.87	0.7	-	-	0.00	0.00	0.00
<a href="#">30</a>	1.80	130.00	0.67	0.92	0.7	-	-	0.00	0.00	0.00

## Morrinhos - Estação Usina CEM - Morrinhos - Novembro de 2019

Para ver os dados horários clique no dia desejado

Dia	Precip.	Prec.Acum.	Vel. Vent. (m/s)	Dir. Vent.	Umid. Relat. AR (Max) %	Umid. Relat. AR (Min) %	Umid. Relat. AR (Média)%	Temp. Max. °C Dia	Temp. Min. °C Dia	Temp. Med. °C do Ar	Temp. 09:00h	Temp. 21:00h	Ponto orvalho	Razao Mistura	Radiação Solar Diária MJ/m²
<a href="#">1</a>	9.40	9.40	3.2	L	94.0	43.0	65	31.3	20.2	24.96	28.3	22.5	-	-	14.4
<a href="#">2</a>	0.00	9.40	2.1	L	89.0	43.0	61	31.6	19.3	25.26	24.8	25.3	-	-	20.7
<a href="#">3</a>	0.80	10.20	4.1	L	91.0	50.0	75.2	30.1	20.8	24.1	25.4	22.1	-	-	20
<a href="#">4</a>	0.00	10.20	2.7	N	94.0	49.0	66.7	30.5	20.7	25.3	28.3	23.5	-	-	14.4
<a href="#">5</a>	0.00	10.20	3.1	N	91.0	41.0	71.5	32.5	21.0	25.36	26.3	23.5	-	-	18
<a href="#">6</a>	0.00	10.20	2.5	N	100.0	54.0	77.5	30.9	21.0	24.84	26.1	23.1	-	-	19.4
<a href="#">7</a>	0.00	10.20	2.6	L	100.0	40.0	61.7	32.5	20.0	25.66	26	24.9	-	-	18.6
<a href="#">8</a>	0.00	10.20	2.9	S	100.0	53.0	69	30.5	19.9	24.2	22.6	24	-	-	15.6
<a href="#">9</a>	13.20	23.40	3.2	L	100.0	37.0	64.7	33.1	20.2	24.86	27.6	21.7	-	-	17.7
<a href="#">10</a>	6.80	30.20	2.2	S	100.0	55.0	85	30.9	19.4	23.46	24.6	21.2	-	-	16.6
<a href="#">11</a>	17.60	47.80	2.6	S	93.0	39.0	63.2	33.1	19.8	25.44	25.1	24.6	-	-	18.7
<a href="#">12</a>	1.00	48.80	2.5	S	96.0	42.0	61	33.3	21.0	26.68	24.9	27.1	-	-	22.8
<a href="#">13</a>	0.00	48.80	4.3	L	77.0	37.0	48	32.3	21.6	27.32	26.1	28.3	-	-	20.1
<a href="#">14</a>	4.20	53.00	2.1	S	100.0	55.0	86.2	29.8	20.4	24.06	27.1	21.5	-	-	14.3
<a href="#">15</a>	18.60	71.60	2.1	O	100.0	61.0	92	27.9	19.5	22.24	23.8	20	-	-	11.9
<a href="#">16</a>	0.00	71.60	2.3	L	100.0	74.0	85	26.4	19.3	22.86	22.6	23	-	-	13
<a href="#">17</a>	0.60	72.20	2.5	N	100.0	47.0	75.2	31.1	19.6	24.42	26.6	22.4	-	-	17.8
<a href="#">18</a>	11.40	83.60	4.1	N	100.0	69.0	94.2	25.8	19.8	21.76	22.6	20.3	-	-	11.4
<a href="#">19</a>	3.00	86.60	2.8	L	100.0	59.0	90.5	28.3	19.0	21.66	22.6	19.2	-	-	14.1
<a href="#">20</a>	0.00	86.60	3.1	L	100.0	55.0	79.2	29.3	18.8	22.98	24.8	21	-	-	20.5
<a href="#">21</a>	0.00	86.60	2.6	L	100.0	51.0	69.5	29.8	19.1	24.32	24.5	24.1	-	-	18.7
<a href="#">22</a>	33.00	119.60	4.1	L	100.0	63.0	89.7	28.0	17.5	22.8	23.3	22.6	-	-	16.9
<a href="#">23</a>	3.00	122.60	3.1	N	100.0	64.0	83.5	27.5	20.3	23.64	25.4	22.5	-	-	14.9
<a href="#">24</a>	0.00	122.60	3.3	N	100.0	59.0	84	28.5	19.6	23.1	24.4	21.5	-	-	14.3
<a href="#">25</a>	23.20	145.80	2.6	N	100.0	57.0	86	30.1	19.4	23.78	26.4	21.5	-	-	16.1
<a href="#">26</a>	0.40	146.20	3.0	L	100.0	63.0	87.7	28.6	20.2	24.18	24.9	23.6	-	-	16.9
<a href="#">27</a>	4.80	151.00	3.7	N	100.0	79.0	100	26.6	20.2	22.32	22.4	21.2	-	-	10.1
<a href="#">28</a>	0.80	151.80	3.0	N	100.0	72.0	91.7	28.1	20.3	23.16	23.6	21.9	-	-	15
<a href="#">29</a>	2.00	153.80	2.6	L	100.0	78.0	94.5	27.1	21.1	23.26	23.3	22.4	-	-	12.6
<a href="#">30</a>	1.20	155.00	3.5	N	100.0	65.0	92.7	28.4	20.4	23.12	22.8	22	-	-	11.2

## Bom Jesus de Goiás - Estação Usina Goiás - Bom Jesus de Goiás - Novembro de 2019

Para ver os dados horários clique no dia desejado

Dia	Precip.	Prec.Acum.	Vel. Vent. (m/s)	Dir. Vent.	Umid. Relat. AR (Max) %	Umid. Relat. AR (Min) %	Umid. Relat. AR (Média)%	Temp. Max. °C Dia	Temp. Min. °C Dia	Temp. Med. °C do Ar	Temp. 09:00h	Temp. 21:00h	Ponto orvalho	Razao Mistura	Radiação Solar Diária MJ/m²
<a href="#">1</a>	0.00	0.00	3.4	L	78.0	35.0	61.7	33.1	21.9	25.92	29	22.8	-	-	14.9
<a href="#">2</a>	0.00	0.00	2.7	L	90.0	30.0	50.2	33.8	19.8	26.76	25.6	27.3	-	-	19.9
<a href="#">3</a>	11.00	11.00	4.8	L	100.0	39.0	66.2	31.5	18.9	24.44	28	21.9	-	-	16.8
<a href="#">4</a>	0.00	11.00	2.8	L	84.0	40.0	63.2	32.7	22.1	26.28	26.4	25.1	-	-	19.5
<a href="#">5</a>	0.00	11.00	3.1	L	82.0	35.0	59	33.6	21.8	26.76	28.6	24.9	-	-	17.3
<a href="#">6</a>	0.20	11.20	3.0	S	90.0	50.0	73	31.1	21.8	24.82	26.6	22.3	-	-	17.5
<a href="#">7</a>	0.20	11.40	2.7	S	100.0	35.0	63.5	33.8	20.5	26.12	27.1	24.6	-	-	17.2
<a href="#">8</a>	0.00	11.40	3.2	S	100.0	42.0	66.7	29.9	19.5	23.62	21.7	23.5	-	-	13.2
<a href="#">9</a>	8.20	19.60	3.8	SE	97.0	37.0	73.7	33.0	21.1	25.42	28	22.5	-	-	13.1
<a href="#">10</a>	1.80	21.40	3.0	S	100.0	41.0	64.5	32.1	19.7	25.06	24.3	24.6	-	-	18.2
<a href="#">11</a>	0.00	21.40	3.4	S	89.0	31.0	56.7	34.0	21.3	26.48	26.1	25.5	-	-	15.8
<a href="#">12</a>	0.00	21.40	3.5	SO	93.0	36.0	54	33.1	21.6	27.58	26	28.6	-	-	19.5
<a href="#">13</a>	0.00	21.40	5.1	SE	71.0	33.0	49.7	33.2	24.6	27.82	29.1	26.1	-	-	17.4
<a href="#">14</a>	2.60	24.00	3.3	S	94.0	39.0	74	32.3	21.7	24.76	25.6	22.1	-	-	15.2
<a href="#">15</a>	7.80	31.80	2.3	O	100.0	53.0	91	29.1	19.8	22.8	25.5	19.8	-	-	10.2
<a href="#">16</a>	0.20	32.00	2.0	NO	100.0	45.0	69.7	30.9	19.6	24.16	23.1	23.6	-	-	16.8
<a href="#">17</a>	0.00	32.00	2.4	L	92.0	41.0	60.7	31.9	20.6	26.24	27.5	25.6	-	-	20
<a href="#">18</a>	5.00	37.00	3.4	N	95.0	60.0	83.2	27.8	20.9	23.18	24.6	21.3	-	-	12.4
<a href="#">19</a>	10.20	47.20	3.0	L	97.0	53.0	84.7	29.5	19.3	22.2	23.6	19.3	-	-	11.6
<a href="#">20</a>	0.00	47.20	2.8	L	91.0	45.0	67.5	30.4	19.5	24.12	26.1	22.3	-	-	16.9
<a href="#">21</a>	1.00	48.20	3.4	L	92.0	40.0	66.2	31.6	20.2	24.12	25.6	21.6	-	-	18.5
<a href="#">22</a>	10.60	58.80	4.5	L	98.0	57.0	78	28.6	17.1	23	24.1	22.6	-	-	17.2
<a href="#">23</a>	2.00	60.80	2.2	NO	86.0	48.0	71.7	30.4	21.9	25.56	26.9	24.3	-	-	15.3
<a href="#">24</a>	2.20	63.00	3.3	SO	99.0	56.0	75.7	29.1	20.8	23.42	23.6	21.8	-	-	11.9
<a href="#">25</a>	11.60	74.60	2.5	L	100.0	50.0	87.7	30.9	20.0	24.02	25.6	21.8	-	-	16
<a href="#">26</a>	0.00	74.60	2.8	L	100.0	53.0	77	29.9	21.0	24.72	25.1	23.8	-	-	14.3
<a href="#">27</a>	13.60	88.20	3.2	L	100.0	73.0	97.7	27.3	19.9	22.8	23.4	21.7	-	-	8.7
<a href="#">28</a>	30.60	118.80	2.3	NO	100.0	63.0	94	28.3	20.3	22.92	22.8	21.6	-	-	11.8
<a href="#">29</a>	21.00	139.80	1.8	NO	100.0	71.0	98.2	26.3	20.7	23.14	21.5	23.6	-	-	5.3
<a href="#">30</a>	0.60	140.40	2.6	N	100.0	69.0	85.7	26.8	20.4	23.06	24.1	22	-	-	10.9



Santa Helena de Goiás - Estação Usina Santa Helena - Santa Helena - Novembro de 2019

Para ver os dados horários clique no dia desejado

Dia	Precip.	Prec.Acum.	Vel. Vent. (m/s)	Dir. Vent.	Umid. Relat. AR (Max) %	Umid. Relat. AR (Min) %	Umid. Relat. AR (Média)%	Temp. Max. °C Dia	Temp. Min. °C Dia	Temp. Med. °C do Ar	Temp. 09:00h	Temp. 21:00h	Ponto orvalho	Razao Mistura	Radiação Solar Diária MJ/m²
<a href="#">1</a>	3.40	3.40	1.5	NO	89.0	36.0	67.7	34.6	22.3	27.28	30.3	24.6	-	-	11.8
<a href="#">2</a>	0.20	3.60	1.3	L	99.0	27.0	57.7	36.0	20.6	27.26	26.9	26.4	-	-	18.4
<a href="#">3</a>	6.80	10.40	1.9	N	96.0	46.0	83	31.6	23.4	26.88	29.8	24.8	-	-	12.6
<a href="#">4</a>	0.00	10.40	1.3	N	100.0	32.0	47	34.7	21.9	28.58	29.1	28.6	-	-	14.3
<a href="#">5</a>	1.80	12.20	1.8	NO	100.0	39.0	84.5	34.2	21.9	26.68	29.1	24.1	-	-	10.2
<a href="#">6</a>	0.20	12.40	1.6	NO	100.0	45.0	75.7	33.6	23.0	26.54	26.9	24.6	-	-	15.6
<a href="#">7</a>	0.00	12.40	1.4	O	100.0	39.0	62	34.8	21.9	27.62	27.6	26.9	-	-	16.9
<a href="#">8</a>	20.80	33.20	1.5	SE	100.0	63.0	91	28.4	20.9	23.8	22.1	23.8	-	-	8.5
<a href="#">9</a>	30.80	64.00	1.5	N	100.0	39.0	73.7	34.3	20.1	25.44	28.6	22.1	-	-	15.7
<a href="#">10</a>	0.00	64.00	1.0	L	100.0	48.0	73.7	32.8	21.1	25.8	25.1	25	-	-	14.9
<a href="#">11</a>	4.60	68.60	1.9	SE	100.0	34.0	69.7	35.1	22.1	26.36	29	22.8	-	-	18.2
<a href="#">12</a>	1.00	69.60	1.4	O	98.0	63.0	83.7	30.1	22.0	25.66	24	26.1	-	-	6.1
<a href="#">13</a>	0.00	69.60	1.7	N	95.0	36.0	57	34.2	23.9	28.48	29.1	27.6	-	-	16.5
<a href="#">14</a>	0.00	69.60	1.1	SE	100.0	38.0	71.5	34.3	22.4	26.5	26.6	24.6	-	-	13.4
<a href="#">15</a>	28.20	97.80	1.3	N	100.0	53.0	92	30.6	20.7	24.24	28.1	20.9	-	-	7.8
<a href="#">16</a>	0.00	97.80	1.0	O	100.0	46.0	81	32.0	20.5	25.32	25.9	24.1	-	-	17.8
<a href="#">17</a>	0.00	97.80	1.3	N	100.0	42.0	62.2	32.2	20.7	26.58	27.8	26.1	-	-	18.6
<a href="#">18</a>	3.40	101.20	2.1	N	100.0	44.0	83	32.0	21.6	24.76	27	21.6	-	-	16.8
<a href="#">19</a>	0.20	101.40	1.4	N	100.0	50.0	79.7	31.1	21.6	24.98	25.6	23.3	-	-	11
<a href="#">20</a>	0.00	101.40	1.4	N	100.0	43.0	73.5	32.5	21.4	25.64	27.1	23.6	-	-	13.9
<a href="#">21</a>	0.40	101.80	1.2	SE	100.0	37.0	67	33.6	20.5	25.64	27.3	23.4	-	-	17.1
<a href="#">22</a>	0.00	101.80	1.5	N	100.0	43.0	74.5	32.2	20.4	25.3	25.3	24.3	-	-	16.1
<a href="#">23</a>	2.60	104.40	1.2	NO	99.0	47.0	82.2	31.8	22.0	26.38	29.3	24.4	-	-	9.3
<a href="#">24</a>	0.20	104.60	1.2	N	100.0	51.0	80.5	31.6	22.1	25.72	27.1	23.9	-	-	10.9
<a href="#">25</a>	0.00	104.60	1.3	O	100.0	59.0	92.5	31.3	21.7	25.58	27.1	23.9	-	-	8.6
<a href="#">26</a>	0.00	104.60	1.4	N	100.0	49.0	76.2	32.0	21.7	26.7	26.6	26.6	-	-	15.2
<a href="#">27</a>	33.80	138.40	2.2	N	100.0	56.0	85	31.6	22.1	25.48	28.1	22.8	-	-	13.1
<a href="#">28</a>	29.40	167.80	1.1	NO	100.0	67.0	100	29.8	21.7	24.06	23.6	22.6	-	-	7.9
<a href="#">29</a>	0.60	168.40	1.2	N	100.0	64.0	92	29.1	22.3	25.22	24.1	25.3	-	-	12.7
<a href="#">30</a>	8.00	176.40	1.7	N	100.0	52.0	89	32.5	21.8	24.88	25.3	22.4	-	-	9.9

Maurilândia - Estação Usina Vale do Verdão - Maurilândia - Novembro de 2019

Para ver os dados horários clique no dia desejado

Dia	Precip.	Prec.Acum.	Vel. Vent. (m/s)	Dir. Vent.	Umid. Relat. AR (Max) %	Umid. Relat. AR (Min) %	Umid. Relat. AR (Média)%	Temp. Max. °C Dia	Temp. Min. °C Dia	Temp. Med. °C do Ar	Temp. 09:00h	Temp. 21:00h	Ponto orvalho	Razao Mistura	Radiação Solar Diária MJ/m²
<a href="#">1</a>	4.20	4.20	2.5	N	0.0	0.0	0	-10.0	-10.0	-10	-10	-10	-	-	14.9
<a href="#">2</a>	0.20	4.40	1.9	SE	0.0	0.0	0	-10.0	-10.0	-10	-10	-10	-	-	18.9
<a href="#">3</a>	0.00	4.40	2.8	O	0.0	0.0	0	-10.0	-10.0	-10	-10	-10	-	-	17.4
<a href="#">4</a>	0.00	4.40	1.9	NO	0.0	0.0	0	-10.0	-10.0	-10	-10	-10	-	-	17
<a href="#">5</a>	0.00	4.40	2.1	NO	0.0	0.0	0	-10.0	-10.0	-10	-10	-10	-	-	11.9
<a href="#">6</a>	0.40	4.80	2.3	NO	0.0	0.0	0	-10.0	-10.0	-10	-10	-10	-	-	17.6
<a href="#">7</a>	9.20	14.00	1.7	L	0.0	0.0	0	-10.0	-10.0	-10	-10	-10	-	-	16.9
<a href="#">8</a>	1.80	15.80	2.0	SE	0.0	0.0	0	-10.0	-10.0	-10	-10	-10	-	-	7.2
<a href="#">9</a>	14.20	30.00	2.0	SO	0.0	0.0	0	-10.0	-10.0	-10	-10	-10	-	-	15
<a href="#">10</a>	0.60	30.60	1.8	L	0.0	0.0	0	-10.0	-10.0	-10	-10	-10	-	-	16.8
<a href="#">11</a>	22.80	53.40	2.8	SE	0.0	0.0	0	-10.0	-10.0	-10	-10	-10	-	-	19.2
<a href="#">12</a>	0.00	53.40	3.1	S	0.0	0.0	0	-10.0	-10.0	-10	-10	-10	-	-	10.6
<a href="#">13</a>	0.00	53.40	3.0	S	0.0	0.0	0	-10.0	-10.0	-10	-10	-10	-	-	14.1
<a href="#">14</a>	2.00	55.40	2.1	S	0.0	0.0	0	-10.0	-10.0	-10	-10	-10	-	-	13.5
<a href="#">15</a>	14.00	69.40	1.5	S	0.0	0.0	0	-10.0	-10.0	-10	-10	-10	-	-	9.6
<a href="#">16</a>	1.20	70.60	1.3	O	0.0	0.0	0	-10.0	-10.0	-10	-10	-10	-	-	13.5
<a href="#">17</a>	0.00	70.60	2.0	NO	0.0	0.0	0	-10.0	-10.0	-10	-10	-10	-	-	17
<a href="#">18</a>	5.00	75.60	2.6	NO	0.0	0.0	0	-10.0	-10.0	-10	-10	-10	-	-	14.6
<a href="#">19</a>	0.00	75.60	1.5	NO	0.0	0.0	0	-10.0	-10.0	-10	-10	-10	-	-	12.9
<a href="#">20</a>	0.00	75.60	1.8	NO	0.0	0.0	0	-10.0	-10.0	-10	-10	-10	-	-	14.3
<a href="#">21</a>	18.80	94.40	2.0	L	0.0	0.0	0	-10.0	-10.0	-10	-10	-10	-	-	16
<a href="#">22</a>	3.20	97.60	1.9	NO	1.0	0.0	0	-10.0	-10.0	-10	-10	-10	-	-	15.4
<a href="#">23</a>	0.00	97.60	1.9	NO	4.0	0.0	0.5	-10.0	-10.0	-10	-10	-10	-	-	14.3
<a href="#">24</a>	3.60	101.20	2.0	S	4.0	0.0	1.2	-10.0	-10.0	-10	-10	-10	-	-	7.8
<a href="#">25</a>	0.40	101.60	1.6	NO	2.0	0.0	0.2	-10.0	-10.0	-10	-10	-10	-	-	11.4
<a href="#">26</a>	2.20	103.80	1.6	NO	2.0	0.0	0.5	-10.0	-10.0	-10	-10	-10	-	-	13.1
<a href="#">27</a>	56.20	160.00	2.5	N	1.0	0.0	0	-10.0	-10.0	-10	-10	-10	-	-	7.7
<a href="#">28</a>	10.20	170.20	1.4	NO	4.0	0.0	2	-10.0	-10.0	-10	-10	-10	-	-	10.5
<a href="#">29</a>	9.60	179.80	1.2	NO	4.0	0.0	1.5	-10.0	-10.0	-10	-10	-10	-	-	9.8
<a href="#">30</a>	45.20	225.00	2.2	NO	5.0	0.0	1.7	-10.0	-10.0	-10	-10	-10	-	-	9.4

## NOTÍCIAS RELACIONADAS

<https://g1.globo.com/go/goias/transito/noticia/2019/11/29/asfalto-cede-durante-chuva-e-engole-carros-na-go-206-em-itaruma.ghtml>

# Asfalto cede durante chuva e 'engole' carros na GO-206, em Itarumã

Motoristas tiveram apenas escuriações. Pista está interditada nos dois sentidos.

Por Vitor Santana, G1 GO

29/11/2019 10h48 · Atualizado há um mês



<http://informatudof.com.br/2019/11/29/asfalto-cede-durante-chuva-e-engole-carros-no-goias/>

## Asfalto cede durante chuva e 'engole' carros no Goiás

Por Redação - 29 de novembro de 2019

COMPARTILHAR

