

Resumo Executivo

O Presente Relatório tem como objetivo a incorporação de informações que sejam relevantes para que se possa fazer a devida associação aos dados contidos no corpo do documento objeto da classificação de Situação de Emergência caracterizada pelo Módulo 8 do Prodist, que tem como foco o impacto do evento sobre determinada rede geelétrica e cuja denominação é definida como CHI (Consumidor hora interrompido). O parâmetro para enquadramento nesta classificação de expurgo tem como premissa inicial o limite de Consumidor hora interrompido definido pela fórmula descrita no Módulo 01 do Prodist (Revisão - 9), acrescido de todos os outros informes e dados listados no Módulo 08 (Revisão 10) do Prodist. Este enquadramento se apresenta na maioria das vezes em condições climáticas adversas com severidade dos fatores inerentes a situação, caracterizado na maioria dos casos por fortes ventos e chuvas de grande intensidade e continuidade.

Entre a manhã do dia 02/12/2019 – segunda-feira – e a manhã de 04/12/2019 – quarta-feira – Houve a formação de nuvens de tempestade, do tipo Cumulonimbus, que avançaram sobre o continente e ajudaram a organizar áreas de instabilidade sobre as Regiões da Enel Distribuição Goiás.

Entre as 11h30 do dia 02 e 11h do dia 04 de dezembro de 2019 tivemos, em todo o Estado de Goiás, incidências de 69.419 descargas atmosféricas (28.184 raios nuvem-solo e 41.235 descargas nuvem-nuvem) sobre a região, o que causou grande instabilidade na rede.

Chuva forte causa alagamentos e transtornos em vários bairros em Itumbiara - A chuva forte que caiu em Itumbiara na manhã e início da tarde desta terça-feira, 03, provocou vários alagamentos em diversos pontos da cidade de Itumbiara. Nas redes sociais foram publicados dezenas de vídeos e fotos com imagens sobre os transtornos com as fortes chuvas. Acesso em: <https://pluralnoticias.com.br/chuva-forte-causa-alagamentos-e-transtornos-em-varios-bairros-em-itumbiara/>

Relatório de Ocorrências do período

Em todo o Estado de Goiás verificou-se também que a intensidade da chuva e dos ventos danificaram a rede de distribuição de energia elétrica em diversos pontos, registrando aproximadamente 209 mil clientes com interrupção no fornecimento de energia elétrica devido a eventos relacionados ao temporal.

Para otimizar o volume de atendimentos e reduzir os tempos de interrupção foram mobilizados os recursos extras da empresa que aumentou o contingente em relação a situação normal de operação. O acompanhamento da quantidade de equipes e o Tempo Médio de Atendimento podem ser consultados na Pág.02 do Relatório em anexo.

O impacto e severidade do evento estão relatados em artigos de mídia, como fotos e reportagens que demonstram os danos na Rede de Distribuição, oriundos dos eventos climáticos no período. Eventos estes que afetaram 208.498 consumidores com CHI de 865.653,97 superior ao de 482.391,86 estabelecido como limite para definição de Situação de Emergência, conforme resumo das informações obrigatórias.

Empresa	ENEL DISTRIBUIÇÃO GOIÁS				
Código do Relatório	CHI-029 - ENEL DISTRIBUIÇÃO GOIÁS				
Evento:	TEMPORAL NA AREA DE CONCESSÃO DA ENEL DISTRIBUIÇÃO GOIAS				
Código COBRADE:	1.3.2.1.2 e 1.3.2.1.5	Data Inicio	02/12/2019	Hora início	11h30
Código do Evento:	CHI-029-ENEL GO	Data Término	04/12/2019	Hora Término	10h44
Valor CHI (Limite e Real)	482.391,86	865.653,97	Subestações Atingidas ABADIANIA / ABC / ACREUNA / ADELANDIA / AEROPORTO / AGUA LIMPA (MARZAGAO) / AGUAS LINDAS / ALEXANIA / ALMERINDONOPOLIS / ALOANDIA / ALTO BURITI / ALTO PARAISO DE GOIAS / ALVORADA DO NORTE / AMERICANO (RIO VERDE) / AMERICANO DO BRASIL / AMORINOPOLIS / ANAPOLIS UNIVERSITARIA / ANHANGUERA / ANICUNS / ANTONIO DO VITTO / APARECIDA DO RIO DOCE / ARACU / ARAGARCAS / ARAGOIANIA / ARAGUAPAZ / ARARAS / AREIAS / ARENOPOLIS / ARUANA / ARUANA (TRANSMISSAO) / ASA BRANCA / ATLANTICO / AURILANDIA / BACURI (RIO VERDE) / BARBOSELANDIA / BARCELONA / BARREIRO (PORANGATU) / BARRO ALTO / BELA VISTA (TRANSMISSAO) / BOM JARDIM / BOM JESUS DE GOIAS / BONFINOPOLIS / BONITO / BONOPOLIS / BRAZABRANTES / BRITANIA / BRITANIA (TRANSMISSAO) / BURITI ALEGRE / BURITI DE GOIAS / BURITIZINHO / CABECEIRAS / CABRIUVA (RIO VERDE) / CACHOEIRA ALTA / CACHOEIRA DOURADA / CACHOEIRA NOVA / CACHOEIRINHA (ITARUMA) / CACU / CAIAPONIA / CALCILANDIA / CALDAS NOVAS / CALDAZINHA / CAMPESTRE / CAMPINAS / CAMPINORTE / CAMPO ALEGRE DE GOIAS / CAMPO NOVO / CAMPOS BELOS / CAMPOS VERDES / CARAIBAS / CARAJAS / CATALAO / CATURAI / CEBRASA FABRICA DA AMBEV / CEMAT/BALIZA / CEPALGO / CEZARINA / CHAPADAO DO CEU / CIDADE OCIDENTAL / COCALZINHO / COLINACU / CORREGO DO OURO / CORUMBA / CORUMBAIBA / CRISTALINA / CRISTALINA TRANSMISSAO / CRISTIANOPOLIS / CRIXAS / CROMINIA / CUMARI / DAIA - ANAPOLIS / DAMOLANDIA / DAVINOPOLIS / DESFECHO / DESTILARIA ALTO PARAISO / DESTILARIA BRASIL CENTRAL / DIMIC / DIORAMA / DORCELINO PEIXOTO DE MORAES / DOVERLANDIA / EDEALINA / EDEIA / ENERSUL / ESTRELA DO NORTE / FAINA / FAZENDA CANADA / FAZENDA NOVA / FERROVIARIO / FIRMINOPOLIS / FLORES DE GOIAS / FORMIGA / FORMOSO / FRONTEIRA / GAMELEIRA / GIRASSOL / GOIANAPOLIS / GOIANDIRA / GOIANESIA / GOIANIA LESTE / GOIANIRA / GOIAS / GOIATUBA / GOUVERLANDIA / GOYA / GUAPO / HEITORAI / HIDROLANDIA / IACIARA / INACIOLANDIA / INDEPENDENCIA / INDIARA / INHUMAS / IPAMERI / IPEGUARI / IPORA / ISRAELANDIA / ITABERAI / ITAGUARI / ITAGUARU / ITAJA / ITAPACI / ITAPACI (TRANSMISSAO) / ITAPIRAPUA / ITAPURANGA / ITARUMA / ITAUCU / ITIQUIRA (FORMOSA) / ITUMBIARA NOVA / ITUMBIARA VELHA / JACILANDIA / JANDAIA / JARAGUA / JARANAPOLIS / JATAI / JAUPACI / JESUPOLIS / JOVIANIA / JUNDIAI / JURUMIRIM / JUSCELANDIA / JUSSARA / LAGES / LAGOA DA SERRA / LAGOA DO BAUZINHO (RIO VERDE) / LEOPOLDO DE BULHOES / LUZIANIA / MAIRIPOTABA / MAMBAI / MARA ROSA / MARAJOARA / MARIAPOLIS (PADRE BERNARDO) / MARZAGAO / MATO GRANDE / MATRINCHA / MAURILANDIA / MEIA PONTE / MINACU / MINEIROS / MOIPORA / MONTES CLAROS DE GOIAS / MONTIVIDIU T / MORRINHOS / MORRO AGUDO / MOSSAMEDES / MOZARLANDIA / MOZARLANDIA (TRANSMISSAO) / MUNDO NOVO DE GOIAS / MUTUNOPOLIS / NAVESLANDIA (JATAI) / NAZARIO / NEROPOLIS / NIQUELANDIA / NOVA AMERICA / NOVA AURORA / NOVA CRIXAS (TRANSMISSAO) / NOVA IGUACU / NOVA PONTE / NOVA VENEZA / NOVO BRASIL / NOVO GAMA / NOVO PLANALTO / OLHOS DAGUA / OLOANA / ORIZONA / OURO VERDE DE GOIAS / OUVIDOR / PACAEMBU (NOVO GAMA) / PADRE BERNARDO / PALESTINA / PALMEIRAS / PALMEIRAS DE GOIAS / PALMELO / PALMINOPOLIS / PAMPLONA / PANAMA / PARANA / PARANAIBA / PARANAIGUARA / PARAUNA SE ALTA TENSÃO / PARQUE DAS EMAS (MINEIROS) / PARQUE DAS NACOES / PEROLANDIA / PETROLINA / PILOANDIA / PIRACANJUBA / PIRANHAS T / PIRENOPOLIS / PIRES BELO / PIRES DO RIO / PLANALTINA / PLANALTINA (TRANSMISSAO) / PLANALTO / PONTALINA / PORANGATU / PORTEIRAO / PORTELANDIA / POSSE / POSSELANDIA / PROFESSOR JAMIL / QUEBRA LINHA / QUIRINOPOLIS / REAL / RETIRO / GOIAS / RIO CLARO JATAI MONTIVIDIU / RIO DO PEIXE / RIO DOS BOIS (MAURILANDIA) / RIO PRETO / RIO QUENTE / RIO VERDE / RIO VERMELHO / RIVERLANDIA (RIO VERDE) / RUBIATABA / SANCLERLANDIA / SANTA BARBARA / SANTA FE DE GOIAS / SANTA HELENA / SANTA RITA DO ARAGUAIA / SANTA ROSA / SANTA ROSA DE GOIAS / SANTA ROSA DO MEIA PONTE / SANTA TEREZA DE GOIAS / SANTA TEREZINHA / SANTO ANTONIO DA BARRA / SANTO ANTONIO DE GOIAS / SANTO ANTONIO DO DESCOBERTO / SAO BARTOLOMEU / SAO DOMINGOS / SAO FRANCISCO DE GOIAS / SAO GABRIEL DE GOIAS / SAO JOAO D ALIANCA / SAO JOAO DA PARAUNA / SAO JUDAS TADEU / SAO LUIZ DOS MONTES BELOS / SAO MIGUEL DO ARAGUAIA / SAO MIGUEL DO PASSA QUATRO / SAO SIMAO / SENADOR CANEDO TRANSMISSAO / SERRA AZUL (JATAI) / SERRA DE CALDAS / SERRA DO OURO / SERRANOPOLIS / SILVANIA		
Código do Decreto (Se Houver):					
Quantidade de Interrupções (Evento)	3.668				
Início 1ª Incidência (Data e Hora)	02/12/2019 11:31				

			/ SITIO DABADIA / SOUZALANDIA / SUCURI / TAIOPA / TAQUARAL / TAQUARI / TEREZOPOLIS / TERRA VERMELHA / TRES BARRAS / TRES RANCHOS / TRINDADE / TURVANIA / TURVELANDIA / URU / URUACU / URUTAI / USINA DE ACUCAR DE GOIANESIA / USINA MAMBAI / VALPARAISO / VARIAO / VENDA SECA / VIANOPOLIS / VICENTINOPOLIS / VILA BOA / VILA CORUMBA / VILA PROPICIO / XAVANTES / XIXA / ZELANDIA / SANTANA / ALTO HORIZONTE / MINEIROS TRANSMISSAO
Início Última Incidência (Data e Hora)	04/12/2019 10:44:00	Municípios Atingidos	ABADIA DE GOIAS / ABADIANIA / ACREUNA / ADELANDIA / AGUA FRIA DE GOIAS / AGUA LIMPA / AGUAS LINDAS DE GOIAS / ALEXANIA / ALTO HORIZONTE / ALTO PARAISO DE GOIAS / ALVORADA DO NORTE / AMARALINA / AMERICANO DO BRASIL / AMORINOPOLIS / ANAPOLIS / ANHANGUERA / ANICUNS / APARECIDA DE GOIANIA / APARECIDA DO RIO DOCE / APORE / ARACU / ARAGARCAS / ARAGOIANIA / ARAGUAPAZ / ARENOPOLIS / ARUANA / AURILANDIA / BALIZA / BARRO ALTO / BELA VISTA DE GOIAS / BOM JARDIM DE GOIAS / BOM JESUS DE GOIAS / BONFINOPOLIS / BONOPOLIS / BRAZABRANTES / BRITANIA / BURITI ALEGRE / BURITI DE GOIAS / BURITINOPOLIS / CABECEIRAS / CACHOEIRA ALTA / CACHOEIRA DE GOIAS / CACHOEIRA DOURADA / CACU / CAIAPONIA / CALDAS NOVAS / CALDAZINHA / CAMPESTRE DE GOIAS / CAMPINACU / CAMPINORTE / CAMPO ALEGRE DE GOIAS / CAMPO LIMPO / CAMPOS BELOS / CAMPOS VERDES / CASTELANDIA / CATALAO / CATURAI / CAVALCANTE / CERES / CEZARINA / CHAPADAO DO CEU / CIDADE OCIDENTAL / COCALZINHO DE GOIAS / COLINAS DO SUL / CORREGO DO OURO / CORUMBA DE GOIAS / CORUMBAIBA / CRISTALINA / CRISTIANOPOLIS / CRIXAS / CROMINIA / CUMARI / DAMIANOPOLIS / DAMOLANDIA / DAVINOPOLIS / DIORAMA / DISTRITO FEDERAL / DIVINOPOLIS DE GOIAS / DOVERLANDIA / EDEALINA / EDEIA / ESTRELA DO NORTE / FAINA / FAZENDA NOVA / FIRMINOPOLIS / FLORES DE GOIAS / FORMOSA / FORMOSO / GAMELEIRA DE GOIAS / GOIANAPOLIS / GOIANDIRA / GOIANESIA / GOIANIA / GOIANIRA / GOIAS / GOIATUBA / GOUVELANDIA / GUAPO / GUARANI DE GOIAS / GUARINOS / HEITORAI / HIDROLANDIA / HIDROLINA / IACIARA / INACIOLANDIA / INDIARA / INHUMAS / IPAMERI / IPORA / ISRAELANDIA / ITABERAI / ITAGUARI / ITAGUARU / ITAJA / ITAPACI / ITAPIRAPUA / ITAPURANGA / ITARUMA / ITAUCU / ITUMBIARA / IVOLANDIA / JANDAIA / JARAGUA / JATAI / JAUPACI / JESUPOLIS / JOVIANIA / JUSSARA / LAGOA SANTA / LEOPOLDO DE BULHOES / LUZIANIA / MAIRIPOTABA / MAMBAI / MARA ROSA / MARZAGAO / MATRINCHA / MAURILANDIA / MIMOSO DE GOIAS / MINACU / MINEIROS / MOIPORA / MONTE ALEGRE DE GOIAS / MONTES CLAROS DE GOIAS / MONTIVIDIU / MONTIVIDIU DO NORTE / MORRINHOS / MORRO AGUDO DE GOIAS / MOSSAMEDES / MOZARLANDIA / MUNDO NOVO DE GOIAS / MUTUNOPOLIS / NAZARIO / NEROPOLIS / NIQUELANDIA / NOVA AMERICA / NOVA AURORA / NOVA CRIXAS / NOVA IGUAQU DE GOIAS / NOVA ROMA / NOVA VENEZA / NOVO BRASIL / NOVO GAMA / NOVO PLANALTO / ORIZONA / OURO VERDE DE GOIAS / OUVIDOR / PADRE BERNARDO / PALESTINA DE GOIAS / PALMEIRAS DE GOIAS / PALMELO / PALMINOPOLIS / PANAMA / PARANAIGUARA / PARAUNA / PEROLANDIA / PETROLINA DE GOIAS / PILAR DE GOIAS / PIRACANJUBA / PIRANHAS / PIRENOPOLIS / PIRES DO RIO / PLANALTINA / PONTALINA / PORANGATU / PORTEIRAO / PORTELANDIA / POSSE / PROFESSOR JAMIL SAFADY / QUIRINOPOLIS / RIALMA / RIO QUENTE / RIO VERDE / RUBIATABA / SANCLERLANDIA / SANTA BARBARA DE GOIAS / SANTA CRUZ DE GOIAS / SANTA FE DE GOIAS / SANTA HELENA DE GOIAS / SANTA RITA DO ARAGUAIA / SANTA RITA DO NOVO DESTINO / SANTA ROSA DE GOIAS / SANTA TEREZA DE GOIAS / SANTA TEREZINHA DE GOIAS / SANTO ANTONIO DA BARRA / SANTO ANTONIO DE GOIAS / SANTO ANTONIO DO DESCOBERTO / SAO DOMINGOS / SAO FRANCISCO DE GOIAS / SAO JOAO D ALIANCA / SAO JOAO DA PARAUNA / SAO LUIS DE MONTES BELOS / SAO LUIZ DO NORTE / SAO MIGUEL DO ARAGUAIA / SAO MIGUEL DO PASSA QUATRO / SAO PATRICIO / SAO SIMAO / SENADOR CANEDO / SERRANOPOLIS / SILVANIA / SIMOLANDIA / SITIO D ABADIA / TAQUARAL DE GOIAS / TERESINA DE GOIAS / TEREZOPOLIS DE GOIAS / TRES RANCHOS / TRINDADE / TROMBAS / TURVANIA / TURVELANDIA / UIRAPURU / URUACU / URUANA / URUTAI / VALPARAISO DE GOIAS / VARJAO / VIANOPOLIS / VICENTINOPOLIS / VILA BOA / VILA PROPICIO
Média de Duração das Incidências (h)	9,61		
Duração da Incidência mais longa (h)	88,37		
Total de Clientes afetados	208.498		

DANOS CAUSADOS			
Equipamentos Danificado	Importância para o Sistema	Local	Quantidade
Disjuntor/Religador Operado	Proteção do Alimentador	Área de Concessão	67
Chaves Fusíveis Operada	Proteção de Ramais de Alimentadores	Área de Concessão	1.223
Transformador Operado	Proteção do Transformador	Área de Concessão	889

Relato técnico sobre a Intervenção realizada em Goiânia e Região Metropolitana			
Informações sobre Equipes	02/12	03/12	
Quantidade Usual	773	773	turmas
Quantidade Adicional	102	93	turmas
Quantidade Total	875	866	turmas
Tempos Médios			
Preparação	6,48	6,56	Horas
Deslocamento	0,89	0,91	Horas
Execução	1,24	1,61	Horas
TMAE	8,62	9,09	Horas

Principais Dificuldades Encontradas:

Chuvas com ventos fortes provocaram muitos pontos de alagamento e enxurrada, trânsito impedido por vários semáforos desligados dificultando a chegada ao atendimento das ocorrências emergenciais. Em determinadas regiões, decorrente dos fortes ventos, houve o tombamento de árvores nas estruturas de alimentação de média tensão, danos em ramais de ligação dos clientes, impedimentos de acesso e atolamentos em estradas rurais.

Empresa	ENEL DISTRIBUIÇÃO GOIAS		
Valor CHI (Limite e Real)	482.391,86		865.653,97

DOC ORIGEM	MIUNICIPIO	EQP_ORIGEM	CONJUNTO	INI_OCORRENC	FIM_OCORRENC	DT_INI_EVENTO	DT_FIM_EVENTO	DURAÇ	UC INT	CHI	EXPURGO
2019122432	ABADIANIA	AA12130228	DAIA S2	02/12/2019 18:13	04/12/2019 00:35	02/12/2019 18:13	02/12/2019 21:30	3,28	30	98,35	CHI
2019122432	ABADIANIA	AA12384735	DAIA S2	02/12/2019 18:13	04/12/2019 00:35	02/12/2019 21:31	04/12/2019 00:35	27,07	30	812,00	CHI
2019122432	ABADIANIA	AA12384735	DAIA S2	02/12/2019 18:13	04/12/2019 00:35	03/12/2019 19:20	04/12/2019 00:35	5,25	90	472,10	CHI
2019126527	ITAPIRAPUA	IU12018852	MATRINCHA	03/12/2019 11:42	03/12/2019 12:48	03/12/2019 11:42	03/12/2019 12:48	1,10	22	24,11	CHI
2019126672	ITAPIRAPUA	IU12073722	MATRINCHA	02/12/2019 12:42	02/12/2019 15:50	02/12/2019 12:42	02/12/2019 15:50	3,13	3	9,39	CHI
2019127768	CAVALCANTE	CJ12396780LD	MINACU	03/12/2019 12:20	04/12/2019 19:38	03/12/2019 12:20	03/12/2019 23:00	10,67	174	1855,90	CHI
2019127768	CAVALCANTE	CJ12396780LD	MINACU	03/12/2019 12:20	04/12/2019 19:38	03/12/2019 12:20	04/12/2019 19:38	31,30	1	31,30	CHI
2019128047	IPAMERI	IP12017029	IPAMERI	02/12/2019 20:46	02/12/2019 21:51	02/12/2019 20:46	02/12/2019 21:51	1,08	15	16,24	CHI
2019128227	RIO VERDE	630017414	RIO VERDE S2	02/12/2019 11:31	02/12/2019 16:20	02/12/2019 11:31	02/12/2019 16:20	4,82	1	4,82	CHI
2019128230	RIO VERDE	630120791	RIO VERDE S1	02/12/2019 11:31	02/12/2019 16:10	02/12/2019 11:31	02/12/2019 16:10	4,65	1	4,65	CHI
2019128240	MONTIVIDIU	MV12301552	MONTIVIDIU T	02/12/2019 11:33	02/12/2019 20:21	02/12/2019 11:33	02/12/2019 20:21	8,79	5	43,97	CHI
2019128248	CABECEIRAS	CW21154405	ITUIQUIRA	02/12/2019 11:34	02/12/2019 14:52	02/12/2019 11:34	02/12/2019 14:52	3,29	1	3,29	CHI
2019128297	MINEIROS	1390015820	PARQUE DAS EMAS	02/12/2019 11:45	02/12/2019 20:04	02/12/2019 11:45	02/12/2019 20:04	8,32	1	8,32	CHI
2019128322	MONTES CLAROS DE GOIAS	ME12334772	ARENOPOLIS	02/12/2019 12:16	03/12/2019 04:40	02/12/2019 12:16	03/12/2019 04:40	16,38	11	180,23	CHI
2019128326	ALTO PARAISO DE GOIAS	JL12257606	SAO JOAO D ALIANCA	03/12/2019 12:59	03/12/2019 20:48	03/12/2019 12:59	03/12/2019 20:48	7,80	2	15,61	CHI
2019128326	SAO JOAO D ALIANCA	JL12257606	SAO JOAO D ALIANCA	03/12/2019 12:59	03/12/2019 20:48	03/12/2019 12:59	03/12/2019 20:48	7,80	69	538,45	CHI
2019128330	ARAGOIANIA	03500214	GUAPO S2	02/12/2019 12:59	02/12/2019 15:24	02/12/2019 12:59	02/12/2019 13:46	0,79	1002	792,69	CHI
2019128330	ARAGOIANIA	03500214	GUAPO S2	02/12/2019 12:59	02/12/2019 15:24	02/12/2019 12:59	02/12/2019 14:53	1,91	139	266,11	CHI
2019128330	ARAGOIANIA	03500214	GUAPO S2	02/12/2019 12:59	02/12/2019 15:24	02/12/2019 12:59	02/12/2019 15:24	2,42	270	654,22	CHI
2019128330	HIDROLANDIA	03500214	GUAPO S2	02/12/2019 12:59	02/12/2019 15:24	02/12/2019 12:59	02/12/2019 15:24	2,42	110	266,54	CHI
2019128330	MAIRIPOTABA	03500214	GUAPO S2	02/12/2019 12:59	02/12/2019 15:24	02/12/2019 12:59	02/12/2019 15:24	2,42	2	4,85	CHI
2019128330	VARJAO	03500214	GUAPO S2	02/12/2019 12:59	02/12/2019 15:24	02/12/2019 12:59	02/12/2019 15:24	2,42	69	167,19	CHI
2019128346	GOIANIA	GN11000630	CAMPINAS S1	02/12/2019 13:27	02/12/2019 14:45	02/12/2019 13:27	02/12/2019 14:45	1,29	166	214,65	CHI
2019128362	FAINA	FC12096433	GOIAS	02/12/2019 13:48	02/12/2019 14:24	02/12/2019 13:48	02/12/2019 14:24	0,60	1	0,60	CHI
2019128366	CATALAO	CT12376075	CATALAO S1	02/12/2019 14:20	02/12/2019 14:26	02/12/2019 14:20	02/12/2019 14:26	0,09	8	0,70	CHI
2019128370	FAINA	FC12399465	GOIAS	02/12/2019 14:45	02/12/2019 15:29	02/12/2019 14:45	02/12/2019 15:29	0,73	1	0,73	CHI
2019128396	UIRAPURU	UP12232520	NOVA CRIXAS	02/12/2019 16:04	02/12/2019 16:40	02/12/2019 16:04	02/12/2019 16:40	0,58	1	0,58	CHI
2019128425	VILA BOA	10008099470	IACIARA S2	02/12/2019 11:53	03/12/2019 12:17	02/12/2019 11:53	03/12/2019 12:17	24,41	1	24,41	CHI
2019128434	ACREUNA	EU12271441	ACREUNA	02/12/2019 11:55	02/12/2019 13:00	02/12/2019 11:55	02/12/2019 13:00	1,08	266	287,28	CHI
2019128436	RIO VERDE	630509256	RIO VERDE S2	02/12/2019 11:55	02/12/2019 16:35	02/12/2019 11:55	02/12/2019 16:35	4,66	1	4,66	CHI
2019128445	PEROLANDIA	JT21152141	JATAI S1	02/12/2019 11:57	02/12/2019 16:25	02/12/2019 11:57	02/12/2019 16:25	4,45	1	4,45	CHI
2019128446	FORMOSA	FA11233704	SAO JOAO D ALIANCA	02/12/2019 11:58	02/12/2019 21:26	02/12/2019 11:58	02/12/2019 21:26	9,46	1	9,46	CHI

2019128462	CACU	IM12234538	CACHOEIRA ALTA	02/12/2019 18:49	03/12/2019 04:00	02/12/2019 18:49	03/12/2019 04:00	9,17	31	284,35	CHI
2019128462	ITARUMA	IM12234538	CACHOEIRA ALTA	02/12/2019 18:49	03/12/2019 04:00	02/12/2019 18:49	03/12/2019 04:00	9,17	15	137,59	CHI
2019128465	GOIANIA	13830922	XAVANTES	02/12/2019 12:02	02/12/2019 13:30	02/12/2019 12:02	02/12/2019 13:30	1,47	1	1,47	CHI
2019128472	DAMOLANDIA	DL21051994	INHUMAS S1	02/12/2019 12:04	02/12/2019 17:30	02/12/2019 12:04	02/12/2019 17:30	5,42	1	5,42	CHI
2019128493	INHUMAS	30003234	INHUMAS S2	02/12/2019 12:09	02/12/2019 19:48	02/12/2019 12:09	02/12/2019 19:48	7,64	1	7,64	CHI
2019128498	FORMOSA	FA11397186	SAO JOAO D ALIANCA	02/12/2019 12:11	02/12/2019 21:55	02/12/2019 12:11	02/12/2019 21:55	9,73	1	9,73	CHI
2019128500	SANTA BARBARA DE GOIAS	TR31047821	TRINDADE	02/12/2019 12:11	02/12/2019 20:40	02/12/2019 12:11	02/12/2019 20:40	8,47	2	16,95	CHI
2019128507	GOIANIRA	8211071	GOIANIRA	02/12/2019 12:12	02/12/2019 16:32	02/12/2019 12:12	02/12/2019 16:15	4,04	14	56,53	CHI
2019128507	GOIANIRA	8211610	GOIANIRA	02/12/2019 12:12	02/12/2019 16:32	02/12/2019 12:12	02/12/2019 16:32	4,32	1	4,32	CHI
2019128521	JATAI	290195949	JATAI S3	02/12/2019 12:16	02/12/2019 14:06	02/12/2019 12:16	02/12/2019 14:06	1,83	1	1,83	CHI
2019128522	SANCLERLANDIA	SC12391405	FIRMINOPOLIS S2	02/12/2019 12:16	02/12/2019 17:15	02/12/2019 12:16	02/12/2019 17:15	4,99	1	4,99	CHI
2019128522	SAO LUIS DE MONTES BELOS	SC12391405	FIRMINOPOLIS S2	02/12/2019 12:16	02/12/2019 17:15	02/12/2019 12:16	02/12/2019 17:15	4,99	4	19,96	CHI
2019128537	ARUANA	2380003161	ARUANA	02/12/2019 12:18	02/12/2019 16:39	02/12/2019 12:18	02/12/2019 16:39	4,35	1	4,35	CHI
2019128546	MAURILANDIA	ML12301541	RIO DOS BOIS	02/12/2019 12:19	02/12/2019 19:15	02/12/2019 12:19	02/12/2019 19:15	6,94	20	138,72	CHI
2019128557	RIO VERDE	10007318764	RIO VERDE S1	02/12/2019 12:22	02/12/2019 18:00	02/12/2019 12:22	02/12/2019 18:00	5,64	1	5,64	CHI
2019128559	GOIAS	90051452	GOIAS	02/12/2019 12:22	02/12/2019 15:04	02/12/2019 12:22	02/12/2019 15:04	2,70	1	2,70	CHI
2019128566	ITAPURANGA	IK21145597	ITAPURANGA	02/12/2019 12:23	02/12/2019 22:10	02/12/2019 12:23	02/12/2019 22:10	9,78	4	39,12	CHI
2019128568	POSSE	IA12035179	IACIARA S2	02/12/2019 12:23	02/12/2019 15:33	02/12/2019 12:23	02/12/2019 15:33	3,15	9	28,36	CHI
2019128585	FORMOSA	FA11233754	SAO JOAO D ALIANCA	02/12/2019 12:27	03/12/2019 12:31	02/12/2019 12:27	03/12/2019 12:31	24,05	1	24,05	CHI
2019128591	TRINDADE	40074468	TRINDADE	02/12/2019 12:29	02/12/2019 17:34	02/12/2019 12:29	02/12/2019 17:34	5,08	1	5,08	CHI
2019128596	MOIPORA	MO12003718	SAO LUIZ DOS MONTES BELOS	02/12/2019 12:30	02/12/2019 20:31	02/12/2019 12:30	02/12/2019 20:31	8,02	8	64,19	CHI
2019128601	ITAPIRAPUA	IU12020184	JUSSARA	02/12/2019 12:31	02/12/2019 17:37	02/12/2019 12:31	02/12/2019 17:37	5,10	6	30,63	CHI
2019128602	ITAPIRAPUA	IU21072518	MATRINCHA	02/12/2019 12:31	03/12/2019 09:09	02/12/2019 12:31	03/12/2019 09:09	20,62	1	20,62	CHI
2019128606	INDIARA	JD12272364	PALMEIRAS	02/12/2019 12:22	02/12/2019 15:35	02/12/2019 12:22	02/12/2019 15:35	3,21	4	12,85	CHI
2019128606	PALMEIRAS DE GOIAS	JD12272364	PALMEIRAS	02/12/2019 12:22	02/12/2019 15:35	02/12/2019 12:22	02/12/2019 15:35	3,21	20	64,24	CHI
2019128611	CAIAPONIA	CP12076264	MONTIVIDIU T	02/12/2019 12:34	02/12/2019 21:58	02/12/2019 12:34	02/12/2019 21:58	9,39	27	253,59	CHI
2019128611	JATAI	CP12076264	MONTIVIDIU T	02/12/2019 12:34	02/12/2019 21:58	02/12/2019 12:34	02/12/2019 21:58	9,39	6	56,35	CHI
2019128611	RIO VERDE	CP12076264	MONTIVIDIU T	02/12/2019 12:34	02/12/2019 21:58	02/12/2019 12:34	02/12/2019 21:58	9,39	10	93,92	CHI
2019128617	CRIXAS	CX21341344	MOZARLANDIA	02/12/2019 12:35	03/12/2019 09:47	02/12/2019 12:35	03/12/2019 09:47	21,18	1	21,18	CHI
2019128622	SILVANIA	SV21284619	VIANOPOLIS	02/12/2019 12:37	03/12/2019 02:19	02/12/2019 12:37	03/12/2019 02:19	13,69	1	13,69	CHI
2019128626	ITAPIRAPUA	IU21212438	JUSSARA	02/12/2019 12:38	03/12/2019 09:49	02/12/2019 12:38	03/12/2019 09:49	21,17	1	21,17	CHI
2019128631	CATURAI	CK21066386	INHUMAS S1	02/12/2019 12:39	02/12/2019 18:38	02/12/2019 12:39	02/12/2019 18:38	5,97	1	5,97	CHI
2019128634	ARAGARCAS	1820001377	ARAGARCAS	02/12/2019 12:40	02/12/2019 16:30	02/12/2019 12:40	02/12/2019 16:30	3,84	1	3,84	CHI

2019128636	AGUA FRIA DE GOIAS	JL12117446	SAO JOAO D ALIANCA	02/12/2019 11:53	03/12/2019 14:57	02/12/2019 11:53	03/12/2019 14:57	27,07	19	514,27	CHI
2019128636	SAO JOAO D ALIANCA	JL12117446	SAO JOAO D ALIANCA	02/12/2019 11:53	03/12/2019 14:57	02/12/2019 11:53	03/12/2019 14:57	27,07	25	676,67	CHI
2019128644	CAIAPONIA	CP21244054	CAIAPONIA	02/12/2019 12:41	02/12/2019 18:14	02/12/2019 12:41	02/12/2019 18:14	5,54	1	5,54	CHI
2019128646	MINEIROS	MY12156849	PARQUE DAS EMAS	02/12/2019 12:28	03/12/2019 15:50	02/12/2019 12:28	03/12/2019 15:50	27,35	11	300,88	CHI
2019128650	QUIRINOPOLIS	80118690	QUIRINOPOLIS	02/12/2019 12:44	02/12/2019 14:17	02/12/2019 12:44	02/12/2019 14:17	1,54	1	1,54	CHI
2019128654	GOIANIA	10006971820	ATLANTICO S1	02/12/2019 12:46	02/12/2019 13:54	02/12/2019 12:46	02/12/2019 13:54	1,13	1	1,13	CHI
2019128656	APARECIDA DE GOIANIA	12027923	INDEPENDENCIA S2	02/12/2019 12:46	02/12/2019 18:28	02/12/2019 12:46	02/12/2019 18:28	5,69	1	5,69	CHI
2019128672	JATAI	290228670	JATAI S3	02/12/2019 12:51	02/12/2019 14:55	02/12/2019 12:51	02/12/2019 14:55	2,06	1	2,06	CHI
2019128685	HIDROLANDIA	HD11246651	CEPAIGO S2	02/12/2019 12:54	02/12/2019 16:19	02/12/2019 12:54	02/12/2019 16:19	3,41	10	34,08	CHI
2019128688	ITAPIRAPUA	NB13396234	JUSSARA	02/12/2019 12:55	02/12/2019 20:38	02/12/2019 12:55	02/12/2019 19:25	6,51	55	357,90	CHI
2019128688	NOVO BRASIL	NB13396234	JUSSARA	02/12/2019 12:55	02/12/2019 20:38	02/12/2019 12:55	02/12/2019 19:25	6,51	203	1320,97	CHI
2019128688	FAZENDA NOVA	NB13292800	JUSSARA	02/12/2019 12:55	02/12/2019 20:38	02/12/2019 12:55	02/12/2019 19:25	6,51	1	6,51	CHI
2019128688	NOVO BRASIL	NB13292800	JUSSARA	02/12/2019 12:55	02/12/2019 20:38	02/12/2019 12:55	02/12/2019 19:25	6,51	36	234,29	CHI
2019128688	FAZENDA NOVA	NB13020240	JUSSARA	02/12/2019 12:55	02/12/2019 20:38	02/12/2019 12:55	02/12/2019 20:38	7,73	98	757,16	CHI
2019128688	NOVO BRASIL	NB13020240	JUSSARA	02/12/2019 12:55	02/12/2019 20:38	02/12/2019 12:55	02/12/2019 20:38	7,73	214	1653,39	CHI
2019128688	NOVO BRASIL	NB13020240	JUSSARA	02/12/2019 12:55	02/12/2019 20:38	02/12/2019 17:25	02/12/2019 20:38	3,23	10	32,26	CHI
2019128689	BRITANIA	IU12025065	MATRINCHA	02/12/2019 12:30	03/12/2019 07:03	02/12/2019 12:30	03/12/2019 07:03	18,54	6	111,25	CHI
2019128689	ITAPIRAPUA	IU12025065	MATRINCHA	02/12/2019 12:30	03/12/2019 07:03	02/12/2019 12:30	03/12/2019 07:03	18,54	15	278,12	CHI
2019128712	GOIANIA	15231835	XAVANTES	02/12/2019 12:58	02/12/2019 17:00	02/12/2019 12:58	02/12/2019 17:00	4,02	1	4,02	CHI
2019128713	SILVANIA	660042230	VIANOPOLIS	02/12/2019 12:59	02/12/2019 16:41	02/12/2019 12:59	02/12/2019 16:41	3,70	1	3,70	CHI
2019128750	ANICUNS	10019658859	ANICUNS	02/12/2019 13:08	02/12/2019 16:01	02/12/2019 13:08	02/12/2019 16:01	2,88	1	2,88	CHI
2019128752	MOSSAMEDES	1310008490	FIRMINOPOLIS S2	02/12/2019 13:09	02/12/2019 16:05	02/12/2019 13:09	02/12/2019 16:05	2,93	1	2,93	CHI
2019128753	NOVA ROMA	ND21146201	IACIARA S2	02/12/2019 13:09	02/12/2019 16:42	02/12/2019 13:09	02/12/2019 16:42	3,55	1	3,55	CHI
2019128763	RIO VERDE	RV11340948	CABRIUVA S1	02/12/2019 13:11	03/12/2019 13:35	02/12/2019 16:56	03/12/2019 13:35	20,65	12	247,80	CHI
2019128770	JATAI	290069865	JATAI S3	02/12/2019 13:12	02/12/2019 15:12	02/12/2019 13:12	02/12/2019 15:12	1,99	1	1,99	CHI
2019128775	CAIAPONIA	930059906	CAIAPONIA	02/12/2019 13:13	03/12/2019 12:27	02/12/2019 13:13	03/12/2019 12:27	23,23	1	23,23	CHI
2019128779	HIDROLANDIA	HD21034366	CEPAIGO S2	02/12/2019 13:15	02/12/2019 16:35	02/12/2019 13:15	02/12/2019 16:35	3,34	1	3,34	CHI
2019128780	JATAI	JT21103997	JATAI S3	02/12/2019 13:15	02/12/2019 18:04	02/12/2019 13:15	02/12/2019 18:04	4,81	1	4,81	CHI
2019128782	AGUA FRIA DE GOIAS	TL11164598	SAO JOAO D ALIANCA	02/12/2019 13:15	02/12/2019 15:55	02/12/2019 13:15	02/12/2019 15:55	2,66	126	335,20	CHI
2019128794	VIANOPOLIS	VN21159799	PIRES DO RIO S2	02/12/2019 13:18	02/12/2019 16:19	02/12/2019 13:18	02/12/2019 16:19	3,01	1	3,01	CHI
2019128803	INHUMAS	30093922	INHUMAS S2	02/12/2019 13:20	02/12/2019 17:08	02/12/2019 13:20	02/12/2019 17:08	3,79	1	3,79	CHI
2019128813	GOIANIA	GN21271806	GOIANIA LESTE S3	02/12/2019 13:22	02/12/2019 16:17	02/12/2019 13:22	02/12/2019 16:17	2,91	1	2,91	CHI
2019128817	ARENOPOLIS	AY21000005	ARENOPOLIS	02/12/2019 13:23	02/12/2019 15:10	02/12/2019 13:23	02/12/2019 15:10	1,78	1	1,78	CHI

2019128824	BELA VISTA DE GOIAS	BV21168313	BELA VISTA S1	02/12/2019 13:24	02/12/2019 15:58	02/12/2019 13:24	02/12/2019 15:58	2,57	1	2,57	CHI
2019128829	GOIANIRA	390047442	GOIANIRA	02/12/2019 13:24	02/12/2019 16:45	02/12/2019 13:24	02/12/2019 16:45	3,34	1	3,34	CHI
2019128838	GUAPO	10024002583	GUAPO S1	02/12/2019 13:26	02/12/2019 17:11	02/12/2019 13:26	02/12/2019 17:11	3,75	1	3,75	CHI
2019128839	MONTIVIDIU	MV21089322	MONTIVIDIU T	02/12/2019 13:26	03/12/2019 00:40	02/12/2019 13:26	03/12/2019 00:40	11,23	1	11,23	CHI
2019128842	GOIAS	GS12073885	MATRINCHA	02/12/2019 12:52	02/12/2019 16:49	02/12/2019 12:52	02/12/2019 16:49	3,95	15	59,22	CHI
2019128846	MORRINHOS	MR21093176	GOIATUBA S1	02/12/2019 13:27	02/12/2019 16:40	02/12/2019 13:27	02/12/2019 16:40	3,20	1	3,20	CHI
2019128850	CRIXAS	CX21240173	MOZARLANDIA	02/12/2019 13:28	03/12/2019 08:51	02/12/2019 13:28	03/12/2019 08:51	19,37	1	19,37	CHI
2019128856	MAIRIPOTABA	MI21060683	PONTALINA	02/12/2019 13:30	02/12/2019 20:16	02/12/2019 13:30	02/12/2019 20:16	6,76	1	6,76	CHI
2019128870	RIO VERDE	630030704	RIO VERDE S1	02/12/2019 13:32	02/12/2019 15:42	02/12/2019 13:32	02/12/2019 15:42	2,17	1	2,17	CHI
2019128878	CALDAS NOVAS	CN21298635	SERRA DE CALDAS	02/12/2019 13:34	02/12/2019 17:30	02/12/2019 13:34	02/12/2019 17:30	3,93	1	3,93	CHI
2019128887	GOIATUBA	140051223	GOIATUBA S2	02/12/2019 13:36	02/12/2019 16:49	02/12/2019 13:36	02/12/2019 16:49	3,21	1	3,21	CHI
2019128888	SENADOR CANEDO	SW11237559	CEPAIGO S1	02/12/2019 13:36	02/12/2019 18:30	02/12/2019 13:36	02/12/2019 18:30	4,89	15	73,32	CHI
2019128891	ITARUMA	IM21150299	CACHOEIRA ALTA	02/12/2019 13:37	02/12/2019 16:22	02/12/2019 13:37	02/12/2019 16:22	2,74	1	2,74	CHI
2019128896	VALPARAISO DE GOIAS	2860248347	PACAEMBU S2	02/12/2019 13:38	02/12/2019 19:59	02/12/2019 13:38	02/12/2019 19:59	6,34	1	6,34	CHI
2019128897	AURILANDIA	AI11076527	FIRMINOPOLIS S2	02/12/2019 13:24	02/12/2019 17:02	02/12/2019 13:24	02/12/2019 17:02	3,63	103	374,38	CHI
2019128913	DIORAMA	DI21065670	IPORA	02/12/2019 13:42	03/12/2019 22:15	02/12/2019 13:42	03/12/2019 21:33	31,85	1	31,85	CHI
2019128913	DIORAMA	DI12065689	IPORA	02/12/2019 13:42	03/12/2019 22:15	03/12/2019 18:07	03/12/2019 22:15	4,14	15	62,15	CHI
2019128929	GOIANDIRA	GD21215576	CATALAO S1	02/12/2019 13:44	02/12/2019 16:50	02/12/2019 13:44	02/12/2019 16:50	3,11	1	3,11	CHI
2019128943	CALDAS NOVAS	760289001	SERRA DE CALDAS	02/12/2019 13:47	02/12/2019 16:14	02/12/2019 13:47	02/12/2019 16:14	2,44	1	2,44	CHI
2019128945	FAINA	FC11194571	GOIAS	02/12/2019 13:47	03/12/2019 13:59	02/12/2019 13:47	03/12/2019 13:59	24,19	2	48,38	CHI
2019128953	FIRMINOPOLIS	900029432	FIRMINOPOLIS S1	02/12/2019 13:48	02/12/2019 15:50	02/12/2019 13:48	02/12/2019 15:50	2,03	1	2,03	CHI
2019128961	SILVANIA	SV21339237	VIANOPOLIS	02/12/2019 13:50	02/12/2019 16:27	02/12/2019 13:50	02/12/2019 16:27	2,62	1	2,62	CHI
2019128962	CALDAS NOVAS	10018099287	CALDAS NOVAS S1	02/12/2019 13:50	02/12/2019 17:17	02/12/2019 13:50	02/12/2019 17:17	3,47	1	3,47	CHI
2019128964	APARECIDA DE GOIANIA	14512520	INDEPENDENCIA S1	02/12/2019 13:50	02/12/2019 16:43	02/12/2019 13:50	02/12/2019 16:43	2,87	1	2,87	CHI
2019128972	JATAI	JT21182234	JATAI S1	02/12/2019 13:52	03/12/2019 13:26	02/12/2019 13:52	03/12/2019 13:26	23,57	1	23,57	CHI
2019128979	CAIAPONIA	CP12354285	CAIAPONIA	02/12/2019 13:52	03/12/2019 09:35	02/12/2019 13:52	03/12/2019 09:35	19,70	12	236,42	CHI
2019128990	MOSSAMEDES	MD12024167	FIRMINOPOLIS S2	02/12/2019 13:31	02/12/2019 16:45	02/12/2019 13:31	02/12/2019 16:45	3,22	46	148,12	CHI
2019128990	SANCLERLANDIA	MD12024167	FIRMINOPOLIS S2	02/12/2019 13:31	02/12/2019 16:45	02/12/2019 13:31	02/12/2019 16:45	3,22	8	25,76	CHI
2019128994	JATAI	290243038	JATAI S3	02/12/2019 13:55	02/12/2019 16:00	02/12/2019 13:55	02/12/2019 16:00	2,08	1	2,08	CHI
2019129001	ANICUNS	AC21278671	FIRMINOPOLIS S2	02/12/2019 13:58	02/12/2019 20:05	02/12/2019 13:58	02/12/2019 20:05	6,12	1	6,12	CHI
2019129010	MORRINHOS	MR21000183	MORRINHOS	02/12/2019 14:00	02/12/2019 16:10	02/12/2019 14:00	02/12/2019 16:10	2,16	1	2,16	CHI
2019129013	ITABERAI	IB21172540	ARACU	02/12/2019 14:01	03/12/2019 12:25	02/12/2019 14:01	03/12/2019 12:25	22,40	1	22,40	CHI
2019129020	BALIZA	BH12331250	CAIAPONIA	02/12/2019 13:24	02/12/2019 17:00	02/12/2019 13:24	02/12/2019 17:00	3,59	99	355,46	CHI

2019129021	GOIANIA	GN12087621	ATLANTICO S1	02/12/2019 14:03	02/12/2019 17:47	02/12/2019 14:03	02/12/2019 17:47	3,73	38	141,92	CHI
2019129034	MONTES CLAROS DE GOIAS	ME12193369	IPORA	02/12/2019 14:05	02/12/2019 18:01	02/12/2019 14:05	02/12/2019 18:01	3,93	21	82,57	CHI
2019129035	CAIAPONIA	930043820	CAIAPONIA	02/12/2019 14:04	02/12/2019 16:19	02/12/2019 14:04	02/12/2019 16:19	2,25	1	2,25	CHI
2019129038	RIO VERDE	RV21029162	SANTA HELENA S1	02/12/2019 14:06	03/12/2019 11:20	02/12/2019 14:06	03/12/2019 11:20	21,24	1	21,24	CHI
2019129040	SERRANOPOLIS	SX21219529	JATAI S1	02/12/2019 14:06	02/12/2019 14:49	02/12/2019 14:06	02/12/2019 14:49	0,72	1	0,72	CHI
2019129042	BALIZA	BH12343730	BOM JARDIM	02/12/2019 14:06	02/12/2019 21:32	02/12/2019 14:06	02/12/2019 21:32	7,42	8	59,40	CHI
2019129043	JUSSARA	RN12072191	BRITANIA	02/12/2019 13:52	03/12/2019 14:36	02/12/2019 13:52	03/12/2019 14:36	24,74	4	98,94	CHI
2019129043	SANTA FE DE GOIAS	RN12072191	BRITANIA	02/12/2019 13:52	03/12/2019 14:36	02/12/2019 13:52	03/12/2019 14:36	24,74	11	272,10	CHI
2019129049	FORMOSA	FA11278113	ITUIQUIRA	02/12/2019 14:08	02/12/2019 20:26	02/12/2019 14:08	02/12/2019 20:26	6,30	1	6,30	CHI
2019129051	TRINDADE	TR12000052	TRINDADE	02/12/2019 14:08	02/12/2019 17:35	02/12/2019 14:08	02/12/2019 17:35	3,44	105	361,52	CHI
2019129062	GOIANIA	GN11003128	FERROVIARIO S2	02/12/2019 14:10	02/12/2019 18:09	02/12/2019 14:10	02/12/2019 18:09	3,97	28	111,22	CHI
2019129064	LUZIANIA	2060055861	PIRES DO RIO S2	02/12/2019 14:10	02/12/2019 17:45	02/12/2019 14:10	02/12/2019 17:45	3,58	1	3,58	CHI
2019129066	ITUMBIARA	690103414	ITUMBIARA NOVA	02/12/2019 14:11	02/12/2019 17:19	02/12/2019 14:11	02/12/2019 17:19	3,13	1	3,13	CHI
2019129070	MAURILANDIA	ML12271554	RIO DOS BOIS	02/12/2019 14:12	02/12/2019 20:14	02/12/2019 14:12	02/12/2019 20:14	6,03	5	30,17	CHI
2019129071	CEZARINA	CZ21158447	GUAPO S2	02/12/2019 14:12	03/12/2019 12:03	02/12/2019 14:12	03/12/2019 12:03	21,85	1	21,85	CHI
2019129073	CEZARINA	CZ12126127	CEZARINA	02/12/2019 14:13	02/12/2019 18:13	02/12/2019 14:13	02/12/2019 18:13	4,00	1	4,00	CHI
2019129077	RIO VERDE	RV21303470	MONTIVIDIU T	02/12/2019 14:14	03/12/2019 08:52	02/12/2019 14:14	03/12/2019 08:52	18,63	2	37,25	CHI
2019129078	AGUAS LINDAS DE GOIAS	4830428420	AGUAS LINDAS DE GOIAS S2	02/12/2019 14:14	02/12/2019 16:16	02/12/2019 14:14	02/12/2019 16:16	2,02	1	2,02	CHI
2019129086	JARAGUA	JA21006444	JARAGUA	02/12/2019 15:26	03/12/2019 14:20	02/12/2019 15:26	03/12/2019 14:20	22,90	1	22,90	CHI
2019129095	CALDAS NOVAS	CN21186180	SERRA DE CALDAS	02/12/2019 14:17	02/12/2019 18:15	02/12/2019 14:17	02/12/2019 18:15	3,95	1	3,95	CHI
2019129096	CIDADE OCIDENTAL	2680129642	MARAJOARA	02/12/2019 14:17	02/12/2019 18:32	02/12/2019 14:17	02/12/2019 18:32	4,23	1	4,23	CHI
2019129097	PARAUNA	980010202	PARAUNA	02/12/2019 14:18	02/12/2019 17:37	02/12/2019 14:18	02/12/2019 17:37	3,31	1	3,31	CHI
2019129099	SENADOR CANEDO	SW11180046	GOIANIA LESTE S2	02/12/2019 13:54	02/12/2019 16:14	02/12/2019 13:54	02/12/2019 16:14	2,32	67	155,66	CHI
2019129111	GOIANIA	11673618	GOYA S2	02/12/2019 14:21	02/12/2019 17:26	02/12/2019 14:21	02/12/2019 17:26	3,08	1	3,08	CHI
2019129112	APARECIDA DE GOIANIA	11971630	ATLANTICO S3	02/12/2019 14:21	02/12/2019 17:28	02/12/2019 14:21	02/12/2019 17:28	3,11	1	3,11	CHI
2019129120	LUZIANIA	LZ21332058	MARAJOARA	02/12/2019 14:23	02/12/2019 21:31	02/12/2019 14:23	02/12/2019 21:31	7,13	1	7,13	CHI
2019129121	CABECEIRAS	CW11264671	ITUIQUIRA	02/12/2019 14:23	02/12/2019 17:31	02/12/2019 14:23	02/12/2019 17:31	3,12	126	392,81	CHI
2019129127	GOIANIRA	250004628	INHUMAS S1	02/12/2019 14:25	02/12/2019 23:45	02/12/2019 14:25	02/12/2019 23:45	9,33	1	9,33	CHI
2019129128	GOIANIA	10202936	AEROPORTO S1	02/12/2019 14:25	02/12/2019 15:32	02/12/2019 14:25	02/12/2019 15:32	1,12	1	1,12	CHI
2019129130	VALPARAISO DE GOIAS	3350008845	PACAEMBU S2	02/12/2019 14:25	02/12/2019 16:41	02/12/2019 14:25	02/12/2019 16:41	2,26	1	2,26	CHI
2019129133	RIO VERDE	10019080016	RIO VERDE S2	02/12/2019 14:26	02/12/2019 17:05	02/12/2019 14:26	02/12/2019 17:05	2,66	1	2,66	CHI
2019129149	GOIANIA	14094502	GOIANIA LESTE S3	02/12/2019 14:28	02/12/2019 19:30	02/12/2019 14:28	02/12/2019 19:30	5,02	1	5,02	CHI
2019129153	TRES RANCHOS	TH12149178	CATALAO S1	02/12/2019 14:28	02/12/2019 15:38	02/12/2019 14:28	02/12/2019 15:38	1,15	14	16,11	CHI

2019129161	JATAI	JT21383928	JATAI S2	02/12/2019 14:29	02/12/2019 16:43	02/12/2019 14:29	02/12/2019 16:43	2,23	1	2,23	CHI
2019129162	PLANALTINA	10004617779	PLANALTINA	02/12/2019 14:29	02/12/2019 16:29	02/12/2019 14:29	02/12/2019 16:29	2,00	1	2,00	CHI
2019129163	CRISTALINA	KR11170180	CRISTALINA S2	02/12/2019 14:29	02/12/2019 19:18	02/12/2019 14:29	02/12/2019 19:18	4,81	12	57,67	CHI
2019129166	JATAI	JT21324878	JATAI S1	02/12/2019 14:30	02/12/2019 16:20	02/12/2019 14:30	02/12/2019 16:20	1,84	1	1,84	CHI
2019129169	AURILANDIA	AI21026590	SAO LUIZ DOS MONTES BELOS	02/12/2019 14:30	02/12/2019 20:08	02/12/2019 14:30	02/12/2019 20:08	5,63	1	5,63	CHI
2019129172	VALPARAISO DE GOIAS	3350116010	PACAEMBU S2	02/12/2019 14:30	02/12/2019 22:08	02/12/2019 14:30	02/12/2019 22:08	7,62	1	7,62	CHI
2019129179	ITARUMA	IM21087822	CACHOEIRA ALTA	02/12/2019 14:30	03/12/2019 09:42	02/12/2019 14:30	03/12/2019 09:42	19,19	1	19,19	CHI
2019129182	GOIANESIA	GE11372424	GOIANESIA S1	02/12/2019 14:33	03/12/2019 14:40	02/12/2019 14:33	03/12/2019 14:40	24,11	1	24,11	CHI
2019129183	JESUPOLIS	1960005732	SAO FRANCISCO DE GOIAS	02/12/2019 14:33	03/12/2019 14:44	02/12/2019 14:33	03/12/2019 14:44	24,18	1	24,18	CHI
2019129190	PIRENOPOLIS	PV21191287	CORUMBA	02/12/2019 14:34	02/12/2019 19:24	02/12/2019 14:34	02/12/2019 19:24	4,82	1	4,82	CHI
2019129191	RUBIATABA	MS21016530	RUBIATABA	02/12/2019 14:35	03/12/2019 12:51	02/12/2019 14:35	03/12/2019 12:51	22,27	1	22,27	CHI
2019129202	QUIRINOPOLIS	QJ21246834	QUIRINOPOLIS	02/12/2019 14:38	02/12/2019 17:21	02/12/2019 14:38	02/12/2019 17:21	2,72	1	2,72	CHI
2019129209	VALPARAISO DE GOIAS	3350025351	PACAEMBU S1	02/12/2019 14:39	02/12/2019 19:41	02/12/2019 14:39	02/12/2019 19:41	5,03	1	5,03	CHI
2019129211	SANTA CRUZ DE GOIAS	BC21159147	PIRES DO RIO S2	02/12/2019 14:40	02/12/2019 21:04	02/12/2019 14:40	02/12/2019 21:04	6,40	2	12,80	CHI
2019129212	ARAGARCAS	AG21223133	ARAGARCAS	02/12/2019 14:40	02/12/2019 17:49	02/12/2019 14:40	02/12/2019 17:49	3,15	1	3,15	CHI
2019129213	ANAPOLIS	21035325	ANAPOLIS UNIVERSITARIO S2	02/12/2019 14:40	02/12/2019 18:40	02/12/2019 14:40	02/12/2019 18:40	4,00	1	4,00	CHI
2019129214	CALDAS NOVAS	10024000092	CALDAS NOVAS S1	02/12/2019 14:40	02/12/2019 19:00	02/12/2019 14:40	02/12/2019 19:00	4,32	1	4,32	CHI
2019129226	GOIANIA	10326492	CAMPINAS S1	02/12/2019 14:42	02/12/2019 17:14	02/12/2019 14:42	02/12/2019 17:14	2,53	1	2,53	CHI
2019129228	ITUMBIARA	690030290	ITUMBIARA VELHA S1	02/12/2019 14:42	02/12/2019 18:00	02/12/2019 14:42	02/12/2019 18:00	3,29	1	3,29	CHI
2019129229	RIO VERDE	630058854	RIO VERDE S2	02/12/2019 14:42	02/12/2019 17:44	02/12/2019 14:42	02/12/2019 17:44	3,03	1	3,03	CHI
2019129230	SERRANOPOLIS	3000016348	ITAJA S1	02/12/2019 14:42	03/12/2019 09:55	02/12/2019 14:42	03/12/2019 09:55	19,22	1	19,22	CHI
2019129249	MINEIROS	1390100665	PARQUE DAS EMAS	02/12/2019 14:45	03/12/2019 09:00	02/12/2019 14:45	03/12/2019 09:00	18,26	1	18,26	CHI
2019129251	BRAZABRANTES	7402809	INHUMAS S1	02/12/2019 14:45	02/12/2019 18:51	02/12/2019 14:45	02/12/2019 18:51	4,09	3	12,28	CHI
2019129251	INHUMAS	7402809	INHUMAS S1	02/12/2019 14:45	02/12/2019 18:51	02/12/2019 14:45	02/12/2019 18:51	4,09	11	45,01	CHI
2019129262	MONTES CLAROS DE GOIAS	ME12029537	BRITANIA	02/12/2019 14:46	04/12/2019 10:35	02/12/2019 14:46	04/12/2019 10:35	43,83	12	525,97	CHI
2019129263	PIRACANJUBA	PJ21315744	PIRACANJUBA	02/12/2019 14:46	02/12/2019 16:35	02/12/2019 14:46	02/12/2019 16:35	1,81	1	1,81	CHI
2019129267	APARECIDA DE GOIANIA	AP11365527	INDEPENDENCIA S2	02/12/2019 14:47	02/12/2019 17:02	02/12/2019 14:47	02/12/2019 17:02	2,23	38	84,89	CHI
2019129268	IVOLANDIA	IV12011808	IPORA	02/12/2019 14:48	02/12/2019 19:20	02/12/2019 14:48	02/12/2019 19:20	4,53	22	99,57	CHI
2019129278	ALTO PARAISO DE GOIAS	3870010342	FLORES DE GOIAS	02/12/2019 14:51	03/12/2019 12:38	02/12/2019 14:51	03/12/2019 12:38	21,80	1	21,80	CHI
2019129280	PORTEIRAO	CL12338603	RIO DOS BOIS	02/12/2019 14:51	02/12/2019 19:38	02/12/2019 14:51	02/12/2019 19:38	4,78	1	4,78	CHI
2019129284	IPORA	IR21014439	IPORA	02/12/2019 14:52	02/12/2019 19:54	02/12/2019 14:52	02/12/2019 19:54	5,02	1	5,02	CHI
2019129286	ALTO PARAISO DE GOIAS	BF21342373	FLORES DE GOIAS	02/12/2019 14:52	03/12/2019 10:12	02/12/2019 14:52	03/12/2019 10:12	19,32	1	19,32	CHI
2019129291	PIRENOPOLIS	PV21086865	CORUMBA	02/12/2019 14:54	02/12/2019 23:14	02/12/2019 14:54	02/12/2019 23:14	8,33	1	8,33	CHI

2019129294	MINACU	IH11135602	MINACU	02/12/2019 14:41	03/12/2019 01:14	02/12/2019 14:41	03/12/2019 01:14	10,55	66	696,19	CHI
2019129295	ARAGUAPAZ	RB21003329	RUBIATABA	02/12/2019 14:54	03/12/2019 15:55	02/12/2019 14:54	03/12/2019 15:55	25,01	1	25,01	CHI
2019129296	RUBIATABA	RB21312118	RUBIATABA	02/12/2019 14:54	03/12/2019 10:11	02/12/2019 14:54	03/12/2019 10:11	19,27	1	19,27	CHI
2019129297	APARECIDA DE GOIANIA	12763962	ATLANTICO S3	02/12/2019 14:54	02/12/2019 16:26	02/12/2019 14:54	02/12/2019 16:26	1,52	1	1,52	CHI
2019129298	CATALAO	1990334912	CATALAO S2	02/12/2019 14:54	02/12/2019 15:53	02/12/2019 14:54	02/12/2019 15:53	0,97	1	0,97	CHI
2019129306	PORANGATU	10021925974	PORANGATU	02/12/2019 14:56	02/12/2019 16:51	02/12/2019 14:56	02/12/2019 16:51	1,91	1	1,91	CHI
2019129311	BELA VISTA DE GOIAS	BV21360011	BELA VISTA S2	02/12/2019 14:57	02/12/2019 17:20	02/12/2019 14:57	02/12/2019 17:20	2,38	1	2,38	CHI
2019129316	MOZARLANDIA	MZ21055665	MOZARLANDIA	02/12/2019 14:59	03/12/2019 15:30	02/12/2019 14:59	03/12/2019 15:30	24,51	1	24,51	CHI
2019129322	GOIANIA	GN11000417	FERROVIARIO S3	02/12/2019 14:56	02/12/2019 16:52	02/12/2019 14:56	02/12/2019 16:52	1,92	89	170,88	CHI
2019129331	SANTA HELENA DE GOIAS	400005359	IPEGUARI	02/12/2019 15:02	02/12/2019 17:37	02/12/2019 15:02	02/12/2019 17:37	2,59	1	2,59	CHI
2019129334	SANTA TEREZINHA DE GOIAS	SG21242366	SANTA TEREZINHA	02/12/2019 15:03	03/12/2019 09:33	02/12/2019 15:03	03/12/2019 09:33	18,48	1	18,48	CHI
2019129346	JATAI	SX12139578	JATAI S1	02/12/2019 14:38	02/12/2019 19:54	02/12/2019 14:38	02/12/2019 19:54	5,26	14	73,69	CHI
2019129346	SERRANOPOLIS	SX12139578	JATAI S1	02/12/2019 14:38	02/12/2019 19:54	02/12/2019 14:38	02/12/2019 19:54	5,26	33	173,69	CHI
2019129349	GOIANIA	GN11185487	XAVANTES	02/12/2019 14:59	02/12/2019 19:21	02/12/2019 14:59	02/12/2019 19:21	4,35	168	730,99	CHI
2019129351	ALTO PARAISO DE GOIAS	10001506704	FLORES DE GOIAS	02/12/2019 15:07	03/12/2019 11:00	02/12/2019 15:07	03/12/2019 11:00	19,89	1	19,89	CHI
2019129355	CIDADE OCIDENTAL	DH11313965	MARAJOARA	02/12/2019 15:07	02/12/2019 17:17	02/12/2019 15:07	02/12/2019 17:17	2,16	1	2,16	CHI
2019129357	SANTA HELENA DE GOIAS	SH12279545	IPEGUARI	02/12/2019 14:44	02/12/2019 18:02	02/12/2019 14:44	02/12/2019 18:02	3,28	10	32,84	CHI
2019129360	GOIANIA	GN12151986	MEIA PONTE	02/12/2019 14:53	02/12/2019 16:27	02/12/2019 14:53	02/12/2019 16:27	1,56	546	852,67	CHI
2019129366	FAZENDA NOVA	FN21113958	IPORA	02/12/2019 15:08	03/12/2019 10:10	02/12/2019 15:08	03/12/2019 10:10	19,02	1	19,02	CHI
2019129367	SILVANIA	SV21192056	VIANOPOLIS	02/12/2019 15:09	02/12/2019 17:06	02/12/2019 15:09	02/12/2019 17:06	1,95	1	1,95	CHI
2019129369	RIO VERDE	RV12051746	MONTIVIDIU T	02/12/2019 14:21	02/12/2019 18:35	02/12/2019 14:21	02/12/2019 18:35	4,23	76	321,23	CHI
2019129370	GOIANIA	GN12222920	ATLANTICO S2	02/12/2019 14:07	02/12/2019 18:01	02/12/2019 14:07	02/12/2019 18:01	3,89	201	782,28	CHI
2019129374	DOVERLANDIA	DV12138335	CAIAPONIA	02/12/2019 15:09	02/12/2019 17:31	02/12/2019 15:09	02/12/2019 17:31	2,37	37	87,58	CHI
2019129376	GOIANAPOLIS	GP12234972	DAIA S2	02/12/2019 15:10	03/12/2019 09:35	02/12/2019 15:10	03/12/2019 09:35	18,41	1	18,41	CHI
2019129378	ANAPOLIS	AN11135790	ANAPOLIS UNIVERSITARIO S1	02/12/2019 14:43	02/12/2019 22:17	02/12/2019 14:43	02/12/2019 22:17	7,56	75	567,19	CHI
2019129379	NEROPOLIS	160032910	NEROPOLIS S2	02/12/2019 15:11	02/12/2019 17:56	02/12/2019 15:11	02/12/2019 17:56	2,75	1	2,75	CHI
2019129382	APARECIDA DE GOIANIA	16774541	ANHANGUERA	02/12/2019 15:11	02/12/2019 22:37	02/12/2019 15:11	02/12/2019 22:37	7,43	1	7,43	CHI
2019129384	SERRANOPOLIS	SX12234204	JATAI S1	02/12/2019 15:11	02/12/2019 19:47	02/12/2019 15:11	02/12/2019 19:47	4,59	2	9,18	CHI
2019129385	ANAPOLIS	21304221	ANAPOLIS UNIVERSITARIO S2	02/12/2019 15:12	02/12/2019 19:16	02/12/2019 15:12	02/12/2019 19:16	4,07	1	4,07	CHI
2019129387	SERRANOPOLIS	SX12260314	JATAI S1	02/12/2019 13:15	02/12/2019 17:48	02/12/2019 13:15	02/12/2019 17:48	4,54	4	18,16	CHI
2019129391	AGUAS LINDAS DE GOIAS	4830183264	AGUAS LINDAS DE GOIAS S1	02/12/2019 15:14	02/12/2019 16:25	02/12/2019 15:14	02/12/2019 16:25	1,18	1	1,18	CHI
2019129393	ITABERAI	IB21099046	ITABERAI S2	02/12/2019 15:14	03/12/2019 06:52	02/12/2019 15:14	03/12/2019 06:52	15,63	1	15,63	CHI
2019129396	PIRENOPOLIS	PV21286406	SAO FRANCISCO DE GOIAS	02/12/2019 15:15	03/12/2019 08:46	02/12/2019 15:15	03/12/2019 08:46	17,51	1	17,51	CHI

2019129399	CIDADE OCIDENTAL	10013650376	MARAJOARA	02/12/2019 15:16	02/12/2019 20:07	02/12/2019 15:16	02/12/2019 20:07	4,86	1	4,86	CHI
2019129402	ANAPOLIS	AN21362279	ANAPOLIS UNIVERSITARIO S2	02/12/2019 15:16	02/12/2019 17:18	02/12/2019 15:16	02/12/2019 17:18	2,02	1	2,02	CHI
2019129408	PIRENOPOLIS	PV21374488	CORUMBA	02/12/2019 15:17	02/12/2019 16:23	02/12/2019 15:17	02/12/2019 16:23	1,09	2	2,17	CHI
2019129413	FORMOSA	10008924420	ITUIQUIRA	02/12/2019 15:18	02/12/2019 18:11	02/12/2019 15:18	02/12/2019 18:11	2,87	1	2,87	CHI
2019129414	SANTA BARBARA DE GOIAS	SB12234175	TRINDADE	02/12/2019 15:04	02/12/2019 17:10	02/12/2019 15:04	02/12/2019 17:10	2,09	11	23,00	CHI
2019129414	TRINDADE	SB12234175	TRINDADE	02/12/2019 15:04	02/12/2019 17:10	02/12/2019 15:04	02/12/2019 17:10	2,09	1	2,09	CHI
2019129420	NOVO GAMA	NJ21163228	PACAEMBU S1	02/12/2019 15:20	02/12/2019 18:36	02/12/2019 15:20	02/12/2019 18:36	3,26	1	3,26	CHI
2019129428	TERESINA DE GOIAS	10020113291	FLORES DE GOIAS	02/12/2019 15:22	02/12/2019 19:57	02/12/2019 15:22	02/12/2019 19:57	4,58	1	4,58	CHI
2019129429	GOIANIA	10649232	CAMPINAS S3	02/12/2019 15:22	02/12/2019 17:47	02/12/2019 15:22	02/12/2019 17:47	2,41	1	2,41	CHI
2019129430	PIRES DO RIO	460053061	PIRES DO RIO S1	02/12/2019 15:23	02/12/2019 16:49	02/12/2019 15:23	02/12/2019 16:49	1,44	1	1,44	CHI
2019129432	MOZARLANDIA	MZ12181320	MOZARLANDIA	02/12/2019 14:01	03/12/2019 10:47	02/12/2019 14:01	03/12/2019 10:47	20,76	22	456,79	CHI
2019129433	FORMOSA	610252185	ITUIQUIRA	02/12/2019 15:23	02/12/2019 18:14	02/12/2019 15:23	02/12/2019 18:14	2,86	1	2,86	CHI
2019129435	ANAPOLIS	AN12261233	ANAPOLIS UNIVERSITARIO S2	02/12/2019 14:58	02/12/2019 18:05	02/12/2019 14:58	02/12/2019 18:05	3,11	14	43,57	CHI
2019129436	MINACU	IH11262687	MINACU	02/12/2019 15:23	02/12/2019 20:17	02/12/2019 15:23	02/12/2019 20:17	4,89	1	4,89	CHI
2019129440	ANAPOLIS	20701100	ANAPOLIS UNIVERSITARIO S1	02/12/2019 15:24	03/12/2019 00:30	02/12/2019 15:24	03/12/2019 00:30	9,09	1	9,09	CHI
2019129442	CAMPESTRE DE GOIAS	GC12005180	TRINDADE	02/12/2019 15:24	03/12/2019 08:34	02/12/2019 15:24	03/12/2019 08:34	17,15	3	51,45	CHI
2019129446	LUZIANIA	120229389	RIO VERMELHO	02/12/2019 15:26	02/12/2019 18:27	02/12/2019 15:26	02/12/2019 18:27	3,02	1	3,02	CHI
2019129447	ALEXANIA	480077629	ALEXANIA	02/12/2019 15:26	02/12/2019 18:16	02/12/2019 15:26	02/12/2019 18:16	2,83	1	2,83	CHI
2019129451	PORANGATU	PO21256446	NOVO PLANALTO	02/12/2019 15:26	02/12/2019 20:36	02/12/2019 15:26	02/12/2019 20:36	5,16	1	5,16	CHI
2019129459	SENADOR CANEDO	12152948	CEPAIGO S1	02/12/2019 15:28	02/12/2019 18:13	02/12/2019 15:28	02/12/2019 18:13	2,75	1	2,75	CHI
2019129461	JUSSARA	1290033150	JUSSARA	02/12/2019 15:28	03/12/2019 11:30	02/12/2019 15:28	03/12/2019 11:30	20,03	1	20,03	CHI
2019129463	CATALAO	CT12338714	CATALAO S1	02/12/2019 15:28	03/12/2019 10:30	02/12/2019 15:28	03/12/2019 10:30	19,03	6	114,15	CHI
2019129465	SANTO ANTONIO DE GOIAS	GR12090049	NEROPOLIS S1	02/12/2019 15:29	02/12/2019 18:24	02/12/2019 15:29	02/12/2019 18:24	2,91	2	5,82	CHI
2019129469	ALTO PARAISO DE GOIAS	BF21265671	NIQUELANDIA SUBTRANSMISSAO	02/12/2019 15:29	03/12/2019 15:50	02/12/2019 15:29	03/12/2019 15:50	24,34	1	24,34	CHI
2019129470	CAIAPONIA	CP21207913	CAIAPONIA	02/12/2019 15:30	03/12/2019 09:31	02/12/2019 15:30	03/12/2019 09:31	18,01	1	18,01	CHI
2019129477	CEZARINA	CZ21138621	CEZARINA	02/12/2019 15:32	03/12/2019 09:23	02/12/2019 15:32	03/12/2019 09:23	17,84	3	53,53	CHI
2019129481	GOIANIA	11408236	GOYA S1	02/12/2019 15:33	02/12/2019 16:44	02/12/2019 15:33	02/12/2019 16:44	1,18	1	1,18	CHI
2019129482	FORMOSA	610013336	ITUIQUIRA	02/12/2019 15:33	03/12/2019 04:45	02/12/2019 15:33	03/12/2019 04:45	13,19	1	13,19	CHI
2019129485	GOIANIA	10005655259	GOIANIA LESTE S2	02/12/2019 15:34	02/12/2019 16:53	02/12/2019 15:34	02/12/2019 16:53	1,32	1	1,32	CHI
2019129490	GOIANIRA	GR12016121	GOIANIRA	02/12/2019 15:35	03/12/2019 07:19	02/12/2019 15:35	03/12/2019 07:19	15,72	1	15,72	CHI
2019129500	GOIAS	GS21021586	GOIAS	02/12/2019 15:38	02/12/2019 16:45	02/12/2019 16:30	02/12/2019 16:45	0,25	1	0,25	CHI
2019129501	PIRENOPOLIS	PV21337726	CORUMBA	02/12/2019 15:38	03/12/2019 08:15	02/12/2019 15:38	03/12/2019 08:15	16,62	1	16,62	CHI
2019129509	BELA VISTA DE GOIAS	BV12011697	BELA VISTA S1	02/12/2019 15:38	02/12/2019 18:19	02/12/2019 15:38	02/12/2019 18:19	2,67	12	32,05	CHI

2019129511	MUTUNOPOLIS	PO12084869	PORANGATU	02/12/2019 15:39	02/12/2019 17:51	02/12/2019 15:39	02/12/2019 17:51	2,20	4	8,79	CHI
2019129511	PORANGATU	PO12084869	PORANGATU	02/12/2019 15:39	02/12/2019 17:51	02/12/2019 15:39	02/12/2019 17:51	2,20	3	6,59	CHI
2019129512	ITARUMA	IM12058485	CACHOEIRA ALTA	02/12/2019 15:39	02/12/2019 16:57	02/12/2019 15:39	02/12/2019 16:57	1,29	3	3,88	CHI
2019129517	ANAPOLIS	21147425	ANAPOLIS UNIVERSITARIO S2	02/12/2019 15:39	02/12/2019 17:33	02/12/2019 15:39	02/12/2019 17:33	1,88	1	1,88	CHI
2019129522	HIDROLANDIA	HD31038566	GUAPO S2	02/12/2019 15:40	02/12/2019 23:39	02/12/2019 15:40	02/12/2019 23:39	7,98	1	7,98	CHI
2019129537	TRES RANCHOS	TH12149178	CATALAO S1	02/12/2019 15:43	02/12/2019 17:16	02/12/2019 15:43	02/12/2019 17:16	1,54	14	21,60	CHI
2019129539	SAO SIMAO	10001392687	CACHOEIRA ALTA	02/12/2019 15:43	02/12/2019 19:38	02/12/2019 15:43	02/12/2019 19:38	3,90	1	3,90	CHI
2019129542	ABADIANIA	AN12221398	ANAPOLIS UNIVERSITARIO S2	02/12/2019 20:23	03/12/2019 00:01	02/12/2019 20:23	03/12/2019 00:01	3,62	17	61,51	CHI
2019129542	ANAPOLIS	AN12221398	ANAPOLIS UNIVERSITARIO S2	02/12/2019 20:23	03/12/2019 00:01	02/12/2019 20:23	03/12/2019 00:01	3,62	2	7,24	CHI
2019129542	PIRENOPOLIS	AN12221398	ANAPOLIS UNIVERSITARIO S2	02/12/2019 20:23	03/12/2019 00:01	02/12/2019 20:23	03/12/2019 00:01	3,62	13	47,04	CHI
2019129553	GOIANIA	GN11337838	FERROVIARIO S2	02/12/2019 15:47	02/12/2019 21:04	02/12/2019 15:47	02/12/2019 21:04	5,27	184	969,99	CHI
2019129556	CACU	CC12322236	CACHOEIRA ALTA	02/12/2019 15:48	02/12/2019 19:00	02/12/2019 15:48	02/12/2019 19:00	3,19	1	3,19	CHI
2019129563	SENADOR CANEDO	10013577342	GOIANIA LESTE S2	02/12/2019 15:23	02/12/2019 17:41	02/12/2019 15:23	02/12/2019 17:41	2,31	1	2,31	CHI
2019129564	PIRACANJUBA	10012085535	PIRACANJUBA	02/12/2019 15:49	02/12/2019 19:01	02/12/2019 15:49	02/12/2019 19:01	3,20	1	3,20	CHI
2019129568	ITAGUARU	IC21250496	ITABERAI S1	02/12/2019 15:49	02/12/2019 18:15	02/12/2019 15:49	02/12/2019 18:15	2,42	1	2,42	CHI
2019129571	URUACU	10000779260	URUACU	02/12/2019 15:50	03/12/2019 10:41	02/12/2019 15:50	03/12/2019 10:41	18,84	1	18,84	CHI
2019129572	GOIANESIA	10019034871	GOIANESIA S2	02/12/2019 15:50	03/12/2019 15:24	02/12/2019 15:50	03/12/2019 15:24	23,56	1	23,56	CHI
2019129575	BELA VISTA DE GOIAS	BV32249964	BELA VISTA S1	02/12/2019 15:50	03/12/2019 00:49	02/12/2019 15:50	03/12/2019 00:49	8,97	47	421,76	CHI
2019129586	PLANALTINA	10013096514	PLANALTINA	02/12/2019 15:53	03/12/2019 11:19	02/12/2019 15:53	03/12/2019 11:19	19,44	1	19,44	CHI
2019129589	PIRES DO RIO	PR12050057	PIRES DO RIO S1	02/12/2019 15:46	03/12/2019 16:52	02/12/2019 15:46	03/12/2019 16:52	25,10	92	2308,94	CHI
2019129591	PORANGATU	PO12139105	PORANGATU	02/12/2019 15:54	03/12/2019 22:20	02/12/2019 15:54	03/12/2019 22:20	30,42	3	91,26	CHI
2019129594	GOIANIRA	10010394271	MEIA PONTE	02/12/2019 15:55	02/12/2019 22:33	02/12/2019 15:55	02/12/2019 22:33	6,65	1	6,65	CHI
2019129595	BARRO ALTO	BA12210736	GOIANESIA S1	02/12/2019 15:09	02/12/2019 20:50	02/12/2019 15:09	02/12/2019 20:50	5,67	20	113,49	CHI
2019129597	SANTA TEREZINHA DE GOIAS	SG11034165	SANTA TEREZINHA	02/12/2019 15:34	02/12/2019 17:59	02/12/2019 15:34	02/12/2019 17:59	2,41	193	465,34	CHI
2019129599	JATAI	10007043838	JATAI S2	02/12/2019 15:55	02/12/2019 18:40	02/12/2019 15:55	02/12/2019 18:40	2,74	1	2,74	CHI
2019129600	GOIANIA	10273153	CAMPINAS S2	02/12/2019 15:56	02/12/2019 20:49	02/12/2019 15:56	02/12/2019 20:49	4,88	1	4,88	CHI
2019129607	GOIANIRA	GR12131271	GOIANIRA	02/12/2019 15:19	02/12/2019 18:09	02/12/2019 15:19	02/12/2019 18:09	2,83	131	370,88	CHI
2019129608	ANAPOLIS	AN10400681	ANAPOLIS UNIVERSITARIO S2	02/12/2019 15:17	03/12/2019 00:07	02/12/2019 15:17	02/12/2019 23:53	8,61	58	499,32	CHI
2019129608	GAMELEIRA DE GOIAS	AN10400681	ANAPOLIS UNIVERSITARIO S2	02/12/2019 15:17	03/12/2019 00:07	02/12/2019 15:17	02/12/2019 23:53	8,61	33	284,09	CHI
2019129608	SILVANIA	AN10400681	ANAPOLIS UNIVERSITARIO S2	02/12/2019 15:17	03/12/2019 00:07	02/12/2019 15:17	02/12/2019 23:53	8,61	1	8,61	CHI
2019129608	ANAPOLIS	AN12382307	ANAPOLIS UNIVERSITARIO S2	02/12/2019 15:17	03/12/2019 00:07	02/12/2019 15:17	03/12/2019 00:07	8,84	40	353,59	CHI
2019129608	GAMELEIRA DE GOIAS	AN12382307	ANAPOLIS UNIVERSITARIO S2	02/12/2019 15:17	03/12/2019 00:07	02/12/2019 15:17	03/12/2019 00:07	8,84	31	274,03	CHI
2019129610	IVOLANDIA	IV21334692	IPORA	02/12/2019 15:58	02/12/2019 23:24	02/12/2019 15:58	02/12/2019 23:24	7,43	1	7,43	CHI

2019129614	GOIANIA	GN12037010	GOIANIA LESTE S1	02/12/2019 15:43	02/12/2019 17:43	02/12/2019 15:43	02/12/2019 17:43	2,00	92	183,74	CHI
2019129616	CORUMBAIBA	CI11215742	VILA CORUMBA	02/12/2019 15:59	02/12/2019 18:40	02/12/2019 15:59	02/12/2019 18:40	2,68	34	91,10	CHI
2019129628	PORANGATU	PO12297141	PORANGATU	02/12/2019 16:01	03/12/2019 08:17	02/12/2019 16:01	03/12/2019 08:17	16,26	18	292,73	CHI
2019129634	ALEXANIA	AX21032757	ALEXANIA	02/12/2019 16:02	03/12/2019 11:48	02/12/2019 16:02	03/12/2019 11:48	19,76	1	19,76	CHI
2019129635	BARRO ALTO	BA11000004	BARRO ALTO	02/12/2019 16:02	02/12/2019 19:45	02/12/2019 16:02	02/12/2019 19:45	3,71	132	489,21	CHI
2019129640	RIO VERDE	RV12297883	MONTIVIDIU T	02/12/2019 15:08	02/12/2019 18:14	02/12/2019 15:08	02/12/2019 18:14	3,09	14	43,29	CHI
2019129641	FAINA	FC21094664	GOIAS	02/12/2019 16:03	03/12/2019 09:41	02/12/2019 16:03	03/12/2019 09:41	17,63	1	17,63	CHI
2019129642	CAIAPONIA	PY12020934	PALESTINA	02/12/2019 16:03	03/12/2019 07:50	02/12/2019 16:03	03/12/2019 07:50	15,78	161	2540,09	CHI
2019129642	PALESTINA DE GOIAS	PY12020934	PALESTINA	02/12/2019 16:03	03/12/2019 07:50	02/12/2019 16:03	03/12/2019 07:50	15,78	25	394,42	CHI
2019129644	GOIANIA	15049474	GOIANIA LESTE S3	02/12/2019 16:04	02/12/2019 19:31	02/12/2019 16:04	02/12/2019 19:31	3,45	1	3,45	CHI
2019129648	GOIANIRA	GR11167473	GOIANIRA	02/12/2019 15:45	02/12/2019 18:31	02/12/2019 15:45	02/12/2019 18:31	2,76	269	743,49	CHI
2019129654	SAO JOAO D ALIANCA	JL11211480	SAO JOAO D ALIANCA	02/12/2019 16:05	03/12/2019 13:18	02/12/2019 16:05	03/12/2019 13:18	21,21	4	84,83	CHI
2019129655	ARAGOIANIA	AO31000373	GUAPO S2	02/12/2019 16:05	03/12/2019 05:19	02/12/2019 16:05	03/12/2019 05:19	13,23	1	13,23	CHI
2019129656	CABECEIRAS	CW12388230	ITUIQUIRA	02/12/2019 16:05	03/12/2019 01:31	02/12/2019 16:05	03/12/2019 01:31	9,42	1	9,42	CHI
2019129658	BARRO ALTO	PV12069121	GOIANESIA S1	02/12/2019 15:24	02/12/2019 18:02	02/12/2019 15:24	02/12/2019 18:02	2,62	1	2,62	CHI
2019129658	VILA PROPICIO	PV12069121	GOIANESIA S1	02/12/2019 15:24	02/12/2019 18:02	02/12/2019 15:24	02/12/2019 18:02	2,62	32	83,98	CHI
2019129659	GOIANIA	11507792	GOIANIA LESTE S1	02/12/2019 16:06	02/12/2019 18:00	02/12/2019 16:06	02/12/2019 18:00	1,90	1	1,90	CHI
2019129661	POSSE	SA12268178	IACIARA S2	02/12/2019 16:06	02/12/2019 18:57	02/12/2019 16:06	02/12/2019 18:57	2,83	3	8,50	CHI
2019129663	BARRO ALTO	BA21097050	BARRO ALTO	02/12/2019 16:07	02/12/2019 16:28	02/12/2019 16:07	02/12/2019 16:28	0,35	1	0,35	CHI
2019129665	LEOPOLDO DE BULHOES	LB21351029	DAIA S2	02/12/2019 16:08	04/12/2019 10:52	02/12/2019 16:08	04/12/2019 10:52	42,73	2	85,46	CHI
2019129666	RIO VERDE	RV12190361	CABRIUVA S2	02/12/2019 16:08	02/12/2019 19:13	02/12/2019 16:08	02/12/2019 19:13	3,08	11	33,86	CHI
2019129668	GOUVELANDIA	GB12116524	QUIRINOPOLIS	02/12/2019 16:08	02/12/2019 20:19	02/12/2019 16:08	02/12/2019 20:19	4,17	4	16,70	CHI
2019129668	QUIRINOPOLIS	GB12116524	QUIRINOPOLIS	02/12/2019 16:08	02/12/2019 20:19	02/12/2019 16:08	02/12/2019 20:19	4,17	7	29,22	CHI
2019129675	CALDAS NOVAS	10010254992	CALDAS NOVAS S2	02/12/2019 16:10	02/12/2019 17:26	02/12/2019 16:10	02/12/2019 17:26	1,26	1	1,26	CHI
2019129679	TRINDADE	11891105	GOYA S1	02/12/2019 16:11	02/12/2019 18:51	02/12/2019 16:11	02/12/2019 18:51	2,66	1	2,66	CHI
2019129685	QUIRINOPOLIS	QI12279586	QUIRINOPOLIS	03/12/2019 14:22	03/12/2019 21:08	03/12/2019 14:22	03/12/2019 21:08	6,75	20	135,02	CHI
2019129687	CRISTALINA	KR11273441	CRISTALINA S2	02/12/2019 16:12	03/12/2019 09:54	02/12/2019 16:12	03/12/2019 09:54	17,69	1	17,69	CHI
2019129688	RIO VERDE	RV12226357	MONTIVIDIU T	02/12/2019 15:24	02/12/2019 20:00	02/12/2019 15:24	02/12/2019 20:00	4,59	68	312,14	CHI
2019129691	GOIANIA	16672161	CARAJAS S1	02/12/2019 16:13	02/12/2019 17:03	02/12/2019 16:13	02/12/2019 17:03	0,82	1	0,82	CHI
2019129698	ITUMBIARA	IT21316684	ITUMBIARA NOVA	02/12/2019 16:15	02/12/2019 18:00	02/12/2019 16:15	02/12/2019 18:00	1,74	1	1,74	CHI
2019129702	COCALZINHO DE GOIAS	ZN12320107	AGUAS LINDAS DE GOIAS S1	02/12/2019 16:16	02/12/2019 20:14	02/12/2019 16:16	02/12/2019 20:14	3,96	13	51,47	CHI
2019129703	GOIANAPOLIS	GP21353319	DAIA S2	02/12/2019 16:16	03/12/2019 10:13	02/12/2019 16:16	03/12/2019 10:13	17,94	2	35,88	CHI
2019129704	CALDAS NOVAS	760305353	CALDAS NOVAS S2	02/12/2019 16:17	02/12/2019 19:32	02/12/2019 16:17	02/12/2019 19:32	3,25	1	3,25	CHI

2019129712	JATAI	JT12061506	JATAI S2	02/12/2019 16:20	03/12/2019 07:44	02/12/2019 16:20	02/12/2019 22:00	5,66	60	339,82	CHI
2019129712	JATAI	JT12061506	JATAI S2	02/12/2019 16:20	03/12/2019 07:44	02/12/2019 18:50	02/12/2019 22:00	3,17	2	6,33	CHI
2019129712	JATAI	JT12061506	JATAI S2	02/12/2019 16:20	03/12/2019 07:44	02/12/2019 16:20	02/12/2019 23:09	6,82	4	27,28	CHI
2019129712	JATAI	JT12159417LD	JATAI S2	02/12/2019 16:20	03/12/2019 07:44	02/12/2019 18:50	02/12/2019 23:09	4,32	1	4,32	CHI
2019129712	JATAI	JT12061506	JATAI S2	02/12/2019 16:20	03/12/2019 07:44	02/12/2019 16:20	03/12/2019 07:44	15,41	2	30,81	CHI
2019129715	QUIRINOPOLIS	QI12303153	QUIRINOPOLIS	02/12/2019 16:20	02/12/2019 23:52	02/12/2019 16:20	02/12/2019 23:52	7,53	5	37,63	CHI
2019129718	SAO LUIS DE MONTES BELOS	SL31125659	FIRMINOPOLIS S1	02/12/2019 16:20	02/12/2019 18:37	02/12/2019 16:20	02/12/2019 18:37	2,28	1	2,28	CHI
2019129729	PANAMA	PX21278933	GOIATUBA S1	02/12/2019 16:23	02/12/2019 18:10	02/12/2019 16:23	02/12/2019 18:10	1,78	1	1,78	CHI
2019129731	HIDROLANDIA	HD31064191	GUAPO S2	02/12/2019 16:25	03/12/2019 08:56	02/12/2019 16:25	03/12/2019 08:56	16,51	1	16,51	CHI
2019129732	GOIANIA	AP12199088	INDEPENDENCIA S2	02/12/2019 16:02	02/12/2019 18:24	02/12/2019 16:02	02/12/2019 18:24	2,37	785	1856,74	CHI
2019129734	GOIANIA	16164891	GOYA S2	02/12/2019 16:25	02/12/2019 17:58	02/12/2019 16:25	02/12/2019 17:58	1,54	1	1,54	CHI
2019129735	ITAJA	XX12379591	CACHOEIRA ALTA	02/12/2019 16:25	03/12/2019 15:52	02/12/2019 16:25	03/12/2019 15:52	23,44	1	23,44	CHI
2019129736	FORMOSO	FO21185344	PORANGATU	02/12/2019 16:26	03/12/2019 12:57	02/12/2019 16:26	03/12/2019 12:57	20,51	2	41,02	CHI
2019129737	AGUAS LINDAS DE GOIAS	10015026254	AGUAS LINDAS DE GOIAS S1	02/12/2019 16:26	02/12/2019 22:09	02/12/2019 16:26	02/12/2019 22:09	5,71	1	5,71	CHI
2019129754	DAMOLANDIA	DL21014352	INHUMAS S1	02/12/2019 16:28	03/12/2019 15:10	02/12/2019 16:28	03/12/2019 15:10	22,70	1	22,70	CHI
2019129756	GOUVELANDIA	GB12402360	QUIRINOPOLIS	02/12/2019 16:29	02/12/2019 17:32	02/12/2019 16:29	02/12/2019 17:32	1,05	3	3,15	CHI
2019129756	QUIRINOPOLIS	GB12402360	QUIRINOPOLIS	02/12/2019 16:29	02/12/2019 17:32	02/12/2019 16:29	02/12/2019 17:32	1,05	4	4,20	CHI
2019129761	PLANALTINA	PI12081001	PLANALTINA	02/12/2019 16:30	03/12/2019 10:49	02/12/2019 16:30	03/12/2019 10:49	18,31	2	36,62	CHI
2019129763	BONOPOLIS	BX12165447	SAO MIGUEL DO ARAGUAIA	02/12/2019 16:30	02/12/2019 21:20	02/12/2019 16:30	02/12/2019 21:20	4,83	3	14,49	CHI
2019129777	ITAJA	IJ12226574	ITAJA S2	02/12/2019 16:35	02/12/2019 17:50	02/12/2019 16:35	02/12/2019 17:50	1,24	8	9,93	CHI
2019129791	JATAI	CP12147712	CAIAPONIA	02/12/2019 15:26	03/12/2019 09:26	02/12/2019 15:26	03/12/2019 09:26	17,99	3	53,96	CHI
2019129791	RIO VERDE	CP12147712	CAIAPONIA	02/12/2019 15:26	03/12/2019 09:26	02/12/2019 15:26	03/12/2019 09:26	17,99	4	71,94	CHI
2019129793	APARECIDA DE GOIANIA	200133561	INDEPENDENCIA S2	02/12/2019 16:38	02/12/2019 18:44	02/12/2019 16:38	02/12/2019 18:44	2,09	1	2,09	CHI
2019129798	APARECIDA DE GOIANIA	200273565	ANHANGUERA	02/12/2019 16:39	02/12/2019 18:40	02/12/2019 16:39	02/12/2019 18:40	2,00	1	2,00	CHI
2019129802	ALVORADA DO NORTE	00010434	IACIARA S2	02/12/2019 16:35	02/12/2019 17:34	02/12/2019 17:24	02/12/2019 17:34	0,17	175	29,99	CHI
2019129802	BURITINOPOLIS	00010434	IACIARA S2	02/12/2019 16:35	02/12/2019 17:34	02/12/2019 17:24	02/12/2019 17:34	0,17	432	74,04	CHI
2019129802	BURITINOPOLIS	00010434	IACIARA S2	02/12/2019 16:35	02/12/2019 17:34	02/12/2019 17:24	02/12/2019 17:34	0,17	7	1,20	CHI
2019129802	DAMIANOPOLIS	00010434	IACIARA S2	02/12/2019 16:35	02/12/2019 17:34	02/12/2019 17:24	02/12/2019 17:34	0,17	130	22,28	CHI
2019129802	DAMIANOPOLIS	00010434	IACIARA S2	02/12/2019 16:35	02/12/2019 17:34	02/12/2019 17:24	02/12/2019 17:34	0,17	1511	258,97	CHI
2019129802	DAMIANOPOLIS	00010434	IACIARA S2	02/12/2019 16:35	02/12/2019 17:34	02/12/2019 17:24	02/12/2019 17:34	0,17	2	0,34	CHI
2019129802	MAMBAI	00010434	IACIARA S2	02/12/2019 16:35	02/12/2019 17:34	02/12/2019 17:24	02/12/2019 17:34	0,17	2867	491,37	CHI
2019129802	MAMBAI	00010434	IACIARA S2	02/12/2019 16:35	02/12/2019 17:34	02/12/2019 17:24	02/12/2019 17:34	0,17	83	14,23	CHI
2019129802	MAMBAI	00010434	IACIARA S2	02/12/2019 16:35	02/12/2019 17:34	02/12/2019 17:24	02/12/2019 17:34	0,17	17	2,91	CHI

2019129802	SITIO D ABADIA	00010434	IACIARA S2	02/12/2019 16:35	02/12/2019 17:34	02/12/2019 17:24	02/12/2019 17:34	0,17	378	64,78	CHI
2019129802	SITIO D ABADIA	00010434	IACIARA S2	02/12/2019 16:35	02/12/2019 17:34	02/12/2019 17:24	02/12/2019 17:34	0,17	90	15,42	CHI
2019129802	SITIO D ABADIA	00010434	IACIARA S2	02/12/2019 16:35	02/12/2019 17:34	02/12/2019 17:24	02/12/2019 17:34	0,17	1	0,17	CHI
2019129802	SITIO D ABADIA	00010434	IACIARA S2	02/12/2019 16:35	02/12/2019 17:34	02/12/2019 17:24	02/12/2019 17:34	0,17	481	82,44	CHI
2019129802	SITIO D ABADIA	00010434	IACIARA S2	02/12/2019 16:35	02/12/2019 17:34	02/12/2019 17:24	02/12/2019 17:34	0,17	35	6,00	CHI
2019129905	MONTIVIDIU	MV12249172	MONTIVIDIU T	02/12/2019 16:40	02/12/2019 19:28	02/12/2019 16:40	02/12/2019 19:28	2,79	3	8,37	CHI
2019129909	PORANGATU	PO21217350	PORANGATU	02/12/2019 16:42	02/12/2019 18:01	02/12/2019 16:42	02/12/2019 18:01	1,32	1	1,32	CHI
2019129911	NAZARIO	NZ12003986	ANICUNS	02/12/2019 16:42	03/12/2019 01:10	02/12/2019 16:42	03/12/2019 01:10	8,46	5	42,32	CHI
2019129913	APARECIDA DE GOIANIA	200412061	INDEPENDENCIA S2	02/12/2019 16:42	02/12/2019 22:17	02/12/2019 16:42	02/12/2019 22:17	5,58	1	5,58	CHI
2019129915	INHUMAS	IN21049750	INHUMAS S2	02/12/2019 16:43	03/12/2019 04:50	02/12/2019 16:43	03/12/2019 04:50	12,11	2	24,22	CHI
2019129919	CALDAS NOVAS	10000194407	SERRA DE CALDAS	02/12/2019 16:44	02/12/2019 20:40	02/12/2019 16:44	02/12/2019 20:40	3,94	1	3,94	CHI
2019129926	CRIXAS	CX11354717	MOZARLANDIA	02/12/2019 16:46	03/12/2019 11:09	02/12/2019 16:46	03/12/2019 11:09	18,38	1	18,38	CHI
2019129933	ANAPOLIS	20191406	JUNDIAI S2	02/12/2019 16:49	02/12/2019 21:15	02/12/2019 16:49	02/12/2019 21:15	4,43	1	4,43	CHI
2019129935	CABECEIRAS	CW21184642	ITUIQUIRA	02/12/2019 16:49	03/12/2019 14:30	02/12/2019 16:49	03/12/2019 14:30	21,68	2	43,36	CHI
2019129938	SANTA HELENA DE GOIAS	SH12296170	IPEGUARI	02/12/2019 16:50	02/12/2019 18:17	02/12/2019 16:50	02/12/2019 18:17	1,46	8	11,69	CHI
2019129940	PIRES DO RIO	460041228	PIRES DO RIO S1	02/12/2019 16:51	02/12/2019 21:04	02/12/2019 16:51	02/12/2019 21:04	4,23	1	4,23	CHI
2019129941	PLANALTINA	10027354952	PLANALTINA	02/12/2019 16:51	02/12/2019 22:38	02/12/2019 16:51	02/12/2019 22:38	5,78	1	5,78	CHI
2019129943	CEZARINA	CZ21277674	CEZARINA	02/12/2019 16:51	03/12/2019 11:40	02/12/2019 16:51	03/12/2019 11:40	18,82	4	75,29	CHI
2019129950	AURILANDIA	CG12391526	FIRMINOPOLIS S2	02/12/2019 16:47	02/12/2019 19:13	02/12/2019 16:47	02/12/2019 19:13	2,44	2	4,87	CHI
2019129950	CACHOEIRA DE GOIAS	CG12391526	FIRMINOPOLIS S2	02/12/2019 16:47	02/12/2019 19:13	02/12/2019 16:47	02/12/2019 19:13	2,44	11	26,79	CHI
2019129950	PARAUNA	CG12391526	FIRMINOPOLIS S2	02/12/2019 16:47	02/12/2019 19:13	02/12/2019 16:47	02/12/2019 19:13	2,44	30	73,05	CHI
2019129962	GOIANIA	10800633	CARAJAS S1	02/12/2019 16:54	02/12/2019 18:05	02/12/2019 16:54	02/12/2019 18:05	1,17	1	1,17	CHI
2019129967	CRIXAS	CX12202134	SERRA DO OURO	02/12/2019 15:08	03/12/2019 12:01	02/12/2019 15:08	03/12/2019 12:01	20,89	46	961,00	CHI
2019129968	BURITI ALEGRE	10021666596	ITUMBIARA VELHA S2	02/12/2019 16:55	03/12/2019 11:08	02/12/2019 16:55	03/12/2019 11:08	18,20	1	18,20	CHI
2019129975	VALPARAISO DE GOIAS	VA11162795	PACAEMBU S2	02/12/2019 16:36	02/12/2019 18:54	02/12/2019 16:36	02/12/2019 18:54	2,29	63	144,37	CHI
2019129976	MOZARLANDIA	MZ12055650	MOZARLANDIA	02/12/2019 16:57	04/12/2019 20:00	03/12/2019 13:26	03/12/2019 22:10	8,73	2	17,46	CHI
2019129976	NOVA CRIXAS	MZ12055650	MOZARLANDIA	02/12/2019 16:57	04/12/2019 20:00	03/12/2019 13:26	03/12/2019 22:10	8,73	24	209,47	CHI
2019129976	MOZARLANDIA	MZ12055650	MOZARLANDIA	02/12/2019 16:57	04/12/2019 20:00	04/12/2019 07:02	04/12/2019 10:08	3,11	2	6,21	CHI
2019129976	NOVA CRIXAS	MZ12055650	MOZARLANDIA	02/12/2019 16:57	04/12/2019 20:00	04/12/2019 07:02	04/12/2019 10:08	3,11	24	74,57	CHI
2019129976	CRIXAS	MZ12150974LD	MOZARLANDIA	02/12/2019 16:57	04/12/2019 20:00	03/12/2019 13:26	04/12/2019 12:08	22,70	76	1725,33	CHI
2019129976	MOZARLANDIA	MZ12150974LD	MOZARLANDIA	02/12/2019 16:57	04/12/2019 20:00	03/12/2019 13:26	04/12/2019 12:08	22,70	3	68,10	CHI
2019129976	NOVA CRIXAS	MZ12150974LD	MOZARLANDIA	02/12/2019 16:57	04/12/2019 20:00	03/12/2019 13:26	04/12/2019 12:08	22,70	4	90,81	CHI
2019129976	MOZARLANDIA	NA12084403	MOZARLANDIA	02/12/2019 16:57	04/12/2019 20:00	04/12/2019 11:56	04/12/2019 20:00	8,06	2	16,13	CHI

2019129976	NOVA CRIXAS	NA12084403	MOZARLANDIA	02/12/2019 16:57	04/12/2019 20:00	04/12/2019 11:56	04/12/2019 20:00	8,06	5	40,32	CHI
2019129977	AURILANDIA	AI21142526	FIRMINOPOLIS S2	02/12/2019 16:57	02/12/2019 21:16	02/12/2019 16:57	02/12/2019 21:16	4,31	1	4,31	CHI
2019129982	VALPARAISO DE GOIAS	2860341888	PACAEMBU S2	02/12/2019 16:57	02/12/2019 19:55	02/12/2019 16:57	02/12/2019 19:55	2,95	1	2,95	CHI
2019129983	RIO VERDE	RV21230872	RIO VERDE S1	02/12/2019 16:58	03/12/2019 10:07	02/12/2019 16:58	03/12/2019 10:07	17,15	1	17,15	CHI
2019129984	GOIANIA	11258858	CAMPINAS S1	02/12/2019 16:58	02/12/2019 20:12	02/12/2019 16:58	02/12/2019 20:12	3,24	1	3,24	CHI
2019129987	BARRO ALTO	1150015874	BARRO ALTO	02/12/2019 16:58	03/12/2019 11:08	02/12/2019 16:58	03/12/2019 11:08	18,16	1	18,16	CHI
2019129992	GOIANIA	GN11169451	ATLANTICO S3	02/12/2019 16:58	02/12/2019 19:25	02/12/2019 16:58	02/12/2019 19:25	2,44	34	82,83	CHI
2019129995	GOIANIRA	GR11076749	GOIANIRA	02/12/2019 15:45	02/12/2019 20:03	02/12/2019 15:45	02/12/2019 20:03	4,30	212	911,01	CHI
2019129996	JATAI	290331500	JATAI S3	02/12/2019 16:59	03/12/2019 00:47	02/12/2019 16:59	03/12/2019 00:47	7,81	1	7,81	CHI
2019129998	PIRENOPOLIS	PV12381294	CORUMBA	02/12/2019 17:00	03/12/2019 11:27	02/12/2019 17:00	03/12/2019 11:27	18,45	8	147,59	CHI
20191210002	RIO VERDE	630100718	CABRIUVA S1	02/12/2019 17:00	03/12/2019 02:23	02/12/2019 17:00	03/12/2019 02:23	9,38	1	9,38	CHI
20191210003	SAO MIGUEL DO ARAGUAIA	SM21132263	SAO MIGUEL DO ARAGUAIA	02/12/2019 17:00	02/12/2019 19:45	02/12/2019 17:00	02/12/2019 19:45	2,75	1	2,75	CHI
20191210007	INHUMAS	IN12402836	INHUMAS S1	02/12/2019 16:11	02/12/2019 21:40	02/12/2019 16:11	02/12/2019 21:40	5,48	3	16,43	CHI
20191210008	QUIRINOPOLIS	80128439	QUIRINOPOLIS	02/12/2019 17:03	02/12/2019 18:40	02/12/2019 17:03	02/12/2019 18:40	1,61	1	1,61	CHI
20191210012	INHUMAS	IN21066359	INHUMAS S2	02/12/2019 17:04	02/12/2019 22:01	02/12/2019 17:04	02/12/2019 22:01	4,95	1	4,95	CHI
20191210023	JATAI	290235765	JATAI S2	02/12/2019 17:06	02/12/2019 20:35	02/12/2019 17:06	02/12/2019 20:35	3,48	1	3,48	CHI
20191210036	PADRE BERNARDO	PB21313493	PADRE BERNARDO	02/12/2019 17:08	02/12/2019 19:18	02/12/2019 17:08	02/12/2019 19:18	2,15	1	2,15	CHI
20191210037	CROMINIA	HD12320395	PONTALINA	02/12/2019 17:08	03/12/2019 09:07	02/12/2019 17:09	03/12/2019 09:07	15,97	1	15,97	CHI
20191210037	HIDROLANDIA	HD12320395	PONTALINA	02/12/2019 17:08	03/12/2019 09:07	02/12/2019 17:09	03/12/2019 09:07	15,97	6	95,79	CHI
20191210040	FORMOSA	FA12233654	SAO JOAO D ALIANCA	02/12/2019 14:28	02/12/2019 19:48	02/12/2019 14:28	02/12/2019 19:48	5,33	10	53,26	CHI
20191210045	FORMOSA	FA21072536	ITUIQUIRA	02/12/2019 17:10	03/12/2019 12:32	02/12/2019 17:10	03/12/2019 12:32	19,37	1	19,37	CHI
20191210052	HIDROLANDIA	180059130	ANHANGUERA	02/12/2019 17:12	02/12/2019 22:46	02/12/2019 17:12	02/12/2019 22:46	5,57	1	5,57	CHI
20191210056	VILA PROPICIO	NP21231820	GOIANESIA S1	02/12/2019 17:13	04/12/2019 00:17	02/12/2019 17:13	04/12/2019 00:17	31,07	1	31,07	CHI
20191210057	NOVA AMERICA	NM21184711	RUBIATABA	02/12/2019 17:13	03/12/2019 17:30	02/12/2019 17:13	03/12/2019 17:30	24,29	1	24,29	CHI
20191210058	SAO LUIS DE MONTES BELOS	SL11215467	SAO LUIZ DOS MONTES BELOS	02/12/2019 17:13	02/12/2019 19:30	02/12/2019 17:13	02/12/2019 19:30	2,28	262	597,72	CHI
20191210060	CASTELANDIA	QJ12296614	QUIRINOPOLIS	02/12/2019 16:57	03/12/2019 08:40	02/12/2019 16:57	03/12/2019 08:40	15,71	1	15,71	CHI
20191210060	QUIRINOPOLIS	QJ12296614	QUIRINOPOLIS	02/12/2019 16:57	03/12/2019 08:40	02/12/2019 16:57	03/12/2019 08:40	15,71	11	172,83	CHI
20191210065	ARAGOIANIA	AO12034433	GUAPO S2	02/12/2019 17:14	03/12/2019 11:51	02/12/2019 17:14	03/12/2019 11:51	18,61	11	204,73	CHI
20191210075	NOVA IGUACU DE GOIAS	NH12202113	SANTA TEREZINHA	02/12/2019 17:18	03/12/2019 11:40	02/12/2019 17:18	03/12/2019 11:40	18,36	60	1101,43	CHI
20191210079	MUTUNOPOLIS	PO12242427	PORANGATU	02/12/2019 17:19	03/12/2019 09:10	02/12/2019 17:19	03/12/2019 09:10	15,84	8	126,75	CHI
20191210079	PORANGATU	PO12242427	PORANGATU	02/12/2019 17:19	03/12/2019 09:10	02/12/2019 17:19	03/12/2019 09:10	15,84	1	15,84	CHI
20191210080	BELA VISTA DE GOIAS	BV12009527	BELA VISTA S1	02/12/2019 17:19	02/12/2019 19:13	02/12/2019 17:19	02/12/2019 19:13	1,90	12	22,75	CHI
20191210091	PALMEIRAS DE GOIAS	PL12390266	PALMEIRAS	02/12/2019 17:13	03/12/2019 08:03	02/12/2019 17:13	03/12/2019 08:03	14,84	5	74,19	CHI

20191210092	GOIANIRA	10007993259	MEIA PONTE	02/12/2019 17:22	03/12/2019 05:49	02/12/2019 17:22	03/12/2019 05:49	12,46	1	12,46	CHI
20191210093	RIO VERDE	10030360283	RIO VERDE S1	02/12/2019 17:22	02/12/2019 18:58	02/12/2019 17:22	02/12/2019 18:58	1,60	1	1,60	CHI
20191210094	HIDROLANDIA	VJ21235143	GUAPO S2	02/12/2019 17:22	02/12/2019 23:55	02/12/2019 17:22	02/12/2019 23:55	6,55	1	6,55	CHI
20191210095	JATAI	SX12374259	JATAI S1	02/12/2019 17:23	02/12/2019 19:29	02/12/2019 17:23	02/12/2019 19:29	2,09	4	8,38	CHI
20191210095	SERRANOPOLIS	SX12374259	JATAI S1	02/12/2019 17:23	02/12/2019 19:29	02/12/2019 17:23	02/12/2019 19:29	2,09	1	2,09	CHI
20191210099	SERRANOPOLIS	SX21153263	JATAI S1	02/12/2019 17:23	03/12/2019 11:32	02/12/2019 17:23	03/12/2019 11:32	18,14	1	18,14	CHI
20191210104	ITAGUARU	IC21131491	ITABERAI S1	02/12/2019 17:25	02/12/2019 19:03	02/12/2019 17:25	02/12/2019 19:03	1,63	1	1,63	CHI
20191210106	SILVANIA	SV21295656	ANAPOLIS UNIVERSITARIO S2	02/12/2019 17:25	02/12/2019 20:10	02/12/2019 17:25	02/12/2019 20:10	2,74	1	2,74	CHI
20191210108	FORMOSA	FA12245860	ITUIQUIRA	02/12/2019 17:26	02/12/2019 23:04	02/12/2019 17:26	02/12/2019 23:04	5,63	58	326,73	CHI
20191210109	ALVORADA DO NORTE	AQ12184658	FLORES DE GOIAS	02/12/2019 16:13	02/12/2019 23:42	02/12/2019 16:13	02/12/2019 23:42	7,48	18	134,61	CHI
20191210114	AGUAS LINDAS DE GOIAS	10024211131	AGUAS LINDAS DE GOIAS S1	02/12/2019 17:25	02/12/2019 21:39	02/12/2019 17:25	02/12/2019 21:39	4,22	1	4,22	CHI
20191210115	SANTO ANTONIO DE GOIAS	BW21274494	NEROPOLIS S1	02/12/2019 17:27	02/12/2019 21:51	02/12/2019 17:27	02/12/2019 21:51	4,39	1	4,39	CHI
20191210116	ARENOPOLIS	AY12040872	ARENOPOLIS	02/12/2019 16:44	02/12/2019 20:17	02/12/2019 16:44	02/12/2019 20:17	3,55	13	46,10	CHI
20191210117	MINACU	IH11202494	MINACU	02/12/2019 17:08	03/12/2019 02:35	02/12/2019 17:08	03/12/2019 02:35	9,44	7	66,05	CHI
20191210119	FORMOSA	FA32051160	SAO JOAO D ALIANCA	02/12/2019 17:28	02/12/2019 20:38	02/12/2019 17:28	02/12/2019 20:38	3,17	2	6,33	CHI
20191210134	GOIAS	GS12206893	GOIAS	02/12/2019 17:30	02/12/2019 22:15	02/12/2019 17:30	02/12/2019 22:15	4,75	4	18,98	CHI
20191210136	INHUMAS	IN12066295	INHUMAS S2	02/12/2019 17:30	03/12/2019 00:06	02/12/2019 17:30	03/12/2019 00:06	6,59	2	13,18	CHI
20191210139	ORIZONA	OZ21128080	PIRES DO RIO S2	02/12/2019 17:31	03/12/2019 11:10	02/12/2019 17:31	03/12/2019 11:10	17,64	1	17,64	CHI
20191210140	RIO VERDE	10020120271	RIO VERDE S1	02/12/2019 17:31	02/12/2019 23:42	02/12/2019 17:31	02/12/2019 23:42	6,19	1	6,19	CHI
20191210145	GOIANDIRA	GD12250481	CATALAO S1	02/12/2019 17:20	02/12/2019 22:08	02/12/2019 17:20	02/12/2019 22:08	4,79	82	392,73	CHI
20191210156	GOIANIA	16460182	CAMPINAS S2	02/12/2019 17:34	02/12/2019 20:12	02/12/2019 17:34	02/12/2019 20:12	2,63	1	2,63	CHI
20191210168	SAO LUIS DE MONTES BELOS	SL12053971	SAO LUIZ DOS MONTES BELOS	02/12/2019 17:34	02/12/2019 19:45	02/12/2019 17:34	02/12/2019 19:45	2,18	12	26,10	CHI
20191210176	FIRMINOPOLIS	FR12391442	FIRMINOPOLIS S2	02/12/2019 17:36	03/12/2019 02:15	02/12/2019 17:36	03/12/2019 02:15	8,65	66	570,62	CHI
20191210176	SAO JOAO DA PARAUNA	FR12391442	FIRMINOPOLIS S2	02/12/2019 17:36	03/12/2019 02:15	02/12/2019 17:36	03/12/2019 02:15	8,65	70	605,21	CHI
20191210181	GUAPO	VJ32066141	GUAPO S2	02/12/2019 17:37	02/12/2019 21:10	02/12/2019 17:37	02/12/2019 21:10	3,55	3	10,64	CHI
20191210181	VARIAO	VJ32066141	GUAPO S2	02/12/2019 17:37	02/12/2019 21:10	02/12/2019 17:37	02/12/2019 21:10	3,55	5	17,73	CHI
20191210183	GUARANI DE GOIAS	GY21267992	IACIARA S1	02/12/2019 17:37	02/12/2019 18:20	02/12/2019 17:37	02/12/2019 18:20	0,70	1	0,70	CHI
20191210184	CORUMBAIBA	CI12000451	VILA CORUMBA	02/12/2019 17:07	03/12/2019 14:12	02/12/2019 17:07	03/12/2019 14:12	21,08	8	168,68	CHI
20191210184	NOVA AURORA	CI12000451	VILA CORUMBA	02/12/2019 17:07	03/12/2019 14:12	02/12/2019 17:07	03/12/2019 14:12	21,08	7	147,59	CHI
20191210187	ALVORADA DO NORTE	SI12262138	IACIARA S2	02/12/2019 16:05	02/12/2019 20:09	02/12/2019 16:05	02/12/2019 20:09	4,05	1	4,05	CHI
20191210187	SITIO D ABADIA	SI12262138	IACIARA S2	02/12/2019 16:05	02/12/2019 20:09	02/12/2019 16:05	02/12/2019 20:09	4,05	1	4,05	CHI
20191210188	CATALAO	CT10400805	CATALAO S2	02/12/2019 17:37	02/12/2019 17:48	02/12/2019 17:39	02/12/2019 17:46	0,12	1646	190,66	CHI
20191210188	CATALAO	CT10400356	CATALAO S2	02/12/2019 17:37	02/12/2019 17:48	02/12/2019 17:39	02/12/2019 17:48	0,16	77	12,56	CHI

20191210188	CUMARI	CT10400356	CATALAO S2	02/12/2019 17:37	02/12/2019 17:48	02/12/2019 17:39	02/12/2019 17:48	0,16	51	8,32	CHI
20191210190	CAMPO ALEGRE DE GOIAS	CM21122441	CAMPO ALEGRE DE GOIAS	02/12/2019 17:39	03/12/2019 07:13	02/12/2019 17:39	03/12/2019 07:13	13,55	1	13,55	CHI
20191210193	CASTELANDIA	ML12064391	RIO DOS BOIS	02/12/2019 17:39	03/12/2019 10:04	02/12/2019 17:39	03/12/2019 10:04	16,40	1	16,40	CHI
20191210193	MAURILANDIA	ML12064391	RIO DOS BOIS	02/12/2019 17:39	03/12/2019 10:04	02/12/2019 17:39	03/12/2019 10:04	16,40	3	49,21	CHI
20191210194	PORANGATU	TA21202577	NOVO PLANALTO	02/12/2019 17:40	02/12/2019 22:40	02/12/2019 17:40	02/12/2019 22:40	5,01	1	5,01	CHI
20191210199	APARECIDA DE GOIANIA	13320993	INDEPENDENCIA S1	02/12/2019 17:40	02/12/2019 19:52	02/12/2019 17:40	02/12/2019 19:52	2,18	1	2,18	CHI
20191210202	SILVANIA	SV21027339	VIANOPOLIS	02/12/2019 17:41	03/12/2019 00:20	02/12/2019 17:41	03/12/2019 00:20	6,65	1	6,65	CHI
20191210210	SAO LUIS DE MONTES BELOS	SL21146336	SAO LUIZ DOS MONTES BELOS	02/12/2019 17:43	02/12/2019 21:43	02/12/2019 17:43	02/12/2019 21:43	4,00	1	4,00	CHI
20191210211	SAO LUIZ DO NORTE	SZ11336121	BARRO ALTO	02/12/2019 17:43	04/12/2019 10:27	02/12/2019 17:43	04/12/2019 10:27	40,73	2	81,46	CHI
20191210212	TEREZOPOLIS DE GOIAS	TJ21327824	DAIA S2	02/12/2019 17:43	03/12/2019 10:21	02/12/2019 17:43	03/12/2019 10:21	16,63	5	83,13	CHI
20191210214	CORUMBAIBA	CI12000461	VILA CORUMBA	02/12/2019 17:41	03/12/2019 10:17	02/12/2019 17:41	03/12/2019 10:17	16,60	4	66,40	CHI
20191210214	CORUMBAIBA	CI12000461	VILA CORUMBA	02/12/2019 17:41	03/12/2019 10:17	02/12/2019 22:19	03/12/2019 10:17	11,97	1	11,97	CHI
20191210217	ORIZONA	2060048108	PIRES DO RIO S2	02/12/2019 17:43	03/12/2019 16:53	02/12/2019 17:43	03/12/2019 16:53	23,17	1	23,17	CHI
20191210223	APARECIDA DE GOIANIA	200196893	INDEPENDENCIA S2	02/12/2019 17:44	02/12/2019 22:31	02/12/2019 17:44	02/12/2019 22:31	4,78	1	4,78	CHI
20191210230	SENADOR CANEDO	190034178	SENADOR CANEDO	02/12/2019 17:46	02/12/2019 18:17	02/12/2019 17:46	02/12/2019 18:17	0,51	1	0,51	CHI
20191210235	QUIRINOPOLIS	QI31049543	QUIRINOPOLIS	02/12/2019 17:47	03/12/2019 10:53	02/12/2019 17:47	03/12/2019 10:53	17,10	2	34,20	CHI
20191210241	GOIANIA	15366224	GOYA S2	02/12/2019 17:47	02/12/2019 20:17	02/12/2019 17:47	02/12/2019 20:17	2,49	1	2,49	CHI
20191210245	MATRINCHA	MP11158190	MATRINCHA	02/12/2019 16:15	03/12/2019 03:42	02/12/2019 16:15	03/12/2019 03:42	11,45	95	1087,64	CHI
20191210247	URUACU	UR21181201	URUACU	02/12/2019 17:48	03/12/2019 10:20	02/12/2019 17:48	03/12/2019 10:20	16,54	1	16,54	CHI
20191210252	CRISTALINA	KR21237873	CRISTALINA S2	02/12/2019 17:48	03/12/2019 09:34	02/12/2019 17:48	03/12/2019 09:34	15,76	1	15,76	CHI
20191210265	APORE	AE21112878	ITAJA S1	02/12/2019 17:51	03/12/2019 09:45	02/12/2019 17:51	03/12/2019 09:45	15,90	1	15,90	CHI
20191210267	LUZIANIA	OZ12402562RE	PIRES DO RIO S2	02/12/2019 15:56	02/12/2019 23:13	02/12/2019 15:56	02/12/2019 23:13	7,27	132	960,04	CHI
20191210267	ORIZONA	OZ12402562RE	PIRES DO RIO S2	02/12/2019 15:56	02/12/2019 23:13	02/12/2019 15:56	02/12/2019 23:13	7,27	7	50,91	CHI
20191210274	CRIXAS	2490031886	SANTA TEREZINHA	02/12/2019 17:52	04/12/2019 18:12	02/12/2019 17:52	04/12/2019 18:12	48,35	1	48,35	CHI
20191210276	ANAPOLIS	21295086	JUNDIAI S2	02/12/2019 17:52	02/12/2019 22:26	02/12/2019 17:52	02/12/2019 22:26	4,56	1	4,56	CHI
20191210277	FAINA	4380008527	MATRINCHA	02/12/2019 17:52	03/12/2019 09:33	02/12/2019 17:52	03/12/2019 09:33	15,68	1	15,68	CHI
20191210282	ABADIANIA	AA21205069	ANAPOLIS UNIVERSITARIO S1	02/12/2019 17:53	03/12/2019 08:47	02/12/2019 17:53	03/12/2019 08:47	14,89	1	14,89	CHI
20191210291	PALMEIRAS DE GOIAS	PL21147535	PALMEIRAS	02/12/2019 17:55	03/12/2019 12:30	02/12/2019 17:55	03/12/2019 12:30	18,58	1	18,58	CHI
20191210292	PALMEIRAS DE GOIAS	PL12398710	PALMEIRAS	02/12/2019 17:33	02/12/2019 22:26	02/12/2019 17:33	02/12/2019 22:26	4,90	21	102,80	CHI
20191210294	URUTAI	UT12080724RE	URUTAI	02/12/2019 16:55	02/12/2019 22:55	02/12/2019 16:55	02/12/2019 22:55	6,01	80	480,42	CHI
20191210296	MONTIVIDIU DO NORTE	9670001814	PORANGATU	02/12/2019 17:57	04/12/2019 13:40	02/12/2019 17:57	04/12/2019 13:40	43,73	1	43,73	CHI
20191210401	AMERICANO DO BRASIL	03070224	ANICUNS	02/12/2019 17:34	02/12/2019 19:11	02/12/2019 17:34	02/12/2019 19:11	1,62	387	625,97	CHI
20191210401	ANICUNS	03070224	ANICUNS	02/12/2019 17:34	02/12/2019 19:11	02/12/2019 17:34	02/12/2019 19:11	1,62	188	304,09	CHI

20191210401	ITABERAI	03070224	ANICUNS	02/12/2019 17:34	02/12/2019 19:11	02/12/2019 17:34	02/12/2019 19:11	1,62	2	3,24	CHI
20191210401	MOSSAMEDES	03070224	ANICUNS	02/12/2019 17:34	02/12/2019 19:11	02/12/2019 17:34	02/12/2019 19:11	1,62	14	22,65	CHI
20191210501	PETROLINA DE GOIAS	PG21116310	INHUMAS S1	02/12/2019 17:58	03/12/2019 11:15	02/12/2019 17:58	03/12/2019 11:15	17,28	2	34,56	CHI
20191210701	UIRAPURU	UP21181161	SANTA TEREZINHA	02/12/2019 17:58	03/12/2019 16:08	02/12/2019 17:58	03/12/2019 16:08	22,17	1	22,17	CHI
20191211215	MINEIROS	MY12166286	CHAPADAO DO CEU	02/12/2019 13:17	02/12/2019 22:11	02/12/2019 13:17	02/12/2019 22:11	8,90	5	44,48	CHI
20191211215	SERRANOPOLIS	MY12166286	CHAPADAO DO CEU	02/12/2019 13:17	02/12/2019 22:11	02/12/2019 13:17	02/12/2019 22:11	8,90	10	88,96	CHI
20191211226	PONTALINA	PK21108776	GOIATUBA S1	02/12/2019 19:35	03/12/2019 15:44	02/12/2019 19:36	03/12/2019 15:44	20,14	1	20,14	CHI
20191211230	MONTIVIDIU DO NORTE	MX12203418	PORANGATU	02/12/2019 19:22	03/12/2019 01:36	02/12/2019 19:22	03/12/2019 01:36	6,23	10	62,28	CHI
20191211242	JATAI	290348882	JATAI S2	02/12/2019 20:38	02/12/2019 20:42	02/12/2019 20:38	02/12/2019 20:42	0,07	1	0,07	CHI
20191211247	MAURILANDIA	ML21147827	SANTA HELENA S1	02/12/2019 21:43	03/12/2019 15:35	02/12/2019 21:45	03/12/2019 15:30	17,76	1	17,76	CHI
20191211247	MAURILANDIA	ML21147890	SANTA HELENA S1	02/12/2019 21:43	03/12/2019 15:35	02/12/2019 21:45	03/12/2019 15:35	17,84	1	17,84	CHI
20191211251	INDIARA	IY12170319	EDEIA	02/12/2019 13:56	03/12/2019 09:08	02/12/2019 13:56	03/12/2019 09:08	19,19	5	95,94	CHI
20191211251	PALMEIRAS DE GOIAS	IY12170319	EDEIA	02/12/2019 13:56	03/12/2019 09:08	02/12/2019 13:56	03/12/2019 09:08	19,19	5	95,94	CHI
20191211301	FORMOSA	610198609	ITUIQUIRA	02/12/2019 17:59	03/12/2019 08:07	02/12/2019 17:59	03/12/2019 08:07	14,13	1	14,13	CHI
20191211401	CATALAO	10027014159	CATALAO S2	02/12/2019 18:00	02/12/2019 20:44	02/12/2019 18:00	02/12/2019 20:44	2,73	1	2,73	CHI
20191211502	SILVANIA	SV21146460	DAIA S2	02/12/2019 18:01	03/12/2019 09:11	02/12/2019 18:01	03/12/2019 09:11	15,15	1	15,15	CHI
20191211601	SANTA RITA DO ARAGUAIA	SU21241294	SANTA RITA DO ARAGUAIA	02/12/2019 18:02	03/12/2019 10:50	02/12/2019 18:02	03/12/2019 10:50	16,80	1	16,80	CHI
20191211701	GOIANIA	12864006	XAVANTES	02/12/2019 18:02	02/12/2019 21:47	02/12/2019 18:02	02/12/2019 21:47	3,75	1	3,75	CHI
20191211801	PLANALTINA	PI21171624	PLANALTINA	02/12/2019 18:02	03/12/2019 10:45	02/12/2019 18:02	03/12/2019 10:45	16,72	1	16,72	CHI
20191211802	ARAGOIANIA	AO11379676	INDEPENDENCIA S2	02/12/2019 18:02	02/12/2019 21:38	02/12/2019 18:02	02/12/2019 21:38	3,59	29	104,11	CHI
20191211805	GOIANIA	10024489350	REAL S2	02/12/2019 18:02	02/12/2019 21:43	02/12/2019 18:02	02/12/2019 21:43	3,67	1	3,67	CHI
20191211902	SENADOR CANEDO	10029502312	SENADOR CANEDO	02/12/2019 16:37	02/12/2019 21:51	02/12/2019 16:37	02/12/2019 21:51	5,23	1	5,23	CHI
20191211906	JARAGUA	JA21380199	JARAGUA	02/12/2019 14:34	02/12/2019 17:30	02/12/2019 14:34	02/12/2019 17:30	2,93	2	5,86	CHI
20191211907	JARAGUA	JA21298029	JARAGUA	02/12/2019 14:54	02/12/2019 19:20	02/12/2019 14:54	02/12/2019 19:20	4,42	1	4,42	CHI
20191211908	JARAGUA	JA21013433	JARAGUA	02/12/2019 15:04	02/12/2019 18:20	02/12/2019 15:04	02/12/2019 18:20	3,27	1	3,27	CHI
20191211909	JARAGUA	JA12382428	JARAGUA	02/12/2019 15:29	03/12/2019 17:50	02/12/2019 15:29	03/12/2019 17:50	26,34	5	131,69	CHI
20191211910	JARAGUA	JA21328444	JARAGUA	02/12/2019 17:44	03/12/2019 15:51	02/12/2019 17:44	03/12/2019 15:51	22,10	1	22,10	CHI
20191212002	RIO VERDE	RV12301118	ACREUNA	02/12/2019 18:04	02/12/2019 21:28	02/12/2019 18:04	02/12/2019 21:28	3,40	2	6,80	CHI
20191212105	JUSSARA	1290015718	JUSSARA	02/12/2019 18:04	03/12/2019 05:56	02/12/2019 18:04	03/12/2019 05:56	11,86	1	11,86	CHI
20191212109	JARAGUA	70130383	JARAGUA	02/12/2019 18:06	03/12/2019 12:20	02/12/2019 18:06	03/12/2019 12:20	18,24	1	18,24	CHI
20191212110	APARECIDA DE GOIANIA	200155593	INDEPENDENCIA S1	02/12/2019 18:06	02/12/2019 23:12	02/12/2019 18:06	02/12/2019 23:12	5,09	1	5,09	CHI
20191212115	PADRE BERNARDO	PB12336085	PADRE BERNARDO	02/12/2019 18:06	02/12/2019 20:29	02/12/2019 18:06	02/12/2019 20:29	2,37	12	28,42	CHI
20191212117	SENADOR CANEDO	SW11094224	SENADOR CANEDO	02/12/2019 18:07	02/12/2019 19:40	02/12/2019 18:07	02/12/2019 19:40	1,55	59	91,35	CHI

20191212125	SENADOR CANEDO	1000537207	SENADOR CANEDO	02/12/2019 18:08	02/12/2019 19:11	02/12/2019 18:08	02/12/2019 19:11	1,04	1	1,04	CHI
20191212126	DIVINOPOLIS DE GOIAS	GH12398369	SAO DOMINGOS	02/12/2019 18:08	02/12/2019 22:00	02/12/2019 18:08	02/12/2019 22:00	3,85	21	80,94	CHI
20191212126	SAO DOMINGOS	GH12398369	SAO DOMINGOS	02/12/2019 18:08	02/12/2019 22:00	02/12/2019 18:08	02/12/2019 22:00	3,85	19	73,23	CHI
20191212201	FORMOSA	10005315040	ITUIQUIRA	02/12/2019 18:08	03/12/2019 00:33	02/12/2019 18:08	03/12/2019 00:33	6,40	1	6,40	CHI
20191212202	ITAPURANGA	IK12274575	ITAPURANGA	02/12/2019 18:09	03/12/2019 19:01	02/12/2019 18:09	03/12/2019 19:01	24,87	1	24,87	CHI
20191212204	MORRINHOS	150072144	MORRINHOS	02/12/2019 18:09	02/12/2019 21:28	02/12/2019 18:09	02/12/2019 21:28	3,31	1	3,31	CHI
20191212205	PONTALINA	PK11148032	PONTALINA	02/12/2019 17:53	02/12/2019 21:43	02/12/2019 17:53	02/12/2019 21:43	3,83	92	352,03	CHI
20191212308	APARECIDA DE GOIANIA	16394045	ATLANTICO S2	02/12/2019 18:11	02/12/2019 20:44	02/12/2019 18:11	02/12/2019 20:44	2,55	1	2,55	CHI
20191212311	PILAR DE GOIAS	GG12100377	SANTA TEREZINHA	02/12/2019 17:08	03/12/2019 00:35	02/12/2019 17:08	03/12/2019 00:35	7,44	2	14,89	CHI
20191212320	MORRINHOS	MR12242419	GOIATUBA S1	02/12/2019 17:35	03/12/2019 17:14	02/12/2019 17:35	03/12/2019 17:14	23,65	12	283,81	CHI
20191212322	FAINA	FC12299792	GOIAS	02/12/2019 13:40	02/12/2019 21:08	02/12/2019 13:40	02/12/2019 21:08	7,47	52	388,25	CHI
20191212325	FORMOSA	FA11344221	ITUIQUIRA	02/12/2019 18:13	02/12/2019 20:08	02/12/2019 18:13	02/12/2019 20:08	1,90	46	87,48	CHI
20191212326	PIRENOPOLIS	220055646	CORUMBA	02/12/2019 18:13	03/12/2019 10:55	02/12/2019 18:13	03/12/2019 10:55	16,68	1	16,68	CHI
20191212330	JANDAIA	JD11126078	PALMEIRAS	02/12/2019 17:24	02/12/2019 21:02	02/12/2019 17:24	02/12/2019 21:02	3,63	129	468,41	CHI
20191212405	FAZENDA NOVA	FN21119499	IPORA	02/12/2019 18:24	03/12/2019 17:40	02/12/2019 18:24	03/12/2019 17:40	23,26	1	23,26	CHI
20191212406	CATALAO	10008392429	CATALAO S1	02/12/2019 18:24	03/12/2019 03:19	02/12/2019 18:24	03/12/2019 03:19	8,91	1	8,91	CHI
20191212409	ARAGARCAS	AG11231066	ARAGARCAS	02/12/2019 18:11	02/12/2019 20:44	02/12/2019 18:11	02/12/2019 20:44	2,54	78	197,84	CHI
20191212416	CRISTALINA	KR12183725	CRISTALINA S2	02/12/2019 18:26	03/12/2019 15:39	02/12/2019 18:26	03/12/2019 15:39	21,22	1	21,22	CHI
20191212417	MUTUNOPOLIS	PO12374520	PORANGATU	02/12/2019 16:57	02/12/2019 22:46	02/12/2019 16:57	02/12/2019 22:46	5,81	18	104,50	CHI
20191212417	PORANGATU	PO12374520	PORANGATU	02/12/2019 16:57	02/12/2019 22:46	02/12/2019 16:57	02/12/2019 22:46	5,81	19	110,31	CHI
20191212420	APARECIDA DE GOIANIA	AP12002060LD	ANHANGUERA	02/12/2019 18:27	03/12/2019 15:00	02/12/2019 18:27	03/12/2019 15:00	20,55	1	20,55	CHI
20191212421	TRINDADE	TR21119006	TRINDADE	02/12/2019 18:27	02/12/2019 23:01	02/12/2019 18:27	02/12/2019 23:01	4,56	1	4,56	CHI
20191212422	MINEIROS	PW10341001	PARQUE DAS EMAS	02/12/2019 18:23	03/12/2019 20:40	02/12/2019 18:24	02/12/2019 20:00	1,60	136	217,64	CHI
20191212422	PORTELANDIA	PW10341001	PARQUE DAS EMAS	02/12/2019 18:23	03/12/2019 20:40	02/12/2019 18:24	02/12/2019 20:00	1,60	150	240,04	CHI
20191212422	MINEIROS	MY13147991	PARQUE DAS EMAS	02/12/2019 18:23	03/12/2019 20:40	02/12/2019 18:24	03/12/2019 08:18	13,91	145	2017,39	CHI
20191212422	SANTA RITA DO ARAGUAIA	MY13147991	PARQUE DAS EMAS	02/12/2019 18:23	03/12/2019 20:40	02/12/2019 18:24	03/12/2019 08:18	13,91	2	27,83	CHI
20191212422	MINEIROS	PW10341001	PARQUE DAS EMAS	02/12/2019 18:23	03/12/2019 20:40	02/12/2019 18:24	03/12/2019 10:09	15,76	1	15,76	CHI
20191212422	MINEIROS	PW10341001	PARQUE DAS EMAS	02/12/2019 18:23	03/12/2019 20:40	03/12/2019 08:39	03/12/2019 10:09	1,51	158	238,40	CHI
20191212422	PORTELANDIA	PW10341001	PARQUE DAS EMAS	02/12/2019 18:23	03/12/2019 20:40	03/12/2019 08:39	03/12/2019 10:09	1,51	150	226,33	CHI
20191212422	DOVERLANDIA	MY12210052LD	PARQUE DAS EMAS	02/12/2019 18:23	03/12/2019 20:40	02/12/2019 18:24	03/12/2019 11:25	17,03	97	1651,75	CHI
20191212422	MINEIROS	MY12210052LD	PARQUE DAS EMAS	02/12/2019 18:23	03/12/2019 20:40	02/12/2019 18:24	03/12/2019 11:25	17,03	36	613,02	CHI
20191212422	DOVERLANDIA	MY12210052LD	PARQUE DAS EMAS	02/12/2019 18:23	03/12/2019 20:40	03/12/2019 01:45	03/12/2019 11:25	9,66	6	57,98	CHI
20191212422	MINEIROS	MY12153327RE	PARQUE DAS EMAS	02/12/2019 18:23	03/12/2019 20:40	03/12/2019 08:39	03/12/2019 12:44	4,09	38	155,54	CHI

20191212422	MINEIROS	MY12358869	PARQUE DAS EMAS	02/12/2019 18:23	03/12/2019 20:40	03/12/2019 08:39	03/12/2019 17:09	8,51	13	110,65	CHI
20191212422	MINEIROS	PW10341001	PARQUE DAS EMAS	02/12/2019 18:23	03/12/2019 20:40	03/12/2019 08:39	03/12/2019 20:02	11,39	75	854,56	CHI
20191212422	SANTA RITA DO ARAGUAIA	PW10341001	PARQUE DAS EMAS	02/12/2019 18:23	03/12/2019 20:40	03/12/2019 08:39	03/12/2019 20:02	11,39	2	22,79	CHI
20191212422	MINEIROS	PW10341001	PARQUE DAS EMAS	02/12/2019 18:23	03/12/2019 20:40	03/12/2019 08:39	03/12/2019 20:40	12,02	31	372,71	CHI
20191212422	SANTA RITA DO ARAGUAIA	PW10341001	PARQUE DAS EMAS	02/12/2019 18:23	03/12/2019 20:40	03/12/2019 08:39	03/12/2019 20:40	12,02	2	24,05	CHI
20191212423	CUMARI	CT12042348	CATALAO S2	02/12/2019 18:27	03/12/2019 10:40	02/12/2019 18:27	03/12/2019 10:40	16,21	6	97,23	CHI
20191212423	GOIANDIRA	CT12042348	CATALAO S2	02/12/2019 18:27	03/12/2019 10:40	02/12/2019 18:27	03/12/2019 10:40	16,21	2	32,41	CHI
20191212432	PIRENOPOLIS	PV21059836	CORUMBA	02/12/2019 18:29	03/12/2019 11:07	02/12/2019 18:29	03/12/2019 11:07	16,63	2	33,25	CHI
20191212446	CRISTALINA	00430424	CRISTALINA S1	02/12/2019 18:30	02/12/2019 23:51	02/12/2019 19:49	02/12/2019 19:53	0,08	2448	183,60	CHI
20191212446	CRISTALINA	00430224	CRISTALINA S1	02/12/2019 18:30	02/12/2019 23:51	02/12/2019 18:30	02/12/2019 20:02	1,52	523	794,52	CHI
20191212446	CRISTALINA	00430424	CRISTALINA S1	02/12/2019 18:30	02/12/2019 23:51	02/12/2019 19:49	02/12/2019 20:02	0,21	164	34,71	CHI
20191212446	CRISTALINA	00430224	CRISTALINA S1	02/12/2019 18:30	02/12/2019 23:51	02/12/2019 18:30	02/12/2019 20:10	1,65	2896	4788,86	CHI
20191212446	CRISTALINA	KR16410054	CRISTALINA S1	02/12/2019 18:30	02/12/2019 23:51	02/12/2019 19:49	02/12/2019 20:10	0,35	210	72,68	CHI
20191212446	CRISTALINA	00430224	CRISTALINA S1	02/12/2019 18:30	02/12/2019 23:51	02/12/2019 18:30	02/12/2019 20:16	1,77	669	1181,71	CHI
20191212446	CRISTALINA	00430224	CRISTALINA S1	02/12/2019 18:30	02/12/2019 23:51	02/12/2019 18:30	02/12/2019 20:24	1,90	2236	4241,57	CHI
20191212446	CRISTALINA	KR16410054	CRISTALINA S1	02/12/2019 18:30	02/12/2019 23:51	02/12/2019 20:29	02/12/2019 21:02	0,55	3669	2021,01	CHI
20191212446	CRISTALINA	KR10400750	CRISTALINA S1	02/12/2019 18:30	02/12/2019 23:51	02/12/2019 20:20	02/12/2019 21:02	0,71	669	473,32	CHI
20191212446	CRISTALINA	KR16410054	CRISTALINA S1	02/12/2019 18:30	02/12/2019 23:51	02/12/2019 20:29	02/12/2019 21:20	0,85	1673	1426,23	CHI
20191212446	CRISTALINA	KR16410054	CRISTALINA S1	02/12/2019 18:30	02/12/2019 23:51	02/12/2019 21:15	02/12/2019 21:20	0,08	2102	175,75	CHI
20191212446	CRISTALINA	KR10400791	CRISTALINA S1	02/12/2019 18:30	02/12/2019 23:51	02/12/2019 21:07	02/12/2019 22:26	1,31	866	1136,63	CHI
20191212446	CRISTALINA	KR12214948LD	CRISTALINA S1	02/12/2019 18:30	02/12/2019 23:51	02/12/2019 21:07	02/12/2019 22:50	1,71	618	1057,98	CHI
20191212446	CRISTALINA	KR12248351LD	CRISTALINA S1	02/12/2019 18:30	02/12/2019 23:51	02/12/2019 21:07	02/12/2019 23:51	2,73	752	2052,12	CHI
20191212449	JARAGUA	JA12035312	JARAGUA	02/12/2019 18:31	03/12/2019 16:30	02/12/2019 18:31	03/12/2019 16:30	21,98	6	131,87	CHI
20191212457	AGUA FRIA DE GOIAS	MJ12305238	PADRE BERNARDO	02/12/2019 18:32	03/12/2019 11:48	02/12/2019 18:32	03/12/2019 11:48	17,27	2	34,53	CHI
20191212457	MIMOSO DE GOIAS	MJ12305238	PADRE BERNARDO	02/12/2019 18:32	03/12/2019 11:48	02/12/2019 18:32	03/12/2019 11:48	17,27	3	51,80	CHI
20191212458	MONTIVIDIU	MV21226307	MONTIVIDIU T	02/12/2019 18:32	02/12/2019 23:18	02/12/2019 18:32	02/12/2019 23:18	4,77	1	4,77	CHI
20191212461	COCALZINHO DE GOIAS	ZN21389817	GOIANESIA S1	02/12/2019 18:32	03/12/2019 14:01	02/12/2019 18:32	03/12/2019 14:01	19,48	2	38,97	CHI
20191212465	ALEXANIA	AX21302104	ALEXANIA	02/12/2019 18:33	03/12/2019 15:06	02/12/2019 18:33	03/12/2019 15:06	20,55	1	20,55	CHI
20191212466	DOVERLANDIA	DV12139919	CAIAPONIA	02/12/2019 17:36	03/12/2019 06:08	02/12/2019 17:36	03/12/2019 06:08	12,53	49	613,83	CHI
20191212470	PALMEIRAS DE GOIAS	PP12000036	PALMEIRAS	02/12/2019 18:29	02/12/2019 23:00	02/12/2019 18:29	02/12/2019 23:00	4,52	52	234,85	CHI
20191212470	PALMINOPOLIS	PP12000036	PALMEIRAS	02/12/2019 18:29	02/12/2019 23:00	02/12/2019 18:29	02/12/2019 23:00	4,52	38	171,62	CHI
20191212471	NIQUELANDIA	NQ21235424	NIQUELANDIA SUBTRANSMISSAO	02/12/2019 18:33	03/12/2019 09:07	02/12/2019 18:33	03/12/2019 09:07	14,55	1	14,55	CHI
20191212475	ANAPOLIS	10003713065	ANAPOLIS UNIVERSITARIO S2	02/12/2019 18:34	02/12/2019 20:10	02/12/2019 18:34	02/12/2019 20:10	1,60	1	1,60	CHI

20191212476	NIQUELANDIA	NQ12316271	BARRO ALTO	02/12/2019 18:34	02/12/2019 22:49	02/12/2019 18:34	02/12/2019 22:49	4,24	3	12,73	CHI
20191212480	CORUMBAIBA	CI21280855	CATALAO S1	02/12/2019 18:35	03/12/2019 16:37	02/12/2019 18:35	03/12/2019 16:37	22,02	1	22,02	CHI
20191212483	TRINDADE	10017858834	MEIA PONTE	02/12/2019 18:35	02/12/2019 22:34	02/12/2019 18:35	02/12/2019 22:34	3,97	1	3,97	CHI
20191212485	ITARUMA	IM21148584	CACHOEIRA ALTA	02/12/2019 18:36	03/12/2019 01:13	02/12/2019 18:36	03/12/2019 01:13	6,62	1	6,62	CHI
20191212488	VILA PROPICIO	NP21339385	GOIANESIA S1	02/12/2019 18:36	03/12/2019 17:11	02/12/2019 18:36	03/12/2019 17:11	22,59	1	22,59	CHI
20191212491	BARRO ALTO	BA11000002	BARRO ALTO	02/12/2019 17:06	02/12/2019 19:50	02/12/2019 17:06	02/12/2019 19:50	2,73	106	289,41	CHI
20191212497	SANTA HELENA DE GOIAS	SH21252618	IPEGUARI	02/12/2019 18:37	03/12/2019 08:50	02/12/2019 18:37	03/12/2019 08:50	14,21	1	14,21	CHI
20191212501	SANTO ANTONIO DE GOIAS	BW21133467	NEROPOLIS S1	02/12/2019 18:43	02/12/2019 22:44	02/12/2019 18:43	02/12/2019 22:44	4,02	3	12,05	CHI
20191212502	TURVANIA	TV12259071	FIRMINOPOLIS S2	02/12/2019 18:43	02/12/2019 20:45	02/12/2019 18:43	02/12/2019 20:45	2,03	6	12,19	CHI
20191212510	CACU	CC12028258	CACHOEIRA ALTA	02/12/2019 18:37	03/12/2019 08:49	02/12/2019 18:37	03/12/2019 08:49	14,19	58	822,86	CHI
20191212510	QUIRINOPOLIS	CC12028258	CACHOEIRA ALTA	02/12/2019 18:37	03/12/2019 08:49	02/12/2019 18:37	03/12/2019 08:49	14,19	1	14,19	CHI
20191212524	NOVA IGUACU DE GOIAS	NH21281691	SANTA TEREZINHA	02/12/2019 18:42	03/12/2019 17:17	02/12/2019 18:42	03/12/2019 17:17	22,58	2	45,16	CHI
20191212534	GOIANIA	AP12199088	INDEPENDENCIA S2	02/12/2019 18:30	02/12/2019 19:48	02/12/2019 18:30	02/12/2019 19:48	1,31	785	1026,39	CHI
20191212536	ITUMBIARA	690301844	ITUMBIARA VELHA S1	02/12/2019 18:45	03/12/2019 09:37	02/12/2019 18:45	03/12/2019 09:37	14,85	1	14,85	CHI
20191212544	PLANALTINA	PI21243000	PLANALTINA	02/12/2019 18:46	03/12/2019 20:46	02/12/2019 18:46	03/12/2019 20:46	25,98	1	25,98	CHI
20191212549	RIO VERDE	630349174	RIO VERDE S1	02/12/2019 18:47	03/12/2019 08:00	02/12/2019 18:47	03/12/2019 08:00	13,21	1	13,21	CHI
20191212552	LUZIANIA	3200079550	MARAJOARA	02/12/2019 18:47	02/12/2019 21:16	02/12/2019 18:47	02/12/2019 21:16	2,47	1	2,47	CHI
20191212558	GOIANIA	GN11001423	FERROVIARIO S1	02/12/2019 18:48	03/12/2019 00:54	02/12/2019 18:48	03/12/2019 00:54	6,10	130	792,75	CHI
20191212574	PIRES DO RIO	10017519355	PIRES DO RIO S1	02/12/2019 18:49	02/12/2019 21:20	02/12/2019 18:49	02/12/2019 21:20	2,51	1	2,51	CHI
20191212584	PORANGATU	PO21102938	PORANGATU	02/12/2019 18:50	03/12/2019 10:33	02/12/2019 18:50	03/12/2019 10:33	15,70	1	15,70	CHI
20191212588	NOVA VENEZA	300027953	INHUMAS S1	02/12/2019 18:51	02/12/2019 20:35	02/12/2019 18:51	02/12/2019 20:35	1,73	1	1,73	CHI
20191212591	CABECEIRAS	CW12049390	ITIQUIRA	02/12/2019 17:43	02/12/2019 22:37	02/12/2019 17:43	02/12/2019 22:37	4,89	15	73,35	CHI
20191212599	MINEIROS	1390040541	PARQUE DAS EMAS	02/12/2019 18:52	03/12/2019 00:33	02/12/2019 18:52	03/12/2019 00:33	5,67	1	5,67	CHI
20191212601	ITARUMA	IM21038171	CACHOEIRA ALTA	02/12/2019 18:53	03/12/2019 09:10	02/12/2019 18:53	03/12/2019 09:10	14,28	1	14,28	CHI
20191212604	FORMOSA	FA21146204	ITIQUIRA	02/12/2019 18:53	03/12/2019 11:45	02/12/2019 18:53	03/12/2019 11:45	16,87	1	16,87	CHI
20191212614	ITAPIRAPUA	IU11000007	MATRINCHA	02/12/2019 15:38	02/12/2019 23:09	02/12/2019 15:38	02/12/2019 23:09	7,51	46	345,66	CHI
20191212615	AGUAS LINDAS DE GOIAS	10004059997	AGUAS LINDAS DE GOIAS S1	02/12/2019 18:54	02/12/2019 20:20	02/12/2019 18:54	02/12/2019 20:20	1,42	1	1,42	CHI
20191212619	PORANGATU	PO12265821	PORANGATU	02/12/2019 18:50	02/12/2019 23:22	02/12/2019 18:50	02/12/2019 23:22	4,52	5	22,62	CHI
20191212621	POSSE	PS21302806	IACIARA S2	02/12/2019 18:55	03/12/2019 10:29	02/12/2019 18:55	03/12/2019 10:29	15,56	11	171,11	CHI
20191212627	RIO VERDE	RV12271283	CABRIUVA S2	02/12/2019 18:56	02/12/2019 21:47	02/12/2019 18:56	02/12/2019 21:47	2,85	20	56,99	CHI
20191212631	PORTELANDIA	PW11066490	PARQUE DAS EMAS	02/12/2019 17:42	03/12/2019 09:30	02/12/2019 17:42	03/12/2019 09:30	15,79	86	1357,70	CHI
20191212634	CUMARI	CY11000061	CATALAO S1	02/12/2019 18:38	03/12/2019 09:31	02/12/2019 18:38	03/12/2019 09:31	14,87	119	1769,99	CHI
20191212637	CRISTALINA	01090414	MARAJOARA	02/12/2019 18:38	02/12/2019 19:24	02/12/2019 18:38	02/12/2019 19:24	0,76	1	0,76	CHI

20191212637	LUZIANIA	01090414	MARAJOARA	02/12/2019 18:38	02/12/2019 19:24	02/12/2019 18:38	02/12/2019 19:24	0,76	309	235,01	CHI
20191212644	CATALAO	1990318281	CATALAO S1	02/12/2019 18:59	02/12/2019 21:09	02/12/2019 18:59	02/12/2019 21:09	2,16	1	2,16	CHI
20191212645	ALTO HORIZONTE	9640005465	SANTA TEREZINHA	02/12/2019 18:59	03/12/2019 13:05	02/12/2019 18:59	03/12/2019 13:05	18,09	1	18,09	CHI
20191212647	FORMOSA	610154497	ITUIQUIRA	02/12/2019 18:59	02/12/2019 21:35	02/12/2019 18:59	02/12/2019 21:35	2,59	1	2,59	CHI
20191212648	LUZIANIA	3200169215	MARAJOARA	02/12/2019 18:59	02/12/2019 20:30	02/12/2019 18:59	02/12/2019 20:30	1,51	1	1,51	CHI
20191212656	ITABERAI	TQ12000081	ITABERAI S2	02/12/2019 13:59	02/12/2019 21:05	02/12/2019 13:59	02/12/2019 21:05	7,08	13	92,10	CHI
20191212656	TAQUARAL DE GOIAS	TQ12000081	ITABERAI S2	02/12/2019 13:59	02/12/2019 21:05	02/12/2019 13:59	02/12/2019 21:05	7,08	1	7,08	CHI
20191212670	CABECEIRAS	CW12108823	ITUIQUIRA	02/12/2019 19:02	03/12/2019 03:11	02/12/2019 19:02	03/12/2019 03:11	8,14	19	154,73	CHI
20191212681	AGUAS LINDAS DE GOIAS	LA11305234	AGUAS LINDAS DE GOIAS S2	02/12/2019 19:01	02/12/2019 19:58	02/12/2019 19:01	02/12/2019 19:58	0,93	215	200,85	CHI
20191212683	CATALAO	CT12215709RE	CATALAO S1	02/12/2019 17:47	03/12/2019 02:03	02/12/2019 17:47	03/12/2019 02:03	8,26	120	991,10	CHI
20191212690	JARAGUA	JA12328516	JARAGUA	02/12/2019 18:35	03/12/2019 03:39	02/12/2019 18:35	03/12/2019 03:39	9,06	20	181,28	CHI
20191212691	MIMOSO DE GOIAS	MJ12246072	PADRE BERNARDO	02/12/2019 19:05	03/12/2019 07:44	02/12/2019 19:05	03/12/2019 07:44	12,64	2	25,27	CHI
20191212696	CATALAO	CT12238478	CATALAO S1	02/12/2019 19:06	03/12/2019 09:02	02/12/2019 19:06	03/12/2019 09:02	13,93	3	41,79	CHI
20191212702	GOIANIA	16622728	XAVANTES	02/12/2019 19:07	02/12/2019 20:16	02/12/2019 19:07	02/12/2019 20:16	1,14	1	1,14	CHI
20191212703	AGUAS LINDAS DE GOIAS	4830200420	AGUAS LINDAS DE GOIAS S2	02/12/2019 19:07	02/12/2019 21:16	02/12/2019 19:07	02/12/2019 21:16	2,14	1	2,14	CHI
20191212707	APARECIDA DE GOIANIA	10009488950	ATLANTICO S3	02/12/2019 19:08	03/12/2019 04:17	02/12/2019 19:08	03/12/2019 04:17	9,15	1	9,15	CHI
20191212712	NOVO PLANALTO	6653634	SAO MIGUEL DO ARAGUAIA	02/12/2019 19:09	04/12/2019 16:50	02/12/2019 19:09	04/12/2019 11:20	40,18	1	40,18	CHI
20191212712	NOVO PLANALTO	TA21239677	SAO MIGUEL DO ARAGUAIA	02/12/2019 19:09	04/12/2019 16:50	04/12/2019 16:02	04/12/2019 16:50	0,80	1	0,80	CHI
20191212713	RIALMA	CB21066193	AGUAS LINDAS DE GOIAS S2	02/12/2019 19:09	03/12/2019 10:09	02/12/2019 19:09	03/12/2019 10:09	14,99	1	14,99	CHI
20191212731	APARECIDA DE GOIANIA	200163310	INDEPENDENCIA S2	02/12/2019 19:12	03/12/2019 00:03	02/12/2019 19:12	03/12/2019 00:03	4,84	1	4,84	CHI
20191212736	ITABERAI	IB11333980	ITABERAI S2	02/12/2019 19:13	02/12/2019 22:50	02/12/2019 19:13	02/12/2019 22:50	3,62	65	235,03	CHI
20191212741	NOVO GAMA	NJ11165095	PACAEMBU S1	02/12/2019 19:07	02/12/2019 22:27	02/12/2019 19:07	02/12/2019 22:27	3,33	103	342,96	CHI
20191212742	PORTELANDIA	PW12303418	PARQUE DAS EMAS	03/12/2019 08:57	03/12/2019 18:12	03/12/2019 08:57	03/12/2019 18:12	9,24	6	55,41	CHI
20191212748	GOIANIA	10011908929	GOYA S1	02/12/2019 19:14	02/12/2019 22:23	02/12/2019 19:14	02/12/2019 22:23	3,14	1	3,14	CHI
20191212750	JATAI	290127981	JATAI S3	02/12/2019 19:15	02/12/2019 21:52	02/12/2019 19:15	02/12/2019 21:52	2,61	1	2,61	CHI
20191212752	POSSE	IA12035179	IACIARA S2	02/12/2019 19:15	02/12/2019 21:45	02/12/2019 19:15	02/12/2019 21:45	2,50	9	22,48	CHI
20191212758	ITAPIRAPUA	IU12014848	MATRINCHA	03/12/2019 06:27	03/12/2019 08:59	03/12/2019 06:27	03/12/2019 08:59	2,53	58	146,72	CHI
20191212763	COCALZINHO DE GOIAS	ZN21186031	COCALZINHO	02/12/2019 19:16	03/12/2019 16:38	02/12/2019 19:16	03/12/2019 16:38	21,35	1	21,35	CHI
20191212771	SANTA HELENA DE GOIAS	400074333	IPEGUARI	02/12/2019 19:17	03/12/2019 09:45	02/12/2019 19:17	03/12/2019 09:45	14,46	1	14,46	CHI
20191212774	EDEIA	1120022580	EDEIA	02/12/2019 19:18	03/12/2019 09:32	02/12/2019 19:18	03/12/2019 09:32	14,23	1	14,23	CHI
20191212776	ARAGARCAS	AG12334918	ARAGARCAS	02/12/2019 19:18	03/12/2019 17:46	02/12/2019 19:18	03/12/2019 17:46	22,45	3	67,36	CHI
20191212779	GOIANIA	15360180	FERROVIARIO S1	02/12/2019 19:18	02/12/2019 22:27	02/12/2019 19:18	02/12/2019 22:27	3,14	1	3,14	CHI
20191212782	MINEIROS	MY12303348	PARQUE DAS EMAS	02/12/2019 19:19	02/12/2019 22:30	02/12/2019 19:19	02/12/2019 22:30	3,18	9	28,64	CHI

20191212794	VIANOPOLIS	VN12107799	VIANOPOLIS	02/12/2019 19:20	03/12/2019 07:38	02/12/2019 19:20	03/12/2019 07:38	12,29	6	73,71	CHI
20191212797	JATAI	290149691	JATAI S2	02/12/2019 19:21	03/12/2019 00:14	02/12/2019 19:21	03/12/2019 00:14	4,88	1	4,88	CHI
20191212803	INDIARA	2710029097	EDEIA	02/12/2019 19:22	03/12/2019 08:34	02/12/2019 19:22	03/12/2019 08:34	13,20	1	13,20	CHI
20191212806	GOIANIA	12813229	CARAJAS S1	02/12/2019 19:22	03/12/2019 00:17	02/12/2019 19:22	03/12/2019 00:17	4,91	1	4,91	CHI
20191212808	SAO LUIS DE MONTES BELOS	6857886	SAO LUIZ DOS MONTES BELOS	02/12/2019 19:23	03/12/2019 01:59	02/12/2019 19:23	03/12/2019 01:59	6,59	1	6,59	CHI
20191212811	GUAPO	GA12000060	GUAPO S2	02/12/2019 19:19	02/12/2019 20:57	02/12/2019 19:19	02/12/2019 20:57	1,63	11	17,88	CHI
20191212816	COCALZINHO DE GOIAS	ZN21297514	COCALZINHO	02/12/2019 19:25	03/12/2019 14:06	02/12/2019 19:25	03/12/2019 14:06	18,68	2	37,36	CHI
20191212818	SANTA ROSA DE GOIAS	SR11104259	INHUMAS S1	02/12/2019 19:25	02/12/2019 21:25	02/12/2019 19:25	02/12/2019 21:25	2,00	60	119,72	CHI
20191212828	MORRO AGUDO DE GOIAS	MS12335823	ITAPURANGA	02/12/2019 16:36	03/12/2019 11:11	02/12/2019 16:36	03/12/2019 11:11	18,59	2	37,18	CHI
20191212833	MINACU	IH11289221	MINACU	02/12/2019 19:26	03/12/2019 16:45	02/12/2019 19:26	03/12/2019 16:45	21,30	16	340,82	CHI
20191212843	PIRACANJUBA	PJ12212152	PIRACANJUBA	02/12/2019 19:11	03/12/2019 17:14	02/12/2019 19:11	03/12/2019 17:14	22,05	37	815,69	CHI
20191212845	GOIATUBA	GT13048367	GOIATUBA S2	02/12/2019 19:28	03/12/2019 01:25	02/12/2019 19:28	02/12/2019 21:47	2,32	2428	5629,59	CHI
20191212845	BURITI ALEGRE	03010224	GOIATUBA S1	02/12/2019 19:28	03/12/2019 01:25	02/12/2019 21:54	03/12/2019 00:10	2,27	2	4,54	CHI
20191212845	GOIATUBA	03010224	GOIATUBA S1	02/12/2019 19:28	03/12/2019 01:25	02/12/2019 21:54	03/12/2019 00:10	2,27	115	260,76	CHI
20191212845	PANAMA	03010224	GOIATUBA S1	02/12/2019 19:28	03/12/2019 01:25	02/12/2019 21:54	03/12/2019 00:10	2,27	12	27,21	CHI
20191212845	GOIATUBA	8551878	GOIATUBA S2	02/12/2019 19:28	03/12/2019 01:25	02/12/2019 19:28	03/12/2019 00:12	4,73	893	4225,38	CHI
20191212845	GOIATUBA	00730234	GOIATUBA S2	02/12/2019 19:28	03/12/2019 01:25	02/12/2019 23:59	03/12/2019 00:12	0,22	1837	401,08	CHI
20191212845	GOIATUBA	GT13000055	GOIATUBA S2	02/12/2019 19:28	03/12/2019 01:25	02/12/2019 21:54	03/12/2019 00:38	2,74	2428	6646,65	CHI
20191212845	GOIATUBA	03010224	GOIATUBA S2	02/12/2019 19:28	03/12/2019 01:25	02/12/2019 21:54	03/12/2019 01:23	3,48	843	2936,45	CHI
20191212845	GOIATUBA	03010224	GOIATUBA S1	02/12/2019 19:28	03/12/2019 01:25	02/12/2019 21:54	03/12/2019 01:25	3,52	11	38,75	CHI
20191212845	PANAMA	03010224	GOIATUBA S1	02/12/2019 19:28	03/12/2019 01:25	02/12/2019 21:54	03/12/2019 01:25	3,52	81	285,37	CHI
20191212847	GOIANIA	10027197342	REAL S2	02/12/2019 19:29	02/12/2019 21:11	02/12/2019 19:29	02/12/2019 21:11	1,70	1	1,70	CHI
20191212852	DOVERLANDIA	DV11139978	CAIAPONIA	02/12/2019 18:02	02/12/2019 23:10	02/12/2019 18:02	02/12/2019 23:10	5,12	146	747,76	CHI
20191212858	ALEXANIA	AX12185636	ALEXANIA	02/12/2019 19:30	03/12/2019 12:29	02/12/2019 19:30	03/12/2019 12:29	16,98	1	16,98	CHI
20191212863	ITUMBIARA	BJ21068956	CACHOEIRA DOURADA	02/12/2019 19:31	02/12/2019 22:27	02/12/2019 19:31	02/12/2019 22:27	2,93	1	2,93	CHI
20191212870	AURILANDIA	AI21232973	FIRMINOPOLIS S2	02/12/2019 19:31	02/12/2019 22:58	02/12/2019 19:31	02/12/2019 22:58	3,44	1	3,44	CHI
20191212872	PETROLINA DE GOIAS	PG21122367	PETROLINA	02/12/2019 19:32	03/12/2019 13:16	02/12/2019 19:32	03/12/2019 13:16	17,73	1	17,73	CHI
20191212884	GOUVELANDIA	QI21155909	QUIRINOPOLIS	02/12/2019 19:34	02/12/2019 22:40	02/12/2019 19:34	02/12/2019 22:40	3,10	2	6,20	CHI
20191212892	ITAPURANGA	IK11051549	ITAPURANGA	02/12/2019 19:25	03/12/2019 06:50	02/12/2019 19:25	03/12/2019 06:50	11,42	195	2227,28	CHI
20191212893	BALIZA	DV12139935	CAIAPONIA	02/12/2019 19:36	03/12/2019 07:38	02/12/2019 19:36	03/12/2019 07:38	12,02	1	12,02	CHI
20191212893	DOVERLANDIA	DV12139935	CAIAPONIA	02/12/2019 19:36	03/12/2019 07:38	02/12/2019 19:36	03/12/2019 07:38	12,02	6	72,14	CHI
20191212895	CALDAS NOVAS	IP21223574	IPAMERI	02/12/2019 19:36	03/12/2019 12:28	02/12/2019 19:36	03/12/2019 12:28	16,85	1	16,85	CHI
20191212898	CATALAO	CT12011272	CATALAO S1	02/12/2019 14:27	03/12/2019 00:43	02/12/2019 14:27	03/12/2019 00:43	10,26	169	1734,60	CHI

20191212903	GOIANIA	10024776325	ATLANTICO S3	02/12/2019 19:39	03/12/2019 00:12	02/12/2019 19:39	03/12/2019 00:12	4,54	1	4,54	CHI
20191212907	MAMBAI	1570010540	IACIARA S2	02/12/2019 19:39	02/12/2019 21:03	02/12/2019 19:39	02/12/2019 21:03	1,39	1	1,39	CHI
20191212917	AGUAS LINDAS DE GOIAS	4830361040	AGUAS LINDAS DE GOIAS S1	02/12/2019 19:41	02/12/2019 21:39	02/12/2019 19:41	02/12/2019 21:39	1,95	1	1,95	CHI
20191212925	RIO VERDE	RV12054354	MONTIVIDIU T	02/12/2019 19:42	03/12/2019 11:10	02/12/2019 19:42	03/12/2019 11:10	15,46	2	30,91	CHI
20191212951	ANAPOLIS	AN21347850	ANAPOLIS UNIVERSITARIO S1	02/12/2019 19:46	03/12/2019 09:50	02/12/2019 19:46	03/12/2019 09:50	14,06	2	28,12	CHI
20191212952	CACU	CC12028172	CACHOEIRA ALTA	02/12/2019 19:47	03/12/2019 11:12	02/12/2019 19:47	03/12/2019 11:12	15,42	3	46,27	CHI
20191212955	CATURAI	CK21018891	INHUMAS S1	02/12/2019 19:47	03/12/2019 13:18	02/12/2019 19:47	03/12/2019 13:18	17,50	1	17,50	CHI
20191212958	ITABERAI	50082516	ITABERAI S2	02/12/2019 19:48	02/12/2019 22:28	02/12/2019 19:48	02/12/2019 22:28	2,67	1	2,67	CHI
20191212959	MOZARLANDIA	MZZ1238339	MOZARLANDIA	02/12/2019 19:48	03/12/2019 16:05	02/12/2019 19:48	03/12/2019 16:05	20,28	1	20,28	CHI
20191212963	GOIAS	8528819	GOIAS	02/12/2019 19:48	03/12/2019 09:31	02/12/2019 19:48	03/12/2019 09:31	13,71	13	178,19	CHI
20191212965	AGUAS LINDAS DE GOIAS	10024211247	AGUAS LINDAS DE GOIAS S1	02/12/2019 19:49	02/12/2019 21:53	02/12/2019 19:49	02/12/2019 21:53	2,07	1	2,07	CHI
20191212970	SENADOR CANEDO	SW11384961	SENADOR CANEDO	02/12/2019 19:42	02/12/2019 20:16	02/12/2019 19:42	02/12/2019 20:16	0,55	169	93,61	CHI
20191212971	AURILANDIA	AI21000011	FIRMINOPOLIS S2	02/12/2019 19:49	02/12/2019 22:22	02/12/2019 19:49	02/12/2019 22:22	2,54	1	2,54	CHI
20191212972	VILA PROPICIO	NP21312746	GOIANESIA S1	02/12/2019 19:49	04/12/2019 01:13	02/12/2019 19:49	04/12/2019 01:13	29,39	1	29,39	CHI
20191212988	PIRENOPOLIS	PV21403574	CORUMBA	02/12/2019 19:52	03/12/2019 15:15	02/12/2019 19:52	03/12/2019 15:15	19,38	2	38,76	CHI
20191212992	INACIOLANDIA	2810016209	QUIRINOPOLIS	02/12/2019 19:53	03/12/2019 08:46	02/12/2019 19:53	03/12/2019 08:46	12,88	1	12,88	CHI
20191212997	GOIANIA	11912832	GOIANIA LESTE S3	02/12/2019 19:54	02/12/2019 22:52	02/12/2019 19:54	02/12/2019 22:52	2,97	1	2,97	CHI
20191213003	VIANOPOLIS	OZ21160203	VIANOPOLIS	02/12/2019 19:56	03/12/2019 08:29	02/12/2019 19:56	03/12/2019 08:29	12,55	1	12,55	CHI
20191213007	DISTRITO FEDERAL	FA12383392	ITIQUEIRA	02/12/2019 19:27	03/12/2019 09:12	02/12/2019 19:27	03/12/2019 09:12	13,74	2	27,48	CHI
20191213018	APARECIDA DE GOIANIA	AP11003027	INDEPENDENCIA S2	02/12/2019 19:50	02/12/2019 20:55	02/12/2019 19:50	02/12/2019 20:55	1,08	211	228,64	CHI
20191213022	PORANGATU	PO12020578	PORANGATU	02/12/2019 20:00	03/12/2019 00:25	02/12/2019 20:00	03/12/2019 00:25	4,42	23	101,58	CHI
20191213024	AGUAS LINDAS DE GOIAS	LA11113295	AGUAS LINDAS DE GOIAS S2	02/12/2019 19:33	02/12/2019 21:04	02/12/2019 19:33	02/12/2019 21:04	1,51	237	358,20	CHI
20191213033	JARAGUA	10004780220	JARAGUA	02/12/2019 20:02	03/12/2019 10:20	02/12/2019 20:02	03/12/2019 10:20	14,30	1	14,30	CHI
20191213034	NOVO GAMA	10004526676	PACAEMBU S1	02/12/2019 20:02	03/12/2019 00:15	02/12/2019 20:02	03/12/2019 00:15	4,21	1	4,21	CHI
20191213036	PARAUNA	PU21059737	FIRMINOPOLIS S2	02/12/2019 20:03	02/12/2019 21:24	02/12/2019 20:03	02/12/2019 21:24	1,35	1	1,35	CHI
20191213039	GOIAS	GS11162401	GOIAS	02/12/2019 20:03	03/12/2019 10:29	02/12/2019 20:03	03/12/2019 10:29	14,42	1	14,42	CHI
20191213047	SAO PATRICIO	RB12053428	RUBIATABA	02/12/2019 17:55	03/12/2019 11:16	02/12/2019 17:55	03/12/2019 11:16	17,33	5	86,67	CHI
20191213048	APARECIDA DE GOIANIA	10618296	ATLANTICO S1	02/12/2019 20:05	03/12/2019 00:09	02/12/2019 20:05	03/12/2019 00:09	4,06	1	4,06	CHI
20191213061	CIDADE OCIDENTAL	10006751987	MARAJOARA	02/12/2019 20:08	02/12/2019 22:02	02/12/2019 20:08	02/12/2019 22:02	1,89	1	1,89	CHI
20191213065	LUZIANIA	LZ11041579	RIO VERMELHO	02/12/2019 19:47	02/12/2019 21:05	02/12/2019 19:47	02/12/2019 21:05	1,29	256	329,39	CHI
20191213067	ITAPIRAPUA	IU21393190	JUSSARA	02/12/2019 20:11	03/12/2019 10:29	02/12/2019 20:11	03/12/2019 10:29	14,29	1	14,29	CHI
20191213068	PLANALTINA	PI21398532	PLANALTINA	02/12/2019 20:12	03/12/2019 15:40	02/12/2019 20:12	03/12/2019 15:40	19,47	1	19,47	CHI
20191213075	TRINDADE	40076520	TRINDADE	02/12/2019 20:14	03/12/2019 00:13	02/12/2019 20:14	03/12/2019 00:13	3,97	1	3,97	CHI

20191213078	BONOPOLIS	BX21265986	NOVO PLANALTO	02/12/2019 20:16	03/12/2019 10:25	02/12/2019 20:16	03/12/2019 10:25	14,14	1	14,14	CHI
20191213086	PIRENOPOLIS	PV12382478	SAO FRANCISCO DE GOIAS	02/12/2019 15:35	03/12/2019 12:21	02/12/2019 15:35	03/12/2019 12:21	20,77	8	166,12	CHI
20191213087	SANTA HELENA DE GOIAS	SH12271563	IPEGUARI	02/12/2019 19:51	02/12/2019 22:00	02/12/2019 19:51	02/12/2019 22:00	2,14	28	60,03	CHI
20191213087	TURVELANDIA	SH12271563	IPEGUARI	02/12/2019 19:51	02/12/2019 22:00	02/12/2019 19:51	02/12/2019 22:00	2,14	12	25,73	CHI
20191213088	PORANGATU	PO21280968	PORANGATU	02/12/2019 20:19	03/12/2019 17:03	02/12/2019 20:19	03/12/2019 17:03	20,72	1	20,72	CHI
20191213089	IPORA	IR12014024	IPORA	02/12/2019 20:14	03/12/2019 05:40	02/12/2019 20:14	03/12/2019 05:40	9,42	17	160,22	CHI
20191213093	CAIAPONIA	930008236	CAIAPONIA	02/12/2019 20:20	03/12/2019 07:22	02/12/2019 20:20	03/12/2019 07:22	11,02	1	11,02	CHI
20191213101	GOIATUBA	GT21000275	GOIATUBA S2	02/12/2019 20:22	03/12/2019 14:07	02/12/2019 20:22	03/12/2019 14:07	17,76	1	17,76	CHI
20191213102	BOM JARDIM DE GOIAS	PH12041074	PIRANHAS	02/12/2019 20:22	03/12/2019 07:44	02/12/2019 20:22	03/12/2019 07:44	11,36	13	147,64	CHI
20191213102	PIRANHAS	PH12041074	PIRANHAS	02/12/2019 20:22	03/12/2019 07:44	02/12/2019 20:22	03/12/2019 07:44	11,36	33	374,77	CHI
20191213104	PARAUNA	RP21102498	PARAUNA	02/12/2019 20:23	02/12/2019 22:35	02/12/2019 20:23	02/12/2019 22:35	2,20	1	2,20	CHI
20191213107	MOSSAMEDES	MD12299605	ITABERAI S2	02/12/2019 20:24	03/12/2019 10:22	02/12/2019 20:24	03/12/2019 10:22	13,96	5	69,82	CHI
20191213108	SANTO ANTONIO DA BARRA	BZ12301421	ACREUNA	02/12/2019 20:24	03/12/2019 08:44	02/12/2019 20:24	03/12/2019 08:44	12,33	3	36,99	CHI
20191213120	ANAPOLIS	10010508188	JUNDIAI S1	02/12/2019 20:25	02/12/2019 23:51	02/12/2019 20:25	02/12/2019 23:51	3,42	1	3,42	CHI
20191213128	VARJAO	VJ12066127	GUAPO S2	02/12/2019 20:28	03/12/2019 07:40	02/12/2019 20:28	03/12/2019 07:40	11,19	28	313,44	CHI
20191213129	GOIANIA	GN12053242	CAMPINAS S1	02/12/2019 20:28	02/12/2019 21:21	02/12/2019 20:28	02/12/2019 21:21	0,87	101	88,07	CHI
20191213130	PLANALTINA	PI11164647	PLANALTINA	02/12/2019 20:26	02/12/2019 21:14	02/12/2019 20:26	02/12/2019 21:14	0,79	113	89,43	CHI
20191213133	TRINDADE	TR11144793	TRINDADE	02/12/2019 19:49	02/12/2019 22:45	02/12/2019 19:49	02/12/2019 22:45	2,93	120	351,60	CHI
20191213135	INHUMAS	IN12012145	INHUMAS S2	02/12/2019 19:24	02/12/2019 22:54	02/12/2019 19:24	02/12/2019 22:54	3,50	6	20,97	CHI
20191213141	BELA VISTA DE GOIAS	BV12103250LD	SENADOR CANEDO	02/12/2019 20:32	03/12/2019 08:33	02/12/2019 20:32	03/12/2019 08:33	12,00	22	264,07	CHI
20191213141	CALDAZINHA	BV12103250LD	SENADOR CANEDO	02/12/2019 20:32	03/12/2019 08:33	02/12/2019 20:32	03/12/2019 08:33	12,00	3	36,01	CHI
20191213153	JATAI	JT12093820	CACHOEIRA ALTA	02/12/2019 20:36	03/12/2019 10:19	02/12/2019 20:36	03/12/2019 10:19	13,70	1	13,70	CHI
20191213154	ANAPOLIS	AN11382188	DAIA S1	02/12/2019 20:25	02/12/2019 22:53	02/12/2019 20:25	02/12/2019 22:53	2,46	62	152,36	CHI
20191213156	URUTAI	UT12016978RE	URUTAI	02/12/2019 17:09	02/12/2019 22:55	02/12/2019 17:09	02/12/2019 22:55	5,76	30	172,92	CHI
20191213168	FORMOSA	10015607443	ITUIQUIRA	02/12/2019 20:42	03/12/2019 02:00	02/12/2019 20:42	03/12/2019 02:00	5,29	1	5,29	CHI
20191213173	SAO MIGUEL DO ARAGUAIA	SM12031421	SAO MIGUEL DO ARAGUAIA	02/12/2019 20:43	03/12/2019 11:42	02/12/2019 20:43	03/12/2019 11:42	14,98	18	269,58	CHI
20191213174	PORANGATU	PO12288780	PORANGATU	02/12/2019 20:44	03/12/2019 08:34	02/12/2019 20:44	03/12/2019 08:34	11,83	1	11,83	CHI
20191213178	JATAI	JT21105136	JATAI S1	02/12/2019 20:44	03/12/2019 11:47	02/12/2019 20:44	03/12/2019 11:47	15,03	1	15,03	CHI
20191213180	LUZIANIA	10009178960	MARAJOARA	02/12/2019 20:46	02/12/2019 22:42	02/12/2019 20:46	02/12/2019 22:42	1,93	1	1,93	CHI
20191213188	APARECIDA DE GOIANIA	13946584	ANHANGUERA	02/12/2019 20:51	03/12/2019 00:42	02/12/2019 20:51	03/12/2019 00:42	3,83	1	3,83	CHI
20191213197	DAMIANOPOLIS	01110214	IACIARA S2	02/12/2019 20:41	03/12/2019 03:19	02/12/2019 20:41	03/12/2019 03:19	6,63	130	861,32	CHI
20191213197	SITIO D ABADIA	01110214	IACIARA S2	02/12/2019 20:41	03/12/2019 03:19	02/12/2019 20:41	03/12/2019 03:19	6,63	378	2504,46	CHI
20191213206	SANCLERLANDIA	SL12019498	SAO LUIZ DOS MONTES BELOS	02/12/2019 20:54	03/12/2019 01:20	02/12/2019 20:54	03/12/2019 01:20	4,42	4	17,70	CHI

20191213207	PIRES DO RIO	460060168	PIRES DO RIO S1	02/12/2019 20:58	02/12/2019 23:16	02/12/2019 20:58	02/12/2019 23:16	2,29	1	2,29	CHI
20191213211	OUIDOR	10018555207	CATALAO S1	02/12/2019 21:02	03/12/2019 08:35	02/12/2019 21:02	03/12/2019 08:35	11,54	1	11,54	CHI
20191213223	GUAPO	GA21008763	GUAPO S2	02/12/2019 21:06	03/12/2019 10:21	02/12/2019 21:06	03/12/2019 10:21	13,25	1	13,25	CHI
20191213228	RIO VERDE	RV11045938	CABRIUVA S1	02/12/2019 20:55	02/12/2019 22:35	02/12/2019 20:55	02/12/2019 22:35	1,66	141	234,06	CHI
20191213234	IPAMERI	IP12041051	IPAMERI	02/12/2019 21:10	02/12/2019 22:59	02/12/2019 21:10	02/12/2019 22:59	1,80	7	12,61	CHI
20191213238	IPORA	730149377	IPORA	02/12/2019 21:10	02/12/2019 22:17	02/12/2019 21:10	02/12/2019 22:17	1,10	1	1,10	CHI
20191213259	GOIANIA	GN11169544	CARAJAS S2	02/12/2019 20:54	02/12/2019 22:55	02/12/2019 20:54	02/12/2019 22:55	2,02	86	173,72	CHI
20191213260	PALMINOPOLIS	PP12307033	PALMEIRAS	02/12/2019 21:18	03/12/2019 12:26	02/12/2019 21:18	03/12/2019 12:26	15,14	2	30,27	CHI
20191213262	NOVO GAMA	NJ11201123	MARAJOARA	02/12/2019 21:04	02/12/2019 22:51	02/12/2019 21:04	02/12/2019 22:51	1,78	143	254,18	CHI
20191213263	FAZENDA NOVA	FN11089961	JUSSARA	02/12/2019 13:16	03/12/2019 08:20	02/12/2019 13:16	03/12/2019 08:20	19,07	83	1582,58	CHI
20191213277	MARA ROSA	MQ12135696	MARA ROSA	02/12/2019 21:25	03/12/2019 08:01	02/12/2019 21:25	03/12/2019 08:01	10,58	10	105,84	CHI
20191213281	SENADOR CANEDO	190001537	SENADOR CANEDO	02/12/2019 21:26	03/12/2019 01:31	02/12/2019 21:26	03/12/2019 01:31	4,08	1	4,08	CHI
20191213284	CATALAO	1990182164	CATALAO S2	02/12/2019 21:27	03/12/2019 16:09	02/12/2019 21:27	03/12/2019 16:09	18,70	1	18,70	CHI
20191213285	CATALAO	CT10400805	CATALAO S2	02/12/2019 20:51	03/12/2019 13:26	02/12/2019 20:51	02/12/2019 21:01	0,17	1723	285,25	CHI
20191213285	CUMARI	CT10400805	CATALAO S2	02/12/2019 20:51	03/12/2019 13:26	02/12/2019 20:51	02/12/2019 21:01	0,17	51	8,44	CHI
20191213285	CATALAO	CT10400805	CATALAO S2	02/12/2019 20:51	03/12/2019 13:26	02/12/2019 21:06	02/12/2019 21:50	0,72	1643	1185,24	CHI
20191213285	CATALAO	CT13000024	CATALAO S2	02/12/2019 20:51	03/12/2019 13:26	02/12/2019 21:06	02/12/2019 22:24	1,30	77	99,72	CHI
20191213285	CUMARI	CT13000024	CATALAO S2	02/12/2019 20:51	03/12/2019 13:26	02/12/2019 21:06	02/12/2019 22:24	1,30	51	66,05	CHI
20191213285	CATALAO	CT13000023	CATALAO S2	02/12/2019 20:51	03/12/2019 13:26	03/12/2019 09:55	03/12/2019 12:51	2,93	63	184,89	CHI
20191213285	CUMARI	CT13000023	CATALAO S2	02/12/2019 20:51	03/12/2019 13:26	03/12/2019 09:55	03/12/2019 12:51	2,93	51	149,67	CHI
20191213285	CATALAO	CT10400805	CATALAO S2	02/12/2019 20:51	03/12/2019 13:26	02/12/2019 21:06	03/12/2019 13:26	16,34	3	49,01	CHI
20191213289	PARAUNA	PU12295855	ACREUNA	02/12/2019 21:28	03/12/2019 01:42	02/12/2019 21:28	03/12/2019 01:42	4,22	4	16,90	CHI
20191213293	GOIANIA	10013238963	ATLANTICO S1	02/12/2019 21:32	03/12/2019 01:25	02/12/2019 21:32	03/12/2019 01:25	3,88	1	3,88	CHI
20191213303	PANAMA	10021349507	CACHOEIRA DOURADA	02/12/2019 21:40	03/12/2019 14:03	02/12/2019 21:40	03/12/2019 14:03	16,38	1	16,38	CHI
20191213309	ITABERAI	IB111206916	ITABERAI S2	02/12/2019 21:43	02/12/2019 23:48	02/12/2019 21:43	02/12/2019 23:48	2,07	157	325,64	CHI
20191213320	SAO LUIS DE MONTES BELOS	500052736	SAO LUIZ DOS MONTES BELOS	02/12/2019 21:51	02/12/2019 23:35	02/12/2019 21:51	02/12/2019 23:35	1,72	1	1,72	CHI
20191213323	GOIANIA	13076061	GOYA S1	02/12/2019 21:57	03/12/2019 03:53	02/12/2019 21:57	03/12/2019 03:53	5,92	1	5,92	CHI
20191213343	RIO VERDE	RV11136155	RIO VERDE S1	02/12/2019 22:05	03/12/2019 03:45	02/12/2019 22:05	03/12/2019 03:45	5,66	100	565,89	CHI
20191213349	SENADOR CANEDO	SW12193555	SENADOR CANEDO	02/12/2019 22:13	03/12/2019 00:40	02/12/2019 22:13	03/12/2019 00:40	2,44	348	848,44	CHI
20191213351	PIRES DO RIO	460052147	PIRES DO RIO S1	02/12/2019 22:26	03/12/2019 01:00	02/12/2019 22:26	03/12/2019 01:00	2,56	1	2,56	CHI
20191213352	GOIANIA	GN11077024	FERROVIARIO S3	02/12/2019 22:30	03/12/2019 01:26	02/12/2019 22:30	03/12/2019 01:26	2,92	49	143,12	CHI
20191213356	BOM JARDIM DE GOIAS	BM21138453	BOM JARDIM	02/12/2019 22:32	03/12/2019 07:37	02/12/2019 22:32	03/12/2019 07:37	9,08	1	9,08	CHI
20191213358	CATALAO	CT12134367	CATALAO S1	02/12/2019 22:35	03/12/2019 10:00	02/12/2019 22:35	03/12/2019 10:00	11,41	11	125,56	CHI

20191213361	CHAPADAO DO CEU	DJ1241806	CHAPADAO DO CEU	02/12/2019 22:37	03/12/2019 09:29	02/12/2019 22:37	03/12/2019 09:29	10,86	1	10,86	CHI
20191213364	RIO VERDE	630217040	RIO VERDE S1	02/12/2019 22:38	03/12/2019 11:30	02/12/2019 22:38	03/12/2019 11:30	12,87	1	12,87	CHI
20191213366	ITAPURANGA	IK12299926	ITAPURANGA	02/12/2019 13:02	03/12/2019 07:56	02/12/2019 13:02	03/12/2019 07:56	18,89	20	377,86	CHI
20191213370	GOIANIA	11269716	ATLANTICO S2	02/12/2019 22:40	03/12/2019 03:03	02/12/2019 22:40	03/12/2019 03:03	4,38	1	4,38	CHI
20191213372	SAO MIGUEL DO ARAGUAIA	SM11352926	SAO MIGUEL DO ARAGUAIA	02/12/2019 22:37	03/12/2019 07:19	02/12/2019 22:37	03/12/2019 07:19	8,69	103	895,41	CHI
20191213375	ANAPOLIS	21386470	JUNDIAI S1	02/12/2019 22:42	03/12/2019 09:58	02/12/2019 22:42	03/12/2019 09:58	11,27	1	11,27	CHI
20191213376	MINACU	IH12230340	MINACU	02/12/2019 22:43	03/12/2019 13:23	02/12/2019 22:43	03/12/2019 13:23	14,66	12	175,86	CHI
20191213381	GOIANIA	15737070	MEIA PONTE	02/12/2019 22:47	02/12/2019 23:34	02/12/2019 22:47	02/12/2019 23:34	0,77	1	0,77	CHI
20191213382	BARRO ALTO	BA12258276	GOIANESIA S1	02/12/2019 21:45	03/12/2019 03:23	02/12/2019 21:45	03/12/2019 03:23	5,62	15	84,30	CHI
20191213382	GOIANESIA	BA12258276	GOIANESIA S1	02/12/2019 21:45	03/12/2019 03:23	02/12/2019 21:45	03/12/2019 03:23	5,62	112	629,41	CHI
20191213382	VILA PROPICIO	BA12258276	GOIANESIA S1	02/12/2019 21:45	03/12/2019 03:23	02/12/2019 21:45	03/12/2019 03:23	5,62	12	67,44	CHI
20191213383	JUSSARA	JR21019327	JUSSARA	02/12/2019 22:49	03/12/2019 16:25	02/12/2019 22:49	03/12/2019 16:25	17,59	1	17,59	CHI
20191213391	GOIANIA	11291308	CAMPINAS S3	02/12/2019 23:02	03/12/2019 02:21	02/12/2019 23:02	03/12/2019 02:21	3,30	1	3,30	CHI
20191213395	CRISTALINA	KR21165543	CRISTALINA S2	02/12/2019 23:03	03/12/2019 12:05	02/12/2019 23:03	03/12/2019 12:05	13,02	1	13,02	CHI
20191213404	APARECIDA DE GOIANIA	AP11004883	ATLANTICO S1	02/12/2019 23:16	03/12/2019 00:31	02/12/2019 23:16	03/12/2019 00:31	1,24	80	99,49	CHI
20191213406	DOVERLANDIA	DV12138540	CAIAPONIA	02/12/2019 19:26	03/12/2019 07:14	02/12/2019 19:26	03/12/2019 07:14	11,80	9	106,20	CHI
20191213407	GOIANIA	10001384072	FERROVIARIO S1	02/12/2019 23:18	03/12/2019 00:45	02/12/2019 23:18	03/12/2019 00:45	1,44	1	1,44	CHI
20191213411	ACREUNA	EU12301162	ACREUNA	02/12/2019 23:23	03/12/2019 08:43	02/12/2019 23:23	03/12/2019 08:43	9,33	1	9,33	CHI
20191213414	ITUMBIARA	IT11363885	ITUMBIARA VELHA S1	02/12/2019 23:19	03/12/2019 12:54	02/12/2019 23:19	03/12/2019 12:54	13,57	131	1777,31	CHI
20191213416	JARAGUA	70058672	JARAGUA	02/12/2019 23:32	03/12/2019 14:23	02/12/2019 23:32	03/12/2019 14:23	14,84	1	14,84	CHI
20191213421	BELA VISTA DE GOIAS	BV12009527	BELA VISTA S1	02/12/2019 23:43	03/12/2019 09:09	02/12/2019 23:43	03/12/2019 09:09	9,43	12	113,18	CHI
20191213423	SAO LUIS DE MONTES BELOS	SL12111560	FIRMINOPOLIS S1	02/12/2019 23:32	03/12/2019 17:40	02/12/2019 23:32	03/12/2019 17:20	17,80	30	533,98	CHI
20191213423	FIRMINOPOLIS	SL12111560	FIRMINOPOLIS S1	02/12/2019 23:32	03/12/2019 17:40	02/12/2019 23:32	03/12/2019 17:40	18,13	6	108,80	CHI
20191213423	SAO LUIS DE MONTES BELOS	SL12111560	FIRMINOPOLIS S1	02/12/2019 23:32	03/12/2019 17:40	02/12/2019 23:32	03/12/2019 17:40	18,13	3	54,40	CHI
20191213429	JATAI	JT11241648	JATAI S3	02/12/2019 23:27	03/12/2019 04:30	02/12/2019 23:27	03/12/2019 04:30	5,04	140	706,14	CHI
20191213511	ABADIANIA	AN12221398	ANAPOLIS UNIVERSITARIO S2	03/12/2019 00:22	03/12/2019 02:45	03/12/2019 00:22	03/12/2019 02:45	2,38	17	40,41	CHI
20191213511	ANAPOLIS	AN12221398	ANAPOLIS UNIVERSITARIO S2	03/12/2019 00:22	03/12/2019 02:45	03/12/2019 00:22	03/12/2019 02:45	2,38	2	4,75	CHI
20191213511	PIRENOPOLIS	AN12221398	ANAPOLIS UNIVERSITARIO S2	03/12/2019 00:22	03/12/2019 02:45	03/12/2019 00:22	03/12/2019 02:45	2,38	13	30,90	CHI
20191213515	GOIANIA	SW12064786	GOIANIA LESTE S2	03/12/2019 05:30	03/12/2019 09:00	03/12/2019 05:30	03/12/2019 09:00	3,49	1	3,49	CHI
20191213515	SENADOR CANEDO	SW12064786	GOIANIA LESTE S2	03/12/2019 05:30	03/12/2019 09:00	03/12/2019 05:30	03/12/2019 09:00	3,49	23	80,28	CHI
20191213517	IACIARA	IA12160059	IACIARA S1	03/12/2019 00:36	03/12/2019 10:00	03/12/2019 00:36	03/12/2019 10:00	9,40	22	206,70	CHI
20191213520	MONTIVIDIU DO NORTE	MX11203346	PORANGATU	02/12/2019 16:41	04/12/2019 11:05	02/12/2019 16:41	04/12/2019 11:05	42,39	1	42,39	CHI
20191213521	MONTIVIDIU DO NORTE	9670005819	PORANGATU	02/12/2019 19:20	03/12/2019 15:45	02/12/2019 19:20	03/12/2019 15:45	20,41	1	20,41	CHI

20191213527	ORIZONA	PR12272876	PIRES DO RIO S1	03/12/2019 01:06	03/12/2019 13:53	03/12/2019 01:06	03/12/2019 13:53	12,78	5	63,89	CHI
20191213527	PIRES DO RIO	PR12272876	PIRES DO RIO S1	03/12/2019 01:06	03/12/2019 13:53	03/12/2019 01:06	03/12/2019 13:53	12,78	7	89,44	CHI
20191213528	ITABERAÍ	IB11206916	ITABERAÍ S2	03/12/2019 01:08	03/12/2019 11:04	03/12/2019 01:08	03/12/2019 11:04	9,92	157	1557,88	CHI
20191213543	PALMEIRAS DE GOIAS	PL12016686	PALMEIRAS	02/12/2019 22:34	03/12/2019 15:30	02/12/2019 22:34	03/12/2019 15:30	16,92	12	203,04	CHI
20191213545	FIRMINOPOLIS	SL12125617	FIRMINOPOLIS S1	02/12/2019 21:04	03/12/2019 05:20	02/12/2019 21:04	03/12/2019 05:20	8,26	17	140,50	CHI
20191213545	SAO LUIS DE MONTES BELOS	SL12125617	FIRMINOPOLIS S1	02/12/2019 21:04	03/12/2019 05:20	02/12/2019 21:04	03/12/2019 05:20	8,26	52	429,78	CHI
20191213545	TURVANIA	SL12125617	FIRMINOPOLIS S1	02/12/2019 21:04	03/12/2019 05:20	02/12/2019 21:04	03/12/2019 05:20	8,26	8	66,12	CHI
20191213548	NOVA ROMA	ND10401466	IACIARA S2	03/12/2019 01:45	05/12/2019 14:53	03/12/2019 01:45	03/12/2019 06:05	4,33	307	1329,91	CHI
20191213548	NOVA ROMA	ND10401466	IACIARA S2	03/12/2019 01:45	05/12/2019 14:53	03/12/2019 08:54	03/12/2019 09:11	0,29	307	90,14	CHI
20191213548	NOVA ROMA	ND10401466	IACIARA S2	03/12/2019 01:45	05/12/2019 14:53	03/12/2019 10:31	03/12/2019 11:14	0,70	307	216,26	CHI
20191213548	MONTE ALEGRE DE GOIAS	ND13218888	IACIARA S2	03/12/2019 01:45	05/12/2019 14:53	03/12/2019 01:45	03/12/2019 12:55	11,16	1	11,16	CHI
20191213548	NOVA ROMA	ND10401466	IACIARA S2	03/12/2019 01:45	05/12/2019 14:53	03/12/2019 01:45	03/12/2019 12:55	11,16	20	223,28	CHI
20191213548	NOVA ROMA	ND13218888	IACIARA S2	03/12/2019 01:45	05/12/2019 14:53	03/12/2019 01:45	03/12/2019 12:55	11,16	931	10393,84	CHI
20191213548	SAO DOMINGOS	ND10401466	IACIARA S2	03/12/2019 01:45	05/12/2019 14:53	03/12/2019 01:45	03/12/2019 12:55	11,16	3	33,49	CHI
20191213548	NOVA ROMA	ND12161820	IACIARA S2	03/12/2019 01:45	05/12/2019 14:53	03/12/2019 01:45	03/12/2019 14:42	12,95	22	284,79	CHI
20191213548	NOVA ROMA	ND12161820	IACIARA S2	03/12/2019 01:45	05/12/2019 14:53	03/12/2019 16:07	03/12/2019 17:08	1,02	22	22,40	CHI
20191213548	NOVA ROMA	ND10401466	IACIARA S2	03/12/2019 01:45	05/12/2019 14:53	03/12/2019 01:45	03/12/2019 17:29	15,74	3	47,22	CHI
20191213548	NOVA ROMA	ND10401466	IACIARA S2	03/12/2019 01:45	05/12/2019 14:53	03/12/2019 01:45	04/12/2019 14:19	36,57	103	3767,11	CHI
20191213548	NOVA ROMA	ND10401466	IACIARA S2	03/12/2019 01:45	05/12/2019 14:53	03/12/2019 01:45	05/12/2019 14:53	61,13	1	61,13	CHI
20191213549	AURILANDIA	RP12076381	FIRMINOPOLIS S2	03/12/2019 01:50	03/12/2019 13:19	03/12/2019 01:50	03/12/2019 13:19	11,48	4	45,91	CHI
20191213549	SAO JOAO DA PARAUNA	RP12076381	FIRMINOPOLIS S2	03/12/2019 01:50	03/12/2019 13:19	03/12/2019 01:50	03/12/2019 13:19	11,48	23	263,96	CHI
20191213550	NOVA CRIXAS	NA12354854	NOVA CRIXAS	03/12/2019 01:53	03/12/2019 08:00	03/12/2019 01:53	03/12/2019 08:00	6,11	9	55,03	CHI
20191213551	GOIANIA	GN21325015	GOYA S2	02/12/2019 19:54	03/12/2019 03:31	02/12/2019 19:54	03/12/2019 03:31	7,61	0	0,00	CHI
20191213564	PONTALINA	PK21050021	PONTALINA	03/12/2019 03:12	03/12/2019 10:20	03/12/2019 03:12	03/12/2019 10:20	7,12	2	14,24	CHI
20191213567	TRINDADE	TR21278799	TRINDADE	03/12/2019 03:24	03/12/2019 08:22	03/12/2019 03:24	03/12/2019 08:22	4,95	2	9,90	CHI
20191213572	HIDROLANDIA	HD21200013	CEPAIGO S2	03/12/2019 03:44	03/12/2019 17:00	03/12/2019 03:44	03/12/2019 17:00	13,27	1	13,27	CHI
20191213573	DIVINOPOLIS DE GOIAS	SD12090135	SAO DOMINGOS	03/12/2019 00:25	03/12/2019 08:36	03/12/2019 00:25	03/12/2019 08:36	8,18	24	196,25	CHI
20191213573	SAO DOMINGOS	SD12090135	SAO DOMINGOS	03/12/2019 00:25	03/12/2019 08:36	03/12/2019 00:25	03/12/2019 08:36	8,18	80	654,18	CHI
20191213582	PORTELANDIA	PW12303462	PARQUE DAS EMAS	03/12/2019 04:23	03/12/2019 10:56	03/12/2019 04:23	03/12/2019 10:56	6,55	8	52,40	CHI
20191213593	PLANALTINA	2960252531	PLANALTINA	03/12/2019 04:41	03/12/2019 07:32	03/12/2019 04:41	03/12/2019 07:32	2,85	1	2,85	CHI
20191213595	CATALAO	CT12333638RE	CATALAO S1	03/12/2019 04:42	04/12/2019 07:15	03/12/2019 04:42	04/12/2019 07:15	26,53	62	1645,10	CHI
20191213601	APARECIDA DO RIO DOCE	AW12341113	CACHOEIRA ALTA	03/12/2019 04:53	05/12/2019 22:32	03/12/2019 04:53	03/12/2019 16:20	11,44	1	11,44	CHI
20191213601	JATAI	AW12341113	CACHOEIRA ALTA	03/12/2019 04:53	05/12/2019 22:32	03/12/2019 04:53	03/12/2019 16:20	11,44	28	320,43	CHI

20191213601	APARECIDA DO RIO DOCE	AW12341113	CACHOEIRA ALTA	03/12/2019 04:53	05/12/2019 22:32	03/12/2019 16:21	03/12/2019 19:30	3,15	1	3,15	CHI
20191213601	JATAI	AW12341113	CACHOEIRA ALTA	03/12/2019 04:53	05/12/2019 22:32	03/12/2019 16:21	03/12/2019 19:30	3,15	6	18,88	CHI
20191213601	JATAI	AW13191580	CACHOEIRA ALTA	03/12/2019 04:53	05/12/2019 22:32	03/12/2019 16:21	05/12/2019 22:32	54,19	22	1192,13	CHI
20191213605	BALIZA	BH12142110	BOM JARDIM	02/12/2019 18:01	03/12/2019 06:39	02/12/2019 18:01	03/12/2019 06:39	12,63	84	1060,83	CHI
20191213606	ARENOPOLIS	AY12000049	ARENOPOLIS	03/12/2019 04:56	03/12/2019 08:01	03/12/2019 04:56	03/12/2019 08:01	3,07	42	129,02	CHI
20191213606	IPORA	AY12000049	ARENOPOLIS	03/12/2019 04:56	03/12/2019 08:01	03/12/2019 04:56	03/12/2019 08:01	3,07	11	33,79	CHI
20191213609	ARENOPOLIS	AY12123896	ARENOPOLIS	03/12/2019 04:23	03/12/2019 06:40	03/12/2019 04:23	03/12/2019 06:40	2,27	14	31,78	CHI
20191213609	DIORAMA	AY12123896	ARENOPOLIS	03/12/2019 04:23	03/12/2019 06:40	03/12/2019 04:23	03/12/2019 06:40	2,27	15	34,05	CHI
20191213610	SAO MIGUEL DO ARAGUAIA	SM12013036	SAO MIGUEL DO ARAGUAIA	03/12/2019 05:02	03/12/2019 10:35	03/12/2019 05:02	03/12/2019 10:35	5,55	22	122,15	CHI
20191213617	ANICUNS	AR12019251	ARACU	03/12/2019 04:12	03/12/2019 09:57	03/12/2019 04:12	03/12/2019 09:57	5,74	69	395,75	CHI
20191213617	ARACU	AR12019251	ARACU	03/12/2019 04:12	03/12/2019 09:57	03/12/2019 04:12	03/12/2019 09:57	5,74	12	68,83	CHI
20191213617	ITABERAI	AR12019251	ARACU	03/12/2019 04:12	03/12/2019 09:57	03/12/2019 04:12	03/12/2019 09:57	5,74	38	217,95	CHI
20191213619	INDIARA	PL12349352	PALMEIRAS	03/12/2019 05:10	03/12/2019 10:40	03/12/2019 05:10	03/12/2019 10:40	5,49	3	16,48	CHI
20191213619	PALMEIRAS DE GOIAS	PL12349352	PALMEIRAS	03/12/2019 05:10	03/12/2019 10:40	03/12/2019 05:10	03/12/2019 10:40	5,49	66	362,51	CHI
20191213620	IPORA	IR11074589	IPORA	03/12/2019 05:11	03/12/2019 17:13	03/12/2019 05:11	03/12/2019 17:13	12,02	2	24,05	CHI
20191213622	MORRINHOS	MR12223453	GOIATUBA S1	03/12/2019 05:18	03/12/2019 15:28	03/12/2019 05:18	03/12/2019 15:28	10,17	35	355,87	CHI
20191213623	NOVA IGUACU DE GOIAS	NH21237320	SANTA TEREZINHA	03/12/2019 05:19	03/12/2019 15:10	03/12/2019 05:19	03/12/2019 15:10	9,85	1	9,85	CHI
20191213626	LEOPOLDO DE BULHOES	LB21180113	DAIA S2	03/12/2019 05:21	03/12/2019 12:30	03/12/2019 05:21	03/12/2019 12:30	7,16	1	7,16	CHI
20191213628	MOSSAMEDES	MD12037744	FIRMINOPOLIS S2	03/12/2019 05:22	03/12/2019 17:06	03/12/2019 05:22	03/12/2019 17:06	11,73	11	129,08	CHI
20191213637	ITUMBIARA	IT12305607	ITUMBIARA NOVA	03/12/2019 05:26	03/12/2019 09:05	03/12/2019 05:26	03/12/2019 09:05	3,66	13	47,52	CHI
20191213641	UIRAPURU	UP12244464	NOVA CRIXAS	03/12/2019 04:37	03/12/2019 09:31	03/12/2019 04:37	03/12/2019 09:31	4,90	24	117,50	CHI
20191213648	GOIANIA	10008175290	AEROPORTO S1	03/12/2019 05:31	03/12/2019 07:26	03/12/2019 05:31	03/12/2019 07:26	1,91	1	1,91	CHI
20191213650	BOM JESUS DE GOIAS	BJ12392116	BOM JESUS DE GOIAS	03/12/2019 05:31	03/12/2019 11:10	03/12/2019 05:31	03/12/2019 11:10	5,65	15	84,79	CHI
20191213653	CACHOEIRA DOURADA	CD21000062	CACHOEIRA DOURADA	03/12/2019 05:33	03/12/2019 10:32	03/12/2019 05:33	03/12/2019 10:32	5,00	1	5,00	CHI
20191213657	JOVIANIA	VI12218198RE	VICENTINOPOLIS	03/12/2019 05:34	03/12/2019 16:22	03/12/2019 05:34	03/12/2019 16:22	10,80	30	324,09	CHI
20191213657	PONTALINA	VI12218198RE	VICENTINOPOLIS	03/12/2019 05:34	03/12/2019 16:22	03/12/2019 05:34	03/12/2019 16:22	10,80	24	259,27	CHI
20191213657	VICENTINOPOLIS	VI12218198RE	VICENTINOPOLIS	03/12/2019 05:34	03/12/2019 16:22	03/12/2019 05:34	03/12/2019 16:22	10,80	14	151,24	CHI
20191213660	CACU	IM12371219	CACHOEIRA ALTA	03/12/2019 05:34	03/12/2019 14:22	03/12/2019 05:34	03/12/2019 14:22	8,78	29	254,73	CHI
20191213660	ITARUMA	IM12371219	CACHOEIRA ALTA	03/12/2019 05:34	03/12/2019 14:22	03/12/2019 05:34	03/12/2019 14:22	8,78	21	184,46	CHI
20191213660	JATAI	IM12371219	CACHOEIRA ALTA	03/12/2019 05:34	03/12/2019 14:22	03/12/2019 05:34	03/12/2019 14:22	8,78	20	175,68	CHI
20191213663	SANCLERLANDIA	SC12005400	FIRMINOPOLIS S2	03/12/2019 05:36	03/12/2019 18:33	03/12/2019 05:36	03/12/2019 18:33	12,93	42	543,25	CHI
20191213663	SAO LUIS DE MONTES BELOS	SC12005400	FIRMINOPOLIS S2	03/12/2019 05:36	03/12/2019 18:33	03/12/2019 05:36	03/12/2019 18:33	12,93	2	25,87	CHI
20191213665	SANTA HELENA DE GOIAS	SH12271563	IPEGUARI	03/12/2019 05:37	03/12/2019 07:35	03/12/2019 05:37	03/12/2019 07:35	1,97	28	55,06	CHI

20191213665	TURVELANDIA	SH12271563	IPEGUARI	03/12/2019 05:37	03/12/2019 07:35	03/12/2019 05:37	03/12/2019 07:35	1,97	12	23,60	CHI
20191213666	GOIAS	GS12087523	GOIAS	03/12/2019 05:37	03/12/2019 08:45	03/12/2019 05:37	03/12/2019 08:45	3,13	68	212,84	CHI
20191213670	POSSE	PS12124656	IACIARA S2	03/12/2019 05:39	03/12/2019 09:08	03/12/2019 05:39	03/12/2019 09:08	3,48	35	121,83	CHI
20191213682	PARAUNA	PU12081329	PARAUNA	03/12/2019 05:41	03/12/2019 09:26	03/12/2019 05:41	03/12/2019 09:26	3,75	53	198,66	CHI
20191213687	AMARALINA	LC12270122	SAO MIGUEL DO ARAGUAIA	03/12/2019 04:25	03/12/2019 09:17	03/12/2019 04:25	03/12/2019 09:17	4,86	11	53,42	CHI
20191213696	BONOPOLIS	BX12263014	SAO MIGUEL DO ARAGUAIA	03/12/2019 05:47	03/12/2019 14:42	03/12/2019 05:47	03/12/2019 14:42	8,92	4	35,67	CHI
20191213697	GOIANIA	15279637	CAMPINAS S1	03/12/2019 05:47	03/12/2019 06:48	03/12/2019 05:47	03/12/2019 06:48	1,02	1	1,02	CHI
20191213698	GOIANIA	13521755	XAVANTES	03/12/2019 05:47	03/12/2019 07:06	03/12/2019 05:47	03/12/2019 07:06	1,31	1	1,31	CHI
20191213699	BRITANIA	7119840	BRITANIA	03/12/2019 05:47	03/12/2019 20:01	03/12/2019 05:47	03/12/2019 20:01	14,22	1	14,22	CHI
20191213703	ANAPOLIS	AN16406957	ANAPOLIS UNIVERSITARIO S2	03/12/2019 06:18	03/12/2019 09:05	03/12/2019 06:18	03/12/2019 07:44	1,43	151	216,01	CHI
20191213703	ANAPOLIS	AN13381268	ANAPOLIS UNIVERSITARIO S2	03/12/2019 06:18	03/12/2019 09:05	03/12/2019 06:18	03/12/2019 08:41	2,39	98	233,87	CHI
20191213703	ANAPOLIS	AN16406957	ANAPOLIS UNIVERSITARIO S2	03/12/2019 06:18	03/12/2019 09:05	03/12/2019 06:18	03/12/2019 08:41	2,39	59	140,80	CHI
20191213703	GAMELEIRA DE GOIAS	AN13381268	ANAPOLIS UNIVERSITARIO S2	03/12/2019 06:18	03/12/2019 09:05	03/12/2019 06:18	03/12/2019 08:41	2,39	64	152,73	CHI
20191213703	GAMELEIRA DE GOIAS	AN16406957	ANAPOLIS UNIVERSITARIO S2	03/12/2019 06:18	03/12/2019 09:05	03/12/2019 06:18	03/12/2019 08:41	2,39	41	97,84	CHI
20191213703	SILVANIA	AN13381268	ANAPOLIS UNIVERSITARIO S2	03/12/2019 06:18	03/12/2019 09:05	03/12/2019 06:18	03/12/2019 08:41	2,39	1	2,39	CHI
20191213703	SILVANIA	AN16406957	ANAPOLIS UNIVERSITARIO S2	03/12/2019 06:18	03/12/2019 09:05	03/12/2019 06:18	03/12/2019 08:41	2,39	39	93,07	CHI
20191213703	ANAPOLIS	AN12090702	ANAPOLIS UNIVERSITARIO S2	03/12/2019 06:18	03/12/2019 09:05	03/12/2019 06:18	03/12/2019 09:05	2,78	5	13,91	CHI
20191213745	GOIANIA	GN11214570	GOIANIA LESTE S2	03/12/2019 08:33	03/12/2019 14:20	03/12/2019 08:33	03/12/2019 14:20	5,78	80	462,16	CHI
20191213764	ARENOPOLIS	AY12381016	IPORA	03/12/2019 07:24	03/12/2019 16:50	03/12/2019 07:24	03/12/2019 16:50	9,43	22	207,47	CHI
20191213764	PIRANHAS	AY12381016	IPORA	03/12/2019 07:24	03/12/2019 16:50	03/12/2019 07:24	03/12/2019 16:50	9,43	1	9,43	CHI
20191213784	ANAPOLIS	AN10404058	JUNDIAI S1	03/12/2019 09:52	03/12/2019 23:50	03/12/2019 09:54	03/12/2019 23:50	13,94	3	41,81	CHI
20191213784	GOIANAPOLIS	AN10404058	JUNDIAI S1	03/12/2019 09:52	03/12/2019 23:50	03/12/2019 09:54	03/12/2019 23:50	13,94	146	2034,71	CHI
20191213784	TEREZOPOLIS DE GOIAS	AN10404058	JUNDIAI S1	03/12/2019 09:52	03/12/2019 23:50	03/12/2019 09:54	03/12/2019 23:50	13,94	44	613,20	CHI
20191213789	MOSSAMEDES	MD21210497	ITABERAÍ S2	02/12/2019 17:50	03/12/2019 13:34	02/12/2019 17:50	03/12/2019 13:34	19,72	1	19,72	CHI
20191213794	MOSSAMEDES	MD12031239	ITABERAÍ S2	03/12/2019 06:57	03/12/2019 12:32	03/12/2019 06:57	03/12/2019 12:32	5,58	4	22,33	CHI
20191213802	GOIAS	GS12056682	GOIAS	03/12/2019 05:48	04/12/2019 11:43	03/12/2019 05:48	04/12/2019 11:43	29,91	7	209,36	CHI
20191213810	PORANGATU	PO12350110	PORANGATU	03/12/2019 05:42	03/12/2019 10:50	03/12/2019 05:42	03/12/2019 10:50	5,14	17	87,30	CHI
20191213812	ITAPIRAPUA	JR12087418	JUSSARA	03/12/2019 05:32	03/12/2019 18:00	03/12/2019 05:32	03/12/2019 18:00	12,46	1	12,46	CHI
20191213812	JUSSARA	JR12087418	JUSSARA	03/12/2019 05:32	03/12/2019 18:00	03/12/2019 05:32	03/12/2019 18:00	12,46	11	137,01	CHI
20191213816	BONOPOLIS	BX12266016	SAO MIGUEL DO ARAGUAIA	03/12/2019 05:51	03/12/2019 14:06	03/12/2019 05:51	03/12/2019 14:06	8,24	9	74,18	CHI
20191213820	GUARANI DE GOIAS	SD12262409	SAO DOMINGOS	03/12/2019 05:52	03/12/2019 10:51	03/12/2019 05:52	03/12/2019 10:51	4,98	3	14,93	CHI
20191213820	SAO DOMINGOS	SD12262409	SAO DOMINGOS	03/12/2019 05:52	03/12/2019 10:51	03/12/2019 05:52	03/12/2019 10:51	4,98	70	348,29	CHI
20191213822	PIRENOPOLIS	PV12312036	CORUMBA	03/12/2019 05:52	03/12/2019 10:17	03/12/2019 05:52	03/12/2019 10:17	4,41	13	57,31	CHI

20191213831	PALMEIRAS DE GOIAS	PL21312516	PALMEIRAS	03/12/2019 05:54	03/12/2019 12:20	03/12/2019 05:54	03/12/2019 12:12	6,31	1	6,31	CHI
20191213831	CEZARINA	PL13259242	PALMEIRAS	03/12/2019 05:54	03/12/2019 12:20	03/12/2019 10:05	03/12/2019 12:20	2,25	1	2,25	CHI
20191213831	PALMEIRAS DE GOIAS	PL13259242	PALMEIRAS	03/12/2019 05:54	03/12/2019 12:20	03/12/2019 10:05	03/12/2019 12:20	2,25	11	24,80	CHI
20191213834	CATALAO	CT21236824	CATALAO S1	03/12/2019 05:55	03/12/2019 09:45	03/12/2019 05:55	03/12/2019 09:45	3,83	1	3,83	CHI
20191213835	ITABERAI	TQ12025622	ITABERAI S1	03/12/2019 05:37	03/12/2019 11:12	03/12/2019 05:37	03/12/2019 11:12	5,57	3	16,71	CHI
20191213835	TAQUARAL DE GOIAS	TQ12025622	ITABERAI S1	03/12/2019 05:37	03/12/2019 11:12	03/12/2019 05:37	03/12/2019 11:12	5,57	34	189,41	CHI
20191213843	PIRANHAS	PH12038593	PIRANHAS	03/12/2019 05:57	03/12/2019 11:19	03/12/2019 05:57	03/12/2019 11:19	5,35	23	123,10	CHI
20191213844	PORANGATU	PO21168243	PORANGATU	03/12/2019 05:58	03/12/2019 13:46	03/12/2019 05:58	03/12/2019 13:46	7,81	1	7,81	CHI
20191213846	CAIAPONIA	PY12040163	PALESTINA	03/12/2019 05:57	03/12/2019 12:14	03/12/2019 05:57	03/12/2019 12:14	6,27	45	282,29	CHI
20191213846	PALESTINA DE GOIAS	PY12040163	PALESTINA	03/12/2019 05:57	03/12/2019 12:14	03/12/2019 05:57	03/12/2019 12:14	6,27	102	639,85	CHI
20191213847	MINEIROS	PW12360810	PARQUE DAS EMAS	03/12/2019 05:59	03/12/2019 11:36	03/12/2019 05:59	03/12/2019 11:36	5,62	7	39,33	CHI
20191213847	PORTELANDIA	PW12360810	PARQUE DAS EMAS	03/12/2019 05:59	03/12/2019 11:36	03/12/2019 05:59	03/12/2019 11:36	5,62	1	5,62	CHI
20191213853	GOIANIA	12467560	CARAJAS S1	03/12/2019 06:01	03/12/2019 08:56	03/12/2019 06:01	03/12/2019 08:56	2,91	1	2,91	CHI
20191213855	MINEIROS	MY21149663	PARQUE DAS EMAS	03/12/2019 06:01	03/12/2019 10:04	03/12/2019 06:01	03/12/2019 10:04	4,04	1	4,04	CHI
20191213857	BONOPOLIS	BX12079321	SAO MIGUEL DO ARAGUAIA	03/12/2019 00:56	03/12/2019 06:50	03/12/2019 00:56	03/12/2019 06:50	5,88	58	341,28	CHI
20191213860	BELA VISTA DE GOIAS	BV12360000	BELA VISTA S2	03/12/2019 06:03	03/12/2019 12:23	03/12/2019 06:03	03/12/2019 12:23	6,33	3	18,99	CHI
20191213861	MOSSAMEDES	MD12057741	FIRMINOPOLIS S2	03/12/2019 04:13	03/12/2019 07:53	03/12/2019 04:13	03/12/2019 07:53	3,66	18	65,80	CHI
20191213861	SANCLERLANDIA	MD12057741	FIRMINOPOLIS S2	03/12/2019 04:13	03/12/2019 07:53	03/12/2019 04:13	03/12/2019 07:53	3,66	1	3,66	CHI
20191213863	CAMPOS BELOS	CH12000001	SAO DOMINGOS	03/12/2019 06:03	03/12/2019 09:06	03/12/2019 06:03	03/12/2019 09:06	3,05	42	127,98	CHI
20191213864	PONTALINA	PK12047371RE	VICENTINOPOLIS	03/12/2019 06:03	03/12/2019 09:04	03/12/2019 06:03	03/12/2019 09:04	3,01	47	141,24	CHI
20191213866	ALTO HORIZONTE	AJ12375615	SANTA TEREZINHA	03/12/2019 06:03	03/12/2019 11:06	03/12/2019 06:03	03/12/2019 11:06	5,03	8	40,27	CHI
20191213870	FORMOSA	FA21330244	ITUIQUIRA	03/12/2019 06:04	05/12/2019 16:43	03/12/2019 06:04	04/12/2019 06:05	24,00	1	24,00	CHI
20191213870	FORMOSA	7647700	ITUIQUIRA	03/12/2019 06:04	05/12/2019 16:43	04/12/2019 06:04	04/12/2019 18:20	12,25	1	12,25	CHI
20191213870	FORMOSA	7647700	ITUIQUIRA	03/12/2019 06:04	05/12/2019 16:43	04/12/2019 06:04	05/12/2019 16:43	34,64	2	69,28	CHI
20191213870	FORMOSA	7647700	ITUIQUIRA	03/12/2019 06:04	05/12/2019 16:43	05/12/2019 15:03	05/12/2019 16:43	1,66	1	1,66	CHI
20191213877	TAQUARAL DE GOIAS	TQ12025614	ITABERAI S1	02/12/2019 23:11	03/12/2019 10:15	02/12/2019 23:11	03/12/2019 10:15	11,05	52	574,73	CHI
20191213886	GOIANIRA	GR11167473	GOIANIRA	03/12/2019 06:09	03/12/2019 09:38	03/12/2019 06:09	03/12/2019 09:38	3,48	269	936,64	CHI
20191213887	CRIXAS	CX21132682	SERRA DO OURO	03/12/2019 06:09	04/12/2019 02:26	03/12/2019 06:09	04/12/2019 02:26	20,28	1	20,28	CHI
20191213889	URUACU	CR12410914	MARA ROSA	03/12/2019 10:33	04/12/2019 20:35	04/12/2019 18:00	04/12/2019 20:35	2,60	15	38,98	CHI
20191213891	CIDADE OCIDENTAL	03890214	MARAJOARA	03/12/2019 05:40	03/12/2019 08:33	03/12/2019 05:40	03/12/2019 08:33	2,88	121	348,55	CHI
20191213891	CRISTALINA	03890214	MARAJOARA	03/12/2019 05:40	03/12/2019 08:33	03/12/2019 05:40	03/12/2019 08:33	2,88	33	95,06	CHI
20191213891	LUZIANIA	03890214	MARAJOARA	03/12/2019 05:40	03/12/2019 08:33	03/12/2019 05:40	03/12/2019 08:33	2,88	165	475,29	CHI
20191213893	INACIOLANDIA	ID11255711	QUIRINOPOLIS	03/12/2019 06:10	03/12/2019 10:24	03/12/2019 06:10	03/12/2019 10:24	4,22	19	80,13	CHI

20191213895	CACU	10021820242	CACHOEIRA ALTA	03/12/2019 06:11	03/12/2019 14:55	03/12/2019 06:11	03/12/2019 14:55	8,73	1	8,73	CHI
20191213908	GOIANIA	GN12052690	MEIA PONTE	03/12/2019 06:13	03/12/2019 10:40	03/12/2019 06:13	03/12/2019 10:40	4,45	3	13,34	CHI
20191213909	CAMPOS VERDES	VD12264097	SANTA TEREZINHA	03/12/2019 06:13	03/12/2019 14:53	03/12/2019 06:13	03/12/2019 14:53	8,66	6	51,97	CHI
20191213911	JATAI	JT12302009LD	JATAI S1	03/12/2019 10:25	03/12/2019 14:00	03/12/2019 10:25	03/12/2019 14:00	3,58	10	35,79	CHI
20191213914	GOIANIA	GN12000078	CAMPINAS S1	03/12/2019 06:14	03/12/2019 07:24	03/12/2019 06:14	03/12/2019 07:24	1,15	433	498,19	CHI
20191213916	ANICUNS	AC12158912	FIRMINOPOLIS S2	03/12/2019 06:15	03/12/2019 07:58	03/12/2019 06:15	03/12/2019 07:58	1,71	60	102,58	CHI
20191213921	CASTELANDIA	QJ21100939	QUIRINOPOLIS	03/12/2019 06:17	03/12/2019 10:50	03/12/2019 06:17	03/12/2019 10:50	4,54	1	4,54	CHI
20191213925	CATALAO	9580006057	CATALAO S1	03/12/2019 06:18	03/12/2019 19:00	03/12/2019 06:18	03/12/2019 19:00	12,71	1	12,71	CHI
20191213927	PARAUNA	PU12044570	ACREUNA	03/12/2019 06:18	03/12/2019 10:28	03/12/2019 06:18	03/12/2019 10:28	4,17	24	100,00	CHI
20191213928	CRIXAS	CX12266385	SERRA DO OURO	03/12/2019 05:53	04/12/2019 17:51	03/12/2019 05:53	04/12/2019 17:51	35,96	14	503,49	CHI
20191213930	NOVA CRIXAS	9320003305	NOVA CRIXAS	03/12/2019 06:18	03/12/2019 12:26	03/12/2019 06:18	03/12/2019 12:26	6,13	1	6,13	CHI
20191213933	MONTES CLAROS DE GOIAS	ME12390172	IPORA	03/12/2019 06:07	03/12/2019 13:40	03/12/2019 06:07	03/12/2019 13:40	7,55	30	226,38	CHI
20191213940	VICENTINOPOLIS	VI121257168	VICENTINOPOLIS	03/12/2019 06:20	03/12/2019 14:40	03/12/2019 06:20	03/12/2019 14:40	8,32	1	8,32	CHI
20191213949	INHUMAS	IN12162096	INHUMAS S2	03/12/2019 06:23	03/12/2019 08:30	03/12/2019 06:23	03/12/2019 08:30	2,11	961	2023,44	CHI
20191213950	JATAI	JT12205194	JATAI S1	03/12/2019 06:12	03/12/2019 09:09	03/12/2019 06:12	03/12/2019 09:09	2,95	7	20,62	CHI
20191213955	BRITANIA	BT12395894	BRITANIA	03/12/2019 06:24	04/12/2019 10:03	03/12/2019 06:24	04/12/2019 10:03	27,64	7	193,51	CHI
20191213957	NOVA IGUACU DE GOIAS	NH12202113	SANTA TEREZINHA	03/12/2019 04:48	03/12/2019 10:55	03/12/2019 04:48	03/12/2019 10:55	6,12	1	6,12	CHI
20191213958	BOM JARDIM DE GOIAS	BM12334813	IPORA	03/12/2019 06:25	03/12/2019 12:35	03/12/2019 06:25	03/12/2019 12:35	6,15	14	86,14	CHI
20191213960	CATALAO	9580007347	CATALAO S1	03/12/2019 06:26	03/12/2019 18:56	03/12/2019 06:26	03/12/2019 18:56	12,51	1	12,51	CHI
20191213963	BARRO ALTO	GE12255886	GOIANESIA S1	03/12/2019 05:52	04/12/2019 07:20	03/12/2019 05:52	04/12/2019 07:20	25,46	1	25,46	CHI
20191213963	GOIANESIA	GE12255886	GOIANESIA S1	03/12/2019 05:52	04/12/2019 07:20	03/12/2019 05:52	04/12/2019 07:20	25,46	4	101,83	CHI
20191213965	AGUA LIMPA	RQ12122106	VILA CORUMBA	03/12/2019 06:26	03/12/2019 10:39	03/12/2019 06:26	03/12/2019 10:39	4,20	7	29,43	CHI
20191213965	RIO QUENTE	RQ12122106	VILA CORUMBA	03/12/2019 06:26	03/12/2019 10:39	03/12/2019 06:26	03/12/2019 10:39	4,20	7	29,43	CHI
20191213968	IPAMERI	IP21071418	IPAMERI	03/12/2019 06:27	03/12/2019 08:15	03/12/2019 06:27	03/12/2019 08:15	1,80	1	1,80	CHI
20191213970	MORRINHOS	MR12040738	GOIATUBA S1	03/12/2019 06:27	03/12/2019 11:45	03/12/2019 06:27	03/12/2019 11:45	5,31	3	15,94	CHI
20191213978	PADRE BERNARDO	PB12376763	PADRE BERNARDO	03/12/2019 06:03	03/12/2019 10:10	03/12/2019 06:03	03/12/2019 10:10	4,11	12	49,28	CHI
20191213979	MUTUNOPOLIS	SE12000015	MARA ROSA	03/12/2019 06:29	03/12/2019 11:29	03/12/2019 06:29	03/12/2019 11:29	4,99	6	29,95	CHI
20191213979	PORANGATU	SE12000015	MARA ROSA	03/12/2019 06:29	03/12/2019 11:29	03/12/2019 06:29	03/12/2019 11:29	4,99	3	14,97	CHI
20191213979	SANTA TEREZA DE GOIAS	SE12000015	MARA ROSA	03/12/2019 06:29	03/12/2019 11:29	03/12/2019 06:29	03/12/2019 11:29	4,99	110	548,99	CHI
20191213980	CALDAS NOVAS	760088330	SERRA DE CALDAS	03/12/2019 06:29	03/12/2019 07:40	03/12/2019 06:29	03/12/2019 07:40	1,17	1	1,17	CHI
20191213984	PONTALINA	JV21352535	GOIATUBA S1	03/12/2019 06:30	03/12/2019 16:12	03/12/2019 06:30	03/12/2019 16:12	9,71	4	38,84	CHI
20191213987	ANAPOLIS	20349660	ANAPOLIS UNIVERSITARIO S2	03/12/2019 06:30	03/12/2019 08:04	03/12/2019 06:30	03/12/2019 08:04	1,55	1	1,55	CHI
20191213988	TURVANIA	TV12005577LD	FIRMINOPOLIS S2	03/12/2019 06:31	03/12/2019 16:03	03/12/2019 06:31	03/12/2019 16:03	9,53	11	104,86	CHI

20191213988	ANICUNS	TV12005577LD	FIRMINOPOLIS S2	03/12/2019 06:31	03/12/2019 16:03	03/12/2019 10:00	03/12/2019 16:03	6,04	4	24,15	CHI
20191213988	TURVANIA	TV12005577LD	FIRMINOPOLIS S2	03/12/2019 06:31	03/12/2019 16:03	03/12/2019 10:00	03/12/2019 16:03	6,04	96	579,68	CHI
20191213988	ANICUNS	TV12005577LD	FIRMINOPOLIS S2	03/12/2019 06:31	03/12/2019 16:03	03/12/2019 13:06	03/12/2019 16:03	2,94	19	55,90	CHI
20191213989	TEREZOPOLIS DE GOIAS	TJ21327826	DAIA S2	03/12/2019 06:31	03/12/2019 16:55	03/12/2019 06:31	03/12/2019 16:55	10,40	2	20,80	CHI
20191213991	IACIARA	IA12194782	IACIARA S1	03/12/2019 06:32	03/12/2019 12:59	03/12/2019 06:32	03/12/2019 12:59	6,45	2	12,90	CHI
20191213995	CALDAS NOVAS	760282687	CALDAS NOVAS S1	03/12/2019 06:32	03/12/2019 10:00	03/12/2019 06:32	03/12/2019 10:00	3,47	1	3,47	CHI
20191213996	RIO VERDE	RV12200774	CABRIUVA S2	03/12/2019 06:33	03/12/2019 09:25	03/12/2019 06:33	03/12/2019 09:25	2,87	17	48,72	CHI
20191213998	VILA PROPICIO	PV21069135	GOIANESIA S1	03/12/2019 06:33	03/12/2019 17:33	03/12/2019 06:33	03/12/2019 17:33	11,00	2	22,00	CHI
20191214001	GOIATUBA	GT12247742	BOM JESUS DE GOIAS	03/12/2019 06:33	03/12/2019 09:24	03/12/2019 06:33	03/12/2019 09:24	2,84	6	17,04	CHI
20191214002	RIO VERDE	RV12271289	CABRIUVA S2	03/12/2019 06:33	03/12/2019 08:29	03/12/2019 06:33	03/12/2019 08:29	1,92	39	74,97	CHI
20191214004	NOVA CRIXAS	NA12038843	NOVA CRIXAS	03/12/2019 06:12	03/12/2019 10:30	03/12/2019 06:12	03/12/2019 10:30	4,29	3	12,88	CHI
20191214006	GOUVELANDIA	QJ12053194	QUIRINOPOLIS	03/12/2019 05:31	03/12/2019 10:04	03/12/2019 05:31	03/12/2019 10:04	4,55	2	9,10	CHI
20191214006	QUIRINOPOLIS	QJ12053194	QUIRINOPOLIS	03/12/2019 05:31	03/12/2019 10:04	03/12/2019 05:31	03/12/2019 10:04	4,55	50	227,46	CHI
20191214008	RIO VERDE	SH12271532	IPEGUARI	03/12/2019 05:44	03/12/2019 09:25	03/12/2019 05:44	03/12/2019 09:25	3,68	1	3,68	CHI
20191214008	SANTA HELENA DE GOIAS	SH12271532	IPEGUARI	03/12/2019 05:44	03/12/2019 09:25	03/12/2019 05:44	03/12/2019 09:25	3,68	23	84,58	CHI
20191214010	SANCLERLANDIA	SC21021367	SAO LUIZ DOS MONTES BELOS	03/12/2019 06:34	03/12/2019 18:00	03/12/2019 06:34	03/12/2019 18:00	11,42	1	11,42	CHI
20191214011	ARACU	AR21019621	ARACU	03/12/2019 06:35	03/12/2019 10:59	03/12/2019 06:35	03/12/2019 10:59	4,40	2	8,80	CHI
20191214012	MINEIROS	MY21336363	SANTA RITA DO ARAGUAIA	03/12/2019 06:35	03/12/2019 10:45	03/12/2019 06:35	03/12/2019 10:45	4,16	1	4,16	CHI
20191214017	ITAPURANGA	IK12310904	ITAPURANGA	02/12/2019 13:19	03/12/2019 22:26	02/12/2019 13:19	03/12/2019 22:26	33,11	3	99,33	CHI
20191214017	ITAPURANGA	IK12310904	ITAPURANGA	02/12/2019 13:19	03/12/2019 22:26	03/12/2019 20:57	03/12/2019 22:26	1,49	8	11,90	CHI
20191214018	ITAPURANGA	IK21310909	ITAPURANGA	02/12/2019 15:50	03/12/2019 18:47	02/12/2019 15:50	03/12/2019 18:47	26,94	1	26,94	CHI
20191214020	CAIAPONIA	CP12389845	CAIAPONIA	03/12/2019 06:35	03/12/2019 12:00	03/12/2019 06:35	03/12/2019 12:00	5,40	4	21,62	CHI
20191214022	ORIZONA	OZ12114509RE	PIRES DO RIO S2	03/12/2019 05:53	03/12/2019 12:45	03/12/2019 05:53	03/12/2019 12:45	6,87	63	432,90	CHI
20191214024	BOM JARDIM DE GOIAS	PH12259349RE	PIRANHAS	03/12/2019 06:36	03/12/2019 08:35	03/12/2019 06:36	03/12/2019 08:35	1,97	5	9,84	CHI
20191214024	PIRANHAS	PH12259349RE	PIRANHAS	03/12/2019 06:36	03/12/2019 08:35	03/12/2019 06:36	03/12/2019 08:35	1,97	40	78,73	CHI
20191214026	AGUA FRIA DE GOIAS	TL12048061	SAO JOAO D ALIANCA	03/12/2019 06:36	03/12/2019 12:46	03/12/2019 06:36	03/12/2019 12:46	6,15	51	313,68	CHI
20191214027	CRISTALINA	KR21245535	CRISTALINA S1	03/12/2019 06:37	03/12/2019 09:34	03/12/2019 06:37	03/12/2019 09:34	2,95	2	5,90	CHI
20191214028	ALVORADA DO NORTE	SI12248880	IACIARA S2	03/12/2019 06:37	03/12/2019 19:55	03/12/2019 06:37	03/12/2019 19:55	13,29	3	39,88	CHI
20191214031	SANTO ANTONIO DO DESCOBERTO	2210123556	AGUAS LINDAS DE GOIAS S2	03/12/2019 06:37	03/12/2019 08:02	03/12/2019 06:37	03/12/2019 08:02	1,40	1	1,40	CHI
20191214033	BARRO ALTO	BA12068485	BARRO ALTO	03/12/2019 05:38	03/12/2019 16:05	03/12/2019 05:38	03/12/2019 16:05	10,45	1	10,45	CHI
20191214033	SANTA RITA DO NOVO DESTINO	BA12068485	BARRO ALTO	03/12/2019 05:38	03/12/2019 16:05	03/12/2019 05:38	03/12/2019 16:05	10,45	32	334,28	CHI
20191214034	MORRINHOS	MR12119700RE	MORRINHOS	03/12/2019 06:06	03/12/2019 11:51	03/12/2019 06:06	03/12/2019 11:51	5,74	40	229,48	CHI
20191214035	SAO LUIS DE MONTES BELOS	SL21003736	SAO LUIZ DOS MONTES BELOS	03/12/2019 06:38	04/12/2019 10:16	03/12/2019 06:38	04/12/2019 10:10	27,53	2	55,06	CHI

20191214035	AURILANDIA	SL10403940	SAO LUIZ DOS MONTES BELOS	03/12/2019 06:38	04/12/2019 10:16	04/12/2019 09:29	04/12/2019 10:16	0,79	17	13,40	CHI
20191214035	CORREGO DO OURO	SL10403940	SAO LUIZ DOS MONTES BELOS	03/12/2019 06:38	04/12/2019 10:16	04/12/2019 09:29	04/12/2019 10:16	0,79	325	256,21	CHI
20191214035	FIRMINOPOLIS	SL10403940	SAO LUIZ DOS MONTES BELOS	03/12/2019 06:38	04/12/2019 10:16	04/12/2019 09:29	04/12/2019 10:16	0,79	109	85,93	CHI
20191214035	MOIPORA	SL10403940	SAO LUIZ DOS MONTES BELOS	03/12/2019 06:38	04/12/2019 10:16	04/12/2019 09:29	04/12/2019 10:16	0,79	28	22,07	CHI
20191214035	SANCLERLANDIA	SL10403940	SAO LUIZ DOS MONTES BELOS	03/12/2019 06:38	04/12/2019 10:16	04/12/2019 09:29	04/12/2019 10:16	0,79	37	29,17	CHI
20191214035	SAO LUIS DE MONTES BELOS	SL10403940	SAO LUIZ DOS MONTES BELOS	03/12/2019 06:38	04/12/2019 10:16	04/12/2019 09:29	04/12/2019 10:16	0,79	270	212,85	CHI
20191214038	ANAPOLIS	AN12008855	ANAPOLIS UNIVERSITARIO S2	03/12/2019 06:38	03/12/2019 09:05	03/12/2019 06:38	03/12/2019 09:05	2,44	13	31,75	CHI
20191214046	PANAMA	PX12171365	GOIATUBA S1	03/12/2019 06:39	03/12/2019 08:50	03/12/2019 06:39	03/12/2019 08:50	2,17	6	13,04	CHI
20191214047	PIRENOPOLIS	PV21000013	CORUMBA	03/12/2019 06:39	03/12/2019 14:29	03/12/2019 06:39	03/12/2019 14:29	7,82	3	23,46	CHI
20191214048	ITABERAI	II12217217	ITABERAI S1	03/12/2019 04:50	03/12/2019 10:44	03/12/2019 04:50	03/12/2019 10:44	5,89	22	129,60	CHI
20191214048	ITAGUARI	II12217217	ITABERAI S1	03/12/2019 04:50	03/12/2019 10:44	03/12/2019 04:50	03/12/2019 10:44	5,89	42	247,41	CHI
20191214048	TAQUARAL DE GOIAS	II12217217	ITABERAI S1	03/12/2019 04:50	03/12/2019 10:44	03/12/2019 04:50	03/12/2019 10:44	5,89	46	270,98	CHI
20191214049	BONOPOLIS	BX12168214	SAO MIGUEL DO ARAGUAIA	02/12/2019 23:49	03/12/2019 08:29	02/12/2019 23:49	03/12/2019 08:29	8,65	121	1046,99	CHI
20191214050	RIO QUENTE	RQ12392082	VILA CORUMBA	03/12/2019 06:40	03/12/2019 16:00	03/12/2019 06:40	03/12/2019 16:00	9,32	14	130,48	CHI
20191214051	ARAGUAPAZ	MS12113246	ITAPURANGA	03/12/2019 06:40	03/12/2019 13:57	03/12/2019 06:40	03/12/2019 13:57	7,27	2	14,55	CHI
20191214051	FAINA	MS12113246	ITAPURANGA	03/12/2019 06:40	03/12/2019 13:57	03/12/2019 06:40	03/12/2019 13:57	7,27	7	50,91	CHI
20191214051	MORRO AGUDO DE GOIAS	MS12113246	ITAPURANGA	03/12/2019 06:40	03/12/2019 13:57	03/12/2019 06:40	03/12/2019 13:57	7,27	7	50,91	CHI
20191214055	LUZIANIA	OZ12195112	PIRES DO RIO S2	03/12/2019 05:04	03/12/2019 17:52	03/12/2019 05:04	03/12/2019 17:52	12,81	72	922,22	CHI
20191214061	MAURILANDIA	ML12301541	RIO DOS BOIS	03/12/2019 05:54	03/12/2019 08:53	03/12/2019 05:54	03/12/2019 08:53	2,98	20	59,57	CHI
20191214066	NOVA AMERICA	NM21190076	RUBIATABA	03/12/2019 06:44	03/12/2019 16:14	03/12/2019 06:44	03/12/2019 16:14	9,50	1	9,50	CHI
20191214073	CABECEIRAS	CW12194580	ITUIQUIRA	03/12/2019 06:44	03/12/2019 11:29	03/12/2019 06:44	03/12/2019 11:29	4,74	5	23,72	CHI
20191214083	BALIZA	BH12381003	BOM JARDIM	03/12/2019 03:56	03/12/2019 07:34	03/12/2019 03:56	03/12/2019 07:34	3,63	23	83,50	CHI
20191214089	CATURAI	CK21030120	INHUMAS S1	03/12/2019 06:47	03/12/2019 11:54	03/12/2019 06:47	03/12/2019 11:54	5,10	3	15,31	CHI
20191214091	JUSSARA	JR12341198	JUSSARA	03/12/2019 06:48	03/12/2019 16:10	03/12/2019 06:48	03/12/2019 16:10	9,36	7	65,51	CHI
20191214101	EDEIA	EA12263293	EDEIA	03/12/2019 06:44	03/12/2019 11:40	03/12/2019 06:44	03/12/2019 11:40	4,94	9	44,48	CHI
20191214107	MORRINHOS	MR12105048	MORRINHOS	03/12/2019 06:49	03/12/2019 10:59	03/12/2019 06:49	03/12/2019 10:59	4,16	5	20,80	CHI
20191214111	MATRINCHA	4370003867	MATRINCHA	03/12/2019 06:50	03/12/2019 17:57	03/12/2019 06:50	03/12/2019 17:57	11,10	1	11,10	CHI
20191214116	AMARALINA	LC12308828	MARA ROSA	03/12/2019 06:51	03/12/2019 13:21	03/12/2019 06:51	03/12/2019 13:21	6,50	2	13,00	CHI
20191214116	MARA ROSA	LC12308828	MARA ROSA	03/12/2019 06:51	03/12/2019 13:21	03/12/2019 06:51	03/12/2019 13:21	6,50	1	6,50	CHI
20191214117	SAO DOMINGOS	SD21322682	SAO DOMINGOS	03/12/2019 06:51	03/12/2019 12:50	03/12/2019 06:51	03/12/2019 12:50	5,98	1	5,98	CHI
20191214125	FORMOSA	FA11085646	ITUIQUIRA	03/12/2019 06:53	03/12/2019 17:59	03/12/2019 06:53	03/12/2019 17:59	11,10	87	965,48	CHI
20191214141	INACIOLANDIA	CD12000137	CACHOEIRA DOURADA	03/12/2019 05:05	03/12/2019 11:58	03/12/2019 05:05	03/12/2019 11:58	6,88	19	130,66	CHI
20191214142	POSSE	PS12234976	IACIARA S2	03/12/2019 05:24	03/12/2019 08:21	03/12/2019 05:24	03/12/2019 08:21	2,95	25	73,65	CHI

20191214147	BOM JESUS DE GOIAS	10017635770	BOM JESUS DE GOIAS	03/12/2019 06:58	03/12/2019 07:50	03/12/2019 06:58	03/12/2019 07:50	0,86	1	0,86	CHI
20191214148	ITAGUARI	JA12217064LD	ITABERAI S1	03/12/2019 02:40	03/12/2019 08:21	03/12/2019 02:40	03/12/2019 08:21	5,67	150	851,08	CHI
20191214148	ITAGUARU	JA12217064LD	ITABERAI S1	03/12/2019 02:40	03/12/2019 08:21	03/12/2019 02:40	03/12/2019 08:21	5,67	1	5,67	CHI
20191214148	JARAGUA	JA12217064LD	ITABERAI S1	03/12/2019 02:40	03/12/2019 08:21	03/12/2019 02:40	03/12/2019 08:21	5,67	26	147,52	CHI
20191214150	BURITINOPOLIS	SU12301950	SANTA RITA DO ARAGUAIA	03/12/2019 06:58	03/12/2019 12:59	03/12/2019 06:58	03/12/2019 12:59	6,00	1	6,00	CHI
20191214150	SANTA RITA DO ARAGUAIA	SU12301950	SANTA RITA DO ARAGUAIA	03/12/2019 06:58	03/12/2019 12:59	03/12/2019 06:58	03/12/2019 12:59	6,00	21	126,04	CHI
20191214153	CATALAO	CT21248197	CATALAO S1	03/12/2019 06:59	03/12/2019 09:30	03/12/2019 06:59	03/12/2019 09:30	2,51	1	2,51	CHI
20191214157	LUZIANIA	LZ12109848	VIANOPOLIS	03/12/2019 07:00	03/12/2019 11:36	03/12/2019 07:00	03/12/2019 11:36	4,59	21	96,47	CHI
20191214157	ORIZONA	LZ12109848	VIANOPOLIS	03/12/2019 07:00	03/12/2019 11:36	03/12/2019 07:00	03/12/2019 11:36	4,59	2	9,19	CHI
20191214159	EDEIA	EA12043985	EDEIA	03/12/2019 06:13	03/12/2019 12:35	03/12/2019 06:13	03/12/2019 12:35	6,37	5	31,85	CHI
20191214163	VIANOPOLIS	VN21012828	VIANOPOLIS	03/12/2019 07:01	03/12/2019 12:30	03/12/2019 07:01	03/12/2019 11:40	4,64	1	4,64	CHI
20191214163	VIANOPOLIS	VN12014624	VIANOPOLIS	03/12/2019 07:01	03/12/2019 12:30	03/12/2019 09:48	03/12/2019 12:30	2,69	1	2,69	CHI
20191214171	EDEIA	EA12078276	EDEIA	03/12/2019 07:02	03/12/2019 12:44	03/12/2019 07:02	03/12/2019 12:44	5,69	4	22,75	CHI
20191214174	ALEXANIA	AX21100161	ALEXANIA	03/12/2019 07:03	03/12/2019 13:51	03/12/2019 07:03	03/12/2019 13:51	6,79	1	6,79	CHI
20191214176	ORIZONA	OZ21338945	PIRES DO RIO S2	03/12/2019 07:03	03/12/2019 13:52	03/12/2019 07:03	03/12/2019 13:52	6,80	2	13,61	CHI
20191214178	ARENOPOLIS	AY12390169	ARENOPOLIS	03/12/2019 07:04	03/12/2019 08:51	03/12/2019 07:04	03/12/2019 08:51	1,78	24	42,69	CHI
20191214178	DIORAMA	AY12390169	ARENOPOLIS	03/12/2019 07:04	03/12/2019 08:51	03/12/2019 07:04	03/12/2019 08:51	1,78	3	5,34	CHI
20191214179	CRIXAS	CX12064145	SANTA TEREZINHA	03/12/2019 06:34	03/12/2019 12:30	03/12/2019 06:34	03/12/2019 12:30	5,93	25	148,13	CHI
20191214179	UIRAPURU	CX12064145	SANTA TEREZINHA	03/12/2019 06:34	03/12/2019 12:30	03/12/2019 06:34	03/12/2019 12:30	5,93	5	29,63	CHI
20191214181	MUTUNOPOLIS	MU12068529	MARA ROSA	03/12/2019 07:04	03/12/2019 10:07	03/12/2019 07:04	03/12/2019 10:07	3,04	44	133,91	CHI
20191214181	PORANGATU	MU12068529	MARA ROSA	03/12/2019 07:04	03/12/2019 10:07	03/12/2019 07:04	03/12/2019 10:07	3,04	12	36,52	CHI
20191214182	FORMOSA	FA12254232	ITUIQUIRA	03/12/2019 05:58	03/12/2019 17:10	03/12/2019 05:58	03/12/2019 17:10	11,19	14	156,73	CHI
20191214184	SAO MIGUEL DO ARAGUAIA	SM12351125	SAO MIGUEL DO ARAGUAIA	03/12/2019 07:05	03/12/2019 12:49	03/12/2019 07:05	03/12/2019 12:49	5,72	5	28,62	CHI
20191214186	BURITI ALEGRE	BG12263639	ALTO BURITI	03/12/2019 07:05	05/12/2019 12:28	03/12/2019 07:05	05/12/2019 12:28	53,38	1	53,38	CHI
20191214189	URUACU	UR21339065	URUACU	03/12/2019 07:06	03/12/2019 13:55	03/12/2019 07:06	03/12/2019 13:55	6,80	2	13,60	CHI
20191214199	CAIAPONIA	CP12076264	MONTIVIDIU T	03/12/2019 06:53	03/12/2019 10:56	03/12/2019 06:53	03/12/2019 10:56	4,04	24	96,84	CHI
20191214199	JATAI	CP12076264	MONTIVIDIU T	03/12/2019 06:53	03/12/2019 10:56	03/12/2019 06:53	03/12/2019 10:56	4,04	6	24,21	CHI
20191214199	RIO VERDE	CP12076264	MONTIVIDIU T	03/12/2019 06:53	03/12/2019 10:56	03/12/2019 06:53	03/12/2019 10:56	4,04	10	40,35	CHI
20191214201	URUACU	UR21181135	URUACU	03/12/2019 12:47	03/12/2019 17:03	03/12/2019 12:47	03/12/2019 17:03	4,26	1	4,26	CHI
20191214202	FORMOSA	7680243	ITUIQUIRA	02/12/2019 19:27	04/12/2019 18:30	02/12/2019 19:27	04/12/2019 18:30	47,04	20	940,76	CHI
20191214203	GOIANIA	GN21000669	GOYA S2	03/12/2019 07:09	03/12/2019 08:58	03/12/2019 07:09	03/12/2019 08:58	1,81	1	1,81	CHI
20191214207	GOIANESIA	SJ21006513	GOIANESIA S1	03/12/2019 07:10	03/12/2019 16:30	03/12/2019 07:10	03/12/2019 16:30	9,33	1	9,33	CHI
20191214212	CRIXAS	CX12190022	RUBIATABA	03/12/2019 07:08	03/12/2019 21:57	03/12/2019 07:08	03/12/2019 21:57	14,81	18	266,49	CHI

20191214214	RIO VERDE	RV12279609	RIO VERDE S1	03/12/2019 06:22	03/12/2019 11:20	03/12/2019 06:22	03/12/2019 11:20	4,96	31	153,80	CHI
20191214220	MORRINHOS	MR21015627	GOIATUBA S2	03/12/2019 07:11	03/12/2019 09:10	03/12/2019 07:11	03/12/2019 09:10	1,97	1	1,97	CHI
20191214225	SANTO ANTONIO DO DESCOBERTO	SN21317769	ALEXANIA	03/12/2019 07:12	04/12/2019 12:43	03/12/2019 07:12	04/12/2019 12:43	29,51	1	29,51	CHI
20191214228	TURVANIA	TV12005582	FIRMINOPOLIS S2	03/12/2019 06:41	03/12/2019 09:11	03/12/2019 06:41	03/12/2019 09:11	2,48	50	124,19	CHI
20191214229	POSSE	SA12256100	IACIARA S2	03/12/2019 07:13	03/12/2019 18:32	03/12/2019 07:13	03/12/2019 18:32	11,31	14	158,35	CHI
20191214229	SIMOLANDIA	SA12256100	IACIARA S2	03/12/2019 07:13	03/12/2019 18:32	03/12/2019 07:13	03/12/2019 18:32	11,31	7	79,17	CHI
20191214234	CATALAO	1990220463	CATALAO S2	03/12/2019 07:14	03/12/2019 09:14	03/12/2019 07:14	03/12/2019 09:14	2,00	1	2,00	CHI
20191214235	GOIANDIRA	GD12237106	CATALAO S1	03/12/2019 07:14	03/12/2019 11:45	03/12/2019 07:14	03/12/2019 11:45	4,51	1	4,51	CHI
20191214237	NIQUELANDIA	NQ12292134	NIQUELANDIA SUBTRANSMISSAO	03/12/2019 07:14	03/12/2019 11:33	03/12/2019 07:14	03/12/2019 11:33	4,31	27	116,24	CHI
20191214242	VILA BOA	FA12065577	ITUIQUIRA	03/12/2019 07:15	04/12/2019 19:30	03/12/2019 07:15	04/12/2019 19:30	36,24	2	72,49	CHI
20191214243	MORRINHOS	MR12040540RE	MORRINHOS	03/12/2019 06:33	03/12/2019 13:21	03/12/2019 06:33	03/12/2019 13:21	6,80	47	319,46	CHI
20191214246	CAIAPONIA	CP12291990	CAIAPONIA	03/12/2019 04:43	03/12/2019 11:20	03/12/2019 04:43	03/12/2019 11:20	6,62	21	139,01	CHI
20191214248	CRISTALINA	KR21092819	PAMPLONA	03/12/2019 07:15	03/12/2019 23:24	03/12/2019 07:15	03/12/2019 23:24	16,14	1	16,14	CHI
20191214249	ALEXANIA	AX21376508	CORUMBA	03/12/2019 07:16	03/12/2019 17:56	03/12/2019 07:16	03/12/2019 17:56	10,67	1	10,67	CHI
20191214250	CAMPO ALEGRE DE GOIAS	CM12192738RE	CAMPO ALEGRE DE GOIAS	03/12/2019 07:06	03/12/2019 08:30	03/12/2019 07:06	03/12/2019 08:30	1,39	50	69,57	CHI
20191214253	SANTA HELENA DE GOIAS	SH12296005	ACREUNA	03/12/2019 07:16	03/12/2019 09:59	03/12/2019 07:16	03/12/2019 09:59	2,72	2	5,44	CHI
20191214253	SANTO ANTONIO DA BARRA	SH12296005	ACREUNA	03/12/2019 07:16	03/12/2019 09:59	03/12/2019 07:16	03/12/2019 09:59	2,72	1	2,72	CHI
20191214265	JATAI	JT12080471	JATAI S1	03/12/2019 07:18	03/12/2019 12:10	03/12/2019 07:18	03/12/2019 12:10	4,86	6	29,16	CHI
20191214268	ORIZONA	OZ12084921RE	PIRES DO RIO S2	03/12/2019 06:38	03/12/2019 09:50	03/12/2019 06:38	03/12/2019 09:50	3,19	109	347,23	CHI
20191214268	VIANOPOLIS	OZ12084921RE	PIRES DO RIO S2	03/12/2019 06:38	03/12/2019 09:50	03/12/2019 06:38	03/12/2019 09:50	3,19	17	54,15	CHI
20191214271	POSSE	PS12212366	IACIARA S1	03/12/2019 07:18	03/12/2019 12:10	03/12/2019 07:18	03/12/2019 12:10	4,85	37	179,49	CHI
20191214276	ARENOPOLIS	AY12040872	ARENOPOLIS	03/12/2019 07:19	03/12/2019 12:55	03/12/2019 07:19	03/12/2019 12:55	5,59	13	72,72	CHI
20191214279	MORRINHOS	MR21100033	MORRINHOS	03/12/2019 07:20	03/12/2019 11:29	03/12/2019 07:20	03/12/2019 11:29	4,15	1	4,15	CHI
20191214280	COCALZINHO DE GOIAS	ZN12330505	AGUAS LINDAS DE GOIAS S2	03/12/2019 06:08	03/12/2019 08:31	03/12/2019 06:08	03/12/2019 08:31	2,38	28	66,73	CHI
20191214280	PADRE BERNARDO	ZN12330505	AGUAS LINDAS DE GOIAS S2	03/12/2019 06:08	03/12/2019 08:31	03/12/2019 06:08	03/12/2019 08:31	2,38	4	9,53	CHI
20191214283	ITAPIRAPUA	IU12018752	MATRINCHA	03/12/2019 06:17	03/12/2019 22:50	03/12/2019 06:17	03/12/2019 22:50	16,54	7	115,77	CHI
20191214287	CUMARI	10005951389	CATALAO S1	03/12/2019 07:21	03/12/2019 09:04	03/12/2019 07:21	03/12/2019 09:04	1,73	1	1,73	CHI
20191214289	LUZIANIA	LZ12097566	CRISTALINA S2	03/12/2019 07:12	03/12/2019 13:15	03/12/2019 07:12	03/12/2019 13:15	6,05	13	78,62	CHI
20191214294	NIQUELANDIA	NQ12039296	BARRO ALTO	03/12/2019 05:23	05/12/2019 10:41	03/12/2019 05:23	03/12/2019 12:25	7,03	44	309,49	CHI
20191214294	NIQUELANDIA	NQ12345204LD	BARRO ALTO	03/12/2019 05:23	05/12/2019 10:41	03/12/2019 05:23	04/12/2019 14:54	33,51	15	502,63	CHI
20191214294	NIQUELANDIA	NQ13345088	BARRO ALTO	03/12/2019 05:23	05/12/2019 10:41	03/12/2019 05:23	04/12/2019 23:12	41,81	22	919,88	CHI
20191214294	NIQUELANDIA	NQ13348689	BARRO ALTO	03/12/2019 05:23	05/12/2019 10:41	03/12/2019 05:23	05/12/2019 10:41	53,29	11	586,20	CHI
20191214296	SANCLERLANDIA	SC12060014	FIRMINOPOLIS S2	03/12/2019 06:49	03/12/2019 11:31	03/12/2019 06:49	03/12/2019 11:31	4,70	10	46,97	CHI

20191214298	FORMOSA	FA12228227	SAO JOAO D ALIANCA	02/12/2019 23:18	03/12/2019 19:52	02/12/2019 23:18	03/12/2019 19:52	20,56	11	226,20	CHI
20191214301	MARA ROSA	VD12201669	SANTA TEREZINHA	03/12/2019 07:22	03/12/2019 11:06	03/12/2019 07:22	03/12/2019 11:06	3,73	2	7,46	CHI
20191214302	CAMPO ALEGRE DE GOIAS	CM12127532	CAMPO ALEGRE DE GOIAS	03/12/2019 06:45	03/12/2019 11:30	03/12/2019 06:45	03/12/2019 11:30	4,74	59	279,41	CHI
20191214304	AURILANDIA	AI12000011	FIRMINOPOLIS S2	03/12/2019 06:12	03/12/2019 15:05	03/12/2019 06:12	03/12/2019 10:50	4,63	38	175,87	CHI
20191214304	FIRMINOPOLIS	AI12000011	FIRMINOPOLIS S2	03/12/2019 06:12	03/12/2019 15:05	03/12/2019 06:12	03/12/2019 10:50	4,63	81	374,87	CHI
20191214304	SAO JOAO DA PARAUNA	AI12000011	FIRMINOPOLIS S2	03/12/2019 06:12	03/12/2019 15:05	03/12/2019 06:12	03/12/2019 10:50	4,63	71	328,59	CHI
20191214304	AURILANDIA	AI12000011	FIRMINOPOLIS S2	03/12/2019 06:12	03/12/2019 15:05	03/12/2019 10:51	03/12/2019 15:05	4,22	38	160,35	CHI
20191214304	FIRMINOPOLIS	AI12000011	FIRMINOPOLIS S2	03/12/2019 06:12	03/12/2019 15:05	03/12/2019 10:51	03/12/2019 15:05	4,22	81	341,80	CHI
20191214304	SAO JOAO DA PARAUNA	AI12000011	FIRMINOPOLIS S2	03/12/2019 06:12	03/12/2019 15:05	03/12/2019 10:51	03/12/2019 15:05	4,22	71	299,60	CHI
20191214312	CRIXAS	CX12297040	SERRA DO OURO	03/12/2019 07:24	04/12/2019 11:34	03/12/2019 07:24	04/12/2019 11:34	28,15	1	28,15	CHI
20191214317	BRITANIA	BT12050924LD	BRITANIA	03/12/2019 07:25	03/12/2019 14:43	03/12/2019 07:25	03/12/2019 14:43	7,29	3	21,87	CHI
20191214321	AMORINOPOLIS	IR12060655	IPORA	03/12/2019 04:54	03/12/2019 09:58	03/12/2019 04:54	03/12/2019 09:58	5,06	8	40,46	CHI
20191214321	IPORA	IR12060655	IPORA	03/12/2019 04:54	03/12/2019 09:58	03/12/2019 04:54	03/12/2019 09:58	5,06	149	753,61	CHI
20191214321	IVOLANDIA	IR12060655	IPORA	03/12/2019 04:54	03/12/2019 09:58	03/12/2019 04:54	03/12/2019 09:58	5,06	57	288,29	CHI
20191214321	MOIPORA	IR12060655	IPORA	03/12/2019 04:54	03/12/2019 09:58	03/12/2019 04:54	03/12/2019 09:58	5,06	14	70,81	CHI
20191214325	PORANGATU	TB12262770	PORANGATU	03/12/2019 06:52	03/12/2019 08:57	03/12/2019 06:52	03/12/2019 08:57	2,08	1	2,08	CHI
20191214325	SANTA TEREZA DE GOIAS	TB12262770	PORANGATU	03/12/2019 06:52	03/12/2019 08:57	03/12/2019 06:52	03/12/2019 08:57	2,08	5	10,42	CHI
20191214325	TROMBAS	TB12262770	PORANGATU	03/12/2019 06:52	03/12/2019 08:57	03/12/2019 06:52	03/12/2019 08:57	2,08	13	27,08	CHI
20191214327	SAO MIGUEL DO ARAGUAIA	SM12000063	SAO MIGUEL DO ARAGUAIA	03/12/2019 07:26	03/12/2019 10:10	03/12/2019 07:26	03/12/2019 10:10	2,72	35	95,27	CHI
20191214328	TURVANIA	TV12259071	FIRMINOPOLIS S2	03/12/2019 07:26	03/12/2019 21:59	03/12/2019 07:26	03/12/2019 21:59	14,54	6	87,23	CHI
20191214329	MONTIVIDIU DO NORTE	MX12203423	PORANGATU	03/12/2019 06:44	03/12/2019 12:35	03/12/2019 06:44	03/12/2019 12:35	5,86	16	93,74	CHI
20191214330	PIRANHAS	PH12201916	BOM JARDIM	03/12/2019 05:57	03/12/2019 10:10	03/12/2019 05:57	03/12/2019 10:10	4,22	9	37,94	CHI
20191214336	PILAR DE GOIAS	GG12243730	SANTA TEREZINHA	03/12/2019 07:14	03/12/2019 16:40	03/12/2019 07:14	03/12/2019 16:40	9,42	28	263,79	CHI
20191214341	PORANGATU	PO12145187	PORANGATU	03/12/2019 07:29	03/12/2019 08:49	03/12/2019 07:29	03/12/2019 08:49	1,32	8	10,59	CHI
20191214348	SAO LUIS DE MONTES BELOS	SL12021470	SAO LUIZ DOS MONTES BELOS	03/12/2019 05:53	03/12/2019 15:57	03/12/2019 05:53	03/12/2019 15:57	10,07	36	362,55	CHI
20191214350	SAO LUIS DE MONTES BELOS	SL12011302	FIRMINOPOLIS S2	03/12/2019 06:12	03/12/2019 10:52	03/12/2019 06:12	03/12/2019 10:52	4,66	11	51,27	CHI
20191214351	IACIARA	IA12257653	IACIARA S1	03/12/2019 07:07	03/12/2019 10:32	03/12/2019 07:07	03/12/2019 10:32	3,40	6	20,41	CHI
20191214355	CRIXAS	CX12134501	RUBIATABA	03/12/2019 07:31	03/12/2019 21:57	03/12/2019 07:31	03/12/2019 21:57	14,42	39	562,49	CHI
20191214355	NOVA IGUAÇU DE GOIAS	CX12134501	RUBIATABA	03/12/2019 07:31	03/12/2019 21:57	03/12/2019 07:31	03/12/2019 21:57	14,42	1	14,42	CHI
20191214356	GUARINOS	SG21071047	SANTA TEREZINHA	03/12/2019 07:31	03/12/2019 18:13	03/12/2019 07:31	03/12/2019 18:13	10,69	1	10,69	CHI
20191214357	RUBIATABA	RB12232743	RUBIATABA	03/12/2019 07:31	03/12/2019 15:48	03/12/2019 07:31	03/12/2019 15:48	8,28	2	16,55	CHI
20191214360	PORANGATU	PO12072275	MARA ROSA	03/12/2019 07:32	03/12/2019 11:50	03/12/2019 07:32	03/12/2019 11:50	4,30	1	4,30	CHI
20191214363	PALESTINA DE GOIAS	PY12138375	PALESTINA	03/12/2019 06:12	03/12/2019 13:11	03/12/2019 06:12	03/12/2019 13:11	6,98	24	167,59	CHI

20191214368	SANTA RITA DO ARAGUAIA	SU21245154	SANTA RITA DO ARAGUAIA	03/12/2019 07:33	04/12/2019 11:53	03/12/2019 07:33	04/12/2019 11:53	28,33	1	28,33	CHI
20191214373	GOIATUBA	GT12390077	BOM JESUS DE GOIAS	03/12/2019 07:33	03/12/2019 10:57	03/12/2019 07:33	03/12/2019 10:57	3,39	1	3,39	CHI
20191214374	QUIRINOPOLIS	QI12137901	QUIRINOPOLIS	03/12/2019 06:24	03/12/2019 18:14	03/12/2019 06:24	03/12/2019 13:34	7,16	10	71,60	CHI
20191214374	QUIRINOPOLIS	QI12137901	QUIRINOPOLIS	03/12/2019 06:24	03/12/2019 18:14	03/12/2019 13:35	03/12/2019 17:14	3,66	8	29,30	CHI
20191214374	QUIRINOPOLIS	QI21157900	QUIRINOPOLIS	03/12/2019 06:24	03/12/2019 18:14	03/12/2019 13:35	03/12/2019 18:14	4,66	2	9,32	CHI
20191214376	GOIANDIRA	GD12078359	CATALAO S1	03/12/2019 07:33	03/12/2019 12:35	03/12/2019 07:33	03/12/2019 12:35	5,03	24	120,62	CHI
20191214378	ARAGARCAS	AG21234233	ARAGARCAS	03/12/2019 07:33	03/12/2019 09:48	03/12/2019 07:33	03/12/2019 09:48	2,24	1	2,24	CHI
20191214382	NOVO BRASIL	NB12206882	JUSSARA	03/12/2019 07:08	04/12/2019 08:47	03/12/2019 07:08	04/12/2019 08:47	25,65	4	102,58	CHI
20191214384	MINACU	IH12392288	MINACU	03/12/2019 07:34	03/12/2019 12:09	03/12/2019 07:34	03/12/2019 12:09	4,57	5	22,87	CHI
20191214401	PILAR DE GOIAS	GG12171805	SANTA TEREZINHA	03/12/2019 07:36	03/12/2019 10:47	03/12/2019 07:36	03/12/2019 10:47	3,17	31	98,19	CHI
20191214401	SANTA TEREZINHA DE GOIAS	GG12171805	SANTA TEREZINHA	03/12/2019 07:36	03/12/2019 10:47	03/12/2019 07:36	03/12/2019 10:47	3,17	44	139,37	CHI
20191214405	ITAPIRAPUA	IU12018840	MATRINCHA	03/12/2019 05:49	03/12/2019 21:45	03/12/2019 05:49	03/12/2019 21:45	15,94	18	286,98	CHI
20191214406	GOIANIA	10004404465	FERROVIARIO S1	03/12/2019 07:38	03/12/2019 10:46	03/12/2019 07:38	03/12/2019 10:46	3,13	1	3,13	CHI
20191214409	AMARALINA	MU12391653	MARA ROSA	03/12/2019 07:38	03/12/2019 13:05	03/12/2019 07:38	03/12/2019 13:05	5,44	20	108,80	CHI
20191214411	HIDROLANDIA	HD21399456	CEPAIGO S1	03/12/2019 07:39	03/12/2019 11:05	03/12/2019 07:39	03/12/2019 11:05	3,44	1	3,44	CHI
20191214414	MONTES CLAROS DE GOIAS	ME12139989	IPORA	03/12/2019 05:51	03/12/2019 18:08	03/12/2019 05:51	03/12/2019 18:08	12,27	64	785,19	CHI
20191214418	MORRINHOS	150121684	MORRINHOS	03/12/2019 07:40	03/12/2019 09:50	03/12/2019 07:40	03/12/2019 09:50	2,16	1	2,16	CHI
20191214422	JANDAIA	PU12205943	PARAUNA	03/12/2019 07:41	04/12/2019 00:20	03/12/2019 07:41	04/12/2019 00:20	16,65	3	49,95	CHI
20191214422	PARAUNA	PU12205943	PARAUNA	03/12/2019 07:41	04/12/2019 00:20	03/12/2019 07:41	04/12/2019 00:20	16,65	27	449,54	CHI
20191214427	GOIANIA	GN12000481	XAVANTES	03/12/2019 07:35	03/12/2019 08:24	03/12/2019 07:35	03/12/2019 08:24	0,81	257	208,10	CHI
20191214431	NOVA VENEZA	NV21275158	INHUMAS S1	03/12/2019 07:41	03/12/2019 09:42	03/12/2019 07:41	03/12/2019 09:42	2,00	1	2,00	CHI
20191214432	PORANGATU	PO12202402	PORANGATU	03/12/2019 07:42	03/12/2019 13:25	03/12/2019 07:42	03/12/2019 13:25	5,72	21	120,02	CHI
20191214433	MARA ROSA	MQ12249312	SANTA TEREZINHA	03/12/2019 05:32	03/12/2019 10:17	03/12/2019 05:32	03/12/2019 10:17	4,74	10	47,37	CHI
20191214434	VICENTINOPOLIS	VI12257166	VICENTINOPOLIS	03/12/2019 06:21	03/12/2019 14:34	03/12/2019 06:21	03/12/2019 14:34	8,22	8	65,74	CHI
20191214436	SANCLERLANDIA	SC21116157	FIRMINOPOLIS S2	03/12/2019 07:42	03/12/2019 21:24	03/12/2019 07:42	03/12/2019 21:24	13,70	1	13,70	CHI
20191214441	MORRINHOS	MR21044928	GOIATUBA S2	03/12/2019 07:43	03/12/2019 11:25	03/12/2019 07:43	03/12/2019 11:25	3,70	1	3,70	CHI
20191214445	NOVA CRIXAS	NA12158763	NOVA CRIXAS	03/12/2019 02:29	03/12/2019 10:30	03/12/2019 02:29	03/12/2019 10:30	8,01	17	136,22	CHI
20191214447	GOUVELANDIA	QI12035777	QUIRINOPOLIS	03/12/2019 07:20	03/12/2019 10:47	03/12/2019 07:20	03/12/2019 10:47	3,44	8	27,49	CHI
20191214457	FAZENDA NOVA	NB12117290	JUSSARA	03/12/2019 07:33	03/12/2019 17:44	03/12/2019 07:33	03/12/2019 17:44	10,18	4	40,70	CHI
20191214457	NOVO BRASIL	NB12117290	JUSSARA	03/12/2019 07:33	03/12/2019 17:44	03/12/2019 07:33	03/12/2019 17:44	10,18	5	50,88	CHI
20191214460	SITIO D ABADIA	SI12247434	IACIARA S2	03/12/2019 07:44	03/12/2019 13:54	03/12/2019 07:44	03/12/2019 13:54	6,15	5	30,77	CHI
20191214461	RIO VERDE	RV12301460	ACREUNA	03/12/2019 07:43	03/12/2019 09:56	03/12/2019 07:43	03/12/2019 09:56	2,20	7	15,41	CHI
20191214461	SANTO ANTONIO DA BARRA	RV12301460	ACREUNA	03/12/2019 07:43	03/12/2019 09:56	03/12/2019 07:43	03/12/2019 09:56	2,20	2	4,40	CHI

20191214463	GOIANIA	10012907489	CAMPINAS S2	03/12/2019 07:45	03/12/2019 11:39	03/12/2019 07:45	03/12/2019 11:39	3,89	1	3,89	CHI
20191214464	CAVALCANTE	CJ21390993	FLORES DE GOIAS	03/12/2019 07:45	04/12/2019 16:38	03/12/2019 07:45	04/12/2019 16:38	32,87	1	32,87	CHI
20191214471	NIQUELANDIA	NQ12262815	NIQUELANDIA SUBTRANSMISSAO	03/12/2019 07:46	03/12/2019 19:58	03/12/2019 07:46	03/12/2019 19:58	12,19	11	134,11	CHI
20191214472	BURITI ALEGRE	BG11000012	ALTO BURITI	03/12/2019 07:46	03/12/2019 14:51	03/12/2019 07:46	03/12/2019 14:51	7,08	84	594,32	CHI
20191214479	UIRAPURU	UP21268654	SANTA TEREZINHA	03/12/2019 07:47	04/12/2019 10:44	03/12/2019 07:47	04/12/2019 10:44	26,94	1	26,94	CHI
20191214488	GOIANDIRA	CT21267153	CATALAO S1	03/12/2019 07:48	03/12/2019 13:00	03/12/2019 07:48	03/12/2019 13:00	5,19	1	5,19	CHI
20191214494	FORMOSA	610090288	ITUIQUIRA	03/12/2019 07:49	04/12/2019 07:23	03/12/2019 07:49	04/12/2019 07:23	23,57	1	23,57	CHI
20191214495	PORANGATU	TB12208457	PORANGATU	03/12/2019 04:54	03/12/2019 09:23	03/12/2019 04:54	03/12/2019 09:23	4,48	1	4,48	CHI
20191214495	TROMBAS	TB12208457	PORANGATU	03/12/2019 04:54	03/12/2019 09:23	03/12/2019 04:54	03/12/2019 09:23	4,48	16	71,63	CHI
20191214496	TEREZOPOLIS DE GOIAS	TJ12000124	DAIA S2	03/12/2019 07:49	03/12/2019 09:19	03/12/2019 07:49	03/12/2019 09:19	1,50	4	5,99	CHI
20191214497	FIRMINOPOLIS	FR21386950	FIRMINOPOLIS S1	03/12/2019 07:49	03/12/2019 22:36	03/12/2019 07:49	03/12/2019 22:36	14,78	1	14,78	CHI
20191214506	FIRMINOPOLIS	FR12126033	FIRMINOPOLIS S1	03/12/2019 07:36	03/12/2019 08:48	03/12/2019 07:36	03/12/2019 08:48	1,21	8	9,70	CHI
20191214509	SANTA TEREZINHA DE GOIAS	SG12391336	SANTA TEREZINHA	03/12/2019 07:44	03/12/2019 12:05	03/12/2019 07:44	03/12/2019 12:05	4,34	16	69,44	CHI
20191214514	MINEIROS	MY12244759	PARQUE DAS EMAS	03/12/2019 06:22	03/12/2019 09:44	03/12/2019 06:22	03/12/2019 09:44	3,36	6	20,14	CHI
20191214515	APARECIDA DE GOIANIA	AP12058747	INDEPENDENCIA S2	03/12/2019 07:53	03/12/2019 11:50	03/12/2019 07:53	03/12/2019 11:50	3,94	1	3,94	CHI
20191214518	IPAMERI	IP12265555	CAMPO ALEGRE DE GOIAS	03/12/2019 07:53	03/12/2019 12:07	03/12/2019 07:53	03/12/2019 12:07	4,22	7	29,56	CHI
20191214521	SAO MIGUEL DO PASSA QUATRO	SQ12088077	CRISTIANOPOLIS	03/12/2019 06:53	03/12/2019 09:58	03/12/2019 06:53	03/12/2019 09:58	3,07	18	55,26	CHI
20191214523	BONFINOPOLIS	BV12205539	GOIANIA LESTE S2	03/12/2019 07:36	03/12/2019 09:33	03/12/2019 07:36	03/12/2019 09:33	1,94	12	23,33	CHI
20191214523	SENADOR CANEDO	BV12205539	GOIANIA LESTE S2	03/12/2019 07:36	03/12/2019 09:33	03/12/2019 07:36	03/12/2019 09:33	1,94	5	9,72	CHI
20191214528	IACIARA	IA12218841	IACIARA S1	03/12/2019 07:54	03/12/2019 11:45	03/12/2019 07:54	03/12/2019 11:45	3,84	3	11,51	CHI
20191214530	AGUAS LINDAS DE GOIAS	10024376491	AGUAS LINDAS DE GOIAS S1	03/12/2019 07:55	03/12/2019 09:42	03/12/2019 07:55	03/12/2019 09:42	1,78	1	1,78	CHI
20191214531	CAMPO ALEGRE DE GOIAS	CM21378456	CAMPO ALEGRE DE GOIAS	03/12/2019 07:55	03/12/2019 10:09	03/12/2019 07:55	03/12/2019 10:09	2,23	1	2,23	CHI
20191214532	MINACU	IH12088797	MINACU	03/12/2019 05:48	03/12/2019 09:37	03/12/2019 05:48	03/12/2019 09:37	3,82	142	542,16	CHI
20191214533	VILA PROPICIO	NP12231823	GOIANESIA S1	03/12/2019 07:21	03/12/2019 16:25	03/12/2019 07:21	03/12/2019 16:25	9,06	15	135,93	CHI
20191214534	NOVA VENEZA	NV21272402	INHUMAS S1	03/12/2019 07:56	03/12/2019 10:57	03/12/2019 07:56	03/12/2019 10:57	3,01	2	6,02	CHI
20191214538	GOIANIA	13755171	GOIANIA LESTE S3	03/12/2019 07:56	03/12/2019 11:07	03/12/2019 07:56	03/12/2019 11:07	3,17	1	3,17	CHI
20191214541	MINEIROS	MY12324396	PARQUE DAS EMAS	03/12/2019 07:16	03/12/2019 09:00	03/12/2019 07:16	03/12/2019 09:00	1,72	20	34,37	CHI
20191214543	PLANALTINA	PI12375541	PLANALTINA	03/12/2019 07:29	03/12/2019 10:14	03/12/2019 07:29	03/12/2019 10:14	2,74	179	489,57	CHI
20191214548	MINEIROS	1390126824	PARQUE DAS EMAS	03/12/2019 07:58	03/12/2019 10:04	03/12/2019 07:58	03/12/2019 10:04	2,09	1	2,09	CHI
20191214552	VICENTINOPOLIS	VI12047297	VICENTINOPOLIS	03/12/2019 07:44	03/12/2019 10:47	03/12/2019 07:44	03/12/2019 10:47	3,04	5	15,20	CHI
20191214556	PIRES DO RIO	PR21372404	PIRES DO RIO S2	03/12/2019 07:59	04/12/2019 08:40	03/12/2019 07:59	04/12/2019 08:40	24,68	1	24,68	CHI
20191214557	MINACU	CR12234940	PORANGATU	03/12/2019 07:59	03/12/2019 12:35	03/12/2019 07:59	03/12/2019 12:35	4,59	9	41,31	CHI
20191214559	CRISTALINA	KR12170316	PAMPLONA	03/12/2019 08:00	03/12/2019 12:44	03/12/2019 08:00	03/12/2019 12:44	4,72	1	4,72	CHI

20191214560	ALTO HORIZONTE	AJ21137957	SANTA TEREZINHA	03/12/2019 08:01	04/12/2019 16:31	03/12/2019 08:01	04/12/2019 16:31	32,50	1	32,50	CHI
20191214565	GOIANIRA	10015414173	MEIA PONTE	03/12/2019 08:02	03/12/2019 11:44	03/12/2019 08:02	03/12/2019 11:44	3,70	1	3,70	CHI
20191214567	ABADIANIA	AA12059632	ANAPOLIS UNIVERSITARIO S2	03/12/2019 07:19	03/12/2019 11:30	03/12/2019 07:19	03/12/2019 11:30	4,18	47	196,28	CHI
20191214567	CORUMBA DE GOIAS	AA12059632	ANAPOLIS UNIVERSITARIO S2	03/12/2019 07:19	03/12/2019 11:30	03/12/2019 07:19	03/12/2019 11:30	4,18	1	4,18	CHI
20191214571	CAMPINACU	UC12400308	MARA ROSA	03/12/2019 06:00	03/12/2019 14:28	03/12/2019 06:00	03/12/2019 14:28	8,46	22	186,18	CHI
20191214580	NOVA CRIXAS	NA12300441	MOZARLANDIA	03/12/2019 08:04	03/12/2019 11:35	03/12/2019 08:04	03/12/2019 11:35	3,51	4	14,06	CHI
20191214582	JATAI	JT12196090	JATAI S2	03/12/2019 08:04	03/12/2019 11:15	03/12/2019 08:04	03/12/2019 11:15	3,18	11	34,95	CHI
20191214584	DOVERLANDIA	DV21138003	CAIAPONIA	03/12/2019 08:04	03/12/2019 09:45	03/12/2019 08:04	03/12/2019 09:45	1,67	2	3,35	CHI
20191214588	APARECIDA DE GOIANIA	15929073	INDEPENDENCIA S2	03/12/2019 08:05	03/12/2019 09:25	03/12/2019 08:05	03/12/2019 09:25	1,33	1	1,33	CHI
20191214592	CAMPINACU	UC21289318	PORANGATU	03/12/2019 08:06	03/12/2019 11:53	03/12/2019 08:06	03/12/2019 11:53	3,78	1	3,78	CHI
20191214593	RIO VERDE	RV11229461	MONTIVIDIU T	03/12/2019 08:06	03/12/2019 17:45	03/12/2019 08:06	03/12/2019 17:45	9,65	1	9,65	CHI
20191214595	JUSSARA	JR12396219	BRITANIA	02/12/2019 19:36	04/12/2019 07:10	02/12/2019 19:36	04/12/2019 07:10	35,57	3	106,70	CHI
20191214597	FORMOSA	610251326	ITIQUEIRA	03/12/2019 08:06	03/12/2019 11:45	03/12/2019 08:06	03/12/2019 11:45	3,65	1	3,65	CHI
20191214600	NIQUELANDIA	NQ21235665	URUACU	03/12/2019 08:06	04/12/2019 12:42	03/12/2019 08:06	04/12/2019 12:42	28,58	1	28,58	CHI
20191214607	GOIATUBA	CL12349482	RIO DOS BOIS	03/12/2019 08:07	04/12/2019 09:07	03/12/2019 08:07	04/12/2019 09:07	24,99	6	149,95	CHI
20191214607	PORTEIRAO	CL12349482	RIO DOS BOIS	03/12/2019 08:07	04/12/2019 09:07	03/12/2019 08:07	04/12/2019 09:07	24,99	1	24,99	CHI
20191214608	PIRACANJUBA	PJ21082314	CRISTIANOPOLIS	03/12/2019 08:07	03/12/2019 12:10	03/12/2019 08:07	03/12/2019 12:10	4,04	1	4,04	CHI
20191214609	FIRMINOPOLIS	FR12096977	FIRMINOPOLIS S1	03/12/2019 07:57	03/12/2019 09:54	03/12/2019 07:57	03/12/2019 09:54	1,94	77	149,76	CHI
20191214612	CRISTALINA	KR12401767	CRISTALINA S1	03/12/2019 07:26	03/12/2019 11:54	03/12/2019 07:26	03/12/2019 11:54	4,46	9	40,11	CHI
20191214614	ARAGUAPAZ	AZ21230675	MOZARLANDIA	03/12/2019 08:08	03/12/2019 16:49	03/12/2019 08:08	03/12/2019 16:49	8,67	2	17,34	CHI
20191214624	RIO VERDE	RV21371547	MONTIVIDIU T	03/12/2019 08:09	03/12/2019 16:46	03/12/2019 08:09	03/12/2019 16:46	8,60	1	8,60	CHI
20191214628	GOIAS	GS12172056	MATRINCHA	03/12/2019 08:10	03/12/2019 12:43	03/12/2019 08:10	03/12/2019 12:43	4,56	4	18,23	CHI
20191214629	ARENOPOLIS	DI12188377	ARENOPOLIS	03/12/2019 07:08	03/12/2019 09:53	03/12/2019 07:08	03/12/2019 09:53	2,74	1	2,74	CHI
20191214629	DIORAMA	DI12188377	ARENOPOLIS	03/12/2019 07:08	03/12/2019 09:53	03/12/2019 07:08	03/12/2019 09:53	2,74	12	32,91	CHI
20191214631	IPAMERI	IP21300934	IPAMERI	03/12/2019 08:10	03/12/2019 10:13	03/12/2019 08:10	03/12/2019 10:13	2,04	1	2,04	CHI
20191214634	ANAPOLIS	LB12078506	DAIA S2	03/12/2019 07:46	03/12/2019 09:37	03/12/2019 07:46	03/12/2019 09:37	1,85	8	14,77	CHI
20191214634	LEOPOLDO DE BULHOES	LB12078506	DAIA S2	03/12/2019 07:46	03/12/2019 09:37	03/12/2019 07:46	03/12/2019 09:37	1,85	4	7,39	CHI
20191214635	RIO VERDE	630016689	RIO VERDE S2	03/12/2019 08:11	04/12/2019 09:53	03/12/2019 08:11	04/12/2019 09:53	25,71	1	25,71	CHI
20191214644	TRINDADE	TR12000048	TRINDADE	03/12/2019 08:13	03/12/2019 09:53	03/12/2019 08:13	03/12/2019 09:53	1,67	6	10,00	CHI
20191214646	CRISTALINA	KR21103517	CRISTALINA S1	03/12/2019 08:13	03/12/2019 12:04	03/12/2019 08:13	03/12/2019 12:04	3,85	4	15,38	CHI
20191214701	PLANALTINA	PI21344331	PLANALTINA	03/12/2019 08:14	03/12/2019 11:05	03/12/2019 08:14	03/12/2019 11:05	2,84	1	2,84	CHI
20191214702	COCALZINHO DE GOIAS	ZN21215030	COCALZINHO	03/12/2019 08:14	03/12/2019 09:52	03/12/2019 08:14	03/12/2019 09:52	1,63	1	1,63	CHI
20191214703	IPAMERI	580035438	IPAMERI	03/12/2019 08:14	03/12/2019 17:02	03/12/2019 08:14	03/12/2019 17:02	8,80	1	8,80	CHI

20191214704	CAIAPONIA	CP12340095	CAIAPONIA	03/12/2019 08:14	03/12/2019 17:07	03/12/2019 08:14	03/12/2019 17:07	8,87	6	53,22	CHI
20191214706	PEROLANDIA	MY21172752	PARQUE DAS EMAS	03/12/2019 08:14	03/12/2019 11:03	03/12/2019 08:14	03/12/2019 11:03	2,81	1	2,81	CHI
20191214708	GOIANIA	GN11169165	FERROVIARIO S1	03/12/2019 07:36	03/12/2019 09:21	03/12/2019 07:36	03/12/2019 09:21	1,75	72	125,78	CHI
20191214713	GOIANIA	10015346208	CARAJAS S2	03/12/2019 08:16	03/12/2019 16:56	03/12/2019 08:16	03/12/2019 16:56	8,66	1	8,66	CHI
20191214718	SAO LUIS DE MONTES BELOS	SL21259188	SAO LUIZ DOS MONTES BELOS	03/12/2019 08:17	03/12/2019 18:46	03/12/2019 08:17	03/12/2019 18:46	10,49	1	10,49	CHI
20191214719	DIORAMA	DI21034206	IPORA	03/12/2019 08:17	03/12/2019 16:45	03/12/2019 08:17	03/12/2019 16:45	8,46	1	8,46	CHI
20191214720	VIANOPOLIS	VN21212526	VIANOPOLIS	03/12/2019 08:16	04/12/2019 08:22	03/12/2019 08:16	04/12/2019 08:22	24,08	1	24,08	CHI
20191214722	CRISTALINA	KR21228574	PAMPLONA	03/12/2019 08:18	03/12/2019 11:22	03/12/2019 08:18	03/12/2019 11:22	3,07	1	3,07	CHI
20191214723	GOIANESIA	550076300	GOIANESIA S2	03/12/2019 08:18	03/12/2019 18:01	03/12/2019 08:18	03/12/2019 18:01	9,72	1	9,72	CHI
20191214727	MONTES CLAROS DE GOIAS	ME12124936	IPORA	03/12/2019 08:18	03/12/2019 12:00	03/12/2019 08:18	03/12/2019 12:00	3,70	10	37,00	CHI
20191214734	VIANOPOLIS	510012085	VIANOPOLIS	03/12/2019 08:19	03/12/2019 10:11	03/12/2019 08:19	03/12/2019 10:11	1,86	1	1,86	CHI
20191214739	CALDAS NOVAS	CN12363797	SERRA DE CALDAS	03/12/2019 08:20	03/12/2019 14:00	03/12/2019 08:20	03/12/2019 14:00	5,66	1	5,66	CHI
20191214740	ITAPURANGA	IK12300238	ITAPURANGA	03/12/2019 07:39	03/12/2019 09:25	03/12/2019 07:39	03/12/2019 09:25	1,76	93	164,04	CHI
20191214742	MOZARLANDIA	410047016	MOZARLANDIA	03/12/2019 08:21	03/12/2019 16:08	03/12/2019 08:21	03/12/2019 16:08	7,78	1	7,78	CHI
20191214743	SAO MIGUEL DO ARAGUAIA	SM12309562	SAO MIGUEL DO ARAGUAIA	03/12/2019 08:21	03/12/2019 12:35	03/12/2019 08:21	03/12/2019 12:35	4,23	2	8,46	CHI
20191214744	ITAUCU	XX08615676	INHUMAS S1	03/12/2019 08:21	03/12/2019 13:30	03/12/2019 08:21	03/12/2019 13:30	5,14	3	15,43	CHI
20191214745	TURVANIA	TV21005599	FIRMINOPOLIS S1	03/12/2019 08:21	04/12/2019 07:53	03/12/2019 08:21	04/12/2019 07:53	23,53	1	23,53	CHI
20191214756	ARUANA	AK12264829	MOZARLANDIA	03/12/2019 08:22	03/12/2019 13:16	03/12/2019 08:22	03/12/2019 13:16	4,88	31	151,40	CHI
20191214757	PORANGATU	PO11227239	PORANGATU	03/12/2019 08:20	03/12/2019 23:57	03/12/2019 08:20	03/12/2019 23:57	15,61	1	15,61	CHI
20191214760	GOIANIA	TR21001618	TRINDADE	03/12/2019 08:23	03/12/2019 09:49	03/12/2019 08:23	03/12/2019 09:49	1,43	1	1,43	CHI
20191214766	MIMOSO DE GOIAS	MJ12288360	PADRE BERNARDO	03/12/2019 08:24	03/12/2019 15:20	03/12/2019 08:24	03/12/2019 15:20	6,92	1	6,92	CHI
20191214771	GOIANESIA	GE21194473	GOIANESIA S1	03/12/2019 08:25	03/12/2019 16:03	03/12/2019 08:25	03/12/2019 16:03	7,64	1	7,64	CHI
20191214776	SAO MIGUEL DO ARAGUAIA	SM11246987	SAO MIGUEL DO ARAGUAIA	03/12/2019 08:25	03/12/2019 13:24	03/12/2019 08:25	03/12/2019 13:24	4,97	1	4,97	CHI
20191214777	JATAI	290139740	JATAI S2	03/12/2019 08:25	03/12/2019 11:26	03/12/2019 08:25	03/12/2019 11:26	3,02	1	3,02	CHI
20191214779	CATALAO	10030623969	CATALAO S2	03/12/2019 08:26	03/12/2019 13:43	03/12/2019 08:26	03/12/2019 13:43	5,29	0	0,00	CHI
20191214782	GOIANDIRA	GD21112497	CATALAO S1	03/12/2019 08:26	03/12/2019 11:35	03/12/2019 08:26	03/12/2019 11:35	3,14	2	6,29	CHI
20191214784	PORANGATU	840086040	PORANGATU	03/12/2019 08:26	03/12/2019 11:47	03/12/2019 08:26	03/12/2019 11:47	3,35	1	3,35	CHI
20191214790	ALVORADA DO NORTE	SI12243039	IACIARA S2	03/12/2019 08:27	03/12/2019 18:08	03/12/2019 08:27	03/12/2019 18:08	9,67	5	48,36	CHI
20191214791	ITUMBIARA	IT12037085	CACHOEIRA DOURADA	03/12/2019 06:22	04/12/2019 14:35	03/12/2019 06:22	04/12/2019 14:35	32,21	12	386,57	CHI
20191214791	PANAMA	IT12037085	CACHOEIRA DOURADA	03/12/2019 06:22	04/12/2019 14:35	03/12/2019 06:22	04/12/2019 14:35	32,21	10	322,14	CHI
20191214792	POSSE	PS12218734	IACIARA S2	03/12/2019 08:27	03/12/2019 20:44	03/12/2019 08:27	03/12/2019 20:44	12,27	1	12,27	CHI
20191214793	SANTA CRUZ DE GOIAS	BC12126991	PIRACANJUBA	03/12/2019 08:24	03/12/2019 13:35	03/12/2019 08:24	03/12/2019 13:35	5,18	21	108,84	CHI
20191214797	GOIANIA	13797748	AEROPORTO S2	03/12/2019 08:28	03/12/2019 12:57	03/12/2019 08:28	03/12/2019 12:57	4,48	1	4,48	CHI

20191214802	ITABERAI	10004277439	ITABERAI S2	03/12/2019 08:28	03/12/2019 11:07	03/12/2019 08:28	03/12/2019 11:07	2,64	1	2,64	CHI
20191214804	ITUMBIARA	IT11000087	ITUMBIARA NOVA	03/12/2019 07:51	03/12/2019 11:30	03/12/2019 07:51	03/12/2019 11:30	3,65	94	342,63	CHI
20191214805	PORANGATU	PO12256448	NOVO PLANALTO	03/12/2019 08:28	05/12/2019 02:48	03/12/2019 08:28	05/12/2019 02:48	42,33	8	338,64	CHI
20191214806	MAURILANDIA	DM21279838	RIO DOS BOIS	03/12/2019 08:29	03/12/2019 12:07	03/12/2019 08:29	03/12/2019 12:07	3,64	1	3,64	CHI
20191214807	PIRENOPOLIS	PV12384891	CORUMBA	03/12/2019 07:32	03/12/2019 12:08	03/12/2019 07:32	03/12/2019 12:08	4,59	14	64,21	CHI
20191214808	CATALAO	10022781712	CATALAO S1	03/12/2019 08:29	03/12/2019 13:40	03/12/2019 08:29	03/12/2019 13:40	5,18	1	5,18	CHI
20191214810	SANTA TEREZA DE GOIAS	2430008150	MARA ROSA	03/12/2019 08:30	03/12/2019 15:44	03/12/2019 08:30	03/12/2019 15:44	7,23	1	7,23	CHI
20191214811	BARRO ALTO	SJ12006466	GOIANESIA S1	03/12/2019 08:23	03/12/2019 14:35	03/12/2019 08:23	03/12/2019 14:35	6,20	1	6,20	CHI
20191214811	GOIANESIA	SJ12006466	GOIANESIA S1	03/12/2019 08:23	03/12/2019 14:35	03/12/2019 08:23	03/12/2019 14:35	6,20	6	37,18	CHI
20191214811	VILA PROPICIO	SJ12006466	GOIANESIA S1	03/12/2019 08:23	03/12/2019 14:35	03/12/2019 08:23	03/12/2019 14:35	6,20	1	6,20	CHI
20191214812	INHUMAS	30089116	INHUMAS S2	03/12/2019 08:30	03/12/2019 13:29	03/12/2019 08:30	03/12/2019 13:29	4,97	1	4,97	CHI
20191214813	SENADOR CANEDO	13063170	CEPAIGO S1	03/12/2019 08:30	03/12/2019 12:47	03/12/2019 08:30	03/12/2019 12:47	4,27	1	4,27	CHI
20191214817	CRISTALINA	KR12133611	CRISTALINA S2	03/12/2019 08:31	03/12/2019 15:37	03/12/2019 08:31	03/12/2019 15:37	7,10	2	14,20	CHI
20191214831	ITAPURANGA	IK12250599	ITAPURANGA	03/12/2019 07:27	03/12/2019 12:20	03/12/2019 07:27	03/12/2019 12:20	4,88	18	87,82	CHI
20191214831	MORRO AGUDO DE GOIAS	IK12250599	ITAPURANGA	03/12/2019 07:27	03/12/2019 12:20	03/12/2019 07:27	03/12/2019 12:20	4,88	5	24,39	CHI
20191214831	SAO PATRICIO	IK12250599	ITAPURANGA	03/12/2019 07:27	03/12/2019 12:20	03/12/2019 07:27	03/12/2019 12:20	4,88	2	9,76	CHI
20191214836	GOIANESIA	550022636	GOIANESIA S2	03/12/2019 08:33	03/12/2019 12:00	03/12/2019 08:33	03/12/2019 12:00	3,44	1	3,44	CHI
20191214840	CRIXAS	NM12270333	RUBIATABA	03/12/2019 06:39	03/12/2019 10:22	03/12/2019 06:39	03/12/2019 10:22	3,70	5	18,52	CHI
20191214840	NOVA AMERICA	NM12270333	RUBIATABA	03/12/2019 06:39	03/12/2019 10:22	03/12/2019 06:39	03/12/2019 10:22	3,70	8	29,63	CHI
20191214841	COCALZINHO DE GOIAS	1200023393	COCALZINHO	03/12/2019 08:34	03/12/2019 22:19	03/12/2019 08:34	03/12/2019 22:19	13,75	1	13,75	CHI
20191214851	SERRANOPOLIS	SX12260467	JATAI S1	03/12/2019 06:26	03/12/2019 11:18	03/12/2019 06:26	03/12/2019 11:18	4,85	7	33,98	CHI
20191214860	PONTALINA	PK12109416	PONTALINA	03/12/2019 06:30	03/12/2019 17:01	03/12/2019 06:30	03/12/2019 17:01	10,52	11	115,73	CHI
20191214863	NOVO PLANALTO	TA12391932	NOVO PLANALTO	03/12/2019 08:36	03/12/2019 15:20	03/12/2019 08:36	03/12/2019 15:20	6,73	6	40,39	CHI
20191214867	SAO LUIS DE MONTES BELOS	SL11259146	SAO LUIZ DOS MONTES BELOS	03/12/2019 07:53	03/12/2019 09:33	03/12/2019 07:53	03/12/2019 09:33	1,66	29	48,04	CHI
20191214868	GOIANESIA	GE21089940	GOIANESIA S2	03/12/2019 08:36	03/12/2019 16:42	03/12/2019 08:36	03/12/2019 16:42	8,10	2	16,19	CHI
20191214870	CAVALCANTE	TE12265878	FLORES DE GOIAS	03/12/2019 08:37	03/12/2019 11:36	03/12/2019 08:37	03/12/2019 11:36	2,98	5	14,92	CHI
20191214870	TERESINA DE GOIAS	TE12265878	FLORES DE GOIAS	03/12/2019 08:37	03/12/2019 11:36	03/12/2019 08:37	03/12/2019 11:36	2,98	1	2,98	CHI
20191214874	VARJAO	VJ12066127	GUAPO S2	03/12/2019 08:37	03/12/2019 16:45	03/12/2019 08:37	03/12/2019 16:45	8,13	28	227,58	CHI
20191214875	SANTA TEREZINHA DE GOIAS	SG12201785	SANTA TEREZINHA	03/12/2019 15:28	03/12/2019 19:26	03/12/2019 15:28	03/12/2019 19:26	3,96	44	174,20	CHI
20191214876	CAMPINORTE	CR11257436	PORANGATU	03/12/2019 08:37	03/12/2019 13:21	03/12/2019 08:37	03/12/2019 13:21	4,72	1	4,72	CHI
20191214880	PLANALTINA	2960184252	PLANALTINA	03/12/2019 08:38	03/12/2019 14:25	03/12/2019 08:38	03/12/2019 14:25	5,79	1	5,79	CHI
20191214881	FORMOSO	FO21145445	PORANGATU	03/12/2019 08:38	03/12/2019 15:10	03/12/2019 08:38	03/12/2019 15:10	6,53	1	6,53	CHI
20191214884	QUIRINOPOLIS	QI21306153	QUIRINOPOLIS	03/12/2019 08:38	03/12/2019 16:20	03/12/2019 08:38	03/12/2019 16:20	7,70	2	15,39	CHI

20191214886	BURITI ALEGRE	BG12229307	ITUMBIARA VELHA S2	03/12/2019 08:38	03/12/2019 14:10	03/12/2019 08:38	03/12/2019 14:10	5,53	3	16,58	CHI
20191214888	NOVO BRASIL	NB12050168	JUSSARA	03/12/2019 08:37	03/12/2019 17:44	03/12/2019 08:37	03/12/2019 17:44	9,11	12	109,31	CHI
20191214892	APARECIDA DE GOIANIA	AP12000021	INDEPENDENCIA S1	03/12/2019 08:31	03/12/2019 11:42	03/12/2019 08:31	03/12/2019 11:42	3,19	844	2689,08	CHI
20191214895	BELA VISTA DE GOIAS	BV32026680	BELA VISTA S1	03/12/2019 07:20	03/12/2019 10:09	03/12/2019 07:20	03/12/2019 10:09	2,81	6	16,85	CHI
20191214898	APORE	AE21365436	ITAJA S2	03/12/2019 08:39	04/12/2019 10:17	03/12/2019 08:39	04/12/2019 10:17	25,62	1	25,62	CHI
20191214899	SAO LUIS DE MONTES BELOS	SL21000050	FIRMINOPOLIS S1	03/12/2019 08:40	03/12/2019 17:40	03/12/2019 08:40	03/12/2019 17:40	9,01	1	9,01	CHI
20191214900	TROMBAS	TB21185280	PORANGATU	03/12/2019 08:40	03/12/2019 15:04	03/12/2019 08:40	03/12/2019 15:04	6,40	1	6,40	CHI
20191214912	CRISTALINA	KR12133609	CRISTALINA S1	03/12/2019 08:41	03/12/2019 16:35	03/12/2019 08:41	03/12/2019 16:35	7,89	6	47,34	CHI
20191214912	IPAMERI	KR12133609	CRISTALINA S1	03/12/2019 08:41	03/12/2019 16:35	03/12/2019 08:41	03/12/2019 16:35	7,89	3	23,67	CHI
20191214917	CRISTALINA	10011268954	CRISTALINA S1	03/12/2019 08:42	03/12/2019 11:05	03/12/2019 08:42	03/12/2019 11:05	2,38	1	2,38	CHI
20191214919	MINEIROS	1390125509	PARQUE DAS EMAS	03/12/2019 08:42	03/12/2019 17:30	03/12/2019 08:42	03/12/2019 17:30	8,81	1	8,81	CHI
20191214922	CRIXAS	CX12392061	SANTA TEREZINHA	03/12/2019 09:38	04/12/2019 10:38	03/12/2019 09:38	04/12/2019 10:38	24,99	7	174,92	CHI
20191214925	CAMPINORTE	CR12164041	MARA ROSA	03/12/2019 06:47	03/12/2019 12:15	03/12/2019 06:47	03/12/2019 12:15	5,47	15	82,00	CHI
20191214925	URUACU	CR12164041	MARA ROSA	03/12/2019 06:47	03/12/2019 12:15	03/12/2019 06:47	03/12/2019 12:15	5,47	4	21,87	CHI
20191214928	BALIZA	BH21358770	BOM JARDIM	03/12/2019 08:43	03/12/2019 18:59	03/12/2019 08:43	03/12/2019 18:59	10,26	1	10,26	CHI
20191214929	PIRANHAS	1930012631	PIRANHAS	03/12/2019 08:41	03/12/2019 12:23	03/12/2019 08:41	03/12/2019 12:23	3,69	1	3,69	CHI
20191214930	ITARUMA	IJ21092220	CACHOEIRA ALTA	03/12/2019 08:43	04/12/2019 10:47	03/12/2019 08:43	04/12/2019 10:47	26,05	1	26,05	CHI
20191214933	PETROLINA DE GOIAS	PG12015831RE	PETROLINA	03/12/2019 03:30	03/12/2019 10:16	03/12/2019 03:30	03/12/2019 10:16	6,77	229	1549,38	CHI
20191214933	SAO FRANCISCO DE GOIAS	PG12015831RE	PETROLINA	03/12/2019 03:30	03/12/2019 10:16	03/12/2019 03:30	03/12/2019 10:16	6,77	34	230,04	CHI
20191214936	MIMOSO DE GOIAS	MJ12286897	PADRE BERNARDO	03/12/2019 08:44	03/12/2019 17:10	03/12/2019 08:44	03/12/2019 17:10	8,42	12	101,04	CHI
20191214938	ITABERAI	IB12274525	ITABERAI S1	03/12/2019 08:44	03/12/2019 10:53	03/12/2019 08:44	03/12/2019 10:53	2,14	6	12,82	CHI
20191214942	ITAPACI	100011755	ITAPACI	03/12/2019 08:45	04/12/2019 11:58	03/12/2019 08:45	04/12/2019 11:58	27,22	1	27,22	CHI
20191214943	PORANGATU	PO12192371	PORANGATU	03/12/2019 08:34	03/12/2019 17:10	03/12/2019 08:34	03/12/2019 17:10	8,60	12	103,16	CHI
20191214946	GOIAS	GS12234111	GOIAS	03/12/2019 08:46	05/12/2019 16:10	03/12/2019 08:46	05/12/2019 16:10	55,41	51	2826,11	CHI
20191214947	ARENOPOLIS	AY12000049	ARENOPOLIS	03/12/2019 08:46	03/12/2019 11:36	03/12/2019 08:46	03/12/2019 11:36	2,83	42	118,94	CHI
20191214947	IPORA	AY12000049	ARENOPOLIS	03/12/2019 08:46	03/12/2019 11:36	03/12/2019 08:46	03/12/2019 11:36	2,83	11	31,15	CHI
20191214954	OURO VERDE DE GOIAS	OV12353393RE	NEROPOLIS S1	03/12/2019 08:47	03/12/2019 12:28	03/12/2019 08:47	03/12/2019 12:28	3,68	41	150,87	CHI
20191214961	MONTES CLAROS DE GOIAS	ME12334764	IPORA	03/12/2019 08:47	03/12/2019 18:08	03/12/2019 08:47	03/12/2019 18:08	9,35	24	224,33	CHI
20191214962	SANTA RITA DO ARAGUAIA	SU11256818	SANTA RITA DO ARAGUAIA	03/12/2019 08:48	04/12/2019 14:04	03/12/2019 08:48	04/12/2019 14:04	29,27	1	29,27	CHI
20191214964	QUIRINOPOLIS	QI21094292	QUIRINOPOLIS	03/12/2019 08:48	03/12/2019 14:06	03/12/2019 08:48	03/12/2019 14:06	5,30	1	5,30	CHI
20191214966	BARRO ALTO	BA21329105	BARRO ALTO	03/12/2019 08:48	04/12/2019 13:50	03/12/2019 08:48	04/12/2019 13:50	29,02	2	58,04	CHI
20191214969	NOVA CRIXAS	8264200	NOVA CRIXAS	03/12/2019 08:47	03/12/2019 12:30	03/12/2019 08:47	03/12/2019 12:30	3,72	1	3,72	CHI
20191214970	GOIANIA	10019332643	XAVANTES	03/12/2019 08:33	03/12/2019 09:49	03/12/2019 08:33	03/12/2019 09:49	1,26	1	1,26	CHI

20191214971	SAO LUIS DE MONTES BELOS	SL21049621	SAO LUIZ DOS MONTES BELOS	03/12/2019 08:49	03/12/2019 12:15	03/12/2019 08:49	03/12/2019 12:15	3,44	1	3,44	CHI
20191214973	CIDADE OCIDENTAL	10014371853	MARAJOARA	03/12/2019 08:49	03/12/2019 11:57	03/12/2019 08:49	03/12/2019 11:57	3,13	1	3,13	CHI
20191214974	MINEIROS	1390078064	PARQUE DAS EMAS	03/12/2019 08:49	03/12/2019 15:53	03/12/2019 08:49	03/12/2019 15:53	7,06	1	7,06	CHI
20191214978	SILVANIA	SV21144065	VIANOPOLIS	03/12/2019 08:49	03/12/2019 11:08	03/12/2019 08:49	03/12/2019 11:08	2,30	1	2,30	CHI
20191214984	TRINDADE	TR32052786	TRINDADE	03/12/2019 08:51	03/12/2019 14:55	03/12/2019 08:51	03/12/2019 14:55	6,07	1	6,07	CHI
20191214992	ARAGOIANIA	AO21219129	GUAPO S2	03/12/2019 08:52	03/12/2019 12:07	03/12/2019 08:52	03/12/2019 12:07	3,26	1	3,26	CHI
20191214998	MONTE ALEGRE DE GOIAS	MA12261976	SAO DOMINGOS	03/12/2019 11:47	03/12/2019 17:13	03/12/2019 11:47	03/12/2019 17:13	5,43	35	189,98	CHI
20191215003	CAVALCANTE	CJ21233594	FLORES DE GOIAS	03/12/2019 07:23	03/12/2019 10:17	03/12/2019 07:23	03/12/2019 10:17	2,89	1	2,89	CHI
20191215006	UIRAPURU	UP21249705	SANTA TEREZINHA	03/12/2019 08:53	03/12/2019 23:23	03/12/2019 08:53	03/12/2019 23:23	14,49	1	14,49	CHI
20191215010	GOIANIA	GN11000417	FERROVIARIO S3	03/12/2019 08:46	03/12/2019 09:58	03/12/2019 08:46	03/12/2019 09:58	1,20	89	106,60	CHI
20191215014	SAO LUIS DE MONTES BELOS	SL12003916	SAO LUIZ DOS MONTES BELOS	03/12/2019 06:53	03/12/2019 16:18	03/12/2019 06:53	03/12/2019 16:18	9,43	18	169,66	CHI
20191215015	UIRAPURU	UP12213099	SANTA TEREZINHA	03/12/2019 08:54	03/12/2019 14:38	03/12/2019 08:54	03/12/2019 12:39	3,74	2	7,48	CHI
20191215015	UIRAPURU	UP12213099	SANTA TEREZINHA	03/12/2019 08:54	03/12/2019 14:38	03/12/2019 08:54	03/12/2019 14:38	5,72	1	5,72	CHI
20191215016	NOVO GAMA	NJ21330673	PACAEMBU S1	03/12/2019 08:55	03/12/2019 10:21	03/12/2019 08:55	03/12/2019 10:21	1,43	1	1,43	CHI
20191215017	PLANALTINA	PI11053637	PLANALTINA	03/12/2019 08:55	03/12/2019 20:00	03/12/2019 08:55	03/12/2019 20:00	11,08	6	66,50	CHI
20191215023	GOIANDIRA	GD21042555	CATALAO S1	03/12/2019 08:55	03/12/2019 11:42	03/12/2019 08:55	03/12/2019 11:42	2,77	1	2,77	CHI
20191215024	CIDADE OCIDENTAL	10013213510	MARAJOARA	03/12/2019 08:56	03/12/2019 12:37	03/12/2019 08:56	03/12/2019 12:37	3,68	1	3,68	CHI
20191215029	ANAPOLIS	AN31000965	JUNDIAI S2	03/12/2019 08:56	03/12/2019 12:40	03/12/2019 08:56	03/12/2019 12:40	3,72	1	3,72	CHI
20191215033	SANTA RITA DO NOVO DESTINO	DF12377521	BARRO ALTO	03/12/2019 06:17	04/12/2019 22:15	03/12/2019 06:17	03/12/2019 14:15	7,97	22	175,24	CHI
20191215033	SANTA RITA DO NOVO DESTINO	DF12377521	BARRO ALTO	03/12/2019 06:17	04/12/2019 22:15	03/12/2019 06:17	04/12/2019 22:15	39,97	1	39,97	CHI
20191215033	SANTA RITA DO NOVO DESTINO	DF12377521	BARRO ALTO	03/12/2019 06:17	04/12/2019 22:15	04/12/2019 16:51	04/12/2019 22:15	5,39	22	118,68	CHI
20191215047	MORRINHOS	MR21121110	MORRINHOS	03/12/2019 08:59	03/12/2019 14:05	03/12/2019 08:59	03/12/2019 14:05	5,10	1	5,10	CHI
20191215051	GOIANIA	16886264	MEIA PONTE	03/12/2019 08:59	03/12/2019 20:24	03/12/2019 08:59	03/12/2019 20:24	11,41	1	11,41	CHI
20191215053	CAIAPONIA	930028922	CAIAPONIA	03/12/2019 08:57	03/12/2019 10:05	03/12/2019 08:57	03/12/2019 10:05	1,13	1	1,13	CHI
20191215056	CRISTALINA	KR21240977	PAMPLONA	03/12/2019 09:00	03/12/2019 15:43	03/12/2019 09:00	03/12/2019 15:43	6,71	1	6,71	CHI
20191215057	APARECIDA DE GOIANIA	200393455	ANHANGUERA	03/12/2019 09:00	03/12/2019 12:59	03/12/2019 09:00	03/12/2019 12:59	3,98	1	3,98	CHI
20191215061	BURITINOPOLIS	BQ12344370RE	IACIARA S2	03/12/2019 06:33	03/12/2019 11:30	03/12/2019 06:33	03/12/2019 11:30	4,95	256	1266,84	CHI
20191215061	MAMBAI	BQ12344370RE	IACIARA S2	03/12/2019 06:33	03/12/2019 11:30	03/12/2019 06:33	03/12/2019 11:30	4,95	1	4,95	CHI
20191215062	IPAMERI	580055280	IPAMERI	03/12/2019 09:01	03/12/2019 16:22	03/12/2019 09:01	03/12/2019 16:22	7,35	1	7,35	CHI
20191215064	COCALZINHO DE GOIAS	ZN12302459	COCALZINHO	03/12/2019 09:01	04/12/2019 16:18	03/12/2019 09:01	04/12/2019 16:18	31,27	2	62,54	CHI
20191215066	GOIANIA	TR32050493	TRINDADE	03/12/2019 07:51	03/12/2019 10:29	03/12/2019 07:51	03/12/2019 10:29	2,63	6	15,76	CHI
20191215069	SAO MIGUEL DO ARAGUAIA	6652801	SAO MIGUEL DO ARAGUAIA	03/12/2019 09:02	03/12/2019 12:45	03/12/2019 09:02	03/12/2019 12:45	3,72	1	3,72	CHI
20191215070	APARECIDA DE GOIANIA	AP11144354	INDEPENDENCIA S2	03/12/2019 08:43	03/12/2019 12:45	03/12/2019 08:43	03/12/2019 12:45	4,04	123	497,26	CHI

20191215074	SANTO ANTONIO DA BARRA	10020050761	ACREUNA	03/12/2019 09:02	03/12/2019 16:51	03/12/2019 09:02	03/12/2019 16:51	7,80	1	7,80	CHI
20191215079	GOIAS	GS12299706	GOIAS	03/12/2019 09:03	03/12/2019 12:10	03/12/2019 09:03	03/12/2019 12:10	3,11	3	9,33	CHI
20191215080	ITAPIRAPUA	IU12089735	MATRINCHA	03/12/2019 07:41	03/12/2019 10:34	03/12/2019 07:41	03/12/2019 10:34	2,87	8	22,98	CHI
20191215084	CRIXAS	GF12243492	SANTA TEREZINHA	03/12/2019 05:29	03/12/2019 22:34	03/12/2019 05:29	03/12/2019 22:34	17,08	36	615,00	CHI
20191215084	GUARINOS	GF12243492	SANTA TEREZINHA	03/12/2019 05:29	03/12/2019 22:34	03/12/2019 05:29	03/12/2019 22:34	17,08	71	1212,92	CHI
20191215084	ITAPACI	GF12243492	SANTA TEREZINHA	03/12/2019 05:29	03/12/2019 22:34	03/12/2019 05:29	03/12/2019 22:34	17,08	6	102,50	CHI
20191215087	SAO LUIS DE MONTES BELOS	FR12000054	FIRMINOPOLIS S1	03/12/2019 09:04	04/12/2019 01:04	03/12/2019 09:04	04/12/2019 01:04	15,98	6	95,90	CHI
20191215088	GOIANIA	14815308	REAL S1	03/12/2019 09:05	03/12/2019 11:22	03/12/2019 09:05	03/12/2019 11:22	2,29	1	2,29	CHI
20191215095	FAINA	FC12204586	GOIAS	03/12/2019 07:10	03/12/2019 18:26	03/12/2019 07:10	03/12/2019 18:26	11,26	3	33,77	CHI
20191215101	ITUMBIARA	690152905	ITUMBIARA VELHA S1	03/12/2019 09:06	03/12/2019 11:13	03/12/2019 09:06	03/12/2019 11:13	2,11	1	2,11	CHI
20191215104	CAMPO ALEGRE DE GOIAS	CM21195389	CAMPO ALEGRE DE GOIAS	03/12/2019 09:06	03/12/2019 11:37	03/12/2019 09:06	03/12/2019 11:37	2,51	1	2,51	CHI
20191215115	ANAPOLIS	20850580	ANAPOLIS UNIVERSITARIO S1	03/12/2019 09:07	03/12/2019 15:47	03/12/2019 09:07	03/12/2019 15:47	6,66	1	6,66	CHI
20191215117	BARRO ALTO	BA12382484	BARRO ALTO	03/12/2019 07:15	04/12/2019 12:08	03/12/2019 07:15	04/12/2019 12:08	28,88	17	490,89	CHI
20191215118	MARA ROSA	ET12391907	MARA ROSA	03/12/2019 05:52	03/12/2019 20:54	03/12/2019 05:52	03/12/2019 20:54	15,03	19	285,60	CHI
20191215124	PONTALINA	210063464	PONTALINA	03/12/2019 09:09	03/12/2019 11:42	03/12/2019 09:09	03/12/2019 11:42	2,55	1	2,55	CHI
20191215130	BRITANIA	BT12250825	BRITANIA	03/12/2019 09:10	03/12/2019 13:43	03/12/2019 09:10	03/12/2019 13:43	4,54	4	18,17	CHI
20191215134	CRISTALINA	KR21171008	CRISTALINA S1	03/12/2019 09:11	03/12/2019 13:27	03/12/2019 09:11	03/12/2019 13:27	4,25	1	4,25	CHI
20191215137	AURILANDIA	AI12377187	FIRMINOPOLIS S2	03/12/2019 08:54	03/12/2019 11:45	03/12/2019 08:54	03/12/2019 11:45	2,85	12	34,18	CHI
20191215143	PARAUNA	PU12194221	ACREUNA	03/12/2019 09:13	03/12/2019 14:18	03/12/2019 09:13	03/12/2019 14:18	5,07	35	177,37	CHI
20191215143	PARAUNA	PU12194221	ACREUNA	03/12/2019 09:13	03/12/2019 14:18	03/12/2019 12:45	03/12/2019 14:18	1,54	2	3,08	CHI
20191215145	ALTO PARAISO DE GOIAS	BF12363301	SAO JOAO D ALIANCA	03/12/2019 09:14	05/12/2019 15:12	03/12/2019 09:14	05/12/2019 14:57	53,73	1	53,73	CHI
20191215145	ALTO PARAISO DE GOIAS	BF12363301	SAO JOAO D ALIANCA	03/12/2019 09:14	05/12/2019 15:12	03/12/2019 09:14	05/12/2019 15:12	53,97	1	53,97	CHI
20191215152	ANAPOLIS	7015081	ANAPOLIS UNIVERSITARIO S2	03/12/2019 09:15	04/12/2019 13:10	03/12/2019 09:15	04/12/2019 12:40	27,40	2	54,80	CHI
20191215152	ANAPOLIS	AN12258851	ANAPOLIS UNIVERSITARIO S2	03/12/2019 09:15	04/12/2019 13:10	03/12/2019 09:15	04/12/2019 13:10	27,91	23	641,84	CHI
20191215153	GOIANIA	10001487122	GOYA S1	03/12/2019 09:16	03/12/2019 12:12	03/12/2019 09:16	03/12/2019 12:12	2,92	1	2,92	CHI
20191215156	LUZIANIA	LZ21065456	VIANOPOLIS	03/12/2019 09:16	03/12/2019 16:45	03/12/2019 09:16	03/12/2019 16:45	7,47	1	7,47	CHI
20191215161	FAZENDA NOVA	NB12396255	JUSSARA	03/12/2019 09:17	03/12/2019 16:51	03/12/2019 09:17	03/12/2019 16:51	7,56	12	90,76	CHI
20191215161	NOVO BRASIL	NB12396255	JUSSARA	03/12/2019 09:17	03/12/2019 16:51	03/12/2019 09:17	03/12/2019 16:51	7,56	1	7,56	CHI
20191215162	CAIAPONIA	CP12260792	MONTIVIDIU T	03/12/2019 09:17	03/12/2019 17:49	03/12/2019 09:17	03/12/2019 17:49	8,53	3	25,59	CHI
20191215162	MONTIVIDIU	CP12260792	MONTIVIDIU T	03/12/2019 09:17	03/12/2019 17:49	03/12/2019 09:17	03/12/2019 17:49	8,53	3	25,59	CHI
20191215166	GOIANIA	TR21151557	TRINDADE	03/12/2019 09:18	03/12/2019 18:11	03/12/2019 09:18	03/12/2019 18:11	8,88	3	26,65	CHI
20191215168	BELA VISTA DE GOIAS	BV11264582	BELA VISTA S1	03/12/2019 09:18	03/12/2019 12:07	03/12/2019 09:18	03/12/2019 12:07	2,81	3	8,44	CHI
20191215178	GOIANIA	13054818	GOYA S2	03/12/2019 09:19	03/12/2019 13:43	03/12/2019 09:19	03/12/2019 13:43	4,39	1	4,39	CHI

20191215180	ACREUNA	EU12230897	ACREUNA	03/12/2019 09:20	03/12/2019 11:41	03/12/2019 09:20	03/12/2019 11:41	2,35	1	2,35	CHI
20191215184	PLANALTINA	PI21264727	PLANALTINA	03/12/2019 07:32	03/12/2019 19:42	03/12/2019 07:32	03/12/2019 19:42	12,16	1	12,16	CHI
20191215190	GOIANIA	GN11070523	CARAJAS S2	03/12/2019 09:08	03/12/2019 11:00	03/12/2019 09:08	03/12/2019 11:00	1,85	139	257,19	CHI
20191215191	QUIRINOPOLIS	QI21116467	QUIRINOPOLIS	03/12/2019 09:21	03/12/2019 17:34	03/12/2019 09:21	03/12/2019 17:34	8,20	1	8,20	CHI
20191215193	IPAMERI	580054780	IPAMERI	03/12/2019 09:21	03/12/2019 20:39	03/12/2019 09:21	03/12/2019 20:39	11,29	1	11,29	CHI
20191215201	AGUA FRIA DE GOIAS	TL12233983	SAO JOAO D ALIANCA	03/12/2019 08:47	03/12/2019 17:00	03/12/2019 08:47	03/12/2019 17:00	8,22	24	197,20	CHI
20191215201	PLANALTINA	TL12233983	SAO JOAO D ALIANCA	03/12/2019 08:47	03/12/2019 17:00	03/12/2019 08:47	03/12/2019 17:00	8,22	1	8,22	CHI
20191215206	CRISTALINA	KR12394905	CRISTALINA S2	03/12/2019 09:23	03/12/2019 12:00	03/12/2019 09:23	03/12/2019 12:00	2,62	15	39,26	CHI
20191215208	BARRO ALTO	BA21064546	BARRO ALTO	03/12/2019 09:23	03/12/2019 19:18	03/12/2019 09:23	03/12/2019 19:18	9,91	1	9,91	CHI
20191215212	ITAPURANGA	IK21222719	ITAPURANGA	03/12/2019 09:23	03/12/2019 11:15	03/12/2019 09:23	03/12/2019 11:15	1,86	2	3,72	CHI
20191215214	ANAPOLIS	10030193468	ANAPOLIS UNIVERSITARIO S2	03/12/2019 09:24	03/12/2019 11:14	03/12/2019 09:24	03/12/2019 11:14	1,83	1	1,83	CHI
20191215221	SILVANIA	SV21284619	VIANOPOLIS	03/12/2019 09:24	03/12/2019 11:04	03/12/2019 09:24	03/12/2019 11:04	1,65	1	1,65	CHI
20191215222	MOZARLANDIA	10000340551	MOZARLANDIA	03/12/2019 09:25	03/12/2019 18:25	03/12/2019 09:25	03/12/2019 18:25	9,01	1	9,01	CHI
20191215224	BOM JESUS DE GOIAS	05210214	CACHOEIRA DOURADA	03/12/2019 09:26	03/12/2019 22:30	03/12/2019 09:26	03/12/2019 11:53	2,46	3	7,37	CHI
20191215224	ITUMBIARA	05210214	CACHOEIRA DOURADA	03/12/2019 09:26	03/12/2019 22:30	03/12/2019 09:26	03/12/2019 11:53	2,46	78	191,64	CHI
20191215224	BOM JESUS DE GOIAS	IT12033089LD	CACHOEIRA DOURADA	03/12/2019 09:26	03/12/2019 22:30	03/12/2019 09:26	03/12/2019 22:30	13,06	30	391,77	CHI
20191215224	GOIATUBA	IT12033089LD	CACHOEIRA DOURADA	03/12/2019 09:26	03/12/2019 22:30	03/12/2019 09:26	03/12/2019 22:30	13,06	7	91,41	CHI
20191215224	ITUMBIARA	IT12033089LD	CACHOEIRA DOURADA	03/12/2019 09:26	03/12/2019 22:30	03/12/2019 09:26	03/12/2019 22:30	13,06	93	1214,48	CHI
20191215224	PANAMA	IT12033089LD	CACHOEIRA DOURADA	03/12/2019 09:26	03/12/2019 22:30	03/12/2019 09:26	03/12/2019 22:30	13,06	8	104,47	CHI
20191215226	BELA VISTA DE GOIAS	BV12045716	SENADOR CANEDO	03/12/2019 09:25	03/12/2019 21:41	03/12/2019 09:25	03/12/2019 21:41	12,26	6	73,57	CHI
20191215228	ITAGUARI	JA12217064LD	ITABERAI S1	03/12/2019 08:37	03/12/2019 13:20	03/12/2019 08:37	03/12/2019 13:20	4,71	110	517,61	CHI
20191215228	ITAGUARU	JA12217064LD	ITABERAI S1	03/12/2019 08:37	03/12/2019 13:20	03/12/2019 08:37	03/12/2019 13:20	4,71	1	4,71	CHI
20191215228	JARAGUA	JA12217064LD	ITABERAI S1	03/12/2019 08:37	03/12/2019 13:20	03/12/2019 08:37	03/12/2019 13:20	4,71	26	122,34	CHI
20191215229	GOIANIA	GN11282962	GOYA S1	03/12/2019 09:25	03/12/2019 13:08	03/12/2019 09:25	03/12/2019 13:08	3,70	78	288,80	CHI
20191215230	JARAGUA	70075270	JARAGUA	03/12/2019 09:25	03/12/2019 11:23	03/12/2019 09:25	03/12/2019 11:23	1,95	1	1,95	CHI
20191215235	PONTALINA	PK21109385	PONTALINA	03/12/2019 09:26	03/12/2019 13:17	03/12/2019 09:26	03/12/2019 13:17	3,84	2	7,67	CHI
20191215237	NOVO PLANALTO	TA21187838	NOVO PLANALTO	03/12/2019 09:26	03/12/2019 17:28	03/12/2019 09:26	03/12/2019 17:28	8,03	1	8,03	CHI
20191215238	LEOPOLDO DE BULHOES	LB12172114	DAIA S2	03/12/2019 09:19	03/12/2019 12:37	03/12/2019 09:19	03/12/2019 12:37	3,30	7	23,07	CHI
20191215238	SILVANIA	LB12172114	DAIA S2	03/12/2019 09:19	03/12/2019 12:37	03/12/2019 09:19	03/12/2019 12:37	3,30	9	29,66	CHI
20191215247	ABADIANIA	AA21205064	ANAPOLIS UNIVERSITARIO S1	03/12/2019 09:28	03/12/2019 11:17	03/12/2019 09:28	03/12/2019 11:17	1,81	1	1,81	CHI
20191215248	ANAPOLIS	AN21335135	JUNDIAI S2	03/12/2019 09:28	03/12/2019 13:40	03/12/2019 09:28	03/12/2019 13:40	4,19	1	4,19	CHI
20191215262	ANAPOLIS	20604920	JUNDIAI S2	03/12/2019 09:31	03/12/2019 12:55	03/12/2019 09:31	03/12/2019 12:55	3,39	1	3,39	CHI
20191215263	PALMEIRAS DE GOIAS	PL12000058	PALMEIRAS	03/12/2019 09:05	03/12/2019 12:32	03/12/2019 09:05	03/12/2019 12:32	3,45	6	20,73	CHI

20191215264	NIQUELANDIA	NQ12295228	NIQUELANDIA SUBTRANSMISSAO	03/12/2019 09:31	03/12/2019 14:28	03/12/2019 09:31	03/12/2019 14:28	4,94	110	543,12	CHI
20191215266	GOIANIA	GN11167739	CAMPINAS S2	03/12/2019 09:31	03/12/2019 15:47	03/12/2019 09:31	03/12/2019 15:47	6,25	93	581,43	CHI
20191215272	INHUMAS	IN12247252	INHUMAS S1	03/12/2019 09:32	03/12/2019 18:00	03/12/2019 09:32	03/12/2019 18:00	8,46	4	33,85	CHI
20191215277	GOIANIRA	10017656794	GOIANIRA	03/12/2019 09:32	03/12/2019 12:22	03/12/2019 09:32	03/12/2019 12:22	2,83	1	2,83	CHI
20191215278	FIRMINOPOLIS	FR12079643	FIRMINOPOLIS S1	03/12/2019 09:32	03/12/2019 22:15	03/12/2019 09:32	03/12/2019 22:15	12,71	1	12,71	CHI
20191215282	ALTO HORIZONTE	AJ21137949	SANTA TEREZINHA	03/12/2019 09:32	04/12/2019 19:20	03/12/2019 09:32	04/12/2019 19:20	33,79	1	33,79	CHI
20191215283	GOIAS	IB21281184	ITABERAI S1	03/12/2019 09:32	03/12/2019 11:21	03/12/2019 09:32	03/12/2019 11:21	1,80	1	1,80	CHI
20191215284	ADELANDIA	DN12145856	FIRMINOPOLIS S2	03/12/2019 08:55	03/12/2019 15:03	03/12/2019 08:55	03/12/2019 11:36	2,68	10	26,79	CHI
20191215284	ADELANDIA	DN12145856	FIRMINOPOLIS S2	03/12/2019 08:55	03/12/2019 15:03	03/12/2019 08:55	03/12/2019 15:03	6,12	10	61,20	CHI
20191215291	SILVANIA	SV21027339	VIANOPOLIS	03/12/2019 09:34	03/12/2019 16:04	03/12/2019 09:34	03/12/2019 16:04	6,49	1	6,49	CHI
20191215292	HIDROLANDIA	HD12000269	CEPAIGO S1	03/12/2019 09:35	03/12/2019 12:37	03/12/2019 09:35	03/12/2019 12:37	3,03	114	345,13	CHI
20191215293	PALMEIRAS DE GOIAS	PL12000270	PALMEIRAS	03/12/2019 09:35	03/12/2019 15:30	03/12/2019 09:35	03/12/2019 15:30	5,91	37	218,64	CHI
20191215296	IPAMERI	580078863	IPAMERI	03/12/2019 09:35	03/12/2019 14:53	03/12/2019 09:35	03/12/2019 14:53	5,29	1	5,29	CHI
20191215301	MINACU	IH21189563	MINACU	03/12/2019 09:36	04/12/2019 03:50	03/12/2019 09:36	04/12/2019 03:33	17,95	2	35,90	CHI
20191215301	MINACU	IH12189548	MINACU	03/12/2019 09:36	04/12/2019 03:50	04/12/2019 00:49	04/12/2019 03:50	3,02	2	6,03	CHI
20191215304	SAO LUIS DE MONTES BELOS	SL31111604	FIRMINOPOLIS S1	03/12/2019 09:36	03/12/2019 11:35	03/12/2019 09:36	03/12/2019 11:35	1,98	1	1,98	CHI
20191215313	MINEIROS	MY11321882	PARQUE DAS EMAS	03/12/2019 09:07	03/12/2019 10:25	03/12/2019 09:07	03/12/2019 10:25	1,30	80	103,76	CHI
20191215320	SAO MIGUEL DO PASSA QUATRO	SV12107881	VIANOPOLIS	03/12/2019 09:26	03/12/2019 18:56	03/12/2019 09:26	03/12/2019 18:56	9,51	59	560,84	CHI
20191215320	SILVANIA	SV12107881	VIANOPOLIS	03/12/2019 09:26	03/12/2019 18:56	03/12/2019 09:26	03/12/2019 18:56	9,51	34	323,20	CHI
20191215320	VIANOPOLIS	SV12107881	VIANOPOLIS	03/12/2019 09:26	03/12/2019 18:56	03/12/2019 09:26	03/12/2019 18:56	9,51	105	998,11	CHI
20191215328	AMERICANO DO BRASIL	KB12065192	ANICUNS	03/12/2019 09:41	03/12/2019 14:12	03/12/2019 09:41	03/12/2019 14:12	4,51	11	49,64	CHI
20191215329	BURITI DE GOIAS	CO12054663	FIRMINOPOLIS S2	03/12/2019 09:03	03/12/2019 16:04	03/12/2019 09:03	03/12/2019 16:04	7,01	10	70,13	CHI
20191215333	HIDROLANDIA	HD21357250	CEPAIGO S2	03/12/2019 09:42	03/12/2019 13:29	03/12/2019 09:42	03/12/2019 13:29	3,79	1	3,79	CHI
20191215337	ITAGUARI	II12030291	ITABERAI S1	03/12/2019 15:59	03/12/2019 22:15	03/12/2019 15:59	03/12/2019 22:15	6,25	72	450,36	CHI
20191215339	SAO MIGUEL DO ARAGUAIA	SM11038061	SAO MIGUEL DO ARAGUAIA	03/12/2019 09:43	03/12/2019 13:45	03/12/2019 09:43	03/12/2019 13:45	4,03	6	24,17	CHI
20191215341	CAMPESTRE DE GOIAS	GC21005195	TRINDADE	03/12/2019 09:43	03/12/2019 17:23	03/12/2019 09:43	03/12/2019 17:23	7,65	3	22,96	CHI
20191215342	PIRACANJUBA	PJ12060443	PIRACANJUBA	03/12/2019 09:43	03/12/2019 12:37	03/12/2019 09:43	03/12/2019 12:37	2,88	3	8,65	CHI
20191215344	GOIANAPOLIS	GP21360108	DAIA S2	03/12/2019 09:44	03/12/2019 16:55	03/12/2019 09:44	03/12/2019 16:55	7,18	1	7,18	CHI
20191215349	PIRES DO RIO	10008343487	PIRES DO RIO S1	03/12/2019 09:44	03/12/2019 13:19	03/12/2019 09:44	03/12/2019 13:19	3,57	1	3,57	CHI
20191215351	ITAPIRAPUA	NB12396088	JUSSARA	03/12/2019 07:49	03/12/2019 22:23	03/12/2019 07:49	03/12/2019 22:23	14,55	4	58,21	CHI
20191215351	NOVO BRASIL	NB12396088	JUSSARA	03/12/2019 07:49	03/12/2019 22:23	03/12/2019 07:49	03/12/2019 22:23	14,55	5	72,76	CHI
20191215354	RIO VERDE	630144345	RIO VERDE S1	03/12/2019 09:45	03/12/2019 11:45	03/12/2019 09:45	03/12/2019 11:45	2,00	1	2,00	CHI
20191215358	VALPARAISO DE GOIAS	LZ12000259	MARAJOARA	03/12/2019 09:46	03/12/2019 12:00	03/12/2019 09:46	03/12/2019 12:00	2,22	79	175,67	CHI

20191215359	RIO VERDE	630014863	RIO VERDE S2	03/12/2019 09:46	03/12/2019 13:45	03/12/2019 09:46	03/12/2019 13:45	3,98	1	3,98	CHI
20191215360	MINEIROS	MY12036636	PARQUE DAS EMAS	03/12/2019 09:46	03/12/2019 19:18	03/12/2019 09:46	03/12/2019 19:18	9,53	7	66,68	CHI
20191215361	POSSE	PS21256085	IACIARA S1	03/12/2019 09:47	03/12/2019 16:54	03/12/2019 09:47	03/12/2019 16:54	7,12	1	7,12	CHI
20191215363	ALEXANIA	AX12379444	ALEXANIA	03/12/2019 09:47	04/12/2019 07:55	03/12/2019 09:47	04/12/2019 07:55	22,13	4	88,51	CHI
20191215364	MORRINHOS	MR21157115	GOIATUBA S1	03/12/2019 09:47	04/12/2019 06:24	03/12/2019 09:47	04/12/2019 06:24	20,62	1	20,62	CHI
20191215366	COCALZINHO DE GOIAS	10008534380	AGUAS LINDAS DE GOIAS S2	03/12/2019 09:47	03/12/2019 11:10	03/12/2019 09:47	03/12/2019 11:10	1,37	1	1,37	CHI
20191215379	APORE	AE12112888	ITAJA S1	03/12/2019 09:49	03/12/2019 19:00	03/12/2019 09:49	03/12/2019 19:00	9,19	2	18,38	CHI
20191215382	CACHOEIRA DE GOIAS	CG12206081	FIRMINOPOLIS S2	03/12/2019 09:37	03/12/2019 16:35	03/12/2019 09:37	03/12/2019 16:35	6,98	8	55,81	CHI
20191215394	CRISTALINA	KR21184978	CRISTALINA S1	03/12/2019 09:51	03/12/2019 14:52	03/12/2019 09:51	03/12/2019 14:52	5,01	1	5,01	CHI
20191215396	GOIAS	GS21259600	GOIAS	03/12/2019 09:51	03/12/2019 16:35	03/12/2019 09:51	03/12/2019 16:35	6,73	1	6,73	CHI
20191215404	MOZARLANDIA	MZ12063134	MOZARLANDIA	03/12/2019 09:30	03/12/2019 13:16	03/12/2019 09:30	03/12/2019 13:16	3,76	183	687,37	CHI
20191215407	JANDAIA	JD12030352	PALMEIRAS	03/12/2019 08:38	03/12/2019 14:15	03/12/2019 08:38	03/12/2019 14:15	5,61	15	84,20	CHI
20191215411	GUAPO	VJ21082349	GUAPO S2	03/12/2019 09:54	03/12/2019 17:03	03/12/2019 09:54	03/12/2019 17:03	7,15	1	7,15	CHI
20191215415	GOIAS	IB12091705	ITABERAI S1	03/12/2019 09:54	03/12/2019 12:23	03/12/2019 09:54	03/12/2019 12:23	2,48	7	17,33	CHI
20191215415	ITABERAI	IB12091705	ITABERAI S1	03/12/2019 09:54	03/12/2019 12:23	03/12/2019 09:54	03/12/2019 12:23	2,48	4	9,90	CHI
20191215417	JARAGUA	JA12298041	JARAGUA	03/12/2019 09:15	04/12/2019 10:54	03/12/2019 09:15	04/12/2019 10:54	25,64	61	1564,26	CHI
20191215421	CALDAZINHA	10007658026	CEPAIGO S2	03/12/2019 09:55	03/12/2019 14:59	03/12/2019 09:55	03/12/2019 14:59	5,05	1	5,05	CHI
20191215428	CATALAO	GD21321919	CATALAO S1	03/12/2019 09:57	03/12/2019 11:53	03/12/2019 09:57	03/12/2019 11:53	1,93	1	1,93	CHI
20191215435	GOIANIA	11039826	AEROPORTO S1	03/12/2019 09:58	03/12/2019 11:32	03/12/2019 09:58	03/12/2019 11:32	1,56	1	1,56	CHI
20191215436	MINACU	IH12386704	MINACU	03/12/2019 09:58	04/12/2019 17:45	03/12/2019 09:58	04/12/2019 17:45	31,78	2	63,55	CHI
20191215439	CRISTALINA	KR21237873	CRISTALINA S2	03/12/2019 09:59	03/12/2019 13:31	03/12/2019 09:59	03/12/2019 13:31	3,53	1	3,53	CHI
20191215443	CATALAO	CT21295497	CAMPO ALEGRE DE GOIAS	03/12/2019 09:59	04/12/2019 12:22	03/12/2019 09:59	04/12/2019 12:22	26,38	1	26,38	CHI
20191215455	BELA VISTA DE GOIAS	BV21010099	BELA VISTA S1	03/12/2019 10:02	03/12/2019 18:16	03/12/2019 10:02	03/12/2019 18:16	8,23	2	16,47	CHI
20191215456	EDEALINA	ED21049306	PONTALINA	03/12/2019 10:01	04/12/2019 11:45	03/12/2019 10:01	04/12/2019 11:45	25,72	1	25,72	CHI
20191215460	MAURILANDIA	ML21303534	RIO DOS BOIS	03/12/2019 10:00	03/12/2019 16:41	03/12/2019 10:00	03/12/2019 16:41	6,67	1	6,67	CHI
20191215464	GOIANIA	GN12151986	MEIA PONTE	03/12/2019 09:57	03/12/2019 11:21	03/12/2019 09:57	03/12/2019 11:21	1,40	546	767,13	CHI
20191215466	PALMINOPOLIS	10023036140	PALMEIRAS	03/12/2019 10:03	03/12/2019 13:32	03/12/2019 10:03	03/12/2019 13:32	3,47	1	3,47	CHI
20191215467	GOIAS	HE12250708	ITAPURANGA	03/12/2019 06:32	03/12/2019 12:16	03/12/2019 06:32	03/12/2019 12:16	5,73	10	57,29	CHI
20191215467	HEITORAI	HE12250708	ITAPURANGA	03/12/2019 06:32	03/12/2019 12:16	03/12/2019 06:32	03/12/2019 12:16	5,73	10	57,29	CHI
20191215471	URUACU	CR21162935	CAMPINORTE	03/12/2019 10:04	03/12/2019 11:11	03/12/2019 10:04	03/12/2019 11:11	1,12	2	2,23	CHI
20191215473	NEROPOLIS	10022423638	NEROPOLIS S2	03/12/2019 10:04	03/12/2019 15:11	03/12/2019 10:04	03/12/2019 15:11	5,12	1	5,12	CHI
20191215481	FAZENDA NOVA	JP12075632	IPORA	03/12/2019 08:36	03/12/2019 17:04	03/12/2019 08:36	03/12/2019 17:04	8,46	3	25,37	CHI
20191215484	APARECIDA DE GOIANIA	10016967028	INDEPENDENCIA S1	03/12/2019 10:06	03/12/2019 11:02	03/12/2019 10:06	03/12/2019 11:02	0,93	1	0,93	CHI

20191215492	GOIANIA	GN11001045	CARAJAS S1	03/12/2019 10:08	03/12/2019 21:39	03/12/2019 20:13	03/12/2019 21:39	1,43	118	168,94	CHI
20191215497	FAINA	FC12299836	GOIAS	03/12/2019 09:48	03/12/2019 18:52	03/12/2019 09:48	03/12/2019 18:52	9,06	2	18,12	CHI
20191215499	GOIANIA	10725362	ATLANTICO S3	03/12/2019 10:10	03/12/2019 12:56	03/12/2019 10:10	03/12/2019 12:56	2,77	1	2,77	CHI
20191215501	PIRANHAS	1930023550	PIRANHAS	03/12/2019 10:10	03/12/2019 14:10	03/12/2019 10:10	03/12/2019 14:10	3,99	1	3,99	CHI
20191215507	INHUMAS	IN12012230	INHUMAS S2	03/12/2019 10:11	03/12/2019 11:49	03/12/2019 10:11	03/12/2019 11:49	1,63	364	591,60	CHI
20191215515	ITUMBIARA	10011420462	ITUMBIARA VELHA S1	03/12/2019 10:13	03/12/2019 11:52	03/12/2019 10:13	03/12/2019 11:52	1,65	1	1,65	CHI
20191215517	URUACU	UR21000033	CAMPINORTE	03/12/2019 10:13	03/12/2019 17:25	03/12/2019 10:13	03/12/2019 17:25	7,21	1	7,21	CHI
20191215520	RIO VERDE	630410094	MONTIVIDIU T	03/12/2019 10:13	04/12/2019 12:44	03/12/2019 10:13	04/12/2019 12:44	26,50	1	26,50	CHI
20191215521	HIDROLINA	HL12003223	SANTA TEREZINHA	03/12/2019 10:14	04/12/2019 16:30	03/12/2019 10:14	04/12/2019 12:32	26,30	1	26,30	CHI
20191215521	PILAR DE GOIAS	HL12003223	SANTA TEREZINHA	03/12/2019 10:14	04/12/2019 16:30	03/12/2019 10:14	04/12/2019 12:32	26,30	28	736,39	CHI
20191215521	PILAR DE GOIAS	HL12210160LD	SANTA TEREZINHA	03/12/2019 10:14	04/12/2019 16:30	03/12/2019 10:14	04/12/2019 16:30	30,27	21	635,58	CHI
20191215521	URUACU	HL12210160LD	SANTA TEREZINHA	03/12/2019 10:14	04/12/2019 16:30	03/12/2019 10:14	04/12/2019 16:30	30,27	4	121,06	CHI
20191215525	CATALAO	GD12127569	CATALAO S1	03/12/2019 10:14	03/12/2019 12:10	03/12/2019 10:14	03/12/2019 12:10	1,92	3	5,77	CHI
20191215525	GOIANDIRA	GD12127569	CATALAO S1	03/12/2019 10:14	03/12/2019 12:10	03/12/2019 10:14	03/12/2019 12:10	1,92	1	1,92	CHI
20191215526	IPORA	IR12014019	IPORA	03/12/2019 10:14	03/12/2019 14:12	03/12/2019 10:14	03/12/2019 14:12	3,96	3	11,87	CHI
20191215530	PADRE BERNARDO	PB12214844	PADRE BERNARDO	03/12/2019 10:15	03/12/2019 12:06	03/12/2019 10:15	03/12/2019 12:06	1,84	1	1,84	CHI
20191215531	RIO VERDE	RV21190352	CABRIUVA S2	03/12/2019 10:16	03/12/2019 15:45	03/12/2019 10:16	03/12/2019 15:45	5,49	1	5,49	CHI
20191215533	MINEIROS	1390107027	PARQUE DAS EMAS	03/12/2019 10:16	03/12/2019 14:22	03/12/2019 10:16	03/12/2019 14:22	4,10	1	4,10	CHI
20191215536	CRISTIANOPOLIS	CF12027894	CRISTIANOPOLIS	03/12/2019 10:16	03/12/2019 15:12	03/12/2019 10:16	03/12/2019 15:12	4,93	6	29,56	CHI
20191215540	FIRMINOPOLIS	FR21096978	FIRMINOPOLIS S1	03/12/2019 10:17	03/12/2019 23:41	03/12/2019 10:17	03/12/2019 23:41	13,39	1	13,39	CHI
20191215541	FIRMINOPOLIS	FR12081367	FIRMINOPOLIS S1	03/12/2019 10:17	03/12/2019 14:20	03/12/2019 10:17	03/12/2019 14:20	4,05	4	16,19	CHI
20191215543	SAO LUIS DE MONTES BELOS	SL21003930	SAO LUIZ DOS MONTES BELOS	03/12/2019 10:18	04/12/2019 09:05	03/12/2019 10:18	04/12/2019 09:05	22,78	1	22,78	CHI
20191215546	SITIO D ABADIA	SI21398703	IACIARA S2	03/12/2019 10:18	03/12/2019 16:06	03/12/2019 10:18	03/12/2019 16:06	5,79	1	5,79	CHI
20191215552	SANTO ANTONIO DE GOIAS	10014115105	NEROPOLIS S1	03/12/2019 10:19	03/12/2019 13:52	03/12/2019 10:19	03/12/2019 13:52	3,54	1	3,54	CHI
20191215557	APARECIDA DE GOIANIA	14700931	REAL S1	03/12/2019 10:20	03/12/2019 12:31	03/12/2019 10:20	03/12/2019 12:31	2,18	1	2,18	CHI
20191215565	VARIAO	VJ31097661	GUAPO S2	03/12/2019 10:22	03/12/2019 16:33	03/12/2019 10:22	03/12/2019 16:33	6,18	1	6,18	CHI
20191215567	SERRANOPOLIS	SX12037652	JATAI S1	03/12/2019 10:22	04/12/2019 11:55	03/12/2019 10:22	04/12/2019 11:55	25,54	1	25,54	CHI
20191215569	NOVO BRASIL	NB21112724	JUSSARA	03/12/2019 10:22	03/12/2019 20:52	03/12/2019 10:22	03/12/2019 20:52	10,50	1	10,50	CHI
20191216001	GOIANIA	10335640	CAMPINAS S1	03/12/2019 10:23	03/12/2019 11:36	03/12/2019 10:23	03/12/2019 11:36	1,21	1	1,21	CHI
20191216102	HEITORAI	03060416	ITABERAI S1	03/12/2019 09:26	03/12/2019 12:31	03/12/2019 09:26	03/12/2019 12:31	3,07	1	3,07	CHI
20191216102	ITABERAI	03060416	ITABERAI S1	03/12/2019 09:26	03/12/2019 12:31	03/12/2019 09:26	03/12/2019 12:31	3,07	4	12,30	CHI
20191216102	ITAGUARI	03060416	ITABERAI S1	03/12/2019 09:26	03/12/2019 12:31	03/12/2019 09:26	03/12/2019 12:31	3,07	103	316,64	CHI
20191216102	ITAGUARU	03060416	ITABERAI S1	03/12/2019 09:26	03/12/2019 12:31	03/12/2019 09:26	03/12/2019 12:31	3,07	180	553,35	CHI

20191216102	ITAGUARU	03060416	ITABERAI S1	03/12/2019 09:26	03/12/2019 12:31	03/12/2019 09:26	03/12/2019 12:31	3,07	2289	7036,77	CHI
20191216102	JARAGUA	03060416	ITABERAI S1	03/12/2019 09:26	03/12/2019 12:31	03/12/2019 09:26	03/12/2019 12:31	3,07	127	390,42	CHI
20191216102	URUANA	03060416	ITABERAI S1	03/12/2019 09:26	03/12/2019 12:31	03/12/2019 09:26	03/12/2019 12:31	3,07	10	30,74	CHI
20191216104	SAO MIGUEL DO ARAGUAIA	SM12170984	SAO MIGUEL DO ARAGUAIA	03/12/2019 10:23	03/12/2019 20:25	03/12/2019 10:23	03/12/2019 20:25	10,02	1	10,02	CHI
20191216115	ITABERAI	IB21029031	ANICUNS	03/12/2019 10:24	03/12/2019 20:39	03/12/2019 10:24	03/12/2019 20:39	10,24	1	10,24	CHI
20191216124	BELA VISTA DE GOIAS	BV12291753	BELA VISTA S1	03/12/2019 10:25	03/12/2019 15:28	03/12/2019 10:25	03/12/2019 15:28	5,06	86	434,83	CHI
20191216126	ANAPOLIS	AN21267974	ANAPOLIS UNIVERSITARIO S2	03/12/2019 10:25	03/12/2019 18:28	03/12/2019 10:25	03/12/2019 18:28	8,04	6	48,23	CHI
20191216130	CALDAS NOVAS	IP12153045	IPAMERI	03/12/2019 09:08	03/12/2019 14:04	03/12/2019 09:08	03/12/2019 14:04	4,92	6	29,51	CHI
20191216130	IPAMERI	IP12153045	IPAMERI	03/12/2019 09:08	03/12/2019 14:04	03/12/2019 09:08	03/12/2019 14:04	4,92	32	157,40	CHI
20191216131	ANAPOLIS	AN12096781	ANAPOLIS UNIVERSITARIO S2	03/12/2019 10:26	03/12/2019 16:05	03/12/2019 10:26	03/12/2019 16:05	5,64	14	78,96	CHI
20191216134	IPORA	IR12033222	IPORA	03/12/2019 10:27	03/12/2019 17:13	03/12/2019 10:27	03/12/2019 17:13	6,76	2	13,52	CHI
20191216138	GOIAS	GS12087523	GOIAS	03/12/2019 09:49	05/12/2019 17:03	03/12/2019 09:49	03/12/2019 18:35	8,76	4	35,05	CHI
20191216138	GOIAS	GS13274437	GOIAS	03/12/2019 09:49	05/12/2019 17:03	03/12/2019 09:49	04/12/2019 17:31	31,70	14	443,76	CHI
20191216138	GOIAS	GS12274214LD	GOIAS	03/12/2019 09:49	05/12/2019 17:03	03/12/2019 09:49	04/12/2019 19:23	33,56	39	1308,74	CHI
20191216138	GOIAS	GS12274214LD	GOIAS	03/12/2019 09:49	05/12/2019 17:03	04/12/2019 19:54	04/12/2019 20:41	0,77	5	3,87	CHI
20191216138	GOIAS	GS1222203LD	GOIAS	03/12/2019 09:49	05/12/2019 17:03	03/12/2019 09:49	04/12/2019 20:41	34,86	11	383,50	CHI
20191216138	GOIAS	GS12274214LD	GOIAS	03/12/2019 09:49	05/12/2019 17:03	04/12/2019 19:54	05/12/2019 13:51	17,95	6	107,69	CHI
20191216138	GOIAS	GS12274214LD	GOIAS	03/12/2019 09:49	05/12/2019 17:03	05/12/2019 12:17	05/12/2019 13:51	1,56	16	24,96	CHI
20191216138	GOIAS	GS12206887	GOIAS	03/12/2019 09:49	05/12/2019 17:03	04/12/2019 19:54	05/12/2019 13:52	17,97	22	395,25	CHI
20191216138	GOIAS	8531797	GOIAS	03/12/2019 09:49	05/12/2019 17:03	04/12/2019 19:54	05/12/2019 17:03	21,15	6	126,91	CHI
20191216139	SANCLERLANDIA	SC21005406	SAO LUIZ DOS MONTES BELOS	03/12/2019 10:27	03/12/2019 15:50	03/12/2019 10:27	03/12/2019 15:50	5,38	1	5,38	CHI
20191216142	PORTELANDIA	PW21209833	PARQUE DAS EMAS	03/12/2019 10:28	04/12/2019 10:51	03/12/2019 10:28	04/12/2019 10:51	24,38	1	24,38	CHI
20191216143	MINEIROS	MY10401436	PARQUE DAS EMAS	03/12/2019 10:53	03/12/2019 10:56	03/12/2019 10:53	03/12/2019 10:56	0,05	36	1,80	CHI
20191216147	ITAPURANGA	IK11051549	ITAPURANGA	03/12/2019 09:11	03/12/2019 16:19	03/12/2019 09:11	03/12/2019 16:19	7,14	195	1392,25	CHI
20191216149	MINEIROS	MY11378109	PARQUE DAS EMAS	03/12/2019 10:29	04/12/2019 07:45	03/12/2019 10:29	04/12/2019 07:45	21,26	14	297,65	CHI
20191216161	PONTALINA	PK21046002	PONTALINA	03/12/2019 10:31	03/12/2019 13:44	03/12/2019 10:31	03/12/2019 13:44	3,22	1	3,22	CHI
20191216164	ITABERAI	IB12210550	ITABERAI S1	03/12/2019 10:14	03/12/2019 13:46	03/12/2019 10:14	03/12/2019 13:46	3,53	4	14,13	CHI
20191216174	PROFESSOR JAMIL SAFADY	JS21181919	ROCHEDO	03/12/2019 10:33	03/12/2019 17:07	03/12/2019 10:33	03/12/2019 17:07	6,57	1	6,57	CHI
20191216178	RUBIATABA	RB21200428	RUBIATABA	03/12/2019 10:33	03/12/2019 18:45	03/12/2019 10:33	03/12/2019 18:45	8,20	1	8,20	CHI
20191216182	ITABERAI	IB12079205	ITABERAI S1	03/12/2019 10:34	03/12/2019 14:17	03/12/2019 10:34	03/12/2019 14:17	3,71	4	14,83	CHI
20191216199	DOVERLANDIA	DV12381093	CAIAPONIA	03/12/2019 10:36	03/12/2019 15:15	03/12/2019 10:36	03/12/2019 15:15	4,64	1	4,64	CHI
20191216702	GOIANIA	04530294	CARAJAS S2	03/12/2019 11:07	03/12/2019 16:35	03/12/2019 11:07	03/12/2019 11:40	0,55	2019	1117,74	CHI
20191216702	ABADIA DE GOIAS	04530294	CARAJAS S2	03/12/2019 11:07	03/12/2019 16:35	03/12/2019 11:07	03/12/2019 14:24	3,28	47	153,94	CHI

20191216702	GOIANIA	04530294	CARAJAS S2	03/12/2019 11:07	03/12/2019 16:35	03/12/2019 11:07	03/12/2019 14:24	3,28	4770	15623,07	CHI
20191216702	GOIANIA	04530294	CARAJAS S2	03/12/2019 11:07	03/12/2019 16:35	03/12/2019 11:07	03/12/2019 16:35	5,46	77	420,36	CHI
20191216807	VICENTINOPOLIS	VI21222494	VICENTINOPOLIS	03/12/2019 10:37	03/12/2019 20:17	03/12/2019 10:37	03/12/2019 20:17	9,65	1	9,65	CHI
20191216813	GUARINOS	GF21128394	ITAPACI	03/12/2019 10:38	05/12/2019 02:19	03/12/2019 10:38	05/12/2019 02:19	39,67	2	79,34	CHI
20191216821	SANTA HELENA DE GOIAS	SH12295844	IPEGUARI	03/12/2019 10:39	04/12/2019 21:45	03/12/2019 10:39	04/12/2019 21:45	35,09	17	596,61	CHI
20191216827	MORRO AGUDO DE GOIAS	MS12318396	ITAPURANGA	03/12/2019 09:38	03/12/2019 14:10	03/12/2019 09:38	03/12/2019 14:10	4,52	4	18,10	CHI
20191216841	DAMOLANDIA	IN12014368	INHUMAS S1	03/12/2019 10:38	03/12/2019 16:58	03/12/2019 10:38	03/12/2019 16:58	6,33	58	367,12	CHI
20191216841	INHUMAS	IN12014368	INHUMAS S1	03/12/2019 10:38	03/12/2019 16:58	03/12/2019 10:38	03/12/2019 16:58	6,33	51	322,82	CHI
20191216841	PETROLINA DE GOIAS	IN12014368	INHUMAS S1	03/12/2019 10:38	03/12/2019 16:58	03/12/2019 10:38	03/12/2019 16:58	6,33	5	31,65	CHI
20191216845	MORRO AGUDO DE GOIAS	RB12156092	RUBIATABA	03/12/2019 09:47	03/12/2019 18:40	03/12/2019 09:47	03/12/2019 18:40	8,88	10	88,78	CHI
20191216854	CALDAS NOVAS	CN12200060RE	CALDAS NOVAS S2	03/12/2019 10:43	03/12/2019 13:36	03/12/2019 10:43	03/12/2019 13:36	2,88	137	394,48	CHI
20191216854	PIRACANJUBA	CN12200060RE	CALDAS NOVAS S2	03/12/2019 10:43	03/12/2019 13:36	03/12/2019 10:43	03/12/2019 13:36	2,88	2	5,76	CHI
20191216858	RIO VERDE	RV12271417	CABRIUVA S2	03/12/2019 10:36	03/12/2019 16:46	03/12/2019 10:36	03/12/2019 16:46	6,16	6	36,98	CHI
20191216861	CAMPO LIMPO	AN21267919	ANAPOLIS UNIVERSITARIO S2	03/12/2019 10:45	04/12/2019 11:13	03/12/2019 10:45	04/12/2019 11:13	24,46	1	24,46	CHI
20191216869	IPAMERI	580055103	IPAMERI	03/12/2019 10:45	03/12/2019 19:23	03/12/2019 10:45	03/12/2019 19:23	8,62	1	8,62	CHI
20191216877	ITABERAI	IB21009810	ARACU	03/12/2019 10:48	04/12/2019 10:29	03/12/2019 10:48	04/12/2019 10:29	23,70	1	23,70	CHI
20191216879	BELA VISTA DE GOIAS	BV12010767	BELA VISTA S1	03/12/2019 10:48	03/12/2019 16:10	03/12/2019 10:48	03/12/2019 14:01	3,22	30	96,72	CHI
20191216879	BELA VISTA DE GOIAS	BV12072188LD	BELA VISTA S1	03/12/2019 10:48	03/12/2019 16:10	03/12/2019 10:48	03/12/2019 16:10	5,38	142	764,20	CHI
20191216880	GOIANIA	15213481	GOIANIA LESTE S1	03/12/2019 10:48	03/12/2019 13:19	03/12/2019 10:48	03/12/2019 13:19	2,51	1	2,51	CHI
20191216882	RIO VERDE	RV12018092	SANTA HELENA S1	03/12/2019 09:23	03/12/2019 15:10	03/12/2019 09:23	03/12/2019 15:10	5,78	28	161,86	CHI
20191216890	GOIANIA	10008330571	GOIANIA LESTE S1	03/12/2019 10:48	03/12/2019 13:19	03/12/2019 10:48	03/12/2019 13:19	2,50	1	2,50	CHI
20191216891	GOIANDIRA	GD21380585	CATALAO S1	03/12/2019 10:49	03/12/2019 18:01	03/12/2019 10:49	03/12/2019 18:01	7,21	1	7,21	CHI
20191216892	ITABERAI	IB11000014	ITABERAI S2	03/12/2019 10:49	03/12/2019 16:19	03/12/2019 15:35	03/12/2019 16:19	0,74	68	50,00	CHI
20191216895	ANAPOLIS	AN21008375	ANAPOLIS UNIVERSITARIO S2	03/12/2019 10:49	03/12/2019 12:56	03/12/2019 10:49	03/12/2019 12:56	2,11	1	2,11	CHI
20191216900	GOIANIA	12522909	FERROVIARIO S3	03/12/2019 10:49	03/12/2019 13:01	03/12/2019 10:49	03/12/2019 13:01	2,19	1	2,19	CHI
20191216901	MUNDO NOVO DE GOIAS	8276217	NOVA CRIXAS	03/12/2019 09:41	04/12/2019 16:02	03/12/2019 09:41	04/12/2019 16:02	30,35	2	60,70	CHI
20191216906	ANAPOLIS	00030424	DAIA S2	03/12/2019 11:18	03/12/2019 18:12	03/12/2019 12:57	03/12/2019 16:55	3,97	8	31,76	CHI
20191216906	ANAPOLIS	00030424	DAIA S2	03/12/2019 11:18	03/12/2019 18:12	03/12/2019 12:57	03/12/2019 16:55	3,97	1	3,97	CHI
20191216906	BONFINOPOLIS	00030424	DAIA S2	03/12/2019 11:18	03/12/2019 18:12	03/12/2019 12:57	03/12/2019 16:55	3,97	52	206,41	CHI
20191216906	BONFINOPOLIS	00030424	DAIA S2	03/12/2019 11:18	03/12/2019 18:12	03/12/2019 12:57	03/12/2019 16:55	3,97	1	3,97	CHI
20191216906	GAMELEIRA DE GOIAS	00030424	DAIA S2	03/12/2019 11:18	03/12/2019 18:12	03/12/2019 12:57	03/12/2019 16:55	3,97	2	7,94	CHI
20191216906	GOIANAPOLIS	00030424	DAIA S2	03/12/2019 11:18	03/12/2019 18:12	03/12/2019 12:57	03/12/2019 16:55	3,97	2099	8331,86	CHI
20191216906	GOIANAPOLIS	00030424	DAIA S2	03/12/2019 11:18	03/12/2019 18:12	03/12/2019 12:57	03/12/2019 16:55	3,97	2	7,94	CHI

20191216906	GOIANAPOLIS	00030424	DAIA S2	03/12/2019 11:18	03/12/2019 18:12	03/12/2019 12:57	03/12/2019 16:55	3,97	217	861,37	CHI
20191216906	GOIANAPOLIS	00030424	DAIA S2	03/12/2019 11:18	03/12/2019 18:12	03/12/2019 12:57	03/12/2019 16:55	3,97	2	7,94	CHI
20191216906	GOIANAPOLIS	00030424	DAIA S2	03/12/2019 11:18	03/12/2019 18:12	03/12/2019 12:57	03/12/2019 16:55	3,97	2	7,94	CHI
20191216906	GOIANIA	00030424	DAIA S2	03/12/2019 11:18	03/12/2019 18:12	03/12/2019 12:57	03/12/2019 16:55	3,97	1	3,97	CHI
20191216906	LEOPOLDO DE BULHOES	00030424	DAIA S2	03/12/2019 11:18	03/12/2019 18:12	03/12/2019 12:57	03/12/2019 16:55	3,97	362	1436,94	CHI
20191216906	LEOPOLDO DE BULHOES	00030424	DAIA S2	03/12/2019 11:18	03/12/2019 18:12	03/12/2019 12:57	03/12/2019 16:55	3,97	1	3,97	CHI
20191216906	NEROPOLIS	00030424	DAIA S2	03/12/2019 11:18	03/12/2019 18:12	03/12/2019 12:57	03/12/2019 16:55	3,97	2	7,94	CHI
20191216906	TEREZOPOLIS DE GOIAS	00030424	DAIA S2	03/12/2019 11:18	03/12/2019 18:12	03/12/2019 12:57	03/12/2019 16:55	3,97	45	178,63	CHI
20191216906	TEREZOPOLIS DE GOIAS	00030424	DAIA S2	03/12/2019 11:18	03/12/2019 18:12	03/12/2019 12:57	03/12/2019 16:55	3,97	805	3195,40	CHI
20191216906	TEREZOPOLIS DE GOIAS	00030424	DAIA S2	03/12/2019 11:18	03/12/2019 18:12	03/12/2019 12:57	03/12/2019 16:55	3,97	99	392,98	CHI
20191216906	TEREZOPOLIS DE GOIAS	00030424	DAIA S2	03/12/2019 11:18	03/12/2019 18:12	03/12/2019 12:57	03/12/2019 16:55	3,97	2	7,94	CHI
20191216906	GOIANAPOLIS	03380224	DAIA S2	03/12/2019 11:18	03/12/2019 18:12	03/12/2019 11:18	03/12/2019 18:12	6,91	1043	7206,55	CHI
20191216906	LEOPOLDO DE BULHOES	03380224	DAIA S2	03/12/2019 11:18	03/12/2019 18:12	03/12/2019 11:18	03/12/2019 18:12	6,91	512	3537,64	CHI
20191217005	SAO LUIS DE MONTES BELOS	SL21035539	SAO LUIZ DOS MONTES BELOS	03/12/2019 10:50	04/12/2019 08:15	03/12/2019 10:50	04/12/2019 08:15	21,41	3	64,22	CHI
20191217007	OURO VERDE DE GOIAS	OV21017890	NEROPOLIS S1	03/12/2019 10:50	03/12/2019 13:02	03/12/2019 10:50	03/12/2019 13:02	2,19	1	2,19	CHI
20191217011	DAMOLANDIA	PG12335038	PETROLINA	03/12/2019 09:38	03/12/2019 17:30	03/12/2019 09:38	03/12/2019 17:30	7,87	1	7,87	CHI
20191217011	PETROLINA DE GOIAS	PG12335038	PETROLINA	03/12/2019 09:38	03/12/2019 17:30	03/12/2019 09:38	03/12/2019 17:30	7,87	25	196,69	CHI
20191217012	NEROPOLIS	NR21000063	NEROPOLIS S2	03/12/2019 10:51	03/12/2019 18:15	03/12/2019 10:51	03/12/2019 18:15	7,39	2	14,78	CHI
20191217023	ITUMBIARA	690294440	ITUMBIARA NOVA	03/12/2019 10:53	03/12/2019 16:08	03/12/2019 10:53	03/12/2019 16:08	5,26	1	5,26	CHI
20191217027	DISTRITO FEDERAL	05410224	MARAJOARA	03/12/2019 10:53	03/12/2019 15:10	03/12/2019 10:53	03/12/2019 15:10	4,27	48	205,03	CHI
20191217027	NOVO GAMA	05410224	MARAJOARA	03/12/2019 10:53	03/12/2019 15:10	03/12/2019 10:53	03/12/2019 15:10	4,27	10	42,71	CHI
20191217027	SANTO ANTONIO DO DESCOBERTO	05410224	MARAJOARA	03/12/2019 10:53	03/12/2019 15:10	03/12/2019 10:53	03/12/2019 15:10	4,27	821	3506,81	CHI
20191217039	NOVO GAMA	10016683208	PACAEMBU S1	03/12/2019 11:34	03/12/2019 16:10	03/12/2019 11:34	03/12/2019 16:10	4,60	1	4,60	CHI
20191217043	APARECIDA DE GOIANIA	AP11162220	INDEPENDENCIA S1	03/12/2019 10:55	03/12/2019 16:30	03/12/2019 10:55	03/12/2019 16:30	5,58	113	630,95	CHI
20191217045	MONTES CLAROS DE GOIAS	3220000093	IPORA	03/12/2019 10:55	03/12/2019 18:10	03/12/2019 10:55	03/12/2019 18:10	7,25	1	7,25	CHI
20191217047	BELA VISTA DE GOIAS	BV21215204	BELA VISTA S1	03/12/2019 10:56	04/12/2019 11:15	03/12/2019 10:56	04/12/2019 11:15	24,32	4	97,26	CHI
20191217048	FORMOSA	FA31057073	ITUIQUIRA	03/12/2019 10:56	04/12/2019 12:10	03/12/2019 10:56	04/12/2019 12:10	25,23	1	25,23	CHI
20191217056	CATALAO	CT21161204	CATALAO S1	03/12/2019 10:57	03/12/2019 16:30	03/12/2019 10:57	03/12/2019 16:30	5,54	1	5,54	CHI
20191217071	MINEIROS	MY12305765	PARQUE DAS EMAS	03/12/2019 10:58	03/12/2019 17:27	03/12/2019 10:58	03/12/2019 17:27	6,47	6	38,83	CHI
20191217074	BALIZA	BH11331166	CAIAPONIA	03/12/2019 10:59	03/12/2019 16:09	03/12/2019 10:59	03/12/2019 16:09	5,15	1	5,15	CHI
20191217079	PORANGATU	PO12390255	PORANGATU	03/12/2019 09:11	03/12/2019 16:46	03/12/2019 09:11	03/12/2019 16:46	7,58	4	30,31	CHI
20191217081	GOUVELANDIA	QI21155909	QUIRINOPOLIS	03/12/2019 11:00	04/12/2019 10:43	03/12/2019 11:00	04/12/2019 10:43	23,70	2	47,41	CHI
20191217082	ANAPOLIS	10029553049	ANAPOLIS UNIVERSITARIO S2	03/12/2019 11:01	03/12/2019 13:14	03/12/2019 11:01	03/12/2019 13:14	2,22	1	2,22	CHI

20191217087	ANAPOLIS	10013272118	ANAPOLIS UNIVERSITARIO S2	03/12/2019 11:01	03/12/2019 14:22	03/12/2019 11:01	03/12/2019 14:22	3,34	1	3,34	CHI
20191217090	ITAPURANGA	IK12300342	ITAPURANGA	03/12/2019 10:25	03/12/2019 16:31	03/12/2019 10:25	03/12/2019 16:31	6,09	38	231,33	CHI
20191217091	CRISTALINA	KR12290773	CRISTALINA S2	03/12/2019 11:01	03/12/2019 17:42	03/12/2019 11:01	03/12/2019 17:42	6,67	5	33,33	CHI
20191217091	LUZIANIA	KR12290773	CRISTALINA S2	03/12/2019 11:01	03/12/2019 17:42	03/12/2019 11:01	03/12/2019 17:42	6,67	3	20,00	CHI
20191217092	CACHOEIRA DE GOIAS	CG12206059	FIRMINOPOLIS S2	03/12/2019 10:32	03/12/2019 19:55	03/12/2019 10:32	03/12/2019 19:55	9,39	25	234,73	CHI
20191217097	GOIANIA	GN11085832	ATLANTICO S2	03/12/2019 11:03	03/12/2019 14:02	03/12/2019 11:03	03/12/2019 14:02	2,98	103	306,83	CHI
20191217098	CORREGO DO OURO	CO21406121	SAO LUIZ DOS MONTES BELOS	03/12/2019 11:03	03/12/2019 14:45	03/12/2019 11:03	03/12/2019 14:45	3,70	2	7,39	CHI
20191217204	PARAUNA	PU21380689	MONTIVIDIU T	03/12/2019 11:05	04/12/2019 10:50	03/12/2019 11:05	04/12/2019 10:50	23,76	1	23,76	CHI
20191217207	NEROPOLIS	GR12133315	NEROPOLIS S1	03/12/2019 11:05	03/12/2019 15:30	03/12/2019 11:05	03/12/2019 15:30	4,41	16	70,51	CHI
20191217207	SANTO ANTONIO DE GOIAS	GR12133315	NEROPOLIS S1	03/12/2019 11:05	03/12/2019 15:30	03/12/2019 11:05	03/12/2019 15:30	4,41	5	22,03	CHI
20191217210	AURILANDIA	AI12000010	FIRMINOPOLIS S2	03/12/2019 11:06	04/12/2019 11:34	03/12/2019 11:06	04/12/2019 11:34	24,47	2	48,94	CHI
20191217210	FIRMINOPOLIS	AI12000010	FIRMINOPOLIS S2	03/12/2019 11:06	04/12/2019 11:34	03/12/2019 11:06	04/12/2019 11:34	24,47	6	146,81	CHI
20191217213	INHUMAS	IN11000057	INHUMAS S2	03/12/2019 11:06	03/12/2019 16:13	03/12/2019 11:06	03/12/2019 16:13	5,11	78	398,69	CHI
20191217215	HIDROLANDIA	HD12024197	CEPAIGO S2	03/12/2019 11:06	03/12/2019 17:10	03/12/2019 11:06	03/12/2019 17:10	6,06	2	12,12	CHI
20191217216	ANAPOLIS	20579056	JUNDIAI S1	03/12/2019 11:06	03/12/2019 13:28	03/12/2019 11:06	03/12/2019 13:28	2,36	1	2,36	CHI
20191217218	AGUA FRIA DE GOIAS	10007590758	SAO JOAO D ALIANCA	03/12/2019 11:06	04/12/2019 10:45	03/12/2019 11:06	04/12/2019 10:45	23,65	1	23,65	CHI
20191217225	TRINDADE	10023000463	TRINDADE	03/12/2019 11:07	03/12/2019 13:53	03/12/2019 11:07	03/12/2019 13:53	2,76	1	2,76	CHI
20191217232	SANTA TEREZA DE GOIAS	SE21000013	MARA ROSA	03/12/2019 11:43	03/12/2019 15:04	03/12/2019 11:43	03/12/2019 15:04	3,34	3	10,01	CHI
20191217237	GOIAS	GS12116902	GOIAS	03/12/2019 11:03	03/12/2019 14:38	03/12/2019 11:03	03/12/2019 14:38	3,58	19	68,07	CHI
20191217244	GOIATUBA	140014184	GOIATUBA S2	03/12/2019 11:09	04/12/2019 17:31	03/12/2019 11:09	04/12/2019 17:31	30,37	1	30,37	CHI
20191217247	ALEXANIA	AX21144104	ALEXANIA	03/12/2019 11:09	03/12/2019 15:23	03/12/2019 11:09	03/12/2019 15:23	4,22	1	4,22	CHI
20191217254	ITUMBIARA	IT21024224	CACHOEIRA DOURADA	03/12/2019 11:10	03/12/2019 17:50	03/12/2019 11:10	03/12/2019 17:50	6,66	1	6,66	CHI
20191217270	SAO LUIS DE MONTES BELOS	SL21283962	FIRMINOPOLIS S2	03/12/2019 11:11	04/12/2019 11:50	03/12/2019 11:11	04/12/2019 11:50	24,64	1	24,64	CHI
20191217283	GOIAS	GS11217937	GOIAS	03/12/2019 11:14	04/12/2019 08:46	03/12/2019 11:14	04/12/2019 08:46	21,53	1	21,53	CHI
20191217286	ALVORADA DO NORTE	AQ21257591	IACIARA S2	03/12/2019 11:14	03/12/2019 17:06	03/12/2019 11:14	03/12/2019 17:06	5,85	1	5,85	CHI
20191217291	GOIANIA	10000166098	FERROVIARIO S1	03/12/2019 11:15	03/12/2019 12:26	03/12/2019 11:15	03/12/2019 12:26	1,18	1	1,18	CHI
20191217301	SAO MIGUEL DO ARAGUAIA	SM12027854	SAO MIGUEL DO ARAGUAIA	03/12/2019 11:43	03/12/2019 12:00	03/12/2019 11:43	03/12/2019 12:00	0,28	3	0,84	CHI
20191217423	MONTES CLAROS DE GOIAS	ME12088949	IPORA	03/12/2019 09:22	03/12/2019 10:33	03/12/2019 09:22	03/12/2019 10:33	1,18	49	57,96	CHI
20191217503	SAO JOAO DA PARAUNA	RP21156229	FIRMINOPOLIS S2	03/12/2019 11:17	03/12/2019 17:24	03/12/2019 11:17	03/12/2019 17:24	6,11	2	12,23	CHI
20191217508	CORUMBAIBA	CI21252060	VILA CORUMBA	03/12/2019 11:17	03/12/2019 14:23	03/12/2019 11:17	03/12/2019 14:23	3,09	2	6,18	CHI
20191217512	SENADOR CANEDO	SW12075324	SENADOR CANEDO	03/12/2019 10:44	03/12/2019 12:20	03/12/2019 10:44	03/12/2019 12:20	1,60	646	1034,32	CHI
20191217525	GOIANIA	11125366	FERROVIARIO S1	03/12/2019 11:20	03/12/2019 12:57	03/12/2019 11:20	03/12/2019 12:57	1,62	1	1,62	CHI
20191217527	PIRES DO RIO	460120360	PIRES DO RIO S1	03/12/2019 11:20	03/12/2019 14:42	03/12/2019 11:20	03/12/2019 14:42	3,36	1	3,36	CHI

20191217529	PIRANHAS	PH12188280	PIRANHAS	03/12/2019 11:20	04/12/2019 10:50	03/12/2019 11:20	04/12/2019 10:50	23,50	6	141,03	CHI
20191217542	SANTO ANTONIO DO DESCOBERTO	2210117593	AGUAS LINDAS DE GOIAS S2	03/12/2019 11:01	03/12/2019 15:33	03/12/2019 11:01	03/12/2019 15:33	4,52	1	4,52	CHI
20191217545	ARAGOIANIA	AO12034433	GUAPO S2	03/12/2019 11:56	03/12/2019 15:50	03/12/2019 11:56	03/12/2019 15:50	3,90	11	42,88	CHI
20191217560	CAVALCANTE	CJ11320546	FLORES DE GOIAS	03/12/2019 11:24	03/12/2019 16:43	03/12/2019 11:24	03/12/2019 16:43	5,30	129	683,77	CHI
20191217562	PADRE BERNARDO	PB12313940	PADRE BERNARDO	03/12/2019 11:25	03/12/2019 15:31	03/12/2019 11:25	03/12/2019 15:31	4,10	5	20,49	CHI
20191217570	GOIANIA	10027197342	REAL S2	03/12/2019 11:26	03/12/2019 15:21	03/12/2019 11:26	03/12/2019 15:21	3,92	1	3,92	CHI
20191217573	SAO MIGUEL DO PASSA QUATRO	VN12117212	PIRES DO RIO S2	03/12/2019 11:12	04/12/2019 15:36	03/12/2019 11:12	04/12/2019 15:36	28,39	2	56,77	CHI
20191217573	VIANOPOLIS	VN12117212	PIRES DO RIO S2	03/12/2019 11:12	04/12/2019 15:36	03/12/2019 11:12	04/12/2019 15:36	28,39	37	1050,29	CHI
20191217579	ANAPOLIS	20853543	ANAPOLIS UNIVERSITARIO S2	03/12/2019 11:27	03/12/2019 13:25	03/12/2019 11:27	03/12/2019 13:25	1,95	1	1,95	CHI
20191217580	ORIZONA	OZ12115295	PIRES DO RIO S2	03/12/2019 11:19	03/12/2019 15:35	03/12/2019 11:19	03/12/2019 15:35	4,26	22	93,71	CHI
20191217585	CRIXAS	2490014293	SERRA DO OURO	03/12/2019 11:28	04/12/2019 14:31	03/12/2019 11:28	04/12/2019 14:31	27,04	1	27,04	CHI
20191217593	ITUMBIARA	690302502	ITUMBIARA VELHA S1	03/12/2019 11:29	03/12/2019 15:55	03/12/2019 11:29	03/12/2019 15:55	4,42	1	4,42	CHI
20191217594	TRINDADE	40160026	GOYA S1	03/12/2019 11:29	03/12/2019 12:59	03/12/2019 11:29	03/12/2019 12:59	1,49	1	1,49	CHI
20191217599	RUBIATABA	780037169	RUBIATABA	03/12/2019 11:30	03/12/2019 16:31	03/12/2019 11:30	03/12/2019 16:31	5,01	1	5,01	CHI
20191217601	GOIANIA	15909323	GOYA S1	03/12/2019 11:30	03/12/2019 13:14	03/12/2019 11:30	03/12/2019 13:14	1,72	1	1,72	CHI
20191217604	CASTELANDIA	CL21384573	RIO DOS BOIS	03/12/2019 11:31	04/12/2019 08:52	03/12/2019 11:31	04/12/2019 08:52	21,34	1	21,34	CHI
20191217606	CAMPESTRE DE GOIAS	GC21152186	TRINDADE	03/12/2019 11:31	03/12/2019 17:29	03/12/2019 11:31	03/12/2019 17:29	5,96	1	5,96	CHI
20191217607	VIANOPOLIS	VN12014638	VIANOPOLIS	03/12/2019 11:22	04/12/2019 07:24	03/12/2019 11:22	04/12/2019 07:24	20,02	6	120,12	CHI
20191217608	SAO LUIS DE MONTES BELOS	SL12391445	FIRMINOPOLIS S1	03/12/2019 08:54	03/12/2019 20:50	03/12/2019 08:54	03/12/2019 20:50	11,92	6	71,51	CHI
20191217610	CORREGO DO OURO	CO12080000	SAO LUIZ DOS MONTES BELOS	03/12/2019 09:17	03/12/2019 13:05	03/12/2019 09:17	03/12/2019 13:05	3,80	47	178,43	CHI
20191217610	MOIPORA	CO12080000	SAO LUIZ DOS MONTES BELOS	03/12/2019 09:17	03/12/2019 13:05	03/12/2019 09:17	03/12/2019 13:05	3,80	2	7,59	CHI
20191217612	NOVA IGUACU DE GOIAS	NH21232518	MARA ROSA	03/12/2019 11:32	03/12/2019 17:24	03/12/2019 11:32	03/12/2019 17:24	5,86	1	5,86	CHI
20191217613	ITABERAI	II12220232	ITABERAI S1	03/12/2019 11:32	03/12/2019 18:50	03/12/2019 11:32	03/12/2019 18:50	7,29	2	14,58	CHI
20191217613	ITAGUARI	II12220232	ITABERAI S1	03/12/2019 11:32	03/12/2019 18:50	03/12/2019 11:32	03/12/2019 18:50	7,29	1	7,29	CHI
20191217613	TAQUARAL DE GOIAS	II12220232	ITABERAI S1	03/12/2019 11:32	03/12/2019 18:50	03/12/2019 11:32	03/12/2019 18:50	7,29	32	233,24	CHI
20191217633	CATALAO	CT12229926	CATALAO S1	03/12/2019 12:04	03/12/2019 12:53	03/12/2019 12:04	03/12/2019 12:53	0,82	4	3,26	CHI
20191217634	DIORAMA	1530004140	IPORA	03/12/2019 11:35	03/12/2019 18:15	03/12/2019 11:35	03/12/2019 18:15	6,67	1	6,67	CHI
20191217639	RIO VERDE	CP12123360	MONTIVIDIU T	03/12/2019 11:35	03/12/2019 19:42	03/12/2019 11:35	03/12/2019 19:42	8,11	6	48,66	CHI
20191217648	CAVALCANTE	740017391	FLORES DE GOIAS	03/12/2019 11:37	03/12/2019 17:51	03/12/2019 11:37	03/12/2019 17:51	6,23	1	6,23	CHI
20191217651	CALDAZINHA	SV12202383	CEPAIGO S2	03/12/2019 11:37	04/12/2019 15:05	03/12/2019 11:37	04/12/2019 15:05	27,45	12	329,44	CHI
20191217651	SILVANIA	SV12202383	CEPAIGO S2	03/12/2019 11:37	04/12/2019 15:05	03/12/2019 11:37	04/12/2019 15:05	27,45	1	27,45	CHI
20191217658	ITABERAI	IB12220228	ITABERAI S2	03/12/2019 10:02	03/12/2019 16:15	03/12/2019 10:02	03/12/2019 16:15	6,21	12	74,46	CHI
20191217658	TAQUARAL DE GOIAS	IB12220228	ITABERAI S2	03/12/2019 10:02	03/12/2019 16:15	03/12/2019 10:02	03/12/2019 16:15	6,21	3	18,62	CHI

20191217673	BRITANIA	BT12274251	BRITANIA	03/12/2019 11:07	03/12/2019 20:32	03/12/2019 11:07	03/12/2019 20:32	9,41	10	94,10	CHI
20191217682	HIDROLANDIA	HD12310178	CEPAIGO S2	03/12/2019 11:42	03/12/2019 14:50	03/12/2019 11:42	03/12/2019 14:50	3,12	10	31,24	CHI
20191217688	ITABERAI	IB12206779	ITABERAI S1	03/12/2019 10:40	03/12/2019 16:00	03/12/2019 10:40	03/12/2019 16:00	5,32	26	138,31	CHI
20191217689	GOIATUBA	00730224	GOIATUBA S1	03/12/2019 12:08	04/12/2019 12:22	03/12/2019 12:08	03/12/2019 13:51	1,72	5	8,61	CHI
20191217689	GOIATUBA	00730224	GOIATUBA S2	03/12/2019 12:08	04/12/2019 12:22	03/12/2019 12:08	03/12/2019 13:51	1,72	3310	5697,80	CHI
20191217689	MORRINHOS	00730224	GOIATUBA S2	03/12/2019 12:08	04/12/2019 12:22	03/12/2019 12:08	03/12/2019 13:51	1,72	3	5,16	CHI
20191217689	GOIATUBA	00730224	GOIATUBA S2	03/12/2019 12:08	04/12/2019 12:22	03/12/2019 12:08	03/12/2019 15:21	3,22	2940	9464,35	CHI
20191217689	MORRINHOS	00730224	GOIATUBA S2	03/12/2019 12:08	04/12/2019 12:22	03/12/2019 12:08	03/12/2019 15:21	3,22	53	170,62	CHI
20191217689	MORRINHOS	GT12000032LD	GOIATUBA S2	03/12/2019 12:08	04/12/2019 12:22	03/12/2019 13:36	03/12/2019 15:21	1,76	5	8,78	CHI
20191217689	GOIATUBA	00730224	GOIATUBA S2	03/12/2019 12:08	04/12/2019 12:22	03/12/2019 12:08	03/12/2019 16:52	4,73	247	1169,20	CHI
20191217689	GOIATUBA	00730224	GOIATUBA S2	03/12/2019 12:08	04/12/2019 12:22	03/12/2019 12:08	04/12/2019 12:22	24,24	14	339,30	CHI
20191217701	BONOPOLIS	BX12292423	SAO MIGUEL DO ARAGUAIA	03/12/2019 11:29	03/12/2019 18:52	03/12/2019 11:29	03/12/2019 18:52	7,37	2	14,75	CHI
20191217708	SANCLERLANDIA	SC21005432	FIRMINOPOLIS S2	03/12/2019 11:47	03/12/2019 17:55	03/12/2019 11:47	03/12/2019 17:55	6,13	1	6,13	CHI
20191217711	GOIANIA	13243238	ATLANTICO S2	03/12/2019 11:47	03/12/2019 13:58	03/12/2019 11:47	03/12/2019 13:58	2,17	1	2,17	CHI
20191217716	ITAGUARI	JA12206769	ITABERAI S1	03/12/2019 09:03	03/12/2019 17:31	03/12/2019 09:03	03/12/2019 17:31	8,46	1	8,46	CHI
20191217716	JARAGUA	JA12206769	ITABERAI S1	03/12/2019 09:03	03/12/2019 17:31	03/12/2019 09:03	03/12/2019 17:31	8,46	214	1810,26	CHI
20191217717	LUZIANIA	LZ12203332	VIANOPOLIS	03/12/2019 11:48	03/12/2019 14:58	03/12/2019 11:48	03/12/2019 14:58	3,16	10	31,60	CHI
20191217718	ITABERAI	50105796	ITABERAI S2	03/12/2019 11:48	03/12/2019 16:36	03/12/2019 11:48	03/12/2019 16:36	4,79	1	4,79	CHI
20191217720	GOIANDIRA	GD21017168	CATALAO S1	03/12/2019 11:49	03/12/2019 17:59	03/12/2019 11:49	03/12/2019 17:59	6,17	1	6,17	CHI
20191217721	PORANGATU	PO12390257	PORANGATU	03/12/2019 11:49	03/12/2019 17:31	03/12/2019 11:49	03/12/2019 17:31	5,70	4	22,80	CHI
20191217723	MINEIROS	MY12219457	PARQUE DAS EMAS	03/12/2019 11:42	03/12/2019 15:08	03/12/2019 11:42	03/12/2019 15:08	3,43	21	72,01	CHI
20191217725	AGUAS LINDAS DE GOIAS	LA21351439	AGUAS LINDAS DE GOIAS S1	03/12/2019 11:49	03/12/2019 15:11	03/12/2019 11:49	03/12/2019 15:11	3,35	13	43,57	CHI
20191217727	FAINA	MP12239999	MATRINCHA	03/12/2019 11:50	03/12/2019 20:02	03/12/2019 11:50	03/12/2019 20:02	8,20	3	24,60	CHI
20191217728	RIO VERDE	RV21028153	SANTA HELENA S1	03/12/2019 11:50	03/12/2019 16:10	03/12/2019 11:50	03/12/2019 16:10	4,33	1	4,33	CHI
20191217739	CIDADE OCIDENTAL	DH21292290	MARAJOARA	03/12/2019 11:51	03/12/2019 18:41	03/12/2019 11:51	03/12/2019 18:41	6,82	1	6,82	CHI
20191217740	JUSSARA	JR21121200	IPORA	03/12/2019 11:52	03/12/2019 19:00	03/12/2019 11:52	03/12/2019 19:00	7,14	1	7,14	CHI
20191217744	GOIANIRA	10010394271	MEIA PONTE	03/12/2019 11:53	03/12/2019 16:45	03/12/2019 11:53	03/12/2019 16:45	4,87	1	4,87	CHI
20191217750	FIRMINOPOLIS	FR12299101	FIRMINOPOLIS S1	03/12/2019 09:44	03/12/2019 16:15	03/12/2019 09:44	03/12/2019 16:15	6,51	4	26,03	CHI
20191217752	BURITI ALEGRE	BG21352570	ITUMBIARA VELHA S2	03/12/2019 11:55	03/12/2019 14:37	03/12/2019 11:55	03/12/2019 14:37	2,69	1	2,69	CHI
20191217758	AGUA FRIA DE GOIAS	TL12208773	SAO JOAO D ALIANCA	03/12/2019 11:56	03/12/2019 18:09	03/12/2019 11:56	03/12/2019 18:09	6,22	14	87,03	CHI
20191217758	MIMOSO DE GOIAS	TL12208773	SAO JOAO D ALIANCA	03/12/2019 11:56	03/12/2019 18:09	03/12/2019 11:56	03/12/2019 18:09	6,22	29	180,28	CHI
20191217763	PIRANHAS	PH21201988	PIRANHAS	03/12/2019 11:58	03/12/2019 17:53	03/12/2019 11:58	03/12/2019 17:53	5,91	1	5,91	CHI
20191217764	GOIANIA	12665680	GOIANIA LESTE S1	03/12/2019 11:58	03/12/2019 15:56	03/12/2019 11:58	03/12/2019 15:56	3,96	1	3,96	CHI

20191217766	ARUANA	AK11015599	ARUANA	03/12/2019 11:37	04/12/2019 07:34	03/12/2019 11:37	04/12/2019 07:34	19,95	70	1396,19	CHI
20191217769	SANTA TEREZINHA DE GOIAS	SG11181030	SANTA TEREZINHA	03/12/2019 11:57	03/12/2019 17:00	03/12/2019 11:57	03/12/2019 17:00	5,05	155	782,36	CHI
20191217770	CAMPESTRE DE GOIAS	GC21000168	TRINDADE	03/12/2019 11:59	03/12/2019 17:17	03/12/2019 11:59	03/12/2019 17:17	5,29	1	5,29	CHI
20191217780	MOZARLANDIA	MZ12055640	MOZARLANDIA	03/12/2019 09:49	04/12/2019 15:58	03/12/2019 09:49	04/12/2019 15:58	30,13	9	271,21	CHI
20191217782	ANAPOLIS	21161586	JUNDIAI S1	03/12/2019 12:01	03/12/2019 15:10	03/12/2019 12:01	03/12/2019 15:10	3,13	1	3,13	CHI
20191217787	CIDADE OCIDENTAL	LZ21152842	MARAJOARA	03/12/2019 12:02	03/12/2019 20:32	03/12/2019 12:02	03/12/2019 20:32	8,49	1	8,49	CHI
20191217788	ABADIANIA	AN12360334	ANAPOLIS UNIVERSITARIO S2	03/12/2019 10:39	03/12/2019 17:12	03/12/2019 10:39	03/12/2019 17:12	6,56	95	623,38	CHI
20191217788	ANAPOLIS	AN12360334	ANAPOLIS UNIVERSITARIO S2	03/12/2019 10:39	03/12/2019 17:12	03/12/2019 10:39	03/12/2019 17:12	6,56	416	2729,77	CHI
20191217793	CRISTALINA	00432204	CRISTALINA S1	03/12/2019 12:04	03/12/2019 12:23	03/12/2019 12:04	03/12/2019 12:23	0,31	6698	2070,80	CHI
20191217797	GUARINOS	IW12201636	ITAPACI	03/12/2019 11:54	03/12/2019 15:12	03/12/2019 11:54	03/12/2019 15:12	3,29	6	19,72	CHI
20191217797	ITAPACI	IW12201636	ITAPACI	03/12/2019 11:54	03/12/2019 15:12	03/12/2019 11:54	03/12/2019 15:12	3,29	245	805,44	CHI
20191217797	PILAR DE GOIAS	IW12201636	ITAPACI	03/12/2019 11:54	03/12/2019 15:12	03/12/2019 11:54	03/12/2019 15:12	3,29	1	3,29	CHI
20191217804	ANAPOLIS	AN12201240	ANAPOLIS UNIVERSITARIO S2	03/12/2019 12:05	04/12/2019 19:17	03/12/2019 12:05	04/12/2019 19:17	31,19	9	280,73	CHI
20191217808	LUZIANIA	LZ12290764	RIO VERMELHO	03/12/2019 12:06	03/12/2019 19:01	03/12/2019 12:06	03/12/2019 19:01	6,93	22	152,36	CHI
20191217821	FLORES DE GOIAS	FB21161681	FLORES DE GOIAS	03/12/2019 12:08	04/12/2019 18:14	03/12/2019 12:08	04/12/2019 18:14	30,10	1	30,10	CHI
20191217825	JATAI	JT21226557	JATAI S1	03/12/2019 12:09	03/12/2019 16:59	03/12/2019 12:09	03/12/2019 16:59	4,83	1	4,83	CHI
20191217833	PORANGATU	840115787	PORANGATU	03/12/2019 12:10	03/12/2019 16:50	03/12/2019 12:10	03/12/2019 16:50	4,66	1	4,66	CHI
20191217844	CAMPO ALEGRE DE GOIAS	CM12252408	CAMPO ALEGRE DE GOIAS	03/12/2019 12:08	04/12/2019 00:03	03/12/2019 12:08	04/12/2019 00:03	11,91	4	47,63	CHI
20191217846	AGUA LIMPA	AL21000258	VILA CORUMBA	03/12/2019 12:12	03/12/2019 15:30	03/12/2019 12:12	03/12/2019 15:30	3,29	1	3,29	CHI
20191217847	BARRO ALTO	BA12210736	GOIANESIA S1	03/12/2019 06:27	03/12/2019 14:47	03/12/2019 06:27	03/12/2019 14:47	8,33	20	166,69	CHI
20191217849	ITUMBIARA	IT12249852	PARANAIBA	03/12/2019 12:12	03/12/2019 13:51	03/12/2019 12:12	03/12/2019 13:51	1,64	278	454,99	CHI
20191217852	LUZIANIA	LZ21261432	MARAJOARA	03/12/2019 12:13	03/12/2019 19:08	03/12/2019 12:13	03/12/2019 19:08	6,91	1	6,91	CHI
20191217858	NAZARIO	NZ21167280	ANICUNS	03/12/2019 12:13	03/12/2019 16:46	03/12/2019 12:13	03/12/2019 16:46	4,54	1	4,54	CHI
20191217863	ITAPIRAPUA	IU11293789	MATRINCHA	03/12/2019 11:36	03/12/2019 21:51	03/12/2019 11:36	03/12/2019 21:51	10,25	95	973,28	CHI
20191217866	NIQUELANDIA	NQ21262680	URUACU	03/12/2019 12:15	03/12/2019 15:52	03/12/2019 12:15	03/12/2019 15:52	3,61	1	3,61	CHI
20191217867	LUZIANIA	LZ11090126	RIO VERMELHO	03/12/2019 12:15	03/12/2019 15:47	03/12/2019 12:15	03/12/2019 15:47	3,53	66	233,00	CHI
20191217870	ABADIANIA	AA12382337	CORUMBA	03/12/2019 11:29	03/12/2019 13:03	03/12/2019 11:29	03/12/2019 13:03	1,55	41	63,75	CHI
20191217871	AGUA LIMPA	AL21316322	VILA CORUMBA	03/12/2019 12:15	03/12/2019 14:48	03/12/2019 12:15	03/12/2019 14:48	2,54	1	2,54	CHI
20191217873	SIMOLANDIA	SA21318333	IACIARA S2	03/12/2019 12:15	03/12/2019 23:07	03/12/2019 12:15	03/12/2019 23:07	10,86	3	32,57	CHI
20191217878	MINACU	IH12192297	MINACU	03/12/2019 12:16	03/12/2019 18:32	03/12/2019 12:16	03/12/2019 18:32	6,26	7	43,85	CHI
20191217881	GOIAS	IB12206778	ITABERAI S1	03/12/2019 12:16	03/12/2019 19:51	03/12/2019 12:16	03/12/2019 19:51	7,57	20	151,35	CHI
20191217883	PONTALINA	MI21033911	PONTALINA	03/12/2019 12:17	03/12/2019 19:31	03/12/2019 12:17	03/12/2019 19:31	7,23	1	7,23	CHI
20191217889	CALDAS NOVAS	760376578	SERRA DE CALDAS	03/12/2019 12:17	03/12/2019 16:10	03/12/2019 12:17	03/12/2019 16:10	3,87	1	3,87	CHI

20191217891	FLORES DE GOIAS	FB12071376	FLORES DE GOIAS	03/12/2019 12:17	04/12/2019 09:35	03/12/2019 12:17	04/12/2019 09:35	21,29	140	2980,95	CHI
20191217894	IPORA	IR12289241	IPORA	03/12/2019 08:24	03/12/2019 17:18	03/12/2019 08:24	03/12/2019 17:18	8,89	5	44,44	CHI
20191217904	PALMEIRAS DE GOIAS	PL21197870	PALMEIRAS	03/12/2019 12:20	03/12/2019 17:51	03/12/2019 12:20	03/12/2019 17:51	5,51	1	5,51	CHI
20191217910	ANAPOLIS	10002204264	JUNDIAI S1	03/12/2019 12:22	03/12/2019 14:06	03/12/2019 12:22	03/12/2019 14:06	1,72	1	1,72	CHI
20191217917	MOSSAMEDES	MD12024167	FIRMINOPOLIS S2	03/12/2019 12:06	03/12/2019 14:17	03/12/2019 12:06	03/12/2019 14:17	2,17	46	99,97	CHI
20191217917	SANCLERLANDIA	MD12024167	FIRMINOPOLIS S2	03/12/2019 12:06	03/12/2019 14:17	03/12/2019 12:06	03/12/2019 14:17	2,17	8	17,39	CHI
20191217928	JATAI	JT12205194	JATAI S1	03/12/2019 12:13	03/12/2019 14:49	03/12/2019 12:13	03/12/2019 14:49	2,60	7	18,19	CHI
20191217930	RIO VERDE	RV12159300	CABRIUVA S2	03/12/2019 12:25	03/12/2019 15:12	03/12/2019 12:25	03/12/2019 15:12	2,78	11	30,57	CHI
20191217932	COCALZINHO DE GOIAS	10002541988	AGUAS LINDAS DE GOIAS S2	03/12/2019 12:25	03/12/2019 14:14	03/12/2019 12:25	03/12/2019 14:14	1,80	1	1,80	CHI
20191217937	TRINDADE	TR11340682	TRINDADE	03/12/2019 12:26	03/12/2019 18:20	03/12/2019 12:26	03/12/2019 18:20	5,89	21	123,74	CHI
20191217941	SANTA FE DE GOIAS	RN12183381	BRITANIA	03/12/2019 12:26	04/12/2019 16:44	03/12/2019 12:26	04/12/2019 16:44	28,29	1	28,29	CHI
20191217942	GOIANIA	GN21345041	XAVANTES	03/12/2019 12:27	03/12/2019 15:12	03/12/2019 12:27	03/12/2019 15:12	2,76	1	2,76	CHI
20191217944	FAZENDA NOVA	FN12073782	IPORA	03/12/2019 11:43	03/12/2019 18:00	03/12/2019 11:43	03/12/2019 18:00	6,27	21	131,69	CHI
20191217944	ISRAELANDIA	FN12073782	IPORA	03/12/2019 11:43	03/12/2019 18:00	03/12/2019 11:43	03/12/2019 18:00	6,27	2	12,54	CHI
20191217948	CAIAPONIA	930006690	CAIAPONIA	03/12/2019 12:28	03/12/2019 16:43	03/12/2019 12:28	03/12/2019 16:43	4,24	1	4,24	CHI
20191217951	COCALZINHO DE GOIAS	ZN12297574	COCALZINHO	03/12/2019 12:28	03/12/2019 14:58	03/12/2019 12:28	03/12/2019 14:58	2,49	1	2,49	CHI
20191217951	CORUMBA DE GOIAS	ZN12297574	COCALZINHO	03/12/2019 12:28	03/12/2019 14:58	03/12/2019 12:28	03/12/2019 14:58	2,49	2	4,97	CHI
20191217961	SANTA BARBARA DE GOIAS	SB31005807	TRINDADE	03/12/2019 12:30	03/12/2019 15:23	03/12/2019 12:30	03/12/2019 15:23	2,88	2	5,76	CHI
20191217967	GOIANIA	GN12151986	MEIA PONTE	03/12/2019 12:31	03/12/2019 15:22	03/12/2019 12:31	03/12/2019 15:22	2,84	366	1041,17	CHI
20191217974	SANTA ROSA DE GOIAS	TQ12320364	INHUMAS S1	03/12/2019 11:09	04/12/2019 12:40	03/12/2019 11:09	04/12/2019 11:38	24,48	4	97,93	CHI
20191217974	TAQUARAL DE GOIAS	TQ12320364	INHUMAS S1	03/12/2019 11:09	04/12/2019 12:40	03/12/2019 11:09	04/12/2019 11:38	24,48	1	24,48	CHI
20191217974	JARAGUA	TQ13320365	INHUMAS S1	03/12/2019 11:09	04/12/2019 12:40	03/12/2019 11:09	04/12/2019 12:40	25,52	2	51,04	CHI
20191217974	SANTA ROSA DE GOIAS	TQ13320365	INHUMAS S1	03/12/2019 11:09	04/12/2019 12:40	03/12/2019 11:09	04/12/2019 12:40	25,52	16	408,33	CHI
20191217974	TAQUARAL DE GOIAS	TQ13320365	INHUMAS S1	03/12/2019 11:09	04/12/2019 12:40	03/12/2019 11:09	04/12/2019 12:40	25,52	18	459,37	CHI
20191217979	PLANALTINA	3890000664	PLANALTINA	03/12/2019 12:32	03/12/2019 16:28	03/12/2019 12:32	03/12/2019 16:28	3,94	1	3,94	CHI
20191217987	GOIANIA	10000271550	GOYA S1	03/12/2019 12:34	03/12/2019 14:29	03/12/2019 12:34	03/12/2019 14:29	1,92	1	1,92	CHI
20191217988	AMERICANO DO BRASIL	10002274130	ANICUNS	03/12/2019 12:34	03/12/2019 15:35	03/12/2019 12:34	03/12/2019 15:35	3,02	1	3,02	CHI
20191217990	JUSSARA	JR12259818	JUSSARA	03/12/2019 10:08	03/12/2019 17:55	03/12/2019 10:08	03/12/2019 17:55	7,77	2	15,54	CHI
20191217991	GOIANIRA	CK21015417	INHUMAS S1	03/12/2019 12:34	04/12/2019 10:37	03/12/2019 12:34	04/12/2019 10:37	22,04	1	22,04	CHI
20191217992	CAMPOS VERDES	VD12390493	SANTA TEREZINHA	03/12/2019 12:34	04/12/2019 22:16	03/12/2019 12:34	04/12/2019 22:16	33,69	11	370,59	CHI
20191217992	MARA ROSA	VD12390493	SANTA TEREZINHA	03/12/2019 12:34	04/12/2019 22:16	03/12/2019 12:34	04/12/2019 22:16	33,69	2	67,38	CHI
20191217993	PALMEIRAS DE GOIAS	PL12046351	PALMEIRAS	03/12/2019 12:32	03/12/2019 16:25	03/12/2019 12:32	03/12/2019 16:25	3,88	4	15,52	CHI
20191218000	ALEXANIA	AX12221351	ALEXANIA	03/12/2019 12:01	03/12/2019 14:22	03/12/2019 12:01	03/12/2019 14:22	2,34	221	518,00	CHI

20191218002	FIRMINOPOLIS	FR12061354	FIRMINOPOLIS S1	03/12/2019 10:20	03/12/2019 18:57	03/12/2019 10:20	03/12/2019 18:57	8,61	20	172,23	CHI
20191218017	FORMOSA	FA21304080	ITUIQUIRA	03/12/2019 12:42	03/12/2019 13:17	03/12/2019 12:42	03/12/2019 13:17	0,58	1	0,58	CHI
20191218020	CALDAS NOVAS	CN12110281	CALDAS NOVAS S1	03/12/2019 12:42	03/12/2019 16:00	03/12/2019 12:42	03/12/2019 16:00	3,29	17	55,91	CHI
20191218023	CAIAPONIA	930013281	CAIAPONIA	03/12/2019 12:43	05/12/2019 12:00	03/12/2019 12:43	05/12/2019 12:00	47,28	1	47,28	CHI
20191218026	GOIANIRA	390084736	MEIA PONTE	03/12/2019 12:44	03/12/2019 15:32	03/12/2019 12:44	03/12/2019 15:32	2,80	1	2,80	CHI
20191218033	PALMINOPOLIS	1340010012	PALMEIRAS	03/12/2019 12:45	03/12/2019 14:20	03/12/2019 12:45	03/12/2019 14:20	1,58	1	1,58	CHI
20191218036	PARANAIGUARA	QJ12279808	QUIRINOPOLIS	03/12/2019 12:45	03/12/2019 15:36	03/12/2019 12:45	03/12/2019 15:36	2,85	44	125,49	CHI
20191218036	QUIRINOPOLIS	QI12279808	QUIRINOPOLIS	03/12/2019 12:45	03/12/2019 15:36	03/12/2019 12:45	03/12/2019 15:36	2,85	63	179,67	CHI
20191218040	MAURILANDIA	ML21326731	RIO DOS BOIS	03/12/2019 12:46	03/12/2019 17:30	03/12/2019 12:46	03/12/2019 17:30	4,73	1	4,73	CHI
20191218041	COLINAS DO SUL	TI12170026	MINACU	03/12/2019 12:46	03/12/2019 14:52	03/12/2019 12:46	03/12/2019 14:52	2,10	6	12,59	CHI
20191218045	LUZIANIA	10017229250	RIO VERMELHO	03/12/2019 12:46	03/12/2019 16:50	03/12/2019 12:46	03/12/2019 16:50	4,07	1	4,07	CHI
20191218046	PIRES DO RIO	PR21207688	PIRES DO RIO S1	03/12/2019 12:47	03/12/2019 12:57	03/12/2019 12:47	03/12/2019 12:57	0,16	2	0,33	CHI
20191218049	GOIANIA	10011783344	GOIANIA LESTE S1	03/12/2019 12:47	03/12/2019 14:14	03/12/2019 12:47	03/12/2019 14:14	1,44	1	1,44	CHI
20191218055	LUZIANIA	120424009	RIO VERMELHO	03/12/2019 12:48	03/12/2019 16:20	03/12/2019 12:48	03/12/2019 16:20	3,52	1	3,52	CHI
20191218057	RIO VERDE	RV21279862	CABRIUVA S2	03/12/2019 12:49	03/12/2019 15:36	03/12/2019 12:49	03/12/2019 15:36	2,78	1	2,78	CHI
20191218060	ALEXANIA	AX12382324	ALEXANIA	03/12/2019 12:49	04/12/2019 10:01	03/12/2019 12:49	04/12/2019 10:01	21,19	5	105,94	CHI
20191218071	DOVERLANDIA	MY12219553	PARQUE DAS EMAS	04/12/2019 06:19	04/12/2019 11:29	04/12/2019 06:19	04/12/2019 11:29	5,16	46	237,40	CHI
20191218072	BARRO ALTO	10000527678	GOIANESIA S1	03/12/2019 12:52	04/12/2019 16:10	03/12/2019 12:52	04/12/2019 16:10	27,31	1	27,31	CHI
20191218073	GOIANESIA	550048583	GOIANESIA S2	03/12/2019 12:52	04/12/2019 10:27	03/12/2019 12:52	04/12/2019 10:27	21,58	1	21,58	CHI
20191218076	NIQUELANDIA	NQ21342840	NIQUELANDIA SUBTRANSMISSAO	03/12/2019 12:53	04/12/2019 08:28	03/12/2019 12:53	04/12/2019 08:28	19,58	1	19,58	CHI
20191218085	SAO FRANCISCO DE GOIAS	SF12297998	SAO FRANCISCO DE GOIAS	03/12/2019 10:01	04/12/2019 10:35	03/12/2019 10:01	03/12/2019 20:13	10,20	85	866,76	CHI
20191218085	SAO FRANCISCO DE GOIAS	SF12297998	SAO FRANCISCO DE GOIAS	03/12/2019 10:01	04/12/2019 10:35	03/12/2019 21:14	04/12/2019 10:35	13,35	35	467,25	CHI
20191218088	COCALZINHO DE GOIAS	PB13248699	PADRE BERNARDO	03/12/2019 12:55	03/12/2019 21:50	03/12/2019 12:55	03/12/2019 21:50	8,91	24	213,92	CHI
20191218088	DISTRITO FEDERAL	PB13248699	PADRE BERNARDO	03/12/2019 12:55	03/12/2019 21:50	03/12/2019 12:55	03/12/2019 21:50	8,91	3	26,74	CHI
20191218088	PADRE BERNARDO	PB13248699	PADRE BERNARDO	03/12/2019 12:55	03/12/2019 21:50	03/12/2019 12:55	03/12/2019 21:50	8,91	666	5936,28	CHI
20191218088	PADRE BERNARDO	PB13248699	PADRE BERNARDO	03/12/2019 12:55	03/12/2019 21:50	03/12/2019 21:17	03/12/2019 21:50	0,55	0	0,00	CHI
20191218091	IPORA	IR12374853	IPORA	03/12/2019 12:56	04/12/2019 12:30	03/12/2019 12:56	04/12/2019 12:30	23,56	2	47,12	CHI
20191218093	BURITI ALEGRE	BG12257085	ITUMBIARA VELHA S2	03/12/2019 12:56	04/12/2019 20:47	03/12/2019 12:56	04/12/2019 20:47	31,84	5	159,20	CHI
20191218093	ITUMBIARA	BG12257085	ITUMBIARA VELHA S2	03/12/2019 12:56	04/12/2019 20:47	03/12/2019 12:56	04/12/2019 20:47	31,84	4	127,36	CHI
20191218103	QUIRINOPOLIS	QI21371247	QUIRINOPOLIS	03/12/2019 12:58	04/12/2019 11:40	03/12/2019 12:58	04/12/2019 11:40	22,70	1	22,70	CHI
20191218104	CORUMBAIBA	CI21112873	VILA CORUMBA	03/12/2019 12:58	03/12/2019 15:55	03/12/2019 12:58	03/12/2019 15:55	2,95	1	2,95	CHI
20191218107	HIDROLANDIA	HD31240955	CEPAIGO S2	03/12/2019 12:58	04/12/2019 08:17	03/12/2019 12:58	04/12/2019 08:17	19,31	1	19,31	CHI
20191218114	SAO LUIS DE MONTES BELOS	SL21145905	SAO LUIZ DOS MONTES BELOS	03/12/2019 12:59	04/12/2019 10:17	03/12/2019 12:59	04/12/2019 10:17	21,30	1	21,30	CHI

20191218115	ITAGUARI	IC21038254	ITABERAI S1	03/12/2019 12:59	03/12/2019 18:13	03/12/2019 12:59	03/12/2019 18:13	5,22	2	10,44	CHI
20191218119	SAO MIGUEL DO ARAGUAIA	SM21315126	SAO MIGUEL DO ARAGUAIA	03/12/2019 13:00	04/12/2019 02:27	03/12/2019 13:00	04/12/2019 02:27	13,45	1	13,45	CHI
20191218123	GOIAS	GS12307383	GOIAS	03/12/2019 11:48	03/12/2019 14:46	03/12/2019 11:48	03/12/2019 14:46	2,96	10	29,64	CHI
20191218130	GOIANIA	TR32050493	TRINDADE	03/12/2019 12:59	03/12/2019 15:54	03/12/2019 12:59	03/12/2019 15:54	2,90	8	23,21	CHI
20191218132	PORTELANDIA	PW21301981	PARQUE DAS EMAS	03/12/2019 13:02	04/12/2019 14:37	03/12/2019 13:02	04/12/2019 14:37	25,59	1	25,59	CHI
20191218138	GUAPO	GA12045522	GUAPO S2	03/12/2019 13:02	03/12/2019 21:40	03/12/2019 13:02	03/12/2019 21:40	8,62	1	8,62	CHI
20191218138	VARJAO	GA12045522	GUAPO S2	03/12/2019 13:02	03/12/2019 21:40	03/12/2019 13:02	03/12/2019 21:40	8,62	1	8,62	CHI
20191218143	SILVANIA	SV12243204	CEPAIGO S2	03/12/2019 12:57	03/12/2019 22:00	03/12/2019 12:57	03/12/2019 22:00	9,04	6	54,26	CHI
20191218144	BALIZA	BH12331359	CAIAPONIA	03/12/2019 13:03	03/12/2019 16:56	03/12/2019 13:03	03/12/2019 16:56	3,87	3	11,62	CHI
20191218145	URUACU	UR12364064	URUACU	03/12/2019 12:41	05/12/2019 12:50	01/12/2019 20:28	03/12/2019 17:00	44,55	6	267,29	CHI
20191218145	URUACU	UR12342129	URUACU	03/12/2019 12:41	05/12/2019 12:50	01/12/2019 20:28	03/12/2019 21:44	49,27	34	1675,09	CHI
20191218145	URUACU	UR12342129	URUACU	03/12/2019 12:41	05/12/2019 12:50	01/12/2019 20:28	03/12/2019 23:26	50,98	6	305,86	CHI
20191218145	URUACU	UR12342129	URUACU	03/12/2019 12:41	05/12/2019 12:50	01/12/2019 20:28	04/12/2019 02:11	53,72	98	5264,97	CHI
20191218145	URUACU	UR12342129	URUACU	03/12/2019 12:41	05/12/2019 12:50	01/12/2019 20:28	04/12/2019 02:48	54,34	2	108,68	CHI
20191218145	URUACU	UR12342129	URUACU	03/12/2019 12:41	05/12/2019 12:50	01/12/2019 20:28	04/12/2019 13:53	65,43	7	458,03	CHI
20191218145	URUACU	UR12342129	URUACU	03/12/2019 12:41	05/12/2019 12:50	04/12/2019 15:02	04/12/2019 17:33	2,51	23	57,67	CHI
20191218145	URUACU	UR12256445	URUACU	03/12/2019 12:41	05/12/2019 12:50	04/12/2019 15:02	04/12/2019 17:45	2,71	11	29,78	CHI
20191218145	URUACU	UR13364066	URUACU	03/12/2019 12:41	05/12/2019 12:50	04/12/2019 15:02	04/12/2019 19:00	3,97	6	23,80	CHI
20191218145	URUACU	UR12374576LD	URUACU	03/12/2019 12:41	05/12/2019 12:50	04/12/2019 15:02	04/12/2019 22:16	7,23	107	773,43	CHI
20191218145	URUACU	UR12342129	URUACU	03/12/2019 12:41	05/12/2019 12:50	01/12/2019 20:28	05/12/2019 12:50	88,37	29	2562,63	CHI
20191218150	FLORES DE GOIAS	04920406	SAO JOAO D ALIANCA	03/12/2019 13:04	04/12/2019 17:09	03/12/2019 13:04	03/12/2019 19:52	6,79	6	40,77	CHI
20191218150	FORMOSA	04920406	SAO JOAO D ALIANCA	03/12/2019 13:04	04/12/2019 17:09	03/12/2019 13:04	03/12/2019 19:52	6,79	418	2840,19	CHI
20191218150	SAO JOAO D ALIANCA	04920406	SAO JOAO D ALIANCA	03/12/2019 13:04	04/12/2019 17:09	03/12/2019 13:04	03/12/2019 19:52	6,79	19	129,10	CHI
20191218150	FORMOSA	04920406	SAO JOAO D ALIANCA	03/12/2019 13:04	04/12/2019 17:09	03/12/2019 13:04	04/12/2019 00:11	11,11	386	4289,10	CHI
20191218150	FORMOSA	FA32042668	SAO JOAO D ALIANCA	03/12/2019 13:04	04/12/2019 17:09	03/12/2019 13:04	04/12/2019 15:53	26,81	1	26,81	CHI
20191218150	FORMOSA	FA12049293LD	SAO JOAO D ALIANCA	03/12/2019 13:04	04/12/2019 17:09	03/12/2019 13:04	04/12/2019 17:09	28,08	2	56,16	CHI
20191218152	PALMINOPOLIS	RP12259184	FIRMINOPOLIS S2	03/12/2019 13:04	04/12/2019 14:12	03/12/2019 13:04	04/12/2019 14:12	25,14	2	50,27	CHI
20191218152	SAO JOAO DA PARAUNA	RP12259184	FIRMINOPOLIS S2	03/12/2019 13:04	04/12/2019 14:12	03/12/2019 13:04	04/12/2019 14:12	25,14	6	150,82	CHI
20191218159	BELA VISTA DE GOIAS	HD12323100	CEPAIGO S2	03/12/2019 10:33	03/12/2019 15:40	03/12/2019 10:33	03/12/2019 15:40	5,11	8	40,88	CHI
20191218159	HIDROLANDIA	HD12323100	CEPAIGO S2	03/12/2019 10:33	03/12/2019 15:40	03/12/2019 10:33	03/12/2019 15:40	5,11	98	500,78	CHI
20191218164	FIRMINOPOLIS	FR12096971	FIRMINOPOLIS S1	03/12/2019 06:46	03/12/2019 15:35	03/12/2019 06:46	03/12/2019 15:35	8,81	2	17,61	CHI
20191218166	SANCLERLANDIA	SC12206496	FIRMINOPOLIS S2	03/12/2019 13:05	03/12/2019 15:57	03/12/2019 13:05	03/12/2019 15:57	2,86	14	40,00	CHI
20191218168	GOIANIA	GN12059752	GOYA S1	03/12/2019 12:32	03/12/2019 14:17	03/12/2019 12:32	03/12/2019 14:17	1,74	70	121,72	CHI

20191218169	SAO MIGUEL DO ARAGUAIA	SM21132263	SAO MIGUEL DO ARAGUAIA	03/12/2019 13:05	03/12/2019 16:46	03/12/2019 13:05	03/12/2019 16:46	3,67	1	3,67	CHI
20191218175	CRISTALINA	KR12351414	PAMPLONA	03/12/2019 13:06	04/12/2019 13:09	03/12/2019 13:06	04/12/2019 13:09	24,04	6	144,24	CHI
20191218179	ARUANA	AK12184500	ARUANA	03/12/2019 13:07	04/12/2019 17:50	03/12/2019 13:07	04/12/2019 17:50	28,72	3	86,16	CHI
20191218180	SANTA FE DE GOIAS	RN12167540	BRITANIA	03/12/2019 13:00	04/12/2019 11:30	03/12/2019 13:00	04/12/2019 11:30	22,49	2	44,98	CHI
20191218187	CASTELANDIA	ML12271556	RIO DOS BOIS	03/12/2019 12:29	03/12/2019 22:20	03/12/2019 12:29	03/12/2019 22:20	9,84	20	196,77	CHI
20191218187	MAURILANDIA	ML12271556	RIO DOS BOIS	03/12/2019 12:29	03/12/2019 22:20	03/12/2019 12:29	03/12/2019 22:20	9,84	9	88,55	CHI
20191218187	RIO VERDE	ML12271556	RIO DOS BOIS	03/12/2019 12:29	03/12/2019 22:20	03/12/2019 12:29	03/12/2019 22:20	9,84	20	196,77	CHI
20191218190	BELA VISTA DE GOIAS	BV12000046	CEPAIGO S2	03/12/2019 12:34	03/12/2019 22:48	03/12/2019 12:34	03/12/2019 22:48	10,23	22	225,07	CHI
20191218192	ANAPOLIS	LB10406649	DAIA S2	03/12/2019 12:58	03/12/2019 18:26	03/12/2019 12:58	03/12/2019 13:02	0,07	2	0,14	CHI
20191218192	LEOPOLDO DE BULHOES	LB10406649	DAIA S2	03/12/2019 12:58	03/12/2019 18:26	03/12/2019 12:58	03/12/2019 13:02	0,07	21	1,43	CHI
20191218192	SILVANIA	LB10406649	DAIA S2	03/12/2019 12:58	03/12/2019 18:26	03/12/2019 12:58	03/12/2019 13:02	0,07	14	0,95	CHI
20191218192	ANAPOLIS	00030414	DAIA S2	03/12/2019 12:58	03/12/2019 18:26	03/12/2019 12:58	03/12/2019 17:06	4,14	13	53,80	CHI
20191218192	ANAPOLIS	AN13383406B	DAIA S2	03/12/2019 12:58	03/12/2019 18:26	03/12/2019 13:01	03/12/2019 17:06	4,09	2	8,19	CHI
20191218192	ANAPOLIS	00030414	DAIA S2	03/12/2019 12:58	03/12/2019 18:26	03/12/2019 12:58	03/12/2019 18:00	5,04	1	5,04	CHI
20191218192	GAMELEIRA DE GOIAS	00030414	DAIA S2	03/12/2019 12:58	03/12/2019 18:26	03/12/2019 12:58	03/12/2019 18:00	5,04	6	30,21	CHI
20191218192	SILVANIA	00030414	DAIA S2	03/12/2019 12:58	03/12/2019 18:26	03/12/2019 12:58	03/12/2019 18:00	5,04	1	5,04	CHI
20191218192	GAMELEIRA DE GOIAS	AN13155298	DAIA S2	03/12/2019 12:58	03/12/2019 18:26	03/12/2019 13:01	03/12/2019 18:00	4,99	1	4,99	CHI
20191218192	ABADIANIA	00030414	DAIA S2	03/12/2019 12:58	03/12/2019 18:26	03/12/2019 12:58	03/12/2019 18:20	5,36	4	21,44	CHI
20191218192	ABADIANIA	00030414	DAIA S2	03/12/2019 12:58	03/12/2019 18:26	03/12/2019 12:58	03/12/2019 18:20	5,36	2	10,72	CHI
20191218192	ABADIANIA	00030414	DAIA S2	03/12/2019 12:58	03/12/2019 18:26	03/12/2019 12:58	03/12/2019 18:20	5,36	137	734,28	CHI
20191218192	ABADIANIA	00030414	DAIA S2	03/12/2019 12:58	03/12/2019 18:26	03/12/2019 12:58	03/12/2019 18:20	5,36	1	5,36	CHI
20191218192	ANAPOLIS	00030414	DAIA S2	03/12/2019 12:58	03/12/2019 18:26	03/12/2019 12:58	03/12/2019 18:20	5,36	3	16,08	CHI
20191218192	BELA VISTA DE GOIAS	00030414	DAIA S2	03/12/2019 12:58	03/12/2019 18:26	03/12/2019 12:58	03/12/2019 18:20	5,36	1	5,36	CHI
20191218192	GAMELEIRA DE GOIAS	00030414	DAIA S2	03/12/2019 12:58	03/12/2019 18:26	03/12/2019 12:58	03/12/2019 18:20	5,36	972	5209,65	CHI
20191218192	GAMELEIRA DE GOIAS	00030414	DAIA S2	03/12/2019 12:58	03/12/2019 18:26	03/12/2019 12:58	03/12/2019 18:20	5,36	157	841,48	CHI
20191218192	GAMELEIRA DE GOIAS	00030414	DAIA S2	03/12/2019 12:58	03/12/2019 18:26	03/12/2019 12:58	03/12/2019 18:20	5,36	1	5,36	CHI
20191218192	GAMELEIRA DE GOIAS	00030414	DAIA S2	03/12/2019 12:58	03/12/2019 18:26	03/12/2019 12:58	03/12/2019 18:20	5,36	5	26,80	CHI
20191218192	GAMELEIRA DE GOIAS	SV13122460	DAIA S2	03/12/2019 12:58	03/12/2019 18:26	03/12/2019 12:58	03/12/2019 18:20	5,36	218	1168,42	CHI
20191218192	SILVANIA	00030414	DAIA S2	03/12/2019 12:58	03/12/2019 18:26	03/12/2019 12:58	03/12/2019 18:20	5,36	355	1902,70	CHI
20191218192	GAMELEIRA DE GOIAS	SV12013378	DAIA S2	03/12/2019 12:58	03/12/2019 18:26	03/12/2019 17:10	03/12/2019 18:20	1,17	6	7,00	CHI
20191218192	GAMELEIRA DE GOIAS	SV12013378	DAIA S2	03/12/2019 12:58	03/12/2019 18:26	03/12/2019 12:58	03/12/2019 18:26	5,47	5	27,34	CHI
20191218197	PLANALTINA	PI12099511	PLANALTINA	03/12/2019 12:40	04/12/2019 09:02	03/12/2019 12:40	04/12/2019 09:02	20,37	17	346,22	CHI
20191218199	ANAPOLIS	AN12221522	JUNDIAI S2	03/12/2019 13:09	05/12/2019 12:43	03/12/2019 13:09	05/12/2019 12:43	47,56	5	237,81	CHI

20191218229	CRIXAS	CX12345437	SERRA DO OURO	03/12/2019 13:05	04/12/2019 13:01	03/12/2019 13:05	04/12/2019 13:01	23,92	2	47,84	CHI
20191218239	PLANALTINA	PI12329738LD	PLANALTINA	03/12/2019 13:59	03/12/2019 15:28	03/12/2019 13:59	03/12/2019 15:28	1,47	10	14,68	CHI
20191218252	BURITINOPOLIS	SU13273995	SANTA RITA DO ARAGUAIA	03/12/2019 14:25	04/12/2019 20:41	03/12/2019 14:25	03/12/2019 15:27	1,02	1	1,02	CHI
20191218252	MINEIROS	SU13273995	SANTA RITA DO ARAGUAIA	03/12/2019 14:25	04/12/2019 20:41	03/12/2019 14:25	03/12/2019 15:27	1,02	11	11,25	CHI
20191218252	SANTA RITA DO ARAGUAIA	SU13273995	SANTA RITA DO ARAGUAIA	03/12/2019 14:25	04/12/2019 20:41	03/12/2019 14:25	03/12/2019 15:27	1,02	1181	1207,90	CHI
20191218252	MINEIROS	SU13191740	SANTA RITA DO ARAGUAIA	03/12/2019 14:25	04/12/2019 20:41	03/12/2019 14:25	03/12/2019 15:28	1,05	31	32,63	CHI
20191218252	SANTA RITA DO ARAGUAIA	SU13191740	SANTA RITA DO ARAGUAIA	03/12/2019 14:25	04/12/2019 20:41	03/12/2019 14:25	03/12/2019 15:28	1,05	2008	2113,42	CHI
20191218252	MINEIROS	02610424	PARQUE DAS EMAS	03/12/2019 14:25	04/12/2019 20:41	03/12/2019 14:25	03/12/2019 18:02	3,61	24	86,75	CHI
20191218252	PORTELANDIA	02610424	PARQUE DAS EMAS	03/12/2019 14:25	04/12/2019 20:41	03/12/2019 14:25	03/12/2019 18:02	3,61	9	32,53	CHI
20191218252	MINEIROS	MY13301880	PARQUE DAS EMAS	03/12/2019 14:25	04/12/2019 20:41	03/12/2019 14:25	03/12/2019 19:42	5,28	39	205,76	CHI
20191218252	PORTELANDIA	MY13301880	PARQUE DAS EMAS	03/12/2019 14:25	04/12/2019 20:41	03/12/2019 14:25	03/12/2019 19:42	5,28	2	10,55	CHI
20191218252	MINEIROS	02610424	PARQUE DAS EMAS	03/12/2019 14:25	04/12/2019 20:41	04/12/2019 08:20	04/12/2019 08:59	0,65	64	41,64	CHI
20191218252	PORTELANDIA	02610424	PARQUE DAS EMAS	03/12/2019 14:25	04/12/2019 20:41	04/12/2019 08:20	04/12/2019 08:59	0,65	12	7,81	CHI
20191218252	MINEIROS	MY13377953	PARQUE DAS EMAS	03/12/2019 14:25	04/12/2019 20:41	03/12/2019 14:25	04/12/2019 14:04	23,64	5	118,20	CHI
20191218252	MINEIROS	SU12184127	SANTA RITA DO ARAGUAIA	03/12/2019 14:25	04/12/2019 20:41	04/12/2019 19:16	04/12/2019 20:41	1,40	14	19,65	CHI
20191218270	CACU	00270444	CACHOEIRA ALTA	03/12/2019 15:02	05/12/2019 21:25	03/12/2019 15:02	03/12/2019 17:23	2,34	60	140,23	CHI
20191218270	ITAJA	00270444	CACHOEIRA ALTA	03/12/2019 15:02	05/12/2019 21:25	03/12/2019 15:02	03/12/2019 17:23	2,34	19	44,41	CHI
20191218270	ITARUMA	00270444	CACHOEIRA ALTA	03/12/2019 15:02	05/12/2019 21:25	03/12/2019 15:02	03/12/2019 17:23	2,34	2248	5254,08	CHI
20191218270	ITARUMA	00270444	CACHOEIRA ALTA	03/12/2019 15:02	05/12/2019 21:25	03/12/2019 15:02	03/12/2019 17:23	2,34	112	261,77	CHI
20191218270	JATAI	00270444	CACHOEIRA ALTA	03/12/2019 15:02	05/12/2019 21:25	03/12/2019 15:02	03/12/2019 17:23	2,34	32	74,79	CHI
20191218270	SERRANOPOLIS	00270444	CACHOEIRA ALTA	03/12/2019 15:02	05/12/2019 21:25	03/12/2019 15:02	03/12/2019 17:23	2,34	49	114,52	CHI
20191218270	CACHOEIRA ALTA	00270444	CACHOEIRA ALTA	03/12/2019 15:02	05/12/2019 21:25	03/12/2019 15:02	03/12/2019 17:50	2,80	16	44,72	CHI
20191218270	CACU	00270444	CACHOEIRA ALTA	03/12/2019 15:02	05/12/2019 21:25	03/12/2019 15:02	03/12/2019 17:50	2,80	150	419,25	CHI
20191218270	CACHOEIRA ALTA	00270444	CACHOEIRA ALTA	03/12/2019 15:02	05/12/2019 21:25	03/12/2019 17:51	03/12/2019 18:29	0,64	16	10,25	CHI
20191218270	CACU	00270444	CACHOEIRA ALTA	03/12/2019 15:02	05/12/2019 21:25	03/12/2019 17:51	03/12/2019 18:29	0,64	50	32,03	CHI
20191218270	ITARUMA	IM13360893	CACHOEIRA ALTA	03/12/2019 15:02	05/12/2019 21:25	03/12/2019 15:02	04/12/2019 09:33	18,52	13	240,72	CHI
20191218270	CACU	CC13082114	CACHOEIRA ALTA	03/12/2019 15:02	05/12/2019 21:25	03/12/2019 17:51	05/12/2019 21:25	51,56	100	5155,92	CHI
20191218273	APARECIDA DE GOIANIA	AP10378543	CARAJAS S1	03/12/2019 15:07	04/12/2019 01:13	03/12/2019 15:07	03/12/2019 16:28	1,35	1979	2680,45	CHI
20191218273	APARECIDA DE GOIANIA	AP10378543	CARAJAS S1	03/12/2019 15:07	04/12/2019 01:13	03/12/2019 15:07	04/12/2019 01:13	10,09	2	20,18	CHI
20191218289	TRINDADE	TR11000016	TRINDADE	03/12/2019 15:49	03/12/2019 17:40	03/12/2019 15:49	03/12/2019 17:40	1,84	53	97,56	CHI
20191218302	ANICUNS	910043875	ANICUNS	03/12/2019 13:09	03/12/2019 19:41	03/12/2019 13:09	03/12/2019 19:41	6,52	1	6,52	CHI
20191218303	COCALZINHO DE GOIAS	ZN21063259	AGUAS LINDAS DE GOIAS S2	03/12/2019 13:10	03/12/2019 14:25	03/12/2019 13:10	03/12/2019 14:25	1,25	1	1,25	CHI
20191218305	GOIANIA	15838961	GOYA S2	03/12/2019 13:10	03/12/2019 15:46	03/12/2019 13:10	03/12/2019 15:46	2,59	1	2,59	CHI

20191218308	ITAPIRAPUA	IU12030155	JUSSARA	03/12/2019 11:40	04/12/2019 11:25	03/12/2019 11:40	04/12/2019 11:25	23,75	42	997,47	CHI
20191218308	NOVO BRASIL	IU12030155	JUSSARA	03/12/2019 11:40	04/12/2019 11:25	03/12/2019 11:40	04/12/2019 11:25	23,75	1	23,75	CHI
20191218314	ITUMBIARA	IT11366594	ITUMBIARA NOVA	03/12/2019 12:54	03/12/2019 15:05	03/12/2019 12:54	03/12/2019 15:05	2,19	51	111,80	CHI
20191218316	LUZIANIA	LZ21192762	VIANOPOLIS	03/12/2019 13:11	03/12/2019 16:06	03/12/2019 13:11	03/12/2019 16:06	2,91	2	5,83	CHI
20191218324	INACIOLANDIA	ID12361052	QUIRINOPOLIS	03/12/2019 13:12	03/12/2019 15:40	03/12/2019 13:12	03/12/2019 15:40	2,46	4	9,86	CHI
20191218324	ITUMBIARA	ID12361052	QUIRINOPOLIS	03/12/2019 13:12	03/12/2019 15:40	03/12/2019 13:12	03/12/2019 15:40	2,46	1	2,46	CHI
20191218331	SANTA CRUZ DE GOIAS	3570010063	PIRES DO RIO S2	03/12/2019 13:13	03/12/2019 17:32	03/12/2019 13:13	03/12/2019 17:32	4,31	1	4,31	CHI
20191218333	ITUMBIARA	10023012585	PARANAIBA	03/12/2019 13:14	03/12/2019 23:37	03/12/2019 13:14	03/12/2019 23:37	10,38	1	10,38	CHI
20191218346	ABADIANIA	AA12295520	ANAPOLIS UNIVERSITARIO S1	03/12/2019 13:16	03/12/2019 16:02	03/12/2019 13:16	03/12/2019 16:02	2,76	6	16,56	CHI
20191218351	VARJAO	10021212994	GUAPO S2	03/12/2019 13:17	03/12/2019 19:23	03/12/2019 13:17	03/12/2019 19:23	6,10	1	6,10	CHI
20191218359	ITUMBIARA	IT12046634	ITUMBIARA NOVA	03/12/2019 13:18	03/12/2019 13:50	03/12/2019 13:18	03/12/2019 13:50	0,53	116	60,96	CHI
20191218363	VIANOPOLIS	VN21107933	VIANOPOLIS	03/12/2019 13:18	04/12/2019 00:32	03/12/2019 13:18	04/12/2019 00:32	11,22	1	11,22	CHI
20191218364	PALESTINA DE GOIAS	PY21345510	ARENOPOLIS	03/12/2019 13:18	04/12/2019 10:46	03/12/2019 13:18	04/12/2019 10:46	21,45	1	21,45	CHI
20191218376	TEREZOPOLIS DE GOIAS	1370015980	DAIA S2	03/12/2019 13:19	03/12/2019 16:20	03/12/2019 13:19	03/12/2019 16:20	3,02	1	3,02	CHI
20191218377	SAO JOAO D ALIANCA	10011941241	SAO JOAO D ALIANCA	03/12/2019 13:21	03/12/2019 16:24	03/12/2019 13:21	03/12/2019 16:24	3,07	1	3,07	CHI
20191218379	VILA PROPICIO	NP11228703	GOIANESIA S1	03/12/2019 13:20	04/12/2019 03:03	03/12/2019 13:20	04/12/2019 03:03	13,71	1	13,71	CHI
20191218381	ANICUNS	AC21289746	ANICUNS	03/12/2019 13:21	04/12/2019 02:04	03/12/2019 13:21	04/12/2019 02:04	12,71	1	12,71	CHI
20191218387	LUZIANIA	LZ12396833	MARAJOARA	03/12/2019 13:22	04/12/2019 08:42	03/12/2019 13:22	04/12/2019 08:42	19,32	18	347,79	CHI
20191218388	GOIANIA	16800485	CAMPINAS S3	03/12/2019 13:22	03/12/2019 16:59	03/12/2019 13:22	03/12/2019 16:59	3,60	1	3,60	CHI
20191218395	VALPARAISO DE GOIAS	10004562990	MARAJOARA	03/12/2019 13:24	03/12/2019 19:41	03/12/2019 13:24	03/12/2019 19:41	6,28	1	6,28	CHI
20191218402	ARUANA	MZ13310703	MOZARLANDIA	03/12/2019 12:53	04/12/2019 00:07	03/12/2019 19:35	03/12/2019 23:43	4,15	95	393,99	CHI
20191218402	ARUANA	AK12307445	MOZARLANDIA	03/12/2019 12:53	04/12/2019 00:07	03/12/2019 12:53	04/12/2019 00:07	11,23	12	134,77	CHI
20191218403	ALTO HORIZONTE	9640004382	SANTA TEREZINHA	03/12/2019 13:24	03/12/2019 16:29	03/12/2019 13:24	03/12/2019 16:29	3,07	1	3,07	CHI
20191218411	NAZARIO	440001092	ANICUNS	03/12/2019 13:26	03/12/2019 16:00	03/12/2019 13:26	03/12/2019 16:00	2,56	1	2,56	CHI
20191218415	NOVA AURORA	NE12127530	CATALAO S1	03/12/2019 13:27	03/12/2019 16:10	03/12/2019 13:27	03/12/2019 16:10	2,71	178	482,03	CHI
20191218416	COCALZINHO DE GOIAS	ZN21185715	COCALZINHO	03/12/2019 13:27	04/12/2019 05:09	03/12/2019 13:27	04/12/2019 05:09	15,69	1	15,69	CHI
20191218417	APARECIDA DE GOIANIA	10000880769	INDEPENDENCIA S2	03/12/2019 13:27	03/12/2019 15:39	03/12/2019 13:27	03/12/2019 15:39	2,19	1	2,19	CHI
20191218418	MINEIROS	01140434	PARQUE DAS EMAS	03/12/2019 13:18	03/12/2019 13:35	03/12/2019 13:18	03/12/2019 13:31	0,22	42	9,28	CHI
20191218418	MINEIROS	01140434	PARQUE DAS EMAS	03/12/2019 13:18	03/12/2019 13:35	03/12/2019 13:18	03/12/2019 13:35	0,28	23	6,49	CHI
20191218419	COLINAS DO SUL	TI11116081	MINACU	03/12/2019 13:28	03/12/2019 15:41	03/12/2019 13:28	03/12/2019 15:41	2,21	57	126,08	CHI
20191218420	PEROLANDIA	MY12324350	PARQUE DAS EMAS	03/12/2019 13:28	03/12/2019 16:20	03/12/2019 13:28	03/12/2019 16:20	2,86	2	5,72	CHI
20191218423	SAO MIGUEL DO ARAGUAIA	SM12334354	SAO MIGUEL DO ARAGUAIA	03/12/2019 13:28	03/12/2019 17:45	03/12/2019 13:28	03/12/2019 17:45	4,27	1	4,27	CHI
20191218426	SAO LUIS DE MONTES BELOS	SL12125680	FIRMINOPOLIS S1	03/12/2019 07:10	03/12/2019 19:27	03/12/2019 07:10	03/12/2019 19:27	12,28	6	73,67	CHI

20191218432	MORRINHOS	MR21112462	MORRINHOS	03/12/2019 13:29	03/12/2019 15:10	03/12/2019 13:29	03/12/2019 15:10	1,68	1	1,68	CHI
20191218433	PIRES DO RIO	PR12337227	PIRES DO RIO S1	03/12/2019 13:29	03/12/2019 19:48	03/12/2019 13:29	03/12/2019 19:48	6,30	39	245,88	CHI
20191218433	SANTA CRUZ DE GOIAS	PR12337227	PIRES DO RIO S1	03/12/2019 13:29	03/12/2019 19:48	03/12/2019 13:29	03/12/2019 19:48	6,30	1	6,30	CHI
20191218438	PLANALTINA	PI12049937	PLANALTINA	03/12/2019 12:11	03/12/2019 15:04	03/12/2019 12:11	03/12/2019 15:04	2,88	284	816,82	CHI
20191218448	FORMOSA	FA12376669	ITUIQUIRA	03/12/2019 12:53	04/12/2019 15:25	03/12/2019 12:53	04/12/2019 15:25	26,53	56	1485,60	CHI
20191218448	VILA BOA	FA12376669	ITUIQUIRA	03/12/2019 12:53	04/12/2019 15:25	03/12/2019 12:53	04/12/2019 15:25	26,53	6	159,17	CHI
20191218452	IPAMERI	UT12016916	URUTAI	03/12/2019 13:32	03/12/2019 16:19	03/12/2019 13:32	03/12/2019 16:19	2,78	3	8,34	CHI
20191218452	URUTAI	UT12016916	URUTAI	03/12/2019 13:32	03/12/2019 16:19	03/12/2019 13:32	03/12/2019 16:19	2,78	18	50,03	CHI
20191218454	VIANOPOLIS	VN12194266	VIANOPOLIS	03/12/2019 13:32	04/12/2019 14:45	03/12/2019 13:32	04/12/2019 14:45	25,21	4	100,85	CHI
20191218455	CIDADE OCIDENTAL	2680020279	MARAJOARA	03/12/2019 13:32	03/12/2019 16:32	03/12/2019 13:32	03/12/2019 16:32	2,99	1	2,99	CHI
20191218457	GOIANIA	GN11135076	GOYA S1	03/12/2019 13:32	03/12/2019 17:23	03/12/2019 13:32	03/12/2019 17:23	3,84	135	518,33	CHI
20191218461	ITUMBIARA	IT12222574	ITUMBIARA NOVA	03/12/2019 13:32	03/12/2019 19:58	03/12/2019 13:32	03/12/2019 19:58	6,42	6	38,50	CHI
20191218473	SANTA TEREZINHA DE GOIAS	SG21145518	SANTA TEREZINHA	03/12/2019 13:34	03/12/2019 17:45	03/12/2019 13:34	03/12/2019 17:45	4,18	1	4,18	CHI
20191218481	GOIANESIA	GE11171628	GOIANESIA S2	03/12/2019 12:19	03/12/2019 15:17	03/12/2019 12:19	03/12/2019 15:17	2,96	74	218,90	CHI
20191218482	PIRANHAS	PH12027930RE	PIRANHAS	03/12/2019 13:35	03/12/2019 18:12	03/12/2019 13:35	03/12/2019 18:12	4,61	15	69,15	CHI
20191218487	FIRMINOPOLIS	FR21186491	FIRMINOPOLIS S1	03/12/2019 13:36	04/12/2019 00:40	03/12/2019 13:36	04/12/2019 00:40	11,07	1	11,07	CHI
20191218497	CRIXAS	CX11108001	SERRA DO OURO	03/12/2019 13:35	04/12/2019 05:17	03/12/2019 13:35	04/12/2019 05:17	15,70	191	2998,70	CHI
20191218503	JATAI	10025335039	JATAI S3	03/12/2019 13:38	03/12/2019 16:55	03/12/2019 13:38	03/12/2019 16:55	3,28	1	3,28	CHI
20191218508	NOVA AURORA	2220003353	CATALAO S1	03/12/2019 13:38	03/12/2019 17:32	03/12/2019 13:38	03/12/2019 17:32	3,89	1	3,89	CHI
20191218512	PONTALINA	PK21151630	VICENTINOPOLIS	03/12/2019 13:39	04/12/2019 10:24	03/12/2019 13:39	04/12/2019 10:24	20,73	1	20,73	CHI
20191218513	COCALZINHO DE GOIAS	ZN21297459	COCALZINHO	03/12/2019 13:40	04/12/2019 11:23	03/12/2019 13:40	04/12/2019 11:23	21,71	1	21,71	CHI
20191218516	ITAPIRAPUA	IU12073722	MATRINCHA	03/12/2019 13:33	04/12/2019 15:27	03/12/2019 13:33	04/12/2019 15:27	25,90	3	77,69	CHI
20191218518	URUTAI	600003991	URUTAI	03/12/2019 13:41	03/12/2019 16:28	03/12/2019 13:41	03/12/2019 16:28	2,79	1	2,79	CHI
20191218526	GUARANI DE GOIAS	GY12271756	SAO DOMINGOS	03/12/2019 13:42	03/12/2019 15:28	03/12/2019 13:42	03/12/2019 15:28	1,76	1	1,76	CHI
20191218528	APARECIDA DE GOIANIA	AP12004887	ATLANTICO S1	03/12/2019 13:24	03/12/2019 15:44	03/12/2019 13:24	03/12/2019 15:44	2,33	697	1623,62	CHI
20191218529	ITAPURANGA	IK21299527	ITAPURANGA	03/12/2019 13:42	04/12/2019 19:15	03/12/2019 13:42	04/12/2019 19:15	29,55	2	59,11	CHI
20191218536	JARAGUA	SF21339502	SAO FRANCISCO DE GOIAS	03/12/2019 13:43	04/12/2019 08:42	03/12/2019 13:43	04/12/2019 08:42	18,97	1	18,97	CHI
20191218537	CRISTALINA	1060021435	CRISTALINA S1	03/12/2019 13:43	04/12/2019 02:26	03/12/2019 13:43	04/12/2019 02:26	12,70	1	12,70	CHI
20191218539	PALMINOPOLIS	PP21007012	PALMEIRAS	03/12/2019 13:44	04/12/2019 09:31	03/12/2019 13:44	04/12/2019 09:31	19,78	1	19,78	CHI
20191218541	ALEXANIA	AX12402036	ALEXANIA	03/12/2019 12:08	03/12/2019 15:39	03/12/2019 12:08	03/12/2019 15:39	3,51	46	161,46	CHI
20191218541	SANTO ANTONIO DO DESCOBERTO	AX12402036	ALEXANIA	03/12/2019 12:08	03/12/2019 15:39	03/12/2019 12:08	03/12/2019 15:39	3,51	1	3,51	CHI
20191218544	CACHOEIRA DOURADA	CD12000050	CACHOEIRA DOURADA	03/12/2019 13:44	04/12/2019 08:28	03/12/2019 13:44	04/12/2019 08:28	18,72	5	93,59	CHI
20191218544	ITUMBIARA	CD12000050	CACHOEIRA DOURADA	03/12/2019 13:44	04/12/2019 08:28	03/12/2019 13:44	04/12/2019 08:28	18,72	2	37,44	CHI

20191218550	GOIANESIA	GE11140947	GOIANESIA S2	03/12/2019 13:07	03/12/2019 16:38	03/12/2019 13:07	03/12/2019 16:38	3,51	113	396,98	CHI
20191218557	ALTO HORIZONTE	10006439177	SANTA TEREZINHA	03/12/2019 13:46	04/12/2019 14:43	03/12/2019 13:46	04/12/2019 14:43	24,95	1	24,95	CHI
20191218562	RUBIATABA	780055238	RUBIATABA	03/12/2019 13:46	03/12/2019 17:48	03/12/2019 13:46	03/12/2019 17:48	4,02	1	4,02	CHI
20191218566	URUACU	640122061	URUACU	03/12/2019 13:47	03/12/2019 15:16	03/12/2019 13:47	03/12/2019 15:16	1,48	1	1,48	CHI
20191218568	GOIANIA	GN11001952	ATLANTICO S3	03/12/2019 13:43	03/12/2019 20:19	03/12/2019 13:43	03/12/2019 20:19	6,59	87	573,38	CHI
20191218571	HIDROLANDIA	HD12000295	CEPAIGO S2	03/12/2019 13:47	03/12/2019 18:25	03/12/2019 13:47	03/12/2019 18:25	4,62	13	60,04	CHI
20191218576	CEZARINA	CZ11074811	CEZARINA	03/12/2019 13:48	03/12/2019 16:29	03/12/2019 13:48	03/12/2019 16:29	2,68	96	257,71	CHI
20191218579	GOIANIA	10006645435	MEIA PONTE	03/12/2019 13:48	03/12/2019 15:25	03/12/2019 13:48	03/12/2019 15:25	1,60	1	1,60	CHI
20191218582	HIDROLANDIA	HD21391755	PONTALINA	03/12/2019 13:49	04/12/2019 12:15	03/12/2019 13:49	04/12/2019 12:15	22,43	1	22,43	CHI
20191218583	CRISTALINA	KR11214878	CRISTALINA S1	03/12/2019 13:31	03/12/2019 17:53	03/12/2019 13:31	03/12/2019 17:53	4,35	103	448,25	CHI
20191218595	ARAGOIANIA	AO11000001	GUAPO S2	03/12/2019 13:50	03/12/2019 17:34	03/12/2019 13:50	03/12/2019 17:34	3,74	10	37,41	CHI
20191218603	BRAZABRANTES	380007472	NEROPOLIS S1	03/12/2019 13:51	04/12/2019 04:50	03/12/2019 13:51	04/12/2019 04:50	14,99	1	14,99	CHI
20191218610	VICENTINOPOLIS	VI21050305	GOIATUBA S1	03/12/2019 13:52	04/12/2019 10:31	03/12/2019 13:52	04/12/2019 10:31	20,64	1	20,64	CHI
20191218614	DOVERLANDIA	DV12334957	PARQUE DAS EMAS	03/12/2019 13:52	04/12/2019 15:51	03/12/2019 13:52	04/12/2019 15:51	25,97	6	155,80	CHI
20191218618	ALEXANIA	480024753	ALEXANIA	03/12/2019 13:53	03/12/2019 16:15	03/12/2019 13:53	03/12/2019 16:15	2,36	1	2,36	CHI
20191218623	PORTEIRAO	CL11280601	RIO DOS BOIS	03/12/2019 11:14	03/12/2019 15:48	03/12/2019 11:14	03/12/2019 15:48	4,56	55	250,65	CHI
20191218624	ITUMBIARA	IT21134691	CACHOEIRA DOURADA	03/12/2019 13:54	03/12/2019 17:52	03/12/2019 13:54	03/12/2019 17:52	3,96	3	11,89	CHI
20191218629	FAZENDA NOVA	FN12341227	IPORA	03/12/2019 13:39	03/12/2019 17:14	03/12/2019 13:39	03/12/2019 17:14	3,57	9	32,17	CHI
20191218630	ITAPIRAPUA	IU11000007	MATRINCHA	03/12/2019 11:15	03/12/2019 19:51	03/12/2019 11:15	03/12/2019 19:51	8,60	46	395,41	CHI
20191218633	NIQUELANDIA	NQ12255371	NIQUELANDIA SUBTRANSMISSAO	03/12/2019 13:53	03/12/2019 16:30	03/12/2019 13:53	03/12/2019 16:30	2,61	19	49,50	CHI
20191218641	PORANGATU	PO21192368	PORANGATU	03/12/2019 13:56	04/12/2019 01:29	03/12/2019 13:56	04/12/2019 01:29	11,54	1	11,54	CHI
20191218655	VIANOPOLIS	VN12058650	VIANOPOLIS	03/12/2019 13:03	03/12/2019 19:15	03/12/2019 13:03	03/12/2019 19:15	6,20	305	1890,66	CHI
20191218660	PADRE BERNARDO	PB21148885	PADRE BERNARDO	03/12/2019 13:59	04/12/2019 11:41	03/12/2019 13:59	04/12/2019 11:41	21,69	2	43,39	CHI
20191218663	POSSE	IA12035179	IACIARA S2	03/12/2019 07:59	03/12/2019 19:56	03/12/2019 07:59	03/12/2019 19:56	11,95	9	107,55	CHI
20191218665	INHUMAS	IN11253149	INHUMAS S2	03/12/2019 13:59	03/12/2019 19:00	03/12/2019 13:59	03/12/2019 19:00	5,02	104	521,79	CHI
20191218666	POSSE	PS12212366	IACIARA S1	03/12/2019 13:59	03/12/2019 19:35	03/12/2019 13:59	03/12/2019 19:35	5,59	37	206,69	CHI
20191218668	LUZIANIA	LZ12330545	MARAJOARA	03/12/2019 13:59	03/12/2019 22:02	03/12/2019 13:59	03/12/2019 22:02	8,03	1	8,03	CHI
20191218669	PALMEIRAS DE GOIAS	PL12118508	PALMEIRAS	03/12/2019 14:00	04/12/2019 09:47	03/12/2019 14:00	04/12/2019 09:47	19,80	3	59,39	CHI
20191218672	NOVO PLANALTO	TA12391924	SAO MIGUEL DO ARAGUAIA	03/12/2019 13:51	03/12/2019 16:29	03/12/2019 13:51	03/12/2019 16:29	2,62	11	28,80	CHI
20191218690	CALDAZINHA	DE21334856	SENADOR CANEDO	03/12/2019 13:05	03/12/2019 21:41	03/12/2019 13:05	03/12/2019 21:41	8,60	6	51,59	CHI
20191218704	SAO LUIS DE MONTES BELOS	SL21312395	SAO LUIZ DOS MONTES BELOS	03/12/2019 14:04	03/12/2019 19:35	03/12/2019 14:04	03/12/2019 19:35	5,53	2	11,06	CHI
20191218708	PARANAIGUARA	PC12306104	QUIRINOPOLIS	03/12/2019 12:42	04/12/2019 12:55	03/12/2019 12:42	04/12/2019 12:55	24,21	3	72,63	CHI
20191218708	QUIRINOPOLIS	PC12306104	QUIRINOPOLIS	03/12/2019 12:42	04/12/2019 12:55	03/12/2019 12:42	04/12/2019 12:55	24,21	3	72,63	CHI

20191218724	BOM JESUS DE GOIAS	1250059012	BOM JESUS DE GOIAS	03/12/2019 14:05	03/12/2019 20:57	03/12/2019 14:05	03/12/2019 20:57	6,86	1	6,86	CHI
20191218734	NOVA AURORA	2220005465	CATALAO S1	03/12/2019 14:06	04/12/2019 17:10	03/12/2019 14:06	04/12/2019 17:10	27,07	1	27,07	CHI
20191218735	FLORES DE GOIAS	3480022283	FLORES DE GOIAS	03/12/2019 14:06	04/12/2019 10:52	03/12/2019 14:06	04/12/2019 10:52	20,76	1	20,76	CHI
20191218740	CRIXAS	SG12291237	SANTA TEREZINHA	03/12/2019 14:06	04/12/2019 15:16	03/12/2019 14:06	04/12/2019 15:16	25,16	13	327,10	CHI
20191218740	GUARINOS	SG12291237	SANTA TEREZINHA	03/12/2019 14:06	04/12/2019 15:16	03/12/2019 14:06	04/12/2019 15:16	25,16	6	150,97	CHI
20191218744	SAO JOAO D ALIANCA	JL11242658	SAO JOAO D ALIANCA	03/12/2019 14:07	03/12/2019 15:02	03/12/2019 14:07	03/12/2019 15:02	0,92	1	0,92	CHI
20191218746	SENADOR CANEDO	10020400665	SENADOR CANEDO	03/12/2019 14:07	03/12/2019 15:28	03/12/2019 14:07	03/12/2019 15:28	1,35	1	1,35	CHI
20191218748	CEZARINA	1650023938	CEZARINA	03/12/2019 14:06	04/12/2019 10:09	03/12/2019 14:06	04/12/2019 10:09	20,05	1	20,05	CHI
20191218755	FIRMINOPOLIS	FR21102791	FIRMINOPOLIS S1	03/12/2019 14:07	04/12/2019 04:51	03/12/2019 14:07	04/12/2019 04:51	14,72	1	14,72	CHI
20191218762	CAIAPONIA	CP12395438	PALESTINA	03/12/2019 14:08	04/12/2019 09:47	03/12/2019 14:08	04/12/2019 09:47	19,64	5	98,20	CHI
20191218762	PALESTINA DE GOIAS	CP12395438	PALESTINA	03/12/2019 14:08	04/12/2019 09:47	03/12/2019 14:08	04/12/2019 09:47	19,64	1	19,64	CHI
20191218765	CRISTALINA	KR11383043	CRISTALINA S1	03/12/2019 14:08	04/12/2019 03:00	03/12/2019 14:08	04/12/2019 03:00	12,85	7	89,96	CHI
20191218766	CATALAO	CT12203164	CATALAO S1	03/12/2019 07:18	03/12/2019 16:20	03/12/2019 07:18	03/12/2019 16:20	9,03	1049	9471,01	CHI
20191218767	GOIANIA	12555666	ATLANTICO S3	03/12/2019 14:09	03/12/2019 16:53	03/12/2019 14:09	03/12/2019 16:53	2,73	1	2,73	CHI
20191218775	PLANALTINA	2960156610	PLANALTINA	03/12/2019 14:11	03/12/2019 17:19	03/12/2019 14:11	03/12/2019 17:19	3,14	1	3,14	CHI
20191218779	QUIRINOPOLIS	80012115	QUIRINOPOLIS	03/12/2019 14:11	03/12/2019 15:41	03/12/2019 14:11	03/12/2019 15:41	1,51	1	1,51	CHI
20191218781	CAMPO ALEGRE DE GOIAS	CM12231703	CAMPO ALEGRE DE GOIAS	03/12/2019 14:03	04/12/2019 15:20	03/12/2019 14:03	04/12/2019 15:20	25,28	10	252,81	CHI
20191218791	BELA VISTA DE GOIAS	BV32026680	BELA VISTA S1	03/12/2019 11:34	03/12/2019 19:49	03/12/2019 11:34	03/12/2019 19:49	8,24	6	49,46	CHI
20191218794	AGUA FRIA DE GOIAS	TL11279968	SAO JOAO D ALIANCA	03/12/2019 14:13	04/12/2019 01:05	03/12/2019 14:13	04/12/2019 01:05	10,85	1	10,85	CHI
20191218799	URUTAI	10007647083	URUTAI	03/12/2019 14:14	03/12/2019 16:33	03/12/2019 14:14	03/12/2019 16:33	2,32	1	2,32	CHI
20191218801	ALTO PARAISO DE GOIAS	05570406	SAO JOAO D ALIANCA	03/12/2019 14:14	04/12/2019 17:32	03/12/2019 14:14	04/12/2019 17:32	27,29	9	245,64	CHI
20191218802	CATALAO	1990122441	CATALAO S1	03/12/2019 14:14	04/12/2019 13:00	03/12/2019 14:14	04/12/2019 13:00	22,77	1	22,77	CHI
20191218807	VALPARAISO DE GOIAS	2860125456	MARAJOARA	03/12/2019 14:15	03/12/2019 21:18	03/12/2019 14:15	03/12/2019 21:18	7,05	1	7,05	CHI
20191218809	FAINA	FC12299983	ITAPURANGA	03/12/2019 14:15	04/12/2019 10:02	03/12/2019 14:15	04/12/2019 10:02	19,78	3	59,34	CHI
20191218812	GOIANIA	16920703	REAL S2	03/12/2019 14:15	03/12/2019 15:38	03/12/2019 14:15	03/12/2019 15:38	1,37	1	1,37	CHI
20191218815	PETROLINA DE GOIAS	PG21111273	PETROLINA	03/12/2019 14:15	04/12/2019 09:35	03/12/2019 14:15	04/12/2019 09:35	19,32	2	38,65	CHI
20191218816	ITAGUARI	II12300111	ITABERAI S1	03/12/2019 14:07	03/12/2019 21:24	03/12/2019 14:07	03/12/2019 21:24	7,27	23	167,26	CHI
20191218816	ITAGUARU	II12300111	ITABERAI S1	03/12/2019 14:07	03/12/2019 21:24	03/12/2019 14:07	03/12/2019 21:24	7,27	1	7,27	CHI
20191218821	CIDADE OCIDENTAL	DH11324645	MARAJOARA	03/12/2019 14:17	03/12/2019 17:50	03/12/2019 14:17	03/12/2019 17:50	3,55	34	120,70	CHI
20191218826	GUAPO	GA21212302	GUAPO S1	03/12/2019 14:17	03/12/2019 17:42	03/12/2019 14:17	03/12/2019 17:42	3,40	1	3,40	CHI
20191218835	MORRINHOS	MR21334312	GOIATUBA S1	03/12/2019 14:18	03/12/2019 15:47	03/12/2019 14:18	03/12/2019 15:47	1,49	1	1,49	CHI
20191218848	TRINDADE	TR11144365	TRINDADE	03/12/2019 14:14	03/12/2019 17:25	03/12/2019 14:14	03/12/2019 17:25	3,17	147	466,36	CHI
20191218854	HIDROLANDIA	HD31060209	CEPAIGO S1	03/12/2019 14:20	03/12/2019 19:38	03/12/2019 14:20	03/12/2019 19:38	5,29	1	5,29	CHI

20191218859	PLANALTINA	PI12100884	PLANALTINA	03/12/2019 12:54	03/12/2019 18:07	03/12/2019 12:54	03/12/2019 18:07	5,21	9	46,92	CHI
20191218864	ITAGUARI	JA12038937	ITABERAI S1	03/12/2019 13:18	04/12/2019 00:27	03/12/2019 13:18	04/12/2019 00:27	11,14	3	33,42	CHI
20191218864	ITAGUARU	JA12038937	ITABERAI S1	03/12/2019 13:18	04/12/2019 00:27	03/12/2019 13:18	04/12/2019 00:27	11,14	1	11,14	CHI
20191218864	JARAGUA	JA12038937	ITABERAI S1	03/12/2019 13:18	04/12/2019 00:27	03/12/2019 13:18	04/12/2019 00:27	11,14	6	66,85	CHI
20191218871	GOIANESIA	GE12379116	GOIANESIA S2	03/12/2019 14:22	03/12/2019 18:33	03/12/2019 14:22	03/12/2019 18:33	4,17	100	417,17	CHI
20191218877	TRINDADE	40098497	TRINDADE	03/12/2019 14:23	03/12/2019 21:24	03/12/2019 14:23	03/12/2019 21:24	7,02	1	7,02	CHI
20191218880	SAO JOAO D ALIANCA	JL21117427	SAO JOAO D ALIANCA	03/12/2019 14:23	04/12/2019 15:50	03/12/2019 14:23	04/12/2019 15:50	25,44	2	50,88	CHI
20191218889	ITUMBIARA	CD21000287	CACHOEIRA DOURADA	03/12/2019 14:24	04/12/2019 09:00	03/12/2019 14:24	04/12/2019 09:00	18,60	3	55,81	CHI
20191218894	LUZIANIA	LZ21370705	VIANOPOLIS	03/12/2019 14:24	03/12/2019 18:37	03/12/2019 14:24	03/12/2019 18:37	4,21	1	4,21	CHI
20191218896	CORREGO DO OURO	CO12300423	SAO LUIZ DOS MONTES BELOS	03/12/2019 08:21	03/12/2019 21:32	03/12/2019 08:21	03/12/2019 21:32	13,18	4	52,70	CHI
20191218900	FIRMINOPOLIS	FR21000040	FIRMINOPOLIS S1	03/12/2019 14:24	04/12/2019 07:38	03/12/2019 14:24	04/12/2019 07:38	17,22	1	17,22	CHI
20191218902	IACIARA	IA12211563	IACIARA S1	03/12/2019 14:24	04/12/2019 13:31	03/12/2019 14:24	04/12/2019 13:31	23,10	2	46,20	CHI
20191218911	CALDAS NOVAS	760143201	SERRA DE CALDAS	03/12/2019 14:25	03/12/2019 17:20	03/12/2019 14:25	03/12/2019 17:20	2,92	1	2,92	CHI
20191218917	JATAI	JT12115871	JATAI S1	03/12/2019 14:25	03/12/2019 18:33	03/12/2019 14:25	03/12/2019 18:33	4,12	7	28,83	CHI
20191218920	SAO SIMAO	SO12338615	CACHOEIRA ALTA	03/12/2019 14:26	03/12/2019 18:57	03/12/2019 14:26	03/12/2019 18:57	4,51	3	13,54	CHI
20191218923	CALDAS NOVAS	10024373115	SERRA DE CALDAS	03/12/2019 14:26	03/12/2019 16:32	03/12/2019 14:26	03/12/2019 16:32	2,10	1	2,10	CHI
20191218924	AURILANDIA	SL12145835	FIRMINOPOLIS S2	03/12/2019 10:02	03/12/2019 22:05	03/12/2019 10:02	03/12/2019 22:05	12,04	1	12,04	CHI
20191218924	SAO LUIS DE MONTES BELOS	SL12145835	FIRMINOPOLIS S2	03/12/2019 10:02	03/12/2019 22:05	03/12/2019 10:02	03/12/2019 22:05	12,04	15	180,55	CHI
20191218926	NOVO BRASIL	1460018051	JUSSARA	03/12/2019 14:26	04/12/2019 11:30	03/12/2019 14:26	04/12/2019 11:30	21,07	1	21,07	CHI
20191218929	CALDAZINHA	SW12091934	SENADOR CANEDO	03/12/2019 14:26	03/12/2019 20:46	03/12/2019 14:26	03/12/2019 20:46	6,32	7	44,24	CHI
20191218929	SENADOR CANEDO	SW12091934	SENADOR CANEDO	03/12/2019 14:26	03/12/2019 20:46	03/12/2019 14:26	03/12/2019 20:46	6,32	2	12,64	CHI
20191218935	GOIANIA	10015743665	GOIANIA LESTE S3	03/12/2019 14:27	03/12/2019 16:27	03/12/2019 14:27	03/12/2019 16:27	1,99	1	1,99	CHI
20191218937	SAO LUIS DE MONTES BELOS	SL12125693	FIRMINOPOLIS S1	03/12/2019 05:52	03/12/2019 19:40	03/12/2019 05:52	03/12/2019 19:40	13,80	5	69,01	CHI
20191218941	CHAPADAO DO CEU	DJ21248437	CHAPADAO DO CEU	03/12/2019 14:27	03/12/2019 16:56	03/12/2019 14:27	03/12/2019 16:56	2,47	1	2,47	CHI
20191218947	ITAJA	IJ21214285	ITAJA S2	03/12/2019 14:28	04/12/2019 03:50	03/12/2019 14:28	04/12/2019 03:50	13,36	1	13,36	CHI
20191218954	PLANALTINA	PI12062190	PLANALTINA	03/12/2019 14:29	04/12/2019 09:02	03/12/2019 14:29	04/12/2019 09:02	18,55	4	74,20	CHI
20191218955	GOIANIA	GN11162032	CAMPINAS S2	03/12/2019 14:29	03/12/2019 17:47	03/12/2019 14:29	03/12/2019 17:47	3,30	76	250,61	CHI
20191218956	POSSE	10006571849	IACIARA S2	03/12/2019 14:29	03/12/2019 16:46	03/12/2019 14:29	03/12/2019 16:46	2,28	1	2,28	CHI
20191218961	NOVA CRIXAS	NA21281137	NOVA CRIXAS	03/12/2019 14:29	04/12/2019 20:03	03/12/2019 14:29	04/12/2019 20:03	29,57	1	29,57	CHI
20191218965	GOIANIA	10006987891	CARAJAS S2	03/12/2019 14:29	03/12/2019 17:30	03/12/2019 14:29	03/12/2019 17:30	3,00	1	3,00	CHI
20191218967	GOIANIA	GN11131177	XAVANTES	03/12/2019 14:26	03/12/2019 17:08	03/12/2019 14:26	03/12/2019 17:08	2,69	112	301,78	CHI
20191218974	VICENTINOPOLIS	1970026460	VICENTINOPOLIS	03/12/2019 14:30	03/12/2019 15:51	03/12/2019 14:30	03/12/2019 15:51	1,35	1	1,35	CHI
20191218988	ITABERAI	IB21009398	ITABERAI S1	03/12/2019 16:32	03/12/2019 20:17	03/12/2019 16:32	03/12/2019 20:17	3,75	1	3,75	CHI

20191218990	MOZARLANDIA	MZ12057128	MOZARLANDIA	03/12/2019 14:32	04/12/2019 20:10	03/12/2019 14:32	04/12/2019 20:10	29,63	5	148,13	CHI
20191218990	NOVA CRIXAS	MZ12057128	MOZARLANDIA	03/12/2019 14:32	04/12/2019 20:10	03/12/2019 14:32	04/12/2019 20:10	29,63	1	29,63	CHI
20191218995	GOIANIA	12954070	ATLANTICO S2	03/12/2019 14:32	03/12/2019 17:13	03/12/2019 14:32	03/12/2019 17:13	2,67	1	2,67	CHI
20191219002	CATALAO	CT10394608	CATALAO S2	03/12/2019 14:31	03/12/2019 23:48	03/12/2019 14:31	03/12/2019 15:42	1,19	464	553,84	CHI
20191219002	CATALAO	05060254	CATALAO S2	03/12/2019 14:31	03/12/2019 23:48	03/12/2019 14:31	03/12/2019 15:43	1,20	30	35,98	CHI
20191219002	CATALAO	CT13102088	CATALAO S2	03/12/2019 14:31	03/12/2019 23:48	03/12/2019 14:31	03/12/2019 18:53	4,37	227	992,18	CHI
20191219002	CATALAO	CT13067769	CATALAO S2	03/12/2019 14:31	03/12/2019 23:48	03/12/2019 14:31	03/12/2019 23:38	9,11	220	2004,93	CHI
20191219002	CATALAO	CT13067769	CATALAO S2	03/12/2019 14:31	03/12/2019 23:48	03/12/2019 22:31	03/12/2019 23:38	1,11	227	251,53	CHI
20191219002	CATALAO	CT11281402	CATALAO S2	03/12/2019 14:31	03/12/2019 23:48	03/12/2019 14:31	03/12/2019 23:48	9,29	51	473,63	CHI
20191219004	GOIANIA	GN12383183	XAVANTES	03/12/2019 14:33	03/12/2019 17:42	03/12/2019 14:33	03/12/2019 17:42	3,15	237	746,48	CHI
20191219005	IVOLANDIA	IV12322053	IPORA	03/12/2019 09:52	03/12/2019 23:45	03/12/2019 09:52	03/12/2019 23:45	13,88	80	1110,60	CHI
20191219005	PALESTINA DE GOIAS	IV12322053	IPORA	03/12/2019 09:52	03/12/2019 23:45	03/12/2019 09:52	03/12/2019 23:45	13,88	33	458,12	CHI
20191219007	INACIOLANDIA	ID21128179	QUIRINOPOLIS	03/12/2019 14:33	04/12/2019 09:56	03/12/2019 14:33	04/12/2019 09:56	19,37	1	19,37	CHI
20191219009	CRISTALINA	KR12376280	PAMPLONA	03/12/2019 14:33	03/12/2019 17:10	03/12/2019 14:33	03/12/2019 17:10	2,61	23	59,92	CHI
20191219021	LUZIANIA	LZ12245978	CRISTALINA S2	03/12/2019 14:07	03/12/2019 20:40	03/12/2019 14:07	03/12/2019 20:40	6,54	8	52,32	CHI
20191219022	LUZIANIA	120328872	RIO VERMELHO	03/12/2019 14:35	03/12/2019 17:44	03/12/2019 14:35	03/12/2019 17:44	3,15	1	3,15	CHI
20191219024	BELA VISTA DE GOIAS	BV12202366	BELA VISTA S2	03/12/2019 14:35	04/12/2019 07:45	03/12/2019 14:35	04/12/2019 07:45	17,16	9	154,47	CHI
20191219029	UIRAPURU	4200005490	SANTA TEREZINHA	03/12/2019 14:35	04/12/2019 10:20	03/12/2019 14:35	04/12/2019 10:20	19,75	1	19,75	CHI
20191219038	ALTO PARAISO DE GOIAS	BF21265759	FLORES DE GOIAS	03/12/2019 14:36	04/12/2019 11:13	03/12/2019 14:36	04/12/2019 11:13	20,61	1	20,61	CHI
20191219040	PIRENOPOLIS	PV21295566	CORUMBA	03/12/2019 14:36	03/12/2019 16:02	03/12/2019 14:36	03/12/2019 16:02	1,43	2	2,86	CHI
20191219042	AMARALINA	MU12384317	MARA ROSA	03/12/2019 14:36	03/12/2019 15:50	03/12/2019 14:36	03/12/2019 15:50	1,23	4	4,90	CHI
20191219042	MUTUNOPOLIS	MU12384317	MARA ROSA	03/12/2019 14:36	03/12/2019 15:50	03/12/2019 14:36	03/12/2019 15:50	1,23	20	24,52	CHI
20191219043	LAGOA SANTA	LS12095824	CACHOEIRA ALTA	03/12/2019 14:36	04/12/2019 05:40	03/12/2019 14:36	04/12/2019 05:40	15,06	3	45,17	CHI
20191219044	CRIXAS	CX21202136	SANTA TEREZINHA	03/12/2019 14:36	04/12/2019 18:02	03/12/2019 14:36	04/12/2019 18:02	27,42	1	27,42	CHI
20191219050	NIQUELANDIA	NQ21274813	BARRO ALTO	03/12/2019 14:37	04/12/2019 09:51	03/12/2019 14:37	04/12/2019 09:51	19,23	1	19,23	CHI
20191219051	GOIANIA	GN11001011	CAMPINAS S1	03/12/2019 14:37	03/12/2019 18:22	03/12/2019 14:37	03/12/2019 15:21	0,73	86	62,78	CHI
20191219051	GOIANIA	GN11001011	CAMPINAS S1	03/12/2019 14:37	03/12/2019 18:22	03/12/2019 15:38	03/12/2019 18:22	2,73	86	234,97	CHI
20191219053	MOZARLANDIA	MZ12055646	MOZARLANDIA	03/12/2019 14:37	04/12/2019 17:40	03/12/2019 14:37	04/12/2019 17:40	27,06	3	81,17	CHI
20191219054	PALMEIRAS DE GOIAS	PL21321985	PALMEIRAS	03/12/2019 14:37	04/12/2019 07:20	03/12/2019 14:37	04/12/2019 07:20	16,71	1	16,71	CHI
20191219055	ALTO PARAISO DE GOIAS	3870009900	FLORES DE GOIAS	03/12/2019 14:38	04/12/2019 16:47	03/12/2019 14:38	04/12/2019 16:47	26,15	1	26,15	CHI
20191219059	MARA ROSA	MQ12208421	MARA ROSA	03/12/2019 14:38	03/12/2019 17:10	03/12/2019 14:38	03/12/2019 17:10	2,53	15	37,88	CHI
20191219079	CATALAO	CT21160925	CATALAO S1	03/12/2019 14:39	03/12/2019 17:50	03/12/2019 14:39	03/12/2019 17:50	3,17	1	3,17	CHI
20191219082	FIRMINOPOLIS	FR12323491	FIRMINOPOLIS S2	03/12/2019 14:05	03/12/2019 18:17	03/12/2019 14:05	03/12/2019 18:17	4,19	3	12,58	CHI

20191219092	ITUMBIARA	IT12309790	ITUMBIARA VELHA S1	03/12/2019 14:41	04/12/2019 08:50	03/12/2019 14:41	04/12/2019 08:50	18,16	1	18,16	CHI
20191219096	GOIAS	GS12220498	GOIAS	03/12/2019 14:41	03/12/2019 18:06	03/12/2019 14:41	03/12/2019 18:06	3,40	46	156,60	CHI
20191219103	BONFINOPOLIS	BO12195685	CEPAIGO S2	03/12/2019 13:27	03/12/2019 18:13	03/12/2019 13:27	03/12/2019 18:13	4,76	189	900,48	CHI
20191219105	ITAGUARI	TQ12030283	ITABERAI S1	03/12/2019 14:05	04/12/2019 18:44	03/12/2019 14:05	04/12/2019 12:37	22,53	3	67,58	CHI
20191219105	ITAGUARI	II12220229LD	ITABERAI S1	03/12/2019 14:05	04/12/2019 18:44	03/12/2019 14:05	04/12/2019 13:59	23,89	13	310,59	CHI
20191219105	ITAGUARI	TQ12030283	ITABERAI S1	03/12/2019 14:05	04/12/2019 18:44	04/12/2019 17:36	04/12/2019 17:43	0,12	16	1,88	CHI
20191219105	ITAGUARI	II12172706	ITABERAI S1	03/12/2019 14:05	04/12/2019 18:44	03/12/2019 14:05	04/12/2019 18:44	28,65	14	401,15	CHI
20191219112	RIO VERDE	630514586	RIO VERDE S2	03/12/2019 14:43	03/12/2019 22:06	03/12/2019 14:43	03/12/2019 22:06	7,40	1	7,40	CHI
20191219119	LUZIANIA	10007477765	MARAJOARA	03/12/2019 14:43	03/12/2019 17:51	03/12/2019 14:43	03/12/2019 17:51	3,12	1	3,12	CHI
20191219124	SERRANOPOLIS	SX12324832	JATAI S1	03/12/2019 13:42	04/12/2019 15:42	03/12/2019 13:42	04/12/2019 15:42	25,99	13	337,90	CHI
20191219128	PORANGATU	PO21115463	PORANGATU	03/12/2019 14:45	03/12/2019 17:36	03/12/2019 14:45	03/12/2019 17:36	2,85	1	2,85	CHI
20191219140	NIQUELANDIA	NQ12221620	URUACU	03/12/2019 14:39	03/12/2019 17:00	03/12/2019 14:39	03/12/2019 17:00	2,36	146	343,91	CHI
20191219146	SANTA BARBARA DE GOIAS	SB31005808	TRINDADE	03/12/2019 14:46	03/12/2019 16:33	03/12/2019 14:46	03/12/2019 16:33	1,77	2	3,54	CHI
20191219149	CAMPINACU	UC12236229	PORANGATU	03/12/2019 14:46	04/12/2019 08:13	03/12/2019 14:46	04/12/2019 08:13	17,44	28	488,44	CHI
20191219156	CRIXAS	CX12202134	SERRA DO OURO	03/12/2019 14:47	04/12/2019 10:42	03/12/2019 14:47	04/12/2019 10:42	19,91	46	916,01	CHI
20191219161	PIRACANJUBA	PJ21009592	PIRACANJUBA	03/12/2019 14:48	03/12/2019 18:51	03/12/2019 14:48	03/12/2019 18:51	4,04	1	4,04	CHI
20191219162	PIRES DO RIO	10014513860	PIRES DO RIO S1	03/12/2019 14:49	04/12/2019 00:23	03/12/2019 14:49	04/12/2019 00:23	9,57	1	9,57	CHI
20191219166	CRIXAS	CX12285344	SANTA TEREZINHA	03/12/2019 14:49	04/12/2019 18:40	03/12/2019 14:49	04/12/2019 18:40	27,86	7	195,03	CHI
20191219167	PADRE BERNARDO	PB12375233	PADRE BERNARDO	03/12/2019 14:49	04/12/2019 03:34	03/12/2019 14:49	04/12/2019 03:34	12,76	1	12,76	CHI
20191219170	CALDAS NOVAS	CN12000057	CALDAS NOVAS S2	03/12/2019 14:12	03/12/2019 18:40	03/12/2019 14:12	03/12/2019 18:40	4,46	40	178,32	CHI
20191219177	SAO SIMAO	SO12000002	CACHOEIRA ALTA	03/12/2019 14:01	03/12/2019 18:14	03/12/2019 14:01	03/12/2019 18:14	4,20	556	2336,59	CHI
20191219179	AMORINOPOLIS	AM21000028	IPORA	03/12/2019 14:49	05/12/2019 09:50	03/12/2019 14:49	05/12/2019 09:50	43,00	1	43,00	CHI
20191219180	PIRACANJUBA	PJ21200032	BELA VISTA S1	03/12/2019 14:49	04/12/2019 10:30	03/12/2019 14:49	04/12/2019 10:30	19,67	1	19,67	CHI
20191219184	RIO VERDE	MV12338540	MONTIVIDIU T	03/12/2019 14:50	03/12/2019 23:19	03/12/2019 14:50	03/12/2019 23:19	8,48	21	178,01	CHI
20191219185	SANTA TEREZA DE GOIAS	SE21017234	MARA ROSA	03/12/2019 14:50	03/12/2019 16:21	03/12/2019 14:50	03/12/2019 16:21	1,51	1	1,51	CHI
20191219198	RIO VERDE	RV11226318	RIO VERDE S1	03/12/2019 14:51	03/12/2019 22:01	03/12/2019 14:51	03/12/2019 22:01	7,17	175	1255,28	CHI
20191219200	FORMOSO	FO12202557	PORANGATU	03/12/2019 14:51	04/12/2019 11:42	03/12/2019 14:51	04/12/2019 11:42	20,85	20	417,02	CHI
20191219200	SANTA TEREZA DE GOIAS	FO12202557	PORANGATU	03/12/2019 14:51	04/12/2019 11:42	03/12/2019 14:51	04/12/2019 11:42	20,85	17	354,46	CHI
20191219202	GOIAS	GS21071247	GOIAS	03/12/2019 14:51	04/12/2019 12:35	03/12/2019 14:51	04/12/2019 12:35	21,72	1	21,72	CHI
20191219208	BARRO ALTO	GE21129088	GOIANESIA S2	03/12/2019 14:52	04/12/2019 18:44	03/12/2019 14:52	04/12/2019 18:44	27,86	1	27,86	CHI
20191219209	CATALAO	CT12130954	CATALAO S2	03/12/2019 14:27	03/12/2019 17:40	03/12/2019 14:27	03/12/2019 17:40	3,20	244	781,88	CHI
20191219214	LEOPOLDO DE BULHOES	GP12039292	DAIA S2	03/12/2019 14:21	04/12/2019 10:20	03/12/2019 14:21	04/12/2019 10:20	19,98	8	159,82	CHI
20191219215	SAO FRANCISCO DE GOIAS	SF12319829	SAO FRANCISCO DE GOIAS	03/12/2019 12:24	03/12/2019 20:49	03/12/2019 12:24	03/12/2019 20:49	8,40	20	168,08	CHI

20191219227	BELA VISTA DE GOIAS	BV12272141	BELA VISTA S2	03/12/2019 12:57	03/12/2019 17:47	03/12/2019 12:57	03/12/2019 17:47	4,83	32	154,63	CHI
20191219227	SAO MIGUEL DO PASSA QUATRO	BV12272141	BELA VISTA S2	03/12/2019 12:57	03/12/2019 17:47	03/12/2019 12:57	03/12/2019 17:47	4,83	89	430,07	CHI
20191219229	MATRINCHA	MP12250744	MATRINCHA	03/12/2019 14:54	04/12/2019 17:20	03/12/2019 14:54	04/12/2019 17:20	26,43	4	105,72	CHI
20191219230	ORIZONA	OZ21014653	VIANOPOLIS	03/12/2019 14:54	04/12/2019 08:55	03/12/2019 14:54	04/12/2019 08:55	18,01	1	18,01	CHI
20191219236	HEITORAI	IC12065281	ITABERAI S1	03/12/2019 07:58	03/12/2019 17:08	03/12/2019 07:58	03/12/2019 17:08	9,16	6	54,94	CHI
20191219236	ITAGUARU	IC12065281	ITABERAI S1	03/12/2019 07:58	03/12/2019 17:08	03/12/2019 07:58	03/12/2019 17:08	9,16	3	27,47	CHI
20191219244	CRISTALINA	KR21248016	CRISTALINA S1	03/12/2019 14:55	04/12/2019 09:49	03/12/2019 14:55	04/12/2019 09:49	18,89	1	18,89	CHI
20191219258	GOIANIA	GN11002892	GOIANIA LESTE S3	03/12/2019 14:56	03/12/2019 16:42	03/12/2019 14:56	03/12/2019 16:42	1,76	77	135,26	CHI
20191219259	MOSSAMEDES	SC12206497	FIRMINOPOLIS S2	03/12/2019 13:10	03/12/2019 16:18	03/12/2019 13:10	03/12/2019 16:18	3,12	2	6,24	CHI
20191219259	SANCLERLANDIA	SC12206497	FIRMINOPOLIS S2	03/12/2019 13:10	03/12/2019 16:18	03/12/2019 13:10	03/12/2019 16:18	3,12	77	240,15	CHI
20191219288	CORUMBAIBA	CI21234688	VILA CORUMBA	03/12/2019 15:01	03/12/2019 17:10	03/12/2019 15:01	03/12/2019 17:10	2,15	1	2,15	CHI
20191219293	AMARALINA	LC12320686	MARA ROSA	03/12/2019 15:02	03/12/2019 17:10	03/12/2019 15:02	03/12/2019 17:10	2,13	9	19,16	CHI
20191219294	CACHOEIRA DOURADA	02670214	CACHOEIRA DOURADA	03/12/2019 14:28	04/12/2019 16:40	04/12/2019 01:00	04/12/2019 03:45	2,73	687	1877,99	CHI
20191219294	CACHOEIRA DOURADA	CD12000067	CACHOEIRA DOURADA	03/12/2019 14:28	04/12/2019 16:40	03/12/2019 17:00	04/12/2019 10:03	17,05	8	136,41	CHI
20191219294	CACHOEIRA DOURADA	CD12000067	CACHOEIRA DOURADA	03/12/2019 14:28	04/12/2019 16:40	04/12/2019 01:00	04/12/2019 10:03	9,05	9	81,46	CHI
20191219294	CACHOEIRA DOURADA	02670214	CACHOEIRA DOURADA	03/12/2019 14:28	04/12/2019 16:40	04/12/2019 11:04	04/12/2019 11:25	0,35	704	244,05	CHI
20191219294	CACHOEIRA DOURADA	CD13000008	CACHOEIRA DOURADA	03/12/2019 14:28	04/12/2019 16:40	04/12/2019 01:00	04/12/2019 14:47	13,80	29	400,06	CHI
20191219294	INACIOLANDIA	CD13000008	CACHOEIRA DOURADA	03/12/2019 14:28	04/12/2019 16:40	04/12/2019 01:00	04/12/2019 14:47	13,80	1	13,80	CHI
20191219294	CACHOEIRA DOURADA	CD13000011	CACHOEIRA DOURADA	03/12/2019 14:28	04/12/2019 16:40	04/12/2019 01:00	04/12/2019 15:00	14,00	1	14,00	CHI
20191219294	INACIOLANDIA	CD13000011	CACHOEIRA DOURADA	03/12/2019 14:28	04/12/2019 16:40	04/12/2019 01:00	04/12/2019 15:00	14,00	3	42,00	CHI
20191219294	CACHOEIRA DOURADA	CD21000054	CACHOEIRA DOURADA	03/12/2019 14:28	04/12/2019 16:40	04/12/2019 15:54	04/12/2019 16:40	0,77	1	0,77	CHI
20191219295	ITUMBIARA	IT11222286	PARANAIBA	03/12/2019 15:02	03/12/2019 19:54	03/12/2019 15:02	03/12/2019 19:54	4,86	57	276,94	CHI
20191219302	PADRE BERNARDO	PB12376763	PADRE BERNARDO	03/12/2019 14:12	05/12/2019 12:11	03/12/2019 14:12	05/12/2019 12:11	45,97	12	551,69	CHI
20191219307	FORMOSA	610006836	ITUIQUIRA	03/12/2019 15:03	03/12/2019 21:15	03/12/2019 15:03	03/12/2019 21:15	6,19	1	6,19	CHI
20191219309	RUBIATABA	780013086	RUBIATABA	03/12/2019 15:03	04/12/2019 12:00	03/12/2019 15:03	04/12/2019 12:00	20,95	1	20,95	CHI
20191219321	TRES RANCHOS	10018390054	CATALAO S1	03/12/2019 15:04	03/12/2019 16:56	03/12/2019 15:04	03/12/2019 16:56	1,86	1	1,86	CHI
20191219328	ITAPURANGA	170089083	ITAPURANGA	03/12/2019 15:05	03/12/2019 21:36	03/12/2019 15:05	03/12/2019 21:36	6,53	1	6,53	CHI
20191219335	PALESTINA DE GOIAS	PY12374894	PALESTINA	03/12/2019 15:05	04/12/2019 10:09	03/12/2019 15:05	04/12/2019 10:09	19,05	2	38,10	CHI
20191219338	VICENTINOPOLIS	VI12257166	VICENTINOPOLIS	03/12/2019 15:06	03/12/2019 19:00	03/12/2019 15:06	03/12/2019 19:00	3,89	8	31,15	CHI
20191219339	AGUAS LINDAS DE GOIAS	LA12157140	AGUAS LINDAS DE GOIAS S1	03/12/2019 15:06	03/12/2019 16:14	03/12/2019 15:06	03/12/2019 16:14	1,12	43	48,33	CHI
20191219342	CATALAO	CT11000068	CATALAO S2	03/12/2019 14:39	04/12/2019 04:57	03/12/2019 14:39	04/12/2019 04:57	14,29	128	1828,48	CHI
20191219347	ITUMBIARA	690151883	CACHOEIRA DOURADA	03/12/2019 15:07	04/12/2019 08:57	03/12/2019 15:07	04/12/2019 08:57	17,84	1	17,84	CHI
20191219369	CRISTALINA	KR21330516	CRISTALINA S2	03/12/2019 15:10	03/12/2019 20:19	03/12/2019 15:10	03/12/2019 20:19	5,15	1	5,15	CHI

20191219370	ANAPOLIS	20199016	JUNDIAI S2	03/12/2019 15:10	03/12/2019 16:28	03/12/2019 15:10	03/12/2019 16:28	1,30	1	1,30	CHI
20191219371	APARECIDA DE GOIANIA	17351145	INDEPENDENCIA S2	03/12/2019 15:10	03/12/2019 17:00	03/12/2019 15:10	03/12/2019 17:00	1,83	1	1,83	CHI
20191219374	ITABERAÍ	IB21034096	ITABERAÍ S2	03/12/2019 15:10	03/12/2019 17:36	03/12/2019 15:10	03/12/2019 17:36	2,43	1	2,43	CHI
20191219375	ALEXANIA	9840001182	ALEXANIA	03/12/2019 15:10	04/12/2019 11:19	03/12/2019 15:10	04/12/2019 11:19	20,14	1	20,14	CHI
20191219404	BONOPOLIS	PO21151759	NOVO PLANALTO	03/12/2019 15:12	03/12/2019 19:41	03/12/2019 15:12	03/12/2019 19:41	4,47	1	4,47	CHI
20191219406	GOIANIA	10008238	REAL S1	03/12/2019 15:12	03/12/2019 17:05	03/12/2019 15:12	03/12/2019 17:05	1,87	1	1,87	CHI
20191219412	NOVO BRASIL	NB12396213	JUSSARA	03/12/2019 15:13	04/12/2019 00:51	03/12/2019 15:13	04/12/2019 00:51	9,62	1	9,62	CHI
20191219415	VILA PROPICIO	GE12000037	GOIANESIA S2	03/12/2019 05:23	04/12/2019 11:21	03/12/2019 05:23	04/12/2019 11:21	29,96	2	59,92	CHI
20191219419	MIMOSO DE GOIAS	MJ12376736	PADRE BERNARDO	03/12/2019 14:31	03/12/2019 16:31	03/12/2019 14:31	03/12/2019 16:31	1,98	26	51,59	CHI
20191219422	CACHOEIRA ALTA	CA12075132	CACHOEIRA ALTA	03/12/2019 15:12	03/12/2019 17:48	03/12/2019 15:12	03/12/2019 17:48	2,60	23	59,85	CHI
20191219426	RIO VERDE	RV11209763	RIO VERDE S2	03/12/2019 15:03	04/12/2019 04:05	03/12/2019 15:03	04/12/2019 04:05	13,03	73	951,51	CHI
20191219428	TERESINA DE GOIAS	TE11047977	FLORES DE GOIAS	03/12/2019 13:02	03/12/2019 19:40	03/12/2019 13:02	03/12/2019 19:40	6,62	134	886,89	CHI
20191219435	VIANOPOLIS	VN12103025	VIANOPOLIS	03/12/2019 15:15	04/12/2019 10:47	03/12/2019 15:15	04/12/2019 10:47	19,52	3	58,57	CHI
20191219437	GOIAS	GS12172048	GOIAS	03/12/2019 15:15	03/12/2019 18:53	03/12/2019 16:40	03/12/2019 18:53	2,22	13	28,82	CHI
20191219438	GOIANDIRA	CY12081407	CATALAO S1	03/12/2019 15:15	04/12/2019 10:29	03/12/2019 15:15	04/12/2019 10:29	19,23	5	96,15	CHI
20191219443	MINEIROS	MY10401436	PARQUE DAS EMAS	03/12/2019 14:23	03/12/2019 15:24	03/12/2019 14:23	03/12/2019 15:24	1,02	36	36,66	CHI
20191219455	CRISTALINA	KR12383056	CRISTALINA S2	03/12/2019 10:34	03/12/2019 19:54	03/12/2019 10:34	03/12/2019 19:54	9,32	6	55,93	CHI
20191219456	GOIANIA	10017498110	GOYA S1	03/12/2019 15:17	03/12/2019 17:22	03/12/2019 15:17	03/12/2019 17:22	2,09	1	2,09	CHI
20191219458	VIANOPOLIS	VN12282707	VIANOPOLIS	03/12/2019 12:32	03/12/2019 20:11	03/12/2019 12:32	03/12/2019 20:11	7,64	16	122,31	CHI
20191219469	AGUAS LINDAS DE GOIAS	4830364301	AGUAS LINDAS DE GOIAS S1	03/12/2019 15:18	03/12/2019 16:58	03/12/2019 15:18	03/12/2019 16:58	1,66	1	1,66	CHI
20191219470	JATAI	JT21099224	JATAI S1	03/12/2019 15:18	03/12/2019 17:25	03/12/2019 15:18	03/12/2019 17:25	2,11	1	2,11	CHI
20191219472	ANHANGUERA	AH21082012	CATALAO S1	03/12/2019 15:18	04/12/2019 15:57	03/12/2019 15:18	04/12/2019 15:57	24,66	1	24,66	CHI
20191219477	MORRINHOS	MR12252186	GOIATUBA S1	03/12/2019 15:18	03/12/2019 19:05	03/12/2019 15:18	03/12/2019 19:05	3,77	3	11,31	CHI
20191219484	MIMOSO DE GOIAS	MJ12126284	PADRE BERNARDO	03/12/2019 15:19	03/12/2019 17:08	03/12/2019 15:19	03/12/2019 17:08	1,81	4	7,25	CHI
20191219486	CRISTALINA	KR12287383	CRISTALINA S1	03/12/2019 11:40	03/12/2019 21:41	03/12/2019 11:40	03/12/2019 21:41	10,01	78	781,04	CHI
20191219501	INHUMAS	IN11365566	INHUMAS S2	03/12/2019 12:43	03/12/2019 19:48	03/12/2019 12:43	03/12/2019 19:48	7,08	48	339,75	CHI
20191219505	NIQUELANDIA	NQ12182461	NIQUELANDIA SUBTRANSMISSAO	03/12/2019 15:11	04/12/2019 09:15	03/12/2019 15:11	04/12/2019 09:15	18,07	4	72,27	CHI
20191219506	SAO SIMAO	SO11054348	CACHOEIRA ALTA	03/12/2019 14:32	03/12/2019 19:48	03/12/2019 14:32	03/12/2019 19:48	5,28	52	274,31	CHI
20191219507	GOIANESIA	BA12163310	GOIANESIA S1	03/12/2019 14:05	03/12/2019 19:13	03/12/2019 14:05	03/12/2019 19:13	5,13	2	10,26	CHI
20191219507	VILA PROPICIO	BA12163310	GOIANESIA S1	03/12/2019 14:05	03/12/2019 19:13	03/12/2019 14:05	03/12/2019 19:13	5,13	11	56,44	CHI
20191219509	MORRINHOS	MR21121294	MORRINHOS	03/12/2019 15:21	03/12/2019 16:40	03/12/2019 15:21	03/12/2019 16:40	1,31	8	10,48	CHI
20191219515	CATALAO	IP12404711	IPAMERI	03/12/2019 13:58	03/12/2019 19:48	03/12/2019 13:58	03/12/2019 19:48	5,83	7	40,82	CHI
20191219515	GOIANDIRA	IP12404711	IPAMERI	03/12/2019 13:58	03/12/2019 19:48	03/12/2019 13:58	03/12/2019 19:48	5,83	15	87,47	CHI

20191219515	IPAMERI	IP12404711	IPAMERI	03/12/2019 13:58	03/12/2019 19:48	03/12/2019 13:58	03/12/2019 19:48	5,83	86	501,50	CHI
20191219523	GOIANIA	GN11050815	REAL S1	03/12/2019 15:04	03/12/2019 17:17	03/12/2019 15:04	03/12/2019 17:17	2,22	181	401,02	CHI
20191219528	MINEIROS	MY12374381	PARQUE DAS EMAS	03/12/2019 15:22	04/12/2019 12:19	03/12/2019 15:22	04/12/2019 12:19	20,94	3	62,81	CHI
20191219530	NIQUELANDIA	NQ12335416	BARRO ALTO	03/12/2019 15:22	04/12/2019 02:13	03/12/2019 15:22	04/12/2019 02:13	10,83	10	108,34	CHI
20191219531	ITUMBIARA	690349890	ITUMBIARA NOVA	03/12/2019 15:22	03/12/2019 17:00	03/12/2019 15:22	03/12/2019 17:00	1,63	1	1,63	CHI
20191219540	RIO VERDE	RV11327010	RIO VERDE S1	03/12/2019 14:50	03/12/2019 18:00	03/12/2019 14:50	03/12/2019 18:00	3,15	43	135,56	CHI
20191219543	SAO SIMAO	SO12370099	CACHOEIRA ALTA	03/12/2019 15:24	03/12/2019 20:31	03/12/2019 15:24	03/12/2019 20:31	5,11	2	10,22	CHI
20191219547	OUVIDOR	OU12358276RE	CATALAO S1	03/12/2019 15:22	05/12/2019 12:12	03/12/2019 15:22	05/12/2019 12:12	44,84	25	1120,90	CHI
20191219548	IPAMERI	IP21041052	IPAMERI	03/12/2019 15:24	04/12/2019 11:54	03/12/2019 15:24	04/12/2019 11:54	20,48	1	20,48	CHI
20191219557	BOM JESUS DE GOIAS	BJ12392122	BOM JESUS DE GOIAS	03/12/2019 15:26	03/12/2019 23:50	03/12/2019 15:26	03/12/2019 23:50	8,39	6	50,36	CHI
20191219562	ITAPIRAPUA	IU21067921	MATRINCHA	03/12/2019 15:27	04/12/2019 17:30	03/12/2019 15:27	04/12/2019 17:30	26,06	1	26,06	CHI
20191219563	ABADIANIA	350002060	ANAPOLIS UNIVERSITARIO S1	03/12/2019 15:27	03/12/2019 22:03	03/12/2019 15:27	03/12/2019 22:03	6,59	1	6,59	CHI
20191219564	MINEIROS	MY12349099	PARQUE DAS EMAS	03/12/2019 15:27	04/12/2019 13:50	03/12/2019 15:27	04/12/2019 13:50	22,38	3	67,13	CHI
20191219566	SENADOR CANEDO	04980244	SENADOR CANEDO	03/12/2019 15:34	04/12/2019 05:38	03/12/2019 15:34	03/12/2019 16:08	0,57	2581	1482,64	CHI
20191219566	SENADOR CANEDO	SW13391387	SENADOR CANEDO	03/12/2019 15:34	04/12/2019 05:38	03/12/2019 15:34	03/12/2019 16:13	0,65	2363	1547,76	CHI
20191219566	SENADOR CANEDO	04980244	SENADOR CANEDO	03/12/2019 15:34	04/12/2019 05:38	03/12/2019 16:23	03/12/2019 16:48	0,43	2581	1105,53	CHI
20191219566	CALDAZINHA	SW13391387	SENADOR CANEDO	03/12/2019 15:34	04/12/2019 05:38	03/12/2019 15:34	03/12/2019 17:51	2,29	104	238,02	CHI
20191219566	SENADOR CANEDO	SW13391387	SENADOR CANEDO	03/12/2019 15:34	04/12/2019 05:38	03/12/2019 15:34	03/12/2019 17:51	2,29	2221	5083,01	CHI
20191219566	SENADOR CANEDO	SW13391387	SENADOR CANEDO	03/12/2019 15:34	04/12/2019 05:38	03/12/2019 16:23	03/12/2019 17:51	1,48	2210	3262,82	CHI
20191219566	SENADOR CANEDO	SW11116069	SENADOR CANEDO	03/12/2019 15:34	04/12/2019 05:38	03/12/2019 16:23	04/12/2019 05:26	13,05	153	1996,31	CHI
20191219566	SENADOR CANEDO	SW11104452	SENADOR CANEDO	03/12/2019 15:34	04/12/2019 05:38	03/12/2019 19:25	04/12/2019 05:38	10,20	181	1846,85	CHI
20191219570	BONOPOLIS	BX12266016	SAO MIGUEL DO ARAGUAIA	03/12/2019 15:28	03/12/2019 23:28	03/12/2019 15:28	03/12/2019 23:28	8,00	8	63,97	CHI
20191219573	DIORAMA	DI21023281	IPORA	03/12/2019 15:28	04/12/2019 12:05	03/12/2019 15:28	04/12/2019 12:05	20,61	2	41,23	CHI
20191219585	PALESTINA DE GOIAS	PY12223011	PALESTINA	03/12/2019 14:26	03/12/2019 20:56	03/12/2019 14:26	03/12/2019 20:56	6,49	114	739,42	CHI
20191219591	GOIANIA	GN11001154	GOIANIA LESTE S1	03/12/2019 15:29	03/12/2019 21:02	03/12/2019 15:29	03/12/2019 21:02	5,54	220	1218,37	CHI
20191219596	PIRENOPOLIS	JA21282505	JARAGUA	03/12/2019 15:30	03/12/2019 18:00	03/12/2019 15:30	03/12/2019 18:00	2,50	1	2,50	CHI
20191219599	CAMPINORTE	04690224	MARA ROSA	03/12/2019 15:18	04/12/2019 17:19	03/12/2019 15:19	04/12/2019 04:28	13,15	89	1170,42	CHI
20191219599	URUACU	04690224	MARA ROSA	03/12/2019 15:18	04/12/2019 17:19	03/12/2019 15:19	04/12/2019 04:28	13,15	122	1604,40	CHI
20191219599	CAMPINORTE	CR13269871	MARA ROSA	03/12/2019 15:18	04/12/2019 17:19	03/12/2019 15:19	04/12/2019 10:58	19,66	64	1258,28	CHI
20191219599	URUACU	CR13269871	MARA ROSA	03/12/2019 15:18	04/12/2019 17:19	03/12/2019 15:19	04/12/2019 10:58	19,66	18	353,89	CHI
20191219599	CAMPINACU	CR13405410	MARA ROSA	03/12/2019 15:18	04/12/2019 17:19	03/12/2019 15:19	04/12/2019 17:19	26,01	221	5748,89	CHI
20191219599	CAMPINORTE	CR13405410	MARA ROSA	03/12/2019 15:18	04/12/2019 17:19	03/12/2019 15:19	04/12/2019 17:19	26,01	33	858,43	CHI
20191219599	URUACU	CR13405410	MARA ROSA	03/12/2019 15:18	04/12/2019 17:19	03/12/2019 15:19	04/12/2019 17:19	26,01	199	5176,60	CHI

20191219599	CAMPINACU	CR13405410	MARA ROSA	03/12/2019 15:18	04/12/2019 17:19	04/12/2019 04:00	04/12/2019 17:19	13,31	55	732,25	CHI
20191219599	CAMPINORTE	CR13405410	MARA ROSA	03/12/2019 15:18	04/12/2019 17:19	04/12/2019 04:00	04/12/2019 17:19	13,31	15	199,70	CHI
20191219599	URUACU	CR13405410	MARA ROSA	03/12/2019 15:18	04/12/2019 17:19	04/12/2019 04:00	04/12/2019 17:19	13,31	4	53,25	CHI
20191219599	URUACU	CR13405410	MARA ROSA	03/12/2019 15:18	04/12/2019 17:19	04/12/2019 10:40	04/12/2019 17:19	6,66	3	19,98	CHI
20191219599	CAMPINACU	CR13405410	MARA ROSA	03/12/2019 15:18	04/12/2019 17:19	04/12/2019 14:15	04/12/2019 17:19	3,06	5	15,32	CHI
20191219599	URUACU	CR13405410	MARA ROSA	03/12/2019 15:18	04/12/2019 17:19	04/12/2019 14:15	04/12/2019 17:19	3,06	1	3,06	CHI
20191219600	PALMEIRAS DE GOIAS	PL21161866	PALMEIRAS	03/12/2019 15:30	04/12/2019 08:30	03/12/2019 15:30	04/12/2019 08:30	17,00	1	17,00	CHI
20191219601	COCALZINHO DE GOIAS	ZN12000140	COCALZINHO	03/12/2019 12:42	03/12/2019 19:11	03/12/2019 12:42	03/12/2019 19:11	6,47	11	71,22	CHI
20191219606	GOIANIRA	GR31135436	INHUMAS S1	03/12/2019 15:31	04/12/2019 08:32	03/12/2019 15:31	04/12/2019 08:32	17,02	1	17,02	CHI
20191219610	APARECIDA DO RIO DOCE	JT12081473	JATAI S1	03/12/2019 12:40	03/12/2019 19:24	03/12/2019 12:40	03/12/2019 19:24	6,73	10	67,32	CHI
20191219616	SANTA HELENA DE GOIAS	400003545	IPEGUARI	03/12/2019 15:31	04/12/2019 17:34	03/12/2019 15:31	04/12/2019 17:34	26,04	1	26,04	CHI
20191219621	GOIANIA	10011530527	GOIANIA LESTE S1	03/12/2019 15:32	03/12/2019 18:36	03/12/2019 15:32	03/12/2019 18:36	3,06	1	3,06	CHI
20191219622	PORTELANDIA	PW21205295	PARQUE DAS EMAS	03/12/2019 15:32	04/12/2019 11:48	03/12/2019 15:32	04/12/2019 11:48	20,26	1	20,26	CHI
20191219627	TRES RANCHOS	TH12149178	CATALAO S1	03/12/2019 15:33	03/12/2019 21:20	03/12/2019 15:33	03/12/2019 20:43	5,17	6	30,99	CHI
20191219627	TRES RANCHOS	TH12149178	CATALAO S1	03/12/2019 15:33	03/12/2019 21:20	03/12/2019 15:33	03/12/2019 21:20	5,78	8	46,25	CHI
20191219627	TRES RANCHOS	TH12149178	CATALAO S1	03/12/2019 15:33	03/12/2019 21:20	03/12/2019 20:48	03/12/2019 21:20	0,52	6	3,12	CHI
20191219645	PADRE BERNARDO	PB12377203	PADRE BERNARDO	03/12/2019 14:40	03/12/2019 23:38	03/12/2019 14:40	03/12/2019 23:38	8,96	14	125,40	CHI
20191219647	POSSE	1480039059	IACIARA S2	03/12/2019 15:34	03/12/2019 17:41	03/12/2019 15:34	03/12/2019 17:41	2,10	1	2,10	CHI
20191219650	IPAMERI	IP21199359	IPAMERI	03/12/2019 15:35	04/12/2019 10:10	03/12/2019 15:35	04/12/2019 10:10	18,58	1	18,58	CHI
20191219661	GOIANIRA	GR31133740	NEROPOLIS S1	03/12/2019 15:36	04/12/2019 08:32	03/12/2019 15:36	04/12/2019 08:32	16,93	1	16,93	CHI
20191219678	CRISTALINA	KR12153067	CRISTALINA S2	03/12/2019 14:45	04/12/2019 12:50	03/12/2019 14:45	04/12/2019 12:50	22,08	3	66,23	CHI
20191219699	PILAR DE GOIAS	GG12341538	SANTA TEREZINHA	03/12/2019 14:13	04/12/2019 10:50	03/12/2019 14:13	04/12/2019 10:50	20,61	14	288,52	CHI
20191219703	PIRENOPOLIS	PV21278900	CORUMBA	03/12/2019 15:40	03/12/2019 16:24	03/12/2019 15:40	03/12/2019 16:24	0,72	1	0,72	CHI
20191219710	CATALAO	CT12130960RE	CATALAO S2	03/12/2019 13:13	04/12/2019 19:12	03/12/2019 13:13	04/12/2019 01:48	12,58	5	62,89	CHI
20191219710	CUMARI	CT12130960RE	CATALAO S2	03/12/2019 13:13	04/12/2019 19:12	03/12/2019 13:13	04/12/2019 01:48	12,58	2	25,16	CHI
20191219710	CATALAO	CT13266260	CATALAO S2	03/12/2019 13:13	04/12/2019 19:12	03/12/2019 13:13	04/12/2019 03:46	14,54	15	218,13	CHI
20191219710	CUMARI	CT13266260	CATALAO S2	03/12/2019 13:13	04/12/2019 19:12	03/12/2019 13:13	04/12/2019 03:46	14,54	18	261,76	CHI
20191219710	CATALAO	CT13333676	CATALAO S2	03/12/2019 13:13	04/12/2019 19:12	03/12/2019 13:13	04/12/2019 19:12	29,97	11	329,70	CHI
20191219710	CUMARI	CT13333676	CATALAO S2	03/12/2019 13:13	04/12/2019 19:12	03/12/2019 13:13	04/12/2019 19:12	29,97	43	1288,83	CHI
20191219710	GOIANDIRA	CT13333676	CATALAO S2	03/12/2019 13:13	04/12/2019 19:12	03/12/2019 13:13	04/12/2019 19:12	29,97	2	59,95	CHI
20191219715	ITUMBIARA	BG12384533	ITUMBIARA VELHA S2	03/12/2019 15:29	04/12/2019 14:30	03/12/2019 15:29	03/12/2019 21:56	6,44	6	38,63	CHI
20191219715	ITUMBIARA	BG12384533	ITUMBIARA VELHA S2	03/12/2019 15:29	04/12/2019 14:30	04/12/2019 12:45	04/12/2019 12:49	0,05	6	0,32	CHI
20191219715	ITUMBIARA	BG13000016	ITUMBIARA VELHA S2	03/12/2019 15:29	04/12/2019 14:30	03/12/2019 15:29	04/12/2019 14:12	22,71	16	363,28	CHI

20191219715	ITUMBIARA	BG13000017	ITUMBIARA VELHA S2	03/12/2019 15:29	04/12/2019 14:30	03/12/2019 15:29	04/12/2019 14:30	23,01	15	345,08	CHI
20191219718	PORANGATU	PO21088722	PORANGATU	03/12/2019 15:42	03/12/2019 17:18	03/12/2019 15:42	03/12/2019 17:18	1,59	1	1,59	CHI
20191219720	GOIANIA	17045551	MEIA PONTE	03/12/2019 15:42	03/12/2019 18:32	03/12/2019 15:42	03/12/2019 18:32	2,83	1	2,83	CHI
20191219723	FAINA	8540277	GOIAS	03/12/2019 15:43	03/12/2019 18:48	03/12/2019 15:43	03/12/2019 18:48	3,08	2	6,16	CHI
20191219724	CRISTALINA	KR12304816	CRISTALINA S2	03/12/2019 14:11	04/12/2019 11:13	03/12/2019 14:11	04/12/2019 11:13	21,03	15	315,42	CHI
20191219731	GOIANDIRA	CY21081493	CATALAO S1	03/12/2019 15:44	04/12/2019 09:47	03/12/2019 15:44	04/12/2019 09:47	18,06	1	18,06	CHI
20191219736	COLINAS DO SUL	TI21196544	MINACU	03/12/2019 15:44	03/12/2019 19:03	03/12/2019 15:44	03/12/2019 19:03	3,30	1	3,30	CHI
20191219751	UIRAPURU	UP21181159	SANTA TEREZINHA	03/12/2019 15:46	03/12/2019 17:45	03/12/2019 15:46	03/12/2019 17:45	1,98	1	1,98	CHI
20191219755	AMARALINA	MU12391672	MARA ROSA	03/12/2019 15:47	03/12/2019 18:19	03/12/2019 15:47	03/12/2019 18:19	2,53	101	255,78	CHI
20191219755	MUTUNOPOLIS	MU12391672	MARA ROSA	03/12/2019 15:47	03/12/2019 18:19	03/12/2019 15:47	03/12/2019 18:19	2,53	7	17,73	CHI
20191219770	CRISTALINA	KR12171519	CRISTALINA S1	03/12/2019 15:30	03/12/2019 23:49	03/12/2019 15:30	03/12/2019 23:49	8,32	12	99,79	CHI
20191219774	MARA ROSA	MQ21249315	SANTA TEREZINHA	03/12/2019 15:48	04/12/2019 17:00	03/12/2019 15:48	04/12/2019 17:00	25,18	1	25,18	CHI
20191219781	MINACU	IH21236143	MINACU	03/12/2019 15:49	04/12/2019 03:51	03/12/2019 15:49	04/12/2019 03:51	12,02	1	12,02	CHI
20191219789	CORUMBA DE GOIAS	CB12398529	CORUMBA	03/12/2019 15:50	03/12/2019 22:31	03/12/2019 15:50	03/12/2019 22:31	6,68	5	33,41	CHI
20191219800	CORUMBA DE GOIAS	CB12072262	COCALZINHO	03/12/2019 14:27	04/12/2019 13:16	03/12/2019 14:27	04/12/2019 13:16	22,83	5	114,15	CHI
20191219801	SAO LUIS DE MONTES BELOS	SL21033987	FIRMINOPOLIS S2	03/12/2019 15:50	04/12/2019 14:08	03/12/2019 15:50	04/12/2019 14:08	22,29	2	44,57	CHI
20191219803	PIRES DO RIO	460018474	PIRES DO RIO S1	03/12/2019 15:51	04/12/2019 13:19	03/12/2019 15:51	04/12/2019 13:19	21,46	1	21,46	CHI
20191219804	CRISTALINA	KR12133610	CRISTALINA S2	03/12/2019 14:19	03/12/2019 16:47	03/12/2019 14:19	03/12/2019 16:47	2,46	12	29,52	CHI
20191219806	FORMOSA	FA12042563	ITUIQUIRA	03/12/2019 13:11	04/12/2019 15:11	03/12/2019 13:11	04/12/2019 15:11	25,99	53	1377,50	CHI
20191219808	SAO MIGUEL DO ARAGUAIA	SM21000029	SAO MIGUEL DO ARAGUAIA	03/12/2019 15:51	03/12/2019 22:35	03/12/2019 15:51	03/12/2019 22:35	6,73	1	6,73	CHI
20191219810	PALMEIRAS DE GOIAS	PL21022483	PALMEIRAS	03/12/2019 15:51	04/12/2019 15:55	03/12/2019 15:51	04/12/2019 15:55	24,06	2	48,12	CHI
20191219811	RIO VERDE	RV11241410	RIO VERDE S2	03/12/2019 15:22	03/12/2019 17:55	03/12/2019 15:22	03/12/2019 17:55	2,56	168	429,29	CHI
20191219812	IPORA	730031287	IPORA	03/12/2019 15:52	04/12/2019 09:20	03/12/2019 15:52	04/12/2019 09:20	17,48	1	17,48	CHI
20191219817	SILVANIA	SV21127388	VIANOPOLIS	03/12/2019 15:52	04/12/2019 12:05	03/12/2019 15:52	04/12/2019 12:05	20,21	1	20,21	CHI
20191219818	NIQUELANDIA	NQ11090395	NIQUELANDIA SUBTRANSMISSAO	03/12/2019 15:07	04/12/2019 01:49	03/12/2019 15:07	04/12/2019 01:49	10,69	109	1165,00	CHI
20191219825	ITARUMA	IM11382660	ITAJA S2	03/12/2019 15:53	03/12/2019 23:48	03/12/2019 15:53	03/12/2019 23:48	7,91	2	15,83	CHI
20191219829	PADRE BERNARDO	PB12165002	PADRE BERNARDO	03/12/2019 15:53	04/12/2019 14:50	03/12/2019 15:53	04/12/2019 14:50	22,93	2	45,87	CHI
20191219836	IVOLANDIA	PU12090442	MONTIVIDIU T	03/12/2019 08:57	04/12/2019 12:00	03/12/2019 08:57	04/12/2019 12:00	27,07	22	595,44	CHI
20191219836	PARAUNA	PU12090442	MONTIVIDIU T	03/12/2019 08:57	04/12/2019 12:00	03/12/2019 08:57	04/12/2019 12:00	27,07	49	1326,21	CHI
20191219852	PIRENOPOLIS	4330001033	CORUMBA	03/12/2019 15:56	03/12/2019 20:04	03/12/2019 15:56	03/12/2019 20:04	4,13	1	4,13	CHI
20191219855	CATALAO	CT11306743	CATALAO S2	03/12/2019 15:57	04/12/2019 12:21	03/12/2019 15:57	04/12/2019 12:21	20,40	42	856,76	CHI
20191219861	BALIZA	BH12210020	BOM JARDIM	03/12/2019 15:36	03/12/2019 19:34	03/12/2019 15:36	03/12/2019 19:34	3,95	93	367,69	CHI
20191219863	PIRENOPOLIS	PV21252300	CORUMBA	03/12/2019 15:57	03/12/2019 18:32	03/12/2019 15:57	03/12/2019 18:32	2,57	1	2,57	CHI

20191219867	SAO MIGUEL DO ARAGUAIA	SM12334418	SAO MIGUEL DO ARAGUAIA	03/12/2019 15:58	04/12/2019 16:10	03/12/2019 15:58	04/12/2019 16:10	24,20	16	387,16	CHI
20191219876	IPAMERI	UT12027074	URUTAI	03/12/2019 13:52	03/12/2019 20:58	03/12/2019 13:52	03/12/2019 20:58	7,09	43	304,74	CHI
20191219876	URUTAI	UT12027074	URUTAI	03/12/2019 13:52	03/12/2019 20:58	03/12/2019 13:52	03/12/2019 20:58	7,09	9	63,78	CHI
20191219907	ITUMBIARA	690216841	ITUMBIARA NOVA	03/12/2019 16:02	03/12/2019 18:07	03/12/2019 16:02	03/12/2019 18:07	2,07	1	2,07	CHI
20191219911	SAO MIGUEL DO ARAGUAIA	SM12137060	SAO MIGUEL DO ARAGUAIA	03/12/2019 16:03	03/12/2019 18:30	03/12/2019 16:03	03/12/2019 18:30	2,45	2	4,90	CHI
20191219921	ITAPURANGA	IK12299287	ITAPURANGA	03/12/2019 16:04	04/12/2019 18:00	03/12/2019 16:04	04/12/2019 11:38	19,58	2	39,15	CHI
20191219921	ITAPURANGA	IK12299287	ITAPURANGA	03/12/2019 16:04	04/12/2019 18:00	03/12/2019 16:04	04/12/2019 18:00	25,93	11	285,24	CHI
20191219921	ITAPURANGA	IK12299287	ITAPURANGA	03/12/2019 16:04	04/12/2019 18:00	04/12/2019 15:40	04/12/2019 18:00	2,33	2	4,67	CHI
20191219927	GOIAS	IU12060536	MATRINCHA	03/12/2019 15:12	03/12/2019 19:13	03/12/2019 15:12	03/12/2019 19:13	4,01	1	4,01	CHI
20191219927	ITAPIRAPUA	IU12060536	MATRINCHA	03/12/2019 15:12	03/12/2019 19:13	03/12/2019 15:12	03/12/2019 19:13	4,01	14	56,13	CHI
20191219932	SANCLERLANDIA	SC12299048	FIRMINOPOLIS S2	03/12/2019 16:05	03/12/2019 19:36	03/12/2019 16:05	03/12/2019 19:36	3,51	4	14,05	CHI
20191219938	INHUMAS	30127944	INHUMAS S2	03/12/2019 16:05	04/12/2019 01:18	03/12/2019 16:05	04/12/2019 01:18	9,21	1	9,21	CHI
20191219939	ALEXANIA	AX10403901	ALEXANIA	03/12/2019 16:09	04/12/2019 00:38	03/12/2019 16:09	04/12/2019 00:38	8,47	313	2652,50	CHI
20191219940	MINACU	IH12181712	MINACU	03/12/2019 16:06	04/12/2019 00:58	03/12/2019 16:06	04/12/2019 00:58	8,87	74	656,28	CHI
20191219950	MINACU	IH12088797	MINACU	03/12/2019 13:47	03/12/2019 19:23	03/12/2019 13:47	03/12/2019 19:23	5,59	165	922,67	CHI
20191219962	NIQUELANDIA	NQ11000009	NIQUELANDIA SUBTRANSMISSAO	03/12/2019 14:35	03/12/2019 18:52	03/12/2019 14:35	03/12/2019 18:52	4,28	181	774,38	CHI
20191219965	MINEIROS	MY12149301	PARQUE DAS EMAS	03/12/2019 15:49	04/12/2019 00:51	03/12/2019 15:49	04/12/2019 00:51	9,03	17	153,43	CHI
20191219965	PEROLANDIA	MY12149301	PARQUE DAS EMAS	03/12/2019 15:49	04/12/2019 00:51	03/12/2019 15:49	04/12/2019 00:51	9,03	1	9,03	CHI
20191219967	INHUMAS	IN21148379	INHUMAS S2	03/12/2019 16:08	04/12/2019 01:50	03/12/2019 16:08	04/12/2019 01:50	9,70	1	9,70	CHI
20191219978	CAIAPONIA	CP21096420	CAIAPONIA	03/12/2019 16:09	04/12/2019 12:52	03/12/2019 16:09	04/12/2019 12:52	20,71	1	20,71	CHI
20191219986	JATAI	JT21104000	JATAI S3	03/12/2019 16:11	03/12/2019 18:15	03/12/2019 16:11	03/12/2019 18:15	2,06	1	2,06	CHI
20191219988	ITAPURANGA	IK12390227	ITAPURANGA	03/12/2019 16:11	03/12/2019 17:26	03/12/2019 16:11	03/12/2019 17:26	1,25	4	4,98	CHI
20191219996	TRES RANCHOS	TH21316091	CATALAO S1	03/12/2019 16:12	04/12/2019 10:40	03/12/2019 16:12	04/12/2019 10:40	18,45	20	369,07	CHI
20191220000	SANTA TEREZA DE GOIAS	SE12361690	MARA ROSA	03/12/2019 15:36	04/12/2019 09:26	03/12/2019 15:36	04/12/2019 09:26	17,82	3	53,46	CHI
20191220026	GOIANESIA	GE11000052	GOIANESIA S2	03/12/2019 17:40	04/12/2019 11:27	03/12/2019 17:40	04/12/2019 11:27	17,77	92	1634,94	CHI
20191220029	DIVINOPOLIS DE GOIAS	GH11262284	SAO DOMINGOS	03/12/2019 18:09	03/12/2019 18:33	03/12/2019 18:09	03/12/2019 18:33	0,40	88	34,88	CHI
20191220045	PALMEIRAS DE GOIAS	PL12087671	PALMEIRAS	03/12/2019 09:46	03/12/2019 20:25	03/12/2019 09:46	03/12/2019 20:25	10,65	1	10,65	CHI
20191220046	GAMELEIRA DE GOIAS	SV12013378	DAIA S2	03/12/2019 18:55	04/12/2019 16:57	03/12/2019 18:55	04/12/2019 16:57	22,03	5	110,16	CHI
20191220065	CAIAPONIA	PY12020934	PALESTINA	03/12/2019 14:16	03/12/2019 22:03	03/12/2019 14:16	03/12/2019 22:03	7,77	161	1251,69	CHI
20191220065	PALESTINA DE GOIAS	PY12020934	PALESTINA	03/12/2019 14:16	03/12/2019 22:03	03/12/2019 14:16	03/12/2019 22:03	7,77	25	194,36	CHI
20191220079	ITAGUARI	10001692818	ITABERAI S1	03/12/2019 16:59	03/12/2019 20:46	03/12/2019 16:59	03/12/2019 20:46	3,78	1	3,78	CHI
20191220088	BALIZA	BH12334522	BOM JARDIM	03/12/2019 15:28	05/12/2019 14:28	03/12/2019 15:28	04/12/2019 11:53	20,41	14	285,75	CHI
20191220088	BALIZA	BH12334522	BOM JARDIM	03/12/2019 15:28	05/12/2019 14:28	03/12/2019 15:28	05/12/2019 14:28	47,00	1	47,00	CHI

20191220094	PARAUNA	PU12103374	PARAUNA	03/12/2019 10:00	04/12/2019 08:10	03/12/2019 10:00	04/12/2019 08:10	22,16	12	265,87	CHI
20191220099	ITARUMA	IM21150299	CACHOEIRA ALTA	03/12/2019 20:13	03/12/2019 20:54	03/12/2019 20:13	03/12/2019 20:54	0,68	1	0,68	CHI
20191220107	CATALAO	CT12267016	CATALAO S1	03/12/2019 14:06	03/12/2019 18:15	03/12/2019 14:06	03/12/2019 18:15	4,15	45	186,64	CHI
20191220112	SENADOR CANEDO	12850240	SENADOR CANEDO	03/12/2019 16:14	04/12/2019 04:51	03/12/2019 16:14	04/12/2019 04:51	12,60	1	12,60	CHI
20191220125	DIVINOPOLIS DE GOIAS	GH12208671	SAO DOMINGOS	03/12/2019 16:16	03/12/2019 18:06	03/12/2019 16:16	03/12/2019 18:06	1,82	527	960,90	CHI
20191220126	SANTO ANTONIO DE GOIAS	BW21297392	NEROPOLIS S1	03/12/2019 16:16	03/12/2019 20:30	03/12/2019 16:16	03/12/2019 20:30	4,22	2	8,44	CHI
20191220127	ITAPACI	IW21150537	ITAPACI	03/12/2019 16:16	04/12/2019 14:26	03/12/2019 16:16	04/12/2019 14:26	22,15	1	22,15	CHI
20191220129	GOIANESIA	GE21382830	GOIANESIA S2	03/12/2019 16:17	04/12/2019 11:29	03/12/2019 16:17	04/12/2019 11:29	19,20	2	38,40	CHI
20191220139	ITAGUARU	IC21294238	ITABERAI S1	03/12/2019 16:18	03/12/2019 20:03	03/12/2019 16:18	03/12/2019 20:03	3,75	4	14,99	CHI
20191220143	OURO VERDE DE GOIAS	OV21014220	INHUMAS S1	03/12/2019 16:18	04/12/2019 00:49	03/12/2019 16:18	04/12/2019 00:49	8,51	1	8,51	CHI
20191220149	SANTA RITA DO NOVO DESTINO	BA12021220	BARRO ALTO	03/12/2019 12:50	03/12/2019 18:35	03/12/2019 12:50	03/12/2019 18:35	5,74	6	34,43	CHI
20191220150	MINEIROS	MY12390605	PARQUE DAS EMAS	03/12/2019 16:20	04/12/2019 13:02	03/12/2019 16:20	04/12/2019 13:02	20,70	15	310,50	CHI
20191220153	MONTIVIDIU DO NORTE	MX10400351	PORANGATU	03/12/2019 10:47	04/12/2019 16:07	03/12/2019 14:08	03/12/2019 18:39	4,51	87	392,71	CHI
20191220153	TROMBAS	MX10400351	PORANGATU	03/12/2019 10:47	04/12/2019 16:07	03/12/2019 14:08	03/12/2019 18:39	4,51	22	99,31	CHI
20191220153	MONTIVIDIU DO NORTE	MX10400351	PORANGATU	03/12/2019 10:47	04/12/2019 16:07	03/12/2019 14:08	03/12/2019 19:48	5,67	29	164,37	CHI
20191220153	MONTIVIDIU DO NORTE	MX10400351	PORANGATU	03/12/2019 10:47	04/12/2019 16:07	03/12/2019 22:13	03/12/2019 23:40	1,45	116	167,88	CHI
20191220153	TROMBAS	MX10400351	PORANGATU	03/12/2019 10:47	04/12/2019 16:07	03/12/2019 22:13	03/12/2019 23:40	1,45	22	31,84	CHI
20191220153	MONTIVIDIU DO NORTE	MX10400351	PORANGATU	03/12/2019 10:47	04/12/2019 16:07	03/12/2019 14:08	04/12/2019 02:24	12,27	279	3423,10	CHI
20191220153	MONTIVIDIU DO NORTE	MX11226403	PORANGATU	03/12/2019 10:47	04/12/2019 16:07	03/12/2019 10:47	04/12/2019 02:24	15,62	1	15,62	CHI
20191220153	MONTIVIDIU DO NORTE	MX10400351	PORANGATU	03/12/2019 10:47	04/12/2019 16:07	03/12/2019 14:08	04/12/2019 16:07	25,97	237	6154,96	CHI
20191220154	MAURILANDIA	ML21303579	RIO DOS BOIS	03/12/2019 16:20	03/12/2019 21:00	03/12/2019 16:20	03/12/2019 21:00	4,66	1	4,66	CHI
20191220160	AGUA FRIA DE GOIAS	MJ12183873	PADRE BERNARDO	03/12/2019 15:00	03/12/2019 19:35	03/12/2019 15:00	03/12/2019 19:35	4,57	1	4,57	CHI
20191220160	MIMOSO DE GOIAS	MJ12183873	PADRE BERNARDO	03/12/2019 15:00	03/12/2019 19:35	03/12/2019 15:00	03/12/2019 19:35	4,57	13	59,37	CHI
20191220172	SANTO ANTONIO DO DESCOBERTO	2210133513	ALEXANIA	03/12/2019 16:22	03/12/2019 18:40	03/12/2019 16:22	03/12/2019 18:40	2,29	1	2,29	CHI
20191220177	CORUMBA DE GOIAS	260021659	CORUMBA	03/12/2019 16:23	03/12/2019 21:04	03/12/2019 16:23	03/12/2019 21:04	4,68	1	4,68	CHI
20191220185	GOIAS	90057417	GOIAS	03/12/2019 16:24	03/12/2019 20:30	03/12/2019 16:24	03/12/2019 20:30	4,11	1	4,11	CHI
20191220206	CATALAO	CT12394011RE	CATALAO S1	03/12/2019 15:00	03/12/2019 19:12	03/12/2019 15:00	03/12/2019 19:12	4,18	47	196,66	CHI
20191220206	OUVIDOR	CT12394011RE	CATALAO S1	03/12/2019 15:00	03/12/2019 19:12	03/12/2019 15:00	03/12/2019 19:12	4,18	38	159,00	CHI
20191220208	BONOPOLIS	SM10396890	SAO MIGUEL DO ARAGUAIA	04/12/2019 08:19	04/12/2019 10:40	04/12/2019 08:19	04/12/2019 10:40	2,34	104	243,56	CHI
20191220208	SAO MIGUEL DO ARAGUAIA	SM10396890	SAO MIGUEL DO ARAGUAIA	04/12/2019 08:19	04/12/2019 10:40	04/12/2019 08:19	04/12/2019 10:40	2,34	111	259,96	CHI
20191220230	BELA VISTA DE GOIAS	SW12091937LD	SENADOR CANEDO	03/12/2019 13:17	03/12/2019 21:41	03/12/2019 13:17	03/12/2019 21:41	8,40	21	176,39	CHI
20191220230	CALDAZINHA	SW12091937LD	SENADOR CANEDO	03/12/2019 13:17	03/12/2019 21:41	03/12/2019 13:17	03/12/2019 21:41	8,40	45	377,98	CHI
20191220230	SENADOR CANEDO	SW12091937LD	SENADOR CANEDO	03/12/2019 13:17	03/12/2019 21:41	03/12/2019 13:17	03/12/2019 21:41	8,40	10	83,99	CHI

20191220236	PARANAIGUARA	QI12101708	QUIRINOPOLIS	03/12/2019 15:18	04/12/2019 09:35	03/12/2019 15:18	04/12/2019 09:35	18,27	3	54,81	CHI
20191220236	QUIRINOPOLIS	QJ12101708	QUIRINOPOLIS	03/12/2019 15:18	04/12/2019 09:35	03/12/2019 15:18	04/12/2019 09:35	18,27	10	182,69	CHI
20191220237	GOIANDIRA	GD12127685	CATALAO S1	03/12/2019 16:01	04/12/2019 09:40	03/12/2019 16:01	04/12/2019 09:15	17,24	10	172,45	CHI
20191220237	NOVA AURORA	GD12127685	CATALAO S1	03/12/2019 16:01	04/12/2019 09:40	03/12/2019 16:01	04/12/2019 09:15	17,24	12	206,94	CHI
20191220237	GOIANDIRA	GD12127674	CATALAO S1	03/12/2019 16:01	04/12/2019 09:40	03/12/2019 16:01	04/12/2019 09:40	17,65	22	388,37	CHI
20191220237	NOVA AURORA	GD12127674	CATALAO S1	03/12/2019 16:01	04/12/2019 09:40	03/12/2019 16:01	04/12/2019 09:40	17,65	3	52,96	CHI
20191220239	ANAPOLIS	AN12261182	JUNDIAI S1	03/12/2019 15:59	03/12/2019 19:14	03/12/2019 15:59	03/12/2019 19:14	3,24	62	200,59	CHI
20191220239	GOIANAPOLIS	AN12261182	JUNDIAI S1	03/12/2019 15:59	03/12/2019 19:14	03/12/2019 15:59	03/12/2019 19:14	3,24	9	29,12	CHI
20191220239	LEOPOLDO DE BULHOES	AN12261182	JUNDIAI S1	03/12/2019 15:59	03/12/2019 19:14	03/12/2019 15:59	03/12/2019 19:14	3,24	5	16,18	CHI
20191220246	MINEIROS	MY21301877	PARQUE DAS EMAS	03/12/2019 16:29	04/12/2019 12:21	03/12/2019 16:29	04/12/2019 12:21	19,86	1	19,86	CHI
20191220252	ITAPACI	IW21035630	ITAPACI	03/12/2019 16:30	03/12/2019 18:28	03/12/2019 16:30	03/12/2019 18:28	1,96	1	1,96	CHI
20191220257	JATAI	04070224	JATAI S1	04/12/2019 06:05	05/12/2019 14:47	04/12/2019 06:05	04/12/2019 18:25	12,32	56	689,86	CHI
20191220257	JATAI	JT13214343	JATAI S1	04/12/2019 06:05	05/12/2019 14:47	04/12/2019 17:58	04/12/2019 18:25	0,45	12	5,40	CHI
20191220257	JATAI	JT13214343	JATAI S1	04/12/2019 06:05	05/12/2019 14:47	04/12/2019 17:58	05/12/2019 14:47	20,82	353	7348,28	CHI
20191220257	SERRANOPOLIS	JT13214343	JATAI S1	04/12/2019 06:05	05/12/2019 14:47	04/12/2019 17:58	05/12/2019 14:47	20,82	41	853,48	CHI
20191220259	IPORA	730008691	IPORA	03/12/2019 16:31	04/12/2019 11:20	03/12/2019 16:31	04/12/2019 11:20	18,82	1	18,82	CHI
20191220260	MONTE ALEGRE DE GOIAS	MA21282245	SAO DOMINGOS	03/12/2019 16:31	03/12/2019 21:48	03/12/2019 16:31	03/12/2019 21:48	5,28	1	5,28	CHI
20191220261	SERRANOPOLIS	SX12296482	JATAI S1	03/12/2019 16:31	04/12/2019 10:01	03/12/2019 16:31	04/12/2019 10:01	17,49	2	34,98	CHI
20191220264	NIQUELANDIA	NQ12378040	NIQUELANDIA SUBTRANSMISSAO	03/12/2019 16:25	04/12/2019 13:51	03/12/2019 16:25	04/12/2019 13:51	21,43	24	514,34	CHI
20191220266	SANTA HELENA DE GOIAS	SH12279869	IPEGUARI	03/12/2019 16:15	03/12/2019 18:40	03/12/2019 16:15	03/12/2019 18:40	2,41	167	401,91	CHI
20191220268	DIVINOPOLIS DE GOIAS	GH12241928	SAO DOMINGOS	03/12/2019 16:19	03/12/2019 20:23	03/12/2019 16:19	03/12/2019 20:23	4,06	40	162,47	CHI
20191220268	MONTE ALEGRE DE GOIAS	GH12241928	SAO DOMINGOS	03/12/2019 16:19	03/12/2019 20:23	03/12/2019 16:19	03/12/2019 20:23	4,06	3	12,19	CHI
20191220268	SAO DOMINGOS	GH12241928	SAO DOMINGOS	03/12/2019 16:19	03/12/2019 20:23	03/12/2019 16:19	03/12/2019 20:23	4,06	12	48,74	CHI
20191220272	CALDAS NOVAS	CN12332905	CALDAS NOVAS S1	03/12/2019 16:32	04/12/2019 09:04	03/12/2019 16:32	04/12/2019 09:04	16,53	30	495,81	CHI
20191220276	JUSSARA	JR12259891	BRITANIA	03/12/2019 16:22	04/12/2019 09:05	03/12/2019 16:22	04/12/2019 09:05	16,71	6	100,27	CHI
20191220287	SANTA TEREZA DE GOIAS	SE12262714	PORANGATU	03/12/2019 15:38	04/12/2019 09:56	03/12/2019 15:38	04/12/2019 09:56	18,29	15	274,33	CHI
20191220289	NIQUELANDIA	NQ12359847	NIQUELANDIA SUBTRANSMISSAO	03/12/2019 16:35	04/12/2019 12:15	03/12/2019 16:35	04/12/2019 12:15	19,66	42	825,77	CHI
20191220290	ORIZONA	OZ12022855	PIRES DO RIO S2	03/12/2019 16:08	03/12/2019 22:39	03/12/2019 16:08	03/12/2019 22:39	6,50	8	52,02	CHI
20191220292	APARECIDA DE GOIANIA	AP11127048	ANHANGUERA	03/12/2019 16:23	03/12/2019 18:45	03/12/2019 16:23	03/12/2019 18:45	2,35	179	420,75	CHI
20191220294	GOIANIA	17317587	CARAJAS S2	03/12/2019 16:35	03/12/2019 18:34	03/12/2019 16:35	03/12/2019 18:34	1,97	1	1,97	CHI
20191220297	JATAI	JT12226497	PARQUE DAS EMAS	03/12/2019 15:35	03/12/2019 19:00	03/12/2019 15:35	03/12/2019 19:00	3,41	23	78,51	CHI
20191220297	MINEIROS	JT12226497	PARQUE DAS EMAS	03/12/2019 15:35	03/12/2019 19:00	03/12/2019 15:35	03/12/2019 19:00	3,41	1	3,41	CHI
20191220297	PEROLANDIA	JT12226497	PARQUE DAS EMAS	03/12/2019 15:35	03/12/2019 19:00	03/12/2019 15:35	03/12/2019 19:00	3,41	17	58,03	CHI

20191220299	ANAPOLIS	AN12390216	DAIA S1	03/12/2019 16:36	04/12/2019 10:16	03/12/2019 16:36	04/12/2019 10:16	17,67	1	17,67	CHI
20191220311	ITABERAÍ	TQ12025622	ITABERAÍ S1	03/12/2019 16:37	03/12/2019 19:55	03/12/2019 16:37	03/12/2019 19:55	3,29	3	9,88	CHI
20191220311	TAQUARAL DE GOIAS	TQ12025622	ITABERAÍ S1	03/12/2019 16:37	03/12/2019 19:55	03/12/2019 16:37	03/12/2019 19:55	3,29	34	112,03	CHI
20191220313	HIDROLINA	SZ12190057	ITAPACI	03/12/2019 13:34	04/12/2019 08:50	03/12/2019 13:34	04/12/2019 08:50	19,27	32	616,53	CHI
20191220313	SAO LUIZ DO NORTE	SZ12190057	ITAPACI	03/12/2019 13:34	04/12/2019 08:50	03/12/2019 13:34	04/12/2019 08:50	19,27	2	38,53	CHI
20191220323	RIO VERDE	RV10406664	CABRIUVA S2	03/12/2019 16:41	05/12/2019 18:57	03/12/2019 16:41	03/12/2019 18:52	2,18	11	24,01	CHI
20191220323	RIO VERDE	RV10406664	CABRIUVA S2	03/12/2019 16:41	05/12/2019 18:57	03/12/2019 16:41	03/12/2019 22:40	6,00	3	17,99	CHI
20191220323	RIO VERDE	RV10406664	CABRIUVA S2	03/12/2019 16:41	05/12/2019 18:57	04/12/2019 12:24	04/12/2019 12:45	0,35	14	4,95	CHI
20191220323	RIO VERDE	RV10406664	CABRIUVA S2	03/12/2019 16:41	05/12/2019 18:57	04/12/2019 15:03	04/12/2019 15:15	0,19	14	2,65	CHI
20191220323	RIO VERDE	RV10406664	CABRIUVA S2	03/12/2019 16:41	05/12/2019 18:57	03/12/2019 16:41	05/12/2019 18:57	50,28	27	1357,43	CHI
20191220323	RIO VERDE	RV13209300	CABRIUVA S2	03/12/2019 16:41	05/12/2019 18:57	04/12/2019 12:45	05/12/2019 18:57	30,21	1	30,21	CHI
20191220330	VICENTINOPOLIS	VI21057735	VICENTINOPOLIS	03/12/2019 16:39	03/12/2019 21:47	03/12/2019 16:39	03/12/2019 21:47	5,13	1	5,13	CHI
20191220334	NIQUELANDIA	NQ12095769	NIQUELANDIA SUBTRANSMISSAO	03/12/2019 16:39	04/12/2019 17:45	03/12/2019 16:39	04/12/2019 17:45	25,09	3	75,27	CHI
20191220338	AGUA FRIA DE GOIAS	PI12048039	SAO JOAO D ALIANCA	03/12/2019 16:40	04/12/2019 16:11	03/12/2019 16:40	04/12/2019 16:11	23,51	44	1034,64	CHI
20191220339	BALIZA	BH11334950	BOM JARDIM	03/12/2019 16:40	04/12/2019 00:29	03/12/2019 16:40	04/12/2019 00:29	7,81	85	664,25	CHI
20191220341	NIQUELANDIA	NQ12262919	NIQUELANDIA SUBTRANSMISSAO	03/12/2019 16:40	04/12/2019 12:23	03/12/2019 16:40	04/12/2019 12:23	19,71	9	177,37	CHI
20191220343	ACREUNA	EU11279445	ACREUNA	03/12/2019 16:40	03/12/2019 23:51	03/12/2019 16:40	03/12/2019 23:51	7,17	8	57,38	CHI
20191220346	NIQUELANDIA	NQ21359813	NIQUELANDIA SUBTRANSMISSAO	03/12/2019 16:41	04/12/2019 10:23	03/12/2019 16:41	04/12/2019 10:23	17,70	1	17,70	CHI
20191220355	PALMEIRAS DE GOIAS	PL21147693	PALMEIRAS	03/12/2019 16:42	04/12/2019 09:00	03/12/2019 16:42	04/12/2019 09:00	16,31	1	16,31	CHI
20191220357	BARRO ALTO	BA12210750	GOIANESIA S1	03/12/2019 16:42	04/12/2019 14:42	03/12/2019 16:42	04/12/2019 14:42	22,00	3	65,99	CHI
20191220363	CAMPOS BELOS	MA12209854	SAO DOMINGOS	03/12/2019 16:31	03/12/2019 20:27	03/12/2019 16:31	03/12/2019 20:27	3,92	4	15,68	CHI
20191220363	MONTE ALEGRE DE GOIAS	MA12209854	SAO DOMINGOS	03/12/2019 16:31	03/12/2019 20:27	03/12/2019 16:31	03/12/2019 20:27	3,92	4	15,68	CHI
20191220379	PROFESSOR JAMIL SAFADY	JS21373961	ROCHEDO	03/12/2019 16:44	03/12/2019 17:28	03/12/2019 16:44	03/12/2019 17:28	0,73	1	0,73	CHI
20191220389	SAO DOMINGOS	SD12161805	SAO DOMINGOS	03/12/2019 16:46	05/12/2019 00:08	03/12/2019 16:46	05/12/2019 00:08	31,36	49	1536,72	CHI
20191220391	PADRE BERNARDO	PI12099216	PLANALTINA	03/12/2019 08:57	03/12/2019 19:42	03/12/2019 08:57	03/12/2019 19:42	10,73	14	150,29	CHI
20191220391	PLANALTINA	PI12099216	PLANALTINA	03/12/2019 08:57	03/12/2019 19:42	03/12/2019 08:57	03/12/2019 19:42	10,73	105	1127,15	CHI
20191220393	ITUMBIARA	690360678	PARANAIBA	03/12/2019 16:46	04/12/2019 10:51	03/12/2019 16:46	04/12/2019 10:51	18,07	1	18,07	CHI
20191220395	GOIATUBA	GT12000370	GOIATUBA S2	03/12/2019 15:54	03/12/2019 20:15	03/12/2019 15:54	03/12/2019 20:15	4,34	11	47,72	CHI
20191220397	MINEIROS	MY12133261	PARQUE DAS EMAS	03/12/2019 16:47	04/12/2019 11:04	03/12/2019 16:47	04/12/2019 11:04	18,27	6	109,64	CHI
20191220398	CORUMBAIBA	CI12234658	VILA CORUMBA	03/12/2019 16:47	04/12/2019 11:24	03/12/2019 16:47	04/12/2019 11:24	18,60	1	18,60	CHI
20191220399	MIMOSO DE GOIAS	MJ12377239	PADRE BERNARDO	03/12/2019 14:58	03/12/2019 18:29	03/12/2019 14:58	03/12/2019 18:29	3,51	5	17,55	CHI
20191220400	GOIANIA	GN12000476	XAVANTES	03/12/2019 16:51	03/12/2019 17:34	03/12/2019 16:51	03/12/2019 17:34	0,72	3	2,15	CHI
20191220401	CRISTALINA	KR12349171	PAMPLONA	03/12/2019 15:04	04/12/2019 00:57	03/12/2019 15:04	04/12/2019 00:57	9,87	1	9,87	CHI

20191220401	LUZIANIA	KR12349171	PAMPLONA	03/12/2019 15:04	04/12/2019 00:57	03/12/2019 15:04	04/12/2019 00:57	9,87	32	315,74	CHI
20191220405	PEROLANDIA	DP12260360	JATAI S1	03/12/2019 16:48	04/12/2019 11:38	03/12/2019 16:48	04/12/2019 11:38	18,83	3	56,49	CHI
20191220411	PORANGATU	PO12241996	PORANGATU	03/12/2019 14:53	03/12/2019 19:03	03/12/2019 14:53	03/12/2019 19:03	4,16	80	332,91	CHI
20191220413	CALDAS NOVAS	CN21110329	CALDAS NOVAS S1	03/12/2019 16:49	04/12/2019 10:00	03/12/2019 16:49	04/12/2019 10:00	17,18	1	17,18	CHI
20191220416	SERRANOPOLIS	SX12216725	JATAI S1	03/12/2019 16:49	04/12/2019 14:08	03/12/2019 16:49	04/12/2019 14:08	21,30	23	489,94	CHI
20191220417	GOIANIA	10001487122	GOYA S1	03/12/2019 16:49	03/12/2019 20:01	03/12/2019 16:49	03/12/2019 20:01	3,18	1	3,18	CHI
20191220418	NIQUELANDIA	2750124240	NIQUELANDIA SUBTRANSMISSAO	03/12/2019 16:50	04/12/2019 04:51	03/12/2019 16:50	04/12/2019 04:51	12,01	1	12,01	CHI
20191220432	ITAPIRAPUA	IU12020184	JUSSARA	03/12/2019 15:05	04/12/2019 17:20	03/12/2019 15:05	04/12/2019 17:20	26,26	6	157,57	CHI
20191220438	TURVANIA	TV12289724	FIRMINOPOLIS S2	03/12/2019 16:51	04/12/2019 11:34	03/12/2019 16:51	04/12/2019 11:34	18,71	2	37,41	CHI
20191220445	CATALAO	TH21192609	CATALAO S1	03/12/2019 16:52	04/12/2019 09:25	03/12/2019 16:52	04/12/2019 09:25	16,55	2	33,10	CHI
20191220448	MINACU	IH12360453	MINACU	04/12/2019 07:39	04/12/2019 14:37	04/12/2019 07:39	04/12/2019 14:37	6,97	47	327,66	CHI
20191220451	GOIAS	GS21310429	ITABERAI S1	03/12/2019 16:52	04/12/2019 09:30	03/12/2019 16:52	04/12/2019 09:30	16,62	1	16,62	CHI
20191220454	MOZARLANDIA	MZ21229196	MOZARLANDIA	03/12/2019 16:53	04/12/2019 21:45	03/12/2019 16:53	04/12/2019 21:45	28,87	1	28,87	CHI
20191220457	HIDROLINA	UR12048650	URUACU	03/12/2019 12:14	04/12/2019 12:10	03/12/2019 12:14	04/12/2019 12:10	23,93	15	359,00	CHI
20191220457	URUACU	UR12048650	URUACU	03/12/2019 12:14	04/12/2019 12:10	03/12/2019 12:14	04/12/2019 12:10	23,93	34	813,73	CHI
20191220460	JOVIANIA	JV12050247	VICENTINOPOLIS	03/12/2019 16:41	04/12/2019 17:02	03/12/2019 16:41	04/12/2019 17:02	24,34	8	194,76	CHI
20191220461	LAGOA SANTA	IJ21370113	CACHOEIRA ALTA	03/12/2019 16:54	04/12/2019 13:32	03/12/2019 16:54	04/12/2019 13:32	20,63	1	20,63	CHI
20191220462	RIO VERDE	RV12279609	RIO VERDE S1	03/12/2019 16:54	04/12/2019 09:57	03/12/2019 16:54	04/12/2019 09:57	17,05	31	528,52	CHI
20191220465	ACREUNA	EU12074859	ACREUNA	03/12/2019 16:54	03/12/2019 22:05	03/12/2019 16:54	03/12/2019 22:05	5,17	48	248,31	CHI
20191220467	ANAPOLIS	20740608	JUNDIAI S1	03/12/2019 16:54	03/12/2019 18:03	03/12/2019 16:54	03/12/2019 18:03	1,14	1	1,14	CHI
20191220471	PILAR DE GOIAS	SG12390506	SANTA TEREZINHA	03/12/2019 14:18	04/12/2019 12:30	03/12/2019 14:18	04/12/2019 12:30	22,20	3	66,60	CHI
20191220471	SANTA TEREZINHA DE GOIAS	SG12390506	SANTA TEREZINHA	03/12/2019 14:18	04/12/2019 12:30	03/12/2019 14:18	04/12/2019 12:30	22,20	50	1110,00	CHI
20191220479	FORMOSA	PI12122031	PLANALTINA	03/12/2019 16:56	04/12/2019 11:25	03/12/2019 16:56	04/12/2019 11:25	18,48	3	55,43	CHI
20191220485	PARANAIGUARA	2230027895	CACHOEIRA ALTA	03/12/2019 16:56	03/12/2019 22:02	03/12/2019 16:56	03/12/2019 22:02	5,09	1	5,09	CHI
20191220486	AMARALINA	ET12000004	MARA ROSA	03/12/2019 16:50	04/12/2019 15:38	03/12/2019 16:50	04/12/2019 15:38	22,79	6	136,75	CHI
20191220486	MUTUNOPOLIS	ET12000004	MARA ROSA	03/12/2019 16:50	04/12/2019 15:38	03/12/2019 16:50	04/12/2019 15:38	22,79	3	68,37	CHI
20191220495	NEROPOLIS	NR21353481	DAIA S2	03/12/2019 16:57	04/12/2019 11:10	03/12/2019 16:57	04/12/2019 11:10	18,20	1	18,20	CHI
20191220498	NIQUELANDIA	NQ12256382	NIQUELANDIA SUBTRANSMISSAO	03/12/2019 16:58	04/12/2019 10:32	03/12/2019 16:58	04/12/2019 10:32	17,57	3	52,70	CHI
20191220499	AMARALINA	LC21327564	MARA ROSA	03/12/2019 16:58	03/12/2019 19:12	03/12/2019 16:58	03/12/2019 19:12	2,23	1	2,23	CHI
20191220501	MINACU	IH21220706	MINACU	03/12/2019 16:58	04/12/2019 12:07	03/12/2019 16:58	04/12/2019 12:07	19,14	1	19,14	CHI
20191220511	GUARANI DE GOIAS	GY21242634	IACIARA S1	03/12/2019 16:56	03/12/2019 22:01	03/12/2019 16:56	03/12/2019 22:01	5,07	1	5,07	CHI
20191220512	PETROLINA DE GOIAS	10030205652	PETROLINA	03/12/2019 16:57	04/12/2019 12:23	03/12/2019 16:57	04/12/2019 12:23	19,42	1	19,42	CHI
20191220515	ITABERAI	IB21022006	ITABERAI S2	03/12/2019 16:59	04/12/2019 06:56	03/12/2019 16:59	04/12/2019 06:56	13,94	4	55,74	CHI

20191220516	LEOPOLDO DE BULHOES	LB12353215	DAIA S2	03/12/2019 11:18	03/12/2019 20:29	03/12/2019 12:57	03/12/2019 20:29	7,53	42	316,40	CHI
20191220516	LEOPOLDO DE BULHOES	LB12353215	DAIA S2	03/12/2019 11:18	03/12/2019 20:29	03/12/2019 14:21	03/12/2019 20:29	6,12	3	18,36	CHI
20191220517	ABADIANIA	AA31025267	ANAPOLIS UNIVERSITARIO S2	03/12/2019 17:00	04/12/2019 12:59	03/12/2019 17:00	04/12/2019 12:59	19,98	1	19,98	CHI
20191220520	ALTO PARAISO DE GOIAS	BF12375518	FLORES DE GOIAS	03/12/2019 16:34	03/12/2019 22:46	03/12/2019 16:34	03/12/2019 22:46	6,19	4	24,75	CHI
20191220521	TURVANIA	TV21005754	FIRMINOPOLIS S2	03/12/2019 17:00	04/12/2019 12:05	03/12/2019 17:00	04/12/2019 12:05	19,09	1	19,09	CHI
20191220524	SAO DOMINGOS	SD12384774	SAO DOMINGOS	03/12/2019 15:48	04/12/2019 17:35	03/12/2019 15:48	04/12/2019 17:35	25,77	40	1030,76	CHI
20191220531	JATAI	JT21357062	JATAI S1	03/12/2019 17:01	03/12/2019 19:55	03/12/2019 17:01	03/12/2019 19:55	2,89	1	2,89	CHI
20191220535	SANTA TEREZA DE GOIAS	TB12170075	PORANGATU	03/12/2019 11:42	04/12/2019 13:20	03/12/2019 11:42	04/12/2019 13:20	25,62	3	76,87	CHI
20191220538	NIQUELANDIA	10006182680	URUACU	03/12/2019 15:42	04/12/2019 11:18	03/12/2019 15:42	04/12/2019 11:18	19,61	1	19,61	CHI
20191220545	AURILANDIA	AI12206461	FIRMINOPOLIS S2	03/12/2019 16:09	03/12/2019 19:02	03/12/2019 16:09	03/12/2019 19:02	2,87	14	40,25	CHI
20191220545	FIRMINOPOLIS	AI12206461	FIRMINOPOLIS S2	03/12/2019 16:09	03/12/2019 19:02	03/12/2019 16:09	03/12/2019 19:02	2,87	15	43,12	CHI
20191220560	SERRANOPOLIS	SX21137271	ITAJA S1	03/12/2019 17:04	04/12/2019 12:47	03/12/2019 17:04	04/12/2019 12:47	19,70	1	19,70	CHI
20191220562	GOIANIA	GN11000058	GOIANIA LESTE S1	03/12/2019 14:55	03/12/2019 22:15	03/12/2019 14:55	03/12/2019 22:15	7,32	32	234,36	CHI
20191220571	EDEALINA	EA12105005	VICENTINOPOLIS	03/12/2019 17:07	04/12/2019 10:10	03/12/2019 17:07	04/12/2019 10:10	17,05	3	51,15	CHI
20191220571	EDEIA	EA12105005	VICENTINOPOLIS	03/12/2019 17:07	04/12/2019 10:10	03/12/2019 17:07	04/12/2019 10:10	17,05	4	68,21	CHI
20191220579	ANAPOLIS	20723751	ANAPOLIS UNIVERSITARIO S2	03/12/2019 17:08	04/12/2019 10:46	03/12/2019 17:08	04/12/2019 10:46	17,63	1	17,63	CHI
20191220581	MINACU	IH12307129	MINACU	03/12/2019 17:08	04/12/2019 04:46	03/12/2019 17:08	04/12/2019 04:46	11,62	12	139,47	CHI
20191220583	SAO DOMINGOS	SD12389200	SAO DOMINGOS	03/12/2019 16:03	03/12/2019 22:36	03/12/2019 16:03	03/12/2019 22:36	6,54	63	412,13	CHI
20191220589	JUSSARA	RN12045571	BRITANIA	03/12/2019 17:20	04/12/2019 17:27	03/12/2019 17:20	04/12/2019 17:27	24,10	4	96,41	CHI
20191220589	SANTA FE DE GOIAS	RN12045571	BRITANIA	03/12/2019 17:20	04/12/2019 17:27	03/12/2019 17:20	04/12/2019 17:27	24,10	7	168,72	CHI
20191220590	AGUA LIMPA	AL21238071	VILA CORUMBA	03/12/2019 17:10	04/12/2019 11:02	03/12/2019 17:10	04/12/2019 11:02	17,86	3	53,57	CHI
20191220603	CALDAS NOVAS	10010019381	CALDAS NOVAS S1	03/12/2019 17:12	03/12/2019 19:30	03/12/2019 17:12	03/12/2019 19:30	2,30	1	2,30	CHI
20191220617	TERESINA DE GOIAS	2650001222	FLORES DE GOIAS	03/12/2019 17:14	03/12/2019 20:17	03/12/2019 17:14	03/12/2019 20:17	3,04	1	3,04	CHI
20191220623	RIO VERDE	RV12371510	RIO VERDE S1	03/12/2019 17:11	04/12/2019 09:30	03/12/2019 17:11	04/12/2019 09:30	16,31	54	880,95	CHI
20191220631	ITARUMA	IM12034973LD	CACHOEIRA ALTA	03/12/2019 15:02	04/12/2019 17:45	03/12/2019 15:02	04/12/2019 17:45	26,71	1	26,71	CHI
20191220631	ITARUMA	IM12034973LD	CACHOEIRA ALTA	03/12/2019 15:02	04/12/2019 17:45	03/12/2019 17:17	04/12/2019 17:45	24,46	3	73,39	CHI
20191220632	SANTA HELENA DE GOIAS	SH12271563	IPEGUARI	03/12/2019 17:17	03/12/2019 18:30	03/12/2019 17:17	03/12/2019 18:30	1,21	28	33,94	CHI
20191220632	TURVELANDIA	SH12271563	IPEGUARI	03/12/2019 17:17	03/12/2019 18:30	03/12/2019 17:17	03/12/2019 18:30	1,21	12	14,55	CHI
20191220633	RIO VERDE	BZ12211442	SANTA HELENA S1	03/12/2019 17:17	03/12/2019 20:36	03/12/2019 17:17	03/12/2019 20:36	3,30	4	13,21	CHI
20191220633	SANTO ANTONIO DA BARRA	BZ12211442	SANTA HELENA S1	03/12/2019 17:17	03/12/2019 20:36	03/12/2019 17:17	03/12/2019 20:36	3,30	20	66,07	CHI
20191220636	GOIANIA	10023959230	MEIA PONTE	03/12/2019 17:18	03/12/2019 21:40	03/12/2019 17:18	03/12/2019 21:40	4,37	1	4,37	CHI
20191220640	BURITI DE GOIAS	1680014022	FIRMINOPOLIS S2	03/12/2019 17:18	03/12/2019 21:58	03/12/2019 17:18	03/12/2019 21:58	4,65	1	4,65	CHI
20191220657	RIO VERDE	BZ12295804LD	ACREUNA	03/12/2019 17:20	03/12/2019 19:50	03/12/2019 17:20	03/12/2019 19:50	2,49	2	4,99	CHI

20191220657	SANTO ANTONIO DA BARRA	BZ12295804LD	ACREUNA	03/12/2019 17:20	03/12/2019 19:50	03/12/2019 17:20	03/12/2019 19:50	2,49	8	19,95	CHI
20191220667	FORMOSA	FA12204612	ITUIQUIRA	03/12/2019 14:17	03/12/2019 18:10	03/12/2019 14:17	03/12/2019 18:10	3,88	11	42,67	CHI
20191220672	SENADOR CANEDO	SW11074733	GOIANIA LESTE S2	03/12/2019 17:07	03/12/2019 20:35	03/12/2019 17:07	03/12/2019 20:35	3,46	166	574,31	CHI
20191220675	PORANGATU	PO12265802	PORANGATU	03/12/2019 15:08	03/12/2019 19:35	03/12/2019 15:08	03/12/2019 19:35	4,44	117	519,84	CHI
20191220690	BRITANIA	BT12183235	BRITANIA	03/12/2019 17:23	04/12/2019 13:27	03/12/2019 17:23	04/12/2019 13:27	20,07	6	120,41	CHI
20191220702	RIO VERDE	RV12322152	RIO VERDE S1	03/12/2019 17:23	04/12/2019 10:13	03/12/2019 17:23	04/12/2019 10:13	16,82	28	470,97	CHI
20191220706	ESTRELA DO NORTE	ET12012492	MARA ROSA	03/12/2019 17:23	04/12/2019 15:05	03/12/2019 17:23	04/12/2019 15:05	21,68	8	173,47	CHI
20191220709	PETROLINA DE GOIAS	6414909	PETROLINA	03/12/2019 11:15	04/12/2019 18:34	03/12/2019 11:15	04/12/2019 18:34	31,33	7	219,28	CHI
20191220709	PETROLINA DE GOIAS	6414909	PETROLINA	03/12/2019 11:15	04/12/2019 18:34	03/12/2019 11:16	04/12/2019 18:34	31,31	6	187,85	CHI
20191220715	JATAI	JT12196090	JATAI S2	03/12/2019 17:13	03/12/2019 19:30	03/12/2019 17:13	03/12/2019 19:30	2,29	12	27,47	CHI
20191220718	IPAMERI	IP21319011	PIRES DO RIO S2	03/12/2019 17:25	04/12/2019 17:20	03/12/2019 17:25	04/12/2019 17:20	23,91	1	23,91	CHI
20191220719	CACHOEIRA DOURADA	CD11166375	CACHOEIRA DOURADA	03/12/2019 17:17	03/12/2019 20:39	03/12/2019 17:17	03/12/2019 20:39	3,38	141	476,42	CHI
20191220723	NIQUELANDIA	NQ12285213	NIQUELANDIA SUBTRANSMISSAO	03/12/2019 17:27	04/12/2019 17:08	03/12/2019 17:27	04/12/2019 17:08	23,68	6	142,09	CHI
20191220735	PONTALINA	PK11000021	PONTALINA	03/12/2019 16:36	04/12/2019 11:01	03/12/2019 16:36	04/12/2019 11:01	18,41	157	2890,94	CHI
20191220736	CORUMBAIBA	CI21252060	VILA CORUMBA	03/12/2019 17:28	04/12/2019 14:48	03/12/2019 17:28	04/12/2019 14:48	21,32	2	42,64	CHI
20191220738	AMARALINA	LC12182362	MARA ROSA	03/12/2019 16:29	03/12/2019 19:00	03/12/2019 16:29	03/12/2019 19:00	2,50	105	262,59	CHI
20191220738	MARA ROSA	LC12182362	MARA ROSA	03/12/2019 16:29	03/12/2019 19:00	03/12/2019 16:29	03/12/2019 19:00	2,50	8	20,01	CHI
20191220738	MUTUNOPOLIS	LC12182362	MARA ROSA	03/12/2019 16:29	03/12/2019 19:00	03/12/2019 16:29	03/12/2019 19:00	2,50	2	5,00	CHI
20191220741	JUSSARA	1290053392	JUSSARA	03/12/2019 17:29	03/12/2019 19:27	03/12/2019 17:29	03/12/2019 19:27	1,97	1	1,97	CHI
20191220742	BOM JESUS DE GOIAS	BJ11263765	VICENTINOPOLIS	03/12/2019 17:29	04/12/2019 12:10	03/12/2019 17:29	04/12/2019 12:10	18,67	1	18,67	CHI
20191220744	MORRINHOS	MR12223465	MORRINHOS	03/12/2019 17:30	03/12/2019 18:42	03/12/2019 17:30	03/12/2019 18:42	1,19	10	11,94	CHI
20191220751	BOM JESUS DE GOIAS	BJ11150140	VICENTINOPOLIS	03/12/2019 17:31	04/12/2019 13:25	03/12/2019 17:31	04/12/2019 13:25	19,90	1	19,90	CHI
20191220760	UIRAPURU	8271959	NOVA CRIXAS	03/12/2019 17:32	04/12/2019 12:46	03/12/2019 17:32	04/12/2019 12:46	19,22	3	57,67	CHI
20191220764	URUACU	CR21101022	CAMPINORTE	03/12/2019 09:32	04/12/2019 00:09	03/12/2019 09:32	04/12/2019 00:09	14,62	2	29,23	CHI
20191220772	ACREUNA	EU21045204	ACREUNA	03/12/2019 17:34	04/12/2019 09:03	03/12/2019 17:34	04/12/2019 09:03	15,48	1	15,48	CHI
20191220804	VILA PROPICIO	NP21140605	GOIANESIA S1	03/12/2019 17:38	03/12/2019 20:08	03/12/2019 17:38	03/12/2019 20:08	2,51	1	2,51	CHI
20191220806	PORANGATU	PO21020563	PORANGATU	03/12/2019 17:38	04/12/2019 08:09	03/12/2019 17:38	04/12/2019 08:09	14,51	1	14,51	CHI
20191220810	CALDAS NOVAS	CN12186173	SERRA DE CALDAS	03/12/2019 17:39	04/12/2019 11:05	03/12/2019 17:39	04/12/2019 11:05	17,44	7	122,06	CHI
20191220831	JATAI	7421584	CACHOEIRA ALTA	03/12/2019 17:42	04/12/2019 16:04	03/12/2019 17:42	04/12/2019 16:04	22,36	1	22,36	CHI
20191220831	RIO VERDE	7421584	CACHOEIRA ALTA	03/12/2019 17:42	04/12/2019 16:04	03/12/2019 17:42	04/12/2019 16:04	22,36	5	111,81	CHI
20191220836	NIQUELANDIA	NQ12235131	URUACU	03/12/2019 17:42	04/12/2019 11:08	03/12/2019 17:42	04/12/2019 11:08	17,42	4	69,70	CHI
20191220840	TRINDADE	14043622	GOYA S2	03/12/2019 17:42	03/12/2019 20:01	03/12/2019 17:42	03/12/2019 20:01	2,30	1	2,30	CHI
20191220842	ALTO PARAISO DE GOIAS	ND12117570LD	IACIARA S2	03/12/2019 11:36	04/12/2019 03:54	03/12/2019 11:36	04/12/2019 03:54	16,31	18	293,54	CHI

20191220842	NOVA ROMA	ND12117570LD	IACIARA S2	03/12/2019 11:36	04/12/2019 03:54	03/12/2019 11:36	04/12/2019 03:54	16,31	96	1565,55	CHI
20191220842	SAO JOAO D ALIANCA	ND12117570LD	IACIARA S2	03/12/2019 11:36	04/12/2019 03:54	03/12/2019 11:36	04/12/2019 03:54	16,31	12	195,69	CHI
20191220842	NOVA ROMA	ND12117570LD	IACIARA S2	03/12/2019 11:36	04/12/2019 03:54	04/12/2019 01:14	04/12/2019 03:54	2,66	2	5,32	CHI
20191220844	PALMEIRAS DE GOIAS	PL12098938	PALMEIRAS	03/12/2019 16:29	04/12/2019 00:10	03/12/2019 16:29	04/12/2019 00:10	7,68	5	38,39	CHI
20191220856	ANAPOLIS	20814197	JUNDAI S2	03/12/2019 17:44	03/12/2019 20:58	03/12/2019 17:44	03/12/2019 20:58	3,23	1	3,23	CHI
20191220857	JATAI	JT12184058	JATAI S2	03/12/2019 17:44	03/12/2019 20:22	03/12/2019 17:44	03/12/2019 20:22	2,63	4	10,51	CHI
20191220858	BONOPOLIS	BX12334622	SAO MIGUEL DO ARAGUAIA	03/12/2019 17:45	04/12/2019 00:39	03/12/2019 17:45	04/12/2019 00:39	6,90	14	96,55	CHI
20191220860	CAMPINACU	IH12320899	MINACU	03/12/2019 16:09	04/12/2019 20:45	03/12/2019 16:09	04/12/2019 20:45	28,60	13	371,75	CHI
20191220860	MINACU	IH12320899	MINACU	03/12/2019 16:09	04/12/2019 20:45	03/12/2019 16:09	04/12/2019 20:45	28,60	9	257,36	CHI
20191220862	ALTO HORIZONTE	AJ21232403	SANTA TEREZINHA	03/12/2019 17:45	04/12/2019 19:46	03/12/2019 17:45	04/12/2019 19:46	26,00	1	26,00	CHI
20191220869	GOIANIA	12373667	CAMPINAS S2	03/12/2019 17:46	04/12/2019 00:18	03/12/2019 17:46	04/12/2019 00:18	6,53	1	6,53	CHI
20191220871	RIO VERDE	RV11249014	RIO VERDE S2	03/12/2019 15:09	04/12/2019 09:51	03/12/2019 15:09	04/12/2019 09:51	18,69	87	1626,27	CHI
20191220873	POSSE	PS21160036	IACIARA S2	03/12/2019 17:47	04/12/2019 08:24	03/12/2019 17:47	04/12/2019 08:24	14,62	1	14,62	CHI
20191220880	JATAI	JT21187711	JATAI S1	03/12/2019 17:48	04/12/2019 09:45	03/12/2019 17:48	04/12/2019 09:45	15,95	1	15,95	CHI
20191220881	EDEIA	VI12352542	VICENTINOPOLIS	03/12/2019 16:40	03/12/2019 21:07	03/12/2019 16:40	03/12/2019 21:07	4,45	2	8,90	CHI
20191220881	VICENTINOPOLIS	VI12352542	VICENTINOPOLIS	03/12/2019 16:40	03/12/2019 21:07	03/12/2019 16:40	03/12/2019 21:07	4,45	12	53,39	CHI
20191220888	ACREUNA	EU21214050	ACREUNA	03/12/2019 17:48	04/12/2019 12:26	03/12/2019 17:48	04/12/2019 12:26	18,63	1	18,63	CHI
20191220890	BARRO ALTO	GE12092176	GOIANESIA S1	03/12/2019 17:49	04/12/2019 11:45	03/12/2019 17:49	04/12/2019 11:45	17,93	1	17,93	CHI
20191220896	PALMEIRAS DE GOIAS	PL21147535	PALMEIRAS	03/12/2019 17:50	04/12/2019 10:05	03/12/2019 17:50	04/12/2019 10:05	16,26	1	16,26	CHI
20191220897	FORMOSO	FO12170963	MARA ROSA	03/12/2019 17:50	04/12/2019 11:04	03/12/2019 17:50	04/12/2019 11:04	17,23	11	189,53	CHI
20191220908	GOIANIA	TR32050493	TRINDADE	03/12/2019 17:17	03/12/2019 19:47	03/12/2019 17:17	03/12/2019 19:47	2,49	8	19,96	CHI
20191220925	UIRAPURU	UP12391847	SANTA TEREZINHA	03/12/2019 17:03	04/12/2019 13:08	03/12/2019 17:03	04/12/2019 13:08	20,08	7	140,53	CHI
20191220926	GOIAS	GS12311034	GOIAS	03/12/2019 17:54	04/12/2019 12:58	03/12/2019 17:54	04/12/2019 12:58	19,06	1	19,06	CHI
20191220928	IPORA	IR12065090	IPORA	03/12/2019 17:20	03/12/2019 19:40	03/12/2019 17:20	03/12/2019 19:40	2,32	30	69,63	CHI
20191220929	SERRANOPOLIS	SX12205266	JATAI S1	03/12/2019 17:54	04/12/2019 14:22	03/12/2019 17:54	04/12/2019 14:22	20,46	2	40,92	CHI
20191220932	PARANAIGUARA	QJ21060520	QUIRINOPOLIS	03/12/2019 17:54	04/12/2019 12:53	03/12/2019 17:54	04/12/2019 12:53	18,97	1	18,97	CHI
20191220933	AMERICANO DO BRASIL	KB21308548	ANICUNS	03/12/2019 17:54	04/12/2019 06:57	03/12/2019 17:54	04/12/2019 06:57	13,04	1	13,04	CHI
20191220934	JATAI	290104907	JATAI S2	03/12/2019 17:55	03/12/2019 19:21	03/12/2019 17:55	03/12/2019 19:21	1,43	1	1,43	CHI
20191220935	RIO VERDE	RV11113537	RIO VERDE S2	03/12/2019 16:57	03/12/2019 22:47	03/12/2019 16:57	03/12/2019 22:47	5,83	186	1084,22	CHI
20191220941	GOIAS	GS11082079	GOIAS	03/12/2019 17:56	04/12/2019 11:13	03/12/2019 17:56	04/12/2019 11:13	17,28	2	34,56	CHI
20191220946	MONTIVIDIU	RV12384572B	MONTIVIDIU T	03/12/2019 17:51	03/12/2019 21:35	03/12/2019 17:51	03/12/2019 21:35	3,73	18	67,21	CHI
20191220947	RIO VERDE	630468126	RIO VERDE S2	03/12/2019 17:56	04/12/2019 09:30	03/12/2019 17:56	04/12/2019 09:30	15,56	1	15,56	CHI
20191220949	UIRAPURU	UP21181267	SANTA TEREZINHA	03/12/2019 17:57	04/12/2019 00:02	03/12/2019 17:57	04/12/2019 00:02	6,08	1	6,08	CHI

20191220951	SERRANOPOLIS	3000018916	CACHOEIRA ALTA	03/12/2019 17:57	04/12/2019 17:29	03/12/2019 17:57	04/12/2019 17:29	23,54	1	23,54	CHI
20191220958	RIO VERDE	RV11231012	RIO VERDE S2	03/12/2019 14:53	04/12/2019 08:32	03/12/2019 14:53	04/12/2019 08:32	17,64	136	2398,66	CHI
20191220963	FORMOSA	610130031	ITIQUEIRA	03/12/2019 17:58	04/12/2019 09:10	03/12/2019 17:58	04/12/2019 09:10	15,18	1	15,18	CHI
20191220965	TURVANIA	TV12215375	FIRMINOPOLIS S1	03/12/2019 15:20	04/12/2019 03:07	03/12/2019 15:20	04/12/2019 03:07	11,78	4	47,12	CHI
20191220970	NIQUELANDIA	NQ21330316	NIQUELANDIA SUBTRANSMISSAO	03/12/2019 17:59	04/12/2019 19:55	03/12/2019 17:59	04/12/2019 19:55	25,94	1	25,94	CHI
20191220971	AMARALINA	LC12270112	SAO MIGUEL DO ARAGUAIA	03/12/2019 17:01	03/12/2019 22:02	03/12/2019 17:01	03/12/2019 22:02	5,01	62	310,57	CHI
20191220974	PETROLINA DE GOIAS	10022595510	PETROLINA	03/12/2019 18:00	04/12/2019 12:03	03/12/2019 18:00	04/12/2019 12:03	18,05	1	18,05	CHI
20191220977	CORUMBA DE GOIAS	CB21062145	CORUMBA	03/12/2019 18:00	04/12/2019 18:46	03/12/2019 18:00	04/12/2019 18:46	24,76	1	24,76	CHI
20191220978	CAMPOS BELOS	CH12218850	SAO DOMINGOS	03/12/2019 18:00	04/12/2019 09:48	03/12/2019 18:00	04/12/2019 09:48	15,78	17	268,34	CHI
20191220979	PLANALTINA	2960216320	PLANALTINA	03/12/2019 18:00	04/12/2019 07:14	03/12/2019 18:00	04/12/2019 07:14	13,22	1	13,22	CHI
20191220980	ITABERAI	IB21000090	ITABERAI S2	03/12/2019 18:02	04/12/2019 12:05	03/12/2019 18:02	04/12/2019 12:05	18,05	1	18,05	CHI
20191220981	FORMOSA	FA12261997	ITIQUEIRA	03/12/2019 06:18	04/12/2019 11:10	03/12/2019 06:18	04/12/2019 11:10	28,86	33	952,48	CHI
20191220983	NOVA AMERICA	NM21334479	RUBIATABA	03/12/2019 18:02	04/12/2019 09:15	03/12/2019 18:02	04/12/2019 09:15	15,21	1	15,21	CHI
20191220984	GUARANI DE GOIAS	GY12276037	IACIARA S1	03/12/2019 18:02	03/12/2019 20:51	03/12/2019 18:02	03/12/2019 20:51	2,80	78	218,68	CHI
20191220999	BURITI ALEGRE	BG12143977	ITUMBIARA VELHA S2	03/12/2019 18:04	04/12/2019 10:10	03/12/2019 18:04	04/12/2019 10:10	16,10	168	2704,71	CHI
20191221012	ABADIANIA	AA12000611	ANAPOLIS UNIVERSITARIO S1	03/12/2019 17:11	03/12/2019 20:08	03/12/2019 17:11	03/12/2019 20:08	2,94	20	58,86	CHI
20191221014	PARAUNA	PU12295868	ACREUNA	03/12/2019 18:04	04/12/2019 14:43	03/12/2019 18:04	04/12/2019 14:43	20,64	10	206,44	CHI
20191221031	AMARALINA	LC12270125	SAO MIGUEL DO ARAGUAIA	03/12/2019 17:45	03/12/2019 21:23	03/12/2019 17:45	03/12/2019 21:23	3,62	41	148,45	CHI
20191221038	MOZARLANDIA	MZZ1181580	MOZARLANDIA	03/12/2019 18:09	04/12/2019 16:17	03/12/2019 18:09	04/12/2019 16:17	22,13	1	22,13	CHI
20191221040	ADELANDIA	DN21021819	FIRMINOPOLIS S2	03/12/2019 18:09	04/12/2019 10:42	03/12/2019 18:09	04/12/2019 10:42	16,55	2	33,09	CHI
20191221045	ABADIANIA	AA21072461	CORUMBA	03/12/2019 18:10	04/12/2019 08:48	03/12/2019 18:10	04/12/2019 08:48	14,62	1	14,62	CHI
20191221050	ANAPOLIS	AN31090536	ANAPOLIS UNIVERSITARIO S2	03/12/2019 18:11	04/12/2019 07:53	03/12/2019 18:11	04/12/2019 07:53	13,70	1	13,70	CHI
20191221052	PONTALINA	JV12223261	GOIATUBA S1	03/12/2019 17:13	04/12/2019 11:51	03/12/2019 17:13	04/12/2019 11:51	18,62	3	55,87	CHI
20191221055	RIO VERDE	RV11240547	RIO VERDE S1	03/12/2019 15:12	04/12/2019 00:05	03/12/2019 15:12	04/12/2019 00:05	8,87	106	940,51	CHI
20191221060	PIRACANJUBA	PJ21040792	PIRACANJUBA	03/12/2019 18:12	03/12/2019 20:11	03/12/2019 18:12	03/12/2019 20:11	1,98	1	1,98	CHI
20191221064	AGUA FRIA DE GOIAS	TL21130371	SAO JOAO D ALIANCA	03/12/2019 18:12	04/12/2019 16:20	03/12/2019 18:12	04/12/2019 16:20	22,12	1	22,12	CHI
20191221066	COCALZINHO DE GOIAS	ZN21290414	COCALZINHO	03/12/2019 18:12	04/12/2019 15:38	03/12/2019 18:12	04/12/2019 15:38	21,42	2	42,84	CHI
20191221069	QUIRINOPOLIS	RV12029069	SANTA HELENA S1	03/12/2019 18:12	04/12/2019 10:10	03/12/2019 18:12	04/12/2019 10:10	15,97	5	79,83	CHI
20191221069	RIO VERDE	RV12029069	SANTA HELENA S1	03/12/2019 18:12	04/12/2019 10:10	03/12/2019 18:12	04/12/2019 10:10	15,97	6	95,80	CHI
20191221070	SANTA HELENA DE GOIAS	400072592	IPEGUARI	03/12/2019 18:12	03/12/2019 21:07	03/12/2019 18:12	03/12/2019 21:07	2,91	1	2,91	CHI
20191221075	PALMEIRAS DE GOIAS	PL11000019	PALMEIRAS	03/12/2019 18:09	03/12/2019 21:48	03/12/2019 18:09	03/12/2019 21:48	3,65	72	262,80	CHI
20191221078	ALTO PARAISO DE GOIAS	NQ12148151	NIQUELANDIA SUBTRANSMISSAO	03/12/2019 12:15	04/12/2019 04:18	03/12/2019 12:15	04/12/2019 04:18	16,04	12	192,45	CHI
20191221078	NIQUELANDIA	NQ12148151	NIQUELANDIA SUBTRANSMISSAO	03/12/2019 12:15	04/12/2019 04:18	03/12/2019 12:15	04/12/2019 04:18	16,04	159	2550,01	CHI

20191221078	SAO JOAO D ALIANCA	NQ12148151	NIQUELANDIA SUBTRANSMISSAO	03/12/2019 12:15	04/12/2019 04:18	03/12/2019 12:15	04/12/2019 04:18	16,04	1	16,04	CHI
20191221081	ACREUNA	SH12271266	SANTA HELENA S1	03/12/2019 18:14	04/12/2019 09:35	03/12/2019 18:14	04/12/2019 09:35	15,34	3	46,02	CHI
20191221081	SANTA HELENA DE GOIAS	SH12271266	SANTA HELENA S1	03/12/2019 18:14	04/12/2019 09:35	03/12/2019 18:14	04/12/2019 09:35	15,34	3	46,02	CHI
20191221088	OUIDOR	OUI2061139	CATALAO S1	03/12/2019 15:18	04/12/2019 16:00	03/12/2019 15:18	04/12/2019 16:00	24,69	5	123,44	CHI
20191221091	SAO DOMINGOS	SD12211512	SAO DOMINGOS	03/12/2019 18:16	04/12/2019 11:06	03/12/2019 18:16	04/12/2019 11:06	16,83	10	168,31	CHI
20191221099	AMARALINA	MU12391981	MARA ROSA	03/12/2019 19:56	04/12/2019 12:30	03/12/2019 19:56	04/12/2019 12:30	16,56	5	82,79	CHI
20191221099	MUTUNOPOLIS	MU12391981	MARA ROSA	03/12/2019 19:56	04/12/2019 12:30	03/12/2019 19:56	04/12/2019 12:30	16,56	5	82,79	CHI
20191221113	CAMPESTRE DE GOIAS	GC21005195	TRINDADE	03/12/2019 18:19	04/12/2019 02:20	03/12/2019 18:19	04/12/2019 02:20	8,00	3	24,00	CHI
20191221114	GOIANIA	13990858	GOYA S2	03/12/2019 18:20	03/12/2019 20:06	03/12/2019 18:20	03/12/2019 20:06	1,76	1	1,76	CHI
20191221115	JANDAIA	JD11215392	PALMEIRAS	03/12/2019 16:04	03/12/2019 22:07	03/12/2019 16:04	03/12/2019 22:07	6,05	122	738,51	CHI
20191221116	MINACU	IH12236254	MINACU	03/12/2019 18:20	04/12/2019 13:25	03/12/2019 18:20	04/12/2019 13:25	19,08	1	19,08	CHI
20191221119	FORMOSO	FO12391929	PORANGATU	03/12/2019 15:50	04/12/2019 12:46	03/12/2019 15:50	04/12/2019 12:46	20,93	11	230,18	CHI
20191221120	ANAPOLIS	20746910	JUNDIAI S2	03/12/2019 18:20	04/12/2019 08:09	03/12/2019 18:20	04/12/2019 08:09	13,81	1	13,81	CHI
20191221122	GOIAS	GS21013007	GOIAS	03/12/2019 18:20	04/12/2019 10:57	03/12/2019 18:20	04/12/2019 10:57	16,61	1	16,61	CHI
20191221124	NOVA IGUACU DE GOIAS	NH12317131	CAMPINORTE	03/12/2019 18:06	04/12/2019 09:50	03/12/2019 18:06	04/12/2019 09:50	15,72	42	660,27	CHI
20191221149	ITUMBIARA	BJ12000264	BOM JESUS DE GOIAS	03/12/2019 18:24	04/12/2019 10:00	03/12/2019 18:24	04/12/2019 10:00	15,59	7	109,13	CHI
20191221160	MAIRIPOTABA	MI12122101	PONTALINA	03/12/2019 18:17	03/12/2019 20:59	03/12/2019 18:17	03/12/2019 20:59	2,69	5	13,47	CHI
20191221167	MOSSAMEDES	MD12277723	FIRMINOPOLIS S2	03/12/2019 18:26	04/12/2019 00:21	03/12/2019 18:26	04/12/2019 00:21	5,90	4	23,62	CHI
20191221169	GUAPO	VJ12000056LD	GUAPO S2	03/12/2019 18:26	04/12/2019 12:00	03/12/2019 18:26	04/12/2019 12:00	17,56	46	807,63	CHI
20191221169	VARJAO	VJ12000056LD	GUAPO S2	03/12/2019 18:26	04/12/2019 12:00	03/12/2019 18:26	04/12/2019 12:00	17,56	75	1316,79	CHI
20191221177	JATAI	RV12248973	CABRIUVA S2	03/12/2019 14:17	04/12/2019 12:57	03/12/2019 14:17	04/12/2019 12:57	22,67	12	272,07	CHI
20191221177	RIO VERDE	RV12248973	CABRIUVA S2	03/12/2019 14:17	04/12/2019 12:57	03/12/2019 14:17	04/12/2019 12:57	22,67	33	748,20	CHI
20191221181	NIQUELANDIA	NQ12146984	URUACU	03/12/2019 18:28	03/12/2019 21:17	03/12/2019 18:28	03/12/2019 21:17	2,81	43	121,01	CHI
20191221187	PALMEIRAS DE GOIAS	PL12398710	PALMEIRAS	03/12/2019 17:57	04/12/2019 07:32	03/12/2019 17:57	04/12/2019 07:32	13,58	21	285,20	CHI
20191221246	RIO VERDE	RV11049007	RIO VERDE S1	03/12/2019 18:30	04/12/2019 01:02	03/12/2019 18:30	04/12/2019 01:02	6,53	102	666,06	CHI
20191221253	BOM JARDIM DE GOIAS	BM12296972	BOM JARDIM	03/12/2019 18:34	04/12/2019 11:08	03/12/2019 18:34	04/12/2019 11:08	16,57	2	33,13	CHI
20191221257	JATAI	290229832	JATAI S2	03/12/2019 18:34	03/12/2019 20:30	03/12/2019 18:34	03/12/2019 20:30	1,92	1	1,92	CHI
20191221258	DOVERLANDIA	DV12138335	CAIAPONIA	03/12/2019 18:34	04/12/2019 06:55	03/12/2019 18:34	04/12/2019 06:55	12,34	37	456,48	CHI
20191221259	ITUMBIARA	IT12046789	ITUMBIARA NOVA	03/12/2019 18:25	03/12/2019 20:33	03/12/2019 18:25	03/12/2019 20:33	2,12	367	778,24	CHI
20191221263	RIO VERDE	RV21214229	MONTIVIDIU T	03/12/2019 18:35	04/12/2019 10:29	03/12/2019 18:35	04/12/2019 10:29	15,90	1	15,90	CHI
20191221279	MINACU	IH11262695	MINACU	03/12/2019 15:57	03/12/2019 21:10	03/12/2019 15:57	03/12/2019 21:10	5,20	17	88,48	CHI
20191221281	GUAPO	GA12395524	GUAPO S1	03/12/2019 17:35	03/12/2019 20:15	03/12/2019 17:35	03/12/2019 20:15	2,66	198	526,68	CHI
20191221282	MONTES CLAROS DE GOIAS	ME12023293	IPORA	03/12/2019 13:07	03/12/2019 21:27	03/12/2019 13:07	03/12/2019 21:27	8,32	11	91,52	CHI

20191221301	ANAPOLIS	20845960	JUNDIAI S1	03/12/2019 18:39	04/12/2019 02:54	03/12/2019 18:39	04/12/2019 02:54	8,23	1	8,23	CHI
20191221305	RIO VERDE	RV12207197	MONTIVIDIU T	03/12/2019 17:35	04/12/2019 12:36	03/12/2019 17:35	04/12/2019 12:36	19,01	18	342,18	CHI
20191221315	GAMELEIRA DE GOIAS	SV21136787	DAIA S2	03/12/2019 18:41	04/12/2019 09:54	03/12/2019 18:41	04/12/2019 09:54	15,22	1	15,22	CHI
20191221321	GOIANIA	10007762214	MEIA PONTE	03/12/2019 18:42	03/12/2019 22:28	03/12/2019 18:42	03/12/2019 22:28	3,76	1	3,76	CHI
20191221327	RIO VERDE	RV12249024	SANTA HELENA S1	03/12/2019 18:39	04/12/2019 08:25	03/12/2019 18:39	04/12/2019 08:25	13,77	7	96,37	CHI
20191221334	RIO VERDE	RV12240068	MONTIVIDIU T	03/12/2019 17:35	04/12/2019 15:33	03/12/2019 17:35	04/12/2019 15:33	21,95	3	65,86	CHI
20191221347	MINEIROS	MY21260358	PARQUE DAS EMAS	03/12/2019 18:45	04/12/2019 11:39	03/12/2019 18:45	04/12/2019 11:39	16,89	1	16,89	CHI
20191221348	PONTALINA	PK21028546	PONTALINA	03/12/2019 08:21	04/12/2019 07:43	03/12/2019 08:21	04/12/2019 07:43	23,35	1	23,35	CHI
20191221354	JATAI	JT21153111	JATAI S1	03/12/2019 18:46	03/12/2019 23:30	03/12/2019 18:46	03/12/2019 23:30	4,72	1	4,72	CHI
20191221355	GOIANIA	17105559	MEIA PONTE	03/12/2019 18:46	03/12/2019 23:41	03/12/2019 18:46	03/12/2019 23:41	4,90	1	4,90	CHI
20191221360	GOIANDIRA	1990223154	CATALAO S1	03/12/2019 18:47	04/12/2019 20:36	03/12/2019 18:47	04/12/2019 20:36	25,82	1	25,82	CHI
20191221361	RIO VERDE	RV21105896	RIO VERDE S1	03/12/2019 18:47	04/12/2019 09:55	03/12/2019 18:47	04/12/2019 09:55	15,12	2	30,25	CHI
20191221364	BOM JARDIM DE GOIAS	BM12334813	IPORA	03/12/2019 16:15	04/12/2019 08:08	03/12/2019 16:15	04/12/2019 08:08	15,87	14	222,21	CHI
20191221372	ALTO HORIZONTE	AJ12404037	MARA ROSA	03/12/2019 13:51	04/12/2019 10:35	03/12/2019 18:36	04/12/2019 10:35	15,98	36	575,25	CHI
20191221372	MARA ROSA	AJ12404037	MARA ROSA	03/12/2019 13:51	04/12/2019 10:35	03/12/2019 18:36	04/12/2019 10:35	15,98	5	79,90	CHI
20191221372	NOVA IGUACU DE GOIAS	AJ12404037	MARA ROSA	03/12/2019 13:51	04/12/2019 10:35	03/12/2019 18:36	04/12/2019 10:35	15,98	12	191,75	CHI
20191221386	BURITI ALEGRE	BG12000005	ALTO BURITI	03/12/2019 17:17	04/12/2019 08:12	03/12/2019 17:17	04/12/2019 08:12	14,91	74	1103,52	CHI
20191221388	MATRINCHA	MP12180079	MATRINCHA	03/12/2019 17:47	03/12/2019 22:42	03/12/2019 17:47	03/12/2019 22:42	4,92	150	737,58	CHI
20191221389	BOM JARDIM DE GOIAS	10003216568	BOM JARDIM	03/12/2019 18:51	04/12/2019 10:01	03/12/2019 18:51	04/12/2019 10:01	15,16	1	15,16	CHI
20191221392	ALTO PARAISO DE GOIAS	3870003945	FLORES DE GOIAS	03/12/2019 18:51	03/12/2019 20:03	03/12/2019 18:51	03/12/2019 20:03	1,19	1	1,19	CHI
20191221393	SERRANOPOLIS	SX10407788	JATAI S1	03/12/2019 18:08	03/12/2019 20:43	03/12/2019 18:08	03/12/2019 20:43	2,58	1289	3322,40	CHI
20191221401	TROMBAS	TB11288282	PORANGATU	03/12/2019 18:53	04/12/2019 11:50	03/12/2019 18:53	04/12/2019 11:50	16,94	2	33,89	CHI
20191221403	CAMPINACU	IH12192447	MINACU	03/12/2019 15:16	03/12/2019 23:40	03/12/2019 15:16	03/12/2019 23:40	8,40	5	41,99	CHI
20191221403	MINACU	IH12192447	MINACU	03/12/2019 15:16	03/12/2019 23:40	03/12/2019 15:16	03/12/2019 23:40	8,40	24	201,56	CHI
20191221408	FIRMINOPOLIS	FR21215349	FIRMINOPOLIS S1	03/12/2019 18:55	04/12/2019 03:57	03/12/2019 18:55	04/12/2019 03:57	9,04	2	18,07	CHI
20191221415	INHUMAS	IN11037440	INHUMAS S2	03/12/2019 18:54	03/12/2019 22:15	03/12/2019 18:54	03/12/2019 22:15	3,34	162	540,81	CHI
20191221422	ITABERAI	IB12300094	ITABERAI S1	03/12/2019 18:56	04/12/2019 00:36	03/12/2019 18:56	04/12/2019 00:36	5,65	2	11,30	CHI
20191221439	SANTA HELENA DE GOIAS	SH12271563	IPEGUARI	03/12/2019 18:52	03/12/2019 22:42	03/12/2019 18:52	03/12/2019 22:42	3,82	28	106,93	CHI
20191221439	TURVELANDIA	SH12271563	IPEGUARI	03/12/2019 18:52	03/12/2019 22:42	03/12/2019 18:52	03/12/2019 22:42	3,82	12	45,83	CHI
20191221441	FORMOSA	FA21115712	ITIQUIRA	03/12/2019 18:59	04/12/2019 12:49	03/12/2019 18:59	04/12/2019 12:49	17,83	1	17,83	CHI
20191221445	ANAPOLIS	20994813	ANAPOLIS UNIVERSITARIO S2	03/12/2019 19:00	04/12/2019 00:58	03/12/2019 19:00	04/12/2019 00:58	5,97	1	5,97	CHI
20191221449	MINACU	IH12328091	MINACU	03/12/2019 19:00	04/12/2019 22:12	03/12/2019 19:00	04/12/2019 22:12	27,19	8	217,50	CHI
20191221450	CAMPINORTE	CR12172326	MARA ROSA	04/12/2019 08:17	05/12/2019 09:20	04/12/2019 08:17	05/12/2019 09:20	25,06	4	100,23	CHI

20191221450	FORMOSO	CR12172326	MARA ROSA	04/12/2019 08:17	05/12/2019 09:20	04/12/2019 08:17	05/12/2019 09:20	25,06	3	75,17	CHI
20191221452	AGUA FRIA DE GOIAS	TL21076116	SAO JOAO D ALIANCA	03/12/2019 19:01	05/12/2019 09:13	03/12/2019 19:01	05/12/2019 09:13	38,19	1	38,19	CHI
20191221456	DOVERLANDIA	DV12395475	CAIAPONIA	03/12/2019 18:36	04/12/2019 09:00	03/12/2019 18:36	04/12/2019 09:00	14,38	11	158,23	CHI
20191221458	QUIRINOPOLIS	80150860	QUIRINOPOLIS	03/12/2019 19:01	04/12/2019 03:20	03/12/2019 19:01	04/12/2019 03:20	8,30	1	8,30	CHI
20191221459	IPORA	IR12033222	IPORA	03/12/2019 19:02	03/12/2019 21:39	03/12/2019 19:02	03/12/2019 21:39	2,61	4	10,45	CHI
20191221464	FIRMINOPOLIS	FR12000059	FIRMINOPOLIS S1	03/12/2019 19:03	03/12/2019 22:25	03/12/2019 19:03	03/12/2019 22:25	3,36	3	10,09	CHI
20191221465	MONTIVIDIU	MV12230886	MONTIVIDIU T	03/12/2019 18:29	04/12/2019 10:14	03/12/2019 18:29	04/12/2019 10:14	15,76	9	141,84	CHI
20191221465	RIO VERDE	MV12230886	MONTIVIDIU T	03/12/2019 18:29	04/12/2019 10:14	03/12/2019 18:29	04/12/2019 10:14	15,76	39	614,63	CHI
20191221469	RIO VERDE	RV11104109	RIO VERDE S2	03/12/2019 18:41	03/12/2019 23:53	03/12/2019 18:41	03/12/2019 23:53	5,20	148	770,18	CHI
20191221472	CAMPINORTE	CR12266635	MARA ROSA	03/12/2019 19:03	04/12/2019 11:33	03/12/2019 19:03	04/12/2019 11:33	16,48	6	98,90	CHI
20191221477	ITABERAI	IB21168377	ARACU	03/12/2019 19:05	04/12/2019 08:05	03/12/2019 19:05	04/12/2019 08:05	13,01	1	13,01	CHI
20191221486	CEZARINA	00370404	CEZARINA	03/12/2019 18:50	04/12/2019 19:26	03/12/2019 18:51	03/12/2019 21:26	2,58	9	23,23	CHI
20191221486	INDIARA	00370404	CEZARINA	03/12/2019 18:50	04/12/2019 19:26	03/12/2019 18:51	03/12/2019 21:26	2,58	3	7,74	CHI
20191221486	CEZARINA	00370404	CEZARINA	03/12/2019 18:50	04/12/2019 19:26	03/12/2019 18:51	03/12/2019 22:48	3,95	238	939,04	CHI
20191221486	CEZARINA	00370404	CEZARINA	03/12/2019 18:50	04/12/2019 19:26	03/12/2019 18:51	04/12/2019 19:26	24,57	4	98,28	CHI
20191221486	INDIARA	00370404	CEZARINA	03/12/2019 18:50	04/12/2019 19:26	03/12/2019 18:51	04/12/2019 19:26	24,57	2	49,14	CHI
20191221487	MOZARLANDIA	MZ12057424	MOZARLANDIA	03/12/2019 18:52	04/12/2019 15:12	03/12/2019 18:52	04/12/2019 15:12	20,32	20	406,49	CHI
20191221488	RIO VERDE	RV12271283	CABRIUVA S2	03/12/2019 16:06	04/12/2019 09:30	03/12/2019 16:06	04/12/2019 09:30	17,40	20	348,04	CHI
20191221490	BURITI ALEGRE	GT21161946	GOIATUBA S2	03/12/2019 19:07	04/12/2019 10:30	03/12/2019 19:07	04/12/2019 10:30	15,37	1	15,37	CHI
20191221493	GOIANIA	10472769	GOIANIA LESTE S1	03/12/2019 19:07	03/12/2019 23:28	03/12/2019 19:07	03/12/2019 23:28	4,34	1	4,34	CHI
20191221494	GOIANIA	GN11247738	XAVANTES	03/12/2019 18:56	04/12/2019 00:24	03/12/2019 18:56	04/12/2019 00:24	5,46	68	371,07	CHI
20191221505	BALIZA	BH12334541	BOM JARDIM	03/12/2019 15:49	03/12/2019 20:42	03/12/2019 15:49	03/12/2019 20:42	4,87	18	87,61	CHI
20191221509	GOIANIA	17158400	ATLANTICO S1	03/12/2019 19:08	03/12/2019 21:01	03/12/2019 19:08	03/12/2019 21:01	1,87	1	1,87	CHI
20191221510	MINACU	4020004536	MINACU	03/12/2019 19:08	03/12/2019 20:20	03/12/2019 19:08	03/12/2019 20:20	1,19	1	1,19	CHI
20191221511	GOIAS	GS11162402	GOIAS	03/12/2019 19:08	04/12/2019 15:59	03/12/2019 19:08	04/12/2019 15:59	20,84	1	20,84	CHI
20191221513	NIQUELANDIA	NQ12318232	URUACU	03/12/2019 19:09	04/12/2019 13:30	03/12/2019 19:09	04/12/2019 13:30	18,35	2	36,70	CHI
20191221514	SAO SIMAO	SO12322242	CACHOEIRA ALTA	03/12/2019 19:09	03/12/2019 19:32	03/12/2019 19:09	03/12/2019 19:32	0,37	3	1,12	CHI
20191221515	JANDAIA	JD12015098	PALMEIRAS	03/12/2019 19:09	04/12/2019 10:09	03/12/2019 19:09	04/12/2019 10:09	15,01	4	60,03	CHI
20191221525	PORANGATU	PO12189564	PORANGATU	03/12/2019 19:11	05/12/2019 01:07	03/12/2019 19:11	05/12/2019 01:07	29,93	1	29,93	CHI
20191221528	ACREUNA	EU12359415	ACREUNA	03/12/2019 18:28	03/12/2019 23:06	03/12/2019 18:28	03/12/2019 23:06	4,62	28	129,30	CHI
20191221533	NIQUELANDIA	NQ12281264	NIQUELANDIA SUBTRANSMISSAO	03/12/2019 14:47	04/12/2019 11:25	03/12/2019 14:47	04/12/2019 11:25	20,62	31	639,16	CHI
20191221562	BELA VISTA DE GOIAS	BV21277835	BELA VISTA S1	03/12/2019 19:12	04/12/2019 12:49	03/12/2019 19:12	04/12/2019 12:49	17,61	2	35,22	CHI
20191221569	VICENTINOPOLIS	VI21050303	GOIATUBA S1	03/12/2019 19:13	04/12/2019 14:28	03/12/2019 19:13	04/12/2019 14:28	19,24	1	19,24	CHI

20191221574	SAO MIGUEL DO PASSA QUATRO	SQ21128976	VIANOPOLIS	03/12/2019 19:15	04/12/2019 15:03	03/12/2019 19:15	04/12/2019 15:03	19,81	1	19,81	CHI
20191221576	MINACU	IH12207388	MINACU	03/12/2019 17:20	04/12/2019 10:05	03/12/2019 17:20	04/12/2019 10:05	16,74	80	1339,60	CHI
20191221581	PALMEIRAS DE GOIAS	PL12000163	PALMEIRAS	03/12/2019 19:16	04/12/2019 19:44	03/12/2019 19:16	04/12/2019 19:44	24,46	2	48,91	CHI
20191221584	SAO MIGUEL DO PASSA QUATRO	SV21039096	VIANOPOLIS	03/12/2019 19:17	04/12/2019 16:24	03/12/2019 19:17	04/12/2019 16:24	21,11	3	63,34	CHI
20191221585	CAIAPONIA	CP21067931	CAIAPONIA	03/12/2019 19:17	04/12/2019 08:12	03/12/2019 19:17	04/12/2019 08:12	12,91	2	25,81	CHI
20191221598	JUSSARA	JR12396256	JUSSARA	03/12/2019 18:23	04/12/2019 12:44	03/12/2019 18:23	04/12/2019 12:44	18,33	5	91,67	CHI
20191221614	ITUMBIARA	IT11000152	ITUMBIARA VELHA S1	03/12/2019 19:20	03/12/2019 23:17	03/12/2019 19:20	03/12/2019 23:17	3,94	158	623,05	CHI
20191221615	PROFESSOR JAMIL SAFADY	JS21319587	ROCHEDO	03/12/2019 19:22	04/12/2019 10:00	03/12/2019 19:22	04/12/2019 10:00	14,63	1	14,63	CHI
20191221616	IPORA	730040318	IPORA	03/12/2019 19:22	03/12/2019 20:42	03/12/2019 19:22	03/12/2019 20:42	1,33	1	1,33	CHI
20191221619	ARAGOIANIA	AO12344629	INDEPENDENCIA S2	03/12/2019 19:22	04/12/2019 12:19	03/12/2019 19:22	04/12/2019 08:40	13,29	1	13,29	CHI
20191221619	ARAGOIANIA	AO12344629	INDEPENDENCIA S2	03/12/2019 19:22	04/12/2019 12:19	04/12/2019 08:45	04/12/2019 12:19	3,57	1	3,57	CHI
20191221620	JANDAIA	1180023836	PALMEIRAS	03/12/2019 19:23	04/12/2019 08:31	03/12/2019 19:23	04/12/2019 08:31	13,15	1	13,15	CHI
20191221622	DAVINOPOLIS	IO12363432	CATALAO S1	03/12/2019 16:37	04/12/2019 09:10	03/12/2019 16:37	04/12/2019 09:10	16,55	22	364,18	CHI
20191221622	OUVIDOR	IO12363432	CATALAO S1	03/12/2019 16:37	04/12/2019 09:10	03/12/2019 16:37	04/12/2019 09:10	16,55	17	281,41	CHI
20191221624	TRINDADE	40180888	TRINDADE	03/12/2019 19:24	03/12/2019 22:43	03/12/2019 19:24	03/12/2019 22:43	3,32	1	3,32	CHI
20191221629	DAVINOPOLIS	IO21150939	CATALAO S1	03/12/2019 19:25	04/12/2019 21:31	03/12/2019 19:25	04/12/2019 21:31	26,10	1	26,10	CHI
20191221630	ANAPOLIS	AN12090701	ANAPOLIS UNIVERSITARIO S2	03/12/2019 16:32	04/12/2019 07:48	03/12/2019 16:32	04/12/2019 07:48	15,26	4	61,03	CHI
20191221631	HIDROLANDIA	HD12065751	PONTALINA	03/12/2019 19:25	04/12/2019 11:30	03/12/2019 19:25	04/12/2019 11:30	16,08	23	369,78	CHI
20191221634	CALDAZINHA	BV12070811	CEPAIGO S2	03/12/2019 11:41	03/12/2019 21:05	03/12/2019 11:41	03/12/2019 21:05	9,38	15	140,76	CHI
20191221636	CABECEIRAS	CW21181820	ITUIQUIRA	03/12/2019 19:26	04/12/2019 00:59	03/12/2019 19:26	04/12/2019 00:59	5,55	1	5,55	CHI
20191221648	NOVA CRIXAS	SM10406657	SAO MIGUEL DO ARAGUAIA	03/12/2019 19:12	04/12/2019 13:47	04/12/2019 10:14	04/12/2019 10:57	0,73	1	0,73	CHI
20191221648	SAO MIGUEL DO ARAGUAIA	SM10406657	SAO MIGUEL DO ARAGUAIA	03/12/2019 19:12	04/12/2019 13:47	04/12/2019 10:14	04/12/2019 10:57	0,73	781	571,43	CHI
20191221648	SAO MIGUEL DO ARAGUAIA	SM12371801B	SAO MIGUEL DO ARAGUAIA	03/12/2019 19:12	04/12/2019 13:47	03/12/2019 19:12	04/12/2019 12:30	17,30	116	2006,70	CHI
20191221648	SAO MIGUEL DO ARAGUAIA	SM12371801B	SAO MIGUEL DO ARAGUAIA	03/12/2019 19:12	04/12/2019 13:47	04/12/2019 10:14	04/12/2019 12:30	2,27	4	9,10	CHI
20191221648	SAO MIGUEL DO ARAGUAIA	SM12371801B	SAO MIGUEL DO ARAGUAIA	03/12/2019 19:12	04/12/2019 13:47	03/12/2019 19:12	04/12/2019 13:47	18,58	107	1988,36	CHI
20191221648	SAO MIGUEL DO ARAGUAIA	SM13274816	SAO MIGUEL DO ARAGUAIA	03/12/2019 19:12	04/12/2019 13:47	04/12/2019 10:14	04/12/2019 13:47	3,56	6	21,35	CHI
20191221673	RIO VERDE	RV12230844	MONTVIDIU T	03/12/2019 21:05	04/12/2019 13:10	03/12/2019 21:05	04/12/2019 13:10	16,09	1	16,09	CHI
20191221685	FORMOSA	FA12204758	ITUIQUIRA	03/12/2019 13:29	04/12/2019 10:16	03/12/2019 13:29	04/12/2019 10:16	20,78	19	394,75	CHI
20191221692	FIRMINOPOLIS	FR12076441	FIRMINOPOLIS S1	03/12/2019 19:35	04/12/2019 00:45	03/12/2019 19:35	04/12/2019 00:45	5,15	1	5,15	CHI
20191221698	POSSE	10025900011	IACIARA S2	03/12/2019 19:36	03/12/2019 22:55	03/12/2019 19:36	03/12/2019 22:55	3,31	1	3,31	CHI
20191221701	MINEIROS	MY12114018	PARQUE DAS EMAS	03/12/2019 14:51	03/12/2019 21:36	03/12/2019 14:51	03/12/2019 21:36	6,75	46	310,45	CHI
20191221702	LUZIANIA	LZ21320194	VIANOPOLIS	03/12/2019 19:37	04/12/2019 09:31	03/12/2019 19:37	04/12/2019 09:31	13,89	1	13,89	CHI
20191221727	ITAPIRAPUA	IU12087963	MATRINCHA	03/12/2019 17:15	04/12/2019 10:03	03/12/2019 17:15	04/12/2019 10:03	16,80	41	688,77	CHI

20191221730	GOIANIA	13944125	MEIA PONTE	03/12/2019 19:42	03/12/2019 20:56	03/12/2019 19:42	03/12/2019 20:56	1,22	1	1,22	CHI
20191221731	CEZARINA	CZ21323652	EDEIA	03/12/2019 19:43	04/12/2019 03:55	03/12/2019 19:43	04/12/2019 03:55	8,20	1	8,20	CHI
20191221733	VIANOPOLIS	VN12068361	VIANOPOLIS	03/12/2019 19:43	04/12/2019 09:40	03/12/2019 19:43	04/12/2019 09:40	13,94	30	418,34	CHI
20191221735	CAIAPONIA	DP12296462	JATAI S1	03/12/2019 19:43	04/12/2019 09:12	03/12/2019 19:43	04/12/2019 09:12	13,47	38	511,89	CHI
20191221735	MINEIROS	DP12296462	JATAI S1	03/12/2019 19:43	04/12/2019 09:12	03/12/2019 19:43	04/12/2019 09:12	13,47	2	26,94	CHI
20191221735	PEROLANDIA	DP12296462	JATAI S1	03/12/2019 19:43	04/12/2019 09:12	03/12/2019 19:43	04/12/2019 09:12	13,47	10	134,71	CHI
20191221737	CORUMBAIBA	CI21000496	VILA CORUMBA	03/12/2019 19:44	04/12/2019 18:20	03/12/2019 19:44	04/12/2019 18:20	22,61	1	22,61	CHI
20191221746	HIDROLANDIA	PJ12000121	PIRACANJUBA	03/12/2019 18:50	03/12/2019 22:33	03/12/2019 18:50	03/12/2019 22:33	3,71	8	29,69	CHI
20191221746	PIRACANJUBA	PJ12000121	PIRACANJUBA	03/12/2019 18:50	03/12/2019 22:33	03/12/2019 18:50	03/12/2019 22:33	3,71	36	133,61	CHI
20191221747	SANCLERLANDIA	SC21259141	FIRMINOPOLIS S2	03/12/2019 19:46	03/12/2019 22:22	03/12/2019 19:46	03/12/2019 22:22	2,59	1	2,59	CHI
20191221756	BELA VISTA DE GOIAS	BV21360011	BELA VISTA S2	03/12/2019 19:47	04/12/2019 01:02	03/12/2019 19:47	04/12/2019 01:02	5,26	1	5,26	CHI
20191221762	AGUA LIMPA	AL12257000	VILA CORUMBA	03/12/2019 19:47	03/12/2019 22:30	03/12/2019 19:47	03/12/2019 22:30	2,72	89	242,08	CHI
20191221768	CAIAPONIA	PY12040163	PALESTINA	03/12/2019 14:35	03/12/2019 21:20	03/12/2019 14:35	03/12/2019 21:20	6,74	45	303,41	CHI
20191221768	PALESTINA DE GOIAS	PY12040163	PALESTINA	03/12/2019 14:35	03/12/2019 21:20	03/12/2019 14:35	03/12/2019 21:20	6,74	102	687,73	CHI
20191221770	PLANALTINA	PI11164611	PLANALTINA	03/12/2019 19:27	03/12/2019 20:58	03/12/2019 19:27	03/12/2019 20:58	1,51	178	269,37	CHI
20191221776	GOIANIA	GN11001969	GOIANIA LESTE S1	03/12/2019 18:40	03/12/2019 21:59	03/12/2019 18:40	03/12/2019 21:59	3,30	101	333,41	CHI
20191221779	PARAUNA	PU12007956	PARAUNA	03/12/2019 19:39	04/12/2019 00:40	03/12/2019 19:39	03/12/2019 20:20	0,67	1411	946,94	CHI
20191221779	PARAUNA	PU11051618	PARAUNA	03/12/2019 19:39	04/12/2019 00:40	03/12/2019 20:54	04/12/2019 00:08	3,23	112	362,16	CHI
20191221779	PARAUNA	PU11215319	PARAUNA	03/12/2019 19:39	04/12/2019 00:40	03/12/2019 19:39	04/12/2019 00:40	5,00	154	770,56	CHI
20191221780	JATAI	JT12000167	JATAI S1	03/12/2019 19:50	03/12/2019 23:24	03/12/2019 19:50	03/12/2019 23:24	3,56	23	81,91	CHI
20191221782	CALDAS NOVAS	CN11107999	CALDAS NOVAS S1	03/12/2019 19:49	04/12/2019 00:04	03/12/2019 23:08	04/12/2019 00:04	0,92	126	116,23	CHI
20191221783	BELA VISTA DE GOIAS	BV11058657	BELA VISTA S2	03/12/2019 19:50	04/12/2019 10:45	03/12/2019 19:50	04/12/2019 10:45	14,91	5	74,56	CHI
20191221815	CATALAO	1990205693	CATALAO S2	03/12/2019 19:55	04/12/2019 09:00	03/12/2019 19:55	04/12/2019 09:00	13,07	1	13,07	CHI
20191221816	AMARALINA	LC12252699	MARA ROSA	03/12/2019 19:55	04/12/2019 15:05	03/12/2019 19:55	04/12/2019 15:05	19,15	8	153,24	CHI
20191221820	TRINDADE	TR11191002	GOYA S2	03/12/2019 19:45	03/12/2019 22:20	03/12/2019 19:45	03/12/2019 22:20	2,58	128	329,85	CHI
20191221827	SERRANOPOLIS	SX21046338	JATAI S1	04/12/2019 06:21	04/12/2019 10:00	04/12/2019 06:21	04/12/2019 10:00	3,64	1	3,64	CHI
20191221833	PIRACANJUBA	PJ12000340	ROCHEDO	03/12/2019 19:58	03/12/2019 21:50	03/12/2019 19:58	03/12/2019 21:50	1,85	8	14,83	CHI
20191221834	SANTA TEREZA DE GOIAS	SE11170077	MARA ROSA	03/12/2019 19:58	04/12/2019 01:54	03/12/2019 19:58	04/12/2019 01:54	5,92	92	544,79	CHI
20191221835	CABECEIRAS	CW11383256	ITIQUIRA	03/12/2019 19:52	03/12/2019 22:33	03/12/2019 19:52	03/12/2019 22:33	2,68	55	147,49	CHI
20191221840	VIANOPOLIS	VN12072835	VIANOPOLIS	03/12/2019 19:59	04/12/2019 08:44	03/12/2019 19:59	04/12/2019 08:44	12,73	1	12,73	CHI
20191221843	CORUMBAIBA	CI21145308	CATALAO S1	03/12/2019 20:01	04/12/2019 13:00	03/12/2019 20:01	04/12/2019 13:00	16,98	1	16,98	CHI
20191221846	SANTA FE DE GOIAS	2070018290	BRITANIA	03/12/2019 20:02	04/12/2019 12:46	03/12/2019 20:02	04/12/2019 12:46	16,73	1	16,73	CHI
20191221852	JUSSARA	JR12033380	BRITANIA	03/12/2019 20:03	04/12/2019 17:30	03/12/2019 20:03	04/12/2019 17:30	21,44	33	707,52	CHI

20191221855	CACU	CC12191711	CACHOEIRA ALTA	03/12/2019 20:04	04/12/2019 16:14	03/12/2019 20:04	04/12/2019 16:14	20,16	4	80,65	CHI
20191221857	BURITI ALEGRE	BG21134663	ITUMBIARA VELHA S2	03/12/2019 20:04	04/12/2019 16:41	03/12/2019 20:04	04/12/2019 16:41	20,61	1	20,61	CHI
20191221858	ORIZONA	OZ13359071	PIRES DO RIO S2	03/12/2019 19:11	04/12/2019 21:44	04/12/2019 10:44	04/12/2019 13:16	2,54	2	5,08	CHI
20191221858	ORIZONA	OZ12115295	PIRES DO RIO S2	03/12/2019 19:11	04/12/2019 21:44	03/12/2019 19:11	04/12/2019 21:44	26,55	22	584,10	CHI
20191221862	PIRACANJUBA	PJ12000113	PIRACANJUBA	03/12/2019 20:06	04/12/2019 10:54	03/12/2019 20:06	04/12/2019 10:54	14,80	1	14,80	CHI
20191221868	GOIANIA	11491050	GOIANIA LESTE S2	03/12/2019 20:07	04/12/2019 04:09	03/12/2019 20:07	04/12/2019 04:09	8,03	1	8,03	CHI
20191221872	HIDROLANDIA	HD21009569	CEPAIGO S2	03/12/2019 20:07	04/12/2019 13:05	03/12/2019 20:07	04/12/2019 13:05	16,97	2	33,93	CHI
20191221873	HIDROLANDIA	VJ21235143	GUAPO S2	03/12/2019 20:08	04/12/2019 20:15	03/12/2019 20:08	04/12/2019 20:15	24,11	1	24,11	CHI
20191221876	VARJAO	940000635	GUAPO S2	03/12/2019 20:08	03/12/2019 23:04	03/12/2019 20:08	03/12/2019 23:04	2,92	1	2,92	CHI
20191221886	MONTES CLAROS DE GOIAS	ME12207822	IPORA	03/12/2019 20:12	04/12/2019 10:14	03/12/2019 20:12	04/12/2019 10:14	14,03	28	392,83	CHI
20191221897	GOIANIA	GN11002387	XAVANTES	03/12/2019 20:02	03/12/2019 22:04	03/12/2019 20:02	03/12/2019 22:04	2,02	163	329,89	CHI
20191221904	CROMINIA	JS12000113	ROCHEDO	03/12/2019 20:16	04/12/2019 13:57	03/12/2019 20:16	04/12/2019 13:57	17,67	16	282,68	CHI
20191221904	PROFESSOR JAMIL SAFADY	JS12000113	ROCHEDO	03/12/2019 20:16	04/12/2019 13:57	03/12/2019 20:16	04/12/2019 13:57	17,67	44	777,36	CHI
20191221905	ITAPURANGA	IK12299324	ITAPURANGA	03/12/2019 20:17	04/12/2019 17:34	03/12/2019 20:17	04/12/2019 17:34	21,28	3	63,83	CHI
20191221911	MAIRIPOTABA	MI12000430	PONTALINA	03/12/2019 19:38	03/12/2019 22:21	03/12/2019 19:38	03/12/2019 22:21	2,71	4	10,82	CHI
20191221914	APARECIDA DE GOIANIA	AP11004147	REAL S1	03/12/2019 20:16	03/12/2019 23:31	03/12/2019 20:16	03/12/2019 23:31	3,24	174	563,81	CHI
20191221920	APARECIDA DE GOIANIA	AP11165023	ATLANTICO S1	03/12/2019 19:36	03/12/2019 22:11	03/12/2019 19:36	03/12/2019 22:11	2,58	42	108,15	CHI
20191221926	BELA VISTA DE GOIAS	HD12323100	CEPAIGO S2	03/12/2019 19:17	04/12/2019 10:12	03/12/2019 19:17	04/12/2019 10:12	14,91	8	119,25	CHI
20191221926	HIDROLANDIA	HD12323100	CEPAIGO S2	03/12/2019 19:17	04/12/2019 10:12	03/12/2019 19:17	04/12/2019 10:12	14,91	96	1431,01	CHI
20191221928	GOIANIA	GN11000057	GOIANIA LESTE S1	03/12/2019 16:17	03/12/2019 23:05	03/12/2019 16:17	03/12/2019 23:05	6,80	34	231,19	CHI
20191221929	APARECIDA DE GOIANIA	10004266780	INDEPENDENCIA S2	03/12/2019 20:23	03/12/2019 21:47	03/12/2019 20:23	03/12/2019 21:47	1,39	1	1,39	CHI
20191221934	GOIANIA	15384044	CARAJAS S2	03/12/2019 20:24	03/12/2019 21:45	03/12/2019 20:24	03/12/2019 21:45	1,34	1	1,34	CHI
20191221936	PEROLANDIA	2370002378	JATAI S1	03/12/2019 20:26	04/12/2019 10:06	03/12/2019 20:26	04/12/2019 10:06	13,67	1	13,67	CHI
20191221937	GOIANIA	10480845	GOIANIA LESTE S1	03/12/2019 20:26	04/12/2019 03:58	03/12/2019 20:26	04/12/2019 03:58	7,53	1	7,53	CHI
20191221959	TRINDADE	10015592195	GOYA S2	03/12/2019 20:32	04/12/2019 01:46	03/12/2019 20:32	04/12/2019 01:46	5,23	1	5,23	CHI
20191221960	MONTIVIDIU	MV12207149	MONTIVIDIU T	03/12/2019 18:36	03/12/2019 22:48	03/12/2019 18:36	03/12/2019 22:48	4,21	33	138,89	CHI
20191221961	CAMPINORTE	CR12082965	CAMPINORTE	03/12/2019 17:43	04/12/2019 04:08	03/12/2019 17:43	04/12/2019 04:08	10,41	349	3633,57	CHI
20191221967	SAO JOAO D ALIANCA	JL21324137	SAO JOAO D ALIANCA	03/12/2019 10:47	04/12/2019 12:19	03/12/2019 10:47	04/12/2019 12:19	25,52	1	25,52	CHI
20191221968	SAO JOAO D ALIANCA	JL11288074	SAO JOAO D ALIANCA	03/12/2019 12:24	04/12/2019 13:02	03/12/2019 12:24	04/12/2019 13:02	24,63	11	270,88	CHI
20191221969	APARECIDA DE GOIANIA	10018474541	INDEPENDENCIA S2	03/12/2019 20:34	03/12/2019 23:14	03/12/2019 20:34	03/12/2019 23:14	2,65	1	2,65	CHI
20191221970	TRINDADE	TR11202903	GOYA S2	03/12/2019 20:03	03/12/2019 23:46	03/12/2019 20:03	03/12/2019 23:46	3,71	28	103,88	CHI
20191221972	HIDROLANDIA	HD12000269	CEPAIGO S1	03/12/2019 20:16	03/12/2019 23:59	03/12/2019 20:16	03/12/2019 23:59	3,71	114	423,35	CHI
20191221975	ITUMBIARA	690178542	ITUMBIARA VELHA S1	03/12/2019 20:36	04/12/2019 12:40	03/12/2019 20:36	04/12/2019 12:40	16,06	1	16,06	CHI

20191221976	CATALAO	1990107166	CATALAO S2	03/12/2019 20:37	04/12/2019 11:18	03/12/2019 20:37	04/12/2019 11:18	14,68	1	14,68	CHI
20191221980	RIO VERDE	630245782	RIO VERDE S2	03/12/2019 20:39	04/12/2019 08:31	03/12/2019 20:39	04/12/2019 08:31	11,86	1	11,86	CHI
20191221984	MUTUNOPOLIS	MU12405206	MARA ROSA	03/12/2019 20:40	04/12/2019 19:11	03/12/2019 20:40	04/12/2019 19:11	22,51	10	225,08	CHI
20191221989	PETROLINA DE GOIAS	PG21073203	INHUMAS S1	03/12/2019 20:41	04/12/2019 10:53	03/12/2019 20:41	04/12/2019 10:53	14,20	2	28,39	CHI
20191221994	FORMOSA	FA21042627	ITUIQUIRA	03/12/2019 19:23	05/12/2019 00:32	03/12/2019 19:23	05/12/2019 00:32	29,15	1	29,15	CHI
20191222000	PALMEIRAS DE GOIAS	590002430	PALMEIRAS	03/12/2019 20:43	04/12/2019 11:01	03/12/2019 20:43	04/12/2019 11:01	14,30	1	14,30	CHI
20191222102	CACHOEIRA ALTA	CA21136014	CACHOEIRA ALTA	03/12/2019 20:44	04/12/2019 12:05	03/12/2019 20:44	04/12/2019 12:05	15,36	1	15,36	CHI
20191222113	MINEIROS	MY13134737	PARQUE DAS EMAS	03/12/2019 20:43	04/12/2019 17:51	03/12/2019 20:43	04/12/2019 17:00	20,27	24	486,45	CHI
20191222113	MINEIROS	MY12159188	PARQUE DAS EMAS	03/12/2019 20:43	04/12/2019 17:51	03/12/2019 20:43	04/12/2019 17:51	21,12	7	147,83	CHI
20191222113	SANTA RITA DO ARAGUAIA	MY12159188	PARQUE DAS EMAS	03/12/2019 20:43	04/12/2019 17:51	03/12/2019 20:43	04/12/2019 17:51	21,12	2	42,24	CHI
20191222117	JATAI	JT12234381	JATAI S3	03/12/2019 20:48	03/12/2019 22:50	03/12/2019 20:48	03/12/2019 22:50	2,04	3	6,13	CHI
20191222118	INHUMAS	IN21066359	INHUMAS S2	03/12/2019 20:48	04/12/2019 09:25	03/12/2019 20:48	04/12/2019 09:25	12,60	1	12,60	CHI
20191222119	GOIANIA	GN11161296	GOIANIA LESTE S2	03/12/2019 20:48	04/12/2019 12:19	04/12/2019 01:52	04/12/2019 07:14	5,37	33	177,10	CHI
20191222119	GOIANIA	00580274	GOIANIA LESTE S2	03/12/2019 20:48	04/12/2019 12:19	04/12/2019 01:30	04/12/2019 09:34	8,06	261	2103,23	CHI
20191222119	GOIANIA	GN10380329	GOIANIA LESTE S2	03/12/2019 20:48	04/12/2019 12:19	04/12/2019 09:24	04/12/2019 09:34	0,15	517	78,41	CHI
20191222119	GOIANIA	GN21000938	GOIANIA LESTE S2	03/12/2019 20:48	04/12/2019 12:19	03/12/2019 20:48	04/12/2019 12:19	15,50	1	15,50	CHI
20191222125	IPAMERI	580044087	IPAMERI	03/12/2019 20:51	04/12/2019 07:38	03/12/2019 20:51	04/12/2019 07:38	10,78	1	10,78	CHI
20191222129	JUSSARA	JR12292743	JUSSARA	03/12/2019 18:17	04/12/2019 06:42	03/12/2019 18:17	04/12/2019 06:42	12,41	95	1179,16	CHI
20191222134	RIO VERDE	RV11273568	SANTA HELENA S1	03/12/2019 20:53	04/12/2019 09:10	03/12/2019 20:53	04/12/2019 09:10	12,28	1	12,28	CHI
20191222135	ORIZONA	PR12000044RE	PIRES DO RIO S1	03/12/2019 20:14	03/12/2019 23:32	03/12/2019 20:14	03/12/2019 23:32	3,30	11	36,30	CHI
20191222135	PIRES DO RIO	PR12000044RE	PIRES DO RIO S1	03/12/2019 20:14	03/12/2019 23:32	03/12/2019 20:14	03/12/2019 23:32	3,30	74	244,18	CHI
20191222142	BONOPOLIS	PO12090602	MARA ROSA	03/12/2019 15:25	04/12/2019 00:52	03/12/2019 15:25	04/12/2019 00:52	9,44	2	18,88	CHI
20191222142	PORANGATU	PO12090602	MARA ROSA	03/12/2019 15:25	04/12/2019 00:52	03/12/2019 15:25	04/12/2019 00:52	9,44	66	622,93	CHI
20191222143	FIRMINOPOLIS	FR21034319	FIRMINOPOLIS S1	03/12/2019 20:56	04/12/2019 00:22	03/12/2019 20:56	04/12/2019 00:22	3,43	1	3,43	CHI
20191222145	GOIANIRA	GR11094696	GOIANIRA	03/12/2019 20:56	04/12/2019 03:46	03/12/2019 20:56	04/12/2019 03:46	6,82	141	962,09	CHI
20191222147	SAO MIGUEL DO PASSA QUATRO	SQ21283978	VIANOPOLIS	03/12/2019 20:57	04/12/2019 16:25	03/12/2019 20:57	04/12/2019 16:25	19,46	1	19,46	CHI
20191222151	INHUMAS	IN11000019	INHUMAS S2	03/12/2019 20:17	03/12/2019 23:17	03/12/2019 20:17	03/12/2019 23:17	2,99	96	287,17	CHI
20191222164	SANTA HELENA DE GOIAS	SH12296170	IPEGUARI	03/12/2019 17:21	03/12/2019 23:45	03/12/2019 17:21	03/12/2019 23:45	6,39	8	51,12	CHI
20191222166	JATAI	JT12202693	JATAI S1	03/12/2019 21:03	03/12/2019 23:20	03/12/2019 21:03	03/12/2019 23:20	2,27	6	13,62	CHI
20191222172	CROMINIA	CQ21000214	PONTALINA	03/12/2019 21:05	04/12/2019 09:45	03/12/2019 21:05	04/12/2019 09:45	12,67	1	12,67	CHI
20191222183	APARECIDA DE GOIANIA	12712875	INDEPENDENCIA S1	03/12/2019 21:09	03/12/2019 23:00	03/12/2019 21:09	03/12/2019 23:00	1,84	1	1,84	CHI
20191222193	GOIANIA	GN12222920	ATLANTICO S2	03/12/2019 21:03	03/12/2019 22:35	03/12/2019 21:03	03/12/2019 22:35	1,54	201	310,10	CHI
20191222194	NIQUELANDIA	NQ21292541	URUACU	03/12/2019 21:13	04/12/2019 16:55	03/12/2019 21:13	04/12/2019 16:55	19,71	1	19,71	CHI

20191222199	ARAGOIANIA	LG21209227	INDEPENDENCIA S2	03/12/2019 21:14	04/12/2019 01:28	03/12/2019 21:14	04/12/2019 01:28	4,23	1	4,23	CHI
20191222200	MINEIROS	MY21043921	PARQUE DAS EMAS	03/12/2019 21:14	04/12/2019 15:47	03/12/2019 21:14	04/12/2019 15:47	18,54	1	18,54	CHI
20191222205	GOIAS	GS12299343	ITAPURANGA	03/12/2019 21:17	04/12/2019 12:49	03/12/2019 21:17	04/12/2019 12:49	15,52	1	15,52	CHI
20191222207	MINEIROS	MY21365156	PARQUE DAS EMAS	03/12/2019 21:19	04/12/2019 14:41	03/12/2019 21:19	04/12/2019 14:41	17,36	1	17,36	CHI
20191222208	GOIANIA	10013260667	CARAJAS S2	03/12/2019 21:19	04/12/2019 02:06	03/12/2019 21:19	04/12/2019 02:06	4,77	1	4,77	CHI
20191222214	SAO JOAO D ALIANCA	BF21274599	SAO JOAO D ALIANCA	03/12/2019 21:21	04/12/2019 13:45	03/12/2019 21:21	04/12/2019 13:45	16,39	1	16,39	CHI
20191222219	JATAI	SX12139578	JATAI S1	03/12/2019 18:57	04/12/2019 10:37	03/12/2019 18:57	04/12/2019 10:37	15,65	14	219,11	CHI
20191222219	SERRANOPOLIS	SX12139578	JATAI S1	03/12/2019 18:57	04/12/2019 10:37	03/12/2019 18:57	04/12/2019 10:37	15,65	33	516,48	CHI
20191222221	SAO MIGUEL DO PASSA QUATRO	10022955885	CRISTIANOPOLIS	03/12/2019 21:23	04/12/2019 14:00	03/12/2019 21:23	04/12/2019 14:00	16,61	1	16,61	CHI
20191222226	FAINA	FC12096060	GOIAS	03/12/2019 07:48	03/12/2019 23:50	03/12/2019 07:48	03/12/2019 23:50	16,03	94	1506,35	CHI
20191222227	MINEIROS	MY21296341	PARQUE DAS EMAS	03/12/2019 21:27	04/12/2019 15:50	03/12/2019 21:27	04/12/2019 15:50	18,38	1	18,38	CHI
20191222229	RIO VERDE	630516881	RIO VERDE S1	03/12/2019 21:28	04/12/2019 11:45	03/12/2019 21:28	04/12/2019 11:45	14,29	1	14,29	CHI
20191222232	GOIANIA	10004567151	GOIANIA LESTE S3	03/12/2019 21:29	04/12/2019 03:20	03/12/2019 21:29	04/12/2019 03:20	5,84	1	5,84	CHI
20191222235	FAZENDA NOVA	20015002	BRITANIA	03/12/2019 21:29	04/12/2019 18:02	03/12/2019 21:29	04/12/2019 18:02	20,55	1	20,55	CHI
20191222235	JAUPACI	20015002	BRITANIA	03/12/2019 21:29	04/12/2019 18:02	03/12/2019 21:29	04/12/2019 18:02	20,55	2	41,09	CHI
20191222236	BOM JESUS DE GOIAS	BJ12000149RE	BOM JESUS DE GOIAS	03/12/2019 21:29	04/12/2019 08:21	03/12/2019 21:29	04/12/2019 08:21	10,86	18	195,45	CHI
20191222239	CRIXAS	2490027100	SERRA DO OURO	03/12/2019 21:32	04/12/2019 16:00	03/12/2019 21:32	04/12/2019 16:00	18,47	1	18,47	CHI
20191222242	GUARANI DE GOIAS	GY12398234	IACIARA S1	03/12/2019 21:33	04/12/2019 18:01	03/12/2019 21:33	04/12/2019 18:01	20,46	27	552,48	CHI
20191222244	PALESTINA DE GOIAS	PY12268539	PALESTINA	03/12/2019 16:31	04/12/2019 09:08	03/12/2019 16:31	04/12/2019 09:08	16,62	5	83,08	CHI
20191222245	FAINA	FC12274382	GOIAS	03/12/2019 21:34	04/12/2019 10:41	03/12/2019 21:34	04/12/2019 10:41	13,11	5	65,55	CHI
20191222246	JUSSARA	RN12259833	BRITANIA	03/12/2019 21:34	04/12/2019 17:13	03/12/2019 21:34	04/12/2019 17:13	19,64	5	98,21	CHI
20191222246	SANTA FE DE GOIAS	RN12259833	BRITANIA	03/12/2019 21:34	04/12/2019 17:13	03/12/2019 21:34	04/12/2019 17:13	19,64	4	78,57	CHI
20191222247	FORMOSO	ET21231918	MARA ROSA	03/12/2019 21:35	04/12/2019 17:06	03/12/2019 21:35	04/12/2019 17:06	19,52	1	19,52	CHI
20191222248	URUACU	UR12361495	URUACU	03/12/2019 19:01	04/12/2019 16:45	03/12/2019 19:01	04/12/2019 16:45	21,74	11	239,13	CHI
20191222252	NOVO BRASIL	NB12019355	JUSSARA	03/12/2019 07:17	03/12/2019 23:07	03/12/2019 07:17	03/12/2019 23:07	15,82	5	79,10	CHI
20191222255	CACU	CC12097088	CACHOEIRA ALTA	03/12/2019 21:40	04/12/2019 10:18	03/12/2019 21:40	04/12/2019 10:18	12,62	9	113,62	CHI
20191222257	GOIANIA	14611910	FERROVIARIO S1	03/12/2019 21:41	04/12/2019 00:05	03/12/2019 21:41	04/12/2019 00:05	2,39	1	2,39	CHI
20191222260	GOIANIRA	GR12323028	TRINDADE	03/12/2019 14:32	04/12/2019 07:28	03/12/2019 14:32	04/12/2019 07:28	16,92	15	253,77	CHI
20191222261	PIRES DO RIO	PR12050057	PIRES DO RIO S1	03/12/2019 21:45	04/12/2019 15:37	03/12/2019 21:45	04/12/2019 15:37	17,86	1	17,86	CHI
20191222266	RIO VERDE	10028055819	RIO VERDE S2	03/12/2019 21:48	04/12/2019 09:28	03/12/2019 21:48	04/12/2019 09:28	11,66	1	11,66	CHI
20191222267	RUBIATABA	RB12303953	RUBIATABA	03/12/2019 21:22	04/12/2019 13:25	03/12/2019 21:22	04/12/2019 13:25	16,05	3	48,15	CHI
20191222269	RIO VERDE	10009757510	RIO VERDE S2	03/12/2019 21:49	04/12/2019 09:21	03/12/2019 21:49	04/12/2019 09:21	11,52	1	11,52	CHI
20191222273	ALTO PARAISO DE GOIAS	BF21397605	FLORES DE GOIAS	03/12/2019 21:50	04/12/2019 15:44	03/12/2019 21:50	04/12/2019 15:44	17,91	1	17,91	CHI

20191222279	TAQUARAL DE GOIAS	I121327342	ITABERAÍ S2	03/12/2019 21:53	04/12/2019 09:56	03/12/2019 21:53	04/12/2019 09:56	12,06	1	12,06	CHI
20191222280	CACHOEIRA DOURADA	CD12222372	CACHOEIRA DOURADA	03/12/2019 21:53	04/12/2019 09:10	03/12/2019 21:53	04/12/2019 09:10	11,28	1	11,28	CHI
20191222285	SÍTIO D ABADIA	5240000169	IACIARA S2	03/12/2019 22:00	04/12/2019 17:59	03/12/2019 22:00	04/12/2019 17:59	19,97	1	19,97	CHI
20191222287	GOIANIA	10611009	AEROPORTO S1	03/12/2019 22:00	04/12/2019 02:19	03/12/2019 22:00	04/12/2019 02:19	4,30	1	4,30	CHI
20191222291	RIO VERDE	630417945	RIO VERDE S2	03/12/2019 22:03	04/12/2019 09:50	03/12/2019 22:03	04/12/2019 09:50	11,77	1	11,77	CHI
20191222292	CATALAO	10022902110	CATALAO S2	03/12/2019 22:03	04/12/2019 07:54	03/12/2019 22:03	04/12/2019 07:54	9,84	1	9,84	CHI
20191222293	NIQUELANDIA	10006398918	NIQUELANDIA SUBTRANSMISSAO	03/12/2019 22:04	04/12/2019 05:44	03/12/2019 22:04	04/12/2019 05:44	7,66	1	7,66	CHI
20191222301	GOIANIA	GN11002066	GOIANIA LESTE S2	03/12/2019 21:13	04/12/2019 00:31	03/12/2019 21:13	04/12/2019 00:31	3,30	86	283,51	CHI
20191222305	CAIAPONIA	DV12332038	CAIAPONIA	03/12/2019 16:02	04/12/2019 06:55	03/12/2019 16:02	04/12/2019 06:55	14,88	22	327,44	CHI
20191222305	DOVERLANDIA	DV12332038	CAIAPONIA	03/12/2019 16:02	04/12/2019 06:55	03/12/2019 16:02	04/12/2019 06:55	14,88	28	416,74	CHI
20191222307	BONFINOPOLIS	TA12247490	NOVO PLANALTO	03/12/2019 22:09	04/12/2019 14:03	03/12/2019 22:09	04/12/2019 14:03	15,90	1	15,90	CHI
20191222307	BONOPOLIS	TA12247490	NOVO PLANALTO	03/12/2019 22:09	04/12/2019 14:03	03/12/2019 22:09	04/12/2019 14:03	15,90	11	174,85	CHI
20191222307	PORANGATU	TA12247490	NOVO PLANALTO	03/12/2019 22:09	04/12/2019 14:03	03/12/2019 22:09	04/12/2019 14:03	15,90	2	31,79	CHI
20191222308	SENADOR CANEDO	SW11188852	SENADOR CANEDO	03/12/2019 22:08	04/12/2019 00:26	03/12/2019 22:08	04/12/2019 00:26	2,29	142	324,63	CHI
20191222319	PIRES DO RIO	BC12051685	PIRES DO RIO S2	03/12/2019 22:17	04/12/2019 16:20	03/12/2019 22:17	04/12/2019 16:20	18,05	52	938,67	CHI
20191222319	SANTA CRUZ DE GOIAS	BC12051685	PIRES DO RIO S2	03/12/2019 22:17	04/12/2019 16:20	03/12/2019 22:17	04/12/2019 16:20	18,05	25	451,28	CHI
20191222322	MARZAGAO	MG12391598	VILA CORUMBA	03/12/2019 22:18	04/12/2019 12:00	03/12/2019 22:18	04/12/2019 12:00	13,70	2	27,41	CHI
20191222323	MONTES CLAROS DE GOIAS	1440030471	ARENOPOLIS	03/12/2019 22:20	04/12/2019 17:05	03/12/2019 22:20	04/12/2019 17:05	18,75	1	18,75	CHI
20191222327	BURITI ALEGRE	BG12257082	ALTO BURITI	03/12/2019 17:36	04/12/2019 12:29	03/12/2019 17:36	04/12/2019 12:29	18,88	29	547,59	CHI
20191222327	MORRINHOS	BG12257082	ALTO BURITI	03/12/2019 17:36	04/12/2019 12:29	03/12/2019 17:36	04/12/2019 12:29	18,88	4	75,53	CHI
20191222336	SANTA TEREZINHA DE GOIAS	2480024769	SANTA TEREZINHA	03/12/2019 22:32	04/12/2019 15:00	03/12/2019 22:32	04/12/2019 15:00	16,47	1	16,47	CHI
20191222338	COLINAS DO SUL	TI21197706	MINACU	03/12/2019 22:33	04/12/2019 01:12	03/12/2019 22:33	04/12/2019 01:12	2,63	1	2,63	CHI
20191222339	FORMOSA	FA12262405	ITUIQUIRA	03/12/2019 19:21	04/12/2019 12:22	03/12/2019 19:21	04/12/2019 10:02	14,67	85	1246,76	CHI
20191222339	FORMOSA	FA12262405	ITUIQUIRA	03/12/2019 19:21	04/12/2019 12:22	03/12/2019 19:21	04/12/2019 11:22	16,00	4	64,00	CHI
20191222339	FORMOSA	FA12262405	ITUIQUIRA	03/12/2019 19:21	04/12/2019 12:22	03/12/2019 19:21	04/12/2019 12:22	17,00	2	34,00	CHI
20191222340	GOIANIA	11152722	CAMPINAS S2	03/12/2019 22:34	03/12/2019 23:46	03/12/2019 22:34	03/12/2019 23:46	1,19	1	1,19	CHI
20191222341	JOVIANIA	01810214	VICENTINOPOLIS	03/12/2019 22:32	04/12/2019 14:44	03/12/2019 22:32	04/12/2019 10:53	12,35	23	284,10	CHI
20191222341	PONTALINA	01810214	VICENTINOPOLIS	03/12/2019 22:32	04/12/2019 14:44	03/12/2019 22:32	04/12/2019 10:53	12,35	1	12,35	CHI
20191222341	VICENTINOPOLIS	01810214	VICENTINOPOLIS	03/12/2019 22:32	04/12/2019 14:44	03/12/2019 22:32	04/12/2019 10:53	12,35	1822	22505,75	CHI
20191222341	VICENTINOPOLIS	VI12047246	VICENTINOPOLIS	03/12/2019 22:32	04/12/2019 14:44	03/12/2019 22:32	04/12/2019 14:33	16,01	113	1808,66	CHI
20191222341	VICENTINOPOLIS	VI11166498	VICENTINOPOLIS	03/12/2019 22:32	04/12/2019 14:44	03/12/2019 22:32	04/12/2019 14:35	16,05	65	1043,02	CHI
20191222341	JOVIANIA	01810224	VICENTINOPOLIS	03/12/2019 22:32	04/12/2019 14:44	04/12/2019 14:40	04/12/2019 14:44	0,07	23	1,53	CHI
20191222341	PONTALINA	01810224	VICENTINOPOLIS	03/12/2019 22:32	04/12/2019 14:44	04/12/2019 14:40	04/12/2019 14:44	0,07	24	1,60	CHI

20191222341	VICENTINOPOLIS	01810224	VICENTINOPOLIS	03/12/2019 22:32	04/12/2019 14:44	04/12/2019 14:40	04/12/2019 14:44	0,07	2000	133,33	CHI
20191222341	VICENTINOPOLIS	01810224	VICENTINOPOLIS	03/12/2019 22:32	04/12/2019 14:44	04/12/2019 14:40	04/12/2019 14:44	0,07	1155	83,42	CHI
20191222345	GOIANIA	15823362	FERROVIARIO S3	03/12/2019 22:37	04/12/2019 00:59	03/12/2019 22:37	04/12/2019 00:59	2,35	1	2,35	CHI
20191222349	GOIANIA	GN11161537	ATLANTICO S1	03/12/2019 22:42	04/12/2019 01:48	03/12/2019 22:42	04/12/2019 01:48	3,09	20	61,76	CHI
20191222351	GOIANIA	10012295947	XAVANTES	03/12/2019 22:46	04/12/2019 03:50	03/12/2019 22:46	04/12/2019 03:50	5,07	1	5,07	CHI
20191222352	CABECEIRAS	CW11000052	ITIQUIRA	03/12/2019 20:08	03/12/2019 23:24	03/12/2019 20:08	03/12/2019 23:24	3,25	121	393,69	CHI
20191222353	SANTA BARBARA DE GOIAS	SB11215475	TRINDADE	03/12/2019 22:18	04/12/2019 00:20	03/12/2019 22:18	04/12/2019 00:20	2,02	197	397,39	CHI
20191222354	CAVALCANTE	CJ12340534	MINACU	03/12/2019 22:47	04/12/2019 19:38	03/12/2019 22:47	04/12/2019 19:38	20,85	17	354,44	CHI
20191222365	GOIANIA	10982127	FERROVIARIO S3	03/12/2019 22:53	04/12/2019 00:10	03/12/2019 22:53	04/12/2019 00:10	1,27	1	1,27	CHI
20191222367	RIO VERDE	630324633	RIO VERDE S2	03/12/2019 22:54	04/12/2019 09:45	03/12/2019 22:54	04/12/2019 09:45	10,84	1	10,84	CHI
20191222373	MINEIROS	1390145843	PARQUE DAS EMAS	03/12/2019 23:05	04/12/2019 17:56	03/12/2019 23:05	04/12/2019 17:56	18,85	1	18,85	CHI
20191222383	ITABERAI	IB21183013	ITABERAI S1	03/12/2019 23:12	04/12/2019 11:57	03/12/2019 23:12	04/12/2019 11:57	12,75	1	12,75	CHI
20191222385	ITAGUARI	II12217087	ITABERAI S1	03/12/2019 23:14	04/12/2019 03:24	03/12/2019 23:14	04/12/2019 03:24	4,16	10	41,60	CHI
20191222385	JARAGUA	II12217087	ITABERAI S1	03/12/2019 23:14	04/12/2019 03:24	03/12/2019 23:14	04/12/2019 03:24	4,16	63	262,08	CHI
20191222385	TAQUARAL DE GOIAS	II12217087	ITABERAI S1	03/12/2019 23:14	04/12/2019 03:24	03/12/2019 23:14	04/12/2019 03:24	4,16	2	8,32	CHI
20191222388	CACU	SO12303104	CACHOEIRA ALTA	03/12/2019 23:20	04/12/2019 15:02	03/12/2019 23:20	04/12/2019 15:02	15,70	1	15,70	CHI
20191222388	SAO SIMAO	SO12303104	CACHOEIRA ALTA	03/12/2019 23:20	04/12/2019 15:02	03/12/2019 23:20	04/12/2019 15:02	15,70	2	31,40	CHI
20191222389	PIRACANJUBA	PJ12212150RE	PIRACANJUBA	03/12/2019 23:20	04/12/2019 13:32	03/12/2019 23:20	04/12/2019 13:32	14,20	64	909,07	CHI
20191222391	ACREUNA	2440080828	ACREUNA	03/12/2019 23:20	04/12/2019 11:06	03/12/2019 23:20	04/12/2019 11:06	11,76	1	11,76	CHI
20191222392	TAQUARAL DE GOIAS	10027955859	ITABERAI S1	03/12/2019 23:22	04/12/2019 12:55	03/12/2019 23:22	04/12/2019 12:55	13,56	1	13,56	CHI
20191222400	PIRACANJUBA	PJ12212207	PIRACANJUBA	03/12/2019 23:26	03/12/2019 23:56	03/12/2019 23:26	03/12/2019 23:56	0,50	9	4,50	CHI
20191222401	APARECIDA DE GOIANIA	16087677	REAL S2	03/12/2019 23:27	04/12/2019 01:07	03/12/2019 23:27	04/12/2019 01:07	1,67	1	1,67	CHI
20191222402	MINACU	IH12288127	MINACU	03/12/2019 23:29	04/12/2019 05:53	03/12/2019 23:29	04/12/2019 05:53	6,39	6	38,33	CHI
20191222405	PLANALTINA	PI11085602	PLANALTINA	03/12/2019 18:55	04/12/2019 01:49	03/12/2019 18:55	04/12/2019 01:49	6,89	71	489,37	CHI
20191222406	GOIANIA	GN11001709	GOIANIA LESTE S3	03/12/2019 23:32	04/12/2019 02:30	03/12/2019 23:32	04/12/2019 02:30	2,95	141	416,54	CHI
20191222409	PROFESSOR JAMIL SAFADY	PJ21240529	ROCHEDO	03/12/2019 23:44	05/12/2019 08:33	03/12/2019 23:44	05/12/2019 08:33	32,81	2	65,62	CHI
20191222414	CATALAO	10012504350	CATALAO S2	03/12/2019 23:58	04/12/2019 10:34	03/12/2019 23:58	04/12/2019 10:34	10,59	1	10,59	CHI
20191222415	PALESTINA DE GOIAS	PY12374893	PALESTINA	03/12/2019 15:49	04/12/2019 14:10	03/12/2019 15:49	04/12/2019 14:10	22,34	8	178,72	CHI
20191222427	MATRINCHA	MP11180110	MATRINCHA	03/12/2019 17:47	04/12/2019 21:35	03/12/2019 17:47	04/12/2019 21:35	27,80	75	2084,98	CHI
20191222428	CATALAO	10000779774	CATALAO S1	04/12/2019 00:29	04/12/2019 18:54	04/12/2019 00:29	04/12/2019 18:54	18,41	1	18,41	CHI
20191222430	GOIANIA	GN12159972	GOIANIA LESTE S3	04/12/2019 00:52	04/12/2019 10:33	04/12/2019 00:52	04/12/2019 10:33	9,68	213	2061,78	CHI
20191222434	ARENOPOLIS	1920010960	ARENOPOLIS	04/12/2019 01:21	04/12/2019 07:20	04/12/2019 01:21	04/12/2019 07:20	5,97	1	5,97	CHI
20191222435	IPORA	IR11245916	IPORA	03/12/2019 23:57	04/12/2019 06:33	03/12/2019 23:57	04/12/2019 06:33	6,59	66	434,61	CHI

20191222444	ISRAELANDIA	00870424	IPORA	04/12/2019 02:11	04/12/2019 13:34	04/12/2019 02:11	04/12/2019 07:49	5,63	54	304,28	CHI
20191222444	ISRAELANDIA	00870424	IPORA	04/12/2019 02:11	04/12/2019 13:34	04/12/2019 08:08	04/12/2019 09:39	1,51	41	62,08	CHI
20191222444	CACHOEIRA DE GOIAS	00870424	IPORA	04/12/2019 02:11	04/12/2019 13:34	04/12/2019 02:11	04/12/2019 13:34	11,39	5	56,94	CHI
20191222444	CORREGO DO OURO	00870424	IPORA	04/12/2019 02:11	04/12/2019 13:34	04/12/2019 02:11	04/12/2019 13:34	11,39	3	34,16	CHI
20191222444	FAZENDA NOVA	00870424	IPORA	04/12/2019 02:11	04/12/2019 13:34	04/12/2019 02:11	04/12/2019 13:34	11,39	200	2277,56	CHI
20191222444	FAZENDA NOVA	00870424	IPORA	04/12/2019 02:11	04/12/2019 13:34	04/12/2019 02:11	04/12/2019 13:34	11,39	22	250,53	CHI
20191222444	ISRAELANDIA	00870424	IPORA	04/12/2019 02:11	04/12/2019 13:34	04/12/2019 02:11	04/12/2019 13:34	11,39	105	1195,72	CHI
20191222444	ISRAELANDIA	00870424	IPORA	04/12/2019 02:11	04/12/2019 13:34	04/12/2019 02:11	04/12/2019 13:34	11,39	15	170,82	CHI
20191222444	ISRAELANDIA	00870424	IPORA	04/12/2019 02:11	04/12/2019 13:34	04/12/2019 02:11	04/12/2019 13:34	11,39	4	45,55	CHI
20191222444	ISRAELANDIA	00870424	IPORA	04/12/2019 02:11	04/12/2019 13:34	04/12/2019 02:11	04/12/2019 13:34	11,39	19	216,37	CHI
20191222444	IVOLANDIA	00870424	IPORA	04/12/2019 02:11	04/12/2019 13:34	04/12/2019 02:11	04/12/2019 13:34	11,39	1012	11524,43	CHI
20191222444	MOIPORA	00870424	IPORA	04/12/2019 02:11	04/12/2019 13:34	04/12/2019 02:11	04/12/2019 13:34	11,39	232	2641,96	CHI
20191222444	MOIPORA	00870424	IPORA	04/12/2019 02:11	04/12/2019 13:34	04/12/2019 02:11	04/12/2019 13:34	11,39	214	2436,98	CHI
20191222444	MOIPORA	00870424	IPORA	04/12/2019 02:11	04/12/2019 13:34	04/12/2019 02:11	04/12/2019 13:34	11,39	330	3757,97	CHI
20191222444	MOIPORA	00870424	IPORA	04/12/2019 02:11	04/12/2019 13:34	04/12/2019 02:11	04/12/2019 13:34	11,39	12	136,65	CHI
20191222444	PARAUNA	00870424	IPORA	04/12/2019 02:11	04/12/2019 13:34	04/12/2019 02:11	04/12/2019 13:34	11,39	7	79,71	CHI
20191222444	ISRAELANDIA	00870424	IPORA	04/12/2019 02:11	04/12/2019 13:34	04/12/2019 08:08	04/12/2019 13:34	5,43	13	70,62	CHI
20191222444	ISRAELANDIA	00870424	IPORA	04/12/2019 02:11	04/12/2019 13:34	04/12/2019 09:41	04/12/2019 13:34	3,90	41	159,74	CHI
20191222455	ALTO HORIZONTE	MQ12181177	MARA ROSA	04/12/2019 03:13	04/12/2019 15:05	04/12/2019 03:13	04/12/2019 15:05	11,86	3	35,59	CHI
20191222455	MARA ROSA	MQ12181177	MARA ROSA	04/12/2019 03:13	04/12/2019 15:05	04/12/2019 03:13	04/12/2019 15:05	11,86	28	332,17	CHI
20191222455	URUACU	MQ12181177	MARA ROSA	04/12/2019 03:13	04/12/2019 15:05	04/12/2019 03:13	04/12/2019 15:05	11,86	1	11,86	CHI
20191222464	RIO VERDE	RV21326980	CABRIUVA S2	04/12/2019 03:28	04/12/2019 15:20	04/12/2019 03:28	04/12/2019 15:20	11,86	1	11,86	CHI
20191222466	RUBIATABA	RB12290996	RUBIATABA	04/12/2019 03:34	04/12/2019 19:50	04/12/2019 03:34	04/12/2019 16:13	12,66	1	12,66	CHI
20191222466	ARAGUAPAZ	RB12318448LD	RUBIATABA	04/12/2019 03:34	04/12/2019 19:50	04/12/2019 03:34	04/12/2019 19:50	16,28	1	16,28	CHI
20191222466	RUBIATABA	RB12318448LD	RUBIATABA	04/12/2019 03:34	04/12/2019 19:50	04/12/2019 03:34	04/12/2019 19:50	16,28	8	130,20	CHI
20191222467	CAIAPONIA	PY12121107	PALESTINA	03/12/2019 22:57	04/12/2019 10:18	03/12/2019 22:57	04/12/2019 10:18	11,34	49	555,76	CHI
20191222467	PALESTINA DE GOIAS	PY12121107	PALESTINA	03/12/2019 22:57	04/12/2019 10:18	03/12/2019 22:57	04/12/2019 10:18	11,34	35	396,97	CHI
20191222469	MORRINHOS	MR12064832	GOIATUBA S1	04/12/2019 03:41	04/12/2019 12:00	04/12/2019 03:41	04/12/2019 12:00	8,32	1	8,32	CHI
20191222472	NOVA CRIXAS	NA12334349	NOVA CRIXAS	04/12/2019 03:53	04/12/2019 10:20	04/12/2019 03:53	04/12/2019 10:20	6,45	86	554,49	CHI
20191222475	JUSSARA	JR11259700	JUSSARA	04/12/2019 04:01	04/12/2019 09:46	04/12/2019 04:01	04/12/2019 09:46	5,75	72	414,00	CHI
20191222476	JATAI	JT12000167	JATAI S1	04/12/2019 04:01	04/12/2019 18:25	04/12/2019 04:01	04/12/2019 08:00	3,98	12	47,74	CHI
20191222476	JATAI	JT12000167	JATAI S1	04/12/2019 04:01	04/12/2019 18:25	04/12/2019 04:01	04/12/2019 18:25	14,40	13	187,14	CHI
20191222481	SAO MIGUEL DO ARAGUAIA	SM12081437	SAO MIGUEL DO ARAGUAIA	04/12/2019 04:05	04/12/2019 11:46	04/12/2019 04:05	04/12/2019 11:46	7,67	23	176,49	CHI

20191222492	CRIXAS	MZ10400707	MOZARLANDIA	04/12/2019 04:17	04/12/2019 17:51	04/12/2019 04:17	04/12/2019 10:56	6,65	3	19,96	CHI
20191222492	MOZARLANDIA	MZ10400707	MOZARLANDIA	04/12/2019 04:17	04/12/2019 17:51	04/12/2019 04:17	04/12/2019 10:56	6,65	21	139,75	CHI
20191222492	NOVA CRIXAS	MZ10400707	MOZARLANDIA	04/12/2019 04:17	04/12/2019 17:51	04/12/2019 04:17	04/12/2019 10:56	6,65	115	765,29	CHI
20191222492	NOVA CRIXAS	MZ10400707	NOVA CRIXAS	04/12/2019 04:17	04/12/2019 17:51	04/12/2019 04:17	04/12/2019 10:56	6,65	1	6,65	CHI
20191222492	NOVA CRIXAS	NA12057172	MOZARLANDIA	04/12/2019 04:17	04/12/2019 17:51	04/12/2019 04:17	04/12/2019 14:03	9,77	20	195,42	CHI
20191222492	NOVA CRIXAS	NA12059867	MOZARLANDIA	04/12/2019 04:17	04/12/2019 17:51	04/12/2019 04:17	04/12/2019 17:51	13,56	1	13,56	CHI
20191222494	APARECIDA DE GOIANIA	200534520	CEPAIGO S1	04/12/2019 04:28	04/12/2019 09:09	04/12/2019 04:28	04/12/2019 09:09	4,67	1	4,67	CHI
20191222495	ANICUNS	AC12299011	FIRMINOPOLIS S2	04/12/2019 04:29	04/12/2019 11:35	04/12/2019 04:29	04/12/2019 11:35	7,10	10	71,00	CHI
20191222498	NOVA IGUACU DE GOIAS	NH12202113	SANTA TEREZINHA	04/12/2019 04:37	04/12/2019 11:58	04/12/2019 04:37	04/12/2019 11:58	7,35	61	448,16	CHI
20191222500	MATRINCHA	MP10400392	MATRINCHA	04/12/2019 04:30	07/12/2019 13:46	04/12/2019 04:30	04/12/2019 09:36	5,09	20	101,72	CHI
20191222500	MATRINCHA	MP10400392	MATRINCHA	04/12/2019 04:30	07/12/2019 13:46	04/12/2019 12:32	04/12/2019 13:33	1,01	20	20,22	CHI
20191222500	MATRINCHA	MP10400392	MATRINCHA	04/12/2019 04:30	07/12/2019 13:46	04/12/2019 04:30	04/12/2019 20:17	15,78	6	94,68	CHI
20191222500	MATRINCHA	MP10400392	MATRINCHA	04/12/2019 04:30	07/12/2019 13:46	05/12/2019 12:59	05/12/2019 13:33	0,56	26	14,61	CHI
20191222500	ARUANA	MP10400392	MATRINCHA	04/12/2019 04:30	07/12/2019 13:46	04/12/2019 04:30	06/12/2019 16:22	59,85	6	359,10	CHI
20191222500	MATRINCHA	MP10400392	MATRINCHA	04/12/2019 04:30	07/12/2019 13:46	04/12/2019 04:30	06/12/2019 16:22	59,85	11	658,36	CHI
20191222500	MATRINCHA	MP10400392	MATRINCHA	04/12/2019 04:30	07/12/2019 13:46	04/12/2019 04:30	06/12/2019 21:58	65,45	85	5563,63	CHI
20191222500	MATRINCHA	MP10400392	MATRINCHA	04/12/2019 04:30	07/12/2019 13:46	04/12/2019 04:30	07/12/2019 13:46	81,26	2	162,52	CHI
20191222501	FAZENDA NOVA	RN10394715	BRITANIA	04/12/2019 03:44	04/12/2019 20:46	04/12/2019 03:44	04/12/2019 03:48	0,05	9	0,49	CHI
20191222501	JUSSARA	RN10394715	BRITANIA	04/12/2019 03:44	04/12/2019 20:46	04/12/2019 03:44	04/12/2019 03:48	0,05	278	15,06	CHI
20191222501	SANTA FE DE GOIAS	RN10394715	BRITANIA	04/12/2019 03:44	04/12/2019 20:46	04/12/2019 03:44	04/12/2019 03:48	0,05	21	1,14	CHI
20191222501	FAZENDA NOVA	JR16410161	BRITANIA	04/12/2019 03:44	04/12/2019 20:46	04/12/2019 03:44	04/12/2019 03:49	0,08	198	16,01	CHI
20191222501	JUSSARA	JR16410161	BRITANIA	04/12/2019 03:44	04/12/2019 20:46	04/12/2019 03:44	04/12/2019 03:49	0,08	31	2,51	CHI
20191222501	FAZENDA NOVA	JR13410161B	BRITANIA	04/12/2019 03:44	04/12/2019 20:46	04/12/2019 03:50	04/12/2019 09:45	5,91	140	827,01	CHI
20191222501	JUSSARA	JR13410161B	BRITANIA	04/12/2019 03:44	04/12/2019 20:46	04/12/2019 03:50	04/12/2019 09:45	5,91	20	118,14	CHI
20191222501	FAZENDA NOVA	RN10394715	BRITANIA	04/12/2019 03:44	04/12/2019 20:46	04/12/2019 13:20	04/12/2019 13:37	0,27	149	39,98	CHI
20191222501	JUSSARA	RN10394715	BRITANIA	04/12/2019 03:44	04/12/2019 20:46	04/12/2019 13:20	04/12/2019 13:37	0,27	308	82,65	CHI
20191222501	SANTA FE DE GOIAS	RN10394715	BRITANIA	04/12/2019 03:44	04/12/2019 20:46	04/12/2019 13:20	04/12/2019 13:37	0,27	21	5,63	CHI
20191222501	FAZENDA NOVA	FN13362430	BRITANIA	04/12/2019 03:44	04/12/2019 20:46	04/12/2019 03:50	04/12/2019 20:45	16,91	15	253,62	CHI
20191222501	FAZENDA NOVA	FN13362430	BRITANIA	04/12/2019 03:44	04/12/2019 20:46	04/12/2019 13:20	04/12/2019 20:45	7,40	1	7,40	CHI
20191222501	FAZENDA NOVA	FN12354616LD	BRITANIA	04/12/2019 03:44	04/12/2019 20:46	04/12/2019 03:50	04/12/2019 20:46	16,93	43	727,86	CHI
20191222501	JUSSARA	FN12354616LD	BRITANIA	04/12/2019 03:44	04/12/2019 20:46	04/12/2019 03:50	04/12/2019 20:46	16,93	11	186,20	CHI
20191222514	AMARALINA	BX10403942	SAO MIGUEL DO ARAGUAIA	04/12/2019 06:31	04/12/2019 06:34	04/12/2019 06:31	04/12/2019 06:34	0,06	212	11,84	CHI
20191222514	BONOPOLIS	BX10403942	SAO MIGUEL DO ARAGUAIA	04/12/2019 06:31	04/12/2019 06:34	04/12/2019 06:31	04/12/2019 06:34	0,06	12	0,67	CHI

20191222526	PALESTINA DE GOIAS	PY12040193	PALESTINA	03/12/2019 23:11	04/12/2019 09:53	03/12/2019 23:11	04/12/2019 09:53	10,70	81	866,61	CHI
20191222543	CAMPINORTE	MQ21000014	MARA ROSA	04/12/2019 07:26	04/12/2019 11:00	04/12/2019 07:26	04/12/2019 11:00	3,57	1	3,57	CHI
20191222580	SERRANOPOLIS	9880007328	CHAPADAO DO CEU	04/12/2019 08:12	04/12/2019 17:54	04/12/2019 08:12	04/12/2019 17:54	9,71	1	9,71	CHI
20191222601	AMARALINA	LC12189854	MARA ROSA	04/12/2019 04:44	04/12/2019 14:17	04/12/2019 04:44	04/12/2019 14:17	9,54	7	66,80	CHI
20191222601	MARA ROSA	LC12189854	MARA ROSA	04/12/2019 04:44	04/12/2019 14:17	04/12/2019 04:44	04/12/2019 14:17	9,54	2	19,08	CHI
20191222603	SAO MIGUEL DO ARAGUAIA	SM12228636	SAO MIGUEL DO ARAGUAIA	04/12/2019 04:47	04/12/2019 13:04	04/12/2019 04:47	04/12/2019 13:04	8,29	56	464,18	CHI
20191222606	IACIARA	IA12085526	IACIARA S1	04/12/2019 04:53	04/12/2019 11:42	04/12/2019 04:53	04/12/2019 11:42	6,80	35	238,14	CHI
20191222611	CORUMBAIBA	CI21110131	VILA CORUMBA	04/12/2019 05:01	04/12/2019 17:55	04/12/2019 05:01	04/12/2019 17:55	12,91	1	12,91	CHI
20191222616	GOIANIA	16935100	GOIANIA LESTE S3	04/12/2019 05:09	04/12/2019 06:50	04/12/2019 05:09	04/12/2019 06:50	1,69	1	1,69	CHI
20191222621	GOIANIA	GN11374095	GOYA S1	04/12/2019 05:11	04/12/2019 10:15	04/12/2019 05:11	04/12/2019 10:15	5,06	66	334,05	CHI
20191222631	ARENOPOLIS	AY13349761	ARENOPOLIS	04/12/2019 05:18	05/12/2019 00:30	04/12/2019 05:18	05/12/2019 00:30	19,20	218	4184,93	CHI
20191222631	DIORAMA	AY13349761	ARENOPOLIS	04/12/2019 05:18	05/12/2019 00:30	04/12/2019 05:18	05/12/2019 00:30	19,20	12	230,36	CHI
20191222631	MONTES CLAROS DE GOIAS	AY13349761	ARENOPOLIS	04/12/2019 05:18	05/12/2019 00:30	04/12/2019 05:18	05/12/2019 00:30	19,20	25	479,92	CHI
20191222631	PALESTINA DE GOIAS	AY13349761	ARENOPOLIS	04/12/2019 05:18	05/12/2019 00:30	04/12/2019 05:18	05/12/2019 00:30	19,20	3	57,59	CHI
20191222631	PIRANHAS	AY13349761	ARENOPOLIS	04/12/2019 05:18	05/12/2019 00:30	04/12/2019 05:18	05/12/2019 00:30	19,20	25	479,92	CHI
20191222631	ARENOPOLIS	AY13349761	ARENOPOLIS	04/12/2019 05:18	05/12/2019 00:30	04/12/2019 19:50	05/12/2019 00:30	4,67	28	130,66	CHI
20191222635	SANCLERLANDIA	SC12008814	FIRMINOPOLIS S2	04/12/2019 05:22	04/12/2019 08:41	04/12/2019 05:22	04/12/2019 08:41	3,31	19	62,92	CHI
20191222640	APORE	IJ12202625	ITAJA S2	04/12/2019 05:25	04/12/2019 08:02	04/12/2019 05:25	04/12/2019 08:02	2,60	4	10,41	CHI
20191222640	ITAJA	IJ12202625	ITAJA S2	04/12/2019 05:25	04/12/2019 08:02	04/12/2019 05:25	04/12/2019 08:02	2,60	17	44,24	CHI
20191222644	PIRACANJUBA	PJ21182955	PIRACANJUBA	04/12/2019 05:28	04/12/2019 11:10	04/12/2019 05:28	04/12/2019 11:10	5,69	1	5,69	CHI
20191222645	CAMPOS VERDES	VD12201660	SANTA TEREZINHA	04/12/2019 05:28	04/12/2019 12:48	04/12/2019 05:28	04/12/2019 12:48	7,32	21	153,72	CHI
20191222645	SANTA TEREZINHA DE GOIAS	VD12201660	SANTA TEREZINHA	04/12/2019 05:28	04/12/2019 12:48	04/12/2019 05:28	04/12/2019 12:48	7,32	44	322,08	CHI
20191222646	HIDROLANDIA	HD11000133	ANHANGUERA	04/12/2019 05:29	04/12/2019 08:13	04/12/2019 05:29	04/12/2019 08:13	2,72	51	138,93	CHI
20191222648	SAO MIGUEL DO ARAGUAIA	SM21128371	SAO MIGUEL DO ARAGUAIA	04/12/2019 05:30	04/12/2019 17:10	04/12/2019 05:30	04/12/2019 17:10	11,66	1	11,66	CHI
20191222649	MUNDO NOVO DE GOIAS	MH12034680	NOVA CRIXAS	04/12/2019 05:30	04/12/2019 08:13	04/12/2019 05:30	04/12/2019 08:13	2,71	28	75,87	CHI
20191222650	ORIZONA	OZ21022893	PIRES DO RIO S2	04/12/2019 05:31	04/12/2019 12:41	04/12/2019 05:51	04/12/2019 12:41	6,84	1	6,84	CHI
20191222652	BALIZA	BH12381003	BOM JARDIM	03/12/2019 20:20	04/12/2019 10:32	03/12/2019 20:20	04/12/2019 10:32	14,19	23	326,36	CHI
20191222657	ORIZONA	OZ12114505	PIRES DO RIO S2	04/12/2019 04:12	04/12/2019 20:22	04/12/2019 04:12	04/12/2019 20:22	16,16	19	307,02	CHI
20191222659	MUTUNOPOLIS	MU12220645	MARA ROSA	04/12/2019 05:34	04/12/2019 14:10	04/12/2019 05:34	04/12/2019 14:10	8,60	31	266,53	CHI
20191222659	PORANGATU	MU12220645	MARA ROSA	04/12/2019 05:34	04/12/2019 14:10	04/12/2019 05:34	04/12/2019 14:10	8,60	44	378,30	CHI
20191222660	ITAPURANGA	IK12298410	ITAPURANGA	04/12/2019 05:35	04/12/2019 10:50	04/12/2019 05:35	04/12/2019 10:50	5,25	12	63,06	CHI
20191222662	BALIZA	BH12331338	CAIAPONIA	04/12/2019 00:16	04/12/2019 11:06	04/12/2019 00:16	04/12/2019 11:06	10,83	78	844,54	CHI
20191222665	FAINA	FC12227862	GOIAS	04/12/2019 05:37	04/12/2019 10:44	04/12/2019 05:37	04/12/2019 10:44	5,11	10	51,11	CHI

20191222666	CRIXAS	NA12078447	NOVA CRIXAS	04/12/2019 05:37	04/12/2019 10:43	04/12/2019 05:37	04/12/2019 10:43	5,09	18	91,65	CHI
20191222666	NOVA CRIXAS	NA12078447	NOVA CRIXAS	04/12/2019 05:37	04/12/2019 10:43	04/12/2019 05:37	04/12/2019 10:43	5,09	19	96,74	CHI
20191222676	PIRES DO RIO	PR12186587	PIRES DO RIO S1	04/12/2019 07:58	04/12/2019 09:33	04/12/2019 07:58	04/12/2019 09:33	1,57	25	39,26	CHI
20191222679	ARAGOIANIA	AO32097662	GUAPO S2	03/12/2019 19:51	04/12/2019 10:45	03/12/2019 19:51	04/12/2019 10:45	14,88	4	59,53	CHI
20191222679	VARJAO	AO32097662	GUAPO S2	03/12/2019 19:51	04/12/2019 10:45	03/12/2019 19:51	04/12/2019 10:45	14,88	5	74,42	CHI
20191222683	RIO VERDE	RV12189031	CACHOEIRA ALTA	04/12/2019 03:11	04/12/2019 12:27	04/12/2019 03:11	04/12/2019 12:27	9,26	27	249,98	CHI
20191222689	JUSSARA	JR12019314	JUSSARA	04/12/2019 01:17	04/12/2019 17:47	04/12/2019 01:17	04/12/2019 17:47	16,50	82	1352,80	CHI
20191222692	PORANGATU	PO12038327	PORANGATU	04/12/2019 05:47	04/12/2019 09:00	04/12/2019 05:47	04/12/2019 09:00	3,21	2	6,42	CHI
20191222693	MINACU	IH12242192	MINACU	04/12/2019 05:47	04/12/2019 11:14	04/12/2019 05:47	04/12/2019 11:14	5,44	28	152,44	CHI
20191222694	JATAI	JT12065798	JATAI S1	04/12/2019 05:48	04/12/2019 09:03	04/12/2019 05:48	04/12/2019 09:03	3,25	7	22,74	CHI
20191222701	PALESTINA DE GOIAS	PY12223011	PALESTINA	03/12/2019 23:30	04/12/2019 08:24	03/12/2019 23:30	04/12/2019 08:24	8,89	114	1013,11	CHI
20191222813	JATAI	290249909	JATAI S1	04/12/2019 05:56	04/12/2019 11:54	04/12/2019 05:56	04/12/2019 11:54	5,96	1	5,96	CHI
20191222815	ARENOPOLIS	PH12243872LD	PIRANHAS	04/12/2019 04:59	05/12/2019 13:30	04/12/2019 04:59	04/12/2019 10:50	5,85	1	5,85	CHI
20191222815	BOM JARDIM DE GOIAS	PH12243872LD	PIRANHAS	04/12/2019 04:59	05/12/2019 13:30	04/12/2019 04:59	04/12/2019 10:50	5,85	18	105,29	CHI
20191222815	PIRANHAS	PH12243872LD	PIRANHAS	04/12/2019 04:59	05/12/2019 13:30	04/12/2019 04:59	04/12/2019 10:50	5,85	484	2831,27	CHI
20191222815	PIRANHAS	PH13023521	PIRANHAS	04/12/2019 04:59	05/12/2019 13:30	04/12/2019 11:15	04/12/2019 12:10	0,92	2	1,84	CHI
20191222815	CAIAPONIA	05560224	PIRANHAS	04/12/2019 04:59	05/12/2019 13:30	04/12/2019 12:10	04/12/2019 12:55	0,74	1	0,74	CHI
20191222815	PIRANHAS	05560224	PIRANHAS	04/12/2019 04:59	05/12/2019 13:30	04/12/2019 12:10	04/12/2019 12:55	0,74	3124	2317,83	CHI
20191222815	PIRANHAS	05560224	PIRANHAS	04/12/2019 04:59	05/12/2019 13:30	04/12/2019 12:35	04/12/2019 12:55	0,32	2	0,65	CHI
20191222815	BOM JARDIM DE GOIAS	PH12243872LD	PIRANHAS	04/12/2019 04:59	05/12/2019 13:30	04/12/2019 11:15	04/12/2019 14:50	3,58	18	64,44	CHI
20191222815	PIRANHAS	PH12243872LD	PIRANHAS	04/12/2019 04:59	05/12/2019 13:30	04/12/2019 11:15	04/12/2019 14:50	3,58	380	1360,40	CHI
20191222815	PIRANHAS	PH12243872LD	PIRANHAS	04/12/2019 04:59	05/12/2019 13:30	04/12/2019 12:35	04/12/2019 14:50	2,24	2	4,48	CHI
20191222815	ARENOPOLIS	05560214	PIRANHAS	04/12/2019 04:59	05/12/2019 13:30	04/12/2019 19:02	04/12/2019 19:07	0,08	10	0,83	CHI
20191222815	BOM JARDIM DE GOIAS	05560214	PIRANHAS	04/12/2019 04:59	05/12/2019 13:30	04/12/2019 19:02	04/12/2019 19:07	0,08	18	1,50	CHI
20191222815	PIRANHAS	05560214	PIRANHAS	04/12/2019 04:59	05/12/2019 13:30	04/12/2019 19:02	04/12/2019 19:07	0,08	2024	168,67	CHI
20191222815	ARENOPOLIS	PH12024549LD	PIRANHAS	04/12/2019 04:59	05/12/2019 13:30	04/12/2019 11:15	05/12/2019 13:30	26,26	1	26,26	CHI
20191222815	PIRANHAS	PH12024549LD	PIRANHAS	04/12/2019 04:59	05/12/2019 13:30	04/12/2019 11:15	05/12/2019 13:30	26,26	108	2835,66	CHI
20191222820	PONTALINA	PK12080060	PONTALINA	04/12/2019 05:58	04/12/2019 15:07	04/12/2019 05:58	04/12/2019 15:07	9,13	28	255,77	CHI
20191222821	HIDROLANDIA	HD31060209	CEPAIGO S1	04/12/2019 05:59	04/12/2019 08:57	04/12/2019 05:59	04/12/2019 08:57	2,96	1	2,96	CHI
20191222828	MONTES CLAROS DE GOIAS	1440021044	IPORA	04/12/2019 06:02	04/12/2019 10:55	04/12/2019 06:02	04/12/2019 10:55	4,88	1	4,88	CHI
20191222832	ITAJA	IJ12179842	ITAJA S2	04/12/2019 06:03	04/12/2019 09:15	04/12/2019 06:03	04/12/2019 09:15	3,20	1	3,20	CHI
20191222838	PORTELANDIA	PW12302970	PARQUE DAS EMAS	04/12/2019 05:50	04/12/2019 13:14	04/12/2019 05:50	04/12/2019 13:14	7,38	4	29,54	CHI
20191222839	MOSSAMEDES	SC12206496	FIRMINOPOLIS S2	04/12/2019 06:04	04/12/2019 06:52	04/12/2019 06:04	04/12/2019 06:52	0,78	2	1,57	CHI

20191222839	SANCLERLANDIA	SC12206496	FIRMINOPOLIS S2	04/12/2019 06:04	04/12/2019 06:52	04/12/2019 06:04	04/12/2019 06:52	0,78	91	71,41	CHI
20191222843	EDEALINA	ED21218137	PONTALINA	04/12/2019 06:06	04/12/2019 13:45	04/12/2019 06:06	04/12/2019 13:45	7,66	1	7,66	CHI
20191222845	SANTA CRUZ DE GOIAS	BC21332223	CRISTIANOPOLIS	04/12/2019 06:06	04/12/2019 08:11	04/12/2019 06:06	04/12/2019 08:11	2,07	1	2,07	CHI
20191222846	MARA ROSA	MQ21353580	MARA ROSA	04/12/2019 06:07	05/12/2019 00:34	04/12/2019 06:07	05/12/2019 00:34	18,45	1	18,45	CHI
20191222849	SANTA CRUZ DE GOIAS	BC21300725	CRISTIANOPOLIS	04/12/2019 06:07	04/12/2019 08:56	04/12/2019 06:07	04/12/2019 08:56	2,80	2	5,61	CHI
20191222851	MINEIROS	MY12045367	PARQUE DAS EMAS	04/12/2019 06:08	04/12/2019 15:27	04/12/2019 06:08	04/12/2019 15:27	9,31	26	242,00	CHI
20191222857	PORANGATU	PO12192315	PORANGATU	04/12/2019 05:51	04/12/2019 12:47	04/12/2019 05:51	04/12/2019 12:47	6,93	19	131,62	CHI
20191222861	PORANGATU	PO12036063	PORANGATU	04/12/2019 05:38	04/12/2019 12:17	04/12/2019 05:38	04/12/2019 12:17	6,64	58	385,27	CHI
20191222863	SAO LUIS DE MONTES BELOS	SL12206033	SAO LUIZ DOS MONTES BELOS	04/12/2019 06:03	04/12/2019 11:30	04/12/2019 06:03	04/12/2019 11:30	5,43	13	70,64	CHI
20191222865	FIRMINOPOLIS	FR12391442	FIRMINOPOLIS S2	03/12/2019 19:18	04/12/2019 18:05	03/12/2019 19:18	04/12/2019 13:01	17,71	7	123,94	CHI
20191222865	SAO JOAO DA PARAUNA	FR12391442	FIRMINOPOLIS S2	03/12/2019 19:18	04/12/2019 18:05	03/12/2019 19:18	04/12/2019 13:01	17,71	18	318,69	CHI
20191222865	FIRMINOPOLIS	FR12383542LD	FIRMINOPOLIS S2	03/12/2019 19:18	04/12/2019 18:05	03/12/2019 19:18	04/12/2019 18:05	22,78	59	1343,76	CHI
20191222865	SAO JOAO DA PARAUNA	FR12383542LD	FIRMINOPOLIS S2	03/12/2019 19:18	04/12/2019 18:05	03/12/2019 19:18	04/12/2019 18:05	22,78	53	1207,10	CHI
20191222866	BELA VISTA DE GOIAS	BV12086489	CEPAIGO S2	04/12/2019 05:39	04/12/2019 09:39	04/12/2019 05:39	04/12/2019 09:39	3,99	13	51,83	CHI
20191222868	MARA ROSA	MQ12086247	MARA ROSA	04/12/2019 06:10	04/12/2019 13:00	04/12/2019 06:10	04/12/2019 13:00	6,82	7	47,72	CHI
20191222875	ARENOPOLIS	AY12000042	ARENOPOLIS	04/12/2019 05:05	04/12/2019 10:14	04/12/2019 05:05	04/12/2019 10:14	5,15	22	113,23	CHI
20191222879	CAIAPONIA	CP12245630	PALESTINA	04/12/2019 06:12	05/12/2019 07:54	04/12/2019 06:12	05/12/2019 07:54	25,69	3	77,06	CHI
20191222883	MINEIROS	MY12209668	PARQUE DAS EMAS	04/12/2019 06:12	04/12/2019 10:39	04/12/2019 06:12	04/12/2019 10:39	4,45	90	400,15	CHI
20191222890	QUIRINOPOLIS	QI12370085	QUIRINOPOLIS	04/12/2019 06:15	04/12/2019 12:33	04/12/2019 06:15	04/12/2019 12:33	6,29	2	12,59	CHI
20191222893	CEZARINA	PL12129777	PALMEIRAS	04/12/2019 07:31	04/12/2019 15:04	04/12/2019 07:31	04/12/2019 15:04	7,55	1	7,55	CHI
20191222893	INDIARA	PL12129777	PALMEIRAS	04/12/2019 07:31	04/12/2019 15:04	04/12/2019 07:31	04/12/2019 15:04	7,55	3	22,64	CHI
20191222893	PALMEIRAS DE GOIAS	PL12129777	PALMEIRAS	04/12/2019 07:31	04/12/2019 15:04	04/12/2019 07:31	04/12/2019 15:04	7,55	99	747,04	CHI
20191222901	MARA ROSA	ET12256314	MARA ROSA	04/12/2019 02:04	04/12/2019 11:00	04/12/2019 02:04	04/12/2019 11:00	8,92	8	71,38	CHI
20191222910	JATAI	JT12000179	JATAI S2	04/12/2019 06:19	04/12/2019 15:38	04/12/2019 06:19	04/12/2019 15:38	9,31	4	37,25	CHI
20191222918	BELA VISTA DE GOIAS	SV21016162	BELA VISTA S2	04/12/2019 06:20	04/12/2019 11:50	04/12/2019 06:20	04/12/2019 11:50	5,50	1	5,50	CHI
20191222933	ORIZONA	OZ12022888	PIRES DO RIO S2	03/12/2019 20:51	04/12/2019 11:52	03/12/2019 20:51	04/12/2019 11:52	15,01	36	540,47	CHI
20191222934	SANCLERLANDIA	SC21019299	FIRMINOPOLIS S2	04/12/2019 06:22	04/12/2019 09:53	04/12/2019 06:22	04/12/2019 09:53	3,51	2	7,01	CHI
20191222948	MOSSAMEDES	MD12005317	FIRMINOPOLIS S2	04/12/2019 06:14	04/12/2019 09:52	04/12/2019 06:14	04/12/2019 09:52	3,63	16	58,07	CHI
20191222952	JATAI	JT12219503	JATAI S3	04/12/2019 06:27	04/12/2019 10:20	04/12/2019 06:27	04/12/2019 10:20	3,88	5	19,40	CHI
20191222956	CAIAPONIA	CP12395435	PALESTINA	04/12/2019 06:28	05/12/2019 09:14	04/12/2019 06:28	05/12/2019 09:14	26,77	5	133,83	CHI
20191222959	PORTELANDIA	PW21303435	PARQUE DAS EMAS	04/12/2019 06:30	04/12/2019 12:00	04/12/2019 06:30	04/12/2019 12:00	5,51	1	5,51	CHI
20191222960	JATAI	JT12000173	JATAI S1	04/12/2019 06:11	04/12/2019 10:21	04/12/2019 06:11	04/12/2019 10:21	4,16	8	33,26	CHI
20191222968	GOIANIA	12538656	ATLANTICO S3	04/12/2019 06:33	04/12/2019 08:48	04/12/2019 06:33	04/12/2019 08:48	2,25	1	2,25	CHI

20191222975	IPAMERI	IP12071421	IPAMERI	04/12/2019 06:34	04/12/2019 12:30	04/12/2019 06:34	04/12/2019 12:30	5,94	3	17,81	CHI
20191222978	CAMPINORTE	CR12398067	CAMPINORTE	04/12/2019 05:28	04/12/2019 15:01	04/12/2019 05:28	04/12/2019 15:01	9,54	9	85,85	CHI
20191222978	URUACU	CR12398067	CAMPINORTE	04/12/2019 05:28	04/12/2019 15:01	04/12/2019 05:28	04/12/2019 15:01	9,54	1	9,54	CHI
20191222981	ARAGARCAS	AG11354634	ARAGARCAS	04/12/2019 06:36	04/12/2019 11:00	04/12/2019 06:36	04/12/2019 11:00	4,39	86	377,95	CHI
20191222995	SANTA CRUZ DE GOIAS	BC12086023	CRISTIANOPOLIS	04/12/2019 06:38	04/12/2019 10:13	04/12/2019 06:38	04/12/2019 10:13	3,57	3	10,71	CHI
20191222997	SANCLERLANDIA	SC12005460	FIRMINOPOLIS S2	04/12/2019 06:38	04/12/2019 11:08	04/12/2019 06:38	04/12/2019 11:08	4,49	4	17,97	CHI
20191223005	FORMOSA	FA21379726	ITIQUIRA	04/12/2019 06:40	04/12/2019 11:27	04/12/2019 06:40	04/12/2019 11:27	4,79	2	9,58	CHI
20191223007	SANTA HELENA DE GOIAS	SH21314149	IPEGUARI	04/12/2019 06:41	04/12/2019 12:18	04/12/2019 06:41	04/12/2019 12:18	5,62	1	5,62	CHI
20191223011	AGUA FRIA DE GOIAS	TL12208773	SAO JOAO D ALIANCA	04/12/2019 05:14	05/12/2019 08:19	04/12/2019 05:14	05/12/2019 08:19	27,08	13	352,00	CHI
20191223011	MIMOSO DE GOIAS	TL12208773	SAO JOAO D ALIANCA	04/12/2019 05:14	05/12/2019 08:19	04/12/2019 05:14	05/12/2019 08:19	27,08	30	812,30	CHI
20191223012	MONTES CLAROS DE GOIAS	ME12139989	IPORA	04/12/2019 05:58	04/12/2019 09:00	04/12/2019 05:58	04/12/2019 09:00	3,02	64	193,30	CHI
20191223017	FORMOSA	FA12042605	ITIQUIRA	04/12/2019 06:43	04/12/2019 14:13	04/12/2019 06:43	04/12/2019 14:13	7,49	3	22,48	CHI
20191223020	FAINA	FC12096060	GOIAS	04/12/2019 03:57	04/12/2019 11:01	04/12/2019 03:57	04/12/2019 11:01	7,06	94	663,43	CHI
20191223031	CUMARI	2000010952	CATALAO S1	04/12/2019 06:45	04/12/2019 12:01	04/12/2019 06:45	04/12/2019 12:01	5,27	1	5,27	CHI
20191223036	FORMOSA	FA21053537	ITIQUIRA	04/12/2019 06:46	04/12/2019 11:55	04/12/2019 06:46	04/12/2019 11:55	5,14	1	5,14	CHI
20191223048	FLORES DE GOIAS	FB12320627	FLORES DE GOIAS	04/12/2019 06:25	04/12/2019 15:21	04/12/2019 06:25	04/12/2019 15:21	8,93	28	249,99	CHI
20191223053	PLANALTINA	10014189834	PLANALTINA	04/12/2019 06:50	04/12/2019 20:15	04/12/2019 06:50	04/12/2019 20:15	13,42	1	13,42	CHI
20191223054	CRIXAS	CX12319064	SERRA DO OURO	04/12/2019 06:50	05/12/2019 09:16	04/12/2019 06:50	05/12/2019 09:16	26,42	3	79,26	CHI
20191223056	RIO VERDE	RV12098526	MONTIVIDIU T	04/12/2019 06:51	04/12/2019 11:05	04/12/2019 06:51	04/12/2019 11:05	4,23	3	12,69	CHI
20191223064	NOVA CRIXAS	NA12038843	NOVA CRIXAS	04/12/2019 06:52	04/12/2019 12:40	04/12/2019 06:52	04/12/2019 12:40	5,81	3	17,43	CHI
20191223082	VARIAO	VJ12085702	CEZARINA	03/12/2019 20:09	04/12/2019 12:50	03/12/2019 20:09	04/12/2019 12:50	16,67	7	116,67	CHI
20191223086	CEZARINA	CZ12102109	CEZARINA	04/12/2019 06:56	04/12/2019 14:15	04/12/2019 06:56	04/12/2019 14:15	7,32	11	80,53	CHI
20191223088	MINEIROS	MY21197250	PARQUE DAS EMAS	04/12/2019 06:56	05/12/2019 08:40	04/12/2019 06:56	05/12/2019 08:40	25,73	1	25,73	CHI
20191223091	ACREUNA	EU12246749	ACREUNA	04/12/2019 06:51	04/12/2019 11:40	04/12/2019 06:51	04/12/2019 11:40	4,83	11	53,08	CHI
20191223091	EDEIA	EU12246749	ACREUNA	04/12/2019 06:51	04/12/2019 11:40	04/12/2019 06:51	04/12/2019 11:40	4,83	13	62,74	CHI
20191223091	TURVANIA	EU12246749	ACREUNA	04/12/2019 06:51	04/12/2019 11:40	04/12/2019 06:51	04/12/2019 11:40	4,83	1	4,83	CHI
20191223091	TURVELANDIA	EU12246749	ACREUNA	04/12/2019 06:51	04/12/2019 11:40	04/12/2019 06:51	04/12/2019 11:40	4,83	25	120,65	CHI
20191223092	CACHOEIRA ALTA	1090023719	CACHOEIRA ALTA	04/12/2019 06:56	04/12/2019 12:32	04/12/2019 06:56	04/12/2019 12:32	5,60	1	5,60	CHI
20191223096	ACREUNA	TD12025721	RIO DOS BOIS	04/12/2019 06:32	04/12/2019 09:46	04/12/2019 06:32	04/12/2019 09:46	3,22	20	64,38	CHI
20191223096	TURVELANDIA	TD12025721	RIO DOS BOIS	04/12/2019 06:32	04/12/2019 09:46	04/12/2019 06:32	04/12/2019 09:46	3,22	34	109,44	CHI
20191223102	ITAPIRAPUA	IU21018856	MATRINCHA	04/12/2019 06:57	04/12/2019 13:50	04/12/2019 06:57	04/12/2019 13:50	6,88	1	6,88	CHI
20191223109	INHUMAS	30168594	INHUMAS S2	04/12/2019 06:59	04/12/2019 13:56	04/12/2019 06:59	04/12/2019 13:56	6,96	1	6,96	CHI
20191223115	JUSSARA	JR11167550	JUSSARA	04/12/2019 04:28	04/12/2019 12:40	04/12/2019 04:28	04/12/2019 12:40	8,20	203	1663,59	CHI

20191223116	CERES	RB12363545	RUBIATABA	04/12/2019 05:09	04/12/2019 11:40	04/12/2019 05:09	04/12/2019 11:40	6,50	7	45,53	CHI
20191223125	BRITANIA	BT11281024	BRITANIA	04/12/2019 07:01	04/12/2019 11:04	04/12/2019 07:01	04/12/2019 11:04	4,04	95	383,85	CHI
20191223131	MORRINHOS	MR32076989	GOIATUBA S1	04/12/2019 06:26	04/12/2019 09:16	04/12/2019 06:26	04/12/2019 09:16	2,84	6	17,05	CHI
20191223132	CATALAO	CT21112615	CATALAO S1	04/12/2019 07:04	04/12/2019 11:43	04/12/2019 07:04	04/12/2019 11:43	4,64	1	4,64	CHI
20191223139	FAINA	FC12147802	GOIAS	04/12/2019 07:05	04/12/2019 13:01	04/12/2019 07:05	04/12/2019 13:01	5,93	13	77,09	CHI
20191223141	JUSSARA	JR12118219	JUSSARA	04/12/2019 07:05	04/12/2019 10:35	04/12/2019 07:05	04/12/2019 10:35	3,51	40	140,38	CHI
20191223141	NOVO BRASIL	JR12118219	JUSSARA	04/12/2019 07:05	04/12/2019 10:35	04/12/2019 07:05	04/12/2019 10:35	3,51	11	38,60	CHI
20191223146	SAO JOAO D ALIANCA	JL12244131	SAO JOAO D ALIANCA	04/12/2019 07:06	04/12/2019 12:40	04/12/2019 07:06	04/12/2019 12:40	5,56	3	16,69	CHI
20191223148	AURILANDIA	SL12003839	SAO LUIZ DOS MONTES BELOS	04/12/2019 07:06	04/12/2019 11:16	04/12/2019 07:06	04/12/2019 11:16	4,15	15	62,31	CHI
20191223148	SAO LUIS DE MONTES BELOS	SL12003839	SAO LUIZ DOS MONTES BELOS	04/12/2019 07:06	04/12/2019 11:16	04/12/2019 07:06	04/12/2019 11:16	4,15	9	37,39	CHI
20191223154	GOIAS	GS12332675	GOIAS	04/12/2019 07:07	04/12/2019 18:00	04/12/2019 07:07	04/12/2019 18:00	10,89	2	21,77	CHI
20191223156	ANICUNS	AC21289746	ANICUNS	04/12/2019 07:07	04/12/2019 11:30	04/12/2019 07:07	04/12/2019 11:30	4,38	1	4,38	CHI
20191223159	PIRACANJUBA	PJ12412508	CRISTIANOPOLIS	04/12/2019 07:06	04/12/2019 11:26	04/12/2019 07:06	04/12/2019 11:26	4,33	12	51,93	CHI
20191223162	MINEIROS	10023272234	PARQUE DAS EMAS	04/12/2019 07:09	04/12/2019 17:35	04/12/2019 07:09	04/12/2019 17:35	10,44	1	10,44	CHI
20191223163	VICENTINOPOLIS	VI21057735	VICENTINOPOLIS	04/12/2019 07:09	04/12/2019 15:15	04/12/2019 07:09	04/12/2019 15:15	8,10	1	8,10	CHI
20191223174	PORANGATU	PO12141124	NOVO PLANALTO	04/12/2019 07:10	04/12/2019 12:50	04/12/2019 07:10	04/12/2019 12:50	5,66	20	113,25	CHI
20191223175	FORMOSA	FA12241609	ITUIQUIRA	03/12/2019 20:05	04/12/2019 10:35	03/12/2019 20:05	04/12/2019 10:35	14,50	16	231,95	CHI
20191223177	SAO MIGUEL DO PASSA QUATRO	SV21270617	BELA VISTA S2	04/12/2019 07:11	04/12/2019 15:28	04/12/2019 07:11	04/12/2019 15:28	8,28	1	8,28	CHI
20191223187	GOIANIA	10016153403	REAL S1	04/12/2019 07:12	04/12/2019 08:39	04/12/2019 07:12	04/12/2019 08:39	1,45	1	1,45	CHI
20191223188	FAINA	FC11250739	GOIAS	04/12/2019 07:05	04/12/2019 10:50	04/12/2019 07:05	04/12/2019 10:50	3,74	126	471,48	CHI
20191223189	PORANGATU	PO12262596	PORANGATU	04/12/2019 06:43	05/12/2019 13:35	04/12/2019 06:43	04/12/2019 11:51	5,12	37	189,45	CHI
20191223189	PORANGATU	PO12262596	PORANGATU	04/12/2019 06:43	05/12/2019 13:35	04/12/2019 11:52	05/12/2019 11:21	23,49	6	140,93	CHI
20191223189	PORANGATU	PO12262596	PORANGATU	04/12/2019 06:43	05/12/2019 13:35	04/12/2019 11:52	05/12/2019 12:54	25,04	17	425,72	CHI
20191223189	PORANGATU	PO13374515	PORANGATU	04/12/2019 06:43	05/12/2019 13:35	04/12/2019 11:52	05/12/2019 13:35	25,72	14	360,11	CHI
20191223195	SAO JOAO D ALIANCA	JL21383263	SAO JOAO D ALIANCA	04/12/2019 07:13	04/12/2019 19:29	04/12/2019 07:13	04/12/2019 19:29	12,26	1	12,26	CHI
20191223201	QUIRINOPOLIS	QI32011354	QUIRINOPOLIS	04/12/2019 06:46	04/12/2019 09:16	04/12/2019 06:46	04/12/2019 09:16	2,49	11	27,39	CHI
20191223204	GOIATUBA	JV12223260	GOIATUBA S1	04/12/2019 07:15	04/12/2019 21:11	04/12/2019 07:15	04/12/2019 21:11	13,93	10	139,32	CHI
20191223209	PALMELO	PR12311676	PIRES DO RIO S2	04/12/2019 07:15	04/12/2019 11:40	04/12/2019 07:15	04/12/2019 11:40	4,41	1	4,41	CHI
20191223209	PIRES DO RIO	PR12311676	PIRES DO RIO S2	04/12/2019 07:15	04/12/2019 11:40	04/12/2019 07:15	04/12/2019 11:40	4,41	5	22,06	CHI
20191223209	SANTA CRUZ DE GOIAS	PR12311676	PIRES DO RIO S2	04/12/2019 07:15	04/12/2019 11:40	04/12/2019 07:15	04/12/2019 11:40	4,41	9	39,71	CHI
20191223212	ALVORADA DO NORTE	AQ12218524	FLORES DE GOIAS	04/12/2019 05:50	04/12/2019 20:48	04/12/2019 05:50	04/12/2019 20:48	14,95	4	59,82	CHI
20191223213	PALESTINA DE GOIAS	10006255866	PALESTINA	04/12/2019 07:16	05/12/2019 00:19	04/12/2019 07:16	05/12/2019 00:19	17,05	1	17,05	CHI
20191223215	HIDROLANDIA	HD12000191	ANHANGUERA	04/12/2019 07:16	04/12/2019 14:53	04/12/2019 07:16	04/12/2019 14:53	7,61	25	190,29	CHI

20191223216	GOIANIRA	GR32045901	TRINDADE	04/12/2019 07:16	04/12/2019 09:53	04/12/2019 07:16	04/12/2019 09:53	2,61	5	13,05	CHI
20191223217	BRITANIA	BT12131110	BRITANIA	04/12/2019 07:16	04/12/2019 16:18	04/12/2019 07:16	04/12/2019 16:18	9,03	30	270,99	CHI
20191223231	TRINDADE	40293373	TRINDADE	04/12/2019 07:17	04/12/2019 11:46	04/12/2019 07:17	04/12/2019 11:46	4,47	1	4,47	CHI
20191223234	CORUMBAIBA	CI12377064	CATALAO S1	04/12/2019 07:00	04/12/2019 11:00	04/12/2019 07:00	04/12/2019 11:00	4,01	12	48,11	CHI
20191223243	ARUANA	AK12307445	MOZARLANDIA	04/12/2019 06:18	04/12/2019 12:08	04/12/2019 06:18	04/12/2019 12:08	5,82	12	69,82	CHI
20191223244	PORANGATU	PO12202421	PORANGATU	04/12/2019 06:49	04/12/2019 12:18	04/12/2019 06:49	04/12/2019 12:18	5,47	6	32,84	CHI
20191223245	MONTES CLAROS DE GOIAS	ME12204930	IPORA	04/12/2019 07:16	04/12/2019 13:57	04/12/2019 07:16	04/12/2019 13:57	6,68	4	26,72	CHI
20191223249	ORIZONA	OZ12105272	PIRES DO RIO S2	04/12/2019 07:20	04/12/2019 10:44	04/12/2019 07:20	04/12/2019 10:44	3,40	33	112,04	CHI
20191223249	VIANOPOLIS	OZ12105272	PIRES DO RIO S2	04/12/2019 07:20	04/12/2019 10:44	04/12/2019 07:20	04/12/2019 10:44	3,40	4	13,58	CHI
20191223253	ALTO HORIZONTE	AJ21100995	SANTA TEREZINHA	04/12/2019 07:21	04/12/2019 13:18	04/12/2019 07:21	04/12/2019 13:18	5,94	1	5,94	CHI
20191223255	ARAGARCAS	AG12092426	ARAGARCAS	04/12/2019 07:21	04/12/2019 08:44	04/12/2019 07:21	04/12/2019 08:44	1,38	4	5,52	CHI
20191223256	BOM JESUS DE GOIAS	IT12034458RE	CACHOEIRA DOURADA	04/12/2019 07:16	04/12/2019 14:35	04/12/2019 07:16	04/12/2019 14:35	7,32	3	21,96	CHI
20191223256	ITUMBIARA	IT12034458RE	CACHOEIRA DOURADA	04/12/2019 07:16	04/12/2019 14:35	04/12/2019 07:16	04/12/2019 14:35	7,32	51	373,38	CHI
20191223256	PANAMA	IT12034458RE	CACHOEIRA DOURADA	04/12/2019 07:16	04/12/2019 14:35	04/12/2019 07:16	04/12/2019 14:35	7,32	3	21,96	CHI
20191223259	SANTA TEREZA DE GOIAS	SE12143627	MARA ROSA	04/12/2019 07:22	04/12/2019 12:34	04/12/2019 07:22	04/12/2019 12:34	5,20	8	41,60	CHI
20191223263	URUACU	UR12210930	URUACU	04/12/2019 07:22	04/12/2019 13:00	04/12/2019 07:22	04/12/2019 13:00	5,62	11	61,85	CHI
20191223264	ITAJA	IJ21154804	ITAJA S2	04/12/2019 07:22	04/12/2019 11:08	04/12/2019 07:22	04/12/2019 11:08	3,76	1	3,76	CHI
20191223268	CASTELANDIA	ML12271556	RIO DOS BOIS	04/12/2019 07:23	04/12/2019 19:33	04/12/2019 07:23	04/12/2019 19:33	12,16	20	243,26	CHI
20191223268	MAURILANDIA	ML12271556	RIO DOS BOIS	04/12/2019 07:23	04/12/2019 19:33	04/12/2019 07:23	04/12/2019 19:33	12,16	9	109,46	CHI
20191223268	RIO VERDE	ML12271556	RIO DOS BOIS	04/12/2019 07:23	04/12/2019 19:33	04/12/2019 07:23	04/12/2019 19:33	12,16	20	243,26	CHI
20191223271	CATALAO	CT12009669	CATALAO S1	04/12/2019 07:23	04/12/2019 10:39	04/12/2019 07:23	04/12/2019 10:39	3,26	2	6,52	CHI
20191223272	MONTES CLAROS DE GOIAS	ME12204928	IPORA	04/12/2019 06:33	04/12/2019 10:45	04/12/2019 06:33	04/12/2019 10:45	4,20	4	16,78	CHI
20191223274	NOVA IGUACU DE GOIAS	MQ12034723	CAMPINORTE	04/12/2019 07:23	04/12/2019 15:36	04/12/2019 07:23	04/12/2019 15:36	8,21	7	57,46	CHI
20191223276	JATAI	JT21142795	JATAI S1	04/12/2019 07:23	04/12/2019 13:30	04/12/2019 07:23	04/12/2019 13:30	6,11	1	6,11	CHI
20191223277	SERRANOPOLIS	SX12216620	JATAI S1	04/12/2019 07:23	04/12/2019 14:36	04/12/2019 07:23	04/12/2019 14:36	7,20	5	36,00	CHI
20191223279	APARECIDA DE GOIANIA	AP11216350	REAL S1	04/12/2019 07:24	04/12/2019 09:00	04/12/2019 07:24	04/12/2019 09:00	1,59	49	77,98	CHI
20191223293	CAMPO ALEGRE DE GOIAS	CM12338725	CAMPO ALEGRE DE GOIAS	04/12/2019 07:25	05/12/2019 07:56	04/12/2019 07:25	05/12/2019 07:56	24,50	3	73,51	CHI
20191223298	PALESTINA DE GOIAS	CP12395427	PALESTINA	04/12/2019 05:33	04/12/2019 10:39	04/12/2019 05:33	04/12/2019 10:39	5,09	6	30,57	CHI
20191223301	FORMOSA	FA21243038	ITUIQUIRA	04/12/2019 07:27	04/12/2019 10:59	04/12/2019 07:27	04/12/2019 10:59	3,54	1	3,54	CHI
20191223302	ESTRELA DO NORTE	MU12075219	MARA ROSA	04/12/2019 07:16	04/12/2019 17:50	04/12/2019 07:16	04/12/2019 17:50	10,56	1	10,56	CHI
20191223302	MUTUNOPOLIS	MU12075219	MARA ROSA	04/12/2019 07:16	04/12/2019 17:50	04/12/2019 07:16	04/12/2019 17:50	10,56	9	95,06	CHI
20191223303	HEITORAI	HE12099418	ITAPURANGA	04/12/2019 07:27	04/12/2019 11:05	04/12/2019 07:27	04/12/2019 11:05	3,63	38	137,83	CHI
20191223332	BALIZA	BM12343637	BOM JARDIM	04/12/2019 07:31	04/12/2019 16:32	04/12/2019 07:31	04/12/2019 16:32	9,01	2	18,02	CHI

20191223333	APARECIDA DE GOIANIA	10000409896	REAL S2	04/12/2019 07:31	04/12/2019 18:07	04/12/2019 07:31	04/12/2019 18:07	10,60	1	10,60	CHI
20191223334	CAIAPONIA	CP12207858	PALESTINA	04/12/2019 05:09	04/12/2019 11:16	04/12/2019 05:09	04/12/2019 11:16	6,10	18	109,83	CHI
20191223334	PALESTINA DE GOIAS	CP12207858	PALESTINA	04/12/2019 05:09	04/12/2019 11:16	04/12/2019 05:09	04/12/2019 11:16	6,10	1	6,10	CHI
20191223336	FAZENDA NOVA	FN12073782	IPORA	04/12/2019 07:17	04/12/2019 22:11	04/12/2019 07:17	04/12/2019 22:11	14,89	21	312,71	CHI
20191223336	ISRAELANDIA	FN12073782	IPORA	04/12/2019 07:17	04/12/2019 22:11	04/12/2019 07:17	04/12/2019 22:11	14,89	2	29,78	CHI
20191223340	BOM JARDIM DE GOIAS	BM12395433	BOM JARDIM	04/12/2019 06:08	05/12/2019 07:44	04/12/2019 06:08	05/12/2019 07:44	25,60	7	179,20	CHI
20191223345	CAMPESTRE DE GOIAS	GC12053748	GUAPO S1	04/12/2019 07:32	04/12/2019 10:49	04/12/2019 07:32	04/12/2019 10:49	3,28	6	19,67	CHI
20191223349	BELA VISTA DE GOIAS	BV12000046	CEPAIGO S2	04/12/2019 07:33	04/12/2019 09:50	04/12/2019 07:33	04/12/2019 09:50	2,28	22	50,21	CHI
20191223353	CEZARINA	2150000113	CEZARINA	04/12/2019 07:33	04/12/2019 11:41	04/12/2019 07:33	04/12/2019 11:41	4,13	1	4,13	CHI
20191223355	ITUMBIARA	IT12000182	ITUMBIARA NOVA	04/12/2019 06:27	04/12/2019 09:37	04/12/2019 06:27	04/12/2019 09:37	3,15	3	9,46	CHI
20191223362	OURO VERDE DE GOIAS	OV12319823	NEROPOLIS S1	04/12/2019 07:14	04/12/2019 10:31	04/12/2019 07:14	04/12/2019 10:31	3,27	23	75,18	CHI
20191223368	CAIAPONIA	CP12349735	CAIAPONIA	04/12/2019 07:30	04/12/2019 11:40	04/12/2019 07:30	04/12/2019 11:40	4,17	7	29,18	CHI
20191223370	DOVERLANDIA	DV12123974	CAIAPONIA	04/12/2019 06:59	04/12/2019 14:54	04/12/2019 06:59	04/12/2019 14:54	7,91	12	94,87	CHI
20191223374	QUIRINOPOLIS	QI21101744	QUIRINOPOLIS	04/12/2019 07:36	04/12/2019 10:25	04/12/2019 07:36	04/12/2019 10:25	2,81	1	2,81	CHI
20191223382	SANCLERLANDIA	SC12308641	FIRMINOPOLIS S2	04/12/2019 07:37	04/12/2019 22:58	04/12/2019 07:37	04/12/2019 22:58	15,35	2	30,71	CHI
20191223388	ESTRELA DO NORTE	SE12053814	MARA ROSA	04/12/2019 07:37	04/12/2019 13:25	04/12/2019 07:37	04/12/2019 13:25	5,80	3	17,41	CHI
20191223388	SANTA TEREZA DE GOIAS	SE12053814	MARA ROSA	04/12/2019 07:37	04/12/2019 13:25	04/12/2019 07:37	04/12/2019 13:25	5,80	5	29,02	CHI
20191223390	NOVA CRIXAS	NA12213190	MOZARLANDIA	04/12/2019 07:11	05/12/2019 09:31	04/12/2019 07:11	05/12/2019 09:31	26,33	23	605,53	CHI
20191223399	SAO DOMINGOS	SD11389104	SAO DOMINGOS	04/12/2019 07:38	04/12/2019 17:15	04/12/2019 07:38	04/12/2019 17:15	9,61	1	9,61	CHI
20191223401	HIDROLINA	7137527	ITAPACI	04/12/2019 07:38	05/12/2019 10:30	04/12/2019 07:38	05/12/2019 10:30	26,87	2	53,74	CHI
20191223403	CATALAO	CT21273137	CATALAO S1	04/12/2019 07:38	04/12/2019 14:05	04/12/2019 07:38	04/12/2019 14:05	6,43	1	6,43	CHI
20191223406	INHUMAS	30026581	INHUMAS S2	04/12/2019 07:39	04/12/2019 11:52	04/12/2019 07:39	04/12/2019 11:52	4,21	1	4,21	CHI
20191223407	SANCLERLANDIA	SC21068239	FIRMINOPOLIS S2	04/12/2019 07:39	04/12/2019 16:18	04/12/2019 07:39	04/12/2019 16:18	8,65	1	8,65	CHI
20191223412	SAO JOAO D ALIANCA	JL21254455	SAO JOAO D ALIANCA	04/12/2019 07:40	05/12/2019 16:26	04/12/2019 07:40	05/12/2019 16:26	32,76	1	32,76	CHI
20191223416	PORANGATU	PO12285190	PORANGATU	04/12/2019 07:35	04/12/2019 10:12	04/12/2019 07:35	04/12/2019 10:12	2,61	3	7,84	CHI
20191223419	ITAUCU	IX12322429	INHUMAS S1	04/12/2019 06:57	04/12/2019 12:54	04/12/2019 06:57	04/12/2019 12:54	5,94	9	53,46	CHI
20191223420	CUMARI	CY12203044	CATALAO S1	04/12/2019 07:41	05/12/2019 10:18	04/12/2019 07:41	05/12/2019 10:18	26,62	2	53,25	CHI
20191223421	RUBIATABA	RB12003320	RUBIATABA	04/12/2019 07:41	04/12/2019 10:51	04/12/2019 07:41	04/12/2019 10:51	3,16	88	277,86	CHI
20191223423	CAMPOS VERDES	VD12201662	SANTA TEREZINHA	04/12/2019 07:41	04/12/2019 18:51	04/12/2019 07:41	04/12/2019 18:51	11,15	5	55,77	CHI
20191223424	PIRES DO RIO	PR21095255	PIRES DO RIO S1	04/12/2019 07:42	05/12/2019 23:43	04/12/2019 07:42	05/12/2019 22:33	38,86	1	38,86	CHI
20191223424	PIRES DO RIO	PR12095256LD	PIRES DO RIO S1	04/12/2019 07:42	05/12/2019 23:43	05/12/2019 20:03	05/12/2019 23:43	3,67	18	66,06	CHI
20191223428	APARECIDA DO RIO DOCE	AW12191577	CACHOEIRA ALTA	04/12/2019 07:42	04/12/2019 13:15	04/12/2019 07:42	04/12/2019 13:15	5,56	10	55,59	CHI
20191223432	MOSSAMEDES	MD21250650	ITABERAÍ S1	04/12/2019 07:42	04/12/2019 11:56	04/12/2019 07:42	04/12/2019 11:56	4,22	1	4,22	CHI

20191223436	ORIZONA	OZ21149546	PIRES DO RIO S2	04/12/2019 07:43	04/12/2019 10:35	04/12/2019 07:43	04/12/2019 10:35	2,86	1	2,86	CHI
20191223441	SAO LUIS DE MONTES BELOS	500032695	SAO LUIZ DOS MONTES BELOS	04/12/2019 07:43	04/12/2019 10:01	04/12/2019 07:43	04/12/2019 10:01	2,30	1	2,30	CHI
20191223448	PIRES DO RIO	460120220	PIRES DO RIO S1	04/12/2019 07:44	05/12/2019 07:23	04/12/2019 07:44	05/12/2019 07:23	23,64	1	23,64	CHI
20191223453	GOIAS	GS12188236	ITABERAI S2	04/12/2019 07:45	04/12/2019 15:49	04/12/2019 07:45	04/12/2019 15:49	8,06	12	96,69	CHI
20191223457	VARJAO	VJ31066142	GUAPO S2	04/12/2019 07:46	04/12/2019 14:21	04/12/2019 07:46	04/12/2019 14:21	6,58	2	13,16	CHI
20191223464	ALTO PARAISO DE GOIAS	JL12383337	SAO JOAO D ALIANCA	04/12/2019 07:25	05/12/2019 08:43	04/12/2019 07:25	05/12/2019 08:43	25,30	1	25,30	CHI
20191223464	SAO JOAO D ALIANCA	JL12383337	SAO JOAO D ALIANCA	04/12/2019 07:25	05/12/2019 08:43	04/12/2019 07:25	05/12/2019 08:43	25,30	13	328,87	CHI
20191223465	GOIANIA	12680310	CAMPINAS S2	04/12/2019 07:47	04/12/2019 09:26	04/12/2019 07:47	04/12/2019 09:26	1,65	1	1,65	CHI
20191223468	CATALAO	CT12278148	CATALAO S1	04/12/2019 07:47	04/12/2019 09:26	04/12/2019 07:47	04/12/2019 09:26	1,64	4	6,56	CHI
20191223469	SAO DOMINGOS	SD12131345	SAO DOMINGOS	04/12/2019 07:32	04/12/2019 16:45	04/12/2019 07:32	04/12/2019 16:45	9,22	7	64,51	CHI
20191223470	DOVERLANDIA	DV12358445	CAIAPONIA	04/12/2019 06:09	04/12/2019 13:20	04/12/2019 06:09	04/12/2019 13:20	7,19	21	150,90	CHI
20191223476	SAO MIGUEL DO ARAGUAIA	SM12239670	SAO MIGUEL DO ARAGUAIA	04/12/2019 07:48	04/12/2019 16:50	04/12/2019 07:48	04/12/2019 16:50	9,04	11	99,47	CHI
20191223480	DIVINOPOLIS DE GOIAS	GH12151252	SAO DOMINGOS	04/12/2019 05:32	04/12/2019 12:36	04/12/2019 05:32	04/12/2019 12:36	7,06	6	42,36	CHI
20191223482	PALMEIRAS DE GOIAS	PL12289855	ANICUNS	04/12/2019 07:31	04/12/2019 11:30	04/12/2019 07:31	04/12/2019 11:30	3,99	22	87,72	CHI
20191223494	MINEIROS	MY12324340	PARQUE DAS EMAS	04/12/2019 07:04	04/12/2019 11:03	04/12/2019 07:04	04/12/2019 11:03	3,97	13	51,58	CHI
20191223502	CALDAS NOVAS	CN12182770	VILA CORUMBA	04/12/2019 07:51	04/12/2019 19:01	04/12/2019 07:51	04/12/2019 19:01	11,18	3	33,53	CHI
20191223510	ITABERAI	IB21037987	ANICUNS	04/12/2019 07:52	04/12/2019 10:57	04/12/2019 07:52	04/12/2019 10:57	3,07	2	6,14	CHI
20191223511	AGUA FRIA DE GOIAS	JL21270091	SAO JOAO D ALIANCA	04/12/2019 07:52	04/12/2019 17:40	04/12/2019 07:52	04/12/2019 17:40	9,80	1	9,80	CHI
20191223513	HIDROLANDIA	AP21280165	ANHANGUERA	04/12/2019 07:53	04/12/2019 10:07	04/12/2019 07:53	04/12/2019 10:07	2,24	1	2,24	CHI
20191223514	GOIANIA	15664569	CARAJAS S2	04/12/2019 07:53	04/12/2019 09:51	04/12/2019 07:53	04/12/2019 09:51	1,96	1	1,96	CHI
20191223515	MOIPORA	MO21184285	IPORA	04/12/2019 07:53	04/12/2019 13:10	04/12/2019 07:53	04/12/2019 13:10	5,29	1	5,29	CHI
20191223520	GOIANIA	GN12000634	CAMPINAS S1	04/12/2019 07:53	04/12/2019 09:47	04/12/2019 07:53	04/12/2019 09:47	1,88	44	82,88	CHI
20191223525	CALDAS NOVAS	CN21060272	RIO QUENTE	04/12/2019 07:54	04/12/2019 10:20	04/12/2019 07:54	04/12/2019 10:20	2,42	1	2,42	CHI
20191223526	CHAPADAO DO CEU	DJ21241806	CHAPADAO DO CEU	04/12/2019 07:54	04/12/2019 09:25	04/12/2019 07:54	04/12/2019 09:25	1,52	1	1,52	CHI
20191223537	GOIANIA	12328042	ATLANTICO S1	04/12/2019 07:55	04/12/2019 11:01	04/12/2019 07:55	04/12/2019 11:01	3,09	1	3,09	CHI
20191223539	GOIANIA	10005874317	FERROVIARIO S3	04/12/2019 07:56	04/12/2019 09:00	04/12/2019 07:56	04/12/2019 09:00	1,07	1	1,07	CHI
20191223540	CATALAO	CT12306664	CATALAO S1	04/12/2019 07:25	04/12/2019 09:42	04/12/2019 07:25	04/12/2019 09:42	2,28	16	36,51	CHI
20191223540	OUVIDOR	CT12306664	CATALAO S1	04/12/2019 07:25	04/12/2019 09:42	04/12/2019 07:25	04/12/2019 09:42	2,28	4	9,13	CHI
20191223552	CEZARINA	CZ12010355	CEZARINA	04/12/2019 07:57	04/12/2019 12:04	04/12/2019 07:57	04/12/2019 12:04	4,12	8	32,94	CHI
20191223555	SAO SIMAO	SO12322242	CACHOEIRA ALTA	04/12/2019 07:58	04/12/2019 15:48	04/12/2019 07:58	04/12/2019 15:48	7,83	3	23,50	CHI
20191223557	PIRACANJUBA	PJ11171383	PIRACANJUBA	04/12/2019 07:58	04/12/2019 12:40	04/12/2019 07:58	04/12/2019 12:40	4,70	1	4,70	CHI
20191223558	NIQUELANDIA	NQ21403460	NIQUELANDIA SUBTRANSMISSAO	04/12/2019 07:58	04/12/2019 12:05	04/12/2019 07:58	04/12/2019 12:05	4,11	1	4,11	CHI
20191223560	POSSE	PS12218794	IACIARA S2	04/12/2019 06:43	05/12/2019 08:25	04/12/2019 06:43	05/12/2019 08:25	25,69	3	77,08	CHI

20191223561	CROMINIA	CQ12007736	PONTALINA	04/12/2019 04:17	04/12/2019 18:21	04/12/2019 04:17	04/12/2019 18:21	14,06	16	225,03	CHI
20191223567	FAINA	FC12067580	GOIAS	04/12/2019 07:29	04/12/2019 16:32	04/12/2019 07:29	04/12/2019 16:32	9,05	3	27,15	CHI
20191223572	ITAPURANGA	IK12071744	ITAPURANGA	04/12/2019 07:49	04/12/2019 12:20	04/12/2019 07:49	04/12/2019 12:20	4,52	9	40,66	CHI
20191223573	AGUA LIMPA	AL21000273	VILA CORUMBA	04/12/2019 08:00	04/12/2019 12:35	04/12/2019 08:00	04/12/2019 12:35	4,57	1	4,57	CHI
20191223574	SANTA HELENA DE GOIAS	10013584900	IPEGUARI	04/12/2019 08:01	04/12/2019 14:12	04/12/2019 08:01	04/12/2019 14:12	6,20	1	6,20	CHI
20191223582	TERESINA DE GOIAS	TE11047978	FLORES DE GOIAS	04/12/2019 07:56	04/12/2019 10:34	04/12/2019 07:56	04/12/2019 10:34	2,63	141	370,83	CHI
20191223586	POSSE	1480028608	IACIARA S2	04/12/2019 08:04	04/12/2019 11:02	04/12/2019 08:04	04/12/2019 11:02	2,97	1	2,97	CHI
20191223594	AGUA FRIA DE GOIAS	TL12151992	SAO JOAO D ALIANCA	04/12/2019 08:04	04/12/2019 14:06	04/12/2019 08:04	04/12/2019 14:06	6,03	5	30,14	CHI
20191223596	CRIXAS	CX21181469	RUBIATABA	04/12/2019 08:04	05/12/2019 13:12	04/12/2019 08:04	05/12/2019 13:12	29,12	1	29,12	CHI
20191223599	SANTA TEREZINHA DE GOIAS	SG21197608	SANTA TEREZINHA	04/12/2019 08:04	04/12/2019 16:00	04/12/2019 08:04	04/12/2019 16:00	7,93	1	7,93	CHI
20191223602	GOIANIA	GN21227550	CEPAIGO S1	04/12/2019 08:05	04/12/2019 10:28	04/12/2019 08:05	04/12/2019 10:28	2,38	4	9,51	CHI
20191223604	FAINA	FC12299839	GOIAS	04/12/2019 05:54	05/12/2019 08:55	04/12/2019 05:54	05/12/2019 08:55	27,02	12	324,20	CHI
20191223611	ACREUNA	EU12114599	ACREUNA	04/12/2019 08:06	04/12/2019 14:34	04/12/2019 08:06	04/12/2019 14:34	6,46	5	32,29	CHI
20191223612	RIO VERDE	630042020	RIO VERDE S1	04/12/2019 08:06	04/12/2019 11:25	04/12/2019 08:06	04/12/2019 11:25	3,32	1	3,32	CHI
20191223616	ALTO PARAISO DE GOIAS	NQ12234731	NIQUELANDIA SUBTRANSMISSAO	04/12/2019 07:11	04/12/2019 17:30	04/12/2019 07:11	04/12/2019 17:30	10,31	12	123,72	CHI
20191223616	NIQUELANDIA	NQ12234731	NIQUELANDIA SUBTRANSMISSAO	04/12/2019 07:11	04/12/2019 17:30	04/12/2019 07:11	04/12/2019 17:30	10,31	13	134,03	CHI
20191223616	SAO JOAO D ALIANCA	NQ12234731	NIQUELANDIA SUBTRANSMISSAO	04/12/2019 07:11	04/12/2019 17:30	04/12/2019 07:11	04/12/2019 17:30	10,31	1	10,31	CHI
20191223617	IPAMERI	IP12000066	IPAMERI	04/12/2019 08:02	04/12/2019 10:03	04/12/2019 08:02	04/12/2019 10:03	2,00	5	10,02	CHI
20191223618	GOIAS	GS21064400	MATRINCHA	04/12/2019 08:07	04/12/2019 18:28	04/12/2019 08:07	04/12/2019 18:28	10,35	1	10,35	CHI
20191223620	SERRANOPOLIS	SX12390596	JATAI S1	04/12/2019 06:34	04/12/2019 13:15	04/12/2019 06:34	04/12/2019 13:15	6,68	33	220,28	CHI
20191223623	PARAUNA	PU12295911	ACREUNA	04/12/2019 08:07	04/12/2019 17:15	04/12/2019 08:07	04/12/2019 17:15	9,13	3	27,38	CHI
20191223629	CAIAPONIA	CP21357553	CAIAPONIA	04/12/2019 08:08	05/12/2019 07:48	04/12/2019 08:08	05/12/2019 07:48	23,67	1	23,67	CHI
20191223630	MARA ROSA	MQ12117969	MARA ROSA	04/12/2019 08:08	05/12/2019 13:21	04/12/2019 08:08	05/12/2019 12:11	28,06	17	477,10	CHI
20191223630	MARA ROSA	MQ12117969	MARA ROSA	04/12/2019 08:08	05/12/2019 13:21	04/12/2019 08:08	05/12/2019 12:31	28,39	8	227,15	CHI
20191223630	MARA ROSA	MQ12117969	MARA ROSA	04/12/2019 08:08	05/12/2019 13:21	04/12/2019 08:08	05/12/2019 12:55	28,79	2	57,57	CHI
20191223630	MARA ROSA	MQ12117969	MARA ROSA	04/12/2019 08:08	05/12/2019 13:21	04/12/2019 08:08	05/12/2019 13:21	29,23	5	146,15	CHI
20191223637	CROMINIA	CQ12212230	PONTALINA	04/12/2019 07:42	04/12/2019 17:17	04/12/2019 07:42	04/12/2019 17:17	9,58	2	19,15	CHI
20191223642	SAO MIGUEL DO ARAGUAIA	SM21101444	SAO MIGUEL DO ARAGUAIA	04/12/2019 08:09	04/12/2019 17:50	04/12/2019 08:09	04/12/2019 17:50	9,69	1	9,69	CHI
20191223643	SERRANOPOLIS	SX12224067	JATAI S1	04/12/2019 08:09	04/12/2019 15:31	04/12/2019 08:09	04/12/2019 15:31	7,36	3	22,08	CHI
20191223644	ORIZONA	OZ21014935	PIRES DO RIO S1	04/12/2019 08:09	04/12/2019 14:10	04/12/2019 08:09	04/12/2019 14:10	6,01	2	12,02	CHI
20191223646	GOIANIA	10016835423	CARAJAS S2	04/12/2019 08:09	04/12/2019 17:09	04/12/2019 08:09	04/12/2019 17:09	8,99	1	8,99	CHI
20191223647	PALMEIRAS DE GOIAS	PL12398710	PALMEIRAS	04/12/2019 08:09	04/12/2019 11:20	04/12/2019 08:09	04/12/2019 11:20	3,19	21	66,92	CHI
20191223651	BOM JESUS DE GOIAS	BJ12021400	CACHOEIRA DOURADA	04/12/2019 08:08	04/12/2019 13:20	04/12/2019 08:08	04/12/2019 13:20	5,19	6	31,15	CHI

20191223670	SITIO D ABADIA	SI21159898	IACIARA S2	04/12/2019 08:11	05/12/2019 12:30	04/12/2019 08:11	05/12/2019 12:30	28,30	1	28,30	CHI
20191223676	LUZIANIA	LZ12239788	VIANOPOLIS	04/12/2019 08:12	04/12/2019 11:54	04/12/2019 08:12	04/12/2019 11:54	3,69	1	3,69	CHI
20191223679	SILVANIA	SV12265338	VIANOPOLIS	04/12/2019 07:51	04/12/2019 11:32	04/12/2019 07:51	04/12/2019 11:32	3,68	137	504,39	CHI
20191223679	VIANOPOLIS	SV12265338	VIANOPOLIS	04/12/2019 07:51	04/12/2019 11:32	04/12/2019 07:51	04/12/2019 11:32	3,68	1	3,68	CHI
20191223682	DOVERLANDIA	DV12138334	CAIAPONIA	04/12/2019 08:07	04/12/2019 17:44	04/12/2019 08:07	04/12/2019 17:44	9,61	15	144,13	CHI
20191223683	INHUMAS	IN11168393	INHUMAS S2	04/12/2019 06:19	04/12/2019 09:56	04/12/2019 06:19	04/12/2019 09:56	3,61	118	425,69	CHI
20191223686	DAVINOPOLIS	IO21073924	CATALAO S1	04/12/2019 08:13	04/12/2019 20:00	04/12/2019 08:13	04/12/2019 20:00	11,77	1	11,77	CHI
20191223687	VIANOPOLIS	VN21159844	VIANOPOLIS	04/12/2019 08:13	04/12/2019 14:51	04/12/2019 08:13	04/12/2019 14:51	6,62	2	13,24	CHI
20191223688	PIRES DO RIO	460072845	PIRES DO RIO S1	04/12/2019 08:13	05/12/2019 00:42	04/12/2019 08:13	05/12/2019 00:42	16,47	1	16,47	CHI
20191223694	SIMOLANDIA	SA12168083	IACIARA S2	04/12/2019 06:13	04/12/2019 14:20	04/12/2019 06:13	04/12/2019 14:20	8,10	37	299,85	CHI
20191223696	ITAPURANGA	IK12300236	ITAPURANGA	04/12/2019 07:48	04/12/2019 09:39	04/12/2019 07:48	04/12/2019 09:39	1,85	11	20,37	CHI
20191223704	ITAPIRAPUA	IU12089733	MATRINCHA	04/12/2019 05:49	04/12/2019 19:21	04/12/2019 05:49	04/12/2019 19:21	13,52	24	324,49	CHI
20191223710	PALESTINA DE GOIAS	930027322	PALESTINA	04/12/2019 08:16	05/12/2019 07:09	04/12/2019 08:16	05/12/2019 07:09	22,89	1	22,89	CHI
20191223720	MARA ROSA	LC12391896	MARA ROSA	04/12/2019 08:17	05/12/2019 00:34	04/12/2019 08:17	05/12/2019 00:34	16,27	3	48,81	CHI
20191223722	PROFESSOR JAMIL SAFADY	JS21092165	ROCHEDO	04/12/2019 08:17	04/12/2019 14:05	04/12/2019 08:17	04/12/2019 14:05	5,78	1	5,78	CHI
20191223723	JATAI	10020467859	JATAI S3	04/12/2019 08:18	04/12/2019 09:45	04/12/2019 08:18	04/12/2019 09:45	1,45	1	1,45	CHI
20191223724	FORMOSO	FO12208460	PORANGATU	04/12/2019 07:32	04/12/2019 12:07	04/12/2019 07:32	04/12/2019 12:07	4,57	11	50,31	CHI
20191223725	BURITINOPOLIS	BQ12149627	IACIARA S2	04/12/2019 06:19	04/12/2019 11:17	04/12/2019 06:19	04/12/2019 11:17	4,96	118	585,61	CHI
20191223727	SANCLERLANDIA	SC21163974	FIRMINOPOLIS S2	04/12/2019 08:18	04/12/2019 18:04	04/12/2019 08:18	04/12/2019 18:04	9,77	2	19,53	CHI
20191223729	SANTA FE DE GOIAS	RN21217247	BRITANIA	04/12/2019 08:18	04/12/2019 15:51	04/12/2019 08:18	04/12/2019 15:51	7,54	1	7,54	CHI
20191223734	MONTES CLAROS DE GOIAS	ME12023298	IPORA	04/12/2019 08:19	04/12/2019 13:45	04/12/2019 08:19	04/12/2019 13:45	5,43	4	21,73	CHI
20191223738	ORIZONA	OZ12300909	PIRES DO RIO S2	04/12/2019 08:19	04/12/2019 14:04	04/12/2019 08:19	04/12/2019 14:04	5,74	13	74,64	CHI
20191223741	SILVANIA	SV12389456	VIANOPOLIS	04/12/2019 08:19	05/12/2019 12:15	04/12/2019 08:19	04/12/2019 17:00	8,69	98	851,16	CHI
20191223741	SILVANIA	SV12389456	VIANOPOLIS	04/12/2019 08:19	05/12/2019 12:15	04/12/2019 17:01	04/12/2019 20:04	3,06	59	180,49	CHI
20191223741	SILVANIA	8203834	VIANOPOLIS	04/12/2019 08:19	05/12/2019 12:15	04/12/2019 08:19	05/12/2019 12:15	27,93	11	307,19	CHI
20191223741	SILVANIA	8203834	VIANOPOLIS	04/12/2019 08:19	05/12/2019 12:15	04/12/2019 17:01	05/12/2019 12:15	19,24	39	750,19	CHI
20191223743	CAVALCANTE	CJ11347366	MINACU	04/12/2019 08:19	05/12/2019 00:26	04/12/2019 08:19	05/12/2019 00:26	16,11	25	402,63	CHI
20191223745	RIO VERDE	BZ12296004	ACREUNA	04/12/2019 08:19	05/12/2019 11:57	04/12/2019 08:19	05/12/2019 11:57	27,62	7	193,34	CHI
20191223745	SANTO ANTONIO DA BARRA	BZ12296004	ACREUNA	04/12/2019 08:19	05/12/2019 11:57	04/12/2019 08:19	05/12/2019 11:57	27,62	1	27,62	CHI
20191223746	PIRACANJUBA	PJ12320300	ROCHEDO	04/12/2019 06:57	04/12/2019 19:51	04/12/2019 06:57	04/12/2019 19:51	12,89	2	25,79	CHI
20191223752	SANTA HELENA DE GOIAS	400050936	IPEGUARI	04/12/2019 08:20	04/12/2019 15:09	04/12/2019 08:20	04/12/2019 15:09	6,81	1	6,81	CHI
20191223760	ARENOPOLIS	AY12390169	ARENOPOLIS	04/12/2019 05:51	04/12/2019 10:57	04/12/2019 05:51	04/12/2019 10:57	5,09	24	122,18	CHI
20191223760	DIORAMA	AY12390169	ARENOPOLIS	04/12/2019 05:51	04/12/2019 10:57	04/12/2019 05:51	04/12/2019 10:57	5,09	1	5,09	CHI

20191223762	CAIAPONIA	CP12267739	MONTIVIDIU T	04/12/2019 08:14	05/12/2019 20:20	04/12/2019 08:14	05/12/2019 20:20	36,10	2	72,20	CHI
20191223762	MONTIVIDIU	CP12267739	MONTIVIDIU T	04/12/2019 08:14	05/12/2019 20:20	04/12/2019 08:14	05/12/2019 20:20	36,10	3	108,30	CHI
20191223765	PIRANHAS	PH12079537	PIRANHAS	04/12/2019 08:21	04/12/2019 18:14	04/12/2019 08:21	04/12/2019 18:14	9,87	4	39,47	CHI
20191223770	SAO MIGUEL DO PASSA QUATRO	SQ21128933	CRISTIANOPOLIS	04/12/2019 08:22	04/12/2019 13:02	04/12/2019 08:22	04/12/2019 13:02	4,66	1	4,66	CHI
20191223771	SENADOR CANEDO	SW11092252	SENADOR CANEDO	04/12/2019 08:22	04/12/2019 09:22	04/12/2019 08:22	04/12/2019 09:22	0,99	114	112,57	CHI
20191223773	ITABERAI	IB21376342	ITABERAI S1	04/12/2019 08:22	04/12/2019 16:42	04/12/2019 08:22	04/12/2019 16:42	8,32	1	8,32	CHI
20191223776	PORANGATU	PO12391670	PORANGATU	04/12/2019 08:04	05/12/2019 12:30	04/12/2019 08:04	05/12/2019 12:30	28,43	4	113,73	CHI
20191223778	VIANOPOLIS	510023710	VIANOPOLIS	04/12/2019 08:23	04/12/2019 13:17	04/12/2019 08:23	04/12/2019 13:17	4,89	1	4,89	CHI
20191223783	JATAI	JT21241256	JATAI S1	04/12/2019 08:23	04/12/2019 12:45	04/12/2019 08:23	04/12/2019 12:45	4,35	2	8,70	CHI
20191223788	URUACU	CR21101022	CAMPINORTE	04/12/2019 08:24	04/12/2019 11:42	04/12/2019 08:24	04/12/2019 11:42	3,29	2	6,58	CHI
20191223795	GOIANIA	GN11282771	CAMPINAS S2	04/12/2019 08:14	04/12/2019 09:22	04/12/2019 08:14	04/12/2019 09:22	1,13	16	18,02	CHI
20191223797	SANTA BARBARA DE GOIAS	SB31005807	TRINDADE	04/12/2019 08:25	04/12/2019 18:35	04/12/2019 08:25	04/12/2019 18:35	10,16	2	20,32	CHI
20191223799	EDEIA	00500414	EDEIA	04/12/2019 08:25	04/12/2019 15:13	04/12/2019 08:25	04/12/2019 15:13	6,80	9	61,20	CHI
20191223801	PROFESSOR JAMIL SAFADY	PJ12320309	ROCHEDO	04/12/2019 08:25	05/12/2019 09:44	04/12/2019 08:25	05/12/2019 09:44	25,31	4	101,23	CHI
20191223806	MORRO AGUDO DE GOIAS	MS12113246	ITAPURANGA	04/12/2019 08:25	05/12/2019 18:10	04/12/2019 08:25	04/12/2019 16:35	8,17	5	40,83	CHI
20191223806	FAINA	MS12154382LD	ITAPURANGA	04/12/2019 08:25	05/12/2019 18:10	04/12/2019 08:25	05/12/2019 12:43	28,30	4	113,19	CHI
20191223806	MORRO AGUDO DE GOIAS	MS12154382LD	ITAPURANGA	04/12/2019 08:25	05/12/2019 18:10	04/12/2019 08:25	05/12/2019 12:43	28,30	2	56,59	CHI
20191223806	FAINA	MS12154382LD	ITAPURANGA	04/12/2019 08:25	05/12/2019 18:10	05/12/2019 12:45	05/12/2019 18:10	5,42	4	21,68	CHI
20191223806	MORRO AGUDO DE GOIAS	MS12154382LD	ITAPURANGA	04/12/2019 08:25	05/12/2019 18:10	05/12/2019 12:45	05/12/2019 18:10	5,42	2	10,84	CHI
20191223806	ARAGUAPAZ	8010627	ITAPURANGA	04/12/2019 08:25	05/12/2019 18:10	04/12/2019 08:25	05/12/2019 18:10	33,75	2	67,49	CHI
20191223806	FAINA	8010627	ITAPURANGA	04/12/2019 08:25	05/12/2019 18:10	04/12/2019 08:25	05/12/2019 18:10	33,75	2	67,49	CHI
20191223807	COLINAS DO SUL	TI12237626	MINACU	04/12/2019 07:29	05/12/2019 00:11	04/12/2019 07:29	05/12/2019 00:11	16,69	50	834,47	CHI
20191223807	NIQUELANDIA	TI12237626	MINACU	04/12/2019 07:29	05/12/2019 00:11	04/12/2019 07:29	05/12/2019 00:11	16,69	1	16,69	CHI
20191223807	URUACU	TI12237626	MINACU	04/12/2019 07:29	05/12/2019 00:11	04/12/2019 07:29	05/12/2019 00:11	16,69	1	16,69	CHI
20191223810	SANTA HELENA DE GOIAS	400040311	IPEGUARI	04/12/2019 08:26	04/12/2019 16:09	04/12/2019 08:26	04/12/2019 16:09	7,73	1	7,73	CHI
20191223821	APARECIDA DE GOIANIA	200534270	INDEPENDENCIA S2	04/12/2019 08:27	04/12/2019 10:39	04/12/2019 08:27	04/12/2019 10:39	2,19	1	2,19	CHI
20191223824	CAIAPONIA	CP12204876	CAIAPONIA	04/12/2019 03:08	04/12/2019 11:00	04/12/2019 03:08	04/12/2019 11:00	7,88	12	94,51	CHI
20191223825	SENADOR CANEDO	SW12092691	CEPAIGO S1	04/12/2019 08:27	04/12/2019 13:30	04/12/2019 08:27	04/12/2019 13:30	5,04	34	171,19	CHI
20191223827	APARECIDA DE GOIANIA	11988472	INDEPENDENCIA S2	04/12/2019 08:28	04/12/2019 10:00	04/12/2019 08:28	04/12/2019 10:00	1,53	1	1,53	CHI
20191223829	RIO VERDE	10024362512	RIO VERDE S1	04/12/2019 08:28	04/12/2019 11:57	04/12/2019 08:28	04/12/2019 11:57	3,48	1	3,48	CHI
20191223833	AURILANDIA	FR21125125	FIRMINOPOLIS S2	04/12/2019 08:30	04/12/2019 20:08	04/12/2019 08:30	04/12/2019 20:08	11,63	1	11,63	CHI
20191223839	SANCLERLANDIA	SC21190769	FIRMINOPOLIS S2	04/12/2019 08:30	04/12/2019 14:37	04/12/2019 08:30	04/12/2019 14:37	6,10	1	6,10	CHI
20191223852	NEROPOLIS	NR21009260	NEROPOLIS S2	04/12/2019 08:32	04/12/2019 14:39	04/12/2019 08:32	04/12/2019 14:39	6,10	1	6,10	CHI

20191223854	GOIANIA	12247625	XAVANTES	04/12/2019 08:33	04/12/2019 10:22	04/12/2019 08:33	04/12/2019 10:22	1,82	1	1,82	CHI
20191223862	DOVERLANDIA	DV21184324	CAIAPONIA	04/12/2019 08:33	04/12/2019 19:43	04/12/2019 08:33	04/12/2019 19:43	11,17	1	11,17	CHI
20191223865	BALIZA	BH12334576	BOM JARDIM	04/12/2019 08:33	04/12/2019 16:35	04/12/2019 08:33	04/12/2019 16:35	8,04	2	16,07	CHI
20191223870	AGUA FRIA DE GOIAS	TL12164607	SAO JOAO D ALIANCA	04/12/2019 08:34	05/12/2019 10:13	04/12/2019 08:34	05/12/2019 10:13	25,65	18	461,63	CHI
20191223874	CORREGO DO OURO	CO21006143	FIRMINOPOLIS S2	04/12/2019 08:34	04/12/2019 15:51	04/12/2019 08:34	04/12/2019 15:51	7,27	1	7,27	CHI
20191223877	NIQUELANDIA	NQ12330279	NIQUELANDIA SUBTRANSMISSAO	04/12/2019 08:35	04/12/2019 17:38	04/12/2019 08:35	04/12/2019 17:38	9,05	4	36,20	CHI
20191223884	MONTIVIDIU	MV12406530	MONTIVIDIU T	04/12/2019 07:13	04/12/2019 10:45	04/12/2019 07:13	04/12/2019 10:45	3,53	9	31,80	CHI
20191223885	PORTELANDIA	1470004139	PARQUE DAS EMAS	04/12/2019 08:36	04/12/2019 19:23	04/12/2019 08:36	04/12/2019 19:23	10,78	1	10,78	CHI
20191223890	ITABERAI	2720000432	ITABERAI S2	04/12/2019 08:37	04/12/2019 11:08	04/12/2019 08:37	04/12/2019 11:08	2,53	1	2,53	CHI
20191223899	GOIANIA	10108208	XAVANTES	04/12/2019 08:38	04/12/2019 10:44	04/12/2019 08:38	04/12/2019 10:44	2,10	1	2,10	CHI
20191223900	RIO VERDE	RV12231014	MONTIVIDIU T	04/12/2019 07:03	05/12/2019 08:33	04/12/2019 07:03	05/12/2019 08:33	25,49	23	586,38	CHI
20191223934	ITUMBIARA	IT21309003	ITUMBIARA NOVA	04/12/2019 09:44	04/12/2019 11:20	04/12/2019 09:44	04/12/2019 11:20	1,59	1	1,59	CHI
20191223941	BURITINOPOLIS	BQ12190586	IACIARA S2	04/12/2019 07:23	04/12/2019 12:57	04/12/2019 07:23	04/12/2019 12:57	5,56	14	77,77	CHI
20191223962	GOIANDIRA	GD21160904	CATALAO S1	04/12/2019 10:29	04/12/2019 11:34	04/12/2019 10:29	04/12/2019 11:34	1,08	1	1,08	CHI
20191224002	CATALAO	CT12266179	CATALAO S1	04/12/2019 07:48	05/12/2019 17:06	04/12/2019 07:48	05/12/2019 17:06	33,29	25	832,27	CHI
20191224007	ALVORADA DO NORTE	AQ12071392	IACIARA S2	04/12/2019 08:38	04/12/2019 09:56	04/12/2019 08:38	04/12/2019 09:56	1,29	314	404,28	CHI
20191224014	CRIXAS	CX12158232	SERRA DO OURO	04/12/2019 08:40	05/12/2019 11:18	04/12/2019 08:40	05/12/2019 11:18	26,62	5	133,11	CHI
20191224016	PORTELANDIA	PW21102828	PARQUE DAS EMAS	04/12/2019 08:40	05/12/2019 10:08	04/12/2019 08:40	05/12/2019 10:08	25,45	1	25,45	CHI
20191224027	SERRANOPOLIS	SX21267471	JATAI S1	04/12/2019 08:41	04/12/2019 20:50	04/12/2019 08:41	04/12/2019 20:50	12,14	1	12,14	CHI
20191224032	SENADOR CANEDO	SW16413309	SENADOR CANEDO	04/12/2019 08:26	04/12/2019 15:30	04/12/2019 08:26	04/12/2019 11:21	2,92	1772	5173,26	CHI
20191224032	SENADOR CANEDO	SW13413209B	SENADOR CANEDO	04/12/2019 08:26	04/12/2019 15:30	04/12/2019 08:26	04/12/2019 12:11	3,76	1448	5441,66	CHI
20191224032	SENADOR CANEDO	SW13399982	SENADOR CANEDO	04/12/2019 08:26	04/12/2019 15:30	04/12/2019 11:16	04/12/2019 15:30	4,23	75	317,42	CHI
20191224035	PORANGATU	PO12028196	PORANGATU	04/12/2019 08:35	04/12/2019 11:00	04/12/2019 08:35	04/12/2019 11:00	2,41	5	12,03	CHI
20191224036	POSSE	1480025450	IACIARA S2	04/12/2019 08:43	04/12/2019 10:18	04/12/2019 08:43	04/12/2019 10:18	1,58	1	1,58	CHI
20191224058	RUBIATABA	RB21150061	RUBIATABA	04/12/2019 08:45	05/12/2019 14:00	04/12/2019 08:45	05/12/2019 14:00	29,24	1	29,24	CHI
20191224062	GOIANIA	GN21128015	XAVANTES	04/12/2019 08:46	04/12/2019 11:47	04/12/2019 08:46	04/12/2019 11:47	3,01	1	3,01	CHI
20191224073	ITAPIRAPUA	NB12020254	JUSSARA	04/12/2019 08:29	04/12/2019 13:45	04/12/2019 08:29	04/12/2019 13:45	5,26	4	21,05	CHI
20191224073	NOVO BRASIL	NB12020254	JUSSARA	04/12/2019 08:29	04/12/2019 13:45	04/12/2019 08:29	04/12/2019 13:45	5,26	24	126,32	CHI
20191224082	URUTAI	UT21095221	URUTAI	04/12/2019 08:47	04/12/2019 15:28	04/12/2019 08:47	04/12/2019 15:28	6,69	1	6,69	CHI
20191224083	ITABERAI	IB21105421	ITABERAI S1	04/12/2019 08:47	04/12/2019 12:20	04/12/2019 08:47	04/12/2019 12:20	3,54	1	3,54	CHI
20191224085	PORTEIRAO	2470020093	RIO DOS BOIS	04/12/2019 08:45	04/12/2019 10:56	04/12/2019 08:45	04/12/2019 10:56	2,17	1	2,17	CHI
20191224106	MONTES CLAROS DE GOIAS	3220001061	IPORA	04/12/2019 08:49	04/12/2019 22:00	04/12/2019 08:49	04/12/2019 22:00	13,18	1	13,18	CHI
20191224112	ANICUNS	AC12404420	ANICUNS	04/12/2019 06:00	04/12/2019 10:38	04/12/2019 06:00	04/12/2019 10:38	4,62	25	115,48	CHI

20191224113	SAO LUIZ DO NORTE	SZ12348617	ITAPACI	04/12/2019 08:23	04/12/2019 17:50	04/12/2019 08:23	04/12/2019 17:50	9,44	12	113,27	CHI
20191224120	SAO LUIS DE MONTES BELOS	SL21081351	FIRMINOPOLIS S1	04/12/2019 08:50	04/12/2019 10:59	04/12/2019 08:50	04/12/2019 10:59	2,14	2	4,28	CHI
20191224131	NIQUELANDIA	NQ12213117	NIQUELANDIA SUBTRANSMISSAO	04/12/2019 06:54	04/12/2019 16:57	04/12/2019 06:54	04/12/2019 16:57	10,04	18	180,66	CHI
20191224134	DIORAMA	DI12065691	IPORA	04/12/2019 08:40	04/12/2019 10:55	04/12/2019 08:40	04/12/2019 10:55	2,25	8	17,98	CHI
20191224135	RIO VERDE	10016133968	RIO VERDE S2	04/12/2019 08:52	04/12/2019 11:48	04/12/2019 08:52	04/12/2019 11:48	2,92	1	2,92	CHI
20191224136	MINACU	IH11262530	MINACU	04/12/2019 08:52	04/12/2019 23:14	04/12/2019 08:52	04/12/2019 23:14	14,35	21	301,42	CHI
20191224137	GOIANIA	16190580	CAMPINAS S1	04/12/2019 08:52	04/12/2019 11:43	04/12/2019 08:52	04/12/2019 11:43	2,83	1	2,83	CHI
20191224138	GOIATUBA	GT12024290	GOIATUBA S2	04/12/2019 07:50	04/12/2019 11:05	04/12/2019 07:50	04/12/2019 11:05	3,26	16	52,15	CHI
20191224139	CAMPINORTE	CR21181238	MARA ROSA	04/12/2019 08:53	04/12/2019 11:20	04/12/2019 08:53	04/12/2019 11:20	2,45	2	4,90	CHI
20191224151	CATALAO	CT12333319	CATALAO S1	04/12/2019 08:54	05/12/2019 06:16	04/12/2019 08:54	05/12/2019 04:12	19,30	5	96,48	CHI
20191224151	CATALAO	CT12333319	CATALAO S1	04/12/2019 08:54	05/12/2019 06:16	05/12/2019 05:55	05/12/2019 06:16	0,36	5	1,79	CHI
20191224152	SITIO D ABADIA	SI21010206	IACIARA S2	04/12/2019 08:54	04/12/2019 18:07	04/12/2019 08:54	04/12/2019 18:07	9,20	1	9,20	CHI
20191224153	BRITANIA	BT11284745	BRITANIA	04/12/2019 08:54	04/12/2019 19:30	04/12/2019 08:54	04/12/2019 19:30	10,59	59	624,65	CHI
20191224159	BONOPOLIS	BX12263014	SAO MIGUEL DO ARAGUAIA	04/12/2019 06:40	04/12/2019 20:18	04/12/2019 06:40	04/12/2019 20:18	13,63	4	54,51	CHI
20191224161	SAO JOAO D ALIANCA	JL21314654	SAO JOAO D ALIANCA	04/12/2019 08:55	05/12/2019 11:30	04/12/2019 08:55	05/12/2019 11:30	26,57	1	26,57	CHI
20191224163	GOIAS	GS12037486	ITABERAÍ S1	04/12/2019 08:44	04/12/2019 09:33	04/12/2019 08:44	04/12/2019 09:33	0,82	20	16,35	CHI
20191224172	POSSE	SA12195795	IACIARA S2	04/12/2019 08:58	05/12/2019 11:01	04/12/2019 08:58	05/12/2019 11:01	26,05	5	130,23	CHI
20191224174	AGUA FRIA DE GOIAS	TL21342342	SAO JOAO D ALIANCA	04/12/2019 08:58	04/12/2019 14:02	04/12/2019 08:58	04/12/2019 14:02	5,06	1	5,06	CHI
20191224178	SAO MIGUEL DO PASSA QUATRO	SQ21128950	CRISTIANOPOLIS	04/12/2019 08:59	04/12/2019 16:45	04/12/2019 08:59	04/12/2019 16:45	7,75	1	7,75	CHI
20191224199	CAMPO ALEGRE DE GOIAS	CM12064010	CAMPO ALEGRE DE GOIAS	04/12/2019 09:03	04/12/2019 12:58	04/12/2019 09:03	04/12/2019 12:58	3,91	2	7,82	CHI
20191224202	PLANALTINA	2960021661	PLANALTINA	04/12/2019 09:03	04/12/2019 11:35	04/12/2019 09:03	04/12/2019 11:35	2,53	1	2,53	CHI
20191224224	ITAPACI	100026564	ITAPACI	04/12/2019 09:06	04/12/2019 14:26	04/12/2019 09:06	04/12/2019 14:26	5,33	1	5,33	CHI
20191224232	SANTA TEREZA DE GOIAS	SE21372091	MARA ROSA	04/12/2019 09:07	04/12/2019 13:36	04/12/2019 09:07	04/12/2019 13:36	4,48	3	13,43	CHI
20191224234	MAURILANDIA	RV12315683	SANTA HELENA S1	04/12/2019 07:44	04/12/2019 20:25	04/12/2019 07:44	04/12/2019 20:25	12,68	4	50,72	CHI
20191224234	RIO VERDE	RV12315683	SANTA HELENA S1	04/12/2019 07:44	04/12/2019 20:25	04/12/2019 07:44	04/12/2019 20:25	12,68	7	88,76	CHI
20191224246	CATALAO	1990221996	CATALAO S2	04/12/2019 09:10	04/12/2019 14:20	04/12/2019 09:10	04/12/2019 14:20	5,17	1	5,17	CHI
20191224259	AMORINOPOLIS	IR12188430	IPORA	04/12/2019 07:38	04/12/2019 11:54	04/12/2019 07:38	04/12/2019 11:54	4,25	7	29,78	CHI
20191224259	IPORA	IR12188430	IPORA	04/12/2019 07:38	04/12/2019 11:54	04/12/2019 07:38	04/12/2019 11:54	4,25	51	217,00	CHI
20191224259	IVOLANDIA	IR12188430	IPORA	04/12/2019 07:38	04/12/2019 11:54	04/12/2019 07:38	04/12/2019 11:54	4,25	82	348,91	CHI
20191224259	PALESTINA DE GOIAS	IR12188430	IPORA	04/12/2019 07:38	04/12/2019 11:54	04/12/2019 07:38	04/12/2019 11:54	4,25	33	140,41	CHI
20191224266	CALDAS NOVAS	760437798	SERRA DE CALDAS	04/12/2019 09:12	04/12/2019 10:55	04/12/2019 09:12	04/12/2019 10:55	1,71	1	1,71	CHI
20191224268	MONTIVIDIU	MV12267612	MONTIVIDIU T	04/12/2019 06:56	04/12/2019 13:08	04/12/2019 06:56	04/12/2019 13:08	6,21	8	49,65	CHI
20191224278	BRITANIA	BT12378825	BRITANIA	04/12/2019 08:04	04/12/2019 15:05	04/12/2019 08:04	04/12/2019 15:05	7,02	2	14,03	CHI

20191224287	ALTO PARAISO DE GOIAS	BF21397611	NIQUELANDIA SUBTRANSMISSAO	04/12/2019 09:14	04/12/2019 19:51	04/12/2019 09:14	04/12/2019 19:51	10,61	2	21,22	CHI
20191224293	SAO MIGUEL DO ARAGUAIA	SM12000050	SAO MIGUEL DO ARAGUAIA	04/12/2019 08:50	04/12/2019 14:37	04/12/2019 08:50	04/12/2019 14:37	5,77	28	161,58	CHI
20191224295	NOVA IGUACU DE GOIAS	CR12291124	MARA ROSA	04/12/2019 09:15	05/12/2019 18:13	04/12/2019 09:15	05/12/2019 18:13	32,96	1	32,96	CHI
20191224302	CAIAPONIA	PY12040195LD	PALESTINA	03/12/2019 21:52	04/12/2019 11:37	03/12/2019 21:52	04/12/2019 11:37	13,74	45	618,40	CHI
20191224306	FORMOSA	FA31042761	SAO JOAO D ALIANCA	04/12/2019 09:17	04/12/2019 16:08	04/12/2019 09:17	04/12/2019 16:08	6,85	1	6,85	CHI
20191224307	HEITORAI	IK12156282	ITAPURANGA	04/12/2019 08:45	04/12/2019 13:35	04/12/2019 08:45	04/12/2019 13:35	4,84	3	14,53	CHI
20191224307	ITAPURANGA	IK12156282	ITAPURANGA	04/12/2019 08:45	04/12/2019 13:35	04/12/2019 08:45	04/12/2019 13:35	4,84	41	198,51	CHI
20191224311	TRINDADE	TR12000012	TRINDADE	04/12/2019 08:49	04/12/2019 11:32	04/12/2019 08:49	04/12/2019 11:32	2,70	414	1118,49	CHI
20191224315	EDEALINA	EA12017169	EDEIA	04/12/2019 07:43	04/12/2019 17:01	04/12/2019 07:43	04/12/2019 17:01	9,30	2	18,59	CHI
20191224328	AMARALINA	MU11215741	MARA ROSA	04/12/2019 09:20	05/12/2019 09:32	04/12/2019 09:20	05/12/2019 09:32	24,20	3	72,59	CHI
20191224337	GOIATUBA	GT12052882	GOIATUBA S1	04/12/2019 09:21	04/12/2019 10:53	04/12/2019 09:21	04/12/2019 10:53	1,53	28	42,80	CHI
20191224338	INHUMAS	IN12014314	INHUMAS S1	04/12/2019 08:31	04/12/2019 12:37	04/12/2019 08:31	04/12/2019 12:37	4,10	27	110,67	CHI
20191224349	FORMOSA	FA21306753	ITUIQUIRA	04/12/2019 09:23	04/12/2019 18:32	04/12/2019 09:23	04/12/2019 18:32	9,14	1	9,14	CHI
20191224356	CACHOEIRA DOURADA	CD21000206	CACHOEIRA DOURADA	04/12/2019 09:24	04/12/2019 18:31	04/12/2019 09:24	04/12/2019 18:31	9,11	1	9,11	CHI
20191224361	PIRES DO RIO	10008343487	PIRES DO RIO S1	04/12/2019 09:25	04/12/2019 15:11	04/12/2019 09:25	04/12/2019 15:11	5,76	1	5,76	CHI
20191224370	PONTALINA	210028129	PONTALINA	04/12/2019 09:26	05/12/2019 12:36	04/12/2019 09:26	05/12/2019 12:36	27,17	1	27,17	CHI
20191224372	MINEIROS	MY12244676	PARQUE DAS EMAS	04/12/2019 07:18	04/12/2019 17:30	04/12/2019 07:18	04/12/2019 17:30	10,19	9	91,68	CHI
20191224381	ARAGUAPAZ	AZ12188011	MOZARLANDIA	04/12/2019 07:20	04/12/2019 13:22	04/12/2019 07:20	04/12/2019 13:22	6,03	8	48,25	CHI
20191224381	MOZARLANDIA	AZ12188011	MOZARLANDIA	04/12/2019 07:20	04/12/2019 13:22	04/12/2019 07:20	04/12/2019 13:22	6,03	2	12,06	CHI
20191224388	CATALAO	CT12333401	CATALAO S1	04/12/2019 09:27	05/12/2019 14:50	04/12/2019 09:27	05/12/2019 14:50	29,37	7	205,57	CHI
20191224403	BONOPOLIS	BX21208637	SAO MIGUEL DO ARAGUAIA	04/12/2019 09:29	05/12/2019 18:34	04/12/2019 09:29	05/12/2019 18:34	33,08	1	33,08	CHI
20191224414	CAVALCANTE	TE21264068	FLORES DE GOIAS	04/12/2019 09:30	05/12/2019 10:47	04/12/2019 09:30	05/12/2019 10:47	25,27	1	25,27	CHI
20191224421	PIRES DO RIO	10026535686	PIRES DO RIO S2	04/12/2019 09:30	04/12/2019 18:27	04/12/2019 09:30	04/12/2019 18:27	8,94	1	8,94	CHI
20191224433	AGUA LIMPA	AL12245823	VILA CORUMBA	04/12/2019 09:32	04/12/2019 16:20	04/12/2019 09:32	04/12/2019 16:20	6,80	1	6,80	CHI
20191224438	IPAMERI	IP21153020	IPAMERI	04/12/2019 09:32	04/12/2019 14:15	04/12/2019 09:32	04/12/2019 14:15	4,72	1	4,72	CHI
20191224439	FIRMINOPOLIS	TV12005563	FIRMINOPOLIS S1	04/12/2019 07:50	04/12/2019 18:54	04/12/2019 07:50	04/12/2019 18:54	11,06	62	685,72	CHI
20191224439	TURVANIA	TV12005563	FIRMINOPOLIS S1	04/12/2019 07:50	04/12/2019 18:54	04/12/2019 07:50	04/12/2019 18:54	11,06	12	132,72	CHI
20191224442	URUACU	640067116	URUACU	04/12/2019 09:33	04/12/2019 14:26	04/12/2019 09:33	04/12/2019 14:26	4,88	1	4,88	CHI
20191224444	SANTA TEREZA DE GOIAS	SE12053821	MARA ROSA	04/12/2019 09:33	04/12/2019 16:38	04/12/2019 09:33	04/12/2019 16:38	7,08	1	7,08	CHI
20191224449	ALTO HORIZONTE	AJ21137906	SANTA TEREZINHA	04/12/2019 07:53	04/12/2019 18:15	04/12/2019 07:53	04/12/2019 18:15	10,36	1	10,36	CHI
20191224461	CATALAO	CT21231656	CATALAO S1	04/12/2019 09:35	04/12/2019 18:37	04/12/2019 09:35	04/12/2019 18:37	9,02	1	9,02	CHI
20191224464	IPAMERI	7920002198	PIRES DO RIO S2	04/12/2019 09:36	04/12/2019 21:33	04/12/2019 09:36	04/12/2019 21:33	11,96	1	11,96	CHI
20191224465	IPAMERI	IP21000058	IPAMERI	04/12/2019 09:36	04/12/2019 16:28	04/12/2019 09:36	04/12/2019 16:28	6,86	1	6,86	CHI

20191224473	BONOPOLIS	PO12394943	MARA ROSA	04/12/2019 09:35	05/12/2019 01:01	04/12/2019 09:35	05/12/2019 01:01	15,42	2	30,85	CHI
20191224473	PORANGATU	PO12394943	MARA ROSA	04/12/2019 09:35	05/12/2019 01:01	04/12/2019 09:35	05/12/2019 01:01	15,42	10	154,23	CHI
20191224476	ITAUCU	IX12000021	INHUMAS S1	04/12/2019 07:38	04/12/2019 14:01	04/12/2019 07:38	04/12/2019 14:01	6,38	14	89,31	CHI
20191224476	TAQUARAL DE GOIAS	IX12000021	INHUMAS S1	04/12/2019 07:38	04/12/2019 14:01	04/12/2019 07:38	04/12/2019 14:01	6,38	7	44,65	CHI
20191224486	NOVA IGUACU DE GOIAS	NH12262884	SANTA TEREZINHA	04/12/2019 07:37	04/12/2019 16:11	04/12/2019 07:37	04/12/2019 16:11	8,56	5	42,80	CHI
20191224489	CAIAPONIA	CP12039210	CAIAPONIA	04/12/2019 07:48	04/12/2019 15:45	04/12/2019 07:48	04/12/2019 15:45	7,94	11	87,39	CHI
20191224491	NIQUELANDIA	NQ12254950	NIQUELANDIA SUBTRANSMISSAO	04/12/2019 09:41	04/12/2019 21:36	04/12/2019 09:41	04/12/2019 21:36	11,90	8	95,21	CHI
20191224503	PLANALTINA	2960057588	PLANALTINA	04/12/2019 09:42	04/12/2019 11:13	04/12/2019 09:42	04/12/2019 11:13	1,51	1	1,51	CHI
20191224514	GOIANDIRA	GD21323418	CATALAO S1	04/12/2019 09:43	04/12/2019 14:27	04/12/2019 09:43	04/12/2019 14:27	4,72	2	9,45	CHI
20191224517	JUSSARA	JR12055957	JUSSARA	04/12/2019 08:25	04/12/2019 14:10	04/12/2019 08:25	04/12/2019 14:10	5,74	4	22,98	CHI
20191224529	ITUMBIARA	10012825032	ITUMBIARA VELHA S1	04/12/2019 09:45	04/12/2019 13:20	04/12/2019 09:45	04/12/2019 13:20	3,57	1	3,57	CHI
20191224568	ITAPACI	100046885	ITAPACI	04/12/2019 09:52	05/12/2019 10:40	04/12/2019 09:52	05/12/2019 10:40	24,80	1	24,80	CHI
20191224572	GOIATUBA	GT21033091	CACHOEIRA DOURADA	04/12/2019 09:52	04/12/2019 14:14	04/12/2019 09:52	04/12/2019 14:14	4,35	1	4,35	CHI
20191224576	CALDAS NOVAS	CN12392073	VILA CORUMBA	04/12/2019 09:54	04/12/2019 14:30	04/12/2019 09:54	04/12/2019 14:30	4,60	3	13,80	CHI
20191224589	ITUMBIARA	BJ12068986	CACHOEIRA DOURADA	04/12/2019 09:56	04/12/2019 13:02	04/12/2019 09:56	04/12/2019 13:02	3,09	4	12,38	CHI
20191224591	GOIATUBA	GT12296905	GOIATUBA S2	04/12/2019 09:56	04/12/2019 13:31	04/12/2019 09:56	04/12/2019 13:31	3,57	6	21,45	CHI
20191224594	CAIAPONIA	CP12260986	MONTIVIDIU T	04/12/2019 07:30	04/12/2019 15:51	04/12/2019 07:30	04/12/2019 15:51	8,35	23	192,01	CHI
20191224595	AGUA FRIA DE GOIAS	TL12381390	SAO JOAO D ALIANCA	04/12/2019 08:15	04/12/2019 15:05	04/12/2019 08:15	04/12/2019 15:05	6,83	3	20,50	CHI
20191224595	PLANALTINA	TL12381390	SAO JOAO D ALIANCA	04/12/2019 08:15	04/12/2019 15:05	04/12/2019 08:15	04/12/2019 15:05	6,83	20	136,67	CHI
20191224596	DOVERLANDIA	DV12156199	PARQUE DAS EMAS	03/12/2019 22:08	04/12/2019 16:28	03/12/2019 22:08	04/12/2019 16:28	18,33	11	201,66	CHI
20191224599	URUACU	640007510	URUACU	04/12/2019 09:57	04/12/2019 13:21	04/12/2019 09:57	04/12/2019 13:21	3,39	1	3,39	CHI
20191224600	IACIARA	IA12160059	IACIARA S1	04/12/2019 06:07	04/12/2019 14:23	04/12/2019 06:07	04/12/2019 14:23	8,26	22	181,66	CHI
20191224604	MORRINHOS	MR21288146	MORRINHOS	04/12/2019 10:00	04/12/2019 11:45	04/12/2019 10:00	04/12/2019 11:45	1,75	2	3,50	CHI
20191224610	MORRINHOS	10020293141	MORRINHOS	04/12/2019 10:01	04/12/2019 13:39	04/12/2019 10:01	04/12/2019 13:39	3,62	1	3,62	CHI
20191224616	CALDAS NOVAS	CN21186190	SERRA DE CALDAS	04/12/2019 10:02	05/12/2019 08:53	04/12/2019 10:02	05/12/2019 08:53	22,84	1	22,84	CHI
20191224652	CAVALCANTE	CJ11347360	MINACU	04/12/2019 10:08	05/12/2019 00:34	04/12/2019 10:08	05/12/2019 00:34	14,42	6	86,53	CHI
20191224653	PROFESSOR JAMIL SAFADY	HD21109194	ROCHEDO	04/12/2019 10:08	04/12/2019 12:40	04/12/2019 10:08	04/12/2019 12:40	2,52	1	2,52	CHI
20191224656	POSSE	8190002730	IACIARA S1	04/12/2019 10:09	04/12/2019 12:23	04/12/2019 10:09	04/12/2019 12:23	2,23	1	2,23	CHI
20191224658	ALTO PARAISO DE GOIAS	BF12244579	SAO JOAO D ALIANCA	04/12/2019 09:41	04/12/2019 15:27	04/12/2019 09:41	04/12/2019 15:27	5,77	33	190,30	CHI
20191224666	NIQUELANDIA	NQ12256621	NIQUELANDIA SUBTRANSMISSAO	04/12/2019 07:10	04/12/2019 14:06	04/12/2019 07:10	04/12/2019 14:06	6,93	8	55,46	CHI
20191224679	CACHOEIRA DOURADA	CD12000188	CACHOEIRA DOURADA	04/12/2019 09:45	04/12/2019 17:10	04/12/2019 09:45	04/12/2019 17:10	7,41	8	59,30	CHI
20191224679	ITUMBIARA	CD12000188	CACHOEIRA DOURADA	04/12/2019 09:45	04/12/2019 17:10	04/12/2019 09:45	04/12/2019 17:10	7,41	2	14,82	CHI
20191224690	ITUMBIARA	10005069120	PARANAIBA	04/12/2019 10:14	04/12/2019 13:01	04/12/2019 10:14	04/12/2019 13:01	2,78	1	2,78	CHI

20191224691	PALESTINA DE GOIAS	PY12023472	PALESTINA	04/12/2019 07:55	04/12/2019 12:09	04/12/2019 07:55	04/12/2019 12:09	4,23	8	33,81	CHI
20191224716	BURITI ALEGRE	GT12263930	GOIATUBA S1	04/12/2019 09:58	05/12/2019 07:46	04/12/2019 09:58	05/12/2019 07:46	21,80	2	43,59	CHI
20191224716	GOIATUBA	GT12263930	GOIATUBA S1	04/12/2019 09:58	05/12/2019 07:46	04/12/2019 09:58	05/12/2019 07:46	21,80	35	762,85	CHI
20191224726	ORIZONA	OZ21326466	PIRES DO RIO S2	04/12/2019 10:21	04/12/2019 11:21	04/12/2019 10:21	04/12/2019 11:21	0,99	1	0,99	CHI
20191224727	FLORES DE GOIAS	FB12248238	FLORES DE GOIAS	04/12/2019 06:16	04/12/2019 12:42	04/12/2019 06:16	04/12/2019 12:42	6,43	96	616,99	CHI
20191224727	SAO JOAO D ALIANCA	FB12248238	FLORES DE GOIAS	04/12/2019 06:16	04/12/2019 12:42	04/12/2019 06:16	04/12/2019 12:42	6,43	40	257,08	CHI
20191224737	AGUA LIMPA	AL21166420	VILA CORUMBA	04/12/2019 10:24	04/12/2019 15:38	04/12/2019 10:24	04/12/2019 15:38	5,22	1	5,22	CHI
20191224745	PORANGATU	840023911	PORANGATU	04/12/2019 10:25	04/12/2019 17:29	04/12/2019 10:25	04/12/2019 17:29	7,05	1	7,05	CHI
20191224748	FORMOSA	FA21033493	SAO JOAO D ALIANCA	04/12/2019 10:26	05/12/2019 12:28	04/12/2019 10:26	05/12/2019 12:28	26,02	1	26,02	CHI
20191224775	OUIDOR	IO21037540	CATALAO S1	04/12/2019 10:31	04/12/2019 19:55	04/12/2019 10:31	04/12/2019 19:55	9,39	1	9,39	CHI
20191224779	VICENTINOPOLIS	VI21222494	VICENTINOPOLIS	04/12/2019 10:31	04/12/2019 20:37	04/12/2019 10:31	04/12/2019 20:37	10,09	1	10,09	CHI
20191224800	ITAGUARI	JA12038937	ITABERAI S1	04/12/2019 05:51	04/12/2019 18:20	04/12/2019 05:51	04/12/2019 18:20	12,47	3	37,42	CHI
20191224800	ITAGUARU	JA12038937	ITABERAI S1	04/12/2019 05:51	04/12/2019 18:20	04/12/2019 05:51	04/12/2019 18:20	12,47	1	12,47	CHI
20191224800	JARAGUA	JA12038937	ITABERAI S1	04/12/2019 05:51	04/12/2019 18:20	04/12/2019 05:51	04/12/2019 18:20	12,47	6	74,85	CHI
20191224832	CATALAO	CT21231785	CATALAO S1	04/12/2019 10:40	05/12/2019 14:07	04/12/2019 10:40	05/12/2019 14:07	27,45	1	27,45	CHI
20191224858	ITUMBIARA	690361324	ITUMBIARA NOVA	04/12/2019 10:44	04/12/2019 13:35	04/12/2019 10:44	04/12/2019 13:35	2,84	1	2,84	CHI
20191224996	PARAUNA	19929826	PARAUNA	03/12/2019 21:20	04/12/2019 16:51	03/12/2019 21:20	04/12/2019 16:51	19,52	4	78,10	CHI
20191224996	JANDAIA	19929826	PARAUNA	03/12/2019 21:20	04/12/2019 16:51	04/12/2019 11:15	04/12/2019 16:51	5,61	3	16,83	CHI
20191224996	PARAUNA	19929826	PARAUNA	03/12/2019 21:20	04/12/2019 16:51	04/12/2019 11:15	04/12/2019 16:51	5,61	48	269,32	CHI
20191224999	AGUA FRIA DE GOIAS	TL12279981	SAO JOAO D ALIANCA	04/12/2019 08:41	04/12/2019 13:07	04/12/2019 08:41	04/12/2019 13:07	4,43	41	181,71	CHI
20191225037	CAIAPONIA	CP12247469	IPORA	04/12/2019 08:03	04/12/2019 17:30	04/12/2019 08:03	04/12/2019 17:30	9,43	4	37,74	CHI
20191225099	PALMINOPOLIS	PP12307055	PALMEIRAS	04/12/2019 06:21	04/12/2019 20:40	04/12/2019 06:21	04/12/2019 20:40	14,32	2	28,64	CHI
20191225220	IACIARA	IA12211563	IACIARA S1	03/12/2019 14:24	04/12/2019 13:31	03/12/2019 14:24	04/12/2019 13:31	23,10	6	138,61	CHI
20191225340	AMARALINA	LC12230319	NOVA CRIXAS	04/12/2019 10:13	05/12/2019 11:59	04/12/2019 10:13	05/12/2019 11:59	25,76	3	77,29	CHI
20191225419	AMARALINA	LC12168855	MARA ROSA	04/12/2019 09:15	04/12/2019 15:30	04/12/2019 09:15	04/12/2019 15:30	6,24	35	218,43	CHI
20191225419	MARA ROSA	LC12168855	MARA ROSA	04/12/2019 09:15	04/12/2019 15:30	04/12/2019 09:15	04/12/2019 15:30	6,24	8	49,93	CHI
20191225430	ITAGUARU	IC12219948	ITABERAI S1	04/12/2019 08:41	04/12/2019 16:47	04/12/2019 08:41	04/12/2019 16:47	8,10	11	89,10	CHI
20191225442	PALESTINA DE GOIAS	CP21117511	PALESTINA	04/12/2019 07:23	04/12/2019 10:00	04/12/2019 07:23	04/12/2019 10:00	2,61	1	2,61	CHI
20191225493	NIQUELANDIA	NQ21371135	SAO JOAO D ALIANCA	04/12/2019 08:58	05/12/2019 10:26	04/12/2019 08:58	05/12/2019 10:26	25,46	1	25,46	CHI
20191225582	FLORES DE GOIAS	FB12252148	FLORES DE GOIAS	04/12/2019 10:07	04/12/2019 17:02	04/12/2019 10:07	04/12/2019 17:02	6,90	10	69,01	CHI
20191225718	PALESTINA DE GOIAS	PY12223011	PALESTINA	04/12/2019 08:36	04/12/2019 16:41	04/12/2019 08:36	04/12/2019 16:41	8,07	114	919,92	CHI
20191225770	EDEALINA	10004901558	PONTALINA	03/12/2019 19:08	04/12/2019 19:48	03/12/2019 19:08	04/12/2019 19:48	24,66	1	24,66	CHI
20191225772	EDEALINA	EA31008804	PONTALINA	04/12/2019 08:16	05/12/2019 11:22	04/12/2019 08:16	05/12/2019 11:22	27,09	3	81,27	CHI

20191225799	GUARANI DE GOIAS	GY21298268	IACIARA S1	04/12/2019 08:31	04/12/2019 20:59	04/12/2019 08:31	04/12/2019 20:59	12,45	1	12,45	CHI
20191225844	NIQUELANDIA	NQ12292134	NIQUELANDIA SUBTRANSMISSAO	04/12/2019 08:12	04/12/2019 14:50	04/12/2019 08:12	04/12/2019 14:50	6,63	27	179,03	CHI
20191226142	CATALAO	CT12130955	CATALAO S1	04/12/2019 07:56	05/12/2019 13:45	04/12/2019 07:56	05/12/2019 13:45	29,81	5	149,06	CHI
20191226142	DISTRITO FEDERAL	CT12130955	CATALAO S1	04/12/2019 07:56	05/12/2019 13:45	04/12/2019 07:56	05/12/2019 13:45	29,81	1	29,81	CHI
20191226171	FIRMINOPOLIS	FR12061354	FIRMINOPOLIS S1	04/12/2019 05:08	04/12/2019 17:15	04/12/2019 05:08	04/12/2019 17:15	12,12	20	242,36	CHI
20191226577	POSSE	PS12152680	IACIARA S2	04/12/2019 07:18	04/12/2019 23:02	04/12/2019 07:18	04/12/2019 23:02	15,73	9	141,58	CHI
20191226784	GUARINOS	GF11113854	SANTA TEREZINHA	04/12/2019 08:21	05/12/2019 09:51	04/12/2019 08:21	05/12/2019 09:51	25,48	12	305,81	CHI
20191227290	ALTO HORIZONTE	AJ21181590	SANTA TEREZINHA	04/12/2019 09:34	04/12/2019 19:19	04/12/2019 09:34	04/12/2019 19:19	9,75	1	9,75	CHI
20191227363	MINACU	IH12314767	MINACU	04/12/2019 09:50	05/12/2019 01:00	04/12/2019 09:50	05/12/2019 01:00	15,17	32	485,30	CHI
20191227562	ORIZONA	OZ12084921RE	PIRES DO RIO S2	04/12/2019 10:26	04/12/2019 21:44	04/12/2019 10:26	04/12/2019 21:44	11,29	86	970,82	CHI
20191227562	VIANOPOLIS	OZ12084921RE	PIRES DO RIO S2	04/12/2019 10:26	04/12/2019 21:44	04/12/2019 10:26	04/12/2019 21:44	11,29	17	191,91	CHI
20191227742	ITAPIRAPUA	IU21145663	MATRINCHA	04/12/2019 08:19	05/12/2019 07:47	04/12/2019 08:19	05/12/2019 07:47	23,47	1	23,47	CHI
20191228370	CEZARINA	IY12089831	CEZARINA	03/12/2019 18:50	05/12/2019 09:31	03/12/2019 18:51	05/12/2019 09:31	38,66	5	193,31	CHI
20191228370	INDIARA	IY12089831	CEZARINA	03/12/2019 18:50	05/12/2019 09:31	03/12/2019 18:51	05/12/2019 09:31	38,66	2	77,32	CHI
20191228370	CEZARINA	IY12089831	CEZARINA	03/12/2019 18:50	05/12/2019 09:31	04/12/2019 19:22	05/12/2019 09:31	14,15	1	14,15	CHI
20191228373	CRIXAS	CX12290228	SERRA DO OURO	04/12/2019 07:26	05/12/2019 13:18	04/12/2019 07:26	05/12/2019 13:18	29,86	19	567,40	CHI
20191229202	GUARINOS	3720005626	ITAPACI	03/12/2019 12:31	05/12/2019 04:57	03/12/2019 12:31	05/12/2019 04:57	40,42	1	40,42	CHI
201912211706	ALVORADA DO NORTE	AQ12347010	IACIARA S2	02/12/2019 18:17	02/12/2019 20:10	02/12/2019 18:17	02/12/2019 20:10	1,87	15	28,04	CHI
201912211761	ALVORADA DO NORTE	AQ12160975	IACIARA S2	02/12/2019 18:20	03/12/2019 08:23	02/12/2019 18:20	03/12/2019 08:23	14,03	17	238,59	CHI
201912212703	ABADIANIA	AA12382337	CORUMBA	02/12/2019 21:35	03/12/2019 00:58	02/12/2019 21:35	03/12/2019 00:58	3,37	43	144,96	CHI
201912213604	FORMOSA	FA12278155	ITIQUIRA	03/12/2019 05:41	04/12/2019 11:10	03/12/2019 05:41	04/12/2019 11:10	29,47	32	943,05	CHI
201912213604	VILA BOA	FA12278155	ITIQUIRA	03/12/2019 05:41	04/12/2019 11:10	03/12/2019 05:41	04/12/2019 11:10	29,47	4	117,88	CHI
201912213902	ALVORADA DO NORTE	FB12143258	IACIARA S2	03/12/2019 06:24	03/12/2019 12:39	03/12/2019 06:24	03/12/2019 12:39	6,24	30	187,30	CHI
201912213902	FLORES DE GOIAS	FB12143258	IACIARA S2	03/12/2019 06:24	03/12/2019 12:39	03/12/2019 06:24	03/12/2019 12:39	6,24	27	168,57	CHI
201912214445	PARAUNA	PU12079036	FIRMINOPOLIS S2	03/12/2019 00:52	03/12/2019 15:36	03/12/2019 00:52	03/12/2019 15:36	14,72	8	117,78	CHI
201912215239	NOVA CRIXAS	NA12220366	MOZARLANDIA	03/12/2019 07:15	03/12/2019 09:22	03/12/2019 07:15	03/12/2019 09:22	2,11	6	12,68	CHI
201912216121	CRIXAS	CX12391852	RUBIATABA	03/12/2019 08:42	03/12/2019 19:05	03/12/2019 08:42	03/12/2019 19:05	10,37	21	217,73	CHI
201912218003	FORMOSA	VB12204775RE	ITIQUIRA	03/12/2019 10:35	04/12/2019 03:41	03/12/2019 10:35	04/12/2019 03:41	17,10	60	1025,80	CHI
201912218003	VILA BOA	VB12204775RE	ITIQUIRA	03/12/2019 10:35	04/12/2019 03:41	03/12/2019 10:35	04/12/2019 03:41	17,10	173	2957,72	CHI
201912228783	INACIOLANDIA	CD12000116	CACHOEIRA DOURADA	03/12/2019 13:12	04/12/2019 10:13	03/12/2019 13:12	04/12/2019 10:13	21,00	13	273,03	CHI
201912230509	BOM JESUS DE GOIAS	00230424	BOM JESUS DE GOIAS	03/12/2019 14:30	03/12/2019 20:26	03/12/2019 18:02	03/12/2019 20:26	2,40	21	50,41	CHI
201912230509	GOIATUBA	00230424	BOM JESUS DE GOIAS	03/12/2019 14:30	03/12/2019 20:26	03/12/2019 18:02	03/12/2019 20:26	2,40	130	312,04	CHI
201912230509	GOIATUBA	00230424	BOM JESUS DE GOIAS	03/12/2019 14:30	03/12/2019 20:26	03/12/2019 18:02	03/12/2019 20:26	2,40	103	247,23	CHI

201912230509	GOIATUBA	00230424	BOM JESUS DE GOIAS	03/12/2019 14:30	03/12/2019 20:26	03/12/2019 18:02	03/12/2019 20:26	2,40	22	52,81	CHI
201912230509	ITUMBIARA	00230424	BOM JESUS DE GOIAS	03/12/2019 14:30	03/12/2019 20:26	03/12/2019 18:02	03/12/2019 20:26	2,40	3	7,20	CHI
201912230551	GOIATUBA	140109018	BOM JESUS DE GOIAS	03/12/2019 16:09	03/12/2019 18:02	03/12/2019 16:09	03/12/2019 18:02	1,88	1	1,88	CHI
201912230746	GOIANIA	GN12000296	GOIANIA LESTE S1	03/12/2019 16:17	03/12/2019 21:03	03/12/2019 16:17	03/12/2019 21:03	4,77	156	743,51	CHI
201912230778	IPAMERI	IP12275536	CAMPO ALEGRE DE GOIAS	03/12/2019 14:32	04/12/2019 15:39	03/12/2019 14:32	04/12/2019 15:39	25,10	7	175,71	CHI
201912231085	MINEIROS	MY12355996	PARQUE DAS EMAS	03/12/2019 15:35	03/12/2019 22:55	03/12/2019 15:35	03/12/2019 22:55	7,32	155	1134,90	CHI
201912233060	SAO DOMINGOS	SD12389177	SAO DOMINGOS	03/12/2019 17:56	04/12/2019 15:55	03/12/2019 17:56	03/12/2019 23:19	5,37	1	5,37	CHI
201912233060	SAO DOMINGOS	SD12389177	SAO DOMINGOS	03/12/2019 17:56	04/12/2019 15:55	03/12/2019 17:56	04/12/2019 15:55	21,97	61	1340,46	CHI
201912233764	BALIZA	BH12380942	BOM JARDIM	04/12/2019 06:08	04/12/2019 21:52	04/12/2019 06:08	04/12/2019 21:52	15,73	7	110,12	CHI
201912233832	AGUA FRIA DE GOIAS	PI12082205	SAO JOAO D ALIANCA	04/12/2019 07:11	04/12/2019 15:16	04/12/2019 07:11	04/12/2019 15:16	8,07	2	16,14	CHI
201912233869	TURVELANDIA	TD12240328	RIO DOS BOIS	04/12/2019 07:28	04/12/2019 12:48	04/12/2019 07:28	04/12/2019 12:48	5,33	3	15,98	CHI
201912234684	NOVA CRIXAS	NA12193698	MOZARLANDIA	04/12/2019 07:37	05/12/2019 11:27	04/12/2019 07:37	05/12/2019 11:27	27,83	1	27,83	CHI
201912234765	CACHOEIRA ALTA	CA12013330	CACHOEIRA ALTA	04/12/2019 07:41	04/12/2019 18:15	04/12/2019 07:41	04/12/2019 18:15	10,56	22	232,34	CHI
201912235306	HIDROLANDIA	HD32060189	CEPAIGO S1	04/12/2019 07:45	04/12/2019 16:14	04/12/2019 14:59	04/12/2019 16:14	1,25	21	26,20	CHI
201912235425	HIDROLANDIA	180063250	CEPAIGO S1	04/12/2019 07:45	04/12/2019 14:59	04/12/2019 07:45	04/12/2019 14:59	7,23	1	7,23	CHI
201912260747	BONOPOLIS	BX12079321	SAO MIGUEL DO ARAGUAIA	04/12/2019 05:49	04/12/2019 16:33	04/12/2019 05:49	04/12/2019 16:33	10,72	58	621,68	CHI
201912260748	AMARALINA	LC12270117	SAO MIGUEL DO ARAGUAIA	04/12/2019 06:03	04/12/2019 12:29	04/12/2019 06:03	04/12/2019 12:29	6,44	9	57,94	CHI
201912260749	NOVO PLANALTO	SM12074646	SAO MIGUEL DO ARAGUAIA	04/12/2019 07:47	04/12/2019 12:33	04/12/2019 07:47	04/12/2019 12:33	4,77	6	28,59	CHI
201912260749	SAO MIGUEL DO ARAGUAIA	SM12074646	SAO MIGUEL DO ARAGUAIA	04/12/2019 07:47	04/12/2019 12:33	04/12/2019 07:47	04/12/2019 12:33	4,77	377	1796,51	CHI
201912260753	BONOPOLIS	BX12364678	SAO MIGUEL DO ARAGUAIA	04/12/2019 08:48	04/12/2019 17:36	04/12/2019 08:48	04/12/2019 17:36	8,79	17	149,39	CHI
201912260757	GOIANIA	GN12001375	FERROVIARIO S2	02/12/2019 14:04	02/12/2019 15:34	02/12/2019 14:04	02/12/2019 15:34	1,49	127	189,55	CHI
201912260758	NIQUELANDIA	NQ12213205	URUACU	02/12/2019 16:15	02/12/2019 18:32	02/12/2019 16:15	02/12/2019 18:32	2,28	1	2,28	CHI
201912260760	CRIXAS	UP12171789	SANTA TEREZINHA	02/12/2019 17:20	02/12/2019 17:47	02/12/2019 17:20	02/12/2019 17:47	0,46	16	7,29	CHI
201912260760	UIRAPURU	UP12171789	SANTA TEREZINHA	02/12/2019 17:20	02/12/2019 17:47	02/12/2019 17:20	02/12/2019 17:47	0,46	50	22,78	CHI
201912260761	BRAZABRANTES	BR12238978	INHUMAS S1	03/12/2019 10:54	03/12/2019 14:32	03/12/2019 10:54	03/12/2019 14:32	3,62	9	32,62	CHI
201912260761	BRAZABRANTES	BR12238978	NEROPOLIS S1	03/12/2019 10:54	03/12/2019 14:32	03/12/2019 10:54	03/12/2019 14:32	3,62	1183	4288,37	CHI
201912260761	BRAZABRANTES	BR12238978	NEROPOLIS S1	03/12/2019 10:54	03/12/2019 14:32	03/12/2019 10:54	03/12/2019 14:32	3,62	374	1355,75	CHI
201912260761	GOIANIRA	BR12238978	NEROPOLIS S1	03/12/2019 10:54	03/12/2019 14:32	03/12/2019 10:54	03/12/2019 14:32	3,62	22	79,75	CHI
201912260761	GOIANIRA	BR12238978	NEROPOLIS S1	03/12/2019 10:54	03/12/2019 14:32	03/12/2019 10:54	03/12/2019 14:32	3,62	30	108,75	CHI
201912260761	NOVA VENEZA	BR12238978	NEROPOLIS S1	03/12/2019 10:54	03/12/2019 14:32	03/12/2019 10:54	03/12/2019 14:32	3,62	3	10,87	CHI
201912260761	SANTO ANTONIO DE GOIAS	BR12238978	NEROPOLIS S1	03/12/2019 10:54	03/12/2019 14:32	03/12/2019 10:54	03/12/2019 14:32	3,62	5	18,12	CHI
201912260769	ALTO HORIZONTE	9640008740	MARA ROSA	03/12/2019 13:51	03/12/2019 18:36	03/12/2019 13:51	03/12/2019 18:36	4,75	1	4,75	CHI
201912260770	RUBIATABA	RB12253964	RUBIATABA	04/12/2019 06:09	04/12/2019 12:49	04/12/2019 06:09	04/12/2019 12:49	6,66	3	19,98	CHI

201912260771	PONTALINA	PK12047398	VICENTINOPOLIS	04/12/2019 07:15	04/12/2019 12:13	04/12/2019 07:15	04/12/2019 12:13	4,96	9	44,66	CHI
201912260773	GOIANIA	10153305	GOIANIA LESTE S1	03/12/2019 23:05	04/12/2019 15:24	03/12/2019 23:05	04/12/2019 15:24	16,32	1	16,32	CHI
201912260890	RIO VERDE	RV10400628	MONTIVIDIU T	03/12/2019 17:35	06/12/2019 01:49	03/12/2019 17:35	03/12/2019 20:58	3,38	4	13,53	CHI
201912260890	RIO VERDE	RV13357266	MONTIVIDIU T	03/12/2019 17:35	06/12/2019 01:49	03/12/2019 17:35	03/12/2019 21:39	4,06	23	93,31	CHI
201912260890	RIO VERDE	RV10400628	MONTIVIDIU T	03/12/2019 17:35	06/12/2019 01:49	04/12/2019 20:17	05/12/2019 00:28	4,19	58	242,81	CHI
201912260890	MONTIVIDIU	RV12219433	MONTIVIDIU T	03/12/2019 17:35	06/12/2019 01:49	03/12/2019 17:35	06/12/2019 01:49	56,22	31	1742,87	CHI
201912260890	RIO VERDE	RV12219433	MONTIVIDIU T	03/12/2019 17:35	06/12/2019 01:49	03/12/2019 17:35	06/12/2019 01:49	56,22	12	674,66	CHI
201912260893	CAMPO ALEGRE DE GOIAS	02250424	CAMPO ALEGRE DE GOIAS	03/12/2019 14:32	04/12/2019 13:50	03/12/2019 14:32	03/12/2019 16:59	2,44	103	251,26	CHI
201912260893	IPAMERI	02250424	CAMPO ALEGRE DE GOIAS	03/12/2019 14:32	04/12/2019 13:50	03/12/2019 14:32	03/12/2019 16:59	2,44	29	70,74	CHI
201912260893	CAMPO ALEGRE DE GOIAS	CM13266893	CAMPO ALEGRE DE GOIAS	03/12/2019 14:32	04/12/2019 13:50	03/12/2019 14:32	03/12/2019 19:53	5,33	175	933,48	CHI
201912260893	CATALAO	CM13266893	CAMPO ALEGRE DE GOIAS	03/12/2019 14:32	04/12/2019 13:50	03/12/2019 14:32	03/12/2019 19:53	5,33	21	112,02	CHI
201912260893	DISTRITO FEDERAL	CM13266893	CAMPO ALEGRE DE GOIAS	03/12/2019 14:32	04/12/2019 13:50	03/12/2019 14:32	03/12/2019 19:53	5,33	1	5,33	CHI
201912260893	IPAMERI	CM13266893	CAMPO ALEGRE DE GOIAS	03/12/2019 14:32	04/12/2019 13:50	03/12/2019 14:32	03/12/2019 19:53	5,33	11	58,68	CHI
201912260893	CAMPO ALEGRE DE GOIAS	02250424	CAMPO ALEGRE DE GOIAS	03/12/2019 14:32	04/12/2019 13:50	03/12/2019 19:54	03/12/2019 20:07	0,22	103	22,20	CHI
201912260893	IPAMERI	02250424	CAMPO ALEGRE DE GOIAS	03/12/2019 14:32	04/12/2019 13:50	03/12/2019 19:54	03/12/2019 20:07	0,22	29	6,25	CHI
201912260893	CAMPO ALEGRE DE GOIAS	IP13231410	CAMPO ALEGRE DE GOIAS	03/12/2019 14:32	04/12/2019 13:50	03/12/2019 14:32	03/12/2019 22:03	7,51	89	668,34	CHI
201912260893	IPAMERI	IP13231410	CAMPO ALEGRE DE GOIAS	03/12/2019 14:32	04/12/2019 13:50	03/12/2019 14:32	03/12/2019 22:03	7,51	62	465,59	CHI
201912260893	CAMPO ALEGRE DE GOIAS	CM13166769	CAMPO ALEGRE DE GOIAS	03/12/2019 14:32	04/12/2019 13:50	03/12/2019 19:54	04/12/2019 13:50	17,92	175	3136,44	CHI
201912260893	CATALAO	CM13166769	CAMPO ALEGRE DE GOIAS	03/12/2019 14:32	04/12/2019 13:50	03/12/2019 19:54	04/12/2019 13:50	17,92	21	376,37	CHI
201912260893	DISTRITO FEDERAL	CM13166769	CAMPO ALEGRE DE GOIAS	03/12/2019 14:32	04/12/2019 13:50	03/12/2019 19:54	04/12/2019 13:50	17,92	1	17,92	CHI
201912260893	IPAMERI	CM13166769	CAMPO ALEGRE DE GOIAS	03/12/2019 14:32	04/12/2019 13:50	03/12/2019 19:54	04/12/2019 13:50	17,92	11	197,15	CHI
201912260906	FLORES DE GOIAS	25901	ITIQUIRA	03/12/2019 14:56	03/12/2019 18:59	03/12/2019 14:57	03/12/2019 15:02	0,08	3	0,23	CHI
201912260906	FORMOSA	25901	ITIQUIRA	03/12/2019 14:56	03/12/2019 18:59	03/12/2019 14:57	03/12/2019 15:02	0,08	259	20,14	CHI
201912260906	FORMOSA	28201	ITIQUIRA	03/12/2019 14:56	03/12/2019 18:59	03/12/2019 14:57	03/12/2019 15:02	0,08	701	54,52	CHI
201912260906	FORMOSA	03740454	ITIQUIRA	03/12/2019 14:56	03/12/2019 18:59	03/12/2019 14:57	03/12/2019 15:02	0,08	912	70,93	CHI
201912260906	SAO JOAO D ALIANCA	25901	ITIQUIRA	03/12/2019 14:56	03/12/2019 18:59	03/12/2019 14:57	03/12/2019 15:02	0,08	228	17,73	CHI
201912260906	VILA BOA	25901	ITIQUIRA	03/12/2019 14:56	03/12/2019 18:59	03/12/2019 14:57	03/12/2019 15:02	0,08	4	0,31	CHI
201912260906	VILA BOA	03740454	ITIQUIRA	03/12/2019 14:56	03/12/2019 18:59	03/12/2019 14:57	03/12/2019 15:02	0,08	22	1,71	CHI
201912260906	FORMOSA	03740454	ITIQUIRA	03/12/2019 14:56	03/12/2019 18:59	03/12/2019 14:57	03/12/2019 17:02	2,08	38	78,89	CHI
201912260906	FORMOSA	FA13262132	ITIQUIRA	03/12/2019 14:56	03/12/2019 18:59	03/12/2019 17:02	03/12/2019 17:41	0,65	1	0,65	CHI
201912260906	CABECEIRAS	03740454	ITIQUIRA	03/12/2019 14:56	03/12/2019 18:59	03/12/2019 14:57	03/12/2019 17:59	3,03	40	121,14	CHI
201912260906	FORMOSA	03740454	ITIQUIRA	03/12/2019 14:56	03/12/2019 18:59	03/12/2019 14:57	03/12/2019 17:59	3,03	1061	3213,36	CHI
201912260906	FORMOSA	03740454	ITIQUIRA	03/12/2019 14:56	03/12/2019 18:59	03/12/2019 17:41	03/12/2019 18:04	0,39	38	14,75	CHI

201912260906	FORMOSA	03740454	ITIQUIRA	03/12/2019 14:56	03/12/2019 18:59	03/12/2019 14:57	03/12/2019 18:17	3,34	98	327,05	CHI
201912260906	FORMOSA	FA13262132	ITIQUIRA	03/12/2019 14:56	03/12/2019 18:59	03/12/2019 18:04	03/12/2019 18:17	0,22	1	0,22	CHI
201912260906	FORMOSA	03740454	ITIQUIRA	03/12/2019 14:56	03/12/2019 18:59	03/12/2019 14:57	03/12/2019 18:34	3,62	91	329,72	CHI
201912260906	FORMOSA	FA13062239	ITIQUIRA	03/12/2019 14:56	03/12/2019 18:59	03/12/2019 18:17	03/12/2019 18:34	0,29	1	0,29	CHI
201912260906	CABECEIRAS	FA13062239	ITIQUIRA	03/12/2019 14:56	03/12/2019 18:59	03/12/2019 18:42	03/12/2019 18:59	0,28	40	11,20	CHI
201912260906	FORMOSA	FA13062239	ITIQUIRA	03/12/2019 14:56	03/12/2019 18:59	03/12/2019 18:42	03/12/2019 18:59	0,28	1419	397,32	CHI

Plotagem das Ocorrências conforme a Especialização das Chuvas

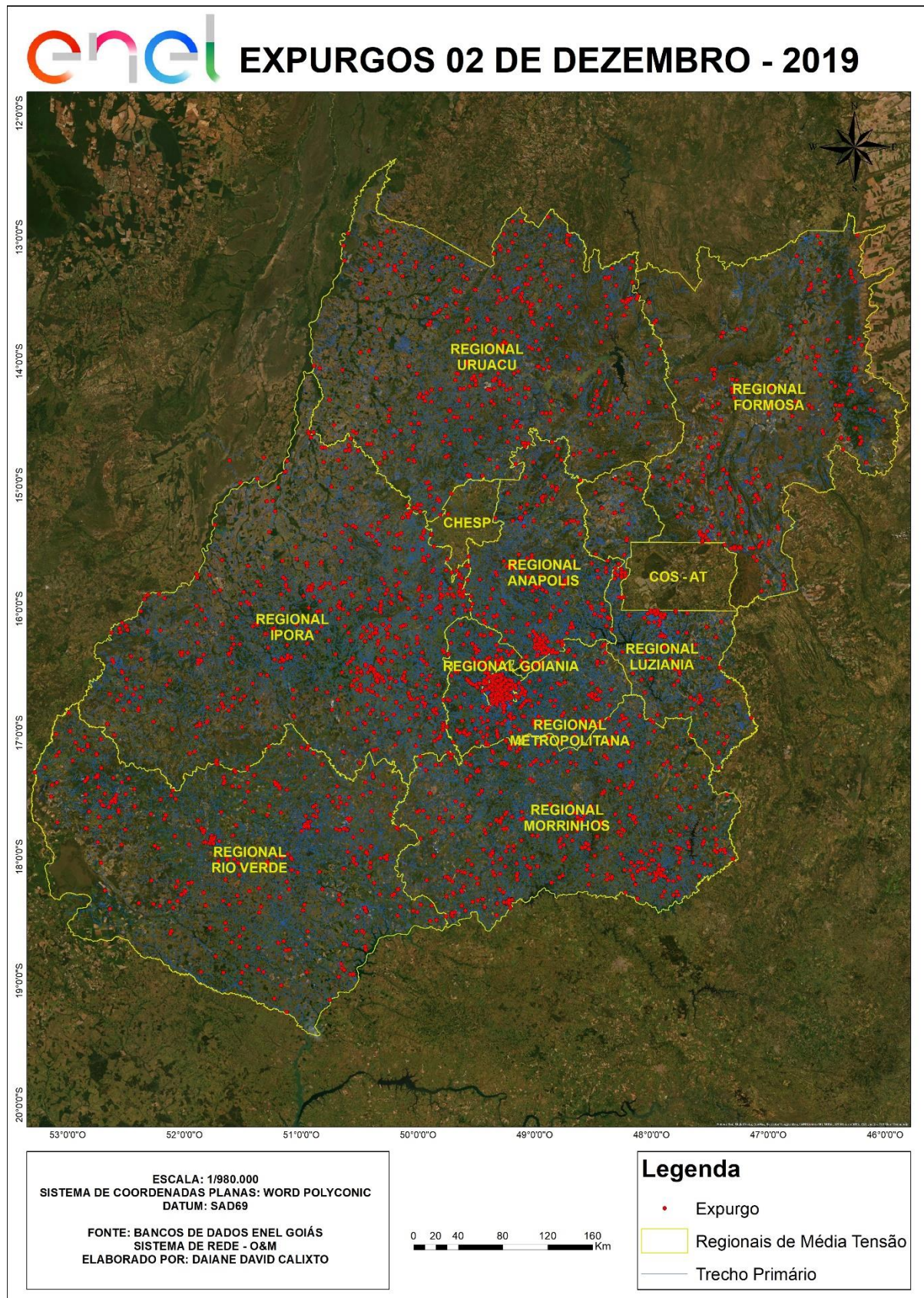

Diagramas Unifilares

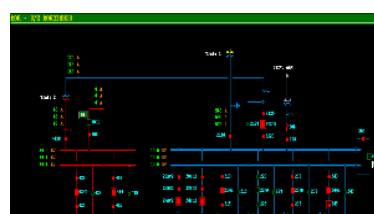
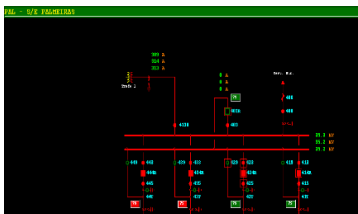
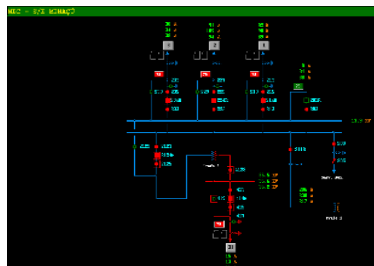
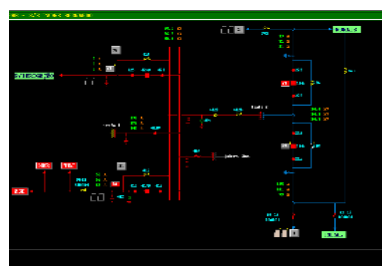
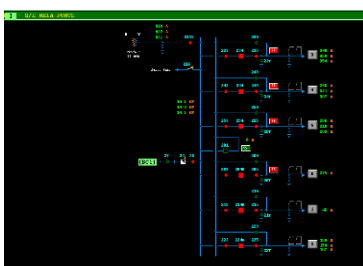
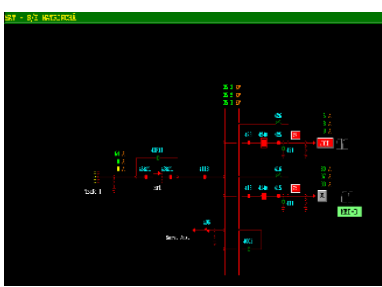
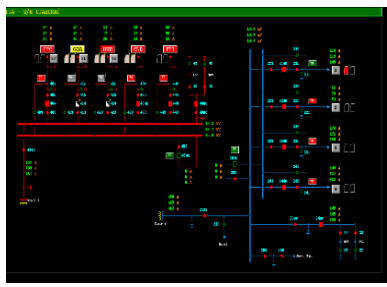
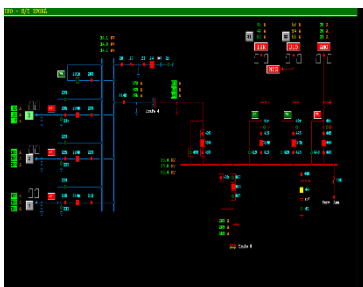
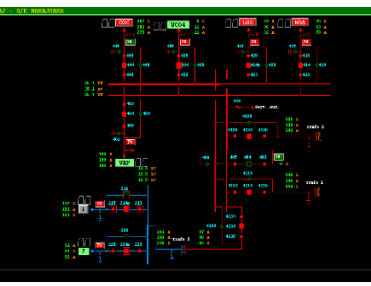
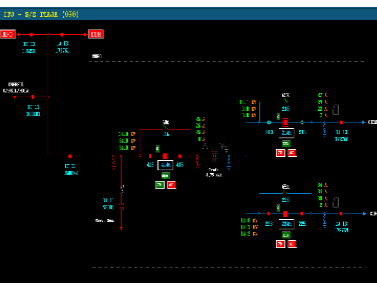
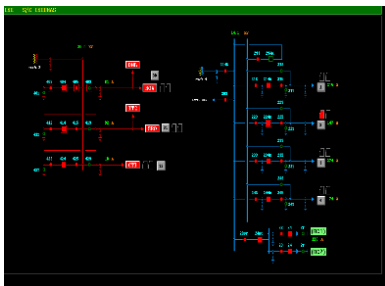
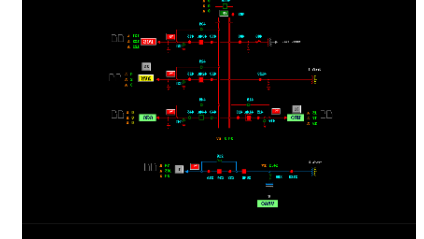
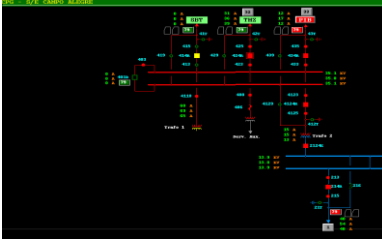
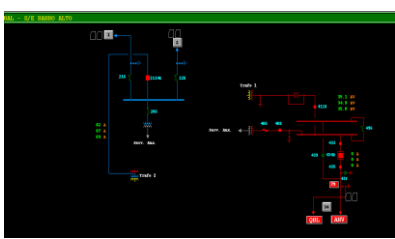
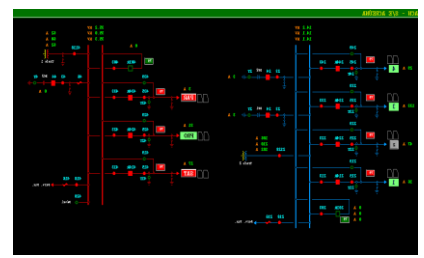
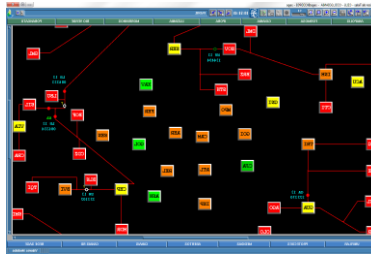
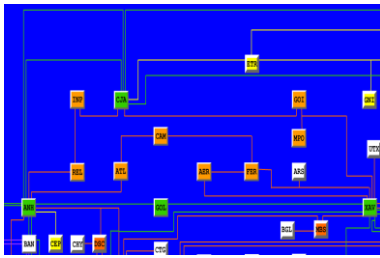

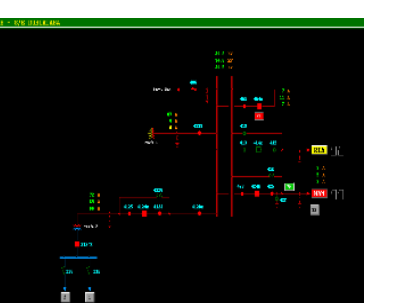
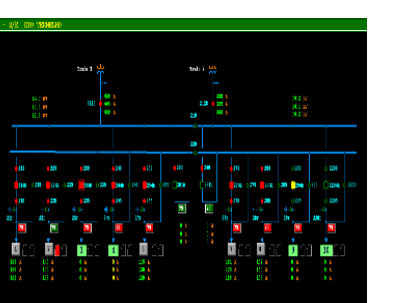
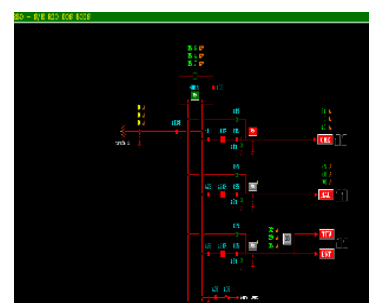
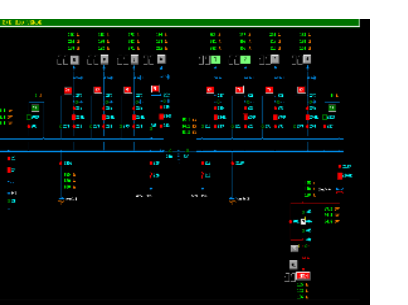
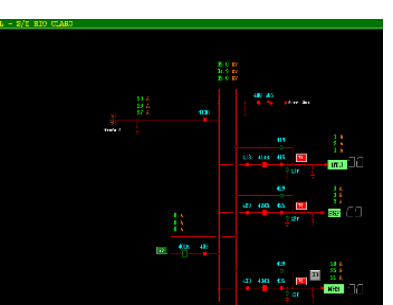
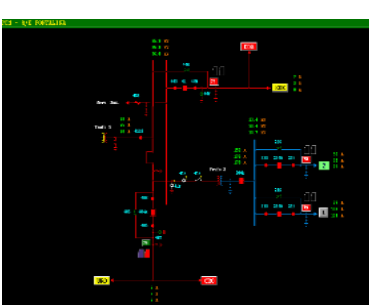
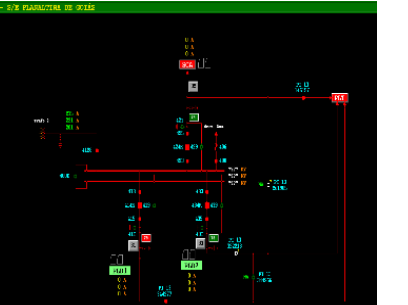
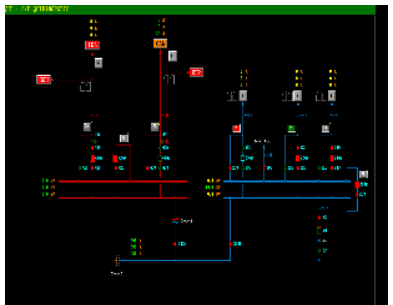
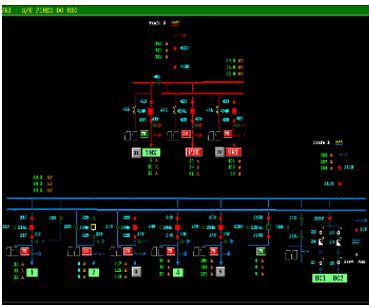
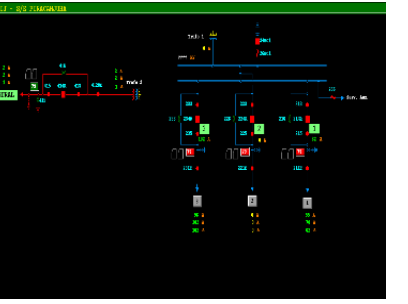
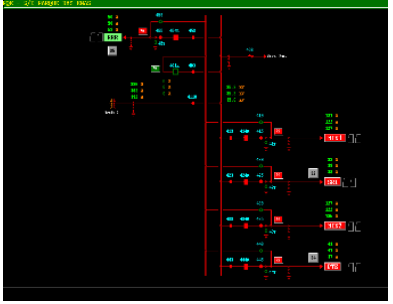
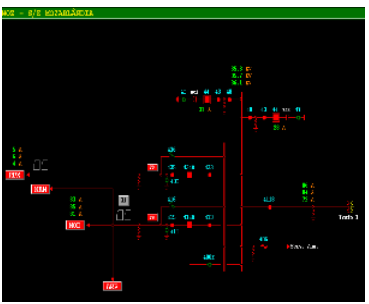
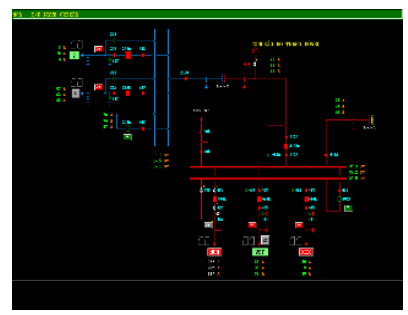
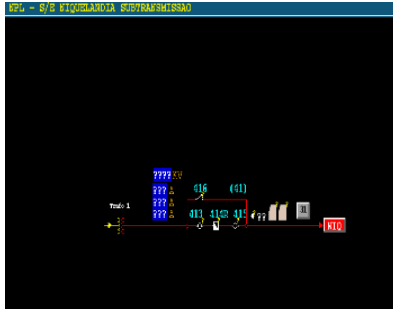

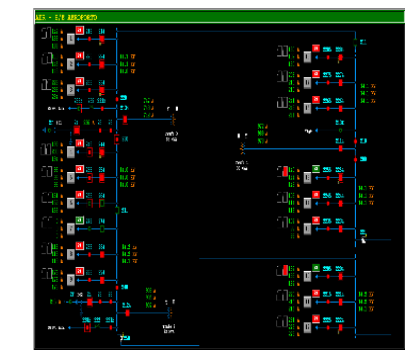
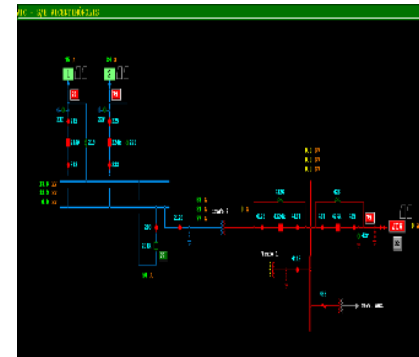
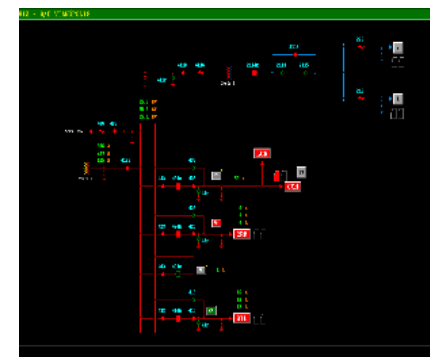
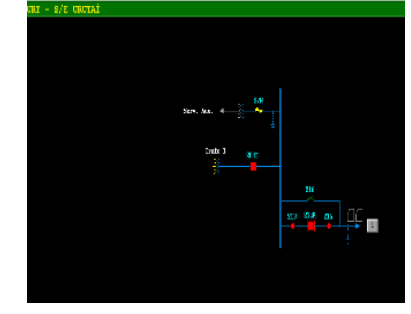
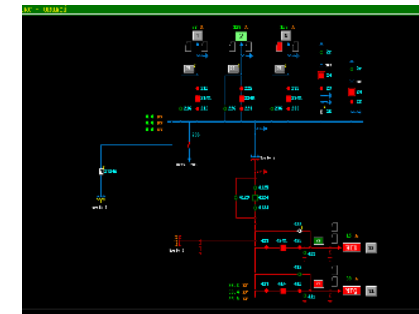
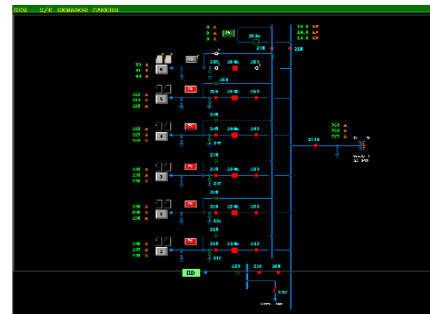
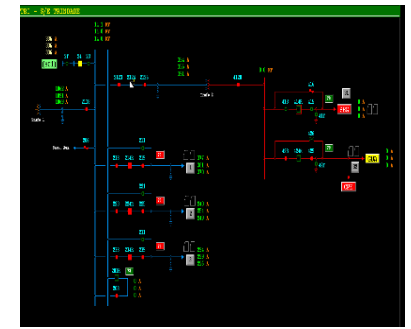
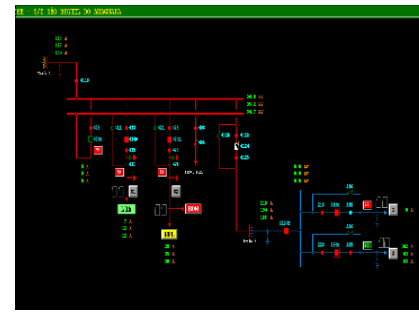
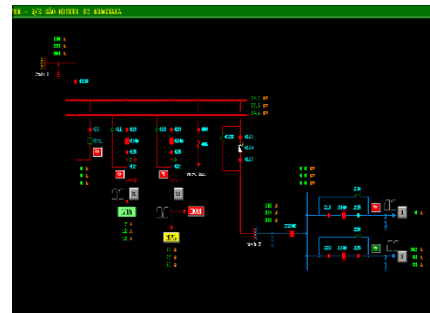
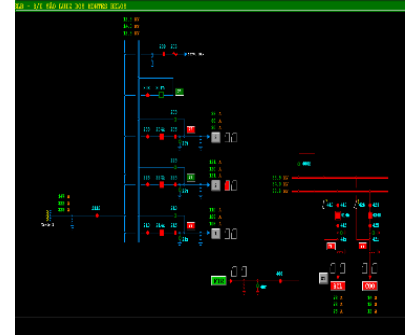
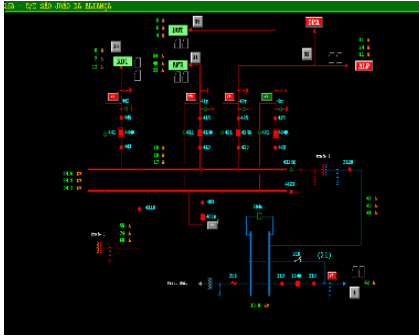
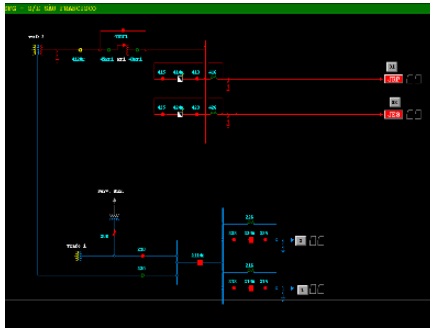
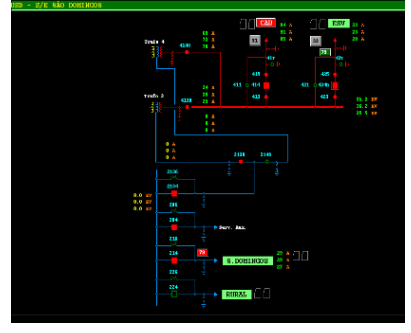
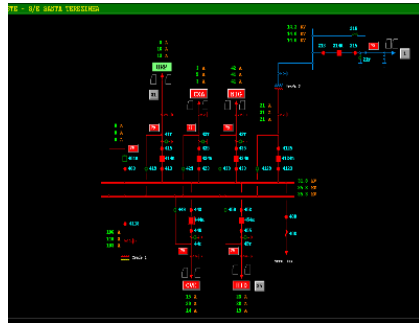
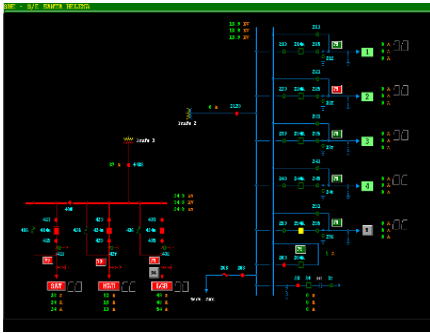

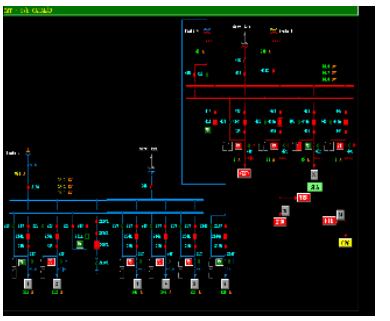
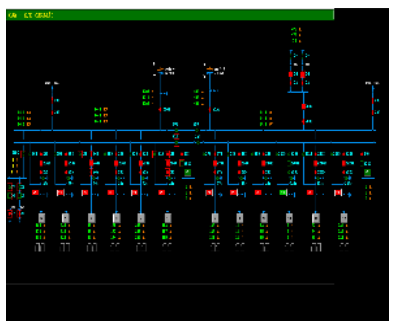
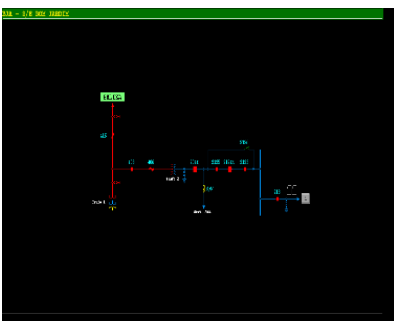
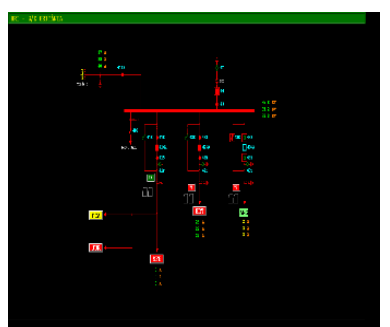
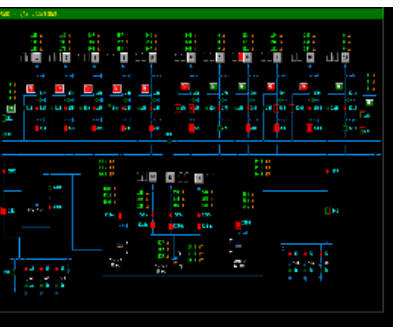
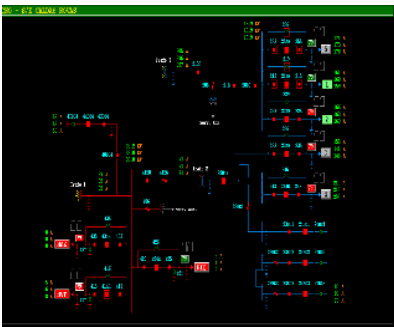
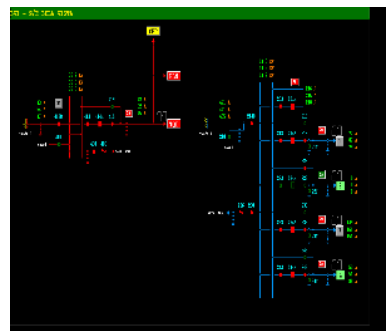
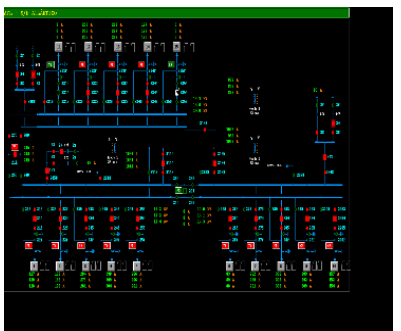
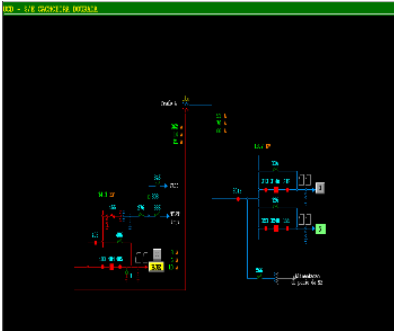
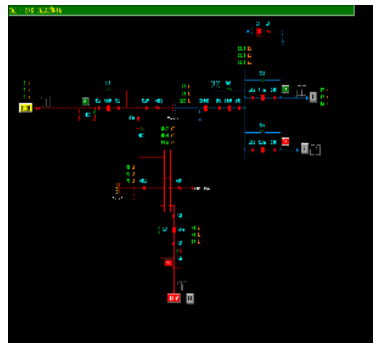
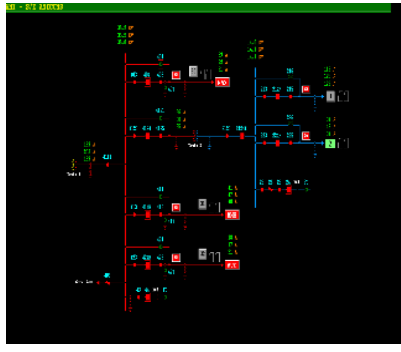
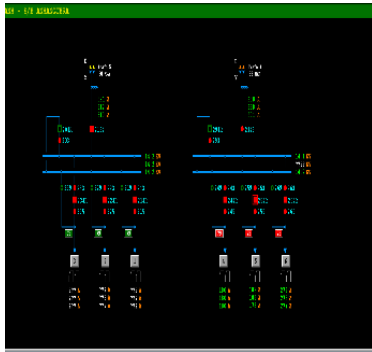
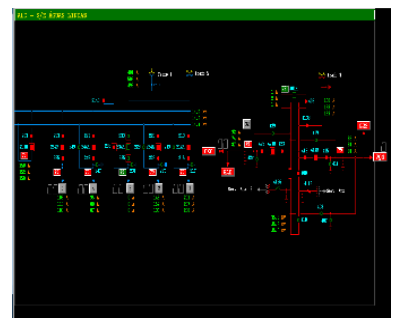
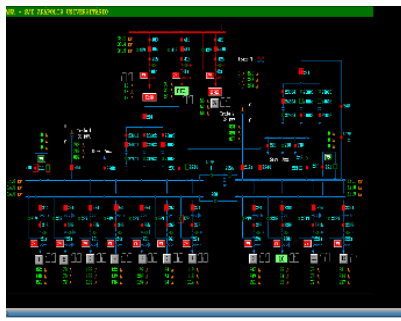
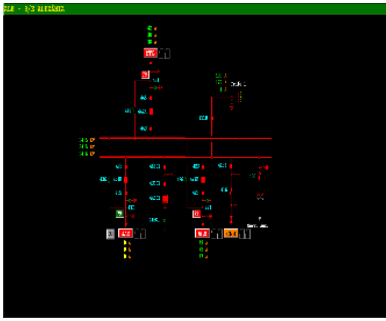

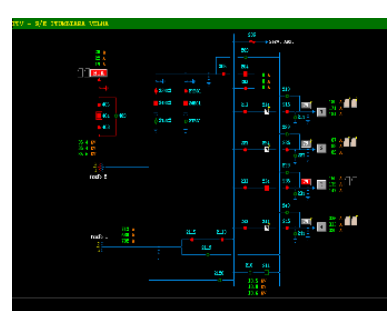
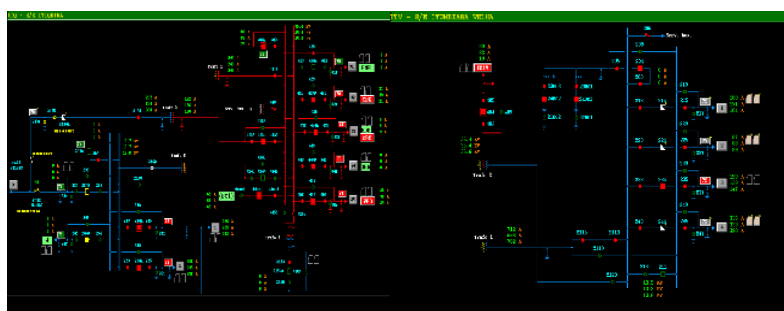
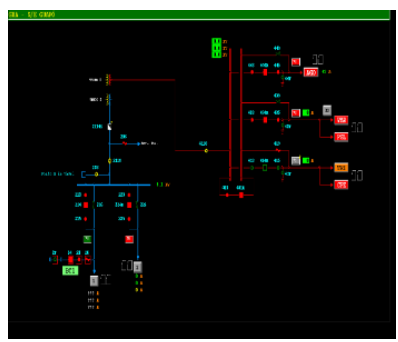
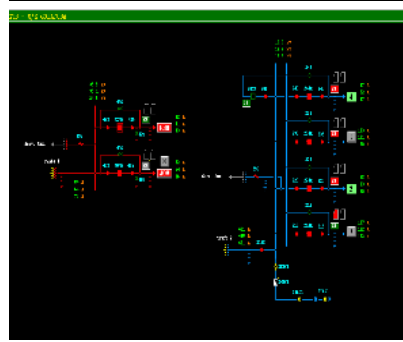
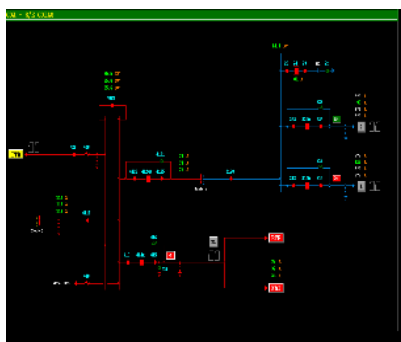
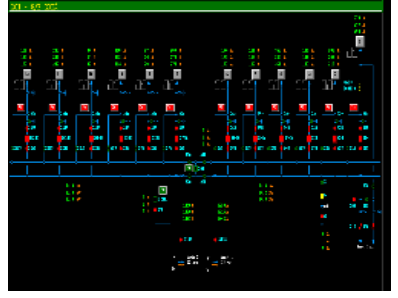
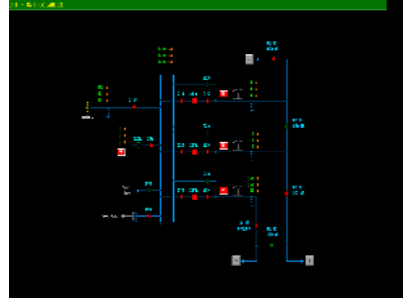
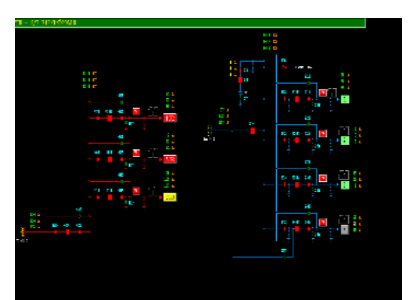
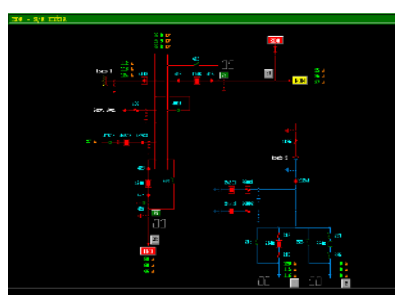
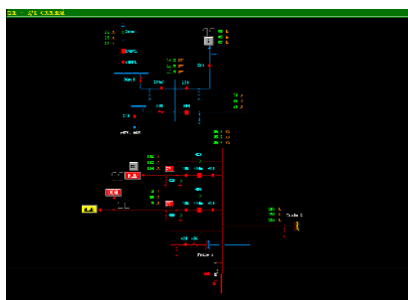
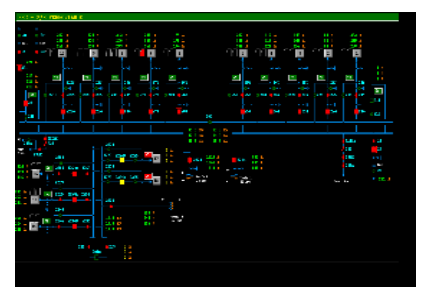
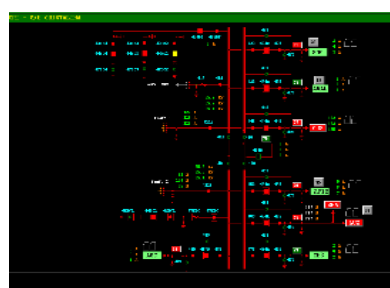
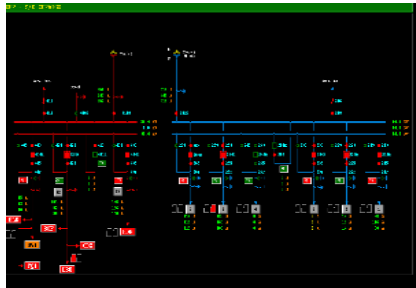
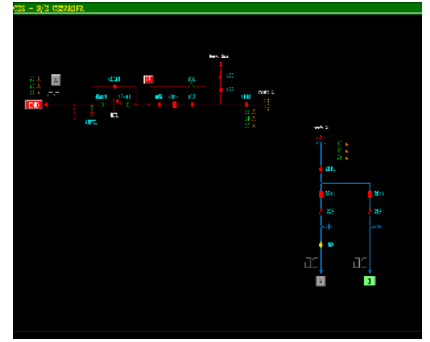
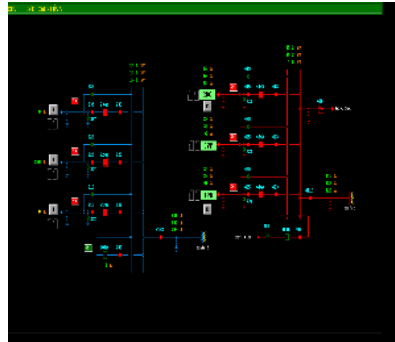
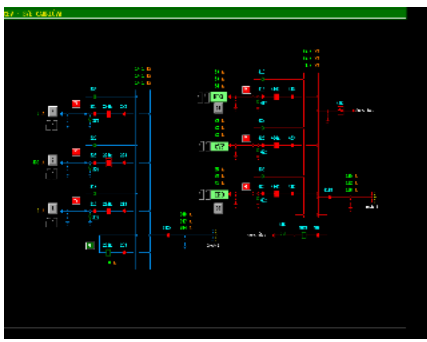

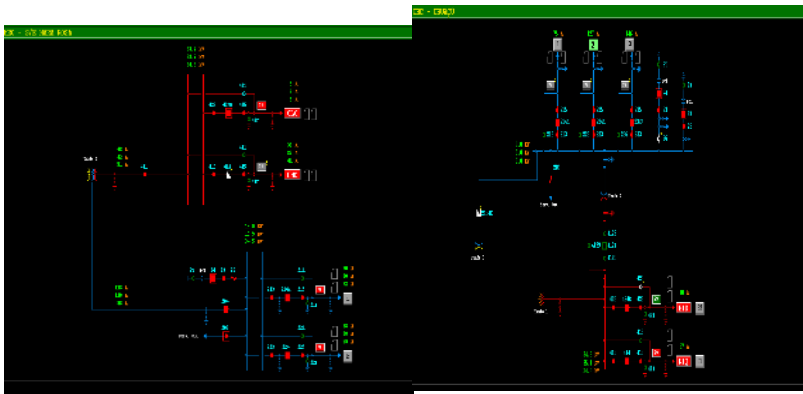
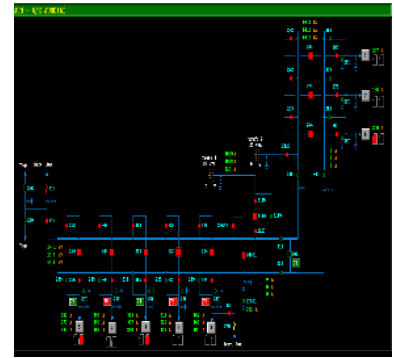
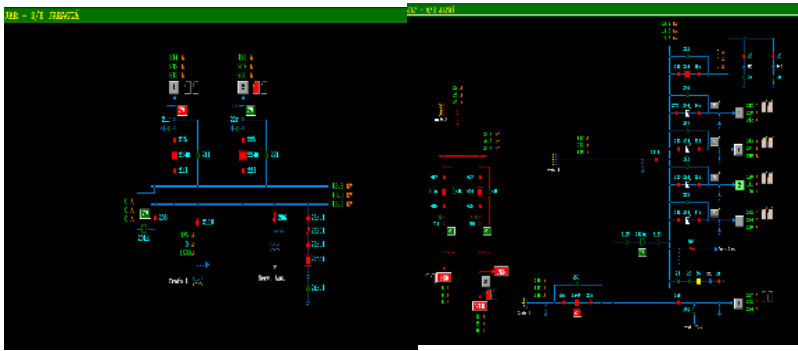

DEMAIS EVIDÊNCIAS

DADOS TÉCNICO - OPERACIONAIS ENEL GO

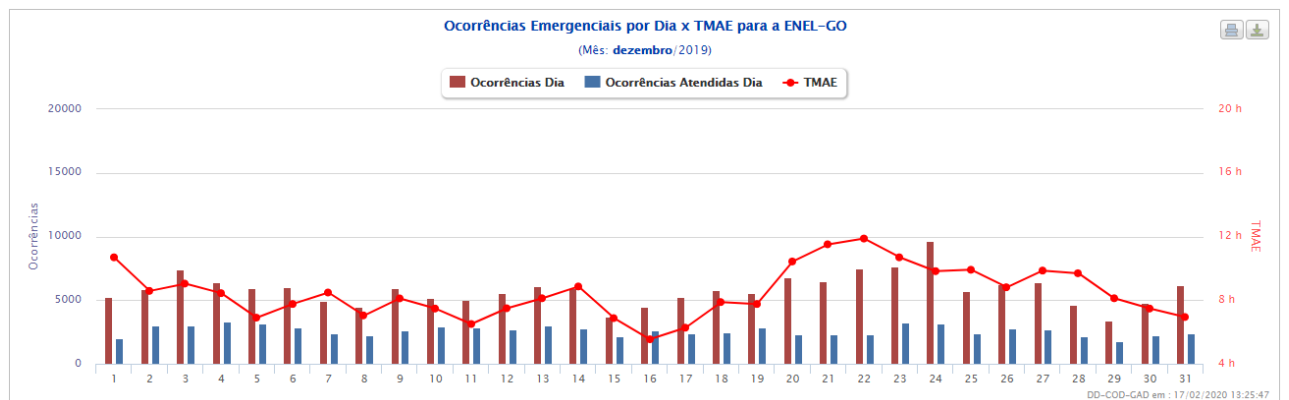
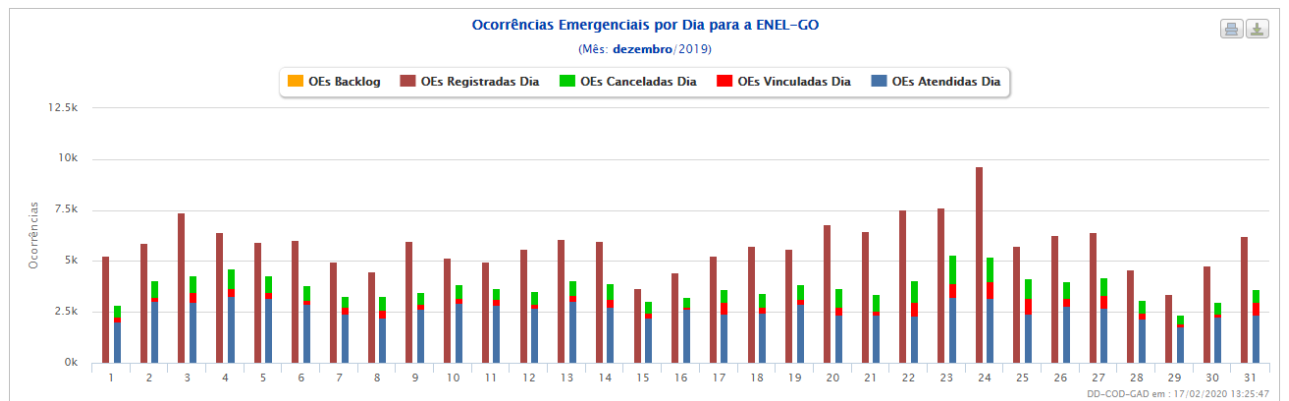
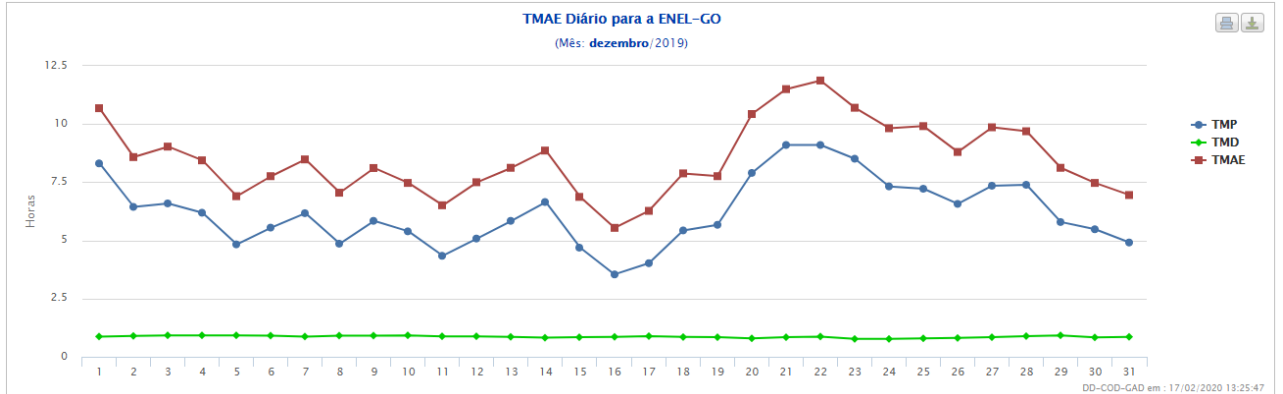

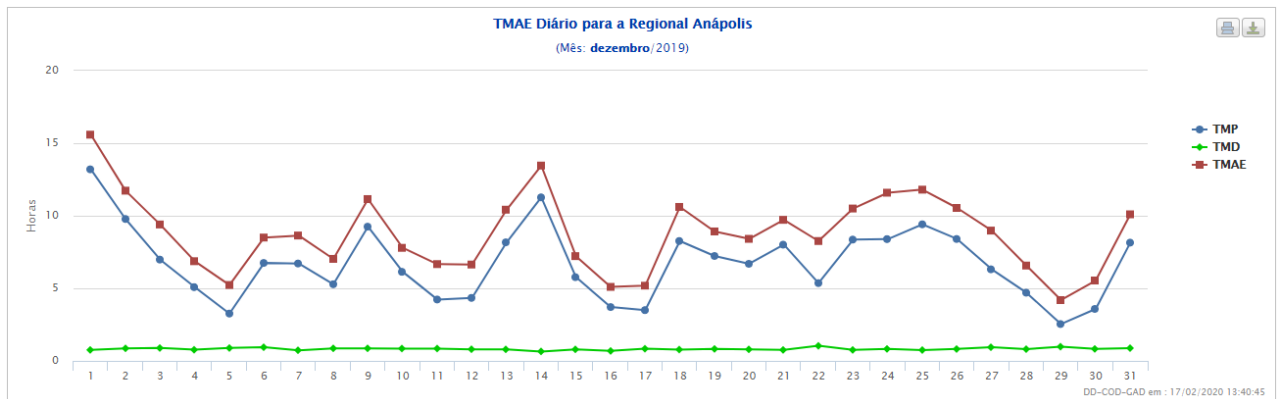
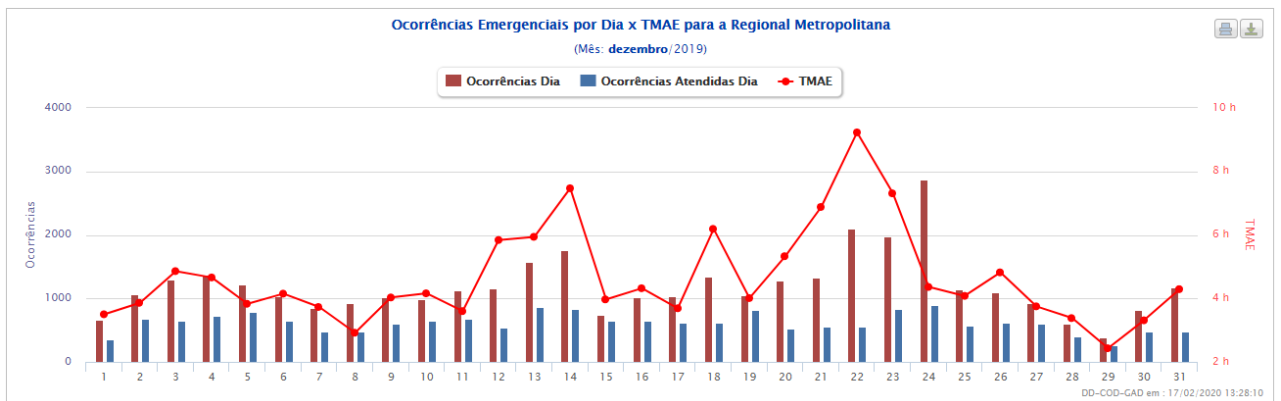
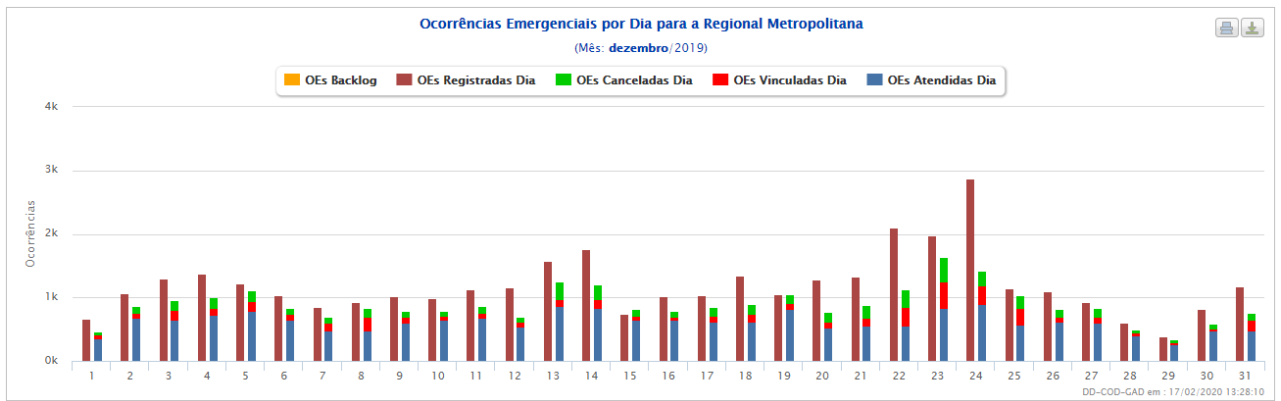
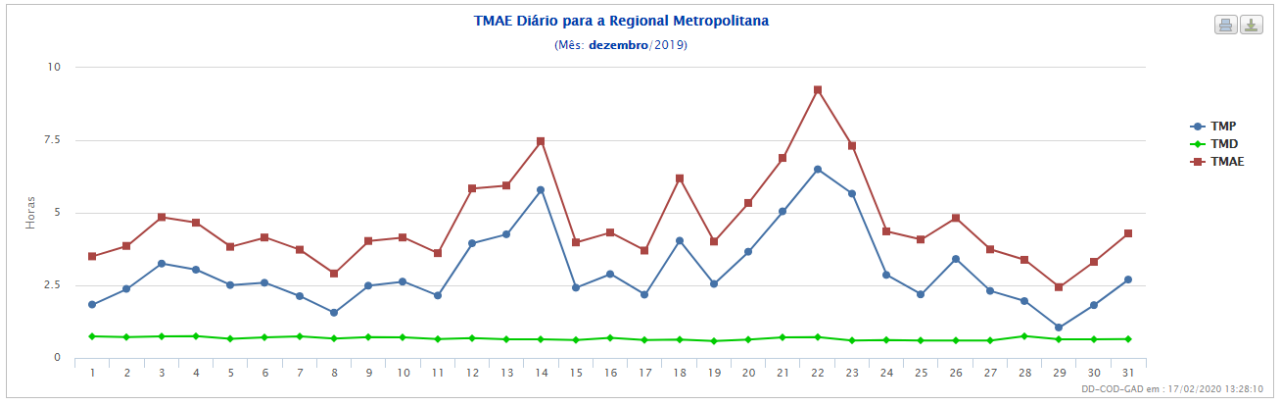

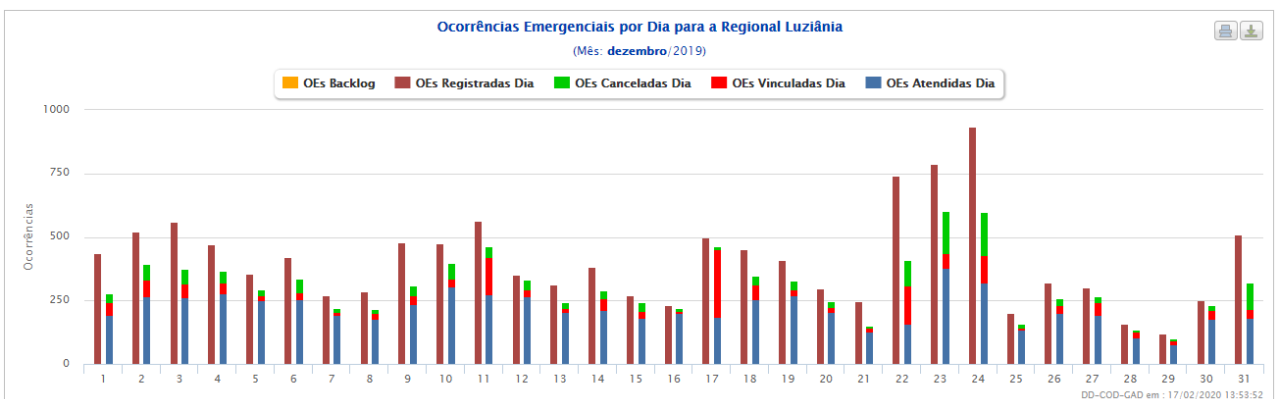
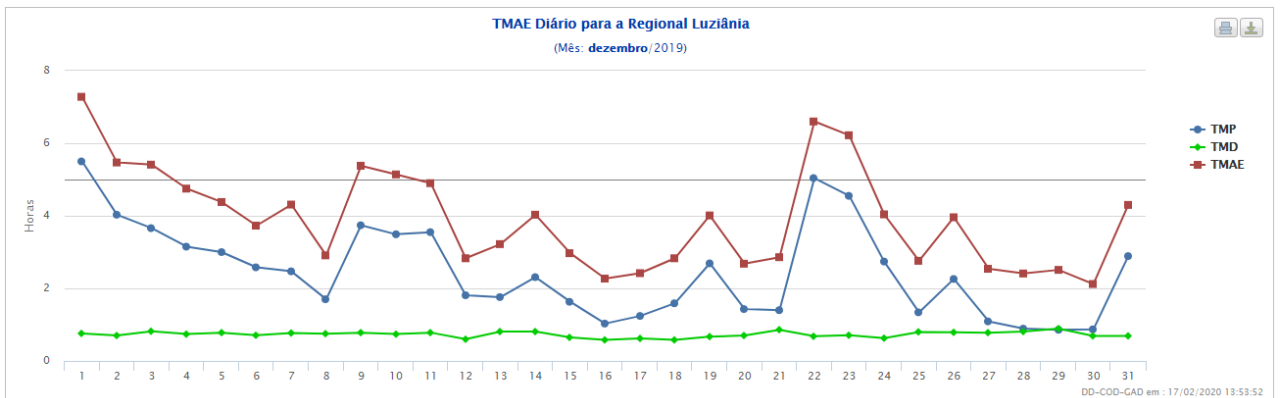
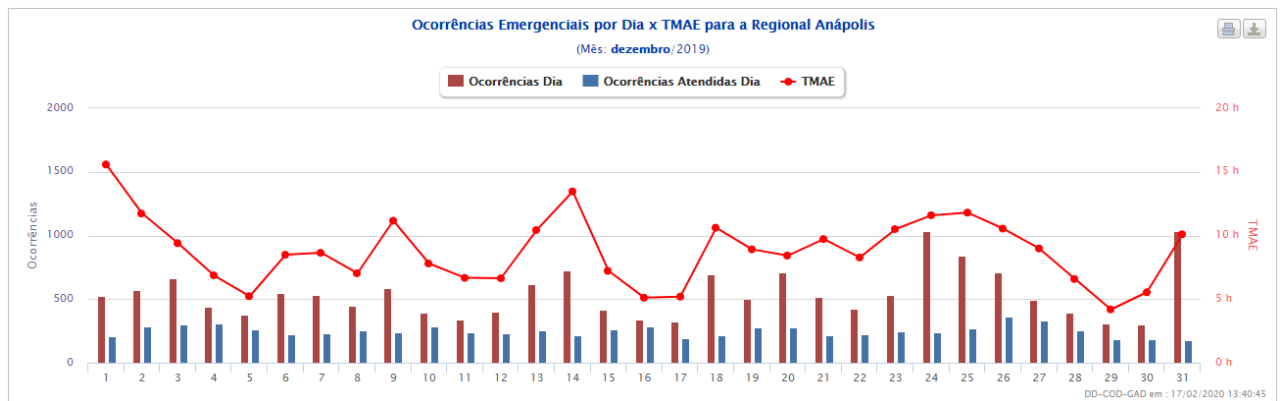
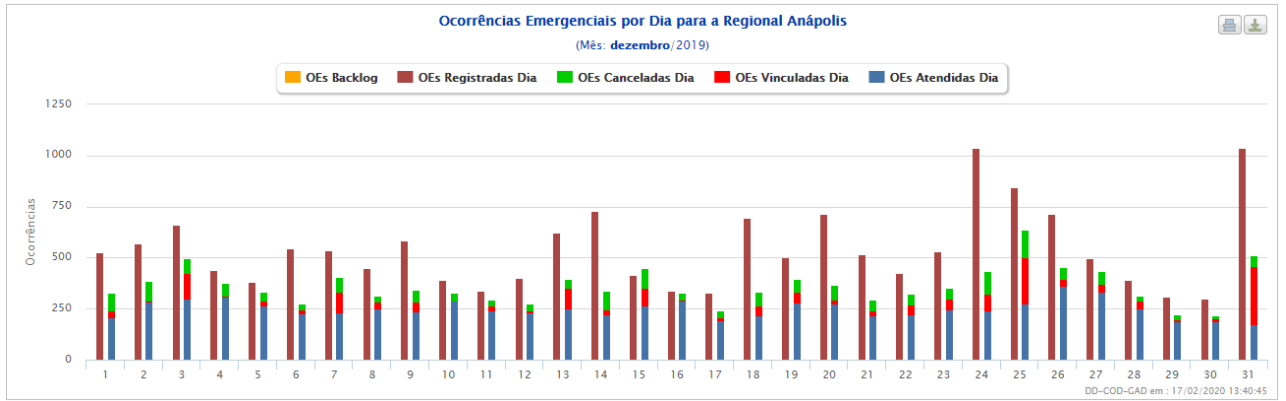

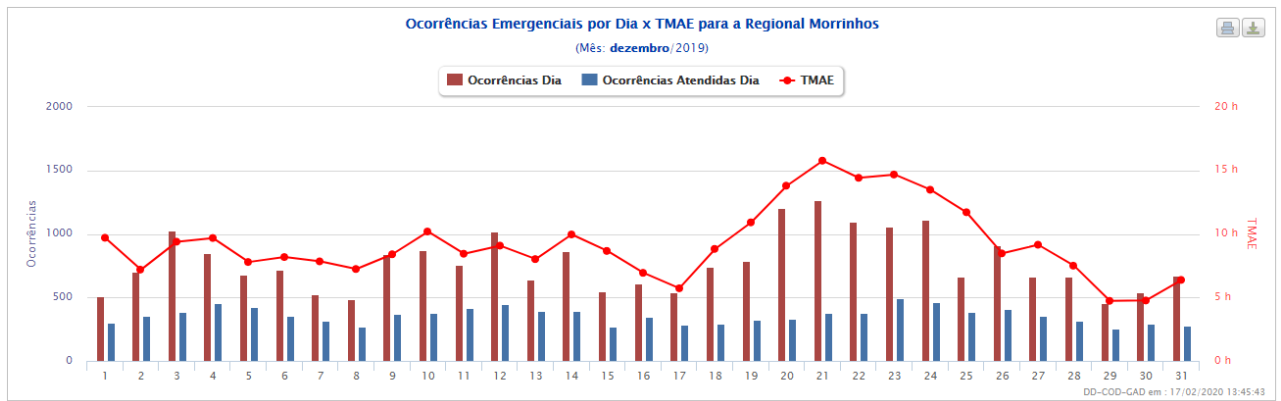
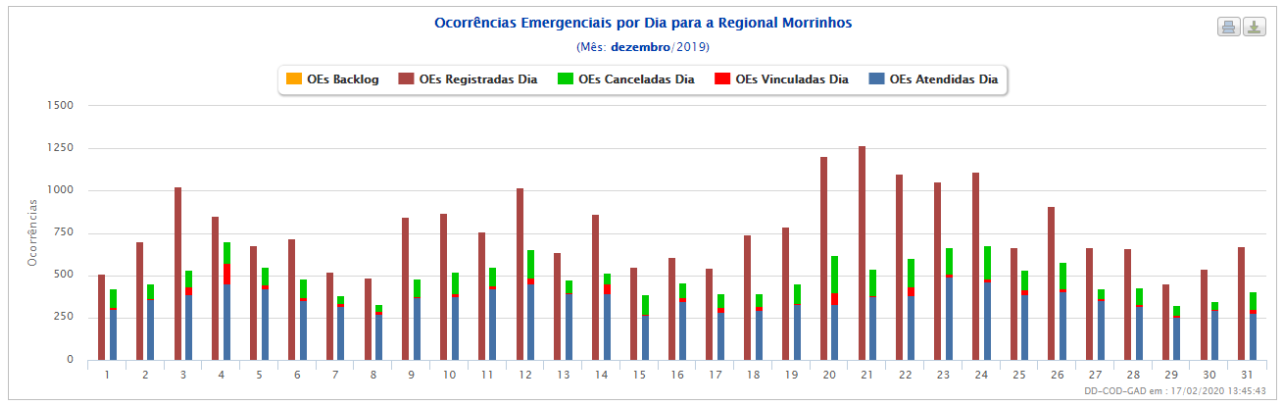
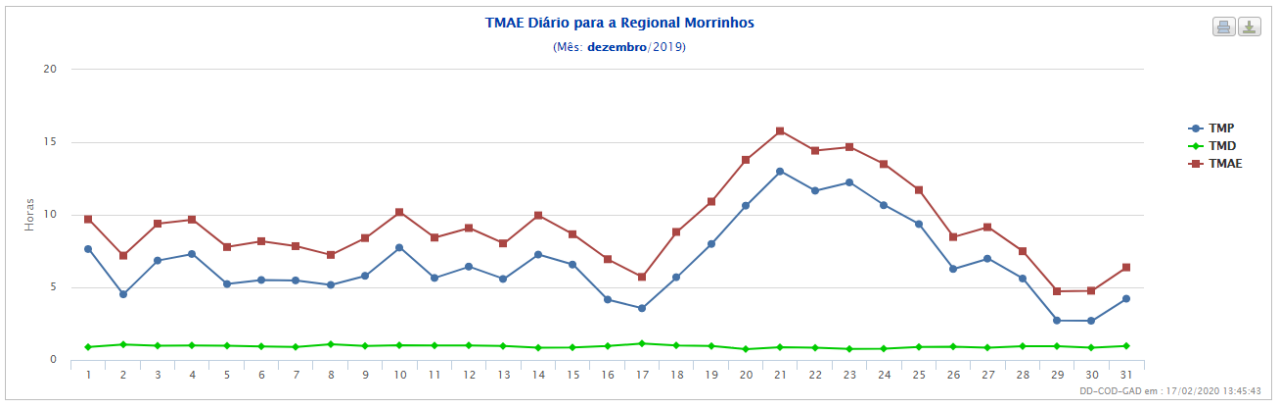
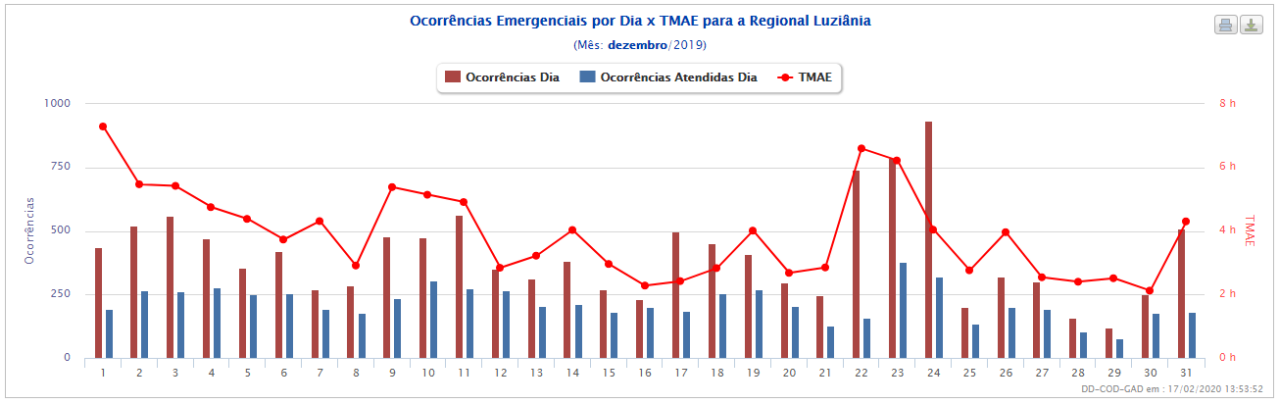

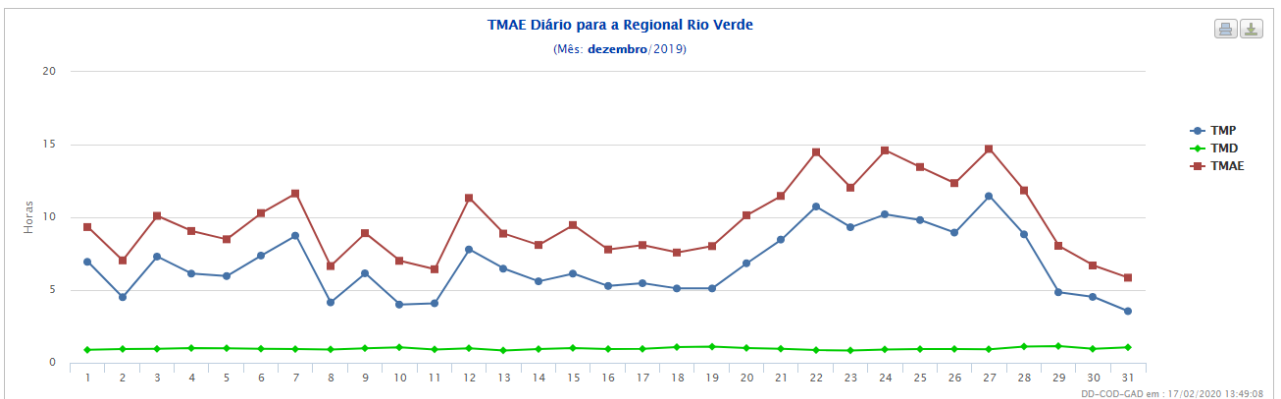
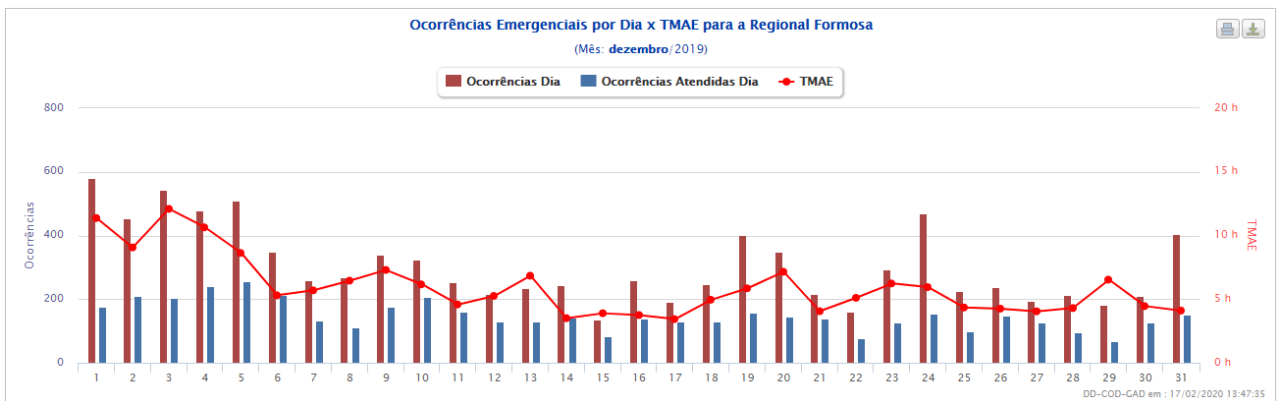
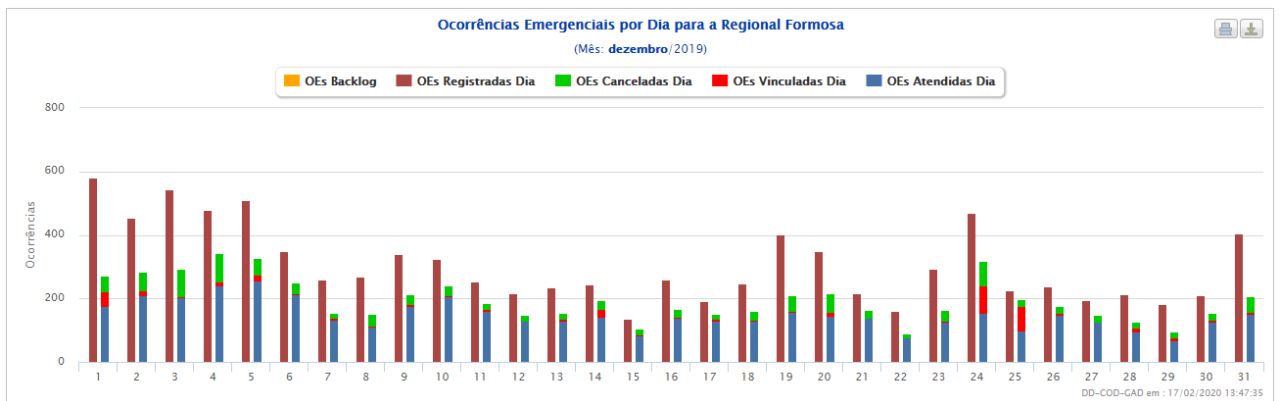
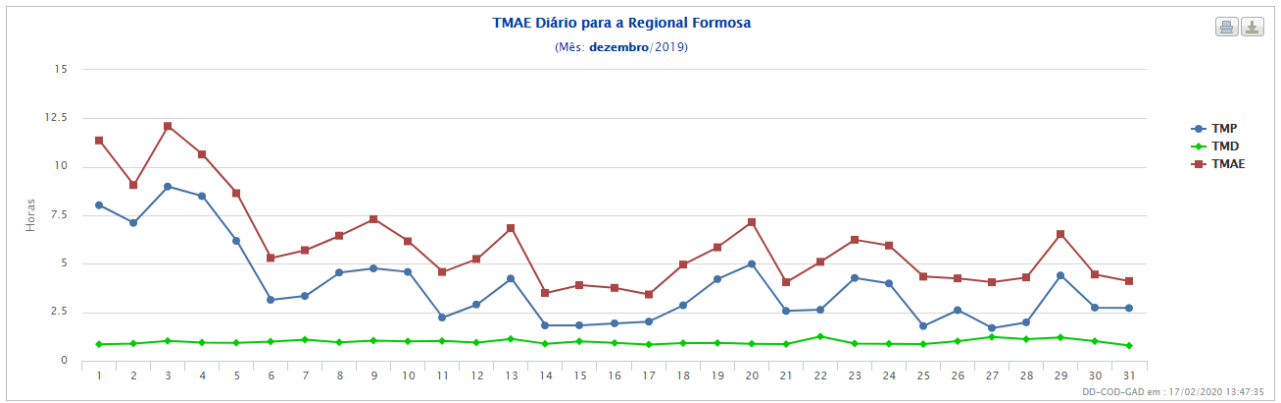

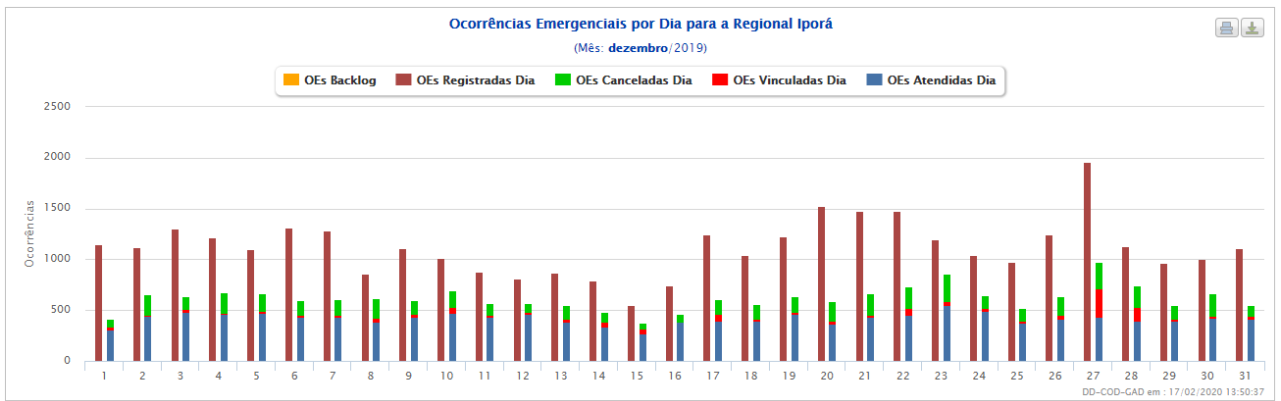
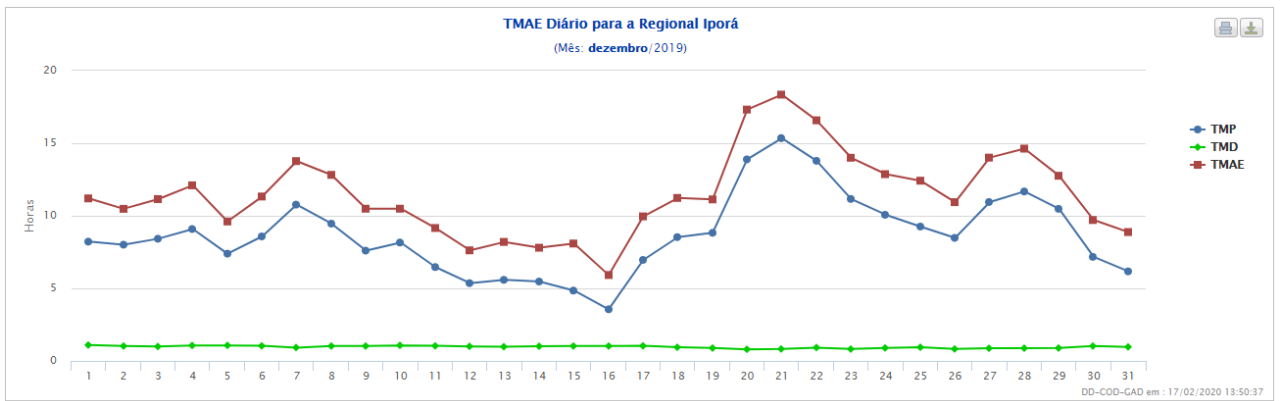
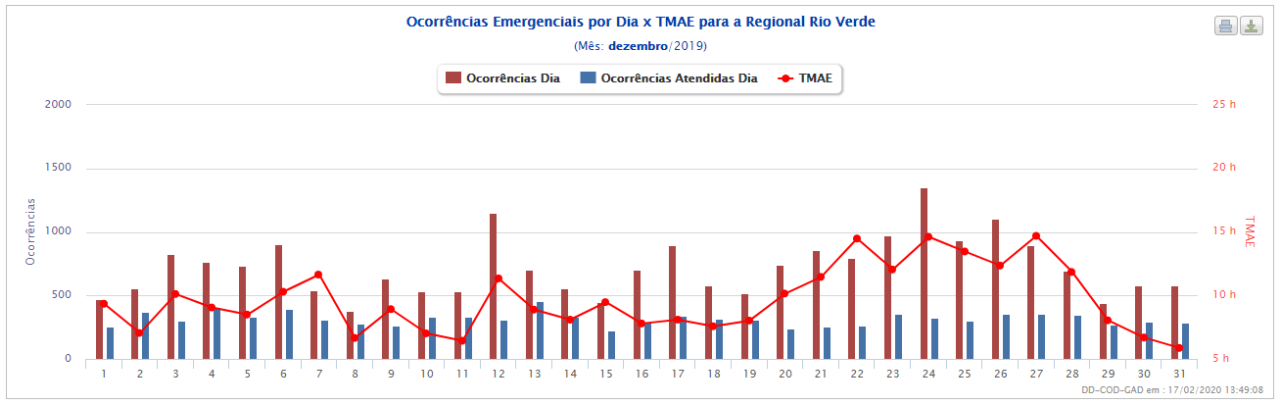
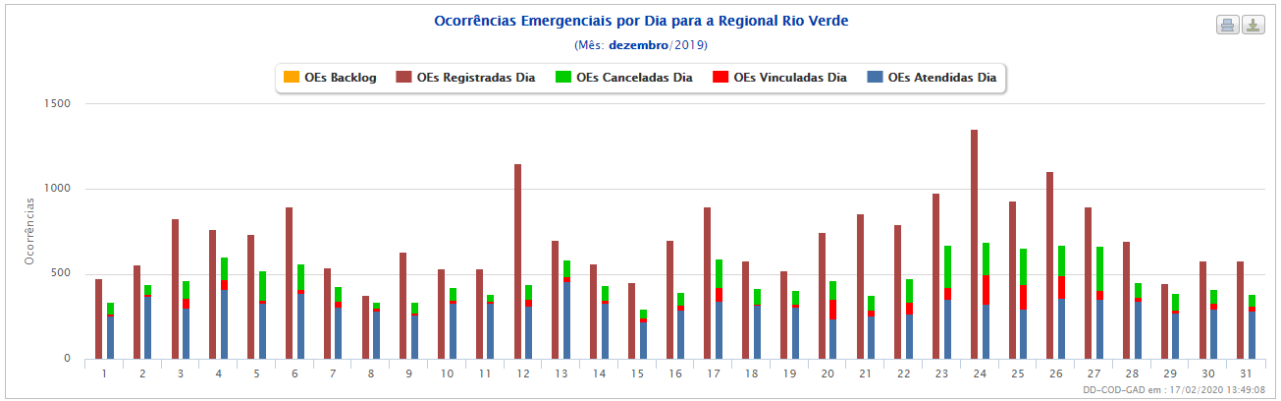

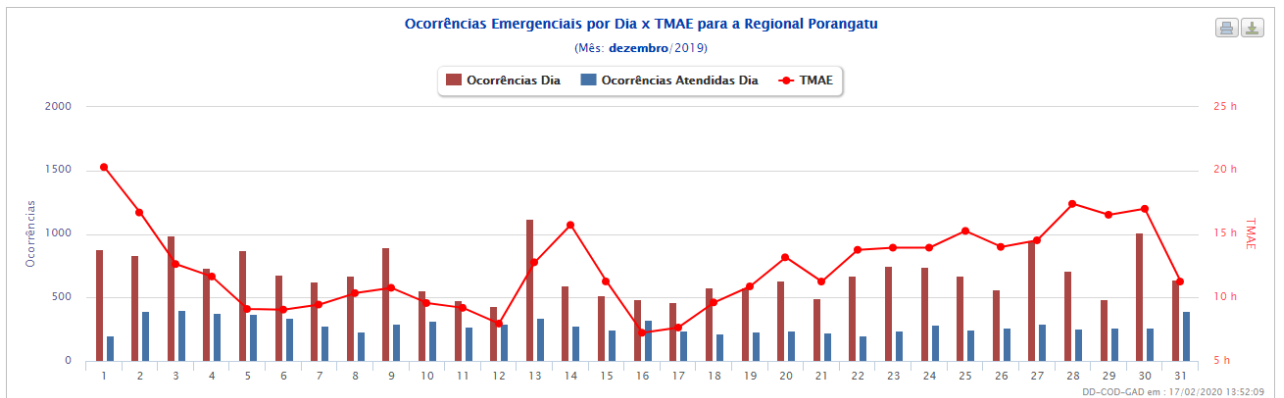
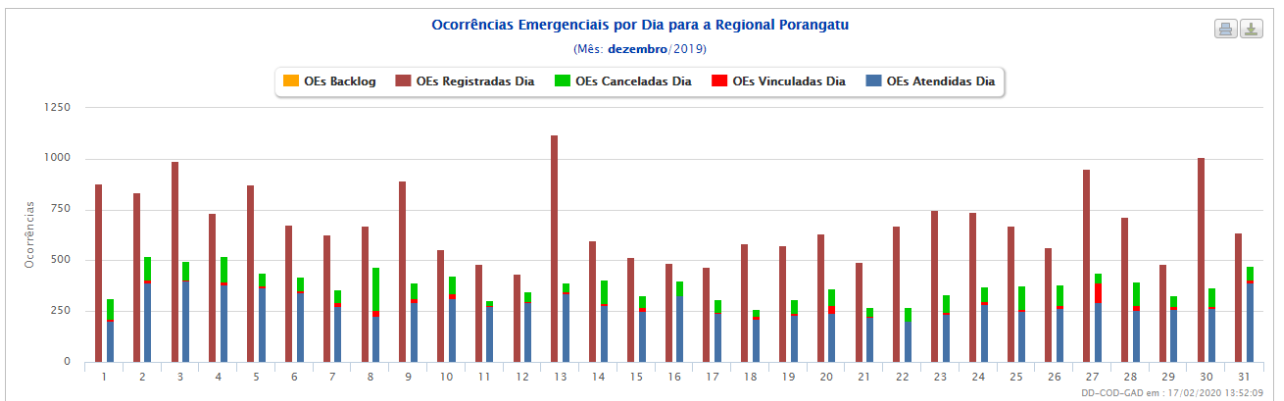
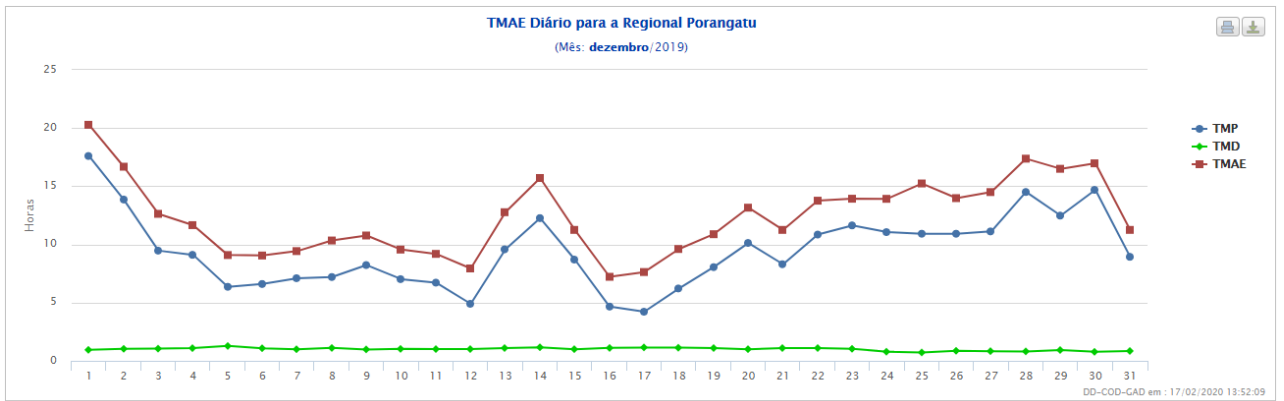
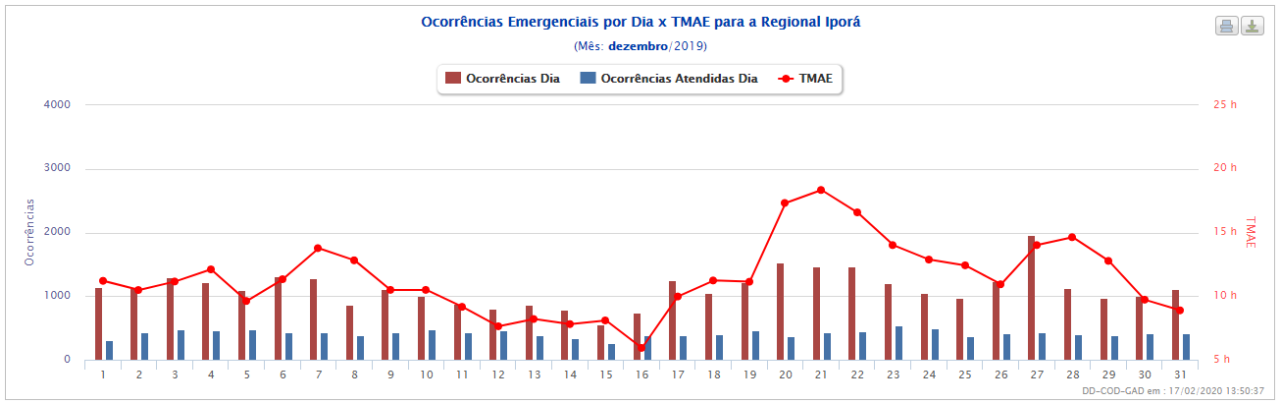

CLIMATEMPO

**Laudo Meteorológico de Evento Climático -
CELG Distribuição S.A. - 02 de dezembro
de 2019**

São Paulo, SP, Brasil

Janeiro de 2020

Sumário

1	ANÁLISE DE EVENTO METEOROLÓGICO	2
1.1	Descrição do Evento.....	2
1.2	Abrangência do Evento	6
2	CLASSIFICAÇÃO COBRADE	17
3	RESUMO DO EVENTO	18
4	REFERÊNCIAS.....	24

1 Análise de Evento Meteorológico

1.1 Descrição do Evento

Na figura a seguir é apresentada a área de concessão da CELG Distribuição, dividida em regiões, a serem analisadas neste relatório.



Figura 1 – Regiões de Goiás atendidas pela CELG Distribuição.

Uma massa de ar quente e úmido e a presença de uma frente fria favoreceram a formação de nuvens de tempestade sobre o estado de Goiás entre a manhã do dia 02 e a manhã do dia 04 de dezembro de 2019.

Nas Figuras 2 e 3 são apresentadas as descargas atmosféricas nuvem-solo (raios) e nuvem-nuvem detectadas pelo sistema Earth Networks. Entre as 11h30 do dia 02 e 11h00 do dia 04 de dezembro foram registrados 28184 raios nuvem-solo e 41235 descargas nuvem-nuvem sobre a área da CELG Distribuição em Goiás.

Estações do Instituto Nacional de Meteorologia (INMET), representativas da área de concessão da CELG Distribuição Goiás, registraram chuva forte (segundo a American Meteorological Society - Sociedade Meteorológica Americana -, chuvas com taxa entre 2,5mm a 7,6 mm por hora são consideradas moderadas e aquelas com taxa superior a

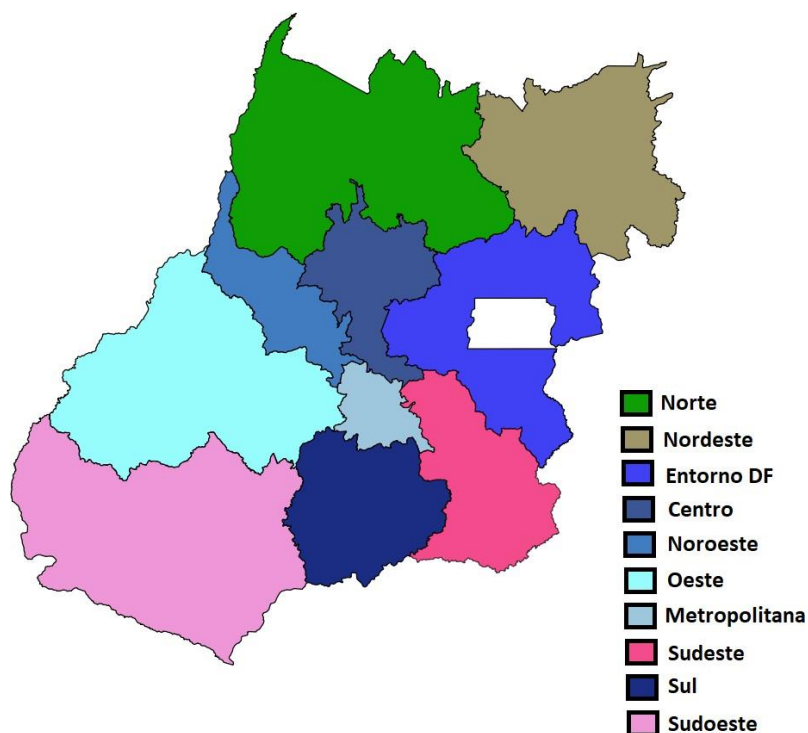
7,6 mm por hora são consideradas chuva forte). Na tabela 1 são apresentados os registros de acumulados horários superiores a 7,6 mm. A chuva acumulada em Itumbiara entre as 12h00 e 13h00 do dia 03 de dezembro corresponde a aproximadamente 14% da média climatológica para todo o mês de dezembro na região. Entre as 09h00 do dia 02 e as 09h00 do dia 04 foram acumulados 76,2 mm de chuva em Catalão, o que equivale a aproximadamente 28% da média do mês de dezembro na região.

Na tabela 2 são apresentadas as rajadas de vento maiores ou iguais a 50 km/h registradas pelo INMET entre a manhã do dia 02 e a manhã do dia 04 de dezembro de 2019. Pela escala Beaufort, ventos entre 50 e 61 km/h são classificados como vento forte.



Figura 2 – Descargas atmosféricas nuvem-solo (em preto) detectadas pelo sistema Earth Networks entre 11h30 do dia 02 e 11h00 do dia 04 de dezembro de 2019 sobre a área de concessão da CELG Distribuição.

Tabela 1 – Acumulado horário de chuva registrada pelo INMET.

Estação	Horário	Precipitação (mm)
Aragarças	Entre 21h e 22h do dia 3/12/2019	10.8
Caiapônia	Entre 19h e 20h do dia 2/12/2019	11.8
Catalão	Entre 16h e 17h do dia 2/12/2019	12.4
Catalão	Entre 14h e 15h do dia 3/12/2019	29.8
Goianésia	Entre 13h e 14h do dia 3/12/2019	33.0
Iporá	Entre 1h e 2h do dia 4/12/2019	12.0
Itumbiara	Entre 12h e 13h do dia 3/12/2019	36.0
Jataí	Entre 17h e 18h do dia 3/12/2019	12.4
Luziânia	Entre 11h e 12h do dia 3/12/2019	10.2

Paraúna	Entre 2h e 3h do dia 4/12/2019	8.6
São Simão	Entre 13h e 14h do dia 3/12/2019	16.2
São Simão	Entre 14h e 15h do dia 3/12/2019	8.2

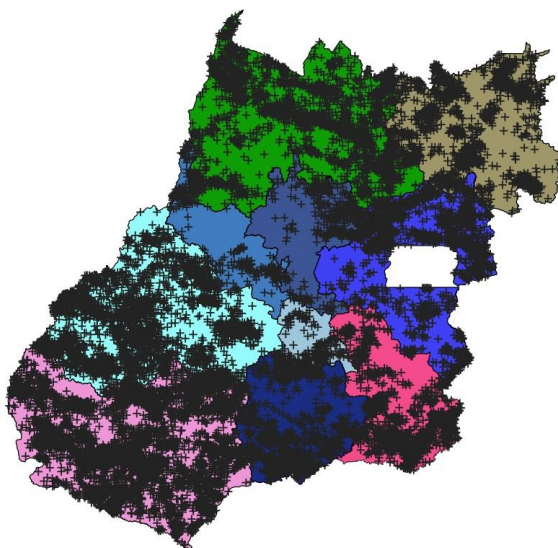
Tabela 2 – Rajadas de vento maiores ou iguais a 50 km/h registradas pelo INMET. Segundo a escala Beaufort, ventos entre 50 e 61 km/h são classificados como vento forte.

Estação	Horário	Rajada (km/h)
Caiapônia	Entre 14h e 15h do dia 2/12/2019	50.4
Caiapônia	Entre 15h e 16h do dia 2/12/2019	50.4
Monte Alegre de Goiás	Entre 14h e 15h do dia 3/12/2019	50.0
São Simão	Entre 13h e 14h do dia 3/12/2019	50.4



Figura 3 – Descargas atmosféricas nuvem-nuvem (em vermelho) detectadas pelo sistema Earth Networks entre 11h30 do dia 02 e 11h00 do dia 04 de dezembro de 2019 sobre a área de concessão da CELG Distribuição.

1.2 Abrangência do Evento

A seguir são apresentadas as imagens realçadas do satélite GOES-16 entre as 13h00 do dia 02 e 09h00 do dia 04 de dezembro de 2019. Os tons em vermelho e preto indicam a presença de nuvens de grande desenvolvimento vertical, geralmente associadas à ocorrência de tempo severo.

13h00 - 02 de dezembro de 2019

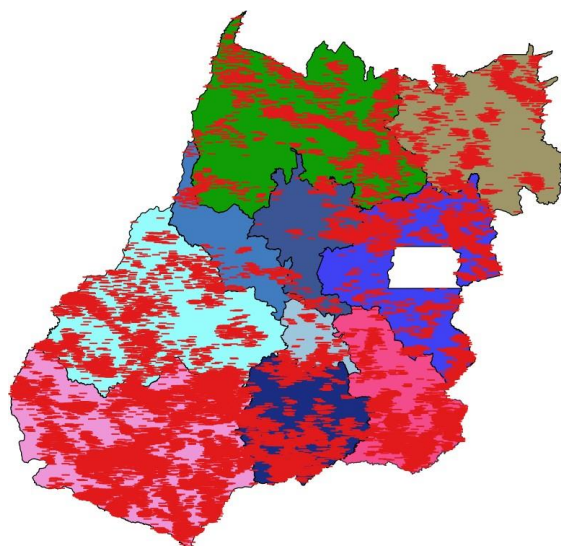

Figura 4 – Imagens realçadas do satélite GOES-16 das 13h00 do dia 02 de dezembro de 2019.
FONTE: Cptec/INPE.

15h00 - 02 de dezembro de 2019

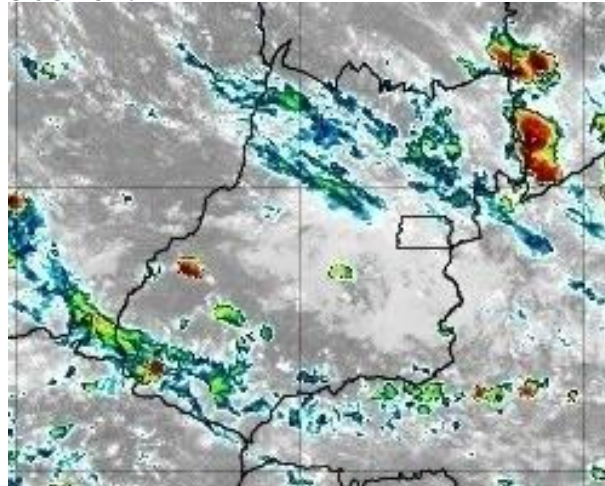

Figura 5 – Imagens realçadas do satélite GOES-16 das 15h00 do dia 02 de dezembro de 2019.
FONTE: Cptec/INPE.

17h00 - 02 de dezembro de 2019

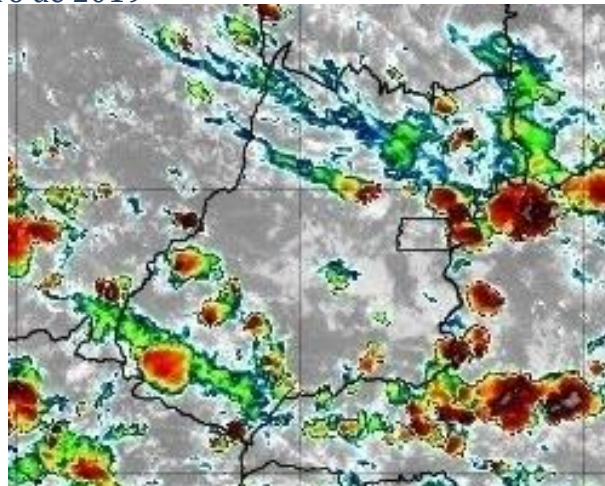

Figura 6 – Imagens realçadas do satélite GOES-16 das 17h00 do dia 02 de dezembro de 2019.
FONTE: Cptec/INPE.

19h00 - 02 de dezembro de 2019

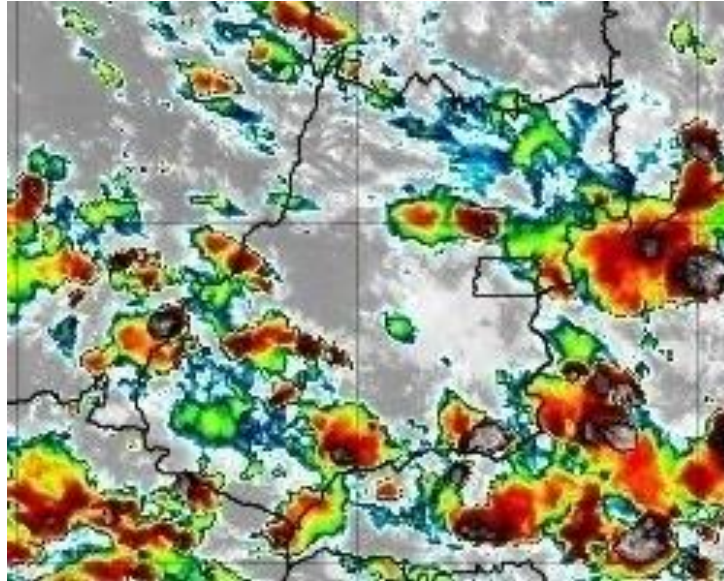

Figura 7 – Imagens realçadas do satélite GOES-16 das 19h00 do dia 02 de dezembro de 2019.
FONTE: Cptec/INPE.

21h00 - 02 de dezembro de 2019



Figura 8 – Imagens realçadas do satélite GOES-16 das 21h00 do dia 02 de dezembro de 2019. FONTE: Cptec/INPE.

23h00 - 02 de dezembro de 2019

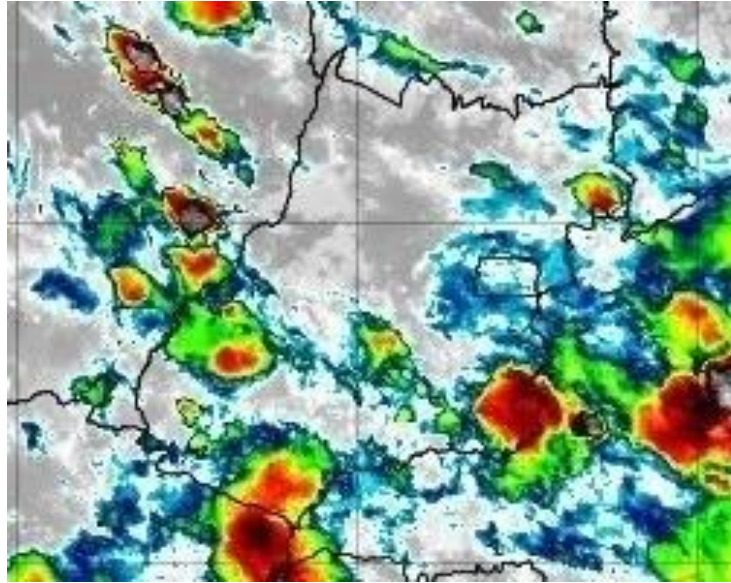

Figura 9 – Imagens realçadas do satélite GOES-16 das 23h00 do dia 02 de dezembro de 2019. FONTE: Cptec/INPE.

01h00 - 03 de dezembro de 2019

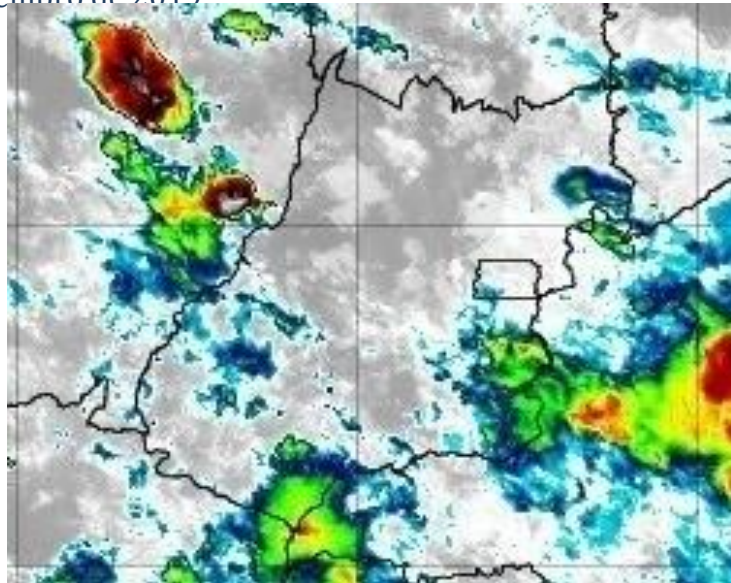

Figura 10 – Imagens realçadas do satélite GOES-16 das 01h00 do dia 03 de dezembro de 2019. FONTE: Cptec/INPE.

03h00 - 03 de dezembro de 2019

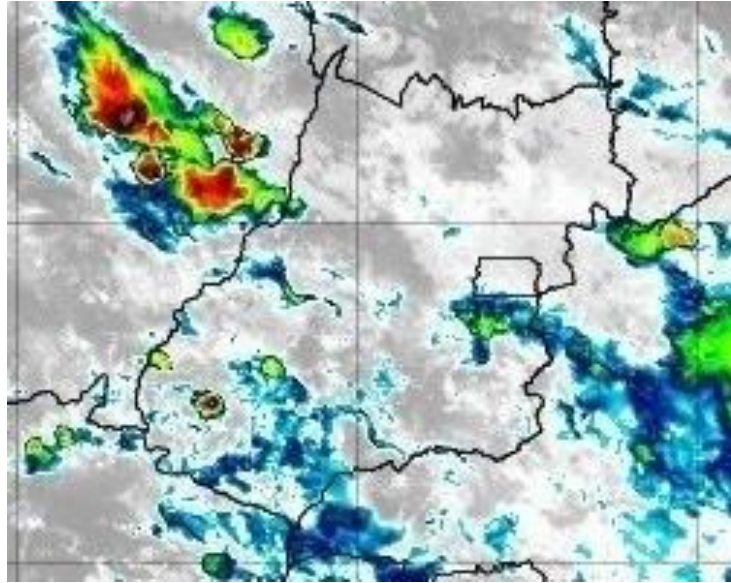

Figura 11 – Imagens realçadas do satélite GOES-16 das 03h00 do dia 03 de dezembro de 2019. FONTE: Cptec/INPE.

05h00 - 03 de dezembro de 2019

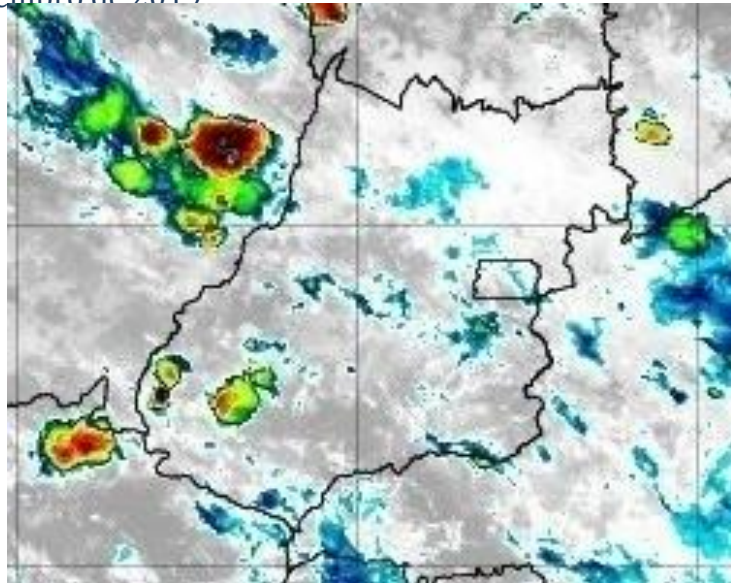

Figura 12 – Imagens realçadas do satélite GOES-16 das 05h00 do dia 03 de dezembro de 2019. FONTE: Cptec/INPE.

07h00 - 03 de dezembro de 2019



Figura 13 – Imagens realçadas do satélite GOES-16 das 07h00 do dia 03 de dezembro de 2019. FONTE: Cptec/INPE.

09h00 - 03 de dezembro de 2019

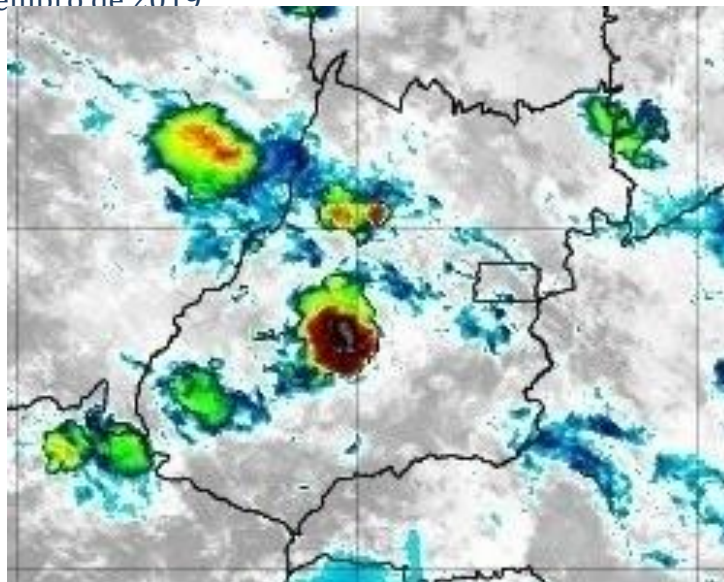

Figura 14 – Imagens realçadas do satélite GOES-16 das 09h00 do dia 03 de dezembro de 2019. FONTE: Cptec/INPE.

11h00 - 03 de dezembro de 2019

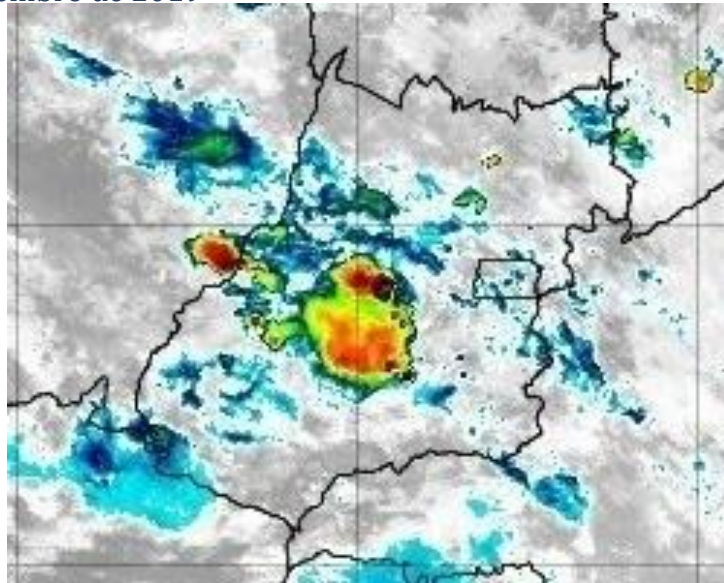

Figura 15 – Imagens realçadas do satélite GOES-16 das 11h00 do dia 03 de dezembro de 2019. FONTE: Cptec/INPE.

13h00 - 03 de dezembro de 2019

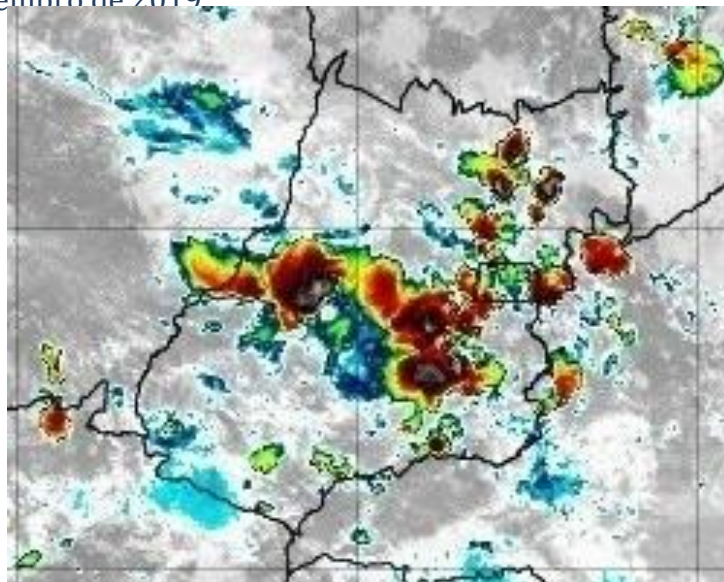

Figura 16 – Imagens realçadas do satélite GOES-16 das 13h00 do dia 03 de dezembro de 2019.
FONTE: Cptec/INPE.

17h00 - 03 de dezembro de 2019

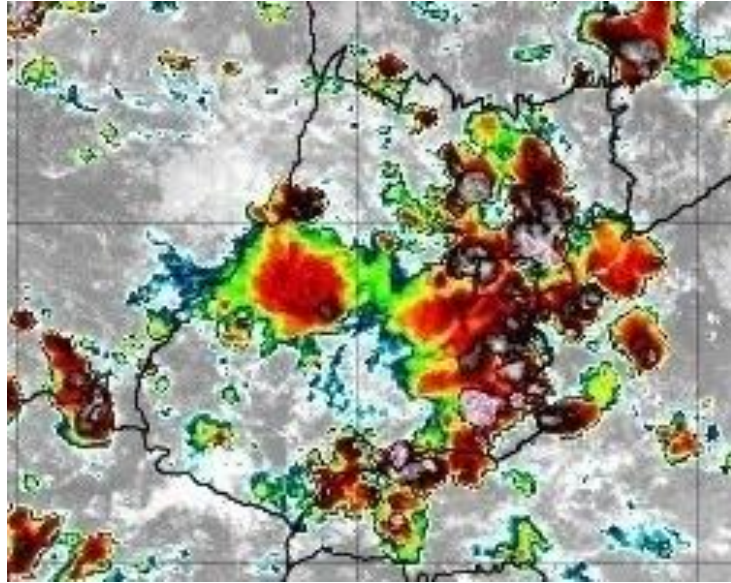

Figura 17 – Imagens realçadas do satélite GOES-16 das 17h00 do dia 03 de dezembro de 2019.
FONTE: Cptec/INPE.

19h00 - 03 de dezembro de 2019

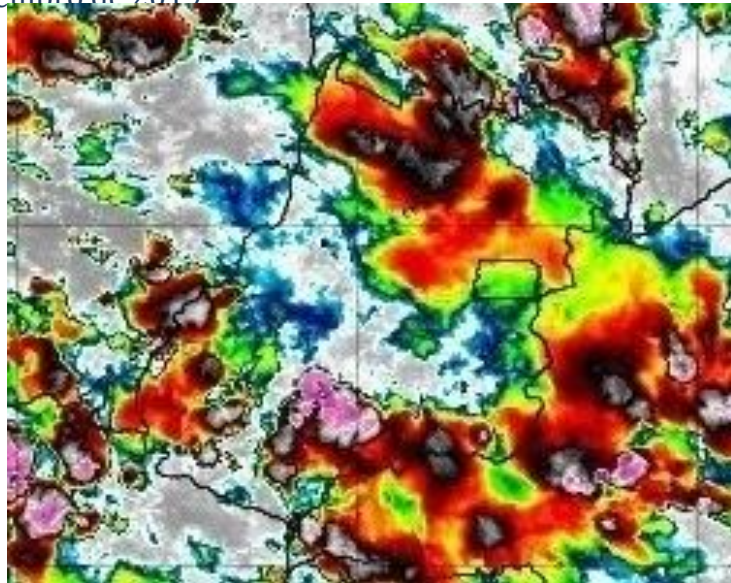

Figura 18 – Imagens realçadas do satélite GOES-16 das 19h00 do dia 03 de dezembro de 2019.
FONTE: Cptec/INPE.

21h00 - 03 de dezembro de 2019

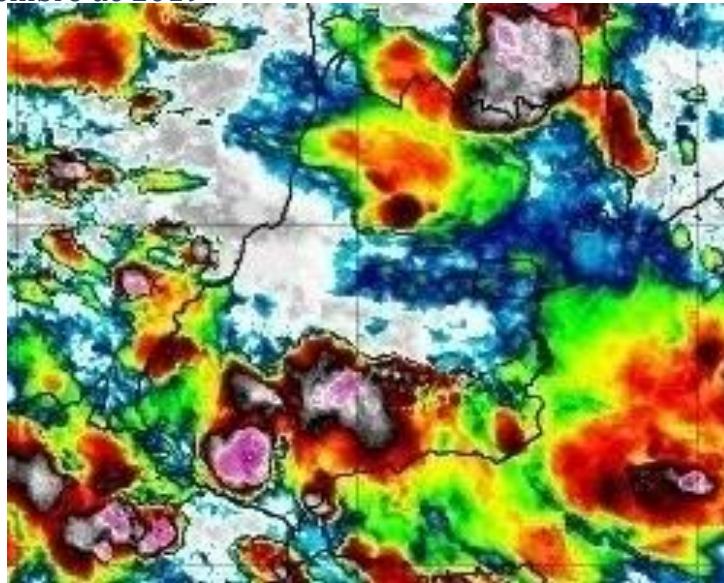

Figura 19 – Imagens realçadas do satélite GOES-16 das 21h00 do dia 03 de dezembro de 2019.
FONTE: Cptec/INPE.

23h00 - 03 de dezembro de 2019

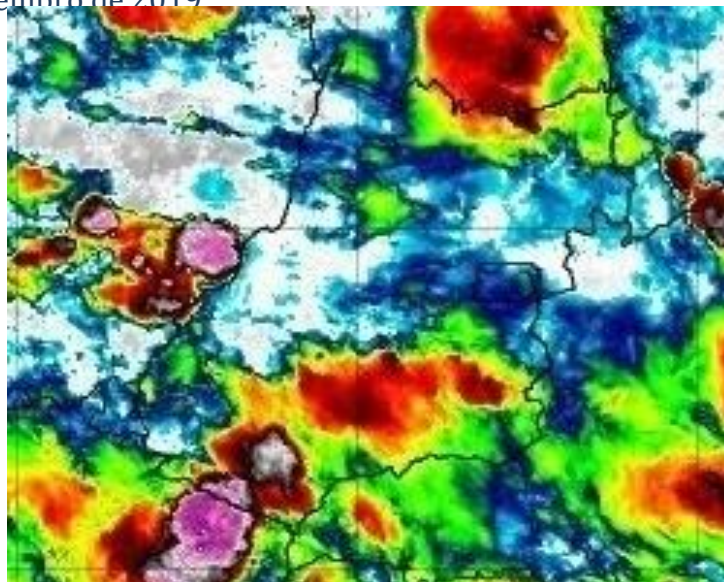

Figura 20 – Imagens realçadas do satélite GOES-16 das 23h00 do dia 03 de dezembro de 2019. FONTE: Cptec/INPE.

01h00 - 04 de dezembro de 2019

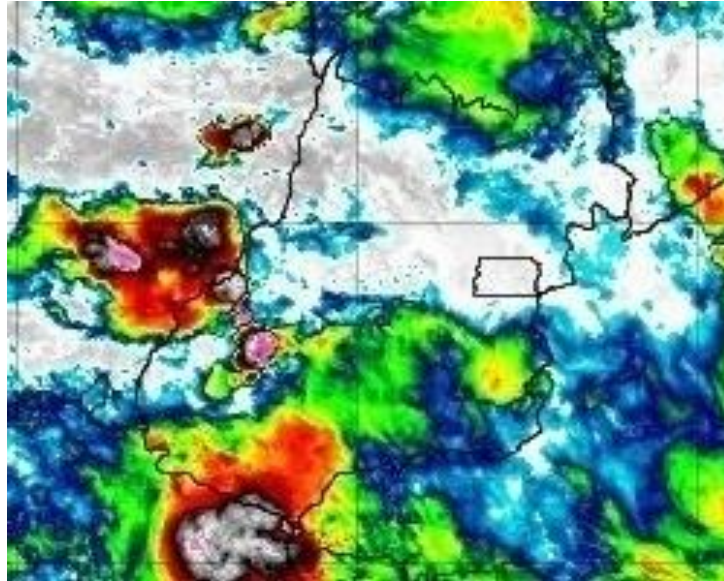

Figura 21 – Imagens realçadas do satélite GOES-16 das 01h00 do dia 04 de dezembro de 2019. FONTE: Cptec/INPE.

03h00 - 04 de dezembro de 2019

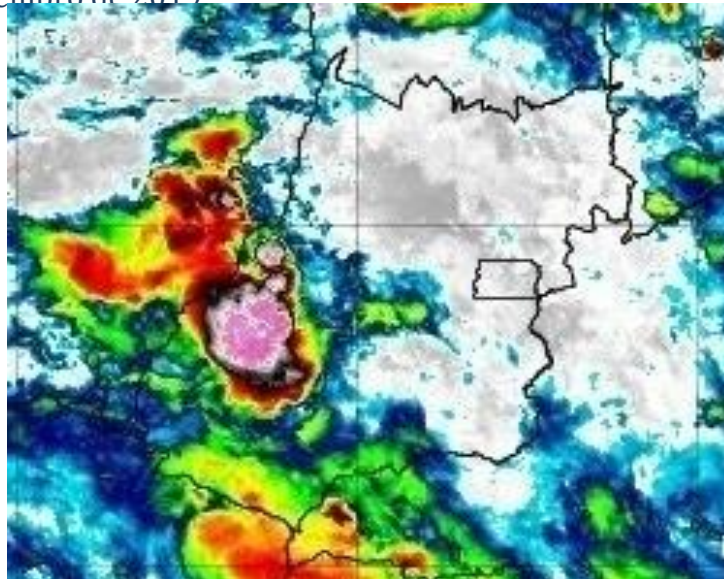

Figura 22 – Imagens realçadas do satélite GOES-16 das 03h00 do dia 04 de dezembro de 2019. FONTE: Cptec/INPE.

05h00 - 04 de dezembro de 2019

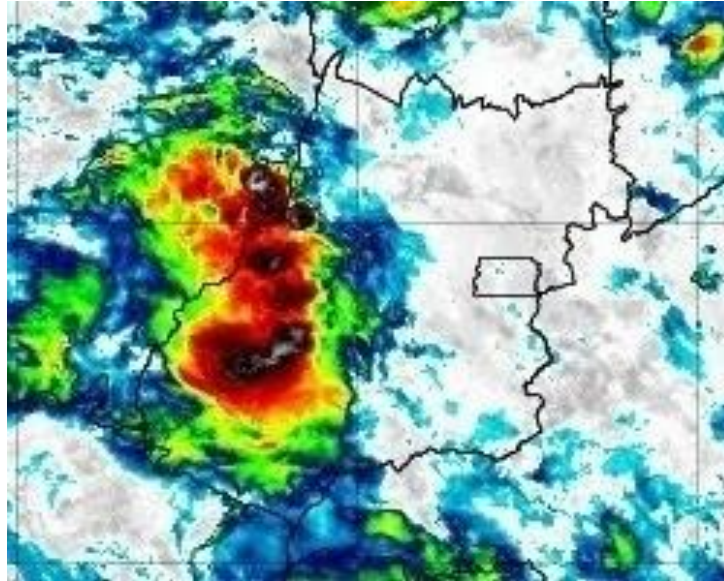

Figura 23 – Imagens realçadas do satélite GOES-16 das 05h00 do dia 04 de dezembro de 2019. FONTE: Cptec/INPE.

07h00 - 04 de dezembro de 2019

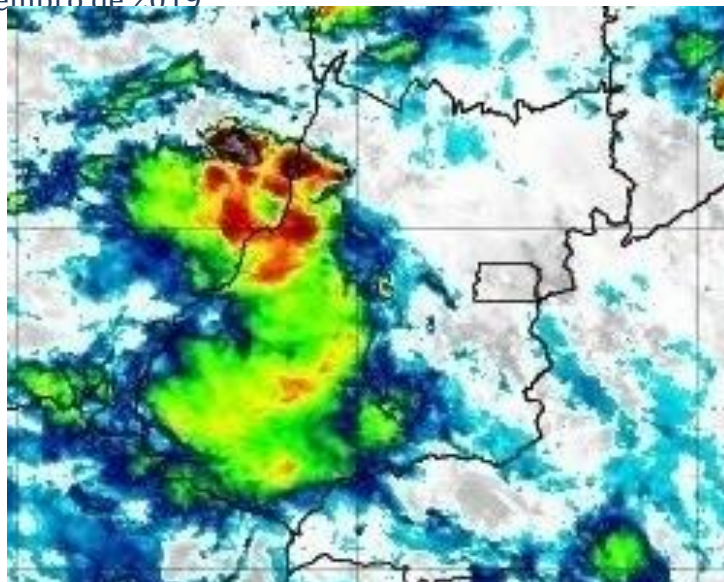

Figura 24 – Imagens realçadas do satélite GOES-16 das 07h00 do dia 04 de dezembro de 2019. FONTE: Cptec/INPE.

09h00 - 04 de dezembro de 2019

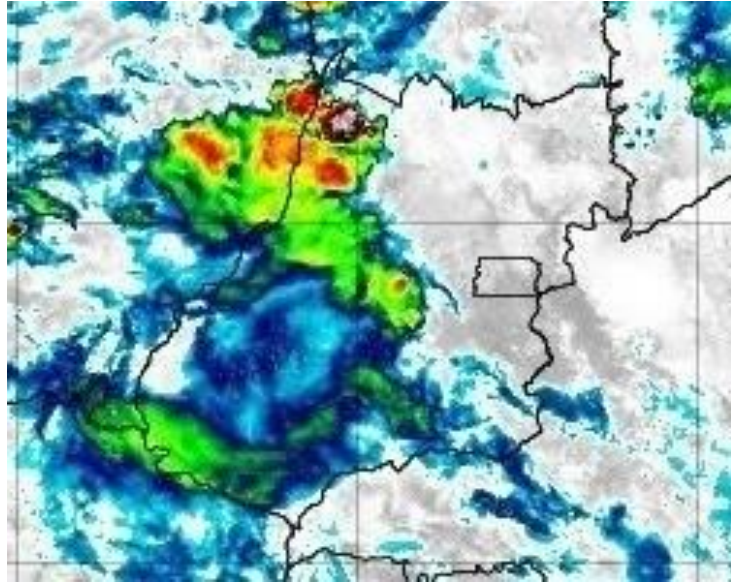

Figura 25 – Imagens realçadas do satélite GOES-16 das 09h00 do dia 04 de dezembro de 2019. FONTE: Cptec/INPE.

2 Classificação COBRADE

O COBRADE (Classificação e Codificação Brasileira de Desastres) foi criado com o intuito de adequar a classificação brasileira à classificação utilizada pela ONU na classificação de desastres e nivelar o país aos demais organismos de gestão de desastres do mundo.

Baseados nos dados analisados nos itens anteriores, podemos classificar o evento ocorrido na CELG Distribuição como Vendaval (Código 1.3.2.1.5) Tempestade de raios (Código 1.3.2.1.2) e Chuvas intensas (Código 1.3.2.1.4).

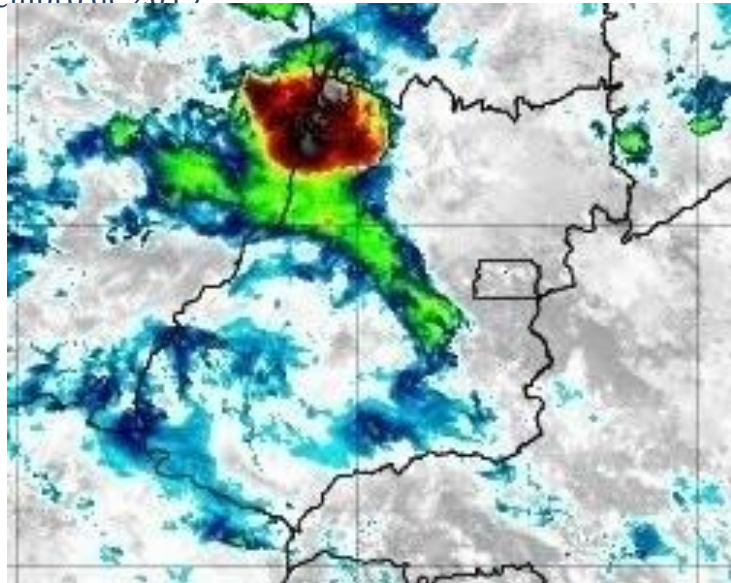
3 Resumo do Evento

A presença de uma frente fria na costa do país e o ar quente e úmido favoreceram a formação de nuvens de tempestade, do tipo Cumulonimbus, entre os dias 02 e 04 de dezembro de 2019 sobre o estado de Goiás.

Entre as 11h30 do dia 02 e 11h00 do dia 04 de dezembro foram detectados 69419 descargas atmosféricas sobre a área de concessão da CELG Distribuição Goiás. Estações do INMET representativas da região de interesse registraram chuva forte durante o período. Rajadas de vento forte, entre 50 e 61 km/h, também foram registradas pelo INMET.

Em Itumbiara foram acumulados 36,0 mm de chuva entre as 12h00 e 13h00 do dia 03 de dezembro (INMET), valor que corresponde a aproximadamente 14% da média climatológica para todo o mês de dezembro na região. Entre as 09h00 do dia 02 e as 09h00 do dia 04 foram acumulados 76,2 mm de chuva em Catalão, o que equivale a aproximadamente 28% da média do mês de dezembro na região.

Tabela 3 – Resumo do evento Região Sudoeste

Número/Código do Evento	
Número/Código do Relatório	
Descrição	Forte deslocamento de uma massa de ar em uma região. Tempestade com intensa atividade elétrica no interior das nuvens, com grande desenvolvimento vertical. Chuvas com acumulados significativos.
Código COBRADE	1.3.2.1.5 - Vendaval, 1.3.2.1.2 - Tempestade de raios e 1.3.2.1.4 - Chuvas intensas
Hora início do evento	11h30 do dia 02 de dezembro de 2019
Hora de fim do evento	01h00 do dia 04 de dezembro de 2019
Abrangência	Região Sudoeste da CELG Distribuição S.A.

Tabela 4 – Resumo do evento Região Sul

Número/Código do Evento	
Número/Código do Relatório	
Descrição	Forte deslocamento de uma massa de ar em uma região. Tempestade com intensa atividade elétrica no interior das nuvens, com grande desenvolvimento vertical. Chuvas com acumulados significativos.
Código COBRADE	1.3.2.1.5 - Vendaval, 1.3.2.1.2 - Tempestade de raios e 1.3.2.1.4 - Chuvas intensas
Hora início do evento	13h00 do dia 02 de dezembro de 2019
Hora de fim do evento	20h30 do dia 03 de dezembro de 2019
Abrangência	Região Sul da CELG Distribuição S.A.

Tabela 5 – Resumo do evento Região Sudeste

Número/Código do Evento	
Número/Código do Relatório	
Descrição	Forte deslocamento de uma massa de ar em uma região. Tempestade com intensa atividade elétrica no interior das nuvens, com grande desenvolvimento vertical. Chuvas com acumulados significativos.
Código COBRADE	1.3.2.1.5 - Vendaval, 1.3.2.1.2 - Tempestade de raios e 1.3.2.1.4 - Chuvas intensas
Hora início do evento	13h00 do dia 02 de dezembro de 2019
Hora de fim do evento	10h45 do dia 04 de dezembro de 2019
Abrangência	Região Sudeste da CELG Distribuição S.A.

Tabela 6 – Resumo do evento Região Metropolitana

Número/Código do Evento	
Número/Código do Relatório	
Descrição	Forte deslocamento de uma massa de ar em uma região. Tempestade com intensa atividade elétrica no interior das nuvens, com grande desenvolvimento vertical. Chuvas com acumulados significativos.
Código COBRADE	1.3.2.1.5 - Vendaval, 1.3.2.1.2 - Tempestade de raios e 1.3.2.1.4 - Chuvas intensas
Hora início do evento	12h00 do dia 02 de dezembro de 2019
Hora de fim do evento	06h00 do dia 04 de dezembro de 2019
Abrangência	Região Metropolitana da CELG Distribuição S.A.

Tabela 7 – Resumo do evento Região Oeste

Número/Código do Evento	
Número/Código do Relatório	
Descrição	Forte deslocamento de uma massa de ar em uma região. Tempestade com intensa atividade elétrica no interior das nuvens, com grande desenvolvimento vertical. Chuvas com acumulados significativos.
Código COBRADE	1.3.2.1.5 - Vendaval, 1.3.2.1.2 - Tempestade de raios e 1.3.2.1.4 - Chuvas intensas
Hora início do evento	12h00 do dia 02 de dezembro de 2019
Hora de fim do evento	04h10 do dia 04 de dezembro de 2019
Abrangência	Região Oeste da CELG Distribuição S.A.

Tabela 8 – Resumo do evento Região EDF

Número/Código do Evento	
Número/Código do Relatório	
Descrição	Forte deslocamento de uma massa de ar em uma região. Tempestade com intensa atividade elétrica no interior das nuvens, com grande desenvolvimento vertical. Chuvas com acumulados significativos.
Código COBRADE	1.3.2.1.5 - Vendaval, 1.3.2.1.2 - Tempestade de raios e 1.3.2.1.4 - Chuvas intensas
Hora início do evento	13h30 do dia 02 de dezembro de 2019
Hora de fim do evento	16h00 do dia 03 de dezembro de 2019
Abrangência	Região EDF da CELG Distribuição S.A.

Tabela 9 – Resumo do evento Região Centro

Número/Código do Evento	
Número/Código do Relatório	
Descrição	Forte deslocamento de uma massa de ar em uma região. Tempestade com intensa atividade elétrica no interior das nuvens, com grande desenvolvimento vertical. Chuvas com acumulados significativos.
Código COBRADE	1.3.2.1.5 - Vendaval, 1.3.2.1.2 - Tempestade de raios e 1.3.2.1.4 - Chuvas intensas
Hora início do evento	14h30 do dia 02 de dezembro de 2019
Hora de fim do evento	19h00 do dia 03 de dezembro de 2019
Abrangência	Região Centro da CELG Distribuição S.A.

Tabela 10 – Resumo do evento Região Noroeste

Número/Código do Evento	
Número/Código do Relatório	
Descrição	Forte deslocamento de uma massa de ar em uma região. Tempestade com intensa atividade elétrica no interior das nuvens, com grande desenvolvimento vertical. Chuvas com acumulados significativos.
Código COBRADE	1.3.2.1.5 - Vendaval, 1.3.2.1.2 - Tempestade de raios e 1.3.2.1.4 - Chuvas intensas
Hora início do evento	23h30 do dia 03 de dezembro de 2019
Hora de fim do evento	05h30 do dia 04 de dezembro de 2019
Abrangência	Região Noroeste da CELG Distribuição S.A.

Tabela 11 – Resumo do evento Região Norte

Número/Código do Evento	
Número/Código do Relatório	
Descrição	Forte deslocamento de uma massa de ar em uma região. Tempestade com intensa atividade elétrica no interior das nuvens, com grande desenvolvimento vertical. Chuvas com acumulados significativos.
Código COBRADE	1.3.2.1.5 - Vendaval, 1.3.2.1.2 - Tempestade de raios e 1.3.2.1.4 - Chuvas intensas
Hora início do evento	14h30 do dia 02 de dezembro de 2019
Hora de fim do evento	10h30 do dia 04 de dezembro de 2019
Abrangência	Região Norte da CELG Distribuição S.A.

Tabela 12 – Resumo do evento Região Nordeste

Número/Código do Evento	
Número/Código do Relatório	
Descrição	Forte deslocamento de uma massa de ar em uma região. Tempestade com intensa atividade elétrica no interior das nuvens, com grande desenvolvimento vertical. Chuvas com acumulados significativos.
Código COBRADE	1.3.2.1.5 - Vendaval, 1.3.2.1.2 - Tempestade de raios e 1.3.2.1.4 - Chuvas intensas
Hora início do evento	11h30 do dia 02 de dezembro de 2019
Hora de fim do evento	10h30 do dia 04 de dezembro de 2019
Abrangência	Região Nordeste da CELG Distribuição S.A.

4 Referências

- RMetS Royal Meteorological Society – Beaufort Scale - <https://www.rmets.org/weather-and-climate/observing/beaufort-scale>

- Instituto Nacional de Meteorologia (INMET) - <http://www.inmet.gov.br>

- Cptec/INPE- <https://www.cptec.inpe.br/>

- Centro de Hidrografia da Marinha do Brasil - <https://www.marinha.mil.br/chm/>

- Meteorology Glossary - American Meteorological Society -
<http://glossary.ametsoc.org/>

A.1 Carta Sinótica



Figura A1 - Carta sinótica para as 1200Z do dia 02 de dezembro de 2019 (09h00 do dia 02 de dezembro de 2019, hora local). FONTE: Marinha do Brasil).



LEGENDA			
	Frente Fria	A	Alta Pressão
	Frente Quente	B	Baixa Pressão
	Instabilidade		Zona de Convergência

Figura A2 - Carta sinótica da Marinha do Brasil para as 0000Z do dia 03 de dezembro de 2019 (21h00 do dia 02 de dezembro de 2019, hora local. FONTE: Marinha do Brasil).

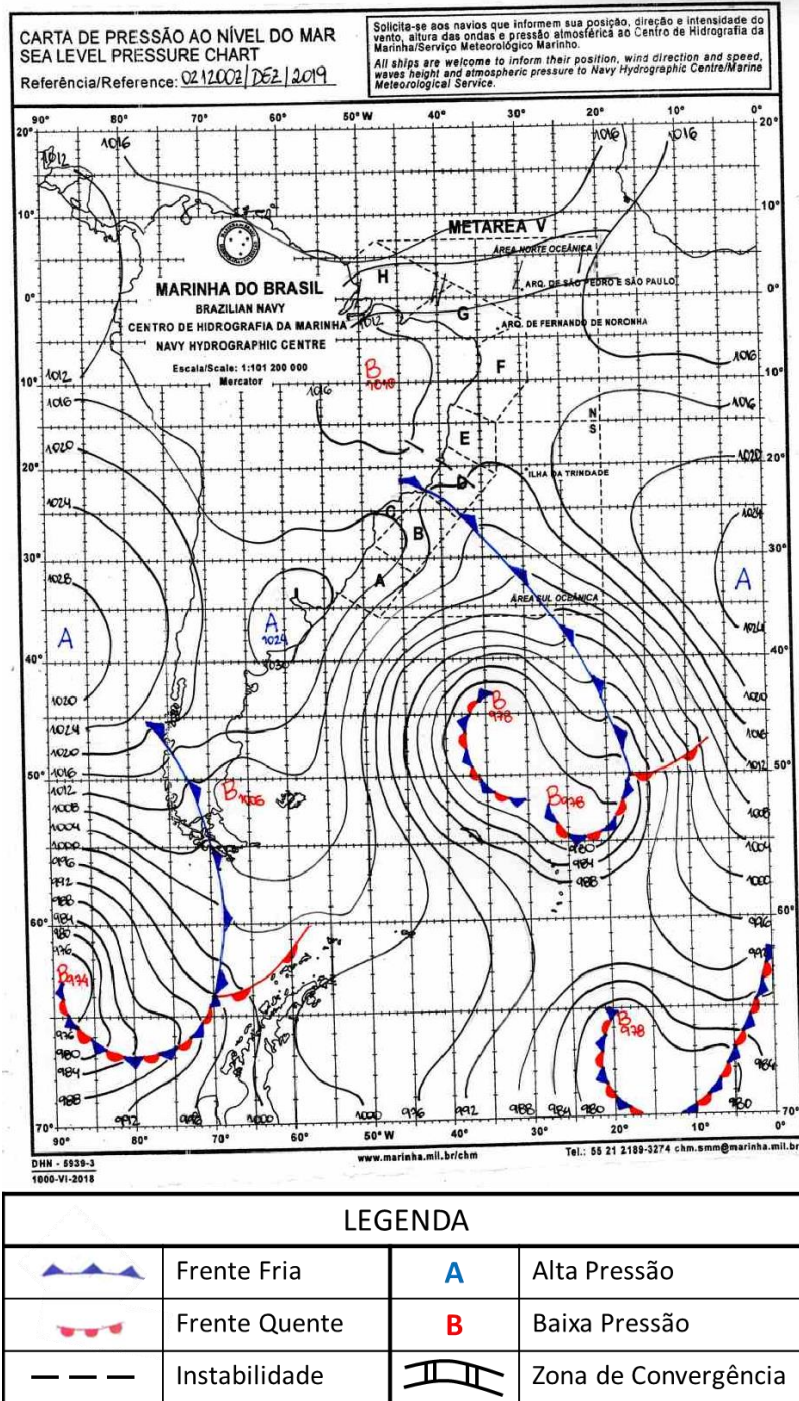
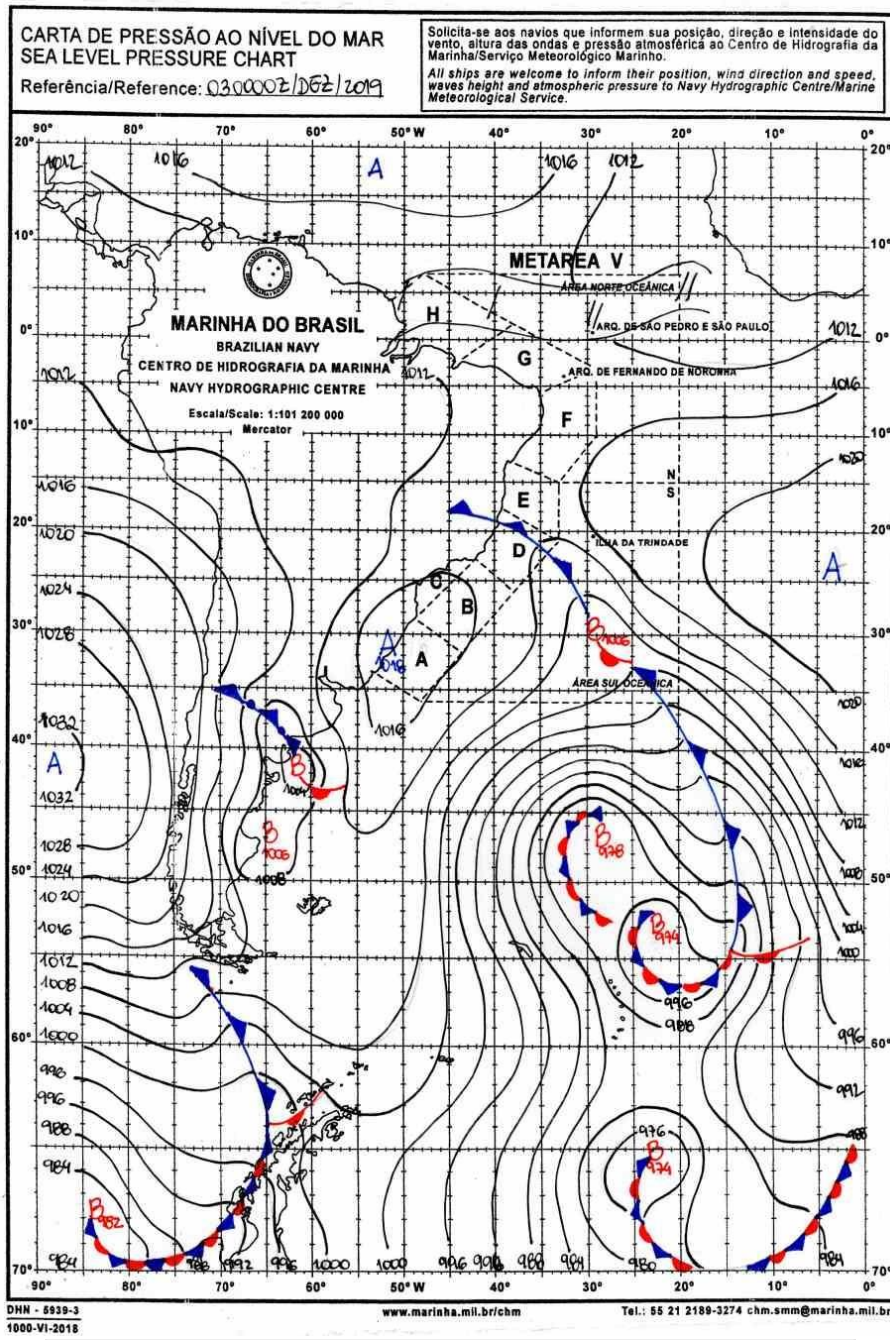

Figura A3 - Carta sinótica da Marinha do Brasil para as 1200Z do dia 03 de dezembro de 2019 (09h00 do dia 03 de dezembro de 2019, hora local. FONTE: Marinha do Brasil).



Figura A4 - Carta sinótica da Marinha do Brasil para as 0000Z do dia 04 de dezembro de 2019 (21h00 do dia 03 de dezembro de 2019, hora local. FONTE: Marinha do Brasil).

A.2 Notícias relacionadas

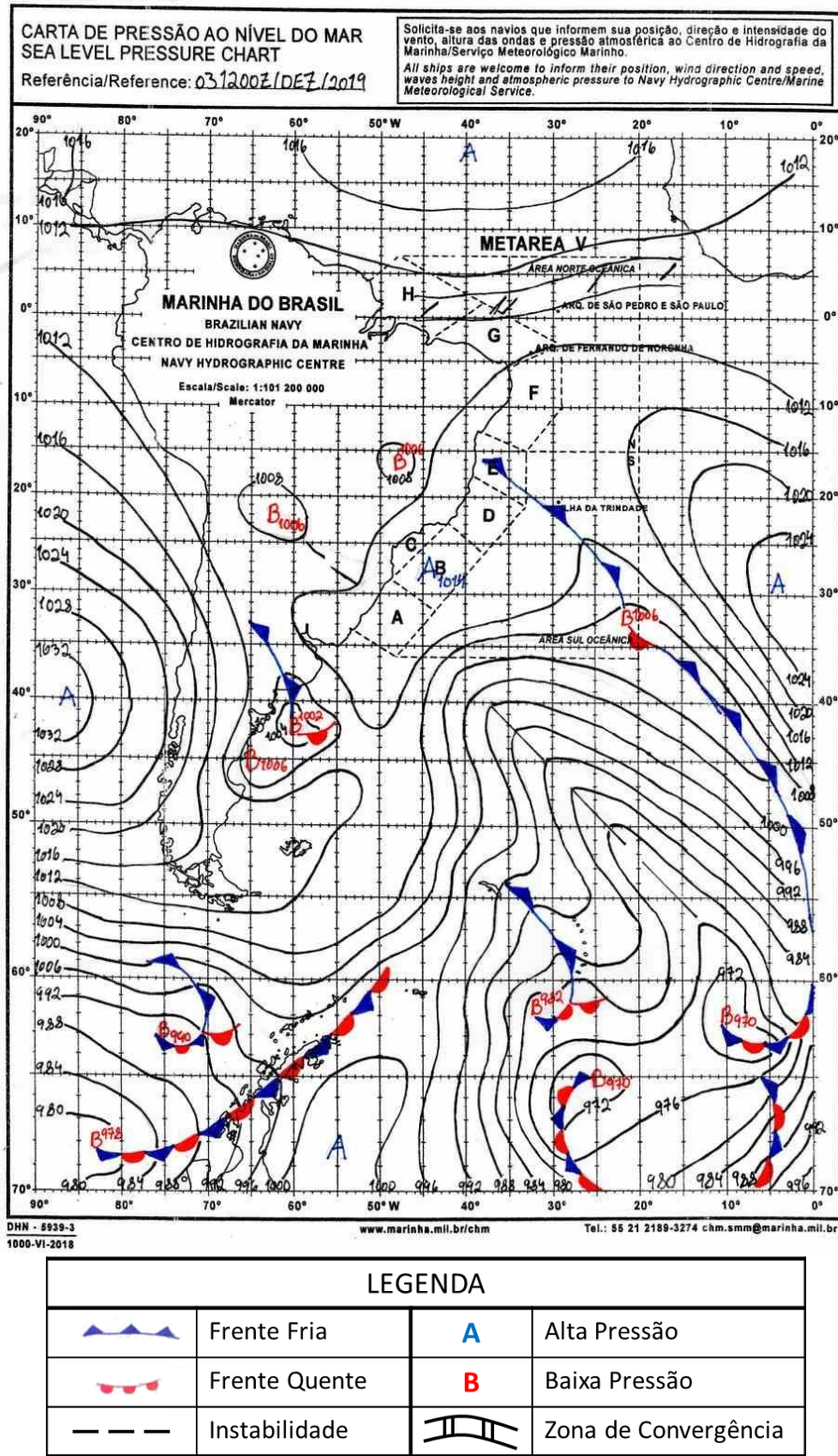
- Com forte chuva, córrego de Itumbiara transborda e alaga rua; veja vídeo
<https://diaonline.ig.com.br/2019/12/03/com-forte-chuva-corrego-de-itumbiara-transborda-e-alaga-rua-veja-video/>
- Chuva causa alagamentos e desabamento de via em Itumbiara - O Popular
<https://www.opopular.com.br/noticias/cidades/chuva-causa-alagamentos-e-desabamento-de-via-em-itumbiara-1.1945780>
- Chuva forte causa alagamentos e transtornos em vários bairros em Itumbiara
<https://pluralnoticias.com.br/chuva-forte-causa-alagamentos-e-transtornos-em-varios-bairros-em-itumbiara/>
- Temporal alaga cidades do interior de Goiás
<http://g1.globo.com/goias/bom-dia-go/videos/t/edicoes/v/temporal-alaga-cidades-do-interior-de-goias/8137767/>

Bianca Lobo Silva
Meteorologista CREA
5063840461

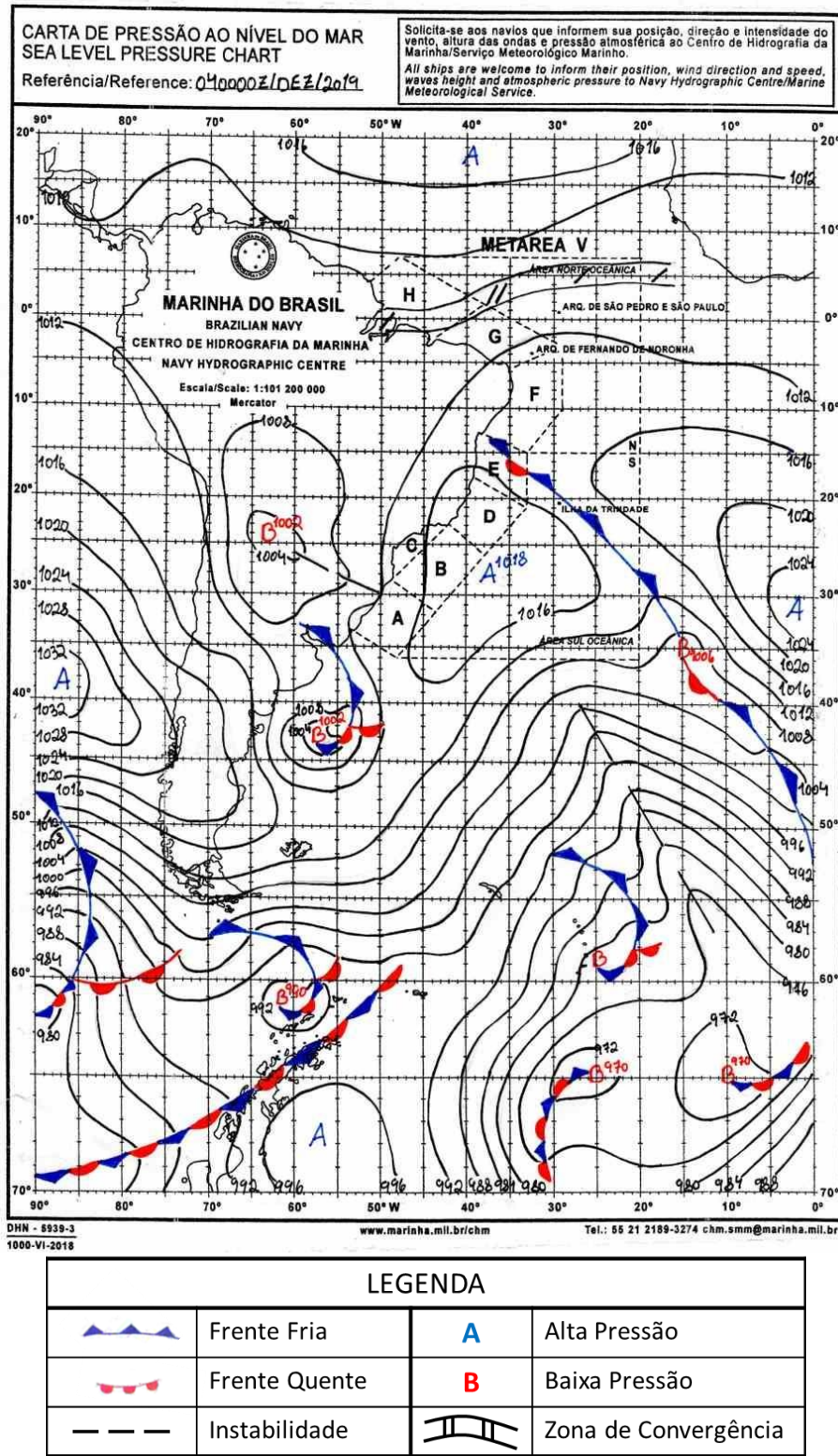
Instituto Nacional de Meteorologia - INMET

Umidade Relativa do Ar 00h UTC
Estação: ARAGARCAS (GO) - 12/2019

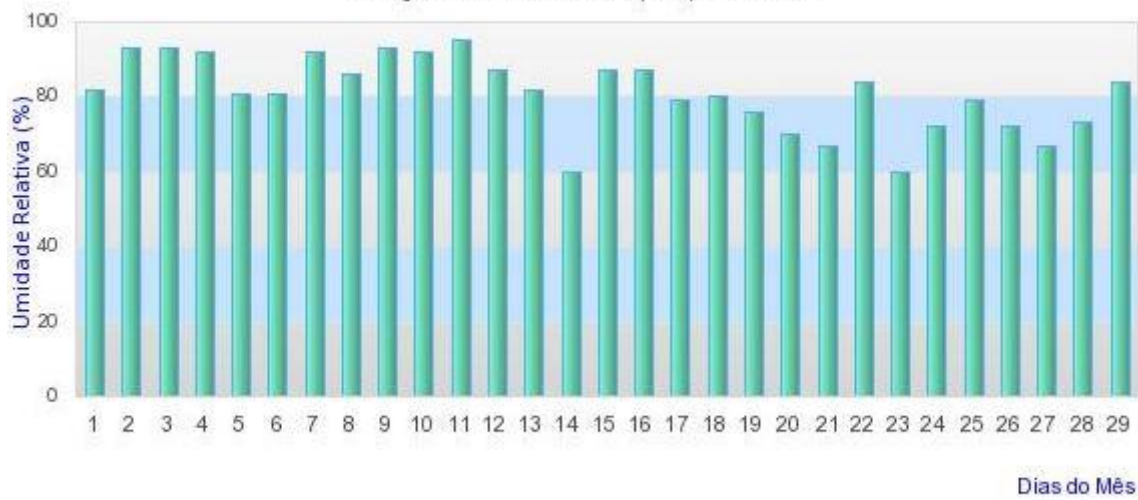

Instituto Nacional de Meteorologia - INMET

Chuva Acumulada 24h
Estação: ARAGARCAS - 12/2019



Instituto Nacional de Meteorologia - INMET

Umidade Relativa do Ar 00h UTC
Estação: CATALAO (GO) - 12/2019

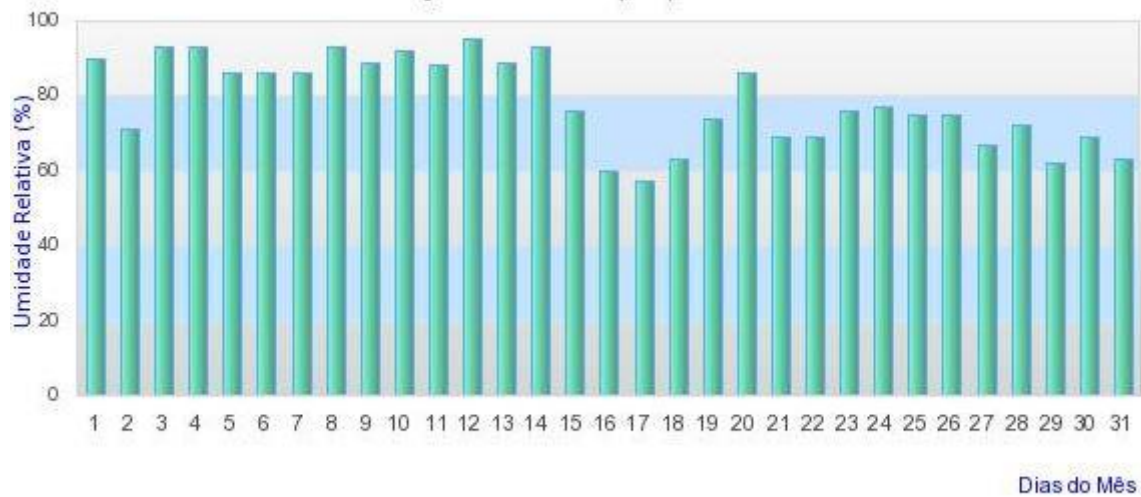

Instituto Nacional de Meteorologia - INMET

Chuva Acumulada 24h
Estação: CATALAO - 12/2019

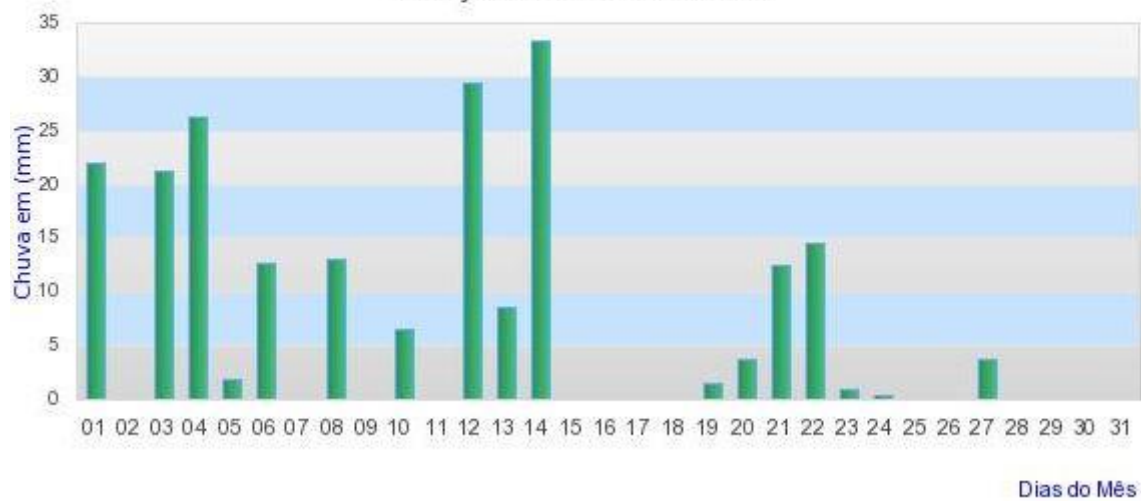

Instituto Nacional de Meteorologia - INMET

Umidade Relativa do Ar 00h UTC
Estação: FORMOSA (GO) - 12/2019



Instituto Nacional de Meteorologia - INMET

Chuva Acumulada 24h
Estação: FORMOSA - 12/2019

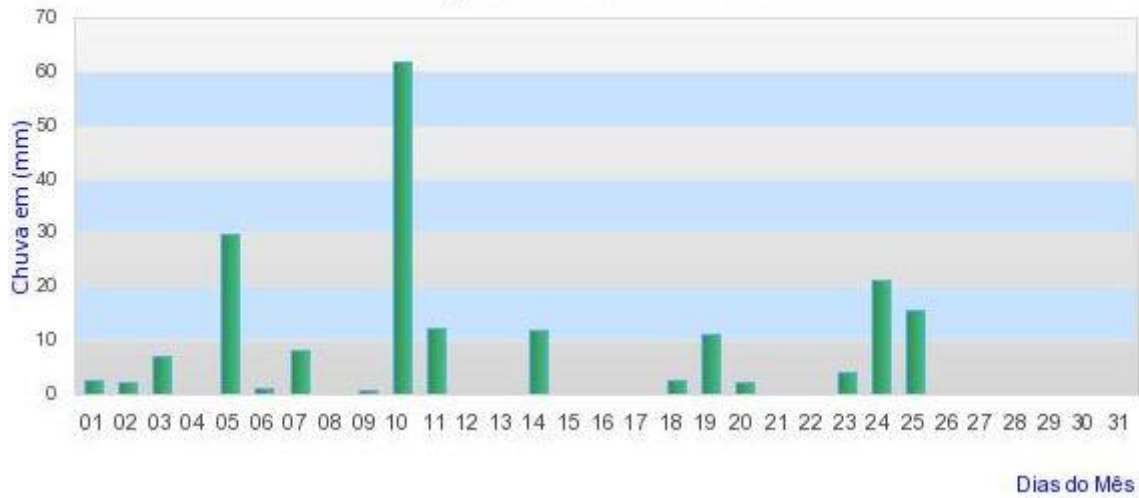

Instituto Nacional de Meteorologia - INMET

Umidade Relativa do Ar 00h UTC
Estação: GOIANIA (GO) - 12/2019

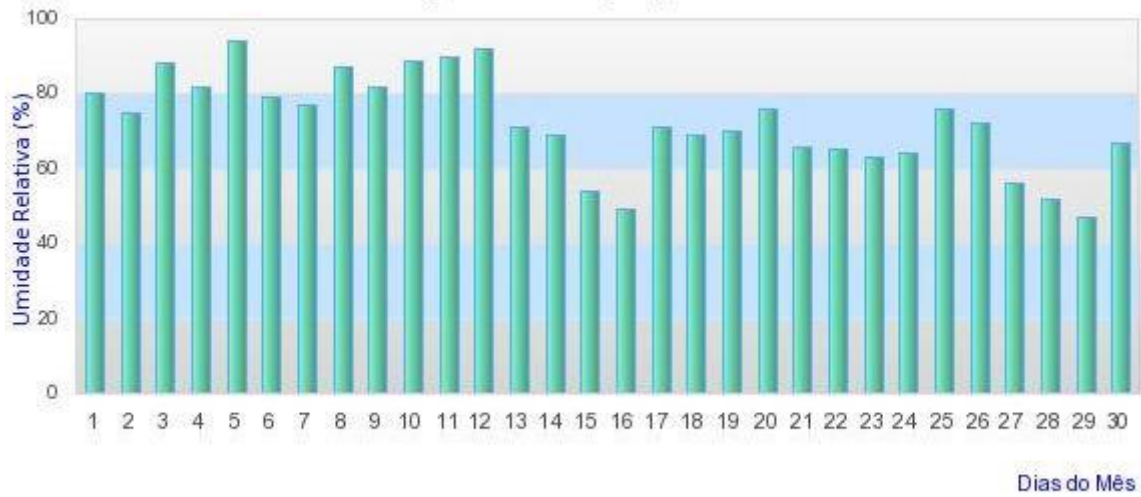

Instituto Nacional de Meteorologia - INMET

Chuva Acumulada 24h
Estação: GOIANIA - 12/2019

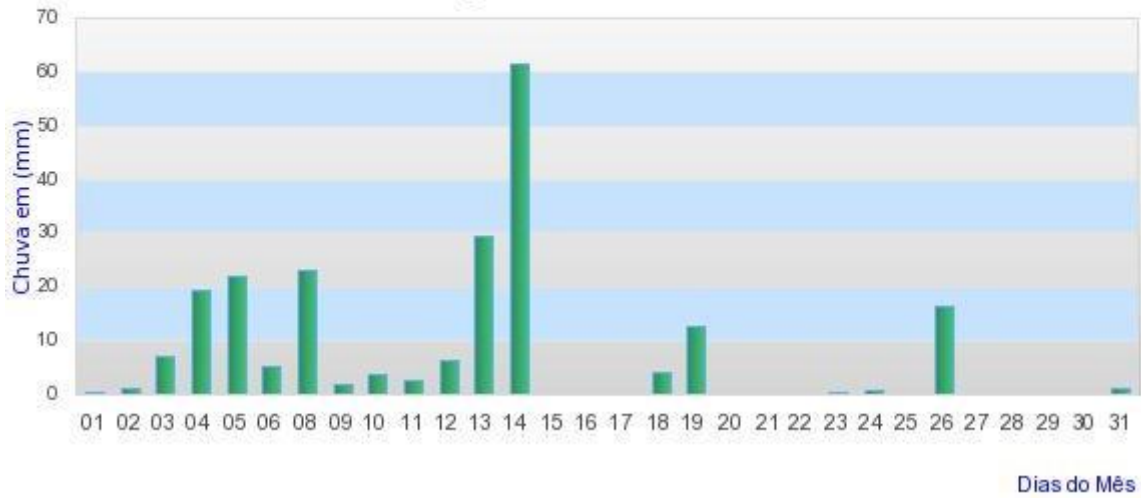

Instituto Nacional de Meteorologia - INMET

Umidade Relativa do Ar 00h UTC

Estação: IPAMERI (GO) - 12/2019

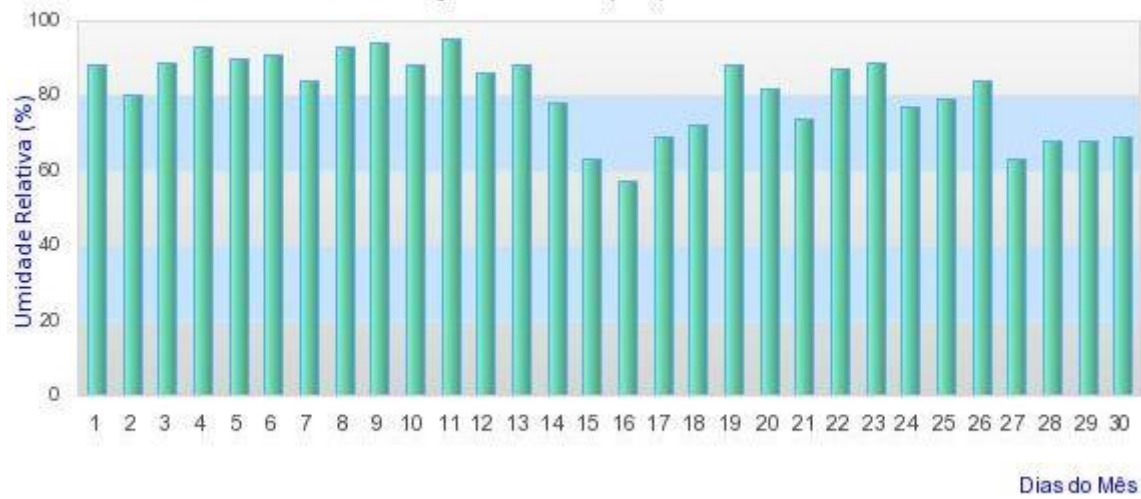

Instituto Nacional de Meteorologia - INMET

Chuva Acumulada 24h

Estação: IPAMERI - 12/2019

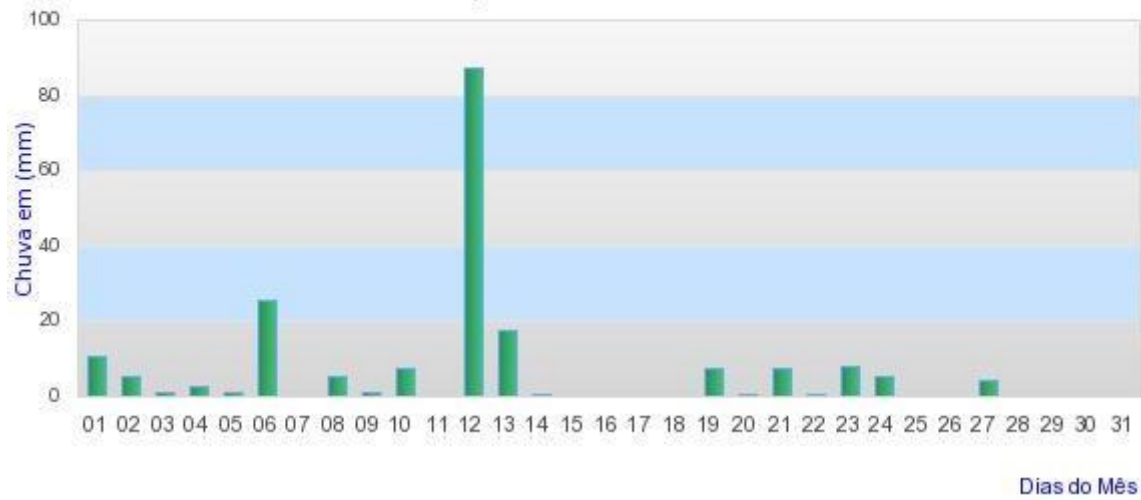

Instituto Nacional de Meteorologia - INMET

Umidade Relativa do Ar 00h UTC

Estação: JATAI (GO) - 12/2019

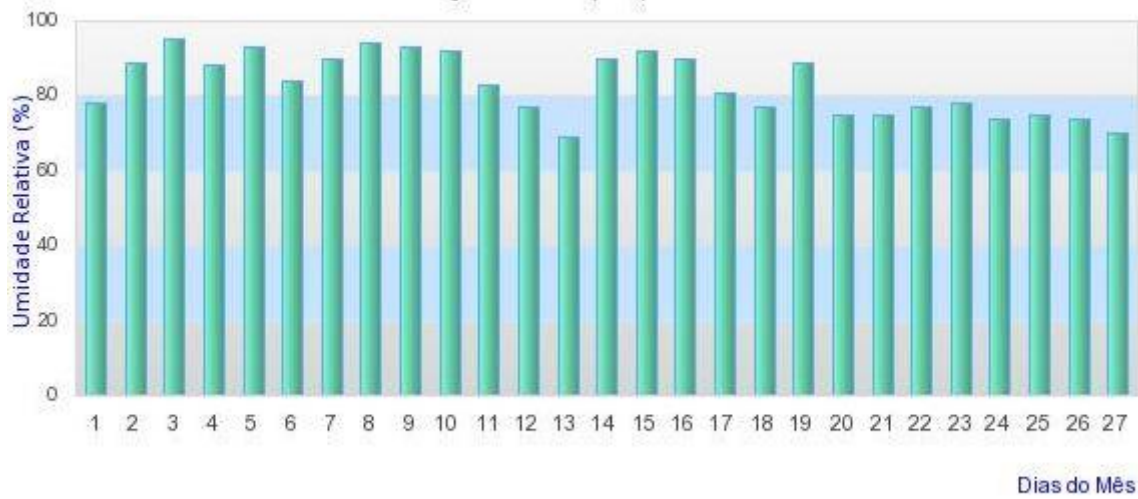

Instituto Nacional de Meteorologia - INMET

Chuva Acumulada 24h

Estação: JATAI - 12/2019

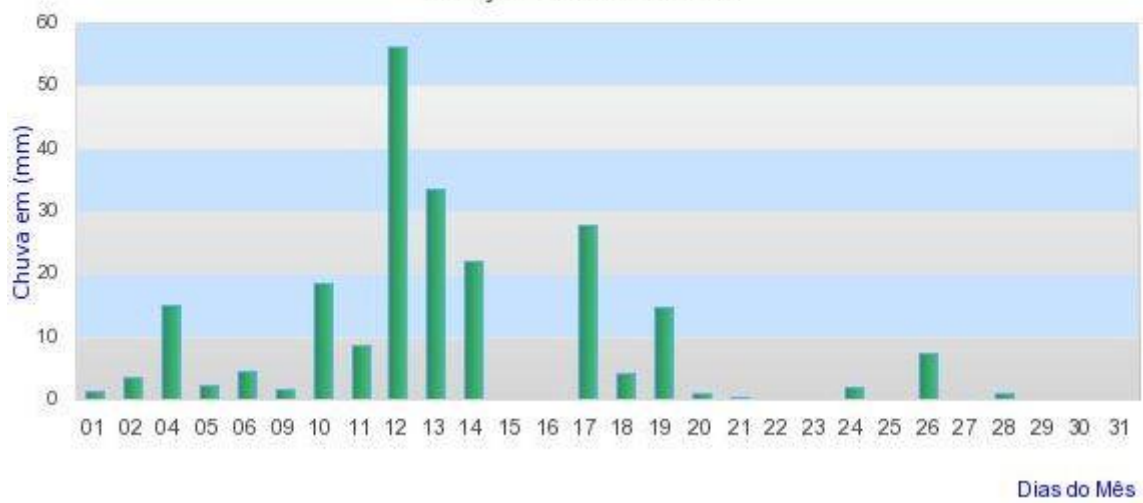

Instituto Nacional de Meteorologia - INMET

Umidade Relativa do Ar 00h UTC
 Estação: PIRENOPOLIS (GO) - 12/2019

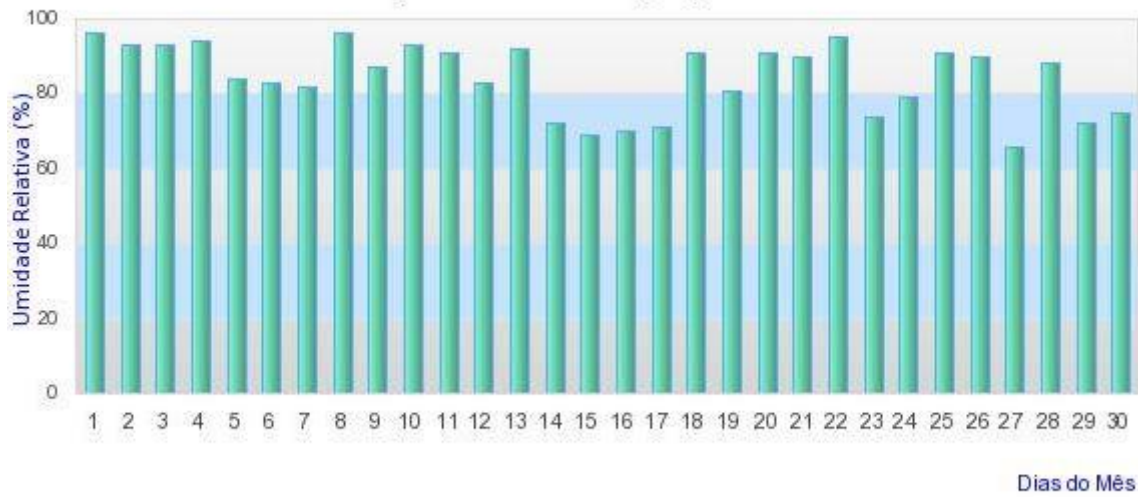

Instituto Nacional de Meteorologia - INMET

Chuva Acumulada 24h
 Estação: PIRENOPOLIS - 12/2019

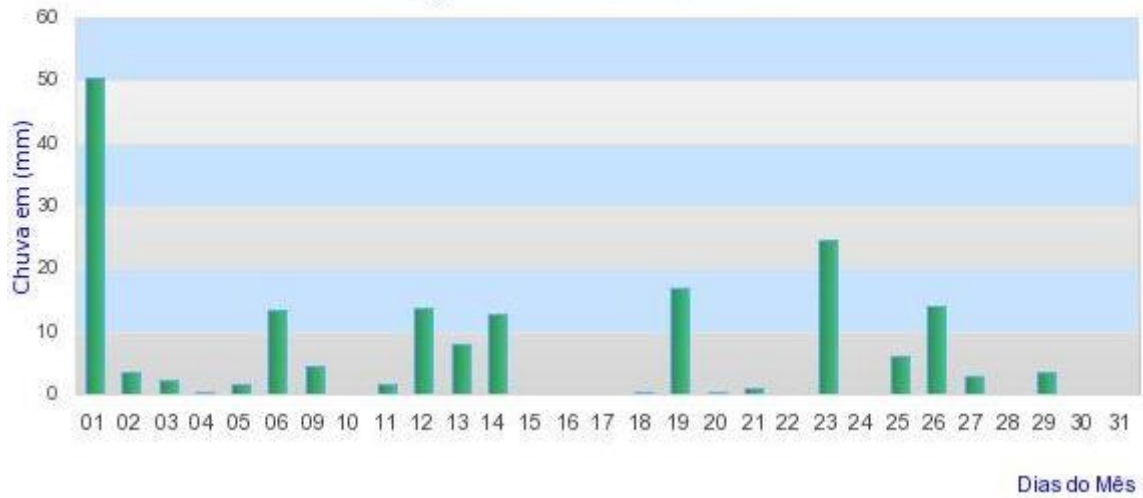

Instituto Nacional de Meteorologia - INMET

Umidade Relativa do Ar 00h UTC

Estação: POSSE (GO) - 12/2019

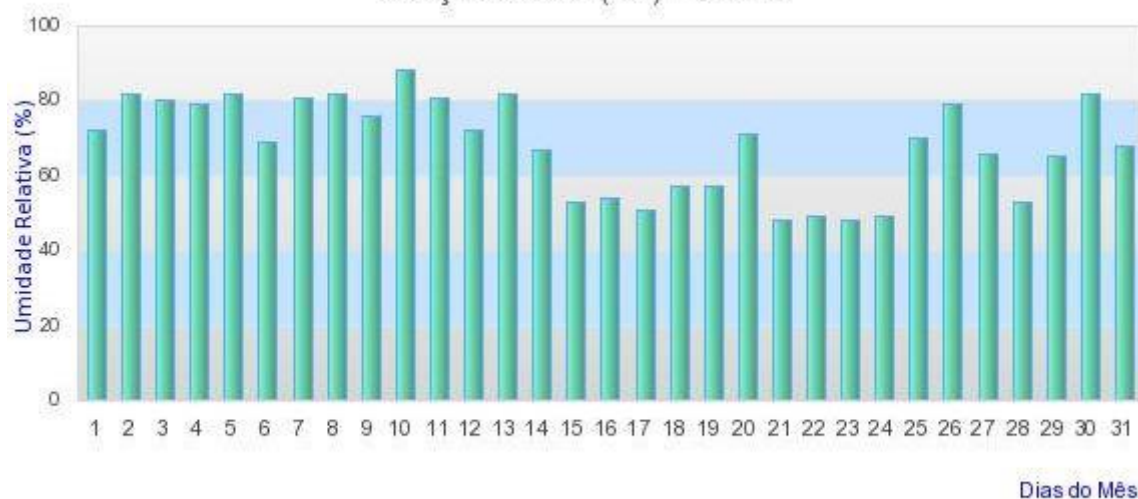

Instituto Nacional de Meteorologia - INMET

Chuva Acumulada 24h

Estação: POSSE - 12/2019

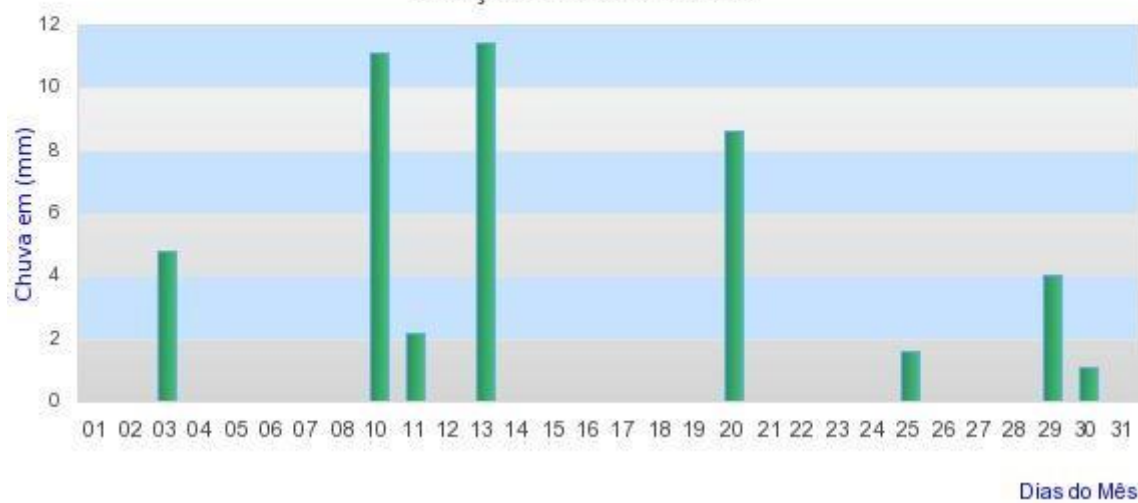

Instituto Nacional de Meteorologia - INMET

Umidade Relativa do Ar 00h UTC
Estação: RIO VERDE (GO) - 12/2019

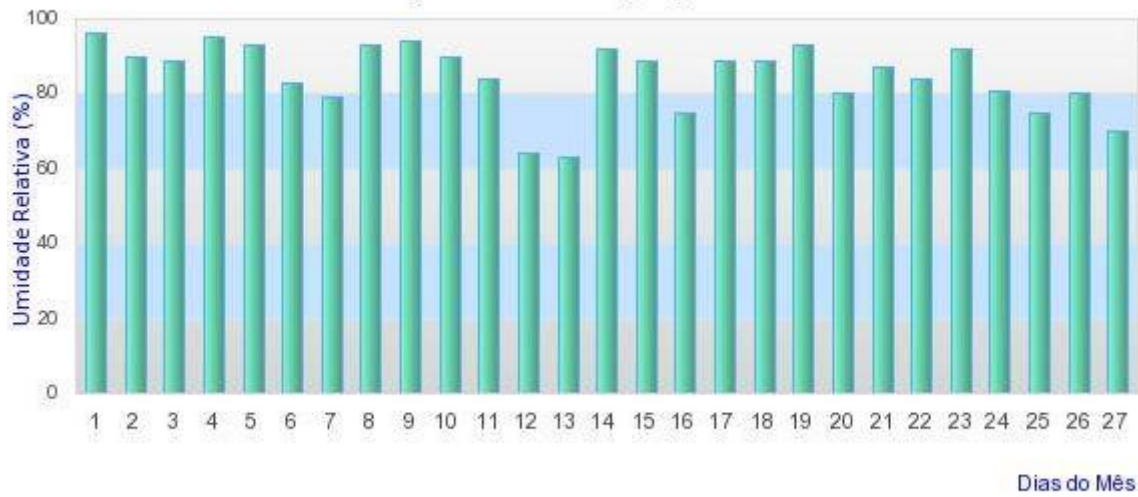

Instituto Nacional de Meteorologia - INMET

Chuva Acumulada 24h
Estação: RIO VERDE - 12/2019

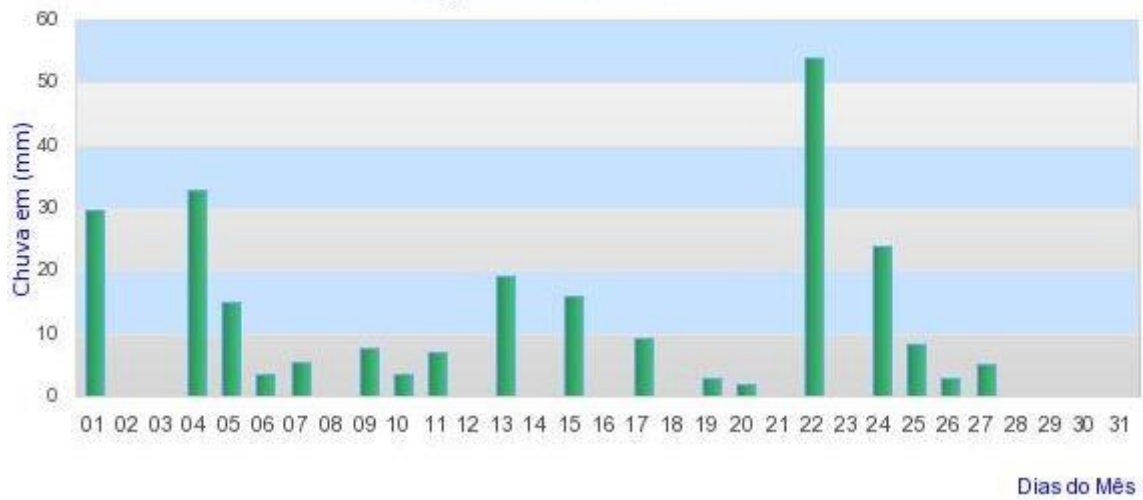

NOTÍCIAS RELACIONADAS

<https://diaonline.ig.com.br/2019/12/03/com-forte-chuva-corrego-de-itumbiara-transborda-e-alaga-rua-veja-video/?utm%ED%A0%B5%ED%B1%A0%ED%A0%B5%ED%B1%9C%ED%A0%B5%ED%B1%A2%ED%A0%B5%ED%B1%9F%ED%A0%B5%ED%B1%90%ED%A0%B5%ED%B1%92>

Com forte chuva, córrego de Itumbiara transborda e alaga rua; veja vídeo

A chuva deve seguir até quarta-feira (4/12), com risco de pancadas e trovoadas isoladas em todo o estado de Goiás.



Dinake Nubia
03/12/2019, 16h33



Foto: Reprodução

A forte chuva da tarde desta terça-feira (3/12) fez o córrego de Itumbiara transbordar e alagar rua da cidade, na região Sul do Estado.

A Avenida Maria Rogelina, no Setor Santa Inês, foi interditada devido ao risco de desabamento na região, após o Córrego Água Suja alargar o local.

O Corpo de Bombeiros está nas ruas atendendo diversas ocorrências ocasionadas pela chuva, entre elas pessoas presas dentro de carros e casas invadidas pela água.

<https://www.opopular.com.br/noticias/cidades/chuva-causa-alagamentos-e-desabamento-de-via-em-itumbiara-1.1945780>

Classi | Clube O Popu

O Popular 62 99995 2795 BUSCAR FERNANDA × AN

CAPA POLÍTICA ECONOMIA MUNDO **CIDADES** ESPORTE MAGAZINE LUDOVICA OPINIÃO ESPECIAIS INFOMERCIAL VÍDEOS GUIAS



Carol Almeida
carol.almeida@
opopular.com.br

CIDADES

Chuva causa alagamentos e desabamento de via em Itumbiara

O Corpo de Bombeiros interditou parte da Avenida Rogelina Maria de Jesus, que fica às margens do Córrego Água Suja. Cinco ocorrências relacionadas a vias alagadas foram atendidas



03/12/2019 - 16:06

Atualizado às 16h12

Parte da Avenida Rogelina Maria de Jesus, no Setor Santa Inês, em Itumbiara, desabou devido à forte chuva registrada na cidade no início da tarde desta terça-feira (3). De acordo com o Corpo de Bombeiros de Goiás, que atua no local, o nível do Córrego Água Suja aumentou devido ao volume da precipitação e parte da via, que está às margens, cedeu. O local foi interditado devido ao risco de novos desabamentos na região, segundo a corporação.

O temporal ocorreu por volta das 13h, no município do Sul do Estado. Dados do Instituto Nacional de Meteorologia (Inmet) apontam que 36 milímetros de chuva foram registrados neste horário. Com isso, a cidade registrou vários pontos de alagamento e cinco ocorrências foram atendidas pelos bombeiros, sendo elas de pessoas e veículos ilhados ou em pontos de risco. Nenhum atendimento de maior complexidade foi solicitado.

<https://pluralnoticias.com.br/chuva-forte-causa-alagamentos-e-transtornos-em-varios-bairros-em-itumbiara/>

PLURAL

N O T Í C I A S

INÍCIO CIDADES ~ EDIÇÃO DA SEMANA EM CIMA DA NOTÍCIA RADAR POLÍTICO REPO
CONTATO

CIDADES

Chuva forte causa alagamentos e transtornos em vários bairros em Itumbiara



<http://g1.globo.com/goias/bom-dia-go/videos/t/edicoes/v/temporal-alaga-cidades-do-interior-de-goias/8137767/>

☰ MENU **G1** GOIÁS  TV ANHANGUERA



Temporal alaga cidades do interior de Goiás

MAIS INFORMAÇÕES |

Tweets

 Curtir 0

