

## Resumo Executivo

O Presente Relatório tem como objetivo a incorporação de informações que sejam relevantes para que se possa fazer a devida associação aos dados contidos no corpo do documento objeto da classificação de Situação de Emergência caracterizada pelo Módulo 8 do Prodist, que tem como foco o impacto do evento sobre determinada rede geelétrica e cuja denominação é definida como CHI (Consumidor hora interrompido). O parâmetro para enquadramento nesta classificação de expurgo tem como premissa inicial o limite de Consumidor hora interrompido definido pela fórmula descrita no Módulo 01 do Prodist (Revisão - 9), acrescido de todos os outros informes e dados listados no Módulo 08 (Revisão 10) do Prodist. Este enquadramento se apresenta na maioria das vezes em condições climáticas adversas com severidade dos fatores inerentes a situação, caracterizado na maioria dos casos por fortes ventos e chuvas de grande intensidade e continuidade.

Entre a manhã do dia 06/12/2019 – sexta-feira – e a manhã de 09/12/2019 –segunda-feira – Houve a formação de nuvens de tempestade, que avançaram sobre o continente e ajudaram a organizar áreas de instabilidade sobre as Regiões da Enel Distribuição Goiás.

Conforme informações do Climatempo Meteorologia, o Instituto Nacional de Meteorologia (INMET) detectou rajadas de vento acima de 50km/h entre a manhã do dia 06 e a manhã do dia 09 de dezembro de 2019. A máxima rajada registrada foi de 53,6km/h, sendo esse vento classificado como vento forte pela escala Beaufort.

Entre as 07h30 do dia 06 e 08h30 do dia 09 de dezembro de 2019 tivemos, em todo o Estado de Goiás, incidências de 81.536 descargas atmosféricas (31.087 raios nuvem-solo e 50.449 descargas nuvem-nuvem) sobre a região, o que causou grande instabilidade na rede.

**Chuva forte alaga estrada e inunda casa na zona rural de Abadiânia** - Chuva teve início às 15h, mas só terminou às 18h; proprietária teve mais de 300 ramos de mandioca destruídas, além da morte de algumas aves e a estrutura de uma represa que ameaça ceder. Acesso em: <https://www.emaisgoias.com.br/chuva-forte-alaga-estrada-e-inunda-casa-na-zona-rural-de-abadiania/>

### Relatório de Ocorrências do período

Em todo o Estado de Goiás verificou-se também que a intensidade da chuva e dos ventos danificaram a rede de distribuição de energia elétrica em diversos pontos, registrando aproximadamente 284 mil clientes com interrupção no fornecimento de energia elétrica devido a eventos relacionados ao temporal.

Para otimizar o volume de atendimentos e reduzir os tempos de interrupção foram mobilizados os recursos extras da empresa que aumentou o contingente em relação a situação normal de operação. O acompanhamento da quantidade de equipes e o Tempo Médio de Atendimento podem ser consultados na Pág.02 do Relatório em anexo.

O impacto e severidade do evento estão relatados em artigos de mídia, como fotos e reportagens que demonstram os danos na Rede de Distribuição, oriundos dos eventos climáticos no período. Eventos estes que afetaram 283.494 consumidores com CHI de 767.414,90 superior ao de 482.391,86 estabelecido como limite para definição de Situação de Emergência, conforme resumo das informações obrigatórias.

<b>Empresa</b>	ENEL DISTRIBUIÇÃO GOIÁS				
<b>Código do Relatório</b>	CHI-030 - ENEL DISTRIBUIÇÃO GOIÁS				
<b>Evento:</b>	TEMPORAL NA AREA DE CONCESSÃO DA ENEL DISTRIBUIÇÃO GOIAS				
<b>Código COBRADE:</b>	1.3.2.1.2 e 1.3.2.1.5	<b>Data Inicio</b>	06/12/2019	<b>Hora início</b>	07h30
<b>Código do Evento:</b>	CHI-030-ENEL GO	<b>Data Término</b>	09/12/2019	<b>Hora Término</b>	08h59
<b>Valor CHI (Limite e Real)</b>	482.391,86	767.414,90	<b>Subestações Atingidas</b> ABADIANIA / ABC / ACREUNA / ADELANDIA / AEROPORTO / AGUA LIMPA (MARZAGAO) / AGUAS LINDAS / ALEXANIA / ALEXANIA TRANSMISSAO / ALMERINDONOPOLIS / ALOANDIA / ALPHAVILLE / ALTO BURITI / ALTO PARAISO DE GOIAS / ALVORADA DO NORTE / AMERICANO ( RIO VERDE ) / AMERICANO DO BRASIL / AMORINOPOLIS / ANAPOLIS UNIVERSITARIA / ANHANGUERA / ANICUNS / ANTONIO DO VITTO / APARECIDA DO RIO DOCE / APORE / ARACU / ARAGARCAS / ARAGOIANA / ARAGUAPAZ / ARARAS / AREIAS / ARENOPOLIS / ARUANA / ARUANA (TRANSMISSAO) / ASA BRANCA / ATLANTICO / AURILANDIA / AVELINOPOLIS / BACURI (RIO VERDE) / BARCELONA / BARREIRO (PORANGATU) / BARRO ALTO / BELA VISTA (TRANSMISSAO) / BOA VISTA / BOM JARDIM / BOM JESUS DE GOIAS / BONFINOPOLIS / BONITO / BONOPOLIS / BRAZABRANTES / BRITANIA / BRITANIA (TRANSMISSAO) / BURITI ALEGRE / BURITI DE GOIAS / BURITIZINHO / CABECEIRAS / CABRIUVA (RIO VERDE) / CACHOEIRA ALTA / CACHOEIRA DOURADA / CACHOEIRA NOVA / CACHOEIRINHA (ITARUMA) / CACU / CAIAPONIA / CALCILANDIA / CALDAS NOVAS / CALDAZINHA / CAMPESTRE / CAMPINAS / CAMPINORTE / CAMPO ALEGRE DE GOIAS / CAMPO LIMPO DE GOIAS / CAMPO NOVO / CAMPOS BELOS / CAMPOS VERDES / CARAIBAS / CARAJAS / CASTELANDIA / CATALAO / CATURAI / CEBRASA FABRICA DA AMBEV / CEMAT/BALIZA / CEPALGO / CEZARINA / CHAPADAO DO CEU / CIDADE OCIDENTAL / COCALZINHO / COLINACU / CORREGO DO OURO / CORUMBA / CORUMBAIBA / CRISTALINA / CRISTALINA TRANSMISSAO / CRISTIANOPOLIS / CRIXAS / CROMINIA / CUMARI / DAIA - ANAPOLIS / DAMOLANDIA / DAVINOPOLIS / DESFECHO / DESTILARIA BRASIL CENTRAL / DIMIC / DIORAMA / DORCELINO PEIXOTO DE MORAES / DOVERLANDIA / EDEALINA / EDEIA / ENERSUL / ESTANIFERA / ESTRELA DO NORTE / FAINA / FAZENDA CANADA / FAZENDA NOVA / FERROVIARIO / FIRMINOPOLIS / FLORES DE GOIAS / FORMIGA / FORMOSO / FRONTEIRA / GAMELEIRA / GIRASSOL / GOIANAPOLIS / GOIANDIRA / GOIANESIA / GOIANIA LESTE / GOIANIRA / GOIAS / GOIATUBA / GOUVERLANDIA / GOYA / GUAPO / HEITORAI / HIDROLANDIA / HIDROLINA / IACIARA / INACIOLANDIA / INDEPENDENCIA / INDIARA / INHUMAS / IPAMERI / IPEGUARI / IPORA / ISRAELANDIA / ITABERAI / ITAGUARI / ITAGUARU / ITAJA / ITAPACI / ITAPACI (TRANSMISSAO) / ITAPIRAPUA / ITAPURANGA / ITAPURANGA (TRANSMISSAO) / ITARUMA / ITAUCU / ITIQUIRA (FORMOSA) / ITUMBIARA NOVA / ITUMBIARA VELHA / JACILANDIA / JANDAIA / JARAGUA / JARANAPOLIS / JATAI / JAUPACI / JESUPOLIS / JOVIANIA / JUNDIAI / JURUMIRIM / JUSCELANDIA / JUSSARA / LAGES / LAGOA DA SERRA / LEOPOLDO DE BULHOES / LUZIANIA / LUZIANIA INDUSTRIAL / MAIRIPOTABA / MAMBAI / MARA ROSA / MARAJOARA / MARCIANOPOLIS / MARIAPOLIS (PADRE BERNARDO) / MATO GRANDE / MATRINCHA / MAURILANDIA / MEIA PONTE / MINACU / MINEIROS / MOIPORA / MONTE ALEGRE / MONTES CLAROS DE GOIAS / MONTIVIDIU T / MORRINHOS / MORRO AGUDO / MOSSAMEDES / MOZARLANDIA / MOZARLANDIA (TRANSMISSAO) / MUTUNOPOLIS / NAVESLANDIA ( JATAI ) / NAZARIO / NEROPOLIS / NIQUELANDIA / NOVA AMERICA / NOVA CRIXAS (TRANSMISSAO) / NOVA IGUAQU / NOVA PONTE / NOVA VENEZA / NOVO BRASIL / NOVO GAMA / NOVO PLANALTO / OLHOS DAGUA / ORIZONA / OURO VERDE DE GOIAS / OUVIDOR / PACAEMBU (NOVO GAMA) / PADRE BERNARDO / PALESTINA / PALMEIRAS / PALMEIRAS DE GOIAS / PALMELO / PALMINOPOLIS / PAMPLONA / PARANA / PARANAIBA / PARANAIGUARA / PARAUNA SE ALTA TENSAO / PARQUE DAS EMAS (MINEIROS) / PARQUE DAS NACOES / PEROLANDIA / PETROLINA / PILAR / PILOANDIA / PIRACANJUBA / PIRANHAS T / PIRENOPOLIS / PIRES BELO / PIRES DO RIO / PLANALTINA / PLANALTINA (TRANSMISSAO) / PLANALTO / PONTALINA / PORANGATU / PORTEIRAO / PORTELANDIA / PORTO SAO SIMAO / POSSE / POSSELANDIA / PROFESSOR JAMIL / QUEBRA LINHA / QUIRINOPOLIS / REAL / RETIRO / GOIAS / RIO CLARO / JATAI MONTIVIDIU / RIO DO PEIXE / RIO DOS BOIS (MAURILANDIA) / RIO PRETO / RIO QUENTE / RIO VERDE / RIO VERMELHO / RIVERLANDIA (RIO VERDE) / RUBIATABA / SANCLERLANDIA / SANTA BARBARA / SANTA FE DE GOIAS / SANTA HELENA / SANTA RITA DO ARAGUAIA / SANTA ROSA / SANTA ROSA DE GOIAS / SANTA ROSA DO MEIA PONTE / SANTA TEREZA DE GOIAS / SANTA TEREZINHA / SANTO ANTONIO DA BARRA / SANTO ANTONIO DO DESCOBERTO / SAO BARTOLOMEU / SAO DOMINGOS / SAO FRANCISCO DE GOIAS / SAO JOAO D ALIANCA / SAO JUDAS TADEU / SAO LUIZ DOS MONTES BELOS / SAO MIGUEL DO ARAGUAIA / SAO MIGUEL DO PASSA QUATRO / SAO SIMAO / SENADOR CANEDO TRANSMISSAO / SERRA AZUL (JATAI) / SERRA DE CALDAS / SERRA DO OURO /		
<b>Código do Decreto (Se Houver):</b>					
<b>Quantidade de Interrupções (Evento)</b>	4.760				
<b>Início 1ª Incidência (Data e Hora)</b>	06/12/2019 07:36:00				

			SERRANOPOLIS / SILVANIA / SOUZALANDIA / SUCURI / TAIOBA / TAQUARAL / TEREZOPOLIS / TERRA VERMELHA / TRAJANOPOLIS (PADRE BERNARDO) / TRES BARRAS / TRES RANCHOS / TRINDADE / TURVANIA / TURVELANDIA / URU / URUACU / URUTAI / USINA DE ACUCAR DE GOIANESIA / USINA MAMBAI / VALPARAISO / VARJAO / VENDA SECA / VIANOPOLIS / VICENTINOPOLIS / VILA BOA / VILA CORUMBA / VILA PROPICIO / XAVANTES / XIXA / ALTO HORIZONTE / MINEIROS TRANSMISSAO / SANTANA
<b>Início Última Incidência (Data e Hora)</b>	09/12/2019 08:59:00		
<b>Média de Duração das Incidências (h)</b>	9,11		
<b>Duração da Incidência mais longa (h)</b>	126,48		
<b>Total de Clientes afetados</b>	283.494	<b>Municípios Atingidos</b>	ABADIA DE GOIAS / ABADIANIA / ACREUNA / ADELANDIA / AGUA FRIA DE GOIAS / AGUA LIMPA / AGUAS LINDAS DE GOIAS / ALEXANIA / ALOANDIA / ALTO HORIZONTE / ALTO PARAISO DE GOIAS / ALVORADA DO NORTE / AMARALINA / AMERICANO DO BRASIL / AMORINOPOLIS / ANAPOLIS / ANHANGUERA / ANICUNS / APARECIDA DE GOIANIA / APARECIDA DO RIO DOCE / APORE / ARACU / ARAGARCAS / ARAGOIANIA / ARAGUAPAZ / ARENOPOLIS / ARUANA / AURILANDIA / AVELINOPOLIS / BALIZA / BARRO ALTO / BELA VISTA DE GOIAS / BOM JARDIM DE GOIAS / BOM JESUS DE GOIAS / BONFINOPOLIS / BONOPOLIS / BRAZABRANTES / BRITANIA / BURITI ALEGRE / BURITI DE GOIAS / BURITINOPOLIS / CABECEIRAS / CACHOEIRA ALTA / CACHOEIRA DE GOIAS / CACHOEIRA DOURADA / CACU / CAIAPONIA / CALDAS NOVAS / CALDAZINHA / CAMPESTRE DE GOIAS / CAMPINACU / CAMPINORTE / CAMPO ALEGRE DE GOIAS / CAMPO LIMPO / CAMPOS BELOS / CAMPOS VERDES / CARMO DO RIO VERDE / CASTELANDIA / CATALAO / CATURAI / CAVALCANTE / CERES / CEZARINA / CHAPADAO DO CEU / CIDADE OCIDENTAL / COCALZINHO DE GOIAS / COLINAS DO SUL / CORREGO DO OURO / CORUMBA DE GOIAS / CORUMBAIBA / CRISTALINA / CRISTIANOPOLIS / CRIXAS / CROMINIA / CUMARI / DAMIANOPOLIS / DAMOLANDIA / DAVINOPOLIS / DIORAMA / DISTRITO FEDERAL / DIVINOPOLIS DE GOIAS / DOVERLANDIA / EDEALINA / EDEIA / ESTRELA DO NORTE / FAINA / FAZENDA NOVA / FIRMINOPOLIS / FLORES DE GOIAS / FORMOSA / FORMOSO / GAMELEIRA DE GOIAS / GOIANAPOLIS / GOIANDIRA / GOIANESIA / GOIANIA / GOIANIRA / GOIAS / GOIATUBA / GOUVELANDIA / GUAPO / GUARAITA / GUARANI DE GOIAS / GUARINOS / HEITORAI / HIDROLANDIA / HIDROLINA / IACIARA / INACIOLANDIA / INDIARA / INHUMAS / IPAMERI / IPIRANGA DE GOIAS / IPORA / ISRAELANDIA / ITABERAI / ITAGUARI / ITAGUARU / ITAJA / ITAPACI / ITAPIRAPUA / ITAPURANGA / ITARUMA / ITAUCU / ITUMBIARA / IVOLANDIA / JANDAIA / JARAGUA / JATAI / JAUPACI / JESUPOLIS / JOVIANIA / JUSSARA / LAGOA SANTA / LEOPOLDO DE BULHOES / LUZIANIA / MAIRIPOTABA / MAMBAI / MARA ROSA / MATRINCHA / MAURILANDIA / MIMOSO DE GOIAS / MINACU / MINEIROS / MOIPORA / MONTE ALEGRE DE GOIAS / MONTES CLAROS DE GOIAS / MONTIVIDIU / MONTIVIDIU DO NORTE / MORRINHOS / MORRO AGUDO DE GOIAS / MOSSAMEDES / MOZARLANDIA / MUNDO NOVO DE GOIAS / MUTUNOPOLIS / NAZARIO / NEROPOLIS / NIQUELANDIA / NOVA AURORA / NOVA CRIXAS / NOVA GLORIA / NOVA IGUACU DE GOIAS / NOVA ROMA / NOVA VENEZA / NOVO BRASIL / NOVO GAMA / NOVO PLANALTO / ORIZONA / OURO VERDE DE GOIAS / OUVIDOR / PADRE BERNARDO / PALESTINA DE GOIAS / PALMEIRAS DE GOIAS / PALMELO / PALMINOPOLIS / PANAMA / PARANAIGUARA / PARAUNA / PEROLANDIA / PETROLINA DE GOIAS / PILAR DE GOIAS / PIRACANJUBA / PIRANHAS / PIRENOPOLIS / PIRES DO RIO / PLANALTINA / PONTALINA / PORANGATU / PORTEIRAO / PORTELANDIA / POSSE / PROFESSOR JAMIL SAFADY / QUIRINOPOLIS / RIO QUENTE / RIO VERDE / RUBIATABA / SANCLERLANDIA / SANTA BARBARA DE GOIAS / SANTA CRUZ DE GOIAS / SANTA FE DE GOIAS / SANTA HELENA DE GOIAS / SANTA RITA DO ARAGUAIA / SANTA RITA DO NOVO DESTINO / SANTA ROSA DE GOIAS / SANTA TEREZA DE GOIAS / SANTA TEREZINHA DE GOIAS / SANTO ANTONIO DA BARRA / SANTO ANTONIO DE GOIAS / SANTO ANTONIO DO DESCOBERTO / SAO DOMINGOS / SAO FRANCISCO DE GOIAS / SAO JOAO D ALIANCA / SAO JOAO DA PARAUNA / SAO LUIS DE MONTES BELOS / SAO LUIZ DO NORTE / SAO MIGUEL DO ARAGUAIA / SAO MIGUEL DO PASSA QUATRO / SAO SIMAO / SENADOR CANEDO / SERRANOPOLIS / SILVANIA / SITIO D ABADIA / TAQUARAL DE GOIAS / TEREZOPOLIS DE GOIAS / TRES RANCHOS / TRINDADE / TROMBAS / TURVANIA / TURVELANDIA / UIRAPURU / URUACU / URUANA / URUTAI / VALPARAISO DE GOIAS / VARJAO / VIANOPOLIS / VICENTINOPOLIS / VILA BOA / VILA PROPICIO

<b>DANOS CAUSADOS</b>			
<b>Equipamentos Danificado</b>	<b>Importância para o Sistema</b>	<b>Local</b>	<b>Quantidade</b>
Disjuntor/Religador Operado	Proteção do Alimentador	Área de Concessão	71
Chaves Fusíveis Operada	Proteção de Ramais de Alimentadores	Área de Concessão	1.618
Transformador Operado	Proteção do Transformador	Área de Concessão	1.075

<b>Relato técnico sobre a Intervenção realizada em Goiânia e Região Metropolitana</b>				
<b>Informações sobre Equipes</b>	06/12	07/12	08/12	
<b>Quantidade Usual</b>	773	731	595	turmas
<b>Quantidade Adicional</b>	93	0	0	turmas
<b>Quantidade Total</b>	866	731	595	turmas
<b>Tempos Médios</b>				
<b>Preparação</b>	5,55	6,18	4,87	Horas
<b>Deslocamento</b>	0,92	0,87	0,90	Horas
<b>Execução</b>	1,30	1,49	1,29	Horas
<b>TMAE</b>	7,76	8,54	7,06	Horas

### **Principais Dificuldades Encontradas:**

Chuvas com ventos fortes provocaram muitos pontos de alagamento e enxurrada, trânsito impedido por vários semáforos desligados dificultando a chegada ao atendimento das ocorrências emergenciais. Em determinadas regiões, decorrente dos fortes ventos, houve o tombamento de árvores nas estruturas de alimentação de média tensão, danos em ramais de ligação dos clientes, impedimentos de acesso e atolamentos em estradas rurais.

<b>Empresa</b>	ENEL DISTRIBUIÇÃO GOIAS		
<b>Valor CHI (Limite e Real)</b>	<b>482.391,86</b>		<b>767.414,90</b>



DOC ORIGEM	MIUNICIPIO	EQP_ORIGEM	CONJUNTO	INI_OCORRENC	FIM_OCORRENC	DT_INI_EVENTO	DT_FIM_EVENTO	DURAÇ	UC INT	CHI	EXPURGO
20191236318	DIVINOPOLIS DE GOIAS	GH12389051	SAO DOMINGOS	06/12/2019 07:36	06/12/2019 12:27	06/12/2019 07:36	06/12/2019 12:27	4,84	23	111,25	CHI
20191236391	SAO JOAO D ALIANCA	JL12383335	SAO JOAO D ALIANCA	06/12/2019 07:44	06/12/2019 10:33	06/12/2019 07:44	06/12/2019 10:33	2,80	12	33,65	CHI
20191236453	POSSE	IA12035179	IACIARA S2	06/12/2019 07:52	06/12/2019 11:46	06/12/2019 07:52	06/12/2019 11:46	3,89	9	34,99	CHI
20191236493	SAO DOMINGOS	SD12384774	SAO DOMINGOS	06/12/2019 07:59	06/12/2019 10:09	06/12/2019 07:59	06/12/2019 10:09	2,16	40	86,23	CHI
20191237193	FORMOSA	FA12242845	ITIQUEIRA	06/12/2019 08:00	06/12/2019 12:40	06/12/2019 08:00	06/12/2019 12:40	4,66	4	18,63	CHI
20191236530	CAMPINORTE	CR21190032	MARA ROSA	06/12/2019 08:03	06/12/2019 17:03	06/12/2019 08:03	06/12/2019 17:03	8,99	1	8,99	CHI
20191236533	SAO MIGUEL DO ARAGUAIA	SM21170928	SAO MIGUEL DO ARAGUAIA	06/12/2019 08:03	06/12/2019 11:37	06/12/2019 08:03	06/12/2019 11:37	3,55	1	3,55	CHI
20191237811	PORANGATU	PO12390257	PORANGATU	06/12/2019 08:06	06/12/2019 12:27	06/12/2019 08:06	06/12/2019 12:27	4,34	4	17,38	CHI
20191238058	AMARALINA	MU12214692	MARA ROSA	06/12/2019 08:06	06/12/2019 12:06	06/12/2019 08:06	06/12/2019 12:06	3,98	1	3,98	CHI
20191238058	MUTUNOPOLIS	MU12214692	MARA ROSA	06/12/2019 08:06	06/12/2019 12:06	06/12/2019 08:06	06/12/2019 12:06	3,98	4	15,94	CHI
20191236617	COLINAS DO SUL	TI12357757	NIQUELANDIA SUBTRANSMISSAO	06/12/2019 08:12	06/12/2019 10:24	06/12/2019 08:12	06/12/2019 10:24	2,19	7	15,33	CHI
20191236664	FORMOSA	FA21330262	SAO JOAO D ALIANCA	06/12/2019 08:22	06/12/2019 12:53	06/12/2019 08:22	06/12/2019 12:53	4,52	1	4,52	CHI
20191236681	PLANALTINA	PI11355729	PLANALTINA	06/12/2019 08:24	06/12/2019 10:40	06/12/2019 08:24	06/12/2019 10:40	2,28	1	2,28	CHI
20191236687	URUACU	UR12339123	MARA ROSA	06/12/2019 08:24	06/12/2019 13:20	06/12/2019 08:24	06/12/2019 13:20	4,92	1	4,92	CHI
20191234392	SAO MIGUEL DO ARAGUAIA	SM12334418	SAO MIGUEL DO ARAGUAIA	06/12/2019 08:27	07/12/2019 21:34	06/12/2019 08:27	07/12/2019 21:34	37,11	5	185,57	CHI
20191236764	COLINAS DO SUL	TI21239431	MINACU	06/12/2019 08:34	06/12/2019 18:48	06/12/2019 08:34	06/12/2019 18:48	10,23	1	10,23	CHI
20191236768	BONOPOLIS	BX12136924	SAO MIGUEL DO ARAGUAIA	06/12/2019 08:34	06/12/2019 16:36	06/12/2019 08:34	06/12/2019 16:36	8,02	5	40,11	CHI
20191237384	IACIARA	PS12235254	IACIARA S2	06/12/2019 08:34	06/12/2019 11:41	06/12/2019 08:34	06/12/2019 11:41	3,11	7	21,79	CHI
20191236907	PLANALTINA	PI21043452	PLANALTINA	06/12/2019 08:46	06/12/2019 12:01	06/12/2019 08:46	06/12/2019 12:01	3,25	2	6,50	CHI
20191236931	CABECEIRAS	CW12245168	ITIQUEIRA	06/12/2019 08:46	06/12/2019 12:09	06/12/2019 08:46	06/12/2019 12:09	3,38	1	3,38	CHI
20191236920	ITAPACI	CX21359378	SANTA TEREZINHA	06/12/2019 08:48	06/12/2019 12:33	06/12/2019 08:48	06/12/2019 12:33	3,73	1	3,73	CHI
20191236955	SANTA TEREZA DE GOIAS	SE12053821	MARA ROSA	06/12/2019 08:54	06/12/2019 11:50	06/12/2019 08:54	06/12/2019 11:50	2,93	1	2,93	CHI
20191236970	SAO MIGUEL DO ARAGUAIA	SM21235531	SAO MIGUEL DO ARAGUAIA	06/12/2019 08:56	06/12/2019 21:00	06/12/2019 08:56	06/12/2019 21:00	12,06	1	12,06	CHI
20191237012	MARA ROSA	MQ12287615	MARA ROSA	06/12/2019 08:59	06/12/2019 22:51	06/12/2019 08:59	06/12/2019 22:51	13,87	4	55,46	CHI
20191236994	NIQUELANDIA	2750069150	NIQUELANDIA SUBTRANSMISSAO	06/12/2019 09:00	06/12/2019 12:33	06/12/2019 09:00	06/12/2019 12:33	3,54	1	3,54	CHI
20191237002	MINACU	4020021959	MINACU	06/12/2019 09:01	06/12/2019 13:13	06/12/2019 09:01	06/12/2019 13:13	4,20	1	4,20	CHI
20191237007	PLANALTINA	PI12257785	PLANALTINA	06/12/2019 09:02	06/12/2019 15:42	06/12/2019 09:02	06/12/2019 15:42	6,66	3	19,97	CHI
20191237022	RUBIATABA	RB21057014	RUBIATABA	06/12/2019 09:04	06/12/2019 11:54	06/12/2019 09:04	06/12/2019 11:54	2,83	1	2,83	CHI
20191237028	PLANALTINA	2960032476	PLANALTINA	06/12/2019 09:04	06/12/2019 10:43	06/12/2019 09:04	06/12/2019 10:43	1,64	1	1,64	CHI
20191237060	SAO MIGUEL DO ARAGUAIA	SM12309562	SAO MIGUEL DO ARAGUAIA	06/12/2019 09:08	06/12/2019 17:49	06/12/2019 09:08	06/12/2019 17:49	8,67	2	17,34	CHI
20191237078	MARA ROSA	2260004060	MARA ROSA	06/12/2019 09:12	07/12/2019 00:18	06/12/2019 09:12	07/12/2019 00:18	15,10	1	15,10	CHI
20191237080	NIQUELANDIA	NQ21234735	NIQUELANDIA SUBTRANSMISSAO	06/12/2019 09:12	07/12/2019 13:00	06/12/2019 09:12	07/12/2019 13:00	27,79	1	27,79	CHI

20191237091	HIDROLINA	HL21237398	ITAPACI	06/12/2019 09:13	06/12/2019 15:07	06/12/2019 09:13	06/12/2019 15:07	5,89	1	5,89	CHI
20191237092	UIRAPURU	UP21283515	SANTA TEREZINHA	06/12/2019 09:13	06/12/2019 16:56	06/12/2019 09:13	06/12/2019 16:56	7,71	1	7,71	CHI
20191237131	MINACU	4020007811	MINACU	06/12/2019 09:17	06/12/2019 18:36	06/12/2019 09:17	06/12/2019 18:36	9,31	1	9,31	CHI
20191237145	ALTO HORIZONTE	9640010539	SANTA TEREZINHA	06/12/2019 09:18	06/12/2019 11:52	06/12/2019 09:18	06/12/2019 11:52	2,56	1	2,56	CHI
20191237147	MINACU	IH12242192	MINACU	06/12/2019 09:18	06/12/2019 19:37	06/12/2019 09:18	06/12/2019 19:37	10,31	49	505,29	CHI
20191237162	PLANALTINA	2960221583	PLANALTINA	06/12/2019 09:20	06/12/2019 11:59	06/12/2019 09:20	06/12/2019 11:59	2,64	1	2,64	CHI
20191237185	POSSE	PS12184932	IACIARA S2	06/12/2019 09:23	06/12/2019 14:29	06/12/2019 09:23	06/12/2019 14:29	5,09	5	25,46	CHI
20191237186	PILAR DE GOIAS	GG12325151	SANTA TEREZINHA	06/12/2019 09:23	06/12/2019 16:47	06/12/2019 09:23	06/12/2019 16:47	7,39	6	44,34	CHI
20191237215	IACIARA	1550034720	IACIARA S1	06/12/2019 09:29	06/12/2019 17:11	06/12/2019 09:29	06/12/2019 17:11	7,70	1	7,70	CHI
20191237238	PORANGATU	PO12104347	PORANGATU	06/12/2019 09:33	06/12/2019 10:55	06/12/2019 09:33	06/12/2019 10:55	1,36	8	10,86	CHI
20191237761	DAMIANOPOLIS	DA12196511	IACIARA S2	06/12/2019 09:37	06/12/2019 12:37	06/12/2019 09:37	06/12/2019 12:37	2,99	31	92,78	CHI
20191237344	CAMPINORTE	CR12309721	MARA ROSA	06/12/2019 09:38	06/12/2019 12:03	06/12/2019 09:38	06/12/2019 12:03	2,40	4	9,60	CHI
20191237344	NOVA IGUACU DE GOIAS	CR12309721	MARA ROSA	06/12/2019 09:38	06/12/2019 12:03	06/12/2019 09:38	06/12/2019 12:03	2,40	2	4,80	CHI
20191237317	IACIARA	IA12262079	IACIARA S1	06/12/2019 09:45	06/12/2019 15:42	06/12/2019 09:45	06/12/2019 15:42	5,95	21	124,85	CHI
20191237322	FORMOSA	610320245	ITUIQUIRA	06/12/2019 09:45	06/12/2019 14:06	06/12/2019 09:45	06/12/2019 14:06	4,34	1	4,34	CHI
20191237341	FORMOSA	FA11389055	SAO JOAO D ALIANCA	06/12/2019 09:48	06/12/2019 11:53	06/12/2019 09:48	06/12/2019 11:53	2,07	1	2,07	CHI
20191237350	URUACU	640011998	URUACU	06/12/2019 09:49	06/12/2019 17:00	06/12/2019 09:49	06/12/2019 17:00	7,17	1	7,17	CHI
20191237353	SAO JOAO D ALIANCA	JL21332978	SAO JOAO D ALIANCA	06/12/2019 09:50	06/12/2019 16:10	06/12/2019 09:50	06/12/2019 16:10	6,32	1	6,32	CHI
20191237423	NOVA IGUACU DE GOIAS	NH21181092	SANTA TEREZINHA	06/12/2019 09:51	06/12/2019 11:24	06/12/2019 09:51	06/12/2019 11:24	1,55	1	1,55	CHI
20191237770	MINACU	IH12182453	MINACU	06/12/2019 09:51	06/12/2019 12:18	06/12/2019 09:51	06/12/2019 12:18	2,46	182	448,02	CHI
20191237424	NOVA IGUACU DE GOIAS	NH21242586	SANTA TEREZINHA	06/12/2019 09:55	06/12/2019 12:54	06/12/2019 09:55	06/12/2019 12:54	2,98	1	2,98	CHI
20191237383	BURITINOPOLIS	4540000562	IACIARA S2	06/12/2019 09:56	06/12/2019 11:23	06/12/2019 09:56	06/12/2019 11:23	1,45	1	1,45	CHI
20191237445	CAMPOS VERDES	VD21086360	SANTA TEREZINHA	06/12/2019 10:06	06/12/2019 11:17	06/12/2019 10:06	06/12/2019 11:17	1,17	2	2,34	CHI
20191237471	NIQUELANDIA	NQ21330292	NIQUELANDIA SUBTRANSMISSAO	06/12/2019 10:11	06/12/2019 12:00	06/12/2019 10:11	06/12/2019 12:00	1,81	1	1,81	CHI
20191237473	RUBIATABA	RB12392304	RUBIATABA	06/12/2019 10:11	06/12/2019 13:38	06/12/2019 10:11	06/12/2019 13:38	3,44	6	20,63	CHI
20191237498	ALTO HORIZONTE	AJ12213238	SANTA TEREZINHA	06/12/2019 10:16	06/12/2019 12:14	06/12/2019 10:16	06/12/2019 12:14	1,96	1	1,96	CHI
20191237518	BONOPOLIS	BX21321746	SAO MIGUEL DO ARAGUAIA	06/12/2019 10:20	06/12/2019 21:15	06/12/2019 10:20	06/12/2019 21:15	10,91	1	10,91	CHI
20191237531	NOVA CRIXAS	NA21059980	NOVA CRIXAS	06/12/2019 10:22	06/12/2019 11:30	06/12/2019 10:22	06/12/2019 11:30	1,12	1	1,12	CHI
20191235552	MARA ROSA	MQ12248126	MARA ROSA	06/12/2019 10:29	06/12/2019 11:20	06/12/2019 10:29	06/12/2019 11:20	0,85	15	12,75	CHI
20191237574	RIO VERDE	RV21303549	SANTA HELENA S1	06/12/2019 10:32	06/12/2019 16:50	06/12/2019 10:32	06/12/2019 16:50	6,29	1	6,29	CHI
20191237576	PARAUNA	PU12304549	PARAUNA	06/12/2019 10:33	06/12/2019 15:05	06/12/2019 10:33	06/12/2019 15:05	4,54	14	63,54	CHI
20191237582	AGUA FRIA DE GOIAS	TL21193632	SAO JOAO D ALIANCA	06/12/2019 10:34	06/12/2019 22:22	06/12/2019 10:34	06/12/2019 22:22	11,80	1	11,80	CHI
20191237766	FORMOSA	FA11278157	ITUIQUIRA	06/12/2019 10:34	06/12/2019 15:02	06/12/2019 10:34	06/12/2019 15:02	4,46	1	4,46	CHI

20191237705	ITABERAÍ	IB21310561	ITABERAÍ S2	06/12/2019 10:38	06/12/2019 12:36	06/12/2019 10:38	06/12/2019 12:36	1,95	1	1,95	CHI
20191237713	DIORAMA	DI12066071	ARENÓPOLIS	06/12/2019 10:41	07/12/2019 00:29	06/12/2019 10:41	07/12/2019 00:29	13,80	28	386,38	CHI
20191237734	FORMOSA	FA21115743	SAO JOAO D ALIANCA	06/12/2019 10:45	06/12/2019 13:04	06/12/2019 10:45	06/12/2019 13:04	2,30	1	2,30	CHI
20191237736	TAQUARAL DE GOIAS	TQ12074928	ITABERAÍ S1	06/12/2019 10:46	06/12/2019 16:29	06/12/2019 10:46	06/12/2019 16:29	5,72	27	154,33	CHI
20191238125	CAIAPONIA	CP12241163	CAIAPONIA	06/12/2019 10:46	06/12/2019 18:00	06/12/2019 10:46	06/12/2019 18:00	7,23	4	28,91	CHI
20191237744	ALTO PARAISO DE GOIAS	BF12129915	FLORES DE GOIAS	06/12/2019 10:48	06/12/2019 13:43	06/12/2019 10:48	06/12/2019 13:43	2,92	23	67,05	CHI
20191237982	PALMEIRAS DE GOIAS	PL12124132	PALMEIRAS	06/12/2019 10:50	06/12/2019 13:48	06/12/2019 10:50	06/12/2019 13:48	2,96	9	26,60	CHI
20191237771	JUSSARA	JR21331755	JUSSARA	06/12/2019 10:52	07/12/2019 10:30	06/12/2019 10:52	07/12/2019 10:30	23,63	1	23,63	CHI
20191237782	GOUVELANDIA	GB21303168	QUIRINÓPOLIS	06/12/2019 10:54	06/12/2019 15:42	06/12/2019 10:54	06/12/2019 15:42	4,79	2	9,58	CHI
20191238896	JATAI	JT11336947	JATAI S3	06/12/2019 10:57	06/12/2019 16:17	06/12/2019 10:57	06/12/2019 16:17	5,33	111	591,14	CHI
20191237923	CAMPINACU	IH12192447	MINACU	06/12/2019 11:00	06/12/2019 20:41	06/12/2019 11:00	06/12/2019 20:41	9,68	5	48,41	CHI
20191237923	MINACU	IH12192447	MINACU	06/12/2019 11:00	06/12/2019 20:41	06/12/2019 11:00	06/12/2019 20:41	9,68	24	232,35	CHI
20191237910	SAO MIGUEL DO ARAGUAIA	SM21291162	SAO MIGUEL DO ARAGUAIA	06/12/2019 11:02	06/12/2019 21:35	06/12/2019 11:02	06/12/2019 21:35	10,56	1	10,56	CHI
20191237914	ITABERAÍ	IB12079205	ITABERAÍ S1	06/12/2019 11:02	06/12/2019 16:00	06/12/2019 11:02	06/12/2019 16:00	4,96	4	19,82	CHI
20191238482	AMARALINA	MQ12170098	NOVA CRIXAS	06/12/2019 11:02	07/12/2019 00:48	06/12/2019 11:02	07/12/2019 00:48	13,76	10	137,61	CHI
20191238482	MARA ROSA	MQ12170098	NOVA CRIXAS	06/12/2019 11:02	07/12/2019 00:48	06/12/2019 11:02	07/12/2019 00:48	13,76	2	27,52	CHI
20191237933	ALTO PARAISO DE GOIAS	BF12375516	FLORES DE GOIAS	06/12/2019 11:05	06/12/2019 14:18	06/12/2019 11:05	06/12/2019 14:18	3,20	7	22,43	CHI
20191237944	RIO VERDE	RV12273766	MONTIVIDIU T	06/12/2019 11:05	06/12/2019 17:38	06/12/2019 11:05	06/12/2019 17:38	6,55	3	19,64	CHI
20191237954	QUIRINÓPOLIS	QI32052457	QUIRINÓPOLIS	06/12/2019 11:08	06/12/2019 14:34	06/12/2019 11:08	06/12/2019 14:34	3,43	9	30,89	CHI
20191237945	ARAGUAPAZ	AZ12274481	GOIAS	06/12/2019 11:10	07/12/2019 08:45	06/12/2019 11:10	07/12/2019 08:45	21,58	1	21,58	CHI
20191233108	FLORES DE GOIAS	FA12397044	ITIQUIRA	06/12/2019 11:11	06/12/2019 14:19	06/12/2019 11:11	06/12/2019 14:19	3,12	1	3,12	CHI
20191233108	FORMOSA	FA12397044	ITIQUIRA	06/12/2019 11:11	06/12/2019 14:19	06/12/2019 11:11	06/12/2019 14:19	3,12	5	15,60	CHI
20191238749	MINACU	IH12348010	MINACU	06/12/2019 11:11	07/12/2019 02:11	06/12/2019 11:11	07/12/2019 02:11	14,99	4	59,98	CHI
20191237959	ITABERAÍ	IB12000032	ITABERAÍ S2	06/12/2019 11:12	07/12/2019 17:07	06/12/2019 11:12	07/12/2019 17:07	29,92	1	29,92	CHI
20191237959	ITABERAÍ	IB12000032	ITABERAÍ S2	06/12/2019 11:12	07/12/2019 17:07	07/12/2019 15:28	07/12/2019 17:07	1,66	1	1,66	CHI
20191237961	MUNDO NOVO DE GOIAS	MH11269142	NOVA CRIXAS	06/12/2019 11:12	06/12/2019 13:59	06/12/2019 11:12	06/12/2019 13:59	2,77	1	2,77	CHI
20191237965	BALIZA	BH12380942	BOM JARDIM	06/12/2019 11:12	06/12/2019 16:04	06/12/2019 11:12	06/12/2019 16:04	4,86	7	34,04	CHI
20191237989	SAO LUIS DE MONTES BELOS	SL21111556	FIRMINÓPOLIS S1	06/12/2019 11:19	06/12/2019 13:53	06/12/2019 11:19	06/12/2019 13:53	2,56	1	2,56	CHI
20191237995	QUIRINÓPOLIS	QI12279590	QUIRINÓPOLIS	06/12/2019 11:19	06/12/2019 13:14	06/12/2019 11:19	06/12/2019 13:14	1,91	6	11,45	CHI
20191238003	RIO VERDE	RV21289565	RIO VERDE S1	06/12/2019 11:24	06/12/2019 16:40	06/12/2019 11:24	06/12/2019 16:30	5,10	1	5,10	CHI
20191238003	RIO VERDE	RV21305818	RIO VERDE S1	06/12/2019 11:24	06/12/2019 16:40	06/12/2019 11:24	06/12/2019 16:40	5,26	2	10,53	CHI
20191238004	FORMOSA	610045635	ITIQUIRA	06/12/2019 11:24	06/12/2019 13:19	06/12/2019 11:24	06/12/2019 13:19	1,91	1	1,91	CHI
20191238007	BONÓPOLIS	BX21375452	SAO MIGUEL DO ARAGUAIA	06/12/2019 11:24	06/12/2019 15:10	06/12/2019 11:24	06/12/2019 15:10	3,76	1	3,76	CHI

20191238155	ANICUNS	AC12259933	FIRMINOPOLIS S2	06/12/2019 11:24	06/12/2019 17:55	06/12/2019 11:24	06/12/2019 17:55	6,52	9	58,68	CHI
20191238024	MINACU	4020082973	MINACU	06/12/2019 11:30	06/12/2019 12:57	06/12/2019 11:30	06/12/2019 12:57	1,44	1	1,44	CHI
20191238032	CATALAO	1990100433	CATALAO S2	06/12/2019 11:31	06/12/2019 13:31	06/12/2019 11:31	06/12/2019 13:31	1,99	1	1,99	CHI
20191238048	SAO MIGUEL DO ARAGUAIA	SM12151000	SAO MIGUEL DO ARAGUAIA	06/12/2019 11:35	06/12/2019 13:41	06/12/2019 11:35	06/12/2019 13:41	2,09	19	39,66	CHI
20191238053	FORMOSO	FO12052572	PORANGATU	06/12/2019 11:37	06/12/2019 15:57	06/12/2019 11:37	06/12/2019 15:57	4,33	3	12,99	CHI
20191238060	POSSE	PS21132160	IACIARA S2	06/12/2019 11:38	06/12/2019 17:15	06/12/2019 11:38	06/12/2019 17:15	5,61	1	5,61	CHI
20191232773	CAMPINACU	UC12239716	PORANGATU	06/12/2019 11:39	06/12/2019 12:11	06/12/2019 11:39	06/12/2019 12:11	0,52	36	18,73	CHI
20191238065	GOIAS	GS12124722	GOIAS	06/12/2019 11:39	06/12/2019 13:51	06/12/2019 11:39	06/12/2019 13:51	2,19	10	21,94	CHI
20191238067	ALVORADA DO NORTE	AQ12302818	IACIARA S2	06/12/2019 11:39	06/12/2019 20:01	06/12/2019 11:39	06/12/2019 20:01	8,36	3	25,08	CHI
20191238080	VICENTINOPOLIS	VI21222494	VICENTINOPOLIS	06/12/2019 11:42	07/12/2019 14:01	06/12/2019 11:42	07/12/2019 14:01	26,31	1	26,31	CHI
20191238097	GOIATUBA	3320005532	BOM JESUS DE GOIAS	06/12/2019 11:46	06/12/2019 19:03	06/12/2019 11:46	06/12/2019 19:03	7,28	1	7,28	CHI
20191238098	MINACU	4020038790	MINACU	06/12/2019 11:46	06/12/2019 19:19	06/12/2019 11:46	06/12/2019 19:19	7,54	1	7,54	CHI
20191238104	AGUA FRIA DE GOIAS	TL21302713	SAO JOAO D ALIANCA	06/12/2019 11:47	06/12/2019 15:37	06/12/2019 11:47	06/12/2019 15:37	3,82	1	3,82	CHI
20191238106	MORRO AGUDO DE GOIAS	3690009362	ITAPURANGA	06/12/2019 11:47	06/12/2019 19:25	06/12/2019 11:47	06/12/2019 19:25	7,64	1	7,64	CHI
20191234826	CAIAPONIA	CP12380880	CAIAPONIA	06/12/2019 11:48	06/12/2019 13:10	06/12/2019 11:48	06/12/2019 13:10	1,38	10	13,79	CHI
20191238116	JATAI	JT12264404	JATAI S1	06/12/2019 11:50	06/12/2019 15:00	06/12/2019 11:50	06/12/2019 15:00	3,18	6	19,08	CHI
20191238344	CAMPINACU	IH12250126	MINACU	06/12/2019 11:51	07/12/2019 00:45	06/12/2019 11:51	07/12/2019 00:45	12,89	9	116,00	CHI
20191238126	PONTALINA	PK21307948	PONTALINA	06/12/2019 11:53	06/12/2019 18:20	06/12/2019 11:53	06/12/2019 18:20	6,45	3	19,35	CHI
20191238136	VICENTINOPOLIS	VI21164306	VICENTINOPOLIS	06/12/2019 11:55	07/12/2019 11:06	06/12/2019 11:55	07/12/2019 11:06	23,19	1	23,19	CHI
20191238137	ITUMBIARA	690324352	ITUMBIARA VELHA S1	06/12/2019 11:56	06/12/2019 14:53	06/12/2019 11:56	06/12/2019 14:53	2,94	1	2,94	CHI
20191238138	SAO MIGUEL DO ARAGUAIA	SM12020663	SAO MIGUEL DO ARAGUAIA	06/12/2019 11:56	06/12/2019 13:55	06/12/2019 11:56	06/12/2019 13:55	1,98	1	1,98	CHI
20191238141	COLINAS DO SUL	TI11037454	NIQUELANDIA SUBTRANSMISSAO	06/12/2019 11:57	06/12/2019 16:28	06/12/2019 11:57	06/12/2019 16:28	4,51	116	523,71	CHI
20191238148	PALMEIRAS DE GOIAS	PL12125675	PALMEIRAS	06/12/2019 11:59	07/12/2019 09:25	06/12/2019 11:59	07/12/2019 09:25	21,43	2	42,86	CHI
20191238152	JATAI	JT12184067	MONTIVIDIU T	06/12/2019 11:59	06/12/2019 14:21	06/12/2019 11:59	06/12/2019 14:21	2,37	2	4,73	CHI
20191238153	SAO MIGUEL DO ARAGUAIA	SM12137060	SAO MIGUEL DO ARAGUAIA	06/12/2019 11:59	07/12/2019 17:01	06/12/2019 11:59	07/12/2019 17:01	29,02	2	58,04	CHI
20191238157	ORIZONA	OZ21113128	PIRES DO RIO S2	06/12/2019 12:00	06/12/2019 18:20	06/12/2019 12:00	06/12/2019 18:20	6,33	2	12,65	CHI
20191238159	PLANALTINA	10014737300	PLANALTINA	06/12/2019 12:00	06/12/2019 13:08	06/12/2019 12:00	06/12/2019 13:08	1,12	1	1,12	CHI
20191238163	MORRO AGUDO DE GOIAS	MS12136795	ITAPURANGA	06/12/2019 12:01	06/12/2019 18:30	06/12/2019 12:01	06/12/2019 18:30	6,48	35	226,87	CHI
20191237839	GOIANIA	GN12395284	XAVANTES	06/12/2019 12:02	06/12/2019 18:40	06/12/2019 16:17	06/12/2019 18:40	2,38	1	2,38	CHI
20191238229	CAMPINORTE	CR12291127	CAMPINORTE	06/12/2019 12:02	06/12/2019 14:32	06/12/2019 12:02	06/12/2019 14:32	2,48	0	0,00	CHI
20191238229	URUACU	CR12291127	CAMPINORTE	06/12/2019 12:02	06/12/2019 14:32	06/12/2019 12:02	06/12/2019 14:32	2,48	170	422,40	CHI
20191238176	TURVELANDIA	TD21040337	RIO DOS BOIS	06/12/2019 12:04	08/12/2019 11:20	06/12/2019 12:04	08/12/2019 11:20	47,27	2	94,54	CHI
20191238177	SAO MIGUEL DO ARAGUAIA	SM21263007	SAO MIGUEL DO ARAGUAIA	06/12/2019 12:04	06/12/2019 17:30	06/12/2019 12:04	06/12/2019 17:30	5,42	1	5,42	CHI

20191238178	ADELANDIA	DN12259109	ANICUNS	06/12/2019 12:04	06/12/2019 15:40	06/12/2019 12:04	06/12/2019 15:40	3,59	7	25,16	CHI
20191238778	SAO MIGUEL DO ARAGUAIA	SM12321016	NOVA CRIXAS	06/12/2019 12:05	06/12/2019 18:22	06/12/2019 12:05	06/12/2019 18:22	6,28	7	43,98	CHI
20191237840	PIRENOPOLIS	02042238	CORUMBA	06/12/2019 12:07	06/12/2019 14:54	06/12/2019 12:15	06/12/2019 14:47	2,53	336	851,20	CHI
20191237840	PIRENOPOLIS	02040234	CORUMBA	06/12/2019 12:07	06/12/2019 14:54	06/12/2019 13:53	06/12/2019 14:47	0,90	95	85,18	CHI
20191237840	PIRENOPOLIS	PV13215149	CORUMBA	06/12/2019 12:07	06/12/2019 14:54	06/12/2019 12:15	06/12/2019 14:54	2,66	3140	8365,48	CHI
20191238189	INDIARA	IY12323655	EDEIA	06/12/2019 12:07	06/12/2019 15:22	06/12/2019 12:07	06/12/2019 15:22	3,26	12	39,14	CHI
20191238194	ANAPOLIS	AN11130801	JUNDIAI S2	06/12/2019 12:08	06/12/2019 14:34	06/12/2019 12:08	06/12/2019 14:34	2,43	126	305,90	CHI
20191238200	CATALAO	CT21272528	CATALAO S1	06/12/2019 12:10	06/12/2019 14:48	06/12/2019 12:10	06/12/2019 14:48	2,63	1	2,63	CHI
20191238378	PORANGATU	PO12020611	NOVO PLANALTO	06/12/2019 12:12	06/12/2019 13:59	06/12/2019 12:12	06/12/2019 13:59	1,79	8	14,30	CHI
20191238213	VILA PROPICIO	NP21231821	GOIANESIA S1	06/12/2019 12:13	07/12/2019 11:40	06/12/2019 12:13	07/12/2019 11:40	23,44	1	23,44	CHI
20191238216	JATAI	JT21138946	JATAI S1	06/12/2019 12:16	06/12/2019 15:07	06/12/2019 12:16	06/12/2019 15:07	2,85	1	2,85	CHI
20191238221	ORIZONA	2060012436	PIRES DO RIO S2	06/12/2019 12:17	06/12/2019 16:37	06/12/2019 12:17	06/12/2019 16:37	4,33	1	4,33	CHI
20191238223	GOIANIA	16336513	GOYA S2	06/12/2019 12:18	06/12/2019 15:46	06/12/2019 12:18	06/12/2019 15:46	3,47	1	3,47	CHI
20191238262	GOIANIA	GN12151986	MEIA PONTE	06/12/2019 12:19	06/12/2019 14:59	06/12/2019 12:19	06/12/2019 14:59	2,66	546	1450,54	CHI
20191238234	FAZENDA NOVA	2290002416	IPORA	06/12/2019 12:21	06/12/2019 14:50	06/12/2019 12:21	06/12/2019 14:50	2,48	1	2,48	CHI
20191238246	CABECEIRAS	860003516	ITUIQUIRA	06/12/2019 12:23	06/12/2019 16:41	06/12/2019 12:23	06/12/2019 16:41	4,30	1	4,30	CHI
20191238247	ARAGUAPAZ	MS12113246	ITAPURANGA	06/12/2019 12:23	06/12/2019 18:00	06/12/2019 12:23	06/12/2019 18:00	5,60	2	11,21	CHI
20191238247	FAINA	MS12113246	ITAPURANGA	06/12/2019 12:23	06/12/2019 18:00	06/12/2019 12:23	06/12/2019 18:00	5,60	7	39,23	CHI
20191238247	MORRO AGUDO DE GOIAS	MS12113246	ITAPURANGA	06/12/2019 12:23	06/12/2019 18:00	06/12/2019 12:23	06/12/2019 18:00	5,60	7	39,23	CHI
20191238545	FLORES DE GOIAS	IA12046295	IACIARA S2	06/12/2019 12:23	06/12/2019 18:14	06/12/2019 12:23	06/12/2019 18:14	5,85	1	5,85	CHI
20191238545	IACIARA	IA12046295	IACIARA S2	06/12/2019 12:23	06/12/2019 18:14	06/12/2019 12:23	06/12/2019 18:14	5,85	65	379,96	CHI
20191238251	BARRO ALTO	BA12342220	GOIANESIA S1	06/12/2019 12:24	06/12/2019 19:04	06/12/2019 12:24	06/12/2019 19:04	6,65	1	6,65	CHI
20191238253	GAMELEIRA DE GOIAS	SV31094799	DAIA S2	06/12/2019 12:25	06/12/2019 16:47	06/12/2019 12:25	06/12/2019 16:47	4,36	1	4,36	CHI
20191238255	NOVA ROMA	ND11314144	IACIARA S2	06/12/2019 12:25	06/12/2019 16:07	06/12/2019 12:25	06/12/2019 16:07	3,69	6	22,14	CHI
20191238758	PIRENOPOLIS	PV11057884	CORUMBA	06/12/2019 12:25	06/12/2019 16:11	06/12/2019 12:25	06/12/2019 16:11	3,76	85	320,00	CHI
20191238261	AGUA FRIA DE GOIAS	TL12279981	SAO JOAO D ALIANCA	06/12/2019 12:26	06/12/2019 16:20	06/12/2019 12:26	06/12/2019 16:20	3,90	41	159,91	CHI
20191238681	ANICUNS	NZ12147519	ANICUNS	06/12/2019 12:26	06/12/2019 15:40	06/12/2019 12:26	06/12/2019 15:40	3,24	110	356,92	CHI
20191238681	NAZARIO	NZ12147519	ANICUNS	06/12/2019 12:26	06/12/2019 15:40	06/12/2019 12:26	06/12/2019 15:40	3,24	100	324,47	CHI
20191238681	PALMEIRAS DE GOIAS	NZ12147519	ANICUNS	06/12/2019 12:26	06/12/2019 15:40	06/12/2019 12:26	06/12/2019 15:40	3,24	3	9,73	CHI
20191238681	TURVANIA	NZ12147519	ANICUNS	06/12/2019 12:26	06/12/2019 15:40	06/12/2019 12:26	06/12/2019 15:40	3,24	48	155,75	CHI
20191238263	TRINDADE	40190316	TRINDADE	06/12/2019 12:27	06/12/2019 17:47	06/12/2019 12:27	06/12/2019 17:47	5,33	1	5,33	CHI
20191239472	GOIANIA	GN11162032	CAMPINAS S2	06/12/2019 12:27	06/12/2019 17:29	06/12/2019 12:27	06/12/2019 17:29	5,04	76	383,17	CHI
20191238272	POSSE	1480058972	IACIARA S2	06/12/2019 12:28	06/12/2019 15:27	06/12/2019 12:28	06/12/2019 15:27	2,98	1	2,98	CHI

20191238273	SAO LUIS DE MONTES BELOS	SL21108202	FIRMINOPOLIS S2	06/12/2019 12:29	06/12/2019 15:48	06/12/2019 12:29	06/12/2019 15:48	3,32	1	3,32	CHI
20191238279	QUIRINOPOLIS	QI12355068	QUIRINOPOLIS	06/12/2019 12:30	06/12/2019 21:01	06/12/2019 12:30	06/12/2019 21:01	8,50	1	8,50	CHI
20191238319	GOIANIA	GN11132350	ATLANTICO S3	06/12/2019 12:30	06/12/2019 14:11	06/12/2019 12:30	06/12/2019 14:11	1,68	60	100,78	CHI
20191238292	ABADIANIA	AA21000036	ANAPOLIS UNIVERSITARIO S1	06/12/2019 12:34	06/12/2019 17:21	06/12/2019 12:34	06/12/2019 17:21	4,78	2	9,56	CHI
20191235951	CAIAPONIA	CP12184786	CAIAPONIA	06/12/2019 12:36	11/12/2019 19:05	06/12/2019 12:36	08/12/2019 01:45	37,15	7	260,06	CHI
20191235951	CAIAPONIA	CP12244449	CAIAPONIA	06/12/2019 12:36	11/12/2019 19:05	06/12/2019 12:36	08/12/2019 10:46	46,17	4	184,67	CHI
20191235951	CAIAPONIA	CP12245754	CAIAPONIA	06/12/2019 12:36	11/12/2019 19:05	06/12/2019 12:36	08/12/2019 12:07	47,50	4	190,01	CHI
20191235951	DOVERLANDIA	CP12245754	CAIAPONIA	06/12/2019 12:36	11/12/2019 19:05	06/12/2019 12:36	08/12/2019 12:07	47,50	1	47,50	CHI
20191235951	CAIAPONIA	CP12204336LD	CAIAPONIA	06/12/2019 12:36	11/12/2019 19:05	06/12/2019 12:36	08/12/2019 22:52	58,26	3	174,77	CHI
20191235951	CAIAPONIA	CP12204336LD	CAIAPONIA	06/12/2019 12:36	11/12/2019 19:05	08/12/2019 23:02	09/12/2019 12:57	13,93	3	41,78	CHI
20191235951	CAIAPONIA	CP12345397	CAIAPONIA	06/12/2019 12:36	11/12/2019 19:05	06/12/2019 12:36	09/12/2019 14:45	74,14	4	296,56	CHI
20191235951	CAIAPONIA	CP12184786	CAIAPONIA	06/12/2019 12:36	11/12/2019 19:05	09/12/2019 17:42	09/12/2019 18:32	0,83	22	18,27	CHI
20191235951	DOVERLANDIA	CP12184786	CAIAPONIA	06/12/2019 12:36	11/12/2019 19:05	09/12/2019 17:42	09/12/2019 18:32	0,83	1	0,83	CHI
20191235951	CAIAPONIA	CP13354286	CAIAPONIA	06/12/2019 12:36	11/12/2019 19:05	06/12/2019 12:36	09/12/2019 22:06	81,49	11	896,38	CHI
20191235951	CAIAPONIA	CP12184786	CAIAPONIA	06/12/2019 12:36	11/12/2019 19:05	10/12/2019 09:10	10/12/2019 16:52	7,72	15	115,73	CHI
20191235951	DOVERLANDIA	CP12184786	CAIAPONIA	06/12/2019 12:36	11/12/2019 19:05	10/12/2019 09:10	10/12/2019 16:52	7,72	1	7,72	CHI
20191235951	CAIAPONIA	CP12184786	CAIAPONIA	06/12/2019 12:36	11/12/2019 19:05	10/12/2019 09:10	10/12/2019 18:42	9,54	18	171,65	CHI
20191235951	CAIAPONIA	CP12345397	CAIAPONIA	06/12/2019 12:36	11/12/2019 19:05	11/12/2019 12:35	11/12/2019 17:24	4,81	4	19,26	CHI
20191235951	CAIAPONIA	CP12345398LD	CAIAPONIA	06/12/2019 12:36	11/12/2019 19:05	06/12/2019 12:36	11/12/2019 18:16	125,66	2	251,33	CHI
20191235951	CAIAPONIA	CP12358475LD	CAIAPONIA	06/12/2019 12:36	11/12/2019 19:05	06/12/2019 12:36	11/12/2019 19:05	126,48	1	126,48	CHI
20191238305	GOIANIRA	GR21015730	INHUMAS S1	06/12/2019 12:36	06/12/2019 20:00	06/12/2019 12:36	06/12/2019 20:00	7,39	1	7,39	CHI
20191237843	JUSSARA	JR12160972	BRITANIA	06/12/2019 12:38	07/12/2019 10:38	06/12/2019 12:38	07/12/2019 10:38	21,99	3	65,98	CHI
20191238312	ANAPOLIS	20266698	JUNDIAI S2	06/12/2019 12:38	06/12/2019 19:35	06/12/2019 12:38	06/12/2019 19:35	6,96	1	6,96	CHI
20191238550	PIRES DO RIO	PR12337227	PIRES DO RIO S1	06/12/2019 12:38	06/12/2019 17:08	06/12/2019 12:38	06/12/2019 17:08	4,48	39	174,90	CHI
20191238550	SANTA CRUZ DE GOIAS	PR12337227	PIRES DO RIO S1	06/12/2019 12:38	06/12/2019 17:08	06/12/2019 12:38	06/12/2019 17:08	4,48	1	4,48	CHI
20191238550	URUTAI	PR12337227	PIRES DO RIO S1	06/12/2019 12:38	06/12/2019 17:08	06/12/2019 12:38	06/12/2019 17:08	4,48	1	4,48	CHI
20191240629	CAIAPONIA	CP12251568	CAIAPONIA	06/12/2019 12:39	07/12/2019 11:04	06/12/2019 12:39	07/12/2019 11:04	22,41	21	470,59	CHI
20191240623	CAMPINORTE	2040028268	MARA ROSA	06/12/2019 12:41	06/12/2019 21:17	06/12/2019 12:41	06/12/2019 21:17	8,60	1	8,60	CHI
20191238465	PALMEIRAS DE GOIAS	PL12028968	PALMEIRAS	06/12/2019 12:42	06/12/2019 15:36	06/12/2019 12:42	06/12/2019 15:36	2,90	4	11,58	CHI
20191238334	PIRACANJUBA	PJ12000079	PIRACANJUBA	06/12/2019 12:43	06/12/2019 17:05	06/12/2019 12:43	06/12/2019 17:05	4,37	26	113,56	CHI
20191238339	COLINAS DO SUL	TI21333946	MINACU	06/12/2019 12:44	06/12/2019 19:09	06/12/2019 12:44	06/12/2019 19:09	6,41	1	6,41	CHI
20191238340	ANICUNS	NZ12003882	ANICUNS	06/12/2019 12:44	06/12/2019 15:50	06/12/2019 12:44	06/12/2019 15:50	3,10	36	111,69	CHI
20191238340	NAZARIO	NZ12003882	ANICUNS	06/12/2019 12:44	06/12/2019 15:50	06/12/2019 12:44	06/12/2019 15:50	3,10	48	148,92	CHI

20191238353	TRINDADE	TR11157607	GOYA S2	06/12/2019 12:44	06/12/2019 14:59	06/12/2019 12:44	06/12/2019 14:59	2,24	131	293,84	CHI
20191238343	GOIANIA	GN11196685	GOIANIA LESTE S2	06/12/2019 12:45	06/12/2019 16:45	06/12/2019 12:45	06/12/2019 16:45	3,99	142	566,42	CHI
20191238532	INHUMAS	IN11132736	INHUMAS S2	06/12/2019 12:46	06/12/2019 16:28	06/12/2019 12:46	06/12/2019 16:28	3,69	100	368,58	CHI
20191238696	AMARALINA	LC12290987	MARA ROSA	06/12/2019 12:46	06/12/2019 16:30	06/12/2019 12:46	06/12/2019 16:30	3,73	2	7,46	CHI
20191238888	JARAGUA	JA12064311	JARAGUA	06/12/2019 12:46	06/12/2019 17:48	06/12/2019 12:46	06/12/2019 17:48	5,04	14	70,49	CHI
201912260739	APARECIDA DE GOIANIA	AP16403900	INDEPENDENCIA S1	06/12/2019 12:46	06/12/2019 17:10	06/12/2019 12:46	06/12/2019 13:10	0,41	9262	3789,70	CHI
201912260739	APARECIDA DE GOIANIA	AP13258423	INDEPENDENCIA S1	06/12/2019 12:46	06/12/2019 17:10	06/12/2019 13:10	06/12/2019 17:10	3,99	331	1320,51	CHI
201912260739	APARECIDA DE GOIANIA	AP13258423	INDEPENDENCIA S1	06/12/2019 12:46	06/12/2019 17:10	06/12/2019 14:44	06/12/2019 17:10	2,43	185	449,50	CHI
20191238363	INHUMAS	30112382	INHUMAS S2	06/12/2019 12:49	06/12/2019 21:53	06/12/2019 12:49	06/12/2019 21:53	9,06	1	9,06	CHI
20191238504	FAZENDA NOVA	FN12341227	IPORA	06/12/2019 12:49	06/12/2019 16:57	06/12/2019 12:49	06/12/2019 16:57	4,13	9	37,14	CHI
20191238365	NIQUELANDIA	NQ12262679	URUACU	06/12/2019 12:50	06/12/2019 23:04	06/12/2019 12:50	06/12/2019 23:04	10,23	17	173,95	CHI
20191238374	JANDAIA	JD21104582	PALMEIRAS	06/12/2019 12:51	06/12/2019 16:10	06/12/2019 12:51	06/12/2019 16:10	3,32	1	3,32	CHI
20191238380	CATALAO	3580002336	CATALAO S1	06/12/2019 12:52	06/12/2019 18:11	06/12/2019 12:52	06/12/2019 18:11	5,31	1	5,31	CHI
20191238456	NIQUELANDIA	NQ12197539	NIQUELANDIA SUBTRANSMISSAO	06/12/2019 12:52	06/12/2019 16:50	06/12/2019 12:52	06/12/2019 16:50	3,96	14	55,45	CHI
20191238449	AGUA FRIA DE GOIAS	PI12048039	SAO JOAO D ALIANCA	06/12/2019 12:53	06/12/2019 13:24	06/12/2019 12:53	06/12/2019 13:24	0,53	43	22,66	CHI
20191238395	CALDAZINHA	BV21022086	CEPAIGO S2	06/12/2019 12:54	06/12/2019 15:22	06/12/2019 12:54	06/12/2019 15:22	2,46	2	4,91	CHI
20191238396	ITAPACI	IW12360508	ITAPACI	06/12/2019 12:54	07/12/2019 15:17	06/12/2019 12:54	07/12/2019 14:48	25,90	2	51,79	CHI
20191238396	ITAPACI	IW12360508	ITAPACI	06/12/2019 12:54	07/12/2019 15:17	06/12/2019 12:54	07/12/2019 15:17	26,38	1	26,38	CHI
20191238399	GOIATUBA	GT12000127	GOIATUBA S2	06/12/2019 12:55	07/12/2019 08:12	06/12/2019 12:55	07/12/2019 08:12	19,27	39	751,61	CHI
20191238697	AMARALINA	MQ21181698	MARA ROSA	06/12/2019 12:56	06/12/2019 16:00	06/12/2019 12:56	06/12/2019 16:00	3,06	1	3,06	CHI
20191238409	CALDAZINHA	DE21324999	CEPAIGO S2	06/12/2019 12:57	06/12/2019 14:21	06/12/2019 12:57	06/12/2019 14:21	1,39	1	1,39	CHI
20191238415	PIRACANJUBA	PJ21161201	PIRACANJUBA	06/12/2019 12:58	07/12/2019 10:03	06/12/2019 12:58	07/12/2019 10:03	21,07	2	42,15	CHI
20191238416	JUSSARA	JR12120986	BRITANIA	06/12/2019 12:58	07/12/2019 12:09	06/12/2019 12:58	07/12/2019 12:09	23,17	3	69,50	CHI
20191238420	INHUMAS	IN21130202	INHUMAS S2	06/12/2019 12:59	07/12/2019 02:43	06/12/2019 12:59	07/12/2019 02:43	13,73	1	13,73	CHI
20191238426	ANAPOLIS	20251890	JUNDIAI S1	06/12/2019 13:00	06/12/2019 16:07	06/12/2019 13:00	06/12/2019 16:07	3,12	1	3,12	CHI
20191238427	AGUAS LINDAS DE GOIAS	10024477760	AGUAS LINDAS DE GOIAS S1	06/12/2019 13:00	06/12/2019 14:29	06/12/2019 13:00	06/12/2019 14:29	1,48	1	1,48	CHI
20191238434	RIO VERDE	630317732	RIO VERDE S1	06/12/2019 13:01	06/12/2019 15:54	06/12/2019 13:01	06/12/2019 15:54	2,88	1	2,88	CHI
20191238437	IPAMERI	IP21359948	IPAMERI	06/12/2019 13:02	06/12/2019 15:06	06/12/2019 13:02	06/12/2019 15:06	2,06	2	4,12	CHI
20191238442	PIRENOPOLIS	220023931	CORUMBA	06/12/2019 13:03	06/12/2019 17:00	06/12/2019 13:03	06/12/2019 17:00	3,94	1	3,94	CHI
20191238460	EDEALINA	ED12049300	PONTALINA	06/12/2019 13:03	06/12/2019 17:11	06/12/2019 13:03	06/12/2019 17:11	4,12	3	12,36	CHI
20191237847	LUZIANIA	LZ11090256	RIO VERMELHO	06/12/2019 13:04	06/12/2019 13:21	06/12/2019 13:04	06/12/2019 13:21	0,27	153	41,10	CHI
20191238448	CEZARINA	CZ21088016	GUAPU S2	06/12/2019 13:04	06/12/2019 17:18	06/12/2019 13:04	06/12/2019 17:18	4,24	2	8,48	CHI
20191238450	HIDROLANDIA	HD11000145	ANHANGUERA	06/12/2019 13:05	06/12/2019 15:17	06/12/2019 13:05	06/12/2019 15:17	2,20	35	76,97	CHI

20191238452	TAQUARAL DE GOIAS	TQ12300097	ITABERAÍ S1	06/12/2019 13:05	06/12/2019 18:10	06/12/2019 13:05	06/12/2019 18:10	5,08	6	30,48	CHI
20191238457	AGUAS LINDAS DE GOIAS	4830393271	AGUAS LINDAS DE GOIAS S1	06/12/2019 13:06	06/12/2019 14:40	06/12/2019 13:06	06/12/2019 14:40	1,56	1	1,56	CHI
20191238459	LUZIANIA	LZ21133511	PACAEMBU S1	06/12/2019 13:06	06/12/2019 16:12	06/12/2019 13:06	06/12/2019 16:12	3,09	1	3,09	CHI
20191238462	URUACU	UR12317135	URUACU	06/12/2019 13:07	06/12/2019 17:31	06/12/2019 13:07	06/12/2019 17:31	4,40	11	48,40	CHI
20191238466	CRIXAS	CX21252972	SANTA TEREZINHA	06/12/2019 13:07	06/12/2019 17:36	06/12/2019 13:07	06/12/2019 17:36	4,47	1	4,47	CHI
20191238682	GOIATUBA	JV12208118	GOIATUBA S1	06/12/2019 13:07	06/12/2019 18:45	06/12/2019 13:07	06/12/2019 18:45	5,63	4	22,52	CHI
20191238682	JOVIANIA	JV12208118	GOIATUBA S1	06/12/2019 13:07	06/12/2019 18:45	06/12/2019 13:07	06/12/2019 18:45	5,63	15	84,47	CHI
20191238472	BARRO ALTO	1150021450	BARRO ALTO	06/12/2019 13:08	07/12/2019 14:49	06/12/2019 13:08	07/12/2019 14:49	25,68	1	25,68	CHI
20191238473	NOVA CRIXAS	NA12300441	MOZARLANDIA	06/12/2019 13:09	06/12/2019 18:41	06/12/2019 13:09	06/12/2019 18:41	5,53	4	22,13	CHI
20191238476	GOIANIA	10944023	FERROVIARIO S1	06/12/2019 13:09	06/12/2019 15:32	06/12/2019 13:09	06/12/2019 15:32	2,38	1	2,38	CHI
20191238481	INDIARA	IY21066107	EDEIA	06/12/2019 13:10	07/12/2019 12:15	06/12/2019 13:10	07/12/2019 12:15	23,08	1	23,08	CHI
20191238714	NIQUELANDIA	NQ11048783	NIQUELANDIA SUBTRANSMISSAO	06/12/2019 13:11	06/12/2019 20:09	06/12/2019 13:11	06/12/2019 20:09	6,96	128	891,31	CHI
20191239066	CALDAS NOVAS	04220224	CALDAS NOVAS S1	06/12/2019 13:13	06/12/2019 18:04	06/12/2019 13:13	06/12/2019 18:04	4,86	5	24,29	CHI
20191239066	PIRACANJUBA	04220224	CALDAS NOVAS S1	06/12/2019 13:13	06/12/2019 18:04	06/12/2019 13:13	06/12/2019 18:04	4,86	79	383,74	CHI
20191239066	SANTA CRUZ DE GOIAS	04220224	CALDAS NOVAS S1	06/12/2019 13:13	06/12/2019 18:04	06/12/2019 13:13	06/12/2019 18:04	4,86	1	4,86	CHI
20191238495	QUIRINOPOLIS	80050128	QUIRINOPOLIS	06/12/2019 13:15	06/12/2019 19:19	06/12/2019 13:15	06/12/2019 19:19	6,06	1	6,06	CHI
20191238499	LUZIANIA	LZ11149779	MARAJOARA	06/12/2019 13:16	06/12/2019 17:14	06/12/2019 15:55	06/12/2019 17:14	1,31	174	227,55	CHI
20191238503	SAO MIGUEL DO ARAGUAIA	SM12328098	SAO MIGUEL DO ARAGUAIA	06/12/2019 13:16	06/12/2019 17:13	06/12/2019 13:16	06/12/2019 17:13	3,94	1	3,94	CHI
20191238508	SENADOR CANEDO	190111112	SENADOR CANEDO	06/12/2019 13:17	06/12/2019 15:56	06/12/2019 13:17	06/12/2019 15:56	2,64	1	2,64	CHI
20191238511	FAZENDA NOVA	FN21019381	JUSSARA	06/12/2019 13:17	07/12/2019 02:27	06/12/2019 13:17	07/12/2019 02:27	13,16	1	13,16	CHI
20191238684	GOIANIA	GN11001093	CAMPINAS S1	06/12/2019 13:17	06/12/2019 18:22	06/12/2019 13:17	06/12/2019 18:22	5,07	103	522,64	CHI
20191238848	ANAPOLIS	AN12258960	ANAPOLIS UNIVERSITARIO S1	06/12/2019 13:17	06/12/2019 16:25	06/12/2019 13:17	06/12/2019 16:25	3,12	7	21,84	CHI
20191238518	SANTA CRUZ DE GOIAS	BC21026079	PIRES DO RIO S2	06/12/2019 13:18	07/12/2019 08:22	06/12/2019 13:18	07/12/2019 08:22	19,06	1	19,06	CHI
20191239687	BONOPOLIS	BX12079321	SAO MIGUEL DO ARAGUAIA	06/12/2019 13:19	06/12/2019 19:04	06/12/2019 13:19	06/12/2019 19:04	5,74	58	332,98	CHI
20191238526	PALESTINA DE GOIAS	PY12068332	PALESTINA	06/12/2019 13:20	06/12/2019 13:57	06/12/2019 13:20	06/12/2019 13:57	0,61	2	1,23	CHI
20191238531	PORTEIRAO	CL21306321	RIO DOS BOIS	06/12/2019 13:22	07/12/2019 20:34	06/12/2019 13:22	07/12/2019 20:34	31,20	1	31,20	CHI
20191238535	CATALAO	CT21127850	CATALAO S1	06/12/2019 13:23	08/12/2019 10:10	06/12/2019 13:23	08/12/2019 10:10	44,78	1	44,78	CHI
20191238536	ANAPOLIS	AN21381424	ANAPOLIS UNIVERSITARIO S2	06/12/2019 13:23	06/12/2019 16:49	06/12/2019 13:23	06/12/2019 16:49	3,43	1	3,43	CHI
20191238537	GOIANIA	14006030	GOIANIA LESTE S1	06/12/2019 13:23	06/12/2019 15:16	06/12/2019 13:23	06/12/2019 15:16	1,88	1	1,88	CHI
20191238538	GOIANIA	16389384	GOIANIA LESTE S1	06/12/2019 13:23	06/12/2019 14:29	06/12/2019 13:23	06/12/2019 14:29	1,09	1	1,09	CHI
20191238540	IACIARA	IA21000007	IACIARA S1	06/12/2019 13:23	06/12/2019 17:38	06/12/2019 13:23	06/12/2019 17:38	4,24	1	4,24	CHI
20191238551	GOIANIA	10520624	GOIANIA LESTE S2	06/12/2019 13:26	06/12/2019 17:25	06/12/2019 13:26	06/12/2019 17:25	3,98	1	3,98	CHI
20191238554	ANAPOLIS	AN12412945	ANAPOLIS UNIVERSITARIO S1	06/12/2019 13:26	06/12/2019 20:20	06/12/2019 13:26	06/12/2019 20:20	6,89	3	20,67	CHI



20191238555	FIRMINOPOLIS	10006478644	FIRMINOPOLIS S1	06/12/2019 13:26	06/12/2019 16:01	06/12/2019 13:26	06/12/2019 16:01	2,58	1	2,58	CHI
20191238591	NOVA CRIXAS	NA12086286	NOVA CRIXAS	06/12/2019 13:26	06/12/2019 20:47	06/12/2019 13:26	06/12/2019 20:47	7,34	9	66,08	CHI
20191238560	NOVA ROMA	ND11266547	IACIARA S2	06/12/2019 13:27	06/12/2019 18:27	06/12/2019 13:27	06/12/2019 18:27	5,00	6	29,97	CHI
20191238564	AGUA FRIA DE GOIAS	JL12117446	SAO JOAO D ALIANCA	06/12/2019 13:27	06/12/2019 15:46	06/12/2019 13:27	06/12/2019 15:46	2,30	19	43,71	CHI
20191238564	SAO JOAO D ALIANCA	JL12117446	SAO JOAO D ALIANCA	06/12/2019 13:27	06/12/2019 15:46	06/12/2019 13:27	06/12/2019 15:46	2,30	25	57,51	CHI
20191238573	BONOPOLIS	BX21277772	SAO MIGUEL DO ARAGUAIA	06/12/2019 13:28	07/12/2019 00:05	06/12/2019 13:28	07/12/2019 00:05	10,60	1	10,60	CHI
20191238680	AMERICANO DO BRASIL	KB12065182	ANICUNS	06/12/2019 13:28	06/12/2019 19:52	06/12/2019 13:28	06/12/2019 19:52	6,38	5	31,92	CHI
20191238672	GOIANIA	GN11160111	GOYA S2	06/12/2019 13:30	06/12/2019 15:22	06/12/2019 13:30	06/12/2019 15:22	1,85	25	46,29	CHI
20191238926	APARECIDA DE GOIANIA	AP12150292	INDEPENDENCIA S2	06/12/2019 13:30	06/12/2019 16:45	06/12/2019 13:30	06/12/2019 16:45	3,23	32	103,52	CHI
20191238590	BONOPOLIS	BX21277771	SAO MIGUEL DO ARAGUAIA	06/12/2019 13:31	06/12/2019 20:11	06/12/2019 13:31	06/12/2019 20:11	6,67	1	6,67	CHI
20191238595	GOIANIA	10326492	CAMPINAS S1	06/12/2019 13:31	06/12/2019 17:36	06/12/2019 13:31	06/12/2019 17:36	4,08	1	4,08	CHI
20191238596	QUIRINOPOLIS	QI12116546	QUIRINOPOLIS	06/12/2019 13:31	06/12/2019 16:30	06/12/2019 13:31	06/12/2019 16:30	2,98	22	65,54	CHI
20191238598	VALPARAISO DE GOIAS	3350033657	PACAEMBU S1	06/12/2019 13:31	06/12/2019 19:25	06/12/2019 13:31	06/12/2019 19:25	5,89	1	5,89	CHI
20191238608	JATAI	JT21334209	JATAI S1	06/12/2019 13:33	07/12/2019 09:40	06/12/2019 13:33	07/12/2019 09:40	20,11	1	20,11	CHI
20191238610	HIDROLANDIA	HD12000142	CEPAIGO S2	06/12/2019 13:33	06/12/2019 22:20	06/12/2019 13:33	06/12/2019 22:20	8,78	14	122,89	CHI
20191238615	ITUMBIARA	690148860	ITUMBIARA VELHA S1	06/12/2019 13:34	06/12/2019 15:27	06/12/2019 13:34	06/12/2019 15:27	1,88	1	1,88	CHI
20191238618	CRIXAS	CX12229814	RUBIATABA	06/12/2019 13:35	06/12/2019 17:49	06/12/2019 13:35	06/12/2019 17:49	4,23	6	25,37	CHI
20191243817	BOM JARDIM DE GOIAS	BM21201508	BOM JARDIM	06/12/2019 13:35	07/12/2019 11:05	06/12/2019 13:35	07/12/2019 11:05	21,50	1	21,50	CHI
20191238623	PALMEIRAS DE GOIAS	PL21000113	PALMEIRAS	06/12/2019 13:36	06/12/2019 19:53	06/12/2019 13:36	06/12/2019 19:53	6,29	1	6,29	CHI
20191238625	ITAJA	IJ21131583	ITAJA S2	06/12/2019 13:36	06/12/2019 17:17	06/12/2019 13:36	06/12/2019 17:17	3,67	2	7,35	CHI
20191238729	FORMOSA	FA12204759	ITIQUEIRA	06/12/2019 13:36	06/12/2019 18:53	06/12/2019 13:36	06/12/2019 18:53	5,28	269	1420,47	CHI
20191238729	VILA BOA	FA12204759	ITIQUEIRA	06/12/2019 13:36	06/12/2019 18:53	06/12/2019 13:36	06/12/2019 18:53	5,28	2	10,56	CHI
20191239231	JUSSARA	RN12035616	BRITANIA	06/12/2019 13:36	07/12/2019 18:00	06/12/2019 13:36	07/12/2019 18:00	28,39	4	113,56	CHI
20191239231	SANTA FE DE GOIAS	RN12035616	BRITANIA	06/12/2019 13:36	07/12/2019 18:00	06/12/2019 13:36	07/12/2019 18:00	28,39	1	28,39	CHI
20191238633	QUIRINOPOLIS	QI21091037	QUIRINOPOLIS	06/12/2019 13:38	06/12/2019 16:15	06/12/2019 13:38	06/12/2019 16:15	2,61	1	2,61	CHI
20191238637	CRIXAS	CX21145547	RUBIATABA	06/12/2019 13:38	07/12/2019 16:50	06/12/2019 13:38	07/12/2019 16:50	27,19	1	27,19	CHI
20191238824	JATAI	CP12191771	MONTIVIDIU T	06/12/2019 13:40	06/12/2019 21:02	06/12/2019 13:40	06/12/2019 18:20	4,67	1	4,67	CHI
20191238824	RIO VERDE	CP12191771	MONTIVIDIU T	06/12/2019 13:40	06/12/2019 21:02	06/12/2019 13:40	06/12/2019 18:20	4,67	1	4,67	CHI
20191238824	CAIAPONIA	CP12191771	MONTIVIDIU T	06/12/2019 13:40	06/12/2019 21:02	06/12/2019 13:40	06/12/2019 21:02	7,36	10	73,65	CHI
20191238824	JATAI	CP12191771	MONTIVIDIU T	06/12/2019 13:40	06/12/2019 21:02	06/12/2019 13:40	06/12/2019 21:02	7,36	6	44,19	CHI
20191238824	RIO VERDE	CP12191771	MONTIVIDIU T	06/12/2019 13:40	06/12/2019 21:02	06/12/2019 13:40	06/12/2019 21:02	7,36	8	58,92	CHI
20191238654	JATAI	JT21000128	JATAI S3	06/12/2019 13:43	06/12/2019 15:54	06/12/2019 13:43	06/12/2019 15:54	2,17	1	2,17	CHI
20191238794	CEZARINA	MI12293021RE	PONTALINA	06/12/2019 13:43	06/12/2019 16:13	06/12/2019 13:43	06/12/2019 16:13	2,49	4	9,97	CHI

20191238794	MAIRIPOTABA	MI12293021RE	PONTALINA	06/12/2019 13:43	06/12/2019 16:13	06/12/2019 13:43	06/12/2019 16:13	2,49	4	9,97	CHI
20191238794	PONTALINA	MI12293021RE	PONTALINA	06/12/2019 13:43	06/12/2019 16:13	06/12/2019 13:43	06/12/2019 16:13	2,49	61	152,09	CHI
20191238756	RUBIATABA	RB12201812	RUBIATABA	06/12/2019 13:44	06/12/2019 15:54	06/12/2019 13:44	06/12/2019 15:54	2,15	14	30,15	CHI
20191238661	LUZIANIA	3200054606	MARAJOARA	06/12/2019 13:45	06/12/2019 18:05	06/12/2019 13:45	06/12/2019 18:05	4,33	1	4,33	CHI
20191239672	ACREUNA	EU12026829	RIO DOS BOIS	06/12/2019 13:45	06/12/2019 23:01	06/12/2019 13:45	06/12/2019 23:01	9,27	4	37,07	CHI
20191239672	SANTA HELENA DE GOIAS	EU12026829	RIO DOS BOIS	06/12/2019 13:45	06/12/2019 23:01	06/12/2019 13:45	06/12/2019 23:01	9,27	18	166,80	CHI
20191239672	TURVELANDIA	EU12026829	RIO DOS BOIS	06/12/2019 13:45	06/12/2019 23:01	06/12/2019 13:45	06/12/2019 23:01	9,27	19	176,07	CHI
20191239429	ITAPACI	IW12000012	ITAPACI	06/12/2019 13:47	06/12/2019 16:19	06/12/2019 13:47	06/12/2019 16:19	2,53	71	179,95	CHI
20191239429	PILAR DE GOIAS	IW12000012	ITAPACI	06/12/2019 13:47	06/12/2019 16:19	06/12/2019 13:47	06/12/2019 16:19	2,53	36	91,24	CHI
20191238678	RIO VERDE	RV12098595	RIO VERDE S1	06/12/2019 13:48	06/12/2019 22:09	06/12/2019 13:48	06/12/2019 22:09	8,34	9	75,06	CHI
20191238678	RIO VERDE	RV12098595	RIO VERDE S1	06/12/2019 13:48	06/12/2019 22:09	06/12/2019 19:18	06/12/2019 22:09	2,84	5	14,19	CHI
20191239390	ALTO HORIZONTE	MQ12181177	MARA ROSA	06/12/2019 13:49	06/12/2019 18:34	06/12/2019 13:49	06/12/2019 18:34	4,75	3	14,25	CHI
20191239390	MARA ROSA	MQ12181177	MARA ROSA	06/12/2019 13:49	06/12/2019 18:34	06/12/2019 13:49	06/12/2019 18:34	4,75	28	132,95	CHI
20191239390	URUACU	MQ12181177	MARA ROSA	06/12/2019 13:49	06/12/2019 18:34	06/12/2019 13:49	06/12/2019 18:34	4,75	1	4,75	CHI
20191238710	DOVERLANDIA	MY12219553	PARQUE DAS EMAS	06/12/2019 13:51	06/12/2019 20:06	06/12/2019 13:51	06/12/2019 20:06	6,25	46	287,35	CHI
20191238699	NIQUELANDIA	2750069150	NIQUELANDIA SUBTRANSMISSAO	06/12/2019 13:52	06/12/2019 22:09	06/12/2019 13:52	06/12/2019 22:09	8,28	1	8,28	CHI
20191238705	GAMELEIRA DE GOIAS	SV21088024	DAIA S2	06/12/2019 13:54	06/12/2019 17:16	06/12/2019 13:54	06/12/2019 17:16	3,36	1	3,36	CHI
20191238809	FLORES DE GOIAS	FB12255011	FLORES DE GOIAS	06/12/2019 13:54	06/12/2019 17:05	06/12/2019 13:54	06/12/2019 17:05	3,18	410	1304,03	CHI
20191238809	NOVA ROMA	FB12255011	FLORES DE GOIAS	06/12/2019 13:54	06/12/2019 17:05	06/12/2019 13:54	06/12/2019 17:05	3,18	2	6,36	CHI
20191238809	SAO JOAO D ALIANCA	FB12255011	FLORES DE GOIAS	06/12/2019 13:54	06/12/2019 17:05	06/12/2019 13:54	06/12/2019 17:05	3,18	45	143,13	CHI
20191239533	ALTO PARAISO DE GOIAS	JL12257606	SAO JOAO D ALIANCA	06/12/2019 13:55	06/12/2019 19:34	06/12/2019 13:55	06/12/2019 19:34	5,66	2	11,32	CHI
20191239533	SAO JOAO D ALIANCA	JL12257606	SAO JOAO D ALIANCA	06/12/2019 13:55	06/12/2019 19:34	06/12/2019 13:55	06/12/2019 19:34	5,66	80	452,73	CHI
20191240529	PIRACANJUBA	PJ12025290	PIRACANJUBA	06/12/2019 13:55	07/12/2019 15:26	06/12/2019 13:55	07/12/2019 15:26	25,50	19	484,51	CHI
20191238713	CAMPO ALEGRE DE GOIAS	CM12166728	CAMPO ALEGRE DE GOIAS	06/12/2019 13:56	06/12/2019 16:18	06/12/2019 13:56	06/12/2019 16:18	2,37	34	80,51	CHI
20191240562	PADRE BERNARDO	PB12305257	PADRE BERNARDO	06/12/2019 13:57	07/12/2019 15:05	06/12/2019 13:57	07/12/2019 15:05	25,13	5	125,66	CHI
20191240562	PLANALTINA	PB12305257	PADRE BERNARDO	06/12/2019 13:57	07/12/2019 15:05	06/12/2019 13:57	07/12/2019 15:05	25,13	69	1734,05	CHI
20191238727	SILVANIA	660037403	VIANOPOLIS	06/12/2019 13:58	06/12/2019 15:25	06/12/2019 13:58	06/12/2019 15:25	1,44	1	1,44	CHI
20191238728	CAMPO LIMPO	AN21297660	NEROPOLIS S1	06/12/2019 13:58	06/12/2019 17:20	06/12/2019 13:58	06/12/2019 17:20	3,36	1	3,36	CHI
20191238731	PARAUNA	PU12295855	ACREUNA	06/12/2019 13:58	06/12/2019 21:12	06/12/2019 13:58	06/12/2019 21:12	7,23	4	28,93	CHI
20191239959	ANICUNS	AC12404424	ANICUNS	06/12/2019 13:58	06/12/2019 22:45	06/12/2019 13:58	06/12/2019 22:45	8,77	13	114,03	CHI
20191238732	GOIAS	GS21073694	MATRINCHA	06/12/2019 13:59	07/12/2019 13:40	06/12/2019 13:59	07/12/2019 13:40	23,69	1	23,69	CHI
20191238741	VILA PROPICIO	550206097	GOIANESIA S1	06/12/2019 14:01	06/12/2019 18:17	06/12/2019 14:01	06/12/2019 18:17	4,27	1	4,27	CHI
20191238743	RIO VERDE	RV11260599	SANTA HELENA S1	06/12/2019 14:01	07/12/2019 11:14	06/12/2019 14:01	07/12/2019 11:14	21,21	56	1187,54	CHI

20191239956	URUACU	UR12339041	URUACU	06/12/2019 14:01	06/12/2019 20:04	06/12/2019 14:01	06/12/2019 20:04	6,04	35	211,31	CHI
20191238744	ITARUMA	03700214	CACHOEIRA ALTA	06/12/2019 14:02	06/12/2019 20:12	06/12/2019 14:02	06/12/2019 20:12	6,16	42	258,67	CHI
20191238862	MOSSAMEDES	MD12024167	FIRMINOPOLIS S2	06/12/2019 14:03	06/12/2019 15:50	06/12/2019 14:03	06/12/2019 15:50	1,78	46	81,88	CHI
20191238862	SANCLERLANDIA	MD12024167	FIRMINOPOLIS S2	06/12/2019 14:03	06/12/2019 15:50	06/12/2019 14:03	06/12/2019 15:50	1,78	8	14,24	CHI
20191238751	RIO VERDE	630531470	MONTIVIDIU T	06/12/2019 14:04	07/12/2019 10:22	06/12/2019 14:04	07/12/2019 10:22	20,32	1	20,32	CHI
20191238753	GOIANIRA	10020334492	MEIA PONTE	06/12/2019 14:04	06/12/2019 16:26	06/12/2019 14:04	06/12/2019 16:26	2,36	1	2,36	CHI
20191238858	BARRO ALTO	BA12156230	BARRO ALTO	06/12/2019 14:04	07/12/2019 20:09	06/12/2019 14:04	06/12/2019 21:15	7,18	42	301,54	CHI
20191238858	SANTA RITA DO NOVO DESTINO	BA12156230	BARRO ALTO	06/12/2019 14:04	07/12/2019 20:09	06/12/2019 14:04	06/12/2019 21:15	7,18	5	35,90	CHI
20191238858	SANTA RITA DO NOVO DESTINO	BA12156230	BARRO ALTO	06/12/2019 14:04	07/12/2019 20:09	06/12/2019 14:04	07/12/2019 12:26	22,37	5	111,83	CHI
20191238858	SANTA RITA DO NOVO DESTINO	BA12156230	BARRO ALTO	06/12/2019 14:04	07/12/2019 20:09	06/12/2019 14:04	07/12/2019 20:09	30,07	3	90,22	CHI
20191238884	TRINDADE	TR11090138	GOYA S1	06/12/2019 14:04	06/12/2019 23:21	06/12/2019 14:04	06/12/2019 23:21	9,27	84	779,01	CHI
20191240561	MARA ROSA	MQ12146955	MARA ROSA	06/12/2019 14:04	06/12/2019 20:00	06/12/2019 14:04	06/12/2019 20:00	5,92	12	71,08	CHI
20191238764	DAMOLANDIA	DL12014118	INHUMAS S1	06/12/2019 14:05	07/12/2019 02:11	06/12/2019 14:05	07/12/2019 02:11	12,10	7	84,72	CHI
20191238767	FAZENDA NOVA	IS12381080	IPORA	06/12/2019 14:05	06/12/2019 21:07	06/12/2019 14:05	06/12/2019 21:07	7,02	9	63,18	CHI
20191238767	ISRAELANDIA	IS12381080	IPORA	06/12/2019 14:05	06/12/2019 21:07	06/12/2019 14:05	06/12/2019 21:07	7,02	2	14,04	CHI
20191238772	SILVANIA	SV21166457	VIANOPOLIS	06/12/2019 14:05	06/12/2019 16:38	06/12/2019 14:05	06/12/2019 16:38	2,54	1	2,54	CHI
20191238785	POSSE	PS12257684	IACIARA S2	06/12/2019 14:08	06/12/2019 19:34	06/12/2019 14:08	06/12/2019 19:34	5,42	5	27,10	CHI
20191238790	MORRINHOS	150093184	MORRINHOS	06/12/2019 14:10	06/12/2019 17:35	06/12/2019 14:10	06/12/2019 17:35	3,42	1	3,42	CHI
20191238798	ANAPOLIS	20073136	ANAPOLIS UNIVERSITARIO S2	06/12/2019 14:11	06/12/2019 16:41	06/12/2019 14:11	06/12/2019 16:41	2,49	1	2,49	CHI
20191238818	SAO DOMINGOS	SD12384778	SAO DOMINGOS	06/12/2019 14:14	06/12/2019 17:21	06/12/2019 14:14	06/12/2019 17:21	3,10	8	24,82	CHI
20191238833	JOVIANIA	JV21320224	GOIATUBA S1	06/12/2019 14:16	06/12/2019 16:45	06/12/2019 14:16	06/12/2019 16:45	2,49	1	2,49	CHI
20191238834	CRIXAS	CX21122013	SERRA DO OURO	06/12/2019 14:16	07/12/2019 11:43	06/12/2019 14:16	07/12/2019 11:43	21,44	1	21,44	CHI
20191239127	GOIANIA	GN11247982	CARAJAS S2	06/12/2019 14:16	06/12/2019 16:10	06/12/2019 14:16	06/12/2019 16:10	1,89	86	162,80	CHI
20191238837	CAMPO ALEGRE DE GOIAS	CM21086099	CAMPO ALEGRE DE GOIAS	06/12/2019 14:17	06/12/2019 15:40	06/12/2019 14:17	06/12/2019 15:40	1,38	1	1,38	CHI
20191238838	RIO VERDE	RV21205445	CABRIUVA S2	06/12/2019 14:17	07/12/2019 17:08	06/12/2019 14:17	07/12/2019 17:08	26,85	1	26,85	CHI
20191238840	TURVELANDIA	TD12277621	RIO DOS BOIS	06/12/2019 14:17	07/12/2019 13:30	06/12/2019 14:17	07/12/2019 13:30	23,21	2	46,41	CHI
20191238843	ANAPOLIS	20103529	JUNDIAI S2	06/12/2019 14:19	06/12/2019 15:35	06/12/2019 14:19	06/12/2019 15:35	1,26	1	1,26	CHI
20191238986	JARAGUA	JA12064321	JARAGUA	06/12/2019 14:19	07/12/2019 09:54	06/12/2019 14:19	07/12/2019 09:54	19,57	4	78,29	CHI
20191240928	BALIZA	BH12064387	BOM JARDIM	06/12/2019 14:21	06/12/2019 23:08	06/12/2019 14:21	06/12/2019 23:08	8,79	3	26,37	CHI
20191237862	AGUAS LINDAS DE GOIAS	4830034933	AGUAS LINDAS DE GOIAS S2	06/12/2019 14:23	06/12/2019 15:57	06/12/2019 14:23	06/12/2019 15:57	1,55	0	0,00	CHI
20191238867	SANCLERLANDIA	SC21323863	FIRMINOPOLIS S2	06/12/2019 14:23	06/12/2019 18:07	06/12/2019 14:23	06/12/2019 18:07	3,72	1	3,72	CHI
20191238871	SANTA HELENA DE GOIAS	SH12301296	SANTA HELENA S1	06/12/2019 14:23	06/12/2019 14:39	06/12/2019 14:23	06/12/2019 14:39	0,26	4	1,04	CHI
20191239319	MOIPORA	MO12130217	IPORA	06/12/2019 14:23	06/12/2019 17:04	06/12/2019 14:23	06/12/2019 17:04	2,67	6	16,01	CHI

20191238873	FORMOSO	2410019104	PORANGATU	06/12/2019 14:24	06/12/2019 20:32	06/12/2019 14:24	06/12/2019 20:32	6,12	1	6,12	CHI
20191238874	JOVIANIA	JV21029728	GOIATUBA S1	06/12/2019 14:24	07/12/2019 00:21	06/12/2019 14:24	07/12/2019 00:21	9,94	2	19,87	CHI
20191240712	VIANOPOLIS	VN12282707	VIANOPOLIS	06/12/2019 14:25	07/12/2019 16:57	06/12/2019 14:25	07/12/2019 16:57	26,52	16	424,29	CHI
20191238882	ANAPOLIS	AN12096781	ANAPOLIS UNIVERSITARIO S2	06/12/2019 14:26	07/12/2019 08:07	06/12/2019 14:26	07/12/2019 08:07	17,67	14	247,41	CHI
20191238885	PALMEIRAS DE GOIAS	PL21233449	PALMEIRAS	06/12/2019 14:27	06/12/2019 18:38	06/12/2019 14:27	06/12/2019 18:38	4,18	1	4,18	CHI
20191239667	RIO VERDE	RV12051746	MONTIVIDIU T	06/12/2019 14:29	06/12/2019 23:55	06/12/2019 14:29	06/12/2019 23:55	9,42	76	716,28	CHI
20191238966	CAIAPONIA	CP12390143	CAIAPONIA	06/12/2019 14:30	06/12/2019 16:15	06/12/2019 14:30	06/12/2019 16:15	1,74	7	12,21	CHI
20191238904	APARECIDA DO RIO DOCE	AW21211292	JATAI S1	06/12/2019 14:32	06/12/2019 16:31	06/12/2019 14:32	06/12/2019 16:31	1,98	1	1,98	CHI
20191238906	GAMELEIRA DE GOIAS	SV21227716	DAIA S2	06/12/2019 14:32	07/12/2019 10:42	06/12/2019 14:32	07/12/2019 10:42	20,15	3	60,46	CHI
20191239033	CRISTALINA	KR12352836	CRISTALINA S1	06/12/2019 14:32	06/12/2019 16:44	06/12/2019 14:32	06/12/2019 16:44	2,20	62	136,45	CHI
20191238912	ANAPOLIS	21256342	ANAPOLIS UNIVERSITARIO S1	06/12/2019 14:33	06/12/2019 19:58	06/12/2019 14:33	06/12/2019 19:58	5,41	1	5,41	CHI
20191239414	CAIAPONIA	MV12267740	MONTIVIDIU T	06/12/2019 14:33	07/12/2019 11:50	06/12/2019 14:33	07/12/2019 11:50	21,27	10	212,75	CHI
20191239414	MONTIVIDIU	MV12267740	MONTIVIDIU T	06/12/2019 14:33	07/12/2019 11:50	06/12/2019 14:33	07/12/2019 11:50	21,27	1	21,27	CHI
20191238920	GUAPO	GA21212302	GUAPO S1	06/12/2019 14:34	06/12/2019 16:31	06/12/2019 14:34	06/12/2019 16:31	1,94	1	1,94	CHI
20191238932	AVELINOPOLIS	AV21323522	ANICUNS	06/12/2019 14:35	07/12/2019 08:30	06/12/2019 14:35	07/12/2019 08:30	17,90	1	17,90	CHI
20191238937	APARECIDA DE GOIANIA	AP11166683	ATLANTICO S3	06/12/2019 14:36	07/12/2019 04:06	06/12/2019 14:36	07/12/2019 04:06	13,49	123	1658,96	CHI
20191239174	MONTIVIDIU	MV12406530	MONTIVIDIU T	06/12/2019 14:36	07/12/2019 11:25	06/12/2019 14:36	07/12/2019 11:25	20,82	9	187,36	CHI
20191238626	SANTA FE DE GOIAS	RN12009764	BRITANIA	06/12/2019 14:37	06/12/2019 17:36	06/12/2019 14:37	06/12/2019 17:36	2,97	6	17,84	CHI
20191238979	JANDAIA	JD12095918	PALMEIRAS	06/12/2019 14:37	06/12/2019 19:00	06/12/2019 14:37	06/12/2019 19:00	4,38	14	61,39	CHI
20191238979	PALMEIRAS DE GOIAS	JD12095918	PALMEIRAS	06/12/2019 14:37	06/12/2019 19:00	06/12/2019 14:37	06/12/2019 19:00	4,38	1	4,38	CHI
20191239244	SANTA FE DE GOIAS	RN12009765	BRITANIA	06/12/2019 14:37	06/12/2019 18:17	06/12/2019 14:37	06/12/2019 18:17	3,66	23	84,09	CHI
20191238940	SANTA HELENA DE GOIAS	SH11159456	IPEGUARI	06/12/2019 14:38	06/12/2019 15:25	06/12/2019 14:38	06/12/2019 15:25	0,77	1	0,77	CHI
20191238942	CEZARINA	CZ21010900	GUAPO S2	06/12/2019 14:38	06/12/2019 18:59	06/12/2019 14:38	06/12/2019 18:59	4,34	2	8,69	CHI
20191238946	ITAPIRAPUA	IU12259711	MATRINCHA	06/12/2019 14:38	06/12/2019 19:25	06/12/2019 14:38	06/12/2019 19:25	4,77	5	23,84	CHI
20191238948	ACREUNA	EU21054382	ACREUNA	06/12/2019 14:39	06/12/2019 21:13	06/12/2019 14:39	06/12/2019 21:13	6,56	1	6,56	CHI
20191238950	JARAGUA	7278837	ITABERA S1	06/12/2019 14:40	06/12/2019 17:15	06/12/2019 14:40	06/12/2019 17:15	2,58	6	15,47	CHI
20191238954	APARECIDA DE GOIANIA	200384879	INDEPENDENCIA S2	06/12/2019 14:40	06/12/2019 17:15	06/12/2019 14:40	06/12/2019 17:15	2,57	1	2,57	CHI
20191239023	PARAUNA	JD12143018	PALMEIRAS	06/12/2019 14:40	06/12/2019 17:19	06/12/2019 14:40	06/12/2019 17:19	2,64	21	55,42	CHI
20191238970	EDEALINA	ED12007679	PONTALINA	06/12/2019 14:43	06/12/2019 21:40	06/12/2019 14:43	06/12/2019 21:40	6,95	16	111,19	CHI
20191238985	SANTA HELENA DE GOIAS	SH12271561	IPEGUARI	06/12/2019 14:44	07/12/2019 00:16	06/12/2019 14:44	07/12/2019 00:16	9,53	11	104,85	CHI
20191239385	CAIAPONIA	CP12076264	MONTIVIDIU T	06/12/2019 14:45	06/12/2019 21:02	06/12/2019 14:45	06/12/2019 21:02	6,27	15	94,02	CHI
20191239385	RIO VERDE	CP12076264	MONTIVIDIU T	06/12/2019 14:45	06/12/2019 21:02	06/12/2019 14:45	06/12/2019 21:02	6,27	3	18,80	CHI
20191238969	POSSE	PS21132330	IACIARA S2	06/12/2019 14:46	06/12/2019 17:53	06/12/2019 14:46	06/12/2019 17:53	3,11	1	3,11	CHI

20191238974	GOIANIRA	390013638	GOIANIRA	06/12/2019 14:47	06/12/2019 20:00	06/12/2019 14:47	06/12/2019 20:00	5,22	1	5,22	CHI
20191238977	NIQUELANDIA	NQ21314131	NIQUELANDIA SUBTRANSMISSAO	06/12/2019 14:47	07/12/2019 22:12	06/12/2019 14:47	07/12/2019 22:12	31,41	1	31,41	CHI
20191238978	MAURILANDIA	ML12271555	RIO DOS BOIS	06/12/2019 14:47	06/12/2019 15:10	06/12/2019 14:47	06/12/2019 15:10	0,37	1	0,37	CHI
20191238978	RIO VERDE	ML12271555	RIO DOS BOIS	06/12/2019 14:47	06/12/2019 15:10	06/12/2019 14:47	06/12/2019 15:10	0,37	8	2,97	CHI
20191240072	ITAPURANGA	IK12221196	ITAPURANGA	06/12/2019 14:48	07/12/2019 08:23	06/12/2019 14:48	07/12/2019 08:23	17,58	14	246,12	CHI
20191242706	DOVERLANDIA	DV21237193	CAIAPONIA	06/12/2019 14:50	07/12/2019 16:35	06/12/2019 14:50	07/12/2019 16:35	25,75	1	25,75	CHI
20191238999	FORMOSA	610019077	ITIQUEIRA	06/12/2019 14:52	06/12/2019 17:29	06/12/2019 14:52	06/12/2019 17:29	2,61	1	2,61	CHI
20191239003	ACREUNA	EU12045032	ACREUNA	06/12/2019 14:54	07/12/2019 12:39	06/12/2019 14:54	07/12/2019 12:39	21,74	2	43,48	CHI
20191239003	TURVELANDIA	EU12045032	ACREUNA	06/12/2019 14:54	07/12/2019 12:39	06/12/2019 14:54	07/12/2019 12:39	21,74	2	43,48	CHI
20191239004	PALMEIRAS DE GOIAS	PL21086235	PALMEIRAS	06/12/2019 14:54	07/12/2019 10:45	06/12/2019 14:54	07/12/2019 10:45	19,84	1	19,84	CHI
20191239007	ALTO HORIZONTE	9640010539	SANTA TEREZINHA	06/12/2019 14:55	06/12/2019 16:10	06/12/2019 14:55	06/12/2019 16:10	1,24	1	1,24	CHI
20191239010	PANAMA	IT21166459	ITUMBIARA NOVA	06/12/2019 14:55	06/12/2019 16:29	06/12/2019 14:55	06/12/2019 16:29	1,57	1	1,57	CHI
20191239018	RIO VERDE	RV12023959	RIO VERDE S1	06/12/2019 14:55	06/12/2019 17:10	06/12/2019 14:55	06/12/2019 17:10	2,25	3	6,74	CHI
20191239012	MINACU	IH12182290	MINACU	06/12/2019 14:56	07/12/2019 00:09	06/12/2019 14:56	07/12/2019 00:09	9,21	49	451,51	CHI
20191239014	GOIANIA	10782308	CARAJAS S1	06/12/2019 14:56	07/12/2019 00:35	06/12/2019 14:56	07/12/2019 00:35	9,64	1	9,64	CHI
20191239019	NIQUELANDIA	NQ21264565	BARRO ALTO	06/12/2019 14:58	07/12/2019 23:38	06/12/2019 14:58	07/12/2019 23:38	32,66	1	32,66	CHI
20191239024	SANTA HELENA DE GOIAS	400020300	IPEGUARI	06/12/2019 14:58	06/12/2019 18:15	06/12/2019 14:58	06/12/2019 18:15	3,28	1	3,28	CHI
20191239029	PALMEIRAS DE GOIAS	PL21125173	PALMEIRAS	06/12/2019 15:00	07/12/2019 09:00	06/12/2019 15:00	07/12/2019 09:00	18,00	1	18,00	CHI
20191239030	NOVO GAMA	4990074234	PACAEMBU S1	06/12/2019 15:00	06/12/2019 17:02	06/12/2019 15:00	06/12/2019 17:02	2,03	1	2,03	CHI
20191239034	PARANAIGUARA	PC21000114	CACHOEIRA ALTA	06/12/2019 15:00	06/12/2019 16:17	06/12/2019 15:00	06/12/2019 16:17	1,27	1	1,27	CHI
20191241179	PALMEIRAS DE GOIAS	PL12000240	PALMEIRAS	06/12/2019 15:00	07/12/2019 09:45	06/12/2019 15:00	07/12/2019 09:45	18,75	6	112,52	CHI
20191239036	AGUA FRIA DE GOIAS	TL21403165	SAO JOAO D ALIANCA	06/12/2019 15:01	06/12/2019 23:12	06/12/2019 15:01	06/12/2019 23:12	8,18	1	8,18	CHI
20191239039	FAZENDA NOVA	NB12250852	JUSSARA	06/12/2019 15:01	06/12/2019 18:18	06/12/2019 15:01	06/12/2019 18:18	3,28	4	13,11	CHI
20191239039	NOVO BRASIL	NB12250852	JUSSARA	06/12/2019 15:01	06/12/2019 18:18	06/12/2019 15:01	06/12/2019 18:18	3,28	2	6,55	CHI
20191239042	ITARUMA	IM21088204	CACHOEIRA ALTA	06/12/2019 15:02	07/12/2019 09:30	06/12/2019 15:02	07/12/2019 09:30	18,47	1	18,47	CHI
20191239044	MONTE ALEGRE DE GOIAS	MA11405162	SAO DOMINGOS	06/12/2019 15:02	06/12/2019 17:13	06/12/2019 15:02	06/12/2019 17:13	2,18	1	2,18	CHI
20191239046	RIO VERDE	RV12327024	CABRIUVA S2	06/12/2019 15:02	07/12/2019 17:08	06/12/2019 15:02	07/12/2019 17:08	26,09	2	52,18	CHI
20191239054	ITARUMA	IM12343779	CACHOEIRA ALTA	06/12/2019 15:04	06/12/2019 19:03	06/12/2019 15:04	06/12/2019 19:03	3,97	1	3,97	CHI
20191239062	BURITI DE GOIAS	1680014678	FIRMINOPOLIS S2	06/12/2019 15:06	06/12/2019 17:12	06/12/2019 15:06	06/12/2019 17:12	2,10	1	2,10	CHI
20191239077	SAO JOAO D ALIANCA	10023120523	SAO JOAO D ALIANCA	06/12/2019 15:07	07/12/2019 09:36	06/12/2019 15:07	07/12/2019 09:36	18,49	1	18,49	CHI
20191239079	GOIANIA	GN12000795	FERROVIARIO S1	06/12/2019 15:07	06/12/2019 16:45	06/12/2019 15:07	06/12/2019 16:45	1,62	46	74,52	CHI
20191239081	LUZIANIA	LZ12000276RE	MARAJOARA	06/12/2019 15:07	06/12/2019 17:58	06/12/2019 15:07	06/12/2019 17:58	2,84	32	90,99	CHI
20191239728	VILA PROPICIO	PV12073537	GOIANESIA S1	06/12/2019 15:07	07/12/2019 10:15	06/12/2019 15:07	07/12/2019 10:15	19,12	7	133,86	CHI

20191239085	GOIANESIA	GE12379116	GOIANESIA S2	06/12/2019 15:09	06/12/2019 17:04	06/12/2019 15:09	06/12/2019 17:04	1,92	100	192,25	CHI
20191239088	SANTA RITA DO ARAGUAIA	SU11271643	SANTA RITA DO ARAGUAIA	06/12/2019 15:09	06/12/2019 18:23	06/12/2019 15:09	06/12/2019 18:23	3,22	33	106,35	CHI
20191239516	PIRENOPOLIS	PV12316020	CORUMBA	06/12/2019 15:10	06/12/2019 22:38	06/12/2019 15:10	06/12/2019 22:38	7,47	14	104,51	CHI
20191239093	CASTELANDIA	DM12305932	RIO DOS BOIS	06/12/2019 15:11	07/12/2019 11:03	06/12/2019 15:11	07/12/2019 11:03	19,86	4	79,46	CHI
20191239093	QUIRINOPOLIS	DM12305932	RIO DOS BOIS	06/12/2019 15:11	07/12/2019 11:03	06/12/2019 15:11	07/12/2019 11:03	19,86	14	278,09	CHI
20191239095	ANAPOLIS	20516034	JUNDIAI S1	06/12/2019 15:11	06/12/2019 18:40	06/12/2019 15:11	06/12/2019 18:40	3,48	1	3,48	CHI
20191239100	VALPARAISO DE GOIAS	10006273155	PACAEMBU S1	06/12/2019 15:13	06/12/2019 21:24	06/12/2019 15:13	06/12/2019 21:24	6,18	1	6,18	CHI
20191239102	CRISTALINA	KR21089576	PAMPLONA	06/12/2019 15:13	06/12/2019 19:50	06/12/2019 15:13	06/12/2019 19:50	4,60	2	9,20	CHI
20191239105	TRINDADE	10013179088	TRINDADE	06/12/2019 15:14	06/12/2019 18:56	06/12/2019 15:14	06/12/2019 18:56	3,69	1	3,69	CHI
20191239119	ITAPURANGA	IK21310931	ITAPURANGA	06/12/2019 15:14	07/12/2019 10:33	06/12/2019 15:14	07/12/2019 10:33	19,32	1	19,32	CHI
20191239109	JARAGUA	JA21149536	JARAGUA	06/12/2019 15:15	07/12/2019 13:56	06/12/2019 15:15	07/12/2019 13:56	22,68	1	22,68	CHI
20191239115	JARAGUA	70026981	JARAGUA	06/12/2019 15:16	06/12/2019 19:55	06/12/2019 15:16	06/12/2019 19:55	4,66	1	4,66	CHI
20191240097	CARMO DO RIO VERDE	IK12310871	ITAPURANGA	06/12/2019 15:17	06/12/2019 19:03	06/12/2019 15:17	06/12/2019 19:03	3,77	4	15,07	CHI
20191240097	ITAPURANGA	IK12310871	ITAPURANGA	06/12/2019 15:17	06/12/2019 19:03	06/12/2019 15:17	06/12/2019 19:03	3,77	181	681,77	CHI
20191239123	URUACU	10006420166	CAMPINORTE	06/12/2019 15:18	07/12/2019 02:24	06/12/2019 15:18	07/12/2019 02:24	11,11	1	11,11	CHI
20191240555	MONTIVIDIU	MV12305802	MONTIVIDIU T	06/12/2019 15:18	07/12/2019 17:57	06/12/2019 15:18	07/12/2019 17:57	26,65	2	53,29	CHI
20191239130	AGUA FRIA DE GOIAS	4440004673	SAO JOAO D ALIANCA	06/12/2019 15:19	07/12/2019 13:02	06/12/2019 15:19	07/12/2019 13:02	21,72	1	21,72	CHI
20191239132	MONTIVIDIU	MV12200183	MONTIVIDIU T	06/12/2019 15:19	08/12/2019 13:06	06/12/2019 15:19	08/12/2019 13:06	45,77	1	45,77	CHI
20191239202	CRISTALINA	KR12351414	PAMPLONA	06/12/2019 15:20	06/12/2019 18:43	06/12/2019 15:20	06/12/2019 18:43	3,38	6	20,29	CHI
20191239176	TRINDADE	TR11068154	TRINDADE	06/12/2019 15:22	06/12/2019 17:12	06/12/2019 15:22	06/12/2019 17:12	1,83	112	205,21	CHI
20191239440	GOIANESIA	GE12384167	GOIANESIA S2	06/12/2019 15:22	07/12/2019 01:48	06/12/2019 15:22	07/12/2019 01:48	10,44	20	208,78	CHI
20191239440	VILA PROPICIO	GE12384167	GOIANESIA S2	06/12/2019 15:22	07/12/2019 01:48	06/12/2019 15:22	07/12/2019 01:48	10,44	6	62,63	CHI
20191239440	GOIANESIA	GE12000009RE	GOIANESIA S2	06/12/2019 15:22	07/12/2019 01:48	06/12/2019 15:22	07/12/2019 01:48	10,44	15	156,58	CHI
20191239440	VILA PROPICIO	GE12000009RE	GOIANESIA S2	06/12/2019 15:22	07/12/2019 01:48	06/12/2019 15:22	07/12/2019 01:48	10,44	2	20,88	CHI
20191239440	GOIANESIA	GE12000009RE	GOIANESIA S2	06/12/2019 15:22	07/12/2019 01:48	07/12/2019 00:29	07/12/2019 01:48	1,31	7	9,17	CHI
20191239146	RIO VERDE	630416680	RIO VERDE S2	06/12/2019 15:23	06/12/2019 18:16	06/12/2019 15:23	06/12/2019 18:16	2,88	1	2,88	CHI
20191239148	RIO QUENTE	RQ11098206	VILA CORUMBA	06/12/2019 15:23	06/12/2019 18:28	06/12/2019 15:23	06/12/2019 18:28	3,08	2	6,17	CHI
20191239324	CAVALCANTE	CJ11071301	FLORES DE GOIAS	06/12/2019 15:24	06/12/2019 18:45	06/12/2019 15:24	06/12/2019 18:45	3,34	50	166,97	CHI
20191239155	COCALZINHO DE GOIAS	ZN21389817	GOIANESIA S1	06/12/2019 15:25	07/12/2019 11:30	06/12/2019 15:25	07/12/2019 11:30	20,08	2	40,16	CHI
20191239235	SANTA FE DE GOIAS	RN12123453	BRITANIA	06/12/2019 15:25	07/12/2019 19:25	06/12/2019 15:25	07/12/2019 19:25	28,00	2	56,00	CHI
20191239181	MINEIROS	10012151880	PARQUE DAS EMAS	06/12/2019 15:27	06/12/2019 18:31	06/12/2019 15:27	06/12/2019 18:31	3,07	1	3,07	CHI
20191241681	VICENTINOPOLIS	VI12028595	VICENTINOPOLIS	06/12/2019 15:27	07/12/2019 15:00	06/12/2019 15:27	07/12/2019 15:00	23,54	6	141,26	CHI
20191239185	GOIATUBA	GT12326708	BOM JESUS DE GOIAS	06/12/2019 15:28	06/12/2019 21:12	06/12/2019 15:28	06/12/2019 21:12	5,73	1	5,73	CHI

20191239186	CATALAO	10028092145	CATALAO S2	06/12/2019 15:28	06/12/2019 17:07	06/12/2019 15:28	06/12/2019 17:07	1,65	1	1,65	CHI
20191240136	COCALZINHO DE GOIAS	PV12227808	COCALZINHO	06/12/2019 15:28	06/12/2019 22:47	06/12/2019 15:28	06/12/2019 22:47	7,31	1	7,31	CHI
20191240136	PIRENOPOLIS	PV12227808	COCALZINHO	06/12/2019 15:28	06/12/2019 22:47	06/12/2019 15:28	06/12/2019 22:47	7,31	8	58,45	CHI
20191239194	GOIANIA	16221837	XAVANTES	06/12/2019 15:29	06/12/2019 18:20	06/12/2019 15:29	06/12/2019 18:20	2,85	1	2,85	CHI
20191239196	FORMOSA	FA21051381	ITUIQUIRA	06/12/2019 15:29	06/12/2019 17:19	06/12/2019 15:29	06/12/2019 17:19	1,83	1	1,83	CHI
20191239197	GOUVELANDIA	GB12261016	QUIRINOPOLIS	06/12/2019 15:29	06/12/2019 16:55	06/12/2019 15:29	06/12/2019 16:55	1,42	3	4,27	CHI
20191239198	JATAI	JT12219503	JATAI S3	06/12/2019 15:29	06/12/2019 16:43	06/12/2019 15:29	06/12/2019 16:43	1,23	5	6,16	CHI
20191239502	PORANGATU	PO12021172	PORANGATU	06/12/2019 15:29	06/12/2019 17:30	06/12/2019 15:29	06/12/2019 17:30	2,01	5	10,05	CHI
20191239303	CRISTALINA	KR21330679	CRISTALINA S1	06/12/2019 15:30	07/12/2019 03:01	06/12/2019 15:30	07/12/2019 03:01	11,51	1	11,51	CHI
20191239725	MORRO AGUDO DE GOIAS	RB12156050	RUBIATABA	06/12/2019 15:30	07/12/2019 08:56	06/12/2019 15:30	07/12/2019 08:56	17,43	10	174,33	CHI
20191239725	RUBIATABA	RB12156050	RUBIATABA	06/12/2019 15:30	07/12/2019 08:56	06/12/2019 15:30	07/12/2019 08:56	17,43	20	348,65	CHI
20191239306	ITAPURANGA	IK12220328	ITAPURANGA	06/12/2019 15:31	06/12/2019 18:26	06/12/2019 15:31	06/12/2019 18:26	2,91	231	673,11	CHI
20191239310	SENADOR CANEDO	GN21090074	GOIANIA LESTE S2	06/12/2019 15:31	06/12/2019 16:53	06/12/2019 15:31	06/12/2019 16:53	1,36	2	2,72	CHI
20191239506	CATURAI	TR12277048	TRINDADE	06/12/2019 15:31	06/12/2019 20:50	06/12/2019 15:31	06/12/2019 20:50	5,31	9	47,78	CHI
20191239506	GOIANIRA	TR12277048	TRINDADE	06/12/2019 15:31	06/12/2019 20:50	06/12/2019 15:31	06/12/2019 20:50	5,31	27	143,35	CHI
20191239506	SANTA BARBARA DE GOIAS	TR12277048	TRINDADE	06/12/2019 15:31	06/12/2019 20:50	06/12/2019 15:31	06/12/2019 20:50	5,31	24	127,42	CHI
20191239506	TRINDADE	TR12277048	TRINDADE	06/12/2019 15:31	06/12/2019 20:50	06/12/2019 15:31	06/12/2019 20:50	5,31	17	90,26	CHI
20191239317	APARECIDA DE GOIANIA	13752431	ATLANTICO S2	06/12/2019 15:32	06/12/2019 18:18	06/12/2019 15:32	06/12/2019 18:18	2,75	1	2,75	CHI
20191239345	GOIANESIA	GE12115090	GOIANESIA S2	06/12/2019 15:32	06/12/2019 19:00	06/12/2019 15:32	06/12/2019 19:00	3,46	297	1029,10	CHI
20191239333	MORRO AGUDO DE GOIAS	MS12086902	ITAPURANGA	06/12/2019 15:34	07/12/2019 12:08	06/12/2019 15:34	07/12/2019 12:08	20,56	3	61,69	CHI
20191240029	BONFINOPOLIS	LB12029184	GOIANIA LESTE S2	06/12/2019 15:34	07/12/2019 07:46	06/12/2019 15:34	07/12/2019 07:46	16,20	55	890,91	CHI
20191241140	CAIAPONIA	CP12268503	CAIAPONIA	06/12/2019 15:34	07/12/2019 08:33	06/12/2019 15:34	07/12/2019 08:33	16,98	11	186,75	CHI
20191239332	CALDAS NOVAS	760325947	SERRA DE CALDAS	06/12/2019 15:35	06/12/2019 20:41	06/12/2019 15:35	06/12/2019 20:41	5,11	1	5,11	CHI
20191239335	MARA ROSA	MQ21182378	MARA ROSA	06/12/2019 15:35	07/12/2019 11:19	06/12/2019 15:35	07/12/2019 11:19	19,72	1	19,72	CHI
20191239337	FORMOSO	FO12185324	PORANGATU	06/12/2019 15:35	07/12/2019 08:44	06/12/2019 15:35	07/12/2019 08:44	17,14	2	34,27	CHI
20191239338	ITARUMA	IM21122630	CACHOEIRA ALTA	06/12/2019 15:35	07/12/2019 11:24	06/12/2019 15:35	07/12/2019 11:24	19,80	1	19,80	CHI
20191239340	GOIANIA	15978163	GOYA S1	06/12/2019 15:35	06/12/2019 17:31	06/12/2019 15:35	06/12/2019 17:31	1,92	1	1,92	CHI
20191239662	ALEXANIA	AX12402036	ALEXANIA	06/12/2019 15:35	06/12/2019 18:51	06/12/2019 15:35	06/12/2019 18:51	3,25	46	149,69	CHI
20191239662	SANTO ANTONIO DO DESCOBERTO	AX12402036	ALEXANIA	06/12/2019 15:35	06/12/2019 18:51	06/12/2019 15:35	06/12/2019 18:51	3,25	1	3,25	CHI
20191241381	ITAPURANGA	IK12310899	ITAPURANGA	06/12/2019 15:36	07/12/2019 13:16	06/12/2019 15:36	07/12/2019 13:16	21,66	18	389,81	CHI
20191239356	PORTELANDIA	PW12205299	PARQUE DAS EMAS	06/12/2019 15:39	07/12/2019 11:44	06/12/2019 15:39	07/12/2019 11:44	20,08	10	200,80	CHI
20191239359	GOIANESIA	550081290	GOIANESIA S2	06/12/2019 15:39	07/12/2019 04:44	06/12/2019 15:39	07/12/2019 04:44	13,07	1	13,07	CHI
20191239365	GOIANIA	14565122	REAL S2	06/12/2019 15:40	06/12/2019 23:23	06/12/2019 15:40	06/12/2019 23:23	7,71	1	7,71	CHI

20191239366	ORIZONA	OZ21114477	PIRES DO RIO S2	06/12/2019 15:40	06/12/2019 20:23	06/12/2019 15:40	06/12/2019 20:23	4,71	1	4,71	CHI
20191239368	JATAI	JT12205270	JATAI S1	06/12/2019 15:41	06/12/2019 19:24	06/12/2019 15:41	06/12/2019 19:24	3,72	2	7,43	CHI
20191239374	PALMEIRAS DE GOIAS	PL21239688	PALMEIRAS	06/12/2019 15:42	06/12/2019 15:48	06/12/2019 15:42	06/12/2019 15:48	0,10	1	0,10	CHI
20191239380	SAO MIGUEL DO ARAGUAIA	SM21128371	SAO MIGUEL DO ARAGUAIA	06/12/2019 15:42	06/12/2019 22:12	06/12/2019 15:42	06/12/2019 22:12	6,49	1	6,49	CHI
20191239891	BOM JARDIM DE GOIAS	BM12395485	BOM JARDIM	06/12/2019 15:42	06/12/2019 21:06	06/12/2019 15:42	06/12/2019 21:06	5,39	7	37,70	CHI
20191239569	CARMO DO RIO VERDE	IK12299464	ITAPURANGA	06/12/2019 15:44	07/12/2019 11:41	06/12/2019 15:44	07/12/2019 11:41	19,94	3	59,81	CHI
20191239569	ITAPURANGA	IK12299464	ITAPURANGA	06/12/2019 15:44	07/12/2019 11:41	06/12/2019 15:44	07/12/2019 11:41	19,94	20	398,71	CHI
20191239977	VIANOPOLIS	VN12070058	VIANOPOLIS	06/12/2019 15:45	07/12/2019 15:26	06/12/2019 15:45	07/12/2019 07:06	15,35	10	153,50	CHI
20191239977	VIANOPOLIS	VN12070058	VIANOPOLIS	06/12/2019 15:45	07/12/2019 15:26	07/12/2019 07:08	07/12/2019 08:44	1,60	10	15,98	CHI
20191239977	VIANOPOLIS	VN12070058	VIANOPOLIS	06/12/2019 15:45	07/12/2019 15:26	06/12/2019 15:45	07/12/2019 09:23	17,62	9	158,59	CHI
20191239977	ORIZONA	OZ12094953	VIANOPOLIS	06/12/2019 15:45	07/12/2019 15:26	06/12/2019 15:45	07/12/2019 09:57	18,20	6	109,19	CHI
20191239977	VIANOPOLIS	OZ12094953	VIANOPOLIS	06/12/2019 15:45	07/12/2019 15:26	06/12/2019 15:45	07/12/2019 09:57	18,20	85	1546,79	CHI
20191239977	ORIZONA	OZ12094953	VIANOPOLIS	06/12/2019 15:45	07/12/2019 15:26	06/12/2019 15:45	07/12/2019 15:26	23,67	1	23,67	CHI
20191239977	VIANOPOLIS	OZ12094953	VIANOPOLIS	06/12/2019 15:45	07/12/2019 15:26	06/12/2019 15:45	07/12/2019 15:26	23,67	18	426,04	CHI
20191239406	GOIANIA	10010899578	XAVANTES	06/12/2019 15:46	06/12/2019 19:29	06/12/2019 15:46	06/12/2019 19:29	3,71	1	3,71	CHI
20191239407	BOM JESUS DE GOIAS	BJ12000149RE	BOM JESUS DE GOIAS	06/12/2019 15:46	06/12/2019 17:15	06/12/2019 15:46	06/12/2019 17:15	1,47	18	26,51	CHI
20191239408	JATAI	JT11182141	JATAI S2	06/12/2019 15:46	06/12/2019 17:39	06/12/2019 15:46	06/12/2019 17:39	1,87	73	136,59	CHI
20191239409	SAO MIGUEL DO PASSA QUATRO	SQ12130588	CRISTIANOPOLIS	06/12/2019 15:46	07/12/2019 07:31	06/12/2019 15:46	07/12/2019 07:31	15,74	6	94,42	CHI
20191239427	MINEIROS	MY12149310	PARQUE DAS EMAS	06/12/2019 15:46	06/12/2019 23:13	06/12/2019 15:46	06/12/2019 23:13	7,45	73	543,79	CHI
20191239930	SENADOR CANEDO	SW11158437	GOIANIA LESTE S2	06/12/2019 15:46	06/12/2019 18:51	06/12/2019 15:46	06/12/2019 18:51	3,07	35	107,59	CHI
20191239413	SANTA RITA DO NOVO DESTINO	10009939138	GOIANESIA S1	06/12/2019 15:47	07/12/2019 13:25	06/12/2019 15:47	07/12/2019 13:25	21,63	1	21,63	CHI
20191239418	ANAPOLIS	20076733	ANAPOLIS UNIVERSITARIO S2	06/12/2019 15:48	06/12/2019 20:42	06/12/2019 15:48	06/12/2019 20:42	4,89	1	4,89	CHI
201912229597	SANTA RITA DO ARAGUAIA	SU12301954	SANTA RITA DO ARAGUAIA	06/12/2019 15:48	08/12/2019 02:50	06/12/2019 20:52	06/12/2019 23:30	2,64	15	39,53	CHI
201912229597	SANTA RITA DO ARAGUAIA	SU21184149	SANTA RITA DO ARAGUAIA	06/12/2019 15:48	08/12/2019 02:50	06/12/2019 15:48	08/12/2019 02:50	35,03	1	35,03	CHI
20191239421	ACREUNA	EU11301648	ACREUNA	06/12/2019 15:49	06/12/2019 19:14	06/12/2019 15:49	06/12/2019 19:14	3,41	38	129,75	CHI
20191239426	BOM JARDIM DE GOIAS	BM12060899	ARAGARCAS	06/12/2019 15:49	06/12/2019 18:04	06/12/2019 15:49	06/12/2019 18:04	2,26	36	81,50	CHI
20191240591	ITAPURANGA	IK12298443	ITAPURANGA	06/12/2019 15:49	07/12/2019 10:41	06/12/2019 15:49	07/12/2019 10:41	18,86	5	94,29	CHI
20191239438	GOIANIA	11195885	CAMPINAS S3	06/12/2019 15:50	06/12/2019 19:45	06/12/2019 15:50	06/12/2019 19:45	3,90	1	3,90	CHI
20191239443	GOIANIA	16433154	MEIA PONTE	06/12/2019 15:51	06/12/2019 20:14	06/12/2019 15:51	06/12/2019 20:14	4,38	1	4,38	CHI
20191239446	MINACU	IH11202506	MINACU	06/12/2019 15:51	06/12/2019 20:14	06/12/2019 15:51	06/12/2019 20:14	4,37	4	17,47	CHI
20191239456	AGUA FRIA DE GOIAS	TL12131760	SAO JOAO D ALIANCA	06/12/2019 15:52	06/12/2019 23:12	06/12/2019 15:52	06/12/2019 23:12	7,32	19	139,14	CHI
20191239456	FORMOSA	TL12131760	SAO JOAO D ALIANCA	06/12/2019 15:52	06/12/2019 23:12	06/12/2019 15:52	06/12/2019 23:12	7,32	2	14,65	CHI
20191239457	GOIATUBA	GT21293090	GOIATUBA S2	06/12/2019 15:52	06/12/2019 18:08	06/12/2019 15:52	06/12/2019 18:08	2,25	3	6,75	CHI



20191239487	BELA VISTA DE GOIAS	SW10406913	SENADOR CANEDO	06/12/2019 15:52	06/12/2019 19:06	06/12/2019 16:23	06/12/2019 19:06	2,71	28	75,96	CHI
20191239487	CALDAZINHA	SW10406913	SENADOR CANEDO	06/12/2019 15:52	06/12/2019 19:06	06/12/2019 16:23	06/12/2019 19:06	2,71	59	160,05	CHI
20191239487	SENADOR CANEDO	SW10406913	SENADOR CANEDO	06/12/2019 15:52	06/12/2019 19:06	06/12/2019 16:23	06/12/2019 19:06	2,71	15	40,69	CHI
20191239685	ABADIANIA	AA12285384	ANAPOLIS UNIVERSITARIO S1	06/12/2019 15:52	06/12/2019 18:51	06/12/2019 15:52	06/12/2019 18:51	2,97	98	290,84	CHI
20191239685	GAMELEIRA DE GOIAS	AA12285384	ANAPOLIS UNIVERSITARIO S1	06/12/2019 15:52	06/12/2019 18:51	06/12/2019 15:52	06/12/2019 18:51	2,97	1	2,97	CHI
20191239797	ABADIANIA	AA12382436	ANAPOLIS UNIVERSITARIO S1	06/12/2019 15:52	06/12/2019 17:49	06/12/2019 15:52	06/12/2019 17:49	1,95	36	70,18	CHI
20191239460	CASTELANDIA	DM21295924	RIO DOS BOIS	06/12/2019 15:53	07/12/2019 12:48	06/12/2019 15:53	07/12/2019 12:48	20,91	4	83,64	CHI
20191239462	URUTAI	UT21016948	URUTAI	06/12/2019 15:53	06/12/2019 18:04	06/12/2019 15:53	06/12/2019 18:04	2,17	1	2,17	CHI
20191239465	MINEIROS	MY21306519	PARQUE DAS EMAS	06/12/2019 15:54	07/12/2019 00:18	06/12/2019 15:54	07/12/2019 00:18	8,40	1	8,40	CHI
20191239470	PORANGATU	840144842	PORANGATU	06/12/2019 15:55	06/12/2019 18:18	06/12/2019 15:55	06/12/2019 18:18	2,37	1	2,37	CHI
20191239471	JARAGUA	JA21355754	ITABERAI S1	06/12/2019 15:55	06/12/2019 21:23	06/12/2019 15:55	06/12/2019 21:23	5,45	1	5,45	CHI
20191239473	ESTRELA DO NORTE	ET12000011	MARA ROSA	06/12/2019 15:56	07/12/2019 10:45	06/12/2019 15:56	07/12/2019 10:45	18,81	4	75,24	CHI
20191239478	BRITANIA	BT12396220	BRITANIA	06/12/2019 15:57	08/12/2019 13:25	06/12/2019 15:57	08/12/2019 13:25	45,47	2	90,94	CHI
20191239478	JUSSARA	BT12396220	BRITANIA	06/12/2019 15:57	08/12/2019 13:25	06/12/2019 15:57	08/12/2019 13:25	45,47	9	409,24	CHI
20191239480	ANAPOLIS	20782627	ANAPOLIS UNIVERSITARIO S2	06/12/2019 15:57	06/12/2019 17:48	06/12/2019 15:57	06/12/2019 17:48	1,84	1	1,84	CHI
20191239481	FLORES DE GOIAS	FB21293606	FLORES DE GOIAS	06/12/2019 15:57	06/12/2019 19:17	06/12/2019 15:57	06/12/2019 19:17	3,32	1	3,32	CHI
20191239493	URUACU	UR21156473	CAMPINORTE	06/12/2019 15:59	07/12/2019 02:50	06/12/2019 15:59	07/12/2019 02:50	10,84	8	86,72	CHI
20191239495	AMARALINA	3590008815	MARA ROSA	06/12/2019 16:00	06/12/2019 22:07	06/12/2019 16:00	06/12/2019 22:07	6,12	1	6,12	CHI
20191239501	SANCLERLANDIA	SC21163980	FIRMINOPOLIS S2	06/12/2019 16:00	07/12/2019 14:35	06/12/2019 16:00	07/12/2019 14:35	22,57	1	22,57	CHI
20191239518	VICENTINOPOLIS	VI21263808	VICENTINOPOLIS	06/12/2019 16:03	07/12/2019 18:20	06/12/2019 16:03	07/12/2019 18:20	26,28	2	52,56	CHI
20191239526	COCALZINHO DE GOIAS	ZN21348116	COCALZINHO	06/12/2019 16:04	07/12/2019 09:28	06/12/2019 16:04	07/12/2019 09:28	17,39	1	17,39	CHI
20191239528	GOIANIA	10017248440	GOIANIA LESTE S3	06/12/2019 16:05	06/12/2019 21:54	06/12/2019 16:05	06/12/2019 21:54	5,81	1	5,81	CHI
20191239538	MONTIVIDIU	MV12267741	MONTIVIDIU T	06/12/2019 16:06	07/12/2019 12:10	06/12/2019 16:06	07/12/2019 12:10	20,07	2	40,13	CHI
20191239539	ABADIANIA	05720424	DAIA S2	06/12/2019 16:06	06/12/2019 20:40	06/12/2019 16:06	06/12/2019 20:40	4,57	1	4,57	CHI
20191239539	ABADIANIA	05720424	DAIA S2	06/12/2019 16:06	06/12/2019 20:40	06/12/2019 16:06	06/12/2019 20:40	4,57	1	4,57	CHI
20191239539	ABADIANIA	GL13380768	DAIA S2	06/12/2019 16:06	06/12/2019 20:40	06/12/2019 20:25	06/12/2019 20:40	0,25	1	0,25	CHI
20191239539	GAMELEIRA DE GOIAS	GL13380768	DAIA S2	06/12/2019 16:06	06/12/2019 20:40	06/12/2019 20:25	06/12/2019 20:40	0,25	155	38,79	CHI
20191239738	ABADIANIA	AA12384735	DAIA S2	06/12/2019 16:06	07/12/2019 02:20	06/12/2019 16:22	06/12/2019 18:47	2,41	120	289,33	CHI
20191239738	ABADIANIA	05730414	DAIA S2	06/12/2019 16:06	07/12/2019 02:20	06/12/2019 16:06	06/12/2019 22:44	6,63	245	1624,69	CHI
20191239738	ABADIANIA	05730414	DAIA S2	06/12/2019 16:06	07/12/2019 02:20	06/12/2019 20:40	06/12/2019 22:44	2,07	132	272,73	CHI
20191239738	ABADIANIA	05730414	DAIA S2	06/12/2019 16:06	07/12/2019 02:20	06/12/2019 16:06	06/12/2019 23:31	7,42	60	444,90	CHI
20191239738	GAMELEIRA DE GOIAS	05730414	DAIA S2	06/12/2019 16:06	07/12/2019 02:20	06/12/2019 16:06	06/12/2019 23:31	7,42	1	7,42	CHI
20191239738	ABADIANIA	05730414	DAIA S2	06/12/2019 16:06	07/12/2019 02:20	06/12/2019 20:40	06/12/2019 23:31	2,85	90	256,48	CHI

20191239738	ABADIANIA	AA12130228	DAIA S2	06/12/2019 16:06	07/12/2019 02:20	06/12/2019 20:40	07/12/2019 02:20	5,67	30	169,98	CHI
20191239939	ITABERAÍ	IB12040786	ITABERAÍ S2	06/12/2019 16:06	07/12/2019 07:41	06/12/2019 16:06	07/12/2019 07:41	15,58	10	155,78	CHI
20191239546	IPIRANGA DE GOIÁS	CE12063327	RUBIATABA	06/12/2019 16:07	07/12/2019 11:19	06/12/2019 16:07	07/12/2019 11:19	19,20	4	76,79	CHI
20191239550	CRISTALINA	1060030023	CRISTALINA S1	06/12/2019 16:07	06/12/2019 17:37	06/12/2019 16:07	06/12/2019 17:37	1,49	1	1,49	CHI
20191240116	GOIANESIA	GE11119924	GOIANESIA S2	06/12/2019 16:08	07/12/2019 03:45	06/12/2019 16:08	07/12/2019 03:45	11,61	139	1614,48	CHI
20191239556	ITAPURANGA	170050518	ITAPURANGA	06/12/2019 16:09	06/12/2019 19:26	06/12/2019 16:09	06/12/2019 19:26	3,28	1	3,28	CHI
20191239562	ANAPOLIS	10004623299	ANAPOLIS UNIVERSITARIO S2	06/12/2019 16:09	06/12/2019 19:01	06/12/2019 16:09	06/12/2019 19:01	2,86	1	2,86	CHI
20191239563	LUZIANIA	120215871	RIO VERMELHO	06/12/2019 16:09	06/12/2019 21:38	06/12/2019 16:09	06/12/2019 21:38	5,47	1	5,47	CHI
20191239565	CROMINIA	CQ12000245	PONTALINA	06/12/2019 16:09	07/12/2019 14:32	06/12/2019 16:09	07/12/2019 14:32	22,37	9	201,31	CHI
20191239684	ABADIANIA	AA12377404	ANAPOLIS UNIVERSITARIO S1	06/12/2019 16:09	06/12/2019 19:37	06/12/2019 16:09	06/12/2019 19:37	3,46	58	200,62	CHI
20191239572	JATAÍ	JT21334203	JATAÍ S1	06/12/2019 16:10	07/12/2019 12:23	06/12/2019 16:10	07/12/2019 12:23	20,20	1	20,20	CHI
20191239575	GOIANDIRA	GD21161085	CATALAO S1	06/12/2019 16:11	06/12/2019 21:56	06/12/2019 16:11	06/12/2019 21:56	5,74	1	5,74	CHI
20191239577	SERRANOPOLIS	SX12318816	JATAÍ S1	06/12/2019 16:12	06/12/2019 18:00	06/12/2019 16:12	06/12/2019 18:00	1,80	21	37,79	CHI
20191239582	SENADOR CANEDO	GN21000247	GOIANIA LESTE S2	06/12/2019 16:12	06/12/2019 21:22	06/12/2019 16:12	06/12/2019 21:22	5,15	1	5,15	CHI
20191239583	CATALAO	10008093375	CATALAO S2	06/12/2019 16:12	06/12/2019 18:52	06/12/2019 16:12	06/12/2019 18:52	2,65	1	2,65	CHI
20191239591	FAZENDA NOVA	FN21199828	IPORA	06/12/2019 16:13	07/12/2019 04:05	06/12/2019 16:13	07/12/2019 04:05	11,87	2	23,74	CHI
20191239748	LUZIANIA	LZ12330783RE	MARAJOARA	06/12/2019 16:13	06/12/2019 20:15	06/12/2019 16:13	06/12/2019 20:15	4,03	203	818,15	CHI
20191239598	MINACU	IH21230508	MINACU	06/12/2019 16:14	07/12/2019 12:57	06/12/2019 16:14	07/12/2019 12:57	20,71	1	20,71	CHI
20191240008	CALDAS NOVAS	CN12142352	CALDAS NOVAS S1	06/12/2019 16:14	07/12/2019 08:35	06/12/2019 16:14	07/12/2019 08:35	16,34	20	326,70	CHI
20191239606	PLANALTINA	PI11361426	PLANALTINA	06/12/2019 16:15	06/12/2019 17:45	06/12/2019 16:15	06/12/2019 17:45	1,50	181	271,65	CHI
20191239611	BOM JARDIM DE GOIÁS	PH12317697	PIRANHAS	06/12/2019 16:15	07/12/2019 10:55	06/12/2019 16:15	07/12/2019 10:55	18,66	2	37,31	CHI
20191239611	PIRANHAS	PH12317697	PIRANHAS	06/12/2019 16:15	07/12/2019 10:55	06/12/2019 16:15	07/12/2019 10:55	18,66	2	37,31	CHI
20191240624	CAMPINORTE	CR12078290	MARA ROSA	06/12/2019 16:15	06/12/2019 22:45	06/12/2019 16:15	06/12/2019 22:45	6,49	4	25,98	CHI
20191239616	GOIANIA	10313096	CAMPINAS S1	06/12/2019 16:16	06/12/2019 19:26	06/12/2019 16:16	06/12/2019 19:26	3,16	1	3,16	CHI
20191239618	JATAÍ	290269234	JATAÍ S3	06/12/2019 16:16	06/12/2019 17:55	06/12/2019 16:16	06/12/2019 17:55	1,64	1	1,64	CHI
20191239620	ANAPOLIS	20038537	ANAPOLIS UNIVERSITARIO S2	06/12/2019 16:16	06/12/2019 18:50	06/12/2019 16:16	06/12/2019 18:50	2,56	1	2,56	CHI
20191240464	MONTIVIDIU	MV12267623	MONTIVIDIU T	06/12/2019 16:16	07/12/2019 12:34	06/12/2019 16:16	07/12/2019 12:34	20,31	29	588,92	CHI
20191240578	ARACU	AV12272362	ANICUNS	06/12/2019 16:16	07/12/2019 07:18	06/12/2019 16:16	07/12/2019 07:18	15,02	4	60,10	CHI
20191240578	ITABERAÍ	AV12272362	ANICUNS	06/12/2019 16:16	07/12/2019 07:18	06/12/2019 16:16	07/12/2019 07:18	15,02	17	255,42	CHI
20191239625	CALDAS NOVAS	CN11213963	SERRA DE CALDAS	06/12/2019 16:17	06/12/2019 18:24	06/12/2019 16:17	06/12/2019 18:24	2,11	33	69,58	CHI
20191239627	JATAÍ	JT12260493	JATAÍ S1	06/12/2019 16:17	07/12/2019 08:23	06/12/2019 16:17	07/12/2019 08:23	16,09	18	289,56	CHI
20191239671	MORRINHOS	MR12000258RE	MORRINHOS	06/12/2019 16:18	07/12/2019 22:34	06/12/2019 16:18	06/12/2019 21:19	5,02	26	130,48	CHI
20191239671	MORRINHOS	MR13000022	MORRINHOS	06/12/2019 16:18	07/12/2019 22:34	06/12/2019 16:18	06/12/2019 23:22	7,07	11	77,79	CHI

20191239671	MORRINHOS	MR13204436	MORRINHOS	06/12/2019 16:18	07/12/2019 22:34	06/12/2019 16:18	07/12/2019 13:05	20,77	4	83,10	CHI
20191239671	MORRINHOS	MR13212244	MORRINHOS	06/12/2019 16:18	07/12/2019 22:34	06/12/2019 16:18	07/12/2019 13:48	21,51	6	129,04	CHI
20191239671	MORRINHOS	MR21236948	MORRINHOS	06/12/2019 16:18	07/12/2019 22:34	06/12/2019 16:18	07/12/2019 22:34	30,26	1	30,26	CHI
2019120600080	GUARINOS	14902	URUACU	06/12/2019 16:18	06/12/2019 16:23	06/12/2019 16:18	06/12/2019 16:23	0,08	11	0,92	CHI
2019120600080	HIDROLINA	07901	URUACU	06/12/2019 16:18	06/12/2019 16:23	06/12/2019 16:18	06/12/2019 16:23	0,08	1253	104,42	CHI
2019120600080	HIDROLINA	07931	URUACU	06/12/2019 16:18	06/12/2019 16:23	06/12/2019 16:18	06/12/2019 16:23	0,08	108	9,00	CHI
2019120600080	HIDROLINA	01800424	URUACU	06/12/2019 16:18	06/12/2019 16:23	06/12/2019 16:18	06/12/2019 16:23	0,08	191	15,92	CHI
2019120600080	ITAPACI	14902	URUACU	06/12/2019 16:18	06/12/2019 16:23	06/12/2019 16:18	06/12/2019 16:23	0,08	2	0,17	CHI
2019120600080	PILAR DE GOIAS	14901	URUACU	06/12/2019 16:18	06/12/2019 16:23	06/12/2019 16:18	06/12/2019 16:23	0,08	56	4,67	CHI
2019120600080	PILAR DE GOIAS	14902	URUACU	06/12/2019 16:18	06/12/2019 16:23	06/12/2019 16:18	06/12/2019 16:23	0,08	697	58,08	CHI
2019120600080	PILAR DE GOIAS	07931	URUACU	06/12/2019 16:18	06/12/2019 16:23	06/12/2019 16:18	06/12/2019 16:23	0,08	42	3,50	CHI
2019120600080	PILAR DE GOIAS	01800424	URUACU	06/12/2019 16:18	06/12/2019 16:23	06/12/2019 16:18	06/12/2019 16:23	0,08	28	2,33	CHI
2019120600080	SANTA TEREZINHA DE GOIAS	14902	URUACU	06/12/2019 16:18	06/12/2019 16:23	06/12/2019 16:18	06/12/2019 16:23	0,08	5	0,42	CHI
2019120600080	URUACU	01800424	URUACU	06/12/2019 16:18	06/12/2019 16:23	06/12/2019 16:18	06/12/2019 16:23	0,08	339	28,25	CHI
20191239633	NEROPOLIS	160064259	NEROPOLIS S2	06/12/2019 16:19	06/12/2019 20:36	06/12/2019 16:19	06/12/2019 20:36	4,28	1	4,28	CHI
20191239636	JATAI	JT21205254	JATAI S1	06/12/2019 16:19	07/12/2019 10:30	06/12/2019 16:19	07/12/2019 10:30	18,17	1	18,17	CHI
20191239639	GOIANIA	11630437	CAMPINAS S2	06/12/2019 16:20	06/12/2019 19:33	06/12/2019 16:20	06/12/2019 19:33	3,21	1	3,21	CHI
20191239644	GOIANIA	13992466	GOYA S2	06/12/2019 16:20	06/12/2019 21:46	06/12/2019 16:20	06/12/2019 21:46	5,42	1	5,42	CHI
20191239645	JATAI	JT21093816	CACHOEIRA ALTA	06/12/2019 16:20	06/12/2019 18:36	06/12/2019 16:20	06/12/2019 18:36	2,26	1	2,26	CHI
20191239665	RIO VERDE	RV12213750	CABRIUVA S2	06/12/2019 16:20	07/12/2019 10:20	06/12/2019 16:20	07/12/2019 10:20	17,99	28	503,73	CHI
20191239647	PALMEIRAS DE GOIAS	PL21197869	PALMEIRAS	06/12/2019 16:21	07/12/2019 09:40	06/12/2019 16:21	07/12/2019 09:40	17,33	1	17,33	CHI
20191239778	ARACU	AR12104723	ARACU	06/12/2019 16:21	07/12/2019 13:51	06/12/2019 16:21	07/12/2019 10:00	17,65	22	388,20	CHI
20191239778	ITAUCU	AR12104723	ARACU	06/12/2019 16:21	07/12/2019 13:51	06/12/2019 16:21	07/12/2019 10:00	17,65	1	17,65	CHI
20191239778	ITAUCU	AR12376846	ARACU	06/12/2019 16:21	07/12/2019 13:51	06/12/2019 16:21	07/12/2019 11:05	18,74	9	168,64	CHI
20191239778	ITAUCU	AR12376846	ARACU	06/12/2019 16:21	07/12/2019 13:51	07/12/2019 11:06	07/12/2019 13:51	2,76	9	24,83	CHI
20191239656	NOVA CRIXAS	NA21322838	MOZARLANDIA	06/12/2019 16:22	07/12/2019 18:39	06/12/2019 16:22	07/12/2019 18:39	26,27	1	26,27	CHI
20191241526	ARUANA	MP13217236	MATRINCHA	06/12/2019 16:22	07/12/2019 13:46	07/12/2019 11:15	07/12/2019 13:46	2,52	6	15,11	CHI
20191241526	MATRINCHA	MP13217236	MATRINCHA	06/12/2019 16:22	07/12/2019 13:46	07/12/2019 11:15	07/12/2019 13:46	2,52	94	236,67	CHI
20191239666	INDIARA	IY12170319	EDEIA	06/12/2019 16:23	07/12/2019 09:17	06/12/2019 16:23	07/12/2019 09:17	16,88	5	84,42	CHI
20191239666	PALMEIRAS DE GOIAS	IY12170319	EDEIA	06/12/2019 16:23	07/12/2019 09:17	06/12/2019 16:23	07/12/2019 09:17	16,88	6	101,31	CHI
20191239668	SENADOR CANEDO	14874799	CEPAIGO S1	06/12/2019 16:24	06/12/2019 18:12	06/12/2019 16:24	06/12/2019 18:12	1,79	1	1,79	CHI
20191239680	PARAUNA	PU12081329	PARAUNA	06/12/2019 16:26	06/12/2019 18:01	06/12/2019 16:26	06/12/2019 18:01	1,59	54	85,73	CHI
20191239682	GOIANIA	16849735	REAL S2	06/12/2019 16:26	06/12/2019 18:25	06/12/2019 16:26	06/12/2019 18:25	1,97	1	1,97	CHI

20191240120	LUZIANIA	LZ12351266RE	MARAJOARA	06/12/2019 16:26	06/12/2019 23:03	06/12/2019 16:26	06/12/2019 23:03	6,61	37	244,70	CHI
20191239688	PORANGATU	10008058421	PORANGATU	06/12/2019 16:27	06/12/2019 17:55	06/12/2019 16:27	06/12/2019 17:55	1,47	1	1,47	CHI
20191239691	APARECIDA DE GOIANIA	10029790580	INDEPENDENCIA S2	06/12/2019 16:28	06/12/2019 17:50	06/12/2019 16:28	06/12/2019 17:50	1,37	1	1,37	CHI
20191240797	LUZIANIA	LZ12290851	MARAJOARA	06/12/2019 16:28	06/12/2019 22:22	06/12/2019 16:28	06/12/2019 22:22	5,90	23	135,66	CHI
20191239777	ANICUNS	IX12200037	ARACU	06/12/2019 16:29	06/12/2019 19:45	06/12/2019 16:29	06/12/2019 19:45	3,26	1	3,26	CHI
20191239777	ITABERAI	IX12200037	ARACU	06/12/2019 16:29	06/12/2019 19:45	06/12/2019 16:29	06/12/2019 19:45	3,26	12	39,09	CHI
20191240114	HIDROLINA	HL12000009	URUACU	06/12/2019 16:29	06/12/2019 20:21	06/12/2019 16:29	06/12/2019 20:21	3,85	4	15,42	CHI
20191239707	TRINDADE	TR21403831	TRINDADE	06/12/2019 16:30	07/12/2019 00:24	06/12/2019 16:30	07/12/2019 00:24	7,89	1	7,89	CHI
20191239708	RIO VERDE	RV21105841	RIO VERDE S1	06/12/2019 16:30	07/12/2019 17:30	06/12/2019 16:30	07/12/2019 17:30	24,99	1	24,99	CHI
20191239709	FORMOSA	FA12000130	ITUIQUIRA	06/12/2019 16:30	06/12/2019 18:14	06/12/2019 16:30	06/12/2019 18:14	1,72	14	24,07	CHI
20191239711	ARAGUAPAZ	AZ21143340	MOZARLANDIA	06/12/2019 16:31	07/12/2019 10:20	06/12/2019 16:31	07/12/2019 10:20	17,81	1	17,81	CHI
20191239713	CERES	JA12273204	RUBIATABA	06/12/2019 16:31	08/12/2019 03:35	06/12/2019 16:31	08/12/2019 03:35	35,06	1	35,06	CHI
20191239715	PIRENOPOLIS	PV21227802	CORUMBA	06/12/2019 16:32	07/12/2019 10:24	06/12/2019 16:32	07/12/2019 10:24	17,86	1	17,86	CHI
20191239716	MORRINHOS	MR21269285	MORRINHOS	06/12/2019 16:32	06/12/2019 19:30	06/12/2019 16:32	06/12/2019 19:30	2,97	2	5,94	CHI
20191241091	ORIZONA	OZ12404726	PIRES DO RIO S1	06/12/2019 16:32	07/12/2019 00:50	06/12/2019 16:32	07/12/2019 00:50	8,30	9	74,66	CHI
20191240596	TRINDADE	TR11185423	TRINDADE	06/12/2019 16:33	06/12/2019 22:30	06/12/2019 16:33	06/12/2019 22:30	5,94	50	297,04	CHI
20191239729	VILA PROPICIO	NP12298249	GOIANESIA S1	06/12/2019 16:34	07/12/2019 14:20	06/12/2019 16:34	07/12/2019 14:20	21,75	9	195,79	CHI
20191239731	MINEIROS	MY21372476	PARQUE DAS EMAS	06/12/2019 16:34	07/12/2019 12:28	06/12/2019 16:34	07/12/2019 12:28	19,90	1	19,90	CHI
20191239736	CRISTALINA	KR12370775	PAMPLONA	06/12/2019 16:35	07/12/2019 09:33	06/12/2019 16:35	07/12/2019 09:33	16,96	9	152,61	CHI
20191239737	LUZIANIA	LZ12396833	MARAJOARA	06/12/2019 16:36	07/12/2019 07:24	06/12/2019 16:36	07/12/2019 07:24	14,80	18	266,39	CHI
20191239743	MINEIROS	MY12360790	PARQUE DAS EMAS	06/12/2019 16:37	06/12/2019 17:40	06/12/2019 16:37	06/12/2019 17:40	1,06	175	184,92	CHI
20191239745	MORRINHOS	MR12000100	MORRINHOS	06/12/2019 16:37	07/12/2019 08:10	06/12/2019 16:37	07/12/2019 08:10	15,54	8	124,35	CHI
20191239793	COCALZINHO DE GOIAS	PB13383679B	PADRE BERNARDO	06/12/2019 16:37	07/12/2019 00:55	06/12/2019 16:37	06/12/2019 23:30	6,89	29	199,91	CHI
20191239793	DISTRITO FEDERAL	PB13383679B	PADRE BERNARDO	06/12/2019 16:37	07/12/2019 00:55	06/12/2019 16:37	06/12/2019 23:30	6,89	3	20,68	CHI
20191239793	PADRE BERNARDO	PB13383679B	PADRE BERNARDO	06/12/2019 16:37	07/12/2019 00:55	06/12/2019 16:37	06/12/2019 23:30	6,89	632	4356,76	CHI
20191239793	PADRE BERNARDO	PB12163212	PADRE BERNARDO	06/12/2019 16:37	07/12/2019 00:55	06/12/2019 16:37	07/12/2019 00:55	8,31	25	207,85	CHI
20191239793	PADRE BERNARDO	PB12163212	PADRE BERNARDO	06/12/2019 16:37	07/12/2019 00:55	06/12/2019 22:49	07/12/2019 00:55	2,11	6	12,64	CHI
20191239750	PIRACANJUBA	PJ21106672	CALDAS NOVAS S1	06/12/2019 16:38	07/12/2019 15:35	06/12/2019 16:38	07/12/2019 15:35	22,95	1	22,95	CHI
20191239751	GOIANIA	17391015	GOIANIA LESTE S3	06/12/2019 16:38	06/12/2019 23:05	06/12/2019 16:38	06/12/2019 23:05	6,45	1	6,45	CHI
20191239753	GOIAS	GS12061061	ITAPURANGA	06/12/2019 16:38	07/12/2019 09:12	06/12/2019 16:38	07/12/2019 09:12	16,56	36	596,13	CHI
20191239756	GOIANIA	10013688365	CAMPINAS S1	06/12/2019 16:38	06/12/2019 19:21	06/12/2019 16:38	06/12/2019 19:21	2,72	1	2,72	CHI
20191241336	MINEIROS	MY12164239	PARQUE DAS EMAS	06/12/2019 16:38	07/12/2019 00:20	06/12/2019 16:38	07/12/2019 00:20	7,70	2	15,39	CHI
20191239759	GOIAS	GS21364825	ITABERAI S1	06/12/2019 16:39	07/12/2019 19:28	06/12/2019 16:39	07/12/2019 19:28	26,82	2	53,63	CHI

20191239762	UIRAPURU	UP12277787	SANTA TEREZINHA	06/12/2019 16:39	07/12/2019 12:34	06/12/2019 16:39	07/12/2019 12:34	19,91	6	119,46	CHI
20191239780	CORUMBAIBA	CI12363786	VILA CORUMBA	06/12/2019 16:39	06/12/2019 19:53	06/12/2019 16:39	06/12/2019 19:53	3,23	18	58,08	CHI
20191239769	LUZIANIA	10004622136	MARAJOARA	06/12/2019 16:40	06/12/2019 20:36	06/12/2019 16:40	06/12/2019 20:36	3,92	1	3,92	CHI
20191240009	MINEIROS	MY12196001	PARQUE DAS EMAS	06/12/2019 16:40	06/12/2019 18:53	06/12/2019 16:40	06/12/2019 18:53	2,21	186	411,52	CHI
20191239772	GUAPO	710025361	GUAPO S1	06/12/2019 16:41	07/12/2019 00:34	06/12/2019 16:41	07/12/2019 00:34	7,88	1	7,88	CHI
20191239784	GOIANIA	14734862	CAMPINAS S2	06/12/2019 16:43	06/12/2019 19:22	06/12/2019 16:43	06/12/2019 19:22	2,65	1	2,65	CHI
20191239787	ITAPACI	IW21335654	RUBIATABA	06/12/2019 16:43	07/12/2019 14:35	06/12/2019 16:43	07/12/2019 14:35	21,86	1	21,86	CHI
20191239790	FORMOSA	FA21138964	SAO JOAO D ALIANCA	06/12/2019 16:43	06/12/2019 19:48	06/12/2019 16:43	06/12/2019 19:48	3,07	1	3,07	CHI
20191239791	BONOPOLIS	PO21103384	NOVO PLANALTO	06/12/2019 16:43	07/12/2019 12:01	06/12/2019 16:43	07/12/2019 12:01	19,29	1	19,29	CHI
20191239794	GOIANIA	12376346	CARAJAS S1	06/12/2019 16:44	06/12/2019 20:36	06/12/2019 16:44	06/12/2019 20:36	3,87	1	3,87	CHI
20191239801	RIO VERDE	RV12341140	CACHOEIRA ALTA	06/12/2019 16:46	06/12/2019 18:00	06/12/2019 16:46	06/12/2019 18:00	1,23	4	4,91	CHI
20191239809	MIMOSO DE GOIAS	MJ21305195	PADRE BERNARDO	06/12/2019 16:47	07/12/2019 03:11	06/12/2019 16:47	07/12/2019 03:11	10,40	1	10,40	CHI
20191239811	CRIXAS	CX21342232	SERRA DO OURO	06/12/2019 16:47	07/12/2019 20:31	06/12/2019 16:47	07/12/2019 20:31	27,73	1	27,73	CHI
20191239813	BELA VISTA DE GOIAS	SW12182558	CEPAIGO S2	06/12/2019 16:47	07/12/2019 01:41	06/12/2019 23:26	06/12/2019 23:34	0,13	114	15,23	CHI
20191239813	BELA VISTA DE GOIAS	BV12000046	CEPAIGO S2	06/12/2019 16:47	07/12/2019 01:41	06/12/2019 16:47	07/12/2019 01:41	8,91	30	267,20	CHI
20191239819	PLANALTINA	PI11322659	PLANALTINA	06/12/2019 16:48	06/12/2019 17:53	06/12/2019 16:48	06/12/2019 17:53	1,07	58	62,29	CHI
20191239825	AURILANDIA	CG12391526	FIRMINOPOLIS S2	06/12/2019 16:49	06/12/2019 19:42	06/12/2019 16:49	06/12/2019 19:42	2,89	2	5,78	CHI
20191239825	CACHOEIRA DE GOIAS	CG12391526	FIRMINOPOLIS S2	06/12/2019 16:49	06/12/2019 19:42	06/12/2019 16:49	06/12/2019 19:42	2,89	11	31,78	CHI
20191239825	PARAUNA	CG12391526	FIRMINOPOLIS S2	06/12/2019 16:49	06/12/2019 19:42	06/12/2019 16:49	06/12/2019 19:42	2,89	32	92,46	CHI
20191239827	ITAPURANGA	IK12071744	ITAPURANGA	06/12/2019 16:49	07/12/2019 16:10	06/12/2019 16:49	07/12/2019 16:10	23,35	10	233,48	CHI
20191239830	RIO QUENTE	RQ21151585	VILA CORUMBA	06/12/2019 16:49	07/12/2019 08:47	06/12/2019 16:49	07/12/2019 08:47	15,96	1	15,96	CHI
20191239837	COCALZINHO DE GOIAS	ZN21328217	COCALZINHO	06/12/2019 16:50	07/12/2019 13:54	06/12/2019 16:50	07/12/2019 13:54	21,06	1	21,06	CHI
20191239841	MINACU	IH11339097	MINACU	06/12/2019 16:51	06/12/2019 21:44	06/12/2019 16:51	06/12/2019 21:44	4,88	1	4,88	CHI
20191239843	NIQUELANDIA	NQ12253279	BARRO ALTO	06/12/2019 16:51	07/12/2019 16:30	06/12/2019 16:51	07/12/2019 16:30	23,65	7	165,52	CHI
20191239885	JATAI	JT11036334	JATAI S3	06/12/2019 16:51	06/12/2019 19:26	06/12/2019 16:51	06/12/2019 19:26	2,58	151	390,04	CHI
20191239852	IPAMERI	IP12237222	IPAMERI	06/12/2019 16:52	06/12/2019 21:19	06/12/2019 16:52	06/12/2019 21:19	4,45	1	4,45	CHI
20191239857	JATAI	JT12241758	JATAI S3	06/12/2019 16:53	07/12/2019 09:48	06/12/2019 16:53	07/12/2019 09:48	16,91	2	33,83	CHI
20191239858	ANAPOLIS	21098669	JUNDIAI S1	06/12/2019 16:53	06/12/2019 20:27	06/12/2019 16:53	06/12/2019 20:27	3,56	1	3,56	CHI
20191239860	RIO VERDE	630475519	RIO VERDE S2	06/12/2019 16:53	07/12/2019 10:18	06/12/2019 16:53	07/12/2019 10:18	17,41	1	17,41	CHI
20191239863	GOIANIA	10322851	CAMPINAS S1	06/12/2019 16:54	06/12/2019 19:29	06/12/2019 16:54	06/12/2019 19:29	2,58	1	2,58	CHI
20191239864	PALMEIRAS DE GOIAS	PL21124694	PALMEIRAS	06/12/2019 16:54	07/12/2019 13:43	06/12/2019 16:54	07/12/2019 13:43	20,82	1	20,82	CHI
20191239871	PIRACANJUBA	PJ11400890	PIRACANJUBA	06/12/2019 16:55	07/12/2019 09:46	06/12/2019 16:55	07/12/2019 09:46	16,85	32	539,08	CHI
20191239880	LUZIANIA	LZ21246078	MARAJOARA	06/12/2019 16:56	07/12/2019 08:07	06/12/2019 16:56	07/12/2019 08:07	15,17	1	15,17	CHI

20191239881	QUIRINOPOLIS	QI12249191	QUIRINOPOLIS	06/12/2019 16:56	07/12/2019 15:03	06/12/2019 16:56	07/12/2019 10:36	17,65	5	88,27	CHI
20191239881	QUIRINOPOLIS	QI12249191	QUIRINOPOLIS	06/12/2019 16:56	07/12/2019 15:03	06/12/2019 16:56	07/12/2019 12:55	19,99	21	419,71	CHI
20191239881	QUIRINOPOLIS	QI12249191	QUIRINOPOLIS	06/12/2019 16:56	07/12/2019 15:03	06/12/2019 16:56	07/12/2019 15:03	22,11	15	331,70	CHI
20191239887	JATAI	290010998	JATAI S2	06/12/2019 16:58	06/12/2019 21:08	06/12/2019 16:58	06/12/2019 21:08	4,17	1	4,17	CHI
20191239894	BOM JARDIM DE GOIAS	BM21150533	IPORA	06/12/2019 16:59	07/12/2019 08:28	06/12/2019 16:59	07/12/2019 08:28	15,47	1	15,47	CHI
20191240625	ITABERAÍ	IB12310505	ITABERAÍ S2	06/12/2019 16:59	07/12/2019 03:38	06/12/2019 16:59	07/12/2019 03:38	10,64	9	95,77	CHI
20191239900	PLANALTINA	10001370128	PLANALTINA	06/12/2019 17:00	06/12/2019 18:10	06/12/2019 17:00	06/12/2019 18:10	1,16	1	1,16	CHI
20191239901	RIO VERDE	10009127877	RIO VERDE S1	06/12/2019 17:00	07/12/2019 09:01	06/12/2019 17:00	07/12/2019 09:01	16,00	1	16,00	CHI
20191239907	SILVANIA	SV12072960	VIANOPOLIS	06/12/2019 17:01	07/12/2019 10:00	06/12/2019 17:01	07/12/2019 02:02	9,00	2	18,01	CHI
20191239907	VIANOPOLIS	SV12072960	VIANOPOLIS	06/12/2019 17:01	07/12/2019 10:00	06/12/2019 17:01	07/12/2019 02:02	9,00	15	135,07	CHI
20191239907	SILVANIA	VN13282997	VIANOPOLIS	06/12/2019 17:01	07/12/2019 10:00	06/12/2019 17:01	07/12/2019 04:12	11,17	10	111,71	CHI
20191239907	VIANOPOLIS	VN13282997	VIANOPOLIS	06/12/2019 17:01	07/12/2019 10:00	06/12/2019 17:01	07/12/2019 04:12	11,17	1	11,17	CHI
20191239907	SILVANIA	SV12056341	VIANOPOLIS	06/12/2019 17:01	07/12/2019 10:00	06/12/2019 17:01	07/12/2019 09:13	16,20	17	275,45	CHI
20191239907	SILVANIA	SV12072960	VIANOPOLIS	06/12/2019 17:01	07/12/2019 10:00	07/12/2019 08:33	07/12/2019 09:13	0,67	12	7,99	CHI
20191239907	VIANOPOLIS	SV12072960	VIANOPOLIS	06/12/2019 17:01	07/12/2019 10:00	07/12/2019 08:33	07/12/2019 09:13	0,67	16	10,65	CHI
20191239907	SILVANIA	SV12340735	VIANOPOLIS	06/12/2019 17:01	07/12/2019 10:00	06/12/2019 17:01	07/12/2019 10:00	16,97	46	780,66	CHI
20191240208	CORUMBA DE GOIAS	CB12302158	ALEXANIA	06/12/2019 17:01	07/12/2019 10:00	06/12/2019 17:01	07/12/2019 10:00	16,98	7	118,83	CHI
20191239918	HIDROLANDIA	HD12120557	CEPAIGO S2	06/12/2019 17:03	06/12/2019 19:33	06/12/2019 17:03	06/12/2019 19:33	2,50	18	44,92	CHI
20191239920	PARAUNA	PU12228062	PARAUNA	06/12/2019 17:03	06/12/2019 18:52	06/12/2019 17:03	06/12/2019 18:52	1,81	6	10,86	CHI
20191239952	ALEXANIA	CB12295651	ALEXANIA	06/12/2019 17:03	06/12/2019 20:01	06/12/2019 17:03	06/12/2019 20:01	2,97	1	2,97	CHI
20191239952	CORUMBA DE GOIAS	CB12295651	ALEXANIA	06/12/2019 17:03	06/12/2019 20:01	06/12/2019 17:03	06/12/2019 20:01	2,97	10	29,66	CHI
20191239926	FORMOSO	FO21181730	PORANGATU	06/12/2019 17:04	06/12/2019 23:54	06/12/2019 17:04	06/12/2019 23:54	6,82	1	6,82	CHI
20191239929	MONTE ALEGRE DE GOIAS	MA12392319	SAO DOMINGOS	06/12/2019 17:04	07/12/2019 12:56	06/12/2019 17:04	07/12/2019 12:56	19,85	55	1091,81	CHI
20191239932	PORANGATU	PO12365601	NOVO PLANALTO	06/12/2019 17:05	06/12/2019 21:10	06/12/2019 17:05	06/12/2019 21:10	4,08	4	16,32	CHI
20191239935	CATALAO	CT21273137	CATALAO S1	06/12/2019 17:05	07/12/2019 11:21	06/12/2019 17:05	07/12/2019 11:21	18,26	1	18,26	CHI
20191239937	PEROLANDIA	DP12210131	PARQUE DAS EMAS	06/12/2019 17:05	07/12/2019 15:23	06/12/2019 17:05	07/12/2019 15:15	22,16	1	22,16	CHI
20191239937	MINEIROS	DP12210131	PARQUE DAS EMAS	06/12/2019 17:05	07/12/2019 15:23	06/12/2019 17:05	07/12/2019 15:23	22,29	5	111,45	CHI
20191239937	PEROLANDIA	DP12210131	PARQUE DAS EMAS	06/12/2019 17:05	07/12/2019 15:23	06/12/2019 17:05	07/12/2019 15:23	22,29	4	89,16	CHI
20191239937	MINEIROS	DP12210131	PARQUE DAS EMAS	06/12/2019 17:05	07/12/2019 15:23	07/12/2019 11:06	07/12/2019 15:23	4,27	8	34,16	CHI
20191239937	PORTELANDIA	DP12210131	PARQUE DAS EMAS	06/12/2019 17:05	07/12/2019 15:23	07/12/2019 11:06	07/12/2019 15:23	4,27	1	4,27	CHI
20191240076	GOIANDIRA	GD12127685	CATALAO S1	06/12/2019 17:05	06/12/2019 21:49	06/12/2019 17:05	06/12/2019 21:49	4,73	10	47,32	CHI
20191240076	NOVA AURORA	GD12127685	CATALAO S1	06/12/2019 17:05	06/12/2019 21:49	06/12/2019 17:05	06/12/2019 21:49	4,73	12	56,78	CHI
20191239940	ITAPIRAPUA	IU12142895	MATRINCHA	06/12/2019 17:06	06/12/2019 20:20	06/12/2019 17:06	06/12/2019 20:20	3,24	7	22,65	CHI

20191239941	NIQUELANDIA	NQ12239432	URUACU	06/12/2019 17:06	07/12/2019 01:56	06/12/2019 17:06	07/12/2019 01:56	8,83	19	167,70	CHI
20191239946	LUZIANIA	LZ21000572	MARAJOARA	06/12/2019 17:07	06/12/2019 20:59	06/12/2019 17:07	06/12/2019 20:59	3,86	1	3,86	CHI
20191239961	GOIANIA	GN11268341	XAVANTES	06/12/2019 17:10	06/12/2019 21:22	06/12/2019 17:10	06/12/2019 21:22	4,19	26	109,03	CHI
20191239966	GUARINOS	GF12051406	SANTA TEREZINHA	06/12/2019 17:10	06/12/2019 20:46	06/12/2019 17:10	06/12/2019 20:46	3,58	9	32,26	CHI
20191239966	SANTA TEREZINHA DE GOIAS	GF12051406	SANTA TEREZINHA	06/12/2019 17:10	06/12/2019 20:46	06/12/2019 17:10	06/12/2019 20:46	3,58	4	14,34	CHI
20191240586	CAMPO ALEGRE DE GOIAS	CM10397305	CAMPO ALEGRE DE GOIAS	06/12/2019 17:10	09/12/2019 19:10	06/12/2019 17:10	06/12/2019 20:22	3,21	23	73,80	CHI
20191240586	CAMPO ALEGRE DE GOIAS	CM10397305	CAMPO ALEGRE DE GOIAS	06/12/2019 17:10	09/12/2019 19:10	06/12/2019 17:12	06/12/2019 20:22	3,17	3	9,51	CHI
20191240586	CAMPO ALEGRE DE GOIAS	CM10397305	CAMPO ALEGRE DE GOIAS	06/12/2019 17:10	09/12/2019 19:10	06/12/2019 17:10	06/12/2019 22:52	5,70	38	216,65	CHI
20191240586	CATALAO	CM10397305	CAMPO ALEGRE DE GOIAS	06/12/2019 17:10	09/12/2019 19:10	06/12/2019 17:10	06/12/2019 22:52	5,70	17	96,92	CHI
20191240586	DISTRITO FEDERAL	CM10397305	CAMPO ALEGRE DE GOIAS	06/12/2019 17:10	09/12/2019 19:10	06/12/2019 17:10	06/12/2019 22:52	5,70	1	5,70	CHI
20191240586	CAMPO ALEGRE DE GOIAS	CM10397305	CAMPO ALEGRE DE GOIAS	06/12/2019 17:10	09/12/2019 19:10	06/12/2019 17:12	06/12/2019 22:52	5,66	16	90,60	CHI
20191240586	CATALAO	CM10397305	CAMPO ALEGRE DE GOIAS	06/12/2019 17:10	09/12/2019 19:10	06/12/2019 17:12	06/12/2019 22:52	5,66	1	5,66	CHI
20191240586	CAMPO ALEGRE DE GOIAS	CM10397305	CAMPO ALEGRE DE GOIAS	06/12/2019 17:10	09/12/2019 19:10	07/12/2019 00:17	07/12/2019 00:44	0,44	84	36,89	CHI
20191240586	CATALAO	CM10397305	CAMPO ALEGRE DE GOIAS	06/12/2019 17:10	09/12/2019 19:10	07/12/2019 00:17	07/12/2019 00:44	0,44	18	7,91	CHI
20191240586	DISTRITO FEDERAL	CM10397305	CAMPO ALEGRE DE GOIAS	06/12/2019 17:10	09/12/2019 19:10	07/12/2019 00:17	07/12/2019 00:44	0,44	1	0,44	CHI
20191240586	CAMPO ALEGRE DE GOIAS	02250424	CAMPO ALEGRE DE GOIAS	06/12/2019 17:10	09/12/2019 19:10	07/12/2019 01:41	07/12/2019 07:06	5,42	103	558,17	CHI
20191240586	IPAMERI	02250424	CAMPO ALEGRE DE GOIAS	06/12/2019 17:10	09/12/2019 19:10	07/12/2019 01:41	07/12/2019 07:06	5,42	36	195,09	CHI
20191240586	CAMPO ALEGRE DE GOIAS	02250424	CAMPO ALEGRE DE GOIAS	06/12/2019 17:10	09/12/2019 19:10	07/12/2019 01:41	07/12/2019 07:20	5,65	126	711,55	CHI
20191240586	CAMPO ALEGRE DE GOIAS	CM13266893	CAMPO ALEGRE DE GOIAS	06/12/2019 17:10	09/12/2019 19:10	07/12/2019 01:41	07/12/2019 07:20	5,65	84	474,37	CHI
20191240586	CATALAO	CM13266893	CAMPO ALEGRE DE GOIAS	06/12/2019 17:10	09/12/2019 19:10	07/12/2019 01:41	07/12/2019 07:20	5,65	18	101,65	CHI
20191240586	DISTRITO FEDERAL	CM13266893	CAMPO ALEGRE DE GOIAS	06/12/2019 17:10	09/12/2019 19:10	07/12/2019 01:41	07/12/2019 07:20	5,65	1	5,65	CHI
20191240586	CAMPO ALEGRE DE GOIAS	02250424	CAMPO ALEGRE DE GOIAS	06/12/2019 17:10	09/12/2019 19:10	07/12/2019 07:20	07/12/2019 07:37	0,28	103	28,35	CHI
20191240586	IPAMERI	02250424	CAMPO ALEGRE DE GOIAS	06/12/2019 17:10	09/12/2019 19:10	07/12/2019 07:20	07/12/2019 07:37	0,28	36	9,91	CHI
20191240586	CAMPO ALEGRE DE GOIAS	CM13266893	CAMPO ALEGRE DE GOIAS	06/12/2019 17:10	09/12/2019 19:10	07/12/2019 07:29	07/12/2019 09:17	1,81	126	228,17	CHI
20191240586	CATALAO	CM13266893	CAMPO ALEGRE DE GOIAS	06/12/2019 17:10	09/12/2019 19:10	07/12/2019 07:29	07/12/2019 09:17	1,81	18	32,60	CHI
20191240586	DISTRITO FEDERAL	CM13266893	CAMPO ALEGRE DE GOIAS	06/12/2019 17:10	09/12/2019 19:10	07/12/2019 07:29	07/12/2019 09:17	1,81	1	1,81	CHI
20191240586	CAMPO ALEGRE DE GOIAS	CM13166769	CAMPO ALEGRE DE GOIAS	06/12/2019 17:10	09/12/2019 19:10	07/12/2019 07:29	07/12/2019 10:33	3,08	29	89,21	CHI
20191240586	CAMPO ALEGRE DE GOIAS	CM13077096	CAMPO ALEGRE DE GOIAS	06/12/2019 17:10	09/12/2019 19:10	07/12/2019 07:29	07/12/2019 11:29	4,01	4	16,03	CHI
20191240586	CAMPO ALEGRE DE GOIAS	CM12192738RE	CAMPO ALEGRE DE GOIAS	06/12/2019 17:10	09/12/2019 19:10	07/12/2019 07:29	07/12/2019 12:12	4,73	50	236,31	CHI
20191240586	CAMPO ALEGRE DE GOIAS	CM10397305	CAMPO ALEGRE DE GOIAS	06/12/2019 17:10	09/12/2019 19:10	07/12/2019 14:02	07/12/2019 14:41	0,64	84	53,95	CHI
20191240586	CATALAO	CM10397305	CAMPO ALEGRE DE GOIAS	06/12/2019 17:10	09/12/2019 19:10	07/12/2019 14:02	07/12/2019 14:41	0,64	18	11,56	CHI
20191240586	DISTRITO FEDERAL	CM10397305	CAMPO ALEGRE DE GOIAS	06/12/2019 17:10	09/12/2019 19:10	07/12/2019 14:02	07/12/2019 14:41	0,64	1	0,64	CHI
20191240586	CAMPO ALEGRE DE GOIAS	CM10397305	CAMPO ALEGRE DE GOIAS	06/12/2019 17:10	09/12/2019 19:10	07/12/2019 16:11	07/12/2019 17:02	0,85	84	71,03	CHI

20191240586	CATALAO	CM10397305	CAMPO ALEGRE DE GOIAS	06/12/2019 17:10	09/12/2019 19:10	07/12/2019 16:11	07/12/2019 17:02	0,85	18	15,22	CHI
20191240586	DISTRITO FEDERAL	CM10397305	CAMPO ALEGRE DE GOIAS	06/12/2019 17:10	09/12/2019 19:10	07/12/2019 16:11	07/12/2019 17:02	0,85	1	0,85	CHI
20191240586	CAMPO ALEGRE DE GOIAS	CM10397305	CAMPO ALEGRE DE GOIAS	06/12/2019 17:10	09/12/2019 19:10	06/12/2019 17:10	07/12/2019 19:50	26,67	15	399,99	CHI
20191240586	CAMPO ALEGRE DE GOIAS	CM12281443	CAMPO ALEGRE DE GOIAS	06/12/2019 17:10	09/12/2019 19:10	06/12/2019 17:10	07/12/2019 23:51	30,68	7	214,79	CHI
20191240586	CAMPO ALEGRE DE GOIAS	CM12281443	CAMPO ALEGRE DE GOIAS	06/12/2019 17:10	09/12/2019 19:10	06/12/2019 17:12	07/12/2019 23:51	30,65	6	183,88	CHI
20191240586	IPAMERI	CM12281443	CAMPO ALEGRE DE GOIAS	06/12/2019 17:10	09/12/2019 19:10	06/12/2019 17:12	07/12/2019 23:51	30,65	1	30,65	CHI
20191240586	CAMPO ALEGRE DE GOIAS	CM12281443	CAMPO ALEGRE DE GOIAS	06/12/2019 17:10	09/12/2019 19:10	07/12/2019 00:17	07/12/2019 23:51	23,56	1	23,56	CHI
20191240586	CAMPO ALEGRE DE GOIAS	CM10397305	CAMPO ALEGRE DE GOIAS	06/12/2019 17:10	09/12/2019 19:10	06/12/2019 17:10	08/12/2019 11:39	42,49	14	594,83	CHI
20191240586	IPAMERI	CM10397305	CAMPO ALEGRE DE GOIAS	06/12/2019 17:10	09/12/2019 19:10	06/12/2019 17:10	08/12/2019 11:39	42,49	10	424,88	CHI
20191240586	CAMPO ALEGRE DE GOIAS	CM13376045	CAMPO ALEGRE DE GOIAS	06/12/2019 17:10	09/12/2019 19:10	08/12/2019 09:01	08/12/2019 11:39	2,64	29	76,49	CHI
20191240586	IPAMERI	CM13376045	CAMPO ALEGRE DE GOIAS	06/12/2019 17:10	09/12/2019 19:10	08/12/2019 09:01	08/12/2019 11:39	2,64	1	2,64	CHI
20191240586	CAMPO ALEGRE DE GOIAS	CM10397305	CAMPO ALEGRE DE GOIAS	06/12/2019 17:10	09/12/2019 19:10	08/12/2019 12:25	08/12/2019 13:01	0,61	127	77,68	CHI
20191240586	CATALAO	CM10397305	CAMPO ALEGRE DE GOIAS	06/12/2019 17:10	09/12/2019 19:10	08/12/2019 12:25	08/12/2019 13:01	0,61	18	11,01	CHI
20191240586	DISTRITO FEDERAL	CM10397305	CAMPO ALEGRE DE GOIAS	06/12/2019 17:10	09/12/2019 19:10	08/12/2019 12:25	08/12/2019 13:01	0,61	1	0,61	CHI
20191240586	IPAMERI	CM10397305	CAMPO ALEGRE DE GOIAS	06/12/2019 17:10	09/12/2019 19:10	08/12/2019 12:25	08/12/2019 13:01	0,61	11	6,73	CHI
20191240586	CAMPO ALEGRE DE GOIAS	CM12195341RE	CAMPO ALEGRE DE GOIAS	06/12/2019 17:10	09/12/2019 19:10	06/12/2019 17:10	09/12/2019 19:10	74,00	4	296,02	CHI
20191240586	CATALAO	CM12195341RE	CAMPO ALEGRE DE GOIAS	06/12/2019 17:10	09/12/2019 19:10	06/12/2019 17:10	09/12/2019 19:10	74,00	3	222,01	CHI
20191240586	CAMPO ALEGRE DE GOIAS	CM12195341RE	CAMPO ALEGRE DE GOIAS	06/12/2019 17:10	09/12/2019 19:10	07/12/2019 00:17	09/12/2019 19:10	66,87	1	66,87	CHI
20191239971	CAIAPONIA	CP12380880	CAIAPONIA	06/12/2019 17:11	06/12/2019 17:15	06/12/2019 17:11	06/12/2019 17:15	0,07	10	0,65	CHI
20191240217	ANICUNS	AC12382504	ANICUNS	06/12/2019 17:11	07/12/2019 01:31	06/12/2019 17:11	07/12/2019 01:31	8,32	28	233,01	CHI
20191240002	CRIXAS	UP12233001	SANTA TEREZINHA	06/12/2019 17:12	07/12/2019 00:35	06/12/2019 17:12	07/12/2019 00:35	7,38	5	36,90	CHI
20191240002	UIRAPURU	UP12233001	SANTA TEREZINHA	06/12/2019 17:12	07/12/2019 00:35	06/12/2019 17:12	07/12/2019 00:35	7,38	41	302,59	CHI
20191240353	EDEALINA	ED21128530	PONTALINA	06/12/2019 17:12	06/12/2019 20:22	06/12/2019 17:12	06/12/2019 20:22	3,15	2	6,30	CHI
20191240550	ITABERAI	IX12016074	INHUMAS S1	06/12/2019 17:12	06/12/2019 22:15	06/12/2019 17:12	06/12/2019 22:15	5,05	18	90,90	CHI
20191240550	ITAUCU	IX12016074	INHUMAS S1	06/12/2019 17:12	06/12/2019 22:15	06/12/2019 17:12	06/12/2019 22:15	5,05	12	60,60	CHI
20191239985	GOIANIA	12085790	GOYA S1	06/12/2019 17:13	06/12/2019 21:23	06/12/2019 17:13	06/12/2019 21:23	4,16	1	4,16	CHI
20191239988	MORRINHOS	150061900	MORRINHOS	06/12/2019 17:13	06/12/2019 22:13	06/12/2019 17:13	06/12/2019 22:13	4,99	1	4,99	CHI
20191239991	JATAI	JT21159983	CACHOEIRA ALTA	06/12/2019 17:13	07/12/2019 14:05	06/12/2019 17:13	07/12/2019 14:05	20,86	1	20,86	CHI
20191239992	ITUMBIARA	IT12404221	PARANAIBA	06/12/2019 17:13	06/12/2019 18:21	06/12/2019 17:13	06/12/2019 18:21	1,12	26	29,21	CHI
20191239995	GOIANIA	16954488	FERROVIARIO S2	06/12/2019 17:13	06/12/2019 19:13	06/12/2019 17:13	06/12/2019 19:13	1,98	1	1,98	CHI
20191240103	PLANALTINA	PI11146248	PLANALTINA	06/12/2019 17:13	06/12/2019 20:41	06/12/2019 17:13	06/12/2019 20:41	3,47	405	1403,66	CHI
20191240148	MINEIROS	MY11036556	PARQUE DAS EMAS	06/12/2019 17:14	06/12/2019 19:40	06/12/2019 17:14	06/12/2019 19:40	2,43	216	525,66	CHI
20191241038	VICENTINOPOLIS	VI12263804	VICENTINOPOLIS	06/12/2019 17:14	06/12/2019 23:01	06/12/2019 17:14	06/12/2019 23:01	5,79	12	69,48	CHI



20191241192	NIQUELANDIA	NQ12280444	URUACU	06/12/2019 17:14	07/12/2019 10:52	06/12/2019 17:14	07/12/2019 10:52	17,62	11	193,80	CHI
201912230817	LUZIANIA	LZ12203332	VIANOPOLIS	06/12/2019 17:14	07/12/2019 02:06	06/12/2019 17:14	07/12/2019 02:06	8,86	16	141,70	CHI
20191240032	PIRENOPOLIS	PV12079157	CORUMBA	06/12/2019 17:16	07/12/2019 09:14	06/12/2019 17:16	07/12/2019 09:14	15,95	4	63,82	CHI
20191240032	SAO FRANCISCO DE GOIAS	PV12079157	CORUMBA	06/12/2019 17:16	07/12/2019 09:14	06/12/2019 17:16	07/12/2019 09:14	15,95	2	31,91	CHI
20191240017	IACIARA	IA21149077	IACIARA S1	06/12/2019 17:17	06/12/2019 20:44	06/12/2019 17:17	06/12/2019 20:44	3,45	1	3,45	CHI
20191240018	ITABERAI	IB21000125	ITABERAI S2	06/12/2019 17:17	07/12/2019 08:36	06/12/2019 17:17	07/12/2019 08:36	15,32	1	15,32	CHI
20191240019	RIO VERDE	RV11000081	RIO VERDE S2	06/12/2019 17:17	07/12/2019 13:30	06/12/2019 17:17	07/12/2019 13:30	20,21	45	909,59	CHI
20191240020	ITAUCU	IX12018278	INHUMAS S1	06/12/2019 17:17	06/12/2019 20:13	06/12/2019 17:17	06/12/2019 20:13	2,93	72	210,76	CHI
20191240022	ITARUMA	CC21000107	CACHOEIRA ALTA	06/12/2019 17:17	07/12/2019 10:35	06/12/2019 17:17	07/12/2019 10:35	17,29	2	34,58	CHI
20191240026	CORUMBAIBA	CI12000533	VILA CORUMBA	06/12/2019 17:18	06/12/2019 22:47	06/12/2019 17:18	06/12/2019 22:47	5,47	3	16,42	CHI
20191240030	TRINDADE	40112123	TRINDADE	06/12/2019 17:18	06/12/2019 21:42	06/12/2019 17:18	06/12/2019 21:42	4,38	1	4,38	CHI
20191240031	APARECIDA DO RIO DOCE	AW12311820	CACHOEIRA ALTA	06/12/2019 17:19	07/12/2019 11:14	06/12/2019 17:19	07/12/2019 11:14	17,91	3	53,74	CHI
20191240359	ITABERAI	IB12172690	ITABERAI S2	06/12/2019 17:19	07/12/2019 04:17	06/12/2019 17:19	07/12/2019 04:17	10,96	6	65,76	CHI
20191240045	AGUA FRIA DE GOIAS	TL21194754	SAO JOAO D ALIANCA	06/12/2019 17:21	07/12/2019 00:51	06/12/2019 17:21	07/12/2019 00:51	7,49	1	7,49	CHI
20191237726	URUACU	CR12410914	MARA ROSA	06/12/2019 17:22	07/12/2019 13:03	06/12/2019 17:22	07/12/2019 12:31	19,14	5	95,69	CHI
20191237726	URUACU	UR12247225	MARA ROSA	06/12/2019 17:22	07/12/2019 13:03	06/12/2019 17:22	07/12/2019 13:02	19,65	7	137,57	CHI
20191237726	URUACU	CR12410914	MARA ROSA	06/12/2019 17:22	07/12/2019 13:03	06/12/2019 17:22	07/12/2019 13:03	19,67	3	59,01	CHI
20191240048	URUACU	20119953	URUACU	06/12/2019 17:22	07/12/2019 13:20	06/12/2019 17:22	07/12/2019 13:20	19,95	1	19,95	CHI
20191240048	URUACU	20119953	URUACU	06/12/2019 17:22	07/12/2019 13:20	07/12/2019 12:20	07/12/2019 13:20	1,00	1	1,00	CHI
20191240077	PEROLANDIA	DP12103843	JATAI S1	06/12/2019 17:22	06/12/2019 18:50	06/12/2019 17:22	06/12/2019 18:50	1,47	14	20,52	CHI
20191240203	MINEIROS	MY11359673	PARQUE DAS EMAS	06/12/2019 17:22	07/12/2019 01:31	06/12/2019 17:22	07/12/2019 01:31	8,14	14	114,01	CHI
20191240052	CAMPO ALEGRE DE GOIAS	IP12373658	PIRES DO RIO S2	06/12/2019 17:23	07/12/2019 09:52	06/12/2019 17:23	07/12/2019 09:52	16,48	1	16,48	CHI
20191240053	OURO VERDE DE GOIAS	OV21332132	NEROPOLIS S2	06/12/2019 17:23	06/12/2019 23:00	06/12/2019 17:23	06/12/2019 23:00	5,61	1	5,61	CHI
20191240056	DIORAMA	1530000741	IPORA	06/12/2019 17:23	07/12/2019 03:02	06/12/2019 17:23	07/12/2019 03:02	9,64	1	9,64	CHI
20191240057	PARAUNA	PU21045166	ACREUNA	06/12/2019 17:23	07/12/2019 12:14	06/12/2019 17:23	07/12/2019 12:14	18,83	1	18,83	CHI
20191240058	JATAI	JT21234382	JATAI S3	06/12/2019 17:24	06/12/2019 20:57	06/12/2019 17:24	06/12/2019 20:57	3,55	1	3,55	CHI
20191240059	ARUANA	10006768804	ARUANA	06/12/2019 17:24	06/12/2019 19:49	06/12/2019 17:24	06/12/2019 19:49	2,42	1	2,42	CHI
20191240066	ANAPOLIS	20651995	ANAPOLIS UNIVERSITARIO S2	06/12/2019 17:24	07/12/2019 01:30	06/12/2019 17:24	07/12/2019 01:30	8,09	1	8,09	CHI
20191240069	GUARANI DE GOIAS	GY21215923	IACIARA S1	06/12/2019 17:24	06/12/2019 19:20	06/12/2019 17:24	06/12/2019 19:20	1,92	1	1,92	CHI
20191240081	APARECIDA DE GOIANIA	200355569	INDEPENDENCIA S2	06/12/2019 17:26	06/12/2019 20:47	06/12/2019 17:26	06/12/2019 20:47	3,34	1	3,34	CHI
20191240690	QUIRINOPOLIS	QI10402443	QUIRINOPOLIS	06/12/2019 17:26	07/12/2019 16:52	06/12/2019 17:26	06/12/2019 23:13	5,78	80	462,38	CHI
20191240690	QUIRINOPOLIS	QI10402443	QUIRINOPOLIS	06/12/2019 17:26	07/12/2019 16:52	06/12/2019 23:14	07/12/2019 10:14	11,01	4	44,04	CHI
20191240690	QUIRINOPOLIS	QI10402443	QUIRINOPOLIS	06/12/2019 17:26	07/12/2019 16:52	06/12/2019 23:14	07/12/2019 16:52	17,64	76	1340,75	CHI

20191240690	QUIRINOPOLIS	QI10402443	QUIRINOPOLIS	06/12/2019 17:26	07/12/2019 16:52	07/12/2019 10:15	07/12/2019 16:52	6,61	4	26,44	CHI
20191240090	AGUA FRIA DE GOIAS	TL21321718	SAO JOAO D ALIANCA	06/12/2019 17:27	06/12/2019 18:30	06/12/2019 17:27	06/12/2019 18:30	1,05	1	1,05	CHI
20191241351	NOVO BRASIL	NB11019356	JUSSARA	06/12/2019 17:27	07/12/2019 00:57	06/12/2019 17:27	07/12/2019 00:57	7,50	146	1094,76	CHI
20191240101	FIRMINOPOLIS	SL12125617	FIRMINOPOLIS S1	06/12/2019 17:29	07/12/2019 22:00	06/12/2019 17:29	06/12/2019 21:50	4,34	16	69,49	CHI
20191240101	SAO LUIS DE MONTES BELOS	SL12125617	FIRMINOPOLIS S1	06/12/2019 17:29	07/12/2019 22:00	06/12/2019 17:29	06/12/2019 21:50	4,34	52	225,85	CHI
20191240101	TURVANIA	SL12125617	FIRMINOPOLIS S1	06/12/2019 17:29	07/12/2019 22:00	06/12/2019 17:29	06/12/2019 21:50	4,34	8	34,75	CHI
20191240101	FIRMINOPOLIS	SL12125617	FIRMINOPOLIS S1	06/12/2019 17:29	07/12/2019 22:00	06/12/2019 21:56	07/12/2019 09:04	11,14	17	189,30	CHI
20191240101	SAO LUIS DE MONTES BELOS	SL12125617	FIRMINOPOLIS S1	06/12/2019 17:29	07/12/2019 22:00	06/12/2019 21:56	07/12/2019 09:04	11,14	52	579,05	CHI
20191240101	TURVANIA	SL12125617	FIRMINOPOLIS S1	06/12/2019 17:29	07/12/2019 22:00	06/12/2019 21:56	07/12/2019 09:04	11,14	8	89,08	CHI
20191240101	SAO LUIS DE MONTES BELOS	SL12125617	FIRMINOPOLIS S1	06/12/2019 17:29	07/12/2019 22:00	07/12/2019 09:07	07/12/2019 17:02	7,90	41	324,06	CHI
20191240101	FIRMINOPOLIS	TV12277681LD	FIRMINOPOLIS S1	06/12/2019 17:29	07/12/2019 22:00	07/12/2019 09:07	07/12/2019 22:00	12,88	16	206,08	CHI
20191240101	SAO LUIS DE MONTES BELOS	TV12277681LD	FIRMINOPOLIS S1	06/12/2019 17:29	07/12/2019 22:00	07/12/2019 09:07	07/12/2019 22:00	12,88	4	51,52	CHI
20191240101	TURVANIA	TV12277681LD	FIRMINOPOLIS S1	06/12/2019 17:29	07/12/2019 22:00	07/12/2019 09:07	07/12/2019 22:00	12,88	8	103,04	CHI
20191242853	FIRMINOPOLIS	SL12111569	FIRMINOPOLIS S1	06/12/2019 17:29	07/12/2019 17:02	07/12/2019 09:07	07/12/2019 17:02	7,90	1	7,90	CHI
20191242853	SAO LUIS DE MONTES BELOS	SL12111569	FIRMINOPOLIS S1	06/12/2019 17:29	07/12/2019 17:02	07/12/2019 09:07	07/12/2019 17:02	7,90	7	55,33	CHI
20191242853	SAO LUIS DE MONTES BELOS	SL12111569	FIRMINOPOLIS S1	06/12/2019 17:29	07/12/2019 17:02	07/12/2019 09:35	07/12/2019 17:02	7,45	11	81,93	CHI
20191240115	IVOLANDIA	IV21141078	IPORA	06/12/2019 17:31	07/12/2019 16:18	06/12/2019 17:31	07/12/2019 16:18	22,77	1	22,77	CHI
20191240117	APARECIDA DE GOIANIA	200317854	ANHANGUERA	06/12/2019 17:31	06/12/2019 18:35	06/12/2019 17:31	06/12/2019 18:35	1,05	1	1,05	CHI
20191240121	SILVANIA	SV12080237	VIANOPOLIS	06/12/2019 17:32	07/12/2019 02:53	06/12/2019 17:32	07/12/2019 02:53	9,34	3	28,03	CHI
20191240122	SANTA TEREZINHA DE GOIAS	SG12181455	SANTA TEREZINHA	06/12/2019 17:32	06/12/2019 23:53	06/12/2019 17:32	06/12/2019 23:53	6,34	16	101,47	CHI
20191240128	TRINDADE	13931507	GOYA S2	06/12/2019 17:33	06/12/2019 20:20	06/12/2019 17:33	06/12/2019 20:20	2,77	1	2,77	CHI
20191240129	AGUAS LINDAS DE GOIAS	LA11148998	AGUAS LINDAS DE GOIAS S1	06/12/2019 17:33	06/12/2019 19:05	06/12/2019 17:33	06/12/2019 19:05	1,52	24	36,55	CHI
20191240130	NIQUELANDIA	4040003604	BARRO ALTO	06/12/2019 17:33	07/12/2019 11:15	06/12/2019 17:33	07/12/2019 11:15	17,69	1	17,69	CHI
20191240174	ITABERAI	IB10403931	ITABERAI S2	06/12/2019 17:33	07/12/2019 00:02	06/12/2019 17:33	06/12/2019 23:19	5,77	23	132,74	CHI
20191240174	AMERICANO DO BRASIL	IB13021948	ITABERAI S2	06/12/2019 17:33	07/12/2019 00:02	06/12/2019 17:33	07/12/2019 00:02	6,49	12	77,84	CHI
20191240174	ITABERAI	IB10403931	ITABERAI S2	06/12/2019 17:33	07/12/2019 00:02	06/12/2019 17:33	07/12/2019 00:02	6,49	17	110,27	CHI
20191240174	ITABERAI	IB13021948	ITABERAI S2	06/12/2019 17:33	07/12/2019 00:02	06/12/2019 17:33	07/12/2019 00:02	6,49	700	4540,47	CHI
20191240431	CAIAPONIA	RV10400619	MONTIVIDIU T	06/12/2019 17:34	07/12/2019 10:45	06/12/2019 17:34	06/12/2019 22:37	5,05	34	171,59	CHI
20191240431	IVOLANDIA	RV10400619	MONTIVIDIU T	06/12/2019 17:34	07/12/2019 10:45	06/12/2019 17:34	06/12/2019 22:37	5,05	17	85,79	CHI
20191240431	MONTIVIDIU	RV10400619	MONTIVIDIU T	06/12/2019 17:34	07/12/2019 10:45	06/12/2019 17:34	06/12/2019 22:37	5,05	32	161,49	CHI
20191240431	PARAUNA	RV10400619	MONTIVIDIU T	06/12/2019 17:34	07/12/2019 10:45	06/12/2019 17:34	06/12/2019 22:37	5,05	145	731,77	CHI
20191240431	RIO VERDE	RV10400619	MONTIVIDIU T	06/12/2019 17:34	07/12/2019 10:45	06/12/2019 17:34	06/12/2019 22:37	5,05	122	615,69	CHI
20191240431	RIO VERDE	RV10400619	MONTIVIDIU T	06/12/2019 17:34	07/12/2019 10:45	06/12/2019 18:13	06/12/2019 22:37	4,39	1	4,39	CHI

20191240431	RIO VERDE	RV12289713	MONTIVIDIU T	06/12/2019 17:34	07/12/2019 10:45	06/12/2019 17:34	06/12/2019 23:37	6,04	13	78,55	CHI
20191240431	PARAUNA	RV12289713	PARAUNA	06/12/2019 17:34	07/12/2019 10:45	06/12/2019 17:34	06/12/2019 23:37	6,04	77	465,25	CHI
20191240431	PARAUNA	RV10400619	PARAUNA	06/12/2019 17:34	07/12/2019 10:45	06/12/2019 17:34	07/12/2019 09:40	16,09	6	96,52	CHI
20191240431	PARAUNA	PU12289841	PARAUNA	06/12/2019 17:34	07/12/2019 10:45	06/12/2019 17:34	07/12/2019 10:15	16,67	10	166,70	CHI
20191240431	PARAUNA	PU12314958	PARAUNA	06/12/2019 17:34	07/12/2019 10:45	06/12/2019 17:34	07/12/2019 10:45	17,17	8	137,38	CHI
20191240431	RIO VERDE	PU12314958	PARAUNA	06/12/2019 17:34	07/12/2019 10:45	06/12/2019 17:34	07/12/2019 10:45	17,17	2	34,34	CHI
20191240147	CRIXAS	SG21000035	SANTA TEREZINHA	06/12/2019 17:36	07/12/2019 10:41	06/12/2019 17:36	07/12/2019 10:41	17,08	1	17,08	CHI
20191240867	PIRACANJUBA	PJ12000079	PIRACANJUBA	06/12/2019 17:36	07/12/2019 23:42	06/12/2019 17:36	07/12/2019 23:42	30,11	26	782,75	CHI
20191240153	ITABERAI	IB21336870	ITABERAI S1	06/12/2019 17:37	07/12/2019 18:53	06/12/2019 17:37	07/12/2019 18:53	25,27	1	25,27	CHI
20191240156	QUIRINOPOLIS	80072045	QUIRINOPOLIS	06/12/2019 17:37	07/12/2019 00:40	06/12/2019 17:37	07/12/2019 00:40	7,06	1	7,06	CHI
20191240160	SAO MIGUEL DO ARAGUAIA	SM12000040	SAO MIGUEL DO ARAGUAIA	06/12/2019 17:37	06/12/2019 22:03	06/12/2019 17:37	06/12/2019 22:03	4,42	1	4,42	CHI
20191240171	JATAI	JT12219536	JATAI S1	06/12/2019 17:41	08/12/2019 15:10	07/12/2019 13:45	08/12/2019 15:10	25,41	2	50,83	CHI
20191240171	SERRANOPOLIS	JT12219536	JATAI S1	06/12/2019 17:41	08/12/2019 15:10	07/12/2019 13:45	08/12/2019 15:10	25,41	2	50,83	CHI
201912260869	SERRANOPOLIS	290203235	JATAI S1	06/12/2019 17:41	07/12/2019 15:10	06/12/2019 17:41	07/12/2019 15:10	21,48	1	21,48	CHI
20191240191	SILVANIA	SV21191399	VIANOPOLIS	06/12/2019 17:43	07/12/2019 12:09	06/12/2019 17:43	07/12/2019 12:09	18,43	1	18,43	CHI
20191240194	AGUA FRIA DE GOIAS	4140004795	SAO JOAO D ALIANCA	06/12/2019 17:43	07/12/2019 13:00	06/12/2019 17:43	07/12/2019 13:00	19,27	1	19,27	CHI
20191240221	LUZIANIA	LZ11149779	MARAJOARA	06/12/2019 17:44	06/12/2019 19:26	06/12/2019 17:44	06/12/2019 19:26	1,69	174	293,33	CHI
20191240209	DIVINOPOLIS DE GOIAS	GH12241928	SAO DOMINGOS	06/12/2019 17:46	06/12/2019 21:08	06/12/2019 17:46	06/12/2019 21:08	3,36	40	134,56	CHI
20191240209	MONTE ALEGRE DE GOIAS	GH12241928	SAO DOMINGOS	06/12/2019 17:46	06/12/2019 21:08	06/12/2019 17:46	06/12/2019 21:08	3,36	3	10,09	CHI
20191240209	SAO DOMINGOS	GH12241928	SAO DOMINGOS	06/12/2019 17:46	06/12/2019 21:08	06/12/2019 17:46	06/12/2019 21:08	3,36	12	40,37	CHI
20191240216	FORMOSA	FA21247779	ITUIQUIRA	06/12/2019 17:46	06/12/2019 21:30	06/12/2019 17:46	06/12/2019 21:30	3,72	1	3,72	CHI
20191240229	ITAPURANGA	IK12310867	ITAPURANGA	06/12/2019 17:48	07/12/2019 18:09	06/12/2019 17:48	07/12/2019 18:09	24,34	11	267,79	CHI
20191240230	GOUVELANDIA	GB12029096	QUIRINOPOLIS	06/12/2019 17:49	07/12/2019 00:57	06/12/2019 17:49	07/12/2019 00:57	7,12	386	2748,11	CHI
20191240234	SANTA FE DE GOIAS	2070012184	BRITANIA	06/12/2019 17:50	07/12/2019 20:25	06/12/2019 17:50	07/12/2019 20:25	26,58	1	26,58	CHI
20191240240	JATAI	JT12267574	JATAI S1	06/12/2019 17:51	07/12/2019 10:15	06/12/2019 17:51	07/12/2019 10:15	16,39	1	16,39	CHI
20191240939	SAO LUIZ DO NORTE	SZ12332178	BARRO ALTO	06/12/2019 17:52	07/12/2019 00:48	06/12/2019 17:52	07/12/2019 00:48	6,92	26	179,91	CHI
20191240645	BELA VISTA DE GOIAS	BC10370909	PIRES DO RIO S2	06/12/2019 17:53	06/12/2019 20:55	06/12/2019 17:53	06/12/2019 20:55	3,02	2	6,05	CHI
20191240645	CRISTIANOPOLIS	BC10370909	PIRES DO RIO S2	06/12/2019 17:53	06/12/2019 20:55	06/12/2019 17:53	06/12/2019 20:55	3,02	27	81,61	CHI
20191240645	PIRES DO RIO	BC10370909	PIRES DO RIO S2	06/12/2019 17:53	06/12/2019 20:55	06/12/2019 17:53	06/12/2019 20:55	3,02	83	250,87	CHI
20191240645	SANTA CRUZ DE GOIAS	BC10370909	PIRES DO RIO S2	06/12/2019 17:53	06/12/2019 20:55	06/12/2019 17:53	06/12/2019 20:55	3,02	484	1462,89	CHI
20191240281	CALDAS NOVAS	CN11213932	CALDAS NOVAS S1	06/12/2019 17:56	06/12/2019 19:51	06/12/2019 17:56	06/12/2019 19:51	1,91	12	22,91	CHI
20191240289	PIRENOPOLIS	PV21227813	COCALZINHO	06/12/2019 17:57	07/12/2019 11:52	06/12/2019 17:57	07/12/2019 11:52	17,91	1	17,91	CHI
20191240304	OURO VERDE DE GOIAS	10005795948	NEROPOLIS S1	06/12/2019 17:59	07/12/2019 08:45	06/12/2019 17:59	07/12/2019 08:45	14,77	1	14,77	CHI

20191240311	JATAI	JT12196098RE	JATAI S3	06/12/2019 17:59	07/12/2019 15:45	06/12/2019 17:59	07/12/2019 15:45	21,76	30	652,67	CHI
20191240312	ARUANA	AK21066591	MOZARLANDIA	06/12/2019 17:59	07/12/2019 16:17	06/12/2019 17:59	07/12/2019 16:17	22,29	1	22,29	CHI
20191240916	ITABERAI	IB12078567	ITABERAI S1	06/12/2019 18:00	06/12/2019 23:10	06/12/2019 18:00	06/12/2019 23:10	5,17	17	87,81	CHI
20191240916	ITAUCU	IB12078567	ITABERAI S1	06/12/2019 18:00	06/12/2019 23:10	06/12/2019 18:00	06/12/2019 23:10	5,17	2	10,33	CHI
20191240326	JATAI	290103952	JATAI S2	06/12/2019 18:01	07/12/2019 09:00	06/12/2019 18:01	07/12/2019 09:00	14,98	1	14,98	CHI
20191240327	ARAGUAPAZ	AZ12042877	MOZARLANDIA	06/12/2019 18:01	06/12/2019 20:38	06/12/2019 18:01	06/12/2019 20:38	2,61	86	224,44	CHI
20191240327	MOZARLANDIA	AZ12042877	MOZARLANDIA	06/12/2019 18:01	06/12/2019 20:38	06/12/2019 18:01	06/12/2019 20:38	2,61	2	5,22	CHI
20191240391	SAO MIGUEL DO ARAGUAIA	SM11217900	SAO MIGUEL DO ARAGUAIA	06/12/2019 18:02	06/12/2019 21:54	06/12/2019 18:02	06/12/2019 21:54	3,86	79	304,94	CHI
20191240341	GOIANIA	14096833	CAMPINAS S2	06/12/2019 18:03	06/12/2019 20:30	06/12/2019 18:03	06/12/2019 20:30	2,45	1	2,45	CHI
20191240347	MOSSAMEDES	MD12024152	FIRMINOPOLIS S2	06/12/2019 18:03	07/12/2019 00:30	06/12/2019 18:03	07/12/2019 00:30	6,43	109	701,35	CHI
20191240347	SANCLERLANDIA	MD12024152	FIRMINOPOLIS S2	06/12/2019 18:03	07/12/2019 00:30	06/12/2019 18:03	07/12/2019 00:30	6,43	9	57,91	CHI
20191240350	GOIANESIA	GE211101490	GOIANESIA S2	06/12/2019 18:04	07/12/2019 13:05	06/12/2019 18:04	07/12/2019 13:05	19,03	2	38,05	CHI
20191240362	JATAI	290253214	JATAI S2	06/12/2019 18:06	07/12/2019 07:55	06/12/2019 18:06	07/12/2019 07:55	13,83	1	13,83	CHI
20191240365	RIO VERDE	630226052	RIO VERDE S1	06/12/2019 18:06	07/12/2019 12:00	06/12/2019 18:06	07/12/2019 12:00	17,89	1	17,89	CHI
20191240379	MAURILANDIA	DM12230837	RIO DOS BOIS	06/12/2019 18:08	07/12/2019 10:57	06/12/2019 18:08	07/12/2019 10:57	16,81	4	67,25	CHI
20191240382	MINEIROS	1390084740	PARQUE DAS EMAS	06/12/2019 18:08	08/12/2019 11:20	06/12/2019 18:08	08/12/2019 11:20	41,19	1	41,19	CHI
20191240383	LUZIANIA	LZ12383010	MARAJOARA	06/12/2019 18:08	07/12/2019 09:38	06/12/2019 18:08	07/12/2019 09:38	15,49	8	123,88	CHI
20191240385	SERRANOPOLIS	SX12216620	JATAI S1	06/12/2019 18:08	07/12/2019 09:41	06/12/2019 18:08	07/12/2019 09:41	15,53	5	77,67	CHI
20191240392	FORMOSA	FA11344132	SAO JOAO D ALIANCA	06/12/2019 18:09	06/12/2019 21:22	06/12/2019 18:09	06/12/2019 21:22	3,20	4	12,82	CHI
20191240397	PIRENOPOLIS	220023530	CORUMBA	06/12/2019 18:10	07/12/2019 13:39	06/12/2019 18:10	07/12/2019 13:39	19,48	1	19,48	CHI
20191240400	SAO MIGUEL DO ARAGUAIA	SM12228636	SAO MIGUEL DO ARAGUAIA	06/12/2019 18:10	07/12/2019 07:53	06/12/2019 18:10	07/12/2019 07:53	13,71	56	767,71	CHI
20191240411	CACHOEIRA ALTA	CA11000029	CACHOEIRA ALTA	06/12/2019 18:10	06/12/2019 20:08	06/12/2019 18:10	06/12/2019 20:08	1,97	90	176,90	CHI
20191240403	ARENOPOLIS	AY12000044	ARENOPOLIS	06/12/2019 18:11	07/12/2019 20:11	06/12/2019 18:11	07/12/2019 20:11	26,00	8	207,98	CHI
20191240408	GOIATUBA	140119085	GOIATUBA S2	06/12/2019 18:12	06/12/2019 23:23	06/12/2019 18:12	06/12/2019 23:23	5,18	1	5,18	CHI
20191240512	GOIANESIA	GE12322006	GOIANESIA S1	06/12/2019 18:14	07/12/2019 11:28	06/12/2019 18:14	07/12/2019 11:28	17,22	7	120,56	CHI
20191240512	SANTA RITA DO NOVO DESTINO	GE12322006	GOIANESIA S1	06/12/2019 18:14	07/12/2019 11:28	06/12/2019 18:14	07/12/2019 11:28	17,22	7	120,56	CHI
20191240440	INHUMAS	IN12325091	INHUMAS S1	06/12/2019 18:15	07/12/2019 04:33	06/12/2019 18:15	07/12/2019 04:33	10,29	14	144,09	CHI
20191240442	CRIXAS	SG21098006	SANTA TEREZINHA	06/12/2019 18:15	07/12/2019 13:43	06/12/2019 18:15	07/12/2019 13:43	19,46	1	19,46	CHI
20191240444	LUZIANIA	LZ12037192	RIO VERMELHO	06/12/2019 18:15	06/12/2019 21:16	06/12/2019 18:15	06/12/2019 21:16	3,00	7	21,02	CHI
20191240820	GAMELEIRA DE GOIAS	SV32093678	DAIA S2	06/12/2019 18:15	07/12/2019 10:42	06/12/2019 18:15	07/12/2019 10:42	16,43	5	82,17	CHI
20191240461	ITAUCU	IX12000067	INHUMAS S1	06/12/2019 18:17	07/12/2019 09:22	06/12/2019 18:17	07/12/2019 09:22	15,08	14	211,12	CHI
20191240484	RIO VERDE	630077721	RIO VERDE S1	06/12/2019 18:20	07/12/2019 08:49	06/12/2019 18:20	07/12/2019 08:49	14,48	1	14,48	CHI
20191240487	CACHOEIRA ALTA	CA12086389	CACHOEIRA ALTA	06/12/2019 18:20	07/12/2019 09:34	06/12/2019 18:20	07/12/2019 09:34	15,23	1	15,23	CHI

20191241390	ARUANA	AK12307445	MOZARLANDIA	06/12/2019 18:20	07/12/2019 10:30	06/12/2019 18:20	07/12/2019 10:30	16,17	12	193,98	CHI
20191239962	MINEIROS	MY12347908	PARQUE DAS EMAS	06/12/2019 18:21	07/12/2019 12:10	06/12/2019 18:21	07/12/2019 12:10	17,82	4	71,28	CHI
20191240497	APARECIDA DE GOIANIA	10149107	REAL S1	06/12/2019 18:21	06/12/2019 22:17	06/12/2019 18:21	06/12/2019 22:17	3,92	1	3,92	CHI
20191240502	GOIANESIA	GE21401943	GOIANESIA S2	06/12/2019 18:22	07/12/2019 16:57	06/12/2019 18:22	07/12/2019 16:57	22,59	1	22,59	CHI
20191240526	CALDAS NOVAS	760098062	SERRA DE CALDAS	06/12/2019 18:25	06/12/2019 22:04	06/12/2019 18:25	06/12/2019 22:04	3,66	1	3,66	CHI
20191240527	AMERICANO DO BRASIL	KB12065193	ANICUNS	06/12/2019 18:25	07/12/2019 01:44	06/12/2019 18:25	07/12/2019 01:44	7,31	36	263,08	CHI
20191240527	ANICUNS	KB12065193	ANICUNS	06/12/2019 18:25	07/12/2019 01:44	06/12/2019 18:25	07/12/2019 01:44	7,31	2	14,62	CHI
20191240527	MOSSAMEDES	KB12065193	ANICUNS	06/12/2019 18:25	07/12/2019 01:44	06/12/2019 18:25	07/12/2019 01:44	7,31	14	102,31	CHI
20191240537	RIO VERDE	630280964	RIO VERDE S1	06/12/2019 18:26	07/12/2019 09:53	06/12/2019 18:26	07/12/2019 09:53	15,44	1	15,44	CHI
20191240542	GOIANIA	10544744	ATLANTICO S3	06/12/2019 18:27	07/12/2019 01:29	06/12/2019 18:27	07/12/2019 01:29	7,03	1	7,03	CHI
20191240544	SERRANOPOLIS	SX12296496	JATAI S1	06/12/2019 18:27	06/12/2019 23:25	06/12/2019 18:27	06/12/2019 23:25	4,96	143	709,72	CHI
20191240545	ACREUNA	EU21363371	ACREUNA	06/12/2019 18:27	06/12/2019 20:45	06/12/2019 18:27	06/12/2019 20:45	2,29	1	2,29	CHI
20191240549	DIORAMA	DI12024588	ARENOPOLIS	06/12/2019 18:27	07/12/2019 10:30	06/12/2019 18:27	07/12/2019 10:30	16,03	1	16,03	CHI
20191240549	IPORA	DI12024588	ARENOPOLIS	06/12/2019 18:27	07/12/2019 10:30	06/12/2019 18:27	07/12/2019 10:30	16,03	5	80,17	CHI
20191240554	CRISTALINA	KR11315552	CRISTALINA S1	06/12/2019 18:28	06/12/2019 22:53	06/12/2019 18:28	06/12/2019 22:53	4,40	3	13,21	CHI
20191240564	MINEIROS	1390090040	PARQUE DAS EMAS	06/12/2019 18:30	07/12/2019 08:04	06/12/2019 18:30	07/12/2019 08:04	13,56	1	13,56	CHI
20191240565	BARRO ALTO	BA21181768	BARRO ALTO	06/12/2019 18:31	07/12/2019 10:45	06/12/2019 18:31	07/12/2019 10:45	16,23	3	48,70	CHI
20191240572	ABADIANIA	AA21297769	ANAPOLIS UNIVERSITARIO S1	06/12/2019 18:31	07/12/2019 08:38	06/12/2019 18:31	07/12/2019 08:38	14,11	1	14,11	CHI
20191240573	ITARUMA	IM21041689	CACHOEIRA ALTA	06/12/2019 18:31	07/12/2019 11:27	06/12/2019 18:31	07/12/2019 11:27	16,92	1	16,92	CHI
20191240619	ALTO PARAISO DE GOIAS	BF12375518	FLORES DE GOIAS	06/12/2019 18:32	06/12/2019 19:47	06/12/2019 18:32	06/12/2019 19:47	1,24	4	4,95	CHI
20191240600	CASTELANDIA	DM12303636	RIO DOS BOIS	06/12/2019 18:35	07/12/2019 14:23	06/12/2019 18:35	07/12/2019 14:23	19,79	1	19,79	CHI
20191240605	SAO LUIS DE MONTES BELOS	SL21004169	FIRMINOPOLIS S2	06/12/2019 18:36	07/12/2019 01:04	06/12/2019 18:36	07/12/2019 01:04	6,47	1	6,47	CHI
20191240610	ISRAELANDIA	IS21158086	IPORA	06/12/2019 18:36	08/12/2019 01:15	06/12/2019 18:36	08/12/2019 01:15	30,64	1	30,64	CHI
20191240618	MATRINCHA	MP12010442	MOZARLANDIA	06/12/2019 18:38	07/12/2019 07:38	06/12/2019 18:38	07/12/2019 07:38	13,00	4	51,99	CHI
20191240621	FORMOSA	610112170	ITUIQUIRA	06/12/2019 18:39	06/12/2019 21:42	06/12/2019 18:39	06/12/2019 21:42	3,05	1	3,05	CHI
20191239273	GOIANIA	GN11047198	XAVANTES	06/12/2019 18:40	06/12/2019 21:01	06/12/2019 18:40	06/12/2019 21:01	2,34	21	49,15	CHI
20191240633	APARECIDA DE GOIANIA	16803425	ATLANTICO S2	06/12/2019 18:41	06/12/2019 23:28	06/12/2019 18:41	06/12/2019 23:28	4,78	1	4,78	CHI
20191240634	PONTALINA	210031130	PONTALINA	06/12/2019 18:41	07/12/2019 07:56	06/12/2019 18:41	07/12/2019 07:56	13,24	1	13,24	CHI
20191240639	MINEIROS	10022752917	PARQUE DAS EMAS	06/12/2019 18:41	07/12/2019 11:39	06/12/2019 18:41	07/12/2019 11:39	16,95	1	16,95	CHI
20191240886	CATALAO	OU12190458RE	CATALAO S1	06/12/2019 18:41	06/12/2019 23:32	06/12/2019 18:41	06/12/2019 23:32	4,84	8	38,73	CHI
20191240886	OUVIDOR	OU12190458RE	CATALAO S1	06/12/2019 18:41	06/12/2019 23:32	06/12/2019 18:41	06/12/2019 23:32	4,84	23	111,35	CHI
20191240643	PALMEIRAS DE GOIAS	PL21032487	PALMEIRAS	06/12/2019 18:42	07/12/2019 10:20	06/12/2019 18:42	07/12/2019 10:20	15,62	1	15,62	CHI
20191240646	JATAI	290327386	JATAI S2	06/12/2019 18:43	07/12/2019 10:25	06/12/2019 18:43	07/12/2019 10:25	15,71	1	15,71	CHI

20191240657	PADRE BERNARDO	PB11283887	PADRE BERNARDO	06/12/2019 18:44	07/12/2019 02:21	06/12/2019 18:44	07/12/2019 02:21	7,60	2	15,21	CHI
20191240658	COCALZINHO DE GOIAS	10016196633	COCALZINHO	06/12/2019 18:44	07/12/2019 08:21	06/12/2019 18:44	07/12/2019 08:21	13,60	1	13,60	CHI
20191240672	VIANOPOLIS	VN12034204	VIANOPOLIS	06/12/2019 18:44	07/12/2019 03:56	06/12/2019 18:44	07/12/2019 03:56	9,19	10	91,89	CHI
20191241000	IPORA	IR12013991	IPORA	06/12/2019 18:44	07/12/2019 00:05	06/12/2019 18:44	07/12/2019 00:05	5,35	45	240,81	CHI
20191240661	SAO FRANCISCO DE GOIAS	490015943	SAO FRANCISCO DE GOIAS	06/12/2019 18:45	07/12/2019 13:20	06/12/2019 18:45	07/12/2019 13:20	18,59	1	18,59	CHI
20191240663	APARECIDA DE GOIANIA	15929073	INDEPENDENCIA S2	06/12/2019 18:45	06/12/2019 21:30	06/12/2019 18:45	06/12/2019 21:30	2,74	1	2,74	CHI
20191240666	APARECIDA DE GOIANIA	13463330	INDEPENDENCIA S2	06/12/2019 18:45	06/12/2019 21:02	06/12/2019 18:45	06/12/2019 21:02	2,27	1	2,27	CHI
20191240668	ANAPOLIS	20418371	ANAPOLIS UNIVERSITARIO S2	06/12/2019 18:46	06/12/2019 20:50	06/12/2019 18:46	06/12/2019 20:50	2,07	1	2,07	CHI
20191240678	TURVELANDIA	TD12301348	IPEGUARI	06/12/2019 18:48	07/12/2019 16:10	06/12/2019 18:48	07/12/2019 16:10	21,36	6	128,15	CHI
20191240680	SENADOR CANEDO	GN21001409	GOIANIA LESTE S2	06/12/2019 18:49	06/12/2019 20:59	06/12/2019 18:49	06/12/2019 20:59	2,16	1	2,16	CHI
20191240684	RIO VERDE	630077630	RIO VERDE S2	06/12/2019 18:49	07/12/2019 10:54	06/12/2019 18:49	07/12/2019 10:54	16,07	1	16,07	CHI
20191240686	MONTIVIDIU	MV12260796	MONTIVIDIU T	06/12/2019 18:49	07/12/2019 11:13	06/12/2019 18:49	07/12/2019 11:13	16,39	2	32,79	CHI
20191240686	RIO VERDE	MV12260796	MONTIVIDIU T	06/12/2019 18:49	07/12/2019 11:13	06/12/2019 18:49	07/12/2019 11:13	16,39	2	32,79	CHI
20191240763	GOIANIA	GN11002186	MEIA PONTE	06/12/2019 18:49	06/12/2019 23:27	06/12/2019 18:49	06/12/2019 23:27	4,63	264	1221,73	CHI
20191240688	CATALAO	1990070430	CATALAO S2	06/12/2019 18:50	07/12/2019 02:55	06/12/2019 18:50	07/12/2019 02:55	8,08	1	8,08	CHI
20191240981	SAO LUIS DE MONTES BELOS	SL12006899	SAO LUIZ DOS MONTES BELOS	06/12/2019 18:50	06/12/2019 21:45	06/12/2019 18:50	06/12/2019 21:45	2,90	36	104,46	CHI
20191241707	IVOLANDIA	IV12098459	IPORA	06/12/2019 18:50	07/12/2019 19:30	06/12/2019 18:50	07/12/2019 19:30	24,66	4	98,64	CHI
20191240697	GOIANIA	12985960	CAMPINAS S1	06/12/2019 18:52	06/12/2019 21:00	06/12/2019 18:52	06/12/2019 21:00	2,13	1	2,13	CHI
20191240701	SANTA CRUZ DE GOIAS	BC21187054	CRISTIANOPOLIS	06/12/2019 18:53	07/12/2019 14:21	06/12/2019 18:53	07/12/2019 14:21	19,45	1	19,45	CHI
20191241167	CALDAS NOVAS	CN12363765	CALDAS NOVAS S1	06/12/2019 18:54	07/12/2019 12:21	06/12/2019 18:54	07/12/2019 12:21	17,44	19	331,35	CHI
20191240711	CAIAPONIA	CP12269004	CAIAPONIA	06/12/2019 18:56	07/12/2019 08:20	06/12/2019 18:56	07/12/2019 08:20	13,40	4	53,60	CHI
20191240718	IVOLANDIA	IV21380814	IPORA	06/12/2019 18:57	07/12/2019 22:23	06/12/2019 18:57	07/12/2019 22:23	27,42	2	54,83	CHI
20191241102	ITAPIRAPUA	IU12060539	MATRINCHA	06/12/2019 18:57	07/12/2019 06:44	06/12/2019 18:57	07/12/2019 06:44	11,77	4	47,08	CHI
20191240723	DIORAMA	IR12014523	IPORA	06/12/2019 18:58	07/12/2019 06:34	06/12/2019 18:58	07/12/2019 06:34	11,59	10	115,92	CHI
20191240723	IPORA	IR12014523	IPORA	06/12/2019 18:58	07/12/2019 06:34	06/12/2019 18:58	07/12/2019 06:34	11,59	43	498,45	CHI
20191240723	ISRAELANDIA	IR12014523	IPORA	06/12/2019 18:58	07/12/2019 06:34	06/12/2019 18:58	07/12/2019 06:34	11,59	3	34,78	CHI
20191240723	JAUPACI	IR12014523	IPORA	06/12/2019 18:58	07/12/2019 06:34	06/12/2019 18:58	07/12/2019 06:34	11,59	17	197,06	CHI
20191240724	JATAI	290060278	JATAI S2	06/12/2019 18:58	06/12/2019 23:54	06/12/2019 18:58	06/12/2019 23:54	4,92	1	4,92	CHI
20191240728	CORUMBA DE GOIAS	CB21146773	CORUMBA	06/12/2019 18:58	07/12/2019 09:33	06/12/2019 18:58	07/12/2019 09:33	14,58	2	29,16	CHI
20191240776	SAO LUIS DE MONTES BELOS	SL32145768	SAO LUIZ DOS MONTES BELOS	06/12/2019 18:58	07/12/2019 02:20	06/12/2019 18:58	07/12/2019 02:20	7,36	30	220,69	CHI
201912231715	ITAPURANGA	IK12310974	ITAPURANGA	06/12/2019 18:58	07/12/2019 12:40	06/12/2019 18:58	07/12/2019 12:40	17,70	3	53,09	CHI
20191240740	NOVA ROMA	ND12051336	IACIARA S2	06/12/2019 18:59	06/12/2019 20:35	06/12/2019 18:59	06/12/2019 20:35	1,58	5	7,92	CHI
20191240862	CAIAPONIA	CP12380880	CAIAPONIA	06/12/2019 18:59	07/12/2019 09:35	06/12/2019 18:59	07/12/2019 09:35	14,59	10	145,92	CHI

20191240750	APARECIDA DE GOIANIA	10001348866	INDEPENDENCIA S1	06/12/2019 19:00	06/12/2019 23:04	06/12/2019 19:00	06/12/2019 23:04	4,05	1	4,05	CHI
20191240751	NIQUELANDIA	NQ12396776	NIQUELANDIA SUBTRANSMISSAO	06/12/2019 19:00	07/12/2019 15:38	06/12/2019 19:00	07/12/2019 15:38	20,62	4	82,47	CHI
20191240757	CACHOEIRA ALTA	CA21022142	CACHOEIRA ALTA	06/12/2019 19:01	07/12/2019 10:50	06/12/2019 19:01	07/12/2019 10:50	15,82	2	31,64	CHI
20191240764	APARECIDA DE GOIANIA	AP12147249	ATLANTICO S2	06/12/2019 19:02	06/12/2019 21:39	06/12/2019 19:02	06/12/2019 21:39	2,61	324	844,65	CHI
20191240875	IPAMERI	IP12275809	IPAMERI	06/12/2019 19:02	06/12/2019 20:38	06/12/2019 19:02	06/12/2019 20:38	1,59	147	233,12	CHI
20191240768	URUACU	UR21361497	URUACU	06/12/2019 19:03	07/12/2019 09:18	06/12/2019 19:03	07/12/2019 09:18	14,25	1	14,25	CHI
20191240775	GOIANIA	12455866	FERROVIARIO S1	06/12/2019 19:04	06/12/2019 23:01	06/12/2019 19:04	06/12/2019 23:01	3,94	1	3,94	CHI
20191240783	HIDROLANDIA	HD21329356	CEPAIGO S2	06/12/2019 19:06	07/12/2019 08:09	06/12/2019 19:06	07/12/2019 08:09	13,05	1	13,05	CHI
20191240786	APARECIDA DE GOIANIA	14400078	INDEPENDENCIA S1	06/12/2019 19:06	06/12/2019 21:47	06/12/2019 19:06	06/12/2019 21:47	2,68	1	2,68	CHI
20191240787	ANAPOLIS	20965850	ANAPOLIS UNIVERSITARIO S2	06/12/2019 19:06	07/12/2019 02:31	06/12/2019 19:06	07/12/2019 02:31	7,41	1	7,41	CHI
20191240788	NOVO PLANALTO	SM12328903	SAO MIGUEL DO ARAGUAIA	06/12/2019 19:06	07/12/2019 10:52	06/12/2019 19:06	07/12/2019 10:52	15,76	10	157,59	CHI
20191240796	JATAI	JT12244304	JATAI S1	06/12/2019 19:06	08/12/2019 13:52	06/12/2019 19:06	08/12/2019 13:52	42,75	10	427,54	CHI
20191240796	SERRANOPOLIS	JT12244304	JATAI S1	06/12/2019 19:06	08/12/2019 13:52	06/12/2019 19:06	08/12/2019 13:52	42,75	2	85,51	CHI
20191240801	FAINA	FC12234951	GOIAS	06/12/2019 19:07	06/12/2019 22:54	06/12/2019 19:07	06/12/2019 22:54	3,77	2	7,55	CHI
20191240804	APORE	AE21107341	ITAJA S1	06/12/2019 19:07	06/12/2019 20:32	06/12/2019 19:07	06/12/2019 20:32	1,41	1	1,41	CHI
20191240808	ACREUNA	EU21214064	ACREUNA	06/12/2019 19:08	07/12/2019 12:08	06/12/2019 19:08	07/12/2019 12:08	16,98	1	16,98	CHI
20191240809	CACU	CC21078617	CACHOEIRA ALTA	06/12/2019 19:09	07/12/2019 23:10	06/12/2019 19:09	07/12/2019 23:10	28,02	1	28,02	CHI
20191240812	ANAPOLIS	20412149	JUNDIAI S1	06/12/2019 19:09	06/12/2019 23:32	06/12/2019 19:09	06/12/2019 23:32	4,37	1	4,37	CHI
20191241184	SAO MIGUEL DO ARAGUAIA	SM12371801B	SAO MIGUEL DO ARAGUAIA	06/12/2019 19:09	07/12/2019 00:35	06/12/2019 19:09	07/12/2019 00:35	5,42	232	1256,99	CHI
20191240816	BOM JESUS DE GOIAS	BJ21310038	CACHOEIRA DOURADA	06/12/2019 19:10	06/12/2019 23:51	06/12/2019 19:10	06/12/2019 23:51	4,68	1	4,68	CHI
20191240829	AURILANDIA	AI12289759	FIRMINOPOLIS S2	06/12/2019 19:12	07/12/2019 08:36	06/12/2019 19:12	07/12/2019 08:36	13,41	4	53,64	CHI
20191240829	FIRMINOPOLIS	AI12289759	FIRMINOPOLIS S2	06/12/2019 19:12	07/12/2019 08:36	06/12/2019 19:12	07/12/2019 08:36	13,41	1	13,41	CHI
20191240830	VILA PROPICIO	GE21376598	GOIANESIA S2	06/12/2019 19:12	07/12/2019 15:50	06/12/2019 19:12	07/12/2019 15:50	20,62	1	20,62	CHI
20191241155	ARAGOIANIA	AO32097677	GUAPU S2	06/12/2019 19:13	06/12/2019 22:55	06/12/2019 19:13	06/12/2019 22:55	3,69	8	29,51	CHI
20191241155	HIDROLANDIA	AO32097677	GUAPU S2	06/12/2019 19:13	06/12/2019 22:55	06/12/2019 19:13	06/12/2019 22:55	3,69	38	140,18	CHI
20191240837	JATAI	290005875	JATAI S2	06/12/2019 19:14	07/12/2019 09:44	06/12/2019 19:14	07/12/2019 09:44	14,50	1	14,50	CHI
20191240845	MORRINHOS	MR21059844	MORRINHOS	06/12/2019 19:14	08/12/2019 10:40	06/12/2019 19:14	08/12/2019 10:40	39,43	1	39,43	CHI
20191240852	PIRENOPOLIS	220032105	CORUMBA	06/12/2019 19:16	07/12/2019 07:59	06/12/2019 19:16	07/12/2019 07:59	12,71	1	12,71	CHI
20191240855	MINEIROS	1390049349	PARQUE DAS EMAS	06/12/2019 19:16	07/12/2019 10:38	06/12/2019 19:16	07/12/2019 10:38	15,36	1	15,36	CHI
20191240961	AGUA FRIA DE GOIAS	TL12279981	SAO JOAO D ALIANCA	06/12/2019 19:16	06/12/2019 22:50	06/12/2019 19:16	06/12/2019 22:50	3,57	41	146,21	CHI
20191241047	ANAPOLIS	AN11351100	ANAPOLIS UNIVERSITARIO S2	06/12/2019 19:16	06/12/2019 22:06	06/12/2019 19:16	06/12/2019 22:06	2,83	110	310,93	CHI
20191241104	HIDROLINA	HL12293464	URUACU	06/12/2019 19:18	07/12/2019 02:52	06/12/2019 19:18	07/12/2019 02:52	7,55	1	7,55	CHI
20191241104	PILAR DE GOIAS	HL12293464	URUACU	06/12/2019 19:18	07/12/2019 02:52	06/12/2019 19:18	07/12/2019 02:52	7,55	6	45,33	CHI

20191240872	CACHOEIRA ALTA	CA12200777	QUIRINOPOLIS	06/12/2019 19:19	07/12/2019 16:49	06/12/2019 19:19	07/12/2019 16:49	21,49	2	42,99	CHI
20191240873	GOIANIRA	10026553897	GOIANIRA	06/12/2019 19:19	06/12/2019 21:44	06/12/2019 19:19	06/12/2019 21:44	2,41	1	2,41	CHI
20191240877	QUIRINOPOLIS	QI21296591	QUIRINOPOLIS	06/12/2019 19:19	07/12/2019 10:06	06/12/2019 19:19	07/12/2019 10:06	14,77	1	14,77	CHI
20191240882	ANAPOLIS	20624566	ANAPOLIS UNIVERSITARIO S1	06/12/2019 19:20	07/12/2019 09:44	06/12/2019 19:20	07/12/2019 09:44	14,38	1	14,38	CHI
20191240884	ARAGUAPAZ	AZ12042908	MOZARLANDIA	06/12/2019 19:21	06/12/2019 23:54	06/12/2019 19:21	06/12/2019 23:54	4,55	46	209,11	CHI
20191240888	ITUMBIARA	10030306270	ITUMBIARA NOVA	06/12/2019 19:22	06/12/2019 22:23	06/12/2019 19:22	06/12/2019 22:23	3,02	1	3,02	CHI
20191240893	MONTES CLAROS DE GOIAS	ME21357463	IPORA	06/12/2019 19:23	07/12/2019 14:45	06/12/2019 19:23	07/12/2019 14:45	19,38	1	19,38	CHI
20191240897	NIQUELANDIA	NQ21086211	URUACU	06/12/2019 19:25	07/12/2019 12:55	06/12/2019 19:25	07/12/2019 12:55	17,50	1	17,50	CHI
20191240927	GOIAS	GS10403938	GOIAS	06/12/2019 19:25	08/12/2019 15:58	06/12/2019 19:25	06/12/2019 19:31	0,10	720	75,00	CHI
20191240927	GOIAS	GS10403938	GOIAS	06/12/2019 19:25	08/12/2019 15:58	06/12/2019 19:25	06/12/2019 19:33	0,13	50	6,32	CHI
20191240927	GOIAS	GS10403938	GOIAS	06/12/2019 19:25	08/12/2019 15:58	06/12/2019 19:25	06/12/2019 21:52	2,44	30	73,20	CHI
20191240927	GOIAS	GS10403938	GOIAS	06/12/2019 19:25	08/12/2019 15:58	06/12/2019 19:25	07/12/2019 08:55	13,50	32	432,09	CHI
20191240927	GOIAS	GS10403938	GOIAS	06/12/2019 19:25	08/12/2019 15:58	06/12/2019 19:25	07/12/2019 10:35	15,17	34	515,78	CHI
20191240927	GOIAS	GS10404197	GOIAS	06/12/2019 19:25	08/12/2019 15:58	07/12/2019 12:29	07/12/2019 12:41	0,20	96	19,36	CHI
20191240927	GOIAS	GS10403938	GOIAS	06/12/2019 19:25	08/12/2019 15:58	06/12/2019 19:25	07/12/2019 13:28	18,04	41	739,80	CHI
20191240927	GOIAS	GS12076721	GOIAS	06/12/2019 19:25	08/12/2019 15:58	06/12/2019 19:25	08/12/2019 15:04	43,64	7	305,51	CHI
20191240927	GOIAS	GS12068609LD	GOIAS	06/12/2019 19:25	08/12/2019 15:58	06/12/2019 19:25	08/12/2019 15:58	44,55	16	712,77	CHI
20191240922	IACIARA	10005238020	IACIARA S1	06/12/2019 19:26	07/12/2019 00:36	06/12/2019 19:26	07/12/2019 00:36	5,15	1	5,15	CHI
20191240923	SAO JOAO DA PARAUNA	FR12299252	FIRMINOPOLIS S2	06/12/2019 19:26	07/12/2019 20:00	06/12/2019 19:26	07/12/2019 20:00	24,55	3	73,66	CHI
20191240925	SANTA HELENA DE GOIAS	SH21134876	IPEGUARI	06/12/2019 19:27	07/12/2019 11:30	06/12/2019 19:27	07/12/2019 11:30	16,05	1	16,05	CHI
20191240934	VILA PROPICIO	NP21248155	GOIANESIA S1	06/12/2019 19:28	07/12/2019 14:52	06/12/2019 19:28	07/12/2019 14:52	19,39	1	19,39	CHI
20191240954	LUZIANIA	LZ11313728	RIO VERMELHO	06/12/2019 19:28	06/12/2019 21:06	06/12/2019 19:28	06/12/2019 21:06	1,63	145	235,83	CHI
20191240948	MOSSAMEDES	MD21089238	ITABERAI S2	06/12/2019 19:30	07/12/2019 16:54	06/12/2019 19:30	07/12/2019 16:54	21,40	1	21,40	CHI
20191241100	MINACU	IH11187761	MINACU	06/12/2019 19:30	06/12/2019 21:09	06/12/2019 19:30	06/12/2019 21:09	1,65	99	163,27	CHI
20191240950	QUIRINOPOLIS	QI21091034	QUIRINOPOLIS	06/12/2019 19:31	07/12/2019 10:47	06/12/2019 19:31	07/12/2019 10:47	15,28	1	15,28	CHI
20191240959	TAQUARAL DE GOIAS	TQ21300110	ITABERAI S1	06/12/2019 19:32	07/12/2019 07:15	06/12/2019 19:32	07/12/2019 07:15	11,71	1	11,71	CHI
20191240962	BELA VISTA DE GOIAS	BV21011705	BELA VISTA S1	06/12/2019 19:32	07/12/2019 10:03	06/12/2019 19:32	07/12/2019 10:03	14,51	1	14,51	CHI
20191240972	SANTA TEREZINHA DE GOIAS	SG12048775	SANTA TEREZINHA	06/12/2019 19:32	07/12/2019 00:41	06/12/2019 19:32	07/12/2019 00:41	5,14	10	51,44	CHI
20191240968	SERRANOPOLIS	SX21314490	JATAI S1	06/12/2019 19:33	07/12/2019 14:25	06/12/2019 19:33	07/12/2019 14:25	18,85	1	18,85	CHI
20191240968	SERRANOPOLIS	SX12314281	JATAI S1	06/12/2019 19:33	07/12/2019 14:25	07/12/2019 13:50	07/12/2019 14:25	0,58	1	0,58	CHI
20191241310	LUZIANIA	LZ11401660	MARAJOARA	06/12/2019 19:34	06/12/2019 22:42	06/12/2019 19:34	06/12/2019 22:42	3,12	77	240,41	CHI
20191242122	DISTRITO FEDERAL	FA12383392	ITIQUEIRA	06/12/2019 19:35	07/12/2019 08:23	06/12/2019 19:35	07/12/2019 08:23	12,79	2	25,58	CHI
20191240982	SAO LUIS DE MONTES BELOS	FR12000054	FIRMINOPOLIS S1	06/12/2019 19:36	06/12/2019 23:43	06/12/2019 19:36	06/12/2019 23:43	4,12	6	24,69	CHI



20191241012	GOIANIA	GN11197491	XAVANTES	06/12/2019 19:36	06/12/2019 21:59	06/12/2019 19:36	06/12/2019 21:59	2,38	18	42,84	CHI
20191240988	FAZENDA NOVA	9680000132	IPORA	06/12/2019 19:37	07/12/2019 11:20	06/12/2019 19:37	07/12/2019 11:20	15,72	1	15,72	CHI
20191240991	NIQUELANDIA	NQ21056789	URUACU	06/12/2019 19:37	07/12/2019 12:29	06/12/2019 19:37	07/12/2019 12:29	16,86	1	16,86	CHI
20191240995	NOVA CRIXAS	NA12228222	MOZARLANDIA	06/12/2019 19:37	07/12/2019 00:10	06/12/2019 19:37	07/12/2019 00:10	4,54	7	31,75	CHI
20191241003	CAVALCANTE	CJ21319287	MINACU	06/12/2019 19:39	07/12/2019 20:30	06/12/2019 19:39	07/12/2019 20:30	24,84	1	24,84	CHI
20191241006	EDEIA	EA12084032	EDEIA	06/12/2019 19:40	07/12/2019 10:16	06/12/2019 19:40	07/12/2019 10:16	14,59	2	29,18	CHI
20191241008	MINEIROS	10018523755	PARQUE DAS EMAS	06/12/2019 19:40	07/12/2019 08:17	06/12/2019 19:40	07/12/2019 08:17	12,60	1	12,60	CHI
20191241019	ITAPURANGA	170025810	ITAPURANGA	06/12/2019 19:43	08/12/2019 10:14	06/12/2019 19:43	08/12/2019 10:14	38,51	1	38,51	CHI
20191241177	ADELANDIA	DN12323607	FIRMINOPOLIS S2	06/12/2019 19:43	07/12/2019 12:57	06/12/2019 19:43	07/12/2019 12:57	17,23	7	120,61	CHI
20191241177	SAO LUIS DE MONTES BELOS	DN12323607	FIRMINOPOLIS S2	06/12/2019 19:43	07/12/2019 12:57	06/12/2019 19:43	07/12/2019 12:57	17,23	7	120,61	CHI
20191241635	VILA PROPICIO	NP12221137	GOIANESIA S1	06/12/2019 19:43	07/12/2019 13:01	06/12/2019 19:43	07/12/2019 13:01	17,28	18	311,12	CHI
20191241022	ITUMBIARA	690295509	ITUMBIARA NOVA	06/12/2019 19:44	06/12/2019 21:39	06/12/2019 19:44	06/12/2019 21:39	1,93	1	1,93	CHI
20191241027	ANAPOLIS	20256840	JUNDIAI S1	06/12/2019 19:44	07/12/2019 09:53	06/12/2019 19:44	07/12/2019 09:53	14,14	1	14,14	CHI
20191241029	GOIANIA	10024189	GOIANIA LESTE S2	06/12/2019 19:45	06/12/2019 23:52	06/12/2019 19:45	06/12/2019 23:52	4,12	1	4,12	CHI
20191241035	SAO MIGUEL DO ARAGUAIA	SM12032000	SAO MIGUEL DO ARAGUAIA	06/12/2019 19:45	07/12/2019 13:30	06/12/2019 19:45	07/12/2019 13:30	17,74	5	88,69	CHI
20191241041	ACREUNA	2440035021	ACREUNA	06/12/2019 19:47	06/12/2019 21:57	06/12/2019 19:47	06/12/2019 21:57	2,16	1	2,16	CHI
20191241044	MINEIROS	MY12184176	PARQUE DAS EMAS	06/12/2019 19:47	07/12/2019 09:58	06/12/2019 19:47	07/12/2019 09:58	14,17	7	99,18	CHI
20191241050	CRISTIANOPOLIS	CF12351954	CRISTIANOPOLIS	06/12/2019 19:49	06/12/2019 21:07	06/12/2019 19:49	06/12/2019 21:07	1,29	8	10,35	CHI
20191241061	VALPARAISO DE GOIAS	2860149266	PACAEMBU S1	06/12/2019 19:50	06/12/2019 22:54	06/12/2019 19:50	06/12/2019 22:54	3,06	1	3,06	CHI
20191241344	ANICUNS	AC12000063	ANICUNS	06/12/2019 19:52	07/12/2019 07:26	06/12/2019 19:52	07/12/2019 07:26	11,56	254	2936,24	CHI
20191241068	ABADIANIA	AA12348133	ANAPOLIS UNIVERSITARIO S1	06/12/2019 19:53	06/12/2019 21:10	06/12/2019 19:53	06/12/2019 21:10	1,27	16	20,32	CHI
20191241074	TURVELANDIA	TD21025683	RIO DOS BOIS	06/12/2019 19:54	07/12/2019 14:50	06/12/2019 19:54	07/12/2019 14:50	18,92	2	37,84	CHI
20191241079	ALEXANIA	480039549	ALEXANIA	06/12/2019 19:55	07/12/2019 08:58	06/12/2019 19:55	07/12/2019 08:58	13,04	1	13,04	CHI
20191241080	ITUMBIARA	BG21316689	ITUMBIARA VELHA S2	06/12/2019 19:55	07/12/2019 10:10	06/12/2019 19:55	07/12/2019 10:10	14,24	1	14,24	CHI
201912233080	FLORES DE GOIAS	FB12384211	IACIARA S2	06/12/2019 19:55	06/12/2019 20:27	06/12/2019 19:55	06/12/2019 20:27	0,53	126	66,95	CHI
201912233080	FORMOSA	FB12384211	IACIARA S2	06/12/2019 19:55	06/12/2019 20:27	06/12/2019 19:55	06/12/2019 20:27	0,53	1	0,53	CHI
201912233080	VILA BOA	FB12384211	IACIARA S2	06/12/2019 19:55	06/12/2019 20:27	06/12/2019 19:55	06/12/2019 20:27	0,53	4	2,13	CHI
20191241092	MONTIVIDIU	2840033908	MONTIVIDIU T	06/12/2019 19:57	07/12/2019 15:25	06/12/2019 19:57	07/12/2019 15:25	19,47	1	19,47	CHI
20191241098	DIORAMA	DI12024594	ARENOPOLIS	06/12/2019 19:58	07/12/2019 13:16	06/12/2019 19:58	07/12/2019 13:16	17,28	5	86,42	CHI
20191241099	FIRMINOPOLIS	TV12005554	FIRMINOPOLIS S1	06/12/2019 19:59	08/12/2019 08:05	06/12/2019 19:59	08/12/2019 08:05	36,12	2	72,23	CHI
20191241099	TURVANIA	TV12005554	FIRMINOPOLIS S1	06/12/2019 19:59	08/12/2019 08:05	06/12/2019 19:59	08/12/2019 08:05	36,12	46	1661,30	CHI
20191242155	SAO LUIS DE MONTES BELOS	SL12007695	SAO LUIZ DOS MONTES BELOS	06/12/2019 20:01	07/12/2019 14:32	06/12/2019 20:01	07/12/2019 14:32	18,52	9	166,70	CHI
20191241112	GOIANIA	10301355	CAMPINAS S2	06/12/2019 20:02	06/12/2019 21:43	06/12/2019 20:02	06/12/2019 21:43	1,69	1	1,69	CHI

20191241116	IPORA	IR12014557	IPORA	06/12/2019 20:04	07/12/2019 08:50	06/12/2019 20:04	07/12/2019 08:50	12,75	22	280,52	CHI
20191241120	SAO LUIS DE MONTES BELOS	SL12111569	FIRMINOPOLIS S1	06/12/2019 20:05	06/12/2019 23:50	06/12/2019 20:05	06/12/2019 23:50	3,73	36	134,45	CHI
20191241125	SANTA BARBARA DE GOIAS	SB21111047	TRINDADE	06/12/2019 20:09	07/12/2019 02:53	06/12/2019 20:09	07/12/2019 02:53	6,73	2	13,46	CHI
20191241131	AGUAS LINDAS DE GOIAS	10007834959	AGUAS LINDAS DE GOIAS S1	06/12/2019 20:12	06/12/2019 21:37	06/12/2019 20:12	06/12/2019 21:37	1,41	1	1,41	CHI
20191241133	VALPARAISO DE GOIAS	10010574652	PACAEMBU S2	06/12/2019 20:12	06/12/2019 22:00	06/12/2019 20:12	06/12/2019 22:00	1,79	1	1,79	CHI
20191241136	ABADIA DE GOIAS	TR31046106	CARAJAS S1	06/12/2019 20:13	07/12/2019 02:18	06/12/2019 20:13	07/12/2019 02:18	6,08	1	6,08	CHI
20191241138	PETROLINA DE GOIAS	PG21111269	SAO FRANCISCO DE GOIAS	06/12/2019 20:13	07/12/2019 11:30	06/12/2019 20:13	07/12/2019 11:30	15,29	1	15,29	CHI
20191241143	AVELINOPOLIS	990004156	ANICUNS	06/12/2019 20:15	07/12/2019 09:57	06/12/2019 20:15	07/12/2019 09:57	13,71	1	13,71	CHI
20191241149	ANICUNS	AC12259090	FIRMINOPOLIS S2	06/12/2019 20:17	07/12/2019 09:47	06/12/2019 20:17	07/12/2019 09:47	13,48	30	404,51	CHI
20191241153	GOIAS	90075171	GOIAS	06/12/2019 20:18	07/12/2019 10:56	06/12/2019 20:18	07/12/2019 10:56	14,64	1	14,64	CHI
20191241154	SAO MIGUEL DO ARAGUAIA	SM12013036	SAO MIGUEL DO ARAGUAIA	06/12/2019 20:18	07/12/2019 13:27	06/12/2019 20:18	07/12/2019 13:27	17,14	22	377,08	CHI
20191241157	CORREGO DO OURO	CO12232969	SAO LUIZ DOS MONTES BELOS	06/12/2019 20:18	08/12/2019 12:38	06/12/2019 20:18	08/12/2019 12:38	40,32	1	40,32	CHI
20191241345	PALMEIRAS DE GOIAS	PL12000078	PALMEIRAS	06/12/2019 20:18	07/12/2019 00:39	06/12/2019 20:18	07/12/2019 00:39	4,34	34	147,47	CHI
20191241163	VALPARAISO DE GOIAS	10005858800	MARAJOARA	06/12/2019 20:19	06/12/2019 22:59	06/12/2019 20:19	06/12/2019 22:59	2,66	1	2,66	CHI
20191241164	CRISTIANOPOLIS	CF12265545	CRISTIANOPOLIS	06/12/2019 20:19	07/12/2019 09:35	06/12/2019 20:19	07/12/2019 08:29	12,18	15	182,63	CHI
20191241164	CRISTIANOPOLIS	CF12265545	CRISTIANOPOLIS	06/12/2019 20:19	07/12/2019 09:35	06/12/2019 20:19	07/12/2019 09:35	13,26	3	39,78	CHI
20191241166	MOSSAMEDES	MD21398969	FIRMINOPOLIS S2	06/12/2019 20:19	08/12/2019 07:27	06/12/2019 20:19	08/12/2019 07:27	35,12	1	35,12	CHI
20191241168	GOIATUBA	VI12166490	VICENTINOPOLIS	06/12/2019 20:20	07/12/2019 22:46	06/12/2019 20:20	07/12/2019 22:46	26,43	4	105,70	CHI
20191241168	VICENTINOPOLIS	VI12166490	VICENTINOPOLIS	06/12/2019 20:20	07/12/2019 22:46	06/12/2019 20:20	07/12/2019 22:46	26,43	2	52,85	CHI
20191241169	APARECIDA DE GOIANIA	12182023	ATLANTICO S3	06/12/2019 20:20	07/12/2019 07:08	06/12/2019 20:20	07/12/2019 07:08	10,79	1	10,79	CHI
20191241170	NIQUELANDIA	2750084058	NIQUELANDIA SUBTRANSMISSAO	06/12/2019 20:20	07/12/2019 02:59	06/12/2019 20:20	07/12/2019 02:59	6,65	1	6,65	CHI
20191241173	ALTO HORIZONTE	10005957247	SANTA TEREZINHA	06/12/2019 20:20	07/12/2019 00:25	06/12/2019 20:20	07/12/2019 00:25	4,07	1	4,07	CHI
20191242537	ANICUNS	AC12035306	ANICUNS	06/12/2019 20:22	07/12/2019 10:12	06/12/2019 20:22	07/12/2019 10:12	13,82	20	276,44	CHI
20191241180	ANAPOLIS	10000469392	ANAPOLIS UNIVERSITARIO S1	06/12/2019 20:23	06/12/2019 21:43	06/12/2019 20:23	06/12/2019 21:43	1,33	1	1,33	CHI
20191241188	PORTELANDIA	PW21301981	PARQUE DAS EMAS	06/12/2019 20:26	07/12/2019 14:38	06/12/2019 20:26	07/12/2019 14:38	18,19	1	18,19	CHI
20191241542	GOIAS	GS12061668	ITABERAÍ S1	06/12/2019 20:29	07/12/2019 07:50	06/12/2019 20:29	07/12/2019 07:50	11,35	18	204,28	CHI
20191241196	GOIATUBA	10000004217	GOIATUBA S2	06/12/2019 20:30	07/12/2019 01:38	06/12/2019 20:30	07/12/2019 01:38	5,14	1	5,14	CHI
20191241352	GOIANESIA	GE21215141	GOIANESIA S2	06/12/2019 20:31	07/12/2019 14:50	06/12/2019 20:31	07/12/2019 14:50	18,31	5	91,55	CHI
20191241605	MOSSAMEDES	SC12323577	FIRMINOPOLIS S2	06/12/2019 20:33	07/12/2019 15:04	06/12/2019 20:33	07/12/2019 15:04	18,51	1	18,51	CHI
20191241605	SANCLERLANDIA	SC12323577	FIRMINOPOLIS S2	06/12/2019 20:33	07/12/2019 15:04	06/12/2019 20:33	07/12/2019 15:04	18,51	63	1165,92	CHI
20191242056	BURITI DE GOIAS	BS12076542	FIRMINOPOLIS S2	06/12/2019 20:35	07/12/2019 11:59	06/12/2019 20:35	07/12/2019 11:59	15,40	38	585,20	CHI
20191241313	LUZIANIA	120432950	RIO VERMELHO	06/12/2019 20:36	06/12/2019 22:42	06/12/2019 20:36	06/12/2019 22:42	2,10	1	2,10	CHI
20191241318	GOIAS	90060118	GOIAS	06/12/2019 20:36	07/12/2019 08:48	06/12/2019 20:36	07/12/2019 08:48	12,19	1	12,19	CHI

20191241322	GOIANIA	10769134	ATLANTICO S1	06/12/2019 20:38	06/12/2019 23:58	06/12/2019 20:38	06/12/2019 23:58	3,32	1	3,32	CHI
20191241323	BRITANIA	BT21250970	BRITANIA	06/12/2019 20:38	07/12/2019 18:09	06/12/2019 20:38	07/12/2019 17:25	20,77	1	20,77	CHI
20191241323	BRITANIA	BT12124815	BRITANIA	06/12/2019 20:38	07/12/2019 18:09	07/12/2019 10:04	07/12/2019 18:09	8,10	12	97,16	CHI
20191241323	JUSSARA	BT12124815	BRITANIA	06/12/2019 20:38	07/12/2019 18:09	07/12/2019 10:04	07/12/2019 18:09	8,10	5	40,48	CHI
20191241325	INACIOLANDIA	ID32128272	QUIRINOPOLIS	06/12/2019 20:40	06/12/2019 22:30	06/12/2019 20:40	06/12/2019 22:30	1,83	8	14,65	CHI
20191241404	ANAPOLIS	AN11211781	ANAPOLIS UNIVERSITARIO S2	06/12/2019 20:41	07/12/2019 00:44	06/12/2019 20:41	07/12/2019 00:44	4,04	138	556,87	CHI
20191241495	HIDROLANDIA	HD12000308	ANHANGUERA	06/12/2019 20:41	07/12/2019 00:54	06/12/2019 20:41	07/12/2019 00:54	4,20	663	2786,63	CHI
20191243304	ARUANA	MP12183061	MOZARLANDIA	06/12/2019 20:41	08/12/2019 11:18	06/12/2019 20:41	08/12/2019 11:18	38,63	8	309,01	CHI
20191243304	MATRINCHA	MP12183061	MOZARLANDIA	06/12/2019 20:41	08/12/2019 11:18	06/12/2019 20:41	08/12/2019 11:18	38,63	27	1042,90	CHI
20191241334	CORREGO DO OURO	CO12308374	FIRMINOPOLIS S2	06/12/2019 20:42	07/12/2019 11:16	06/12/2019 20:42	07/12/2019 11:16	14,55	25	363,76	CHI
20191241341	IPORA	IR21102698	IPORA	06/12/2019 20:45	07/12/2019 09:28	06/12/2019 20:45	07/12/2019 09:28	12,70	1	12,70	CHI
20191241346	LUZIANIA	LZ21086783	VIANOPOLIS	06/12/2019 20:48	07/12/2019 03:00	06/12/2019 20:48	07/12/2019 03:00	6,19	2	12,38	CHI
20191241354	PILAR DE GOIAS	GG12318450	URUACU	06/12/2019 20:51	07/12/2019 12:45	06/12/2019 20:51	07/12/2019 12:45	15,89	3	47,67	CHI
20191242145	ARAGUAPAZ	AZ12238877	MOZARLANDIA	06/12/2019 20:54	07/12/2019 10:22	06/12/2019 20:54	07/12/2019 10:22	13,46	15	201,84	CHI
20191242500	BURITI DE GOIAS	BS21167293	FIRMINOPOLIS S2	06/12/2019 20:58	07/12/2019 17:18	06/12/2019 20:58	07/12/2019 17:18	20,33	1	20,33	CHI
20191241442	FORMOSA	FA12254232	ITUIQUIRA	06/12/2019 21:00	06/12/2019 22:43	06/12/2019 21:00	06/12/2019 22:43	1,71	14	23,88	CHI
20191241377	ITUMBIARA	690117929	PARANAIBA	06/12/2019 21:01	06/12/2019 23:35	06/12/2019 21:01	06/12/2019 23:35	2,56	1	2,56	CHI
20191241383	GOIANIA	12706220	GOYA S1	06/12/2019 21:04	06/12/2019 23:09	06/12/2019 21:04	06/12/2019 23:09	2,08	1	2,08	CHI
20191241388	MINEIROS	MY21364488	PARQUE DAS EMAS	06/12/2019 21:07	07/12/2019 14:28	06/12/2019 21:07	07/12/2019 14:28	17,36	1	17,36	CHI
20191241394	RIO VERDE	RV21131539	MONTIVIDIU T	06/12/2019 21:08	07/12/2019 18:55	06/12/2019 21:08	07/12/2019 18:55	21,77	1	21,77	CHI
20191241400	PORANGATU	840058615	PORANGATU	06/12/2019 21:11	06/12/2019 22:44	06/12/2019 21:11	06/12/2019 22:44	1,55	1	1,55	CHI
20191241402	RIO VERDE	630450808	RIO VERDE S1	06/12/2019 21:11	07/12/2019 10:27	06/12/2019 21:11	07/12/2019 10:27	13,26	1	13,26	CHI
20191242447	FIRMINOPOLIS	FR12061354	FIRMINOPOLIS S1	06/12/2019 21:12	07/12/2019 12:36	06/12/2019 21:12	07/12/2019 12:36	15,39	20	307,90	CHI
20191241408	ABADIANIA	AA21221341	ANAPOLIS UNIVERSITARIO S1	06/12/2019 21:17	07/12/2019 10:25	06/12/2019 21:17	07/12/2019 10:25	13,13	1	13,13	CHI
20191241409	PALMEIRAS DE GOIAS	590028820	PALMEIRAS	06/12/2019 21:17	07/12/2019 08:28	06/12/2019 21:17	07/12/2019 08:28	11,18	1	11,18	CHI
20191241455	MARA ROSA	MQ12051065	MARA ROSA	06/12/2019 21:17	07/12/2019 02:29	06/12/2019 21:17	07/12/2019 02:29	5,19	21	109,00	CHI
20191241416	TRES RANCHOS	2170008014	CATALAO S1	06/12/2019 21:20	07/12/2019 00:40	06/12/2019 21:20	07/12/2019 00:40	3,33	1	3,33	CHI
20191241417	ANAPOLIS	20038318	ANAPOLIS UNIVERSITARIO S2	06/12/2019 21:20	07/12/2019 14:26	06/12/2019 21:20	07/12/2019 14:26	17,09	1	17,09	CHI
20191241961	ADELANDIA	DN12053892	FIRMINOPOLIS S2	06/12/2019 21:21	07/12/2019 12:30	06/12/2019 21:21	07/12/2019 12:30	15,14	10	151,39	CHI
20191241420	CACU	SO21013213	CACHOEIRA ALTA	06/12/2019 21:23	07/12/2019 12:20	06/12/2019 21:23	07/12/2019 12:20	14,94	1	14,94	CHI
20191241964	CACHOEIRA ALTA	RV12227747	QUIRINOPOLIS	06/12/2019 21:24	07/12/2019 10:20	06/12/2019 21:24	07/12/2019 10:20	12,92	7	90,43	CHI
20191241964	RIO VERDE	RV12227747	QUIRINOPOLIS	06/12/2019 21:24	07/12/2019 10:20	06/12/2019 21:24	07/12/2019 10:20	12,92	3	38,76	CHI
20191241428	PIRES DO RIO	460005108	PIRES DO RIO S1	06/12/2019 21:26	07/12/2019 09:56	06/12/2019 21:26	07/12/2019 09:56	12,49	1	12,49	CHI

20191241430	ANICUNS	TV12304696	FIRMINOPOLIS S2	06/12/2019 21:27	07/12/2019 15:35	06/12/2019 21:27	07/12/2019 15:35	18,13	3	54,39	CHI
20191241430	TURVANIA	TV12304696	FIRMINOPOLIS S2	06/12/2019 21:27	07/12/2019 15:35	06/12/2019 21:27	07/12/2019 15:35	18,13	14	253,84	CHI
20191241433	MINEIROS	MY11358861	PARQUE DAS EMAS	06/12/2019 21:29	07/12/2019 04:54	06/12/2019 21:29	07/12/2019 04:54	7,41	90	667,05	CHI
20191241437	BONOPOLIS	BX12234949	SAO MIGUEL DO ARAGUAIA	06/12/2019 21:30	07/12/2019 00:42	06/12/2019 21:30	07/12/2019 00:42	3,19	3	9,58	CHI
20191241439	TRINDADE	TR31047822	TRINDADE	06/12/2019 21:31	07/12/2019 08:45	06/12/2019 21:31	07/12/2019 08:45	11,23	2	22,45	CHI
20191241450	MINEIROS	MY12043894	PARQUE DAS EMAS	06/12/2019 21:31	07/12/2019 09:44	06/12/2019 21:31	07/12/2019 09:44	12,21	102	1245,51	CHI
20191244866	VICENTINOPOLIS	VI12047315	VICENTINOPOLIS	06/12/2019 21:40	08/12/2019 08:15	06/12/2019 21:40	08/12/2019 08:15	34,58	1	34,58	CHI
20191241468	PLANALTINA	PI11153072	PLANALTINA	06/12/2019 21:51	07/12/2019 01:20	06/12/2019 21:51	07/12/2019 01:20	3,47	318	1104,17	CHI
20191241525	FIRMINOPOLIS	FR12096968	FIRMINOPOLIS S1	06/12/2019 21:52	07/12/2019 02:25	06/12/2019 21:52	07/12/2019 02:25	4,54	23	104,44	CHI
20191241466	ALEXANIA	10027678561	ALEXANIA	06/12/2019 21:54	07/12/2019 11:21	06/12/2019 21:54	07/12/2019 11:21	13,45	1	13,45	CHI
20191241470	APORE	AE10396071	ITAJA S1	06/12/2019 21:56	07/12/2019 11:26	06/12/2019 21:56	07/12/2019 08:12	10,28	185	1902,21	CHI
20191241470	APORE	AE10396071	ITAJA S1	06/12/2019 21:56	07/12/2019 11:26	06/12/2019 21:56	07/12/2019 08:12	10,28	47	483,26	CHI
20191241470	ITARUMA	AE10396071	ITAJA S1	06/12/2019 21:56	07/12/2019 11:26	06/12/2019 21:56	07/12/2019 08:12	10,28	1	10,28	CHI
20191241470	APORE	AE10396071	ITAJA S1	06/12/2019 21:56	07/12/2019 11:26	07/12/2019 08:13	07/12/2019 09:23	1,17	185	216,19	CHI
20191241470	ITARUMA	AE10396071	ITAJA S1	06/12/2019 21:56	07/12/2019 11:26	07/12/2019 08:13	07/12/2019 09:23	1,17	1	1,17	CHI
20191241470	APORE	AE13209675	ITAJA S1	06/12/2019 21:56	07/12/2019 11:26	07/12/2019 08:13	07/12/2019 09:25	1,21	47	56,82	CHI
20191241470	APORE	AE13209675	ITAJA S1	06/12/2019 21:56	07/12/2019 11:26	07/12/2019 09:26	07/12/2019 11:26	2,00	47	94,03	CHI
20191243001	SAO LUIS DE MONTES BELOS	SL12206033	SAO LUIZ DOS MONTES BELOS	06/12/2019 21:57	07/12/2019 16:36	06/12/2019 21:57	07/12/2019 16:36	18,66	13	242,52	CHI
20191241471	CORUMBA DE GOIAS	CB12089104	ALEXANIA	06/12/2019 21:59	07/12/2019 11:01	06/12/2019 21:59	07/12/2019 11:01	13,02	4	52,07	CHI
20191238294	PALMEIRAS DE GOIAS	PL12076534	PALMEIRAS	06/12/2019 22:00	07/12/2019 08:40	06/12/2019 22:00	07/12/2019 08:40	10,66	7	74,60	CHI
20191241473	JANDAIA	JD21233511	PALMEIRAS	06/12/2019 22:00	07/12/2019 07:41	06/12/2019 22:00	07/12/2019 07:41	9,67	3	29,01	CHI
20191241474	PLANALTINA	10013236120	PLANALTINA	06/12/2019 22:03	06/12/2019 23:06	06/12/2019 22:03	06/12/2019 23:06	1,04	1	1,04	CHI
20191241489	INHUMAS	IN11012237	INHUMAS S2	06/12/2019 22:04	06/12/2019 23:31	06/12/2019 22:04	06/12/2019 23:31	1,44	78	111,97	CHI
20191241523	PIRACANJUBA	PJ12036384	CRISTIANOPOLIS	06/12/2019 22:04	07/12/2019 00:23	06/12/2019 22:04	07/12/2019 00:23	2,31	16	36,91	CHI
20191241484	MINEIROS	1390116533	PARQUE DAS EMAS	06/12/2019 22:07	07/12/2019 11:01	06/12/2019 22:07	07/12/2019 11:01	12,89	1	12,89	CHI
20191242650	CRIXAS	CX12276582	SERRA DO OURO	06/12/2019 22:10	07/12/2019 14:16	06/12/2019 22:10	07/12/2019 14:16	16,09	3	48,28	CHI
20191241493	ITAJA	IJ12202625	ITAJA S2	06/12/2019 22:11	08/12/2019 20:10	06/12/2019 22:11	07/12/2019 12:47	14,60	3	43,79	CHI
20191241493	ITAJA	IJ12202625	ITAJA S2	06/12/2019 22:11	08/12/2019 20:10	07/12/2019 07:45	07/12/2019 12:47	5,04	2	10,09	CHI
20191241493	ITAJA	IJ12202625	ITAJA S2	06/12/2019 22:11	08/12/2019 20:10	06/12/2019 22:11	07/12/2019 17:26	19,25	3	57,75	CHI
20191241493	ITAJA	IJ12202625	ITAJA S2	06/12/2019 22:11	08/12/2019 20:10	07/12/2019 07:45	07/12/2019 17:26	9,70	5	48,49	CHI
20191241493	ITAJA	IJ12202625	ITAJA S2	06/12/2019 22:11	08/12/2019 20:10	06/12/2019 22:11	08/12/2019 20:10	45,97	5	229,84	CHI
20191241493	ITAJA	IJ12202625	ITAJA S2	06/12/2019 22:11	08/12/2019 20:10	07/12/2019 07:45	08/12/2019 20:10	36,42	5	182,08	CHI
20191241493	APORE	IJ12202625	ITAJA S2	06/12/2019 22:11	08/12/2019 20:10	06/12/2019 22:11	08/12/2019 20:10	45,97	4	183,87	CHI

20191241493	ITAJA	IJ12202625	ITAJA S2	06/12/2019 22:11	08/12/2019 20:10	06/12/2019 22:11	08/12/2019 20:10	45,97	1	45,97	CHI
20191241494	SANCLERLANDIA	1210017237	FIRMINOPOLIS S2	06/12/2019 22:11	07/12/2019 15:49	06/12/2019 22:11	07/12/2019 15:49	17,63	1	17,63	CHI
20191241497	RIO VERDE	RV21074479	RIO VERDE S1	06/12/2019 22:13	07/12/2019 12:34	06/12/2019 22:13	07/12/2019 12:34	14,34	2	28,68	CHI
20191241501	DAMIANOPOLIS	01110214	IACIARA S2	06/12/2019 22:20	07/12/2019 04:40	06/12/2019 22:20	07/12/2019 04:40	6,32	130	821,96	CHI
20191241501	SITIO D ABADIA	01110214	IACIARA S2	06/12/2019 22:20	07/12/2019 04:40	06/12/2019 22:20	07/12/2019 04:40	6,32	378	2390,01	CHI
20191242452	SAO LUIS DE MONTES BELOS	SL12006949	SAO LUIZ DOS MONTES BELOS	06/12/2019 22:22	07/12/2019 09:56	06/12/2019 22:22	07/12/2019 09:56	11,57	41	474,55	CHI
20191241503	SAO LUIS DE MONTES BELOS	SL12299105	FIRMINOPOLIS S1	06/12/2019 22:24	08/12/2019 09:58	06/12/2019 22:24	08/12/2019 09:58	35,56	1	35,56	CHI
20191241522	MINACU	IH12182352	MINACU	06/12/2019 22:28	07/12/2019 02:30	07/12/2019 00:54	07/12/2019 02:10	1,26	71	89,20	CHI
20191241522	MINACU	IH11182332	MINACU	06/12/2019 22:28	07/12/2019 02:30	06/12/2019 22:28	07/12/2019 02:30	4,03	134	539,54	CHI
20191241513	ANAPOLIS	10016132767	ANAPOLIS UNIVERSITARIO S2	06/12/2019 22:30	07/12/2019 12:33	06/12/2019 22:30	07/12/2019 12:33	14,05	1	14,05	CHI
20191241606	JATAI	JT11348899	JATAI S3	06/12/2019 22:38	07/12/2019 20:15	06/12/2019 22:38	07/12/2019 20:15	21,61	54	1167,17	CHI
20191242119	SANCLERLANDIA	SC12161001	FIRMINOPOLIS S2	06/12/2019 22:39	07/12/2019 12:20	06/12/2019 22:39	07/12/2019 12:20	13,67	5	68,36	CHI
20191241539	JARAGUA	JA21124491	JARAGUA	06/12/2019 22:45	07/12/2019 17:34	06/12/2019 22:45	07/12/2019 17:34	18,81	1	18,81	CHI
20191241546	CATALAO	CT21389991	CATALAO S1	06/12/2019 22:50	07/12/2019 09:35	06/12/2019 22:50	07/12/2019 09:35	10,75	2	21,51	CHI
20191241548	PALMEIRAS DE GOIAS	PL21147535	PALMEIRAS	06/12/2019 22:51	07/12/2019 11:50	06/12/2019 22:51	07/12/2019 11:50	12,99	1	12,99	CHI
20191241639	RIO VERDE	RV12000159	RIO VERDE S1	06/12/2019 22:54	07/12/2019 11:20	06/12/2019 22:54	07/12/2019 10:40	11,75	580	6817,42	CHI
20191241639	RIO VERDE	RV12000159	RIO VERDE S1	06/12/2019 22:54	07/12/2019 11:20	06/12/2019 22:54	07/12/2019 11:20	12,43	94	1168,52	CHI
20191241570	APARECIDA DE GOIANIA	AP11138859	ATLANTICO S2	06/12/2019 22:55	07/12/2019 00:17	06/12/2019 22:55	07/12/2019 00:17	1,35	127	171,87	CHI
20191241617	GOIANESIA	GE12000180	GOIANESIA S2	06/12/2019 23:03	07/12/2019 15:16	06/12/2019 23:03	07/12/2019 15:16	16,20	20	324,08	CHI
20191241567	RIO VERDE	RV12279861	CABRIUVA S2	06/12/2019 23:05	07/12/2019 11:38	06/12/2019 23:05	07/12/2019 11:38	12,55	1	12,55	CHI
20191241568	ITABERAI	50119424	ITABERAI S2	06/12/2019 23:07	07/12/2019 10:39	06/12/2019 23:07	07/12/2019 10:39	11,53	1	11,53	CHI
20191241574	JARAGUA	JA12298122	JARAGUA	06/12/2019 23:10	07/12/2019 15:42	06/12/2019 23:10	07/12/2019 15:42	16,53	1	16,53	CHI
20191241586	ITAGUARI	JA12038937	ITABERAI S1	06/12/2019 23:19	07/12/2019 09:19	06/12/2019 23:19	07/12/2019 09:19	10,00	3	29,99	CHI
20191241586	ITAGUARU	JA12038937	ITABERAI S1	06/12/2019 23:19	07/12/2019 09:19	06/12/2019 23:19	07/12/2019 09:19	10,00	1	10,00	CHI
20191241586	JARAGUA	JA12038937	ITABERAI S1	06/12/2019 23:19	07/12/2019 09:19	06/12/2019 23:19	07/12/2019 09:19	10,00	6	59,98	CHI
20191246443	ISRAELANDIA	IS11015574	IPORA	06/12/2019 23:19	08/12/2019 00:15	06/12/2019 23:19	08/12/2019 00:15	24,92	93	2317,64	CHI
20191241596	GOIAS	GS12332675	GOIAS	06/12/2019 23:27	07/12/2019 17:56	06/12/2019 23:27	07/12/2019 17:56	18,48	2	36,95	CHI
20191241610	GOIANIA	00610234	CAMPINAS S1	06/12/2019 23:32	07/12/2019 03:30	06/12/2019 23:32	07/12/2019 00:15	0,71	2057	1466,76	CHI
20191241610	GOIANIA	GN13000397	CAMPINAS S1	06/12/2019 23:32	07/12/2019 03:30	06/12/2019 23:32	07/12/2019 00:29	0,96	328	314,33	CHI
20191241610	GOIANIA	GN10385848	CAMPINAS S1	06/12/2019 23:32	07/12/2019 03:30	06/12/2019 23:32	07/12/2019 03:30	3,96	1422	5635,86	CHI
20191241601	GOIANIA	GN11210900	CARAJAS S2	06/12/2019 23:33	07/12/2019 03:42	06/12/2019 23:33	07/12/2019 03:42	4,15	137	567,98	CHI
20191241604	IPAMERI	IP21071490	PIRES DO RIO S2	06/12/2019 23:35	07/12/2019 09:03	06/12/2019 23:35	07/12/2019 09:03	9,45	1	9,45	CHI
20191241611	GOIANIRA	10004816755	MEIA PONTE	06/12/2019 23:37	07/12/2019 07:12	06/12/2019 23:37	07/12/2019 07:12	7,57	1	7,57	CHI

20191241612	JATAI	JT12182074	JATAI S1	06/12/2019 23:37	08/12/2019 09:00	06/12/2019 23:37	08/12/2019 09:00	33,38	8	267,02	CHI
20191241614	AGUA FRIA DE GOIAS	TL12131760	SAO JOAO D ALIANCA	06/12/2019 23:37	07/12/2019 16:26	06/12/2019 23:37	07/12/2019 09:34	9,95	11	109,41	CHI
20191241614	AGUA FRIA DE GOIAS	TL12131760	SAO JOAO D ALIANCA	06/12/2019 23:37	07/12/2019 16:26	07/12/2019 10:28	07/12/2019 12:06	1,64	12	19,71	CHI
20191241614	AGUA FRIA DE GOIAS	TL12342505LD	SAO JOAO D ALIANCA	06/12/2019 23:37	07/12/2019 16:26	06/12/2019 23:37	07/12/2019 16:12	16,58	1	16,58	CHI
20191241614	AGUA FRIA DE GOIAS	TL12342505LD	SAO JOAO D ALIANCA	06/12/2019 23:37	07/12/2019 16:26	07/12/2019 10:28	07/12/2019 16:12	5,74	5	28,69	CHI
20191241614	FORMOSA	TL12342505LD	SAO JOAO D ALIANCA	06/12/2019 23:37	07/12/2019 16:26	07/12/2019 10:28	07/12/2019 16:12	5,74	2	11,48	CHI
20191241614	AGUA FRIA DE GOIAS	TL12403164	SAO JOAO D ALIANCA	06/12/2019 23:37	07/12/2019 16:26	06/12/2019 23:37	07/12/2019 16:26	16,81	1	16,81	CHI
20191241615	FORMOSA	FA21247779	ITIQUEIRA	06/12/2019 23:39	07/12/2019 09:02	06/12/2019 23:39	07/12/2019 09:02	9,37	1	9,37	CHI
20191241622	RIO VERDE	RV21213756	CABRIUVA S2	06/12/2019 23:45	07/12/2019 17:08	06/12/2019 23:45	07/12/2019 17:08	17,38	1	17,38	CHI
20191241625	FORMOSA	10006898899	ITIQUEIRA	06/12/2019 23:51	07/12/2019 01:49	06/12/2019 23:51	07/12/2019 01:49	1,95	1	1,95	CHI
20191241629	SERRANOPOLIS	SX12296482	JATAI S1	06/12/2019 23:57	07/12/2019 18:42	06/12/2019 23:57	07/12/2019 18:42	18,75	2	37,49	CHI
20191242198	CORREGO DO OURO	CO12079990	SAO LUIZ DOS MONTES BELOS	07/12/2019 00:46	07/12/2019 17:50	07/12/2019 00:46	07/12/2019 17:50	17,07	35	597,46	CHI
20191242198	MOIPORA	CO12079990	SAO LUIZ DOS MONTES BELOS	07/12/2019 00:46	07/12/2019 17:50	07/12/2019 00:46	07/12/2019 17:50	17,07	2	34,14	CHI
20191241985	ARAGUAPAZ	AZ12238876	MOZARLANDIA	07/12/2019 01:39	07/12/2019 10:48	07/12/2019 01:39	07/12/2019 10:48	9,13	15	137,01	CHI
20191242378	ITABERAI	IB12102567	ITABERAI S1	07/12/2019 01:46	07/12/2019 09:04	07/12/2019 01:46	07/12/2019 09:04	7,29	4	29,15	CHI
20191242378	ITAUCU	IB12102567	ITABERAI S1	07/12/2019 01:46	07/12/2019 09:04	07/12/2019 01:46	07/12/2019 09:04	7,29	1	7,29	CHI
20191241679	SANCLERLANDIA	SC10404262	FIRMINOPOLIS S2	07/12/2019 01:56	07/12/2019 22:00	07/12/2019 01:56	07/12/2019 09:48	7,87	20	157,38	CHI
20191241679	SAO LUIS DE MONTES BELOS	SC10404262	FIRMINOPOLIS S2	07/12/2019 01:56	07/12/2019 22:00	07/12/2019 01:56	07/12/2019 09:48	7,87	4	31,48	CHI
20191241679	SANCLERLANDIA	SC10404262	FIRMINOPOLIS S2	07/12/2019 01:56	07/12/2019 22:00	07/12/2019 01:56	07/12/2019 11:17	9,36	2	18,72	CHI
20191241679	BURITI DE GOIAS	SC10404262	FIRMINOPOLIS S2	07/12/2019 01:56	07/12/2019 22:00	07/12/2019 01:56	07/12/2019 11:57	10,03	3	30,08	CHI
20191241679	SANCLERLANDIA	SC10404262	FIRMINOPOLIS S2	07/12/2019 01:56	07/12/2019 22:00	07/12/2019 01:56	07/12/2019 11:57	10,03	29	290,81	CHI
20191241679	SAO LUIS DE MONTES BELOS	SC10404262	FIRMINOPOLIS S2	07/12/2019 01:56	07/12/2019 22:00	07/12/2019 01:56	07/12/2019 11:57	10,03	48	481,35	CHI
20191241679	SANCLERLANDIA	SC10404262	FIRMINOPOLIS S2	07/12/2019 01:56	07/12/2019 22:00	07/12/2019 11:58	07/12/2019 12:38	0,68	22	14,95	CHI
20191241679	SAO LUIS DE MONTES BELOS	SC10404262	FIRMINOPOLIS S2	07/12/2019 01:56	07/12/2019 22:00	07/12/2019 11:58	07/12/2019 12:38	0,68	4	2,72	CHI
20191241679	BURITI DE GOIAS	SC13102361	FIRMINOPOLIS S2	07/12/2019 01:56	07/12/2019 22:00	07/12/2019 11:58	07/12/2019 22:00	10,03	3	30,10	CHI
20191241679	SANCLERLANDIA	SC13102361	FIRMINOPOLIS S2	07/12/2019 01:56	07/12/2019 22:00	07/12/2019 11:58	07/12/2019 22:00	10,03	29	290,97	CHI
20191241679	SAO LUIS DE MONTES BELOS	SC13102361	FIRMINOPOLIS S2	07/12/2019 01:56	07/12/2019 22:00	07/12/2019 11:58	07/12/2019 22:00	10,03	48	481,60	CHI
20191241680	INHUMAS	IN21083416	INHUMAS S1	07/12/2019 02:04	07/12/2019 12:02	07/12/2019 02:04	07/12/2019 12:02	9,96	1	9,96	CHI
20191241685	GOIAS	8527596	GOIAS	07/12/2019 02:14	08/12/2019 00:33	07/12/2019 02:14	08/12/2019 00:33	22,30	2	44,61	CHI
20191241687	GOIANIA	GN12001501	XAVANTES	07/12/2019 02:22	07/12/2019 04:09	07/12/2019 02:22	07/12/2019 04:09	1,79	213	381,74	CHI
20191241691	SANTO ANTONIO DO DESCOBERTO	SN12133153	AGUAS LINDAS DE GOIAS S2	07/12/2019 02:33	07/12/2019 07:47	07/12/2019 02:33	07/12/2019 07:47	5,22	4	20,88	CHI
20191241942	RIO VERDE	RV11271372	RIO VERDE S1	07/12/2019 02:41	07/12/2019 09:00	07/12/2019 02:41	07/12/2019 09:00	6,30	119	749,87	CHI
20191241830	JUSSARA	JR12019314	JUSSARA	07/12/2019 02:52	07/12/2019 06:01	07/12/2019 02:52	07/12/2019 06:01	3,14	82	257,82	CHI

20191241801	PALMINOPOLIS	PP21005795	FIRMINOPOLIS S2	07/12/2019 03:03	07/12/2019 10:45	07/12/2019 03:03	07/12/2019 10:45	7,70	2	15,40	CHI
20191241881	ARAGUAPAZ	RB12290996	RUBIATABA	07/12/2019 03:17	07/12/2019 10:41	07/12/2019 03:17	07/12/2019 10:41	7,39	1	7,39	CHI
20191241881	RUBIATABA	RB12290996	RUBIATABA	07/12/2019 03:17	07/12/2019 10:41	07/12/2019 03:17	07/12/2019 10:41	7,39	9	66,52	CHI
20191243010	AMARALINA	LC12215796	MARA ROSA	07/12/2019 03:20	07/12/2019 11:24	07/12/2019 03:20	07/12/2019 11:24	8,06	13	104,73	CHI
20191241816	MINEIROS	MY12149315	PARQUE DAS EMAS	07/12/2019 03:28	07/12/2019 16:36	07/12/2019 03:28	07/12/2019 16:36	13,14	27	354,67	CHI
20191241817	NOVA IGUACU DE GOIAS	UR12407359	URUACU	07/12/2019 03:29	07/12/2019 12:15	07/12/2019 03:29	07/12/2019 12:15	8,76	20	175,27	CHI
20191241817	PILAR DE GOIAS	UR12407359	URUACU	07/12/2019 03:29	07/12/2019 12:15	07/12/2019 03:29	07/12/2019 12:15	8,76	1	8,76	CHI
20191241817	URUACU	UR12407359	URUACU	07/12/2019 03:29	07/12/2019 12:15	07/12/2019 03:29	07/12/2019 12:15	8,76	30	262,91	CHI
20191241821	DIORAMA	DI12354638	IPORA	07/12/2019 03:33	07/12/2019 09:14	07/12/2019 03:33	07/12/2019 09:14	5,67	4	22,67	CHI
20191242165	MINACU	IH11182332	MINACU	07/12/2019 03:35	07/12/2019 08:35	07/12/2019 03:35	07/12/2019 08:35	4,99	134	669,03	CHI
20191241825	GOIAS	IU12089755	MATRINCHA	07/12/2019 03:38	07/12/2019 08:15	07/12/2019 03:38	07/12/2019 08:15	4,61	1	4,61	CHI
20191241825	ITAPIRAPUA	IU12089755	MATRINCHA	07/12/2019 03:38	07/12/2019 08:15	07/12/2019 03:38	07/12/2019 08:15	4,61	56	258,19	CHI
20191241887	MUNDO NOVO DE GOIAS	MH12357676	NOVA CRIXAS	07/12/2019 03:49	07/12/2019 07:47	07/12/2019 03:49	07/12/2019 07:47	3,97	24	95,19	CHI
20191241829	ARENOPOLIS	AY12000049	ARENOPOLIS	07/12/2019 03:53	07/12/2019 09:21	07/12/2019 03:53	07/12/2019 09:21	5,45	42	229,00	CHI
20191241829	IPORA	AY12000049	ARENOPOLIS	07/12/2019 03:53	07/12/2019 09:21	07/12/2019 03:53	07/12/2019 09:21	5,45	11	59,98	CHI
20191241888	BONOPOLIS	TA12263013	NOVO PLANALTO	07/12/2019 03:59	07/12/2019 09:20	07/12/2019 03:59	07/12/2019 09:20	5,35	31	165,80	CHI
20191244244	SANCLERLANDIA	SL32154587	FIRMINOPOLIS S2	07/12/2019 04:09	07/12/2019 16:00	07/12/2019 04:09	07/12/2019 16:00	11,84	10	118,40	CHI
20191244244	SAO LUIS DE MONTES BELOS	SL32154587	FIRMINOPOLIS S2	07/12/2019 04:09	07/12/2019 16:00	07/12/2019 04:09	07/12/2019 16:00	11,84	9	106,56	CHI
20191242191	BOM JARDIM DE GOIAS	BM12390150	BOM JARDIM	07/12/2019 04:13	09/12/2019 01:03	07/12/2019 04:13	08/12/2019 22:47	42,58	7	298,03	CHI
20191242191	BALIZA	BM12139951LD	BOM JARDIM	07/12/2019 04:13	09/12/2019 01:03	07/12/2019 04:13	09/12/2019 01:03	44,83	51	2286,56	CHI
20191242191	BOM JARDIM DE GOIAS	BM12139951LD	BOM JARDIM	07/12/2019 04:13	09/12/2019 01:03	07/12/2019 04:13	09/12/2019 01:03	44,83	2	89,67	CHI
20191241843	GOIAS	GS12217234	MATRINCHA	07/12/2019 04:16	07/12/2019 16:01	07/12/2019 04:16	07/12/2019 16:01	11,74	82	962,82	CHI
20191241843	ITAPIRAPUA	GS12217234	MATRINCHA	07/12/2019 04:16	07/12/2019 16:01	07/12/2019 04:16	07/12/2019 16:01	11,74	1	11,74	CHI
20191241843	NOVO BRASIL	GS12217234	MATRINCHA	07/12/2019 04:16	07/12/2019 16:01	07/12/2019 04:16	07/12/2019 16:01	11,74	36	422,70	CHI
20191242431	GOIANESIA	GE12297305	GOIANESIA S1	07/12/2019 04:18	07/12/2019 17:46	07/12/2019 04:18	07/12/2019 17:18	13,00	41	532,86	CHI
20191242431	GOIANESIA	GE12297305	GOIANESIA S1	07/12/2019 04:18	07/12/2019 17:46	07/12/2019 14:24	07/12/2019 17:18	2,90	1	2,90	CHI
20191242431	GOIANESIA	GE12376533	GOIANESIA S1	07/12/2019 04:18	07/12/2019 17:46	07/12/2019 04:18	07/12/2019 17:46	13,45	88	1183,75	CHI
20191242018	ANHANGUERA	AH12082016RE	CATALAO S1	07/12/2019 04:20	08/12/2019 18:00	07/12/2019 04:20	07/12/2019 11:30	7,16	11	78,78	CHI
20191242018	CUMARI	AH12082016RE	CATALAO S1	07/12/2019 04:20	08/12/2019 18:00	07/12/2019 04:20	07/12/2019 11:30	7,16	21	150,40	CHI
20191242018	ANHANGUERA	AH12082016RE	CATALAO S1	07/12/2019 04:20	08/12/2019 18:00	07/12/2019 11:54	08/12/2019 18:00	30,11	11	331,26	CHI
20191242018	CUMARI	AH12082016RE	CATALAO S1	07/12/2019 04:20	08/12/2019 18:00	07/12/2019 11:54	08/12/2019 18:00	30,11	21	632,41	CHI
20191241898	PORANGATU	PO12064911	NOVO PLANALTO	07/12/2019 04:21	07/12/2019 08:11	07/12/2019 04:21	07/12/2019 08:11	3,82	134	511,55	CHI
20191242150	MONTE ALEGRE DE GOIAS	MA12261959	SAO DOMINGOS	07/12/2019 04:29	07/12/2019 08:48	07/12/2019 04:29	07/12/2019 08:48	4,30	28	120,42	CHI

20191241853	BONOPOLIS	BX12079321	SAO MIGUEL DO ARAGUAIA	07/12/2019 04:31	07/12/2019 08:02	07/12/2019 04:31	07/12/2019 08:02	3,50	58	203,18	CHI
20191241854	GOIANIRA	TR32045819	MEIA PONTE	07/12/2019 04:32	07/12/2019 08:50	07/12/2019 04:32	07/12/2019 08:50	4,30	23	98,90	CHI
20191241854	TRINDADE	TR32045819	MEIA PONTE	07/12/2019 04:32	07/12/2019 08:50	07/12/2019 04:32	07/12/2019 08:50	4,30	4	17,20	CHI
20191241970	ITAPIRAPUA	IU12018852	MATRINCHA	07/12/2019 04:32	08/12/2019 00:27	07/12/2019 04:32	08/12/2019 00:27	19,91	35	696,86	CHI
20191242589	CRIXAS	MZ12055628	MOZARLANDIA	07/12/2019 04:33	07/12/2019 09:55	07/12/2019 04:33	07/12/2019 09:55	5,36	26	139,40	CHI
20191242589	MOZARLANDIA	MZ12055628	MOZARLANDIA	07/12/2019 04:33	07/12/2019 09:55	07/12/2019 04:33	07/12/2019 09:55	5,36	38	203,74	CHI
20191241857	CORUMBAIBA	CI12092099	VILA CORUMBA	07/12/2019 04:35	07/12/2019 12:50	07/12/2019 04:35	07/12/2019 12:50	8,25	2	16,50	CHI
20191241861	SAO MIGUEL DO ARAGUAIA	SM12081437	SAO MIGUEL DO ARAGUAIA	07/12/2019 04:37	07/12/2019 11:05	07/12/2019 04:37	07/12/2019 11:05	6,47	23	148,73	CHI
20191242123	SANTA ROSA DE GOIAS	03040224	INHUMAS S1	07/12/2019 04:41	07/12/2019 19:58	07/12/2019 04:41	07/12/2019 09:30	4,81	723	3475,82	CHI
20191242123	JARAGUA	03040224	INHUMAS S1	07/12/2019 04:41	07/12/2019 19:58	07/12/2019 04:41	07/12/2019 10:00	5,31	2	10,61	CHI
20191242123	SANTA ROSA DE GOIAS	03040224	INHUMAS S1	07/12/2019 04:41	07/12/2019 19:58	07/12/2019 04:41	07/12/2019 10:00	5,31	85	451,14	CHI
20191242123	TAQUARAL DE GOIAS	03040224	INHUMAS S1	07/12/2019 04:41	07/12/2019 19:58	07/12/2019 04:41	07/12/2019 10:00	5,31	44	233,53	CHI
20191242123	SANTA ROSA DE GOIAS	03040224	INHUMAS S1	07/12/2019 04:41	07/12/2019 19:58	07/12/2019 04:41	07/12/2019 10:48	6,11	61	372,57	CHI
20191242123	JARAGUA	03040224	INHUMAS S1	07/12/2019 04:41	07/12/2019 19:58	07/12/2019 12:38	07/12/2019 12:55	0,27	2	0,54	CHI
20191242123	SANTA ROSA DE GOIAS	03040224	INHUMAS S1	07/12/2019 04:41	07/12/2019 19:58	07/12/2019 12:38	07/12/2019 12:55	0,27	868	232,19	CHI
20191242123	TAQUARAL DE GOIAS	03040224	INHUMAS S1	07/12/2019 04:41	07/12/2019 19:58	07/12/2019 12:38	07/12/2019 12:55	0,27	44	11,77	CHI
20191242123	JARAGUA	03040224	INHUMAS S1	07/12/2019 04:41	07/12/2019 19:58	07/12/2019 04:41	07/12/2019 13:44	9,05	6	54,28	CHI
20191242123	JESUPOLIS	03040224	INHUMAS S1	07/12/2019 04:41	07/12/2019 19:58	07/12/2019 04:41	07/12/2019 13:44	9,05	7	63,33	CHI
20191242123	SANTA ROSA DE GOIAS	03040224	INHUMAS S1	07/12/2019 04:41	07/12/2019 19:58	07/12/2019 04:41	07/12/2019 13:44	9,05	40	361,88	CHI
20191242123	JARAGUA	03040224	INHUMAS S1	07/12/2019 04:41	07/12/2019 19:58	07/12/2019 04:41	07/12/2019 19:58	15,28	31	473,59	CHI
20191242123	JESUPOLIS	03040224	INHUMAS S1	07/12/2019 04:41	07/12/2019 19:58	07/12/2019 04:41	07/12/2019 19:58	15,28	17	259,71	CHI
20191241867	MARA ROSA	MQ10403947	MARA ROSA	07/12/2019 04:42	07/12/2019 09:25	07/12/2019 04:42	07/12/2019 07:22	2,67	52	138,96	CHI
20191241867	MARA ROSA	MQ10403947	MARA ROSA	07/12/2019 04:42	07/12/2019 09:25	07/12/2019 04:42	07/12/2019 08:41	3,99	102	406,70	CHI
20191241867	NOVA IGUACU DE GOIAS	MQ10403947	MARA ROSA	07/12/2019 04:42	07/12/2019 09:25	07/12/2019 04:42	07/12/2019 08:41	3,99	12	47,85	CHI
20191241867	ALTO HORIZONTE	MQ10403947	MARA ROSA	07/12/2019 04:42	07/12/2019 09:25	07/12/2019 04:42	07/12/2019 09:25	4,71	84	395,69	CHI
20191241867	MARA ROSA	MQ10403947	MARA ROSA	07/12/2019 04:42	07/12/2019 09:25	07/12/2019 04:42	07/12/2019 09:25	4,71	40	188,42	CHI
20191241867	NOVA IGUACU DE GOIAS	MQ10403947	MARA ROSA	07/12/2019 04:42	07/12/2019 09:25	07/12/2019 04:42	07/12/2019 09:25	4,71	12	56,53	CHI
20191241867	URUACU	MQ10403947	MARA ROSA	07/12/2019 04:42	07/12/2019 09:25	07/12/2019 04:42	07/12/2019 09:25	4,71	1	4,71	CHI
20191241868	NOVA CRIXAS	NA12181524	NOVA CRIXAS	07/12/2019 04:47	07/12/2019 09:05	07/12/2019 04:47	07/12/2019 09:05	4,29	2	8,59	CHI
20191244536	SAO LUIS DE MONTES BELOS	SL12308509	SAO LUIZ DOS MONTES BELOS	07/12/2019 04:53	08/12/2019 00:34	07/12/2019 04:53	08/12/2019 00:34	19,68	4	78,71	CHI
20191241870	PORANGATU	TB12208457	PORANGATU	07/12/2019 04:55	07/12/2019 08:55	07/12/2019 04:55	07/12/2019 08:55	4,00	1	4,00	CHI
20191241870	TROMBAS	TB12208457	PORANGATU	07/12/2019 04:55	07/12/2019 08:55	07/12/2019 04:55	07/12/2019 08:55	4,00	16	63,94	CHI
20191241947	ITAPIRAPUA	IU12018777	JUSSARA	07/12/2019 04:59	07/12/2019 08:30	07/12/2019 04:59	07/12/2019 08:30	3,51	12	42,12	CHI



20191241875	BONOPOLIS	BX12263014	SAO MIGUEL DO ARAGUAIA	07/12/2019 05:00	07/12/2019 07:20	07/12/2019 05:00	07/12/2019 07:20	2,32	4	9,29	CHI
20191242646	AURILANDIA	CG12391526	FIRMINOPOLIS S2	07/12/2019 05:02	07/12/2019 19:02	07/12/2019 05:02	07/12/2019 19:02	14,00	2	28,00	CHI
20191242646	CACHOEIRA DE GOIAS	CG12391526	FIRMINOPOLIS S2	07/12/2019 05:02	07/12/2019 19:02	07/12/2019 05:02	07/12/2019 19:02	14,00	11	154,00	CHI
20191242646	PARAUNA	CG12391526	FIRMINOPOLIS S2	07/12/2019 05:02	07/12/2019 19:02	07/12/2019 05:02	07/12/2019 19:02	14,00	32	448,00	CHI
20191241878	MINEIROS	PW12336959	PARQUE DAS EMAS	07/12/2019 05:03	07/12/2019 23:26	07/12/2019 05:03	07/12/2019 23:26	18,37	4	73,47	CHI
20191242398	ANICUNS	AC12304664	FIRMINOPOLIS S2	07/12/2019 05:03	07/12/2019 10:52	07/12/2019 05:03	07/12/2019 10:52	5,82	14	81,44	CHI
20191241879	NOVA CRIXAS	NA12354854	NOVA CRIXAS	07/12/2019 05:04	07/12/2019 08:16	07/12/2019 05:04	07/12/2019 08:16	3,20	9	28,77	CHI
20191241954	ITAUCU	PV17246847	CORUMBA	07/12/2019 05:06	07/12/2019 09:03	07/12/2019 05:06	07/12/2019 09:03	3,94	1	3,94	CHI
20191241954	PIRENOPOLIS	PV17246847	CORUMBA	07/12/2019 05:06	07/12/2019 09:03	07/12/2019 05:06	07/12/2019 09:03	3,94	70	276,01	CHI
20191241885	ARENOPOLIS	PH12193383	PIRANHAS	07/12/2019 05:08	07/12/2019 07:43	07/12/2019 05:08	07/12/2019 07:43	2,57	1	2,57	CHI
20191241885	PIRANHAS	PH12193383	PIRANHAS	07/12/2019 05:08	07/12/2019 07:43	07/12/2019 05:08	07/12/2019 07:43	2,57	67	172,02	CHI
20191241901	BALIZA	BH12334823	BOM JARDIM	07/12/2019 05:17	07/12/2019 07:51	07/12/2019 05:17	07/12/2019 07:51	2,56	201	514,00	CHI
20191241893	VICENTINOPOLIS	VI12263804	VICENTINOPOLIS	07/12/2019 05:19	07/12/2019 10:50	07/12/2019 05:19	07/12/2019 10:50	5,51	15	82,65	CHI
20191241894	BRITANIA	BT12395894	BRITANIA	07/12/2019 05:19	10/12/2019 13:41	07/12/2019 05:19	08/12/2019 21:09	39,84	2	79,68	CHI
20191241894	BRITANIA	BT12395894	BRITANIA	07/12/2019 05:19	10/12/2019 13:41	07/12/2019 05:19	08/12/2019 22:43	41,39	1	41,39	CHI
20191241894	BRITANIA	BT12395894	BRITANIA	07/12/2019 05:19	10/12/2019 13:41	07/12/2019 05:19	08/12/2019 23:41	42,38	1	42,38	CHI
20191241894	BRITANIA	BT12395894	BRITANIA	07/12/2019 05:19	10/12/2019 13:41	07/12/2019 05:19	09/12/2019 23:22	66,05	2	132,10	CHI
20191241894	BRITANIA	BT12395894	BRITANIA	07/12/2019 05:19	10/12/2019 13:41	07/12/2019 05:19	10/12/2019 13:41	80,37	1	80,37	CHI
20191241897	PIRENOPOLIS	PV12302141	SAO FRANCISCO DE GOIAS	07/12/2019 05:20	07/12/2019 09:33	07/12/2019 05:20	07/12/2019 09:33	4,21	93	391,09	CHI
20191241537	CAMPOS BELOS	MA12150372	SAO DOMINGOS	07/12/2019 05:24	07/12/2019 07:43	07/12/2019 05:24	07/12/2019 07:43	2,30	20	46,08	CHI
20191241537	MONTE ALEGRE DE GOIAS	MA12150372	SAO DOMINGOS	07/12/2019 05:24	07/12/2019 07:43	07/12/2019 05:24	07/12/2019 07:43	2,30	39	89,86	CHI
20191241902	APARECIDA DE GOIANIA	AP12150292	INDEPENDENCIA S2	07/12/2019 05:24	07/12/2019 10:26	07/12/2019 05:24	07/12/2019 10:26	5,03	32	161,06	CHI
20191242627	PALMEIRAS DE GOIAS	PL12000078	PALMEIRAS	07/12/2019 05:25	07/12/2019 10:50	07/12/2019 05:25	07/12/2019 10:50	5,42	34	184,30	CHI
20191242416	CAMPOS BELOS	CH12384777	SAO DOMINGOS	07/12/2019 05:26	07/12/2019 08:53	07/12/2019 05:26	07/12/2019 08:53	3,44	13	44,70	CHI
20191241907	CAMPINACU	IH12320899	MINACU	07/12/2019 05:28	07/12/2019 09:12	07/12/2019 05:28	07/12/2019 09:12	3,72	13	48,36	CHI
20191241907	MINACU	IH12320899	MINACU	07/12/2019 05:28	07/12/2019 09:12	07/12/2019 05:28	07/12/2019 09:12	3,72	9	33,48	CHI
201912233292	MOSSAMEDES	MD12005317	FIRMINOPOLIS S2	07/12/2019 05:29	07/12/2019 15:59	07/12/2019 05:29	07/12/2019 15:59	10,49	16	167,78	CHI
20191240890	ITAUCU	IX12326187	INHUMAS S1	07/12/2019 05:30	07/12/2019 08:37	07/12/2019 05:30	07/12/2019 08:37	3,10	7	21,73	CHI
20191241746	TAQUARAL DE GOIAS	TQ12250778	INHUMAS S1	07/12/2019 05:30	07/12/2019 11:28	07/12/2019 05:30	07/12/2019 11:28	5,95	38	226,26	CHI
20191241911	AGUA FRIA DE GOIAS	MJ12040650	PADRE BERNARDO	07/12/2019 05:31	07/12/2019 09:07	07/12/2019 05:31	07/12/2019 09:07	3,58	9	32,26	CHI
20191241911	MIMOSO DE GOIAS	MJ12040650	PADRE BERNARDO	07/12/2019 05:31	07/12/2019 09:07	07/12/2019 05:31	07/12/2019 09:07	3,58	12	43,02	CHI
20191241913	CAMPESTRE DE GOIAS	GA12008543	GUAPO S2	07/12/2019 05:32	07/12/2019 09:25	07/12/2019 05:32	07/12/2019 09:25	3,88	11	42,64	CHI
20191241913	GUAPO	GA12008543	GUAPO S2	07/12/2019 05:32	07/12/2019 09:25	07/12/2019 05:32	07/12/2019 09:25	3,88	26	100,79	CHI

20191242059	EDEIA	IY12010954	EDEIA	07/12/2019 05:32	07/12/2019 08:25	07/12/2019 05:32	07/12/2019 08:25	2,88	5	14,42	CHI
20191242059	INDIARA	IY12010954	EDEIA	07/12/2019 05:32	07/12/2019 08:25	07/12/2019 05:32	07/12/2019 08:25	2,88	46	132,62	CHI
20191242699	ALTO PARAISO DE GOIAS	ND12302636	IACIARA S2	07/12/2019 05:34	07/12/2019 10:22	07/12/2019 05:34	07/12/2019 10:22	4,79	18	86,19	CHI
20191242699	NOVA ROMA	ND12302636	IACIARA S2	07/12/2019 05:34	07/12/2019 10:22	07/12/2019 05:34	07/12/2019 10:22	4,79	96	459,71	CHI
20191242699	SAO JOAO D ALIANCA	ND12302636	IACIARA S2	07/12/2019 05:34	07/12/2019 10:22	07/12/2019 05:34	07/12/2019 10:22	4,79	12	57,46	CHI
20191241715	CASTELANDIA	DM12000064	RIO DOS BOIS	07/12/2019 05:37	07/12/2019 12:12	07/12/2019 05:37	07/12/2019 12:12	6,57	10	65,73	CHI
20191241715	MAURILANDIA	DM12000064	RIO DOS BOIS	07/12/2019 05:37	07/12/2019 12:12	07/12/2019 05:37	07/12/2019 12:12	6,57	1	6,57	CHI
20191241924	SANTO ANTONIO DO DESCOBERTO	2210156872	ALEXANIA	07/12/2019 05:37	07/12/2019 09:03	07/12/2019 05:37	07/12/2019 09:03	3,42	1	3,42	CHI
20191241930	FLORES DE GOIAS	FA12042061	ITIQUEIRA	07/12/2019 05:40	07/12/2019 10:00	07/12/2019 05:40	07/12/2019 10:00	4,32	2	8,64	CHI
20191241930	VILA BOA	FA12042061	ITIQUEIRA	07/12/2019 05:40	07/12/2019 10:00	07/12/2019 05:40	07/12/2019 10:00	4,32	1	4,32	CHI
20191242453	PORANGATU	PO12241996	PORANGATU	07/12/2019 05:42	07/12/2019 09:28	07/12/2019 05:42	07/12/2019 09:28	3,75	80	300,38	CHI
20191241935	NOVA CRIXAS	NA12349203	NOVA CRIXAS	07/12/2019 05:44	07/12/2019 09:52	07/12/2019 05:44	07/12/2019 09:52	4,12	4	16,50	CHI
20191241936	AMARALINA	LC12168855	MARA ROSA	07/12/2019 05:45	07/12/2019 10:28	07/12/2019 05:45	07/12/2019 10:28	4,72	35	165,03	CHI
20191241936	MARA ROSA	LC12168855	MARA ROSA	07/12/2019 05:45	07/12/2019 10:28	07/12/2019 05:45	07/12/2019 10:28	4,72	8	37,72	CHI
20191242360	GOIAS	GS12206865	MATRINCHA	07/12/2019 05:48	07/12/2019 17:50	07/12/2019 05:48	07/12/2019 17:50	12,03	67	805,99	CHI
20191243637	MOSSAMEDES	MD12000176	FIRMINOPOLIS S2	07/12/2019 05:49	07/12/2019 14:51	07/12/2019 05:49	07/12/2019 14:51	9,04	32	289,24	CHI
20191241959	VICENTINOPOLIS	VI21372843	VICENTINOPOLIS	07/12/2019 05:52	07/12/2019 11:20	07/12/2019 05:52	07/12/2019 11:20	5,45	1	5,45	CHI
20191241962	ARUANA	AK21310707	ARUANA	07/12/2019 05:53	07/12/2019 06:49	07/12/2019 05:53	07/12/2019 06:49	0,92	1	0,92	CHI
20191241968	BONOPOLIS	BX12193536	SAO MIGUEL DO ARAGUAIA	07/12/2019 05:54	07/12/2019 07:41	07/12/2019 05:54	07/12/2019 07:41	1,77	10	17,68	CHI
20191241969	APARECIDA DE GOIANIA	AP12004887	ATLANTICO S1	07/12/2019 05:55	07/12/2019 08:05	07/12/2019 05:55	07/12/2019 08:05	2,16	697	1507,07	CHI
20191241973	ABADIANIA	AA21184724	ANAPOLIS UNIVERSITARIO S1	07/12/2019 05:55	07/12/2019 13:30	07/12/2019 05:55	07/12/2019 13:30	7,57	2	15,14	CHI
20191242009	PORANGATU	MU12094084	MARA ROSA	07/12/2019 05:55	07/12/2019 07:46	07/12/2019 05:55	07/12/2019 07:46	1,84	66	121,24	CHI
20191242046	BONOPOLIS	BX12202542	SAO MIGUEL DO ARAGUAIA	07/12/2019 05:55	07/12/2019 11:00	07/12/2019 05:55	07/12/2019 11:00	5,07	55	278,99	CHI
20191242046	PORANGATU	BX12202542	SAO MIGUEL DO ARAGUAIA	07/12/2019 05:55	07/12/2019 11:00	07/12/2019 05:55	07/12/2019 11:00	5,07	1	5,07	CHI
20191241979	INHUMAS	30128493	INHUMAS S2	07/12/2019 05:58	07/12/2019 09:39	07/12/2019 05:58	07/12/2019 09:39	3,68	1	3,68	CHI
20191242698	FAINA	FC12124752	GOIAS	07/12/2019 05:59	07/12/2019 09:38	07/12/2019 05:59	07/12/2019 09:38	3,65	25	91,16	CHI
20191241984	NOVA CRIXAS	NA12391603	NOVA CRIXAS	07/12/2019 06:00	07/12/2019 08:30	07/12/2019 06:00	07/12/2019 08:30	2,49	41	101,90	CHI
20191241994	ANAPOLIS	AN31000788	ANAPOLIS UNIVERSITARIO S2	07/12/2019 06:04	07/12/2019 07:50	07/12/2019 06:04	07/12/2019 07:50	1,76	1	1,76	CHI
20191242176	BARRO ALTO	GE12000092	GOIANESIA S1	07/12/2019 06:04	07/12/2019 12:11	07/12/2019 06:04	07/12/2019 12:11	6,11	2	12,23	CHI
20191242176	GOIANESIA	GE12000092	GOIANESIA S1	07/12/2019 06:04	07/12/2019 12:11	07/12/2019 06:04	07/12/2019 12:11	6,11	19	116,17	CHI
20191242000	SANTA CRUZ DE GOIAS	BC12389804	PIRES DO RIO S2	07/12/2019 06:06	08/12/2019 17:10	07/12/2019 06:06	07/12/2019 15:56	9,83	8	78,65	CHI
20191242000	SANTA CRUZ DE GOIAS	7546919	PIRES DO RIO S2	07/12/2019 06:06	08/12/2019 17:10	07/12/2019 15:57	08/12/2019 16:50	24,88	8	199,05	CHI
20191242000	SANTA CRUZ DE GOIAS	BC12095321	PIRES DO RIO S2	07/12/2019 06:06	08/12/2019 17:10	07/12/2019 06:06	08/12/2019 17:10	35,07	14	490,93	CHI

20191242020	BOM JARDIM DE GOIAS	BM12155682	BOM JARDIM	07/12/2019 06:06	07/12/2019 09:44	07/12/2019 06:06	07/12/2019 09:44	3,63	14	50,80	CHI
20191242020	PIRANHAS	BM12155682	BOM JARDIM	07/12/2019 06:06	07/12/2019 09:44	07/12/2019 06:06	07/12/2019 09:44	3,63	4	14,52	CHI
20191243215	GOIAS	GS12071232	GOIAS	07/12/2019 06:06	07/12/2019 14:42	07/12/2019 06:06	07/12/2019 14:42	8,60	38	326,79	CHI
20191242003	PLANALTINA	PI12359150	PLANALTINA	07/12/2019 06:07	07/12/2019 07:56	07/12/2019 06:07	07/12/2019 07:56	1,82	20	36,32	CHI
20191242006	GOIANAPOLIS	GP12285356	DAIA S2	07/12/2019 06:07	07/12/2019 09:47	07/12/2019 06:07	07/12/2019 09:47	3,66	8	29,24	CHI
20191242007	URUACU	UR12243628	MARA ROSA	07/12/2019 06:07	07/12/2019 19:46	07/12/2019 06:07	07/12/2019 19:46	13,65	3	40,95	CHI
20191242432	BONOPOLIS	BX12391936	SAO MIGUEL DO ARAGUAIA	07/12/2019 06:07	07/12/2019 08:51	07/12/2019 06:07	07/12/2019 08:51	2,73	29	79,12	CHI
20191242015	IPORA	IR12014001	IPORA	07/12/2019 06:10	07/12/2019 09:58	07/12/2019 06:10	07/12/2019 09:58	3,78	10	37,85	CHI
20191242017	CRISTIANOPOLIS	CF12086343	CRISTIANOPOLIS	07/12/2019 06:12	07/12/2019 09:35	07/12/2019 06:12	07/12/2019 09:35	3,37	1	3,37	CHI
20191241796	VIANOPOLIS	OZ12094962	VIANOPOLIS	07/12/2019 06:14	07/12/2019 15:26	07/12/2019 06:14	07/12/2019 15:26	9,20	1	9,20	CHI
20191242027	PORANGATU	TB12262770	PORANGATU	07/12/2019 06:15	07/12/2019 09:30	07/12/2019 06:15	07/12/2019 09:30	3,25	1	3,25	CHI
20191242027	SANTA TEREZA DE GOIAS	TB12262770	PORANGATU	07/12/2019 06:15	07/12/2019 09:30	07/12/2019 06:15	07/12/2019 09:30	3,25	5	16,24	CHI
20191242027	TROMBAS	TB12262770	PORANGATU	07/12/2019 06:15	07/12/2019 09:30	07/12/2019 06:15	07/12/2019 09:30	3,25	13	42,23	CHI
20191242033	ITUMBIAARA	BJ12000194	CACHOEIRA DOURADA	07/12/2019 06:17	07/12/2019 08:21	07/12/2019 06:17	07/12/2019 08:21	2,05	6	12,31	CHI
20191242034	GOIAS	GS12068550	MATRINCHA	07/12/2019 06:17	07/12/2019 22:03	07/12/2019 06:17	07/12/2019 22:03	15,75	19	299,29	CHI
20191242035	ANICUNS	AC21000080	ANICUNS	07/12/2019 06:18	07/12/2019 14:40	07/12/2019 06:18	07/12/2019 14:40	8,37	2	16,73	CHI
20191243610	GOIAS	GS12021056	GOIAS	07/12/2019 06:18	07/12/2019 18:28	07/12/2019 06:18	07/12/2019 18:28	12,16	27	328,25	CHI
20191242044	PIRACANJUBA	PJ12070778	PIRACANJUBA	07/12/2019 06:20	07/12/2019 13:30	07/12/2019 06:20	07/12/2019 13:30	7,16	2	14,31	CHI
20191242048	MAIRIPOTABA	PK12293392	PONTALINA	07/12/2019 06:20	08/12/2019 08:30	07/12/2019 06:20	08/12/2019 08:30	26,15	1	26,15	CHI
20191242048	PONTALINA	PK12293392	PONTALINA	07/12/2019 06:20	08/12/2019 08:30	07/12/2019 06:20	08/12/2019 08:30	26,15	13	339,96	CHI
20191242602	JUSSARA	RN12138786	BRITANIA	07/12/2019 06:20	07/12/2019 14:12	07/12/2019 06:20	07/12/2019 14:12	7,86	1	7,86	CHI
20191242602	SANTA FE DE GOIAS	RN12138786	BRITANIA	07/12/2019 06:20	07/12/2019 14:12	07/12/2019 06:20	07/12/2019 14:12	7,86	8	62,91	CHI
20191243005	ABADIANIA	AA12388804	DAIA S2	07/12/2019 06:20	07/12/2019 11:29	07/12/2019 06:20	07/12/2019 11:29	5,14	27	138,66	CHI
20191243420	FIRMINOPOLIS	SL12111561	FIRMINOPOLIS S1	07/12/2019 06:20	07/12/2019 17:50	07/12/2019 06:20	07/12/2019 17:50	11,49	6	68,96	CHI
20191243420	SAO LUIS DE MONTES BELOS	SL12111561	FIRMINOPOLIS S1	07/12/2019 06:20	07/12/2019 17:50	07/12/2019 06:20	07/12/2019 17:50	11,49	3	34,48	CHI
20191242053	HIDROLANDIA	HD32093244	CEPAIGO S1	07/12/2019 06:22	07/12/2019 12:19	07/12/2019 06:22	07/12/2019 12:19	5,94	6	35,64	CHI
20191242058	IACIARA	IA12160059	IACIARA S1	07/12/2019 06:24	07/12/2019 09:26	07/12/2019 06:24	07/12/2019 09:26	3,03	22	66,65	CHI
20191242065	INHUMAS	30167334	INHUMAS S2	07/12/2019 06:25	07/12/2019 20:44	07/12/2019 06:25	07/12/2019 20:44	14,30	1	14,30	CHI
20191242204	PARAUNA	PU12081329	PARAUNA	07/12/2019 06:25	08/12/2019 23:49	07/12/2019 06:25	08/12/2019 09:48	27,38	21	574,97	CHI
20191242204	PARAUNA	PU12194219LD	PARAUNA	07/12/2019 06:25	08/12/2019 23:49	07/12/2019 06:25	08/12/2019 11:05	28,66	33	945,88	CHI
20191242204	PARAUNA	PU12336678	PARAUNA	07/12/2019 06:25	08/12/2019 23:49	08/12/2019 11:16	08/12/2019 16:30	5,23	2	10,45	CHI
20191242204	PARAUNA	PU12081329	PARAUNA	07/12/2019 06:25	08/12/2019 23:49	08/12/2019 19:47	08/12/2019 20:36	0,82	23	18,88	CHI
20191242204	PARAUNA	PU12336680LD	PARAUNA	07/12/2019 06:25	08/12/2019 23:49	08/12/2019 11:16	08/12/2019 22:22	11,10	11	122,14	CHI

20191242204	PARAUNA	PU12336680LD	PARAUNA	07/12/2019 06:25	08/12/2019 23:49	08/12/2019 11:16	08/12/2019 22:58	11,70	20	233,94	CHI
20191242204	PARAUNA	PU12336680LD	PARAUNA	07/12/2019 06:25	08/12/2019 23:49	08/12/2019 11:16	08/12/2019 23:33	12,28	4	49,12	CHI
20191242204	PARAUNA	PU12336680LD	PARAUNA	07/12/2019 06:25	08/12/2019 23:49	08/12/2019 11:16	08/12/2019 23:48	12,53	5	62,65	CHI
20191242204	PARAUNA	PU12336680LD	PARAUNA	07/12/2019 06:25	08/12/2019 23:49	08/12/2019 11:16	08/12/2019 23:49	12,54	1	12,54	CHI
20191242066	SANTA TEREZINHA DE GOIAS	SG12201785	SANTA TEREZINHA	07/12/2019 06:26	08/12/2019 22:40	07/12/2019 06:26	08/12/2019 17:57	35,52	9	319,70	CHI
20191242066	SANTA TEREZINHA DE GOIAS	SG12237416LD	SANTA TEREZINHA	07/12/2019 06:26	08/12/2019 22:40	07/12/2019 06:26	08/12/2019 21:44	39,29	30	1178,75	CHI
20191242066	SANTA TEREZINHA DE GOIAS	SG12201785	SANTA TEREZINHA	07/12/2019 06:26	08/12/2019 22:40	07/12/2019 06:26	08/12/2019 22:40	40,23	5	201,13	CHI
20191242067	CACHOEIRA ALTA	CA12384079	CACHOEIRA ALTA	07/12/2019 06:26	07/12/2019 15:30	07/12/2019 06:26	07/12/2019 15:30	9,06	4	36,25	CHI
20191242069	JUSSARA	JR12114074	JUSSARA	07/12/2019 06:27	07/12/2019 17:00	07/12/2019 06:27	07/12/2019 17:00	10,54	20	210,78	CHI
20191242075	BOM JARDIM DE GOIAS	BM12065725	BOM JARDIM	07/12/2019 06:29	07/12/2019 16:15	07/12/2019 06:29	07/12/2019 16:15	9,75	102	994,81	CHI
20191242075	PIRANHAS	BM12065725	BOM JARDIM	07/12/2019 06:29	07/12/2019 16:15	07/12/2019 06:29	07/12/2019 16:15	9,75	9	87,78	CHI
20191242079	CAIAPONIA	PH12207936	PIRANHAS	07/12/2019 06:29	08/12/2019 12:26	07/12/2019 06:29	08/12/2019 12:26	29,94	8	239,54	CHI
20191242307	PEROLANDIA	DP12209129	JATAI S1	07/12/2019 06:29	07/12/2019 16:03	07/12/2019 06:29	07/12/2019 16:03	9,56	7	66,92	CHI
20191242900	CAIAPONIA	CP12329080	CAIAPONIA	07/12/2019 06:30	08/12/2019 08:09	07/12/2019 06:30	08/12/2019 08:09	25,65	38	974,58	CHI
201912260782	PIRACANJUBA	PJ12000052RE	PIRACANJUBA	07/12/2019 06:30	07/12/2019 16:20	07/12/2019 06:30	07/12/2019 16:20	9,83	51	501,17	CHI
201912260782	PROFESSOR JAMIL SAFADY	PJ12000052RE	PIRACANJUBA	07/12/2019 06:30	07/12/2019 16:20	07/12/2019 06:30	07/12/2019 16:20	9,83	3	29,48	CHI
20191242084	ITAPIRAPUA	IU12018810	MATRINCHA	07/12/2019 06:31	07/12/2019 13:25	07/12/2019 06:31	07/12/2019 13:25	6,88	27	185,87	CHI
20191242086	FORMOSA	FA21329740	ITUIQUIRA	07/12/2019 06:32	07/12/2019 12:05	07/12/2019 06:32	07/12/2019 12:05	5,54	1	5,54	CHI
20191242240	CAMPINACU	IH12360453	MINACU	07/12/2019 06:34	07/12/2019 11:07	07/12/2019 06:34	07/12/2019 11:07	4,55	5	22,74	CHI
20191242240	MINACU	IH12360453	MINACU	07/12/2019 06:34	07/12/2019 11:07	07/12/2019 06:34	07/12/2019 11:07	4,55	72	327,46	CHI
20191242312	MAIRIPOTABA	MI12000426	PONTALINA	07/12/2019 06:35	07/12/2019 09:29	07/12/2019 06:35	07/12/2019 09:29	2,90	9	26,08	CHI
20191242762	IACIARA	IA12257653	IACIARA S1	07/12/2019 06:36	07/12/2019 10:48	07/12/2019 06:36	07/12/2019 10:48	4,19	6	25,16	CHI
20191243396	FAINA	FC12299779	MATRINCHA	07/12/2019 06:37	08/12/2019 15:58	07/12/2019 06:37	08/12/2019 15:58	33,34	15	500,12	CHI
20191243396	MATRINCHA	FC12299779	MATRINCHA	07/12/2019 06:37	08/12/2019 15:58	07/12/2019 06:37	08/12/2019 15:58	33,34	38	1266,97	CHI
20191242108	SILVANIA	SV12205354	DAIA S2	07/12/2019 06:38	07/12/2019 12:50	07/12/2019 06:38	07/12/2019 12:50	6,20	38	235,60	CHI
20191242113	FAINA	FC12299839	GOIAS	07/12/2019 06:40	08/12/2019 06:59	07/12/2019 06:40	08/12/2019 06:59	24,31	12	291,73	CHI
20191242114	APARECIDA DE GOIANIA	200199328	CEPAIGO S1	07/12/2019 06:40	07/12/2019 09:56	07/12/2019 06:40	07/12/2019 09:56	3,26	1	3,26	CHI
20191242116	SANTA FE DE GOIAS	2070020016	BRITANIA	07/12/2019 06:41	07/12/2019 21:06	07/12/2019 06:41	07/12/2019 21:06	14,42	1	14,42	CHI
20191242118	CACU	CC12063061	CACHOEIRA ALTA	07/12/2019 06:42	07/12/2019 14:56	07/12/2019 06:42	07/12/2019 14:56	8,23	1	8,23	CHI
20191242118	ITARUMA	CC12063061	CACHOEIRA ALTA	07/12/2019 06:42	07/12/2019 14:56	07/12/2019 06:42	07/12/2019 14:56	8,23	4	32,92	CHI
20191241717	SANCLERLANDIA	SC21169231	FIRMINOPOLIS S2	07/12/2019 06:43	07/12/2019 15:50	07/12/2019 06:43	07/12/2019 15:50	9,13	1	9,13	CHI
20191242125	CORREGO DO OURO	CO12299163	FIRMINOPOLIS S2	07/12/2019 06:45	07/12/2019 14:12	07/12/2019 06:45	07/12/2019 14:12	7,44	13	96,76	CHI
20191242190	PONTALINA	PK12063352	PONTALINA	07/12/2019 06:45	07/12/2019 08:06	07/12/2019 06:45	07/12/2019 08:06	1,34	17	22,72	CHI

20191242127	LUZIANIA	LZ11163847	RIO VERMELHO	07/12/2019 06:46	07/12/2019 10:59	07/12/2019 06:46	07/12/2019 10:59	4,22	154	649,28	CHI
20191242129	TRES RANCHOS	TH21195262	CATALAO S1	07/12/2019 06:46	07/12/2019 08:32	07/12/2019 06:46	07/12/2019 08:32	1,76	2	3,51	CHI
20191242134	PILAR DE GOIAS	HL12292476	URUACU	07/12/2019 06:47	07/12/2019 10:21	07/12/2019 06:47	07/12/2019 10:21	3,55	1	3,55	CHI
20191242135	OUIDOR	OU12358276RE	CATALAO S1	07/12/2019 06:48	07/12/2019 09:50	07/12/2019 06:48	07/12/2019 09:50	3,03	25	75,81	CHI
20191241465	ALEXANIA	AX12061853	ALEXANIA	07/12/2019 06:49	07/12/2019 10:42	07/12/2019 06:49	07/12/2019 10:42	3,88	5	19,39	CHI
20191242139	ITABERAI	IX12320351	INHUMAS S1	07/12/2019 06:49	07/12/2019 10:54	07/12/2019 06:49	07/12/2019 10:54	4,08	3	12,24	CHI
20191242139	ITAUCU	IX12320351	INHUMAS S1	07/12/2019 06:49	07/12/2019 10:54	07/12/2019 06:49	07/12/2019 10:54	4,08	7	28,56	CHI
20191242142	HIDROLINA	HL21202124	URUACU	07/12/2019 06:49	07/12/2019 08:45	07/12/2019 06:49	07/12/2019 08:45	1,92	1	1,92	CHI
20191242213	CORREGO DO OURO	CO12206022	FIRMINOPOLIS S2	07/12/2019 06:49	07/12/2019 10:44	07/12/2019 06:49	07/12/2019 10:44	3,91	8	31,30	CHI
20191243218	ITAJA	IJ2214312	ITAJA S2	07/12/2019 06:49	07/12/2019 15:10	07/12/2019 06:49	07/12/2019 15:10	8,34	5	41,71	CHI
20191242148	DAMOLANDIA	DL12014118	INHUMAS S1	07/12/2019 06:50	07/12/2019 10:06	07/12/2019 06:50	07/12/2019 10:06	3,26	7	22,80	CHI
20191242149	CACHOEIRA ALTA	CA12041706	CACHOEIRA ALTA	07/12/2019 06:50	07/12/2019 13:45	07/12/2019 06:50	07/12/2019 13:45	6,91	9	62,17	CHI
20191242151	ARUANA	AK12183185	BRITANIA	07/12/2019 06:50	08/12/2019 11:41	07/12/2019 06:50	08/12/2019 11:41	28,85	5	144,26	CHI
20191242230	MUNDO NOVO DE GOIAS	NA12035650	NOVA CRIXAS	07/12/2019 06:53	07/12/2019 09:45	07/12/2019 06:53	07/12/2019 09:45	2,86	8	22,84	CHI
20191242230	NOVA CRIXAS	NA12035650	NOVA CRIXAS	07/12/2019 06:53	07/12/2019 09:45	07/12/2019 06:53	07/12/2019 09:45	2,86	22	62,82	CHI
20191242210	GOIAS	IU12375067	MATRINCHA	07/12/2019 06:54	07/12/2019 09:30	07/12/2019 06:54	07/12/2019 09:30	2,60	12	31,16	CHI
20191242180	JUSSARA	RN12079527	BRITANIA	07/12/2019 06:59	08/12/2019 03:35	07/12/2019 06:59	08/12/2019 03:35	20,60	2	41,19	CHI
20191242180	SANTA FE DE GOIAS	RN12079527	BRITANIA	07/12/2019 06:59	08/12/2019 03:35	07/12/2019 06:59	08/12/2019 03:35	20,60	11	226,56	CHI
20191242181	GOIANIA	16717557	XAVANTES	07/12/2019 06:59	07/12/2019 08:30	07/12/2019 06:59	07/12/2019 08:30	1,51	1	1,51	CHI
20191242182	MARA ROSA	MQ12262723	MARA ROSA	07/12/2019 06:59	07/12/2019 20:00	07/12/2019 06:59	07/12/2019 20:00	13,01	2	26,02	CHI
20191242413	ARENOPOLIS	PH12233032	PIRANHAS	07/12/2019 07:01	08/12/2019 15:48	07/12/2019 07:01	08/12/2019 15:48	32,77	3	98,31	CHI
20191242413	PIRANHAS	PH12233032	PIRANHAS	07/12/2019 07:01	08/12/2019 15:48	07/12/2019 07:01	08/12/2019 15:48	32,77	4	131,08	CHI
201912233204	MORRINHOS	MR12000194	MORRINHOS	07/12/2019 07:01	07/12/2019 14:15	07/12/2019 07:01	07/12/2019 10:51	3,82	31	118,56	CHI
201912233204	MORRINHOS	MR32092122	MORRINHOS	07/12/2019 07:01	07/12/2019 14:15	07/12/2019 07:01	07/12/2019 14:15	7,23	5	36,17	CHI
20191242202	PIRANHAS	PH12207935	PIRANHAS	07/12/2019 07:04	08/12/2019 10:30	07/12/2019 07:04	08/12/2019 06:43	23,67	4	94,66	CHI
20191242202	PIRANHAS	PH12207935	PIRANHAS	07/12/2019 07:04	08/12/2019 10:30	08/12/2019 06:44	08/12/2019 10:30	3,78	4	15,10	CHI
20191242205	PIRACANJUBA	PJ21111807	PIRACANJUBA	07/12/2019 07:04	07/12/2019 11:19	07/12/2019 07:04	07/12/2019 11:19	4,24	1	4,24	CHI
20191242952	ORIZONA	OZ12114504	PIRES DO RIO S2	07/12/2019 07:05	07/12/2019 14:00	07/12/2019 07:05	07/12/2019 14:00	6,91	9	62,23	CHI
20191242211	LEOPOLDO DE BULHOES	LB21021165	DAIA S2	07/12/2019 07:06	07/12/2019 10:57	07/12/2019 07:06	07/12/2019 10:57	3,85	1	3,85	CHI
20191242212	SAO DOMINGOS	SD12389200	SAO DOMINGOS	07/12/2019 07:06	07/12/2019 12:09	07/12/2019 07:06	07/12/2019 12:09	5,05	63	318,06	CHI
20191242322	GOIATUBA	GT12050351	GOIATUBA S1	07/12/2019 07:06	07/12/2019 15:32	07/12/2019 07:06	07/12/2019 15:32	8,42	2	16,83	CHI
20191242322	VICENTINOPOLIS	GT12050351	GOIATUBA S1	07/12/2019 07:06	07/12/2019 15:32	07/12/2019 07:06	07/12/2019 15:32	8,42	3	25,25	CHI
20191243261	JATAI	RV12038514	CABRIUVA S1	07/12/2019 07:06	07/12/2019 18:45	07/12/2019 07:06	07/12/2019 18:45	11,63	6	69,81	CHI

20191243261	RIO VERDE	RV12038514	CABRIUVA S1	07/12/2019 07:06	07/12/2019 18:45	07/12/2019 07:06	07/12/2019 18:45	11,63	74	860,97	CHI
20191242218	JOVIANIA	JV21009025	GOIATUBA S1	07/12/2019 07:07	07/12/2019 10:57	07/12/2019 07:07	07/12/2019 10:57	3,84	1	3,84	CHI
20191242219	PIRACANJUBA	PJ12000119	PIRACANJUBA	07/12/2019 07:07	07/12/2019 11:18	07/12/2019 07:07	07/12/2019 11:18	4,17	6	25,04	CHI
20191242221	ABADIANIA	AA12271855	ANAPOLIS UNIVERSITARIO S1	07/12/2019 07:08	07/12/2019 08:58	07/12/2019 07:08	07/12/2019 08:58	1,83	7	12,83	CHI
20191242225	CAIAPONIA	CP12160772	MONTIVIDIU T	07/12/2019 07:08	07/12/2019 12:06	07/12/2019 07:08	07/12/2019 12:06	4,96	13	64,47	CHI
20191242225	JATAI	CP12160772	MONTIVIDIU T	07/12/2019 07:08	07/12/2019 12:06	07/12/2019 07:08	07/12/2019 12:06	4,96	6	29,76	CHI
20191242225	RIO VERDE	CP12160772	MONTIVIDIU T	07/12/2019 07:08	07/12/2019 12:06	07/12/2019 07:08	07/12/2019 12:06	4,96	12	59,51	CHI
20191242510	PIRENOPOLIS	PV12355915	CORUMBA	07/12/2019 07:09	07/12/2019 11:07	07/12/2019 07:09	07/12/2019 11:07	3,96	21	83,20	CHI
20191242234	CORUMBAIBA	CI12000451	VILA CORUMBA	07/12/2019 07:10	07/12/2019 19:43	07/12/2019 14:33	07/12/2019 19:43	5,17	8	41,34	CHI
20191242234	NOVA AURORA	CI12000451	VILA CORUMBA	07/12/2019 07:10	07/12/2019 19:43	07/12/2019 14:33	07/12/2019 19:43	5,17	7	36,17	CHI
20191242940	ITAJA	IJ12226574	ITAJA S2	07/12/2019 07:10	09/12/2019 23:00	07/12/2019 07:10	08/12/2019 08:20	25,16	3	75,47	CHI
20191242940	ITAJA	IJ12226574	ITAJA S2	07/12/2019 07:10	09/12/2019 23:00	07/12/2019 07:10	09/12/2019 23:00	63,83	5	319,14	CHI
20191242940	ITAJA	IJ12226574	ITAJA S2	07/12/2019 07:10	09/12/2019 23:00	09/12/2019 21:35	09/12/2019 23:00	1,42	3	4,27	CHI
20191242692	GOIAS	GS12056682	GOIAS	07/12/2019 07:11	07/12/2019 17:37	07/12/2019 07:11	07/12/2019 17:37	10,43	7	72,99	CHI
20191242696	NOVO BRASIL	NB11019356	JUSSARA	07/12/2019 07:11	07/12/2019 10:20	07/12/2019 07:11	07/12/2019 10:20	3,14	146	458,44	CHI
20191242242	CRISTIANOPOLIS	CF12300616	CRISTIANOPOLIS	07/12/2019 07:13	07/12/2019 14:03	07/12/2019 07:13	07/12/2019 14:03	6,85	8	54,76	CHI
20191242251	DOVERLANDIA	DV12207962	CAIAPONIA	07/12/2019 07:15	07/12/2019 10:30	07/12/2019 07:15	07/12/2019 10:30	3,24	7	22,70	CHI
20191242313	PADRE BERNARDO	PB12347929	PADRE BERNARDO	07/12/2019 07:18	07/12/2019 11:17	07/12/2019 07:18	07/12/2019 11:17	3,97	6	23,83	CHI
20191242318	SILVANIA	SV12358037	BELA VISTA S2	07/12/2019 07:19	07/12/2019 10:29	07/12/2019 07:19	07/12/2019 10:29	3,16	3	9,47	CHI
20191242495	MORRINHOS	MR11223275	MORRINHOS	07/12/2019 07:19	07/12/2019 10:28	07/12/2019 07:19	07/12/2019 10:28	3,15	84	264,53	CHI
20191242320	CORUMBAIBA	CI12149233	VILA CORUMBA	07/12/2019 07:20	07/12/2019 13:46	07/12/2019 07:20	07/12/2019 13:46	6,42	8	51,36	CHI
20191242324	RIO VERDE	RV21213395	MONTIVIDIU T	07/12/2019 07:21	07/12/2019 09:53	07/12/2019 07:21	07/12/2019 09:53	2,53	1	2,53	CHI
20191243240	RIO VERDE	RV12260132	CABRIUVA S2	07/12/2019 07:21	07/12/2019 11:05	07/12/2019 07:21	07/12/2019 11:05	3,72	19	70,73	CHI
20191242338	FORMOSA	FA12261996	ITIQUEIRA	07/12/2019 07:24	07/12/2019 13:38	07/12/2019 07:24	07/12/2019 13:38	6,22	4	24,88	CHI
20191242341	MONTES CLAROS DE GOIAS	ME12140008	IPORA	07/12/2019 07:25	07/12/2019 17:06	07/12/2019 07:25	07/12/2019 17:06	9,68	17	164,56	CHI
20191243264	MINACU	IH12317057	MINACU	07/12/2019 07:25	07/12/2019 14:12	07/12/2019 07:25	07/12/2019 14:12	6,78	5	33,91	CHI
20191242352	LUZIANIA	LZ12203332	VIANOPOLIS	07/12/2019 07:27	07/12/2019 10:51	07/12/2019 07:27	07/12/2019 10:51	3,39	12	40,69	CHI
20191242356	PALMINOPOLIS	PP12053936	PALMEIRAS	07/12/2019 07:28	07/12/2019 12:05	07/12/2019 07:28	07/12/2019 12:05	4,60	2	9,20	CHI
20191242361	CROMINIA	CQ21158591	PONTALINA	07/12/2019 07:30	07/12/2019 10:59	07/12/2019 07:30	07/12/2019 10:59	3,48	1	3,48	CHI
20191242364	LUZIANIA	LZ12349111	MARAJOARA	07/12/2019 07:30	07/12/2019 09:22	07/12/2019 07:30	07/12/2019 09:22	1,86	155	287,83	CHI
20191242829	RIO VERDE	RV12098593	RIO VERDE S1	07/12/2019 07:30	07/12/2019 16:05	07/12/2019 07:30	07/12/2019 16:05	8,57	9	77,14	CHI
20191242367	TAQUARAL DE GOIAS	TQ21277060	ITABERAI S1	07/12/2019 07:31	07/12/2019 12:58	07/12/2019 07:31	07/12/2019 12:58	5,44	3	16,31	CHI
20191242369	NOVO BRASIL	NB21183377	JUSSARA	07/12/2019 07:31	08/12/2019 17:47	07/12/2019 07:31	08/12/2019 17:47	34,26	1	34,26	CHI

20191242370	NOVA ROMA	ND21117601	IACIARA S2	07/12/2019 07:31	07/12/2019 11:23	07/12/2019 07:31	07/12/2019 11:23	3,85	1	3,85	CHI
20191242371	CRIXAS	NA12229644	NOVA CRIXAS	07/12/2019 07:32	07/12/2019 14:44	07/12/2019 07:32	07/12/2019 14:44	7,19	2	14,39	CHI
20191242371	NOVA CRIXAS	NA12229644	NOVA CRIXAS	07/12/2019 07:32	07/12/2019 14:44	07/12/2019 07:32	07/12/2019 14:44	7,19	1	7,19	CHI
20191242911	COCALZINHO DE GOIAS	ZN12216781	PADRE BERNARDO	07/12/2019 07:32	07/12/2019 16:43	07/12/2019 07:32	07/12/2019 16:43	9,18	3	27,53	CHI
20191242389	CAMPINORTE	CR12164041	MARA ROSA	07/12/2019 07:35	07/12/2019 14:21	07/12/2019 07:35	07/12/2019 14:21	6,77	15	101,54	CHI
20191242389	URUACU	CR12164041	MARA ROSA	07/12/2019 07:35	07/12/2019 14:21	07/12/2019 07:35	07/12/2019 14:21	6,77	4	27,08	CHI
20191242393	GUARANI DE GOIAS	GY12344199	IACIARA S1	07/12/2019 07:36	07/12/2019 09:45	07/12/2019 07:36	07/12/2019 09:45	2,14	5	10,71	CHI
20191242397	ITARUMA	IM12226504	CACHOEIRA ALTA	07/12/2019 07:37	07/12/2019 13:07	07/12/2019 07:37	07/12/2019 13:07	5,49	2	10,98	CHI
20191242638	MONTES CLAROS DE GOIAS	ME12066160	IPORA	07/12/2019 07:38	07/12/2019 17:00	07/12/2019 07:38	07/12/2019 17:00	9,37	80	749,36	CHI
20191242402	GOIANIA	10013431208	GOYA S1	07/12/2019 07:39	07/12/2019 09:14	07/12/2019 07:39	07/12/2019 09:14	1,58	1	1,58	CHI
20191242411	BOM JARDIM DE GOIAS	BM12259514	BOM JARDIM	07/12/2019 07:39	08/12/2019 10:08	07/12/2019 07:39	08/12/2019 08:50	25,18	8	201,41	CHI
20191242411	BOM JARDIM DE GOIAS	BM12202993	BOM JARDIM	07/12/2019 07:39	08/12/2019 10:08	07/12/2019 07:39	08/12/2019 10:08	26,47	3	79,41	CHI
20191242415	ORIZONA	OZ21095272	PIRES DO RIO S2	07/12/2019 07:40	07/12/2019 09:30	07/12/2019 07:40	07/12/2019 09:30	1,83	1	1,83	CHI
20191242417	ORIZONA	OZ21114899	PIRES DO RIO S1	07/12/2019 07:40	07/12/2019 13:58	07/12/2019 07:40	07/12/2019 13:58	6,29	1	6,29	CHI
20191241505	JATAI	JT13234317	JATAI S3	07/12/2019 07:41	07/12/2019 08:44	07/12/2019 07:41	07/12/2019 08:44	1,04	2	2,07	CHI
20191243120	SAO LUIS DE MONTES BELOS	SL12021470	SAO LUIZ DOS MONTES BELOS	07/12/2019 07:41	07/12/2019 15:11	07/12/2019 07:41	07/12/2019 15:11	7,49	36	269,77	CHI
20191242425	ANAPOLIS	20296964	JUNDIAI S1	07/12/2019 07:43	07/12/2019 10:15	07/12/2019 07:43	07/12/2019 10:15	2,54	1	2,54	CHI
20191242426	BALIZA	BH11259290	CAIAPONIA	07/12/2019 07:43	08/12/2019 12:31	07/12/2019 07:43	08/12/2019 12:31	28,80	1	28,80	CHI
20191242428	ORIZONA	OZ12404724	PIRES DO RIO S1	07/12/2019 07:43	07/12/2019 13:58	07/12/2019 07:43	07/12/2019 13:58	6,25	22	137,40	CHI
20191242429	CRISTALINA	KR12153067	CRISTALINA S2	07/12/2019 07:43	07/12/2019 10:21	07/12/2019 07:43	07/12/2019 10:21	2,62	3	7,87	CHI
20191242907	NOVA CRIXAS	NA12220366	MOZARLANDIA	07/12/2019 07:43	07/12/2019 15:50	07/12/2019 07:43	07/12/2019 15:50	8,10	6	48,61	CHI
20191242435	BELA VISTA DE GOIAS	BV21203962	BELA VISTA S1	07/12/2019 07:44	07/12/2019 09:01	07/12/2019 07:44	07/12/2019 09:01	1,27	1	1,27	CHI
20191242438	CRISTALINA	KR12287383	CRISTALINA S1	07/12/2019 07:44	07/12/2019 12:43	07/12/2019 07:44	07/12/2019 12:43	4,97	78	387,47	CHI
20191242442	ITAUCU	XX08623065	INHUMAS S1	07/12/2019 07:44	07/12/2019 12:30	07/12/2019 07:44	07/12/2019 12:30	4,76	1	4,76	CHI
20191242437	PADRE BERNARDO	PB11283887	PADRE BERNARDO	07/12/2019 07:45	07/12/2019 11:03	07/12/2019 07:45	07/12/2019 11:03	3,30	2	6,59	CHI
20191242443	MORRINHOS	MR21189888	MORRINHOS	07/12/2019 07:45	07/12/2019 12:04	07/12/2019 07:45	07/12/2019 12:04	4,32	1	4,32	CHI
20191241165	SAO LUIS DE MONTES BELOS	SL12145840	FIRMINOPOLIS S2	07/12/2019 07:46	07/12/2019 11:37	07/12/2019 07:46	07/12/2019 11:37	3,84	6	23,05	CHI
20191242450	MINACU	4020052567	MINACU	07/12/2019 07:46	07/12/2019 18:08	07/12/2019 07:46	07/12/2019 18:08	10,35	1	10,35	CHI
20191242961	SAO LUIS DE MONTES BELOS	SL12289750	FIRMINOPOLIS S2	07/12/2019 07:46	07/12/2019 15:41	07/12/2019 07:46	07/12/2019 15:41	7,92	3	23,75	CHI
20191242961	TURVANIA	SL12289750	FIRMINOPOLIS S2	07/12/2019 07:46	07/12/2019 15:41	07/12/2019 07:46	07/12/2019 15:41	7,92	2	15,83	CHI
20191242455	CRISTALINA	KR21304811	CRISTALINA S2	07/12/2019 07:47	07/12/2019 13:24	07/12/2019 07:47	07/12/2019 13:24	5,61	1	5,61	CHI
20191242457	GOIANIA	10019531182	ATLANTICO S2	07/12/2019 07:47	07/12/2019 09:11	07/12/2019 07:47	07/12/2019 09:11	1,39	1	1,39	CHI
20191239417	CAIAPONIA	CP12260792	MONTIVIDIU T	07/12/2019 07:48	07/12/2019 19:50	07/12/2019 07:48	07/12/2019 19:50	12,02	3	36,05	CHI

20191239417	MONTIVIDIU	CP12260792	MONTIVIDIU T	07/12/2019 07:48	07/12/2019 19:50	07/12/2019 07:48	07/12/2019 19:50	12,02	3	36,05	CHI
20191242463	MINACU	IH21192300	MINACU	07/12/2019 07:48	07/12/2019 15:00	07/12/2019 07:48	07/12/2019 15:00	7,20	1	7,20	CHI
20191241632	IVOLANDIA	PU12090442	MONTIVIDIU T	07/12/2019 07:49	07/12/2019 13:24	07/12/2019 07:49	07/12/2019 13:24	5,58	3	16,74	CHI
20191241632	PARAUNA	PU12090442	MONTIVIDIU T	07/12/2019 07:49	07/12/2019 13:24	07/12/2019 07:49	07/12/2019 13:24	5,58	49	273,45	CHI
20191242597	MORRINHOS	MR12121217	MORRINHOS	07/12/2019 07:49	07/12/2019 11:45	07/12/2019 07:49	07/12/2019 11:45	3,93	14	55,00	CHI
20191242467	GOUVELANDIA	GB11269716	QUIRINOPOLIS	07/12/2019 07:50	07/12/2019 10:53	07/12/2019 07:50	07/12/2019 10:53	3,05	41	125,03	CHI
20191242469	GOIANDIRA	GD12160903	CATALAO S1	07/12/2019 07:50	07/12/2019 14:20	07/12/2019 07:50	07/12/2019 14:20	6,50	1	6,50	CHI
20191242470	URUACU	UR12256445	URUACU	07/12/2019 07:50	07/12/2019 12:11	07/12/2019 07:50	07/12/2019 12:11	4,36	11	47,95	CHI
20191242471	QUIRINOPOLIS	QI21100528	QUIRINOPOLIS	07/12/2019 07:50	07/12/2019 12:13	07/12/2019 07:50	07/12/2019 12:13	4,39	1	4,39	CHI
20191242474	JATAI	6137676	JATAI S2	07/12/2019 07:50	08/12/2019 10:12	07/12/2019 07:50	08/12/2019 10:12	26,37	1	26,37	CHI
20191242478	ITAPURANGA	IK12250516	ITAPURANGA	07/12/2019 07:51	07/12/2019 10:55	07/12/2019 07:51	07/12/2019 10:55	3,05	15	45,78	CHI
20191241587	CORREGO DO OURO	IS13349695	IPORA	07/12/2019 07:54	07/12/2019 18:30	07/12/2019 07:54	07/12/2019 18:30	10,60	3	31,79	CHI
20191241587	FAZENDA NOVA	IS13349695	IPORA	07/12/2019 07:54	07/12/2019 18:30	07/12/2019 07:54	07/12/2019 18:30	10,60	200	2119,11	CHI
20191241587	ISRAELANDIA	IS13349695	IPORA	07/12/2019 07:54	07/12/2019 18:30	07/12/2019 07:54	07/12/2019 18:30	10,60	12	127,15	CHI
20191242491	IPAMERI	IP21073338	CAMPO ALEGRE DE GOIAS	07/12/2019 07:54	07/12/2019 11:00	07/12/2019 07:54	07/12/2019 11:00	3,10	1	3,10	CHI
20191242494	GOIAS	GS21288488	GOIAS	07/12/2019 07:54	07/12/2019 23:05	07/12/2019 07:54	07/12/2019 23:05	15,17	1	15,17	CHI
20191242496	BOM JARDIM DE GOIAS	BM12334832	BOM JARDIM	07/12/2019 07:54	07/12/2019 11:51	07/12/2019 07:54	07/12/2019 11:51	3,94	8	31,51	CHI
20191243378	AURILANDIA	SL12003839	SAO LUIZ DOS MONTES BELOS	07/12/2019 07:54	07/12/2019 16:34	07/12/2019 07:54	07/12/2019 16:34	8,67	15	130,11	CHI
20191243378	SAO LUIS DE MONTES BELOS	SL12003839	SAO LUIZ DOS MONTES BELOS	07/12/2019 07:54	07/12/2019 16:34	07/12/2019 07:54	07/12/2019 16:34	8,67	9	78,07	CHI
20191242498	TURVELANDIA	TD21303615	RIO DOS BOIS	07/12/2019 07:55	07/12/2019 22:25	07/12/2019 07:55	07/12/2019 22:25	14,50	1	14,50	CHI
20191242503	ANICUNS	910066188	ANICUNS	07/12/2019 07:55	07/12/2019 09:04	07/12/2019 07:55	07/12/2019 09:04	1,14	1	1,14	CHI
20191242766	ANICUNS	AC12090273	ANICUNS	07/12/2019 07:55	07/12/2019 12:43	07/12/2019 07:55	07/12/2019 12:43	4,80	21	100,78	CHI
20191243114	BURITI DE GOIAS	BS12099754	FIRMINOPOLIS S2	07/12/2019 07:55	07/12/2019 12:27	07/12/2019 07:55	07/12/2019 12:27	4,53	13	58,83	CHI
20191242505	SANTA TEREZINHA DE GOIAS	SG21201783	SANTA TEREZINHA	07/12/2019 07:56	07/12/2019 11:20	07/12/2019 07:56	07/12/2019 11:20	3,40	1	3,40	CHI
20191242511	MOZARLANDIA	MZ12058584	MOZARLANDIA	07/12/2019 07:56	07/12/2019 15:32	07/12/2019 07:56	07/12/2019 15:32	7,59	13	98,67	CHI
20191242519	PALMEIRAS DE GOIAS	10005671947	PALMEIRAS	07/12/2019 07:57	07/12/2019 11:11	07/12/2019 07:57	07/12/2019 11:11	3,23	1	3,23	CHI
20191242520	ITAPIRAPUA	IU21183412	MATRINCHA	07/12/2019 07:57	07/12/2019 11:02	07/12/2019 07:57	07/12/2019 11:02	3,07	1	3,07	CHI
20191242781	MOSSAMEDES	MD12024167	FIRMINOPOLIS S2	07/12/2019 07:57	07/12/2019 15:23	07/12/2019 07:57	07/12/2019 15:23	7,43	46	341,87	CHI
20191242781	SANCLERLANDIA	MD12024167	FIRMINOPOLIS S2	07/12/2019 07:57	07/12/2019 15:23	07/12/2019 07:57	07/12/2019 15:23	7,43	8	59,46	CHI
20191242521	CRISTALINA	KR11060230	PAMPLONA	07/12/2019 07:58	07/12/2019 13:45	07/12/2019 07:58	07/12/2019 13:45	5,78	192	1109,23	CHI
20191242522	GOIANDIRA	GD21160907	CATALAO S1	07/12/2019 07:58	07/12/2019 17:58	07/12/2019 07:58	07/12/2019 17:58	10,00	1	10,00	CHI
20191245143	FIRMINOPOLIS	SL12206323	FIRMINOPOLIS S1	07/12/2019 07:58	07/12/2019 19:02	07/12/2019 07:58	07/12/2019 19:02	11,05	6	66,33	CHI
20191245143	SAO LUIS DE MONTES BELOS	SL12206323	FIRMINOPOLIS S1	07/12/2019 07:58	07/12/2019 19:02	07/12/2019 07:58	07/12/2019 19:02	11,05	48	530,61	CHI



20191236096	ARUANA	MZ12057162	MOZARLANDIA	07/12/2019 07:59	07/12/2019 11:48	07/12/2019 07:59	07/12/2019 11:48	3,81	2	7,63	CHI
20191236096	MOZARLANDIA	MZ12057162	MOZARLANDIA	07/12/2019 07:59	07/12/2019 11:48	07/12/2019 07:59	07/12/2019 11:48	3,81	4	15,25	CHI
20191242526	GOIATUBA	GT31052923	GOIATUBA S2	07/12/2019 07:59	07/12/2019 11:53	07/12/2019 07:59	07/12/2019 11:53	3,90	3	11,69	CHI
20191242534	FORMOSA	10006898899	ITUIQUIRA	07/12/2019 08:00	07/12/2019 10:46	07/12/2019 08:00	07/12/2019 10:46	2,77	1	2,77	CHI
20191242535	ABADIANIA	AA21289612	ANAPOLIS UNIVERSITARIO S1	07/12/2019 08:00	07/12/2019 09:42	07/12/2019 08:00	07/12/2019 09:42	1,69	1	1,69	CHI
20191242539	OUVIDOR	CT21266219	CATALAO S1	07/12/2019 08:00	07/12/2019 09:49	07/12/2019 08:00	07/12/2019 09:49	1,80	1	1,80	CHI
20191242576	PORANGATU	PO12020611	NOVO PLANALTO	07/12/2019 08:00	07/12/2019 10:20	07/12/2019 08:00	07/12/2019 10:20	2,32	8	18,58	CHI
20191242542	PORANGATU	PO12050744	PORANGATU	07/12/2019 08:01	07/12/2019 08:38	07/12/2019 08:01	07/12/2019 08:38	0,61	4	2,46	CHI
20191242544	ITABERAI	IB21300319	ITABERAI S2	07/12/2019 08:01	08/12/2019 08:23	07/12/2019 08:01	08/12/2019 08:23	24,36	1	24,36	CHI
20191242545	ALVORADA DO NORTE	AQ21251197	IACIARA S2	07/12/2019 08:01	07/12/2019 11:02	07/12/2019 08:01	07/12/2019 11:02	3,01	1	3,01	CHI
20191242546	VIANOPOLIS	VN21151112	VIANOPOLIS	07/12/2019 08:01	07/12/2019 14:54	07/12/2019 08:01	07/12/2019 14:54	6,87	1	6,87	CHI
20191242549	TURVELANDIA	TD21303761	RIO DOS BOIS	07/12/2019 08:01	07/12/2019 11:47	07/12/2019 08:01	07/12/2019 11:47	3,75	1	3,75	CHI
20191242551	SAO LUIZ DO NORTE	3090007251	ITAPACI	07/12/2019 08:02	07/12/2019 11:49	07/12/2019 08:02	07/12/2019 11:49	3,78	1	3,78	CHI
20191242554	ACREUNA	EU21197364	ACREUNA	07/12/2019 08:03	07/12/2019 14:10	07/12/2019 08:03	07/12/2019 14:10	6,12	1	6,12	CHI
20191242559	JATAI	290122340	JATAI S2	07/12/2019 08:03	07/12/2019 11:28	07/12/2019 08:03	07/12/2019 11:28	3,40	1	3,40	CHI
20191243219	DIORAMA	ME12204905	IPORA	07/12/2019 08:03	07/12/2019 16:15	07/12/2019 08:03	07/12/2019 16:15	8,20	1	8,20	CHI
20191243219	MONTES CLAROS DE GOIAS	ME12204905	IPORA	07/12/2019 08:03	07/12/2019 16:15	07/12/2019 08:03	07/12/2019 16:15	8,20	45	368,96	CHI
20191242562	PORANGATU	PO12240663	PORANGATU	07/12/2019 08:04	07/12/2019 10:29	07/12/2019 08:04	07/12/2019 10:29	2,42	3	7,25	CHI
20191242563	GOIANIA	10734030	ATLANTICO S1	07/12/2019 08:04	07/12/2019 10:30	07/12/2019 08:04	07/12/2019 10:30	2,43	1	2,43	CHI
20191242565	ORIZONA	OZ12404726	PIRES DO RIO S1	07/12/2019 08:04	07/12/2019 12:00	07/12/2019 08:04	07/12/2019 12:00	3,94	9	35,47	CHI
20191241724	MINEIROS	MY12301848LD	PARQUE DAS EMAS	07/12/2019 08:05	07/12/2019 15:00	07/12/2019 10:15	07/12/2019 15:00	4,75	2	9,50	CHI
20191242629	UIRAPURU	UP12391847	SANTA TEREZINHA	07/12/2019 08:05	07/12/2019 17:55	07/12/2019 08:05	07/12/2019 17:55	9,82	7	68,77	CHI
20191242980	INHUMAS	IN11365566	INHUMAS S2	07/12/2019 08:05	07/12/2019 10:18	07/12/2019 08:05	07/12/2019 10:18	2,22	48	106,64	CHI
20191242748	LEOPOLDO DE BULHOES	LB12281923	DAIA S2	07/12/2019 08:06	07/12/2019 09:56	07/12/2019 08:06	07/12/2019 09:56	1,82	92	167,26	CHI
20191242585	GAMELEIRA DE GOIAS	SV21087261	DAIA S2	07/12/2019 08:07	07/12/2019 14:12	07/12/2019 08:07	07/12/2019 14:12	6,07	1	6,07	CHI
20191242587	CALDAZINHA	SV21143458	CEPAIGO S2	07/12/2019 08:07	07/12/2019 12:44	07/12/2019 08:07	07/12/2019 12:44	4,60	1	4,60	CHI
20191242590	GOIAS	GS21183477	GOIAS	07/12/2019 08:08	07/12/2019 10:10	07/12/2019 08:08	07/12/2019 10:10	2,04	1	2,04	CHI
20191242592	FORMOSA	FA21106961	ITUIQUIRA	07/12/2019 08:08	07/12/2019 10:50	07/12/2019 08:08	07/12/2019 10:50	2,71	1	2,71	CHI
20191242599	PIRENOPOLIS	PV12084700	SAO FRANCISCO DE GOIAS	07/12/2019 08:08	07/12/2019 10:46	07/12/2019 08:08	07/12/2019 10:46	2,62	13	34,05	CHI
20191243060	FIRMINOPOLIS	SL12072420	SAO LUIZ DOS MONTES BELOS	07/12/2019 08:08	07/12/2019 13:30	07/12/2019 08:08	07/12/2019 13:30	5,37	45	241,54	CHI
20191242600	MOZARLANDIA	MZ21259650	MOZARLANDIA	07/12/2019 08:09	07/12/2019 11:34	07/12/2019 08:09	07/12/2019 11:34	3,41	1	3,41	CHI
20191242608	TURVELANDIA	SH12026451	RIO DOS BOIS	07/12/2019 08:10	08/12/2019 07:40	07/12/2019 08:10	08/12/2019 07:40	23,51	1	23,51	CHI
20191242776	PONTALINA	JV12223261	GOIATUBA S1	07/12/2019 08:10	07/12/2019 12:11	07/12/2019 08:10	07/12/2019 12:11	4,02	2	8,03	CHI

20191242839	JUSSARA	JR12008743	BRITANIA	07/12/2019 08:10	07/12/2019 15:26	07/12/2019 08:10	07/12/2019 15:26	7,27	38	276,33	CHI
20191242903	PIRENOPOLIS	PV12384891	CORUMBA	07/12/2019 08:10	07/12/2019 10:34	07/12/2019 08:10	07/12/2019 10:34	2,39	14	33,51	CHI
20191242946	IPORA	IR12070197	IPORA	07/12/2019 08:10	08/12/2019 03:01	07/12/2019 08:10	08/12/2019 03:01	18,85	15	282,70	CHI
20191242614	FLORES DE GOIAS	3480013336	FLORES DE GOIAS	07/12/2019 08:11	07/12/2019 11:15	07/12/2019 08:11	07/12/2019 11:15	3,07	1	3,07	CHI
20191242615	JATAI	JT21267550	JATAI S1	07/12/2019 08:11	07/12/2019 11:45	07/12/2019 08:11	07/12/2019 11:45	3,56	1	3,56	CHI
20191242619	ITAPURANGA	IK21222723	ITAPURANGA	07/12/2019 08:11	08/12/2019 15:46	07/12/2019 08:11	08/12/2019 15:46	31,57	1	31,57	CHI
20191242620	PALMEIRAS DE GOIAS	PL12304488	PALMEIRAS	07/12/2019 08:12	07/12/2019 12:20	07/12/2019 08:12	07/12/2019 12:20	4,13	1	4,13	CHI
20191242623	GOIANESIA	GE12079223	GOIANESIA S1	07/12/2019 08:12	07/12/2019 18:10	07/12/2019 08:12	07/12/2019 18:10	9,96	1	9,96	CHI
20191242623	VILA PROPICIO	GE12079223	GOIANESIA S1	07/12/2019 08:12	07/12/2019 18:10	07/12/2019 08:12	07/12/2019 18:10	9,96	4	39,83	CHI
20191243585	SERRANOPOLIS	SX12241664	JATAI S1	07/12/2019 08:12	07/12/2019 12:33	07/12/2019 08:12	07/12/2019 12:33	4,34	2	8,67	CHI
20191242631	ABADIA DE GOIAS	TR31046106	CARAJAS S1	07/12/2019 08:14	07/12/2019 15:00	07/12/2019 08:14	07/12/2019 15:00	6,77	1	6,77	CHI
20191242634	LUZIANIA	LZ21320060	CRISTALINA S2	07/12/2019 08:14	07/12/2019 13:30	07/12/2019 08:14	07/12/2019 13:30	5,25	1	5,25	CHI
20191242635	ITAPURANGA	IK12311015	ITAPURANGA	07/12/2019 08:14	08/12/2019 19:25	07/12/2019 08:14	08/12/2019 19:25	35,17	2	70,35	CHI
20191242635	ITAPURANGA	IK12311015	ITAPURANGA	07/12/2019 08:14	08/12/2019 19:25	08/12/2019 17:10	08/12/2019 19:25	2,25	55	123,61	CHI
20191243059	PALESTINA DE GOIAS	PY12396116	PALESTINA	07/12/2019 08:14	08/12/2019 02:41	07/12/2019 08:14	08/12/2019 02:41	18,44	6	110,64	CHI
20191243263	NIQUELANDIA	NQ12359872	BARRO ALTO	07/12/2019 08:14	07/12/2019 23:03	07/12/2019 08:14	07/12/2019 23:03	14,81	16	237,01	CHI
20191242642	SAO DOMINGOS	SD12344108	SAO DOMINGOS	07/12/2019 08:16	07/12/2019 11:15	07/12/2019 08:16	07/12/2019 11:15	2,98	2	5,96	CHI
20191242648	MONTES CLAROS DE GOIAS	ME21126781	IPORA	07/12/2019 08:16	08/12/2019 12:38	07/12/2019 08:16	08/12/2019 12:38	28,35	1	28,35	CHI
20191242649	SENADOR CANEDO	GN21001409	GOIANIA LESTE S2	07/12/2019 08:16	07/12/2019 10:53	07/12/2019 08:16	07/12/2019 10:53	2,60	1	2,60	CHI
20191242655	APARECIDA DE GOIANIA	14529919	ATLANTICO S2	07/12/2019 08:17	07/12/2019 09:37	07/12/2019 08:17	07/12/2019 09:37	1,34	1	1,34	CHI
20191242656	GOIANIA	10011593774	CARAJAS S1	07/12/2019 08:17	07/12/2019 10:06	07/12/2019 08:17	07/12/2019 10:06	1,81	1	1,81	CHI
20191242937	JARAGUA	JA12000239	JARAGUA	07/12/2019 08:17	08/12/2019 02:37	07/12/2019 08:17	07/12/2019 13:56	5,65	9	50,87	CHI
20191242937	JARAGUA	JA21051281	JARAGUA	07/12/2019 08:17	08/12/2019 02:37	07/12/2019 08:17	08/12/2019 00:40	16,39	1	16,39	CHI
20191242937	JARAGUA	JA21051282	JARAGUA	07/12/2019 08:17	08/12/2019 02:37	07/12/2019 08:17	08/12/2019 00:48	16,52	1	16,52	CHI
20191242937	JARAGUA	JA21051283	JARAGUA	07/12/2019 08:17	08/12/2019 02:37	07/12/2019 08:17	08/12/2019 02:37	18,35	1	18,35	CHI
20191243753	ANICUNS	AC12236854	FIRMINOPOLIS S2	07/12/2019 08:17	07/12/2019 17:50	07/12/2019 08:17	07/12/2019 17:50	9,56	2	19,12	CHI
20191242665	ITABERAI	10008408422	ITABERAI S2	07/12/2019 08:18	07/12/2019 10:38	07/12/2019 08:18	07/12/2019 10:38	2,35	1	2,35	CHI
20191242667	SANTA TEREZINHA DE GOIAS	GG12181600	SANTA TEREZINHA	07/12/2019 08:18	08/12/2019 00:44	07/12/2019 08:18	08/12/2019 00:44	16,43	7	114,98	CHI
20191242669	SANCLERLANDIA	SC21192126	FIRMINOPOLIS S2	07/12/2019 08:18	07/12/2019 16:21	07/12/2019 08:18	07/12/2019 16:21	8,04	1	8,04	CHI
20191242670	CAMPO ALEGRE DE GOIAS	CM21042390	CAMPO ALEGRE DE GOIAS	07/12/2019 08:18	07/12/2019 13:10	07/12/2019 08:18	07/12/2019 13:10	4,85	1	4,85	CHI
20191242675	FORMOSA	610255472	ITIQUIRA	07/12/2019 08:19	07/12/2019 09:56	07/12/2019 08:19	07/12/2019 09:56	1,61	1	1,61	CHI
20191242676	PORANGATU	PO12391931LD	PORANGATU	07/12/2019 08:19	07/12/2019 12:03	07/12/2019 08:19	07/12/2019 12:03	3,73	13	48,53	CHI
20191242678	BONFINOPOLIS	LB12032331	GOIANIA LESTE S2	07/12/2019 08:19	07/12/2019 10:30	07/12/2019 08:19	07/12/2019 10:30	2,17	25	54,23	CHI

20191242685	EDEIA	EA12263286	RIO DOS BOIS	07/12/2019 08:20	08/12/2019 11:20	07/12/2019 08:20	08/12/2019 11:20	26,99	2	53,98	CHI
20191242685	TURVELANDIA	EA12263286	RIO DOS BOIS	07/12/2019 08:20	08/12/2019 11:20	07/12/2019 08:20	08/12/2019 11:20	26,99	11	296,89	CHI
20191242688	PIRENOPOLIS	PV21215227	SAO FRANCISCO DE GOIAS	07/12/2019 08:21	07/12/2019 12:18	07/12/2019 08:21	07/12/2019 12:18	3,95	1	3,95	CHI
20191242694	CAIAPONIA	CP12075032	CAIAPONIA	07/12/2019 08:22	07/12/2019 20:09	07/12/2019 08:22	07/12/2019 20:09	11,78	10	117,83	CHI
20191242697	PORANGATU	PO12028736	PORANGATU	07/12/2019 08:22	07/12/2019 09:40	07/12/2019 08:22	07/12/2019 09:40	1,29	4	5,17	CHI
20191242700	ABADIANIA	AA12285384	ANAPOLIS UNIVERSITARIO S1	07/12/2019 08:23	07/12/2019 13:30	07/12/2019 08:23	07/12/2019 13:30	5,11	97	495,94	CHI
20191242700	GAMELEIRA DE GOIAS	AA12285384	ANAPOLIS UNIVERSITARIO S1	07/12/2019 08:23	07/12/2019 13:30	07/12/2019 08:23	07/12/2019 13:30	5,11	1	5,11	CHI
20191242701	CATALAO	CT21231547	CATALAO S1	07/12/2019 08:23	07/12/2019 10:20	07/12/2019 08:23	07/12/2019 10:20	1,95	2	3,89	CHI
20191242702	PARANAIGUARA	PC21193918	QUIRINOPOLIS	07/12/2019 08:23	07/12/2019 11:59	07/12/2019 08:23	07/12/2019 11:59	3,59	1	3,59	CHI
20191242709	MINACU	IH12182290	MINACU	07/12/2019 08:24	07/12/2019 14:55	07/12/2019 08:24	07/12/2019 14:55	6,52	49	319,25	CHI
20191242710	CAMPINACU	UC12197170	PORANGATU	07/12/2019 08:24	07/12/2019 10:32	07/12/2019 08:24	07/12/2019 10:32	2,13	13	27,69	CHI
20191242710	MINACU	UC12197170	PORANGATU	07/12/2019 08:24	07/12/2019 10:32	07/12/2019 08:24	07/12/2019 10:32	2,13	1	2,13	CHI
20191242711	ALEXANIA	AX21102403	ALEXANIA	07/12/2019 08:24	07/12/2019 12:24	07/12/2019 08:24	07/12/2019 12:24	3,99	1	3,99	CHI
20191243020	SAO LUIS DE MONTES BELOS	SL21006786	SAO LUIZ DOS MONTES BELOS	07/12/2019 08:24	07/12/2019 18:28	07/12/2019 08:24	07/12/2019 18:28	10,06	1	10,06	CHI
20191244807	MATRINCHA	MP12010442	MOZARLANDIA	07/12/2019 08:24	08/12/2019 10:55	07/12/2019 08:24	08/12/2019 10:55	26,53	4	106,11	CHI
20191242715	SENADOR CANEDO	SW21076755	CEPAIGO S1	07/12/2019 08:25	07/12/2019 13:17	07/12/2019 08:25	07/12/2019 13:17	4,86	2	9,73	CHI
20191242722	MARA ROSA	MQ12140367	MARA ROSA	07/12/2019 08:25	08/12/2019 10:04	07/12/2019 08:25	08/12/2019 09:26	25,02	34	850,55	CHI
20191242722	MARA ROSA	MQ12140367	MARA ROSA	07/12/2019 08:25	08/12/2019 10:04	07/12/2019 08:25	08/12/2019 10:04	25,64	23	589,82	CHI
20191242726	ANAPOLIS	20244885	ANAPOLIS UNIVERSITARIO S2	07/12/2019 08:26	07/12/2019 11:51	07/12/2019 08:26	07/12/2019 11:51	3,41	1	3,41	CHI
20191242732	SERRANOPOLIS	SX21137486	JATAI S1	07/12/2019 08:26	08/12/2019 14:40	07/12/2019 08:26	08/12/2019 14:40	30,22	1	30,22	CHI
20191242786	POSSE	PS12257688	IACIARA S2	07/12/2019 08:26	07/12/2019 09:51	07/12/2019 08:26	07/12/2019 09:51	1,41	21	29,56	CHI
20191242979	FAZENDA NOVA	JR12362437	BRITANIA	07/12/2019 08:26	08/12/2019 10:25	07/12/2019 08:26	08/12/2019 10:25	25,97	3	77,90	CHI
20191242979	JUSSARA	JR12362437	BRITANIA	07/12/2019 08:26	08/12/2019 10:25	07/12/2019 08:26	08/12/2019 10:25	25,97	7	181,77	CHI
20191242735	GOIANDIRA	GD21231710	CATALAO S1	07/12/2019 08:27	07/12/2019 09:20	07/12/2019 08:27	07/12/2019 09:20	0,88	1	0,88	CHI
20191242740	PIRENOPOLIS	PV21185574	CORUMBA	07/12/2019 08:28	07/12/2019 11:12	07/12/2019 08:28	07/12/2019 11:12	2,73	2	5,46	CHI
201912260741	GOIATUBA	GT12392084	GOIATUBA S2	07/12/2019 08:28	07/12/2019 10:49	07/12/2019 08:28	07/12/2019 10:49	2,34	20	46,87	CHI
20191242831	MINEIROS	MY12234339	PARQUE DAS EMAS	07/12/2019 08:29	07/12/2019 18:20	07/12/2019 08:29	07/12/2019 18:20	9,86	11	108,42	CHI
20191242845	ITABERAI	IB12172690	ITABERAI S2	07/12/2019 08:29	07/12/2019 19:38	07/12/2019 08:29	07/12/2019 19:38	11,15	6	66,88	CHI
20191242825	GOIAS	GS12319412	ITAPURANGA	07/12/2019 08:30	08/12/2019 08:05	07/12/2019 08:30	08/12/2019 08:05	23,57	7	165,02	CHI
20191242768	CACHOEIRA ALTA	CA21090002	CACHOEIRA ALTA	07/12/2019 08:31	07/12/2019 23:15	07/12/2019 08:31	07/12/2019 23:15	14,72	1	14,72	CHI
20191242775	TRES RANCHOS	TH21165231	CATALAO S1	07/12/2019 08:32	07/12/2019 10:28	07/12/2019 08:32	07/12/2019 10:28	1,92	1	1,92	CHI
20191242780	TRINDADE	TR12343758	TRINDADE	07/12/2019 08:33	07/12/2019 09:40	07/12/2019 08:33	07/12/2019 09:40	1,12	16	17,84	CHI
20191243535	ITUMBIARA	BG21000143	ITUMBIARA VELHA S2	07/12/2019 08:33	08/12/2019 18:00	07/12/2019 08:33	08/12/2019 17:40	33,11	1	33,11	CHI

20191243535	ITUMBIARA	BG12000164	ITUMBIARA VELHA S2	07/12/2019 08:33	08/12/2019 18:00	08/12/2019 15:30	08/12/2019 18:00	2,50	1	2,50	CHI
20191242785	APARECIDA DE GOIANIA	16473048	REAL S1	07/12/2019 08:34	07/12/2019 10:25	07/12/2019 08:34	07/12/2019 10:25	1,85	1	1,85	CHI
20191242788	QUIRINOPOLIS	QI31134437	QUIRINOPOLIS	07/12/2019 08:35	07/12/2019 10:04	07/12/2019 08:35	07/12/2019 10:04	1,48	1	1,48	CHI
20191242790	GUAPO	GA21212302	GUAPO S1	07/12/2019 08:35	07/12/2019 10:39	07/12/2019 08:35	07/12/2019 10:39	2,06	1	2,06	CHI
20191241791	SERRANOPOLIS	SX21214388	JATAI S1	07/12/2019 08:36	07/12/2019 20:18	07/12/2019 08:36	07/12/2019 20:18	11,69	1	11,69	CHI
20191242796	ITAUCU	IX21016877	INHUMAS S1	07/12/2019 08:36	07/12/2019 14:03	07/12/2019 08:36	07/12/2019 14:03	5,45	1	5,45	CHI
20191242798	INHUMAS	IX12016046	INHUMAS S1	07/12/2019 08:36	07/12/2019 12:07	07/12/2019 08:36	07/12/2019 12:07	3,51	8	28,09	CHI
20191242798	ITAUCU	IX12016046	INHUMAS S1	07/12/2019 08:36	07/12/2019 12:07	07/12/2019 08:36	07/12/2019 12:07	3,51	3	10,53	CHI
20191243320	SILVANIA	VN12400021	VIANOPOLIS	07/12/2019 08:36	07/12/2019 13:19	07/12/2019 08:36	07/12/2019 13:19	4,71	21	98,95	CHI
20191243320	VIANOPOLIS	VN12400021	VIANOPOLIS	07/12/2019 08:36	07/12/2019 13:19	07/12/2019 08:36	07/12/2019 13:19	4,71	97	457,06	CHI
20191242809	QUIRINOPOLIS	10021758210	QUIRINOPOLIS	07/12/2019 08:37	07/12/2019 11:27	07/12/2019 08:37	07/12/2019 11:27	2,82	1	2,82	CHI
20191242812	NOVA VENEZA	10005597003	NEROPOLIS S1	07/12/2019 08:39	07/12/2019 10:45	07/12/2019 08:39	07/12/2019 10:45	2,10	1	2,10	CHI
20191242814	INHUMAS	IN21064125	INHUMAS S1	07/12/2019 08:39	07/12/2019 14:28	07/12/2019 08:39	07/12/2019 14:28	5,81	2	11,63	CHI
20191242816	SAO MIGUEL DO ARAGUAIA	SM12020623	SAO MIGUEL DO ARAGUAIA	07/12/2019 08:39	07/12/2019 11:05	07/12/2019 08:39	07/12/2019 11:05	2,43	6	14,60	CHI
20191242818	SILVANIA	SV21197306	VIANOPOLIS	07/12/2019 08:39	07/12/2019 12:58	07/12/2019 08:39	07/12/2019 12:58	4,30	2	8,61	CHI
20191242836	IPAMERI	IP21226872	IPAMERI	07/12/2019 08:42	07/12/2019 15:36	07/12/2019 08:42	07/12/2019 15:36	6,89	1	6,89	CHI
20191244354	SAO LUIS DE MONTES BELOS	SL21126215	FIRMINOPOLIS S1	07/12/2019 08:42	07/12/2019 18:39	07/12/2019 08:42	07/12/2019 18:39	9,95	1	9,95	CHI
201912233261	FLORES DE GOIAS	FB12321139	IACIARA S2	07/12/2019 08:42	07/12/2019 11:29	07/12/2019 08:42	07/12/2019 11:29	2,78	3	8,33	CHI
20191242843	CRISTIANOPOLIS	CF21107174	CRISTIANOPOLIS	07/12/2019 08:43	07/12/2019 10:43	07/12/2019 08:43	07/12/2019 10:43	2,00	1	2,00	CHI
20191242948	ITAPURANGA	IK12311324	ITAPURANGA	07/12/2019 08:43	07/12/2019 16:12	07/12/2019 08:43	07/12/2019 16:12	7,48	6	44,89	CHI
20191242854	PORANGATU	PO12390257	PORANGATU	07/12/2019 08:45	07/12/2019 14:42	07/12/2019 08:45	07/12/2019 14:42	5,95	4	23,79	CHI
20191242861	BELA VISTA DE GOIAS	BV11187588	BELA VISTA S1	07/12/2019 08:45	07/12/2019 13:04	07/12/2019 08:45	07/12/2019 13:04	4,30	47	202,18	CHI
20191243527	FAZENDA NOVA	FN12040960	JUSSARA	07/12/2019 08:47	07/12/2019 13:17	07/12/2019 08:47	07/12/2019 13:17	4,50	8	36,04	CHI
20191244103	ITABERAI	IB10395407	ITABERAI S2	07/12/2019 08:47	07/12/2019 18:26	07/12/2019 16:45	07/12/2019 18:26	1,68	358	602,63	CHI
201912260910	ITABERAI	50032306	ITABERAI S2	07/12/2019 08:47	07/12/2019 16:45	07/12/2019 08:47	07/12/2019 16:45	7,96	1	7,96	CHI
20191242877	BONFINOPOLIS	LB12032351	CEPAIGO S2	07/12/2019 08:48	07/12/2019 17:18	07/12/2019 08:48	07/12/2019 17:18	8,48	1	8,48	CHI
20191242877	LEOPOLDO DE BULHOES	LB12032351	CEPAIGO S2	07/12/2019 08:48	07/12/2019 17:18	07/12/2019 08:48	07/12/2019 17:18	8,48	8	67,88	CHI
20191242882	GOIANIA	GN21131282	CARAJAS S1	07/12/2019 08:49	07/12/2019 09:37	07/12/2019 08:49	07/12/2019 09:37	0,80	1	0,80	CHI
20191242883	ANAPOLIS	20025816	ANAPOLIS UNIVERSITARIO S2	07/12/2019 08:49	07/12/2019 09:52	07/12/2019 08:49	07/12/2019 09:52	1,04	1	1,04	CHI
20191242887	CAIAPONIA	CP11292058	CAIAPONIA	07/12/2019 08:50	07/12/2019 17:45	07/12/2019 08:50	07/12/2019 17:45	8,91	1	8,91	CHI
20191242888	GOIANIA	10007361589	CARAJAS S2	07/12/2019 08:50	07/12/2019 09:36	07/12/2019 08:50	07/12/2019 09:36	0,76	1	0,76	CHI
20191242892	SANTA TEREZA DE GOIAS	2430009608	MARA ROSA	07/12/2019 08:50	07/12/2019 12:43	07/12/2019 08:50	07/12/2019 12:43	3,87	1	3,87	CHI
20191242893	CRIXAS	CX12391833	RUBIATABA	07/12/2019 08:50	08/12/2019 03:05	07/12/2019 08:50	08/12/2019 03:05	18,24	7	127,66	CHI

20191242893	NOVA IGUACU DE GOIAS	CX12391833	RUBIATABA	07/12/2019 08:50	08/12/2019 03:05	07/12/2019 08:50	08/12/2019 03:05	18,24	1	18,24	CHI
20191242906	CAIAPONIA	CP21067931	CAIAPONIA	07/12/2019 08:51	09/12/2019 10:57	07/12/2019 08:51	09/12/2019 10:12	49,35	2	98,69	CHI
20191242906	CAIAPONIA	CP12067935	CAIAPONIA	07/12/2019 08:51	09/12/2019 10:57	09/12/2019 09:23	09/12/2019 10:57	1,56	4	6,26	CHI
20191244159	SAO MIGUEL DO ARAGUAIA	SM12208936	SAO MIGUEL DO ARAGUAIA	07/12/2019 08:51	07/12/2019 15:30	07/12/2019 08:51	07/12/2019 15:30	6,65	10	66,48	CHI
20191242914	RIO VERDE	RV10406661	MONTIVIDIU T	07/12/2019 08:53	07/12/2019 16:55	07/12/2019 15:33	07/12/2019 16:09	0,60	62	37,32	CHI
20191242914	MONTIVIDIU	MV21025906	MONTIVIDIU T	07/12/2019 08:53	07/12/2019 16:55	07/12/2019 08:53	07/12/2019 16:55	8,03	1	8,03	CHI
20191242914	MONTIVIDIU	MV13384551	MONTIVIDIU T	07/12/2019 08:53	07/12/2019 16:55	07/12/2019 15:33	07/12/2019 16:55	1,36	13	17,67	CHI
20191242914	RIO VERDE	MV13384551	MONTIVIDIU T	07/12/2019 08:53	07/12/2019 16:55	07/12/2019 15:33	07/12/2019 16:55	1,36	50	67,94	CHI
20191242915	SERRANOPOLIS	SX12390579	JATAI S1	07/12/2019 08:53	08/12/2019 17:49	07/12/2019 08:53	08/12/2019 17:49	32,93	3	98,79	CHI
20191242917	ABADIANIA	AA21184565	DAIA S2	07/12/2019 08:53	07/12/2019 15:54	07/12/2019 08:53	07/12/2019 15:54	7,01	1	7,01	CHI
20191242922	ITABERAI	IB21105420	ITABERAI S2	07/12/2019 08:54	08/12/2019 08:15	07/12/2019 08:54	08/12/2019 08:15	23,35	1	23,35	CHI
20191242924	FAZENDA NOVA	FN12013300	FIRMINOPOLIS S2	07/12/2019 08:54	09/12/2019 12:35	07/12/2019 08:54	09/12/2019 12:35	51,68	8	413,43	CHI
20191242975	NOVA GLORIA	NG12262859	ITAPACI	07/12/2019 08:54	07/12/2019 14:20	07/12/2019 08:54	07/12/2019 14:20	5,42	10	54,23	CHI
20191242929	ITAPIRAPUA	IU21259701	MATRINCHA	07/12/2019 08:55	08/12/2019 08:20	07/12/2019 08:55	08/12/2019 08:20	23,42	2	46,83	CHI
20191242934	ITUMBIARA	690119677	ITUMBIARA NOVA	07/12/2019 08:56	07/12/2019 10:08	07/12/2019 08:56	07/12/2019 10:08	1,21	1	1,21	CHI
20191243434	PLANALTINA	PI12322780	SAO JOAO D ALIANCA	07/12/2019 08:56	07/12/2019 18:06	07/12/2019 08:56	07/12/2019 18:06	9,16	7	64,14	CHI
20191242941	SANTA HELENA DE GOIAS	SH21296123	IPEGUARI	07/12/2019 08:57	07/12/2019 10:43	07/12/2019 08:57	07/12/2019 10:43	1,76	1	1,76	CHI
20191242945	GOIANIA	GN12323267	CEPAIGO S1	07/12/2019 08:58	07/12/2019 11:00	07/12/2019 08:58	07/12/2019 10:10	1,20	78	93,82	CHI
20191242945	GOIANIA	GN12074741	CEPAIGO S1	07/12/2019 08:58	07/12/2019 11:00	07/12/2019 08:58	07/12/2019 11:00	2,04	1	2,04	CHI
20191242947	SAO DOMINGOS	SD12317864	SAO DOMINGOS	07/12/2019 08:58	07/12/2019 12:32	07/12/2019 08:58	07/12/2019 12:32	3,56	34	121,15	CHI
20191242953	ITABERAI	IB12037891	ITABERAI S2	07/12/2019 08:58	07/12/2019 14:42	07/12/2019 08:58	07/12/2019 14:42	5,72	5	28,62	CHI
20191242955	ORIZONA	OZ21236978	PIRES DO RIO S2	07/12/2019 08:59	07/12/2019 11:15	07/12/2019 08:59	07/12/2019 11:15	2,26	1	2,26	CHI
20191242956	CAMPINORTE	UR21243263	MARA ROSA	07/12/2019 08:59	07/12/2019 17:20	07/12/2019 08:59	07/12/2019 17:20	8,34	1	8,34	CHI
20191242957	BONOPOLIS	BX12334597	NOVO PLANALTO	07/12/2019 08:59	07/12/2019 17:10	07/12/2019 08:59	07/12/2019 17:10	8,19	3	24,56	CHI
20191242963	ANAPOLIS	20817617	JUNDIAI S1	07/12/2019 08:59	07/12/2019 10:40	07/12/2019 08:59	07/12/2019 10:40	1,67	1	1,67	CHI
20191242967	DAMOLANDIA	IN21172599	INHUMAS S1	07/12/2019 09:01	07/12/2019 15:26	07/12/2019 09:01	07/12/2019 15:26	6,41	1	6,41	CHI
20191242969	NOVA CRIXAS	NA12391603	NOVA CRIXAS	07/12/2019 09:02	07/12/2019 10:10	07/12/2019 09:02	07/12/2019 10:10	1,13	41	46,27	CHI
20191242971	PORANGATU	PO12021172	PORANGATU	07/12/2019 09:02	07/12/2019 10:47	07/12/2019 09:02	07/12/2019 10:47	1,74	5	8,71	CHI
20191242972	COCALZINHO DE GOIAS	ZN12353427	COCALZINHO	07/12/2019 09:02	07/12/2019 18:17	07/12/2019 09:02	07/12/2019 18:17	9,24	6	55,45	CHI
20191243154	TRINDADE	TR32055812	TRINDADE	07/12/2019 09:02	07/12/2019 11:51	07/12/2019 09:02	07/12/2019 11:51	2,80	13	36,45	CHI
20191244000	SERRANOPOLIS	SX12318831	JATAI S1	07/12/2019 09:02	08/12/2019 14:28	07/12/2019 09:02	08/12/2019 14:28	29,42	5	147,11	CHI
20191241753	BURITI DE GOIAS	NB21300401	FIRMINOPOLIS S2	07/12/2019 09:03	07/12/2019 18:26	07/12/2019 09:03	07/12/2019 18:26	9,37	1	9,37	CHI
20191242981	TRES RANCHOS	TH12077320	CATALAO S1	07/12/2019 09:03	07/12/2019 11:33	07/12/2019 09:03	07/12/2019 11:33	2,49	7	17,42	CHI

20191242983	LUZIANIA	LZ12137225	VIANOPOLIS	07/12/2019 09:03	07/12/2019 12:19	07/12/2019 09:03	07/12/2019 12:19	3,25	14	45,52	CHI
20191242984	JOVIANIA	JV12218134	GOIATUBA S1	07/12/2019 09:03	07/12/2019 12:59	07/12/2019 09:03	07/12/2019 12:59	3,92	1	3,92	CHI
20191242985	PADRE BERNARDO	PB12375253	PADRE BERNARDO	07/12/2019 09:04	07/12/2019 11:06	07/12/2019 09:04	07/12/2019 11:06	2,03	1	2,03	CHI
20191242989	ARAGARCAS	AG12380335	ARAGARCAS	07/12/2019 09:04	07/12/2019 11:11	07/12/2019 09:04	07/12/2019 11:11	2,10	27	56,78	CHI
20191242989	BOM JARDIM DE GOIAS	AG12380335	ARAGARCAS	07/12/2019 09:04	07/12/2019 11:11	07/12/2019 09:04	07/12/2019 11:11	2,10	1	2,10	CHI
20191242992	CRISTALINA	KR12209611	PAMPLONA	07/12/2019 09:04	07/12/2019 11:10	07/12/2019 09:04	07/12/2019 11:10	2,08	4	8,34	CHI
20191243128	RIO VERDE	RV12207197	MONTIVIDIU T	07/12/2019 09:04	07/12/2019 15:45	07/12/2019 09:04	07/12/2019 15:45	6,68	18	120,27	CHI
20191242993	MINEIROS	10029373016	PARQUE DAS EMAS	07/12/2019 09:05	07/12/2019 16:46	07/12/2019 09:05	07/12/2019 16:46	7,68	1	7,68	CHI
20191242994	RIO VERDE	RV21271607	CABRIUVA S2	07/12/2019 09:05	07/12/2019 11:54	07/12/2019 09:05	07/12/2019 11:54	2,81	1	2,81	CHI
20191242998	FORMOSA	FA12404383	ITIQUEIRA	07/12/2019 09:05	07/12/2019 13:18	07/12/2019 09:05	07/12/2019 13:18	4,20	11	46,24	CHI
20191243002	ITUMBIARA	IT12000242	ITUMBIARA NOVA	07/12/2019 09:06	07/12/2019 10:02	07/12/2019 09:06	07/12/2019 10:02	0,93	3	2,78	CHI
20191243016	FORMOSA	FA12202247	ITIQUEIRA	07/12/2019 09:09	07/12/2019 10:55	07/12/2019 09:09	07/12/2019 10:55	1,77	5	8,83	CHI
20191243021	ANAPOLIS	20088875	ANAPOLIS UNIVERSITARIO S2	07/12/2019 09:09	07/12/2019 10:47	07/12/2019 09:09	07/12/2019 10:47	1,62	1	1,62	CHI
20191243025	ANICUNS	AC21019290	ANICUNS	07/12/2019 09:10	07/12/2019 11:40	07/12/2019 09:10	07/12/2019 11:40	2,50	2	5,00	CHI
20191243027	PIRENOPOLIS	CB21130159	CORUMBA	07/12/2019 09:10	07/12/2019 11:01	07/12/2019 09:10	07/12/2019 11:01	1,84	1	1,84	CHI
20191241749	JATAI	290019576	JATAI S3	07/12/2019 09:12	07/12/2019 16:28	07/12/2019 09:12	07/12/2019 16:28	7,26	1	7,26	CHI
20191243030	MINACU	IH21187813	MINACU	07/12/2019 09:12	07/12/2019 13:58	07/12/2019 09:12	07/12/2019 13:58	4,77	1	4,77	CHI
20191243040	GOIANIA	12260010	AEROPORTO S2	07/12/2019 09:15	07/12/2019 10:50	07/12/2019 09:15	07/12/2019 10:50	1,58	1	1,58	CHI
20191243044	GOIANIA	GN11247957	GOYA S2	07/12/2019 09:16	07/12/2019 12:18	07/12/2019 09:16	07/12/2019 12:18	3,03	119	360,17	CHI
20191243047	MORRINHOS	MR12000350	GOIATUBA S1	07/12/2019 09:16	07/12/2019 12:15	07/12/2019 09:16	07/12/2019 12:15	2,97	3	8,91	CHI
20191243048	LUZIANIA	LZ12349110	MARAJOARA	07/12/2019 09:17	07/12/2019 10:00	07/12/2019 09:17	07/12/2019 10:00	0,71	15	10,71	CHI
20191243050	JATAI	10007297120	JATAI S2	07/12/2019 09:17	07/12/2019 13:43	07/12/2019 09:17	07/12/2019 13:43	4,42	1	4,42	CHI
20191243063	MINACU	IH12247493	MINACU	07/12/2019 09:17	07/12/2019 12:27	07/12/2019 09:17	07/12/2019 12:27	3,16	63	198,85	CHI
20191243142	CALDAS NOVAS	CN12102170	CALDAS NOVAS S1	07/12/2019 09:17	07/12/2019 11:15	07/12/2019 09:17	07/12/2019 11:15	1,96	149	292,62	CHI
20191243053	AURILANDIA	AI21032166	FIRMINOPOLIS S2	07/12/2019 09:18	08/12/2019 08:02	07/12/2019 09:18	08/12/2019 08:02	22,73	2	45,47	CHI
20191243058	CRIXAS	CX21150744	SANTA TEREZINHA	07/12/2019 09:19	08/12/2019 02:04	07/12/2019 09:19	08/12/2019 02:04	16,76	1	16,76	CHI
20191243070	CAMPESTRE DE GOIAS	GC11277331	TRINDADE	07/12/2019 09:21	07/12/2019 14:24	07/12/2019 09:21	07/12/2019 14:24	5,04	1	5,04	CHI
20191244186	SITIO D ABADIA	SI12099872	IACIARA S2	07/12/2019 09:21	07/12/2019 18:21	07/12/2019 09:21	07/12/2019 18:21	9,00	30	269,96	CHI
20191243077	ITABERAI	IB21105421	ITABERAI S1	07/12/2019 09:22	08/12/2019 08:34	07/12/2019 09:22	08/12/2019 08:34	23,19	1	23,19	CHI
20191243080	VICENTINOPOLIS	VI21028475	VICENTINOPOLIS	07/12/2019 09:22	08/12/2019 13:07	07/12/2019 09:22	08/12/2019 13:07	27,74	1	27,74	CHI
20191243090	GUAPO	710037296	GUAPO S2	07/12/2019 09:24	07/12/2019 14:00	07/12/2019 09:24	07/12/2019 14:00	4,60	1	4,60	CHI
20191243091	IPAMERI	IP11332955	IPAMERI	07/12/2019 09:24	07/12/2019 13:15	07/12/2019 09:24	07/12/2019 13:15	3,85	2	7,69	CHI
20191243092	VALPARAISO DE GOIAS	10001688373	PACAEMBU S1	07/12/2019 09:24	07/12/2019 12:25	07/12/2019 09:24	07/12/2019 12:25	3,01	1	3,01	CHI

20191243095	PEROLANDIA	DP12182220	JATAI S1	07/12/2019 09:24	07/12/2019 17:36	07/12/2019 09:24	07/12/2019 17:36	8,19	7	57,35	CHI
20191243100	MUTUNOPOLIS	MU12214690	MARA ROSA	07/12/2019 09:25	07/12/2019 16:20	07/12/2019 09:25	07/12/2019 16:20	6,91	1	6,91	CHI
20191243363	MINACU	IH12182352	MINACU	07/12/2019 09:25	07/12/2019 11:27	07/12/2019 09:25	07/12/2019 11:27	2,03	205	416,55	CHI
20191243103	JARAGUA	JA21377531	SAO FRANCISCO DE GOIAS	07/12/2019 09:26	07/12/2019 17:10	07/12/2019 09:26	07/12/2019 17:10	7,74	2	15,49	CHI
20191243106	CATALAO	10007527398	CATALAO S1	07/12/2019 09:26	07/12/2019 12:28	07/12/2019 09:26	07/12/2019 12:28	3,02	1	3,02	CHI
20191243109	JUSSARA	JR21059811	IPORA	07/12/2019 09:27	07/12/2019 12:12	07/12/2019 09:27	07/12/2019 12:12	2,74	1	2,74	CHI
20191243111	ITAUCU	IX31130177	INHUMAS S1	07/12/2019 09:27	07/12/2019 16:43	07/12/2019 09:27	07/12/2019 16:43	7,26	1	7,26	CHI
20191243115	APARECIDA DE GOIANIA	10009934624	ANHANGUERA	07/12/2019 09:28	07/12/2019 10:18	07/12/2019 09:28	07/12/2019 10:18	0,82	1	0,82	CHI
20191243117	LUZIANIA	LZ21304790	PAMPLONA	07/12/2019 09:29	07/12/2019 12:20	07/12/2019 09:29	07/12/2019 12:20	2,85	1	2,85	CHI
20191243121	GOIANESIA	550064941	GOIANESIA S2	07/12/2019 09:29	07/12/2019 19:17	07/12/2019 09:29	07/12/2019 19:17	9,78	1	9,78	CHI
20191243122	SANTO ANTONIO DO DESCOBERTO	SN12183611	AGUAS LINDAS DE GOIAS S2	07/12/2019 09:29	07/12/2019 10:48	07/12/2019 09:29	07/12/2019 10:48	1,30	5	6,50	CHI
20191243139	PLANALTINA	PI12100884	PLANALTINA	07/12/2019 09:30	07/12/2019 11:06	07/12/2019 09:30	07/12/2019 11:06	1,60	9	14,39	CHI
201912233105	CACHOEIRA ALTA	CA12370046	CACHOEIRA ALTA	07/12/2019 09:30	07/12/2019 11:50	07/12/2019 09:30	07/12/2019 11:50	2,32	22	51,11	CHI
20191243130	BURITI DE GOIAS	BS12308352	FIRMINOPOLIS S2	07/12/2019 09:31	07/12/2019 14:17	07/12/2019 11:10	07/12/2019 14:17	3,13	4	12,52	CHI
20191243134	RIO VERDE	RV12214248	MONTIVIDIU T	07/12/2019 09:32	07/12/2019 17:00	07/12/2019 09:32	07/12/2019 17:00	7,46	3	22,39	CHI
20191243135	RIO VERDE	930063685	MONTIVIDIU T	07/12/2019 09:32	07/12/2019 16:45	07/12/2019 09:32	07/12/2019 16:45	7,23	1	7,23	CHI
20191243239	RIO VERDE	RV12360702	MONTIVIDIU T	07/12/2019 09:32	07/12/2019 14:10	07/12/2019 09:32	07/12/2019 14:10	4,63	12	55,54	CHI
20191243141	MINEIROS	MY12260370	PARQUE DAS EMAS	07/12/2019 09:33	08/12/2019 09:18	07/12/2019 09:33	08/12/2019 09:18	23,74	6	142,45	CHI
20191243150	QUIRINOPOLIS	QI12101348	QUIRINOPOLIS	07/12/2019 09:34	07/12/2019 15:20	07/12/2019 09:34	07/12/2019 15:20	5,75	53	304,93	CHI
20191243153	ITABERAI	IB21310535	ITABERAI S2	07/12/2019 09:35	08/12/2019 12:37	07/12/2019 09:35	08/12/2019 12:37	27,03	1	27,03	CHI
20191243155	PORANGATU	PO12100815	NOVO PLANALTO	07/12/2019 09:35	07/12/2019 13:01	07/12/2019 09:35	07/12/2019 13:01	3,42	3	10,27	CHI
20191243591	SANCLERLANDIA	SC12206379	FIRMINOPOLIS S2	07/12/2019 09:35	07/12/2019 14:03	07/12/2019 09:35	07/12/2019 14:03	4,46	6	26,76	CHI
20191243650	JAUPACI	JP12349752	IPORA	07/12/2019 09:35	07/12/2019 17:01	07/12/2019 09:35	07/12/2019 17:01	7,42	8	59,36	CHI
20191243161	TURVANIA	TV21005753	FIRMINOPOLIS S2	07/12/2019 09:36	07/12/2019 18:52	07/12/2019 09:36	07/12/2019 18:52	9,27	1	9,27	CHI
20191243162	PALMEIRAS DE GOIAS	PL21216913	PALMEIRAS	07/12/2019 09:36	07/12/2019 13:25	07/12/2019 09:36	07/12/2019 13:25	3,82	1	3,82	CHI
20191243167	PORANGATU	PO12262596	PORANGATU	07/12/2019 09:37	07/12/2019 11:42	07/12/2019 09:37	07/12/2019 11:42	2,08	37	76,81	CHI
20191243168	RIO VERDE	10003500363	RIO VERDE S1	07/12/2019 09:37	07/12/2019 12:12	07/12/2019 09:37	07/12/2019 12:12	2,57	1	2,57	CHI
201912260911	ITABERAI	50015709	ITABERAI S2	07/12/2019 09:37	07/12/2019 16:45	07/12/2019 09:37	07/12/2019 16:45	7,13	1	7,13	CHI
20191243176	CRIXAS	NA12078447	NOVA CRIXAS	07/12/2019 09:38	07/12/2019 14:44	07/12/2019 09:38	07/12/2019 14:44	5,08	16	81,35	CHI
20191243176	NOVA CRIXAS	NA12078447	NOVA CRIXAS	07/12/2019 09:38	07/12/2019 14:44	07/12/2019 09:38	07/12/2019 14:44	5,08	18	91,52	CHI
20191243190	SAO LUIS DE MONTES BELOS	SL12003965	SAO LUIZ DOS MONTES BELOS	07/12/2019 09:38	07/12/2019 16:32	07/12/2019 09:38	07/12/2019 16:32	6,88	11	75,73	CHI
20191243178	GOUVELANDIA	QI21014261	QUIRINOPOLIS	07/12/2019 09:39	07/12/2019 13:37	07/12/2019 09:39	07/12/2019 13:37	3,96	1	3,96	CHI
20191243181	PADRE BERNARDO	PB12163217	PADRE BERNARDO	07/12/2019 09:40	07/12/2019 12:55	07/12/2019 09:40	07/12/2019 12:55	3,25	20	64,95	CHI

20191243183	PILAR DE GOIAS	HL21140759	URUACU	07/12/2019 09:40	07/12/2019 14:39	07/12/2019 09:40	07/12/2019 14:39	4,98	1	4,98	CHI
20191243187	SANTA TEREZINHA DE GOIAS	7830004078	SANTA TEREZINHA	07/12/2019 09:41	08/12/2019 14:09	07/12/2019 09:41	08/12/2019 14:09	28,47	1	28,47	CHI
20191243195	GOIANIA	10193339	AEROPORTO S1	07/12/2019 09:42	07/12/2019 10:50	07/12/2019 09:42	07/12/2019 10:50	1,12	1	1,12	CHI
20191243200	DAMIANOPOLIS	DA12196511	IACIARA S2	07/12/2019 09:44	07/12/2019 15:50	07/12/2019 09:44	07/12/2019 15:50	6,09	31	188,89	CHI
20191243201	CATALAO	1990298579	CATALAO S1	07/12/2019 09:44	07/12/2019 13:03	07/12/2019 09:44	07/12/2019 13:03	3,31	1	3,31	CHI
20191243203	ARENOPOLIS	AY12259343	IPORA	07/12/2019 09:44	08/12/2019 10:53	07/12/2019 09:44	08/12/2019 10:53	25,14	2	50,28	CHI
20191243498	GOIAS	GS12220301	GOIAS	07/12/2019 09:44	07/12/2019 14:41	07/12/2019 09:44	07/12/2019 14:41	4,94	6	29,65	CHI
20191244419	FIRMINOPOLIS	FR12013010	FIRMINOPOLIS S1	07/12/2019 09:44	08/12/2019 08:40	07/12/2019 09:44	08/12/2019 08:40	22,93	4	91,73	CHI
20191243213	RIO VERDE	10023271645	RIO VERDE S2	07/12/2019 09:45	07/12/2019 14:44	07/12/2019 09:45	07/12/2019 14:44	4,97	1	4,97	CHI
20191243217	NIQUELANDIA	NQ21372494	NIQUELANDIA SUBTRANSMISSAO	07/12/2019 09:47	07/12/2019 15:11	07/12/2019 09:47	07/12/2019 15:11	5,40	1	5,40	CHI
20191239836	JATAI	JT12354973	JATAI S1	07/12/2019 09:48	07/12/2019 18:30	07/12/2019 09:48	07/12/2019 18:30	8,69	34	295,44	CHI
20191243226	JARAGUA	JA11054423	JARAGUA	07/12/2019 09:49	07/12/2019 15:40	07/12/2019 09:49	07/12/2019 15:40	5,86	18	105,48	CHI
20191243228	NIQUELANDIA	NQ12312783	NIQUELANDIA SUBTRANSMISSAO	07/12/2019 09:49	08/12/2019 11:35	07/12/2019 09:49	08/12/2019 11:35	25,76	2	51,52	CHI
20191243265	CRIXAS	CX12190045	SERRA DO OURO	07/12/2019 09:49	07/12/2019 17:25	07/12/2019 09:49	07/12/2019 17:25	7,58	9	68,26	CHI
20191243250	URUACU	UR12231336	MARA ROSA	07/12/2019 09:54	07/12/2019 21:30	07/12/2019 09:54	07/12/2019 21:30	11,60	6	69,61	CHI
20191243250	CAMPINORTE	UR12231336	MARA ROSA	07/12/2019 09:54	07/12/2019 21:30	07/12/2019 19:25	07/12/2019 21:30	2,09	2	4,19	CHI
20191243250	URUACU	UR12231336	MARA ROSA	07/12/2019 09:54	07/12/2019 21:30	07/12/2019 19:25	07/12/2019 21:30	2,09	15	31,39	CHI
20191243254	GOIANIA	10965221	CAMPINAS S3	07/12/2019 09:54	07/12/2019 11:24	07/12/2019 09:54	07/12/2019 11:24	1,49	1	1,49	CHI
20191243257	LUZIANIA	LZ21290867	MARAJOARA	07/12/2019 09:55	07/12/2019 11:01	07/12/2019 09:55	07/12/2019 11:01	1,09	1	1,09	CHI
20191243258	ITABERAI	IB11359474	ITABERAI S2	07/12/2019 09:55	08/12/2019 07:27	07/12/2019 09:55	08/12/2019 07:27	21,53	1	21,53	CHI
20191243460	SAO MIGUEL DO ARAGUAIA	SM11216322	SAO MIGUEL DO ARAGUAIA	07/12/2019 09:55	07/12/2019 16:21	07/12/2019 09:55	07/12/2019 16:21	6,43	142	912,59	CHI
20191243275	CABECEIRAS	CW21109342	ITIQUEIRA	07/12/2019 09:56	07/12/2019 11:40	07/12/2019 09:56	07/12/2019 11:40	1,72	1	1,72	CHI
20191243330	SANTA FE DE GOIAS	RN12232821	BRITANIA	07/12/2019 09:56	07/12/2019 21:45	07/12/2019 09:56	07/12/2019 21:45	11,81	3	35,42	CHI
20191241755	ITAPIRAPUA	IU12121382	MATRINCHA	07/12/2019 09:57	07/12/2019 12:36	07/12/2019 09:57	07/12/2019 12:36	2,64	15	39,65	CHI
20191243279	ITABERAI	IB21188706	ITABERAI S2	07/12/2019 09:57	08/12/2019 10:36	07/12/2019 09:57	08/12/2019 10:36	24,64	2	49,29	CHI
20191243280	JAUPACI	JP12251548	IPORA	07/12/2019 09:57	07/12/2019 16:06	07/12/2019 09:57	07/12/2019 16:06	6,14	3	18,43	CHI
20191243286	ANAPOLIS	20771174	JUNDIAI S1	07/12/2019 09:58	07/12/2019 11:15	07/12/2019 09:58	07/12/2019 11:15	1,28	1	1,28	CHI
20191243288	ITUMBIARA	IT12257075	ITUMBIARA NOVA	07/12/2019 09:58	07/12/2019 11:15	07/12/2019 09:58	07/12/2019 11:15	1,28	18	22,96	CHI
20191243289	VILA PROPICIO	PV21151980	GOIANESIA S1	07/12/2019 09:58	07/12/2019 12:02	07/12/2019 09:58	07/12/2019 12:02	2,05	1	2,05	CHI
20191243726	CRIXAS	CX12290228	SERRA DO OURO	07/12/2019 09:58	07/12/2019 17:07	07/12/2019 09:58	07/12/2019 17:07	7,15	19	135,84	CHI
20191243291	ANAPOLIS	00050254	ANAPOLIS UNIVERSITARIO S1	07/12/2019 09:59	07/12/2019 10:05	07/12/2019 09:59	07/12/2019 10:03	0,07	2177	152,39	CHI
20191243291	ANAPOLIS	00050254	ANAPOLIS UNIVERSITARIO S1	07/12/2019 09:59	07/12/2019 10:05	07/12/2019 09:59	07/12/2019 10:03	0,08	2071	162,23	CHI
20191243291	ANAPOLIS	00050254	ANAPOLIS UNIVERSITARIO S1	07/12/2019 09:59	07/12/2019 10:05	07/12/2019 09:59	07/12/2019 10:04	0,09	1909	176,05	CHI



20191243291	ANAPOLIS	00050254	ANAPOLIS UNIVERSITARIO S1	07/12/2019 09:59	07/12/2019 10:05	07/12/2019 09:59	07/12/2019 10:05	0,10	3034	317,73	CHI
20191243294	LUZIANIA	LZ21256465	MARAJOARA	07/12/2019 10:00	07/12/2019 22:12	07/12/2019 10:00	07/12/2019 22:12	12,20	1	12,20	CHI
20191243295	MARA ROSA	MQ12287615	MARA ROSA	07/12/2019 10:00	07/12/2019 13:43	07/12/2019 10:00	07/12/2019 13:43	3,72	4	14,86	CHI
20191243296	ANAPOLIS	AN31096739	ANAPOLIS UNIVERSITARIO S2	07/12/2019 10:00	07/12/2019 11:40	07/12/2019 10:00	07/12/2019 11:40	1,67	1	1,67	CHI
20191243297	JARAGUA	70062791	JARAGUA	07/12/2019 10:00	07/12/2019 15:53	07/12/2019 10:00	07/12/2019 15:53	5,88	1	5,88	CHI
20191243302	ITAPIRAPUA	IU21009135	MATRINCHA	07/12/2019 10:00	08/12/2019 09:32	07/12/2019 10:00	08/12/2019 09:32	23,52	1	23,52	CHI
20191243311	ALEXANIA	AX12335042	ALEXANIA	07/12/2019 10:01	07/12/2019 12:50	07/12/2019 10:01	07/12/2019 12:50	2,80	1	2,80	CHI
20191243325	SANCLERLANDIA	SC12391519	FIRMINOPOLIS S2	07/12/2019 10:03	08/12/2019 10:18	07/12/2019 10:03	08/12/2019 10:18	24,24	1	24,24	CHI
20191243325	SAO LUIS DE MONTES BELOS	SC12391519	FIRMINOPOLIS S2	07/12/2019 10:03	08/12/2019 10:18	07/12/2019 10:03	08/12/2019 10:18	24,24	2	48,49	CHI
20191243341	NOVO GAMA	LZ21041592	PACAEMBU S1	07/12/2019 10:05	07/12/2019 11:41	07/12/2019 10:05	07/12/2019 11:41	1,59	0	0,00	CHI
20191243346	GOIANIA	12214395	GOYA S1	07/12/2019 10:06	07/12/2019 12:05	07/12/2019 10:06	07/12/2019 12:05	1,98	1	1,98	CHI
20191243347	BOM JARDIM DE GOIAS	BM12334813	IPORA	07/12/2019 10:06	08/12/2019 03:50	07/12/2019 10:06	07/12/2019 21:40	11,56	12	138,77	CHI
20191243347	BOM JARDIM DE GOIAS	8648973	IPORA	07/12/2019 10:06	08/12/2019 03:50	07/12/2019 10:06	08/12/2019 03:50	17,73	2	35,46	CHI
20191243350	MORRINHOS	MR12352594	MORRINHOS	07/12/2019 10:06	07/12/2019 13:54	07/12/2019 10:06	07/12/2019 13:54	3,80	7	26,63	CHI
20191243350	PIRACANJUBA	MR12352594	MORRINHOS	07/12/2019 10:06	07/12/2019 13:54	07/12/2019 10:06	07/12/2019 13:54	3,80	2	7,61	CHI
20191243356	ARENOPOLIS	AY12000021	ARENOPOLIS	07/12/2019 10:07	07/12/2019 18:47	07/12/2019 10:07	07/12/2019 18:47	8,66	19	164,60	CHI
20191243357	FIRMINOPOLIS	2940000226	FIRMINOPOLIS S1	07/12/2019 10:07	07/12/2019 16:30	07/12/2019 10:07	07/12/2019 16:30	6,38	1	6,38	CHI
20191243362	ANICUNS	AC21095671	ANICUNS	07/12/2019 10:07	07/12/2019 14:29	07/12/2019 10:07	07/12/2019 14:29	4,36	1	4,36	CHI
20191243364	CAMPO ALEGRE DE GOIAS	CM21333062	CAMPO ALEGRE DE GOIAS	07/12/2019 10:07	07/12/2019 12:39	07/12/2019 10:07	07/12/2019 12:39	2,52	1	2,52	CHI
20191243444	AGUA FRIA DE GOIAS	JL12262352	SAO JOAO D ALIANCA	07/12/2019 10:08	07/12/2019 13:04	07/12/2019 10:08	07/12/2019 13:04	2,92	6	17,50	CHI
20191243444	SAO JOAO D ALIANCA	JL12262352	SAO JOAO D ALIANCA	07/12/2019 10:08	07/12/2019 13:04	07/12/2019 10:08	07/12/2019 13:04	2,92	104	303,36	CHI
20191243371	SAO FRANCISCO DE GOIAS	SF21285016	SAO FRANCISCO DE GOIAS	07/12/2019 10:09	07/12/2019 18:20	07/12/2019 10:09	07/12/2019 18:20	8,18	1	8,18	CHI
20191243375	PIRENOPOLIS	PV31000620	SAO FRANCISCO DE GOIAS	07/12/2019 10:10	07/12/2019 11:18	07/12/2019 10:10	07/12/2019 11:18	1,13	1	1,13	CHI
20191243543	ABADIANIA	AA12333151	DAIA S2	07/12/2019 10:10	07/12/2019 12:16	07/12/2019 10:10	07/12/2019 12:16	2,10	21	44,04	CHI
20191243384	JATAI	10003529078	JATAI S3	07/12/2019 10:11	07/12/2019 12:05	07/12/2019 10:11	07/12/2019 12:05	1,89	1	1,89	CHI
20191243393	ARAGARCAS	AG12354689	ARAGARCAS	07/12/2019 10:15	07/12/2019 18:32	07/12/2019 10:15	07/12/2019 18:32	8,28	2	16,55	CHI
20191243399	PARAUNA	PU12083901LD	PARAUNA	07/12/2019 10:17	08/12/2019 14:29	07/12/2019 10:17	07/12/2019 16:05	5,79	13	75,33	CHI
20191243399	PARAUNA	PU12395671	PARAUNA	07/12/2019 10:17	08/12/2019 14:29	07/12/2019 19:40	07/12/2019 20:48	1,14	47	53,46	CHI
20191243399	PARAUNA	PU12083901LD	PARAUNA	07/12/2019 10:17	08/12/2019 14:29	07/12/2019 10:17	07/12/2019 22:57	12,66	8	101,31	CHI
20191243399	PARAUNA	PU12083901LD	PARAUNA	07/12/2019 10:17	08/12/2019 14:29	07/12/2019 19:30	07/12/2019 22:57	3,45	13	44,89	CHI
20191243399	PARAUNA	PU12395671	PARAUNA	07/12/2019 10:17	08/12/2019 14:29	08/12/2019 01:20	08/12/2019 07:20	6,00	250	1500,00	CHI
20191243399	PARAUNA	PU12126120LD	PARAUNA	07/12/2019 10:17	08/12/2019 14:29	07/12/2019 10:17	08/12/2019 14:29	28,21	2	56,41	CHI
20191243401	CUMARI	CT21077581	CATALAO S2	07/12/2019 10:17	07/12/2019 11:20	07/12/2019 10:17	07/12/2019 11:20	1,04	1	1,04	CHI

20191243405	VICENTINOPOLIS	VI21216810	VICENTINOPOLIS	07/12/2019 10:18	08/12/2019 15:06	07/12/2019 10:18	08/12/2019 15:06	28,80	2	57,59	CHI
20191243406	ITAJA	IJ21154804	ITAJA S2	07/12/2019 10:18	07/12/2019 15:48	07/12/2019 10:18	07/12/2019 15:48	5,50	1	5,50	CHI
20191243409	EDEALINA	ED12049300	PONTALINA	07/12/2019 10:18	07/12/2019 13:39	07/12/2019 10:18	07/12/2019 13:39	3,34	3	10,01	CHI
20191242487	GOIANESIA	GE12376587	GOIANESIA S2	07/12/2019 10:20	07/12/2019 13:18	07/12/2019 10:20	07/12/2019 13:18	2,96	2	5,92	CHI
20191242487	VILA PROPICIO	GE12376587	GOIANESIA S2	07/12/2019 10:20	07/12/2019 13:18	07/12/2019 10:20	07/12/2019 13:18	2,96	1	2,96	CHI
20191243413	LUZIANIA	LZ21335967	MARAJOARA	07/12/2019 10:20	07/12/2019 19:08	07/12/2019 10:20	07/12/2019 19:08	8,80	1	8,80	CHI
20191243418	GOIAS	GS11222213	GOIAS	07/12/2019 10:20	07/12/2019 19:39	07/12/2019 10:20	07/12/2019 19:39	9,30	1	9,30	CHI
20191243419	PIRANHAS	PH21233050	PIRANHAS	07/12/2019 10:20	08/12/2019 17:45	07/12/2019 10:20	08/12/2019 17:45	31,40	1	31,40	CHI
20191243848	CACHOEIRA ALTA	QI12119881	QUIRINOPOLIS	07/12/2019 10:22	07/12/2019 17:49	07/12/2019 10:22	07/12/2019 17:49	7,44	6	44,67	CHI
20191243848	QUIRINOPOLIS	QI12119881	QUIRINOPOLIS	07/12/2019 10:22	07/12/2019 17:49	07/12/2019 10:22	07/12/2019 17:49	7,44	18	134,00	CHI
20191243429	VILA BOA	2880001888	IACIARA S2	07/12/2019 10:23	07/12/2019 15:16	07/12/2019 10:23	07/12/2019 15:16	4,88	1	4,88	CHI
20191243489	NAZARIO	NZ12383577	ANICUNS	07/12/2019 10:23	07/12/2019 12:20	07/12/2019 10:23	07/12/2019 12:20	1,93	4	7,74	CHI
20191244080	CRIXAS	NA12220357	MOZARLANDIA	07/12/2019 10:23	07/12/2019 17:03	07/12/2019 10:23	07/12/2019 17:03	6,65	2	13,31	CHI
20191244080	NOVA CRIXAS	NA12220357	MOZARLANDIA	07/12/2019 10:23	07/12/2019 17:03	07/12/2019 10:23	07/12/2019 17:03	6,65	6	39,92	CHI
20191246157	DIORAMA	DI12056935	ARENOPOLIS	07/12/2019 10:23	08/12/2019 06:56	07/12/2019 10:23	08/12/2019 06:56	20,55	2	41,09	CHI
20191243436	LUZIANIA	LZ21357801	MARAJOARA	07/12/2019 10:24	07/12/2019 17:01	07/12/2019 10:24	07/12/2019 17:01	6,61	2	13,22	CHI
20191243438	EDEIA	ED21000029	PONTALINA	07/12/2019 10:24	07/12/2019 18:11	07/12/2019 10:24	07/12/2019 18:11	7,77	1	7,77	CHI
20191243439	GOIANIRA	GR11274998	MEIA PONTE	07/12/2019 10:24	07/12/2019 12:12	07/12/2019 10:24	07/12/2019 12:12	1,79	204	364,48	CHI
20191243440	VICENTINOPOLIS	VI21013547	VICENTINOPOLIS	07/12/2019 10:25	07/12/2019 14:14	07/12/2019 10:25	07/12/2019 14:14	3,81	2	7,62	CHI
20191243601	AGUA FRIA DE GOIAS	MJ12040650	PADRE BERNARDO	07/12/2019 10:25	07/12/2019 14:11	07/12/2019 10:25	07/12/2019 14:11	3,75	9	33,77	CHI
20191243601	MIMOSO DE GOIAS	MJ12040650	PADRE BERNARDO	07/12/2019 10:25	07/12/2019 14:11	07/12/2019 10:25	07/12/2019 14:11	3,75	12	45,03	CHI
20191243447	ITABERAI	50065361	ITABERAI S2	07/12/2019 10:26	07/12/2019 12:11	07/12/2019 10:26	07/12/2019 12:11	1,74	1	1,74	CHI
20191243452	ANAPOLIS	AN13077986	ANAPOLIS UNIVERSITARIO S1	07/12/2019 10:26	07/12/2019 14:29	07/12/2019 10:26	07/12/2019 11:56	1,49	1437	2140,73	CHI
20191243452	ANAPOLIS	AN13130818	ANAPOLIS UNIVERSITARIO S1	07/12/2019 10:26	07/12/2019 14:29	07/12/2019 12:06	07/12/2019 14:29	2,39	113	270,45	CHI
20191243449	ITAPURANGA	IK21298526	ITAPURANGA	07/12/2019 10:27	08/12/2019 12:20	07/12/2019 10:27	08/12/2019 12:20	25,89	1	25,89	CHI
20191243455	ITUMBIARA	IT12065311	CACHOEIRA DOURADA	07/12/2019 10:29	07/12/2019 12:14	07/12/2019 10:29	07/12/2019 12:14	1,75	3	5,25	CHI
20191243456	RIO VERDE	RV12279692	RIO VERDE S1	07/12/2019 10:29	07/12/2019 20:49	07/12/2019 10:29	07/12/2019 20:49	10,33	1	10,33	CHI
20191243462	FORMOSA	FA11278165	ITUIQUIRA	07/12/2019 10:30	07/12/2019 14:56	07/12/2019 10:30	07/12/2019 14:56	4,43	1	4,43	CHI
20191243491	NOVA CRIXAS	NA21193686	MOZARLANDIA	07/12/2019 10:32	07/12/2019 17:50	07/12/2019 10:32	07/12/2019 17:50	7,30	1	7,30	CHI
20191243493	CALDAZINHA	BV21049109	CEPAIGO S2	07/12/2019 10:32	07/12/2019 13:59	07/12/2019 10:32	07/12/2019 13:59	3,46	1	3,46	CHI
20191243495	CRIXAS	CX21229809	RUBIATABA	07/12/2019 10:32	08/12/2019 09:15	07/12/2019 10:32	08/12/2019 09:15	22,71	1	22,71	CHI
20191239821	PILAR DE GOIAS	GG12405274	ITAPACI	07/12/2019 10:34	07/12/2019 13:01	07/12/2019 10:34	07/12/2019 13:01	2,45	16	39,16	CHI
20191241789	ARAGOIANIA	AO32097677	GUAPO S2	07/12/2019 10:34	07/12/2019 15:04	07/12/2019 10:34	07/12/2019 15:04	4,50	8	35,97	CHI

20191241789	HIDROLANDIA	AO32097677	GUAPO S2	07/12/2019 10:34	07/12/2019 15:04	07/12/2019 10:34	07/12/2019 15:04	4,50	38	170,86	CHI
20191243506	ITABERAI	IB11359516	ITABERAI S2	07/12/2019 10:34	08/12/2019 11:50	07/12/2019 10:34	08/12/2019 11:50	25,26	1	25,26	CHI
20191243509	TRINDADE	40033119	TRINDADE	07/12/2019 10:34	07/12/2019 12:45	07/12/2019 10:34	07/12/2019 12:45	2,17	1	2,17	CHI
20191243819	BOM JARDIM DE GOIAS	BM12297154	BOM JARDIM	07/12/2019 10:35	07/12/2019 22:10	07/12/2019 10:35	07/12/2019 22:10	11,59	2	23,18	CHI
20191244555	IPORA	IR12035147	IPORA	07/12/2019 10:35	07/12/2019 22:20	07/12/2019 10:35	07/12/2019 22:20	11,74	6	70,44	CHI
20191243517	ITAUCU	AR21168383	INHUMAS S1	07/12/2019 10:36	08/12/2019 04:01	07/12/2019 10:36	08/12/2019 04:01	17,42	1	17,42	CHI
20191243523	JANDAIA	JD21243889	PALMEIRAS	07/12/2019 10:36	07/12/2019 15:20	07/12/2019 10:36	07/12/2019 15:20	4,73	1	4,73	CHI
20191243525	FORMOSA	FA31042727	SAO JOAO D ALIANCA	07/12/2019 10:36	07/12/2019 13:35	07/12/2019 10:36	07/12/2019 13:35	2,97	1	2,97	CHI
20191243806	NIQUELANDIA	NQ12362992	URUACU	07/12/2019 10:36	07/12/2019 14:04	07/12/2019 10:36	07/12/2019 14:04	3,46	371	1284,59	CHI
20191243927	SANCLERLANDIA	SC12229501	FIRMINOPOLIS S2	07/12/2019 10:36	08/12/2019 08:08	07/12/2019 10:36	08/12/2019 08:08	21,52	2	43,05	CHI
20191243528	NOVA CRIXAS	NA12281134	MOZARLANDIA	07/12/2019 10:37	07/12/2019 21:00	07/12/2019 10:37	07/12/2019 21:00	10,37	1	10,37	CHI
20191243529	BONFINOPOLIS	BO21281336	GOIANIA LESTE S2	07/12/2019 10:38	07/12/2019 15:44	07/12/2019 10:38	07/12/2019 15:44	5,10	1	5,10	CHI
20191245611	ITUMBIARA	IT21075710	ITUMBIARA VELHA S2	07/12/2019 10:38	07/12/2019 20:59	07/12/2019 10:38	07/12/2019 20:59	10,34	1	10,34	CHI
20191243539	RIO VERDE	630302145	RIO VERDE S1	07/12/2019 10:39	07/12/2019 18:28	07/12/2019 10:39	07/12/2019 18:28	7,82	1	7,82	CHI
20191243540	CALDAS NOVAS	CN12103298	CALDAS NOVAS S1	07/12/2019 10:39	07/12/2019 14:47	07/12/2019 10:39	07/12/2019 14:47	4,12	9	37,12	CHI
20191243545	PLANALTINA	PI21252544	PLANALTINA	07/12/2019 10:40	07/12/2019 16:40	07/12/2019 10:40	07/12/2019 16:40	5,99	2	11,99	CHI
20191243678	INHUMAS	IN12015946	INHUMAS S2	07/12/2019 10:40	07/12/2019 13:51	07/12/2019 10:40	07/12/2019 13:51	3,17	10	31,68	CHI
20191243505	HIDROLANDIA	VJ12019862	GUAPO S2	07/12/2019 10:42	07/12/2019 13:54	07/12/2019 10:42	07/12/2019 13:54	3,20	1	3,20	CHI
20191243505	MAIRIPOTABA	VJ12019862	GUAPO S2	07/12/2019 10:42	07/12/2019 13:54	07/12/2019 10:42	07/12/2019 13:54	3,20	2	6,40	CHI
20191243505	VARJAO	VJ12019862	GUAPO S2	07/12/2019 10:42	07/12/2019 13:54	07/12/2019 10:42	07/12/2019 13:54	3,20	6	19,19	CHI
20191243560	ITAUCU	IX21172673	INHUMAS S1	07/12/2019 10:42	07/12/2019 18:03	07/12/2019 10:42	07/12/2019 18:03	7,34	1	7,34	CHI
20191243569	SAO MIGUEL DO ARAGUAIA	SM21263000	SAO MIGUEL DO ARAGUAIA	07/12/2019 10:44	07/12/2019 13:11	07/12/2019 10:44	07/12/2019 13:11	2,43	1	2,43	CHI
20191243570	SAO MIGUEL DO ARAGUAIA	SM12238712	SAO MIGUEL DO ARAGUAIA	07/12/2019 10:45	07/12/2019 15:02	07/12/2019 10:45	07/12/2019 15:02	4,28	3	12,84	CHI
20191243578	CAMPINACU	5700006277	PORANGATU	07/12/2019 10:47	07/12/2019 14:21	07/12/2019 10:47	07/12/2019 14:21	3,56	1	3,56	CHI
20191243582	AURILANDIA	10018666408	FIRMINOPOLIS S2	07/12/2019 10:48	07/12/2019 18:25	07/12/2019 10:48	07/12/2019 18:25	7,62	1	7,62	CHI
20191243586	PONTALINA	JV12218123	GOIATUBA S1	07/12/2019 10:49	07/12/2019 19:19	07/12/2019 10:49	07/12/2019 19:19	8,50	5	42,49	CHI
20191239051	CACHOEIRA ALTA	CA12041710	CACHOEIRA ALTA	07/12/2019 10:50	07/12/2019 12:25	07/12/2019 10:50	07/12/2019 12:25	1,58	7	11,03	CHI
20191243593	ITUMBIARA	IT11352774	ITUMBIARA VELHA S2	07/12/2019 10:50	07/12/2019 13:28	07/12/2019 10:50	07/12/2019 13:28	2,63	15	39,52	CHI
20191243603	RIO VERDE	630507960	RIO VERDE S1	07/12/2019 10:54	07/12/2019 15:53	07/12/2019 10:54	07/12/2019 15:53	4,99	1	4,99	CHI
20191243607	FAINA	FC12204586	GOIAS	07/12/2019 10:55	08/12/2019 08:36	07/12/2019 10:55	08/12/2019 08:36	21,67	3	65,02	CHI
20191243619	LUZIANIA	LZ21261580	CRISTALINA S2	07/12/2019 10:59	07/12/2019 15:16	07/12/2019 10:59	07/12/2019 15:16	4,27	1	4,27	CHI
20191243621	GOIANIA	10002714351	GOYA S2	07/12/2019 11:00	07/12/2019 13:19	07/12/2019 11:00	07/12/2019 13:19	2,31	1	2,31	CHI
20191243622	RIO VERDE	10016149163	RIO VERDE S2	07/12/2019 11:00	08/12/2019 08:35	07/12/2019 11:00	08/12/2019 08:35	21,57	1	21,57	CHI

20191243624	IPAMERI	IP21149947	URUTAI	07/12/2019 11:01	08/12/2019 00:30	07/12/2019 11:01	08/12/2019 00:30	13,47	1	13,47	CHI
20191243625	CORUMBA DE GOIAS	CB21172023	ALEXANIA	07/12/2019 11:01	07/12/2019 13:36	07/12/2019 11:01	07/12/2019 13:36	2,57	1	2,57	CHI
20191243638	SANTA HELENA DE GOIAS	SH13400171	IPEGUARI	07/12/2019 11:02	07/12/2019 18:17	07/12/2019 16:33	07/12/2019 16:37	0,07	1897	126,47	CHI
20191243638	SANTA HELENA DE GOIAS	SH10404082	IPEGUARI	07/12/2019 11:02	07/12/2019 18:17	07/12/2019 16:46	07/12/2019 18:17	1,52	23	34,85	CHI
20191243639	JESUPOLIS	SF12066019	SAO FRANCISCO DE GOIAS	07/12/2019 11:04	07/12/2019 14:32	07/12/2019 11:04	07/12/2019 14:32	3,46	12	41,52	CHI
20191243639	SAO FRANCISCO DE GOIAS	SF12066019	SAO FRANCISCO DE GOIAS	07/12/2019 11:04	07/12/2019 14:32	07/12/2019 11:04	07/12/2019 14:32	3,46	10	34,60	CHI
20191243647	SANCLERLANDIA	SC12373733	FIRMINOPOLIS S2	07/12/2019 11:05	07/12/2019 11:10	07/12/2019 11:05	07/12/2019 11:10	0,08	1	0,08	CHI
20191243646	JARAGUA	JA12000214	JARAGUA	07/12/2019 11:06	07/12/2019 16:26	07/12/2019 11:06	07/12/2019 16:26	5,33	51	271,94	CHI
20191243656	GUARINOS	GF21323913	SANTA TEREZINHA	07/12/2019 11:08	08/12/2019 10:07	07/12/2019 11:08	08/12/2019 10:07	22,98	1	22,98	CHI
20191244269	PALESTINA DE GOIAS	CP12395428	PALESTINA	07/12/2019 11:08	08/12/2019 10:46	07/12/2019 11:08	08/12/2019 10:46	23,62	5	118,10	CHI
20191243661	APARECIDA DE GOIANIA	200341728	INDEPENDENCIA S2	07/12/2019 11:09	07/12/2019 11:54	07/12/2019 11:09	07/12/2019 11:54	0,74	1	0,74	CHI
20191243662	ITABERAI	50020560	ITABERAI S2	07/12/2019 11:09	08/12/2019 10:35	07/12/2019 11:09	08/12/2019 10:35	23,42	1	23,42	CHI
20191243664	ANAPOLIS	10000718384	ANAPOLIS UNIVERSITARIO S2	07/12/2019 11:10	07/12/2019 17:25	07/12/2019 11:10	07/12/2019 17:25	6,26	1	6,26	CHI
20191243665	INDIARA	JD12323641	ACREUNA	07/12/2019 11:10	09/12/2019 21:03	07/12/2019 11:10	07/12/2019 18:05	6,92	19	131,40	CHI
20191243665	INDIARA	JD12323641	ACREUNA	07/12/2019 11:10	09/12/2019 21:03	08/12/2019 00:26	08/12/2019 14:18	13,86	20	277,27	CHI
20191243665	ACREUNA	IY13097068	ACREUNA	07/12/2019 11:10	09/12/2019 21:03	07/12/2019 11:10	08/12/2019 22:05	34,92	1	34,92	CHI
20191243665	INDIARA	IY13097068	ACREUNA	07/12/2019 11:10	09/12/2019 21:03	07/12/2019 11:10	08/12/2019 22:05	34,92	1	34,92	CHI
20191243665	INDIARA	IY13097068	ACREUNA	07/12/2019 11:10	09/12/2019 21:03	08/12/2019 00:26	08/12/2019 22:05	21,65	1	21,65	CHI
20191243665	ACREUNA	IY12039705	EDEIA	07/12/2019 11:10	09/12/2019 21:03	09/12/2019 14:12	09/12/2019 21:03	6,85	8	54,77	CHI
20191243665	INDIARA	IY12039705	EDEIA	07/12/2019 11:10	09/12/2019 21:03	09/12/2019 14:12	09/12/2019 21:03	6,85	3	20,54	CHI
20191243860	MINACU	IH12207740	MINACU	07/12/2019 11:10	07/12/2019 16:08	07/12/2019 11:10	07/12/2019 16:08	4,95	100	495,47	CHI
20191243671	INHUMAS	10020978721	INHUMAS S2	07/12/2019 11:11	07/12/2019 14:02	07/12/2019 11:11	07/12/2019 14:02	2,85	1	2,85	CHI
20191243672	GOIANIA	AP11169101	INDEPENDENCIA S2	07/12/2019 11:11	07/12/2019 14:01	07/12/2019 11:11	07/12/2019 14:01	2,82	85	239,65	CHI
20191243674	LUZIANIA	LZ21290865	MARAJOARA	07/12/2019 11:12	07/12/2019 13:19	07/12/2019 11:12	07/12/2019 13:19	2,12	1	2,12	CHI
20191243675	CAIAPONIA	CP12252503	CAIAPONIA	07/12/2019 11:12	07/12/2019 17:57	07/12/2019 11:12	07/12/2019 17:57	6,74	5	33,72	CHI
20191243679	RIO VERDE	RV12271578	MONTIVIDIU T	07/12/2019 11:13	08/12/2019 10:01	07/12/2019 11:13	08/12/2019 10:01	22,80	4	91,19	CHI
20191243784	ARAGUAPAZ	FC12071270	GOIAS	07/12/2019 11:13	07/12/2019 18:40	07/12/2019 11:13	07/12/2019 18:40	7,44	4	29,77	CHI
20191243784	FAINA	FC12071270	GOIAS	07/12/2019 11:13	07/12/2019 18:40	07/12/2019 11:13	07/12/2019 18:40	7,44	3	22,32	CHI
20191244874	GOIAS	GS12234131	GOIAS	07/12/2019 11:13	08/12/2019 08:15	07/12/2019 11:13	08/12/2019 08:15	21,03	11	231,34	CHI
20191243685	SAO JOAO D ALIANCA	JL21194273	SAO JOAO D ALIANCA	07/12/2019 11:14	08/12/2019 01:55	07/12/2019 11:14	08/12/2019 01:55	14,67	1	14,67	CHI
20191243788	BONOPOLIS	BX12391936	SAO MIGUEL DO ARAGUAIA	07/12/2019 11:14	07/12/2019 14:09	07/12/2019 11:14	07/12/2019 14:09	2,91	29	84,35	CHI
20191243686	JUSSARA	JR21114090	BRITANIA	07/12/2019 11:15	08/12/2019 11:30	07/12/2019 11:15	08/12/2019 11:30	24,25	1	24,25	CHI
20191243688	URUACU	UR11352983	URUACU	07/12/2019 11:15	08/12/2019 11:24	07/12/2019 11:15	08/12/2019 11:24	24,14	1	24,14	CHI

20191243689	GOIANIA	13954799	MEIA PONTE	07/12/2019 11:15	07/12/2019 13:58	07/12/2019 11:15	07/12/2019 13:58	2,70	1	2,70	CHI
20191243690	JATAI	290115590	JATAI S3	07/12/2019 11:16	07/12/2019 22:19	07/12/2019 11:16	07/12/2019 22:19	11,05	1	11,05	CHI
20191243692	INDIARA	IY12323655	EDEIA	07/12/2019 11:16	07/12/2019 14:48	07/12/2019 11:16	07/12/2019 14:48	3,54	12	42,44	CHI
20191243694	NOVO GAMA	10003956707	PACAMBU S1	07/12/2019 11:16	07/12/2019 13:28	07/12/2019 11:16	07/12/2019 13:28	2,19	1	2,19	CHI
20191243696	GOIANIA	10002942494	FERROVIARIO S1	07/12/2019 11:17	07/12/2019 13:33	07/12/2019 11:17	07/12/2019 13:33	2,27	1	2,27	CHI
20191243705	CATALAO	1990110293	CATALAO S2	07/12/2019 11:19	07/12/2019 13:43	07/12/2019 11:19	07/12/2019 13:43	2,39	1	2,39	CHI
20191243706	ALTO PARAISO DE GOIAS	BF21248526	FLORES DE GOIAS	07/12/2019 11:19	07/12/2019 13:53	07/12/2019 11:19	07/12/2019 13:53	2,55	1	2,55	CHI
20191243707	CORUMBA DE GOIAS	CB21381641	ALEXANIA	07/12/2019 11:20	07/12/2019 14:32	07/12/2019 11:20	07/12/2019 14:32	3,19	2	6,38	CHI
20191243709	RIO VERDE	RV21303469	MONTIVIDIU T	07/12/2019 11:21	08/12/2019 11:30	07/12/2019 11:21	08/12/2019 11:30	24,15	1	24,15	CHI
20191243719	MORRINHOS	MR11255604	GOIATUBA S1	07/12/2019 11:23	07/12/2019 13:06	07/12/2019 11:23	07/12/2019 13:06	1,71	1	1,71	CHI
20191243722	INHUMAS	10024590523	INHUMAS S2	07/12/2019 11:24	07/12/2019 13:52	07/12/2019 11:24	07/12/2019 13:52	2,47	1	2,47	CHI
20191243723	LUZIANIA	LZ21114237	CRISTALINA S2	07/12/2019 11:24	07/12/2019 18:13	07/12/2019 11:24	07/12/2019 18:13	6,80	1	6,80	CHI
20191243724	CRISTALINA	10030547430	CRISTALINA S1	07/12/2019 11:24	07/12/2019 14:53	07/12/2019 11:24	07/12/2019 14:53	3,47	1	3,47	CHI
20191243727	BELA VISTA DE GOIAS	BV21164319	SENADOR CANEDO	07/12/2019 11:25	07/12/2019 13:13	07/12/2019 11:25	07/12/2019 13:13	1,79	2	3,58	CHI
20191243733	FAINA	FC12271131	GOIAS	07/12/2019 11:26	08/12/2019 19:03	07/12/2019 11:26	08/12/2019 19:03	31,61	2	63,21	CHI
20191243735	ARENOPOLIS	AY12100675	ARENOPOLIS	07/12/2019 11:27	07/12/2019 21:45	07/12/2019 11:27	07/12/2019 21:45	10,30	2	20,60	CHI
20191243739	SAO MIGUEL DO ARAGUAIA	SM21262603	SAO MIGUEL DO ARAGUAIA	07/12/2019 11:28	07/12/2019 16:55	07/12/2019 11:28	07/12/2019 16:55	5,44	1	5,44	CHI
20191243744	CATALAO	CT21229959	CATALAO S1	07/12/2019 11:29	07/12/2019 13:28	07/12/2019 11:29	07/12/2019 13:28	1,97	1	1,97	CHI
20191243745	LUZIANIA	LZ12203332	VIANOPOLIS	07/12/2019 11:29	07/12/2019 14:58	07/12/2019 11:29	07/12/2019 14:58	3,47	12	41,67	CHI
20191243746	ITAPIRAPUA	IU21018791	JUSSARA	07/12/2019 11:29	08/12/2019 07:18	07/12/2019 11:29	08/12/2019 07:18	19,80	1	19,80	CHI
20191243799	BONOPOLIS	BX12391924	SAO MIGUEL DO ARAGUAIA	07/12/2019 11:29	07/12/2019 14:40	07/12/2019 11:29	07/12/2019 14:40	3,18	27	85,84	CHI
20191243799	SAO MIGUEL DO ARAGUAIA	BX12391924	SAO MIGUEL DO ARAGUAIA	07/12/2019 11:29	07/12/2019 14:40	07/12/2019 11:29	07/12/2019 14:40	3,18	0	0,00	CHI
20191243748	GOIANIA	16627453	CAMPINAS S2	07/12/2019 11:30	07/12/2019 12:59	07/12/2019 11:30	07/12/2019 12:59	1,48	1	1,48	CHI
20191243781	ANAPOLIS	AN12377708	ANAPOLIS UNIVERSITARIO S2	07/12/2019 11:30	07/12/2019 13:24	07/12/2019 11:30	07/12/2019 13:24	1,88	20	37,69	CHI
20191243781	CAMPO LIMPO	AN12377708	ANAPOLIS UNIVERSITARIO S2	07/12/2019 11:30	07/12/2019 13:24	07/12/2019 11:30	07/12/2019 13:24	1,88	7	13,19	CHI
20191243754	AMERICANO DO BRASIL	KB21061376	ANICUNS	07/12/2019 11:31	07/12/2019 15:25	07/12/2019 11:31	07/12/2019 15:25	3,89	1	3,89	CHI
20191243802	GOIAS	GS12325824	GOIAS	07/12/2019 11:32	07/12/2019 15:22	07/12/2019 11:32	07/12/2019 15:22	3,83	2	7,66	CHI
20191243762	LUZIANIA	LZ21244585	CRISTALINA S2	07/12/2019 11:33	08/12/2019 00:32	07/12/2019 11:33	08/12/2019 00:32	12,98	1	12,98	CHI
20191243768	ITABERAI	IB31183015	ITABERAI S2	07/12/2019 11:35	08/12/2019 09:26	07/12/2019 11:35	08/12/2019 09:26	21,84	1	21,84	CHI
20191243769	ARAGARCAS	AG21154735	ARAGARCAS	07/12/2019 11:35	07/12/2019 21:30	07/12/2019 11:35	07/12/2019 21:30	9,90	1	9,90	CHI
20191243772	COCALZINHO DE GOIAS	PB12382216	PADRE BERNARDO	07/12/2019 11:36	07/12/2019 14:27	07/12/2019 11:36	07/12/2019 14:27	2,84	1	2,84	CHI
20191243772	PADRE BERNARDO	PB12382216	PADRE BERNARDO	07/12/2019 11:36	07/12/2019 14:27	07/12/2019 11:36	07/12/2019 14:27	2,84	6	17,03	CHI
20191243774	PALESTINA DE GOIAS	PY21345522	PALESTINA	07/12/2019 11:37	08/12/2019 12:00	07/12/2019 11:37	08/12/2019 12:00	24,38	2	48,75	CHI

20191243777	PLANALTINA	10016408835	PLANALTINA	07/12/2019 11:39	07/12/2019 16:10	07/12/2019 11:39	07/12/2019 16:10	4,52	1	4,52	CHI
20191243779	NOVO BRASIL	NB12087607	JUSSARA	07/12/2019 11:39	08/12/2019 13:03	07/12/2019 11:39	08/12/2019 13:03	25,39	10	253,85	CHI
20191244281	BONOPOLIS	BX12168258	SAO MIGUEL DO ARAGUAIA	07/12/2019 11:41	07/12/2019 18:44	07/12/2019 11:41	07/12/2019 18:44	7,04	19	133,83	CHI
20191244281	CACU	BX12168258	SAO MIGUEL DO ARAGUAIA	07/12/2019 11:41	07/12/2019 18:44	07/12/2019 11:41	07/12/2019 18:44	7,04	1	7,04	CHI
20191243785	PIRES DO RIO	PR21272840	PIRES DO RIO S1	07/12/2019 11:42	07/12/2019 18:26	07/12/2019 11:42	07/12/2019 18:26	6,73	2	13,46	CHI
20191243786	ANICUNS	910062110	ANICUNS	07/12/2019 11:42	07/12/2019 12:29	07/12/2019 11:42	07/12/2019 12:29	0,79	1	0,79	CHI
20191243793	ITAPURANGA	2780001805	ITAPURANGA	07/12/2019 11:44	07/12/2019 14:34	07/12/2019 11:44	07/12/2019 14:34	2,82	1	2,82	CHI
20191243795	GOIANIA	13946535	MEIA PONTE	07/12/2019 11:45	07/12/2019 15:01	07/12/2019 11:45	07/12/2019 15:01	3,25	1	3,25	CHI
20191243827	COCALZINHO DE GOIAS	ZN12382373	COCALZINHO	07/12/2019 11:45	07/12/2019 19:16	07/12/2019 11:45	07/12/2019 19:16	7,50	5	37,52	CHI
20191243827	CORUMBA DE GOIAS	ZN12382373	COCALZINHO	07/12/2019 11:45	07/12/2019 19:16	07/12/2019 11:45	07/12/2019 19:16	7,50	29	217,64	CHI
20191243808	JUSSARA	JR12220051	JUSSARA	07/12/2019 11:48	08/12/2019 12:40	07/12/2019 11:48	08/12/2019 12:40	24,86	71	1765,34	CHI
20191244016	COCALZINHO DE GOIAS	ZN12000125	COCALZINHO	07/12/2019 11:50	07/12/2019 22:49	07/12/2019 11:50	07/12/2019 22:49	10,98	41	450,20	CHI
20191244016	CORUMBA DE GOIAS	ZN12000125	COCALZINHO	07/12/2019 11:50	07/12/2019 22:49	07/12/2019 11:50	07/12/2019 22:49	10,98	19	208,63	CHI
20191243820	PIRENOPOLIS	PV12014768	SAO FRANCISCO DE GOIAS	07/12/2019 11:52	07/12/2019 13:15	07/12/2019 11:52	07/12/2019 13:15	1,38	7	9,67	CHI
20191243821	ACREUNA	EU21104084	ACREUNA	07/12/2019 11:52	07/12/2019 13:45	07/12/2019 11:52	07/12/2019 13:45	1,88	1	1,88	CHI
20191243834	CATALAO	1990238200	CATALAO S2	07/12/2019 11:55	07/12/2019 14:19	07/12/2019 11:55	07/12/2019 14:19	2,38	1	2,38	CHI
20191243840	ABADIANIA	AA21205074	ANAPOLIS UNIVERSITARIO S1	07/12/2019 11:57	07/12/2019 17:03	07/12/2019 11:57	07/12/2019 17:03	5,09	1	5,09	CHI
20191243846	ITAGUARI	IC21327350	ITABERAI S1	07/12/2019 12:00	07/12/2019 21:10	07/12/2019 12:00	07/12/2019 21:10	9,17	1	9,17	CHI
20191243852	QUIRINOPOLIS	QI32094315	QUIRINOPOLIS	07/12/2019 12:00	07/12/2019 17:29	07/12/2019 12:00	07/12/2019 17:29	5,47	3	16,42	CHI
20191243856	PORANGATU	PO12020947	PORANGATU	07/12/2019 12:01	07/12/2019 16:59	07/12/2019 12:01	07/12/2019 16:59	4,96	44	218,28	CHI
20191244014	CAIAPONIA	CP12247460	CAIAPONIA	07/12/2019 12:01	07/12/2019 15:54	07/12/2019 12:01	07/12/2019 15:54	3,87	3	11,62	CHI
20191243868	IPAMERI	IP21195248	IPAMERI	07/12/2019 12:04	07/12/2019 16:08	07/12/2019 12:04	07/12/2019 16:08	4,06	2	8,12	CHI
20191243871	PARAUNA	PU12295869	ACREUNA	07/12/2019 12:04	07/12/2019 15:00	07/12/2019 12:04	07/12/2019 15:00	2,92	2	5,84	CHI
20191243872	AGUA FRIA DE GOIAS	TL12394165	SAO JOAO D ALIANCA	07/12/2019 12:04	07/12/2019 15:50	07/12/2019 12:04	07/12/2019 15:50	3,75	18	67,55	CHI
20191243879	GOIANAPOLIS	950005629	DAIA S2	07/12/2019 12:06	07/12/2019 16:09	07/12/2019 12:06	07/12/2019 16:09	4,04	1	4,04	CHI
20191243881	SANTA RITA DO ARAGUAIA	SU21142751	SANTA RITA DO ARAGUAIA	07/12/2019 12:06	07/12/2019 14:18	07/12/2019 12:06	07/12/2019 14:18	2,19	1	2,19	CHI
20191243915	ANICUNS	AC21306974	ANICUNS	07/12/2019 12:07	07/12/2019 12:46	07/12/2019 12:07	07/12/2019 12:46	0,66	2	1,31	CHI
20191243887	GOIANIA	10718655	ATLANTICO S3	07/12/2019 12:09	07/12/2019 13:50	07/12/2019 12:09	07/12/2019 13:50	1,68	1	1,68	CHI
20191238632	CAVALCANTE	CJ12346073	MINACU	07/12/2019 12:12	07/12/2019 18:04	07/12/2019 12:12	07/12/2019 18:04	5,85	181	1059,40	CHI
20191243895	PLANALTINA	PI11043458	PLANALTINA	07/12/2019 12:12	07/12/2019 14:56	07/12/2019 12:12	07/12/2019 14:56	2,73	31	84,48	CHI
20191243898	RIO VERDE	630526965	RIO VERDE S2	07/12/2019 12:13	07/12/2019 19:50	07/12/2019 12:13	07/12/2019 19:50	7,61	1	7,61	CHI
20191243903	SAO LUIS DE MONTES BELOS	SL11347406	SAO LUIZ DOS MONTES BELOS	07/12/2019 12:15	07/12/2019 19:15	07/12/2019 12:15	07/12/2019 19:15	6,99	59	412,62	CHI
20191243904	MINEIROS	10005197218	PARQUE DAS EMAS	07/12/2019 12:15	07/12/2019 17:53	07/12/2019 12:15	07/12/2019 17:53	5,64	1	5,64	CHI

20191243905	BURITI DE GOIAS	BS21300408	FIRMINOPOLIS S2	07/12/2019 12:16	08/12/2019 12:13	07/12/2019 12:16	08/12/2019 12:13	23,95	1	23,95	CHI
20191245320	SANTO ANTONIO DA BARRA	BZ12048954	ACREUNA	07/12/2019 12:16	08/12/2019 07:39	07/12/2019 12:16	08/12/2019 07:39	19,37	4	77,50	CHI
20191243913	GOIANIA	10626463	AEROPORTO S2	07/12/2019 12:17	07/12/2019 15:39	07/12/2019 12:17	07/12/2019 15:39	3,36	1	3,36	CHI
20191243946	FAZENDA NOVA	FN12223049	IPORA	07/12/2019 12:17	07/12/2019 20:15	07/12/2019 12:17	07/12/2019 20:15	7,97	8	63,73	CHI
20191243946	ISRAELANDIA	FN12223049	IPORA	07/12/2019 12:17	07/12/2019 20:15	07/12/2019 12:17	07/12/2019 20:15	7,97	2	15,93	CHI
20191243924	DAMIANOPOLIS	DA21256664	IACIARA S2	07/12/2019 12:21	07/12/2019 14:58	07/12/2019 12:21	07/12/2019 14:58	2,61	4	10,44	CHI
20191243928	JARAGUA	JA21006437	JARAGUA	07/12/2019 12:22	08/12/2019 09:25	07/12/2019 12:22	08/12/2019 09:25	21,04	1	21,04	CHI
20191243932	CORREGO DO OURO	CO12229858	FIRMINOPOLIS S2	07/12/2019 12:23	07/12/2019 17:11	07/12/2019 12:23	07/12/2019 17:11	4,79	2	9,58	CHI
20191243935	APARECIDA DE GOIANIA	10423590	REAL S1	07/12/2019 12:23	07/12/2019 15:37	07/12/2019 12:23	07/12/2019 15:37	3,22	1	3,22	CHI
20191244110	MAURILANDIA	DM12230837	RIO DOS BOIS	07/12/2019 12:23	07/12/2019 19:07	07/12/2019 12:23	07/12/2019 19:07	6,72	4	26,90	CHI
20191243940	ANAPOLIS	AN11335063	ANAPOLIS UNIVERSITARIO S1	07/12/2019 12:25	07/12/2019 16:17	07/12/2019 12:25	07/12/2019 16:17	3,86	16	61,82	CHI
20191243942	SILVANIA	SV12389456	VIANOPOLIS	07/12/2019 12:26	07/12/2019 16:27	07/12/2019 12:26	07/12/2019 16:27	4,02	60	241,02	CHI
20191243949	JESUPOLIS	JE21342163	PETROLINA	07/12/2019 12:28	08/12/2019 12:30	07/12/2019 12:28	08/12/2019 12:30	24,03	1	24,03	CHI
20191243951	LEOPOLDO DE BULHOES	LB21084064	DAIA S2	07/12/2019 12:28	07/12/2019 17:13	07/12/2019 12:28	07/12/2019 17:13	4,74	2	9,48	CHI
20191243952	ITAPIRAPUA	IU21198830	MATRINCHA	07/12/2019 12:28	08/12/2019 10:18	07/12/2019 12:28	08/12/2019 10:18	21,82	1	21,82	CHI
20191243959	PIRACANJUBA	PJ21026157	CALDAS NOVAS S1	07/12/2019 12:29	08/12/2019 11:50	07/12/2019 12:29	08/12/2019 11:50	23,33	1	23,33	CHI
20191244121	NIQUELANDIA	NQ12253797	URUACU	07/12/2019 12:29	07/12/2019 19:33	07/12/2019 12:29	07/12/2019 19:33	7,06	21	148,20	CHI
20191244315	GOIANIA	GN11000058	GOIANIA LESTE S1	07/12/2019 12:30	07/12/2019 16:28	07/12/2019 12:30	07/12/2019 16:28	3,96	32	126,71	CHI
201912233434	GOIANIA	GN12000296	GOIANIA LESTE S1	07/12/2019 12:30	07/12/2019 15:28	07/12/2019 12:30	07/12/2019 15:28	2,96	156	461,72	CHI
20191243964	PADRE BERNARDO	PB12377293	PADRE BERNARDO	07/12/2019 12:31	07/12/2019 15:47	07/12/2019 12:31	07/12/2019 15:47	3,26	12	39,13	CHI
20191243966	PIRENOPOLIS	PV21334684	CORUMBA	07/12/2019 12:31	07/12/2019 14:28	07/12/2019 12:31	07/12/2019 14:28	1,94	1	1,94	CHI
20191243967	CIDADE OCIDENTAL	2680013469	MARAJOARA	07/12/2019 12:31	07/12/2019 14:03	07/12/2019 12:31	07/12/2019 14:03	1,52	1	1,52	CHI
20191243969	CAMPINACU	UC12236229	PORANGATU	07/12/2019 12:31	07/12/2019 15:25	07/12/2019 12:31	07/12/2019 15:25	2,90	28	81,16	CHI
20191243972	NOVO PLANALTO	TA12192342	NOVO PLANALTO	07/12/2019 12:32	07/12/2019 16:45	07/12/2019 12:32	07/12/2019 16:45	4,21	1	4,21	CHI
20191243972	PORANGATU	TA12192342	NOVO PLANALTO	07/12/2019 12:32	07/12/2019 16:45	07/12/2019 12:32	07/12/2019 16:45	4,21	9	37,87	CHI
20191243988	CRISTALINA	KR21322836	PAMPLONA	07/12/2019 12:35	07/12/2019 13:29	07/12/2019 12:35	07/12/2019 13:29	0,90	1	0,90	CHI
20191244810	RIO VERDE	RV12230830	MONTIVIDIU T	07/12/2019 12:35	07/12/2019 19:47	07/12/2019 12:35	07/12/2019 19:47	7,20	39	280,62	CHI
20191244877	MINACU	IH11202448	MINACU	07/12/2019 12:35	07/12/2019 17:25	07/12/2019 12:35	07/12/2019 17:25	4,83	15	72,45	CHI
20191243996	MONTIVIDIU DO NORTE	MX12270910	PORANGATU	07/12/2019 12:38	07/12/2019 17:00	07/12/2019 12:38	07/12/2019 17:00	4,35	7	30,48	CHI
20191241792	CAMPINORTE	04690214	MARA ROSA	07/12/2019 12:40	09/12/2019 16:06	07/12/2019 12:40	07/12/2019 14:59	2,31	172	397,42	CHI
20191241792	CAMPINORTE	04690214	MARA ROSA	07/12/2019 12:40	09/12/2019 16:06	07/12/2019 12:40	07/12/2019 18:12	5,53	24	132,71	CHI
20191241792	MARA ROSA	04690214	MARA ROSA	07/12/2019 12:40	09/12/2019 16:06	07/12/2019 12:40	07/12/2019 18:12	5,53	5	27,65	CHI
20191241792	CAMPINORTE	04690214	MARA ROSA	07/12/2019 12:40	09/12/2019 16:06	07/12/2019 18:30	07/12/2019 19:00	0,50	196	97,29	CHI

20191241792	MARA ROSA	04690214	MARA ROSA	07/12/2019 12:40	09/12/2019 16:06	07/12/2019 18:30	07/12/2019 19:00	0,50	5	2,48	CHI
20191241792	CAMPINORTE	04690214	MARA ROSA	07/12/2019 12:40	09/12/2019 16:06	07/12/2019 12:40	07/12/2019 19:10	6,50	2	13,00	CHI
20191241792	CAMPINORTE	04690214	MARA ROSA	07/12/2019 12:40	09/12/2019 16:06	07/12/2019 12:40	07/12/2019 21:13	8,54	13	110,96	CHI
20191241792	CAMPINORTE	04690214	MARA ROSA	07/12/2019 12:40	09/12/2019 16:06	07/12/2019 12:40	07/12/2019 22:25	9,74	6	58,47	CHI
20191241792	MARA ROSA	04690214	MARA ROSA	07/12/2019 12:40	09/12/2019 16:06	07/12/2019 12:40	07/12/2019 22:25	9,74	5	48,72	CHI
20191241792	URUACU	04690214	MARA ROSA	07/12/2019 12:40	09/12/2019 16:06	07/12/2019 12:40	07/12/2019 22:25	9,74	1	9,74	CHI
20191241792	CAMPINORTE	CR13405405	MARA ROSA	07/12/2019 12:40	09/12/2019 16:06	07/12/2019 18:30	07/12/2019 22:25	3,92	1	3,92	CHI
20191241792	CAMPINORTE	04690214	MARA ROSA	07/12/2019 12:40	09/12/2019 16:06	07/12/2019 12:40	08/12/2019 23:40	34,99	18	629,88	CHI
20191241792	CAMPINORTE	04690214	MARA ROSA	07/12/2019 12:40	09/12/2019 16:06	08/12/2019 23:51	09/12/2019 01:10	1,31	218	286,43	CHI
20191241792	MARA ROSA	04690214	MARA ROSA	07/12/2019 12:40	09/12/2019 16:06	08/12/2019 23:51	09/12/2019 01:10	1,31	10	13,14	CHI
20191241792	URUACU	04690214	MARA ROSA	07/12/2019 12:40	09/12/2019 16:06	08/12/2019 23:51	09/12/2019 01:10	1,31	1	1,31	CHI
20191241792	CAMPINACU	04690214	MARA ROSA	07/12/2019 12:40	09/12/2019 16:06	07/12/2019 12:40	09/12/2019 16:06	51,42	11	565,63	CHI
20191241792	CAMPINORTE	04690214	MARA ROSA	07/12/2019 12:40	09/12/2019 16:06	07/12/2019 12:40	09/12/2019 16:06	51,42	45	2313,95	CHI
20191241792	FORMOSO	04690214	MARA ROSA	07/12/2019 12:40	09/12/2019 16:06	07/12/2019 12:40	09/12/2019 16:06	51,42	3	154,26	CHI
20191241792	CAMPINORTE	CR13291044	MARA ROSA	07/12/2019 12:40	09/12/2019 16:06	08/12/2019 23:51	09/12/2019 16:06	16,24	18	292,27	CHI
20191244081	CAIAPONIA	CP12380880	CAIAPONIA	07/12/2019 12:40	07/12/2019 21:40	07/12/2019 12:40	07/12/2019 21:40	8,99	10	89,86	CHI
20191244005	COCALZINHO DE GOIAS	PB21219627	AGUAS LINDAS DE GOIAS S2	07/12/2019 12:41	07/12/2019 17:09	07/12/2019 12:41	07/12/2019 17:09	4,46	1	4,46	CHI
20191244009	PALMEIRAS DE GOIAS	PL12085277	PALMEIRAS	07/12/2019 12:42	07/12/2019 15:40	07/12/2019 12:42	07/12/2019 15:40	2,97	12	35,59	CHI
20191244013	PIRANHAS	PH21070222	ARENOPOLIS	07/12/2019 12:44	08/12/2019 16:46	07/12/2019 12:44	08/12/2019 16:46	28,02	1	28,02	CHI
20191244015	ALEXANIA	AX12203689	ALEXANIA	07/12/2019 12:46	07/12/2019 15:06	07/12/2019 12:46	07/12/2019 15:06	2,33	118	274,68	CHI
20191246229	INHUMAS	IX12016046	INHUMAS S1	07/12/2019 12:47	08/12/2019 04:07	07/12/2019 12:47	08/12/2019 04:07	15,32	8	122,58	CHI
20191246229	ITAUCU	IX12016046	INHUMAS S1	07/12/2019 12:47	08/12/2019 04:07	07/12/2019 12:47	08/12/2019 04:07	15,32	3	45,97	CHI
20191244025	FORMOSA	10029184604	ITUIQUIRA	07/12/2019 12:50	07/12/2019 16:15	07/12/2019 12:50	07/12/2019 16:15	3,42	1	3,42	CHI
20191244031	QUIRINOPOLIS	80136692	QUIRINOPOLIS	07/12/2019 12:51	07/12/2019 15:08	07/12/2019 12:51	07/12/2019 15:08	2,28	1	2,28	CHI
20191244077	ITABERAI	IB12353033	ITABERAI S1	07/12/2019 12:53	07/12/2019 20:19	07/12/2019 12:53	07/12/2019 20:19	7,42	5	37,10	CHI
20191244045	SANTO ANTONIO DO DESCOBERTO	SN21158443	AGUAS LINDAS DE GOIAS S2	07/12/2019 12:54	07/12/2019 15:06	07/12/2019 12:54	07/12/2019 15:06	2,19	1	2,19	CHI
20191244046	SAO MIGUEL DO ARAGUAIA	SM21059985	SAO MIGUEL DO ARAGUAIA	07/12/2019 12:55	07/12/2019 18:15	07/12/2019 12:55	07/12/2019 18:15	5,33	1	5,33	CHI
20191244048	SAO MIGUEL DO ARAGUAIA	SM12394085	SAO MIGUEL DO ARAGUAIA	07/12/2019 12:55	08/12/2019 01:22	07/12/2019 12:55	08/12/2019 01:22	12,44	8	99,50	CHI
20191244068	CACHOEIRA ALTA	CA13219232	CACHOEIRA ALTA	07/12/2019 12:55	07/12/2019 22:35	07/12/2019 18:58	07/12/2019 22:35	3,61	66	238,42	CHI
20191244050	DIVINOPOLIS DE GOIAS	GH12383359	SAO DOMINGOS	07/12/2019 12:56	07/12/2019 18:14	07/12/2019 12:56	07/12/2019 18:14	5,30	7	37,07	CHI
20191244052	PIRACANJUBA	MR21000197	MORRINHOS	07/12/2019 12:56	08/12/2019 07:44	07/12/2019 12:56	08/12/2019 07:44	18,79	1	18,79	CHI
20191244061	IPAMERI	UT12027074	URUTAI	07/12/2019 12:59	08/12/2019 00:30	07/12/2019 12:59	08/12/2019 00:30	11,50	42	483,15	CHI
20191244061	URUTAI	UT12027074	URUTAI	07/12/2019 12:59	08/12/2019 00:30	07/12/2019 12:59	08/12/2019 00:30	11,50	9	103,53	CHI



20191244063	EDEIA	EA21025321	EDEIA	07/12/2019 13:00	07/12/2019 16:24	07/12/2019 13:00	07/12/2019 16:24	3,39	2	6,78	CHI
20191244936	MONTIVIDIU	MV21249056	MONTIVIDIU T	07/12/2019 13:00	07/12/2019 14:40	07/12/2019 13:00	07/12/2019 14:40	1,67	1	1,67	CHI
20191244064	APARECIDA DE GOIANIA	200369234	INDEPENDENCIA S2	07/12/2019 13:01	07/12/2019 16:11	07/12/2019 13:01	07/12/2019 16:11	3,17	1	3,17	CHI
20191244914	HIDROLINA	HL12292557	URUACU	07/12/2019 13:02	07/12/2019 20:52	07/12/2019 13:02	07/12/2019 20:52	7,82	2	15,65	CHI
20191244071	ANAPOLIS	21293727	JUNDIAI S1	07/12/2019 13:03	07/12/2019 16:40	07/12/2019 13:03	07/12/2019 16:40	3,63	1	3,63	CHI
20191244353	URUACU	CR12410914	MARA ROSA	07/12/2019 13:04	08/12/2019 14:49	07/12/2019 13:04	08/12/2019 14:49	25,76	3	77,29	CHI
20191244353	URUACU	CR12410914	MARA ROSA	07/12/2019 13:04	08/12/2019 14:49	08/12/2019 10:44	08/12/2019 14:49	4,10	12	49,15	CHI
20191244083	CAMPOS VERDES	VD12181203	SANTA TEREZINHA	07/12/2019 13:06	08/12/2019 00:45	07/12/2019 13:06	08/12/2019 00:45	11,64	12	139,72	CHI
20191244191	PADRE BERNARDO	PB11347956	PADRE BERNARDO	07/12/2019 13:07	07/12/2019 16:38	07/12/2019 13:07	07/12/2019 16:38	3,51	33	115,98	CHI
201912260912	ITABERAI	50094725	ITABERAI S2	07/12/2019 13:07	07/12/2019 16:45	07/12/2019 13:07	07/12/2019 16:45	3,63	1	3,63	CHI
20191244088	PORANGATU	PO21243464	PORANGATU	07/12/2019 13:08	07/12/2019 16:07	07/12/2019 13:08	07/12/2019 16:07	2,99	1	2,99	CHI
20191244091	ANICUNS	AC11323463	ANICUNS	07/12/2019 13:09	07/12/2019 17:43	07/12/2019 13:09	07/12/2019 17:43	4,55	7	31,87	CHI
20191244093	NOVA CRIXAS	NA12228222	MOZARLANDIA	07/12/2019 13:10	07/12/2019 16:12	07/12/2019 13:10	07/12/2019 16:12	3,03	7	21,20	CHI
20191244105	TRINDADE	10024745446	TRINDADE	07/12/2019 13:13	07/12/2019 14:32	07/12/2019 13:13	07/12/2019 14:32	1,31	1	1,31	CHI
201912260913	ITABERAI	50108748	ITABERAI S2	07/12/2019 13:13	07/12/2019 16:45	07/12/2019 13:13	07/12/2019 16:45	3,53	1	3,53	CHI
20191244114	CAMPINACU	IH12360453	MINACU	07/12/2019 13:15	07/12/2019 19:50	07/12/2019 13:15	07/12/2019 19:50	6,57	5	32,84	CHI
20191244114	MINACU	IH12360453	MINACU	07/12/2019 13:15	07/12/2019 19:50	07/12/2019 13:15	07/12/2019 19:50	6,57	72	472,96	CHI
20191241793	SAO MIGUEL DO ARAGUAIA	SM10404193	SAO MIGUEL DO ARAGUAIA	07/12/2019 13:16	07/12/2019 17:28	07/12/2019 13:16	07/12/2019 17:28	4,20	12	50,38	CHI
20191244564	JATAI	JT12264371	JATAI S3	07/12/2019 13:16	07/12/2019 17:00	07/12/2019 13:16	07/12/2019 17:00	3,73	320	1194,67	CHI
20191244716	CRIXAS	MZ12310637	MOZARLANDIA	07/12/2019 13:16	07/12/2019 16:21	07/12/2019 13:16	07/12/2019 16:21	3,07	102	312,86	CHI
20191244716	MOZARLANDIA	MZ12310637	MOZARLANDIA	07/12/2019 13:16	07/12/2019 16:21	07/12/2019 13:16	07/12/2019 16:21	3,07	77	236,18	CHI
20191244716	NOVA CRIXAS	MZ12310637	MOZARLANDIA	07/12/2019 13:16	07/12/2019 16:21	07/12/2019 13:16	07/12/2019 16:21	3,07	27	82,81	CHI
20191244123	JUSSARA	RN12045571	BRITANIA	07/12/2019 13:17	11/12/2019 19:20	07/12/2019 13:17	11/12/2019 19:20	102,06	4	408,25	CHI
20191244123	SANTA FE DE GOIAS	RN12045571	BRITANIA	07/12/2019 13:17	11/12/2019 19:20	07/12/2019 13:17	11/12/2019 19:20	102,06	7	714,44	CHI
20191244132	MARA ROSA	MQ12291947	MARA ROSA	07/12/2019 13:20	08/12/2019 09:38	07/12/2019 13:20	08/12/2019 09:38	20,29	2	40,58	CHI
20191244133	SAO DOMINGOS	SD12344108	SAO DOMINGOS	07/12/2019 13:20	07/12/2019 20:03	07/12/2019 13:20	07/12/2019 20:03	6,70	2	13,41	CHI
20191244137	ARAGARCAS	AG21245909	ARAGARCAS	07/12/2019 13:21	07/12/2019 17:02	07/12/2019 13:21	07/12/2019 17:02	3,68	2	7,35	CHI
20191244138	APARECIDA DE GOIANIA	14769554	INDEPENDENCIA S1	07/12/2019 13:21	07/12/2019 15:15	07/12/2019 13:21	07/12/2019 15:15	1,89	1	1,89	CHI
20191245211	PORANGATU	PO12020611	NOVO PLANALTO	07/12/2019 13:21	07/12/2019 18:32	07/12/2019 13:21	07/12/2019 18:32	5,18	8	41,42	CHI
20191244143	PORANGATU	PO12020593	PORANGATU	07/12/2019 13:23	07/12/2019 19:43	07/12/2019 13:23	07/12/2019 19:43	6,33	1	6,33	CHI
20191244148	ALTO PARAISO DE GOIAS	BF12385529	NIQUELANDIA SUBTRANSMISSAO	07/12/2019 13:24	07/12/2019 14:53	07/12/2019 13:24	07/12/2019 14:53	1,48	2	2,96	CHI
20191244149	MORRO AGUDO DE GOIAS	MS12251782	ITAPURANGA	07/12/2019 13:24	07/12/2019 15:55	07/12/2019 13:24	07/12/2019 15:55	2,52	2	5,03	CHI
20191244150	ABADIANIA	AA21127301	ANAPOLIS UNIVERSITARIO S1	07/12/2019 13:24	07/12/2019 17:08	07/12/2019 13:24	07/12/2019 17:08	3,72	1	3,72	CHI

20191244151	CAMPOS BELOS	CH21397126	SAO DOMINGOS	07/12/2019 13:25	07/12/2019 14:34	07/12/2019 13:25	07/12/2019 14:34	1,15	1	1,15	CHI
20191244152	DAMOLANDIA	DL31025234	INHUMAS S1	07/12/2019 13:25	07/12/2019 21:47	07/12/2019 13:25	07/12/2019 21:47	8,36	1	8,36	CHI
20191244155	MINEIROS	MY21365427	JATAI S1	07/12/2019 13:26	08/12/2019 10:03	07/12/2019 13:26	08/12/2019 10:03	20,61	1	20,61	CHI
20191244157	RIO VERDE	630187344	RIO VERDE S1	07/12/2019 13:26	07/12/2019 17:01	07/12/2019 13:26	07/12/2019 17:01	3,57	1	3,57	CHI
20191244161	PORANGATU	PO12020618	PORANGATU	07/12/2019 13:27	07/12/2019 15:45	07/12/2019 13:27	07/12/2019 15:45	2,29	24	54,98	CHI
20191244785	ESTRELA DO NORTE	ET12036513	MARA ROSA	07/12/2019 13:29	07/12/2019 20:52	07/12/2019 13:29	07/12/2019 20:52	7,38	3	22,13	CHI
20191244785	FORMOSO	ET12036513	MARA ROSA	07/12/2019 13:29	07/12/2019 20:52	07/12/2019 13:29	07/12/2019 20:52	7,38	1	7,38	CHI
20191244785	MARA ROSA	ET12036513	MARA ROSA	07/12/2019 13:29	07/12/2019 20:52	07/12/2019 13:29	07/12/2019 20:52	7,38	6	44,26	CHI
20191244880	BONOPOLIS	BX21254002	NOVO PLANALTO	07/12/2019 13:31	07/12/2019 20:21	07/12/2019 13:31	07/12/2019 20:21	6,83	1	6,83	CHI
20191244572	CATALAO	CT21238477	CATALAO S1	07/12/2019 13:32	08/12/2019 08:35	07/12/2019 13:32	08/12/2019 08:35	19,04	1	19,04	CHI
20191244178	PORANGATU	PO12020608	NOVO PLANALTO	07/12/2019 13:33	07/12/2019 16:18	07/12/2019 13:33	07/12/2019 16:18	2,75	3	8,25	CHI
20191244182	PLANALTINA	6787099	PLANALTINA	07/12/2019 13:34	07/12/2019 15:21	07/12/2019 13:34	07/12/2019 15:21	1,77	3	5,31	CHI
20191244857	NIQUELANDIA	NQ12396775	NIQUELANDIA SUBTRANSMISSAO	07/12/2019 13:35	08/12/2019 04:13	07/12/2019 13:35	08/12/2019 04:13	14,63	27	394,94	CHI
20191245568	COCALZINHO DE GOIAS	ZN12302517	COCALZINHO	07/12/2019 13:36	09/12/2019 00:01	07/12/2019 13:36	09/12/2019 00:01	34,40	7	240,83	CHI
20191243017	FIRMINOPOLIS	FR12096977	FIRMINOPOLIS S1	07/12/2019 13:37	07/12/2019 21:55	07/12/2019 13:37	07/12/2019 21:55	8,29	79	655,04	CHI
20191244194	SENADOR CANEDO	190023168	SENADOR CANEDO	07/12/2019 13:37	07/12/2019 15:30	07/12/2019 13:37	07/12/2019 15:30	1,87	1	1,87	CHI
20191244577	FIRMINOPOLIS	900039863	SAO LUIZ DOS MONTES BELOS	07/12/2019 13:37	07/12/2019 16:50	07/12/2019 13:37	07/12/2019 16:50	3,20	1	3,20	CHI
20191244197	CAMPO ALEGRE DE GOIAS	CM21000002	CAMPO ALEGRE DE GOIAS	07/12/2019 13:38	07/12/2019 17:52	07/12/2019 13:38	07/12/2019 17:52	4,22	1	4,22	CHI
20191244201	JANDAIA	JD12308473	PALMEIRAS	07/12/2019 13:40	07/12/2019 16:37	07/12/2019 13:40	07/12/2019 16:37	2,95	7	20,64	CHI
20191244209	GOIANESIA	GE21135869	GOIANESIA S1	07/12/2019 13:42	07/12/2019 15:10	07/12/2019 13:42	07/12/2019 15:10	1,47	1	1,47	CHI
20191244210	RIO VERDE	RV21257507	RIO VERDE S1	07/12/2019 13:42	08/12/2019 11:10	07/12/2019 13:42	08/12/2019 11:10	21,46	1	21,46	CHI
20191244212	BONOPOLIS	BX12398148	SAO MIGUEL DO ARAGUAIA	07/12/2019 13:43	07/12/2019 22:49	07/12/2019 13:43	07/12/2019 22:49	9,10	16	145,53	CHI
20191244221	ALEXANIA	AX12061983	ALEXANIA	07/12/2019 13:43	07/12/2019 15:32	07/12/2019 13:43	07/12/2019 15:32	1,80	12	21,65	CHI
20191244221	CORUMBA DE GOIAS	AX12061983	ALEXANIA	07/12/2019 13:43	07/12/2019 15:32	07/12/2019 13:43	07/12/2019 15:32	1,80	1	1,80	CHI
20191244217	AGUA FRIA DE GOIAS	TL12302771LD	SAO JOAO D ALIANCA	07/12/2019 13:45	07/12/2019 17:15	07/12/2019 13:45	07/12/2019 17:15	3,49	19	66,29	CHI
20191244217	SAO JOAO D ALIANCA	TL12302771LD	SAO JOAO D ALIANCA	07/12/2019 13:45	07/12/2019 17:15	07/12/2019 13:45	07/12/2019 17:15	3,49	13	45,36	CHI
20191244217	SAO JOAO D ALIANCA	TL12302771LD	SAO JOAO D ALIANCA	07/12/2019 13:45	07/12/2019 17:15	07/12/2019 16:04	07/12/2019 17:15	1,18	11	12,96	CHI
20191244240	NOVO PLANALTO	TA12369993	NOVO PLANALTO	07/12/2019 13:45	07/12/2019 14:53	07/12/2019 13:45	07/12/2019 14:53	1,12	51	57,32	CHI
20191244219	MINEIROS	1390114615	PARQUE DAS EMAS	07/12/2019 13:46	07/12/2019 21:41	07/12/2019 13:46	07/12/2019 21:41	7,91	1	7,91	CHI
20191244220	ANICUNS	AC21158666	ANICUNS	07/12/2019 13:46	07/12/2019 18:37	07/12/2019 13:46	07/12/2019 18:37	4,84	2	9,67	CHI
20191244167	MONTIVIDIU	MV12267634	MONTIVIDIU T	07/12/2019 13:47	07/12/2019 23:50	07/12/2019 13:47	07/12/2019 23:50	10,05	17	170,80	CHI
20191246421	CATALAO	CT12333570	CATALAO S1	07/12/2019 13:47	08/12/2019 08:35	07/12/2019 13:47	08/12/2019 08:35	18,79	111	2086,18	CHI
20191244227	ADELANDIA	DN21233498	FIRMINOPOLIS S2	07/12/2019 13:48	07/12/2019 19:23	07/12/2019 13:48	07/12/2019 19:23	5,58	1	5,58	CHI

20191244233	ANAPOLIS	10001686931	JUNDIAI S1	07/12/2019 13:50	07/12/2019 15:45	07/12/2019 13:50	07/12/2019 15:45	1,93	1	1,93	CHI
20191244237	CORREGO DO OURO	CO12054528	FIRMINOPOLIS S2	07/12/2019 13:50	07/12/2019 15:39	07/12/2019 13:50	07/12/2019 15:39	1,81	8	14,46	CHI
20191244245	CIDADE OCIDENTAL	DH12383019	MARAJOARA	07/12/2019 13:53	07/12/2019 16:57	07/12/2019 13:53	07/12/2019 16:57	3,06	30	91,88	CHI
20191244247	PORANGATU	PO12048411	PORANGATU	07/12/2019 13:53	07/12/2019 18:30	07/12/2019 13:53	07/12/2019 18:30	4,60	17	78,21	CHI
20191244248	GOIANIA	10002810253	XAVANTES	07/12/2019 13:54	07/12/2019 16:51	07/12/2019 13:54	07/12/2019 16:51	2,94	1	2,94	CHI
20191244284	SILVANIA	SV12084550	VIANOPOLIS	07/12/2019 13:54	08/12/2019 09:50	07/12/2019 13:54	08/12/2019 09:50	19,92	49	976,03	CHI
20191244257	ALEXANIA	AX12185636	ALEXANIA	07/12/2019 13:55	07/12/2019 17:17	07/12/2019 13:55	07/12/2019 17:17	3,35	1	3,35	CHI
20191244552	FAINA	FC12147800	GOIAS	07/12/2019 13:55	07/12/2019 17:07	07/12/2019 13:55	07/12/2019 17:07	3,20	90	287,60	CHI
20191246913	AMARALINA	LC12245280	MARA ROSA	07/12/2019 13:55	08/12/2019 10:37	07/12/2019 13:55	08/12/2019 10:37	20,69	4	82,77	CHI
20191244259	HIDROLANDIA	HD31060209	CEPAIGO S1	07/12/2019 13:56	07/12/2019 20:52	07/12/2019 13:56	07/12/2019 20:52	6,93	1	6,93	CHI
20191244264	LUZIANIA	LZ11061815	RIO VERMELHO	07/12/2019 13:57	07/12/2019 15:25	07/12/2019 13:57	07/12/2019 15:25	1,45	124	180,14	CHI
20191244266	IPAMERI	IP12275536	CAMPO ALEGRE DE GOIAS	07/12/2019 13:58	07/12/2019 18:50	07/12/2019 13:58	07/12/2019 18:50	4,87	7	34,11	CHI
20191244267	NOVA VENEZA	NV21078489	INHUMAS S1	07/12/2019 13:58	07/12/2019 16:40	07/12/2019 13:58	07/12/2019 16:40	2,69	1	2,69	CHI
20191244271	JARAGUA	70119960	JARAGUA	07/12/2019 13:59	08/12/2019 10:10	07/12/2019 13:59	08/12/2019 10:10	20,19	1	20,19	CHI
20191244277	LUZIANIA	LZ21290821	PAMPLONA	07/12/2019 13:59	07/12/2019 21:35	07/12/2019 13:59	07/12/2019 21:35	7,58	1	7,58	CHI
20191244673	FAINA	FC12274421	GOIAS	07/12/2019 13:59	08/12/2019 18:09	07/12/2019 13:59	08/12/2019 18:09	28,16	17	478,77	CHI
20191244278	TRINDADE	40133783	MEIA PONTE	07/12/2019 14:00	07/12/2019 16:43	07/12/2019 14:00	07/12/2019 16:43	2,72	1	2,72	CHI
20191244279	APARECIDA DO RIO DOCE	3650006714	CACHOEIRA ALTA	07/12/2019 14:00	08/12/2019 09:44	07/12/2019 14:00	08/12/2019 09:44	19,73	1	19,73	CHI
20191244282	MUNDO NOVO DE GOIAS	8272906	NOVA CRIXAS	07/12/2019 14:00	07/12/2019 18:54	07/12/2019 14:00	07/12/2019 18:54	4,89	3	14,67	CHI
20191244305	CRISTALINA	KR10400710	PAMPLONA	07/12/2019 14:00	07/12/2019 18:35	07/12/2019 14:03	07/12/2019 15:48	1,74	21	36,61	CHI
20191244305	CRISTALINA	KR13351313	PAMPLONA	07/12/2019 14:00	07/12/2019 18:35	07/12/2019 14:03	07/12/2019 18:03	4,00	13	52,02	CHI
20191244305	CRISTALINA	KR12320123LD	PAMPLONA	07/12/2019 14:00	07/12/2019 18:35	07/12/2019 14:03	07/12/2019 18:35	4,53	32	144,92	CHI
20191244365	BOM JARDIM DE GOIAS	BM12334832	BOM JARDIM	07/12/2019 14:01	08/12/2019 09:51	07/12/2019 14:01	08/12/2019 09:51	19,84	8	158,69	CHI
20191244803	VIANOPOLIS	VN12012100	VIANOPOLIS	07/12/2019 14:01	08/12/2019 08:22	07/12/2019 14:01	08/12/2019 08:22	18,34	7	128,40	CHI
20191244288	PORANGATU	PO11208632	PORANGATU	07/12/2019 14:02	07/12/2019 15:13	07/12/2019 14:02	07/12/2019 15:13	1,18	74	87,48	CHI
20191244292	HIDROLANDIA	BV12117089	BELA VISTA S1	07/12/2019 14:02	07/12/2019 23:33	07/12/2019 14:02	07/12/2019 23:33	9,51	4	38,04	CHI
20191244296	SAO MIGUEL DO PASSA QUATRO	SQ12130588	CRISTIANOPOLIS	07/12/2019 14:03	07/12/2019 15:56	07/12/2019 14:03	07/12/2019 15:56	1,89	6	11,33	CHI
20191244695	BRITANIA	BT12210599	BRITANIA	07/12/2019 14:03	08/12/2019 14:41	07/12/2019 14:03	08/12/2019 09:14	19,19	13	249,49	CHI
20191244695	BRITANIA	BT12210599	BRITANIA	07/12/2019 14:03	08/12/2019 14:41	07/12/2019 14:03	08/12/2019 11:17	21,24	18	382,34	CHI
20191244695	BRITANIA	BT12210599	BRITANIA	07/12/2019 14:03	08/12/2019 14:41	07/12/2019 14:03	08/12/2019 13:29	23,45	13	304,79	CHI
20191244695	BRITANIA	BT12210599	BRITANIA	07/12/2019 14:03	08/12/2019 14:41	07/12/2019 14:03	08/12/2019 14:28	24,42	7	170,91	CHI
20191244695	BRITANIA	BT13008704	BRITANIA	07/12/2019 14:03	08/12/2019 14:41	07/12/2019 14:03	08/12/2019 14:41	24,64	647	15941,00	CHI
20191244695	JUSSARA	BT13008704	BRITANIA	07/12/2019 14:03	08/12/2019 14:41	07/12/2019 14:03	08/12/2019 14:41	24,64	48	1182,64	CHI

20191244695	BRITANIA	BT13008704	BRITANIA	07/12/2019 14:03	08/12/2019 14:41	08/12/2019 08:03	08/12/2019 14:41	6,63	4	26,53	CHI
20191244406	GOIATUBA	VI12057732	VICENTINOPOLIS	07/12/2019 14:06	07/12/2019 23:52	07/12/2019 14:06	07/12/2019 23:52	9,77	2	19,53	CHI
20191244416	BONOPOLIS	BX12165447	SAO MIGUEL DO ARAGUAIA	07/12/2019 14:08	08/12/2019 07:58	07/12/2019 14:08	08/12/2019 07:58	17,82	3	53,47	CHI
20191244511	BURITI ALEGRE	BG12000103	ITUMBIARA VELHA S2	07/12/2019 14:08	07/12/2019 18:14	07/12/2019 14:08	07/12/2019 18:14	4,09	42	171,80	CHI
20191244421	CACHOEIRA DOURADA	CD12000228	CACHOEIRA DOURADA	07/12/2019 14:10	07/12/2019 18:30	07/12/2019 14:10	07/12/2019 18:30	4,33	2	8,67	CHI
20191244421	ITUMBIARA	CD12000228	CACHOEIRA DOURADA	07/12/2019 14:10	07/12/2019 18:30	07/12/2019 14:10	07/12/2019 18:30	4,33	1	4,33	CHI
20191244423	ACREUNA	IY12039705	EDEIA	07/12/2019 14:11	07/12/2019 19:37	07/12/2019 14:11	07/12/2019 19:37	5,45	8	43,59	CHI
20191244423	INDIARA	IY12039705	EDEIA	07/12/2019 14:11	07/12/2019 19:37	07/12/2019 14:11	07/12/2019 19:37	5,45	3	16,35	CHI
20191244426	NIQUELANDIA	NQ12181068	URUACU	07/12/2019 14:12	07/12/2019 17:59	07/12/2019 14:12	07/12/2019 17:59	3,77	103	388,68	CHI
20191244427	CATALAO	10003745447	CATALAO S2	07/12/2019 14:12	07/12/2019 16:47	07/12/2019 14:12	07/12/2019 16:47	2,58	1	2,58	CHI
20191244434	VALPARAISO DE GOIAS	10019485440	MARAJOARA	07/12/2019 14:14	07/12/2019 21:36	07/12/2019 14:14	07/12/2019 21:36	7,36	1	7,36	CHI
20191244444	BURITI DE GOIAS	BS21323790	FIRMINOPOLIS S2	07/12/2019 14:15	07/12/2019 18:26	07/12/2019 14:15	07/12/2019 18:26	4,18	1	4,18	CHI
20191244515	ITUMBIARA	CD21000165	CACHOEIRA DOURADA	07/12/2019 14:19	07/12/2019 18:23	07/12/2019 14:19	07/12/2019 18:23	4,06	1	4,06	CHI
20191244521	LUZIANIA	10009197190	MARAJOARA	07/12/2019 14:20	07/12/2019 16:30	07/12/2019 14:20	07/12/2019 16:30	2,16	1	2,16	CHI
20191244522	NIQUELANDIA	NQ12227348	URUACU	07/12/2019 14:20	08/12/2019 00:20	07/12/2019 14:20	08/12/2019 00:20	10,00	45	449,79	CHI
20191244527	VIANOPOLIS	10003447616	VIANOPOLIS	07/12/2019 14:21	07/12/2019 17:46	07/12/2019 14:21	07/12/2019 17:46	3,41	1	3,41	CHI
20191244581	BELA VISTA DE GOIAS	BV12000019	BELA VISTA S1	07/12/2019 14:21	07/12/2019 16:13	07/12/2019 14:21	07/12/2019 16:13	1,85	30	55,51	CHI
20191244533	GOIANIA	12450730	CARAJAS S1	07/12/2019 14:22	07/12/2019 15:37	07/12/2019 14:22	07/12/2019 15:37	1,23	1	1,23	CHI
20191244722	BELA VISTA DE GOIAS	BV12120914	BELA VISTA S1	07/12/2019 14:22	07/12/2019 18:27	07/12/2019 14:22	07/12/2019 18:27	4,10	306	1253,16	CHI
20191244537	ALEXANIA	AX21155287	ALEXANIA	07/12/2019 14:23	07/12/2019 17:30	07/12/2019 14:23	07/12/2019 17:30	3,10	1	3,10	CHI
20191244541	ITAPIRAPUA	IU21145677	MATRINCHA	07/12/2019 14:24	08/12/2019 10:10	07/12/2019 14:24	08/12/2019 10:10	19,76	1	19,76	CHI
20191244544	ITUMBIARA	IT12257075	ITUMBIARA NOVA	07/12/2019 14:25	08/12/2019 07:07	07/12/2019 14:25	08/12/2019 07:07	16,69	18	300,38	CHI
20191244545	GOIANIA	10889279	GOIANIA LESTE S3	07/12/2019 14:25	07/12/2019 17:27	07/12/2019 14:25	07/12/2019 17:27	3,03	1	3,03	CHI
20191244548	CAMPINACU	UC12208549	PORANGATU	07/12/2019 14:26	07/12/2019 17:05	07/12/2019 14:26	07/12/2019 17:05	2,64	4	10,57	CHI
20191244313	MATRINCHA	MP12307659	MATRINCHA	07/12/2019 14:28	09/12/2019 18:47	07/12/2019 14:28	09/12/2019 18:47	52,31	1	52,31	CHI
20191244557	ITARUMA	2310007840	CACHOEIRA ALTA	07/12/2019 14:28	07/12/2019 18:56	07/12/2019 14:28	07/12/2019 18:56	4,46	1	4,46	CHI
20191244561	PARANAIGUARA	PC21193920	QUIRINOPOLIS	07/12/2019 14:28	07/12/2019 16:15	07/12/2019 14:28	07/12/2019 16:15	1,77	1	1,77	CHI
20191244563	ABADIANIA	AA21127303	ANAPOLIS UNIVERSITARIO S1	07/12/2019 14:29	07/12/2019 17:20	07/12/2019 14:29	07/12/2019 17:20	2,85	1	2,85	CHI
20191244574	GAMELEIRA DE GOIAS	SV12027617	DAIA S2	07/12/2019 14:30	08/12/2019 15:15	07/12/2019 14:30	08/12/2019 11:40	21,15	22	465,36	CHI
20191244574	GAMELEIRA DE GOIAS	SV12027617	DAIA S2	07/12/2019 14:30	08/12/2019 15:15	08/12/2019 13:46	08/12/2019 15:15	1,48	22	32,49	CHI
20191244575	BELA VISTA DE GOIAS	BV11134496	BELA VISTA S1	07/12/2019 14:30	07/12/2019 15:55	07/12/2019 14:30	07/12/2019 15:55	1,40	113	158,48	CHI
20191244728	BELA VISTA DE GOIAS	BV32063026	BELA VISTA S1	07/12/2019 14:30	07/12/2019 16:15	07/12/2019 14:30	07/12/2019 16:15	1,74	69	119,95	CHI
20191244579	ITAJA	IJ21191717	ITAJA S2	07/12/2019 14:31	07/12/2019 16:42	07/12/2019 14:31	07/12/2019 16:42	2,17	1	2,17	CHI

20191244583	TURVELANDIA	7277178	RIO DOS BOIS	07/12/2019 14:32	09/12/2019 14:02	07/12/2019 14:32	09/12/2019 14:02	47,49	4	189,97	CHI
20191244583	TURVELANDIA	7277178	RIO DOS BOIS	07/12/2019 14:32	09/12/2019 14:02	09/12/2019 10:30	09/12/2019 14:02	3,53	6	21,17	CHI
20191244586	NOVO BRASIL	1460003448	JUSSARA	07/12/2019 14:33	08/12/2019 09:56	07/12/2019 14:33	08/12/2019 09:56	19,37	1	19,37	CHI
20191245347	NOVA CRIXAS	NA12072222	MOZARLANDIA	07/12/2019 14:34	08/12/2019 08:11	07/12/2019 14:34	08/12/2019 08:11	17,61	2	35,22	CHI
20191244593	BELA VISTA DE GOIAS	BV21170317	BELA VISTA S2	07/12/2019 14:36	07/12/2019 17:56	07/12/2019 14:36	07/12/2019 17:56	3,33	1	3,33	CHI
20191246476	IPORA	IR12032738	IPORA	07/12/2019 14:38	08/12/2019 06:13	07/12/2019 14:38	08/12/2019 06:13	15,58	7	109,08	CHI
20191244605	GOIANIA	10782333	CARAJAS S1	07/12/2019 14:39	07/12/2019 18:14	07/12/2019 14:39	07/12/2019 18:14	3,58	1	3,58	CHI
20191244608	PORANGATU	840124715	PORANGATU	07/12/2019 14:39	07/12/2019 20:39	07/12/2019 14:39	07/12/2019 20:39	5,99	1	5,99	CHI
20191244610	CRISTALINA	KR11383043	CRISTALINA S1	07/12/2019 14:39	07/12/2019 15:33	07/12/2019 14:39	07/12/2019 15:33	0,89	7	6,21	CHI
20191244611	NIQUELANDIA	NQ12358188	URUACU	07/12/2019 14:39	08/12/2019 07:56	07/12/2019 14:39	08/12/2019 07:56	17,27	83	1433,34	CHI
20191244963	CAMPINORTE	UR12074233	URUACU	07/12/2019 14:39	07/12/2019 17:33	07/12/2019 14:39	07/12/2019 17:32	2,89	23	66,43	CHI
20191244963	URUACU	UR12074233	URUACU	07/12/2019 14:39	07/12/2019 17:33	07/12/2019 14:39	07/12/2019 17:32	2,89	94	271,48	CHI
20191244963	URUACU	UR21386893	URUACU	07/12/2019 14:39	07/12/2019 17:33	07/12/2019 14:39	07/12/2019 17:33	2,90	1	2,90	CHI
20191244613	URUACU	UR12317135	URUACU	07/12/2019 14:42	07/12/2019 22:16	07/12/2019 14:42	07/12/2019 22:16	7,57	11	83,22	CHI
20191244614	MAMBAI	1570013436	IACIARA S2	07/12/2019 14:42	07/12/2019 19:15	07/12/2019 14:42	07/12/2019 19:15	4,55	1	4,55	CHI
20191244625	FORMOSA	FA12218592	ITIQUEIRA	07/12/2019 14:44	07/12/2019 18:06	07/12/2019 14:44	07/12/2019 18:06	3,35	6	20,10	CHI
20191244629	CRIXAS	CX21000043	SANTA TEREZINHA	07/12/2019 14:45	07/12/2019 21:49	07/12/2019 14:45	07/12/2019 21:49	7,06	1	7,06	CHI
20191244641	FORMOSA	610238000	ITIQUEIRA	07/12/2019 14:47	07/12/2019 16:24	07/12/2019 14:47	07/12/2019 16:24	1,60	1	1,60	CHI
20191244642	VILA PROPICIO	NP21298238	GOIANESIA S1	07/12/2019 14:48	07/12/2019 18:02	07/12/2019 14:48	07/12/2019 18:02	3,23	2	6,46	CHI
20191244647	CABECEIRAS	CW12262301	ITIQUEIRA	07/12/2019 14:49	07/12/2019 16:13	07/12/2019 14:49	07/12/2019 16:13	1,40	43	60,13	CHI
20191244647	DISTRITO FEDERAL	CW12262301	ITIQUEIRA	07/12/2019 14:49	07/12/2019 16:13	07/12/2019 14:49	07/12/2019 16:13	1,40	1	1,40	CHI
20191244720	ALTO PARAISO DE GOIAS	BF12365266	SAO JOAO D ALIANCA	07/12/2019 14:49	07/12/2019 16:36	07/12/2019 14:49	07/12/2019 16:36	1,78	12	21,37	CHI
20191245540	NIQUELANDIA	NQ12374779	URUACU	07/12/2019 14:49	08/12/2019 02:18	07/12/2019 14:49	08/12/2019 02:18	11,48	29	332,98	CHI
20191244654	FIRMINOPOLIS	FR12096973	FIRMINOPOLIS S1	07/12/2019 14:50	07/12/2019 17:44	07/12/2019 14:50	07/12/2019 17:44	2,89	9	25,99	CHI
20191244656	APARECIDA DE GOIANIA	10024385881	INDEPENDENCIA S1	07/12/2019 14:50	07/12/2019 16:35	07/12/2019 14:50	07/12/2019 16:35	1,73	1	1,73	CHI
20191244658	GOIANIA	11534813	GOIANIA LESTE S2	07/12/2019 14:51	07/12/2019 15:50	07/12/2019 14:51	07/12/2019 15:50	0,98	1	0,98	CHI
20191244935	BELA VISTA DE GOIAS	BV32010041	BELA VISTA S1	07/12/2019 14:51	07/12/2019 17:07	07/12/2019 14:51	07/12/2019 17:07	2,26	5	11,31	CHI
20191244660	PADRE BERNARDO	PB11289472	PADRE BERNARDO	07/12/2019 14:52	07/12/2019 20:04	07/12/2019 14:52	07/12/2019 20:04	5,19	3	15,56	CHI
20191244662	SAO DOMINGOS	4950003400	SAO DOMINGOS	07/12/2019 14:53	07/12/2019 17:10	07/12/2019 14:53	07/12/2019 17:10	2,29	1	2,29	CHI
20191244668	PALMEIRAS DE GOIAS	PL12098934	PALMEIRAS	07/12/2019 14:54	07/12/2019 22:08	07/12/2019 14:54	07/12/2019 22:08	7,23	6	43,41	CHI
20191244677	BONOPOLIS	BX12255666	SAO MIGUEL DO ARAGUAIA	07/12/2019 14:55	08/12/2019 08:24	07/12/2019 14:55	08/12/2019 08:24	17,48	5	87,39	CHI
2019120700016	ORIZONA	01480414	PIRES DO RIO S2	07/12/2019 14:56	07/12/2019 15:00	07/12/2019 14:56	07/12/2019 15:00	0,07	2	0,13	CHI
2019120700016	PIRES DO RIO	01480414	PIRES DO RIO S2	07/12/2019 14:56	07/12/2019 15:00	07/12/2019 14:56	07/12/2019 15:00	0,07	10	0,67	CHI

2019120700016	URUTAI	01480414	PIRES DO RIO S2	07/12/2019 14:56	07/12/2019 15:00	07/12/2019 14:56	07/12/2019 15:00	0,07	62	4,13	CHI
20191244682	CRIXAS	CX12330137	RUBIATABA	07/12/2019 14:57	08/12/2019 10:35	07/12/2019 14:57	08/12/2019 10:35	19,63	36	706,64	CHI
20191244723	CRISTALINA	KR12087952	CRISTALINA S2	07/12/2019 14:57	07/12/2019 16:29	07/12/2019 14:57	07/12/2019 16:29	1,52	31	47,25	CHI
20191247057	ARAGARCAS	AG11000007	ARAGARCAS	07/12/2019 14:57	08/12/2019 08:57	07/12/2019 14:57	08/12/2019 08:57	17,99	53	953,57	CHI
20191244688	GOIANIA	15010338	GOYA S2	07/12/2019 14:58	07/12/2019 16:34	07/12/2019 14:58	07/12/2019 16:34	1,59	1	1,59	CHI
20191244689	GOIANIA	12984917	GOYA S2	07/12/2019 14:59	07/12/2019 16:31	07/12/2019 14:59	07/12/2019 16:31	1,53	1	1,53	CHI
20191244691	NOVA GLORIA	NG21088704	ITAPACI	07/12/2019 15:00	08/12/2019 09:20	07/12/2019 15:00	08/12/2019 09:20	18,33	1	18,33	CHI
20191244692	COCALZINHO DE GOIAS	10003359300	COCALZINHO	07/12/2019 15:00	07/12/2019 18:39	07/12/2019 15:00	07/12/2019 18:39	3,65	1	3,65	CHI
20191244693	BELA VISTA DE GOIAS	BV21185834	BELA VISTA S2	07/12/2019 15:00	08/12/2019 02:54	07/12/2019 15:00	08/12/2019 02:54	11,89	1	11,89	CHI
20191244694	APARECIDA DE GOIANIA	10020045636	INDEPENDENCIA S2	07/12/2019 15:01	07/12/2019 16:47	07/12/2019 15:01	07/12/2019 16:47	1,77	1	1,77	CHI
20191244700	PORANGATU	PO12208396	PORANGATU	07/12/2019 15:01	08/12/2019 09:04	07/12/2019 15:01	08/12/2019 09:04	18,04	1	18,04	CHI
20191244832	AGUA FRIA DE GOIAS	MJ12040650	PADRE BERNARDO	07/12/2019 15:02	07/12/2019 21:40	07/12/2019 15:02	07/12/2019 21:40	6,64	9	59,74	CHI
20191244832	MIMOSO DE GOIAS	MJ12040650	PADRE BERNARDO	07/12/2019 15:02	07/12/2019 21:40	07/12/2019 15:02	07/12/2019 21:40	6,64	12	79,66	CHI
20191245975	ORIZONA	OZ12216015	VIANOPOLIS	07/12/2019 15:03	07/12/2019 20:14	07/12/2019 15:03	07/12/2019 20:14	5,18	22	113,92	CHI
20191244729	MONTIVIDIU	MV12267741	MONTIVIDIU T	07/12/2019 15:08	08/12/2019 19:05	07/12/2019 15:08	08/12/2019 19:05	27,94	2	55,89	CHI
20191244733	LUZIANIA	LZ12203332	VIANOPOLIS	07/12/2019 15:08	07/12/2019 23:12	07/12/2019 15:08	07/12/2019 23:12	8,05	10	80,52	CHI
20191244736	ARUANA	AK12184500	ARUANA	07/12/2019 15:09	07/12/2019 16:32	07/12/2019 15:09	07/12/2019 16:32	1,37	3	4,11	CHI
20191244745	QUIRINOPOLIS	QI12096888	QUIRINOPOLIS	07/12/2019 15:10	07/12/2019 17:28	07/12/2019 15:10	07/12/2019 17:28	2,29	20	45,79	CHI
20191244743	NOVO PLANALTO	TA12253750	NOVO PLANALTO	07/12/2019 15:12	07/12/2019 17:55	07/12/2019 15:12	07/12/2019 17:55	2,70	122	329,81	CHI
20191245309	URUACU	UR11065511	URUACU	07/12/2019 15:12	07/12/2019 19:25	07/12/2019 15:12	07/12/2019 19:25	4,21	18	75,72	CHI
20191244747	MINEIROS	1390049258	PARQUE DAS EMAS	07/12/2019 15:14	07/12/2019 18:04	07/12/2019 15:14	07/12/2019 18:04	2,83	1	2,83	CHI
20191244844	CORUMBAIBA	IP12071439	IPAMERI	07/12/2019 15:14	07/12/2019 20:13	07/12/2019 15:14	07/12/2019 20:13	4,97	4	19,89	CHI
20191244844	IPAMERI	IP12071439	IPAMERI	07/12/2019 15:14	07/12/2019 20:13	07/12/2019 15:14	07/12/2019 20:13	4,97	23	114,38	CHI
20191244844	NOVA AURORA	IP12071439	IPAMERI	07/12/2019 15:14	07/12/2019 20:13	07/12/2019 15:14	07/12/2019 20:13	4,97	2	9,95	CHI
20191244756	CALDAS NOVAS	760192303	SERRA DE CALDAS	07/12/2019 15:15	07/12/2019 17:18	07/12/2019 15:15	07/12/2019 17:18	2,04	1	2,04	CHI
20191244765	APORE	AE12162697	ITAJA S2	07/12/2019 15:16	07/12/2019 16:54	07/12/2019 15:16	07/12/2019 16:54	1,62	1	1,62	CHI
20191244831	URUACU	UR12136315	CAMPINORTE	07/12/2019 15:16	07/12/2019 23:38	07/12/2019 15:16	07/12/2019 23:38	8,36	3	25,07	CHI
20191244763	VALPARAISO DE GOIAS	10029339209	MARAJOARA	07/12/2019 15:17	07/12/2019 16:51	07/12/2019 15:17	07/12/2019 16:51	1,56	1	1,56	CHI
20191244767	CATALAO	CT21166721	CATALAO S1	07/12/2019 15:17	07/12/2019 22:51	07/12/2019 15:17	07/12/2019 22:51	7,55	2	15,11	CHI
20191244769	GOIANIA	11605790	CAMPINAS S2	07/12/2019 15:17	07/12/2019 17:13	07/12/2019 15:17	07/12/2019 17:13	1,92	1	1,92	CHI
20191244773	RIO VERDE	RV21260620	CABRIUVA S1	07/12/2019 15:18	08/12/2019 10:39	07/12/2019 15:18	08/12/2019 10:39	19,36	1	19,36	CHI
20191244774	GUARINOS	9210000255	SANTA TEREZINHA	07/12/2019 15:19	08/12/2019 09:21	07/12/2019 15:19	08/12/2019 09:21	18,02	1	18,02	CHI
20191244780	FAINA	FC21252473	ITAPURANGA	07/12/2019 15:22	08/12/2019 17:20	07/12/2019 15:22	08/12/2019 17:20	25,96	1	25,96	CHI

20191245387	ESTRELA DO NORTE	ET12105649	MARA ROSA	07/12/2019 15:23	07/12/2019 20:40	07/12/2019 15:23	07/12/2019 20:40	5,28	245	1292,65	CHI
20191245833	PONTALINA	PK12000100	PONTALINA	07/12/2019 15:23	07/12/2019 23:22	07/12/2019 15:23	07/12/2019 23:22	7,98	10	79,82	CHI
20191244786	NAZARIO	10002166583	ANICUNS	07/12/2019 15:24	07/12/2019 17:27	07/12/2019 15:24	07/12/2019 17:27	2,05	1	2,05	CHI
20191244788	LUZIANIA	120161424	RIO VERMELHO	07/12/2019 15:24	07/12/2019 17:56	07/12/2019 15:24	07/12/2019 17:56	2,53	1	2,53	CHI
20191244791	SANTA HELENA DE GOIAS	10000565804	IPEGUARI	07/12/2019 15:24	07/12/2019 19:17	07/12/2019 15:24	07/12/2019 19:17	3,88	1	3,88	CHI
20191244793	LUZIANIA	120430540	RIO VERMELHO	07/12/2019 15:25	07/12/2019 16:39	07/12/2019 15:25	07/12/2019 16:39	1,24	1	1,24	CHI
20191244800	CRISTIANOPOLIS	CF21300865	CRISTIANOPOLIS	07/12/2019 15:28	07/12/2019 17:00	07/12/2019 15:28	07/12/2019 17:00	1,52	1	1,52	CHI
20191244805	ITAPURANGA	IK21310966	ITAPURANGA	07/12/2019 15:29	08/12/2019 22:25	07/12/2019 15:29	08/12/2019 22:24	30,92	1	30,92	CHI
20191244805	ITAPURANGA	IK12310974	ITAPURANGA	07/12/2019 15:29	08/12/2019 22:25	08/12/2019 21:07	08/12/2019 22:25	1,29	2	2,59	CHI
20191244847	SILVANIA	SV12131990	VIANOPOLIS	07/12/2019 15:29	07/12/2019 20:13	07/12/2019 15:29	07/12/2019 20:13	4,72	30	141,68	CHI
20191244808	BELA VISTA DE GOIAS	BV31157907	BELA VISTA S1	07/12/2019 15:30	07/12/2019 23:15	07/12/2019 15:30	07/12/2019 23:15	7,75	1	7,75	CHI
20191244813	VALPARAISO DE GOIAS	10029926422	MARAJOARA	07/12/2019 15:31	07/12/2019 19:11	07/12/2019 15:31	07/12/2019 19:11	3,66	1	3,66	CHI
20191244816	BELA VISTA DE GOIAS	BV12037009	BELA VISTA S1	07/12/2019 15:31	07/12/2019 19:21	07/12/2019 15:31	07/12/2019 19:21	3,83	2	7,65	CHI
20191244817	TRINDADE	40303019	TRINDADE	07/12/2019 15:31	07/12/2019 18:05	07/12/2019 15:31	07/12/2019 18:05	2,55	1	2,55	CHI
20191244819	LUZIANIA	LZ12084127	PIRES DO RIO S2	07/12/2019 15:32	07/12/2019 19:09	07/12/2019 15:32	07/12/2019 19:09	3,61	8	28,87	CHI
20191244819	ORIZONA	LZ12084127	PIRES DO RIO S2	07/12/2019 15:32	07/12/2019 19:09	07/12/2019 15:32	07/12/2019 19:09	3,61	1	3,61	CHI
20191244822	JATAI	JT11083816	JATAI S2	07/12/2019 15:32	08/12/2019 18:36	07/12/2019 15:32	08/12/2019 18:36	27,05	1	27,05	CHI
20191244823	URUACU	UR12398011	URUACU	07/12/2019 15:33	08/12/2019 04:54	07/12/2019 15:33	08/12/2019 04:54	13,35	4	53,40	CHI
20191244829	RIO QUENTE	RQ21063120	VILA CORUMBA	07/12/2019 15:34	08/12/2019 09:00	07/12/2019 15:34	08/12/2019 09:00	17,45	1	17,45	CHI
20191244834	PIRACANJUBA	PJ12212207	PIRACANJUBA	07/12/2019 15:35	08/12/2019 09:29	07/12/2019 15:35	08/12/2019 09:29	17,89	6	107,34	CHI
20191244839	PIRACANJUBA	PJ21182749	PIRACANJUBA	07/12/2019 15:36	07/12/2019 17:03	07/12/2019 15:36	07/12/2019 17:03	1,44	1	1,44	CHI
20191244840	INHUMAS	30153724	INHUMAS S2	07/12/2019 15:36	07/12/2019 21:17	07/12/2019 15:36	07/12/2019 21:17	5,67	1	5,67	CHI
20191244843	BELA VISTA DE GOIAS	BV12079385	BELA VISTA S1	07/12/2019 15:37	07/12/2019 23:54	07/12/2019 15:37	07/12/2019 23:54	8,28	2	16,56	CHI
20191244850	BONFINOPOLIS	LB21351055	DAIA S2	07/12/2019 15:39	07/12/2019 20:04	07/12/2019 15:39	07/12/2019 20:04	4,42	1	4,42	CHI
20191244854	IPORA	IR21203620	IPORA	07/12/2019 15:39	08/12/2019 07:59	07/12/2019 15:39	08/12/2019 07:59	16,32	1	16,32	CHI
20191244859	BELA VISTA DE GOIAS	BV12012595	BELA VISTA S1	07/12/2019 15:40	07/12/2019 23:40	07/12/2019 15:40	07/12/2019 23:40	7,99	3	23,97	CHI
20191244860	MAURILANDIA	1040011163	RIO DOS BOIS	07/12/2019 15:40	08/12/2019 08:16	07/12/2019 15:40	08/12/2019 08:16	16,59	1	16,59	CHI
20191244864	SAO SIMAO	6898371	CACHOEIRA ALTA	07/12/2019 15:41	07/12/2019 17:55	07/12/2019 15:41	07/12/2019 17:55	2,24	1981	4436,34	CHI
20191244865	ALTO PARAISO DE GOIAS	BF21180889	NIQUELANDIA SUBTRANSMISSAO	07/12/2019 15:41	07/12/2019 19:09	07/12/2019 15:41	07/12/2019 19:09	3,46	1	3,46	CHI
20191245118	URUACU	UR12221685	URUACU	07/12/2019 15:42	07/12/2019 20:23	07/12/2019 15:42	07/12/2019 20:23	4,68	20	93,56	CHI
20191244870	GOIANIA	10496828	GOIANIA LESTE S3	07/12/2019 15:43	07/12/2019 19:33	07/12/2019 15:43	07/12/2019 19:33	3,83	1	3,83	CHI
20191244872	LUZIANIA	LZ21237822	PIRES DO RIO S2	07/12/2019 15:43	07/12/2019 17:42	07/12/2019 15:43	07/12/2019 17:42	1,97	1	1,97	CHI
20191244873	LUZIANIA	LZ12109848	VIANOPOLIS	07/12/2019 15:44	08/12/2019 02:17	07/12/2019 15:44	08/12/2019 02:17	10,54	21	221,28	CHI

20191244873	ORIZONA	LZ12109848	VIANOPOLIS	07/12/2019 15:44	08/12/2019 02:17	07/12/2019 15:44	08/12/2019 02:17	10,54	2	21,07	CHI
20191244886	URUACU	UR21000025	URUACU	07/12/2019 15:47	08/12/2019 07:43	07/12/2019 15:47	08/12/2019 07:43	15,92	1	15,92	CHI
20191244888	ITAPURANGA	7358798	ITAPURANGA	07/12/2019 15:47	08/12/2019 15:34	07/12/2019 15:47	08/12/2019 15:34	23,77	15	356,59	CHI
20191244374	VIANOPOLIS	VN12026007	VIANOPOLIS	07/12/2019 15:48	08/12/2019 19:15	07/12/2019 15:48	08/12/2019 12:11	20,40	30	611,88	CHI
20191244374	MORRINHOS	VN12026007	VIANOPOLIS	07/12/2019 15:48	08/12/2019 19:15	07/12/2019 15:48	08/12/2019 19:15	27,45	1	27,45	CHI
20191244374	ORIZONA	VN12026007	VIANOPOLIS	07/12/2019 15:48	08/12/2019 19:15	07/12/2019 15:48	08/12/2019 19:15	27,45	51	1399,79	CHI
20191244374	SILVANIA	VN12026007	VIANOPOLIS	07/12/2019 15:48	08/12/2019 19:15	07/12/2019 15:48	08/12/2019 19:15	27,45	5	137,23	CHI
20191244374	VIANOPOLIS	VN12026007	VIANOPOLIS	07/12/2019 15:48	08/12/2019 19:15	07/12/2019 15:48	08/12/2019 19:15	27,45	23	631,28	CHI
20191244890	RIO VERDE	RV12384685	RIO VERDE S2	07/12/2019 15:48	08/12/2019 10:00	07/12/2019 15:48	08/12/2019 10:00	18,20	2	36,40	CHI
20191245400	ARUANA	MP12099916	MATRINCHA	07/12/2019 15:50	08/12/2019 12:27	07/12/2019 15:50	08/12/2019 12:27	20,63	5	103,15	CHI
20191245400	MATRINCHA	MP12099916	MATRINCHA	07/12/2019 15:50	08/12/2019 12:27	07/12/2019 15:50	08/12/2019 12:27	20,63	2	41,26	CHI
20191245583	SERRANOPOLIS	SX12268627	JATAI S1	07/12/2019 15:50	08/12/2019 12:49	07/12/2019 15:50	08/12/2019 12:49	20,97	3	62,91	CHI
20191244902	CAMPOS VERDES	SG12202098	SANTA TEREZINHA	07/12/2019 15:52	08/12/2019 08:34	08/12/2019 07:52	08/12/2019 08:34	0,70	40	28,01	CHI
20191244902	SANTA TEREZINHA DE GOIAS	SG12202098	SANTA TEREZINHA	07/12/2019 15:52	08/12/2019 08:34	08/12/2019 07:52	08/12/2019 08:34	0,70	132	92,44	CHI
20191244902	UIRAPURU	SG12202098	SANTA TEREZINHA	07/12/2019 15:52	08/12/2019 08:34	08/12/2019 07:52	08/12/2019 08:34	0,70	56	39,22	CHI
20191244903	CIDADE OCIDENTAL	2680021909	MARAJOARA	07/12/2019 15:52	07/12/2019 19:08	07/12/2019 15:52	07/12/2019 19:08	3,27	1	3,27	CHI
201912260870	UIRAPURU	4200006183	SANTA TEREZINHA	07/12/2019 15:52	08/12/2019 07:52	07/12/2019 15:52	08/12/2019 07:52	15,99	1	15,99	CHI
20191244913	CACHOEIRA ALTA	CA12132264	CACHOEIRA ALTA	07/12/2019 15:53	08/12/2019 15:57	07/12/2019 15:53	08/12/2019 15:57	24,05	2	48,10	CHI
20191244917	IPORA	IR21135103	ARENOPOLIS	07/12/2019 15:54	08/12/2019 08:48	07/12/2019 15:54	08/12/2019 08:48	16,89	1	16,89	CHI
20191244918	CORREGO DO OURO	1070009432	FIRMINOPOLIS S2	07/12/2019 15:54	08/12/2019 04:35	07/12/2019 15:54	08/12/2019 04:35	12,67	1	12,67	CHI
20191244925	BURITI ALEGRE	BG21000026	ALTO BURITI	07/12/2019 15:57	07/12/2019 22:25	07/12/2019 15:57	07/12/2019 22:25	6,48	1	6,48	CHI
20191244927	PIRACANJUBA	PJ21134775	PIRACANJUBA	07/12/2019 15:57	08/12/2019 09:29	07/12/2019 15:57	08/12/2019 09:29	17,53	1	17,53	CHI
20191244932	MORRO AGUDO DE GOIAS	RB12156092	RUBIATABA	07/12/2019 15:57	08/12/2019 13:33	07/12/2019 15:57	08/12/2019 13:33	21,59	10	215,88	CHI
20191245010	PLANALTINA	PI11130059	PLANALTINA	07/12/2019 15:57	07/12/2019 17:46	07/12/2019 15:57	07/12/2019 17:46	1,81	157	283,78	CHI
20191245014	JUSSARA	JR11025073	JUSSARA	07/12/2019 15:57	07/12/2019 19:30	07/12/2019 15:57	07/12/2019 19:30	3,55	174	617,60	CHI
20191244940	BELA VISTA DE GOIAS	BV21000048	BELA VISTA S1	07/12/2019 15:59	08/12/2019 07:59	07/12/2019 15:59	08/12/2019 07:59	15,99	2	31,99	CHI
20191244941	CRISTALINA	KR12133610	CRISTALINA S2	07/12/2019 15:59	07/12/2019 17:42	07/12/2019 15:59	07/12/2019 17:42	1,71	12	20,49	CHI
20191244946	PEROLANDIA	DP12346700	JATAI S1	07/12/2019 16:01	08/12/2019 09:49	07/12/2019 16:01	08/12/2019 09:49	17,80	1	17,80	CHI
20191244948	SAO SIMAO	2240040860	CACHOEIRA ALTA	07/12/2019 16:02	07/12/2019 19:18	07/12/2019 16:02	07/12/2019 19:18	3,27	1	3,27	CHI
20191244967	CABECEIRAS	CW12218489	ITUIQUIRA	07/12/2019 16:05	07/12/2019 17:46	07/12/2019 16:05	07/12/2019 17:46	1,68	10	16,78	CHI
20191244974	CATALAO	CT21281494	CATALAO S1	07/12/2019 16:07	08/12/2019 10:59	07/12/2019 16:07	08/12/2019 10:59	18,86	1	18,86	CHI
20191244975	PIRACANJUBA	PJ21000102	PIRACANJUBA	07/12/2019 16:07	08/12/2019 14:20	07/12/2019 16:07	08/12/2019 14:20	22,21	1	22,21	CHI
20191245039	CATALAO	CT12130960RE	CATALAO S2	07/12/2019 16:09	08/12/2019 13:40	07/12/2019 16:09	07/12/2019 17:47	1,63	23	37,48	CHI



20191245039	CUMARI	CT12130960RE	CATALAO S2	07/12/2019 16:09	08/12/2019 13:40	07/12/2019 16:09	07/12/2019 17:47	1,63	159	259,08	CHI
20191245039	GOIANDIRA	CT12130960RE	CATALAO S2	07/12/2019 16:09	08/12/2019 13:40	07/12/2019 16:09	07/12/2019 17:47	1,63	6	9,78	CHI
20191245039	CATALAO	CT12130960RE	CATALAO S2	07/12/2019 16:09	08/12/2019 13:40	07/12/2019 17:48	07/12/2019 21:59	4,20	5	20,98	CHI
20191245039	CUMARI	CT13358441	CATALAO S2	07/12/2019 16:09	08/12/2019 13:40	07/12/2019 17:48	08/12/2019 01:40	7,88	8	63,02	CHI
20191245039	CUMARI	CT12011258	CATALAO S2	07/12/2019 16:09	08/12/2019 13:40	07/12/2019 17:48	08/12/2019 02:15	8,45	25	211,22	CHI
20191245039	GOIANDIRA	CT12011258	CATALAO S2	07/12/2019 16:09	08/12/2019 13:40	07/12/2019 17:48	08/12/2019 02:15	8,45	3	25,35	CHI
20191245039	CATALAO	CT13333676	CATALAO S2	07/12/2019 16:09	08/12/2019 13:40	07/12/2019 17:48	08/12/2019 03:18	9,51	10	95,07	CHI
20191245039	CUMARI	CT13333676	CATALAO S2	07/12/2019 16:09	08/12/2019 13:40	07/12/2019 17:48	08/12/2019 03:18	9,51	25	237,67	CHI
20191245039	GOIANDIRA	CT13333676	CATALAO S2	07/12/2019 16:09	08/12/2019 13:40	07/12/2019 17:48	08/12/2019 03:18	9,51	3	28,52	CHI
20191245039	CATALAO	CT12266150RE	CATALAO S2	07/12/2019 16:09	08/12/2019 13:40	07/12/2019 17:48	08/12/2019 04:39	10,86	2	21,72	CHI
20191245039	CUMARI	CT12266150RE	CATALAO S2	07/12/2019 16:09	08/12/2019 13:40	07/12/2019 17:48	08/12/2019 04:39	10,86	50	543,06	CHI
20191245039	CUMARI	CY12144249RE	CATALAO S2	07/12/2019 16:09	08/12/2019 13:40	07/12/2019 17:48	08/12/2019 09:24	15,60	22	343,28	CHI
20191245039	CUMARI	CY12061105RE	CATALAO S2	07/12/2019 16:09	08/12/2019 13:40	07/12/2019 17:48	08/12/2019 10:26	16,63	19	316,03	CHI
20191245039	CATALAO	CY13358249	CATALAO S2	07/12/2019 16:09	08/12/2019 13:40	07/12/2019 17:48	08/12/2019 11:52	18,08	3	54,24	CHI
20191245039	CUMARI	CY13358249	CATALAO S2	07/12/2019 16:09	08/12/2019 13:40	07/12/2019 17:48	08/12/2019 11:52	18,08	7	126,56	CHI
20191245039	CATALAO	CY12064048	CATALAO S2	07/12/2019 16:09	08/12/2019 13:40	07/12/2019 17:48	08/12/2019 13:40	19,86	3	59,59	CHI
20191245039	CUMARI	CY12064048	CATALAO S2	07/12/2019 16:09	08/12/2019 13:40	07/12/2019 17:48	08/12/2019 13:40	19,86	3	59,59	CHI
20191244982	BALIZA	BH21360362	BOM JARDIM	07/12/2019 16:10	08/12/2019 11:28	07/12/2019 16:10	08/12/2019 11:28	19,30	1	19,30	CHI
20191244987	BELA VISTA DE GOIAS	BV12000030	BELA VISTA S1	07/12/2019 16:11	08/12/2019 07:15	07/12/2019 16:11	08/12/2019 07:15	15,06	11	165,66	CHI
20191244987	HIDROLANDIA	BV12000030	BELA VISTA S1	07/12/2019 16:11	08/12/2019 07:15	07/12/2019 16:11	08/12/2019 07:15	15,06	1	15,06	CHI
20191244987	PIRACANJUBA	BV12000030	BELA VISTA S1	07/12/2019 16:11	08/12/2019 07:15	07/12/2019 16:11	08/12/2019 07:15	15,06	2	30,12	CHI
20191244988	MONTIVIDIU	MV21249056	MONTIVIDIU T	07/12/2019 16:11	07/12/2019 20:05	07/12/2019 16:11	07/12/2019 20:05	3,89	1	3,89	CHI
20191244993	MONTES CLAROS DE GOIAS	ME12162575	IPORA	07/12/2019 16:12	08/12/2019 21:12	07/12/2019 16:12	08/12/2019 21:12	28,99	1	28,99	CHI
20191244996	LUZIANIA	3200074988	MARAJOARA	07/12/2019 16:14	07/12/2019 19:03	07/12/2019 16:14	07/12/2019 19:03	2,81	1	2,81	CHI
20191244997	RIO VERDE	630144059	RIO VERDE S1	07/12/2019 16:14	07/12/2019 18:05	07/12/2019 16:14	07/12/2019 18:05	1,85	1	1,85	CHI
20191245004	JANDAIA	JD12008635	PALMEIRAS	07/12/2019 16:16	07/12/2019 19:01	07/12/2019 16:16	07/12/2019 19:01	2,74	12	32,93	CHI
20191245007	AGUAS LINDAS DE GOIAS	4830105101	AGUAS LINDAS DE GOIAS S2	07/12/2019 16:17	07/12/2019 17:23	07/12/2019 16:17	07/12/2019 17:23	1,09	1	1,09	CHI
20191245112	ITAPIRAPUA	IU12259711	MATRINCHA	07/12/2019 16:17	08/12/2019 06:00	07/12/2019 16:17	08/12/2019 06:00	13,71	5	68,55	CHI
20191245383	NIQUELANDIA	NQ12400337	URUACU	07/12/2019 16:17	08/12/2019 03:10	07/12/2019 16:17	08/12/2019 03:10	10,88	16	174,04	CHI
20191245016	SAO SIMAO	SO21152195	CACHOEIRA ALTA	07/12/2019 16:20	07/12/2019 18:46	07/12/2019 16:20	07/12/2019 18:46	2,43	1	2,43	CHI
20191245020	CRISTALINA	KR21247880	CRISTALINA S2	07/12/2019 16:20	07/12/2019 17:49	07/12/2019 16:20	07/12/2019 17:49	1,47	2	2,94	CHI
20191245063	FAZENDA NOVA	FN12040960	JUSSARA	07/12/2019 16:20	08/12/2019 17:05	07/12/2019 16:20	08/12/2019 17:05	24,76	8	198,06	CHI
20191245021	APARECIDA DE GOIANIA	200165501	INDEPENDENCIA S1	07/12/2019 16:21	07/12/2019 17:26	07/12/2019 16:21	07/12/2019 17:26	1,08	1	1,08	CHI

20191245031	PIRES DO RIO	PR12409073	PIRES DO RIO S2	07/12/2019 16:23	07/12/2019 23:16	07/12/2019 16:23	07/12/2019 23:16	6,87	3	20,60	CHI
20191245035	TURVELANDIA	TD21303761	RIO DOS BOIS	07/12/2019 16:24	09/12/2019 16:48	07/12/2019 16:24	09/12/2019 16:48	48,39	1	48,39	CHI
20191245036	ARACU	AR21228341	ARACU	07/12/2019 16:24	08/12/2019 01:16	07/12/2019 16:24	08/12/2019 01:16	8,85	2	17,71	CHI
20191244891	VIANOPOLIS	VN12085182	VIANOPOLIS	07/12/2019 16:25	08/12/2019 11:06	07/12/2019 16:25	08/12/2019 11:06	18,68	10	186,82	CHI
20191245045	RIO VERDE	630360108	CABRIUVA S1	07/12/2019 16:26	08/12/2019 13:10	07/12/2019 16:26	08/12/2019 13:10	20,72	1	20,72	CHI
20191245047	RIO VERDE	RV12098526	MONTIVIDIU T	07/12/2019 16:26	07/12/2019 23:40	07/12/2019 16:26	07/12/2019 23:40	7,22	3	21,66	CHI
20191245048	SENADOR CANEDO	SW11094224	SENADOR CANEDO	07/12/2019 16:26	07/12/2019 17:26	07/12/2019 16:26	07/12/2019 17:26	0,99	59	58,13	CHI
2019120700032	ARAGARCAS	00242124	BOM JARDIM	07/12/2019 16:26	07/12/2019 18:24	07/12/2019 16:26	07/12/2019 18:24	1,97	118	232,07	CHI
2019120700032	BALIZA	00242124	BOM JARDIM	07/12/2019 16:26	07/12/2019 18:24	07/12/2019 16:26	07/12/2019 18:24	1,97	276	542,80	CHI
2019120700032	BOM JARDIM DE GOIAS	00242124	BOM JARDIM	07/12/2019 16:26	07/12/2019 18:24	07/12/2019 16:26	07/12/2019 18:24	1,97	3900	7670,00	CHI
2019120700032	PIRANHAS	00242124	BOM JARDIM	07/12/2019 16:26	07/12/2019 18:24	07/12/2019 16:26	07/12/2019 18:24	1,97	42	82,60	CHI
20191245051	ITAPURANGA	IK21300210	ITAPURANGA	07/12/2019 16:27	08/12/2019 18:15	07/12/2019 16:27	08/12/2019 18:15	25,80	1	25,80	CHI
20191245052	AGUAS LINDAS DE GOIAS	10001335446	AGUAS LINDAS DE GOIAS S1	07/12/2019 16:27	07/12/2019 18:15	07/12/2019 16:27	07/12/2019 18:15	1,79	1	1,79	CHI
20191245436	INDIARA	JD12391452	PALMEIRAS	07/12/2019 16:27	07/12/2019 21:59	07/12/2019 16:27	07/12/2019 21:59	5,54	5	27,70	CHI
20191245436	JANDAIA	JD12391452	PALMEIRAS	07/12/2019 16:27	07/12/2019 21:59	07/12/2019 16:27	07/12/2019 21:59	5,54	4	22,16	CHI
20191245054	INDIARA	IY21010935	PALMEIRAS	07/12/2019 16:28	08/12/2019 08:49	07/12/2019 16:28	08/12/2019 08:49	16,35	1	16,35	CHI
20191245070	PONTALINA	PK21204455	PONTALINA	07/12/2019 16:30	08/12/2019 01:38	07/12/2019 16:30	08/12/2019 01:38	9,12	1	9,12	CHI
20191245573	TROMBAS	TB12321782	PORANGATU	07/12/2019 16:30	07/12/2019 19:49	07/12/2019 16:30	07/12/2019 19:49	3,30	4	13,21	CHI
20191245078	PORANGATU	PO12027986	PORANGATU	07/12/2019 16:32	08/12/2019 08:17	07/12/2019 16:32	08/12/2019 08:17	15,74	22	346,32	CHI
20191245085	BONFINOPOLIS	BO21281335	CEPAIGO S2	07/12/2019 16:33	08/12/2019 17:07	07/12/2019 16:33	08/12/2019 17:07	24,55	1	24,55	CHI
20191246248	PIRENOPOLIS	PV12295641	SAO FRANCISCO DE GOIAS	07/12/2019 16:33	09/12/2019 22:40	07/12/2019 16:33	08/12/2019 10:08	17,60	91	1601,25	CHI
20191246248	PIRENOPOLIS	PV12295641	SAO FRANCISCO DE GOIAS	07/12/2019 16:33	09/12/2019 22:40	08/12/2019 10:15	08/12/2019 13:04	2,82	66	185,92	CHI
20191246248	PIRENOPOLIS	PV12295641	SAO FRANCISCO DE GOIAS	07/12/2019 16:33	09/12/2019 22:40	07/12/2019 16:33	09/12/2019 14:40	46,13	73	3367,35	CHI
20191246248	PIRENOPOLIS	PV12295641	SAO FRANCISCO DE GOIAS	07/12/2019 16:33	09/12/2019 22:40	08/12/2019 13:05	09/12/2019 14:40	25,59	32	819,03	CHI
20191246248	PIRENOPOLIS	PV12295641	SAO FRANCISCO DE GOIAS	07/12/2019 16:33	09/12/2019 22:40	08/12/2019 18:37	09/12/2019 14:40	20,05	20	401,05	CHI
20191246248	PIRENOPOLIS	PV12382302	SAO FRANCISCO DE GOIAS	07/12/2019 16:33	09/12/2019 22:40	08/12/2019 13:05	09/12/2019 18:05	29,00	6	174,00	CHI
20191246248	PIRENOPOLIS	PV12084700	SAO FRANCISCO DE GOIAS	07/12/2019 16:33	09/12/2019 22:40	08/12/2019 13:05	09/12/2019 18:26	29,36	13	381,69	CHI
20191246248	PIRENOPOLIS	PV12370312	SAO FRANCISCO DE GOIAS	07/12/2019 16:33	09/12/2019 22:40	08/12/2019 10:15	09/12/2019 18:56	32,68	17	555,60	CHI
20191246248	PIRENOPOLIS	PV12319630	SAO FRANCISCO DE GOIAS	07/12/2019 16:33	09/12/2019 22:40	08/12/2019 13:05	09/12/2019 19:32	30,46	5	152,29	CHI
20191246248	PIRENOPOLIS	PV12295538	SAO FRANCISCO DE GOIAS	07/12/2019 16:33	09/12/2019 22:40	08/12/2019 13:05	09/12/2019 20:29	31,41	9	282,69	CHI
20191246248	PIRENOPOLIS	PV12061976	SAO FRANCISCO DE GOIAS	07/12/2019 16:33	09/12/2019 22:40	08/12/2019 10:15	09/12/2019 21:06	34,85	8	278,78	CHI
20191246248	PIRENOPOLIS	PV12295641	SAO FRANCISCO DE GOIAS	07/12/2019 16:33	09/12/2019 22:40	08/12/2019 13:05	09/12/2019 21:35	32,50	1	32,50	CHI
20191246248	PIRENOPOLIS	8193470	SAO FRANCISCO DE GOIAS	07/12/2019 16:33	09/12/2019 22:40	09/12/2019 21:42	09/12/2019 22:40	0,97	3	2,90	CHI

20191245088	CABECEIRAS	CW21137976	ITUIQUIRA	07/12/2019 16:34	07/12/2019 18:19	07/12/2019 16:34	07/12/2019 18:19	1,75	1	1,75	CHI
20191245297	GAMELEIRA DE GOIAS	SV12033468	DAIA S2	07/12/2019 16:34	07/12/2019 18:37	07/12/2019 16:34	07/12/2019 18:37	2,04	13	26,52	CHI
20191245297	SILVANIA	SV12033468	DAIA S2	07/12/2019 16:34	07/12/2019 18:37	07/12/2019 16:34	07/12/2019 18:37	2,04	121	246,87	CHI
20191244342	SAO LUIZ DO NORTE	SZ21348611	ITAPACI	07/12/2019 16:35	07/12/2019 16:44	07/12/2019 16:35	07/12/2019 16:44	0,15	1	0,15	CHI
20191245096	ANAPOLIS	10029782153	ANAPOLIS UNIVERSITARIO S2	07/12/2019 16:35	08/12/2019 08:29	07/12/2019 16:35	08/12/2019 08:29	15,90	1	15,90	CHI
20191245762	PILAR DE GOIAS	GG12238584	SANTA TEREZINHA	07/12/2019 16:35	08/12/2019 09:30	07/12/2019 16:35	08/12/2019 09:30	16,92	8	135,33	CHI
20191245108	CRISTALINA	KR12304801	CRISTALINA S2	07/12/2019 16:36	08/12/2019 10:57	07/12/2019 16:36	08/12/2019 10:57	18,35	2	36,70	CHI
20191245107	BONFINOPOLIS	10014272146	CEPAIGO S2	07/12/2019 16:37	07/12/2019 18:26	07/12/2019 16:37	07/12/2019 18:26	1,81	1	1,81	CHI
20191245164	ALEXANIA	AX12353458	ALEXANIA	07/12/2019 16:39	08/12/2019 11:17	07/12/2019 16:39	08/12/2019 11:17	18,63	15	279,50	CHI
20191245168	SANTA CRUZ DE GOIAS	BC12110028RE	PIRES DO RIO S2	07/12/2019 16:39	08/12/2019 09:22	07/12/2019 16:39	08/12/2019 09:22	16,71	19	317,52	CHI
20191245336	NIQUELANDIA	NQ11035206	NIQUELANDIA SUBTRANSMISSAO	07/12/2019 16:39	07/12/2019 19:25	07/12/2019 16:39	07/12/2019 19:25	2,76	124	342,03	CHI
20191245399	VIANOPOLIS	VN12033292	VIANOPOLIS	07/12/2019 16:39	08/12/2019 08:59	07/12/2019 16:39	08/12/2019 08:59	16,33	21	342,83	CHI
20191245126	FAZENDA NOVA	NB12117282	JUSSARA	07/12/2019 16:40	08/12/2019 20:53	07/12/2019 16:40	08/12/2019 20:53	28,21	1	28,21	CHI
20191245126	JUSSARA	NB12117282	JUSSARA	07/12/2019 16:40	08/12/2019 20:53	07/12/2019 16:40	08/12/2019 20:53	28,21	1	28,21	CHI
20191245126	NOVO BRASIL	NB12117282	JUSSARA	07/12/2019 16:40	08/12/2019 20:53	07/12/2019 16:40	08/12/2019 20:53	28,21	13	366,77	CHI
20191245127	AURILANDIA	AI21140758	SAO LUIZ DOS MONTES BELOS	07/12/2019 16:41	08/12/2019 11:35	07/12/2019 16:41	08/12/2019 11:35	18,89	1	18,89	CHI
20191245133	CALDAS NOVAS	CN21298758	CALDAS NOVAS S1	07/12/2019 16:41	08/12/2019 10:40	07/12/2019 16:41	08/12/2019 10:40	17,97	1	17,97	CHI
20191245146	TRINDADE	10027237425	TRINDADE	07/12/2019 16:43	07/12/2019 18:50	07/12/2019 16:43	07/12/2019 18:50	2,12	1	2,12	CHI
20191245189	NOVO BRASIL	NB11020195	JUSSARA	07/12/2019 16:43	07/12/2019 22:11	07/12/2019 16:43	07/12/2019 22:11	5,45	127	692,19	CHI
20191246275	CASTELANDIA	DM12000064	RIO DOS BOIS	07/12/2019 16:43	08/12/2019 15:15	07/12/2019 16:43	08/12/2019 15:15	22,53	10	225,26	CHI
20191246275	MAURILANDIA	DM12000064	RIO DOS BOIS	07/12/2019 16:43	08/12/2019 15:15	07/12/2019 16:43	08/12/2019 15:15	22,53	1	22,53	CHI
20191245158	CASTELANDIA	ML12064391	RIO DOS BOIS	07/12/2019 16:44	08/12/2019 16:15	07/12/2019 16:44	08/12/2019 16:15	23,51	1	23,51	CHI
20191245158	MAURILANDIA	ML12064391	RIO DOS BOIS	07/12/2019 16:44	08/12/2019 16:15	07/12/2019 16:44	08/12/2019 16:15	23,51	3	70,52	CHI
20191245269	ALEXANIA	AX21096697	ALEXANIA	07/12/2019 16:44	07/12/2019 18:41	07/12/2019 16:44	07/12/2019 18:41	1,96	1	1,96	CHI
20191245162	SERRANOPOLIS	SX21323807	JATAI S1	07/12/2019 16:45	08/12/2019 13:10	07/12/2019 16:45	08/12/2019 13:10	20,41	2	40,81	CHI
20191245172	APARECIDA DE GOIANIA	10009810682	INDEPENDENCIA S1	07/12/2019 16:47	07/12/2019 17:39	07/12/2019 16:47	07/12/2019 17:39	0,86	1	0,86	CHI
20191245175	GOIANIRA	390065638	GOIANIRA	07/12/2019 16:48	07/12/2019 20:09	07/12/2019 16:48	07/12/2019 20:09	3,35	1	3,35	CHI
20191245182	GOIATUBA	GT21021250	BOM JESUS DE GOIAS	07/12/2019 16:48	08/12/2019 10:24	07/12/2019 16:48	08/12/2019 10:24	17,59	3	52,78	CHI
20191245200	CRISTALINA	KR12287383	CRISTALINA S1	07/12/2019 16:48	07/12/2019 20:10	07/12/2019 16:48	07/12/2019 20:10	3,36	78	262,12	CHI
20191245711	ABADIANIA	AA12413713	DAIA S2	07/12/2019 16:48	08/12/2019 10:24	07/12/2019 16:48	08/12/2019 10:24	17,59	49	862,10	CHI
201912233681	ABADIANIA	AA12258351	DAIA S2	07/12/2019 16:49	07/12/2019 20:54	07/12/2019 16:49	07/12/2019 20:54	4,07	23	93,69	CHI
20191245198	PIRES DO RIO	460049549	PIRES DO RIO S1	07/12/2019 16:50	07/12/2019 20:45	07/12/2019 16:50	07/12/2019 20:45	3,91	1	3,91	CHI
20191245207	ITABERAI	50109935	ITABERAI S2	07/12/2019 16:51	07/12/2019 18:05	07/12/2019 16:51	07/12/2019 18:05	1,22	1	1,22	CHI

20191245351	CATALAO	CT12266142RE	CATALAO S1	07/12/2019 16:51	07/12/2019 18:24	07/12/2019 16:51	07/12/2019 18:24	1,54	107	165,20	CHI
20191245351	GOIANDIRA	CT12266142RE	CATALAO S1	07/12/2019 16:51	07/12/2019 18:24	07/12/2019 16:51	07/12/2019 18:24	1,54	43	66,39	CHI
20191245216	URUACU	UR21038775	URUACU	07/12/2019 16:52	07/12/2019 20:06	07/12/2019 16:52	07/12/2019 20:06	3,22	1	3,22	CHI
20191245219	APARECIDA DE GOIANIA	10011978110	REAL S2	07/12/2019 16:53	07/12/2019 19:41	07/12/2019 16:53	07/12/2019 19:41	2,80	1	2,80	CHI
20191245222	AMORINOPOLIS	AM11000001	IPORA	07/12/2019 16:53	08/12/2019 04:15	07/12/2019 16:53	08/12/2019 04:15	11,36	122	1385,41	CHI
20191245745	NOVA CRIXAS	NA12057386	NOVA CRIXAS	07/12/2019 16:53	07/12/2019 22:40	07/12/2019 16:53	07/12/2019 22:40	5,78	9	52,04	CHI
20191245230	SAO MIGUEL DO ARAGUAIA	SM21132263	SAO MIGUEL DO ARAGUAIA	07/12/2019 16:55	07/12/2019 19:54	07/12/2019 16:55	07/12/2019 19:54	2,97	1	2,97	CHI
20191245236	RIO VERDE	RV12154033	MONTIVIDIU T	07/12/2019 16:55	08/12/2019 08:25	07/12/2019 16:55	08/12/2019 08:25	15,49	15	232,31	CHI
20191245239	GOIANIRA	10000077435	MEIA PONTE	07/12/2019 16:56	07/12/2019 22:37	07/12/2019 16:56	07/12/2019 22:37	5,69	1	5,69	CHI
20191245240	FAZENDA NOVA	FN21237032	BRITANIA	07/12/2019 16:56	08/12/2019 15:30	07/12/2019 16:56	08/12/2019 15:30	22,56	1	22,56	CHI
20191245242	LUZIANIA	LZ12137225	VIANOPOLIS	07/12/2019 16:57	08/12/2019 10:55	07/12/2019 16:57	08/12/2019 10:55	17,97	14	251,58	CHI
20191245244	PALMINOPOLIS	1340007670	PALMEIRAS	07/12/2019 16:57	07/12/2019 21:25	07/12/2019 16:57	07/12/2019 21:25	4,47	1	4,47	CHI
20191245250	JARAGUA	JA21148832	JARAGUA	07/12/2019 16:58	08/12/2019 11:35	07/12/2019 16:58	08/12/2019 11:35	18,61	2	37,23	CHI
20191245254	URUACU	UR12117983	URUACU	07/12/2019 16:58	08/12/2019 11:16	07/12/2019 16:58	08/12/2019 11:16	18,29	4	73,16	CHI
20191244363	ALEXANIA	AX21062000	ALEXANIA	07/12/2019 17:00	07/12/2019 19:17	07/12/2019 17:00	07/12/2019 19:17	2,27	1	2,27	CHI
20191245268	GOIANIA	13705891	FERROVIARIO S2	07/12/2019 17:00	07/12/2019 18:51	07/12/2019 17:00	07/12/2019 18:51	1,84	1	1,84	CHI
20191245272	SENADOR CANEDO	190155899	SENADOR CANEDO	07/12/2019 17:01	07/12/2019 18:41	07/12/2019 17:01	07/12/2019 18:41	1,66	1	1,66	CHI
20191245283	GUAPO	10000697131	GUAPO S1	07/12/2019 17:02	07/12/2019 20:01	07/12/2019 17:02	07/12/2019 20:01	2,98	1	2,98	CHI
20191245285	QUIRINOPOLIS	QI21239494	QUIRINOPOLIS	07/12/2019 17:02	07/12/2019 20:30	07/12/2019 17:02	07/12/2019 20:30	3,46	1	3,46	CHI
20191245288	PETROLINA DE GOIAS	PG21221580	PETROLINA	07/12/2019 17:02	08/12/2019 10:37	07/12/2019 17:02	08/12/2019 10:37	17,58	1	17,58	CHI
20191245289	APARECIDA DE GOIANIA	200463780	ANHANGUERA	07/12/2019 17:02	07/12/2019 21:07	07/12/2019 17:02	07/12/2019 21:07	4,07	1	4,07	CHI
20191245292	IPAMERI	580042972	IPAMERI	07/12/2019 17:02	07/12/2019 23:11	07/12/2019 17:02	07/12/2019 23:11	6,13	1	6,13	CHI
20191245293	JUSSARA	JR12118219	JUSSARA	07/12/2019 17:03	08/12/2019 20:10	07/12/2019 17:03	07/12/2019 21:00	3,95	8	31,61	CHI
20191245293	JUSSARA	JR13341268	JUSSARA	07/12/2019 17:03	08/12/2019 20:10	07/12/2019 17:03	08/12/2019 09:16	16,23	10	162,27	CHI
20191245293	NOVO BRASIL	JR13341268	JUSSARA	07/12/2019 17:03	08/12/2019 20:10	07/12/2019 17:03	08/12/2019 09:16	16,23	4	64,91	CHI
20191245293	JUSSARA	NB12068896	JUSSARA	07/12/2019 17:03	08/12/2019 20:10	07/12/2019 17:03	08/12/2019 11:30	18,45	2	36,90	CHI
20191245293	NOVO BRASIL	NB12068896	JUSSARA	07/12/2019 17:03	08/12/2019 20:10	07/12/2019 17:03	08/12/2019 11:30	18,45	7	129,13	CHI
20191245293	JUSSARA	JR12114074	JUSSARA	07/12/2019 17:03	08/12/2019 20:10	07/12/2019 17:03	08/12/2019 16:35	23,53	8	188,24	CHI
20191245293	JUSSARA	JR12114074	JUSSARA	07/12/2019 17:03	08/12/2019 20:10	07/12/2019 17:03	08/12/2019 20:10	27,11	12	325,36	CHI
20191245293	JUSSARA	JR12114074	JUSSARA	07/12/2019 17:03	08/12/2019 20:10	08/12/2019 18:40	08/12/2019 20:10	1,50	8	12,00	CHI
20191245485	AGUA FRIA DE GOIAS	TL12320523	SAO JOAO D ALIANCA	07/12/2019 17:03	07/12/2019 22:56	07/12/2019 17:03	07/12/2019 22:56	5,88	11	64,64	CHI
20191245302	PARAUNA	PU12079039	PARAUNA	07/12/2019 17:04	07/12/2019 19:44	07/12/2019 17:04	07/12/2019 19:44	2,66	37	98,51	CHI
20191245308	NIQUELANDIA	NQ12235663	URUACU	07/12/2019 17:05	08/12/2019 11:25	07/12/2019 17:05	08/12/2019 11:25	18,32	8	146,57	CHI

20191245311	MONTES CLAROS DE GOIAS	ME21206428	BRITANIA	07/12/2019 17:06	08/12/2019 09:30	07/12/2019 17:06	08/12/2019 09:30	16,40	4	65,59	CHI
20191245317	GOIANIA	10005909447	XAVANTES	07/12/2019 17:06	07/12/2019 19:28	07/12/2019 17:06	07/12/2019 19:28	2,35	1	2,35	CHI
20191245318	SAO LUIS DE MONTES BELOS	SL21342940	FIRMINOPOLIS S1	07/12/2019 17:06	07/12/2019 21:27	07/12/2019 17:06	07/12/2019 21:27	4,34	1	4,34	CHI
20191245321	GOIANESIA	550073310	GOIANESIA S2	07/12/2019 17:08	07/12/2019 20:17	07/12/2019 17:08	07/12/2019 20:17	3,15	1	3,15	CHI
20191245325	NOVO BRASIL	NB12120651LD	MATRINCHA	07/12/2019 17:09	08/12/2019 16:01	07/12/2019 17:09	08/12/2019 16:01	22,86	22	502,89	CHI
20191245330	AGUAS LINDAS DE GOIAS	4830136330	AGUAS LINDAS DE GOIAS S1	07/12/2019 17:11	07/12/2019 18:23	07/12/2019 17:11	07/12/2019 18:23	1,20	1	1,20	CHI
20191245602	NIQUELANDIA	NQ12257262	URUACU	07/12/2019 17:13	08/12/2019 07:43	07/12/2019 17:13	08/12/2019 07:43	14,49	8	115,95	CHI
20191245340	SAO MIGUEL DO ARAGUAIA	SM21328591	SAO MIGUEL DO ARAGUAIA	07/12/2019 17:14	08/12/2019 07:45	07/12/2019 17:14	08/12/2019 07:45	14,52	1	14,52	CHI
20191245431	PONTALINA	VI12047300	VICENTINOPOLIS	07/12/2019 17:14	08/12/2019 08:34	07/12/2019 17:14	08/12/2019 08:34	15,33	2	30,66	CHI
20191245431	VICENTINOPOLIS	VI12047300	VICENTINOPOLIS	07/12/2019 17:14	08/12/2019 08:34	07/12/2019 17:14	08/12/2019 08:34	15,33	3	45,99	CHI
20191245349	SAO JOAO D ALIANCA	JL21316554	SAO JOAO D ALIANCA	07/12/2019 17:16	08/12/2019 11:30	07/12/2019 17:16	08/12/2019 11:30	18,22	1	18,22	CHI
20191245362	ANAPOLIS	00050244	ANAPOLIS UNIVERSITARIO S2	07/12/2019 17:17	08/12/2019 09:14	07/12/2019 18:10	07/12/2019 18:14	0,06	6870	410,29	CHI
20191245362	CAMPO LIMPO	00050244	ANAPOLIS UNIVERSITARIO S2	07/12/2019 17:17	08/12/2019 09:14	07/12/2019 18:10	07/12/2019 18:14	0,06	7	0,42	CHI
20191245362	ANAPOLIS	AN16407972	ANAPOLIS UNIVERSITARIO S2	07/12/2019 17:17	08/12/2019 09:14	07/12/2019 18:10	07/12/2019 20:59	2,82	326	918,23	CHI
20191245362	CAMPO LIMPO	AN16407972	ANAPOLIS UNIVERSITARIO S2	07/12/2019 17:17	08/12/2019 09:14	07/12/2019 18:10	07/12/2019 20:59	2,82	10	28,17	CHI
20191245362	ANAPOLIS	00050244	ANAPOLIS UNIVERSITARIO S2	07/12/2019 17:17	08/12/2019 09:14	07/12/2019 21:00	07/12/2019 21:03	0,05	6870	362,58	CHI
20191245362	CAMPO LIMPO	00050244	ANAPOLIS UNIVERSITARIO S2	07/12/2019 17:17	08/12/2019 09:14	07/12/2019 21:00	07/12/2019 21:03	0,05	7	0,37	CHI
20191245362	ANAPOLIS	AN16407972	ANAPOLIS UNIVERSITARIO S2	07/12/2019 17:17	08/12/2019 09:14	07/12/2019 21:00	07/12/2019 22:17	1,30	133	172,35	CHI
20191245362	CAMPO LIMPO	AN16407972	ANAPOLIS UNIVERSITARIO S2	07/12/2019 17:17	08/12/2019 09:14	07/12/2019 21:00	07/12/2019 22:17	1,30	2	2,59	CHI
20191245362	ANAPOLIS	AN16407972	ANAPOLIS UNIVERSITARIO S2	07/12/2019 17:17	08/12/2019 09:14	07/12/2019 22:29	07/12/2019 22:47	0,31	133	41,23	CHI
20191245362	CAMPO LIMPO	AN16407972	ANAPOLIS UNIVERSITARIO S2	07/12/2019 17:17	08/12/2019 09:14	07/12/2019 22:29	07/12/2019 22:47	0,31	2	0,62	CHI
20191245362	ANAPOLIS	AN13384950B	ANAPOLIS UNIVERSITARIO S2	07/12/2019 17:17	08/12/2019 09:14	07/12/2019 18:10	08/12/2019 08:37	14,45	1	14,45	CHI
20191245362	ANAPOLIS	AN13384950B	ANAPOLIS UNIVERSITARIO S2	07/12/2019 17:17	08/12/2019 09:14	07/12/2019 21:00	08/12/2019 08:37	11,63	132	1534,94	CHI
20191245362	ANAPOLIS	AN16407972	ANAPOLIS UNIVERSITARIO S2	07/12/2019 17:17	08/12/2019 09:14	07/12/2019 21:00	08/12/2019 08:37	11,63	62	720,96	CHI
20191245362	CAMPO LIMPO	AN16407972	ANAPOLIS UNIVERSITARIO S2	07/12/2019 17:17	08/12/2019 09:14	07/12/2019 21:00	08/12/2019 08:37	11,63	8	93,03	CHI
20191245362	ANAPOLIS	AN16407972	ANAPOLIS UNIVERSITARIO S2	07/12/2019 17:17	08/12/2019 09:14	08/12/2019 08:29	08/12/2019 08:37	0,14	133	19,03	CHI
20191245362	CAMPO LIMPO	AN16407972	ANAPOLIS UNIVERSITARIO S2	07/12/2019 17:17	08/12/2019 09:14	08/12/2019 08:29	08/12/2019 08:37	0,14	2	0,29	CHI
20191245362	ANAPOLIS	AN13384950B	ANAPOLIS UNIVERSITARIO S2	07/12/2019 17:17	08/12/2019 09:14	07/12/2019 18:10	08/12/2019 08:45	14,57	377	5492,26	CHI
20191245362	PIRENOPOLIS	AN13384950B	ANAPOLIS UNIVERSITARIO S2	07/12/2019 17:17	08/12/2019 09:14	07/12/2019 18:10	08/12/2019 08:45	14,57	54	786,69	CHI
20191245362	ANAPOLIS	AN16407972	ANAPOLIS UNIVERSITARIO S2	07/12/2019 17:17	08/12/2019 09:14	07/12/2019 22:29	08/12/2019 08:45	10,26	2	20,53	CHI
20191245362	ANAPOLIS	AN13384950B	ANAPOLIS UNIVERSITARIO S2	07/12/2019 17:17	08/12/2019 09:14	07/12/2019 18:10	08/12/2019 08:47	14,60	474	6921,19	CHI
20191245362	ANAPOLIS	AN10404178	ANAPOLIS UNIVERSITARIO S2	07/12/2019 17:17	08/12/2019 09:14	07/12/2019 17:17	08/12/2019 09:14	15,96	48	765,84	CHI
20191245362	PIRENOPOLIS	AN10404178	ANAPOLIS UNIVERSITARIO S2	07/12/2019 17:17	08/12/2019 09:14	07/12/2019 17:17	08/12/2019 09:14	15,96	16	255,28	CHI

20191245362	ABADIANIA	AN10404178	ANAPOLIS UNIVERSITARIO S2	07/12/2019 17:17	08/12/2019 09:14	07/12/2019 18:10	08/12/2019 09:14	15,08	17	256,29	CHI
20191245362	ANAPOLIS	AN10404178	ANAPOLIS UNIVERSITARIO S2	07/12/2019 17:17	08/12/2019 09:14	07/12/2019 18:10	08/12/2019 09:14	15,08	114	1718,68	CHI
20191245362	PIRENOPOLIS	AN10404178	ANAPOLIS UNIVERSITARIO S2	07/12/2019 17:17	08/12/2019 09:14	07/12/2019 18:10	08/12/2019 09:14	15,08	13	195,99	CHI
20191245362	ANAPOLIS	AN10404178	ANAPOLIS UNIVERSITARIO S2	07/12/2019 17:17	08/12/2019 09:14	07/12/2019 19:27	08/12/2019 09:14	13,79	25	344,78	CHI
20191246425	JUSSARA	JR11256549	JUSSARA	07/12/2019 17:18	08/12/2019 06:04	07/12/2019 17:18	08/12/2019 06:04	12,75	64	816,23	CHI
20191245361	IPAMERI	IP12000086	IPAMERI	07/12/2019 17:19	07/12/2019 21:47	07/12/2019 17:19	07/12/2019 21:47	4,46	5	22,31	CHI
20191245581	JANDAIA	JD12008638	PALMEIRAS	07/12/2019 17:19	08/12/2019 08:16	07/12/2019 17:19	08/12/2019 08:16	14,95	118	1763,84	CHI
20191245581	PALESTINA DE GOIAS	JD12008638	PALMEIRAS	07/12/2019 17:19	08/12/2019 08:16	07/12/2019 17:19	08/12/2019 08:16	14,95	1	14,95	CHI
20191245581	PALMEIRAS DE GOIAS	JD12008638	PALMEIRAS	07/12/2019 17:19	08/12/2019 08:16	07/12/2019 17:19	08/12/2019 08:16	14,95	95	1420,04	CHI
20191245581	PALMINOPOLIS	JD12008638	PALMEIRAS	07/12/2019 17:19	08/12/2019 08:16	07/12/2019 17:19	08/12/2019 08:16	14,95	14	209,27	CHI
20191245363	COLINAS DO SUL	9700004411	NIQUELANDIA SUBTRANSMISSAO	07/12/2019 17:20	07/12/2019 19:11	07/12/2019 17:20	07/12/2019 19:11	1,85	1	1,85	CHI
20191245373	GAMELEIRA DE GOIAS	AN12285354	ANAPOLIS UNIVERSITARIO S2	07/12/2019 17:20	07/12/2019 19:54	07/12/2019 17:20	07/12/2019 19:54	2,56	9	23,00	CHI
20191245373	SILVANIA	AN12285354	ANAPOLIS UNIVERSITARIO S2	07/12/2019 17:20	07/12/2019 19:54	07/12/2019 17:20	07/12/2019 19:54	2,56	19	48,55	CHI
20191245442	ITUMBIARA	IT12404221	PARANAIBA	07/12/2019 17:20	07/12/2019 20:33	07/12/2019 17:20	07/12/2019 20:33	3,20	25	80,04	CHI
20191245369	ALTO PARAISO DE GOIAS	BF12364994	SAO JOAO D ALIANCA	07/12/2019 17:21	07/12/2019 19:38	07/12/2019 17:21	07/12/2019 19:38	2,28	2	4,56	CHI
20191243374	BALIZA	10002479590	BOM JARDIM	07/12/2019 17:22	07/12/2019 20:33	07/12/2019 17:22	07/12/2019 20:33	3,18	1	3,18	CHI
20191245372	GUAPO	710013954	GUAPO S1	07/12/2019 17:22	07/12/2019 18:49	07/12/2019 17:22	07/12/2019 18:49	1,45	1	1,45	CHI
20191245375	CATALAO	CT21195445	CATALAO S1	07/12/2019 17:22	08/12/2019 09:48	07/12/2019 17:22	08/12/2019 09:48	16,43	1	16,43	CHI
20191244349	DOVERLANDIA	MY12219553	PARQUE DAS EMAS	07/12/2019 17:23	08/12/2019 00:33	07/12/2019 17:23	08/12/2019 00:33	7,16	46	329,17	CHI
20191245384	NOVA CRIXAS	NA12220366	MOZARLANDIA	07/12/2019 17:24	09/12/2019 17:37	07/12/2019 17:24	09/12/2019 17:37	48,23	6	289,35	CHI
20191245389	APARECIDA DE GOIANIA	16500933	INDEPENDENCIA S2	07/12/2019 17:24	07/12/2019 19:12	07/12/2019 17:24	07/12/2019 19:12	1,79	1	1,79	CHI
20191245392	SILVANIA	SV21392200	VIANOPOLIS	07/12/2019 17:25	07/12/2019 22:51	07/12/2019 17:25	07/12/2019 22:51	5,43	1	5,43	CHI
20191245402	CRIXAS	CX21190220	SERRA DO OURO	07/12/2019 17:26	08/12/2019 10:32	07/12/2019 17:26	08/12/2019 10:32	17,09	1	17,09	CHI
20191245416	ANAPOLIS	AN12261182	JUNDIAI S1	07/12/2019 17:26	07/12/2019 20:01	07/12/2019 17:26	07/12/2019 20:01	2,57	149	383,10	CHI
20191245416	GOIANAPOLIS	AN12261182	JUNDIAI S1	07/12/2019 17:26	07/12/2019 20:01	07/12/2019 17:26	07/12/2019 20:01	2,57	9	23,14	CHI
20191245416	LEOPOLDO DE BULHOES	AN12261182	JUNDIAI S1	07/12/2019 17:26	07/12/2019 20:01	07/12/2019 17:26	07/12/2019 20:01	2,57	5	12,86	CHI
20191245441	NIQUELANDIA	NQ12239305	NIQUELANDIA SUBTRANSMISSAO	07/12/2019 17:26	08/12/2019 04:58	07/12/2019 17:26	08/12/2019 04:58	11,53	12	138,39	CHI
20191245409	RIO VERDE	10004864849	RIO VERDE S1	07/12/2019 17:27	07/12/2019 21:40	07/12/2019 17:27	07/12/2019 21:40	4,21	1	4,21	CHI
20191245410	SAO LUIS DE MONTES BELOS	SL32111626	FIRMINOPOLIS S1	07/12/2019 17:27	08/12/2019 09:33	07/12/2019 17:27	08/12/2019 09:33	16,09	2	32,19	CHI
20191245411	TRINDADE	10008551586	TRINDADE	07/12/2019 17:27	07/12/2019 19:22	07/12/2019 17:27	07/12/2019 19:22	1,90	1	1,90	CHI
20191245414	MINACU	IH21236067	MINACU	07/12/2019 17:28	07/12/2019 19:29	07/12/2019 17:28	07/12/2019 19:29	2,02	1	2,02	CHI
20191245428	MOSSAMEDES	MD21144829	FIRMINOPOLIS S2	07/12/2019 17:30	07/12/2019 21:13	07/12/2019 17:30	07/12/2019 21:13	3,71	1	3,71	CHI
20191245429	NIQUELANDIA	NQ21147623	URUACU	07/12/2019 17:30	08/12/2019 12:28	07/12/2019 17:30	08/12/2019 12:28	18,96	1	18,96	CHI

20191245569	CALDAS NOVAS	CN13059926	CALDAS NOVAS S1	07/12/2019 17:31	08/12/2019 14:12	07/12/2019 17:31	08/12/2019 09:52	16,34	249	4068,73	CHI
20191245569	PIRACANJUBA	CN13059926	CALDAS NOVAS S1	07/12/2019 17:31	08/12/2019 14:12	07/12/2019 17:31	08/12/2019 09:52	16,34	1	16,34	CHI
20191245569	CALDAS NOVAS	CN13059926	CALDAS NOVAS S1	07/12/2019 17:31	08/12/2019 14:12	08/12/2019 10:10	08/12/2019 13:13	3,05	5	15,25	CHI
20191245569	CALDAS NOVAS	CN13059926	CALDAS NOVAS S1	07/12/2019 17:31	08/12/2019 14:12	08/12/2019 10:10	08/12/2019 13:13	3,05	249	759,66	CHI
20191245569	PIRACANJUBA	CN13059926	CALDAS NOVAS S1	07/12/2019 17:31	08/12/2019 14:12	08/12/2019 10:10	08/12/2019 13:13	3,05	75	228,81	CHI
20191245569	PIRACANJUBA	CN13059926	CALDAS NOVAS S1	07/12/2019 17:31	08/12/2019 14:12	08/12/2019 10:10	08/12/2019 13:13	3,05	1	3,05	CHI
20191245569	SANTA CRUZ DE GOIAS	CN13059926	CALDAS NOVAS S1	07/12/2019 17:31	08/12/2019 14:12	08/12/2019 10:10	08/12/2019 13:13	3,05	1	3,05	CHI
20191245569	CALDAS NOVAS	PJ13000022	CALDAS NOVAS S1	07/12/2019 17:31	08/12/2019 14:12	08/12/2019 14:01	08/12/2019 14:12	0,19	1	0,19	CHI
20191245569	PIRACANJUBA	PJ13000022	CALDAS NOVAS S1	07/12/2019 17:31	08/12/2019 14:12	08/12/2019 14:01	08/12/2019 14:12	0,19	171	32,06	CHI
20191245437	FORMOSA	FA32042723	SAO JOAO D ALIANCA	07/12/2019 17:32	07/12/2019 21:37	07/12/2019 17:32	07/12/2019 21:37	4,08	1	4,08	CHI
20191245508	OUVIDOR	OU12358276RE	CATALAO S1	07/12/2019 17:32	07/12/2019 19:40	07/12/2019 17:32	07/12/2019 19:40	2,13	8	17,01	CHI
20191245445	JATAI	290224718	JATAI S3	07/12/2019 17:33	07/12/2019 21:26	07/12/2019 17:33	07/12/2019 21:26	3,88	1	3,88	CHI
20191245446	ITABERAI	IB12000032	ITABERAI S2	07/12/2019 17:33	07/12/2019 22:38	07/12/2019 17:33	07/12/2019 22:38	5,08	2	10,15	CHI
20191245475	SANTA CRUZ DE GOIAS	BC12110027RE	PIRES DO RIO S2	07/12/2019 17:33	07/12/2019 21:15	07/12/2019 17:33	07/12/2019 21:15	3,70	27	99,82	CHI
20191245448	MOSSAMEDES	MD12091062	FIRMINOPOLIS S2	07/12/2019 17:34	07/12/2019 22:50	07/12/2019 17:34	07/12/2019 22:50	5,25	1	5,25	CHI
20191245450	RIO VERDE	630431942	RIO VERDE S1	07/12/2019 17:35	08/12/2019 09:27	07/12/2019 17:35	08/12/2019 09:27	15,86	1	15,86	CHI
20191245452	APARECIDA DE GOIANIA	15836344	INDEPENDENCIA S1	07/12/2019 17:35	07/12/2019 18:43	07/12/2019 17:35	07/12/2019 18:43	1,13	1	1,13	CHI
20191245737	SITIO D ABADIA	SI21234151	IACIARA S2	07/12/2019 17:35	08/12/2019 21:57	07/12/2019 17:35	08/12/2019 21:57	28,37	3	85,11	CHI
20191244351	DIORAMA	ME12124938	IPORA	07/12/2019 17:36	07/12/2019 17:56	07/12/2019 17:36	07/12/2019 17:56	0,33	1	0,33	CHI
20191244351	MONTES CLAROS DE GOIAS	ME12124938	IPORA	07/12/2019 17:36	07/12/2019 17:56	07/12/2019 17:36	07/12/2019 17:56	0,33	44	14,50	CHI
20191245457	CORUMBA DE GOIAS	260034873	ANAPOLIS UNIVERSITARIO S1	07/12/2019 17:36	07/12/2019 20:30	07/12/2019 17:36	07/12/2019 20:30	2,89	1	2,89	CHI
20191245462	AGUAS LINDAS DE GOIAS	4830195965	AGUAS LINDAS DE GOIAS S2	07/12/2019 17:38	07/12/2019 18:32	07/12/2019 17:38	07/12/2019 18:32	0,90	1	0,90	CHI
20191245467	ITAPIRAPUA	IU21329943	MATRINCHA	07/12/2019 17:39	08/12/2019 02:40	07/12/2019 17:39	08/12/2019 02:40	9,01	1	9,01	CHI
20191245470	URUTAI	UT21382048	PIRES DO RIO S2	07/12/2019 17:39	07/12/2019 20:53	07/12/2019 17:39	07/12/2019 20:53	3,22	1	3,22	CHI
20191246000	CAIAPONIA	PY12020938LD	PALESTINA	07/12/2019 17:39	07/12/2019 23:00	07/12/2019 17:39	07/12/2019 23:00	5,35	49	261,93	CHI
20191246000	PALESTINA DE GOIAS	PY12020938LD	PALESTINA	07/12/2019 17:39	07/12/2019 23:00	07/12/2019 17:39	07/12/2019 23:00	5,35	1146	6126,01	CHI
20191246000	CAIAPONIA	03800224	PALESTINA	07/12/2019 17:39	07/12/2019 23:00	07/12/2019 22:41	07/12/2019 23:00	0,31	347	107,57	CHI
20191246000	PALESTINA DE GOIAS	03800224	PALESTINA	07/12/2019 17:39	07/12/2019 23:00	07/12/2019 22:41	07/12/2019 23:00	0,31	326	101,06	CHI
20191245476	NOVA GLORIA	IW21201623	RUBIATABA	07/12/2019 17:40	08/12/2019 10:52	07/12/2019 17:40	08/12/2019 10:52	17,19	1	17,19	CHI
20191245479	HIDROLINA	UR12374713	URUACU	07/12/2019 17:42	07/12/2019 22:00	07/12/2019 17:42	07/12/2019 22:00	4,31	4	17,24	CHI
20191245479	URUACU	UR12374713	URUACU	07/12/2019 17:42	07/12/2019 22:00	07/12/2019 17:42	07/12/2019 22:00	4,31	3	12,93	CHI
20191245484	LUZIANIA	LZ21145564	RIO VERMELHO	07/12/2019 17:43	08/12/2019 09:15	07/12/2019 17:43	08/12/2019 09:15	15,53	1	15,53	CHI
20191245493	ITAPURANGA	IK12311313	ITAPURANGA	07/12/2019 17:43	08/12/2019 20:58	07/12/2019 17:43	08/12/2019 20:58	27,24	3	81,73	CHI

20191245556	MOSSAMEDES	MD12024152	FIRMINOPOLIS S2	07/12/2019 17:44	07/12/2019 20:20	07/12/2019 17:44	07/12/2019 20:20	2,59	109	282,19	CHI
20191245556	SANCLERLANDIA	MD12024152	FIRMINOPOLIS S2	07/12/2019 17:44	07/12/2019 20:20	07/12/2019 17:44	07/12/2019 20:20	2,59	9	23,30	CHI
20191245577	BELA VISTA DE GOIAS	BV12402719	BELA VISTA S1	07/12/2019 17:46	07/12/2019 20:24	07/12/2019 17:46	07/12/2019 20:24	2,65	164	434,05	CHI
20191245599	JANDAIA	JD12260012	PALMEIRAS	07/12/2019 17:46	08/12/2019 09:32	07/12/2019 17:46	08/12/2019 09:32	15,75	14	220,52	CHI
20191245512	PIRES DO RIO	PR12359913	PIRES DO RIO S1	07/12/2019 17:47	08/12/2019 10:50	07/12/2019 17:47	08/12/2019 10:50	17,04	1	17,04	CHI
20191245515	PIRES DO RIO	PR12000076	PIRES DO RIO S1	07/12/2019 17:48	08/12/2019 09:26	07/12/2019 17:48	08/12/2019 09:26	15,63	3	46,89	CHI
20191245516	AGUAS LINDAS DE GOIAS	4830034337	AGUAS LINDAS DE GOIAS S1	07/12/2019 17:48	07/12/2019 19:16	07/12/2019 17:48	07/12/2019 19:16	1,46	1	1,46	CHI
201912233533	MOSSAMEDES	MD12300425	FIRMINOPOLIS S2	07/12/2019 17:48	08/12/2019 16:00	07/12/2019 17:48	08/12/2019 16:00	22,19	4	88,77	CHI
20191245525	VALPARAISO DE GOIAS	10018151793	PACAEMBU S2	07/12/2019 17:49	07/12/2019 23:27	07/12/2019 17:49	07/12/2019 23:27	5,62	1	5,62	CHI
20191245937	SAO LUIS DE MONTES BELOS	SL32125648	FIRMINOPOLIS S1	07/12/2019 17:49	07/12/2019 23:57	07/12/2019 17:49	07/12/2019 23:57	6,13	5	30,65	CHI
20191245535	AGUA FRIA DE GOIAS	JL12117446	SAO JOAO D ALIANCA	07/12/2019 17:50	07/12/2019 20:30	07/12/2019 17:50	07/12/2019 20:30	2,65	19	50,36	CHI
20191245535	SAO JOAO D ALIANCA	JL12117446	SAO JOAO D ALIANCA	07/12/2019 17:50	07/12/2019 20:30	07/12/2019 17:50	07/12/2019 20:30	2,65	22	58,31	CHI
20191245553	LEOPOLDO DE BULHOES	LB12000624	DAIA S1	07/12/2019 17:50	07/12/2019 19:19	07/12/2019 17:50	07/12/2019 19:19	1,48	2	2,96	CHI
20191245553	LEOPOLDO DE BULHOES	LB12000624	DAIA S1	07/12/2019 17:50	07/12/2019 19:19	07/12/2019 17:50	07/12/2019 19:19	1,48	30	44,45	CHI
20191245537	LUZIANIA	LZ12313691	CRISTALINA S2	07/12/2019 17:51	07/12/2019 21:30	07/12/2019 17:51	07/12/2019 21:30	3,65	21	76,57	CHI
20191245539	ITARUMA	IM21041691	CACHOEIRA ALTA	07/12/2019 17:51	08/12/2019 09:28	07/12/2019 17:51	08/12/2019 09:28	15,61	3	46,83	CHI
20191245549	LUZIANIA	LZ11170140	MARAJOARA	07/12/2019 17:52	07/12/2019 21:05	07/12/2019 17:52	07/12/2019 21:05	3,21	10	32,12	CHI
20191245551	AMARALINA	LC11270210	SAO MIGUEL DO ARAGUAIA	07/12/2019 17:52	08/12/2019 00:23	07/12/2019 17:52	08/12/2019 00:23	6,50	1	6,50	CHI
20191245985	FAINA	MP12096007	MATRINCHA	07/12/2019 17:52	08/12/2019 16:25	07/12/2019 17:52	08/12/2019 16:25	22,54	8	180,30	CHI
20191245560	ITUMBIARA	10022049108	PARANAIBA	07/12/2019 17:55	07/12/2019 21:25	07/12/2019 17:55	07/12/2019 21:25	3,50	1	3,50	CHI
20191245563	PALMEIRAS DE GOIAS	PL21124141	PALMEIRAS	07/12/2019 17:55	08/12/2019 10:28	07/12/2019 17:55	08/12/2019 10:28	16,55	2	33,10	CHI
20191245564	JATAI	JT12260451	JATAI S1	07/12/2019 17:55	08/12/2019 19:00	07/12/2019 17:55	08/12/2019 19:00	25,08	4	100,30	CHI
20191245564	SERRANOPOLIS	JT12260451	JATAI S1	07/12/2019 17:55	08/12/2019 19:00	07/12/2019 17:55	08/12/2019 19:00	25,08	1	25,08	CHI
20191245566	MINACU	10002117329	MINACU	07/12/2019 17:55	07/12/2019 20:52	07/12/2019 17:55	07/12/2019 20:52	2,93	1	2,93	CHI
20191245636	ANICUNS	AC12382504	ANICUNS	07/12/2019 17:55	07/12/2019 21:46	07/12/2019 17:55	07/12/2019 21:46	3,84	28	107,62	CHI
20191245579	GOIATUBA	GT11000062	GOIATUBA S2	07/12/2019 17:58	07/12/2019 20:00	07/12/2019 17:58	07/12/2019 20:00	2,04	179	364,46	CHI
20191245584	RIO VERDE	RV11229473	MONTIVIDIU T	07/12/2019 18:00	07/12/2019 22:10	07/12/2019 18:00	07/12/2019 22:10	4,17	1	4,17	CHI
20191245589	GOIAS	GS12056682	GOIAS	07/12/2019 18:01	08/12/2019 11:35	07/12/2019 18:01	08/12/2019 11:35	17,57	7	122,96	CHI
20191245590	GOIANESIA	550062348	GOIANESIA S2	07/12/2019 18:01	07/12/2019 19:34	07/12/2019 18:01	07/12/2019 19:34	1,55	1	1,55	CHI
20191245592	URUTAI	UT21080757	PIRES DO RIO S2	07/12/2019 18:01	08/12/2019 09:51	07/12/2019 18:01	08/12/2019 09:51	15,82	2	31,64	CHI
20191245595	CRISTALINA	KR21171595	CRISTALINA S2	07/12/2019 18:02	07/12/2019 22:01	07/12/2019 18:02	07/12/2019 22:01	3,98	1	3,98	CHI
20191245597	CUMARI	CY21315067	CATALAO S1	07/12/2019 18:02	07/12/2019 18:07	07/12/2019 18:02	07/12/2019 18:07	0,08	2	0,15	CHI
20191245603	SENADOR CANEDO	SW11092646	SENADOR CANEDO	07/12/2019 18:04	07/12/2019 19:33	07/12/2019 18:04	07/12/2019 19:33	1,47	139	204,75	CHI



20191245604	MUTUNOPOLIS	MU21000002	MARA ROSA	07/12/2019 18:04	07/12/2019 21:55	07/12/2019 18:04	07/12/2019 21:55	3,84	1	3,84	CHI
20191245710	ITABERAÍ	IB12310476	ITABERAÍ S2	07/12/2019 18:05	08/12/2019 04:08	07/12/2019 18:05	08/12/2019 04:08	10,04	3	30,13	CHI
20191245613	SAO DOMINGOS	8680003465	SAO DOMINGOS	07/12/2019 18:06	08/12/2019 02:47	07/12/2019 18:06	08/12/2019 02:47	8,68	1	8,68	CHI
20191245614	CIDADE OCIDENTAL	2680159233	MARAJÓARA	07/12/2019 18:06	07/12/2019 20:10	07/12/2019 18:06	07/12/2019 20:10	2,08	1	2,08	CHI
20191245619	ANICUNS	AC21232046	ANICUNS	07/12/2019 18:07	08/12/2019 10:00	07/12/2019 18:07	08/12/2019 10:00	15,89	1	15,89	CHI
20191245620	GOIANESIA	GE21080420	GOIANESIA S2	07/12/2019 18:07	08/12/2019 07:31	07/12/2019 18:07	08/12/2019 07:31	13,39	1	13,39	CHI
20191245622	URUACU	UR11094174	URUACU	07/12/2019 18:08	08/12/2019 10:43	07/12/2019 18:08	08/12/2019 10:43	16,58	24	397,95	CHI
20191245662	NIQUELANDIA	NQ12039296	BARRO ALTO	07/12/2019 18:09	07/12/2019 21:52	07/12/2019 18:09	07/12/2019 21:52	3,72	92	341,91	CHI
20191245632	CAIAPONIA	CP12200873	PALESTINA	07/12/2019 18:10	08/12/2019 12:02	07/12/2019 18:10	08/12/2019 12:02	17,86	54	964,32	CHI
20191245639	JUSSARA	JR12114069	JUSSARA	07/12/2019 18:12	09/12/2019 02:30	07/12/2019 18:12	09/12/2019 02:30	32,30	1	32,30	CHI
20191245647	FAZENDA NOVA	10022600335	JUSSARA	07/12/2019 18:13	08/12/2019 17:45	07/12/2019 18:13	08/12/2019 17:45	23,54	1	23,54	CHI
20191245670	BARRO ALTO	PV12069121	GOIANESIA S1	07/12/2019 18:13	08/12/2019 16:00	07/12/2019 18:13	08/12/2019 16:00	21,78	1	21,78	CHI
20191245670	VILA PROPICIO	PV12069121	GOIANESIA S1	07/12/2019 18:13	08/12/2019 16:00	07/12/2019 18:13	08/12/2019 16:00	21,78	34	740,43	CHI
20191245657	SAO SIMAO	2910003511	CACHOEIRA ALTA	07/12/2019 18:15	07/12/2019 20:35	07/12/2019 18:15	07/12/2019 20:35	2,33	1	2,33	CHI
20191246733	URUACU	UR12364091	URUACU	07/12/2019 18:15	08/12/2019 03:43	07/12/2019 18:15	08/12/2019 03:43	9,45	12	113,44	CHI
20191246232	DIORAMA	JP12074459	IPORA	07/12/2019 18:17	08/12/2019 09:22	07/12/2019 18:17	08/12/2019 09:22	15,07	3	45,20	CHI
20191246232	JAUPACI	JP12074459	IPORA	07/12/2019 18:17	08/12/2019 09:22	07/12/2019 18:17	08/12/2019 09:22	15,07	5	75,34	CHI
20191246563	CACHOEIRA DE GOIAS	CG12018660	FIRMINOPOLIS S2	07/12/2019 18:17	08/12/2019 17:24	07/12/2019 18:17	08/12/2019 17:24	23,12	36	832,22	CHI
20191245668	MUNDO NOVO DE GOIAS	MH12208599	NOVA CRIXAS	07/12/2019 18:18	08/12/2019 08:36	07/12/2019 18:18	08/12/2019 08:36	14,30	2	28,59	CHI
20191245671	SAO DOMINGOS	SD12224217	SAO DOMINGOS	07/12/2019 18:18	08/12/2019 10:18	07/12/2019 18:18	08/12/2019 10:18	15,99	2	31,97	CHI
20191245674	ITARUMA	IM21306137	CACHOEIRA ALTA	07/12/2019 18:19	08/12/2019 12:56	07/12/2019 18:19	08/12/2019 12:56	18,60	1	18,60	CHI
20191245675	SAO MIGUEL DO ARAGUAIA	SM12032000	SAO MIGUEL DO ARAGUAIA	07/12/2019 18:20	08/12/2019 23:30	07/12/2019 18:20	08/12/2019 23:30	29,17	5	145,85	CHI
20191245676	FAINA	GS12220409	GOIAS	07/12/2019 18:20	08/12/2019 09:32	07/12/2019 18:20	08/12/2019 09:32	15,20	1	15,20	CHI
20191245676	GOIAS	GS12220409	GOIAS	07/12/2019 18:20	08/12/2019 09:32	07/12/2019 18:20	08/12/2019 09:32	15,20	81	1230,80	CHI
20191245678	IPAMERI	6940006559	CRISTALINA S1	07/12/2019 18:20	08/12/2019 07:10	07/12/2019 18:20	08/12/2019 07:10	12,82	1	12,82	CHI
20191245679	CALDAS NOVAS	CN21039602	CALDAS NOVAS S2	07/12/2019 18:20	07/12/2019 20:40	07/12/2019 18:20	07/12/2019 20:40	2,32	2	4,65	CHI
20191245685	ANICUNS	AC12307010	ANICUNS	07/12/2019 18:22	08/12/2019 09:05	07/12/2019 18:22	08/12/2019 09:05	14,71	4	58,85	CHI
20191245690	ORIZONA	10016161090	PIRES DO RIO S2	07/12/2019 18:23	07/12/2019 23:59	07/12/2019 18:23	07/12/2019 23:59	5,59	1	5,59	CHI
20191244364	ABADIANIA	05720224	DAIA S2	07/12/2019 18:27	08/12/2019 13:50	07/12/2019 18:27	08/12/2019 01:12	6,75	2	13,49	CHI
20191244364	GAMELEIRA DE GOIAS	05720224	DAIA S2	07/12/2019 18:27	08/12/2019 13:50	07/12/2019 18:27	08/12/2019 01:12	6,75	76	512,77	CHI
20191244364	GAMELEIRA DE GOIAS	SV13062537	DAIA S2	07/12/2019 18:27	08/12/2019 13:50	07/12/2019 18:27	08/12/2019 13:20	18,87	12	226,47	CHI
20191244364	GAMELEIRA DE GOIAS	SV12072514	DAIA S2	07/12/2019 18:27	08/12/2019 13:50	07/12/2019 18:27	08/12/2019 13:39	19,20	11	211,23	CHI
20191244364	GAMELEIRA DE GOIAS	SV12278872	DAIA S2	07/12/2019 18:27	08/12/2019 13:50	07/12/2019 18:27	08/12/2019 13:50	19,37	37	716,78	CHI

20191246013	DAMIANOPOLIS	SI13322748	IACIARA S2	07/12/2019 18:27	08/12/2019 21:33	07/12/2019 18:27	08/12/2019 00:46	6,33	130	822,90	CHI
20191246013	SITIO D ABADIA	SI13322748	IACIARA S2	07/12/2019 18:27	08/12/2019 21:33	07/12/2019 18:27	08/12/2019 00:46	6,33	314	1987,62	CHI
20191246013	SITIO D ABADIA	SI12010205	IACIARA S2	07/12/2019 18:27	08/12/2019 21:33	07/12/2019 18:27	08/12/2019 21:00	26,55	41	1088,57	CHI
20191246013	SITIO D ABADIA	SI12143367	IACIARA S2	07/12/2019 18:27	08/12/2019 21:33	07/12/2019 18:27	08/12/2019 21:33	27,10	20	542,07	CHI
20191245714	AVELINOPOLIS	AV21272337	ANICUNS	07/12/2019 18:28	08/12/2019 08:58	07/12/2019 18:28	08/12/2019 08:58	14,49	1	14,49	CHI
20191245715	MINEIROS	MY12347908	PARQUE DAS EMAS	07/12/2019 18:28	08/12/2019 10:30	07/12/2019 18:28	08/12/2019 10:30	16,02	4	64,08	CHI
20191245716	ITARUMA	IM12034973LD	CACHOEIRA ALTA	07/12/2019 18:28	08/12/2019 15:04	07/12/2019 18:28	08/12/2019 15:04	20,59	4	82,34	CHI
20191245717	SAO MIGUEL DO ARAGUAIA	SM12031421	SAO MIGUEL DO ARAGUAIA	07/12/2019 18:28	08/12/2019 13:00	07/12/2019 18:28	08/12/2019 12:00	17,52	7	122,64	CHI
20191245717	SAO MIGUEL DO ARAGUAIA	SM12342059	SAO MIGUEL DO ARAGUAIA	07/12/2019 18:28	08/12/2019 13:00	07/12/2019 18:28	08/12/2019 12:34	18,09	9	162,78	CHI
20191245717	SAO MIGUEL DO ARAGUAIA	SM12208485	SAO MIGUEL DO ARAGUAIA	07/12/2019 18:28	08/12/2019 13:00	07/12/2019 18:28	08/12/2019 13:00	18,52	2	37,04	CHI
20191245718	BELA VISTA DE GOIAS	BV31093009	BELA VISTA S1	07/12/2019 18:28	08/12/2019 09:14	07/12/2019 18:28	08/12/2019 09:14	14,75	1	14,75	CHI
20191245734	GOIAS	GS12353054	MATRINCHA	07/12/2019 18:30	08/12/2019 11:54	07/12/2019 18:30	08/12/2019 11:54	17,40	7	121,77	CHI
20191246106	ACREUNA	EU12077053	ACREUNA	07/12/2019 18:30	07/12/2019 23:04	07/12/2019 18:30	07/12/2019 23:04	4,57	26	118,73	CHI
20191246111	PARAUNA	PU11083565	PARAUNA	07/12/2019 18:32	07/12/2019 22:14	07/12/2019 18:32	07/12/2019 22:14	3,69	74	273,20	CHI
20191245739	GOIANIA	13934260	MEIA PONTE	07/12/2019 18:33	07/12/2019 19:34	07/12/2019 18:33	07/12/2019 19:34	1,00	1	1,00	CHI
20191244371	MIMOSO DE GOIAS	00180434	BARRO ALTO	07/12/2019 18:34	08/12/2019 16:36	07/12/2019 18:34	07/12/2019 18:40	0,11	9	0,99	CHI
20191244371	MIMOSO DE GOIAS	00180434	BARRO ALTO	07/12/2019 18:34	08/12/2019 16:36	07/12/2019 18:34	07/12/2019 18:40	0,11	4	0,44	CHI
20191244371	NIQUELANDIA	00180434	BARRO ALTO	07/12/2019 18:34	08/12/2019 16:36	07/12/2019 18:34	07/12/2019 18:40	0,11	174	19,09	CHI
20191244371	NIQUELANDIA	00180434	BARRO ALTO	07/12/2019 18:34	08/12/2019 16:36	07/12/2019 18:34	07/12/2019 18:40	0,11	915	100,40	CHI
20191244371	VILA PROPICIO	00180434	BARRO ALTO	07/12/2019 18:34	08/12/2019 16:36	07/12/2019 18:34	07/12/2019 18:40	0,11	50	5,49	CHI
20191244371	VILA PROPICIO	00180434	BARRO ALTO	07/12/2019 18:34	08/12/2019 16:36	07/12/2019 18:34	07/12/2019 18:40	0,11	30	3,29	CHI
20191244371	VILA PROPICIO	BA10400442	BARRO ALTO	07/12/2019 18:34	08/12/2019 16:36	07/12/2019 18:34	07/12/2019 18:40	0,11	1	0,11	CHI
20191244371	MIMOSO DE GOIAS	00180434	BARRO ALTO	07/12/2019 18:34	08/12/2019 16:36	08/12/2019 01:34	08/12/2019 01:38	0,07	9	0,64	CHI
20191244371	MIMOSO DE GOIAS	00180434	BARRO ALTO	07/12/2019 18:34	08/12/2019 16:36	08/12/2019 01:34	08/12/2019 01:38	0,07	4	0,28	CHI
20191244371	NIQUELANDIA	00180434	BARRO ALTO	07/12/2019 18:34	08/12/2019 16:36	08/12/2019 01:34	08/12/2019 01:38	0,07	174	12,32	CHI
20191244371	NIQUELANDIA	00180434	BARRO ALTO	07/12/2019 18:34	08/12/2019 16:36	08/12/2019 01:34	08/12/2019 01:38	0,07	1027	72,75	CHI
20191244371	VILA PROPICIO	00180434	BARRO ALTO	07/12/2019 18:34	08/12/2019 16:36	08/12/2019 01:34	08/12/2019 01:38	0,07	49	3,47	CHI
20191244371	VILA PROPICIO	00180434	BARRO ALTO	07/12/2019 18:34	08/12/2019 16:36	08/12/2019 01:34	08/12/2019 01:38	0,07	32	2,27	CHI
20191244371	VILA PROPICIO	00180434	BARRO ALTO	07/12/2019 18:34	08/12/2019 16:36	08/12/2019 01:34	08/12/2019 01:38	0,07	1	0,07	CHI
20191244371	BARRO ALTO	00180434	BARRO ALTO	07/12/2019 18:34	08/12/2019 16:36	07/12/2019 18:34	08/12/2019 03:30	8,93	22	196,45	CHI
20191244371	GOIANESIA	00180434	BARRO ALTO	07/12/2019 18:34	08/12/2019 16:36	07/12/2019 18:34	08/12/2019 03:30	8,93	4	35,72	CHI
20191244371	SANTA RITA DO NOVO DESTINO	00180434	BARRO ALTO	07/12/2019 18:34	08/12/2019 16:36	07/12/2019 18:34	08/12/2019 03:30	8,93	210	1875,18	CHI
20191244371	SANTA RITA DO NOVO DESTINO	GE13006500	BARRO ALTO	07/12/2019 18:34	08/12/2019 16:36	07/12/2019 18:34	08/12/2019 03:30	8,93	2	17,86	CHI

20191244371	SAO LUIZ DO NORTE	00180434	BARRO ALTO	07/12/2019 18:34	08/12/2019 16:36	07/12/2019 18:34	08/12/2019 03:30	8,93	13	116,08	CHI
20191244371	BARRO ALTO	GE13006500	BARRO ALTO	07/12/2019 18:34	08/12/2019 16:36	07/12/2019 18:38	08/12/2019 03:30	8,85	2	17,71	CHI
20191244371	SANTA RITA DO NOVO DESTINO	GE13006500	BARRO ALTO	07/12/2019 18:34	08/12/2019 16:36	07/12/2019 18:38	08/12/2019 03:30	8,85	1	8,85	CHI
20191244371	SAO LUIZ DO NORTE	GE13006500	BARRO ALTO	07/12/2019 18:34	08/12/2019 16:36	07/12/2019 18:38	08/12/2019 03:30	8,85	1	8,85	CHI
20191244371	BARRO ALTO	BA10401412	BARRO ALTO	07/12/2019 18:34	08/12/2019 16:36	07/12/2019 18:34	08/12/2019 16:36	22,04	2	44,07	CHI
20191244371	HIDROLINA	00180434	BARRO ALTO	07/12/2019 18:34	08/12/2019 16:36	07/12/2019 18:34	08/12/2019 16:36	22,04	1	22,04	CHI
20191244371	SANTA RITA DO NOVO DESTINO	BA10401412	BARRO ALTO	07/12/2019 18:34	08/12/2019 16:36	07/12/2019 18:34	08/12/2019 16:36	22,04	7	154,26	CHI
20191244371	SAO LUIZ DO NORTE	00180434	BARRO ALTO	07/12/2019 18:34	08/12/2019 16:36	07/12/2019 18:34	08/12/2019 16:36	22,04	96	2115,60	CHI
20191244371	SAO LUIZ DO NORTE	BA10401412	BARRO ALTO	07/12/2019 18:34	08/12/2019 16:36	07/12/2019 18:34	08/12/2019 16:36	22,04	2	44,07	CHI
20191245749	CRISTALINA	KR21332748	CRISTALINA S2	07/12/2019 18:36	08/12/2019 09:50	07/12/2019 18:36	08/12/2019 09:50	15,23	1	15,23	CHI
20191245755	GOIANIA	12086812	CARAJAS S2	07/12/2019 18:36	07/12/2019 21:18	07/12/2019 18:36	07/12/2019 21:18	2,68	1	2,68	CHI
20191245759	CRISTALINA	1060009976	CRISTALINA S1	07/12/2019 18:37	07/12/2019 20:16	07/12/2019 18:37	07/12/2019 20:16	1,64	1	1,64	CHI
20191245760	PLANALTINA	PI11062212	PLANALTINA	07/12/2019 18:37	07/12/2019 19:24	07/12/2019 18:37	07/12/2019 19:24	0,77	20	15,46	CHI
20191245767	TRINDADE	10020571869	MEIA PONTE	07/12/2019 18:39	07/12/2019 21:52	07/12/2019 18:39	07/12/2019 21:52	3,21	1	3,21	CHI
20191245820	SANCLERLANDIA	SC12307091	FIRMINOPOLIS S2	07/12/2019 18:39	08/12/2019 08:40	07/12/2019 18:39	08/12/2019 08:40	14,00	6	84,03	CHI
20191245921	SAO MIGUEL DO PASSA QUATRO	SQ12231379	CRISTIANOPOLIS	07/12/2019 18:39	08/12/2019 12:48	07/12/2019 18:39	08/12/2019 12:48	18,14	13	235,85	CHI
20191245921	VIANOPOLIS	SQ12231379	CRISTIANOPOLIS	07/12/2019 18:39	08/12/2019 12:48	07/12/2019 18:39	08/12/2019 12:48	18,14	6	108,85	CHI
20191245774	BOM JARDIM DE GOIAS	1880028491	BOM JARDIM	07/12/2019 18:40	08/12/2019 09:52	07/12/2019 18:40	08/12/2019 09:52	15,21	1	15,21	CHI
20191245777	PIRES DO RIO	PR21337200	PIRES DO RIO S1	07/12/2019 18:40	08/12/2019 01:15	07/12/2019 18:40	08/12/2019 01:15	6,57	1	6,57	CHI
20191245785	TRINDADE	40086902	TRINDADE	07/12/2019 18:41	07/12/2019 21:16	07/12/2019 18:41	07/12/2019 21:16	2,57	1	2,57	CHI
20191245787	CAMPOS BELOS	CH12261981	SAO DOMINGOS	07/12/2019 18:41	07/12/2019 20:37	07/12/2019 18:41	07/12/2019 20:37	1,92	74	141,98	CHI
20191246465	JATAI	JT12182190	JATAI S1	07/12/2019 18:41	08/12/2019 00:50	07/12/2019 18:41	08/12/2019 00:50	6,14	25	153,52	CHI
20191245791	IVOLANDIA	IV21358517	IPORA	07/12/2019 18:42	08/12/2019 15:30	07/12/2019 18:42	08/12/2019 15:30	20,79	1	20,79	CHI
20191245793	URUACU	UR12339064	CAMPINORTE	07/12/2019 18:43	08/12/2019 16:40	07/12/2019 18:43	08/12/2019 16:40	21,95	2	43,90	CHI
20191245794	CIDADE OCIDENTAL	DH11248725	MARAJOARA	07/12/2019 18:43	07/12/2019 20:28	07/12/2019 18:43	07/12/2019 20:28	1,75	19	33,24	CHI
20191245798	AGUAS LINDAS DE GOIAS	LA11370820	AGUAS LINDAS DE GOIAS S1	07/12/2019 18:43	07/12/2019 22:58	07/12/2019 18:43	07/12/2019 22:58	4,24	64	271,06	CHI
20191245800	SILVANIA	SV21160596	DAIA S2	07/12/2019 18:43	08/12/2019 11:56	07/12/2019 18:43	08/12/2019 11:56	17,21	1	17,21	CHI
20191245805	MINACU	IH21242189	MINACU	07/12/2019 18:44	08/12/2019 11:01	07/12/2019 18:44	08/12/2019 11:01	16,27	1	16,27	CHI
20191245810	ITABERAI	IB21217052	ITABERAI S2	07/12/2019 18:45	08/12/2019 16:30	07/12/2019 18:45	08/12/2019 16:30	21,75	1	21,75	CHI
20191245813	PLANALTINA	PI21125282	SAO JOAO D ALIANCA	07/12/2019 18:45	08/12/2019 09:42	07/12/2019 18:45	08/12/2019 09:42	14,93	1	14,93	CHI
20191245814	FORMOSA	FA12067441	ITIQUEIRA	07/12/2019 18:45	07/12/2019 20:11	07/12/2019 18:45	07/12/2019 20:11	1,42	6	8,53	CHI
20191245823	JATAI	290282159	JATAI S3	07/12/2019 18:47	07/12/2019 23:53	07/12/2019 18:47	07/12/2019 23:53	5,09	1	5,09	CHI
20191247872	RIO VERDE	RV21371325	QUIRINOPOLIS	07/12/2019 18:47	08/12/2019 11:19	07/12/2019 18:47	08/12/2019 11:19	16,52	2	33,05	CHI

20191245830	BELA VISTA DE GOIAS	BV21228834	BELA VISTA S1	07/12/2019 18:48	08/12/2019 10:49	07/12/2019 18:48	08/12/2019 10:49	16,00	2	32,00	CHI
20191246470	ALTO PARAISO DE GOIAS	NQ12148151	NIQUELANDIA SUBTRANSMISSAO	07/12/2019 18:48	08/12/2019 02:33	07/12/2019 18:48	08/12/2019 02:33	7,73	12	92,81	CHI
20191246470	NIQUELANDIA	NQ12148151	NIQUELANDIA SUBTRANSMISSAO	07/12/2019 18:48	08/12/2019 02:33	07/12/2019 18:48	08/12/2019 02:33	7,73	158	1222,00	CHI
20191246470	SAO JOAO D ALIANCA	NQ12148151	NIQUELANDIA SUBTRANSMISSAO	07/12/2019 18:48	08/12/2019 02:33	07/12/2019 18:48	08/12/2019 02:33	7,73	1	7,73	CHI
20191245835	ITARUMA	IM21138076	CACHOEIRA ALTA	07/12/2019 18:50	08/12/2019 16:01	07/12/2019 18:50	08/12/2019 16:01	21,18	1	21,18	CHI
20191245842	NEROPOLIS	NR12010422	NEROPOLIS S2	07/12/2019 18:51	07/12/2019 19:56	07/12/2019 18:51	07/12/2019 19:56	1,07	4	4,29	CHI
20191245843	ITAGUARI	770011780	ITABERAI S1	07/12/2019 18:51	07/12/2019 20:10	07/12/2019 18:51	07/12/2019 20:10	1,30	1	1,30	CHI
20191245848	NOVO GAMA	LZ21041592	PACAEMBU S1	07/12/2019 18:52	07/12/2019 20:44	07/12/2019 18:52	07/12/2019 20:44	1,87	0	0,00	CHI
20191245851	ANAPOLIS	10017747587	ANAPOLIS UNIVERSITARIO S2	07/12/2019 18:52	07/12/2019 19:50	07/12/2019 18:52	07/12/2019 19:50	0,95	1	0,95	CHI
20191245852	GOIANIA	16183125	XAVANTES	07/12/2019 18:52	07/12/2019 20:31	07/12/2019 18:52	07/12/2019 20:31	1,64	1	1,64	CHI
20191245855	CRIXAS	2490035260	SERRA DO OURO	07/12/2019 18:53	08/12/2019 09:19	07/12/2019 18:53	08/12/2019 09:19	14,42	1	14,42	CHI
20191245980	JANDAIA	JD12096921	PALMEIRAS	07/12/2019 18:53	08/12/2019 15:30	07/12/2019 18:53	08/12/2019 15:30	20,61	4	82,46	CHI
20191245857	GOIANIA	10052835	XAVANTES	07/12/2019 18:54	07/12/2019 21:01	07/12/2019 18:54	07/12/2019 21:01	2,11	1	2,11	CHI
20191245861	LUZIANIA	120048826	RIO VERMELHO	07/12/2019 18:54	07/12/2019 21:14	07/12/2019 18:54	07/12/2019 21:14	2,32	1	2,32	CHI
201912260792	ITAPURANGA	IK12299456	ITAPURANGA	07/12/2019 18:54	08/12/2019 20:58	07/12/2019 18:54	08/12/2019 20:58	26,07	5	130,33	CHI
20191245865	TRINDADE	40111120	TRINDADE	07/12/2019 18:55	07/12/2019 20:14	07/12/2019 18:55	07/12/2019 20:14	1,31	1	1,31	CHI
20191245954	ANAPOLIS	AN11051291	ANAPOLIS UNIVERSITARIO S1	07/12/2019 18:56	08/12/2019 08:03	07/12/2019 18:56	08/12/2019 08:03	13,12	125	1639,48	CHI
20191245869	CORUMBA DE GOIAS	260023164	CORUMBA	07/12/2019 18:57	07/12/2019 22:30	07/12/2019 18:57	07/12/2019 22:30	3,55	1	3,55	CHI
20191245872	CAMPO ALEGRE DE GOIAS	CM21000002	CAMPO ALEGRE DE GOIAS	07/12/2019 18:58	08/12/2019 11:01	07/12/2019 18:58	08/12/2019 11:01	16,05	1	16,05	CHI
20191245876	ACREUNA	2440060489	ACREUNA	07/12/2019 18:58	07/12/2019 22:20	07/12/2019 18:58	07/12/2019 22:20	3,35	1	3,35	CHI
20191245877	GOIANESIA	GE11336602	GOIANESIA S2	07/12/2019 18:58	07/12/2019 22:04	07/12/2019 18:58	07/12/2019 22:04	3,09	85	262,41	CHI
20191245891	INHUMAS	30183730	INHUMAS S2	07/12/2019 19:02	07/12/2019 22:05	07/12/2019 19:02	07/12/2019 22:05	3,05	1	3,05	CHI
20191245892	SANCLERLANDIA	1210008595	FIRMINOPOLIS S2	07/12/2019 19:02	07/12/2019 21:23	07/12/2019 19:02	07/12/2019 21:23	2,35	1	2,35	CHI
20191245896	GOIANIA	15012037	XAVANTES	07/12/2019 19:03	07/12/2019 20:10	07/12/2019 19:03	07/12/2019 20:10	1,10	1	1,10	CHI
20191246198	TAQUARAL DE GOIAS	TQ12299904	ITABERAI S1	07/12/2019 19:03	07/12/2019 23:41	07/12/2019 19:03	07/12/2019 23:41	4,62	3	13,85	CHI
20191245898	CAVALCANTE	CJ11389898	SAO DOMINGOS	07/12/2019 19:04	08/12/2019 16:05	07/12/2019 19:04	08/12/2019 16:05	21,02	1	21,02	CHI
20191245899	SAO MIGUEL DO ARAGUAIA	830032216	SAO MIGUEL DO ARAGUAIA	07/12/2019 19:04	08/12/2019 00:34	07/12/2019 19:04	08/12/2019 00:34	5,50	1	5,50	CHI
20191245904	SAO JOAO D ALIANCA	3840023681	SAO JOAO D ALIANCA	07/12/2019 19:05	08/12/2019 01:42	07/12/2019 19:05	08/12/2019 01:42	6,61	1	6,61	CHI
20191245906	BELA VISTA DE GOIAS	BV31043522	BELA VISTA S1	07/12/2019 19:05	08/12/2019 04:08	07/12/2019 19:05	08/12/2019 04:08	9,04	1	9,04	CHI
20191245951	DIVINOPOLIS DE GOIAS	SD12090135	SAO DOMINGOS	07/12/2019 19:08	08/12/2019 02:00	07/12/2019 19:08	08/12/2019 02:00	6,86	24	164,53	CHI
20191245951	SAO DOMINGOS	SD12090135	SAO DOMINGOS	07/12/2019 19:08	08/12/2019 02:00	07/12/2019 19:08	08/12/2019 02:00	6,86	80	548,42	CHI
20191246410	ARAGARCAS	BM12204856	BOM JARDIM	07/12/2019 19:09	07/12/2019 23:30	07/12/2019 19:09	07/12/2019 23:30	4,35	24	104,29	CHI
20191246410	BALIZA	BM12204856	BOM JARDIM	07/12/2019 19:09	07/12/2019 23:30	07/12/2019 19:09	07/12/2019 23:30	4,35	50	217,28	CHI

20191245927	PARAUNA	980001481	PARAUNA	07/12/2019 19:10	08/12/2019 10:16	07/12/2019 19:10	08/12/2019 10:16	15,11	1	15,11	CHI
20191245949	NIQUELANDIA	NQ21197690	NIQUELANDIA SUBTRANSMISSAO	07/12/2019 19:14	08/12/2019 14:24	07/12/2019 19:14	08/12/2019 14:24	19,16	1	19,16	CHI
20191245956	PIRENOPOLIS	PV12093290	SAO FRANCISCO DE GOIAS	07/12/2019 19:15	08/12/2019 15:02	07/12/2019 19:15	08/12/2019 15:02	19,77	3	59,31	CHI
20191245960	VIANOPOLIS	VN21072136	VIANOPOLIS	07/12/2019 19:17	08/12/2019 12:15	07/12/2019 19:17	08/12/2019 12:15	16,96	1	16,96	CHI
20191245961	ITUMBIARA	10021183692	ITUMBIARA VELHA S1	07/12/2019 19:17	07/12/2019 23:25	07/12/2019 19:17	07/12/2019 23:25	4,13	1	4,13	CHI
20191245965	ITAJA	IJ12200624	CACHOEIRA ALTA	07/12/2019 19:18	08/12/2019 08:32	07/12/2019 19:18	08/12/2019 08:32	13,23	3	39,68	CHI
20191245968	GOIANIA	GN11167910	FERROVIARIO S1	07/12/2019 19:19	07/12/2019 21:11	07/12/2019 19:19	07/12/2019 21:11	1,86	55	102,44	CHI
20191245969	PORANGATU	PO12240663	PORANGATU	07/12/2019 19:19	08/12/2019 09:48	07/12/2019 19:19	08/12/2019 09:48	14,48	3	43,43	CHI
20191245971	SANTA ROSA DE GOIAS	SR21029652	INHUMAS S1	07/12/2019 19:19	08/12/2019 12:45	07/12/2019 19:19	08/12/2019 12:45	17,42	2	34,85	CHI
20191245978	ITARUMA	IM12247825	CACHOEIRA ALTA	07/12/2019 19:21	08/12/2019 14:17	07/12/2019 19:21	08/12/2019 14:17	18,93	2	37,86	CHI
20191246213	RIO VERDE	RV11000107	RIO VERDE S1	07/12/2019 19:21	07/12/2019 23:10	07/12/2019 19:21	07/12/2019 23:10	3,81	94	358,19	CHI
20191245984	FORMOSA	610191202	ITUIQUIRA	07/12/2019 19:22	07/12/2019 20:37	07/12/2019 19:22	07/12/2019 20:37	1,24	1	1,24	CHI
20191245987	APARECIDA DE GOIANIA	11269133	REAL S1	07/12/2019 19:23	07/12/2019 20:38	07/12/2019 19:23	07/12/2019 20:38	1,24	1	1,24	CHI
20191245988	SAO JOAO DA PARAUNA	RP21288896	FIRMINOPOLIS S2	07/12/2019 19:23	08/12/2019 11:19	07/12/2019 19:23	08/12/2019 11:19	15,92	1	15,92	CHI
20191245991	CORUMBA DE GOIAS	CB12297776	CORUMBA	07/12/2019 19:24	08/12/2019 09:00	07/12/2019 19:24	08/12/2019 09:00	13,59	9	122,34	CHI
20191245993	LUZIANIA	LZ12249222	VIANOPOLIS	07/12/2019 19:24	08/12/2019 00:52	07/12/2019 19:24	08/12/2019 00:52	5,46	2	10,91	CHI
20191245999	PETROLINA DE GOIAS	10022776794	PETROLINA	07/12/2019 19:25	08/12/2019 11:43	07/12/2019 19:25	08/12/2019 11:43	16,29	1	16,29	CHI
20191246105	CRISTALINA	KR21163628	PAMPLONA	07/12/2019 19:28	08/12/2019 11:42	07/12/2019 19:28	08/12/2019 11:42	16,22	1	16,22	CHI
20191246107	PIRENOPOLIS	PV12122918	CORUMBA	07/12/2019 19:30	08/12/2019 09:06	07/12/2019 19:30	08/12/2019 09:06	13,60	59	802,33	CHI
20191246107	SAO FRANCISCO DE GOIAS	PV12122918	CORUMBA	07/12/2019 19:30	08/12/2019 09:06	07/12/2019 19:30	08/12/2019 09:06	13,60	2	27,20	CHI
20191246109	ANAPOLIS	21289426	ANAPOLIS UNIVERSITARIO S2	07/12/2019 19:30	08/12/2019 11:31	07/12/2019 19:30	08/12/2019 11:31	16,03	1	16,03	CHI
20191246168	SENADOR CANEDO	SW11366013	SENADOR CANEDO	07/12/2019 19:33	07/12/2019 21:05	07/12/2019 19:33	07/12/2019 21:05	1,53	50	76,37	CHI
20191246018	BOM JARDIM DE GOIAS	BM11231853	BOM JARDIM	07/12/2019 19:34	07/12/2019 22:06	07/12/2019 19:34	07/12/2019 22:06	2,53	1	2,53	CHI
20191246127	NOVA ROMA	ND12117611	IACIARA S2	07/12/2019 19:35	07/12/2019 22:29	07/12/2019 19:35	07/12/2019 22:29	2,89	8	23,08	CHI
20191246128	CAMPINORTE	10009287769	CAMPINORTE	07/12/2019 19:36	08/12/2019 09:49	07/12/2019 19:36	08/12/2019 09:49	14,20	1	14,20	CHI
20191246129	PADRE BERNARDO	PB12305257	PADRE BERNARDO	07/12/2019 19:36	10/12/2019 00:49	07/12/2019 19:36	08/12/2019 09:20	13,72	5	68,60	CHI
20191246129	PLANALTINA	PB12305257	PADRE BERNARDO	07/12/2019 19:36	10/12/2019 00:49	07/12/2019 19:36	08/12/2019 09:20	13,72	20	274,39	CHI
20191246129	PLANALTINA	PI13262054	PADRE BERNARDO	07/12/2019 19:36	10/12/2019 00:49	07/12/2019 19:36	08/12/2019 12:17	16,68	8	133,44	CHI
20191246129	PLANALTINA	PI13329674	PADRE BERNARDO	07/12/2019 19:36	10/12/2019 00:49	07/12/2019 19:36	08/12/2019 15:58	20,35	15	305,29	CHI
20191246129	PLANALTINA	8524257	PADRE BERNARDO	07/12/2019 19:36	10/12/2019 00:49	07/12/2019 19:36	09/12/2019 16:33	44,95	26	1168,69	CHI
20191246129	PLANALTINA	8524257	PADRE BERNARDO	07/12/2019 19:36	10/12/2019 00:49	09/12/2019 13:59	09/12/2019 16:33	2,57	11	28,24	CHI
20191246129	PADRE BERNARDO	PB12305257	PADRE BERNARDO	07/12/2019 19:36	10/12/2019 00:49	09/12/2019 16:34	10/12/2019 00:49	8,26	5	41,32	CHI
20191246129	PLANALTINA	PB12305257	PADRE BERNARDO	07/12/2019 19:36	10/12/2019 00:49	09/12/2019 16:34	10/12/2019 00:49	8,26	69	570,27	CHI

20191246133	CRISTALINA	KR21183732	CRISTALINA S2	07/12/2019 19:37	08/12/2019 10:36	07/12/2019 19:37	08/12/2019 10:36	14,97	1	14,97	CHI
20191246272	ANAPOLIS	AN12009330	NEROPOLIS S1	07/12/2019 19:37	08/12/2019 12:07	07/12/2019 19:37	08/12/2019 12:07	16,49	25	412,24	CHI
20191246272	PIRENOPOLIS	AN12009330	NEROPOLIS S1	07/12/2019 19:37	08/12/2019 12:07	07/12/2019 19:37	08/12/2019 12:07	16,49	19	313,30	CHI
20191246139	ARENOPOLIS	AY12204302	ARENOPOLIS	07/12/2019 19:38	08/12/2019 17:35	07/12/2019 19:38	08/12/2019 17:35	21,94	2	43,88	CHI
20191246140	FIRMINOPOLIS	8081784	FIRMINOPOLIS S1	07/12/2019 19:38	08/12/2019 01:50	07/12/2019 19:38	08/12/2019 01:50	6,18	34	210,29	CHI
20191246140	TURVANIA	8081784	FIRMINOPOLIS S1	07/12/2019 19:38	08/12/2019 01:50	07/12/2019 19:38	08/12/2019 01:50	6,18	1	6,18	CHI
20191246710	ANAPOLIS	OV12037464	NEROPOLIS S1	07/12/2019 19:38	08/12/2019 10:40	07/12/2019 19:38	08/12/2019 10:40	15,02	41	616,01	CHI
20191246710	OURO VERDE DE GOIAS	OV12037464	NEROPOLIS S1	07/12/2019 19:38	08/12/2019 10:40	07/12/2019 19:38	08/12/2019 10:40	15,02	9	135,22	CHI
20191246710	PETROLINA DE GOIAS	OV12037464	NEROPOLIS S1	07/12/2019 19:38	08/12/2019 10:40	07/12/2019 19:38	08/12/2019 10:40	15,02	10	150,25	CHI
20191246710	PIRENOPOLIS	OV12037464	NEROPOLIS S1	07/12/2019 19:38	08/12/2019 10:40	07/12/2019 19:38	08/12/2019 10:40	15,02	30	450,74	CHI
20191246145	ANAPOLIS	21149665	JUNDIAI S1	07/12/2019 19:40	08/12/2019 15:16	07/12/2019 19:40	08/12/2019 15:16	19,61	1	19,61	CHI
20191246147	PALMEIRAS DE GOIAS	10011984838	PALMEIRAS	07/12/2019 19:40	08/12/2019 08:57	07/12/2019 19:40	08/12/2019 08:57	13,28	1	13,28	CHI
20191246156	URUACU	CR21181432	CAMPINORTE	07/12/2019 19:41	08/12/2019 09:08	07/12/2019 19:41	08/12/2019 09:08	13,44	25	335,94	CHI
20191246158	AGUAS LINDAS DE GOIAS	LA11345884	AGUAS LINDAS DE GOIAS S1	07/12/2019 19:41	07/12/2019 21:24	07/12/2019 19:41	07/12/2019 21:24	1,70	52	88,59	CHI
20191246167	TRINDADE	40157570	TRINDADE	07/12/2019 19:41	08/12/2019 07:08	07/12/2019 19:41	08/12/2019 07:08	11,44	1	11,44	CHI
20191246323	RIO VERDE	RV21205445	CABRIUVA S2	07/12/2019 19:41	09/12/2019 14:09	07/12/2019 19:41	09/12/2019 13:01	41,33	1	41,33	CHI
20191246323	RIO VERDE	RV21207169	CABRIUVA S2	07/12/2019 19:41	09/12/2019 14:09	07/12/2019 19:41	09/12/2019 13:27	41,76	1	41,76	CHI
20191246323	RIO VERDE	RV21412028	CABRIUVA S2	07/12/2019 19:41	09/12/2019 14:09	07/12/2019 19:41	09/12/2019 14:09	42,47	1	42,47	CHI
20191246177	AURILANDIA	SL12003813	SAO LUIZ DOS MONTES BELOS	07/12/2019 19:44	08/12/2019 11:02	07/12/2019 19:44	08/12/2019 11:02	15,30	6	91,79	CHI
20191246177	FIRMINOPOLIS	SL12003813	SAO LUIZ DOS MONTES BELOS	07/12/2019 19:44	08/12/2019 11:02	07/12/2019 19:44	08/12/2019 11:02	15,30	2	30,60	CHI
20191246177	SANCLERLANDIA	SL12003813	SAO LUIZ DOS MONTES BELOS	07/12/2019 19:44	08/12/2019 11:02	07/12/2019 19:44	08/12/2019 11:02	15,30	1	15,30	CHI
20191246177	SAO LUIS DE MONTES BELOS	SL12003813	SAO LUIZ DOS MONTES BELOS	07/12/2019 19:44	08/12/2019 11:02	07/12/2019 19:44	08/12/2019 11:02	15,30	19	290,66	CHI
20191246180	CIDADE OCIDENTAL	2680077204	MARAJOARA	07/12/2019 19:44	07/12/2019 21:02	07/12/2019 19:44	07/12/2019 21:02	1,30	1	1,30	CHI
20191246187	QUIRINOPOLIS	QI21326610	CACHOEIRA ALTA	07/12/2019 19:46	08/12/2019 18:22	07/12/2019 19:46	08/12/2019 18:22	22,60	1	22,60	CHI
20191247213	PIRENOPOLIS	PV12000460	SAO FRANCISCO DE GOIAS	07/12/2019 19:47	08/12/2019 09:45	07/12/2019 19:47	08/12/2019 09:45	13,95	3	41,85	CHI
20191247062	COCALZINHO DE GOIAS	ZN12201365	COCALZINHO	07/12/2019 19:49	08/12/2019 11:24	07/12/2019 19:49	08/12/2019 11:24	15,58	3	46,73	CHI
20191247062	CORUMBA DE GOIAS	ZN12201365	COCALZINHO	07/12/2019 19:49	08/12/2019 11:24	07/12/2019 19:49	08/12/2019 11:24	15,58	16	249,25	CHI
20191246199	INDIARA	IY12170319	EDEIA	07/12/2019 19:50	08/12/2019 14:18	07/12/2019 19:50	08/12/2019 14:18	18,47	5	92,37	CHI
20191246199	PALMEIRAS DE GOIAS	IY12170319	EDEIA	07/12/2019 19:50	08/12/2019 14:18	07/12/2019 19:50	08/12/2019 14:18	18,47	6	110,85	CHI
20191246200	SANTA CRUZ DE GOIAS	BC21300735	CRISTIANOPOLIS	07/12/2019 19:50	07/12/2019 23:18	07/12/2019 19:50	07/12/2019 23:18	3,46	1	3,46	CHI
20191246041	LUZIANIA	10011760379	MARAJOARA	07/12/2019 19:51	07/12/2019 22:37	07/12/2019 19:51	07/12/2019 22:37	2,76	1	2,76	CHI
20191246203	LUZIANIA	LZ11376217	MARAJOARA	07/12/2019 19:51	07/12/2019 21:26	07/12/2019 19:51	07/12/2019 21:26	1,58	44	69,65	CHI
20191246204	APARECIDA DE GOIANIA	200131138	INDEPENDENCIA S2	07/12/2019 19:51	07/12/2019 21:04	07/12/2019 19:51	07/12/2019 21:04	1,20	1	1,20	CHI

20191246205	URUACU	UR21320924	URUACU	07/12/2019 19:53	08/12/2019 12:15	07/12/2019 19:53	08/12/2019 12:15	16,37	1	16,37	CHI
20191246212	GOIANIA	14424435	GOYA S2	07/12/2019 19:53	07/12/2019 20:53	07/12/2019 19:53	07/12/2019 20:53	0,99	1	0,99	CHI
20191246222	PIRES DO RIO	10029884940	PIRES DO RIO S1	07/12/2019 19:56	07/12/2019 23:21	07/12/2019 19:56	07/12/2019 23:21	3,43	1	3,43	CHI
20191246225	FAZENDA NOVA	FN21237252	IPORA	07/12/2019 19:56	08/12/2019 19:15	07/12/2019 19:56	08/12/2019 19:15	23,32	1	23,32	CHI
20191246241	GOUVELANDIA	QI12000340	QUIRINOPOLIS	07/12/2019 20:00	07/12/2019 21:19	07/12/2019 20:00	07/12/2019 21:19	1,31	17	22,27	CHI
20191246245	SANTA HELENA DE GOIAS	SH21022685	IPEGUARI	07/12/2019 20:01	08/12/2019 08:40	07/12/2019 20:01	08/12/2019 08:40	12,65	1	12,65	CHI
20191246413	ABADIANIA	AA12130228	DAIA S2	07/12/2019 20:01	08/12/2019 09:40	07/12/2019 20:01	08/12/2019 09:40	13,65	6	81,89	CHI
20191246255	JATAI	JT12381432	JATAI S1	07/12/2019 20:02	08/12/2019 13:30	07/12/2019 20:02	08/12/2019 13:30	17,45	1	17,45	CHI
20191246259	ACREUNA	2440019740	ACREUNA	07/12/2019 20:03	08/12/2019 09:58	07/12/2019 20:03	08/12/2019 09:58	13,90	1	13,90	CHI
20191246267	GOIANIRA	GR32045904	TRINDADE	07/12/2019 20:03	07/12/2019 23:38	07/12/2019 20:03	07/12/2019 23:38	3,57	4	14,29	CHI
20191246267	TRINDADE	GR32045904	TRINDADE	07/12/2019 20:03	07/12/2019 23:38	07/12/2019 20:03	07/12/2019 23:38	3,57	4	14,29	CHI
20191246266	CACU	CC12226513	CACHOEIRA ALTA	07/12/2019 20:05	07/12/2019 22:48	07/12/2019 20:05	07/12/2019 22:48	2,72	3	8,15	CHI
20191246278	PIRACANJUBA	PJ12257992	PIRACANJUBA	07/12/2019 20:08	08/12/2019 10:46	07/12/2019 20:08	08/12/2019 10:46	14,62	12	175,42	CHI
20191246279	FAZENDA NOVA	FN21113489	JUSSARA	07/12/2019 20:09	09/12/2019 03:48	07/12/2019 20:09	09/12/2019 03:48	31,64	1	31,64	CHI
20191246280	PARAUNA	PU12079039	PARAUNA	07/12/2019 20:09	07/12/2019 23:25	07/12/2019 20:09	07/12/2019 23:25	3,26	37	120,56	CHI
20191246380	PETROLINA DE GOIAS	PG12031546	PETROLINA	07/12/2019 20:10	08/12/2019 11:50	07/12/2019 20:10	08/12/2019 11:50	15,66	25	391,53	CHI
20191246292	PALMEIRAS DE GOIAS	590035009	PALMEIRAS	07/12/2019 20:11	08/12/2019 09:51	07/12/2019 20:11	08/12/2019 09:51	13,66	1	13,66	CHI
20191246297	OUVIDOR	2180015374	CATALAO S1	07/12/2019 20:13	08/12/2019 08:36	07/12/2019 20:13	08/12/2019 08:36	12,39	1	12,39	CHI
201912260881	SANTA RITA DO NOVO DESTINO	BA12156230	BARRO ALTO	07/12/2019 20:13	09/12/2019 14:40	07/12/2019 20:13	09/12/2019 14:40	42,46	3	127,38	CHI
201912260881	BARRO ALTO	BA12156230	BARRO ALTO	07/12/2019 20:13	09/12/2019 14:40	09/12/2019 11:23	09/12/2019 14:40	3,29	45	148,16	CHI
201912260881	SANTA RITA DO NOVO DESTINO	BA12156230	BARRO ALTO	07/12/2019 20:13	09/12/2019 14:40	09/12/2019 11:23	09/12/2019 14:40	3,29	10	32,93	CHI
20191246300	NIQUELANDIA	NQ12253797	URUACU	07/12/2019 20:14	08/12/2019 09:36	07/12/2019 20:14	08/12/2019 09:36	13,37	21	280,69	CHI
20191246303	PADRE BERNARDO	3160004725	PADRE BERNARDO	07/12/2019 20:15	08/12/2019 07:54	07/12/2019 20:15	08/12/2019 07:54	11,65	1	11,65	CHI
20191246305	RIO VERDE	RV21191980	CABRIUVA S1	07/12/2019 20:16	08/12/2019 11:38	07/12/2019 20:16	08/12/2019 11:38	15,37	1	15,37	CHI
20191246306	GOIANESIA	GE21000086	GOIANESIA S1	07/12/2019 20:17	08/12/2019 10:57	07/12/2019 20:17	08/12/2019 10:57	14,66	2	29,33	CHI
20191246309	PROFESSOR JAMIL SAFADY	JS21296764	ROCHEDO	07/12/2019 20:18	08/12/2019 10:06	07/12/2019 20:18	08/12/2019 10:06	13,80	1	13,80	CHI
20191246318	EDEIA	EA21363390	EDEIA	07/12/2019 20:20	08/12/2019 15:39	07/12/2019 20:20	08/12/2019 15:39	19,32	1	19,32	CHI
20191246322	ITARUMA	IM11398162	CACHOEIRA ALTA	07/12/2019 20:21	08/12/2019 13:53	07/12/2019 20:21	08/12/2019 13:53	17,52	1	17,52	CHI
20191246341	FIRMINOPOLIS	00490214	FIRMINOPOLIS S1	07/12/2019 20:22	08/12/2019 14:18	07/12/2019 20:22	07/12/2019 21:18	0,94	120	112,47	CHI
20191246341	SAO LUIS DE MONTES BELOS	00490214	FIRMINOPOLIS S1	07/12/2019 20:22	08/12/2019 14:18	07/12/2019 20:22	07/12/2019 21:18	0,94	4	3,75	CHI
20191246341	TURVANIA	00490214	FIRMINOPOLIS S1	07/12/2019 20:22	08/12/2019 14:18	07/12/2019 20:22	07/12/2019 21:18	0,94	26	24,37	CHI
20191246341	FIRMINOPOLIS	00490214	FIRMINOPOLIS S1	07/12/2019 20:22	08/12/2019 14:18	07/12/2019 20:22	07/12/2019 22:25	2,05	28	57,28	CHI
20191246341	FIRMINOPOLIS	00490214	FIRMINOPOLIS S1	07/12/2019 20:22	08/12/2019 14:18	07/12/2019 20:22	07/12/2019 23:35	3,21	245	787,06	CHI

20191246341	FIRMINOPOLIS	00490214	FIRMINOPOLIS S1	07/12/2019 20:22	08/12/2019 14:18	07/12/2019 20:22	08/12/2019 00:20	3,96	9	35,66	CHI
20191246341	FIRMINOPOLIS	00490214	FIRMINOPOLIS S1	07/12/2019 20:22	08/12/2019 14:18	07/12/2019 20:22	08/12/2019 01:39	5,28	33	174,21	CHI
20191246341	FIRMINOPOLIS	00490214	FIRMINOPOLIS S1	07/12/2019 20:22	08/12/2019 14:18	07/12/2019 20:22	08/12/2019 02:14	5,86	27	158,28	CHI
20191246341	FIRMINOPOLIS	00490214	FIRMINOPOLIS S1	07/12/2019 20:22	08/12/2019 14:18	08/12/2019 02:26	08/12/2019 04:07	1,68	213	358,79	CHI
20191246341	SAO LUIS DE MONTES BELOS	00490214	FIRMINOPOLIS S1	07/12/2019 20:22	08/12/2019 14:18	08/12/2019 02:26	08/12/2019 04:07	1,68	4	6,74	CHI
20191246341	TURVANIA	00490214	FIRMINOPOLIS S1	07/12/2019 20:22	08/12/2019 14:18	08/12/2019 02:26	08/12/2019 04:07	1,68	27	45,48	CHI
20191246341	FIRMINOPOLIS	00490214	FIRMINOPOLIS S1	07/12/2019 20:22	08/12/2019 14:18	08/12/2019 02:26	08/12/2019 07:34	5,13	28	143,76	CHI
20191246341	FIRMINOPOLIS	00490214	FIRMINOPOLIS S1	07/12/2019 20:22	08/12/2019 14:18	08/12/2019 02:26	08/12/2019 09:01	6,58	245	1611,69	CHI
20191246341	FIRMINOPOLIS	00490214	FIRMINOPOLIS S1	07/12/2019 20:22	08/12/2019 14:18	08/12/2019 09:41	08/12/2019 10:01	0,33	488	162,12	CHI
20191246341	SAO LUIS DE MONTES BELOS	00490214	FIRMINOPOLIS S1	07/12/2019 20:22	08/12/2019 14:18	08/12/2019 09:41	08/12/2019 10:01	0,33	4	1,33	CHI
20191246341	TURVANIA	00490214	FIRMINOPOLIS S1	07/12/2019 20:22	08/12/2019 14:18	08/12/2019 09:41	08/12/2019 10:01	0,33	73	24,25	CHI
20191246341	FIRMINOPOLIS	00490214	FIRMINOPOLIS S1	07/12/2019 20:22	08/12/2019 14:18	08/12/2019 02:26	08/12/2019 13:51	11,41	9	102,71	CHI
20191246341	FIRMINOPOLIS	00490214	FIRMINOPOLIS S1	07/12/2019 20:22	08/12/2019 14:18	08/12/2019 02:26	08/12/2019 14:18	11,86	60	711,35	CHI
20191246325	GOIANIA	15339439	MEIA PONTE	07/12/2019 20:23	07/12/2019 23:22	07/12/2019 20:23	07/12/2019 23:22	2,97	1	2,97	CHI
20191246392	PORANGATU	PO1200035LD	PORANGATU	07/12/2019 20:24	08/12/2019 09:38	07/12/2019 20:24	08/12/2019 09:38	13,25	229	3033,23	CHI
20191246375	PADRE BERNARDO	PB12377211	PADRE BERNARDO	07/12/2019 20:26	08/12/2019 07:19	07/12/2019 20:26	08/12/2019 07:19	10,88	12	130,54	CHI
20191246340	PROFESSOR JAMIL SAFADY	JS21129664	ROCHEDO	07/12/2019 20:27	08/12/2019 10:42	07/12/2019 20:27	08/12/2019 10:42	14,24	1	14,24	CHI
20191246343	ACREUNA	2440058793	ACREUNA	07/12/2019 20:28	08/12/2019 00:21	07/12/2019 20:28	08/12/2019 00:21	3,87	1	3,87	CHI
20191246504	SANTA ROSA DE GOIAS	SR12297940	INHUMAS S1	07/12/2019 20:29	08/12/2019 05:48	07/12/2019 20:29	08/12/2019 05:48	9,31	4	37,23	CHI
20191247121	PETROLINA DE GOIAS	PG12101826	PETROLINA	07/12/2019 20:30	08/12/2019 12:10	07/12/2019 20:30	08/12/2019 12:10	15,67	10	156,74	CHI
20191246390	VALPARAISO DE GOIAS	VA11169032	PACAEMBU S2	07/12/2019 20:31	07/12/2019 22:38	07/12/2019 20:31	07/12/2019 22:38	2,11	161	339,80	CHI
20191246350	SAO MIGUEL DO ARAGUAIA	10015211604	SAO MIGUEL DO ARAGUAIA	07/12/2019 20:32	08/12/2019 01:49	07/12/2019 20:32	08/12/2019 01:49	5,28	1	5,28	CHI
20191246355	CABECEIRAS	CW21137976	ITUIQUIRA	07/12/2019 20:34	08/12/2019 10:26	07/12/2019 20:34	08/12/2019 10:26	13,86	1	13,86	CHI
20191246367	AGUA FRIA DE GOIAS	TL21150859	SAO JOAO D ALIANCA	07/12/2019 20:38	08/12/2019 12:48	07/12/2019 20:38	08/12/2019 12:48	16,16	1	16,16	CHI
20191246372	APORE	AE12316391	ITAJA S2	07/12/2019 20:41	09/12/2019 04:14	07/12/2019 20:41	09/12/2019 04:14	31,55	1	31,55	CHI
20191246379	PORANGATU	PO21339758	PORANGATU	07/12/2019 20:44	08/12/2019 11:32	07/12/2019 20:44	08/12/2019 11:32	14,79	1	14,79	CHI
20191246387	ANAPOLIS	20873086	ANAPOLIS UNIVERSITARIO S1	07/12/2019 20:48	08/12/2019 12:05	07/12/2019 20:48	08/12/2019 12:05	15,29	1	15,29	CHI
20191246388	TURVANIA	TV21259935	FIRMINOPOLIS S2	07/12/2019 20:49	08/12/2019 11:50	07/12/2019 20:49	08/12/2019 11:50	15,02	2	30,03	CHI
20191246416	PETROLINA DE GOIAS	PV12302405	SAO FRANCISCO DE GOIAS	07/12/2019 20:49	08/12/2019 17:12	07/12/2019 20:49	08/12/2019 17:12	20,38	5	101,89	CHI
20191246416	PIRENOPOLIS	PV12302405	SAO FRANCISCO DE GOIAS	07/12/2019 20:49	08/12/2019 17:12	07/12/2019 20:49	08/12/2019 17:12	20,38	60	1222,72	CHI
20191246416	SAO FRANCISCO DE GOIAS	PV12302405	SAO FRANCISCO DE GOIAS	07/12/2019 20:49	08/12/2019 17:12	07/12/2019 20:49	08/12/2019 17:12	20,38	19	387,19	CHI
20191246397	PARAUNA	PU21318262	PARAUNA	07/12/2019 20:52	08/12/2019 14:44	07/12/2019 20:52	08/12/2019 14:44	17,86	1	17,86	CHI
20191246398	APORE	3110003774	ITAJA S1	07/12/2019 20:52	08/12/2019 10:55	07/12/2019 20:52	08/12/2019 10:55	14,04	1	14,04	CHI



20191246401	RIO VERDE	MV12260790	MONTIVIDIU T	07/12/2019 20:53	08/12/2019 18:38	07/12/2019 20:53	08/12/2019 18:38	21,74	19	413,04	CHI
20191246402	MUNDO NOVO DE GOIAS	MH11275556	NOVA CRIXAS	07/12/2019 20:54	08/12/2019 09:36	07/12/2019 20:54	08/12/2019 09:36	12,69	2	25,38	CHI
20191246408	ITAJA	IJ21000069	CACHOEIRA ALTA	07/12/2019 20:55	08/12/2019 09:50	07/12/2019 20:55	08/12/2019 09:50	12,91	1	12,91	CHI
20191246445	CROMINIA	CQ12000220	PONTALINA	07/12/2019 20:55	08/12/2019 10:23	07/12/2019 20:55	08/12/2019 10:23	13,46	6	80,76	CHI
20191246445	MAIRIPOTABA	CQ12000220	PONTALINA	07/12/2019 20:55	08/12/2019 10:23	07/12/2019 20:55	08/12/2019 10:23	13,46	7	94,22	CHI
20191246411	MINEIROS	MY11359703	PARQUE DAS EMAS	07/12/2019 20:56	07/12/2019 23:43	07/12/2019 22:27	07/12/2019 23:43	1,27	19	24,07	CHI
20191246412	BURITI ALEGRE	BG12039116	ITUMBIARA VELHA S2	07/12/2019 20:57	08/12/2019 14:00	07/12/2019 20:57	08/12/2019 14:00	17,05	10	170,47	CHI
20191246418	SAO MIGUEL DO ARAGUAIA	SM21245795	SAO MIGUEL DO ARAGUAIA	07/12/2019 21:00	08/12/2019 08:32	07/12/2019 21:00	08/12/2019 08:32	11,53	1	11,53	CHI
20191246676	ANICUNS	AC12306940	ANICUNS	07/12/2019 21:01	08/12/2019 07:03	07/12/2019 21:01	08/12/2019 07:03	10,03	35	351,09	CHI
20191246676	ITABERAI	AC12306940	ANICUNS	07/12/2019 21:01	08/12/2019 07:03	07/12/2019 21:01	08/12/2019 07:03	10,03	2	20,06	CHI
20191246427	COCALZINHO DE GOIAS	ZN12377435	COCALZINHO	07/12/2019 21:06	08/12/2019 08:57	07/12/2019 21:06	08/12/2019 08:57	11,83	54	639,03	CHI
20191246430	ANICUNS	AC11000020	ANICUNS	07/12/2019 21:07	08/12/2019 00:18	07/12/2019 21:07	08/12/2019 00:18	3,18	122	387,82	CHI
20191246654	JANDAIA	JD12391449	PALMEIRAS	07/12/2019 21:07	08/12/2019 08:40	07/12/2019 21:07	08/12/2019 08:40	11,54	3	34,63	CHI
20191246433	GOIAS	10018588652	GOIAS	07/12/2019 21:08	08/12/2019 10:51	07/12/2019 21:08	08/12/2019 10:51	13,72	1	13,72	CHI
20191246438	PIRENOPOLIS	PV21334684	CORUMBA	07/12/2019 21:11	08/12/2019 10:50	07/12/2019 21:11	08/12/2019 10:50	13,65	1	13,65	CHI
20191246439	PLANALTINA	PI21359024	PLANALTINA	07/12/2019 21:11	08/12/2019 13:12	07/12/2019 21:11	08/12/2019 13:12	16,01	1	16,01	CHI
20191246454	ITAUCU	IX21016909	INHUMAS S1	07/12/2019 21:18	08/12/2019 09:45	07/12/2019 21:18	08/12/2019 09:45	12,44	4	49,77	CHI
20191246455	MOSSAMEDES	MD21121038	FIRMINOPOLIS S2	07/12/2019 21:19	08/12/2019 00:30	07/12/2019 21:19	08/12/2019 00:30	3,18	1	3,18	CHI
20191246463	GOIANIA	GN12134464LD	XAVANTES	07/12/2019 21:19	08/12/2019 00:25	07/12/2019 21:19	08/12/2019 00:25	3,09	64	197,53	CHI
20191246458	AGUAS LINDAS DE GOIAS	10008308010	AGUAS LINDAS DE GOIAS S1	07/12/2019 21:20	07/12/2019 23:22	07/12/2019 21:20	07/12/2019 23:22	2,02	1	2,02	CHI
20191246461	ITABERAI	IB12172690	ITABERAI S2	07/12/2019 21:23	08/12/2019 11:11	07/12/2019 21:23	08/12/2019 11:11	13,79	6	82,72	CHI
20191246462	RIO VERDE	RV11359402	RIO VERDE S2	07/12/2019 21:23	08/12/2019 00:45	07/12/2019 21:23	08/12/2019 00:45	3,35	25	83,84	CHI
20191246469	MATRINCHA	MP11223805	MATRINCHA	07/12/2019 21:26	08/12/2019 09:30	07/12/2019 21:26	08/12/2019 09:30	12,05	1	12,05	CHI
20191246474	ANAPOLIS	20616259	JUNDIAI S2	07/12/2019 21:31	07/12/2019 22:56	07/12/2019 21:31	07/12/2019 22:56	1,41	1	1,41	CHI
20191246475	AGUAS LINDAS DE GOIAS	4830251725	AGUAS LINDAS DE GOIAS S1	07/12/2019 21:32	07/12/2019 23:20	07/12/2019 21:32	07/12/2019 23:20	1,79	1	1,79	CHI
20191246479	APARECIDA DE GOIANIA	AP11095066	ANHANGUERA	07/12/2019 21:35	08/12/2019 18:23	07/12/2019 21:35	08/12/2019 18:23	20,80	101	2100,41	CHI
20191246043	CAMPINACU	IH10284240	MINACU	07/12/2019 21:44	08/12/2019 18:50	07/12/2019 21:44	07/12/2019 21:47	0,05	27	1,40	CHI
20191246043	MINACU	IH10284240	MINACU	07/12/2019 21:44	08/12/2019 18:50	07/12/2019 21:44	07/12/2019 21:47	0,05	1777	91,81	CHI
20191246043	TROMBAS	IH10284240	MINACU	07/12/2019 21:44	08/12/2019 18:50	07/12/2019 21:44	07/12/2019 21:47	0,05	6	0,31	CHI
20191246043	MINACU	IH16404036	MINACU	07/12/2019 21:44	08/12/2019 18:50	07/12/2019 21:48	07/12/2019 22:52	1,08	352	379,77	CHI
20191246043	MINACU	IH16404036	MINACU	07/12/2019 21:44	08/12/2019 18:50	07/12/2019 22:53	08/12/2019 00:08	1,26	91	114,48	CHI
20191246043	MINACU	IH16404036	MINACU	07/12/2019 21:44	08/12/2019 18:50	08/12/2019 00:09	08/12/2019 18:17	18,13	1	18,13	CHI
20191246043	MINACU	IH16404036	MINACU	07/12/2019 21:44	08/12/2019 18:50	07/12/2019 21:48	08/12/2019 18:50	21,03	1005	21135,15	CHI

20191246043	TROMBAS	IH16404036	MINACU	07/12/2019 21:44	08/12/2019 18:50	07/12/2019 21:48	08/12/2019 18:50	21,03	6	126,18	CHI
20191246043	MINACU	IH16404036	MINACU	07/12/2019 21:44	08/12/2019 18:50	07/12/2019 22:53	08/12/2019 18:50	19,95	261	5206,15	CHI
20191246043	MINACU	IH16404036	MINACU	07/12/2019 21:44	08/12/2019 18:50	08/12/2019 00:09	08/12/2019 18:50	18,68	90	1681,37	CHI
20191246043	MINACU	IH13377677	MINACU	07/12/2019 21:44	08/12/2019 18:50	08/12/2019 12:12	08/12/2019 18:50	6,63	17	112,67	CHI
20191246491	APARECIDA DE GOIANIA	AP11378264	ANHANGUERA	07/12/2019 21:48	08/12/2019 01:30	07/12/2019 21:48	08/12/2019 01:30	3,70	116	428,62	CHI
20191246791	TAQUARAL DE GOIAS	TQ12025616	ITABERAI S1	07/12/2019 21:48	08/12/2019 21:59	07/12/2019 21:48	08/12/2019 21:59	24,18	3	72,53	CHI
20191246496	INACIOLANDIA	ID12306349	CACHOEIRA DOURADA	07/12/2019 21:49	07/12/2019 22:59	07/12/2019 21:49	07/12/2019 22:59	1,16	5	5,80	CHI
20191246497	COLINAS DO SUL	9700001665	NIQUELANDIA SUBTRANSMISSAO	07/12/2019 21:50	07/12/2019 23:29	07/12/2019 21:50	07/12/2019 23:29	1,64	1	1,64	CHI
20191246798	SAO FRANCISCO DE GOIAS	SF12080076	SAO FRANCISCO DE GOIAS	07/12/2019 21:51	08/12/2019 09:11	07/12/2019 21:51	08/12/2019 09:11	11,33	17	192,64	CHI
20191246501	ADELANDIA	DN21016333	FIRMINOPOLIS S2	07/12/2019 21:53	08/12/2019 09:19	07/12/2019 21:53	08/12/2019 09:19	11,43	2	22,86	CHI
20191246509	GOIANIA	17314057	REAL S2	07/12/2019 22:00	07/12/2019 23:57	07/12/2019 22:00	07/12/2019 23:57	1,94	1	1,94	CHI
20191246511	CAIAPONIA	CP12380880	CAIAPONIA	07/12/2019 22:01	09/12/2019 06:42	07/12/2019 22:01	09/12/2019 06:42	32,67	10	326,72	CHI
20191246514	ABADIA DE GOIAS	AP13401618	INDEPENDENCIA S2	07/12/2019 22:01	07/12/2019 23:30	07/12/2019 22:01	07/12/2019 22:57	0,93	1172	1093,87	CHI
20191246514	APARECIDA DE GOIANIA	AP13401618	INDEPENDENCIA S2	07/12/2019 22:01	07/12/2019 23:30	07/12/2019 22:01	07/12/2019 22:57	0,93	4145	3868,67	CHI
20191246514	ARAGOIANIA	AP13401618	INDEPENDENCIA S2	07/12/2019 22:01	07/12/2019 23:30	07/12/2019 22:01	07/12/2019 22:57	0,93	411	383,60	CHI
20191246514	GOIANIA	AP13401618	INDEPENDENCIA S2	07/12/2019 22:01	07/12/2019 23:30	07/12/2019 22:01	07/12/2019 22:57	0,93	955	891,33	CHI
20191246514	GUAPO	AP13401618	INDEPENDENCIA S2	07/12/2019 22:01	07/12/2019 23:30	07/12/2019 22:01	07/12/2019 22:57	0,93	14	13,07	CHI
20191246514	APARECIDA DE GOIANIA	AP13401618	INDEPENDENCIA S2	07/12/2019 22:01	07/12/2019 23:30	07/12/2019 22:02	07/12/2019 22:57	0,90	1673	1506,16	CHI
20191246514	APARECIDA DE GOIANIA	AP16407615	INDEPENDENCIA S2	07/12/2019 22:01	07/12/2019 23:30	07/12/2019 22:53	07/12/2019 23:30	0,63	759	474,80	CHI
20191246528	GOIANIA	GN12023360	REAL S1	07/12/2019 22:03	07/12/2019 23:46	07/12/2019 22:03	07/12/2019 23:46	1,71	263	450,31	CHI
20191246539	APARECIDA DE GOIANIA	10024368723	INDEPENDENCIA S2	07/12/2019 22:06	08/12/2019 08:13	07/12/2019 22:06	08/12/2019 08:13	10,10	1	10,10	CHI
20191246543	FORMOSA	10005215283	ITIQUEIRA	07/12/2019 22:08	07/12/2019 23:40	07/12/2019 22:08	07/12/2019 23:40	1,53	1	1,53	CHI
20191246551	AGUA FRIA DE GOIAS	JL12117446	SAO JOAO D ALIANCA	07/12/2019 22:09	08/12/2019 13:31	07/12/2019 22:09	08/12/2019 13:31	15,36	19	291,81	CHI
20191246551	SAO JOAO D ALIANCA	JL12117446	SAO JOAO D ALIANCA	07/12/2019 22:09	08/12/2019 13:31	07/12/2019 22:09	08/12/2019 13:31	15,36	18	276,45	CHI
20191246551	SAO JOAO D ALIANCA	TL12204731LD	SAO JOAO D ALIANCA	07/12/2019 22:09	08/12/2019 13:31	07/12/2019 22:09	08/12/2019 13:31	15,36	7	107,51	CHI
20191246747	ORIZONA	PR12333485	PIRES DO RIO S2	07/12/2019 22:09	08/12/2019 10:56	07/12/2019 22:09	08/12/2019 10:56	12,78	5	63,91	CHI
20191246747	PIRES DO RIO	PR12333485	PIRES DO RIO S2	07/12/2019 22:09	08/12/2019 10:56	07/12/2019 22:09	08/12/2019 10:56	12,78	5	63,91	CHI
20191246557	TRINDADE	10017147377	TRINDADE	07/12/2019 22:11	08/12/2019 03:16	07/12/2019 22:11	08/12/2019 03:16	5,09	1	5,09	CHI
20191246653	GOIANIA	AP11160157	INDEPENDENCIA S2	07/12/2019 22:11	07/12/2019 23:54	07/12/2019 22:11	07/12/2019 23:54	1,73	110	189,93	CHI
20191246626	APARECIDA DE GOIANIA	AP12058737	INDEPENDENCIA S1	07/12/2019 22:13	08/12/2019 00:48	07/12/2019 22:13	08/12/2019 00:48	2,58	225	580,62	CHI
20191247421	RIO VERDE	RV12393335	MONTIVIDIU T	07/12/2019 22:17	08/12/2019 11:40	07/12/2019 22:17	08/12/2019 11:40	13,38	17	227,40	CHI
20191246599	CATALAO	10008459981	CATALAO S1	07/12/2019 22:18	08/12/2019 07:08	07/12/2019 22:18	08/12/2019 07:08	8,82	1	8,82	CHI
20191246045	HIDROLANDIA	HD11000036	CEPAIGO S2	07/12/2019 22:25	07/12/2019 22:35	07/12/2019 22:25	07/12/2019 22:35	0,16	215	34,94	CHI

20191246631	ISRAELANDIA	IS21015575	IPORA	07/12/2019 22:25	08/12/2019 18:15	07/12/2019 22:25	08/12/2019 18:15	19,83	1	19,83	CHI
20191246645	ANAPOLIS	20689962	ANAPOLIS UNIVERSITARIO S2	07/12/2019 22:29	08/12/2019 08:53	07/12/2019 22:29	08/12/2019 08:53	10,39	1	10,39	CHI
20191246666	FIRMINOPOLIS	FR12028946	FIRMINOPOLIS S1	07/12/2019 22:35	08/12/2019 10:48	07/12/2019 22:35	08/12/2019 10:48	12,20	21	256,27	CHI
20191246671	QUIRINOPOLIS	QI11000006	QUIRINOPOLIS	07/12/2019 22:36	08/12/2019 01:51	07/12/2019 23:05	08/12/2019 01:51	2,77	98	271,13	CHI
20191246722	GOIANIA	GN11169427	REAL S1	07/12/2019 22:42	08/12/2019 00:32	07/12/2019 22:42	08/12/2019 00:32	1,82	59	107,40	CHI
20191246763	MINACU	IH11202492	MINACU	07/12/2019 22:49	08/12/2019 08:50	07/12/2019 22:49	08/12/2019 08:50	10,00	11	110,01	CHI
20191246768	PLANALTINA	PI11062212	PLANALTINA	07/12/2019 22:49	08/12/2019 00:39	07/12/2019 22:49	08/12/2019 00:39	1,83	20	36,64	CHI
20191246719	SAO LUIS DE MONTES BELOS	SL12376360	FIRMINOPOLIS S2	07/12/2019 22:55	08/12/2019 11:20	07/12/2019 22:55	08/12/2019 11:20	12,42	10	124,16	CHI
20191246720	GOIANIA	12540833	GOIANIA LESTE S3	07/12/2019 22:55	08/12/2019 01:41	07/12/2019 22:55	08/12/2019 01:41	2,75	1	2,75	CHI
20191247115	PARAUNA	PU12159023	PARAUNA	07/12/2019 23:01	09/12/2019 12:32	07/12/2019 23:01	08/12/2019 22:32	23,50	1	23,50	CHI
20191247115	PARAUNA	PU12159023	PARAUNA	07/12/2019 23:01	09/12/2019 12:32	07/12/2019 23:01	09/12/2019 10:40	35,65	2	71,29	CHI
20191247115	PARAUNA	PU12159023	PARAUNA	07/12/2019 23:01	09/12/2019 12:32	07/12/2019 23:01	09/12/2019 12:32	37,51	1	37,51	CHI
20191246729	DAVINOPOLIS	IO12000011RE	CATALAO S1	07/12/2019 23:04	08/12/2019 22:04	07/12/2019 23:04	08/12/2019 14:20	15,26	31	473,09	CHI
20191246729	DISTRITO FEDERAL	IO12000011RE	CATALAO S1	07/12/2019 23:04	08/12/2019 22:04	07/12/2019 23:04	08/12/2019 14:20	15,26	3	45,78	CHI
20191246729	OUVIDOR	IO12000011RE	CATALAO S1	07/12/2019 23:04	08/12/2019 22:04	07/12/2019 23:04	08/12/2019 14:20	15,26	7	106,83	CHI
20191246729	TRES RANCHOS	IO12000011RE	CATALAO S1	07/12/2019 23:04	08/12/2019 22:04	07/12/2019 23:04	08/12/2019 14:20	15,26	4	61,04	CHI
20191246729	DAVINOPOLIS	IO12000011RE	CATALAO S1	07/12/2019 23:04	08/12/2019 22:04	07/12/2019 23:04	08/12/2019 22:04	23,00	2	45,99	CHI
20191246729	OUVIDOR	IO12000011RE	CATALAO S1	07/12/2019 23:04	08/12/2019 22:04	07/12/2019 23:04	08/12/2019 22:04	23,00	5	114,98	CHI
20191246729	DAVINOPOLIS	IO12190489LD	CATALAO S1	07/12/2019 23:04	08/12/2019 22:04	08/12/2019 20:52	08/12/2019 22:04	1,20	27	32,48	CHI
20191246729	DISTRITO FEDERAL	IO12190489LD	CATALAO S1	07/12/2019 23:04	08/12/2019 22:04	08/12/2019 20:52	08/12/2019 22:04	1,20	3	3,61	CHI
20191246729	OUVIDOR	IO12190489LD	CATALAO S1	07/12/2019 23:04	08/12/2019 22:04	08/12/2019 20:52	08/12/2019 22:04	1,20	7	8,42	CHI
20191246729	TRES RANCHOS	IO12190489LD	CATALAO S1	07/12/2019 23:04	08/12/2019 22:04	08/12/2019 20:52	08/12/2019 22:04	1,20	4	4,81	CHI
20191246732	SAO LUIS DE MONTES BELOS	SL21283618	FIRMINOPOLIS S2	07/12/2019 23:06	08/12/2019 12:07	07/12/2019 23:06	08/12/2019 12:07	13,01	1	13,01	CHI
20191246734	CABECEIRAS	CW12181812	ITIQUEIRA	07/12/2019 23:10	08/12/2019 08:56	07/12/2019 23:10	08/12/2019 08:56	9,76	2	19,52	CHI
20191246736	GOIANIA	GN11003154	ATLANTICO S1	07/12/2019 23:11	08/12/2019 01:48	07/12/2019 23:11	08/12/2019 01:48	2,62	51	133,73	CHI
20191246737	GOIANIA	GN11001370	ATLANTICO S1	07/12/2019 23:11	08/12/2019 04:09	07/12/2019 23:11	08/12/2019 00:11	0,99	87	85,79	CHI
20191246737	GOIANIA	GN11001370	ATLANTICO S1	07/12/2019 23:11	08/12/2019 04:09	08/12/2019 00:32	08/12/2019 04:09	3,62	87	315,25	CHI
20191246738	ANAPOLIS	21164745	ANAPOLIS UNIVERSITARIO S2	07/12/2019 23:11	08/12/2019 08:40	07/12/2019 23:11	08/12/2019 08:40	9,47	1	9,47	CHI
20191246746	AGUAS LINDAS DE GOIAS	10018078298	AGUAS LINDAS DE GOIAS S1	07/12/2019 23:17	07/12/2019 23:49	07/12/2019 23:17	07/12/2019 23:49	0,53	1	0,53	CHI
20191246751	ITARUMA	2310004152	CACHOEIRA ALTA	07/12/2019 23:20	08/12/2019 14:43	07/12/2019 23:20	08/12/2019 14:43	15,38	1	15,38	CHI
20191246754	MAMBAI	MB12190551	IACIARA S2	07/12/2019 23:24	08/12/2019 16:03	07/12/2019 23:24	08/12/2019 16:03	16,65	3	49,94	CHI
20191246756	GOIANIA	10011882	AEROPORTO S3	07/12/2019 23:28	08/12/2019 01:28	07/12/2019 23:28	08/12/2019 01:28	2,00	1	2,00	CHI
20191246766	TURVELANDIA	TD21303615	RIO DOS BOIS	07/12/2019 23:44	08/12/2019 11:42	07/12/2019 23:44	08/12/2019 11:42	11,97	1	11,97	CHI

20191246771	VALPARAISO DE GOIAS	2860062665	PACAEMBU S2	07/12/2019 23:52	08/12/2019 02:03	07/12/2019 23:52	08/12/2019 02:03	2,17	1	2,17	CHI
20191246777	PIRES DO RIO	PR21407522	PIRES DO RIO S2	08/12/2019 00:07	08/12/2019 12:57	08/12/2019 00:07	08/12/2019 12:57	12,83	1	12,83	CHI
20191247187	SANTO ANTONIO DA BARRA	BZ12048972	ACREUNA	08/12/2019 00:10	08/12/2019 09:45	08/12/2019 00:10	08/12/2019 09:45	9,58	4	38,32	CHI
20191246780	QUIRINOPOLIS	QI12296596	QUIRINOPOLIS	08/12/2019 00:14	08/12/2019 04:56	08/12/2019 00:14	08/12/2019 04:56	4,70	61	286,65	CHI
20191246909	ITAPIRAPUA	JR12087418	JUSSARA	08/12/2019 00:16	08/12/2019 22:40	08/12/2019 00:16	08/12/2019 22:40	22,40	1	22,40	CHI
20191246909	JUSSARA	JR12087418	JUSSARA	08/12/2019 00:16	08/12/2019 22:40	08/12/2019 00:16	08/12/2019 22:40	22,40	11	246,42	CHI
20191247068	COCALZINHO DE GOIAS	ZN12000125	COCALZINHO	08/12/2019 00:29	08/12/2019 10:09	08/12/2019 00:29	08/12/2019 10:09	9,66	41	396,01	CHI
20191247068	CORUMBA DE GOIAS	ZN12000125	COCALZINHO	08/12/2019 00:29	08/12/2019 10:09	08/12/2019 00:29	08/12/2019 10:09	9,66	19	183,52	CHI
20191246790	PARAUNA	BZ10407792	ACREUNA	08/12/2019 00:35	08/12/2019 05:14	08/12/2019 00:35	08/12/2019 05:14	4,66	157	731,53	CHI
20191246790	RIO VERDE	BZ10407792	ACREUNA	08/12/2019 00:35	08/12/2019 05:14	08/12/2019 00:35	08/12/2019 05:14	4,66	142	661,64	CHI
20191246790	SANTO ANTONIO DA BARRA	BZ10407792	ACREUNA	08/12/2019 00:35	08/12/2019 05:14	08/12/2019 00:35	08/12/2019 05:14	4,66	90	419,35	CHI
20191246790	SANTO ANTONIO DA BARRA	BZ10407792	ACREUNA	08/12/2019 00:35	08/12/2019 05:14	08/12/2019 04:55	08/12/2019 05:14	0,32	93	29,99	CHI
20191246797	HIDROLINA	UR12374713	URUACU	08/12/2019 00:55	08/12/2019 09:28	08/12/2019 00:55	08/12/2019 09:28	8,54	4	34,15	CHI
20191246797	URUACU	UR12374713	URUACU	08/12/2019 00:55	08/12/2019 09:28	08/12/2019 00:55	08/12/2019 09:28	8,54	3	25,61	CHI
20191246796	DOVERLANDIA	DV12358445	CAIAPONIA	08/12/2019 00:56	08/12/2019 07:05	08/12/2019 00:56	08/12/2019 07:05	6,15	21	129,15	CHI
20191246799	GOIANIA	10493888	GOIANIA LESTE S3	08/12/2019 01:11	08/12/2019 02:30	08/12/2019 01:11	08/12/2019 02:30	1,31	1	1,31	CHI
20191246908	SAO LUIS DE MONTES BELOS	500115862	SAO LUIZ DOS MONTES BELOS	08/12/2019 01:33	08/12/2019 11:41	08/12/2019 01:33	08/12/2019 11:41	10,14	1	10,14	CHI
20191247072	PLANALTINA	PI11062212	PLANALTINA	08/12/2019 01:43	08/12/2019 09:07	08/12/2019 01:43	08/12/2019 09:07	7,39	20	147,71	CHI
20191246918	ARUANA	AK12404527	MOZARLANDIA	08/12/2019 02:23	08/12/2019 07:28	08/12/2019 02:23	08/12/2019 07:28	5,07	34	172,32	CHI
20191246920	TRINDADE	40244192	TRINDADE	08/12/2019 02:31	08/12/2019 05:10	08/12/2019 02:31	08/12/2019 05:10	2,64	1	2,64	CHI
20191246921	RIO VERDE	RV12191832	CABRIUVA S2	08/12/2019 02:42	08/12/2019 13:15	08/12/2019 02:42	08/12/2019 13:15	10,55	7	73,83	CHI
20191247095	NOVA IGUACU DE GOIAS	NH12317131	CAMPINORTE	08/12/2019 02:53	08/12/2019 15:50	08/12/2019 02:53	08/12/2019 15:50	12,95	42	543,77	CHI
20191246980	NIQUELANDIA	NQ12039296	BARRO ALTO	08/12/2019 03:13	10/12/2019 15:33	08/12/2019 03:13	08/12/2019 10:52	7,65	22	168,27	CHI
20191246980	NIQUELANDIA	NQ13345208	BARRO ALTO	08/12/2019 03:13	10/12/2019 15:33	08/12/2019 03:13	08/12/2019 13:16	10,05	22	221,08	CHI
20191246980	NIQUELANDIA	NQ12345204LD	BARRO ALTO	08/12/2019 03:13	10/12/2019 15:33	08/12/2019 03:13	09/12/2019 01:08	21,91	15	328,61	CHI
20191246980	NIQUELANDIA	NQ13345088	BARRO ALTO	08/12/2019 03:13	10/12/2019 15:33	08/12/2019 03:13	09/12/2019 22:57	43,73	22	962,10	CHI
20191246980	NIQUELANDIA	NQ13348689	BARRO ALTO	08/12/2019 03:13	10/12/2019 15:33	08/12/2019 03:13	10/12/2019 15:33	60,32	11	663,50	CHI
20191247015	DISTRITO FEDERAL	05410224	MARAJOARA	08/12/2019 03:29	08/12/2019 08:17	08/12/2019 03:29	08/12/2019 08:17	4,80	48	230,27	CHI
20191247015	NOVO GAMA	05410224	MARAJOARA	08/12/2019 03:29	08/12/2019 08:17	08/12/2019 03:29	08/12/2019 08:17	4,80	10	47,97	CHI
20191247015	SANTO ANTONIO DO DESCOBERTO	05410224	MARAJOARA	08/12/2019 03:29	08/12/2019 08:17	08/12/2019 03:29	08/12/2019 08:17	4,80	820	3933,72	CHI
20191246929	SAO MIGUEL DO ARAGUAIA	SM12228636	SAO MIGUEL DO ARAGUAIA	08/12/2019 03:31	08/12/2019 12:14	08/12/2019 03:31	08/12/2019 12:14	8,71	56	487,88	CHI
20191246930	SILVANIA	SV12340735	VIANOPOLIS	08/12/2019 03:31	08/12/2019 11:47	08/12/2019 03:31	08/12/2019 11:47	8,26	46	379,99	CHI
20191246931	COCALZINHO DE GOIAS	ZN12330505	AGUAS LINDAS DE GOIAS S2	08/12/2019 03:40	08/12/2019 10:23	08/12/2019 03:40	08/12/2019 10:23	6,70	28	187,63	CHI

20191246931	PADRE BERNARDO	ZN12330505	AGUAS LINDAS DE GOIAS S2	08/12/2019 03:40	08/12/2019 10:23	08/12/2019 03:40	08/12/2019 10:23	6,70	4	26,80	CHI
20191246935	MUTUNOPOLIS	MU12220645	MARA ROSA	08/12/2019 03:52	08/12/2019 08:32	08/12/2019 03:52	08/12/2019 08:32	4,67	31	144,63	CHI
20191246935	PORANGATU	MU12220645	MARA ROSA	08/12/2019 03:52	08/12/2019 08:32	08/12/2019 03:52	08/12/2019 08:32	4,67	44	205,28	CHI
20191246937	ALEXANIA	AX21090406	ALEXANIA	08/12/2019 04:01	08/12/2019 12:42	08/12/2019 04:01	08/12/2019 12:42	8,67	1	8,67	CHI
20191246803	SAO MIGUEL DO ARAGUAIA	SM10404193	SAO MIGUEL DO ARAGUAIA	08/12/2019 04:09	08/12/2019 07:17	08/12/2019 04:09	08/12/2019 07:17	3,13	12	37,55	CHI
20191247126	GOIANESIA	GE12352313	GOIANESIA S1	08/12/2019 04:19	08/12/2019 12:08	08/12/2019 04:19	08/12/2019 12:08	7,82	23	179,77	CHI
20191247126	SAO LUIZ DO NORTE	GE12352313	GOIANESIA S1	08/12/2019 04:19	08/12/2019 12:08	08/12/2019 04:19	08/12/2019 12:08	7,82	21	164,14	CHI
20191246940	SERRANOPOLIS	SX12216620	JATAI S1	08/12/2019 04:25	08/12/2019 14:15	08/12/2019 04:25	08/12/2019 14:15	9,83	5	49,14	CHI
201912233851	JATAI	JT12214374	JATAI S3	08/12/2019 04:25	08/12/2019 08:02	08/12/2019 04:25	08/12/2019 08:02	3,61	6	21,66	CHI
20191247017	RIO VERDE	RV12371578	RIO VERDE S1	08/12/2019 04:30	08/12/2019 10:05	08/12/2019 04:30	08/12/2019 10:05	5,57	91	507,25	CHI
20191247277	CEZARINA	CZ12314870	CEZARINA	08/12/2019 04:31	08/12/2019 09:50	08/12/2019 04:31	08/12/2019 09:50	5,30	22	116,69	CHI
20191247964	PALMINOPOLIS	PP12259150	PALMEIRAS	08/12/2019 04:37	08/12/2019 20:15	08/12/2019 04:37	08/12/2019 20:15	15,63	8	125,02	CHI
20191247138	SANTA FE DE GOIAS	RN12009764	BRITANIA	08/12/2019 04:38	09/12/2019 07:38	08/12/2019 04:38	09/12/2019 07:38	26,99	6	161,91	CHI
20191246948	DOVERLANDIA	DV12139919	CAIAPONIA	08/12/2019 04:44	08/12/2019 11:01	08/12/2019 04:44	08/12/2019 11:01	6,27	49	307,11	CHI
20191246950	NOVO PLANALTO	TA12192342	NOVO PLANALTO	08/12/2019 04:47	08/12/2019 10:03	08/12/2019 04:47	08/12/2019 10:03	5,25	1	5,25	CHI
20191246950	PORANGATU	TA12192342	NOVO PLANALTO	08/12/2019 04:47	08/12/2019 10:03	08/12/2019 04:47	08/12/2019 10:03	5,25	9	47,27	CHI
20191247846	JUSSARA	JR12198907	BRITANIA	08/12/2019 04:51	08/12/2019 22:08	08/12/2019 04:51	08/12/2019 22:08	17,28	36	621,92	CHI
20191247065	PONTALINA	PK12000100	PONTALINA	08/12/2019 04:52	08/12/2019 16:37	08/12/2019 04:52	08/12/2019 16:37	11,74	11	129,17	CHI
20191247101	ALTO HORIZONTE	MQ12181177	MARA ROSA	08/12/2019 04:53	08/12/2019 15:24	08/12/2019 04:53	08/12/2019 15:24	10,51	3	31,54	CHI
20191247101	MARA ROSA	MQ12181177	MARA ROSA	08/12/2019 04:53	08/12/2019 15:24	08/12/2019 04:53	08/12/2019 15:24	10,51	28	294,34	CHI
20191247101	URUACU	MQ12181177	MARA ROSA	08/12/2019 04:53	08/12/2019 15:24	08/12/2019 04:53	08/12/2019 15:24	10,51	1	10,51	CHI
20191246973	APARECIDA DE GOIANIA	AP11164424	INDEPENDENCIA S2	08/12/2019 05:03	08/12/2019 08:08	08/12/2019 05:03	08/12/2019 08:08	3,08	80	246,49	CHI
20191246975	BELA VISTA DE GOIAS	BV31022395	BELA VISTA S1	08/12/2019 05:10	08/12/2019 10:05	08/12/2019 05:10	08/12/2019 10:05	4,92	1	4,92	CHI
20191246976	BONOPOLIS	BX12079321	SAO MIGUEL DO ARAGUAIA	08/12/2019 05:10	08/12/2019 07:04	08/12/2019 05:10	08/12/2019 07:04	1,89	58	109,67	CHI
20191246977	BOM JESUS DE GOIAS	BJ12030804	RIO DOS BOIS	08/12/2019 05:11	08/12/2019 08:58	08/12/2019 05:11	08/12/2019 08:58	3,77	4	15,07	CHI
20191246977	GOIATUBA	BJ12030804	RIO DOS BOIS	08/12/2019 05:11	08/12/2019 08:58	08/12/2019 05:11	08/12/2019 08:58	3,77	1	3,77	CHI
20191247100	PORANGATU	PO12104347	PORANGATU	08/12/2019 05:13	08/12/2019 07:39	08/12/2019 05:13	08/12/2019 07:39	2,43	8	19,46	CHI
20191246982	CAVALCANTE	TI12156216RE	MINACU	08/12/2019 05:14	08/12/2019 14:37	08/12/2019 05:14	08/12/2019 14:37	9,37	65	609,16	CHI
20191246982	COLINAS DO SUL	TI12156216RE	MINACU	08/12/2019 05:14	08/12/2019 14:37	08/12/2019 05:14	08/12/2019 14:37	9,37	34	318,64	CHI
20191247055	MAMBAI	MB12302924	IACIARA S2	08/12/2019 05:15	08/12/2019 17:00	08/12/2019 05:15	08/12/2019 17:00	11,75	30	352,47	CHI
20191247079	CAIAPONIA	PY12011439	PALESTINA	08/12/2019 05:16	08/12/2019 10:03	08/12/2019 05:16	08/12/2019 10:03	4,78	91	435,21	CHI
20191247079	PALESTINA DE GOIAS	PY12011439	PALESTINA	08/12/2019 05:16	08/12/2019 10:03	08/12/2019 05:16	08/12/2019 10:03	4,78	25	119,56	CHI
20191246986	ANAPOLIS	AN21262502	NEROPOLIS S1	08/12/2019 05:17	08/12/2019 13:04	08/12/2019 05:17	08/12/2019 13:04	7,78	1	7,78	CHI

20191246991	CAMPO ALEGRE DE GOIAS	CM12358430RE	CAMPO ALEGRE DE GOIAS	08/12/2019 05:17	08/12/2019 09:45	08/12/2019 05:17	08/12/2019 09:45	4,47	32	142,88	CHI
20191246991	IPAMERI	CM12358430RE	CAMPO ALEGRE DE GOIAS	08/12/2019 05:17	08/12/2019 09:45	08/12/2019 05:17	08/12/2019 09:45	4,47	29	129,49	CHI
20191246989	PIRES DO RIO	460140504	PIRES DO RIO S2	08/12/2019 05:19	08/12/2019 18:03	08/12/2019 05:19	08/12/2019 18:03	12,73	1	12,73	CHI
20191247268	ALOANDIA	AD12011372RE	GOIATUBA S1	08/12/2019 05:24	08/12/2019 10:20	08/12/2019 05:24	08/12/2019 10:20	4,92	22	108,24	CHI
20191247268	MORRINHOS	AD12011372RE	GOIATUBA S1	08/12/2019 05:24	08/12/2019 10:20	08/12/2019 05:24	08/12/2019 10:20	4,92	21	103,32	CHI
20191247268	PONTALINA	AD12011372RE	GOIATUBA S1	08/12/2019 05:24	08/12/2019 10:20	08/12/2019 05:24	08/12/2019 10:20	4,92	7	34,44	CHI
20191247005	CORREGO DO OURO	IS13349695	IPORA	08/12/2019 05:26	08/12/2019 12:09	08/12/2019 05:26	08/12/2019 12:09	6,71	3	20,12	CHI
20191247005	FAZENDA NOVA	IS13349695	IPORA	08/12/2019 05:26	08/12/2019 12:09	08/12/2019 05:26	08/12/2019 12:09	6,71	200	1341,06	CHI
20191247005	ISRAELANDIA	IS13349695	IPORA	08/12/2019 05:26	08/12/2019 12:09	08/12/2019 05:26	08/12/2019 12:09	6,71	104	697,35	CHI
20191247041	ANICUNS	AC12304664	FIRMINOPOLIS S2	08/12/2019 05:27	08/12/2019 07:44	08/12/2019 05:27	08/12/2019 07:44	2,28	14	31,92	CHI
20191246136	QUIRINOPOLIS	03670416	SANTA HELENA S1	08/12/2019 05:28	08/12/2019 12:11	08/12/2019 09:26	08/12/2019 12:11	2,74	42	114,99	CHI
20191246136	RIO VERDE	03670416	SANTA HELENA S1	08/12/2019 05:28	08/12/2019 12:11	08/12/2019 09:26	08/12/2019 12:11	2,74	385	1054,04	CHI
20191246136	RIO VERDE	03670416	SANTA HELENA S1	08/12/2019 05:28	08/12/2019 12:11	08/12/2019 09:26	08/12/2019 12:11	2,74	651	1782,29	CHI
20191246136	SANTA HELENA DE GOIAS	03670416	SANTA HELENA S1	08/12/2019 05:28	08/12/2019 12:11	08/12/2019 09:26	08/12/2019 12:11	2,74	1	2,74	CHI
20191246998	ACREUNA	8590757	ACREUNA	08/12/2019 05:29	08/12/2019 09:15	08/12/2019 05:29	08/12/2019 09:15	3,76	15	56,37	CHI
20191248969	MOZARLANDIA	NA12084403	MOZARLANDIA	08/12/2019 05:29	09/12/2019 09:02	08/12/2019 05:29	09/12/2019 09:02	27,55	2	55,10	CHI
20191248969	NOVA CRIXAS	NA12084403	MOZARLANDIA	08/12/2019 05:29	09/12/2019 09:02	08/12/2019 05:29	09/12/2019 09:02	27,55	5	137,74	CHI
20191247080	MORRINHOS	MR12389873	MORRINHOS	08/12/2019 05:30	08/12/2019 09:03	08/12/2019 05:30	08/12/2019 09:03	3,54	38	134,53	CHI
20191247124	PORANGATU	PO12297140	PORANGATU	08/12/2019 05:31	08/12/2019 09:25	08/12/2019 05:31	08/12/2019 09:25	3,90	16	62,39	CHI
20191247124	SANTA TEREZA DE GOIAS	PO12297140	PORANGATU	08/12/2019 05:31	08/12/2019 09:25	08/12/2019 05:31	08/12/2019 09:25	3,90	11	42,89	CHI
20191247124	TROMBAS	PO12297140	PORANGATU	08/12/2019 05:31	08/12/2019 09:25	08/12/2019 05:31	08/12/2019 09:25	3,90	169	658,96	CHI
20191247004	SANCLERLANDIA	SC21192126	FIRMINOPOLIS S2	08/12/2019 05:34	08/12/2019 09:20	08/12/2019 05:34	08/12/2019 09:20	3,77	1	3,77	CHI
20191247927	MONTES CLAROS DE GOIAS	ME11374846	IPORA	08/12/2019 05:39	08/12/2019 18:43	08/12/2019 05:39	08/12/2019 18:43	13,05	97	1265,88	CHI
20191247930	RUBIATABA	RB12028116	RUBIATABA	08/12/2019 05:41	08/12/2019 15:25	08/12/2019 05:41	08/12/2019 15:25	9,73	89	866,24	CHI
20191247703	SANTA ROSA DE GOIAS	SR12013528	INHUMAS S1	08/12/2019 05:45	08/12/2019 16:38	08/12/2019 05:45	08/12/2019 16:38	10,88	3	32,64	CHI
20191247133	CAMPOS VERDES	VD12253107	SANTA TEREZINHA	08/12/2019 05:50	08/12/2019 21:39	08/12/2019 05:50	08/12/2019 21:39	15,81	4	63,24	CHI
20191247022	SAO MIGUEL DO ARAGUAIA	SM12315127	SAO MIGUEL DO ARAGUAIA	08/12/2019 05:52	08/12/2019 13:30	08/12/2019 05:52	08/12/2019 13:30	7,63	2	15,26	CHI
20191247582	ITAPIRAPUA	IU12018840	MATRINCHA	08/12/2019 05:53	09/12/2019 12:56	08/12/2019 05:53	09/12/2019 09:19	27,44	14	384,15	CHI
20191247582	ITAPIRAPUA	IU12018840	MATRINCHA	08/12/2019 05:53	09/12/2019 12:56	08/12/2019 05:53	09/12/2019 12:56	31,07	4	124,26	CHI
20191247056	LUZIANIA	OZ12402562RE	PIRES DO RIO S2	08/12/2019 06:00	08/12/2019 08:10	08/12/2019 06:00	08/12/2019 08:10	2,16	132	285,56	CHI
20191247056	ORIZONA	OZ12402562RE	PIRES DO RIO S2	08/12/2019 06:00	08/12/2019 08:10	08/12/2019 06:00	08/12/2019 08:10	2,16	7	15,14	CHI
20191247040	GOIANIA	GN11003139	GOYA S1	08/12/2019 06:02	08/12/2019 08:14	08/12/2019 06:02	08/12/2019 08:14	2,19	140	306,25	CHI
20191247261	RIO VERDE	RV12279609	RIO VERDE S1	08/12/2019 06:04	08/12/2019 09:55	08/12/2019 06:04	08/12/2019 09:55	3,86	31	119,61	CHI

20191247253	ARAGARCAS	AG12138460	ARAGARCAS	08/12/2019 06:05	08/12/2019 10:56	08/12/2019 06:05	08/12/2019 10:56	4,84	13	62,96	CHI
20191247467	RIO VERDE	RV12271281	ACREUNA	08/12/2019 06:05	08/12/2019 12:07	08/12/2019 06:05	08/12/2019 12:07	6,03	9	54,29	CHI
20191247052	RIO VERDE	10000901197	RIO VERDE S2	08/12/2019 06:06	08/12/2019 10:36	08/12/2019 06:06	08/12/2019 10:36	4,50	1	4,50	CHI
20191247054	JUSSARA	JR21097495	JUSSARA	08/12/2019 06:07	09/12/2019 10:30	08/12/2019 06:07	09/12/2019 10:30	28,38	1	28,38	CHI
20191247271	SANTA ROSA DE GOIAS	SR12078211	INHUMAS S1	08/12/2019 06:09	08/12/2019 14:46	08/12/2019 06:09	08/12/2019 14:46	8,61	4	34,44	CHI
20191247064	PLANALTINA	PI21369971	PLANALTINA	08/12/2019 06:10	08/12/2019 10:01	08/12/2019 06:10	08/12/2019 10:01	3,86	1	3,86	CHI
20191247116	CORREGO DO OURO	CO12054528	FIRMINOPOLIS S2	08/12/2019 06:10	08/12/2019 11:07	08/12/2019 06:10	08/12/2019 11:07	4,94	8	39,48	CHI
20191247163	ITABERAI	IB12310476	ITABERAI S2	08/12/2019 06:11	08/12/2019 09:36	08/12/2019 06:11	08/12/2019 09:36	3,41	3	10,22	CHI
20191247983	CAIAPONIA	CP12020902	PIRANHAS	08/12/2019 06:12	08/12/2019 15:43	08/12/2019 06:12	08/12/2019 15:43	9,50	4	38,01	CHI
20191247128	BONOPOLIS	BX12391936	SAO MIGUEL DO ARAGUAIA	08/12/2019 06:13	08/12/2019 09:16	08/12/2019 06:13	08/12/2019 09:16	3,05	29	88,44	CHI
20191248734	BOM JARDIM DE GOIAS	BM12231130	BOM JARDIM	08/12/2019 06:14	08/12/2019 20:53	08/12/2019 06:14	08/12/2019 20:53	14,64	10	146,36	CHI
20191247077	PIRACANJUBA	PJ21182642	PIRACANJUBA	08/12/2019 06:15	08/12/2019 09:48	08/12/2019 06:15	08/12/2019 09:48	3,55	1	3,55	CHI
20191247078	PONTALINA	PK32047344	VICENTINOPOLIS	08/12/2019 06:15	08/12/2019 09:04	08/12/2019 06:15	08/12/2019 09:04	2,80	25	70,06	CHI
20191247084	INDIARA	JD12005507	PALMEIRAS	08/12/2019 06:17	08/12/2019 16:30	08/12/2019 06:17	08/12/2019 16:30	10,23	91	930,50	CHI
20191247084	JANDAIA	JD12005507	PALMEIRAS	08/12/2019 06:17	08/12/2019 16:30	08/12/2019 06:17	08/12/2019 16:30	10,23	29	296,53	CHI
20191247084	PALMEIRAS DE GOIAS	JD12005507	PALMEIRAS	08/12/2019 06:17	08/12/2019 16:30	08/12/2019 06:17	08/12/2019 16:30	10,23	38	388,56	CHI
20191247085	PIRACANJUBA	PJ12011464	MORRINHOS	08/12/2019 06:17	09/12/2019 00:57	08/12/2019 06:17	08/12/2019 11:22	5,08	34	172,69	CHI
20191247085	PIRACANJUBA	PJ12011464	MORRINHOS	08/12/2019 06:17	09/12/2019 00:57	08/12/2019 06:17	09/12/2019 00:57	18,67	2	37,34	CHI
20191247085	PIRACANJUBA	PJ12011464	MORRINHOS	08/12/2019 06:17	09/12/2019 00:57	08/12/2019 23:12	09/12/2019 00:57	1,75	34	59,67	CHI
20191247086	PALMELO	BC12075753	PIRES DO RIO S2	08/12/2019 06:17	08/12/2019 09:32	08/12/2019 06:17	08/12/2019 09:32	3,24	3	9,73	CHI
20191247086	SANTA CRUZ DE GOIAS	BC12075753	PIRES DO RIO S2	08/12/2019 06:17	08/12/2019 09:32	08/12/2019 06:17	08/12/2019 09:32	3,24	4	12,98	CHI
20191247087	JARAGUA	JA21000170	JARAGUA	08/12/2019 06:17	08/12/2019 12:30	08/12/2019 06:17	08/12/2019 12:30	6,21	1	6,21	CHI
20191248231	ALVORADA DO NORTE	FB12062290LD	FLORES DE GOIAS	08/12/2019 06:17	09/12/2019 12:19	08/12/2019 06:17	09/12/2019 12:19	30,02	34	1020,80	CHI
20191248231	FLORES DE GOIAS	FB12062290LD	FLORES DE GOIAS	08/12/2019 06:17	09/12/2019 12:19	08/12/2019 06:17	09/12/2019 12:19	30,02	19	570,45	CHI
20191248231	IACIARA	FB12062290LD	FLORES DE GOIAS	08/12/2019 06:17	09/12/2019 12:19	08/12/2019 06:17	09/12/2019 12:19	30,02	16	480,38	CHI
20191248231	POSSE	FB12062290LD	FLORES DE GOIAS	08/12/2019 06:17	09/12/2019 12:19	08/12/2019 06:17	09/12/2019 12:19	30,02	2	60,05	CHI
20191248703	NIQUELANDIA	NQ12262955	NIQUELANDIA SUBTRANSMISSAO	08/12/2019 06:17	08/12/2019 17:50	08/12/2019 06:17	08/12/2019 17:50	11,53	4	46,14	CHI
20191247092	TRINDADE	TR11230639	TRINDADE	08/12/2019 06:18	08/12/2019 08:36	08/12/2019 06:18	08/12/2019 08:36	2,29	85	194,82	CHI
20191247788	DAVINOPOLIS	IO12085152	CATALAO S1	08/12/2019 06:18	09/12/2019 08:26	08/12/2019 06:18	09/12/2019 08:26	26,15	8	209,19	CHI
20191247094	CALDAS NOVAS	CN12088405	CALDAS NOVAS S1	08/12/2019 06:19	08/12/2019 13:56	08/12/2019 06:19	08/12/2019 13:56	7,61	4	30,45	CHI
20191249983	INDIARA	IY12312450	CEZARINA	08/12/2019 06:19	09/12/2019 03:10	08/12/2019 06:19	09/12/2019 03:10	20,85	27	562,89	CHI
20191247526	ISRAELANDIA	IS12040136	IPORA	08/12/2019 06:20	08/12/2019 15:27	08/12/2019 06:20	08/12/2019 15:27	9,11	16	145,83	CHI
20191247274	JARAGUA	JA12040435	SAO FRANCISCO DE GOIAS	08/12/2019 06:22	08/12/2019 11:37	08/12/2019 06:22	08/12/2019 11:37	5,24	3	15,72	CHI

20191247274	JESUPOLIS	JA12040435	SAO FRANCISCO DE GOIAS	08/12/2019 06:22	08/12/2019 11:37	08/12/2019 06:22	08/12/2019 11:37	5,24	19	99,59	CHI
20191246842	BELA VISTA DE GOIAS	BV32063026	BELA VISTA S1	08/12/2019 06:24	08/12/2019 11:48	08/12/2019 06:24	08/12/2019 11:48	5,39	69	371,95	CHI
20191247107	CACHOEIRA ALTA	CA21153976	CACHOEIRA ALTA	08/12/2019 06:24	08/12/2019 12:18	08/12/2019 06:24	08/12/2019 12:18	5,88	1	5,88	CHI
20191247112	PORANGATU	PO12048411	PORANGATU	08/12/2019 06:26	08/12/2019 08:59	08/12/2019 06:26	08/12/2019 08:59	2,54	17	43,17	CHI
20191247113	GOIAS	GS12068550	MATRINCHA	08/12/2019 06:26	08/12/2019 17:48	08/12/2019 06:26	08/12/2019 17:48	11,35	17	192,98	CHI
20191247152	AURILANDIA	AI12206461	FIRMINOPOLIS S2	08/12/2019 06:27	08/12/2019 11:58	08/12/2019 06:27	08/12/2019 11:58	5,51	14	77,16	CHI
20191247152	FIRMINOPOLIS	AI12206461	FIRMINOPOLIS S2	08/12/2019 06:27	08/12/2019 11:58	08/12/2019 06:27	08/12/2019 11:58	5,51	15	82,67	CHI
20191247805	GOIAS	8530608	GOIAS	08/12/2019 06:28	08/12/2019 21:06	08/12/2019 06:28	08/12/2019 21:06	14,63	37	541,30	CHI
20191247412	ITAPIRAPUA	IU12121437	MATRINCHA	08/12/2019 06:29	08/12/2019 12:53	08/12/2019 06:29	08/12/2019 12:53	6,38	16	102,14	CHI
20191247468	PARAUNA	RV12301719	ACREUNA	08/12/2019 06:29	08/12/2019 11:26	08/12/2019 06:29	08/12/2019 11:26	4,95	19	93,96	CHI
20191247468	SANTO ANTONIO DA BARRA	RV12301719	ACREUNA	08/12/2019 06:29	08/12/2019 11:26	08/12/2019 06:29	08/12/2019 11:26	4,95	3	14,84	CHI
20191247129	CAMPINORTE	CR12398067	CAMPINORTE	08/12/2019 06:32	08/12/2019 11:34	08/12/2019 06:32	08/12/2019 11:34	5,03	9	45,28	CHI
20191247129	URUACU	CR12398067	CAMPINORTE	08/12/2019 06:32	08/12/2019 11:34	08/12/2019 06:32	08/12/2019 11:34	5,03	1	5,03	CHI
20191247130	ACREUNA	2440041033	ACREUNA	08/12/2019 06:32	08/12/2019 12:08	08/12/2019 06:32	08/12/2019 12:08	5,60	1	5,60	CHI
20191247559	ITABERAI	IB12198803	ITABERAI S2	08/12/2019 06:32	08/12/2019 11:31	08/12/2019 06:32	08/12/2019 11:31	4,97	51	253,56	CHI
20191247559	TAQUARAL DE GOIAS	IB12198803	ITABERAI S2	08/12/2019 06:32	08/12/2019 11:31	08/12/2019 06:32	08/12/2019 11:31	4,97	3	14,92	CHI
20191247134	ITUMBIARA	IT12404221	PARANAIBA	08/12/2019 06:33	08/12/2019 08:09	08/12/2019 06:33	08/12/2019 08:09	1,59	26	41,38	CHI
20191247151	OURO VERDE DE GOIAS	OV12319823	NEROPOLIS S1	08/12/2019 06:33	08/12/2019 10:13	08/12/2019 06:33	08/12/2019 10:13	3,66	23	84,29	CHI
20191247136	GOIANIA	GN12002715	ATLANTICO S1	08/12/2019 06:34	08/12/2019 07:48	08/12/2019 06:34	08/12/2019 07:48	1,23	51	62,73	CHI
20191246903	MOZARLANDIA	MZ12066086	MOZARLANDIA	08/12/2019 06:37	08/12/2019 08:53	08/12/2019 06:37	08/12/2019 08:53	2,26	5	11,32	CHI
20191247144	TRINDADE	TR11291620	TRINDADE	08/12/2019 06:37	08/12/2019 12:20	08/12/2019 06:37	08/12/2019 12:20	5,72	52	297,25	CHI
20191247145	GOIAS	GS12313352	GOIAS	08/12/2019 06:37	08/12/2019 16:51	08/12/2019 06:37	08/12/2019 16:51	10,23	2	20,46	CHI
20191247146	CAMPO ALEGRE DE GOIAS	CM21238479	CAMPO ALEGRE DE GOIAS	08/12/2019 06:37	08/12/2019 09:40	08/12/2019 06:37	08/12/2019 09:40	3,05	1	3,05	CHI
20191247147	TRINDADE	10021404974	TRINDADE	08/12/2019 06:38	08/12/2019 09:12	08/12/2019 06:38	08/12/2019 09:12	2,57	1	2,57	CHI
20191247148	MARA ROSA	MQ21182378	MARA ROSA	08/12/2019 06:39	08/12/2019 16:37	08/12/2019 06:39	08/12/2019 16:37	9,96	1	9,96	CHI
20191247155	NIQUELANDIA	NQ12262821	URUACU	08/12/2019 06:41	08/12/2019 14:45	08/12/2019 06:41	08/12/2019 14:45	8,05	8	64,44	CHI
20191247158	HIDROLANDIA	HD21132321	BELA VISTA S1	08/12/2019 06:41	08/12/2019 11:46	08/12/2019 06:41	08/12/2019 11:46	5,07	2	10,14	CHI
20191247244	CAMPOS VERDES	VD12243626	SANTA TEREZINHA	08/12/2019 06:41	08/12/2019 21:00	08/12/2019 06:41	08/12/2019 21:00	14,31	20	286,12	CHI
20191247697	PALMEIRAS DE GOIAS	PL12092997	PALMEIRAS	08/12/2019 06:41	08/12/2019 11:35	08/12/2019 06:41	08/12/2019 11:35	4,90	33	161,67	CHI
20191247161	GOIAS	GS12250582	GOIAS	08/12/2019 06:42	08/12/2019 18:49	08/12/2019 06:42	08/12/2019 18:49	12,10	10	121,02	CHI
20191247165	AVELINOPOLIS	990000667	ANICUNS	08/12/2019 06:44	08/12/2019 08:12	08/12/2019 06:44	08/12/2019 08:12	1,46	1	1,46	CHI
20191247166	TURVANIA	1220018123	FIRMINOPOLIS S2	08/12/2019 06:44	08/12/2019 12:54	08/12/2019 06:44	08/12/2019 12:54	6,16	1	6,16	CHI
20191247199	ANAPOLIS	AN12381272	ANAPOLIS UNIVERSITARIO S2	08/12/2019 06:44	08/12/2019 10:35	08/12/2019 06:44	08/12/2019 10:35	3,84	11	42,22	CHI



20191245496	PORANGATU	PO12391931LD	PORANGATU	08/12/2019 06:46	08/12/2019 08:20	08/12/2019 06:46	08/12/2019 08:20	1,56	13	20,23	CHI
20191247221	SAO JOAO D ALIANCA	JL12049201	SAO JOAO D ALIANCA	08/12/2019 06:46	08/12/2019 11:03	08/12/2019 06:46	08/12/2019 11:03	4,28	96	411,09	CHI
20191247227	CRISTALINA	KR12304800	CRISTALINA S2	08/12/2019 06:49	08/12/2019 10:03	08/12/2019 06:49	08/12/2019 10:03	3,23	65	209,73	CHI
20191247188	INHUMAS	CK21015952	INHUMAS S2	08/12/2019 06:51	08/12/2019 09:40	08/12/2019 06:51	08/12/2019 09:40	2,81	1	2,81	CHI
20191247196	CORUMBA DE GOIAS	CB12319750	CORUMBA	08/12/2019 06:54	08/12/2019 11:42	08/12/2019 06:54	08/12/2019 11:42	4,80	17	81,54	CHI
20191247198	MUNDO NOVO DE GOIAS	NA12050943LD	NOVA CRIXAS	08/12/2019 06:55	08/12/2019 15:04	08/12/2019 11:19	08/12/2019 12:28	1,15	2	2,31	CHI
20191247198	NOVA CRIXAS	NA21238345	NOVA CRIXAS	08/12/2019 06:55	08/12/2019 15:04	08/12/2019 06:55	08/12/2019 14:29	7,57	1	7,57	CHI
20191247198	MUNDO NOVO DE GOIAS	NA12050943LD	NOVA CRIXAS	08/12/2019 06:55	08/12/2019 15:04	08/12/2019 11:19	08/12/2019 15:04	3,75	5	18,73	CHI
20191247198	NOVA CRIXAS	NA12050943LD	NOVA CRIXAS	08/12/2019 06:55	08/12/2019 15:04	08/12/2019 11:19	08/12/2019 15:04	3,75	12	44,96	CHI
20191247198	MUNDO NOVO DE GOIAS	NA12050943LD	NOVA CRIXAS	08/12/2019 06:55	08/12/2019 15:04	08/12/2019 14:34	08/12/2019 15:04	0,50	2	1,00	CHI
20191247214	CEZARINA	CZ12000034	CEZARINA	08/12/2019 06:56	09/12/2019 08:44	08/12/2019 06:56	09/12/2019 08:44	25,80	22	567,59	CHI
20191247214	INDIARA	CZ12000034	CEZARINA	08/12/2019 06:56	09/12/2019 08:44	08/12/2019 06:56	09/12/2019 08:44	25,80	9	232,19	CHI
20191247460	AMARALINA	LC12215796	MARA ROSA	08/12/2019 06:56	08/12/2019 09:39	08/12/2019 06:56	08/12/2019 09:39	2,70	13	35,14	CHI
20191247634	BELA VISTA DE GOIAS	BV32026680	BELA VISTA S1	08/12/2019 06:56	08/12/2019 09:55	08/12/2019 06:56	08/12/2019 09:55	2,98	6	17,88	CHI
20191247865	MARA ROSA	MQ12220617	MARA ROSA	08/12/2019 06:57	08/12/2019 12:01	08/12/2019 06:57	08/12/2019 12:01	5,05	7	35,36	CHI
20191247212	GOIAS	GS12250574	GOIAS	08/12/2019 06:59	08/12/2019 16:43	08/12/2019 06:59	08/12/2019 16:43	9,73	8	77,84	CHI
20191247472	SANTO ANTONIO DA BARRA	BZ12214190	ACREUNA	08/12/2019 07:00	08/12/2019 10:18	08/12/2019 07:00	08/12/2019 10:18	3,30	8	26,37	CHI
20191247867	POSSE	PS12180788	IACIARA S2	08/12/2019 07:00	08/12/2019 09:35	08/12/2019 07:00	08/12/2019 09:35	2,57	40	102,81	CHI
20191247225	URUACU	UR12003416	URUACU	08/12/2019 07:03	08/12/2019 08:49	08/12/2019 07:03	08/12/2019 08:49	1,76	1	1,76	CHI
20191247226	LUZIANIA	LZ21086779	VIANOPOLIS	08/12/2019 07:04	08/12/2019 12:49	08/12/2019 07:04	08/12/2019 12:49	5,76	1	5,76	CHI
20191247236	MARA ROSA	MQ21360410	MARA ROSA	08/12/2019 07:05	08/12/2019 15:51	08/12/2019 07:05	08/12/2019 15:51	8,76	1	8,76	CHI
201912260783	TRINDADE	TR12347400	TRINDADE	08/12/2019 07:05	08/12/2019 09:30	08/12/2019 07:05	08/12/2019 09:30	2,40	93	223,61	CHI
20191247241	MARA ROSA	MQ12141875	MARA ROSA	08/12/2019 07:06	08/12/2019 11:24	08/12/2019 07:06	08/12/2019 11:24	4,29	11	47,19	CHI
20191247451	BALIZA	BH12331370	CAIAPONIA	08/12/2019 07:06	08/12/2019 17:20	08/12/2019 07:06	08/12/2019 17:20	10,22	13	132,92	CHI
20191247250	URUACU	UR21135291	URUACU	08/12/2019 07:08	08/12/2019 13:05	08/12/2019 07:08	08/12/2019 13:05	5,95	2	11,90	CHI
20191247251	MINEIROS	PW12296306	PARQUE DAS EMAS	08/12/2019 07:08	08/12/2019 11:21	08/12/2019 07:08	08/12/2019 11:21	4,21	27	113,77	CHI
20191247251	PORTELANDIA	PW12296306	PARQUE DAS EMAS	08/12/2019 07:08	08/12/2019 11:21	08/12/2019 07:08	08/12/2019 11:21	4,21	8	33,71	CHI
20191247254	PALMEIRAS DE GOIAS	590044084	PALMEIRAS	08/12/2019 07:08	08/12/2019 08:22	08/12/2019 07:08	08/12/2019 08:22	1,24	1	1,24	CHI
20191247263	ARENOPOLIS	AY12316423	ARENOPOLIS	08/12/2019 07:10	08/12/2019 21:50	08/12/2019 07:10	08/12/2019 21:50	14,65	5	73,26	CHI
20191250918	CEZARINA	CZ12314845	CEZARINA	08/12/2019 07:10	10/12/2019 12:43	08/12/2019 07:10	10/12/2019 12:38	53,46	1	53,46	CHI
20191250918	CEZARINA	CZ12314845	CEZARINA	08/12/2019 07:10	10/12/2019 12:43	08/12/2019 07:10	10/12/2019 12:38	53,46	2	106,93	CHI
20191250918	CEZARINA	CZ12314845	CEZARINA	08/12/2019 07:10	10/12/2019 12:43	08/12/2019 07:10	10/12/2019 12:40	53,50	2	106,99	CHI
20191250918	CEZARINA	CZ12314845	CEZARINA	08/12/2019 07:10	10/12/2019 12:43	08/12/2019 07:10	10/12/2019 12:41	53,51	1	53,51	CHI

20191250918	CEZARINA	CZ12314845	CEZARINA	08/12/2019 07:10	10/12/2019 12:43	08/12/2019 07:10	10/12/2019 12:43	53,54	2	107,07	CHI
20191247672	ITAPACI	IW12167983	ITAPACI	08/12/2019 07:11	08/12/2019 20:39	08/12/2019 07:11	08/12/2019 20:39	13,46	29	390,44	CHI
20191247292	ACREUNA	EU12114599	ACREUNA	08/12/2019 07:13	08/12/2019 09:03	08/12/2019 07:13	08/12/2019 09:03	1,83	6	10,97	CHI
20191247279	MUNDO NOVO DE GOIAS	MH11275558	NOVA CRIXAS	08/12/2019 07:16	08/12/2019 12:18	08/12/2019 07:16	08/12/2019 12:18	5,03	2	10,06	CHI
20191247508	PORTELANDIA	PW12303420	PARQUE DAS EMAS	08/12/2019 07:17	08/12/2019 10:11	08/12/2019 07:17	08/12/2019 10:11	2,89	14	40,48	CHI
20191247286	IVOLANDIA	IV12231245	ARENOPOLIS	08/12/2019 07:18	08/12/2019 10:44	08/12/2019 07:18	08/12/2019 10:44	3,43	13	44,62	CHI
20191247286	PALESTINA DE GOIAS	IV12231245	ARENOPOLIS	08/12/2019 07:18	08/12/2019 10:44	08/12/2019 07:18	08/12/2019 10:44	3,43	4	13,73	CHI
20191247291	ITAPIRAPUA	IU12250533	MATRINCHA	08/12/2019 07:18	08/12/2019 12:54	08/12/2019 07:18	08/12/2019 12:54	5,58	1	5,58	CHI
20191247650	JESUPOLIS	SF12066019	SAO FRANCISCO DE GOIAS	08/12/2019 07:18	08/12/2019 11:00	08/12/2019 07:18	08/12/2019 11:00	3,70	12	44,39	CHI
20191247650	SAO FRANCISCO DE GOIAS	SF12066019	SAO FRANCISCO DE GOIAS	08/12/2019 07:18	08/12/2019 11:00	08/12/2019 07:18	08/12/2019 11:00	3,70	10	36,99	CHI
20191247293	CRISTALINA	KR12027635	PAMPLONA	08/12/2019 07:19	08/12/2019 11:46	08/12/2019 07:19	08/12/2019 11:46	4,44	3	13,31	CHI
20191247295	SAO MIGUEL DO ARAGUAIA	SM12059999	SAO MIGUEL DO ARAGUAIA	08/12/2019 07:21	08/12/2019 15:20	08/12/2019 07:21	08/12/2019 15:20	7,98	10	79,79	CHI
20191247300	FORMOSA	FA12270551LD	ITIQUEIRA	08/12/2019 07:21	08/12/2019 11:34	08/12/2019 07:21	08/12/2019 11:34	4,21	46	193,53	CHI
20191247301	MUTUNOPOLIS	PO12084869	PORANGATU	08/12/2019 07:21	08/12/2019 10:54	08/12/2019 07:21	08/12/2019 10:54	3,54	4	14,16	CHI
20191247301	PORANGATU	PO12084869	PORANGATU	08/12/2019 07:21	08/12/2019 10:54	08/12/2019 07:21	08/12/2019 10:54	3,54	3	10,62	CHI
20191247535	BELA VISTA DE GOIAS	SW12091937LD	SENADOR CANEDO	08/12/2019 07:21	08/12/2019 10:30	08/12/2019 07:21	08/12/2019 10:30	3,13	22	68,94	CHI
20191247535	CALDAZINHA	SW12091937LD	SENADOR CANEDO	08/12/2019 07:21	08/12/2019 10:30	08/12/2019 07:21	08/12/2019 10:30	3,13	8	25,07	CHI
20191247535	SENADOR CANEDO	SW12091937LD	SENADOR CANEDO	08/12/2019 07:21	08/12/2019 10:30	08/12/2019 07:21	08/12/2019 10:30	3,13	10	31,34	CHI
20191247305	BOM JARDIM DE GOIAS	BM21245759	BOM JARDIM	08/12/2019 07:22	09/12/2019 09:18	08/12/2019 07:22	09/12/2019 09:18	25,93	1	25,93	CHI
20191247405	PORANGATU	PO12094123	PORANGATU	08/12/2019 07:24	08/12/2019 09:12	08/12/2019 07:24	08/12/2019 09:12	1,79	1	1,79	CHI
20191247407	CORUMBAIBA	CI12035404	VILA CORUMBA	08/12/2019 07:24	08/12/2019 10:27	08/12/2019 07:24	08/12/2019 10:27	3,04	84	255,10	CHI
201912234673	CAIAPONIA	CP12410631	CAIAPONIA	08/12/2019 07:24	09/12/2019 11:55	08/12/2019 07:24	09/12/2019 11:55	28,51	17	484,70	CHI
20191247409	ITAUCU	AR21168383	INHUMAS S1	08/12/2019 07:25	08/12/2019 13:20	08/12/2019 07:25	08/12/2019 13:20	5,91	1	5,91	CHI
20191247411	BALIZA	BH12380942	BOM JARDIM	08/12/2019 07:26	08/12/2019 18:50	08/12/2019 07:26	08/12/2019 18:50	11,40	7	79,78	CHI
20191247415	NOVA CRIXAS	NA12086286	NOVA CRIXAS	08/12/2019 07:26	08/12/2019 09:17	08/12/2019 07:26	08/12/2019 09:17	1,85	9	16,64	CHI
20191247418	SAO DOMINGOS	SD12398397	SAO DOMINGOS	08/12/2019 07:27	08/12/2019 11:38	08/12/2019 07:27	08/12/2019 11:38	4,17	6	25,04	CHI
20191247419	ARAGUAPAZ	AZ21143340	MOZARLANDIA	08/12/2019 07:28	08/12/2019 10:14	08/12/2019 07:28	08/12/2019 10:14	2,77	1	2,77	CHI
20191247420	CRIXAS	CX21353896	NOVA CRIXAS	08/12/2019 07:28	08/12/2019 21:52	08/12/2019 07:28	08/12/2019 21:52	14,40	1	14,40	CHI
20191247429	IPAMERI	IP21409465	IPAMERI	08/12/2019 07:30	08/12/2019 08:32	08/12/2019 07:30	08/12/2019 08:32	1,03	1	1,03	CHI
20191247432	APARECIDA DE GOIANIA	AP12150292	INDEPENDENCIA S2	08/12/2019 07:31	08/12/2019 10:57	08/12/2019 07:31	08/12/2019 10:57	3,42	32	109,51	CHI
20191247434	BELA VISTA DE GOIAS	BV12000046	CEPAIGO S2	08/12/2019 07:31	08/12/2019 12:12	08/12/2019 07:31	08/12/2019 12:12	4,67	29	135,45	CHI
20191248578	MONTIVIDIU	MV12267720	MONTIVIDIU T	08/12/2019 07:31	08/12/2019 21:10	08/12/2019 07:31	08/12/2019 21:10	13,65	3	40,96	CHI
20191247436	IACIARA	IA12218798LD	IACIARA S2	08/12/2019 07:32	08/12/2019 12:05	08/12/2019 07:32	08/12/2019 12:05	4,54	1	4,54	CHI

20191247436	SAO DOMINGOS	IA12218798LD	IACIARA S2	08/12/2019 07:32	08/12/2019 12:05	08/12/2019 07:32	08/12/2019 12:05	4,54	3	13,63	CHI
20191247437	MONTIVIDIU	RV12205424	MONTIVIDIU T	08/12/2019 07:32	08/12/2019 11:24	08/12/2019 07:32	08/12/2019 11:24	3,87	1	3,87	CHI
20191247437	RIO VERDE	RV12205424	MONTIVIDIU T	08/12/2019 07:32	08/12/2019 11:24	08/12/2019 07:32	08/12/2019 11:24	3,87	39	151,05	CHI
20191247515	CORREGO DO OURO	BS12009575	FIRMINOPOLIS S2	08/12/2019 07:32	08/12/2019 10:16	08/12/2019 07:32	08/12/2019 10:16	2,72	11	29,96	CHI
20191247540	URUACU	UR12353573	URUACU	08/12/2019 07:33	08/12/2019 11:53	08/12/2019 07:33	08/12/2019 11:53	4,33	10	43,31	CHI
20191247447	CATALAO	CT21267117	CATALAO S1	08/12/2019 07:34	08/12/2019 08:55	08/12/2019 07:34	08/12/2019 08:55	1,34	2	2,69	CHI
20191247456	FAINA	FC12063187	GOIAS	08/12/2019 07:36	09/12/2019 09:29	08/12/2019 07:36	09/12/2019 09:29	25,88	6	155,30	CHI
20191247457	APARECIDA DE GOIANIA	10004291911	REAL S1	08/12/2019 07:36	08/12/2019 09:34	08/12/2019 07:36	08/12/2019 09:34	1,96	1	1,96	CHI
20191247808	AGUA FRIA DE GOIAS	NQ12140182	SAO JOAO D ALIANCA	08/12/2019 07:36	08/12/2019 15:22	08/12/2019 07:36	08/12/2019 15:22	7,76	69	535,38	CHI
20191247808	NIQUELANDIA	NQ12140182	SAO JOAO D ALIANCA	08/12/2019 07:36	08/12/2019 15:22	08/12/2019 07:36	08/12/2019 15:22	7,76	6	46,55	CHI
20191247866	ITABERAI	IB12210957	ITABERAI S1	08/12/2019 07:36	08/12/2019 14:20	08/12/2019 07:36	08/12/2019 14:20	6,73	12	80,74	CHI
20191247462	TRINDADE	40157428	GOYA S1	08/12/2019 07:37	08/12/2019 13:20	08/12/2019 07:37	08/12/2019 13:20	5,72	1	5,72	CHI
20191247476	POSSE	IA12060874	IACIARA S2	08/12/2019 07:38	08/12/2019 09:30	08/12/2019 07:38	08/12/2019 09:30	1,86	42	78,28	CHI
20191247478	ITAGUARU	IC12063042	ITABERAI S1	08/12/2019 07:38	09/12/2019 10:37	08/12/2019 07:38	09/12/2019 10:37	26,98	2	53,96	CHI
20191247479	MINEIROS	MY12325793	PARQUE DAS EMAS	08/12/2019 07:38	08/12/2019 12:45	08/12/2019 07:38	08/12/2019 12:45	5,11	3	15,33	CHI
20191247480	VIANOPOLIS	VN12194266	VIANOPOLIS	08/12/2019 07:38	08/12/2019 14:25	08/12/2019 07:38	08/12/2019 14:25	6,77	5	33,85	CHI
20191247482	SAO DOMINGOS	SD21344087	SAO DOMINGOS	08/12/2019 07:39	08/12/2019 09:28	08/12/2019 07:39	08/12/2019 09:28	1,81	1	1,81	CHI
20191247486	JAUPACI	JP12078430LD	IPORA	08/12/2019 07:40	09/12/2019 18:31	08/12/2019 07:40	09/12/2019 18:31	34,84	4	139,36	CHI
20191247500	CAMPINORTE	MQ12051960	MARA ROSA	08/12/2019 07:40	08/12/2019 14:06	08/12/2019 07:40	08/12/2019 14:06	6,42	2	12,84	CHI
20191248469	CAIAPONIA	CP12267739	MONTIVIDIU T	08/12/2019 07:40	09/12/2019 15:00	08/12/2019 07:40	09/12/2019 15:00	31,33	2	62,66	CHI
20191248469	MONTIVIDIU	CP12267739	MONTIVIDIU T	08/12/2019 07:40	09/12/2019 15:00	08/12/2019 07:40	09/12/2019 15:00	31,33	3	93,99	CHI
20191247487	GOIATUBA	VI21263288	VICENTINOPOLIS	08/12/2019 07:41	08/12/2019 11:15	08/12/2019 07:41	08/12/2019 11:15	3,56	1	3,56	CHI
20191247495	BOM JARDIM DE GOIAS	BM12212490	BOM JARDIM	08/12/2019 07:41	08/12/2019 18:21	08/12/2019 07:41	08/12/2019 18:21	10,65	1	10,65	CHI
20191247923	APARECIDA DO RIO DOCE	JT12063291	JATAI S1	08/12/2019 07:41	08/12/2019 16:03	08/12/2019 07:41	08/12/2019 16:03	8,35	4	33,42	CHI
20191247502	GUAPO	GA21212302	GUAPO S1	08/12/2019 07:43	08/12/2019 09:50	08/12/2019 07:43	08/12/2019 09:50	2,11	1	2,11	CHI
20191247506	LAGOA SANTA	IJ21017225	CACHOEIRA ALTA	08/12/2019 07:44	08/12/2019 12:13	08/12/2019 07:44	08/12/2019 12:13	4,48	1	4,48	CHI
20191247507	ANAPOLIS	10003501653	ANAPOLIS UNIVERSITARIO S2	08/12/2019 07:44	08/12/2019 10:09	08/12/2019 07:44	08/12/2019 10:09	2,41	1	2,41	CHI
20191250056	CAIAPONIA	CP12068509	IPORA	08/12/2019 07:44	09/12/2019 03:11	08/12/2019 07:44	09/12/2019 03:11	19,45	2	38,90	CHI
20191250056	IVOLANDIA	CP12068509	IPORA	08/12/2019 07:44	09/12/2019 03:11	08/12/2019 07:44	09/12/2019 03:11	19,45	2	38,90	CHI
20191247510	PALMEIRAS DE GOIAS	PL21000165	PALMEIRAS	08/12/2019 07:45	08/12/2019 15:35	08/12/2019 07:45	08/12/2019 15:35	7,83	1	7,83	CHI
20191247512	PONTALINA	PK12091118	VICENTINOPOLIS	08/12/2019 07:45	08/12/2019 13:30	08/12/2019 07:45	08/12/2019 13:30	5,74	1	5,74	CHI
20191247541	ITABERAI	IB12304486	ANICUNS	08/12/2019 07:45	08/12/2019 14:40	08/12/2019 07:45	08/12/2019 14:40	6,90	56	386,54	CHI
20191247541	MOSSAMEDES	IB12304486	ANICUNS	08/12/2019 07:45	08/12/2019 14:40	08/12/2019 07:45	08/12/2019 14:40	6,90	5	34,51	CHI

20191247519	RIO VERDE	RV12279519	RIO VERDE S1	08/12/2019 07:47	08/12/2019 12:57	08/12/2019 07:47	08/12/2019 12:57	5,16	34	175,49	CHI
20191247520	CRIXAS	CX12248286	SERRA DO OURO	08/12/2019 07:47	08/12/2019 15:14	08/12/2019 07:47	08/12/2019 15:14	7,44	17	126,41	CHI
20191247800	CALDAS NOVAS	CN12363988	CALDAS NOVAS S2	08/12/2019 07:47	08/12/2019 16:07	08/12/2019 07:47	08/12/2019 16:07	8,33	11	91,68	CHI
20191248575	NIQUELANDIA	NQ12396775	NIQUELANDIA SUBTRANSMISSAO	08/12/2019 07:48	08/12/2019 17:17	08/12/2019 07:48	08/12/2019 17:17	9,48	41	388,78	CHI
20191247528	GOIANIRA	BW12291579	NEROPOLIS S1	08/12/2019 07:49	08/12/2019 09:49	08/12/2019 07:49	08/12/2019 09:49	2,00	3	6,00	CHI
20191247528	SANTO ANTONIO DE GOIAS	BW12291579	NEROPOLIS S1	08/12/2019 07:49	08/12/2019 09:49	08/12/2019 07:49	08/12/2019 09:49	2,00	2	4,00	CHI
20191247531	ITABERAI	IB12310580	ITABERAI S2	08/12/2019 07:49	09/12/2019 14:53	08/12/2019 07:49	09/12/2019 14:53	31,06	1	31,06	CHI
20191248483	SILVANIA	SV12382760	VIANOPOLIS	08/12/2019 07:49	08/12/2019 16:24	08/12/2019 07:49	08/12/2019 16:24	8,58	2	17,17	CHI
20191247534	PLANALTINA	10024534330	PLANALTINA	08/12/2019 07:50	08/12/2019 09:34	08/12/2019 07:50	08/12/2019 09:34	1,72	1	1,72	CHI
20191247763	JARAGUA	JA12221418	JARAGUA	08/12/2019 07:50	08/12/2019 11:22	08/12/2019 07:50	08/12/2019 11:22	3,53	17	60,04	CHI
20191247926	NOVA IGUACU DE GOIAS	NH12374720	URUACU	08/12/2019 07:50	08/12/2019 23:01	08/12/2019 07:50	08/12/2019 23:01	15,18	7	106,23	CHI
20191247544	ARAGUAPAZ	FC12404555	GOIAS	08/12/2019 07:52	08/12/2019 18:18	08/12/2019 07:52	08/12/2019 18:18	10,42	2	20,83	CHI
20191247544	FAINA	FC12404555	GOIAS	08/12/2019 07:52	08/12/2019 18:18	08/12/2019 07:52	08/12/2019 18:18	10,42	4	41,67	CHI
20191247546	ITAPURANGA	IK12299350	ITAPURANGA	08/12/2019 07:53	09/12/2019 17:38	08/12/2019 07:53	08/12/2019 18:35	10,69	13	138,98	CHI
20191247546	ITAPURANGA	IK12299350	ITAPURANGA	08/12/2019 07:53	09/12/2019 17:38	08/12/2019 19:09	09/12/2019 10:24	15,24	6	91,47	CHI
20191247546	ITAPURANGA	IK12220912	ITAPURANGA	08/12/2019 07:53	09/12/2019 17:38	08/12/2019 19:09	09/12/2019 17:38	22,48	7	157,38	CHI
20191247548	PIRES DO RIO	10013675077	PIRES DO RIO S1	08/12/2019 07:53	08/12/2019 16:54	08/12/2019 07:53	08/12/2019 16:54	9,01	1	9,01	CHI
20191247553	PIRACANJUBA	PJ12000119	PIRACANJUBA	08/12/2019 07:54	08/12/2019 11:35	08/12/2019 07:54	08/12/2019 11:35	3,67	6	22,01	CHI
20191247886	RIO VERDE	BZ12255714	ACREUNA	08/12/2019 07:54	08/12/2019 14:52	08/12/2019 07:54	08/12/2019 14:52	6,96	6	41,77	CHI
20191247886	SANTO ANTONIO DA BARRA	BZ12255714	ACREUNA	08/12/2019 07:54	08/12/2019 14:52	08/12/2019 07:54	08/12/2019 14:52	6,96	5	34,80	CHI
20191247855	GOIANIA	GN12291454	INDEPENDENCIA S2	08/12/2019 07:55	08/12/2019 09:51	08/12/2019 07:55	08/12/2019 09:51	1,93	11	21,28	CHI
20191247565	ORIZONA	OZZ1067563	PIRES DO RIO S2	08/12/2019 07:57	08/12/2019 11:14	08/12/2019 07:57	08/12/2019 11:14	3,28	2	6,56	CHI
20191247567	PIRACANJUBA	PJ12027588	PIRACANJUBA	08/12/2019 07:57	08/12/2019 13:11	08/12/2019 07:57	08/12/2019 13:11	5,22	2	10,45	CHI
20191247568	DAMIANOPOLIS	DA21309347	IACIARA S2	08/12/2019 07:57	09/12/2019 08:48	08/12/2019 07:57	09/12/2019 08:48	24,84	1	24,84	CHI
20191247569	BARRO ALTO	GE12000092	GOIANESIA S1	08/12/2019 07:57	08/12/2019 09:19	08/12/2019 07:57	08/12/2019 09:19	1,36	2	2,71	CHI
20191247569	GOIANESIA	GE12000092	GOIANESIA S1	08/12/2019 07:57	08/12/2019 09:19	08/12/2019 07:57	08/12/2019 09:19	1,36	17	23,06	CHI
20191247574	JARAGUA	GE21000230	GOIANESIA S2	08/12/2019 07:59	08/12/2019 14:08	08/12/2019 07:59	08/12/2019 14:08	6,14	1	6,14	CHI
20191247577	GOIANDIRA	2010003830	CATALAO S1	08/12/2019 07:59	08/12/2019 09:38	08/12/2019 07:59	08/12/2019 09:38	1,64	1	1,64	CHI
20191247578	INHUMAS	IN11086980	INHUMAS S2	08/12/2019 07:59	08/12/2019 09:32	08/12/2019 07:59	08/12/2019 09:32	1,53	83	127,34	CHI
20191247963	ALTO HORIZONTE	AJ12321045	SANTA TEREZINHA	08/12/2019 07:59	09/12/2019 00:25	08/12/2019 07:59	08/12/2019 18:20	10,35	5	51,76	CHI
20191247963	ALTO HORIZONTE	AJ12213243LD	SANTA TEREZINHA	08/12/2019 07:59	09/12/2019 00:25	08/12/2019 07:59	09/12/2019 00:25	16,43	10	164,32	CHI
20191248321	CRISTALINA	KR12404430	CRISTALINA S1	08/12/2019 07:59	08/12/2019 11:56	08/12/2019 07:59	08/12/2019 11:56	3,95	15	59,24	CHI
20191247579	JATAI	JT12402412	JATAI S2	08/12/2019 08:00	08/12/2019 09:36	08/12/2019 08:00	08/12/2019 09:36	1,60	448	716,43	CHI

20191247581	IPAMERI	IP12031357	IPAMERI	08/12/2019 08:00	08/12/2019 16:59	08/12/2019 08:00	08/12/2019 16:59	8,98	2	17,96	CHI
20191247716	VIANOPOLIS	VN12282707	VIANOPOLIS	08/12/2019 08:01	08/12/2019 10:18	08/12/2019 08:01	08/12/2019 10:18	2,28	16	36,51	CHI
20191246219	NIQUELANDIA	NQ12140184	SAO JOAO D ALIANCA	08/12/2019 08:02	08/12/2019 11:37	08/12/2019 08:02	08/12/2019 11:37	3,57	60	214,15	CHI
20191247599	PALMEIRAS DE GOIAS	590052767	PALMEIRAS	08/12/2019 08:04	09/12/2019 07:22	08/12/2019 08:04	09/12/2019 07:22	23,30	1	23,30	CHI
20191247600	MINEIROS	MY12240339	PARQUE DAS EMAS	08/12/2019 08:04	08/12/2019 18:53	08/12/2019 08:04	08/12/2019 18:53	10,81	2	21,63	CHI
20191247604	MOZARLANDIA	MZ12055640	MOZARLANDIA	08/12/2019 08:04	08/12/2019 19:57	08/12/2019 08:04	08/12/2019 19:57	11,89	9	106,97	CHI
20191247614	JUSSARA	JR10401446	BRITANIA	08/12/2019 08:04	08/12/2019 20:12	08/12/2019 08:13	08/12/2019 15:12	6,99	19	132,84	CHI
20191247614	JUSSARA	JR10401446	BRITANIA	08/12/2019 08:04	08/12/2019 20:12	08/12/2019 08:13	08/12/2019 20:12	11,99	187	2242,70	CHI
20191247614	JUSSARA	JR13188496	BRITANIA	08/12/2019 08:04	08/12/2019 20:12	08/12/2019 08:13	08/12/2019 20:12	11,99	6	71,96	CHI
20191247614	MONTES CLAROS DE GOIAS	JR10401446	BRITANIA	08/12/2019 08:04	08/12/2019 20:12	08/12/2019 08:13	08/12/2019 20:12	11,99	417	5001,10	CHI
20191247614	JUSSARA	JR13188496	BRITANIA	08/12/2019 08:04	08/12/2019 20:12	08/12/2019 19:54	08/12/2019 20:12	0,30	112	34,00	CHI
20191247614	SANTA FE DE GOIAS	JR13188496	BRITANIA	08/12/2019 08:04	08/12/2019 20:12	08/12/2019 19:54	08/12/2019 20:12	0,30	21	6,38	CHI
20191247606	PLANALTINA	10016459871	PLANALTINA	08/12/2019 08:05	08/12/2019 10:20	08/12/2019 08:05	08/12/2019 10:20	2,24	1	2,24	CHI
20191247611	SANTA ROSA DE GOIAS	SR21315703	INHUMAS S1	08/12/2019 08:06	08/12/2019 16:40	08/12/2019 08:06	08/12/2019 16:40	8,56	1	8,56	CHI
20191247838	SILVANIA	LZ12168079	VIANOPOLIS	08/12/2019 08:06	08/12/2019 12:18	08/12/2019 08:06	08/12/2019 12:18	4,19	46	192,51	CHI
20191247617	BRITANIA	BT21220512	BRITANIA	08/12/2019 08:07	08/12/2019 19:30	08/12/2019 08:07	08/12/2019 19:30	11,38	1	11,38	CHI
20191247619	JOVIANIA	JV12000029	GOIATUBA S1	08/12/2019 08:07	08/12/2019 10:50	08/12/2019 08:07	08/12/2019 10:50	2,70	4	10,81	CHI
20191247619	VICENTINOPOLIS	JV12000029	GOIATUBA S1	08/12/2019 08:07	08/12/2019 10:50	08/12/2019 08:07	08/12/2019 10:50	2,70	6	16,22	CHI
20191247620	CAMPOS VERDES	VD11201673	SANTA TEREZINHA	08/12/2019 08:08	08/12/2019 19:54	08/12/2019 08:08	08/12/2019 19:54	11,76	8	94,11	CHI
20191247621	APARECIDA DE GOIANIA	AP12375913	INDEPENDENCIA S2	08/12/2019 08:08	08/12/2019 10:56	08/12/2019 08:08	08/12/2019 10:56	2,80	328	919,22	CHI
20191247624	GOIAS	GS12310648	GOIAS	08/12/2019 08:08	08/12/2019 13:10	08/12/2019 08:08	08/12/2019 13:10	5,02	2	10,04	CHI
20191247630	SAO MIGUEL DO ARAGUAIA	SM12291166	SAO MIGUEL DO ARAGUAIA	08/12/2019 08:10	08/12/2019 15:09	08/12/2019 08:10	08/12/2019 15:09	6,98	8	55,84	CHI
20191247633	EDEALINA	EA12257971	EDEIA	08/12/2019 08:10	08/12/2019 10:36	08/12/2019 08:10	08/12/2019 10:36	2,42	7	16,96	CHI
20191247633	INDIARA	EA12257971	EDEIA	08/12/2019 08:10	08/12/2019 10:36	08/12/2019 08:10	08/12/2019 10:36	2,42	2	4,85	CHI
20191247646	GOIAS	GS11217115	GOIAS	08/12/2019 08:13	08/12/2019 13:35	08/12/2019 08:13	08/12/2019 13:35	5,36	1	5,36	CHI
20191248153	CALDAZINHA	BO12400523	CEPAIGO S2	08/12/2019 08:13	08/12/2019 12:39	08/12/2019 08:13	08/12/2019 12:39	4,43	2	8,85	CHI
20191248153	LEOPOLDO DE BULHOES	BO12400523	CEPAIGO S2	08/12/2019 08:13	08/12/2019 12:39	08/12/2019 08:13	08/12/2019 12:39	4,43	30	132,82	CHI
20191247651	GOIANIA	10565462	REAL S2	08/12/2019 08:15	08/12/2019 10:13	08/12/2019 08:15	08/12/2019 10:13	1,96	1	1,96	CHI
20191247653	NOVA GLORIA	NG12074654	RUBIATABA	08/12/2019 08:15	09/12/2019 00:54	08/12/2019 08:15	09/12/2019 00:54	16,64	2	33,28	CHI
20191247661	MINEIROS	MY12303454	PARQUE DAS EMAS	08/12/2019 08:16	08/12/2019 11:30	08/12/2019 08:16	08/12/2019 11:30	3,23	12	38,74	CHI
20191247734	MINEIROS	MY11095199	PARQUE DAS EMAS	08/12/2019 08:17	08/12/2019 12:20	08/12/2019 08:17	08/12/2019 12:20	4,05	194	785,43	CHI
20191247673	SAO MIGUEL DO PASSA QUATRO	SQ12101209	CRISTIANOPOLIS	08/12/2019 08:18	08/12/2019 14:24	08/12/2019 08:18	08/12/2019 14:24	6,09	1	6,09	CHI
20191247678	APARECIDA DE GOIANIA	200063339	INDEPENDENCIA S1	08/12/2019 08:19	08/12/2019 10:56	08/12/2019 08:19	08/12/2019 10:56	2,61	1	2,61	CHI

20191247685	OUIDOR	OU12358276RE	CATALAO S1	08/12/2019 08:19	08/12/2019 08:50	08/12/2019 08:19	08/12/2019 08:50	0,51	24	12,17	CHI
20191246759	INHUMAS	IN12282891	INHUMAS S2	08/12/2019 08:20	08/12/2019 09:45	08/12/2019 08:20	08/12/2019 09:45	1,42	128	181,26	CHI
20191246759	ITAUCU	IN12282891	INHUMAS S2	08/12/2019 08:20	08/12/2019 09:45	08/12/2019 08:20	08/12/2019 09:45	1,42	65	92,05	CHI
20191246759	PETROLINA DE GOIAS	IN12282891	INHUMAS S2	08/12/2019 08:20	08/12/2019 09:45	08/12/2019 08:20	08/12/2019 09:45	1,42	2	2,83	CHI
20191246759	SANTA ROSA DE GOIAS	IN12282891	INHUMAS S2	08/12/2019 08:20	08/12/2019 09:45	08/12/2019 08:20	08/12/2019 09:45	1,42	10	14,16	CHI
20191247686	CORUMBAIBA	IP12404719	IPAMERI	08/12/2019 08:20	08/12/2019 11:06	08/12/2019 08:20	08/12/2019 11:06	2,76	12	33,10	CHI
20191247686	IPAMERI	IP12404719	IPAMERI	08/12/2019 08:20	08/12/2019 11:06	08/12/2019 08:20	08/12/2019 11:06	2,76	49	135,16	CHI
20191247688	IACIARA	IA12195949	IACIARA S1	08/12/2019 08:20	08/12/2019 10:40	08/12/2019 08:20	08/12/2019 10:40	2,32	19	44,12	CHI
20191247693	ACREUNA	EU11000003	ACREUNA	08/12/2019 08:21	08/12/2019 21:52	08/12/2019 08:21	08/12/2019 21:52	13,51	91	1229,66	CHI
20191248577	PROFESSOR JAMIL SAFADY	PJ12316660	ROCHEDO	08/12/2019 08:21	08/12/2019 17:41	08/12/2019 08:21	08/12/2019 17:41	9,33	29	270,61	CHI
20191247698	SAO JOAO D ALIANCA	JL12255660	SAO JOAO D ALIANCA	08/12/2019 08:22	08/12/2019 18:47	08/12/2019 08:22	08/12/2019 18:47	10,41	6	62,49	CHI
20191247891	CRISTALINA	KR12313666	CRISTALINA S2	08/12/2019 08:22	08/12/2019 13:02	08/12/2019 08:22	08/12/2019 13:02	4,66	6	27,94	CHI
20191248289	CACHOEIRA ALTA	7219611	CACHOEIRA ALTA	08/12/2019 08:22	08/12/2019 12:27	08/12/2019 08:22	08/12/2019 12:27	4,08	20	81,60	CHI
20191248289	QUIRINOPOLIS	7219611	CACHOEIRA ALTA	08/12/2019 08:22	08/12/2019 12:27	08/12/2019 08:22	08/12/2019 12:27	4,08	2	8,16	CHI
20191247711	IACIARA	IA12262079	IACIARA S1	08/12/2019 08:23	08/12/2019 13:05	08/12/2019 08:23	08/12/2019 13:05	4,69	21	98,57	CHI
20191247722	VILA PROPICIO	PV21074934	GOIANESIA S1	08/12/2019 08:25	08/12/2019 11:23	08/12/2019 08:25	08/12/2019 11:23	2,96	1	2,96	CHI
20191247724	PORANGATU	PO12390257	PORANGATU	08/12/2019 08:25	08/12/2019 11:40	08/12/2019 08:25	08/12/2019 11:40	3,24	4	12,97	CHI
20191247726	MUNDO NOVO DE GOIAS	8270678	NOVA CRIXAS	08/12/2019 08:25	08/12/2019 10:53	08/12/2019 08:25	08/12/2019 10:53	2,46	1	2,46	CHI
20191247735	LUZIANIA	LZ21149901	VIANOPOLIS	08/12/2019 08:26	08/12/2019 14:13	08/12/2019 08:26	08/12/2019 14:13	5,78	1	5,78	CHI
20191247738	ABADIANIA	AA12297735	CORUMBA	08/12/2019 08:27	08/12/2019 18:52	08/12/2019 08:27	08/12/2019 17:54	9,45	10	94,53	CHI
20191247738	PIRENOPOLIS	AA12297735	CORUMBA	08/12/2019 08:27	08/12/2019 18:52	08/12/2019 08:27	08/12/2019 17:54	9,45	1	9,45	CHI
20191247738	ABADIANIA	PV12137052LD	CORUMBA	08/12/2019 08:27	08/12/2019 18:52	08/12/2019 08:27	08/12/2019 18:52	10,41	3	31,24	CHI
20191247738	PIRENOPOLIS	PV12137052LD	CORUMBA	08/12/2019 08:27	08/12/2019 18:52	08/12/2019 08:27	08/12/2019 18:52	10,41	7	72,90	CHI
20191247744	BOM JARDIM DE GOIAS	BM12065611	BOM JARDIM	08/12/2019 08:27	08/12/2019 21:28	08/12/2019 08:27	08/12/2019 21:28	13,02	4	52,09	CHI
20191247747	PIRANHAS	PH21201836	PIRANHAS	08/12/2019 08:28	08/12/2019 17:09	08/12/2019 08:28	08/12/2019 17:09	8,68	1	8,68	CHI
20191248007	SILVANIA	SV12235952	DAIA S2	08/12/2019 08:28	08/12/2019 11:18	08/12/2019 08:28	08/12/2019 11:18	2,83	13	36,77	CHI
20191247797	NIQUELANDIA	NQ12255072	BARRO ALTO	08/12/2019 08:29	09/12/2019 05:25	08/12/2019 08:29	09/12/2019 05:25	20,93	7	146,51	CHI
20191247760	SAO JOAO D ALIANCA	JL21384959	SAO JOAO D ALIANCA	08/12/2019 08:30	08/12/2019 17:05	08/12/2019 08:30	08/12/2019 17:05	8,58	1	8,58	CHI
20191247765	PEROLANDIA	DP11254573	JATAI S1	08/12/2019 08:31	08/12/2019 09:47	08/12/2019 08:31	08/12/2019 09:47	1,27	1	1,27	CHI
20191247769	IPAMERI	460142574	URUTAI	08/12/2019 08:31	08/12/2019 14:50	08/12/2019 08:31	08/12/2019 14:50	6,31	1	6,31	CHI
20191247771	ANICUNS	AC12020526	ANICUNS	08/12/2019 08:31	08/12/2019 10:49	08/12/2019 08:31	08/12/2019 10:49	2,29	8	18,30	CHI
20191248761	COCALZINHO DE GOIAS	CB12051789	GOIANESIA S1	08/12/2019 08:31	08/12/2019 19:32	08/12/2019 08:31	08/12/2019 19:32	11,00	8	88,03	CHI
20191247775	CRISTALINA	KR21133668	CRISTALINA S2	08/12/2019 08:32	08/12/2019 11:56	08/12/2019 08:32	08/12/2019 11:56	3,39	1	3,39	CHI

20191247777	CRISTALINA	KR21304810	CRISTALINA S2	08/12/2019 08:32	08/12/2019 11:33	08/12/2019 08:32	08/12/2019 11:33	3,00	1	3,00	CHI
201912235225	ALVORADA DO NORTE	AQ12160975	IACIARA S2	08/12/2019 08:32	08/12/2019 11:00	08/12/2019 08:32	08/12/2019 11:00	2,45	17	41,69	CHI
20191247784	SAO JOAO D ALIANCA	JL21325744	SAO JOAO D ALIANCA	08/12/2019 08:33	08/12/2019 20:25	08/12/2019 08:33	08/12/2019 20:25	11,86	1	11,86	CHI
20191247786	SAO LUIS DE MONTES BELOS	SL21019519	SAO LUIZ DOS MONTES BELOS	08/12/2019 08:33	08/12/2019 17:04	08/12/2019 08:33	08/12/2019 17:04	8,53	2	17,05	CHI
20191247791	QUIRINOPOLIS	QI21100921	QUIRINOPOLIS	08/12/2019 08:33	08/12/2019 11:05	08/12/2019 08:33	08/12/2019 11:05	2,53	1	2,53	CHI
20191247792	INHUMAS	IN12032032	INHUMAS S1	08/12/2019 08:34	08/12/2019 12:08	08/12/2019 08:34	08/12/2019 12:08	3,57	6	21,45	CHI
20191247928	MAIRIPOTABA	PK12263491	PONTALINA	08/12/2019 08:34	08/12/2019 13:24	08/12/2019 08:34	08/12/2019 13:24	4,82	5	24,09	CHI
20191247928	PONTALINA	PK12263491	PONTALINA	08/12/2019 08:34	08/12/2019 13:24	08/12/2019 08:34	08/12/2019 13:24	4,82	30	144,52	CHI
20191248374	BOM JESUS DE GOIAS	BJ12389715	BOM JESUS DE GOIAS	08/12/2019 08:36	08/12/2019 14:38	08/12/2019 08:36	08/12/2019 14:38	6,02	2	12,04	CHI
20191248374	QUIRINOPOLIS	BJ12389715	BOM JESUS DE GOIAS	08/12/2019 08:36	08/12/2019 14:38	08/12/2019 08:36	08/12/2019 14:38	6,02	2	12,04	CHI
20191247802	CRISTALINA	KR21171595	CRISTALINA S2	08/12/2019 08:37	08/12/2019 13:53	08/12/2019 08:37	08/12/2019 13:53	5,28	1	5,28	CHI
20191247807	MUTUNOPOLIS	SE12352924	MARA ROSA	08/12/2019 08:37	08/12/2019 13:31	08/12/2019 08:37	08/12/2019 13:31	4,89	6	29,33	CHI
20191247807	SANTA TEREZA DE GOIAS	SE12352924	MARA ROSA	08/12/2019 08:37	08/12/2019 13:31	08/12/2019 08:37	08/12/2019 13:31	4,89	1	4,89	CHI
20191247859	CACHOEIRA ALTA	PC12000077	CACHOEIRA ALTA	08/12/2019 08:37	08/12/2019 10:40	08/12/2019 08:37	08/12/2019 10:40	2,04	8	16,35	CHI
20191247859	PARANAIGUARA	PC12000077	CACHOEIRA ALTA	08/12/2019 08:37	08/12/2019 10:40	08/12/2019 08:37	08/12/2019 10:40	2,04	3	6,13	CHI
20191247812	QUIRINOPOLIS	QI21125826	QUIRINOPOLIS	08/12/2019 08:38	08/12/2019 09:45	08/12/2019 08:38	08/12/2019 09:45	1,11	1	1,11	CHI
20191247815	CRISTALINA	1060107172	CRISTALINA S1	08/12/2019 08:38	08/12/2019 11:47	08/12/2019 08:38	08/12/2019 11:47	3,14	1	3,14	CHI
20191247816	MONTIVIDIU DO NORTE	MX12270910	PORANGATU	08/12/2019 08:39	08/12/2019 20:13	08/12/2019 08:39	08/12/2019 20:13	11,57	7	80,97	CHI
20191247818	SANTA RITA DO NOVO DESTINO	10028788085	BARRO ALTO	08/12/2019 08:39	09/12/2019 10:10	08/12/2019 08:39	09/12/2019 10:10	25,52	1	25,52	CHI
20191247822	PETROLINA DE GOIAS	PG12021488	PETROLINA	08/12/2019 08:39	08/12/2019 16:00	08/12/2019 08:39	08/12/2019 16:00	7,34	4	29,35	CHI
20191248489	CAMPOS VERDES	SG12202098	SANTA TEREZINHA	08/12/2019 08:39	08/12/2019 12:21	08/12/2019 08:39	08/12/2019 12:21	3,69	40	147,63	CHI
20191248489	SANTA TEREZINHA DE GOIAS	SG12202098	SANTA TEREZINHA	08/12/2019 08:39	08/12/2019 12:21	08/12/2019 08:39	08/12/2019 12:21	3,69	130	479,81	CHI
20191248489	UIRAPURU	SG12202098	SANTA TEREZINHA	08/12/2019 08:39	08/12/2019 12:21	08/12/2019 08:39	08/12/2019 12:21	3,69	56	206,69	CHI
20191247825	SANTA FE DE GOIAS	RN21232822	BRITANIA	08/12/2019 08:40	09/12/2019 08:40	08/12/2019 08:40	09/12/2019 08:40	24,00	1	24,00	CHI
20191247944	SANTA HELENA DE GOIAS	SH12296189	IPEGUARI	08/12/2019 08:40	08/12/2019 10:20	08/12/2019 08:40	08/12/2019 10:20	1,66	11	18,31	CHI
20191247832	GUAPO	GA11381320	GUAPO S2	08/12/2019 08:41	08/12/2019 11:49	08/12/2019 08:41	08/12/2019 11:49	3,13	2	6,26	CHI
20191247835	CATALAO	CT12134367	CATALAO S1	08/12/2019 08:41	08/12/2019 12:32	08/12/2019 08:41	08/12/2019 12:32	3,83	11	42,18	CHI
20191247845	APARECIDA DE GOIANIA	AP11094806	INDEPENDENCIA S1	08/12/2019 08:42	08/12/2019 10:00	08/12/2019 08:42	08/12/2019 10:00	1,30	226	294,43	CHI
20191247844	ITAPACI	10000283957	ITAPACI	08/12/2019 08:43	08/12/2019 14:26	08/12/2019 08:43	08/12/2019 14:26	5,71	1	5,71	CHI
20191247850	TRINDADE	TR12014577	TRINDADE	08/12/2019 08:44	08/12/2019 11:56	08/12/2019 08:44	08/12/2019 11:56	3,20	12	38,42	CHI
20191247860	BONOPOLIS	BX12266004	NOVO PLANALTO	08/12/2019 08:44	08/12/2019 11:40	08/12/2019 08:44	08/12/2019 11:40	2,93	3	8,80	CHI
20191247854	ALTO PARAISO DE GOIAS	BF12180774	FLORES DE GOIAS	08/12/2019 08:45	08/12/2019 10:20	08/12/2019 08:45	08/12/2019 10:20	1,57	13	20,41	CHI
20191247856	APARECIDA DE GOIANIA	13062591	REAL S1	08/12/2019 08:46	08/12/2019 10:35	08/12/2019 08:46	08/12/2019 10:35	1,81	1	1,81	CHI

20191247632	FAINA	AZ12375706	GOIAS	08/12/2019 08:48	08/12/2019 17:37	08/12/2019 08:48	08/12/2019 17:37	8,81	6	52,87	CHI
20191247871	GOIANIA	11744431	GOIANIA LESTE S1	08/12/2019 08:49	08/12/2019 09:55	08/12/2019 08:49	08/12/2019 09:55	1,09	1	1,09	CHI
20191247873	GOIAS	GS11000002	GOIAS	08/12/2019 08:50	08/12/2019 09:44	08/12/2019 08:50	08/12/2019 09:44	0,90	37	33,42	CHI
20191247878	CRISTALINA	KR21171551	CRISTALINA S2	08/12/2019 08:51	08/12/2019 15:10	08/12/2019 08:51	08/12/2019 15:10	6,32	1	6,32	CHI
20191247880	PLANALTINA	2960077903	PLANALTINA	08/12/2019 08:51	08/12/2019 11:38	08/12/2019 08:51	08/12/2019 11:38	2,78	1	2,78	CHI
20191247882	ARAGOIANIA	AO21219129	GUAPO S2	08/12/2019 08:51	08/12/2019 12:01	08/12/2019 08:51	08/12/2019 12:01	3,16	1	3,16	CHI
20191247884	SANTO ANTONIO DO DESCOBERTO	1850001884	ALEXANIA	08/12/2019 08:51	08/12/2019 15:44	08/12/2019 08:51	08/12/2019 15:44	6,87	1	6,87	CHI
20191248035	SAO JOAO D ALIANCA	JL12237037	ITUIQUIRA	08/12/2019 08:52	08/12/2019 15:51	08/12/2019 08:52	08/12/2019 15:51	6,98	20	139,63	CHI
20191247900	ANHANGUERA	CY12071528	CATALAO S1	08/12/2019 08:54	08/12/2019 10:27	08/12/2019 08:54	08/12/2019 10:27	1,54	2	3,09	CHI
20191247902	LUZIANIA	LZ12217681	VIANOPOLIS	08/12/2019 08:54	08/12/2019 23:27	08/12/2019 08:54	08/12/2019 23:27	14,53	3	43,60	CHI
20191247906	RIO VERDE	630354212	RIO VERDE S1	08/12/2019 08:55	08/12/2019 11:52	08/12/2019 08:55	08/12/2019 11:52	2,96	1	2,96	CHI
20191247907	ITAPURANGA	IK21087775	ITAPURANGA	08/12/2019 08:55	10/12/2019 15:52	08/12/2019 08:55	10/12/2019 15:52	54,95	1	54,95	CHI
20191247912	RIO VERDE	10030277696	RIO VERDE S1	08/12/2019 08:56	08/12/2019 12:26	08/12/2019 08:56	08/12/2019 12:26	3,50	1	3,50	CHI
20191246862	SANTA CRUZ DE GOIAS	BC21137545	PIRACANJUBA	08/12/2019 08:58	08/12/2019 14:02	08/12/2019 08:58	08/12/2019 14:02	5,07	1	5,07	CHI
20191247925	SAO JOAO D ALIANCA	JL12324141	SAO JOAO D ALIANCA	08/12/2019 08:58	09/12/2019 11:41	08/12/2019 08:58	09/12/2019 11:41	26,71	4	106,82	CHI
20191247924	URUTAI	UT12337239	PIRES DO RIO S2	08/12/2019 08:59	08/12/2019 12:54	08/12/2019 08:59	08/12/2019 12:54	3,91	7	27,40	CHI
20191247929	CAVALCANTE	CJ21319288	MINACU	08/12/2019 09:00	08/12/2019 09:11	08/12/2019 09:00	08/12/2019 09:11	0,17	1	0,17	CHI
20191248438	NOVO BRASIL	NB12378883	JUSSARA	08/12/2019 09:01	09/12/2019 08:59	08/12/2019 09:01	09/12/2019 08:59	23,96	4	95,82	CHI
20191247936	URUACU	UR12181375	URUACU	08/12/2019 09:02	08/12/2019 12:40	08/12/2019 09:02	08/12/2019 12:40	3,63	2	7,26	CHI
20191247937	LUZIANIA	LZ11330458	MARAJOARA	08/12/2019 09:02	08/12/2019 12:48	08/12/2019 09:02	08/12/2019 12:48	3,76	60	225,75	CHI
20191247938	ALEXANIA	AX21000185	ALEXANIA	08/12/2019 09:02	08/12/2019 18:09	08/12/2019 09:02	08/12/2019 18:09	9,11	1	9,11	CHI
20191247939	SANTA CRUZ DE GOIAS	BC12389807	PIRES DO RIO S2	08/12/2019 09:02	08/12/2019 12:01	08/12/2019 09:02	08/12/2019 12:01	2,98	8	23,82	CHI
20191248100	JATAI	JT12296500	JATAI S3	08/12/2019 09:03	08/12/2019 12:04	08/12/2019 09:03	08/12/2019 12:04	3,01	435	1311,40	CHI
20191247949	SANTA HELENA DE GOIAS	SH21301259	ACREUNA	08/12/2019 09:04	08/12/2019 12:25	08/12/2019 09:04	08/12/2019 12:25	3,36	1	3,36	CHI
20191248305	PIRACANJUBA	PJ12024136	PIRACANJUBA	08/12/2019 09:04	08/12/2019 14:46	08/12/2019 09:04	08/12/2019 14:46	5,69	3	17,08	CHI
20191247957	OUVIDOR	IO21061161	CATALAO S1	08/12/2019 09:06	08/12/2019 12:42	08/12/2019 09:06	08/12/2019 12:42	3,60	1	3,60	CHI
20191247960	BOM JARDIM DE GOIAS	BM21229617	BOM JARDIM	08/12/2019 09:07	08/12/2019 10:56	08/12/2019 09:07	08/12/2019 10:56	1,82	1	1,82	CHI
20191247961	ITAPIRAPUA	IU12077173	JUSSARA	08/12/2019 09:07	08/12/2019 13:50	08/12/2019 09:07	08/12/2019 13:50	4,71	6	28,25	CHI
20191247962	CRISTALINA	KR21195570	PAMPLONA	08/12/2019 09:08	08/12/2019 14:02	08/12/2019 09:08	08/12/2019 14:02	4,90	1	4,90	CHI
20191247972	PALMEIRAS DE GOIAS	590029381	PALMEIRAS	08/12/2019 09:10	08/12/2019 16:24	08/12/2019 09:10	08/12/2019 16:24	7,23	1	7,23	CHI
20191245469	CRIXAS	CX21231933	SANTA TEREZINHA	08/12/2019 09:11	08/12/2019 12:39	08/12/2019 09:11	08/12/2019 12:39	3,45	1	3,45	CHI
20191247977	RIO VERDE	RV21131539	MONTIVIDIU T	08/12/2019 09:11	09/12/2019 14:54	08/12/2019 09:11	09/12/2019 14:54	29,71	1	29,71	CHI
20191247978	ITARUMA	IM21160695	CACHOEIRA ALTA	08/12/2019 09:11	08/12/2019 16:08	08/12/2019 09:11	08/12/2019 16:08	6,94	1	6,94	CHI



20191247979	VILA PROPICIO	NP11253328	GOIANESIA S1	08/12/2019 09:11	08/12/2019 14:34	08/12/2019 09:11	08/12/2019 14:34	5,37	2	10,75	CHI
20191247980	BOM JESUS DE GOIAS	BJ12007756	BOM JESUS DE GOIAS	08/12/2019 09:11	08/12/2019 13:30	08/12/2019 09:11	08/12/2019 13:30	4,31	2	8,61	CHI
20191247987	GOIANIA	10005975393	ATLANTICO S1	08/12/2019 09:12	08/12/2019 10:56	08/12/2019 09:12	08/12/2019 10:56	1,72	1	1,72	CHI
20191247989	PIRENOPOLIS	PV21060507	CORUMBA	08/12/2019 09:12	09/12/2019 11:00	08/12/2019 09:12	09/12/2019 11:00	25,79	1	25,79	CHI
20191247995	TURVANIA	TV21266587	ANICUNS	08/12/2019 09:15	08/12/2019 10:50	08/12/2019 09:15	08/12/2019 10:50	1,59	1	1,59	CHI
20191247996	AGUA FRIA DE GOIAS	MJ12305239	PADRE BERNARDO	08/12/2019 09:15	08/12/2019 13:34	08/12/2019 09:15	08/12/2019 13:34	4,31	1	4,31	CHI
20191247996	MIMOSO DE GOIAS	MJ12305239	PADRE BERNARDO	08/12/2019 09:15	08/12/2019 13:34	08/12/2019 09:15	08/12/2019 13:34	4,31	2	8,63	CHI
20191247997	ANAPOLIS	AN31131185	ANAPOLIS UNIVERSITARIO S2	08/12/2019 09:15	08/12/2019 10:33	08/12/2019 09:15	08/12/2019 10:33	1,29	1	1,29	CHI
20191248006	AMARALINA	LC12290987	MARA ROSA	08/12/2019 09:18	08/12/2019 10:45	08/12/2019 09:18	08/12/2019 10:45	1,44	2	2,89	CHI
20191245310	FAINA	FC12299837	GOIAS	08/12/2019 09:19	08/12/2019 11:23	08/12/2019 09:19	08/12/2019 11:23	2,05	6	12,32	CHI
20191248021	GOIANIA	11845454	CAMPINAS S2	08/12/2019 09:20	08/12/2019 11:19	08/12/2019 09:20	08/12/2019 11:19	1,97	1	1,97	CHI
20191248025	PIRANHAS	1930005894	PIRANHAS	08/12/2019 09:22	09/12/2019 07:09	08/12/2019 09:22	09/12/2019 07:09	21,78	1	21,78	CHI
20191248026	CIDADE OCIDENTAL	2680035015	MARAJOARA	08/12/2019 09:22	08/12/2019 11:03	08/12/2019 09:22	08/12/2019 11:03	1,67	1	1,67	CHI
20191248414	PORANGATU	PO12192457LD	PORANGATU	08/12/2019 09:25	08/12/2019 22:55	08/12/2019 09:25	08/12/2019 22:55	13,50	9	121,51	CHI
20191248414	PORANGATU	PO12192457LD	PORANGATU	08/12/2019 09:25	08/12/2019 22:55	08/12/2019 21:07	08/12/2019 22:55	1,81	2	3,61	CHI
20191248040	CATALAO	CT21131480	CATALAO S1	08/12/2019 09:27	08/12/2019 16:22	08/12/2019 09:27	08/12/2019 16:22	6,92	1	6,92	CHI
20191248041	NEROPOLIS	10028279776	NEROPOLIS S2	08/12/2019 09:27	08/12/2019 11:56	08/12/2019 09:27	08/12/2019 11:56	2,47	1	2,47	CHI
20191248042	IPORA	IR21112683	ARENOPOLIS	08/12/2019 09:27	09/12/2019 00:30	08/12/2019 09:27	09/12/2019 00:30	15,05	1	15,05	CHI
20191248228	PORANGATU	PO12297140	PORANGATU	08/12/2019 09:27	08/12/2019 11:43	08/12/2019 09:27	08/12/2019 11:43	2,26	16	36,18	CHI
20191248228	SANTA TEREZA DE GOIAS	PO12297140	PORANGATU	08/12/2019 09:27	08/12/2019 11:43	08/12/2019 09:27	08/12/2019 11:43	2,26	11	24,88	CHI
20191248228	TROMBAS	PO12297140	PORANGATU	08/12/2019 09:27	08/12/2019 11:43	08/12/2019 09:27	08/12/2019 11:43	2,26	169	382,17	CHI
20191248044	BURITI DE GOIAS	BS12076542	FIRMINOPOLIS S2	08/12/2019 09:28	08/12/2019 12:41	08/12/2019 09:28	08/12/2019 12:41	3,21	38	122,06	CHI
20191248049	RIO VERDE	RV12076181	RIO VERDE S1	08/12/2019 09:28	08/12/2019 16:00	08/12/2019 09:28	08/12/2019 16:00	6,52	3	19,56	CHI
20191248051	BOM JESUS DE GOIAS	BJ21031865	BOM JESUS DE GOIAS	08/12/2019 09:28	08/12/2019 14:01	08/12/2019 09:28	08/12/2019 14:01	4,54	1	4,54	CHI
20191248053	PALMEIRAS DE GOIAS	PL21321982	PALMEIRAS	08/12/2019 09:29	09/12/2019 01:50	08/12/2019 09:29	09/12/2019 01:50	16,34	1	16,34	CHI
20191248059	CATALAO	CT21157380	CATALAO S1	08/12/2019 09:31	08/12/2019 18:12	08/12/2019 09:31	08/12/2019 18:12	8,68	1	8,68	CHI
20191248335	IPAMERI	IP12000086	IPAMERI	08/12/2019 09:31	08/12/2019 13:14	08/12/2019 09:31	08/12/2019 13:14	3,71	5	18,53	CHI
20191248062	GOIANIA	12600088	GOIANIA LESTE S3	08/12/2019 09:32	08/12/2019 11:02	08/12/2019 09:32	08/12/2019 11:02	1,49	1	1,49	CHI
20191248064	APARECIDA DE GOIANIA	200175932	ANHANGUERA	08/12/2019 09:32	08/12/2019 12:09	08/12/2019 09:32	08/12/2019 12:09	2,61	1	2,61	CHI
20191248073	CAIAPONIA	MV12267740	MONTIVIDIU T	08/12/2019 09:34	08/12/2019 22:10	08/12/2019 09:34	08/12/2019 22:10	12,60	10	126,02	CHI
20191248073	MONTIVIDIU	MV12267740	MONTIVIDIU T	08/12/2019 09:34	08/12/2019 22:10	08/12/2019 09:34	08/12/2019 22:10	12,60	1	12,60	CHI
20191248075	RIO VERDE	RV12303875	ACREUNA	08/12/2019 09:35	08/12/2019 19:40	08/12/2019 09:35	08/12/2019 19:40	10,08	42	423,42	CHI
20191248326	ANAPOLIS	AN12347854RE	ANAPOLIS UNIVERSITARIO S2	08/12/2019 09:35	08/12/2019 13:15	08/12/2019 09:35	08/12/2019 13:15	3,66	65	238,19	CHI

20191248082	COCALZINHO DE GOIAS	10026407050	COCALZINHO	08/12/2019 09:36	08/12/2019 12:59	08/12/2019 09:36	08/12/2019 12:59	3,37	1	3,37	CHI
20191248087	FORMOSA	FA31042761	SAO JOAO D ALIANCA	08/12/2019 09:38	08/12/2019 12:10	08/12/2019 09:38	08/12/2019 12:10	2,53	1	2,53	CHI
20191248097	SAO MIGUEL DO ARAGUAIA	SM21089292	SAO MIGUEL DO ARAGUAIA	08/12/2019 09:40	08/12/2019 14:49	08/12/2019 09:40	08/12/2019 14:49	5,15	1	5,15	CHI
20191248098	GOIANESIA	GE21000123	GOIANESIA S1	08/12/2019 09:40	08/12/2019 15:28	08/12/2019 09:40	08/12/2019 15:28	5,80	1	5,80	CHI
20191248102	PARAUNA	PU21110512	ACREUNA	08/12/2019 09:41	08/12/2019 19:33	08/12/2019 09:41	08/12/2019 19:33	9,86	1	9,86	CHI
20191248104	CORUMBAIBA	CI2280791	VILA CORUMBA	08/12/2019 09:41	08/12/2019 12:10	08/12/2019 09:41	08/12/2019 12:10	2,48	16	39,67	CHI
20191248114	GOIANIA	17019977	CARAJAS S1	08/12/2019 09:42	08/12/2019 16:26	08/12/2019 09:42	08/12/2019 16:26	6,72	1	6,72	CHI
20191248774	LUZIANIA	LZ12349111	MARAJOARA	08/12/2019 09:42	08/12/2019 14:04	08/12/2019 09:42	08/12/2019 14:04	4,35	155	674,34	CHI
20191248116	GUARANI DE GOIAS	GY21215923	IACIARA S1	08/12/2019 09:43	08/12/2019 12:19	08/12/2019 09:43	08/12/2019 12:19	2,60	1	2,60	CHI
20191248132	GOIANIA	GN11042210	AEROPORTO S1	08/12/2019 09:43	08/12/2019 12:13	08/12/2019 09:43	08/12/2019 12:13	2,50	111	277,01	CHI
20191248123	PLANALTINA	PI21043452	PLANALTINA	08/12/2019 09:44	08/12/2019 11:03	08/12/2019 09:44	08/12/2019 11:03	1,31	2	2,63	CHI
20191248481	NIQUELANDIA	NQ12285213	NIQUELANDIA SUBTRANSMISSAO	08/12/2019 09:44	08/12/2019 17:15	08/12/2019 09:44	08/12/2019 17:15	7,50	6	45,02	CHI
20191248126	DAMIANOPOLIS	DA12399316	IACIARA S2	08/12/2019 09:45	09/12/2019 08:33	08/12/2019 09:45	09/12/2019 08:33	22,80	1	22,80	CHI
20191248127	PIRES DO RIO	460069275	PIRES DO RIO S1	08/12/2019 09:45	08/12/2019 17:49	08/12/2019 09:45	08/12/2019 17:49	8,07	1	8,07	CHI
20191248381	CRIXAS	CX12391662	SANTA TEREZINHA	08/12/2019 09:46	08/12/2019 16:18	08/12/2019 09:46	08/12/2019 16:18	6,54	38	248,37	CHI
20191248137	ORIZONA	OZ12114480	VIANOPOLIS	08/12/2019 09:47	08/12/2019 21:23	08/12/2019 09:47	08/12/2019 21:23	11,60	8	92,79	CHI
20191248138	ESTRELA DO NORTE	ET12000003	MARA ROSA	08/12/2019 09:47	08/12/2019 12:39	08/12/2019 09:47	08/12/2019 12:39	2,85	1	2,85	CHI
20191248138	MARA ROSA	ET12000003	MARA ROSA	08/12/2019 09:47	08/12/2019 12:39	08/12/2019 09:47	08/12/2019 12:39	2,85	2	5,71	CHI
20191248139	RIO VERDE	630358140	RIO VERDE S1	08/12/2019 09:47	08/12/2019 12:22	08/12/2019 09:47	08/12/2019 12:22	2,58	1	2,58	CHI
20191248141	CRISTALINA	10020136895	CRISTALINA S1	08/12/2019 09:48	08/12/2019 12:42	08/12/2019 09:48	08/12/2019 12:42	2,90	1	2,90	CHI
20191248146	ANICUNS	AC12091322	ANICUNS	08/12/2019 09:49	08/12/2019 12:20	08/12/2019 09:49	08/12/2019 12:20	2,53	7	17,69	CHI
20191248399	LUZIANIA	LZ12304862	VIANOPOLIS	08/12/2019 09:49	08/12/2019 12:14	08/12/2019 09:49	08/12/2019 12:14	2,41	4	9,63	CHI
20191248149	CATALAO	CT12078768	CATALAO S1	08/12/2019 09:50	08/12/2019 11:40	08/12/2019 09:50	08/12/2019 11:40	1,83	2	3,66	CHI
20191248150	ISRAELANDIA	IS21184701	IPORA	08/12/2019 09:50	08/12/2019 17:09	08/12/2019 09:50	08/12/2019 17:09	7,30	1	7,30	CHI
20191248161	ACREUNA	EU21044254	ACREUNA	08/12/2019 09:53	08/12/2019 12:18	08/12/2019 09:53	08/12/2019 12:18	2,41	1	2,41	CHI
20191248164	ABADIA DE GOIAS	GN31050562	TRINDADE	08/12/2019 09:53	08/12/2019 13:40	08/12/2019 09:53	08/12/2019 13:40	3,78	1	3,78	CHI
20191248168	ANAPOLIS	AN12000433	ANAPOLIS UNIVERSITARIO S2	08/12/2019 09:53	08/12/2019 16:53	08/12/2019 09:53	08/12/2019 16:53	6,98	1	6,98	CHI
20191248168	PIRENOPOLIS	AN12000433	ANAPOLIS UNIVERSITARIO S2	08/12/2019 09:53	08/12/2019 16:53	08/12/2019 09:53	08/12/2019 16:53	6,98	9	62,86	CHI
20191248169	NOVA CRIXAS	NA12058013	MOZARLANDIA	08/12/2019 09:54	08/12/2019 14:23	08/12/2019 09:54	08/12/2019 14:23	4,48	2	8,97	CHI
20191248171	SAO MIGUEL DO ARAGUAIA	SM21328585	SAO MIGUEL DO ARAGUAIA	08/12/2019 09:54	08/12/2019 18:18	08/12/2019 09:54	08/12/2019 18:18	8,39	1	8,39	CHI
20191248172	URUACU	UR12298845	URUACU	08/12/2019 09:55	08/12/2019 20:43	08/12/2019 09:55	08/12/2019 20:43	10,80	1	10,80	CHI
20191248173	ABADIANIA	AA21144035	ANAPOLIS UNIVERSITARIO S1	08/12/2019 09:55	08/12/2019 12:26	08/12/2019 09:55	08/12/2019 12:26	2,51	1	2,51	CHI
20191248178	CEZARINA	CZ10406616	CEZARINA	08/12/2019 09:55	08/12/2019 12:46	08/12/2019 09:55	08/12/2019 12:46	2,85	308	876,86	CHI

20191248178	INDIARA	CZ10406616	CEZARINA	08/12/2019 09:55	08/12/2019 12:46	08/12/2019 09:55	08/12/2019 12:46	2,85	16	45,55	CHI
20191248179	CACHOEIRA ALTA	7419662	CACHOEIRA ALTA	08/12/2019 09:55	08/12/2019 11:53	08/12/2019 09:55	08/12/2019 11:53	1,96	1	1,96	CHI
20191248180	SANTO ANTONIO DO DESCOBERTO	2210033075	ALEXANIA	08/12/2019 09:55	08/12/2019 11:40	08/12/2019 09:55	08/12/2019 11:40	1,74	1	1,74	CHI
20191248182	APARECIDA DE GOIANIA	AP11137105	INDEPENDENCIA S1	08/12/2019 09:56	08/12/2019 13:07	08/12/2019 09:56	08/12/2019 13:07	3,18	183	582,35	CHI
20191248184	PADRE BERNARDO	PB12275443	PADRE BERNARDO	08/12/2019 09:56	08/12/2019 12:51	08/12/2019 09:56	08/12/2019 12:51	2,91	39	113,67	CHI
20191248541	COLINAS DO SUL	TI12357757	NIQUELANDIA SUBTRANSMISSAO	08/12/2019 09:56	09/12/2019 23:16	08/12/2019 09:56	09/12/2019 23:16	37,32	7	261,25	CHI
20191248189	AMORINOPOLIS	AM12260035	IPORA	08/12/2019 09:57	09/12/2019 05:57	08/12/2019 09:57	09/12/2019 05:57	19,99	1	19,99	CHI
20191248191	RIO VERDE	RV12154033	MONTIVIDIU T	08/12/2019 09:58	08/12/2019 20:52	08/12/2019 09:58	08/12/2019 20:52	10,90	15	163,49	CHI
20191248194	CALDAS NOVAS	CN11283162	CALDAS NOVAS S1	08/12/2019 09:59	08/12/2019 16:35	08/12/2019 09:59	08/12/2019 16:35	6,59	1	6,59	CHI
20191248196	AGUA LIMPA	AL21134570	VILA CORUMBA	08/12/2019 09:59	08/12/2019 12:51	08/12/2019 09:59	08/12/2019 12:51	2,86	2	5,72	CHI
20191248197	QUIRINOPOLIS	80082660	QUIRINOPOLIS	08/12/2019 09:59	08/12/2019 15:03	08/12/2019 09:59	08/12/2019 15:03	5,06	1	5,06	CHI
20191248198	NOVO GAMA	10014661002	PACAEMBU S1	08/12/2019 09:59	08/12/2019 11:22	08/12/2019 09:59	08/12/2019 11:22	1,37	1	1,37	CHI
20191248201	GOIANIA	10202912	AEROPORTO S1	08/12/2019 09:59	08/12/2019 10:38	08/12/2019 09:59	08/12/2019 10:38	0,64	1	0,64	CHI
20191246847	PILAR DE GOIAS	GG21232304	SANTA TEREZINHA	08/12/2019 10:00	08/12/2019 14:11	08/12/2019 10:00	08/12/2019 14:11	4,19	1	4,19	CHI
20191248206	CATALAO	1990147036	CATALAO S2	08/12/2019 10:01	08/12/2019 11:19	08/12/2019 10:01	08/12/2019 11:19	1,30	1	1,30	CHI
20191248208	JANDAIA	JD21037036	PALMEIRAS	08/12/2019 10:01	09/12/2019 07:00	08/12/2019 10:01	09/12/2019 07:00	20,99	1	20,99	CHI
20191248211	PLANALTINA	2960149562	PLANALTINA	08/12/2019 10:03	08/12/2019 11:19	08/12/2019 10:03	08/12/2019 11:19	1,26	1	1,26	CHI
20191248213	OUVIDOR	OU21157968	CATALAO S1	08/12/2019 10:03	08/12/2019 11:40	08/12/2019 10:03	08/12/2019 11:40	1,62	1	1,62	CHI
20191246848	CRIXAS	RB12039306	RUBIATABA	08/12/2019 10:04	08/12/2019 11:34	08/12/2019 10:04	08/12/2019 11:34	1,49	1	1,49	CHI
20191248214	PORANGATU	PO21150785	PORANGATU	08/12/2019 10:04	08/12/2019 13:10	08/12/2019 10:04	08/12/2019 13:10	3,10	1	3,10	CHI
20191248222	ITAPACI	IW12071383	ITAPACI	08/12/2019 10:05	08/12/2019 11:44	08/12/2019 10:05	08/12/2019 11:44	1,65	44	72,38	CHI
20191248224	BOM JESUS DE GOIAS	1250062679	BOM JESUS DE GOIAS	08/12/2019 10:06	08/12/2019 18:43	08/12/2019 10:06	08/12/2019 18:43	8,61	1	8,61	CHI
20191248234	PIRES DO RIO	460035484	PIRES DO RIO S1	08/12/2019 10:08	08/12/2019 16:34	08/12/2019 10:08	08/12/2019 16:34	6,43	1	6,43	CHI
20191248344	GOIAS	GS12310531	GOIAS	08/12/2019 10:08	08/12/2019 14:48	08/12/2019 10:08	08/12/2019 14:48	4,67	17	79,40	CHI
20191248344	GUARAITA	GS12310531	GOIAS	08/12/2019 10:08	08/12/2019 14:48	08/12/2019 10:08	08/12/2019 14:48	4,67	2	9,34	CHI
20191248344	ITAPURANGA	GS12310531	GOIAS	08/12/2019 10:08	08/12/2019 14:48	08/12/2019 10:08	08/12/2019 14:48	4,67	2	9,34	CHI
20191248317	COCALZINHO DE GOIAS	1200028676	COCALZINHO	08/12/2019 10:09	08/12/2019 17:42	08/12/2019 10:09	08/12/2019 17:42	7,53	1	7,53	CHI
20191248349	SANTA CRUZ DE GOIAS	PJ12212225	PIRACANJUBA	08/12/2019 10:09	08/12/2019 13:11	08/12/2019 10:09	08/12/2019 13:11	3,03	6	18,17	CHI
20191248241	RIO VERDE	RV21296053	RIO VERDE S1	08/12/2019 10:11	08/12/2019 17:00	08/12/2019 10:11	08/12/2019 17:00	6,82	1	6,82	CHI
20191248244	JARAGUA	70096120	JARAGUA	08/12/2019 10:12	08/12/2019 11:28	08/12/2019 10:12	08/12/2019 11:28	1,26	1	1,26	CHI
20191248348	GOIANIA	AP12265057	INDEPENDENCIA S2	08/12/2019 10:12	08/12/2019 11:56	08/12/2019 10:12	08/12/2019 11:56	1,72	1190	2046,14	CHI
20191248623	ABADIANIA	AA11084599	ANAPOLIS UNIVERSITARIO S1	08/12/2019 10:13	08/12/2019 13:23	08/12/2019 10:13	08/12/2019 13:23	3,16	108	341,61	CHI
20191248251	GOIANIA	14527121	CARAJAS S2	08/12/2019 10:14	08/12/2019 13:13	08/12/2019 10:14	08/12/2019 13:13	2,97	1	2,97	CHI

20191248254	JATAI	JT11055291	JATAI S2	08/12/2019 10:15	08/12/2019 13:39	08/12/2019 10:15	08/12/2019 13:39	3,40	83	281,99	CHI
20191248257	PALMEIRAS DE GOIAS	590022260	PALMEIRAS	08/12/2019 10:15	09/12/2019 09:35	08/12/2019 10:15	09/12/2019 09:35	23,33	1	23,33	CHI
20191248259	ITABERAI	IB21156273	ITABERAI S2	08/12/2019 10:17	08/12/2019 17:21	08/12/2019 10:17	08/12/2019 17:21	7,07	2	14,13	CHI
20191248260	PLANALTINA	PI12149019	PLANALTINA	08/12/2019 10:17	08/12/2019 13:03	08/12/2019 10:17	08/12/2019 13:03	2,76	596	1643,14	CHI
20191248262	BELA VISTA DE GOIAS	BV21010795	BELA VISTA S1	08/12/2019 10:17	08/12/2019 13:09	08/12/2019 10:17	08/12/2019 13:09	2,86	1	2,86	CHI
20191248823	ANAPOLIS	AN21062476	ANAPOLIS UNIVERSITARIO S2	08/12/2019 10:18	08/12/2019 14:56	08/12/2019 10:18	08/12/2019 14:56	4,62	1	4,62	CHI
20191248269	RIO VERDE	630511275	RIO VERDE S1	08/12/2019 10:19	08/12/2019 15:30	08/12/2019 10:19	08/12/2019 15:30	5,19	1	5,19	CHI
20191248271	OUVIDOR	OU21140986	CATALAO S1	08/12/2019 10:19	08/12/2019 17:20	08/12/2019 10:19	08/12/2019 17:20	7,01	1	7,01	CHI
20191248283	ITABERAI	IB12274550	ITABERAI S1	08/12/2019 10:20	08/12/2019 16:56	08/12/2019 10:20	08/12/2019 16:56	6,59	6	39,51	CHI
20191248684	PIRES DO RIO	BC12051685	PIRES DO RIO S2	08/12/2019 10:20	08/12/2019 16:44	08/12/2019 10:20	08/12/2019 16:44	6,38	52	331,99	CHI
20191248684	SANTA CRUZ DE GOIAS	BC12051685	PIRES DO RIO S2	08/12/2019 10:20	08/12/2019 16:44	08/12/2019 10:20	08/12/2019 16:44	6,38	25	159,61	CHI
20191248292	FORMOSA	TL21344153	SAO JOAO D ALIANCA	08/12/2019 10:25	08/12/2019 14:48	08/12/2019 10:25	08/12/2019 14:48	4,38	1	4,38	CHI
20191248297	GOIANIRA	390002902	GOIANIRA	08/12/2019 10:25	08/12/2019 15:09	08/12/2019 10:25	08/12/2019 15:09	4,72	1	4,72	CHI
20191248303	CRISTALINA	1060041847	CRISTALINA S1	08/12/2019 10:26	08/12/2019 15:24	08/12/2019 10:26	08/12/2019 15:24	4,96	1	4,96	CHI
20191248316	JATAI	10028037217	JATAI S3	08/12/2019 10:28	08/12/2019 14:30	08/12/2019 10:28	08/12/2019 14:30	4,02	1	4,02	CHI
20191248359	APARECIDA DE GOIANIA	AP11094806	INDEPENDENCIA S1	08/12/2019 10:28	08/12/2019 12:08	08/12/2019 10:28	08/12/2019 12:08	1,66	226	375,85	CHI
20191248329	NIQUELANDIA	NQ12235637	URUACU	08/12/2019 10:32	09/12/2019 21:59	08/12/2019 10:32	09/12/2019 21:59	35,45	3	106,35	CHI
20191248331	VIANOPOLIS	VN21157263	VIANOPOLIS	08/12/2019 10:32	08/12/2019 15:54	08/12/2019 10:32	08/12/2019 15:54	5,36	1	5,36	CHI
20191248333	ITUMBIARA	10006133540	ITUMBIARA VELHA S1	08/12/2019 10:33	08/12/2019 14:22	08/12/2019 10:33	08/12/2019 14:22	3,82	1	3,82	CHI
20191248336	BELA VISTA DE GOIAS	HD12323100	CEPAIGO S2	08/12/2019 10:33	08/12/2019 14:36	08/12/2019 10:33	08/12/2019 14:36	4,04	8	32,35	CHI
20191248336	HIDROLANDIA	HD12323100	CEPAIGO S2	08/12/2019 10:33	08/12/2019 14:36	08/12/2019 10:33	08/12/2019 14:36	4,04	98	396,33	CHI
20191248338	CATALAO	CT21230609	CATALAO S1	08/12/2019 10:33	08/12/2019 16:47	08/12/2019 10:33	08/12/2019 16:47	6,23	1	6,23	CHI
20191248686	COCALZINHO DE GOIAS	ZN12377411	COCALZINHO	08/12/2019 10:34	08/12/2019 17:20	08/12/2019 10:34	08/12/2019 17:20	6,76	17	114,87	CHI
20191248347	ITAPIRAPUA	3270006777	MATRINCHA	08/12/2019 10:35	09/12/2019 13:25	08/12/2019 10:35	09/12/2019 13:25	26,82	1	26,82	CHI
20191248350	PIRES DO RIO	PR12000095	PIRES DO RIO S1	08/12/2019 10:36	08/12/2019 10:40	08/12/2019 10:36	08/12/2019 10:40	0,06	17	0,97	CHI
20191248350	URUTAI	PR12000095	PIRES DO RIO S1	08/12/2019 10:36	08/12/2019 10:40	08/12/2019 10:36	08/12/2019 10:40	0,06	13	0,74	CHI
20191248351	RIO VERDE	RV21303872	ACREUNA	08/12/2019 10:36	08/12/2019 12:45	08/12/2019 10:36	08/12/2019 12:45	2,14	2	4,27	CHI
20191248352	QUIRINOPOLIS	QI12096888	QUIRINOPOLIS	08/12/2019 10:36	08/12/2019 13:36	08/12/2019 10:36	08/12/2019 13:36	2,99	20	59,72	CHI
20191248354	ITABERAI	IB21274440	ITABERAI S2	08/12/2019 10:37	08/12/2019 16:39	08/12/2019 10:37	08/12/2019 16:39	6,03	1	6,03	CHI
20191248357	FAZENDA NOVA	FN21113499	IPORA	08/12/2019 10:37	08/12/2019 21:55	08/12/2019 10:37	08/12/2019 21:55	11,29	2	22,58	CHI
20191248993	NIQUELANDIA	NQ12235622	URUACU	08/12/2019 10:37	09/12/2019 01:53	08/12/2019 10:37	09/12/2019 01:53	15,26	29	442,64	CHI
20191246320	LUZIANIA	LZ12084127	PIRES DO RIO S2	08/12/2019 10:38	08/12/2019 14:12	08/12/2019 10:38	08/12/2019 14:12	3,56	8	28,51	CHI
20191246320	ORIZONA	LZ12084127	PIRES DO RIO S2	08/12/2019 10:38	08/12/2019 14:12	08/12/2019 10:38	08/12/2019 14:12	3,56	1	3,56	CHI

20191248361	ANAPOLIS	AN11130801	JUNDIAI S2	08/12/2019 10:38	08/12/2019 12:22	08/12/2019 10:38	08/12/2019 12:22	1,72	126	216,37	CHI
20191248363	DIVINOPOLIS DE GOIAS	2570002271	SAO DOMINGOS	08/12/2019 10:39	08/12/2019 13:47	08/12/2019 10:39	08/12/2019 13:47	3,13	1	3,13	CHI
20191248366	RIO VERDE	630363985	RIO VERDE S1	08/12/2019 10:40	08/12/2019 15:04	08/12/2019 10:40	08/12/2019 15:04	4,40	1	4,40	CHI
20191248367	SANTA ROSA DE GOIAS	SR21312806	INHUMAS S1	08/12/2019 10:40	09/12/2019 09:05	08/12/2019 10:40	09/12/2019 09:05	22,42	2	44,84	CHI
20191248373	ORIZONA	2060058734	PIRES DO RIO S2	08/12/2019 10:42	08/12/2019 17:08	08/12/2019 10:42	08/12/2019 17:08	6,43	1	6,43	CHI
20191249778	URUACU	UR12384347	URUACU	08/12/2019 10:48	08/12/2019 20:18	08/12/2019 10:48	08/12/2019 20:18	9,50	25	237,38	CHI
20191248393	MINEIROS	MY11036556	PARQUE DAS EMAS	08/12/2019 10:50	08/12/2019 16:27	08/12/2019 10:50	08/12/2019 16:27	5,61	216	1211,22	CHI
20191248400	PIRENOPOLIS	PV12156881	CORUMBA	08/12/2019 10:50	08/12/2019 12:27	08/12/2019 10:50	08/12/2019 12:27	1,61	265	425,40	CHI
20191246860	NIQUELANDIA	NQ11362166	BARRO ALTO	08/12/2019 10:51	09/12/2019 03:50	08/12/2019 10:51	09/12/2019 03:50	16,98	2	33,96	CHI
20191248395	HIDROLANDIA	HD21063202	CEPAIGO S2	08/12/2019 10:51	08/12/2019 17:24	08/12/2019 10:51	08/12/2019 17:24	6,54	1	6,54	CHI
20191248396	ITAPACI	100090011	ITAPACI	08/12/2019 10:51	08/12/2019 16:30	08/12/2019 10:51	08/12/2019 16:30	5,64	1	5,64	CHI
20191248406	SENADOR CANEDO	190036000	SENADOR CANEDO	08/12/2019 10:54	08/12/2019 12:42	08/12/2019 10:54	08/12/2019 12:42	1,79	1	1,79	CHI
20191248408	PIRACANJUBA	BV21055786	BELA VISTA S1	08/12/2019 10:55	08/12/2019 16:52	08/12/2019 10:55	08/12/2019 16:52	5,96	1	5,96	CHI
20191248415	CAIAPONIA	CP21247799	PALESTINA	08/12/2019 10:56	09/12/2019 10:48	08/12/2019 10:56	09/12/2019 10:48	23,87	1	23,87	CHI
20191248416	ANAPOLIS	20363618	ANAPOLIS UNIVERSITARIO S2	08/12/2019 10:57	08/12/2019 12:02	08/12/2019 10:57	08/12/2019 12:02	1,08	1	1,08	CHI
20191248419	GOIAS	90074579	GOIAS	08/12/2019 10:58	08/12/2019 19:47	08/12/2019 10:58	08/12/2019 19:47	8,81	1	8,81	CHI
20191248421	PONTALINA	MI12320239	PONTALINA	08/12/2019 10:58	08/12/2019 18:06	08/12/2019 10:58	08/12/2019 18:06	7,12	5	35,62	CHI
20191249351	CATALAO	CT12333570	CATALAO S1	08/12/2019 10:59	10/12/2019 13:44	08/12/2019 10:59	08/12/2019 23:00	12,02	31	372,61	CHI
20191249351	CATALAO	CT12333570	CATALAO S1	08/12/2019 10:59	10/12/2019 13:44	10/12/2019 09:25	10/12/2019 09:38	0,22	31	6,79	CHI
20191249351	CATALAO	CT13281404	CATALAO S1	08/12/2019 10:59	10/12/2019 13:44	08/12/2019 10:59	10/12/2019 10:54	47,92	74	3546,45	CHI
20191249351	CATALAO	CT13281406	CATALAO S1	08/12/2019 10:59	10/12/2019 13:44	08/12/2019 10:59	10/12/2019 13:44	50,75	7	355,23	CHI
20191249237	EDEALINA	EA12257971	EDEIA	08/12/2019 11:00	08/12/2019 16:47	08/12/2019 11:00	08/12/2019 16:47	5,79	7	40,54	CHI
20191249237	INDIARA	EA12257971	EDEIA	08/12/2019 11:00	08/12/2019 16:47	08/12/2019 11:00	08/12/2019 16:47	5,79	2	11,58	CHI
20191248429	ALEXANIA	AX21302173	ALEXANIA	08/12/2019 11:02	08/12/2019 15:00	08/12/2019 11:02	08/12/2019 15:00	3,95	1	3,95	CHI
20191248432	BONOPOLIS	BX12398148	SAO MIGUEL DO ARAGUAIA	08/12/2019 11:03	08/12/2019 20:50	08/12/2019 11:03	08/12/2019 20:50	9,79	16	156,63	CHI
20191248436	ANAPOLIS	AN21262480	ANAPOLIS UNIVERSITARIO S2	08/12/2019 11:06	08/12/2019 17:04	08/12/2019 11:06	08/12/2019 17:04	5,97	1	5,97	CHI
20191248440	APARECIDA DE GOIANIA	200229370	INDEPENDENCIA S2	08/12/2019 11:08	08/12/2019 13:34	08/12/2019 11:08	08/12/2019 13:34	2,43	1	2,43	CHI
20191248442	CATALAO	CT21280751	CATALAO S1	08/12/2019 11:08	09/12/2019 11:27	08/12/2019 11:08	09/12/2019 11:27	24,33	1	24,33	CHI
20191248443	CACHOEIRA DE GOIAS	CG12233441	FIRMINOPOLIS S2	08/12/2019 11:09	09/12/2019 09:30	08/12/2019 11:09	09/12/2019 09:30	22,35	4	89,42	CHI
20191248453	RIO VERDE	RV21279855	ACREUNA	08/12/2019 11:11	08/12/2019 13:14	08/12/2019 11:11	08/12/2019 13:14	2,04	3	6,12	CHI
20191248454	GOIANIA	10722750	ATLANTICO S2	08/12/2019 11:12	08/12/2019 13:39	08/12/2019 11:12	08/12/2019 13:39	2,44	1	2,44	CHI
20191248475	CABECEIRAS	CW21108827	ITIQUEIRA	08/12/2019 11:15	08/12/2019 14:27	08/12/2019 11:15	08/12/2019 14:27	3,19	1	3,19	CHI
20191248480	GOIANIA	14878574	FERROVIARIO S3	08/12/2019 11:17	08/12/2019 12:11	08/12/2019 11:17	08/12/2019 12:11	0,89	1	0,89	CHI

20191248482	AGUAS LINDAS DE GOIAS	4830028325	AGUAS LINDAS DE GOIAS S2	08/12/2019 11:18	08/12/2019 12:20	08/12/2019 11:18	08/12/2019 12:20	1,02	1	1,02	CHI
20191248487	FORMOSA	FA21334124	SAO JOAO D ALIANCA	08/12/2019 11:19	08/12/2019 13:57	08/12/2019 11:19	08/12/2019 13:57	2,63	1	2,63	CHI
20191248488	APARECIDA DO RIO DOCE	10001965903	CACHOEIRA ALTA	08/12/2019 11:19	09/12/2019 08:24	08/12/2019 11:19	09/12/2019 08:24	21,08	1	21,08	CHI
20191248502	APARECIDA DE GOIANIA	200305037	INDEPENDENCIA S2	08/12/2019 11:19	08/12/2019 18:23	08/12/2019 11:19	08/12/2019 18:23	7,06	1	7,06	CHI
20191248504	RIO VERDE	630202357	RIO VERDE S1	08/12/2019 11:19	08/12/2019 16:46	08/12/2019 11:19	08/12/2019 16:46	5,44	1	5,44	CHI
20191248503	ANAPOLIS	20542689	ANAPOLIS UNIVERSITARIO S2	08/12/2019 11:20	08/12/2019 12:45	08/12/2019 11:20	08/12/2019 12:45	1,41	1	1,41	CHI
20191248524	MOSSAMEDES	MD12024167	FIRMINOPOLIS S2	08/12/2019 11:21	08/12/2019 15:01	08/12/2019 11:21	08/12/2019 15:01	3,66	46	168,31	CHI
20191248524	SANCLERLANDIA	MD12024167	FIRMINOPOLIS S2	08/12/2019 11:21	08/12/2019 15:01	08/12/2019 11:21	08/12/2019 15:01	3,66	8	29,27	CHI
20191248515	CAMPINORTE	CR21228669	CAMPINORTE	08/12/2019 11:22	08/12/2019 15:43	08/12/2019 11:22	08/12/2019 15:43	4,35	1	4,35	CHI
20191248517	GOIANIA	10322851	CAMPINAS S1	08/12/2019 11:23	08/12/2019 15:18	08/12/2019 11:23	08/12/2019 15:18	3,91	1	3,91	CHI
20191248518	ANAPOLIS	10015938814	JUNDIAI S1	08/12/2019 11:23	08/12/2019 17:52	08/12/2019 11:23	08/12/2019 17:52	6,47	1	6,47	CHI
20191248519	APARECIDA DE GOIANIA	AP11291450	INDEPENDENCIA S2	08/12/2019 11:24	08/12/2019 13:07	08/12/2019 11:24	08/12/2019 13:07	1,72	328	562,61	CHI
20191248520	AURILANDIA	AI21000009	FIRMINOPOLIS S2	08/12/2019 11:24	08/12/2019 18:27	08/12/2019 11:24	08/12/2019 18:27	7,04	1	7,04	CHI
20191248526	AMARALINA	LC21288785	MARA ROSA	08/12/2019 11:26	08/12/2019 11:46	08/12/2019 11:26	08/12/2019 11:46	0,33	1	0,33	CHI
20191248543	BARRO ALTO	BA12132080	GOIANESIA S1	08/12/2019 11:26	08/12/2019 13:04	08/12/2019 11:26	08/12/2019 13:04	1,62	6	9,75	CHI
20191248532	ABADIANIA	10014096194	ANAPOLIS UNIVERSITARIO S1	08/12/2019 11:27	08/12/2019 14:24	08/12/2019 11:27	08/12/2019 14:24	2,94	1	2,94	CHI
20191248539	JESUPOLIS	SF12066019	SAO FRANCISCO DE GOIAS	08/12/2019 11:32	08/12/2019 13:15	08/12/2019 11:32	08/12/2019 13:15	1,72	12	20,67	CHI
20191248539	SAO FRANCISCO DE GOIAS	SF12066019	SAO FRANCISCO DE GOIAS	08/12/2019 11:32	08/12/2019 13:15	08/12/2019 11:32	08/12/2019 13:15	1,72	10	17,22	CHI
20191248542	ANICUNS	AC21318960	FIRMINOPOLIS S2	08/12/2019 11:34	08/12/2019 13:55	08/12/2019 11:34	08/12/2019 13:55	2,36	1	2,36	CHI
20191248544	SANTA HELENA DE GOIAS	400105147	IPEGUARI	08/12/2019 11:36	08/12/2019 13:20	08/12/2019 11:36	08/12/2019 13:20	1,74	1	1,74	CHI
20191248549	JATAI	290061970	JATAI S3	08/12/2019 11:36	08/12/2019 17:00	08/12/2019 11:36	08/12/2019 17:00	5,40	1	5,40	CHI
20191248548	ITABERAI	IB21310482	ITABERAI S2	08/12/2019 11:37	09/12/2019 16:19	08/12/2019 11:37	09/12/2019 16:19	28,69	1	28,69	CHI
20191248553	PALESTINA DE GOIAS	CP21117698	PALESTINA	08/12/2019 11:39	09/12/2019 09:35	08/12/2019 11:39	09/12/2019 09:35	21,92	1	21,92	CHI
20191248556	CORUMBA DE GOIAS	260005964	CORUMBA	08/12/2019 11:40	08/12/2019 14:22	08/12/2019 11:40	08/12/2019 14:22	2,68	1	2,68	CHI
20191248557	MAIRIPOTABA	MI21362221	PONTALINA	08/12/2019 11:41	08/12/2019 13:45	08/12/2019 11:41	08/12/2019 13:45	2,07	1	2,07	CHI
20191248714	GOIAS	GS12274247	GOIAS	08/12/2019 11:41	08/12/2019 16:15	08/12/2019 11:41	08/12/2019 16:15	4,55	10	45,53	CHI
20191248561	SANTA CRUZ DE GOIAS	BC12300693	PIRES DO RIO S2	08/12/2019 11:42	08/12/2019 15:45	08/12/2019 11:42	08/12/2019 15:45	4,04	5	20,20	CHI
20191248562	ANICUNS	1410010846	ANICUNS	08/12/2019 11:42	08/12/2019 17:19	08/12/2019 11:42	08/12/2019 17:19	5,61	1	5,61	CHI
20191248565	PIRES DO RIO	460079300	PIRES DO RIO S1	08/12/2019 11:43	08/12/2019 16:38	08/12/2019 11:43	08/12/2019 16:38	4,93	1	4,93	CHI
20191248567	SENADOR CANEDO	SW11205665	SENADOR CANEDO	08/12/2019 11:43	08/12/2019 14:45	08/12/2019 11:43	08/12/2019 14:45	3,03	10	30,33	CHI
20191248568	SAO FRANCISCO DE GOIAS	SF21377533	SAO FRANCISCO DE GOIAS	08/12/2019 11:44	08/12/2019 17:55	08/12/2019 11:44	08/12/2019 17:55	6,19	1	6,19	CHI
20191248570	ABADIA DE GOIAS	TR32052038	CARAJAS S1	08/12/2019 11:44	08/12/2019 14:38	08/12/2019 11:44	08/12/2019 14:38	2,89	2	5,78	CHI
20191248572	NEROPOLIS	160045253	NEROPOLIS S2	08/12/2019 11:45	08/12/2019 13:58	08/12/2019 11:45	08/12/2019 13:58	2,21	1	2,21	CHI

20191248597	ANICUNS	NZ12003882	ANICUNS	08/12/2019 11:48	08/12/2019 13:25	08/12/2019 11:48	08/12/2019 13:25	1,61	146	235,59	CHI
20191248597	NAZARIO	NZ12003882	ANICUNS	08/12/2019 11:48	08/12/2019 13:25	08/12/2019 11:48	08/12/2019 13:25	1,61	148	238,81	CHI
20191248597	PALMEIRAS DE GOIAS	NZ12003882	ANICUNS	08/12/2019 11:48	08/12/2019 13:25	08/12/2019 11:48	08/12/2019 13:25	1,61	3	4,84	CHI
20191248597	TURVANIA	NZ12003882	ANICUNS	08/12/2019 11:48	08/12/2019 13:25	08/12/2019 11:48	08/12/2019 13:25	1,61	48	77,45	CHI
20191248580	PARAUNA	PU12034828	ACREUNA	08/12/2019 11:49	08/12/2019 20:59	08/12/2019 11:49	08/12/2019 20:59	9,17	14	128,33	CHI
20191248581	FORMOSA	FA11278203	ITIQUEIRA	08/12/2019 11:49	08/12/2019 16:59	08/12/2019 11:49	08/12/2019 16:59	5,17	1	5,17	CHI
20191248585	ANAPOLIS	10006783714	ANAPOLIS UNIVERSITARIO S2	08/12/2019 11:50	08/12/2019 13:13	08/12/2019 11:50	08/12/2019 13:13	1,38	1	1,38	CHI
20191248588	CORUMBA DE GOIAS	CB21191408	CORUMBA	08/12/2019 11:50	08/12/2019 16:29	08/12/2019 11:50	08/12/2019 16:29	4,65	1	4,65	CHI
20191248763	NIQUELANDIA	NQ12396807	URUACU	08/12/2019 11:50	09/12/2019 20:21	08/12/2019 11:50	09/12/2019 11:50	24,00	3	72,00	CHI
20191248763	NIQUELANDIA	NQ12396807	URUACU	08/12/2019 11:50	09/12/2019 20:21	08/12/2019 11:50	09/12/2019 20:21	32,52	1	32,52	CHI
20191248591	SILVANIA	SV12347736	VIANOPOLIS	08/12/2019 11:51	08/12/2019 16:19	08/12/2019 11:51	08/12/2019 16:19	4,46	2	8,93	CHI
20191248593	PARAUNA	PU21141574	PARAUNA	08/12/2019 11:51	08/12/2019 16:07	08/12/2019 11:51	08/12/2019 16:07	4,27	1	4,27	CHI
20191248598	DIVINOPOLIS DE GOIAS	GH12151252	SAO DOMINGOS	08/12/2019 11:51	08/12/2019 12:51	08/12/2019 11:51	08/12/2019 12:51	0,99	6	5,92	CHI
20191248596	ALTO PARAISO DE GOIAS	BF21325527	NIQUELANDIA SUBTRANSMISSAO	08/12/2019 11:52	08/12/2019 14:11	08/12/2019 11:52	08/12/2019 14:11	2,31	1	2,31	CHI
20191248601	GOIANIA	13951920	MEIA PONTE	08/12/2019 11:54	08/12/2019 15:10	08/12/2019 11:54	08/12/2019 15:10	3,26	1	3,26	CHI
20191248603	GUAPO	GA12391644	GUAPO S1	08/12/2019 11:55	08/12/2019 14:18	08/12/2019 11:55	08/12/2019 14:18	2,38	6	14,27	CHI
20191248603	TRINDADE	GA12391644	GUAPO S1	08/12/2019 11:55	08/12/2019 14:18	08/12/2019 11:55	08/12/2019 14:18	2,38	2	4,76	CHI
20191248765	SANTA HELENA DE GOIAS	SH11226272	IPEGUARI	08/12/2019 11:56	08/12/2019 15:42	08/12/2019 11:56	08/12/2019 15:42	3,76	38	143,03	CHI
20191248607	ANICUNS	10030414910	ANICUNS	08/12/2019 11:57	08/12/2019 13:18	08/12/2019 11:57	08/12/2019 13:18	1,35	1	1,35	CHI
20191248657	INHUMAS	IX12016046	INHUMAS S1	08/12/2019 11:57	08/12/2019 14:43	08/12/2019 11:57	08/12/2019 14:43	2,77	8	22,16	CHI
20191248657	ITAUCU	IX12016046	INHUMAS S1	08/12/2019 11:57	08/12/2019 14:43	08/12/2019 11:57	08/12/2019 14:43	2,77	3	8,31	CHI
20191248687	ANAPOLIS	AN12166243	ANAPOLIS UNIVERSITARIO S2	08/12/2019 11:57	08/12/2019 13:50	08/12/2019 11:57	08/12/2019 13:50	1,87	195	364,16	CHI
20191248616	JANDAIA	JD21226923	PALMEIRAS	08/12/2019 11:58	09/12/2019 12:22	08/12/2019 11:58	09/12/2019 12:22	24,39	1	24,39	CHI
20191251628	RIO VERDE	RV12330018	MONTIVIDIU T	08/12/2019 11:58	09/12/2019 14:08	08/12/2019 11:58	09/12/2019 14:08	26,16	3	78,47	CHI
20191248617	JATAI	10026557302	JATAI S3	08/12/2019 11:59	08/12/2019 14:50	08/12/2019 11:59	08/12/2019 14:50	2,86	1	2,86	CHI
20191248632	GOIANIA	10007662589	XAVANTES	08/12/2019 12:02	08/12/2019 13:19	08/12/2019 12:02	08/12/2019 13:19	1,27	1	1,27	CHI
20191248633	SAO LUIS DE MONTES BELOS	10022523470	SAO LUIZ DOS MONTES BELOS	08/12/2019 12:03	08/12/2019 17:37	08/12/2019 12:03	08/12/2019 17:37	5,57	1	5,57	CHI
20191248634	MATRINCHA	FC21148761	MATRINCHA	08/12/2019 12:04	08/12/2019 19:12	08/12/2019 12:04	08/12/2019 19:12	7,13	1	7,13	CHI
20191248636	GOIANIA	GN11271087	XAVANTES	08/12/2019 12:04	08/12/2019 14:00	08/12/2019 12:04	08/12/2019 14:00	1,93	91	175,40	CHI
20191248638	BOM JESUS DE GOIAS	BJ21352777	BOM JESUS DE GOIAS	08/12/2019 12:04	08/12/2019 19:28	08/12/2019 12:04	08/12/2019 19:28	7,39	1	7,39	CHI
20191248641	GOIANIA	10083352	CAMPINAS S1	08/12/2019 12:05	08/12/2019 15:51	08/12/2019 12:05	08/12/2019 15:51	3,76	1	3,76	CHI
20191248642	EDEIA	EA21182693	EDEIA	08/12/2019 12:05	08/12/2019 16:50	08/12/2019 12:05	08/12/2019 16:50	4,74	1	4,74	CHI
20191248644	TROMBAS	TB12288306	PORANGATU	08/12/2019 12:05	08/12/2019 15:07	08/12/2019 12:05	08/12/2019 15:07	3,02	24	72,57	CHI

20191248664	OURO VERDE DE GOIAS	OV12362285	NEROPOLIS S1	08/12/2019 12:06	08/12/2019 12:52	08/12/2019 12:06	08/12/2019 12:52	0,76	2	1,52	CHI
20191248664	PETROLINA DE GOIAS	OV12362285	NEROPOLIS S1	08/12/2019 12:06	08/12/2019 12:52	08/12/2019 12:06	08/12/2019 12:52	0,76	1	0,76	CHI
20191248648	CORUMBAIBA	CI11142363	VILA CORUMBA	08/12/2019 12:07	08/12/2019 16:49	08/12/2019 12:07	08/12/2019 16:49	4,69	40	187,46	CHI
20191248650	CRISTALINA	KR12304869	CRISTALINA S2	08/12/2019 12:08	08/12/2019 15:09	08/12/2019 12:08	08/12/2019 15:09	3,01	15	45,12	CHI
20191248651	FIRMINOPOLIS	FR21076462	FIRMINOPOLIS S1	08/12/2019 12:08	08/12/2019 15:17	08/12/2019 12:08	08/12/2019 15:17	3,13	1	3,13	CHI
20191248653	MARA ROSA	MQ12391777	SANTA TEREZINHA	08/12/2019 12:10	09/12/2019 12:33	08/12/2019 12:10	09/12/2019 12:33	24,38	4	97,53	CHI
20191248658	GOIANIA	13715884	CAMPINAS S1	08/12/2019 12:10	08/12/2019 15:02	08/12/2019 12:10	08/12/2019 15:02	2,85	1	2,85	CHI
20191248659	JARAGUA	JA21297000	GOIANESIA S2	08/12/2019 12:11	08/12/2019 14:45	08/12/2019 12:11	08/12/2019 14:45	2,56	2	5,12	CHI
20191248662	TRES RANCHOS	TH11077399	CATALAO S1	08/12/2019 12:12	08/12/2019 15:41	08/12/2019 12:12	08/12/2019 15:41	3,48	20	69,52	CHI
20191248663	CRISTALINA	KR12087952	CRISTALINA S2	08/12/2019 12:12	08/12/2019 15:49	08/12/2019 12:12	08/12/2019 14:33	2,34	37	86,63	CHI
20191248663	CRISTALINA	KR12087952	CRISTALINA S2	08/12/2019 12:12	08/12/2019 15:49	08/12/2019 12:12	08/12/2019 15:49	3,61	1	3,61	CHI
20191248834	RIO VERDE	03670224	SANTA HELENA S1	08/12/2019 12:12	09/12/2019 01:45	08/12/2019 12:12	08/12/2019 15:10	2,97	148	439,11	CHI
20191248834	SANTA HELENA DE GOIAS	03670224	SANTA HELENA S1	08/12/2019 12:12	09/12/2019 01:45	08/12/2019 12:12	08/12/2019 15:10	2,97	1	2,97	CHI
20191248834	QUIRINOPOLIS	RV13303547	SANTA HELENA S1	08/12/2019 12:12	09/12/2019 01:45	08/12/2019 12:12	09/12/2019 01:45	13,55	42	569,22	CHI
20191248834	RIO VERDE	RV13303547	SANTA HELENA S1	08/12/2019 12:12	09/12/2019 01:45	08/12/2019 12:12	09/12/2019 01:45	13,55	503	6817,05	CHI
20191248797	TRINDADE	TR11090138	GOYA S1	08/12/2019 12:13	08/12/2019 14:44	08/12/2019 12:13	08/12/2019 14:44	2,51	84	211,24	CHI
20191248672	LUZIANIA	10029833947	MARAJOARA	08/12/2019 12:17	08/12/2019 17:56	08/12/2019 12:17	08/12/2019 17:56	5,64	1	5,64	CHI
20191249456	DOVERLANDIA	MY12219553	PARQUE DAS EMAS	08/12/2019 12:17	08/12/2019 18:37	08/12/2019 12:17	08/12/2019 18:37	6,33	46	291,05	CHI
20191248673	GOIANIRA	10000077435	MEIA PONTE	08/12/2019 12:18	08/12/2019 16:24	08/12/2019 12:18	08/12/2019 16:24	4,10	1	4,10	CHI
20191248674	GOIAS	GS21091153	GOIAS	08/12/2019 12:18	08/12/2019 19:10	08/12/2019 12:18	08/12/2019 19:10	6,86	1	6,86	CHI
20191248676	PLANALTINA	6787099	PLANALTINA	08/12/2019 12:19	08/12/2019 15:46	08/12/2019 12:19	08/12/2019 15:46	3,45	3	10,34	CHI
20191248678	RIO VERDE	MV12301707	MONTIVIDIU T	08/12/2019 12:19	08/12/2019 21:40	08/12/2019 12:19	08/12/2019 21:40	9,34	7	65,35	CHI
20191249632	NIQUELANDIA	NQ13058947	NIQUELANDIA SUBTRANSMISSAO	08/12/2019 12:19	08/12/2019 18:46	08/12/2019 12:19	08/12/2019 18:46	6,44	136	875,99	CHI
20191248685	FORMOSA	610293102	ITIQUEIRA	08/12/2019 12:22	08/12/2019 14:03	08/12/2019 12:22	08/12/2019 14:03	1,67	1	1,67	CHI
20191248688	TRINDADE	10028548017	TRINDADE	08/12/2019 12:23	08/12/2019 13:57	08/12/2019 12:23	08/12/2019 13:57	1,56	1	1,56	CHI
20191248689	PIRENOPOLIS	PV21230765	CORUMBA	08/12/2019 12:23	08/12/2019 15:37	08/12/2019 12:23	08/12/2019 15:37	3,23	1	3,23	CHI
20191248690	IVOLANDIA	PU12090442	MONTIVIDIU T	08/12/2019 12:23	09/12/2019 11:22	08/12/2019 12:23	09/12/2019 11:22	22,97	22	505,39	CHI
20191248690	PARAUNA	PU12090442	MONTIVIDIU T	08/12/2019 12:23	09/12/2019 11:22	08/12/2019 12:23	09/12/2019 11:22	22,97	49	1125,64	CHI
20191248865	LUZIANIA	OZ12195112	PIRES DO RIO S2	08/12/2019 12:24	08/12/2019 18:48	08/12/2019 12:24	08/12/2019 18:48	6,38	72	459,70	CHI
20191248696	MINEIROS	1390051824	PARQUE DAS EMAS	08/12/2019 12:26	08/12/2019 16:20	08/12/2019 12:26	08/12/2019 16:20	3,90	1	3,90	CHI
20191248699	RIO VERDE	630261532	RIO VERDE S2	08/12/2019 12:26	08/12/2019 15:26	08/12/2019 12:26	08/12/2019 15:26	3,00	1	3,00	CHI
20191248700	CAMPINORTE	CR21327263	MARA ROSA	08/12/2019 12:26	08/12/2019 20:28	08/12/2019 12:26	08/12/2019 20:28	8,02	1	8,02	CHI
20191248704	MONTIVIDIU	MV13384551	MONTIVIDIU T	08/12/2019 12:27	09/12/2019 16:01	08/12/2019 23:15	09/12/2019 16:01	16,76	14	234,70	CHI



20191248704	RIO VERDE	MV13384551	MONTIVIDIU T	08/12/2019 12:27	09/12/2019 16:01	08/12/2019 23:15	09/12/2019 16:01	16,76	62	1039,40	CHI
20191248705	INHUMAS	IN21310636	INHUMAS S1	08/12/2019 12:27	08/12/2019 15:37	08/12/2019 12:27	08/12/2019 15:37	3,16	1	3,16	CHI
20191248708	ANAPOLIS	10001186122	JUNDIAI S1	08/12/2019 12:29	08/12/2019 16:18	08/12/2019 12:29	08/12/2019 16:18	3,81	1	3,81	CHI
20191248724	PORANGATU	PO10391977	PORANGATU	08/12/2019 12:29	08/12/2019 19:49	08/12/2019 12:29	08/12/2019 13:56	1,46	188	274,69	CHI
20191248724	PORANGATU	PO12057986	PORANGATU	08/12/2019 12:29	08/12/2019 19:49	08/12/2019 12:29	08/12/2019 13:56	1,46	154	225,05	CHI
20191248724	PORANGATU	PO12328896	PORANGATU	08/12/2019 12:29	08/12/2019 19:49	08/12/2019 12:29	08/12/2019 17:35	5,10	8	40,80	CHI
20191248724	PORANGATU	PO10391977	PORANGATU	08/12/2019 12:29	08/12/2019 19:49	08/12/2019 12:29	08/12/2019 19:49	7,33	16	117,30	CHI
20191248709	PROFESSOR JAMIL SAFADY	JS21363825	ROCHEDO	08/12/2019 12:30	08/12/2019 22:19	08/12/2019 12:30	08/12/2019 22:19	9,83	1	9,83	CHI
20191248722	PIRENOPOLIS	SF21080096	CORUMBA	08/12/2019 12:33	09/12/2019 12:45	08/12/2019 12:33	09/12/2019 12:45	24,19	1	24,19	CHI
20191248723	COCALZINHO DE GOIAS	ZN12201365	COCALZINHO	08/12/2019 12:33	08/12/2019 21:27	08/12/2019 12:33	08/12/2019 21:27	8,88	3	26,65	CHI
20191248723	CORUMBA DE GOIAS	ZN12201365	COCALZINHO	08/12/2019 12:33	08/12/2019 21:27	08/12/2019 12:33	08/12/2019 21:27	8,88	16	142,14	CHI
20191248798	GOIAS	IB12210550	ITABERAI S1	08/12/2019 12:33	08/12/2019 19:35	08/12/2019 12:33	08/12/2019 19:35	7,03	3	21,09	CHI
20191248798	ITABERAI	IB12210550	ITABERAI S1	08/12/2019 12:33	08/12/2019 19:35	08/12/2019 12:33	08/12/2019 19:35	7,03	36	253,04	CHI
20191248726	URUACU	UR12327259	CAMPINORTE	08/12/2019 12:34	08/12/2019 21:27	08/12/2019 12:34	08/12/2019 21:27	8,88	1	8,88	CHI
20191248745	AMARALINA	MU12060988	MARA ROSA	08/12/2019 12:35	09/12/2019 15:10	08/12/2019 12:35	08/12/2019 20:28	7,88	47	370,50	CHI
20191248745	MUTUNOPOLIS	MU12060988	MARA ROSA	08/12/2019 12:35	09/12/2019 15:10	08/12/2019 12:35	08/12/2019 20:28	7,88	31	244,37	CHI
20191248745	AMARALINA	MU12060988	MARA ROSA	08/12/2019 12:35	09/12/2019 15:10	08/12/2019 12:35	08/12/2019 22:57	10,37	24	248,93	CHI
20191248745	AMARALINA	MU12060988	MARA ROSA	08/12/2019 12:35	09/12/2019 15:10	08/12/2019 12:35	09/12/2019 01:46	13,18	51	672,42	CHI
20191248745	AMARALINA	MU12060988	MARA ROSA	08/12/2019 12:35	09/12/2019 15:10	08/12/2019 12:35	09/12/2019 11:12	22,62	11	248,79	CHI
20191248745	AMARALINA	MU12391672	MARA ROSA	08/12/2019 12:35	09/12/2019 15:10	09/12/2019 11:32	09/12/2019 13:11	1,65	82	135,07	CHI
20191248745	MUTUNOPOLIS	MU12391672	MARA ROSA	08/12/2019 12:35	09/12/2019 15:10	09/12/2019 11:32	09/12/2019 13:11	1,65	7	11,53	CHI
20191248745	AMARALINA	LC13208585	MARA ROSA	08/12/2019 12:35	09/12/2019 15:10	09/12/2019 11:32	09/12/2019 14:40	3,12	11	34,31	CHI
20191248745	AMARALINA	MU12060988	MARA ROSA	08/12/2019 12:35	09/12/2019 15:10	08/12/2019 12:35	09/12/2019 15:10	26,59	8	212,72	CHI
20191248730	GOIANIA	10064862	GOIANIA LESTE S1	08/12/2019 12:36	08/12/2019 14:52	08/12/2019 12:36	08/12/2019 14:52	2,25	1	2,25	CHI
20191248732	RIO VERDE	10030675438	RIO VERDE S2	08/12/2019 12:37	08/12/2019 16:44	08/12/2019 12:37	08/12/2019 16:44	4,11	0	0,00	CHI
20191248738	GOIANESIA	10012619424	GOIANESIA S2	08/12/2019 12:38	08/12/2019 18:56	08/12/2019 12:38	08/12/2019 18:56	6,29	1	6,29	CHI
20191248740	JANDAIA	1180008458	PALMEIRAS	08/12/2019 12:38	09/12/2019 10:29	08/12/2019 12:38	09/12/2019 10:29	21,85	1	21,85	CHI
20191248742	BOM JARDIM DE GOIAS	BM12360370	BOM JARDIM	08/12/2019 12:40	08/12/2019 20:18	08/12/2019 12:40	08/12/2019 20:18	7,63	1	7,63	CHI
20191253420	FAZENDA NOVA	FN21311836	IPORA	08/12/2019 12:40	09/12/2019 11:30	08/12/2019 12:40	09/12/2019 11:30	22,82	1	22,82	CHI
20191248754	ITAUCU	PV17246847	CORUMBA	08/12/2019 12:41	08/12/2019 15:25	08/12/2019 12:41	08/12/2019 15:25	2,72	1	2,72	CHI
20191248754	PIRENOPOLIS	PV17246847	CORUMBA	08/12/2019 12:41	08/12/2019 15:25	08/12/2019 12:41	08/12/2019 15:25	2,72	70	190,58	CHI
20191246874	ALTO PARAISO DE GOIAS	BF10400725	NIQUELANDIA SUBTRANSMISSAO	08/12/2019 12:42	08/12/2019 16:39	08/12/2019 12:42	08/12/2019 16:23	3,67	380	1395,87	CHI
20191246874	ALTO PARAISO DE GOIAS	BF10400725	NIQUELANDIA SUBTRANSMISSAO	08/12/2019 12:42	08/12/2019 16:39	08/12/2019 12:42	08/12/2019 16:39	3,94	140	551,29	CHI

20191246874	ALTO PARAISO DE GOIAS	BF13120581	NIQUELANDIA SUBTRANSMISSAO	08/12/2019 12:42	08/12/2019 16:39	08/12/2019 14:15	08/12/2019 16:39	2,40	1	2,40	CHI
20191248858	GOIAS	GS12234131	GOIAS	08/12/2019 12:42	08/12/2019 17:05	08/12/2019 12:42	08/12/2019 17:05	4,37	11	48,11	CHI
20191250332	ALTO PARAISO DE GOIAS	BF21144675	NIQUELANDIA SUBTRANSMISSAO	08/12/2019 12:42	08/12/2019 21:24	08/12/2019 12:42	08/12/2019 21:24	8,69	1	8,69	CHI
20191248755	SAO JOAO D ALIANCA	3840008059	SAO JOAO D ALIANCA	08/12/2019 12:43	08/12/2019 16:02	08/12/2019 12:43	08/12/2019 16:02	3,32	1	3,32	CHI
20191248758	PADRE BERNARDO	PB12163211	PADRE BERNARDO	08/12/2019 12:44	08/12/2019 16:13	08/12/2019 12:44	08/12/2019 16:13	3,47	3	10,41	CHI
20191248760	SANCLERLANDIA	DN21016331	FIRMINOPOLIS S2	08/12/2019 12:46	08/12/2019 16:31	08/12/2019 12:46	08/12/2019 16:31	3,75	1	3,75	CHI
20191248762	JATAI	290319833	JATAI S3	08/12/2019 12:46	08/12/2019 16:15	08/12/2019 12:46	08/12/2019 16:15	3,48	1	3,48	CHI
20191248764	VIANOPOLIS	VN21275099	PIRES DO RIO S2	08/12/2019 12:47	08/12/2019 15:24	08/12/2019 12:47	08/12/2019 15:24	2,61	1	2,61	CHI
20191248767	APORE	AE21216568	ITAJA S1	08/12/2019 12:47	08/12/2019 16:34	08/12/2019 12:47	08/12/2019 16:34	3,77	1	3,77	CHI
20191248769	APARECIDA DE GOIANIA	AP11203821	ANHANGUERA	08/12/2019 12:48	08/12/2019 15:43	08/12/2019 12:48	08/12/2019 15:43	2,91	8	23,26	CHI
20191248779	PLANALTINA	PI12063560	PLANALTINA	08/12/2019 12:52	08/12/2019 17:55	08/12/2019 12:52	08/12/2019 17:55	5,05	14	70,74	CHI
20191248781	GOIANIA	12446841	FERROVIARIO S2	08/12/2019 12:53	08/12/2019 15:07	08/12/2019 12:53	08/12/2019 15:07	2,22	1	2,22	CHI
20191248782	ACREUNA	EU12219444	ACREUNA	08/12/2019 12:53	08/12/2019 15:43	08/12/2019 12:53	08/12/2019 15:43	2,82	1	2,82	CHI
20191248789	TURVELANDIA	TD12246841	RIO DOS BOIS	08/12/2019 12:55	08/12/2019 18:54	08/12/2019 12:55	08/12/2019 18:54	5,97	6	35,82	CHI
20191248790	MOIPIORA	MO21072544	IPORA	08/12/2019 12:56	09/12/2019 08:05	08/12/2019 12:56	09/12/2019 08:05	19,14	1	19,14	CHI
20191248795	PALMEIRAS DE GOIAS	10005468408	PALMEIRAS	08/12/2019 12:56	09/12/2019 09:14	08/12/2019 12:56	09/12/2019 09:14	20,29	1	20,29	CHI
20191248801	RIO VERDE	CP12191909	MONTIVIDIU T	08/12/2019 12:56	09/12/2019 13:50	08/12/2019 12:56	09/12/2019 13:50	24,89	3	74,68	CHI
20191248794	TRES RANCHOS	TH21165135	CATALAO S1	08/12/2019 12:57	08/12/2019 14:46	08/12/2019 12:57	08/12/2019 14:46	1,81	1	1,81	CHI
20191248796	FORMOSA	FA21211683	ITIQUEIRA	08/12/2019 12:57	08/12/2019 15:58	08/12/2019 12:57	08/12/2019 15:58	3,02	2	6,03	CHI
20191248935	LUZIANIA	SV12350759LD	VIANOPOLIS	08/12/2019 12:58	08/12/2019 23:24	08/12/2019 19:04	08/12/2019 23:24	4,34	355	1539,32	CHI
20191248804	PARAUNA	980022230	PARAUNA	08/12/2019 12:59	08/12/2019 17:22	08/12/2019 12:59	08/12/2019 17:22	4,37	1	4,37	CHI
20191248807	GOIAS	GS21145728	GOIAS	08/12/2019 13:00	09/12/2019 08:01	08/12/2019 13:00	09/12/2019 08:01	19,01	1	19,01	CHI
20191248810	GOIANIA	10011857771	AEROPORTO S1	08/12/2019 13:01	08/12/2019 17:47	08/12/2019 13:01	08/12/2019 17:47	4,77	1	4,77	CHI
20191248811	AGUAS LINDAS DE GOIAS	10005693908	AGUAS LINDAS DE GOIAS S1	08/12/2019 13:02	08/12/2019 13:42	08/12/2019 13:02	08/12/2019 13:42	0,67	1	0,67	CHI
20191248836	HIDROLINA	HL21201754	URUACU	08/12/2019 13:05	08/12/2019 18:54	08/12/2019 13:05	08/12/2019 18:54	5,82	1	5,82	CHI
20191248837	MINEIROS	MY12149301	PARQUE DAS EMAS	08/12/2019 13:05	08/12/2019 18:53	08/12/2019 13:05	08/12/2019 18:53	5,79	15	86,85	CHI
20191248837	PEROLANDIA	MY12149301	PARQUE DAS EMAS	08/12/2019 13:05	08/12/2019 18:53	08/12/2019 13:05	08/12/2019 18:53	5,79	1	5,79	CHI
20191248839	ARAGARCAS	AG21320802	ARAGARCAS	08/12/2019 13:06	08/12/2019 17:04	08/12/2019 13:06	08/12/2019 17:04	3,96	1	3,96	CHI
20191248841	DAMOLANDIA	DL12014118	INHUMAS S1	08/12/2019 13:08	08/12/2019 16:53	08/12/2019 13:08	08/12/2019 16:53	3,75	7	26,22	CHI
20191248853	PADRE BERNARDO	PB12275443	PADRE BERNARDO	08/12/2019 13:14	08/12/2019 19:12	08/12/2019 13:14	08/12/2019 19:12	5,96	39	232,36	CHI
20191248857	ANAPOLIS	20986520	ANAPOLIS UNIVERSITARIO S2	08/12/2019 13:15	08/12/2019 15:45	08/12/2019 13:15	08/12/2019 15:45	2,49	1	2,49	CHI
20191248893	CORUMBA DE GOIAS	CB12056813	CORUMBA	08/12/2019 13:15	08/12/2019 15:04	08/12/2019 13:15	08/12/2019 15:04	1,81	24	43,54	CHI
20191248860	CRISTALINA	KR12290773	CRISTALINA S2	08/12/2019 13:16	08/12/2019 16:59	08/12/2019 13:16	08/12/2019 16:59	3,70	5	18,51	CHI

20191248860	LUZIANIA	KR12290773	CRISTALINA S2	08/12/2019 13:16	08/12/2019 16:59	08/12/2019 13:16	08/12/2019 16:59	3,70	3	11,11	CHI
20191248861	URUACU	640116541	URUACU	08/12/2019 13:17	08/12/2019 17:03	08/12/2019 13:17	08/12/2019 17:03	3,77	1	3,77	CHI
20191248867	GOIANIA	14175782	FERROVIARIO S1	08/12/2019 13:20	08/12/2019 14:13	08/12/2019 13:20	08/12/2019 14:13	0,88	1	0,88	CHI
20191248868	SAO MIGUEL DO ARAGUAIA	SM12074411	SAO MIGUEL DO ARAGUAIA	08/12/2019 13:20	08/12/2019 17:57	08/12/2019 13:20	08/12/2019 17:57	4,61	5	23,07	CHI
20191248871	JARAGUA	JA21114571	GOIANESIA S2	08/12/2019 13:20	08/12/2019 15:21	08/12/2019 13:20	08/12/2019 15:21	2,01	1	2,01	CHI
20191248874	APARECIDA DE GOIANIA	10000488532	INDEPENDENCIA S2	08/12/2019 13:20	08/12/2019 16:41	08/12/2019 13:20	08/12/2019 16:41	3,34	1	3,34	CHI
20191248876	SAO SIMAO	SO11000026	CACHOEIRA ALTA	08/12/2019 13:22	08/12/2019 19:25	08/12/2019 13:22	08/12/2019 19:25	6,05	49	296,23	CHI
20191248877	CORUMBA DE GOIAS	CB21102095	COCALZINHO	08/12/2019 13:22	09/12/2019 09:36	08/12/2019 13:22	09/12/2019 09:36	20,23	1	20,23	CHI
20191248886	RUBIATABA	780057703	RUBIATABA	08/12/2019 13:24	09/12/2019 01:50	08/12/2019 13:24	09/12/2019 01:50	12,42	1	12,42	CHI
20191249286	IPAMERI	IP12275809	IPAMERI	08/12/2019 13:24	08/12/2019 16:22	08/12/2019 13:24	08/12/2019 16:22	2,96	148	438,57	CHI
20191248890	SANTO ANTONIO DO DESCOBERTO	SN21305162	MARAJOARA	08/12/2019 13:27	08/12/2019 17:38	08/12/2019 13:27	08/12/2019 17:38	4,18	1	4,18	CHI
20191250442	ITABERAI	IB12018316	ITABERAI S2	08/12/2019 13:28	09/12/2019 08:36	08/12/2019 13:28	09/12/2019 08:36	19,13	3	57,40	CHI
20191248899	ABADIA DE GOIAS	TR31046106	CARAJAS S1	08/12/2019 13:31	08/12/2019 16:15	08/12/2019 13:31	08/12/2019 16:15	2,73	1	2,73	CHI
20191248909	MORRINHOS	MR21000069	MORRINHOS	08/12/2019 13:35	08/12/2019 18:25	08/12/2019 13:35	08/12/2019 18:25	4,82	1	4,82	CHI
20191248910	PORANGATU	PO21020605	PORANGATU	08/12/2019 13:35	08/12/2019 17:29	08/12/2019 13:35	08/12/2019 17:29	3,88	1	3,88	CHI
20191248978	LUZIANIA	LZ12417538	MARAJOARA	08/12/2019 13:36	08/12/2019 16:26	08/12/2019 13:36	08/12/2019 16:26	2,82	26	73,36	CHI
20191248924	PIRENOPOLIS	PV21236037	CORUMBA	08/12/2019 13:39	09/12/2019 08:47	08/12/2019 13:39	09/12/2019 08:47	19,12	1	19,12	CHI
20191249325	IPORA	IR12065090	IPORA	08/12/2019 13:39	08/12/2019 16:47	08/12/2019 13:39	08/12/2019 16:47	3,12	30	93,66	CHI
20191248926	NOVO GAMA	LZ21046979	PACAEMBU S1	08/12/2019 13:41	08/12/2019 20:22	08/12/2019 13:41	08/12/2019 20:22	6,68	1	6,68	CHI
20191248927	LUZIANIA	LZ11072900	MARAJOARA	08/12/2019 13:41	08/12/2019 15:56	08/12/2019 13:41	08/12/2019 15:56	2,24	19	42,58	CHI
20191248930	ITABERAI	IB12274551	ITABERAI S2	08/12/2019 13:42	08/12/2019 22:00	08/12/2019 13:42	08/12/2019 19:57	6,24	23	143,57	CHI
20191248930	ITABERAI	IB12040786	ITABERAI S2	08/12/2019 13:42	08/12/2019 22:00	08/12/2019 13:42	08/12/2019 22:00	8,29	10	82,88	CHI
20191249367	CORUMBA DE GOIAS	CB12033602	CORUMBA	08/12/2019 13:42	08/12/2019 16:55	08/12/2019 13:42	08/12/2019 16:55	3,21	6	19,25	CHI
20191249816	LUZIANIA	LZ12351401RE	MARAJOARA	08/12/2019 13:43	08/12/2019 18:13	08/12/2019 13:43	08/12/2019 18:13	4,49	28	125,64	CHI
20191248933	COCALZINHO DE GOIAS	ZN12295673	COCALZINHO	08/12/2019 13:44	08/12/2019 18:12	08/12/2019 13:44	08/12/2019 18:12	4,46	5	22,31	CHI
20191248939	SAO LUIS DE MONTES BELOS	SL32111626	FIRMINOPOLIS S1	08/12/2019 13:48	08/12/2019 16:09	08/12/2019 13:48	08/12/2019 16:09	2,35	2	4,69	CHI
20191248940	VALPARAISO DE GOIAS	2860202700	MARAJOARA	08/12/2019 13:49	08/12/2019 14:55	08/12/2019 13:49	08/12/2019 14:55	1,10	1	1,10	CHI
20191248941	AVELINOPOLIS	AV12323530	ANICUNS	08/12/2019 13:49	08/12/2019 22:02	08/12/2019 13:49	08/12/2019 22:02	8,21	15	123,19	CHI
20191248953	IPORA	IR12374853	IPORA	08/12/2019 13:53	08/12/2019 21:12	08/12/2019 13:53	08/12/2019 21:12	7,31	2	14,61	CHI
20191248955	BELA VISTA DE GOIAS	BV31060478	BELA VISTA S1	08/12/2019 13:55	08/12/2019 16:57	08/12/2019 13:55	08/12/2019 16:57	3,03	1	3,03	CHI
20191248956	GOIANIA	13427362	MEIA PONTE	08/12/2019 13:56	08/12/2019 14:58	08/12/2019 13:56	08/12/2019 14:58	1,03	1	1,03	CHI
20191248961	CATURAI	CK11148603	GOIANIRA	08/12/2019 13:59	08/12/2019 16:44	08/12/2019 13:59	08/12/2019 16:44	2,75	84	230,81	CHI
20191248962	ANICUNS	AC21304586	FIRMINOPOLIS S2	08/12/2019 13:59	08/12/2019 17:00	08/12/2019 13:59	08/12/2019 17:00	3,02	1	3,02	CHI

20191248965	NAZARIO	440015066	ANICUNS	08/12/2019 14:00	08/12/2019 15:00	08/12/2019 14:00	08/12/2019 15:00	0,99	1	0,99	CHI
20191248968	NOVO PLANALTO	TA12099914	NOVO PLANALTO	08/12/2019 14:01	09/12/2019 11:36	08/12/2019 14:01	09/12/2019 11:36	21,57	2	43,15	CHI
20191249603	PIRENOPOLIS	ZN12273387	COCALZINHO	08/12/2019 14:01	09/12/2019 13:11	08/12/2019 14:01	09/12/2019 13:11	23,16	14	324,24	CHI
20191248972	DAVINOPOLIS	IO21085109	CATALAO S1	08/12/2019 14:04	08/12/2019 16:40	08/12/2019 14:04	08/12/2019 16:40	2,60	1	2,60	CHI
20191248974	NOVO GAMA	NJ12136548	MARAJOARA	08/12/2019 14:05	08/12/2019 18:59	08/12/2019 14:05	08/12/2019 18:59	4,90	404	1978,14	CHI
20191251101	DIORAMA	DI12381021	IPORA	08/12/2019 14:05	08/12/2019 22:46	08/12/2019 14:05	08/12/2019 22:46	8,67	3	26,02	CHI
20191248979	ABADIANIA	00400424	CORUMBA	08/12/2019 14:06	09/12/2019 18:19	09/12/2019 02:01	09/12/2019 03:41	1,66	675	1119,56	CHI
20191248979	ANAPOLIS	00400424	CORUMBA	08/12/2019 14:06	09/12/2019 18:19	09/12/2019 02:01	09/12/2019 03:41	1,66	1	1,66	CHI
20191248979	CORUMBA DE GOIAS	00400424	CORUMBA	08/12/2019 14:06	09/12/2019 18:19	09/12/2019 02:01	09/12/2019 03:41	1,66	33	54,73	CHI
20191248979	CORUMBA DE GOIAS	00400424	CORUMBA	08/12/2019 14:06	09/12/2019 18:19	09/12/2019 02:01	09/12/2019 03:41	1,66	276	457,78	CHI
20191248979	GOIANESIA	00400424	CORUMBA	08/12/2019 14:06	09/12/2019 18:19	09/12/2019 02:01	09/12/2019 03:41	1,66	10	16,59	CHI
20191248979	ITAUCU	00400424	CORUMBA	08/12/2019 14:06	09/12/2019 18:19	09/12/2019 02:01	09/12/2019 03:41	1,66	1	1,66	CHI
20191248979	JARAGUA	00400424	CORUMBA	08/12/2019 14:06	09/12/2019 18:19	09/12/2019 02:01	09/12/2019 03:41	1,66	17	28,20	CHI
20191248979	PIRENOPOLIS	00400424	CORUMBA	08/12/2019 14:06	09/12/2019 18:19	09/12/2019 02:01	09/12/2019 03:41	1,66	2534	4202,92	CHI
20191248979	PIRENOPOLIS	00400424	CORUMBA	08/12/2019 14:06	09/12/2019 18:19	09/12/2019 02:01	09/12/2019 03:41	1,66	3817	6330,92	CHI
20191248979	PIRENOPOLIS	00400424	CORUMBA	08/12/2019 14:06	09/12/2019 18:19	09/12/2019 02:01	09/12/2019 03:41	1,66	4150	6883,24	CHI
20191248979	PIRENOPOLIS	00400424	CORUMBA	08/12/2019 14:06	09/12/2019 18:19	09/12/2019 02:01	09/12/2019 03:41	1,66	604	1001,80	CHI
20191248979	PIRENOPOLIS	00400424	CORUMBA	08/12/2019 14:06	09/12/2019 18:19	09/12/2019 02:01	09/12/2019 03:41	1,66	100	165,86	CHI
20191248979	SAO FRANCISCO DE GOIAS	00400424	CORUMBA	08/12/2019 14:06	09/12/2019 18:19	09/12/2019 02:01	09/12/2019 03:41	1,66	2	3,32	CHI
20191248979	VILA PROPICIO	00400424	CORUMBA	08/12/2019 14:06	09/12/2019 18:19	09/12/2019 02:01	09/12/2019 03:41	1,66	16	26,54	CHI
20191248979	CORUMBA DE GOIAS	CB12215013	CORUMBA	08/12/2019 14:06	09/12/2019 18:19	09/12/2019 02:01	09/12/2019 03:45	1,73	3	5,18	CHI
20191248979	CORUMBA DE GOIAS	CB12348149	CORUMBA	08/12/2019 14:06	09/12/2019 18:19	09/12/2019 02:01	09/12/2019 17:38	15,62	1	15,62	CHI
20191248979	CORUMBA DE GOIAS	CB21148174	CORUMBA	08/12/2019 14:06	09/12/2019 18:19	08/12/2019 14:06	09/12/2019 18:19	28,22	1	28,22	CHI
20191249615	ABADIANIA	AA12286755	ANAPOLIS UNIVERSITARIO S2	08/12/2019 14:09	08/12/2019 17:03	08/12/2019 14:09	08/12/2019 17:03	2,89	20	57,82	CHI
20191248991	SERRANOPOLIS	DJ12164061	CHAPADAO DO CEU	08/12/2019 14:12	08/12/2019 15:40	08/12/2019 14:12	08/12/2019 15:40	1,46	2	2,93	CHI
20191248994	APARECIDA DE GOIANIA	200070514	INDEPENDENCIA S1	08/12/2019 14:13	08/12/2019 15:32	08/12/2019 14:13	08/12/2019 15:32	1,31	1	1,31	CHI
20191248996	BELA VISTA DE GOIAS	BV32060969	BELA VISTA S1	08/12/2019 14:13	08/12/2019 17:30	08/12/2019 14:13	08/12/2019 17:30	3,28	3	9,85	CHI
20191249000	APORE	AE12324795	ITAJA S1	08/12/2019 14:14	08/12/2019 17:58	08/12/2019 14:14	08/12/2019 17:58	3,72	5	18,59	CHI
20191249272	INHUMAS	IX12000030	INHUMAS S1	08/12/2019 14:14	08/12/2019 15:36	08/12/2019 14:14	08/12/2019 15:36	1,37	12	16,41	CHI
20191249272	ITAUCU	IX12000030	INHUMAS S1	08/12/2019 14:14	08/12/2019 15:36	08/12/2019 14:14	08/12/2019 15:36	1,37	4	5,47	CHI
20191249004	TRINDADE	14213394	GOYA S2	08/12/2019 14:15	08/12/2019 16:00	08/12/2019 14:15	08/12/2019 16:00	1,76	1	1,76	CHI
20191249006	BARRO ALTO	BA21154654	GOIANESIA S1	08/12/2019 14:16	08/12/2019 16:43	08/12/2019 14:16	08/12/2019 16:43	2,44	1	2,44	CHI
20191249466	APARECIDA DE GOIANIA	AP10400574	REAL S1	08/12/2019 14:17	08/12/2019 14:33	08/12/2019 14:17	08/12/2019 14:21	0,05	6285	331,71	CHI

20191249466	APARECIDA DE GOIANIA	AP10400439	REAL S1	08/12/2019 14:17	08/12/2019 14:33	08/12/2019 14:17	08/12/2019 14:21	0,07	5192	351,90	CHI
20191249466	APARECIDA DE GOIANIA	GN10383685	REAL S2	08/12/2019 14:17	08/12/2019 14:33	08/12/2019 14:17	08/12/2019 14:22	0,08	548	43,08	CHI
20191249466	GOIANIA	GN10383685	REAL S2	08/12/2019 14:17	08/12/2019 14:33	08/12/2019 14:17	08/12/2019 14:22	0,08	1437	112,96	CHI
20191249466	APARECIDA DE GOIANIA	AP10383687	REAL S1	08/12/2019 14:17	08/12/2019 14:33	08/12/2019 14:17	08/12/2019 14:23	0,09	4480	390,76	CHI
20191249466	APARECIDA DE GOIANIA	00570213	REAL S1	08/12/2019 14:17	08/12/2019 14:33	08/12/2019 14:17	08/12/2019 14:24	0,12	554	66,02	CHI
20191249466	GOIANIA	00570213	REAL S1	08/12/2019 14:17	08/12/2019 14:33	08/12/2019 14:17	08/12/2019 14:24	0,12	4286	510,75	CHI
20191249466	APARECIDA DE GOIANIA	00570233	ANHANGUERA	08/12/2019 14:17	08/12/2019 14:33	08/12/2019 14:17	08/12/2019 14:25	0,12	2869	352,25	CHI
20191249466	APARECIDA DE GOIANIA	00570233	REAL S1	08/12/2019 14:17	08/12/2019 14:33	08/12/2019 14:17	08/12/2019 14:25	0,12	1704	209,21	CHI
20191249466	APARECIDA DE GOIANIA	00570233	REAL S1	08/12/2019 14:17	08/12/2019 14:33	08/12/2019 14:17	08/12/2019 14:25	0,12	10741	1318,76	CHI
20191249466	GOIANIA	00570233	REAL S1	08/12/2019 14:17	08/12/2019 14:33	08/12/2019 14:17	08/12/2019 14:25	0,12	803	98,59	CHI
20191249466	APARECIDA DE GOIANIA	00570273	REAL S1	08/12/2019 14:17	08/12/2019 14:33	08/12/2019 14:17	08/12/2019 14:26	0,14	2358	333,40	CHI
20191249466	GOIANIA	00570273	REAL S1	08/12/2019 14:17	08/12/2019 14:33	08/12/2019 14:17	08/12/2019 14:26	0,14	9070	1282,40	CHI
20191249466	APARECIDA DE GOIANIA	00570273	REAL S2	08/12/2019 14:17	08/12/2019 14:33	08/12/2019 14:17	08/12/2019 14:26	0,14	1262	178,43	CHI
20191249466	GOIANIA	00570273	REAL S2	08/12/2019 14:17	08/12/2019 14:33	08/12/2019 14:17	08/12/2019 14:26	0,14	1854	262,14	CHI
20191249466	APARECIDA DE GOIANIA	00570283	REAL S2	08/12/2019 14:17	08/12/2019 14:33	08/12/2019 14:17	08/12/2019 14:26	0,14	199	28,30	CHI
20191249466	APARECIDA DE GOIANIA	00570293	REAL S2	08/12/2019 14:17	08/12/2019 14:33	08/12/2019 14:17	08/12/2019 14:26	0,15	1652	239,54	CHI
20191249466	GOIANIA	00570293	REAL S2	08/12/2019 14:17	08/12/2019 14:33	08/12/2019 14:17	08/12/2019 14:26	0,15	200	29,00	CHI
20191249466	GOIANIA	00572203	ATLANTICO S3	08/12/2019 14:17	08/12/2019 14:33	08/12/2019 14:17	08/12/2019 14:26	0,15	2344	345,09	CHI
20191249466	APARECIDA DE GOIANIA	00572203	REAL S2	08/12/2019 14:17	08/12/2019 14:33	08/12/2019 14:17	08/12/2019 14:26	0,15	1523	224,22	CHI
20191249466	GOIANIA	00572203	REAL S2	08/12/2019 14:17	08/12/2019 14:33	08/12/2019 14:17	08/12/2019 14:26	0,15	8696	1280,24	CHI
20191249466	APARECIDA DE GOIANIA	00572213	REAL S2	08/12/2019 14:17	08/12/2019 14:33	08/12/2019 14:17	08/12/2019 14:26	0,15	10480	1542,89	CHI
20191249466	GOIANIA	00572213	REAL S2	08/12/2019 14:17	08/12/2019 14:33	08/12/2019 14:17	08/12/2019 14:26	0,15	1193	175,64	CHI
20191249466	GOIANIA	GN10385820	REAL S1	08/12/2019 14:17	08/12/2019 14:33	08/12/2019 14:17	08/12/2019 14:27	0,16	4181	658,51	CHI
20191249466	GOIANIA	GN16407219	REAL S2	08/12/2019 14:17	08/12/2019 14:33	08/12/2019 14:17	08/12/2019 14:28	0,18	1885	331,45	CHI
20191249466	GOIANIA	GN10383685	REAL S2	08/12/2019 14:17	08/12/2019 14:33	08/12/2019 14:29	08/12/2019 14:33	0,07	2852	198,85	CHI
20191249803	CORUMBA DE GOIAS	CB12114199	CORUMBA	08/12/2019 14:17	08/12/2019 18:20	08/12/2019 14:17	08/12/2019 18:20	4,05	14	56,64	CHI
20191251012	JATAI	10003001197	JATAI S1	08/12/2019 14:17	08/12/2019 18:20	08/12/2019 14:17	08/12/2019 18:20	4,06	1	4,06	CHI
20191249021	DAVINOPOLIS	IO21127842	CATALAO S1	08/12/2019 14:18	09/12/2019 10:50	08/12/2019 14:18	09/12/2019 10:50	20,52	1	20,52	CHI
20191249030	MATRINCHA	MP12321180	MATRINCHA	08/12/2019 14:19	08/12/2019 22:06	08/12/2019 14:19	08/12/2019 22:06	7,77	10	77,69	CHI
20191249032	PIRANHAS	PH12207935	PIRANHAS	08/12/2019 14:19	09/12/2019 15:46	08/12/2019 14:19	09/12/2019 15:46	25,45	4	101,78	CHI
20191249368	SAO LUIS DE MONTES BELOS	SL12125617	FIRMINOPOLIS S1	08/12/2019 14:19	10/12/2019 20:08	08/12/2019 14:19	08/12/2019 22:17	7,97	31	247,22	CHI
20191249368	FIRMINOPOLIS	SL12125617	FIRMINOPOLIS S1	08/12/2019 14:19	10/12/2019 20:08	08/12/2019 14:19	08/12/2019 23:10	8,85	17	150,37	CHI
20191249368	SAO LUIS DE MONTES BELOS	SL12125617	FIRMINOPOLIS S1	08/12/2019 14:19	10/12/2019 20:08	08/12/2019 14:19	08/12/2019 23:10	8,85	11	97,30	CHI

20191249368	TURVANIA	SL12125617	FIRMINOPOLIS S1	08/12/2019 14:19	10/12/2019 20:08	08/12/2019 14:19	08/12/2019 23:10	8,85	8	70,76	CHI
20191249368	SAO LUIS DE MONTES BELOS	SL12125617	FIRMINOPOLIS S1	08/12/2019 14:19	10/12/2019 20:08	08/12/2019 14:19	09/12/2019 09:41	19,38	9	174,38	CHI
20191249368	FIRMINOPOLIS	SL12125617	FIRMINOPOLIS S1	08/12/2019 14:19	10/12/2019 20:08	09/12/2019 10:13	09/12/2019 10:31	0,30	16	4,82	CHI
20191249368	SAO LUIS DE MONTES BELOS	SL12125617	FIRMINOPOLIS S1	08/12/2019 14:19	10/12/2019 20:08	09/12/2019 10:13	09/12/2019 10:31	0,30	50	15,06	CHI
20191249368	TURVANIA	SL12125617	FIRMINOPOLIS S1	08/12/2019 14:19	10/12/2019 20:08	09/12/2019 10:13	09/12/2019 10:31	0,30	8	2,41	CHI
20191249368	FIRMINOPOLIS	SL12125617	FIRMINOPOLIS S1	08/12/2019 14:19	10/12/2019 20:08	09/12/2019 10:35	09/12/2019 11:42	1,13	16	18,04	CHI
20191249368	SAO LUIS DE MONTES BELOS	SL12125617	FIRMINOPOLIS S1	08/12/2019 14:19	10/12/2019 20:08	09/12/2019 10:35	09/12/2019 11:42	1,13	41	46,23	CHI
20191249368	TURVANIA	SL12125617	FIRMINOPOLIS S1	08/12/2019 14:19	10/12/2019 20:08	09/12/2019 10:35	09/12/2019 11:42	1,13	8	9,02	CHI
20191249368	SAO LUIS DE MONTES BELOS	SL12125617	FIRMINOPOLIS S1	08/12/2019 14:19	10/12/2019 20:08	09/12/2019 11:47	09/12/2019 13:37	1,84	31	56,94	CHI
20191249368	SAO LUIS DE MONTES BELOS	SL12125617	FIRMINOPOLIS S1	08/12/2019 14:19	10/12/2019 20:08	09/12/2019 10:35	10/12/2019 13:23	26,80	9	241,22	CHI
20191249368	SAO LUIS DE MONTES BELOS	SL12125617	FIRMINOPOLIS S1	08/12/2019 14:19	10/12/2019 20:08	09/12/2019 13:46	10/12/2019 13:23	23,62	25	590,38	CHI
20191249368	FIRMINOPOLIS	SL13277752	FIRMINOPOLIS S1	08/12/2019 14:19	10/12/2019 20:08	09/12/2019 11:47	10/12/2019 16:32	28,75	16	459,96	CHI
20191249368	SAO LUIS DE MONTES BELOS	SL13277752	FIRMINOPOLIS S1	08/12/2019 14:19	10/12/2019 20:08	09/12/2019 11:47	10/12/2019 16:32	28,75	10	287,47	CHI
20191249368	TURVANIA	SL13277752	FIRMINOPOLIS S1	08/12/2019 14:19	10/12/2019 20:08	09/12/2019 11:47	10/12/2019 16:32	28,75	8	229,98	CHI
20191249368	SAO LUIS DE MONTES BELOS	SL12391445	FIRMINOPOLIS S1	08/12/2019 14:19	10/12/2019 20:08	09/12/2019 13:46	10/12/2019 17:17	27,51	6	165,07	CHI
20191249368	SAO LUIS DE MONTES BELOS	SL12125617	FIRMINOPOLIS S1	08/12/2019 14:19	10/12/2019 20:08	08/12/2019 14:19	10/12/2019 20:08	53,82	1	53,82	CHI
20191249368	SAO LUIS DE MONTES BELOS	SL12125616	FIRMINOPOLIS S1	08/12/2019 14:19	10/12/2019 20:08	10/12/2019 18:27	10/12/2019 20:08	1,68	9	15,15	CHI
20191249047	JATAI	10012086990	JATAI S3	08/12/2019 14:20	08/12/2019 15:50	08/12/2019 14:20	08/12/2019 15:50	1,51	1	1,51	CHI
20191249110	ITARUMA	IM21150262	CACHOEIRA ALTA	08/12/2019 14:21	08/12/2019 15:24	08/12/2019 14:21	08/12/2019 15:24	1,04	1	1,04	CHI
20191249122	PIRENOPOLIS	PV12196919	SAO FRANCISCO DE GOIAS	08/12/2019 14:22	08/12/2019 17:55	08/12/2019 14:22	08/12/2019 17:55	3,54	9	31,90	CHI
20191249197	PORTELANDIA	MY12358864	PARQUE DAS EMAS	08/12/2019 14:25	09/12/2019 09:35	08/12/2019 14:25	09/12/2019 09:35	19,16	1	19,16	CHI
20191249197	PORTELANDIA	MY21358855	PARQUE DAS EMAS	08/12/2019 14:25	09/12/2019 09:35	08/12/2019 14:25	09/12/2019 09:35	19,16	1	19,16	CHI
20191249212	CRIXAS	CX12266383	SERRA DO OURO	08/12/2019 14:25	08/12/2019 17:27	08/12/2019 14:25	08/12/2019 17:27	3,02	4	12,07	CHI
20191249216	QUIRINOPOLIS	QI12096888	QUIRINOPOLIS	08/12/2019 14:26	08/12/2019 18:21	08/12/2019 14:26	08/12/2019 18:21	3,91	20	78,28	CHI
20191249218	FORMOSA	FA21017451	ITUIQUIRA	08/12/2019 14:26	08/12/2019 16:53	08/12/2019 14:26	08/12/2019 16:53	2,46	1	2,46	CHI
20191249225	JUSSARA	JR21074367	BRITANIA	08/12/2019 14:26	10/12/2019 08:42	08/12/2019 14:26	10/12/2019 08:42	42,26	6	253,55	CHI
20191249228	PIRES DO RIO	PR12064876RE	PIRES DO RIO S1	08/12/2019 14:26	08/12/2019 19:23	08/12/2019 14:26	08/12/2019 19:23	4,94	33	163,07	CHI
20191249232	CAMPO ALEGRE DE GOIAS	CM12192738RE	CAMPO ALEGRE DE GOIAS	08/12/2019 14:26	09/12/2019 16:22	08/12/2019 14:26	08/12/2019 20:51	6,40	43	275,28	CHI
20191249232	CAMPO ALEGRE DE GOIAS	CM12192738RE	CAMPO ALEGRE DE GOIAS	08/12/2019 14:26	09/12/2019 16:22	08/12/2019 14:26	09/12/2019 16:22	25,92	3	77,76	CHI
20191249238	SANTA ROSA DE GOIAS	SR21019081	INHUMAS S1	08/12/2019 14:27	08/12/2019 19:25	08/12/2019 14:27	08/12/2019 19:25	4,96	1	4,96	CHI
20191249265	MINEIROS	MY21303456	PARQUE DAS EMAS	08/12/2019 14:31	09/12/2019 21:50	08/12/2019 14:31	09/12/2019 21:50	31,30	1	31,30	CHI
20191249388	APARECIDA DE GOIANIA	AP12150292	INDEPENDENCIA S2	08/12/2019 14:31	08/12/2019 18:16	08/12/2019 14:31	08/12/2019 16:57	2,44	32	77,97	CHI
20191249388	APARECIDA DE GOIANIA	AP12150292	INDEPENDENCIA S2	08/12/2019 14:31	08/12/2019 18:16	08/12/2019 17:04	08/12/2019 18:16	1,20	32	38,43	CHI

20191249274	JARAGUA	SR12321527	INHUMAS S1	08/12/2019 14:32	08/12/2019 15:49	08/12/2019 14:32	08/12/2019 15:49	1,28	8	10,27	CHI
20191249295	GOIANIA	GN11167772	FERROVIARIO S1	08/12/2019 14:32	08/12/2019 15:10	08/12/2019 14:32	08/12/2019 15:10	0,62	91	56,77	CHI
20191249649	ANICUNS	AC12259090	FIRMINOPOLIS S2	08/12/2019 14:32	08/12/2019 17:40	08/12/2019 14:32	08/12/2019 17:40	3,14	29	91,01	CHI
20191249374	MORRINHOS	MR12000100	MORRINHOS	08/12/2019 14:35	08/12/2019 16:00	08/12/2019 14:35	08/12/2019 16:00	1,42	8	11,32	CHI
20191249301	VILA BOA	FA12102763	ITUIQUIRA	08/12/2019 14:36	08/12/2019 19:43	08/12/2019 14:36	08/12/2019 19:43	5,11	1	5,11	CHI
20191251236	DOVERLANDIA	DV12138540	CAIAPONIA	08/12/2019 14:36	09/12/2019 08:47	08/12/2019 14:36	09/12/2019 08:47	18,17	9	163,55	CHI
20191249397	ANAPOLIS	AN11000183	JUNDIAI S1	08/12/2019 14:37	08/12/2019 18:21	08/12/2019 14:37	08/12/2019 18:21	3,72	145	539,32	CHI
20191249308	COCALZINHO DE GOIAS	10000705657	AGUAS LINDAS DE GOIAS S1	08/12/2019 14:38	08/12/2019 15:53	08/12/2019 14:38	08/12/2019 15:53	1,25	1	1,25	CHI
20191249381	ABADIANIA	AA12258346	ANAPOLIS UNIVERSITARIO S1	08/12/2019 14:39	08/12/2019 17:46	08/12/2019 14:39	08/12/2019 17:46	3,10	22	68,23	CHI
20191249381	CORUMBA DE GOIAS	AA12258346	ANAPOLIS UNIVERSITARIO S1	08/12/2019 14:39	08/12/2019 17:46	08/12/2019 14:39	08/12/2019 17:46	3,10	2	6,20	CHI
20191249647	ABADIANIA	AA12241539	ANAPOLIS UNIVERSITARIO S1	08/12/2019 14:40	08/12/2019 17:46	08/12/2019 14:40	08/12/2019 17:46	3,09	8	24,70	CHI
20191249317	ANAPOLIS	AN11258075	ANAPOLIS UNIVERSITARIO S2	08/12/2019 14:42	08/12/2019 19:29	08/12/2019 14:42	08/12/2019 19:29	4,78	63	300,98	CHI
20191249318	PIRES DO RIO	PR12322076	PIRES DO RIO S2	08/12/2019 14:42	08/12/2019 19:04	08/12/2019 14:42	08/12/2019 19:04	4,36	2	8,71	CHI
20191249443	IPAMERI	UT12000608	URUTAI	08/12/2019 14:47	08/12/2019 20:00	08/12/2019 14:47	08/12/2019 20:00	5,21	3	15,64	CHI
20191249443	URUTAI	UT12000608	URUTAI	08/12/2019 14:47	08/12/2019 20:00	08/12/2019 14:47	08/12/2019 20:00	5,21	26	135,58	CHI
20191246890	SAO JOAO D ALIANCA	TL12204731LD	SAO JOAO D ALIANCA	08/12/2019 14:49	09/12/2019 18:12	08/12/2019 14:49	09/12/2019 18:12	27,39	7	191,70	CHI
20191249429	DAVINOPOLIS	IO12077438	CATALAO S1	08/12/2019 14:49	09/12/2019 10:51	08/12/2019 14:49	09/12/2019 10:51	20,03	2	40,06	CHI
20191249429	DISTRITO FEDERAL	IO12077438	CATALAO S1	08/12/2019 14:49	09/12/2019 10:51	08/12/2019 14:49	09/12/2019 10:51	20,03	5	100,15	CHI
20191249338	NEROPOLIS	NR11008340	NEROPOLIS S2	08/12/2019 14:50	08/12/2019 16:28	08/12/2019 14:50	08/12/2019 16:28	1,62	134	216,86	CHI
20191249010	JATAI	JT1380680	JATAI S1	08/12/2019 14:51	08/12/2019 17:40	08/12/2019 14:51	08/12/2019 17:40	2,81	1	2,81	CHI
20191249342	CORUMBA DE GOIAS	CB12382193	CORUMBA	08/12/2019 14:51	08/12/2019 17:54	08/12/2019 14:51	08/12/2019 17:54	3,04	4	12,14	CHI
20191249343	ABADIANIA	AA12377756	ANAPOLIS UNIVERSITARIO S1	08/12/2019 14:52	08/12/2019 16:56	08/12/2019 14:52	08/12/2019 16:56	2,06	6	12,37	CHI
20191249345	ANAPOLIS	AN12258234	NEROPOLIS S1	08/12/2019 14:52	08/12/2019 20:28	08/12/2019 14:52	08/12/2019 20:28	5,59	3	16,78	CHI
20191249345	CAMPO LIMPO	AN12258234	NEROPOLIS S1	08/12/2019 14:52	08/12/2019 20:28	08/12/2019 14:52	08/12/2019 20:28	5,59	28	156,64	CHI
20191249347	ITUMBIARA	IT12033779RE	CACHOEIRA DOURADA	08/12/2019 14:54	08/12/2019 17:15	08/12/2019 14:54	08/12/2019 17:15	2,34	60	140,63	CHI
20191249349	MINEIROS	MY21043921	PARQUE DAS EMAS	08/12/2019 14:54	09/12/2019 01:14	08/12/2019 14:54	09/12/2019 01:14	10,32	1	10,32	CHI
20191249352	OURO VERDE DE GOIAS	OV12384177	NEROPOLIS S1	08/12/2019 14:55	09/12/2019 11:14	08/12/2019 14:55	09/12/2019 11:14	20,31	8	162,45	CHI
20191249357	PIRENOPOLIS	PV11273082	CORUMBA	08/12/2019 14:58	08/12/2019 19:08	08/12/2019 14:58	08/12/2019 19:08	4,16	26	108,07	CHI
20191249358	GOIANDIRA	GD21157526	CATALAO S1	08/12/2019 14:58	09/12/2019 15:46	08/12/2019 14:58	09/12/2019 15:46	24,79	1	24,79	CHI
20191249359	APARECIDA DE GOIANIA	10029669837	ATLANTICO S3	08/12/2019 14:59	08/12/2019 18:41	08/12/2019 14:59	08/12/2019 18:41	3,69	1	3,69	CHI
20191249361	GOIANIA	12081292	GOYA S1	08/12/2019 15:00	08/12/2019 17:03	08/12/2019 15:00	08/12/2019 17:03	2,04	1	2,04	CHI
20191250348	CAMPO LIMPO	AN12265111	ANAPOLIS UNIVERSITARIO S2	08/12/2019 15:02	09/12/2019 15:35	08/12/2019 15:02	09/12/2019 15:35	24,54	6	147,27	CHI
20191249372	LUZIANIA	120189355	RIO VERMELHO	08/12/2019 15:04	08/12/2019 17:12	08/12/2019 15:04	08/12/2019 17:12	2,13	1	2,13	CHI

20191249849	ABADIANIA	AA11199757	ANAPOLIS UNIVERSITARIO S1	08/12/2019 15:05	08/12/2019 17:01	08/12/2019 15:05	08/12/2019 17:01	1,93	99	191,40	CHI
20191249380	MOZARLANDIA	MZ21147390	MOZARLANDIA	08/12/2019 15:06	08/12/2019 22:37	08/12/2019 15:06	08/12/2019 22:37	7,52	1	7,52	CHI
20191249384	POSSE	IA12035179	IACIARA S2	08/12/2019 15:07	08/12/2019 16:21	08/12/2019 15:07	08/12/2019 16:21	1,22	9	11,01	CHI
20191249617	DOVERLANDIA	DV12358445	CAIAPONIA	08/12/2019 15:07	09/12/2019 06:44	08/12/2019 15:07	09/12/2019 06:44	15,60	21	327,64	CHI
20191249389	FORMOSA	FA12218264	ITIQUEIRA	08/12/2019 15:08	08/12/2019 16:50	08/12/2019 15:08	08/12/2019 16:50	1,69	96	162,37	CHI
20191249389	VILA BOA	FA12218264	ITIQUEIRA	08/12/2019 15:08	08/12/2019 16:50	08/12/2019 15:08	08/12/2019 16:50	1,69	4	6,77	CHI
20191249390	CAMPINORTE	MQ21230391	MARA ROSA	08/12/2019 15:08	08/12/2019 19:22	08/12/2019 15:08	08/12/2019 19:22	4,22	1	4,22	CHI
20191249393	ABADIANIA	AA1291803	ANAPOLIS UNIVERSITARIO S2	08/12/2019 15:08	09/12/2019 10:05	08/12/2019 15:08	09/12/2019 10:05	18,93	2	37,87	CHI
20191249451	ANAPOLIS	AN12258810	JUNDIAI S2	08/12/2019 15:09	08/12/2019 16:18	08/12/2019 15:09	08/12/2019 16:18	1,14	20	22,90	CHI
201912260794	DAMIANOPOLIS	MB12180672	IACIARA S2	08/12/2019 15:09	08/12/2019 23:00	08/12/2019 15:09	08/12/2019 23:00	7,84	9	70,56	CHI
20191249405	MORRINHOS	MR11090179	MORRINHOS	08/12/2019 15:11	08/12/2019 17:23	08/12/2019 15:11	08/12/2019 17:23	2,19	152	333,64	CHI
20191249652	ARACU	AV12272362	ANICUNS	08/12/2019 15:11	09/12/2019 08:40	08/12/2019 15:11	08/12/2019 19:34	4,38	2	8,77	CHI
20191249652	ITABERAI	AV12272362	ANICUNS	08/12/2019 15:11	09/12/2019 08:40	08/12/2019 15:11	08/12/2019 19:34	4,38	3	13,15	CHI
20191249652	ITABERAI	AV12323612LD	ANICUNS	08/12/2019 15:11	09/12/2019 08:40	08/12/2019 15:11	08/12/2019 20:53	5,69	11	62,59	CHI
20191249652	ARACU	AV12037535LD	ANICUNS	08/12/2019 15:11	09/12/2019 08:40	08/12/2019 15:11	09/12/2019 08:40	17,47	2	34,95	CHI
20191249652	ITABERAI	AV12037535LD	ANICUNS	08/12/2019 15:11	09/12/2019 08:40	08/12/2019 15:11	09/12/2019 08:40	17,47	3	52,42	CHI
20191249652	ARACU	AV12272362	ANICUNS	08/12/2019 15:11	09/12/2019 08:40	09/12/2019 07:04	09/12/2019 08:40	1,59	2	3,18	CHI
20191249652	ITABERAI	AV12272362	ANICUNS	08/12/2019 15:11	09/12/2019 08:40	09/12/2019 07:04	09/12/2019 08:40	1,59	14	22,24	CHI
20191249411	GOIANIA	16629218	CARAJAS S1	08/12/2019 15:12	08/12/2019 17:42	08/12/2019 15:12	08/12/2019 17:42	2,50	1	2,50	CHI
20191249422	PIRENOPOLIS	PV12185248	CORUMBA	08/12/2019 15:14	10/12/2019 18:06	08/12/2019 15:14	10/12/2019 18:06	50,86	24	1220,75	CHI
20191249428	PARAUNA	PU21000013	PARAUNA	08/12/2019 15:15	08/12/2019 18:55	08/12/2019 15:15	08/12/2019 18:55	3,65	2	7,31	CHI
20191249488	DOVERLANDIA	DV12172484	CAIAPONIA	08/12/2019 15:16	08/12/2019 18:54	08/12/2019 15:16	08/12/2019 18:54	3,63	32	116,23	CHI
20191250064	ITABERAI	IB12000115	ITABERAI S2	08/12/2019 15:16	08/12/2019 22:38	08/12/2019 15:16	08/12/2019 22:38	7,36	31	228,01	CHI
20191249438	URUTAI	UT21108014	URUTAI	08/12/2019 15:17	08/12/2019 21:18	08/12/2019 15:17	08/12/2019 21:18	6,00	1	6,00	CHI
20191249439	MORRINHOS	MR12035910	MORRINHOS	08/12/2019 15:18	09/12/2019 10:50	08/12/2019 15:18	09/12/2019 10:50	19,55	6	117,29	CHI
20191249440	BOM JARDIM DE GOIAS	BM21296971	BOM JARDIM	08/12/2019 15:18	08/12/2019 22:45	08/12/2019 15:18	08/12/2019 22:45	7,45	1	7,45	CHI
20191249457	SAO MIGUEL DO PASSA QUATRO	SQ21300637	CRISTIANOPOLIS	08/12/2019 15:20	08/12/2019 17:06	08/12/2019 15:20	08/12/2019 17:06	1,75	1	1,75	CHI
20191249461	CORUMBA DE GOIAS	10030574151	CORUMBA	08/12/2019 15:21	08/12/2019 20:31	08/12/2019 15:21	08/12/2019 20:31	5,16	1	5,16	CHI
20191249465	PORANGATU	PO12145187	PORANGATU	08/12/2019 15:21	09/12/2019 00:42	08/12/2019 15:21	09/12/2019 00:42	9,34	8	74,74	CHI
20191250246	ABADIANIA	AA12326382	CORUMBA	08/12/2019 15:21	08/12/2019 18:59	08/12/2019 15:21	08/12/2019 18:59	3,62	5	18,10	CHI
20191250246	CORUMBA DE GOIAS	AA12326382	CORUMBA	08/12/2019 15:21	08/12/2019 18:59	08/12/2019 15:21	08/12/2019 18:59	3,62	2	7,24	CHI
20191250529	DAVINOPOLIS	IO12071453	CATALAO S1	08/12/2019 15:21	09/12/2019 10:50	08/12/2019 15:21	09/12/2019 10:50	19,47	5	97,36	CHI
20191250529	OUIDOR	IO12071453	CATALAO S1	08/12/2019 15:21	09/12/2019 10:50	08/12/2019 15:21	09/12/2019 10:50	19,47	1	19,47	CHI



20191249470	GOIANESIA	GE12115081	GOIANESIA S1	08/12/2019 15:22	09/12/2019 15:23	08/12/2019 15:22	09/12/2019 15:23	24,03	3	72,09	CHI
20191249486	LUZIANIA	LZ11351403	MARAJOARA	08/12/2019 15:24	08/12/2019 17:14	08/12/2019 15:24	08/12/2019 17:14	1,84	14	25,70	CHI
20191249487	ANAPOLIS	AN11264485	JUNDIAI S2	08/12/2019 15:24	08/12/2019 17:34	08/12/2019 15:24	08/12/2019 17:34	2,15	53	114,04	CHI
20191249491	ITABERAI	IB11227081	ITABERAI S1	08/12/2019 15:26	09/12/2019 11:40	08/12/2019 15:26	09/12/2019 11:40	20,25	1	20,25	CHI
20191249493	ITUMBIARA	690160380	PARANAIBA	08/12/2019 15:26	08/12/2019 17:13	08/12/2019 15:26	08/12/2019 17:13	1,77	1	1,77	CHI
20191250373	MONTES CLAROS DE GOIAS	ME12139989	IPORA	08/12/2019 15:27	11/12/2019 13:39	08/12/2019 15:27	09/12/2019 11:02	19,57	62	1213,60	CHI
20191250373	MONTES CLAROS DE GOIAS	ME12139989	IPORA	08/12/2019 15:27	11/12/2019 13:39	09/12/2019 11:03	11/12/2019 11:13	48,16	1	48,16	CHI
20191250373	MONTES CLAROS DE GOIAS	ME12353746LD	IPORA	08/12/2019 15:27	11/12/2019 13:39	08/12/2019 15:27	11/12/2019 11:20	67,87	2	135,74	CHI
20191250373	MONTES CLAROS DE GOIAS	ME12139989	IPORA	08/12/2019 15:27	11/12/2019 13:39	09/12/2019 11:03	11/12/2019 11:45	48,70	1	48,70	CHI
20191250373	MONTES CLAROS DE GOIAS	ME12139989	IPORA	08/12/2019 15:27	11/12/2019 13:39	09/12/2019 11:03	11/12/2019 11:46	48,71	1	48,71	CHI
20191250373	MONTES CLAROS DE GOIAS	ME12139989	IPORA	08/12/2019 15:27	11/12/2019 13:39	11/12/2019 12:10	11/12/2019 12:38	0,47	5	2,34	CHI
20191250373	MONTES CLAROS DE GOIAS	ME12139989	IPORA	08/12/2019 15:27	11/12/2019 13:39	09/12/2019 11:03	11/12/2019 13:08	50,09	1	50,09	CHI
20191250373	MONTES CLAROS DE GOIAS	ME12139989	IPORA	08/12/2019 15:27	11/12/2019 13:39	11/12/2019 13:00	11/12/2019 13:25	0,42	5	2,08	CHI
20191250373	MONTES CLAROS DE GOIAS	ME12139989	IPORA	08/12/2019 15:27	11/12/2019 13:39	09/12/2019 11:03	11/12/2019 13:39	50,61	58	2935,12	CHI
20191249604	ITABERAI	IB11227432	ITABERAI S1	08/12/2019 15:29	09/12/2019 11:30	08/12/2019 15:29	09/12/2019 11:30	20,01	1	20,01	CHI
20191249605	DISTRITO FEDERAL	PB12163215	PADRE BERNARDO	08/12/2019 15:29	08/12/2019 19:12	08/12/2019 15:29	08/12/2019 19:12	3,71	3	11,12	CHI
20191249605	PADRE BERNARDO	PB12163215	PADRE BERNARDO	08/12/2019 15:29	08/12/2019 19:12	08/12/2019 15:29	08/12/2019 19:12	3,71	239	886,09	CHI
20191249607	ITABERAI	IB21253935	ANICUNS	08/12/2019 15:29	09/12/2019 11:18	08/12/2019 15:29	09/12/2019 11:18	19,80	1	19,80	CHI
20191249671	JARAGUA	JA12000001LD	JARAGUA	08/12/2019 15:30	08/12/2019 17:54	08/12/2019 15:30	08/12/2019 17:54	2,39	376	898,95	CHI
20191249671	PIRENOPOLIS	JA12000001LD	JARAGUA	08/12/2019 15:30	08/12/2019 17:54	08/12/2019 15:30	08/12/2019 17:54	2,39	54	129,11	CHI
20191249673	CORUMBA DE GOIAS	CB12058982	CORUMBA	08/12/2019 15:30	08/12/2019 17:20	08/12/2019 15:30	08/12/2019 17:20	1,83	9	16,43	CHI
20191250083	MONTIVIDIU DO NORTE	TB12143685	PORANGATU	08/12/2019 15:31	09/12/2019 09:15	08/12/2019 15:31	09/12/2019 09:15	17,72	10	177,22	CHI
20191250083	TROMBAS	TB12143685	PORANGATU	08/12/2019 15:31	09/12/2019 09:15	08/12/2019 15:31	09/12/2019 09:15	17,72	18	318,99	CHI
20191249626	CAIAPONIA	PH12221148	PIRANHAS	08/12/2019 15:32	09/12/2019 11:48	08/12/2019 15:32	09/12/2019 11:48	20,26	3	60,79	CHI
20191249685	TEREZOPOLIS DE GOIAS	GP12075863	JUNDIAI S1	08/12/2019 15:32	08/12/2019 16:39	08/12/2019 15:32	08/12/2019 16:39	1,11	14	15,56	CHI
20191250167	NIQUELANDIA	NQ12232473	NIQUELANDIA SUBTRANSMISSAO	08/12/2019 15:32	09/12/2019 01:03	08/12/2019 15:32	09/12/2019 01:03	9,51	43	409,06	CHI
20191249630	FORMOSA	FA11269919	ITUIQUIRA	08/12/2019 15:33	08/12/2019 17:56	08/12/2019 15:33	08/12/2019 17:56	2,38	1	2,38	CHI
20191249634	PIRENOPOLIS	PV31130774	SAO FRANCISCO DE GOIAS	08/12/2019 15:34	10/12/2019 01:08	08/12/2019 15:34	10/12/2019 01:08	33,56	1	33,56	CHI
20191249638	SANTA HELENA DE GOIAS	400105147	IPEGUARI	08/12/2019 15:35	08/12/2019 21:24	08/12/2019 15:35	08/12/2019 21:24	5,82	1	5,82	CHI
20191249640	APARECIDA DE GOIANIA	AP11251798	REAL S1	08/12/2019 15:35	08/12/2019 17:34	08/12/2019 15:35	08/12/2019 17:34	1,98	194	383,69	CHI
20191250139	CAMPO ALEGRE DE GOIAS	CM12333544	CAMPO ALEGRE DE GOIAS	08/12/2019 15:35	10/12/2019 11:21	08/12/2019 15:35	10/12/2019 11:21	43,76	1	43,76	CHI
20191250139	CATALAO	CM12333544	CAMPO ALEGRE DE GOIAS	08/12/2019 15:35	10/12/2019 11:21	08/12/2019 15:35	10/12/2019 11:21	43,76	1	43,76	CHI
20191250519	PLANALTINA	PI12218356	PLANALTINA	08/12/2019 15:35	09/12/2019 08:44	08/12/2019 15:35	09/12/2019 08:44	17,14	29	497,20	CHI

20191249645	RIO VERDE	RV21098572	RIO VERDE S1	08/12/2019 15:36	08/12/2019 18:53	08/12/2019 15:36	08/12/2019 18:53	3,28	1	3,28	CHI
20191249650	BELA VISTA DE GOIAS	BV12185857	CEPAIGO S2	08/12/2019 15:37	08/12/2019 17:17	08/12/2019 15:37	08/12/2019 17:17	1,66	3	4,97	CHI
20191249653	CIDADE OCIDENTAL	DH21290894	MARAJOARA	08/12/2019 15:37	08/12/2019 19:36	08/12/2019 15:37	08/12/2019 19:36	3,97	1	3,97	CHI
20191249654	DOVERLANDIA	DV21156595	CAIAPONIA	08/12/2019 15:38	08/12/2019 20:45	08/12/2019 15:38	08/12/2019 20:45	5,11	1	5,11	CHI
20191249655	APARECIDA DE GOIANIA	13213519	ANHANGUERA	08/12/2019 15:38	08/12/2019 17:23	08/12/2019 15:38	08/12/2019 17:23	1,74	1	1,74	CHI
20191249658	MORRINHOS	MR21394373	MORRINHOS	08/12/2019 15:39	09/12/2019 02:23	08/12/2019 15:39	09/12/2019 02:23	10,72	1	10,72	CHI
20191250111	ITABERAI	03020416	ITABERAI S1	08/12/2019 15:39	08/12/2019 20:26	08/12/2019 15:39	08/12/2019 18:11	2,52	22	55,37	CHI
20191250111	ITAGUARI	03020416	ITABERAI S1	08/12/2019 15:39	08/12/2019 20:26	08/12/2019 15:39	08/12/2019 18:11	2,52	987	2484,22	CHI
20191250111	TAQUARAL DE GOIAS	03020416	ITABERAI S1	08/12/2019 15:39	08/12/2019 20:26	08/12/2019 15:39	08/12/2019 18:11	2,52	46	115,78	CHI
20191250111	ITABERAI	03020416	ITABERAI S1	08/12/2019 15:39	08/12/2019 20:26	08/12/2019 15:39	08/12/2019 18:58	3,32	6	19,89	CHI
20191250111	ITAGUARI	03020416	ITABERAI S1	08/12/2019 15:39	08/12/2019 20:26	08/12/2019 15:39	08/12/2019 18:58	3,32	1251	4147,41	CHI
20191250111	ITAGUARU	03020416	ITABERAI S1	08/12/2019 15:39	08/12/2019 20:26	08/12/2019 15:39	08/12/2019 18:58	3,32	1	3,32	CHI
20191250111	JARAGUA	03020416	ITABERAI S1	08/12/2019 15:39	08/12/2019 20:26	08/12/2019 15:39	08/12/2019 18:58	3,32	270	895,13	CHI
20191250111	TAQUARAL DE GOIAS	03020416	ITABERAI S1	08/12/2019 15:39	08/12/2019 20:26	08/12/2019 15:39	08/12/2019 18:58	3,32	165	547,02	CHI
20191250111	ITABERAI	03020214	ITABERAI S1	08/12/2019 15:39	08/12/2019 20:26	08/12/2019 18:49	08/12/2019 20:25	1,60	21	33,66	CHI
20191250111	ITAGUARI	03020214	ITABERAI S1	08/12/2019 15:39	08/12/2019 20:26	08/12/2019 18:49	08/12/2019 20:25	1,60	987	1581,94	CHI
20191250111	TAQUARAL DE GOIAS	03020214	ITABERAI S1	08/12/2019 15:39	08/12/2019 20:26	08/12/2019 18:49	08/12/2019 20:25	1,60	46	73,73	CHI
20191250111	ITAGUARI	II12000101LD	ITABERAI S1	08/12/2019 15:39	08/12/2019 20:26	08/12/2019 15:39	08/12/2019 20:26	4,78	149	712,05	CHI
20191249661	CATALAO	CT21192132	CATALAO S2	08/12/2019 15:40	09/12/2019 11:49	08/12/2019 15:40	09/12/2019 11:49	20,15	1	20,15	CHI
20191249664	ANAPOLIS	AN21392227	JUNDIAI S2	08/12/2019 15:42	08/12/2019 18:31	08/12/2019 15:42	08/12/2019 18:31	2,82	2	5,64	CHI
20191249665	PIRES DO RIO	PR21195244	PIRES DO RIO S1	08/12/2019 15:42	09/12/2019 01:40	08/12/2019 15:42	09/12/2019 01:40	9,97	1	9,97	CHI
20191250386	CAIAPONIA	CP12241166	PALESTINA	08/12/2019 15:42	09/12/2019 07:47	08/12/2019 15:42	09/12/2019 07:47	16,07	4	64,27	CHI
20191250460	CEZARINA	VJ12320434	GUAPO S2	08/12/2019 15:43	08/12/2019 20:30	08/12/2019 15:43	08/12/2019 20:30	4,78	117	559,23	CHI
20191250460	INDIARA	VJ12320434	GUAPO S2	08/12/2019 15:43	08/12/2019 20:30	08/12/2019 15:43	08/12/2019 20:30	4,78	1	4,78	CHI
20191250460	VARJAO	VJ12320434	GUAPO S2	08/12/2019 15:43	08/12/2019 20:30	08/12/2019 15:43	08/12/2019 20:30	4,78	94	449,29	CHI
20191249670	GOIANIA	GN12000233	GOIANIA LESTE S1	08/12/2019 15:44	08/12/2019 17:16	08/12/2019 15:44	08/12/2019 16:49	1,08	72	77,80	CHI
20191249670	GOIANIA	GN11000312	GOIANIA LESTE S1	08/12/2019 15:44	08/12/2019 17:16	08/12/2019 15:44	08/12/2019 17:16	1,53	35	53,53	CHI
20191249677	ABADIANIA	AA12130228	DAIA S2	08/12/2019 15:46	08/12/2019 18:11	08/12/2019 15:46	08/12/2019 18:11	2,41	30	72,35	CHI
20191249680	APARECIDA DO RIO DOCE	AW21193917	CACHOEIRA ALTA	08/12/2019 15:46	09/12/2019 10:49	08/12/2019 15:46	09/12/2019 10:49	19,04	1	19,04	CHI
20191249708	CALDAS NOVAS	IP12195205	IPAMERI	08/12/2019 15:46	08/12/2019 18:21	08/12/2019 15:46	08/12/2019 18:21	2,57	7	18,02	CHI
20191249708	CORUMBAIBA	IP12195205	IPAMERI	08/12/2019 15:46	08/12/2019 18:21	08/12/2019 15:46	08/12/2019 18:21	2,57	3	7,72	CHI
20191249708	IPAMERI	IP12195205	IPAMERI	08/12/2019 15:46	08/12/2019 18:21	08/12/2019 15:46	08/12/2019 18:21	2,57	68	175,08	CHI
20191249686	CHAPADAO DO CEU	9880016846	CHAPADAO DO CEU	08/12/2019 15:48	08/12/2019 19:43	08/12/2019 15:48	08/12/2019 19:43	3,93	1	3,93	CHI

20191251463	AGUA FRIA DE GOIAS	PI12325588	SAO JOAO D ALIANCA	08/12/2019 15:48	09/12/2019 10:55	08/12/2019 15:48	09/12/2019 10:55	19,11	1	19,11	CHI
20191251463	PLANALTINA	PI12325588	SAO JOAO D ALIANCA	08/12/2019 15:48	09/12/2019 10:55	08/12/2019 15:48	09/12/2019 10:55	19,11	103	1968,33	CHI
20191249730	MINEIROS	MY12241805	PARQUE DAS EMAS	08/12/2019 15:49	09/12/2019 07:47	08/12/2019 15:49	09/12/2019 07:47	15,96	15	239,37	CHI
20191250110	ABADIANIA	AA12000008	ANAPOLIS UNIVERSITARIO S1	08/12/2019 15:50	08/12/2019 19:38	08/12/2019 15:50	08/12/2019 19:38	3,80	97	368,22	CHI
20191249706	RUBIATABA	6567988	RUBIATABA	08/12/2019 15:53	09/12/2019 03:29	08/12/2019 15:53	09/12/2019 03:29	11,59	15	173,88	CHI
20191250337	AGUA FRIA DE GOIAS	MJ12040650	PADRE BERNARDO	08/12/2019 15:53	08/12/2019 19:10	08/12/2019 15:53	08/12/2019 19:10	3,28	9	29,48	CHI
20191250337	MIMOSO DE GOIAS	MJ12040650	PADRE BERNARDO	08/12/2019 15:53	08/12/2019 19:10	08/12/2019 15:53	08/12/2019 19:10	3,28	12	39,30	CHI
20191249711	IPAMERI	IP12215594	PIRES DO RIO S2	08/12/2019 15:54	09/12/2019 14:19	08/12/2019 15:54	09/12/2019 14:19	22,41	7	156,89	CHI
20191249713	MORRINHOS	150068554	MORRINHOS	08/12/2019 15:54	08/12/2019 23:10	08/12/2019 15:54	08/12/2019 23:10	7,27	1	7,27	CHI
20191249714	SAO JOAO DA PARAUNA	FR12299252	FIRMINOPOLIS S2	08/12/2019 15:54	08/12/2019 19:41	08/12/2019 15:54	08/12/2019 19:41	3,79	3	11,36	CHI
20191249715	GOIANESIA	GE21185210	GOIANESIA S1	08/12/2019 15:54	08/12/2019 18:33	08/12/2019 15:54	08/12/2019 18:33	2,65	1	2,65	CHI
20191249718	ITAUCU	PV12271945	CORUMBA	08/12/2019 15:55	08/12/2019 23:22	08/12/2019 15:55	08/12/2019 23:22	7,44	1	7,44	CHI
20191249718	PIRENOPOLIS	PV12271945	CORUMBA	08/12/2019 15:55	08/12/2019 23:22	08/12/2019 15:55	08/12/2019 23:22	7,44	12	89,32	CHI
20191249720	VIANOPOLIS	VN21072136	VIANOPOLIS	08/12/2019 15:56	08/12/2019 17:23	08/12/2019 15:56	08/12/2019 17:23	1,45	1	1,45	CHI
20191249722	GOIANIA	10491909	GOIANIA LESTE S1	08/12/2019 15:57	08/12/2019 17:21	08/12/2019 15:57	08/12/2019 17:21	1,40	1	1,40	CHI
20191249724	VARJAO	VJ32066252	GUAPO S2	08/12/2019 15:57	08/12/2019 19:35	08/12/2019 15:57	08/12/2019 19:35	3,63	4	14,52	CHI
20191249728	SILVANIA	SV12400025	VIANOPOLIS	08/12/2019 15:58	08/12/2019 23:52	08/12/2019 15:58	08/12/2019 23:52	7,90	2	15,79	CHI
20191249739	GOIANIA	GN11201062	SENADOR CANEDO	08/12/2019 15:59	08/12/2019 21:14	08/12/2019 15:59	08/12/2019 21:14	5,24	183	958,77	CHI
20191249742	FAINA	GS12042217	GOIAS	08/12/2019 16:00	08/12/2019 20:48	08/12/2019 16:00	08/12/2019 20:48	4,79	71	339,97	CHI
20191249571	AGUA FRIA DE GOIAS	MJ12305239	PADRE BERNARDO	08/12/2019 16:01	08/12/2019 20:13	08/12/2019 16:01	08/12/2019 20:13	4,20	2	8,40	CHI
20191249571	MIMOSO DE GOIAS	MJ12305239	PADRE BERNARDO	08/12/2019 16:01	08/12/2019 20:13	08/12/2019 16:01	08/12/2019 20:13	4,20	2	8,40	CHI
20191249748	CATALAO	CT12134367	CATALAO S1	08/12/2019 16:01	09/12/2019 10:14	08/12/2019 16:01	09/12/2019 10:14	18,23	11	200,49	CHI
20191249756	ARAGOIANIA	AO11272623	INDEPENDENCIA S2	08/12/2019 16:01	08/12/2019 17:55	08/12/2019 16:01	08/12/2019 17:55	1,89	6	11,33	CHI
20191250104	GOIANIA	GN12002245	GOIANIA LESTE S1	08/12/2019 16:02	08/12/2019 17:57	08/12/2019 16:02	08/12/2019 17:57	1,90	560	1064,31	CHI
20191250104	SENADOR CANEDO	GN12002245	GOIANIA LESTE S1	08/12/2019 16:02	08/12/2019 17:57	08/12/2019 16:02	08/12/2019 17:57	1,90	95	180,55	CHI
20191250403	FAINA	FC11250649	GOIAS	08/12/2019 16:02	08/12/2019 22:49	08/12/2019 16:02	08/12/2019 22:49	6,78	45	305,26	CHI
20191249762	PLANALTINA	PI21125296	SAO JOAO D ALIANCA	08/12/2019 16:03	09/12/2019 15:30	08/12/2019 16:03	09/12/2019 15:30	23,46	1	23,46	CHI
20191249772	BOM JESUS DE GOIAS	1250012573	BOM JESUS DE GOIAS	08/12/2019 16:04	09/12/2019 00:29	08/12/2019 16:04	09/12/2019 00:29	8,40	1	8,40	CHI
20191249777	SAO LUIS DE MONTES BELOS	SL12125618	FIRMINOPOLIS S1	08/12/2019 16:05	08/12/2019 17:17	08/12/2019 16:05	08/12/2019 17:17	1,19	2	2,38	CHI
20191249787	GOIANIA	GN11151326	MEIA PONTE	08/12/2019 16:08	08/12/2019 22:32	08/12/2019 16:08	08/12/2019 22:32	6,40	116	741,88	CHI
20191249802	APARECIDA DE GOIANIA	AP11003004	REAL S1	08/12/2019 16:08	08/12/2019 18:44	08/12/2019 16:08	08/12/2019 18:44	2,59	99	256,41	CHI
20191249807	FORMOSA	FA12071048	ITIQUEIRA	08/12/2019 16:11	08/12/2019 17:41	08/12/2019 16:11	08/12/2019 17:41	1,49	14	20,86	CHI
20191250070	PALMEIRAS DE GOIAS	PL12050550	PALMEIRAS	08/12/2019 16:11	08/12/2019 21:04	08/12/2019 16:11	08/12/2019 21:04	4,89	3	14,66	CHI

20191249817	ITAJA	IJ12203996	ITAJA S2	08/12/2019 16:13	09/12/2019 02:17	08/12/2019 16:13	09/12/2019 02:17	10,06	2	20,13	CHI
20191249820	GOIANIA	14068564	GOYA S2	08/12/2019 16:13	08/12/2019 18:38	08/12/2019 16:13	08/12/2019 18:38	2,41	1	2,41	CHI
20191249826	BARRO ALTO	GE12000092	GOIANESIA S1	08/12/2019 16:14	09/12/2019 10:44	08/12/2019 16:14	09/12/2019 10:44	18,50	2	37,00	CHI
20191249826	GOIANESIA	GE12000092	GOIANESIA S1	08/12/2019 16:14	09/12/2019 10:44	08/12/2019 16:14	09/12/2019 10:44	18,50	19	351,52	CHI
20191249831	URUACU	UR21136330	CAMPINORTE	08/12/2019 16:14	09/12/2019 01:04	08/12/2019 16:14	09/12/2019 01:04	8,82	1	8,82	CHI
20191249839	APARECIDA DE GOIANIA	AP11347529	ANHANGUERA	08/12/2019 16:15	08/12/2019 18:42	08/12/2019 16:15	08/12/2019 18:42	2,44	43	105,05	CHI
20191250465	ABADIANIA	AA12302116	ANAPOLIS UNIVERSITARIO S1	08/12/2019 16:15	08/12/2019 20:27	08/12/2019 16:15	08/12/2019 20:27	4,20	17	71,40	CHI
20191250465	CORUMBA DE GOIAS	AA12302116	ANAPOLIS UNIVERSITARIO S1	08/12/2019 16:15	08/12/2019 20:27	08/12/2019 16:15	08/12/2019 20:27	4,20	1	4,20	CHI
20191249843	NOVO GAMA	NJ21153848	PACAEMBU S1	08/12/2019 16:16	08/12/2019 18:36	08/12/2019 16:16	08/12/2019 18:36	2,33	2	4,66	CHI
20191249847	ANAPOLIS	AN21050441	ANAPOLIS UNIVERSITARIO S2	08/12/2019 16:16	08/12/2019 18:43	08/12/2019 16:16	08/12/2019 18:43	2,44	2	4,87	CHI
20191250293	PLANALTINA	PI12049937	PLANALTINA	08/12/2019 16:16	08/12/2019 19:21	08/12/2019 16:16	08/12/2019 19:21	3,08	192	591,20	CHI
20191250293	PLANALTINA	PI11164651	PLANALTINA	08/12/2019 16:16	08/12/2019 19:21	08/12/2019 16:16	08/12/2019 19:21	3,08	92	283,31	CHI
20191249955	CRISTALINA	KR12168494	CRISTALINA S2	08/12/2019 16:17	08/12/2019 19:30	08/12/2019 16:17	08/12/2019 19:30	3,21	19	60,90	CHI
20191249851	CATALAO	CT21149248	CATALAO S1	08/12/2019 16:18	09/12/2019 15:40	08/12/2019 16:18	09/12/2019 15:40	23,36	2	46,73	CHI
20191249857	MORRINHOS	MR21373957	MORRINHOS	08/12/2019 16:19	08/12/2019 18:26	08/12/2019 16:19	08/12/2019 18:26	2,10	1	2,10	CHI
20191249866	PIRACANJUBA	PJ12083290	PIRACANJUBA	08/12/2019 16:20	08/12/2019 21:08	08/12/2019 16:20	08/12/2019 21:08	4,80	23	110,32	CHI
20191249869	BELA VISTA DE GOIAS	BV32028722	BELA VISTA S1	08/12/2019 16:20	08/12/2019 18:46	08/12/2019 16:20	08/12/2019 18:46	2,42	16	38,76	CHI
20191249874	ITAUCU	IX21125341	INHUMAS S1	08/12/2019 16:22	08/12/2019 18:45	08/12/2019 16:22	08/12/2019 18:45	2,38	2	4,76	CHI
20191250065	CAVALCANTE	TI12156216RE	MINACU	08/12/2019 16:22	10/12/2019 08:51	08/12/2019 16:22	08/12/2019 18:07	1,76	65	114,08	CHI
20191250065	COLINAS DO SUL	TI12156216RE	MINACU	08/12/2019 16:22	10/12/2019 08:51	08/12/2019 16:22	08/12/2019 18:07	1,76	34	59,67	CHI
20191250065	COLINAS DO SUL	TI12156216RE	MINACU	08/12/2019 16:22	10/12/2019 08:51	08/12/2019 18:32	09/12/2019 09:10	14,63	7	102,41	CHI
20191250065	COLINAS DO SUL	TI12156216RE	MINACU	08/12/2019 16:22	10/12/2019 08:51	08/12/2019 18:32	09/12/2019 09:38	15,09	6	90,52	CHI
20191250065	COLINAS DO SUL	TI12156216RE	MINACU	08/12/2019 16:22	10/12/2019 08:51	08/12/2019 18:32	09/12/2019 10:06	15,56	3	46,69	CHI
20191250065	CAVALCANTE	TI12156216RE	MINACU	08/12/2019 16:22	10/12/2019 08:51	08/12/2019 18:32	09/12/2019 15:34	21,02	2	42,04	CHI
20191250065	CAVALCANTE	TI12212411LD	MINACU	08/12/2019 16:22	10/12/2019 08:51	08/12/2019 18:32	10/12/2019 05:22	34,83	63	2194,29	CHI
20191250065	COLINAS DO SUL	TI12212411LD	MINACU	08/12/2019 16:22	10/12/2019 08:51	08/12/2019 18:32	10/12/2019 05:22	34,83	23	801,09	CHI
20191250065	CAVALCANTE	TI12156216RE	MINACU	08/12/2019 16:22	10/12/2019 08:51	08/12/2019 18:32	10/12/2019 08:05	37,55	1	37,55	CHI
20191250065	COLINAS DO SUL	TI12156216RE	MINACU	08/12/2019 16:22	10/12/2019 08:51	08/12/2019 18:32	10/12/2019 08:51	38,31	1	38,31	CHI
20191251392	GOIANESIA	GE12140828	GOIANESIA S1	08/12/2019 16:22	08/12/2019 23:50	08/12/2019 16:22	08/12/2019 23:50	7,45	2	14,90	CHI
20191251392	VILA PROPICIO	GE12140828	GOIANESIA S1	08/12/2019 16:22	08/12/2019 23:50	08/12/2019 16:22	08/12/2019 23:50	7,45	16	119,23	CHI
20191249878	QUIRINOPOLIS	QI21100924	QUIRINOPOLIS	08/12/2019 16:23	08/12/2019 23:30	08/12/2019 16:23	08/12/2019 23:30	7,11	1	7,11	CHI
20191249879	CALDAS NOVAS	CN31060269	RIO QUENTE	08/12/2019 16:23	08/12/2019 18:25	08/12/2019 16:23	08/12/2019 18:25	2,02	1	2,02	CHI
20191249880	NIQUELANDIA	10003084858	NIQUELANDIA SUBTRANSMISSAO	08/12/2019 16:23	08/12/2019 21:33	08/12/2019 16:23	08/12/2019 21:33	5,15	1	5,15	CHI

20191249881	ANAPOLIS	AN12096740	JUNDIAI S2	08/12/2019 16:24	08/12/2019 18:31	08/12/2019 16:24	08/12/2019 18:31	2,13	19	40,41	CHI
20191249883	MINEIROS	MY11050090	PARQUE DAS EMAS	08/12/2019 16:24	09/12/2019 19:40	08/12/2019 16:24	09/12/2019 19:40	27,27	15	409,09	CHI
20191249938	GOIANIA	GN12000805	XAVANTES	08/12/2019 16:25	08/12/2019 19:38	08/12/2019 16:25	08/12/2019 19:38	3,20	15	48,02	CHI
20191250179	BARRO ALTO	SJ12006466	GOIANESIA S1	08/12/2019 16:25	09/12/2019 04:14	08/12/2019 16:25	09/12/2019 04:14	11,80	1	11,80	CHI
20191250179	GOIANESIA	SJ12006466	GOIANESIA S1	08/12/2019 16:25	09/12/2019 04:14	08/12/2019 16:25	09/12/2019 04:14	11,80	7	82,63	CHI
20191250179	VILA PROPICIO	SJ12006466	GOIANESIA S1	08/12/2019 16:25	09/12/2019 04:14	08/12/2019 16:25	09/12/2019 04:14	11,80	1	11,80	CHI
20191249895	RIO VERDE	RV21192221	MONTIVIDIU T	08/12/2019 16:27	08/12/2019 21:45	08/12/2019 16:27	08/12/2019 21:45	5,30	1	5,30	CHI
20191250165	IPAMERI	IP11332849	IPAMERI	08/12/2019 16:29	08/12/2019 19:37	08/12/2019 16:29	08/12/2019 19:37	3,12	1	3,12	CHI
20191250505	CORUMBA DE GOIAS	CB12211844	CORUMBA	08/12/2019 16:29	08/12/2019 19:37	08/12/2019 16:29	08/12/2019 19:37	3,12	5	15,62	CHI
20191250505	PIRENOPOLIS	CB12211844	CORUMBA	08/12/2019 16:29	08/12/2019 19:37	08/12/2019 16:29	08/12/2019 19:37	3,12	1	3,12	CHI
20191249918	PARAUNA	PU12295869	ACREUNA	08/12/2019 16:33	09/12/2019 16:55	08/12/2019 16:33	09/12/2019 16:55	24,37	2	48,73	CHI
20191249927	LUZIANIA	LZ11030598	RIO VERMELHO	08/12/2019 16:35	08/12/2019 19:08	08/12/2019 16:35	08/12/2019 19:08	2,54	157	399,00	CHI
20191249932	MINEIROS	10001951163	PARQUE DAS EMAS	08/12/2019 16:35	08/12/2019 19:33	08/12/2019 16:35	08/12/2019 19:33	2,96	1	2,96	CHI
20191249940	PLANALTINA	PI12262312	PLANALTINA	08/12/2019 16:38	09/12/2019 03:50	08/12/2019 16:38	09/12/2019 03:50	11,19	10	111,89	CHI
20191249943	APARECIDA DE GOIANIA	13197514	ATLANTICO S3	08/12/2019 16:38	08/12/2019 19:25	08/12/2019 16:38	08/12/2019 19:25	2,77	1	2,77	CHI
20191250174	NIQUELANDIA	NQ11048775	NIQUELANDIA SUBTRANSMISSAO	08/12/2019 16:38	08/12/2019 19:04	08/12/2019 16:38	08/12/2019 19:04	2,43	109	265,05	CHI
20191249945	EDEALINA	EA12034059	VICENTINOPOLIS	08/12/2019 16:39	08/12/2019 21:01	08/12/2019 16:39	08/12/2019 21:01	4,35	4	17,42	CHI
20191249574	JATAI	JT12378114	JATAI S3	08/12/2019 16:40	09/12/2019 14:25	08/12/2019 18:46	09/12/2019 14:25	19,65	3	58,94	CHI
20191249954	ITAGUARU	JA12328472	JARAGUA	08/12/2019 16:40	08/12/2019 20:00	08/12/2019 16:40	08/12/2019 20:00	3,32	17	56,48	CHI
20191249954	JARAGUA	JA12328472	JARAGUA	08/12/2019 16:40	08/12/2019 20:00	08/12/2019 16:40	08/12/2019 20:00	3,32	1	3,32	CHI
20191250249	NIQUELANDIA	NQ11000021	NIQUELANDIA SUBTRANSMISSAO	08/12/2019 16:41	08/12/2019 19:45	08/12/2019 16:41	08/12/2019 19:45	3,05	113	344,93	CHI
20191249964	MONTE ALEGRE DE GOIAS	MA12238057	SAO DOMINGOS	08/12/2019 16:42	08/12/2019 20:27	08/12/2019 16:42	08/12/2019 20:27	3,74	32	119,83	CHI
20191249965	INACIOLANDIA	ID12304325	CACHOEIRA DOURADA	08/12/2019 16:42	08/12/2019 18:13	08/12/2019 16:42	08/12/2019 18:13	1,51	6	9,06	CHI
20191250304	EDEALINA	ED12103817	EDEIA	08/12/2019 16:42	08/12/2019 19:31	08/12/2019 16:42	08/12/2019 19:31	2,82	3	8,45	CHI
20191250304	INDIARA	ED12103817	EDEIA	08/12/2019 16:42	08/12/2019 19:31	08/12/2019 16:42	08/12/2019 19:31	2,82	4	11,27	CHI
20191249970	IPAMERI	IP12404728	IPAMERI	08/12/2019 16:43	08/12/2019 20:49	08/12/2019 16:43	08/12/2019 20:49	4,10	10	40,96	CHI
20191249975	POSSE	IA12035179	IACIARA S2	08/12/2019 16:43	08/12/2019 18:08	08/12/2019 16:43	08/12/2019 18:08	1,40	9	12,61	CHI
20191249981	ANAPOLIS	AN21248874	ANAPOLIS UNIVERSITARIO S2	08/12/2019 16:44	08/12/2019 20:09	08/12/2019 16:44	08/12/2019 20:09	3,41	2	6,81	CHI
20191249982	APARECIDA DE GOIANIA	200028807	INDEPENDENCIA S1	08/12/2019 16:44	08/12/2019 17:59	08/12/2019 16:44	08/12/2019 17:59	1,24	1	1,24	CHI
20191251493	CAMPO ALEGRE DE GOIAS	CM12280738	CAMPO ALEGRE DE GOIAS	08/12/2019 16:44	09/12/2019 12:48	08/12/2019 16:44	09/12/2019 12:48	20,07	3	60,20	CHI
20191249993	CATALAO	CT12077605	CATALAO S1	08/12/2019 16:46	09/12/2019 09:40	08/12/2019 16:46	09/12/2019 09:40	16,89	8	135,08	CHI
20191250001	FORMOSA	FA21334124	SAO JOAO D ALIANCA	08/12/2019 16:48	08/12/2019 19:37	08/12/2019 16:48	08/12/2019 19:37	2,80	1	2,80	CHI
20191250005	VIANOPOLIS	VN21103030	VIANOPOLIS	08/12/2019 16:50	09/12/2019 04:29	08/12/2019 16:50	09/12/2019 04:29	11,64	1	11,64	CHI

20191250015	JUSSARA	RN12138786	BRITANIA	08/12/2019 16:51	09/12/2019 17:46	08/12/2019 16:51	09/12/2019 17:46	24,91	1	24,91	CHI
20191250015	SANTA FE DE GOIAS	RN12138786	BRITANIA	08/12/2019 16:51	09/12/2019 17:46	08/12/2019 16:51	09/12/2019 17:46	24,91	8	199,24	CHI
20191250016	MORRINHOS	6264488	MORRINHOS	08/12/2019 16:51	09/12/2019 00:18	08/12/2019 16:51	09/12/2019 00:18	7,44	3	22,32	CHI
20191250017	MORRO AGUDO DE GOIAS	MS21331551	ITAPURANGA	08/12/2019 16:51	09/12/2019 08:38	08/12/2019 16:51	09/12/2019 08:38	15,77	1	15,77	CHI
20191250042	NIQUELANDIA	NQ11197624	NIQUELANDIA SUBTRANSMISSAO	08/12/2019 16:51	08/12/2019 22:59	08/12/2019 16:51	08/12/2019 22:59	6,13	51	312,55	CHI
20191250018	CRISTALINA	KR12250014	PAMPLONA	08/12/2019 16:52	08/12/2019 18:24	08/12/2019 16:52	08/12/2019 18:24	1,53	31	47,52	CHI
20191250019	SILVANIA	SV12270699	DAIA S2	08/12/2019 16:52	08/12/2019 18:32	08/12/2019 16:52	08/12/2019 18:32	1,66	6	9,97	CHI
20191250022	BURITI ALEGRE	BG12294720	GOIATUBA S2	08/12/2019 16:52	08/12/2019 19:53	08/12/2019 16:52	08/12/2019 19:53	3,01	1	3,01	CHI
20191250022	GOIATUBA	BG12294720	GOIATUBA S2	08/12/2019 16:52	08/12/2019 19:53	08/12/2019 16:52	08/12/2019 19:53	3,01	1	3,01	CHI
20191250027	TRINDADE	TR21018401	GOIANIRA	08/12/2019 16:53	08/12/2019 20:15	08/12/2019 16:53	08/12/2019 20:15	3,36	2	6,71	CHI
20191250031	INDIARA	PL12349352	PALMEIRAS	08/12/2019 16:54	08/12/2019 19:47	08/12/2019 16:54	08/12/2019 19:47	2,89	3	8,66	CHI
20191250031	PALMEIRAS DE GOIAS	PL12349352	PALMEIRAS	08/12/2019 16:54	08/12/2019 19:47	08/12/2019 16:54	08/12/2019 19:47	2,89	66	190,59	CHI
20191250032	MOZARLANDIA	MZ13057078	MOZARLANDIA	08/12/2019 16:54	09/12/2019 13:55	09/12/2019 11:22	09/12/2019 13:55	2,54	5	12,72	CHI
20191251292	SILVANIA	VN12012123	VIANOPOLIS	08/12/2019 16:55	08/12/2019 21:46	08/12/2019 16:55	08/12/2019 21:46	4,83	16	77,34	CHI
20191250040	BRITANIA	BT12010479	BRITANIA	08/12/2019 16:56	09/12/2019 07:59	08/12/2019 16:56	09/12/2019 07:59	15,05	9	135,45	CHI
20191250048	SENADOR CANEDO	SW11282642	GOIANIA LESTE S1	08/12/2019 16:56	08/12/2019 21:14	08/12/2019 16:56	08/12/2019 21:14	4,29	45	193,01	CHI
20191250049	ANAPOLIS	10012417180	JUNDIAI S1	08/12/2019 16:56	08/12/2019 18:19	08/12/2019 16:56	08/12/2019 18:19	1,37	1	1,37	CHI
20191250086	GOIANIA	GN11001609	ATLANTICO S1	08/12/2019 16:56	08/12/2019 17:27	08/12/2019 16:56	08/12/2019 17:27	0,51	84	42,82	CHI
20191250133	GOIAS	GS11067664	GOIAS	08/12/2019 16:56	08/12/2019 20:07	08/12/2019 16:56	08/12/2019 20:07	3,18	112	356,00	CHI
20191250053	LUZIANIA	120254633	RIO VERMELHO	08/12/2019 16:57	08/12/2019 18:32	08/12/2019 16:57	08/12/2019 18:32	1,59	1	1,59	CHI
20191250366	BELA VISTA DE GOIAS	SW12091937LD	SENADOR CANEDO	08/12/2019 16:57	08/12/2019 20:30	08/12/2019 16:57	08/12/2019 20:30	3,55	27	95,74	CHI
20191250366	CALDAZINHA	SW12091937LD	SENADOR CANEDO	08/12/2019 16:57	08/12/2019 20:30	08/12/2019 16:57	08/12/2019 20:30	3,55	51	180,84	CHI
20191250375	CEZARINA	IY12010392	EDEIA	08/12/2019 16:57	09/12/2019 09:55	08/12/2019 16:57	09/12/2019 09:55	16,96	6	101,73	CHI
20191250375	INDIARA	IY12010392	EDEIA	08/12/2019 16:57	09/12/2019 09:55	08/12/2019 16:57	09/12/2019 09:55	16,96	7	118,69	CHI
20191250062	ITAUCU	IX21017281	INHUMAS S2	08/12/2019 16:58	08/12/2019 18:36	08/12/2019 16:58	08/12/2019 18:36	1,62	1	1,62	CHI
20191250271	PLANALTINA	PI12139795	PLANALTINA	08/12/2019 16:59	08/12/2019 19:26	08/12/2019 16:59	08/12/2019 19:26	2,44	316	772,53	CHI
20191250071	CORUMBA DE GOIAS	CB21172010	CORUMBA	08/12/2019 17:00	08/12/2019 17:16	08/12/2019 17:00	08/12/2019 17:16	0,26	1	0,26	CHI
20191250075	ARUANA	AK11376357	ARUANA	08/12/2019 17:00	08/12/2019 23:53	08/12/2019 17:00	08/12/2019 23:53	6,88	1	6,88	CHI
20191250078	MORRO AGUDO DE GOIAS	MS12017328	ITAPURANGA	08/12/2019 17:00	09/12/2019 07:53	08/12/2019 17:00	09/12/2019 07:53	14,87	10	148,71	CHI
20191250094	FORMOSO	TB12003843	PORANGATU	08/12/2019 17:01	08/12/2019 18:37	08/12/2019 17:01	08/12/2019 17:37	0,60	1	0,60	CHI
20191250094	MINACU	TB12003843	PORANGATU	08/12/2019 17:01	08/12/2019 18:37	08/12/2019 17:01	08/12/2019 17:37	0,60	12	7,24	CHI
20191250094	TROMBAS	TB12003843	PORANGATU	08/12/2019 17:01	08/12/2019 18:37	08/12/2019 17:01	08/12/2019 17:37	0,60	1133	683,89	CHI
20191250094	FORMOSO	TB12003843	PORANGATU	08/12/2019 17:01	08/12/2019 18:37	08/12/2019 18:00	08/12/2019 18:37	0,61	1	0,61	CHI

20191250094	MINACU	TB12003843	PORANGATU	08/12/2019 17:01	08/12/2019 18:37	08/12/2019 18:00	08/12/2019 18:37	0,61	12	7,31	CHI
20191250094	TROMBAS	TB12003843	PORANGATU	08/12/2019 17:01	08/12/2019 18:37	08/12/2019 18:00	08/12/2019 18:37	0,61	1133	689,87	CHI
20191250161	PLANALTINA	PI11164640	PLANALTINA	08/12/2019 17:01	08/12/2019 18:43	08/12/2019 17:01	08/12/2019 18:43	1,70	105	178,15	CHI
20191250088	CORUMBA DE GOIAS	CB12297734	CORUMBA	08/12/2019 17:02	09/12/2019 17:15	08/12/2019 17:02	09/12/2019 17:15	24,21	6	145,26	CHI
20191250092	JARAGUA	JA21116896	JARAGUA	08/12/2019 17:02	08/12/2019 20:27	08/12/2019 17:02	08/12/2019 20:27	3,42	1	3,42	CHI
20191250090	CAVALCANTE	CJ11389069	SAO DOMINGOS	08/12/2019 17:03	08/12/2019 17:16	08/12/2019 17:03	08/12/2019 17:16	0,21	1	0,21	CHI
20191250093	TURVANIA	TV12005718	FIRMINOPOLIS S2	08/12/2019 17:03	08/12/2019 18:48	08/12/2019 17:03	08/12/2019 18:48	1,75	7	12,22	CHI
20191250109	APARECIDA DE GOIANIA	200066651	ANHANGUERA	08/12/2019 17:05	08/12/2019 18:48	08/12/2019 17:05	08/12/2019 18:48	1,70	1	1,70	CHI
20191250130	PALMEIRAS DE GOIAS	PL21000160	PALMEIRAS	08/12/2019 17:08	09/12/2019 07:15	08/12/2019 17:08	09/12/2019 07:15	14,12	2	28,24	CHI
20191250138	RIO VERDE	RV21240283	RIO VERDE S1	08/12/2019 17:10	08/12/2019 19:43	08/12/2019 17:10	08/12/2019 19:43	2,54	1	2,54	CHI
20191250146	RIO VERDE	630251125	RIO VERDE S2	08/12/2019 17:12	08/12/2019 19:33	08/12/2019 17:12	08/12/2019 19:33	2,36	1	2,36	CHI
20191250157	IVOLANDIA	IV21337730	IPORA	08/12/2019 17:15	09/12/2019 02:07	08/12/2019 17:15	09/12/2019 02:07	8,87	1	8,87	CHI
20191250162	ALTO PARAISO DE GOIAS	BF21325527	NIQUELANDIA SUBTRANSMISSAO	08/12/2019 17:16	08/12/2019 20:33	08/12/2019 17:16	08/12/2019 20:33	3,27	1	3,27	CHI
20191250169	APARECIDA DE GOIANIA	200241400	INDEPENDENCIA S1	08/12/2019 17:18	08/12/2019 19:15	08/12/2019 17:18	08/12/2019 19:15	1,94	1	1,94	CHI
20191251200	GOIAS	GS12067665	GOIAS	08/12/2019 17:18	08/12/2019 20:07	08/12/2019 17:18	08/12/2019 20:07	2,82	150	422,37	CHI
20191250171	ITUMBIARA	BG12000052	ITUMBIARA VELHA S2	08/12/2019 17:19	08/12/2019 19:24	08/12/2019 17:19	08/12/2019 19:24	2,08	6	12,48	CHI
20191250464	COCALZINHO DE GOIAS	ZN12258524RE	COCALZINHO	08/12/2019 17:19	08/12/2019 20:44	08/12/2019 17:19	08/12/2019 20:44	3,41	55	187,44	CHI
20191250177	GOIANIA	11472832	CAMPINAS S2	08/12/2019 17:20	08/12/2019 18:50	08/12/2019 17:20	08/12/2019 18:50	1,49	1	1,49	CHI
20191250384	PETROLINA DE GOIAS	PV12302405	SAO FRANCISCO DE GOIAS	08/12/2019 17:20	08/12/2019 19:30	08/12/2019 17:20	08/12/2019 19:30	2,15	5	10,77	CHI
20191250384	PIRENOPOLIS	PV12302405	SAO FRANCISCO DE GOIAS	08/12/2019 17:20	08/12/2019 19:30	08/12/2019 17:20	08/12/2019 19:30	2,15	60	129,20	CHI
20191250384	SAO FRANCISCO DE GOIAS	PV12302405	SAO FRANCISCO DE GOIAS	08/12/2019 17:20	08/12/2019 19:30	08/12/2019 17:20	08/12/2019 19:30	2,15	19	40,91	CHI
20191250183	QUIRINOPOLIS	QI12273812	QUIRINOPOLIS	08/12/2019 17:21	08/12/2019 22:19	08/12/2019 17:21	08/12/2019 22:19	4,95	7	34,67	CHI
20191251165	MATRINCHA	MP12198020	MATRINCHA	08/12/2019 17:21	09/12/2019 08:20	08/12/2019 17:21	09/12/2019 08:20	14,98	3	44,94	CHI
20191250948	CAMPO ALEGRE DE GOIAS	CM12166727	CAMPO ALEGRE DE GOIAS	08/12/2019 17:22	09/12/2019 10:59	08/12/2019 17:22	09/12/2019 10:59	17,62	6	105,70	CHI
20191250194	PIRENOPOLIS	PV21185581	CORUMBA	08/12/2019 17:23	08/12/2019 21:20	08/12/2019 17:23	08/12/2019 21:20	3,94	2	7,87	CHI
20191250201	PALESTINA DE GOIAS	PY21121099	PALESTINA	08/12/2019 17:24	09/12/2019 13:20	08/12/2019 17:24	09/12/2019 13:20	19,92	1	19,92	CHI
20191250208	TRINDADE	10011852761	GOYA S1	08/12/2019 17:25	08/12/2019 19:00	08/12/2019 17:25	08/12/2019 19:00	1,58	1	1,58	CHI
20191250212	TRINDADE	TR31089357	TRINDADE	08/12/2019 17:26	08/12/2019 22:03	08/12/2019 17:26	08/12/2019 22:03	4,61	1	4,61	CHI
20191250213	MORRINHOS	MR21119714	MORRINHOS	08/12/2019 17:26	09/12/2019 12:30	08/12/2019 17:26	09/12/2019 12:30	19,06	1	19,06	CHI
20191250215	GOIANIA	10992285	FERROVIARIO S1	08/12/2019 17:27	08/12/2019 20:32	08/12/2019 17:27	08/12/2019 20:32	3,08	1	3,08	CHI
20191250222	ITAGUARI	IC12219941	ITABERAI S1	08/12/2019 17:27	09/12/2019 14:32	08/12/2019 17:27	09/12/2019 10:44	17,29	6	103,72	CHI
20191250222	ITAGUARU	IC12219941	ITABERAI S1	08/12/2019 17:27	09/12/2019 14:32	08/12/2019 17:27	09/12/2019 10:44	17,29	7	121,00	CHI
20191250222	ITAGUARI	IC12038617	ITABERAI S1	08/12/2019 17:27	09/12/2019 14:32	08/12/2019 17:27	09/12/2019 11:28	18,02	19	342,34	CHI

20191250222	ITAGUARU	IC12038617	ITABERAÍ S1	08/12/2019 17:27	09/12/2019 14:32	08/12/2019 17:27	09/12/2019 11:28	18,02	11	198,20	CHI
20191250222	ITAGUARI	IC12219941	ITABERAÍ S1	08/12/2019 17:27	09/12/2019 14:32	08/12/2019 17:27	09/12/2019 14:32	21,08	6	126,49	CHI
20191250222	ITAGUARU	IC12219941	ITABERAÍ S1	08/12/2019 17:27	09/12/2019 14:32	08/12/2019 17:27	09/12/2019 14:32	21,08	3	63,25	CHI
20191250265	ANAPOLIS	AN12004481	NEROPOLIS S1	08/12/2019 17:27	08/12/2019 18:52	08/12/2019 17:27	08/12/2019 18:52	1,40	8	11,22	CHI
20191250221	FIRMINOPOLIS	900025402	FIRMINOPOLIS S1	08/12/2019 17:28	08/12/2019 19:33	08/12/2019 17:28	08/12/2019 19:33	2,09	1	2,09	CHI
20191250229	CORUMBA DE GOIAS	CB21227482	CORUMBA	08/12/2019 17:29	09/12/2019 16:33	08/12/2019 17:29	09/12/2019 16:33	23,06	2	46,13	CHI
20191250232	CAMPO ALEGRE DE GOIAS	CM12164117	CAMPO ALEGRE DE GOIAS	08/12/2019 17:29	09/12/2019 16:22	08/12/2019 17:29	09/12/2019 16:22	22,88	1	22,88	CHI
20191250232	CAMPO ALEGRE DE GOIAS	CM12358428RE	CAMPO ALEGRE DE GOIAS	08/12/2019 17:29	09/12/2019 16:22	09/12/2019 06:50	09/12/2019 16:22	9,53	1	9,53	CHI
20191250569	TAQUARAL DE GOIAS	TQ11000031	ITABERAÍ S1	08/12/2019 17:29	08/12/2019 23:43	08/12/2019 17:29	08/12/2019 23:43	6,23	128	796,91	CHI
20191250617	PLANALTINA	PI11129918	PLANALTINA	08/12/2019 17:29	08/12/2019 19:47	08/12/2019 17:29	08/12/2019 19:47	2,30	177	406,46	CHI
20191250236	ABADIANIA	AA12302324	ANAPOLIS UNIVERSITARIO S1	08/12/2019 17:31	09/12/2019 12:10	08/12/2019 17:31	09/12/2019 12:10	18,64	4	74,57	CHI
20191250242	NOVA CRIXAS	7940685	MOZARLANDIA	08/12/2019 17:32	09/12/2019 13:21	08/12/2019 17:32	09/12/2019 13:21	19,82	1	19,82	CHI
20191251140	PONTALINA	PK12000100	PONTALINA	08/12/2019 17:33	09/12/2019 06:53	08/12/2019 17:33	09/12/2019 06:53	13,33	11	146,62	CHI
20191250250	CRISTIANOPOLIS	CF12045580	CRISTIANOPOLIS	08/12/2019 17:35	08/12/2019 18:34	08/12/2019 17:35	08/12/2019 18:34	0,98	4	3,93	CHI
20191250252	LUZIANIA	3200161496	MARAJOARA	08/12/2019 17:35	08/12/2019 18:49	08/12/2019 17:35	08/12/2019 18:49	1,23	1	1,23	CHI
20191250774	PIRACANJUBA	PJ12212194	PIRACANJUBA	08/12/2019 17:36	09/12/2019 18:54	08/12/2019 17:36	09/12/2019 18:54	25,29	19	480,56	CHI
20191249566	ALTO PARAISO DE GOIAS	BF10400725	NIQUELANDIA SUBTRANSMISSAO	08/12/2019 17:39	08/12/2019 19:51	08/12/2019 17:39	08/12/2019 19:51	2,20	520	1143,42	CHI
20191250264	SAO LUIZ DO NORTE	SZ21353578	ITAPACI	08/12/2019 17:39	09/12/2019 08:54	08/12/2019 17:39	09/12/2019 08:54	15,25	1	15,25	CHI
20191250266	PIRES DO RIO	PR21095358	PIRES DO RIO S1	08/12/2019 17:39	08/12/2019 21:10	08/12/2019 17:39	08/12/2019 21:10	3,51	1	3,51	CHI
20191250269	IPAMERI	IP12272854	IPAMERI	08/12/2019 17:40	08/12/2019 22:00	08/12/2019 17:40	08/12/2019 22:00	4,33	5	21,66	CHI
20191250272	MINEIROS	MY12400231	PARQUE DAS EMAS	08/12/2019 17:40	08/12/2019 22:47	08/12/2019 17:40	08/12/2019 22:47	5,11	1	5,11	CHI
20191250276	SANTO ANTONIO DO DESCOBERTO	2210108415	AGUAS LINDAS DE GOIAS S2	08/12/2019 17:41	08/12/2019 20:03	08/12/2019 17:41	08/12/2019 20:03	2,35	1	2,35	CHI
20191250285	GOIANIA	10158509	FERROVIARIO S3	08/12/2019 17:44	08/12/2019 18:48	08/12/2019 17:44	08/12/2019 18:48	1,06	1	1,06	CHI
20191250291	TEREZOPOLIS DE GOIAS	GP31017509	JUNDIAI S1	08/12/2019 17:45	08/12/2019 19:11	08/12/2019 17:45	08/12/2019 19:11	1,43	4	5,71	CHI
20191250350	PIRES DO RIO	PR11000019	PIRES DO RIO S1	08/12/2019 17:45	08/12/2019 21:48	08/12/2019 17:45	08/12/2019 21:48	4,04	135	544,73	CHI
20191250297	TURVELANDIA	SH12026451	RIO DOS BOIS	08/12/2019 17:46	08/12/2019 22:00	08/12/2019 17:46	08/12/2019 22:00	4,23	1	4,23	CHI
20191250299	IPORA	730085144	IPORA	08/12/2019 17:46	08/12/2019 20:50	08/12/2019 17:46	08/12/2019 20:50	3,06	1	3,06	CHI
20191250300	NIQUELANDIA	NQ21239310	NIQUELANDIA SUBTRANSMISSAO	08/12/2019 17:46	09/12/2019 12:26	08/12/2019 17:46	09/12/2019 12:26	18,65	1	18,65	CHI
20191250312	CATALAO	10015098190	CATALAO S2	08/12/2019 17:48	09/12/2019 00:07	08/12/2019 17:48	09/12/2019 00:07	6,30	1	6,30	CHI
20191250415	AGUA FRIA DE GOIAS	TL12381390	SAO JOAO D ALIANCA	08/12/2019 17:48	09/12/2019 10:05	08/12/2019 17:48	09/12/2019 10:05	16,29	3	48,86	CHI
20191250415	PLANALTINA	TL12381390	SAO JOAO D ALIANCA	08/12/2019 17:48	09/12/2019 10:05	08/12/2019 17:48	09/12/2019 10:05	16,29	20	325,76	CHI
20191250697	APARECIDA DE GOIANIA	AP11004844	REAL S1	08/12/2019 17:48	09/12/2019 01:34	08/12/2019 17:48	09/12/2019 01:34	7,77	44	341,75	CHI
20191250370	ARAGARCAS	AG12341726	IPORA	08/12/2019 17:49	08/12/2019 22:46	08/12/2019 17:49	08/12/2019 22:46	4,95	28	138,47	CHI



20191250320	PLANALTINA	PI12131790	PLANALTINA	08/12/2019 17:50	08/12/2019 21:03	08/12/2019 17:50	08/12/2019 21:03	3,22	18	57,88	CHI
20191250356	CORUMBA DE GOIAS	CB12302158	ALEXANIA	08/12/2019 17:50	08/12/2019 19:47	08/12/2019 17:50	08/12/2019 19:47	1,94	7	13,55	CHI
20191250324	ANAPOLIS	AN12026164	ANAPOLIS UNIVERSITARIO S2	08/12/2019 17:51	08/12/2019 21:18	08/12/2019 17:51	08/12/2019 21:18	3,45	2	6,89	CHI
20191250326	ANAPOLIS	10007274600	JUNDIAI S1	08/12/2019 17:51	08/12/2019 19:10	08/12/2019 17:51	08/12/2019 19:10	1,31	1	1,31	CHI
20191250329	ANAPOLIS	10007756648	JUNDIAI S2	08/12/2019 17:51	09/12/2019 01:01	08/12/2019 17:51	09/12/2019 01:01	7,15	1	7,15	CHI
20191250301	CAMPO ALEGRE DE GOIAS	CM21157448	CAMPO ALEGRE DE GOIAS	08/12/2019 17:52	09/12/2019 11:16	08/12/2019 17:52	09/12/2019 11:16	17,40	1	17,40	CHI
20191250331	JUSSARA	JR12101970RE	BRITANIA	08/12/2019 17:52	09/12/2019 21:38	08/12/2019 17:52	09/12/2019 21:38	27,75	11	305,30	CHI
20191250335	LEOPOLDO DE BULHOES	6740001104	DAIA S2	08/12/2019 17:53	08/12/2019 19:11	08/12/2019 17:53	08/12/2019 19:11	1,29	1	1,29	CHI
20191250338	SANTA HELENA DE GOIAS	400058546	IPEGUARI	08/12/2019 17:53	08/12/2019 20:00	08/12/2019 17:53	08/12/2019 20:00	2,12	1	2,12	CHI
20191250344	IPAMERI	IP12000086	IPAMERI	08/12/2019 17:55	09/12/2019 10:08	08/12/2019 17:55	09/12/2019 10:08	16,21	5	81,04	CHI
201912260786	FLORES DE GOIAS	9620004686	IACIARA S2	08/12/2019 17:55	09/12/2019 09:43	08/12/2019 17:55	09/12/2019 09:43	15,79	1	15,79	CHI
20191250352	LUZIANIA	LZ21120208	MARAJOARA	08/12/2019 17:57	08/12/2019 21:33	08/12/2019 17:57	08/12/2019 21:33	3,58	2	7,17	CHI
20191250365	ITAGUARU	230009300	ITABERAI S1	08/12/2019 18:01	08/12/2019 23:17	08/12/2019 18:01	08/12/2019 23:17	5,26	1	5,26	CHI
20191250369	CALDAS NOVAS	CN12054006	SERRA DE CALDAS	08/12/2019 18:02	08/12/2019 19:22	08/12/2019 18:02	08/12/2019 19:22	1,33	227	301,53	CHI
20191250511	CALDAS NOVAS	CN11054003	SERRA DE CALDAS	08/12/2019 18:02	08/12/2019 20:09	08/12/2019 18:02	08/12/2019 20:09	2,11	223	470,84	CHI
20191250377	GOUVELANDIA	GB12402363	QUIRINOPOLIS	08/12/2019 18:04	08/12/2019 19:47	08/12/2019 18:04	08/12/2019 19:47	1,71	7	11,96	CHI
20191250378	CORUMBA DE GOIAS	CB21114971	CORUMBA	08/12/2019 18:04	09/12/2019 10:55	08/12/2019 18:04	09/12/2019 10:55	16,84	1	16,84	CHI
20191250379	PIRES DO RIO	PR21272844	PIRES DO RIO S1	08/12/2019 18:04	08/12/2019 23:52	08/12/2019 18:04	08/12/2019 23:52	5,79	1	5,79	CHI
20191250382	FAINA	MP12096007	MATRINCHA	08/12/2019 18:06	09/12/2019 17:13	08/12/2019 18:06	09/12/2019 17:13	23,11	8	184,91	CHI
20191250383	JARAGUA	JA21140680	JARAGUA	08/12/2019 18:06	08/12/2019 19:37	08/12/2019 18:06	08/12/2019 19:37	1,51	3	4,53	CHI
20191250387	FIRMINOPOLIS	FR21018607	FIRMINOPOLIS S1	08/12/2019 18:08	08/12/2019 20:32	08/12/2019 18:08	08/12/2019 20:32	2,40	1	2,40	CHI
20191250389	GOIANIA	14817251	XAVANTES	08/12/2019 18:08	08/12/2019 20:27	08/12/2019 18:08	08/12/2019 20:27	2,31	1	2,31	CHI
20191250400	ALVORADA DO NORTE	1510020758	IACIARA S2	08/12/2019 18:11	08/12/2019 22:11	08/12/2019 18:11	08/12/2019 22:11	3,99	1	3,99	CHI
201912260787	GOIANIRA	GR12275444	MEIA PONTE	08/12/2019 18:12	08/12/2019 20:40	08/12/2019 18:12	08/12/2019 20:40	2,46	102	251,17	CHI
20191250409	PIRACANJUBA	PJ21010881	BELA VISTA S1	08/12/2019 18:13	09/12/2019 20:11	08/12/2019 18:13	09/12/2019 20:11	25,95	1	25,95	CHI
20191250679	NIQUELANDIA	NQ11048782	NIQUELANDIA SUBTRANSMISSAO	08/12/2019 18:13	08/12/2019 22:14	08/12/2019 18:13	08/12/2019 22:14	4,01	105	420,93	CHI
20191250411	GUAPO	GA21054266	GUAPO S2	08/12/2019 18:14	08/12/2019 21:50	08/12/2019 18:14	08/12/2019 21:50	3,60	3	10,79	CHI
20191250417	CIDADE OCIDENTAL	10003074577	MARAJOARA	08/12/2019 18:15	08/12/2019 20:24	08/12/2019 18:15	08/12/2019 20:24	2,15	1	2,15	CHI
20191250433	BRAZABRANTES	BR12319562	NEROPOLIS S1	08/12/2019 18:15	08/12/2019 19:51	08/12/2019 18:15	08/12/2019 19:51	1,60	39	62,31	CHI
20191250422	JARAGUA	JA12298032	JARAGUA	08/12/2019 18:16	08/12/2019 20:36	08/12/2019 18:16	08/12/2019 20:36	2,33	137	318,75	CHI
20191250424	COCALZINHO DE GOIAS	ZN12330505	AGUAS LINDAS DE GOIAS S2	08/12/2019 18:17	09/12/2019 01:06	08/12/2019 18:17	09/12/2019 01:06	6,81	28	190,59	CHI
20191250424	PADRE BERNARDO	ZN12330505	AGUAS LINDAS DE GOIAS S2	08/12/2019 18:17	09/12/2019 01:06	08/12/2019 18:17	09/12/2019 01:06	6,81	4	27,23	CHI
20191250425	BELA VISTA DE GOIAS	BV32058331	BELA VISTA S1	08/12/2019 18:17	08/12/2019 21:57	08/12/2019 18:17	08/12/2019 21:57	3,66	38	138,91	CHI

20191250428	APORE	10012504449	ITAJA S1	08/12/2019 18:18	09/12/2019 12:53	08/12/2019 18:18	09/12/2019 12:53	18,57	1	18,57	CHI
20191250453	POSSE	PS11329680	IACIARA S2	08/12/2019 18:20	09/12/2019 02:45	08/12/2019 18:20	09/12/2019 02:45	8,41	165	1386,87	CHI
20191250441	CATALAO	CT12042339	CATALAO S1	08/12/2019 18:22	09/12/2019 09:59	08/12/2019 18:22	09/12/2019 09:59	15,62	9	140,59	CHI
20191250451	ABADIANIA	AA11061924	ANAPOLIS UNIVERSITARIO S1	08/12/2019 18:22	09/12/2019 00:16	08/12/2019 18:22	09/12/2019 00:16	5,89	99	582,84	CHI
20191251114	CEZARINA	CZ12035074	CEZARINA	08/12/2019 18:23	09/12/2019 00:28	08/12/2019 18:23	09/12/2019 00:28	6,07	361	2190,57	CHI
20191250459	FIRMINOPOLIS	FR21381763	FIRMINOPOLIS S1	08/12/2019 18:24	08/12/2019 21:10	08/12/2019 18:24	08/12/2019 21:10	2,77	1	2,77	CHI
20191250466	GOIANIA	10005064269	GOYA S2	08/12/2019 18:26	08/12/2019 19:45	08/12/2019 18:26	08/12/2019 19:45	1,31	1	1,31	CHI
20191250776	CRISTALINA	KR12304869	CRISTALINA S2	08/12/2019 18:28	08/12/2019 21:45	08/12/2019 18:28	08/12/2019 21:45	3,27	14	45,81	CHI
20191250506	JARAGUA	JA21298028	JARAGUA	08/12/2019 18:29	09/12/2019 05:38	08/12/2019 18:29	09/12/2019 05:38	11,14	1	11,14	CHI
20191250509	ALEXANIA	480027195	ALEXANIA	08/12/2019 18:30	08/12/2019 20:35	08/12/2019 18:30	08/12/2019 20:35	2,09	1	2,09	CHI
20191250515	AGUAS LINDAS DE GOIAS	10005693908	AGUAS LINDAS DE GOIAS S1	08/12/2019 18:31	08/12/2019 20:19	08/12/2019 18:31	08/12/2019 20:19	1,79	1	1,79	CHI
20191252003	CAIAPONIA	PH21191190	PIRANHAS	08/12/2019 18:31	09/12/2019 13:01	08/12/2019 18:31	09/12/2019 13:01	18,49	1	18,49	CHI
20191250523	SAO FRANCISCO DE GOIAS	SF21000132	SAO FRANCISCO DE GOIAS	08/12/2019 18:32	09/12/2019 09:45	08/12/2019 18:32	09/12/2019 09:45	15,21	1	15,21	CHI
20191250534	ABADIANIA	AA21295633	DAIA S2	08/12/2019 18:34	08/12/2019 18:55	08/12/2019 18:34	08/12/2019 18:55	0,34	2	0,68	CHI
20191250536	GOIATUBA	GT21190875	RIO DOS BOIS	08/12/2019 18:34	08/12/2019 22:22	08/12/2019 18:34	08/12/2019 22:22	3,80	1	3,80	CHI
20191250537	CRISTALINA	7518339	CRISTALINA S2	08/12/2019 18:35	08/12/2019 20:19	08/12/2019 18:35	08/12/2019 20:19	1,73	1	1,73	CHI
20191250543	ITUMBIARA	690074189	ITUMBIARA NOVA	08/12/2019 18:36	09/12/2019 00:08	08/12/2019 18:36	09/12/2019 00:08	5,54	1	5,54	CHI
20191250577	ABADIANIA	AA12258346	ANAPOLIS UNIVERSITARIO S1	08/12/2019 18:36	09/12/2019 07:48	08/12/2019 18:36	09/12/2019 07:48	13,19	22	290,19	CHI
20191250577	CORUMBA DE GOIAS	AA12258346	ANAPOLIS UNIVERSITARIO S1	08/12/2019 18:36	09/12/2019 07:48	08/12/2019 18:36	09/12/2019 07:48	13,19	2	26,38	CHI
20191250554	ANAPOLIS	10007448129	ANAPOLIS UNIVERSITARIO S2	08/12/2019 18:38	08/12/2019 19:51	08/12/2019 18:38	08/12/2019 19:51	1,21	1	1,21	CHI
20191250555	CALDAS NOVAS	CN12200060RE	CALDAS NOVAS S2	08/12/2019 18:38	08/12/2019 20:55	08/12/2019 18:38	08/12/2019 20:55	2,28	137	312,55	CHI
20191250555	PIRACANJUBA	CN12200060RE	CALDAS NOVAS S2	08/12/2019 18:38	08/12/2019 20:55	08/12/2019 18:38	08/12/2019 20:55	2,28	2	4,56	CHI
20191250556	PARAUNA	PU12228062	PARAUNA	08/12/2019 18:38	09/12/2019 07:15	08/12/2019 18:38	09/12/2019 07:15	12,60	6	75,61	CHI
20191250852	MINACU	IH12182352	MINACU	08/12/2019 18:38	08/12/2019 20:24	08/12/2019 18:38	08/12/2019 20:24	1,76	205	361,37	CHI
20191250564	PROFESSOR JAMIL SAFADY	PJ12088033	ROCHEDO	08/12/2019 18:41	09/12/2019 19:28	08/12/2019 18:41	09/12/2019 19:28	24,78	4	99,12	CHI
20191250568	BOM JESUS DE GOIAS	BJ21000110	BOM JESUS DE GOIAS	08/12/2019 18:42	08/12/2019 20:38	08/12/2019 18:42	08/12/2019 20:38	1,93	1	1,93	CHI
20191250578	GOUVELANDIA	GB12301502	QUIRINOPOLIS	08/12/2019 18:44	08/12/2019 21:43	08/12/2019 18:44	08/12/2019 21:43	2,98	7	20,88	CHI
20191250583	SAO FRANCISCO DE GOIAS	SF12000171	SAO FRANCISCO DE GOIAS	08/12/2019 18:44	09/12/2019 01:04	08/12/2019 18:44	09/12/2019 01:04	6,33	15	94,99	CHI
20191250782	JARAGUA	JA12064311	JARAGUA	08/12/2019 18:44	09/12/2019 03:52	08/12/2019 18:44	09/12/2019 03:52	9,13	14	127,84	CHI
20191250584	PIRENOPOLIS	PV12062557	ANAPOLIS UNIVERSITARIO S2	08/12/2019 18:45	09/12/2019 13:30	08/12/2019 18:45	09/12/2019 13:30	18,75	6	112,50	CHI
20191250586	IPORA	730020265	IPORA	08/12/2019 18:45	08/12/2019 21:56	08/12/2019 18:45	08/12/2019 21:56	3,17	1	3,17	CHI
20191249573	JATAI	JT12378114	JATAI S3	08/12/2019 18:46	09/12/2019 14:25	08/12/2019 18:46	09/12/2019 14:25	19,64	2	39,27	CHI
20191250642	BOM JARDIM DE GOIAS	BM12243912	BOM JARDIM	08/12/2019 18:50	09/12/2019 08:11	08/12/2019 18:50	09/12/2019 08:11	13,36	11	146,91	CHI

20191250642	PIRANHAS	BM12243912	BOM JARDIM	08/12/2019 18:50	09/12/2019 08:11	08/12/2019 18:50	09/12/2019 08:11	13,36	9	120,20	CHI
20191250644	MORRINHOS	MR21150861	MORRINHOS	08/12/2019 18:50	09/12/2019 11:03	08/12/2019 18:50	09/12/2019 11:03	16,22	1	16,22	CHI
20191250645	SANTA RITA DO NOVO DESTINO	DF12215093	GOIANESIA S1	08/12/2019 18:50	09/12/2019 11:06	08/12/2019 18:50	09/12/2019 11:06	16,26	2	32,53	CHI
20191250658	GOIANDIRA	GD21294347	CATALAO S1	08/12/2019 18:50	09/12/2019 16:15	08/12/2019 18:50	09/12/2019 16:15	21,41	1	21,41	CHI
20191250659	IPORA	IR11074589	IPORA	08/12/2019 18:50	08/12/2019 21:27	08/12/2019 18:50	08/12/2019 21:27	2,61	2	5,22	CHI
20191250790	JARAGUA	JA12221349	JARAGUA	08/12/2019 18:51	08/12/2019 20:56	08/12/2019 18:51	08/12/2019 20:56	2,07	6	12,44	CHI
20191250686	ITAJA	IJ21210118	ITAJA S2	08/12/2019 18:52	09/12/2019 02:37	08/12/2019 18:52	09/12/2019 02:37	7,74	1	7,74	CHI
20191250693	MATRINCHA	MP12010442	MOZARLANDIA	08/12/2019 18:52	12/12/2019 18:59	08/12/2019 18:52	09/12/2019 02:25	7,55	4	30,20	CHI
20191250693	MATRINCHA	MP12010442	MOZARLANDIA	08/12/2019 18:52	12/12/2019 18:59	09/12/2019 02:26	09/12/2019 03:06	0,67	1	0,67	CHI
20191250693	MATRINCHA	MP12017420LD	MOZARLANDIA	08/12/2019 18:52	12/12/2019 18:59	09/12/2019 02:26	10/12/2019 16:19	37,89	3	113,66	CHI
20191250693	MATRINCHA	MP12017420LD	MOZARLANDIA	08/12/2019 18:52	12/12/2019 18:59	10/12/2019 16:20	12/12/2019 18:59	50,66	3	151,99	CHI
20191250759	ALEXANIA	AX21102403	ALEXANIA	08/12/2019 18:56	08/12/2019 21:34	08/12/2019 18:56	08/12/2019 21:34	2,63	1	2,63	CHI
20191250788	LUZIANIA	LZ21195041	PIRES DO RIO S2	08/12/2019 18:58	08/12/2019 22:31	08/12/2019 18:58	08/12/2019 22:31	3,55	1	3,55	CHI
20191250820	MINACU	IH21192300	MINACU	08/12/2019 18:59	09/12/2019 17:30	08/12/2019 18:59	09/12/2019 17:30	22,51	1	22,51	CHI
20191250824	BOM JARDIM DE GOIAS	BM21372303	BOM JARDIM	08/12/2019 19:00	09/12/2019 10:40	08/12/2019 19:00	09/12/2019 10:40	15,67	1	15,67	CHI
20191250956	BARRO ALTO	BA12210750	GOIANESIA S1	08/12/2019 19:00	09/12/2019 03:48	08/12/2019 19:00	09/12/2019 03:48	8,79	3	26,38	CHI
20191250895	AGUAS LINDAS DE GOIAS	4830101740	AGUAS LINDAS DE GOIAS S2	08/12/2019 19:07	08/12/2019 21:15	08/12/2019 19:07	08/12/2019 21:15	2,12	1	2,12	CHI
20191250911	ANICUNS	AC12259090	FIRMINOPOLIS S2	08/12/2019 19:09	09/12/2019 00:08	08/12/2019 19:09	09/12/2019 00:08	4,98	30	149,41	CHI
20191250915	CATALAO	10012807719	CATALAO S2	08/12/2019 19:09	09/12/2019 10:42	08/12/2019 19:09	09/12/2019 10:42	15,55	1	15,55	CHI
201912260795	MINEIROS	MY11166011	PARQUE DAS EMAS	08/12/2019 19:09	09/12/2019 11:24	08/12/2019 19:09	09/12/2019 11:24	16,24	218	3539,23	CHI
20191250943	JOVIANIA	JV21134627	GOIATUBA S1	08/12/2019 19:12	08/12/2019 22:29	08/12/2019 19:12	08/12/2019 22:29	3,28	1	3,28	CHI
20191250945	CACHOEIRA ALTA	1090009176	CACHOEIRA ALTA	08/12/2019 19:12	08/12/2019 22:53	08/12/2019 19:12	08/12/2019 22:53	3,67	1	3,67	CHI
20191250955	GOIANDIRA	GD21246953	CATALAO S1	08/12/2019 19:14	10/12/2019 08:45	08/12/2019 19:14	10/12/2019 08:45	37,51	1	37,51	CHI
20191250962	JATAI	JT12234355	JATAI S1	08/12/2019 19:15	09/12/2019 16:25	08/12/2019 19:15	09/12/2019 16:25	21,16	5	105,78	CHI
20191250963	ABADIANIA	AA12389728	ANAPOLIS UNIVERSITARIO S1	08/12/2019 19:15	09/12/2019 09:15	08/12/2019 19:15	09/12/2019 09:15	13,99	2	27,98	CHI
20191250970	FIRMINOPOLIS	FR12096845	FIRMINOPOLIS S1	08/12/2019 19:17	08/12/2019 21:19	08/12/2019 19:17	08/12/2019 21:19	2,04	17	34,66	CHI
20191250971	COCALZINHO DE GOIAS	ZN12258986	COCALZINHO	08/12/2019 19:17	09/12/2019 17:46	08/12/2019 19:17	09/12/2019 17:46	22,48	21	472,08	CHI
20191250973	PORANGATU	PO21049563	NOVO PLANALTO	08/12/2019 19:17	09/12/2019 09:53	08/12/2019 19:17	09/12/2019 09:53	14,59	1	14,59	CHI
20191250986	PORTEIRAO	CL21230804	RIO DOS BOIS	08/12/2019 19:18	08/12/2019 22:45	08/12/2019 19:18	08/12/2019 22:45	3,44	1	3,44	CHI
20191250988	TROMBAS	2560008045	PORANGATU	08/12/2019 19:19	09/12/2019 12:38	08/12/2019 19:19	09/12/2019 12:38	17,31	1	17,31	CHI
20191250998	COCALZINHO DE GOIAS	ZN12377413	COCALZINHO	08/12/2019 19:22	09/12/2019 16:33	08/12/2019 19:22	09/12/2019 16:33	21,17	3	63,51	CHI
20191251106	IPORA	730043691	IPORA	08/12/2019 19:24	08/12/2019 23:41	08/12/2019 19:24	08/12/2019 23:41	4,27	1	4,27	CHI
20191251108	TURVELANDIA	SH21153952	IPEGUARI	08/12/2019 19:25	09/12/2019 10:23	08/12/2019 19:25	09/12/2019 10:23	14,96	1	14,96	CHI

20191251115	ANAPOLIS	AN11003272	JUNDIAI S1	08/12/2019 19:25	08/12/2019 20:53	08/12/2019 19:25	08/12/2019 20:53	1,47	140	205,22	CHI
20191251113	PADRE BERNARDO	PB12313941	PADRE BERNARDO	08/12/2019 19:26	08/12/2019 22:05	08/12/2019 19:26	08/12/2019 22:05	2,64	4	10,57	CHI
20191251120	MINACU	IH12236142	MINACU	08/12/2019 19:28	08/12/2019 22:35	08/12/2019 19:28	08/12/2019 22:35	3,12	28	87,24	CHI
20191251122	ITUMBIRA	CD21222294	CACHOEIRA DOURADA	08/12/2019 19:28	09/12/2019 08:22	08/12/2019 19:28	09/12/2019 08:22	12,89	1	12,89	CHI
20191251127	CRISTALINA	KR12162507	CRISTALINA S1	08/12/2019 19:30	08/12/2019 22:37	08/12/2019 19:30	08/12/2019 22:37	3,11	12	37,34	CHI
20191251136	INACIOLANDIA	CD12000114	CACHOEIRA DOURADA	08/12/2019 19:33	10/12/2019 13:21	08/12/2019 19:33	10/12/2019 13:21	41,81	2	83,61	CHI
20191251137	CATALAO	1990213732	CATALAO S2	08/12/2019 19:33	09/12/2019 11:55	08/12/2019 19:33	09/12/2019 11:55	16,37	1	16,37	CHI
20191251141	DAVINOPOLIS	IO21127836	CATALAO S1	08/12/2019 19:34	09/12/2019 10:36	08/12/2019 19:34	09/12/2019 10:36	15,03	2	30,06	CHI
20191251222	PIRES DO RIO	PR12080258RE	URUTAI	08/12/2019 19:34	08/12/2019 22:20	08/12/2019 19:34	08/12/2019 22:20	2,76	8	22,09	CHI
20191251222	URUTAI	PR12080258RE	URUTAI	08/12/2019 19:34	08/12/2019 22:20	08/12/2019 19:34	08/12/2019 22:20	2,76	62	171,17	CHI
20191251146	TRES RANCHOS	2170003430	CATALAO S1	08/12/2019 19:35	09/12/2019 08:22	08/12/2019 19:35	09/12/2019 08:22	12,77	1	12,77	CHI
20191251152	MARA ROSA	MQ21182378	MARA ROSA	08/12/2019 19:38	09/12/2019 17:19	08/12/2019 19:38	09/12/2019 17:19	21,68	1	21,68	CHI
20191251153	NIQUELANDIA	NQ11219006	NIQUELANDIA SUBTRANSMISSAO	08/12/2019 19:38	09/12/2019 19:54	08/12/2019 19:38	09/12/2019 19:54	24,27	21	509,59	CHI
20191251154	CALDAS NOVAS	CN12110281	CALDAS NOVAS S1	08/12/2019 19:38	09/12/2019 08:05	08/12/2019 19:38	09/12/2019 08:05	12,45	16	199,17	CHI
20191251156	JANDAIA	JD21008599	PALMEIRAS	08/12/2019 19:38	09/12/2019 08:16	08/12/2019 19:38	09/12/2019 08:16	12,62	1	12,62	CHI
20191251157	CATALAO	CT21216967	CATALAO S2	08/12/2019 19:38	09/12/2019 11:22	08/12/2019 19:38	09/12/2019 11:22	15,72	1	15,72	CHI
20191251171	JATAI	RV12212665	CABRIUVA S2	08/12/2019 19:43	09/12/2019 10:12	08/12/2019 19:43	09/12/2019 10:12	14,48	12	173,70	CHI
20191251171	RIO VERDE	RV12212665	CABRIUVA S2	08/12/2019 19:43	09/12/2019 10:12	08/12/2019 19:43	09/12/2019 10:12	14,48	46	665,86	CHI
20191251179	PIRENOPOLIS	PV12382305	SAO FRANCISCO DE GOIAS	08/12/2019 19:45	10/12/2019 09:55	08/12/2019 19:45	10/12/2019 09:55	38,15	4	152,61	CHI
20191251302	MINEIROS	MY11359694	PARQUE DAS EMAS	08/12/2019 19:45	10/12/2019 11:15	08/12/2019 19:45	10/12/2019 11:15	39,49	19	750,27	CHI
20191251186	MATRINCHA	10002775849	MATRINCHA	08/12/2019 19:47	09/12/2019 06:30	08/12/2019 19:47	09/12/2019 06:30	10,70	1	10,70	CHI
20191251196	BALIZA	BH12331383	CAIAPONIA	08/12/2019 19:49	08/12/2019 23:10	08/12/2019 19:49	08/12/2019 23:10	3,34	9	30,03	CHI
20191251290	SAO LUIS DE MONTES BELOS	SL12007006	FIRMINOPOLIS S1	08/12/2019 19:52	08/12/2019 22:25	08/12/2019 19:52	08/12/2019 22:25	2,54	10	25,43	CHI
20191251205	CALDAS NOVAS	CN21223437	CALDAS NOVAS S1	08/12/2019 19:53	09/12/2019 08:33	08/12/2019 19:53	09/12/2019 08:33	12,66	1	12,66	CHI
20191251208	BELA VISTA DE GOIAS	BV21024269	CRISTIANOPOLIS	08/12/2019 19:53	09/12/2019 10:42	08/12/2019 19:53	09/12/2019 10:42	14,81	1	14,81	CHI
20191251212	ARAGUAPAZ	AZ12070035	GOIAS	08/12/2019 19:54	09/12/2019 11:40	08/12/2019 19:54	09/12/2019 11:40	15,76	6	94,57	CHI
20191251220	ANAPOLIS	10006378038	ANAPOLIS UNIVERSITARIO S2	08/12/2019 19:57	08/12/2019 23:22	08/12/2019 19:57	08/12/2019 23:22	3,40	1	3,40	CHI
20191251226	URUTAI	PR21265567	URUTAI	08/12/2019 20:00	08/12/2019 22:58	08/12/2019 20:00	08/12/2019 22:58	2,96	1	2,96	CHI
20191251227	CAMPINACU	UC12354229	MARA ROSA	08/12/2019 20:00	09/12/2019 10:45	08/12/2019 20:00	09/12/2019 10:45	14,74	16	235,76	CHI
20191251284	SAO SIMAO	SO11194915	CACHOEIRA ALTA	08/12/2019 20:02	08/12/2019 22:19	08/12/2019 20:02	08/12/2019 22:19	2,29	72	164,72	CHI
20191251249	SANTA HELENA DE GOIAS	10002959281	IPEGUARI	08/12/2019 20:09	09/12/2019 00:00	08/12/2019 20:09	09/12/2019 00:00	3,85	1	3,85	CHI
20191251282	BONOPOLIS	TA13083010	SAO MIGUEL DO ARAGUAIA	08/12/2019 20:10	09/12/2019 13:33	09/12/2019 04:40	09/12/2019 11:08	6,48	3	19,43	CHI
20191251282	NOVO PLANALTO	TA13083010	SAO MIGUEL DO ARAGUAIA	08/12/2019 20:10	09/12/2019 13:33	09/12/2019 04:40	09/12/2019 11:08	6,48	176	1139,70	CHI

20191251282	NOVO PLANALTO	TA13083010	SAO MIGUEL DO ARAGUAIA	08/12/2019 20:10	09/12/2019 13:33	09/12/2019 04:40	09/12/2019 11:52	7,20	9	64,80	CHI
20191251282	NOVO PLANALTO	TA13083010	SAO MIGUEL DO ARAGUAIA	08/12/2019 20:10	09/12/2019 13:33	09/12/2019 13:23	09/12/2019 13:33	0,16	67	10,63	CHI
20191251254	CAMPINACU	IH12360453	MINACU	08/12/2019 20:12	09/12/2019 01:53	08/12/2019 20:12	09/12/2019 01:53	5,68	5	28,38	CHI
20191251254	MINACU	IH12360453	MINACU	08/12/2019 20:12	09/12/2019 01:53	08/12/2019 20:12	09/12/2019 01:53	5,68	70	397,39	CHI
20191251359	JUSSARA	JR12011813	BRITANIA	08/12/2019 20:13	09/12/2019 17:49	08/12/2019 20:13	09/12/2019 17:49	21,60	20	431,92	CHI
20191251268	ABADIANIA	350039112	ANAPOLIS UNIVERSITARIO S1	08/12/2019 20:15	09/12/2019 18:10	08/12/2019 20:15	09/12/2019 18:10	21,92	1	21,92	CHI
20191251272	PIRES DO RIO	PR21337200	PIRES DO RIO S1	08/12/2019 20:16	09/12/2019 02:30	08/12/2019 20:16	09/12/2019 02:30	6,22	1	6,22	CHI
20191251273	CACU	CC12063061	CACHOEIRA ALTA	08/12/2019 20:18	09/12/2019 07:52	08/12/2019 20:18	09/12/2019 07:52	11,57	1	11,57	CHI
20191251273	ITARUMA	CC12063061	CACHOEIRA ALTA	08/12/2019 20:18	09/12/2019 07:52	08/12/2019 20:18	09/12/2019 07:52	11,57	4	46,26	CHI
20191251311	ITUMBIARA	IT11000155	PARANAIBA	08/12/2019 20:18	08/12/2019 23:10	08/12/2019 20:18	08/12/2019 23:10	2,85	74	211,02	CHI
20191251277	NOVO GAMA	2460059894	PACAEMBU S1	08/12/2019 20:19	09/12/2019 10:00	08/12/2019 20:19	09/12/2019 10:00	13,67	1	13,67	CHI
20191251294	ACREUNA	EU21317012	RIO DOS BOIS	08/12/2019 20:26	09/12/2019 10:04	08/12/2019 20:26	09/12/2019 10:04	13,63	1	13,63	CHI
20191251296	PALMEIRAS DE GOIAS	590000652	PALMEIRAS	08/12/2019 20:26	09/12/2019 10:46	08/12/2019 20:26	09/12/2019 10:46	14,33	1	14,33	CHI
20191251300	CATALAO	CT12316068	CATALAO S2	08/12/2019 20:29	09/12/2019 12:00	08/12/2019 20:29	09/12/2019 11:31	15,03	1	15,03	CHI
20191251300	CATALAO	CT12316068	CATALAO S2	08/12/2019 20:29	09/12/2019 12:00	08/12/2019 20:29	09/12/2019 12:00	15,51	10	155,10	CHI
20191251300	CUMARI	CT12316068	CATALAO S2	08/12/2019 20:29	09/12/2019 12:00	08/12/2019 20:29	09/12/2019 12:00	15,51	1	15,51	CHI
20191251303	CAIAPONIA	CP12245299	CAIAPONIA	08/12/2019 20:31	09/12/2019 15:40	08/12/2019 20:31	09/12/2019 15:40	19,15	8	153,16	CHI
20191251306	TEREZOPOLIS DE GOIAS	GP31017509	JUNDIAI S1	08/12/2019 20:32	08/12/2019 21:52	08/12/2019 20:32	08/12/2019 21:52	1,32	4	5,28	CHI
20191251314	TAQUARAL DE GOIAS	340011701	ITABERAI S1	08/12/2019 20:39	09/12/2019 11:44	08/12/2019 20:39	09/12/2019 11:44	15,08	1	15,08	CHI
20191251315	CEZARINA	CZ21060580	PONTALINA	08/12/2019 20:40	09/12/2019 11:00	08/12/2019 20:40	09/12/2019 11:00	14,33	1	14,33	CHI
20191251316	CRISTALINA	KR12133633	PAMPLONA	08/12/2019 20:40	09/12/2019 11:28	08/12/2019 20:40	09/12/2019 11:28	14,79	3	44,38	CHI
20191251322	CRISTALINA	KR21165546	CRISTALINA S1	08/12/2019 20:44	08/12/2019 22:55	08/12/2019 20:44	08/12/2019 22:55	2,17	1	2,17	CHI
20191251325	PALESTINA DE GOIAS	PY21380594	PALESTINA	08/12/2019 20:47	09/12/2019 10:41	08/12/2019 20:47	09/12/2019 10:41	13,90	1	13,90	CHI
20191251326	CRISTALINA	KR21183732	CRISTALINA S2	08/12/2019 20:47	09/12/2019 02:33	08/12/2019 20:47	09/12/2019 02:33	5,76	1	5,76	CHI
20191252129	NOVA CRIXAS	NA12092868	MOZARLANDIA	08/12/2019 20:49	09/12/2019 18:38	08/12/2019 20:49	09/12/2019 18:38	21,82	4	87,27	CHI
20191251334	GOUVELANDIA	GB12116577	QUIRINOPOLIS	08/12/2019 20:52	08/12/2019 22:50	08/12/2019 20:52	08/12/2019 22:50	1,96	35	68,43	CHI
20191251334	QUIRINOPOLIS	GB12116577	QUIRINOPOLIS	08/12/2019 20:52	08/12/2019 22:50	08/12/2019 20:52	08/12/2019 22:50	1,96	13	25,42	CHI
20191251335	JATAI	290066463	JATAI S3	08/12/2019 20:53	09/12/2019 03:56	08/12/2019 20:53	09/12/2019 03:56	7,04	1	7,04	CHI
20191251338	PIRACANJUBA	PJ21087294	PIRACANJUBA	08/12/2019 20:54	09/12/2019 21:14	08/12/2019 20:54	09/12/2019 21:14	24,32	1	24,32	CHI
20191251340	URUACU	CR12410914	MARA ROSA	08/12/2019 20:55	09/12/2019 13:19	08/12/2019 20:55	09/12/2019 13:19	16,40	15	246,06	CHI
20191251364	MIMOSO DE GOIAS	MJ12290430	PADRE BERNARDO	08/12/2019 21:12	08/12/2019 22:30	08/12/2019 21:12	08/12/2019 22:30	1,30	4	5,19	CHI
20191251368	LUZIANIA	LZ21320060	CRISTALINA S2	08/12/2019 21:16	08/12/2019 23:13	08/12/2019 21:16	08/12/2019 23:13	1,94	1	1,94	CHI
20191251369	PALMEIRAS DE GOIAS	590053036	PALMEIRAS	08/12/2019 21:16	09/12/2019 11:37	08/12/2019 21:16	09/12/2019 11:37	14,35	1	14,35	CHI

20191251388	CRIXAS	CX11056777	SERRA DO OURO	08/12/2019 21:22	09/12/2019 01:10	08/12/2019 21:22	09/12/2019 01:10	3,80	113	429,96	CHI
20191251378	RIO VERDE	RV12123392	RIO VERDE S1	08/12/2019 21:28	09/12/2019 00:40	08/12/2019 21:28	09/12/2019 00:40	3,20	1	3,20	CHI
20191251380	JAUPACI	JP12045494	IPORA	08/12/2019 21:30	09/12/2019 11:50	08/12/2019 21:30	09/12/2019 11:50	14,34	10	143,36	CHI
20191251385	JUSSARA	JR12114074	JUSSARA	08/12/2019 21:33	10/12/2019 21:24	09/12/2019 08:02	09/12/2019 09:50	1,79	8	14,35	CHI
20191251385	JUSSARA	JR12087980LD	JUSSARA	08/12/2019 21:33	10/12/2019 21:24	08/12/2019 21:33	09/12/2019 12:55	15,35	4	61,42	CHI
20191251385	JUSSARA	JR12087980LD	JUSSARA	08/12/2019 21:33	10/12/2019 21:24	08/12/2019 21:33	10/12/2019 12:49	39,25	4	157,02	CHI
20191251385	JUSSARA	JR12087980LD	JUSSARA	08/12/2019 21:33	10/12/2019 21:24	10/12/2019 11:32	10/12/2019 12:49	1,27	4	5,08	CHI
20191251385	JUSSARA	JR12087980LD	JUSSARA	08/12/2019 21:33	10/12/2019 21:24	08/12/2019 21:33	10/12/2019 21:24	47,85	4	191,38	CHI
20191251385	JUSSARA	JR12087980LD	JUSSARA	08/12/2019 21:33	10/12/2019 21:24	10/12/2019 20:50	10/12/2019 21:24	0,56	8	4,50	CHI
20191251383	CORUMBA DE GOIAS	CB21357051	CORUMBA	08/12/2019 21:34	09/12/2019 14:44	08/12/2019 21:34	09/12/2019 14:44	17,16	3	51,48	CHI
20191252748	MIMOSO DE GOIAS	04560224	BARRO ALTO	08/12/2019 21:40	09/12/2019 09:30	09/12/2019 07:09	09/12/2019 09:30	2,34	4	9,34	CHI
20191252748	NIQUELANDIA	04560224	BARRO ALTO	08/12/2019 21:40	09/12/2019 09:30	09/12/2019 07:09	09/12/2019 09:30	2,34	994	2321,27	CHI
20191252748	VILA PROPICIO	04560224	BARRO ALTO	08/12/2019 21:40	09/12/2019 09:30	09/12/2019 07:09	09/12/2019 09:30	2,34	32	74,73	CHI
201912252659	NIQUELANDIA	NQ21281638	BARRO ALTO	08/12/2019 21:40	09/12/2019 09:30	08/12/2019 21:40	09/12/2019 09:30	11,82	1	11,82	CHI
20191248744	FAZENDA NOVA	FN21221803	IPORA	08/12/2019 21:45	09/12/2019 10:59	08/12/2019 21:45	09/12/2019 10:59	13,22	1	13,22	CHI
20191251397	AMARALINA	10017628731	MARA ROSA	08/12/2019 21:50	09/12/2019 14:43	08/12/2019 21:50	09/12/2019 14:43	16,88	1	16,88	CHI
20191251399	MINACU	IH12202490	MINACU	08/12/2019 21:50	09/12/2019 15:30	08/12/2019 21:50	09/12/2019 15:30	17,66	3	52,98	CHI
20191251402	ACREUNA	EU21213342	ACREUNA	08/12/2019 21:52	09/12/2019 10:04	08/12/2019 21:52	09/12/2019 10:04	12,20	1	12,20	CHI
20191251774	IVOLANDIA	MO12336568	IPORA	08/12/2019 21:56	09/12/2019 06:40	08/12/2019 21:56	09/12/2019 06:40	8,73	6	52,36	CHI
20191251774	MOIPORA	MO12336568	IPORA	08/12/2019 21:56	09/12/2019 06:40	08/12/2019 21:56	09/12/2019 06:40	8,73	6	52,36	CHI
20191251410	IPAMERI	IP21133657	CRISTALINA S2	08/12/2019 21:57	09/12/2019 01:43	08/12/2019 21:57	09/12/2019 01:43	3,76	1	3,76	CHI
20191251412	RIO VERDE	RV12000297	RIO VERDE S1	08/12/2019 22:00	09/12/2019 07:50	08/12/2019 22:00	09/12/2019 07:50	9,84	5	49,21	CHI
20191251414	DOVERLANDIA	DV21253633	CAIAPONIA	08/12/2019 22:04	10/12/2019 07:47	08/12/2019 22:04	10/12/2019 07:47	33,72	1	33,72	CHI
20191251436	URUACU	UR12285343	CAMPINORTE	08/12/2019 22:11	09/12/2019 11:49	08/12/2019 22:11	09/12/2019 11:49	13,63	2	27,26	CHI
20191251454	MOZARLANDIA	MZ21334468	MOZARLANDIA	08/12/2019 22:12	09/12/2019 10:14	08/12/2019 22:12	09/12/2019 10:14	12,02	1	12,02	CHI
20191251490	IVOLANDIA	IV12162551	IPORA	08/12/2019 22:26	09/12/2019 09:39	08/12/2019 22:26	09/12/2019 09:39	11,22	2	22,43	CHI
20191252031	NIQUELANDIA	NQ21239424	URUACU	08/12/2019 22:34	10/12/2019 14:24	08/12/2019 22:34	10/12/2019 14:24	39,83	1	39,83	CHI
20191251500	MOZARLANDIA	410051342	MOZARLANDIA	08/12/2019 22:43	09/12/2019 11:58	08/12/2019 22:43	09/12/2019 11:58	13,25	1	13,25	CHI
20191251826	BONOPOLIS	BX12079321	SAO MIGUEL DO ARAGUAIA	08/12/2019 22:58	09/12/2019 12:02	08/12/2019 22:58	09/12/2019 12:02	13,06	58	757,45	CHI
20191251612	ALTO HORIZONTE	MQ13074153	MARA ROSA	08/12/2019 23:01	09/12/2019 02:49	09/12/2019 02:29	09/12/2019 02:38	0,16	3	0,49	CHI
20191251612	AMARALINA	MQ13074153	MARA ROSA	08/12/2019 23:01	09/12/2019 02:49	09/12/2019 02:29	09/12/2019 02:38	0,16	1001	162,94	CHI
20191251612	MARA ROSA	MQ13074153	MARA ROSA	08/12/2019 23:01	09/12/2019 02:49	09/12/2019 02:29	09/12/2019 02:38	0,16	365	59,41	CHI
20191251612	MUTUNOPOLIS	MQ13074153	MARA ROSA	08/12/2019 23:01	09/12/2019 02:49	09/12/2019 02:29	09/12/2019 02:38	0,16	2	0,33	CHI

20191251612	AMARALINA	LC11333903	MARA ROSA	08/12/2019 23:01	09/12/2019 02:49	08/12/2019 23:01	09/12/2019 02:49	3,80	46	174,98	CHI
20191251614	DISTRITO FEDERAL	10001002021	MARAJÓARA	08/12/2019 23:12	09/12/2019 00:33	08/12/2019 23:12	09/12/2019 00:33	1,35	1	1,35	CHI
20191251619	ABADIANIA	AA21077922	ANAPOLIS UNIVERSITARIO S1	08/12/2019 23:17	09/12/2019 13:29	08/12/2019 23:17	09/12/2019 13:29	14,20	1	14,20	CHI
20191251623	CAMPINACU	IH21250151	MINACU	08/12/2019 23:30	09/12/2019 10:59	08/12/2019 23:30	09/12/2019 10:59	11,49	1	11,49	CHI
20191251509	SAO MIGUEL DO ARAGUAIA	SM10404184	SAO MIGUEL DO ARAGUAIA	08/12/2019 23:43	09/12/2019 13:11	08/12/2019 23:43	09/12/2019 13:11	13,47	27	363,67	CHI
20191256220	NIQUELANDIA	NQ12239432	URUACU	08/12/2019 23:52	09/12/2019 22:50	08/12/2019 23:52	09/12/2019 22:50	22,96	18	413,26	CHI
20191251635	PARAUNA	PU21229418	PARAUNA	09/12/2019 00:05	09/12/2019 19:58	09/12/2019 00:05	09/12/2019 19:58	19,89	1	19,89	CHI
20191251764	SANTA TEREZINHA DE GOIAS	SG11034165	SANTA TEREZINHA	09/12/2019 00:37	09/12/2019 07:03	09/12/2019 00:37	09/12/2019 07:03	6,42	193	1239,86	CHI
20191251703	ANAPOLIS	AN11096885	JUNDIAI S1	09/12/2019 01:21	09/12/2019 12:58	09/12/2019 01:21	09/12/2019 12:58	11,63	79	918,70	CHI
20191251915	FIRMINOPOLIS	SL12034655	SAO LUIZ DOS MONTES BELOS	09/12/2019 01:27	09/12/2019 07:18	09/12/2019 01:27	09/12/2019 07:18	5,84	27	157,79	CHI
20191251915	SAO LUIS DE MONTES BELOS	SL12034655	SAO LUIZ DOS MONTES BELOS	09/12/2019 01:27	09/12/2019 07:18	09/12/2019 01:27	09/12/2019 07:18	5,84	2	11,69	CHI
20191251870	MUNDO NOVO DE GOIAS	NA12035650	NOVA CRIXAS	09/12/2019 02:16	09/12/2019 09:18	09/12/2019 02:16	09/12/2019 09:18	7,03	8	56,22	CHI
20191251870	NOVA CRIXAS	NA12035650	NOVA CRIXAS	09/12/2019 02:16	09/12/2019 09:18	09/12/2019 02:16	09/12/2019 09:18	7,03	24	168,67	CHI
20191251719	ALTO HORIZONTE	NH12202110	SANTA TEREZINHA	09/12/2019 02:45	09/12/2019 09:15	09/12/2019 02:45	09/12/2019 09:15	6,50	13	84,50	CHI
20191251719	PILAR DE GOIAS	NH12202110	SANTA TEREZINHA	09/12/2019 02:45	09/12/2019 09:15	09/12/2019 02:45	09/12/2019 09:15	6,50	9	58,50	CHI
20191251719	SANTA TEREZINHA DE GOIAS	NH12202110	SANTA TEREZINHA	09/12/2019 02:45	09/12/2019 09:15	09/12/2019 02:45	09/12/2019 09:15	6,50	23	149,50	CHI
20191251790	SANCLERLANDIA	SL12019284	SAO LUIZ DOS MONTES BELOS	09/12/2019 03:40	09/12/2019 07:20	09/12/2019 03:40	09/12/2019 07:20	3,68	28	102,96	CHI
20191251790	SAO LUIS DE MONTES BELOS	SL12019284	SAO LUIZ DOS MONTES BELOS	09/12/2019 03:40	09/12/2019 07:20	09/12/2019 03:40	09/12/2019 07:20	3,68	56	205,92	CHI
20191251735	ARUANA	BT10396174	BRITANIA	09/12/2019 03:45	10/12/2019 10:47	09/12/2019 03:45	09/12/2019 03:48	0,05	25	1,33	CHI
20191251735	BRITANIA	BT10396174	BRITANIA	09/12/2019 03:45	10/12/2019 10:47	09/12/2019 03:45	09/12/2019 03:48	0,05	132	7,00	CHI
20191251735	ITAPIRAPUA	BT10396174	BRITANIA	09/12/2019 03:45	10/12/2019 10:47	09/12/2019 03:45	09/12/2019 03:48	0,05	2	0,11	CHI
20191251735	BRITANIA	BT10396174	BRITANIA	09/12/2019 03:45	10/12/2019 10:47	09/12/2019 03:49	09/12/2019 05:59	2,17	65	140,87	CHI
20191251735	ARUANA	BT13378843	BRITANIA	09/12/2019 03:45	10/12/2019 10:47	09/12/2019 03:49	09/12/2019 10:03	6,23	25	155,67	CHI
20191251735	BRITANIA	BT13378843	BRITANIA	09/12/2019 03:45	10/12/2019 10:47	09/12/2019 03:49	09/12/2019 10:03	6,23	45	280,20	CHI
20191251735	BRITANIA	BT12183055	BRITANIA	09/12/2019 03:45	10/12/2019 10:47	09/12/2019 03:49	09/12/2019 12:29	8,66	10	86,64	CHI
20191251735	BRITANIA	BT12005369LD	BRITANIA	09/12/2019 03:45	10/12/2019 10:47	09/12/2019 03:49	10/12/2019 09:45	29,93	4	119,74	CHI
20191251735	ITAPIRAPUA	BT12329979	BRITANIA	09/12/2019 03:45	10/12/2019 10:47	09/12/2019 03:49	10/12/2019 10:16	30,44	2	60,88	CHI
20191251735	BRITANIA	BT12183057	BRITANIA	09/12/2019 03:45	10/12/2019 10:47	09/12/2019 03:49	10/12/2019 10:47	30,96	8	247,66	CHI
20191251738	CORREGO DO OURO	CO12004040	FIRMINOPOLIS S2	09/12/2019 03:52	09/12/2019 08:40	09/12/2019 03:52	09/12/2019 08:40	4,80	4	19,21	CHI
20191252040	NOVA CRIXAS	NA12087039	NOVA CRIXAS	09/12/2019 03:54	09/12/2019 08:36	09/12/2019 03:54	09/12/2019 08:36	4,70	4	18,79	CHI
20191252649	PORANGATU	PO12139169	PORANGATU	09/12/2019 03:54	09/12/2019 10:13	09/12/2019 03:54	09/12/2019 10:13	6,31	93	586,60	CHI
20191251847	ITAPACI	SZ12243712	ITAPACI	09/12/2019 04:16	09/12/2019 10:02	09/12/2019 04:16	09/12/2019 10:02	5,76	3	17,27	CHI
20191251847	SAO LUIZ DO NORTE	SZ12243712	ITAPACI	09/12/2019 04:16	09/12/2019 10:02	09/12/2019 04:16	09/12/2019 10:02	5,76	13	74,84	CHI

20191251751	SAO MIGUEL DO ARAGUAIA	SM12013236	SAO MIGUEL DO ARAGUAIA	09/12/2019 04:19	09/12/2019 16:10	09/12/2019 04:19	09/12/2019 16:10	11,84	28	331,41	CHI
20191251758	NOVO BRASIL	NB12047598	JUSSARA	09/12/2019 04:24	09/12/2019 08:40	09/12/2019 04:24	09/12/2019 08:40	4,25	13	55,28	CHI
20191249887	NOVO PLANALTO	SM12074646	SAO MIGUEL DO ARAGUAIA	09/12/2019 04:27	09/12/2019 13:35	09/12/2019 04:27	09/12/2019 08:59	4,53	0	0,00	CHI
20191249887	SAO MIGUEL DO ARAGUAIA	SM12074646	SAO MIGUEL DO ARAGUAIA	09/12/2019 04:27	09/12/2019 13:35	09/12/2019 04:27	09/12/2019 08:59	4,53	193	873,49	CHI
20191249887	NOVO PLANALTO	SM12074646	SAO MIGUEL DO ARAGUAIA	09/12/2019 04:27	09/12/2019 13:35	09/12/2019 04:27	09/12/2019 13:35	9,13	1	9,13	CHI
20191249887	SAO MIGUEL DO ARAGUAIA	SM12074646	SAO MIGUEL DO ARAGUAIA	09/12/2019 04:27	09/12/2019 13:35	09/12/2019 04:27	09/12/2019 13:35	9,13	12	109,52	CHI
20191251760	SAO MIGUEL DO ARAGUAIA	SM12228636	SAO MIGUEL DO ARAGUAIA	09/12/2019 04:30	09/12/2019 10:05	09/12/2019 04:30	09/12/2019 10:05	5,57	56	311,94	CHI
20191252681	PORANGATU	PO12048411	PORANGATU	09/12/2019 04:31	09/12/2019 12:24	09/12/2019 04:31	09/12/2019 12:24	7,89	17	134,08	CHI
20191251765	ITABERAI	IB12078567	ITABERAI S1	09/12/2019 04:39	09/12/2019 11:10	09/12/2019 04:39	09/12/2019 11:10	6,51	14	91,12	CHI
20191251765	ITAUCU	IB12078567	ITABERAI S1	09/12/2019 04:39	09/12/2019 11:10	09/12/2019 04:39	09/12/2019 11:10	6,51	2	13,02	CHI
20191251767	BOM JARDIM DE GOIAS	BM12311829	BOM JARDIM	09/12/2019 04:41	09/12/2019 10:40	09/12/2019 04:41	09/12/2019 10:40	5,98	28	167,43	CHI
20191251768	SANTA FE DE GOIAS	RN12206843	BRITANIA	09/12/2019 04:47	09/12/2019 10:13	09/12/2019 04:47	09/12/2019 10:13	5,42	20	108,39	CHI
20191251779	MOSSAMEDES	MD12119449	ANICUNS	09/12/2019 04:59	09/12/2019 14:01	09/12/2019 04:59	09/12/2019 14:01	9,03	16	144,43	CHI
20191251775	ITAPIRAPUA	IU12030113	MATRINCHA	09/12/2019 05:04	09/12/2019 11:20	09/12/2019 05:04	09/12/2019 11:20	6,27	11	68,92	CHI
20191252239	PETROLINA DE GOIAS	PV12302405	SAO FRANCISCO DE GOIAS	09/12/2019 05:11	10/12/2019 01:31	09/12/2019 05:11	10/12/2019 01:31	20,32	5	101,61	CHI
20191252239	PIRENOPOLIS	PV12302405	SAO FRANCISCO DE GOIAS	09/12/2019 05:11	10/12/2019 01:31	09/12/2019 05:11	10/12/2019 01:31	20,32	60	1219,33	CHI
20191252239	SAO FRANCISCO DE GOIAS	PV12302405	SAO FRANCISCO DE GOIAS	09/12/2019 05:11	10/12/2019 01:31	09/12/2019 05:11	10/12/2019 01:31	20,32	19	386,12	CHI
20191252408	MUTUNOPOLIS	MU12129781	MARA ROSA	09/12/2019 05:12	09/12/2019 15:14	09/12/2019 05:12	09/12/2019 15:14	10,04	7	70,29	CHI
20191251788	BONOPOLIS	BX12168214	SAO MIGUEL DO ARAGUAIA	09/12/2019 05:13	09/12/2019 10:37	09/12/2019 05:13	09/12/2019 10:37	5,39	124	668,95	CHI
20191251789	CRISTALINA	KR12330533	CRISTALINA S1	09/12/2019 05:13	09/12/2019 07:12	09/12/2019 05:13	09/12/2019 07:12	1,97	33	65,07	CHI
20191251789	IPAMERI	KR12330533	CRISTALINA S1	09/12/2019 05:13	09/12/2019 07:12	09/12/2019 05:13	09/12/2019 07:12	1,97	1	1,97	CHI
20191251789	LUZIANIA	KR12330533	CRISTALINA S1	09/12/2019 05:13	09/12/2019 07:12	09/12/2019 05:13	09/12/2019 07:12	1,97	8	15,78	CHI
20191250540	ITAGUARI	IC12353098	ITABERAI S1	09/12/2019 05:16	09/12/2019 10:06	09/12/2019 05:16	09/12/2019 10:06	4,83	47	226,87	CHI
20191250540	ITAGUARU	IC12353098	ITABERAI S1	09/12/2019 05:16	09/12/2019 10:06	09/12/2019 05:16	09/12/2019 10:06	4,83	79	381,33	CHI
20191250540	JARAGUA	IC12353098	ITABERAI S1	09/12/2019 05:16	09/12/2019 10:06	09/12/2019 05:16	09/12/2019 10:06	4,83	127	613,02	CHI
20191252822	GOIANESIA	GE12215070	GOIANESIA S1	09/12/2019 05:16	09/12/2019 15:50	09/12/2019 05:16	09/12/2019 15:50	10,55	24	253,29	CHI
20191251794	IPAMERI	10024896371	CRISTALINA S1	09/12/2019 05:18	09/12/2019 09:02	09/12/2019 05:18	09/12/2019 09:02	3,73	1	3,73	CHI
20191251795	BALIZA	BM12390150	BOM JARDIM	09/12/2019 05:18	09/12/2019 07:26	09/12/2019 05:18	09/12/2019 07:26	2,12	51	108,32	CHI
20191251795	BOM JARDIM DE GOIAS	BM12390150	BOM JARDIM	09/12/2019 05:18	09/12/2019 07:26	09/12/2019 05:18	09/12/2019 07:26	2,12	9	19,12	CHI
20191252127	SAO MIGUEL DO ARAGUAIA	SM12262599	SAO MIGUEL DO ARAGUAIA	09/12/2019 05:18	09/12/2019 07:50	09/12/2019 05:18	09/12/2019 07:50	2,52	143	360,44	CHI
20191251800	CRIXAS	CX12181454LD	RUBIATABA	09/12/2019 05:22	09/12/2019 11:40	09/12/2019 05:22	09/12/2019 11:40	6,29	18	113,17	CHI
20191251803	GOIAS	GS12071232	GOIAS	09/12/2019 05:24	09/12/2019 10:04	09/12/2019 05:24	09/12/2019 10:04	4,66	39	181,73	CHI
20191252371	SAO MIGUEL DO ARAGUAIA	SM12089543	SAO MIGUEL DO ARAGUAIA	09/12/2019 05:27	09/12/2019 13:39	09/12/2019 05:27	09/12/2019 13:39	8,19	8	65,51	CHI



20191251896	GOIAS	IB12210550	ITABERAI S1	09/12/2019 05:28	09/12/2019 07:43	09/12/2019 05:28	09/12/2019 07:43	2,24	3	6,73	CHI
20191251896	ITABERAI	IB12210550	ITABERAI S1	09/12/2019 05:28	09/12/2019 07:43	09/12/2019 05:28	09/12/2019 07:43	2,24	36	80,74	CHI
20191252214	GOIAS	GS12220493LD	MATRINCHA	09/12/2019 05:28	09/12/2019 09:50	09/12/2019 05:28	09/12/2019 09:50	4,37	14	61,13	CHI
20191252074	MARA ROSA	MQ12249312	SANTA TEREZINHA	09/12/2019 05:30	09/12/2019 18:01	09/12/2019 05:30	09/12/2019 18:01	12,51	10	125,08	CHI
20191253323	PORANGATU	PO12052522	PORANGATU	09/12/2019 05:30	09/12/2019 12:40	09/12/2019 05:30	09/12/2019 12:40	7,18	62	445,09	CHI
20191251824	MUTUNOPOLIS	MU12068520	MARA ROSA	09/12/2019 05:31	09/12/2019 12:59	09/12/2019 05:31	09/12/2019 12:59	7,46	2	14,92	CHI
20191251824	PORANGATU	MU12068520	MARA ROSA	09/12/2019 05:31	09/12/2019 12:59	09/12/2019 05:31	09/12/2019 12:59	7,46	12	89,50	CHI
20191251825	SAO MIGUEL DO ARAGUAIA	SM12239670	SAO MIGUEL DO ARAGUAIA	09/12/2019 05:32	09/12/2019 18:55	09/12/2019 05:32	09/12/2019 18:55	13,38	11	147,16	CHI
20191252688	ESTRELA DO NORTE	ET12036513	MARA ROSA	09/12/2019 05:34	09/12/2019 16:15	09/12/2019 05:34	09/12/2019 16:15	10,68	3	32,05	CHI
20191252688	FORMOSO	ET12036513	MARA ROSA	09/12/2019 05:34	09/12/2019 16:15	09/12/2019 05:34	09/12/2019 16:15	10,68	1	10,68	CHI
20191252688	MARA ROSA	ET12036513	MARA ROSA	09/12/2019 05:34	09/12/2019 16:15	09/12/2019 05:34	09/12/2019 16:15	10,68	6	64,09	CHI
20191253367	SAO MIGUEL DO ARAGUAIA	SM12208936	SAO MIGUEL DO ARAGUAIA	09/12/2019 05:36	09/12/2019 14:28	09/12/2019 05:36	09/12/2019 14:28	8,87	10	88,66	CHI
20191253696	GOIANESIA	GE12372623	GOIANESIA S1	09/12/2019 05:36	09/12/2019 15:11	09/12/2019 05:36	09/12/2019 15:11	9,57	30	287,18	CHI
20191252331	PALMEIRAS DE GOIAS	PL12194014	PALMEIRAS	09/12/2019 05:39	09/12/2019 08:25	09/12/2019 05:39	09/12/2019 08:25	2,77	60	166,27	CHI
20191251842	ITAPURANGA	IK12220548	ITAPURANGA	09/12/2019 05:41	09/12/2019 11:30	09/12/2019 05:41	09/12/2019 11:30	5,80	11	63,81	CHI
20191252134	CAMPOS VERDES	VD12253107	SANTA TEREZINHA	09/12/2019 05:43	09/12/2019 09:17	09/12/2019 05:43	09/12/2019 09:17	3,56	4	14,23	CHI
20191251851	CRISTALINA	KR12153067	CRISTALINA S2	09/12/2019 05:44	09/12/2019 08:45	09/12/2019 05:44	09/12/2019 08:45	3,01	3	9,02	CHI
20191251938	ANICUNS	AC12382504	ANICUNS	09/12/2019 05:44	09/12/2019 09:46	09/12/2019 05:44	09/12/2019 09:46	4,03	28	112,93	CHI
20191252021	GOIAS	IU12089755	MATRINCHA	09/12/2019 05:44	09/12/2019 10:35	09/12/2019 05:44	09/12/2019 10:35	4,85	1	4,85	CHI
20191252021	ITAPIRAPUA	IU12089755	MATRINCHA	09/12/2019 05:44	09/12/2019 10:35	09/12/2019 05:44	09/12/2019 10:35	4,85	56	271,35	CHI
201912173288	RUBIATABA	RB12060966	RUBIATABA	09/12/2019 05:46	09/12/2019 08:23	09/12/2019 05:46	09/12/2019 08:23	2,61	15	39,18	CHI
20191246859	NIQUELANDIA	NQ12292585	NIQUELANDIA SUBTRANSMISSAO	09/12/2019 05:47	09/12/2019 10:33	09/12/2019 05:47	09/12/2019 10:33	4,76	98	466,04	CHI
20191251944	JARAGUA	UA12078282	JARAGUA	09/12/2019 05:48	09/12/2019 08:10	09/12/2019 05:48	09/12/2019 08:10	2,35	3	7,06	CHI
20191251944	URUANA	UA12078282	JARAGUA	09/12/2019 05:48	09/12/2019 08:10	09/12/2019 05:48	09/12/2019 08:10	2,35	8	18,84	CHI
20191252200	FAINA	FC12158864	GOIAS	09/12/2019 05:48	09/12/2019 09:32	09/12/2019 05:48	09/12/2019 09:32	3,72	10	37,18	CHI
20191251871	AMARALINA	MU12087485	MARA ROSA	09/12/2019 05:49	09/12/2019 10:53	09/12/2019 05:49	09/12/2019 10:53	5,06	5	25,29	CHI
20191251871	MUTUNOPOLIS	MU12087485	MARA ROSA	09/12/2019 05:49	09/12/2019 10:53	09/12/2019 05:49	09/12/2019 10:53	5,06	11	55,63	CHI
20191252136	SANTA TEREZA DE GOIAS	SE12262714	PORANGATU	09/12/2019 05:49	09/12/2019 08:51	09/12/2019 05:49	09/12/2019 08:51	3,02	15	45,35	CHI
20191251876	BALIZA	BH12079598	BOM JARDIM	09/12/2019 05:50	09/12/2019 09:34	09/12/2019 05:50	09/12/2019 09:34	3,73	25	93,22	CHI
20191252005	BONFINOPOLIS	TA12247490	NOVO PLANALTO	09/12/2019 05:51	09/12/2019 12:45	09/12/2019 05:51	09/12/2019 12:45	6,90	1	6,90	CHI
20191252005	BONOPOLIS	TA12247490	NOVO PLANALTO	09/12/2019 05:51	09/12/2019 12:45	09/12/2019 05:51	09/12/2019 12:45	6,90	11	75,87	CHI
20191252005	PORANGATU	TA12247490	NOVO PLANALTO	09/12/2019 05:51	09/12/2019 12:45	09/12/2019 05:51	09/12/2019 12:45	6,90	2	13,79	CHI
20191252691	NOVO PLANALTO	TA12121348	SAO MIGUEL DO ARAGUAIA	09/12/2019 05:51	09/12/2019 14:49	09/12/2019 05:51	09/12/2019 14:49	8,96	40	358,53	CHI

20191251887	MOSSAMEDES	MD12121049	ITABERAÍ S2	09/12/2019 05:52	09/12/2019 09:15	09/12/2019 05:52	09/12/2019 09:15	3,38	25	84,38	CHI
20191253835	AMERICANO DO BRASIL	AC12304494	ANICUNS	09/12/2019 05:52	09/12/2019 14:06	09/12/2019 05:52	09/12/2019 14:06	8,23	14	115,21	CHI
20191253835	ANICUNS	AC12304494	ANICUNS	09/12/2019 05:52	09/12/2019 14:06	09/12/2019 05:52	09/12/2019 14:06	8,23	1	8,23	CHI
20191251891	PIRANHAS	PH12381053	PIRANHAS	09/12/2019 05:54	09/12/2019 09:18	09/12/2019 05:54	09/12/2019 09:18	3,40	9	30,57	CHI
20191252322	SANTA TEREZINHA DE GOIAS	SG12201785	SANTA TEREZINHA	09/12/2019 05:54	09/12/2019 10:10	09/12/2019 05:54	09/12/2019 10:10	4,27	44	187,89	CHI
20191251965	NIQUELANDIA	NQ12171080	BARRO ALTO	09/12/2019 05:56	09/12/2019 15:21	09/12/2019 05:56	09/12/2019 15:21	9,42	11	103,61	CHI
20191251902	GOIAS	IU21140487	MATRINCHA	09/12/2019 05:57	09/12/2019 10:50	09/12/2019 05:57	09/12/2019 10:50	4,87	2	9,74	CHI
20191251905	BOM JARDIM DE GOIAS	BM12334785	BOM JARDIM	09/12/2019 05:58	09/12/2019 12:05	09/12/2019 05:58	09/12/2019 12:05	6,12	58	354,80	CHI
20191251910	NIQUELANDIA	NQ12375605	URUACU	09/12/2019 05:58	09/12/2019 11:30	09/12/2019 05:58	09/12/2019 11:30	5,52	29	160,02	CHI
20191252889	IPORA	IR12040160	IPORA	09/12/2019 05:58	09/12/2019 12:50	09/12/2019 05:58	09/12/2019 12:50	6,86	8	54,84	CHI
20191252543	SAO MIGUEL DO ARAGUAIA	SM12220658	SAO MIGUEL DO ARAGUAIA	09/12/2019 06:00	09/12/2019 10:19	09/12/2019 06:00	09/12/2019 10:19	4,32	4	17,26	CHI
20191251918	PIRENOPOLIS	PV21185574	CORUMBA	09/12/2019 06:02	09/12/2019 10:09	09/12/2019 06:02	09/12/2019 10:09	4,11	2	8,22	CHI
20191251919	GUARINOS	3720001864	SANTA TEREZINHA	09/12/2019 06:02	09/12/2019 11:57	09/12/2019 06:02	09/12/2019 11:57	5,91	1	5,91	CHI
20191252000	URUACU	UR12342129	URUACU	09/12/2019 06:02	09/12/2019 09:25	09/12/2019 06:02	09/12/2019 09:25	3,37	176	593,46	CHI
20191251923	GOIAS	GS12250872	GOIAS	09/12/2019 06:03	09/12/2019 09:41	09/12/2019 06:03	09/12/2019 09:41	3,63	33	119,75	CHI
20191251926	SANTA RITA DO NOVO DESTINO	BA12163300	BARRO ALTO	09/12/2019 06:03	09/12/2019 14:05	09/12/2019 06:03	09/12/2019 14:05	8,03	7	56,18	CHI
20191251986	BONOPOLIS	TA12263013	NOVO PLANALTO	09/12/2019 06:05	09/12/2019 13:27	09/12/2019 06:05	09/12/2019 13:27	7,36	31	228,16	CHI
20191251952	SAO MIGUEL DO ARAGUAIA	SM12031421	SAO MIGUEL DO ARAGUAIA	09/12/2019 06:10	09/12/2019 18:07	09/12/2019 06:10	09/12/2019 18:07	11,95	18	215,10	CHI
20191253097	CRIXAS	NA12220357	MOZARLANDIA	09/12/2019 06:10	09/12/2019 18:37	09/12/2019 06:10	09/12/2019 18:37	12,45	2	24,89	CHI
20191253097	NOVA CRIXAS	NA12220357	MOZARLANDIA	09/12/2019 06:10	09/12/2019 18:37	09/12/2019 06:10	09/12/2019 18:37	12,45	6	74,68	CHI
20191252186	JARAGUA	JA12298041	JARAGUA	09/12/2019 06:11	09/12/2019 09:47	09/12/2019 06:11	09/12/2019 09:47	3,60	61	219,41	CHI
20191251960	JANDAIA	JD12005515	PALMEIRAS	09/12/2019 06:12	09/12/2019 09:20	09/12/2019 06:12	09/12/2019 09:20	3,13	7	21,90	CHI
20191252330	AURILANDIA	AI12377187	FIRMINOPOLIS S2	09/12/2019 06:12	09/12/2019 11:59	09/12/2019 06:12	09/12/2019 11:59	5,78	12	69,38	CHI
20191251962	PIRENOPOLIS	10004062467	CORUMBA	09/12/2019 06:13	09/12/2019 15:35	09/12/2019 06:13	09/12/2019 15:35	9,38	1	9,38	CHI
20191252538	MUNDO NOVO DE GOIAS	MH12274702	NOVA CRIXAS	09/12/2019 06:13	09/12/2019 15:47	09/12/2019 06:13	09/12/2019 15:47	9,56	44	420,82	CHI
20191251983	SAO MIGUEL DO ARAGUAIA	SM12000042	SAO MIGUEL DO ARAGUAIA	09/12/2019 06:14	09/12/2019 10:45	09/12/2019 06:14	09/12/2019 10:45	4,52	2	9,03	CHI
20191252202	ANICUNS	AC12391418	ANICUNS	09/12/2019 06:14	09/12/2019 11:18	09/12/2019 06:14	09/12/2019 11:18	5,08	17	86,34	CHI
20191251980	PORANGATU	PO12094123	PORANGATU	09/12/2019 06:15	09/12/2019 17:01	09/12/2019 06:15	09/12/2019 17:01	10,76	1	10,76	CHI
20191252801	COCALZINHO DE GOIAS	ZN12201365	COCALZINHO	09/12/2019 06:18	09/12/2019 20:28	09/12/2019 06:18	09/12/2019 20:28	14,16	3	42,48	CHI
20191252801	CORUMBA DE GOIAS	ZN12201365	COCALZINHO	09/12/2019 06:18	09/12/2019 20:28	09/12/2019 06:18	09/12/2019 20:28	14,16	16	226,55	CHI
20191251996	CORREGO DO OURO	BS12009575	FIRMINOPOLIS S2	09/12/2019 06:19	09/12/2019 09:31	09/12/2019 06:19	09/12/2019 09:31	3,20	11	35,20	CHI
20191252060	ANAPOLIS	AA12382489	ANAPOLIS UNIVERSITARIO S1	09/12/2019 06:21	09/12/2019 14:42	09/12/2019 06:21	09/12/2019 14:42	8,34	5	41,70	CHI
20191252184	ITAPACI	IW12141396	ITAPACI	09/12/2019 06:22	09/12/2019 08:03	09/12/2019 06:22	09/12/2019 08:03	1,67	12	20,09	CHI

20191252120	PETROLINA DE GOIAS	PG32086638	SAO FRANCISCO DE GOIAS	09/12/2019 06:23	09/12/2019 10:50	09/12/2019 06:23	09/12/2019 10:50	4,44	40	177,67	CHI
20191253636	GOIANESIA	GE12382867	GOIANESIA S1	09/12/2019 06:23	09/12/2019 14:05	09/12/2019 06:23	09/12/2019 14:05	7,70	4	30,80	CHI
20191252811	SAO MIGUEL DO ARAGUAIA	SM11100824	SAO MIGUEL DO ARAGUAIA	09/12/2019 06:24	09/12/2019 12:19	09/12/2019 06:24	09/12/2019 12:19	5,90	63	371,98	CHI
20191252033	TURVANIA	TV21083107	FIRMINOPOLIS S2	09/12/2019 06:28	09/12/2019 08:00	09/12/2019 06:28	09/12/2019 08:00	1,53	1	1,53	CHI
20191252155	ITAPIRAPUA	IU12037339	JUSSARA	09/12/2019 06:28	09/12/2019 09:38	09/12/2019 06:28	09/12/2019 09:38	3,17	6	19,01	CHI
20191252155	NOVO BRASIL	IU12037339	JUSSARA	09/12/2019 06:28	09/12/2019 09:38	09/12/2019 06:28	09/12/2019 09:38	3,17	1	3,17	CHI
20191256221	NIQUELANDIA	NQ12181068	URUACU	09/12/2019 06:28	09/12/2019 18:40	09/12/2019 06:28	09/12/2019 18:40	12,19	84	1023,80	CHI
20191252035	ITABERAI	IB12031401	ITABERAI S2	09/12/2019 06:29	09/12/2019 10:01	09/12/2019 06:29	09/12/2019 10:01	3,53	20	70,59	CHI
20191252440	ABADIANIA	AA12130228	DAIA S2	09/12/2019 06:29	09/12/2019 09:36	09/12/2019 06:29	09/12/2019 09:36	3,11	30	93,29	CHI
20191252119	GOIANESIA	GE12379116	GOIANESIA S2	09/12/2019 06:30	09/12/2019 07:55	09/12/2019 06:30	09/12/2019 07:55	1,41	100	141,08	CHI
20191253804	IVOLANDIA	IV12231245	ARENOPOLIS	09/12/2019 06:32	09/12/2019 19:09	09/12/2019 06:32	09/12/2019 19:09	12,61	13	163,97	CHI
20191253804	PALESTINA DE GOIAS	IV12231245	ARENOPOLIS	09/12/2019 06:32	09/12/2019 19:09	09/12/2019 06:32	09/12/2019 19:09	12,61	4	50,45	CHI
20191252045	LUZIANIA	120407231	RIO VERMELHO	09/12/2019 06:33	09/12/2019 07:20	09/12/2019 06:33	09/12/2019 07:20	0,78	1	0,78	CHI
20191252055	ARAGARCAS	BM12316457	BOM JARDIM	09/12/2019 06:35	09/12/2019 18:10	09/12/2019 06:35	09/12/2019 18:10	11,58	2	23,15	CHI
20191252055	BOM JARDIM DE GOIAS	BM12316457	BOM JARDIM	09/12/2019 06:35	09/12/2019 18:10	09/12/2019 06:35	09/12/2019 18:10	11,58	4	46,30	CHI
20191252056	GOIAS	GS12021582	GOIAS	09/12/2019 06:35	09/12/2019 10:10	09/12/2019 06:35	09/12/2019 10:10	3,57	55	196,49	CHI
20191252061	CORUMBA DE GOIAS	CB21148109	CORUMBA	09/12/2019 06:36	09/12/2019 21:33	09/12/2019 06:36	09/12/2019 21:33	14,94	1	14,94	CHI
20191252951	PIRANHAS	PH12354683	PIRANHAS	09/12/2019 06:36	09/12/2019 19:11	09/12/2019 06:36	09/12/2019 19:11	12,59	15	188,80	CHI
20191253114	ABADIANIA	AA12297735	CORUMBA	09/12/2019 06:37	09/12/2019 21:09	09/12/2019 06:37	09/12/2019 21:09	14,53	13	188,85	CHI
20191253114	PIRENOPOLIS	AA12297735	CORUMBA	09/12/2019 06:37	09/12/2019 21:09	09/12/2019 06:37	09/12/2019 21:09	14,53	8	116,22	CHI
20191252081	JARAGUA	JA11070675	JARAGUA	09/12/2019 06:40	09/12/2019 10:12	09/12/2019 06:40	09/12/2019 10:12	3,52	21	73,97	CHI
20191252084	NOVO PLANALTO	TA12271828	NOVO PLANALTO	09/12/2019 06:41	09/12/2019 12:20	09/12/2019 06:41	09/12/2019 12:20	5,65	14	79,08	CHI
20191252088	ITAPURANGA	IK21298361	ITAPURANGA	09/12/2019 06:41	09/12/2019 09:50	09/12/2019 06:41	09/12/2019 09:50	3,14	1	3,14	CHI
20191252104	MOSSAMEDES	MD12206498	FIRMINOPOLIS S2	09/12/2019 06:42	09/12/2019 08:04	09/12/2019 06:42	09/12/2019 08:04	1,36	43	58,35	CHI
20191252104	SANCLERLANDIA	MD12206498	FIRMINOPOLIS S2	09/12/2019 06:42	09/12/2019 08:04	09/12/2019 06:42	09/12/2019 08:04	1,36	8	10,86	CHI
20191252391	ITABERAI	IB12336400	ITABERAI S2	09/12/2019 06:42	09/12/2019 15:06	09/12/2019 06:42	09/12/2019 15:06	8,38	16	134,15	CHI
20191252445	ITAPIRAPUA	IU12073722	MATRINCHA	09/12/2019 06:42	09/12/2019 11:40	09/12/2019 06:42	09/12/2019 11:40	4,97	3	14,91	CHI
20191253619	GOIAS	GS12336386	GOIAS	09/12/2019 06:42	09/12/2019 12:11	09/12/2019 06:42	09/12/2019 12:11	5,48	10	54,79	CHI
20191252118	JUSSARA	JR12341198	JUSSARA	09/12/2019 06:46	09/12/2019 16:53	09/12/2019 06:46	09/12/2019 16:53	10,11	7	70,79	CHI
20191252121	MOSSAMEDES	MD21157139	FIRMINOPOLIS S2	09/12/2019 06:47	09/12/2019 10:05	09/12/2019 06:47	09/12/2019 10:05	3,30	1	3,30	CHI
20191252126	PALMEIRAS DE GOIAS	PL21118648	PALMEIRAS	09/12/2019 06:48	09/12/2019 08:27	09/12/2019 06:48	09/12/2019 08:27	1,66	1	1,66	CHI
20191252271	HEITORAI	HE12099418	ITAPURANGA	09/12/2019 06:48	09/12/2019 12:17	09/12/2019 06:48	09/12/2019 12:17	5,47	38	207,74	CHI
20191252139	CRISTALINA	KR21163665	PAMPLONA	09/12/2019 06:50	09/12/2019 15:52	09/12/2019 06:50	09/12/2019 15:52	9,03	1	9,03	CHI

20191252142	ITAPURANGA	IK12311015	ITAPURANGA	09/12/2019 06:50	09/12/2019 09:31	09/12/2019 06:50	09/12/2019 09:31	2,67	141	376,08	CHI
20191252244	URUACU	UR12353573	URUACU	09/12/2019 06:51	09/12/2019 08:35	09/12/2019 06:51	09/12/2019 08:35	1,72	10	17,21	CHI
20191252152	CRIXAS	CX12060513	RUBIATABA	09/12/2019 06:52	09/12/2019 17:30	09/12/2019 06:52	09/12/2019 17:30	10,63	2	21,25	CHI
20191252154	FAINA	FC12278266	GOIAS	09/12/2019 06:52	09/12/2019 12:47	09/12/2019 06:52	09/12/2019 12:47	5,90	7	41,30	CHI
20191252164	GOIANAPOLIS	GP12000087	DAIA S2	09/12/2019 06:54	09/12/2019 13:11	09/12/2019 06:54	09/12/2019 13:11	6,28	3	18,85	CHI
20191252400	NOVO BRASIL	NB12187510	JUSSARA	09/12/2019 06:56	09/12/2019 15:39	09/12/2019 06:56	09/12/2019 15:39	8,71	16	139,30	CHI
20191254947	HIDROLINA	GE12382134	BARRO ALTO	09/12/2019 06:56	09/12/2019 15:10	09/12/2019 06:56	09/12/2019 15:10	8,23	1	8,23	CHI
20191254947	SAO LUIZ DO NORTE	GE12382134	BARRO ALTO	09/12/2019 06:56	09/12/2019 15:10	09/12/2019 06:56	09/12/2019 15:10	8,23	4	32,93	CHI
20191252193	ITAPACI	IW21361464	ITAPACI	09/12/2019 06:58	09/12/2019 14:56	09/12/2019 06:58	09/12/2019 14:56	7,97	1	7,97	CHI
20191252229	PIRENOPOLIS	PV12297714	CORUMBA	09/12/2019 06:58	10/12/2019 08:40	09/12/2019 06:58	10/12/2019 08:40	25,70	7	179,90	CHI
20191252211	MIMOSO DE GOIAS	MJ12377231	PADRE BERNARDO	09/12/2019 07:00	09/12/2019 08:30	09/12/2019 07:00	09/12/2019 08:30	1,48	45	66,79	CHI
20191253014	NOVO PLANALTO	TA12391932	NOVO PLANALTO	09/12/2019 07:00	09/12/2019 12:02	09/12/2019 07:00	09/12/2019 12:02	5,03	6	30,17	CHI
20191253675	CEZARINA	CZ12314852	CEZARINA	09/12/2019 07:03	09/12/2019 15:42	09/12/2019 07:03	09/12/2019 15:42	8,65	8	69,18	CHI
20191255647	SAO LUIZ DO NORTE	SZ12333922	BARRO ALTO	09/12/2019 07:03	10/12/2019 11:43	09/12/2019 07:03	10/12/2019 11:43	28,65	10	286,52	CHI
20191253428	JUSSARA	JR12092772	JUSSARA	09/12/2019 07:04	09/12/2019 13:38	09/12/2019 07:04	09/12/2019 13:38	6,57	13	85,42	CHI
20191252242	GOIAS	NB12092962	MATRINCHA	09/12/2019 07:06	09/12/2019 18:13	09/12/2019 07:06	09/12/2019 18:13	11,10	3	33,31	CHI
20191252242	ITAPIRAPUA	NB12092962	MATRINCHA	09/12/2019 07:06	09/12/2019 18:13	09/12/2019 07:06	09/12/2019 18:13	11,10	1	11,10	CHI
20191252242	NOVO BRASIL	NB12092962	MATRINCHA	09/12/2019 07:06	09/12/2019 18:13	09/12/2019 07:06	09/12/2019 18:13	11,10	5	55,52	CHI
20191252532	ANICUNS	TV12304696	FIRMINOPOLIS S2	09/12/2019 07:07	09/12/2019 09:00	09/12/2019 07:07	09/12/2019 09:00	1,89	3	5,66	CHI
20191252532	TURVANIA	TV12304696	FIRMINOPOLIS S2	09/12/2019 07:07	09/12/2019 09:00	09/12/2019 07:07	09/12/2019 09:00	1,89	14	26,43	CHI
20191252254	NOVA CRIXAS	NA12213169	NOVA CRIXAS	09/12/2019 07:08	10/12/2019 13:20	09/12/2019 07:08	09/12/2019 12:36	5,46	6	32,74	CHI
20191252254	NOVA CRIXAS	NA13110923	NOVA CRIXAS	09/12/2019 07:08	10/12/2019 13:20	09/12/2019 07:08	09/12/2019 14:13	7,08	11	77,89	CHI
20191252254	NOVA CRIXAS	NA13110894	NOVA CRIXAS	09/12/2019 07:08	10/12/2019 13:20	09/12/2019 07:08	10/12/2019 13:20	30,19	1	30,19	CHI
20191252899	BARRO ALTO	DF12194371	BARRO ALTO	09/12/2019 07:09	09/12/2019 13:45	09/12/2019 07:09	09/12/2019 13:45	6,59	67	441,27	CHI
20191252899	SANTA RITA DO NOVO DESTINO	DF12194371	BARRO ALTO	09/12/2019 07:09	09/12/2019 13:45	09/12/2019 07:09	09/12/2019 13:45	6,59	33	217,34	CHI
20191252270	FORMOSO	FO12071135	PORANGATU	09/12/2019 07:10	09/12/2019 10:39	09/12/2019 07:10	09/12/2019 10:39	3,47	4	13,88	CHI
20191252458	CRIXAS	CX12284417	SERRA DO OURO	09/12/2019 07:11	09/12/2019 09:00	09/12/2019 07:11	09/12/2019 09:00	1,82	325	590,15	CHI
20191252794	NOVO PLANALTO	SM12328903	SAO MIGUEL DO ARAGUAIA	09/12/2019 07:12	09/12/2019 18:38	09/12/2019 07:12	09/12/2019 18:38	11,42	10	114,22	CHI
20191252299	GOIANESIA	GE21036607	GOIANESIA S2	09/12/2019 07:14	09/12/2019 16:17	09/12/2019 07:14	09/12/2019 16:17	9,04	1	9,04	CHI
20191252805	AMARALINA	LC12230319	NOVA CRIXAS	09/12/2019 07:14	09/12/2019 19:43	09/12/2019 07:14	09/12/2019 19:43	12,47	3	37,40	CHI
20191260001	PIRANHAS	PH12256780	PIRANHAS	09/12/2019 07:14	10/12/2019 10:31	09/12/2019 07:14	10/12/2019 10:31	27,28	5	136,38	CHI
20191252302	BOM JARDIM DE GOIAS	BM21231166	BOM JARDIM	09/12/2019 07:15	10/12/2019 07:10	09/12/2019 07:15	10/12/2019 07:10	23,91	2	47,82	CHI
20191252306	CRISTALINA	KR13237736	PAMPLONA	09/12/2019 07:15	09/12/2019 11:15	09/12/2019 07:15	09/12/2019 11:15	3,99	2	7,97	CHI

20191252316	SANCLERLANDIA	SC21164049	FIRMINOPOLIS S2	09/12/2019 07:16	09/12/2019 10:50	09/12/2019 07:16	09/12/2019 10:50	3,57	1	3,57	CHI
20191252363	ARENOPOLIS	AY12223136	IPORA	09/12/2019 07:16	10/12/2019 12:07	09/12/2019 07:16	10/12/2019 12:07	28,85	9	259,61	CHI
20191252594	CAMPINORTE	CR12282384	MARA ROSA	09/12/2019 07:16	09/12/2019 16:35	09/12/2019 07:16	09/12/2019 16:35	9,31	1	9,31	CHI
20191252594	URUACU	CR12282384	MARA ROSA	09/12/2019 07:16	09/12/2019 16:35	09/12/2019 07:16	09/12/2019 16:35	9,31	4	37,24	CHI
20191252539	ITAPACI	IW12351183LD	ITAPACI	09/12/2019 07:17	09/12/2019 09:44	09/12/2019 07:17	09/12/2019 09:44	2,46	561	1379,44	CHI
20191252539	NOVA GLORIA	IW12351183LD	ITAPACI	09/12/2019 07:17	09/12/2019 09:44	09/12/2019 07:17	09/12/2019 09:44	2,46	4	9,84	CHI
20191252353	CAMPINACU	UC12055175	PORANGATU	09/12/2019 07:21	09/12/2019 08:27	09/12/2019 07:21	09/12/2019 08:27	1,08	17	18,44	CHI
20191255274	SAO LUIZ DO NORTE	SZ12325125	BARRO ALTO	09/12/2019 07:21	10/12/2019 02:00	09/12/2019 07:21	10/12/2019 02:00	18,64	3	55,91	CHI
20191252361	ANAPOLIS	AN12326446	JUNDIAI S1	09/12/2019 07:22	09/12/2019 09:32	09/12/2019 07:22	09/12/2019 09:32	2,15	63	135,73	CHI
20191252361	GOIANAPOLIS	AN12326446	JUNDIAI S1	09/12/2019 07:22	09/12/2019 09:32	09/12/2019 07:22	09/12/2019 09:32	2,15	34	73,25	CHI
20191252364	PARAUNA	980037128	PARAUNA	09/12/2019 07:22	09/12/2019 22:20	09/12/2019 07:22	09/12/2019 22:20	14,95	1	14,95	CHI
20191252447	ITAPURANGA	IK12300252	ITAPURANGA	09/12/2019 07:22	09/12/2019 09:28	09/12/2019 07:22	09/12/2019 09:28	2,09	14	29,28	CHI
20191254431	GOIANESIA	GE12354272	GOIANESIA S1	09/12/2019 07:22	09/12/2019 20:00	09/12/2019 07:22	09/12/2019 20:00	12,62	6	75,72	CHI
20191256601	ALTO HORIZONTE	NH12202112RE	SANTA TEREZINHA	09/12/2019 07:22	09/12/2019 17:29	09/12/2019 07:22	09/12/2019 17:29	10,11	58	586,12	CHI
20191256601	CAMPOS VERDES	NH12202112RE	SANTA TEREZINHA	09/12/2019 07:22	09/12/2019 17:29	09/12/2019 07:22	09/12/2019 17:29	10,11	8	80,84	CHI
20191256601	NOVA IGUAQU DE GOIAS	NH12202112RE	SANTA TEREZINHA	09/12/2019 07:22	09/12/2019 17:29	09/12/2019 07:22	09/12/2019 17:29	10,11	6	60,63	CHI
20191256601	PILAR DE GOIAS	NH12202112RE	SANTA TEREZINHA	09/12/2019 07:22	09/12/2019 17:29	09/12/2019 07:22	09/12/2019 17:29	10,11	1	10,11	CHI
20191252502	SAO MIGUEL DO ARAGUAIA	SM12000010	SAO MIGUEL DO ARAGUAIA	09/12/2019 07:23	09/12/2019 09:12	09/12/2019 07:23	09/12/2019 09:12	1,81	137	248,01	CHI
20191252390	GOIAS	8528819	GOIAS	09/12/2019 07:24	09/12/2019 10:29	09/12/2019 07:24	09/12/2019 10:29	3,07	13	39,90	CHI
20191252569	ANAPOLIS	AN12382480	ANAPOLIS UNIVERSITARIO S2	09/12/2019 07:25	09/12/2019 14:14	09/12/2019 07:25	09/12/2019 14:14	6,81	22	149,72	CHI
20191252569	GAMELEIRA DE GOIAS	AN12382480	ANAPOLIS UNIVERSITARIO S2	09/12/2019 07:25	09/12/2019 14:14	09/12/2019 07:25	09/12/2019 14:14	6,81	41	279,03	CHI
20191252569	SILVANIA	AN12382480	ANAPOLIS UNIVERSITARIO S2	09/12/2019 07:25	09/12/2019 14:14	09/12/2019 07:25	09/12/2019 14:14	6,81	39	265,42	CHI
20191252414	VILA PROPICIO	NP12235934	GOIANESIA S1	09/12/2019 07:29	09/12/2019 13:46	09/12/2019 07:29	09/12/2019 13:46	6,28	8	50,28	CHI
20191253833	CORUMBA DE GOIAS	CB12382194	CORUMBA	09/12/2019 07:29	09/12/2019 15:08	09/12/2019 07:29	09/12/2019 15:08	7,64	3	22,93	CHI
20191252424	JAUPACI	JP12028023	IPORA	09/12/2019 07:30	09/12/2019 11:00	09/12/2019 07:30	09/12/2019 11:00	3,50	7	24,51	CHI
20191252427	MUTUNOPOLIS	PO12084869	PORANGATU	09/12/2019 07:30	09/12/2019 20:00	09/12/2019 07:30	09/12/2019 13:15	5,74	1	5,74	CHI
20191252427	PORANGATU	PO12084869	PORANGATU	09/12/2019 07:30	09/12/2019 20:00	09/12/2019 07:30	09/12/2019 13:15	5,74	3	17,23	CHI
20191252427	MUTUNOPOLIS	MU12243328LD	PORANGATU	09/12/2019 07:30	09/12/2019 20:00	09/12/2019 07:30	09/12/2019 20:00	12,51	3	37,52	CHI
20191252430	ITAPIRAPUA	IU12018846	MATRINCHA	09/12/2019 07:30	09/12/2019 09:45	09/12/2019 07:30	09/12/2019 09:45	2,24	4	8,96	CHI
20191252460	GOIANESIA	SZ12366599	GOIANESIA S1	09/12/2019 07:30	09/12/2019 16:30	09/12/2019 07:30	09/12/2019 16:30	9,00	5	44,98	CHI
20191252443	CAMPINACU	UC12236261	PORANGATU	09/12/2019 07:32	09/12/2019 15:49	09/12/2019 07:32	09/12/2019 15:49	8,27	19	157,07	CHI
20191252443	PORANGATU	UC12236261	PORANGATU	09/12/2019 07:32	09/12/2019 15:49	09/12/2019 07:32	09/12/2019 15:49	8,27	1	8,27	CHI
20191252515	GOIANESIA	GE21137460	GOIANESIA S1	09/12/2019 07:37	10/12/2019 09:51	09/12/2019 07:37	10/12/2019 09:51	26,23	1	26,23	CHI

20191252518	MOSSAMEDES	MD12005317	FIRMINOPOLIS S2	09/12/2019 07:37	09/12/2019 17:20	09/12/2019 07:37	09/12/2019 17:20	9,71	16	155,30	CHI
20191252524	CACHOEIRA DE GOIAS	CG12377182	FIRMINOPOLIS S2	09/12/2019 07:38	09/12/2019 11:37	09/12/2019 07:38	09/12/2019 11:37	3,99	10	39,86	CHI
20191252527	FIRMINOPOLIS	FR12096809	FIRMINOPOLIS S1	09/12/2019 07:38	09/12/2019 09:14	09/12/2019 07:38	09/12/2019 09:14	1,60	5	7,99	CHI
20191252529	AGUAS LINDAS DE GOIAS	10018094552	AGUAS LINDAS DE GOIAS S1	09/12/2019 07:38	09/12/2019 10:19	09/12/2019 07:38	09/12/2019 10:19	2,68	1	2,68	CHI
20191252548	FAINA	FC12038664	GOIAS	09/12/2019 07:40	09/12/2019 15:03	09/12/2019 07:40	09/12/2019 15:03	7,37	10	73,69	CHI
20191253020	JANDAIA	JD12046344	PALMEIRAS	09/12/2019 07:40	09/12/2019 11:09	09/12/2019 07:40	09/12/2019 11:09	3,49	5	17,43	CHI
20191252552	ANICUNS	3550000374	ANICUNS	09/12/2019 07:41	09/12/2019 16:57	09/12/2019 07:41	09/12/2019 16:57	9,27	1	9,27	CHI
20191252558	CRIXAS	NA12229644	NOVA CRIXAS	09/12/2019 07:42	09/12/2019 10:19	09/12/2019 07:42	09/12/2019 10:19	2,61	2	5,23	CHI
20191252558	NOVA CRIXAS	NA12229644	NOVA CRIXAS	09/12/2019 07:42	09/12/2019 10:19	09/12/2019 07:42	09/12/2019 10:19	2,61	1	2,61	CHI
20191252561	URUACU	UR12317135	URUACU	09/12/2019 07:42	09/12/2019 10:55	09/12/2019 07:42	09/12/2019 10:55	3,21	11	35,29	CHI
20191252581	CRISTALINA	KR21195570	PAMPLONA	09/12/2019 07:45	09/12/2019 12:24	09/12/2019 07:45	09/12/2019 12:24	4,64	1	4,64	CHI
20191253355	JUSSARA	JR12250544	BRITANIA	09/12/2019 07:45	09/12/2019 16:30	09/12/2019 07:45	09/12/2019 16:30	8,75	30	262,44	CHI
20191254155	NIQUELANDIA	NQ11219005	NIQUELANDIA SUBTRANSMISSAO	09/12/2019 07:45	10/12/2019 01:41	09/12/2019 07:45	10/12/2019 01:41	17,92	22	394,22	CHI
20191252595	NOVA GLORIA	NG12181400	ITAPACI	09/12/2019 07:47	09/12/2019 13:53	09/12/2019 07:47	09/12/2019 13:53	6,10	6	36,57	CHI
20191252610	ITABERAI	IB21105421	ITABERAI S1	09/12/2019 07:50	09/12/2019 09:26	09/12/2019 07:50	09/12/2019 09:26	1,60	1	1,60	CHI
20191252614	ALTO PARAISO DE GOIAS	BF12268365	NIQUELANDIA SUBTRANSMISSAO	09/12/2019 07:50	09/12/2019 09:34	09/12/2019 07:50	09/12/2019 09:34	1,73	6	10,37	CHI
20191252620	DOVERLANDIA	DV21217834	CAIAPONIA	09/12/2019 07:51	10/12/2019 09:02	09/12/2019 07:51	10/12/2019 09:02	25,17	1	25,17	CHI
20191254257	ALEXANIA	AX12379444	ALEXANIA	09/12/2019 07:51	09/12/2019 17:20	09/12/2019 07:51	09/12/2019 17:20	9,47	4	37,88	CHI
20191252625	JARAGUA	JA12221349	JARAGUA	09/12/2019 07:52	09/12/2019 11:20	09/12/2019 07:52	09/12/2019 11:20	3,47	6	20,85	CHI
20191252628	PALMINOPOLIS	PP21006950	PALMEIRAS	09/12/2019 07:52	09/12/2019 12:41	09/12/2019 07:52	09/12/2019 12:41	4,81	1	4,81	CHI
20191252875	GOIAS	GS12274373	GOIAS	09/12/2019 07:52	09/12/2019 10:32	09/12/2019 07:52	09/12/2019 10:32	2,66	11	29,28	CHI
20191252635	ARAGUAPAZ	AZ12041200	GOIAS	09/12/2019 07:54	09/12/2019 12:16	09/12/2019 07:54	09/12/2019 12:16	4,36	3	13,08	CHI
20191252640	CRIXAS	NA21382462	NOVA CRIXAS	09/12/2019 07:54	09/12/2019 09:32	09/12/2019 07:54	09/12/2019 09:32	1,62	2	3,25	CHI
20191252657	ANAPOLIS	GP31027307	JUNDIAI S1	09/12/2019 07:56	09/12/2019 11:44	09/12/2019 07:56	09/12/2019 11:44	3,79	1	3,79	CHI
20191252659	NOVO GAMA	4990084872	PACAEMBU S1	09/12/2019 07:57	09/12/2019 09:22	09/12/2019 07:57	09/12/2019 09:22	1,42	1	1,42	CHI
20191253321	JARAGUA	JA12297901	JARAGUA	09/12/2019 07:57	09/12/2019 12:07	09/12/2019 07:57	09/12/2019 12:07	4,17	18	75,00	CHI
20191252675	PARAUNA	PU12007899	PARAUNA	09/12/2019 07:59	09/12/2019 11:16	09/12/2019 07:59	09/12/2019 11:16	3,28	2	6,56	CHI
20191252682	ANICUNS	AC12206370	ANICUNS	09/12/2019 08:00	09/12/2019 11:07	09/12/2019 08:00	09/12/2019 11:07	3,11	2	6,23	CHI
20191252682	ITABERAI	AC12206370	ANICUNS	09/12/2019 08:00	09/12/2019 11:07	09/12/2019 08:00	09/12/2019 11:07	3,11	1	3,11	CHI
20191252684	LUZIANIA	LZ21335967	MARAJOARA	09/12/2019 08:00	09/12/2019 10:05	09/12/2019 08:00	09/12/2019 10:05	2,08	1	2,08	CHI
20191252690	SAO MIGUEL DO ARAGUAIA	SM12074411	SAO MIGUEL DO ARAGUAIA	09/12/2019 08:01	09/12/2019 16:51	09/12/2019 08:01	09/12/2019 16:51	8,83	5	44,16	CHI
20191252706	PALESTINA DE GOIAS	PY12237027	PALESTINA	09/12/2019 08:02	09/12/2019 12:20	09/12/2019 08:02	09/12/2019 12:20	4,30	5	21,48	CHI
201912260798	BALIZA	BH12142110	BOM JARDIM	09/12/2019 08:02	09/12/2019 11:21	09/12/2019 08:02	09/12/2019 11:21	3,32	84	278,58	CHI

20191252711	SAO MIGUEL DO ARAGUAIA	SM21170928	SAO MIGUEL DO ARAGUAIA	09/12/2019 08:03	10/12/2019 02:03	09/12/2019 08:03	10/12/2019 02:03	17,99	1	17,99	CHI
20191252716	PIRENOPOLIS	PV21084581	JARAGUA	09/12/2019 08:04	09/12/2019 13:14	09/12/2019 08:04	09/12/2019 13:14	5,16	1	5,16	CHI
20191252721	LUZIANIA	10025639380	RIO VERMELHO	09/12/2019 08:04	09/12/2019 11:59	09/12/2019 08:04	09/12/2019 11:59	3,90	1	3,90	CHI
20191252722	MARA ROSA	MQ12279137	MARA ROSA	09/12/2019 08:05	09/12/2019 23:55	09/12/2019 08:05	09/12/2019 23:55	15,83	2	31,67	CHI
20191252723	ANAPOLIS	AN12003366	ANAPOLIS UNIVERSITARIO S2	09/12/2019 08:05	09/12/2019 10:28	09/12/2019 08:05	09/12/2019 10:28	2,38	422	1005,18	CHI
20191252727	CAIAPONIA	CP21342201	PALESTINA	09/12/2019 08:05	09/12/2019 09:45	09/12/2019 08:05	09/12/2019 09:45	1,68	1	1,68	CHI
20191252747	AURILANDIA	AI12068190	FIRMINOPOLIS S2	09/12/2019 08:07	09/12/2019 21:12	09/12/2019 08:07	09/12/2019 21:12	13,08	3	39,25	CHI
20191252755	ANICUNS	910037425	ANICUNS	09/12/2019 08:08	09/12/2019 14:46	09/12/2019 08:08	09/12/2019 14:46	6,64	1	6,64	CHI
20191252758	SAO MIGUEL DO ARAGUAIA	SM21000028	SAO MIGUEL DO ARAGUAIA	09/12/2019 08:09	09/12/2019 12:05	09/12/2019 08:09	09/12/2019 12:05	3,93	1	3,93	CHI
20191252785	JARAGUA	JA12221352	JARAGUA	09/12/2019 08:11	09/12/2019 12:10	09/12/2019 08:11	09/12/2019 12:10	3,97	55	218,50	CHI
20191252790	ANAPOLIS	21282754	ANAPOLIS UNIVERSITARIO S2	09/12/2019 08:12	09/12/2019 16:49	09/12/2019 08:12	09/12/2019 16:49	8,61	1	8,61	CHI
20191252793	PIRENOPOLIS	PV21286505	CORUMBA	09/12/2019 08:13	09/12/2019 12:01	09/12/2019 08:13	09/12/2019 12:01	3,80	2	7,60	CHI
20191252796	PIRENOPOLIS	PV21362323	CORUMBA	09/12/2019 08:13	10/12/2019 10:03	09/12/2019 08:13	10/12/2019 10:03	25,83	1	25,83	CHI
20191252799	URUACU	640005135	URUACU	09/12/2019 08:14	09/12/2019 10:14	09/12/2019 08:14	09/12/2019 10:14	2,00	1	2,00	CHI
20191252803	ANAPOLIS	10010947661	JUNDIAI S2	09/12/2019 08:14	09/12/2019 13:58	09/12/2019 08:14	09/12/2019 13:58	5,72	1	5,72	CHI
20191252810	ABADIANIA	AA21200922	ANAPOLIS UNIVERSITARIO S1	09/12/2019 08:15	09/12/2019 17:50	09/12/2019 08:15	09/12/2019 17:50	9,57	1	9,57	CHI
20191252827	ARENOPOLIS	AY12000027	ARENOPOLIS	09/12/2019 08:15	09/12/2019 21:01	09/12/2019 08:15	09/12/2019 21:01	12,75	39	497,27	CHI
20191252827	PIRANHAS	AY12000027	ARENOPOLIS	09/12/2019 08:15	09/12/2019 21:01	09/12/2019 08:15	09/12/2019 21:01	12,75	4	51,00	CHI
20191252823	RUBIATABA	780028983	RUBIATABA	09/12/2019 08:17	09/12/2019 09:45	09/12/2019 08:17	09/12/2019 09:45	1,46	1	1,46	CHI
20191252830	SAO LUIS DE MONTES BELOS	SL32145763	SAO LUIZ DOS MONTES BELOS	09/12/2019 08:18	09/12/2019 20:25	09/12/2019 08:18	09/12/2019 20:25	12,11	3	36,34	CHI
20191252831	CRISTALINA	KR21163739	PAMPLONA	09/12/2019 08:18	09/12/2019 12:58	09/12/2019 08:18	09/12/2019 12:58	4,66	1	4,66	CHI
20191252835	ARAGARCAS	AG11341727	IPORA	09/12/2019 08:19	09/12/2019 14:22	09/12/2019 08:19	09/12/2019 14:22	6,05	18	108,94	CHI
20191252837	ABADIANIA	AA12374423	ANAPOLIS UNIVERSITARIO S1	09/12/2019 08:20	09/12/2019 11:25	09/12/2019 08:20	09/12/2019 11:25	3,08	1	3,08	CHI
20191252838	URUACU	UR21313125	URUACU	09/12/2019 08:20	09/12/2019 11:59	09/12/2019 08:20	09/12/2019 11:59	3,65	1	3,65	CHI
20191253269	PADRE BERNARDO	PB12163217	PADRE BERNARDO	09/12/2019 08:20	09/12/2019 10:03	09/12/2019 08:20	09/12/2019 10:03	1,70	18	30,65	CHI
20191252848	JARAGUA	70049130	JARAGUA	09/12/2019 08:21	09/12/2019 11:15	09/12/2019 08:21	09/12/2019 11:15	2,90	1	2,90	CHI
20191252867	CRIXAS	NA21268892	SERRA DO OURO	09/12/2019 08:24	09/12/2019 12:37	09/12/2019 08:24	09/12/2019 12:37	4,21	1	4,21	CHI
20191252869	ALEXANIA	AX21066475	ALEXANIA	09/12/2019 08:24	10/12/2019 06:22	09/12/2019 08:24	10/12/2019 05:43	21,30	1	21,30	CHI
20191252869	ALEXANIA	AX12295664	ALEXANIA	09/12/2019 08:24	10/12/2019 06:22	10/12/2019 03:50	10/12/2019 06:22	2,53	16	40,54	CHI
20191252876	IPORA	730080286	IPORA	09/12/2019 08:25	09/12/2019 13:37	09/12/2019 08:25	09/12/2019 13:37	5,20	1	5,20	CHI
20191252893	GOIAS	90037455	ITABERAÍ S2	09/12/2019 08:27	09/12/2019 11:12	09/12/2019 08:27	09/12/2019 11:12	2,75	1	2,75	CHI
20191252918	GOIAS	GS21150083	MATRINCHA	09/12/2019 08:30	09/12/2019 21:11	09/12/2019 08:30	09/12/2019 21:11	12,67	1	12,67	CHI
20191254755	DIORAMA	DI12381021	IPORA	09/12/2019 08:31	09/12/2019 20:22	09/12/2019 08:31	09/12/2019 20:22	11,84	3	35,53	CHI

20191252929	CORUMBA DE GOIAS	10004625160	CORUMBA	09/12/2019 08:32	09/12/2019 12:22	09/12/2019 08:32	09/12/2019 12:22	3,83	1	3,83	CHI
20191252937	NIQUELANDIA	10007786377	URUACU	09/12/2019 08:33	09/12/2019 16:21	09/12/2019 08:33	09/12/2019 16:21	7,79	1	7,79	CHI
20191253893	SANTA RITA DO NOVO DESTINO	DF12229507	BARRO ALTO	09/12/2019 08:36	09/12/2019 14:47	09/12/2019 08:36	09/12/2019 14:47	6,17	32	197,50	CHI
20191252965	PADRE BERNARDO	ZN12342164	PADRE BERNARDO	09/12/2019 08:37	09/12/2019 18:15	09/12/2019 08:37	09/12/2019 18:15	9,63	5	48,13	CHI
20191252967	ITABERAI	IB12079203	ITABERAI S1	09/12/2019 08:37	09/12/2019 10:36	09/12/2019 08:37	09/12/2019 10:36	1,97	23	45,42	CHI
20191253701	ANAPOLIS	AN12267911	ANAPOLIS UNIVERSITARIO S2	09/12/2019 08:37	09/12/2019 13:26	09/12/2019 08:37	09/12/2019 13:26	4,81	44	211,62	CHI
20191253701	CAMPO LIMPO	AN12267911	ANAPOLIS UNIVERSITARIO S2	09/12/2019 08:37	09/12/2019 13:26	09/12/2019 08:37	09/12/2019 13:26	4,81	1	4,81	CHI
20191252973	HIDROLINA	HL21144934	URUACU	09/12/2019 08:38	09/12/2019 18:26	09/12/2019 08:38	09/12/2019 18:26	9,80	1	9,80	CHI
20191253909	PIRENOPOLIS	PV21284253	CORUMBA	09/12/2019 08:39	09/12/2019 15:32	09/12/2019 08:39	09/12/2019 15:32	6,87	1	6,87	CHI
20191252992	CRISTALINA	KR21332608	PAMPLONA	09/12/2019 08:41	09/12/2019 12:16	09/12/2019 08:41	09/12/2019 12:16	3,57	1	3,57	CHI
20191252993	JARAGUA	JA21116882	JARAGUA	09/12/2019 08:41	09/12/2019 13:06	09/12/2019 08:41	09/12/2019 13:06	4,41	2	8,81	CHI
20191252995	CORUMBA DE GOIAS	CB12203650	ALEXANIA	09/12/2019 08:41	10/12/2019 14:35	09/12/2019 08:41	10/12/2019 14:35	29,90	3	89,69	CHI
20191252996	ARUANA	AK12016455	BRITANIA	09/12/2019 08:42	09/12/2019 11:13	09/12/2019 08:42	09/12/2019 11:13	2,51	2	5,03	CHI
20191252996	BRITANIA	AK12016455	BRITANIA	09/12/2019 08:42	09/12/2019 11:13	09/12/2019 08:42	09/12/2019 11:13	2,51	8	20,11	CHI
20191252996	BRITANIA	AK12016455	BRITANIA	09/12/2019 08:42	09/12/2019 11:13	09/12/2019 08:42	09/12/2019 11:13	2,51	11	27,65	CHI
20191253006	SAO FRANCISCO DE GOIAS	SF12248837	SAO FRANCISCO DE GOIAS	09/12/2019 08:44	09/12/2019 16:46	09/12/2019 08:44	09/12/2019 16:46	8,02	4	32,10	CHI
20191253010	SAO MIGUEL DO ARAGUAIA	SM21230357	SAO MIGUEL DO ARAGUAIA	09/12/2019 08:45	09/12/2019 16:36	09/12/2019 08:45	09/12/2019 16:36	7,86	1	7,86	CHI
20191253012	GOIAS	GS12071260	GOIAS	09/12/2019 08:45	09/12/2019 11:50	09/12/2019 08:45	09/12/2019 11:50	3,08	7	21,56	CHI
20191254221	NOVO PLANALTO	SM12074386	SAO MIGUEL DO ARAGUAIA	09/12/2019 08:46	09/12/2019 13:35	09/12/2019 08:46	09/12/2019 13:35	4,80	5	24,01	CHI
20191254221	SAO MIGUEL DO ARAGUAIA	SM12074386	SAO MIGUEL DO ARAGUAIA	09/12/2019 08:46	09/12/2019 13:35	09/12/2019 08:46	09/12/2019 13:35	4,80	123	590,54	CHI
20191253031	CRISTALINA	KR12376992	CRISTALINA S2	09/12/2019 08:47	09/12/2019 12:47	09/12/2019 08:47	09/12/2019 12:47	3,99	10	39,94	CHI
20191253101	CRISTALINA	KR12217277	CRISTALINA S1	09/12/2019 08:48	09/12/2019 11:59	09/12/2019 08:48	09/12/2019 11:59	3,17	12	38,08	CHI
20191253041	MINACU	IH21187826	MINACU	09/12/2019 08:49	09/12/2019 10:25	09/12/2019 08:49	09/12/2019 10:25	1,60	1	1,60	CHI
20191253042	JUSSARA	JR12206758	BRITANIA	09/12/2019 08:49	10/12/2019 18:35	09/12/2019 08:49	10/12/2019 18:35	33,76	1	33,76	CHI
20191253046	CRISTALINA	KR21335866	CRISTALINA S1	09/12/2019 08:50	09/12/2019 10:18	09/12/2019 08:50	09/12/2019 10:18	1,45	1	1,45	CHI
20191253048	CRIXAS	CX12213587	SANTA TEREZINHA	09/12/2019 08:50	09/12/2019 18:40	09/12/2019 08:50	09/12/2019 18:40	9,82	2	19,65	CHI
20191253048	UIRAPURU	CX12213587	SANTA TEREZINHA	09/12/2019 08:50	09/12/2019 18:40	09/12/2019 08:50	09/12/2019 18:40	9,82	9	88,42	CHI
20191253051	JANDAIA	1180022947	PALMEIRAS	09/12/2019 08:51	09/12/2019 14:34	09/12/2019 08:51	09/12/2019 14:34	5,72	1	5,72	CHI
20191253055	BARRO ALTO	GE12115071	GOIANESIA S1	09/12/2019 08:52	09/12/2019 15:23	09/12/2019 08:52	09/12/2019 15:23	6,53	2	13,05	CHI
20191253055	GOIANESIA	GE12115071	GOIANESIA S1	09/12/2019 08:52	09/12/2019 15:23	09/12/2019 08:52	09/12/2019 15:23	6,53	7	45,69	CHI
20191253543	COCALZINHO DE GOIAS	CB12084585	COCALZINHO	09/12/2019 08:53	09/12/2019 14:21	09/12/2019 08:53	09/12/2019 14:21	5,46	4	21,82	CHI
20191253068	MOSSAMEDES	MD12091062	FIRMINOPOLIS S2	09/12/2019 08:54	09/12/2019 12:28	09/12/2019 08:54	09/12/2019 12:28	3,56	1	3,56	CHI
20191253084	FAINA	FC12396481	ITAPURANGA	09/12/2019 08:56	09/12/2019 16:27	09/12/2019 08:56	09/12/2019 16:27	7,51	3	22,52	CHI



20191254109	JANDAIA	JD12055081	PALMEIRAS	09/12/2019 08:56	09/12/2019 11:53	09/12/2019 08:56	09/12/2019 11:53	2,95	11	32,48	CHI
20191253091	CRISTALINA	KR21399485	CRISTALINA S1	09/12/2019 08:57	09/12/2019 10:05	09/12/2019 08:57	09/12/2019 10:05	1,12	1	1,12	CHI
20191253094	SANTA TEREZINHA DE GOIAS	SG21321804	SANTA TEREZINHA	09/12/2019 08:57	09/12/2019 13:28	09/12/2019 08:57	09/12/2019 13:28	4,50	1	4,50	CHI
20191253098	SAO LUIZ DO NORTE	SZ11082991	ITAPACI	09/12/2019 08:58	10/12/2019 17:53	09/12/2019 08:58	10/12/2019 14:15	29,27	1	29,27	CHI
20191253098	SAO LUIZ DO NORTE	SZ12046339	ITAPACI	09/12/2019 08:58	10/12/2019 17:53	10/12/2019 14:15	10/12/2019 17:53	3,64	1	3,64	CHI
20191253102	JARAGUA	JA21140692	JARAGUA	09/12/2019 08:59	09/12/2019 15:25	09/12/2019 08:59	09/12/2019 15:25	6,43	1	6,43	CHI
20191253103	BALIZA	BM12390150	BOM JARDIM	09/12/2019 08:59	09/12/2019 17:49	09/12/2019 08:59	09/12/2019 17:49	8,83	51	450,27	CHI
20191253103	BOM JARDIM DE GOIAS	BM12390150	BOM JARDIM	09/12/2019 08:59	09/12/2019 17:49	09/12/2019 08:59	09/12/2019 17:49	8,83	9	79,46	CHI
20191253106	MINACU	IH12348054	MINACU	09/12/2019 08:59	09/12/2019 16:35	09/12/2019 08:59	09/12/2019 16:35	7,59	5	37,95	CHI

# Plotagem das Ocorrências conforme a Espacialização das Chuvas

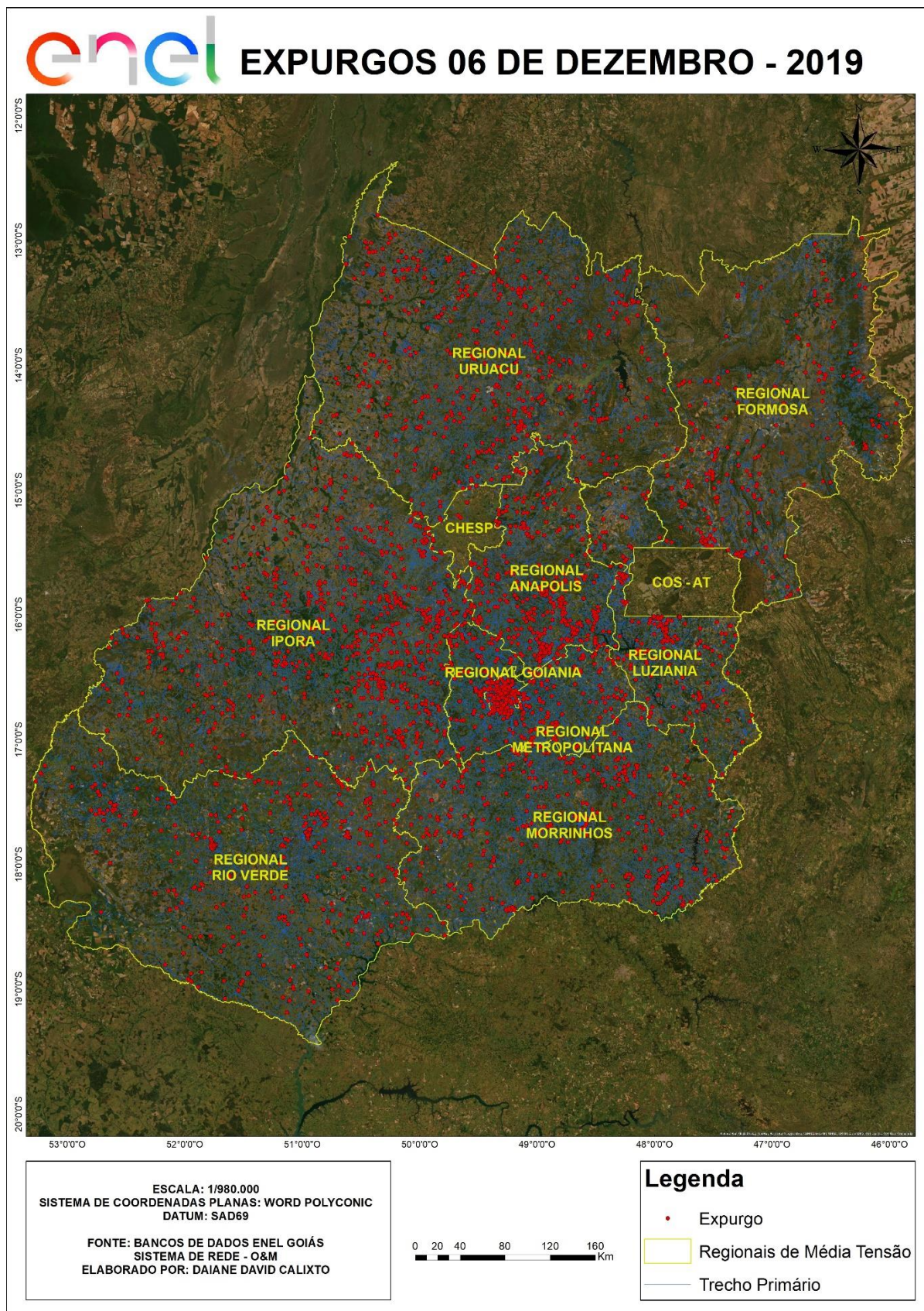

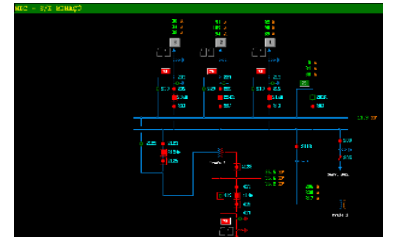
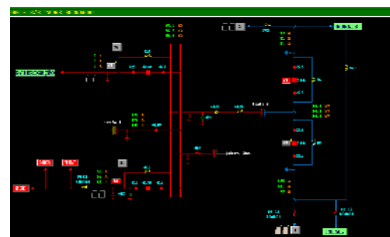
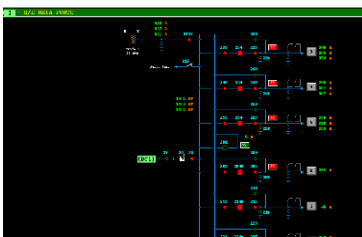
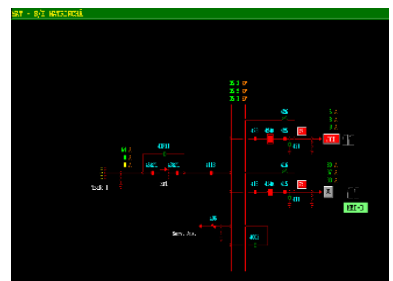
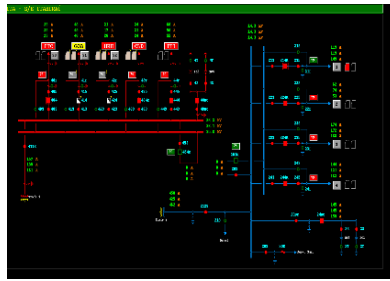
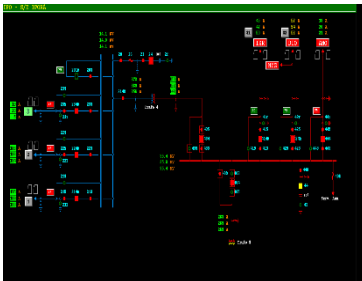
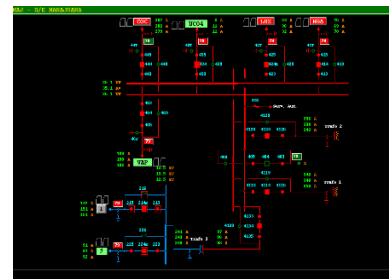
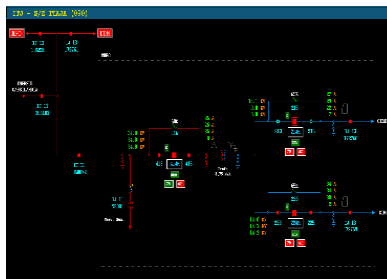
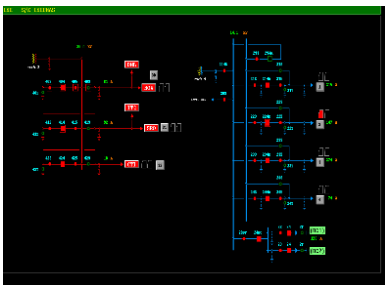
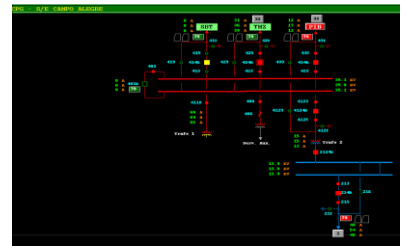
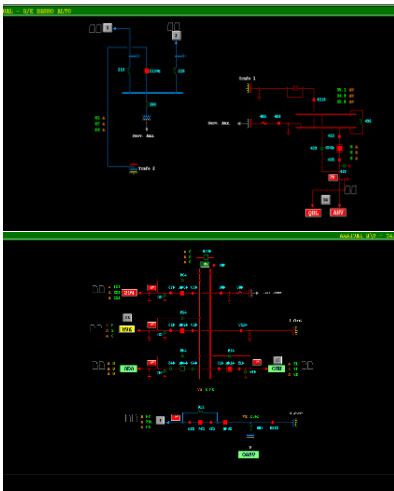
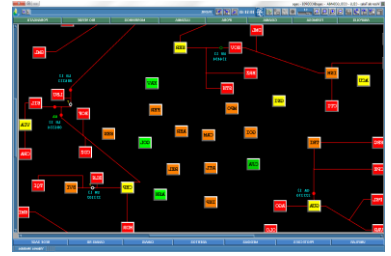
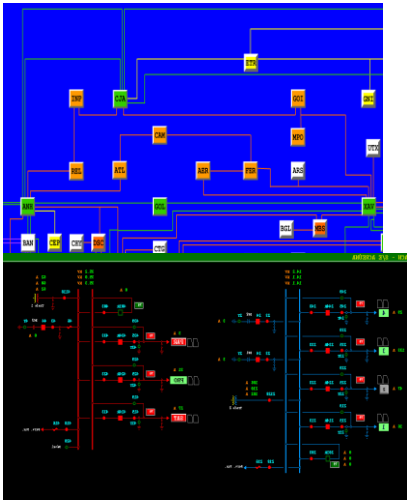

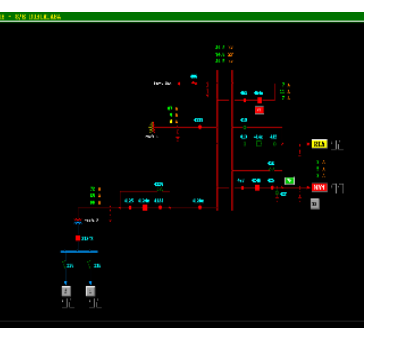
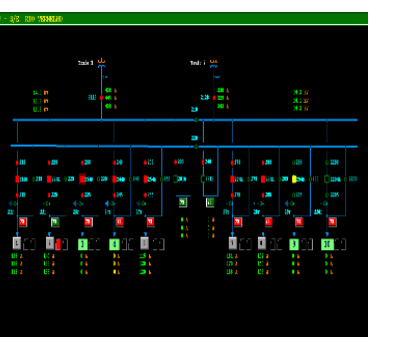
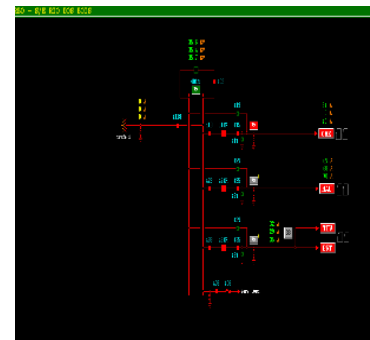
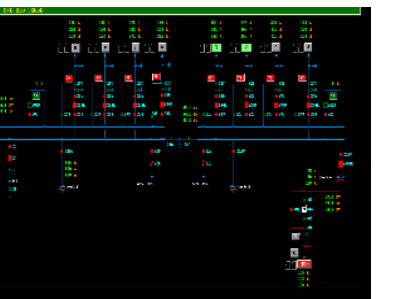
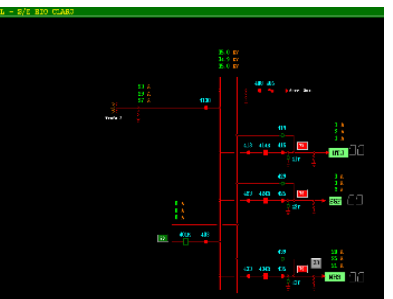
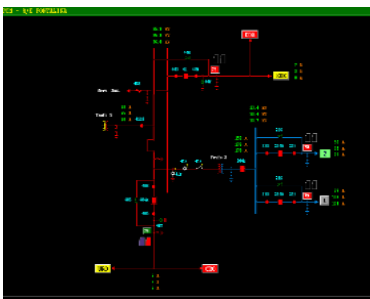
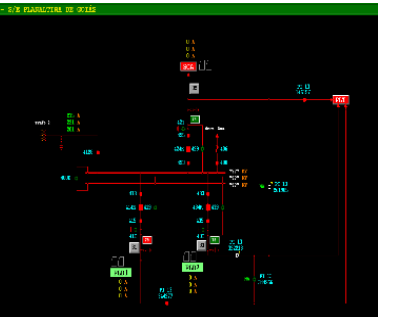
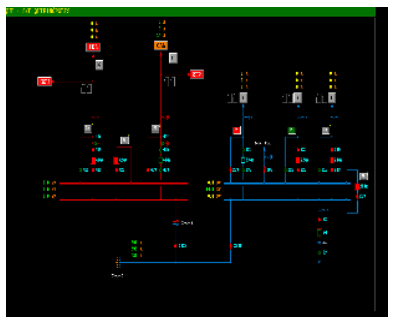
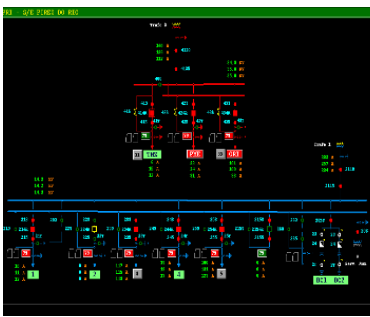
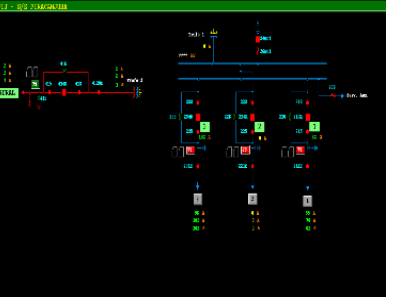
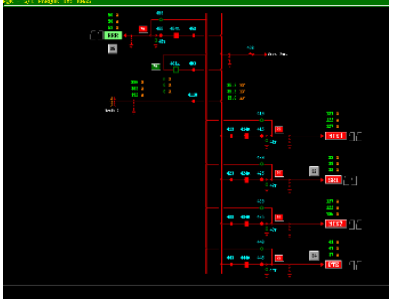
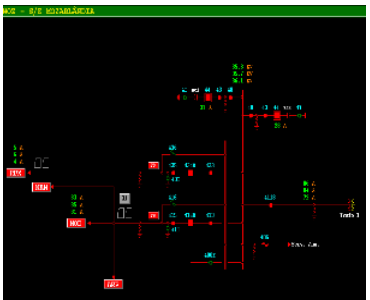
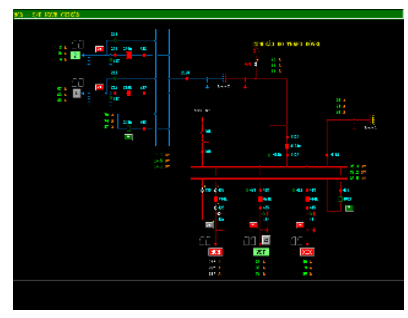
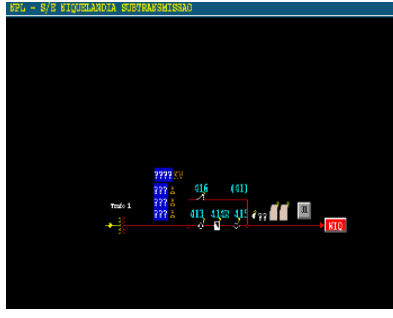



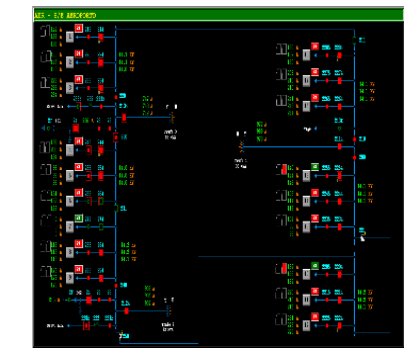
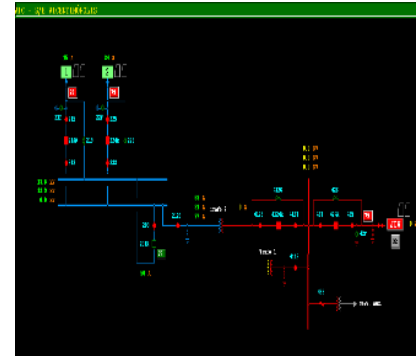
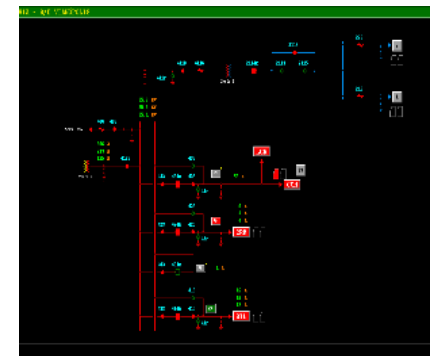
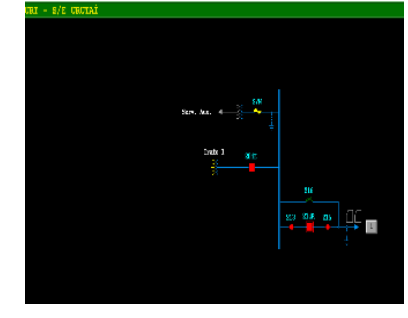
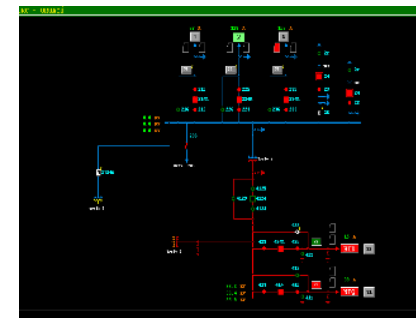
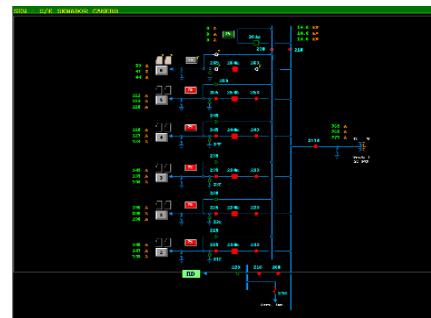
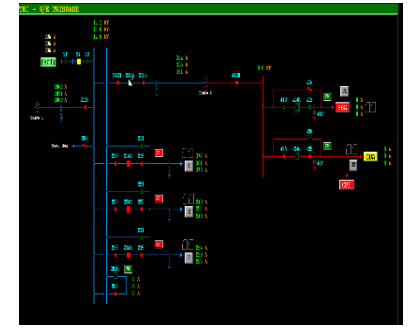
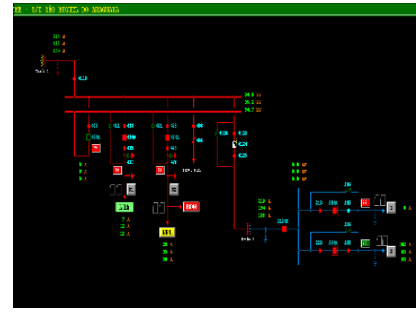
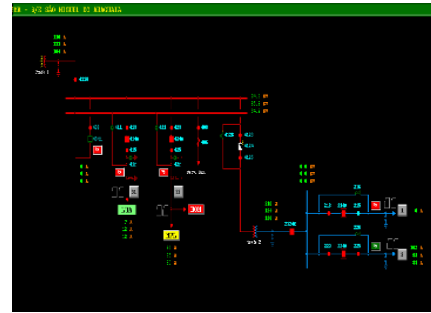
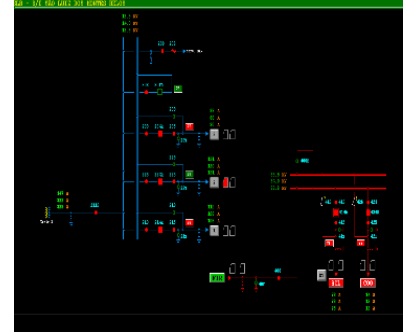
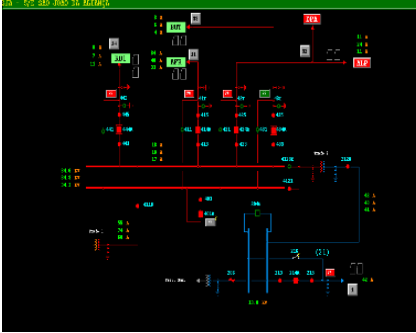
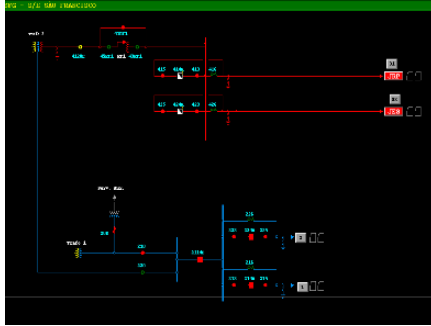
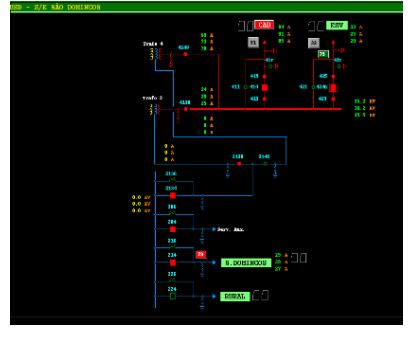
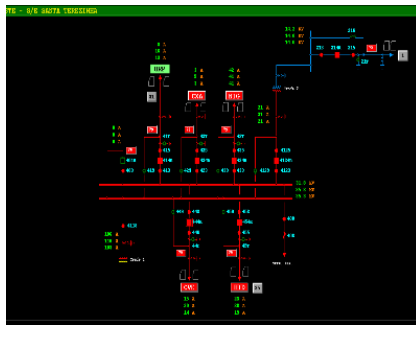
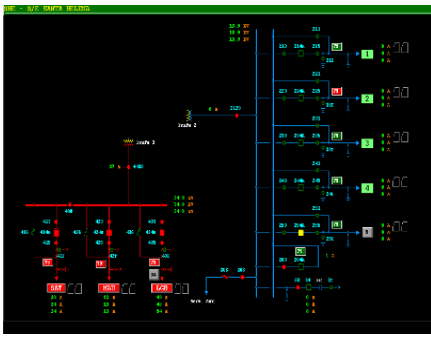

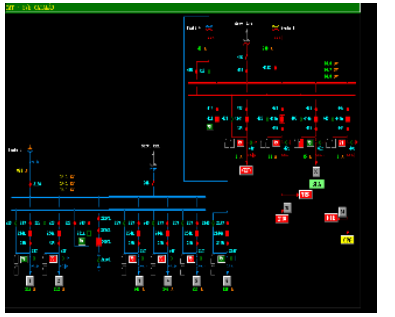
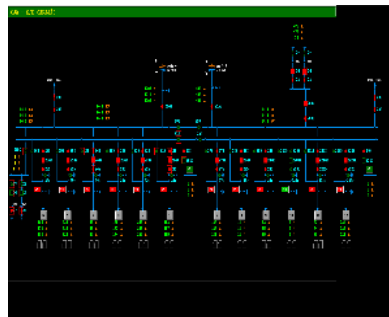
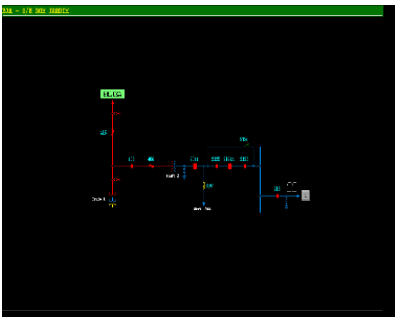
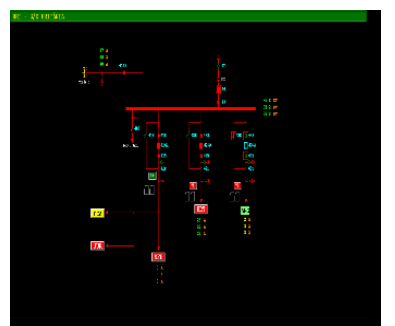
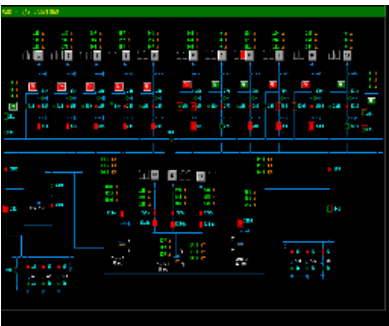
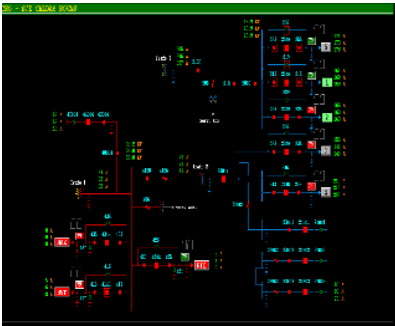
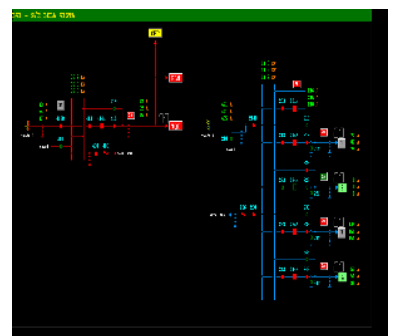
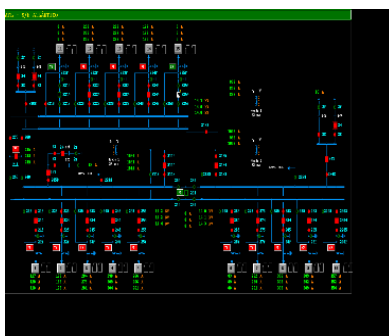
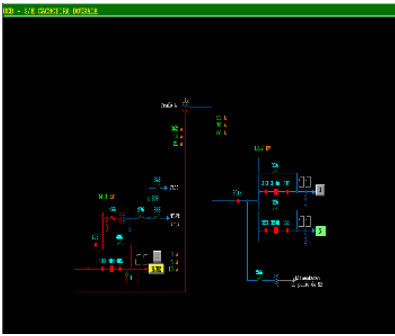
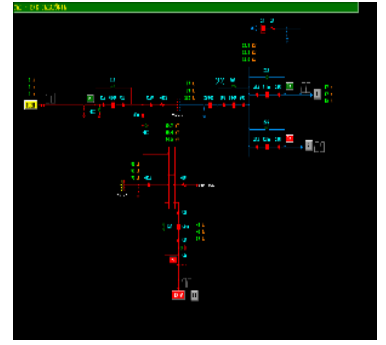
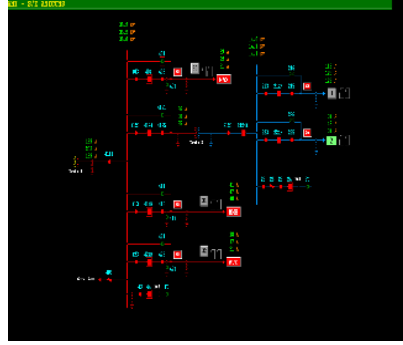
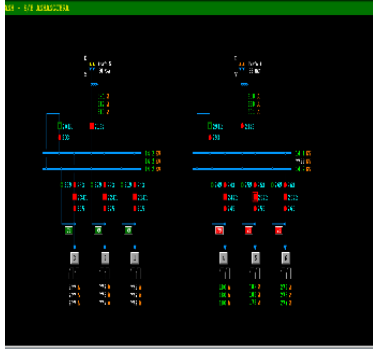
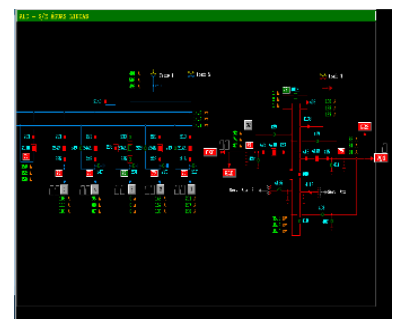
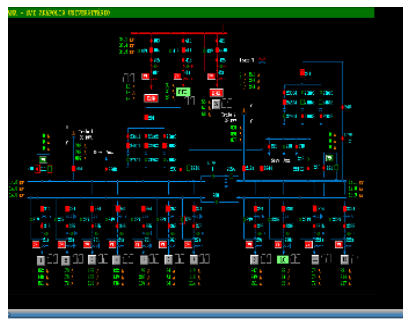
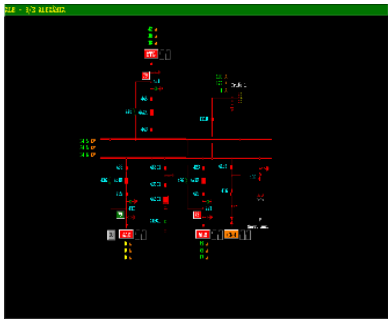



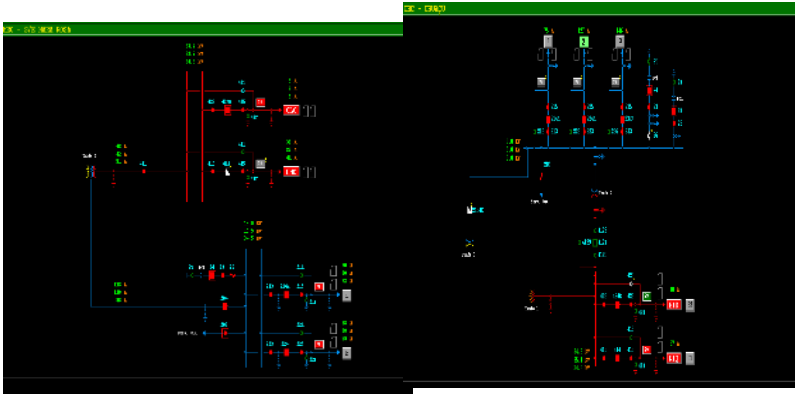
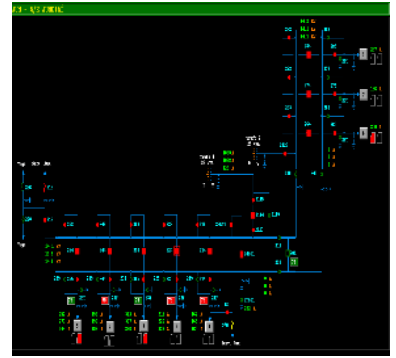
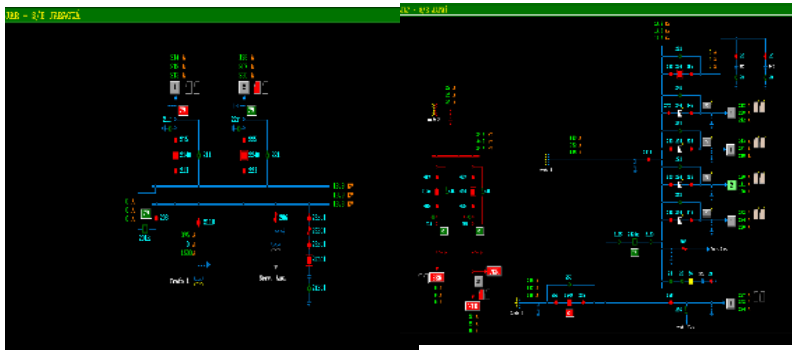



# DEMAIS EVIDÊNCIAS

## DADOS TÉCNICO - OPERACIONAIS ENEL GO

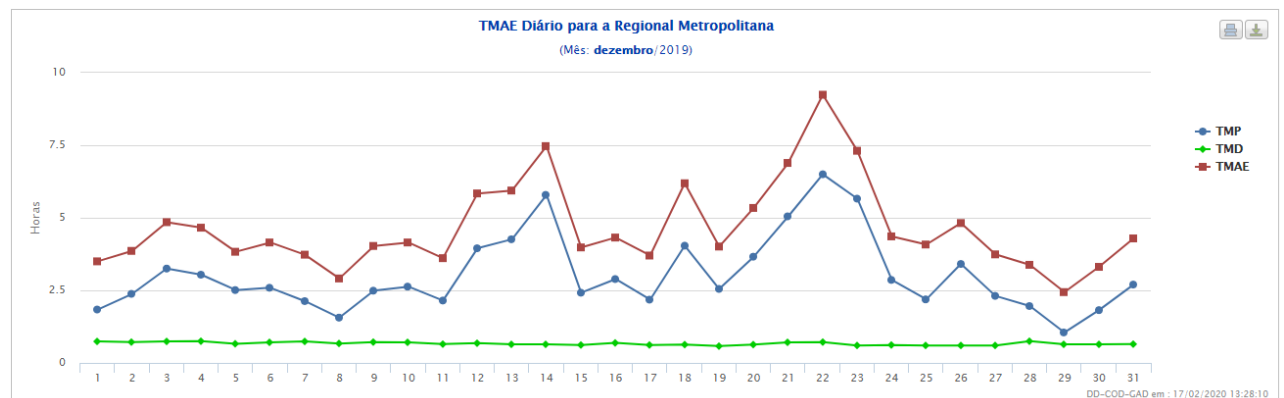
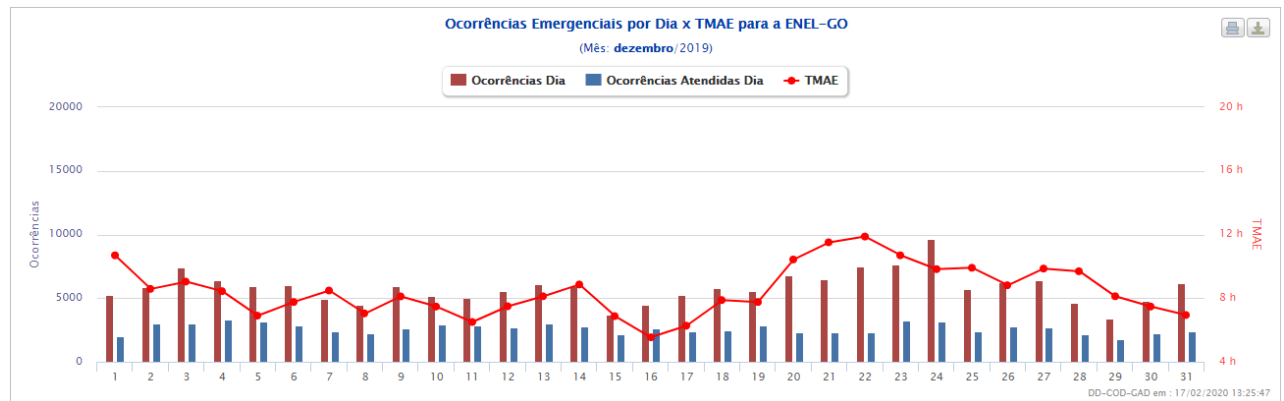
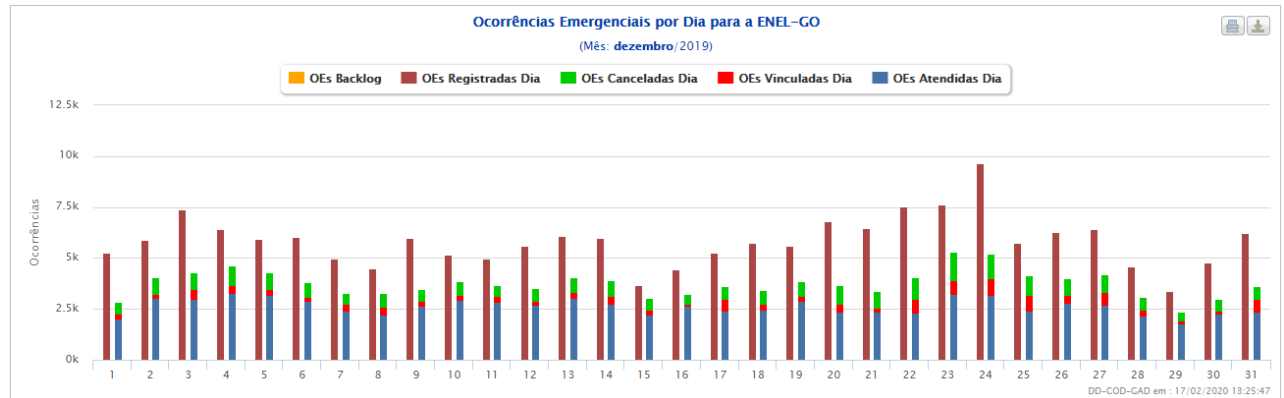
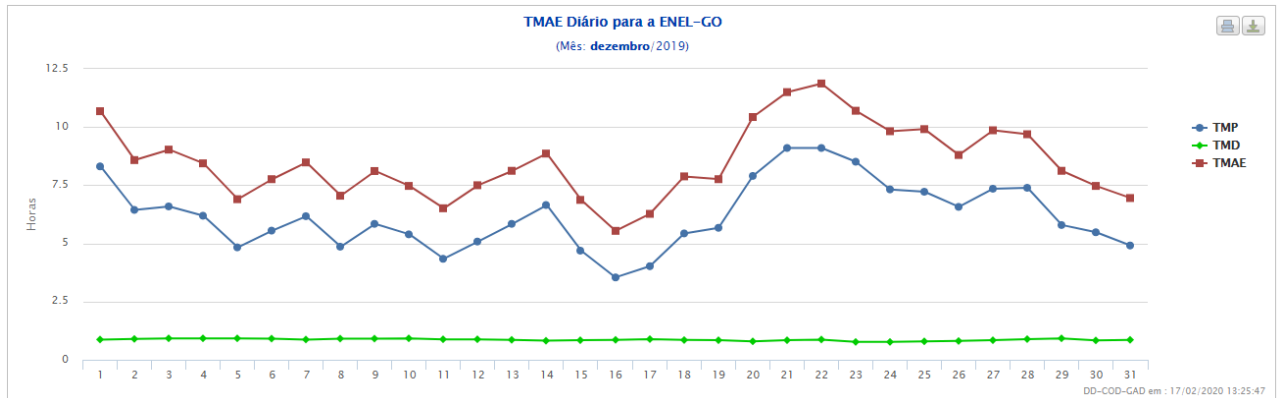

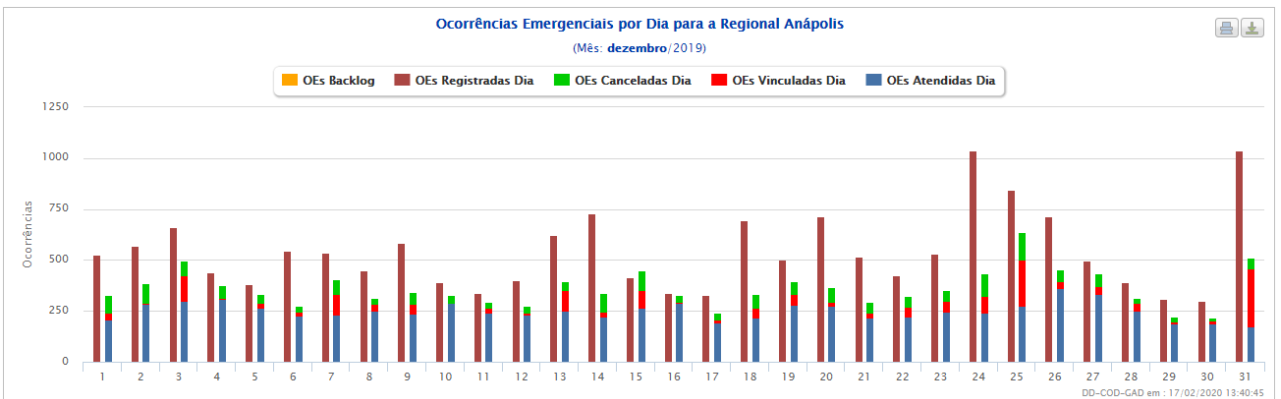
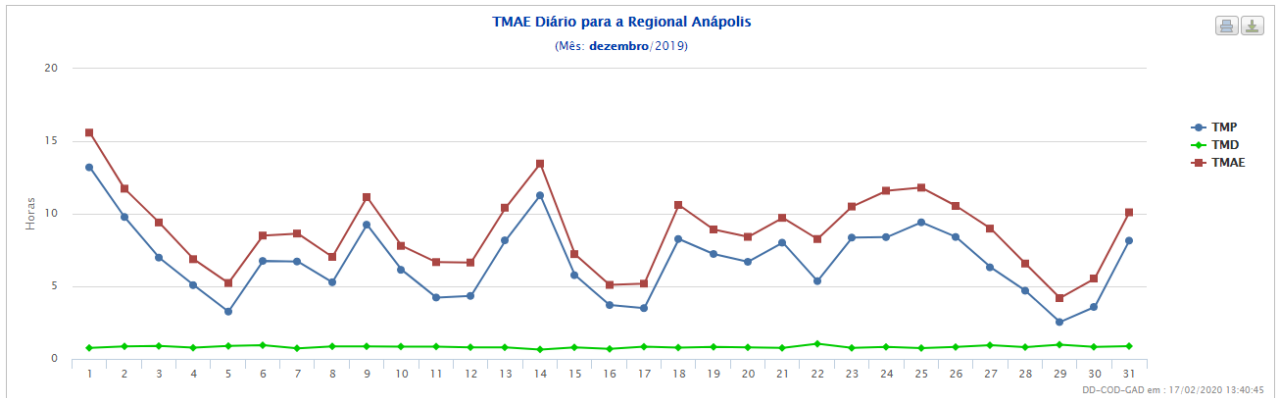
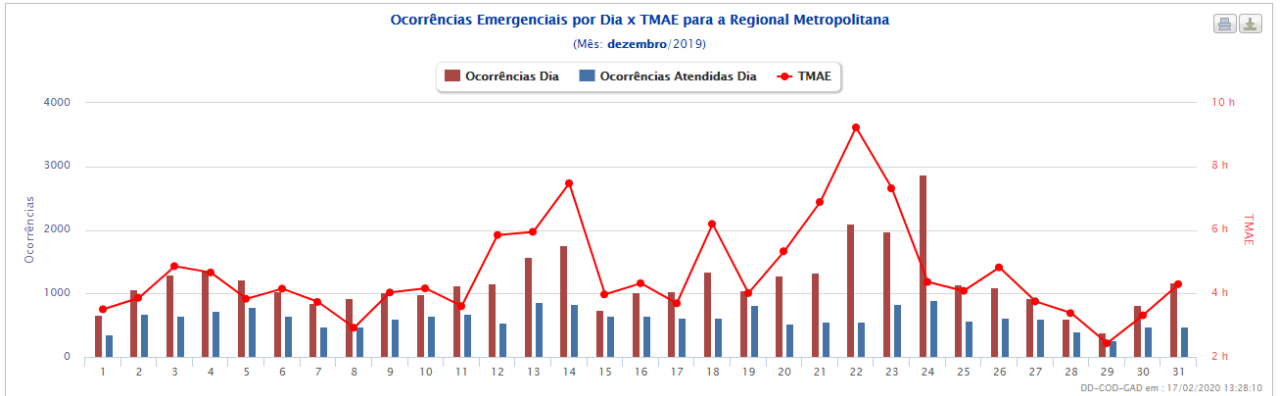
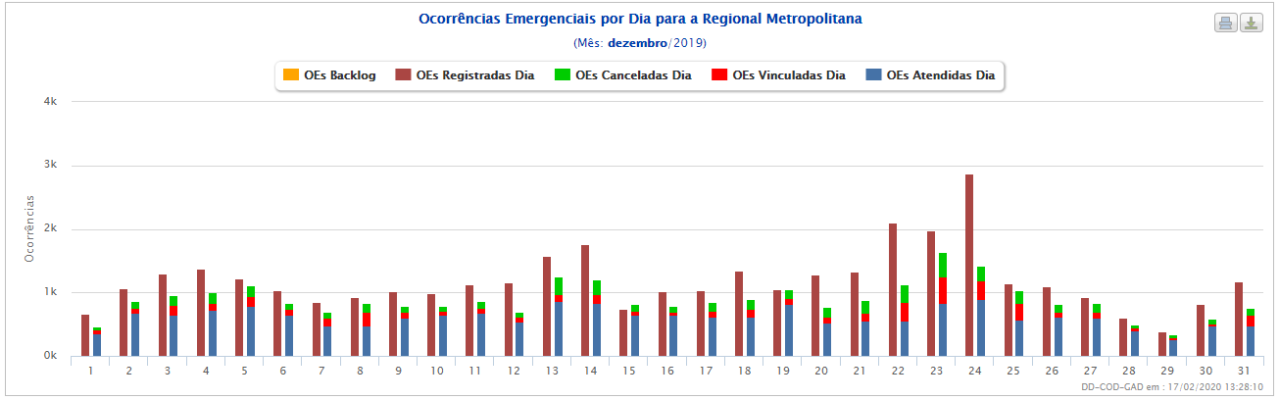

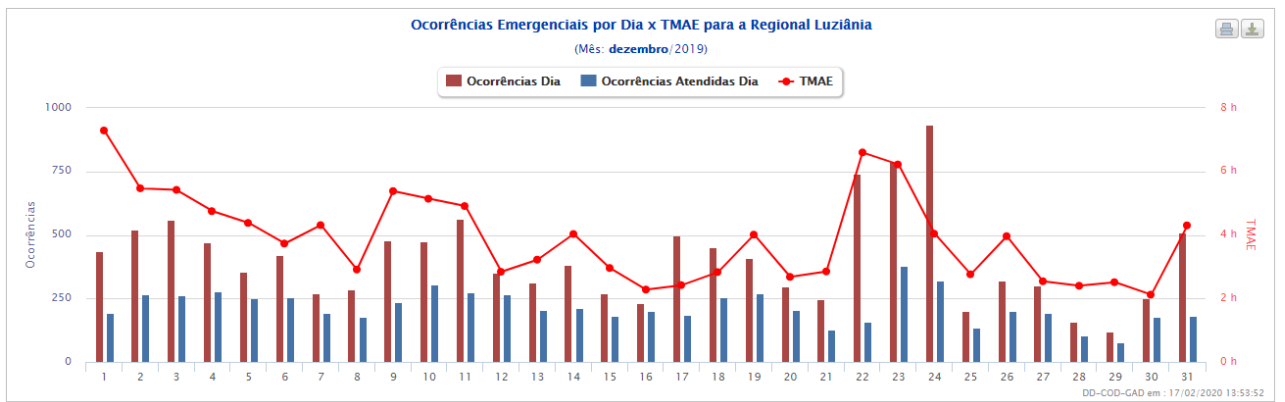
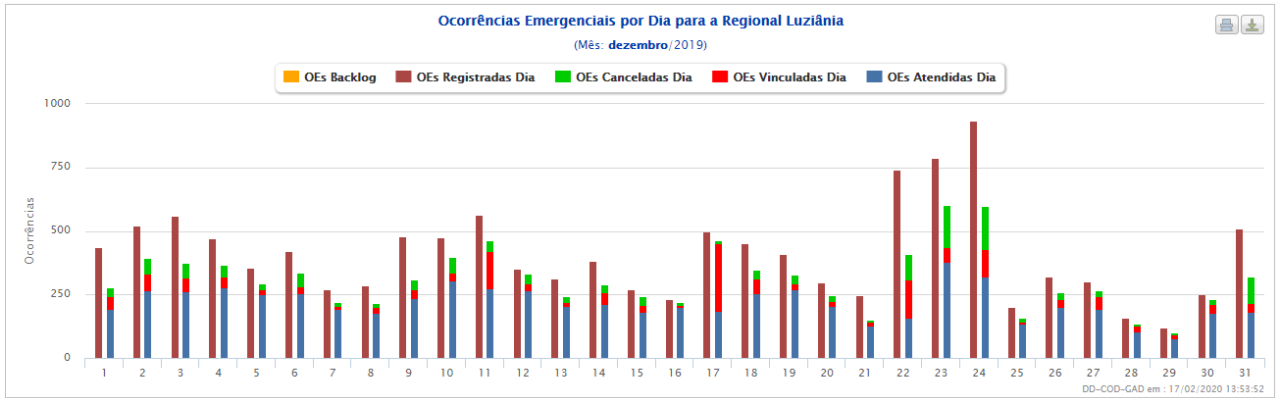
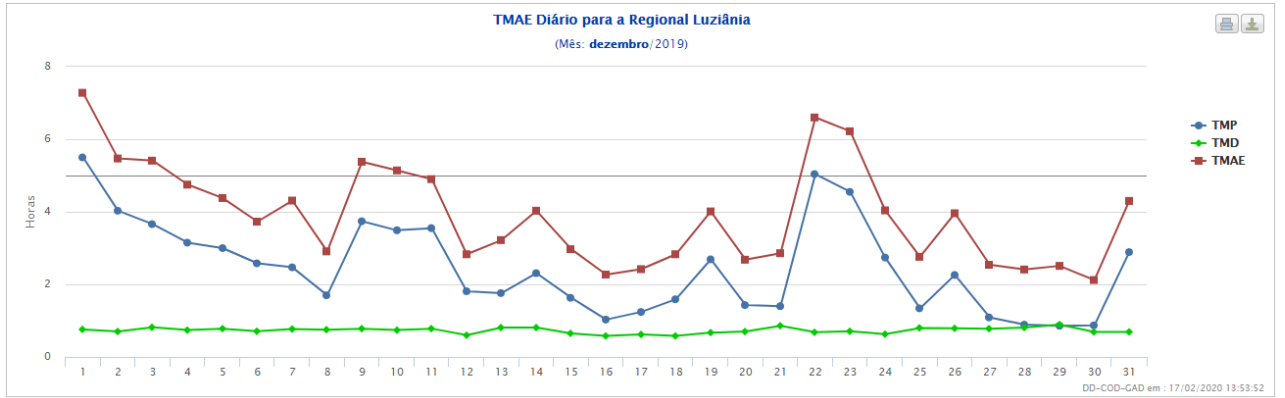
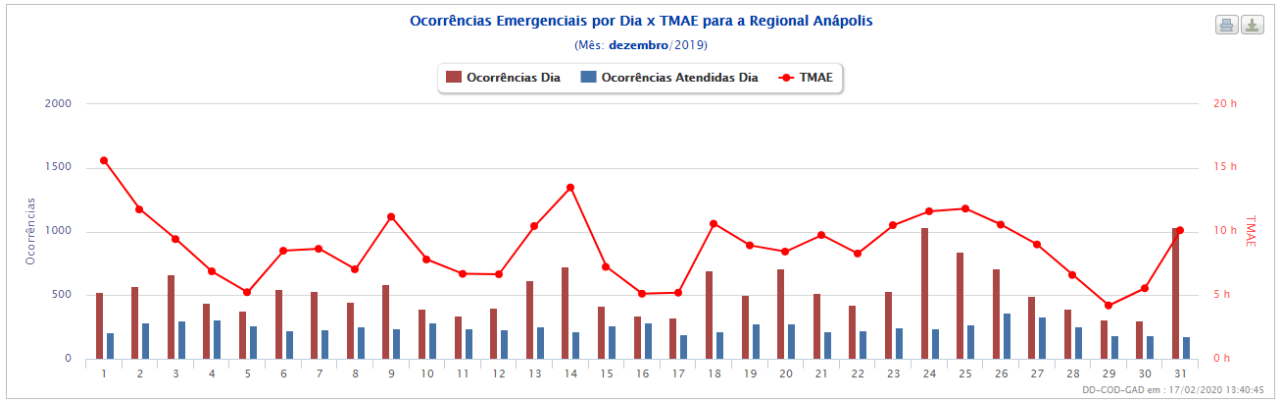

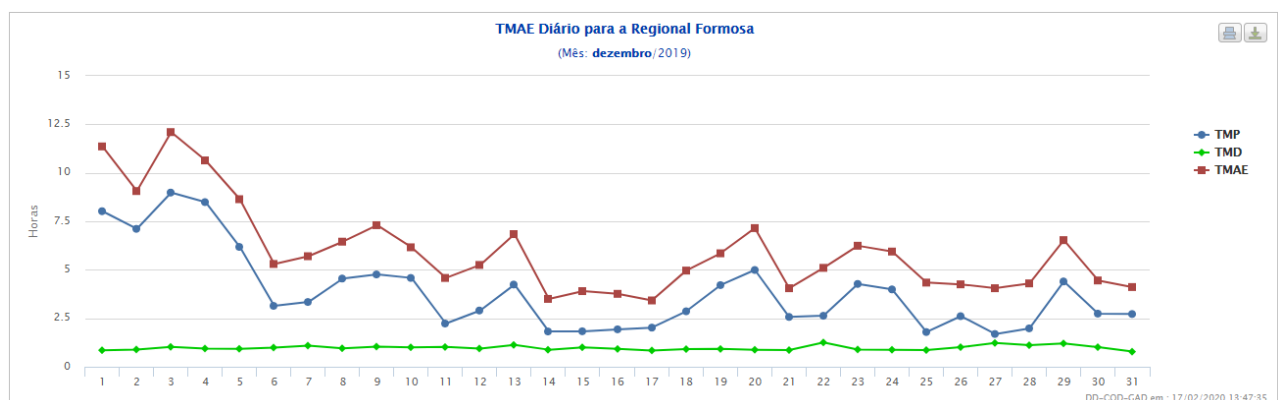
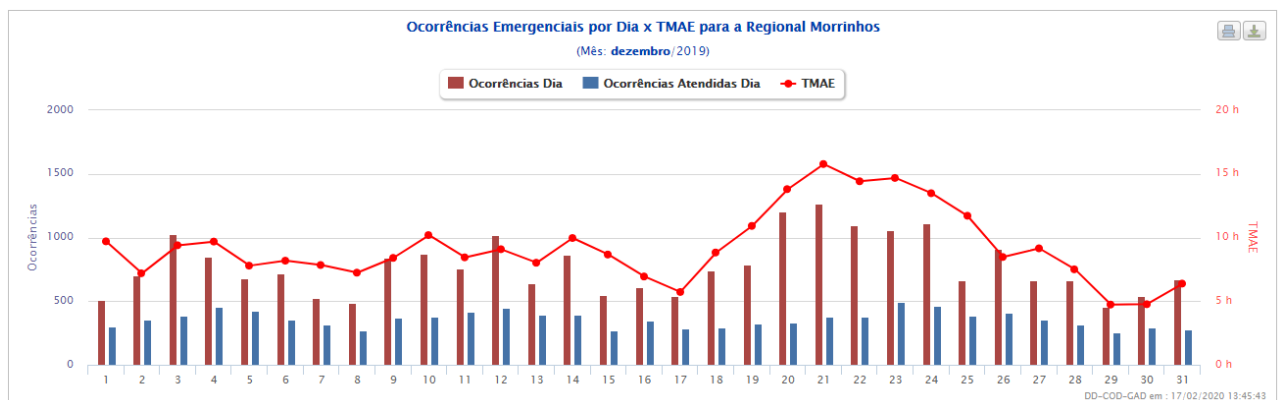
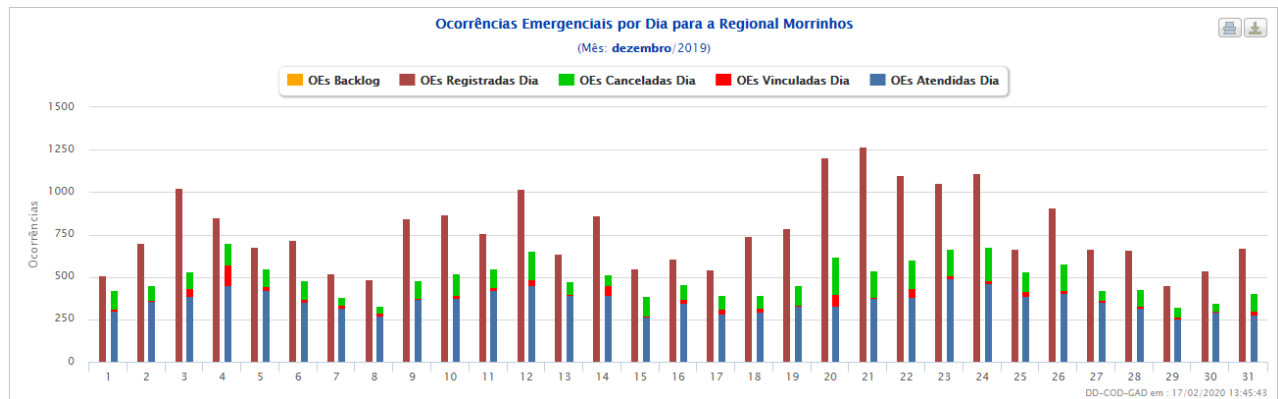
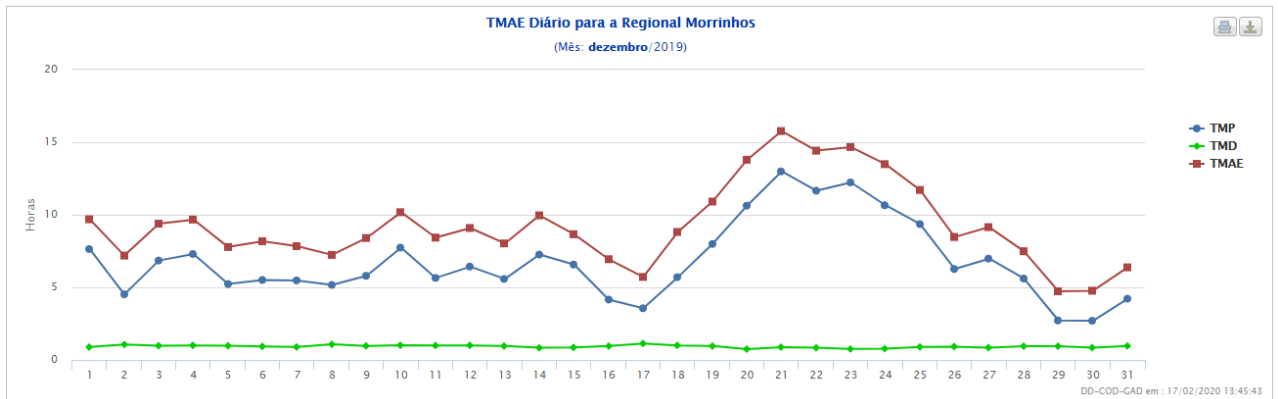

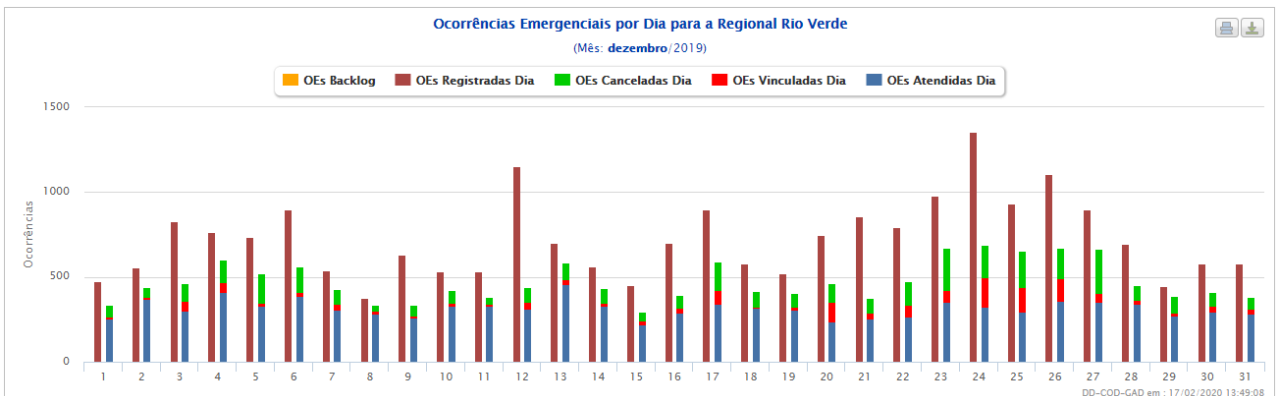
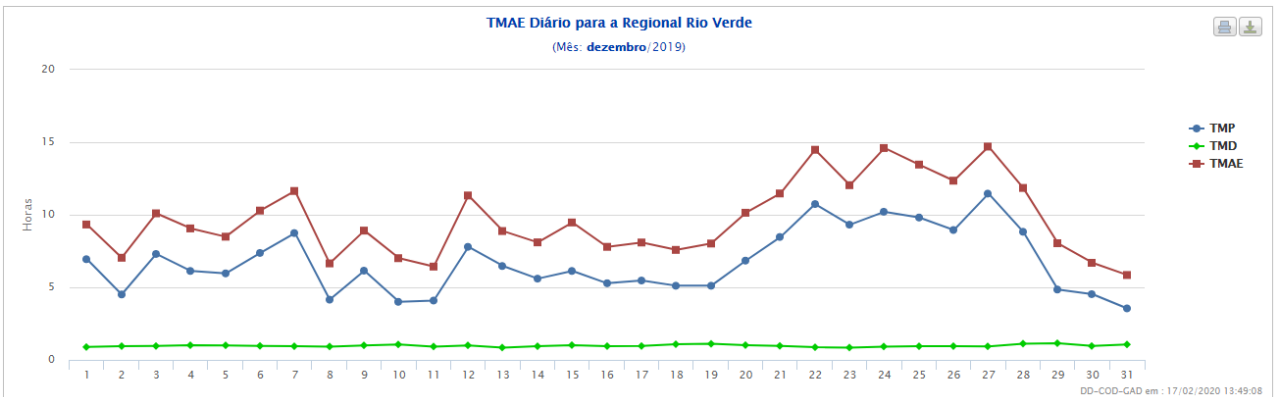
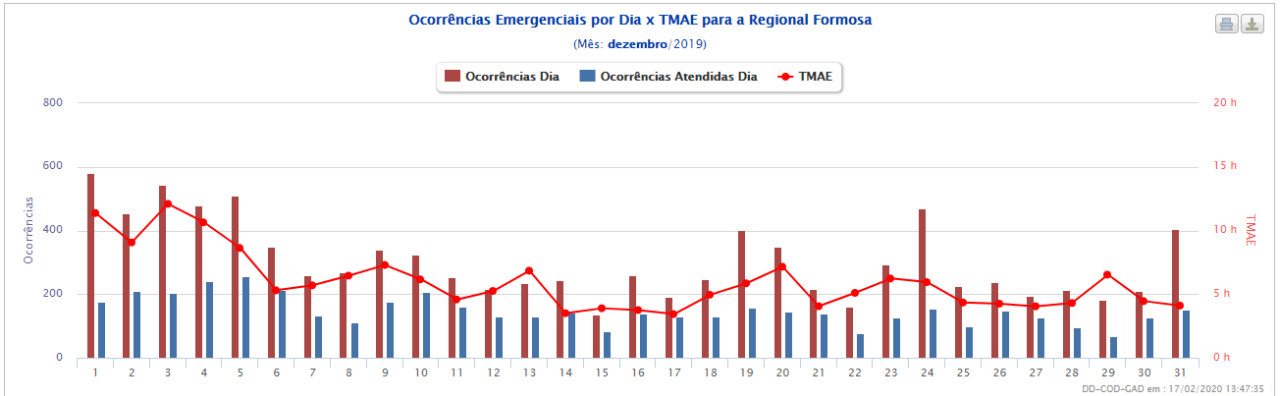
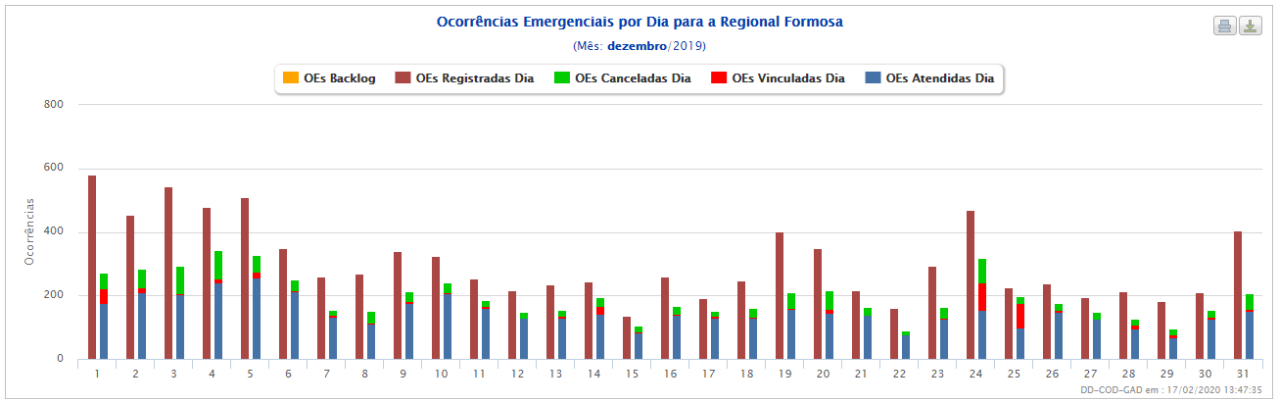

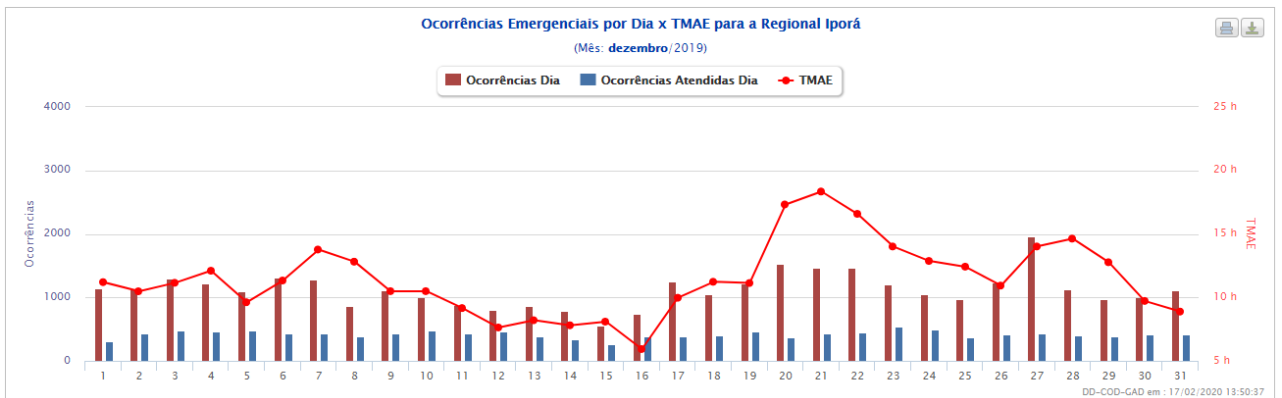
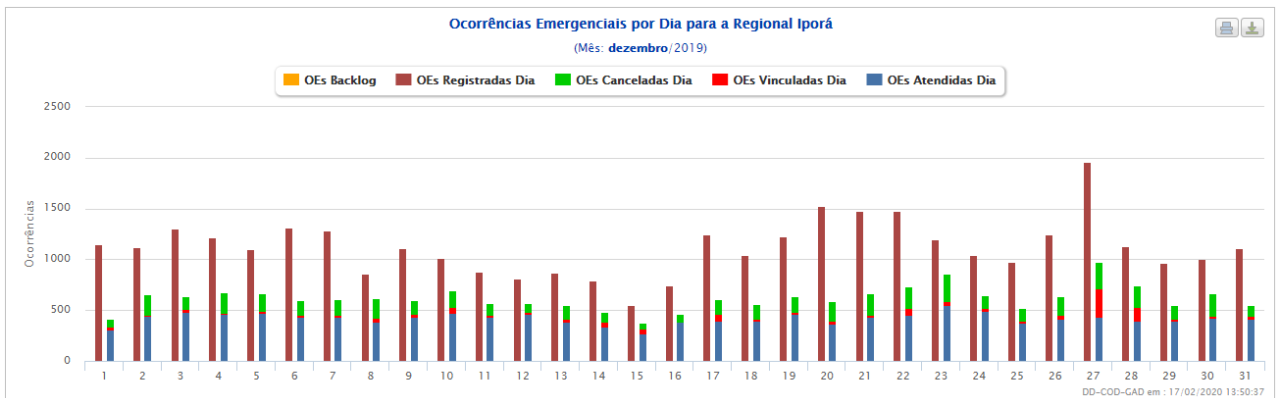
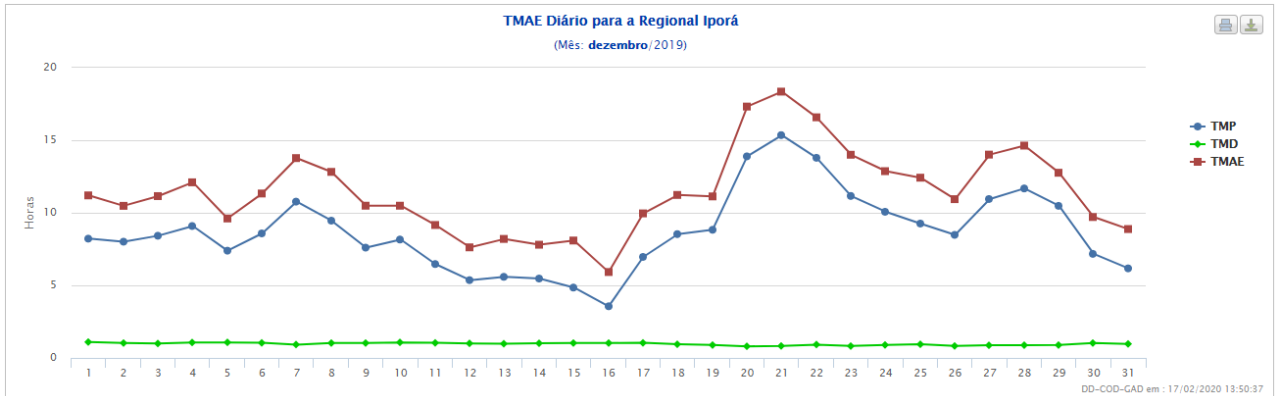
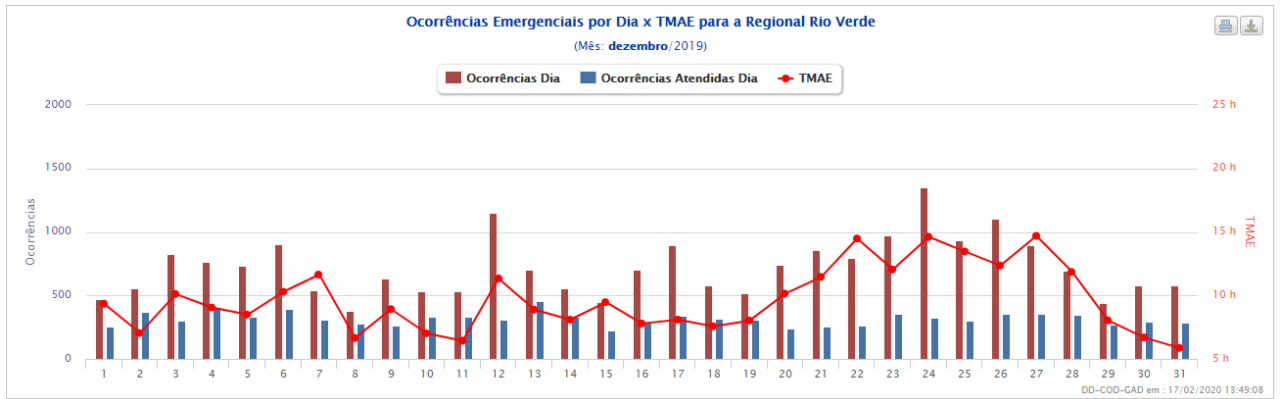

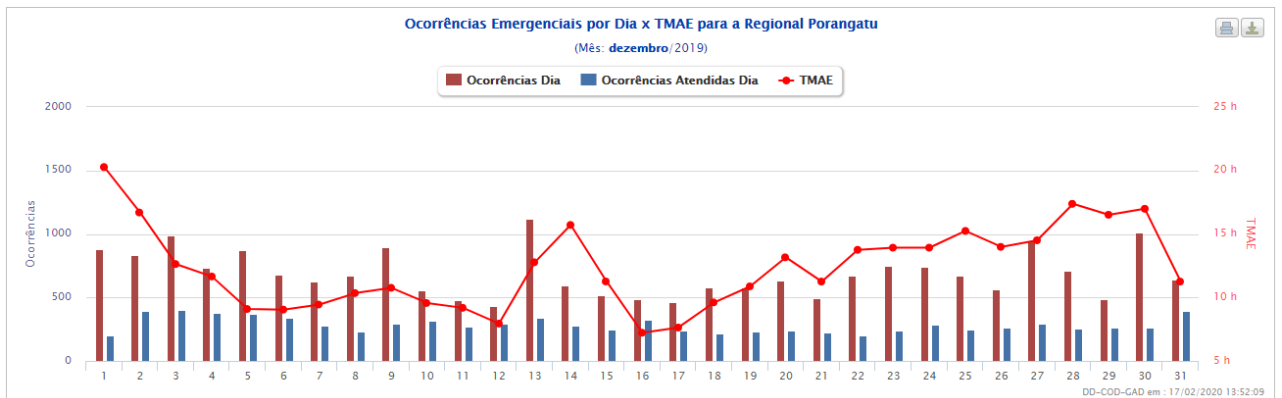
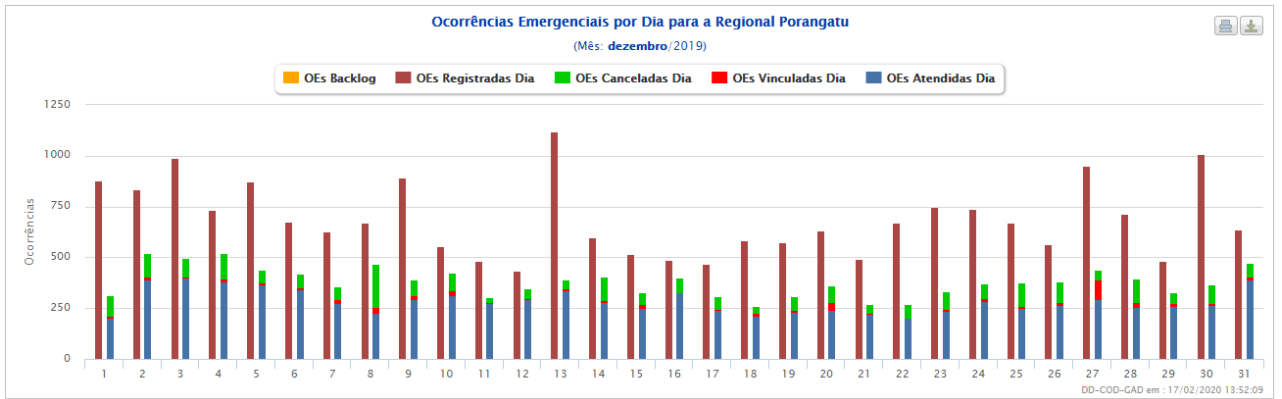
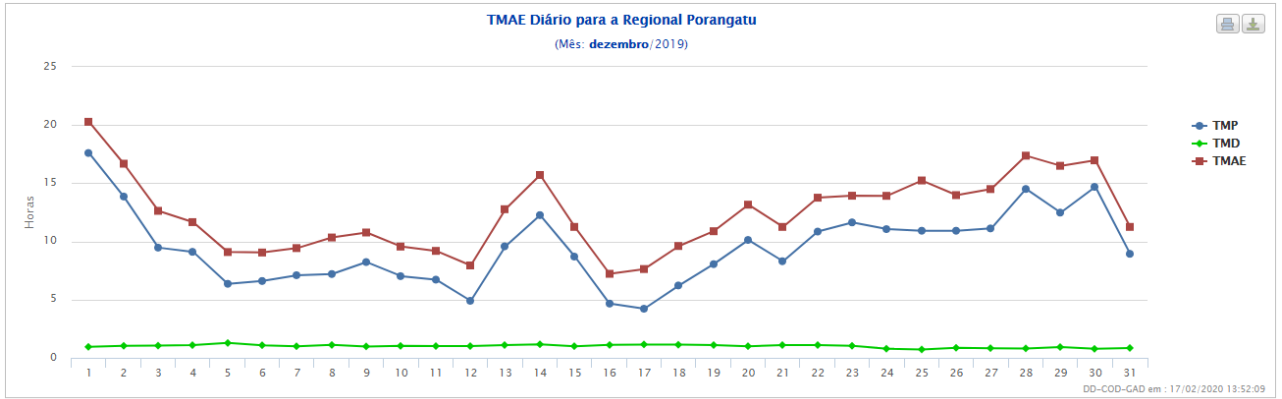

CLIMATEMPO

**Laudo Meteorológico de Evento Climático  
- CELG Distribuição S.A. - 06 de  
dezembro de 2019**

São Paulo, SP,  
Brasil Janeiro de  
2020



## Sumário

<b>1</b>	<b>ANÁLISE DE EVENTO METEOROLÓGICO .....</b>	<b>2</b>
<b>1.1</b>	<b>Descrição do Evento.....</b>	<b>2</b>
<b>1.2</b>	<b>Abrangência do Evento .....</b>	<b>7</b>
<b>2</b>	<b>CLASSIFICAÇÃO COBRADE .....</b>	<b>19</b>
<b>3</b>	<b>RESUMO DO EVENTO .....</b>	<b>20</b>
<b>4</b>	<b>REFERÊNCIAS.....</b>	<b>24</b>

# 1 Análise de Evento Meteorológico

## 1.1 Descrição do Evento

Na figura a seguir é apresentada a área de concessão da CELG Distribuição, dividida em regiões, a serem analisadas neste relatório.



Figura 1 – Regiões de Goiás atendidas pela CELG Distribuição.

Uma Zona de Convergência de Umidade ajudou a organizar áreas de instabilidade sobre o país entre os dias 06 e 09 de dezembro de 2019. As instabilidades favoreceram a formação de nuvens de tempestade que avançaram sobre o estado de Goiás durante o período.

Nas Figuras 2 e 3 são apresentadas as descargas atmosféricas nuvem-solo (raios) e nuvem-nuvem detectadas pelo sistema Earth Networks. Entre as 07h30 do dia 06 e 08h30 do dia 09 de dezembro foram registrados 31087 raios nuvem-solo e 50449 descargas nuvem-nuvem sobre a área da CELG Distribuição em Goiás.

Estações do Instituto Nacional de Meteorologia (INMET), representativas da área de concessão da CELG Distribuição Goiás, registraram chuva forte (segundo a American Meteorological Society - Sociedade Meteorológica Americana -, chuvas com taxa entre

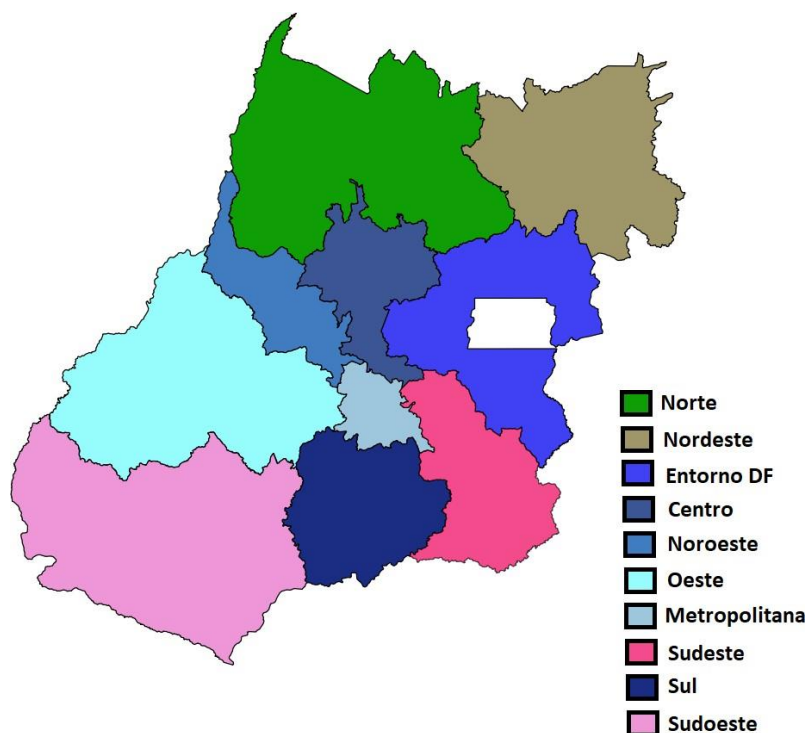
2,5mm a 7,6 mm por hora são consideradas moderadas e aquelas com taxa superior a 7,6 mm por hora são consideradas chuva forte). Na tabela 1 são apresentados os registros de acumulados horários superiores a 7,6 mm. Nas tabelas 2, 3 e 4 são apresentados os maiores acumulados diários registrados pelo INMET em estações no estado de Goiás entre os dias 06 e 09 de dezembro de 2019.

A chuva acumulada entre as 09h00 do dia 06 e 09h00 do dia 07 de dezembro em Iporá corresponde a aproximadamente 16% da média climatológica (1981-2010) para o mês de dezembro na região, em Porangatu a chuva acumulada entre as 09h00 do dia 07 e 09h00 do dia 08 corresponde a 22% da média para o mês e em Morrinhos o acumulado de chuva entre 09h00 do dia 08 e 09h00 do dia 09 corresponde a aproximadamente 20% da média climatológica.

Na tabela 5 são apresentadas as rajadas de vento maiores ou iguais a 50 km/h registradas pelo INMET entre os dias 06 e 09 de dezembro. O maior valor de rajada registrado foi de 53,6 km/h entre as 15h e 16h do dia 08 na estação de Caiapônia. Segundo a escala Beaufort, ventos com tal intensidade podem ser classificados como vento forte.



Figura 2 – Descargas atmosféricas nuvem-solo (em preto) detectadas pelo sistema Earth Networks entre 07h30 do dia 06 e 08h30 do dia 09 de dezembro de 2019 sobre a área de concessão da CELG Distribuição.



Figura 3 – Descargas atmosféricas nuvem-nuvem (em vermelho) detectadas pelo sistema Earth Networks entre 07h30 do dia 06 e 08h30 do dia 09 de dezembro de 2019 sobre a área de concessão da CELG Distribuição.

Tabela 1 – Acumulado horário de chuva registrada pelo INMET.

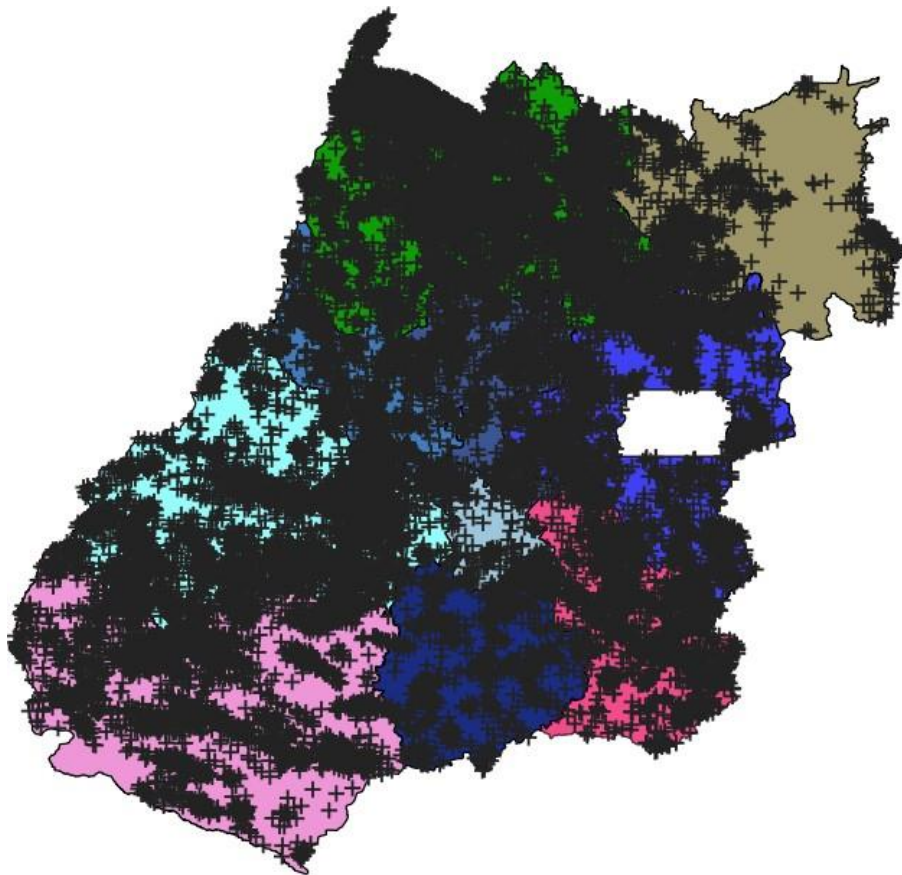
Estação	Horário	Precipitação (mm)
Alto Araguaia	Entre 14h e 15h do dia 6/12/2019	28.
Alto Paraíso de Goiás	Entre 10h e 11h do dia 6/12/2019	31.4
Aragarças	Entre 17h e 18h do dia 6/12/2019	10.2
Caiapônia	Entre 14h e 15h do dia 6/12/2019	12.4
Caiapônia	Entre 1h e 2h do dia 7/12/2019	8.0
Caiapônia	Entre 15h e 16h do dia 8/12/2019	12.6
Catalão	Entre 16h e 17h do dia 7/12/2019	10.0
Goianésia	Entre 16h e 17h do dia 6/12/2019	8.2
Goiânia	Entre 12h e 13h do dia 7/12/2019	9.2
Goiás	Entre 19h e 20h do dia 6/12/2019	15.6
Iporá	Entre 18h e 19h do dia 6/12/2019	21.0
Itumbiara	Entre 19h e 20h do dia 6/12/2019	8.4
Jataí	Entre 15h e 16h do dia 6/12/2019	12.8
Luziânia	Entre 12h e 13h do dia 7/12/2019	7.8
Luziânia	Entre 13h e 14h do dia 8/12/2019	14.6
Luziânia	Entre 14h e 15h do dia 8/12/2019	10.4

Mineiros	Entre 16h e 17h do dia 8/12/2019	8.0
Morrinhos	Entre 16h e 17h do dia 6/12/2019	10.8
Morrinhos	Entre 13h e 14h do dia 8/12/2019	11.8
Morrinhos	Entre 14h e 15h do dia 8/12/2019	37.4
Paraúna	Entre 17h e 18h do dia 7/12/2019	45.4
Pires do Rio	Entre 14h e 15h do dia 7/12/2019	24.0
Pires do Rio	Entre 16h e 17h do dia 7/12/2019	12.2
Pires do Rio	Entre 18h e 19h do dia 8/12/2019	10.2
Silvânia	Entre 13h e 14h do dia 6/12/2019	14.4

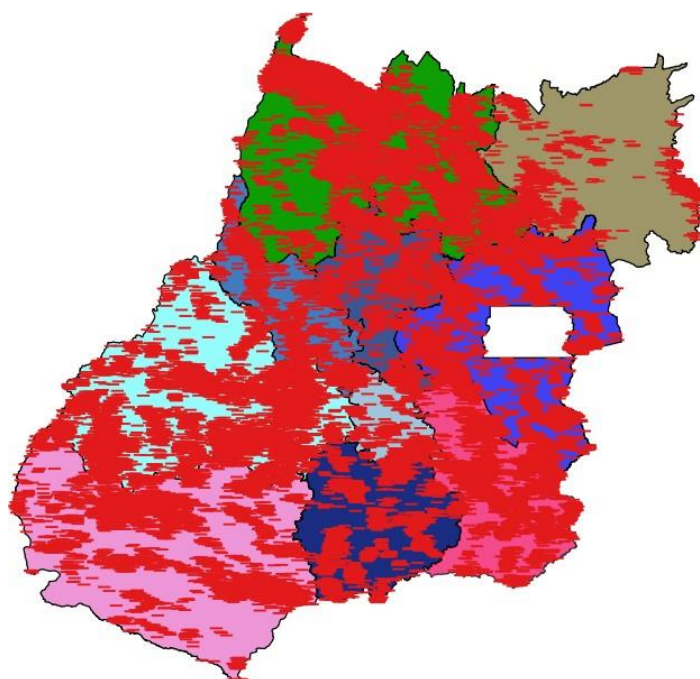
Tabela 2 – Precipitação acumulada entre 09h do dia 06 e 09h do dia 07 de dezembro de 2019. FONTE: INMET

Estação	Precipitação Acumulada(mm)
IPORÁ	49,2
CAIAPONIA	33,0
ALTO PARAISO DE GOIAS	33,0

Tabela 3 – Precipitação acumulada entre 09h do dia 07 e 09h do dia 08 de dezembro de 2019. FONTE: INMET

Estação	Precipitação Acumulada(mm)
PORANGATU	55,4
PARAUNA	53,0
PIRES DO RIO	43,4

Tabela 4 – Precipitação acumulada entre 09h do dia 08 e 09h do dia 09 de dezembro de 2019. FONTE: INMET

Estação	Precipitação Acumulada(mm)
MORRINHOS	50,4
ITAPACI	41,6

Tabela 5 – Rajadas de vento maiores ou iguais a 50 km/h registradas pelo INMET. Segundo a escala Beaufort, ventos entre 50 e 61 km/h são classificados como vento forte.

Estação	Horário	Rajada (km/h)
Caiapônia	Entre 13h e 14h do dia 6/12/2019	50.0
Caiapônia	Entre 14h e 15h do dia 6/12/2019	50.0
Caiapônia	Entre 15h e 16h do dia 8/12/2019	53.6
Luziânia	Entre 13h e 14h do dia 8/12/2019	52.6
Mineiros	Entre 15h e 16h do dia 6/12/2019	54.0

## 1.2 Abrangência do Evento

A seguir são apresentadas as imagens realçadas do satélite GOES-16 entre as 13h00 do dia 05 e 05h00 do dia 06 de dezembro de 2019. Os tons em vermelho e preto indicam a presença de nuvens de grande desenvolvimento vertical, geralmente associadas à ocorrência de tempo severo.

11h00 - 06 de dezembro de 2019



Figura 4 – Imagens realçadas do satélite GOES-16 das 11h00 do dia 06 de dezembro de 2019.  
FONTE: Cptec/INPE.

13h00 - 06 de dezembro de 2019



Figura 5 – Imagens realçadas do satélite GOES-16 das 13h00 do dia 06 de dezembro de 2019.  
FONTE: Cptec/INPE.



**15h00 - 06 de dezembro de 2019**

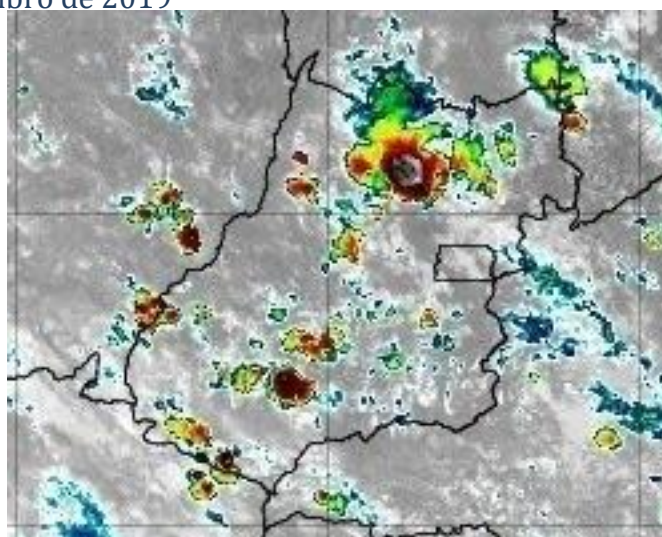

Figura 6 – Imagens realçadas do satélite GOES-16 das 15h00 do dia 06 de dezembro de 2019.  
FONTE: Cptec/INPE.

**17h00 - 06 de dezembro de 2019**

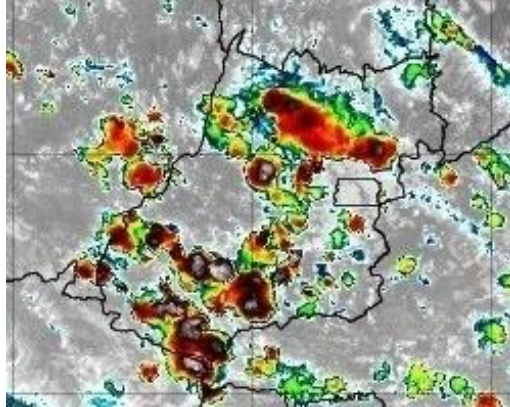

Figura 7 – Imagens realçadas do satélite GOES-16 das 17h00 do dia 06 de dezembro de 2019.  
FONTE: Cptec/INPE.

**19h00 - 06 de dezembro de 2019**



Figura 8 – Imagens realçadas do satélite GOES-16 das 19h00 do dia 06 de dezembro de 2019. FONTE:  
Cptec/INPE.

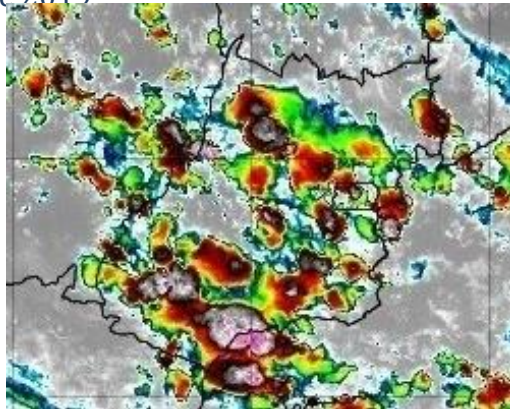

**21h00 - 06 de dezembro de 2019**

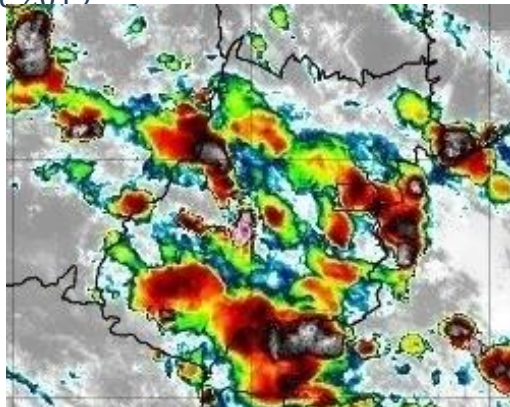

Figura 9 – Imagens realçadas do satélite GOES-16 das 21h00 do dia 06 de dezembro de 2019. FONTE: Cptec/INPE.

**23h00 - 06 de dezembro de 2019**

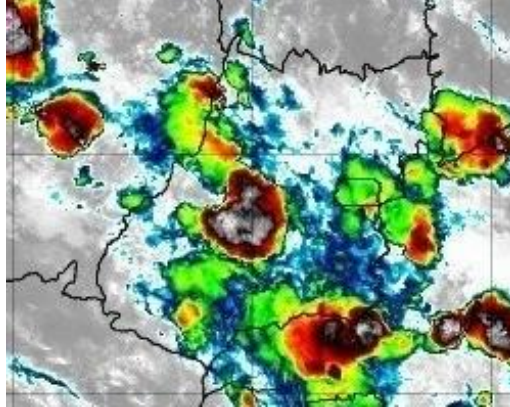

Figura 10 – Imagens realçadas do satélite GOES-16 das 23h00 do dia 06 de dezembro de 2019. FONTE: Cptec/INPE.

**01h00 - 07 de dezembro de 2019**

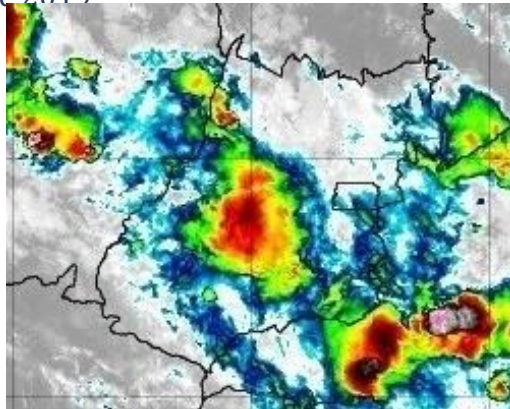

Figura 11 – Imagens realçadas do satélite GOES-16 das 01h00 do dia 07 de dezembro de 2019. FONTE: Cptec/INPE.

03h00 - 07 de dezembro de 2019

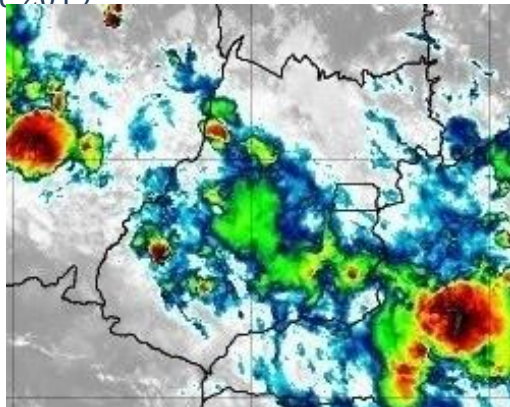

Figura 12 – Imagens realçadas do satélite GOES-16 das 03h00 do dia 07 de dezembro de 2019. FONTE: Cptec/INPE.

05h00 - 07 de dezembro de 2019

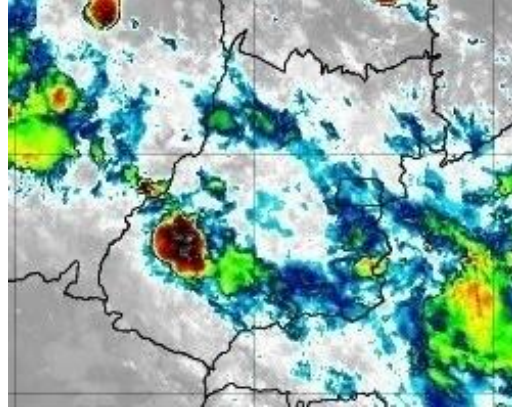

Figura 13 – Imagens realçadas do satélite GOES-16 das 05h00 do dia 07 de dezembro de 2019. FONTE: Cptec/INPE.

07h00 - 07 de dezembro de 2019

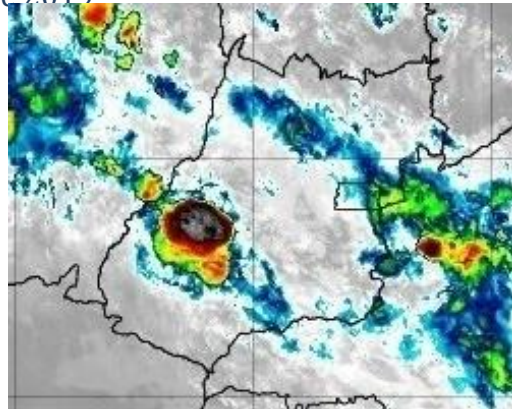

Figura 14 – Imagens realçadas do satélite GOES-16 das 07h00 do dia 07 de dezembro de 2019. FONTE: Cptec/INPE.

**09h00 - 07 de dezembro de 2019**

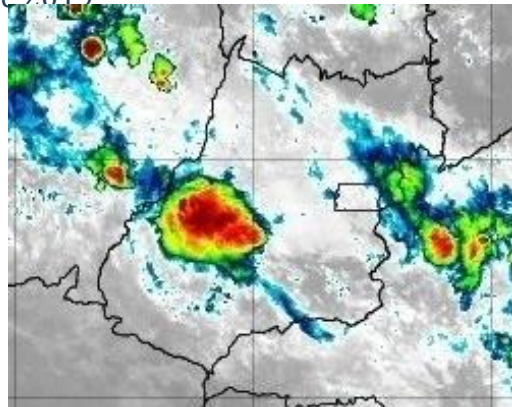

Figura 15 – Imagens realçadas do satélite GOES-16 das 09h00 do dia 07 de dezembro de 2019. FONTE: Cptec/INPE.

11h00 - 07 de dezembro de 2019



Figura 16 – Imagens realçadas do satélite GOES-16 das 11h00 do dia 07 de dezembro de 2019. FONTE: Cptec/INPE.

13h00 - 07 de dezembro de 2019



Figura 17 – Imagens realçadas do satélite GOES-16 das 13h00 do dia 07 de dezembro de 2019. FONTE: Cptec/INPE.

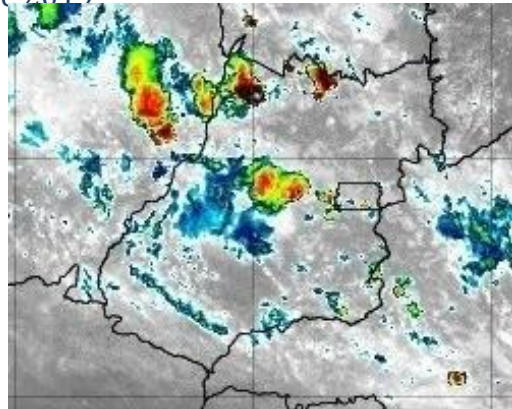

15h00 - 07 de dezembro de 2019

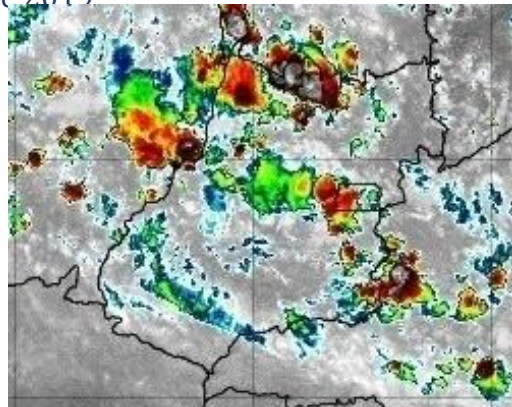

Figura 18 – Imagens realçadas do satélite GOES-16 das 15h00 do dia 07 de dezembro de 2019.  
FONTE: Cptec/INPE.

17h00 - 07 de dezembro de 2019

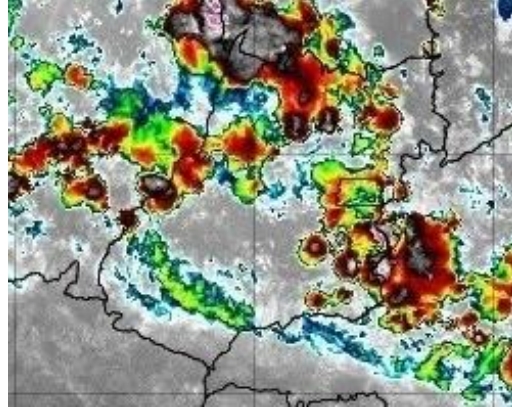

Figura 19 – Imagens realçadas do satélite GOES-16 das 17h00 do dia 07 de dezembro de 2019.  
FONTE: Cptec/INPE.

19h00 - 07 de dezembro de 2019

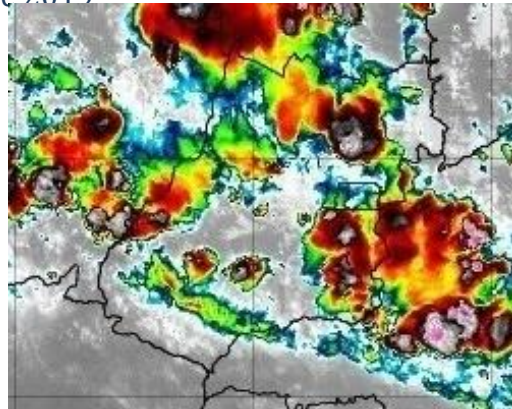

Figura 20 – Imagens realçadas do satélite GOES-16 das 19h00 do dia 07 de dezembro de 2019. FONTE:  
Cptec/INPE.

**21h00 - 07 de dezembro de 2019**

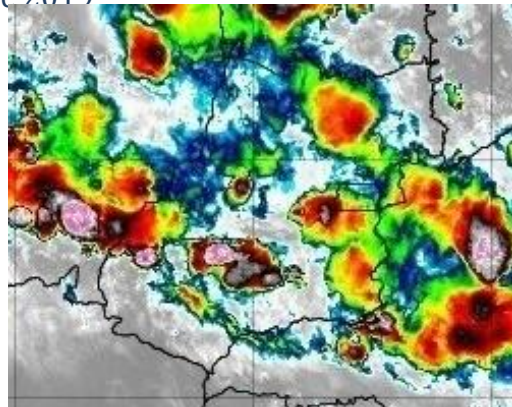

Figura 21 – Imagens realçadas do satélite GOES-16 das 21h00 do dia 07 de dezembro de 2019. FONTE: Cptec/INPE.

23h00 - 07 de dezembro de 2019

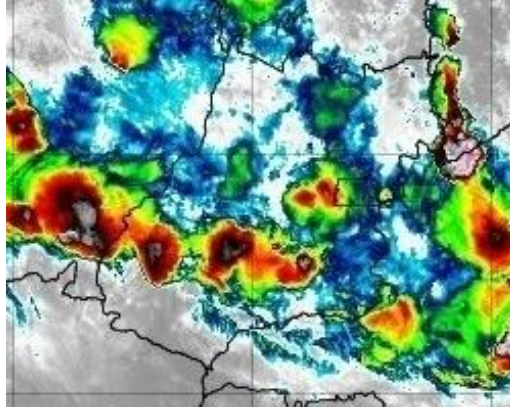

Figura 22 – Imagens realçadas do satélite GOES-16 das 23h00 do dia 07 de dezembro de 2019. FONTE: Cptec/INPE.

01h00 - 08 de dezembro de 2019



Figura 23 – Imagens realçadas do satélite GOES-16 das 01h00 do dia 08 de dezembro de 2019. FONTE: Cptec/INPE.

**03h00 - 08 de dezembro de 2019**

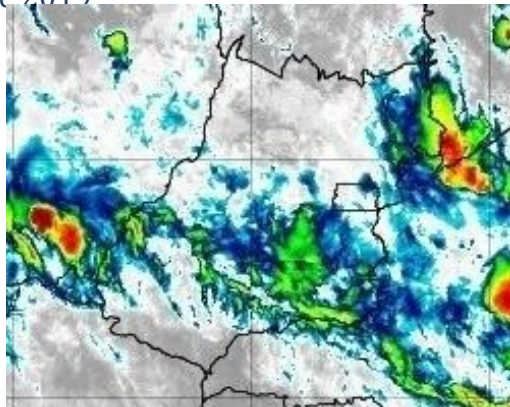

Figura 24 – Imagens realçadas do satélite GOES-16 das 03h00 do dia 08 de dezembro de 2019. FONTE: Cptec/INPE.

**05h00 - 08 de dezembro de 2019**

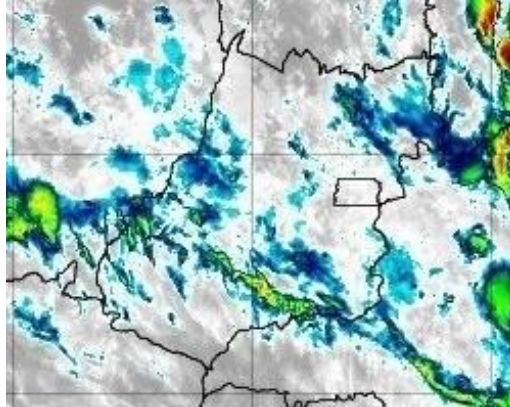

Figura 25 – Imagens realçadas do satélite GOES-16 das 05h00 do dia 08 de dezembro de 2019. FONTE: Cptec/INPE.

**07h00 - 08 de dezembro de 2019**



Figura 26 – Imagens realçadas do satélite GOES-16 das 07h00 do dia 08 de dezembro de 2019. FONTE: Cptec/INPE.



**09h00 - 08 de dezembro de 2019**

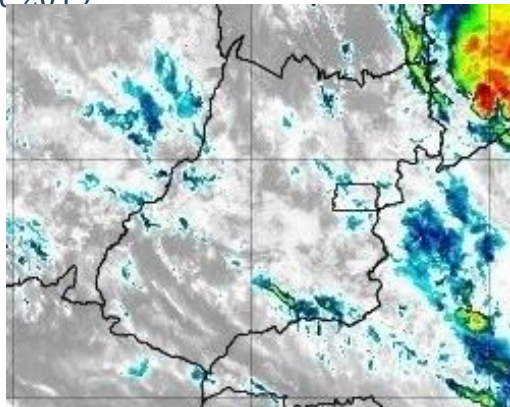

Figura 27 – Imagens realçadas do satélite GOES-16 das 09h00 do dia 08 de dezembro de 2019. FONTE: Cptec/INPE.

**11h00 - 08 de dezembro de 2019**

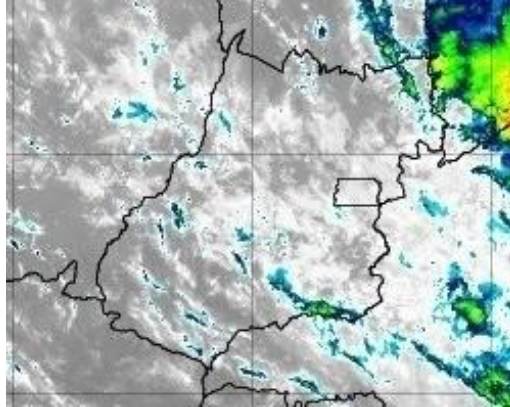

Figura 28 – Imagens realçadas do satélite GOES-16 das 11h00 do dia 08 de dezembro de 2019. FONTE: Cptec/INPE.

**13h00 - 08 de dezembro de 2019**

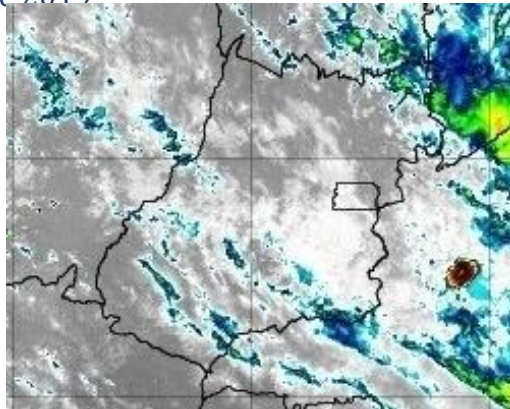

Figura 29 – Imagens realçadas do satélite GOES-16 das 13h00 do dia 08 de dezembro de 2019. FONTE: Cptec/INPE.

15h00 - 08 de dezembro de 2019

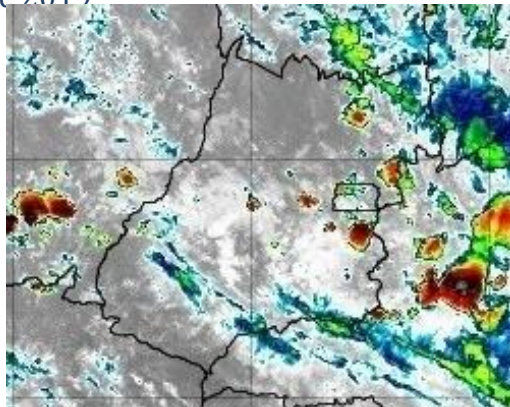

Figura 30 – Imagens realçadas do satélite GOES-16 das 15h00 do dia 08 de dezembro de 2019. FONTE: Cptec/INPE.

17h00 - 08 de dezembro de 2019

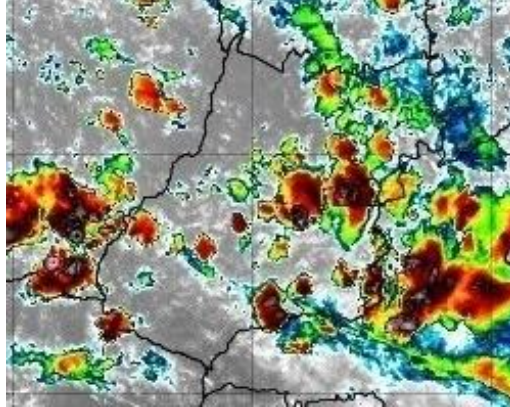

Figura 31 – Imagens realçadas do satélite GOES-16 das 17h00 do dia 08 de dezembro de 2019. FONTE: Cptec/INPE.

19h00 - 08 de dezembro de 2019



Figura 32 – Imagens realçadas do satélite GOES-16 das 19h00 do dia 08 de dezembro de 2019. FONTE: Cptec/INPE.

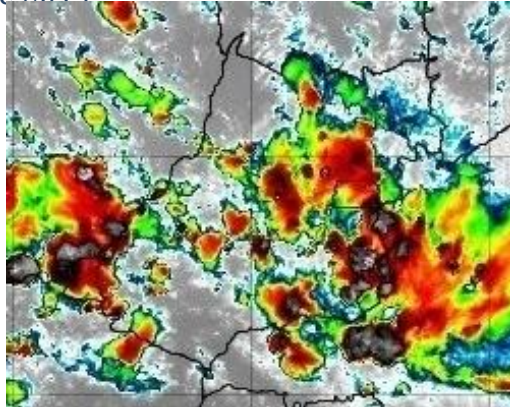

**21h00 - 08 de dezembro de 2019**

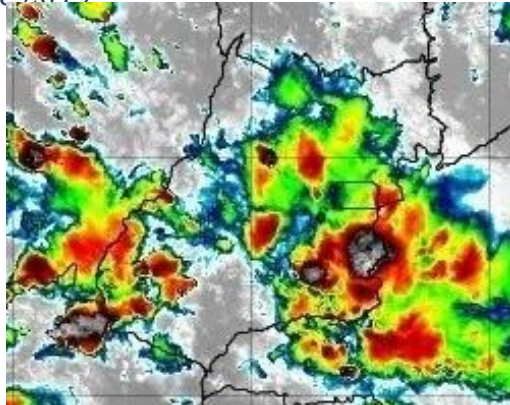

Figura 33 – Imagens realçadas do satélite GOES-16 das 21h00 do dia 08 de dezembro de 2019. FONTE: Cptec/INPE.

**23h00 - 08 de dezembro de 2019**

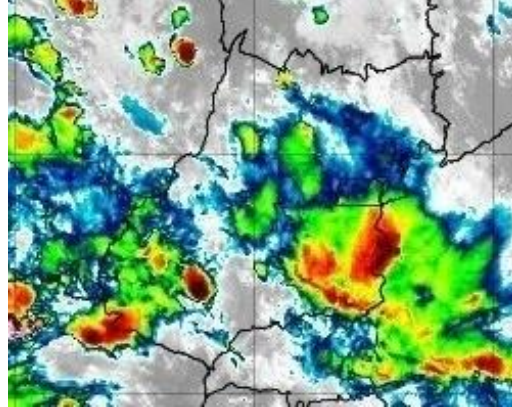

Figura 34 – Imagens realçadas do satélite GOES-16 das 23h00 do dia 08 de dezembro de 2019. FONTE: Cptec/INPE.

**01h00 - 09 de dezembro de 2019**

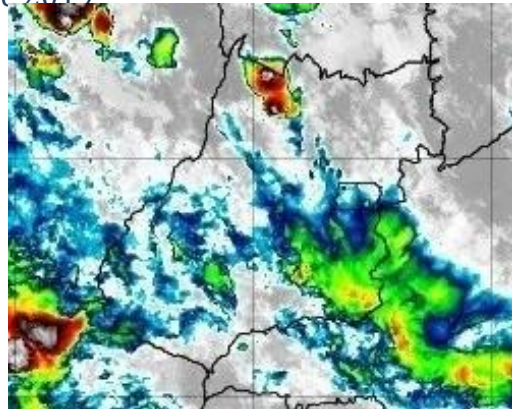

Figura 35 – Imagens realçadas do satélite GOES-16 das 01h00 do dia 09 de dezembro de 2019. FONTE: Cptec/INPE.

03h00 - 09 de dezembro de 2019

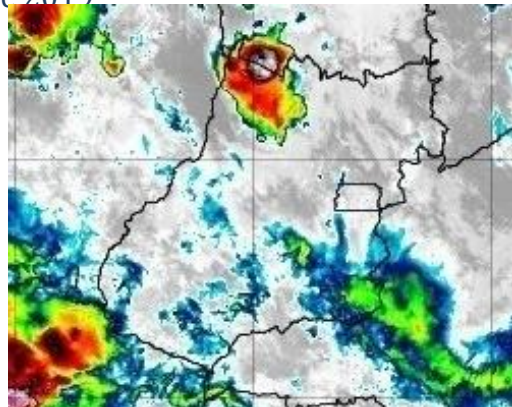

Figura 36 – Imagens realçadas do satélite GOES-16 das 03h00 do dia 09 de dezembro de 2019. FONTE: Cptec/INPE.

05h00 - 09 de dezembro de 2019

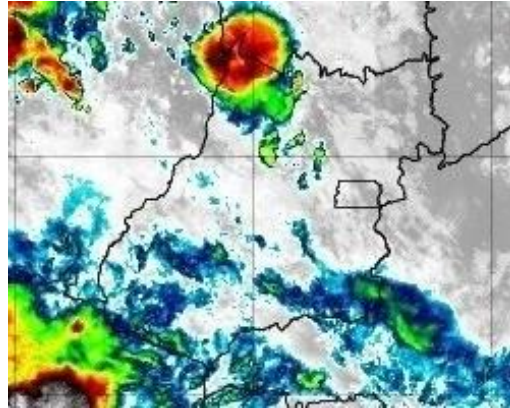

Figura 37 – Imagens realçadas do satélite GOES-16 das 05h00 do dia 09 de dezembro de 2019. FONTE: Cptec/INPE.

## 2 Classificação COBRADE

O COBRADE (Classificação e Codificação Brasileira de Desastres) foi criado com o intuito de adequar a classificação brasileira à classificação utilizada pela ONU na classificação de desastres e nivelar o país aos demais organismos de gestão de desastres do mundo.

Baseados nos dados analisados nos itens anteriores, podemos classificar o evento ocorrido na CELG Distribuição como Zona de Convergência (Código COBRADE 1.3.1.2.0).

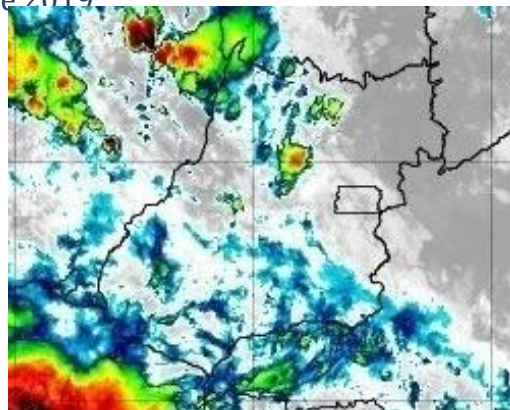
### 3 Resumo do Evento

Áreas de instabilidade organizadas por uma Zona de Convergência de Umidade favoreceram a formação de nuvens de tempestade que atuaram sobre o estado de Goiás entre a manhã do dia 06 e a manhã do dia 09 de dezembro de 2019

O sistema de detecção da EarthNetworks registrou 81536 descargas atmosféricas sobre a área de concessão da CELG Distribuição Goiás entre as 07h30 do dia 06 e 08h30 do dia 09 de dezembro de 2019. Estações do INMET representativas da região de interesse registraram chuva e vento forte durante o período.

A chuva acumulada entre os dias 06 e 07 de dezembro em Iporá corresponde a aproximadamente 16% da média climatológica (1981-2010) para o mês de dezembro na região, em Porangatu a chuva acumulada entre os dias 07 e 08 de dezembro corresponde a 22% da média para o mês e em Morrinhos o acumulado de chuva entre os dias 08 e 09 corresponde a aproximadamente 20% da média climatológica.

Tabela 6 – Resumo do evento Região Sudoeste

Número/Código do Evento	
Número/Código do Relatório	
Descrição	Região ligada à tempestade causada por uma zona de baixa pressão atmosférica, provocando forte deslocamento de massas de ar, vendavais, chuvas intensa e possível queda de granizo.
Código COBRADE	1.3.1.2.0 – Zona de Convergência
Hora início do evento	10h30 do dia 06 de dezembro de 2019
Hora de fim do evento	22h00 do dia 08 de dezembro de 2019
Abrangência	Região Sudoeste da CELG Distribuição S.A.

Tabela 7 – Resumo do evento Região Sul

Número/Código do Evento	
Número/Código do Relatório	
Descrição	Região ligada à tempestade causada por uma zona de baixa pressão atmosférica, provocando forte deslocamento de massas de ar, vendavais, chuvas intensa e possível queda de granizo.
Código COBRADE	1.3.1.2.0 – Zona de Convergência
Hora início do evento	11h30 do dia 06 de dezembro de 2019
Hora de fim do evento	21h00 do dia 08 de dezembro de 2019
Abrangência	Região Sul da CELG Distribuição S.A.

Tabela 8 – Resumo do evento Região Sudeste

Número/Código do Evento	
Número/Código do Relatório	
Descrição	Região ligada à tempestade causada por uma zona de baixa pressão atmosférica, provocando forte deslocamento de massas de ar, vendavais, chuvas intensa e possível queda de granizo.
Código COBRADE	1.3.1.2.0 – Zona de Convergência
Hora início do evento	12h30 do dia 06 de dezembro de 2019
Hora de fim do evento	20h00 do dia 08 de dezembro de 2019
Abrangência	Região Sudeste da CELG Distribuição S.A.

Tabela 9 – Resumo do evento Região Metropolitana

Número/Código do Evento	
Número/Código do Relatório	
Descrição	Região ligada à tempestade causada por uma zona de baixa pressão atmosférica, provocando forte deslocamento de massas de ar, vendavais, chuvas intensa e possível queda de granizo.
Código COBRADE	1.3.1.2.0 – Zona de Convergência
Hora início do evento	12h00 do dia 06 de dezembro de 2019
Hora de fim do evento	18h30 do dia 08 de dezembro de 2019
Abrangência	Região Metropolitana da CELG Distribuição S.A.

Tabela 10 – Resumo do evento Região Oeste

Número/Código do Evento	
Número/Código do Relatório	
Descrição	Região ligada à tempestade causada por uma zona de baixa pressão atmosférica, provocando forte deslocamento de massas de ar, vendavais, chuvas intensa e possível queda de granizo.
Código COBRADE	1.3.1.2.0 – Zona de Convergência
Hora início do evento	10h30 do dia 06 de dezembro de 2019
Hora de fim do evento	07h00 do dia 09 de dezembro de 2019
Abrangência	Região Oeste da CELG Distribuição S.A.

Tabela 11 – Resumo do evento Região Entorno DF

Número/Código do Evento	
Número/Código do Relatório	
Descrição	Região ligada à tempestade causada por uma zona de baixa pressão atmosférica, provocando forte deslocamento de massas de ar, vendavais, chuvas intensa e possível queda de granizo.
Código COBRADE	1.3.1.2.0 – Zona de Convergência
Hora início do evento	13h00 do dia 06 de dezembro de 2019
Hora de fim do evento	03h00 do dia 09 de dezembro de 2019
Abrangência	Região Entorno DF da CELG Distribuição S.A.

Tabela 12 – Resumo do evento Região Centro

Número/Código do Evento	
Número/Código do Relatório	
Descrição	Região ligada à tempestade causada por uma zona de baixa pressão atmosférica, provocando forte deslocamento de massas de ar, vendavais, chuvas intensa e possível queda de granizo.
Código COBRADE	1.3.1.2.0 – Zona de Convergência
Hora início do evento	12h00 do dia 06 de dezembro de 2019
Hora de fim do evento	08h30 do dia 09 de dezembro de 2019
Abrangência	Região Centro da CELG Distribuição S.A.

Tabela 13 – Resumo do evento Região Noroeste

Número/Código do Evento	
Número/Código do Relatório	
Descrição	Região ligada à tempestade causada por uma zona de baixa pressão atmosférica, provocando forte deslocamento de massas de ar, vendavais, chuvas intensa e possível queda de granizo.
Código COBRADE	1.3.1.2.0 – Zona de Convergência
Hora início do evento	12h00 do dia 06 de dezembro de 2019
Hora de fim do evento	19h00 do dia 08 de dezembro de 2019
Abrangência	Região Noroeste da CELG Distribuição S.A.

Tabela 14 – Resumo do evento Região Norte

Número/Código do Evento	
Número/Código do Relatório	
Descrição	Região ligada à tempestade causada por uma zona de baixa pressão atmosférica, provocando forte deslocamento de massas de ar, vendavais, chuvas intensa e possível queda de granizo.
Código COBRADE	1.3.1.2.0 – Zona de Convergência
Hora início do evento	08h00 do dia 06 de dezembro de 2019
Hora de fim do evento	07h30 do dia 09 de dezembro de 2019
Abrangência	Região Norte da CELG Distribuição S.A.

Tabela 15 – Resumo do evento Região Nordeste

Número/Código do Evento	
Número/Código do Relatório	
Descrição	Região ligada à tempestade causada por uma zona de baixa pressão atmosférica, provocando forte deslocamento de massas de ar, vendavais, chuvas intensa e possível queda de granizo.
Código COBRADE	1.3.1.2.0 – Zona de Convergência
Hora início do evento	07h30 do dia 06 de dezembro de 2019
Hora de fim do evento	18h30 do dia 08 de dezembro de 2019
Abrangência	Região Norte da CELG Distribuição S.A.

#### 4 Referências

- RMetS Royal Meteorological Society – Beaufort Scale - <https://www.rmets.org/weather-and-climate/observing/beaufort-scale>

- Instituto Nacional de Meteorologia (INMET) - <http://www.inmet.gov.br>

- Cptec/INPE- <https://www.cptec.inpe.br/>

- Centro de Hidrografia da Marinha do Brasil - <https://www.marinha.mil.br/chm/>

- Meteorology Glossary - American Meteorological Society -  
<http://glossary.ametsoc.org/>



Anexos

A.1 Carta Sinótica



Figura A1 - Carta sinótica da Marinha do Brasil para as 0000Z do dia 07 de dezembro de 2019 (21h00 do dia 06 de dezembro de 2019, hora local. FONTE: Marinha do Brasil).



LEGENDA			
	Frente Fria	<b>A</b>	Alta Pressão
	Frente Quente	<b>B</b>	Baixa Pressão
	Instabilidade		Zona de Convergência

Figura A2 - Carta sinótica da Marinha do Brasil para as 1200Z do dia 07 de dezembro de 2019 (09h00 do dia 07 de dezembro de 2019, hora local). FONTE: Marinha do Brasil).

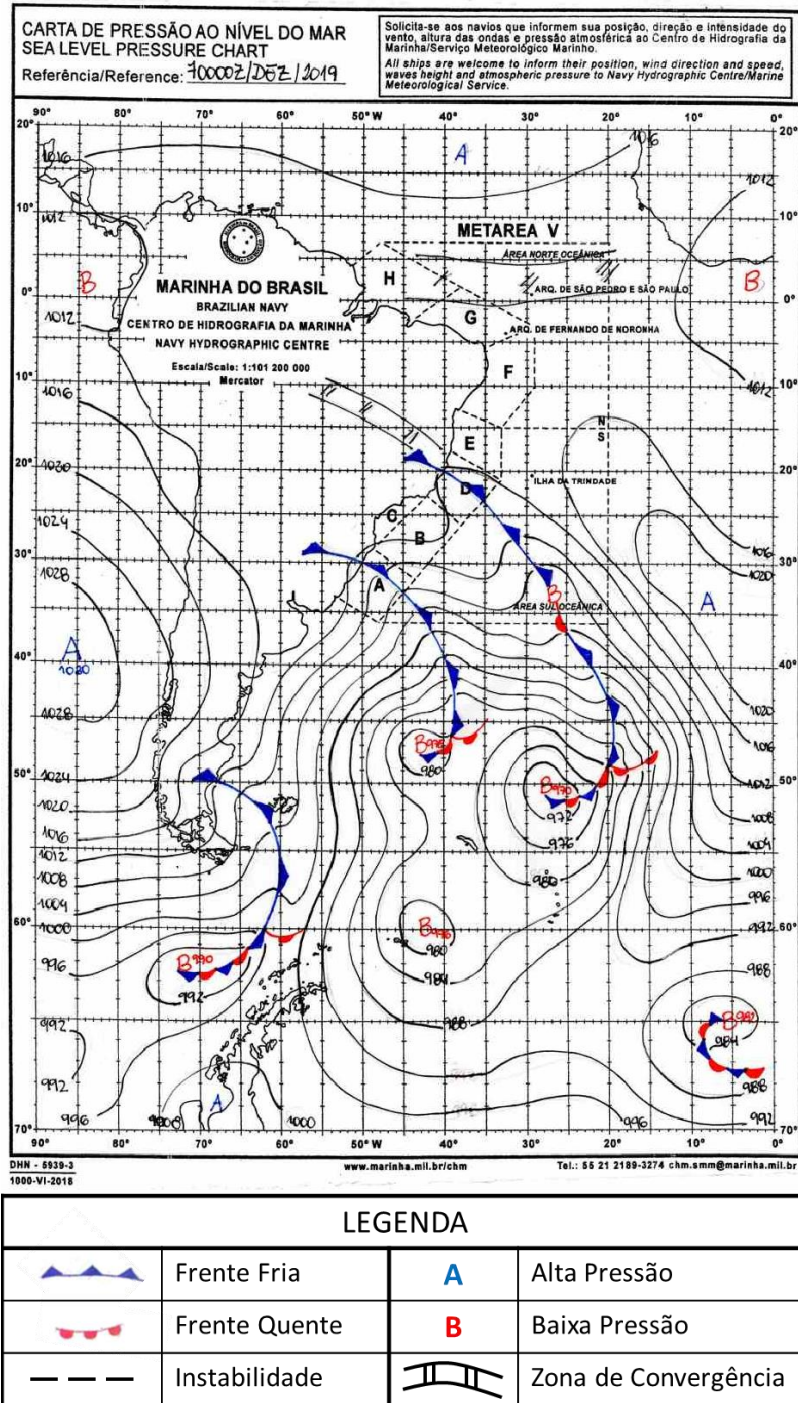
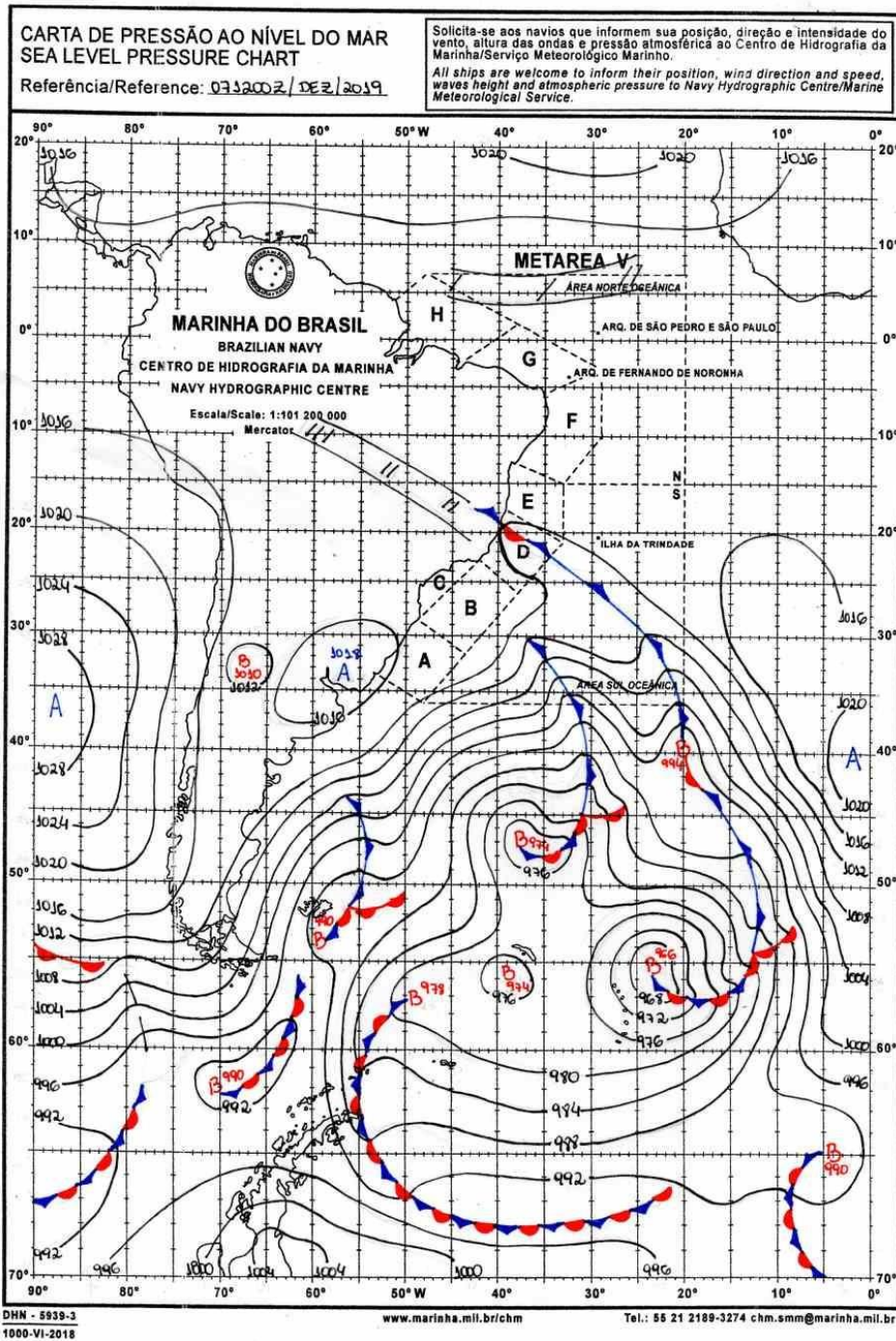

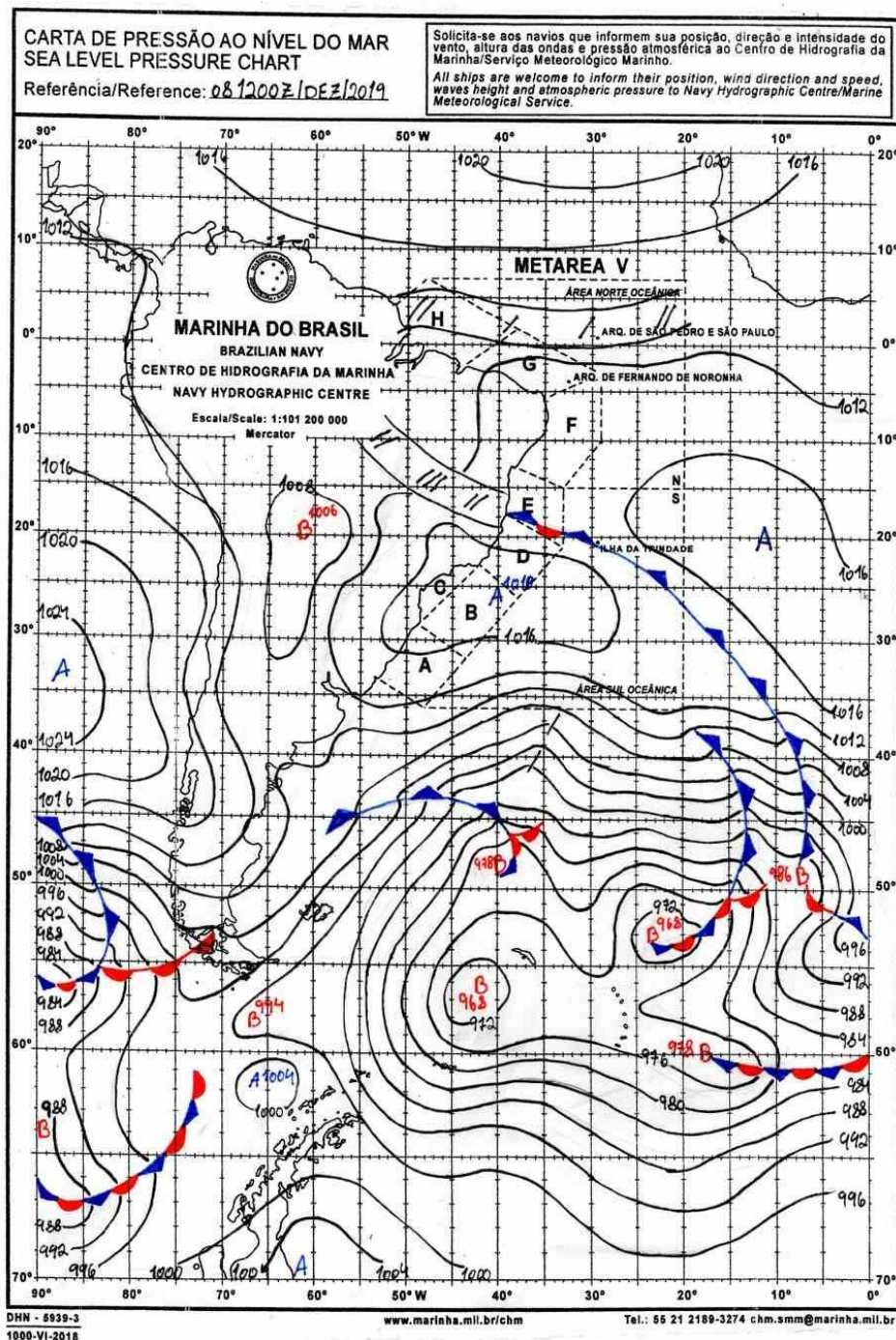

LEGENDA			
	Frente Fria	<b>A</b>	Alta Pressão
	Frente Quente	<b>B</b>	Baixa Pressão
	Instabilidade		Zona de Convergência

Figura A3 - Carta sinótica da Marinha do Brasil para as 1200Z do dia 08 de dezembro de 2019 (09h00 do dia 08 de dezembro de 2019, hora local). FONTE: Marinha do Brasil).

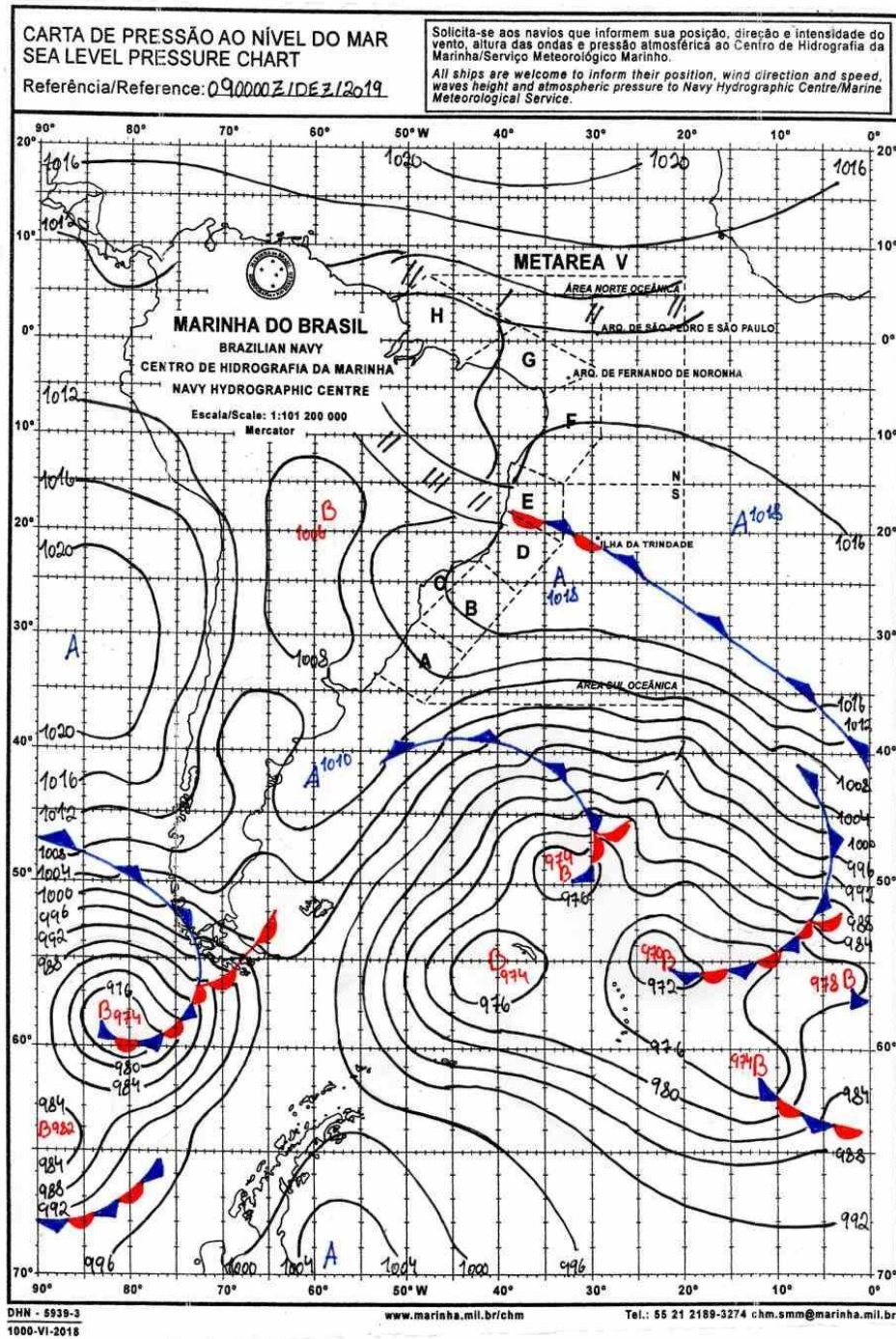

LEGENDA			
	Frente Fria	<b>A</b>	Alta Pressão
	Frente Quente	<b>B</b>	Baixa Pressão
	Instabilidade		Zona de Convergência

Figura A4 - Carta sinótica da Marinha do Brasil para as 0000Z do dia 09 de dezembro de 2019 (21h00 do dia 08 de dezembro de 2019, hora local). FONTE: Marinha do Brasil).



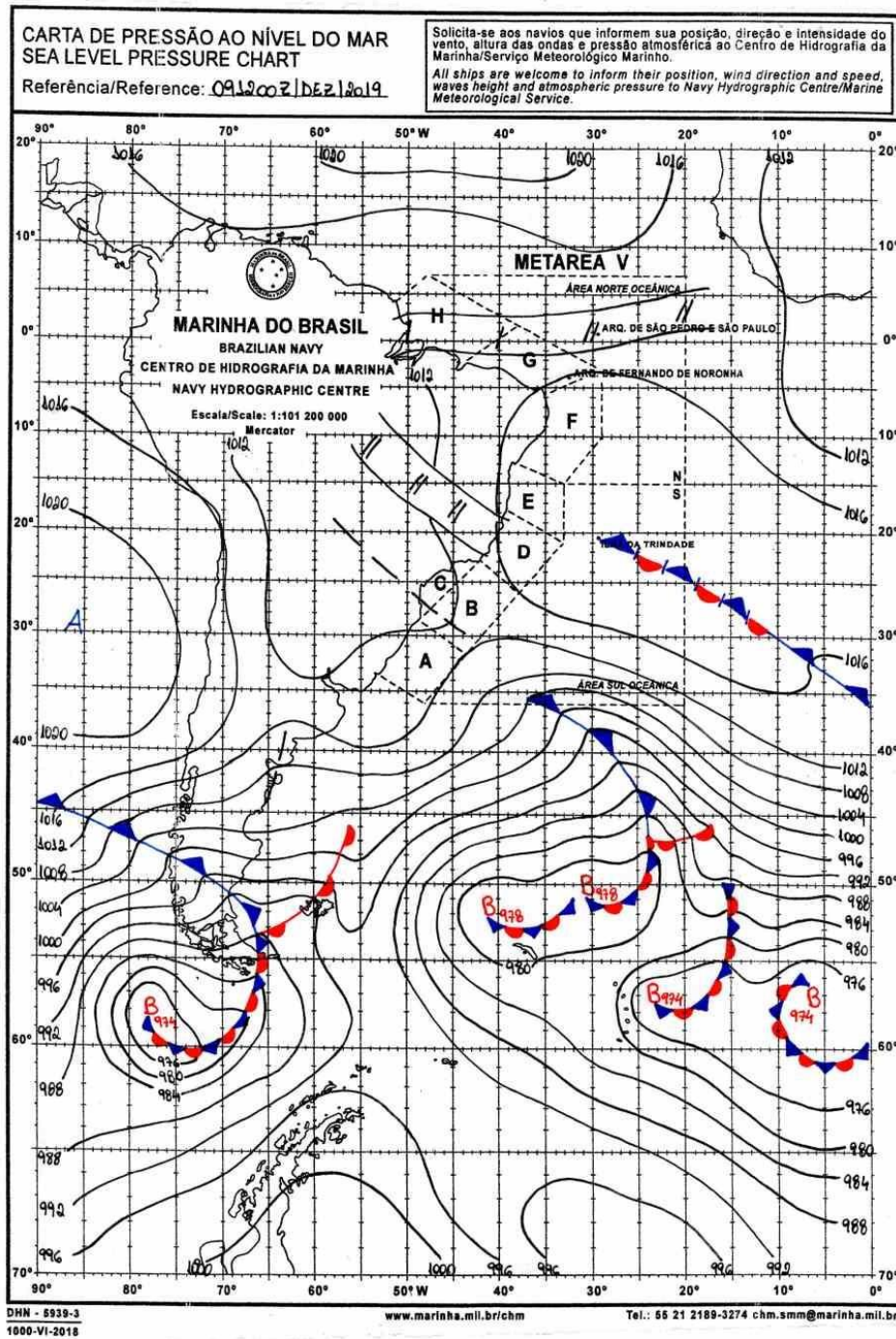

LEGENDA			
	Frente Fria	<b>A</b>	Alta Pressão
	Frente Quente	<b>B</b>	Baixa Pressão
	Instabilidade		Zona de Convergência

Figura A5 - Carta sinótica da Marinha do Brasil para as 1200Z do dia 09 de dezembro de 2019 (09h00 do dia 09 de dezembro de 2019, hora local). FONTE: Marinha do Brasil).

## A.2 Média climatológica (1981-2010) de precipitação acumulada para o mês de dezembro



Figura A6 - Média climatológica (1981-2010) de precipitação acumulada para o mês de dezembro.  
Fonte: INMET).

---

### A.3 Notícias associadas

- Inauguração da Casa do Papai Noel é adiada por causa da chuva em Morrinhos

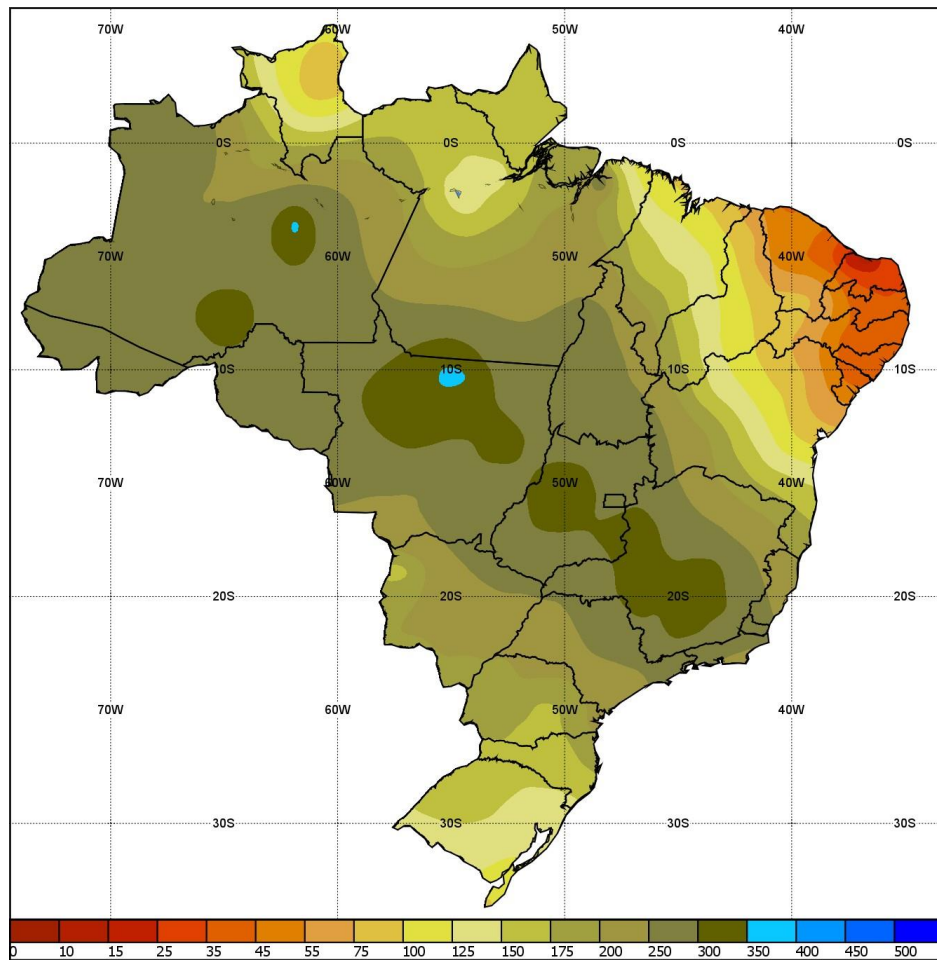
<https://morrinhos.go.gov.br/site/2019/12/inauguracao-da-casa-do-papai-noel-e-adiada-por-causa-da-chuva-em-morrinhos/>

- Chuva forte alaga estrada e inunda casa na zona rural de Abadiânia

<https://www.emaisgoias.com.br/chuva-forte-alaga-estrada-e-inunda-casa-na-zona-rural-de-abadiania/>

- Cratera se forma devido a forte chuva em Anápolis

<https://anapolisnoticias.com.br/cratera-se-forma-devido-a-forte-chuva-em-anapolis/>

Bianca Lobo Silva

Meteorologista

CREA 5063840461

## Instituto Nacional de Meteorologia - INMET

Umidade Relativa do Ar 00h UTC  
Estação: ARAGARCAS (GO) - 12/2019

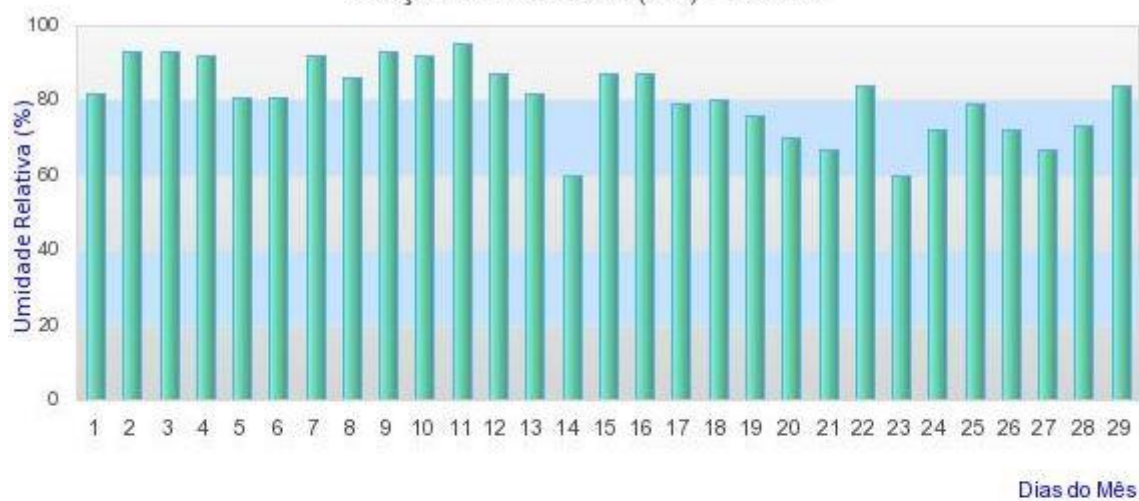

## Instituto Nacional de Meteorologia - INMET

Chuva Acumulada 24h  
Estação: ARAGARCAS - 12/2019

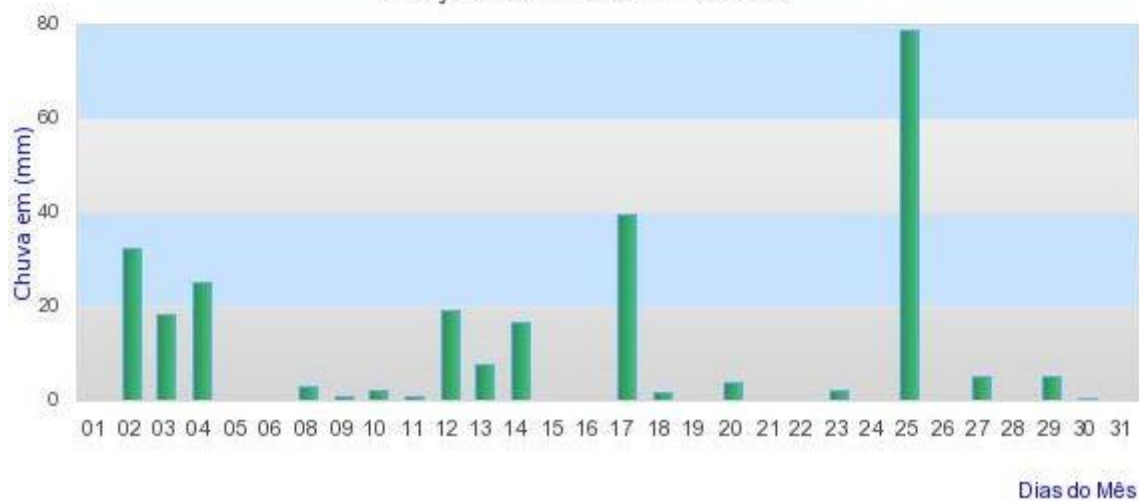



# Instituto Nacional de Meteorologia - INMET

Umidade Relativa do Ar 00h UTC  
Estação: CATALAO (GO) - 12/2019

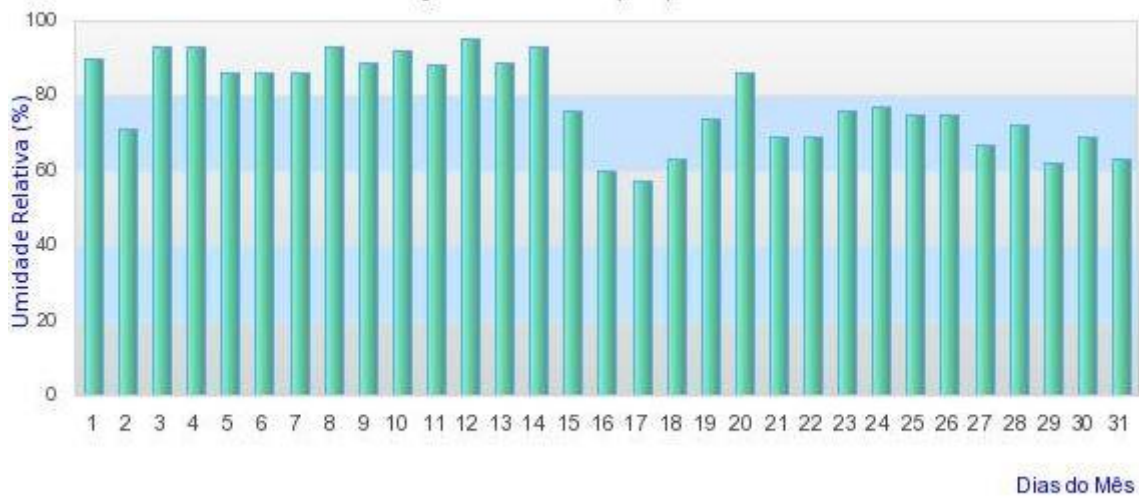

# Instituto Nacional de Meteorologia - INMET

Chuva Acumulada 24h  
Estação: CATALAO - 12/2019

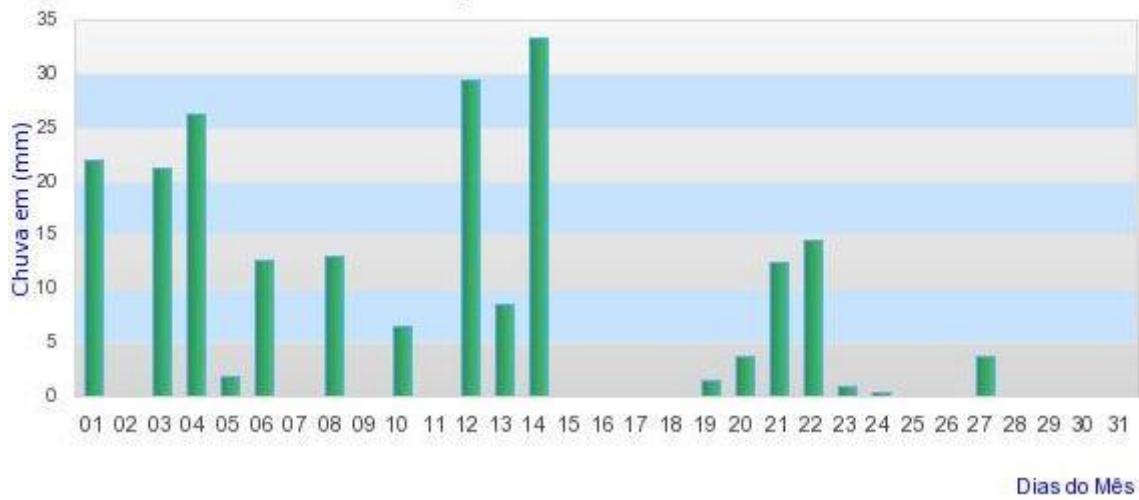

## Instituto Nacional de Meteorologia - INMET

Umidade Relativa do Ar 00h UTC  
Estação: FORMOSA (GO) - 12/2019



## Instituto Nacional de Meteorologia - INMET

Chuva Acumulada 24h  
Estação: FORMOSA - 12/2019



## Instituto Nacional de Meteorologia - INMET

Umidade Relativa do Ar 00h UTC  
Estação: GOIANIA (GO) - 12/2019

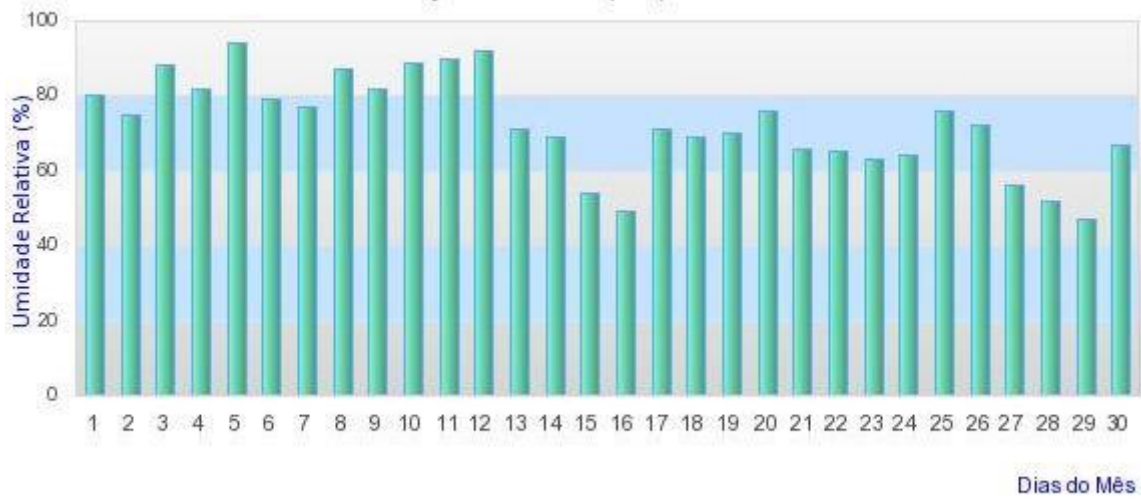

## Instituto Nacional de Meteorologia - INMET

Chuva Acumulada 24h  
Estação: GOIANIA - 12/2019

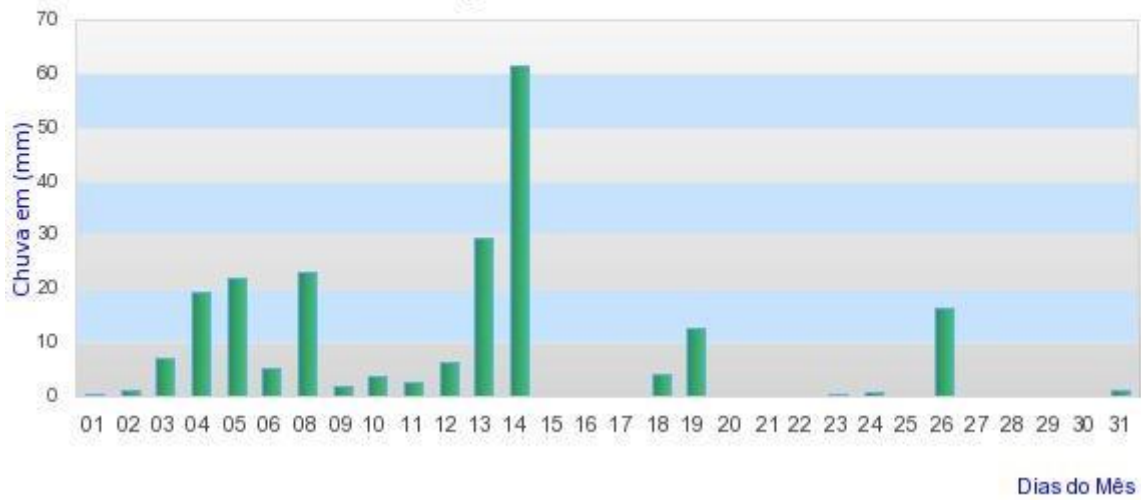

## Instituto Nacional de Meteorologia - INMET

Umidade Relativa do Ar 00h UTC

Estação: IPAMERI (GO) - 12/2019



## Instituto Nacional de Meteorologia - INMET

Chuva Acumulada 24h

Estação: IPAMERI - 12/2019

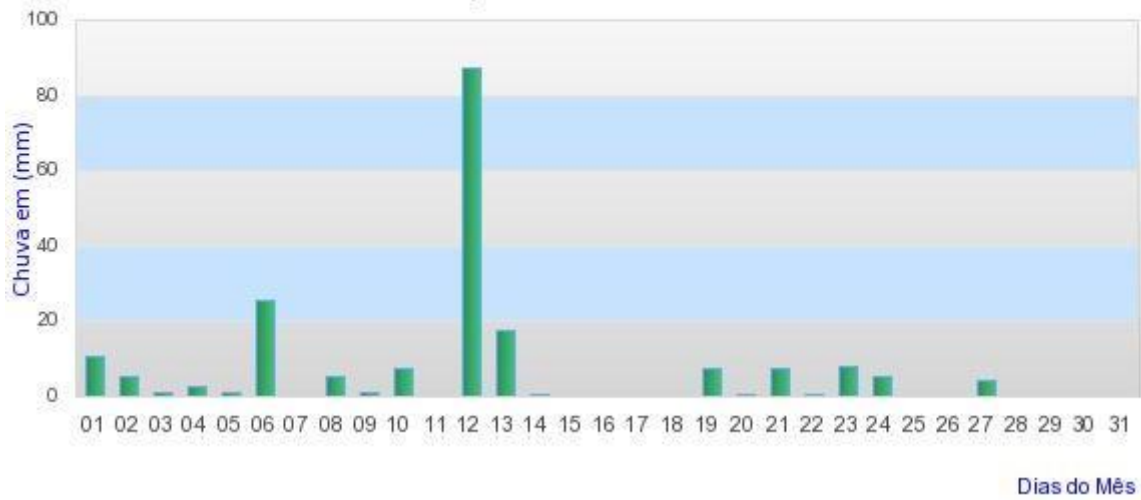

# Instituto Nacional de Meteorologia - INMET

Umidade Relativa do Ar 00h UTC

Estação: JATAI (GO) - 12/2019

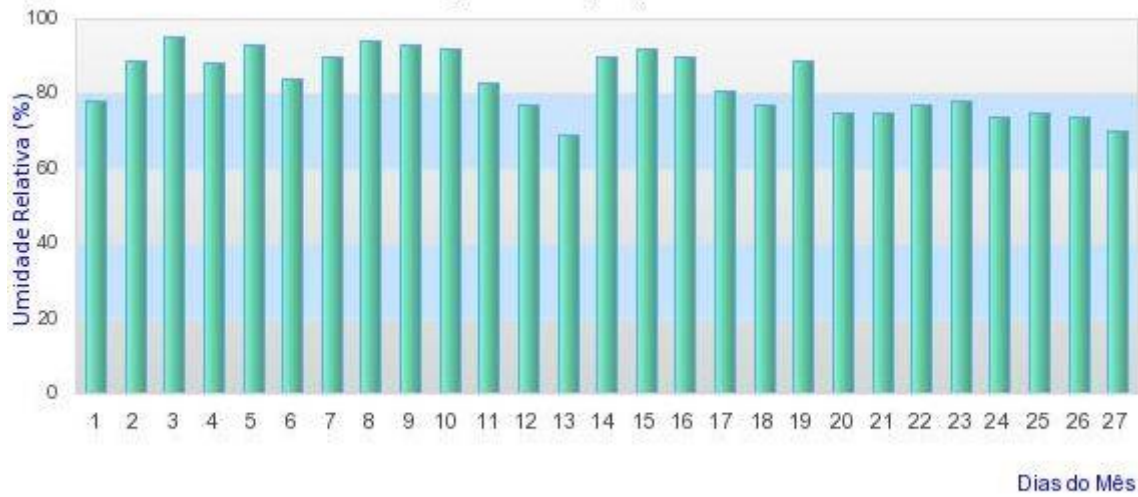

# Instituto Nacional de Meteorologia - INMET

Chuva Acumulada 24h

Estação: JATAI - 12/2019

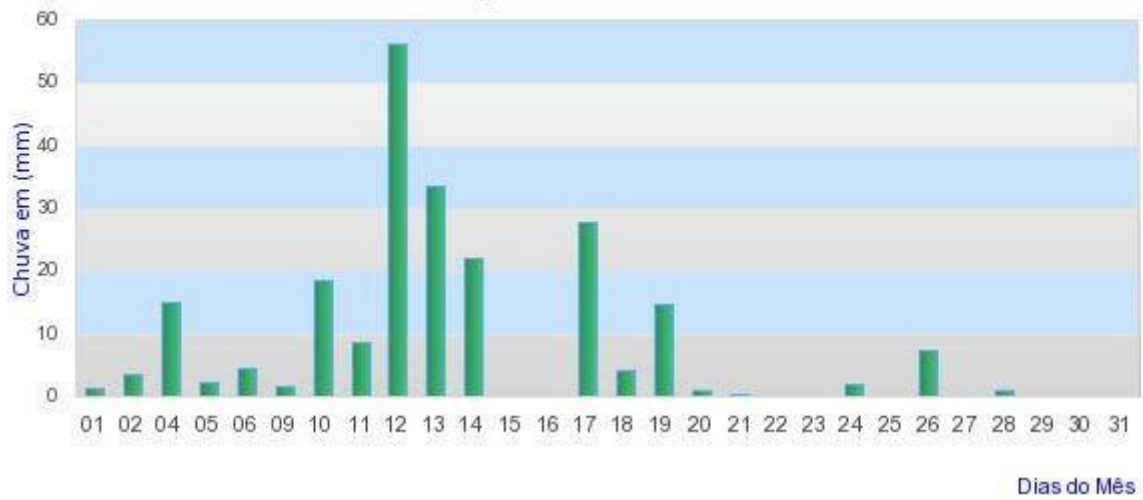

## Instituto Nacional de Meteorologia - INMET

Umidade Relativa do Ar 00h UTC  
Estação: PIRENOPOLIS (GO) - 12/2019

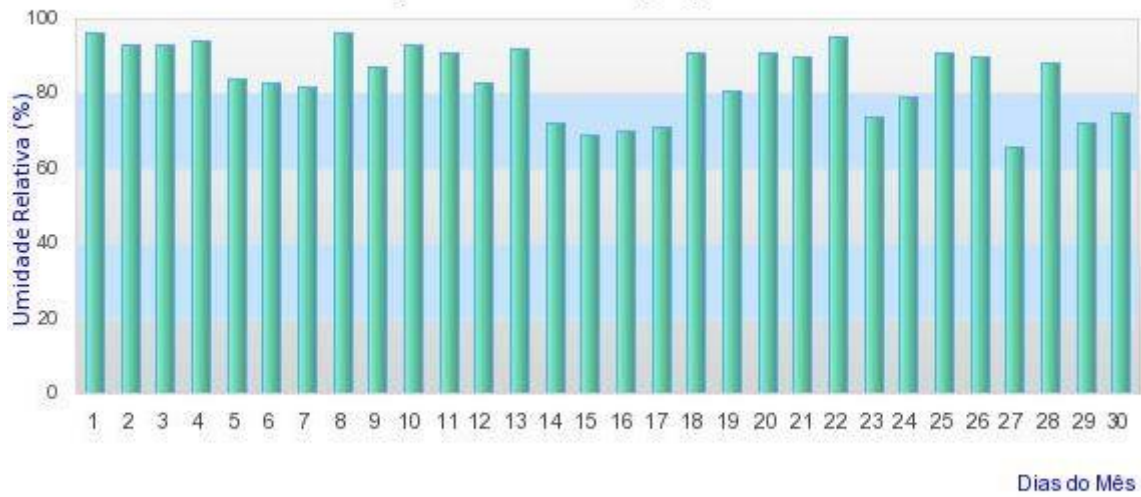

## Instituto Nacional de Meteorologia - INMET

Chuva Acumulada 24h  
Estação: PIRENOPOLIS - 12/2019





### Instituto Nacional de Meteorologia - INMET

Umidade Relativa do Ar 00h UTC

Estação: POSSE (GO) - 12/2019

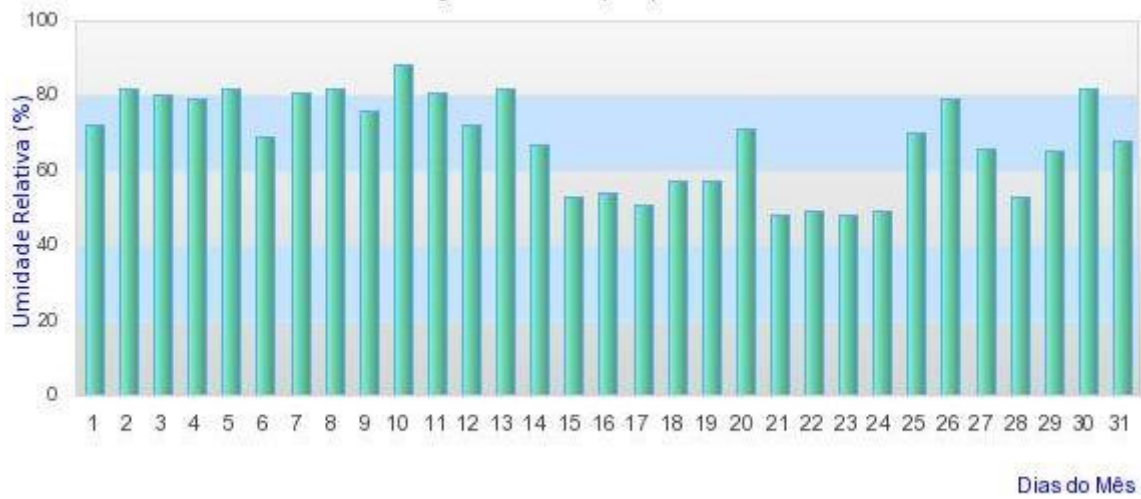

### Instituto Nacional de Meteorologia - INMET

Chuva Acumulada 24h

Estação: POSSE - 12/2019

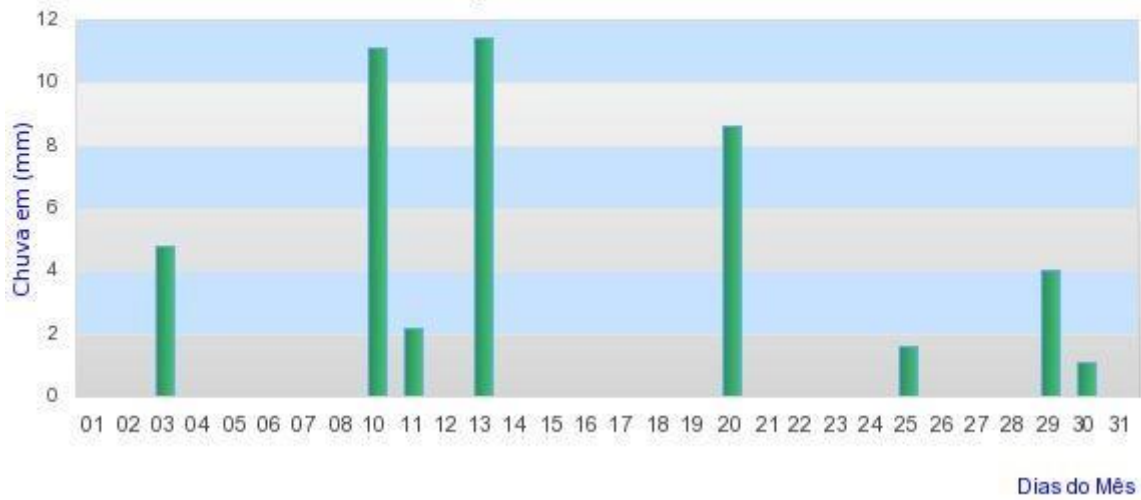

## Instituto Nacional de Meteorologia - INMET

Umidade Relativa do Ar 00h UTC  
Estação: RIO VERDE (GO) - 12/2019

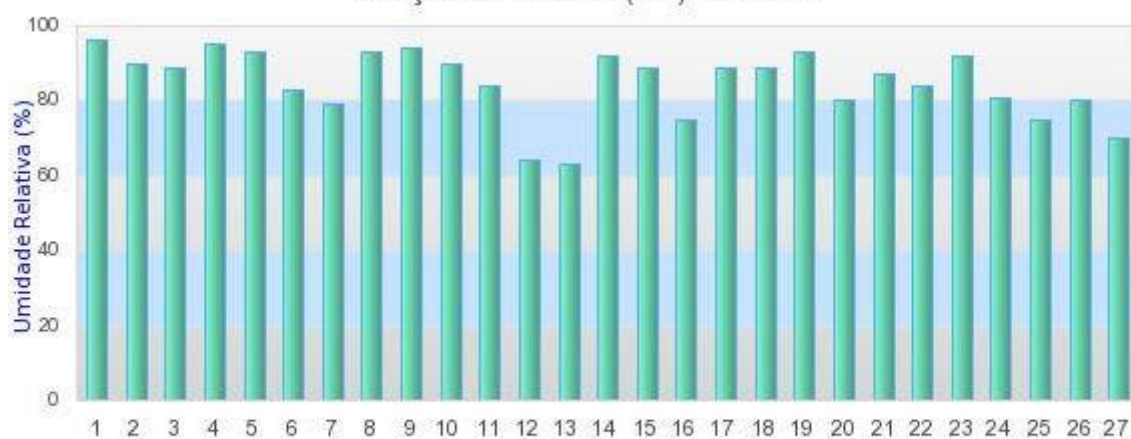

Dias do Mês

## Instituto Nacional de Meteorologia - INMET

Chuva Acumulada 24h  
Estação: RIO VERDE - 12/2019



Dias do Mês



## NOTÍCIAS RELACIONADAS

<https://morrinhos.go.gov.br/site/2019/12/inauguracao-da-casa-do-papai-noel-e-adiada-por-causa-da-chuva-em-morrinhos/>



TRANSPARÊNCIA E-SIC NOTÍCIAS CIDADE LEIS

### Inauguração da Casa do Papai Noel é adiada por causa da chuva em Morrinhos



A inauguração da Casa do Papai Noel, que estava programada para ser realizada na noite deste sexta-feira, 6 de dezembro, foi adiada. Segundo a Assessoria de Comunicação da Prefeitura de Morrinhos, a decisão foi tomada por causa da forte chuva que cai desde às 16h. O Executivo vai remarcar a programação e comunicar uma nova data para toda comunidade receber o bom velhinho.



TEMPORAL

## Chuva forte alaga estrada e inunda casa na zona rural de Abadiânia

Chuva teve início às 15h, mas só terminou às 18h; proprietária teve mais de 300 ramos de mandioca destruídas, além da morte de algumas aves e a estrutura de uma represa que ameaça ceder



Mãe e dois filhos tentaram empurrar a água da chuva com a ajuda de rodos (Foto: Reprodução)

Publicidade

Uma forte **chuva** caiu, no último final de semana sobre o município de **Abadiânia**, localizado na região **Leste** de Goiás. Durante o **temporal**, a água da chuva alagou uma estrada e inundou uma casa da zona rural da cidade e provocou vários prejuízos à propriedade. Em entrevista ao **Mais Goiás**, a funcionária pública Daniela de Paula Vieira conta que viveu momentos de pânico ao ver a própria residência ser tomada

pela enxurrada, registrada no sábado (7). Ninguém ficou ferido.

Anápolis

## Cratera se forma devido a forte chuva em Anápolis



Uma cratera se abriu na última sexta-feira (06) às margens da BR-153 na entrada do bairro Ana Carolina próximo ao Parque da Jaiara em Anápolis, devido a intensa chuva. O local já foi devidamente sinalizado pela CMTT.

Entramos em contato com a Secretaria de Obras que nos informou que por estar localizada às margens da BR-153 a responsabilidade é do DNIT.

Entretanto em uma parceria à prefeitura está entrando com a mão-de-obra é o maquinário, e o DENIT com o combustível e o material.