

Resumo Executivo

O Presente Relatório tem como objetivo a incorporação de informações que sejam relevantes para que se possa fazer a devida associação aos dados contidos no corpo do documento objeto da classificação de Situação de Emergência caracterizada pelo Módulo 8 do Prodist, que tem como foco o impacto do evento sobre determinada rede geométrica e cuja denominação é definida como CHI (Consumidor hora interrompido). O parâmetro para enquadramento nesta classificação de expurgo tem como premissa inicial o limite de Consumidor hora interrompido definido pela fórmula descrita no Módulo 01 do Prodist (Revisão - 9), acrescido de todos os outros informes e dados listados no Módulo 08 (Revisão 10) do Prodist. Este enquadramento se apresenta na maioria das vezes em condições climáticas adversas com severidade dos fatores inerentes a situação, caracterizado na maioria dos casos por fortes ventos e chuvas de grande intensidade e continuidade.

Entre a manhã do dia 09/12/2019 – segunda-feira – e a manhã de 13/12/2019 –sexta-feira – Houve a chegada de uma frente fria favorecendo a organização de um novo canal de umidade, que avançaram sobre o continente e ajudaram a organizar áreas de instabilidade sobre as Regiões da Enel Distribuição Goiás.

Conforme informações do Climatempo Meteorologia, o Instituto Nacional de Meteorologia (INMET) detectou rajadas de vento acima de 50km/h entre a manhã do dia 09 e a manhã do dia 13 de dezembro de 2019. A máxima rajada registrada foi de 59,8km/h, sendo esse vento classificado como vento forte pela escala Beaufort.

Entre as 09h do dia 09 e 08h do dia 13 de dezembro de 2019 tivemos, em todo o Estado de Goiás, incidências de 143.983 descargas atmosféricas (48.250 raios nuvem-solo e 95.733 descargas nuvem-nuvem) sobre a região, o que causou grande instabilidade na rede.

Casa de idosos é invadida por forte enxurrada em Fazenda Nova. Confira vídeo - Imagens foram feitas por neto do casal, que informou que problema é recorrente. Apesar do susto, ninguém se feriu. Acesso em: <https://www.emaisgoias.com.br/casa-de-idosos-e-invadida-por-forte-enxurrada-em-fazenda-nova-confira-video//>

Relatório de Ocorrências do período

Em todo o Estado de Goiás verificou-se também que a intensidade da chuva e dos ventos danificaram a rede de distribuição de energia elétrica em diversos pontos, registrando aproximadamente 352 mil clientes com interrupção no fornecimento de energia elétrica devido a eventos relacionados ao temporal.

Para otimizar o volume de atendimentos e reduzir os tempos de interrupção foram mobilizados os recursos extras da empresa que aumentou o contingente em relação a situação normal de operação. O acompanhamento da quantidade de equipes e o Tempo Médio de Atendimento podem ser consultados na Pág.02 do Relatório em anexo.

O impacto e severidade do evento estão relatados em artigos de mídia, como fotos e reportagens que demonstram os danos na Rede de Distribuição, oriundos dos eventos climáticos no período. Eventos estes que afetaram 351.991 consumidores com CHI de 1.232.948,09 superior ao de 482.391,86 estabelecido como limite para definição de Situação de Emergência, conforme resumo das informações obrigatórias.

Empresa	ENEL DISTRIBUIÇÃO GOIÁS				
Código do Relatório	CHI-031 - ENEL DISTRIBUIÇÃO GOIÁS				
Evento:	TEMPORAL NA AREA DE CONCESSÃO DA ENEL DISTRIBUIÇÃO GOIAS				
Código COBRADE:	1.3.2.1.2 e 1.3.2.1.5	Data Início	09/12/2019	Hora início	09h00
Código do Evento:	CHI-031-ENEL GO	Data Término	13/12/2019	Hora Término	08h59
Valor CHI (Limite e Real)	482.391,86	1.232.948,09	Subestações Atingidas ABADIANIA / ABC / ACREUNA / ADELANDIA / AEROPORTO / AGUA LIMPA (MARZAGAO) / AGUAS LINDAS / ALEXANIA / ALEXANIA TRANSMISSAO / ALMERINDONOPOLIS / ALOANDIA / ALPHAVILLE / ALTO BURITI / ALTO PARAISO DE GOIAS / ALVORADA DO NORTE / AMERICANO (RIO VERDE) / AMERICANO DO BRASIL / AMORINOPOLIS / ANAPOLIS UNIVERSITARIA / ANHANGUERA / ANICUNS / ANTONIO DO VITTO / APARECIDA DO RIO DOCE / APORE / ARACU / ARAGARCAS / ARAGOIANA / ARAGUAPAZ / ARARAS / AREIAS / ARENOPOLIS / ASA BRANCA / ATLANTICO / AURILANDIA / AVELINOPOLIS / BACURI (RIO VERDE) / BARCELONA / BARREIRO (PORANGATU) / BARRO ALTO / BELA VISTA (TRANSMISSAO) / BOA VISTA / BOM JARDIM / BOM JESUS DE GOIAS / BONFINOPOLIS / BONITO / BONOPOLIS / BONSUCESSO (RIO VERDE) / BRAZABRANTES / BRITANIA / BRITANIA (TRANSMISSAO) / BURITI ALEGRE / BURITI DE GOIAS / BURITIZINHO / CABECEIRAS / CABRIUVA (RIO VERDE) / CACHOEIRA ALTA / CACHOEIRA DOURADA / CACHOEIRA NOVA / CACHOEIRINHA (ITARUMA) / CACU / CAIAPONIA / CALCILANDIA / CALDAS NOVAS / CALDAZINHA / CAMPESTRE / CAMPINAS / CAMPINORTE / CAMPO ALEGRE DE GOIAS / CAMPO LIMPO DE GOIAS / CAMPO NOVO / CAMPOS BELOS / CAMPOS VERDES / CARAIBAS / CARAJAS / CASTELANDIA / CATALAO / CATURAI / CEBRASA FABRICA DA AMBEV / CEMAT/BALIZA / CEPALGO / CEZARINA / CHAPADAO DO CEU / CIDADE OCIDENTAL / COCALZINHO / COLINACU / CORREGO ALEGRE / CORREGO DO OURO / CORUMBA / CORUMBAIBA / CRISTALINA / CRISTALINA TRANSMISSAO / CRISTIANOPOLIS / CRIXAS / CROMINIA / CUMARI / DAIA - ANAPOLIS / DAMOLANDIA / DAVINOPOLIS / DESFECHO / DESTILARIA BRASIL CENTRAL / DIMIC / DIORAMA / DORCELINO PEIXOTO DE MORAES / DOVERLANDIA / EDEALINA / EDEIA / ENERSUL / ESTANIFERA / ESTRELA DO NORTE / FAINA / FAZENDA CANADA / FAZENDA NOVA / FERROVIARIO / FIRMINOPOLIS / FLORES DE GOIAS / FORMIGA / FORMOSO / FRONTEIRA / GAMELEIRA / GIRASSOL / GOIANAPOLIS / GOIANDIRA / GOIANESIA / GOIANIA LESTE / GOIANIRA / GOIAS / GOIATUBA / GOUVERLANDIA / GOYA / GUAPO / HEITORAI / HIDROLANDIA / IACIARA / INACIOLANDIA / INDEPENDENCIA / INDIARA / INHUMAS / IPAMERI / IPEGUARI / IPORA / ISRAELANDIA / ITABERAI / ITAGUARI / ITAGUARU / ITAJA / ITAPACI / ITAPACI (TRANSMISSAO) / ITAPIRAPUA / ITAPURANGA / ITAPURANGA (TRANSMISSAO) / ITARUMA / ITAUCU / ITIQUIRA (FORMOSA) / ITUMBIARA NOVA / ITUMBIARA VELHA / JACILANDIA / JANDAIA / JARAGUA / JARANAPOLIS / JATAI / JAUPACI / JESUPOLIS / JOVIANIA / JUNDIAI / JURUMIRIM / JUSCELANDIA / JUSSARA / LAGES / LAGOA DA SERRA / LAGOA DO BAUZINHO (RIO VERDE) / LEOPOLDO DE BULHOES / LUZIANIA / MAIRIPOTABA / MAMBAI / MARA ROSA / MARAJOARA / MARCIANOPOLIS / MARIAPOLIS (PADRE BERNARDO) / MARZAGAO / MATO GRANDE / MATRINCHA / MAURILANDIA / MEIA PONTE / MINACU / MINEIROS / MOIPORA / MONTE ALEGRE / MONTES CLAROS DE GOIAS / MONTIVIDIU T / MORRINHOS / MORRO AGUDO / MOSSAMEDES / MOZARLANDIA / MOZARLANDIA (TRANSMISSAO) / MUNDO NOVO DE GOIAS / MUTUNOPOLIS / NAVESLANDIA (JATAI) / NAZARIO / NEROPOLIS / NIQUELANDIA / NOVA AMERICA / NOVA AURORA / NOVA CRIXAS (TRANSMISSAO) / NOVA IGUACU / NOVA PONTE / NOVA VENEZA / NOVO BRASIL / NOVO GAMA / NOVO PLANALTO / OLHOS DAGUA / OLOANA / ORIZONA / OURO VERDE DE GOIAS / OUVIDOR / PACAEMBU (NOVO GAMA) / PADRE BERNARDO / PALESTINA / PALMEIRAS / PALMEIRAS DE GOIAS / PALMELO / PALMINOPOLIS / PAMPLONA / PANAMA / PARANA / PARANAIBA / PARANAIGUARA / PARAUNA SE ALTA TENSAO / PARQUE DAS EMAS (MINEIROS) / PARQUE DAS NACOES / PEROLANDIA / PETROLINA / PILAR / PILOANDIA / PIRACANJUBA / PIRANHAS T / PIRENOPOLIS / PIRES BELO / PIRES DO RIO / PLANALTINA / PLANALTINA (TRANSMISSAO) / PLANALTO / PONTALINA / PORANGATU / PORTEIRAO / PORTELANDIA / PORTO SAO SIMAO / POSSE / POSSELANDIA / PROFESSOR JAMIL / QUEBRA LINHA / QUIRINOPOLIS / REAL / RETIRO / GOIAS / RIO CLARO JATAI MONTIVIDIU / RIO DO PEIXE / RIO DOS BOIS (MAURILANDIA) / RIO PRETO / RIO QUENTE / RIO VERDE / RIO VERMELHO / RIVERLANDIA (RIO VERDE) / ROCHEDO (UEH) / RUBIATABA / SANCLERLANDIA / SANTA BARBARA / SANTA FE DE GOIAS / SANTA HELENA / SANTA RITA DO ARAGUAIA / SANTA ROSA / SANTA ROSA DE GOIAS / SANTA ROSA DO MEIA PONTE / SANTA TEREZA DE GOIAS / SANTA TEREZINHA / SANTO ANTONIO DA BARRA / SANTO ANTONIO DE GOIAS / SANTO ANTONIO DO DESCOBERTO / SAO BARTOLOMEU / SAO DOMINGOS / SAO FRANCISCO DE GOIAS / SAO JOAO D ALIANCA / SAO JOAO DA PARAUNA / SAO JUDAS TADEU / SAO LUIZ DOS MONTES BELOS		
Código do Decreto (Se Houver):					
Quantidade de Interrupções (Evento)	7.215				
Início 1ª Incidência (Data e Hora)	09/12/2019 09:01:00				

			/SAO MIGUEL DO ARAGUAIA / SAO MIGUEL DO PASSA QUATRO / SAO SIMAO / SENADOR CANEDO TRANSMISSAO / SERRA AZUL (JATAI) / SERRA DE CALDAS / SERRANOPOLIS / SILVANIA / SITIO DABADIA / SOUZALANDIA / SUCURI / TAIOBA / TAQUARAL / TAQUARI / TEREZOPOLIS / TERRA VERMELHA / TRAJANOPOLIS (PADRE BERNARDO) / TRES BARRAS / TRES RANCHOS / TRINDADE / TUCUNARE / TURVANIA / TURVELANDIA / URUACU / URUTAI / USINA DE ACUCAR DE GOIANESIA / USINA MAMBAI / VALPARAISO / VARJAO / VENDA SECA / VIANOPOLIS / VICENTINOPOLIS / VILA CORUMBA / VILA PROPICIO / XAVANTES / XIXA / ZELANDIA / MINEIROS TRANSMISSAO / SANTANA / ALTO HORIZONTE
Início Última Incidência (Data e Hora)	13/12/2019 08:59:00		ABADIA DE GOIAS / ABADIANIA / ACREUNA / ADELANDIA / AGUA FRIA DE GOIAS / AGUA LIMPA / AGUAS LINDAS DE GOIAS / ALEXANIA / ALOANDIA / ALTO HORIZONTE / ALTO PARAISO DE GOIAS / ALVORADA DO NORTE / AMARALINA / AMERICANO DO BRASIL / AMORINOPOLIS / ANAPOLIS / ANHANGUERA / ANICUNS / APARECIDA DE GOIANIA / APARECIDA DO RIO DOCE / APORE / ARACU / ARAGARCAS / ARAGOIANA / ARAGUAPAZ / ARENOPOLIS / ARUANA / AURILANDIA / AVELINOPOLIS / BALIZA / BARRO ALTO / BELA VISTA DE GOIAS / BOM JARDIM DE GOIAS / BOM JESUS DE GOIAS / BONFINOPOLIS / BONOPOLIS / BRAZABRANTES / BRITANIA / BURITI ALEGRE / BURITI DE GOIAS / BURITINOPOLIS / CABECEIRAS / CACHOEIRA ALTA / CACHOEIRA DE GOIAS / CACHOEIRA DOURADA / CACU / CAIAPONIA / CALDAS NOVAS / CALDAZINHA / CAMPESTRE DE GOIAS / CAMPINACU / CAMPINORTE / CAMPO ALEGRE DE GOIAS / CAMPO LIMPO / CAMPOS BELOS / CAMPOS VERDES / CARMO DO RIO VERDE / CASTELANDIA / CATALAO / CATURAI / CAVALCANTE / CERES / CEZARINA / CHAPADAO DO CEU / CIDADE OCIDENTAL / COCALZINHO DE GOIAS / COLINAS DO SUL / CORREGO DO OURO / CORUMBA DE GOIAS / CORUMBAIBA / CRISTALINA / CRISTIANOPOLIS / CRIXAS / CROMINIA / CUMARI / DAMIANOPOLIS / DAMOLANDIA / DAVINOPOLIS / DIORAMA / DISTRITO FEDERAL / DIVINOPOLIS DE GOIAS / DOVERLANDIA / EDEALINA / EDEIA / ESTRELA DO NORTE / FAINA / FAZENDA NOVA / FIRMINOPOLIS / FLORES DE GOIAS / FORMOSA / FORMOSO / GAMELEIRA DE GOIAS / GOIANAPOLIS / GOIANDIRA / GOIANESIA / GOIANIA / GOIANIRA / GOIAS / GOIATUBA / GOUVELANDIA / GUAPO / GUARAITA / GUARANI DE GOIAS / GUARINOS / HEITORAI / HIDROLANDIA / HIDROLINA / IACIARA / INACIOLANDIA / INDIARA / INHUMAS / IPAMERI / IPIRANGA DE GOIAS / IPORA / ISRAELANDIA / ITABERAI / ITAGUARI / ITAGUARU / ITAJA / ITAPACI / ITAPIRAPUA / ITAPURANGA / ITARUMA / ITAUCU / ITUMBIARA / IVOLANDIA / JANDAIA / JARAGUA / JATAI / JAUPACI / JOVIANIA / JUSSARA / LAGOA SANTA / LEOPOLDO DE BULHOES / LUZIANIA / MAIRIPOTABA / MAMBAI / MARA ROSA / MARZAGAO / MATRINCHA / MAURILANDIA / MIMOSO DE GOIAS / MINACU / MINEIROS / MOIPORA / MONTE ALEGRE DE GOIAS / MONTES CLAROS DE GOIAS / MONTIVIDIU / MONTIVIDIU DO NORTE / MORRINHOS / MORRO AGUDO DE GOIAS / MOSSAMEDES / MOZARLANDIA / MUNDO NOVO DE GOIAS / MUTUNOPOLIS / NAZARIO / NEROPOLIS / NIQUELANDIA / NOVA AMERICA / NOVA AURORA / NOVA CRIXAS / NOVA IGUACU DE GOIAS / NOVA ROMA / NOVA VENEZA / NOVO BRASIL / NOVO GAMA / NOVO PLANALTO / ORIZONA / OURO VERDE DE GOIAS / OUVIDOR / PADRE BERNARDO / PALESTINA DE GOIAS / PALMEIRAS DE GOIAS / PALMELO / PALMINOPOLIS / PANAMA / PARANAIGUARA / PARAUNA / PEROLANDIA / PETROLINA DE GOIAS / PILAR DE GOIAS / PIRACANJUBA / PIRANHAS / PIRENOPOLIS / PIRES DO RIO / PLANALTINA / PONTALINA / PORANGATU / PORTEIRAO / PORTELANDIA / POSSE / PROFESSOR JAMIL SAFADY / QUIRINOPOLIS / RIO QUENTE / RIO VERDE / RUBIATABA / SANCLERLANDIA / SANTA BARBARA DE GOIAS / SANTA CRUZ DE GOIAS / SANTA FE DE GOIAS / SANTA HELENA DE GOIAS / SANTA ISABEL / SANTA RITA DO ARAGUAIA / SANTA RITA DO NOVO DESTINO / SANTA ROSA DE GOIAS / SANTA TEREZA DE GOIAS / SANTA TEREZINHA DE GOIAS / SANTO ANTONIO DA BARRA / SANTO ANTONIO DE GOIAS / SANTO ANTONIO DO DESCOBERTO / SAO DOMINGOS / SAO FRANCISCO DE GOIAS / SAO JOAO D ALIANCA / SAO JOAO DA PARAUNA / SAO LUIS DE MONTES BELOS / SAO LUIZ DO NORTE / SAO MIGUEL DO ARAGUAIA / SAO MIGUEL DO PASSA QUATRO / SAO PATRICIO / SAO SIMAO / SENADOR CANEDO / SERRANOPOLIS / SILVANIA / SIMOLANDIA / SITIO D ABADIA / TAQUARAL DE GOIAS / TERESINA DE GOIAS / TEREZOPOLIS DE GOIAS / TRES RANCHOS / TRINDADE / TROMBAS / TURVANIA / TURVELANDIA / UIRAPURU / URUACU / URUANA / URUTAI / VALPARAISO DE GOIAS / VARJAO / VIANOPOLIS / VICENTINOPOLIS / VILA BOA / VILA PROPICIO
Média de Duração das Incidências (h)	8,18		
Duração da Incidência mais longa (h)	78,91		
Total de Clientes afetados	351.991	Municípios Atingidos	

DANOS CAUSADOS			
Equipamentos Danificado	Importância para o Sistema	Local	Quantidade
Disjuntor/Religador Operado	Proteção do Alimentador	Área de Concessão	121
Chaves Fusíveis Operada	Proteção de Ramais de Alimentadores	Área de Concessão	2.143
Transformador Operado	Proteção do Transformador	Área de Concessão	1.879

Relato técnico sobre a Intervenção realizada em Goiânia e Região Metropolitana					
Informações sobre Equipes	09/12	10/12	11/12	12/12	
Quantidade Usual	773	773	773	773	turmas
Quantidade Adicional	17	55	68	85	turmas
Quantidade Total	790	828	841	858	turmas
Tempos Médios					
Preparação	5,83	5,39	4,33	5,06	Horas
Deslocamento	0,91	0,92	0,87	0,88	Horas
Execução	1,36	1,21	1,34	1,54	Horas
TMAE	8,10	7,52	6,54	7,48	Horas

Principais Dificuldades Encontradas:

Chuvas com ventos fortes provocaram muitos pontos de alagamento e enxurrada, trânsito impedido por vários semáforos desligados dificultando a chegada ao atendimento das ocorrências emergenciais. Em determinadas regiões, decorrente dos fortes ventos, houve o tombamento de árvores nas estruturas de alimentação de média tensão, danos em ramais de ligação dos clientes, impedimentos de acesso e atolamentos em estradas rurais.

Empresa	ENEL DISTRIBUIÇÃO GOIAS		
Valor CHI (Limite e Real)	482.391,86		1.232.948,09

DOC ORIGEM	MIUNICIPIO	EQP_ORIGEM	CONJUNTO	INI_OCORRENC	FIM_OCORRENC	DT_INI_EVENTO	DT_FIM_EVENTO	DURAÇ	UC INT	CHI	EXPURGO
20191253124	RIO VERDE	RV21159305	ACREUNA	09/12/2019 09:01	09/12/2019 10:52	09/12/2019 09:01	09/12/2019 10:52	1,85	1	1,85	CHI
20191253128	IPORA	IR11014377	IPORA	09/12/2019 09:01	09/12/2019 11:34	09/12/2019 09:01	09/12/2019 11:34	2,54	95	241,54	CHI
20191253131	PARAUNA	980024808	PARAUNA	09/12/2019 09:01	10/12/2019 07:00	09/12/2019 09:01	10/12/2019 07:00	21,98	1	21,98	CHI
20191253135	JATAI	JT21165976	JATAI S1	09/12/2019 09:02	09/12/2019 14:19	09/12/2019 09:02	09/12/2019 14:19	5,28	1	5,28	CHI
20191253161	FIRMINOPOLIS	900025402	FIRMINOPOLIS S1	09/12/2019 09:05	09/12/2019 17:34	09/12/2019 09:05	09/12/2019 17:34	8,49	1	8,49	CHI
20191253166	JATAI	01030414	JATAI S1	09/12/2019 09:05	09/12/2019 19:25	09/12/2019 16:46	09/12/2019 17:13	0,44	7	3,08	CHI
20191253166	JATAI	JT13363948	JATAI S1	09/12/2019 09:05	09/12/2019 19:25	09/12/2019 16:40	09/12/2019 17:20	0,68	1	0,68	CHI
20191253166	JATAI	8044736	JATAI S1	09/12/2019 09:05	09/12/2019 19:25	09/12/2019 16:40	09/12/2019 18:55	2,25	3	6,75	CHI
20191253166	JATAI	JT13365072	JATAI S1	09/12/2019 09:05	09/12/2019 19:25	09/12/2019 16:40	09/12/2019 18:55	2,25	10	22,50	CHI
20191253166	JATAI	01030414	JATAI S1	09/12/2019 09:05	09/12/2019 19:25	09/12/2019 19:16	09/12/2019 19:20	0,08	7	0,56	CHI
20191253166	JATAI	JT13365071	JATAI S1	09/12/2019 09:05	09/12/2019 19:25	09/12/2019 19:16	09/12/2019 19:25	0,15	14	2,08	CHI
20191253213	BOM JARDIM DE GOIAS	BM21233797	BOM JARDIM	09/12/2019 09:11	10/12/2019 10:24	09/12/2019 09:11	10/12/2019 10:24	25,21	1	25,21	CHI
20191253257	GOIAS	90109284	GOIAS	09/12/2019 09:16	09/12/2019 10:51	09/12/2019 09:16	09/12/2019 10:51	1,58	1	1,58	CHI
20191253258	RIO VERDE	8324979	MONTIVIDIU T	09/12/2019 09:16	10/12/2019 11:20	09/12/2019 09:16	10/12/2019 11:20	26,05	1	26,05	CHI
20191253285	JATAI	10014382570	JATAI S2	09/12/2019 09:20	09/12/2019 10:56	09/12/2019 09:20	09/12/2019 10:56	1,59	1	1,59	CHI
20191253292	MONTES CLAROS DE GOIAS	ME12334764	IPORA	09/12/2019 09:20	09/12/2019 16:53	09/12/2019 09:20	09/12/2019 16:53	7,54	24	180,99	CHI
20191253296	MONTIVIDIU	MV12376249	MONTIVIDIU T	09/12/2019 09:21	09/12/2019 12:07	09/12/2019 09:21	09/12/2019 12:07	2,76	3	8,28	CHI
20191253307	SANTA HELENA DE GOIAS	SH11228506	RIO VERDE S2	09/12/2019 09:22	09/12/2019 12:00	09/12/2019 09:22	09/12/2019 12:00	2,62	1	2,62	CHI
20191253328	QUIRINOPOLIS	QI21050380	QUIRINOPOLIS	09/12/2019 09:25	09/12/2019 16:47	09/12/2019 09:25	09/12/2019 16:47	7,35	1	7,35	CHI
20191253342	RIO VERDE	630109928	RIO VERDE S2	09/12/2019 09:28	09/12/2019 11:11	09/12/2019 09:28	09/12/2019 11:11	1,72	1	1,72	CHI
20191253361	MINEIROS	1390025060	PARQUE DAS EMAS	09/12/2019 09:28	09/12/2019 11:17	09/12/2019 09:28	09/12/2019 11:17	1,82	1	1,82	CHI
20191253349	PALMEIRAS DE GOIAS	PL21046350	PALMEIRAS	09/12/2019 09:29	09/12/2019 11:50	09/12/2019 09:29	09/12/2019 11:50	2,35	1	2,35	CHI
20191253377	CACU	IM12107402	CACHOEIRA ALTA	09/12/2019 09:34	09/12/2019 17:10	09/12/2019 09:34	09/12/2019 17:10	7,59	3	22,77	CHI
20191253377	ITARUMA	IM12107402	CACHOEIRA ALTA	09/12/2019 09:34	09/12/2019 17:10	09/12/2019 09:34	09/12/2019 17:10	7,59	30	227,74	CHI
20191253508	SANTA HELENA DE GOIAS	10011382641	IPEGUARI	09/12/2019 09:36	09/12/2019 14:25	09/12/2019 09:36	09/12/2019 14:25	4,82	1	4,82	CHI
20191253523	RIO VERDE	RV12193032	MONTIVIDIU T	09/12/2019 09:38	09/12/2019 14:42	09/12/2019 09:38	09/12/2019 14:42	5,07	5	25,36	CHI
20191253588	MONTES CLAROS DE GOIAS	ME21086445	IPORA	09/12/2019 09:47	09/12/2019 11:50	09/12/2019 09:47	09/12/2019 11:50	2,05	1	2,05	CHI

20191253825	SAO LUIS DE MONTES BELOS	SL12006899	SAO LUIZ DOS MONTES BELOS	09/12/2019 09:50	09/12/2019 12:05	09/12/2019 09:50	09/12/2019 12:05	2,26	36	81,35	CHI
201912260800	JUSSARA	JR12160186	BRITANIA	09/12/2019 09:51	09/12/2019 11:24	09/12/2019 09:51	09/12/2019 11:24	1,55	5	7,73	CHI
20191253818	JATAI	JT12141670	JATAI S2	09/12/2019 09:57	10/12/2019 11:21	09/12/2019 09:57	10/12/2019 11:21	25,39	1	25,39	CHI
20191253678	SAO JOAO DA PARAUNA	FR21126064	FIRMINOPOLIS S2	09/12/2019 09:59	09/12/2019 11:45	09/12/2019 09:59	09/12/2019 11:45	1,76	1	1,76	CHI
20191253682	INDIARA	CZ21156544	CEZARINA	09/12/2019 10:00	09/12/2019 11:12	09/12/2019 10:00	09/12/2019 11:12	1,21	1	1,21	CHI
20191253689	SAO JOAO DA PARAUNA	1000010147	FIRMINOPOLIS S2	09/12/2019 10:01	09/12/2019 12:46	09/12/2019 10:01	09/12/2019 12:46	2,75	1	2,75	CHI
20191253698	TURVELANDIA	TD1240353	RIO DOS BOIS	09/12/2019 10:02	09/12/2019 18:25	09/12/2019 10:02	09/12/2019 18:25	8,38	3	25,15	CHI
20191253719	NOVA IGUACU DE GOIAS	NH1242586	SANTA TEREZINHA	09/12/2019 10:05	10/12/2019 10:55	09/12/2019 10:05	10/12/2019 10:55	24,82	1	24,82	CHI
20191254940	CAMPINORTE	UR12243278	MARA ROSA	09/12/2019 10:05	09/12/2019 14:34	09/12/2019 10:05	09/12/2019 14:34	4,48	7	31,35	CHI
20191254940	URUACU	UR12243278	MARA ROSA	09/12/2019 10:05	09/12/2019 14:34	09/12/2019 10:05	09/12/2019 14:34	4,48	15	67,18	CHI
20191253807	PORANGATU	PO12230431	PORANGATU	09/12/2019 10:08	09/12/2019 14:18	09/12/2019 10:08	09/12/2019 14:18	4,16	2	8,32	CHI
20191253808	IPORA	IR12228448	IPORA	09/12/2019 10:09	10/12/2019 04:22	09/12/2019 10:09	10/12/2019 04:22	18,22	1	18,22	CHI
20191253829	MINEIROS	MY21324471	PARQUE DAS EMAS	09/12/2019 10:13	09/12/2019 16:10	09/12/2019 10:13	09/12/2019 16:10	5,96	1	5,96	CHI
20191253842	NIQUELANDIA	NQ11346850	NIQUELANDIA SUBTRANSMISSAO	09/12/2019 10:16	10/12/2019 12:23	09/12/2019 10:16	10/12/2019 12:23	26,11	17	443,95	CHI
20191253851	NOVA IGUACU DE GOIAS	UR1243578	URUACU	09/12/2019 10:17	09/12/2019 19:31	09/12/2019 10:17	09/12/2019 19:31	9,22	1	9,22	CHI
20191253865	SAO MIGUEL DO ARAGUAIA	SM12096089	SAO MIGUEL DO ARAGUAIA	09/12/2019 10:20	11/12/2019 02:31	09/12/2019 10:20	11/12/2019 02:31	40,17	27	1084,63	CHI
20191255657	GUARINOS	IW12181515	RUBIATABA	09/12/2019 10:20	10/12/2019 09:41	09/12/2019 10:20	10/12/2019 09:41	23,33	3	70,00	CHI
20191255657	ITAPACI	IW12181515	RUBIATABA	09/12/2019 10:20	10/12/2019 09:41	09/12/2019 10:20	10/12/2019 09:41	23,33	4	93,34	CHI
20191253871	TURVELANDIA	SH12026451	RIO DOS BOIS	09/12/2019 10:21	09/12/2019 17:06	09/12/2019 10:21	09/12/2019 17:06	6,75	1	6,75	CHI
20191253878	CAMPO ALEGRE DE GOIAS	CM12287022	CAMPO ALEGRE DE GOIAS	09/12/2019 10:22	10/12/2019 17:27	09/12/2019 10:22	10/12/2019 17:27	31,08	1	31,08	CHI
20191253880	GOIATUBA	140075835	GOIATUBA S2	09/12/2019 10:22	09/12/2019 16:42	09/12/2019 10:22	09/12/2019 16:42	6,34	1	6,34	CHI
20191253882	RIO VERDE	BZ12211442	SANTA HELENA S1	09/12/2019 10:23	09/12/2019 12:15	09/12/2019 10:23	09/12/2019 12:15	1,86	2	3,73	CHI
20191253882	SANTO ANTONIO DA BARRA	BZ12211442	SANTA HELENA S1	09/12/2019 10:23	09/12/2019 12:15	09/12/2019 10:23	09/12/2019 12:15	1,86	3	5,59	CHI
20191254116	MOSSAMEDES	MD12024167	FIRMINOPOLIS S2	09/12/2019 10:23	09/12/2019 19:17	09/12/2019 10:23	09/12/2019 19:17	8,90	46	409,51	CHI
20191254116	SANCLERLANDIA	MD12024167	FIRMINOPOLIS S2	09/12/2019 10:23	09/12/2019 19:17	09/12/2019 10:23	09/12/2019 19:17	8,90	8	71,22	CHI
20191253898	QUIRINOPOLIS	QI10402443	QUIRINOPOLIS	09/12/2019 10:25	09/12/2019 11:33	09/12/2019 10:25	09/12/2019 11:33	1,13	68	76,99	CHI
20191253895	SAO MIGUEL DO ARAGUAIA	SM11247003	SAO MIGUEL DO ARAGUAIA	09/12/2019 10:26	09/12/2019 14:23	09/12/2019 10:26	09/12/2019 14:23	3,94	1	3,94	CHI
20191253904	CRISTIANOPOLIS	BV21222666	CRISTIANOPOLIS	09/12/2019 10:27	09/12/2019 19:23	09/12/2019 10:27	09/12/2019 19:23	8,93	1	8,93	CHI
20191253911	PORTELANDIA	PW12324411	PARQUE DAS EMAS	09/12/2019 10:29	09/12/2019 16:30	09/12/2019 10:29	09/12/2019 16:30	6,01	2	12,02	CHI
20191252358	PIRANHAS	PH12170743	PIRANHAS	09/12/2019 10:31	09/12/2019 19:40	09/12/2019 10:31	09/12/2019 19:40	9,15	17	155,53	CHI
20191253932	PONTALINA	PK21127720	PONTALINA	09/12/2019 10:33	09/12/2019 18:02	09/12/2019 10:33	09/12/2019 18:02	7,47	2	14,94	CHI
20191253944	JUSSARA	JR10401446	BRITANIA	09/12/2019 10:35	09/12/2019 16:59	09/12/2019 10:35	09/12/2019 13:09	2,57	23	59,22	CHI
20191253944	JUSSARA	JR10401446	BRITANIA	09/12/2019 10:35	09/12/2019 16:59	09/12/2019 13:34	09/12/2019 14:28	0,90	23	20,72	CHI

20191253944	JUSSARA	JR10401446	BRITANIA	09/12/2019 10:35	09/12/2019 16:59	09/12/2019 10:35	09/12/2019 15:03	4,47	88	393,58	CHI
20191253944	MONTES CLAROS DE GOIAS	JR10401446	BRITANIA	09/12/2019 10:35	09/12/2019 16:59	09/12/2019 10:35	09/12/2019 15:03	4,47	160	715,60	CHI
20191253944	JUSSARA	JR10401446	BRITANIA	09/12/2019 10:35	09/12/2019 16:59	09/12/2019 14:30	09/12/2019 15:03	0,56	23	12,79	CHI
20191253944	JUSSARA	JR12204144	BRITANIA	09/12/2019 10:35	09/12/2019 16:59	09/12/2019 13:34	09/12/2019 16:59	3,41	2	6,83	CHI
20191253946	ITUMBIARA	690098297	ITUMBIARA VELHA S1	09/12/2019 10:35	09/12/2019 11:20	09/12/2019 10:35	09/12/2019 11:20	0,74	1	0,74	CHI
20191258564	JUSSARA	JR12022269	BRITANIA	09/12/2019 10:35	10/12/2019 11:05	09/12/2019 10:35	10/12/2019 11:05	24,50	29	710,50	CHI
20191258564	MONTES CLAROS DE GOIAS	JR12022269	BRITANIA	09/12/2019 10:35	10/12/2019 11:05	09/12/2019 10:35	10/12/2019 11:05	24,50	2	49,00	CHI
20191258564	JUSSARA	JR12022269	BRITANIA	09/12/2019 10:35	10/12/2019 11:05	09/12/2019 13:27	10/12/2019 11:05	21,63	1	21,63	CHI
20191258564	MONTES CLAROS DE GOIAS	JR12022269	BRITANIA	09/12/2019 10:35	10/12/2019 11:05	09/12/2019 13:27	10/12/2019 11:05	21,63	259	5602,17	CHI
20191253962	IPORA	IR11349679	IPORA	09/12/2019 10:41	09/12/2019 16:44	09/12/2019 10:41	09/12/2019 16:44	6,05	57	344,85	CHI
20191253963	INACIOLANDIA	ID31128244	QUIRINOPOLIS	09/12/2019 10:41	09/12/2019 16:29	09/12/2019 10:41	09/12/2019 16:29	5,80	1	5,80	CHI
20191253968	PANAMA	PX21239988	ITUMBIARA NOVA	09/12/2019 10:41	09/12/2019 12:00	09/12/2019 10:41	09/12/2019 12:00	1,30	1	1,30	CHI
20191254125	FAZENDA NOVA	JR12139962	JUSSARA	09/12/2019 10:42	10/12/2019 08:49	09/12/2019 10:42	10/12/2019 08:49	22,11	6	132,63	CHI
20191254125	JUSSARA	JR12139962	JUSSARA	09/12/2019 10:42	10/12/2019 08:49	09/12/2019 10:42	10/12/2019 08:49	22,11	131	2895,83	CHI
20191253977	MINACU	IH21378914	MINACU	09/12/2019 10:43	09/12/2019 15:18	09/12/2019 10:43	09/12/2019 15:18	4,58	1	4,58	CHI
20191253983	ITABERAI	IB31198962	ITABERAI S2	09/12/2019 10:43	09/12/2019 12:18	09/12/2019 10:43	09/12/2019 12:18	1,58	1	1,58	CHI
20191254643	FAZENDA NOVA	FN12396225	JUSSARA	09/12/2019 10:45	09/12/2019 14:45	09/12/2019 10:45	09/12/2019 14:45	4,00	10	40,01	CHI
20191254105	MINACU	IH21236055	MINACU	09/12/2019 10:47	09/12/2019 14:50	09/12/2019 10:47	09/12/2019 14:50	4,04	2	8,08	CHI
20191254107	ORIZONA	3950000377	PIRES DO RIO S2	09/12/2019 10:48	09/12/2019 13:06	09/12/2019 10:48	09/12/2019 13:06	2,30	1	2,30	CHI
20191254114	ALTO PARAISO DE GOIAS	BF21180778	NIQUELANDIA SUBTRANSMISSAO	09/12/2019 10:49	09/12/2019 15:42	09/12/2019 10:49	09/12/2019 15:42	4,87	1	4,87	CHI
20191254122	SANTA TEREZINHA DE GOIAS	GG21244240	SANTA TEREZINHA	09/12/2019 10:51	09/12/2019 19:56	09/12/2019 10:51	09/12/2019 19:56	9,07	1	9,07	CHI
20191254132	SAO MIGUEL DO ARAGUAIA	830045697	SAO MIGUEL DO ARAGUAIA	09/12/2019 10:53	09/12/2019 15:36	09/12/2019 10:53	09/12/2019 15:36	4,72	1	4,72	CHI
20191254133	ORIZONA	OZ12017081LD	PIRES DO RIO S2	09/12/2019 10:53	09/12/2019 12:29	09/12/2019 10:53	09/12/2019 12:29	1,61	245	394,65	CHI
20191254133	PIRES DO RIO	OZ12017081LD	PIRES DO RIO S2	09/12/2019 10:53	09/12/2019 12:29	09/12/2019 10:53	09/12/2019 12:29	1,61	11	17,72	CHI
20191254133	SAO MIGUEL DO PASSA QUATRO	OZ12017081LD	PIRES DO RIO S2	09/12/2019 10:53	09/12/2019 12:29	09/12/2019 10:53	09/12/2019 12:29	1,61	2	3,22	CHI
20191254133	VIANOPOLIS	OZ12017081LD	PIRES DO RIO S2	09/12/2019 10:53	09/12/2019 12:29	09/12/2019 10:53	09/12/2019 12:29	1,61	81	130,48	CHI
20191254156	CEZARINA	CZ12313065	CEZARINA	09/12/2019 10:58	10/12/2019 15:35	09/12/2019 10:58	10/12/2019 15:35	28,62	1	28,62	CHI
20191254163	CATALAO	CT11379394	CATALAO S2	09/12/2019 11:00	09/12/2019 11:24	09/12/2019 11:00	09/12/2019 11:24	0,39	14	5,52	CHI
20191254165	MINACU	IH12171869	MINACU	09/12/2019 11:00	09/12/2019 14:04	09/12/2019 11:00	09/12/2019 14:04	3,06	74	226,23	CHI
20191254167	APARECIDA DE GOIANIA	16447591	INDEPENDENCIA S1	09/12/2019 11:00	09/12/2019 14:17	09/12/2019 11:00	09/12/2019 14:17	3,29	1	3,29	CHI
20191254554	BALIZA	BH12334535	BOM JARDIM	09/12/2019 11:02	09/12/2019 19:07	09/12/2019 11:02	09/12/2019 19:07	8,08	18	145,48	CHI
20191254179	CAIAPONIA	CP21222955	CAIAPONIA	09/12/2019 11:03	09/12/2019 15:28	09/12/2019 11:03	09/12/2019 15:28	4,41	1	4,41	CHI
20191254182	SAO LUIZ DO NORTE	3090002320	ITAPACI	09/12/2019 11:03	10/12/2019 08:47	09/12/2019 11:03	10/12/2019 08:47	21,72	1	21,72	CHI

20191256146	APARECIDA DE GOIANIA	200467785	INDEPENDENCIA S1	09/12/2019 11:03	09/12/2019 13:00	09/12/2019 11:03	09/12/2019 13:00	1,94	1	1,94	CHI
20191254191	FIRMINOPOLIS	900002451	FIRMINOPOLIS S1	09/12/2019 11:05	09/12/2019 21:08	09/12/2019 11:05	09/12/2019 21:08	10,04	1	10,04	CHI
20191254196	TRINDADE	40286666	TRINDADE	09/12/2019 11:07	09/12/2019 12:58	09/12/2019 11:07	09/12/2019 12:58	1,86	1	1,86	CHI
20191254198	CALDAS NOVAS	CN18335577TS	CALDAS NOVAS S1	09/12/2019 11:07	09/12/2019 23:55	09/12/2019 11:07	09/12/2019 23:55	12,80	59	755,36	CHI
20191254202	ITAPACI	IW21335658	ITAPACI	09/12/2019 11:08	09/12/2019 14:03	09/12/2019 11:08	09/12/2019 14:03	2,91	1	2,91	CHI
20191255292	SENADOR CANEDO	SW21160836	SENADOR CANEDO	09/12/2019 11:08	09/12/2019 18:07	09/12/2019 11:08	09/12/2019 18:07	6,98	1	6,98	CHI
20191254207	ARAGARCAS	AG11341728	IPORA	09/12/2019 11:09	09/12/2019 17:30	09/12/2019 11:09	09/12/2019 17:30	6,35	9	57,11	CHI
20191254220	GOIANIA	10014054882	FERROVIARIO S2	09/12/2019 11:12	09/12/2019 13:18	09/12/2019 11:12	09/12/2019 13:18	2,10	1	2,10	CHI
20191254222	ACREUNA	2440062050	ACREUNA	09/12/2019 11:13	09/12/2019 12:24	09/12/2019 11:13	09/12/2019 12:24	1,17	1	1,17	CHI
20191254223	PROFESSOR JAMIL SAFADY	PJ12000360	ROCHEDO	09/12/2019 11:14	09/12/2019 17:10	09/12/2019 11:14	09/12/2019 17:10	5,94	8	47,48	CHI
20191254242	RIO VERDE	SH12024691	RIO VERDE S1	09/12/2019 11:20	09/12/2019 14:53	09/12/2019 11:20	09/12/2019 14:53	3,53	1	3,53	CHI
20191254247	JANDAIA	6784961	PALMEIRAS	09/12/2019 11:22	09/12/2019 18:00	09/12/2019 11:22	09/12/2019 18:00	6,63	4	26,53	CHI
20191254251	RIO VERDE	RV21271577	MONTIVIDIU T	09/12/2019 11:23	09/12/2019 16:18	09/12/2019 11:23	09/12/2019 16:18	4,90	1	4,90	CHI
20191254253	CALDAS NOVAS	CN21221959	CALDAS NOVAS S2	09/12/2019 11:25	09/12/2019 18:51	09/12/2019 11:25	09/12/2019 18:51	7,43	1	7,43	CHI
20191254254	GOIANIA	15079417	CARAJAS S1	09/12/2019 11:25	09/12/2019 12:41	09/12/2019 11:25	09/12/2019 12:41	1,27	1	1,27	CHI
20191254258	SAO JOAO DA PARAUNA	RP21026464	FIRMINOPOLIS S2	09/12/2019 11:26	09/12/2019 13:41	09/12/2019 11:26	09/12/2019 13:41	2,24	1	2,24	CHI
20191254555	DOVERLANDIA	MY12219553	PARQUE DAS EMAS	09/12/2019 11:27	10/12/2019 21:30	09/12/2019 11:27	10/12/2019 21:30	34,05	46	1566,38	CHI
20191254560	BURITI DE GOIAS	BS12008816	FIRMINOPOLIS S2	09/12/2019 11:28	09/12/2019 14:15	09/12/2019 11:28	09/12/2019 14:15	2,80	2	5,59	CHI
20191254282	MINEIROS	MY11036556	PARQUE DAS EMAS	09/12/2019 11:32	09/12/2019 15:52	09/12/2019 11:32	09/12/2019 15:52	4,33	216	934,44	CHI
20191254636	CACHOEIRA DE GOIAS	CG12018660	FIRMINOPOLIS S2	09/12/2019 11:33	09/12/2019 19:28	09/12/2019 11:33	09/12/2019 19:28	7,92	36	285,29	CHI
20191254281	ITAPURANGA	10015126496	ITAPURANGA	09/12/2019 11:35	09/12/2019 13:45	09/12/2019 11:35	09/12/2019 13:45	2,16	1	2,16	CHI
20191254289	CALDAS NOVAS	CN12298658	CALDAS NOVAS S1	09/12/2019 11:37	09/12/2019 16:19	09/12/2019 11:37	09/12/2019 16:19	4,71	1	4,71	CHI
20191254290	RUBIATABA	RB12156045	RUBIATABA	09/12/2019 11:38	09/12/2019 19:40	09/12/2019 11:38	09/12/2019 19:40	8,03	2	16,06	CHI
20191254569	JATAI	JT12336920	JATAI S1	09/12/2019 11:38	09/12/2019 15:19	09/12/2019 11:38	09/12/2019 15:19	3,67	10	36,75	CHI
20191254292	JATAI	JT12303012	JATAI S1	09/12/2019 11:39	10/12/2019 07:51	09/12/2019 11:39	10/12/2019 07:51	20,20	2	40,40	CHI
20191254294	TRINDADE	40259225	TRINDADE	09/12/2019 11:40	09/12/2019 17:38	09/12/2019 11:40	09/12/2019 17:38	5,96	1	5,96	CHI
20191254297	GOIAS	GS21140285	MATRINCHA	09/12/2019 11:41	09/12/2019 16:40	09/12/2019 11:41	09/12/2019 16:40	4,98	2	9,97	CHI
20191254300	FORMOSA	FA12357518	SAO JOAO D ALIANCA	09/12/2019 11:42	09/12/2019 15:46	09/12/2019 11:42	09/12/2019 15:46	4,06	10	40,58	CHI
20191254401	MINACU	4020019515	MINACU	09/12/2019 11:42	09/12/2019 18:30	09/12/2019 11:42	09/12/2019 18:30	6,79	1	6,79	CHI
20191254403	NEROPOLIS	NR12029257	NEROPOLIS S2	09/12/2019 11:43	09/12/2019 20:53	09/12/2019 11:43	09/12/2019 20:53	9,16	9	82,43	CHI
20191258267	NIQUELANDIA	NQ12397472	NIQUELANDIA SUBTRANSMISSAO	09/12/2019 11:43	10/12/2019 11:02	09/12/2019 11:43	10/12/2019 11:02	23,31	16	373,00	CHI
20191258267	URUACU	NQ12397472	NIQUELANDIA SUBTRANSMISSAO	09/12/2019 11:43	10/12/2019 11:02	09/12/2019 11:43	10/12/2019 11:02	23,31	1	23,31	CHI
20191254410	MINACU	IH11212285	MINACU	09/12/2019 11:46	09/12/2019 16:35	09/12/2019 11:46	09/12/2019 16:35	4,82	3	14,47	CHI

20191254539	JARAGUA	JA12040522	ITABERAI S1	09/12/2019 11:46	10/12/2019 08:12	09/12/2019 11:46	10/12/2019 08:12	20,43	20	408,53	CHI
20191254416	URUTAI	UT12016954	URUTAI	09/12/2019 11:48	09/12/2019 17:00	09/12/2019 11:48	09/12/2019 17:00	5,19	2	10,39	CHI
20191254418	GOIANIA	GN11363200	CARAJAS S1	09/12/2019 11:49	09/12/2019 15:13	09/12/2019 11:49	09/12/2019 15:13	3,39	39	132,18	CHI
20191255389	ITAGUARU	IC12068838	ITABERAI S1	09/12/2019 11:49	10/12/2019 07:14	09/12/2019 11:49	10/12/2019 07:14	19,41	12	232,92	CHI
20191254424	GOIAS	GS12274247	GOIAS	09/12/2019 11:50	09/12/2019 15:21	09/12/2019 11:50	09/12/2019 15:21	3,50	10	35,02	CHI
20191255064	SANTA HELENA DE GOIAS	SH11226279	IPEGUARI	09/12/2019 11:50	09/12/2019 23:30	09/12/2019 11:50	09/12/2019 23:30	11,65	38	442,82	CHI
20191254426	FAZENDA NOVA	FN21022383	IPORA	09/12/2019 11:52	10/12/2019 07:28	09/12/2019 11:52	10/12/2019 07:28	19,59	1	19,59	CHI
20191254434	FORMOSA	2920003039	ITUIQUIRA	09/12/2019 11:54	09/12/2019 13:21	09/12/2019 11:54	09/12/2019 13:21	1,45	1	1,45	CHI
20191254501	MORRINHOS	MR12402501	GOIATUBA S1	09/12/2019 11:54	09/12/2019 17:00	09/12/2019 11:54	09/12/2019 17:00	5,10	46	234,41	CHI
20191254504	CATALAO	1990286152	CATALAO S2	09/12/2019 11:55	09/12/2019 13:17	09/12/2019 11:55	09/12/2019 13:17	1,36	1	1,36	CHI
20191254509	MOZARLANDIA	MZ12055636	MOZARLANDIA	09/12/2019 11:56	09/12/2019 16:00	09/12/2019 11:56	09/12/2019 16:00	4,06	3	12,17	CHI
20191255665	MINEIROS	MY12358869	PARQUE DAS EMAS	09/12/2019 11:56	09/12/2019 23:35	09/12/2019 11:56	09/12/2019 23:35	11,64	120	1396,67	CHI
20191255665	SANTA RITA DO ARAGUAIA	MY12358869	PARQUE DAS EMAS	09/12/2019 11:56	09/12/2019 23:35	09/12/2019 11:56	09/12/2019 23:35	11,64	4	46,56	CHI
20191254317	CAIAPONIA	CP11243831	CAIAPONIA	09/12/2019 11:57	09/12/2019 13:27	09/12/2019 11:57	09/12/2019 13:27	1,49	2	2,98	CHI
20191254978	JUSSARA	JR12009940	JUSSARA	09/12/2019 12:00	09/12/2019 13:29	09/12/2019 12:00	09/12/2019 13:29	1,49	4	5,97	CHI
20191254518	GUAPO	GA12006365	GUAPO S1	09/12/2019 12:01	09/12/2019 16:40	09/12/2019 12:01	09/12/2019 16:40	4,64	2	9,27	CHI
20191254933	PIRES DO RIO	PZ12000507LD	PIRES DO RIO S2	09/12/2019 12:02	10/12/2019 16:39	09/12/2019 12:02	10/12/2019 16:39	28,60	11	314,65	CHI
20191254933	SANTA CRUZ DE GOIAS	PZ12000507LD	PIRES DO RIO S2	09/12/2019 12:02	10/12/2019 16:39	09/12/2019 12:02	10/12/2019 16:39	28,60	76	2173,94	CHI
20191254933	PALMELO	PZ12000507LD	PIRES DO RIO S2	09/12/2019 12:02	10/12/2019 16:39	10/12/2019 14:17	10/12/2019 16:39	2,36	44	103,91	CHI
20191254933	PIRES DO RIO	PZ12000507LD	PIRES DO RIO S2	09/12/2019 12:02	10/12/2019 16:39	10/12/2019 14:17	10/12/2019 16:39	2,36	1	2,36	CHI
20191254933	SANTA CRUZ DE GOIAS	PZ12000507LD	PIRES DO RIO S2	09/12/2019 12:02	10/12/2019 16:39	10/12/2019 14:17	10/12/2019 16:39	2,36	44	103,91	CHI
20191254527	NOVO GAMA	NJ11201176	PACAEMBU S1	09/12/2019 12:03	09/12/2019 12:57	09/12/2019 12:03	09/12/2019 12:57	0,89	117	104,55	CHI
20191255707	CAMPO ALEGRE DE GOIAS	CM12156359	CAMPO ALEGRE DE GOIAS	09/12/2019 12:05	10/12/2019 08:10	09/12/2019 12:05	10/12/2019 08:10	20,07	31	622,32	CHI
20191254536	CAIAPONIA	CP21131633	MONTIVIDIU T	09/12/2019 12:06	10/12/2019 16:40	09/12/2019 12:06	10/12/2019 16:40	28,56	1	28,56	CHI
20191254540	GOIANIA	15388451	GOIANIA LESTE S1	09/12/2019 12:07	09/12/2019 13:26	09/12/2019 12:07	09/12/2019 13:26	1,31	1	1,31	CHI
20191254542	NIQUELANDIA	NQ21227325	URUACU	09/12/2019 12:07	09/12/2019 16:30	09/12/2019 12:07	09/12/2019 16:30	4,38	22	96,40	CHI
20191254544	GUARANI DE GOIAS	GY12257673	IACIARA S1	09/12/2019 12:08	09/12/2019 20:05	09/12/2019 12:08	09/12/2019 20:05	7,95	95	755,20	CHI
20191254544	IACIARA	GY12257673	IACIARA S1	09/12/2019 12:08	09/12/2019 20:05	09/12/2019 12:08	09/12/2019 20:05	7,95	5	39,75	CHI
20191255119	DOVERLANDIA	DV12139919	CAIAPONIA	09/12/2019 12:11	09/12/2019 16:00	09/12/2019 12:11	09/12/2019 16:00	3,81	48	182,83	CHI
20191255003	SILVANIA	SV12400029	VIANOPOLIS	09/12/2019 12:13	09/12/2019 16:17	09/12/2019 12:13	09/12/2019 16:17	4,07	93	378,20	CHI
20191254567	GOIATUBA	GT21013086	GOIATUBA S2	09/12/2019 12:15	09/12/2019 14:18	09/12/2019 12:15	09/12/2019 14:18	2,05	1	2,05	CHI
20191255327	NOVO PLANALTO	TA12192346	SAO MIGUEL DO ARAGUAIA	09/12/2019 12:15	09/12/2019 18:58	09/12/2019 12:15	09/12/2019 17:37	5,36	4	21,44	CHI
20191255327	NOVO PLANALTO	TA12192346	SAO MIGUEL DO ARAGUAIA	09/12/2019 12:15	09/12/2019 18:58	09/12/2019 12:15	09/12/2019 18:58	6,71	97	650,79	CHI

20191254572	PARANAIGUARA	QI12276207	QUIRINOPOLIS	09/12/2019 12:16	09/12/2019 16:31	09/12/2019 12:16	09/12/2019 16:31	4,24	5	21,20	CHI
20191254572	QUIRINOPOLIS	QI12276207	QUIRINOPOLIS	09/12/2019 12:16	09/12/2019 16:31	09/12/2019 12:16	09/12/2019 16:31	4,24	51	216,20	CHI
20191254575	QUIRINOPOLIS	QI21014940	QUIRINOPOLIS	09/12/2019 12:17	09/12/2019 13:55	09/12/2019 12:17	09/12/2019 13:55	1,64	1	1,64	CHI
20191254580	SAO LUIS DE MONTES BELOS	10028428275	SAO LUIZ DOS MONTES BELOS	09/12/2019 12:18	09/12/2019 18:25	09/12/2019 12:18	09/12/2019 18:25	6,10	1	6,10	CHI
20191254582	SAO JOAO D ALIANCA	JL12146134	SAO JOAO D ALIANCA	09/12/2019 12:19	10/12/2019 19:34	09/12/2019 12:19	10/12/2019 19:34	31,26	1	31,26	CHI
20191254585	ALEXANIA	AX21161202	ALEXANIA	09/12/2019 12:20	09/12/2019 18:52	09/12/2019 12:20	09/12/2019 18:52	6,53	1	6,53	CHI
20191254586	JATAI	JT21241680	JATAI S1	09/12/2019 12:20	09/12/2019 14:48	09/12/2019 12:20	09/12/2019 14:48	2,45	1	2,45	CHI
20191254591	QUIRINOPOLIS	QI12096888	QUIRINOPOLIS	09/12/2019 12:21	09/12/2019 15:03	09/12/2019 12:21	09/12/2019 15:03	2,70	20	53,95	CHI
20191254592	JARAGUA	JA21297921	JARAGUA	09/12/2019 12:21	09/12/2019 13:55	09/12/2019 12:21	09/12/2019 13:55	1,56	5	7,82	CHI
20191254596	AGUA FRIA DE GOIAS	TL12264641	SAO JOAO D ALIANCA	09/12/2019 12:21	09/12/2019 17:01	09/12/2019 12:21	09/12/2019 17:01	4,65	12	55,84	CHI
20191256643	NIQUELANDIA	NQ21317225	URUACU	09/12/2019 12:21	09/12/2019 22:23	09/12/2019 12:21	09/12/2019 22:23	10,03	1	10,03	CHI
20191260708	SAO MIGUEL DO ARAGUAIA	SM13349178	SAO MIGUEL DO ARAGUAIA	09/12/2019 12:21	10/12/2019 08:29	09/12/2019 12:21	10/12/2019 08:29	20,12	80	1609,47	CHI
20191254599	VALPARAISO DE GOIAS	VA11067696	MARAJOARA	09/12/2019 12:22	09/12/2019 16:00	09/12/2019 12:22	09/12/2019 16:00	3,62	63	228,31	CHI
20191254604	PIRANHAS	PH12204964	PIRANHAS	09/12/2019 12:23	10/12/2019 09:08	09/12/2019 12:23	10/12/2019 09:08	20,74	5	103,70	CHI
20191254605	PORANGATU	PO21301004	NOVO PLANALTO	09/12/2019 12:24	09/12/2019 17:20	09/12/2019 12:24	09/12/2019 17:20	4,94	1	4,94	CHI
20191254608	COLINAS DO SUL	TI21236614	MINACU	09/12/2019 12:25	10/12/2019 13:01	09/12/2019 12:25	10/12/2019 13:01	24,60	6	147,61	CHI
20191254673	BELA VISTA DE GOIAS	LB12270662	DAIA S2	09/12/2019 12:25	09/12/2019 17:09	09/12/2019 12:25	09/12/2019 17:09	4,73	1	4,73	CHI
20191254673	CALDAZINHA	LB12270662	DAIA S2	09/12/2019 12:25	09/12/2019 17:09	09/12/2019 12:25	09/12/2019 17:09	4,73	70	331,33	CHI
20191254673	LEOPOLDO DE BULHOES	LB12270662	DAIA S2	09/12/2019 12:25	09/12/2019 17:09	09/12/2019 12:25	09/12/2019 17:09	4,73	6	28,40	CHI
20191254673	SILVANIA	LB12270662	DAIA S2	09/12/2019 12:25	09/12/2019 17:09	09/12/2019 12:25	09/12/2019 17:09	4,73	59	279,27	CHI
20191254617	BELA VISTA DE GOIAS	BV11130692	BELA VISTA S2	09/12/2019 12:26	09/12/2019 17:52	09/12/2019 12:26	09/12/2019 17:52	5,43	80	434,33	CHI
20191254619	PIRES DO RIO	PR21075723	PIRES DO RIO S1	09/12/2019 12:26	09/12/2019 19:15	09/12/2019 12:26	09/12/2019 19:15	6,81	1	6,81	CHI
20191255710	GOIAS	IU12198548	MATRINCHA	09/12/2019 12:26	09/12/2019 16:08	09/12/2019 12:26	09/12/2019 16:08	3,70	1	3,70	CHI
20191255710	ITAPIRAPUA	IU12198548	MATRINCHA	09/12/2019 12:26	09/12/2019 16:08	09/12/2019 12:26	09/12/2019 16:08	3,70	2	7,39	CHI
20191254622	GOIAS	GS21250689	GOIAS	09/12/2019 12:27	09/12/2019 14:21	09/12/2019 12:27	09/12/2019 14:21	1,90	1	1,90	CHI
20191254623	GAMELEIRA DE GOIAS	SV21125452	DAIA S2	09/12/2019 12:27	09/12/2019 20:33	09/12/2019 12:27	09/12/2019 20:33	8,09	1	8,09	CHI
20191254632	ITARUMA	IM12234538	CACHOEIRA ALTA	09/12/2019 12:29	10/12/2019 07:43	09/12/2019 12:29	10/12/2019 07:43	19,22	4	76,90	CHI
20191256208	TRINDADE	TR12187584	TRINDADE	09/12/2019 12:31	09/12/2019 17:33	09/12/2019 12:31	09/12/2019 17:33	5,03	3	15,09	CHI
20191254640	ANAPOLIS	AN31080802	JUNDIAI S2	09/12/2019 12:32	09/12/2019 17:45	09/12/2019 12:32	09/12/2019 17:45	5,22	1	5,22	CHI
20191254677	GOIATUBA	GT12097335	GOIATUBA S2	09/12/2019 12:33	09/12/2019 14:04	09/12/2019 12:33	09/12/2019 14:04	1,51	5	7,55	CHI
20191254653	CATALAO	1990196357	CATALAO S2	09/12/2019 12:34	09/12/2019 17:30	09/12/2019 12:34	09/12/2019 17:30	4,92	1	4,92	CHI
20191254654	ITUMBIARA	690220959	ITUMBIARA NOVA	09/12/2019 12:34	09/12/2019 13:50	09/12/2019 12:34	09/12/2019 13:50	1,26	1	1,26	CHI
20191255048	ALTO PARAISO DE GOIAS	ND12302636	IACIARA S2	09/12/2019 12:34	09/12/2019 17:04	09/12/2019 12:34	09/12/2019 17:04	4,49	18	80,90	CHI

20191255048	NOVA ROMA	ND12302636	IACIARA S2	09/12/2019 12:34	09/12/2019 17:04	09/12/2019 12:34	09/12/2019 17:04	4,49	96	431,47	CHI
20191255048	SAO JOAO D ALIANCA	ND12302636	IACIARA S2	09/12/2019 12:34	09/12/2019 17:04	09/12/2019 12:34	09/12/2019 17:04	4,49	12	53,93	CHI
20191254656	MORRINHOS	MR12092130	MORRINHOS	09/12/2019 12:35	09/12/2019 17:20	09/12/2019 12:35	09/12/2019 17:20	4,75	12	56,99	CHI
20191255270	GUARINOS	IW12201636	ITAPACI	09/12/2019 12:35	09/12/2019 15:04	09/12/2019 12:35	09/12/2019 15:04	2,47	7	17,28	CHI
20191255270	ITAPACI	IW12201636	ITAPACI	09/12/2019 12:35	09/12/2019 15:04	09/12/2019 12:35	09/12/2019 15:04	2,47	245	604,74	CHI
20191255270	PILAR DE GOIAS	IW12201636	ITAPACI	09/12/2019 12:35	09/12/2019 15:04	09/12/2019 12:35	09/12/2019 15:04	2,47	1	2,47	CHI
20191254665	APARECIDA DE GOIANIA	12036894	REAL S2	09/12/2019 12:37	09/12/2019 15:29	09/12/2019 12:37	09/12/2019 15:29	2,86	1	2,86	CHI
20191254669	PETROLINA DE GOIAS	PG21280544	SAO FRANCISCO DE GOIAS	09/12/2019 12:38	09/12/2019 18:30	09/12/2019 12:38	09/12/2019 18:30	5,87	1	5,87	CHI
20191254679	TURVANIA	10002171099	FIRMINOPOLIS S2	09/12/2019 12:41	09/12/2019 23:38	09/12/2019 12:41	09/12/2019 23:38	10,96	1	10,96	CHI
20191254680	SANTA TEREZA DE GOIAS	10005833270	MARA ROSA	09/12/2019 12:41	10/12/2019 00:10	09/12/2019 12:41	10/12/2019 00:10	11,48	1	11,48	CHI
20191254936	CACHOEIRA DOURADA	CD12000067	CACHOEIRA DOURADA	09/12/2019 12:42	11/12/2019 00:07	09/12/2019 12:42	10/12/2019 10:00	21,30	46	979,85	CHI
20191254936	INACIOLANDIA	CD12000067	CACHOEIRA DOURADA	09/12/2019 12:42	11/12/2019 00:07	09/12/2019 12:42	10/12/2019 10:00	21,30	1	21,30	CHI
20191254936	CACHOEIRA DOURADA	CD12000067	CACHOEIRA DOURADA	09/12/2019 12:42	11/12/2019 00:07	09/12/2019 12:42	10/12/2019 11:19	22,61	1	22,61	CHI
20191254936	INACIOLANDIA	CD12000067	CACHOEIRA DOURADA	09/12/2019 12:42	11/12/2019 00:07	09/12/2019 12:42	10/12/2019 11:19	22,61	8	180,88	CHI
20191254936	INACIOLANDIA	ID13289354	CACHOEIRA DOURADA	09/12/2019 12:42	11/12/2019 00:07	09/12/2019 12:42	10/12/2019 13:21	24,65	75	1848,96	CHI
20191254936	INACIOLANDIA	CD12000067	CACHOEIRA DOURADA	09/12/2019 12:42	11/12/2019 00:07	09/12/2019 12:42	11/12/2019 00:07	35,41	17	601,98	CHI
20191254936	ITUMBIAIRA	CD12000067	CACHOEIRA DOURADA	09/12/2019 12:42	11/12/2019 00:07	09/12/2019 12:42	11/12/2019 00:07	35,41	13	460,34	CHI
20191254686	PALESTINA DE GOIAS	PY21334961	PALESTINA	09/12/2019 12:43	10/12/2019 06:55	09/12/2019 12:43	10/12/2019 06:55	18,20	1	18,20	CHI
20191254687	PIRENOPOLIS	10009996670	SAO FRANCISCO DE GOIAS	09/12/2019 12:43	10/12/2019 13:52	09/12/2019 12:43	10/12/2019 13:52	25,14	1	25,14	CHI
20191254690	QUIRINOPOLIS	QI31014937	QUIRINOPOLIS	09/12/2019 12:44	09/12/2019 14:45	09/12/2019 12:44	09/12/2019 14:45	2,01	1	2,01	CHI
20191254696	DIORAMA	DI21207849	ARENOPOLIS	09/12/2019 12:44	10/12/2019 07:02	09/12/2019 12:44	10/12/2019 07:02	18,29	1	18,29	CHI
20191254990	MINEIROS	MY12241805	PARQUE DAS EMAS	09/12/2019 12:44	10/12/2019 07:56	09/12/2019 12:44	10/12/2019 07:56	19,19	15	287,79	CHI
20191254700	APARECIDA DE GOIANIA	10018119911	INDEPENDENCIA S2	09/12/2019 12:46	09/12/2019 15:55	09/12/2019 12:46	09/12/2019 15:55	3,15	1	3,15	CHI
20191254704	APARECIDA DE GOIANIA	14440118	REAL S2	09/12/2019 12:47	09/12/2019 17:21	09/12/2019 12:47	09/12/2019 17:21	4,57	1	4,57	CHI
20191254708	ORIZONA	OZ21300783	PIRES DO RIO S2	09/12/2019 12:48	09/12/2019 18:37	09/12/2019 12:48	09/12/2019 18:37	5,82	3	17,45	CHI
20191254712	MUNDO NOVO DE GOIAS	4240017702	NOVA CRIXAS	09/12/2019 12:48	09/12/2019 20:24	09/12/2019 12:48	09/12/2019 20:24	7,59	1	7,59	CHI
20191254722	GOIAS	IB12300059	ITABERAI S2	09/12/2019 12:50	09/12/2019 16:33	09/12/2019 12:50	09/12/2019 16:33	3,72	67	248,92	CHI
20191254722	ITABERAI	IB12300059	ITABERAI S2	09/12/2019 12:50	09/12/2019 16:33	09/12/2019 12:50	09/12/2019 16:33	3,72	13	48,30	CHI
20191254723	BELA VISTA DE GOIAS	BV21200317	BELA VISTA S2	09/12/2019 12:50	10/12/2019 07:04	09/12/2019 12:50	10/12/2019 07:04	18,22	1	18,22	CHI
20191255265	BALIZA	BH12210020	BOM JARDIM	09/12/2019 12:50	09/12/2019 15:41	09/12/2019 12:50	09/12/2019 15:41	2,84	93	264,02	CHI
20191254725	INHUMAS	IN21052328	INHUMAS S2	09/12/2019 12:51	09/12/2019 16:00	09/12/2019 12:51	09/12/2019 16:00	3,16	1	3,16	CHI
20191254734	ALVORADA DO NORTE	1510023498	IACIARA S2	09/12/2019 12:53	09/12/2019 17:49	09/12/2019 12:53	09/12/2019 17:49	4,93	1	4,93	CHI
20191254735	JATAI	10012437032	JATAI S2	09/12/2019 12:53	09/12/2019 16:03	09/12/2019 12:53	09/12/2019 16:03	3,16	1	3,16	CHI

20191254773	JATAI	JT12303380	JATAI S1	09/12/2019 12:53	09/12/2019 17:25	09/12/2019 12:53	09/12/2019 17:25	4,52	25	113,07	CHI
20191254741	GOIANIA	GN11050039	ATLANTICO S1	09/12/2019 12:54	09/12/2019 15:44	09/12/2019 12:54	09/12/2019 15:44	2,83	88	249,28	CHI
20191254746	PORANGATU	PO12360153	PORANGATU	09/12/2019 12:55	09/12/2019 17:35	09/12/2019 12:55	09/12/2019 17:35	4,66	3	13,99	CHI
20191254748	CAMPO ALEGRE DE GOIAS	CM21073555	CAMPO ALEGRE DE GOIAS	09/12/2019 12:56	10/12/2019 09:59	09/12/2019 12:56	10/12/2019 09:59	21,06	1	21,06	CHI
20191254750	CORUMBAIBA	CI12377073	CATALAO S1	09/12/2019 12:56	09/12/2019 17:19	09/12/2019 12:56	09/12/2019 17:19	4,38	6	26,26	CHI
20191254750	NOVA AURORA	CI12377073	CATALAO S1	09/12/2019 12:56	09/12/2019 17:19	09/12/2019 12:56	09/12/2019 17:19	4,38	8	35,01	CHI
20191254757	PADRE BERNARDO	PB12389559	PADRE BERNARDO	09/12/2019 12:57	09/12/2019 15:34	09/12/2019 12:57	09/12/2019 15:34	2,61	14	36,50	CHI
20191254760	SAO DOMINGOS	SD12344108	SAO DOMINGOS	09/12/2019 12:58	10/12/2019 10:59	09/12/2019 12:58	10/12/2019 10:59	22,01	2	44,01	CHI
20191254761	MINEIROS	1390092309	PARQUE DAS EMAS	09/12/2019 12:58	10/12/2019 11:08	09/12/2019 12:58	10/12/2019 11:08	22,16	1	22,16	CHI
20191254765	ACREUNA	EU12179663	ACREUNA	09/12/2019 12:59	09/12/2019 14:50	09/12/2019 12:59	09/12/2019 14:50	1,84	1	1,84	CHI
20191254767	GOIANIA	10861725	GOIANIA LESTE S3	09/12/2019 13:00	09/12/2019 14:27	09/12/2019 13:00	09/12/2019 14:27	1,45	1	1,45	CHI
20191255053	BALIZA	BH10406688	BOM JARDIM	09/12/2019 13:00	09/12/2019 19:09	09/12/2019 13:00	09/12/2019 19:09	6,15	12	73,78	CHI
20191254775	GOIANESIA	GE12382866	GOIANESIA S1	09/12/2019 13:02	09/12/2019 16:55	09/12/2019 13:02	09/12/2019 16:55	3,88	6	23,29	CHI
20191257047	DOVERLANDIA	DV12349725	CAIAPONIA	09/12/2019 13:02	10/12/2019 06:49	09/12/2019 13:02	10/12/2019 06:49	17,78	3	53,33	CHI
20191254787	CAMPOS VERDES	VD12243626	SANTA TEREZINHA	09/12/2019 13:03	09/12/2019 17:15	09/12/2019 13:03	09/12/2019 17:15	4,19	20	83,73	CHI
20191255302	NIQUELANDIA	NQ12243469	NIQUELANDIA SUBTRANSMISSAO	09/12/2019 13:04	10/12/2019 16:29	09/12/2019 13:04	10/12/2019 16:29	27,41	60	1644,80	CHI
20191254793	CAMPO ALEGRE DE GOIAS	CM21102373	CAMPO ALEGRE DE GOIAS	09/12/2019 13:05	10/12/2019 10:12	09/12/2019 13:05	10/12/2019 10:12	21,12	1	21,12	CHI
20191254797	PLANALTINA	PI1218310	PLANALTINA	09/12/2019 13:05	09/12/2019 15:08	09/12/2019 13:05	09/12/2019 15:08	2,04	2	4,07	CHI
20191255531	PIRES DO RIO	PR12064876RE	PIRES DO RIO S1	09/12/2019 13:05	10/12/2019 08:48	09/12/2019 13:05	10/12/2019 08:48	19,71	25	492,73	CHI
20191257249	CAIAPONIA	PW12374317	PARQUE DAS EMAS	09/12/2019 13:05	10/12/2019 10:21	09/12/2019 13:05	10/12/2019 10:21	21,25	1	21,25	CHI
20191257249	DOVERLANDIA	PW12374317	PARQUE DAS EMAS	09/12/2019 13:05	10/12/2019 10:21	09/12/2019 13:05	10/12/2019 10:21	21,25	4	85,02	CHI
20191257249	MINEIROS	PW12374317	PARQUE DAS EMAS	09/12/2019 13:05	10/12/2019 10:21	09/12/2019 13:05	10/12/2019 10:21	21,25	16	340,08	CHI
20191257249	PEROLANDIA	PW12374317	PARQUE DAS EMAS	09/12/2019 13:05	10/12/2019 10:21	09/12/2019 13:05	10/12/2019 10:21	21,25	3	63,76	CHI
20191257249	PORTELANDIA	PW12374317	PARQUE DAS EMAS	09/12/2019 13:05	10/12/2019 10:21	09/12/2019 13:05	10/12/2019 10:21	21,25	7	148,78	CHI
20191254799	ORIZONA	OZ12083185	PIRES DO RIO S1	09/12/2019 13:06	09/12/2019 17:10	09/12/2019 13:06	09/12/2019 17:10	4,08	3	12,24	CHI
20191254901	PIRENOPOLIS	PV21297745	CORUMBA	09/12/2019 13:06	10/12/2019 13:50	09/12/2019 13:06	10/12/2019 13:50	24,73	1	24,73	CHI
20191254903	PILAR DE GOIAS	GG12128447	SANTA TEREZINHA	09/12/2019 13:06	10/12/2019 11:33	09/12/2019 13:06	10/12/2019 11:33	22,44	39	875,35	CHI
20191254907	NIQUELANDIA	NQ12197539	NIQUELANDIA SUBTRANSMISSAO	09/12/2019 13:07	10/12/2019 09:45	09/12/2019 13:07	10/12/2019 09:45	20,62	14	288,71	CHI
20191259702	ORIZONA	OZ12404726	PIRES DO RIO S1	09/12/2019 13:07	10/12/2019 00:56	09/12/2019 13:07	10/12/2019 00:56	11,81	9	106,26	CHI
20191254910	ITAPACI	10007375555	ITAPACI	09/12/2019 13:08	10/12/2019 11:19	09/12/2019 13:08	10/12/2019 11:19	22,18	1	22,18	CHI
20191280465	PIRANHAS	PH21201803	PIRANHAS	09/12/2019 13:09	11/12/2019 08:35	09/12/2019 13:09	11/12/2019 08:35	43,43	1	43,43	CHI
20191254919	JARAGUA	10009865304	JARAGUA	09/12/2019 13:10	09/12/2019 15:59	09/12/2019 13:10	09/12/2019 15:59	2,80	1	2,80	CHI
20191254921	PIRACANJUBA	60065515	PIRACANJUBA	09/12/2019 13:11	09/12/2019 19:37	09/12/2019 13:11	09/12/2019 19:37	6,42	1	6,42	CHI

20191254922	RIO VERDE	630399499	RIO VERDE S2	09/12/2019 13:11	09/12/2019 15:26	09/12/2019 13:11	09/12/2019 15:26	2,25	1	2,25	CHI
20191255299	INHUMAS	IX12016046	INHUMAS S1	09/12/2019 13:11	09/12/2019 15:47	09/12/2019 13:11	09/12/2019 15:47	2,59	8	20,73	CHI
20191255299	ITAUCU	IX12016046	INHUMAS S1	09/12/2019 13:11	09/12/2019 15:47	09/12/2019 13:11	09/12/2019 15:47	2,59	3	7,77	CHI
20191255348	JATAI	JT12184049	JATAI S1	09/12/2019 13:11	10/12/2019 06:55	09/12/2019 13:11	10/12/2019 06:55	17,72	27	478,39	CHI
20191255348	SERRANOPOLIS	JT12184049	JATAI S1	09/12/2019 13:11	10/12/2019 06:55	09/12/2019 13:11	10/12/2019 06:55	17,72	3	53,15	CHI
20191254925	INDIARA	2710007302	EDEIA	09/12/2019 13:12	09/12/2019 17:48	09/12/2019 13:12	09/12/2019 17:48	4,60	1	4,60	CHI
20191254926	SANCLERLANDIA	SC21164056	FIRMINOPOLIS S2	09/12/2019 13:12	10/12/2019 08:40	09/12/2019 13:12	10/12/2019 08:40	19,46	1	19,46	CHI
20191254930	VALPARAISO DE GOIAS	3350020948	PACAEMBU S2	09/12/2019 13:13	09/12/2019 20:22	09/12/2019 13:13	09/12/2019 20:22	7,14	1	7,14	CHI
20191254937	PARAUNA	PU21387511	PARAUNA	09/12/2019 13:15	09/12/2019 15:55	09/12/2019 13:15	09/12/2019 15:55	2,68	1	2,68	CHI
20191254939	MIMOSO DE GOIAS	04560224	BARRO ALTO	09/12/2019 13:15	09/12/2019 16:08	09/12/2019 13:15	09/12/2019 16:08	2,88	4	11,52	CHI
20191254939	NIQUELANDIA	04560224	BARRO ALTO	09/12/2019 13:15	09/12/2019 16:08	09/12/2019 13:15	09/12/2019 16:08	2,88	991	2854,91	CHI
20191254939	VILA PROPICIO	04560224	BARRO ALTO	09/12/2019 13:15	09/12/2019 16:08	09/12/2019 13:15	09/12/2019 16:08	2,88	32	92,19	CHI
20191254941	PARANAIGUARA	PC12193843	QUIRINOPOLIS	09/12/2019 13:15	09/12/2019 22:44	09/12/2019 13:15	09/12/2019 22:44	9,48	1	9,48	CHI
20191254995	CACU	CA12196122	CACHOEIRA ALTA	09/12/2019 13:17	09/12/2019 15:13	09/12/2019 13:17	09/12/2019 15:13	1,93	39	75,32	CHI
20191254953	MONTES CLAROS DE GOIAS	ME21403117	IPORA	09/12/2019 13:18	09/12/2019 15:55	09/12/2019 13:18	09/12/2019 15:55	2,62	1	2,62	CHI
20191254956	MINEIROS	MY12036561	PARQUE DAS EMAS	09/12/2019 13:19	09/12/2019 17:02	09/12/2019 13:19	09/12/2019 17:02	3,71	1146	4254,21	CHI
20191255007	NOVA AURORA	NE12143243	CATALAO S1	09/12/2019 13:19	09/12/2019 15:42	09/12/2019 13:19	09/12/2019 15:42	2,38	5	11,88	CHI
20191254985	MINEIROS	MY10401497	PARQUE DAS EMAS	09/12/2019 13:20	09/12/2019 13:40	09/12/2019 13:20	09/12/2019 13:40	0,34	65	22,23	CHI
20191254968	CAMPO ALEGRE DE GOIAS	CM12333445RE	CAMPO ALEGRE DE GOIAS	09/12/2019 13:21	09/12/2019 19:50	09/12/2019 13:21	09/12/2019 19:50	6,47	64	414,36	CHI
20191254968	CATALAO	CM12333445RE	CAMPO ALEGRE DE GOIAS	09/12/2019 13:21	09/12/2019 19:50	09/12/2019 13:21	09/12/2019 19:50	6,47	19	123,01	CHI
20191254968	IPAMERI	CM12333445RE	CAMPO ALEGRE DE GOIAS	09/12/2019 13:21	09/12/2019 19:50	09/12/2019 13:21	09/12/2019 19:50	6,47	8	51,80	CHI
20191254420	MORRINHOS	MR12000135RE	GOIATUBA S1	09/12/2019 13:22	09/12/2019 17:00	09/12/2019 13:22	09/12/2019 17:00	3,64	86	312,97	CHI
20191254975	GOIANIA	10015279217	CARAJAS S1	09/12/2019 13:22	09/12/2019 15:30	09/12/2019 13:22	09/12/2019 15:30	2,12	1	2,12	CHI
20191255358	PIRANHAS	PH12184391	PIRANHAS	09/12/2019 13:22	09/12/2019 22:03	09/12/2019 13:22	09/12/2019 22:03	8,68	44	381,99	CHI
20191254805	PALESTINA DE GOIAS	PY21345522	PALESTINA	09/12/2019 13:23	09/12/2019 14:15	09/12/2019 13:23	09/12/2019 14:15	0,86	2	1,73	CHI
20191254984	ITUMBIARA	IT121232612	ITUMBIARA NOVA	09/12/2019 13:23	09/12/2019 15:00	09/12/2019 13:23	09/12/2019 15:00	1,60	1	1,60	CHI
20191255301	CEZARINA	CZ12212231	PONTALINA	09/12/2019 13:23	09/12/2019 17:36	09/12/2019 13:23	09/12/2019 17:36	4,20	4	16,81	CHI
20191254988	QUIRINOPOLIS	QI31249039	QUIRINOPOLIS	09/12/2019 13:24	09/12/2019 17:19	09/12/2019 13:24	09/12/2019 17:19	3,91	1	3,91	CHI
20191254989	JATAI	JT12065798	JATAI S1	09/12/2019 13:24	09/12/2019 20:42	09/12/2019 13:24	09/12/2019 20:42	7,30	7	51,07	CHI
20191254992	PIRANHAS	PH12233053	PIRANHAS	09/12/2019 13:24	10/12/2019 10:10	09/12/2019 13:24	10/12/2019 10:10	20,75	1	20,75	CHI
20191254998	QUIRINOPOLIS	DM12023081	RIO DOS BOIS	09/12/2019 13:25	09/12/2019 19:55	09/12/2019 13:25	09/12/2019 19:55	6,49	2	12,97	CHI
20191255278	GOIATUBA	CL12295951	RIO DOS BOIS	09/12/2019 13:25	09/12/2019 19:19	09/12/2019 13:25	09/12/2019 19:19	5,90	10	58,99	CHI
20191254999	CATALAO	10025295070	CATALAO S1	09/12/2019 13:26	09/12/2019 16:21	09/12/2019 13:26	09/12/2019 16:21	2,92	1	2,92	CHI

20191255000	GOIANIA	12669921	MEIA PONTE	09/12/2019 13:26	09/12/2019 17:11	09/12/2019 13:26	09/12/2019 17:11	3,75	1	3,75	CHI
20191255008	ARENOPOLIS	AY21217618	ARENOPOLIS	09/12/2019 13:27	10/12/2019 12:26	09/12/2019 13:27	10/12/2019 12:26	22,99	1	22,99	CHI
20191255009	AGUA FRIA DE GOIAS	TL21321721	SAO JOAO D ALIANCA	09/12/2019 13:27	10/12/2019 17:40	09/12/2019 13:27	10/12/2019 17:40	28,22	1	28,22	CHI
20191255010	CRIXAS	CX11357828	RUBIATABA	09/12/2019 13:27	10/12/2019 11:47	09/12/2019 13:27	10/12/2019 11:47	22,33	1	22,33	CHI
20191255013	GOIAS	IK12250614	ITAPURANGA	09/12/2019 13:27	09/12/2019 17:50	09/12/2019 13:27	09/12/2019 17:50	4,39	2	8,79	CHI
20191255013	GUARAITA	IK12250614	ITAPURANGA	09/12/2019 13:27	09/12/2019 17:50	09/12/2019 13:27	09/12/2019 17:50	4,39	18	79,07	CHI
20191255013	ITAPURANGA	IK12250614	ITAPURANGA	09/12/2019 13:27	09/12/2019 17:50	09/12/2019 13:27	09/12/2019 17:50	4,39	22	96,64	CHI
20191255015	MINEIROS	MY10396070	PARQUE DAS EMAS	09/12/2019 13:27	09/12/2019 13:45	09/12/2019 13:28	09/12/2019 13:45	0,29	127	37,08	CHI
20191255015	SERRANOPOLIS	MY10396070	PARQUE DAS EMAS	09/12/2019 13:27	09/12/2019 13:45	09/12/2019 13:28	09/12/2019 13:45	0,29	7	2,04	CHI
20191255019	GUARINOS	10029458895	SANTA TEREZINHA	09/12/2019 13:27	09/12/2019 21:29	09/12/2019 13:27	09/12/2019 21:29	8,04	1	8,04	CHI
20191255025	CATALAO	CT12266095	CATALAO S1	09/12/2019 13:27	09/12/2019 15:20	09/12/2019 13:27	09/12/2019 15:20	1,88	1	1,88	CHI
20191255027	CRISTALINA	KR21261294	CRISTALINA S2	09/12/2019 13:27	10/12/2019 16:31	09/12/2019 13:27	10/12/2019 16:31	27,06	1	27,06	CHI
20191255028	GOIANIA	15458003	GOYA S2	09/12/2019 13:27	09/12/2019 18:20	09/12/2019 13:27	09/12/2019 18:20	4,88	1	4,88	CHI
20191255033	BELA VISTA DE GOIAS	BV21270616	BELA VISTA S2	09/12/2019 13:27	10/12/2019 09:35	09/12/2019 13:27	10/12/2019 09:35	20,13	1	20,13	CHI
20191255524	PALMEIRAS DE GOIAS	PL12026608	PALMEIRAS	09/12/2019 13:27	10/12/2019 14:20	09/12/2019 13:27	10/12/2019 14:20	24,88	8	199,02	CHI
20191255749	CAMPINACU	UC12285921	PORANGATU	09/12/2019 13:28	09/12/2019 20:58	09/12/2019 13:28	09/12/2019 20:58	7,49	39	292,08	CHI
20191255049	ANAPOLIS	10001502300	ANAPOLIS UNIVERSITARIO S1	09/12/2019 13:29	10/12/2019 08:23	09/12/2019 13:29	10/12/2019 08:23	18,89	1	18,89	CHI
20191255339	CAMPOS VERDES	SG12203146	SANTA TEREZINHA	09/12/2019 13:30	09/12/2019 21:47	09/12/2019 13:30	09/12/2019 21:47	8,28	8	66,26	CHI
20191255339	SANTA TEREZINHA DE GOIAS	SG12203146	SANTA TEREZINHA	09/12/2019 13:30	09/12/2019 21:47	09/12/2019 13:30	09/12/2019 21:47	8,28	8	66,26	CHI
20191255065	CRISTALINA	KR12237804	CRISTALINA S1	09/12/2019 13:31	10/12/2019 11:35	09/12/2019 13:31	10/12/2019 11:35	22,06	7	154,42	CHI
20191255085	GOIANIA	14332980	CARAJAS S2	09/12/2019 13:33	09/12/2019 16:25	09/12/2019 13:33	09/12/2019 16:25	2,86	1	2,86	CHI
20191255090	SAO LUIS DE MONTES BELOS	SL21006786	SAO LUIZ DOS MONTES BELOS	09/12/2019 13:33	09/12/2019 21:26	09/12/2019 13:33	09/12/2019 21:26	7,89	1	7,89	CHI
20191255091	CATALAO	CT21286307	CATALAO S1	09/12/2019 13:33	09/12/2019 16:47	09/12/2019 13:33	09/12/2019 16:47	3,23	2	6,47	CHI
20191255095	GOIANIA	13005261	FERROVIARIO S1	09/12/2019 13:33	09/12/2019 14:17	09/12/2019 13:33	09/12/2019 14:17	0,73	1	0,73	CHI
20191255097	DIVINOPOLIS DE GOIAS	GH21242734	SAO DOMINGOS	09/12/2019 13:33	10/12/2019 10:39	09/12/2019 13:33	10/12/2019 10:39	21,10	1	21,10	CHI
20191255100	SANTA CRUZ DE GOIAS	BC21300725	CRISTIANOPOLIS	09/12/2019 13:33	09/12/2019 18:16	09/12/2019 13:33	09/12/2019 18:16	4,71	2	9,42	CHI
20191255110	CRISTALINA	IP21147561	CRISTALINA S1	09/12/2019 13:33	09/12/2019 17:33	09/12/2019 13:33	09/12/2019 17:33	3,99	1	3,99	CHI
20191255115	PLANALTINA	6787099	PLANALTINA	09/12/2019 13:33	09/12/2019 18:20	09/12/2019 13:33	09/12/2019 18:20	4,77	3	14,32	CHI
20191255236	ITAGUARI	JA12038937	ITABERAI S1	09/12/2019 13:33	09/12/2019 21:01	09/12/2019 13:33	09/12/2019 21:01	7,46	3	22,39	CHI
20191255236	ITAGUARU	JA12038937	ITABERAI S1	09/12/2019 13:33	09/12/2019 21:01	09/12/2019 13:33	09/12/2019 21:01	7,46	1	7,46	CHI
20191255236	JARAGUA	JA12038937	ITABERAI S1	09/12/2019 13:33	09/12/2019 21:01	09/12/2019 13:33	09/12/2019 21:01	7,46	6	44,77	CHI
20191256192	BONFINOPOLIS	LB12258821	DAIA S2	09/12/2019 13:33	10/12/2019 11:20	09/12/2019 13:33	10/12/2019 11:20	21,78	1	21,78	CHI
20191256192	LEOPOLDO DE BULHOES	LB12258821	DAIA S2	09/12/2019 13:33	10/12/2019 11:20	09/12/2019 13:33	10/12/2019 11:20	21,78	6	130,69	CHI

20191255201	LUZIANIA	120406421	RIO VERMELHO	09/12/2019 13:34	09/12/2019 15:04	09/12/2019 13:34	09/12/2019 15:04	1,48	1	1,48	CHI
20191255202	LUZIANIA	3200101256	MARAJOARA	09/12/2019 13:34	09/12/2019 17:18	09/12/2019 13:34	09/12/2019 17:18	3,73	1	3,73	CHI
20191259290	BOM JARDIM DE GOIAS	BM12064234	BOM JARDIM	09/12/2019 13:34	10/12/2019 09:48	09/12/2019 13:34	10/12/2019 09:48	20,22	4	80,90	CHI
20191255207	SIMOLANDIA	SA11208834	IACIARA S2	09/12/2019 13:35	09/12/2019 16:15	09/12/2019 13:35	09/12/2019 16:15	2,67	12	31,99	CHI
20191255208	ITAPACI	100030180	ITAPACI	09/12/2019 13:35	10/12/2019 09:35	09/12/2019 13:35	10/12/2019 09:35	20,00	1	20,00	CHI
20191255212	APORE	IJ12202625	ITAJA S2	09/12/2019 13:35	09/12/2019 23:41	09/12/2019 13:35	09/12/2019 23:41	10,10	4	40,39	CHI
20191255212	ITAJA	IJ12202625	ITAJA S2	09/12/2019 13:35	09/12/2019 23:41	09/12/2019 13:35	09/12/2019 23:41	10,10	24	242,35	CHI
20191255213	NOVO PLANALTO	TA21187910	NOVO PLANALTO	09/12/2019 13:35	09/12/2019 16:08	09/12/2019 13:35	09/12/2019 16:08	2,55	1	2,55	CHI
20191255215	BONOPOLIS	BX21252457	SAO MIGUEL DO ARAGUAIA	09/12/2019 13:35	09/12/2019 15:38	09/12/2019 13:35	09/12/2019 15:38	2,06	1	2,06	CHI
20191255218	MINEIROS	1390109693	PARQUE DAS EMAS	09/12/2019 13:35	10/12/2019 13:08	09/12/2019 13:35	10/12/2019 13:08	23,54	1	23,54	CHI
20191255226	PARAUNA	PU12326806	ACREUNA	09/12/2019 13:35	09/12/2019 18:25	09/12/2019 13:35	09/12/2019 18:25	4,82	1	4,82	CHI
20191255231	JARAGUA	JA12000236	JARAGUA	09/12/2019 13:35	09/12/2019 15:06	09/12/2019 13:35	09/12/2019 15:06	1,51	25	37,71	CHI
20191255755	SAO MIGUEL DO ARAGUAIA	SM12151000	SAO MIGUEL DO ARAGUAIA	09/12/2019 13:35	10/12/2019 01:47	09/12/2019 13:35	10/12/2019 01:47	12,20	19	231,78	CHI
20191255242	BELA VISTA DE GOIAS	BV12242097	BELA VISTA S1	09/12/2019 13:36	09/12/2019 17:17	09/12/2019 13:36	09/12/2019 17:17	3,68	10	36,81	CHI
20191255254	PLANALTINA	PI21149429	SAO JOAO D ALIANCA	09/12/2019 13:37	09/12/2019 16:50	09/12/2019 13:37	09/12/2019 16:50	3,21	1	3,21	CHI
20191255708	BRITANIA	BT12124845	BRITANIA	09/12/2019 13:37	10/12/2019 13:47	09/12/2019 13:37	10/12/2019 13:47	24,16	3	72,47	CHI
20191265070	PIRANHAS	PH12201916	BOM JARDIM	09/12/2019 13:37	10/12/2019 13:01	09/12/2019 13:37	10/12/2019 13:01	23,40	9	210,58	CHI
20191255257	URUACU	UR21092978	URUACU	09/12/2019 13:38	09/12/2019 15:18	09/12/2019 13:38	09/12/2019 15:18	1,66	1	1,66	CHI
20191255262	CAIAPONIA	PH12221148	PIRANHAS	09/12/2019 13:38	10/12/2019 12:50	09/12/2019 13:38	10/12/2019 12:50	23,21	3	69,62	CHI
20191255943	IPAMERI	IP12404728	IPAMERI	09/12/2019 13:38	09/12/2019 16:40	09/12/2019 13:38	09/12/2019 16:40	3,03	10	30,26	CHI
20191255772	SAO FRANCISCO DE GOIAS	SF21285021	SAO FRANCISCO DE GOIAS	09/12/2019 13:39	09/12/2019 18:10	09/12/2019 13:39	09/12/2019 18:10	4,51	1	4,51	CHI
20191255272	GOIANIA	GN11222648	GOIANIA LESTE S1	09/12/2019 13:40	09/12/2019 15:59	09/12/2019 13:40	09/12/2019 15:59	2,32	78	180,59	CHI
20191255276	GOIANESIA	550180229	GOIANESIA S2	09/12/2019 13:40	10/12/2019 11:55	09/12/2019 13:40	10/12/2019 11:55	22,25	1	22,25	CHI
20191255280	ANAPOLIS	AN11270449	DAIA S1	09/12/2019 13:41	10/12/2019 14:01	09/12/2019 13:41	10/12/2019 14:01	24,33	1	24,33	CHI
20191255734	SAO MIGUEL DO PASSA QUATRO	SV12277356	BELA VISTA S2	09/12/2019 13:41	09/12/2019 17:22	09/12/2019 13:41	09/12/2019 17:22	3,68	10	36,78	CHI
20191255734	SILVANIA	SV12277356	BELA VISTA S2	09/12/2019 13:41	09/12/2019 17:22	09/12/2019 13:41	09/12/2019 17:22	3,68	11	40,46	CHI
20191255283	APORE	AE21214465	ITAJA S1	09/12/2019 13:42	10/12/2019 10:29	09/12/2019 13:42	10/12/2019 10:29	20,78	1	20,78	CHI
20191255286	SAO LUIZ DO NORTE	3090003830	ITAPACI	09/12/2019 13:42	10/12/2019 10:14	09/12/2019 13:42	10/12/2019 10:14	20,52	1	20,52	CHI
20191255287	CORUMBA DE GOIAS	CB21339505	CORUMBA	09/12/2019 13:42	09/12/2019 14:46	09/12/2019 13:42	09/12/2019 14:46	1,06	2	2,11	CHI
20191255288	MONTES CLAROS DE GOIAS	ME12260033	IPORA	09/12/2019 13:42	09/12/2019 16:25	09/12/2019 13:42	09/12/2019 16:25	2,70	4	10,82	CHI
20191255293	TRINDADE	10024500419	TRINDADE	09/12/2019 13:43	09/12/2019 19:05	09/12/2019 13:43	09/12/2019 19:05	5,36	1	5,36	CHI
20191255295	CRIXAS	CX21252991	RUBIATABA	09/12/2019 13:43	10/12/2019 11:24	09/12/2019 13:43	10/12/2019 11:24	21,67	1	21,67	CHI
20191255298	IPAMERI	IP21000059	IPAMERI	09/12/2019 13:44	10/12/2019 08:10	09/12/2019 13:44	10/12/2019 08:10	18,42	1	18,42	CHI

20191255300	APARECIDA DE GOIANIA	10025165230	INDEPENDENCIA S2	09/12/2019 13:44	09/12/2019 16:48	09/12/2019 13:44	09/12/2019 16:48	3,05	1	3,05	CHI
20191255303	MORRINHOS	MR21231868	MORRINHOS	09/12/2019 13:45	09/12/2019 14:30	09/12/2019 13:45	09/12/2019 14:30	0,73	1	0,73	CHI
20191255304	SAO LUIS DE MONTES BELOS	500061774	SAO LUIZ DOS MONTES BELOS	09/12/2019 13:45	09/12/2019 16:26	09/12/2019 13:45	09/12/2019 16:26	2,68	1	2,68	CHI
20191255309	DIVINOPOLIS DE GOIAS	SD12090135	SAO DOMINGOS	09/12/2019 13:46	09/12/2019 16:48	09/12/2019 13:46	09/12/2019 16:48	3,02	24	72,57	CHI
20191255309	SAO DOMINGOS	SD12090135	SAO DOMINGOS	09/12/2019 13:46	09/12/2019 16:48	09/12/2019 13:46	09/12/2019 16:48	3,02	80	241,89	CHI
20191255314	URUTAI	UT21195221	URUTAI	09/12/2019 13:47	09/12/2019 17:24	09/12/2019 13:47	09/12/2019 17:24	3,62	1	3,62	CHI
20191255315	MINEIROS	MY12248429	PARQUE DAS EMAS	09/12/2019 13:47	09/12/2019 18:32	09/12/2019 13:47	09/12/2019 18:32	4,76	18	85,68	CHI
20191255319	MORRINHOS	MR12231867	MORRINHOS	09/12/2019 13:47	09/12/2019 14:47	09/12/2019 13:47	09/12/2019 14:47	0,99	1	0,99	CHI
20191256543	SAO JOAO DA PARAUNA	FR12299252	FIRMINOPOLIS S2	09/12/2019 13:47	09/12/2019 20:25	09/12/2019 13:47	09/12/2019 20:25	6,63	3	19,88	CHI
20191255324	FORMOSA	FA21106836	SAO JOAO D ALIANCA	09/12/2019 13:48	09/12/2019 17:55	09/12/2019 13:48	09/12/2019 17:55	4,11	1	4,11	CHI
20191256147	CACHOEIRA ALTA	CA12191598	CACHOEIRA ALTA	09/12/2019 13:48	09/12/2019 16:31	09/12/2019 13:48	09/12/2019 16:31	2,73	25	68,22	CHI
20191256147	CACU	CA12191598	CACHOEIRA ALTA	09/12/2019 13:48	09/12/2019 16:31	09/12/2019 13:48	09/12/2019 16:31	2,73	5	13,64	CHI
20191255326	MONTES CLAROS DE GOIAS	ME21039912	IPORA	09/12/2019 13:49	09/12/2019 15:40	09/12/2019 13:49	09/12/2019 15:40	1,85	1	1,85	CHI
20191255341	DOVERLANDIA	DV21138090	CAIAPONIA	09/12/2019 13:52	10/12/2019 08:33	09/12/2019 13:52	10/12/2019 08:33	18,67	1	18,67	CHI
20191255347	MONTIVIDIU	MV12249172	MONTIVIDIU T	09/12/2019 13:53	09/12/2019 16:40	09/12/2019 13:53	09/12/2019 16:40	2,77	3	8,31	CHI
20191255378	ITUMBIARA	IT12257075	ITUMBIARA NOVA	09/12/2019 13:53	09/12/2019 16:48	09/12/2019 13:53	09/12/2019 16:48	2,91	18	52,34	CHI
20191255387	GOIANIA	GN12151986	MEIA PONTE	09/12/2019 13:54	09/12/2019 14:42	09/12/2019 13:54	09/12/2019 14:42	0,80	546	435,74	CHI
20191255355	AGUAS LINDAS DE GOIAS	10017898682	AGUAS LINDAS DE GOIAS S1	09/12/2019 13:55	09/12/2019 15:59	09/12/2019 13:55	09/12/2019 15:59	2,06	1	2,06	CHI
20191255357	URUACU	UR21295343	CAMPINORTE	09/12/2019 13:55	10/12/2019 09:52	09/12/2019 13:55	10/12/2019 09:52	19,94	1	19,94	CHI
20191255364	JATAI	JT21142796	JATAI S1	09/12/2019 13:56	10/12/2019 10:30	09/12/2019 13:56	10/12/2019 10:30	20,55	1	20,55	CHI
20191255365	ANAPOLIS	AN12384292	ANAPOLIS UNIVERSITARIO S2	09/12/2019 13:56	10/12/2019 10:07	09/12/2019 13:56	10/12/2019 10:07	20,17	17	342,85	CHI
20191255367	CACHOEIRA ALTA	CA12047662	CACHOEIRA ALTA	09/12/2019 13:56	10/12/2019 13:42	09/12/2019 13:56	10/12/2019 13:42	23,75	4	95,00	CHI
20191255369	ITUMBIARA	BG12000052	ITUMBIARA VELHA S2	09/12/2019 13:57	09/12/2019 15:24	09/12/2019 13:57	09/12/2019 15:24	1,46	6	8,79	CHI
20191255372	ORIZONA	OZ12052340	PIRES DO RIO S2	09/12/2019 13:57	09/12/2019 21:19	09/12/2019 13:57	09/12/2019 21:19	7,36	12	88,35	CHI
20191255374	CAMPO ALEGRE DE GOIAS	CM12376048	CAMPO ALEGRE DE GOIAS	09/12/2019 13:57	10/12/2019 11:37	09/12/2019 13:57	10/12/2019 10:38	20,68	1	20,68	CHI
20191255374	CATALAO	CM12376048	CAMPO ALEGRE DE GOIAS	09/12/2019 13:57	10/12/2019 11:37	09/12/2019 13:57	10/12/2019 10:38	20,68	1	20,68	CHI
20191255374	CAMPO ALEGRE DE GOIAS	CM12376048	CAMPO ALEGRE DE GOIAS	09/12/2019 13:57	10/12/2019 11:37	09/12/2019 13:57	10/12/2019 11:37	21,66	11	238,27	CHI
20191255374	CATALAO	CM12376048	CAMPO ALEGRE DE GOIAS	09/12/2019 13:57	10/12/2019 11:37	09/12/2019 13:57	10/12/2019 11:37	21,66	13	281,59	CHI
20191255374	DISTRITO FEDERAL	CM12376048	CAMPO ALEGRE DE GOIAS	09/12/2019 13:57	10/12/2019 11:37	09/12/2019 13:57	10/12/2019 11:37	21,66	1	21,66	CHI
20191255377	INACIOLANDIA	ID31128249	QUIRINOPOLIS	09/12/2019 13:57	09/12/2019 16:42	09/12/2019 13:57	09/12/2019 16:42	2,74	2	5,48	CHI
20191255385	MINEIROS	MY10396070	PARQUE DAS EMAS	09/12/2019 13:57	09/12/2019 21:45	09/12/2019 13:57	09/12/2019 16:11	2,23	50	111,53	CHI
20191255385	MINEIROS	MY10396070	PARQUE DAS EMAS	09/12/2019 13:57	09/12/2019 21:45	09/12/2019 16:18	09/12/2019 16:44	0,44	36	15,77	CHI
20191255385	MINEIROS	MY10396070	PARQUE DAS EMAS	09/12/2019 13:57	09/12/2019 21:45	09/12/2019 16:51	09/12/2019 17:52	1,02	3	3,07	CHI

20191255385	MINEIROS	MY12341117LD	PARQUE DAS EMAS	09/12/2019 13:57	09/12/2019 21:45	09/12/2019 13:57	09/12/2019 18:10	4,22	77	324,60	CHI
20191255385	SERRANOPOLIS	MY12341117LD	PARQUE DAS EMAS	09/12/2019 13:57	09/12/2019 21:45	09/12/2019 13:57	09/12/2019 18:10	4,22	7	29,51	CHI
20191255385	MINEIROS	MY12341117LD	PARQUE DAS EMAS	09/12/2019 13:57	09/12/2019 21:45	09/12/2019 16:18	09/12/2019 18:10	1,87	14	26,17	CHI
20191255385	MINEIROS	MY13360699	PARQUE DAS EMAS	09/12/2019 13:57	09/12/2019 21:45	09/12/2019 16:51	09/12/2019 21:45	4,90	33	161,64	CHI
20191255393	MORRINHOS	MR12133255	MORRINHOS	09/12/2019 13:57	09/12/2019 15:44	09/12/2019 13:57	09/12/2019 15:44	1,78	11	19,53	CHI
20191255383	ANAPOLIS	21289840	ANAPOLIS UNIVERSITARIO S2	09/12/2019 13:58	10/12/2019 00:52	09/12/2019 13:58	10/12/2019 00:52	10,89	1	10,89	CHI
20191255386	MONTIVIDIU	MV12387737	MONTIVIDIU T	09/12/2019 13:58	09/12/2019 16:15	09/12/2019 13:58	09/12/2019 16:15	2,28	2	4,56	CHI
20191255391	SERRANOPOLIS	SX21357276	JATAI S1	09/12/2019 13:59	10/12/2019 17:35	09/12/2019 13:59	10/12/2019 17:35	27,60	1	27,60	CHI
20191255395	CRISTALINA	1060036426	CRISTALINA S1	09/12/2019 13:59	09/12/2019 16:15	09/12/2019 13:59	09/12/2019 16:15	2,25	1	2,25	CHI
20191255399	BONOPOLIS	BX21128369	SAO MIGUEL DO ARAGUAIA	09/12/2019 14:00	09/12/2019 18:15	09/12/2019 14:00	09/12/2019 18:15	4,25	1	4,25	CHI
20191255507	ITARUMA	IM21148584	CACHOEIRA ALTA	09/12/2019 14:00	10/12/2019 09:36	09/12/2019 14:00	10/12/2019 09:36	19,59	1	19,59	CHI
20191255522	CORUMBA DE GOIAS	CB21381641	ALEXANIA	09/12/2019 14:00	10/12/2019 12:22	09/12/2019 14:00	10/12/2019 12:22	22,35	2	44,70	CHI
20191255509	PLANALTINA	PI12344175	SAO JOAO D ALIANCA	09/12/2019 14:01	10/12/2019 18:08	09/12/2019 14:01	10/12/2019 18:08	28,11	23	646,63	CHI
20191255510	CRISTALINA	KR12183710	CRISTALINA S2	09/12/2019 14:01	09/12/2019 17:17	09/12/2019 14:01	09/12/2019 17:17	3,26	1	3,26	CHI
20191255513	ITAJA	04400224	CACHOEIRA ALTA	09/12/2019 14:01	11/12/2019 02:04	09/12/2019 14:01	09/12/2019 19:50	5,81	66	383,33	CHI
20191255513	LAGOA SANTA	04400224	CACHOEIRA ALTA	09/12/2019 14:01	11/12/2019 02:04	09/12/2019 14:01	09/12/2019 19:50	5,81	8	46,46	CHI
20191255513	ITAJA	04400224	CACHOEIRA ALTA	09/12/2019 14:01	11/12/2019 02:04	09/12/2019 18:40	09/12/2019 19:50	1,17	1	1,17	CHI
20191255513	ITAJA	04400224	CACHOEIRA ALTA	09/12/2019 14:01	11/12/2019 02:04	09/12/2019 14:01	10/12/2019 09:39	19,63	11	215,91	CHI
20191255513	LAGOA SANTA	04400224	CACHOEIRA ALTA	09/12/2019 14:01	11/12/2019 02:04	09/12/2019 14:01	10/12/2019 09:39	19,63	2	39,26	CHI
20191255513	LAGOA SANTA	04400224	CACHOEIRA ALTA	09/12/2019 14:01	11/12/2019 02:04	09/12/2019 14:01	11/12/2019 01:14	35,21	3	105,63	CHI
20191255513	LAGOA SANTA	04400224	CACHOEIRA ALTA	09/12/2019 14:01	11/12/2019 02:04	09/12/2019 14:01	11/12/2019 02:03	36,03	49	1765,48	CHI
20191255513	LAGOA SANTA	7953558	CACHOEIRA ALTA	09/12/2019 14:01	11/12/2019 02:04	10/12/2019 13:19	11/12/2019 02:04	12,75	5	63,76	CHI
20191255514	ITUMBIARA	IT11305364	PARANAIBA	09/12/2019 14:01	09/12/2019 15:37	09/12/2019 14:01	09/12/2019 15:37	1,59	123	195,33	CHI
20191255516	JOVIANIA	JV21263673	GOIATUBA S1	09/12/2019 14:02	09/12/2019 16:10	09/12/2019 14:02	09/12/2019 16:10	2,13	1	2,13	CHI
20191255517	RIO VERDE	RV12024714	RIO VERDE S1	09/12/2019 14:03	09/12/2019 17:07	09/12/2019 14:03	09/12/2019 17:07	3,06	25	76,62	CHI
20191255521	URUACU	640005135	URUACU	09/12/2019 14:04	09/12/2019 17:52	09/12/2019 14:04	09/12/2019 17:52	3,79	1	3,79	CHI
20191262007	SANTA CRUZ DE GOIAS	BC12083189	PIRES DO RIO S2	09/12/2019 14:04	10/12/2019 08:35	09/12/2019 14:04	10/12/2019 08:35	18,51	8	148,07	CHI
20191255523	PARAUNA	PU21090444	MONTIVIDIU T	09/12/2019 14:05	10/12/2019 09:42	09/12/2019 14:05	10/12/2019 09:42	19,62	1	19,62	CHI
20191255532	CRISTALINA	KR11283785	CRISTALINA S1	09/12/2019 14:05	09/12/2019 16:30	09/12/2019 14:39	09/12/2019 15:50	1,17	201	235,00	CHI
20191255532	CRISTALINA	KR12256292	CRISTALINA S1	09/12/2019 14:05	09/12/2019 16:30	09/12/2019 14:40	09/12/2019 16:30	1,82	7	12,76	CHI
20191255535	BONOPOLIS	4350001026	SAO MIGUEL DO ARAGUAIA	09/12/2019 14:08	09/12/2019 19:20	09/12/2019 14:08	09/12/2019 19:20	5,20	1	5,20	CHI
20191255537	SILVANIA	SV21229404	VIANOPOLIS	09/12/2019 14:08	09/12/2019 17:19	09/12/2019 14:08	09/12/2019 17:19	3,17	2	6,34	CHI
20191255650	PALMELO	PR12031289	PIRES DO RIO S1	09/12/2019 14:08	09/12/2019 16:09	09/12/2019 14:08	09/12/2019 16:09	2,00	4	8,01	CHI

20191255650	PIRES DO RIO	PR12031289	PIRES DO RIO S1	09/12/2019 14:08	09/12/2019 16:09	09/12/2019 14:08	09/12/2019 16:09	2,00	1	2,00	CHI
20191255406	GOIANIA	GN11168419	MEIA PONTE	09/12/2019 14:09	09/12/2019 14:27	09/12/2019 14:09	09/12/2019 14:27	0,30	202	60,32	CHI
20191255542	GAMELEIRA DE GOIAS	SV12027617	DAIA S2	09/12/2019 14:10	09/12/2019 20:52	09/12/2019 14:10	09/12/2019 20:52	6,70	4	26,78	CHI
20191255543	TRINDADE	40059455	TRINDADE	09/12/2019 14:10	09/12/2019 20:45	09/12/2019 14:10	09/12/2019 20:45	6,57	1	6,57	CHI
20191255546	ANHANGUERA	AH21143400	CATALAO S1	09/12/2019 14:11	09/12/2019 17:31	09/12/2019 14:11	09/12/2019 17:31	3,33	1	3,33	CHI
20191255558	PORTEIRAO	10028875590	RIO DOS BOIS	09/12/2019 14:12	09/12/2019 23:17	09/12/2019 14:12	09/12/2019 23:17	9,08	1	9,08	CHI
20191255559	CORUMBA DE GOIAS	CB21382196	CORUMBA	09/12/2019 14:12	09/12/2019 16:43	09/12/2019 14:12	09/12/2019 16:43	2,50	1	2,50	CHI
20191255562	PIRENOPOLIS	220041830	CORUMBA	09/12/2019 14:12	10/12/2019 14:05	09/12/2019 14:12	10/12/2019 14:05	23,87	1	23,87	CHI
20191255645	LUZIANIA	LZ11061777	MARAJOARA	09/12/2019 14:13	09/12/2019 17:14	09/12/2019 14:13	09/12/2019 17:14	3,02	25	75,39	CHI
20191255572	SAO LUIS DE MONTES BELOS	SL21126258	FIRMINOPOLIS S1	09/12/2019 14:14	09/12/2019 19:19	09/12/2019 14:14	09/12/2019 19:19	5,07	1	5,07	CHI
20191255574	LUZIANIA	LZ11128900	MARAJOARA	09/12/2019 14:14	09/12/2019 17:43	09/12/2019 14:14	09/12/2019 17:43	3,47	14	48,56	CHI
20191255575	APARECIDA DE GOIANIA	14461456	REAL S2	09/12/2019 14:14	09/12/2019 18:26	09/12/2019 14:14	09/12/2019 18:26	4,18	1	4,18	CHI
20191255799	ARAGARCAS	BM12204856	BOM JARDIM	09/12/2019 14:14	09/12/2019 18:00	09/12/2019 14:14	09/12/2019 18:00	3,75	24	90,01	CHI
20191255799	BALIZA	BM12204856	BOM JARDIM	09/12/2019 14:14	09/12/2019 18:00	09/12/2019 14:14	09/12/2019 18:00	3,75	48	180,01	CHI
20191261901	BALIZA	BH21151367	BOM JARDIM	09/12/2019 14:14	09/12/2019 18:40	09/12/2019 14:14	09/12/2019 18:40	4,42	1	4,42	CHI
20191255582	URUACU	UR11395655	URUACU	09/12/2019 14:16	10/12/2019 11:19	09/12/2019 14:16	10/12/2019 11:19	21,05	1	21,05	CHI
20191255595	CAIAPONIA	CP21151387	IPORA	09/12/2019 14:18	10/12/2019 23:40	09/12/2019 14:18	10/12/2019 23:40	33,36	1	33,36	CHI
20191255599	CALDAS NOVAS	760060990	CALDAS NOVAS S1	09/12/2019 14:18	09/12/2019 16:27	09/12/2019 14:18	09/12/2019 16:27	2,14	1	2,14	CHI
20191258981	PIRENOPOLIS	PV12312036	CORUMBA	09/12/2019 14:18	10/12/2019 11:11	09/12/2019 14:18	10/12/2019 11:11	20,88	13	271,42	CHI
20191255603	CATALAO	1990206363	CATALAO S2	09/12/2019 14:19	09/12/2019 17:08	09/12/2019 14:19	09/12/2019 17:08	2,81	1	2,81	CHI
20191255605	CACHOEIRA ALTA	QI12189166	CACHOEIRA ALTA	09/12/2019 14:19	10/12/2019 03:46	09/12/2019 14:19	10/12/2019 03:46	13,44	3	40,31	CHI
20191255605	QUIRINOPOLIS	QI12189166	CACHOEIRA ALTA	09/12/2019 14:19	10/12/2019 03:46	09/12/2019 14:19	10/12/2019 03:46	13,44	2	26,88	CHI
20191255606	VICENTINOPOLIS	VI121227979	VICENTINOPOLIS	09/12/2019 14:19	09/12/2019 15:55	09/12/2019 14:19	09/12/2019 15:55	1,59	1	1,59	CHI
20191255610	PARAUNA	PU12115312	PARAUNA	09/12/2019 14:20	09/12/2019 20:30	09/12/2019 14:20	09/12/2019 20:30	6,17	1	6,17	CHI
20191256621	ARENOPOLIS	AY12235874	IPORA	09/12/2019 14:20	10/12/2019 11:35	09/12/2019 14:20	10/12/2019 11:35	21,26	7	148,82	CHI
20191256621	PIRANHAS	AY12235874	IPORA	09/12/2019 14:20	10/12/2019 11:35	09/12/2019 14:20	10/12/2019 11:35	21,26	1	21,26	CHI
20191260175	MINEIROS	PW12045348	PARQUE DAS EMAS	09/12/2019 14:20	10/12/2019 04:52	09/12/2019 14:20	10/12/2019 04:52	14,53	4	58,12	CHI
20191260175	PORTELANDIA	PW12045348	PARQUE DAS EMAS	09/12/2019 14:20	10/12/2019 04:52	09/12/2019 14:20	10/12/2019 04:52	14,53	6	87,17	CHI
20191255617	PIRACANJUBA	PJ121010882	BELA VISTA S1	09/12/2019 14:21	09/12/2019 21:04	09/12/2019 14:21	09/12/2019 21:04	6,72	1	6,72	CHI
20191255622	CAMPINORTE	CR12093167	CAMPINORTE	09/12/2019 14:21	10/12/2019 09:01	09/12/2019 14:21	10/12/2019 09:01	18,65	26	485,00	CHI
20191255622	NOVA IGUACU DE GOIAS	CR12093167	CAMPINORTE	09/12/2019 14:21	10/12/2019 09:01	09/12/2019 14:21	10/12/2019 09:01	18,65	4	74,62	CHI
20191255625	ALTO HORIZONTE	AJ121243441	SANTA TEREZINHA	09/12/2019 14:23	09/12/2019 18:59	09/12/2019 14:23	09/12/2019 18:59	4,60	2	9,19	CHI
20191255630	HIDROLANDIA	HD121308650	CEPAIGO S1	09/12/2019 14:24	09/12/2019 17:20	09/12/2019 14:24	09/12/2019 17:20	2,93	1	2,93	CHI

20191255637	QUIRINOPOLIS	QI31007606	SANTA HELENA S1	09/12/2019 14:25	10/12/2019 10:45	09/12/2019 14:25	10/12/2019 10:45	20,32	2	40,64	CHI
20191255639	TRINDADE	10004262539	TRINDADE	09/12/2019 14:25	09/12/2019 21:07	09/12/2019 14:25	09/12/2019 21:07	6,70	1	6,70	CHI
20191255648	BONOPOLIS	BX21277772	SAO MIGUEL DO ARAGUAIA	09/12/2019 14:27	09/12/2019 16:03	09/12/2019 14:27	09/12/2019 16:03	1,61	1	1,61	CHI
20191255653	ANAPOLIS	AN21270423	ANAPOLIS UNIVERSITARIO S2	09/12/2019 14:28	10/12/2019 11:00	09/12/2019 14:28	09/12/2019 19:17	4,83	1	4,83	CHI
20191255653	ABADIANIA	AN12221398	ANAPOLIS UNIVERSITARIO S2	09/12/2019 14:28	10/12/2019 11:00	09/12/2019 19:17	10/12/2019 11:00	15,71	17	267,02	CHI
20191255653	ANAPOLIS	AN12221398	ANAPOLIS UNIVERSITARIO S2	09/12/2019 14:28	10/12/2019 11:00	09/12/2019 19:17	10/12/2019 11:00	15,71	2	31,41	CHI
20191255653	PIRENOPOLIS	AN12221398	ANAPOLIS UNIVERSITARIO S2	09/12/2019 14:28	10/12/2019 11:00	09/12/2019 19:17	10/12/2019 11:00	15,71	13	204,19	CHI
20191255654	ALVORADA DO NORTE	AQ12302818	IACIARA S2	09/12/2019 14:28	11/12/2019 16:53	09/12/2019 20:27	09/12/2019 21:36	1,14	2	2,29	CHI
20191255654	ALVORADA DO NORTE	AQ12302818	IACIARA S2	09/12/2019 14:28	11/12/2019 16:53	10/12/2019 18:40	10/12/2019 19:21	0,68	2	1,36	CHI
20191255654	ALVORADA DO NORTE	SI12314288	IACIARA S2	09/12/2019 14:28	11/12/2019 16:53	09/12/2019 14:28	11/12/2019 16:53	50,42	1	50,42	CHI
20191255664	AGUA FRIA DE GOIAS	TL21342341	SAO JOAO D ALIANCA	09/12/2019 14:29	09/12/2019 21:36	09/12/2019 14:29	09/12/2019 21:18	6,82	1	6,82	CHI
20191255664	AGUA FRIA DE GOIAS	TL12335713	SAO JOAO D ALIANCA	09/12/2019 14:29	09/12/2019 21:36	09/12/2019 20:09	09/12/2019 21:36	1,44	1	1,44	CHI
20191255994	ACREUNA	EU12214067	ACREUNA	09/12/2019 14:29	09/12/2019 19:09	09/12/2019 14:29	09/12/2019 19:09	4,66	52	242,09	CHI
20191255667	AGUAS LINDAS DE GOIAS	4830248787	AGUAS LINDAS DE GOIAS S2	09/12/2019 14:30	09/12/2019 17:53	09/12/2019 14:30	09/12/2019 17:53	3,37	1	3,37	CHI
20191255669	ITABERAI	50036683	ITABERAI S2	09/12/2019 14:31	09/12/2019 16:34	09/12/2019 14:31	09/12/2019 16:34	2,05	1	2,05	CHI
20191255672	GOIANIRA	10010434664	GOIANIRA	09/12/2019 14:31	09/12/2019 15:39	09/12/2019 14:31	09/12/2019 15:39	1,12	1	1,12	CHI
20191255679	TURVANIA	TV12259061	FIRMINOPOLIS S2	09/12/2019 14:32	10/12/2019 10:17	09/12/2019 14:32	09/12/2019 22:37	8,07	3	24,22	CHI
20191255679	TURVANIA	TV12259061	FIRMINOPOLIS S2	09/12/2019 14:32	10/12/2019 10:17	09/12/2019 14:32	10/12/2019 08:09	17,61	4	70,44	CHI
20191255679	TURVANIA	TV12259061	FIRMINOPOLIS S2	09/12/2019 14:32	10/12/2019 10:17	10/12/2019 08:13	10/12/2019 08:44	0,50	7	3,52	CHI
20191255679	TURVANIA	TV12259061	FIRMINOPOLIS S2	09/12/2019 14:32	10/12/2019 10:17	09/12/2019 14:32	10/12/2019 10:17	19,74	2	39,48	CHI
20191257730	APORE	AE12209682	ITAJA S2	09/12/2019 14:32	10/12/2019 09:59	09/12/2019 14:32	10/12/2019 09:59	19,45	11	213,90	CHI
20191255681	TERESINA DE GOIAS	TE11257467	FLORES DE GOIAS	09/12/2019 14:33	10/12/2019 02:00	09/12/2019 14:33	10/12/2019 02:00	11,46	65	744,65	CHI
20191255682	SAO MIGUEL DO PASSA QUATRO	SQ12104016	BELA VISTA S2	09/12/2019 14:33	09/12/2019 18:08	09/12/2019 14:33	09/12/2019 18:08	3,58	13	46,54	CHI
20191255682	SILVANIA	SQ12104016	BELA VISTA S2	09/12/2019 14:33	09/12/2019 18:08	09/12/2019 14:33	09/12/2019 18:08	3,58	1	3,58	CHI
20191255683	CAMPINORTE	UR21147058	URUACU	09/12/2019 14:33	10/12/2019 10:46	09/12/2019 14:33	10/12/2019 10:46	20,21	2	40,43	CHI
20191255687	CAVALCANTE	MA12280212LD	SAO DOMINGOS	09/12/2019 14:33	09/12/2019 18:58	09/12/2019 14:33	09/12/2019 18:58	4,41	169	744,96	CHI
20191255687	MONTE ALEGRE DE GOIAS	MA12280212LD	SAO DOMINGOS	09/12/2019 14:33	09/12/2019 18:58	09/12/2019 14:33	09/12/2019 18:58	4,41	169	744,96	CHI
20191255690	CALDAS NOVAS	CN11213907	SERRA DE CALDAS	09/12/2019 14:34	09/12/2019 16:28	09/12/2019 14:34	09/12/2019 16:28	1,89	5	9,47	CHI
20191255696	CALDAZINHA	SV12202383	CEPAIGO S2	09/12/2019 14:35	10/12/2019 09:00	09/12/2019 14:35	10/12/2019 09:00	18,42	12	221,00	CHI
20191255697	PIRES DO RIO	460108761	PIRES DO RIO S1	09/12/2019 14:35	09/12/2019 16:48	09/12/2019 14:35	09/12/2019 16:48	2,22	1	2,22	CHI
20191255723	ABADIANIA	AA12258346	ANAPOLIS UNIVERSITARIO S1	09/12/2019 14:35	09/12/2019 19:58	09/12/2019 14:35	09/12/2019 19:58	5,37	22	118,12	CHI
20191255723	CORUMBA DE GOIAS	AA12258346	ANAPOLIS UNIVERSITARIO S1	09/12/2019 14:35	09/12/2019 19:58	09/12/2019 14:35	09/12/2019 19:58	5,37	2	10,74	CHI
20191255704	CAMPOS BELOS	CH21375550	SAO DOMINGOS	09/12/2019 14:36	09/12/2019 17:38	09/12/2019 14:36	09/12/2019 17:38	3,03	1	3,03	CHI

20191255705	FAINA	FC12199793	GOIAS	09/12/2019 14:36	09/12/2019 18:40	09/12/2019 14:36	09/12/2019 18:40	4,06	17	69,01	CHI
20191255706	PLANALTINA	PI12053628	PLANALTINA	09/12/2019 14:36	10/12/2019 13:50	10/12/2019 11:24	10/12/2019 13:50	2,43	2	4,87	CHI
20191255706	PLANALTINA	PI11053637	PLANALTINA	09/12/2019 14:36	10/12/2019 13:50	09/12/2019 14:36	10/12/2019 13:50	23,24	6	139,43	CHI
20191255721	MINEIROS	MY10401497	PARQUE DAS EMAS	09/12/2019 14:36	09/12/2019 19:44	09/12/2019 14:36	09/12/2019 17:59	3,39	55	186,39	CHI
20191255721	MINEIROS	MY12306489	PARQUE DAS EMAS	09/12/2019 14:36	09/12/2019 19:44	09/12/2019 14:36	09/12/2019 19:34	4,96	3	14,88	CHI
20191255721	MINEIROS	MY12303860	PARQUE DAS EMAS	09/12/2019 14:36	09/12/2019 19:44	09/12/2019 14:36	09/12/2019 19:44	5,13	5	25,63	CHI
20191255713	ADELANDIA	2330005228	FIRMINOPOLIS S2	09/12/2019 14:37	10/12/2019 09:01	09/12/2019 14:37	10/12/2019 09:01	18,39	1	18,39	CHI
20191256122	ANAPOLIS	AN11166258	ANAPOLIS UNIVERSITARIO S1	09/12/2019 14:37	09/12/2019 17:46	09/12/2019 14:37	09/12/2019 16:27	1,84	177	325,14	CHI
20191256122	ANAPOLIS	AN12130816	ANAPOLIS UNIVERSITARIO S1	09/12/2019 14:37	09/12/2019 17:46	09/12/2019 14:37	09/12/2019 17:46	3,16	775	2445,99	CHI
20191256122	ANAPOLIS	AN12130816	ANAPOLIS UNIVERSITARIO S1	09/12/2019 14:37	09/12/2019 17:46	09/12/2019 17:14	09/12/2019 17:46	0,54	171	92,58	CHI
20191255726	SANTO ANTONIO DO DESCOBERTO	2210081057	AGUAS LINDAS DE GOIAS S2	09/12/2019 14:39	09/12/2019 16:00	09/12/2019 14:39	09/12/2019 16:00	1,35	1	1,35	CHI
20191255728	ITARUMA	IM12062396	CACHOEIRA ALTA	09/12/2019 14:39	09/12/2019 18:45	09/12/2019 14:39	09/12/2019 18:45	4,09	10	40,91	CHI
20191255731	GOIATUBA	GT21088633	GOIATUBA S2	09/12/2019 14:40	09/12/2019 16:11	09/12/2019 14:40	09/12/2019 16:11	1,52	1	1,52	CHI
20191255739	COCALZINHO DE GOIAS	ZN21201341	COCALZINHO	09/12/2019 14:42	10/12/2019 08:38	09/12/2019 14:42	10/12/2019 08:38	17,93	1	17,93	CHI
20191255742	PARAUNA	PU12299203	FIRMINOPOLIS S2	09/12/2019 14:42	09/12/2019 23:10	09/12/2019 14:42	09/12/2019 23:10	8,45	3	25,35	CHI
20191255744	JATAI	JT21184094	JATAI S1	09/12/2019 14:43	09/12/2019 21:45	09/12/2019 14:43	09/12/2019 21:45	7,03	2	14,06	CHI
20191256187	NOVA IGUACU DE GOIAS	UR12000054	CAMPINORTE	09/12/2019 14:44	09/12/2019 18:11	09/12/2019 14:44	09/12/2019 18:11	3,45	15	51,71	CHI
20191256187	URUACU	UR12000054	CAMPINORTE	09/12/2019 14:44	09/12/2019 18:11	09/12/2019 14:44	09/12/2019 18:11	3,45	90	310,25	CHI
20191255768	MINACU	IH21338797	MINACU	09/12/2019 14:47	09/12/2019 18:28	09/12/2019 14:47	09/12/2019 18:28	3,70	2	7,39	CHI
20191255769	PALMEIRAS DE GOIAS	PL12376414	PALMEIRAS	09/12/2019 14:47	10/12/2019 11:15	09/12/2019 14:47	09/12/2019 18:56	4,15	3	12,44	CHI
20191255769	PALMEIRAS DE GOIAS	PL12376414	PALMEIRAS	09/12/2019 14:47	10/12/2019 11:15	09/12/2019 14:47	10/12/2019 09:34	18,79	1	18,79	CHI
20191255769	PALMEIRAS DE GOIAS	PL12376414	PALMEIRAS	09/12/2019 14:47	10/12/2019 11:15	09/12/2019 14:47	10/12/2019 09:46	19,00	29	550,86	CHI
20191255769	INDIARA	PL12376414	PALMEIRAS	09/12/2019 14:47	10/12/2019 11:15	09/12/2019 14:47	10/12/2019 09:50	19,06	3	57,17	CHI
20191255769	PALMEIRAS DE GOIAS	PL12376414	PALMEIRAS	09/12/2019 14:47	10/12/2019 11:15	09/12/2019 14:47	10/12/2019 09:50	19,06	9	171,50	CHI
20191255769	PALMEIRAS DE GOIAS	PL12376414	PALMEIRAS	09/12/2019 14:47	10/12/2019 11:15	09/12/2019 14:47	10/12/2019 10:07	19,33	1	19,33	CHI
20191255769	PALMEIRAS DE GOIAS	PL12376414	PALMEIRAS	09/12/2019 14:47	10/12/2019 11:15	09/12/2019 14:47	10/12/2019 10:43	19,94	1	19,94	CHI
20191255769	PALMEIRAS DE GOIAS	PL12376414	PALMEIRAS	09/12/2019 14:47	10/12/2019 11:15	09/12/2019 14:47	10/12/2019 11:05	20,30	1	20,30	CHI
20191255769	PALMEIRAS DE GOIAS	PL12376414	PALMEIRAS	09/12/2019 14:47	10/12/2019 11:15	09/12/2019 14:47	10/12/2019 11:15	20,48	3	61,44	CHI
20191255777	VALPARAISO DE GOIAS	VA12370668	PACAEMBU S2	09/12/2019 14:49	09/12/2019 19:05	09/12/2019 14:49	09/12/2019 19:05	4,26	182	775,72	CHI
20191255779	POSSE	IA12035179	IACIARA S2	09/12/2019 14:49	10/12/2019 08:40	09/12/2019 14:49	10/12/2019 08:40	17,84	9	160,56	CHI
20191255785	GOIATUBA	140109018	BOM JESUS DE GOIAS	09/12/2019 14:50	09/12/2019 16:48	09/12/2019 14:50	09/12/2019 16:48	1,96	1	1,96	CHI
20191255786	BELA VISTA DE GOIAS	BV21038086	BELA VISTA S1	09/12/2019 14:50	10/12/2019 08:06	09/12/2019 14:50	10/12/2019 08:06	17,25	3	51,75	CHI
20191255787	RIO VERDE	630349174	RIO VERDE S1	09/12/2019 14:50	09/12/2019 20:42	09/12/2019 14:50	09/12/2019 20:42	5,86	1	5,86	CHI

20191255788	CRISTALINA	KR21170493	CRISTALINA S2	09/12/2019 14:51	10/12/2019 15:32	09/12/2019 14:51	10/12/2019 15:32	24,68	1	24,68	CHI
20191255794	LAGOA SANTA	IJ12096135	CACHOEIRA ALTA	09/12/2019 14:52	09/12/2019 17:11	09/12/2019 14:52	09/12/2019 17:11	2,31	7	16,18	CHI
20191255804	SAO MIGUEL DO ARAGUAIA	SM12137060	SAO MIGUEL DO ARAGUAIA	09/12/2019 14:52	09/12/2019 22:58	09/12/2019 14:52	09/12/2019 15:20	0,47	1	0,47	CHI
20191255804	SAO MIGUEL DO ARAGUAIA	SM12298991LD	SAO MIGUEL DO ARAGUAIA	09/12/2019 14:52	09/12/2019 22:58	09/12/2019 14:52	09/12/2019 22:58	8,10	1	8,10	CHI
20191255953	INHUMAS	IN11012242	INHUMAS S2	09/12/2019 14:53	09/12/2019 15:53	09/12/2019 14:53	09/12/2019 15:53	1,00	95	95,37	CHI
20191255909	APARECIDA DE GOIANIA	AP21135481	CEPAIGO S1	09/12/2019 14:54	09/12/2019 17:27	09/12/2019 14:54	09/12/2019 17:27	2,54	1	2,54	CHI
20191255914	ITABERAI	IB21254680	ITABERAI S1	09/12/2019 14:55	10/12/2019 07:31	09/12/2019 14:55	10/12/2019 07:31	16,60	1	16,60	CHI
20191255915	CRISTALINA	KR21345954	CRISTALINA S1	09/12/2019 14:55	10/12/2019 11:19	09/12/2019 14:55	10/12/2019 11:19	20,41	1	20,41	CHI
20191255917	ANAPOLIS	20756800	ANAPOLIS UNIVERSITARIO S2	09/12/2019 14:56	09/12/2019 18:16	09/12/2019 14:56	09/12/2019 18:16	3,33	1	3,33	CHI
20191255923	MARA ROSA	ET12391906	MARA ROSA	09/12/2019 14:56	09/12/2019 22:40	09/12/2019 14:56	09/12/2019 22:40	7,72	10	77,19	CHI
20191255924	IPAMERI	IP12275812	IPAMERI	09/12/2019 14:56	10/12/2019 17:23	09/12/2019 14:56	10/12/2019 17:23	26,44	21	555,19	CHI
20191256612	ITAPURANGA	IK12300342	ITAPURANGA	09/12/2019 14:56	10/12/2019 09:28	09/12/2019 14:56	10/12/2019 09:28	18,53	38	704,22	CHI
20191256666	ITAGUARI	II11259559	ITABERAI S1	09/12/2019 14:57	10/12/2019 00:30	09/12/2019 14:57	10/12/2019 00:30	9,54	103	982,73	CHI
20191255936	BELA VISTA DE GOIAS	BV21344741	BELA VISTA S2	09/12/2019 14:58	09/12/2019 22:33	09/12/2019 14:58	09/12/2019 22:33	7,58	1	7,58	CHI
20191255942	JANDAIA	JD21024396	PALMEIRAS	09/12/2019 14:59	10/12/2019 14:42	09/12/2019 14:59	10/12/2019 14:42	23,71	2	47,42	CHI
20191255946	CRISTALINA	KR21133527	PAMPLONA	09/12/2019 15:00	10/12/2019 18:55	09/12/2019 15:00	10/12/2019 18:55	27,91	1	27,91	CHI
20191255954	ANAPOLIS	10029511990	ANAPOLIS UNIVERSITARIO S2	09/12/2019 15:00	10/12/2019 17:03	09/12/2019 15:00	10/12/2019 17:03	26,03	1	26,03	CHI
20191255959	APARECIDA DE GOIANIA	16552027	REAL S1	09/12/2019 15:01	09/12/2019 18:59	09/12/2019 15:01	09/12/2019 18:59	3,96	1	3,96	CHI
20191256001	PIRENOPOLIS	PV21000709	ANAPOLIS UNIVERSITARIO S2	09/12/2019 15:01	09/12/2019 15:14	09/12/2019 15:01	09/12/2019 15:14	0,21	1	0,21	CHI
20191255964	GOIANIA	15010922	GOYA S2	09/12/2019 15:02	09/12/2019 17:01	09/12/2019 15:02	09/12/2019 17:01	1,99	1	1,99	CHI
20191256191	ANAPOLIS	AN11382870	ANAPOLIS UNIVERSITARIO S2	09/12/2019 15:03	09/12/2019 16:29	09/12/2019 15:03	09/12/2019 16:29	1,43	72	103,20	CHI
20191256289	ITAPURANGA	IK12311318	ITAPURANGA	09/12/2019 15:04	09/12/2019 19:50	09/12/2019 15:04	09/12/2019 19:50	4,77	13	61,96	CHI
20191255980	CHAPADAO DO CEU	DJ12284819	CHAPADAO DO CEU	09/12/2019 15:05	09/12/2019 21:25	09/12/2019 15:05	09/12/2019 21:25	6,34	1	6,34	CHI
20191255984	PADRE BERNARDO	PB12162859	PADRE BERNARDO	09/12/2019 15:06	09/12/2019 18:07	09/12/2019 15:06	09/12/2019 18:07	3,01	1	3,01	CHI
20191256127	CACHOEIRA DOURADA	00280314	CACHOEIRA DOURADA	09/12/2019 15:08	09/12/2019 15:12	09/12/2019 15:08	09/12/2019 15:12	0,06	397	23,16	CHI
20191256127	ITUMBIARA	00280314	CACHOEIRA DOURADA	09/12/2019 15:08	09/12/2019 15:12	09/12/2019 15:08	09/12/2019 15:12	0,06	32	1,87	CHI
20191255998	TRINDADE	TR12230638	TRINDADE	09/12/2019 15:09	09/12/2019 18:11	09/12/2019 16:22	09/12/2019 16:47	0,41	1332	540,57	CHI
20191255998	TRINDADE	TR11340654	TRINDADE	09/12/2019 15:09	09/12/2019 18:11	09/12/2019 16:22	09/12/2019 18:11	1,82	75	136,29	CHI
20191256104	IVOLANDIA	IV11256512	IPORA	09/12/2019 15:09	10/12/2019 00:05	09/12/2019 15:09	10/12/2019 00:05	8,92	3	26,77	CHI
20191256210	MOZARLANDIA	MZ10398421	MOZARLANDIA	09/12/2019 15:09	10/12/2019 16:06	09/12/2019 15:09	09/12/2019 17:24	2,25	20	44,97	CHI
20191256210	NOVA CRIXAS	MZ10398421	MOZARLANDIA	09/12/2019 15:09	10/12/2019 16:06	09/12/2019 15:09	09/12/2019 18:23	3,23	20	64,59	CHI
20191256210	NOVA CRIXAS	MZ10398421	MOZARLANDIA	09/12/2019 15:09	10/12/2019 16:06	09/12/2019 15:09	10/12/2019 08:44	17,58	5	87,90	CHI
20191256210	NOVA CRIXAS	MZ10398421	MOZARLANDIA	09/12/2019 15:09	10/12/2019 16:06	09/12/2019 15:09	10/12/2019 16:06	24,95	8	199,58	CHI

20191256210	NOVA CRIXAS	NA13250765	MOZARLANDIA	09/12/2019 15:09	10/12/2019 16:06	10/12/2019 09:08	10/12/2019 16:06	6,97	5	34,85	CHI
20191256210	NOVA CRIXAS	NA13250765	MOZARLANDIA	09/12/2019 15:09	10/12/2019 16:06	10/12/2019 15:41	10/12/2019 16:06	0,41	1	0,41	CHI
20191256203	AMERICANO DO BRASIL	KB12031452	ANICUNS	09/12/2019 15:11	10/12/2019 11:14	09/12/2019 15:11	10/12/2019 11:14	20,05	9	180,49	CHI
20191256203	ANICUNS	KB12031452	ANICUNS	09/12/2019 15:11	10/12/2019 11:14	09/12/2019 15:11	10/12/2019 11:14	20,05	23	461,26	CHI
20191257772	SANTA TEREZINHA DE GOIAS	GG12181600	SANTA TEREZINHA	09/12/2019 15:11	09/12/2019 20:53	09/12/2019 15:11	09/12/2019 20:53	5,69	7	39,85	CHI
20191256121	CACU	CC12027354	CACHOEIRA ALTA	09/12/2019 15:12	10/12/2019 12:10	09/12/2019 15:12	10/12/2019 12:10	20,96	5	104,82	CHI
20191256129	APARECIDA DE GOIANIA	10019115081	REAL S2	09/12/2019 15:13	09/12/2019 19:19	09/12/2019 15:13	09/12/2019 19:19	4,10	1	4,10	CHI
20191257239	ALEXANIA	AX11000007	ALEXANIA	09/12/2019 15:13	09/12/2019 17:55	09/12/2019 15:13	09/12/2019 17:55	2,69	116	311,49	CHI
20191256139	CRISTALINA	KR10400710	PAMPLONA	09/12/2019 15:14	10/12/2019 16:21	09/12/2019 19:24	09/12/2019 23:56	4,54	34	154,35	CHI
20191256139	CRISTALINA	KR12320123LD	PAMPLONA	09/12/2019 15:14	10/12/2019 16:21	09/12/2019 19:24	10/12/2019 04:38	9,23	30	277,02	CHI
20191256139	CRISTALINA	KR21376271	PAMPLONA	09/12/2019 15:14	10/12/2019 16:21	09/12/2019 15:14	10/12/2019 15:51	24,61	1	24,61	CHI
20191256139	CRISTALINA	KR12362711	PAMPLONA	09/12/2019 15:14	10/12/2019 16:21	10/12/2019 01:47	10/12/2019 16:21	14,57	3	43,71	CHI
20191257836	MORRINHOS	MR12000148	MORRINHOS	09/12/2019 15:14	10/12/2019 08:49	09/12/2019 15:14	10/12/2019 08:49	17,58	25	439,59	CHI
20191256142	JANDAIA	1180020409	PALMEIRAS	09/12/2019 15:15	10/12/2019 09:37	09/12/2019 15:15	10/12/2019 09:37	18,38	1	18,38	CHI
20191256145	CAIAPONIA	CP12395438	PALESTINA	09/12/2019 15:15	09/12/2019 19:00	09/12/2019 15:15	09/12/2019 19:00	3,75	5	18,73	CHI
20191256145	PALESTINA DE GOIAS	CP12395438	PALESTINA	09/12/2019 15:15	09/12/2019 19:00	09/12/2019 15:15	09/12/2019 19:00	3,75	1	3,75	CHI
20191256153	CRIXAS	CX21280674	SANTA TEREZINHA	09/12/2019 15:16	10/12/2019 14:24	09/12/2019 15:16	10/12/2019 14:24	23,13	1	23,13	CHI
20191256177	ITABERAI	19616294	ITABERAI S2	09/12/2019 15:16	09/12/2019 17:49	09/12/2019 15:16	09/12/2019 17:49	2,54	225	570,50	CHI
20191256214	ITABERAI	IB12307666	ITABERAI S2	09/12/2019 15:16	09/12/2019 18:44	09/12/2019 15:16	09/12/2019 18:44	3,46	17	58,88	CHI
20191256157	SANTO ANTONIO DO DESCOBERTO	SN12305157	MARAJOARA	09/12/2019 15:17	09/12/2019 22:34	09/12/2019 15:17	09/12/2019 22:34	7,28	14	101,87	CHI
20191256161	MOZARLANDIA	AZ12326097	MOZARLANDIA	09/12/2019 15:17	10/12/2019 18:10	09/12/2019 15:17	10/12/2019 18:10	26,87	1	26,87	CHI
20191256163	ITAPURANGA	IK11051551	ITAPURANGA	09/12/2019 15:17	10/12/2019 12:50	09/12/2019 15:17	10/12/2019 12:50	21,54	106	2283,45	CHI
20191258271	SANTA RITA DO NOVO DESTINO	DF12229507	BARRO ALTO	09/12/2019 15:17	10/12/2019 13:56	09/12/2019 15:17	10/12/2019 13:56	22,64	32	724,44	CHI
20191256166	ARUANA	AK12307445	MOZARLANDIA	09/12/2019 15:18	09/12/2019 18:34	09/12/2019 15:18	09/12/2019 18:34	3,25	12	39,02	CHI
20191256587	ITABERAI	IB12000115	ITABERAI S2	09/12/2019 15:19	09/12/2019 20:02	09/12/2019 15:19	09/12/2019 20:02	4,71	31	146,13	CHI
20191256175	PLANALTINA	2960047169	PLANALTINA	09/12/2019 15:20	10/12/2019 04:15	09/12/2019 15:20	10/12/2019 04:15	12,91	1	12,91	CHI
20191256188	NIQUELANDIA	NQ12088704	URUACU	09/12/2019 15:20	09/12/2019 23:31	09/12/2019 15:20	09/12/2019 23:31	8,17	21	171,63	CHI
20191258532	SAO DOMINGOS	SD12161807	SAO DOMINGOS	09/12/2019 15:20	10/12/2019 10:44	09/12/2019 15:20	10/12/2019 10:44	19,39	18	348,95	CHI
20191256186	RIO VERDE	RV12021374	RIO VERDE S1	09/12/2019 15:21	09/12/2019 17:30	09/12/2019 15:21	09/12/2019 17:30	2,14	18	38,48	CHI
20191256199	NOVA CRIXAS	NA21057239	MOZARLANDIA	09/12/2019 15:23	10/12/2019 20:32	09/12/2019 15:23	10/12/2019 20:32	29,14	1	29,14	CHI
20191256216	AMERICANO DO BRASIL	KB12065193	ANICUNS	09/12/2019 15:23	09/12/2019 19:40	09/12/2019 15:23	09/12/2019 19:40	4,28	36	154,12	CHI
20191256216	ANICUNS	KB12065193	ANICUNS	09/12/2019 15:23	09/12/2019 19:40	09/12/2019 15:23	09/12/2019 19:40	4,28	2	8,56	CHI
20191256216	MOSSAMEDES	KB12065193	ANICUNS	09/12/2019 15:23	09/12/2019 19:40	09/12/2019 15:23	09/12/2019 19:40	4,28	14	59,94	CHI

20191256299	ITABERAI	IB12206931	ITABERAI S2	09/12/2019 15:23	09/12/2019 19:07	09/12/2019 15:23	09/12/2019 19:07	3,72	12	44,69	CHI
20191256521	BELA VISTA DE GOIAS	SW12091937LD	SENADOR CANEDO	09/12/2019 15:23	10/12/2019 01:00	09/12/2019 15:23	10/12/2019 01:00	9,60	27	259,22	CHI
20191256521	CALDAZINHA	SW12091937LD	SENADOR CANEDO	09/12/2019 15:23	10/12/2019 01:00	09/12/2019 15:23	10/12/2019 01:00	9,60	51	489,64	CHI
20191256521	SENADOR CANEDO	SW12091937LD	SENADOR CANEDO	09/12/2019 15:23	10/12/2019 01:00	09/12/2019 15:23	10/12/2019 01:00	9,60	10	96,01	CHI
20191256205	JOVIANIA	JV21229879	GOIATUBA S1	09/12/2019 15:24	09/12/2019 21:19	09/12/2019 15:24	09/12/2019 21:19	5,90	1	5,90	CHI
20191256206	ITABERAI	IB21000088	ITABERAI S2	09/12/2019 15:24	09/12/2019 17:37	09/12/2019 15:24	09/12/2019 17:37	2,20	6	13,22	CHI
20191256215	ALVORADA DO NORTE	AQ21344368	IACIARA S2	09/12/2019 15:25	09/12/2019 19:52	09/12/2019 15:25	09/12/2019 19:52	4,45	2	8,89	CHI
20191256227	APARECIDA DE GOIANIA	16996641	INDEPENDENCIA S2	09/12/2019 15:25	09/12/2019 16:42	09/12/2019 15:25	09/12/2019 16:42	1,27	1	1,27	CHI
20191256228	GOIANESIA	550042933	GOIANESIA S2	09/12/2019 15:25	10/12/2019 11:04	09/12/2019 15:25	10/12/2019 11:04	19,64	1	19,64	CHI
20191256230	CAIAPONIA	930061779	CAIAPONIA	09/12/2019 15:26	10/12/2019 21:44	09/12/2019 15:26	10/12/2019 21:44	30,30	1	30,30	CHI
20191256231	PLANALTINA	PI11136680	PLANALTINA	09/12/2019 15:26	09/12/2019 19:01	09/12/2019 15:26	09/12/2019 19:01	3,58	23	82,30	CHI
20191256233	PLANALTINA	PI11218372	PLANALTINA	09/12/2019 15:27	09/12/2019 20:48	09/12/2019 15:27	09/12/2019 20:48	5,35	12	64,20	CHI
20191256237	CATALAO	1990084579	CATALAO S2	09/12/2019 15:27	09/12/2019 18:30	09/12/2019 15:27	09/12/2019 18:30	3,04	1	3,04	CHI
20191256238	PARAUNA	PU21362239	PARAUNA	09/12/2019 15:27	10/12/2019 08:03	09/12/2019 15:27	10/12/2019 08:03	16,59	1	16,59	CHI
20191256241	JATAI	JT12104469	JATAI S1	09/12/2019 15:28	10/12/2019 13:40	09/12/2019 15:28	10/12/2019 13:40	22,19	5	110,97	CHI
20191256249	ITAGUARI	II21217197	ITABERAI S1	09/12/2019 15:29	10/12/2019 09:04	09/12/2019 15:29	10/12/2019 09:04	17,57	1	17,57	CHI
20191256250	ITABERAI	50097015	ITABERAI S2	09/12/2019 15:29	09/12/2019 21:10	09/12/2019 15:29	09/12/2019 21:10	5,67	1	5,67	CHI
20191256252	AGUA FRIA DE GOIAS	TL21205634	SAO JOAO D ALIANCA	09/12/2019 15:30	09/12/2019 22:29	09/12/2019 15:30	09/12/2019 22:29	6,97	2	13,95	CHI
20191256503	ABADIA DE GOIAS	19993915	CARAJAS S1	09/12/2019 15:31	10/12/2019 03:02	09/12/2019 15:31	10/12/2019 03:02	11,50	19	218,54	CHI
20191256267	GOIANIA	14144876	CAMPINAS S1	09/12/2019 15:32	09/12/2019 18:15	09/12/2019 15:32	09/12/2019 18:15	2,70	1	2,70	CHI
20191256269	CAIAPONIA	CP12303512	MONTIVIDIU T	09/12/2019 15:32	09/12/2019 18:55	09/12/2019 15:32	09/12/2019 18:55	3,37	17	57,28	CHI
20191256269	MONTIVIDIU	CP12303512	MONTIVIDIU T	09/12/2019 15:32	09/12/2019 18:55	09/12/2019 15:32	09/12/2019 18:55	3,37	2	6,74	CHI
20191256279	PIRACANJUBA	PJ21263444	PIRACANJUBA	09/12/2019 15:34	10/12/2019 11:27	09/12/2019 15:34	10/12/2019 11:27	19,88	1	19,88	CHI
20191256280	ITAPURANGA	IK12311015	ITAPURANGA	09/12/2019 15:34	09/12/2019 19:25	09/12/2019 15:34	09/12/2019 19:25	3,84	142	545,91	CHI
20191256525	CAMPO ALEGRE DE GOIAS	CM12252408	CAMPO ALEGRE DE GOIAS	09/12/2019 15:34	10/12/2019 14:58	09/12/2019 15:34	10/12/2019 14:58	23,40	4	93,59	CHI
20191257040	PLANALTINA	PI11202293	PLANALTINA	09/12/2019 15:34	09/12/2019 18:39	09/12/2019 15:34	09/12/2019 18:39	3,08	15	46,15	CHI
20191256403	JARAGUA	JA21328492	JARAGUA	09/12/2019 15:36	09/12/2019 18:35	09/12/2019 15:36	09/12/2019 18:35	2,99	1	2,99	CHI
20191256581	GOIANIA	GN11068952	GOIANIA LESTE S3	09/12/2019 15:36	09/12/2019 16:52	09/12/2019 15:36	09/12/2019 16:52	1,27	186	235,44	CHI
20191257822	CRIXAS	CX12209957	SANTA TEREZINHA	09/12/2019 15:36	10/12/2019 02:14	09/12/2019 15:36	10/12/2019 02:14	10,63	4	42,53	CHI
20191260143	SAO DOMINGOS	SD12344106	SAO DOMINGOS	09/12/2019 15:36	10/12/2019 09:35	09/12/2019 15:36	10/12/2019 09:35	17,97	6	107,83	CHI
20191260798	PIRANHAS	PH12212440	PIRANHAS	09/12/2019 15:36	10/12/2019 06:58	09/12/2019 15:36	10/12/2019 06:58	15,37	11	169,02	CHI
20191256511	CALDAS NOVAS	CN12182822	SERRA DE CALDAS	09/12/2019 15:38	09/12/2019 17:33	09/12/2019 15:38	09/12/2019 17:33	1,91	68	130,07	CHI
20191257257	ANICUNS	AC12158688	ANICUNS	09/12/2019 15:38	09/12/2019 21:17	09/12/2019 15:38	09/12/2019 21:17	5,65	5	28,24	CHI

20191256517	MINEIROS	10027048258	PARQUE DAS EMAS	09/12/2019 15:39	10/12/2019 09:16	09/12/2019 15:39	10/12/2019 09:16	17,62	1	17,62	CHI
20191256523	NIQUELANDIA	BA12194392	BARRO ALTO	09/12/2019 15:39	10/12/2019 17:44	09/12/2019 15:39	10/12/2019 17:44	26,07	4	104,27	CHI
20191257266	SAO MIGUEL DO ARAGUAIA	SM12276148	SAO MIGUEL DO ARAGUAIA	09/12/2019 15:39	09/12/2019 18:10	09/12/2019 15:39	09/12/2019 18:10	2,51	11	27,62	CHI
20191257890	JATAI	JT12264366	JATAI S2	09/12/2019 15:39	09/12/2019 20:00	09/12/2019 15:39	09/12/2019 20:00	4,34	65	282,19	CHI
20191258798	SAO MIGUEL DO ARAGUAIA	SM12238245	SAO MIGUEL DO ARAGUAIA	09/12/2019 15:39	10/12/2019 10:28	09/12/2019 15:39	10/12/2019 10:28	18,82	17	319,86	CHI
20191256527	FIRMINOPOLIS	FR21206061	FIRMINOPOLIS S1	09/12/2019 15:40	09/12/2019 18:48	09/12/2019 15:40	09/12/2019 18:48	3,14	1	3,14	CHI
20191256531	TRES RANCHOS	TH12068478	CATALAO S1	09/12/2019 15:40	09/12/2019 17:55	09/12/2019 15:40	09/12/2019 17:55	2,24	13	29,11	CHI
20191256534	ANICUNS	AC12158912	FIRMINOPOLIS S2	09/12/2019 15:41	09/12/2019 18:18	09/12/2019 15:41	09/12/2019 18:18	2,61	60	156,77	CHI
20191256535	CACHOEIRA DOURADA	CD12000044	CACHOEIRA DOURADA	09/12/2019 15:41	09/12/2019 17:31	09/12/2019 15:41	09/12/2019 17:31	1,82	9	16,41	CHI
20191256548	JANDAIA	JD12008671	PALMEIRAS	09/12/2019 15:42	10/12/2019 19:36	09/12/2019 15:42	09/12/2019 22:05	6,37	1	6,37	CHI
20191256548	JANDAIA	JD12289826LD	PALMEIRAS	09/12/2019 15:42	10/12/2019 19:36	09/12/2019 15:42	10/12/2019 19:36	27,90	26	725,43	CHI
20191256547	CACHOEIRA DE GOIAS	CG21165643	FIRMINOPOLIS S2	09/12/2019 15:43	10/12/2019 05:26	09/12/2019 15:43	10/12/2019 05:26	13,72	1	13,72	CHI
20191256550	NOVO BRASIL	NB21255389	JUSSARA	09/12/2019 15:43	09/12/2019 20:20	09/12/2019 15:43	09/12/2019 20:20	4,60	1	4,60	CHI
20191258768	AGUA FRIA DE GOIAS	NQ12140182	SAO JOAO D ALIANCA	09/12/2019 15:43	10/12/2019 15:30	09/12/2019 15:43	10/12/2019 15:30	23,78	68	1616,81	CHI
20191258768	NIQUELANDIA	NQ12140182	SAO JOAO D ALIANCA	09/12/2019 15:43	10/12/2019 15:30	09/12/2019 15:43	10/12/2019 15:30	23,78	6	142,66	CHI
20191259403	VILA PROPICIO	NP12188681	GOIANESIA S1	09/12/2019 15:43	10/12/2019 12:47	09/12/2019 15:43	09/12/2019 21:17	5,56	51	283,63	CHI
20191259403	VILA PROPICIO	NP12223827LD	GOIANESIA S1	09/12/2019 15:43	10/12/2019 12:47	09/12/2019 15:43	10/12/2019 12:47	21,07	34	716,53	CHI
20191256558	CAMPO LIMPO	AN21267874	NEROPOLIS S1	09/12/2019 15:45	10/12/2019 10:30	09/12/2019 15:45	10/12/2019 10:30	18,75	6	112,50	CHI
20191256563	FAZENDA NOVA	1080012403	JUSSARA	09/12/2019 15:45	09/12/2019 19:13	09/12/2019 15:45	09/12/2019 19:13	3,46	1	3,46	CHI
20191256564	CATALAO	1990247092	CATALAO S2	09/12/2019 15:46	09/12/2019 19:03	09/12/2019 15:46	09/12/2019 19:03	3,27	1	3,27	CHI
20191256579	PONTALINA	PK12057483	VICENTINOPOLIS	09/12/2019 15:46	09/12/2019 22:08	09/12/2019 15:46	09/12/2019 22:08	6,36	7	44,50	CHI
20191257760	MOZARLANDIA	MZ11247710	MOZARLANDIA	09/12/2019 15:46	09/12/2019 23:20	09/12/2019 15:46	09/12/2019 23:20	7,55	108	815,46	CHI
20191256570	GOIANIA	10004288236	CARAJAS S2	09/12/2019 15:47	09/12/2019 17:29	09/12/2019 15:47	09/12/2019 17:29	1,70	1	1,70	CHI
20191256571	CAMPESTRE DE GOIAS	GA12011344	GUAPO S2	09/12/2019 15:47	09/12/2019 19:38	09/12/2019 15:47	09/12/2019 19:38	3,84	12	46,10	CHI
20191256571	GUAPO	GA12011344	GUAPO S2	09/12/2019 15:47	09/12/2019 19:38	09/12/2019 15:47	09/12/2019 19:38	3,84	54	207,44	CHI
20191257003	MINACU	IH11192444	MINACU	09/12/2019 15:47	09/12/2019 18:53	09/12/2019 15:47	09/12/2019 18:53	3,09	69	213,23	CHI
20191256576	GOIANIA	GN11167561	MEIA PONTE	09/12/2019 15:48	09/12/2019 18:51	09/12/2019 15:48	09/12/2019 18:51	3,05	122	372,10	CHI
20191256580	HIDROLANDIA	HD31197428	INDEPENDENCIA S1	09/12/2019 15:48	09/12/2019 18:58	09/12/2019 15:48	09/12/2019 18:58	3,16	1	3,16	CHI
20191256583	CRISTALINA	KR12383065	CRISTALINA S2	09/12/2019 15:48	10/12/2019 12:16	09/12/2019 15:48	10/12/2019 12:16	20,45	3	61,36	CHI
20191256586	PIRES DO RIO	PR21318944	PIRES DO RIO S2	09/12/2019 15:48	09/12/2019 19:19	09/12/2019 15:48	09/12/2019 19:19	3,50	1	3,50	CHI
20191256589	CAMPO ALEGRE DE GOIAS	CM21164123	CAMPO ALEGRE DE GOIAS	09/12/2019 15:49	10/12/2019 12:27	09/12/2019 15:49	10/12/2019 12:27	20,63	1	20,63	CHI
20191256595	GOIANIA	10721411	ATLANTICO S2	09/12/2019 15:51	09/12/2019 23:03	09/12/2019 15:51	09/12/2019 23:03	7,20	1	7,20	CHI
20191256596	GOIANIA	10021756510	GOYA S1	09/12/2019 15:52	09/12/2019 20:54	09/12/2019 15:52	09/12/2019 20:54	5,03	1	5,03	CHI

20191256603	JUSSARA	JR21365106	JUSSARA	09/12/2019 15:52	10/12/2019 12:40	09/12/2019 15:52	10/12/2019 12:40	20,79	1	20,79	CHI
20191256701	ABADIANIA	AA21393146	ANAPOLIS UNIVERSITARIO S1	09/12/2019 15:52	10/12/2019 17:50	09/12/2019 15:52	10/12/2019 17:50	25,96	2	51,93	CHI
20191257060	ANICUNS	AC12000089	ANICUNS	09/12/2019 15:52	09/12/2019 17:13	09/12/2019 15:52	09/12/2019 17:13	1,34	45	60,09	CHI
20191257060	TURVANIA	AC12000089	ANICUNS	09/12/2019 15:52	09/12/2019 17:13	09/12/2019 15:52	09/12/2019 17:13	1,34	8	10,68	CHI
20191257248	URUACU	UR12066508	URUACU	09/12/2019 15:52	09/12/2019 22:22	09/12/2019 15:52	09/12/2019 22:22	6,49	13	84,40	CHI
20191256638	ITUMBIARA	IT11263996	PARANAIBA	09/12/2019 15:53	09/12/2019 16:30	09/12/2019 15:53	09/12/2019 16:30	0,62	40	24,60	CHI
20191257289	RIO VERDE	RV12228007	MONTIVIDIU T	09/12/2019 15:53	10/12/2019 09:19	09/12/2019 15:53	10/12/2019 09:19	17,44	2	34,88	CHI
20191261501	RIO VERDE	RV12297883	MONTIVIDIU T	09/12/2019 15:53	10/12/2019 09:19	09/12/2019 15:53	10/12/2019 09:19	17,44	12	209,29	CHI
20191256616	PIRENOPOLIS	PV31045780	SAO FRANCISCO DE GOIAS	09/12/2019 15:54	10/12/2019 15:05	09/12/2019 15:54	10/12/2019 15:05	23,17	1	23,17	CHI
20191256618	JATAI	JT21374247	MONTIVIDIU T	09/12/2019 15:54	10/12/2019 10:47	09/12/2019 15:54	10/12/2019 10:47	18,87	1	18,87	CHI
20191256634	SERRANOPOLIS	SX21137487	JATAI S1	09/12/2019 15:54	10/12/2019 13:30	09/12/2019 15:54	10/12/2019 13:30	21,58	1	21,58	CHI
20191257243	APORE	AE12168304	ITAJA S2	09/12/2019 15:56	10/12/2019 02:23	09/12/2019 15:56	10/12/2019 02:23	10,45	9	94,02	CHI
20191256645	SITIO D ABADIA	FB21204645	IACIARA S2	09/12/2019 15:59	09/12/2019 19:47	09/12/2019 15:59	09/12/2019 19:47	3,78	1	3,78	CHI
20191260158	CRISTALINA	KR12217277	CRISTALINA S1	09/12/2019 15:59	09/12/2019 20:42	09/12/2019 15:59	09/12/2019 20:42	4,71	13	61,23	CHI
20191256646	GOIANESIA	GE21000106	GOIANESIA S1	09/12/2019 16:00	10/12/2019 16:31	09/12/2019 16:00	10/12/2019 16:31	24,52	1	24,52	CHI
20191257838	COCALZINHO DE GOIAS	ZN12389400	AGUAS LINDAS DE GOIAS S2	09/12/2019 16:00	09/12/2019 18:51	09/12/2019 16:00	09/12/2019 18:51	2,84	103	292,18	CHI
20191257838	PADRE BERNARDO	ZN12389400	AGUAS LINDAS DE GOIAS S2	09/12/2019 16:00	09/12/2019 18:51	09/12/2019 16:00	09/12/2019 18:51	2,84	4	11,35	CHI
20191256654	LUZIANIA	LZ12290683	MARAJOARA	09/12/2019 16:02	10/12/2019 08:54	09/12/2019 16:02	10/12/2019 08:54	16,86	16	269,81	CHI
20191257242	PLANALTINA	PI12085617RE	PLANALTINA	09/12/2019 16:02	09/12/2019 17:58	09/12/2019 16:02	09/12/2019 17:58	1,92	390	747,72	CHI
20191256661	GOIANIA	10667453	AEROPORTO S3	09/12/2019 16:03	09/12/2019 20:04	09/12/2019 16:03	09/12/2019 20:04	4,02	1	4,02	CHI
20191256662	CRIXAS	2490011589	SERRA DO OURO	09/12/2019 16:03	10/12/2019 14:58	09/12/2019 16:03	10/12/2019 14:58	22,91	1	22,91	CHI
20191256669	ITUMBIARA	BG12000147	ITUMBIARA VELHA S2	09/12/2019 16:03	09/12/2019 20:31	09/12/2019 16:03	09/12/2019 20:31	4,45	1	4,45	CHI
20191262224	AMARALINA	LC21252704	MARA ROSA	09/12/2019 16:03	10/12/2019 13:03	09/12/2019 16:03	10/12/2019 13:03	20,99	1	20,99	CHI
20191256689	VILA PROPICIO	GE11321379	GOIANESIA S2	09/12/2019 16:06	10/12/2019 09:49	09/12/2019 16:06	10/12/2019 09:49	17,70	1	17,70	CHI
20191256695	APORE	AE12105144	ITAJA S2	09/12/2019 16:07	10/12/2019 10:43	09/12/2019 16:07	10/12/2019 10:43	18,59	1	18,59	CHI
20191257004	MINEIROS	MY21043921	PARQUE DAS EMAS	09/12/2019 16:09	10/12/2019 11:55	09/12/2019 16:09	10/12/2019 11:55	19,76	1	19,76	CHI
20191257006	CAMPINORTE	UR12231322	MARA ROSA	09/12/2019 16:09	10/12/2019 11:40	09/12/2019 16:09	10/12/2019 11:40	19,52	4	78,08	CHI
20191257007	CORUMBAIBA	CI21203003	VILA CORUMBA	09/12/2019 16:09	10/12/2019 10:14	09/12/2019 16:09	10/12/2019 10:14	18,07	1	18,07	CHI
20191257008	SENADOR CANEDO	190129712	CEPAIGO S2	09/12/2019 16:09	10/12/2019 09:56	09/12/2019 16:09	10/12/2019 09:56	17,77	1	17,77	CHI
20191257009	ITABERAI	50040546	ITABERAI S2	09/12/2019 16:09	09/12/2019 18:31	09/12/2019 16:09	09/12/2019 18:31	2,35	1	2,35	CHI
20191257011	QUIRINOPOLIS	QI12296616	QUIRINOPOLIS	09/12/2019 16:10	09/12/2019 17:02	09/12/2019 16:10	09/12/2019 17:02	0,87	87	76,12	CHI
20191257018	ORIZONA	2060019923	PIRES DO RIO S2	09/12/2019 16:11	09/12/2019 19:17	09/12/2019 16:11	09/12/2019 19:17	3,09	1	3,09	CHI
20191257707	MINEIROS	MY11036556	PARQUE DAS EMAS	09/12/2019 16:12	10/12/2019 00:46	09/12/2019 16:12	10/12/2019 00:46	8,55	216	1847,34	CHI

20191257029	ANAPOLIS	AN12388771	ANAPOLIS UNIVERSITARIO S2	09/12/2019 16:13	10/12/2019 16:29	09/12/2019 16:13	10/12/2019 16:29	24,25	2	48,50	CHI
20191257037	ABADIA DE GOIAS	TR31099097	GUAPO S1	09/12/2019 16:14	10/12/2019 02:53	09/12/2019 16:14	10/12/2019 02:53	10,64	2	21,27	CHI
20191257041	FLORES DE GOIAS	FB12106993	FLORES DE GOIAS	09/12/2019 16:14	09/12/2019 21:58	09/12/2019 16:14	09/12/2019 21:58	5,72	15	85,84	CHI
20191257041	FORMOSA	FB12106993	FLORES DE GOIAS	09/12/2019 16:14	09/12/2019 21:58	09/12/2019 16:14	09/12/2019 21:58	5,72	137	783,98	CHI
20191257041	FORMOSO	FB12106993	FLORES DE GOIAS	09/12/2019 16:14	09/12/2019 21:58	09/12/2019 16:14	09/12/2019 21:58	5,72	1	5,72	CHI
20191257041	SAO JOAO D ALIANCA	FB12106993	FLORES DE GOIAS	09/12/2019 16:14	09/12/2019 21:58	09/12/2019 16:14	09/12/2019 21:58	5,72	5	28,61	CHI
20191257038	MIMOSO DE GOIAS	MJ12377205	PADRE BERNARDO	09/12/2019 16:15	09/12/2019 18:07	09/12/2019 16:15	09/12/2019 18:07	1,87	3	5,60	CHI
20191257050	SANTA TEREZINHA DE GOIAS	SG21353615	SANTA TEREZINHA	09/12/2019 16:16	10/12/2019 19:25	09/12/2019 16:16	10/12/2019 19:25	27,14	1	27,14	CHI
20191257053	APARECIDA DE GOIANIA	16685635	REAL S1	09/12/2019 16:16	09/12/2019 17:31	09/12/2019 16:16	09/12/2019 17:31	1,24	1	1,24	CHI
20191257058	GOIAS	GS12336539	GOIAS	09/12/2019 16:17	10/12/2019 08:25	09/12/2019 16:17	10/12/2019 08:25	16,12	2	32,24	CHI
20191257204	GOIANIA	10628551	AEROPORTO S2	09/12/2019 16:18	09/12/2019 19:29	09/12/2019 16:18	09/12/2019 19:29	3,18	1	3,18	CHI
20191257210	GOIANIRA	GR12016579LD	GOIANIRA	09/12/2019 16:20	10/12/2019 13:44	09/12/2019 16:20	10/12/2019 13:44	21,41	6	128,44	CHI
20191257215	ITAPURANGA	170042560	ITAPURANGA	09/12/2019 16:20	10/12/2019 08:57	09/12/2019 16:20	10/12/2019 08:57	16,61	1	16,61	CHI
20191257217	DAMOLANDIA	DL12272312	INHUMAS S1	09/12/2019 16:20	09/12/2019 18:13	09/12/2019 16:20	09/12/2019 18:13	1,87	15	28,06	CHI
20191257217	INHUMAS	DL12272312	INHUMAS S1	09/12/2019 16:20	09/12/2019 18:13	09/12/2019 16:20	09/12/2019 18:13	1,87	3	5,61	CHI
20191257221	CALDAS NOVAS	CN21212405	VILA CORUMBA	09/12/2019 16:21	10/12/2019 09:18	09/12/2019 16:21	10/12/2019 09:18	16,95	1	16,95	CHI
20191257224	GOIAS	GS12065878	MATRINCHA	09/12/2019 16:21	09/12/2019 23:06	09/12/2019 16:21	09/12/2019 23:06	6,74	2	13,48	CHI
20191257235	IPAMERI	IP21112287	IPAMERI	09/12/2019 16:23	10/12/2019 08:38	09/12/2019 16:23	10/12/2019 08:38	16,24	1	16,24	CHI
20191257745	ITAPURANGA	IK12022966	ITAPURANGA	09/12/2019 16:23	09/12/2019 21:00	09/12/2019 16:23	09/12/2019 21:00	4,62	2	9,23	CHI
20191258715	MINACU	IH12247493	MINACU	09/12/2019 16:23	09/12/2019 19:03	09/12/2019 16:23	09/12/2019 19:03	2,66	100	266,08	CHI
20191257245	ITUMBIARA	10030615036	ITUMBIARA VELHA S1	09/12/2019 16:25	09/12/2019 17:40	09/12/2019 16:25	09/12/2019 17:40	1,25	1	1,25	CHI
20191257250	FAZENDA NOVA	FN21113489	JUSSARA	09/12/2019 16:25	09/12/2019 21:30	09/12/2019 16:25	09/12/2019 21:30	5,07	1	5,07	CHI
20191257252	SILVANIA	SV21385040	VIANOPOLIS	09/12/2019 16:26	10/12/2019 11:16	09/12/2019 16:26	10/12/2019 11:16	18,83	1	18,83	CHI
20191257253	APARECIDA DE GOIANIA	AP11383836	INDEPENDENCIA S2	09/12/2019 16:26	09/12/2019 19:27	09/12/2019 16:26	09/12/2019 19:27	3,01	31	93,40	CHI
20191260152	SAO MIGUEL DO ARAGUAIA	SM12095569	SAO MIGUEL DO ARAGUAIA	09/12/2019 16:26	10/12/2019 09:49	09/12/2019 16:26	10/12/2019 09:49	17,38	5	86,91	CHI
20191257259	JATAI	10003284300	JATAI S2	09/12/2019 16:28	09/12/2019 19:55	09/12/2019 16:28	09/12/2019 19:55	3,46	1	3,46	CHI
20191257261	CRISTALINA	KR21132662	CRISTALINA S1	09/12/2019 16:28	10/12/2019 14:09	09/12/2019 16:28	10/12/2019 14:09	21,69	1	21,69	CHI
20191258703	GOIAS	GS12250698	ITABERAI S1	09/12/2019 16:28	09/12/2019 22:59	09/12/2019 16:28	09/12/2019 22:59	6,51	28	182,23	CHI
20191257267	ANAPOLIS	20509133	JUNDIAI S1	09/12/2019 16:29	09/12/2019 18:24	09/12/2019 16:29	09/12/2019 18:24	1,91	1	1,91	CHI
20191257270	GUAPO	10011120248	GUAPO S1	09/12/2019 16:29	09/12/2019 22:17	09/12/2019 16:29	09/12/2019 22:17	5,80	1	5,80	CHI
20191258724	SAO LUIZ DO NORTE	SZ12348617	ITAPACI	09/12/2019 16:29	10/12/2019 00:10	09/12/2019 16:29	10/12/2019 00:10	7,67	32	245,36	CHI
20191257850	CATALAO	CT12149164RE	CATALAO S1	09/12/2019 16:30	09/12/2019 20:05	09/12/2019 16:30	09/12/2019 20:05	3,58	144	515,48	CHI
20191257880	TERESINA DE GOIAS	TE11257468	FLORES DE GOIAS	09/12/2019 16:32	10/12/2019 00:00	09/12/2019 16:32	10/12/2019 00:00	7,47	127	948,30	CHI

20191259218	CALDAS NOVAS	CN11107999	CALDAS NOVAS S1	09/12/2019 16:32	09/12/2019 21:10	09/12/2019 16:32	09/12/2019 21:10	4,63	126	583,35	CHI
20191257297	PORTELANDIA	PW12303420	PARQUE DAS EMAS	09/12/2019 16:34	10/12/2019 11:34	09/12/2019 16:34	10/12/2019 11:34	19,00	14	265,95	CHI
20191257701	MOZARLANDIA	MZ12063700	MOZARLANDIA	09/12/2019 16:35	10/12/2019 18:50	09/12/2019 16:35	10/12/2019 18:50	26,25	1	26,25	CHI
20191257705	LUZIANIA	LZ12261331	VIANOPOLIS	09/12/2019 16:35	09/12/2019 23:37	09/12/2019 16:35	09/12/2019 23:37	7,03	6	42,16	CHI
20191257708	OURO VERDE DE GOIAS	NR21221921	NEROPOLIS S2	09/12/2019 16:35	09/12/2019 22:49	09/12/2019 16:35	09/12/2019 22:49	6,22	3	18,66	CHI
20191264618	CALDAZINHA	BV12032340	CEPAIGO S2	09/12/2019 16:35	10/12/2019 09:10	09/12/2019 16:35	10/12/2019 09:10	16,58	19	314,99	CHI
20191264618	SENADOR CANEDO	BV12032340	CEPAIGO S2	09/12/2019 16:35	10/12/2019 09:10	09/12/2019 16:35	10/12/2019 09:10	16,58	1	16,58	CHI
20191257712	GOIANDIRA	GD21035395	CATALAO S1	09/12/2019 16:36	10/12/2019 08:45	09/12/2019 16:36	10/12/2019 08:30	15,91	2	31,81	CHI
20191257712	CATALAO	GD12165162	CATALAO S1	09/12/2019 16:36	10/12/2019 08:45	09/12/2019 16:36	10/12/2019 08:45	16,14	3	48,42	CHI
20191257712	GOIANDIRA	GD12165162	CATALAO S1	09/12/2019 16:36	10/12/2019 08:45	09/12/2019 16:36	10/12/2019 08:45	16,14	8	129,13	CHI
20191257717	ANICUNS	910003300	ANICUNS	09/12/2019 16:36	09/12/2019 19:10	09/12/2019 16:36	09/12/2019 19:10	2,55	1	2,55	CHI
20191258930	VILA PROPICIO	PV12115145	GOIANESIA S1	09/12/2019 16:36	10/12/2019 14:25	09/12/2019 16:36	10/12/2019 14:25	21,82	18	392,69	CHI
20191257722	AGUAS LINDAS DE GOIAS	LA12379013	AGUAS LINDAS DE GOIAS S2	09/12/2019 16:37	09/12/2019 18:20	09/12/2019 16:37	09/12/2019 18:20	1,71	32	54,59	CHI
20191257722	PADRE BERNARDO	LA12379013	AGUAS LINDAS DE GOIAS S2	09/12/2019 16:37	09/12/2019 18:20	09/12/2019 16:37	09/12/2019 18:20	1,71	0	0,00	CHI
20191257831	GOIANIA	GN11002314	CAMPINAS S2	09/12/2019 16:37	09/12/2019 17:44	09/12/2019 16:37	09/12/2019 17:44	1,12	115	128,32	CHI
20191257728	IPAMERI	IP12403328	PIRES DO RIO S2	09/12/2019 16:38	10/12/2019 09:25	09/12/2019 16:38	10/12/2019 09:25	16,78	7	117,46	CHI
20191257731	CHAPADAO DO CEU	DJ12365007	CHAPADAO DO CEU	09/12/2019 16:39	10/12/2019 09:20	09/12/2019 16:39	10/12/2019 09:20	16,68	8	133,46	CHI
20191257731	MINEIROS	DJ12365007	CHAPADAO DO CEU	09/12/2019 16:39	10/12/2019 09:20	09/12/2019 16:39	10/12/2019 09:20	16,68	2	33,37	CHI
20191257739	IACIARA	IA12264175	IACIARA S2	09/12/2019 16:39	10/12/2019 12:46	09/12/2019 16:39	10/12/2019 12:46	20,11	5	100,56	CHI
20191257743	RIO VERDE	QI21150106	QUIRINOPOLIS	09/12/2019 16:39	09/12/2019 18:37	09/12/2019 16:39	09/12/2019 18:37	1,95	1	1,95	CHI
20191257823	MINEIROS	MY12024312	PARQUE DAS EMAS	09/12/2019 16:40	09/12/2019 22:57	09/12/2019 16:40	09/12/2019 22:57	6,28	71	445,68	CHI
20191257823	SANTA RITA DO ARAGUAIA	MY12024312	PARQUE DAS EMAS	09/12/2019 16:40	09/12/2019 22:57	09/12/2019 16:40	09/12/2019 22:57	6,28	17	106,71	CHI
20191257748	NOVA VENEZA	NV11373065	INHUMAS S1	09/12/2019 16:41	09/12/2019 19:36	09/12/2019 16:41	09/12/2019 19:36	2,92	10	29,16	CHI
20191257753	ITUMBIARA	IT21232617	ITUMBIARA VELHA S1	09/12/2019 16:41	09/12/2019 19:42	09/12/2019 16:41	09/12/2019 19:42	3,00	2	6,00	CHI
20191257754	ANICUNS	AC21148070	ANICUNS	09/12/2019 16:41	10/12/2019 12:43	09/12/2019 16:41	10/12/2019 12:43	20,02	1	20,02	CHI
20191257755	CAIAPONIA	CP12259379	CAIAPONIA	09/12/2019 16:42	10/12/2019 12:50	09/12/2019 16:42	10/12/2019 12:50	20,14	2	40,29	CHI
20191257759	GOIANIA	10005621893	GOYA S1	09/12/2019 16:42	09/12/2019 20:01	09/12/2019 16:42	09/12/2019 20:01	3,33	1	3,33	CHI
20191257766	PETROLINA DE GOIAS	PV21196887	SAO FRANCISCO DE GOIAS	09/12/2019 16:43	10/12/2019 09:32	09/12/2019 16:43	10/12/2019 09:32	16,80	1	16,80	CHI
20191257767	CAMPO LIMPO	AN12267847	NEROPOLIS S1	09/12/2019 16:43	09/12/2019 20:39	09/12/2019 16:43	09/12/2019 20:39	3,92	62	242,89	CHI
20191257768	DOVERLANDIA	MY12036563	PARQUE DAS EMAS	09/12/2019 16:44	10/12/2019 21:30	09/12/2019 16:44	10/12/2019 21:30	28,78	26	748,31	CHI
20191257770	SAO DOMINGOS	8680002928	SAO DOMINGOS	09/12/2019 16:44	10/12/2019 09:20	09/12/2019 16:44	10/12/2019 09:20	16,60	1	16,60	CHI
20191257849	NEROPOLIS	NR11133825	NEROPOLIS S2	09/12/2019 16:44	09/12/2019 18:11	09/12/2019 16:44	09/12/2019 18:11	1,45	278	402,56	CHI
20191258702	AMARALINA	LC12215796	MARA ROSA	09/12/2019 16:44	09/12/2019 21:20	09/12/2019 16:44	09/12/2019 21:20	4,59	13	59,63	CHI

20191257777	MUNDO NOVO DE GOIAS	MH11255526	NOVA CRIXAS	09/12/2019 16:45	09/12/2019 18:30	09/12/2019 16:45	09/12/2019 18:30	1,75	53	92,75	CHI
20191257779	TRINDADE	10026613040	TRINDADE	09/12/2019 16:45	09/12/2019 22:14	09/12/2019 16:45	09/12/2019 22:14	5,47	1	5,47	CHI
20191257782	IPAMERI	IP21275821	IPAMERI	09/12/2019 16:46	09/12/2019 23:45	09/12/2019 16:46	09/12/2019 23:45	6,97	1	6,97	CHI
20191257783	FAINA	FC21217541	GOIAS	09/12/2019 16:46	10/12/2019 11:04	09/12/2019 16:46	10/12/2019 11:04	18,29	1	18,29	CHI
20191257784	ANAPOLIS	20634894	ANAPOLIS UNIVERSITARIO S2	09/12/2019 16:46	10/12/2019 08:31	09/12/2019 16:46	10/12/2019 08:31	15,74	1	15,74	CHI
20191261382	ANICUNS	AC12304607	FIRMINOPOLIS S2	09/12/2019 16:46	10/12/2019 01:17	09/12/2019 16:46	10/12/2019 01:17	8,51	3	25,54	CHI
20191257790	BOM JESUS DE GOIAS	BJ11150140	VICENTINOPOLIS	09/12/2019 16:47	09/12/2019 19:40	09/12/2019 16:47	09/12/2019 19:40	2,87	1	2,87	CHI
20191257802	CALDAS NOVAS	01240414	MORRINHOS	09/12/2019 16:47	10/12/2019 11:16	09/12/2019 16:47	10/12/2019 07:55	15,14	2	30,28	CHI
20191257802	MORRINHOS	01240414	MORRINHOS	09/12/2019 16:47	10/12/2019 11:16	09/12/2019 16:47	10/12/2019 07:55	15,14	236	3573,56	CHI
20191257802	RIO QUENTE	01240414	MORRINHOS	09/12/2019 16:47	10/12/2019 11:16	09/12/2019 16:47	10/12/2019 07:55	15,14	19	287,70	CHI
20191257802	MORRINHOS	01240414	MORRINHOS	09/12/2019 16:47	10/12/2019 11:16	09/12/2019 17:24	10/12/2019 07:55	14,52	1	14,52	CHI
20191257802	MORRINHOS	01240414	MORRINHOS	09/12/2019 16:47	10/12/2019 11:16	09/12/2019 16:47	10/12/2019 08:50	16,05	74	1187,62	CHI
20191257802	MORRINHOS	01240414	MORRINHOS	09/12/2019 16:47	10/12/2019 11:16	09/12/2019 16:47	10/12/2019 09:03	16,27	365	5939,46	CHI
20191257802	MORRINHOS	01240414	MORRINHOS	09/12/2019 16:47	10/12/2019 11:16	09/12/2019 16:47	10/12/2019 09:14	16,46	13	213,98	CHI
20191257802	MORRINHOS	01240414	MORRINHOS	09/12/2019 16:47	10/12/2019 11:16	09/12/2019 16:47	10/12/2019 09:20	16,56	1	16,56	CHI
20191257802	CALDAS NOVAS	MR10394713	MORRINHOS	09/12/2019 16:47	10/12/2019 11:16	10/12/2019 10:11	10/12/2019 10:17	0,10	7	0,72	CHI
20191257802	MORRINHOS	MR10394713	MORRINHOS	09/12/2019 16:47	10/12/2019 11:16	10/12/2019 10:11	10/12/2019 10:17	0,10	1	0,10	CHI
20191257802	MORRINHOS	MR10394713	MORRINHOS	09/12/2019 16:47	10/12/2019 11:16	10/12/2019 10:11	10/12/2019 10:17	0,10	24	2,47	CHI
20191257802	MORRINHOS	MR10394713	MORRINHOS	09/12/2019 16:47	10/12/2019 11:16	10/12/2019 10:11	10/12/2019 10:17	0,10	339	34,94	CHI
20191257802	PIRACANJUBA	MR10394713	MORRINHOS	09/12/2019 16:47	10/12/2019 11:16	10/12/2019 10:11	10/12/2019 10:17	0,10	125	12,88	CHI
20191257802	PIRACANJUBA	MR10394713	MORRINHOS	09/12/2019 16:47	10/12/2019 11:16	10/12/2019 10:11	10/12/2019 10:17	0,10	2	0,21	CHI
20191257802	MORRINHOS	MR10394713	MORRINHOS	09/12/2019 16:47	10/12/2019 11:16	10/12/2019 10:11	10/12/2019 11:15	1,06	365	386,09	CHI
20191257802	CALDAS NOVAS	MR10394713	MORRINHOS	09/12/2019 16:47	10/12/2019 11:16	10/12/2019 10:11	10/12/2019 11:16	1,07	2	2,15	CHI
20191257802	MORRINHOS	MR10394713	MORRINHOS	09/12/2019 16:47	10/12/2019 11:16	10/12/2019 10:11	10/12/2019 11:16	1,07	235	252,43	CHI
20191257802	RIO QUENTE	MR10394713	MORRINHOS	09/12/2019 16:47	10/12/2019 11:16	10/12/2019 10:11	10/12/2019 11:16	1,07	19	20,41	CHI
20191257793	ITABERAI	50064599	ITABERAI S2	09/12/2019 16:48	09/12/2019 18:04	09/12/2019 16:48	09/12/2019 18:04	1,26	1	1,26	CHI
20191257795	IPORA	IR12112737	IPORA	09/12/2019 16:48	10/12/2019 07:22	09/12/2019 16:48	10/12/2019 07:22	14,56	11	160,16	CHI
20191257799	BOM JESUS DE GOIAS	BJ11263765	VICENTINOPOLIS	09/12/2019 16:49	09/12/2019 20:31	09/12/2019 16:49	09/12/2019 20:31	3,70	1	3,70	CHI
20191257800	VICENTINOPOLIS	VI21263808	VICENTINOPOLIS	09/12/2019 16:49	09/12/2019 17:43	09/12/2019 16:49	09/12/2019 17:43	0,89	2	1,79	CHI
20191257804	MINEIROS	MY12166286	CHAPADAO DO CEU	09/12/2019 16:49	10/12/2019 18:58	09/12/2019 16:49	10/12/2019 18:06	25,27	5	126,37	CHI
20191257804	SERRANOPOLIS	MY12166286	CHAPADAO DO CEU	09/12/2019 16:49	10/12/2019 18:58	09/12/2019 16:49	10/12/2019 18:06	25,27	9	227,47	CHI
20191257804	SERRANOPOLIS	MY12166305LD	CHAPADAO DO CEU	09/12/2019 16:49	10/12/2019 18:58	09/12/2019 16:49	10/12/2019 18:58	26,14	1	26,14	CHI
20191257820	GOIAS	GK12220543	ITAPURANGA	09/12/2019 16:49	10/12/2019 08:02	09/12/2019 16:49	10/12/2019 08:02	15,21	11	167,32	CHI

20191257820	GUARAITA	GK12220543	ITAPURANGA	09/12/2019 16:49	10/12/2019 08:02	09/12/2019 16:49	10/12/2019 08:02	15,21	22	334,64	CHI
20191257815	ORIZONA	IP12217837	PIRES DO RIO S2	09/12/2019 16:50	10/12/2019 12:03	09/12/2019 16:50	10/12/2019 12:03	19,20	1	19,20	CHI
20191257816	JATAI	JT12260302	JATAI S3	09/12/2019 16:51	10/12/2019 11:26	09/12/2019 16:51	10/12/2019 11:26	18,58	3	55,74	CHI
20191258001	ORIZONA	OZ21114411	VIANOPOLIS	09/12/2019 16:51	10/12/2019 21:25	09/12/2019 16:51	10/12/2019 21:25	28,56	1	28,56	CHI
20191257828	SENADOR CANEDO	10005851090	CEPAIGO S2	09/12/2019 16:52	09/12/2019 18:33	09/12/2019 16:52	09/12/2019 18:33	1,67	1	1,67	CHI
20191257840	BALIZA	BH12381003	BOM JARDIM	09/12/2019 16:52	10/12/2019 08:19	09/12/2019 16:52	10/12/2019 08:19	15,43	23	355,00	CHI
20191257842	PORANGATU	10020598368	PORANGATU	09/12/2019 16:54	10/12/2019 07:42	09/12/2019 16:54	10/12/2019 07:42	14,79	1	14,79	CHI
20191258102	ALTO HORIZONTE	AJ13405231	SANTA TEREZINHA	09/12/2019 16:54	10/12/2019 00:03	09/12/2019 18:15	10/12/2019 00:03	5,80	1378	7994,70	CHI
20191257847	AGUAS LINDAS DE GOIAS	LA11375293	AGUAS LINDAS DE GOIAS S1	09/12/2019 16:55	09/12/2019 18:06	09/12/2019 16:55	09/12/2019 18:06	1,17	107	125,49	CHI
201912260863	JATAI	290285628	JATAI S3	09/12/2019 16:58	10/12/2019 08:26	09/12/2019 16:58	10/12/2019 08:26	15,48	1	15,48	CHI
20191257861	QUIRINOPOLIS	80035115	QUIRINOPOLIS	09/12/2019 16:59	09/12/2019 18:57	09/12/2019 16:59	09/12/2019 18:57	1,96	1	1,96	CHI
20191257866	GOIAS	GS21259596	ITABERAI S2	09/12/2019 16:59	10/12/2019 15:19	09/12/2019 16:59	10/12/2019 15:19	22,32	1	22,32	CHI
20191257879	GOIANIA	12899252	GOIANIA LESTE S3	09/12/2019 17:02	09/12/2019 18:46	09/12/2019 17:02	09/12/2019 18:46	1,73	1	1,73	CHI
20191258259	PIRACANJUBA	PJ12076794	MORRINHOS	09/12/2019 17:02	10/12/2019 10:08	09/12/2019 17:02	10/12/2019 10:08	17,10	3	51,29	CHI
20191258233	DAVINOPOLIS	IO12073927	CATALAO S1	09/12/2019 17:03	09/12/2019 21:02	09/12/2019 17:03	09/12/2019 21:02	3,97	49	194,53	CHI
20191258202	EDEIA	EA12038795	EDEIA	09/12/2019 17:04	10/12/2019 18:35	09/12/2019 17:04	10/12/2019 18:35	25,51	8	204,05	CHI
20191259239	ITAPURANGA	IK12250609	ITAPURANGA	09/12/2019 17:04	10/12/2019 17:51	09/12/2019 17:04	10/12/2019 17:51	24,78	22	545,15	CHI
20191257898	ALEXANIA	480057618	ALEXANIA	09/12/2019 17:05	10/12/2019 15:20	09/12/2019 17:05	10/12/2019 15:20	22,24	1	22,24	CHI
20191257900	NIQUELANDIA	NQ12097007	BARRO ALTO	09/12/2019 17:05	10/12/2019 06:19	09/12/2019 17:05	10/12/2019 06:19	13,22	3	39,65	CHI
20191258205	ITAPURANGA	IK21220973	ITAPURANGA	09/12/2019 17:06	10/12/2019 13:44	09/12/2019 17:06	10/12/2019 13:44	20,62	1	20,62	CHI
20191258207	PIRES DO RIO	460079141	PIRES DO RIO S1	09/12/2019 17:07	09/12/2019 20:40	09/12/2019 17:07	09/12/2019 20:40	3,55	1	3,55	CHI
20191258208	ARAGARCAS	AG12092426	ARAGARCAS	09/12/2019 17:07	10/12/2019 00:07	09/12/2019 17:07	10/12/2019 00:07	6,99	4	27,97	CHI
20191258209	AGUA LIMPA	AL12242538	VILA CORUMBA	09/12/2019 17:07	10/12/2019 10:50	09/12/2019 17:07	10/12/2019 10:50	17,71	4	70,83	CHI
20191258212	ANAPOLIS	10016048618	ANAPOLIS UNIVERSITARIO S2	09/12/2019 17:08	09/12/2019 18:55	09/12/2019 17:08	09/12/2019 18:55	1,78	1	1,78	CHI
20191258220	TRINDADE	10022349993	GOYA S2	09/12/2019 17:10	10/12/2019 00:20	09/12/2019 17:10	10/12/2019 00:20	7,16	1	7,16	CHI
20191258222	APORE	AE21155312	ITAJA S2	09/12/2019 17:10	10/12/2019 10:23	09/12/2019 17:10	10/12/2019 10:23	17,20	1	17,20	CHI
20191258223	PIRACANJUBA	PJ21282980	PIRACANJUBA	09/12/2019 17:10	09/12/2019 18:27	09/12/2019 17:10	09/12/2019 18:27	1,28	1	1,28	CHI
20191258552	PONTALINA	PK11048363	PONTALINA	09/12/2019 17:10	09/12/2019 19:20	09/12/2019 17:10	09/12/2019 19:20	2,16	169	365,32	CHI
20191258751	HIDROLANDIA	AO12394650	GUAPU S2	09/12/2019 17:10	10/12/2019 08:25	09/12/2019 17:10	10/12/2019 08:25	15,24	3	45,73	CHI
20191258301	MORRINHOS	MR12000131	GOIATUBA S1	09/12/2019 17:12	09/12/2019 17:16	09/12/2019 17:12	09/12/2019 17:16	0,06	1	0,06	CHI
20191259294	NAZARIO	NZ12000054	ANICUNS	09/12/2019 17:12	10/12/2019 07:50	09/12/2019 17:12	10/12/2019 07:50	14,63	3	43,88	CHI
20191259294	PALMEIRAS DE GOIAS	NZ12000054	ANICUNS	09/12/2019 17:12	10/12/2019 07:50	09/12/2019 17:12	10/12/2019 07:50	14,63	19	277,89	CHI
20191259294	SANTA BARBARA DE GOIAS	NZ12000054	ANICUNS	09/12/2019 17:12	10/12/2019 07:50	09/12/2019 17:12	10/12/2019 07:50	14,63	19	277,89	CHI

20191258236	BELA VISTA DE GOIAS	BV21324940	BELA VISTA S2	09/12/2019 17:13	09/12/2019 18:35	09/12/2019 17:13	09/12/2019 18:35	1,37	1	1,37	CHI
20191258239	CACU	CC21084240	CACHOEIRA ALTA	09/12/2019 17:14	09/12/2019 20:45	09/12/2019 17:14	09/12/2019 20:45	3,51	1	3,51	CHI
20191258240	ALTO PARAISO DE GOIAS	BF21129910	FLORES DE GOIAS	09/12/2019 17:14	09/12/2019 18:48	09/12/2019 17:14	09/12/2019 18:48	1,56	1	1,56	CHI
20191258241	SANTO ANTONIO DO DESCOBERTO	SN12376767	AGUAS LINDAS DE GOIAS S2	09/12/2019 17:14	09/12/2019 19:12	09/12/2019 17:14	09/12/2019 19:12	1,96	1001	1958,07	CHI
20191258586	SANTA CRUZ DE GOIAS	PZ12073341RE	PIRES DO RIO S2	09/12/2019 17:14	12/12/2019 16:55	09/12/2019 17:14	09/12/2019 20:20	3,10	36	111,71	CHI
20191258586	SANTA CRUZ DE GOIAS	PZ12073341RE	PIRES DO RIO S2	09/12/2019 17:14	12/12/2019 16:55	09/12/2019 20:21	09/12/2019 22:30	2,15	19	40,76	CHI
20191258586	SANTA CRUZ DE GOIAS	PZ12073341RE	PIRES DO RIO S2	09/12/2019 17:14	12/12/2019 16:55	09/12/2019 22:37	10/12/2019 16:56	18,32	3	54,95	CHI
20191258586	SANTA CRUZ DE GOIAS	PZ12073341RE	PIRES DO RIO S2	09/12/2019 17:14	12/12/2019 16:55	10/12/2019 19:54	10/12/2019 21:03	1,15	3	3,45	CHI
20191258586	SANTA CRUZ DE GOIAS	PZ12073341RE	PIRES DO RIO S2	09/12/2019 17:14	12/12/2019 16:55	09/12/2019 22:37	11/12/2019 00:59	26,36	8	210,90	CHI
20191258586	SANTA CRUZ DE GOIAS	PZ12073341RE	PIRES DO RIO S2	09/12/2019 17:14	12/12/2019 16:55	11/12/2019 00:41	11/12/2019 00:59	0,28	3	0,85	CHI
20191258586	PALMELO	PZ12063775RE	PIRES DO RIO S2	09/12/2019 17:14	12/12/2019 16:55	09/12/2019 17:14	11/12/2019 01:48	32,56	23	748,77	CHI
20191258586	PIRES DO RIO	PZ12063775RE	PIRES DO RIO S2	09/12/2019 17:14	12/12/2019 16:55	09/12/2019 17:14	11/12/2019 01:48	32,56	6	195,33	CHI
20191258586	SANTA CRUZ DE GOIAS	PZ12063775RE	PIRES DO RIO S2	09/12/2019 17:14	12/12/2019 16:55	09/12/2019 17:14	11/12/2019 01:48	32,56	26	846,44	CHI
20191258586	SANTA CRUZ DE GOIAS	PZ12073341RE	PIRES DO RIO S2	09/12/2019 17:14	12/12/2019 16:55	09/12/2019 22:37	11/12/2019 02:00	27,39	7	191,75	CHI
20191258586	SANTA CRUZ DE GOIAS	BC12068914LD	PIRES DO RIO S2	09/12/2019 17:14	12/12/2019 16:55	09/12/2019 20:21	11/12/2019 09:00	36,66	17	623,15	CHI
20191258586	SANTA CRUZ DE GOIAS	BC12027030	PIRES DO RIO S2	09/12/2019 17:14	12/12/2019 16:55	11/12/2019 14:25	11/12/2019 15:04	0,65	24	15,63	CHI
20191258586	SANTA CRUZ DE GOIAS	PZ12073341RE	PIRES DO RIO S2	09/12/2019 17:14	12/12/2019 16:55	09/12/2019 22:37	12/12/2019 16:55	66,30	1	66,30	CHI
20191258247	ITUMBIARA	690151172	ITUMBIARA NOVA	09/12/2019 17:15	10/12/2019 03:08	09/12/2019 17:15	10/12/2019 03:08	9,89	1	9,89	CHI
20191258249	CAMPOS BELOS	CH21144707	SAO DOMINGOS	09/12/2019 17:15	09/12/2019 19:37	09/12/2019 17:15	09/12/2019 19:37	2,36	1	2,36	CHI
20191258253	FORMOSA	FA11129972	ITUIQUIRA	09/12/2019 17:15	09/12/2019 19:06	09/12/2019 17:15	09/12/2019 19:06	1,83	111	203,68	CHI
20191258257	RIO VERDE	RV13326778	RIO VERDE S1	09/12/2019 17:16	10/12/2019 12:49	10/12/2019 10:48	10/12/2019 12:49	2,03	1270	2572,10	CHI
20191260757	NOVO PLANALTO	TA12391924	SAO MIGUEL DO ARAGUAIA	09/12/2019 17:16	10/12/2019 03:45	09/12/2019 17:16	10/12/2019 03:45	10,48	11	115,31	CHI
201912260858	RIO VERDE	630173953	RIO VERDE S1	09/12/2019 17:16	10/12/2019 10:48	09/12/2019 17:16	10/12/2019 10:48	17,52	1	17,52	CHI
20191258264	LUZIANIA	120106632	RIO VERMELHO	09/12/2019 17:17	09/12/2019 18:58	09/12/2019 17:17	09/12/2019 18:58	1,67	1	1,67	CHI
20191258265	ITAPURANGA	IK21112857	ITAPURANGA	09/12/2019 17:17	10/12/2019 10:02	09/12/2019 17:17	10/12/2019 10:02	16,74	3	50,21	CHI
20191258288	CEZARINA	04880216	PALMEIRAS	09/12/2019 17:18	09/12/2019 18:42	09/12/2019 17:18	09/12/2019 18:42	1,40	5	7,00	CHI
20191258288	PALMEIRAS DE GOIAS	04880216	PALMEIRAS	09/12/2019 17:18	09/12/2019 18:42	09/12/2019 17:18	09/12/2019 18:42	1,40	356	498,30	CHI
20191258275	LUZIANIA	10030183381	RIO VERMELHO	09/12/2019 17:20	09/12/2019 18:51	09/12/2019 17:20	09/12/2019 18:51	1,51	1	1,51	CHI
20191259301	GOIAS	GS21302554	GOIAS	09/12/2019 17:20	09/12/2019 23:35	09/12/2019 17:20	09/12/2019 23:35	6,24	1	6,24	CHI
20191258278	ORIZONA	OZ12085006	PIRES DO RIO S2	09/12/2019 17:21	10/12/2019 10:26	09/12/2019 17:21	10/12/2019 10:26	17,08	1	17,08	CHI
20191258280	ORIZONA	OZ21186674	PIRES DO RIO S2	09/12/2019 17:21	10/12/2019 09:23	09/12/2019 17:21	10/12/2019 09:23	16,02	1	16,02	CHI
20191258281	SAO MIGUEL DO PASSA QUATRO	SQ21111729	BELA VISTA S2	09/12/2019 17:21	09/12/2019 19:02	09/12/2019 17:21	09/12/2019 19:02	1,67	1	1,67	CHI
20191258283	SAO DOMINGOS	SD12170576	SAO DOMINGOS	09/12/2019 17:21	09/12/2019 21:18	09/12/2019 17:21	09/12/2019 21:18	3,94	36	141,81	CHI

20191260150	PIRACANJUBA	PJ12223377	MORRINHOS	09/12/2019 17:21	10/12/2019 11:07	09/12/2019 17:21	10/12/2019 11:07	17,75	32	568,14	CHI
20191260150	PIRACANJUBA	PJ12223377	ROCHEDO	09/12/2019 17:21	10/12/2019 11:07	09/12/2019 17:21	10/12/2019 11:07	17,75	13	230,81	CHI
20191258291	RIO VERDE	RV21213512	CABRIUVA S2	09/12/2019 17:22	09/12/2019 21:45	09/12/2019 17:22	09/12/2019 21:45	4,38	1	4,38	CHI
20191258295	GOIANIA	10494881	GOIANIA LESTE S1	09/12/2019 17:23	09/12/2019 20:12	09/12/2019 17:23	09/12/2019 20:12	2,81	0	0,00	CHI
20191258507	GOIANIA	10003595534	MEIA PONTE	09/12/2019 17:25	09/12/2019 19:29	09/12/2019 17:25	09/12/2019 19:29	2,06	1	2,06	CHI
20191259527	CEZARINA	CZ12314870	CEZARINA	09/12/2019 17:25	10/12/2019 11:05	09/12/2019 17:25	10/12/2019 09:56	16,50	19	313,53	CHI
20191259527	CEZARINA	CZ12314877	CEZARINA	09/12/2019 17:25	10/12/2019 11:05	09/12/2019 17:25	10/12/2019 11:05	17,65	3	52,96	CHI
20191258527	FAZENDA NOVA	NB12250852	JUSSARA	09/12/2019 17:29	10/12/2019 09:51	09/12/2019 17:29	10/12/2019 09:51	16,36	4	65,45	CHI
20191258528	PLANALTINA	PI11043458	PLANALTINA	09/12/2019 17:29	09/12/2019 19:56	09/12/2019 17:29	09/12/2019 19:56	2,44	31	75,76	CHI
20191258538	GOIANIA	GN12035097	CARAJAS S2	09/12/2019 17:30	09/12/2019 20:19	09/12/2019 17:30	09/12/2019 20:19	2,81	269	755,29	CHI
20191257014	GOIAS	GS21150088	GOIAS	09/12/2019 17:31	09/12/2019 19:38	09/12/2019 17:31	09/12/2019 19:38	2,12	1	2,12	CHI
20191258546	ITUMBIARA	BG21000085	ITUMBIARA VELHA S2	09/12/2019 17:31	10/12/2019 08:12	09/12/2019 17:31	10/12/2019 08:12	14,68	1	14,68	CHI
20191258547	BARRO ALTO	BA21144968	GOIANESIA S1	09/12/2019 17:31	10/12/2019 20:42	09/12/2019 17:31	10/12/2019 20:42	27,18	2	54,36	CHI
20191260178	CALDAS NOVAS	CN11213963	SERRA DE CALDAS	09/12/2019 17:31	09/12/2019 20:21	09/12/2019 17:31	09/12/2019 20:21	2,82	33	93,20	CHI
20191258740	ANAPOLIS	O3120216	NEROPOLIS S1	09/12/2019 17:33	09/12/2019 19:27	09/12/2019 17:33	09/12/2019 19:27	1,89	191	360,14	CHI
20191258740	CAMPO LIMPO	O3120216	NEROPOLIS S1	09/12/2019 17:33	09/12/2019 19:27	09/12/2019 17:33	09/12/2019 19:27	1,89	16	30,17	CHI
20191258740	OURO VERDE DE GOIAS	O3120216	NEROPOLIS S1	09/12/2019 17:33	09/12/2019 19:27	09/12/2019 17:33	09/12/2019 19:27	1,89	1433	2702,00	CHI
20191258740	PETROLINA DE GOIAS	O3120216	NEROPOLIS S1	09/12/2019 17:33	09/12/2019 19:27	09/12/2019 17:33	09/12/2019 19:27	1,89	13	24,51	CHI
20191258740	PIRENOPOLIS	O3120216	NEROPOLIS S1	09/12/2019 17:33	09/12/2019 19:27	09/12/2019 17:33	09/12/2019 19:27	1,89	49	92,39	CHI
20191258578	GOIANIA	GN21000554	CARAJAS S1	09/12/2019 17:35	09/12/2019 19:06	09/12/2019 17:35	09/12/2019 19:06	1,52	1	1,52	CHI
20191258580	MUNDO NOVO DE GOIAS	4240018202	NOVA CRIXAS	09/12/2019 17:36	09/12/2019 21:45	09/12/2019 17:36	09/12/2019 21:45	4,16	1	4,16	CHI
20191258583	CRISTALINA	KR12230274	CRISTALINA S2	09/12/2019 17:36	10/12/2019 15:22	09/12/2019 17:36	10/12/2019 15:22	21,75	1	21,75	CHI
20191259585	LUZIANIA	LZ12349111	MARAJOARA	09/12/2019 17:37	10/12/2019 01:43	09/12/2019 17:37	10/12/2019 01:43	8,09	139	1124,63	CHI
20191258952	NOVA ROMA	TE12284926	FLORES DE GOIAS	09/12/2019 17:38	09/12/2019 21:39	09/12/2019 17:38	09/12/2019 21:39	4,01	23	92,27	CHI
20191258952	TERESINA DE GOIAS	TE12284926	FLORES DE GOIAS	09/12/2019 17:38	09/12/2019 21:39	09/12/2019 17:38	09/12/2019 21:39	4,01	11	44,13	CHI
20191258953	DAVINOPOLIS	IO12281489RE	CATALAO S1	09/12/2019 17:38	09/12/2019 19:58	09/12/2019 17:38	09/12/2019 19:58	2,33	6	13,99	CHI
20191258953	OUVIDOR	IO12281489RE	CATALAO S1	09/12/2019 17:38	09/12/2019 19:58	09/12/2019 17:38	09/12/2019 19:58	2,33	28	65,28	CHI
20191258953	TRES RANCHOS	IO12281489RE	CATALAO S1	09/12/2019 17:38	09/12/2019 19:58	09/12/2019 17:38	09/12/2019 19:58	2,33	1	2,33	CHI
20191258707	ITAPURANGA	IK21167554	ITAPURANGA	09/12/2019 17:39	10/12/2019 13:16	09/12/2019 17:39	10/12/2019 13:16	19,61	1	19,61	CHI
20191258712	LUZIANIA	LZ11133119	MARAJOARA	09/12/2019 17:39	09/12/2019 19:12	09/12/2019 17:39	09/12/2019 19:12	1,54	105	161,61	CHI
20191261451	MINEIROS	MY11348939	PARQUE DAS EMAS	09/12/2019 17:39	09/12/2019 23:27	09/12/2019 17:39	09/12/2019 23:27	5,79	30	173,67	CHI
20191258726	ANAPOLIS	10030616458	ANAPOLIS UNIVERSITARIO S2	09/12/2019 17:42	10/12/2019 16:27	09/12/2019 17:42	10/12/2019 16:27	22,75	1	22,75	CHI
20191258729	AMORINOPOLIS	AM21140039	IPORA	09/12/2019 17:42	10/12/2019 09:04	09/12/2019 17:42	10/12/2019 09:04	15,36	2	30,71	CHI

20191258737	GOIANESIA	550092742	GOIANESIA S2	09/12/2019 17:43	10/12/2019 13:33	09/12/2019 17:43	10/12/2019 13:33	19,83	1	19,83	CHI
20191258929	SANTO ANTONIO DO DESCOBERTO	SN11047441	AGUAS LINDAS DE GOIAS S2	09/12/2019 17:43	10/12/2019 02:01	09/12/2019 17:43	10/12/2019 02:01	8,29	109	904,06	CHI
20191259247	SAO LUIS DE MONTES BELOS	SL11167295	SAO LUIZ DOS MONTES BELOS	09/12/2019 17:43	10/12/2019 00:58	09/12/2019 17:43	10/12/2019 00:58	7,24	135	976,99	CHI
20191258760	VALPARAISO DE GOIAS	3350031170	PACAEMBU S2	09/12/2019 17:47	09/12/2019 21:05	09/12/2019 17:47	09/12/2019 21:05	3,29	1	3,29	CHI
20191260566	SANTO ANTONIO DO DESCOBERTO	SN12064481LD	MARAJOARA	09/12/2019 17:47	10/12/2019 00:26	09/12/2019 17:47	10/12/2019 00:26	6,64	46	305,45	CHI
20191258791	ANICUNS	AC12000089	ANICUNS	09/12/2019 17:49	09/12/2019 20:39	09/12/2019 17:49	09/12/2019 20:39	2,82	45	126,89	CHI
20191258791	TURVANIA	AC12000089	ANICUNS	09/12/2019 17:49	09/12/2019 20:39	09/12/2019 17:49	09/12/2019 20:39	2,82	8	22,56	CHI
20191258778	GOIANIA	10024381720	XAVANTES	09/12/2019 17:50	09/12/2019 21:45	09/12/2019 17:50	09/12/2019 21:45	3,92	1	3,92	CHI
20191258782	CAMPINORTE	CR12266635	MARA ROSA	09/12/2019 17:50	10/12/2019 18:36	09/12/2019 17:50	10/12/2019 18:36	24,75	6	148,52	CHI
20191258784	CRIXAS	CX21318751	RUBIATABA	09/12/2019 17:51	10/12/2019 13:09	09/12/2019 17:51	10/12/2019 13:09	19,29	1	19,29	CHI
20191258787	CALDAS NOVAS	760136592	SERRA DE CALDAS	09/12/2019 17:51	10/12/2019 01:59	09/12/2019 17:51	10/12/2019 01:59	8,12	1	8,12	CHI
20191258790	GOIANESIA	550096590	GOIANESIA S2	09/12/2019 17:52	10/12/2019 13:55	09/12/2019 17:52	10/12/2019 13:55	20,04	1	20,04	CHI
20191258795	PETROLINA DE GOIAS	PV21072284	SAO FRANCISCO DE GOIAS	09/12/2019 17:53	10/12/2019 10:25	09/12/2019 17:53	10/12/2019 10:25	16,54	1	16,54	CHI
20191261306	BOM JESUS DE GOIAS	BJ12208032	BOM JESUS DE GOIAS	09/12/2019 17:53	09/12/2019 23:54	09/12/2019 17:53	09/12/2019 23:54	6,01	2	12,02	CHI
20191261306	ITUMBIARA	BJ12208032	BOM JESUS DE GOIAS	09/12/2019 17:53	09/12/2019 23:54	09/12/2019 17:53	09/12/2019 23:54	6,01	3	18,02	CHI
20191258905	ANAPOLIS	21337913	ANAPOLIS UNIVERSITARIO S1	09/12/2019 17:54	09/12/2019 20:59	09/12/2019 17:54	09/12/2019 20:59	3,08	1	3,08	CHI
20191258985	SANTA HELENA DE GOIAS	SH12279533	IPEGUARI	09/12/2019 17:54	10/12/2019 08:40	09/12/2019 17:54	10/12/2019 08:40	14,75	32	472,04	CHI
20191259264	ANAPOLIS	AN11157955	ANAPOLIS UNIVERSITARIO S2	09/12/2019 17:54	09/12/2019 19:48	09/12/2019 17:54	09/12/2019 19:48	1,89	113	213,38	CHI
20191258913	AGUAS LINDAS DE GOIAS	LA12157307	AGUAS LINDAS DE GOIAS S2	09/12/2019 17:55	09/12/2019 18:57	09/12/2019 17:55	09/12/2019 18:57	1,03	1	1,03	CHI
20191258917	ITAPURANGA	IK21311448	ITAPURANGA	09/12/2019 17:56	10/12/2019 08:55	09/12/2019 17:56	10/12/2019 08:55	14,97	1	14,97	CHI
20191259281	BONFINOPOLIS	LB12032351	CEPAIGO S2	09/12/2019 17:56	10/12/2019 10:45	09/12/2019 17:56	10/12/2019 10:45	16,80	1	16,80	CHI
20191259281	LEOPOLDO DE BULHOES	LB12032351	CEPAIGO S2	09/12/2019 17:56	10/12/2019 10:45	09/12/2019 17:56	10/12/2019 10:45	16,80	8	134,42	CHI
20191258919	CRISTALINA	KR21332509	CRISTALINA S2	09/12/2019 17:57	10/12/2019 15:36	09/12/2019 17:57	10/12/2019 15:36	21,65	1	21,65	CHI
20191261805	SAO MIGUEL DO ARAGUAIA	SM11000002	SAO MIGUEL DO ARAGUAIA	09/12/2019 17:57	10/12/2019 07:49	09/12/2019 17:57	10/12/2019 07:49	13,85	56	775,63	CHI
20191258931	MINEIROS	10030097388	PARQUE DAS EMAS	09/12/2019 17:58	10/12/2019 11:38	09/12/2019 17:58	10/12/2019 11:38	17,67	1	17,67	CHI
20191258955	AVELINOPOLIS	990003670	ANICUNS	09/12/2019 17:58	10/12/2019 11:52	09/12/2019 17:58	10/12/2019 11:52	17,90	1	17,90	CHI
20191258935	SAO JOAO D ALIANCA	JL12325678	SAO JOAO D ALIANCA	09/12/2019 17:59	10/12/2019 13:50	09/12/2019 17:59	10/12/2019 13:50	19,85	6	119,09	CHI
20191258938	LUZIANIA	10021397900	RIO VERMELHO	09/12/2019 17:59	09/12/2019 19:43	09/12/2019 17:59	09/12/2019 19:43	1,73	1	1,73	CHI
20191258939	TRINDADE	40194267	GOYA S1	09/12/2019 17:59	09/12/2019 23:31	09/12/2019 17:59	09/12/2019 23:31	5,53	1	5,53	CHI
20191260902	CORUMBA DE GOIAS	CB12093242	CORUMBA	09/12/2019 17:59	09/12/2019 22:56	09/12/2019 17:59	09/12/2019 22:56	4,95	117	578,73	CHI
20191258949	NIQUELANDIA	NQ12262955	NIQUELANDIA SUBTRANSMISSAO	09/12/2019 18:00	10/12/2019 14:17	09/12/2019 18:00	10/12/2019 14:17	20,27	4	81,10	CHI
20191270301	JUSSARA	JR21388932	JUSSARA	09/12/2019 18:00	11/12/2019 06:56	09/12/2019 18:00	11/12/2019 06:56	36,92	2	73,84	CHI
20191259508	MORRINHOS	MR12402529	MORRINHOS	09/12/2019 18:01	09/12/2019 21:12	09/12/2019 18:01	09/12/2019 21:12	3,18	1288	4090,12	CHI

20191260154	IACIARA	IA12206170	IACIARA S1	09/12/2019 18:01	10/12/2019 19:01	09/12/2019 18:01	09/12/2019 22:01	4,00	28	112,03	CHI
20191260154	IACIARA	IA12206170	IACIARA S1	09/12/2019 18:01	10/12/2019 19:01	09/12/2019 18:01	09/12/2019 23:20	5,31	7	37,20	CHI
20191260154	IACIARA	IA12206170	IACIARA S1	09/12/2019 18:01	10/12/2019 19:01	10/12/2019 02:40	10/12/2019 09:36	6,92	28	193,88	CHI
20191260154	IACIARA	IA12206170	IACIARA S1	09/12/2019 18:01	10/12/2019 19:01	10/12/2019 16:09	10/12/2019 19:01	2,86	28	79,99	CHI
20191260154	IACIARA	IA12206170	IACIARA S1	09/12/2019 18:01	10/12/2019 19:01	09/12/2019 18:01	10/12/2019 19:01	25,00	45	1124,79	CHI
20191260154	IACIARA	IA12206170	IACIARA S1	09/12/2019 18:01	10/12/2019 19:01	10/12/2019 02:40	10/12/2019 19:01	16,34	7	114,38	CHI
20191261836	ANAPOLIS	AN12026162	ANAPOLIS UNIVERSITARIO S2	09/12/2019 18:01	10/12/2019 10:43	09/12/2019 18:01	10/12/2019 10:43	16,70	6	100,19	CHI
20191258961	LUZIANIA	LZ21109854	VIANOPOLIS	09/12/2019 18:02	10/12/2019 15:37	09/12/2019 18:02	10/12/2019 15:37	21,60	1	21,60	CHI
20191258967	ANAPOLIS	20424474	ANAPOLIS UNIVERSITARIO S2	09/12/2019 18:02	09/12/2019 20:08	09/12/2019 18:02	09/12/2019 20:08	2,09	1	2,09	CHI
20191258971	GOIAS	GS21183486	GOIAS	09/12/2019 18:03	10/12/2019 11:30	09/12/2019 18:03	10/12/2019 11:30	17,45	1	17,45	CHI
20191258976	ANAPOLIS	AN21341928	JUNDIAI S1	09/12/2019 18:04	09/12/2019 20:32	09/12/2019 18:04	09/12/2019 20:32	2,46	1	2,46	CHI
20191258979	MAIRIPOTABA	MI21078674	PONTALINA	09/12/2019 18:04	10/12/2019 00:01	09/12/2019 18:04	10/12/2019 00:01	5,94	1	5,94	CHI
20191258992	ALTO PARAISO DE GOIAS	BF12170287	NIQUELANDIA SUBTRANSMISSAO	09/12/2019 18:04	09/12/2019 19:27	09/12/2019 18:04	09/12/2019 19:27	1,37	11	15,12	CHI
20191258987	FORMOSO	FO21145106	PORANGATU	09/12/2019 18:05	09/12/2019 21:05	09/12/2019 18:05	09/12/2019 21:05	2,99	2	5,99	CHI
20191258990	ABADIANIA	AA12302332	ANAPOLIS UNIVERSITARIO S1	09/12/2019 18:05	10/12/2019 16:07	09/12/2019 18:05	10/12/2019 16:07	22,02	1	22,02	CHI
20191258994	GUAPO	710044070	GUAPO S1	09/12/2019 18:06	09/12/2019 23:18	09/12/2019 18:06	09/12/2019 23:18	5,20	1	5,20	CHI
20191259201	GOIANIA	10006309451	INDEPENDENCIA S2	09/12/2019 18:07	09/12/2019 21:10	09/12/2019 18:07	09/12/2019 21:10	3,05	1	3,05	CHI
20191263720	GOIATUBA	GT12190955	GOIATUBA S1	09/12/2019 18:07	10/12/2019 09:00	09/12/2019 18:07	10/12/2019 09:00	14,89	7	104,20	CHI
20191259220	PIRACANJUBA	PJ12212153	PIRACANJUBA	09/12/2019 18:09	10/12/2019 12:19	09/12/2019 18:09	10/12/2019 12:19	18,16	6	108,93	CHI
20191259225	CRISTIANOPOLIS	CF21093862	CRISTIANOPOLIS	09/12/2019 18:10	09/12/2019 23:48	09/12/2019 18:10	09/12/2019 23:48	5,63	1	5,63	CHI
20191259228	CORUMBA DE GOIAS	CB21171917	CORUMBA	09/12/2019 18:10	10/12/2019 09:54	09/12/2019 18:10	10/12/2019 09:54	15,73	1	15,73	CHI
20191260722	PIRACANJUBA	PJ12212152	PIRACANJUBA	09/12/2019 18:10	09/12/2019 23:01	09/12/2019 18:10	09/12/2019 23:01	4,84	37	179,18	CHI
20191261347	ALTO PARAISO DE GOIAS	JL12257606	SAO JOAO D ALIANCA	09/12/2019 18:10	10/12/2019 10:00	09/12/2019 18:10	10/12/2019 10:00	15,83	2	31,66	CHI
20191261347	SAO JOAO D ALIANCA	JL12257606	SAO JOAO D ALIANCA	09/12/2019 18:10	10/12/2019 10:00	09/12/2019 18:10	10/12/2019 10:00	15,83	81	1282,21	CHI
20191259237	ITABERAI	IB11359481	ITABERAI S2	09/12/2019 18:12	10/12/2019 13:43	09/12/2019 18:12	10/12/2019 13:43	19,51	1	19,51	CHI
20191259244	JANDAIA	JD21026383	PALMEIRAS	09/12/2019 18:13	10/12/2019 07:49	09/12/2019 18:13	10/12/2019 07:49	13,59	1	13,59	CHI
20191259246	ITAGUARI	IC21250497	ITABERAI S1	09/12/2019 18:14	10/12/2019 19:01	09/12/2019 18:14	10/12/2019 19:01	24,78	1	24,78	CHI
20191259248	JUSSARA	JR12076127	BRITANIA	09/12/2019 18:14	09/12/2019 18:20	09/12/2019 18:14	09/12/2019 18:20	0,09	1	0,09	CHI
20191259249	MONTE ALEGRE DE GOIAS	MA12240201	SAO DOMINGOS	09/12/2019 18:14	09/12/2019 21:46	09/12/2019 18:14	09/12/2019 21:46	3,53	13	45,89	CHI
20191259260	MAIRIPOTABA	MI12011393	PONTALINA	09/12/2019 18:14	09/12/2019 22:05	09/12/2019 18:14	09/12/2019 22:05	3,84	31	119,08	CHI
20191259256	ABADIANIA	AA21205075	DAIA S2	09/12/2019 18:15	10/12/2019 09:30	09/12/2019 18:15	10/12/2019 09:30	15,24	1	15,24	CHI
20191259262	DOVERLANDIA	DV21138539	CAIAPONIA	09/12/2019 18:16	10/12/2019 10:00	09/12/2019 18:16	10/12/2019 10:00	15,74	1	15,74	CHI
20191259266	GOIATUBA	GT21137918	GOIATUBA S2	09/12/2019 18:16	10/12/2019 10:44	09/12/2019 18:16	10/12/2019 10:44	16,46	1	16,46	CHI

20191259267	ITAPURANGA	10003731241	ITAPURANGA	09/12/2019 18:16	10/12/2019 13:28	09/12/2019 18:16	10/12/2019 13:28	19,19	1	19,19	CHI
20191259271	SANTO ANTONIO DO DESCOBERTO	SN21082949	MARAJOARA	09/12/2019 18:16	10/12/2019 17:13	09/12/2019 18:16	10/12/2019 17:13	22,94	2	45,87	CHI
20191260543	COCALZINHO DE GOIAS	ZN12377411	COCALZINHO	09/12/2019 18:19	09/12/2019 21:29	09/12/2019 18:19	09/12/2019 21:29	3,16	17	53,80	CHI
20191263522	MORRINHOS	MR12000099	MORRINHOS	09/12/2019 18:19	10/12/2019 07:33	09/12/2019 18:19	10/12/2019 07:33	13,22	3	39,67	CHI
20191259296	FAINA	FC12274380	GOIAS	09/12/2019 18:20	10/12/2019 02:50	09/12/2019 18:20	10/12/2019 02:50	8,49	2	16,98	CHI
20191259503	FORMOSA	FA12206227	ITIQUEIRA	09/12/2019 18:21	09/12/2019 21:34	09/12/2019 18:21	09/12/2019 21:34	3,21	26	83,50	CHI
20191259506	SILVANIA	SV21152366	DAIA S2	09/12/2019 18:21	10/12/2019 09:42	09/12/2019 18:21	10/12/2019 09:42	15,34	1	15,34	CHI
20191259509	APARECIDA DE GOIANIA	12665710	REAL S1	09/12/2019 18:21	09/12/2019 20:11	09/12/2019 18:21	09/12/2019 20:11	1,82	1	1,82	CHI
20191259510	INDIARA	IY21341555	EDEIA	09/12/2019 18:21	10/12/2019 15:16	09/12/2019 18:21	10/12/2019 15:16	20,92	1	20,92	CHI
20191259518	SANTO ANTONIO DO DESCOBERTO	SN12275494	MARAJOARA	09/12/2019 18:21	10/12/2019 10:04	09/12/2019 18:21	10/12/2019 10:04	15,71	8	125,70	CHI
20191259601	QUIRINOPOLIS	QI21306072	QUIRINOPOLIS	09/12/2019 18:21	09/12/2019 18:27	09/12/2019 18:21	09/12/2019 18:27	0,09	1	0,09	CHI
20191259515	PORANGATU	PO12371842	NOVO PLANALTO	09/12/2019 18:22	10/12/2019 10:38	09/12/2019 18:22	10/12/2019 10:38	16,26	1	16,26	CHI
20191259523	PIRACANJUBA	PJ21162145	PIRACANJUBA	09/12/2019 18:23	10/12/2019 11:25	09/12/2019 18:23	10/12/2019 11:25	17,02	1	17,02	CHI
20191260137	DAMOLANDIA	DL12021273	INHUMAS S1	09/12/2019 18:26	09/12/2019 21:26	09/12/2019 18:26	09/12/2019 21:26	3,00	8	24,00	CHI
20191260137	INHUMAS	DL12021273	INHUMAS S1	09/12/2019 18:26	09/12/2019 21:26	09/12/2019 18:26	09/12/2019 21:26	3,00	3	9,00	CHI
20191259546	COCALZINHO DE GOIAS	LA12382945	AGUAS LINDAS DE GOIAS S2	09/12/2019 18:27	10/12/2019 14:06	09/12/2019 18:27	10/12/2019 14:06	19,63	1	19,63	CHI
20191259547	BELA VISTA DE GOIAS	10016490744	BELA VISTA S2	09/12/2019 18:27	10/12/2019 02:17	09/12/2019 18:27	10/12/2019 02:17	7,82	1	7,82	CHI
20191259549	ABADIANIA	AA12000048RE	ANAPOLIS UNIVERSITARIO S1	09/12/2019 18:28	09/12/2019 21:33	09/12/2019 18:28	09/12/2019 21:33	3,08	88	270,82	CHI
20191259554	GOIANIA	11482539	CAMPINAS S1	09/12/2019 18:29	09/12/2019 20:51	09/12/2019 18:29	09/12/2019 20:51	2,36	1	2,36	CHI
20191259556	LUZIANIA	LZ21149931	VIANOPOLIS	09/12/2019 18:29	10/12/2019 09:42	09/12/2019 18:29	10/12/2019 09:42	15,21	1	15,21	CHI
20191261495	ABADIANIA	AA12085971	ANAPOLIS UNIVERSITARIO S1	09/12/2019 18:29	09/12/2019 22:53	09/12/2019 18:29	09/12/2019 22:53	4,39	12	52,70	CHI
20191259561	ALEXANIA	AX21221531	ALEXANIA	09/12/2019 18:30	10/12/2019 17:26	09/12/2019 18:30	10/12/2019 17:26	22,93	1	22,93	CHI
20191259566	APARECIDA DO RIO DOCE	AW21122608	JATAI S1	09/12/2019 18:31	10/12/2019 18:47	09/12/2019 18:31	10/12/2019 18:47	24,26	1	24,26	CHI
20191259569	NIQUELANDIA	NQ21262876	URUACU	09/12/2019 18:31	10/12/2019 17:40	09/12/2019 18:31	10/12/2019 17:40	23,14	1	23,14	CHI
20191259574	ANAPOLIS	20574721	ANAPOLIS UNIVERSITARIO S2	09/12/2019 18:32	10/12/2019 11:40	09/12/2019 18:32	10/12/2019 11:40	17,12	1	17,12	CHI
20191259577	GOIANIA	GN11313188	NEROPOLIS S1	09/12/2019 18:33	09/12/2019 20:58	09/12/2019 18:33	09/12/2019 20:58	2,42	15	36,23	CHI
20191260785	ABADIANIA	AA12285384	ANAPOLIS UNIVERSITARIO S1	09/12/2019 18:33	09/12/2019 20:40	09/12/2019 18:33	09/12/2019 20:40	2,12	99	209,39	CHI
20191260785	GAMELEIRA DE GOIAS	AA12285384	ANAPOLIS UNIVERSITARIO S1	09/12/2019 18:33	09/12/2019 20:40	09/12/2019 18:33	09/12/2019 20:40	2,12	1	2,12	CHI
20191259583	ANICUNS	AC12073802	ANICUNS	09/12/2019 18:34	10/12/2019 00:00	09/12/2019 18:34	10/12/2019 00:00	5,42	3	16,27	CHI
20191259587	SILVANIA	SV12041094	DAIA S1	09/12/2019 18:35	10/12/2019 10:51	09/12/2019 18:35	10/12/2019 10:51	16,27	7	113,86	CHI
20191259592	MORRINHOS	MR12040540RE	MORRINHOS	09/12/2019 18:35	10/12/2019 07:20	09/12/2019 18:35	10/12/2019 07:20	12,75	48	611,84	CHI
20191259593	AGUAS LINDAS DE GOIAS	LA11330501	AGUAS LINDAS DE GOIAS S1	09/12/2019 18:35	09/12/2019 22:42	09/12/2019 18:35	09/12/2019 22:42	4,10	8	32,82	CHI
20191260585	FORMOSO	FO12145300	PORANGATU	09/12/2019 18:35	09/12/2019 20:35	09/12/2019 18:35	09/12/2019 20:35	2,00	11	21,98	CHI

20191258793	ITUMBIARA	IT1257076	ITUMBIARA NOVA	09/12/2019 18:36	10/12/2019 16:24	09/12/2019 18:36	10/12/2019 16:24	21,79	18	392,28	CHI
20191260578	MINACU	IH12242191	MINACU	09/12/2019 18:36	09/12/2019 22:40	09/12/2019 18:36	09/12/2019 22:40	4,06	7	28,42	CHI
20191260504	EDEIA	EA12308014	EDEIA	09/12/2019 18:37	12/12/2019 14:05	09/12/2019 18:37	11/12/2019 02:00	31,40	6	188,38	CHI
20191260504	EDEIA	EA12308014	EDEIA	09/12/2019 18:37	12/12/2019 14:05	11/12/2019 02:01	12/12/2019 14:05	36,07	6	216,42	CHI
20191261432	PORANGATU	PO12230401	MARA ROSA	09/12/2019 18:37	10/12/2019 09:06	09/12/2019 18:37	10/12/2019 09:06	14,48	5	72,39	CHI
20191260917	SAO JOAO D ALIANCA	JL12383338	SAO JOAO D ALIANCA	09/12/2019 18:38	09/12/2019 23:37	09/12/2019 18:38	09/12/2019 23:37	4,98	39	194,25	CHI
20191261307	ABADIANIA	AA12377770	ANAPOLIS UNIVERSITARIO S1	09/12/2019 18:38	09/12/2019 23:51	09/12/2019 18:38	09/12/2019 23:51	5,21	11	57,30	CHI
20191260111	BOM JARDIM DE GOIAS	BM12390150	BOM JARDIM	09/12/2019 18:39	10/12/2019 14:47	09/12/2019 18:39	09/12/2019 23:05	4,43	7	31,01	CHI
20191260111	BOM JARDIM DE GOIAS	BM12390150	BOM JARDIM	09/12/2019 18:39	10/12/2019 14:47	10/12/2019 07:00	10/12/2019 07:20	0,35	7	2,45	CHI
20191260111	BALIZA	BM12390150	BOM JARDIM	09/12/2019 18:39	10/12/2019 14:47	09/12/2019 18:39	10/12/2019 14:47	20,13	51	1026,62	CHI
20191260111	BOM JARDIM DE GOIAS	BM12390150	BOM JARDIM	09/12/2019 18:39	10/12/2019 14:47	09/12/2019 18:39	10/12/2019 14:47	20,13	2	40,26	CHI
20191260111	BOM JARDIM DE GOIAS	BM12390150	BOM JARDIM	09/12/2019 18:39	10/12/2019 14:47	10/12/2019 09:00	10/12/2019 14:47	5,78	7	40,48	CHI
20191260115	CATALAO	CT12209404	CATALAO S1	09/12/2019 18:40	10/12/2019 08:09	09/12/2019 18:40	10/12/2019 08:09	13,48	2	26,96	CHI
20191260128	ANAPOLIS	AN12000193RE	ANAPOLIS UNIVERSITARIO S2	09/12/2019 18:42	10/12/2019 05:29	09/12/2019 18:42	10/12/2019 05:29	10,78	48	517,59	CHI
20191260128	PIRENOPOLIS	AN12000193RE	ANAPOLIS UNIVERSITARIO S2	09/12/2019 18:42	10/12/2019 05:29	09/12/2019 18:42	10/12/2019 05:29	10,78	16	172,53	CHI
20191260130	GOIANIA	10003383391	GOYA S2	09/12/2019 18:43	09/12/2019 20:43	09/12/2019 18:43	09/12/2019 20:43	2,00	1	2,00	CHI
20191260131	CACHOEIRA DOURADA	CD21000037	CACHOEIRA DOURADA	09/12/2019 18:43	10/12/2019 09:20	09/12/2019 18:43	10/12/2019 09:20	14,61	1	14,61	CHI
20191260135	PIRENOPOLIS	PV12273236	SAO FRANCISCO DE GOIAS	09/12/2019 18:43	09/12/2019 22:29	09/12/2019 18:43	09/12/2019 22:29	3,75	13	48,79	CHI
20191260135	SAO FRANCISCO DE GOIAS	PV12273236	SAO FRANCISCO DE GOIAS	09/12/2019 18:43	09/12/2019 22:29	09/12/2019 18:43	09/12/2019 22:29	3,75	11	41,29	CHI
20191260148	ABADIANIA	AA21148506	ANAPOLIS UNIVERSITARIO S1	09/12/2019 18:45	10/12/2019 01:27	09/12/2019 18:45	10/12/2019 01:27	6,69	1	6,69	CHI
20191253941	FIRMINOPOLIS	SL12206323	FIRMINOPOLIS S1	09/12/2019 18:46	09/12/2019 21:40	09/12/2019 18:46	09/12/2019 21:40	2,89	6	17,33	CHI
20191253941	SAO LUIS DE MONTES BELOS	SL12206323	FIRMINOPOLIS S1	09/12/2019 18:46	09/12/2019 21:40	09/12/2019 18:46	09/12/2019 21:40	2,89	46	132,85	CHI
20191260787	AGUAS LINDAS DE GOIAS	LA12146699	AGUAS LINDAS DE GOIAS S1	09/12/2019 18:46	09/12/2019 20:26	09/12/2019 18:46	09/12/2019 20:26	1,66	1013	1679,05	CHI
20191260160	LUZIANIA	LZ11061785	MARAJOARA	09/12/2019 18:48	09/12/2019 20:55	09/12/2019 18:48	09/12/2019 20:55	2,12	9	19,04	CHI
20191260747	NIQUELANDIA	NQ11243529	BARRO ALTO	09/12/2019 18:48	10/12/2019 05:10	09/12/2019 18:48	10/12/2019 05:10	10,36	125	1294,93	CHI
20191260189	SAO MIGUEL DO ARAGUAIA	SM12276125	SAO MIGUEL DO ARAGUAIA	09/12/2019 18:49	09/12/2019 19:35	09/12/2019 18:49	09/12/2019 19:35	0,77	44	33,86	CHI
20191260170	NOVO GAMA	2900013726	MARAJOARA	09/12/2019 18:50	09/12/2019 22:54	09/12/2019 18:50	09/12/2019 22:54	4,06	1	4,06	CHI
20191260172	CAIAPONIA	CP12269004	CAIAPONIA	09/12/2019 18:50	10/12/2019 18:50	09/12/2019 18:50	10/12/2019 18:50	23,99	3	71,98	CHI
20191281261	CAIAPONIA	CP21374829	CAIAPONIA	09/12/2019 18:50	11/12/2019 22:53	09/12/2019 18:50	11/12/2019 22:53	52,04	1	52,04	CHI
20191260176	CALDAZINHA	DE21370392	CEPAIGO S2	09/12/2019 18:51	10/12/2019 09:56	09/12/2019 18:51	10/12/2019 09:56	15,08	1	15,08	CHI
20191260530	JATAI	JT12274032	JATAI S2	09/12/2019 18:52	10/12/2019 08:40	09/12/2019 18:52	10/12/2019 08:40	13,79	10	137,91	CHI
20191260742	GOIANIA	GN11002604	CARAJAS S2	09/12/2019 18:52	09/12/2019 20:40	09/12/2019 18:52	09/12/2019 20:40	1,80	121	217,50	CHI
20191260192	ALTO PARAISO DE GOIAS	BF21129911	FLORES DE GOIAS	09/12/2019 18:54	09/12/2019 19:54	09/12/2019 18:54	09/12/2019 19:54	1,00	1	1,00	CHI

20191260196	PONTALINA	PK12099030	PONTALINA	09/12/2019 18:55	10/12/2019 07:36	09/12/2019 18:55	10/12/2019 07:36	12,68	10	126,82	CHI
20191260501	FAINA	FC12274383	GOIAS	09/12/2019 18:56	10/12/2019 12:49	09/12/2019 18:56	10/12/2019 12:49	17,88	5	89,39	CHI
20191260765	MATRINCHA	MP11073658	MATRINCHA	09/12/2019 18:56	10/12/2019 06:58	09/12/2019 18:56	10/12/2019 06:58	12,02	105	1262,54	CHI
20191260507	NOVA IGUACU DE GOIAS	NH21137734	SANTA TEREZINHA	09/12/2019 18:57	10/12/2019 15:47	09/12/2019 18:57	10/12/2019 15:47	20,83	1	20,83	CHI
20191260511	APARECIDA DE GOIANIA	200069639	INDEPENDENCIA S1	09/12/2019 18:58	09/12/2019 21:34	09/12/2019 18:58	09/12/2019 21:34	2,58	1	2,58	CHI
20191260514	COCALZINHO DE GOIAS	ZN21135353	COCALZINHO	09/12/2019 18:59	10/12/2019 10:02	09/12/2019 18:59	10/12/2019 10:02	15,04	1	15,04	CHI
20191260517	RIO QUENTE	2530025764	RIO QUENTE	09/12/2019 19:00	10/12/2019 10:57	09/12/2019 19:00	10/12/2019 10:57	15,95	1	15,95	CHI
20191260525	PALMEIRAS DE GOIAS	10009305538	PALMEIRAS	09/12/2019 19:01	10/12/2019 02:04	09/12/2019 19:01	10/12/2019 02:04	7,06	1	7,06	CHI
20191260529	ARUANA	AK21096000	MOZARLANDIA	09/12/2019 19:02	09/12/2019 22:20	09/12/2019 19:02	09/12/2019 22:20	3,29	1	3,29	CHI
20191260534	APARECIDA DE GOIANIA	10133641	REAL S1	09/12/2019 19:04	09/12/2019 21:00	09/12/2019 19:04	09/12/2019 21:00	1,92	1	1,92	CHI
20191260545	CACHOEIRA DOURADA	CD12057901	CACHOEIRA DOURADA	09/12/2019 19:08	10/12/2019 09:15	09/12/2019 19:08	10/12/2019 09:15	14,12	2	28,24	CHI
20191260548	COCALZINHO DE GOIAS	ZN12330505	AGUAS LINDAS DE GOIAS S2	09/12/2019 19:08	10/12/2019 06:35	09/12/2019 19:08	10/12/2019 06:35	11,43	28	320,16	CHI
20191260548	PADRE BERNARDO	ZN12330505	AGUAS LINDAS DE GOIAS S2	09/12/2019 19:08	10/12/2019 06:35	09/12/2019 19:08	10/12/2019 06:35	11,43	4	45,74	CHI
20191260554	INHUMAS	IN21063061	INHUMAS S1	09/12/2019 19:10	09/12/2019 21:18	09/12/2019 19:10	09/12/2019 21:18	2,13	2	4,26	CHI
20191263582	MOSSAMEDES	MD12089231	ITABERAI S2	09/12/2019 19:10	10/12/2019 08:24	09/12/2019 19:10	10/12/2019 08:24	13,22	9	119,02	CHI
20191260562	IPAMERI	580055619	IPAMERI	09/12/2019 19:11	09/12/2019 21:26	09/12/2019 19:11	09/12/2019 21:26	2,25	1	2,25	CHI
20191260564	CATALAO	CY21061111	CATALAO S2	09/12/2019 19:11	10/12/2019 11:29	09/12/2019 19:11	10/12/2019 11:29	16,29	2	32,58	CHI
20191260565	RIO VERDE	RV12349531	MONTIVIDIU T	09/12/2019 19:11	10/12/2019 11:08	09/12/2019 19:11	10/12/2019 11:08	15,94	3	47,82	CHI
20191260569	MOSSAMEDES	MD12091062	FIRMINOPOLIS S2	09/12/2019 19:12	10/12/2019 10:03	09/12/2019 19:12	10/12/2019 10:03	14,85	1	14,85	CHI
20191260571	JANDAIA	JD21338277	PALMEIRAS	09/12/2019 19:12	10/12/2019 10:48	09/12/2019 19:12	10/12/2019 10:48	15,61	1	15,61	CHI
20191260575	RUBIATABA	RB21412779	RUBIATABA	09/12/2019 19:12	10/12/2019 15:55	09/12/2019 19:12	10/12/2019 15:55	20,70	1	20,70	CHI
20191260947	SITIO D ABADIA	FB12285685	IACIARA S2	09/12/2019 19:12	09/12/2019 20:29	09/12/2019 19:12	09/12/2019 20:29	1,28	69	88,45	CHI
20191260584	ABADIANIA	AA21062504	ANAPOLIS UNIVERSITARIO S1	09/12/2019 19:14	10/12/2019 10:04	09/12/2019 19:14	10/12/2019 10:04	14,82	1	14,82	CHI
20191260592	GOIANIA	13994505	XAVANTES	09/12/2019 19:15	09/12/2019 21:35	09/12/2019 19:15	09/12/2019 21:35	2,32	1	2,32	CHI
20191260593	PALMEIRAS DE GOIAS	590077510	PALMEIRAS	09/12/2019 19:15	10/12/2019 03:45	09/12/2019 19:15	10/12/2019 03:45	8,50	1	8,50	CHI
20191261337	AGUA FRIA DE GOIAS	MJ12305239	PADRE BERNARDO	09/12/2019 19:15	10/12/2019 11:55	09/12/2019 19:15	10/12/2019 11:55	16,66	2	33,32	CHI
20191261337	MIMOSO DE GOIAS	MJ12305239	PADRE BERNARDO	09/12/2019 19:15	10/12/2019 11:55	09/12/2019 19:15	10/12/2019 11:55	16,66	2	33,32	CHI
20191262285	MINEIROS	1390112242	PARQUE DAS EMAS	09/12/2019 19:15	10/12/2019 12:18	09/12/2019 19:15	10/12/2019 12:18	17,06	1	17,06	CHI
20191260703	CATALAO	CT12755322	CAMPO ALEGRE DE GOIAS	09/12/2019 19:16	10/12/2019 09:32	09/12/2019 19:16	10/12/2019 09:32	14,26	2	28,51	CHI
20191260711	ORIZONA	2060034341	PIRES DO RIO S2	09/12/2019 19:17	10/12/2019 08:19	09/12/2019 19:17	10/12/2019 08:19	13,02	1	13,02	CHI
20191260733	PORANGATU	PO12390255	PORANGATU	09/12/2019 19:17	10/12/2019 09:30	09/12/2019 19:17	10/12/2019 09:30	14,21	4	56,83	CHI
20191260760	ABADIANIA	AA12349440	ANAPOLIS UNIVERSITARIO S1	09/12/2019 19:17	10/12/2019 00:28	09/12/2019 19:17	10/12/2019 00:28	5,17	8	41,35	CHI
20191260760	GAMELEIRA DE GOIAS	AA12349440	ANAPOLIS UNIVERSITARIO S1	09/12/2019 19:17	10/12/2019 00:28	09/12/2019 19:17	10/12/2019 00:28	5,17	8	41,35	CHI

20191260713	APARECIDA DE GOIANIA	13842470	INDEPENDENCIA S1	09/12/2019 19:18	09/12/2019 20:35	09/12/2019 19:18	09/12/2019 20:35	1,28	1	1,28	CHI
20191260913	LUZIANIA	LZ12216262	MARAJOARA	09/12/2019 19:18	09/12/2019 21:32	09/12/2019 19:18	09/12/2019 21:32	2,22	219	486,12	CHI
20191260720	GOIANIA	GN12001705	CARAJAS S1	09/12/2019 19:19	10/12/2019 10:59	09/12/2019 19:19	10/12/2019 10:59	15,67	1	15,67	CHI
20191260726	VIANOPOLIS	VN21159794	VIANOPOLIS	09/12/2019 19:20	10/12/2019 13:00	09/12/2019 19:20	10/12/2019 13:00	17,66	1	17,66	CHI
20191260727	NOVO PLANALTO	TA11293664	SAO MIGUEL DO ARAGUAIA	09/12/2019 19:20	10/12/2019 11:29	09/12/2019 19:20	10/12/2019 11:29	16,14	1	16,14	CHI
20191260728	IPIRANGA DE GOIAS	RB12194283	RUBIATABA	09/12/2019 19:20	10/12/2019 09:45	09/12/2019 19:20	10/12/2019 09:45	14,41	2	28,81	CHI
20191260729	MORRINHOS	MR21373957	MORRINHOS	09/12/2019 19:20	10/12/2019 10:20	09/12/2019 19:20	10/12/2019 10:20	14,99	1	14,99	CHI
20191260731	MARA ROSA	2260039851	MARA ROSA	09/12/2019 19:20	09/12/2019 21:59	09/12/2019 19:20	09/12/2019 21:59	2,63	1	2,63	CHI
20191262294	ABADIANIA	GL12376845	DAIA S2	09/12/2019 19:21	10/12/2019 10:59	09/12/2019 19:21	10/12/2019 10:59	15,62	4	62,47	CHI
20191260736	JARAGUA	JA21074212	JARAGUA	09/12/2019 19:22	10/12/2019 07:12	09/12/2019 19:22	10/12/2019 07:12	11,83	1	11,83	CHI
20191260740	CATALAO	1990127232	CATALAO S1	09/12/2019 19:22	09/12/2019 21:17	09/12/2019 19:22	09/12/2019 21:17	1,91	1	1,91	CHI
20191260749	ITABERAI	IB11336283	ITABERAI S2	09/12/2019 19:23	09/12/2019 22:20	09/12/2019 19:23	09/12/2019 22:20	2,94	27	79,38	CHI
20191260751	ITABERAI	IB12300069	ITABERAI S2	09/12/2019 19:23	10/12/2019 11:47	09/12/2019 19:23	10/12/2019 11:47	16,39	8	131,11	CHI
20191260764	IPAMERI	IP12112780	IPAMERI	09/12/2019 19:25	10/12/2019 07:53	09/12/2019 19:25	10/12/2019 07:53	12,46	10	124,56	CHI
20191260767	BURITI ALEGRE	BG11335208	ALTO BURITI	09/12/2019 19:26	10/12/2019 11:03	09/12/2019 19:26	10/12/2019 11:03	15,61	9	140,47	CHI
20191260774	ALTO PARAISO DE GOIAS	BF21163462	FLORES DE GOIAS	09/12/2019 19:27	09/12/2019 20:08	09/12/2019 19:27	09/12/2019 20:08	0,67	1	0,67	CHI
20191260929	RIO VERDE	RV12214126	RIO VERDE S1	09/12/2019 19:27	09/12/2019 22:04	09/12/2019 19:27	09/12/2019 22:04	2,61	72	187,58	CHI
20191260929	SANTA HELENA DE GOIAS	RV12214126	RIO VERDE S1	09/12/2019 19:27	09/12/2019 22:04	09/12/2019 19:27	09/12/2019 22:04	2,61	45	117,24	CHI
20191260777	IPAMERI	IP12000091	IPAMERI	09/12/2019 19:28	09/12/2019 23:01	09/12/2019 19:28	09/12/2019 23:01	3,54	1	3,54	CHI
20191260779	NIQUELANDIA	NQ12265697	BARRO ALTO	09/12/2019 19:28	10/12/2019 13:05	09/12/2019 19:28	10/12/2019 13:05	17,60	7	123,20	CHI
20191260780	CATALAO	CT21318681	CATALAO S1	09/12/2019 19:29	10/12/2019 11:40	09/12/2019 19:29	10/12/2019 11:40	16,18	1	16,18	CHI
20191260959	NIQUELANDIA	NQ12171080	BARRO ALTO	09/12/2019 19:29	10/12/2019 00:12	09/12/2019 19:29	10/12/2019 00:12	4,72	11	51,91	CHI
201912260914	NOVA VENEZA	300027631	INHUMAS S1	09/12/2019 19:30	10/12/2019 03:25	09/12/2019 19:30	10/12/2019 03:25	7,90	1	7,90	CHI
20191260790	ITAPURANGA	IK21310831	ITAPURANGA	09/12/2019 19:31	10/12/2019 09:45	09/12/2019 19:31	10/12/2019 09:45	14,23	1	14,23	CHI
20191260799	APARECIDA DE GOIANIA	10010661814	INDEPENDENCIA S2	09/12/2019 19:33	09/12/2019 21:29	09/12/2019 19:33	09/12/2019 21:29	1,92	1	1,92	CHI
20191264382	ITAPIRAPUA	IU12067918	MATRINCHA	09/12/2019 19:33	10/12/2019 09:40	09/12/2019 19:33	10/12/2019 09:40	14,11	13	183,47	CHI
20191260901	PIRENOPOLIS	PV21284253	CORUMBA	09/12/2019 19:34	10/12/2019 15:14	09/12/2019 19:34	10/12/2019 15:14	19,66	1	19,66	CHI
20191260905	CAMPOS VERDES	3790046125	SANTA TEREZINHA	09/12/2019 19:35	09/12/2019 22:37	09/12/2019 19:35	09/12/2019 22:37	3,02	1	3,02	CHI
20191261406	MORRINHOS	MR11000058	MORRINHOS	09/12/2019 19:35	09/12/2019 23:36	09/12/2019 19:35	09/12/2019 23:36	4,00	140	560,35	CHI
20191260922	FORMOSA	FA11383255	ITUIQUIRA	09/12/2019 19:39	09/12/2019 21:01	09/12/2019 19:39	09/12/2019 21:01	1,36	8	10,84	CHI
20191260937	TEREZOPOLIS DE GOIAS	TJ11203378	DAIA S2	09/12/2019 19:39	09/12/2019 22:24	09/12/2019 19:39	09/12/2019 22:24	2,75	166	455,95	CHI
20191260924	NIQUELANDIA	NQ12311495	BARRO ALTO	09/12/2019 19:40	10/12/2019 22:25	09/12/2019 19:40	10/12/2019 22:25	26,74	7	187,19	CHI
20191260925	SITIO D ABADIA	SI12180979LD	IACIARA S2	09/12/2019 19:41	09/12/2019 22:15	09/12/2019 19:41	09/12/2019 22:15	2,56	3	7,69	CHI

20191260940	SENADOR CANEDO	SW12079052	CEPAIGO S1	09/12/2019 19:45	10/12/2019 11:15	09/12/2019 19:45	10/12/2019 11:15	15,49	3	46,48	CHI
20191260946	NOVO GAMA	2900108877	MARAJOARA	09/12/2019 19:46	10/12/2019 11:50	09/12/2019 19:46	10/12/2019 11:50	16,05	1	16,05	CHI
201912260915	NOVA VENEZA	300027540	INHUMAS S1	09/12/2019 19:46	10/12/2019 03:25	09/12/2019 19:46	10/12/2019 03:25	7,65	1	7,65	CHI
20191260951	SAO SIMAO	SO11194915	CACHOEIRA ALTA	09/12/2019 19:47	10/12/2019 08:05	09/12/2019 19:47	10/12/2019 08:05	12,29	72	884,72	CHI
20191260960	PLANALTINA	2960170885	PLANALTINA	09/12/2019 19:50	09/12/2019 21:22	09/12/2019 19:50	09/12/2019 21:22	1,53	1	1,53	CHI
20191260962	INHUMAS	AR12247240	ARACU	09/12/2019 19:51	10/12/2019 01:03	09/12/2019 19:51	10/12/2019 01:03	5,20	8	41,56	CHI
20191260963	PALMEIRAS DE GOIAS	590057741	PALMEIRAS	09/12/2019 19:51	10/12/2019 16:11	09/12/2019 19:51	10/12/2019 16:11	20,34	1	20,34	CHI
20191264699	GOIAS	GS12021056	GOIAS	09/12/2019 19:51	10/12/2019 14:59	09/12/2019 19:51	10/12/2019 08:43	12,86	25	321,59	CHI
20191264699	GOIAS	GS12021056	GOIAS	09/12/2019 19:51	10/12/2019 14:59	09/12/2019 19:51	10/12/2019 14:59	19,13	1	19,13	CHI
20191260969	LUZIANIA	LZ12313611	VIANOPOLIS	09/12/2019 19:53	10/12/2019 14:00	09/12/2019 19:53	10/12/2019 14:00	18,10	11	199,15	CHI
20191260970	CAIAPONIA	930024175	CAIAPONIA	09/12/2019 19:53	10/12/2019 06:01	09/12/2019 19:53	10/12/2019 06:01	10,12	1	10,12	CHI
20191261331	ITAPIRAPUA	IU10400394	MATRINCHA	09/12/2019 19:53	09/12/2019 20:03	09/12/2019 19:55	09/12/2019 20:00	0,09	12	1,13	CHI
20191261331	GOIAS	IU10400394	MATRINCHA	09/12/2019 19:53	09/12/2019 20:03	09/12/2019 19:55	09/12/2019 20:03	0,13	567	74,81	CHI
20191261331	ITAPIRAPUA	IU10400394	MATRINCHA	09/12/2019 19:53	09/12/2019 20:03	09/12/2019 19:55	09/12/2019 20:03	0,13	1642	216,65	CHI
20191261331	NOVO BRASIL	IU10400394	MATRINCHA	09/12/2019 19:53	09/12/2019 20:03	09/12/2019 19:55	09/12/2019 20:03	0,13	34	4,49	CHI
20191261331	ITAPIRAPUA	IU10400394	MATRINCHA	09/12/2019 19:53	09/12/2019 20:03	09/12/2019 19:55	09/12/2019 20:03	0,13	1390	185,33	CHI
20191263766	ITAPIRAPUA	IU12089733	MATRINCHA	09/12/2019 19:53	10/12/2019 14:20	09/12/2019 19:55	10/12/2019 14:20	18,41	22	405,12	CHI
20191263766	ITAPIRAPUA	IU12089733	MATRINCHA	09/12/2019 19:53	10/12/2019 14:20	09/12/2019 19:58	10/12/2019 14:20	18,36	2	36,72	CHI
20191260975	GOIANIA	16071487	CARAJAS S1	09/12/2019 19:56	09/12/2019 21:47	09/12/2019 19:56	09/12/2019 21:47	1,85	1	1,85	CHI
20191260976	NIQUELANDIA	NQ21360529	NIQUELANDIA SUBTRANSMISSAO	09/12/2019 19:56	10/12/2019 17:20	09/12/2019 19:56	10/12/2019 17:20	21,39	1	21,39	CHI
20191260980	BURITI ALEGRE	BG21192122	ITUMBIARA VELHA S2	09/12/2019 19:57	10/12/2019 12:56	09/12/2019 19:57	10/12/2019 12:56	16,97	1	16,97	CHI
20191261303	FORMOSA	FA11085625	ITIQUIRA	09/12/2019 19:57	09/12/2019 21:32	09/12/2019 19:57	09/12/2019 21:32	1,57	29	45,48	CHI
20191260987	CATALAO	CT12112594	CATALAO S1	09/12/2019 19:58	10/12/2019 07:48	09/12/2019 19:58	10/12/2019 07:48	11,83	4	47,32	CHI
20191261857	SILVANIA	SV12103765	VIANOPOLIS	09/12/2019 19:58	10/12/2019 08:20	09/12/2019 19:58	10/12/2019 08:20	12,36	10	123,61	CHI
20191260998	MORRINHOS	150095077	MORRINHOS	09/12/2019 20:02	10/12/2019 09:28	09/12/2019 20:02	10/12/2019 09:28	13,43	1	13,43	CHI
20191261000	ABADIANIA	AA21152674	DAIA S2	09/12/2019 20:02	10/12/2019 11:17	09/12/2019 20:02	10/12/2019 11:17	15,24	1	15,24	CHI
20191261324	ITUMBIARA	IT10396082	ITUMBIARA NOVA	09/12/2019 20:04	09/12/2019 22:40	09/12/2019 20:04	09/12/2019 22:31	2,46	7	17,23	CHI
20191261324	ITUMBIARA	IT10396082	ITUMBIARA NOVA	09/12/2019 20:04	09/12/2019 22:40	09/12/2019 20:04	09/12/2019 22:34	2,51	247	619,08	CHI
20191261324	PANAMA	IT10396082	ITUMBIARA NOVA	09/12/2019 20:04	09/12/2019 22:40	09/12/2019 20:04	09/12/2019 22:34	2,51	105	263,17	CHI
20191261324	ITUMBIARA	IT10396082	ITUMBIARA NOVA	09/12/2019 20:04	09/12/2019 22:40	09/12/2019 20:04	09/12/2019 22:40	2,60	44	114,36	CHI
20191261310	SANTA ROSA DE GOIAS	SR21339444	INHUMAS S1	09/12/2019 20:05	10/12/2019 10:25	09/12/2019 20:05	10/12/2019 10:25	14,34	1	14,34	CHI
20191261312	CALDAS NOVAS	CN11213840	SERRA DE CALDAS	09/12/2019 20:05	10/12/2019 10:30	09/12/2019 20:05	10/12/2019 10:30	14,40	230	3312,83	CHI
20191261357	CRISTALINA	KR12074919	CRISTALINA S2	09/12/2019 20:05	10/12/2019 08:15	09/12/2019 20:05	10/12/2019 08:15	12,16	85	1033,43	CHI

20191261316	FORMOSA	FA11164511	ITUIQUIRA	09/12/2019 20:06	09/12/2019 21:51	09/12/2019 20:06	09/12/2019 21:51	1,74	8	13,94	CHI
20191261318	MORRINHOS	MR21196289	GOIATUBA S1	09/12/2019 20:06	10/12/2019 11:50	09/12/2019 20:06	10/12/2019 11:50	15,72	1	15,72	CHI
20191261320	ANAPOLIS	10010272249	JUNDIAI S1	09/12/2019 20:07	10/12/2019 06:59	09/12/2019 20:07	10/12/2019 06:59	10,86	1	10,86	CHI
20191261322	MORRINHOS	MR12056651	MORRINHOS	09/12/2019 20:08	10/12/2019 10:45	09/12/2019 20:08	10/12/2019 10:45	14,61	3	43,84	CHI
20191261323	GOIATUBA	140008135	GOIATUBA S2	09/12/2019 20:08	10/12/2019 12:04	09/12/2019 20:08	10/12/2019 12:04	15,93	1	15,93	CHI
20191261326	GOIANIA	10992133	FERROVIARIO S1	09/12/2019 20:09	09/12/2019 21:30	09/12/2019 20:09	09/12/2019 21:30	1,33	1	1,33	CHI
20191261328	GOIANIA	10354086	CAMPINAS S1	09/12/2019 20:10	10/12/2019 00:56	09/12/2019 20:10	10/12/2019 00:56	4,76	1	4,76	CHI
20191261336	SANTA HELENA DE GOIAS	400052283	IPEGUARI	09/12/2019 20:12	10/12/2019 11:50	09/12/2019 20:12	10/12/2019 11:50	15,63	1	15,63	CHI
20191263780	DOVERLANDIA	DV12187350	CAIAPONIA	09/12/2019 20:13	10/12/2019 13:50	09/12/2019 20:13	10/12/2019 13:50	17,63	17	299,66	CHI
20191261349	PLANALTINA	2960015570	PLANALTINA	09/12/2019 20:16	10/12/2019 05:49	09/12/2019 20:16	10/12/2019 05:49	9,54	1	9,54	CHI
20191261362	CRISTALINA	1060023857	CRISTALINA S1	09/12/2019 20:25	10/12/2019 11:43	09/12/2019 20:25	10/12/2019 11:43	15,30	1	15,30	CHI
20191264362	ITAPIRAPUA	IU12073722	MATRINCHA	09/12/2019 20:25	10/12/2019 13:18	09/12/2019 20:25	10/12/2019 13:18	16,87	3	50,61	CHI
20191261367	CAIAPONIA	PH12341859	PIRANHAS	09/12/2019 20:26	10/12/2019 13:05	09/12/2019 20:26	10/12/2019 13:05	16,66	7	116,63	CHI
20191261383	GOIANIA	GN12275486	GOYA S2	09/12/2019 20:26	09/12/2019 22:51	09/12/2019 20:26	09/12/2019 22:40	2,23	48	106,97	CHI
20191261383	GOIANIA	GN11292155	GOYA S2	09/12/2019 20:26	09/12/2019 22:51	09/12/2019 20:26	09/12/2019 22:51	2,42	150	363,50	CHI
20191261393	ACREUNA	00080424	ACREUNA	09/12/2019 20:26	09/12/2019 21:07	09/12/2019 20:26	09/12/2019 21:07	0,69	29	19,88	CHI
20191261393	INDIARA	00080424	ACREUNA	09/12/2019 20:26	09/12/2019 21:07	09/12/2019 20:26	09/12/2019 21:07	0,69	25	17,14	CHI
20191261393	JANDAIA	00080424	ACREUNA	09/12/2019 20:26	09/12/2019 21:07	09/12/2019 20:26	09/12/2019 21:07	0,69	33	22,62	CHI
20191261393	PARAUNA	00080424	ACREUNA	09/12/2019 20:26	09/12/2019 21:07	09/12/2019 20:26	09/12/2019 21:07	0,69	1	0,69	CHI
20191261393	ACREUNA	IY13167236	ACREUNA	09/12/2019 20:26	09/12/2019 21:07	09/12/2019 20:50	09/12/2019 21:07	0,29	6	1,77	CHI
20191261393	INDIARA	IY13167236	ACREUNA	09/12/2019 20:26	09/12/2019 21:07	09/12/2019 20:50	09/12/2019 21:07	0,29	2	0,59	CHI
20191261368	SANTO ANTONIO DO DESCOBERTO	2210045570	ALEXANIA	09/12/2019 20:27	10/12/2019 03:45	09/12/2019 20:27	10/12/2019 03:45	7,31	1	7,31	CHI
20191261371	VILA BOA	VB11270076	ITUIQUIRA	09/12/2019 20:27	10/12/2019 09:46	09/12/2019 20:27	10/12/2019 09:46	13,30	7	93,13	CHI
20191261440	ANICUNS	AC12075338	FIRMINOPOLIS S2	09/12/2019 20:27	10/12/2019 01:16	09/12/2019 20:27	10/12/2019 01:16	4,81	16	76,96	CHI
20191261374	ALTO PARAISO DE GOIAS	BF21144675	NIQUELANDIA SUBTRANSMISSAO	09/12/2019 20:28	09/12/2019 22:31	09/12/2019 20:28	09/12/2019 22:31	2,04	1	2,04	CHI
20191261380	SILVANIA	SV12011218	DAIA S2	09/12/2019 20:29	10/12/2019 08:14	09/12/2019 20:29	10/12/2019 08:14	11,74	18	211,38	CHI
20191267501	NOVO PLANALTO	TA12293695	SAO MIGUEL DO ARAGUAIA	09/12/2019 20:29	11/12/2019 01:25	09/12/2019 20:29	10/12/2019 15:13	18,73	6	112,36	CHI
20191267501	NOVO PLANALTO	TA12339771LD	SAO MIGUEL DO ARAGUAIA	09/12/2019 20:29	11/12/2019 01:25	09/12/2019 20:29	11/12/2019 01:25	28,94	1	28,94	CHI
20191261388	MIMOSO DE GOIAS	MJ12295024	PADRE BERNARDO	09/12/2019 20:30	10/12/2019 15:07	09/12/2019 20:30	10/12/2019 15:07	18,62	3	55,87	CHI
20191261395	FORMOSA	610264000	ITUIQUIRA	09/12/2019 20:34	10/12/2019 07:05	09/12/2019 20:34	10/12/2019 07:05	10,51	1	10,51	CHI
20191261396	FORMOSA	10003388261	ITUIQUIRA	09/12/2019 20:34	10/12/2019 07:52	09/12/2019 20:34	10/12/2019 07:52	11,29	1	11,29	CHI
20191261400	AGUAS LINDAS DE GOIAS	4830362080	AGUAS LINDAS DE GOIAS S1	09/12/2019 20:37	10/12/2019 10:01	09/12/2019 20:37	10/12/2019 10:01	13,40	1	13,40	CHI
20191263589	SANTA FE DE GOIAS	RN12378850	BRITANIA	09/12/2019 20:39	10/12/2019 23:41	09/12/2019 20:39	10/12/2019 23:41	27,03	19	513,57	CHI

20191261408	LUZIANIA	LZ11253462	VIANOPOLIS	09/12/2019 20:40	10/12/2019 14:51	09/12/2019 20:40	10/12/2019 14:51	18,17	1	18,17	CHI
20191261439	GOIANIA	GN12383183	XAVANTES	09/12/2019 20:43	09/12/2019 23:30	09/12/2019 20:43	09/12/2019 21:27	0,72	177	127,24	CHI
20191261439	GOIANIA	GN21000222	XAVANTES	09/12/2019 20:43	09/12/2019 23:30	09/12/2019 20:43	09/12/2019 23:30	2,77	3	8,31	CHI
20191261447	ANICUNS	AC12024032	ANICUNS	09/12/2019 20:45	09/12/2019 22:53	09/12/2019 20:45	09/12/2019 22:53	2,12	24	50,83	CHI
20191261447	TURVANIA	AC12024032	ANICUNS	09/12/2019 20:45	09/12/2019 22:53	09/12/2019 20:45	09/12/2019 22:53	2,12	4	8,47	CHI
20191261427	SANTO ANTONIO DO DESCOBERTO	10020483218	ALEXANIA	09/12/2019 20:47	10/12/2019 11:09	09/12/2019 20:47	10/12/2019 11:09	14,36	1	14,36	CHI
20191261429	APARECIDA DE GOIANIA	10003494754	INDEPENDENCIA S1	09/12/2019 20:50	09/12/2019 22:26	09/12/2019 20:50	09/12/2019 22:26	1,60	1	1,60	CHI
20191261437	CALDAS NOVAS	CN12298650	SERRA DE CALDAS	09/12/2019 20:50	10/12/2019 10:03	09/12/2019 20:50	10/12/2019 10:03	13,20	5	66,01	CHI
20191261436	SENADOR CANEDO	SW21160836	SENADOR CANEDO	09/12/2019 20:51	10/12/2019 12:00	09/12/2019 20:51	10/12/2019 12:00	15,14	1	15,14	CHI
20191261438	MARZAGAO	10010234916	VILA CORUMBA	09/12/2019 20:51	10/12/2019 12:00	09/12/2019 20:51	10/12/2019 12:00	15,14	1	15,14	CHI
20191264367	PLANALTINA	PI12262312	PLANALTINA	09/12/2019 20:52	10/12/2019 08:37	09/12/2019 20:52	10/12/2019 08:37	11,74	10	117,36	CHI
20191261444	ORIZONA	OZ12114480	VIANOPOLIS	09/12/2019 20:53	10/12/2019 12:45	09/12/2019 20:53	10/12/2019 12:45	15,86	8	126,91	CHI
20191261446	GAMELEIRA DE GOIAS	SV12272205	DAIA S2	09/12/2019 20:53	10/12/2019 00:22	09/12/2019 20:53	10/12/2019 00:22	3,48	11	38,26	CHI
20191261448	APARECIDA DE GOIANIA	200365009	ANHANGUERA	09/12/2019 20:53	09/12/2019 22:50	09/12/2019 20:53	09/12/2019 22:50	1,93	1	1,93	CHI
20191261807	GOIANIA	GN12034775	CAMPINAS S1	09/12/2019 20:53	09/12/2019 23:37	09/12/2019 20:53	09/12/2019 23:37	2,73	983	2686,87	CHI
20191261458	GOIANIA	10008302810	GOYA S2	09/12/2019 20:56	09/12/2019 23:32	09/12/2019 20:56	09/12/2019 23:32	2,60	1	2,60	CHI
20191261459	CUMARI	CY21250214	CATALAO S1	09/12/2019 20:56	10/12/2019 15:39	09/12/2019 20:56	10/12/2019 15:39	18,73	1	18,73	CHI
20191261479	NIQUELANDIA	NQ21082995	URUACU	09/12/2019 20:58	10/12/2019 16:45	09/12/2019 20:58	10/12/2019 16:45	19,78	1	19,78	CHI
201912260916	NOVA VENEZA	300027655	INHUMAS S1	09/12/2019 21:00	10/12/2019 03:25	09/12/2019 21:00	10/12/2019 03:25	6,41	1	6,41	CHI
20191261489	BONOPOLIS	BX21277771	SAO MIGUEL DO ARAGUAIA	09/12/2019 21:04	10/12/2019 19:16	10/12/2019 07:42	10/12/2019 18:38	10,94	1	10,94	CHI
20191261489	BONOPOLIS	BX21252457	SAO MIGUEL DO ARAGUAIA	09/12/2019 21:04	10/12/2019 19:16	10/12/2019 08:10	10/12/2019 18:46	10,61	1	10,61	CHI
20191261489	BONOPOLIS	BX21277772	SAO MIGUEL DO ARAGUAIA	09/12/2019 21:04	10/12/2019 19:16	09/12/2019 21:04	10/12/2019 18:56	21,86	1	21,86	CHI
20191261489	BONOPOLIS	BX21277773	SAO MIGUEL DO ARAGUAIA	09/12/2019 21:04	10/12/2019 19:16	10/12/2019 17:56	10/12/2019 19:16	1,33	1	1,33	CHI
20191261491	PLANALTINA	PI11043458	PLANALTINA	09/12/2019 21:04	10/12/2019 09:39	09/12/2019 21:04	10/12/2019 09:39	12,58	31	389,88	CHI
20191261493	MOSSAMEDES	MD12060620	ITABERAI S2	09/12/2019 21:05	10/12/2019 11:21	09/12/2019 21:05	10/12/2019 11:21	14,26	10	142,64	CHI
20191261494	FORMOSA	610236192	ITUIQUIRA	09/12/2019 21:05	10/12/2019 08:36	09/12/2019 21:05	10/12/2019 08:36	11,51	1	11,51	CHI
20191267089	NOVO PLANALTO	TA12293622	SAO MIGUEL DO ARAGUAIA	09/12/2019 21:05	10/12/2019 20:15	09/12/2019 21:05	10/12/2019 20:15	23,16	19	440,13	CHI
20191261801	MOSSAMEDES	MD21089238	ITABERAI S2	09/12/2019 21:06	10/12/2019 08:56	09/12/2019 21:06	10/12/2019 08:56	11,82	1	11,82	CHI
20191262301	ACREUNA	IY13167236	ACREUNA	09/12/2019 21:08	11/12/2019 17:17	09/12/2019 21:08	11/12/2019 17:17	44,15	6	264,90	CHI
20191262301	INDIARA	IY13167236	ACREUNA	09/12/2019 21:08	11/12/2019 17:17	09/12/2019 21:08	11/12/2019 17:17	44,15	2	88,30	CHI
20191261811	GUARAITA	IK21308327	ITAPURANGA	09/12/2019 21:10	10/12/2019 08:21	09/12/2019 21:10	10/12/2019 08:21	11,17	2	22,34	CHI
20191262258	MORRINHOS	MR12000315	MORRINHOS	09/12/2019 21:15	10/12/2019 10:52	09/12/2019 21:15	10/12/2019 10:52	13,62	12	163,40	CHI
20191261822	INDIARA	10009346412	ACREUNA	09/12/2019 21:19	10/12/2019 17:48	09/12/2019 21:19	10/12/2019 17:48	20,48	1	20,48	CHI

20191261825	PIRES DO RIO	460115364	PIRES DO RIO S1	09/12/2019 21:21	09/12/2019 23:13	09/12/2019 21:21	09/12/2019 23:13	1,86	1	1,86	CHI
20191261832	FIRMINOPOLIS	FR12061354	FIRMINOPOLIS S1	09/12/2019 21:25	10/12/2019 19:38	09/12/2019 21:25	10/12/2019 00:37	3,21	20	64,19	CHI
20191261832	FIRMINOPOLIS	FR12061354	FIRMINOPOLIS S1	09/12/2019 21:25	10/12/2019 19:38	10/12/2019 00:38	10/12/2019 12:15	11,61	13	150,98	CHI
20191261832	FIRMINOPOLIS	FR12061354	FIRMINOPOLIS S1	09/12/2019 21:25	10/12/2019 19:38	10/12/2019 00:38	10/12/2019 19:38	19,01	7	133,04	CHI
20191261832	FIRMINOPOLIS	FR12061354	FIRMINOPOLIS S1	09/12/2019 21:25	10/12/2019 19:38	10/12/2019 18:27	10/12/2019 19:38	1,18	13	15,33	CHI
20191261833	LUZIANIA	LZ11000211	MARAJOARA	09/12/2019 21:25	09/12/2019 23:00	09/12/2019 21:25	09/12/2019 23:00	1,58	179	282,72	CHI
20191261837	BALIZA	BH12064387	BOM JARDIM	09/12/2019 21:27	10/12/2019 11:19	09/12/2019 21:27	10/12/2019 11:19	13,85	3	41,56	CHI
20191261845	APARECIDA DE GOIANIA	03440234	ANHANGUERA	09/12/2019 21:28	09/12/2019 23:04	09/12/2019 21:32	09/12/2019 22:34	1,04	928	961,25	CHI
20191261845	APARECIDA DE GOIANIA	AP13399992	ANHANGUERA	09/12/2019 21:28	09/12/2019 23:04	09/12/2019 21:32	09/12/2019 22:56	1,40	1484	2074,30	CHI
20191261845	APARECIDA DE GOIANIA	AP13323227	ANHANGUERA	09/12/2019 21:28	09/12/2019 23:04	09/12/2019 21:32	09/12/2019 23:04	1,53	1363	2086,90	CHI
20191261841	UIRAPURU	UP12036688	NOVA CRIXAS	09/12/2019 21:29	10/12/2019 13:23	09/12/2019 21:29	10/12/2019 13:23	15,89	6	95,33	CHI
20191267562	IPAMERI	IP12068500	CRISTALINA S2	09/12/2019 21:29	10/12/2019 17:05	09/12/2019 21:29	10/12/2019 17:05	19,59	64	1254,04	CHI
20191261843	PROFESSOR JAMIL SAFADY	JS21000113	ROCHEDO	09/12/2019 21:30	10/12/2019 10:10	09/12/2019 21:30	10/12/2019 10:10	12,66	2	25,32	CHI
20191261871	AGUAS LINDAS DE GOIAS	LA11104728	AGUAS LINDAS DE GOIAS S1	09/12/2019 21:30	09/12/2019 22:49	09/12/2019 21:30	09/12/2019 22:49	1,31	196	256,22	CHI
20191261848	ITUMBIARA	10021346990	ITUMBIARA NOVA	09/12/2019 21:33	09/12/2019 23:24	09/12/2019 21:33	09/12/2019 23:24	1,84	1	1,84	CHI
20191261849	LUZIANIA	3200197879	MARAJOARA	09/12/2019 21:33	09/12/2019 23:26	09/12/2019 21:33	09/12/2019 23:26	1,88	1	1,88	CHI
20191261850	FLORES DE GOIAS	FB12302811	FLORES DE GOIAS	09/12/2019 21:34	10/12/2019 00:34	09/12/2019 21:34	10/12/2019 00:34	2,99	73	218,53	CHI
20191262228	FORMOSA	PI12208713	PLANALTINA	09/12/2019 21:36	09/12/2019 23:31	09/12/2019 21:36	09/12/2019 23:31	1,91	1	1,91	CHI
20191262228	PLANALTINA	PI12208713	PLANALTINA	09/12/2019 21:36	09/12/2019 23:31	09/12/2019 21:36	09/12/2019 23:31	1,91	247	473,00	CHI
20191263709	PONTALINA	PK12047233	PONTALINA	09/12/2019 21:36	10/12/2019 11:09	09/12/2019 21:36	10/12/2019 11:09	13,54	13	176,00	CHI
20191261864	GOIANIA	GN11002182	FERROVIARIO S1	09/12/2019 21:38	10/12/2019 02:14	09/12/2019 21:38	10/12/2019 02:14	4,60	155	712,48	CHI
20191265418	PALMEIRAS DE GOIAS	PL12312577	PALMEIRAS	09/12/2019 21:38	10/12/2019 12:30	09/12/2019 21:38	10/12/2019 12:30	14,88	7	104,13	CHI
20191261866	CAMPESTRE DE GOIAS	10023523989	TRINDADE	09/12/2019 21:42	10/12/2019 03:30	09/12/2019 21:42	10/12/2019 03:30	5,80	1	5,80	CHI
20191261887	MINEIROS	10002219318	PARQUE DAS EMAS	09/12/2019 21:47	10/12/2019 07:54	09/12/2019 21:47	10/12/2019 07:54	10,12	1	10,12	CHI
20191261894	JATAI	JT11060148	JATAI S2	09/12/2019 21:50	10/12/2019 01:59	09/12/2019 21:50	10/12/2019 01:59	4,15	165	684,38	CHI
20191262204	RIO VERDE	RV11231012	RIO VERDE S2	09/12/2019 21:50	09/12/2019 23:25	09/12/2019 21:50	09/12/2019 23:25	1,57	136	213,29	CHI
20191261900	AMARALINA	LC12230319	NOVA CRIXAS	09/12/2019 21:54	10/12/2019 09:05	09/12/2019 21:54	10/12/2019 09:05	11,18	3	33,53	CHI
20191262201	SILVANIA	660041443	VIANOPOLIS	09/12/2019 21:54	10/12/2019 04:31	09/12/2019 21:54	10/12/2019 04:31	6,61	1	6,61	CHI
20191262210	SAO LUIS DE MONTES BELOS	900016747	FIRMINOPOLIS S1	09/12/2019 22:00	09/12/2019 23:32	09/12/2019 22:00	09/12/2019 23:32	1,53	1	1,53	CHI
20191262218	AGUAS LINDAS DE GOIAS	LA11305234	AGUAS LINDAS DE GOIAS S2	09/12/2019 22:05	09/12/2019 23:32	09/12/2019 22:05	09/12/2019 23:32	1,44	215	308,94	CHI
20191262220	FAINA	FC21148758	GOIAS	09/12/2019 22:06	10/12/2019 18:03	09/12/2019 22:06	10/12/2019 18:03	19,95	1	19,95	CHI
20191263823	ANICUNS	AC12304663	FIRMINOPOLIS S2	09/12/2019 22:09	10/12/2019 08:03	09/12/2019 22:09	10/12/2019 08:03	9,89	11	108,83	CHI
20191262231	CRISTALINA	KR12183725	CRISTALINA S2	09/12/2019 22:12	10/12/2019 09:54	09/12/2019 22:12	10/12/2019 09:54	11,69	1	11,69	CHI

20191262235	GOIANIA	16174471	CAMPINAS S2	09/12/2019 22:15	10/12/2019 00:40	09/12/2019 22:15	10/12/2019 00:40	2,40	1	2,40	CHI
20191266097	LUZIANIA	LZ12203332	VIANOPOLIS	09/12/2019 22:26	10/12/2019 11:06	09/12/2019 22:26	10/12/2019 11:06	12,65	10	126,54	CHI
20191262252	JATAI	10016227920	JATAI S2	09/12/2019 22:32	10/12/2019 11:32	09/12/2019 22:32	10/12/2019 11:32	13,00	1	13,00	CHI
20191262260	PADRE BERNARDO	2800011094	PADRE BERNARDO	09/12/2019 22:40	10/12/2019 00:00	09/12/2019 22:40	10/12/2019 00:00	1,32	1	1,32	CHI
20191262262	ITAPURANGA	IK21289410	ITAPURANGA	09/12/2019 22:41	10/12/2019 11:11	09/12/2019 22:41	10/12/2019 11:11	12,50	1	12,50	CHI
20191262263	AGUAS LINDAS DE GOIAS	LA12100236	AGUAS LINDAS DE GOIAS S1	09/12/2019 22:42	10/12/2019 00:35	09/12/2019 22:42	10/12/2019 00:35	1,87	440	823,04	CHI
20191262264	LUZIANIA	120022084	RIO VERMELHO	09/12/2019 22:44	09/12/2019 23:43	09/12/2019 22:44	09/12/2019 23:43	0,98	1	0,98	CHI
20191262265	CACHOEIRA DE GOIAS	CG21255686	FIRMINOPOLIS S2	09/12/2019 22:45	10/12/2019 08:35	09/12/2019 22:45	10/12/2019 08:35	9,84	1	9,84	CHI
20191263546	CALDAZINHA	BV12034389	CEPAIGO S2	09/12/2019 22:51	10/12/2019 07:40	09/12/2019 22:51	10/12/2019 07:40	8,81	47	414,16	CHI
20191254415	BRITANIA	BT12210599	BRITANIA	09/12/2019 22:58	11/12/2019 01:19	09/12/2019 22:58	10/12/2019 06:45	7,78	543	4227,25	CHI
20191254415	JUSSARA	BT12210599	BRITANIA	09/12/2019 22:58	11/12/2019 01:19	09/12/2019 22:58	10/12/2019 06:45	7,78	48	373,68	CHI
20191254415	BRITANIA	BT10400610	BRITANIA	09/12/2019 22:58	11/12/2019 01:19	09/12/2019 22:58	10/12/2019 08:56	9,96	4	39,83	CHI
20191254415	BRITANIA	BT10400610	BRITANIA	09/12/2019 22:58	11/12/2019 01:19	09/12/2019 22:58	11/12/2019 01:19	26,34	1	26,34	CHI
20191262275	GOIANIA	13976291	MEIA PONTE	09/12/2019 22:59	10/12/2019 02:10	09/12/2019 22:59	10/12/2019 02:10	3,17	1	3,17	CHI
20191263402	NOVA CRIXAS	NA12334349	NOVA CRIXAS	09/12/2019 22:59	10/12/2019 08:26	09/12/2019 22:59	10/12/2019 08:26	9,44	85	802,82	CHI
20191262283	PIRACANJUBA	PJ21083295	CALDAS NOVAS S1	09/12/2019 23:11	10/12/2019 15:30	09/12/2019 23:11	10/12/2019 14:50	15,64	2	31,29	CHI
20191262283	PIRACANJUBA	PJ21233827	CALDAS NOVAS S1	09/12/2019 23:11	10/12/2019 15:30	10/12/2019 14:47	10/12/2019 14:55	0,12	1	0,12	CHI
20191262283	PIRACANJUBA	PJ21233828	CALDAS NOVAS S1	09/12/2019 23:11	10/12/2019 15:30	10/12/2019 14:49	10/12/2019 15:14	0,43	1	0,43	CHI
20191262283	PIRACANJUBA	PJ21032903	CALDAS NOVAS S1	09/12/2019 23:11	10/12/2019 15:30	10/12/2019 14:50	10/12/2019 15:30	0,67	1	0,67	CHI
20191262291	RIO VERDE	RV21024687	RIO VERDE S1	09/12/2019 23:20	10/12/2019 09:12	09/12/2019 23:20	10/12/2019 09:12	9,87	1	9,87	CHI
20191262293	ARUANA	AK12250809	ARUANA	09/12/2019 23:26	10/12/2019 08:21	09/12/2019 23:26	10/12/2019 08:21	8,91	2	17,81	CHI
20191262806	ANAPOLIS	AN11064982	ANAPOLIS UNIVERSITARIO S2	09/12/2019 23:28	10/12/2019 01:56	09/12/2019 23:28	10/12/2019 01:56	2,46	122	299,61	CHI
20191262296	APARECIDA DE GOIANIA	AP21212345	CEPAIGO S1	09/12/2019 23:30	10/12/2019 07:59	09/12/2019 23:30	10/12/2019 07:59	8,47	3	25,42	CHI
20191262297	PADRE BERNARDO	10011883187	PADRE BERNARDO	09/12/2019 23:30	10/12/2019 11:16	09/12/2019 23:30	10/12/2019 11:16	11,76	1	11,76	CHI
20191262809	APARECIDA DE GOIANIA	AP11278728	INDEPENDENCIA S2	09/12/2019 23:39	10/12/2019 01:33	09/12/2019 23:39	10/12/2019 01:33	1,90	147	279,22	CHI
20191263001	IPAMERI	IP21127600	PIRES DO RIO S2	09/12/2019 23:44	10/12/2019 00:47	09/12/2019 23:44	10/12/2019 00:47	1,06	1	1,06	CHI
20191262802	NIQUELANDIA	NQ12239432	URUACU	09/12/2019 23:45	10/12/2019 14:24	09/12/2019 23:45	10/12/2019 14:24	14,64	18	263,59	CHI
20191262810	PANAMA	PX21121236	ITUMBIARA NOVA	10/12/2019 00:13	10/12/2019 12:42	10/12/2019 00:13	10/12/2019 12:42	12,49	1	12,49	CHI
20191262811	ITUMBIARA	IT11290353	ITUMBIARA NOVA	10/12/2019 00:15	10/12/2019 09:01	10/12/2019 00:15	10/12/2019 09:01	8,77	1	8,77	CHI
20191262812	ANICUNS	AC21393595	ANICUNS	10/12/2019 00:15	10/12/2019 13:34	10/12/2019 00:15	10/12/2019 13:34	13,30	1	13,30	CHI
20191262813	APARECIDA DE GOIANIA	03440234	ANHANGUERA	10/12/2019 00:22	10/12/2019 13:04	10/12/2019 00:58	10/12/2019 01:01	0,05	3774	200,23	CHI
20191262813	APARECIDA DE GOIANIA	AP11003015	ANHANGUERA	10/12/2019 00:22	10/12/2019 13:04	10/12/2019 10:34	10/12/2019 11:54	1,34	32	42,77	CHI
20191262813	APARECIDA DE GOIANIA	AP21320835	ANHANGUERA	10/12/2019 00:22	10/12/2019 13:04	10/12/2019 00:58	10/12/2019 13:04	12,10	1	12,10	CHI

20191263201	SANTA HELENA DE GOIAS	SH21034295	RIO VERDE S1	10/12/2019 00:32	10/12/2019 01:34	10/12/2019 00:32	10/12/2019 01:34	1,02	1	1,02	CHI
20191262818	CAMPO ALEGRE DE GOIAS	CM10397305	CAMPO ALEGRE DE GOIAS	10/12/2019 00:33	10/12/2019 11:37	10/12/2019 00:33	10/12/2019 10:46	10,23	8	81,85	CHI
20191262818	CAMPO ALEGRE DE GOIAS	CM10397305	CAMPO ALEGRE DE GOIAS	10/12/2019 00:33	10/12/2019 11:37	10/12/2019 00:33	10/12/2019 11:37	11,07	110	1217,21	CHI
20191262818	CATALAO	CM10397305	CAMPO ALEGRE DE GOIAS	10/12/2019 00:33	10/12/2019 11:37	10/12/2019 00:33	10/12/2019 11:37	11,07	6	66,39	CHI
20191262818	IPAMERI	CM10397305	CAMPO ALEGRE DE GOIAS	10/12/2019 00:33	10/12/2019 11:37	10/12/2019 00:33	10/12/2019 11:37	11,07	11	121,72	CHI
20191263733	BALIZA	BH12331445	CAIAPONIA	10/12/2019 00:37	10/12/2019 21:29	10/12/2019 00:37	10/12/2019 21:29	20,85	16	333,65	CHI
20191262819	SAO MIGUEL DO ARAGUAIA	SM12371801B	SAO MIGUEL DO ARAGUAIA	10/12/2019 00:48	10/12/2019 10:02	10/12/2019 00:48	10/12/2019 10:02	9,22	229	2111,38	CHI
20191262820	SANTO ANTONIO DA BARRA	01690214	ACREUNA	10/12/2019 00:49	10/12/2019 15:10	10/12/2019 00:49	10/12/2019 02:33	1,72	1443	2483,56	CHI
20191262820	SANTO ANTONIO DA BARRA	01690214	ACREUNA	10/12/2019 00:49	10/12/2019 15:10	10/12/2019 03:46	10/12/2019 04:26	0,67	1443	960,80	CHI
20191262820	SANTO ANTONIO DA BARRA	01690214	ACREUNA	10/12/2019 00:49	10/12/2019 15:10	10/12/2019 00:49	10/12/2019 05:43	4,89	72	351,98	CHI
20191262820	PARAUNA	01690214	ACREUNA	10/12/2019 00:49	10/12/2019 15:10	10/12/2019 00:49	10/12/2019 15:10	14,35	157	2252,21	CHI
20191262820	RIO VERDE	01690214	ACREUNA	10/12/2019 00:49	10/12/2019 15:10	10/12/2019 00:49	10/12/2019 15:10	14,35	142	2037,03	CHI
20191262820	SANTO ANTONIO DA BARRA	01690214	ACREUNA	10/12/2019 00:49	10/12/2019 15:10	10/12/2019 00:49	10/12/2019 15:10	14,35	123	1764,47	CHI
20191267059	SANTO ANTONIO DO DESCOBERTO	SN12084484	MARAJOARA	10/12/2019 01:35	12/12/2019 00:45	10/12/2019 01:35	11/12/2019 16:27	38,87	53	2060,01	CHI
20191267059	SANTO ANTONIO DO DESCOBERTO	SN12084484	MARAJOARA	10/12/2019 01:35	12/12/2019 00:45	11/12/2019 23:03	12/12/2019 00:45	1,70	53	90,28	CHI
20191262847	LEOPOLDO DE BULHOES	LB12012193	DAIA S2	10/12/2019 02:04	10/12/2019 08:11	10/12/2019 02:04	10/12/2019 08:11	6,10	189	1153,58	CHI
20191264638	SAO LUIS DE MONTES BELOS	SL32145768	SAO LUIZ DOS MONTES BELOS	10/12/2019 02:13	10/12/2019 09:20	10/12/2019 02:13	10/12/2019 09:20	7,12	30	213,47	CHI
20191264398	CALDAZINHA	BO12400523	CEPAIGO S2	10/12/2019 02:21	10/12/2019 16:27	10/12/2019 02:21	10/12/2019 16:27	14,09	2	28,18	CHI
20191264398	LEOPOLDO DE BULHOES	BO12400523	CEPAIGO S2	10/12/2019 02:21	10/12/2019 16:27	10/12/2019 02:21	10/12/2019 16:27	14,09	33	464,96	CHI
20191262865	JUSSARA	IU12292910	JUSSARA	10/12/2019 02:24	10/12/2019 10:07	10/12/2019 02:24	10/12/2019 10:07	7,71	27	208,08	CHI
20191262867	INDIARA	IY11392473	PALMEIRAS	10/12/2019 02:32	10/12/2019 14:42	10/12/2019 02:32	10/12/2019 14:42	12,15	8	97,24	CHI
20191262869	FAZENDA NOVA	RN10394715	BRITANIA	10/12/2019 02:46	10/12/2019 03:35	10/12/2019 02:46	10/12/2019 03:35	0,81	209	169,41	CHI
20191262869	JAUPACI	RN10394715	BRITANIA	10/12/2019 02:46	10/12/2019 03:35	10/12/2019 02:46	10/12/2019 03:35	0,81	2	1,62	CHI
20191262869	JUSSARA	RN10394715	BRITANIA	10/12/2019 02:46	10/12/2019 03:35	10/12/2019 02:46	10/12/2019 03:35	0,81	323	261,81	CHI
20191262869	SANTA FE DE GOIAS	RN10394715	BRITANIA	10/12/2019 02:46	10/12/2019 03:35	10/12/2019 02:46	10/12/2019 03:35	0,81	25	20,26	CHI
20191263594	PLANALTINA	PI12056840	PLANALTINA	10/12/2019 02:48	10/12/2019 07:56	10/12/2019 02:48	10/12/2019 07:56	5,12	1433	7340,94	CHI
20191262871	PLANALTINA	PI21243161	PLANALTINA	10/12/2019 03:35	10/12/2019 12:48	10/12/2019 03:35	10/12/2019 12:48	9,21	1	9,21	CHI
20191263506	ABADIANIA	AA12285384	ANAPOLIS UNIVERSITARIO S1	10/12/2019 03:41	10/12/2019 16:50	10/12/2019 03:41	10/12/2019 08:55	5,24	36	188,54	CHI
20191263506	ABADIANIA	AA13059871	ANAPOLIS UNIVERSITARIO S1	10/12/2019 03:41	10/12/2019 16:50	10/12/2019 03:41	10/12/2019 16:50	13,14	63	828,07	CHI
20191263506	GAMELEIRA DE GOIAS	AA13059871	ANAPOLIS UNIVERSITARIO S1	10/12/2019 03:41	10/12/2019 16:50	10/12/2019 03:41	10/12/2019 16:50	13,14	1	13,14	CHI
20191263585	AGUA FRIA DE GOIAS	TL12279981	SAO JOAO D ALIANCA	10/12/2019 03:44	10/12/2019 09:57	10/12/2019 03:44	10/12/2019 09:57	6,21	41	254,64	CHI
20191262874	FORMOSO	FO12328885	PORANGATU	10/12/2019 03:48	10/12/2019 12:02	10/12/2019 03:48	10/12/2019 12:02	8,22	4	32,89	CHI
20191262874	SANTA TEREZA DE GOIAS	FO12328885	PORANGATU	10/12/2019 03:48	10/12/2019 12:02	10/12/2019 03:48	10/12/2019 12:02	8,22	12	98,66	CHI

20191262875	ABADIA DE GOIAS	19993915	CARAJAS S1	10/12/2019 03:52	10/12/2019 10:04	10/12/2019 03:52	10/12/2019 10:04	6,20	20	123,96	CHI
20191262877	RIO QUENTE	CN21000050	RIO QUENTE	10/12/2019 03:58	10/12/2019 09:42	10/12/2019 03:58	10/12/2019 09:42	5,73	1	5,73	CHI
20191262879	DISTRITO FEDERAL	FA12383392	ITIQUEIRA	10/12/2019 04:00	10/12/2019 09:23	10/12/2019 04:00	10/12/2019 09:23	5,38	2	10,76	CHI
20191276249	PIRENOPOLIS	PV12319787	CORUMBA	10/12/2019 04:09	10/12/2019 15:30	10/12/2019 04:09	10/12/2019 15:30	11,34	8	90,73	CHI
20191262883	APARECIDA DE GOIANIA	AP12036019	CEPAIGO S1	10/12/2019 04:15	10/12/2019 10:42	10/12/2019 04:15	10/12/2019 10:42	6,44	27	173,76	CHI
20191262884	ARAGUAPAZ	AZ12210560	MOZARLANDIA	10/12/2019 04:30	10/12/2019 07:00	10/12/2019 04:30	10/12/2019 07:00	2,50	10	24,95	CHI
20191262885	PORANGATU	PO12048411	PORANGATU	10/12/2019 04:30	10/12/2019 09:17	10/12/2019 04:30	10/12/2019 09:17	4,78	17	81,23	CHI
20191262887	CAMPESTRE DE GOIAS	GC12248061	TRINDADE	10/12/2019 04:34	10/12/2019 09:59	10/12/2019 04:34	10/12/2019 09:59	5,41	135	730,69	CHI
20191262888	CAMPO LIMPO	AN21267919	ANAPOLIS UNIVERSITARIO S2	10/12/2019 04:39	10/12/2019 16:35	10/12/2019 04:39	10/12/2019 16:35	11,93	1	11,93	CHI
20191262899	CACHOEIRA DE GOIAS	CG12289761	FIRMINOPOLIS S2	10/12/2019 04:48	10/12/2019 09:40	10/12/2019 04:48	10/12/2019 09:40	4,87	18	87,60	CHI
20191262894	PORANGATU	PO12052522	PORANGATU	10/12/2019 04:51	10/12/2019 12:10	10/12/2019 04:51	10/12/2019 12:10	7,31	62	452,94	CHI
20191262895	ACREUNA	PU12295915	ACREUNA	10/12/2019 04:57	10/12/2019 16:36	10/12/2019 04:57	10/12/2019 16:36	11,65	1	11,65	CHI
20191262895	PARAUNA	PU12295915	ACREUNA	10/12/2019 04:57	10/12/2019 16:36	10/12/2019 04:57	10/12/2019 16:36	11,65	18	209,69	CHI
20191262896	ITAJA	IJ12200693	ITAJA S2	10/12/2019 05:01	10/12/2019 21:04	10/12/2019 05:01	10/12/2019 21:04	16,05	5	80,23	CHI
20191262897	ITAPIRAPUA	IU12014848	MATRINCHA	10/12/2019 05:02	10/12/2019 11:48	10/12/2019 05:02	10/12/2019 11:48	6,75	58	391,76	CHI
20191262898	IVOLANDIA	IV12062833	IPORA	10/12/2019 05:02	10/12/2019 14:11	10/12/2019 05:02	10/12/2019 14:11	9,15	19	173,86	CHI
20191263501	AMARALINA	LC12295201	MARA ROSA	10/12/2019 05:08	10/12/2019 14:21	10/12/2019 05:08	10/12/2019 14:21	9,22	10	92,17	CHI
20191263503	ABADIA DE GOIAS	TR12391385	GUAPO S1	10/12/2019 05:12	10/12/2019 16:02	10/12/2019 05:12	10/12/2019 11:15	6,05	2	12,10	CHI
20191263503	ABADIA DE GOIAS	TR12291557LD	GUAPO S1	10/12/2019 05:12	10/12/2019 16:02	10/12/2019 05:12	10/12/2019 16:02	10,83	104	1125,97	CHI
20191263503	GUAPO	TR12291557LD	GUAPO S1	10/12/2019 05:12	10/12/2019 16:02	10/12/2019 05:12	10/12/2019 16:02	10,83	4	43,31	CHI
20191263504	TRINDADE	TR12343758	TRINDADE	10/12/2019 05:12	10/12/2019 10:23	10/12/2019 05:12	10/12/2019 10:23	5,18	16	82,94	CHI
20191263889	MINEIROS	MY12043897	PARQUE DAS EMAS	10/12/2019 05:14	10/12/2019 15:26	10/12/2019 05:14	10/12/2019 15:26	10,19	70	713,49	CHI
20191263889	MINEIROS	MY12043897	PARQUE DAS EMAS	10/12/2019 05:14	10/12/2019 15:26	10/12/2019 12:11	10/12/2019 15:26	3,25	53	172,25	CHI
20191263511	BONOPOLIS	BX12168214	SAO MIGUEL DO ARAGUAIA	10/12/2019 05:18	10/12/2019 08:58	10/12/2019 05:18	10/12/2019 08:58	3,66	124	453,39	CHI
20191263514	VILA BOA	FA21102776	ITIQUEIRA	10/12/2019 05:20	10/12/2019 11:34	10/12/2019 05:20	10/12/2019 11:34	6,23	1	6,23	CHI
20191263516	ARAGUAPAZ	AZ12041362	MOZARLANDIA	10/12/2019 05:25	10/12/2019 14:47	10/12/2019 05:25	10/12/2019 14:47	9,37	24	224,80	CHI
20191263520	PETROLINA DE GOIAS	PG12335599	PETROLINA	10/12/2019 05:25	10/12/2019 11:35	10/12/2019 05:25	10/12/2019 11:35	6,16	6	36,95	CHI
20191263577	PALMINOPOLIS	PP12013618	PALMEIRAS	10/12/2019 05:25	10/12/2019 11:53	10/12/2019 05:25	10/12/2019 11:53	6,46	13	84,01	CHI
20191263899	DOVERLANDIA	DV12400429	CAIAPONIA	10/12/2019 05:25	10/12/2019 19:29	10/12/2019 05:25	10/12/2019 19:29	14,06	67	941,98	CHI
20191264652	INDIARA	IY12312450	CEZARINA	10/12/2019 05:25	10/12/2019 17:50	10/12/2019 05:25	10/12/2019 17:50	12,41	27	335,13	CHI
20191263523	NOVA AURORA	NE21399063	CATALAO S1	10/12/2019 05:26	10/12/2019 16:15	10/12/2019 05:26	10/12/2019 16:15	10,82	1	10,82	CHI
20191263524	GOIAS	GS12087523	GOIAS	10/12/2019 05:27	10/12/2019 10:24	10/12/2019 05:27	10/12/2019 10:24	4,95	67	331,91	CHI
20191276808	PETROLINA DE GOIAS	PV12302405	SAO FRANCISCO DE GOIAS	10/12/2019 05:27	10/12/2019 14:51	10/12/2019 05:27	10/12/2019 14:51	9,39	5	46,93	CHI

20191276808	PIRENOPOLIS	PV12302405	SAO FRANCISCO DE GOIAS	10/12/2019 05:27	10/12/2019 14:51	10/12/2019 05:27	10/12/2019 14:51	9,39	60	563,13	CHI
20191276808	SAO FRANCISCO DE GOIAS	PV12302405	SAO FRANCISCO DE GOIAS	10/12/2019 05:27	10/12/2019 14:51	10/12/2019 05:27	10/12/2019 14:51	9,39	19	178,33	CHI
20191263603	ALTO HORIZONTE	03400224	MARA ROSA	10/12/2019 05:31	10/12/2019 07:54	10/12/2019 05:31	10/12/2019 07:51	2,33	84	195,63	CHI
20191263603	MARA ROSA	03400224	MARA ROSA	10/12/2019 05:31	10/12/2019 07:54	10/12/2019 05:31	10/12/2019 07:51	2,33	196	456,46	CHI
20191263603	NOVA IGUACU DE GOIAS	03400224	MARA ROSA	10/12/2019 05:31	10/12/2019 07:54	10/12/2019 05:31	10/12/2019 07:51	2,33	24	55,89	CHI
20191263603	URUACU	03400224	MARA ROSA	10/12/2019 05:31	10/12/2019 07:54	10/12/2019 05:31	10/12/2019 07:51	2,33	1	2,33	CHI
20191263603	ALTO HORIZONTE	03400224	SANTA TEREZINHA	10/12/2019 05:31	10/12/2019 07:54	10/12/2019 05:31	10/12/2019 07:51	2,33	833	1939,96	CHI
20191263603	ALTO HORIZONTE	03400224	SANTA TEREZINHA	10/12/2019 05:31	10/12/2019 07:54	10/12/2019 05:31	10/12/2019 07:51	2,33	87	202,61	CHI
20191263603	ALTO HORIZONTE	03400224	SANTA TEREZINHA	10/12/2019 05:31	10/12/2019 07:54	10/12/2019 05:31	10/12/2019 07:51	2,33	1378	3209,21	CHI
20191263603	CAMPOS VERDES	03400224	SANTA TEREZINHA	10/12/2019 05:31	10/12/2019 07:54	10/12/2019 05:31	10/12/2019 07:51	2,33	8	18,63	CHI
20191263603	NOVA IGUACU DE GOIAS	03400224	SANTA TEREZINHA	10/12/2019 05:31	10/12/2019 07:54	10/12/2019 05:31	10/12/2019 07:51	2,33	362	843,06	CHI
20191263603	PILAR DE GOIAS	03400224	SANTA TEREZINHA	10/12/2019 05:31	10/12/2019 07:54	10/12/2019 05:31	10/12/2019 07:51	2,33	1	2,33	CHI
20191263603	ALTO HORIZONTE	03404114	SANTA TEREZINHA	10/12/2019 05:31	10/12/2019 07:54	10/12/2019 05:33	10/12/2019 07:54	2,34	13	30,42	CHI
20191263603	NOVA IGUACU DE GOIAS	03404114	SANTA TEREZINHA	10/12/2019 05:31	10/12/2019 07:54	10/12/2019 05:33	10/12/2019 07:54	2,34	818	1913,89	CHI
20191263603	PILAR DE GOIAS	03404114	SANTA TEREZINHA	10/12/2019 05:31	10/12/2019 07:54	10/12/2019 05:33	10/12/2019 07:54	2,34	169	395,41	CHI
20191263603	SANTA TEREZINHA DE GOIAS	03404114	SANTA TEREZINHA	10/12/2019 05:31	10/12/2019 07:54	10/12/2019 05:33	10/12/2019 07:54	2,34	62	145,06	CHI
20191263530	CALDAS NOVAS	CN12132835LD	CALDAS NOVAS S1	10/12/2019 05:32	10/12/2019 11:25	10/12/2019 05:32	10/12/2019 11:25	5,88	119	700,28	CHI
20191263536	ABADIANIA	AA12033506	CORUMBA	10/12/2019 05:34	10/12/2019 10:18	10/12/2019 05:34	10/12/2019 10:18	4,72	7	33,06	CHI
20191263536	CORUMBA DE GOIAS	AA12033506	CORUMBA	10/12/2019 05:34	10/12/2019 10:18	10/12/2019 05:34	10/12/2019 10:18	4,72	2	9,45	CHI
20191265405	NIQUELANDIA	NQ12171080	BARRO ALTO	10/12/2019 05:34	10/12/2019 10:57	10/12/2019 05:34	10/12/2019 10:57	5,38	11	59,16	CHI
20191271627	BONOPOLIS	BX12202593	SAO MIGUEL DO ARAGUAIA	10/12/2019 05:35	10/12/2019 12:44	10/12/2019 05:35	10/12/2019 12:44	7,14	4	28,56	CHI
20191275271	MAIRIPOTABA	MI12060613	PONTALINA	10/12/2019 05:35	10/12/2019 15:04	10/12/2019 05:35	10/12/2019 15:04	9,47	4	37,89	CHI
20191263830	GOIAS	GS12217745	MATRINCHA	10/12/2019 05:39	10/12/2019 13:45	10/12/2019 05:39	10/12/2019 13:45	8,09	3	24,28	CHI
20191263551	ACREUNA	8590757	ACREUNA	10/12/2019 05:41	10/12/2019 09:15	10/12/2019 05:41	10/12/2019 09:15	3,57	15	53,49	CHI
20191264310	SANTO ANTONIO DO DESCOBERTO	05410224	MARAJOARA	10/12/2019 05:41	10/12/2019 14:48	10/12/2019 05:41	10/12/2019 11:46	6,08	74	450,13	CHI
20191264310	DISTRITO FEDERAL	05410224	MARAJOARA	10/12/2019 05:41	10/12/2019 14:48	10/12/2019 05:41	10/12/2019 12:31	6,84	48	328,27	CHI
20191264310	SANTO ANTONIO DO DESCOBERTO	05410224	MARAJOARA	10/12/2019 05:41	10/12/2019 14:48	10/12/2019 05:41	10/12/2019 12:31	6,84	686	4691,48	CHI
20191264310	NOVO GAMA	SN13410946B	MARAJOARA	10/12/2019 05:41	10/12/2019 14:48	10/12/2019 05:41	10/12/2019 14:48	9,11	10	91,06	CHI
20191264310	SANTO ANTONIO DO DESCOBERTO	SN13410946B	MARAJOARA	10/12/2019 05:41	10/12/2019 14:48	10/12/2019 05:41	10/12/2019 14:48	9,11	59	537,26	CHI
20191265074	MONTES CLAROS DE GOIAS	ME12204886	IPORA	10/12/2019 05:41	10/12/2019 18:37	10/12/2019 05:41	10/12/2019 18:37	12,93	77	995,57	CHI
20191265445	ITAPIRAPUA	IU12016406	MATRINCHA	10/12/2019 05:41	10/12/2019 12:39	10/12/2019 05:41	10/12/2019 12:39	6,96	12	83,47	CHI
20191278992	CAMPINORTE	CR12164041	MARA ROSA	10/12/2019 05:41	10/12/2019 17:33	10/12/2019 05:41	10/12/2019 17:33	11,87	15	177,99	CHI
20191278992	URUACU	CR12164041	MARA ROSA	10/12/2019 05:41	10/12/2019 17:33	10/12/2019 05:41	10/12/2019 17:33	11,87	4	47,46	CHI

20191263560	INHUMAS	30098439	INHUMAS S2	10/12/2019 05:42	10/12/2019 09:03	10/12/2019 05:42	10/12/2019 09:03	3,35	1	3,35	CHI
20191264675	CAIAPONIA	CP12207858	PALESTINA	10/12/2019 05:42	10/12/2019 13:10	10/12/2019 05:42	10/12/2019 13:10	7,46	18	134,33	CHI
20191264675	PALESTINA DE GOIAS	CP12207858	PALESTINA	10/12/2019 05:42	10/12/2019 13:10	10/12/2019 05:42	10/12/2019 13:10	7,46	1	7,46	CHI
20191263564	BONOPOLIS	BX12263014	SAO MIGUEL DO ARAGUAIA	10/12/2019 05:44	10/12/2019 14:05	10/12/2019 05:44	10/12/2019 14:05	8,35	4	33,39	CHI
20191263567	FLORES DE GOIAS	FB12106993	FLORES DE GOIAS	10/12/2019 05:45	10/12/2019 09:25	10/12/2019 05:45	10/12/2019 09:25	3,66	10	36,64	CHI
20191263567	FORMOSA	FB12106993	FLORES DE GOIAS	10/12/2019 05:45	10/12/2019 09:25	10/12/2019 05:45	10/12/2019 09:25	3,66	8	29,31	CHI
20191263567	SAO JOAO D ALIANCA	FB12106993	FLORES DE GOIAS	10/12/2019 05:45	10/12/2019 09:25	10/12/2019 05:45	10/12/2019 09:25	3,66	4	14,66	CHI
20191263568	MINEIROS	MY12045367	PARQUE DAS EMAS	10/12/2019 05:45	10/12/2019 10:40	10/12/2019 05:45	10/12/2019 10:40	4,91	26	127,73	CHI
20191269036	BALIZA	BH12334535	BOM JARDIM	10/12/2019 05:45	10/12/2019 17:50	10/12/2019 05:45	10/12/2019 17:50	12,08	18	217,47	CHI
20191263570	CRISTALINA	KR21089576	PAMPLONA	10/12/2019 05:46	10/12/2019 11:39	10/12/2019 05:46	10/12/2019 11:39	5,87	2	11,75	CHI
20191263572	VICENTINOPOLIS	VI12203267RE	VICENTINOPOLIS	10/12/2019 05:47	11/12/2019 13:49	10/12/2019 05:47	10/12/2019 09:19	3,53	80	282,49	CHI
20191263572	VICENTINOPOLIS	VI13218203	VICENTINOPOLIS	10/12/2019 05:47	11/12/2019 13:49	10/12/2019 05:47	10/12/2019 13:13	7,44	8	59,53	CHI
20191263572	VICENTINOPOLIS	VI12203267RE	VICENTINOPOLIS	10/12/2019 05:47	11/12/2019 13:49	10/12/2019 05:47	10/12/2019 20:42	14,91	2	29,83	CHI
20191263572	VICENTINOPOLIS	VI21200198	VICENTINOPOLIS	10/12/2019 05:47	11/12/2019 13:49	10/12/2019 05:47	11/12/2019 13:49	32,04	1	32,04	CHI
20191263573	ITUMBIARA	CD12000215	CACHOEIRA DOURADA	10/12/2019 05:47	10/12/2019 09:14	10/12/2019 05:47	10/12/2019 09:14	3,44	6	20,61	CHI
20191263576	TRINDADE	TR12071655	TRINDADE	10/12/2019 05:48	10/12/2019 08:23	10/12/2019 05:48	10/12/2019 08:23	2,58	62	159,98	CHI
20191263581	SANTA FE DE GOIAS	RN21152632	JUSSARA	10/12/2019 05:48	10/12/2019 08:46	10/12/2019 05:48	10/12/2019 08:46	2,96	1	2,96	CHI
20191263728	GOIAS	NB12064413LD	MATRINCHA	10/12/2019 05:48	10/12/2019 19:41	10/12/2019 05:48	10/12/2019 19:41	13,88	1	13,88	CHI
20191263728	NOVO BRASIL	NB12064413LD	MATRINCHA	10/12/2019 05:48	10/12/2019 19:41	10/12/2019 05:48	10/12/2019 19:41	13,88	30	416,33	CHI
20191263586	PORANGATU	PO12094123	PORANGATU	10/12/2019 05:51	10/12/2019 09:20	10/12/2019 05:51	10/12/2019 09:20	3,48	1	3,48	CHI
20191264363	DAMOLANDIA	DL12200062	INHUMAS S1	10/12/2019 05:51	10/12/2019 08:22	10/12/2019 05:51	10/12/2019 08:22	2,51	27	67,70	CHI
20191263591	PIRENOPOLIS	PV21155046	JARAGUA	10/12/2019 05:52	10/12/2019 20:04	10/12/2019 05:52	10/12/2019 20:04	14,18	1	14,18	CHI
20191263592	SAO MIGUEL DO ARAGUAIA	SM21000022	SAO MIGUEL DO ARAGUAIA	10/12/2019 05:53	10/12/2019 09:21	10/12/2019 05:53	10/12/2019 09:21	3,46	1	3,46	CHI
20191263593	SAO LUIS DE MONTES BELOS	SL11404964	SAO LUIZ DOS MONTES BELOS	10/12/2019 05:54	10/12/2019 09:29	10/12/2019 05:54	10/12/2019 09:29	3,60	143	514,36	CHI
20191263600	RIO VERDE	SH12296215	IPEGUARI	10/12/2019 05:56	10/12/2019 08:45	10/12/2019 05:56	10/12/2019 08:45	2,80	3	8,41	CHI
20191263600	SANTA HELENA DE GOIAS	SH12296215	IPEGUARI	10/12/2019 05:56	10/12/2019 08:45	10/12/2019 05:56	10/12/2019 08:45	2,80	39	109,28	CHI
20191263701	GOIANIA	GN11199192	ATLANTICO S3	10/12/2019 05:57	10/12/2019 07:40	10/12/2019 05:57	10/12/2019 07:40	1,72	121	207,72	CHI
20191263703	CAIAPONIA	CP12301812	CAIAPONIA	10/12/2019 05:57	11/12/2019 07:55	10/12/2019 05:57	11/12/2019 07:55	25,97	9	233,72	CHI
20191263706	SAO LUIS DE MONTES BELOS	SL21020355	SAO LUIZ DOS MONTES BELOS	10/12/2019 05:59	10/12/2019 10:21	10/12/2019 05:59	10/12/2019 10:21	4,36	1	4,36	CHI
20191263708	ITAPURANGA	IK12250516	ITAPURANGA	10/12/2019 05:59	10/12/2019 09:00	10/12/2019 05:59	10/12/2019 09:00	3,00	15	45,03	CHI
20191265045	MINEIROS	MY12048095	PARQUE DAS EMAS	10/12/2019 05:59	10/12/2019 10:38	10/12/2019 05:59	10/12/2019 10:38	4,64	22	102,07	CHI
20191263712	INHUMAS	IN21359786	INHUMAS S2	10/12/2019 06:01	10/12/2019 10:59	10/12/2019 06:01	10/12/2019 10:59	4,97	1	4,97	CHI
20191263714	ITAPURANGA	19637142	ITAPURANGA	10/12/2019 06:01	10/12/2019 14:00	10/12/2019 06:01	10/12/2019 14:00	7,98	13	103,71	CHI

20191263718	PIRANHAS	PH12273643	PIRANHAS	10/12/2019 06:03	10/12/2019 11:17	10/12/2019 06:03	10/12/2019 11:17	5,24	15	78,56	CHI
20191263721	GOIANESIA	8240698	GOIANESIA S2	10/12/2019 06:03	10/12/2019 12:18	10/12/2019 06:03	10/12/2019 12:18	6,24	2	12,47	CHI
20191254117	CRISTALINA	KR12330533	CRISTALINA S1	10/12/2019 06:04	10/12/2019 15:52	10/12/2019 06:04	10/12/2019 14:09	8,08	10	80,84	CHI
20191254117	CRISTALINA	KR12158335LD	CRISTALINA S1	10/12/2019 06:04	10/12/2019 15:52	10/12/2019 06:04	10/12/2019 15:52	9,80	21	205,86	CHI
20191254117	IPAMERI	KR12158335LD	CRISTALINA S1	10/12/2019 06:04	10/12/2019 15:52	10/12/2019 06:04	10/12/2019 15:52	9,80	1	9,80	CHI
20191254117	LUZIANIA	KR12158335LD	CRISTALINA S1	10/12/2019 06:04	10/12/2019 15:52	10/12/2019 06:04	10/12/2019 15:52	9,80	8	78,42	CHI
20191263723	VICENTINOPOLIS	VI12263802	VICENTINOPOLIS	10/12/2019 06:04	10/12/2019 20:42	10/12/2019 06:04	10/12/2019 20:42	14,63	1	14,63	CHI
20191263727	VICENTINOPOLIS	VI121372843	VICENTINOPOLIS	10/12/2019 06:05	10/12/2019 20:08	10/12/2019 06:05	10/12/2019 20:08	14,04	1	14,04	CHI
20191263732	ARAGOIANIA	AO32097677	GUAPO S2	10/12/2019 06:06	10/12/2019 09:58	10/12/2019 06:06	10/12/2019 09:58	3,87	8	30,93	CHI
20191263732	HIDROLANDIA	AO32097677	GUAPO S2	10/12/2019 06:06	10/12/2019 09:58	10/12/2019 06:06	10/12/2019 09:58	3,87	38	146,93	CHI
20191263734	ARUANA	AK12198048	ARUANA	10/12/2019 06:06	10/12/2019 09:23	10/12/2019 06:06	10/12/2019 09:23	3,28	2	6,55	CHI
20191263735	URUACU	UR12398066	CAMPINORTE	10/12/2019 06:06	10/12/2019 11:27	10/12/2019 06:06	10/12/2019 11:27	5,34	6	32,02	CHI
20191263736	BOM JESUS DE GOIAS	BJ12000088RE	BOM JESUS DE GOIAS	10/12/2019 06:06	10/12/2019 07:53	10/12/2019 06:06	10/12/2019 07:53	1,77	10	17,70	CHI
20191263736	GOIATUBA	BJ12000088RE	BOM JESUS DE GOIAS	10/12/2019 06:06	10/12/2019 07:53	10/12/2019 06:06	10/12/2019 07:53	1,77	44	77,87	CHI
20191263739	HIDROLANDIA	HD11384996	CEPAIGO S2	10/12/2019 06:07	10/12/2019 07:26	10/12/2019 06:07	10/12/2019 07:26	1,31	8	10,48	CHI
20191265472	ABADIANIA	AA12382488	ANAPOLIS UNIVERSITARIO S1	10/12/2019 06:08	10/12/2019 12:28	10/12/2019 06:08	10/12/2019 12:28	6,33	5	31,63	CHI
20191263749	EDEIA	EA12263391	EDEIA	10/12/2019 06:09	10/12/2019 11:11	10/12/2019 06:09	10/12/2019 11:11	5,02	19	95,42	CHI
20191263754	BONOPOLIS	BX12198529	NOVO PLANALTO	10/12/2019 06:10	10/12/2019 14:53	10/12/2019 06:10	10/12/2019 14:53	8,70	1	8,70	CHI
20191264361	SANTA CRUZ DE GOIAS	BC12319013	PIRES DO RIO S2	10/12/2019 06:10	10/12/2019 12:55	10/12/2019 06:10	10/12/2019 12:55	6,74	7	47,21	CHI
20191264697	SAO MIGUEL DO ARAGUAIA	SM12182432	SAO MIGUEL DO ARAGUAIA	10/12/2019 06:10	10/12/2019 09:03	10/12/2019 06:10	10/12/2019 09:03	2,87	8	22,96	CHI
20191263756	SAO JOAO DA PARAUNA	FR12299252	FIRMINOPOLIS S2	10/12/2019 06:11	10/12/2019 13:52	10/12/2019 06:11	10/12/2019 13:52	7,68	3	23,03	CHI
20191265448	JATAI	JT12182074	JATAI S1	10/12/2019 06:11	10/12/2019 10:47	10/12/2019 06:11	10/12/2019 10:47	4,58	8	36,67	CHI
20191265006	CALDAZINHA	LB12270648	DAIA S2	10/12/2019 06:12	10/12/2019 09:40	10/12/2019 06:12	10/12/2019 09:40	3,46	1	3,46	CHI
20191265006	LEOPOLDO DE BULHOES	LB12270648	DAIA S2	10/12/2019 06:12	10/12/2019 09:40	10/12/2019 06:12	10/12/2019 09:40	3,46	18	62,22	CHI
20191265424	PORTELANDIA	PW12046135	PARQUE DAS EMAS	10/12/2019 06:12	10/12/2019 10:08	10/12/2019 06:12	10/12/2019 10:08	3,93	168	660,24	CHI
20191263770	DIORAMA	DI12251384	IPORA	10/12/2019 06:15	11/12/2019 07:05	10/12/2019 06:15	11/12/2019 07:05	24,82	4	99,28	CHI
20191263871	FORMOSA	FA32042714	SAO JOAO D ALIANCA	10/12/2019 06:15	10/12/2019 12:40	10/12/2019 06:15	10/12/2019 12:40	6,40	8	51,21	CHI
20191263772	JANDAIA	JD12005515	PALMEIRAS	10/12/2019 06:16	10/12/2019 11:52	10/12/2019 06:16	10/12/2019 11:52	5,60	7	39,21	CHI
20191263773	BOM JESUS DE GOIAS	ID10396083	QUIRINOPOLIS	10/12/2019 06:16	10/12/2019 12:50	10/12/2019 09:13	10/12/2019 12:48	3,58	69	247,19	CHI
20191263773	INACIOLANDIA	ID10396083	QUIRINOPOLIS	10/12/2019 06:16	10/12/2019 12:50	10/12/2019 09:13	10/12/2019 12:48	3,58	49	175,54	CHI
20191263773	ITUMBIARA	ID10396083	QUIRINOPOLIS	10/12/2019 06:16	10/12/2019 12:50	10/12/2019 09:13	10/12/2019 12:48	3,58	5	17,91	CHI
20191263773	INACIOLANDIA	ID21306049	QUIRINOPOLIS	10/12/2019 06:16	10/12/2019 12:50	10/12/2019 06:16	10/12/2019 12:50	6,57	1	6,57	CHI
20191263774	FORMOSO	FO12060936	PORANGATU	10/12/2019 06:16	10/12/2019 11:40	10/12/2019 06:16	10/12/2019 11:40	5,39	5	26,94	CHI

20191263774	SANTA TEREZA DE GOIAS	FO12060936	PORANGATU	10/12/2019 06:16	10/12/2019 11:40	10/12/2019 06:16	10/12/2019 11:40	5,39	36	193,96	CHI
20191263777	PARAUNA	PU21028675	PARAUNA	10/12/2019 06:18	10/12/2019 18:04	10/12/2019 06:18	10/12/2019 18:04	11,77	1	11,77	CHI
20191258250	CATALAO	CT12266234RE	CATALAO S2	10/12/2019 06:19	10/12/2019 10:02	10/12/2019 06:19	10/12/2019 10:02	3,71	2	7,43	CHI
20191258250	CUMARI	CT12266234RE	CATALAO S2	10/12/2019 06:19	10/12/2019 10:02	10/12/2019 06:19	10/12/2019 10:02	3,71	17	63,15	CHI
20191263785	ITAGUARU	IC21065766	ITABERAI S1	10/12/2019 06:20	10/12/2019 13:28	10/12/2019 06:20	10/12/2019 13:28	7,13	3	21,39	CHI
20191263787	DIVINOPOLIS DE GOIAS	GH12156343RE	SAO DOMINGOS	10/12/2019 06:20	10/12/2019 13:45	10/12/2019 06:20	10/12/2019 13:45	7,41	126	933,63	CHI
20191263787	MONTE ALEGRE DE GOIAS	GH12156343RE	SAO DOMINGOS	10/12/2019 06:20	10/12/2019 13:45	10/12/2019 06:20	10/12/2019 13:45	7,41	15	111,15	CHI
20191263787	SAO DOMINGOS	GH12156343RE	SAO DOMINGOS	10/12/2019 06:20	10/12/2019 13:45	10/12/2019 06:20	10/12/2019 13:45	7,41	1	7,41	CHI
20191263790	QUIRINOPOLIS	QI32053205	QUIRINOPOLIS	10/12/2019 06:21	10/12/2019 08:58	10/12/2019 06:21	10/12/2019 08:58	2,60	3	7,81	CHI
20191265436	BONOPOLIS	BX12391924	SAO MIGUEL DO ARAGUAIA	10/12/2019 06:22	10/12/2019 11:02	10/12/2019 06:22	10/12/2019 11:02	4,66	27	125,75	CHI
20191265436	SAO MIGUEL DO ARAGUAIA	BX12391924	SAO MIGUEL DO ARAGUAIA	10/12/2019 06:22	10/12/2019 11:02	10/12/2019 06:22	10/12/2019 11:02	4,66	0	0,00	CHI
20191263798	CORUMBA DE GOIAS	CB21148109	CORUMBA	10/12/2019 06:23	10/12/2019 15:18	10/12/2019 06:23	10/12/2019 15:18	8,91	1	8,91	CHI
20191263802	ITAPIRAPUA	IU12030113	MATRINCHA	10/12/2019 06:24	10/12/2019 11:39	10/12/2019 06:24	10/12/2019 11:39	5,24	11	57,62	CHI
20191264698	BARRO ALTO	GE12000092	GOIANESIA S1	10/12/2019 06:25	10/12/2019 13:18	10/12/2019 06:25	10/12/2019 13:18	6,88	2	13,77	CHI
20191264698	GOIANESIA	GE12000092	GOIANESIA S1	10/12/2019 06:25	10/12/2019 13:18	10/12/2019 06:25	10/12/2019 13:18	6,88	19	130,78	CHI
20191272376	SANTA FE DE GOIAS	RN12009764	BRITANIA	10/12/2019 06:27	10/12/2019 18:13	10/12/2019 06:27	10/12/2019 18:13	11,76	6	70,56	CHI
201912260803	NOVA CRIXAS	NA12213190	MOZARLANDIA	10/12/2019 06:27	10/12/2019 22:43	10/12/2019 06:27	10/12/2019 22:43	16,25	23	373,81	CHI
20191276217	DAVINOPOLIS	IO12394027	CATALAO S1	10/12/2019 06:28	10/12/2019 14:19	10/12/2019 06:28	10/12/2019 14:19	7,84	8	62,69	CHI
20191263826	GOIANAPOLIS	GP12000040	DAIA S2	10/12/2019 06:30	10/12/2019 09:24	10/12/2019 06:30	10/12/2019 09:24	2,89	6	17,34	CHI
20191263827	RIO VERDE	RV12226300	MONTIVIDIU T	10/12/2019 06:30	10/12/2019 10:27	10/12/2019 06:30	10/12/2019 10:27	3,94	14	55,11	CHI
20191263831	FORMOSO	FO12185319	PORANGATU	10/12/2019 06:31	10/12/2019 09:04	10/12/2019 06:31	10/12/2019 09:04	2,55	26	66,22	CHI
20191267560	ALEXANIA	AX12061853	ALEXANIA	10/12/2019 06:31	10/12/2019 15:53	10/12/2019 06:31	10/12/2019 15:53	9,37	4	37,47	CHI
20191263836	MUNDO NOVO DE GOIAS	MH12391968	NOVA CRIXAS	10/12/2019 06:32	10/12/2019 15:00	10/12/2019 06:32	10/12/2019 15:00	8,46	5	42,31	CHI
20191264692	PLANALTINA	PI12375539	PLANALTINA	10/12/2019 06:32	10/12/2019 10:13	10/12/2019 06:32	10/12/2019 10:13	3,67	41	150,42	CHI
20191263841	SAO MIGUEL DO ARAGUAIA	SM12208485	SAO MIGUEL DO ARAGUAIA	10/12/2019 06:34	10/12/2019 16:15	10/12/2019 06:34	10/12/2019 16:15	9,69	2	19,38	CHI
20191272327	PETROLINA DE GOIAS	PV12382115	SAO FRANCISCO DE GOIAS	10/12/2019 06:36	10/12/2019 20:23	10/12/2019 06:36	10/12/2019 20:23	13,78	1	13,78	CHI
20191272327	PIRENOPOLIS	PV12382115	SAO FRANCISCO DE GOIAS	10/12/2019 06:36	10/12/2019 20:23	10/12/2019 06:36	10/12/2019 20:23	13,78	7	96,45	CHI
20191262211	CAMPO ALEGRE DE GOIAS	CM12192738RE	CAMPO ALEGRE DE GOIAS	10/12/2019 06:37	10/12/2019 09:48	10/12/2019 06:37	10/12/2019 09:48	3,19	49	156,21	CHI
20191263846	MINEIROS	1390084581	PARQUE DAS EMAS	10/12/2019 06:37	10/12/2019 10:24	10/12/2019 06:37	10/12/2019 10:24	3,78	1	3,78	CHI
20191263848	SAO LUIS DE MONTES BELOS	SL21067901	SAO LUIZ DOS MONTES BELOS	10/12/2019 06:37	10/12/2019 17:26	10/12/2019 06:37	10/12/2019 17:26	10,81	2	21,63	CHI
20191280475	ITAJA	IJ12096170	ITAJA S2	10/12/2019 06:37	11/12/2019 08:28	10/12/2019 06:37	11/12/2019 08:28	25,85	3	77,55	CHI
20191263853	ITARUMA	IM21205240	CACHOEIRA ALTA	10/12/2019 06:39	10/12/2019 07:59	10/12/2019 06:39	10/12/2019 07:59	1,33	1	1,33	CHI
20191280834	NOVA CRIXAS	NA12057227	MOZARLANDIA	10/12/2019 06:40	10/12/2019 22:43	10/12/2019 06:40	10/12/2019 22:43	16,04	7	112,30	CHI

20191281259	PIRENOPOLIS	PV12360338RE	CORUMBA	10/12/2019 06:41	10/12/2019 19:19	10/12/2019 06:41	10/12/2019 19:19	12,63	94	1187,19	CHI
20191263858	MORRINHOS	MR21060101	MORRINHOS	10/12/2019 06:42	10/12/2019 12:51	10/12/2019 06:42	10/12/2019 12:51	6,15	1	6,15	CHI
20191263863	SENADOR CANEDO	SW12343133	SENADOR CANEDO	10/12/2019 06:43	10/12/2019 08:37	10/12/2019 06:43	10/12/2019 08:37	1,89	652	1230,65	CHI
20191263866	CRISTALINA	KR12209473	CRISTALINA S2	10/12/2019 06:45	10/12/2019 11:42	10/12/2019 06:45	10/12/2019 11:42	4,94	8	39,52	CHI
20191263867	COLINAS DO SUL	TI12396761	MINACU	10/12/2019 06:45	10/12/2019 11:25	10/12/2019 06:45	10/12/2019 11:25	4,65	2	9,31	CHI
20191263883	ITAGUARU	IC12336553	ITABERAI S1	10/12/2019 06:45	10/12/2019 13:26	10/12/2019 06:45	10/12/2019 13:26	6,67	4	26,68	CHI
20191263873	PROFESSOR JAMIL SAFADY	PJ12084882	ROCHEDO	10/12/2019 06:46	10/12/2019 09:26	10/12/2019 06:46	10/12/2019 09:26	2,65	28	74,30	CHI
20191263874	PIRACANJUBA	60010113	PIRACANJUBA	10/12/2019 06:46	10/12/2019 11:23	10/12/2019 06:46	10/12/2019 11:23	4,60	1	4,60	CHI
20191264396	ITUMBIARA	BG12273858	ITUMBIARA VELHA S2	10/12/2019 06:46	10/12/2019 11:30	10/12/2019 06:46	10/12/2019 11:30	4,74	14	66,37	CHI
20191265429	FORMOSO	FO12145300	PORANGATU	10/12/2019 06:46	10/12/2019 13:04	10/12/2019 06:46	10/12/2019 13:04	6,29	11	69,19	CHI
20191263877	ABADIANIA	AA21184584	DAIA S2	10/12/2019 06:47	10/12/2019 12:28	10/12/2019 06:47	10/12/2019 12:28	5,67	1	5,67	CHI
20191266021	SAO MIGUEL DO ARAGUAIA	SM12220886	SAO MIGUEL DO ARAGUAIA	10/12/2019 06:47	10/12/2019 12:28	10/12/2019 06:47	10/12/2019 12:28	5,67	17	96,37	CHI
20191263892	ITUMBIARA	IT21395618	ITUMBIARA VELHA S1	10/12/2019 06:49	10/12/2019 08:25	10/12/2019 06:49	10/12/2019 08:25	1,59	1	1,59	CHI
20191280416	PIRANHAS	PH12381017	PIRANHAS	10/12/2019 06:49	10/12/2019 17:12	10/12/2019 06:49	10/12/2019 17:12	10,37	12	124,47	CHI
20191263895	CAMPOS BELOS	CH12376679	SAO DOMINGOS	10/12/2019 06:50	10/12/2019 09:39	10/12/2019 06:50	10/12/2019 09:39	2,80	13	36,41	CHI
20191266087	AGUA FRIA DE GOIAS	TL12381390	SAO JOAO D ALIANCA	10/12/2019 06:50	10/12/2019 10:45	10/12/2019 06:50	10/12/2019 10:45	3,90	3	11,71	CHI
20191266087	PLANALTINA	TL12381390	SAO JOAO D ALIANCA	10/12/2019 06:50	10/12/2019 10:45	10/12/2019 06:50	10/12/2019 10:45	3,90	20	78,06	CHI
20191263896	MONTIVIDIU DO NORTE	MX12143686	PORANGATU	10/12/2019 06:51	10/12/2019 09:52	10/12/2019 06:51	10/12/2019 09:52	3,02	104	313,65	CHI
20191263898	FAINA	FC12274380	GOIAS	10/12/2019 06:51	10/12/2019 18:25	10/12/2019 06:51	10/12/2019 18:25	11,56	2	23,13	CHI
20191264304	IPAMERI	IP12041051	IPAMERI	10/12/2019 06:53	10/12/2019 16:27	10/12/2019 06:53	10/12/2019 14:45	7,88	6	47,28	CHI
20191264304	IPAMERI	IP12045140LD	IPAMERI	10/12/2019 06:53	10/12/2019 16:27	10/12/2019 06:53	10/12/2019 16:27	9,58	1	9,58	CHI
20191264306	BALIZA	BH12331395	CAIAPONIA	10/12/2019 06:53	10/12/2019 11:00	10/12/2019 06:53	10/12/2019 11:00	4,11	70	287,62	CHI
20191261854	PARAUNA	PU12039209	PARAUNA	10/12/2019 06:54	10/12/2019 09:50	10/12/2019 06:54	10/12/2019 09:50	2,93	5	14,67	CHI
20191257738	MINACU	IH12247493	MINACU	10/12/2019 06:55	10/12/2019 07:46	10/12/2019 06:55	10/12/2019 07:46	0,84	100	84,03	CHI
20191264352	MINEIROS	MY12324503	PARQUE DAS EMAS	10/12/2019 06:56	10/12/2019 11:30	10/12/2019 06:56	10/12/2019 11:30	4,55	2	9,11	CHI
20191265056	CAMPINORTE	CR12053035	MARA ROSA	10/12/2019 06:56	10/12/2019 15:36	10/12/2019 06:56	10/12/2019 11:14	4,31	3	12,94	CHI
20191265056	CAMPINORTE	CR12335550LD	MARA ROSA	10/12/2019 06:56	10/12/2019 15:36	10/12/2019 06:56	10/12/2019 15:36	8,67	1	8,67	CHI
20191267097	GOIANAPOLIS	GP12285356	DAIA S2	10/12/2019 06:57	10/12/2019 15:00	10/12/2019 06:57	10/12/2019 15:00	8,04	8	64,29	CHI
20191264331	MUNDO NOVO DE GOIAS	MH11269248	NOVA CRIXAS	10/12/2019 06:59	10/12/2019 11:15	10/12/2019 06:59	10/12/2019 11:15	4,26	1	4,26	CHI
20191264336	GOIATUBA	GT12041277	GOIATUBA S2	10/12/2019 07:00	10/12/2019 08:37	10/12/2019 07:00	10/12/2019 08:37	1,60	2	3,21	CHI
20191264338	BELA VISTA DE GOIAS	240045828	BELA VISTA S2	10/12/2019 07:00	10/12/2019 09:02	10/12/2019 07:00	10/12/2019 09:02	2,02	1	2,02	CHI
20191266069	PADRE BERNARDO	PB12347929	PADRE BERNARDO	10/12/2019 07:00	10/12/2019 23:18	10/12/2019 07:00	10/12/2019 21:37	14,62	4	58,46	CHI
20191266069	PADRE BERNARDO	PB21347928	PADRE BERNARDO	10/12/2019 07:00	10/12/2019 23:18	10/12/2019 07:00	10/12/2019 23:18	16,30	1	16,30	CHI

20191264388	FAZENDA NOVA	JP12207789	IPORA	10/12/2019 07:01	10/12/2019 11:52	10/12/2019 07:01	10/12/2019 11:52	4,84	19	91,88	CHI
20191264388	JAUPACI	JP12207789	IPORA	10/12/2019 07:01	10/12/2019 11:52	10/12/2019 07:01	10/12/2019 11:52	4,84	16	77,37	CHI
20191264395	CACHOEIRA DOURADA	CD12000007RE	CACHOEIRA DOURADA	10/12/2019 07:01	10/12/2019 11:51	10/12/2019 07:01	10/12/2019 11:51	4,82	27	130,15	CHI
20191264395	ITUMBUIARA	CD12000007RE	CACHOEIRA DOURADA	10/12/2019 07:01	10/12/2019 11:51	10/12/2019 07:01	10/12/2019 11:51	4,82	26	125,33	CHI
20191265011	BONOPOLIS	BX12079316	SAO MIGUEL DO ARAGUAIA	10/12/2019 07:01	10/12/2019 11:04	10/12/2019 07:01	10/12/2019 11:04	4,04	8	32,35	CHI
20191267051	ABADIANIA	AA12271855	ANAPOLIS UNIVERSITARIO S1	10/12/2019 07:01	10/12/2019 11:01	10/12/2019 07:01	10/12/2019 11:01	3,99	7	27,96	CHI
20191264348	APARECIDA DE GOIANIA	13139101	REAL S1	10/12/2019 07:02	10/12/2019 09:24	10/12/2019 07:02	10/12/2019 09:24	2,36	1	2,36	CHI
20191264350	NOVA CRIXAS	NA21170013	MOZARLANDIA	10/12/2019 07:02	10/12/2019 22:43	10/12/2019 07:02	10/12/2019 22:43	15,67	1	15,67	CHI
20191264351	CACHOEIRA ALTA	CA12196160	CACHOEIRA ALTA	10/12/2019 07:02	11/12/2019 01:36	10/12/2019 18:00	11/12/2019 01:36	7,61	31	236,00	CHI
20191264351	CACHOEIRA ALTA	CA12196161	CACHOEIRA ALTA	10/12/2019 07:02	11/12/2019 01:36	10/12/2019 07:02	11/12/2019 01:36	18,57	10	185,71	CHI
20191280926	NIQUELANDIA	4040003604	BARRO ALTO	10/12/2019 07:02	11/12/2019 04:30	10/12/2019 07:02	11/12/2019 04:30	21,46	1	21,46	CHI
20191266056	SAO MIGUEL DO ARAGUAIA	SM12151000	SAO MIGUEL DO ARAGUAIA	10/12/2019 07:03	10/12/2019 16:01	10/12/2019 07:03	10/12/2019 15:17	8,23	17	139,96	CHI
20191266056	SAO MIGUEL DO ARAGUAIA	SM12300949LD	SAO MIGUEL DO ARAGUAIA	10/12/2019 07:03	10/12/2019 16:01	10/12/2019 07:03	10/12/2019 16:01	8,96	2	17,91	CHI
20191264357	ANAPOLIS	AN21262474	JUNDIAI S2	10/12/2019 07:04	10/12/2019 17:31	10/12/2019 07:04	10/12/2019 17:31	10,44	2	20,88	CHI
20191264358	JATAI	JT12196090	JATAI S2	10/12/2019 07:04	10/12/2019 08:17	10/12/2019 07:04	10/12/2019 08:17	1,21	12	14,47	CHI
20191264359	FORMOSO	FO12391992	PORANGATU	10/12/2019 07:04	10/12/2019 08:02	10/12/2019 07:04	10/12/2019 08:02	0,96	3	2,87	CHI
20191264365	ALTO PARAISO DE GOIAS	BF21163462	FLORES DE GOIAS	10/12/2019 07:05	10/12/2019 09:14	10/12/2019 07:05	10/12/2019 09:14	2,15	1	2,15	CHI
201912260802	NOVA VENEZA	NV12111337	INHUMAS S1	10/12/2019 07:05	10/12/2019 09:52	10/12/2019 07:05	10/12/2019 09:52	2,78	18	50,06	CHI
20191264374	POSSE	PS11212688	IACIARA S1	10/12/2019 07:06	10/12/2019 10:40	10/12/2019 07:06	10/12/2019 10:40	3,55	4	14,21	CHI
20191264376	CATALAO	CT21160937	CATALAO S1	10/12/2019 07:07	11/12/2019 11:00	10/12/2019 07:07	11/12/2019 11:00	27,88	1	27,88	CHI
20191264379	LUZIANIA	LZ12383009	MARAJOARA	10/12/2019 07:07	10/12/2019 11:29	10/12/2019 07:07	10/12/2019 11:29	4,36	10	43,59	CHI
20191264381	SAO DOMINGOS	SD12161808	SAO DOMINGOS	10/12/2019 07:07	10/12/2019 11:40	10/12/2019 07:07	10/12/2019 11:40	4,54	28	127,04	CHI
20191267029	NIQUELANDIA	NQ12374575	NIQUELANDIA SUBTRANSMISSAO	10/12/2019 07:08	10/12/2019 16:05	10/12/2019 07:08	10/12/2019 16:05	8,94	12	107,28	CHI
20191264390	APARECIDA DE GOIANIA	14295131	ANHANGUERA	10/12/2019 07:09	10/12/2019 08:13	10/12/2019 07:09	10/12/2019 08:13	1,07	1	1,07	CHI
20191272301	POSSE	PS12184932	IACIARA S2	10/12/2019 07:09	10/12/2019 12:21	10/12/2019 07:09	10/12/2019 12:21	5,19	5	25,96	CHI
20191264604	MORRINHOS	MR12010209	MORRINHOS	10/12/2019 07:11	10/12/2019 10:00	10/12/2019 07:11	10/12/2019 10:00	2,81	8	22,47	CHI
20191264605	GOIANIA	200309602	INDEPENDENCIA S2	10/12/2019 07:11	10/12/2019 10:20	10/12/2019 07:11	10/12/2019 10:20	3,14	1	3,14	CHI
20191264608	CAMPINORTE	20403809	CAMPINORTE	10/12/2019 07:11	10/12/2019 16:38	10/12/2019 07:11	10/12/2019 16:38	9,44	1	9,44	CHI
20191264609	INDIARA	IY12170319	EDEIA	10/12/2019 07:11	10/12/2019 15:30	10/12/2019 07:11	10/12/2019 15:30	8,32	5	41,58	CHI
20191264609	PALMEIRAS DE GOIAS	IY12170319	EDEIA	10/12/2019 07:11	10/12/2019 15:30	10/12/2019 07:11	10/12/2019 15:30	8,32	6	49,89	CHI
20191266020	IPORA	IR12289239	IPORA	10/12/2019 07:12	10/12/2019 15:54	10/12/2019 07:12	10/12/2019 15:54	8,69	9	78,24	CHI
20191267003	ARAGARCAS	BM12204856	BOM JARDIM	10/12/2019 07:12	10/12/2019 10:57	10/12/2019 07:12	10/12/2019 10:57	3,75	24	89,95	CHI
20191267003	BALIZA	BM12204856	BOM JARDIM	10/12/2019 07:12	10/12/2019 10:57	10/12/2019 07:12	10/12/2019 10:57	3,75	50	187,39	CHI

20191264617	ARAGARCAS	1820014920	ARAGARCAS	10/12/2019 07:13	10/12/2019 09:03	10/12/2019 07:13	10/12/2019 09:03	1,82	1	1,82	CHI
20191264626	URUACU	UR12364091	URUACU	10/12/2019 07:13	10/12/2019 09:56	10/12/2019 07:13	10/12/2019 09:56	2,70	12	32,41	CHI
20191264624	FORMOSA	FA21146183	SAO JOAO D ALIANCA	10/12/2019 07:14	10/12/2019 09:43	10/12/2019 07:14	10/12/2019 09:43	2,48	2	4,95	CHI
20191265451	CAMPINACU	UC12237456	MARA ROSA	10/12/2019 07:14	10/12/2019 12:31	10/12/2019 07:14	10/12/2019 12:31	5,27	7	36,92	CHI
20191265451	URUACU	UC12237456	MARA ROSA	10/12/2019 07:14	10/12/2019 12:31	10/12/2019 07:14	10/12/2019 12:31	5,27	5	26,37	CHI
20191264628	SANTA ISABEL	GE12000131	GOIANESIA S1	10/12/2019 07:15	10/12/2019 11:56	10/12/2019 07:15	10/12/2019 11:56	4,68	2	9,36	CHI
20191264629	BALIZA	BM11227617	BOM JARDIM	10/12/2019 07:15	10/12/2019 17:10	10/12/2019 07:15	10/12/2019 17:10	9,92	1	9,92	CHI
20191267080	AGUAS LINDAS DE GOIAS	LA12313875	AGUAS LINDAS DE GOIAS S1	10/12/2019 07:16	10/12/2019 11:47	10/12/2019 07:16	10/12/2019 11:47	4,50	94	423,42	CHI
20191267080	COCALZINHO DE GOIAS	LA12313875	AGUAS LINDAS DE GOIAS S1	10/12/2019 07:16	10/12/2019 11:47	10/12/2019 07:16	10/12/2019 11:47	4,50	1	4,50	CHI
20191267080	SANTO ANTONIO DO DESCOBERTO	LA12313875	AGUAS LINDAS DE GOIAS S1	10/12/2019 07:16	10/12/2019 11:47	10/12/2019 07:16	10/12/2019 11:47	4,50	18	81,08	CHI
20191264637	BELA VISTA DE GOIAS	BV12041021	BELA VISTA S1	10/12/2019 07:17	10/12/2019 10:00	10/12/2019 07:17	10/12/2019 10:00	2,71	5	13,54	CHI
20191265002	PIRACANJUBA	PJ12249833	PIRACANJUBA	10/12/2019 07:18	10/12/2019 10:38	10/12/2019 07:18	10/12/2019 10:38	3,33	77	256,39	CHI
20191266043	CAIAPONIA	CP12252503	CAIAPONIA	10/12/2019 07:18	11/12/2019 13:53	10/12/2019 07:18	11/12/2019 13:53	30,57	6	183,45	CHI
20191269883	ORIZONA	OZ12080797	VIANOPOLIS	10/12/2019 07:18	11/12/2019 15:45	10/12/2019 07:18	11/12/2019 15:45	32,45	5	162,24	CHI
20191269883	SILVANIA	OZ12080797	VIANOPOLIS	10/12/2019 07:18	11/12/2019 15:45	10/12/2019 07:18	11/12/2019 15:45	32,45	4	129,79	CHI
20191264660	MIMOSO DE GOIAS	MJ12246072	PADRE BERNARDO	10/12/2019 07:20	10/12/2019 18:04	10/12/2019 07:20	10/12/2019 18:04	10,72	2	21,44	CHI
20191264662	APARECIDA DE GOIANIA	200526716	INDEPENDENCIA S2	10/12/2019 07:20	10/12/2019 10:12	10/12/2019 07:20	10/12/2019 10:12	2,85	1	2,85	CHI
20191264669	CATALAO	CT21231774	CATALAO S1	10/12/2019 07:21	10/12/2019 18:15	10/12/2019 07:21	10/12/2019 18:15	10,89	1	10,89	CHI
20191264670	ANAPOLIS	10001490158	ANAPOLIS UNIVERSITARIO S1	10/12/2019 07:21	10/12/2019 11:54	10/12/2019 07:21	10/12/2019 11:54	4,53	1	4,53	CHI
20191256692	LUZIANIA	LZ12290851	MARAJOARA	10/12/2019 07:22	10/12/2019 09:40	10/12/2019 07:22	10/12/2019 09:40	2,29	23	52,57	CHI
20191264671	PLANALTINA	PI21262306	PADRE BERNARDO	10/12/2019 07:22	10/12/2019 13:04	10/12/2019 07:22	10/12/2019 13:04	5,70	1	5,70	CHI
20191264672	TURVANIA	TV12170250	FIRMINOPOLIS S1	10/12/2019 07:22	10/12/2019 09:21	10/12/2019 07:22	10/12/2019 09:21	1,98	2	3,96	CHI
20191264674	CAMPOS VERDES	VD12390436	SANTA TEREZINHA	10/12/2019 07:22	10/12/2019 10:28	10/12/2019 07:22	10/12/2019 10:28	3,09	8	24,72	CHI
20191264678	NOVA CRIXAS	NA21095933	NOVA CRIXAS	10/12/2019 07:23	10/12/2019 14:02	10/12/2019 07:23	10/12/2019 14:02	6,66	1	6,66	CHI
20191264679	TURVANIA	TV21111584	FIRMINOPOLIS S1	10/12/2019 07:23	10/12/2019 10:19	10/12/2019 07:23	10/12/2019 10:19	2,93	3	8,79	CHI
20191264681	CRISTALINA	KR12203334	CRISTALINA S2	10/12/2019 07:23	10/12/2019 16:04	10/12/2019 07:23	10/12/2019 16:04	8,68	6	52,09	CHI
20191264685	CRISTALINA	KR12162504	CRISTALINA S1	10/12/2019 07:23	10/12/2019 16:22	10/12/2019 07:23	10/12/2019 16:22	8,97	10	89,71	CHI
20191264901	ITAJA	IJ12226574	ITAJA S2	10/12/2019 07:24	11/12/2019 13:47	10/12/2019 12:23	10/12/2019 13:20	0,95	3	2,86	CHI
20191264901	ITAJA	IJ12226574	ITAJA S2	10/12/2019 07:24	11/12/2019 13:47	10/12/2019 12:23	11/12/2019 13:47	25,41	5	127,05	CHI
20191264901	ITAJA	IJ12226574	ITAJA S2	10/12/2019 07:24	11/12/2019 13:47	11/12/2019 12:43	11/12/2019 13:47	1,07	3	3,21	CHI
20191275204	COCALZINHO DE GOIAS	ZN12377435	COCALZINHO	10/12/2019 07:26	10/12/2019 20:11	10/12/2019 07:26	10/12/2019 20:11	12,74	54	687,84	CHI
20191264700	MINEIROS	MY12149301	PARQUE DAS EMAS	10/12/2019 07:27	10/12/2019 10:35	10/12/2019 07:27	10/12/2019 10:35	3,12	17	53,12	CHI
20191264700	PEROLANDIA	MY12149301	PARQUE DAS EMAS	10/12/2019 07:27	10/12/2019 10:35	10/12/2019 07:27	10/12/2019 10:35	3,12	1	3,12	CHI

20191265001	ITAJA	IJ12096116	ITAJA S2	10/12/2019 07:27	10/12/2019 19:59	10/12/2019 07:27	10/12/2019 19:59	12,52	1	12,52	CHI
20191265008	RIO VERDE	RV12260255	RIO VERDE S1	10/12/2019 07:29	10/12/2019 11:40	10/12/2019 07:29	10/12/2019 11:40	4,18	5	20,91	CHI
20191265015	NOVA ROMA	IA12180523	IACIARA S2	10/12/2019 07:30	10/12/2019 16:53	10/12/2019 07:30	10/12/2019 16:53	9,38	2	18,76	CHI
20191265016	PIRES DO RIO	PR21318985	PIRES DO RIO S1	10/12/2019 07:30	10/12/2019 08:52	10/12/2019 07:30	10/12/2019 08:52	1,36	1	1,36	CHI
20191265019	JATAI	JT12241750	JATAI S1	10/12/2019 07:30	10/12/2019 11:59	10/12/2019 07:30	10/12/2019 11:59	4,47	1	4,47	CHI
20191267507	CAMPO ALEGRE DE GOIAS	CM12127532	CAMPO ALEGRE DE GOIAS	10/12/2019 07:30	10/12/2019 14:42	10/12/2019 07:30	10/12/2019 14:42	7,20	19	136,82	CHI
20191265025	ITAPIRAPUA	IU12027608	MATRINCHA	10/12/2019 07:31	10/12/2019 09:16	10/12/2019 07:31	10/12/2019 09:16	1,74	1	1,74	CHI
20191265027	GOIANIA	11856180	FERROVIARIO S1	10/12/2019 07:31	10/12/2019 08:59	10/12/2019 07:31	10/12/2019 08:59	1,45	1	1,45	CHI
20191265051	CATALAO	CT12130948	CATALAO S1	10/12/2019 07:31	10/12/2019 12:12	10/12/2019 07:31	10/12/2019 12:12	4,68	7	32,77	CHI
20191265028	RIO VERDE	RV12279861	CABRIUVA S2	10/12/2019 07:32	10/12/2019 16:40	10/12/2019 07:32	10/12/2019 16:40	9,13	1	9,13	CHI
20191265033	URUACU	UR21181140	URUACU	10/12/2019 07:32	10/12/2019 13:25	10/12/2019 07:32	10/12/2019 13:25	5,87	2	11,75	CHI
20191266004	ARAGARCAS	AG12341726	IPORA	10/12/2019 07:32	10/12/2019 19:51	10/12/2019 07:32	10/12/2019 19:51	12,31	28	344,68	CHI
20191265037	CALDAS NOVAS	CN21352166	CALDAS NOVAS S1	10/12/2019 07:33	10/12/2019 15:42	10/12/2019 07:33	10/12/2019 15:42	8,15	1	8,15	CHI
20191265038	GOIANESIA	GE21000267	GOIANESIA S2	10/12/2019 07:33	10/12/2019 13:04	10/12/2019 07:33	10/12/2019 13:04	5,52	1	5,52	CHI
20191265040	MUTUNOPOLIS	PO12084869	PORANGATU	10/12/2019 07:33	10/12/2019 12:15	10/12/2019 07:33	10/12/2019 12:15	4,69	4	18,77	CHI
20191265040	PORANGATU	PO12084869	PORANGATU	10/12/2019 07:33	10/12/2019 12:15	10/12/2019 07:33	10/12/2019 12:15	4,69	3	14,08	CHI
20191265041	FAINA	FC12063187	GOIAS	10/12/2019 07:34	10/12/2019 16:21	10/12/2019 07:34	10/12/2019 16:21	8,78	6	52,69	CHI
20191265043	MORRINHOS	MR12251748RE	MORRINHOS	10/12/2019 07:34	10/12/2019 13:33	10/12/2019 07:34	10/12/2019 13:33	5,98	7	41,84	CHI
20191265052	PIRACANJUBA	PJ12043107	ROCHEDO	10/12/2019 07:35	10/12/2019 18:55	10/12/2019 07:35	10/12/2019 18:55	11,35	3	34,04	CHI
20191265053	NIQUELANDIA	NQ21237369	URUACU	10/12/2019 07:35	10/12/2019 20:16	10/12/2019 07:35	10/12/2019 20:16	12,68	1	12,68	CHI
20191265057	VIANOPOLIS	VN12282838	VIANOPOLIS	10/12/2019 07:36	10/12/2019 10:42	10/12/2019 07:36	10/12/2019 10:42	3,10	1	3,10	CHI
20191265062	MORRINHOS	MR21000245	MORRINHOS	10/12/2019 07:36	10/12/2019 09:02	10/12/2019 07:36	10/12/2019 09:02	1,42	1	1,42	CHI
20191265063	JUSSARA	JR12241057	BRITANIA	10/12/2019 07:36	11/12/2019 20:46	10/12/2019 07:36	11/12/2019 20:46	37,16	1	37,16	CHI
20191266061	EDEIA	EA12056550	EDEIA	10/12/2019 07:36	10/12/2019 21:33	10/12/2019 07:36	10/12/2019 21:33	13,96	3	41,87	CHI
20191266061	INDIARA	EA12056550	EDEIA	10/12/2019 07:36	10/12/2019 21:33	10/12/2019 07:36	10/12/2019 21:33	13,96	2	27,91	CHI
20191265064	CATALAO	1990206363	CATALAO S2	10/12/2019 07:37	10/12/2019 09:59	10/12/2019 07:37	10/12/2019 09:59	2,37	1	2,37	CHI
20191265065	GOIANIA	10029802693	MEIA PONTE	10/12/2019 07:37	10/12/2019 09:41	10/12/2019 07:37	10/12/2019 09:41	2,06	1	2,06	CHI
20191265066	AGUAS LINDAS DE GOIAS	LA12412178	AGUAS LINDAS DE GOIAS S1	10/12/2019 07:37	10/12/2019 15:03	10/12/2019 07:37	10/12/2019 15:03	7,43	9	66,88	CHI
20191265073	PARAUNA	10010918971	PARAUNA	10/12/2019 07:38	10/12/2019 10:20	10/12/2019 07:38	10/12/2019 10:20	2,71	1	2,71	CHI
20191265075	MONTES CLAROS DE GOIAS	ME21144411	IPORA	10/12/2019 07:38	11/12/2019 18:28	10/12/2019 07:38	11/12/2019 18:28	34,83	1	34,83	CHI
20191265076	ITAPIRAPUA	IU12020174	JUSSARA	10/12/2019 07:38	10/12/2019 10:45	10/12/2019 07:38	10/12/2019 10:45	3,12	5	15,59	CHI
20191265077	CACU	CC21125942	CACHOEIRA ALTA	10/12/2019 07:38	10/12/2019 13:24	10/12/2019 07:38	10/12/2019 13:24	5,75	1	5,75	CHI
20191265080	IPAMERI	IP12016968RE	URUTAI	10/12/2019 07:39	11/12/2019 00:38	10/12/2019 07:39	11/12/2019 00:38	16,99	2	33,98	CHI

20191265080	URUTAI	IP12016968RE	URUTAI	10/12/2019 07:39	11/12/2019 00:38	10/12/2019 07:39	11/12/2019 00:38	16,99	5	84,96	CHI
20191265080	IPAMERI	IP12016968RE	URUTAI	10/12/2019 07:39	11/12/2019 00:38	10/12/2019 19:46	11/12/2019 00:38	4,88	7	34,13	CHI
20191265080	URUTAI	IP12016968RE	URUTAI	10/12/2019 07:39	11/12/2019 00:38	10/12/2019 19:46	11/12/2019 00:38	4,88	4	19,50	CHI
20191265084	GOIANIA	13976291	MEIA PONTE	10/12/2019 07:40	10/12/2019 08:57	10/12/2019 07:40	10/12/2019 08:57	1,28	1	1,28	CHI
20191266017	MONTES CLAROS DE GOIAS	ME12161605	IPORA	10/12/2019 07:40	10/12/2019 22:18	10/12/2019 07:40	10/12/2019 22:18	14,63	4	58,51	CHI
20191267595	PADRE BERNARDO	PI12099216	PLANALTINA	10/12/2019 07:40	10/12/2019 11:36	10/12/2019 07:40	10/12/2019 11:36	3,93	14	54,97	CHI
20191267595	PLANALTINA	PI12099216	PLANALTINA	10/12/2019 07:40	10/12/2019 11:36	10/12/2019 07:40	10/12/2019 11:36	3,93	108	424,05	CHI
20191265092	CAVALCANTE	10010106136	MINACU	10/12/2019 07:41	11/12/2019 15:07	10/12/2019 07:41	11/12/2019 15:07	31,43	1	31,43	CHI
20191266031	FORMOSO	FO12071146	PORANGATU	10/12/2019 07:41	10/12/2019 13:52	10/12/2019 07:41	10/12/2019 13:52	6,17	4	24,69	CHI
20191265401	UIRAPURU	UP21119083	NOVA CRIXAS	10/12/2019 07:42	10/12/2019 17:12	10/12/2019 07:42	10/12/2019 17:12	9,49	1	9,49	CHI
20191265409	MONTES CLAROS DE GOIAS	ME21039672	IPORA	10/12/2019 07:44	10/12/2019 20:53	10/12/2019 07:44	10/12/2019 20:53	13,14	1	13,14	CHI
20191265412	NOVA VENEZA	NV21372113	INHUMAS S1	10/12/2019 07:45	10/12/2019 10:28	10/12/2019 07:45	10/12/2019 10:28	2,72	1	2,72	CHI
20191265415	MOSSAMEDES	MD21089219	ITABERAI S2	10/12/2019 07:45	10/12/2019 13:20	10/12/2019 07:45	10/12/2019 13:20	5,58	1	5,58	CHI
20191265416	INHUMAS	30088768	INHUMAS S2	10/12/2019 07:45	10/12/2019 09:42	10/12/2019 07:45	10/12/2019 09:42	1,94	1	1,94	CHI
20191265417	LAGOA SANTA	IJ21192012	CACHOEIRA ALTA	10/12/2019 07:45	11/12/2019 00:15	10/12/2019 07:45	11/12/2019 00:15	16,49	1	16,49	CHI
20191267050	ITAPURANGA	IK12298443	ITAPURANGA	10/12/2019 07:45	10/12/2019 10:32	10/12/2019 07:45	10/12/2019 10:32	2,78	5	13,90	CHI
20191265421	GOIANIA	16342100	MEIA PONTE	10/12/2019 07:47	10/12/2019 12:04	10/12/2019 07:47	10/12/2019 12:04	4,28	1	4,28	CHI
20191265428	RIO VERDE	RV12018096	SANTA HELENA S1	10/12/2019 07:48	10/12/2019 10:35	10/12/2019 07:48	10/12/2019 10:35	2,78	5	13,90	CHI
20191265430	CALDAS NOVAS	8064371	SERRA DE CALDAS	10/12/2019 07:48	10/12/2019 13:27	10/12/2019 07:48	10/12/2019 13:27	5,64	15	84,61	CHI
20191265439	IACIARA	IA12132252	IACIARA S2	10/12/2019 07:50	10/12/2019 15:38	10/12/2019 07:50	10/12/2019 15:38	7,79	2	15,58	CHI
20191265439	POSSE	IA12132252	IACIARA S2	10/12/2019 07:50	10/12/2019 15:38	10/12/2019 07:50	10/12/2019 15:38	7,79	1	7,79	CHI
20191274240	CRISTALINA	KR12133609	CRISTALINA S1	10/12/2019 07:50	10/12/2019 12:51	10/12/2019 07:50	10/12/2019 12:51	5,01	6	30,09	CHI
20191274240	IPAMERI	KR12133609	CRISTALINA S1	10/12/2019 07:50	10/12/2019 12:51	10/12/2019 07:50	10/12/2019 12:51	5,01	6	30,09	CHI
20191265801	CRIXAS	SG10394720	SANTA TEREZINHA	10/12/2019 07:52	11/12/2019 15:42	10/12/2019 07:52	10/12/2019 10:18	2,44	263	640,48	CHI
20191265801	GUARINOS	SG10394720	SANTA TEREZINHA	10/12/2019 07:52	11/12/2019 15:42	10/12/2019 07:52	10/12/2019 10:18	2,44	79	192,39	CHI
20191265801	PILAR DE GOIAS	SG10394720	SANTA TEREZINHA	10/12/2019 07:52	11/12/2019 15:42	10/12/2019 07:52	10/12/2019 10:18	2,44	45	109,59	CHI
20191265801	SANTA TEREZINHA DE GOIAS	SG10394720	SANTA TEREZINHA	10/12/2019 07:52	11/12/2019 15:42	10/12/2019 07:52	10/12/2019 10:18	2,44	203	494,36	CHI
20191265801	GUARINOS	GF13213140	SANTA TEREZINHA	10/12/2019 07:52	11/12/2019 15:42	10/12/2019 07:52	10/12/2019 19:40	11,81	270	3187,58	CHI
20191265801	PILAR DE GOIAS	GF13213140	SANTA TEREZINHA	10/12/2019 07:52	11/12/2019 15:42	10/12/2019 07:52	10/12/2019 19:40	11,81	0	0,00	CHI
20191265801	CRIXAS	SG10394720	SANTA TEREZINHA	10/12/2019 07:52	11/12/2019 15:42	10/12/2019 19:05	10/12/2019 19:40	0,59	264	156,35	CHI
20191265801	GUARINOS	SG10394720	SANTA TEREZINHA	10/12/2019 07:52	11/12/2019 15:42	10/12/2019 19:05	10/12/2019 19:40	0,59	79	46,79	CHI
20191265801	PILAR DE GOIAS	SG10394720	SANTA TEREZINHA	10/12/2019 07:52	11/12/2019 15:42	10/12/2019 19:05	10/12/2019 19:40	0,59	45	26,65	CHI
20191265801	SANTA TEREZINHA DE GOIAS	SG10394720	SANTA TEREZINHA	10/12/2019 07:52	11/12/2019 15:42	10/12/2019 19:05	10/12/2019 19:40	0,59	203	120,22	CHI

20191265801	CRIXAS	SG10394720	SANTA TEREZINHA	10/12/2019 07:52	11/12/2019 15:42	10/12/2019 20:34	10/12/2019 22:20	1,77	264	466,18	CHI
20191265801	GUARINOS	SG10394720	SANTA TEREZINHA	10/12/2019 07:52	11/12/2019 15:42	10/12/2019 20:34	10/12/2019 22:20	1,77	79	139,50	CHI
20191265801	PILAR DE GOIAS	SG10394720	SANTA TEREZINHA	10/12/2019 07:52	11/12/2019 15:42	10/12/2019 20:34	10/12/2019 22:20	1,77	45	79,46	CHI
20191265801	SANTA TEREZINHA DE GOIAS	SG10394720	SANTA TEREZINHA	10/12/2019 07:52	11/12/2019 15:42	10/12/2019 20:34	10/12/2019 22:20	1,77	203	358,46	CHI
20191265801	CRIXAS	GF13213140	SANTA TEREZINHA	10/12/2019 07:52	11/12/2019 15:42	10/12/2019 07:52	11/12/2019 02:33	18,68	36	672,48	CHI
20191265801	GUARINOS	GF12117930LD	SANTA TEREZINHA	10/12/2019 07:52	11/12/2019 15:42	10/12/2019 07:52	11/12/2019 02:33	18,68	490	9153,20	CHI
20191265801	GUARINOS	GF13213140	SANTA TEREZINHA	10/12/2019 07:52	11/12/2019 15:42	10/12/2019 07:52	11/12/2019 02:33	18,68	73	1363,64	CHI
20191265801	ITAPACI	GF13213140	SANTA TEREZINHA	10/12/2019 07:52	11/12/2019 15:42	10/12/2019 07:52	11/12/2019 02:33	18,68	6	112,08	CHI
20191265801	GUARINOS	GF13213140	SANTA TEREZINHA	10/12/2019 07:52	11/12/2019 15:42	10/12/2019 20:34	11/12/2019 02:33	5,98	270	1613,85	CHI
20191265801	PILAR DE GOIAS	GF13213140	SANTA TEREZINHA	10/12/2019 07:52	11/12/2019 15:42	10/12/2019 20:34	11/12/2019 02:33	5,98	0	0,00	CHI
20191265801	GUARINOS	GF21280895	SANTA TEREZINHA	10/12/2019 07:52	11/12/2019 15:42	10/12/2019 07:52	11/12/2019 15:26	31,56	1	31,56	CHI
20191265801	GUARINOS	GF21164078	SANTA TEREZINHA	10/12/2019 07:52	11/12/2019 15:42	10/12/2019 07:52	11/12/2019 15:42	31,83	2	63,66	CHI
20191265449	URUACU	UR12243259	MARA ROSA	10/12/2019 07:53	10/12/2019 16:34	10/12/2019 07:53	10/12/2019 16:34	8,69	7	60,85	CHI
20191265450	NOVO BRASIL	NB12019396	JUSSARA	10/12/2019 07:53	10/12/2019 16:35	10/12/2019 07:53	10/12/2019 16:35	8,69	41	356,49	CHI
20191265460	FORMOSA	FA32042689	SAO JOAO D ALIANCA	10/12/2019 07:55	10/12/2019 14:25	10/12/2019 07:55	10/12/2019 14:25	6,49	4	25,97	CHI
20191273316	BALIZA	BH12331510	CAIAPONIA	10/12/2019 07:55	10/12/2019 17:31	10/12/2019 07:55	10/12/2019 17:31	9,59	30	287,57	CHI
20191275409	PIRANHAS	PH12390163	PIRANHAS	10/12/2019 07:55	10/12/2019 15:50	10/12/2019 07:55	10/12/2019 15:50	7,91	10	79,12	CHI
20191270830	MORRINHOS	MR32092122	MORRINHOS	10/12/2019 07:56	10/12/2019 15:22	10/12/2019 07:56	10/12/2019 15:22	7,43	5	37,13	CHI
20191265471	IPAMERI	IP12404738	IPAMERI	10/12/2019 07:57	10/12/2019 16:41	10/12/2019 07:57	10/12/2019 16:41	8,73	4	34,92	CHI
20191266010	CASTELANDIA	DM12054353	RIO DOS BOIS	10/12/2019 07:57	10/12/2019 12:52	10/12/2019 12:00	10/12/2019 12:52	0,87	49	42,47	CHI
20191266006	PALMEIRAS DE GOIAS	10002249420	PALMEIRAS	10/12/2019 07:58	10/12/2019 10:58	10/12/2019 07:58	10/12/2019 10:58	3,00	1	3,00	CHI
20191266007	MUTUNOPOLIS	MU21000002	MARA ROSA	10/12/2019 07:58	10/12/2019 10:38	10/12/2019 07:58	10/12/2019 10:38	2,66	1	2,66	CHI
20191266009	VILA PROPICIO	6749507	GOIANESIA S1	10/12/2019 07:58	11/12/2019 10:49	10/12/2019 07:58	11/12/2019 10:49	26,84	8	214,73	CHI
20191266018	TERESINA DE GOIAS	TE21328532	FLORES DE GOIAS	10/12/2019 07:59	10/12/2019 18:31	10/12/2019 07:59	10/12/2019 18:31	10,52	1	10,52	CHI
20191267599	FORMOSA	FA12116856	SAO JOAO D ALIANCA	10/12/2019 07:59	10/12/2019 13:48	10/12/2019 07:59	10/12/2019 13:48	5,81	6	34,85	CHI
20191280992	CATALAO	CT12077499	CATALAO S1	10/12/2019 08:00	10/12/2019 20:34	10/12/2019 08:00	10/12/2019 20:34	12,55	6	75,33	CHI
20191266026	CORUMBA DE GOIAS	CB21227491	CORUMBA	10/12/2019 08:01	10/12/2019 09:26	10/12/2019 08:01	10/12/2019 09:26	1,42	1	1,42	CHI
20191266029	MORRINHOS	MR21000166	MORRINHOS	10/12/2019 08:01	10/12/2019 17:42	10/12/2019 08:01	10/12/2019 17:42	9,67	1	9,67	CHI
20191266030	PALMINOPOLIS	PP12006641	PALMEIRAS	10/12/2019 08:01	10/12/2019 17:34	10/12/2019 08:01	10/12/2019 17:34	9,54	13	124,08	CHI
20191266032	CRIXAS	CX21000043	SANTA TEREZINHA	10/12/2019 08:02	10/12/2019 18:31	10/12/2019 08:02	10/12/2019 18:31	10,48	1	10,48	CHI
20191266033	ITABERAI	10006037486	ITABERAI S2	10/12/2019 08:02	10/12/2019 08:56	10/12/2019 08:02	10/12/2019 08:56	0,89	1	0,89	CHI
20191266034	PLANALTINA	10001985777	PLANALTINA	10/12/2019 08:02	10/12/2019 09:05	10/12/2019 08:02	10/12/2019 09:05	1,04	1	1,04	CHI
20191266038	TAQUARAL DE GOIAS	TQ12376457	ITABERAI S1	10/12/2019 08:02	10/12/2019 11:09	10/12/2019 08:02	10/12/2019 11:09	3,10	6	18,60	CHI

20191266045	ITUMBIARA	IT12000255	ITUMBIARA NOVA	10/12/2019 08:03	10/12/2019 12:07	10/12/2019 08:03	10/12/2019 12:07	4,06	1	4,06	CHI
20191266045	PANAMA	IT12000255	ITUMBIARA NOVA	10/12/2019 08:03	10/12/2019 12:07	10/12/2019 08:03	10/12/2019 12:07	4,06	4	16,22	CHI
20191266052	JARAGUA	70077710	JARAGUA	10/12/2019 08:04	10/12/2019 10:20	10/12/2019 08:04	10/12/2019 10:20	2,26	1	2,26	CHI
20191266054	DOVERLANDIA	DV21139970	CAIAPONIA	10/12/2019 08:04	10/12/2019 13:21	10/12/2019 08:04	10/12/2019 13:21	5,27	1	5,27	CHI
20191269037	ADELANDIA	DN12259109	ANICUNS	10/12/2019 08:04	10/12/2019 13:05	10/12/2019 08:04	10/12/2019 13:05	5,02	7	35,17	CHI
20191273341	DAVINOPOLIS	IO12085152	CATALAO S1	10/12/2019 08:04	10/12/2019 15:53	10/12/2019 08:04	10/12/2019 15:53	7,82	8	62,53	CHI
20191266059	RUBIATABA	RB21070866	RUBIATABA	10/12/2019 08:05	10/12/2019 11:23	10/12/2019 08:05	10/12/2019 11:23	3,29	1	3,29	CHI
20191267536	DAVINOPOLIS	OU12085107	CATALAO S1	10/12/2019 08:05	10/12/2019 12:31	10/12/2019 08:05	10/12/2019 12:31	4,43	6	26,57	CHI
20191267536	OUVIDOR	OU12085107	CATALAO S1	10/12/2019 08:05	10/12/2019 12:31	10/12/2019 08:05	10/12/2019 12:31	4,43	3	13,29	CHI
20191266064	CORREGO DO OURO	CO21319961	FIRMINOPOLIS S2	10/12/2019 08:07	10/12/2019 10:35	10/12/2019 08:07	10/12/2019 10:35	2,47	1	2,47	CHI
20191280528	FAZENDA NOVA	FN12199825	JUSSARA	10/12/2019 08:07	10/12/2019 21:53	10/12/2019 08:07	10/12/2019 21:53	13,77	3	41,30	CHI
20191266067	PADRE BERNARDO	PB21092815	PADRE BERNARDO	10/12/2019 08:08	10/12/2019 15:47	10/12/2019 08:08	10/12/2019 15:47	7,64	1	7,64	CHI
20191261370	ITAPURANGA	IK12250599	ITAPURANGA	10/12/2019 08:09	11/12/2019 19:59	10/12/2019 08:09	11/12/2019 08:10	24,01	8	192,12	CHI
20191261370	ITAPURANGA	IK12250599	ITAPURANGA	10/12/2019 08:09	11/12/2019 19:59	10/12/2019 08:09	11/12/2019 19:59	35,84	10	358,39	CHI
20191261370	MORRO AGUDO DE GOIAS	IK12250599	ITAPURANGA	10/12/2019 08:09	11/12/2019 19:59	10/12/2019 08:09	11/12/2019 19:59	35,84	5	179,20	CHI
20191261370	SAO PATRICIO	IK12250599	ITAPURANGA	10/12/2019 08:09	11/12/2019 19:59	10/12/2019 08:09	11/12/2019 19:59	35,84	2	71,68	CHI
20191261370	ITAPURANGA	IK12250599	ITAPURANGA	10/12/2019 08:09	11/12/2019 19:59	11/12/2019 18:09	11/12/2019 19:59	1,84	8	14,70	CHI
20191266072	SAO JOAO DA PARAUNA	RP12384674	FIRMINOPOLIS S2	10/12/2019 08:09	10/12/2019 19:32	10/12/2019 10:21	10/12/2019 10:40	0,31	93	28,70	CHI
20191266072	AURILANDIA	O1700214	FIRMINOPOLIS S2	10/12/2019 08:09	10/12/2019 19:32	10/12/2019 11:35	10/12/2019 11:39	0,07	4	0,29	CHI
20191266072	SAO JOAO DA PARAUNA	O1700214	FIRMINOPOLIS S2	10/12/2019 08:09	10/12/2019 19:32	10/12/2019 11:35	10/12/2019 11:39	0,07	737	53,23	CHI
20191266072	SAO JOAO DA PARAUNA	RP21194022	FIRMINOPOLIS S2	10/12/2019 08:09	10/12/2019 19:32	10/12/2019 09:27	10/12/2019 12:10	2,70	1	2,70	CHI
20191266072	SAO JOAO DA PARAUNA	RP12076382	FIRMINOPOLIS S2	10/12/2019 08:09	10/12/2019 19:32	10/12/2019 10:21	10/12/2019 16:45	6,39	4	25,54	CHI
20191266072	SAO JOAO DA PARAUNA	RP12049414	FIRMINOPOLIS S2	10/12/2019 08:09	10/12/2019 19:32	10/12/2019 10:21	10/12/2019 17:05	6,72	31	208,29	CHI
20191266072	SAO JOAO DA PARAUNA	RP12076382	FIRMINOPOLIS S2	10/12/2019 08:09	10/12/2019 19:32	10/12/2019 10:21	10/12/2019 19:32	9,18	18	165,23	CHI
20191266072	SAO JOAO DA PARAUNA	RP12026463LD	FIRMINOPOLIS S2	10/12/2019 08:09	10/12/2019 19:32	10/12/2019 11:35	10/12/2019 19:32	7,95	2	15,90	CHI
20191274402	CALDAZINHA	LB21010542	DAIA S2	10/12/2019 08:12	10/12/2019 14:56	10/12/2019 08:12	10/12/2019 14:56	6,73	1	6,73	CHI
20191266076	GOIANESIA	GE12297424	GOIANESIA S1	10/12/2019 08:13	10/12/2019 11:40	10/12/2019 08:13	10/12/2019 11:40	3,45	1	3,45	CHI
20191266082	ITAPURANGA	IK21308320	ITAPURANGA	10/12/2019 08:14	10/12/2019 12:08	10/12/2019 08:14	10/12/2019 12:08	3,90	1	3,90	CHI
20191266089	ITAPURANGA	10014865767	ITAPURANGA	10/12/2019 08:14	10/12/2019 14:23	10/12/2019 08:14	10/12/2019 14:23	6,15	1	6,15	CHI
20191266090	FAZENDA NOVA	JR12362437	BRITANIA	10/12/2019 08:14	10/12/2019 09:55	10/12/2019 08:14	10/12/2019 09:55	1,68	3	5,05	CHI
20191266090	JUSSARA	JR12362437	BRITANIA	10/12/2019 08:14	10/12/2019 09:55	10/12/2019 08:14	10/12/2019 09:55	1,68	7	11,78	CHI
20191266092	ACREUNA	EU12000002	ACREUNA	10/12/2019 08:14	10/12/2019 11:17	10/12/2019 08:14	10/12/2019 11:17	3,05	6	18,27	CHI
20191266095	MORRINHOS	MR21306869	GOIATUBA S1	10/12/2019 08:14	10/12/2019 10:50	10/12/2019 08:14	10/12/2019 10:50	2,59	2	5,19	CHI

20191266096	JATAI	JT21334262	JATAI S3	10/12/2019 08:14	10/12/2019 13:07	10/12/2019 08:14	10/12/2019 13:07	4,88	1	4,88	CHI
20191267002	LUZIANIA	3200189111	MARAJOARA	10/12/2019 08:14	10/12/2019 09:45	10/12/2019 08:14	10/12/2019 09:45	1,51	1	1,51	CHI
20191267006	PARAUNA	PU21198714	FIRMINOPOLIS S2	10/12/2019 08:14	10/12/2019 15:01	10/12/2019 08:14	10/12/2019 15:01	6,78	1	6,78	CHI
20191267503	CAIAPONIA	CP12380880	CAIAPONIA	10/12/2019 08:14	10/12/2019 22:10	10/12/2019 08:14	10/12/2019 22:10	13,94	10	139,36	CHI
20191267017	EDEALINA	ED12044487	PONTALINA	10/12/2019 08:16	10/12/2019 11:10	10/12/2019 08:16	10/12/2019 11:10	2,89	22	63,67	CHI
20191267018	GOIATUBA	GT21081076	RIO DOS BOIS	10/12/2019 08:16	11/12/2019 10:40	10/12/2019 08:16	11/12/2019 10:40	26,39	1	26,39	CHI
20191267019	SAO FRANCISCO DE GOIAS	SF21037728	SAO FRANCISCO DE GOIAS	10/12/2019 08:16	10/12/2019 16:07	10/12/2019 08:16	10/12/2019 16:07	7,84	1	7,84	CHI
20191267020	MUNDO NOVO DE GOIAS	MH11269235	NOVA CRIXAS	10/12/2019 08:16	10/12/2019 11:40	10/12/2019 08:16	10/12/2019 11:40	3,39	1	3,39	CHI
20191267022	GOIAS	GS12336487	ITABERAI S1	10/12/2019 08:16	10/12/2019 17:40	10/12/2019 08:16	10/12/2019 17:40	9,39	2	18,78	CHI
20191267023	JUSSARA	IU12087423	MATRINCHA	10/12/2019 08:16	10/12/2019 16:50	10/12/2019 08:16	10/12/2019 16:50	8,55	4	34,22	CHI
20191267026	BOM JESUS DE GOIAS	BJ21000063	BOM JESUS DE GOIAS	10/12/2019 08:17	10/12/2019 12:42	10/12/2019 08:17	10/12/2019 12:42	4,41	1	4,41	CHI
20191267028	GOIANIA	13005390	REAL S1	10/12/2019 08:17	10/12/2019 10:01	10/12/2019 08:17	10/12/2019 10:01	1,72	1	1,72	CHI
20191267033	PALMEIRAS DE GOIAS	PL21124141	PALMEIRAS	10/12/2019 08:18	10/12/2019 09:47	10/12/2019 08:18	10/12/2019 09:47	1,50	2	2,99	CHI
20191267034	URUACU	640016005	URUACU	10/12/2019 08:18	10/12/2019 12:25	10/12/2019 08:18	10/12/2019 12:25	4,11	1	4,11	CHI
20191267035	MINEIROS	MY12241802	PARQUE DAS EMAS	10/12/2019 08:18	10/12/2019 17:57	10/12/2019 08:18	10/12/2019 17:57	9,64	9	86,76	CHI
20191267039	GOIANIA	10770033	ATLANTICO S1	10/12/2019 08:19	10/12/2019 09:37	10/12/2019 08:19	10/12/2019 09:37	1,29	1	1,29	CHI
20191267040	IPAMERI	IP21363869	URUTAI	10/12/2019 08:19	11/12/2019 19:08	10/12/2019 08:19	11/12/2019 19:08	34,82	1	34,82	CHI
20191267088	VARJAO	VJ31066249	GUAPU S2	10/12/2019 08:19	10/12/2019 12:28	10/12/2019 08:19	10/12/2019 12:28	4,13	3	12,40	CHI
20191267044	PALESTINA DE GOIAS	PY21345532	PALESTINA	10/12/2019 08:20	10/12/2019 12:47	10/12/2019 08:20	10/12/2019 12:47	4,45	1	4,45	CHI
20191267049	PIRANHAS	PH21343661	PIRANHAS	10/12/2019 08:20	10/12/2019 20:30	10/12/2019 08:20	10/12/2019 20:30	12,17	1	12,17	CHI
20191267079	JUSSARA	JR12105382	BRITANIA	10/12/2019 08:20	11/12/2019 16:13	10/12/2019 08:20	11/12/2019 16:13	31,88	2	63,76	CHI
20191269825	MONTE ALEGRE DE GOIAS	MA12392319	SAO DOMINGOS	10/12/2019 08:20	10/12/2019 16:34	10/12/2019 08:20	10/12/2019 16:34	8,23	55	452,47	CHI
20191267053	GOIAS	GS12219907	GOIAS	10/12/2019 08:21	10/12/2019 14:59	10/12/2019 08:21	10/12/2019 14:59	6,63	1	6,63	CHI
20191267054	ITAPIRAPUA	IU12284913	MATRINCHA	10/12/2019 08:21	11/12/2019 10:36	10/12/2019 08:21	11/12/2019 10:36	26,24	2	52,48	CHI
20191267061	PORANGATU	PO12294487	SAO MIGUEL DO ARAGUAIA	10/12/2019 08:22	10/12/2019 12:50	10/12/2019 08:22	10/12/2019 12:50	4,46	1	4,46	CHI
20191267062	NAZARIO	440028723	ANICUNS	10/12/2019 08:22	10/12/2019 10:03	10/12/2019 08:22	10/12/2019 10:03	1,69	1	1,69	CHI
20191275290	MIMOSO DE GOIAS	MJ12295025	SAO JOAO D ALIANCA	10/12/2019 08:22	10/12/2019 13:07	10/12/2019 08:22	10/12/2019 13:07	4,74	6	28,44	CHI
20191267064	PADRE BERNARDO	PB21074283	PADRE BERNARDO	10/12/2019 08:23	10/12/2019 18:02	10/12/2019 08:23	10/12/2019 18:02	9,65	1	9,65	CHI
20191267067	INDIARA	JD12005507	PALMEIRAS	10/12/2019 08:23	10/12/2019 14:42	10/12/2019 08:23	10/12/2019 14:42	6,31	83	523,85	CHI
20191267067	JANDAIA	JD12005507	PALMEIRAS	10/12/2019 08:23	10/12/2019 14:42	10/12/2019 08:23	10/12/2019 14:42	6,31	30	189,34	CHI
20191267067	PALMEIRAS DE GOIAS	JD12005507	PALMEIRAS	10/12/2019 08:23	10/12/2019 14:42	10/12/2019 08:23	10/12/2019 14:42	6,31	38	239,83	CHI
20191267077	GOIANIA	GN11265866	CEPAIGO S1	10/12/2019 08:24	10/12/2019 10:39	10/12/2019 08:24	10/12/2019 10:39	2,24	6	13,45	CHI
20191267081	CRISTALINA	KR21000015	CRISTALINA S2	10/12/2019 08:24	10/12/2019 16:58	10/12/2019 08:24	10/12/2019 16:58	8,56	1	8,56	CHI

20191267085	SAO FRANCISCO DE GOIAS	SF12080076	SAO FRANCISCO DE GOIAS	10/12/2019 08:24	10/12/2019 16:05	10/12/2019 08:24	10/12/2019 16:05	7,68	17	130,53	CHI
20191268354	CALDAZINHA	LB12180205	DAIA S2	10/12/2019 08:25	10/12/2019 12:21	10/12/2019 08:25	10/12/2019 12:21	3,93	2	7,86	CHI
20191268354	LEOPOLDO DE BULHOES	LB12180205	DAIA S2	10/12/2019 08:25	10/12/2019 12:21	10/12/2019 08:25	10/12/2019 12:21	3,93	1	3,93	CHI
20191257856	JATAI	JT21103939	JATAI S3	10/12/2019 08:26	10/12/2019 10:01	10/12/2019 08:26	10/12/2019 10:01	1,57	1	1,57	CHI
20191267098	IPAMERI	IP21157433	IPAMERI	10/12/2019 08:27	10/12/2019 12:52	10/12/2019 08:27	10/12/2019 12:52	4,41	1	4,41	CHI
20191280469	PIRANHAS	PH21201813	PIRANHAS	10/12/2019 08:27	10/12/2019 23:47	10/12/2019 08:27	10/12/2019 23:47	15,32	1	15,32	CHI
20191267504	IPAMERI	580039500	IPAMERI	10/12/2019 08:28	10/12/2019 11:43	10/12/2019 08:28	10/12/2019 11:43	3,25	1	3,25	CHI
20191267506	GUARAITA	GK12250513	ITAPURANGA	10/12/2019 08:28	10/12/2019 12:25	10/12/2019 08:28	10/12/2019 12:25	3,94	4	15,75	CHI
20191267508	ITABERAI	IB21000061	ITABERAI S2	10/12/2019 08:28	10/12/2019 12:49	10/12/2019 08:28	10/12/2019 12:49	4,33	1	4,33	CHI
20191267511	LUZIANIA	LZ21156995	MARAJOARA	10/12/2019 08:29	10/12/2019 10:59	10/12/2019 08:29	10/12/2019 10:59	2,49	2	4,97	CHI
20191267513	ITABERAI	50108712	ITABERAI S2	10/12/2019 08:29	10/12/2019 10:04	10/12/2019 08:29	10/12/2019 10:04	1,57	1	1,57	CHI
20191267529	ORIZONA	OZ12109773	VIANOPOLIS	10/12/2019 08:29	10/12/2019 11:12	10/12/2019 08:29	10/12/2019 11:12	2,72	17	46,22	CHI
20191267517	CAIAPONIA	930047655	CAIAPONIA	10/12/2019 08:30	10/12/2019 10:21	10/12/2019 08:30	10/12/2019 10:21	1,85	1	1,85	CHI
20191267518	ARAGUAPAZ	AZ21234901	GOIAS	10/12/2019 08:30	10/12/2019 20:18	10/12/2019 08:30	10/12/2019 20:18	11,80	1	11,80	CHI
20191267522	CABECEIRAS	CW21381539	ITUIQUIRA	10/12/2019 08:30	10/12/2019 11:59	10/12/2019 08:30	10/12/2019 11:59	3,48	2	6,96	CHI
20191267523	LUZIANIA	LZ11031094	RIO VERMELHO	10/12/2019 08:30	10/12/2019 11:14	10/12/2019 08:30	10/12/2019 11:14	2,74	4	10,97	CHI
20191271669	SANCLERLANDIA	SL12323584	SAO LUIZ DOS MONTES BELOS	10/12/2019 08:30	10/12/2019 21:44	10/12/2019 08:30	10/12/2019 21:44	13,24	18	238,28	CHI
20191267524	MORRINHOS	MR12040536	MORRINHOS	10/12/2019 08:31	10/12/2019 12:56	10/12/2019 08:31	10/12/2019 12:56	4,42	8	35,38	CHI
20191267526	CATALAO	CT21266326	CATALAO S1	10/12/2019 08:31	10/12/2019 16:22	10/12/2019 08:31	10/12/2019 16:22	7,86	1	7,86	CHI
20191267530	SAO MIGUEL DO ARAGUAIA	SM21300951	SAO MIGUEL DO ARAGUAIA	10/12/2019 08:32	10/12/2019 13:13	10/12/2019 08:32	10/12/2019 13:13	4,68	1	4,68	CHI
20191267533	PROFESSOR JAMIL SAFADY	PJ21043090	ROCHEDO	10/12/2019 08:32	10/12/2019 18:55	10/12/2019 08:32	10/12/2019 18:55	10,39	1	10,39	CHI
20191267537	ALTO PARAISO DE GOIAS	BF21208748	NIQUELANDIA SUBTRANSMISSAO	10/12/2019 08:32	10/12/2019 10:55	10/12/2019 08:32	10/12/2019 10:55	2,37	1	2,37	CHI
20191275261	BALIZA	BH12331486	CAIAPONIA	10/12/2019 08:33	10/12/2019 17:52	10/12/2019 08:33	10/12/2019 17:52	9,30	8	74,40	CHI
20191267544	SANTA HELENA DE GOIAS	SH21024970	IPEGUARI	10/12/2019 08:34	10/12/2019 10:25	10/12/2019 08:34	10/12/2019 10:25	1,84	1	1,84	CHI
20191267549	MUTUNOPOLIS	MU12395764	MARA ROSA	10/12/2019 08:35	10/12/2019 16:17	10/12/2019 08:35	10/12/2019 16:17	7,69	9	69,20	CHI
20191267555	PORANGATU	840146590	PORANGATU	10/12/2019 08:36	10/12/2019 16:14	10/12/2019 08:36	10/12/2019 16:14	7,62	1	7,62	CHI
20191269856	CAVALCANTE	CJ12163386	FLORES DE GOIAS	10/12/2019 08:36	10/12/2019 11:40	10/12/2019 08:36	10/12/2019 11:40	3,06	7	21,42	CHI
20191267564	ITAGUARU	HE12023212	ITAPURANGA	10/12/2019 08:38	10/12/2019 16:00	10/12/2019 08:38	10/12/2019 16:00	7,36	1	7,36	CHI
20191267565	ALTO PARAISO DE GOIAS	BF12365282	SAO JOAO D ALIANCA	10/12/2019 08:38	10/12/2019 11:11	10/12/2019 08:38	10/12/2019 11:11	2,54	47	119,16	CHI
20191267575	NEROPOLIS	NR21254808	NEROPOLIS S2	10/12/2019 08:40	10/12/2019 12:09	10/12/2019 08:40	10/12/2019 12:09	3,48	1	3,48	CHI
20191267581	JANDAIA	1180009256	PALMEIRAS	10/12/2019 08:40	10/12/2019 21:14	10/12/2019 08:40	10/12/2019 21:14	12,56	1	12,56	CHI
20191260953	FLORES DE GOIAS	FB12245566	IACIARA S2	10/12/2019 08:41	10/12/2019 12:30	10/12/2019 08:41	10/12/2019 12:30	3,81	74	281,98	CHI
20191260953	SITIO D ABADIA	FB12245566	IACIARA S2	10/12/2019 08:41	10/12/2019 12:30	10/12/2019 08:41	10/12/2019 12:30	3,81	37	140,99	CHI

20191267583	APORE	AE12274132	ITAJA S1	10/12/2019 08:41	10/12/2019 17:20	10/12/2019 08:41	10/12/2019 17:20	8,67	2	17,33	CHI
20191267588	MINEIROS	1390068629	PARQUE DAS EMAS	10/12/2019 08:41	10/12/2019 12:25	10/12/2019 08:41	10/12/2019 12:25	3,72	1	3,72	CHI
20191267591	CACU	CC12191711	CACHOEIRA ALTA	10/12/2019 08:41	10/12/2019 13:37	10/12/2019 08:41	10/12/2019 13:37	4,92	4	19,68	CHI
20191267593	MORRINHOS	MR11275874	MORRINHOS	10/12/2019 08:42	10/12/2019 14:32	10/12/2019 08:42	10/12/2019 14:32	5,83	1	5,83	CHI
20191267596	CATALAO	CT21077471	CATALAO S1	10/12/2019 08:42	10/12/2019 10:18	10/12/2019 08:42	10/12/2019 10:18	1,59	1	1,59	CHI
20191268302	IACIARA	IA21000007	IACIARA S1	10/12/2019 08:43	10/12/2019 19:00	10/12/2019 08:43	10/12/2019 19:00	10,27	1	10,27	CHI
20191268303	PORANGATU	PO12208396	PORANGATU	10/12/2019 08:43	10/12/2019 15:25	10/12/2019 08:43	10/12/2019 15:25	6,68	1	6,68	CHI
20191268305	PLANALTINA	PI12302898	PLANALTINA	10/12/2019 08:44	10/12/2019 12:49	10/12/2019 08:44	10/12/2019 12:49	4,08	70	285,78	CHI
20191268308	HIDROLANDIA	HD21000165	CEPAIGO S2	10/12/2019 08:44	10/12/2019 11:40	10/12/2019 08:44	10/12/2019 11:40	2,93	1	2,93	CHI
20191268310	SAO FRANCISCO DE GOIAS	SF12248837	SAO FRANCISCO DE GOIAS	10/12/2019 08:44	10/12/2019 15:06	10/12/2019 08:44	10/12/2019 15:06	6,36	4	25,44	CHI
20191282304	BOM JARDIM DE GOIAS	BM12208862	BOM JARDIM	10/12/2019 08:44	11/12/2019 08:29	10/12/2019 08:44	11/12/2019 08:29	23,76	32	760,37	CHI
20191268315	MORRINHOS	MR21040740	MORRINHOS	10/12/2019 08:45	10/12/2019 09:35	10/12/2019 08:45	10/12/2019 09:35	0,82	2	1,64	CHI
20191269048	GOIANIA	GN11199192	ATLANTICO S3	10/12/2019 08:45	10/12/2019 10:37	10/12/2019 08:45	10/12/2019 10:37	1,86	121	225,53	CHI
20191268323	IPORA	IR12031700	IPORA	10/12/2019 08:47	11/12/2019 10:10	10/12/2019 08:47	11/12/2019 10:10	25,38	1	25,38	CHI
20191268325	PONTALINA	210046296	PONTALINA	10/12/2019 08:47	10/12/2019 09:58	10/12/2019 08:47	10/12/2019 09:58	1,17	1	1,17	CHI
20191268326	GOIANIA	14206985	MEIA PONTE	10/12/2019 08:47	10/12/2019 10:19	10/12/2019 08:47	10/12/2019 10:19	1,52	1	1,52	CHI
20191268327	PETROLINA DE GOIAS	PG12298070	PETROLINA	10/12/2019 08:48	10/12/2019 14:05	10/12/2019 08:48	10/12/2019 14:05	5,29	17	89,88	CHI
20191268330	SAO MIGUEL DO ARAGUAIA	SM12000023	SAO MIGUEL DO ARAGUAIA	10/12/2019 08:48	10/12/2019 12:43	10/12/2019 08:48	10/12/2019 12:43	3,91	2	7,81	CHI
20191275257	NIQUELANDIA	NQ12235112	URUACU	10/12/2019 08:48	10/12/2019 16:15	10/12/2019 08:48	10/12/2019 16:15	7,44	11	81,80	CHI
20191268344	SAO JOAO D ALIANCA	JL21312352	FLORES DE GOIAS	10/12/2019 08:50	10/12/2019 19:30	10/12/2019 08:50	10/12/2019 19:30	10,66	1	10,66	CHI
20191268345	MORRINHOS	MR21000281	MORRINHOS	10/12/2019 08:50	10/12/2019 11:54	10/12/2019 08:50	10/12/2019 11:54	3,05	1	3,05	CHI
20191268346	GOIANIA	10016994939	CAMPINAS S3	10/12/2019 08:50	10/12/2019 12:01	10/12/2019 08:50	10/12/2019 12:01	3,17	1	3,17	CHI
20191268347	PIRENOPOLIS	PV12122920	CORUMBA	10/12/2019 08:50	10/12/2019 13:17	10/12/2019 08:50	10/12/2019 13:17	4,43	2	8,87	CHI
20191268352	SAO LUIS DE MONTES BELOS	SL31145804	FIRMINOPOLIS S2	10/12/2019 08:51	10/12/2019 17:18	10/12/2019 08:51	10/12/2019 17:18	8,45	1	8,45	CHI
20191268355	CIDADE OCIDENTAL	DH12092831	MARAJOARA	10/12/2019 08:51	10/12/2019 10:20	10/12/2019 08:51	10/12/2019 10:20	1,47	33	48,47	CHI
20191267066	MONTE ALEGRE DE GOIAS	MA21358015	SAO DOMINGOS	10/12/2019 08:52	11/12/2019 11:22	10/12/2019 08:52	11/12/2019 11:22	26,49	1	26,49	CHI
20191268358	RIO VERDE	RV12100652	MONTIVIDIU T	10/12/2019 08:52	10/12/2019 11:58	10/12/2019 08:52	10/12/2019 11:58	3,10	10	30,98	CHI
20191268359	JATAI	10018550558	JATAI S3	10/12/2019 08:52	10/12/2019 11:49	10/12/2019 08:52	10/12/2019 11:49	2,94	1	2,94	CHI
20191268361	IPAMERI	IP12266903	IPAMERI	10/12/2019 08:52	11/12/2019 13:30	10/12/2019 08:52	11/12/2019 13:30	28,62	3	85,86	CHI
20191268371	PARAUNA	PU21222624	MONTIVIDIU T	10/12/2019 08:53	12/12/2019 07:15	10/12/2019 08:53	12/12/2019 07:15	46,35	1	46,35	CHI
20191269878	PORANGATU	PO12291105	PORANGATU	10/12/2019 08:53	10/12/2019 15:45	10/12/2019 08:53	10/12/2019 15:45	6,87	3	20,61	CHI
20191270867	NOVA IGUAQU DE GOIAS	NH12094070	CAMPINORTE	10/12/2019 08:53	10/12/2019 18:20	10/12/2019 08:53	10/12/2019 18:20	9,44	5	47,21	CHI
20191277977	GUARINOS	IW12072411	ITAPACI	10/12/2019 08:53	10/12/2019 16:51	10/12/2019 08:53	10/12/2019 16:51	7,96	20	159,21	CHI

20191277977	ITAPACI	IW12072411	ITAPACI	10/12/2019 08:53	10/12/2019 16:51	10/12/2019 08:53	10/12/2019 16:51	7,96	60	477,63	CHI
20191268376	PALMELO	PZ21027009	PIRES DO RIO S2	10/12/2019 08:54	11/12/2019 10:53	10/12/2019 08:54	11/12/2019 10:53	25,98	1	25,98	CHI
20191268379	CAVALCANTE	BF21264703	FLORES DE GOIAS	10/12/2019 08:54	10/12/2019 10:31	10/12/2019 08:54	10/12/2019 10:31	1,61	1	1,61	CHI
20191268380	TRES RANCHOS	TH12057694	CATALAO S1	10/12/2019 08:54	10/12/2019 11:20	10/12/2019 08:54	10/12/2019 11:20	2,43	56	136,22	CHI
20191268385	IPAMERI	580035438	IPAMERI	10/12/2019 08:55	10/12/2019 10:34	10/12/2019 08:55	10/12/2019 10:34	1,65	1	1,65	CHI
20191268391	FAINA	MS12220561	ITAPURANGA	10/12/2019 08:55	10/12/2019 14:02	10/12/2019 08:55	10/12/2019 14:02	5,11	10	51,14	CHI
20191280450	CRISTALINA	KR21092819	PAMPLONA	10/12/2019 08:55	10/12/2019 17:59	10/12/2019 08:55	10/12/2019 17:59	9,07	1	9,07	CHI
20191268393	SANTA CRUZ DE GOIAS	BC21012518	PIRES DO RIO S2	10/12/2019 08:56	11/12/2019 00:32	10/12/2019 08:56	11/12/2019 00:32	15,61	1	15,61	CHI
20191268394	NOVO GAMA	10010522075	MARAJOARA	10/12/2019 08:56	10/12/2019 10:40	10/12/2019 08:56	10/12/2019 10:40	1,73	1	1,73	CHI
20191268398	PLANALTINA	PI11149012	PLANALTINA	10/12/2019 08:56	10/12/2019 10:21	10/12/2019 08:56	10/12/2019 10:21	1,41	34	47,93	CHI
20191268399	OURO VERDE DE GOIAS	OV21191414	NEROPOLIS S1	10/12/2019 08:56	10/12/2019 12:22	10/12/2019 08:56	10/12/2019 12:22	3,43	1	3,43	CHI
20191269003	GOIANIA	10027070148	GOYA S1	10/12/2019 08:56	10/12/2019 10:02	10/12/2019 08:56	10/12/2019 10:02	1,09	1	1,09	CHI
20191270899	PIRENOPOLIS	PV12295641	SAO FRANCISCO DE GOIAS	10/12/2019 08:56	10/12/2019 13:00	10/12/2019 08:56	10/12/2019 13:00	4,06	181	734,26	CHI
20191269008	CRISTALINA	KR21082836	PAMPLONA	10/12/2019 08:57	10/12/2019 17:47	10/12/2019 08:57	10/12/2019 17:47	8,83	2	17,66	CHI
20191269010	SENADOR CANEDO	SW11343128	SENADOR CANEDO	10/12/2019 08:57	10/12/2019 10:50	10/12/2019 08:57	10/12/2019 10:50	1,87	52	97,24	CHI
20191271666	GOIANESIA	NP12240132	GOIANESIA S1	10/12/2019 08:57	10/12/2019 13:18	10/12/2019 08:57	10/12/2019 13:18	4,35	1	4,35	CHI
20191271666	VILA PROPICIO	NP12240132	GOIANESIA S1	10/12/2019 08:57	10/12/2019 13:18	10/12/2019 08:57	10/12/2019 13:18	4,35	9	39,13	CHI
20191274405	CALDAZINHA	LB21200283	DAIA S2	10/12/2019 08:57	10/12/2019 17:59	10/12/2019 08:57	10/12/2019 17:59	9,03	1	9,03	CHI
20191269015	VIANOPOLIS	VN21072136	VIANOPOLIS	10/12/2019 08:58	10/12/2019 13:50	10/12/2019 08:58	10/12/2019 13:50	4,86	1	4,86	CHI
20191269020	ITUMBIARA	690183252	ITUMBIARA VELHA S1	10/12/2019 08:59	10/12/2019 10:37	10/12/2019 08:59	10/12/2019 10:37	1,63	1	1,63	CHI
20191269021	JATAI	JT12398520	JATAI S1	10/12/2019 08:59	10/12/2019 22:49	10/12/2019 08:59	10/12/2019 22:49	13,83	9	124,47	CHI
20191280449	CRISTALINA	KR21082324	PAMPLONA	10/12/2019 08:59	10/12/2019 18:12	10/12/2019 08:59	10/12/2019 18:12	9,21	1	9,21	CHI
20191269030	SANTO ANTONIO DO DESCOBERTO	SN21163812	MARAJOARA	10/12/2019 09:01	10/12/2019 20:28	10/12/2019 09:01	10/12/2019 20:28	11,45	2	22,89	CHI
20191269035	CRISTALINA	KR21160959	CRISTALINA S1	10/12/2019 09:01	10/12/2019 17:08	10/12/2019 09:01	10/12/2019 17:08	8,11	1	8,11	CHI
20191269040	LUZIANIA	LZ12394914	MARAJOARA	10/12/2019 09:02	10/12/2019 11:45	10/12/2019 09:02	10/12/2019 11:45	2,71	8	21,72	CHI
20191278332	HIDROLINA	HL12003223	SANTA TEREZINHA	10/12/2019 09:02	10/12/2019 21:08	10/12/2019 09:02	10/12/2019 21:08	12,09	1	12,09	CHI
20191278332	PILAR DE GOIAS	HL12003223	SANTA TEREZINHA	10/12/2019 09:02	10/12/2019 21:08	10/12/2019 09:02	10/12/2019 21:08	12,09	49	592,30	CHI
20191278332	URUACU	HL12003223	SANTA TEREZINHA	10/12/2019 09:02	10/12/2019 21:08	10/12/2019 09:02	10/12/2019 21:08	12,09	4	48,35	CHI
20191269052	MINEIROS	SU12184133	SANTA RITA DO ARAGUAIA	10/12/2019 09:03	10/12/2019 13:48	10/12/2019 09:03	10/12/2019 13:48	4,73	11	52,08	CHI
20191269052	SANTA RITA DO ARAGUAIA	SU12184133	SANTA RITA DO ARAGUAIA	10/12/2019 09:03	10/12/2019 13:48	10/12/2019 09:03	10/12/2019 13:48	4,73	23	108,90	CHI
20191277901	ORIZONA	OZ12390023	VIANOPOLIS	10/12/2019 09:03	10/12/2019 22:36	10/12/2019 09:03	10/12/2019 22:36	13,54	8	108,31	CHI
20191269068	PLANALTINA	2960003191	PLANALTINA	10/12/2019 09:04	10/12/2019 11:17	10/12/2019 09:04	10/12/2019 11:17	2,21	1	2,21	CHI
20191269069	ITABERAI	10026513402	ITABERAI S2	10/12/2019 09:05	10/12/2019 12:15	10/12/2019 09:05	10/12/2019 12:15	3,18	1	3,18	CHI

20191269070	FIRMINOPOLIS	AI21125194	FIRMINOPOLIS S2	10/12/2019 09:05	10/12/2019 13:23	10/12/2019 09:05	10/12/2019 13:23	4,30	1	4,30	CHI
20191269085	TROMBAS	TB11288887	PORANGATU	10/12/2019 09:07	10/12/2019 15:00	10/12/2019 09:07	10/12/2019 15:00	5,88	2	11,76	CHI
20191269091	GOIANESIA	GE21358977	GOIANESIA S1	10/12/2019 09:07	10/12/2019 11:51	10/12/2019 09:07	10/12/2019 11:51	2,73	1	2,73	CHI
20191269092	GUARAITA	GK21216831	ITAPURANGA	10/12/2019 09:07	10/12/2019 12:20	10/12/2019 09:07	10/12/2019 12:20	3,21	1	3,21	CHI
20191269094	ITAPIRAPUA	IU12260001	MATRINCHA	10/12/2019 09:07	10/12/2019 17:55	10/12/2019 09:07	10/12/2019 17:55	8,80	2	17,60	CHI
20191269095	AGUA FRIA DE GOIAS	TL12302766	SAO JOAO D ALIANCA	10/12/2019 09:08	10/12/2019 11:20	10/12/2019 09:08	10/12/2019 11:20	2,20	76	166,99	CHI
20191269095	SAO JOAO D ALIANCA	TL12302766	SAO JOAO D ALIANCA	10/12/2019 09:08	10/12/2019 11:20	10/12/2019 09:08	10/12/2019 11:20	2,20	1	2,20	CHI
20191269099	BALIZA	BH11331487	CAIAPONIA	10/12/2019 09:08	11/12/2019 18:34	10/12/2019 09:08	11/12/2019 18:34	33,42	1	33,42	CHI
20191269100	VIANOPOLIS	VN12062749	VIANOPOLIS	10/12/2019 09:09	10/12/2019 14:20	10/12/2019 09:09	10/12/2019 14:20	5,18	2	10,36	CHI
20191269802	RIO VERDE	RV21212714	CABRIUVA S2	10/12/2019 09:09	10/12/2019 11:22	10/12/2019 09:09	10/12/2019 11:22	2,21	1	2,21	CHI
20191269806	RIO VERDE	RV11217549	JATAI S2	10/12/2019 09:10	10/12/2019 14:10	10/12/2019 09:10	10/12/2019 14:10	4,99	1	4,99	CHI
20191276214	CAMPINORTE	CR12094178	CAMPINORTE	10/12/2019 09:10	10/12/2019 14:36	10/12/2019 09:10	10/12/2019 14:36	5,42	11	59,66	CHI
20191253610	BRITANIA	BT12210599	BRITANIA	10/12/2019 09:11	11/12/2019 01:19	10/12/2019 09:11	10/12/2019 18:17	9,10	10	90,98	CHI
20191253610	BRITANIA	BT13249632	BRITANIA	10/12/2019 09:11	11/12/2019 01:19	10/12/2019 09:11	11/12/2019 01:19	16,13	598	9647,73	CHI
20191253610	JUSSARA	BT13249632	BRITANIA	10/12/2019 09:11	11/12/2019 01:19	10/12/2019 09:11	11/12/2019 01:19	16,13	41	661,47	CHI
20191269831	PARAUNA	PU21081343	FIRMINOPOLIS S2	10/12/2019 09:13	10/12/2019 15:30	10/12/2019 09:13	10/12/2019 15:30	6,28	1	6,28	CHI
20191269830	DAMIANOPOLIS	SI13322748	IACIARA S2	10/12/2019 09:14	10/12/2019 12:08	10/12/2019 11:57	10/12/2019 12:08	0,17	130	22,43	CHI
20191269830	SITIO D ABADIA	SI13322748	IACIARA S2	10/12/2019 09:14	10/12/2019 12:08	10/12/2019 11:57	10/12/2019 12:08	0,17	378	65,21	CHI
20191269832	NIQUELANDIA	NQ21227325	URUACU	10/12/2019 09:14	10/12/2019 22:31	10/12/2019 09:14	10/12/2019 22:31	13,28	22	292,17	CHI
20191269837	GOIANIA	17287583	FERROVIARIO S1	10/12/2019 09:15	10/12/2019 12:58	10/12/2019 09:15	10/12/2019 12:58	3,71	1	3,71	CHI
20191269838	GOIANIA	GN11002040	REAL S2	10/12/2019 09:15	10/12/2019 10:38	10/12/2019 09:15	10/12/2019 10:38	1,38	38	52,32	CHI
20191269839	ITUMBIARA	690198930	ITUMBIARA NOVA	10/12/2019 09:15	10/12/2019 13:23	10/12/2019 09:15	10/12/2019 13:23	4,14	1	4,14	CHI
20191269848	CAMPO ALEGRE DE GOIAS	CM12077543	CAMPO ALEGRE DE GOIAS	10/12/2019 09:18	10/12/2019 17:45	10/12/2019 09:18	10/12/2019 17:45	8,44	16	135,04	CHI
20191277017	AURILANDIA	AI12000011	FIRMINOPOLIS S2	10/12/2019 09:20	10/12/2019 13:52	10/12/2019 09:20	10/12/2019 13:52	4,53	37	167,68	CHI
20191277017	FIRMINOPOLIS	AI12000011	FIRMINOPOLIS S2	10/12/2019 09:20	10/12/2019 13:52	10/12/2019 09:20	10/12/2019 13:52	4,53	81	367,09	CHI
20191277017	SAO JOAO DA PARAUNA	AI12000011	FIRMINOPOLIS S2	10/12/2019 09:20	10/12/2019 13:52	10/12/2019 09:20	10/12/2019 13:52	4,53	66	299,11	CHI
20191269861	SAO MIGUEL DO ARAGUAIA	SM12074411	SAO MIGUEL DO ARAGUAIA	10/12/2019 09:21	10/12/2019 12:05	10/12/2019 09:21	10/12/2019 12:05	2,73	10	27,31	CHI
20191269869	CRISTALINA	KR21251302	CRISTALINA S2	10/12/2019 09:22	10/12/2019 12:51	10/12/2019 09:22	10/12/2019 12:51	3,48	1	3,48	CHI
20191269874	SITIO D ABADIA	FB11285671	IACIARA S2	10/12/2019 09:23	10/12/2019 17:52	10/12/2019 09:23	10/12/2019 17:52	8,48	1	8,48	CHI
20191269875	CATALAO	1990270430	CATALAO S2	10/12/2019 09:23	10/12/2019 11:15	10/12/2019 09:23	10/12/2019 11:15	1,86	1	1,86	CHI
20191269879	RIO VERDE	RV21365471	MONTIVIDIU T	10/12/2019 09:24	10/12/2019 14:20	10/12/2019 09:24	10/12/2019 14:20	4,93	1	4,93	CHI
20191269880	ANAPOLIS	20291220	JUNDIAI S1	10/12/2019 09:24	10/12/2019 17:28	10/12/2019 09:24	10/12/2019 17:28	8,06	1	8,06	CHI
20191269882	JATAI	10009860159	JATAI S3	10/12/2019 09:24	10/12/2019 10:47	10/12/2019 09:24	10/12/2019 10:47	1,38	1	1,38	CHI

20191269884	JATAI	JT21359291	JATAI S1	10/12/2019 09:24	10/12/2019 12:40	10/12/2019 09:24	10/12/2019 12:40	3,26	1	3,26	CHI
20191260581	CATALAO	CT12064049	CATALAO S2	10/12/2019 09:26	10/12/2019 20:42	10/12/2019 09:26	10/12/2019 20:42	11,26	3	33,77	CHI
20191260581	CUMARI	CT12064049	CATALAO S2	10/12/2019 09:26	10/12/2019 20:42	10/12/2019 09:26	10/12/2019 20:42	11,26	3	33,77	CHI
20191269898	ESTRELA DO NORTE	0207214	MARA ROSA	10/12/2019 09:26	10/12/2019 15:18	10/12/2019 09:26	10/12/2019 11:11	1,75	3	5,24	CHI
20191269898	FORMOSO	0207214	MARA ROSA	10/12/2019 09:26	10/12/2019 15:18	10/12/2019 09:26	10/12/2019 11:11	1,75	102	178,27	CHI
20191269898	MUTUNOPOLIS	0207214	MARA ROSA	10/12/2019 09:26	10/12/2019 15:18	10/12/2019 09:26	10/12/2019 11:11	1,75	6	10,49	CHI
20191269898	PORANGATU	0207214	MARA ROSA	10/12/2019 09:26	10/12/2019 15:18	10/12/2019 09:26	10/12/2019 11:11	1,75	3	5,24	CHI
20191269898	SANTA TEREZA DE GOIAS	0207214	MARA ROSA	10/12/2019 09:26	10/12/2019 15:18	10/12/2019 09:26	10/12/2019 11:11	1,75	1575	2752,75	CHI
20191269898	SANTA TEREZA DE GOIAS	SE13070423	MARA ROSA	10/12/2019 09:26	10/12/2019 15:18	10/12/2019 10:40	10/12/2019 11:11	0,52	10	5,20	CHI
20191269898	ESTRELA DO NORTE	SE13297080	MARA ROSA	10/12/2019 09:26	10/12/2019 15:18	10/12/2019 12:03	10/12/2019 12:16	0,21	19	4,01	CHI
20191269898	SANTA TEREZA DE GOIAS	SE13297080	MARA ROSA	10/12/2019 09:26	10/12/2019 15:18	10/12/2019 12:03	10/12/2019 12:16	0,21	12	2,53	CHI
20191269898	ESTRELA DO NORTE	00470414	MARA ROSA	10/12/2019 09:26	10/12/2019 15:18	10/12/2019 12:03	10/12/2019 12:16	0,22	31	6,67	CHI
20191269898	FORMOSO	00470414	MARA ROSA	10/12/2019 09:26	10/12/2019 15:18	10/12/2019 12:03	10/12/2019 12:16	0,22	6	1,29	CHI
20191269898	ESTRELA DO NORTE	ET13257896	MARA ROSA	10/12/2019 09:26	10/12/2019 15:18	10/12/2019 14:51	10/12/2019 15:18	0,45	31	13,81	CHI
20191269898	FORMOSO	ET13257896	MARA ROSA	10/12/2019 09:26	10/12/2019 15:18	10/12/2019 14:51	10/12/2019 15:18	0,45	6	2,67	CHI
20191269899	ANAPOLIS	10012115086	ANAPOLIS UNIVERSITARIO S2	10/12/2019 09:26	10/12/2019 10:46	10/12/2019 09:26	10/12/2019 10:46	1,33	1	1,33	CHI
20191270809	ITUMBIARA	690118570	ITUMBIARA NOVA	10/12/2019 09:27	10/12/2019 14:12	10/12/2019 09:27	10/12/2019 14:12	4,75	1	4,75	CHI
20191270810	MINACU	4020023130	MINACU	10/12/2019 09:27	10/12/2019 10:48	10/12/2019 09:27	10/12/2019 10:48	1,35	1	1,35	CHI
20191270811	LUZIANIA	LZ12304862	VIANOPOLIS	10/12/2019 09:27	10/12/2019 11:21	10/12/2019 09:27	10/12/2019 11:21	1,90	4	7,58	CHI
20191273385	JOVIANIA	JV11247730	GOIATUBA S1	10/12/2019 09:29	10/12/2019 13:47	10/12/2019 09:29	10/12/2019 13:47	4,29	45	193,10	CHI
20191270827	SAO DOMINGOS	SD12211512	SAO DOMINGOS	10/12/2019 09:30	10/12/2019 16:43	10/12/2019 09:30	10/12/2019 16:43	7,21	10	72,10	CHI
20191270829	APARECIDA DE GOIANIA	10016358919	REAL S2	10/12/2019 09:30	10/12/2019 13:20	10/12/2019 09:30	10/12/2019 13:20	3,82	1	3,82	CHI
20191275229	DAVINOPOLIS	IO12028236	CATALAO S1	10/12/2019 09:30	10/12/2019 13:06	10/12/2019 09:30	10/12/2019 13:06	3,60	3	10,79	CHI
20191275229	OUVIDOR	IO12028236	CATALAO S1	10/12/2019 09:30	10/12/2019 13:06	10/12/2019 09:30	10/12/2019 13:06	3,60	23	82,72	CHI
20191275229	TRES RANCHOS	IO12028236	CATALAO S1	10/12/2019 09:30	10/12/2019 13:06	10/12/2019 09:30	10/12/2019 13:06	3,60	1	3,60	CHI
20191270834	VARJAO	VJ32064254	GUAPO S2	10/12/2019 09:31	10/12/2019 14:26	10/12/2019 09:31	10/12/2019 14:26	4,91	4	19,63	CHI
20191270836	CAMPOS VERDES	3790046046	SANTA TEREZINHA	10/12/2019 09:31	10/12/2019 19:49	10/12/2019 09:31	10/12/2019 19:49	10,29	1	10,29	CHI
20191270839	CAVALCANTE	BF21264648	FLORES DE GOIAS	10/12/2019 09:33	10/12/2019 09:55	10/12/2019 09:33	10/12/2019 09:55	0,38	1	0,38	CHI
20191270840	CATALAO	1990146860	CATALAO S2	10/12/2019 09:33	10/12/2019 11:24	10/12/2019 09:33	10/12/2019 11:24	1,85	1	1,85	CHI
20191270841	CORUMBA DE GOIAS	ZN21273285	COCALZINHO	10/12/2019 09:33	10/12/2019 21:20	10/12/2019 09:33	10/12/2019 21:20	11,77	1	11,77	CHI
20191270842	PALESTINA DE GOIAS	PY21374917	PALESTINA	10/12/2019 09:33	10/12/2019 14:59	10/12/2019 09:33	10/12/2019 14:59	5,42	1	5,42	CHI
20191270845	GOIANIA	GN21001712	XAVANTES	10/12/2019 09:34	10/12/2019 10:54	10/12/2019 09:34	10/12/2019 10:54	1,33	1	1,33	CHI
20191270846	NOVO BRASIL	JR21092771	JUSSARA	10/12/2019 09:34	10/12/2019 18:40	10/12/2019 09:34	10/12/2019 18:40	9,10	1	9,10	CHI

20191270847	NIQUELANDIA	NQ12268706	NIQUELANDIA SUBTRANSMISSAO	10/12/2019 09:34	10/12/2019 19:57	10/12/2019 09:34	10/12/2019 19:57	10,37	1	10,37	CHI
20191270852	COCALZINHO DE GOIAS	ZN21201265	COCALZINHO	10/12/2019 09:37	10/12/2019 14:43	10/12/2019 09:37	10/12/2019 14:43	5,10	1	5,10	CHI
20191270855	LUZIANIA	120056290	RIO VERMELHO	10/12/2019 09:37	10/12/2019 12:32	10/12/2019 09:37	10/12/2019 12:32	2,91	1	2,91	CHI
20191274276	JATAI	JT12109029	JATAI S1	10/12/2019 09:37	10/12/2019 13:40	10/12/2019 09:37	10/12/2019 13:40	4,06	28	113,62	CHI
20191270856	JARAGUA	JA21121772	JARAGUA	10/12/2019 09:38	10/12/2019 14:35	10/12/2019 09:38	10/12/2019 14:35	4,96	1	4,96	CHI
20191270857	PALMEIRAS DE GOIAS	PL21321982	PALMEIRAS	10/12/2019 09:38	10/12/2019 11:00	10/12/2019 09:38	10/12/2019 11:00	1,37	1	1,37	CHI
20191270858	PETROLINA DE GOIAS	10009275930	PETROLINA	10/12/2019 09:38	10/12/2019 15:49	10/12/2019 09:38	10/12/2019 15:49	6,18	1	6,18	CHI
20191270859	GOIATUBA	GT12041937	GOIATUBA S2	10/12/2019 09:38	10/12/2019 19:01	10/12/2019 09:38	10/12/2019 19:01	9,37	2	18,75	CHI
20191270860	RUBIATABA	RB21312150	RUBIATABA	10/12/2019 09:38	10/12/2019 13:54	10/12/2019 09:38	10/12/2019 13:54	4,26	2	8,51	CHI
20191270865	AGUA FRIA DE GOIAS	TL12208770	SAO JOAO D ALIANCA	10/12/2019 09:39	10/12/2019 17:40	10/12/2019 09:39	10/12/2019 17:40	8,02	58	465,21	CHI
20191270873	MINACU	IH12230480	MINACU	10/12/2019 09:40	10/12/2019 11:32	10/12/2019 09:40	10/12/2019 11:32	1,85	17	31,50	CHI
20191270874	SAO MIGUEL DO ARAGUAIA	830037100	SAO MIGUEL DO ARAGUAIA	10/12/2019 09:40	10/12/2019 15:45	10/12/2019 09:40	10/12/2019 15:45	6,08	1	6,08	CHI
20191277501	COCALZINHO DE GOIAS	1200033910	COCALZINHO	10/12/2019 09:41	10/12/2019 18:09	10/12/2019 09:41	10/12/2019 18:09	8,46	1	8,46	CHI
20191270879	MINEIROS	1390101220	PARQUE DAS EMAS	10/12/2019 09:42	10/12/2019 19:40	10/12/2019 09:42	10/12/2019 19:40	9,97	1	9,97	CHI
20191270881	DISTRITO FEDERAL	PB12342133LD	PADRE BERNARDO	10/12/2019 09:42	10/12/2019 21:37	10/12/2019 09:42	10/12/2019 21:37	11,91	3	35,73	CHI
20191270881	PLANALTINA	PB12342133LD	PADRE BERNARDO	10/12/2019 09:42	10/12/2019 21:37	10/12/2019 09:42	10/12/2019 21:37	11,91	4	47,64	CHI
20191270886	CRISTALINA	1060063806	CRISTALINA S1	10/12/2019 09:43	10/12/2019 16:00	10/12/2019 09:43	10/12/2019 16:00	6,28	1	6,28	CHI
20191270888	CATALAO	CT21237602	CATALAO S1	10/12/2019 09:43	11/12/2019 10:55	10/12/2019 09:43	11/12/2019 10:55	25,20	1	25,20	CHI
20191270891	HIDROLINA	HL21135621	ITAPACI	10/12/2019 09:44	11/12/2019 10:48	10/12/2019 09:44	11/12/2019 10:48	25,06	1	25,06	CHI
20191270896	PLANALTINA	PI12359108	PLANALTINA	10/12/2019 09:46	10/12/2019 13:32	10/12/2019 09:46	10/12/2019 13:32	3,76	1	3,76	CHI
20191271676	FAINA	FC11220259	GOIAS	10/12/2019 09:46	10/12/2019 14:25	10/12/2019 09:46	10/12/2019 14:25	4,64	68	315,31	CHI
20191272385	ANAPOLIS	AN11040774	ANAPOLIS UNIVERSITARIO S2	10/12/2019 09:48	10/12/2019 12:04	10/12/2019 09:48	10/12/2019 12:04	2,27	111	251,48	CHI
20191271613	AGUAS LINDAS DE GOIAS	LA11089677	AGUAS LINDAS DE GOIAS S1	10/12/2019 09:50	10/12/2019 13:52	10/12/2019 09:50	10/12/2019 13:52	4,02	185	743,13	CHI
20191271614	SANTA BARBARA DE GOIAS	TR12323215	TRINDADE	10/12/2019 09:51	11/12/2019 12:36	10/12/2019 09:51	11/12/2019 12:36	26,75	2	53,51	CHI
20191271619	GOIANIA	16615918	GOYA S2	10/12/2019 09:51	10/12/2019 11:07	10/12/2019 09:51	10/12/2019 11:07	1,26	1	1,26	CHI
20191271621	ANICUNS	910064398	FIRMINOPOLIS S2	10/12/2019 09:51	10/12/2019 18:41	10/12/2019 09:51	10/12/2019 18:41	8,83	1	8,83	CHI
20191272358	FORMOSA	FA12204612	ITIQUEIRA	10/12/2019 09:51	10/12/2019 11:39	10/12/2019 09:51	10/12/2019 11:39	1,79	12	21,51	CHI
20191271625	CALDAS NOVAS	760025046	SERRA DE CALDAS	10/12/2019 09:52	10/12/2019 17:55	10/12/2019 09:52	10/12/2019 17:55	8,06	1	8,06	CHI
20191271631	ITAPURANGA	IK21311416	ITAPURANGA	10/12/2019 09:53	10/12/2019 11:36	10/12/2019 09:53	10/12/2019 11:36	1,71	1	1,71	CHI
20191271645	CRISTALINA	KR21112980	PAMPLONA	10/12/2019 09:55	10/12/2019 19:28	10/12/2019 09:55	10/12/2019 19:28	9,55	1	9,55	CHI
20191271649	QUIRINOPOLIS	80033039	QUIRINOPOLIS	10/12/2019 09:55	10/12/2019 11:10	10/12/2019 09:55	10/12/2019 11:10	1,24	1	1,24	CHI
20191271650	BELA VISTA DE GOIAS	BV21245052	BELA VISTA S2	10/12/2019 09:55	10/12/2019 18:04	10/12/2019 09:55	10/12/2019 18:04	8,14	1	8,14	CHI
20191271657	CRISTALINA	IP21386743	CRISTALINA S1	10/12/2019 09:57	10/12/2019 16:33	10/12/2019 09:57	10/12/2019 16:33	6,59	1	6,59	CHI

20191271660	NEROPOLIS	NR21374635	NEROPOLIS S2	10/12/2019 09:58	10/12/2019 18:03	10/12/2019 09:58	10/12/2019 18:03	8,08	1	8,08	CHI
20191271661	SANTO ANTONIO DE GOIAS	BW21013395	NEROPOLIS S1	10/12/2019 09:58	11/12/2019 03:20	10/12/2019 09:58	11/12/2019 03:20	17,37	1	17,37	CHI
20191271662	ITUMBIARA	IT21010401	PARANAIBA	10/12/2019 09:58	10/12/2019 18:16	10/12/2019 09:58	10/12/2019 18:16	8,30	1	8,30	CHI
20191271663	SANCLERLANDIA	SC21186053	FIRMINOPOLIS S2	10/12/2019 09:58	12/12/2019 00:42	10/12/2019 09:58	12/12/2019 00:42	38,73	1	38,73	CHI
20191271679	GOIANIA	GN12000608	CAMPINAS S3	10/12/2019 10:01	10/12/2019 11:34	10/12/2019 10:01	10/12/2019 11:34	1,54	76	117,15	CHI
20191271687	SAO MIGUEL DO ARAGUAIA	SM21141141	SAO MIGUEL DO ARAGUAIA	10/12/2019 10:03	10/12/2019 14:45	10/12/2019 10:03	10/12/2019 14:45	4,69	1	4,69	CHI
20191271688	MORRINHOS	MR21100036	MORRINHOS	10/12/2019 10:04	10/12/2019 14:31	10/12/2019 10:04	10/12/2019 14:31	4,45	1	4,45	CHI
20191271690	FORMOSA	FA12204777	ITUIQUIRA	10/12/2019 10:04	10/12/2019 13:41	10/12/2019 10:04	10/12/2019 13:41	3,61	2	7,22	CHI
20191271691	LUZIANIA	10023341139	RIO VERMELHO	10/12/2019 10:04	10/12/2019 15:00	10/12/2019 10:04	10/12/2019 15:00	4,93	1	4,93	CHI
20191271697	GOIAS	GS21079309	MATRINCHA	10/12/2019 10:06	10/12/2019 18:10	10/12/2019 10:06	10/12/2019 18:10	8,08	1	8,08	CHI
20191271700	PLANALTINA	PI12344170	PLANALTINA	10/12/2019 10:07	10/12/2019 15:32	10/12/2019 10:07	10/12/2019 15:32	5,41	1	5,41	CHI
20191272309	APORE	AE12301939	ITAJA S2	10/12/2019 10:08	10/12/2019 13:30	10/12/2019 10:08	10/12/2019 13:30	3,35	1	3,35	CHI
20191272314	NOVA VENEZA	NV21280958	INHUMAS S1	10/12/2019 10:08	10/12/2019 23:02	10/12/2019 10:08	10/12/2019 23:02	12,89	11	141,83	CHI
20191272310	ABADIANIA	AN21022160	ANAPOLIS UNIVERSITARIO S2	10/12/2019 10:09	10/12/2019 17:34	10/12/2019 10:09	10/12/2019 17:34	7,41	1	7,41	CHI
20191272322	CATALAO	CT21281426	CATALAO S1	10/12/2019 10:11	11/12/2019 15:07	10/12/2019 10:11	11/12/2019 15:07	28,93	1	28,93	CHI
20191272349	APORE	AE12301941	ITAJA S2	10/12/2019 10:11	10/12/2019 12:31	10/12/2019 10:11	10/12/2019 12:31	2,33	3	6,99	CHI
20191272332	GOIANIA	16697832	ATLANTICO S1	10/12/2019 10:13	10/12/2019 11:49	10/12/2019 10:13	10/12/2019 11:49	1,59	1	1,59	CHI
20191272397	LEOPOLDO DE BULHOES	LB12032455	DAIA S2	10/12/2019 10:13	10/12/2019 11:37	10/12/2019 10:13	10/12/2019 11:37	1,40	45	62,82	CHI
20191272337	GOIANIA	GN11000865	GOIANIA LESTE S3	10/12/2019 10:14	10/12/2019 13:34	10/12/2019 10:14	10/12/2019 13:34	3,32	80	265,64	CHI
20191272345	URUACU	UR12325199	URUACU	10/12/2019 10:16	10/12/2019 16:36	10/12/2019 10:16	10/12/2019 16:36	6,33	8	50,62	CHI
20191272351	BOM JESUS DE GOIAS	1250059826	BOM JESUS DE GOIAS	10/12/2019 10:17	10/12/2019 18:52	10/12/2019 10:17	10/12/2019 18:52	8,57	1	8,57	CHI
20191272355	CRISTALINA	KR21165906	CRISTALINA S2	10/12/2019 10:18	10/12/2019 19:53	10/12/2019 10:18	10/12/2019 19:53	9,57	2	19,15	CHI
20191272357	JATAI	JT12000085	JATAI S3	10/12/2019 10:18	10/12/2019 11:56	10/12/2019 10:18	10/12/2019 11:56	1,62	1413	2291,41	CHI
20191276259	NIQUELANDIA	NQ12256380	NIQUELANDIA SUBTRANSMISSAO	10/12/2019 10:19	10/12/2019 15:19	10/12/2019 10:19	10/12/2019 15:19	4,99	12	59,87	CHI
20191272363	PLANALTINA	2960249179	PLANALTINA	10/12/2019 10:20	10/12/2019 15:05	10/12/2019 10:20	10/12/2019 15:05	4,74	1	4,74	CHI
20191275211	CAIAPONIA	IV12249611	IPORA	10/12/2019 10:20	11/12/2019 08:20	10/12/2019 10:20	11/12/2019 08:20	21,99	2	43,98	CHI
20191275211	IVOLANDIA	IV12249611	IPORA	10/12/2019 10:20	11/12/2019 08:20	10/12/2019 10:20	11/12/2019 08:20	21,99	7	153,94	CHI
20191273301	PALMEIRAS DE GOIAS	PL12046351	PALMEIRAS	10/12/2019 10:21	10/12/2019 15:59	10/12/2019 10:21	10/12/2019 15:59	5,64	4	22,58	CHI
20191272375	LUZIANIA	LZ21075049	RIO VERMELHO	10/12/2019 10:23	10/12/2019 12:42	10/12/2019 10:23	10/12/2019 12:42	2,31	1	2,31	CHI
20191273001	ABADIA DE GOIAS	AO21239147	CARAJAS S1	10/12/2019 10:23	10/12/2019 10:53	10/12/2019 10:23	10/12/2019 10:53	0,50	2	1,00	CHI
20191272382	ALEXANIA	480034795	ALEXANIA	10/12/2019 10:24	10/12/2019 16:33	10/12/2019 10:24	10/12/2019 16:33	6,14	1	6,14	CHI
20191272386	ITUMBIARA	BG21000085	ITUMBIARA VELHA S2	10/12/2019 10:24	10/12/2019 13:11	10/12/2019 10:24	10/12/2019 13:11	2,78	1	2,78	CHI
20191272388	CALDAS NOVAS	CN21142374	SERRA DE CALDAS	10/12/2019 10:25	10/12/2019 12:25	10/12/2019 10:25	10/12/2019 12:25	1,99	1	1,99	CHI

20191283052	BARRO ALTO	BA12068485	BARRO ALTO	10/12/2019 10:25	11/12/2019 08:30	10/12/2019 10:25	11/12/2019 08:30	22,08	1	22,08	CHI
20191283052	SANTA RITA DO NOVO DESTINO	BA12068485	BARRO ALTO	10/12/2019 10:25	11/12/2019 08:30	10/12/2019 10:25	11/12/2019 08:30	22,08	32	706,47	CHI
20191272393	GOIANIA	14984763	XAVANTES	10/12/2019 10:26	10/12/2019 13:16	10/12/2019 10:26	10/12/2019 13:16	2,82	1	2,82	CHI
20191272396	FAINA	FC12299837	GOIAS	10/12/2019 10:27	10/12/2019 17:13	10/12/2019 10:27	10/12/2019 17:13	6,76	6	40,54	CHI
20191278386	ITAPIRAPUA	IU12089742	MATRINCHA	10/12/2019 10:27	10/12/2019 14:58	10/12/2019 10:27	10/12/2019 14:58	4,51	6	27,08	CHI
20191274249	MATRINCHA	MP12098851	MATRINCHA	10/12/2019 10:28	10/12/2019 17:50	10/12/2019 10:28	10/12/2019 17:50	7,37	77	567,11	CHI
201912260806	NIQUELANDIA	NQ12274742	BARRO ALTO	10/12/2019 10:28	11/12/2019 05:28	10/12/2019 10:28	11/12/2019 05:28	19,00	17	323,08	CHI
20191273310	GOIANIA	10006233668	CARAJAS S1	10/12/2019 10:30	10/12/2019 12:14	10/12/2019 10:30	10/12/2019 12:14	1,73	1	1,73	CHI
20191273315	GOIANESIA	SJ21006513	GOIANESIA S1	10/12/2019 10:30	10/12/2019 14:43	10/12/2019 10:30	10/12/2019 14:43	4,22	1	4,22	CHI
20191273319	GOIATUBA	GT12247742	BOM JESUS DE GOIAS	10/12/2019 10:30	10/12/2019 14:36	10/12/2019 10:30	10/12/2019 14:36	4,09	4	16,35	CHI
20191273323	ABADIANIA	AA21062504	ANAPOLIS UNIVERSITARIO S1	10/12/2019 10:32	10/12/2019 14:47	10/12/2019 10:32	10/12/2019 14:47	4,24	1	4,24	CHI
20191273324	LUZIANIA	LZ12214787	CRISTALINA S2	10/12/2019 10:32	10/12/2019 18:45	10/12/2019 10:32	10/12/2019 18:45	8,21	8	65,64	CHI
20191273326	JATAI	JT21214330	JATAI S1	10/12/2019 10:33	10/12/2019 15:20	10/12/2019 10:33	10/12/2019 15:20	4,78	1	4,78	CHI
20191273329	SAO LUIZ DO NORTE	DF12241242	BARRO ALTO	10/12/2019 10:33	11/12/2019 19:17	10/12/2019 10:33	11/12/2019 13:29	26,93	4	107,73	CHI
20191273329	SAO LUIZ DO NORTE	8256733	BARRO ALTO	10/12/2019 10:33	11/12/2019 19:17	10/12/2019 10:33	11/12/2019 19:17	32,73	1	32,73	CHI
20191273337	CRISTALINA	KR21249211	PAMPLONA	10/12/2019 10:34	10/12/2019 19:22	10/12/2019 10:34	10/12/2019 19:22	8,80	1	8,80	CHI
20191273346	PIRACANJUBA	PJ21019532	BELA VISTA S1	10/12/2019 10:37	10/12/2019 11:51	10/12/2019 10:37	10/12/2019 11:51	1,23	1	1,23	CHI
20191273351	URUTAI	UT21060653	URUTAI	10/12/2019 10:37	10/12/2019 14:17	10/12/2019 10:37	10/12/2019 14:17	3,65	2	7,31	CHI
20191273352	VIANOPOLIS	VN21157771	VIANOPOLIS	10/12/2019 10:37	10/12/2019 14:22	10/12/2019 10:37	10/12/2019 14:22	3,73	1	3,73	CHI
20191273355	ACREUNA	EU21301579	ACREUNA	10/12/2019 10:38	10/12/2019 12:17	10/12/2019 10:38	10/12/2019 12:17	1,64	1	1,64	CHI
20191273356	CACU	CC21193892	CACHOEIRA ALTA	10/12/2019 10:39	10/12/2019 15:41	10/12/2019 10:39	10/12/2019 15:41	5,03	1	5,03	CHI
20191273362	CORUMBAIBA	CI21076934	VILA CORUMBA	10/12/2019 10:40	10/12/2019 12:01	10/12/2019 10:40	10/12/2019 12:01	1,34	1	1,34	CHI
20191273365	LUZIANIA	LZ21241083	VIANOPOLIS	10/12/2019 10:42	10/12/2019 12:56	10/12/2019 10:42	10/12/2019 12:56	2,23	2	4,46	CHI
20191273370	ALTO PARAISO DE GOIAS	BF12206283	FLORES DE GOIAS	10/12/2019 10:43	10/12/2019 15:24	10/12/2019 10:43	10/12/2019 15:24	4,68	4	18,70	CHI
20191273375	ORIZONA	OZ21304975	VIANOPOLIS	10/12/2019 10:44	10/12/2019 21:17	10/12/2019 10:44	10/12/2019 21:17	10,54	1	10,54	CHI
20191273382	BONFINOPOLIS	BO12071851LD	DAIA S2	10/12/2019 10:45	10/12/2019 19:04	10/12/2019 10:45	10/12/2019 19:04	8,30	9	74,73	CHI
20191273388	LUZIANIA	LZ21138106	PIRES DO RIO S2	10/12/2019 10:47	11/12/2019 23:50	10/12/2019 10:47	11/12/2019 23:50	37,05	1	37,05	CHI
20191273389	BALIZA	BH11331050	CAIAPONIA	10/12/2019 10:47	11/12/2019 16:36	10/12/2019 10:47	11/12/2019 16:36	29,82	1	29,82	CHI
20191274205	GOIANESIA	550151941	GOIANESIA S2	10/12/2019 10:47	10/12/2019 13:43	10/12/2019 10:47	10/12/2019 13:43	2,94	1	2,94	CHI
20191273395	ANAPOLIS	20297178	JUNDIAI S2	10/12/2019 10:48	10/12/2019 12:00	10/12/2019 10:48	10/12/2019 12:00	1,20	1	1,20	CHI
20191274201	ANAPOLIS	10008357585	JUNDIAI S2	10/12/2019 10:49	10/12/2019 16:12	10/12/2019 10:49	10/12/2019 16:12	5,38	1	5,38	CHI
20191274206	FIRMINOPOLIS	FR12005240	FIRMINOPOLIS S1	10/12/2019 10:49	10/12/2019 17:31	10/12/2019 10:49	10/12/2019 17:31	6,68	2	13,37	CHI
20191274208	ITAPIRAPUA	IU21143217	MATRINCHA	10/12/2019 10:50	11/12/2019 00:00	10/12/2019 10:50	11/12/2019 00:00	13,16	2	26,31	CHI

20191274210	NOVA IGUACU DE GOIAS	7830004273	SANTA TEREZINHA	10/12/2019 10:50	10/12/2019 11:56	10/12/2019 10:50	10/12/2019 11:56	1,09	1	1,09	CHI
20191274296	SAO DOMINGOS	SD12348628	SAO DOMINGOS	10/12/2019 10:50	10/12/2019 14:59	10/12/2019 10:50	10/12/2019 14:59	4,13	13	53,75	CHI
20191277048	JUSSARA	JR12017175	JUSSARA	10/12/2019 10:50	10/12/2019 16:06	10/12/2019 10:50	10/12/2019 16:06	5,26	7	36,84	CHI
20191274214	ARAGOIANIA	AO21007295	GUAPU S2	10/12/2019 10:51	10/12/2019 18:39	10/12/2019 10:51	10/12/2019 18:39	7,79	1	7,79	CHI
20191274601	AGUAS LINDAS DE GOIAS	LA11087886	AGUAS LINDAS DE GOIAS S1	10/12/2019 10:51	10/12/2019 14:50	10/12/2019 10:51	10/12/2019 14:40	3,82	31	118,32	CHI
20191274601	AGUAS LINDAS DE GOIAS	LA11261569	AGUAS LINDAS DE GOIAS S1	10/12/2019 10:51	10/12/2019 14:50	10/12/2019 11:52	10/12/2019 14:50	2,96	36	106,42	CHI
20191274218	PIRES DO RIO	460064356	PIRES DO RIO S1	10/12/2019 10:52	10/12/2019 19:51	10/12/2019 10:52	10/12/2019 19:51	8,98	1	8,98	CHI
20191274224	PORANGATU	PO12189501	PORANGATU	10/12/2019 10:54	10/12/2019 17:55	10/12/2019 10:54	10/12/2019 17:55	7,02	1	7,02	CHI
20191274225	SILVANIA	SV21086401	VIANOPOLIS	10/12/2019 10:54	10/12/2019 15:27	10/12/2019 10:54	10/12/2019 15:27	4,55	1	4,55	CHI
20191274233	FORMOSA	FA32029913	SAO JOAO D ALIANCA	10/12/2019 10:55	10/12/2019 15:28	10/12/2019 10:55	10/12/2019 15:28	4,53	1	4,53	CHI
20191274234	PIRENOPOLIS	PV21155083	CORUMBA	10/12/2019 10:56	10/12/2019 20:46	10/12/2019 10:56	10/12/2019 20:46	9,83	3	29,50	CHI
20191274237	ITABERAI	IB11000013	ITABERAI S2	10/12/2019 10:56	10/12/2019 12:53	10/12/2019 10:56	10/12/2019 12:53	1,95	74	144,14	CHI
20191274238	PADRE BERNARDO	3160011160	PADRE BERNARDO	10/12/2019 10:56	10/12/2019 23:51	10/12/2019 10:56	10/12/2019 23:51	12,91	1	12,91	CHI
20191274243	CATALAO	CT21333395	CATALAO S1	10/12/2019 10:56	11/12/2019 10:18	10/12/2019 10:56	11/12/2019 10:18	23,37	1	23,37	CHI
20191274260	GOIANIA	GN12202310	CARAJAS S2	10/12/2019 11:00	10/12/2019 12:43	10/12/2019 11:00	10/12/2019 12:43	1,71	137	233,78	CHI
20191275235	FAZENDA NOVA	RN10394715	BRITANIA	10/12/2019 11:00	10/12/2019 19:52	10/12/2019 11:01	10/12/2019 11:06	0,09	209	18,93	CHI
20191275235	JAUPACI	RN10394715	BRITANIA	10/12/2019 11:00	10/12/2019 19:52	10/12/2019 11:01	10/12/2019 11:06	0,09	2	0,18	CHI
20191275235	JUSSARA	RN10394715	BRITANIA	10/12/2019 11:00	10/12/2019 19:52	10/12/2019 11:01	10/12/2019 11:06	0,09	323	29,25	CHI
20191275235	SANTA FE DE GOIAS	RN10394715	BRITANIA	10/12/2019 11:00	10/12/2019 19:52	10/12/2019 11:01	10/12/2019 11:06	0,09	25	2,26	CHI
20191275235	FAZENDA NOVA	RN10394715	BRITANIA	10/12/2019 11:00	10/12/2019 19:52	10/12/2019 11:26	10/12/2019 13:22	1,94	9	17,43	CHI
20191275235	JUSSARA	RN10394715	BRITANIA	10/12/2019 11:00	10/12/2019 19:52	10/12/2019 11:26	10/12/2019 13:22	1,94	292	565,51	CHI
20191275235	SANTA FE DE GOIAS	RN10394715	BRITANIA	10/12/2019 11:00	10/12/2019 19:52	10/12/2019 11:26	10/12/2019 13:22	1,94	25	48,42	CHI
20191275235	FAZENDA NOVA	JR16410161	BRITANIA	10/12/2019 11:00	10/12/2019 19:52	10/12/2019 11:26	10/12/2019 19:08	7,70	140	1077,53	CHI
20191275235	JUSSARA	JR16410161	BRITANIA	10/12/2019 11:00	10/12/2019 19:52	10/12/2019 11:26	10/12/2019 19:08	7,70	20	153,93	CHI
20191275235	FAZENDA NOVA	FN13362430	BRITANIA	10/12/2019 11:00	10/12/2019 19:52	10/12/2019 11:26	10/12/2019 19:52	8,44	60	506,17	CHI
20191275235	JAUPACI	FN13362430	BRITANIA	10/12/2019 11:00	10/12/2019 19:52	10/12/2019 11:26	10/12/2019 19:52	8,44	2	16,87	CHI
20191275235	JUSSARA	FN13362430	BRITANIA	10/12/2019 11:00	10/12/2019 19:52	10/12/2019 11:26	10/12/2019 19:52	8,44	11	92,80	CHI
20191274265	JATAI	JT21234495	JATAI S3	10/12/2019 11:03	10/12/2019 13:22	10/12/2019 11:03	10/12/2019 13:22	2,30	3	6,91	CHI
20191274269	GOIANIA	12482535	GOIANIA LESTE S1	10/12/2019 11:04	10/12/2019 12:31	10/12/2019 11:04	10/12/2019 12:31	1,44	1	1,44	CHI
20191274275	TURVELANDIA	SH12026451	RIO DOS BOIS	10/12/2019 11:05	10/12/2019 15:46	10/12/2019 11:05	10/12/2019 15:46	4,67	1	4,67	CHI
20191274277	FIRMINOPOLIS	FR21206422	FIRMINOPOLIS S1	10/12/2019 11:06	10/12/2019 14:51	10/12/2019 11:06	10/12/2019 14:51	3,75	1	3,75	CHI
20191274285	ANAPOLIS	20113638	ANAPOLIS UNIVERSITARIO S2	10/12/2019 11:07	10/12/2019 18:06	10/12/2019 11:07	10/12/2019 18:06	6,97	1	6,97	CHI
20191274299	CALDAS NOVAS	CN11163543	CALDAS NOVAS S2	10/12/2019 11:07	10/12/2019 12:50	10/12/2019 11:07	10/12/2019 12:50	1,71	43	73,57	CHI

20191274287	MONTIVIDIU	RV12205424	MONTIVIDIU T	10/12/2019 11:08	10/12/2019 16:33	10/12/2019 11:08	10/12/2019 16:33	5,43	1	5,43	CHI
20191274287	RIO VERDE	RV12205424	MONTIVIDIU T	10/12/2019 11:08	10/12/2019 16:33	10/12/2019 11:08	10/12/2019 16:33	5,43	39	211,75	CHI
20191274289	CAVALCANTE	10026905319	SAO DOMINGOS	10/12/2019 11:08	11/12/2019 12:56	10/12/2019 11:08	11/12/2019 12:56	25,81	1	25,81	CHI
20191274291	URUTAI	UT21230592	URUTAI	10/12/2019 11:08	11/12/2019 12:01	10/12/2019 11:08	11/12/2019 12:01	24,88	1	24,88	CHI
20191274293	CAVALCANTE	CJ21286669	MINACU	10/12/2019 11:08	11/12/2019 16:38	10/12/2019 11:08	11/12/2019 16:38	29,49	1	29,49	CHI
20191274294	GOIANESIA	10022420418	GOIANESIA S2	10/12/2019 11:08	11/12/2019 07:52	10/12/2019 11:08	11/12/2019 07:52	20,72	1	20,72	CHI
20191275288	ITAPACI	IW12210233	ITAPACI	10/12/2019 11:08	10/12/2019 12:38	10/12/2019 11:08	10/12/2019 12:38	1,49	110	164,02	CHI
20191274300	SANTA CRUZ DE GOIAS	BC21027013	PIRES DO RIO S2	10/12/2019 11:11	10/12/2019 19:59	10/12/2019 11:11	10/12/2019 19:59	8,80	1	8,80	CHI
20191275205	ALTO PARAISO DE GOIAS	BF12385529	NIQUELANDIA SUBTRANSMISSAO	10/12/2019 11:11	10/12/2019 15:09	10/12/2019 11:11	10/12/2019 15:09	3,96	2	7,92	CHI
20191275276	ITAPURANGA	IK10396072	ITAPURANGA	10/12/2019 11:11	11/12/2019 15:11	10/12/2019 11:11	10/12/2019 12:37	1,44	42	60,50	CHI
20191275276	ITAPURANGA	IK13000018	ITAPURANGA	10/12/2019 11:11	11/12/2019 15:11	10/12/2019 11:11	10/12/2019 14:00	2,82	332	935,50	CHI
20191275276	ITAPURANGA	IK10396072	ITAPURANGA	10/12/2019 11:11	11/12/2019 15:11	10/12/2019 18:29	10/12/2019 19:35	1,11	389	432,11	CHI
20191275276	ITAPURANGA	IK13250517	ITAPURANGA	10/12/2019 11:11	11/12/2019 15:11	10/12/2019 11:11	11/12/2019 14:47	27,61	52	1435,56	CHI
20191275276	GOIAS	IK12250614	ITAPURANGA	10/12/2019 11:11	11/12/2019 15:11	10/12/2019 11:11	11/12/2019 15:11	28,00	2	56,01	CHI
20191275276	GUARAITA	IK12250614	ITAPURANGA	10/12/2019 11:11	11/12/2019 15:11	10/12/2019 11:11	11/12/2019 15:11	28,00	16	448,04	CHI
20191275276	ITAPURANGA	IK12250614	ITAPURANGA	10/12/2019 11:11	11/12/2019 15:11	10/12/2019 11:11	11/12/2019 15:11	28,00	22	616,06	CHI
20191276293	CALDAS NOVAS	CN12163530	CALDAS NOVAS S2	10/12/2019 11:12	10/12/2019 12:50	10/12/2019 11:12	10/12/2019 12:50	1,62	616	998,95	CHI
20191275216	CORUMBA DE GOIAS	CB21146773	CORUMBA	10/12/2019 11:13	10/12/2019 18:00	10/12/2019 11:13	10/12/2019 18:00	6,79	2	13,57	CHI
20191275220	CRISTALINA	KR21305151	PAMPLONA	10/12/2019 11:13	10/12/2019 12:35	10/12/2019 11:13	10/12/2019 12:35	1,35	1	1,35	CHI
20191277021	FAZENDA NOVA	NB12099378	JUSSARA	10/12/2019 11:13	11/12/2019 08:19	10/12/2019 11:13	11/12/2019 08:19	21,09	3	63,28	CHI
20191277021	NOVO BRASIL	NB12099378	JUSSARA	10/12/2019 11:13	11/12/2019 08:19	10/12/2019 11:13	11/12/2019 08:19	21,09	1	21,09	CHI
20191279378	JUSSARA	JR12092772	JUSSARA	10/12/2019 11:13	10/12/2019 17:55	10/12/2019 11:13	10/12/2019 17:55	6,69	12	80,32	CHI
20191275226	CATALAO	GD12064004	CATALAO S1	10/12/2019 11:15	10/12/2019 13:44	10/12/2019 11:15	10/12/2019 13:44	2,47	4	9,88	CHI
20191275226	GOIANDIRA	GD12064004	CATALAO S1	10/12/2019 11:15	10/12/2019 13:44	10/12/2019 11:15	10/12/2019 13:44	2,47	1	2,47	CHI
20191275230	AGUAS LINDAS DE GOIAS	10025677185	AGUAS LINDAS DE GOIAS S1	10/12/2019 11:16	10/12/2019 12:32	10/12/2019 11:16	10/12/2019 12:32	1,25	1	1,25	CHI
20191275501	BALIZA	BH21253694	BOM JARDIM	10/12/2019 11:17	10/12/2019 11:40	10/12/2019 11:17	10/12/2019 11:40	0,39	1	0,39	CHI
20191275240	MORRINHOS	MR21157115	GOIATUBA S1	10/12/2019 11:18	10/12/2019 15:45	10/12/2019 11:18	10/12/2019 15:45	4,44	1	4,44	CHI
20191275242	GUAPO	VJ31066136	GUAPO S2	10/12/2019 11:19	10/12/2019 20:29	10/12/2019 11:19	10/12/2019 20:29	9,17	1	9,17	CHI
20191279329	CAMPO LIMPO	AN12347857	NEROPOLIS S1	10/12/2019 11:20	10/12/2019 17:02	10/12/2019 11:20	10/12/2019 17:02	5,69	17	96,65	CHI
20191275258	FORMOSA	FA12042628	ITUIQUIRA	10/12/2019 11:24	10/12/2019 12:27	10/12/2019 11:24	10/12/2019 12:27	1,04	1	1,04	CHI
20191275259	CACHOEIRA DE GOIAS	CG21222199	FIRMINOPOLIS S2	10/12/2019 11:24	10/12/2019 18:07	10/12/2019 11:24	10/12/2019 18:07	6,71	1	6,71	CHI
20191276229	SANTA FE DE GOIAS	RN12206843	BRITANIA	10/12/2019 11:24	10/12/2019 21:18	10/12/2019 11:24	10/12/2019 21:18	9,90	20	197,99	CHI
20191275262	URUACU	640038219	URUACU	10/12/2019 11:25	10/12/2019 15:28	10/12/2019 11:25	10/12/2019 15:28	4,04	1	4,04	CHI

20191275264	MINEIROS	MY12360240	PARQUE DAS EMAS	10/12/2019 11:25	10/12/2019 16:15	10/12/2019 11:25	10/12/2019 16:15	4,82	36	173,41	CHI
20191275265	PALMEIRAS DE GOIAS	10026226802	PALMEIRAS	10/12/2019 11:26	10/12/2019 14:15	10/12/2019 11:26	10/12/2019 14:15	2,82	1	2,82	CHI
20191275272	NIQUELANDIA	NQ21292511	URUACU	10/12/2019 11:26	10/12/2019 17:23	10/12/2019 11:26	10/12/2019 17:23	5,94	1	5,94	CHI
20191278968	CATALAO	CT12042339	CATALAO S1	10/12/2019 11:26	10/12/2019 17:34	10/12/2019 11:26	10/12/2019 17:34	6,13	8	49,01	CHI
20191275277	APARECIDA DO RIO DOCE	AW12341096	CACHOEIRA ALTA	10/12/2019 11:27	10/12/2019 18:44	10/12/2019 11:27	10/12/2019 18:44	7,27	2	14,54	CHI
20191275280	CACHOEIRA DOURADA	CD12057901	CACHOEIRA DOURADA	10/12/2019 11:28	10/12/2019 13:33	10/12/2019 11:28	10/12/2019 13:33	2,09	2	4,19	CHI
20191275282	ITABERAI	IB21310482	ITABERAI S2	10/12/2019 11:28	10/12/2019 16:20	10/12/2019 11:28	10/12/2019 16:20	4,86	1	4,86	CHI
20191275283	GOIANIA	12540833	GOIANIA LESTE S3	10/12/2019 11:28	10/12/2019 13:04	10/12/2019 11:28	10/12/2019 13:04	1,59	1	1,59	CHI
20191275284	GUAPO	710015902	GUAPO S1	10/12/2019 11:28	10/12/2019 16:17	10/12/2019 11:28	10/12/2019 16:17	4,81	1	4,81	CHI
20191275292	COLINAS DO SUL	9700005452	NIQUELANDIA SUBTRANSMISSAO	10/12/2019 11:29	10/12/2019 19:40	10/12/2019 11:29	10/12/2019 19:40	8,17	1	8,17	CHI
20191276101	BALIZA	BH21358820	BOM JARDIM	10/12/2019 11:29	10/12/2019 17:33	10/12/2019 11:29	10/12/2019 17:33	6,06	1	6,06	CHI
20191275293	PIRACANJUBA	PJ21228152	PIRACANJUBA	10/12/2019 11:31	11/12/2019 12:36	10/12/2019 11:31	11/12/2019 12:36	25,08	1	25,08	CHI
20191275294	LUZIANIA	LZ11329353	VIANOPOLIS	10/12/2019 11:31	10/12/2019 12:15	10/12/2019 11:31	10/12/2019 12:15	0,72	18	12,98	CHI
20191276205	GOIANIA	14282215	CAMPINAS S3	10/12/2019 11:33	10/12/2019 12:50	10/12/2019 11:33	10/12/2019 12:50	1,28	1	1,28	CHI
20191276206	ANAPOLIS	AN21311869	ANAPOLIS UNIVERSITARIO S2	10/12/2019 11:33	10/12/2019 18:25	10/12/2019 11:33	10/12/2019 18:25	6,86	1	6,86	CHI
20191276207	PALMELO	450000357	PIRES DO RIO S2	10/12/2019 11:33	10/12/2019 17:14	10/12/2019 11:33	10/12/2019 17:14	5,69	1	5,69	CHI
20191277326	CACU	CC12191705	CACHOEIRA ALTA	10/12/2019 11:35	10/12/2019 18:05	10/12/2019 11:35	10/12/2019 18:05	6,50	48	312,11	CHI
20191281268	BALIZA	BH11331473	CAIAPONIA	10/12/2019 11:35	11/12/2019 14:17	10/12/2019 11:35	11/12/2019 14:17	26,70	1	26,70	CHI
20191276220	LUZIANIA	LZ21041598	PAMPLONA	10/12/2019 11:37	10/12/2019 13:34	10/12/2019 11:37	10/12/2019 13:34	1,94	1	1,94	CHI
20191276222	CRISTALINA	KR21000019	CRISTALINA S2	10/12/2019 11:38	10/12/2019 17:22	10/12/2019 11:38	10/12/2019 17:22	5,73	1	5,73	CHI
20191276239	SANTA HELENA DE GOIAS	SH11219377	RIO VERDE S2	10/12/2019 11:42	10/12/2019 14:20	10/12/2019 11:42	10/12/2019 14:20	2,63	1	2,63	CHI
20191277399	SAO MIGUEL DO ARAGUAIA	SM12244559	SAO MIGUEL DO ARAGUAIA	10/12/2019 11:43	10/12/2019 15:21	10/12/2019 11:43	10/12/2019 15:21	3,62	5	18,12	CHI
20191276258	DOVERLANDIA	DV21207783	CAIAPONIA	10/12/2019 11:44	10/12/2019 17:00	10/12/2019 11:44	10/12/2019 17:00	5,28	2	10,56	CHI
20191276262	CACHOEIRA ALTA	CA21154434	CACHOEIRA ALTA	10/12/2019 11:45	10/12/2019 14:34	10/12/2019 11:45	10/12/2019 14:34	2,81	1	2,81	CHI
20191276263	JARAGUA	JA21114626	JARAGUA	10/12/2019 11:45	10/12/2019 20:59	10/12/2019 11:45	10/12/2019 20:59	9,22	1	9,22	CHI
20191276265	CATALAO	10030504676	CATALAO S2	10/12/2019 11:45	10/12/2019 17:04	10/12/2019 11:45	10/12/2019 17:04	5,30	1	5,30	CHI
20191276266	LUZIANIA	LZ21230123	MARAJOARA	10/12/2019 11:46	10/12/2019 16:55	10/12/2019 11:46	10/12/2019 16:55	5,15	1	5,15	CHI
20191276267	BALIZA	BH12064258	BOM JARDIM	10/12/2019 11:46	10/12/2019 20:20	10/12/2019 11:46	10/12/2019 20:20	8,56	11	94,18	CHI
20191276269	NOVO GAMA	NJ11376138	PACAEMBU S1	10/12/2019 11:46	10/12/2019 13:56	10/12/2019 11:46	10/12/2019 13:56	2,15	101	217,49	CHI
20191281160	VILA PROPICIO	PV12115031	GOIANESIA S1	10/12/2019 11:47	10/12/2019 19:55	10/12/2019 11:47	10/12/2019 19:55	8,13	24	195,12	CHI
20191276277	SAO LUIS DE MONTES BELOS	10020000438	SAO LUIZ DOS MONTES BELOS	10/12/2019 11:49	10/12/2019 17:24	10/12/2019 11:49	10/12/2019 17:24	5,57	1	5,57	CHI
20191276279	ANICUNS	AC21000080	ANICUNS	10/12/2019 11:50	10/12/2019 16:41	10/12/2019 11:50	10/12/2019 16:41	4,85	2	9,70	CHI
20191276280	CAMPOS VERDES	VD21257434	SANTA TEREZINHA	10/12/2019 11:50	11/12/2019 17:04	10/12/2019 11:50	11/12/2019 17:04	29,22	1	29,22	CHI

20191276286	ANAPOLIS	10007994522	JUNDIAI S2	10/12/2019 11:53	10/12/2019 15:39	10/12/2019 11:53	10/12/2019 15:39	3,76	1	3,76	CHI
20191277309	LUZIANIA	LZ11261515	RIO VERMELHO	10/12/2019 11:53	10/12/2019 13:18	10/12/2019 11:53	10/12/2019 13:18	1,40	124	173,74	CHI
20191278953	TRINDADE	TR12045105	INHUMAS S1	10/12/2019 11:53	10/12/2019 16:35	10/12/2019 11:53	10/12/2019 16:35	4,69	15	70,35	CHI
20191276295	GOIATUBA	140060558	GOIATUBA S2	10/12/2019 11:55	11/12/2019 09:50	10/12/2019 11:55	11/12/2019 09:50	21,93	1	21,93	CHI
20191276296	NIQUELANDIA	NQ21262803	URUACU	10/12/2019 11:55	11/12/2019 21:00	10/12/2019 11:55	11/12/2019 21:00	33,08	1	33,08	CHI
20191276297	APARECIDA DE GOIANIA	13844568	ATLANTICO S2	10/12/2019 11:55	10/12/2019 13:22	10/12/2019 11:55	10/12/2019 13:22	1,44	1	1,44	CHI
20191277001	FORMOSA	10000710898	ITUIQUIRA	10/12/2019 11:56	10/12/2019 13:10	10/12/2019 11:56	10/12/2019 13:10	1,22	1	1,22	CHI
20191277007	NOVA VENEZA	NV12111337	INHUMAS S1	10/12/2019 11:57	10/12/2019 22:15	10/12/2019 11:57	10/12/2019 22:15	10,29	18	185,17	CHI
20191277330	CARMO DO RIO VERDE	IK12298505	ITAPURANGA	10/12/2019 11:57	10/12/2019 16:09	10/12/2019 11:57	10/12/2019 16:09	4,20	33	138,46	CHI
20191277330	ITAPURANGA	IK12298505	ITAPURANGA	10/12/2019 11:57	10/12/2019 16:09	10/12/2019 11:57	10/12/2019 16:09	4,20	9	37,76	CHI
20191277912	LUZIANIA	LZ12261516	RIO VERMELHO	10/12/2019 11:57	10/12/2019 13:44	10/12/2019 11:57	10/12/2019 13:44	1,77	238	420,73	CHI
20191279361	LUZIANIA	LZ11163794	RIO VERMELHO	10/12/2019 11:57	10/12/2019 16:02	10/12/2019 11:57	10/12/2019 16:02	4,07	172	699,80	CHI
20191277015	GOIANIA	13455515	MEIA PONTE	10/12/2019 11:58	10/12/2019 15:34	10/12/2019 11:58	10/12/2019 15:34	3,59	1	3,59	CHI
20191277016	PARANAIGUARA	PC21214412	QUIRINOPOLIS	10/12/2019 11:58	10/12/2019 17:10	10/12/2019 11:58	10/12/2019 17:10	5,19	1	5,19	CHI
20191277022	MINACU	IH11044624	MINACU	10/12/2019 11:59	10/12/2019 18:50	10/12/2019 11:59	10/12/2019 18:50	6,83	64	437,42	CHI
20191281870	BOM JARDIM DE GOIAS	BM12065725	BOM JARDIM	10/12/2019 12:00	11/12/2019 08:58	11/12/2019 04:39	11/12/2019 08:46	4,13	93	384,27	CHI
20191281870	PIRANHAS	BM12065725	BOM JARDIM	10/12/2019 12:00	11/12/2019 08:58	11/12/2019 04:39	11/12/2019 08:46	4,13	9	37,19	CHI
20191281870	BOM JARDIM DE GOIAS	BM12205302	BOM JARDIM	10/12/2019 12:00	11/12/2019 08:58	10/12/2019 12:00	11/12/2019 08:58	20,97	9	188,73	CHI
20191277028	LUZIANIA	LZ21109852	VIANOPOLIS	10/12/2019 12:01	10/12/2019 18:49	10/12/2019 12:01	10/12/2019 18:49	6,79	1	6,79	CHI
20191277030	NOVO GAMA	NJ21305266	PACAEMBU S1	10/12/2019 12:01	10/12/2019 19:10	10/12/2019 12:01	10/12/2019 19:10	7,14	1	7,14	CHI
20191278312	NOVO BRASIL	NB11020195	JUSSARA	10/12/2019 12:01	10/12/2019 16:10	10/12/2019 12:01	10/12/2019 16:10	4,13	127	525,04	CHI
20191282011	DIVINOPOLIS DE GOIAS	2570013281	SAO DOMINGOS	10/12/2019 12:02	10/12/2019 19:26	10/12/2019 12:02	10/12/2019 19:26	7,39	1	7,39	CHI
20191277039	PLANALTINA	PI21088240	PLANALTINA	10/12/2019 12:05	10/12/2019 17:24	10/12/2019 12:05	10/12/2019 17:24	5,31	1	5,31	CHI
20191277044	APARECIDA DE GOIANIA	AP21000075	CEPAIGO S1	10/12/2019 12:06	10/12/2019 16:30	10/12/2019 12:06	10/12/2019 16:30	4,40	1	4,40	CHI
20191277046	ALTO HORIZONTE	9640005660	SANTA TEREZINHA	10/12/2019 12:06	10/12/2019 16:54	10/12/2019 12:06	10/12/2019 16:54	4,79	1	4,79	CHI
20191281602	PADRE BERNARDO	PB12351378	PADRE BERNARDO	10/12/2019 12:06	10/12/2019 23:22	10/12/2019 12:06	10/12/2019 23:22	11,26	4	45,03	CHI
20191277050	PORTELANDIA	MY21360834	PARQUE DAS EMAS	10/12/2019 12:07	11/12/2019 11:07	10/12/2019 12:07	11/12/2019 11:07	23,00	1	23,00	CHI
20191277052	CATALAO	1990058362	CATALAO S2	10/12/2019 12:07	10/12/2019 15:27	10/12/2019 12:07	10/12/2019 15:27	3,33	1	3,33	CHI
20191277053	AGUAS LINDAS DE GOIAS	4830395188	AGUAS LINDAS DE GOIAS S1	10/12/2019 12:07	10/12/2019 16:06	10/12/2019 12:07	10/12/2019 16:06	3,98	1	3,98	CHI
20191277057	ANAPOLIS	20078705	ANAPOLIS UNIVERSITARIO S2	10/12/2019 12:08	10/12/2019 15:08	10/12/2019 12:08	10/12/2019 15:08	3,00	1	3,00	CHI
20191277063	ARAGARCAS	1820032131	ARAGARCAS	10/12/2019 12:09	10/12/2019 17:07	10/12/2019 12:09	10/12/2019 17:07	4,95	1	4,95	CHI
20191277068	SILVANIA	SV12082718	VIANOPOLIS	10/12/2019 12:10	10/12/2019 16:16	10/12/2019 12:10	10/12/2019 16:16	4,08	2	8,17	CHI
20191277990	URUACU	UR11056768	URUACU	10/12/2019 12:10	10/12/2019 14:36	10/12/2019 12:10	10/12/2019 14:36	2,42	200	485,00	CHI

20191277075	FORMOSA	FA21211594	ITIQUEIRA	10/12/2019 12:13	10/12/2019 17:01	10/12/2019 12:13	10/12/2019 17:01	4,79	1	4,79	CHI
20191277082	BRITANIA	BT12183057	BRITANIA	10/12/2019 12:14	11/12/2019 16:30	10/12/2019 12:14	11/12/2019 16:30	28,25	8	226,03	CHI
20191277085	URUACU	UR21066509	URUACU	10/12/2019 12:15	11/12/2019 00:31	10/12/2019 12:15	10/12/2019 18:53	6,62	1	6,62	CHI
20191277085	URUACU	UR12066508	URUACU	10/12/2019 12:15	11/12/2019 00:31	10/12/2019 20:40	11/12/2019 00:31	3,85	13	50,06	CHI
20191277086	PIRES DO RIO	PR21300847	PIRES DO RIO S1	10/12/2019 12:15	10/12/2019 23:49	10/12/2019 12:15	10/12/2019 23:49	11,56	1	11,56	CHI
20191277903	NOVO BRASIL	NB12019355	JUSSARA	10/12/2019 12:15	10/12/2019 21:02	10/12/2019 12:15	10/12/2019 21:02	8,77	5	43,85	CHI
20191277088	CATALAO	CT12316116	CATALAO S1	10/12/2019 12:16	10/12/2019 20:44	10/12/2019 12:16	10/12/2019 20:44	8,47	3	25,40	CHI
20191277089	LUZIANIA	LZ12239788	VIANOPOLIS	10/12/2019 12:16	10/12/2019 15:12	10/12/2019 12:16	10/12/2019 15:12	2,93	1	2,93	CHI
20191277090	SITIO D ABADIA	SI12236808	IACIARA S2	10/12/2019 12:16	10/12/2019 17:33	10/12/2019 12:16	10/12/2019 17:33	5,27	11	58,02	CHI
20191277091	MOSSAMEDES	MD12091062	FIRMINOPOLIS S2	10/12/2019 12:16	10/12/2019 18:18	10/12/2019 12:16	10/12/2019 18:18	6,03	1	6,03	CHI
20191277095	LUZIANIA	3200153554	MARAJOARA	10/12/2019 12:17	10/12/2019 14:37	10/12/2019 12:17	10/12/2019 14:37	2,33	1	2,33	CHI
20191277096	SAO MIGUEL DO ARAGUAIA	SM21328554	SAO MIGUEL DO ARAGUAIA	10/12/2019 12:17	10/12/2019 14:58	10/12/2019 12:17	10/12/2019 14:58	2,68	1	2,68	CHI
20191278935	ANAPOLIS	AN11090384	ANAPOLIS UNIVERSITARIO S1	10/12/2019 12:17	10/12/2019 16:59	10/12/2019 12:17	10/12/2019 16:59	4,69	96	450,21	CHI
20191277302	GOIANDIRA	GD12127691	CATALAO S1	10/12/2019 12:18	10/12/2019 16:41	10/12/2019 12:18	10/12/2019 16:41	4,37	2	8,73	CHI
20191278350	EDEALINA	EA13282645	VICENTINOPOLIS	10/12/2019 12:18	10/12/2019 16:50	10/12/2019 16:20	10/12/2019 16:50	0,50	13	6,50	CHI
20191278350	EDEIA	EA13282645	VICENTINOPOLIS	10/12/2019 12:18	10/12/2019 16:50	10/12/2019 16:20	10/12/2019 16:50	0,50	8	4,00	CHI
20191278350	PONTALINA	EA13282645	VICENTINOPOLIS	10/12/2019 12:18	10/12/2019 16:50	10/12/2019 16:20	10/12/2019 16:50	0,50	1	0,50	CHI
20191278350	VICENTINOPOLIS	EA13282645	VICENTINOPOLIS	10/12/2019 12:18	10/12/2019 16:50	10/12/2019 16:20	10/12/2019 16:50	0,50	1	0,50	CHI
20191278350	EDEIA	EA12160410	VICENTINOPOLIS	10/12/2019 12:18	10/12/2019 16:50	10/12/2019 12:18	10/12/2019 16:50	4,54	22	99,89	CHI
20191277305	PIRACANJUBA	60084054	PIRACANJUBA	10/12/2019 12:20	11/12/2019 06:09	10/12/2019 12:20	11/12/2019 06:09	17,82	1	17,82	CHI
20191277358	INHUMAS	IX12016046	INHUMAS S1	10/12/2019 12:20	10/12/2019 14:30	10/12/2019 12:20	10/12/2019 14:30	2,17	8	17,33	CHI
20191277358	ITAUCU	IX12016046	INHUMAS S1	10/12/2019 12:20	10/12/2019 14:30	10/12/2019 12:20	10/12/2019 14:30	2,17	3	6,50	CHI
20191277315	ARUANA	AK12183185	BRITANIA	10/12/2019 12:22	11/12/2019 08:34	10/12/2019 12:22	11/12/2019 08:34	20,19	5	100,94	CHI
20191278335	BELA VISTA DE GOIAS	SW12062064	CEPAIGO S2	10/12/2019 12:23	10/12/2019 15:20	10/12/2019 12:23	10/12/2019 15:20	2,95	3	8,84	CHI
20191278335	SENADOR CANEDO	SW12062064	CEPAIGO S2	10/12/2019 12:23	10/12/2019 15:20	10/12/2019 12:23	10/12/2019 15:20	2,95	256	754,20	CHI
20191277320	NOVO GAMA	NJ11290801	PACAEMBU S1	10/12/2019 12:24	10/12/2019 14:35	10/12/2019 12:24	10/12/2019 14:35	2,18	10	21,83	CHI
20191277321	PIRACANJUBA	10011208137	PIRACANJUBA	10/12/2019 12:24	11/12/2019 06:06	10/12/2019 12:24	11/12/2019 06:06	17,71	1	17,71	CHI
20191280603	ITAGUARI	II11259578	ITABERAI S1	10/12/2019 12:26	10/12/2019 18:13	10/12/2019 12:26	10/12/2019 18:13	5,77	43	248,05	CHI
20191277334	ITABERAI	IB21336870	ITABERAI S1	10/12/2019 12:27	10/12/2019 16:34	10/12/2019 12:27	10/12/2019 16:34	4,11	1	4,11	CHI
20191277335	SAO LUIS DE MONTES BELOS	3930000992	SAO LUIZ DOS MONTES BELOS	10/12/2019 12:27	10/12/2019 15:51	10/12/2019 12:27	10/12/2019 15:51	3,40	1	3,40	CHI
20191277337	FORMOSA	FA12062379	ITIQUEIRA	10/12/2019 12:27	10/12/2019 15:42	10/12/2019 12:27	10/12/2019 15:42	3,24	6	19,43	CHI
20191277344	PLANALTINA	10026496672	PLANALTINA	10/12/2019 12:28	10/12/2019 14:04	10/12/2019 12:28	10/12/2019 14:04	1,59	1	1,59	CHI
20191277346	CERES	RB12392307	RUBIATABA	10/12/2019 12:28	10/12/2019 18:02	10/12/2019 12:28	10/12/2019 18:02	5,55	26	144,33	CHI

20191277346	RUBIATABA	RB12392307	RUBIATABA	10/12/2019 12:28	10/12/2019 18:02	10/12/2019 12:28	10/12/2019 18:02	5,55	16	88,82	CHI
20191277995	JUSSARA	JR11220336	JUSSARA	10/12/2019 12:28	10/12/2019 20:43	10/12/2019 12:28	10/12/2019 20:43	8,24	23	189,63	CHI
20191280693	GUARAITA	GK21289039	ITAPURANGA	10/12/2019 12:28	11/12/2019 14:40	10/12/2019 12:28	11/12/2019 14:40	26,18	1	26,18	CHI
20191277350	CAMPO LIMPO	960016740	NEROPOLIS S1	10/12/2019 12:29	10/12/2019 14:15	10/12/2019 12:29	10/12/2019 14:15	1,76	1	1,76	CHI
20191277353	APARECIDA DE GOIANIA	AP11038685	CEPAIGO S1	10/12/2019 12:29	10/12/2019 16:44	10/12/2019 12:29	10/12/2019 16:44	4,23	20	84,69	CHI
20191277357	BOM JARDIM DE GOIAS	BM21100433	BOM JARDIM	10/12/2019 12:31	11/12/2019 08:18	10/12/2019 12:31	11/12/2019 08:18	19,78	1	19,78	CHI
20191277360	PORANGATU	PO12230431	PORANGATU	10/12/2019 12:31	10/12/2019 15:37	10/12/2019 12:31	10/12/2019 15:37	3,10	2	6,20	CHI
20191278981	AGUAS LINDAS DE GOIAS	LA12313875	AGUAS LINDAS DE GOIAS S1	10/12/2019 12:32	10/12/2019 16:23	10/12/2019 12:32	10/12/2019 16:23	3,84	94	360,78	CHI
20191278981	COCALZINHO DE GOIAS	LA12313875	AGUAS LINDAS DE GOIAS S1	10/12/2019 12:32	10/12/2019 16:23	10/12/2019 12:32	10/12/2019 16:23	3,84	1	3,84	CHI
20191278981	SANTO ANTONIO DO DESCOBERTO	LA12313875	AGUAS LINDAS DE GOIAS S1	10/12/2019 12:32	10/12/2019 16:23	10/12/2019 12:32	10/12/2019 16:23	3,84	18	69,08	CHI
20191280874	GOIANESIA	GE12079223	GOIANESIA S1	10/12/2019 12:32	11/12/2019 02:22	10/12/2019 12:32	11/12/2019 02:22	13,82	1	13,82	CHI
20191280874	VILA PROPICIO	GE12079223	GOIANESIA S1	10/12/2019 12:32	11/12/2019 02:22	10/12/2019 12:32	11/12/2019 02:22	13,82	4	55,28	CHI
20191277374	NAZARIO	440018948	ANICUNS	10/12/2019 12:33	10/12/2019 14:49	10/12/2019 12:33	10/12/2019 14:49	2,26	1	2,26	CHI
20191277379	PIRACANJUBA	60050731	PIRACANJUBA	10/12/2019 12:35	10/12/2019 16:29	10/12/2019 12:35	10/12/2019 16:29	3,90	1	3,90	CHI
20191277381	GOIAS	GS12090816	GOIAS	10/12/2019 12:35	10/12/2019 18:50	10/12/2019 12:35	10/12/2019 18:50	6,24	9	56,13	CHI
20191277385	GOIANIA	GN21278720	GOIANIA LESTE S3	10/12/2019 12:36	10/12/2019 14:54	10/12/2019 12:36	10/12/2019 14:54	2,30	1	2,30	CHI
20191277386	APARECIDA DE GOIANIA	12167812	ATLANTICO S3	10/12/2019 12:36	10/12/2019 15:53	10/12/2019 12:36	10/12/2019 15:53	3,28	1	3,28	CHI
20191277387	URUACU	10000779260	URUACU	10/12/2019 12:36	10/12/2019 16:40	10/12/2019 12:36	10/12/2019 16:40	4,06	1	4,06	CHI
20191277400	LUZIANIA	3200111249	MARAJOARA	10/12/2019 12:40	10/12/2019 15:08	10/12/2019 12:40	10/12/2019 15:08	2,46	1	2,46	CHI
20191277906	IPAMERI	IP21332307	IPAMERI	10/12/2019 12:42	10/12/2019 14:27	10/12/2019 12:42	10/12/2019 14:27	1,75	1	1,75	CHI
20191277908	FORMOSA	FA12062189	ITIQUIRA	10/12/2019 12:42	10/12/2019 17:51	10/12/2019 12:42	10/12/2019 17:51	5,14	1	5,14	CHI
20191277910	AGUA FRIA DE GOIAS	TL21076103	SAO JOAO D ALIANCA	10/12/2019 12:43	11/12/2019 14:34	10/12/2019 12:43	11/12/2019 14:34	25,85	1	25,85	CHI
20191277913	LUZIANIA	LZ11351324	MARAJOARA	10/12/2019 12:44	10/12/2019 16:02	10/12/2019 12:44	10/12/2019 16:02	3,31	10	33,06	CHI
20191277925	GOIANIA	GN11241425	CARAJAS S1	10/12/2019 12:47	10/12/2019 15:32	10/12/2019 12:47	10/12/2019 15:32	2,75	62	170,26	CHI
20191277926	GOIANIA	11080279	GOIANIA LESTE S2	10/12/2019 12:47	10/12/2019 17:18	10/12/2019 12:47	10/12/2019 17:18	4,51	1	4,51	CHI
20191277953	CRISTALINA	KR12304816	CRISTALINA S2	10/12/2019 12:47	10/12/2019 15:02	10/12/2019 12:47	10/12/2019 15:02	2,25	14	31,49	CHI
20191277932	PARAUNA	10010891771	PARAUNA	10/12/2019 12:49	10/12/2019 17:04	10/12/2019 12:49	10/12/2019 17:04	4,25	1	4,25	CHI
20191278925	SAO DOMINGOS	SD12254497	SAO DOMINGOS	10/12/2019 12:49	10/12/2019 18:50	10/12/2019 12:49	10/12/2019 17:41	4,88	4	19,50	CHI
20191278925	SAO DOMINGOS	6882741	SAO DOMINGOS	10/12/2019 12:49	10/12/2019 18:50	10/12/2019 12:49	10/12/2019 18:50	6,01	4	24,05	CHI
20191277936	VIANOPOLIS	VN21228250	VIANOPOLIS	10/12/2019 12:50	10/12/2019 18:34	10/12/2019 12:50	10/12/2019 18:34	5,73	1	5,73	CHI
20191277938	CRISTALINA	1060046249	CRISTALINA S1	10/12/2019 12:50	10/12/2019 21:11	10/12/2019 12:50	10/12/2019 21:11	8,35	1	8,35	CHI
20191277941	QUIRINOPOLIS	QI12096888	QUIRINOPOLIS	10/12/2019 12:52	10/12/2019 17:45	10/12/2019 12:52	10/12/2019 17:45	4,88	20	97,66	CHI
20191277942	ANAPOLIS	AN31009006	ANAPOLIS UNIVERSITARIO S2	10/12/2019 12:52	10/12/2019 19:19	10/12/2019 12:52	10/12/2019 19:19	6,45	5	32,23	CHI

20191277950	AGUA FRIA DE GOIAS	6910045	SAO JOAO D ALIANCA	10/12/2019 12:53	11/12/2019 09:00	10/12/2019 12:53	11/12/2019 09:00	20,11	1	20,11	CHI
20191277951	GOIATUBA	GT12008206	BOM JESUS DE GOIAS	10/12/2019 12:53	11/12/2019 09:10	10/12/2019 12:53	11/12/2019 09:10	20,29	15	304,32	CHI
20191277952	ITUMBIARA	IT12330365	CACHOEIRA DOURADA	10/12/2019 12:53	10/12/2019 16:40	10/12/2019 12:53	10/12/2019 16:40	3,77	1	3,77	CHI
20191278995	FAZENDA NOVA	FN12220464	JUSSARA	10/12/2019 12:53	10/12/2019 18:11	10/12/2019 12:53	10/12/2019 18:11	5,28	29	153,26	CHI
20191277080	LUZIANIA	LZ16408245	MARAJOARA	10/12/2019 12:54	10/12/2019 18:36	10/12/2019 12:54	10/12/2019 17:13	4,32	189	815,90	CHI
20191277080	LUZIANIA	LZ13376283	MARAJOARA	10/12/2019 12:54	10/12/2019 18:36	10/12/2019 12:54	10/12/2019 18:36	5,71	156	890,67	CHI
20191277956	MOSSAMEDES	MD21343868	ITABERAI S2	10/12/2019 12:54	10/12/2019 15:22	10/12/2019 12:54	10/12/2019 15:22	2,47	1	2,47	CHI
20191277958	ANAPOLIS	20349610	JUNDIAI S1	10/12/2019 12:54	10/12/2019 14:09	10/12/2019 12:54	10/12/2019 14:09	1,24	1	1,24	CHI
20191277959	GOIANIA	GN11268341	XAVANTES	10/12/2019 12:54	10/12/2019 16:21	10/12/2019 12:54	10/12/2019 16:21	3,44	26	89,36	CHI
20191277965	LUZIANIA	LZ21031675	CRISTALINA S2	10/12/2019 12:56	10/12/2019 21:42	10/12/2019 12:56	10/12/2019 21:42	8,76	1	8,76	CHI
20191277967	RIO VERDE	630361319	RIO VERDE S1	10/12/2019 12:56	10/12/2019 16:15	10/12/2019 12:56	10/12/2019 16:15	3,31	1	3,31	CHI
20191277969	GOIANIA	14363537	CARAJAS S1	10/12/2019 12:57	10/12/2019 13:49	10/12/2019 12:57	10/12/2019 13:49	0,87	1	0,87	CHI
20191277970	NOVA AMERICA	2160007864	RUBIATABA	10/12/2019 12:57	10/12/2019 16:50	10/12/2019 12:57	10/12/2019 16:50	3,88	1	3,88	CHI
20191277974	SAO MIGUEL DO ARAGUAIA	SM21138134	SAO MIGUEL DO ARAGUAIA	10/12/2019 12:57	10/12/2019 15:55	10/12/2019 12:57	10/12/2019 15:55	2,96	1	2,96	CHI
20191280635	JANDAIA	JD11126078	PALMEIRAS	10/12/2019 12:57	10/12/2019 19:55	10/12/2019 12:57	10/12/2019 19:55	6,96	129	897,45	CHI
20191277976	GOIANIA	AP11162180	REAL S1	10/12/2019 12:58	10/12/2019 14:53	10/12/2019 12:58	10/12/2019 14:53	1,90	184	350,26	CHI
20191277979	LEOPOLDO DE BULHOES	870005133	DAIA S2	10/12/2019 12:59	10/12/2019 15:53	10/12/2019 12:59	10/12/2019 15:53	2,89	1	2,89	CHI
20191277980	POSSE	IA12035179	IACIARA S2	10/12/2019 12:59	10/12/2019 18:26	10/12/2019 12:59	10/12/2019 18:26	5,44	9	48,95	CHI
20191277986	APARECIDA DE GOIANIA	10006383694	REAL S2	10/12/2019 13:01	10/12/2019 15:03	10/12/2019 13:01	10/12/2019 15:03	2,04	1	2,04	CHI
20191277989	GOIANIA	10666436	AEROPORTO S2	10/12/2019 13:02	10/12/2019 17:13	10/12/2019 13:02	10/12/2019 17:13	4,18	1	4,18	CHI
20191277992	SAO JOAO D ALIANCA	FB12254528	FLORES DE GOIAS	10/12/2019 13:03	11/12/2019 19:14	10/12/2019 13:03	11/12/2019 19:14	30,17	7	211,22	CHI
20191280983	ITAPACI	IW12210233	ITAPACI	10/12/2019 13:05	10/12/2019 18:31	10/12/2019 13:05	10/12/2019 18:31	5,43	110	597,39	CHI
20191278303	RUBIATABA	RB21286132	RUBIATABA	10/12/2019 13:06	11/12/2019 13:42	10/12/2019 13:06	11/12/2019 13:42	24,59	2	49,18	CHI
20191278304	MONTIVIDIU DO NORTE	MX21146546	PORANGATU	10/12/2019 13:07	10/12/2019 16:40	10/12/2019 13:07	10/12/2019 16:40	3,56	1	3,56	CHI
20191278315	SANTO ANTONIO DO DESCOBERTO	10005198419	ALEXANIA	10/12/2019 13:09	10/12/2019 16:44	10/12/2019 13:09	10/12/2019 16:44	3,58	1	3,58	CHI
20191278319	TRINDADE	40172995	TRINDADE	10/12/2019 13:09	10/12/2019 17:32	10/12/2019 13:09	10/12/2019 17:32	4,38	1	4,38	CHI
20191278980	NOVO GAMA	NJ11183935	PACAEMBU S1	10/12/2019 13:09	10/12/2019 15:47	10/12/2019 13:09	10/12/2019 15:47	2,62	112	293,50	CHI
20191278325	MARA ROSA	MQ21338162	MARA ROSA	10/12/2019 13:12	10/12/2019 14:48	10/12/2019 13:12	10/12/2019 14:48	1,59	1	1,59	CHI
20191278327	VILA PROPICIO	PV21147432	GOIANESIA S1	10/12/2019 13:13	11/12/2019 12:49	10/12/2019 13:13	11/12/2019 12:49	23,59	1	23,59	CHI
20191278329	AGUAS LINDAS DE GOIAS	4830220870	AGUAS LINDAS DE GOIAS S1	10/12/2019 13:14	10/12/2019 18:11	10/12/2019 13:14	10/12/2019 18:11	4,95	1	4,95	CHI
20191278330	MINEIROS	MY21240274	PARQUE DAS EMAS	10/12/2019 13:14	11/12/2019 10:04	10/12/2019 13:14	11/12/2019 10:04	20,83	1	20,83	CHI
20191278333	URUTAI	UT21027111	URUTAI	10/12/2019 13:14	10/12/2019 18:08	10/12/2019 13:14	10/12/2019 18:08	4,88	1	4,88	CHI
20191278338	FORMOSA	610087861	ITUIQUIRA	10/12/2019 13:15	10/12/2019 13:42	10/12/2019 13:15	10/12/2019 13:42	0,44	1	0,44	CHI

20191278339	SAO MIGUEL DO ARAGUAIA	SM11276109	SAO MIGUEL DO ARAGUAIA	10/12/2019 13:16	10/12/2019 18:20	10/12/2019 13:16	10/12/2019 18:20	5,08	1	5,08	CHI
20191278341	MINACU	IH12392287	MINACU	10/12/2019 13:16	10/12/2019 14:05	10/12/2019 13:16	10/12/2019 14:05	0,82	5	4,08	CHI
20191278342	MUNDO NOVO DE GOIAS	MH11269591	NOVA CRIXAS	10/12/2019 13:16	10/12/2019 16:35	10/12/2019 13:16	10/12/2019 16:35	3,31	1	3,31	CHI
20191278348	SILVANIA	SV12143185	VIANOPOLIS	10/12/2019 13:17	10/12/2019 17:10	10/12/2019 13:17	10/12/2019 17:10	3,87	12	46,41	CHI
20191278349	ANICUNS	10003544387	FIRMINOPOLIS S2	10/12/2019 13:18	10/12/2019 16:02	10/12/2019 13:18	10/12/2019 16:02	2,72	1	2,72	CHI
20191278923	JUSSARA	02704118	BRITANIA	10/12/2019 13:18	11/12/2019 15:56	10/12/2019 13:18	10/12/2019 13:50	0,53	23	12,27	CHI
20191278923	JUSSARA	02704118	BRITANIA	10/12/2019 13:18	11/12/2019 15:56	10/12/2019 13:18	10/12/2019 13:50	0,53	8	4,27	CHI
20191278923	SANTA FE DE GOIAS	02704118	BRITANIA	10/12/2019 13:18	11/12/2019 15:56	10/12/2019 13:18	10/12/2019 13:50	0,53	360	192,00	CHI
20191278923	SANTA FE DE GOIAS	02704118	BRITANIA	10/12/2019 13:18	11/12/2019 15:56	10/12/2019 13:18	10/12/2019 13:50	0,53	1589	847,47	CHI
20191278923	JUSSARA	02704118	BRITANIA	10/12/2019 13:18	11/12/2019 15:56	10/12/2019 13:18	10/12/2019 14:43	1,43	184	262,46	CHI
20191278923	JUSSARA	02704118	BRITANIA	10/12/2019 13:18	11/12/2019 15:56	10/12/2019 13:18	10/12/2019 14:43	1,43	122	174,02	CHI
20191278923	MONTES CLAROS DE GOIAS	02704118	BRITANIA	10/12/2019 13:18	11/12/2019 15:56	10/12/2019 13:18	10/12/2019 14:43	1,43	411	586,25	CHI
20191278923	SANTA FE DE GOIAS	02704118	BRITANIA	10/12/2019 13:18	11/12/2019 15:56	10/12/2019 13:18	10/12/2019 14:43	1,43	21	29,95	CHI
20191278923	BRITANIA	02704118	BRITANIA	10/12/2019 13:18	11/12/2019 15:56	10/12/2019 13:18	10/12/2019 14:58	1,68	12	20,18	CHI
20191278923	JUSSARA	02704118	BRITANIA	10/12/2019 13:18	11/12/2019 15:56	10/12/2019 13:18	10/12/2019 14:58	1,68	9	15,14	CHI
20191278923	JUSSARA	02704118	BRITANIA	10/12/2019 13:18	11/12/2019 15:56	10/12/2019 13:18	10/12/2019 14:58	1,68	8	13,46	CHI
20191278923	SANTA FE DE GOIAS	02704118	BRITANIA	10/12/2019 13:18	11/12/2019 15:56	10/12/2019 13:18	10/12/2019 14:58	1,68	36	60,55	CHI
20191278923	SANTA FE DE GOIAS	02704118	BRITANIA	10/12/2019 13:18	11/12/2019 15:56	10/12/2019 13:18	10/12/2019 14:58	1,68	8	13,46	CHI
20191278923	BRITANIA	02700414	BRITANIA	10/12/2019 13:18	11/12/2019 15:56	10/12/2019 15:10	10/12/2019 17:00	1,83	12	21,96	CHI
20191278923	ITAPIRAPUA	02700414	BRITANIA	10/12/2019 13:18	11/12/2019 15:56	10/12/2019 15:10	10/12/2019 17:00	1,83	2	3,66	CHI
20191278923	JUSSARA	02700414	BRITANIA	10/12/2019 13:18	11/12/2019 15:56	10/12/2019 15:10	10/12/2019 17:00	1,83	4	7,32	CHI
20191278923	JUSSARA	02700414	BRITANIA	10/12/2019 13:18	11/12/2019 15:56	10/12/2019 15:10	10/12/2019 17:00	1,83	9	16,47	CHI
20191278923	SANTA FE DE GOIAS	02700414	BRITANIA	10/12/2019 13:18	11/12/2019 15:56	10/12/2019 15:10	10/12/2019 17:00	1,83	35	64,06	CHI
20191278923	SANTA FE DE GOIAS	02700414	BRITANIA	10/12/2019 13:18	11/12/2019 15:56	10/12/2019 15:10	10/12/2019 17:00	1,83	9	16,47	CHI
20191278923	JUSSARA	02700414	BRITANIA	10/12/2019 13:18	11/12/2019 15:56	10/12/2019 17:01	10/12/2019 19:25	2,40	4	9,60	CHI
20191278923	BRITANIA	BT13396216	BRITANIA	10/12/2019 13:18	11/12/2019 15:56	10/12/2019 17:01	10/12/2019 19:58	2,95	12	35,45	CHI
20191278923	ITAPIRAPUA	BT13396216	BRITANIA	10/12/2019 13:18	11/12/2019 15:56	10/12/2019 17:01	10/12/2019 19:58	2,95	2	5,91	CHI
20191278923	JUSSARA	BT13396216	BRITANIA	10/12/2019 13:18	11/12/2019 15:56	10/12/2019 17:01	10/12/2019 19:58	2,95	9	26,59	CHI
20191278923	SANTA FE DE GOIAS	BT13396216	BRITANIA	10/12/2019 13:18	11/12/2019 15:56	10/12/2019 17:01	10/12/2019 19:58	2,95	34	100,44	CHI
20191278923	SANTA FE DE GOIAS	BT13396216	BRITANIA	10/12/2019 13:18	11/12/2019 15:56	10/12/2019 17:01	10/12/2019 19:58	2,95	9	26,59	CHI
20191278923	JUSSARA	02700414	BRITANIA	10/12/2019 13:18	11/12/2019 15:56	10/12/2019 15:10	10/12/2019 19:59	4,82	6	28,90	CHI
20191278923	SANTA FE DE GOIAS	02700414	BRITANIA	10/12/2019 13:18	11/12/2019 15:56	10/12/2019 15:10	10/12/2019 19:59	4,82	37	178,21	CHI
20191278923	SANTA FE DE GOIAS	RN13091523	BRITANIA	10/12/2019 13:18	11/12/2019 15:56	10/12/2019 17:01	11/12/2019 15:56	22,92	1	22,92	CHI

20191278352	ITUMBIARA	IT21047501	ITUMBIARA VELHA S2	10/12/2019 13:19	11/12/2019 07:05	10/12/2019 13:19	11/12/2019 07:05	17,77	1	17,77	CHI
20191278364	JUSSARA	JR12078132	JUSSARA	10/12/2019 13:22	11/12/2019 11:48	10/12/2019 13:22	11/12/2019 11:48	22,42	5	112,11	CHI
20191278369	SANTA TEREZINHA DE GOIAS	10021521610	SANTA TEREZINHA	10/12/2019 13:23	11/12/2019 11:30	10/12/2019 13:23	11/12/2019 11:30	22,11	1	22,11	CHI
20191278601	OUIDOR	IO12234709	CATALAO S1	10/12/2019 13:23	10/12/2019 16:19	10/12/2019 13:23	10/12/2019 16:19	2,93	1	2,93	CHI
20191280760	NIQUELANDIA	NQ12213117	NIQUELANDIA SUBTRANSMISSAO	10/12/2019 13:24	10/12/2019 23:10	10/12/2019 13:24	10/12/2019 23:10	9,75	18	175,51	CHI
20191278376	GOIANIA	10004969390	MEIA PONTE	10/12/2019 13:25	10/12/2019 14:45	10/12/2019 13:25	10/12/2019 14:45	1,33	1	1,33	CHI
20191278377	SAO MIGUEL DO ARAGUAIA	830025078	SAO MIGUEL DO ARAGUAIA	10/12/2019 13:25	10/12/2019 18:00	10/12/2019 13:25	10/12/2019 18:00	4,59	1	4,59	CHI
20191279327	ALTO PARAISO DE GOIAS	ND12302636	IACIARA S2	10/12/2019 13:25	10/12/2019 17:55	10/12/2019 13:25	10/12/2019 17:55	4,49	18	80,84	CHI
20191279327	NOVA ROMA	ND12302636	IACIARA S2	10/12/2019 13:25	10/12/2019 17:55	10/12/2019 13:25	10/12/2019 17:55	4,49	96	431,17	CHI
20191279327	SAO JOAO D ALIANCA	ND12302636	IACIARA S2	10/12/2019 13:25	10/12/2019 17:55	10/12/2019 13:25	10/12/2019 17:55	4,49	12	53,90	CHI
20191278384	CALDAS NOVAS	CN12000057	CALDAS NOVAS S2	10/12/2019 13:26	10/12/2019 17:55	10/12/2019 13:26	10/12/2019 17:55	4,47	31	138,51	CHI
20191278385	PIRANHAS	PH21092244	BOM JARDIM	10/12/2019 13:27	11/12/2019 12:07	10/12/2019 13:27	11/12/2019 12:07	22,66	1	22,66	CHI
20191278390	GOIANIA	11097000	GOIANIA LESTE S1	10/12/2019 13:28	10/12/2019 16:56	10/12/2019 13:28	10/12/2019 16:56	3,46	1	3,46	CHI
20191278391	PARAUNA	PU11000001	PARAUNA	10/12/2019 13:28	10/12/2019 16:33	10/12/2019 13:28	10/12/2019 16:33	3,08	112	344,87	CHI
20191278393	IPORA	IR12202000	ARENOPOLIS	10/12/2019 13:28	11/12/2019 11:28	10/12/2019 13:28	11/12/2019 11:28	22,00	8	175,99	CHI
20191278394	PADRE BERNARDO	PB21344775	PADRE BERNARDO	10/12/2019 13:29	11/12/2019 01:44	10/12/2019 13:29	11/12/2019 01:44	12,24	1	12,24	CHI
20191278398	ITAPIRAPUA	IU12014779	MATRINCHA	10/12/2019 13:29	11/12/2019 13:32	10/12/2019 13:29	11/12/2019 13:32	24,03	12	288,42	CHI
20191278400	PARANAIGUARA	10025165400	CACHOEIRA ALTA	10/12/2019 13:30	10/12/2019 16:36	10/12/2019 13:30	10/12/2019 16:36	3,10	1	3,10	CHI
20191278902	RIO VERDE	630390241	CABRIUVA S1	10/12/2019 13:30	10/12/2019 15:27	10/12/2019 13:30	10/12/2019 15:27	1,94	1	1,94	CHI
20191278905	PIRENOPOLIS	PV21121808	SAO FRANCISCO DE GOIAS	10/12/2019 13:31	10/12/2019 23:51	10/12/2019 13:31	10/12/2019 23:51	10,33	3	31,00	CHI
20191278909	MOSSAMEDES	MD21247142	ITABERAI S2	10/12/2019 13:31	10/12/2019 17:01	10/12/2019 13:31	10/12/2019 17:01	3,49	1	3,49	CHI
20191278938	CRIXAS	CX12162721	SANTA TEREZINHA	10/12/2019 13:32	10/12/2019 16:00	10/12/2019 13:32	10/12/2019 16:00	2,45	5	12,26	CHI
20191280735	PROFESSOR JAMIL SAFADY	JS12296761	ROCHEDO	10/12/2019 13:32	11/12/2019 11:47	10/12/2019 13:32	11/12/2019 11:47	22,25	25	556,26	CHI
20191278919	JARAGUA	JA21148828	ITABERAI S1	10/12/2019 13:33	10/12/2019 20:18	10/12/2019 13:33	10/12/2019 20:18	6,74	1	6,74	CHI
20191281288	NOVO PLANALTO	TA11100823	NOVO PLANALTO	10/12/2019 13:33	10/12/2019 22:35	10/12/2019 13:33	10/12/2019 22:35	9,03	88	794,47	CHI
20191278927	BRITANIA	BT12396220	BRITANIA	10/12/2019 13:34	12/12/2019 02:30	10/12/2019 13:34	12/12/2019 02:30	36,93	2	73,85	CHI
20191278927	JUSSARA	BT12396220	BRITANIA	10/12/2019 13:34	12/12/2019 02:30	10/12/2019 13:34	12/12/2019 02:30	36,93	9	332,34	CHI
20191278934	CALDAS NOVAS	10029951249	SERRA DE CALDAS	10/12/2019 13:35	10/12/2019 16:35	10/12/2019 13:35	10/12/2019 16:35	2,99	1	2,99	CHI
20191281250	CALDAS NOVAS	CN12298752	CALDAS NOVAS S2	10/12/2019 13:35	11/12/2019 09:58	10/12/2019 13:35	11/12/2019 09:58	20,38	9	183,40	CHI
20191278937	PALMEIRAS DE GOIAS	590046597	PALMEIRAS	10/12/2019 13:36	10/12/2019 16:53	10/12/2019 13:36	10/12/2019 16:53	3,29	1	3,29	CHI
20191278940	JOVIANIA	JV12381188	GOIATUBA S1	10/12/2019 13:36	11/12/2019 08:23	10/12/2019 13:36	11/12/2019 08:23	18,77	3	56,32	CHI
20191278944	PANAMA	10006646440	GOIATUBA S1	10/12/2019 13:37	10/12/2019 16:52	10/12/2019 13:37	10/12/2019 16:52	3,25	1	3,25	CHI
20191278945	MARA ROSA	MQ21266666	MARA ROSA	10/12/2019 13:37	10/12/2019 18:48	10/12/2019 13:37	10/12/2019 18:48	5,18	1	5,18	CHI

20191278947	SAO DOMINGOS	SD12257712	SAO DOMINGOS	10/12/2019 13:37	10/12/2019 15:53	10/12/2019 13:37	10/12/2019 15:53	2,26	240	541,40	CHI
20191278949	LUZIANIA	LZ21183536	VIANOPOLIS	10/12/2019 13:37	11/12/2019 00:55	10/12/2019 13:37	11/12/2019 00:55	11,29	1	11,29	CHI
20191280698	FAZENDA NOVA	FN12223049	IPORA	10/12/2019 13:38	10/12/2019 19:36	10/12/2019 13:38	10/12/2019 19:36	5,97	8	47,74	CHI
20191280698	ISRAELANDIA	FN12223049	IPORA	10/12/2019 13:38	10/12/2019 19:36	10/12/2019 13:38	10/12/2019 19:36	5,97	2	11,93	CHI
20191278954	IPORA	IR21259434	IPORA	10/12/2019 13:39	11/12/2019 13:46	10/12/2019 13:39	11/12/2019 13:46	24,11	2	48,23	CHI
20191278955	PIRENOPOLIS	PV21286487	SAO FRANCISCO DE GOIAS	10/12/2019 13:39	11/12/2019 08:20	10/12/2019 13:39	11/12/2019 08:20	18,68	1	18,68	CHI
20191278961	SAO SIMAO	2240025524	CACHOEIRA ALTA	10/12/2019 13:39	10/12/2019 16:39	10/12/2019 13:39	10/12/2019 16:39	3,01	1	3,01	CHI
20191278963	ABADIANIA	670003098	ANAPOLIS UNIVERSITARIO S1	10/12/2019 13:41	10/12/2019 17:40	10/12/2019 13:41	10/12/2019 17:40	3,98	1	3,98	CHI
20191278998	GOIATUBA	GT12263957	BOM JESUS DE GOIAS	10/12/2019 13:41	11/12/2019 08:28	10/12/2019 13:41	11/12/2019 08:28	18,78	5	93,89	CHI
20191278966	JARAGUA	70082194	JARAGUA	10/12/2019 13:42	10/12/2019 17:31	10/12/2019 13:42	10/12/2019 17:31	3,83	1	3,83	CHI
20191278969	BRITANIA	BT12316224LD	BRITANIA	10/12/2019 13:42	11/12/2019 17:17	10/12/2019 13:42	11/12/2019 17:17	27,59	1	27,59	CHI
20191278970	FORMOSA	FA21124659	ITIQUEIRA	10/12/2019 13:42	10/12/2019 18:25	10/12/2019 13:42	10/12/2019 18:25	4,71	4	18,83	CHI
20191278983	NOVO GAMA	2460195431	PACAEMBU S1	10/12/2019 13:44	10/12/2019 16:40	10/12/2019 13:44	10/12/2019 16:40	2,92	1	2,92	CHI
20191278988	GOIANIA	10000233402	MEIA PONTE	10/12/2019 13:45	10/12/2019 22:10	10/12/2019 13:45	10/12/2019 22:10	8,41	1	8,41	CHI
20191278997	LEOPOLDO DE BULHOES	LB12032461	DAIA S2	10/12/2019 13:46	10/12/2019 15:35	10/12/2019 13:46	10/12/2019 15:35	1,81	1	1,81	CHI
20191279304	CALDAS NOVAS	CN12231992	CALDAS NOVAS S1	10/12/2019 13:46	11/12/2019 01:43	10/12/2019 13:46	11/12/2019 01:43	11,93	60	716,07	CHI
20191279318	GOIANIA	GN11041888	SENADOR CANEDO	10/12/2019 13:46	10/12/2019 15:33	10/12/2019 13:46	10/12/2019 15:33	1,78	133	236,70	CHI
20191279306	CHAPADAO DO CEU	DJ21132278	CHAPADAO DO CEU	10/12/2019 13:47	10/12/2019 15:15	10/12/2019 13:47	10/12/2019 15:15	1,46	1	1,46	CHI
20191279309	FORMOSA	FA11388190	ITIQUEIRA	10/12/2019 13:47	10/12/2019 17:49	10/12/2019 13:47	10/12/2019 17:49	4,02	1	4,02	CHI
20191279311	VIANOPOLIS	510029486	VIANOPOLIS	10/12/2019 13:48	10/12/2019 15:16	10/12/2019 13:48	10/12/2019 15:16	1,46	1	1,46	CHI
20191280600	GOIATUBA	GT12030782	RIO DOS BOIS	10/12/2019 13:48	10/12/2019 16:50	10/12/2019 13:48	10/12/2019 16:50	3,04	1	3,04	CHI
20191280600	GOIATUBA	GT12030782	RIO DOS BOIS	10/12/2019 13:48	10/12/2019 16:50	10/12/2019 13:48	10/12/2019 16:50	3,04	7	21,25	CHI
20191280600	PORTEIRAO	GT12030782	RIO DOS BOIS	10/12/2019 13:48	10/12/2019 16:50	10/12/2019 13:48	10/12/2019 16:50	3,04	3	9,11	CHI
20191280600	PORTEIRAO	GT12030782	RIO DOS BOIS	10/12/2019 13:48	10/12/2019 16:50	10/12/2019 13:48	10/12/2019 16:50	3,04	4	12,14	CHI
20191279323	RIO VERDE	630117160	RIO VERDE S2	10/12/2019 13:50	10/12/2019 18:07	10/12/2019 13:50	10/12/2019 18:07	4,27	1	4,27	CHI
20191279324	CRISTALINA	LZ12076063	CRISTALINA S2	10/12/2019 13:50	10/12/2019 19:20	10/12/2019 13:50	10/12/2019 19:20	5,49	3	16,47	CHI
20191279324	LUZIANIA	LZ12076063	CRISTALINA S2	10/12/2019 13:50	10/12/2019 19:20	10/12/2019 13:50	10/12/2019 19:20	5,49	1	5,49	CHI
20191279334	CALDAS NOVAS	CN12392109	SERRA DE CALDAS	10/12/2019 13:52	10/12/2019 20:00	10/12/2019 13:52	10/12/2019 20:00	6,12	105	643,07	CHI
20191280632	DIVINOPOLIS DE GOIAS	GH21271758	SAO DOMINGOS	10/12/2019 13:52	10/12/2019 19:19	10/12/2019 13:52	10/12/2019 19:19	5,45	1	5,45	CHI
20191279338	CORREGO DO OURO	CO12307017	SAO LUIZ DOS MONTES BELOS	10/12/2019 13:53	10/12/2019 22:49	10/12/2019 13:53	10/12/2019 22:49	8,93	2	17,86	CHI
20191279339	DAVINOPOLIS	IO21085113	CATALAO S1	10/12/2019 13:53	12/12/2019 16:25	10/12/2019 13:53	12/12/2019 16:25	50,52	1	50,52	CHI
20191280848	GOIANDIRA	GD12131094	CATALAO S1	10/12/2019 13:53	10/12/2019 17:43	10/12/2019 13:53	10/12/2019 17:43	3,84	7	26,90	CHI
20191280848	NOVA AURORA	GD12131094	CATALAO S1	10/12/2019 13:53	10/12/2019 17:43	10/12/2019 13:53	10/12/2019 17:43	3,84	3	11,53	CHI

20191279340	ACREUNA	EU21197364	ACREUNA	10/12/2019 13:54	10/12/2019 15:59	10/12/2019 13:54	10/12/2019 15:59	2,08	1	2,08	CHI
20191279343	FORMOSA	610087290	ITIQUEIRA	10/12/2019 13:54	10/12/2019 17:16	10/12/2019 13:54	10/12/2019 17:16	3,37	1	3,37	CHI
20191279355	CROMINIA	CQ12308010	ROCHEDO	10/12/2019 13:54	11/12/2019 13:52	10/12/2019 13:54	11/12/2019 13:52	23,96	5	119,79	CHI
20191279344	CALDAZINHA	LB21334026	DAIA S2	10/12/2019 13:55	11/12/2019 08:45	10/12/2019 13:55	11/12/2019 08:45	18,83	1	18,83	CHI
20191279354	IPORA	730132663	IPORA	10/12/2019 13:57	11/12/2019 04:19	10/12/2019 13:57	11/12/2019 04:19	14,35	1	14,35	CHI
20191279356	GOIANIRA	GR11167474	GOIANIRA	10/12/2019 13:58	10/12/2019 23:45	10/12/2019 13:58	10/12/2019 23:45	9,78	183	1790,15	CHI
20191279357	LUZIANIA	LZ21376150	VIANOPOLIS	10/12/2019 13:58	10/12/2019 20:30	10/12/2019 13:58	10/12/2019 20:30	6,53	2	13,07	CHI
20191280585	SAO JOAO D ALIANCA	JL12255660	SAO JOAO D ALIANCA	10/12/2019 14:00	10/12/2019 20:07	10/12/2019 14:00	10/12/2019 20:07	6,11	6	36,65	CHI
20191279369	CATURAI	CK21018891	INHUMAS S1	10/12/2019 14:02	10/12/2019 17:16	10/12/2019 14:02	10/12/2019 17:16	3,23	1	3,23	CHI
20191279370	MINEIROS	1390051836	PARQUE DAS EMAS	10/12/2019 14:02	11/12/2019 12:01	10/12/2019 14:02	11/12/2019 12:01	21,97	1	21,97	CHI
20191279372	ANAPOLIS	20040027	ANAPOLIS UNIVERSITARIO S2	10/12/2019 14:03	10/12/2019 15:33	10/12/2019 14:03	10/12/2019 15:33	1,50	1	1,50	CHI
20191279376	ISRAELANDIA	IS21139428	IPORA	10/12/2019 14:03	11/12/2019 17:52	10/12/2019 14:03	11/12/2019 17:52	27,81	1	27,81	CHI
20191279379	CALDAS NOVAS	PJ12263230	CALDAS NOVAS S1	10/12/2019 14:03	11/12/2019 10:57	10/12/2019 14:03	11/12/2019 10:57	20,89	1	20,89	CHI
20191279379	PIRACANJUBA	PJ12263230	CALDAS NOVAS S1	10/12/2019 14:03	11/12/2019 10:57	10/12/2019 14:03	11/12/2019 10:57	20,89	17	355,08	CHI
20191279382	JATAI	JT12196087	JATAI S1	10/12/2019 14:04	10/12/2019 15:55	10/12/2019 14:04	10/12/2019 15:55	1,84	2	3,68	CHI
20191280642	MIMOSO DE GOIAS	6904136	SAO JOAO D ALIANCA	10/12/2019 14:04	10/12/2019 17:44	10/12/2019 14:04	10/12/2019 17:44	3,66	2	7,32	CHI
20191279395	NEROPOLIS	NR12319494	NEROPOLIS S2	10/12/2019 14:05	10/12/2019 15:29	10/12/2019 14:05	10/12/2019 15:29	1,39	1	1,39	CHI
20191279395	OURO VERDE DE GOIAS	NR12319494	NEROPOLIS S2	10/12/2019 14:05	10/12/2019 15:29	10/12/2019 14:05	10/12/2019 15:29	1,39	21	29,29	CHI
20191279388	RIO VERDE	RV21260186	CABRIUVA S1	10/12/2019 14:06	10/12/2019 15:58	10/12/2019 14:06	10/12/2019 15:58	1,85	1	1,85	CHI
20191280897	PROFESSOR JAMIL SAFADY	JS12163474	ROCHEDO	10/12/2019 14:07	10/12/2019 17:45	10/12/2019 14:07	10/12/2019 17:45	3,62	10	36,20	CHI
20191279394	FORMOSA	FA21218670	ITIQUEIRA	10/12/2019 14:08	10/12/2019 16:16	10/12/2019 14:08	10/12/2019 16:16	2,13	1	2,13	CHI
20191279398	ORIZONA	2060022612	PIRES DO RIO S2	10/12/2019 14:09	11/12/2019 15:46	10/12/2019 14:09	11/12/2019 15:46	25,62	1	25,62	CHI
20191280539	PIRACANJUBA	PJ12171368	PIRACANJUBA	10/12/2019 14:10	11/12/2019 09:35	10/12/2019 14:10	11/12/2019 09:35	19,41	10	194,06	CHI
20191280105	OURO VERDE DE GOIAS	OV21203409	NEROPOLIS S2	10/12/2019 14:11	11/12/2019 06:46	10/12/2019 14:11	11/12/2019 06:46	16,58	2	33,15	CHI
20191280107	GOIANIA	10018692220	CAMPINAS S1	10/12/2019 14:11	10/12/2019 17:35	10/12/2019 14:11	10/12/2019 17:35	3,39	1	3,39	CHI
20191280109	VILA PROPICIO	NP12188681	GOIANESIA S1	10/12/2019 14:12	10/12/2019 18:42	10/12/2019 14:12	10/12/2019 18:42	4,49	87	390,51	CHI
20191280504	TRINDADE	40268123	TRINDADE	10/12/2019 14:14	10/12/2019 21:49	10/12/2019 14:14	10/12/2019 21:49	7,59	1	7,59	CHI
20191280683	CACU	CC12028172	CACHOEIRA ALTA	10/12/2019 14:14	10/12/2019 21:42	10/12/2019 14:14	10/12/2019 21:42	7,46	4	29,82	CHI
20191281050	TRINDADE	TR12343758	TRINDADE	10/12/2019 14:15	10/12/2019 18:10	10/12/2019 14:15	10/12/2019 18:10	3,90	16	62,43	CHI
20191280508	SAO MIGUEL DO ARAGUAIA	SM13208945	SAO MIGUEL DO ARAGUAIA	10/12/2019 14:16	10/12/2019 17:30	10/12/2019 14:16	10/12/2019 17:30	3,25	9	29,24	CHI
20191280511	PIRES DO RIO	PR12255829	PIRES DO RIO S1	10/12/2019 14:16	11/12/2019 13:08	10/12/2019 14:16	11/12/2019 09:43	19,45	5	97,26	CHI
20191280511	PIRES DO RIO	PR12075741LD	PIRES DO RIO S1	10/12/2019 14:16	11/12/2019 13:08	10/12/2019 14:16	11/12/2019 13:08	22,86	2	45,71	CHI
20191280512	GUAPO	GA11207403	GUAPO S1	10/12/2019 14:16	10/12/2019 15:39	10/12/2019 14:16	10/12/2019 15:39	1,37	145	198,81	CHI

20191280513	FORMOSA	FA12381552	ITIQUEIRA	10/12/2019 14:16	10/12/2019 21:09	10/12/2019 14:16	10/12/2019 21:09	6,87	2	13,74	CHI
20191281463	PORANGATU	PO12254765	PORANGATU	10/12/2019 14:16	10/12/2019 23:59	10/12/2019 14:16	10/12/2019 23:59	9,71	4	38,83	CHI
20191280515	JANDAIA	10004636781	PALMEIRAS	10/12/2019 14:18	10/12/2019 23:20	10/12/2019 14:18	10/12/2019 23:20	9,03	1	9,03	CHI
20191280748	MOIPIORA	MO12073947	IPORA	10/12/2019 14:18	10/12/2019 17:42	10/12/2019 14:18	10/12/2019 17:42	3,39	9	30,54	CHI
20191280772	NAZARIO	NZ12003897	ANICUNS	10/12/2019 14:18	10/12/2019 17:06	10/12/2019 14:18	10/12/2019 17:06	2,80	18	50,40	CHI
20191280529	EDEALINA	O1510444	PONTALINA	10/12/2019 14:19	11/12/2019 22:34	10/12/2019 14:19	10/12/2019 15:42	1,39	28	38,96	CHI
20191280529	PONTALINA	O1510444	PONTALINA	10/12/2019 14:19	11/12/2019 22:34	10/12/2019 14:19	10/12/2019 15:42	1,39	269	374,28	CHI
20191280529	EDEALINA	O1510444	EDEIA	10/12/2019 14:19	11/12/2019 22:34	10/12/2019 14:19	10/12/2019 17:08	2,82	1	2,82	CHI
20191280529	CEZARINA	O1510444	PONTALINA	10/12/2019 14:19	11/12/2019 22:34	10/12/2019 14:19	10/12/2019 17:08	2,82	4	11,29	CHI
20191280529	EDEALINA	O1510444	PONTALINA	10/12/2019 14:19	11/12/2019 22:34	10/12/2019 14:19	10/12/2019 17:08	2,82	2002	5648,98	CHI
20191280529	EDEIA	O1510444	PONTALINA	10/12/2019 14:19	11/12/2019 22:34	10/12/2019 14:19	10/12/2019 17:08	2,82	131	369,64	CHI
20191280529	INDIARA	O1510444	PONTALINA	10/12/2019 14:19	11/12/2019 22:34	10/12/2019 14:19	10/12/2019 17:08	2,82	2	5,64	CHI
20191280529	PONTALINA	O1510444	PONTALINA	10/12/2019 14:19	11/12/2019 22:34	10/12/2019 14:19	10/12/2019 17:08	2,82	22	62,08	CHI
20191280529	EDEALINA	O1510444	PONTALINA	10/12/2019 14:19	11/12/2019 22:34	10/12/2019 15:43	10/12/2019 17:08	1,41	28	39,58	CHI
20191280529	PONTALINA	O1510444	PONTALINA	10/12/2019 14:19	11/12/2019 22:34	10/12/2019 15:43	10/12/2019 17:08	1,41	269	380,26	CHI
20191280529	EDEALINA	ED13368840	EDEIA	10/12/2019 14:19	11/12/2019 22:34	10/12/2019 14:19	10/12/2019 18:01	3,71	2	7,43	CHI
20191280529	EDEIA	EA10401417	EDEIA	10/12/2019 14:19	11/12/2019 22:34	10/12/2019 14:19	10/12/2019 22:26	8,13	8	65,02	CHI
20191280529	EDEIA	EA13335188	EDEIA	10/12/2019 14:19	11/12/2019 22:34	10/12/2019 14:19	11/12/2019 22:34	32,26	3	96,77	CHI
20191280533	BOM JARDIM DE GOIAS	BM21355364	IPORA	10/12/2019 14:21	10/12/2019 21:51	10/12/2019 14:21	10/12/2019 21:51	7,50	1	7,50	CHI
20191280537	GOIANIA	10014457	CAMPINAS S3	10/12/2019 14:21	10/12/2019 17:11	10/12/2019 14:21	10/12/2019 17:11	2,82	1	2,82	CHI
20191280544	JATAI	JT21092391	JATAI S1	10/12/2019 14:23	10/12/2019 16:31	10/12/2019 14:23	10/12/2019 16:31	2,12	2	4,24	CHI
20191280633	CAMPO ALEGRE DE GOIAS	CM10397305	CAMPO ALEGRE DE GOIAS	10/12/2019 14:25	11/12/2019 13:48	10/12/2019 14:25	11/12/2019 11:37	21,19	8	169,51	CHI
20191280633	CAMPO ALEGRE DE GOIAS	CM10397305	CAMPO ALEGRE DE GOIAS	10/12/2019 14:25	11/12/2019 13:48	10/12/2019 14:25	11/12/2019 12:19	21,89	8	175,12	CHI
20191280633	CAMPO ALEGRE DE GOIAS	CM13266056	CAMPO ALEGRE DE GOIAS	10/12/2019 14:25	11/12/2019 13:48	10/12/2019 14:25	11/12/2019 13:06	22,68	103	2335,90	CHI
20191280633	CATALAO	CM13266056	CAMPO ALEGRE DE GOIAS	10/12/2019 14:25	11/12/2019 13:48	10/12/2019 14:25	11/12/2019 13:06	22,68	21	476,25	CHI
20191280633	DISTRITO FEDERAL	CM13266056	CAMPO ALEGRE DE GOIAS	10/12/2019 14:25	11/12/2019 13:48	10/12/2019 14:25	11/12/2019 13:06	22,68	1	22,68	CHI
20191280633	IPAMERI	CM13266056	CAMPO ALEGRE DE GOIAS	10/12/2019 14:25	11/12/2019 13:48	10/12/2019 14:25	11/12/2019 13:06	22,68	11	249,46	CHI
20191280633	CAMPO ALEGRE DE GOIAS	CM12347169	CAMPO ALEGRE DE GOIAS	10/12/2019 14:25	11/12/2019 13:48	10/12/2019 14:25	11/12/2019 13:48	23,37	13	303,84	CHI
20191280552	CALDAS NOVAS	CN11107999	CALDAS NOVAS S1	10/12/2019 14:26	10/12/2019 21:23	10/12/2019 14:26	10/12/2019 21:23	6,94	126	875,03	CHI
20191280553	MORRINHOS	PK12095164RE	PONTALINA	10/12/2019 14:26	11/12/2019 11:27	10/12/2019 14:26	11/12/2019 11:27	21,01	4	84,02	CHI
20191280553	PONTALINA	PK12095164RE	PONTALINA	10/12/2019 14:26	11/12/2019 11:27	10/12/2019 14:26	11/12/2019 11:27	21,01	13	273,08	CHI
20191280594	SANTA CRUZ DE GOIAS	BC12027033	PIRES DO RIO S2	10/12/2019 14:26	11/12/2019 13:09	10/12/2019 14:26	11/12/2019 08:50	18,39	4	73,55	CHI
20191280594	SANTA CRUZ DE GOIAS	BC12083173LD	PIRES DO RIO S2	10/12/2019 14:26	11/12/2019 13:09	10/12/2019 14:26	11/12/2019 13:09	22,72	15	340,76	CHI

20191280561	ITAPURANGA	IK12220328	ITAPURANGA	10/12/2019 14:28	10/12/2019 15:15	10/12/2019 14:28	10/12/2019 15:15	0,78	231	179,86	CHI
20191280567	GOIANIA	12035520	ATLANTICO S2	10/12/2019 14:28	10/12/2019 16:07	10/12/2019 14:28	10/12/2019 16:07	1,64	1	1,64	CHI
20191280618	GOIANIA	GN11068176	CAMPINAS S2	10/12/2019 14:28	10/12/2019 17:19	10/12/2019 14:28	10/12/2019 17:19	2,85	127	361,49	CHI
20191280570	AGUAS LINDAS DE GOIAS	4830424899	AGUAS LINDAS DE GOIAS S2	10/12/2019 14:30	10/12/2019 19:51	10/12/2019 14:30	10/12/2019 19:51	5,34	1	5,34	CHI
20191280571	GUAPO	GA21215880	GUAPO S2	10/12/2019 14:30	11/12/2019 04:40	10/12/2019 14:30	11/12/2019 04:40	14,16	1	14,16	CHI
20191280575	AMARALINA	LC12308828	MARA ROSA	10/12/2019 14:31	10/12/2019 22:10	10/12/2019 14:31	10/12/2019 22:10	7,64	2	15,28	CHI
20191280575	MARA ROSA	LC12308828	MARA ROSA	10/12/2019 14:31	10/12/2019 22:10	10/12/2019 14:31	10/12/2019 22:10	7,64	1	7,64	CHI
20191280576	JUSSARA	JR12396232	JUSSARA	10/12/2019 14:32	10/12/2019 19:40	10/12/2019 14:32	10/12/2019 19:40	5,13	2	10,27	CHI
20191280583	GOIANIA	11226020	CAMPINAS S1	10/12/2019 14:32	10/12/2019 16:37	10/12/2019 14:32	10/12/2019 16:37	2,08	1	2,08	CHI
20191280584	SANTA TEREZA DE GOIAS	SE12060934	PORANGATU	10/12/2019 14:32	10/12/2019 22:06	10/12/2019 14:32	10/12/2019 22:06	7,56	6	45,34	CHI
20191280586	GOIANIA	10025583	CARAJAS S1	10/12/2019 14:33	10/12/2019 16:45	10/12/2019 14:33	10/12/2019 16:45	2,20	1	2,20	CHI
20191280588	URUANA	UA21078295	JARAGUA	10/12/2019 14:33	10/12/2019 20:09	10/12/2019 14:33	10/12/2019 20:09	5,60	1	5,60	CHI
20191280590	GOIAS	GS12313352	GOIAS	10/12/2019 14:33	10/12/2019 17:45	10/12/2019 14:33	10/12/2019 17:45	3,20	2	6,39	CHI
20191280592	ALTO PARAISO DE GOIAS	BF12096495	SAO JOAO D ALIANCA	10/12/2019 14:34	10/12/2019 19:11	10/12/2019 14:34	10/12/2019 19:11	4,62	7	32,31	CHI
20191281031	GOIANIRA	TR32045819	MEIA PONTE	10/12/2019 14:35	10/12/2019 18:20	10/12/2019 14:35	10/12/2019 18:20	3,75	23	86,17	CHI
20191281031	TRINDADE	TR32045819	MEIA PONTE	10/12/2019 14:35	10/12/2019 18:20	10/12/2019 14:35	10/12/2019 18:20	3,75	4	14,99	CHI
20191281156	GOIANESIA	GE12384171	GOIANESIA S2	10/12/2019 14:36	10/12/2019 17:21	10/12/2019 14:36	10/12/2019 17:21	2,75	1	2,75	CHI
20191281156	VILA PROPICIO	GE12384171	GOIANESIA S2	10/12/2019 14:36	10/12/2019 17:21	10/12/2019 14:36	10/12/2019 17:21	2,75	2	5,50	CHI
20191281143	CORUMBA DE GOIAS	CB12144031	CORUMBA	10/12/2019 14:37	10/12/2019 19:44	10/12/2019 14:37	10/12/2019 19:44	5,11	8	40,85	CHI
20191280611	PADRE BERNARDO	PB12290529	PADRE BERNARDO	10/12/2019 14:38	10/12/2019 22:39	10/12/2019 14:38	10/12/2019 22:39	8,01	12	96,15	CHI
20191281026	GOIANIA	GN12151971	MEIA PONTE	10/12/2019 14:38	10/12/2019 16:58	10/12/2019 14:38	10/12/2019 16:58	2,32	354	820,69	CHI
20191280640	SANTA FE DE GOIAS	RN12397579	BRITANIA	10/12/2019 14:39	11/12/2019 16:00	10/12/2019 14:39	11/12/2019 16:00	25,35	1	25,35	CHI
20191280627	SANTA HELENA DE GOIAS	400051436	IPEGUARI	10/12/2019 14:40	10/12/2019 18:30	10/12/2019 14:40	10/12/2019 18:30	3,83	1	3,83	CHI
20191281310	BURITI ALEGRE	BG12161938	ITUMBIARA VELHA S2	10/12/2019 14:40	11/12/2019 08:50	10/12/2019 14:40	11/12/2019 08:50	18,17	2	36,33	CHI
20191281733	ITUMBIARA	IT12088642	ITUMBIARA NOVA	10/12/2019 14:40	11/12/2019 07:15	10/12/2019 14:40	11/12/2019 07:15	16,57	10	165,71	CHI
20191282421	GOIANESIA	GE12358979	GOIANESIA S2	10/12/2019 14:40	11/12/2019 03:12	10/12/2019 14:40	11/12/2019 03:12	12,53	4	50,11	CHI
20191282421	VILA PROPICIO	GE12358979	GOIANESIA S2	10/12/2019 14:40	11/12/2019 03:12	10/12/2019 14:40	11/12/2019 03:12	12,53	8	100,22	CHI
20191282012	DIVINOPOLIS DE GOIAS	2570017432	SAO DOMINGOS	10/12/2019 14:42	10/12/2019 20:16	10/12/2019 14:42	10/12/2019 20:16	5,56	1	5,56	CHI
20191280636	PIRENOPOLIS	PV21278533	SAO FRANCISCO DE GOIAS	10/12/2019 14:43	11/12/2019 07:33	10/12/2019 14:43	11/12/2019 07:33	16,83	1	16,83	CHI
20191280637	CORREGO DO OURO	CO21200892	SAO LUIZ DOS MONTES BELOS	10/12/2019 14:43	11/12/2019 08:20	10/12/2019 14:43	11/12/2019 08:20	17,62	1	17,62	CHI
20191280641	CORUMBAIBA	CI12149233	VILA CORUMBA	10/12/2019 14:44	10/12/2019 16:43	10/12/2019 14:44	10/12/2019 16:43	1,97	8	15,78	CHI
20191280654	MORRINHOS	01240234	MORRINHOS	10/12/2019 14:44	11/12/2019 08:57	10/12/2019 14:44	10/12/2019 15:49	1,08	3764	4071,39	CHI
20191280654	BURITI ALEGRE	01240234	MORRINHOS	10/12/2019 14:44	11/12/2019 08:57	10/12/2019 14:44	10/12/2019 16:20	1,59	1	1,59	CHI

20191280654	MORRINHOS	01240234	MORRINHOS	10/12/2019 14:44	11/12/2019 08:57	10/12/2019 14:44	10/12/2019 16:20	1,59	2746	4370,72	CHI
20191280654	MORRINHOS	01240234	MORRINHOS	10/12/2019 14:44	11/12/2019 08:57	10/12/2019 14:44	10/12/2019 16:55	2,18	1470	3209,50	CHI
20191280654	MORRINHOS	01240234	MORRINHOS	10/12/2019 14:44	11/12/2019 08:57	10/12/2019 14:44	10/12/2019 18:50	4,11	15	61,60	CHI
20191280654	CALDAS NOVAS	01240234	MORRINHOS	10/12/2019 14:44	11/12/2019 08:57	10/12/2019 14:44	10/12/2019 19:05	4,34	7	30,41	CHI
20191280654	MORRINHOS	01240234	MORRINHOS	10/12/2019 14:44	11/12/2019 08:57	10/12/2019 14:44	10/12/2019 19:05	4,34	24	104,27	CHI
20191280654	PIRACANJUBA	01240234	MORRINHOS	10/12/2019 14:44	11/12/2019 08:57	10/12/2019 14:44	10/12/2019 19:05	4,34	126	547,44	CHI
20191280654	MORRINHOS	01240234	MORRINHOS	10/12/2019 14:44	11/12/2019 08:57	10/12/2019 14:44	10/12/2019 19:40	4,92	183	901,07	CHI
20191280654	PIRACANJUBA	01240234	MORRINHOS	10/12/2019 14:44	11/12/2019 08:57	10/12/2019 14:44	10/12/2019 19:40	4,92	2	9,85	CHI
20191280654	MORRINHOS	MR10394713	MORRINHOS	10/12/2019 14:44	11/12/2019 08:57	10/12/2019 18:52	10/12/2019 19:40	0,78	15	11,76	CHI
20191280654	MORRINHOS	MR10394713	MORRINHOS	10/12/2019 14:44	11/12/2019 08:57	10/12/2019 19:41	10/12/2019 19:44	0,05	15	0,80	CHI
20191280654	MORRINHOS	01240234	MORRINHOS	10/12/2019 14:44	11/12/2019 08:57	10/12/2019 14:44	10/12/2019 20:40	5,92	85	503,53	CHI
20191280654	MORRINHOS	01240234	MORRINHOS	10/12/2019 14:44	11/12/2019 08:57	10/12/2019 14:44	10/12/2019 21:50	7,10	1	7,10	CHI
20191280654	MORRINHOS	01240234	MORRINHOS	10/12/2019 14:44	11/12/2019 08:57	10/12/2019 14:44	11/12/2019 08:56	18,20	56	1019,11	CHI
20191280654	MORRINHOS	MR13263693	MORRINHOS	10/12/2019 14:44	11/12/2019 08:57	10/12/2019 19:41	11/12/2019 08:57	13,27	183	2428,31	CHI
20191280654	PIRACANJUBA	MR13263693	MORRINHOS	10/12/2019 14:44	11/12/2019 08:57	10/12/2019 19:41	11/12/2019 08:57	13,27	2	26,54	CHI
20191280646	LUZIANIA	10008378868	RIO VERMELHO	10/12/2019 14:45	10/12/2019 17:08	10/12/2019 14:45	10/12/2019 17:08	2,37	1	2,37	CHI
20191280648	BOM JESUS DE GOIAS	BJ12000347	BOM JESUS DE GOIAS	10/12/2019 14:45	10/12/2019 20:01	10/12/2019 14:45	10/12/2019 20:01	5,25	2	10,50	CHI
20191280405	URUACU	10030693185	URUACU	10/12/2019 14:47	10/12/2019 16:39	10/12/2019 14:47	10/12/2019 16:39	1,86	0	0,00	CHI
20191280653	SAO MIGUEL DO ARAGUAIA	SM21157240	SAO MIGUEL DO ARAGUAIA	10/12/2019 14:47	10/12/2019 17:24	10/12/2019 14:47	10/12/2019 17:24	2,61	1	2,61	CHI
20191280657	ABADIANIA	AN21261176	ANAPOLIS UNIVERSITARIO S2	10/12/2019 14:47	10/12/2019 16:00	10/12/2019 14:47	10/12/2019 16:00	1,20	1	1,20	CHI
20191280795	ARAGOIANIA	AO12340604	GUAPU S2	10/12/2019 14:47	10/12/2019 16:50	10/12/2019 14:47	10/12/2019 16:50	2,04	44	89,81	CHI
20191280689	BELA VISTA DE GOIAS	BV12000046	CEPAIGO S2	10/12/2019 14:48	10/12/2019 18:26	10/12/2019 14:48	10/12/2019 18:26	3,63	30	108,84	CHI
20191280664	PARAUNA	PU12301132	ACREUNA	10/12/2019 14:49	10/12/2019 19:48	10/12/2019 14:49	10/12/2019 19:48	4,98	2	9,96	CHI
20191280444	CALDAS NOVAS	CN11142391	SERRA DE CALDAS	10/12/2019 14:50	10/12/2019 18:26	10/12/2019 14:50	10/12/2019 18:26	3,59	36	129,26	CHI
20191280668	BONOPOLIS	BX12234949	SAO MIGUEL DO ARAGUAIA	10/12/2019 14:50	10/12/2019 15:32	10/12/2019 14:50	10/12/2019 15:32	0,70	3	2,10	CHI
20191280686	NIQUELANDIA	NQ11000003	NIQUELANDIA SUBTRANSMISSAO	10/12/2019 14:50	10/12/2019 15:33	10/12/2019 14:50	10/12/2019 15:33	0,71	108	77,04	CHI
20191281605	PIRACANJUBA	PJ12223259	MORRINHOS	10/12/2019 14:50	10/12/2019 20:55	10/12/2019 14:50	10/12/2019 20:55	6,07	32	194,31	CHI
20191281605	PIRACANJUBA	PJ12223259	ROCHEDO	10/12/2019 14:50	10/12/2019 20:55	10/12/2019 14:50	10/12/2019 20:55	6,07	47	285,39	CHI
20191280677	LUZIANIA	120244445	RIO VERMELHO	10/12/2019 14:52	10/12/2019 15:56	10/12/2019 14:52	10/12/2019 15:56	1,07	1	1,07	CHI
20191281097	FAZENDA NOVA	FN12396225	JUSSARA	10/12/2019 14:52	11/12/2019 11:12	10/12/2019 14:52	11/12/2019 11:12	20,32	10	203,20	CHI
20191280692	LUZIANIA	LZ12330886	VIANOPOLIS	10/12/2019 14:54	10/12/2019 16:34	10/12/2019 14:54	10/12/2019 16:34	1,66	7	11,59	CHI
20191280704	CROMINIA	CQ12000217	PONTALINA	10/12/2019 14:56	10/12/2019 16:42	10/12/2019 14:56	10/12/2019 16:42	1,76	13	22,88	CHI
20191280705	MONTES CLAROS DE GOIAS	ME21133464	IPORA	10/12/2019 14:56	11/12/2019 17:48	10/12/2019 14:56	11/12/2019 17:48	26,86	1	26,86	CHI

20191281242	MAIRIPOTABA	MI12078688	PONTALINA	10/12/2019 14:56	11/12/2019 09:08	10/12/2019 14:56	11/12/2019 09:08	18,20	8	145,57	CHI
20191281490	CROMINIA	MI12249916RE	PONTALINA	10/12/2019 14:56	11/12/2019 10:09	10/12/2019 14:56	11/12/2019 10:09	19,21	13	249,77	CHI
20191281490	MAIRIPOTABA	MI12249916RE	PONTALINA	10/12/2019 14:56	11/12/2019 10:09	10/12/2019 14:56	11/12/2019 10:09	19,21	57	1095,14	CHI
20191280707	LUZIANIA	120040359	RIO VERMELHO	10/12/2019 14:57	10/12/2019 15:48	10/12/2019 14:57	10/12/2019 15:48	0,85	1	0,85	CHI
20191280714	PORTELANDIA	PW21303426	PARQUE DAS EMAS	10/12/2019 14:57	10/12/2019 17:30	10/12/2019 14:57	10/12/2019 17:30	2,54	1	2,54	CHI
20191280715	ABADIA DE GOIAS	GN31052067	CARAJAS S1	10/12/2019 14:57	10/12/2019 22:45	10/12/2019 14:57	10/12/2019 22:45	7,79	3	23,37	CHI
20191280928	NIQUELANDIA	NQ12274796	BARRO ALTO	10/12/2019 14:57	11/12/2019 15:08	10/12/2019 14:57	11/12/2019 15:08	24,18	1	24,18	CHI
20191280718	GOIANESIA	550092067	GOIANESIA S2	10/12/2019 14:58	10/12/2019 19:48	10/12/2019 14:58	10/12/2019 19:48	4,84	1	4,84	CHI
20191280719	RUBIATABA	RB12156045	RUBIATABA	10/12/2019 14:58	11/12/2019 08:48	10/12/2019 14:58	11/12/2019 08:48	17,83	2	35,65	CHI
20191280728	GOIANIRA	1360003270	NEROPOLIS S1	10/12/2019 14:59	10/12/2019 21:00	10/12/2019 14:59	10/12/2019 21:00	6,01	1	6,01	CHI
20191280729	APARECIDA DE GOIANIA	AP11095067	ANHANGUERA	10/12/2019 14:59	10/12/2019 21:25	10/12/2019 14:59	10/12/2019 21:25	6,42	50	320,90	CHI
20191280734	RIO VERDE	630008863	RIO VERDE S2	10/12/2019 15:01	10/12/2019 18:16	10/12/2019 15:01	10/12/2019 18:16	3,25	1	3,25	CHI
20191281171	RIO VERDE	RV11000026	RIO VERDE S2	10/12/2019 15:02	10/12/2019 16:37	10/12/2019 15:02	10/12/2019 16:37	1,57	151	237,53	CHI
20191280409	GOIATUBA	GT21247743	BOM JESUS DE GOIAS	10/12/2019 15:03	11/12/2019 16:10	10/12/2019 15:03	11/12/2019 15:31	24,46	1	24,46	CHI
20191280409	GOIATUBA	GT12247742	BOM JESUS DE GOIAS	10/12/2019 15:03	11/12/2019 16:10	11/12/2019 11:58	11/12/2019 16:10	4,20	5	21,02	CHI
20191280744	ITUMBIARA	690328874	ITUMBIARA VELHA S1	10/12/2019 15:03	10/12/2019 18:45	10/12/2019 15:03	10/12/2019 18:45	3,69	1	3,69	CHI
20191280470	PIRANHAS	PH21204994	PIRANHAS	10/12/2019 15:04	11/12/2019 07:11	10/12/2019 15:04	11/12/2019 07:11	16,11	1	16,11	CHI
20191280869	GOIANIA	GN12001687	GOYA S1	10/12/2019 15:04	10/12/2019 18:38	10/12/2019 15:04	10/12/2019 18:38	3,56	92	327,11	CHI
20191280765	SANTA HELENA DE GOIAS	SH21076331	SANTA HELENA S1	10/12/2019 15:07	10/12/2019 22:17	10/12/2019 15:07	10/12/2019 22:17	7,16	1	7,16	CHI
20191280768	VALPARAISO DE GOIAS	10019485440	MARAJOARA	10/12/2019 15:07	10/12/2019 16:35	10/12/2019 15:07	10/12/2019 16:35	1,45	1	1,45	CHI
20191280770	MAIRIPOTABA	CQ21028523	PONTALINA	10/12/2019 15:08	11/12/2019 17:30	10/12/2019 15:08	11/12/2019 17:30	26,37	3	79,10	CHI
20191280771	FORMOSO	FO21071181	PORANGATU	10/12/2019 15:08	11/12/2019 00:28	10/12/2019 15:08	11/12/2019 00:08	9,01	1	9,01	CHI
20191280771	FORMOSO	FO12071146	PORANGATU	10/12/2019 15:08	11/12/2019 00:28	10/12/2019 21:59	11/12/2019 00:28	2,49	3	7,47	CHI
20191280833	MAIRIPOTABA	PK12046050	PONTALINA	10/12/2019 15:09	11/12/2019 11:35	10/12/2019 15:09	11/12/2019 11:35	20,43	3	61,28	CHI
20191280833	PONTALINA	PK12046050	PONTALINA	10/12/2019 15:09	11/12/2019 11:35	10/12/2019 15:09	11/12/2019 11:35	20,43	57	1164,24	CHI
20191280779	ARAGOIANIA	AO32097677	GUAPO S2	10/12/2019 15:10	10/12/2019 17:49	10/12/2019 15:10	10/12/2019 17:49	2,65	8	21,19	CHI
20191280779	HIDROLANDIA	AO32097677	GUAPO S2	10/12/2019 15:10	10/12/2019 17:49	10/12/2019 15:10	10/12/2019 17:49	2,65	37	97,99	CHI
20191280780	GOIANIA	10294041	CAMPINAS S2	10/12/2019 15:10	10/12/2019 17:38	10/12/2019 15:10	10/12/2019 17:38	2,46	1	2,46	CHI
20191280781	ANAPOLIS	20090468	JUNDIAI S2	10/12/2019 15:10	10/12/2019 16:53	10/12/2019 15:10	10/12/2019 16:53	1,71	1	1,71	CHI
20191280784	LUZIANIA	LZ21192914	CRISTALINA S2	10/12/2019 15:10	10/12/2019 20:14	10/12/2019 15:10	10/12/2019 20:14	5,05	1	5,05	CHI
20191280785	OUVIDOR	10023788729	CATALAO S1	10/12/2019 15:10	11/12/2019 16:29	10/12/2019 15:10	11/12/2019 16:29	25,30	1	25,30	CHI
20191281729	MONTES CLAROS DE GOIAS	ME12204928	IPORA	10/12/2019 15:10	11/12/2019 10:04	10/12/2019 15:10	11/12/2019 10:04	18,88	3	56,65	CHI
20191280789	FORMOSA	FA21218274	ITUIQUIRA	10/12/2019 15:12	10/12/2019 19:31	10/12/2019 15:12	10/12/2019 19:31	4,32	1	4,32	CHI

20191280791	GOIANIRA	GR21129176	GOIANIRA	10/12/2019 15:12	10/12/2019 20:46	10/12/2019 15:12	10/12/2019 20:46	5,56	1	5,56	CHI
20191280801	GOIANIA	14539779	CARAJAS S2	10/12/2019 15:14	10/12/2019 17:27	10/12/2019 15:14	10/12/2019 17:27	2,20	1	2,20	CHI
20191280802	CORREGO DO OURO	CO12300423	SAO LUIZ DOS MONTES BELOS	10/12/2019 15:14	11/12/2019 11:07	10/12/2019 15:14	11/12/2019 11:07	19,87	4	79,48	CHI
20191280807	MOZARLANDIA	MZ21089903	MOZARLANDIA	10/12/2019 15:15	11/12/2019 08:01	10/12/2019 15:15	11/12/2019 08:01	16,76	1	16,76	CHI
20191280810	TRINDADE	TR12133859	GOIANIRA	10/12/2019 15:15	10/12/2019 22:34	10/12/2019 15:15	10/12/2019 22:34	7,30	4	29,22	CHI
20191280811	VARJAO	940006297	GUAPO S2	10/12/2019 15:15	10/12/2019 21:32	10/12/2019 15:15	10/12/2019 21:32	6,29	1	6,29	CHI
20191282219	CAIAPONIA	CP12238699	PALESTINA	10/12/2019 15:15	10/12/2019 23:51	10/12/2019 15:15	10/12/2019 23:51	8,59	8	68,75	CHI
20191280815	PIRENOPOLIS	PV21284253	CORUMBA	10/12/2019 15:16	10/12/2019 17:57	10/12/2019 15:16	10/12/2019 17:57	2,67	1	2,67	CHI
20191280824	INDIARA	10017069139	EDEIA	10/12/2019 15:18	10/12/2019 22:40	10/12/2019 15:18	10/12/2019 22:40	7,37	1	7,37	CHI
20191280825	SANTO ANTONIO DA BARRA	BZ21230931	ACREUNA	10/12/2019 15:18	10/12/2019 16:25	10/12/2019 15:18	10/12/2019 16:25	1,11	1	1,11	CHI
20191280826	GOIAS	GS21073694	MATRINCHA	10/12/2019 15:18	10/12/2019 20:21	10/12/2019 15:18	10/12/2019 20:21	5,05	1	5,05	CHI
20191280830	NOVA CRIXAS	NA21121188	NOVA CRIXAS	10/12/2019 15:19	10/12/2019 17:20	10/12/2019 15:19	10/12/2019 17:20	2,02	1	2,02	CHI
20191280835	APORE	AE21365436	ITAJA S2	10/12/2019 15:19	10/12/2019 17:38	10/12/2019 15:19	10/12/2019 17:38	2,31	1	2,31	CHI
20191280838	PARANAIGUARA	PC21316879	CACHOEIRA ALTA	10/12/2019 15:19	10/12/2019 21:45	10/12/2019 15:19	10/12/2019 21:45	6,43	1	6,43	CHI
20191280968	INDIARA	IY11000003	EDEIA	10/12/2019 15:19	10/12/2019 20:16	10/12/2019 15:19	10/12/2019 20:16	4,94	116	572,56	CHI
20191280844	INDIARA	IY11000001	EDEIA	10/12/2019 15:21	10/12/2019 19:11	10/12/2019 15:21	10/12/2019 19:11	3,85	161	619,54	CHI
20191280850	ARENOPOLIS	AY12123896	ARENOPOLIS	10/12/2019 15:22	11/12/2019 19:01	10/12/2019 15:22	11/12/2019 19:01	27,64	14	386,92	CHI
20191280850	DIORAMA	AY12123896	ARENOPOLIS	10/12/2019 15:22	11/12/2019 19:01	10/12/2019 15:22	11/12/2019 19:01	27,64	15	414,56	CHI
20191280854	VILA PROPICIO	NP21251963	GOIANESIA S1	10/12/2019 15:23	11/12/2019 11:23	10/12/2019 15:23	11/12/2019 11:23	19,99	1	19,99	CHI
20191280857	FORMOSA	FA12383232	ITUIQUIRA	10/12/2019 15:23	10/12/2019 16:58	10/12/2019 15:23	10/12/2019 16:58	1,57	2	3,14	CHI
20191280859	VIANOPOLIS	VN21072136	VIANOPOLIS	10/12/2019 15:24	10/12/2019 17:33	10/12/2019 15:24	10/12/2019 17:33	2,15	1	2,15	CHI
20191280861	MORRINHOS	MR12040536	MORRINHOS	10/12/2019 15:24	11/12/2019 11:45	11/12/2019 10:35	11/12/2019 11:06	0,53	5	2,66	CHI
20191280861	MORRINHOS	MR31056726	MORRINHOS	10/12/2019 15:24	11/12/2019 11:45	10/12/2019 15:24	11/12/2019 11:45	20,34	1	20,34	CHI
20191280862	CALDAS NOVAS	CN21090589	RIO QUENTE	10/12/2019 15:24	11/12/2019 13:29	10/12/2019 15:24	11/12/2019 13:29	22,07	1	22,07	CHI
20191280890	BOM JESUS DE GOIAS	1250005118	BOM JESUS DE GOIAS	10/12/2019 15:24	10/12/2019 17:34	10/12/2019 15:24	10/12/2019 17:34	2,16	1	2,16	CHI
20191280864	SAO MIGUEL DO ARAGUAIA	SM12074411	SAO MIGUEL DO ARAGUAIA	10/12/2019 15:25	10/12/2019 18:15	10/12/2019 15:25	10/12/2019 18:15	2,83	9	25,46	CHI
20191280867	BOM JARDIM DE GOIAS	BM21071770	IPORA	10/12/2019 15:25	10/12/2019 21:10	10/12/2019 15:25	10/12/2019 21:10	5,73	1	5,73	CHI
20191280925	ITABERAI	IB11000014	ITABERAI S2	10/12/2019 15:26	10/12/2019 23:09	10/12/2019 15:26	10/12/2019 23:09	7,70	68	523,71	CHI
20191280875	SAO SIMAO	SO21000082	CACHOEIRA ALTA	10/12/2019 15:27	10/12/2019 18:29	10/12/2019 15:27	10/12/2019 18:29	3,03	1	3,03	CHI
20191280876	APARECIDA DE GOIANIA	AP11004863	ATLANTICO S1	10/12/2019 15:27	11/12/2019 01:24	10/12/2019 15:27	11/12/2019 01:24	9,94	93	924,29	CHI
20191280880	CATALAO	CT12209404	CATALAO S1	10/12/2019 15:28	12/12/2019 11:20	10/12/2019 15:28	12/12/2019 11:20	43,86	3	131,57	CHI
20191280882	JATAI	JT12214362	JATAI S3	10/12/2019 15:28	10/12/2019 18:20	10/12/2019 15:28	10/12/2019 18:20	2,86	3	8,58	CHI
20191280883	RIO VERDE	SH12273765	SANTA HELENA S1	10/12/2019 15:28	10/12/2019 17:05	10/12/2019 15:28	10/12/2019 17:05	1,62	3	4,85	CHI

20191280883	SANTA HELENA DE GOIAS	SH12273765	SANTA HELENA S1	10/12/2019 15:28	10/12/2019 17:05	10/12/2019 15:28	10/12/2019 17:05	1,62	15	24,25	CHI
20191280884	JATAI	290029144	JATAI S2	10/12/2019 15:28	11/12/2019 00:11	10/12/2019 15:28	11/12/2019 00:11	8,72	1	8,72	CHI
20191280944	GOIATUBA	GT12048503	GOIATUBA S2	10/12/2019 15:30	10/12/2019 18:33	10/12/2019 15:30	10/12/2019 18:33	3,05	21	64,00	CHI
20191280896	SANTA ROSA DE GOIAS	SR21216368	INHUMAS S1	10/12/2019 15:31	10/12/2019 17:44	10/12/2019 15:31	10/12/2019 17:44	2,22	1	2,22	CHI
20191280899	ANAPOLIS	10000180341	JUNDIAI S1	10/12/2019 15:31	10/12/2019 18:12	10/12/2019 15:31	10/12/2019 18:12	2,67	1	2,67	CHI
20191280923	GOIANIA	GN12159964	XAVANTES	10/12/2019 15:32	10/12/2019 17:22	10/12/2019 15:32	10/12/2019 17:22	1,83	439	802,03	CHI
20191280914	APARECIDA DE GOIANIA	14409185	ANHANGUERA	10/12/2019 15:33	10/12/2019 18:04	10/12/2019 15:33	10/12/2019 18:04	2,51	1	2,51	CHI
20191280915	TRINDADE	40048536	TRINDADE	10/12/2019 15:33	10/12/2019 23:38	10/12/2019 15:33	10/12/2019 23:38	8,09	1	8,09	CHI
20191280917	SANTA HELENA DE GOIAS	SH12247775	SANTA HELENA S1	10/12/2019 15:33	11/12/2019 14:02	10/12/2019 15:33	10/12/2019 23:50	8,27	1	8,27	CHI
20191280917	SANTA HELENA DE GOIAS	SH12247775	SANTA HELENA S1	10/12/2019 15:33	11/12/2019 14:02	10/12/2019 15:33	11/12/2019 14:02	22,48	1	22,48	CHI
20191280918	BOM JARDIM DE GOIAS	BM12334813	IPORA	10/12/2019 15:34	10/12/2019 18:21	10/12/2019 15:34	10/12/2019 18:21	2,78	12	33,39	CHI
20191280921	TRINDADE	40219320	GOIANIRA	10/12/2019 15:34	10/12/2019 20:20	10/12/2019 15:34	10/12/2019 20:20	4,76	1	4,76	CHI
20191280922	MORRINHOS	MR11000048	MORRINHOS	10/12/2019 15:34	10/12/2019 17:15	10/12/2019 15:34	10/12/2019 17:15	1,67	27	45,17	CHI
20191280924	MORRINHOS	10030614170	MORRINHOS	10/12/2019 15:35	10/12/2019 17:05	10/12/2019 15:35	10/12/2019 17:05	1,50	1	1,50	CHI
20191280931	RIO VERDE	630076765	RIO VERDE S2	10/12/2019 15:36	10/12/2019 17:37	10/12/2019 15:36	10/12/2019 17:37	2,03	1	2,03	CHI
20191280934	GOIANIRA	10010235882	MEIA PONTE	10/12/2019 15:36	10/12/2019 20:40	10/12/2019 15:36	10/12/2019 20:40	5,05	1	5,05	CHI
20191280764	HIDROLANDIA	JS12000108RE	ROCHEDO	10/12/2019 15:37	11/12/2019 03:40	10/12/2019 15:37	11/12/2019 03:40	12,05	9	108,43	CHI
20191280764	PIRACANJUBA	JS12000108RE	ROCHEDO	10/12/2019 15:37	11/12/2019 03:40	10/12/2019 15:37	11/12/2019 03:40	12,05	251	3024,06	CHI
20191280764	PROFESSOR JAMIL SAFADY	JS12000108RE	ROCHEDO	10/12/2019 15:37	11/12/2019 03:40	10/12/2019 15:37	11/12/2019 03:40	12,05	29	349,39	CHI
20191280940	PIRES DO RIO	PR11049602	PIRES DO RIO S1	10/12/2019 15:37	10/12/2019 18:09	10/12/2019 15:37	10/12/2019 18:09	2,52	174	438,09	CHI
20191280951	MORRINHOS	MR12264053	MORRINHOS	10/12/2019 15:38	10/12/2019 20:29	10/12/2019 15:38	10/12/2019 20:29	4,85	9	43,65	CHI
20191280946	CEZARINA	CZ21011070	CEZARINA	10/12/2019 15:39	10/12/2019 18:59	10/12/2019 15:39	10/12/2019 18:59	3,35	1	3,35	CHI
20191281000	GOIANIA	GN12000805	XAVANTES	10/12/2019 15:40	10/12/2019 18:39	10/12/2019 15:40	10/12/2019 18:39	2,97	15	44,58	CHI
20191280958	PADRE BERNARDO	PB21133689	PADRE BERNARDO	10/12/2019 15:41	10/12/2019 23:04	10/12/2019 15:41	10/12/2019 23:04	7,38	4	29,52	CHI
20191281069	MINEIROS	MY21400211	PARQUE DAS EMAS	10/12/2019 15:41	10/12/2019 18:53	10/12/2019 15:41	10/12/2019 18:53	3,19	1	3,19	CHI
20191281434	PARANAIGUARA	QI12101708	QUIRINOPOLIS	10/12/2019 15:41	11/12/2019 00:31	10/12/2019 15:41	11/12/2019 00:31	8,82	3	26,45	CHI
20191281434	QUIRINOPOLIS	QI12101708	QUIRINOPOLIS	10/12/2019 15:41	11/12/2019 00:31	10/12/2019 15:41	11/12/2019 00:31	8,82	10	88,18	CHI
20191280967	MARA ROSA	ET12391905	MARA ROSA	10/12/2019 15:42	11/12/2019 03:11	10/12/2019 15:42	11/12/2019 03:11	11,48	2	22,96	CHI
20191280972	OUVIDOR	IO21037584	CATALAO S1	10/12/2019 15:42	11/12/2019 03:54	10/12/2019 15:42	11/12/2019 03:54	12,19	1	12,19	CHI
20191280973	SANTO ANTONIO DA BARRA	BZ21279421	ACREUNA	10/12/2019 15:42	10/12/2019 17:45	10/12/2019 15:42	10/12/2019 17:45	2,04	1	2,04	CHI
20191281133	GOIATUBA	GT12052893RE	GOIATUBA S1	10/12/2019 15:42	10/12/2019 22:31	10/12/2019 15:42	10/12/2019 22:31	6,81	5	34,04	CHI
20191281133	JOVIANIA	GT12052893RE	GOIATUBA S1	10/12/2019 15:42	10/12/2019 22:31	10/12/2019 15:42	10/12/2019 22:31	6,81	9	61,27	CHI
20191280976	SAO LUIS DE MONTES BELOS	SL21167247	SAO LUIZ DOS MONTES BELOS	10/12/2019 15:43	10/12/2019 18:31	10/12/2019 15:43	10/12/2019 18:31	2,79	1	2,79	CHI

20191280978	MAURILANDIA	ML12303334	RIO DOS BOIS	10/12/2019 15:44	10/12/2019 18:13	10/12/2019 15:44	10/12/2019 18:13	2,48	14	34,73	CHI
20191280978	RIO VERDE	ML12303334	RIO DOS BOIS	10/12/2019 15:44	10/12/2019 18:13	10/12/2019 15:44	10/12/2019 18:13	2,48	2	4,96	CHI
20191280980	GOIATUBA	GT12000081	GOIATUBA S2	10/12/2019 15:44	10/12/2019 19:16	10/12/2019 15:44	10/12/2019 18:43	2,97	6	17,84	CHI
20191280980	GOIATUBA	GT12000081	GOIATUBA S2	10/12/2019 15:44	10/12/2019 19:16	10/12/2019 15:44	10/12/2019 19:16	3,52	4	14,09	CHI
20191280982	AGUAS LINDAS DE GOIAS	4830309533	AGUAS LINDAS DE GOIAS S1	10/12/2019 15:45	10/12/2019 16:58	10/12/2019 15:45	10/12/2019 16:58	1,21	1	1,21	CHI
20191281204	PIRES DO RIO	PR11186669	PIRES DO RIO S1	10/12/2019 15:45	10/12/2019 20:38	10/12/2019 15:45	10/12/2019 20:38	4,88	118	576,17	CHI
20191281091	BELA VISTA DE GOIAS	BV12103250LD	SENADOR CANEDO	10/12/2019 15:47	10/12/2019 17:43	10/12/2019 15:47	10/12/2019 17:43	1,93	21	40,52	CHI
20191280991	GOIANIA	15810586	GOIANIA LESTE S3	10/12/2019 15:48	10/12/2019 18:18	10/12/2019 15:48	10/12/2019 18:18	2,50	1	2,50	CHI
20191281303	GOIANIRA	GR12009114	NEROPOLIS S1	10/12/2019 15:48	10/12/2019 21:31	10/12/2019 15:48	10/12/2019 21:31	5,71	4	22,85	CHI
20191280997	HIDROLANDIA	HD12007560	PONTALINA	10/12/2019 15:49	10/12/2019 20:32	10/12/2019 15:49	10/12/2019 20:32	4,71	14	66,00	CHI
20191280998	GOIANIA	13585599	REAL S2	10/12/2019 15:49	10/12/2019 18:10	10/12/2019 15:49	10/12/2019 18:10	2,35	1	2,35	CHI
20191281011	BELA VISTA DE GOIAS	BV21000047	BELA VISTA S1	10/12/2019 15:51	10/12/2019 18:12	10/12/2019 15:51	10/12/2019 18:12	2,35	3	7,04	CHI
20191281795	PORTELANDIA	PW11234348	PARQUE DAS EMAS	10/12/2019 15:52	10/12/2019 21:08	10/12/2019 15:52	10/12/2019 21:08	5,25	142	745,78	CHI
20191281023	ITAUCU	IX12392345	INHUMAS S1	10/12/2019 15:53	10/12/2019 17:46	10/12/2019 15:53	10/12/2019 17:46	1,87	36	67,24	CHI
20191281096	ALTO PARAISO DE GOIAS	BF12231960	NIQUELANDIA SUBTRANSMISSAO	10/12/2019 15:53	10/12/2019 20:02	10/12/2019 15:53	10/12/2019 20:02	4,14	20	82,74	CHI
20191281115	CAIAPONIA	CP12207858	PALESTINA	10/12/2019 15:53	10/12/2019 22:47	10/12/2019 15:53	10/12/2019 22:47	6,89	18	123,93	CHI
20191281115	PALESTINA DE GOIAS	CP12207858	PALESTINA	10/12/2019 15:53	10/12/2019 22:47	10/12/2019 15:53	10/12/2019 22:47	6,89	1	6,89	CHI
20191281296	IPORA	IR12212994	IPORA	10/12/2019 15:54	10/12/2019 18:34	10/12/2019 15:54	10/12/2019 18:34	2,65	186	493,78	CHI
20191281965	GUARINOS	GG12318452	URUACU	10/12/2019 15:54	11/12/2019 00:24	10/12/2019 15:54	11/12/2019 00:24	8,49	1	8,49	CHI
20191281965	PILAR DE GOIAS	GG12318452	URUACU	10/12/2019 15:54	11/12/2019 00:24	10/12/2019 15:54	11/12/2019 00:24	8,49	84	713,46	CHI
20191281965	SANTA TEREZINHA DE GOIAS	GG12318452	URUACU	10/12/2019 15:54	11/12/2019 00:24	10/12/2019 15:54	11/12/2019 00:24	8,49	4	33,97	CHI
20191281032	ITUMBIARA	690119677	ITUMBIARA NOVA	10/12/2019 15:55	10/12/2019 22:21	10/12/2019 15:55	10/12/2019 22:21	6,42	1	6,42	CHI
20191281038	JUSSARA	1290050378	JUSSARA	10/12/2019 15:56	10/12/2019 22:45	10/12/2019 15:56	10/12/2019 22:45	6,82	1	6,82	CHI
20191281040	SAO JOAO D ALIANCA	JL12180616	SAO JOAO D ALIANCA	10/12/2019 15:56	11/12/2019 12:06	10/12/2019 15:56	11/12/2019 12:06	20,15	5	100,77	CHI
20191281043	ANICUNS	AC12158693	ANICUNS	10/12/2019 15:57	10/12/2019 21:03	10/12/2019 15:57	10/12/2019 21:03	5,10	1	5,10	CHI
20191281047	BRAZABRANTES	BR21011965	NEROPOLIS S1	10/12/2019 15:57	10/12/2019 20:03	10/12/2019 15:57	10/12/2019 20:03	4,09	1	4,09	CHI
20191280428	PARAUNA	PU21305730	ACREUNA	10/12/2019 15:58	10/12/2019 19:33	10/12/2019 15:58	10/12/2019 19:33	3,57	1	3,57	CHI
20191281051	ORIZONA	OZ21043241	PIRES DO RIO S2	10/12/2019 15:58	11/12/2019 11:05	10/12/2019 15:58	11/12/2019 11:05	19,12	1	19,12	CHI
20191281056	RIO VERDE	RV12214221	MONTIVIDIU T	10/12/2019 15:58	10/12/2019 21:15	10/12/2019 15:58	10/12/2019 19:30	3,54	2	7,08	CHI
20191281056	RIO VERDE	RV12301330	MONTIVIDIU T	10/12/2019 15:58	10/12/2019 21:15	10/12/2019 15:58	10/12/2019 20:12	4,23	1	4,23	CHI
20191281056	RIO VERDE	RV12360609	MONTIVIDIU T	10/12/2019 15:58	10/12/2019 21:15	10/12/2019 15:58	10/12/2019 20:46	4,79	1	4,79	CHI
20191281056	RIO VERDE	RV21214223	MONTIVIDIU T	10/12/2019 15:58	10/12/2019 21:15	10/12/2019 15:58	10/12/2019 21:15	5,28	1	5,28	CHI
20191281057	CROMINIA	CQ21000303	PONTALINA	10/12/2019 15:58	11/12/2019 14:20	10/12/2019 15:58	11/12/2019 14:20	22,35	1	22,35	CHI

20191281267	CORUMBAIBA	CI12000093RE	VILA CORUMBA	10/12/2019 15:58	10/12/2019 22:34	10/12/2019 15:58	10/12/2019 22:34	6,60	140	923,57	CHI
20191281061	CORUMBAIBA	CI12263342	VILA CORUMBA	10/12/2019 15:59	10/12/2019 17:34	10/12/2019 15:59	10/12/2019 17:34	1,57	362	569,65	CHI
20191281064	JATAI	10007038257	JATAI S2	10/12/2019 16:01	10/12/2019 17:57	10/12/2019 16:01	10/12/2019 17:57	1,92	1	1,92	CHI
20191281065	IPAMERI	IP21275752	IPAMERI	10/12/2019 16:01	11/12/2019 08:20	10/12/2019 16:01	11/12/2019 08:20	16,30	3	48,91	CHI
20191281066	CAIAPONIA	CP21119252	CAIAPONIA	10/12/2019 16:01	10/12/2019 20:20	10/12/2019 16:01	10/12/2019 20:20	4,31	1	4,31	CHI
20191281070	FORMOSA	610040790	ITIQUEIRA	10/12/2019 16:02	11/12/2019 11:14	10/12/2019 16:02	11/12/2019 11:14	19,19	1	19,19	CHI
20191281071	GOIANESIA	PV21073540	GOIANESIA S1	10/12/2019 16:02	11/12/2019 12:00	10/12/2019 16:02	11/12/2019 12:00	19,95	1	19,95	CHI
20191281073	JANDAIA	JD12404417	PALMEIRAS	10/12/2019 16:02	11/12/2019 07:20	10/12/2019 16:02	11/12/2019 07:20	15,28	3	45,85	CHI
20191281077	ESTRELA DO NORTE	ET12051068	MARA ROSA	10/12/2019 16:04	11/12/2019 17:16	10/12/2019 16:04	11/12/2019 17:16	25,21	2	50,42	CHI
20191281078	MORRINHOS	MR21399301	MORRINHOS	10/12/2019 16:04	11/12/2019 12:50	10/12/2019 16:04	11/12/2019 12:50	20,76	2	41,53	CHI
20191281083	IPAMERI	IP12203208	IPAMERI	10/12/2019 16:04	10/12/2019 21:45	10/12/2019 16:04	10/12/2019 21:45	5,67	167	947,35	CHI
20191281085	SANTA TEREZA DE GOIAS	SE12332803	MARA ROSA	10/12/2019 16:04	11/12/2019 09:04	10/12/2019 16:04	11/12/2019 09:04	16,99	4	67,95	CHI
20191281090	NIQUELANDIA	NQ12253797	URUACU	10/12/2019 16:05	12/12/2019 12:51	10/12/2019 16:05	10/12/2019 23:59	7,91	19	150,34	CHI
20191281090	NIQUELANDIA	NQ12253797	URUACU	10/12/2019 16:05	12/12/2019 12:51	10/12/2019 16:05	12/12/2019 12:51	44,76	2	89,53	CHI
20191281090	NIQUELANDIA	NQ12253797	URUACU	10/12/2019 16:05	12/12/2019 12:51	11/12/2019 00:06	12/12/2019 12:51	36,74	19	698,03	CHI
20191281094	BELA VISTA DE GOIAS	BV21020408	BELA VISTA S2	10/12/2019 16:05	10/12/2019 17:14	10/12/2019 16:05	10/12/2019 17:14	1,13	1	1,13	CHI
20191281148	RIO VERDE	RV12020010	CABRIUVA S2	10/12/2019 16:05	10/12/2019 19:22	10/12/2019 16:05	10/12/2019 19:22	3,28	48	157,60	CHI
20191281549	SANTA BARBARA DE GOIAS	SB12299230	TRINDADE	10/12/2019 16:06	10/12/2019 22:30	10/12/2019 16:06	10/12/2019 22:30	6,39	20	127,77	CHI
20191281549	TRINDADE	SB12299230	TRINDADE	10/12/2019 16:06	10/12/2019 22:30	10/12/2019 16:06	10/12/2019 22:30	6,39	3	19,16	CHI
20191281101	LUZIANIA	LZ21147922	VIANOPOLIS	10/12/2019 16:07	10/12/2019 19:27	10/12/2019 16:07	10/12/2019 19:27	3,33	1	3,33	CHI
20191281113	VALPARAISO DE GOIAS	VA11110928	MARAJOARA	10/12/2019 16:08	10/12/2019 17:48	10/12/2019 16:08	10/12/2019 17:48	1,66	90	149,33	CHI
20191281114	GOIANIA	13390788	REAL S1	10/12/2019 16:08	10/12/2019 20:51	10/12/2019 16:08	10/12/2019 20:51	4,71	1	4,71	CHI
20191281116	VIANOPOLIS	510038633	VIANOPOLIS	10/12/2019 16:08	10/12/2019 17:33	10/12/2019 16:08	10/12/2019 17:33	1,40	1	1,40	CHI
20191281119	APARECIDA DE GOIANIA	200186334	ANHANGUERA	10/12/2019 16:09	10/12/2019 22:59	10/12/2019 16:09	10/12/2019 22:59	6,83	1	6,83	CHI
20191281120	BELA VISTA DE GOIAS	BV21185846	BELA VISTA S1	10/12/2019 16:09	10/12/2019 17:42	10/12/2019 16:09	10/12/2019 17:42	1,53	2	3,07	CHI
20191281541	RIO VERDE	RV11241410	RIO VERDE S2	10/12/2019 16:09	10/12/2019 17:35	10/12/2019 16:09	10/12/2019 17:35	1,43	168	240,10	CHI
20191281122	CRISTIANOPOLIS	CF12242662	PIRES DO RIO S2	10/12/2019 16:10	11/12/2019 09:43	10/12/2019 16:10	11/12/2019 09:43	17,54	4	70,15	CHI
20191281128	JUSSARA	JR21259914	JUSSARA	10/12/2019 16:11	10/12/2019 18:45	10/12/2019 16:11	10/12/2019 18:45	2,57	1	2,57	CHI
20191281137	GOUVELANDIA	GB10402438	QUIRINOPOLIS	10/12/2019 16:11	11/12/2019 00:05	10/12/2019 16:11	10/12/2019 19:10	2,99	40	119,57	CHI
20191281137	QUIRINOPOLIS	GB10402438	QUIRINOPOLIS	10/12/2019 16:11	11/12/2019 00:05	10/12/2019 16:11	10/12/2019 19:10	2,99	13	38,86	CHI
20191281137	GOUVELANDIA	GB13000238	QUIRINOPOLIS	10/12/2019 16:11	11/12/2019 00:05	10/12/2019 16:11	10/12/2019 19:50	3,64	59	214,92	CHI
20191281137	GOUVELANDIA	GB10402438	QUIRINOPOLIS	10/12/2019 16:11	11/12/2019 00:05	10/12/2019 19:52	10/12/2019 20:08	0,26	40	10,40	CHI
20191281137	QUIRINOPOLIS	GB10402438	QUIRINOPOLIS	10/12/2019 16:11	11/12/2019 00:05	10/12/2019 19:52	10/12/2019 20:08	0,26	13	3,38	CHI

20191281137	GOUVELANDIA	GB13000238	QUIRINOPOLIS	10/12/2019 16:11	11/12/2019 00:05	10/12/2019 19:52	10/12/2019 23:41	3,82	59	225,13	CHI
20191281137	GOUVELANDIA	QJ32050838	QUIRINOPOLIS	10/12/2019 16:11	11/12/2019 00:05	10/12/2019 16:11	11/12/2019 00:05	7,90	2	15,80	CHI
20191281132	MINACU	IH21220714	MINACU	10/12/2019 16:12	10/12/2019 21:28	10/12/2019 16:12	10/12/2019 21:28	5,26	1	5,26	CHI
20191281134	MOIPIORA	MO12374844	IPORA	10/12/2019 16:13	10/12/2019 19:11	10/12/2019 16:13	10/12/2019 19:11	2,97	10	29,66	CHI
20191281138	JUSSARA	1290023880	JUSSARA	10/12/2019 16:14	11/12/2019 13:00	10/12/2019 16:14	11/12/2019 13:00	20,78	1	20,78	CHI
20191282758	ITAPIRAPUA	IU12014848	MATRINCHA	10/12/2019 16:14	11/12/2019 13:32	10/12/2019 16:14	11/12/2019 09:32	17,29	2	34,58	CHI
20191282758	ITAPIRAPUA	IU13014776	MATRINCHA	10/12/2019 16:14	11/12/2019 13:32	10/12/2019 16:14	11/12/2019 13:32	21,28	44	936,49	CHI
20191281145	GOIANIRA	10011776623	MEIA PONTE	10/12/2019 16:15	10/12/2019 22:04	10/12/2019 16:15	10/12/2019 22:04	5,81	0	0,00	CHI
20191281153	TRINDADE	40068729	TRINDADE	10/12/2019 16:17	11/12/2019 01:07	10/12/2019 16:17	11/12/2019 01:07	8,82	1	8,82	CHI
20191281164	PIRES DO RIO	PR12328727	PIRES DO RIO S2	10/12/2019 16:19	11/12/2019 09:08	10/12/2019 16:19	11/12/2019 09:08	16,81	5	84,07	CHI
20191281167	RIO VERDE	RV11306529	CABRIUVA S1	10/12/2019 16:19	11/12/2019 02:03	10/12/2019 16:19	11/12/2019 02:03	9,72	35	340,31	CHI
20191281176	RIO VERDE	RV21301476	ACREUNA	10/12/2019 16:21	10/12/2019 22:49	10/12/2019 16:21	10/12/2019 22:49	6,47	1	6,47	CHI
20191281194	JANDAIA	JD12005515	PALMEIRAS	10/12/2019 16:24	11/12/2019 22:05	10/12/2019 16:24	11/12/2019 09:46	17,36	3	52,09	CHI
20191281194	JANDAIA	JD12005515	PALMEIRAS	10/12/2019 16:24	11/12/2019 22:05	10/12/2019 16:24	11/12/2019 22:05	29,68	4	118,71	CHI
20191281194	JANDAIA	JD12005515	PALMEIRAS	10/12/2019 16:24	11/12/2019 22:05	11/12/2019 20:23	11/12/2019 22:05	1,70	3	5,10	CHI
20191281197	INHUMAS	10030627379	INHUMAS S2	10/12/2019 16:24	10/12/2019 19:38	10/12/2019 16:24	10/12/2019 19:38	3,23	1	3,23	CHI
20191281206	PIRACANJUBA	PJ21196481	PIRACANJUBA	10/12/2019 16:27	11/12/2019 10:17	10/12/2019 16:27	11/12/2019 10:17	17,83	2	35,66	CHI
20191281207	SERRANOPOLIS	DJ12164061	CHAPADAO DO CEU	10/12/2019 16:27	11/12/2019 10:43	10/12/2019 16:27	11/12/2019 10:43	18,26	2	36,53	CHI
20191281210	GOIATUBA	GT21016327	BOM JESUS DE GOIAS	10/12/2019 16:28	11/12/2019 10:36	10/12/2019 16:28	11/12/2019 10:36	18,13	1	18,13	CHI
20191281212	GOIANIA	10029562870	GOIANIA LESTE S1	10/12/2019 16:29	10/12/2019 18:15	10/12/2019 16:29	10/12/2019 18:15	1,76	1	1,76	CHI
20191281214	CAMPINACU	UC21239734	PORANGATU	10/12/2019 16:29	11/12/2019 08:07	10/12/2019 16:29	11/12/2019 08:07	15,62	1	15,62	CHI
20191281217	ANAPOLIS	AN12384291	ANAPOLIS UNIVERSITARIO S2	10/12/2019 16:30	10/12/2019 20:45	10/12/2019 16:30	10/12/2019 20:45	4,25	45	191,24	CHI
20191281219	PLANALTINA	PI11043458	PLANALTINA	10/12/2019 16:30	11/12/2019 12:32	10/12/2019 16:30	11/12/2019 12:32	20,03	31	620,97	CHI
20191281224	BURITI ALEGRE	BG21000006	GOIATUBA S2	10/12/2019 16:30	11/12/2019 13:36	10/12/2019 16:30	11/12/2019 13:36	21,09	1	21,09	CHI
20191281265	MOSSAMEDES	MD12057741	FIRMINOPOLIS S2	10/12/2019 16:30	10/12/2019 17:34	10/12/2019 16:30	10/12/2019 17:34	1,06	18	19,15	CHI
20191281265	SANCLERLANDIA	MD12057741	FIRMINOPOLIS S2	10/12/2019 16:30	10/12/2019 17:34	10/12/2019 16:30	10/12/2019 17:34	1,06	1	1,06	CHI
20191281489	GOIATUBA	GT12000100	GOIATUBA S2	10/12/2019 16:30	10/12/2019 18:16	10/12/2019 16:30	10/12/2019 18:16	1,76	20	35,28	CHI
20191281743	AGUA FRIA DE GOIAS	NQ12140182	SAO JOAO D ALIANCA	10/12/2019 16:30	10/12/2019 21:39	10/12/2019 16:30	10/12/2019 21:39	5,15	68	350,22	CHI
20191281743	NIQUELANDIA	NQ12140182	SAO JOAO D ALIANCA	10/12/2019 16:30	10/12/2019 21:39	10/12/2019 16:30	10/12/2019 21:39	5,15	6	30,90	CHI
20191282216	FORMOSO	FO12060936	PORANGATU	10/12/2019 16:30	10/12/2019 22:06	10/12/2019 16:30	10/12/2019 22:06	5,59	5	27,96	CHI
20191282216	SANTA TEREZA DE GOIAS	FO12060936	PORANGATU	10/12/2019 16:30	10/12/2019 22:06	10/12/2019 16:30	10/12/2019 22:06	5,59	30	167,73	CHI
20191281233	SAO MIGUEL DO ARAGUAIA	SM21089292	SAO MIGUEL DO ARAGUAIA	10/12/2019 16:31	10/12/2019 19:20	10/12/2019 16:31	10/12/2019 19:20	2,81	1	2,81	CHI
20191281236	SANTO ANTONIO DE GOIAS	GR31018510	NEROPOLIS S1	10/12/2019 16:31	11/12/2019 04:34	10/12/2019 16:31	11/12/2019 04:34	12,04	1	12,04	CHI

20191281241	VICENTINOPOLIS	1970001840	VICENTINOPOLIS	10/12/2019 16:32	11/12/2019 14:51	10/12/2019 16:32	11/12/2019 14:51	22,32	1	22,32	CHI
20191281244	SAO JOAO D ALIANCA	JL12325678	SAO JOAO D ALIANCA	10/12/2019 16:33	10/12/2019 21:24	10/12/2019 16:33	10/12/2019 21:24	4,84	6	29,03	CHI
20191281245	HIDROLANDIA	HD32016316	CEPAIGO S1	10/12/2019 16:33	10/12/2019 21:40	10/12/2019 16:33	10/12/2019 21:40	5,11	9	45,95	CHI
20191281263	GOIANESIA	GE12372415	GOIANESIA S1	10/12/2019 16:35	10/12/2019 17:34	10/12/2019 16:35	10/12/2019 17:34	0,98	28	27,33	CHI
20191281260	GOIANIRA	390083185	GOIANIRA	10/12/2019 16:37	10/12/2019 20:33	10/12/2019 16:37	10/12/2019 20:33	3,94	1	3,94	CHI
20191281264	SAO FRANCISCO DE GOIAS	SF21037728	SAO FRANCISCO DE GOIAS	10/12/2019 16:38	10/12/2019 20:15	10/12/2019 16:38	10/12/2019 20:15	3,62	1	3,62	CHI
20191281266	QUIRINOPOLIS	QI21116446	QUIRINOPOLIS	10/12/2019 16:39	10/12/2019 21:35	10/12/2019 16:39	10/12/2019 21:35	4,92	3	14,76	CHI
20191281274	ALTO PARAISO DE GOIAS	BF21231958	FLORES DE GOIAS	10/12/2019 16:40	10/12/2019 20:08	10/12/2019 16:40	10/12/2019 20:08	3,46	1	3,46	CHI
20191281277	CABECEIRAS	CW12052029	ITIQUEIRA	10/12/2019 16:40	10/12/2019 18:49	10/12/2019 16:40	10/12/2019 18:49	2,13	6	12,81	CHI
20191282165	MAIRIPIOTABA	MI31060557	PONTALINA	10/12/2019 16:41	11/12/2019 09:45	10/12/2019 16:41	11/12/2019 09:45	17,06	1	17,06	CHI
20191280438	MORRINHOS	MR12333296	GOIATUBA S1	10/12/2019 16:43	10/12/2019 20:38	10/12/2019 16:43	10/12/2019 20:38	3,91	2	7,81	CHI
20191281300	PIRES DO RIO	460069056	PIRES DO RIO S1	10/12/2019 16:45	10/12/2019 23:58	10/12/2019 16:45	10/12/2019 23:58	7,20	1	7,20	CHI
20191281504	GOIANIA	GN11002632	CAMPINAS S1	10/12/2019 16:45	10/12/2019 18:44	10/12/2019 16:45	10/12/2019 18:44	1,99	82	163,09	CHI
20191281306	ITUMBIARA	690237406	ITUMBIARA NOVA	10/12/2019 16:47	11/12/2019 01:18	10/12/2019 16:47	11/12/2019 01:18	8,52	1	8,52	CHI
20191281315	GOIATUBA	GT12000084	GOIATUBA S2	10/12/2019 16:48	10/12/2019 19:16	10/12/2019 16:48	10/12/2019 19:16	2,45	1	2,45	CHI
20191281316	CIDADE OCIDENTAL	2680065652	MARAJOARA	10/12/2019 16:49	10/12/2019 19:18	10/12/2019 16:49	10/12/2019 19:18	2,48	1	2,48	CHI
20191281319	MINACU	IH12242191	MINACU	10/12/2019 16:49	10/12/2019 20:55	10/12/2019 16:49	10/12/2019 20:55	4,09	7	28,63	CHI
20191281321	RIO VERDE	RV12303300	ACREUNA	10/12/2019 16:49	10/12/2019 22:15	10/12/2019 16:49	10/12/2019 22:15	5,43	3	16,30	CHI
20191281619	PIRANHAS	PH12074241	ARENOPOLIS	10/12/2019 16:49	11/12/2019 14:30	10/12/2019 16:49	11/12/2019 14:30	21,67	7	151,72	CHI
20191281322	GOIANIA	GN11251809	MEIA PONTE	10/12/2019 16:50	10/12/2019 21:20	10/12/2019 16:50	10/12/2019 21:20	4,50	152	683,83	CHI
20191281325	PARAUNA	PU21351543	ACREUNA	10/12/2019 16:50	10/12/2019 18:10	10/12/2019 16:50	10/12/2019 18:10	1,33	1	1,33	CHI
20191281326	UIRAPURU	UP12391847	SANTA TEREZINHA	10/12/2019 16:51	11/12/2019 10:10	10/12/2019 16:51	11/12/2019 10:10	17,31	7	121,20	CHI
20191280441	PORANGATU	PO10400350	PORANGATU	10/12/2019 16:52	11/12/2019 21:29	10/12/2019 16:55	10/12/2019 18:29	1,58	80	126,33	CHI
20191280441	PORANGATU	PO13320884	PORANGATU	10/12/2019 16:52	11/12/2019 21:29	10/12/2019 16:55	10/12/2019 18:47	1,88	91	171,18	CHI
20191280441	PORANGATU	PO13374525	PORANGATU	10/12/2019 16:52	11/12/2019 21:29	10/12/2019 16:55	10/12/2019 19:06	2,20	143	314,32	CHI
20191280441	PORANGATU	PO10400350	PORANGATU	10/12/2019 16:52	11/12/2019 21:29	10/12/2019 19:14	10/12/2019 20:03	0,82	171	140,98	CHI
20191280441	PORANGATU	01520404	PORANGATU	10/12/2019 16:52	11/12/2019 21:29	10/12/2019 20:25	10/12/2019 20:35	0,17	1	0,17	CHI
20191280441	MONTIVIDIU DO NORTE	01520404	PORANGATU	10/12/2019 16:52	11/12/2019 21:29	10/12/2019 20:31	10/12/2019 20:35	0,06	6	0,33	CHI
20191280441	PORANGATU	01520404	PORANGATU	10/12/2019 16:52	11/12/2019 21:29	10/12/2019 20:31	10/12/2019 20:35	0,06	163	9,06	CHI
20191280441	PORANGATU	01520404	PORANGATU	10/12/2019 16:52	11/12/2019 21:29	10/12/2019 20:31	10/12/2019 20:35	0,06	987	54,83	CHI
20191280441	PORANGATU	01520404	PORANGATU	10/12/2019 16:52	11/12/2019 21:29	10/12/2019 20:31	10/12/2019 20:35	0,06	180	10,00	CHI
20191280441	SANTA TEREZA DE GOIAS	01520404	PORANGATU	10/12/2019 16:52	11/12/2019 21:29	10/12/2019 20:31	10/12/2019 20:35	0,06	11	0,61	CHI
20191280441	TROMBAS	01520404	PORANGATU	10/12/2019 16:52	11/12/2019 21:29	10/12/2019 20:31	10/12/2019 20:35	0,06	169	9,39	CHI

20191280441	MONTIVIDIU DO NORTE	01520404	PORANGATU	10/12/2019 16:52	11/12/2019 21:29	10/12/2019 20:39	10/12/2019 20:46	0,13	6	0,78	CHI
20191280441	PORANGATU	01520404	PORANGATU	10/12/2019 16:52	11/12/2019 21:29	10/12/2019 20:39	10/12/2019 20:46	0,13	163	21,10	CHI
20191280441	PORANGATU	01520404	PORANGATU	10/12/2019 16:52	11/12/2019 21:29	10/12/2019 20:39	10/12/2019 20:46	0,13	988	127,89	CHI
20191280441	PORANGATU	PO10406906	PORANGATU	10/12/2019 16:52	11/12/2019 21:29	10/12/2019 20:39	10/12/2019 20:46	0,13	9	1,17	CHI
20191280441	SANTA TEREZA DE GOIAS	01520404	PORANGATU	10/12/2019 16:52	11/12/2019 21:29	10/12/2019 20:39	10/12/2019 20:46	0,13	11	1,42	CHI
20191280441	TROMBAS	01520404	PORANGATU	10/12/2019 16:52	11/12/2019 21:29	10/12/2019 20:39	10/12/2019 20:46	0,13	169	21,88	CHI
20191280441	PORANGATU	PO10400350	PORANGATU	10/12/2019 16:52	11/12/2019 21:29	10/12/2019 20:39	10/12/2019 20:51	0,21	171	36,15	CHI
20191280441	PORANGATU	PO13083034	PORANGATU	10/12/2019 16:52	11/12/2019 21:29	10/12/2019 19:14	10/12/2019 22:26	3,20	144	460,68	CHI
20191280441	PORANGATU	PO13374525	PORANGATU	10/12/2019 16:52	11/12/2019 21:29	10/12/2019 20:52	10/12/2019 23:42	2,84	91	258,39	CHI
20191280441	PORANGATU	PO10400350	PORANGATU	10/12/2019 16:52	11/12/2019 21:29	10/12/2019 20:52	11/12/2019 00:17	3,43	5	17,15	CHI
20191280441	PORANGATU	PO10400350	PORANGATU	10/12/2019 16:52	11/12/2019 21:29	10/12/2019 20:52	11/12/2019 08:28	11,61	31	359,94	CHI
20191280441	PORANGATU	PO10400350	PORANGATU	10/12/2019 16:52	11/12/2019 21:29	11/12/2019 08:29	11/12/2019 08:53	0,39	5	1,95	CHI
20191280441	PORANGATU	PO10400350	PORANGATU	10/12/2019 16:52	11/12/2019 21:29	10/12/2019 20:52	11/12/2019 21:29	24,63	44	1083,66	CHI
20191280441	PORANGATU	PO13083033	PORANGATU	10/12/2019 16:52	11/12/2019 21:29	11/12/2019 08:29	11/12/2019 21:29	13,00	31	402,91	CHI
20191281330	AURILANDIA	AI21311130	FIRMINOPOLIS S2	10/12/2019 16:52	10/12/2019 20:30	10/12/2019 16:52	10/12/2019 20:30	3,65	1	3,65	CHI
20191281333	PIRENOPOLIS	PV21185581	CORUMBA	10/12/2019 16:52	11/12/2019 10:06	10/12/2019 16:52	11/12/2019 10:06	17,23	2	34,45	CHI
20191281406	GOIANIA	17350165	CARAJAS S2	10/12/2019 16:54	10/12/2019 19:50	10/12/2019 16:54	10/12/2019 19:50	2,93	1	2,93	CHI
20191281408	CRISTALINA	KR12377452	CRISTALINA S1	10/12/2019 16:54	11/12/2019 11:21	10/12/2019 16:54	11/12/2019 11:21	18,44	2	36,89	CHI
20191281478	PONTALINA	PK12218118	GOIATUBA S1	10/12/2019 16:54	11/12/2019 08:25	10/12/2019 16:54	11/12/2019 08:25	15,50	3	46,51	CHI
20191280440	AGUAS LINDAS DE GOIAS	LA11377274	AGUAS LINDAS DE GOIAS S1	10/12/2019 16:55	10/12/2019 21:00	10/12/2019 18:06	10/12/2019 21:00	2,89	99	286,39	CHI
20191281414	QUIRINOPOLIS	80122085	QUIRINOPOLIS	10/12/2019 16:55	11/12/2019 06:33	10/12/2019 16:55	11/12/2019 06:33	13,63	1	13,63	CHI
20191281415	NOVA CRIXAS	NA12055700	MOZARLANDIA	10/12/2019 16:55	11/12/2019 09:17	10/12/2019 16:55	11/12/2019 09:17	16,36	4	65,44	CHI
20191281418	APARECIDA DE GOIANIA	13139101	REAL S1	10/12/2019 16:55	10/12/2019 19:04	10/12/2019 16:55	10/12/2019 19:04	2,14	1	2,14	CHI
20191281419	CRIXAS	CX21181633	SERRA DO OURO	10/12/2019 16:56	11/12/2019 14:29	10/12/2019 16:56	11/12/2019 14:29	21,54	1	21,54	CHI
20191281420	SERRANOPOLIS	SX11129744	JATAI S1	10/12/2019 16:56	10/12/2019 19:22	10/12/2019 16:56	10/12/2019 19:22	2,43	57	138,29	CHI
20191281421	GOIANESIA	10004192298	GOIANESIA S2	10/12/2019 16:56	11/12/2019 10:06	10/12/2019 16:56	11/12/2019 10:06	17,17	1	17,17	CHI
20191281426	FORMOSA	610138091	ITUIQUIRA	10/12/2019 16:57	10/12/2019 20:44	10/12/2019 16:57	10/12/2019 20:44	3,78	1	3,78	CHI
20191281427	DAVINOPOLIS	IO21105617	CATALAO S1	10/12/2019 16:57	11/12/2019 04:37	10/12/2019 16:57	11/12/2019 04:37	11,66	1	11,66	CHI
20191281428	URUACU	UR12339123	MARA ROSA	10/12/2019 16:57	11/12/2019 01:48	10/12/2019 16:57	11/12/2019 01:48	8,84	1	8,84	CHI
20191281438	LUZIANIA	120106632	RIO VERMELHO	10/12/2019 16:59	10/12/2019 20:03	10/12/2019 16:59	10/12/2019 20:03	3,07	1	3,07	CHI
20191281441	GOIANESIA	GE21292256	GOIANESIA S1	10/12/2019 16:59	11/12/2019 00:04	10/12/2019 16:59	11/12/2019 00:04	7,07	1	7,07	CHI
20191281445	GOIANIRA	10000565251	GOIANIRA	10/12/2019 17:00	11/12/2019 00:01	10/12/2019 17:00	11/12/2019 00:01	7,03	1	7,03	CHI
20191281448	TRINDADE	TR21016599	GOIANIRA	10/12/2019 17:00	11/12/2019 00:27	10/12/2019 17:00	11/12/2019 00:27	7,45	1	7,45	CHI

20191281480	ABADIA DE GOIAS	TR12391385	GUAPO S1	10/12/2019 17:00	10/12/2019 18:48	10/12/2019 17:00	10/12/2019 18:48	1,80	106	190,80	CHI
20191281480	GUAPO	TR12391385	GUAPO S1	10/12/2019 17:00	10/12/2019 18:48	10/12/2019 17:00	10/12/2019 18:48	1,80	4	7,20	CHI
20191281432	PIRENOPOLIS	PV12289876	SAO FRANCISCO DE GOIAS	10/12/2019 17:01	10/12/2019 19:28	10/12/2019 17:01	10/12/2019 19:28	2,43	15	36,51	CHI
20191281450	ACREUNA	2440023535	ACREUNA	10/12/2019 17:01	10/12/2019 19:24	10/12/2019 17:01	10/12/2019 19:24	2,38	1	2,38	CHI
20191282272	CASTELANDIA	DM11054349	RIO DOS BOIS	10/12/2019 17:01	11/12/2019 08:08	10/12/2019 17:01	11/12/2019 08:08	15,11	111	1677,73	CHI
20191281459	SILVANIA	SV31086539	ANAPOLIS UNIVERSITARIO S2	10/12/2019 17:03	10/12/2019 19:07	10/12/2019 17:03	10/12/2019 19:07	2,06	2	4,12	CHI
20191281461	GOIANIRA	GR21011986	NEROPOLIS S1	10/12/2019 17:03	11/12/2019 09:53	10/12/2019 17:03	11/12/2019 09:53	16,83	1	16,83	CHI
20191281473	GOIANIA	GN11151988	MEIA PONTE	10/12/2019 17:04	10/12/2019 19:19	10/12/2019 17:04	10/12/2019 19:19	2,24	170	380,52	CHI
20191281589	MONTES CLAROS DE GOIAS	ME12029537	BRITANIA	10/12/2019 17:04	11/12/2019 08:05	10/12/2019 17:04	11/12/2019 08:05	15,01	12	180,10	CHI
20191281613	ALOANDIA	AD12108919	GOIATUBA S1	10/12/2019 17:06	11/12/2019 07:17	10/12/2019 17:06	11/12/2019 07:17	14,17	11	155,87	CHI
20191281613	PONTALINA	AD12108919	GOIATUBA S1	10/12/2019 17:06	11/12/2019 07:17	10/12/2019 17:06	11/12/2019 07:17	14,17	3	42,51	CHI
20191281750	LUZIANIA	LZ12389577	VIANOPOLIS	10/12/2019 17:07	11/12/2019 07:50	10/12/2019 17:07	11/12/2019 07:50	14,71	2	29,43	CHI
20191283240	ARUANA	04940204	ARUANA	10/12/2019 17:07	11/12/2019 10:55	10/12/2019 17:07	11/12/2019 10:55	17,79	56	996,02	CHI
20191281487	CACHOEIRA ALTA	CA12013266	CACHOEIRA ALTA	10/12/2019 17:08	10/12/2019 21:00	10/12/2019 17:08	10/12/2019 21:00	3,86	16	61,83	CHI
20191281492	GOIANIA	11192719	CAMPINAS S1	10/12/2019 17:09	10/12/2019 20:07	10/12/2019 17:09	10/12/2019 20:07	2,97	1	2,97	CHI
20191281493	NOVO GAMA	2460095310	PACAEMBU S1	10/12/2019 17:09	10/12/2019 19:04	10/12/2019 17:09	10/12/2019 19:04	1,91	1	1,91	CHI
20191281498	CAMPO LIMPO	960001220	NEROPOLIS S1	10/12/2019 17:09	10/12/2019 19:17	10/12/2019 17:09	10/12/2019 19:17	2,13	1	2,13	CHI
20191281500	DAVINOPOLIS	IO21127518	CATALAO S1	10/12/2019 17:10	11/12/2019 14:47	10/12/2019 17:10	11/12/2019 14:47	21,62	2	43,23	CHI
20191281502	JUSSARA	1290054580	JUSSARA	10/12/2019 17:10	11/12/2019 03:38	10/12/2019 17:10	11/12/2019 03:38	10,47	1	10,47	CHI
20191281501	NIQUELANDIA	NQ12359847	NIQUELANDIA SUBTRANSMISSAO	10/12/2019 17:11	11/12/2019 01:35	10/12/2019 17:11	11/12/2019 01:35	8,39	43	360,89	CHI
20191281513	RIO VERDE	RV12305859	MONTIVIDIU T	10/12/2019 17:11	11/12/2019 14:43	10/12/2019 17:11	11/12/2019 14:43	21,53	3	64,58	CHI
20191281514	EDEIA	EA21039698	PONTALINA	10/12/2019 17:11	11/12/2019 12:45	10/12/2019 17:11	11/12/2019 12:45	19,56	1	19,56	CHI
20191281516	APARECIDA DE GOIANIA	200273863	INDEPENDENCIA S2	10/12/2019 17:11	10/12/2019 20:26	10/12/2019 17:11	10/12/2019 20:26	3,23	1	3,23	CHI
20191282660	NIQUELANDIA	NQ21359844	NIQUELANDIA SUBTRANSMISSAO	10/12/2019 17:11	11/12/2019 17:12	10/12/2019 17:11	11/12/2019 17:12	24,01	1	24,01	CHI
20191281518	CACHOEIRA DOURADA	CD12000228	CACHOEIRA DOURADA	10/12/2019 17:12	10/12/2019 23:46	10/12/2019 17:12	10/12/2019 23:46	6,56	2	13,13	CHI
20191281518	ITUMBIARA	CD12000228	CACHOEIRA DOURADA	10/12/2019 17:12	10/12/2019 23:46	10/12/2019 17:12	10/12/2019 23:46	6,56	1	6,56	CHI
20191281523	COCALZINHO DE GOIAS	ZN21186979	COCALZINHO	10/12/2019 17:12	11/12/2019 08:58	10/12/2019 17:12	11/12/2019 08:58	15,75	1	15,75	CHI
20191281525	SAO LUIS DE MONTES BELOS	500050636	SAO LUIZ DOS MONTES BELOS	10/12/2019 17:13	10/12/2019 20:13	10/12/2019 17:13	10/12/2019 20:13	3,00	1	3,00	CHI
20191281529	ITARUMA	IM12089328	CACHOEIRA ALTA	10/12/2019 17:15	11/12/2019 09:52	10/12/2019 17:15	11/12/2019 09:52	16,61	3	49,84	CHI
20191281531	GOIATUBA	GT21102736	GOIATUBA S2	10/12/2019 17:16	11/12/2019 07:21	10/12/2019 17:16	11/12/2019 07:21	14,08	1	14,08	CHI
20191281533	MOIPORA	MO21304439	SAO LUIZ DOS MONTES BELOS	10/12/2019 17:16	11/12/2019 10:29	10/12/2019 17:16	11/12/2019 10:29	17,22	1	17,22	CHI
20191281534	GOIANESIA	GE21000282	GOIANESIA S1	10/12/2019 17:16	11/12/2019 11:40	10/12/2019 17:16	11/12/2019 10:40	17,40	1	17,40	CHI
20191281534	SANTA RITA DO NOVO DESTINO	GE12000108	GOIANESIA S1	10/12/2019 17:16	11/12/2019 11:40	10/12/2019 17:18	11/12/2019 11:40	18,38	1	18,38	CHI

20191281540	DAVINOPOLIS	IO21332202	CATALAO S1	10/12/2019 17:18	11/12/2019 20:51	10/12/2019 17:18	11/12/2019 20:51	27,55	1	27,55	CHI
20191282143	SANTO ANTONIO DE GOIAS	BW12232189	NEROPOLIS S1	10/12/2019 17:18	10/12/2019 23:15	10/12/2019 17:18	10/12/2019 23:15	5,96	358	2134,48	CHI
20191281641	MORRINHOS	MR12000350	GOIATUBA S1	10/12/2019 17:19	11/12/2019 11:39	10/12/2019 17:19	11/12/2019 11:39	18,33	3	54,98	CHI
20191281599	CRISTALINA	KR10400736	CRISTALINA S2	10/12/2019 17:20	10/12/2019 22:17	10/12/2019 17:20	10/12/2019 22:10	4,83	45	217,42	CHI
20191281599	IPAMERI	KR10400736	CRISTALINA S2	10/12/2019 17:20	10/12/2019 22:17	10/12/2019 17:20	10/12/2019 22:10	4,83	79	381,70	CHI
20191281599	IPAMERI	KR10400736	CRISTALINA S2	10/12/2019 17:20	10/12/2019 22:17	10/12/2019 22:05	10/12/2019 22:10	0,09	5	0,44	CHI
20191281599	CRISTALINA	IP12376116LD	CRISTALINA S2	10/12/2019 17:20	10/12/2019 22:17	10/12/2019 17:20	10/12/2019 22:17	4,95	12	59,34	CHI
20191281599	IPAMERI	IP12376116LD	CRISTALINA S2	10/12/2019 17:20	10/12/2019 22:17	10/12/2019 17:20	10/12/2019 22:17	4,95	11	54,40	CHI
20191282152	MINACU	IH12181637	MINACU	10/12/2019 17:20	10/12/2019 21:28	10/12/2019 17:20	10/12/2019 21:28	4,13	7	28,91	CHI
20191281551	RIO VERDE	RV21267632	RIO VERDE S1	10/12/2019 17:21	11/12/2019 09:16	10/12/2019 17:21	11/12/2019 09:16	15,91	1	15,91	CHI
20191281634	ABADIANIA	AA13377661	DAIA S2	10/12/2019 17:21	11/12/2019 16:31	10/12/2019 17:21	10/12/2019 22:55	5,55	61	338,62	CHI
20191281634	GAMELEIRA DE GOIAS	AA13377661	DAIA S2	10/12/2019 17:21	11/12/2019 16:31	10/12/2019 17:21	10/12/2019 22:55	5,55	1	5,55	CHI
20191281634	ABADIANIA	05730224	DAIA S2	10/12/2019 17:21	11/12/2019 16:31	10/12/2019 22:57	11/12/2019 00:01	1,07	17	18,13	CHI
20191281634	ABADIANIA	AA13377661	DAIA S2	10/12/2019 17:21	11/12/2019 16:31	10/12/2019 17:21	11/12/2019 16:31	23,16	120	2779,63	CHI
20191281634	ABADIANIA	05730224	DAIA S2	10/12/2019 17:21	11/12/2019 16:31	10/12/2019 22:57	11/12/2019 16:31	17,58	44	773,48	CHI
20191281634	GAMELEIRA DE GOIAS	05730224	DAIA S2	10/12/2019 17:21	11/12/2019 16:31	10/12/2019 22:57	11/12/2019 16:31	17,58	1	17,58	CHI
20191281634	ABADIANIA	05730224	DAIA S2	10/12/2019 17:21	11/12/2019 16:31	11/12/2019 00:02	11/12/2019 16:31	16,48	17	280,20	CHI
20191281556	GOIANIA	13483468	GOIANIA LESTE S3	10/12/2019 17:22	10/12/2019 21:03	10/12/2019 17:22	10/12/2019 21:03	3,68	1	3,68	CHI
20191281703	CATALAO	CT12394011RE	CATALAO S1	10/12/2019 17:22	10/12/2019 22:55	10/12/2019 17:22	10/12/2019 22:55	5,54	47	260,31	CHI
20191281703	OUVIDOR	CT12394011RE	CATALAO S1	10/12/2019 17:22	10/12/2019 22:55	10/12/2019 17:22	10/12/2019 22:55	5,54	38	210,47	CHI
20191281564	SANTA CRUZ DE GOIAS	CN21193834	CALDAS NOVAS S1	10/12/2019 17:24	11/12/2019 09:32	10/12/2019 17:24	11/12/2019 09:32	16,12	1	16,12	CHI
20191281568	CATURAI	CK21014372	INHUMAS S1	10/12/2019 17:25	11/12/2019 08:15	10/12/2019 17:25	11/12/2019 08:15	14,83	1	14,83	CHI
20191281570	FLORES DE GOIAS	FB21334129	FLORES DE GOIAS	10/12/2019 17:25	11/12/2019 20:27	10/12/2019 17:25	11/12/2019 20:27	27,02	1	27,02	CHI
20191281726	CRISTALINA	KR11032674	CRISTALINA S1	10/12/2019 17:26	10/12/2019 20:37	10/12/2019 17:26	10/12/2019 20:37	3,17	63	199,62	CHI
20191281582	NOVA ROMA	ND21218868	IACIARA S2	10/12/2019 17:27	10/12/2019 20:19	10/12/2019 17:27	10/12/2019 20:19	2,86	1	2,86	CHI
20191281583	FORMOSA	FA12218592	ITIQUEIRA	10/12/2019 17:27	10/12/2019 20:42	10/12/2019 17:27	10/12/2019 20:42	3,24	6	19,42	CHI
20191281584	NOVA IGUACU DE GOIAS	7830003372	SANTA TEREZINHA	10/12/2019 17:27	10/12/2019 19:27	10/12/2019 17:27	10/12/2019 19:27	1,99	1	1,99	CHI
20191281587	APARECIDA DE GOIANIA	13280338	REAL S1	10/12/2019 17:28	10/12/2019 19:43	10/12/2019 17:28	10/12/2019 19:43	2,24	1	2,24	CHI
20191281592	SANTA CRUZ DE GOIAS	BC11272809	PIRES DO RIO S2	10/12/2019 17:29	10/12/2019 20:46	10/12/2019 17:29	10/12/2019 20:46	3,28	4	13,11	CHI
20191281597	CRISTALINA	IP12100702	CRISTALINA S2	10/12/2019 17:29	10/12/2019 23:24	10/12/2019 17:29	10/12/2019 23:24	5,91	18	106,40	CHI
20191281597	IPAMERI	IP12100702	CRISTALINA S2	10/12/2019 17:29	10/12/2019 23:24	10/12/2019 17:29	10/12/2019 23:24	5,91	9	53,20	CHI
20191281739	CRISTALINA	KR12087952	CRISTALINA S2	10/12/2019 17:29	10/12/2019 20:09	10/12/2019 17:29	10/12/2019 20:09	2,67	19	50,67	CHI
20191281792	APARECIDA DE GOIANIA	AP11383868	INDEPENDENCIA S1	10/12/2019 17:29	10/12/2019 19:30	10/12/2019 17:29	10/12/2019 19:30	2,00	124	248,34	CHI

20191281600	AGUA FRIA DE GOIAS	PI12048037	SAO JOAO D ALIANCA	10/12/2019 17:30	11/12/2019 08:10	10/12/2019 17:30	11/12/2019 08:10	14,66	7	102,64	CHI
20191281607	MOSSAMEDES	MD12000176	FIRMINOPOLIS S2	10/12/2019 17:31	10/12/2019 19:55	10/12/2019 17:31	10/12/2019 19:55	2,39	19	45,34	CHI
20191281920	MONTES CLAROS DE GOIAS	ME12062838	IPORA	10/12/2019 17:31	11/12/2019 03:02	10/12/2019 17:31	11/12/2019 03:02	9,50	14	133,06	CHI
20191281778	IPORA	IR12014029	IPORA	10/12/2019 17:32	10/12/2019 19:47	10/12/2019 17:32	10/12/2019 19:47	2,24	45	100,64	CHI
20191281616	PORANGATU	PO12282160	PORANGATU	10/12/2019 17:33	11/12/2019 11:40	10/12/2019 17:33	11/12/2019 11:40	18,11	11	199,19	CHI
20191281734	SAO JOAO D ALIANCA	JL12268121	SAO JOAO D ALIANCA	10/12/2019 17:34	10/12/2019 23:06	10/12/2019 17:34	10/12/2019 23:06	5,53	7	38,73	CHI
20191281628	RIO VERDE	RV12231014	MONTIVIDIU T	10/12/2019 17:35	11/12/2019 01:50	10/12/2019 17:35	11/12/2019 01:50	8,24	11	90,62	CHI
20191281822	CATALAO	CT12127882	CATALAO S1	10/12/2019 17:35	10/12/2019 22:30	10/12/2019 17:35	10/12/2019 22:30	4,91	18	88,34	CHI
20191283040	NOVO BRASIL	NB12206882	JUSSARA	10/12/2019 17:35	11/12/2019 15:20	10/12/2019 17:35	11/12/2019 15:20	21,75	4	86,99	CHI
20191281632	PIRES DO RIO	10027860351	PIRES DO RIO S1	10/12/2019 17:36	11/12/2019 02:07	10/12/2019 17:36	11/12/2019 02:07	8,52	1	8,52	CHI
20191281635	SAO MIGUEL DO ARAGUAIA	SM21013064	SAO MIGUEL DO ARAGUAIA	10/12/2019 17:36	10/12/2019 18:27	10/12/2019 17:36	10/12/2019 18:27	0,85	1	0,85	CHI
20191281636	COCALZINHO DE GOIAS	LA21169014	AGUAS LINDAS DE GOIAS S2	10/12/2019 17:36	10/12/2019 20:50	10/12/2019 17:36	10/12/2019 20:50	3,22	2	6,44	CHI
20191281813	VILA PROPICIO	NP12235934	GOIANESIA S1	10/12/2019 17:37	11/12/2019 17:11	10/12/2019 17:37	11/12/2019 17:11	23,58	8	188,61	CHI
20191281911	RIO VERDE	RV21213512	CABRIUVA S2	10/12/2019 17:37	10/12/2019 22:24	10/12/2019 17:37	10/12/2019 22:24	4,78	1	4,78	CHI
20191281648	MINEIROS	MY10396070	PARQUE DAS EMAS	10/12/2019 17:39	11/12/2019 18:17	11/12/2019 13:46	11/12/2019 14:46	1,00	115	114,94	CHI
20191281648	SERRANOPOLIS	MY10396070	PARQUE DAS EMAS	10/12/2019 17:39	11/12/2019 18:17	11/12/2019 13:46	11/12/2019 14:46	1,00	7	7,00	CHI
20191281648	MINEIROS	MY13324464	PARQUE DAS EMAS	10/12/2019 17:39	11/12/2019 18:17	11/12/2019 13:35	11/12/2019 18:16	4,69	10	46,86	CHI
20191281648	MINEIROS	MY21159422	PARQUE DAS EMAS	10/12/2019 17:39	11/12/2019 18:17	10/12/2019 17:39	11/12/2019 18:17	24,63	1	24,63	CHI
20191281650	MARA ROSA	MQ21192335	MARA ROSA	10/12/2019 17:39	11/12/2019 09:50	10/12/2019 17:39	11/12/2019 09:50	16,17	1	16,17	CHI
20191281627	NOVO BRASIL	NB12396222	JUSSARA	10/12/2019 17:40	11/12/2019 09:50	10/12/2019 17:40	11/12/2019 09:50	16,17	1	16,17	CHI
20191281656	APARECIDA DE GOIANIA	10021583658	INDEPENDENCIA S1	10/12/2019 17:40	10/12/2019 19:41	10/12/2019 17:40	10/12/2019 19:41	2,01	1	2,01	CHI
20191281657	PONTALINA	PK21045993	PONTALINA	10/12/2019 17:40	11/12/2019 12:43	10/12/2019 17:40	11/12/2019 12:43	19,04	2	38,08	CHI
20191281780	RIO VERDE	RV12025889	RIO VERDE S2	10/12/2019 17:40	10/12/2019 21:00	10/12/2019 17:40	10/12/2019 21:00	3,33	27	89,96	CHI
20191281661	IPAMERI	IP21127600	PIRES DO RIO S2	10/12/2019 17:41	11/12/2019 09:40	10/12/2019 17:41	11/12/2019 09:40	15,97	1	15,97	CHI
20191281830	SENADOR CANEDO	SW11343128	SENADOR CANEDO	10/12/2019 17:42	10/12/2019 20:02	10/12/2019 17:42	10/12/2019 20:02	2,32	52	120,51	CHI
20191281669	SAO JOAO D ALIANCA	JL12324141	SAO JOAO D ALIANCA	10/12/2019 17:44	11/12/2019 09:19	10/12/2019 17:44	11/12/2019 09:19	15,58	4	62,33	CHI
20191281673	APARECIDA DE GOIANIA	15298267	ATLANTICO S1	10/12/2019 17:44	11/12/2019 07:37	10/12/2019 17:44	11/12/2019 07:37	13,87	1	13,87	CHI
20191281728	CATALAO	CT12063921	CATALAO S1	10/12/2019 17:45	10/12/2019 22:05	10/12/2019 17:45	10/12/2019 22:05	4,33	14	60,64	CHI
20191281821	PORTEIRAO	CL12214128	RIO DOS BOIS	10/12/2019 17:45	10/12/2019 20:25	10/12/2019 17:45	10/12/2019 20:25	2,67	4	10,67	CHI
20191282619	MONTIVIDIU	MV21260840	MONTIVIDIU T	10/12/2019 17:45	11/12/2019 11:54	10/12/2019 17:45	11/12/2019 11:54	18,14	1	18,14	CHI
20191281687	CALDAS NOVAS	760372950	SERRA DE CALDAS	10/12/2019 17:47	11/12/2019 09:45	10/12/2019 17:47	11/12/2019 09:45	15,98	1	15,98	CHI
20191281690	BOM JESUS DE GOIAS	BJ21222340	BOM JESUS DE GOIAS	10/12/2019 17:47	10/12/2019 21:17	10/12/2019 17:47	10/12/2019 21:17	3,49	1	3,49	CHI
20191281725	CRISTALINA	KR12163740	CRISTALINA S2	10/12/2019 17:47	11/12/2019 07:56	10/12/2019 17:47	11/12/2019 07:56	14,14	9	127,29	CHI

20191281692	APARECIDA DE GOIANIA	10001060676	INDEPENDENCIA S1	10/12/2019 17:48	11/12/2019 07:53	10/12/2019 17:48	11/12/2019 07:53	14,08	1	14,08	CHI
20191281693	ITUMBIARA	690332117	ITUMBIARA VELHA S1	10/12/2019 17:48	10/12/2019 19:56	10/12/2019 17:48	10/12/2019 19:56	2,13	1	2,13	CHI
20191281698	PROFESSOR JAMIL SAFADY	JS21307913	ROCHEDO	10/12/2019 17:48	11/12/2019 15:50	10/12/2019 17:48	11/12/2019 15:50	22,02	3	66,06	CHI
20191281843	IPORA	IR12289239	IPORA	10/12/2019 17:48	10/12/2019 21:05	10/12/2019 17:48	10/12/2019 21:05	3,28	9	29,51	CHI
20191281699	PARAUNA	PU12159023	PARAUNA	10/12/2019 17:49	10/12/2019 21:09	10/12/2019 17:49	10/12/2019 21:09	3,35	4	13,39	CHI
20191281700	PANAMA	PX21278933	GOIATUBA S1	10/12/2019 17:49	11/12/2019 07:58	10/12/2019 17:49	11/12/2019 07:58	14,15	1	14,15	CHI
20191281710	GOIANIA	GN21123577	ATLANTICO S2	10/12/2019 17:51	10/12/2019 20:29	10/12/2019 17:51	10/12/2019 20:29	2,62	1	2,62	CHI
20191281712	AGUA LIMPA	AL21263207	VILA CORUMBA	10/12/2019 17:51	11/12/2019 11:03	10/12/2019 17:51	11/12/2019 11:03	17,19	1	17,19	CHI
20191281784	APARECIDA DE GOIANIA	AP11141263	CEPAIGO S1	10/12/2019 17:51	10/12/2019 23:22	10/12/2019 17:51	10/12/2019 23:22	5,51	198	1090,70	CHI
20191281716	GOIANIA	14292040	FERROVIARIO S3	10/12/2019 17:52	10/12/2019 21:05	10/12/2019 17:52	10/12/2019 21:05	3,21	1	3,21	CHI
20191281727	JATAI	290207290	JATAI S3	10/12/2019 17:54	10/12/2019 19:10	10/12/2019 17:54	10/12/2019 19:10	1,26	1	1,26	CHI
20191281730	MINEIROS	PW21209814	PARQUE DAS EMAS	10/12/2019 17:55	11/12/2019 11:50	10/12/2019 17:55	11/12/2019 11:50	17,90	1	17,90	CHI
20191281736	GOIANIA	GN11042193	GOIANIA LESTE S1	10/12/2019 17:57	10/12/2019 18:29	10/12/2019 17:57	10/12/2019 18:29	0,52	149	77,81	CHI
20191281737	ABADIANIA	AA12297723	CORUMBA	10/12/2019 17:57	11/12/2019 09:12	10/12/2019 17:57	11/12/2019 09:12	15,24	2	30,47	CHI
20191281740	SAO JOAO D ALIANCA	JL31198426	SAO JOAO D ALIANCA	10/12/2019 17:58	11/12/2019 12:15	10/12/2019 17:58	11/12/2019 12:15	18,27	2	36,54	CHI
20191281791	BONFINOPOLIS	LB12032330	GOIANIA LESTE S2	10/12/2019 17:58	10/12/2019 19:10	10/12/2019 17:58	10/12/2019 19:10	1,18	36	42,62	CHI
20191281742	ARAGOIANIA	AO12395541	GUAPU S2	10/12/2019 17:59	11/12/2019 02:02	10/12/2019 17:59	11/12/2019 02:02	8,05	7	56,32	CHI
20191281744	MUTUNOPOLIS	PO12084869	PORANGATU	10/12/2019 17:59	11/12/2019 15:09	10/12/2019 17:59	11/12/2019 15:09	21,16	4	84,65	CHI
20191281744	PORANGATU	PO12084869	PORANGATU	10/12/2019 17:59	11/12/2019 15:09	10/12/2019 17:59	11/12/2019 15:09	21,16	3	63,48	CHI
20191281772	PORANGATU	PO12020611	NOVO PLANALTO	10/12/2019 18:00	11/12/2019 11:29	10/12/2019 18:00	11/12/2019 11:29	17,48	8	139,81	CHI
20191282985	EDEALINA	ED12047071	PONTALINA	10/12/2019 18:00	11/12/2019 13:49	10/12/2019 18:00	11/12/2019 13:49	19,81	3	59,42	CHI
20191282985	EDEIA	ED12047071	PONTALINA	10/12/2019 18:00	11/12/2019 13:49	10/12/2019 18:00	11/12/2019 13:49	19,81	2	39,61	CHI
20191281720	CATALAO	02630416	CATALAO S1	10/12/2019 18:01	11/12/2019 02:06	10/12/2019 18:01	10/12/2019 20:38	2,61	13	33,97	CHI
20191281720	OUVIDOR	02630416	CATALAO S1	10/12/2019 18:01	11/12/2019 02:06	10/12/2019 18:01	10/12/2019 20:38	2,61	2981	7790,35	CHI
20191281720	TRES RANCHOS	02630416	CATALAO S1	10/12/2019 18:01	11/12/2019 02:06	10/12/2019 18:01	10/12/2019 20:38	2,61	20	52,27	CHI
20191281720	OUVIDOR	OU13190456	CATALAO S1	10/12/2019 18:01	11/12/2019 02:06	10/12/2019 18:01	10/12/2019 23:18	5,27	2	10,54	CHI
20191281720	DAVINOPOLIS	OU13333483	CATALAO S1	10/12/2019 18:01	11/12/2019 02:06	10/12/2019 18:01	11/12/2019 02:06	8,07	10	80,72	CHI
20191281720	OUVIDOR	OU13333483	CATALAO S1	10/12/2019 18:01	11/12/2019 02:06	10/12/2019 18:01	11/12/2019 02:06	8,07	603	4867,72	CHI
20191281720	TRES RANCHOS	OU13333483	CATALAO S1	10/12/2019 18:01	11/12/2019 02:06	10/12/2019 18:01	11/12/2019 02:06	8,07	25	201,81	CHI
20191281755	GOUVELANDIA	GB12303132	QUIRINOPOLIS	10/12/2019 18:01	11/12/2019 10:44	10/12/2019 18:01	11/12/2019 10:44	16,71	48	802,09	CHI
20191281758	CAVALCANTE	TI12162624	NIQUELANDIA SUBTRANSMISSAO	10/12/2019 18:01	10/12/2019 22:39	10/12/2019 18:01	10/12/2019 22:39	4,62	55	254,10	CHI
20191281758	COLINAS DO SUL	TI12162624	NIQUELANDIA SUBTRANSMISSAO	10/12/2019 18:01	10/12/2019 22:39	10/12/2019 18:01	10/12/2019 22:39	4,62	17	78,54	CHI
20191281759	MINEIROS	MY21324490	PARQUE DAS EMAS	10/12/2019 18:01	11/12/2019 08:35	10/12/2019 18:01	11/12/2019 08:35	14,55	1	14,55	CHI

20191281964	TRINDADE	TR11000035	TRINDADE	10/12/2019 18:01	10/12/2019 20:31	10/12/2019 18:01	10/12/2019 20:31	2,50	112	279,69	CHI
20191281764	PALMINOPOLIS	PP12006641	PALMEIRAS	10/12/2019 18:02	10/12/2019 20:09	10/12/2019 18:02	10/12/2019 20:09	2,10	13	27,35	CHI
20191281786	GOIANESIA	GE12379116	GOIANESIA S2	10/12/2019 18:06	10/12/2019 19:36	10/12/2019 18:06	10/12/2019 19:36	1,50	100	149,58	CHI
20191281805	AGUAS LINDAS DE GOIAS	LA11305234	AGUAS LINDAS DE GOIAS S2	10/12/2019 18:06	10/12/2019 18:49	10/12/2019 18:06	10/12/2019 18:49	0,71	215	151,99	CHI
20191282286	PORANGATU	PO12262720	PORANGATU	10/12/2019 18:06	11/12/2019 12:48	10/12/2019 18:06	11/12/2019 12:48	18,70	4	74,78	CHI
20191280478	ITAJA	IJ21384553	ITAJA S2	10/12/2019 18:09	10/12/2019 21:30	10/12/2019 18:09	10/12/2019 21:30	3,34	1	3,34	CHI
20191281794	VILA PROPICIO	9290000484	GOIANESIA S1	10/12/2019 18:09	11/12/2019 09:58	10/12/2019 18:09	11/12/2019 09:58	15,81	1	15,81	CHI
20191281796	MINACU	4020001079	MINACU	10/12/2019 18:09	10/12/2019 21:35	10/12/2019 18:09	10/12/2019 21:35	3,43	1	3,43	CHI
20191281800	CAMPINORTE	CR21325215	MARA ROSA	10/12/2019 18:09	11/12/2019 11:54	10/12/2019 18:09	11/12/2019 11:54	17,74	1	17,74	CHI
20191281872	LUZIANIA	LZ11351403	MARAJOARA	10/12/2019 18:10	10/12/2019 19:24	10/12/2019 18:10	10/12/2019 19:24	1,23	14	17,20	CHI
20191281809	SAO DOMINGOS	SD21224217	SAO DOMINGOS	10/12/2019 18:11	11/12/2019 10:07	10/12/2019 18:11	11/12/2019 10:07	15,93	2	31,87	CHI
20191281811	GOIANIA	14882231	CAMPINAS S2	10/12/2019 18:11	10/12/2019 19:59	10/12/2019 18:11	10/12/2019 19:59	1,79	1	1,79	CHI
20191281833	GOIANIA	GN12001113	GOYA S2	10/12/2019 18:14	10/12/2019 20:39	10/12/2019 18:14	10/12/2019 20:39	2,41	3	7,24	CHI
20191281834	CALDAS NOVAS	760329758	SERRA DE CALDAS	10/12/2019 18:14	11/12/2019 11:30	10/12/2019 18:14	11/12/2019 11:30	17,27	1	17,27	CHI
20191281837	PLANALTINA	PI12375567	PLANALTINA	10/12/2019 18:15	10/12/2019 23:15	10/12/2019 18:15	10/12/2019 23:15	4,99	13	64,89	CHI
20191281839	LUZIANIA	LZ11061802	RIO VERMELHO	10/12/2019 18:15	10/12/2019 20:27	10/12/2019 18:15	10/12/2019 20:27	2,20	20	44,03	CHI
20191281844	SANTO ANTONIO DO DESCOBERTO	SN12082917	MARAJOARA	10/12/2019 18:15	10/12/2019 20:56	10/12/2019 18:15	10/12/2019 20:56	2,67	31	82,71	CHI
20191281847	GOIATUBA	GT12273961	GOIATUBA S2	10/12/2019 18:16	10/12/2019 23:21	10/12/2019 18:16	10/12/2019 23:21	5,07	2	10,15	CHI
20191281848	MINEIROS	MY12377494	PARQUE DAS EMAS	10/12/2019 18:16	11/12/2019 13:42	10/12/2019 18:16	11/12/2019 13:42	19,42	1	19,42	CHI
20191281848	SERRANOPOLIS	MY12377494	PARQUE DAS EMAS	10/12/2019 18:16	11/12/2019 13:42	10/12/2019 18:16	11/12/2019 13:42	19,42	2	38,84	CHI
20191281856	MORRINHOS	MR21000089	GOIATUBA S1	10/12/2019 18:19	11/12/2019 08:57	10/12/2019 18:19	11/12/2019 08:57	14,63	1	14,63	CHI
20191281861	SAO DOMINGOS	SD21261922	SAO DOMINGOS	10/12/2019 18:20	10/12/2019 20:45	10/12/2019 18:20	10/12/2019 20:45	2,41	1	2,41	CHI
20191280463	MINEIROS	PW12045348	PARQUE DAS EMAS	10/12/2019 18:21	10/12/2019 18:46	10/12/2019 18:21	10/12/2019 18:46	0,41	3	1,22	CHI
20191280463	PORTELANDIA	PW12045348	PARQUE DAS EMAS	10/12/2019 18:21	10/12/2019 18:46	10/12/2019 18:21	10/12/2019 18:46	0,41	10	4,08	CHI
20191281868	PLANALTINA	TL21206259	SAO JOAO D ALIANCA	10/12/2019 18:21	11/12/2019 11:43	10/12/2019 18:21	11/12/2019 11:43	17,35	1	17,35	CHI
20191282073	CRISTALINA	KR11376179	CRISTALINA S1	10/12/2019 18:21	10/12/2019 19:57	10/12/2019 18:21	10/12/2019 19:57	1,60	14	22,39	CHI
20191281873	SANTO ANTONIO DO DESCOBERTO	2210030025	AGUAS LINDAS DE GOIAS S2	10/12/2019 18:22	11/12/2019 00:26	10/12/2019 18:22	11/12/2019 00:26	6,07	1	6,07	CHI
20191281875	MARA ROSA	VD12201669	SANTA TEREZINHA	10/12/2019 18:22	11/12/2019 11:56	10/12/2019 18:22	11/12/2019 11:56	17,56	2	35,11	CHI
20191281879	FORMOSA	FA21320493	ITIQUEIRA	10/12/2019 18:23	11/12/2019 09:33	10/12/2019 18:23	11/12/2019 09:33	15,16	1	15,16	CHI
20191281885	RIO VERDE	RV21123325	RIO VERDE S1	10/12/2019 18:23	11/12/2019 11:12	10/12/2019 18:23	11/12/2019 11:12	16,80	1	16,80	CHI
20191281893	JATAI	JT12109029	JATAI S1	10/12/2019 18:23	10/12/2019 20:46	10/12/2019 18:23	10/12/2019 20:46	2,38	28	66,51	CHI
20191281889	ALTO HORIZONTE	AJ21318487	SANTA TEREZINHA	10/12/2019 18:24	11/12/2019 13:34	10/12/2019 18:24	11/12/2019 13:34	19,16	1	19,16	CHI
20191281890	SILVANIA	SV21159693	VIANOPOLIS	10/12/2019 18:24	11/12/2019 19:28	10/12/2019 18:24	11/12/2019 19:08	24,74	1	24,74	CHI

20191281890	SILVANIA	SV12103758LD	VIANOPOLIS	10/12/2019 18:24	11/12/2019 19:28	11/12/2019 17:24	11/12/2019 19:28	2,06	6	12,33	CHI
20191281894	CAMPINORTE	CR21281706	MARA ROSA	10/12/2019 18:25	11/12/2019 15:09	10/12/2019 18:25	11/12/2019 15:09	20,73	1	20,73	CHI
20191281681	MONTIVIDIU	MV12267712	MONTIVIDIU T	10/12/2019 18:26	10/12/2019 21:57	10/12/2019 18:26	10/12/2019 21:57	3,51	27	94,76	CHI
20191281899	FORMOSA	FA32042689	SAO JOAO D ALIANCA	10/12/2019 18:26	11/12/2019 17:17	10/12/2019 18:26	11/12/2019 17:17	22,85	4	91,39	CHI
20191281901	ITUMBIARA	690308048	ITUMBIARA VELHA S1	10/12/2019 18:26	10/12/2019 23:54	10/12/2019 18:26	10/12/2019 23:54	5,46	1	5,46	CHI
20191281904	GOIATUBA	GT12013083	GOIATUBA S2	10/12/2019 18:26	11/12/2019 09:28	10/12/2019 18:26	11/12/2019 09:28	15,02	9	135,17	CHI
20191281912	BELA VISTA DE GOIAS	SW12045850	CEPAIGO S2	10/12/2019 18:27	10/12/2019 22:56	10/12/2019 18:27	10/12/2019 22:56	4,49	3	13,47	CHI
20191281925	TRINDADE	TR11005104	TRINDADE	10/12/2019 18:27	10/12/2019 21:30	10/12/2019 18:27	10/12/2019 21:30	3,04	60	182,43	CHI
20191282484	RIO VERDE	RV21296258	CABRIUVA S2	10/12/2019 18:27	10/12/2019 22:48	10/12/2019 18:27	10/12/2019 22:48	4,34	1	4,34	CHI
20191281921	JATAI	290330919	JATAI S3	10/12/2019 18:28	11/12/2019 18:57	10/12/2019 18:28	11/12/2019 18:57	24,48	1	24,48	CHI
20191281923	COLINAS DO SUL	TI21138222	MINACU	10/12/2019 18:29	11/12/2019 11:12	10/12/2019 18:29	11/12/2019 11:12	16,71	2	33,41	CHI
20191281926	CATALAO	CT21127856	CATALAO S1	10/12/2019 18:30	10/12/2019 22:50	10/12/2019 18:30	10/12/2019 22:50	4,33	1	4,33	CHI
20191281927	TRINDADE	40076039	TRINDADE	10/12/2019 18:30	11/12/2019 01:22	10/12/2019 18:30	11/12/2019 01:22	6,85	1	6,85	CHI
20191281931	ITUMBIARA	690108280	PARANAIBA	10/12/2019 18:31	10/12/2019 20:41	10/12/2019 18:31	10/12/2019 20:41	2,16	1	2,16	CHI
20191281935	GOIANIA	11336470	ATLANTICO S3	10/12/2019 18:31	10/12/2019 20:52	10/12/2019 18:31	10/12/2019 20:52	2,33	1	2,33	CHI
20191282213	APARECIDA DE GOIANIA	AP11079021	INDEPENDENCIA S1	10/12/2019 18:31	10/12/2019 22:29	10/12/2019 18:31	10/12/2019 22:29	3,96	83	328,91	CHI
20191283636	BALIZA	BH12331510	CAIAPONIA	10/12/2019 18:31	11/12/2019 09:19	10/12/2019 18:31	11/12/2019 09:19	14,79	30	443,63	CHI
20191281937	JOVIANIA	570018055	GOIATUBA S1	10/12/2019 18:32	11/12/2019 09:54	10/12/2019 18:32	11/12/2019 09:54	15,36	1	15,36	CHI
20191281940	ITUMBIARA	10027421986	ITUMBIARA NOVA	10/12/2019 18:33	11/12/2019 08:45	10/12/2019 18:33	11/12/2019 08:45	14,21	1	14,21	CHI
20191281942	CAVALCANTE	CJ21412401	MINACU	10/12/2019 18:33	11/12/2019 10:15	10/12/2019 18:33	11/12/2019 10:15	15,71	1	15,71	CHI
20191281943	IPAMERI	IP21226879	IPAMERI	10/12/2019 18:33	11/12/2019 09:10	10/12/2019 18:33	11/12/2019 09:10	14,61	1	14,61	CHI
20191281954	ARAGOIANIA	AO32000285	GUAPO S2	10/12/2019 18:34	11/12/2019 09:35	11/12/2019 08:34	11/12/2019 09:35	1,02	51	51,86	CHI
20191281954	HIDROLANDIA	AO32000285	GUAPO S2	10/12/2019 18:34	11/12/2019 09:35	11/12/2019 08:34	11/12/2019 09:35	1,02	107	108,81	CHI
20191281954	MAIRIPOTABA	AO32000285	GUAPO S2	10/12/2019 18:34	11/12/2019 09:35	11/12/2019 08:34	11/12/2019 09:35	1,02	2	2,03	CHI
20191281954	VARJAO	AO32000285	GUAPO S2	10/12/2019 18:34	11/12/2019 09:35	11/12/2019 08:34	11/12/2019 09:35	1,02	69	70,17	CHI
20191282348	GOIANIA	GN12395280	GOYA S2	10/12/2019 18:34	11/12/2019 00:23	10/12/2019 18:34	11/12/2019 00:23	5,81	79	458,64	CHI
201912260917	HIDROLANDIA	680036090	GUAPO S2	10/12/2019 18:34	11/12/2019 08:34	10/12/2019 18:34	11/12/2019 08:34	13,99	1	13,99	CHI
20191281959	GOIAS	GS12090342LD	GOIAS	10/12/2019 18:36	10/12/2019 19:45	10/12/2019 18:36	10/12/2019 19:45	1,14	632	722,76	CHI
20191281966	SANTO ANTONIO DA BARRA	2270010353	ACREUNA	10/12/2019 18:37	11/12/2019 10:48	10/12/2019 18:37	11/12/2019 10:48	16,18	1	16,18	CHI
20191281979	APARECIDA DE GOIANIA	200238656	INDEPENDENCIA S1	10/12/2019 18:39	10/12/2019 21:17	10/12/2019 18:39	10/12/2019 21:17	2,62	1	2,62	CHI
20191282062	PLANALTINA	PI11208660	PLANALTINA	10/12/2019 18:39	10/12/2019 19:27	10/12/2019 18:39	10/12/2019 19:27	0,79	172	135,88	CHI
20191283190	MINEIROS	MY12149301	PARQUE DAS EMAS	10/12/2019 18:39	13/12/2019 18:05	10/12/2019 18:39	13/12/2019 15:31	68,86	6	413,17	CHI
20191283190	MINEIROS	MY12149301	PARQUE DAS EMAS	10/12/2019 18:39	13/12/2019 18:05	10/12/2019 18:39	13/12/2019 17:10	70,50	8	564,02	CHI

20191283190	MINEIROS	MY12149301	PARQUE DAS EMAS	10/12/2019 18:39	13/12/2019 18:05	10/12/2019 18:39	13/12/2019 17:35	70,92	2	141,85	CHI
20191283190	MINEIROS	MY12149301	PARQUE DAS EMAS	10/12/2019 18:39	13/12/2019 18:05	10/12/2019 18:39	13/12/2019 18:05	71,43	1	71,43	CHI
20191283190	PEROLANDIA	MY12149301	PARQUE DAS EMAS	10/12/2019 18:39	13/12/2019 18:05	10/12/2019 18:39	13/12/2019 18:05	71,43	1	71,43	CHI
20191281993	GOIANIA	11934384	GOIANIA LESTE S2	10/12/2019 18:42	10/12/2019 21:25	10/12/2019 18:42	10/12/2019 21:25	2,71	1	2,71	CHI
20191282003	MINACU	IH21208337	MINACU	10/12/2019 18:44	11/12/2019 00:40	10/12/2019 18:44	11/12/2019 00:40	5,93	1	5,93	CHI
20191282007	RIO VERDE	RV21056892	ACREUNA	10/12/2019 18:45	11/12/2019 10:36	10/12/2019 18:45	11/12/2019 10:36	15,84	1	15,84	CHI
20191282020	BALIZA	BH11331159	CAIAPONIA	10/12/2019 18:48	11/12/2019 17:15	10/12/2019 18:48	11/12/2019 17:15	22,45	1	22,45	CHI
20191282025	GOIAS	GS12065878	MATRINCHA	10/12/2019 18:48	10/12/2019 22:30	10/12/2019 18:48	10/12/2019 22:30	3,69	2	7,38	CHI
20191282028	TRINDADE	TR31045865	TRINDADE	10/12/2019 18:49	11/12/2019 09:50	10/12/2019 18:49	11/12/2019 09:50	15,01	1	15,01	CHI
20191280471	UIRAPURU	UP10398079	SANTA TEREZINHA	10/12/2019 18:50	12/12/2019 23:13	10/12/2019 18:50	10/12/2019 23:13	4,39	10	43,85	CHI
20191280471	SANTA TEREZINHA DE GOIAS	UP10398079	SANTA TEREZINHA	10/12/2019 18:50	12/12/2019 23:13	10/12/2019 18:50	11/12/2019 11:00	16,16	79	1276,73	CHI
20191280471	UIRAPURU	UP10398079	SANTA TEREZINHA	10/12/2019 18:50	12/12/2019 23:13	10/12/2019 18:50	11/12/2019 11:00	16,16	10	161,61	CHI
20191280471	SANTA TEREZINHA DE GOIAS	SG12323395LD	SANTA TEREZINHA	10/12/2019 18:50	12/12/2019 23:13	10/12/2019 18:50	11/12/2019 13:43	18,89	19	358,84	CHI
20191280471	CAMPOS VERDES	UP10398079	SANTA TEREZINHA	10/12/2019 18:50	12/12/2019 23:13	10/12/2019 18:50	12/12/2019 09:57	39,11	1	39,11	CHI
20191280471	MARA ROSA	UP10398079	SANTA TEREZINHA	10/12/2019 18:50	12/12/2019 23:13	10/12/2019 18:50	12/12/2019 09:57	39,11	15	586,71	CHI
20191280471	SANTA TEREZINHA DE GOIAS	UP10398079	SANTA TEREZINHA	10/12/2019 18:50	12/12/2019 23:13	10/12/2019 18:50	12/12/2019 09:57	39,11	19	743,17	CHI
20191280471	CAMPOS VERDES	UP10398079	SANTA TEREZINHA	10/12/2019 18:50	12/12/2019 23:13	12/12/2019 14:49	12/12/2019 15:19	0,50	1	0,50	CHI
20191280471	MARA ROSA	UP10398079	SANTA TEREZINHA	10/12/2019 18:50	12/12/2019 23:13	12/12/2019 14:49	12/12/2019 15:19	0,50	15	7,57	CHI
20191280471	SANTA TEREZINHA DE GOIAS	UP10398079	SANTA TEREZINHA	10/12/2019 18:50	12/12/2019 23:13	12/12/2019 14:49	12/12/2019 15:19	0,50	117	59,05	CHI
20191280471	UIRAPURU	UP10398079	SANTA TEREZINHA	10/12/2019 18:50	12/12/2019 23:13	12/12/2019 14:49	12/12/2019 15:19	0,50	20	10,09	CHI
20191280471	MARA ROSA	MQ12325667LD	SANTA TEREZINHA	10/12/2019 18:50	12/12/2019 23:13	10/12/2019 18:50	12/12/2019 16:10	45,33	11	498,61	CHI
20191280471	CAMPOS VERDES	UP10398079	SANTA TEREZINHA	10/12/2019 18:50	12/12/2019 23:13	12/12/2019 21:51	12/12/2019 22:29	0,62	1	0,62	CHI
20191280471	MARA ROSA	UP10398079	SANTA TEREZINHA	10/12/2019 18:50	12/12/2019 23:13	12/12/2019 21:51	12/12/2019 22:29	0,62	26	16,12	CHI
20191280471	SANTA TEREZINHA DE GOIAS	UP10398079	SANTA TEREZINHA	10/12/2019 18:50	12/12/2019 23:13	12/12/2019 21:51	12/12/2019 22:29	0,62	118	73,16	CHI
20191280471	UIRAPURU	UP10398079	SANTA TEREZINHA	10/12/2019 18:50	12/12/2019 23:13	12/12/2019 21:51	12/12/2019 22:29	0,62	20	12,40	CHI
20191280471	MARA ROSA	MQ12232537LD	SANTA TEREZINHA	10/12/2019 18:50	12/12/2019 23:13	10/12/2019 18:50	12/12/2019 22:46	51,93	1	51,93	CHI
20191280471	MARA ROSA	MQ12232537LD	SANTA TEREZINHA	10/12/2019 18:50	12/12/2019 23:13	10/12/2019 18:50	12/12/2019 23:06	52,28	1	52,28	CHI
20191280471	MARA ROSA	MQ12232537LD	SANTA TEREZINHA	10/12/2019 18:50	12/12/2019 23:13	10/12/2019 18:50	12/12/2019 23:13	52,39	48	2514,75	CHI
20191282035	GOIANESIA	550120981	GOIANESIA S2	10/12/2019 18:50	11/12/2019 09:00	10/12/2019 18:50	11/12/2019 09:00	14,17	1	14,17	CHI
20191282395	LUZIANIA	LZ12304863	MARAJOARA	10/12/2019 18:51	11/12/2019 11:34	10/12/2019 18:51	11/12/2019 11:34	16,70	64	1068,82	CHI
20191282049	LEOPOLDO DE BULHOES	LB21218412	DAIA S2	10/12/2019 18:52	11/12/2019 10:15	10/12/2019 18:52	11/12/2019 10:15	15,37	1	15,37	CHI
20191282051	GOIANIA	15477769	CAMPINAS S1	10/12/2019 18:52	10/12/2019 20:56	10/12/2019 18:52	10/12/2019 20:56	2,06	1	2,06	CHI
20191282139	CRISTALINA	KR12404430	CRISTALINA S1	10/12/2019 18:52	10/12/2019 20:43	10/12/2019 18:52	10/12/2019 20:43	1,84	15	27,65	CHI

20191282052	ARAGARCAS	10026417900	ARAGARCAS	10/12/2019 18:53	10/12/2019 22:37	10/12/2019 18:53	10/12/2019 22:37	3,73	1	3,73	CHI
20191282060	APARECIDA DE GOIANIA	10005269120	ANHANGUERA	10/12/2019 18:54	10/12/2019 21:11	10/12/2019 18:54	10/12/2019 21:11	2,28	1	2,28	CHI
20191282066	NOVA CRIXAS	NA11229646	NOVA CRIXAS	10/12/2019 18:55	11/12/2019 15:06	10/12/2019 18:55	11/12/2019 15:06	20,19	1	20,19	CHI
20191282074	VIANOPOLIS	510022765	VIANOPOLIS	10/12/2019 18:56	11/12/2019 07:29	10/12/2019 18:56	11/12/2019 07:29	12,55	1	12,55	CHI
20191282079	GOIANIA	13958628	MEIA PONTE	10/12/2019 18:57	10/12/2019 23:17	10/12/2019 18:57	10/12/2019 23:17	4,33	1	4,33	CHI
20191282083	FORMOSA	FA12228228	SAO JOAO D ALIANCA	10/12/2019 18:58	11/12/2019 13:33	10/12/2019 18:58	11/12/2019 13:33	18,58	2	37,16	CHI
20191282087	CACHOEIRA DOURADA	10025588875	CACHOEIRA DOURADA	10/12/2019 18:59	11/12/2019 09:33	10/12/2019 18:59	11/12/2019 09:33	14,56	1	14,56	CHI
20191282091	IPAMERI	IP21202973	URUTAI	10/12/2019 18:59	11/12/2019 11:37	10/12/2019 18:59	11/12/2019 11:37	16,62	1	16,62	CHI
20191282092	PONTALINA	PK21283468	PONTALINA	10/12/2019 18:59	11/12/2019 13:41	10/12/2019 18:59	11/12/2019 13:41	18,69	1	18,69	CHI
20191282096	JUSSARA	JR12331712	JUSSARA	10/12/2019 19:00	10/12/2019 19:45	10/12/2019 19:00	10/12/2019 19:45	0,76	2	1,52	CHI
20191282100	LUZIANIA	120022084	RIO VERMELHO	10/12/2019 19:01	10/12/2019 20:53	10/12/2019 19:01	10/12/2019 20:53	1,86	1	1,86	CHI
20191282196	ANAPOLIS	AN11166255	JUNDIAI S1	10/12/2019 19:01	10/12/2019 20:17	10/12/2019 19:01	10/12/2019 20:17	1,26	113	142,51	CHI
20191282106	CATALAO	CT21000029	CATALAO S2	10/12/2019 19:02	11/12/2019 19:49	10/12/2019 19:02	11/12/2019 19:49	24,77	1	24,77	CHI
20191282108	PORANGATU	PO12390255	PORANGATU	10/12/2019 19:03	11/12/2019 12:59	10/12/2019 19:03	11/12/2019 12:59	17,92	4	71,69	CHI
20191282114	ANAPOLIS	10003694648	ANAPOLIS UNIVERSITARIO S2	10/12/2019 19:04	10/12/2019 20:26	10/12/2019 19:04	10/12/2019 20:26	1,36	1	1,36	CHI
20191282116	SILVANIA	SV21245588	DAIA S2	10/12/2019 19:05	10/12/2019 23:43	10/12/2019 19:05	10/12/2019 23:43	4,63	2	9,27	CHI
20191282117	PORANGATU	PO12192371	PORANGATU	10/12/2019 19:05	10/12/2019 23:19	10/12/2019 19:05	10/12/2019 23:19	4,23	12	50,75	CHI
20191282119	JARAGUA	JA21192204	JARAGUA	10/12/2019 19:05	11/12/2019 00:01	10/12/2019 19:05	11/12/2019 00:01	4,92	2	9,85	CHI
20191282125	PORANGATU	PO12391647	NOVO PLANALTO	10/12/2019 19:07	11/12/2019 10:32	10/12/2019 19:07	11/12/2019 10:32	15,41	25	385,33	CHI
20191282128	FAINA	FC12299837	GOIAS	10/12/2019 19:08	11/12/2019 17:04	10/12/2019 19:08	11/12/2019 17:04	21,93	6	131,59	CHI
20191282133	ITAPIRAPUA	IU21198760	MATRINCHA	10/12/2019 19:09	11/12/2019 19:57	10/12/2019 19:09	11/12/2019 19:57	24,79	1	24,79	CHI
20191282141	POSSE	PS12235404	IACIARA S2	10/12/2019 19:12	10/12/2019 21:03	10/12/2019 19:12	10/12/2019 21:03	1,84	32	58,89	CHI
20191282148	CIDADE OCIDENTAL	10000159954	MARAJOARA	10/12/2019 19:13	10/12/2019 22:19	10/12/2019 19:13	10/12/2019 22:19	3,09	1	3,09	CHI
20191282151	BALIZA	BH21360379	BOM JARDIM	10/12/2019 19:14	11/12/2019 09:58	10/12/2019 19:14	11/12/2019 09:58	14,73	1	14,73	CHI
20191282154	LEOPOLDO DE BULHOES	LB21168939	CEPAIGO S2	10/12/2019 19:14	10/12/2019 22:23	10/12/2019 19:14	10/12/2019 22:23	3,13	2	6,27	CHI
20191282162	NOVA ROMA	ND12051336	IACIARA S2	10/12/2019 19:17	10/12/2019 20:19	10/12/2019 19:17	10/12/2019 20:19	1,03	4	4,13	CHI
20191282385	APARECIDA DE GOIANIA	AP11040977	INDEPENDENCIA S1	10/12/2019 19:18	10/12/2019 21:58	10/12/2019 19:18	10/12/2019 21:58	2,66	170	451,40	CHI
20191282178	GOIANIRA	390032463	GOIANIRA	10/12/2019 19:20	11/12/2019 01:00	10/12/2019 19:20	11/12/2019 01:00	5,67	1	5,67	CHI
20191282180	CRISTALINA	KR12203334	CRISTALINA S2	10/12/2019 19:21	11/12/2019 09:37	10/12/2019 19:21	11/12/2019 09:37	14,26	6	85,57	CHI
20191282184	SANTA CRUZ DE GOIAS	BC11286287	PIRES DO RIO S2	10/12/2019 19:21	11/12/2019 13:13	10/12/2019 19:21	11/12/2019 13:13	17,86	2	35,71	CHI
20191282192	GOIANIA	GN11150240	GOYA S2	10/12/2019 19:21	10/12/2019 22:23	10/12/2019 19:21	10/12/2019 22:23	3,02	273	825,67	CHI
20191282282	EDEIA	EA11142339	EDEIA	10/12/2019 19:21	11/12/2019 11:15	10/12/2019 19:21	11/12/2019 11:15	15,89	86	1366,85	CHI
20191282186	GOIANIA	10025099483	GOYA S2	10/12/2019 19:22	11/12/2019 03:53	10/12/2019 19:22	11/12/2019 03:53	8,50	1	8,50	CHI

20191282193	ARENOPOLIS	1920004510	ARENOPOLIS	10/12/2019 19:24	11/12/2019 17:53	10/12/2019 19:24	11/12/2019 17:53	22,47	1	22,47	CHI
20191282194	PIRENOPOLIS	PV12285301	CORUMBA	10/12/2019 19:24	11/12/2019 09:14	10/12/2019 19:24	11/12/2019 09:14	13,82	54	746,40	CHI
20191282251	CRISTALINA	KR11032621	PAMPLONA	10/12/2019 19:24	10/12/2019 20:33	10/12/2019 19:24	10/12/2019 20:33	1,15	81	92,92	CHI
20191282277	ANAPOLIS	AN11072568	JUNDIAI S1	10/12/2019 19:25	10/12/2019 20:58	10/12/2019 19:25	10/12/2019 20:58	1,54	143	220,14	CHI
20191282201	APARECIDA DE GOIANIA	AP21063302	CEPAIGO S1	10/12/2019 19:26	11/12/2019 08:02	10/12/2019 19:26	11/12/2019 08:02	12,60	2	25,20	CHI
20191282371	LUZIANIA	LZ12376186	RIO VERMELHO	10/12/2019 19:26	10/12/2019 21:28	10/12/2019 19:26	10/12/2019 21:28	2,03	13	26,43	CHI
20191282205	ITAPURANGA	IK21060500	ITAPURANGA	10/12/2019 19:27	11/12/2019 11:10	10/12/2019 19:27	11/12/2019 11:10	15,70	2	31,40	CHI
20191282207	ITAPURANGA	GS21234130	ITAPURANGA	10/12/2019 19:28	11/12/2019 13:00	10/12/2019 19:28	11/12/2019 13:00	17,53	1	17,53	CHI
20191282209	INHUMAS	10014277857	INHUMAS S2	10/12/2019 19:29	11/12/2019 09:28	10/12/2019 19:29	11/12/2019 09:28	13,99	1	13,99	CHI
20191282212	EDEIA	ED21000028	PONTALINA	10/12/2019 19:29	11/12/2019 12:00	10/12/2019 19:29	11/12/2019 12:00	16,50	1	16,50	CHI
20191280473	SERRANOPOLIS	MY21166297	CHAPADAO DO CEU	10/12/2019 19:30	11/12/2019 15:55	10/12/2019 19:30	11/12/2019 15:55	20,42	1	20,42	CHI
20191282221	PLANALTINA	PI11136680	PLANALTINA	10/12/2019 19:32	10/12/2019 21:56	10/12/2019 19:32	10/12/2019 21:56	2,40	23	55,12	CHI
20191282224	CORUMBAIBA	CI21000522	VILA CORUMBA	10/12/2019 19:32	11/12/2019 10:48	10/12/2019 19:32	11/12/2019 10:48	15,26	1	15,26	CHI
20191282231	LUZIANIA	LZ12203332	VIANOPOLIS	10/12/2019 19:35	10/12/2019 22:40	10/12/2019 19:35	10/12/2019 22:40	3,08	16	49,23	CHI
20191282239	GOIANIA	15576371	CARAJAS S1	10/12/2019 19:36	10/12/2019 21:02	10/12/2019 19:36	10/12/2019 21:02	1,42	1	1,42	CHI
20191282242	GOIANIRA	GR21011972	NEROPOLIS S1	10/12/2019 19:36	11/12/2019 11:15	10/12/2019 19:36	11/12/2019 11:15	15,63	1	15,63	CHI
20191282463	ANAPOLIS	AN11130801	JUNDIAI S2	10/12/2019 19:36	10/12/2019 22:51	10/12/2019 19:36	10/12/2019 22:51	3,24	126	408,62	CHI
20191280479	PARAUNA	PU21305730	ACREUNA	10/12/2019 19:39	10/12/2019 20:53	10/12/2019 19:39	10/12/2019 20:53	1,23	1	1,23	CHI
20191282250	SIMOLANDIA	1940008417	IACIARA S2	10/12/2019 19:39	10/12/2019 20:42	10/12/2019 19:39	10/12/2019 20:42	1,04	1	1,04	CHI
20191282252	MARA ROSA	MQ12182423	MARA ROSA	10/12/2019 19:39	11/12/2019 15:38	10/12/2019 19:39	11/12/2019 15:38	19,98	2	39,95	CHI
20191282253	DOVERLANDIA	DV21188436	CAIAPONIA	10/12/2019 19:40	11/12/2019 11:50	10/12/2019 19:40	11/12/2019 11:50	16,17	1	16,17	CHI
20191282257	TURVELANDIA	10009807240	RIO DOS BOIS	10/12/2019 19:41	11/12/2019 12:20	10/12/2019 19:41	11/12/2019 12:20	16,65	1	16,65	CHI
20191282258	RIO VERDE	630526618	CABRIUVA S1	10/12/2019 19:41	10/12/2019 23:45	10/12/2019 19:41	10/12/2019 23:45	4,05	1	4,05	CHI
20191282260	GOIANIA	17105559	MEIA PONTE	10/12/2019 19:42	10/12/2019 21:50	10/12/2019 19:42	10/12/2019 21:50	2,13	1	2,13	CHI
20191282261	APARECIDA DE GOIANIA	200666885	CEPAIGO S1	10/12/2019 19:42	11/12/2019 09:26	10/12/2019 19:42	11/12/2019 09:26	13,74	1	13,74	CHI
20191283268	PIRENOPOLIS	PV12302141	SAO FRANCISCO DE GOIAS	10/12/2019 19:42	11/12/2019 07:52	10/12/2019 19:42	11/12/2019 07:52	12,16	93	1130,70	CHI
20191282269	PIRES DO RIO	460058861	PIRES DO RIO S1	10/12/2019 19:45	11/12/2019 01:13	10/12/2019 19:45	11/12/2019 01:13	5,46	1	5,46	CHI
20191282320	APARECIDA DE GOIANIA	AP12383867	INDEPENDENCIA S1	10/12/2019 19:47	10/12/2019 21:30	10/12/2019 19:47	10/12/2019 21:30	1,72	124	212,69	CHI
20191282289	NIQUELANDIA	NQ21135593	URUACU	10/12/2019 19:51	11/12/2019 01:03	10/12/2019 19:51	11/12/2019 01:03	5,19	1	5,19	CHI
20191282290	PIRANHAS	PH21238180	PIRANHAS	10/12/2019 19:51	10/12/2019 20:54	10/12/2019 19:51	10/12/2019 20:54	1,04	1	1,04	CHI
20191282292	FAINA	FC12274380	GOIAS	10/12/2019 19:52	11/12/2019 14:41	10/12/2019 19:52	11/12/2019 14:41	18,81	2	37,62	CHI
20191282313	CAMPO LIMPO	AN12267847	NEROPOLIS S1	10/12/2019 19:52	11/12/2019 10:48	10/12/2019 19:52	11/12/2019 10:48	14,92	62	924,97	CHI
20191282298	GOIANIA	10015767580	MEIA PONTE	10/12/2019 19:53	11/12/2019 01:13	10/12/2019 19:53	11/12/2019 01:13	5,32	1	5,32	CHI

20191282301	ANAPOLIS	20753111	ANAPOLIS UNIVERSITARIO S1	10/12/2019 19:54	11/12/2019 08:38	10/12/2019 19:54	11/12/2019 08:38	12,74	1	12,74	CHI
20191282302	GOIANIA	16087628	CARAJAS S1	10/12/2019 19:54	10/12/2019 21:15	10/12/2019 19:54	10/12/2019 21:15	1,35	1	1,35	CHI
20191282307	GOIAS	GS21210482	GOIAS	10/12/2019 19:55	11/12/2019 08:55	10/12/2019 19:55	11/12/2019 08:55	12,99	1	12,99	CHI
20191282309	TEREZOPOLIS DE GOIAS	TJ21353269	DAIA S2	10/12/2019 19:55	11/12/2019 14:19	10/12/2019 19:55	11/12/2019 14:19	18,39	1	18,39	CHI
20191282322	FAZENDA NOVA	FN21130300	FIRMINOPOLIS S2	10/12/2019 20:01	11/12/2019 11:44	10/12/2019 20:01	11/12/2019 11:44	15,71	2	31,43	CHI
20191282324	SENADOR CANEDO	190075181	SENADOR CANEDO	10/12/2019 20:01	10/12/2019 21:00	10/12/2019 20:01	10/12/2019 21:00	0,97	1	0,97	CHI
20191282326	FORMOSA	FA21130043	ITUIQUIRA	10/12/2019 20:02	10/12/2019 20:59	10/12/2019 20:02	10/12/2019 20:59	0,94	1	0,94	CHI
20191282327	CATALAO	9580003070	CATALAO S1	10/12/2019 20:02	11/12/2019 10:32	10/12/2019 20:02	11/12/2019 10:32	14,50	1	14,50	CHI
20191282333	MAURILANDIA	CL12306027	RIO DOS BOIS	10/12/2019 20:05	11/12/2019 11:05	10/12/2019 20:05	11/12/2019 11:05	15,01	4	60,03	CHI
20191282333	PORTEIRAO	CL12306027	RIO DOS BOIS	10/12/2019 20:05	11/12/2019 11:05	10/12/2019 20:05	11/12/2019 11:05	15,01	3	45,03	CHI
20191282338	CRIXAS	CX12252981	SERRA DO OURO	10/12/2019 20:05	11/12/2019 17:10	10/12/2019 20:05	11/12/2019 17:10	21,07	5	105,35	CHI
20191282340	SILVANIA	SV12012807	VIANOPOLIS	10/12/2019 20:07	11/12/2019 11:24	10/12/2019 20:07	11/12/2019 11:24	15,28	4	61,12	CHI
20191282342	ITAJA	IJ12200688	ITAJA S2	10/12/2019 20:07	11/12/2019 09:34	10/12/2019 20:07	11/12/2019 09:34	13,44	2	26,89	CHI
20191282343	APARECIDA DE GOIANIA	10029984082	INDEPENDENCIA S1	10/12/2019 20:07	11/12/2019 09:09	10/12/2019 20:07	11/12/2019 09:09	13,03	1	13,03	CHI
20191282355	JANDAIA	JD21301617	ACREUNA	10/12/2019 20:10	11/12/2019 09:23	10/12/2019 20:10	11/12/2019 09:23	13,22	1	13,22	CHI
20191282356	MORRINHOS	MR21417457	MORRINHOS	10/12/2019 20:10	11/12/2019 07:25	10/12/2019 20:10	11/12/2019 07:25	11,25	1	11,25	CHI
20191282388	GOIANIA	GN11049382	ATLANTICO S3	10/12/2019 20:10	11/12/2019 00:42	10/12/2019 20:10	11/12/2019 00:42	4,52	195	881,89	CHI
20191282360	RUBIATABA	RB21312105	RUBIATABA	10/12/2019 20:11	11/12/2019 10:27	10/12/2019 20:11	11/12/2019 10:27	14,27	1	14,27	CHI
20191282361	JUSSARA	1290049224	JUSSARA	10/12/2019 20:11	11/12/2019 08:20	10/12/2019 20:11	11/12/2019 08:20	12,15	1	12,15	CHI
20191282363	JATAI	JT12260302	JATAI S3	10/12/2019 20:13	10/12/2019 21:30	10/12/2019 20:13	10/12/2019 21:30	1,28	3	3,84	CHI
20191282366	GOIANIA	10013925081	GOIANIA LESTE S1	10/12/2019 20:13	10/12/2019 22:27	10/12/2019 20:13	10/12/2019 22:27	2,22	1	2,22	CHI
20191282367	CRIXAS	CX21132275	SERRA DO OURO	10/12/2019 20:13	12/12/2019 18:35	10/12/2019 20:13	12/12/2019 18:35	46,36	1	46,36	CHI
20191282368	CAMPESTRE DE GOIAS	10023523989	TRINDADE	10/12/2019 20:14	11/12/2019 08:00	10/12/2019 20:14	11/12/2019 08:00	11,75	1	11,75	CHI
20191282387	GOIANIA	GN11209264	CARAJAS S1	10/12/2019 20:17	11/12/2019 01:47	10/12/2019 20:17	11/12/2019 01:47	5,50	142	780,80	CHI
20191282379	RIO VERDE	630222782	RIO VERDE S2	10/12/2019 20:18	11/12/2019 04:00	10/12/2019 20:18	11/12/2019 04:00	7,70	1	7,70	CHI
20191282391	BOM JESUS DE GOIAS	02320214	RIO DOS BOIS	10/12/2019 20:18	11/12/2019 17:30	10/12/2019 20:18	10/12/2019 21:18	0,99	21	20,87	CHI
20191282391	CASTELANDIA	02320214	RIO DOS BOIS	10/12/2019 20:18	11/12/2019 17:30	10/12/2019 20:18	10/12/2019 21:18	0,99	59	58,62	CHI
20191282391	GOIATUBA	02320214	RIO DOS BOIS	10/12/2019 20:18	11/12/2019 17:30	10/12/2019 20:18	10/12/2019 21:18	0,99	21	20,87	CHI
20191282391	GOIATUBA	02320214	RIO DOS BOIS	10/12/2019 20:18	11/12/2019 17:30	10/12/2019 20:18	10/12/2019 21:18	0,99	7	6,96	CHI
20191282391	MAURILANDIA	02320214	RIO DOS BOIS	10/12/2019 20:18	11/12/2019 17:30	10/12/2019 20:18	10/12/2019 21:18	0,99	1	0,99	CHI
20191282391	PORTEIRAO	02320214	RIO DOS BOIS	10/12/2019 20:18	11/12/2019 17:30	10/12/2019 20:18	10/12/2019 21:18	0,99	7	6,96	CHI
20191282391	PORTEIRAO	02320214	RIO DOS BOIS	10/12/2019 20:18	11/12/2019 17:30	10/12/2019 20:18	10/12/2019 21:18	0,99	4	3,97	CHI
20191282391	CASTELANDIA	02320214	RIO DOS BOIS	10/12/2019 20:18	11/12/2019 17:30	10/12/2019 20:21	10/12/2019 21:18	0,95	1354	1283,29	CHI

20191282391	BOM JESUS DE GOIAS	DM13213276	RIO DOS BOIS	10/12/2019 20:18	11/12/2019 17:30	10/12/2019 20:21	11/12/2019 17:30	21,15	1	21,15	CHI
20191282391	CASTELANDIA	DM13213276	RIO DOS BOIS	10/12/2019 20:18	11/12/2019 17:30	10/12/2019 20:21	11/12/2019 17:30	21,15	35	740,15	CHI
20191282391	MAURILANDIA	DM13213276	RIO DOS BOIS	10/12/2019 20:18	11/12/2019 17:30	10/12/2019 20:21	11/12/2019 17:30	21,15	1	21,15	CHI
20191282391	QUIRINOPOLIS	DM13213276	RIO DOS BOIS	10/12/2019 20:18	11/12/2019 17:30	10/12/2019 20:21	11/12/2019 17:30	21,15	44	930,48	CHI
20191282381	CRISTALINA	1060128187	CRISTALINA S1	10/12/2019 20:19	11/12/2019 03:32	10/12/2019 20:19	11/12/2019 03:32	7,21	1	7,21	CHI
20191282392	ALEXANIA	AX21102403	ALEXANIA	10/12/2019 20:21	10/12/2019 22:31	10/12/2019 20:21	10/12/2019 22:31	2,15	1	2,15	CHI
20191282600	PORANGATU	PO12230401	MARA ROSA	10/12/2019 20:24	11/12/2019 19:45	10/12/2019 20:24	11/12/2019 19:45	23,35	5	116,74	CHI
20191282400	PORTELANDIA	PW12151599	PARQUE DAS EMAS	10/12/2019 20:26	11/12/2019 09:15	10/12/2019 20:26	11/12/2019 09:15	12,81	5	64,04	CHI
20191282657	ITAPACI	IW12201633	ITAPACI	10/12/2019 20:26	11/12/2019 10:12	10/12/2019 20:26	11/12/2019 10:12	13,76	11	151,33	CHI
20191282406	APARECIDA DE GOIANIA	13919052	INDEPENDENCIA S1	10/12/2019 20:28	10/12/2019 21:45	10/12/2019 20:28	10/12/2019 21:45	1,27	1	1,27	CHI
20191282407	GOIANIRA	GR12394658	GOIANIRA	10/12/2019 20:28	11/12/2019 08:35	10/12/2019 20:28	11/12/2019 08:35	12,10	2	24,20	CHI
20191282407	TRINDADE	GR12394658	GOIANIRA	10/12/2019 20:28	11/12/2019 08:35	10/12/2019 20:28	11/12/2019 08:35	12,10	3	36,30	CHI
20191282409	CATURAI	IN21293441	ARACU	10/12/2019 20:29	11/12/2019 09:08	10/12/2019 20:29	11/12/2019 09:08	12,64	1	12,64	CHI
20191282416	BURITINOPOLIS	SU12301950	SANTA RITA DO ARAGUAIA	10/12/2019 20:31	11/12/2019 01:33	10/12/2019 20:31	11/12/2019 01:33	5,02	1	5,02	CHI
20191282416	SANTA RITA DO ARAGUAIA	SU12301950	SANTA RITA DO ARAGUAIA	10/12/2019 20:31	11/12/2019 01:33	10/12/2019 20:31	11/12/2019 01:33	5,02	21	105,43	CHI
20191282417	APARECIDA DE GOIANIA	10003469555	REAL S1	10/12/2019 20:32	11/12/2019 08:11	10/12/2019 20:32	11/12/2019 08:11	11,64	1	11,64	CHI
20191282419	PROFESSOR JAMIL SAFADY	JS12074215	ROCHEDO	10/12/2019 20:33	11/12/2019 12:20	10/12/2019 20:33	11/12/2019 12:20	15,78	2	31,56	CHI
20191282424	SANTO ANTONIO DO DESCOBERTO	SN21330691	MARAJOARA	10/12/2019 20:36	11/12/2019 19:48	10/12/2019 20:36	11/12/2019 19:48	23,20	1	23,20	CHI
20191282428	APARECIDA DE GOIANIA	10002414714	INDEPENDENCIA S2	10/12/2019 20:37	11/12/2019 09:16	10/12/2019 20:37	11/12/2019 09:16	12,64	1	12,64	CHI
20191282429	RIO VERDE	630392274	RIO VERDE S1	10/12/2019 20:38	11/12/2019 00:00	10/12/2019 20:38	11/12/2019 00:00	3,36	1	3,36	CHI
20191282430	ANAPOLIS	10008088665	JUNDIAI S2	10/12/2019 20:38	10/12/2019 23:44	10/12/2019 20:38	10/12/2019 23:44	3,09	1	3,09	CHI
20191282431	MORRINHOS	MR21212505	MORRINHOS	10/12/2019 20:38	11/12/2019 02:56	10/12/2019 20:38	11/12/2019 02:56	6,29	2	12,58	CHI
20191283910	JUSSARA	JR12076133	BRITANIA	10/12/2019 20:39	11/12/2019 18:24	10/12/2019 20:39	11/12/2019 18:24	21,75	3	65,25	CHI
20191282434	ANAPOLIS	10011269942	ANAPOLIS UNIVERSITARIO S2	10/12/2019 20:40	11/12/2019 10:21	10/12/2019 20:40	11/12/2019 10:21	13,68	1	13,68	CHI
20191282474	TERESINA DE GOIAS	TE12257469	FLORES DE GOIAS	10/12/2019 20:40	10/12/2019 22:02	10/12/2019 20:40	10/12/2019 22:02	1,36	127	173,14	CHI
20191282437	JUSSARA	JR21114098	JUSSARA	10/12/2019 20:41	11/12/2019 08:40	10/12/2019 20:41	11/12/2019 08:40	11,98	1	11,98	CHI
20191282438	AGUAS LINDAS DE GOIAS	10017464194	AGUAS LINDAS DE GOIAS S1	10/12/2019 20:41	10/12/2019 22:04	10/12/2019 20:41	10/12/2019 22:04	1,37	1	1,37	CHI
20191282440	MINEIROS	MY12043893	PARQUE DAS EMAS	10/12/2019 20:42	11/12/2019 13:08	10/12/2019 20:42	11/12/2019 13:08	16,43	4	65,73	CHI
20191282445	GOIANIA	14244100	GOIANIA LESTE S3	10/12/2019 20:43	10/12/2019 23:02	10/12/2019 20:43	10/12/2019 23:02	2,32	1	2,32	CHI
20191282446	CATALAO	CT21215629	CATALAO S1	10/12/2019 20:43	10/12/2019 22:01	10/12/2019 20:43	10/12/2019 22:01	1,30	2	2,60	CHI
20191282455	FAZENDA NOVA	FN12183426	IPORA	10/12/2019 20:45	11/12/2019 12:28	10/12/2019 20:45	11/12/2019 12:28	15,71	9	141,42	CHI
20191282471	ANAPOLIS	AN11003272	JUNDIAI S1	10/12/2019 20:46	10/12/2019 21:58	10/12/2019 20:46	10/12/2019 21:58	1,19	140	166,91	CHI
20191282460	GOIANIA	11044147	GOYA S2	10/12/2019 20:47	10/12/2019 23:05	10/12/2019 20:47	10/12/2019 23:05	2,30	1	2,30	CHI

20191282465	ITAPURANGA	IK11051551	ITAPURANGA	10/12/2019 20:49	10/12/2019 22:47	10/12/2019 20:49	10/12/2019 22:47	1,95	106	206,99	CHI
20191282654	ARAGUAPAZ	AZ21143377	MOZARLANDIA	10/12/2019 20:50	11/12/2019 03:36	10/12/2019 20:58	11/12/2019 03:36	6,63	1	6,63	CHI
2019121000099	ARAGUAPAZ	03374118	MOZARLANDIA	10/12/2019 20:50	10/12/2019 22:43	10/12/2019 20:58	10/12/2019 22:43	1,75	2828	4949,00	CHI
2019121000099	ARAGUAPAZ	MZ10400739	MOZARLANDIA	10/12/2019 20:50	10/12/2019 22:43	10/12/2019 20:58	10/12/2019 22:43	1,75	35	61,25	CHI
2019121000099	ARUANA	03374118	MOZARLANDIA	10/12/2019 20:50	10/12/2019 22:43	10/12/2019 20:58	10/12/2019 22:43	1,75	73	127,75	CHI
2019121000099	ARUANA	03374118	MOZARLANDIA	10/12/2019 20:50	10/12/2019 22:43	10/12/2019 20:58	10/12/2019 22:43	1,75	124	217,00	CHI
2019121000099	CRIXAS	03374118	MOZARLANDIA	10/12/2019 20:50	10/12/2019 22:43	10/12/2019 20:58	10/12/2019 22:43	1,75	105	183,75	CHI
2019121000099	MATRINCHA	03374118	MOZARLANDIA	10/12/2019 20:50	10/12/2019 22:43	10/12/2019 20:58	10/12/2019 22:43	1,75	38	66,50	CHI
2019121000099	MOZARLANDIA	03374118	MOZARLANDIA	10/12/2019 20:50	10/12/2019 22:43	10/12/2019 20:58	10/12/2019 22:43	1,75	4873	8527,75	CHI
2019121000099	MOZARLANDIA	03374118	MOZARLANDIA	10/12/2019 20:50	10/12/2019 22:43	10/12/2019 20:58	10/12/2019 22:43	1,75	9	15,75	CHI
2019121000099	MOZARLANDIA	03374118	MOZARLANDIA	10/12/2019 20:50	10/12/2019 22:43	10/12/2019 20:58	10/12/2019 22:43	1,75	4	7,00	CHI
2019121000099	MOZARLANDIA	03374118	MOZARLANDIA	10/12/2019 20:50	10/12/2019 22:43	10/12/2019 20:58	10/12/2019 22:43	1,75	815	1426,25	CHI
2019121000099	MOZARLANDIA	03374118	MOZARLANDIA	10/12/2019 20:50	10/12/2019 22:43	10/12/2019 20:58	10/12/2019 22:43	1,75	13	22,75	CHI
2019121000099	MOZARLANDIA	MZ10400739	MOZARLANDIA	10/12/2019 20:50	10/12/2019 22:43	10/12/2019 20:58	10/12/2019 22:43	1,75	334	584,50	CHI
2019121000099	MOZARLANDIA	03374118	MOZARLANDIA	10/12/2019 20:50	10/12/2019 22:43	10/12/2019 20:58	10/12/2019 22:43	1,75	4	7,00	CHI
2019121000099	NOVA CRIXAS	03374118	MOZARLANDIA	10/12/2019 20:50	10/12/2019 22:43	10/12/2019 20:58	10/12/2019 22:43	1,75	172	301,00	CHI
2019121000099	NOVA CRIXAS	03374118	MOZARLANDIA	10/12/2019 20:50	10/12/2019 22:43	10/12/2019 20:58	10/12/2019 22:43	1,75	8	14,00	CHI
2019121000099	ARUANA	01630424	MOZARLANDIA	10/12/2019 20:50	10/12/2019 22:43	10/12/2019 21:48	10/12/2019 22:43	0,90	8	7,23	CHI
2019121000099	MOZARLANDIA	01630424	MOZARLANDIA	10/12/2019 20:50	10/12/2019 22:43	10/12/2019 21:48	10/12/2019 22:43	0,90	96	86,75	CHI
2019121000099	NOVA CRIXAS	01630424	MOZARLANDIA	10/12/2019 20:50	10/12/2019 22:43	10/12/2019 21:48	10/12/2019 22:43	0,90	31	28,01	CHI
20191282470	MIMOSO DE GOIAS	MJ12376788	PADRE BERNARDO	10/12/2019 20:51	11/12/2019 08:16	10/12/2019 20:51	11/12/2019 08:16	11,40	2	22,80	CHI
20191282478	SANTA TEREZA DE GOIAS	SE12053812	MARA ROSA	10/12/2019 20:55	11/12/2019 11:06	10/12/2019 20:55	11/12/2019 11:06	14,18	3	42,55	CHI
20191282482	ANAPOLIS	21023463	JUNDIAI S2	10/12/2019 20:58	11/12/2019 12:40	10/12/2019 20:58	11/12/2019 12:40	15,69	1	15,69	CHI
20191282561	GOIANIA	GN11209253	CARAJAS S1	10/12/2019 20:58	10/12/2019 22:45	10/12/2019 20:58	10/12/2019 22:45	1,78	88	157,01	CHI
2019121000101	AMARALINA	05635114	NOVA CRIXAS	10/12/2019 20:58	10/12/2019 21:06	10/12/2019 20:58	10/12/2019 21:06	0,13	78	10,40	CHI
2019121000101	CRIXAS	05635114	NOVA CRIXAS	10/12/2019 20:58	10/12/2019 21:06	10/12/2019 20:58	10/12/2019 21:06	0,13	3	0,40	CHI
2019121000101	CRIXAS	05635114	NOVA CRIXAS	10/12/2019 20:58	10/12/2019 21:06	10/12/2019 20:58	10/12/2019 21:06	0,13	22	2,93	CHI
2019121000101	MARA ROSA	05635114	NOVA CRIXAS	10/12/2019 20:58	10/12/2019 21:06	10/12/2019 20:58	10/12/2019 21:06	0,13	44	5,87	CHI
2019121000101	MUNDO NOVO DE GOIAS	15901	NOVA CRIXAS	10/12/2019 20:58	10/12/2019 21:06	10/12/2019 20:58	10/12/2019 21:06	0,13	1868	249,07	CHI
2019121000101	MUNDO NOVO DE GOIAS	05635114	NOVA CRIXAS	10/12/2019 20:58	10/12/2019 21:06	10/12/2019 20:58	10/12/2019 21:06	0,13	45	6,00	CHI
2019121000101	MUNDO NOVO DE GOIAS	05635114	NOVA CRIXAS	10/12/2019 20:58	10/12/2019 21:06	10/12/2019 20:58	10/12/2019 21:06	0,13	819	109,20	CHI
2019121000101	NOVA CRIXAS	39601	NOVA CRIXAS	10/12/2019 20:58	10/12/2019 21:06	10/12/2019 20:58	10/12/2019 21:06	0,13	2	0,27	CHI
2019121000101	NOVA CRIXAS	05635114	NOVA CRIXAS	10/12/2019 20:58	10/12/2019 21:06	10/12/2019 20:58	10/12/2019 21:06	0,13	3837	511,60	CHI

2019121000101	NOVA CRIXAS	39602	NOVA CRIXAS	10/12/2019 20:58	10/12/2019 21:06	10/12/2019 20:58	10/12/2019 21:06	0,13	1	0,13	CHI
2019121000101	NOVA CRIXAS	05635114	NOVA CRIXAS	10/12/2019 20:58	10/12/2019 21:06	10/12/2019 20:58	10/12/2019 21:06	0,13	64	8,53	CHI
2019121000101	NOVA CRIXAS	05635114	NOVA CRIXAS	10/12/2019 20:58	10/12/2019 21:06	10/12/2019 20:58	10/12/2019 21:06	0,13	21	2,80	CHI
2019121000101	NOVA CRIXAS	05635114	NOVA CRIXAS	10/12/2019 20:58	10/12/2019 21:06	10/12/2019 20:58	10/12/2019 21:06	0,13	1310	174,67	CHI
2019121000101	SANTA TEREZINHA DE GOIAS	05635114	NOVA CRIXAS	10/12/2019 20:58	10/12/2019 21:06	10/12/2019 20:58	10/12/2019 21:06	0,13	1	0,13	CHI
2019121000101	SAO MIGUEL DO ARAGUAIA	05635114	NOVA CRIXAS	10/12/2019 20:58	10/12/2019 21:06	10/12/2019 20:58	10/12/2019 21:06	0,13	21	2,80	CHI
2019121000101	UIRAPURU	05635114	NOVA CRIXAS	10/12/2019 20:58	10/12/2019 21:06	10/12/2019 20:58	10/12/2019 21:06	0,13	312	41,60	CHI
2019121000101	CRIXAS	05635114	SANTA TEREZINHA	10/12/2019 20:58	10/12/2019 21:06	10/12/2019 20:58	10/12/2019 21:06	0,13	146	19,47	CHI
2019121000101	SANTA TEREZINHA DE GOIAS	05635114	SANTA TEREZINHA	10/12/2019 20:58	10/12/2019 21:06	10/12/2019 20:58	10/12/2019 21:06	0,13	7	0,93	CHI
2019121000101	UIRAPURU	05635114	SANTA TEREZINHA	10/12/2019 20:58	10/12/2019 21:06	10/12/2019 20:58	10/12/2019 21:06	0,13	955	127,33	CHI
2019121000103	ALTO HORIZONTE	24901	SANTA TEREZINHA	10/12/2019 20:58	10/12/2019 21:07	10/12/2019 20:58	10/12/2019 21:07	0,15	9	1,35	CHI
2019121000103	ALTO HORIZONTE	34001	SANTA TEREZINHA	10/12/2019 20:58	10/12/2019 21:07	10/12/2019 20:58	10/12/2019 21:07	0,15	13	1,95	CHI
2019121000103	ALTO HORIZONTE	34002	SANTA TEREZINHA	10/12/2019 20:58	10/12/2019 21:07	10/12/2019 20:58	10/12/2019 21:07	0,15	86	12,90	CHI
2019121000103	CAMPOS VERDES	24901	SANTA TEREZINHA	10/12/2019 20:58	10/12/2019 21:07	10/12/2019 20:58	10/12/2019 21:07	0,15	2002	300,30	CHI
2019121000103	CAMPOS VERDES	24902	SANTA TEREZINHA	10/12/2019 20:58	10/12/2019 21:07	10/12/2019 20:58	10/12/2019 21:07	0,15	47	7,05	CHI
2019121000103	CAMPOS VERDES	34002	SANTA TEREZINHA	10/12/2019 20:58	10/12/2019 21:07	10/12/2019 20:58	10/12/2019 21:07	0,15	8	1,20	CHI
2019121000103	CAMPOS VERDES	01735114	SANTA TEREZINHA	10/12/2019 20:58	10/12/2019 21:07	10/12/2019 20:58	10/12/2019 21:07	0,15	66	9,90	CHI
2019121000103	CRIXAS	01735114	SANTA TEREZINHA	10/12/2019 20:58	10/12/2019 21:07	10/12/2019 20:58	10/12/2019 21:07	0,15	255	38,25	CHI
2019121000103	CRIXAS	01735114	SANTA TEREZINHA	10/12/2019 20:58	10/12/2019 21:07	10/12/2019 20:58	10/12/2019 21:07	0,15	14	2,10	CHI
2019121000103	GUARINOS	01735114	SANTA TEREZINHA	10/12/2019 20:58	10/12/2019 21:07	10/12/2019 20:58	10/12/2019 21:07	0,15	279	41,85	CHI
2019121000103	HIDROLINA	01735114	SANTA TEREZINHA	10/12/2019 20:58	10/12/2019 21:07	10/12/2019 20:58	10/12/2019 21:07	0,15	16	2,40	CHI
2019121000103	MARA ROSA	24901	SANTA TEREZINHA	10/12/2019 20:58	10/12/2019 21:07	10/12/2019 20:58	10/12/2019 21:07	0,15	65	9,75	CHI
2019121000103	NOVA IGUACU DE GOIAS	34001	SANTA TEREZINHA	10/12/2019 20:58	10/12/2019 21:07	10/12/2019 20:58	10/12/2019 21:07	0,15	818	122,70	CHI
2019121000103	NOVA IGUACU DE GOIAS	34002	SANTA TEREZINHA	10/12/2019 20:58	10/12/2019 21:07	10/12/2019 20:58	10/12/2019 21:07	0,15	364	54,60	CHI
2019121000103	NOVA IGUACU DE GOIAS	01735114	SANTA TEREZINHA	10/12/2019 20:58	10/12/2019 21:07	10/12/2019 20:58	10/12/2019 21:07	0,15	1	0,15	CHI
2019121000103	PILAR DE GOIAS	24901	SANTA TEREZINHA	10/12/2019 20:58	10/12/2019 21:07	10/12/2019 20:58	10/12/2019 21:07	0,15	6	0,90	CHI
2019121000103	PILAR DE GOIAS	34001	SANTA TEREZINHA	10/12/2019 20:58	10/12/2019 21:07	10/12/2019 20:58	10/12/2019 21:07	0,15	169	25,35	CHI
2019121000103	PILAR DE GOIAS	34002	SANTA TEREZINHA	10/12/2019 20:58	10/12/2019 21:07	10/12/2019 20:58	10/12/2019 21:07	0,15	1	0,15	CHI
2019121000103	PILAR DE GOIAS	01735114	SANTA TEREZINHA	10/12/2019 20:58	10/12/2019 21:07	10/12/2019 20:58	10/12/2019 21:07	0,15	11	1,65	CHI
2019121000103	PILAR DE GOIAS	01735114	SANTA TEREZINHA	10/12/2019 20:58	10/12/2019 21:07	10/12/2019 20:58	10/12/2019 21:07	0,15	151	22,65	CHI
2019121000103	SANTA TEREZINHA DE GOIAS	01735114	SANTA TEREZINHA	10/12/2019 20:58	10/12/2019 21:07	10/12/2019 20:58	10/12/2019 21:07	0,15	3182	477,30	CHI
2019121000103	SANTA TEREZINHA DE GOIAS	24901	SANTA TEREZINHA	10/12/2019 20:58	10/12/2019 21:07	10/12/2019 20:58	10/12/2019 21:07	0,15	48	7,20	CHI
2019121000103	SANTA TEREZINHA DE GOIAS	34001	SANTA TEREZINHA	10/12/2019 20:58	10/12/2019 21:07	10/12/2019 20:58	10/12/2019 21:07	0,15	62	9,30	CHI

2019121000103	SANTA TEREZINHA DE GOIAS	01735114	SANTA TEREZINHA	10/12/2019 20:58	10/12/2019 21:07	10/12/2019 20:58	10/12/2019 21:07	0,15	1	0,15	CHI
2019121000103	SANTA TEREZINHA DE GOIAS	01735114	SANTA TEREZINHA	10/12/2019 20:58	10/12/2019 21:07	10/12/2019 20:58	10/12/2019 21:07	0,15	3	0,45	CHI
2019121000103	SANTA TEREZINHA DE GOIAS	01735114	SANTA TEREZINHA	10/12/2019 20:58	10/12/2019 21:07	10/12/2019 20:58	10/12/2019 21:07	0,15	146	21,90	CHI
2019121000103	SANTA TEREZINHA DE GOIAS	01735114	SANTA TEREZINHA	10/12/2019 20:58	10/12/2019 21:07	10/12/2019 20:58	10/12/2019 21:07	0,15	529	79,35	CHI
2019121000103	SANTA TEREZINHA DE GOIAS	01735114	SANTA TEREZINHA	10/12/2019 20:58	10/12/2019 21:07	10/12/2019 20:58	10/12/2019 21:07	0,15	460	69,00	CHI
2019121000103	UIRAPURU	01735114	SANTA TEREZINHA	10/12/2019 20:58	10/12/2019 21:07	10/12/2019 20:58	10/12/2019 21:07	0,15	56	8,40	CHI
20191282487	IPAMERI	IP12086070	CAMPO ALEGRE DE GOIAS	10/12/2019 20:59	11/12/2019 10:35	10/12/2019 20:59	11/12/2019 10:35	13,59	10	135,85	CHI
20191283121	ORIZONA	OZ12022888	PIRES DO RIO S2	10/12/2019 21:05	13/12/2019 03:05	10/12/2019 21:05	11/12/2019 11:38	14,54	33	479,89	CHI
20191283121	ORIZONA	6767366	PIRES DO RIO S2	10/12/2019 21:05	13/12/2019 03:05	10/12/2019 21:05	13/12/2019 03:05	53,99	4	215,97	CHI
20191283255	CALDAS NOVAS	CN12182601	SERRA DE CALDAS	10/12/2019 21:05	11/12/2019 13:30	10/12/2019 21:05	11/12/2019 13:30	16,41	13	213,33	CHI
20191282525	JATAI	290058879	JATAI S3	10/12/2019 21:08	10/12/2019 23:17	10/12/2019 21:08	10/12/2019 23:17	2,16	1	2,16	CHI
20191280493	PIRANHAS	PH11273640	PIRANHAS	10/12/2019 21:09	10/12/2019 23:25	10/12/2019 21:09	10/12/2019 23:25	2,26	1	2,26	CHI
20191280494	PIRANHAS	PH11273658	PIRANHAS	10/12/2019 21:10	10/12/2019 23:40	10/12/2019 21:10	10/12/2019 23:40	2,49	1	2,49	CHI
20191280495	PIRANHAS	PH11273659	PIRANHAS	10/12/2019 21:11	10/12/2019 23:31	10/12/2019 21:11	10/12/2019 23:31	2,33	1	2,33	CHI
20191282538	FAZENDA NOVA	FN21229887	FIRMINOPOLIS S2	10/12/2019 21:11	11/12/2019 20:06	10/12/2019 21:11	11/12/2019 20:06	22,92	1	22,92	CHI
20191282539	ANAPOLIS	10027391599	ANAPOLIS UNIVERSITARIO S1	10/12/2019 21:11	11/12/2019 07:32	10/12/2019 21:11	11/12/2019 07:32	10,34	1	10,34	CHI
20191282550	ANAPOLIS	AN12026164	ANAPOLIS UNIVERSITARIO S2	10/12/2019 21:13	11/12/2019 05:44	10/12/2019 21:13	11/12/2019 05:44	8,51	2	17,03	CHI
20191282554	GOIANIA	10007028367	GOYA S2	10/12/2019 21:13	11/12/2019 02:28	10/12/2019 21:13	11/12/2019 02:28	5,23	1	5,23	CHI
20191282590	GOIANIA	GN11167794	MEIA PONTE	10/12/2019 21:16	10/12/2019 22:53	10/12/2019 21:16	10/12/2019 22:53	1,61	313	505,15	CHI
20191282568	MINEIROS	1390167620	PARQUE DAS EMAS	10/12/2019 21:17	11/12/2019 02:32	10/12/2019 21:17	11/12/2019 02:32	5,24	1	5,24	CHI
20191282570	PIRENOPOLIS	PV21121869	CORUMBA	10/12/2019 21:17	11/12/2019 08:08	10/12/2019 21:17	11/12/2019 08:08	10,84	1	10,84	CHI
20191282587	HIDROLINA	UR13374715	URUACU	10/12/2019 21:21	11/12/2019 15:51	11/12/2019 09:54	11/12/2019 15:51	5,95	13	77,39	CHI
20191282587	URUACU	UR13374715	URUACU	10/12/2019 21:21	11/12/2019 15:51	11/12/2019 09:54	11/12/2019 15:51	5,95	16	95,25	CHI
20191282587	URUACU	20120520	URUACU	10/12/2019 21:21	11/12/2019 15:51	10/12/2019 21:21	11/12/2019 15:51	18,49	1	18,49	CHI
20191282592	ACREUNA	EU12045032	ACREUNA	10/12/2019 21:23	11/12/2019 08:50	10/12/2019 21:23	11/12/2019 08:50	11,44	2	22,88	CHI
20191282592	TURVELANDIA	EU12045032	ACREUNA	10/12/2019 21:23	11/12/2019 08:50	10/12/2019 21:23	11/12/2019 08:50	11,44	2	22,88	CHI
20191282595	GOIANIA	GN11000735	GOIANIA LESTE S2	10/12/2019 21:24	10/12/2019 22:29	10/12/2019 21:24	10/12/2019 22:29	1,08	140	151,04	CHI
20191282601	BALIZA	BH12190378	BOM JARDIM	10/12/2019 21:26	11/12/2019 12:40	10/12/2019 21:26	11/12/2019 12:40	15,23	4	60,91	CHI
20191282603	GOIANIA	11291308	CAMPINAS S3	10/12/2019 21:27	10/12/2019 23:16	10/12/2019 21:27	10/12/2019 23:16	1,81	1	1,81	CHI
20191282604	VALPARAISO DE GOIAS	VA11370768	PACAEMBU S1	10/12/2019 21:28	10/12/2019 22:50	10/12/2019 21:28	10/12/2019 22:50	1,36	49	66,83	CHI
20191282609	ARAGOIANIA	680041280	GUAPU S2	10/12/2019 21:31	10/12/2019 23:23	10/12/2019 21:31	10/12/2019 23:23	1,87	1	1,87	CHI
20191282631	AGUAS LINDAS DE GOIAS	LA11118900	AGUAS LINDAS DE GOIAS S2	10/12/2019 21:35	10/12/2019 23:32	10/12/2019 21:35	10/12/2019 23:32	1,95	204	397,12	CHI
20191282917	GOIANESIA	GE12379116	GOIANESIA S2	10/12/2019 21:37	11/12/2019 04:09	10/12/2019 21:37	11/12/2019 04:09	6,52	100	652,00	CHI

20191282628	ITUMBIARA	690110777	ITUMBIARA VELHA S1	10/12/2019 21:40	10/12/2019 22:50	10/12/2019 21:40	10/12/2019 22:50	1,16	1	1,16	CHI
20191282640	GOIAS	GS12220498	GOIAS	10/12/2019 21:49	11/12/2019 09:21	10/12/2019 21:49	11/12/2019 09:21	11,52	46	530,00	CHI
20191282641	APARECIDA DE GOIANIA	10003691428	ANHANGUERA	10/12/2019 21:54	11/12/2019 03:17	10/12/2019 21:54	11/12/2019 03:17	5,38	1	5,38	CHI
20191282646	NEROPOLIS	160025760	NEROPOLIS S2	10/12/2019 21:55	11/12/2019 00:43	10/12/2019 21:55	11/12/2019 00:43	2,79	1	2,79	CHI
20191282647	MINEIROS	1390173530	PARQUE DAS EMAS	10/12/2019 21:55	11/12/2019 03:34	10/12/2019 21:55	11/12/2019 03:34	5,64	1	5,64	CHI
20191282656	CRISTALINA	KR21320039	CRISTALINA S2	10/12/2019 22:02	11/12/2019 16:03	10/12/2019 22:02	11/12/2019 16:03	18,01	1	18,01	CHI
20191282663	INDIARA	IY21056551	EDEIA	10/12/2019 22:07	11/12/2019 11:52	10/12/2019 22:07	11/12/2019 11:52	13,75	2	27,49	CHI
20191282666	ITUMBIARA	690265979	ITUMBIARA NOVA	10/12/2019 22:09	11/12/2019 01:16	10/12/2019 22:09	11/12/2019 01:16	3,10	1	3,10	CHI
20191282668	DAVINOPOLIS	IO12190490	CATALAO S1	10/12/2019 22:11	11/12/2019 00:27	10/12/2019 22:11	11/12/2019 00:27	2,26	1	2,26	CHI
20191282668	OUVIDOR	IO12190490	CATALAO S1	10/12/2019 22:11	11/12/2019 00:27	10/12/2019 22:11	11/12/2019 00:27	2,26	3	6,78	CHI
20191282671	GUARINOS	IW12335647	RUBIATABA	10/12/2019 22:14	11/12/2019 15:39	10/12/2019 22:14	11/12/2019 15:39	17,40	2	34,81	CHI
20191282671	ITAPACI	IW12335647	RUBIATABA	10/12/2019 22:14	11/12/2019 15:39	10/12/2019 22:14	11/12/2019 15:39	17,40	2	34,81	CHI
20191282675	GOIANIA	12683772	GOIANIA LESTE S1	10/12/2019 22:17	11/12/2019 00:18	10/12/2019 22:17	11/12/2019 00:18	2,01	1	2,01	CHI
20191282679	JUSSARA	1290054219	JUSSARA	10/12/2019 22:19	11/12/2019 11:08	10/12/2019 22:19	11/12/2019 11:08	12,80	1	12,80	CHI
20191282693	AGUAS LINDAS DE GOIAS	LA11113295	AGUAS LINDAS DE GOIAS S2	10/12/2019 22:19	11/12/2019 00:01	10/12/2019 22:19	11/12/2019 00:01	1,69	237	400,53	CHI
20191282687	MUNDO NOVO DE GOIAS	4240002838	NOVA CRIXAS	10/12/2019 22:26	11/12/2019 06:56	10/12/2019 22:26	11/12/2019 06:56	8,49	1	8,49	CHI
20191282705	GOIANIA	10011105036	GOYA S1	10/12/2019 22:43	11/12/2019 00:29	10/12/2019 22:43	11/12/2019 00:29	1,76	1	1,76	CHI
20191282709	ARACU	750013527	ARACU	10/12/2019 22:50	11/12/2019 07:49	10/12/2019 22:50	11/12/2019 07:49	8,98	1	8,98	CHI
20191282715	GOIANIA	10006609862	GOYA S1	10/12/2019 22:52	11/12/2019 03:10	10/12/2019 22:52	11/12/2019 03:10	4,30	1	4,30	CHI
20191282718	SAO DOMINGOS	SD12344108	SAO DOMINGOS	10/12/2019 22:54	11/12/2019 10:05	10/12/2019 22:54	11/12/2019 10:05	11,18	2	22,36	CHI
20191282723	GOIANIA	11819017	REAL S2	10/12/2019 22:56	11/12/2019 00:46	10/12/2019 22:56	11/12/2019 00:46	1,82	1	1,82	CHI
20191282752	GOIAS	GS11096239	GOIAS	10/12/2019 22:58	11/12/2019 04:25	10/12/2019 22:58	11/12/2019 04:25	5,45	147	800,91	CHI
20191282726	PLANALTINA	2960123251	PLANALTINA	10/12/2019 23:01	11/12/2019 01:38	10/12/2019 23:01	11/12/2019 01:38	2,61	1	2,61	CHI
20191282737	APARECIDA DE GOIANIA	AP11004883	ATLANTICO S1	10/12/2019 23:11	11/12/2019 00:39	10/12/2019 23:11	11/12/2019 00:39	1,46	80	117,02	CHI
20191282742	GOIANIA	GN11374197	GOYA S2	10/12/2019 23:28	11/12/2019 04:25	10/12/2019 23:28	11/12/2019 04:25	4,94	79	389,97	CHI
20191282809	SERRANOPOLIS	3000016336	JATAI S1	10/12/2019 23:47	12/12/2019 04:16	10/12/2019 23:47	12/12/2019 04:16	28,48	1	28,48	CHI
20191282755	GOIANIA	10006190640	REAL S1	10/12/2019 23:56	11/12/2019 01:52	10/12/2019 23:56	11/12/2019 01:52	1,93	1	1,93	CHI
20191282901	GOIAS	GS12299709	GOIAS	11/12/2019 00:16	11/12/2019 09:44	11/12/2019 00:16	11/12/2019 09:44	9,46	13	123,02	CHI
2019121100004	CACHOEIRA ALTA	48601	QUIRINOPOLIS	11/12/2019 00:41	11/12/2019 00:44	11/12/2019 00:41	11/12/2019 00:44	0,05	37	1,85	CHI
2019121100004	CACHOEIRA ALTA	48602	QUIRINOPOLIS	11/12/2019 00:41	11/12/2019 00:44	11/12/2019 00:41	11/12/2019 00:44	0,05	3	0,15	CHI
2019121100004	PARANAIGUARA	01560404	QUIRINOPOLIS	11/12/2019 00:41	11/12/2019 00:44	11/12/2019 00:41	11/12/2019 00:44	0,05	177	8,85	CHI
2019121100004	QUIRINOPOLIS	42301	QUIRINOPOLIS	11/12/2019 00:41	11/12/2019 00:44	11/12/2019 00:41	11/12/2019 00:44	0,05	61	3,05	CHI
2019121100004	QUIRINOPOLIS	48601	QUIRINOPOLIS	11/12/2019 00:41	11/12/2019 00:44	11/12/2019 00:41	11/12/2019 00:44	0,05	86	4,30	CHI

2019121100004	QUIRINOPOLIS	48602	QUIRINOPOLIS	11/12/2019 00:41	11/12/2019 00:44	11/12/2019 00:41	11/12/2019 00:44	0,05	287	14,35	CHI
2019121100004	QUIRINOPOLIS	01560404	QUIRINOPOLIS	11/12/2019 00:41	11/12/2019 00:44	11/12/2019 00:41	11/12/2019 00:44	0,05	474	23,70	CHI
2019121100004	RIO VERDE	48601	QUIRINOPOLIS	11/12/2019 00:41	11/12/2019 00:44	11/12/2019 00:41	11/12/2019 00:44	0,05	111	5,55	CHI
2019121100004	RIO VERDE	48602	QUIRINOPOLIS	11/12/2019 00:41	11/12/2019 00:44	11/12/2019 00:41	11/12/2019 00:44	0,05	43	2,15	CHI
20191283174	GUARINOS	GF12164878	SANTA TEREZINHA	11/12/2019 01:29	11/12/2019 10:21	11/12/2019 01:29	11/12/2019 10:21	8,86	57	505,21	CHI
20191283115	FIRMINOPOLIS	SL12306929	SAO LUIZ DOS MONTES BELOS	11/12/2019 01:43	11/12/2019 08:13	11/12/2019 01:43	11/12/2019 08:13	6,48	39	252,86	CHI
20191283115	SAO LUIS DE MONTES BELOS	SL12306929	SAO LUIZ DOS MONTES BELOS	11/12/2019 01:43	11/12/2019 08:13	11/12/2019 01:43	11/12/2019 08:13	6,48	22	142,64	CHI
20191282922	MUNDO NOVO DE GOIAS	MH12262742	NOVA CRIXAS	11/12/2019 02:33	11/12/2019 08:27	11/12/2019 02:33	11/12/2019 08:27	5,89	400	2355,78	CHI
20191283001	MUTUNOPOLIS	MU10400644	MARA ROSA	11/12/2019 02:55	11/12/2019 17:15	11/12/2019 02:57	11/12/2019 14:39	11,71	5	58,56	CHI
20191283001	AMARALINA	MU13088714	MARA ROSA	11/12/2019 02:55	11/12/2019 17:15	11/12/2019 02:57	11/12/2019 15:04	12,12	7	84,82	CHI
20191283001	BONOPOLIS	MU13088714	MARA ROSA	11/12/2019 02:55	11/12/2019 17:15	11/12/2019 02:57	11/12/2019 15:04	12,12	2	24,23	CHI
20191283001	MUTUNOPOLIS	MU10400644	MARA ROSA	11/12/2019 02:55	11/12/2019 17:15	11/12/2019 02:57	11/12/2019 15:04	12,12	40	484,67	CHI
20191283001	MUTUNOPOLIS	MU13088714	MARA ROSA	11/12/2019 02:55	11/12/2019 17:15	11/12/2019 02:57	11/12/2019 15:04	12,12	116	1405,53	CHI
20191283001	PORANGATU	MU13088714	MARA ROSA	11/12/2019 02:55	11/12/2019 17:15	11/12/2019 02:57	11/12/2019 15:04	12,12	114	1381,30	CHI
20191283001	MUTUNOPOLIS	MU12068522	MARA ROSA	11/12/2019 02:55	11/12/2019 17:15	11/12/2019 02:57	11/12/2019 15:48	12,85	62	796,94	CHI
20191283001	PORANGATU	MU12068522	MARA ROSA	11/12/2019 02:55	11/12/2019 17:15	11/12/2019 02:57	11/12/2019 15:48	12,85	31	398,47	CHI
20191283001	MUTUNOPOLIS	MU10400644	MARA ROSA	11/12/2019 02:55	11/12/2019 17:15	11/12/2019 02:57	11/12/2019 17:15	14,31	1	14,31	CHI
20191282924	CATALAO	CT21281454	CATALAO S2	11/12/2019 02:58	11/12/2019 15:55	11/12/2019 02:58	11/12/2019 15:55	12,95	1	12,95	CHI
20191283123	CATALAO	CT12215619	CATALAO S1	11/12/2019 03:08	11/12/2019 19:53	11/12/2019 03:08	11/12/2019 19:53	16,75	34	569,59	CHI
20191282930	RIO VERDE	RV12049063	RIO VERDE S1	11/12/2019 03:18	11/12/2019 08:57	11/12/2019 03:18	11/12/2019 08:57	5,64	22	124,16	CHI
20191282931	CRIXAS	SG12291237	SANTA TEREZINHA	11/12/2019 03:21	11/12/2019 11:09	11/12/2019 03:21	11/12/2019 11:09	7,79	13	101,32	CHI
20191282931	GUARINOS	SG12291237	SANTA TEREZINHA	11/12/2019 03:21	11/12/2019 11:09	11/12/2019 03:21	11/12/2019 11:09	7,79	6	46,76	CHI
20191283250	APARECIDA DE GOIANIA	AP11079021	INDEPENDENCIA S1	11/12/2019 03:28	11/12/2019 09:08	11/12/2019 03:28	11/12/2019 09:08	5,66	83	469,39	CHI
20191283271	ITAPURANGA	IK12060514	ITAPURANGA	11/12/2019 03:38	11/12/2019 10:10	11/12/2019 03:38	11/12/2019 10:10	6,52	18	117,41	CHI
20191283271	ITAPURANGA	IK12060514	ITAPURANGA	11/12/2019 03:38	11/12/2019 10:10	11/12/2019 03:38	11/12/2019 10:10	6,52	46	299,83	CHI
20191282935	PORTELANDIA	PW12054988	PARQUE DAS EMAS	11/12/2019 03:40	11/12/2019 10:49	11/12/2019 03:40	11/12/2019 10:49	7,14	25	178,60	CHI
20191282936	JATAI	JT12000067	JATAI S3	11/12/2019 03:41	11/12/2019 07:18	11/12/2019 03:41	11/12/2019 07:18	3,60	598	2155,79	CHI
20191282937	JARAGUA	JA21339848	JARAGUA	11/12/2019 03:42	11/12/2019 05:03	11/12/2019 03:42	11/12/2019 05:03	1,34	2	2,68	CHI
20191282938	JARAGUA	JA21024490	JARAGUA	11/12/2019 03:43	11/12/2019 10:51	11/12/2019 03:43	11/12/2019 10:51	7,12	1	7,12	CHI
20191283002	AMARALINA	MQ10400666	MARA ROSA	11/12/2019 03:53	11/12/2019 12:50	11/12/2019 03:57	11/12/2019 07:26	3,50	12	41,99	CHI
20191283002	MARA ROSA	MQ10400666	MARA ROSA	11/12/2019 03:53	11/12/2019 12:50	11/12/2019 03:57	11/12/2019 07:26	3,50	44	153,96	CHI
20191283002	MARA ROSA	MQ10400666	MARA ROSA	11/12/2019 03:53	11/12/2019 12:50	11/12/2019 07:27	11/12/2019 11:59	4,54	18	81,73	CHI
20191283002	AMARALINA	MQ13170942	MARA ROSA	11/12/2019 03:53	11/12/2019 12:50	11/12/2019 03:57	11/12/2019 12:50	8,89	734	6522,20	CHI

20191283002	MARA ROSA	MQ13170942	MARA ROSA	11/12/2019 03:53	11/12/2019 12:50	11/12/2019 03:57	11/12/2019 12:50	8,89	13	115,52	CHI
20191283002	MUTUNOPOLIS	MQ13170942	MARA ROSA	11/12/2019 03:53	11/12/2019 12:50	11/12/2019 03:57	11/12/2019 12:50	8,89	2	17,77	CHI
20191283002	AMARALINA	MQ13170942	MARA ROSA	11/12/2019 03:53	11/12/2019 12:50	11/12/2019 07:27	11/12/2019 12:50	5,39	12	64,63	CHI
20191283002	MARA ROSA	MQ13170942	MARA ROSA	11/12/2019 03:53	11/12/2019 12:50	11/12/2019 07:27	11/12/2019 12:50	5,39	26	140,04	CHI
20191284011	ITAPIRAPUA	IU12072503	JUSSARA	11/12/2019 04:05	11/12/2019 12:58	11/12/2019 04:05	11/12/2019 12:58	8,87	11	97,55	CHI
20191284418	EDEIA	EA12000059RE	EDEIA	11/12/2019 04:05	11/12/2019 16:08	11/12/2019 04:05	11/12/2019 16:08	12,04	93	1119,38	CHI
20191283210	SAO MIGUEL DO PASSA QUATRO	VN12028924	VIANOPOLIS	11/12/2019 04:11	11/12/2019 09:15	11/12/2019 04:11	11/12/2019 09:15	5,07	25	126,65	CHI
20191283210	SILVANIA	VN12028924	VIANOPOLIS	11/12/2019 04:11	11/12/2019 09:15	11/12/2019 04:11	11/12/2019 09:15	5,07	1	5,07	CHI
20191283210	VIANOPOLIS	VN12028924	VIANOPOLIS	11/12/2019 04:11	11/12/2019 09:15	11/12/2019 04:11	11/12/2019 09:15	5,07	15	75,99	CHI
20191282945	CACHOEIRA ALTA	PC12000077	CACHOEIRA ALTA	11/12/2019 04:12	11/12/2019 08:30	11/12/2019 04:12	11/12/2019 08:30	4,29	8	34,29	CHI
20191282945	PARANAIGUARA	PC12000077	CACHOEIRA ALTA	11/12/2019 04:12	11/12/2019 08:30	11/12/2019 04:12	11/12/2019 08:30	4,29	3	12,86	CHI
20191282972	NIQUELANDIA	04560224	BARRO ALTO	11/12/2019 04:19	12/12/2019 00:59	11/12/2019 04:19	11/12/2019 10:00	5,67	744	4222,20	CHI
20191282972	VILA PROPICIO	04560224	BARRO ALTO	11/12/2019 04:19	12/12/2019 00:59	11/12/2019 04:19	11/12/2019 10:00	5,67	32	181,60	CHI
20191282972	NIQUELANDIA	04560224	BARRO ALTO	11/12/2019 04:19	12/12/2019 00:59	11/12/2019 08:00	11/12/2019 10:00	2,00	17	34,00	CHI
20191282972	MIMOSO DE GOIAS	04560224	BARRO ALTO	11/12/2019 04:19	12/12/2019 00:59	11/12/2019 04:19	11/12/2019 11:15	6,94	4	27,75	CHI
20191282972	NIQUELANDIA	04560224	BARRO ALTO	11/12/2019 04:19	12/12/2019 00:59	11/12/2019 04:19	11/12/2019 11:15	6,94	243	1686,08	CHI
20191282972	NIQUELANDIA	04560224	BARRO ALTO	11/12/2019 04:19	12/12/2019 00:59	11/12/2019 04:19	11/12/2019 17:10	12,85	1	12,85	CHI
20191282972	NIQUELANDIA	04560224	BARRO ALTO	11/12/2019 04:19	12/12/2019 00:59	11/12/2019 04:19	12/12/2019 00:59	20,67	22	454,84	CHI
20191282949	INACIOLANDIA	ID31128267	QUIRINOPOLIS	11/12/2019 04:24	11/12/2019 08:27	11/12/2019 04:24	11/12/2019 08:27	4,04	1	4,04	CHI
20191283175	MUTUNOPOLIS	PO12297103	PORANGATU	11/12/2019 04:24	11/12/2019 07:03	11/12/2019 04:24	11/12/2019 07:03	2,65	4	10,59	CHI
20191283175	PORANGATU	PO12297103	PORANGATU	11/12/2019 04:24	11/12/2019 07:03	11/12/2019 04:24	11/12/2019 07:03	2,65	32	84,75	CHI
20191282952	APARECIDA DE GOIANIA	200342710	INDEPENDENCIA S2	11/12/2019 04:29	11/12/2019 07:37	11/12/2019 04:29	11/12/2019 07:37	3,12	1	3,12	CHI
20191282940	NOVA CRIXAS	NA12095931LD	NOVA CRIXAS	11/12/2019 04:31	11/12/2019 19:11	11/12/2019 04:31	11/12/2019 19:11	14,66	24	351,87	CHI
20191282956	CAMPINORTE	CR12398061	CAMPINORTE	11/12/2019 04:32	11/12/2019 09:36	11/12/2019 04:32	11/12/2019 09:36	5,06	13	65,76	CHI
20191282956	URUACU	CR12398061	CAMPINORTE	11/12/2019 04:32	11/12/2019 09:36	11/12/2019 04:32	11/12/2019 09:36	5,06	15	75,88	CHI
20191283379	ADELANDIA	DN12277724	FIRMINOPOLIS S2	11/12/2019 04:40	11/12/2019 08:58	11/12/2019 04:40	11/12/2019 08:58	4,30	59	253,60	CHI
20191283379	MOSSAMEDES	DN12277724	FIRMINOPOLIS S2	11/12/2019 04:40	11/12/2019 08:58	11/12/2019 04:40	11/12/2019 08:58	4,30	5	21,49	CHI
20191283379	SANCLERLANDIA	DN12277724	FIRMINOPOLIS S2	11/12/2019 04:40	11/12/2019 08:58	11/12/2019 04:40	11/12/2019 08:58	4,30	30	128,95	CHI
20191283379	SAO LUIS DE MONTES BELOS	DN12277724	FIRMINOPOLIS S2	11/12/2019 04:40	11/12/2019 08:58	11/12/2019 04:40	11/12/2019 08:58	4,30	62	266,50	CHI
20191282961	CAIAPONIA	PW12374317	PARQUE DAS EMAS	11/12/2019 04:41	11/12/2019 10:04	11/12/2019 04:41	11/12/2019 10:04	5,37	1	5,37	CHI
20191282961	DOVERLANDIA	PW12374317	PARQUE DAS EMAS	11/12/2019 04:41	11/12/2019 10:04	11/12/2019 04:41	11/12/2019 10:04	5,37	4	21,48	CHI
20191282961	MINEIROS	PW12374317	PARQUE DAS EMAS	11/12/2019 04:41	11/12/2019 10:04	11/12/2019 04:41	11/12/2019 10:04	5,37	16	85,92	CHI
20191282961	PEROLANDIA	PW12374317	PARQUE DAS EMAS	11/12/2019 04:41	11/12/2019 10:04	11/12/2019 04:41	11/12/2019 10:04	5,37	3	16,11	CHI

20191282961	PORTELANDIA	PW12374317	PARQUE DAS EMAS	11/12/2019 04:41	11/12/2019 10:04	11/12/2019 04:41	11/12/2019 10:04	5,37	6	32,22	CHI
20191283374	NOVA CRIXAS	NA12197190	NOVA CRIXAS	11/12/2019 04:43	11/12/2019 09:20	11/12/2019 04:43	11/12/2019 09:20	4,61	143	658,52	CHI
20191283005	SAO MIGUEL DO ARAGUAIA	SM10388763	SAO MIGUEL DO ARAGUAIA	11/12/2019 04:47	12/12/2019 18:19	11/12/2019 04:47	11/12/2019 05:00	0,22	125	27,01	CHI
20191283005	SAO MIGUEL DO ARAGUAIA	SM10388763	SAO MIGUEL DO ARAGUAIA	11/12/2019 04:47	12/12/2019 18:19	11/12/2019 04:49	11/12/2019 05:00	0,19	189	35,75	CHI
20191283005	SAO MIGUEL DO ARAGUAIA	SM13342075	SAO MIGUEL DO ARAGUAIA	11/12/2019 04:47	12/12/2019 18:19	11/12/2019 04:49	11/12/2019 12:03	7,25	2	14,50	CHI
20191283005	SAO MIGUEL DO ARAGUAIA	SM12046407	SAO MIGUEL DO ARAGUAIA	11/12/2019 04:47	12/12/2019 18:19	11/12/2019 04:49	11/12/2019 12:33	7,75	4	30,99	CHI
20191283005	SAO MIGUEL DO ARAGUAIA	SM12043260LD	SAO MIGUEL DO ARAGUAIA	11/12/2019 04:47	12/12/2019 18:19	11/12/2019 04:49	12/12/2019 18:19	37,51	6	225,09	CHI
20191283687	MARA ROSA	MQ12028228	MARA ROSA	11/12/2019 04:53	11/12/2019 16:27	11/12/2019 04:53	11/12/2019 16:27	11,56	14	161,82	CHI
20191282968	SANTA CRUZ DE GOIAS	BC12300692	PIRES DO RIO S2	11/12/2019 04:54	11/12/2019 22:38	11/12/2019 04:54	11/12/2019 22:38	17,72	10	177,17	CHI
20191282969	ARAGOIANIA	AO21197016	GUAPU S2	11/12/2019 04:57	11/12/2019 08:50	11/12/2019 04:57	11/12/2019 08:50	3,88	1	3,88	CHI
20191282969	ARAGOIANIA	7527551	GUAPU S2	11/12/2019 04:57	11/12/2019 08:50	11/12/2019 04:57	11/12/2019 08:50	3,87	1	3,87	CHI
20191283432	ORIZONA	OZ12114505	PIRES DO RIO S2	11/12/2019 05:17	11/12/2019 15:39	11/12/2019 05:17	11/12/2019 15:39	10,36	19	196,92	CHI
20191276701	BRITANIA	BT12131110	BRITANIA	11/12/2019 05:19	13/12/2019 15:21	11/12/2019 05:19	11/12/2019 12:08	6,82	8	54,54	CHI
20191276701	BRITANIA	BT12131110	BRITANIA	11/12/2019 05:19	13/12/2019 15:21	11/12/2019 21:52	11/12/2019 23:35	1,70	8	13,64	CHI
20191276701	BRITANIA	BT13130430	BRITANIA	11/12/2019 05:19	13/12/2019 15:21	11/12/2019 05:19	12/12/2019 12:57	31,63	12	379,52	CHI
20191276701	BRITANIA	BT12131110	BRITANIA	11/12/2019 05:19	13/12/2019 15:21	12/12/2019 12:58	12/12/2019 14:15	1,30	8	10,37	CHI
20191276701	BRITANIA	BT13130430	BRITANIA	11/12/2019 05:19	13/12/2019 15:21	12/12/2019 12:58	12/12/2019 19:33	6,59	2	13,17	CHI
20191276701	BRITANIA	BT13130430	BRITANIA	11/12/2019 05:19	13/12/2019 15:21	11/12/2019 05:19	12/12/2019 19:54	38,58	1	38,58	CHI
20191276701	BRITANIA	BT12274251	BRITANIA	11/12/2019 05:19	13/12/2019 15:21	12/12/2019 12:58	12/12/2019 20:03	7,10	10	70,96	CHI
20191276701	BRITANIA	BT13117805	BRITANIA	11/12/2019 05:19	13/12/2019 15:21	11/12/2019 05:19	12/12/2019 21:00	39,68	9	357,13	CHI
20191276701	BRITANIA	BT12171488	BRITANIA	11/12/2019 05:19	13/12/2019 15:21	12/12/2019 21:01	13/12/2019 15:21	18,35	2	36,70	CHI
20191282986	ABADIANIA	AA12033506	CORUMBA	11/12/2019 05:25	11/12/2019 07:59	11/12/2019 05:25	11/12/2019 07:59	2,56	7	17,90	CHI
20191282986	CORUMBA DE GOIAS	AA12033506	CORUMBA	11/12/2019 05:25	11/12/2019 07:59	11/12/2019 05:25	11/12/2019 07:59	2,56	2	5,11	CHI
20191283462	AURILANDIA	CG12391407	FIRMINOPOLIS S2	11/12/2019 05:25	11/12/2019 12:25	11/12/2019 05:25	11/12/2019 12:25	6,99	2	13,98	CHI
20191283462	CACHOEIRA DE GOIAS	CG12391407	FIRMINOPOLIS S2	11/12/2019 05:25	11/12/2019 12:25	11/12/2019 05:25	11/12/2019 12:25	6,99	66	461,25	CHI
20191283462	PARAUNA	CG12391407	FIRMINOPOLIS S2	11/12/2019 05:25	11/12/2019 12:25	11/12/2019 05:25	11/12/2019 12:25	6,99	32	223,64	CHI
20191282989	LUZIANIA	LZ12330886	VIANOPOLIS	11/12/2019 05:27	11/12/2019 12:45	11/12/2019 05:27	11/12/2019 12:10	6,73	3	20,19	CHI
20191282989	LUZIANIA	LZ12264837LD	VIANOPOLIS	11/12/2019 05:27	11/12/2019 12:45	11/12/2019 05:27	11/12/2019 12:45	7,31	6	43,84	CHI
20191283381	NOVO PLANALTO	TA12139159	NOVO PLANALTO	11/12/2019 05:27	11/12/2019 09:35	11/12/2019 05:27	11/12/2019 09:35	4,13	8	33,01	CHI
20191283381	PORANGATU	TA12139159	NOVO PLANALTO	11/12/2019 05:27	11/12/2019 09:35	11/12/2019 05:27	11/12/2019 09:35	4,13	13	53,64	CHI
20191283381	PORANGATU	TA12139159	PORANGATU	11/12/2019 05:27	11/12/2019 09:35	11/12/2019 05:27	11/12/2019 09:35	4,13	92	379,60	CHI
20191283387	SAO MIGUEL DO ARAGUAIA	SM10371101	SAO MIGUEL DO ARAGUAIA	11/12/2019 05:27	11/12/2019 11:00	11/12/2019 05:27	11/12/2019 11:00	5,54	203	1125,47	CHI
20191282703	LUZIANIA	LZ12396830	MARAJOARA	11/12/2019 05:28	11/12/2019 07:51	11/12/2019 05:28	11/12/2019 07:51	2,38	56	133,26	CHI

20191282997	ITUMBIARA	IT12273840RE	ITUMBIARA NOVA	11/12/2019 05:28	11/12/2019 07:40	11/12/2019 05:28	11/12/2019 07:40	2,19	45	98,59	CHI
20191283000	CRIXAS	CX21000042	SERRA DO OURO	11/12/2019 05:28	11/12/2019 09:20	11/12/2019 05:28	11/12/2019 09:20	3,85	1	3,85	CHI
20191283537	PONTALINA	PK12181924	VICENTINOPOLIS	11/12/2019 05:28	11/12/2019 14:59	11/12/2019 05:28	11/12/2019 14:59	9,50	21	199,59	CHI
20191284051	DIORAMA	ME12062803	ARENOPOLIS	11/12/2019 05:28	11/12/2019 17:07	11/12/2019 05:28	11/12/2019 17:07	11,64	2	23,28	CHI
20191284051	MONTES CLAROS DE GOIAS	ME12062803	ARENOPOLIS	11/12/2019 05:28	11/12/2019 17:07	11/12/2019 05:28	11/12/2019 17:07	11,64	6	69,83	CHI
20191283101	DIORAMA	DI12063504	IPORA	11/12/2019 05:29	11/12/2019 08:54	11/12/2019 05:29	11/12/2019 08:54	3,41	5	17,03	CHI
20191283101	IPORA	DI12063504	IPORA	11/12/2019 05:29	11/12/2019 08:54	11/12/2019 05:29	11/12/2019 08:54	3,41	5	17,03	CHI
20191283102	IACIARA	IA12206170	IACIARA S1	11/12/2019 05:29	11/12/2019 08:27	11/12/2019 05:29	11/12/2019 08:27	2,95	80	236,27	CHI
20191282914	PIRACANJUBA	PJ12000052RE	PIRACANJUBA	11/12/2019 05:30	11/12/2019 08:27	11/12/2019 05:30	11/12/2019 08:27	2,94	51	150,08	CHI
20191282914	PROFESSOR JAMIL SAFADY	PJ12000052RE	PIRACANJUBA	11/12/2019 05:30	11/12/2019 08:27	11/12/2019 05:30	11/12/2019 08:27	2,94	3	8,83	CHI
20191283509	CAMPOS VERDES	VD12251079	SANTA TEREZINHA	11/12/2019 05:35	11/12/2019 23:30	11/12/2019 05:35	11/12/2019 23:30	17,91	3	53,73	CHI
20191283509	SANTA TEREZINHA DE GOIAS	VD12251079	SANTA TEREZINHA	11/12/2019 05:35	11/12/2019 23:30	11/12/2019 05:35	11/12/2019 23:30	17,91	3	53,73	CHI
20191283109	ITUMBIARA	IT21122222	ITUMBIARA NOVA	11/12/2019 05:36	11/12/2019 08:28	11/12/2019 05:36	11/12/2019 08:28	2,86	1	2,86	CHI
20191283113	JATAI	JT12182066	JATAI S1	11/12/2019 05:39	11/12/2019 11:50	11/12/2019 05:39	11/12/2019 11:50	6,18	23	142,15	CHI
20191283114	CATALAO	CT12231647RE	CATALAO S1	11/12/2019 05:40	12/12/2019 20:25	11/12/2019 05:40	12/12/2019 13:28	31,80	75	2384,83	CHI
20191283114	CATALAO	CT12231647RE	CATALAO S1	11/12/2019 05:40	12/12/2019 20:25	11/12/2019 18:12	12/12/2019 13:28	19,27	1	19,27	CHI
20191283114	CATALAO	CT12231647RE	CATALAO S1	11/12/2019 05:40	12/12/2019 20:25	11/12/2019 05:40	12/12/2019 20:25	38,75	22	852,60	CHI
20191283116	APARECIDA DE GOIANIA	200193934	CEPAIGO S1	11/12/2019 05:41	11/12/2019 10:02	11/12/2019 05:41	11/12/2019 10:02	4,35	1	4,35	CHI
20191283120	ITAPIRAPUA	IU12250542	MATRINCHA	11/12/2019 05:42	11/12/2019 11:58	11/12/2019 05:42	11/12/2019 11:58	6,26	9	56,31	CHI
20191283277	PLANALTINA	PI12375567	PLANALTINA	11/12/2019 05:46	11/12/2019 10:48	11/12/2019 05:46	11/12/2019 10:48	5,02	14	70,34	CHI
20191283169	BURITI DE GOIAS	BS12076542	FIRMINOPOLIS S2	11/12/2019 05:47	11/12/2019 07:45	11/12/2019 05:47	11/12/2019 07:45	1,95	38	74,24	CHI
20191284244	SANTA TEREZINHA DE GOIAS	SG12246311	SANTA TEREZINHA	11/12/2019 05:47	11/12/2019 19:49	11/12/2019 05:47	11/12/2019 19:49	14,03	4	56,12	CHI
20191283132	APARECIDA DE GOIANIA	12228278	INDEPENDENCIA S2	11/12/2019 05:50	11/12/2019 08:32	11/12/2019 05:50	11/12/2019 08:32	2,68	1	2,68	CHI
20191283137	GOIANIA	10024751284	GOYA S1	11/12/2019 05:52	11/12/2019 08:52	11/12/2019 05:52	11/12/2019 08:52	3,00	1	3,00	CHI
20191284601	MONTES CLAROS DE GOIAS	ME12062838	IPORA	11/12/2019 05:52	12/12/2019 04:26	11/12/2019 05:52	12/12/2019 04:26	22,57	15	338,50	CHI
20191283140	INACIOLANDIA	ID32128258	QUIRINOPOLIS	11/12/2019 05:53	11/12/2019 08:05	11/12/2019 05:53	11/12/2019 08:05	2,19	5	10,93	CHI
20191283142	GOIANAPOLIS	GP12285356	DAIA S2	11/12/2019 05:54	11/12/2019 10:46	11/12/2019 05:54	11/12/2019 10:46	4,86	8	38,86	CHI
20191283483	MORRINHOS	PK12293231	PONTALINA	11/12/2019 05:54	11/12/2019 16:05	11/12/2019 05:54	11/12/2019 16:05	10,18	1	10,18	CHI
20191283483	PONTALINA	PK12293231	PONTALINA	11/12/2019 05:54	11/12/2019 16:05	11/12/2019 05:54	11/12/2019 16:05	10,18	19	193,48	CHI
20191283343	ACREUNA	BZ12219419	ACREUNA	11/12/2019 05:55	11/12/2019 09:07	11/12/2019 05:55	11/12/2019 09:07	3,19	5	15,93	CHI
20191283343	RIO VERDE	BZ12219419	ACREUNA	11/12/2019 05:55	11/12/2019 09:07	11/12/2019 05:55	11/12/2019 09:07	3,19	23	73,30	CHI
20191283343	SANTA HELENA DE GOIAS	BZ12219419	ACREUNA	11/12/2019 05:55	11/12/2019 09:07	11/12/2019 05:55	11/12/2019 09:07	3,19	85	270,89	CHI
20191283343	SANTO ANTONIO DA BARRA	BZ12219419	ACREUNA	11/12/2019 05:55	11/12/2019 09:07	11/12/2019 05:55	11/12/2019 09:07	3,19	170	541,78	CHI

20191283148	ALTO HORIZONTE	AJ12320992	SANTA TEREZINHA	11/12/2019 05:57	11/12/2019 09:38	11/12/2019 05:57	11/12/2019 09:38	3,68	46	169,37	CHI
20191283257	ANAPOLIS	AN11003272	JUNDIAI S1	11/12/2019 05:57	11/12/2019 07:44	11/12/2019 05:57	11/12/2019 07:44	1,77	140	247,45	CHI
20191283580	PIRENOPOLIS	PV12000461	SAO FRANCISCO DE GOIAS	11/12/2019 05:59	11/12/2019 08:49	11/12/2019 05:59	11/12/2019 08:49	2,82	64	180,48	CHI
20191283154	NOVA ROMA	ND21218861	IACIARA S2	11/12/2019 06:00	11/12/2019 11:59	11/12/2019 06:00	11/12/2019 11:59	5,98	1	5,98	CHI
20191283795	ITAPIRAPUA	IU12206870	MATRINCHA	11/12/2019 06:00	11/12/2019 15:30	11/12/2019 06:00	11/12/2019 15:30	9,48	8	75,87	CHI
20191283159	DOVERLANDIA	MY12219553	PARQUE DAS EMAS	11/12/2019 06:01	11/12/2019 12:36	11/12/2019 06:01	11/12/2019 12:36	6,58	46	302,81	CHI
20191283161	BARRO ALTO	GE21255965	GOIANESIA S1	11/12/2019 06:02	11/12/2019 13:02	11/12/2019 06:02	11/12/2019 13:02	7,00	1	7,00	CHI
20191283163	CRIXAS	CX21346649	SANTA TEREZINHA	11/12/2019 06:02	11/12/2019 13:50	11/12/2019 06:02	11/12/2019 13:50	7,79	1	7,79	CHI
20191283165	ARUANA	03960214	NOVA CRIXAS	11/12/2019 06:03	11/12/2019 08:26	11/12/2019 06:03	11/12/2019 08:26	2,37	25	59,31	CHI
20191283165	NOVA CRIXAS	03960214	NOVA CRIXAS	11/12/2019 06:03	11/12/2019 08:26	11/12/2019 06:03	11/12/2019 08:26	2,37	91	215,90	CHI
20191283167	BELA VISTA DE GOIAS	SV12389455	DAIA S2	11/12/2019 06:03	11/12/2019 11:02	11/12/2019 06:03	11/12/2019 11:02	4,97	7	34,77	CHI
20191283167	SILVANIA	SV12389455	DAIA S2	11/12/2019 06:03	11/12/2019 11:02	11/12/2019 06:03	11/12/2019 11:02	4,97	122	605,97	CHI
20191283227	PARAUNA	05760234	PARAUNA	11/12/2019 06:03	11/12/2019 09:50	11/12/2019 06:03	11/12/2019 07:57	1,91	406	775,57	CHI
20191283227	PARAUNA	05760234	PARAUNA	11/12/2019 06:03	11/12/2019 09:50	11/12/2019 06:03	11/12/2019 07:57	1,91	282	538,70	CHI
20191283227	PARAUNA	PU10377154	PARAUNA	11/12/2019 06:03	11/12/2019 09:50	11/12/2019 06:04	11/12/2019 07:57	1,88	8	15,07	CHI
20191283227	PARAUNA	05760234	PARAUNA	11/12/2019 06:03	11/12/2019 09:50	11/12/2019 06:05	11/12/2019 07:57	1,88	1	1,88	CHI
20191283227	PARAUNA	PU10377154	PARAUNA	11/12/2019 06:03	11/12/2019 09:50	11/12/2019 06:03	11/12/2019 08:58	2,92	14	40,83	CHI
20191283227	FIRMINOPOLIS	PU13289698	FIRMINOPOLIS S1	11/12/2019 06:03	11/12/2019 09:50	11/12/2019 06:03	11/12/2019 09:50	3,78	10	37,83	CHI
20191283227	PALMINOPOLIS	PU13289698	FIRMINOPOLIS S1	11/12/2019 06:03	11/12/2019 09:50	11/12/2019 06:03	11/12/2019 09:50	3,78	1	3,78	CHI
20191283227	SAO JOAO DA PARAUNA	PU13289698	FIRMINOPOLIS S1	11/12/2019 06:03	11/12/2019 09:50	11/12/2019 06:03	11/12/2019 09:50	3,78	20	75,66	CHI
20191283227	JANDAIA	PU13289698	PARAUNA	11/12/2019 06:03	11/12/2019 09:50	11/12/2019 06:03	11/12/2019 09:50	3,78	3	11,35	CHI
20191283227	PARAUNA	05760234	PARAUNA	11/12/2019 06:03	11/12/2019 09:50	11/12/2019 06:03	11/12/2019 09:50	3,78	545	2061,77	CHI
20191283227	PARAUNA	PU13289698	PARAUNA	11/12/2019 06:03	11/12/2019 09:50	11/12/2019 06:03	11/12/2019 09:50	3,78	90	340,47	CHI
20191283227	SAO JOAO DA PARAUNA	PU13289698	PARAUNA	11/12/2019 06:03	11/12/2019 09:50	11/12/2019 06:03	11/12/2019 09:50	3,78	48	181,59	CHI
20191284461	PARAUNA	PU12007956	PARAUNA	11/12/2019 06:03	11/12/2019 11:25	11/12/2019 06:03	11/12/2019 11:25	5,37	1565	8411,44	CHI
20191283172	JATAI	JT12226497	PARQUE DAS EMAS	11/12/2019 06:05	11/12/2019 09:07	11/12/2019 06:05	11/12/2019 09:07	3,02	23	69,51	CHI
20191283172	MINEIROS	JT12226497	PARQUE DAS EMAS	11/12/2019 06:05	11/12/2019 09:07	11/12/2019 06:05	11/12/2019 09:07	3,02	1	3,02	CHI
20191283172	PEROLANDIA	JT12226497	PARQUE DAS EMAS	11/12/2019 06:05	11/12/2019 09:07	11/12/2019 06:05	11/12/2019 09:07	3,02	18	54,40	CHI
20191283578	GOIAS	8528819	GOIAS	11/12/2019 06:09	11/12/2019 09:28	11/12/2019 06:09	11/12/2019 09:28	3,31	13	43,02	CHI
20191283185	NIQUELANDIA	NQ12375605	URUACU	11/12/2019 06:11	11/12/2019 15:17	11/12/2019 06:11	11/12/2019 13:34	7,38	42	310,05	CHI
20191283185	NIQUELANDIA	NQ12375605	URUACU	11/12/2019 06:11	11/12/2019 15:17	11/12/2019 11:20	11/12/2019 13:34	2,24	1	2,24	CHI
20191283185	NIQUELANDIA	NQ12375605	URUACU	11/12/2019 06:11	11/12/2019 15:17	11/12/2019 06:11	11/12/2019 15:17	9,11	1	9,11	CHI
20191283187	CORREGO DO OURO	CO12054528	FIRMINOPOLIS S2	11/12/2019 06:11	11/12/2019 08:30	11/12/2019 06:11	11/12/2019 08:30	2,31	8	18,48	CHI

20191283199	CALDAS NOVAS	CN12066113	CALDAS NOVAS S2	11/12/2019 06:11	11/12/2019 07:53	11/12/2019 06:11	11/12/2019 07:53	1,69	202	341,88	CHI
20191283983	JARAGUA	JA12297835	JARAGUA	11/12/2019 06:11	11/12/2019 16:40	11/12/2019 06:11	11/12/2019 16:40	10,47	18	188,50	CHI
20191283192	ITAPIRAPUA	IU12030113	MATRINCHA	11/12/2019 06:12	11/12/2019 18:27	11/12/2019 06:12	11/12/2019 18:27	12,24	11	134,66	CHI
20191283193	ANAPOLIS	10018198390	JUNDIAI S1	11/12/2019 06:12	11/12/2019 12:39	11/12/2019 06:12	11/12/2019 12:39	6,44	1	6,44	CHI
20191283194	ARUANA	MP12183061	MOZARLANDIA	11/12/2019 06:12	11/12/2019 18:03	11/12/2019 06:12	11/12/2019 10:31	4,31	1	4,31	CHI
20191283194	MATRINCHA	MP12183061	MOZARLANDIA	11/12/2019 06:12	11/12/2019 18:03	11/12/2019 06:12	11/12/2019 10:31	4,31	16	68,89	CHI
20191283194	ARUANA	MP13170271	MOZARLANDIA	11/12/2019 06:12	11/12/2019 18:03	11/12/2019 06:12	11/12/2019 16:51	10,64	2	21,27	CHI
20191283194	MATRINCHA	MP13170271	MOZARLANDIA	11/12/2019 06:12	11/12/2019 18:03	11/12/2019 06:12	11/12/2019 16:51	10,64	7	74,46	CHI
20191283194	ARUANA	MP12274498	MOZARLANDIA	11/12/2019 06:12	11/12/2019 18:03	11/12/2019 06:12	11/12/2019 18:03	11,84	5	59,22	CHI
20191283194	MATRINCHA	MP12274498	MOZARLANDIA	11/12/2019 06:12	11/12/2019 18:03	11/12/2019 06:12	11/12/2019 18:03	11,84	3	35,53	CHI
20191283198	PARAUNA	PU12010292	FIRMINOPOLIS S2	11/12/2019 06:14	11/12/2019 12:15	11/12/2019 06:14	11/12/2019 12:15	6,01	27	162,32	CHI
20191283200	MARA ROSA	MQ21273602	MARA ROSA	11/12/2019 06:14	11/12/2019 11:14	11/12/2019 06:14	11/12/2019 11:14	4,99	1	4,99	CHI
20191283207	ITUMBIARA	690247734	ITUMBIARA NOVA	11/12/2019 06:16	11/12/2019 09:05	11/12/2019 06:16	11/12/2019 09:05	2,82	1	2,82	CHI
20191283214	PARAUNA	PU12194221	ACREUNA	11/12/2019 06:17	11/12/2019 12:38	11/12/2019 06:17	11/12/2019 12:38	6,34	37	234,41	CHI
20191283245	JARAGUA	JA12000214	JARAGUA	11/12/2019 06:19	11/12/2019 10:04	11/12/2019 06:19	11/12/2019 10:04	3,74	51	190,71	CHI
20191283224	SAO MIGUEL DO ARAGUAIA	SM21245816	SAO MIGUEL DO ARAGUAIA	11/12/2019 06:21	11/12/2019 09:20	11/12/2019 06:21	11/12/2019 09:20	2,98	1	2,98	CHI
20191283228	CATALAO	CT12270789	CATALAO S2	11/12/2019 06:22	11/12/2019 10:20	11/12/2019 06:22	11/12/2019 10:20	3,97	3	11,91	CHI
20191283228	CUMARI	CT12270789	CATALAO S2	11/12/2019 06:22	11/12/2019 10:20	11/12/2019 06:22	11/12/2019 10:20	3,97	8	31,77	CHI
20191283231	SAO FRANCISCO DE GOIAS	SF12377792	SAO FRANCISCO DE GOIAS	11/12/2019 06:22	11/12/2019 12:54	11/12/2019 06:22	11/12/2019 12:54	6,52	9	58,68	CHI
20191283234	URUACU	UR21117931	URUACU	11/12/2019 06:24	11/12/2019 08:23	11/12/2019 06:24	11/12/2019 08:23	1,98	1	1,98	CHI
20191283816	SAO LUIZ DO NORTE	SZ12333922	BARRO ALTO	11/12/2019 06:24	12/12/2019 02:23	11/12/2019 06:24	12/12/2019 02:23	19,98	10	199,82	CHI
20191283241	BOM JESUS DE GOIAS	6970508	RIO DOS BOIS	11/12/2019 06:25	11/12/2019 18:19	11/12/2019 06:25	11/12/2019 18:19	11,90	3	35,70	CHI
20191283727	SANTA TEREZINHA DE GOIAS	SG11088385	SANTA TEREZINHA	11/12/2019 06:25	11/12/2019 14:35	11/12/2019 06:25	11/12/2019 14:35	8,18	83	678,82	CHI
20191283557	JARAGUA	JA12059976	JARAGUA	11/12/2019 06:28	11/12/2019 14:10	11/12/2019 06:28	11/12/2019 14:10	7,69	2	15,39	CHI
20191283557	PIRENOPOLIS	JA12059976	JARAGUA	11/12/2019 06:28	11/12/2019 14:10	11/12/2019 06:28	11/12/2019 14:10	7,69	95	730,95	CHI
20191283258	LUZIANIA	LZ121276308	VIANOPOLIS	11/12/2019 06:29	11/12/2019 08:56	11/12/2019 06:29	11/12/2019 08:56	2,44	1	2,44	CHI
20191282285	PIRACANJUBA	PJ12233807	MORRINHOS	11/12/2019 06:30	11/12/2019 08:39	11/12/2019 06:30	11/12/2019 08:39	2,14	23	49,29	CHI
20191282285	PIRACANJUBA	PJ12233807	ROCHEDO	11/12/2019 06:30	11/12/2019 08:39	11/12/2019 06:30	11/12/2019 08:39	2,14	8	17,14	CHI
20191283270	ALTO PARAISO DE GOIAS	ND12302636	IACIARA S2	11/12/2019 06:33	11/12/2019 10:19	11/12/2019 06:33	11/12/2019 10:19	3,76	18	67,60	CHI
20191283270	NOVA ROMA	ND12302636	IACIARA S2	11/12/2019 06:33	11/12/2019 10:19	11/12/2019 06:33	11/12/2019 10:19	3,76	96	360,51	CHI
20191283270	SAO JOAO D ALIANCA	ND12302636	IACIARA S2	11/12/2019 06:33	11/12/2019 10:19	11/12/2019 06:33	11/12/2019 10:19	3,76	12	45,06	CHI
20191283275	IVOLANDIA	PU12090442	MONTIVIDIU T	11/12/2019 06:34	12/12/2019 07:15	11/12/2019 06:34	12/12/2019 07:15	24,67	20	493,39	CHI
20191283275	PARAUNA	PU12090442	MONTIVIDIU T	11/12/2019 06:34	12/12/2019 07:15	11/12/2019 06:34	12/12/2019 07:15	24,67	46	1134,81	CHI

20191285261	PARAUNA	PU21090444	MONTIVIDIU T	11/12/2019 06:34	12/12/2019 07:15	11/12/2019 06:34	12/12/2019 07:15	24,67	1	24,67	CHI
20191283278	BARRO ALTO	BA21161147	GOIANESIA S1	11/12/2019 06:36	11/12/2019 15:15	11/12/2019 06:36	11/12/2019 15:15	8,65	1	8,65	CHI
20191283279	CATALAO	CT12127882	CATALAO S1	11/12/2019 06:36	11/12/2019 09:30	11/12/2019 06:36	11/12/2019 09:30	2,89	18	52,06	CHI
20191283284	FORMOSA	FA12208813	SAO JOAO D ALIANCA	11/12/2019 06:37	11/12/2019 12:54	11/12/2019 06:37	11/12/2019 12:54	6,27	1	6,27	CHI
20191283285	CRISTALINA	KR11273722	CRISTALINA S2	11/12/2019 06:37	11/12/2019 10:46	11/12/2019 06:37	11/12/2019 10:46	4,13	1	4,13	CHI
20191283290	GUARAITA	GK21208916	ITAPURANGA	11/12/2019 06:39	11/12/2019 10:30	11/12/2019 06:39	11/12/2019 10:30	3,84	1	3,84	CHI
20191283657	EDEIA	EA12040100	EDEIA	11/12/2019 06:39	11/12/2019 18:14	11/12/2019 06:39	11/12/2019 18:14	11,57	6	69,41	CHI
20191283657	INDIARA	EA12040100	EDEIA	11/12/2019 06:39	11/12/2019 18:14	11/12/2019 06:39	11/12/2019 18:14	11,57	4	46,27	CHI
20191283657	PONTALINA	EA12040100	EDEIA	11/12/2019 06:39	11/12/2019 18:14	11/12/2019 06:39	11/12/2019 18:14	11,57	1	11,57	CHI
20191283296	AMORINOPOLIS	IV12165613	IPORA	11/12/2019 06:41	11/12/2019 19:09	11/12/2019 06:41	11/12/2019 19:09	12,46	6	74,75	CHI
20191283296	IVOLANDIA	IV12165613	IPORA	11/12/2019 06:41	11/12/2019 19:09	11/12/2019 06:41	11/12/2019 19:09	12,46	6	74,75	CHI
20191283301	PORANGATU	PO12297140	PORANGATU	11/12/2019 06:42	11/12/2019 17:15	11/12/2019 06:42	11/12/2019 17:15	10,55	16	168,76	CHI
20191283301	SANTA TEREZA DE GOIAS	PO12297140	PORANGATU	11/12/2019 06:42	11/12/2019 17:15	11/12/2019 06:42	11/12/2019 17:15	10,55	11	116,03	CHI
20191283301	TROMBAS	PO12297140	PORANGATU	11/12/2019 06:42	11/12/2019 17:15	11/12/2019 06:42	11/12/2019 17:15	10,55	169	1782,57	CHI
20191283305	GOIATUBA	GT21150893	GOIATUBA S2	11/12/2019 06:45	11/12/2019 10:19	11/12/2019 06:45	11/12/2019 10:19	3,57	1	3,57	CHI
20191283662	LUZIANIA	LZ12351401RE	MARAJOARA	11/12/2019 06:46	11/12/2019 09:44	11/12/2019 06:46	11/12/2019 09:44	2,95	27	79,70	CHI
20191283434	ARAGOIANIA	AO12000102	GUAPO S2	11/12/2019 06:47	11/12/2019 08:03	11/12/2019 06:47	11/12/2019 08:03	1,26	21	26,51	CHI
20191283564	PORANGATU	PO12328829	PORANGATU	11/12/2019 06:47	11/12/2019 13:40	11/12/2019 06:47	11/12/2019 13:40	6,88	5	34,38	CHI
20191283327	CRISTALINA	KR21139066	CRISTALINA S1	11/12/2019 06:48	11/12/2019 15:32	11/12/2019 06:48	11/12/2019 15:32	8,73	1	8,73	CHI
20191283330	ITABERAI	50088282	ITABERAI S1	11/12/2019 06:48	12/12/2019 12:36	11/12/2019 06:48	12/12/2019 12:36	29,80	1	29,80	CHI
20191283333	ITAGUARU	IC21068797	ITABERAI S1	11/12/2019 06:49	11/12/2019 09:16	11/12/2019 06:49	11/12/2019 09:16	2,44	1	2,44	CHI
20191283335	BOM JARDIM DE GOIAS	BM12311829	BOM JARDIM	11/12/2019 06:50	11/12/2019 10:22	11/12/2019 06:50	11/12/2019 10:22	3,53	29	102,47	CHI
20191283419	ESTRELA DO NORTE	MU12391986	MARA ROSA	11/12/2019 06:50	11/12/2019 10:23	11/12/2019 06:50	11/12/2019 10:23	3,55	1	3,55	CHI
20191283419	MUTUNOPOLIS	MU12391986	MARA ROSA	11/12/2019 06:50	11/12/2019 10:23	11/12/2019 06:50	11/12/2019 10:23	3,55	101	358,55	CHI
20191283342	AGUA LIMPA	AL12392069	VILA CORUMBA	11/12/2019 06:53	11/12/2019 14:16	11/12/2019 06:53	11/12/2019 14:16	7,38	2	14,76	CHI
20191283342	CORUMBAIBA	AL12392069	VILA CORUMBA	11/12/2019 06:53	11/12/2019 14:16	11/12/2019 06:53	11/12/2019 14:16	7,38	1	7,38	CHI
20191283345	ESTRELA DO NORTE	2420008267	MARA ROSA	11/12/2019 06:53	11/12/2019 18:33	11/12/2019 06:53	11/12/2019 18:33	11,65	1	11,65	CHI
20191283347	ARUANA	AK12274205	MOZARLANDIA	11/12/2019 06:55	11/12/2019 15:42	11/12/2019 06:55	11/12/2019 15:42	8,79	1	8,79	CHI
20191283348	SAO MIGUEL DO ARAGUAIA	SM12282216	SAO MIGUEL DO ARAGUAIA	11/12/2019 06:55	11/12/2019 11:13	11/12/2019 06:55	11/12/2019 11:13	4,30	2	8,60	CHI
20191283349	DOVERLANDIA	DV12380595	PARQUE DAS EMAS	11/12/2019 06:55	12/12/2019 08:42	11/12/2019 06:55	12/12/2019 08:42	25,78	3	77,35	CHI
20191283350	GOIAS	GS12250871LD	GOIAS	11/12/2019 06:55	11/12/2019 10:14	11/12/2019 06:55	11/12/2019 10:14	3,30	11	36,32	CHI
20191283354	CAIAPONIA	CP12410631	CAIAPONIA	11/12/2019 06:56	12/12/2019 08:05	11/12/2019 06:56	12/12/2019 08:05	25,14	17	427,41	CHI
20191283360	NIQUELANDIA	NQ12213117	NIQUELANDIA SUBTRANSMISSAO	11/12/2019 06:57	11/12/2019 13:30	11/12/2019 06:57	11/12/2019 13:30	6,54	18	117,70	CHI

20191264615	ITAPACI	SZ12243712	ITAPACI	11/12/2019 06:58	11/12/2019 08:36	11/12/2019 06:58	11/12/2019 08:36	1,63	3	4,88	CHI
20191264615	SAO LUIZ DO NORTE	SZ12243712	ITAPACI	11/12/2019 06:58	11/12/2019 08:36	11/12/2019 06:58	11/12/2019 08:36	1,63	13	21,14	CHI
20191283361	GOIANIA	11090900	GOYA S1	11/12/2019 06:58	11/12/2019 08:15	11/12/2019 06:58	11/12/2019 08:15	1,28	1	1,28	CHI
20191283369	ITAGUARU	JA12036439	ITABERAI S1	11/12/2019 07:00	11/12/2019 19:19	11/12/2019 07:00	11/12/2019 19:19	12,31	1	12,31	CHI
20191283369	JARAGUA	JA12036439	ITABERAI S1	11/12/2019 07:00	11/12/2019 19:19	11/12/2019 07:00	11/12/2019 19:19	12,31	7	86,17	CHI
20191283370	COCALZINHO DE GOIAS	LA21169014	AGUAS LINDAS DE GOIAS S2	11/12/2019 07:01	11/12/2019 09:36	11/12/2019 07:01	11/12/2019 09:36	2,58	2	5,16	CHI
20191283733	NOVA ROMA	ND12392238	IACIARA S2	11/12/2019 07:01	11/12/2019 10:11	11/12/2019 07:01	11/12/2019 10:11	3,16	232	732,99	CHI
20191283378	MIMOSO DE GOIAS	MJ12377231	PADRE BERNARDO	11/12/2019 07:02	11/12/2019 13:30	11/12/2019 07:02	11/12/2019 13:30	6,45	45	290,31	CHI
20191283386	TEREZOPOLIS DE GOIAS	TJ12353418	DAIA S2	11/12/2019 07:04	11/12/2019 17:31	11/12/2019 07:04	11/12/2019 17:31	10,44	11	114,82	CHI
20191283393	CIDADE OCIDENTAL	LZ11041531	MARAJOARA	11/12/2019 07:07	11/12/2019 13:46	11/12/2019 07:07	11/12/2019 13:46	6,65	7	46,53	CHI
20191283398	LEOPOLDO DE BULHOES	BO21270651	DAIA S2	11/12/2019 07:07	11/12/2019 10:23	11/12/2019 07:07	11/12/2019 10:23	3,25	3	9,76	CHI
201912260808	PILAR DE GOIAS	GG12341672	SANTA TEREZINHA	11/12/2019 07:07	11/12/2019 22:17	11/12/2019 07:07	11/12/2019 22:17	15,16	2	30,32	CHI
20191283403	MORRINHOS	MR21000338	MORRINHOS	11/12/2019 07:09	11/12/2019 09:41	11/12/2019 07:09	11/12/2019 09:41	2,53	1	2,53	CHI
20191283408	OUVIDOR	OU13190456	CATALAO S1	11/12/2019 07:09	11/12/2019 17:06	11/12/2019 12:53	11/12/2019 13:35	0,70	1	0,70	CHI
20191283408	DAVINOPOLIS	OU13333483	CATALAO S1	11/12/2019 07:09	11/12/2019 17:06	11/12/2019 07:09	11/12/2019 17:06	9,95	10	99,49	CHI
20191283408	OUVIDOR	OU13333483	CATALAO S1	11/12/2019 07:09	11/12/2019 17:06	11/12/2019 07:09	11/12/2019 17:06	9,95	599	5959,22	CHI
20191283408	TRES RANCHOS	OU13333483	CATALAO S1	11/12/2019 07:09	11/12/2019 17:06	11/12/2019 07:09	11/12/2019 17:06	9,95	25	248,72	CHI
20191283408	OUVIDOR	OU13333483	CATALAO S1	11/12/2019 07:09	11/12/2019 17:06	11/12/2019 12:53	11/12/2019 17:06	4,22	1	4,22	CHI
20191283409	IPAMERI	IP12041051	IPAMERI	11/12/2019 07:09	11/12/2019 10:57	11/12/2019 07:09	11/12/2019 10:57	3,79	7	26,51	CHI
20191283410	FLORES DE GOIAS	FB21106990	FLORES DE GOIAS	11/12/2019 07:09	11/12/2019 16:15	11/12/2019 07:09	11/12/2019 15:40	8,51	1	8,51	CHI
20191283410	FLORES DE GOIAS	FB12106993	FLORES DE GOIAS	11/12/2019 07:09	11/12/2019 16:15	11/12/2019 11:00	11/12/2019 16:15	5,25	14	73,56	CHI
20191283410	FORMOSA	FB12106993	FLORES DE GOIAS	11/12/2019 07:09	11/12/2019 16:15	11/12/2019 11:00	11/12/2019 16:15	5,25	137	719,86	CHI
20191283410	FORMOSO	FB12106993	FLORES DE GOIAS	11/12/2019 07:09	11/12/2019 16:15	11/12/2019 11:00	11/12/2019 16:15	5,25	1	5,25	CHI
20191283410	SAO JOAO D ALIANCA	FB12106993	FLORES DE GOIAS	11/12/2019 07:09	11/12/2019 16:15	11/12/2019 11:00	11/12/2019 16:15	5,25	5	26,27	CHI
20191284650	PORANGATU	PO12390257	PORANGATU	11/12/2019 07:09	11/12/2019 13:13	11/12/2019 07:09	11/12/2019 13:13	6,07	4	24,26	CHI
20191285102	CRISTALINA	KR12261714	CRISTALINA S2	11/12/2019 07:09	11/12/2019 17:53	11/12/2019 07:09	11/12/2019 17:53	10,73	12	128,75	CHI
20191283024	COLINAS DO SUL	TI11268726	NIQUELANDIA SUBTRANSMISSAO	11/12/2019 07:10	11/12/2019 09:45	11/12/2019 07:10	11/12/2019 09:45	2,57	40	102,84	CHI
20191283450	COCALZINHO DE GOIAS	ZN12384877	COCALZINHO	11/12/2019 07:10	11/12/2019 11:05	11/12/2019 07:10	11/12/2019 11:05	3,90	6	23,41	CHI
20191283694	TRINDADE	GR12394656	GOIANIRA	11/12/2019 07:10	11/12/2019 10:19	11/12/2019 07:10	11/12/2019 10:19	3,15	2	6,30	CHI
20191283414	ORIZONA	VN12250208	VIANOPOLIS	11/12/2019 07:11	11/12/2019 10:58	11/12/2019 07:11	11/12/2019 10:58	3,78	5	18,88	CHI
20191283414	VIANOPOLIS	VN12250208	VIANOPOLIS	11/12/2019 07:11	11/12/2019 10:58	11/12/2019 07:11	11/12/2019 10:58	3,78	1	3,78	CHI
20191283484	RIO VERDE	BZ12048964	ACREUNA	11/12/2019 07:11	11/12/2019 10:07	11/12/2019 07:11	11/12/2019 10:07	2,92	21	61,38	CHI
20191283484	SANTO ANTONIO DA BARRA	BZ12048964	ACREUNA	11/12/2019 07:11	11/12/2019 10:07	11/12/2019 07:11	11/12/2019 10:07	2,92	35	102,31	CHI

20191283423	CRISTALINA	KR21133543	CRISTALINA S1	11/12/2019 07:12	11/12/2019 16:23	11/12/2019 07:12	11/12/2019 16:23	9,17	1	9,17	CHI
20191283426	GUAPO	GA11251616	GUAPO S1	11/12/2019 07:13	11/12/2019 10:26	11/12/2019 07:13	11/12/2019 10:26	3,20	159	509,24	CHI
20191283435	PALMINOPOLIS	PP21006725	PALMEIRAS	11/12/2019 07:14	11/12/2019 10:01	11/12/2019 07:14	11/12/2019 10:01	2,77	1	2,77	CHI
20191283512	FAZENDA NOVA	JR12362437	BRITANIA	11/12/2019 07:14	11/12/2019 20:07	11/12/2019 07:14	11/12/2019 20:07	12,88	3	38,65	CHI
20191283512	JUSSARA	JR12362437	BRITANIA	11/12/2019 07:14	11/12/2019 20:07	11/12/2019 07:14	11/12/2019 20:07	12,88	7	90,18	CHI
20191283438	CRISTALINA	KR11276358	CRISTALINA S1	11/12/2019 07:15	11/12/2019 13:35	11/12/2019 07:15	11/12/2019 13:35	6,33	69	436,88	CHI
20191283445	FLORES DE GOIAS	6071224	IACIARA S2	11/12/2019 07:16	11/12/2019 12:40	11/12/2019 07:16	11/12/2019 12:40	5,39	1	5,39	CHI
20191283445	SITIO D ABADIA	6071224	IACIARA S2	11/12/2019 07:16	11/12/2019 12:40	11/12/2019 07:16	11/12/2019 12:40	5,39	3	16,17	CHI
20191283453	CACHOEIRA ALTA	CA12094277	CACHOEIRA ALTA	11/12/2019 07:16	11/12/2019 08:43	11/12/2019 07:16	11/12/2019 08:43	1,45	3	4,34	CHI
20191284904	MORRINHOS	MR12000194	MORRINHOS	11/12/2019 07:17	11/12/2019 14:09	11/12/2019 07:17	11/12/2019 14:09	6,86	30	205,93	CHI
20191283539	BELA VISTA DE GOIAS	BV32060709	BELA VISTA S1	11/12/2019 07:18	11/12/2019 09:36	11/12/2019 07:18	11/12/2019 09:36	2,29	12	27,54	CHI
20191283457	ITUMBIARA	690030289	ITUMBIARA VELHA S1	11/12/2019 07:19	11/12/2019 10:01	11/12/2019 07:19	11/12/2019 10:01	2,70	1	2,70	CHI
20191283458	RIO VERDE	RV12098593	RIO VERDE S1	11/12/2019 07:20	11/12/2019 10:40	11/12/2019 07:20	11/12/2019 10:40	3,33	9	29,99	CHI
20191284191	CATALAO	CT12042339	CATALAO S1	11/12/2019 07:23	11/12/2019 09:53	11/12/2019 07:23	11/12/2019 09:53	2,51	7	17,54	CHI
20191283902	ITAPIRAPUA	IU12020174	JUSSARA	11/12/2019 07:24	11/12/2019 10:30	11/12/2019 07:24	11/12/2019 10:30	3,09	5	15,47	CHI
20191283480	VICENTINOPOLIS	10030696672	VICENTINOPOLIS	11/12/2019 07:25	11/12/2019 11:33	11/12/2019 07:25	11/12/2019 11:33	4,13	0	0,00	CHI
20191283722	APARECIDA DE GOIANIA	AP11144595	INDEPENDENCIA S2	11/12/2019 07:25	11/12/2019 13:19	11/12/2019 07:25	11/12/2019 13:19	5,89	248	1460,58	CHI
20191283495	IPAMERI	580058220	IPAMERI	11/12/2019 07:26	11/12/2019 10:44	11/12/2019 07:26	11/12/2019 10:44	3,29	1	3,29	CHI
20191283496	FORMOSA	FA12206255	ITIQUEIRA	11/12/2019 07:26	11/12/2019 10:49	11/12/2019 07:26	11/12/2019 10:49	3,38	2	6,76	CHI
20191283669	MONTIVIDIU	MV12207748	MONTIVIDIU T	11/12/2019 07:26	11/12/2019 10:00	11/12/2019 07:26	11/12/2019 10:00	2,55	8	20,44	CHI
20191283503	QUIRINOPOLIS	QI21054723	QUIRINOPOLIS	11/12/2019 07:27	11/12/2019 11:05	11/12/2019 07:27	11/12/2019 11:05	3,62	1	3,62	CHI
20191283522	PONTALINA	PK21160467	PONTALINA	11/12/2019 07:31	11/12/2019 18:35	11/12/2019 07:31	11/12/2019 18:17	10,76	1	10,76	CHI
20191283522	PONTALINA	PK12000027	PONTALINA	11/12/2019 07:31	11/12/2019 18:35	11/12/2019 10:55	11/12/2019 18:35	7,67	2	15,35	CHI
20191283525	ALEXANIA	AX12384862	ALEXANIA	11/12/2019 07:32	11/12/2019 12:43	11/12/2019 07:32	11/12/2019 12:43	5,17	2	10,35	CHI
20191283530	CRISTALINA	KR12389576	CRISTALINA S2	11/12/2019 07:33	11/12/2019 10:19	11/12/2019 07:33	11/12/2019 10:19	2,78	39	108,24	CHI
20191283532	RIO VERDE	RV12271356	CABRIUVA S2	11/12/2019 07:33	11/12/2019 10:40	11/12/2019 07:33	11/12/2019 10:40	3,13	4	12,50	CHI
20191283535	OUIDOR	2180020126	CATALAO S1	11/12/2019 07:33	11/12/2019 11:13	11/12/2019 07:33	11/12/2019 11:13	3,66	1	3,66	CHI
20191283768	RIO VERDE	RV12214248	MONTIVIDIU T	11/12/2019 07:33	11/12/2019 11:47	11/12/2019 07:33	11/12/2019 11:47	4,23	3	12,69	CHI
20191283540	MORRINHOS	MR21223298	MORRINHOS	11/12/2019 07:35	11/12/2019 17:23	11/12/2019 07:35	11/12/2019 17:23	9,79	1	9,79	CHI
20191283541	RIO VERDE	10002621817	CABRIUVA S1	11/12/2019 07:35	11/12/2019 10:25	11/12/2019 07:35	11/12/2019 10:25	2,83	1	2,83	CHI
20191283544	HIDROLANDIA	HD21117901	CEPAIGO S2	11/12/2019 07:35	11/12/2019 11:35	11/12/2019 07:35	11/12/2019 11:35	3,99	1	3,99	CHI
20191283623	MOSSAMEDES	MD12364733	FIRMINOPOLIS S2	11/12/2019 07:35	11/12/2019 10:20	11/12/2019 07:35	11/12/2019 10:20	2,74	18	49,23	CHI
20191283548	CAMPO LIMPO	AN21267919	ANAPOLIS UNIVERSITARIO S2	11/12/2019 07:36	11/12/2019 10:21	11/12/2019 07:36	11/12/2019 10:21	2,75	1	2,75	CHI

20191283549	SANTA TEREZA DE GOIAS	SE12143627	MARA ROSA	11/12/2019 07:36	11/12/2019 15:12	11/12/2019 07:36	11/12/2019 15:12	7,60	9	68,44	CHI
20191283772	SAO JOAO D ALIANCA	JL12049201	SAO JOAO D ALIANCA	11/12/2019 07:36	11/12/2019 10:23	11/12/2019 07:36	11/12/2019 10:23	2,78	91	252,70	CHI
20191284457	CRISTALINA	KR12237804	CRISTALINA S1	11/12/2019 07:36	11/12/2019 15:03	11/12/2019 07:36	11/12/2019 15:03	7,44	5	37,18	CHI
20191283558	JARAGUA	JA12064321	JARAGUA	11/12/2019 07:37	11/12/2019 12:40	11/12/2019 07:37	11/12/2019 12:40	5,05	4	20,21	CHI
20191283567	PLANALTINA	PI21243063	PLANALTINA	11/12/2019 07:38	11/12/2019 11:47	11/12/2019 07:38	11/12/2019 11:47	4,14	1	4,14	CHI
20191283579	PLANALTINA	PI11248195	PLANALTINA	11/12/2019 07:39	11/12/2019 13:42	11/12/2019 07:39	11/12/2019 13:42	6,04	1	6,04	CHI
20191283584	ITAPACI	IW21181587	ITAPACI	11/12/2019 07:40	12/12/2019 01:39	11/12/2019 07:40	12/12/2019 01:39	17,97	1	17,97	CHI
20191283585	ITAJA	IJ12088193	CACHOEIRA ALTA	11/12/2019 07:40	11/12/2019 13:08	11/12/2019 07:40	11/12/2019 13:08	5,46	5	27,29	CHI
20191283587	MOSSAMEDES	MD21343854	ITABERAI S2	11/12/2019 07:40	11/12/2019 09:39	11/12/2019 07:40	11/12/2019 09:39	1,97	1	1,97	CHI
20191283604	MONTIVIDIU	MV12065978	MONTIVIDIU T	11/12/2019 07:43	11/12/2019 10:05	11/12/2019 07:43	11/12/2019 10:05	2,38	22	52,32	CHI
20191283605	GOIANIRA	GR21207401	GOIANIRA	11/12/2019 07:43	11/12/2019 16:50	11/12/2019 07:43	11/12/2019 16:50	9,11	1	9,11	CHI
20191283607	MARA ROSA	MQ21134085	MARA ROSA	11/12/2019 07:43	11/12/2019 12:45	11/12/2019 07:43	11/12/2019 12:45	5,03	1	5,03	CHI
20191283610	ITARUMA	IM12303143	CACHOEIRA ALTA	11/12/2019 07:43	11/12/2019 14:04	11/12/2019 07:43	11/12/2019 14:04	6,33	2	12,67	CHI
20191283612	PORANGATU	PO12139105	PORANGATU	11/12/2019 07:44	11/12/2019 23:02	11/12/2019 07:44	11/12/2019 23:02	15,30	3	45,89	CHI
20191283614	MORRINHOS	MR21320269	MORRINHOS	11/12/2019 07:44	11/12/2019 17:23	11/12/2019 07:44	11/12/2019 17:23	9,64	2	19,28	CHI
20191283615	DAVINOPOLIS	IO21085201	CATALAO S1	11/12/2019 07:44	11/12/2019 11:20	11/12/2019 07:44	11/12/2019 11:20	3,59	1	3,59	CHI
20191283622	GOIANIA	10014107153	MEIA PONTE	11/12/2019 07:46	11/12/2019 09:17	11/12/2019 07:46	11/12/2019 09:17	1,51	1	1,51	CHI
20191283624	BURITI ALEGRE	BG12055919	ITUMBIARA VELHA S2	11/12/2019 07:46	11/12/2019 13:03	11/12/2019 07:46	11/12/2019 13:03	5,28	5	26,38	CHI
20191283627	PEROLANDIA	DP12264396	JATAI S1	11/12/2019 07:47	11/12/2019 10:00	11/12/2019 07:47	11/12/2019 10:00	2,21	2	4,43	CHI
20191283706	JATAI	JT12378137	JATAI S2	11/12/2019 07:48	11/12/2019 10:37	11/12/2019 07:48	11/12/2019 10:37	2,81	8	22,49	CHI
20191283638	NIQUELANDIA	NQ21197532	NIQUELANDIA SUBTRANSMISSAO	11/12/2019 07:49	11/12/2019 15:43	11/12/2019 07:49	11/12/2019 15:43	7,91	5	39,56	CHI
20191283639	GOIANIA	10013530567	GOYA S2	11/12/2019 07:49	11/12/2019 10:10	11/12/2019 07:49	11/12/2019 10:10	2,35	1	2,35	CHI
20191283641	GOIANIA	GN12098424	XAVANTES	11/12/2019 07:50	11/12/2019 09:33	11/12/2019 07:50	11/12/2019 09:33	1,72	18	30,90	CHI
20191283647	LUZIANIA	LZ12304862	VIANOPOLIS	11/12/2019 07:50	11/12/2019 15:45	11/12/2019 07:50	11/12/2019 15:45	7,91	4	31,63	CHI
20191283654	ANICUNS	3550001032	ANICUNS	11/12/2019 07:51	11/12/2019 12:31	11/12/2019 07:51	11/12/2019 12:31	4,66	1	4,66	CHI
20191283667	ITUMBIARA	690372346	ITUMBIARA NOVA	11/12/2019 07:55	11/12/2019 09:52	11/12/2019 07:55	11/12/2019 09:52	1,94	1	1,94	CHI
20191283668	CAMPINORTE	CR21147054	CAMPINORTE	11/12/2019 07:55	11/12/2019 10:55	11/12/2019 07:55	11/12/2019 10:55	2,99	1	2,99	CHI
20191283674	AMERICANO DO BRASIL	AC12304575	ANICUNS	11/12/2019 07:56	11/12/2019 11:01	11/12/2019 07:56	11/12/2019 11:01	3,07	5	15,34	CHI
20191283675	SANTA RITA DO NOVO DESTINO	DF12229507	BARRO ALTO	11/12/2019 07:57	11/12/2019 12:27	11/12/2019 07:57	11/12/2019 12:27	4,50	25	112,50	CHI
20191283677	CORUMBAIBA	CI21000540	VILA CORUMBA	11/12/2019 07:57	11/12/2019 16:14	11/12/2019 07:57	11/12/2019 16:14	8,28	1	8,28	CHI
20191283680	ITUMBIARA	690119677	ITUMBIARA NOVA	11/12/2019 07:58	11/12/2019 16:43	11/12/2019 07:58	11/12/2019 16:43	8,76	1	8,76	CHI
20191283683	OURO VERDE DE GOIAS	OV21227025	INHUMAS S1	11/12/2019 07:58	11/12/2019 12:51	11/12/2019 07:58	11/12/2019 12:51	4,87	1	4,87	CHI
20191283691	DAMIANOPOLIS	MB12192159	IACIARA S2	11/12/2019 08:00	11/12/2019 08:46	11/12/2019 08:00	11/12/2019 08:46	0,76	15	11,38	CHI

20191283691	MAMBAI	MB12192159	IACIARA S2	11/12/2019 08:00	11/12/2019 08:46	11/12/2019 08:00	11/12/2019 08:46	0,76	30	22,76	CHI
20191283692	CATALAO	1990243311	CATALAO S2	11/12/2019 08:00	11/12/2019 09:17	11/12/2019 08:00	11/12/2019 09:17	1,27	1	1,27	CHI
20191283695	QUIRINOPOLIS	QI11365697	QUIRINOPOLIS	11/12/2019 08:01	11/12/2019 09:18	11/12/2019 08:01	11/12/2019 09:18	1,28	26	33,18	CHI
20191283696	GOIANIA	15178298	ATLANTICO S1	11/12/2019 08:01	11/12/2019 09:38	11/12/2019 08:01	11/12/2019 09:38	1,61	1	1,61	CHI
20191283700	GOIAS	GS12058298	MATRINCHA	11/12/2019 08:01	11/12/2019 10:38	11/12/2019 08:01	11/12/2019 10:38	2,60	27	70,32	CHI
20191283703	RUBIATABA	780029586	RUBIATABA	11/12/2019 08:02	11/12/2019 10:52	11/12/2019 08:02	11/12/2019 10:52	2,83	1	2,83	CHI
20191283708	LEOPOLDO DE BULHOES	LB12217020	DAIA S2	11/12/2019 08:02	11/12/2019 12:20	11/12/2019 08:02	11/12/2019 12:20	4,29	193	827,86	CHI
20191283710	PARAUNA	PU21351543	ACREUNA	11/12/2019 08:03	11/12/2019 15:35	11/12/2019 08:03	11/12/2019 15:35	7,53	1	7,53	CHI
20191283713	CATALAO	10003693510	CATALAO S2	11/12/2019 08:03	11/12/2019 09:04	11/12/2019 08:03	11/12/2019 09:04	1,01	1	1,01	CHI
20191283715	GOIAS	4050000995	MATRINCHA	11/12/2019 08:03	11/12/2019 10:46	11/12/2019 08:03	11/12/2019 10:46	2,71	1	2,71	CHI
20191283718	CRIXAS	CX12319094	SERRA DO OURO	11/12/2019 08:03	11/12/2019 18:18	11/12/2019 08:03	11/12/2019 18:18	10,26	5	51,28	CHI
20191282963	DAMOLANDIA	7402352	INHUMAS S1	11/12/2019 08:04	11/12/2019 10:48	11/12/2019 08:04	11/12/2019 10:48	2,73	16	43,69	CHI
20191282963	OURO VERDE DE GOIAS	7402352	INHUMAS S1	11/12/2019 08:04	11/12/2019 10:48	11/12/2019 08:04	11/12/2019 10:48	2,73	7	19,12	CHI
20191282963	PETROLINA DE GOIAS	7402352	INHUMAS S1	11/12/2019 08:04	11/12/2019 10:48	11/12/2019 08:04	11/12/2019 10:48	2,73	6	16,38	CHI
20191283728	CATALAO	10007540521	CATALAO S1	11/12/2019 08:04	11/12/2019 09:33	11/12/2019 08:04	11/12/2019 09:33	1,48	1	1,48	CHI
20191283737	TRINDADE	40045626	TRINDADE	11/12/2019 08:06	11/12/2019 12:59	11/12/2019 08:06	11/12/2019 12:59	4,88	1	4,88	CHI
20191283739	BELA VISTA DE GOIAS	BV12000046	CEPAIGO S2	11/12/2019 08:06	11/12/2019 10:57	11/12/2019 08:06	11/12/2019 10:57	2,84	30	85,28	CHI
20191283741	AURILANDIA	AI12215430	FIRMINOPOLIS S2	11/12/2019 08:06	11/12/2019 12:46	11/12/2019 08:06	11/12/2019 12:46	4,65	9	41,87	CHI
20191283741	FIRMINOPOLIS	AI12215430	FIRMINOPOLIS S2	11/12/2019 08:06	11/12/2019 12:46	11/12/2019 08:06	11/12/2019 12:46	4,65	7	32,57	CHI
20191283743	LUZIANIA	3200141230	MARAJOARA	11/12/2019 08:06	11/12/2019 09:40	11/12/2019 08:06	11/12/2019 09:40	1,55	1	1,55	CHI
20191283745	NOVA IGUACU DE GOIAS	NH12202113	SANTA TEREZINHA	11/12/2019 08:07	11/12/2019 10:54	11/12/2019 08:07	11/12/2019 10:54	2,78	61	169,63	CHI
20191283746	BURITI DE GOIAS	CO12054663	FIRMINOPOLIS S2	11/12/2019 08:07	11/12/2019 10:47	11/12/2019 08:07	11/12/2019 10:47	2,66	10	26,63	CHI
20191283748	SAO JOAO D ALIANCA	JL12256882	SAO JOAO D ALIANCA	11/12/2019 08:07	11/12/2019 20:11	11/12/2019 08:07	11/12/2019 20:11	12,06	3	36,18	CHI
20191285219	TERESINA DE GOIAS	TE12321608	FLORES DE GOIAS	11/12/2019 08:07	11/12/2019 13:59	11/12/2019 08:07	11/12/2019 13:59	5,87	2	11,73	CHI
20191283751	CRISTALINA	10015085951	CRISTALINA S1	11/12/2019 08:08	11/12/2019 11:34	11/12/2019 08:08	11/12/2019 11:34	3,43	1	3,43	CHI
20191283753	TRINDADE	40162217	TRINDADE	11/12/2019 08:08	11/12/2019 15:30	11/12/2019 08:08	11/12/2019 15:30	7,37	1	7,37	CHI
20191283824	CRIXAS	CX10401472	RUBIATABA	11/12/2019 08:08	13/12/2019 02:12	11/12/2019 08:08	11/12/2019 18:19	10,18	38	386,88	CHI
20191283824	CRIXAS	CX10401472	RUBIATABA	11/12/2019 08:08	13/12/2019 02:12	12/12/2019 04:31	12/12/2019 04:44	0,22	38	8,19	CHI
20191283824	CRIXAS	CX13206782	RUBIATABA	11/12/2019 08:08	13/12/2019 02:12	12/12/2019 12:52	12/12/2019 17:20	4,47	38	169,73	CHI
20191283824	CRIXAS	6338460	RUBIATABA	11/12/2019 08:08	13/12/2019 02:12	11/12/2019 08:08	13/12/2019 02:12	42,07	255	10727,57	CHI
20191283824	NOVA IGUACU DE GOIAS	6338460	RUBIATABA	11/12/2019 08:08	13/12/2019 02:12	11/12/2019 08:08	13/12/2019 02:12	42,07	1	42,07	CHI
20191283761	JATAI	JT21377341	JATAI S3	11/12/2019 08:09	11/12/2019 16:35	11/12/2019 08:09	11/12/2019 16:35	8,42	1	8,42	CHI
20191283767	CAIAPONIA	1930045995	PIRANHAS	11/12/2019 08:09	12/12/2019 04:21	11/12/2019 08:09	12/12/2019 04:21	20,20	1	20,20	CHI

20191283765	AGUA FRIA DE GOIAS	JL12261887	SAO JOAO D ALIANCA	11/12/2019 08:10	11/12/2019 10:44	11/12/2019 08:10	11/12/2019 10:44	2,56	2	5,12	CHI
20191283765	SAO JOAO D ALIANCA	JL12261887	SAO JOAO D ALIANCA	11/12/2019 08:10	11/12/2019 10:44	11/12/2019 08:10	11/12/2019 10:44	2,56	5	12,79	CHI
20191283766	GUARINOS	GF12237440	SANTA TEREZINHA	11/12/2019 08:10	12/12/2019 01:00	11/12/2019 08:10	12/12/2019 01:00	16,83	11	185,08	CHI
20191283774	NIQUELANDIA	NQ12345105	NIQUELANDIA SUBTRANSMISSAO	11/12/2019 08:11	11/12/2019 14:50	11/12/2019 08:11	11/12/2019 14:50	6,66	11	73,27	CHI
20191283776	MARA ROSA	MQ12246483	MARA ROSA	11/12/2019 08:11	11/12/2019 16:15	11/12/2019 08:11	11/12/2019 16:15	8,06	4	32,25	CHI
20191283779	MINACU	IH21240760	MINACU	11/12/2019 08:11	11/12/2019 09:58	11/12/2019 08:11	11/12/2019 09:58	1,78	1	1,78	CHI
20191285050	JATAI	10003375542	JATAI S3	11/12/2019 08:12	11/12/2019 16:25	11/12/2019 08:12	11/12/2019 16:25	8,21	1	8,21	CHI
20191283787	CRIXAS	CX21314992	SANTA TEREZINHA	11/12/2019 08:13	11/12/2019 17:10	11/12/2019 08:13	11/12/2019 17:10	8,94	1	8,94	CHI
20191283790	OUVIDOR	IO21250453	CATALAO S1	11/12/2019 08:13	11/12/2019 18:24	11/12/2019 08:13	11/12/2019 18:24	10,17	2	20,35	CHI
20191283793	GOIANIA	13863629	CAMPINAS S1	11/12/2019 08:13	11/12/2019 09:37	11/12/2019 08:13	11/12/2019 09:37	1,39	1	1,39	CHI
20191283796	PARAUNA	PU12301614	PARAUNA	11/12/2019 08:13	11/12/2019 14:58	11/12/2019 08:13	11/12/2019 14:58	6,73	2	13,47	CHI
20191283805	NIQUELANDIA	NQ21257248	NIQUELANDIA SUBTRANSMISSAO	11/12/2019 08:15	12/12/2019 00:21	11/12/2019 08:15	12/12/2019 00:21	16,09	1	16,09	CHI
20191283814	GOIATUBA	GT12052882	GOIATUBA S1	11/12/2019 08:17	11/12/2019 11:03	11/12/2019 08:17	11/12/2019 11:03	2,75	27	74,31	CHI
20191284227	FAINA	FC12084191	GOIAS	11/12/2019 08:18	11/12/2019 12:47	11/12/2019 08:18	11/12/2019 12:47	4,48	3	13,43	CHI
20191283819	ITAPURANGA	IK12299996	ITAPURANGA	11/12/2019 08:19	11/12/2019 12:30	11/12/2019 08:19	11/12/2019 12:30	4,18	6	25,10	CHI
20191283820	NIQUELANDIA	2750058977	NIQUELANDIA SUBTRANSMISSAO	11/12/2019 08:19	11/12/2019 19:18	11/12/2019 08:19	11/12/2019 19:18	10,98	1	10,98	CHI
20191283821	PLANALTINA	PI21105191	PLANALTINA	11/12/2019 08:19	11/12/2019 12:08	11/12/2019 08:19	11/12/2019 12:08	3,82	1	3,82	CHI
20191283829	RIO VERDE	RV21301722	ACREUNA	11/12/2019 08:19	11/12/2019 11:00	11/12/2019 08:19	11/12/2019 11:00	2,67	1	2,67	CHI
20191283831	GOIAS	GS11217177	GOIAS	11/12/2019 08:19	11/12/2019 11:12	11/12/2019 08:19	11/12/2019 11:12	2,87	1	2,87	CHI
201912260810	CATALAO	CT12044351	CATALAO S2	11/12/2019 08:19	11/12/2019 12:27	11/12/2019 08:19	11/12/2019 12:27	4,13	18	74,29	CHI
20191283834	CEZARINA	CZ21011070	CEZARINA	11/12/2019 08:20	11/12/2019 09:58	11/12/2019 08:20	11/12/2019 09:58	1,64	1	1,64	CHI
20191283835	MOSSAMEDES	MD12000176	FIRMINOPOLIS S2	11/12/2019 08:20	11/12/2019 10:20	11/12/2019 08:20	11/12/2019 10:20	1,99	19	37,88	CHI
20191283836	CORUMBAIBA	CI12000529	VILA CORUMBA	11/12/2019 08:20	11/12/2019 12:10	11/12/2019 08:20	11/12/2019 12:10	3,83	2	7,65	CHI
20191283838	QUIRINOPOLIS	QI12322037	QUIRINOPOLIS	11/12/2019 08:20	11/12/2019 10:16	11/12/2019 08:20	11/12/2019 10:16	1,92	1	1,92	CHI
20191283839	FLORES DE GOIAS	FB21146236	FLORES DE GOIAS	11/12/2019 08:20	11/12/2019 10:43	11/12/2019 08:20	11/12/2019 10:43	2,37	1	2,37	CHI
20191283840	BELA VISTA DE GOIAS	BV21000047	BELA VISTA S1	11/12/2019 08:21	11/12/2019 14:53	11/12/2019 08:21	11/12/2019 14:53	6,52	3	19,57	CHI
20191283850	SAO MIGUEL DO ARAGUAIA	SM21187907	SAO MIGUEL DO ARAGUAIA	11/12/2019 08:22	11/12/2019 10:13	11/12/2019 08:22	11/12/2019 10:13	1,83	1	1,83	CHI
20191283851	ARAGARCAS	1820050807	ARAGARCAS	11/12/2019 08:22	11/12/2019 18:47	11/12/2019 08:22	11/12/2019 18:47	10,40	1	10,40	CHI
20191283853	GOIANIA	15141032	INDEPENDENCIA S2	11/12/2019 08:23	11/12/2019 11:05	11/12/2019 08:23	11/12/2019 11:05	2,69	1	2,69	CHI
20191280993	ITAPURANGA	19644994	ITAPURANGA	11/12/2019 08:25	11/12/2019 16:55	11/12/2019 08:25	11/12/2019 16:55	8,49	1	8,49	CHI
20191280993	ITAPURANGA	19644994	ITAPURANGA	11/12/2019 08:25	11/12/2019 16:55	11/12/2019 11:00	11/12/2019 16:55	5,92	1	5,92	CHI
20191283863	NOVA CRIXAS	NA21259716	MOZARLANDIA	11/12/2019 08:25	11/12/2019 11:34	11/12/2019 08:25	11/12/2019 11:34	3,15	1	3,15	CHI
20191283865	INHUMAS	30093661	INHUMAS S2	11/12/2019 08:25	11/12/2019 11:00	11/12/2019 08:25	11/12/2019 11:00	2,57	1	2,57	CHI

20191283890	GUARINOS	GG12316076	ITAPACI	11/12/2019 08:26	11/12/2019 16:53	11/12/2019 08:26	11/12/2019 16:53	8,44	3	25,31	CHI
20191283892	CORREGO DO OURO	SC12034208	FIRMINOPOLIS S2	11/12/2019 08:27	11/12/2019 10:36	11/12/2019 08:27	11/12/2019 10:36	2,15	1	2,15	CHI
20191283892	SANCLERLANDIA	SC12034208	FIRMINOPOLIS S2	11/12/2019 08:27	11/12/2019 10:36	11/12/2019 08:27	11/12/2019 10:36	2,15	3	6,45	CHI
20191283895	GOIATUBA	140120014	GOIATUBA S2	11/12/2019 08:28	11/12/2019 10:30	11/12/2019 08:28	11/12/2019 10:30	2,03	1	2,03	CHI
20191283901	ORIZONA	OZ21185916	PIRES DO RIO S2	11/12/2019 08:29	11/12/2019 13:10	11/12/2019 08:29	11/12/2019 13:10	4,68	1	4,68	CHI
20191283911	FORMOSA	10025059791	ITIQUEIRA	11/12/2019 08:30	11/12/2019 11:35	11/12/2019 08:30	11/12/2019 11:35	3,09	1	3,09	CHI
20191283975	AGUA FRIA DE GOIAS	NQ12140182	SAO JOAO D ALIANCA	11/12/2019 08:30	12/12/2019 15:17	11/12/2019 08:30	12/12/2019 15:17	30,77	68	2092,64	CHI
20191283975	NIQUELANDIA	NQ12140182	SAO JOAO D ALIANCA	11/12/2019 08:30	12/12/2019 15:17	11/12/2019 08:30	12/12/2019 15:17	30,77	6	184,65	CHI
20191283915	SANTA FE DE GOIAS	RN21188038	BRITANIA	11/12/2019 08:31	11/12/2019 18:50	11/12/2019 08:31	11/12/2019 18:50	10,32	1	10,32	CHI
20191283933	SANTO ANTONIO DA BARRA	10024011477	ACREUNA	11/12/2019 08:31	11/12/2019 12:30	11/12/2019 08:31	11/12/2019 12:30	3,98	1	3,98	CHI
20191283922	PLANALTINA	PI21326711	SAO JOAO D ALIANCA	11/12/2019 08:32	11/12/2019 14:41	11/12/2019 08:32	11/12/2019 14:41	6,14	1	6,14	CHI
20191283927	BOM JESUS DE GOIAS	10001319440	BOM JESUS DE GOIAS	11/12/2019 08:32	11/12/2019 09:30	11/12/2019 08:32	11/12/2019 09:30	0,96	1	0,96	CHI
20191283923	ANAPOLIS	20444308	ANAPOLIS UNIVERSITARIO S2	11/12/2019 08:33	11/12/2019 11:46	11/12/2019 08:33	11/12/2019 11:46	3,22	1	3,22	CHI
20191283925	ALEXANIA	AX31196597	ALEXANIA	11/12/2019 08:33	11/12/2019 15:25	11/12/2019 08:33	11/12/2019 15:25	6,86	2	13,72	CHI
20191283926	ANAPOLIS	20162224	ANAPOLIS UNIVERSITARIO S2	11/12/2019 08:33	11/12/2019 15:16	11/12/2019 08:33	11/12/2019 15:16	6,71	1	6,71	CHI
20191283930	RIO VERDE	RV12279830	CABRIUVA S2	11/12/2019 08:33	11/12/2019 12:51	11/12/2019 08:33	11/12/2019 12:51	4,29	13	55,76	CHI
20191283932	APARECIDA DE GOIANIA	16077740	ANHANGUERA	11/12/2019 08:33	11/12/2019 11:18	11/12/2019 08:33	11/12/2019 11:18	2,74	1	2,74	CHI
20191283935	PLANALTINA	2960123354	PLANALTINA	11/12/2019 08:33	11/12/2019 10:04	11/12/2019 08:33	11/12/2019 10:04	1,51	1	1,51	CHI
20191283938	IPAMERI	580068055	IPAMERI	11/12/2019 08:34	11/12/2019 15:24	11/12/2019 08:34	11/12/2019 15:24	6,83	1	6,83	CHI
20191283939	NIQUELANDIA	NQ21202107	URUACU	11/12/2019 08:34	12/12/2019 10:40	11/12/2019 08:34	12/12/2019 10:40	26,09	1	26,09	CHI
20191283941	NOVA CRIXAS	NA12201789	NOVA CRIXAS	11/12/2019 08:34	12/12/2019 17:25	11/12/2019 08:34	12/12/2019 17:25	32,84	27	886,73	CHI
20191283942	BONOPOLIS	BX12234949	SAO MIGUEL DO ARAGUAIA	11/12/2019 08:34	11/12/2019 12:04	11/12/2019 08:34	11/12/2019 12:04	3,49	3	10,47	CHI
20191283944	PALESTINA DE GOIAS	PY12068332	PALESTINA	11/12/2019 08:34	12/12/2019 11:30	11/12/2019 08:34	12/12/2019 11:30	26,92	2	53,84	CHI
20191283945	ITUMBIARA	BJ12068979	BOM JESUS DE GOIAS	11/12/2019 08:34	11/12/2019 11:28	11/12/2019 08:34	11/12/2019 11:28	2,89	3	8,67	CHI
20191283948	PIRENOPOLIS	PV21185574	CORUMBA	11/12/2019 08:35	11/12/2019 12:45	11/12/2019 08:35	11/12/2019 12:45	4,17	2	8,33	CHI
20191283950	GOIANIA	10751683	CAMPINAS S1	11/12/2019 08:35	11/12/2019 10:23	11/12/2019 08:35	11/12/2019 10:23	1,79	1	1,79	CHI
20191283957	MOZARLANDIA	MZ12057415	MOZARLANDIA	11/12/2019 08:36	11/12/2019 10:50	11/12/2019 08:36	11/12/2019 10:50	2,23	2	4,46	CHI
20191283964	VIANOPOLIS	VN12103699	VIANOPOLIS	11/12/2019 08:36	11/12/2019 14:54	11/12/2019 08:36	11/12/2019 14:54	6,30	5	31,50	CHI
20191284157	GUARAITA	GK12234057	ITAPURANGA	11/12/2019 08:36	11/12/2019 18:42	11/12/2019 08:36	11/12/2019 18:42	10,10	5	50,49	CHI
20191283970	GUAPO	10019104039	GUAPO S1	11/12/2019 08:38	11/12/2019 12:39	11/12/2019 08:38	11/12/2019 12:39	4,01	1	4,01	CHI
20191283972	TRINDADE	TR11366162	GOYA S1	11/12/2019 08:39	11/12/2019 11:00	11/12/2019 08:39	11/12/2019 11:00	2,35	53	124,56	CHI
20191283974	GOIANIA	14700487	MEIA PONTE	11/12/2019 08:39	11/12/2019 10:47	11/12/2019 08:39	11/12/2019 10:47	2,13	1	2,13	CHI
20191283977	PIRANHAS	PH12390160	PIRANHAS	11/12/2019 08:39	12/12/2019 06:31	11/12/2019 08:39	12/12/2019 06:31	21,86	2	43,72	CHI

20191285021	PROFESSOR JAMIL SAFADY	JS21276581	ROCHEDO	11/12/2019 08:39	11/12/2019 17:45	11/12/2019 08:39	11/12/2019 17:45	9,09	1	9,09	CHI
20191283980	AGUAS LINDAS DE GOIAS	10016521550	AGUAS LINDAS DE GOIAS S1	11/12/2019 08:40	11/12/2019 11:22	11/12/2019 08:40	11/12/2019 11:22	2,70	1	2,70	CHI
20191283984	GOIANIRA	390062480	GOIANIRA	11/12/2019 08:40	11/12/2019 12:53	11/12/2019 08:40	11/12/2019 12:53	4,21	1	4,21	CHI
20191283985	MINEIROS	MY12209666	PARQUE DAS EMAS	11/12/2019 08:40	11/12/2019 16:31	11/12/2019 08:40	11/12/2019 16:31	7,84	3	23,51	CHI
20191283988	SENADOR CANEDO	190103796	SENADOR CANEDO	11/12/2019 08:41	11/12/2019 11:17	11/12/2019 08:41	11/12/2019 11:17	2,59	1	2,59	CHI
20191284929	SAO FRANCISCO DE GOIAS	PV21029726	SAO FRANCISCO DE GOIAS	11/12/2019 08:41	11/12/2019 12:48	11/12/2019 08:41	11/12/2019 12:48	4,10	1	4,10	CHI
20191283994	CRIXAS	NA12126913	NOVA CRIXAS	11/12/2019 08:42	11/12/2019 20:55	11/12/2019 08:42	11/12/2019 20:55	12,21	3	36,64	CHI
20191283994	NOVA CRIXAS	NA12126913	NOVA CRIXAS	11/12/2019 08:42	11/12/2019 20:55	11/12/2019 08:42	11/12/2019 20:55	12,21	5	61,06	CHI
20191283996	MINEIROS	MY21375082	PARQUE DAS EMAS	11/12/2019 08:42	11/12/2019 12:46	11/12/2019 08:42	11/12/2019 12:46	4,06	1	4,06	CHI
20191284193	AGUAS LINDAS DE GOIAS	LA11335891	AGUAS LINDAS DE GOIAS S1	11/12/2019 08:42	11/12/2019 10:34	11/12/2019 08:42	11/12/2019 10:34	1,85	124	229,47	CHI
20191283078	CATALAO	CT11377087	CATALAO S1	11/12/2019 08:43	11/12/2019 12:09	11/12/2019 08:43	11/12/2019 12:09	3,43	11	37,75	CHI
20191284006	ACREUNA	EU12045193	ACREUNA	11/12/2019 08:43	11/12/2019 10:43	11/12/2019 08:43	11/12/2019 10:43	1,99	23	45,74	CHI
20191284007	BRITANIA	BT21020163	BRITANIA	11/12/2019 08:43	11/12/2019 20:01	11/12/2019 08:43	11/12/2019 20:01	11,29	2	22,58	CHI
20191284009	CALDAS NOVAS	760184847	CALDAS NOVAS S1	11/12/2019 08:44	11/12/2019 11:40	11/12/2019 08:44	11/12/2019 11:40	2,94	1	2,94	CHI
20191284014	SANTA CRUZ DE GOIAS	CN21114881	CALDAS NOVAS S1	11/12/2019 08:44	11/12/2019 10:02	11/12/2019 08:44	11/12/2019 10:02	1,29	1	1,29	CHI
20191284069	JARAGUA	JA12072746	JARAGUA	11/12/2019 08:44	11/12/2019 14:52	11/12/2019 08:44	11/12/2019 14:52	6,13	39	239,17	CHI
20191284093	CAMPINORTE	CR12028610	CAMPINORTE	11/12/2019 08:45	11/12/2019 12:07	11/12/2019 08:45	11/12/2019 12:07	3,36	2	6,73	CHI
20191284511	PORANGATU	MU12266664	MARA ROSA	11/12/2019 08:45	11/12/2019 11:10	11/12/2019 08:45	11/12/2019 11:10	2,41	48	115,45	CHI
20191284030	GOIANIA	17272531	XAVANTES	11/12/2019 08:46	11/12/2019 10:30	11/12/2019 08:46	11/12/2019 10:30	1,72	1	1,72	CHI
20191284033	NIQUELANDIA	NQ21282380	NIQUELANDIA SUBTRANSMISSAO	11/12/2019 08:47	12/12/2019 02:21	11/12/2019 08:47	12/12/2019 02:21	17,56	12	210,71	CHI
20191284034	APARECIDA DE GOIANIA	14580792	REAL S1	11/12/2019 08:47	11/12/2019 10:37	11/12/2019 08:47	11/12/2019 10:37	1,83	1	1,83	CHI
20191284036	ANICUNS	AC12404420	ANICUNS	11/12/2019 08:47	11/12/2019 11:38	11/12/2019 08:47	11/12/2019 11:38	2,84	25	70,95	CHI
20191284041	PARANAIGUARA	PC21204116	QUIRINOPOLIS	11/12/2019 08:48	11/12/2019 10:00	11/12/2019 08:48	11/12/2019 10:00	1,19	1	1,19	CHI
20191284042	GOIANESIA	550093590	GOIANESIA S2	11/12/2019 08:48	11/12/2019 17:50	11/12/2019 08:48	11/12/2019 17:50	9,02	1	9,02	CHI
20191290624	PIRACANJUBA	PJ21159981	ROCHEDO	11/12/2019 08:48	12/12/2019 12:13	11/12/2019 08:48	12/12/2019 12:13	27,41	1	27,41	CHI
20191284044	COCALZINHO DE GOIAS	ZN12312225	COCALZINHO	11/12/2019 08:49	11/12/2019 18:48	11/12/2019 08:49	11/12/2019 18:48	9,98	8	79,83	CHI
20191284044	VILA PROPICIO	ZN12312225	COCALZINHO	11/12/2019 08:49	11/12/2019 18:48	11/12/2019 08:49	11/12/2019 18:48	9,98	1	9,98	CHI
20191284046	NOVO PLANALTO	TA11293650	SAO MIGUEL DO ARAGUAIA	11/12/2019 08:49	11/12/2019 11:55	11/12/2019 08:49	11/12/2019 11:55	3,09	1	3,09	CHI
20191284052	APORE	AE21125247	ITAJA S1	11/12/2019 08:50	13/12/2019 14:18	11/12/2019 08:50	13/12/2019 14:18	53,46	1	53,46	CHI
20191284055	INDIARA	3740000701	EDEIA	11/12/2019 08:50	11/12/2019 11:48	11/12/2019 08:50	11/12/2019 11:48	2,96	1	2,96	CHI
20191284156	GUARINOS	GF12128386	ITAPACI	11/12/2019 08:51	11/12/2019 17:05	11/12/2019 08:51	11/12/2019 17:05	8,22	6	49,31	CHI
20191284061	JARAGUA	JA12377750	SAO FRANCISCO DE GOIAS	11/12/2019 08:52	11/12/2019 18:44	11/12/2019 08:52	11/12/2019 18:44	9,86	13	128,23	CHI
20191284063	FORMOSO	FO21145445	PORANGATU	11/12/2019 08:52	11/12/2019 15:15	11/12/2019 08:52	11/12/2019 15:15	6,38	1	6,38	CHI

20191284065	LUZIANIA	LZ21109852	VIANOPOLIS	11/12/2019 08:52	11/12/2019 11:45	11/12/2019 08:52	11/12/2019 11:45	2,88	1	2,88	CHI
20191284067	IVOLANDIA	IV21323726	IPORA	11/12/2019 08:52	12/12/2019 10:24	11/12/2019 08:52	12/12/2019 10:24	25,52	1	25,52	CHI
20191284070	CIDADE OCIDENTAL	2680163145	MARAJOARA	11/12/2019 08:53	11/12/2019 10:34	11/12/2019 08:53	11/12/2019 10:34	1,68	1	1,68	CHI
20191284071	NAZARIO	440009510	ANICUNS	11/12/2019 08:53	11/12/2019 12:37	11/12/2019 08:53	11/12/2019 12:37	3,74	1	3,74	CHI
20191284073	VIANOPOLIS	VN21028923	VIANOPOLIS	11/12/2019 08:53	11/12/2019 11:53	11/12/2019 08:53	11/12/2019 11:53	2,99	2	5,99	CHI
20191284077	FORMOSA	10002212739	ITUIQUIRA	11/12/2019 08:53	11/12/2019 12:45	11/12/2019 08:53	11/12/2019 12:45	3,86	1	3,86	CHI
20191284081	GOIANIA	10029810491	CARAJAS S1	11/12/2019 08:54	11/12/2019 10:10	11/12/2019 08:54	11/12/2019 10:10	1,26	1	1,26	CHI
20191284082	CALDAZINHA	SV21143458	CEPAIGO S2	11/12/2019 08:54	11/12/2019 11:58	11/12/2019 08:54	11/12/2019 11:58	3,06	1	3,06	CHI
20191284085	MONTIVIDIU	2840032989	MONTIVIDIU T	11/12/2019 08:55	11/12/2019 12:15	11/12/2019 08:55	11/12/2019 12:15	3,35	1	3,35	CHI
20191284105	ALTO PARAISO DE GOIAS	BF12244571	SAO JOAO D ALIANCA	11/12/2019 08:55	11/12/2019 10:58	11/12/2019 08:55	11/12/2019 10:58	2,05	25	51,14	CHI
20191284090	CORUMBAIBA	CI21285067	VILA CORUMBA	11/12/2019 08:56	11/12/2019 15:56	11/12/2019 08:56	11/12/2019 15:56	7,02	1	7,02	CHI
20191284204	ANAPOLIS	AN11130801	JUNDIAI S2	11/12/2019 08:56	11/12/2019 11:36	11/12/2019 08:56	11/12/2019 11:36	2,66	126	334,81	CHI
20191284412	CALDAZINHA	BV12054591	CEPAIGO S2	11/12/2019 08:57	11/12/2019 15:35	11/12/2019 08:57	11/12/2019 15:35	6,62	3	19,85	CHI
20191284100	CATALAO	10008392429	CATALAO S1	11/12/2019 08:58	11/12/2019 10:45	11/12/2019 08:58	11/12/2019 10:45	1,78	1	1,78	CHI
20191284131	FIRMINOPOLIS	SL12206323	FIRMINOPOLIS S1	11/12/2019 08:58	11/12/2019 14:52	11/12/2019 08:58	11/12/2019 14:52	5,90	6	35,41	CHI
20191284131	SAO LUIS DE MONTES BELOS	SL12206323	FIRMINOPOLIS S1	11/12/2019 08:58	11/12/2019 14:52	11/12/2019 08:58	11/12/2019 14:52	5,90	48	283,31	CHI
20191284240	IACIARA	IA12206170	IACIARA S1	11/12/2019 08:59	11/12/2019 11:30	11/12/2019 08:59	11/12/2019 11:30	2,50	80	200,04	CHI
20191284109	GOIAS	IB12132416	ITABERAI S1	11/12/2019 09:01	11/12/2019 10:46	11/12/2019 09:01	11/12/2019 10:46	1,75	1	1,75	CHI
20191284109	ITABERAI	IB12132416	ITABERAI S1	11/12/2019 09:01	11/12/2019 10:46	11/12/2019 09:01	11/12/2019 10:46	1,75	15	26,22	CHI
20191284111	CABECEIRAS	CW21257768	ITUIQUIRA	11/12/2019 09:01	11/12/2019 11:18	11/12/2019 09:01	11/12/2019 11:18	2,27	1	2,27	CHI
20191284755	PIRENOPOLIS	220079493	SAO FRANCISCO DE GOIAS	11/12/2019 09:01	11/12/2019 14:00	11/12/2019 09:01	11/12/2019 14:00	4,98	1	4,98	CHI
20191284113	RIO VERDE	630358953	RIO VERDE S2	11/12/2019 09:02	11/12/2019 11:00	11/12/2019 09:02	11/12/2019 11:00	1,96	1	1,96	CHI
20191284120	CACU	CC12161613	CACHOEIRA ALTA	11/12/2019 09:04	11/12/2019 10:12	11/12/2019 09:04	11/12/2019 10:12	1,13	7	7,92	CHI
20191284120	QUIRINOPOLIS	CC12161613	CACHOEIRA ALTA	11/12/2019 09:04	11/12/2019 10:12	11/12/2019 09:04	11/12/2019 10:12	1,13	1	1,13	CHI
20191284121	GOIANIA	16813200	GOYA S2	11/12/2019 09:04	11/12/2019 10:41	11/12/2019 09:04	11/12/2019 10:41	1,61	1	1,61	CHI
20191284124	GOIANIA	10671353	AEROPORTO S3	11/12/2019 09:04	11/12/2019 11:13	11/12/2019 09:04	11/12/2019 11:13	2,14	1	2,14	CHI
20191284126	SAO FRANCISCO DE GOIAS	SF21022062	SAO FRANCISCO DE GOIAS	11/12/2019 09:04	11/12/2019 12:06	11/12/2019 09:04	11/12/2019 12:06	3,02	1	3,02	CHI
20191284135	SAO LUIZ DO NORTE	GE12382134	BARRO ALTO	11/12/2019 09:07	12/12/2019 12:32	11/12/2019 09:07	12/12/2019 12:05	26,96	4	107,84	CHI
20191284135	SAO LUIZ DO NORTE	SZ12237361	BARRO ALTO	11/12/2019 09:07	12/12/2019 12:32	11/12/2019 09:07	12/12/2019 12:32	27,42	4	109,69	CHI
20191284136	GOIANIA	13652102	CARAJAS S1	11/12/2019 09:07	11/12/2019 10:12	11/12/2019 09:07	11/12/2019 10:12	1,08	1	1,08	CHI
20191284137	APARECIDA DE GOIANIA	AP11350539	CEPAIGO S1	11/12/2019 09:07	11/12/2019 11:02	11/12/2019 09:07	11/12/2019 11:02	1,91	36	68,62	CHI
20191284420	MORRINHOS	MR11000013	MORRINHOS	11/12/2019 09:07	11/12/2019 11:04	11/12/2019 09:07	11/12/2019 11:04	1,94	117	226,49	CHI
201912228900	HIDROLINA	SZ21237360	BARRO ALTO	11/12/2019 09:07	12/12/2019 22:06	11/12/2019 09:07	12/12/2019 22:06	36,98	1	36,98	CHI

20191284144	CAMPO ALEGRE DE GOIAS	CM21250408	CAMPO ALEGRE DE GOIAS	11/12/2019 09:08	11/12/2019 15:16	11/12/2019 09:08	11/12/2019 15:16	6,13	1	6,13	CHI
20191284147	IVOLANDIA	1560006769	IPORA	11/12/2019 09:09	11/12/2019 13:24	11/12/2019 09:09	11/12/2019 13:24	4,25	1	4,25	CHI
20191284150	CAMPO ALEGRE DE GOIAS	CM21077541	CAMPO ALEGRE DE GOIAS	11/12/2019 09:09	11/12/2019 11:10	11/12/2019 09:09	11/12/2019 11:10	2,01	1	2,01	CHI
20191284153	URUACU	640020677	URUACU	11/12/2019 09:10	11/12/2019 10:41	11/12/2019 09:10	11/12/2019 10:41	1,51	1	1,51	CHI
20191284162	HIDROLANDIA	HD31197428	INDEPENDENCIA S1	11/12/2019 09:10	11/12/2019 13:50	11/12/2019 09:10	11/12/2019 13:50	4,65	1	4,65	CHI
20191284662	ABADIANIA	AA12258346	ANAPOLIS UNIVERSITARIO S1	11/12/2019 09:10	11/12/2019 14:39	11/12/2019 09:10	11/12/2019 14:39	5,47	22	120,36	CHI
20191284662	CORUMBA DE GOIAS	AA12258346	ANAPOLIS UNIVERSITARIO S1	11/12/2019 09:10	11/12/2019 14:39	11/12/2019 09:10	11/12/2019 14:39	5,47	2	10,94	CHI
20191284174	TRES RANCHOS	TH21068004	CATALAO S1	11/12/2019 09:12	11/12/2019 11:46	11/12/2019 09:12	11/12/2019 11:46	2,56	3	7,67	CHI
20191284176	CAIAPONIA	CP11292058	CAIAPONIA	11/12/2019 09:12	11/12/2019 15:20	11/12/2019 09:12	11/12/2019 15:20	6,13	1	6,13	CHI
20191284177	MORRINHOS	MR13212295	MORRINHOS	11/12/2019 09:12	11/12/2019 14:30	11/12/2019 09:12	11/12/2019 13:25	4,21	182	765,77	CHI
20191284177	PIRACANJUBA	MR13212295	MORRINHOS	11/12/2019 09:12	11/12/2019 14:30	11/12/2019 09:12	11/12/2019 13:25	4,21	2	8,42	CHI
20191284177	MORRINHOS	MR13263693	MORRINHOS	11/12/2019 09:12	11/12/2019 14:30	11/12/2019 14:25	11/12/2019 14:30	0,08	226	18,83	CHI
20191284177	PIRACANJUBA	MR13263693	MORRINHOS	11/12/2019 09:12	11/12/2019 14:30	11/12/2019 14:25	11/12/2019 14:30	0,08	2	0,17	CHI
20191284181	ITUMBIARA	690323426	ITUMBIARA VELHA S1	11/12/2019 09:13	11/12/2019 12:12	11/12/2019 09:13	11/12/2019 12:12	2,97	1	2,97	CHI
20191284184	PARAUNA	EU12054056	ACREUNA	11/12/2019 09:14	11/12/2019 21:40	11/12/2019 09:14	11/12/2019 21:40	12,43	4	49,72	CHI
20191284197	CORUMBAIBA	CI21062835	VILA CORUMBA	11/12/2019 09:15	11/12/2019 14:28	11/12/2019 09:15	11/12/2019 14:28	5,20	1	5,20	CHI
20191284289	GOIANIA	GN11065494	GOIANIA LESTE S1	11/12/2019 09:15	11/12/2019 10:49	11/12/2019 09:15	11/12/2019 10:49	1,56	96	149,76	CHI
20191284202	GOUVELANDIA	GB21303119	QUIRINOPOLIS	11/12/2019 09:16	11/12/2019 11:46	11/12/2019 09:16	11/12/2019 11:46	2,49	1	2,49	CHI
20191284858	GOIAS	IU12198548	MATRINCHA	11/12/2019 09:16	11/12/2019 17:02	11/12/2019 09:16	11/12/2019 17:02	7,76	1	7,76	CHI
20191284858	ITAPIRAPUA	IU12198548	MATRINCHA	11/12/2019 09:16	11/12/2019 17:02	11/12/2019 09:16	11/12/2019 17:02	7,76	2	15,52	CHI
20191284205	ARAGOIANIA	AO31048894	GUAPU S1	11/12/2019 09:17	11/12/2019 11:00	11/12/2019 09:17	11/12/2019 11:00	1,71	1	1,71	CHI
20191284207	CACU	CC21191644	CACHOEIRA ALTA	11/12/2019 09:19	11/12/2019 15:16	11/12/2019 09:19	11/12/2019 15:16	5,94	1	5,94	CHI
20191284208	CAIAPONIA	930036475	CAIAPONIA	11/12/2019 09:20	12/12/2019 19:47	11/12/2019 09:20	12/12/2019 19:47	34,46	1	34,46	CHI
20191284219	GOIANIA	13971608	MEIA PONTE	11/12/2019 09:21	11/12/2019 09:55	11/12/2019 09:21	11/12/2019 09:55	0,56	1	0,56	CHI
20191284226	INHUMAS	30054448	INHUMAS S2	11/12/2019 09:22	11/12/2019 14:39	11/12/2019 09:22	11/12/2019 14:39	5,28	1	5,28	CHI
20191284230	GOIANIA	14474153	GOYA S2	11/12/2019 09:22	11/12/2019 11:12	11/12/2019 09:22	11/12/2019 11:12	1,82	1	1,82	CHI
20191284231	IPORA	IR21193381	ARENOPOLIS	11/12/2019 09:22	12/12/2019 07:13	11/12/2019 09:22	12/12/2019 07:13	21,83	1	21,83	CHI
20191284421	BONOPOLIS	BX12246493	SAO MIGUEL DO ARAGUAIA	11/12/2019 09:22	11/12/2019 14:35	11/12/2019 09:22	11/12/2019 14:35	5,21	4	20,86	CHI
20191287442	CAMPO ALEGRE DE GOIAS	CM12192738RE	CAMPO ALEGRE DE GOIAS	11/12/2019 09:22	12/12/2019 09:10	11/12/2019 09:22	12/12/2019 09:10	23,80	48	1142,24	CHI
20191287442	CAMPO ALEGRE DE GOIAS	CM12192738RE	CAMPO ALEGRE DE GOIAS	11/12/2019 09:22	12/12/2019 09:10	11/12/2019 09:22	12/12/2019 09:10	23,80	3	71,39	CHI
20191284234	RIO VERDE	RV21153932	RIO VERDE S1	11/12/2019 09:23	11/12/2019 11:57	11/12/2019 09:23	11/12/2019 11:57	2,56	1	2,56	CHI
20191284237	ANICUNS	AC21095605	ANICUNS	11/12/2019 09:23	11/12/2019 11:39	11/12/2019 09:23	11/12/2019 11:39	2,27	1	2,27	CHI
20191284248	CIDADE OCIDENTAL	LZ12041538	MARAJOARA	11/12/2019 09:26	11/12/2019 13:46	11/12/2019 09:26	11/12/2019 13:46	4,33	9	38,95	CHI

20191284251	IPAMERI	580021129	IPAMERI	11/12/2019 09:27	11/12/2019 16:42	11/12/2019 09:27	11/12/2019 16:42	7,25	1	7,25	CHI
20191284253	AGUA FRIA DE GOIAS	TL21164495	SAO JOAO D ALIANCA	11/12/2019 09:27	11/12/2019 23:59	11/12/2019 09:27	11/12/2019 23:58	14,51	1	14,51	CHI
20191284253	AGUA FRIA DE GOIAS	TL13342347	SAO JOAO D ALIANCA	11/12/2019 09:27	11/12/2019 23:59	11/12/2019 21:12	11/12/2019 23:59	2,78	7	19,49	CHI
20191284256	VICENTINOPOLIS	VI12218168	VICENTINOPOLIS	11/12/2019 09:27	11/12/2019 12:04	11/12/2019 09:27	11/12/2019 12:04	2,61	47	122,49	CHI
20191284260	FORMOSA	FA11233646	SAO JOAO D ALIANCA	11/12/2019 09:28	11/12/2019 14:10	11/12/2019 09:28	11/12/2019 14:10	4,69	1	4,69	CHI
20191284269	ALEXANIA	AX21144073	ALEXANIA	11/12/2019 09:29	11/12/2019 14:49	11/12/2019 09:29	11/12/2019 14:49	5,33	2	10,67	CHI
20191284277	MUNDO NOVO DE GOIAS	4240004422	NOVA CRIXAS	11/12/2019 09:33	11/12/2019 11:33	11/12/2019 09:33	11/12/2019 11:33	1,99	1	1,99	CHI
20191284283	PLANALTINA	PI21088240	PLANALTINA	11/12/2019 09:35	11/12/2019 14:55	11/12/2019 09:35	11/12/2019 14:55	5,33	1	5,33	CHI
20191284286	CRISTALINA	7518339	CRISTALINA S2	11/12/2019 09:35	11/12/2019 13:06	11/12/2019 09:35	11/12/2019 13:06	3,51	1	3,51	CHI
20191284314	GOIANIA	GN11129034	CARAJAS S2	11/12/2019 09:35	11/12/2019 10:49	11/12/2019 09:35	11/12/2019 10:49	1,22	173	211,35	CHI
20191284672	GOIANIRA	BW12291579	NEROPOLIS S1	11/12/2019 09:35	11/12/2019 15:30	11/12/2019 09:35	11/12/2019 15:30	5,92	3	17,75	CHI
20191284672	SANTO ANTONIO DE GOIAS	BW12291579	NEROPOLIS S1	11/12/2019 09:35	11/12/2019 15:30	11/12/2019 09:35	11/12/2019 15:30	5,92	2	11,83	CHI
20191284290	ITABERAÍ	IB12310510	ITABERAÍ S2	11/12/2019 09:36	11/12/2019 12:41	11/12/2019 09:36	11/12/2019 12:41	3,08	1	3,08	CHI
20191284299	PALMEIRAS DE GOIAS	10015137544	PALMEIRAS	11/12/2019 09:37	11/12/2019 10:16	11/12/2019 09:37	11/12/2019 10:16	0,65	1	0,65	CHI
20191284403	LEOPOLDO DE BULHOES	LB21186540	DAIA S2	11/12/2019 09:38	11/12/2019 15:56	11/12/2019 09:38	11/12/2019 15:56	6,29	2	12,59	CHI
20191284406	GOIAS	GS12310648	GOIAS	11/12/2019 09:38	11/12/2019 10:55	11/12/2019 09:38	11/12/2019 10:55	1,28	2	2,55	CHI
20191284407	AURILANDIA	1010005811	FIRMINOPOLIS S2	11/12/2019 09:38	11/12/2019 11:30	11/12/2019 09:38	11/12/2019 11:30	1,87	1	1,87	CHI
20191284413	INHUMAS	IX12016046	INHUMAS S1	11/12/2019 09:39	11/12/2019 16:20	11/12/2019 09:39	11/12/2019 16:20	6,67	8	53,36	CHI
20191284413	ITAUCU	IX12016046	INHUMAS S1	11/12/2019 09:39	11/12/2019 16:20	11/12/2019 09:39	11/12/2019 16:20	6,67	3	20,01	CHI
20191284419	BOM JARDIM DE GOIAS	BM12394990	BOM JARDIM	11/12/2019 09:40	11/12/2019 17:00	11/12/2019 09:40	11/12/2019 17:00	7,32	7	51,23	CHI
20191284424	URUACU	UR12088762	CAMPINORTE	11/12/2019 09:41	11/12/2019 12:08	11/12/2019 09:41	11/12/2019 12:08	2,44	3	7,33	CHI
20191284427	CRIXAS	CX12190092	SERRA DO OURO	11/12/2019 09:41	11/12/2019 20:32	11/12/2019 09:41	11/12/2019 20:32	10,84	4	43,35	CHI
20191284429	DAVINOPOLIS	IO12000003RE	CATALAO S1	11/12/2019 09:42	12/12/2019 16:25	11/12/2019 09:42	12/12/2019 16:25	30,70	63	1934,15	CHI
20191284429	OUVIDOR	IO12000003RE	CATALAO S1	11/12/2019 09:42	12/12/2019 16:25	11/12/2019 09:42	12/12/2019 16:25	30,70	6	184,21	CHI
20191284432	ANAPOLIS	10030554878	ANAPOLIS UNIVERSITARIO S2	11/12/2019 09:44	11/12/2019 16:17	11/12/2019 09:44	11/12/2019 16:17	6,55	1	6,55	CHI
20191284434	BALIZA	BH11331121	CAIAPONIA	11/12/2019 09:44	11/12/2019 19:15	11/12/2019 09:44	11/12/2019 19:15	9,50	1	9,50	CHI
20191284443	RIO VERDE	630415079	RIO VERDE S2	11/12/2019 09:46	11/12/2019 11:46	11/12/2019 09:46	11/12/2019 11:46	2,01	1	2,01	CHI
20191284451	VIANOPOLIS	VN21153490	VIANOPOLIS	11/12/2019 09:48	11/12/2019 12:30	11/12/2019 09:48	11/12/2019 12:30	2,69	2	5,37	CHI
20191284455	URUACU	UR12327258	MARA ROSA	11/12/2019 09:50	11/12/2019 18:05	11/12/2019 09:50	11/12/2019 18:05	8,25	2	16,49	CHI
20191284459	RIO VERDE	630000153	RIO VERDE S1	11/12/2019 09:50	11/12/2019 12:45	11/12/2019 09:50	11/12/2019 12:45	2,92	1	2,92	CHI
20191284462	PIRACANJUBA	PJ21011467	MORRINHOS	11/12/2019 09:51	11/12/2019 17:31	11/12/2019 09:51	11/12/2019 17:31	7,66	1	7,66	CHI
20191284466	ITUMBIARA	10004152164	ITUMBIARA NOVA	11/12/2019 09:52	11/12/2019 12:51	11/12/2019 09:52	11/12/2019 12:51	2,98	1	2,98	CHI
20191284470	VIANOPOLIS	VN12346882	VIANOPOLIS	11/12/2019 09:52	11/12/2019 18:28	11/12/2019 09:52	11/12/2019 12:14	2,36	1	2,36	CHI

20191284470	VIANOPOLIS	VN21346883	VIANOPOLIS	11/12/2019 09:52	11/12/2019 18:28	11/12/2019 12:15	11/12/2019 18:28	6,23	1	6,23	CHI
20191284473	IACIARA	IA12302810	FLORES DE GOIAS	11/12/2019 09:54	11/12/2019 14:04	11/12/2019 09:54	11/12/2019 14:04	4,17	16	66,65	CHI
20191284477	BURITI ALEGRE	BG21222262	ALTO BURITI	11/12/2019 09:54	11/12/2019 13:32	11/12/2019 09:54	11/12/2019 13:32	3,64	1	3,64	CHI
20191284328	SAO DOMINGOS	SD11389104	SAO DOMINGOS	11/12/2019 09:55	11/12/2019 11:34	11/12/2019 09:55	11/12/2019 11:34	1,65	1	1,65	CHI
20191284479	GOIANIA	10015058431	CARAJAS S2	11/12/2019 09:55	11/12/2019 11:04	11/12/2019 09:55	11/12/2019 11:04	1,15	1	1,15	CHI
20191284481	HIDROLANDIA	HD11198183	ANHANGUERA	11/12/2019 09:55	11/12/2019 15:43	11/12/2019 09:55	11/12/2019 15:43	5,79	37	214,20	CHI
20191284486	NIQUELANDIA	4760001488	NIQUELANDIA SUBTRANSMISSAO	11/12/2019 09:56	12/12/2019 10:48	11/12/2019 09:56	12/12/2019 10:48	24,87	1	24,87	CHI
20191283576	PILAR DE GOIAS	GG12318427	URUACU	11/12/2019 09:57	11/12/2019 15:04	11/12/2019 09:57	11/12/2019 15:04	5,10	10	51,04	CHI
20191284490	BOM JESUS DE GOIAS	CL21153887	RIO DOS BOIS	11/12/2019 09:57	11/12/2019 15:00	11/12/2019 09:57	11/12/2019 15:00	5,03	2	10,07	CHI
20191284491	URUACU	UR21247222	MARA ROSA	11/12/2019 09:58	11/12/2019 13:59	11/12/2019 09:58	11/12/2019 13:59	4,02	1	4,02	CHI
20191284529	ITAGUARI	II12274243	ITABERAI S1	11/12/2019 09:58	11/12/2019 11:47	11/12/2019 09:58	11/12/2019 11:47	1,81	4	7,23	CHI
20191284529	JARAGUA	II12274243	ITABERAI S1	11/12/2019 09:58	11/12/2019 11:47	11/12/2019 09:58	11/12/2019 11:47	1,81	2	3,62	CHI
20191284499	MARA ROSA	2260018094	MARA ROSA	11/12/2019 09:59	11/12/2019 15:05	11/12/2019 09:59	11/12/2019 15:05	5,09	1	5,09	CHI
20191283719	GOIANIA	11950833	GOIANIA LESTE S3	11/12/2019 10:00	11/12/2019 12:37	11/12/2019 10:00	11/12/2019 12:37	2,61	1	2,61	CHI
20191284502	LEOPOLDO DE BULHOES	LB21313046	DAIA S2	11/12/2019 10:00	11/12/2019 15:00	11/12/2019 10:00	11/12/2019 15:00	5,00	2	9,99	CHI
20191284506	ITABERAI	IB21105421	ITABERAI S1	11/12/2019 10:00	11/12/2019 12:22	11/12/2019 10:00	11/12/2019 12:22	2,36	1	2,36	CHI
20191284510	JAUPACI	JP11348748	IPORA	11/12/2019 10:00	11/12/2019 21:02	11/12/2019 10:00	11/12/2019 21:02	11,02	1	11,02	CHI
20191284513	GOIANIA	13584224	ATLANTICO S1	11/12/2019 10:01	11/12/2019 13:57	11/12/2019 10:01	11/12/2019 13:57	3,94	1	3,94	CHI
20191284515	BALIZA	BM21233800	BOM JARDIM	11/12/2019 10:01	11/12/2019 16:30	11/12/2019 10:01	11/12/2019 16:30	6,48	1	6,48	CHI
20191284519	DAMIANOPOLIS	MB12159132	IACIARA S2	11/12/2019 10:01	11/12/2019 10:35	11/12/2019 10:01	11/12/2019 10:35	0,56	15	8,37	CHI
20191284519	MAMBAI	MB12159132	IACIARA S2	11/12/2019 10:01	11/12/2019 10:35	11/12/2019 10:01	11/12/2019 10:35	0,56	47	26,22	CHI
20191284698	PIRES DO RIO	PR12337227	PIRES DO RIO S1	11/12/2019 10:01	11/12/2019 16:32	11/12/2019 10:01	11/12/2019 16:32	6,53	39	254,54	CHI
20191284698	SANTA CRUZ DE GOIAS	PR12337227	PIRES DO RIO S1	11/12/2019 10:01	11/12/2019 16:32	11/12/2019 10:01	11/12/2019 16:32	6,53	1	6,53	CHI
20191284698	URUTAI	PR12337227	PIRES DO RIO S1	11/12/2019 10:01	11/12/2019 16:32	11/12/2019 10:01	11/12/2019 16:32	6,53	1	6,53	CHI
20191284520	PLANALTINA	PI21149424	PLANALTINA	11/12/2019 10:02	11/12/2019 16:01	11/12/2019 10:02	11/12/2019 16:01	5,97	1	5,97	CHI
20191284521	APARECIDA DE GOIANIA	16927849	INDEPENDENCIA S2	11/12/2019 10:02	11/12/2019 11:56	11/12/2019 10:02	11/12/2019 11:56	1,89	1	1,89	CHI
20191284526	MUNDO NOVO DE GOIAS	MH21041801	NOVA CRIXAS	11/12/2019 10:04	11/12/2019 12:53	11/12/2019 10:04	11/12/2019 12:53	2,81	1	2,81	CHI
20191284530	SAO JOAO DA PARAUNA	RP21026464	FIRMINOPOLIS S2	11/12/2019 10:04	11/12/2019 12:10	11/12/2019 10:04	11/12/2019 12:10	2,10	1	2,10	CHI
20191284538	LUZIANIA	LZ21201435	CRISTALINA S2	11/12/2019 10:06	11/12/2019 19:22	11/12/2019 10:06	11/12/2019 19:22	9,25	1	9,25	CHI
20191284541	JATAI	10027327050	JATAI S3	11/12/2019 10:07	11/12/2019 12:03	11/12/2019 10:07	11/12/2019 12:03	1,93	1	1,93	CHI
20191284542	CORUMBAIBA	CI21134629	VILA CORUMBA	11/12/2019 10:07	12/12/2019 10:52	11/12/2019 10:07	12/12/2019 10:52	24,74	1	24,74	CHI
20191284546	SAO MIGUEL DO ARAGUAIA	SM11240704	SAO MIGUEL DO ARAGUAIA	11/12/2019 10:08	11/12/2019 13:57	11/12/2019 10:08	11/12/2019 13:57	3,82	1	3,82	CHI
20191284547	CRIXAS	CX12162721	SANTA TEREZINHA	11/12/2019 10:08	11/12/2019 19:31	11/12/2019 10:08	11/12/2019 19:31	9,38	5	46,88	CHI

20191284594	CATALAO	CT12127882	CATALAO S1	11/12/2019 10:08	11/12/2019 12:55	11/12/2019 10:08	11/12/2019 12:55	2,77	18	49,92	CHI
20191284561	ITAPACI	IW21181003	ITAPACI	11/12/2019 10:10	11/12/2019 12:54	11/12/2019 10:10	11/12/2019 12:54	2,73	1	2,73	CHI
20191284747	ARAGARCAS	BM12316457	BOM JARDIM	11/12/2019 10:10	11/12/2019 13:22	11/12/2019 10:10	11/12/2019 13:22	3,21	2	6,42	CHI
20191284747	BOM JARDIM DE GOIAS	BM12316457	BOM JARDIM	11/12/2019 10:10	11/12/2019 13:22	11/12/2019 10:10	11/12/2019 13:22	3,21	4	12,85	CHI
20191284563	GOIANIA	10959634	GOIANIA LESTE S3	11/12/2019 10:11	11/12/2019 11:36	11/12/2019 10:11	11/12/2019 11:36	1,41	1	1,41	CHI
20191284570	RUBIATABA	780045737	RUBIATABA	11/12/2019 10:12	11/12/2019 17:52	11/12/2019 10:12	11/12/2019 17:52	7,66	1	7,66	CHI
20191284573	CABECEIRAS	CW12150392LD	ITUIQUIRA	11/12/2019 10:12	11/12/2019 17:47	11/12/2019 10:12	11/12/2019 17:47	7,58	1	7,58	CHI
20191284577	SERRANOPOLIS	SX21241848	JATAI S1	11/12/2019 10:13	11/12/2019 18:43	11/12/2019 10:13	11/12/2019 18:43	8,50	1	8,50	CHI
20191284593	CORREGO DO OURO	CO12080000	SAO LUIZ DOS MONTES BELOS	11/12/2019 10:13	11/12/2019 17:09	11/12/2019 10:13	11/12/2019 17:09	6,94	49	339,99	CHI
20191284593	MOIPORA	CO12080000	SAO LUIZ DOS MONTES BELOS	11/12/2019 10:13	11/12/2019 17:09	11/12/2019 10:13	11/12/2019 17:09	6,94	2	13,88	CHI
20191284579	AGUAS LINDAS DE GOIAS	10012621712	AGUAS LINDAS DE GOIAS S1	11/12/2019 10:14	11/12/2019 14:17	11/12/2019 10:14	11/12/2019 14:17	4,05	1	4,05	CHI
20191284580	INHUMAS	10009361349	INHUMAS S2	11/12/2019 10:14	11/12/2019 17:03	11/12/2019 10:14	11/12/2019 17:03	6,81	1	6,81	CHI
20191284582	FAINA	MP12194509	MATRINCHA	11/12/2019 10:14	11/12/2019 22:46	11/12/2019 10:14	11/12/2019 22:46	12,52	3	37,57	CHI
20191284582	MATRINCHA	MP12194509	MATRINCHA	11/12/2019 10:14	11/12/2019 22:46	11/12/2019 10:14	11/12/2019 22:46	12,52	3	37,57	CHI
20191284598	DOVERLANDIA	MY12209127	PARQUE DAS EMAS	11/12/2019 10:19	12/12/2019 09:55	11/12/2019 10:19	12/12/2019 09:55	23,59	4	94,38	CHI
20191284611	ITABERAI	IB21171534	ANICUNS	11/12/2019 10:20	11/12/2019 21:15	11/12/2019 10:20	11/12/2019 21:15	10,91	1	10,91	CHI
20191284612	CATALAO	1990121217	CATALAO S2	11/12/2019 10:21	11/12/2019 12:40	11/12/2019 10:21	11/12/2019 12:40	2,32	1	2,32	CHI
20191284616	ACREUNA	EU12045047LD	ACREUNA	11/12/2019 10:21	11/12/2019 17:25	11/12/2019 10:21	11/12/2019 17:25	7,07	22	155,45	CHI
20191284616	EDEIA	EU12045047LD	ACREUNA	11/12/2019 10:21	11/12/2019 17:25	11/12/2019 10:21	11/12/2019 17:25	7,07	13	91,86	CHI
20191284616	TURVANIA	EU12045047LD	ACREUNA	11/12/2019 10:21	11/12/2019 17:25	11/12/2019 10:21	11/12/2019 17:25	7,07	1	7,07	CHI
20191284616	TURVELANDIA	EU12045047LD	ACREUNA	11/12/2019 10:21	11/12/2019 17:25	11/12/2019 10:21	11/12/2019 17:25	7,07	30	211,98	CHI
20191284616	ACREUNA	EU12045047LD	ACREUNA	11/12/2019 10:21	11/12/2019 17:25	11/12/2019 14:00	11/12/2019 17:25	3,42	4	13,69	CHI
20191284617	GOIANIA	12487557	FERROVIARIO S3	11/12/2019 10:21	11/12/2019 11:28	11/12/2019 10:21	11/12/2019 11:28	1,10	1	1,10	CHI
20191284619	JUSSARA	JR12396245	BRITANIA	11/12/2019 10:21	12/12/2019 09:00	11/12/2019 10:21	12/12/2019 09:00	22,64	2	45,28	CHI
20191284353	GOIANIA	GN11001126	ATLANTICO S2	11/12/2019 10:22	11/12/2019 11:57	11/12/2019 10:22	11/12/2019 11:57	1,57	175	275,58	CHI
20191284623	FORMOSA	610020821	ITUIQUIRA	11/12/2019 10:23	11/12/2019 12:16	11/12/2019 10:23	11/12/2019 12:16	1,88	1	1,88	CHI
20191284786	MATRINCHA	MP12321180	MATRINCHA	11/12/2019 10:23	11/12/2019 18:51	11/12/2019 10:23	11/12/2019 18:51	8,46	10	84,61	CHI
20191284628	ALTO HORIZONTE	AJ21317704	SANTA TEREZINHA	11/12/2019 10:24	11/12/2019 11:50	11/12/2019 10:24	11/12/2019 11:50	1,43	1	1,43	CHI
20191284630	SANTA CRUZ DE GOIAS	BC21027011	PIRES DO RIO S2	11/12/2019 10:24	11/12/2019 15:18	11/12/2019 10:24	11/12/2019 15:18	4,89	1	4,89	CHI
20191284629	MORRINHOS	MR12000148	MORRINHOS	11/12/2019 10:25	11/12/2019 12:30	11/12/2019 10:25	11/12/2019 12:30	2,08	24	49,96	CHI
20191284637	IPAMERI	IP12385744	CRISTALINA S2	11/12/2019 10:27	11/12/2019 20:09	11/12/2019 10:27	11/12/2019 20:09	9,70	1	9,70	CHI
20191284639	TRINDADE	40114326	TRINDADE	11/12/2019 10:27	11/12/2019 17:01	11/12/2019 10:27	11/12/2019 17:01	6,56	1	6,56	CHI
20191284356	JATAI	JT21103939	JATAI S3	11/12/2019 10:28	11/12/2019 17:01	11/12/2019 10:28	11/12/2019 17:01	6,54	1	6,54	CHI

20191284871	ITABERAÍ	AV12020479	ANICUNS	11/12/2019 10:29	11/12/2019 13:45	11/12/2019 10:29	11/12/2019 13:45	3,27	16	52,36	CHI
20191284671	NIQUELANDIA	2750006618	NIQUELANDIA SUBTRANSMISSAO	11/12/2019 10:33	12/12/2019 03:45	11/12/2019 10:33	12/12/2019 03:45	17,20	1	17,20	CHI
20191284673	PIRANHAS	PH21201988	PIRANHAS	11/12/2019 10:33	11/12/2019 19:10	11/12/2019 10:33	11/12/2019 19:10	8,61	1	8,61	CHI
20191284674	CEZARINA	CZ21011070	CEZARINA	11/12/2019 10:33	11/12/2019 13:20	11/12/2019 10:33	11/12/2019 13:20	2,78	1	2,78	CHI
20191284675	JATAÍ	290124920	JATAÍ S2	11/12/2019 10:34	11/12/2019 12:51	11/12/2019 10:34	11/12/2019 12:51	2,29	1	2,29	CHI
20191284723	AMERICANO DO BRASIL	KB12000021	ANICUNS	11/12/2019 10:34	11/12/2019 13:35	11/12/2019 10:34	11/12/2019 13:35	3,02	9	27,18	CHI
20191284723	ITABERAÍ	KB12000021	ANICUNS	11/12/2019 10:34	11/12/2019 13:35	11/12/2019 10:34	11/12/2019 13:35	3,02	98	295,91	CHI
20191284723	MOSSAMEDES	KB12000021	ANICUNS	11/12/2019 10:34	11/12/2019 13:35	11/12/2019 10:34	11/12/2019 13:35	3,02	14	42,27	CHI
20191284683	CRISTALINA	KR11288022	CRISTALINA S1	11/12/2019 10:35	12/12/2019 08:30	11/12/2019 10:35	12/12/2019 08:30	21,91	1	21,91	CHI
20191284690	PORTELANDIA	PW21200670	PARQUE DAS EMAS	11/12/2019 10:36	12/12/2019 09:50	11/12/2019 10:36	12/12/2019 09:50	23,23	1	23,23	CHI
20191284695	SANTO ANTONIO DO DESCOBERTO	2210152398	ALEXANIA	11/12/2019 10:38	11/12/2019 13:38	11/12/2019 10:38	11/12/2019 13:38	3,00	1	3,00	CHI
20191284696	MORRINHOS	MR21386623	MORRINHOS	11/12/2019 10:38	11/12/2019 17:58	11/12/2019 10:38	11/12/2019 17:58	7,34	1	7,34	CHI
20191284697	PLANALTINA	2960001091	PLANALTINA	11/12/2019 10:38	11/12/2019 12:50	11/12/2019 10:38	11/12/2019 12:50	2,19	1	2,19	CHI
20191284700	AGUAS LINDAS DE GOIAS	4830144600	AGUAS LINDAS DE GOIAS S1	11/12/2019 10:39	11/12/2019 14:12	11/12/2019 10:39	11/12/2019 14:12	3,54	1	3,54	CHI
20191284702	MINEIROS	1390007975	PARQUE DAS EMAS	11/12/2019 10:39	11/12/2019 12:14	11/12/2019 10:39	11/12/2019 12:14	1,57	1	1,57	CHI
20191284705	ANAPOLIS	20142882	JUNDIAI S2	11/12/2019 10:40	11/12/2019 13:13	11/12/2019 10:40	11/12/2019 13:13	2,55	1	2,55	CHI
20191284778	ITABERAÍ	03550224	ITABERAÍ S1	11/12/2019 10:40	11/12/2019 19:37	11/12/2019 10:40	11/12/2019 13:21	2,70	3	8,09	CHI
20191284778	TAQUARAL DE GOIAS	03550224	ITABERAÍ S1	11/12/2019 10:40	11/12/2019 19:37	11/12/2019 10:40	11/12/2019 13:21	2,70	124	334,28	CHI
20191284778	TAQUARAL DE GOIAS	03550224	ITABERAÍ S1	11/12/2019 10:40	11/12/2019 19:37	11/12/2019 13:22	11/12/2019 14:52	1,50	76	114,34	CHI
20191284778	ITABERAÍ	TQ12376477	ITABERAÍ S1	11/12/2019 10:40	11/12/2019 19:37	11/12/2019 13:22	11/12/2019 14:58	1,60	3	4,79	CHI
20191284778	TAQUARAL DE GOIAS	TQ12376477	ITABERAÍ S1	11/12/2019 10:40	11/12/2019 19:37	11/12/2019 13:22	11/12/2019 14:58	1,60	49	78,16	CHI
20191284778	ITABERAÍ	TQ12376477	ITABERAÍ S1	11/12/2019 10:40	11/12/2019 19:37	11/12/2019 15:00	11/12/2019 16:42	1,68	3	5,05	CHI
20191284778	TAQUARAL DE GOIAS	TQ12376477	ITABERAÍ S1	11/12/2019 10:40	11/12/2019 19:37	11/12/2019 15:00	11/12/2019 16:42	1,68	49	82,55	CHI
20191284778	ITABERAÍ	IB13000015	ITABERAÍ S2	11/12/2019 10:40	11/12/2019 19:37	11/12/2019 16:15	11/12/2019 17:45	1,51	15	22,67	CHI
20191284778	ITABERAÍ	IB13000029	ITABERAÍ S2	11/12/2019 10:40	11/12/2019 19:37	11/12/2019 16:15	11/12/2019 18:55	2,66	18	47,96	CHI
20191284778	TAQUARAL DE GOIAS	IB13000029	ITABERAÍ S2	11/12/2019 10:40	11/12/2019 19:37	11/12/2019 16:15	11/12/2019 18:55	2,66	5	13,32	CHI
20191284778	ITABERAÍ	TQ12000081	ITABERAÍ S2	11/12/2019 10:40	11/12/2019 19:37	11/12/2019 16:15	11/12/2019 19:37	3,38	13	43,90	CHI
20191284778	TAQUARAL DE GOIAS	TQ12000081	ITABERAÍ S2	11/12/2019 10:40	11/12/2019 19:37	11/12/2019 16:15	11/12/2019 19:37	3,38	13	43,90	CHI
20191284711	CAMPINORTE	2040008518	CAMPINORTE	11/12/2019 10:41	11/12/2019 15:29	11/12/2019 10:41	11/12/2019 15:29	4,80	1	4,80	CHI
20191284712	CEZARINA	1650015425	CEZARINA	11/12/2019 10:42	11/12/2019 12:35	11/12/2019 10:42	11/12/2019 12:35	1,89	1	1,89	CHI
20191284715	JATAÍ	290020153	JATAÍ S3	11/12/2019 10:43	11/12/2019 19:46	11/12/2019 10:43	11/12/2019 19:46	9,06	1	9,06	CHI
20191284718	MORRINHOS	MR12000324	MORRINHOS	11/12/2019 10:44	11/12/2019 16:05	11/12/2019 10:44	11/12/2019 16:05	5,34	4	21,36	CHI
20191284719	PROFESSOR JAMIL SAFADY	JS21109204	ROCHEDO	11/12/2019 10:45	11/12/2019 17:07	11/12/2019 10:45	11/12/2019 17:07	6,36	1	6,36	CHI

20191284722	PROFESSOR JAMIL SAFADY	JS21025865	ROCHEDO	11/12/2019 10:45	11/12/2019 13:42	11/12/2019 10:45	11/12/2019 13:42	2,93	1	2,93	CHI
20191284738	CAMPOS VERDES	VD12266622	SANTA TEREZINHA	11/12/2019 10:47	12/12/2019 14:41	11/12/2019 10:47	12/12/2019 14:41	27,90	1	27,90	CHI
20191284740	APARECIDA DE GOIANIA	10010515656	INDEPENDENCIA S2	11/12/2019 10:47	11/12/2019 13:09	11/12/2019 10:47	11/12/2019 13:09	2,36	1	2,36	CHI
20191284744	SAO LUIZ DO NORTE	SZ21353876	ITAPACI	11/12/2019 10:49	11/12/2019 14:40	11/12/2019 10:49	11/12/2019 14:40	3,85	1	3,85	CHI
20191284753	APORE	AE12209701	ITAJA S1	11/12/2019 10:51	13/12/2019 17:20	11/12/2019 10:51	12/12/2019 19:40	32,81	46	1509,39	CHI
20191284753	ITARUMA	AE12209701	ITAJA S1	11/12/2019 10:51	13/12/2019 17:20	11/12/2019 10:51	12/12/2019 19:40	32,81	1	32,81	CHI
20191284753	APORE	6085036	ITAJA S1	11/12/2019 10:51	13/12/2019 17:20	11/12/2019 10:51	13/12/2019 17:20	54,49	1	54,49	CHI
20191284754	RIO VERDE	630064453	RIO VERDE S2	11/12/2019 10:51	11/12/2019 19:30	11/12/2019 10:51	11/12/2019 19:30	8,64	1	8,64	CHI
20191284756	JANDAIA	1180019717	PALMEIRAS	11/12/2019 10:52	11/12/2019 14:25	11/12/2019 10:52	11/12/2019 14:25	3,55	1	3,55	CHI
20191284759	NOVA CRIXAS	NA12294695	NOVA CRIXAS	11/12/2019 10:53	11/12/2019 13:50	11/12/2019 10:53	11/12/2019 13:50	2,93	3	8,80	CHI
20191284776	PALMEIRAS DE GOIAS	PL32004714	PALMEIRAS	11/12/2019 10:54	11/12/2019 19:25	11/12/2019 10:54	11/12/2019 19:25	8,51	2	17,03	CHI
20191284362	GOIAS	IB12132416	ITABERAI S1	11/12/2019 10:55	11/12/2019 16:57	11/12/2019 10:55	11/12/2019 16:57	6,03	1	6,03	CHI
20191284362	ITABERAI	IB12132416	ITABERAI S1	11/12/2019 10:55	11/12/2019 16:57	11/12/2019 10:55	11/12/2019 16:57	6,03	14	84,38	CHI
20191284763	GOIANIA	10438518	GOIANIA LESTE S1	11/12/2019 10:55	11/12/2019 15:23	11/12/2019 10:55	11/12/2019 15:23	4,46	1	4,46	CHI
20191285268	PONTALINA	PK12312433	PONTALINA	11/12/2019 10:55	11/12/2019 15:08	11/12/2019 10:55	11/12/2019 15:08	4,20	126	529,48	CHI
20191284766	LEOPOLDO DE BULHOES	LB21125715	CEPAIGO S2	11/12/2019 10:56	11/12/2019 17:49	11/12/2019 10:56	11/12/2019 17:49	6,88	1	6,88	CHI
20191284767	PORTELANDIA	PW21194460	PARQUE DAS EMAS	11/12/2019 10:56	11/12/2019 18:14	11/12/2019 10:56	11/12/2019 18:14	7,29	1	7,29	CHI
20191284777	CAMPINACU	10008860295	PORANGATU	11/12/2019 10:58	11/12/2019 16:03	11/12/2019 10:58	11/12/2019 16:03	5,07	1	5,07	CHI
20191284782	MOSSAMEDES	MD12005317	FIRMINOPOLIS S2	11/12/2019 11:00	11/12/2019 12:15	11/12/2019 11:00	11/12/2019 12:15	1,25	16	20,03	CHI
20191284787	ITABERAI	IB12000079	ITABERAI S2	11/12/2019 11:02	11/12/2019 17:33	11/12/2019 11:02	11/12/2019 17:33	6,51	9	58,62	CHI
20191284803	SENADOR CANEDO	190041067	SENADOR CANEDO	11/12/2019 11:06	11/12/2019 17:29	11/12/2019 11:06	11/12/2019 17:29	6,39	1	6,39	CHI
20191284810	GOIANIA	GN21123873	XAVANTES	11/12/2019 11:07	11/12/2019 15:14	11/12/2019 11:07	11/12/2019 15:14	4,11	1	4,11	CHI
20191284813	RIO VERDE	RV21296258	CABRIUVA S2	11/12/2019 11:08	11/12/2019 15:58	11/12/2019 11:08	11/12/2019 15:58	4,83	1	4,83	CHI
20191284816	VALPARAISO DE GOIAS	3350047668	PACAEMBU S1	11/12/2019 11:08	11/12/2019 12:32	11/12/2019 11:08	11/12/2019 12:32	1,39	1	1,39	CHI
20191284821	FORMOSA	FA21365951	ITUIQUIRA	11/12/2019 11:09	11/12/2019 16:20	11/12/2019 11:09	11/12/2019 16:00	4,85	1	4,85	CHI
20191284821	FORMOSA	FA12206255	ITUIQUIRA	11/12/2019 11:09	11/12/2019 16:20	11/12/2019 15:00	11/12/2019 16:20	1,32	1	1,32	CHI
20191284823	GOIANIA	14146885	CARAJAS S1	11/12/2019 11:10	11/12/2019 14:57	11/12/2019 11:10	11/12/2019 14:57	3,78	1	3,78	CHI
20191284824	CACU	1140006797	CACHOEIRA ALTA	11/12/2019 11:10	11/12/2019 14:50	11/12/2019 11:10	11/12/2019 14:50	3,66	1	3,66	CHI
20191284826	RIO VERDE	630562635	RIO VERDE S2	11/12/2019 11:10	11/12/2019 14:57	11/12/2019 11:10	11/12/2019 14:57	3,78	1	3,78	CHI
20191284833	GOIANIA	13812919	GOIANIA LESTE S2	11/12/2019 11:11	11/12/2019 11:52	11/12/2019 11:11	11/12/2019 11:52	0,67	1	0,67	CHI
20191284364	SAO MIGUEL DO ARAGUAIA	SM12074411	SAO MIGUEL DO ARAGUAIA	11/12/2019 11:12	11/12/2019 11:30	11/12/2019 11:12	11/12/2019 11:30	0,29	10	2,91	CHI
20191284835	CORREGO DO OURO	CO21320848	FIRMINOPOLIS S2	11/12/2019 11:12	11/12/2019 14:00	11/12/2019 11:12	11/12/2019 14:00	2,80	1	2,80	CHI
20191284842	ACREUNA	EU21260860	ACREUNA	11/12/2019 11:12	11/12/2019 14:13	11/12/2019 11:12	11/12/2019 14:13	3,01	1	3,01	CHI

20191284857	CATALAO	CT12042339	CATALAO S1	11/12/2019 11:12	12/12/2019 14:50	11/12/2019 11:12	12/12/2019 14:50	27,63	9	248,63	CHI
20191284877	MATRINCHA	MP12250740	MATRINCHA	11/12/2019 11:12	11/12/2019 19:54	11/12/2019 11:12	11/12/2019 19:54	8,70	9	78,29	CHI
20191284851	VILA PROPICIO	NP21298222	GOIANESIA S2	11/12/2019 11:13	11/12/2019 12:46	11/12/2019 11:13	11/12/2019 12:46	1,54	1	1,54	CHI
20191284852	GOIANIA	10002253001	GOYA S1	11/12/2019 11:13	11/12/2019 16:40	11/12/2019 11:13	11/12/2019 16:40	5,44	1	5,44	CHI
20191284859	ALTO PARAISO DE GOIAS	BF12096495	SAO JOAO D ALIANCA	11/12/2019 11:14	11/12/2019 12:05	11/12/2019 11:14	11/12/2019 12:05	0,84	7	5,90	CHI
20191284869	QUIRINOPOLIS	QI12296643	QUIRINOPOLIS	11/12/2019 11:16	11/12/2019 12:20	11/12/2019 11:16	11/12/2019 12:20	1,05	1	1,05	CHI
20191284872	LUZIANIA	LZ21097580	VIANOPOLIS	11/12/2019 11:16	12/12/2019 07:55	11/12/2019 11:16	12/12/2019 07:55	20,63	1	20,63	CHI
20191284876	ANAPOLIS	10009910334	ANAPOLIS UNIVERSITARIO S2	11/12/2019 11:17	11/12/2019 14:45	11/12/2019 11:17	11/12/2019 14:45	3,47	1	3,47	CHI
20191284878	QUIRINOPOLIS	QI12096888	QUIRINOPOLIS	11/12/2019 11:17	11/12/2019 14:35	11/12/2019 11:17	11/12/2019 14:35	3,29	20	65,80	CHI
20191284883	BRITANIA	BT12223993	BRITANIA	11/12/2019 11:18	12/12/2019 09:45	11/12/2019 11:18	12/12/2019 09:45	22,45	3	67,34	CHI
20191284884	JANDAIA	JD21008225	PALMEIRAS	11/12/2019 11:18	11/12/2019 16:37	11/12/2019 11:18	11/12/2019 16:37	5,32	2	10,63	CHI
20191284888	NOVA VENEZA	NV21132796	INHUMAS S1	11/12/2019 11:18	11/12/2019 18:10	11/12/2019 11:18	11/12/2019 18:10	6,85	1	6,85	CHI
20191284954	GOIANIA	GN12159195	XAVANTES	11/12/2019 11:20	11/12/2019 15:14	11/12/2019 11:20	11/12/2019 15:14	3,89	28	108,87	CHI
20191284918	APARECIDA DO RIO DOCE	AW21342525	JATAI S1	11/12/2019 11:21	11/12/2019 14:57	11/12/2019 11:21	11/12/2019 14:57	3,60	1	3,60	CHI
20191284926	MOIPIORA	MO12042808	SAO LUIZ DOS MONTES BELOS	11/12/2019 11:22	12/12/2019 06:59	11/12/2019 11:22	12/12/2019 06:59	19,61	1	19,61	CHI
20191284945	PARAUNA	PU12079039	PARAUNA	11/12/2019 11:22	11/12/2019 14:59	11/12/2019 11:22	11/12/2019 14:59	3,61	37	133,72	CHI
20191284935	PARANAIGUARA	2230020426	CACHOEIRA ALTA	11/12/2019 11:23	11/12/2019 12:57	11/12/2019 11:23	11/12/2019 12:57	1,57	1	1,57	CHI
20191285735	PIRACANJUBA	PJ12359676	MORRINHOS	11/12/2019 11:23	11/12/2019 17:13	11/12/2019 11:23	11/12/2019 17:13	5,82	7	40,75	CHI
20191284952	NOVA VENEZA	NV12078794	INHUMAS S1	11/12/2019 11:25	11/12/2019 19:30	11/12/2019 11:25	11/12/2019 19:30	8,07	12	96,85	CHI
20191284962	COCALZINHO DE GOIAS	PB21149732	AGUAS LINDAS DE GOIAS S2	11/12/2019 11:28	11/12/2019 16:25	11/12/2019 11:28	11/12/2019 16:25	4,95	1	4,95	CHI
20191284970	CAMPINORTE	MQ21050722	MARA ROSA	11/12/2019 11:29	12/12/2019 11:01	11/12/2019 11:29	12/12/2019 11:01	23,53	1	23,53	CHI
20191284982	CALDAS NOVAS	10027425302	CALDAS NOVAS S2	11/12/2019 11:32	11/12/2019 15:29	11/12/2019 11:32	11/12/2019 15:29	3,94	1	3,94	CHI
20191284990	ANICUNS	AC12391419	ANICUNS	11/12/2019 11:32	11/12/2019 14:35	11/12/2019 11:32	11/12/2019 14:35	3,06	307	940,61	CHI
20191285290	NOVA CRIXAS	NA11254943	NOVA CRIXAS	11/12/2019 11:32	11/12/2019 16:54	11/12/2019 11:32	11/12/2019 16:54	5,36	13	69,72	CHI
20191284984	TROMBAS	TB12286019	PORANGATU	11/12/2019 11:33	11/12/2019 14:43	11/12/2019 11:33	11/12/2019 14:43	3,17	1	3,17	CHI
20191284992	FORMOSA	610340580	ITIQUEIRA	11/12/2019 11:36	11/12/2019 15:19	11/12/2019 11:36	11/12/2019 15:19	3,71	1	3,71	CHI
20191284998	JANDAIA	PU12357332	PARAUNA	11/12/2019 11:39	11/12/2019 13:21	11/12/2019 11:39	11/12/2019 13:21	1,70	3	5,09	CHI
20191284998	PARAUNA	PU12357332	PARAUNA	11/12/2019 11:39	11/12/2019 13:21	11/12/2019 11:39	11/12/2019 13:21	1,70	30	50,94	CHI
20191285106	APARECIDA DE GOIANIA	200469540	INDEPENDENCIA S1	11/12/2019 11:40	11/12/2019 13:17	11/12/2019 11:40	11/12/2019 13:17	1,61	1	1,61	CHI
20191285121	ANAPOLIS	AN31096737	ANAPOLIS UNIVERSITARIO S2	11/12/2019 11:43	11/12/2019 16:30	11/12/2019 11:43	11/12/2019 16:30	4,78	1	4,78	CHI
20191285123	GOIANIA	GN12268342LD	XAVANTES	11/12/2019 11:43	11/12/2019 15:01	11/12/2019 11:43	11/12/2019 15:01	3,28	26	85,38	CHI
20191285129	ITARUMA	10009756602	CACHOEIRA ALTA	11/12/2019 11:45	11/12/2019 18:12	11/12/2019 11:45	11/12/2019 18:12	6,45	1	6,45	CHI
20191285138	RIO VERDE	RV12260579	RIO VERDE S1	11/12/2019 11:48	11/12/2019 15:20	11/12/2019 11:48	11/12/2019 15:20	3,53	16	56,52	CHI

20191285139	CRIXAS	2490020682	SERRA DO OURO	11/12/2019 11:48	11/12/2019 15:39	11/12/2019 11:48	11/12/2019 15:39	3,84	1	3,84	CHI
20191285149	PALMEIRAS DE GOIAS	PL12048169	PALMEIRAS	11/12/2019 11:48	11/12/2019 19:00	11/12/2019 11:48	11/12/2019 19:00	7,20	19	136,87	CHI
20191285271	CAIAPONIA	CP12380880	CAIAPONIA	11/12/2019 11:48	12/12/2019 18:26	11/12/2019 11:48	12/12/2019 18:26	30,62	10	306,20	CHI
20191285144	BELA VISTA DE GOIAS	BV12202366	BELA VISTA S2	11/12/2019 11:49	11/12/2019 15:35	11/12/2019 11:49	11/12/2019 15:35	3,75	9	33,78	CHI
20191285147	SAO LUIS DE MONTES BELOS	500063734	SAO LUIZ DOS MONTES BELOS	11/12/2019 11:50	11/12/2019 16:08	11/12/2019 11:50	11/12/2019 16:08	4,30	1	4,30	CHI
20191285148	FORMOSA	FA11397197	SAO JOAO D ALIANCA	11/12/2019 11:50	11/12/2019 14:55	11/12/2019 11:50	11/12/2019 14:55	3,07	1	3,07	CHI
20191285154	NOVA VENEZA	NV21160079	INHUMAS S1	11/12/2019 11:53	11/12/2019 17:37	11/12/2019 11:53	11/12/2019 17:37	5,72	1	5,72	CHI
20191285155	BOM JARDIM DE GOIAS	10019920340	BOM JARDIM	11/12/2019 11:53	11/12/2019 15:25	11/12/2019 11:53	11/12/2019 15:25	3,52	1	3,52	CHI
20191285160	VARJAO	GA21359455	GUAPO S1	11/12/2019 11:54	11/12/2019 14:05	11/12/2019 11:54	11/12/2019 14:05	2,17	2	4,34	CHI
20191285166	PARAUNA	PU12081329	PARAUNA	11/12/2019 11:54	11/12/2019 15:03	11/12/2019 11:54	11/12/2019 15:03	3,15	64	201,49	CHI
20191285162	ESTRELA DO NORTE	2420000232	MARA ROSA	11/12/2019 11:56	12/12/2019 01:30	11/12/2019 11:56	12/12/2019 01:30	13,57	1	13,57	CHI
20191285164	SAO LUIS DE MONTES BELOS	SL21035050	SAO LUIZ DOS MONTES BELOS	11/12/2019 11:56	11/12/2019 14:17	11/12/2019 11:56	11/12/2019 14:17	2,35	1	2,35	CHI
20191285172	PORANGATU	840068451	PORANGATU	11/12/2019 11:59	11/12/2019 21:01	11/12/2019 11:59	11/12/2019 21:01	9,03	1	9,03	CHI
20191285178	VARJAO	940015900	GUAPO S2	11/12/2019 12:00	11/12/2019 15:25	11/12/2019 12:00	11/12/2019 15:25	3,42	1	3,42	CHI
20191285179	BELA VISTA DE GOIAS	240038605	BELA VISTA S1	11/12/2019 12:01	11/12/2019 16:06	11/12/2019 12:01	11/12/2019 16:06	4,08	1	4,08	CHI
20191285191	SAO LUIS DE MONTES BELOS	SL12000038	SAO LUIZ DOS MONTES BELOS	11/12/2019 12:02	11/12/2019 14:49	11/12/2019 12:02	11/12/2019 14:49	2,78	306	849,32	CHI
20191285183	GOIAS	8704990	MATRINCHA	11/12/2019 12:03	11/12/2019 16:55	11/12/2019 12:03	11/12/2019 16:55	4,86	2	9,73	CHI
20191285188	CRISTALINA	1060068002	CRISTALINA S1	11/12/2019 12:05	11/12/2019 16:24	11/12/2019 12:05	11/12/2019 16:24	4,31	1	4,31	CHI
20191285225	ITUMBIARA	IT11000089	ITUMBIARA VELHA S1	11/12/2019 12:05	11/12/2019 13:13	11/12/2019 12:05	11/12/2019 13:13	1,13	69	78,22	CHI
20191285193	BONFINOPOLIS	SW21270670	CEPAIGO S2	11/12/2019 12:06	11/12/2019 17:45	11/12/2019 12:06	11/12/2019 17:45	5,64	1	5,64	CHI
20191285194	RIO VERDE	630196023	CABRIUVA S1	11/12/2019 12:07	11/12/2019 16:07	11/12/2019 12:07	11/12/2019 16:07	4,00	1	4,00	CHI
20191285195	ITAPIRAPUA	IU12220057	MATRINCHA	11/12/2019 12:07	11/12/2019 20:30	11/12/2019 12:07	11/12/2019 20:30	8,38	2	16,75	CHI
20191285200	MORRINHOS	10025333214	MORRINHOS	11/12/2019 12:08	11/12/2019 15:26	11/12/2019 12:08	11/12/2019 15:26	3,29	1	3,29	CHI
20191286275	IVOLANDIA	PU12090442	MONTVIDIU T	11/12/2019 12:08	12/12/2019 07:15	11/12/2019 12:08	12/12/2019 07:15	19,11	2	38,22	CHI
20191285207	CRIXAS	CX12312176	SANTA TEREZINHA	11/12/2019 12:10	11/12/2019 17:38	11/12/2019 12:10	11/12/2019 17:38	5,45	4	21,81	CHI
20191285215	VALPARAISO DE GOIAS	2860307560	MARAJOARA	11/12/2019 12:13	11/12/2019 14:00	11/12/2019 12:13	11/12/2019 14:00	1,78	1	1,78	CHI
20191285232	DOVERLANDIA	DV21207783	CAIAPONIA	11/12/2019 12:20	11/12/2019 22:18	11/12/2019 12:20	11/12/2019 22:18	9,95	2	19,90	CHI
20191285243	COLINAS DO SUL	TI11268726	NIQUELANDIA SUBTRANSMISSAO	11/12/2019 12:22	11/12/2019 13:30	11/12/2019 12:22	11/12/2019 13:30	1,12	40	44,82	CHI
20191285244	PALMEIRAS DE GOIAS	590029381	PALMEIRAS	11/12/2019 12:22	11/12/2019 14:23	11/12/2019 12:22	11/12/2019 14:23	2,01	1	2,01	CHI
20191285252	BELA VISTA DE GOIAS	BV31095403	BELA VISTA S1	11/12/2019 12:25	11/12/2019 16:34	11/12/2019 12:25	11/12/2019 16:34	4,14	1	4,14	CHI
20191285333	GOIANIA	GN11001970	FERROVIARIO S2	11/12/2019 12:25	11/12/2019 14:47	11/12/2019 12:25	11/12/2019 14:47	2,36	84	197,98	CHI
20191285017	MONTE ALEGRE DE GOIAS	MA21358015	SAO DOMINGOS	11/12/2019 12:27	11/12/2019 13:00	11/12/2019 12:27	11/12/2019 13:00	0,55	1	0,55	CHI
20191285258	POSSE	1480055818	IACIARA S2	11/12/2019 12:27	11/12/2019 14:29	11/12/2019 12:27	11/12/2019 14:29	2,02	1	2,02	CHI

20191285263	ANICUNS	AC12259088	ANICUNS	11/12/2019 12:29	11/12/2019 21:05	11/12/2019 12:29	11/12/2019 21:05	8,59	53	455,17	CHI
20191285273	ORIZONA	OZ21412137	PIRES DO RIO S2	11/12/2019 12:34	12/12/2019 08:22	11/12/2019 12:34	12/12/2019 08:22	19,80	1	19,80	CHI
20191285276	PARAUNA	PU21305888	ACREUNA	11/12/2019 12:35	11/12/2019 16:40	11/12/2019 12:35	11/12/2019 16:40	4,07	1	4,07	CHI
20191285277	JARAGUA	70049828	JARAGUA	11/12/2019 12:35	11/12/2019 15:40	11/12/2019 12:35	11/12/2019 15:40	3,08	1	3,08	CHI
20191285301	IPORA	IR12202000	ARENOPOLIS	11/12/2019 12:36	12/12/2019 03:33	11/12/2019 12:36	12/12/2019 03:33	14,94	8	119,54	CHI
20191285750	SANTO ANTONIO DO DESCOBERTO	SN12214872	ALEXANIA	11/12/2019 12:39	11/12/2019 17:23	11/12/2019 12:39	11/12/2019 17:23	4,73	280	1324,32	CHI
20191285289	LUZIANIA	LZ21065448	VIANOPOLIS	11/12/2019 12:40	11/12/2019 17:24	11/12/2019 12:40	11/12/2019 17:24	4,73	1	4,73	CHI
20191285293	GOIANIA	GN11329314	CARAJAS S2	11/12/2019 12:41	11/12/2019 22:34	11/12/2019 12:41	11/12/2019 22:34	9,87	180	1776,15	CHI
20191285297	APARECIDA DE GOIANIA	14968721	REAL S1	11/12/2019 12:42	12/12/2019 10:10	11/12/2019 12:42	12/12/2019 10:10	21,45	1	21,45	CHI
20191285298	GOIANIA	11275870	AEROPORTO S1	11/12/2019 12:43	11/12/2019 14:54	11/12/2019 12:43	11/12/2019 14:54	2,18	1	2,18	CHI
20191285302	BOM JESUS DE GOIAS	10005577207	BOM JESUS DE GOIAS	11/12/2019 12:45	11/12/2019 14:50	11/12/2019 12:45	11/12/2019 14:50	2,07	0	0,00	CHI
20191285022	SAO FRANCISCO DE GOIAS	PV21354709	SAO FRANCISCO DE GOIAS	11/12/2019 12:46	11/12/2019 13:12	11/12/2019 12:46	11/12/2019 13:12	0,42	1	0,42	CHI
20191285303	ALEXANIA	AX21066471	ALEXANIA	11/12/2019 12:46	11/12/2019 18:48	11/12/2019 12:46	11/12/2019 18:48	6,03	1	6,03	CHI
20191285306	GOIAS	GS21140296	MATRINCHA	11/12/2019 12:47	11/12/2019 16:00	11/12/2019 12:47	11/12/2019 16:00	3,23	2	6,46	CHI
20191285308	PONTALINA	MR12249782	PONTALINA	11/12/2019 12:48	11/12/2019 18:00	11/12/2019 12:48	11/12/2019 18:00	5,20	6	31,19	CHI
20191285331	NOVO GAMA	LZ12082801	MARAJOARA	11/12/2019 12:48	11/12/2019 16:23	11/12/2019 12:48	11/12/2019 16:23	3,57	28	99,94	CHI
20191285476	PARANAIGUARA	PC11095015	CACHOEIRA ALTA	11/12/2019 12:48	11/12/2019 16:01	11/12/2019 12:48	11/12/2019 16:01	3,22	106	341,26	CHI
20191285314	CATURAI	AR12402818	ARACU	11/12/2019 12:49	11/12/2019 18:55	11/12/2019 12:49	11/12/2019 18:55	6,10	2	12,20	CHI
20191285316	URUACU	640074728	URUACU	11/12/2019 12:49	11/12/2019 15:40	11/12/2019 12:49	11/12/2019 15:40	2,84	1	2,84	CHI
20191285319	DOVERLANDIA	DV21156479	CAIAPONIA	11/12/2019 12:50	11/12/2019 21:20	11/12/2019 12:50	11/12/2019 21:20	8,49	1	8,49	CHI
20191285320	NIQUELANDIA	NQ21197545	NIQUELANDIA SUBTRANSMISSAO	11/12/2019 12:50	11/12/2019 21:49	11/12/2019 12:50	11/12/2019 21:49	8,97	1	8,97	CHI
20191285321	LUZIANIA	LZ11128900	MARAJOARA	11/12/2019 12:52	11/12/2019 20:07	11/12/2019 12:52	11/12/2019 20:07	7,25	14	101,47	CHI
20191285322	CALDAS NOVAS	760176190	SERRA DE CALDAS	11/12/2019 12:52	11/12/2019 15:20	11/12/2019 12:52	11/12/2019 15:20	2,47	1	2,47	CHI
20191285323	GOIANIA	10003396523	MEIA PONTE	11/12/2019 12:52	11/12/2019 14:39	11/12/2019 12:52	11/12/2019 14:39	1,77	1	1,77	CHI
20191285325	GOIANIA	13050242	MEIA PONTE	11/12/2019 12:54	11/12/2019 15:10	11/12/2019 12:54	11/12/2019 15:10	2,27	1	2,27	CHI
20191285327	VILA PROPICIO	NP21231820	GOIANESIA S1	11/12/2019 12:54	11/12/2019 17:20	11/12/2019 12:54	11/12/2019 17:20	4,44	1	4,44	CHI
20191285328	CRISTALINA	KR11287387	CRISTALINA S1	11/12/2019 12:54	11/12/2019 16:16	11/12/2019 12:54	11/12/2019 16:16	3,36	4	13,43	CHI
20191285731	SANTA RITA DO NOVO DESTINO	DF12382140	BARRO ALTO	11/12/2019 12:55	12/12/2019 16:57	11/12/2019 12:55	12/12/2019 16:57	28,02	15	420,28	CHI
20191285338	MOZARLANDIA	410009854	MOZARLANDIA	11/12/2019 12:56	11/12/2019 16:32	11/12/2019 12:56	11/12/2019 16:32	3,60	1	3,60	CHI
20191285352	ACREUNA	EU21197364	ACREUNA	11/12/2019 12:57	11/12/2019 15:48	11/12/2019 12:57	11/12/2019 15:48	2,85	1	2,85	CHI
20191285354	JAUPACI	JP12315944	IPORA	11/12/2019 12:57	12/12/2019 13:05	11/12/2019 12:57	12/12/2019 13:05	24,13	2	48,27	CHI
20191285363	VARJAO	VJ21216391	GUAPU S2	11/12/2019 12:58	11/12/2019 16:41	11/12/2019 12:58	11/12/2019 16:41	3,70	3	11,11	CHI
20191285383	INHUMAS	IN12060938	INHUMAS S2	11/12/2019 12:58	11/12/2019 14:45	11/12/2019 12:58	11/12/2019 14:45	1,78	17	30,26	CHI

20191285370	ITAPIRAPUA	IU21071457	JUSSARA	11/12/2019 13:00	11/12/2019 16:34	11/12/2019 13:00	11/12/2019 16:34	3,56	1	3,56	CHI
20191285372	HIDROLANDIA	HD21010529	CEPAIGO S2	11/12/2019 13:01	11/12/2019 17:00	11/12/2019 13:01	11/12/2019 17:00	3,98	1	3,98	CHI
20191285374	COLINAS DO SUL	TI21364449	MINACU	11/12/2019 13:02	11/12/2019 14:32	11/12/2019 13:02	11/12/2019 14:32	1,50	1	1,50	CHI
20191285830	TRINDADE	TR12071529	TRINDADE	11/12/2019 13:02	11/12/2019 17:21	11/12/2019 13:02	11/12/2019 17:21	4,30	90	387,13	CHI
20191285440	MINEIROS	MY12034227	PARQUE DAS EMAS	11/12/2019 13:03	11/12/2019 19:08	11/12/2019 13:03	11/12/2019 19:08	6,08	30	182,27	CHI
20191285440	SANTA RITA DO ARAGUAIA	MY12034227	PARQUE DAS EMAS	11/12/2019 13:03	11/12/2019 19:08	11/12/2019 13:03	11/12/2019 19:08	6,08	2	12,15	CHI
20191285667	ALEXANIA	AX12071329	ALEXANIA	11/12/2019 13:05	11/12/2019 15:59	11/12/2019 13:05	11/12/2019 15:59	2,90	14	40,60	CHI
20191285667	SANTO ANTONIO DO DESCOBERTO	AX12071329	ALEXANIA	11/12/2019 13:05	11/12/2019 15:59	11/12/2019 13:05	11/12/2019 15:59	2,90	1	2,90	CHI
20191285393	SAO MIGUEL DO ARAGUAIA	SM12384276	SAO MIGUEL DO ARAGUAIA	11/12/2019 13:07	11/12/2019 18:15	11/12/2019 13:07	11/12/2019 18:15	5,13	3	15,39	CHI
20191285396	HIDROLANDIA	HD21010536	CEPAIGO S2	11/12/2019 13:07	11/12/2019 18:15	11/12/2019 13:07	11/12/2019 18:15	5,12	1	5,12	CHI
20191283124	CAIAPONIA	DV12332038	CAIAPONIA	11/12/2019 13:08	11/12/2019 19:13	11/12/2019 13:08	11/12/2019 19:13	6,08	22	133,82	CHI
20191283124	DOVERLANDIA	DV12332038	CAIAPONIA	11/12/2019 13:08	11/12/2019 19:13	11/12/2019 13:08	11/12/2019 19:13	6,08	28	170,32	CHI
20191285398	MORRINHOS	MR12263331	MORRINHOS	11/12/2019 13:08	12/12/2019 19:40	11/12/2019 13:08	12/12/2019 19:40	30,53	9	274,74	CHI
20191285400	NOVA CRIXAS	NA11391140	NOVA CRIXAS	11/12/2019 13:08	11/12/2019 18:05	11/12/2019 13:08	11/12/2019 18:05	4,94	13	64,16	CHI
20191285402	CAMPINORTE	CR21266658	MARA ROSA	11/12/2019 13:09	12/12/2019 14:38	11/12/2019 13:09	12/12/2019 14:38	25,48	1	25,48	CHI
20191285405	CRISTALINA	KR21320145	CRISTALINA S2	11/12/2019 13:10	11/12/2019 15:40	11/12/2019 13:10	11/12/2019 15:40	2,49	1	2,49	CHI
20191285704	CAIAPONIA	CP12204876	CAIAPONIA	11/12/2019 13:11	11/12/2019 18:30	11/12/2019 13:11	11/12/2019 18:30	5,32	12	63,83	CHI
20191285410	SILVANIA	SV12169400	VIANOPOLIS	11/12/2019 13:12	11/12/2019 19:40	11/12/2019 13:12	11/12/2019 19:40	6,47	76	491,42	CHI
20191285412	INHUMAS	IN21092600	INHUMAS S2	11/12/2019 13:13	11/12/2019 18:07	11/12/2019 13:13	11/12/2019 18:07	4,90	1	4,90	CHI
20191285413	ITARUMA	IM11370120	CACHOEIRA ALTA	11/12/2019 13:13	11/12/2019 17:05	11/12/2019 13:13	11/12/2019 17:05	3,86	57	220,19	CHI
20191285414	DIORAMA	DI12381021	IPORA	11/12/2019 13:13	12/12/2019 10:59	11/12/2019 13:13	12/12/2019 10:59	21,76	3	65,27	CHI
20191285418	MORRINHOS	MR21076971	GOIATUBA S2	11/12/2019 13:14	11/12/2019 16:30	11/12/2019 13:14	11/12/2019 16:30	3,26	1	3,26	CHI
20191285423	RUBIATABA	780002349	RUBIATABA	11/12/2019 13:15	12/12/2019 08:40	11/12/2019 13:15	12/12/2019 08:40	19,41	1	19,41	CHI
20191285424	CRISTALINA	KR21209629	CRISTALINA S1	11/12/2019 13:15	11/12/2019 18:15	11/12/2019 13:15	11/12/2019 18:15	4,99	1	4,99	CHI
20191285430	TURVELANDIA	TD21240351	RIO DOS BOIS	11/12/2019 13:18	11/12/2019 23:30	11/12/2019 13:18	11/12/2019 23:30	10,20	1	10,20	CHI
20191285432	QUIRINOPOLIS	QI21143197	QUIRINOPOLIS	11/12/2019 13:18	11/12/2019 15:13	11/12/2019 13:18	11/12/2019 15:13	1,91	1	1,91	CHI
20191285433	CRISTALINA	KR12153067	CRISTALINA S2	11/12/2019 13:18	11/12/2019 22:11	11/12/2019 13:18	11/12/2019 22:11	8,87	3	26,61	CHI
20191285436	CRISTIANOPOLIS	CF21300628	CRISTIANOPOLIS	11/12/2019 13:19	11/12/2019 14:48	11/12/2019 13:19	11/12/2019 14:48	1,48	1	1,48	CHI
20191285437	APARECIDA DE GOIANIA	AP11007361	INDEPENDENCIA S1	11/12/2019 13:19	11/12/2019 16:39	11/12/2019 13:19	11/12/2019 16:39	3,33	153	509,32	CHI
20191285438	PIRANHAS	1930015784	PIRANHAS	11/12/2019 13:19	11/12/2019 19:54	11/12/2019 13:19	11/12/2019 19:54	6,58	1	6,58	CHI
20191285441	RIO VERDE	RV21215830	CABRIUVA S2	11/12/2019 13:19	11/12/2019 14:10	11/12/2019 13:19	11/12/2019 14:10	0,84	1	0,84	CHI
20191285473	SANTO ANTONIO DO DESCOBERTO	SN11163878	ALEXANIA	11/12/2019 13:19	11/12/2019 16:06	11/12/2019 13:19	11/12/2019 16:06	2,78	176	489,87	CHI
20191285444	ITABERAÍ	IB21310535	ITABERAÍ S2	11/12/2019 13:20	11/12/2019 18:00	11/12/2019 13:20	11/12/2019 18:00	4,68	1	4,68	CHI

20191285448	CAIAPONIA	930036580	CAIAPONIA	11/12/2019 13:20	12/12/2019 08:12	11/12/2019 13:20	12/12/2019 08:12	18,85	1	18,85	CHI
20191285451	SANCLERLANDIA	1210005442	FIRMINOPOLIS S2	11/12/2019 13:21	11/12/2019 16:47	11/12/2019 13:21	11/12/2019 16:47	3,43	1	3,43	CHI
20191285457	GUARAITA	GK12299438	ITAPURANGA	11/12/2019 13:22	11/12/2019 15:10	11/12/2019 13:22	11/12/2019 15:10	1,79	1	1,79	CHI
20191285466	AGUAS LINDAS DE GOIAS	10027034966	AGUAS LINDAS DE GOIAS S1	11/12/2019 13:24	11/12/2019 14:47	11/12/2019 13:24	11/12/2019 14:47	1,38	1	1,38	CHI
20191285467	NOVA CRIXAS	8580003376	NOVA CRIXAS	11/12/2019 13:24	11/12/2019 17:50	11/12/2019 13:24	11/12/2019 17:50	4,42	1	4,42	CHI
20191285468	GOIATUBA	GT21102732	BOM JESUS DE GOIAS	11/12/2019 13:24	11/12/2019 15:15	11/12/2019 13:24	11/12/2019 15:15	1,84	1	1,84	CHI
20191285470	DOVERLANDIA	CP12389843	CAIAPONIA	11/12/2019 13:26	12/12/2019 17:00	11/12/2019 13:26	12/12/2019 17:00	27,56	7	192,95	CHI
20191285513	GOIANDIRA	CT12075551	CATALAO S1	11/12/2019 13:26	12/12/2019 19:55	11/12/2019 13:26	12/12/2019 19:55	30,49	2	60,98	CHI
20191285478	MORRINHOS	MR21399301	MORRINHOS	11/12/2019 13:30	12/12/2019 08:10	11/12/2019 13:30	12/12/2019 08:10	18,67	2	37,35	CHI
20191285481	CRISTALINA	KR12389576	CRISTALINA S2	11/12/2019 13:31	11/12/2019 17:23	11/12/2019 13:31	11/12/2019 17:23	3,86	38	146,71	CHI
20191285490	CAMPINORTE	CR21325215	MARA ROSA	11/12/2019 13:34	12/12/2019 13:09	11/12/2019 13:34	12/12/2019 13:09	23,58	1	23,58	CHI
20191285494	PALMEIRAS DE GOIAS	10006070491	PALMEIRAS	11/12/2019 13:35	11/12/2019 16:19	11/12/2019 13:35	11/12/2019 16:19	2,73	1	2,73	CHI
20191285496	GOIAS	GS21245256	GOIAS	11/12/2019 13:35	12/12/2019 07:39	11/12/2019 13:35	12/12/2019 07:39	18,06	1	18,06	CHI
20191285515	RIO VERDE	10020164490	RIO VERDE S2	11/12/2019 13:39	11/12/2019 14:45	11/12/2019 13:39	11/12/2019 14:45	1,10	1	1,10	CHI
20191285518	NIQUELANDIA	NQ21201677	URUACU	11/12/2019 13:39	12/12/2019 09:52	11/12/2019 13:39	12/12/2019 09:52	20,20	16	323,21	CHI
20191285522	ARUANA	AK21066597	ARUANA	11/12/2019 13:41	11/12/2019 17:03	11/12/2019 13:41	11/12/2019 17:03	3,37	1	3,37	CHI
20191285524	MINACU	IH12246544	MINACU	11/12/2019 13:41	11/12/2019 15:39	11/12/2019 13:41	11/12/2019 15:39	1,96	1	1,96	CHI
20191285529	SANTA HELENA DE GOIAS	SH12301062	RIO DOS BOIS	11/12/2019 13:42	11/12/2019 17:56	11/12/2019 13:42	11/12/2019 17:56	4,22	3	12,67	CHI
20191285529	TURVELANDIA	SH12301062	RIO DOS BOIS	11/12/2019 13:42	11/12/2019 17:56	11/12/2019 13:42	11/12/2019 17:56	4,22	3	12,67	CHI
20191285601	ARUANA	AK12250809	ARUANA	11/12/2019 13:43	11/12/2019 16:21	11/12/2019 13:43	11/12/2019 16:21	2,63	2	5,26	CHI
20191285650	MUNDO NOVO DE GOIAS	MH12189540	NOVA CRIXAS	11/12/2019 13:43	11/12/2019 17:25	11/12/2019 13:43	11/12/2019 17:25	3,69	5	18,44	CHI
20191285541	PALMELO	450013297	PIRES DO RIO S2	11/12/2019 13:46	12/12/2019 10:51	11/12/2019 13:46	12/12/2019 10:51	21,08	1	21,08	CHI
20191285545	LUZIANIA	120057591	RIO VERMELHO	11/12/2019 13:48	11/12/2019 15:19	11/12/2019 13:48	11/12/2019 15:19	1,51	1	1,51	CHI
20191285546	CATALAO	CM21063950	CAMPO ALEGRE DE GOIAS	11/12/2019 13:49	11/12/2019 22:22	11/12/2019 13:49	11/12/2019 22:22	8,55	1	8,55	CHI
20191285551	FORMOSO	FO21258035	MARA ROSA	11/12/2019 13:51	11/12/2019 16:25	11/12/2019 13:51	11/12/2019 16:25	2,57	1	2,57	CHI
20191285552	GOIANIA	GN12036026LD	GOYA S1	11/12/2019 13:51	11/12/2019 15:34	11/12/2019 13:51	11/12/2019 15:34	1,70	7	11,91	CHI
20191285557	CRISTALINA	10024263468	CRISTALINA S1	11/12/2019 13:54	11/12/2019 19:56	11/12/2019 13:54	11/12/2019 19:56	6,03	1	6,03	CHI
20191285563	PIRANHAS	1930036787	PIRANHAS	11/12/2019 13:54	12/12/2019 11:21	11/12/2019 13:54	12/12/2019 11:21	21,45	1	21,45	CHI
20191285565	SILVANIA	SV12091766	VIANOPOLIS	11/12/2019 13:57	11/12/2019 20:15	11/12/2019 13:57	11/12/2019 20:15	6,30	1	6,30	CHI
20191285571	NOVO GAMA	NJ21163233	PACAEMBU S1	11/12/2019 13:58	11/12/2019 20:13	11/12/2019 13:58	11/12/2019 20:13	6,25	1	6,25	CHI
20191285572	SANTA HELENA DE GOIAS	SH11159477	IPEGUARI	11/12/2019 13:58	11/12/2019 15:52	11/12/2019 13:58	11/12/2019 15:52	1,89	35	66,25	CHI
20191285573	ANAPOLIS	AN21349371	ANAPOLIS UNIVERSITARIO S2	11/12/2019 13:58	11/12/2019 17:25	11/12/2019 13:58	11/12/2019 17:25	3,46	1	3,46	CHI
20191285579	CACU	CC21159993	CACHOEIRA ALTA	11/12/2019 13:59	11/12/2019 17:50	11/12/2019 13:59	11/12/2019 17:50	3,84	1	3,84	CHI

20191285590	ITAJA	IJ12200688	ITAJA S2	11/12/2019 14:02	12/12/2019 17:51	11/12/2019 14:02	12/12/2019 15:38	25,59	2	51,19	CHI
20191285590	ITAJA	IJ12200688	ITAJA S2	11/12/2019 14:02	12/12/2019 17:51	11/12/2019 19:20	12/12/2019 15:38	20,31	1	20,31	CHI
20191285590	ITAJA	IJ12200688	ITAJA S2	11/12/2019 14:02	12/12/2019 17:51	11/12/2019 14:02	12/12/2019 17:51	27,81	1	27,81	CHI
20191285609	GOIANIA	GN11247749	GOYA S2	11/12/2019 14:02	11/12/2019 14:19	11/12/2019 14:02	11/12/2019 14:19	0,28	112	31,11	CHI
20191285598	ITUMBIARA	690186812	ITUMBIARA VELHA S1	11/12/2019 14:03	11/12/2019 16:03	11/12/2019 14:03	11/12/2019 16:03	1,99	1	1,99	CHI
20191285753	CAIAPONIA	CP12200875	CAIAPONIA	11/12/2019 14:05	11/12/2019 20:00	11/12/2019 14:05	11/12/2019 20:00	5,93	9	53,34	CHI
20191285610	GOIAS	GS12234122	GOIAS	11/12/2019 14:07	12/12/2019 12:13	11/12/2019 14:07	12/12/2019 12:13	22,09	1	22,09	CHI
20191285624	CAMPO LIMPO	CV21297834	NEROPOLIS S1	11/12/2019 14:11	11/12/2019 16:04	11/12/2019 14:11	11/12/2019 16:04	1,88	1	1,88	CHI
20191285625	GOIANESIA	10030262532	GOIANESIA S2	11/12/2019 14:11	11/12/2019 19:55	11/12/2019 14:11	11/12/2019 19:55	5,73	1	5,73	CHI
20191285053	SANTA HELENA DE GOIAS	SH12316189	SANTA HELENA S1	11/12/2019 14:12	11/12/2019 17:50	11/12/2019 14:12	11/12/2019 17:50	3,64	1	3,64	CHI
20191285627	MINEIROS	1390127385	PARQUE DAS EMAS	11/12/2019 14:12	11/12/2019 20:39	11/12/2019 14:12	11/12/2019 20:39	6,46	1	6,46	CHI
20191285629	GOIANIA	10005072997	FERROVIARIO S1	11/12/2019 14:12	11/12/2019 16:32	11/12/2019 14:12	11/12/2019 16:32	2,33	1	2,33	CHI
20191285636	PIRENOPOLIS	PV21121842	CORUMBA	11/12/2019 14:14	11/12/2019 16:08	11/12/2019 14:14	11/12/2019 16:08	1,89	1	1,89	CHI
20191285637	SILVANIA	SV21015039	VIANOPOLIS	11/12/2019 14:14	11/12/2019 16:42	11/12/2019 14:14	11/12/2019 16:42	2,45	1	2,45	CHI
20191285638	QUIRINOPOLIS	QI21101739	QUIRINOPOLIS	11/12/2019 14:15	11/12/2019 18:23	11/12/2019 14:15	11/12/2019 18:23	4,13	1	4,13	CHI
20191285058	RIO VERDE	RV11349517	RIO VERDE S2	11/12/2019 14:18	11/12/2019 19:33	11/12/2019 17:06	11/12/2019 19:33	2,45	40	98,01	CHI
20191285656	CALDAS NOVAS	10006543691	CALDAS NOVAS S1	11/12/2019 14:20	11/12/2019 21:22	11/12/2019 14:20	11/12/2019 21:22	7,03	1	7,03	CHI
20191285999	PORANGATU	PO12230431	PORANGATU	11/12/2019 14:20	11/12/2019 18:47	11/12/2019 14:20	11/12/2019 18:47	4,44	2	8,88	CHI
20191285661	JATAI	290179889	JATAI S2	11/12/2019 14:21	11/12/2019 17:40	11/12/2019 14:21	11/12/2019 17:40	3,32	1	3,32	CHI
20191285662	QUIRINOPOLIS	QI21152300	QUIRINOPOLIS	11/12/2019 14:21	11/12/2019 19:24	11/12/2019 14:21	11/12/2019 19:24	5,04	1	5,04	CHI
20191287066	ACREUNA	EU12301454	ACREUNA	11/12/2019 14:21	11/12/2019 20:01	11/12/2019 14:21	11/12/2019 20:01	5,65	3	16,95	CHI
20191285666	LEOPOLDO DE BULHOES	870016830	DAIA S2	11/12/2019 14:23	11/12/2019 17:37	11/12/2019 14:23	11/12/2019 17:37	3,23	1	3,23	CHI
20191285669	NOVO PLANALTO	TA11293647	SAO MIGUEL DO ARAGUAIA	11/12/2019 14:23	11/12/2019 16:30	11/12/2019 14:23	11/12/2019 16:30	2,12	1	2,12	CHI
20191285671	MONTIVIDIU	MV21306283	MONTIVIDIU T	11/12/2019 14:23	11/12/2019 17:10	11/12/2019 14:23	11/12/2019 17:10	2,77	1	2,77	CHI
20191285678	MINEIROS	MY12241778	PARQUE DAS EMAS	11/12/2019 14:25	11/12/2019 18:12	11/12/2019 14:25	11/12/2019 18:12	3,77	12	45,27	CHI
20191287304	GUARINOS	GF12164878	SANTA TEREZINHA	11/12/2019 14:25	12/12/2019 01:39	11/12/2019 14:25	12/12/2019 01:39	11,23	57	640,05	CHI
20191285062	GOIANIA	GN12247768	GOYA S2	11/12/2019 14:26	11/12/2019 17:52	11/12/2019 14:26	11/12/2019 17:52	3,42	112	383,07	CHI
20191285806	GOIAS	GS12217745	MATRINCHA	11/12/2019 14:26	11/12/2019 17:59	11/12/2019 14:26	11/12/2019 17:59	3,54	3	10,63	CHI
20191285708	CRISTALINA	KR11032676	CRISTALINA S1	11/12/2019 14:27	11/12/2019 15:00	11/12/2019 14:45	11/12/2019 15:00	0,25	164	41,05	CHI
20191285692	CIDADE OCIDENTAL	2680015983	MARAJOARA	11/12/2019 14:29	11/12/2019 15:59	11/12/2019 14:29	11/12/2019 15:59	1,49	1	1,49	CHI
20191285695	CAIAPONIA	CP12151179	CAIAPONIA	11/12/2019 14:30	12/12/2019 10:15	11/12/2019 14:30	12/12/2019 10:15	19,75	78	1540,26	CHI
20191285715	ANAPOLIS	AN11288615	JUNDIAI S2	11/12/2019 14:33	11/12/2019 17:07	11/12/2019 14:33	11/12/2019 17:07	2,57	34	87,26	CHI
20191285709	GOUVELANDIA	QI21143196	QUIRINOPOLIS	11/12/2019 14:34	11/12/2019 17:09	11/12/2019 14:34	11/12/2019 17:09	2,58	2	5,15	CHI

20191285769	GOIATUBA	GT11134698	GOIATUBA S2	11/12/2019 14:34	11/12/2019 19:13	11/12/2019 14:34	11/12/2019 19:13	4,63	97	449,54	CHI
20191285714	APARECIDA DE GOIANIA	200083661	INDEPENDENCIA S1	11/12/2019 14:35	11/12/2019 17:07	11/12/2019 14:35	11/12/2019 17:07	2,52	1	2,52	CHI
20191285720	SAO FRANCISCO DE GOIAS	SF21114680	SAO FRANCISCO DE GOIAS	11/12/2019 14:36	11/12/2019 15:45	11/12/2019 14:36	11/12/2019 15:45	1,14	2	2,27	CHI
20191286422	MONTES CLAROS DE GOIAS	ME12023298	IPORA	11/12/2019 14:38	12/12/2019 07:59	11/12/2019 14:38	12/12/2019 07:11	16,55	2	33,10	CHI
20191286422	MONTES CLAROS DE GOIAS	ME12288701LD	IPORA	11/12/2019 14:38	12/12/2019 07:59	11/12/2019 14:38	12/12/2019 07:59	17,35	2	34,70	CHI
20191285732	FAZENDA NOVA	NB12099378	JUSSARA	11/12/2019 14:39	11/12/2019 17:38	11/12/2019 14:39	11/12/2019 17:38	2,98	3	8,93	CHI
20191285732	NOVO BRASIL	NB12099378	JUSSARA	11/12/2019 14:39	11/12/2019 17:38	11/12/2019 14:39	11/12/2019 17:38	2,98	1	2,98	CHI
20191286213	SANTO ANTONIO DO DESCOBERTO	SN11248663	ALEXANIA	11/12/2019 14:41	11/12/2019 17:55	11/12/2019 14:41	11/12/2019 17:55	3,22	68	218,79	CHI
20191285748	AMARALINA	MU12060988	MARA ROSA	11/12/2019 14:42	12/12/2019 21:15	11/12/2019 14:42	11/12/2019 22:41	7,97	2	15,95	CHI
20191285748	MUTUNOPOLIS	MU12060988	MARA ROSA	11/12/2019 14:42	12/12/2019 21:15	11/12/2019 14:42	11/12/2019 22:41	7,97	9	71,77	CHI
20191285748	AMARALINA	MU12060988	MARA ROSA	11/12/2019 14:42	12/12/2019 21:15	12/12/2019 11:12	12/12/2019 12:13	1,02	2	2,04	CHI
20191285748	MUTUNOPOLIS	MU12060988	MARA ROSA	11/12/2019 14:42	12/12/2019 21:15	12/12/2019 11:12	12/12/2019 12:13	1,02	9	9,17	CHI
20191285748	AMARALINA	MU12060988	MARA ROSA	11/12/2019 14:42	12/12/2019 21:15	11/12/2019 14:42	12/12/2019 18:13	27,51	45	1237,86	CHI
20191285748	MUTUNOPOLIS	MU12060988	MARA ROSA	11/12/2019 14:42	12/12/2019 21:15	11/12/2019 14:42	12/12/2019 18:13	27,51	22	605,18	CHI
20191285748	AMARALINA	MU12060988	MARA ROSA	11/12/2019 14:42	12/12/2019 21:15	11/12/2019 14:42	12/12/2019 21:15	30,55	94	2871,62	CHI
20191285749	ITAJA	2300001816	ITAJA S2	11/12/2019 14:43	12/12/2019 01:33	11/12/2019 14:43	12/12/2019 01:33	10,83	1	10,83	CHI
20191285781	HEITORAI	HE11188085	ITAPURANGA	11/12/2019 14:46	11/12/2019 16:56	11/12/2019 14:46	11/12/2019 16:56	2,17	74	160,29	CHI
20191286151	SANTO ANTONIO DO DESCOBERTO	SN21253957	ALEXANIA	11/12/2019 14:46	11/12/2019 21:31	11/12/2019 14:46	11/12/2019 21:31	6,74	1	6,74	CHI
20191285780	PALMEIRAS DE GOIAS	PL12000158	PALMEIRAS	11/12/2019 14:48	11/12/2019 17:31	11/12/2019 14:48	11/12/2019 17:31	2,72	15	40,79	CHI
20191286469	VICENTINOPOLIS	VI12166491	VICENTINOPOLIS	11/12/2019 14:48	12/12/2019 11:10	11/12/2019 14:48	12/12/2019 11:10	20,36	26	529,27	CHI
20191285771	MORRINHOS	MR12380550	PONTALINA	11/12/2019 14:49	11/12/2019 18:25	11/12/2019 14:49	11/12/2019 18:25	3,59	1	3,59	CHI
20191285773	MONTES CLAROS DE GOIAS	1440011075	IPORA	11/12/2019 14:49	12/12/2019 10:40	11/12/2019 14:49	12/12/2019 10:40	19,84	1	19,84	CHI
20191285774	GOIANIRA	GR11241328	GOIANIRA	11/12/2019 14:49	11/12/2019 16:15	11/12/2019 14:49	11/12/2019 16:15	1,42	131	186,49	CHI
20191285791	CATALAO	CT21192694	CATALAO S1	11/12/2019 14:54	11/12/2019 17:20	11/12/2019 14:54	11/12/2019 17:20	2,43	1	2,43	CHI
20191285795	PARAUNA	PU12079036	FIRMINOPOLIS S2	11/12/2019 14:54	11/12/2019 17:05	11/12/2019 14:54	11/12/2019 17:05	2,19	8	17,55	CHI
20191285872	SANTO ANTONIO DO DESCOBERTO	SN12330527	MARAJOARA	11/12/2019 14:54	11/12/2019 17:46	11/12/2019 14:54	11/12/2019 17:46	2,86	15	42,92	CHI
20191285801	NOVO GAMA	2460046840	PACAMBU S1	11/12/2019 14:55	11/12/2019 17:40	11/12/2019 14:55	11/12/2019 17:40	2,75	1	2,75	CHI
20191285802	PIRES DO RIO	460125412	PIRES DO RIO S1	11/12/2019 14:55	11/12/2019 17:50	11/12/2019 14:55	11/12/2019 17:50	2,92	1	2,92	CHI
20191285803	CRISTALINA	KR12249257	CRISTALINA S1	11/12/2019 14:55	12/12/2019 04:31	11/12/2019 14:55	12/12/2019 04:31	13,60	3	40,79	CHI
20191285808	FORMOSA	FA21062336	SAO JOAO D ALIANCA	11/12/2019 14:57	11/12/2019 15:51	11/12/2019 14:57	11/12/2019 15:51	0,90	1	0,90	CHI
20191285812	PORANGATU	PO11217314	PORANGATU	11/12/2019 14:57	12/12/2019 07:46	11/12/2019 14:57	12/12/2019 07:46	16,80	1	16,80	CHI
20191285818	ABADIANIA	AA21318075	ANAPOLIS UNIVERSITARIO S1	11/12/2019 14:57	11/12/2019 16:52	11/12/2019 14:57	11/12/2019 16:52	1,92	1	1,92	CHI
20191285819	PARAUNA	PU12323593	ACREUNA	11/12/2019 14:59	11/12/2019 18:23	11/12/2019 14:59	11/12/2019 18:23	3,40	95	322,97	CHI

20191285821	SAO MIGUEL DO ARAGUAIA	830037184	SAO MIGUEL DO ARAGUAIA	11/12/2019 15:00	11/12/2019 20:18	11/12/2019 15:00	11/12/2019 20:18	5,30	1	5,30	CHI
20191285839	PARAUNA	PU12109627	PARAUNA	11/12/2019 15:00	11/12/2019 18:25	11/12/2019 15:00	11/12/2019 18:25	3,42	23	78,58	CHI
20191285825	ACREUNA	EU12000002	ACREUNA	11/12/2019 15:01	12/12/2019 01:39	11/12/2019 15:01	12/12/2019 01:39	10,63	6	63,75	CHI
20191286023	LUZIANIA	LZ12061391	MARAJOARA	11/12/2019 15:01	11/12/2019 18:44	11/12/2019 15:01	11/12/2019 18:44	3,71	70	259,66	CHI
20191285831	PORANGATU	840030228	PORANGATU	11/12/2019 15:03	11/12/2019 17:37	11/12/2019 15:03	11/12/2019 17:37	2,56	1	2,56	CHI
20191285834	RIO VERDE	10017785780	CABRIUVA S1	11/12/2019 15:04	11/12/2019 16:46	11/12/2019 15:04	11/12/2019 16:46	1,71	1	1,71	CHI
20191285855	MOZARLANDIA	MZ21057137	MOZARLANDIA	11/12/2019 15:07	11/12/2019 19:26	11/12/2019 15:07	11/12/2019 19:12	4,08	1	4,08	CHI
20191285855	MOZARLANDIA	MZ12057128	MOZARLANDIA	11/12/2019 15:07	11/12/2019 19:26	11/12/2019 17:43	11/12/2019 19:26	1,71	4	6,82	CHI
20191285855	NOVA CRIXAS	MZ12057128	MOZARLANDIA	11/12/2019 15:07	11/12/2019 19:26	11/12/2019 17:43	11/12/2019 19:26	1,71	1	1,71	CHI
20191286266	CROMINIA	JS12000108RE	ROCHEDO	11/12/2019 15:08	11/12/2019 18:59	11/12/2019 15:08	11/12/2019 18:59	3,85	4	15,39	CHI
20191286266	HIDROLANDIA	JS12000108RE	ROCHEDO	11/12/2019 15:08	11/12/2019 18:59	11/12/2019 15:08	11/12/2019 18:59	3,85	9	34,62	CHI
20191286266	PIRACANJUBA	JS12000108RE	ROCHEDO	11/12/2019 15:08	11/12/2019 18:59	11/12/2019 15:08	11/12/2019 18:59	3,85	282	1084,76	CHI
20191286266	PROFESSOR JAMIL SAFADY	JS12000108RE	ROCHEDO	11/12/2019 15:08	11/12/2019 18:59	11/12/2019 15:08	11/12/2019 18:59	3,85	179	688,55	CHI
20191285875	SAO LUIS DE MONTES BELOS	SL12000072	SAO LUIZ DOS MONTES BELOS	11/12/2019 15:09	11/12/2019 16:54	11/12/2019 15:09	11/12/2019 16:54	1,76	140	245,93	CHI
20191286372	IPAMERI	IP12068500	CRISTALINA S2	11/12/2019 15:10	11/12/2019 18:54	11/12/2019 15:10	11/12/2019 18:54	3,72	62	230,71	CHI
20191285865	LUZIANIA	LZ12203332	VIANOPOLIS	11/12/2019 15:11	11/12/2019 22:14	11/12/2019 15:11	11/12/2019 22:14	7,05	12	84,60	CHI
20191285866	NAZARIO	NZ21167176	ANICUNS	11/12/2019 15:11	11/12/2019 19:30	11/12/2019 15:11	11/12/2019 19:30	4,31	1	4,31	CHI
20191285871	ARENOPOLIS	AY12040872	ARENOPOLIS	11/12/2019 15:12	12/12/2019 20:26	11/12/2019 15:12	12/12/2019 11:30	20,30	8	162,42	CHI
20191285871	ARENOPOLIS	AY12331912LD	ARENOPOLIS	11/12/2019 15:12	12/12/2019 20:26	11/12/2019 15:12	12/12/2019 20:26	29,24	5	146,20	CHI
20191285874	GOIANIA	GN11136790	FERROVIARIO S1	11/12/2019 15:12	11/12/2019 21:04	11/12/2019 15:12	11/12/2019 21:04	5,86	112	655,79	CHI
20191285880	ITABERAI	1810002932	ITABERAI S1	11/12/2019 15:14	11/12/2019 17:56	11/12/2019 15:14	11/12/2019 17:56	2,70	1	2,70	CHI
20191285881	FORMOSA	FA11262049	ITIQUIRA	11/12/2019 15:14	11/12/2019 18:25	11/12/2019 15:14	11/12/2019 18:25	3,17	21	66,53	CHI
20191285886	AGUA FRIA DE GOIAS	TL21342506	SAO JOAO D ALIANCA	11/12/2019 15:15	11/12/2019 18:55	11/12/2019 15:15	11/12/2019 18:55	3,65	1	3,65	CHI
20191285890	GOIANIA	GN11170727	GOIANIA LESTE S3	11/12/2019 15:15	11/12/2019 15:33	11/12/2019 15:15	11/12/2019 15:33	0,30	30	8,94	CHI
20191285893	AGUA FRIA DE GOIAS	PI12325588	SAO JOAO D ALIANCA	11/12/2019 15:16	11/12/2019 19:30	11/12/2019 15:16	11/12/2019 19:30	4,22	1	4,22	CHI
20191285893	PLANALTINA	PI12325588	SAO JOAO D ALIANCA	11/12/2019 15:16	11/12/2019 19:30	11/12/2019 15:16	11/12/2019 19:30	4,22	96	405,55	CHI
20191285897	ALEXANIA	AX12401149	ALEXANIA	11/12/2019 15:17	11/12/2019 17:54	11/12/2019 15:17	11/12/2019 17:54	2,60	1	2,60	CHI
20191286147	DOVERLANDIA	DV12400429	CAIAPONIA	11/12/2019 15:17	11/12/2019 20:15	11/12/2019 15:17	11/12/2019 20:15	4,96	147	728,71	CHI
20191285904	ALEXANIA	AX12297688	ALEXANIA	11/12/2019 15:19	11/12/2019 20:12	11/12/2019 15:19	11/12/2019 20:12	4,87	7	34,11	CHI
20191285928	SAO LUIS DE MONTES BELOS	SL12071351	SAO LUIZ DOS MONTES BELOS	11/12/2019 15:19	11/12/2019 18:17	11/12/2019 15:19	11/12/2019 18:17	2,97	527	1564,31	CHI
20191285907	GOIANIA	GN11000003	FERROVIARIO S1	11/12/2019 15:20	11/12/2019 16:43	11/12/2019 15:20	11/12/2019 16:43	1,37	87	119,46	CHI
20191285917	MAMBAI	1570015822	IACIARA S2	11/12/2019 15:22	11/12/2019 16:40	11/12/2019 15:22	11/12/2019 16:40	1,30	1	1,30	CHI
20191285918	SILVANIA	SV21284584	VIANOPOLIS	11/12/2019 15:22	11/12/2019 17:58	11/12/2019 15:22	11/12/2019 17:58	2,60	1	2,60	CHI

20191285922	ACREUNA	BZ12219419	ACREUNA	11/12/2019 15:22	11/12/2019 21:00	11/12/2019 15:22	11/12/2019 21:00	5,62	5	28,09	CHI
20191285922	RIO VERDE	BZ12219419	ACREUNA	11/12/2019 15:22	11/12/2019 21:00	11/12/2019 15:22	11/12/2019 21:00	5,62	24	134,85	CHI
20191285922	SANTA HELENA DE GOIAS	BZ12219419	ACREUNA	11/12/2019 15:22	11/12/2019 21:00	11/12/2019 15:22	11/12/2019 21:00	5,62	85	477,58	CHI
20191285922	SANTO ANTONIO DA BARRA	BZ12219419	ACREUNA	11/12/2019 15:22	11/12/2019 21:00	11/12/2019 15:22	11/12/2019 21:00	5,62	171	960,78	CHI
20191285924	CAMPO ALEGRE DE GOIAS	CM21195382	CAMPO ALEGRE DE GOIAS	11/12/2019 15:23	11/12/2019 20:59	11/12/2019 15:23	11/12/2019 20:59	5,60	1	5,60	CHI
20191285925	PALMEIRAS DE GOIAS	10002770260	PALMEIRAS	11/12/2019 15:23	11/12/2019 16:55	11/12/2019 15:23	11/12/2019 16:55	1,54	1	1,54	CHI
20191285926	CACHOEIRA ALTA	CA12053365	CACHOEIRA ALTA	11/12/2019 15:23	11/12/2019 20:34	11/12/2019 15:23	11/12/2019 20:34	5,18	8	41,42	CHI
20191285930	BELA VISTA DE GOIAS	BV12043557	BELA VISTA S1	11/12/2019 15:24	11/12/2019 19:39	11/12/2019 15:24	11/12/2019 19:39	4,25	2	8,49	CHI
20191285936	ARAGARCAS	1820049076	ARAGARCAS	11/12/2019 15:25	11/12/2019 17:13	11/12/2019 15:25	11/12/2019 17:13	1,79	1	1,79	CHI
20191285949	CAMPO ALEGRE DE GOIAS	CM21389958	CAMPO ALEGRE DE GOIAS	11/12/2019 15:27	12/12/2019 12:29	11/12/2019 15:27	12/12/2019 12:29	21,03	1	21,03	CHI
20191285952	PLANALTINA	2960174003	PLANALTINA	11/12/2019 15:28	11/12/2019 17:34	11/12/2019 15:28	11/12/2019 17:34	2,10	1	2,10	CHI
20191285958	ORIZONA	OZ21186672	PIRES DO RIO S2	11/12/2019 15:29	12/12/2019 10:59	11/12/2019 15:29	12/12/2019 10:59	19,50	1	19,50	CHI
20191285959	GOIANIA	10010063160	CARAJAS S1	11/12/2019 15:29	11/12/2019 16:39	11/12/2019 15:29	11/12/2019 16:39	1,15	1	1,15	CHI
20191286050	ITAPACI	IW12181422	ITAPACI	11/12/2019 15:29	12/12/2019 07:53	11/12/2019 15:29	12/12/2019 07:53	16,39	15	245,90	CHI
20191285979	ITUMBIARA	05210224	CACHOEIRA DOURADA	11/12/2019 15:32	12/12/2019 10:35	11/12/2019 15:32	11/12/2019 17:47	2,26	285	643,15	CHI
20191285979	ITUMBIARA	BJ13000034	CACHOEIRA DOURADA	11/12/2019 15:32	12/12/2019 10:35	11/12/2019 15:32	11/12/2019 20:02	4,50	21	94,54	CHI
20191285979	ITUMBIARA	05210224	CACHOEIRA DOURADA	11/12/2019 15:32	12/12/2019 10:35	11/12/2019 20:39	11/12/2019 21:07	0,46	306	140,42	CHI
20191285979	CACHOEIRA DOURADA	BJ13000034	CACHOEIRA DOURADA	11/12/2019 15:32	12/12/2019 10:35	11/12/2019 15:32	12/12/2019 10:35	19,04	28	533,21	CHI
20191285979	ITUMBIARA	BJ13000034	CACHOEIRA DOURADA	11/12/2019 15:32	12/12/2019 10:35	11/12/2019 15:32	12/12/2019 10:35	19,04	61	1161,63	CHI
20191285978	CRISTALINA	KR21090203	CRISTALINA S1	11/12/2019 15:33	12/12/2019 00:16	11/12/2019 15:33	11/12/2019 23:44	8,18	1	8,18	CHI
20191285978	CRISTALINA	KR13253160	CRISTALINA S1	11/12/2019 15:33	12/12/2019 00:16	11/12/2019 21:34	12/12/2019 00:16	2,71	285	771,95	CHI
20191285978	IPAMERI	KR13253160	CRISTALINA S1	11/12/2019 15:33	12/12/2019 00:16	11/12/2019 21:34	12/12/2019 00:16	2,71	6	16,25	CHI
20191285987	CATALAO	CT12390283	CATALAO S1	11/12/2019 15:35	12/12/2019 11:39	11/12/2019 15:35	12/12/2019 11:39	20,06	16	321,00	CHI
20191285989	VIANOPOLIS	VN21109899	VIANOPOLIS	11/12/2019 15:35	11/12/2019 19:09	11/12/2019 15:35	11/12/2019 19:09	3,55	1	3,55	CHI
20191285992	MINACU	4020009250	MINACU	11/12/2019 15:36	11/12/2019 17:20	11/12/2019 15:36	11/12/2019 17:20	1,73	1	1,73	CHI
20191285993	PIRANHAS	PH12074241	ARENOPOLIS	11/12/2019 15:36	11/12/2019 21:48	11/12/2019 15:36	11/12/2019 21:48	6,20	7	43,37	CHI
20191285998	GOIANDIRA	GD21127543	CATALAO S1	11/12/2019 15:37	12/12/2019 22:33	11/12/2019 15:37	12/12/2019 22:33	30,92	1	30,92	CHI
20191286000	GOIANIA	GN11002202	AEROPORTO S2	11/12/2019 15:38	11/12/2019 16:46	11/12/2019 15:38	11/12/2019 16:46	1,13	99	112,01	CHI
20191286288	DOVERLANDIA	DV12354650	CAIAPONIA	11/12/2019 15:39	11/12/2019 20:47	11/12/2019 15:39	11/12/2019 20:47	5,12	49	251,12	CHI
20191286021	CORUMBA DE GOIAS	260010042	CORUMBA	11/12/2019 15:41	11/12/2019 18:15	11/12/2019 15:41	11/12/2019 18:15	2,55	1	2,55	CHI
20191286043	PADRE BERNARDO	PB12152732	PADRE BERNARDO	11/12/2019 15:41	11/12/2019 19:56	11/12/2019 15:41	11/12/2019 19:56	4,24	14	59,38	CHI
20191286026	VILA PROPICIO	10027883149	GOIANESIA S1	11/12/2019 15:42	12/12/2019 18:13	11/12/2019 15:42	12/12/2019 18:13	26,50	1	26,50	CHI
20191285085	GOIANIA	GN16404314	AEROPORTO S1	11/12/2019 15:43	11/12/2019 17:40	11/12/2019 15:43	11/12/2019 16:20	0,61	1365	831,13	CHI

20191285085	GOIANIA	GN13047485	AEROPORTO S1	11/12/2019 15:43	11/12/2019 17:40	11/12/2019 15:43	11/12/2019 17:40	1,96	1078	2109,29	CHI
20191286042	SANTA HELENA DE GOIAS	SH12301310	SANTA HELENA S1	11/12/2019 15:45	11/12/2019 18:30	11/12/2019 15:45	11/12/2019 18:30	2,75	2	5,49	CHI
20191286042	TURVELANDIA	SH12301310	SANTA HELENA S1	11/12/2019 15:45	11/12/2019 18:30	11/12/2019 15:45	11/12/2019 18:30	2,75	5	13,74	CHI
20191286052	PROFESSOR JAMIL SAFADY	JS12230014	ROCHEDO	11/12/2019 15:47	12/12/2019 09:45	11/12/2019 15:47	12/12/2019 09:45	17,96	1	17,96	CHI
20191286054	GOIATUBA	GT12104434	BOM JESUS DE GOIAS	11/12/2019 15:48	11/12/2019 21:26	11/12/2019 15:48	11/12/2019 21:26	5,62	3	16,87	CHI
20191286690	CATALAO	CT12025155	CATALAO S1	11/12/2019 15:48	11/12/2019 20:11	11/12/2019 15:48	11/12/2019 20:11	4,38	6	26,30	CHI
20191286063	PORTEIRAO	02650224	RIO DOS BOIS	11/12/2019 15:50	14/12/2019 19:10	11/12/2019 16:46	11/12/2019 17:14	0,48	1552	749,27	CHI
20191286063	PORTEIRAO	CL12030933LD	RIO DOS BOIS	11/12/2019 15:50	14/12/2019 19:10	11/12/2019 16:46	11/12/2019 17:28	0,71	3	2,13	CHI
20191286063	EDEIA	CL13230807	RIO DOS BOIS	11/12/2019 15:50	14/12/2019 19:10	11/12/2019 16:46	11/12/2019 17:50	1,07	2	2,13	CHI
20191286063	GOIATUBA	CL13230807	RIO DOS BOIS	11/12/2019 15:50	14/12/2019 19:10	11/12/2019 16:46	11/12/2019 17:50	1,07	18	19,20	CHI
20191286063	PORTEIRAO	CL13230807	RIO DOS BOIS	11/12/2019 15:50	14/12/2019 19:10	11/12/2019 16:46	11/12/2019 17:50	1,07	31	33,07	CHI
20191286063	VICENTINOPOLIS	CL13230807	RIO DOS BOIS	11/12/2019 15:50	14/12/2019 19:10	11/12/2019 16:46	11/12/2019 17:50	1,07	4	4,27	CHI
20191286063	ACREUNA	CL13214131	RIO DOS BOIS	11/12/2019 15:50	14/12/2019 19:10	11/12/2019 16:46	11/12/2019 17:55	1,15	14	16,15	CHI
20191286063	EDEIA	CL13214131	RIO DOS BOIS	11/12/2019 15:50	14/12/2019 19:10	11/12/2019 16:46	11/12/2019 17:55	1,15	48	55,37	CHI
20191286063	PORTEIRAO	CL13214131	RIO DOS BOIS	11/12/2019 15:50	14/12/2019 19:10	11/12/2019 16:46	11/12/2019 17:55	1,15	8	9,23	CHI
20191286063	TURVELANDIA	CL13214131	RIO DOS BOIS	11/12/2019 15:50	14/12/2019 19:10	11/12/2019 16:46	11/12/2019 17:55	1,15	13	15,00	CHI
20191286063	EDEIA	CL13214131	RIO DOS BOIS	11/12/2019 15:50	14/12/2019 19:10	11/12/2019 18:00	11/12/2019 18:45	0,76	24	18,26	CHI
20191286063	PORTEIRAO	CL13214131	RIO DOS BOIS	11/12/2019 15:50	14/12/2019 19:10	11/12/2019 18:00	11/12/2019 18:45	0,76	8	6,09	CHI
20191286063	TURVELANDIA	CL13214131	RIO DOS BOIS	11/12/2019 15:50	14/12/2019 19:10	11/12/2019 18:00	11/12/2019 18:45	0,76	13	9,89	CHI
20191286063	EDEIA	02650224	RIO DOS BOIS	11/12/2019 15:50	14/12/2019 19:10	11/12/2019 20:00	11/12/2019 20:03	0,05	25	1,33	CHI
20191286063	GOIATUBA	02650224	RIO DOS BOIS	11/12/2019 15:50	14/12/2019 19:10	11/12/2019 20:00	11/12/2019 20:03	0,05	18	0,96	CHI
20191286063	PORTEIRAO	02650224	RIO DOS BOIS	11/12/2019 15:50	14/12/2019 19:10	11/12/2019 20:00	11/12/2019 20:03	0,05	39	2,07	CHI
20191286063	PORTEIRAO	02650224	RIO DOS BOIS	11/12/2019 15:50	14/12/2019 19:10	11/12/2019 20:00	11/12/2019 20:03	0,05	1555	82,50	CHI
20191286063	PORTEIRAO	02650224	RIO DOS BOIS	11/12/2019 15:50	14/12/2019 19:10	11/12/2019 20:00	11/12/2019 20:03	0,05	5	0,27	CHI
20191286063	TURVELANDIA	02650224	RIO DOS BOIS	11/12/2019 15:50	14/12/2019 19:10	11/12/2019 20:00	11/12/2019 20:03	0,05	13	0,69	CHI
20191286063	VICENTINOPOLIS	02650224	RIO DOS BOIS	11/12/2019 15:50	14/12/2019 19:10	11/12/2019 20:00	11/12/2019 20:03	0,05	3	0,16	CHI
20191286063	ACREUNA	EA13263298	RIO DOS BOIS	11/12/2019 15:50	14/12/2019 19:10	11/12/2019 18:00	14/12/2019 19:10	73,17	14	1024,33	CHI
20191286063	EDEIA	EA13263298	RIO DOS BOIS	11/12/2019 15:50	14/12/2019 19:10	11/12/2019 18:00	14/12/2019 19:10	73,17	24	1756,00	CHI
20191286065	PALESTINA DE GOIAS	PY12374894	PALESTINA	11/12/2019 15:50	12/12/2019 09:15	11/12/2019 15:50	12/12/2019 09:15	17,40	2	34,80	CHI
20191286066	ITAPURANGA	IK21299930	ITAPURANGA	11/12/2019 15:50	11/12/2019 17:50	11/12/2019 15:50	11/12/2019 17:50	1,98	2	3,97	CHI
20191286074	PALMEIRAS DE GOIAS	PP12000036	PALMEIRAS	11/12/2019 15:50	11/12/2019 17:56	11/12/2019 15:50	11/12/2019 17:56	2,11	52	109,56	CHI
20191286074	PALMINOPOLIS	PP12000036	PALMEIRAS	11/12/2019 15:50	11/12/2019 17:56	11/12/2019 15:50	11/12/2019 17:56	2,11	38	80,06	CHI
20191286116	CALDAS NOVAS	CN11044750	CALDAS NOVAS S2	11/12/2019 15:50	11/12/2019 17:12	11/12/2019 15:50	11/12/2019 17:12	1,37	58	79,17	CHI

20191286068	TRINDADE	10005955112	GOYA S2	11/12/2019 15:51	11/12/2019 18:05	11/12/2019 15:51	11/12/2019 18:05	2,23	1	2,23	CHI
20191286073	JARAGUA	JA21119295	JARAGUA	11/12/2019 15:52	11/12/2019 17:05	11/12/2019 15:52	11/12/2019 17:05	1,21	1	1,21	CHI
20191286078	AGUA FRIA DE GOIAS	TL21322494	SAO JOAO D ALIANCA	11/12/2019 15:53	12/12/2019 12:30	11/12/2019 15:53	12/12/2019 12:30	20,61	3	61,83	CHI
20191286079	ALEXANIA	AX31082628	ALEXANIA	11/12/2019 15:53	11/12/2019 19:50	11/12/2019 15:53	11/12/2019 19:50	3,94	1	3,94	CHI
20191286080	ORIZONA	OZ21114447	VIANOPOLIS	11/12/2019 15:53	12/12/2019 09:33	11/12/2019 15:53	12/12/2019 09:33	17,65	1	17,65	CHI
20191286094	MORRINHOS	MR12000148	MORRINHOS	11/12/2019 15:57	11/12/2019 17:34	11/12/2019 15:57	11/12/2019 17:34	1,61	24	38,61	CHI
20191286095	CACHOEIRA DOURADA	IT12081121	CACHOEIRA DOURADA	11/12/2019 15:57	11/12/2019 17:57	11/12/2019 15:57	11/12/2019 17:57	2,00	1	2,00	CHI
20191286096	APARECIDA DE GOIANIA	12369792	INDEPENDENCIA S2	11/12/2019 15:57	11/12/2019 17:45	11/12/2019 15:57	11/12/2019 17:45	1,79	1	1,79	CHI
20191286248	SENADOR CANEDO	SW12313112	SENADOR CANEDO	11/12/2019 15:57	11/12/2019 17:45	11/12/2019 15:57	11/12/2019 17:45	1,80	123	220,85	CHI
20191286114	JANDAIA	PU12172481	PARAUNA	11/12/2019 15:58	11/12/2019 19:47	11/12/2019 15:58	11/12/2019 19:47	3,82	3	11,46	CHI
20191286114	PARAUNA	PU12172481	PARAUNA	11/12/2019 15:58	11/12/2019 19:47	11/12/2019 15:58	11/12/2019 19:47	3,82	6	22,93	CHI
20191286231	PIRANHAS	PH12024557	ARENOPOLIS	11/12/2019 16:01	11/12/2019 20:21	11/12/2019 16:01	11/12/2019 20:21	4,33	8	34,65	CHI
20191286119	PIRACANJUBA	PJ121282980	PIRACANJUBA	11/12/2019 16:02	11/12/2019 18:37	11/12/2019 16:02	11/12/2019 18:37	2,59	1	2,59	CHI
20191286128	GOIAS	GS12334023	GOIAS	11/12/2019 16:05	12/12/2019 13:40	11/12/2019 16:05	12/12/2019 13:40	21,58	3	64,74	CHI
20191286132	IPAMERI	IP21202973	URUTAI	11/12/2019 16:05	12/12/2019 08:45	11/12/2019 16:05	12/12/2019 08:45	16,66	1	16,66	CHI
20191288139	CAMPO ALEGRE DE GOIAS	02250424	CAMPO ALEGRE DE GOIAS	11/12/2019 16:06	12/12/2019 01:44	12/12/2019 00:40	12/12/2019 01:44	1,07	277	297,62	CHI
20191288139	CATALAO	02250424	CAMPO ALEGRE DE GOIAS	11/12/2019 16:06	12/12/2019 01:44	12/12/2019 00:40	12/12/2019 01:44	1,07	21	22,56	CHI
20191288139	DISTRITO FEDERAL	02250424	CAMPO ALEGRE DE GOIAS	11/12/2019 16:06	12/12/2019 01:44	12/12/2019 00:40	12/12/2019 01:44	1,07	1	1,07	CHI
20191288139	IPAMERI	02250424	CAMPO ALEGRE DE GOIAS	11/12/2019 16:06	12/12/2019 01:44	12/12/2019 00:40	12/12/2019 01:44	1,07	11	11,82	CHI
20191286139	MINEIROS	1390070429	PARQUE DAS EMAS	11/12/2019 16:07	11/12/2019 18:37	11/12/2019 16:07	11/12/2019 18:37	2,51	1	2,51	CHI
20191286141	ANAPOLIS	AN12000092	ANAPOLIS UNIVERSITARIO S2	11/12/2019 16:07	12/12/2019 00:06	11/12/2019 16:07	12/12/2019 00:06	7,97	146	1163,90	CHI
20191286175	RIO VERDE	RV21246770	CABRIUVA S2	11/12/2019 16:07	11/12/2019 19:30	11/12/2019 16:07	11/12/2019 19:30	3,39	1	3,39	CHI
20191286354	GOIANIA	GN11240463	FERROVIARIO S1	11/12/2019 16:08	11/12/2019 17:37	11/12/2019 16:08	11/12/2019 17:37	1,48	172	254,85	CHI
20191286148	TRINDADE	12206714	GOYA S2	11/12/2019 16:09	11/12/2019 20:17	11/12/2019 16:09	11/12/2019 20:17	4,12	1	4,12	CHI
20191286149	SANTA CRUZ DE GOIAS	10030615354	PIRES DO RIO S2	11/12/2019 16:09	11/12/2019 19:14	11/12/2019 16:09	11/12/2019 19:14	3,07	0	0,00	CHI
20191286152	CATALAO	CT21077473	CATALAO S1	11/12/2019 16:11	12/12/2019 13:20	11/12/2019 16:11	12/12/2019 13:20	21,15	2	42,30	CHI
20191286153	ABADIANIA	AA21271856	ANAPOLIS UNIVERSITARIO S1	11/12/2019 16:11	11/12/2019 19:31	11/12/2019 16:11	11/12/2019 19:31	3,32	0	0,00	CHI
20191286156	CRIXAS	2490000970	SERRA DO OURO	11/12/2019 16:11	12/12/2019 09:20	11/12/2019 16:11	12/12/2019 09:20	17,15	1	17,15	CHI
20191286157	PILAR DE GOIAS	GG21243188	SANTA TEREZINHA	11/12/2019 16:11	12/12/2019 09:54	11/12/2019 16:11	12/12/2019 09:54	17,70	1	17,70	CHI
20191286217	CRIXAS	CX12321941	SERRA DO OURO	11/12/2019 16:11	11/12/2019 19:41	11/12/2019 16:11	11/12/2019 19:41	3,49	18	62,82	CHI
20191286217	NOVA CRIXAS	CX12321941	SERRA DO OURO	11/12/2019 16:11	11/12/2019 19:41	11/12/2019 16:11	11/12/2019 19:41	3,49	6	20,94	CHI
20191286282	SANTA HELENA DE GOIAS	SH13400226	IPEGUARI	11/12/2019 16:13	11/12/2019 18:45	11/12/2019 16:13	11/12/2019 18:45	2,53	1328	3361,68	CHI
20191286167	FAINA	FC12271131	GOIAS	11/12/2019 16:14	11/12/2019 18:55	11/12/2019 16:14	11/12/2019 18:55	2,68	2	5,36	CHI

20191286272	RIO VERDE	RV12153892	RIO VERDE S2	11/12/2019 16:14	11/12/2019 17:24	11/12/2019 16:14	11/12/2019 17:24	1,18	9	10,59	CHI
20191286174	FIRMINOPOLIS	SL12306929	SAO LUIZ DOS MONTES BELOS	11/12/2019 16:15	11/12/2019 17:40	11/12/2019 16:15	11/12/2019 17:40	1,41	39	55,17	CHI
20191286174	SAO LUIS DE MONTES BELOS	SL12306929	SAO LUIZ DOS MONTES BELOS	11/12/2019 16:15	11/12/2019 17:40	11/12/2019 16:15	11/12/2019 17:40	1,41	22	31,12	CHI
20191286450	ORIZONA	OZ12022880RE	PIRES DO RIO S2	11/12/2019 16:15	13/12/2019 17:14	11/12/2019 16:15	13/12/2019 12:14	43,99	18	791,80	CHI
20191286450	ORIZONA	OZ12022880RE	PIRES DO RIO S2	11/12/2019 16:15	13/12/2019 17:14	11/12/2019 16:15	13/12/2019 16:40	48,42	22	1065,29	CHI
20191286450	ORIZONA	OZ12022880RE	PIRES DO RIO S2	11/12/2019 16:15	13/12/2019 17:14	11/12/2019 16:15	13/12/2019 17:14	48,98	18	881,69	CHI
20191286188	MUTUNOPOLIS	MU21147227	MARA ROSA	11/12/2019 16:18	12/12/2019 10:40	11/12/2019 16:18	12/12/2019 10:40	18,37	1	18,37	CHI
20191286190	EDEIA	ED21000028	PONTALINA	11/12/2019 16:18	12/12/2019 09:52	11/12/2019 16:18	12/12/2019 09:52	17,56	1	17,56	CHI
20191286196	SANCLERLANDIA	SC21169231	FIRMINOPOLIS S2	11/12/2019 16:19	11/12/2019 19:12	11/12/2019 16:19	11/12/2019 19:12	2,88	1	2,88	CHI
20191286198	MONTE ALEGRE DE GOIAS	MA21282247	SAO DOMINGOS	11/12/2019 16:19	11/12/2019 19:15	11/12/2019 16:19	11/12/2019 19:15	2,93	1	2,93	CHI
20191286208	CALDAS NOVAS	760000773	CALDAS NOVAS S2	11/12/2019 16:19	11/12/2019 17:23	11/12/2019 16:19	11/12/2019 17:23	1,06	1	1,06	CHI
20191286796	RUBIATABA	RB12003332	RUBIATABA	11/12/2019 16:19	12/12/2019 09:37	11/12/2019 16:19	12/12/2019 09:37	17,30	3	51,90	CHI
20191286225	FIRMINOPOLIS	TV12105317	FIRMINOPOLIS S1	11/12/2019 16:20	11/12/2019 19:21	11/12/2019 16:20	11/12/2019 19:21	3,01	9	27,06	CHI
20191286215	CIDADE OCIDENTAL	DH12383019	MARAJOARA	11/12/2019 16:21	11/12/2019 18:24	11/12/2019 16:21	11/12/2019 18:24	2,04	30	61,21	CHI
20191286216	ANICUNS	AC12000082	ANICUNS	11/12/2019 16:21	11/12/2019 22:20	11/12/2019 16:21	11/12/2019 22:20	5,98	52	310,87	CHI
20191286219	INHUMAS	IN12326287	INHUMAS S2	11/12/2019 16:22	11/12/2019 20:45	11/12/2019 16:22	11/12/2019 20:45	4,38	9	39,43	CHI
20191286224	VILA PROPICIO	NP21298238	GOIANESIA S1	11/12/2019 16:23	12/12/2019 11:16	11/12/2019 16:23	12/12/2019 11:16	18,88	2	37,76	CHI
20191286227	RIO VERDE	RV12260579	RIO VERDE S1	11/12/2019 16:23	12/12/2019 21:05	11/12/2019 16:23	12/12/2019 21:05	28,69	16	459,00	CHI
20191286240	BOM JARDIM DE GOIAS	BM11380934	BOM JARDIM	11/12/2019 16:23	12/12/2019 15:14	12/12/2019 11:50	12/12/2019 15:14	3,41	60	204,77	CHI
20191286232	ABADIANIA	AA21072461	CORUMBA	11/12/2019 16:24	11/12/2019 18:57	11/12/2019 16:24	11/12/2019 18:57	2,54	1	2,54	CHI
20191286239	AMORINOPOLIS	AM21031318	IPORA	11/12/2019 16:25	12/12/2019 09:09	11/12/2019 16:25	12/12/2019 09:09	16,73	1	16,73	CHI
20191286244	BRITANIA	BT12360137	BRITANIA	11/12/2019 16:25	12/12/2019 11:45	11/12/2019 16:25	12/12/2019 11:45	19,32	2	38,65	CHI
20191286260	DOVERLANDIA	DV11220999	CAIAPONIA	11/12/2019 16:28	12/12/2019 06:46	11/12/2019 16:28	12/12/2019 06:46	14,29	1	14,29	CHI
20191287438	MAURILANDIA	ML12303327	RIO DOS BOIS	11/12/2019 16:28	12/12/2019 10:04	11/12/2019 16:28	12/12/2019 10:04	17,59	26	457,29	CHI
20191286262	NAZARIO	8688429	ANICUNS	11/12/2019 16:29	12/12/2019 20:35	11/12/2019 16:30	12/12/2019 09:20	16,83	1	16,83	CHI
20191286262	NAZARIO	NZ21206365	ANICUNS	11/12/2019 16:29	12/12/2019 20:35	11/12/2019 16:29	12/12/2019 19:52	27,39	2	54,78	CHI
20191286262	NAZARIO	8688429	ANICUNS	11/12/2019 16:29	12/12/2019 20:35	12/12/2019 15:30	12/12/2019 20:35	5,08	1	5,08	CHI
20191286268	PONTALINA	PK21041758	PONTALINA	11/12/2019 16:30	11/12/2019 21:31	11/12/2019 16:30	11/12/2019 21:31	5,01	1	5,01	CHI
20191286269	ANAPOLIS	AN21258656	JUNDIAI S1	11/12/2019 16:30	11/12/2019 19:10	11/12/2019 16:30	11/12/2019 19:10	2,67	1	2,67	CHI
20191286277	INDIARA	IY21312415	CEZARINA	11/12/2019 16:32	11/12/2019 18:55	11/12/2019 16:32	11/12/2019 18:55	2,38	1	2,38	CHI
20191286286	CRISTALINA	KR21139066	CRISTALINA S1	11/12/2019 16:32	12/12/2019 23:02	11/12/2019 16:32	12/12/2019 23:02	30,50	1	30,50	CHI
20191286375	NOVO BRASIL	NB11020195	JUSSARA	11/12/2019 16:32	11/12/2019 20:21	11/12/2019 16:32	11/12/2019 20:21	3,81	127	483,94	CHI
20191286289	ITUMBIARA	IT12273840RE	ITUMBIARA NOVA	11/12/2019 16:34	13/12/2019 12:47	11/12/2019 16:34	11/12/2019 21:40	5,10	18	91,88	CHI

20191286289	ITUMBIARA	IT13208004	ITUMBIARA NOVA	11/12/2019 16:34	13/12/2019 12:47	11/12/2019 16:34	12/12/2019 20:35	28,01	14	392,21	CHI
20191286289	ITUMBIARA	IT12031395	ITUMBIARA NOVA	11/12/2019 16:34	13/12/2019 12:47	11/12/2019 16:34	12/12/2019 22:15	29,70	4	118,79	CHI
20191286289	ITUMBIARA	IT12310029LD	ITUMBIARA NOVA	11/12/2019 16:34	13/12/2019 12:47	11/12/2019 16:34	12/12/2019 23:25	30,86	6	185,15	CHI
20191286289	ITUMBIARA	IT12287947LD	ITUMBIARA NOVA	11/12/2019 16:34	13/12/2019 12:47	11/12/2019 16:34	13/12/2019 12:47	44,22	2	88,44	CHI
20191286476	CRIXAS	GF12135520	SANTA TEREZINHA	11/12/2019 16:35	12/12/2019 15:19	11/12/2019 16:35	12/12/2019 15:19	22,72	3	68,16	CHI
20191286476	GUARINOS	GF12135520	SANTA TEREZINHA	11/12/2019 16:35	12/12/2019 15:19	11/12/2019 16:35	12/12/2019 15:19	22,72	5	113,60	CHI
20191286312	PLANALTINA	10017709014	PLANALTINA	11/12/2019 16:37	11/12/2019 17:54	11/12/2019 16:37	11/12/2019 17:54	1,28	1	1,28	CHI
20191286313	GOIANIA	10599710	AEROPORTO S1	11/12/2019 16:37	11/12/2019 20:02	11/12/2019 16:37	11/12/2019 20:02	3,41	1	3,41	CHI
20191286315	ITAPURANGA	IK21023055	ITAPURANGA	11/12/2019 16:37	11/12/2019 19:00	11/12/2019 16:37	11/12/2019 19:00	2,37	1	2,37	CHI
20191287378	MINEIROS	MY12156849	PARQUE DAS EMAS	11/12/2019 16:37	11/12/2019 22:11	11/12/2019 16:37	11/12/2019 22:11	5,56	11	61,19	CHI
20191286324	ANAPOLIS	20050215	JUNDIAI S2	11/12/2019 16:39	11/12/2019 17:44	11/12/2019 16:39	11/12/2019 17:44	1,08	1	1,08	CHI
20191286326	CACU	CC12125875	CACHOEIRA ALTA	11/12/2019 16:39	11/12/2019 20:20	11/12/2019 16:39	11/12/2019 20:20	3,67	2	7,34	CHI
20191286337	ANAPOLIS	AN12026162	ANAPOLIS UNIVERSITARIO S2	11/12/2019 16:42	11/12/2019 18:31	11/12/2019 16:42	11/12/2019 18:31	1,81	6	10,89	CHI
20191286344	PIRES DO RIO	460090227	PIRES DO RIO S1	11/12/2019 16:43	11/12/2019 19:37	11/12/2019 16:43	11/12/2019 19:37	2,89	1	2,89	CHI
20191286349	GOIANIRA	TR32045819	MEIA PONTE	11/12/2019 16:44	11/12/2019 23:33	11/12/2019 16:44	11/12/2019 23:33	6,82	23	156,82	CHI
20191286349	TRINDADE	TR32045819	MEIA PONTE	11/12/2019 16:44	11/12/2019 23:33	11/12/2019 16:44	11/12/2019 23:33	6,82	4	27,27	CHI
20191286351	AGUAS LINDAS DE GOIAS	4830001022	AGUAS LINDAS DE GOIAS S2	11/12/2019 16:44	11/12/2019 18:06	11/12/2019 16:44	11/12/2019 18:06	1,36	1	1,36	CHI
20191286353	PALMEIRAS DE GOIAS	PL21010892	PALMEIRAS	11/12/2019 16:44	12/12/2019 11:38	11/12/2019 16:44	12/12/2019 11:38	18,88	3	56,65	CHI
20191286365	COCALZINHO DE GOIAS	ZN21153765	COCALZINHO	11/12/2019 16:46	12/12/2019 15:26	11/12/2019 16:46	12/12/2019 15:26	22,66	1	22,66	CHI
20191286412	EDEIA	EA12026646	EDEIA	11/12/2019 16:46	12/12/2019 07:37	11/12/2019 16:46	12/12/2019 07:37	14,84	9	133,60	CHI
20191286370	AMARALINA	MQ12288718LD	NOVA CRIXAS	11/12/2019 16:48	12/12/2019 16:20	11/12/2019 16:48	12/12/2019 15:50	23,03	2	46,06	CHI
20191286370	AMARALINA	MQ12410863	NOVA CRIXAS	11/12/2019 16:48	12/12/2019 16:20	11/12/2019 16:48	12/12/2019 16:20	23,53	1	23,53	CHI
20191286373	CALDAS NOVAS	CN12118543	CALDAS NOVAS S1	11/12/2019 16:48	11/12/2019 19:20	11/12/2019 16:48	11/12/2019 19:20	2,53	4	10,13	CHI
20191286374	LUZIANIA	3200083746	MARAJOARA	11/12/2019 16:49	11/12/2019 17:55	11/12/2019 16:49	11/12/2019 17:55	1,11	1	1,11	CHI
20191286377	FORMOSA	FA11000001	ITUIQUIRA	11/12/2019 16:49	11/12/2019 18:22	11/12/2019 16:49	11/12/2019 18:22	1,54	170	262,22	CHI
20191286378	SILVANIA	SV21153510	DAIA S2	11/12/2019 16:49	11/12/2019 19:07	11/12/2019 16:49	11/12/2019 19:07	2,29	2	4,58	CHI
20191286388	PARAUNA	PU12205943	PARAUNA	11/12/2019 16:49	11/12/2019 19:47	11/12/2019 16:49	11/12/2019 19:47	2,97	21	62,32	CHI
20191286382	INDIARA	2710022066	EDEIA	11/12/2019 16:50	11/12/2019 22:23	11/12/2019 16:50	11/12/2019 22:23	5,55	1	5,55	CHI
20191286384	LEOPOLDO DE BULHOES	LB21321491	DAIA S2	11/12/2019 16:50	12/12/2019 03:24	11/12/2019 16:50	12/12/2019 03:24	10,56	3	31,67	CHI
20191286392	NIQUELANDIA	NQ12398048	URUACU	11/12/2019 16:52	12/12/2019 12:51	11/12/2019 16:52	12/12/2019 12:51	19,98	81	1618,00	CHI
20191286394	MORRINHOS	MR21335155	MORRINHOS	11/12/2019 16:52	12/12/2019 12:40	11/12/2019 16:52	12/12/2019 12:40	19,81	1	19,81	CHI
20191286399	LUZIANIA	10010170110	MARAJOARA	11/12/2019 16:54	11/12/2019 19:48	11/12/2019 16:54	11/12/2019 19:48	2,90	1	2,90	CHI
20191286400	CORUMBAIBA	00840214	VILA CORUMBA	11/12/2019 16:54	11/12/2019 20:28	11/12/2019 16:54	11/12/2019 19:03	2,15	3438	7384,06	CHI

20191286400	NOVA AURORA	00840214	VILA CORUMBA	11/12/2019 16:54	11/12/2019 20:28	11/12/2019 16:54	11/12/2019 19:03	2,15	7	15,03	CHI
20191286400	CORUMBAIBA	CI13215738	VILA CORUMBA	11/12/2019 16:54	11/12/2019 20:28	11/12/2019 16:54	11/12/2019 20:28	3,55	1001	3557,72	CHI
20191286402	CALDAZINHA	SV21143458	CEPAIGO S2	11/12/2019 16:54	11/12/2019 19:37	11/12/2019 16:54	11/12/2019 19:37	2,71	1	2,71	CHI
20191286463	GOIANESIA	GE12000016	GOIANESIA S2	11/12/2019 16:55	13/12/2019 21:18	11/12/2019 16:55	12/12/2019 14:13	21,31	1	21,31	CHI
20191286463	GOIANESIA	GE12000016	GOIANESIA S2	11/12/2019 16:55	13/12/2019 21:18	11/12/2019 16:55	12/12/2019 20:19	27,40	4	109,58	CHI
20191286463	VILA PROPICIO	GE12000016	GOIANESIA S2	11/12/2019 16:55	13/12/2019 21:18	11/12/2019 16:55	12/12/2019 20:19	27,40	3	82,19	CHI
20191286463	GOIANESIA	GE12000016	GOIANESIA S2	11/12/2019 16:55	13/12/2019 21:18	12/12/2019 19:50	12/12/2019 20:19	0,47	1	0,47	CHI
20191286463	GOIANESIA	GE12000016	GOIANESIA S2	11/12/2019 16:55	13/12/2019 21:18	11/12/2019 16:55	13/12/2019 21:18	52,38	3	157,15	CHI
20191286463	VILA PROPICIO	GE12000016	GOIANESIA S2	11/12/2019 16:55	13/12/2019 21:18	11/12/2019 16:55	13/12/2019 21:18	52,38	2	104,77	CHI
20191286463	GOIANESIA	GE12000016	GOIANESIA S2	11/12/2019 16:55	13/12/2019 21:18	12/12/2019 20:20	13/12/2019 21:18	24,96	5	124,78	CHI
20191286463	VILA PROPICIO	GE12000016	GOIANESIA S2	11/12/2019 16:55	13/12/2019 21:18	12/12/2019 20:20	13/12/2019 21:18	24,96	3	74,87	CHI
20191287196	SANTA HELENA DE GOIAS	SH12279869	IPEGUARI	11/12/2019 16:55	11/12/2019 20:20	11/12/2019 16:55	11/12/2019 20:20	3,41	167	570,30	CHI
20191286433	MOSSAMEDES	SC12206496	FIRMINOPOLIS S2	11/12/2019 16:56	11/12/2019 18:14	11/12/2019 16:56	11/12/2019 18:14	1,30	2	2,60	CHI
20191286433	SANCLERLANDIA	SC12206496	FIRMINOPOLIS S2	11/12/2019 16:56	11/12/2019 18:14	11/12/2019 16:56	11/12/2019 18:14	1,30	91	118,20	CHI
20191286434	IACIARA	IA21131409	IACIARA S1	11/12/2019 16:58	11/12/2019 18:20	11/12/2019 16:58	11/12/2019 18:20	1,36	1	1,36	CHI
20191286475	GOIANIRA	GR11241328	GOIANIRA	11/12/2019 16:59	11/12/2019 20:19	11/12/2019 16:59	11/12/2019 20:19	3,34	131	437,29	CHI
20191286453	JANDAIA	JD21022246	PALMEIRAS	11/12/2019 17:01	12/12/2019 08:06	11/12/2019 17:01	12/12/2019 08:06	15,08	1	15,08	CHI
20191286459	TRINDADE	40185837	TRINDADE	11/12/2019 17:02	11/12/2019 20:57	11/12/2019 17:02	11/12/2019 20:57	3,92	1	3,92	CHI
20191286465	ITUMBIARA	IT12257179RE	BOM JESUS DE GOIAS	11/12/2019 17:03	12/12/2019 10:35	11/12/2019 17:03	12/12/2019 10:35	17,53	2	35,05	CHI
20191286466	CATALAO	CT21272524	CATALAO S1	11/12/2019 17:03	12/12/2019 14:10	11/12/2019 17:03	12/12/2019 14:10	21,11	1	21,11	CHI
20191286471	ANAPOLIS	10023581288	ANAPOLIS UNIVERSITARIO S2	11/12/2019 17:03	12/12/2019 00:57	11/12/2019 17:03	12/12/2019 00:57	7,89	1	7,89	CHI
201912260813	ARENOPOLIS	AY12223147	IPORA	11/12/2019 17:03	11/12/2019 22:46	11/12/2019 17:03	11/12/2019 22:46	5,71	58	331,16	CHI
201912260813	MONTES CLAROS DE GOIAS	AY12223147	IPORA	11/12/2019 17:03	11/12/2019 22:46	11/12/2019 17:03	11/12/2019 22:46	5,71	1	5,71	CHI
201912260813	PIRANHAS	AY12223147	IPORA	11/12/2019 17:03	11/12/2019 22:46	11/12/2019 17:03	11/12/2019 22:46	5,71	1	5,71	CHI
20191286473	APORE	AE21340780	ITAJA S1	11/12/2019 17:04	13/12/2019 16:20	11/12/2019 17:04	13/12/2019 16:20	47,26	1	47,26	CHI
20191286474	MARA ROSA	MQ21308198	MARA ROSA	11/12/2019 17:04	11/12/2019 18:38	11/12/2019 17:04	11/12/2019 18:38	1,56	1	1,56	CHI
20191286758	ORIZONA	OZ12143757	PIRES DO RIO S2	11/12/2019 17:05	11/12/2019 22:09	11/12/2019 17:05	11/12/2019 22:09	5,05	39	196,99	CHI
20191286489	CATALAO	CT21127858	CATALAO S1	11/12/2019 17:07	12/12/2019 12:20	11/12/2019 17:07	12/12/2019 12:20	19,21	2	38,42	CHI
20191286495	QUIRINOPOLIS	QI12054920	QUIRINOPOLIS	11/12/2019 17:08	12/12/2019 05:49	11/12/2019 17:08	12/12/2019 05:49	12,68	3	38,04	CHI
20191286625	FAINA	FC12038664	GOIAS	11/12/2019 17:08	12/12/2019 08:18	11/12/2019 17:08	12/12/2019 08:18	15,16	10	151,57	CHI
20191286612	ITAPURANGA	IK12311015	ITAPURANGA	11/12/2019 17:09	11/12/2019 20:46	11/12/2019 17:09	11/12/2019 20:46	3,61	141	508,50	CHI
20191286614	BRAZABRANTES	BR12166574	NEROPOLIS S1	11/12/2019 17:10	11/12/2019 20:21	11/12/2019 17:10	11/12/2019 20:21	3,18	2	6,36	CHI
20191286614	GOIANIRA	BR12166574	NEROPOLIS S1	11/12/2019 17:10	11/12/2019 20:21	11/12/2019 17:10	11/12/2019 20:21	3,18	20	63,61	CHI

20191286614	SANTO ANTONIO DE GOIAS	BR12166574	NEROPOLIS S1	11/12/2019 17:10	11/12/2019 20:21	11/12/2019 17:10	11/12/2019 20:21	3,18	3	9,54	CHI
20191286621	NOVA CRIXAS	NA21342061	NOVA CRIXAS	11/12/2019 17:12	12/12/2019 08:32	11/12/2019 17:12	12/12/2019 08:32	15,32	1	15,32	CHI
20191286623	PARANAIGUARA	PC12191594	CACHOEIRA ALTA	11/12/2019 17:12	11/12/2019 18:02	11/12/2019 17:12	11/12/2019 18:02	0,82	724	592,27	CHI
20191286626	GOIANESIA	550100453	GOIANESIA S2	11/12/2019 17:13	11/12/2019 18:35	11/12/2019 17:13	11/12/2019 18:35	1,36	1	1,36	CHI
20191286627	TAQUARAL DE GOIAS	TQ12300097	ITABERAI S1	11/12/2019 17:14	11/12/2019 22:51	11/12/2019 17:14	11/12/2019 22:51	5,61	5	28,05	CHI
20191286629	SAO LUIS DE MONTES BELOS	SL21259222	SAO LUIZ DOS MONTES BELOS	11/12/2019 17:14	11/12/2019 18:54	11/12/2019 17:14	11/12/2019 18:54	1,67	1	1,67	CHI
20191286635	ABADIANIA	AA21273148	DAIA S2	11/12/2019 17:15	11/12/2019 19:11	11/12/2019 17:15	11/12/2019 19:11	1,93	1	1,93	CHI
20191286638	VICENTINOPOLIS	VI21269126	VICENTINOPOLIS	11/12/2019 17:15	12/12/2019 12:00	11/12/2019 17:15	12/12/2019 12:00	18,73	1	18,73	CHI
20191286645	ARAGUAPAZ	FC12250652LD	GOIAS	11/12/2019 17:16	12/12/2019 02:14	12/12/2019 00:44	12/12/2019 02:14	1,50	103	154,79	CHI
20191286645	FAINA	FC12250652LD	GOIAS	11/12/2019 17:16	12/12/2019 02:14	12/12/2019 00:44	12/12/2019 02:14	1,50	532	799,48	CHI
20191286645	GOIAS	FC12250652LD	GOIAS	11/12/2019 17:16	12/12/2019 02:14	12/12/2019 00:44	12/12/2019 02:14	1,50	8	12,02	CHI
20191286646	ANICUNS	KB21031447	ANICUNS	11/12/2019 17:17	12/12/2019 07:26	11/12/2019 17:17	12/12/2019 07:26	14,15	1	14,15	CHI
20191286647	PORTELANDIA	PW12301806	PARQUE DAS EMAS	11/12/2019 17:17	12/12/2019 09:50	11/12/2019 17:17	12/12/2019 09:50	16,55	4	66,19	CHI
20191286651	NIQUELANDIA	2750085762	NIQUELANDIA SUBTRANSMISSAO	11/12/2019 17:17	12/12/2019 06:28	11/12/2019 17:17	12/12/2019 06:28	13,17	1	13,17	CHI
20191286655	PADRE BERNARDO	10018001082	PADRE BERNARDO	11/12/2019 17:18	11/12/2019 19:19	11/12/2019 17:18	11/12/2019 19:19	2,00	1	2,00	CHI
20191286657	MINEIROS	MY21303792	PARQUE DAS EMAS	11/12/2019 17:19	12/12/2019 15:15	11/12/2019 17:19	12/12/2019 15:15	21,94	1	21,94	CHI
20191286661	PARAUNA	PU12303601	PARAUNA	11/12/2019 17:19	11/12/2019 21:21	11/12/2019 17:19	11/12/2019 21:21	4,04	5	20,20	CHI
20191286935	GOIANESIA	GE11000018	GOIANESIA S2	11/12/2019 17:22	11/12/2019 20:22	11/12/2019 17:22	11/12/2019 20:22	3,00	89	267,37	CHI
20191286667	ITABERAI	GS12379734	ITABERAI S1	11/12/2019 17:23	11/12/2019 22:11	11/12/2019 17:23	11/12/2019 22:11	4,80	4	19,20	CHI
20191286673	PARANAIGUARA	2230020426	CACHOEIRA ALTA	11/12/2019 17:24	11/12/2019 19:39	11/12/2019 17:24	11/12/2019 19:39	2,24	1	2,24	CHI
20191286689	CEZARINA	VJ12320434	GUAPO S2	11/12/2019 17:26	12/12/2019 22:22	11/12/2019 17:26	12/12/2019 03:30	10,05	28	281,46	CHI
20191286689	VARJAO	VJ12320434	GUAPO S2	11/12/2019 17:26	12/12/2019 22:22	11/12/2019 17:26	12/12/2019 03:30	10,05	94	944,91	CHI
20191286689	CEZARINA	03320214	GUAPO S2	11/12/2019 17:26	12/12/2019 22:22	12/12/2019 10:18	12/12/2019 11:45	1,45	140	203,00	CHI
20191286689	VARJAO	03320214	GUAPO S2	11/12/2019 17:26	12/12/2019 22:22	12/12/2019 10:18	12/12/2019 11:45	1,45	1679	2434,55	CHI
20191286689	CEZARINA	VJ13312864	GUAPO S2	11/12/2019 17:26	12/12/2019 22:22	11/12/2019 17:26	12/12/2019 21:52	28,43	12	341,17	CHI
20191286689	CEZARINA	VJ13312864	GUAPO S2	11/12/2019 17:26	12/12/2019 22:22	12/12/2019 02:58	12/12/2019 21:52	18,90	59	1115,33	CHI
20191286689	INDIARA	VJ13312864	GUAPO S2	11/12/2019 17:26	12/12/2019 22:22	12/12/2019 02:58	12/12/2019 21:52	18,90	1	18,90	CHI
20191286689	CEZARINA	CZ12145875LD	GUAPO S2	11/12/2019 17:26	12/12/2019 22:22	12/12/2019 02:58	12/12/2019 22:22	19,40	18	349,20	CHI
20191286702	JUSSARA	JR12023506	IPORA	11/12/2019 17:26	12/12/2019 08:10	11/12/2019 17:26	12/12/2019 08:10	14,73	7	103,08	CHI
20191286695	GOIANESIA	550154929	GOIANESIA S1	11/12/2019 17:29	12/12/2019 10:55	11/12/2019 17:29	12/12/2019 10:55	17,43	1	17,43	CHI
20191286708	CACHOEIRA DOURADA	00280324	CACHOEIRA DOURADA	11/12/2019 17:29	11/12/2019 19:01	11/12/2019 17:29	11/12/2019 18:28	0,98	1319	1296,65	CHI
20191286708	ITUMBIARA	00280324	CACHOEIRA DOURADA	11/12/2019 17:29	11/12/2019 19:01	11/12/2019 17:29	11/12/2019 18:28	0,98	27	26,54	CHI
20191286708	CACHOEIRA DOURADA	00280324	CACHOEIRA DOURADA	11/12/2019 17:29	11/12/2019 19:01	11/12/2019 17:29	11/12/2019 18:46	1,29	1169	1504,76	CHI

20191286708	ITUMBIARA	00280324	CACHOEIRA DOURADA	11/12/2019 17:29	11/12/2019 19:01	11/12/2019 17:29	11/12/2019 18:46	1,29	19	24,46	CHI
20191286708	CACHOEIRA DOURADA	00280324	CACHOEIRA DOURADA	11/12/2019 17:29	11/12/2019 19:01	11/12/2019 17:29	11/12/2019 19:01	1,53	365	558,96	CHI
20191286708	ITUMBIARA	00280324	CACHOEIRA DOURADA	11/12/2019 17:29	11/12/2019 19:01	11/12/2019 17:29	11/12/2019 19:01	1,53	20	30,63	CHI
20191286698	GOIANIA	GN12001010	GOYA S2	11/12/2019 17:30	11/12/2019 19:58	11/12/2019 17:30	11/12/2019 19:58	2,45	23	56,41	CHI
20191286705	GOIANIA	GN11383108	CARAJAS S1	11/12/2019 17:31	11/12/2019 18:53	11/12/2019 17:31	11/12/2019 18:53	1,35	45	60,81	CHI
20191286821	GOIANIA	GN12211337	GOYA S2	11/12/2019 17:31	11/12/2019 18:36	11/12/2019 17:31	11/12/2019 18:36	1,08	355	382,81	CHI
20191286714	JARAGUA	JA21148825	JARAGUA	11/12/2019 17:33	11/12/2019 18:45	11/12/2019 17:33	11/12/2019 18:45	1,20	2	2,40	CHI
20191286716	MUTUNOPOLIS	MU21147223	MARA ROSA	11/12/2019 17:33	11/12/2019 19:04	11/12/2019 17:33	11/12/2019 19:04	1,51	1	1,51	CHI
20191286718	MORRINHOS	MR12028754	MORRINHOS	11/12/2019 17:33	11/12/2019 20:46	11/12/2019 17:33	11/12/2019 20:46	3,22	43	138,34	CHI
20191286719	BELA VISTA DE GOIAS	BV21010487	BELA VISTA S1	11/12/2019 17:34	11/12/2019 18:30	11/12/2019 17:34	11/12/2019 18:30	0,93	1	0,93	CHI
20191286721	LUZIANIA	LZ21215777	CRISTALINA S2	11/12/2019 17:34	12/12/2019 11:02	11/12/2019 17:34	12/12/2019 11:02	17,46	1	17,46	CHI
20191286757	GOIANIA	GN11002632	CAMPINAS S1	11/12/2019 17:35	12/12/2019 04:32	11/12/2019 17:35	12/12/2019 04:32	10,95	82	897,72	CHI
20191286730	CALDAS NOVAS	CN12110281	CALDAS NOVAS S1	11/12/2019 17:36	11/12/2019 21:00	11/12/2019 17:36	11/12/2019 21:00	3,39	17	57,67	CHI
20191286734	ANAPOLIS	21194944	JUNDIAI S1	11/12/2019 17:37	12/12/2019 00:47	11/12/2019 17:37	12/12/2019 00:47	7,16	1	7,16	CHI
20191286740	CATALAO	10017155884	CATALAO S1	11/12/2019 17:38	11/12/2019 18:43	11/12/2019 17:38	11/12/2019 18:43	1,08	1	1,08	CHI
20191286742	MORRINHOS	MR12128631	MORRINHOS	11/12/2019 17:38	12/12/2019 13:45	11/12/2019 17:38	12/12/2019 13:45	20,11	14	281,61	CHI
20191286745	APARECIDA DE GOIANIA	13318688	INDEPENDENCIA S2	11/12/2019 17:39	11/12/2019 20:18	11/12/2019 17:39	11/12/2019 20:18	2,65	1	2,65	CHI
20191286747	GOIANIA	10014395159	CARAJAS S2	11/12/2019 17:39	11/12/2019 20:03	11/12/2019 17:39	11/12/2019 20:03	2,39	1	2,39	CHI
20191286748	ITAPURANGA	IK12071747	ITAPURANGA	11/12/2019 17:39	11/12/2019 20:55	11/12/2019 17:39	11/12/2019 20:55	3,26	52	169,64	CHI
20191286749	JARAGUA	JA21000173	JARAGUA	11/12/2019 17:40	12/12/2019 09:15	11/12/2019 17:40	12/12/2019 09:15	15,58	1	15,58	CHI
20191286755	MONTIVIDIU	2840001075	MONTIVIDIU T	11/12/2019 17:41	11/12/2019 18:20	11/12/2019 17:41	11/12/2019 18:20	0,66	1	0,66	CHI
20191286760	GOIANIA	GN11246239	GOIANIA LESTE S3	11/12/2019 17:42	11/12/2019 20:51	11/12/2019 17:42	11/12/2019 20:51	3,14	13	40,78	CHI
20191286765	SILVANIA	SV12112223	VIANOPOLIS	11/12/2019 17:43	11/12/2019 19:30	11/12/2019 17:43	11/12/2019 19:30	1,78	8	14,20	CHI
20191286774	GOIANIA	GN12246285	FERROVIARIO S1	11/12/2019 17:43	11/12/2019 19:25	11/12/2019 17:43	11/12/2019 19:25	1,69	244	412,22	CHI
20191286817	LUZIANIA	LZ11169039	RIO VERMELHO	11/12/2019 17:44	11/12/2019 18:52	11/12/2019 17:44	11/12/2019 18:52	1,13	169	190,97	CHI
20191286839	PIRES DO RIO	PR11000030	PIRES DO RIO S1	11/12/2019 17:44	11/12/2019 22:28	11/12/2019 17:44	11/12/2019 22:28	4,73	90	425,60	CHI
20191287065	NOVO GAMA	NJ11162881	PACAEMBU S1	11/12/2019 17:44	11/12/2019 18:54	11/12/2019 17:44	11/12/2019 18:54	1,16	112	129,58	CHI
20191286550	ITAPURANGA	IK21274564	ITAPURANGA	11/12/2019 17:45	12/12/2019 09:59	11/12/2019 17:45	12/12/2019 09:59	16,22	1	16,22	CHI
20191286826	ITAPURANGA	IK12299882	ITAPURANGA	11/12/2019 17:45	11/12/2019 22:29	11/12/2019 17:45	11/12/2019 22:29	4,72	10	47,22	CHI
20191286789	SAO DOMINGOS	SD12384778	SAO DOMINGOS	11/12/2019 17:47	11/12/2019 20:51	11/12/2019 17:47	11/12/2019 20:51	3,07	7	21,46	CHI
20191286791	NOVO PLANALTO	10012166136	NOVO PLANALTO	11/12/2019 17:47	12/12/2019 01:50	11/12/2019 17:47	12/12/2019 01:50	8,05	1	8,05	CHI
20191286799	TRINDADE	TR32045862	TRINDADE	11/12/2019 17:47	11/12/2019 21:50	11/12/2019 17:47	11/12/2019 21:50	4,03	4	16,14	CHI
20191286800	NEROPOLIS	NR21268874	NEROPOLIS S2	11/12/2019 17:47	11/12/2019 23:00	11/12/2019 17:47	11/12/2019 23:00	5,20	2	10,40	CHI

20191286802	BOM JESUS DE GOIAS	10013041469	BOM JESUS DE GOIAS	11/12/2019 17:48	11/12/2019 23:43	11/12/2019 17:48	11/12/2019 23:43	5,91	1	5,91	CHI
20191286803	PALMEIRAS DE GOIAS	590045222	PALMEIRAS	11/12/2019 17:48	11/12/2019 21:34	11/12/2019 17:48	11/12/2019 21:34	3,76	1	3,76	CHI
20191286804	AMORINOPOLIS	IV21165810	IPORA	11/12/2019 17:48	12/12/2019 12:08	11/12/2019 17:48	12/12/2019 12:08	18,33	1	18,33	CHI
20191286805	ANAPOLIS	21379531	JUNDAI S2	11/12/2019 17:48	11/12/2019 19:09	11/12/2019 17:48	11/12/2019 19:09	1,36	1	1,36	CHI
20191286809	SANTO ANTONIO DO DESCOBERTO	SN12198677	AGUAS LINDAS DE GOIAS S2	11/12/2019 17:48	11/12/2019 19:45	11/12/2019 17:48	11/12/2019 19:45	1,93	4	7,74	CHI
20191287470	CAMPINORTE	CR11071483	CAMPINORTE	11/12/2019 17:48	11/12/2019 23:41	11/12/2019 17:48	11/12/2019 23:41	5,87	135	792,45	CHI
20191286819	TRINDADE	TR32001819	TRINDADE	11/12/2019 17:49	11/12/2019 20:26	11/12/2019 17:49	11/12/2019 20:26	2,62	2	5,23	CHI
20191286840	GOIANIA	GN11001039	CARAJAS S1	11/12/2019 17:49	11/12/2019 21:18	11/12/2019 17:49	11/12/2019 21:18	3,48	73	254,18	CHI
20191287496	QUIRINOPOLIS	QI11034380	QUIRINOPOLIS	11/12/2019 17:50	11/12/2019 22:58	11/12/2019 17:50	11/12/2019 22:58	5,12	104	532,86	CHI
20191286828	IACIARA	10014209398	IACIARA S1	11/12/2019 17:51	11/12/2019 19:40	11/12/2019 17:51	11/12/2019 19:40	1,81	1	1,81	CHI
20191286831	CATALAO	CT121077506	CATALAO S1	11/12/2019 17:51	12/12/2019 13:28	11/12/2019 17:51	12/12/2019 13:28	19,61	1	19,61	CHI
20191286837	GOIANESIA	550103739	GOIANESIA S2	11/12/2019 17:53	11/12/2019 19:50	11/12/2019 17:53	11/12/2019 19:50	1,96	1	1,96	CHI
20191286838	BELA VISTA DE GOIAS	BV21197925	CEPAIGO S2	11/12/2019 17:53	11/12/2019 23:57	11/12/2019 17:53	11/12/2019 23:57	6,06	1	6,06	CHI
20191287287	GOIANIA	GN11191074	CARAJAS S2	11/12/2019 17:55	11/12/2019 20:53	11/12/2019 17:55	11/12/2019 20:53	2,96	100	296,22	CHI
20191286858	PORANGATU	PO21020605	PORANGATU	11/12/2019 17:56	12/12/2019 00:00	11/12/2019 17:56	12/12/2019 00:00	6,05	1	6,05	CHI
20191286860	RIO VERDE	10002744820	RIO VERDE S1	11/12/2019 17:56	12/12/2019 10:02	11/12/2019 17:56	12/12/2019 10:02	16,08	1	16,08	CHI
20191286861	VILA PROPICIO	550193625	GOIANESIA S1	11/12/2019 17:57	12/12/2019 10:00	11/12/2019 17:57	12/12/2019 10:00	16,06	1	16,06	CHI
20191286863	SITIO D ABADIA	FB11277958	IACIARA S2	11/12/2019 17:57	11/12/2019 22:01	11/12/2019 17:57	11/12/2019 22:01	4,06	1	4,06	CHI
20191286865	LUZIANIA	LZ21000271	RIO VERMELHO	11/12/2019 17:57	11/12/2019 22:20	11/12/2019 17:57	11/12/2019 22:20	4,37	1	4,37	CHI
20191286871	SAO LUIS DE MONTES BELOS	SL21343012	SAO LUIZ DOS MONTES BELOS	11/12/2019 17:59	11/12/2019 19:13	11/12/2019 17:59	11/12/2019 19:13	1,25	2	2,49	CHI
20191286876	PALMEIRAS DE GOIAS	590041514	PALMEIRAS	11/12/2019 18:00	12/12/2019 00:50	11/12/2019 18:00	12/12/2019 00:50	6,83	1	6,83	CHI
20191286880	GOIANIA	14125535	GOIANIA LESTE S1	11/12/2019 18:01	11/12/2019 20:46	11/12/2019 18:01	11/12/2019 20:46	2,74	1	2,74	CHI
20191286888	INDIARA	EA12056548	EDEIA	11/12/2019 18:03	12/12/2019 08:44	11/12/2019 18:03	12/12/2019 08:44	14,68	7	102,73	CHI
20191286891	FORMOSA	10009114287	ITIQUEIRA	11/12/2019 18:04	12/12/2019 08:18	11/12/2019 18:04	12/12/2019 08:18	14,23	1	14,23	CHI
20191286894	CACU	CC21295775	CACHOEIRA ALTA	11/12/2019 18:05	11/12/2019 23:28	11/12/2019 18:05	11/12/2019 23:28	5,38	1	5,38	CHI
20191286899	GOIANIA	15069643	CARAJAS S2	11/12/2019 18:06	11/12/2019 21:54	11/12/2019 18:06	11/12/2019 21:54	3,80	1	3,80	CHI
20191286902	ARAGOIANIA	AO32097677	GUAPU S2	11/12/2019 18:06	11/12/2019 20:22	11/12/2019 18:06	11/12/2019 20:22	2,26	8	18,05	CHI
20191286902	HIDROLANDIA	AO32097677	GUAPU S2	11/12/2019 18:06	11/12/2019 20:22	11/12/2019 18:06	11/12/2019 20:22	2,26	38	85,74	CHI
20191286905	SILVANIA	SV21392200	VIANOPOLIS	11/12/2019 18:07	12/12/2019 12:53	11/12/2019 18:07	12/12/2019 12:53	18,76	1	18,76	CHI
20191286911	TRINDADE	10013481841	TRINDADE	11/12/2019 18:08	12/12/2019 03:05	11/12/2019 18:08	12/12/2019 03:05	8,94	1	8,94	CHI
20191286912	FORMOSO	FO12185324	PORANGATU	11/12/2019 18:08	11/12/2019 21:23	11/12/2019 18:08	11/12/2019 21:23	3,24	2	6,48	CHI
20191287627	URUACU	UR21335913	URUACU	11/12/2019 18:08	11/12/2019 21:40	11/12/2019 18:08	11/12/2019 21:40	3,52	1	3,52	CHI
20191286921	CUMARI	CY21127645	CATALAO S1	11/12/2019 18:10	12/12/2019 13:18	11/12/2019 18:10	12/12/2019 13:18	19,14	1	19,14	CHI

20191286924	GOIANIA	12899033	GOIANIA LESTE S3	11/12/2019 18:10	11/12/2019 22:21	11/12/2019 18:10	11/12/2019 22:21	4,17	1	4,17	CHI
20191286994	ANAPOLIS	AN12351048	ANAPOLIS UNIVERSITARIO S2	11/12/2019 18:11	11/12/2019 20:15	11/12/2019 18:11	11/12/2019 20:15	2,05	17	34,87	CHI
20191286932	LUZIANIA	120305185	RIO VERMELHO	11/12/2019 18:12	12/12/2019 08:47	11/12/2019 18:12	12/12/2019 08:47	14,58	1	14,58	CHI
20191286934	APARECIDA DE GOIANIA	17134067	INDEPENDENCIA S2	11/12/2019 18:12	11/12/2019 19:58	11/12/2019 18:12	11/12/2019 19:58	1,76	1	1,76	CHI
20191287096	JANDAIA	JD12314913	PALMEIRAS	11/12/2019 18:12	12/12/2019 08:55	11/12/2019 18:12	12/12/2019 08:55	14,70	18	264,64	CHI
20191286940	JARAGUA	10002279922	JARAGUA	11/12/2019 18:13	12/12/2019 09:11	11/12/2019 18:13	12/12/2019 09:11	14,95	1	14,95	CHI
20191286942	SENADOR CANEDO	190002414	SENADOR CANEDO	11/12/2019 18:14	11/12/2019 20:58	11/12/2019 18:14	11/12/2019 20:58	2,73	1	2,73	CHI
20191286945	CAMPO LIMPO	AN21185589	NEROPOLIS S1	11/12/2019 18:15	12/12/2019 02:17	11/12/2019 18:15	12/12/2019 02:17	8,03	1	8,03	CHI
20191286956	APARECIDA DE GOIANIA	00360234	CEPAIGO S1	11/12/2019 18:15	12/12/2019 02:45	11/12/2019 18:15	11/12/2019 18:30	0,26	1496	389,79	CHI
20191286956	HIDROLANDIA	00360234	CEPAIGO S1	11/12/2019 18:15	12/12/2019 02:45	11/12/2019 18:15	11/12/2019 18:30	0,26	565	147,21	CHI
20191286956	APARECIDA DE GOIANIA	00360234	CEPAIGO S1	11/12/2019 18:15	12/12/2019 02:45	11/12/2019 19:23	11/12/2019 21:12	1,81	1	1,81	CHI
20191286956	HIDROLANDIA	HD13200318	CEPAIGO S1	11/12/2019 18:15	12/12/2019 02:45	11/12/2019 19:23	11/12/2019 21:50	2,45	555	1361,75	CHI
20191286956	APARECIDA DE GOIANIA	AP13264927	CEPAIGO S1	11/12/2019 18:15	12/12/2019 02:45	11/12/2019 19:23	12/12/2019 02:45	7,38	1495	11027,70	CHI
20191286956	HIDROLANDIA	AP13264927	CEPAIGO S1	11/12/2019 18:15	12/12/2019 02:45	11/12/2019 19:23	12/12/2019 02:45	7,38	10	73,76	CHI
20191286957	JARAGUA	JA12278893	JARAGUA	11/12/2019 18:16	12/12/2019 12:39	11/12/2019 18:16	12/12/2019 12:39	18,38	1	18,38	CHI
20191286958	CAIAPONIA	CP12135376	CAIAPONIA	11/12/2019 18:16	12/12/2019 08:51	11/12/2019 18:16	12/12/2019 08:51	14,58	8	116,65	CHI
20191286960	ANAPOLIS	AN21062641	NEROPOLIS S1	11/12/2019 18:16	12/12/2019 07:46	11/12/2019 18:16	12/12/2019 07:46	13,49	1	13,49	CHI
20191286962	URUACU	UR21212330	URUACU	11/12/2019 18:16	12/12/2019 08:35	11/12/2019 18:16	12/12/2019 08:35	14,30	2	28,60	CHI
20191286965	JANDAIA	PL21308448	PALMEIRAS	11/12/2019 18:17	12/12/2019 11:53	11/12/2019 18:17	12/12/2019 11:53	17,60	2	35,21	CHI
20191286966	GOIANIA	10022754570	CARAJAS S2	11/12/2019 18:17	12/12/2019 02:53	11/12/2019 18:17	12/12/2019 02:53	8,59	1	8,59	CHI
20191286967	FORMOSA	FA11062235	ITUIQUIRA	11/12/2019 18:17	11/12/2019 20:24	11/12/2019 18:17	11/12/2019 20:24	2,11	3	6,32	CHI
20191286972	INHUMAS	IX12016046	INHUMAS S1	11/12/2019 18:18	11/12/2019 21:21	11/12/2019 18:18	11/12/2019 21:21	3,04	8	24,36	CHI
20191286972	ITAUCU	IX12016046	INHUMAS S1	11/12/2019 18:18	11/12/2019 21:21	11/12/2019 18:18	11/12/2019 21:21	3,04	3	9,13	CHI
20191287075	GOIANIA	GN12001687	GOYA S1	11/12/2019 18:18	11/12/2019 20:20	11/12/2019 18:18	11/12/2019 20:20	2,03	92	186,63	CHI
20191286977	CAIAPONIA	MY12184177	PARQUE DAS EMAS	11/12/2019 18:19	12/12/2019 13:00	11/12/2019 18:19	12/12/2019 13:00	18,68	3	56,05	CHI
20191286978	ANAPOLIS	10011776062	ANAPOLIS UNIVERSITARIO S2	11/12/2019 18:19	11/12/2019 19:43	11/12/2019 18:19	11/12/2019 19:43	1,40	1	1,40	CHI
20191287103	GOIANIA	GN11191071	CARAJAS S2	11/12/2019 18:20	11/12/2019 19:52	11/12/2019 18:20	11/12/2019 19:52	1,52	93	141,33	CHI
20191286993	CEZARINA	10020620207	CEZARINA	11/12/2019 18:21	11/12/2019 20:21	11/12/2019 18:21	11/12/2019 20:21	2,00	1	2,00	CHI
20191286995	PALMEIRAS DE GOIAS	PL12345461	PALMEIRAS	11/12/2019 18:21	11/12/2019 23:28	11/12/2019 18:21	11/12/2019 23:28	5,12	1	5,12	CHI
20191287006	GOIANAPOLIS	GP12388837	DAIA S2	11/12/2019 18:24	12/12/2019 10:16	11/12/2019 18:24	12/12/2019 10:16	15,87	3	47,62	CHI
20191287070	NOVO GAMA	NJ11073459	PACAEMBU S1	11/12/2019 18:25	11/12/2019 19:16	11/12/2019 18:25	11/12/2019 19:16	0,84	177	148,24	CHI
20191287401	LUZIANIA	OZ12195112	PIRES DO RIO S2	11/12/2019 18:25	11/12/2019 23:50	11/12/2019 18:25	11/12/2019 23:50	5,40	71	383,46	CHI
20191287020	SANTO ANTONIO DO DESCOBERTO	2210189774	ALEXANIA	11/12/2019 18:26	11/12/2019 19:44	11/12/2019 18:26	11/12/2019 19:44	1,29	1	1,29	CHI

20191287025	GOUVELANDIA	GB12402364	QUIRINOPOLIS	11/12/2019 18:27	11/12/2019 22:55	11/12/2019 18:27	11/12/2019 22:55	4,46	10	44,59	CHI
20191287105	ARAGARCAS	BM12010412LD	BOM JARDIM	11/12/2019 18:27	12/12/2019 12:56	11/12/2019 18:27	12/12/2019 12:56	18,48	111	2051,10	CHI
20191287105	BALIZA	BM12010412LD	BOM JARDIM	11/12/2019 18:27	12/12/2019 12:56	11/12/2019 18:27	12/12/2019 12:56	18,48	276	5100,02	CHI
20191287105	BOM JARDIM DE GOIAS	BM12010412LD	BOM JARDIM	11/12/2019 18:27	12/12/2019 12:56	11/12/2019 18:27	12/12/2019 12:56	18,48	105	1940,23	CHI
20191287031	BELA VISTA DE GOIAS	BV11188879	CEPAIGO S2	11/12/2019 18:28	11/12/2019 22:23	11/12/2019 18:28	11/12/2019 22:23	3,91	19	74,21	CHI
20191287037	FAZENDA NOVA	FN12183426	IPORA	11/12/2019 18:29	12/12/2019 16:36	11/12/2019 18:29	12/12/2019 16:36	22,11	9	198,99	CHI
20191287050	APARECIDA DE GOIANIA	10000783518	INDEPENDENCIA S1	11/12/2019 18:31	11/12/2019 19:50	11/12/2019 18:31	11/12/2019 19:50	1,32	1	1,32	CHI
20191287055	AGUAS LINDAS DE GOIAS	LA12078171	AGUAS LINDAS DE GOIAS S1	11/12/2019 18:32	11/12/2019 22:37	11/12/2019 18:32	11/12/2019 22:37	4,08	6	24,47	CHI
20191287056	CAMPINACU	10008860295	PORANGATU	11/12/2019 18:32	12/12/2019 00:08	11/12/2019 18:32	12/12/2019 00:08	5,59	1	5,59	CHI
20191287060	INACIOLANDIA	ID21214153	QUIRINOPOLIS	11/12/2019 18:33	11/12/2019 22:09	11/12/2019 18:33	11/12/2019 22:09	3,60	1	3,60	CHI
20191287072	GOIANIA	13070125	AEROPORTO S1	11/12/2019 18:35	11/12/2019 21:35	11/12/2019 18:35	11/12/2019 21:35	2,99	1	2,99	CHI
20191287076	CIDADE OCIDENTAL	DH11248725	MARAJOARA	11/12/2019 18:36	11/12/2019 23:51	11/12/2019 18:36	11/12/2019 21:55	3,31	19	62,95	CHI
20191287076	CIDADE OCIDENTAL	DH12172744	MARAJOARA	11/12/2019 18:36	11/12/2019 23:51	11/12/2019 21:56	11/12/2019 23:51	1,93	195	375,70	CHI
20191287159	GOUVELANDIA	QI12402335	QUIRINOPOLIS	11/12/2019 18:36	11/12/2019 22:12	11/12/2019 18:36	11/12/2019 22:12	3,59	19	68,26	CHI
20191287080	CALDAS NOVAS	CN12082137	SERRA DE CALDAS	11/12/2019 18:37	11/12/2019 19:02	11/12/2019 18:37	11/12/2019 19:02	0,43	1	0,43	CHI
20191287308	AMARALINA	MU12391981	MARA ROSA	11/12/2019 18:37	12/12/2019 11:59	11/12/2019 18:37	12/12/2019 11:59	17,37	5	86,83	CHI
20191287308	MUTUNOPOLIS	MU12391981	MARA ROSA	11/12/2019 18:37	12/12/2019 11:59	11/12/2019 18:37	12/12/2019 11:59	17,37	5	86,83	CHI
20191287091	GOIATUBA	GT21346874	RIO DOS BOIS	11/12/2019 18:40	11/12/2019 22:52	11/12/2019 18:40	11/12/2019 22:52	4,20	1	4,20	CHI
20191287094	GOIANDIRA	GD21237114	CATALAO S1	11/12/2019 18:40	12/12/2019 11:06	11/12/2019 18:40	12/12/2019 11:06	16,44	1	16,44	CHI
20191287110	PIRANHAS	PH12343679	PIRANHAS	11/12/2019 18:44	11/12/2019 20:55	11/12/2019 18:44	11/12/2019 20:55	2,18	2	4,37	CHI
20191287118	MINACU	IH21236115	MINACU	11/12/2019 18:45	12/12/2019 01:19	11/12/2019 18:45	12/12/2019 01:19	6,55	1	6,55	CHI
20191287126	CAIAPONIA	10024852064	PALESTINA	11/12/2019 18:48	12/12/2019 11:55	11/12/2019 18:48	12/12/2019 11:55	17,12	1	17,12	CHI
20191287127	BELA VISTA DE GOIAS	BV12045716	SENADOR CANEDO	11/12/2019 18:48	11/12/2019 21:21	11/12/2019 18:48	11/12/2019 21:21	2,54	6	15,23	CHI
20191287130	NOVO GAMA	NJ21206706	MARAJOARA	11/12/2019 18:49	12/12/2019 11:22	11/12/2019 18:49	12/12/2019 11:22	16,54	1	16,54	CHI
20191287132	GOIANIA	10634903	AEROPORTO S2	11/12/2019 18:50	11/12/2019 23:52	11/12/2019 18:50	11/12/2019 23:52	5,03	1	5,03	CHI
20191287137	GOIANIRA	390057733	GOIANIRA	11/12/2019 18:50	12/12/2019 05:52	11/12/2019 18:50	12/12/2019 05:52	11,02	1	11,02	CHI
20191287139	PIRACANJUBA	PJ12363975	MORRINHOS	11/12/2019 18:50	12/12/2019 09:37	11/12/2019 18:50	12/12/2019 09:37	14,77	4	59,07	CHI
20191287141	PIRES DO RIO	460047073	PIRES DO RIO S1	11/12/2019 18:51	12/12/2019 01:22	11/12/2019 18:51	12/12/2019 01:22	6,51	1	6,51	CHI
20191287147	JOVIANIA	JV21218128	GOIATUBA S1	11/12/2019 18:52	12/12/2019 15:50	11/12/2019 18:52	12/12/2019 15:50	20,96	2	41,92	CHI
20191287150	MINACU	10007427601	MINACU	11/12/2019 18:53	11/12/2019 22:31	11/12/2019 18:53	11/12/2019 22:31	3,65	1	3,65	CHI
20191287179	GOIANIA	GN11053056	GOYA S1	11/12/2019 18:55	11/12/2019 20:50	11/12/2019 18:55	11/12/2019 20:50	1,91	145	276,83	CHI
20191288647	CORREGO DO OURO	CO12300423	SAO LUIZ DOS MONTES BELOS	11/12/2019 18:56	12/12/2019 16:10	11/12/2019 18:56	12/12/2019 16:10	21,23	4	84,93	CHI
20191287170	GOIANIA	11189587	FERROVIARIO S2	11/12/2019 18:57	11/12/2019 20:25	11/12/2019 18:57	11/12/2019 20:25	1,46	1	1,46	CHI

20191287180	SENADOR CANEDO	190157823	SENADOR CANEDO	11/12/2019 18:59	11/12/2019 20:29	11/12/2019 18:59	11/12/2019 20:29	1,49	1	1,49	CHI
20191287181	ANICUNS	AC21259212	ANICUNS	11/12/2019 19:00	12/12/2019 08:30	11/12/2019 19:00	12/12/2019 08:30	13,50	1	13,50	CHI
20191287189	GOIANIA	11933628	ATLANTICO S1	11/12/2019 19:01	11/12/2019 21:29	11/12/2019 19:01	11/12/2019 21:29	2,46	1	2,46	CHI
20191287192	GOIANIA	GN11219065	ATLANTICO S1	11/12/2019 19:01	11/12/2019 20:19	11/12/2019 19:01	11/12/2019 20:19	1,29	38	48,97	CHI
20191287955	UIRAPURU	UP11181596	SANTA TEREZINHA	11/12/2019 19:01	12/12/2019 04:51	11/12/2019 19:01	12/12/2019 04:51	9,83	78	766,78	CHI
20191287199	GOIANIA	10008537761	XAVANTES	11/12/2019 19:03	11/12/2019 21:58	11/12/2019 19:03	11/12/2019 21:58	2,91	1	2,91	CHI
20191287202	CATALAO	CT12266142RE	CATALAO S1	11/12/2019 19:03	12/12/2019 19:55	11/12/2019 19:03	12/12/2019 19:55	24,87	108	2686,02	CHI
20191287202	GOIANDIRA	CT12266142RE	CATALAO S1	11/12/2019 19:03	12/12/2019 19:55	11/12/2019 19:03	12/12/2019 19:55	24,87	41	1019,69	CHI
20191287203	PIRACANJUBA	PJ11171422	PIRACANJUBA	11/12/2019 19:03	12/12/2019 12:15	11/12/2019 19:03	12/12/2019 12:15	17,19	1	17,19	CHI
20191287205	CACHOEIRA DOURADA	CD12000067	CACHOEIRA DOURADA	11/12/2019 19:03	13/12/2019 17:29	11/12/2019 19:03	12/12/2019 00:20	5,27	43	226,60	CHI
20191287205	INACIOLANDIA	CD12000067	CACHOEIRA DOURADA	11/12/2019 19:03	13/12/2019 17:29	11/12/2019 19:03	12/12/2019 00:20	5,27	1	5,27	CHI
20191287205	CACHOEIRA DOURADA	CD13000011	CACHOEIRA DOURADA	11/12/2019 19:03	13/12/2019 17:29	11/12/2019 19:03	12/12/2019 09:20	14,28	1	14,28	CHI
20191287205	INACIOLANDIA	CD13000011	CACHOEIRA DOURADA	11/12/2019 19:03	13/12/2019 17:29	11/12/2019 19:03	12/12/2019 09:20	14,28	3	42,85	CHI
20191287205	CACHOEIRA DOURADA	CD12000067	CACHOEIRA DOURADA	11/12/2019 19:03	13/12/2019 17:29	12/12/2019 12:26	12/12/2019 16:20	3,89	47	182,67	CHI
20191287205	INACIOLANDIA	CD12000067	CACHOEIRA DOURADA	11/12/2019 19:03	13/12/2019 17:29	12/12/2019 12:26	12/12/2019 16:20	3,89	4	15,55	CHI
20191287205	INACIOLANDIA	CD12000067	CACHOEIRA DOURADA	11/12/2019 19:03	13/12/2019 17:29	12/12/2019 15:54	12/12/2019 16:20	0,43	81	34,45	CHI
20191287205	INACIOLANDIA	ID12371230LD	CACHOEIRA DOURADA	11/12/2019 19:03	13/12/2019 17:29	11/12/2019 19:03	12/12/2019 19:07	24,06	14	336,90	CHI
20191287205	ITUMBIARA	CD12000232	CACHOEIRA DOURADA	11/12/2019 19:03	13/12/2019 17:29	11/12/2019 19:03	12/12/2019 22:25	27,35	5	136,76	CHI
20191287205	INACIOLANDIA	ID12371230LD	CACHOEIRA DOURADA	11/12/2019 19:03	13/12/2019 17:29	11/12/2019 19:03	13/12/2019 17:29	46,42	2	92,84	CHI
20191287205	ITUMBIARA	ID12371230LD	CACHOEIRA DOURADA	11/12/2019 19:03	13/12/2019 17:29	11/12/2019 19:03	13/12/2019 17:29	46,42	8	371,35	CHI
20191287205	INACIOLANDIA	CD13000016	CACHOEIRA DOURADA	11/12/2019 19:03	13/12/2019 17:29	12/12/2019 12:26	13/12/2019 17:29	29,03	1	29,03	CHI
20191287208	ARAGARCAS	AG12380911	ARAGARCAS	11/12/2019 19:04	12/12/2019 09:36	11/12/2019 19:04	12/12/2019 09:36	14,53	1	14,53	CHI
20191287211	COCALZINHO DE GOIAS	ZN21238149	COCALZINHO	11/12/2019 19:04	12/12/2019 10:20	11/12/2019 19:04	12/12/2019 10:20	15,26	1	15,26	CHI
20191287488	ARAGARCAS	BM12354693	BOM JARDIM	11/12/2019 19:04	12/12/2019 06:10	11/12/2019 19:04	12/12/2019 06:10	11,09	7	77,63	CHI
20191287488	BOM JARDIM DE GOIAS	BM12354693	BOM JARDIM	11/12/2019 19:04	12/12/2019 06:10	11/12/2019 19:04	12/12/2019 06:10	11,09	40	443,58	CHI
20191287216	GOIANIA	14518648	FERROVIARIO S1	11/12/2019 19:05	11/12/2019 22:12	11/12/2019 19:05	11/12/2019 22:12	3,11	1	3,11	CHI
20191287220	VALPARAISO DE GOIAS	10020395700	MARAJOARA	11/12/2019 19:05	11/12/2019 23:32	11/12/2019 19:05	11/12/2019 23:32	4,43	1	4,43	CHI
20191287249	APARECIDA DO RIO DOCE	AW12337007	JATAI S1	11/12/2019 19:05	12/12/2019 08:34	11/12/2019 19:05	12/12/2019 08:34	13,47	5	67,36	CHI
20191287415	PALMEIRAS DE GOIAS	PL11312588	PALMEIRAS	11/12/2019 19:05	11/12/2019 20:35	11/12/2019 19:05	11/12/2019 20:35	1,50	334	499,52	CHI
20191287222	PIRES DO RIO	PR21337200	PIRES DO RIO S1	11/12/2019 19:06	12/12/2019 03:05	11/12/2019 19:06	12/12/2019 03:05	7,99	1	7,99	CHI
20191287223	ANAPOLIS	21185300	ANAPOLIS UNIVERSITARIO S2	11/12/2019 19:06	11/12/2019 20:41	11/12/2019 19:06	11/12/2019 20:41	1,58	1	1,58	CHI
20191287225	ANAPOLIS	10000269857	ANAPOLIS UNIVERSITARIO S2	11/12/2019 19:07	12/12/2019 11:37	11/12/2019 19:07	12/12/2019 11:37	16,50	1	16,50	CHI
20191287231	ITAPIRAPUA	IU12030113	MATRINCHA	11/12/2019 19:08	12/12/2019 03:17	11/12/2019 19:08	12/12/2019 03:17	8,14	11	89,56	CHI

20191287370	GOIANIA	GN11132333	GOYA S1	11/12/2019 19:08	11/12/2019 21:30	11/12/2019 19:08	11/12/2019 21:30	2,36	197	464,43	CHI
20191287235	MOSSAMEDES	MD12091062	FIRMINOPOLIS S2	11/12/2019 19:09	11/12/2019 20:25	11/12/2019 19:09	11/12/2019 20:25	1,26	1	1,26	CHI
20191287236	ARUANA	MP12274498	MOZARLANDIA	11/12/2019 19:09	12/12/2019 12:10	11/12/2019 19:09	12/12/2019 12:10	17,01	5	85,05	CHI
20191287236	MATRINCHA	MP12274498	MOZARLANDIA	11/12/2019 19:09	12/12/2019 12:10	11/12/2019 19:09	12/12/2019 12:10	17,01	3	51,03	CHI
20191287238	APARECIDA DE GOIANIA	10024971519	INDEPENDENCIA S2	11/12/2019 19:09	11/12/2019 20:27	11/12/2019 19:09	11/12/2019 20:27	1,28	1	1,28	CHI
20191287773	PALMEIRAS DE GOIAS	PL12027449	PALMEIRAS	11/12/2019 19:09	12/12/2019 08:02	11/12/2019 19:09	12/12/2019 08:02	12,88	4	51,54	CHI
20191287239	CABECEIRAS	CW21381539	ITUIQUIRA	11/12/2019 19:10	11/12/2019 20:56	11/12/2019 19:10	11/12/2019 20:56	1,77	2	3,53	CHI
20191286526	IPAMERI	IP12363868	URUTAI	11/12/2019 19:11	12/12/2019 16:58	11/12/2019 19:11	12/12/2019 16:58	21,77	1	21,77	CHI
20191287247	ITUMBIARA	BJ12383475	BOM JESUS DE GOIAS	11/12/2019 19:11	12/12/2019 08:48	11/12/2019 19:11	12/12/2019 08:48	13,61	2	27,22	CHI
20191287248	IACIARA	IA12262078	IACIARA S1	11/12/2019 19:11	11/12/2019 20:41	11/12/2019 19:11	11/12/2019 20:41	1,49	2	2,98	CHI
20191287253	MARA ROSA	MQ12295285LD	MARA ROSA	11/12/2019 19:12	12/12/2019 07:15	11/12/2019 19:12	12/12/2019 07:15	12,04	5	60,21	CHI
20191287257	PIRACANJUBA	PJ12268166	ROCHEDO	11/12/2019 19:12	11/12/2019 22:30	11/12/2019 19:12	11/12/2019 22:30	3,29	172	565,40	CHI
20191287647	GOIANIA	GN12211337	GOYA S2	11/12/2019 19:12	11/12/2019 20:56	11/12/2019 19:12	11/12/2019 20:56	1,73	355	614,15	CHI
20191287267	ITAGUARI	7268145	ITABERAI S1	11/12/2019 19:14	12/12/2019 07:05	11/12/2019 19:14	12/12/2019 07:05	11,85	1	11,85	CHI
20191287268	ANAPOLIS	2080002084	ANAPOLIS UNIVERSITARIO S1	11/12/2019 19:14	11/12/2019 22:08	11/12/2019 19:14	11/12/2019 22:08	2,89	1	2,89	CHI
20191287270	NOVA CRIXAS	8570020274	NOVA CRIXAS	11/12/2019 19:14	12/12/2019 00:20	11/12/2019 19:14	12/12/2019 00:20	5,08	1	5,08	CHI
20191287271	GOIANIA	GN11154616	GOIANIA LESTE S3	11/12/2019 19:15	12/12/2019 03:29	11/12/2019 19:15	12/12/2019 03:29	8,23	41	337,57	CHI
20191287273	CAMPINACU	IH12192447	MINACU	11/12/2019 19:15	12/12/2019 01:44	11/12/2019 19:15	12/12/2019 01:44	6,48	5	32,38	CHI
20191287273	MINACU	IH12192447	MINACU	11/12/2019 19:15	12/12/2019 01:44	11/12/2019 19:15	12/12/2019 01:44	6,48	24	155,42	CHI
20191287367	INHUMAS	IN11000019	INHUMAS S2	11/12/2019 19:15	11/12/2019 22:20	11/12/2019 19:15	11/12/2019 22:20	3,07	96	294,48	CHI
20191287276	AURILANDIA	AI21143100	FIRMINOPOLIS S2	11/12/2019 19:16	11/12/2019 21:12	11/12/2019 19:16	11/12/2019 21:12	1,94	1	1,94	CHI
20191287277	JAUPACI	JP12193313	IPORA	11/12/2019 19:16	12/12/2019 18:06	11/12/2019 19:16	12/12/2019 18:06	22,83	2	45,67	CHI
20191287280	GOIANIA	12323962	REAL S1	11/12/2019 19:16	11/12/2019 21:39	11/12/2019 19:16	11/12/2019 21:39	2,37	1	2,37	CHI
20191287281	VILA BOA	VB21235782	IACIARA S2	11/12/2019 19:16	11/12/2019 20:44	11/12/2019 19:16	11/12/2019 20:44	1,46	1	1,46	CHI
20191287316	AGUAS LINDAS DE GOIAS	LA11261061	AGUAS LINDAS DE GOIAS S1	11/12/2019 19:17	11/12/2019 20:26	11/12/2019 19:17	11/12/2019 20:26	1,14	128	146,35	CHI
20191287467	ANAPOLIS	AN11000045	ANAPOLIS UNIVERSITARIO S2	11/12/2019 19:17	11/12/2019 20:45	11/12/2019 19:17	11/12/2019 20:45	1,46	123	179,92	CHI
20191287295	CAMPO LIMPO	10002682298	NEROPOLIS S1	11/12/2019 19:18	12/12/2019 02:52	11/12/2019 19:18	12/12/2019 02:52	7,55	1	7,55	CHI
20191287359	ANAPOLIS	AN12312044LD	ANAPOLIS UNIVERSITARIO S2	11/12/2019 19:18	11/12/2019 21:38	11/12/2019 19:18	11/12/2019 21:38	2,32	18	41,79	CHI
20191287359	GAMELEIRA DE GOIAS	AN12312044LD	ANAPOLIS UNIVERSITARIO S2	11/12/2019 19:18	11/12/2019 21:38	11/12/2019 19:18	11/12/2019 21:38	2,32	16	37,15	CHI
20191287305	GOIANIA	10021199190	GOIANIA LESTE S3	11/12/2019 19:20	11/12/2019 21:40	11/12/2019 19:20	11/12/2019 21:40	2,33	1	2,33	CHI
20191287307	GOIANIA	10365400	CAMPINAS S1	11/12/2019 19:20	11/12/2019 21:16	11/12/2019 19:20	11/12/2019 21:16	1,92	1	1,92	CHI
20191287311	PIRACANJUBA	PJ12043108	PIRACANJUBA	11/12/2019 19:21	12/12/2019 11:12	11/12/2019 19:21	12/12/2019 11:12	15,86	12	190,34	CHI
20191287313	IPORA	IR12014029	IPORA	11/12/2019 19:21	12/12/2019 11:10	11/12/2019 19:21	12/12/2019 11:10	15,81	45	711,51	CHI

20191287318	APARECIDA DE GOIANIA	11666341	INDEPENDENCIA S2	11/12/2019 19:22	11/12/2019 21:23	11/12/2019 19:22	11/12/2019 21:23	2,01	1	2,01	CHI
20191287320	GOIANIA	14749750	CAMPINAS S1	11/12/2019 19:22	12/12/2019 01:58	11/12/2019 19:22	12/12/2019 01:58	6,59	1	6,59	CHI
20191287321	DAMIANOPOLIS	MB12180672	IACIARA S2	11/12/2019 19:22	11/12/2019 23:28	11/12/2019 19:22	11/12/2019 23:28	4,09	9	36,77	CHI
20191287324	ITAUCU	IX21236804	INHUMAS S1	11/12/2019 19:23	11/12/2019 22:50	11/12/2019 19:23	11/12/2019 22:50	3,44	1	3,44	CHI
20191287331	SANTA HELENA DE GOIAS	400059496	IPEGUARI	11/12/2019 19:24	12/12/2019 10:00	11/12/2019 19:24	12/12/2019 10:00	14,60	1	14,60	CHI
20191287336	GOIAS	GS21189953	GOIAS	11/12/2019 19:24	12/12/2019 10:30	11/12/2019 19:24	12/12/2019 10:30	15,09	1	15,09	CHI
20191287338	APARECIDA DE GOIANIA	200487449	INDEPENDENCIA S2	11/12/2019 19:24	11/12/2019 21:19	11/12/2019 19:24	11/12/2019 21:19	1,90	1	1,90	CHI
20191287384	PORANGATU	PO11004361	PORANGATU	11/12/2019 19:24	11/12/2019 20:19	11/12/2019 19:24	11/12/2019 20:19	0,92	117	107,22	CHI
201912260862	CAMPO ALEGRE DE GOIAS	CM12358430RE	CAMPO ALEGRE DE GOIAS	11/12/2019 19:24	12/12/2019 09:51	11/12/2019 19:24	12/12/2019 05:03	9,64	29	279,68	CHI
201912260862	IPAMERI	CM12358430RE	CAMPO ALEGRE DE GOIAS	11/12/2019 19:24	12/12/2019 09:51	11/12/2019 19:24	12/12/2019 05:03	9,64	32	308,61	CHI
201912260862	CAMPO ALEGRE DE GOIAS	CM12358430RE	CAMPO ALEGRE DE GOIAS	11/12/2019 19:24	12/12/2019 09:51	11/12/2019 19:24	12/12/2019 09:51	14,44	4	57,75	CHI
201912260862	IPAMERI	CM12358430RE	CAMPO ALEGRE DE GOIAS	11/12/2019 19:24	12/12/2019 09:51	11/12/2019 19:24	12/12/2019 09:51	14,44	4	57,75	CHI
20191287352	DAMIANOPOLIS	01110214	IACIARA S2	11/12/2019 19:27	11/12/2019 21:08	11/12/2019 19:27	11/12/2019 21:08	1,67	130	217,03	CHI
20191287352	SITIO D ABADIA	01110214	IACIARA S2	11/12/2019 19:27	11/12/2019 21:08	11/12/2019 19:27	11/12/2019 21:08	1,67	378	631,05	CHI
20191287356	VALPARAISO DE GOIAS	3350003914	PACAEMBU S1	11/12/2019 19:28	11/12/2019 20:53	11/12/2019 19:28	11/12/2019 20:53	1,41	1	1,41	CHI
20191287361	JATAI	JT21104678	JATAI S1	11/12/2019 19:29	12/12/2019 08:16	11/12/2019 19:29	12/12/2019 08:16	12,78	1	12,78	CHI
20191287725	GUARAITA	GK12299411	ITAPURANGA	11/12/2019 19:29	12/12/2019 09:06	11/12/2019 19:29	12/12/2019 09:06	13,61	19	258,52	CHI
20191287478	EDEIA	EA12160409	VICENTINOPOLIS	11/12/2019 19:32	11/12/2019 23:25	11/12/2019 19:32	11/12/2019 23:25	3,87	20	77,37	CHI
20191287388	IPAMERI	IP12188743	PIRES DO RIO S2	11/12/2019 19:34	12/12/2019 14:50	11/12/2019 19:34	12/12/2019 14:50	19,27	3	57,81	CHI
20191287391	GOIANESIA	GE21317816	GOIANESIA S2	11/12/2019 19:34	12/12/2019 07:11	11/12/2019 19:34	12/12/2019 07:11	11,61	1	11,61	CHI
20191287423	IPAMERI	IP12404733	IPAMERI	11/12/2019 19:34	11/12/2019 21:08	11/12/2019 19:34	11/12/2019 21:08	1,56	8	12,50	CHI
20191287393	GOIANIA	10365126	CAMPINAS S1	11/12/2019 19:35	11/12/2019 22:01	11/12/2019 19:35	11/12/2019 22:01	2,43	1	2,43	CHI
20191287400	NOVO BRASIL	1460011044	JUSSARA	11/12/2019 19:37	12/12/2019 16:42	11/12/2019 19:37	12/12/2019 16:42	21,08	1	21,08	CHI
20191287402	HIDROLANDIA	180022842	CEPAIGO S2	11/12/2019 19:37	12/12/2019 04:17	11/12/2019 19:37	12/12/2019 04:17	8,66	1	8,66	CHI
20191287410	SANTA HELENA DE GOIAS	SH12296117	IPEGUARI	11/12/2019 19:39	12/12/2019 09:51	11/12/2019 19:39	12/12/2019 09:51	14,19	5	70,96	CHI
20191287413	PALESTINA DE GOIAS	PY21097755	ARENOPOLIS	11/12/2019 19:40	12/12/2019 04:00	11/12/2019 19:40	12/12/2019 04:00	8,33	1	8,33	CHI
20191287414	APARECIDA DE GOIANIA	200191305	INDEPENDENCIA S2	11/12/2019 19:40	11/12/2019 22:28	11/12/2019 19:40	11/12/2019 22:28	2,79	1	2,79	CHI
20191287416	LUZIANIA	LZ12082911	MARAJOARA	11/12/2019 19:41	12/12/2019 00:07	11/12/2019 19:41	12/12/2019 00:07	4,43	1	4,43	CHI
20191287441	BALIZA	BH12334535	BOM JARDIM	11/12/2019 19:41	12/12/2019 07:27	11/12/2019 19:41	12/12/2019 07:27	11,76	18	211,61	CHI
20191287424	IPAMERI	IP12275819	IPAMERI	11/12/2019 19:42	12/12/2019 14:02	11/12/2019 19:42	12/12/2019 12:28	16,77	1	16,77	CHI
20191287424	IPAMERI	IP12275820	IPAMERI	11/12/2019 19:42	12/12/2019 14:02	11/12/2019 19:42	12/12/2019 14:02	18,34	1	18,34	CHI
20191287430	PORANGATU	PO12208614	PORANGATU	11/12/2019 19:43	12/12/2019 01:59	11/12/2019 19:43	12/12/2019 01:59	6,26	9	56,34	CHI
20191287776	CACHOEIRA DOURADA	CD12190755	CACHOEIRA DOURADA	11/12/2019 19:43	12/12/2019 16:08	11/12/2019 19:43	12/12/2019 16:08	20,42	59	1204,55	CHI

20191287439	HIDROLANDIA	HD11252474	ANHANGUERA	11/12/2019 19:45	11/12/2019 23:43	11/12/2019 19:45	11/12/2019 23:43	3,97	21	83,29	CHI
20191287448	GOIANIA	GN31082416	GOYA S2	11/12/2019 19:45	11/12/2019 23:44	11/12/2019 23:28	11/12/2019 23:44	0,27	2	0,53	CHI
20191287449	SAO LUIZ DO NORTE	3090006106	ITAPACI	11/12/2019 19:46	12/12/2019 08:24	11/12/2019 19:46	12/12/2019 08:24	12,63	1	12,63	CHI
20191287862	CATALAO	CT12061265RE	CATALAO S1	11/12/2019 19:46	12/12/2019 08:24	11/12/2019 19:46	12/12/2019 08:24	12,62	15	189,27	CHI
20191287862	DAVINOPOLIS	CT12061265RE	CATALAO S1	11/12/2019 19:46	12/12/2019 08:24	11/12/2019 19:46	12/12/2019 08:24	12,62	71	895,88	CHI
20191287862	OUVIDOR	CT12061265RE	CATALAO S1	11/12/2019 19:46	12/12/2019 08:24	11/12/2019 19:46	12/12/2019 08:24	12,62	53	668,76	CHI
20191288056	NOVA CRIXAS	NA12158763	NOVA CRIXAS	11/12/2019 19:48	12/12/2019 07:30	11/12/2019 19:48	12/12/2019 07:30	11,70	17	198,88	CHI
20191287462	PALMEIRAS DE GOIAS	590009667	PALMEIRAS	11/12/2019 19:49	11/12/2019 23:14	11/12/2019 19:49	11/12/2019 23:14	3,42	1	3,42	CHI
20191287463	ACREUNA	2440023791	ACREUNA	11/12/2019 19:49	11/12/2019 22:38	11/12/2019 19:49	11/12/2019 22:38	2,80	1	2,80	CHI
20191287472	GAMELEIRA DE GOIAS	AN21165599	DAIA S2	11/12/2019 19:51	12/12/2019 13:17	11/12/2019 19:51	12/12/2019 13:17	17,43	1	17,43	CHI
20191287490	IPAMERI	IP21086061	CAMPO ALEGRE DE GOIAS	11/12/2019 19:57	12/12/2019 12:27	11/12/2019 19:57	12/12/2019 12:27	16,51	1	16,51	CHI
20191287501	JATAI	JT21260395	JATAI S1	11/12/2019 20:00	12/12/2019 10:02	11/12/2019 20:00	12/12/2019 10:02	14,04	1	14,04	CHI
20191287602	ARAGARCAS	1820068241	ARAGARCAS	11/12/2019 20:00	12/12/2019 07:37	11/12/2019 20:00	12/12/2019 07:37	11,60	1	11,60	CHI
20191287605	ACREUNA	2440076801	ACREUNA	11/12/2019 20:01	11/12/2019 22:00	11/12/2019 20:01	11/12/2019 22:00	1,99	1	1,99	CHI
20191287608	ITAPURANGA	IK11051549	ITAPURANGA	11/12/2019 20:01	11/12/2019 21:38	11/12/2019 20:01	11/12/2019 21:38	1,61	195	314,11	CHI
20191287616	NOVA CRIXAS	10003737037	NOVA CRIXAS	11/12/2019 20:03	11/12/2019 22:25	11/12/2019 20:03	11/12/2019 22:25	2,36	1	2,36	CHI
20191287619	FORMOSA	FA21051136	ITUIQUIRA	11/12/2019 20:03	11/12/2019 22:29	11/12/2019 20:03	11/12/2019 22:29	2,42	1	2,42	CHI
20191287621	SANTO ANTONIO DO DESCOBERTO	SN12332025	MARAJOARA	11/12/2019 20:04	12/12/2019 09:50	11/12/2019 20:04	12/12/2019 09:50	13,76	1	13,76	CHI
20191287623	MUNDO NOVO DE GOIAS	10019686984	NOVA CRIXAS	11/12/2019 20:04	11/12/2019 22:16	11/12/2019 20:04	11/12/2019 22:16	2,19	1	2,19	CHI
20191287628	TRINDADE	40306306	TRINDADE	11/12/2019 20:06	12/12/2019 00:35	11/12/2019 20:06	12/12/2019 00:35	4,48	1	4,48	CHI
20191287682	CATALAO	CT11281402	CATALAO S2	11/12/2019 20:06	12/12/2019 07:08	11/12/2019 20:06	12/12/2019 07:08	11,03	51	562,47	CHI
20191287635	RIO VERDE	630091810	RIO VERDE S2	11/12/2019 20:07	11/12/2019 22:29	11/12/2019 20:07	11/12/2019 22:29	2,35	1	2,35	CHI
20191287641	GOIANIA	15277495	CARAJAS S2	11/12/2019 20:07	12/12/2019 01:49	11/12/2019 20:07	12/12/2019 01:49	5,70	1	5,70	CHI
20191287637	FORMOSA	610267565	ITUIQUIRA	11/12/2019 20:08	11/12/2019 21:30	11/12/2019 20:08	11/12/2019 21:30	1,37	1	1,37	CHI
20191287922	SANTA TEREZINHA DE GOIAS	SG11048646	SANTA TEREZINHA	11/12/2019 20:09	12/12/2019 01:18	11/12/2019 20:09	12/12/2019 01:18	5,15	191	983,49	CHI
20191287656	CATALAO	CT11333470	CATALAO S2	11/12/2019 20:11	12/12/2019 12:32	11/12/2019 20:11	12/12/2019 12:32	16,35	27	441,37	CHI
20191287659	ANAPOLIS	20671581	DAIA S1	11/12/2019 20:11	11/12/2019 21:35	11/12/2019 20:11	11/12/2019 21:35	1,39	1	1,39	CHI
20191287740	SAO LUIS DE MONTES BELOS	SL12006908	SAO LUIZ DOS MONTES BELOS	11/12/2019 20:11	11/12/2019 22:48	11/12/2019 20:11	11/12/2019 22:48	2,63	6	15,78	CHI
20191287680	CATALAO	CT13000015	CATALAO S2	11/12/2019 20:12	12/12/2019 17:24	11/12/2019 20:12	12/12/2019 00:01	3,81	451	1719,94	CHI
20191287680	CATALAO	CT11000030	CATALAO S2	11/12/2019 20:12	12/12/2019 17:24	12/12/2019 15:21	12/12/2019 17:14	1,89	80	151,16	CHI
20191287680	CATALAO	CT11000029	CATALAO S2	11/12/2019 20:12	12/12/2019 17:24	12/12/2019 15:21	12/12/2019 17:24	2,06	97	199,69	CHI
20191287664	SANTO ANTONIO DO DESCOBERTO	2210036507	ALEXANIA	11/12/2019 20:13	12/12/2019 08:00	11/12/2019 20:13	12/12/2019 08:00	11,78	1	11,78	CHI
20191287665	IVOLANDIA	1560005390	IPORA	11/12/2019 20:13	12/12/2019 09:30	11/12/2019 20:13	12/12/2019 09:30	13,28	1	13,28	CHI

20191287747	FAZENDA NOVA	NB12020219LD	JUSSARA	11/12/2019 20:15	12/12/2019 03:50	11/12/2019 20:15	12/12/2019 03:50	7,58	38	287,87	CHI
20191287747	JUSSARA	NB12020219LD	JUSSARA	11/12/2019 20:15	12/12/2019 03:50	11/12/2019 20:15	12/12/2019 03:50	7,58	1	7,58	CHI
20191287747	NOVO BRASIL	NB12020219LD	JUSSARA	11/12/2019 20:15	12/12/2019 03:50	11/12/2019 20:15	12/12/2019 03:50	7,58	35	265,14	CHI
20191287672	SAO LUIS DE MONTES BELOS	SL32145964	SAO LUIZ DOS MONTES BELOS	11/12/2019 20:16	12/12/2019 07:41	11/12/2019 20:16	12/12/2019 07:41	11,42	36	411,05	CHI
20191287676	CATALAO	1990331108	CATALAO S2	11/12/2019 20:17	12/12/2019 08:26	11/12/2019 20:17	12/12/2019 08:26	12,15	1	12,15	CHI
20191287687	INDIARA	2710031535	EDEIA	11/12/2019 20:20	12/12/2019 08:50	11/12/2019 20:20	12/12/2019 08:50	12,51	1	12,51	CHI
20191287710	VALPARAISO DE GOIAS	VA12261801	PACAEMBU S2	11/12/2019 20:20	11/12/2019 21:56	11/12/2019 20:20	11/12/2019 21:56	1,58	447	707,87	CHI
20191287829	GOIANIA	GN11191071	CARAJAS S2	11/12/2019 20:20	12/12/2019 01:15	11/12/2019 20:20	12/12/2019 01:15	4,91	93	456,53	CHI
20191287692	URUACU	10018596280	URUACU	11/12/2019 20:21	12/12/2019 01:23	11/12/2019 20:21	12/12/2019 01:23	5,03	1	5,03	CHI
20191287695	FIRMINOPOLIS	FR12027222	SAO LUIZ DOS MONTES BELOS	11/12/2019 20:21	11/12/2019 22:07	11/12/2019 20:21	11/12/2019 22:07	1,76	10	17,61	CHI
20191287695	SAO LUIS DE MONTES BELOS	FR12027222	SAO LUIZ DOS MONTES BELOS	11/12/2019 20:21	11/12/2019 22:07	11/12/2019 20:21	11/12/2019 22:07	1,76	2	3,52	CHI
20191287698	NIQUELANDIA	NQ12396776	NIQUELANDIA SUBTRANSMISSAO	11/12/2019 20:22	12/12/2019 11:03	11/12/2019 20:22	12/12/2019 11:03	14,67	4	58,68	CHI
20191287703	AGUAS LINDAS DE GOIAS	4830254337	AGUAS LINDAS DE GOIAS S1	11/12/2019 20:24	12/12/2019 08:26	11/12/2019 20:24	12/12/2019 08:26	12,03	1	12,03	CHI
20191287704	AGUA FRIA DE GOIAS	TL12164597	SAO JOAO D ALIANCA	11/12/2019 20:24	11/12/2019 22:29	11/12/2019 20:24	11/12/2019 22:29	2,07	373	772,94	CHI
20191287707	FIRMINOPOLIS	FR21283492	FIRMINOPOLIS S1	11/12/2019 20:25	12/12/2019 07:05	11/12/2019 20:25	12/12/2019 07:05	10,68	1	10,68	CHI
20191287713	PARAUNA	PU21249060	PARAUNA	11/12/2019 20:26	12/12/2019 00:43	11/12/2019 20:26	12/12/2019 00:43	4,29	1	4,29	CHI
20191287818	GOIANIA	GN11129237	GOYA S1	11/12/2019 20:26	11/12/2019 23:07	11/12/2019 20:26	11/12/2019 23:07	2,68	98	262,64	CHI
20191287853	PETROLINA DE GOIAS	PG12031546	PETROLINA	11/12/2019 20:28	12/12/2019 02:14	11/12/2019 20:28	12/12/2019 02:14	5,76	25	143,91	CHI
20191287950	CATALAO	CT11166784	CATALAO S2	11/12/2019 20:28	12/12/2019 01:59	11/12/2019 20:28	12/12/2019 01:59	5,51	132	726,84	CHI
20191287727	CUMARI	CT21164149	CATALAO S2	11/12/2019 20:30	12/12/2019 08:30	11/12/2019 20:30	12/12/2019 08:30	12,00	1	12,00	CHI
20191287728	TRINDADE	TR11111544	TRINDADE	11/12/2019 20:30	11/12/2019 22:43	11/12/2019 20:30	11/12/2019 22:43	2,20	184	405,21	CHI
20191287744	GOIAS	GS21087756	GOIAS	11/12/2019 20:33	12/12/2019 12:54	11/12/2019 20:33	12/12/2019 12:54	16,34	2	32,68	CHI
20191287801	DAVINOPOLIS	IO12000011RE	CATALAO S1	11/12/2019 20:34	12/12/2019 11:36	11/12/2019 20:34	12/12/2019 11:36	15,03	33	495,93	CHI
20191287801	DISTRITO FEDERAL	IO12000011RE	CATALAO S1	11/12/2019 20:34	12/12/2019 11:36	11/12/2019 20:34	12/12/2019 11:36	15,03	3	45,08	CHI
20191287801	OUVIDOR	IO12000011RE	CATALAO S1	11/12/2019 20:34	12/12/2019 11:36	11/12/2019 20:34	12/12/2019 11:36	15,03	12	180,34	CHI
20191287801	TRES RANCHOS	IO12000011RE	CATALAO S1	11/12/2019 20:34	12/12/2019 11:36	11/12/2019 20:34	12/12/2019 11:36	15,03	4	60,11	CHI
20191287901	BONOPOLIS	BX12364615	SAO MIGUEL DO ARAGUAIA	11/12/2019 20:34	12/12/2019 09:50	11/12/2019 20:34	12/12/2019 09:50	13,25	19	251,80	CHI
201912260814	CUMARI	CT12266194	CATALAO S2	11/12/2019 20:35	12/12/2019 09:25	11/12/2019 20:35	12/12/2019 09:25	12,84	9	115,53	CHI
20191287892	GOIANESIA	GE12402091	GOIANESIA S2	11/12/2019 20:37	12/12/2019 11:34	11/12/2019 20:37	12/12/2019 11:34	14,94	34	507,91	CHI
20191287767	HIDROLANDIA	10008747308	CEPAIGO S2	11/12/2019 20:38	12/12/2019 01:58	11/12/2019 20:38	12/12/2019 01:58	5,33	1	5,33	CHI
20191286455	IPORA	IR12033222	IPORA	11/12/2019 20:42	11/12/2019 22:10	11/12/2019 20:42	11/12/2019 22:10	1,46	4	5,85	CHI
20191287784	TRINDADE	13929926	GOYA S2	11/12/2019 20:42	12/12/2019 00:31	11/12/2019 20:42	12/12/2019 00:31	3,81	1	3,81	CHI
20191287785	OUVIDOR	2180001387	CATALAO S1	11/12/2019 20:42	12/12/2019 08:01	11/12/2019 20:42	12/12/2019 08:01	11,31	1	11,31	CHI

20191287788	FORMOSA	10019140574	ITUIQUIRA	11/12/2019 20:43	11/12/2019 23:11	11/12/2019 20:43	11/12/2019 23:11	2,46	1	2,46	CHI
20191287790	CAIAPONIA	CP12354285	CAIAPONIA	11/12/2019 20:43	12/12/2019 14:10	11/12/2019 20:43	12/12/2019 14:10	17,44	12	209,33	CHI
20191289230	PIRACANJUBA	PJ12249833	PIRACANJUBA	11/12/2019 20:43	12/12/2019 13:01	11/12/2019 20:43	12/12/2019 13:01	16,31	81	1320,84	CHI
20191287791	AGUAS LINDAS DE GOIAS	10006320439	AGUAS LINDAS DE GOIAS S1	11/12/2019 20:44	11/12/2019 22:20	11/12/2019 20:44	11/12/2019 22:20	1,60	1	1,60	CHI
20191287795	CORUMBA DE GOIAS	CB11351483	CORUMBA	11/12/2019 20:44	11/12/2019 22:44	11/12/2019 20:44	11/12/2019 22:44	1,99	47	93,53	CHI
20191287841	CACU	CA12080196	CACHOEIRA ALTA	11/12/2019 20:44	12/12/2019 09:31	11/12/2019 20:44	12/12/2019 09:31	12,77	7	89,37	CHI
20191287874	FORMOSA	FA11131872	ITUIQUIRA	11/12/2019 20:44	11/12/2019 22:05	11/12/2019 20:44	11/12/2019 22:05	1,35	155	208,56	CHI
20191287805	AGUAS LINDAS DE GOIAS	4830227036	AGUAS LINDAS DE GOIAS S1	11/12/2019 20:46	11/12/2019 21:53	11/12/2019 20:46	11/12/2019 21:53	1,11	1	1,11	CHI
20191287806	ANICUNS	AC12391421	ANICUNS	11/12/2019 20:46	12/12/2019 11:00	11/12/2019 20:46	12/12/2019 11:00	14,22	3	42,67	CHI
20191287850	CIDADE OCIDENTAL	DH11313959	MARAJOARA	11/12/2019 20:46	12/12/2019 00:12	11/12/2019 20:46	12/12/2019 00:12	3,43	87	298,10	CHI
20191287895	CATALAO	IP12404711	IPAMERI	11/12/2019 20:46	12/12/2019 00:24	11/12/2019 20:46	12/12/2019 00:24	3,63	7	25,43	CHI
20191287895	GOIANDIRA	IP12404711	IPAMERI	11/12/2019 20:46	12/12/2019 00:24	11/12/2019 20:46	12/12/2019 00:24	3,63	15	54,50	CHI
20191287895	IPAMERI	IP12404711	IPAMERI	11/12/2019 20:46	12/12/2019 00:24	11/12/2019 20:46	12/12/2019 00:24	3,63	87	316,10	CHI
20191287819	GOIANESIA	550076554	GOIANESIA S2	11/12/2019 20:50	12/12/2019 09:57	11/12/2019 20:50	12/12/2019 09:57	13,12	1	13,12	CHI
20191287822	CATALAO	CT12250337	CATALAO S1	11/12/2019 20:51	12/12/2019 10:59	11/12/2019 20:51	12/12/2019 10:59	14,13	30	423,96	CHI
20191287877	FORMOSA	FA11131890	ITUIQUIRA	11/12/2019 20:52	11/12/2019 22:24	11/12/2019 20:52	11/12/2019 22:24	1,53	79	121,11	CHI
20191287828	MATRINCHA	MP12299692	MATRINCHA	11/12/2019 20:53	12/12/2019 04:26	11/12/2019 20:53	12/12/2019 04:26	7,54	4	30,17	CHI
20191287833	CATALAO	GD12127624RE	CATALAO S1	11/12/2019 20:55	12/12/2019 11:09	11/12/2019 20:55	12/12/2019 11:09	14,24	14	199,42	CHI
20191287833	GOIANDIRA	GD12127624RE	CATALAO S1	11/12/2019 20:55	12/12/2019 11:09	11/12/2019 20:55	12/12/2019 11:09	14,24	17	242,16	CHI
20191287833	IPAMERI	GD12127624RE	CATALAO S1	11/12/2019 20:55	12/12/2019 11:09	11/12/2019 20:55	12/12/2019 11:09	14,24	7	99,71	CHI
20191287836	DOVERLANDIA	DV21188462	CAIAPONIA	11/12/2019 20:56	12/12/2019 19:39	11/12/2019 20:56	12/12/2019 19:39	22,71	1	22,71	CHI
20191287847	CATALAO	GD12063788	CATALAO S1	11/12/2019 20:58	12/12/2019 14:35	11/12/2019 20:58	12/12/2019 14:35	17,60	3	52,81	CHI
20191287898	AGUAS LINDAS DE GOIAS	LA11113295	AGUAS LINDAS DE GOIAS S2	11/12/2019 20:58	11/12/2019 21:54	11/12/2019 20:58	11/12/2019 21:54	0,92	237	218,30	CHI
20191287860	MINEIROS	MY10396070	PARQUE DAS EMAS	11/12/2019 21:00	14/12/2019 16:10	11/12/2019 21:05	11/12/2019 21:49	0,74	36	26,47	CHI
20191287860	MINEIROS	MY12341117LD	PARQUE DAS EMAS	11/12/2019 21:00	14/12/2019 16:10	11/12/2019 21:05	11/12/2019 23:24	2,31	14	32,37	CHI
20191287860	MINEIROS	MY13324495	PARQUE DAS EMAS	11/12/2019 21:00	14/12/2019 16:10	11/12/2019 21:05	12/12/2019 10:39	13,57	27	366,41	CHI
20191287860	MINEIROS	MY13324463	PARQUE DAS EMAS	11/12/2019 21:00	14/12/2019 16:10	11/12/2019 21:05	12/12/2019 14:40	17,58	21	369,22	CHI
20191287860	MINEIROS	MY10396070	PARQUE DAS EMAS	11/12/2019 21:00	14/12/2019 16:10	12/12/2019 15:48	12/12/2019 16:36	0,80	36	28,83	CHI
20191287860	MINEIROS	MY12341117LD	PARQUE DAS EMAS	11/12/2019 21:00	14/12/2019 16:10	12/12/2019 15:48	12/12/2019 17:58	2,17	14	30,34	CHI
20191287860	MINEIROS	MY13324496	PARQUE DAS EMAS	11/12/2019 21:00	14/12/2019 16:10	12/12/2019 15:48	12/12/2019 19:22	3,57	27	96,39	CHI
20191287860	MINEIROS	MY10396070	PARQUE DAS EMAS	11/12/2019 21:00	14/12/2019 16:10	12/12/2019 20:12	12/12/2019 21:10	0,96	77	74,26	CHI
20191287860	MINEIROS	MY13324463	PARQUE DAS EMAS	11/12/2019 21:00	14/12/2019 16:10	12/12/2019 15:48	13/12/2019 10:19	18,52	21	388,94	CHI
20191287860	MINEIROS	MY13324497	PARQUE DAS EMAS	11/12/2019 21:00	14/12/2019 16:10	11/12/2019 21:05	13/12/2019 11:52	38,79	30	1163,59	CHI

20191287860	SERRANOPOLIS	MY13324497	PARQUE DAS EMAS	11/12/2019 21:00	14/12/2019 16:10	11/12/2019 21:05	13/12/2019 11:52	38,79	7	271,50	CHI
20191287860	MINEIROS	MY10396070	PARQUE DAS EMAS	11/12/2019 21:00	14/12/2019 16:10	13/12/2019 12:16	13/12/2019 12:40	0,40	128	51,77	CHI
20191287860	SERRANOPOLIS	MY10396070	PARQUE DAS EMAS	11/12/2019 21:00	14/12/2019 16:10	13/12/2019 12:16	13/12/2019 12:40	0,40	7	2,83	CHI
20191287860	MINEIROS	MY10396070	PARQUE DAS EMAS	11/12/2019 21:00	14/12/2019 16:10	13/12/2019 12:41	13/12/2019 13:16	0,60	98	58,61	CHI
20191287860	MINEIROS	MY13324497	PARQUE DAS EMAS	11/12/2019 21:00	14/12/2019 16:10	13/12/2019 12:41	13/12/2019 15:40	2,99	17	50,85	CHI
20191287860	SERRANOPOLIS	MY13324497	PARQUE DAS EMAS	11/12/2019 21:00	14/12/2019 16:10	13/12/2019 12:41	13/12/2019 15:40	2,99	7	20,94	CHI
20191287860	MINEIROS	MY13409363	PARQUE DAS EMAS	11/12/2019 21:00	14/12/2019 16:10	13/12/2019 12:41	14/12/2019 01:58	13,30	13	172,85	CHI
20191287860	SERRANOPOLIS	DJ12136065	CHAPADAO DO CEU	11/12/2019 21:00	14/12/2019 16:10	14/12/2019 01:59	14/12/2019 07:52	5,90	2	11,79	CHI
20191287860	MINEIROS	MY13324464	PARQUE DAS EMAS	11/12/2019 21:00	14/12/2019 16:10	14/12/2019 01:59	14/12/2019 12:01	10,03	1	10,03	CHI
20191287860	MINEIROS	MY13337099	PARQUE DAS EMAS	11/12/2019 21:00	14/12/2019 16:10	14/12/2019 01:59	14/12/2019 16:10	14,18	12	170,20	CHI
20191287854	ITAPACI	100001180	ITAPACI	11/12/2019 21:01	12/12/2019 13:40	11/12/2019 21:01	12/12/2019 13:40	16,66	1	16,66	CHI
20191287858	RIO VERDE	RV12279799	CABRIUVA S2	11/12/2019 21:02	12/12/2019 11:00	11/12/2019 21:02	12/12/2019 11:00	13,97	3	41,91	CHI
20191287865	PORANGATU	PO12094123	PORANGATU	11/12/2019 21:03	12/12/2019 02:22	11/12/2019 21:03	12/12/2019 02:22	5,30	1	5,30	CHI
20191287866	PILAR DE GOIAS	GG21341549	URUACU	11/12/2019 21:04	12/12/2019 12:15	11/12/2019 21:04	12/12/2019 12:15	15,19	1	15,19	CHI
20191287869	GOIANIA	17105535	CARAJAS S1	11/12/2019 21:05	12/12/2019 02:31	11/12/2019 21:05	12/12/2019 02:31	5,42	1	5,42	CHI
20191287875	GAMELEIRA DE GOIAS	AN12165598	DAIA S2	11/12/2019 21:07	12/12/2019 10:45	11/12/2019 21:07	12/12/2019 10:45	13,62	3	40,86	CHI
20191287875	SILVANIA	AN12165598	DAIA S2	11/12/2019 21:07	12/12/2019 10:45	11/12/2019 21:07	12/12/2019 10:45	13,62	1	13,62	CHI
20191287879	GOIATUBA	GT11000011	GOIATUBA S2	11/12/2019 21:08	12/12/2019 07:01	11/12/2019 21:08	12/12/2019 07:01	9,87	48	473,68	CHI
20191287880	ABADIANIA	AA12258346	ANAPOLIS UNIVERSITARIO S1	11/12/2019 21:08	12/12/2019 01:50	11/12/2019 21:08	12/12/2019 01:50	4,69	22	103,08	CHI
20191287880	CORUMBA DE GOIAS	AA12258346	ANAPOLIS UNIVERSITARIO S1	11/12/2019 21:08	12/12/2019 01:50	11/12/2019 21:08	12/12/2019 01:50	4,69	2	9,37	CHI
20191287884	IPAMERI	IP12376252	CRISTALINA S2	11/12/2019 21:09	12/12/2019 08:05	11/12/2019 21:09	12/12/2019 08:05	10,93	18	196,67	CHI
20191287887	ANICUNS	AC21024366	ANICUNS	11/12/2019 21:09	12/12/2019 08:58	11/12/2019 21:09	12/12/2019 08:58	11,81	1	11,81	CHI
20191287889	VICENTINOPOLIS	1970006137	VICENTINOPOLIS	11/12/2019 21:10	12/12/2019 12:25	11/12/2019 21:10	12/12/2019 12:25	15,25	1	15,25	CHI
20191287945	CATALAO	CT12000051RE	CATALAO S1	11/12/2019 21:11	12/12/2019 08:00	11/12/2019 21:11	12/12/2019 08:00	10,81	63	681,33	CHI
20191287902	ITUMBIARA	IT21309836	ITUMBIARA NOVA	11/12/2019 21:15	12/12/2019 12:40	11/12/2019 21:15	12/12/2019 12:40	15,41	2	30,82	CHI
20191288508	JATAI	JT12354963	JATAI S1	11/12/2019 21:16	12/12/2019 08:28	11/12/2019 21:16	12/12/2019 08:28	11,20	8	89,60	CHI
20191287907	TAQUARAL DE GOIAS	TQ21300110	ITABERAI S1	11/12/2019 21:17	12/12/2019 08:08	11/12/2019 21:17	12/12/2019 08:08	10,84	1	10,84	CHI
20191287912	BRITANIA	BT12106215	BRITANIA	11/12/2019 21:21	12/12/2019 09:50	11/12/2019 21:21	12/12/2019 09:50	12,48	10	124,83	CHI
20191287946	ARAGARCAS	AG10396203	ARAGARCAS	11/12/2019 21:31	12/12/2019 18:38	11/12/2019 21:31	12/12/2019 08:05	10,57	47	496,95	CHI
20191287946	BOM JARDIM DE GOIAS	AG10396203	ARAGARCAS	11/12/2019 21:31	12/12/2019 18:38	11/12/2019 21:31	12/12/2019 08:05	10,57	13	137,45	CHI
20191287946	ARAGARCAS	AG10396203	ARAGARCAS	11/12/2019 21:31	12/12/2019 18:38	11/12/2019 21:31	12/12/2019 18:38	21,11	58	1224,49	CHI
20191287946	BOM JARDIM DE GOIAS	AG10396203	ARAGARCAS	11/12/2019 21:31	12/12/2019 18:38	11/12/2019 21:31	12/12/2019 18:38	21,11	41	865,59	CHI
20191287946	ARAGARCAS	AG10396203	ARAGARCAS	11/12/2019 21:31	12/12/2019 18:38	12/12/2019 08:06	12/12/2019 18:38	10,53	47	494,98	CHI

20191287946	BOM JARDIM DE GOIAS	AG10396203	ARAGARCAS	11/12/2019 21:31	12/12/2019 18:38	12/12/2019 08:06	12/12/2019 18:38	10,53	13	136,91	CHI
20191287960	MORRINHOS	MR21223298	MORRINHOS	11/12/2019 21:44	12/12/2019 10:31	11/12/2019 21:44	12/12/2019 10:31	12,78	1	12,78	CHI
20191287964	PORANGATU	PO13320884	PORANGATU	11/12/2019 21:45	11/12/2019 23:34	11/12/2019 22:25	11/12/2019 22:45	0,34	80	27,56	CHI
20191287964	PORANGATU	PO10400350	PORANGATU	11/12/2019 21:45	11/12/2019 23:34	11/12/2019 23:24	11/12/2019 23:34	0,17	314	52,68	CHI
20191287973	CATALAO	CT11333625	CATALAO S2	11/12/2019 21:49	12/12/2019 08:17	11/12/2019 21:49	12/12/2019 08:17	10,47	30	313,99	CHI
20191289030	CATALAO	10017098643	CATALAO S2	11/12/2019 21:49	12/12/2019 08:59	11/12/2019 21:49	12/12/2019 08:59	11,17	1	11,17	CHI
20191287980	PORANGATU	PO12373464	PORANGATU	11/12/2019 21:52	12/12/2019 09:52	11/12/2019 21:52	12/12/2019 09:52	11,98	2	23,97	CHI
20191287983	ADELANDIA	DN12039706	FIRMINOPOLIS S2	11/12/2019 21:54	12/12/2019 02:40	11/12/2019 21:54	12/12/2019 02:40	4,76	4	19,05	CHI
20191287983	AURILANDIA	DN12039706	FIRMINOPOLIS S2	11/12/2019 21:54	12/12/2019 02:40	11/12/2019 21:54	12/12/2019 02:40	4,76	1	4,76	CHI
20191287983	SAO LUIS DE MONTES BELOS	DN12039706	FIRMINOPOLIS S2	11/12/2019 21:54	12/12/2019 02:40	11/12/2019 21:54	12/12/2019 02:40	4,76	39	185,77	CHI
20191287983	TURVANIA	DN12039706	FIRMINOPOLIS S2	11/12/2019 21:54	12/12/2019 02:40	11/12/2019 21:54	12/12/2019 02:40	4,76	2	9,53	CHI
20191287984	CRIXAS	10009181065	SERRA DO OURO	11/12/2019 21:55	12/12/2019 11:41	11/12/2019 21:55	12/12/2019 11:41	13,76	1	13,76	CHI
20191288005	AGUAS LINDAS DE GOIAS	LA11113295	AGUAS LINDAS DE GOIAS S2	11/12/2019 21:56	11/12/2019 23:12	11/12/2019 21:56	11/12/2019 23:12	1,25	237	296,51	CHI
20191287992	SILVANIA	SV12151524	VIANOPOLIS	11/12/2019 21:57	12/12/2019 13:09	11/12/2019 21:57	12/12/2019 13:09	15,20	9	136,81	CHI
20191287995	CAIAPONIA	CP21354330	CAIAPONIA	11/12/2019 21:59	13/12/2019 11:08	11/12/2019 21:59	13/12/2019 11:08	37,15	1	37,15	CHI
20191288002	GOIANIA	10464347	AEROPORTO S1	11/12/2019 22:04	12/12/2019 00:20	11/12/2019 22:04	12/12/2019 00:20	2,25	1	2,25	CHI
20191288010	MORRINHOS	150163952	GOIATUBA S1	11/12/2019 22:13	12/12/2019 12:55	11/12/2019 22:13	12/12/2019 12:55	14,70	1	14,70	CHI
20191288020	ANICUNS	10012898030	ANICUNS	11/12/2019 22:25	12/12/2019 10:58	11/12/2019 22:25	12/12/2019 10:58	12,55	1	12,55	CHI
20191288022	MUNDO NOVO DE GOIAS	4240022941	NOVA CRIXAS	11/12/2019 22:25	12/12/2019 00:55	11/12/2019 22:25	12/12/2019 00:55	2,48	1	2,48	CHI
20191288037	GOIANIA	GN12169154	CAMPINAS S1	11/12/2019 22:27	12/12/2019 02:21	11/12/2019 22:27	12/12/2019 02:21	3,90	103	401,27	CHI
20191288027	GOIANIA	14508576	ATLANTICO S3	11/12/2019 22:34	12/12/2019 01:00	11/12/2019 22:34	12/12/2019 01:00	2,43	1	2,43	CHI
20191288029	ARAGUAPAZ	AZ12404560	GOIAS	11/12/2019 22:37	12/12/2019 07:52	11/12/2019 22:37	12/12/2019 07:52	9,25	4	36,99	CHI
20191288030	ANAPOLIS	10012134170	ANAPOLIS UNIVERSITARIO S2	11/12/2019 22:37	12/12/2019 09:09	11/12/2019 22:37	12/12/2019 09:09	10,53	1	10,53	CHI
20191288055	ANAPOLIS	AN11003272	JUNDIAI S1	11/12/2019 22:39	12/12/2019 00:05	11/12/2019 22:39	12/12/2019 00:05	1,42	140	199,19	CHI
20191288040	SAO MIGUEL DO ARAGUAIA	SM11352926	SAO MIGUEL DO ARAGUAIA	11/12/2019 22:40	12/12/2019 02:00	11/12/2019 22:40	12/12/2019 02:00	3,33	103	342,79	CHI
20191288179	ORIZONA	OZ12022850RE	PIRES DO RIO S2	11/12/2019 22:47	12/12/2019 07:45	11/12/2019 22:47	12/12/2019 07:45	8,98	9	80,79	CHI
20191288179	PIRES DO RIO	OZ12022850RE	PIRES DO RIO S2	11/12/2019 22:47	12/12/2019 07:45	11/12/2019 22:47	12/12/2019 07:45	8,98	56	502,69	CHI
20191288081	IPAMERI	UT12265585	URUTAI	11/12/2019 22:48	12/12/2019 08:50	11/12/2019 22:48	12/12/2019 08:50	10,02	5	50,12	CHI
20191288081	URUTAI	UT12265585	URUTAI	11/12/2019 22:48	12/12/2019 08:50	11/12/2019 22:48	12/12/2019 08:50	10,02	17	170,40	CHI
20191288050	TURVANIA	TV12005717	FIRMINOPOLIS S2	11/12/2019 22:49	12/12/2019 08:30	11/12/2019 22:49	12/12/2019 08:30	9,69	2	19,37	CHI
20191288053	GOIANIA	10016997636	CARAJAS S2	11/12/2019 22:53	12/12/2019 02:30	11/12/2019 22:53	12/12/2019 02:30	3,61	1	3,61	CHI
20191288054	MAURILANDIA	1040029416	RIO DOS BOIS	11/12/2019 22:53	12/12/2019 08:32	11/12/2019 22:53	12/12/2019 08:32	9,64	1	9,64	CHI
20191288057	MORRINHOS	150098832	MORRINHOS	11/12/2019 22:55	12/12/2019 08:15	11/12/2019 22:55	12/12/2019 08:15	9,33	1	9,33	CHI

20191288061	PIRANHAS	PH21341749	PIRANHAS	11/12/2019 23:01	12/12/2019 01:17	11/12/2019 23:01	12/12/2019 01:17	2,26	1	2,26	CHI
20191288062	ANAPOLIS	20158658	JUNDIAI S1	11/12/2019 23:02	12/12/2019 11:58	11/12/2019 23:02	12/12/2019 11:58	12,92	1	12,92	CHI
20191288063	TROMBAS	TB12202556	PORANGATU	11/12/2019 23:03	12/12/2019 02:53	11/12/2019 23:03	12/12/2019 02:53	3,82	2	7,64	CHI
20191288064	BRITANIA	BT12183057	BRITANIA	11/12/2019 23:04	12/12/2019 12:23	11/12/2019 23:04	12/12/2019 12:23	13,32	8	106,52	CHI
20191288066	CRIXAS	2490050480	SERRA DO OURO	11/12/2019 23:05	12/12/2019 10:44	11/12/2019 23:05	12/12/2019 10:44	11,64	1	11,64	CHI
20191288067	RIO VERDE	RV12296281	ACREUNA	11/12/2019 23:07	12/12/2019 11:40	11/12/2019 23:07	12/12/2019 11:40	12,55	2	25,10	CHI
20191288069	VICENTINOPOLIS	VI21263320	VICENTINOPOLIS	11/12/2019 23:08	12/12/2019 12:45	11/12/2019 23:08	12/12/2019 12:45	13,62	2	27,24	CHI
20191288070	JATAI	290115620	JATAI S3	11/12/2019 23:08	12/12/2019 08:29	11/12/2019 23:08	12/12/2019 08:29	9,34	1	9,34	CHI
20191288089	SAO SIMAO	2240036686	CACHOEIRA ALTA	11/12/2019 23:24	12/12/2019 07:38	11/12/2019 23:24	12/12/2019 07:38	8,24	1	8,24	CHI
20191288144	PIRACANJUBA	PJ11182780	PIRACANJUBA	11/12/2019 23:36	12/12/2019 03:48	11/12/2019 23:36	12/12/2019 03:48	4,19	128	535,82	CHI
20191286558	AGUA FRIA DE GOIAS	TL11211627	SAO JOAO D ALIANCA	11/12/2019 23:47	12/12/2019 01:38	11/12/2019 23:47	12/12/2019 01:38	1,85	162	298,89	CHI
20191288118	PALESTINA DE GOIAS	PY12354654	ARENOPOLIS	11/12/2019 23:54	12/12/2019 16:50	11/12/2019 23:54	12/12/2019 16:50	16,94	1	16,94	CHI
20191288120	EDEIA	ED21254471	EDEIA	11/12/2019 23:57	12/12/2019 16:25	11/12/2019 23:57	12/12/2019 16:25	16,46	1	16,46	CHI
20191288124	CACU	1140028495	CACHOEIRA ALTA	12/12/2019 00:06	12/12/2019 08:52	12/12/2019 00:06	12/12/2019 08:52	8,75	1	8,75	CHI
20191288143	CALDAS NOVAS	CN12200060RE	CALDAS NOVAS S2	12/12/2019 00:13	12/12/2019 09:56	12/12/2019 00:13	12/12/2019 09:56	9,70	137	1329,09	CHI
20191288143	PIRACANJUBA	CN12200060RE	CALDAS NOVAS S2	12/12/2019 00:13	12/12/2019 09:56	12/12/2019 00:13	12/12/2019 09:56	9,70	2	19,40	CHI
20191288171	IPAMERI	IP12195204	IPAMERI	12/12/2019 00:19	12/12/2019 10:01	12/12/2019 00:19	12/12/2019 10:01	9,68	3	29,05	CHI
2019121200042	CAMPO ALEGRE DE GOIAS	01480414	CAMPO ALEGRE DE GOIAS	12/12/2019 00:30	12/12/2019 01:35	12/12/2019 00:30	12/12/2019 01:35	1,08	5	5,42	CHI
2019121200042	IPAMERI	01480414	CAMPO ALEGRE DE GOIAS	12/12/2019 00:30	12/12/2019 01:35	12/12/2019 00:30	12/12/2019 01:35	1,08	61	66,08	CHI
2019121200042	CAMPO ALEGRE DE GOIAS	01480414	PIRES DO RIO S2	12/12/2019 00:30	12/12/2019 01:35	12/12/2019 00:30	12/12/2019 01:35	1,08	21	22,75	CHI
2019121200042	IPAMERI	01480414	PIRES DO RIO S2	12/12/2019 00:30	12/12/2019 01:35	12/12/2019 00:30	12/12/2019 01:35	1,08	251	271,92	CHI
2019121200042	ORIZONA	01480414	PIRES DO RIO S2	12/12/2019 00:30	12/12/2019 01:35	12/12/2019 00:30	12/12/2019 01:35	1,08	9	9,75	CHI
2019121200042	PIRES DO RIO	01480414	PIRES DO RIO S2	12/12/2019 00:30	12/12/2019 01:35	12/12/2019 00:30	12/12/2019 01:35	1,08	10	10,83	CHI
2019121200042	URUTAI	01480414	PIRES DO RIO S2	12/12/2019 00:30	12/12/2019 01:35	12/12/2019 00:30	12/12/2019 01:35	1,08	100	108,33	CHI
20191288140	CALDAS NOVAS	IP10375985	IPAMERI	12/12/2019 00:36	12/12/2019 13:05	12/12/2019 00:39	12/12/2019 13:05	12,42	10	124,24	CHI
20191288140	CORUMBAIBA	IP10375985	IPAMERI	12/12/2019 00:36	12/12/2019 13:05	12/12/2019 00:39	12/12/2019 13:05	12,42	19	236,05	CHI
20191288140	IPAMERI	IP10375985	IPAMERI	12/12/2019 00:36	12/12/2019 13:05	12/12/2019 00:39	12/12/2019 13:05	12,42	432	5367,00	CHI
20191288137	IPAMERI	580076222	IPAMERI	12/12/2019 00:37	12/12/2019 14:00	12/12/2019 00:37	12/12/2019 14:00	13,37	1	13,37	CHI
20191288142	RIO VERDE	630491630	RIO VERDE S2	12/12/2019 00:44	12/12/2019 10:00	12/12/2019 00:44	12/12/2019 10:00	9,28	1	9,28	CHI
20191288147	APORE	AE10396071	ITAJA S1	12/12/2019 00:53	12/12/2019 23:59	12/12/2019 00:53	12/12/2019 04:20	3,45	64	220,94	CHI
20191288147	APORE	AE12000046LD	ITAJA S1	12/12/2019 00:53	12/12/2019 23:59	12/12/2019 00:53	12/12/2019 05:55	5,02	20	100,49	CHI
20191288147	APORE	AE10396071	ITAJA S1	12/12/2019 00:53	12/12/2019 23:59	12/12/2019 00:53	12/12/2019 09:50	8,94	3	26,81	CHI
20191288147	APORE	AE10396071	ITAJA S1	12/12/2019 00:53	12/12/2019 23:59	12/12/2019 14:11	12/12/2019 14:14	0,05	87	4,35	CHI

20191288147	APORE	AE10396071	ITAJA S1	12/12/2019 00:53	12/12/2019 23:59	12/12/2019 00:53	12/12/2019 23:59	23,10	31	716,22	CHI
20191288146	MINEIROS	MY11171859	PARQUE DAS EMAS	12/12/2019 00:56	12/12/2019 02:51	12/12/2019 00:56	12/12/2019 02:51	1,90	130	247,36	CHI
20191289138	HIDROLANDIA	JS12000108RE	ROCHEDO	12/12/2019 01:00	12/12/2019 09:01	12/12/2019 01:00	12/12/2019 09:01	8,02	9	72,15	CHI
20191289138	PIRACANJUBA	JS12000108RE	ROCHEDO	12/12/2019 01:00	12/12/2019 09:01	12/12/2019 01:00	12/12/2019 09:01	8,02	262	2100,29	CHI
20191289138	PROFESSOR JAMIL SAFADY	JS12000108RE	ROCHEDO	12/12/2019 01:00	12/12/2019 09:01	12/12/2019 01:00	12/12/2019 09:01	8,02	91	729,49	CHI
20191288662	CACHOEIRA ALTA	QI12119881	QUIRINOPOLIS	12/12/2019 01:09	12/12/2019 10:36	12/12/2019 01:09	12/12/2019 10:36	9,44	6	56,61	CHI
20191288662	QUIRINOPOLIS	QI12119881	QUIRINOPOLIS	12/12/2019 01:09	12/12/2019 10:36	12/12/2019 01:09	12/12/2019 10:36	9,44	18	169,83	CHI
20191288162	SANTA CRUZ DE GOIAS	BC12027033	PIRES DO RIO S2	12/12/2019 02:14	12/12/2019 08:54	12/12/2019 02:14	12/12/2019 08:54	6,66	19	126,62	CHI
20191288163	ITAPURANGA	IK12298413	ITAPURANGA	12/12/2019 02:16	12/12/2019 17:39	12/12/2019 02:16	12/12/2019 17:39	15,37	13	199,84	CHI
20191288759	ARENOPOLIS	PH12023602	PIRANHAS	12/12/2019 02:25	13/12/2019 09:05	12/12/2019 02:25	13/12/2019 09:05	30,66	6	183,94	CHI
20191288759	PIRANHAS	PH12023602	PIRANHAS	12/12/2019 02:25	13/12/2019 09:05	12/12/2019 02:25	13/12/2019 09:05	30,66	9	275,91	CHI
20191288170	INACIOLANDIA	ID32128284	QUIRINOPOLIS	12/12/2019 02:49	12/12/2019 14:47	12/12/2019 02:49	12/12/2019 14:47	11,95	2	23,91	CHI
20191288172	FIRMINOPOLIS	FR12382556	FIRMINOPOLIS S1	12/12/2019 02:56	12/12/2019 09:37	12/12/2019 02:56	12/12/2019 09:37	6,67	22	146,84	CHI
20191288172	SAO LUIS DE MONTES BELOS	FR12382556	FIRMINOPOLIS S1	12/12/2019 02:56	12/12/2019 09:37	12/12/2019 02:56	12/12/2019 09:37	6,67	7	46,72	CHI
20191288173	JATAI	290045824	JATAI S3	12/12/2019 02:58	12/12/2019 07:32	12/12/2019 02:58	12/12/2019 07:32	4,56	1	4,56	CHI
20191288174	NAZARIO	NZ21307002	ANICUNS	12/12/2019 03:00	12/12/2019 07:42	12/12/2019 03:00	12/12/2019 07:42	4,69	1	4,69	CHI
20191288175	LUZIANIA	LZ11128900	MARAJOARA	12/12/2019 03:09	12/12/2019 08:32	12/12/2019 03:09	12/12/2019 08:32	5,37	14	75,22	CHI
20191288177	SENADOR CANEDO	10010168760	GOIANIA LESTE S1	12/12/2019 03:17	12/12/2019 05:33	12/12/2019 03:17	12/12/2019 05:33	2,25	1	2,25	CHI
20191288181	RIO VERDE	6395978	SANTA HELENA S1	12/12/2019 03:54	12/12/2019 11:06	12/12/2019 03:54	12/12/2019 11:06	7,20	4	28,80	CHI
20191288181	SANTA HELENA DE GOIAS	6395978	SANTA HELENA S1	12/12/2019 03:54	12/12/2019 11:06	12/12/2019 03:54	12/12/2019 11:06	7,20	3	21,60	CHI
20191288182	PALMEIRAS DE GOIAS	PL21124110	PALMEIRAS	12/12/2019 03:59	12/12/2019 07:35	12/12/2019 03:59	12/12/2019 07:35	3,60	1	3,60	CHI
20191289019	JARAGUA	JA12297949	JARAGUA	12/12/2019 04:08	12/12/2019 18:29	12/12/2019 04:08	12/12/2019 18:29	14,34	28	401,41	CHI
20191288363	SAO MIGUEL DO PASSA QUATRO	SV12107881	VIANOPOLIS	12/12/2019 04:13	12/12/2019 07:19	12/12/2019 04:13	12/12/2019 07:19	3,09	59	182,38	CHI
20191288363	SILVANIA	SV12107881	VIANOPOLIS	12/12/2019 04:13	12/12/2019 07:19	12/12/2019 04:13	12/12/2019 07:19	3,09	34	105,10	CHI
20191288363	VIANOPOLIS	SV12107881	VIANOPOLIS	12/12/2019 04:13	12/12/2019 07:19	12/12/2019 04:13	12/12/2019 07:19	3,09	105	324,57	CHI
20191288187	ANAPOLIS	AN12258715	ANAPOLIS UNIVERSITARIO S2	12/12/2019 04:17	13/12/2019 11:26	12/12/2019 04:17	12/12/2019 10:51	6,56	13	85,32	CHI
20191288187	ANAPOLIS	AN12258715	ANAPOLIS UNIVERSITARIO S2	12/12/2019 04:17	13/12/2019 11:26	12/12/2019 10:52	12/12/2019 11:05	0,22	13	2,92	CHI
20191288187	ANAPOLIS	AN13059860	ANAPOLIS UNIVERSITARIO S2	12/12/2019 04:17	13/12/2019 11:26	12/12/2019 04:17	12/12/2019 16:19	12,03	18	216,59	CHI
20191288187	ANAPOLIS	AN12381272	ANAPOLIS UNIVERSITARIO S2	12/12/2019 04:17	13/12/2019 11:26	12/12/2019 04:17	12/12/2019 17:25	13,13	11	144,42	CHI
20191288187	ANAPOLIS	AN12258715	ANAPOLIS UNIVERSITARIO S2	12/12/2019 04:17	13/12/2019 11:26	13/12/2019 09:15	13/12/2019 10:35	1,34	42	56,07	CHI
20191288187	ANAPOLIS	AN12349368	ANAPOLIS UNIVERSITARIO S2	12/12/2019 04:17	13/12/2019 11:26	12/12/2019 04:17	13/12/2019 11:26	31,14	7	218,01	CHI
20191289064	CALDAS NOVAS	RQ12063069	VILA CORUMBA	12/12/2019 04:23	12/12/2019 12:29	12/12/2019 04:23	12/12/2019 12:29	8,10	8	64,78	CHI
20191288190	BOM JARDIM DE GOIAS	BM12212797	BOM JARDIM	12/12/2019 04:28	12/12/2019 10:15	12/12/2019 04:28	12/12/2019 10:15	5,77	87	501,99	CHI

20191288190	PIRANHAS	BM12212797	BOM JARDIM	12/12/2019 04:28	12/12/2019 10:15	12/12/2019 04:28	12/12/2019 10:15	5,77	2	11,54	CHI
20191288192	INHUMAS	IX12326257	INHUMAS S1	12/12/2019 04:35	12/12/2019 14:53	12/12/2019 04:35	12/12/2019 14:53	10,29	19	195,46	CHI
20191288775	BOM JARDIM DE GOIAS	BM12064260	BOM JARDIM	12/12/2019 04:45	12/12/2019 12:22	12/12/2019 04:45	12/12/2019 12:22	7,62	17	129,55	CHI
20191288518	JANDAIA	JD12024301	PALMEIRAS	12/12/2019 04:52	12/12/2019 09:10	12/12/2019 04:52	12/12/2019 09:10	4,31	9	38,77	CHI
20191288196	ITARUMA	IM12029171	CACHOEIRA ALTA	12/12/2019 04:54	12/12/2019 16:25	12/12/2019 04:54	12/12/2019 16:25	11,51	5	57,56	CHI
20191288301	PORANGATU	PO12321067	NOVO PLANALTO	12/12/2019 05:01	12/12/2019 21:09	12/12/2019 05:01	12/12/2019 21:09	16,12	3	48,36	CHI
20191288731	RIO QUENTE	RQ12098228	RIO QUENTE	12/12/2019 05:05	12/12/2019 10:30	12/12/2019 05:05	12/12/2019 10:30	5,41	13	70,33	CHI
20191288305	SANTA FE DE GOIAS	RN21065446	BRITANIA	12/12/2019 05:06	12/12/2019 10:40	12/12/2019 05:06	12/12/2019 10:40	5,58	2	11,15	CHI
20191288306	PIRACANJUBA	PJ10394717	PIRACANJUBA	12/12/2019 05:11	12/12/2019 22:52	12/12/2019 05:11	12/12/2019 09:33	4,36	136	592,88	CHI
20191288306	PIRACANJUBA	01460216	PIRACANJUBA	12/12/2019 05:11	12/12/2019 22:52	12/12/2019 09:50	12/12/2019 12:00	2,17	3144	6830,34	CHI
20191288306	PROFESSOR JAMIL SAFADY	01460216	PIRACANJUBA	12/12/2019 05:11	12/12/2019 22:52	12/12/2019 09:50	12/12/2019 12:00	2,17	3	6,52	CHI
20191288306	PIRACANJUBA	PJ10394717	PIRACANJUBA	12/12/2019 05:11	12/12/2019 22:52	12/12/2019 11:56	12/12/2019 12:00	0,06	2	0,11	CHI
20191288306	PIRACANJUBA	PJ10394717	PIRACANJUBA	12/12/2019 05:11	12/12/2019 22:52	12/12/2019 05:11	12/12/2019 12:35	7,41	31	229,62	CHI
20191288306	PIRACANJUBA	PJ10394717	PIRACANJUBA	12/12/2019 05:11	12/12/2019 22:52	12/12/2019 09:50	12/12/2019 12:35	2,76	28	77,40	CHI
20191288306	PIRACANJUBA	PJ13000022	PIRACANJUBA	12/12/2019 05:11	12/12/2019 22:52	12/12/2019 09:50	12/12/2019 17:45	7,93	92	729,30	CHI
20191288306	PIRACANJUBA	PJ13216538	PIRACANJUBA	12/12/2019 05:11	12/12/2019 22:52	12/12/2019 09:50	12/12/2019 22:52	13,03	16	208,53	CHI
20191289607	CATALAO	CT12266062RE	CATALAO S1	12/12/2019 05:15	12/12/2019 11:44	12/12/2019 05:15	12/12/2019 11:44	6,47	83	537,15	CHI
20191289607	OUVIDOR	CT12266062RE	CATALAO S1	12/12/2019 05:15	12/12/2019 11:44	12/12/2019 05:15	12/12/2019 11:44	6,47	1	6,47	CHI
20191288755	JUSSARA	JR12008743	BRITANIA	12/12/2019 05:18	12/12/2019 10:05	12/12/2019 05:18	12/12/2019 10:05	4,78	38	181,64	CHI
20191288309	QUIRINOPOLIS	QI12207130	QUIRINOPOLIS	12/12/2019 05:19	12/12/2019 07:08	12/12/2019 05:19	12/12/2019 07:08	1,82	619	1124,17	CHI
20191288367	CALDAS NOVAS	CN12263879	RIO QUENTE	12/12/2019 05:20	12/12/2019 10:43	12/12/2019 05:20	12/12/2019 10:43	5,37	2	10,74	CHI
20191288367	RIO QUENTE	CN12263879	RIO QUENTE	12/12/2019 05:20	12/12/2019 10:43	12/12/2019 05:20	12/12/2019 10:43	5,37	6	32,23	CHI
20191288962	ANICUNS	AC12000067	ANICUNS	12/12/2019 05:20	12/12/2019 12:05	12/12/2019 05:20	12/12/2019 12:05	6,74	15	101,15	CHI
20191288313	NOVA VENEZA	NV21078493	INHUMAS S1	12/12/2019 05:21	12/12/2019 07:27	12/12/2019 05:21	12/12/2019 07:27	2,09	1	2,09	CHI
20191288315	SAO MIGUEL DO ARAGUAIA	SM12228636	SAO MIGUEL DO ARAGUAIA	12/12/2019 05:21	12/12/2019 07:31	12/12/2019 05:21	12/12/2019 07:31	2,16	55	118,63	CHI
20191288563	ABADIANIA	AA12241539	ANAPOLIS UNIVERSITARIO S1	12/12/2019 05:25	12/12/2019 09:54	12/12/2019 05:25	12/12/2019 09:54	4,48	36	161,21	CHI
20191288563	CORUMBA DE GOIAS	AA12241539	ANAPOLIS UNIVERSITARIO S1	12/12/2019 05:25	12/12/2019 09:54	12/12/2019 05:25	12/12/2019 09:54	4,48	2	8,96	CHI
20191288682	NIQUELANDIA	NQ12197661	BARRO ALTO	12/12/2019 05:27	12/12/2019 10:45	12/12/2019 05:27	12/12/2019 10:45	5,30	11	58,26	CHI
20191288401	CRIXAS	CX10394718	SERRA DO OURO	12/12/2019 05:30	12/12/2019 10:21	12/12/2019 05:30	12/12/2019 08:44	3,24	89	288,68	CHI
20191288401	CRIXAS	CX12132683LD	SERRA DO OURO	12/12/2019 05:30	12/12/2019 10:21	12/12/2019 05:30	12/12/2019 09:59	4,49	74	332,51	CHI
20191288401	CRIXAS	CX10394718	SERRA DO OURO	12/12/2019 05:30	12/12/2019 10:21	12/12/2019 05:30	12/12/2019 10:21	4,86	59	286,46	CHI
20191288401	NOVA CRIXAS	CX10394718	SERRA DO OURO	12/12/2019 05:30	12/12/2019 10:21	12/12/2019 05:30	12/12/2019 10:21	4,86	6	29,13	CHI
20191288817	CIDADE OCIDENTAL	DH11313959	MARAJOARA	12/12/2019 05:30	12/12/2019 08:56	12/12/2019 05:30	12/12/2019 08:56	3,43	87	298,48	CHI

20191288328	ITUMBIARA	IT12033049	BOM JESUS DE GOIAS	12/12/2019 05:32	12/12/2019 11:23	12/12/2019 05:32	12/12/2019 11:23	5,85	7	40,94	CHI
201912260816	APORE	SX12264389	JATAI S1	12/12/2019 05:33	12/12/2019 11:01	12/12/2019 05:33	12/12/2019 11:01	5,47	7	38,26	CHI
201912260816	ITARUMA	SX12264389	JATAI S1	12/12/2019 05:33	12/12/2019 11:01	12/12/2019 05:33	12/12/2019 11:01	5,47	1	5,47	CHI
201912260816	SERRANOPOLIS	SX12264389	JATAI S1	12/12/2019 05:33	12/12/2019 11:01	12/12/2019 05:33	12/12/2019 11:01	5,47	53	289,69	CHI
20191288335	SANTA RITA DO NOVO DESTINO	BA12021220	BARRO ALTO	12/12/2019 05:34	12/12/2019 14:00	12/12/2019 05:34	12/12/2019 14:00	8,43	6	50,59	CHI
20191288514	SANTA CRUZ DE GOIAS	BC12126991	PIRACANJUBA	12/12/2019 05:35	12/12/2019 08:33	12/12/2019 05:35	12/12/2019 08:33	2,97	21	62,28	CHI
20191288189	RIO QUENTE	RQ12392077	VILA CORUMBA	12/12/2019 05:37	12/12/2019 09:39	12/12/2019 05:37	12/12/2019 09:39	4,02	7	28,17	CHI
20191288704	JUSSARA	JR12092772	JUSSARA	12/12/2019 05:37	12/12/2019 11:30	12/12/2019 05:37	12/12/2019 11:30	5,88	13	76,43	CHI
20191288727	FAZENDA NOVA	FN12042812	JUSSARA	12/12/2019 05:37	12/12/2019 11:44	12/12/2019 05:37	12/12/2019 11:44	6,11	10	61,15	CHI
20191288342	PORANGATU	PO21240712	PORANGATU	12/12/2019 05:40	12/12/2019 14:53	12/12/2019 05:40	12/12/2019 14:53	9,21	1	9,21	CHI
20191288529	APORE	AE12112891	ITAJA S1	12/12/2019 05:40	13/12/2019 15:20	12/12/2019 05:40	13/12/2019 15:20	33,67	27	908,98	CHI
20191288344	GOUVELANDIA	GB11348171	QUIRINOPOLIS	12/12/2019 05:41	12/12/2019 10:35	12/12/2019 05:41	12/12/2019 10:35	4,90	20	97,91	CHI
20191288380	MORRINHOS	PK12293231	PONTALINA	12/12/2019 05:43	12/12/2019 07:34	12/12/2019 05:43	12/12/2019 07:34	1,84	1	1,84	CHI
20191288380	PONTALINA	PK12293231	PONTALINA	12/12/2019 05:43	12/12/2019 07:34	12/12/2019 05:43	12/12/2019 07:34	1,84	19	34,92	CHI
20191288349	LEOPOLDO DE BULHOES	LB12384839	DAIA S2	12/12/2019 05:45	12/12/2019 09:32	12/12/2019 05:45	12/12/2019 09:32	3,78	4	15,12	CHI
20191288355	CACU	CC21026103	CACHOEIRA ALTA	12/12/2019 05:48	12/12/2019 09:08	12/12/2019 05:48	12/12/2019 09:08	3,33	1	3,33	CHI
20191288358	NOVA CRIXAS	NA12090020	NOVA CRIXAS	12/12/2019 05:48	12/12/2019 10:03	12/12/2019 05:48	12/12/2019 10:03	4,24	12	50,86	CHI
20191288627	BALIZA	BH12331338	CAIAPONIA	12/12/2019 05:48	12/12/2019 09:03	12/12/2019 05:48	12/12/2019 09:03	3,24	78	252,37	CHI
20191289042	NIQUELANDIA	NQ12374575	NIQUELANDIA SUBTRANSMISSAO	12/12/2019 05:48	12/12/2019 10:36	12/12/2019 05:48	12/12/2019 10:36	4,79	12	57,51	CHI
20191288729	SAO JOAO D ALIANCA	JL12237037	ITIQUIRA	12/12/2019 05:51	13/12/2019 18:58	12/12/2019 05:51	12/12/2019 15:56	10,08	10	100,77	CHI
20191288729	FORMOSA	FA12164536	ITIQUIRA	12/12/2019 05:51	13/12/2019 18:58	13/12/2019 10:43	13/12/2019 18:11	7,48	2	14,96	CHI
20191288729	SAO JOAO D ALIANCA	FA12164536	ITIQUIRA	12/12/2019 05:51	13/12/2019 18:58	13/12/2019 10:43	13/12/2019 18:11	7,48	217	1622,62	CHI
20191288729	SAO JOAO D ALIANCA	JL12295142LD	ITIQUIRA	12/12/2019 05:51	13/12/2019 18:58	12/12/2019 05:51	13/12/2019 18:32	36,69	5	183,45	CHI
20191288729	SAO JOAO D ALIANCA	JL12295141LD	ITIQUIRA	12/12/2019 05:51	13/12/2019 18:58	12/12/2019 05:51	13/12/2019 18:58	37,12	6	222,71	CHI
20191288368	GUAPO	GC12000274	GUAPO S1	12/12/2019 05:52	12/12/2019 12:07	12/12/2019 05:52	12/12/2019 12:07	6,24	38	237,12	CHI
20191288368	TRINDADE	GC12000274	GUAPO S1	12/12/2019 05:52	12/12/2019 12:07	12/12/2019 05:52	12/12/2019 12:07	6,24	37	230,88	CHI
20191288496	CALDAS NOVAS	CN12263786	RIO QUENTE	12/12/2019 05:52	12/12/2019 11:45	12/12/2019 05:52	12/12/2019 11:45	5,88	22	129,36	CHI
20191288496	RIO QUENTE	CN12263786	RIO QUENTE	12/12/2019 05:52	12/12/2019 11:45	12/12/2019 05:52	12/12/2019 11:45	5,88	1	5,88	CHI
20191284038	PIRACANJUBA	PJ12233807	ROCHEDO	12/12/2019 05:53	12/12/2019 11:10	12/12/2019 05:53	12/12/2019 11:10	5,27	8	42,14	CHI
20191288369	SANTA CRUZ DE GOIAS	BC12083189	PIRES DO RIO S2	12/12/2019 05:53	12/12/2019 09:54	12/12/2019 05:53	12/12/2019 09:54	4,01	8	32,07	CHI
20191288371	NOVA AMERICA	NM12318470	RUBIATABA	12/12/2019 05:54	12/12/2019 09:56	12/12/2019 05:54	12/12/2019 09:56	4,03	16	64,52	CHI
20191288807	DIORAMA	ME12184441	IPORA	12/12/2019 05:54	12/12/2019 09:19	12/12/2019 05:54	12/12/2019 09:19	3,42	11	37,57	CHI
20191288807	MONTES CLAROS DE GOIAS	ME12184441	IPORA	12/12/2019 05:54	12/12/2019 09:19	12/12/2019 05:54	12/12/2019 09:19	3,42	69	235,67	CHI

20191290411	RIO VERDE	RV10394614	CABRIUVA S1	12/12/2019 05:55	12/12/2019 14:47	12/12/2019 13:35	12/12/2019 13:51	0,27	690	188,02	CHI
20191290411	JATAI	RV10396199	CABRIUVA S1	12/12/2019 05:55	12/12/2019 14:47	12/12/2019 13:34	12/12/2019 14:46	1,20	8	9,60	CHI
20191290411	RIO VERDE	RV10396199	CABRIUVA S1	12/12/2019 05:55	12/12/2019 14:47	12/12/2019 13:34	12/12/2019 14:46	1,20	197	236,35	CHI
20191290411	RIO VERDE	RV10396199	CABRIUVA S2	12/12/2019 05:55	12/12/2019 14:47	12/12/2019 13:34	12/12/2019 14:46	1,20	56	67,18	CHI
20191290411	RIO VERDE	RV12260701	CABRIUVA S1	12/12/2019 05:55	12/12/2019 14:47	12/12/2019 05:55	12/12/2019 14:47	8,86	2	17,72	CHI
20191288523	PORANGATU	PO12390255	PORANGATU	12/12/2019 05:56	12/12/2019 08:11	12/12/2019 05:56	12/12/2019 08:11	2,24	4	8,97	CHI
20191288750	BOM JARDIM DE GOIAS	BM12259512	BOM JARDIM	12/12/2019 05:56	12/12/2019 12:58	12/12/2019 05:56	12/12/2019 12:58	7,03	18	126,56	CHI
20191289562	GAMELEIRA DE GOIAS	SV12090745	ANAPOLIS UNIVERSITARIO S2	12/12/2019 05:56	12/12/2019 12:27	12/12/2019 05:56	12/12/2019 12:27	6,50	10	65,02	CHI
20191289562	SILVANIA	SV12090745	ANAPOLIS UNIVERSITARIO S2	12/12/2019 05:56	12/12/2019 12:27	12/12/2019 05:56	12/12/2019 12:27	6,50	1	6,50	CHI
20191288386	PORANGATU	TA12114216	NOVO PLANALTO	12/12/2019 05:59	12/12/2019 11:40	12/12/2019 05:59	12/12/2019 11:40	5,67	6	34,02	CHI
20191288389	SAO LUIS DE MONTES BELOS	SL21151317	SAO LUIZ DOS MONTES BELOS	12/12/2019 06:00	12/12/2019 08:17	12/12/2019 06:00	12/12/2019 08:17	2,29	2	4,57	CHI
20191289355	PIRANHAS	PH12170738	PIRANHAS	12/12/2019 06:00	12/12/2019 13:45	12/12/2019 06:00	12/12/2019 13:45	7,74	7	54,21	CHI
20191288502	SITIO D ABADIA	SI12131972	IACIARA S2	12/12/2019 06:01	12/12/2019 08:13	12/12/2019 06:01	12/12/2019 08:13	2,19	44	96,48	CHI
20191288672	CAIAPONIA	CP11161698	CAIAPONIA	12/12/2019 06:03	12/12/2019 09:22	12/12/2019 06:03	12/12/2019 09:22	3,31	75	247,90	CHI
20191288710	FLORES DE GOIAS	FB12218636	IACIARA S2	12/12/2019 06:04	12/12/2019 11:50	12/12/2019 06:04	12/12/2019 11:50	5,76	4	23,05	CHI
20191288503	CORUMBAIBA	CI21000469	VILA CORUMBA	12/12/2019 06:06	12/12/2019 17:56	12/12/2019 06:06	12/12/2019 17:56	11,83	1	11,83	CHI
20191288506	CHAPADAO DO CEU	DJ12284819	CHAPADAO DO CEU	12/12/2019 06:07	13/12/2019 13:30	12/12/2019 06:07	13/12/2019 13:30	31,37	1	31,37	CHI
20191288509	CACU	CC12350891	CACHOEIRA ALTA	12/12/2019 06:08	12/12/2019 10:00	12/12/2019 06:08	12/12/2019 10:00	3,85	6	23,11	CHI
20191288511	MORRINHOS	MR12335225	MORRINHOS	12/12/2019 06:09	12/12/2019 11:22	12/12/2019 06:09	12/12/2019 11:22	5,21	3	15,63	CHI
20191288516	ANICUNS	AC21251393	ANICUNS	12/12/2019 06:10	12/12/2019 13:33	12/12/2019 06:10	12/12/2019 13:33	7,38	2	14,76	CHI
20191288519	PORANGATU	TB12262770	PORANGATU	12/12/2019 06:12	12/12/2019 09:15	12/12/2019 06:12	12/12/2019 09:15	3,04	1	3,04	CHI
20191288519	SANTA TEREZA DE GOIAS	TB12262770	PORANGATU	12/12/2019 06:12	12/12/2019 09:15	12/12/2019 06:12	12/12/2019 09:15	3,04	5	15,20	CHI
20191288519	TROMBAS	TB12262770	PORANGATU	12/12/2019 06:12	12/12/2019 09:15	12/12/2019 06:12	12/12/2019 09:15	3,04	13	39,52	CHI
20191288520	SAO LUIS DE MONTES BELOS	SL12383600	SAO LUIZ DOS MONTES BELOS	12/12/2019 06:12	12/12/2019 10:15	12/12/2019 06:12	12/12/2019 10:15	4,05	9	36,44	CHI
20191288526	GOIANIA	GN11053699	FERROVIARIO S1	12/12/2019 06:15	12/12/2019 08:45	12/12/2019 06:15	12/12/2019 08:45	2,50	91	227,30	CHI
20191288457	QUIRINOPOLIS	QI12239488	QUIRINOPOLIS	12/12/2019 06:16	12/12/2019 10:55	12/12/2019 06:16	12/12/2019 10:55	4,65	4	18,59	CHI
20191288534	PLANALTINA	PI21043440	PLANALTINA	12/12/2019 06:16	12/12/2019 14:44	12/12/2019 06:16	12/12/2019 14:44	8,46	1	8,46	CHI
20191288540	CAMPO ALEGRE DE GOIAS	CM21073555	CAMPO ALEGRE DE GOIAS	12/12/2019 06:18	12/12/2019 09:09	12/12/2019 06:18	12/12/2019 09:09	2,84	1	2,84	CHI
20191288543	IVOLANDIA	IV12223012	IPORA	12/12/2019 06:19	12/12/2019 14:24	12/12/2019 06:19	12/12/2019 14:24	8,08	11	88,92	CHI
20191289753	CHAPADAO DO CEU	DJ12248471	CHAPADAO DO CEU	12/12/2019 06:20	12/12/2019 11:07	12/12/2019 06:20	12/12/2019 11:07	4,77	7	33,40	CHI
20191288885	SAO MIGUEL DO ARAGUAIA	SM12351125	SAO MIGUEL DO ARAGUAIA	12/12/2019 06:23	12/12/2019 08:45	12/12/2019 06:23	12/12/2019 08:45	2,36	5	11,78	CHI
20191288556	PARAUNA	PU12159023	PARAUNA	12/12/2019 06:24	12/12/2019 08:13	12/12/2019 06:24	12/12/2019 08:13	1,81	4	7,24	CHI
20191288557	SANTA CRUZ DE GOIAS	BC12286288	PIRES DO RIO S2	12/12/2019 06:24	12/12/2019 14:19	12/12/2019 06:24	12/12/2019 14:19	7,91	24	189,83	CHI

20191288639	JATAI	JT12000096	JATAI S3	12/12/2019 06:25	12/12/2019 09:28	12/12/2019 06:25	12/12/2019 09:28	3,05	16	48,86	CHI
20191288565	JATAI	JT12182074	JATAI S1	12/12/2019 06:27	12/12/2019 11:09	12/12/2019 06:27	12/12/2019 11:09	4,70	7	32,87	CHI
20191288566	GOIANIA	13825239	INDEPENDENCIA S2	12/12/2019 06:27	12/12/2019 09:10	12/12/2019 06:27	12/12/2019 09:10	2,71	1	2,71	CHI
20191288567	ORIZONA	OZ21248900	PIRES DO RIO S2	12/12/2019 06:27	12/12/2019 09:48	12/12/2019 06:27	12/12/2019 09:48	3,35	1	3,35	CHI
20191288605	SANCLERLANDIA	SC21169330	FIRMINOPOLIS S2	12/12/2019 06:28	12/12/2019 08:30	12/12/2019 06:28	12/12/2019 08:30	2,03	1	2,03	CHI
20191288606	SANTA CRUZ DE GOIAS	BC21221714	PIRES DO RIO S2	12/12/2019 06:29	12/12/2019 14:05	12/12/2019 06:29	12/12/2019 14:05	7,60	1	7,60	CHI
20191288612	PADRE BERNARDO	PB12152732	PADRE BERNARDO	12/12/2019 06:30	12/12/2019 08:52	12/12/2019 06:30	12/12/2019 08:52	2,36	14	33,03	CHI
20191288614	SAO MIGUEL DO ARAGUAIA	SM12282216	SAO MIGUEL DO ARAGUAIA	12/12/2019 06:31	12/12/2019 10:30	12/12/2019 06:31	12/12/2019 10:30	3,98	2	7,96	CHI
20191288616	GOIANDIRA	CT12338786	CATALAO S1	12/12/2019 06:31	12/12/2019 11:20	12/12/2019 06:31	12/12/2019 11:20	4,81	2	9,62	CHI
20191288618	GOIAS	GS12250574	GOIAS	12/12/2019 06:32	12/12/2019 09:40	12/12/2019 06:32	12/12/2019 09:40	3,12	8	25,00	CHI
20191289652	CATALAO	TH12165137	CATALAO S1	12/12/2019 06:32	12/12/2019 13:12	12/12/2019 06:32	12/12/2019 13:12	6,66	5	33,31	CHI
20191289652	TRES RANCHOS	TH12165137	CATALAO S1	12/12/2019 06:32	12/12/2019 13:12	12/12/2019 06:32	12/12/2019 13:12	6,66	47	313,07	CHI
20191288621	PLANALTINA	10005787244	PLANALTINA	12/12/2019 06:33	12/12/2019 08:22	12/12/2019 06:33	12/12/2019 08:22	1,81	1	1,81	CHI
20191288624	SANTO ANTONIO DE GOIAS	GR21090050	NEROPOLIS S1	12/12/2019 06:35	12/12/2019 10:48	12/12/2019 06:35	12/12/2019 10:48	4,21	1	4,21	CHI
20191287957	JATAI	JT12000160	JATAI S2	12/12/2019 06:36	12/12/2019 12:40	12/12/2019 06:36	12/12/2019 12:40	6,06	36	218,02	CHI
20191288628	ITAPACI	IW21361461	ITAPACI	12/12/2019 06:36	12/12/2019 14:10	12/12/2019 06:36	12/12/2019 14:10	7,57	1	7,57	CHI
20191289172	CATALAO	CT12267145	CATALAO S1	12/12/2019 06:36	12/12/2019 15:53	12/12/2019 06:36	12/12/2019 15:53	9,28	12	111,35	CHI
20191288638	NOVA CRIXAS	NA21250951	NOVA CRIXAS	12/12/2019 06:37	12/12/2019 10:03	12/12/2019 06:37	12/12/2019 10:03	3,43	1	3,43	CHI
20191288641	PIRENOPOLIS	PV12000073	CORUMBA	12/12/2019 06:38	12/12/2019 11:00	12/12/2019 06:38	12/12/2019 11:00	4,36	9	39,25	CHI
20191288169	CATALAO	CT12203164	CATALAO S1	12/12/2019 06:40	12/12/2019 07:40	12/12/2019 06:40	12/12/2019 07:40	0,99	1059	1044,88	CHI
20191288644	BOM JARDIM DE GOIAS	BM12074235	PIRANHAS	12/12/2019 06:40	12/12/2019 10:52	12/12/2019 06:40	12/12/2019 10:52	4,20	12	50,36	CHI
20191290635	DOVERLANDIA	DV12204907	CAIAPONIA	12/12/2019 06:40	12/12/2019 19:12	12/12/2019 06:40	12/12/2019 19:12	12,52	4	50,09	CHI
20191288648	PIRENOPOLIS	PV21230705	CORUMBA	12/12/2019 06:41	12/12/2019 12:33	12/12/2019 06:41	12/12/2019 12:33	5,86	1	5,86	CHI
20191288649	JUSSARA	RN12045571	BRITANIA	12/12/2019 06:41	12/12/2019 09:36	12/12/2019 06:41	12/12/2019 09:36	2,90	4	11,62	CHI
20191288649	SANTA FE DE GOIAS	RN12045571	BRITANIA	12/12/2019 06:41	12/12/2019 09:36	12/12/2019 06:41	12/12/2019 09:36	2,90	7	20,33	CHI
20191288650	GOIANIA	GN11001128	FERROVIARIO S3	12/12/2019 06:41	12/12/2019 10:00	12/12/2019 06:41	12/12/2019 10:00	3,30	90	297,10	CHI
20191288832	RIO VERDE	SH12221237	RIO VERDE S2	12/12/2019 06:42	12/12/2019 11:30	12/12/2019 06:42	12/12/2019 11:30	4,79	12	57,49	CHI
20191288832	SANTA HELENA DE GOIAS	SH12221237	RIO VERDE S2	12/12/2019 06:42	12/12/2019 11:30	12/12/2019 06:42	12/12/2019 11:30	4,79	7	33,54	CHI
20191288655	CACU	CC12338617	CACHOEIRA ALTA	12/12/2019 06:43	12/12/2019 11:52	12/12/2019 06:43	12/12/2019 11:52	5,15	5	25,75	CHI
20191288656	PIRACANJUBA	PJ21263700	PIRACANJUBA	12/12/2019 06:43	12/12/2019 14:50	12/12/2019 06:43	12/12/2019 14:50	8,11	2	16,22	CHI
20191288661	FAZENDA NOVA	FN12250853	FIRMINOPOLIS S2	12/12/2019 06:44	12/12/2019 15:53	12/12/2019 06:44	12/12/2019 15:53	9,14	4	36,54	CHI
20191288663	ABADIANIA	AN21258644	ANAPOLIS UNIVERSITARIO S2	12/12/2019 06:45	12/12/2019 08:23	12/12/2019 06:45	12/12/2019 08:23	1,63	1	1,63	CHI
20191288664	CAMPINACU	UC21321306	PORANGATU	12/12/2019 06:45	12/12/2019 08:20	12/12/2019 06:45	12/12/2019 08:20	1,57	1	1,57	CHI

20191288665	SILVANIA	SV12390025	VIANOPOLIS	12/12/2019 06:45	12/12/2019 12:11	12/12/2019 06:45	12/12/2019 12:11	5,42	1	5,42	CHI
201912260815	SERRANOPOLIS	SX12296514	JATAI S1	12/12/2019 06:47	12/12/2019 10:20	12/12/2019 06:47	12/12/2019 10:20	3,55	22	78,15	CHI
20191287447	ISRAELANDIA	IS12018686	IPORA	12/12/2019 06:49	12/12/2019 11:20	12/12/2019 06:49	12/12/2019 11:20	4,52	27	121,95	CHI
20191287447	JAUPACI	IS12018686	IPORA	12/12/2019 06:49	12/12/2019 11:20	12/12/2019 06:49	12/12/2019 11:20	4,52	49	221,32	CHI
20191288677	CAMPOS VERDES	VD21253082	SANTA TEREZINHA	12/12/2019 06:49	13/12/2019 08:17	12/12/2019 06:49	13/12/2019 08:17	25,45	1	25,45	CHI
20191288820	SERRANOPOLIS	SX12166082	JATAI S1	12/12/2019 06:50	12/12/2019 10:12	12/12/2019 06:50	12/12/2019 10:12	3,36	18	60,51	CHI
20191288688	ARAGOIANIA	AO31097642	GUAPO S2	12/12/2019 06:51	12/12/2019 12:21	12/12/2019 06:51	12/12/2019 12:21	5,49	1	5,49	CHI
20191288689	PORANGATU	PO12291266	PORANGATU	12/12/2019 06:52	12/12/2019 10:28	12/12/2019 06:52	12/12/2019 10:28	3,60	7	25,19	CHI
20191288690	NIQUELANDIA	2750084368	NIQUELANDIA SUBTRANSMISSAO	12/12/2019 06:52	12/12/2019 11:46	12/12/2019 06:52	12/12/2019 11:46	4,90	1	4,90	CHI
20191288986	TURVANIA	TV12005581	FIRMINOPOLIS S2	12/12/2019 06:52	12/12/2019 09:20	12/12/2019 06:52	12/12/2019 09:20	2,46	11	27,04	CHI
20191288696	CRIXAS	NA12294705	NOVA CRIXAS	12/12/2019 06:54	12/12/2019 10:25	12/12/2019 06:54	12/12/2019 10:25	3,51	2	7,02	CHI
20191288700	QUIRINOPOLIS	10018349623	QUIRINOPOLIS	12/12/2019 06:54	12/12/2019 08:43	12/12/2019 06:54	12/12/2019 08:43	1,81	1	1,81	CHI
20191288702	QUIRINOPOLIS	QI12101220	QUIRINOPOLIS	12/12/2019 06:55	12/12/2019 11:05	12/12/2019 06:55	12/12/2019 11:05	4,16	4	16,65	CHI
20191288712	PIRANHAS	PH12204954	PIRANHAS	12/12/2019 06:56	13/12/2019 08:42	12/12/2019 06:56	13/12/2019 08:42	25,75	1	25,75	CHI
20191288813	MORRINHOS	MR12000350	GOIATUBA S1	12/12/2019 06:56	12/12/2019 17:26	12/12/2019 06:56	12/12/2019 17:26	10,48	3	31,45	CHI
20191288899	GOIAS	GS12206887	GOIAS	12/12/2019 06:56	12/12/2019 09:57	12/12/2019 06:56	12/12/2019 09:57	3,00	22	66,05	CHI
20191289217	PORANGATU	PO12343297	PORANGATU	12/12/2019 06:58	12/12/2019 11:02	12/12/2019 06:58	12/12/2019 11:02	4,06	19	77,10	CHI
20191288720	COCALZINHO DE GOIAS	ZN11327401	GOIANESIA S1	12/12/2019 06:59	12/12/2019 13:58	12/12/2019 06:59	12/12/2019 13:58	6,98	1	6,98	CHI
20191288725	SAO LUIZ DO NORTE	SZ12333922	BARRO ALTO	12/12/2019 07:01	12/12/2019 13:34	12/12/2019 07:01	12/12/2019 13:34	6,55	10	65,50	CHI
20191288728	MAURILANDIA	ML121205447	SANTA HELENA S1	12/12/2019 07:01	12/12/2019 11:00	12/12/2019 07:01	12/12/2019 11:00	3,97	1	3,97	CHI
20191288738	JARAGUA	JA12221349	JARAGUA	12/12/2019 07:03	12/12/2019 09:58	12/12/2019 07:03	12/12/2019 09:58	2,92	6	17,49	CHI
20191288742	JATAI	JT12241750	JATAI S1	12/12/2019 07:03	12/12/2019 11:16	12/12/2019 07:03	12/12/2019 11:16	4,21	1	4,21	CHI
20191288743	SAO MIGUEL DO ARAGUAIA	SM12000065	SAO MIGUEL DO ARAGUAIA	12/12/2019 07:03	12/12/2019 13:53	12/12/2019 07:03	12/12/2019 09:11	2,13	15	31,98	CHI
20191288743	SAO MIGUEL DO ARAGUAIA	SM13253733	SAO MIGUEL DO ARAGUAIA	12/12/2019 07:03	12/12/2019 13:53	12/12/2019 07:03	12/12/2019 10:02	2,97	3	8,92	CHI
20191288743	SAO MIGUEL DO ARAGUAIA	SM13253733	SAO MIGUEL DO ARAGUAIA	12/12/2019 07:03	12/12/2019 13:53	12/12/2019 07:03	12/12/2019 13:53	6,83	6	40,96	CHI
20191288743	SAO MIGUEL DO ARAGUAIA	SM13253733	SAO MIGUEL DO ARAGUAIA	12/12/2019 07:03	12/12/2019 13:53	12/12/2019 13:18	12/12/2019 13:53	0,58	3	1,73	CHI
20191288744	CAMPO LIMPO	AN12084795	NEROPOLIS S1	12/12/2019 07:03	12/12/2019 09:08	12/12/2019 07:03	12/12/2019 09:08	2,07	11	22,79	CHI
20191288944	IPAMERI	IP12404733	IPAMERI	12/12/2019 07:03	12/12/2019 10:04	12/12/2019 07:03	12/12/2019 10:04	3,01	8	24,07	CHI
20191288882	MONTES CLAROS DE GOIAS	ME12155653	IPORA	12/12/2019 07:04	12/12/2019 13:58	12/12/2019 07:04	12/12/2019 13:58	6,90	37	255,15	CHI
20191288531	QUIRINOPOLIS	QI21100920	QUIRINOPOLIS	12/12/2019 07:05	12/12/2019 09:17	12/12/2019 07:05	12/12/2019 09:17	2,19	1	2,19	CHI
20191288691	ACREUNA	EU11249128	ACREUNA	12/12/2019 07:05	12/12/2019 20:35	12/12/2019 07:05	12/12/2019 20:35	13,50	68	917,91	CHI
20191288752	CAMPOS BELOS	CH12242796	SAO DOMINGOS	12/12/2019 07:05	12/12/2019 08:36	12/12/2019 07:05	12/12/2019 08:36	1,51	10	15,14	CHI
20191288757	PORANGATU	10001517510	PORANGATU	12/12/2019 07:05	12/12/2019 08:25	12/12/2019 07:05	12/12/2019 08:25	1,32	1	1,32	CHI

20191288758	BELA VISTA DE GOIAS	BV12185857	CEPAIGO S2	12/12/2019 07:05	12/12/2019 09:09	12/12/2019 07:05	12/12/2019 09:09	2,05	3	6,16	CHI
20191288761	SANTA HELENA DE GOIAS	SH12296128	IPEGUARI	12/12/2019 07:07	12/12/2019 15:25	12/12/2019 07:07	12/12/2019 15:25	8,30	8	66,40	CHI
20191288763	SANTA CRUZ DE GOIAS	BC21033279	CRISTIANOPOLIS	12/12/2019 07:07	12/12/2019 11:30	12/12/2019 07:07	12/12/2019 11:30	4,38	2	8,76	CHI
20191290473	FAZENDA NOVA	FN12390152	IPORA	12/12/2019 07:07	12/12/2019 17:23	12/12/2019 07:07	12/12/2019 17:23	10,26	12	123,09	CHI
20191290473	ISRAELANDIA	FN12390152	IPORA	12/12/2019 07:07	12/12/2019 17:23	12/12/2019 07:07	12/12/2019 17:23	10,26	2	20,51	CHI
20191288767	ANAPOLIS	20041184	ANAPOLIS UNIVERSITARIO S2	12/12/2019 07:08	12/12/2019 08:05	12/12/2019 07:08	12/12/2019 08:05	0,96	1	0,96	CHI
20191288790	IPAMERI	IP12252405	PIRES DO RIO S2	12/12/2019 07:08	12/12/2019 11:04	12/12/2019 07:08	12/12/2019 11:04	3,92	2	7,85	CHI
20191288918	DIORAMA	DI12024588	ARENOPOLIS	12/12/2019 07:08	12/12/2019 09:14	12/12/2019 07:08	12/12/2019 09:14	2,09	1	2,09	CHI
20191288918	IPORA	DI12024588	ARENOPOLIS	12/12/2019 07:08	12/12/2019 09:14	12/12/2019 07:08	12/12/2019 09:14	2,09	5	10,44	CHI
20191288773	CORUMBAIBA	CI12000543	VILA CORUMBA	12/12/2019 07:09	12/12/2019 11:14	12/12/2019 07:09	12/12/2019 11:14	4,08	9	36,72	CHI
20191288774	SANTO ANTONIO DO DESCOBERTO	SN12345926	MARAJOARA	12/12/2019 07:09	12/12/2019 13:46	12/12/2019 07:09	12/12/2019 13:46	6,61	2	13,22	CHI
20191288776	PIRACANJUBA	PJ12223522	ROCHEDO	12/12/2019 07:10	12/12/2019 15:40	12/12/2019 07:10	12/12/2019 15:40	8,50	1	8,50	CHI
20191288779	CACU	CC21030246	CACHOEIRA ALTA	12/12/2019 07:10	12/12/2019 12:30	12/12/2019 07:10	12/12/2019 12:30	5,33	1	5,33	CHI
20191288780	CATALAO	CT12130960RE	CATALAO S2	12/12/2019 07:10	12/12/2019 12:03	12/12/2019 07:10	12/12/2019 12:03	4,88	23	112,20	CHI
20191288780	CUMARI	CT12130960RE	CATALAO S2	12/12/2019 07:10	12/12/2019 12:03	12/12/2019 07:10	12/12/2019 12:03	4,88	159	775,61	CHI
20191288780	GOIANDIRA	CT12130960RE	CATALAO S2	12/12/2019 07:10	12/12/2019 12:03	12/12/2019 07:10	12/12/2019 12:03	4,88	6	29,27	CHI
20191288782	PIRES DO RIO	PR12337227	PIRES DO RIO S1	12/12/2019 07:10	12/12/2019 15:20	12/12/2019 07:10	12/12/2019 15:20	8,16	39	318,09	CHI
20191288782	SANTA CRUZ DE GOIAS	PR12337227	PIRES DO RIO S1	12/12/2019 07:10	12/12/2019 15:20	12/12/2019 07:10	12/12/2019 15:20	8,16	1	8,16	CHI
20191288782	URUTAI	PR12337227	PIRES DO RIO S1	12/12/2019 07:10	12/12/2019 15:20	12/12/2019 07:10	12/12/2019 15:20	8,16	1	8,16	CHI
20191288783	CAVALCANTE	TE21321616	FLORES DE GOIAS	12/12/2019 07:10	12/12/2019 10:02	12/12/2019 07:10	12/12/2019 10:02	2,85	1	2,85	CHI
20191289114	CACU	CC11000017	CACHOEIRA ALTA	12/12/2019 07:10	12/12/2019 10:51	12/12/2019 07:10	12/12/2019 10:51	3,67	116	426,14	CHI
20191288792	CATALAO	CT12203060	CATALAO S1	12/12/2019 07:11	12/12/2019 14:29	12/12/2019 07:11	12/12/2019 14:29	7,30	16	116,81	CHI
20191289132	MORRINHOS	MR12000291	MORRINHOS	12/12/2019 07:11	12/12/2019 11:28	12/12/2019 07:11	12/12/2019 11:28	4,28	7	29,95	CHI
20191288416	JUSSARA	JR11169220	JUSSARA	12/12/2019 07:12	12/12/2019 10:27	12/12/2019 07:12	12/12/2019 10:27	3,25	31	100,70	CHI
20191288798	FORMOSA	FA21257564	ITUIQUIRA	12/12/2019 07:12	12/12/2019 11:30	12/12/2019 07:12	12/12/2019 11:30	4,31	1	4,31	CHI
20191288800	ABADIA DE GOIAS	LG21047844	GUAPO S1	12/12/2019 07:13	12/12/2019 10:32	12/12/2019 07:13	12/12/2019 10:32	3,31	2	6,62	CHI
20191288803	BOM JARDIM DE GOIAS	BM21065650	BOM JARDIM	12/12/2019 07:13	12/12/2019 14:59	12/12/2019 07:13	12/12/2019 14:59	7,75	1	7,75	CHI
20191289521	CACHOEIRA DOURADA	CD12000008RE	CACHOEIRA DOURADA	12/12/2019 07:13	12/12/2019 12:44	12/12/2019 07:13	12/12/2019 12:44	5,51	15	82,70	CHI
20191289521	ITUMBIARA	CD12000008RE	CACHOEIRA DOURADA	12/12/2019 07:13	12/12/2019 12:44	12/12/2019 07:13	12/12/2019 12:44	5,51	16	88,22	CHI
20191289521	ITUMBIARA	CD12000008RE	CACHOEIRA DOURADA	12/12/2019 07:13	12/12/2019 12:44	12/12/2019 09:50	12/12/2019 12:44	2,89	3	8,67	CHI
20191288804	EDEIA	EA12160409	VICENTINOPOLIS	12/12/2019 07:14	12/12/2019 19:13	12/12/2019 07:14	12/12/2019 19:13	11,98	20	239,57	CHI
20191289061	GAMELEIRA DE GOIAS	LB12000008	DAIA S2	12/12/2019 07:15	12/12/2019 10:07	12/12/2019 07:15	12/12/2019 10:07	2,85	15	42,76	CHI
20191289061	LEOPOLDO DE BULHOES	LB12000008	DAIA S2	12/12/2019 07:15	12/12/2019 10:07	12/12/2019 07:15	12/12/2019 10:07	2,85	152	433,28	CHI

20191289061	SILVANIA	LB12000008	DAIA S2	12/12/2019 07:15	12/12/2019 10:07	12/12/2019 07:15	12/12/2019 10:07	2,85	91	259,40	CHI
20191296143	SERRANOPOLIS	SX12216731	JATAI S1	12/12/2019 07:15	14/12/2019 15:13	12/12/2019 07:15	12/12/2019 13:22	6,12	75	458,75	CHI
20191296143	SERRANOPOLIS	SX12216731	JATAI S1	12/12/2019 07:15	14/12/2019 15:13	12/12/2019 13:23	13/12/2019 09:51	20,46	43	879,98	CHI
20191296143	SERRANOPOLIS	SX13324833	JATAI S1	12/12/2019 07:15	14/12/2019 15:13	12/12/2019 13:23	13/12/2019 10:20	20,95	35	733,18	CHI
20191296143	SERRANOPOLIS	SX12390577	JATAI S1	12/12/2019 07:15	14/12/2019 15:13	13/12/2019 09:52	13/12/2019 12:33	2,68	6	16,10	CHI
20191296143	SERRANOPOLIS	SX12268627	JATAI S1	12/12/2019 07:15	14/12/2019 15:13	13/12/2019 13:17	14/12/2019 15:13	25,93	3	77,79	CHI
20191287334	RIO VERDE	RV21226316	MONTIVIDIU T	12/12/2019 07:16	12/12/2019 09:47	12/12/2019 07:16	12/12/2019 09:47	2,51	1	2,51	CHI
20191288812	SANTA CRUZ DE GOIAS	BC12023183	CRISTIANOPOLIS	12/12/2019 07:16	12/12/2019 11:30	12/12/2019 07:16	12/12/2019 11:30	4,22	42	177,24	CHI
20191288994	SANTA CRUZ DE GOIAS	PJ12212218	PIRACANJUBA	12/12/2019 07:16	13/12/2019 09:04	12/12/2019 07:16	13/12/2019 09:04	25,80	15	386,93	CHI
20191288814	JATAI	JT12211164	JATAI S2	12/12/2019 07:17	12/12/2019 10:25	12/12/2019 07:17	12/12/2019 10:25	3,13	10	31,29	CHI
20191288815	NIQUELANDIA	NQ12262804	URUACU	12/12/2019 07:17	12/12/2019 10:00	12/12/2019 07:17	12/12/2019 10:00	2,73	2	5,45	CHI
20191289101	VICENTINOPOLIS	VI12263852	VICENTINOPOLIS	12/12/2019 07:19	12/12/2019 15:14	12/12/2019 07:19	12/12/2019 15:14	7,90	8	63,21	CHI
20191288834	PIRANHAS	PH21187274	PIRANHAS	12/12/2019 07:20	12/12/2019 13:36	12/12/2019 07:20	12/12/2019 13:36	6,26	1	6,26	CHI
20191288884	SILVANIA	SV12131990	VIANOPOLIS	12/12/2019 07:20	12/12/2019 10:27	12/12/2019 07:20	12/12/2019 10:27	3,11	30	93,33	CHI
20191289796	PALMEIRAS DE GOIAS	PL12390265	PALMEIRAS	12/12/2019 07:20	12/12/2019 13:56	12/12/2019 07:20	12/12/2019 13:56	6,59	5	32,96	CHI
20191288479	GOIANIA	GN11111861	MEIA PONTE	12/12/2019 07:21	12/12/2019 11:20	12/12/2019 07:21	12/12/2019 11:20	3,97	224	889,78	CHI
20191288837	SAO FRANCISCO DE GOIAS	SF12278287	SAO FRANCISCO DE GOIAS	12/12/2019 07:21	12/12/2019 10:35	12/12/2019 07:21	12/12/2019 10:35	3,23	4	12,91	CHI
20191288838	GOIANIA	GN11002516	MEIA PONTE	12/12/2019 07:21	12/12/2019 10:44	12/12/2019 07:21	12/12/2019 10:44	3,37	167	563,16	CHI
20191288845	PORANGATU	PO12139105	PORANGATU	12/12/2019 07:22	12/12/2019 09:36	12/12/2019 07:22	12/12/2019 09:36	2,23	3	6,68	CHI
20191288846	GOIANIRA	GR12056290	NEROPOLIS S1	12/12/2019 07:22	12/12/2019 14:34	12/12/2019 07:22	12/12/2019 14:34	7,20	5	36,02	CHI
20191288846	SANTO ANTONIO DE GOIAS	GR12056290	NEROPOLIS S1	12/12/2019 07:22	12/12/2019 14:34	12/12/2019 07:22	12/12/2019 14:34	7,20	5	36,02	CHI
20191288847	URUACU	UR21285106	SANTA TEREZINHA	12/12/2019 07:22	13/12/2019 04:18	12/12/2019 07:22	13/12/2019 04:18	20,92	1	20,92	CHI
20191288848	VIANOPOLIS	VN21086361	VIANOPOLIS	12/12/2019 07:22	12/12/2019 12:09	12/12/2019 07:22	12/12/2019 12:09	4,77	1	4,77	CHI
20191288854	CORUMBA DE GOIAS	CB21089115	ALEXANIA	12/12/2019 07:24	12/12/2019 10:33	12/12/2019 07:24	12/12/2019 10:33	3,14	3	9,43	CHI
20191289527	BURITI ALEGRE	GT12000112	GOIATUBA S2	12/12/2019 07:24	12/12/2019 14:48	12/12/2019 07:24	12/12/2019 14:48	7,39	7	51,70	CHI
20191288861	CATALAO	2010025897	CATALAO S1	12/12/2019 07:25	12/12/2019 13:39	12/12/2019 07:25	12/12/2019 13:39	6,23	1	6,23	CHI
20191288868	AURILANDIA	AI21033024	FIRMINOPOLIS S2	12/12/2019 07:25	12/12/2019 10:58	12/12/2019 07:25	12/12/2019 10:58	3,54	1	3,54	CHI
20191288869	PALMEIRAS DE GOIAS	PL12000092	PALMEIRAS	12/12/2019 07:26	12/12/2019 13:10	12/12/2019 07:26	12/12/2019 13:10	5,74	3	17,21	CHI
20191288873	MORRINHOS	MR12000244	MORRINHOS	12/12/2019 07:27	12/12/2019 11:13	12/12/2019 07:27	12/12/2019 11:13	3,75	1	3,75	CHI
20191289609	ESTRELA DO NORTE	MU12075219	MARA ROSA	12/12/2019 07:27	12/12/2019 11:26	12/12/2019 07:27	12/12/2019 11:26	3,98	1	3,98	CHI
20191289609	MUTUNOPOLIS	MU12075219	MARA ROSA	12/12/2019 07:27	12/12/2019 11:26	12/12/2019 07:27	12/12/2019 11:26	3,98	9	35,84	CHI
20191288881	SAO LUIZ DO NORTE	SZ21170035	ITAPACI	12/12/2019 07:30	13/12/2019 08:30	12/12/2019 07:30	13/12/2019 08:30	25,00	1	25,00	CHI
20191288888	ITAPIRAPUA	IU12018752	MATRINCHA	12/12/2019 07:31	12/12/2019 13:00	12/12/2019 07:31	12/12/2019 13:00	5,48	7	38,38	CHI

2019128894	CORUMBAIBA	CI21081019	VILA CORUMBA	12/12/2019 07:32	12/12/2019 15:05	12/12/2019 07:32	12/12/2019 15:05	7,54	1	7,54	CHI
20191288908	RIO VERDE	630303575	RIO VERDE S2	12/12/2019 07:35	12/12/2019 10:40	12/12/2019 07:35	12/12/2019 10:40	3,08	1	3,08	CHI
20191289231	APARECIDA DE GOIANIA	AP12144270	INDEPENDENCIA S1	12/12/2019 07:35	12/12/2019 10:35	12/12/2019 07:35	12/12/2019 10:35	2,99	106	316,73	CHI
20191288912	SAO MIGUEL DO PASSA QUATRO	SQ21265387	VIANOPOLIS	12/12/2019 07:36	12/12/2019 11:10	12/12/2019 07:36	12/12/2019 11:10	3,56	1	3,56	CHI
20191288913	PARAUNA	980050108	MONTIVIDIU T	12/12/2019 07:36	12/12/2019 12:28	12/12/2019 07:36	12/12/2019 12:28	4,87	1	4,87	CHI
20191288915	BELA VISTA DE GOIAS	240086363	CEPAIGO S2	12/12/2019 07:36	12/12/2019 16:05	12/12/2019 07:36	12/12/2019 16:05	8,47	1	8,47	CHI
20191288983	POSSE	SA12211553	IACIARA S2	12/12/2019 07:36	12/12/2019 09:53	12/12/2019 07:36	12/12/2019 09:53	2,27	2	4,54	CHI
20191288983	SIMOLANDIA	SA12211553	IACIARA S2	12/12/2019 07:36	12/12/2019 09:53	12/12/2019 07:36	12/12/2019 09:53	2,27	12	27,23	CHI
20191288925	CAMPOS BELOS	MA12233172	SAO DOMINGOS	12/12/2019 07:38	12/12/2019 10:12	12/12/2019 07:38	12/12/2019 10:12	2,56	9	23,03	CHI
20191288925	MONTE ALEGRE DE GOIAS	MA12233172	SAO DOMINGOS	12/12/2019 07:38	12/12/2019 10:12	12/12/2019 07:38	12/12/2019 10:12	2,56	8	20,47	CHI
20191288926	OUVIDOR	OU21061214	CATALAO S1	12/12/2019 07:38	13/12/2019 11:08	12/12/2019 07:38	13/12/2019 11:08	27,50	1	27,50	CHI
20191288524	GOIAS	8050483	GOIAS	12/12/2019 07:39	12/12/2019 10:40	12/12/2019 07:39	12/12/2019 10:40	3,01	13	39,12	CHI
20191288524	GUARAITA	8050483	GOIAS	12/12/2019 07:39	12/12/2019 10:40	12/12/2019 07:39	12/12/2019 10:40	3,01	2	6,02	CHI
20191288524	ITAPURANGA	8050483	GOIAS	12/12/2019 07:39	12/12/2019 10:40	12/12/2019 07:39	12/12/2019 10:40	3,01	2	6,02	CHI
20191288707	ITUMBIARA	IT16411375	ITUMBIARA VELHA S1	12/12/2019 07:40	12/12/2019 11:54	12/12/2019 10:07	12/12/2019 11:18	1,19	356	424,13	CHI
20191288707	ITUMBIARA	IT12081100	ITUMBIARA VELHA S1	12/12/2019 07:40	12/12/2019 11:54	12/12/2019 10:07	12/12/2019 11:54	1,79	620	1108,42	CHI
20191288707	ITUMBIARA	19935768	ITUMBIARA VELHA S1	12/12/2019 07:40	12/12/2019 11:54	12/12/2019 07:40	12/12/2019 11:54	4,23	977	4137,32	CHI
20191288947	CRIXAS	SG10394720	SANTA TEREZINHA	12/12/2019 07:40	12/12/2019 18:48	12/12/2019 07:40	12/12/2019 07:46	0,11	272	29,09	CHI
20191288947	GUARINOS	SG10394720	SANTA TEREZINHA	12/12/2019 07:40	12/12/2019 18:48	12/12/2019 07:40	12/12/2019 07:46	0,11	863	92,29	CHI
20191288947	ITAPACI	SG10394720	SANTA TEREZINHA	12/12/2019 07:40	12/12/2019 18:48	12/12/2019 07:40	12/12/2019 07:46	0,11	6	0,64	CHI
20191288947	PILAR DE GOIAS	SG10394720	SANTA TEREZINHA	12/12/2019 07:40	12/12/2019 18:48	12/12/2019 07:40	12/12/2019 07:46	0,11	45	4,81	CHI
20191288947	SANTA TEREZINHA DE GOIAS	SG10394720	SANTA TEREZINHA	12/12/2019 07:40	12/12/2019 18:48	12/12/2019 07:40	12/12/2019 07:46	0,11	202	21,60	CHI
20191288947	CRIXAS	SG10394720	SANTA TEREZINHA	12/12/2019 07:40	12/12/2019 18:48	12/12/2019 07:47	12/12/2019 12:43	4,95	272	1345,57	CHI
20191288947	GUARINOS	SG10394720	SANTA TEREZINHA	12/12/2019 07:40	12/12/2019 18:48	12/12/2019 07:47	12/12/2019 12:43	4,95	863	4269,21	CHI
20191288947	ITAPACI	SG10394720	SANTA TEREZINHA	12/12/2019 07:40	12/12/2019 18:48	12/12/2019 07:47	12/12/2019 12:43	4,95	6	29,68	CHI
20191288947	PILAR DE GOIAS	SG10394720	SANTA TEREZINHA	12/12/2019 07:40	12/12/2019 18:48	12/12/2019 07:47	12/12/2019 12:43	4,95	45	222,61	CHI
20191288947	SANTA TEREZINHA DE GOIAS	SG10394720	SANTA TEREZINHA	12/12/2019 07:40	12/12/2019 18:48	12/12/2019 07:47	12/12/2019 12:43	4,95	202	999,28	CHI
20191288947	CRIXAS	CX12097448	SANTA TEREZINHA	12/12/2019 07:40	12/12/2019 18:48	12/12/2019 12:10	12/12/2019 18:48	6,63	25	165,83	CHI
20191288947	GUARINOS	CX12097448	SANTA TEREZINHA	12/12/2019 07:40	12/12/2019 18:48	12/12/2019 12:10	12/12/2019 18:48	6,63	45	298,50	CHI
20191288941	IPAMERI	IP21152435	IPAMERI	12/12/2019 07:41	12/12/2019 12:57	12/12/2019 07:41	12/12/2019 12:57	5,25	1	5,25	CHI
20191289555	CORUMBAIBA	CI12035400	VILA CORUMBA	12/12/2019 07:41	12/12/2019 12:44	12/12/2019 07:41	12/12/2019 12:44	5,04	8	40,33	CHI
20191289272	GOIATUBA	GT11000023	GOIATUBA S2	12/12/2019 07:42	12/12/2019 09:15	12/12/2019 07:42	12/12/2019 09:15	1,54	95	146,72	CHI
20191288948	CRISTIANOPOLIS	CF21316285	CRISTIANOPOLIS	12/12/2019 07:43	12/12/2019 10:59	12/12/2019 07:43	12/12/2019 10:59	3,26	1	3,26	CHI

20191288952	JATAI	10012359759	JATAI S1	12/12/2019 07:43	12/12/2019 11:22	12/12/2019 07:43	12/12/2019 11:22	3,66	1	3,66	CHI
20191288954	NOVA AMERICA	NM12291589	RUBIATABA	12/12/2019 07:43	12/12/2019 15:34	12/12/2019 07:43	12/12/2019 15:34	7,84	1	7,84	CHI
20191288438	MOIPORA	MO21304439	SAO LUIZ DOS MONTES BELOS	12/12/2019 07:44	12/12/2019 13:27	12/12/2019 07:44	12/12/2019 13:27	5,71	1	5,71	CHI
20191288956	MINACU	IH21255547	MINACU	12/12/2019 07:45	12/12/2019 09:53	12/12/2019 07:45	12/12/2019 09:53	2,13	1	2,13	CHI
20191288967	CACHOEIRA DOURADA	CD12000228	CACHOEIRA DOURADA	12/12/2019 07:48	12/12/2019 15:35	12/12/2019 07:48	12/12/2019 15:35	7,78	2	15,56	CHI
20191288967	ITUMBIARA	CD12000228	CACHOEIRA DOURADA	12/12/2019 07:48	12/12/2019 15:35	12/12/2019 07:48	12/12/2019 15:35	7,78	1	7,78	CHI
20191288969	SERRANOPOLIS	SX21209928	JATAI S1	12/12/2019 07:48	12/12/2019 12:56	12/12/2019 07:48	12/12/2019 12:56	5,13	1	5,13	CHI
20191288974	NOVO GAMA	10004466991	PACAEMBU S1	12/12/2019 07:48	12/12/2019 12:23	12/12/2019 07:48	12/12/2019 12:23	4,57	1	4,57	CHI
20191289251	ANAPOLIS	AN12370346	ANAPOLIS UNIVERSITARIO S2	12/12/2019 07:48	12/12/2019 09:55	12/12/2019 07:48	12/12/2019 09:55	2,11	397	838,44	CHI
20191289299	FAZENDA NOVA	JR12362437	BRITANIA	12/12/2019 07:48	12/12/2019 13:48	12/12/2019 07:48	12/12/2019 13:48	5,99	3	17,97	CHI
20191289299	JUSSARA	JR12362437	BRITANIA	12/12/2019 07:48	12/12/2019 13:48	12/12/2019 07:48	12/12/2019 13:48	5,99	7	41,93	CHI
20191288980	CAMPO ALEGRE DE GOIAS	CM12358290	CAMPO ALEGRE DE GOIAS	12/12/2019 07:49	12/12/2019 19:30	12/12/2019 07:49	12/12/2019 19:30	11,68	1	11,68	CHI
20191288982	SANTA CRUZ DE GOIAS	BC12300692	PIRES DO RIO S2	12/12/2019 07:49	12/12/2019 11:43	12/12/2019 07:49	12/12/2019 11:43	3,89	7	27,23	CHI
20191289731	SAO DOMINGOS	SD12170547	SAO DOMINGOS	12/12/2019 07:49	12/12/2019 16:12	12/12/2019 07:49	12/12/2019 16:12	8,37	13	108,85	CHI
20191288985	MAURILANDIA	ML21147857	SANTA HELENA S1	12/12/2019 07:50	12/12/2019 11:49	12/12/2019 07:50	12/12/2019 11:49	3,98	1	3,98	CHI
20191288987	FORMOSA	FA12195774	ITIQUEIRA	12/12/2019 07:50	12/12/2019 10:14	12/12/2019 07:50	12/12/2019 10:14	2,40	664	1590,46	CHI
20191288989	MINEIROS	MY12301837	PARQUE DAS EMAS	12/12/2019 07:51	12/12/2019 12:49	12/12/2019 07:51	12/12/2019 12:49	4,97	2	9,93	CHI
20191288989	PEROLANDIA	MY12301837	PARQUE DAS EMAS	12/12/2019 07:51	12/12/2019 12:49	12/12/2019 07:51	12/12/2019 12:49	4,97	3	14,90	CHI
20191289066	NAZARIO	NZ12003897	ANICUNS	12/12/2019 07:51	12/12/2019 10:10	12/12/2019 07:51	12/12/2019 10:10	2,30	18	41,49	CHI
20191288998	PETROLINA DE GOIAS	320008873	PETROLINA	12/12/2019 07:52	12/12/2019 10:35	12/12/2019 07:52	12/12/2019 10:35	2,71	1	2,71	CHI
20191289003	RIO VERDE	RV12074513	RIO VERDE S1	12/12/2019 07:53	12/12/2019 11:30	12/12/2019 07:53	12/12/2019 11:30	3,61	1	3,61	CHI
20191289006	BELA VISTA DE GOIAS	BV21020408	BELA VISTA S2	12/12/2019 07:53	12/12/2019 10:30	12/12/2019 07:53	12/12/2019 10:30	2,61	1	2,61	CHI
20191289007	BARRO ALTO	BA21045686	BARRO ALTO	12/12/2019 07:53	12/12/2019 12:51	12/12/2019 07:53	12/12/2019 12:51	4,95	1	4,95	CHI
20191289008	DOVERLANDIA	DV21207783	CAIAPONIA	12/12/2019 07:53	12/12/2019 12:35	12/12/2019 07:53	12/12/2019 12:35	4,70	2	9,41	CHI
20191289010	INDIARA	IY21312419	CEZARINA	12/12/2019 07:53	12/12/2019 09:21	12/12/2019 07:53	12/12/2019 09:21	1,46	1	1,46	CHI
20191289016	APARECIDA DO RIO DOCE	3650010742	CACHOEIRA ALTA	12/12/2019 07:54	12/12/2019 12:16	12/12/2019 07:54	12/12/2019 12:16	4,36	1	4,36	CHI
20191289018	PALMEIRAS DE GOIAS	PL12000180	PALMEIRAS	12/12/2019 07:54	12/12/2019 15:50	12/12/2019 07:54	12/12/2019 15:50	7,93	1	7,93	CHI
20191289206	COCALZINHO DE GOIAS	ZN12273061	COCALZINHO	12/12/2019 07:54	12/12/2019 09:20	12/12/2019 07:54	12/12/2019 09:20	1,43	26	37,16	CHI
20191289022	CALDAS NOVAS	CN12392138	VILA CORUMBA	12/12/2019 07:55	12/12/2019 10:02	12/12/2019 07:55	12/12/2019 10:02	2,11	4	8,43	CHI
20191289024	GOIANIA	GN21134921	CEPAIGO S1	12/12/2019 07:56	12/12/2019 10:00	12/12/2019 07:56	12/12/2019 10:00	2,06	2	4,13	CHI
20191289036	DOVERLANDIA	DV11204234	CAIAPONIA	12/12/2019 07:59	12/12/2019 21:00	12/12/2019 07:59	12/12/2019 21:00	13,01	2	26,02	CHI
20191289039	PORANGATU	PO21134038	PORANGATU	12/12/2019 07:59	12/12/2019 12:37	12/12/2019 07:59	12/12/2019 12:37	4,63	1	4,63	CHI
20191289045	HIDROLANDIA	HD21200305	CEPAIGO S1	12/12/2019 08:00	12/12/2019 15:39	12/12/2019 08:00	12/12/2019 15:39	7,64	1	7,64	CHI

20191289049	JATAI	10005764651	JATAI S3	12/12/2019 08:01	12/12/2019 12:45	12/12/2019 08:01	12/12/2019 12:45	4,73	1	4,73	CHI
20191289051	TRINDADE	40100935	GOYA S1	12/12/2019 08:02	12/12/2019 10:58	12/12/2019 08:02	12/12/2019 10:58	2,93	1	2,93	CHI
20191289057	APORE	AE11163940	ITAJA S1	12/12/2019 08:02	12/12/2019 16:10	12/12/2019 08:02	12/12/2019 16:10	8,12	74	600,74	CHI
20191289062	ANAPOLIS	AN11000166	JUNDIAI S2	12/12/2019 08:03	12/12/2019 10:25	12/12/2019 08:03	12/12/2019 10:25	2,35	127	298,84	CHI
20191289071	PIRENOPOLIS	PV21230764	SAO FRANCISCO DE GOIAS	12/12/2019 08:04	12/12/2019 10:50	12/12/2019 08:04	12/12/2019 10:50	2,78	1	2,78	CHI
20191289148	CAMPO LIMPO	AN12347857	NEROPOLIS S1	12/12/2019 08:04	12/12/2019 10:09	12/12/2019 08:04	12/12/2019 10:09	2,08	16	33,25	CHI
20191289078	MORRINHOS	MR12015085	MORRINHOS	12/12/2019 08:05	12/12/2019 13:28	12/12/2019 08:05	12/12/2019 13:28	5,38	9	48,39	CHI
20191289080	CABECEIRAS	CW11218385	ITUIQUIRA	12/12/2019 08:05	12/12/2019 10:05	12/12/2019 08:05	12/12/2019 10:05	1,99	54	107,31	CHI
20191289093	GOIANIA	10025851312	ATLANTICO S1	12/12/2019 08:07	12/12/2019 09:39	12/12/2019 08:07	12/12/2019 09:39	1,52	1	1,52	CHI
20191289102	SANTO ANTONIO DO DESCOBERTO	SN21163812	MARAJOARA	12/12/2019 08:09	12/12/2019 15:48	12/12/2019 08:09	12/12/2019 15:48	7,65	2	15,29	CHI
20191289103	QUIRINOPOLIS	QI21296552	QUIRINOPOLIS	12/12/2019 08:09	12/12/2019 12:37	12/12/2019 08:09	12/12/2019 12:37	4,46	1	4,46	CHI
20191289109	CATURAI	AV12019656	ANICUNS	12/12/2019 08:09	13/12/2019 09:07	12/12/2019 08:09	13/12/2019 09:07	24,96	6	149,75	CHI
20191290419	SANTO ANTONIO DO DESCOBERTO	SN12261265	ALEXANIA	12/12/2019 08:09	12/12/2019 12:29	12/12/2019 08:09	12/12/2019 12:29	4,32	15	64,79	CHI
20191289117	URUACU	UR12210930	URUACU	12/12/2019 08:10	12/12/2019 14:20	12/12/2019 08:10	12/12/2019 14:20	6,16	11	67,74	CHI
20191289130	NIQUELANDIA	NQ12375605	URUACU	12/12/2019 08:12	12/12/2019 09:52	12/12/2019 08:12	12/12/2019 09:52	1,67	28	46,66	CHI
20191289139	ORIZONA	OZ21319332	VIANOPOLIS	12/12/2019 08:12	12/12/2019 10:46	12/12/2019 08:12	12/12/2019 10:46	2,55	1	2,55	CHI
20191289479	MINEIROS	MY12156849	PARQUE DAS EMAS	12/12/2019 08:12	12/12/2019 19:35	12/12/2019 08:12	12/12/2019 19:35	11,37	11	125,08	CHI
20191289142	APARECIDA DE GOIANIA	200268272	INDEPENDENCIA S1	12/12/2019 08:13	12/12/2019 11:48	12/12/2019 08:13	12/12/2019 11:48	3,58	1	3,58	CHI
20191289146	CAIAPONIA	CP21259339	CAIAPONIA	12/12/2019 08:13	12/12/2019 11:06	12/12/2019 08:13	12/12/2019 11:06	2,87	1	2,87	CHI
20191289147	BOM JESUS DE GOIAS	BJ12226866	RIO DOS BOIS	12/12/2019 08:13	12/12/2019 15:30	12/12/2019 08:13	12/12/2019 15:30	7,27	5	36,35	CHI
20191289152	ITUMBIARA	IT12000055	ITUMBIARA VELHA S1	12/12/2019 08:13	12/12/2019 10:43	12/12/2019 08:13	12/12/2019 10:43	2,48	191	474,42	CHI
20191289136	MINEIROS	MY12324537	PARQUE DAS EMAS	12/12/2019 08:14	12/12/2019 13:09	12/12/2019 08:14	12/12/2019 13:09	4,90	10	49,04	CHI
20191289155	HIDROLANDIA	HD21006311	CEPAIGO S2	12/12/2019 08:14	12/12/2019 13:40	12/12/2019 08:14	12/12/2019 13:40	5,44	1	5,44	CHI
20191289157	SENADOR CANEDO	190075740	SENADOR CANEDO	12/12/2019 08:14	12/12/2019 10:32	12/12/2019 08:14	12/12/2019 10:32	2,30	1	2,30	CHI
20191289158	ITARUMA	IM21058761	CACHOEIRA ALTA	12/12/2019 08:14	12/12/2019 16:30	12/12/2019 08:14	12/12/2019 16:30	8,26	1	8,26	CHI
20191289165	SAO MIGUEL DO ARAGUAIA	SM21096098	SAO MIGUEL DO ARAGUAIA	12/12/2019 08:15	12/12/2019 09:20	12/12/2019 08:15	12/12/2019 09:20	1,07	1	1,07	CHI
20191289166	APARECIDA DE GOIANIA	AP12392966	INDEPENDENCIA S1	12/12/2019 08:15	12/12/2019 10:20	12/12/2019 08:15	12/12/2019 10:20	2,07	5	10,35	CHI
20191289171	CORUMBA DE GOIAS	ZN21273285	COCALZINHO	12/12/2019 08:16	12/12/2019 12:16	12/12/2019 08:16	12/12/2019 12:16	3,99	1	3,99	CHI
20191289174	GOUVELANDIA	GB21340793	QUIRINOPOLIS	12/12/2019 08:17	12/12/2019 10:58	12/12/2019 08:17	12/12/2019 10:58	2,68	2	5,36	CHI
20191289175	RIO VERDE	RV12326969	RIO VERDE S1	12/12/2019 08:17	12/12/2019 10:50	12/12/2019 08:17	12/12/2019 10:50	2,56	1	2,56	CHI
20191289180	ACREUNA	8590757	ACREUNA	12/12/2019 08:18	12/12/2019 10:50	12/12/2019 08:18	12/12/2019 10:50	2,53	13	32,88	CHI
20191293858	ITAJA	IJ12214312	ITAJA S2	12/12/2019 08:19	13/12/2019 11:48	12/12/2019 08:19	13/12/2019 11:48	27,48	4	109,93	CHI
20191289190	BOM JARDIM DE GOIAS	BM21396516	BOM JARDIM	12/12/2019 08:20	13/12/2019 08:17	12/12/2019 08:20	13/12/2019 08:17	23,95	1	23,95	CHI

20191289191	URUACU	UR12247225	MARA ROSA	12/12/2019 08:20	12/12/2019 12:23	12/12/2019 08:20	12/12/2019 12:23	4,04	7	28,28	CHI
20191289195	CAIAPONIA	PH21228552	PIRANHAS	12/12/2019 08:20	12/12/2019 17:38	12/12/2019 08:20	12/12/2019 17:38	9,31	1	9,31	CHI
20191289193	PORANGATU	PO12328829	PORANGATU	12/12/2019 08:21	12/12/2019 17:22	12/12/2019 11:55	12/12/2019 14:40	2,74	4	10,94	CHI
20191289193	PORANGATU	PO12187950	PORANGATU	12/12/2019 08:21	12/12/2019 17:22	12/12/2019 08:21	12/12/2019 17:22	9,02	1	9,02	CHI
20191289194	RIO VERDE	RV32191873	QUIRINOPOLIS	12/12/2019 08:21	12/12/2019 12:41	12/12/2019 08:21	12/12/2019 12:41	4,33	11	47,65	CHI
20191289196	PIRES DO RIO	PR21159831	PIRES DO RIO S2	12/12/2019 08:21	12/12/2019 12:18	12/12/2019 08:21	12/12/2019 12:18	3,95	1	3,95	CHI
20191289199	CATALAO	CT12000051RE	CATALAO S1	12/12/2019 08:21	12/12/2019 17:36	12/12/2019 08:21	12/12/2019 17:27	9,10	63	573,13	CHI
20191289199	CATALAO	CT12358247	CATALAO S1	12/12/2019 08:21	12/12/2019 17:36	12/12/2019 17:28	12/12/2019 17:36	0,13	34	4,34	CHI
20191289668	BALIZA	BH12331413	CAIAPONIA	12/12/2019 08:21	12/12/2019 10:37	12/12/2019 08:21	12/12/2019 10:37	2,25	12	27,04	CHI
20191288471	ANAPOLIS	AN21000040	ANAPOLIS UNIVERSITARIO S2	12/12/2019 08:22	12/12/2019 08:43	12/12/2019 08:22	12/12/2019 08:43	0,34	1	0,34	CHI
20191289210	MAIRIPOTABA	MI21078698	PONTALINA	12/12/2019 08:23	12/12/2019 11:49	12/12/2019 08:23	12/12/2019 11:49	3,43	1	3,43	CHI
20191289211	APARECIDA DE GOIANIA	13843060	INDEPENDENCIA S2	12/12/2019 08:23	12/12/2019 13:03	12/12/2019 08:23	12/12/2019 13:03	4,66	1	4,66	CHI
20191289215	GOIANIA	12083240	GOYA S1	12/12/2019 08:24	12/12/2019 14:31	12/12/2019 08:24	12/12/2019 14:31	6,11	1	6,11	CHI
20191289223	RIO VERDE	RV12260249	RIO VERDE S2	12/12/2019 08:25	12/12/2019 11:10	12/12/2019 08:25	12/12/2019 11:10	2,75	2	5,50	CHI
20191289224	SANTA CRUZ DE GOIAS	CN21180316	CALDAS NOVAS S1	12/12/2019 08:26	12/12/2019 11:00	12/12/2019 08:26	12/12/2019 11:00	2,57	1	2,57	CHI
20191289240	DAVINOPOLIS	IO12073876	CATALAO S1	12/12/2019 08:28	12/12/2019 17:25	12/12/2019 08:28	12/12/2019 17:25	8,94	3	26,82	CHI
20191289240	OUVIDOR	IO12073876	CATALAO S1	12/12/2019 08:28	12/12/2019 17:25	12/12/2019 08:28	12/12/2019 17:25	8,94	4	35,76	CHI
20191289241	ITAPURANGA	IK21300344	ITAPURANGA	12/12/2019 08:28	12/12/2019 10:13	12/12/2019 08:28	12/12/2019 10:13	1,74	1	1,74	CHI
201912260817	CATALAO	CT12000011	CATALAO S2	12/12/2019 08:28	12/12/2019 13:39	12/12/2019 08:28	12/12/2019 13:39	5,17	501	2590,87	CHI
20191289248	GUARANI DE GOIAS	GY12267993	IACIARA S1	12/12/2019 08:29	12/12/2019 12:04	12/12/2019 08:29	12/12/2019 12:04	3,57	50	178,60	CHI
20191289254	HIDROLANDIA	HD11393257	CEPAIGO S1	12/12/2019 08:30	12/12/2019 19:35	12/12/2019 08:30	12/12/2019 19:35	11,08	4	44,31	CHI
20191289262	VALPARAISO DE GOIAS	VA11078412	PACAEMBU S1	12/12/2019 08:31	12/12/2019 10:46	12/12/2019 08:31	12/12/2019 10:46	2,24	133	298,29	CHI
20191289264	PIRES DO RIO	PR21248335	PIRES DO RIO S2	12/12/2019 08:31	12/12/2019 11:12	12/12/2019 08:31	12/12/2019 11:12	2,68	2	5,36	CHI
20191289266	ARAGUAPAZ	AZ12329934	MOZARLANDIA	12/12/2019 08:31	12/12/2019 10:48	12/12/2019 08:31	12/12/2019 10:48	2,27	2	4,54	CHI
20191289269	TURVANIA	TV12005565	FIRMINOPOLIS S2	12/12/2019 08:32	12/12/2019 12:25	12/12/2019 08:32	12/12/2019 12:25	3,89	4	15,55	CHI
20191289271	PORANGATU	840030228	PORANGATU	12/12/2019 08:32	12/12/2019 09:59	12/12/2019 08:32	12/12/2019 09:59	1,44	1	1,44	CHI
20191289274	MUTUNOPOLIS	MU12068520	MARA ROSA	12/12/2019 08:33	12/12/2019 10:55	12/12/2019 08:33	12/12/2019 10:55	2,35	2	4,71	CHI
20191289274	PORANGATU	MU12068520	MARA ROSA	12/12/2019 08:33	12/12/2019 10:55	12/12/2019 08:33	12/12/2019 10:55	2,35	12	28,23	CHI
20191289280	APORE	AE21112879	ITAJA S1	12/12/2019 08:34	12/12/2019 15:18	12/12/2019 08:34	12/12/2019 15:18	6,72	1	6,72	CHI
20191289284	DOVERLANDIA	DV21237157	CAIAPONIA	12/12/2019 08:35	12/12/2019 16:13	12/12/2019 08:35	12/12/2019 16:13	7,62	1	7,62	CHI
20191289285	MOZARLANDIA	MZ12330409	MOZARLANDIA	12/12/2019 08:35	12/12/2019 14:49	12/12/2019 08:35	12/12/2019 14:49	6,22	1	6,22	CHI
20191289287	GOIATUBA	140054170	GOIATUBA S2	12/12/2019 08:36	12/12/2019 16:57	12/12/2019 08:36	12/12/2019 16:57	8,35	1	8,35	CHI
20191289293	SAO MIGUEL DO ARAGUAIA	SM21147665	SAO MIGUEL DO ARAGUAIA	12/12/2019 08:37	12/12/2019 14:01	12/12/2019 08:37	12/12/2019 14:01	5,40	1	5,40	CHI

20191289294	CORUMBA DE GOIAS	CB11351483	CORUMBA	12/12/2019 08:37	12/12/2019 09:33	12/12/2019 08:37	12/12/2019 09:33	0,93	47	43,63	CHI
20191289297	MORRINHOS	MR21333124	MORRINHOS	12/12/2019 08:37	12/12/2019 17:01	12/12/2019 08:37	12/12/2019 17:01	8,38	1	8,38	CHI
20191289298	JATAI	JT21279571	CABRIUVA S1	12/12/2019 08:37	12/12/2019 14:00	12/12/2019 08:37	12/12/2019 14:00	5,37	1	5,37	CHI
20191289302	PONTALINA	PK12263503	PONTALINA	12/12/2019 08:39	12/12/2019 15:33	12/12/2019 08:39	12/12/2019 15:33	6,89	15	103,42	CHI
20191289304	ANAPOLIS	20597400	JUNDIAI S1	12/12/2019 08:39	12/12/2019 12:04	12/12/2019 08:39	12/12/2019 12:04	3,41	1	3,41	CHI
20191289305	APARECIDA DE GOIANIA	13846747	ANHANGUERA	12/12/2019 08:39	12/12/2019 12:26	12/12/2019 08:39	12/12/2019 12:26	3,77	1	3,77	CHI
20191291937	SANTO ANTONIO DO DESCOBERTO	SN12037174	MARAJOARA	12/12/2019 08:39	12/12/2019 15:43	12/12/2019 08:39	12/12/2019 15:43	7,05	7	49,38	CHI
20191289310	MATRINCHA	MP11223802	MATRINCHA	12/12/2019 08:40	12/12/2019 17:46	12/12/2019 08:40	12/12/2019 17:46	9,10	1	9,10	CHI
20191289311	APARECIDA DE GOIANIA	200466513	INDEPENDENCIA S2	12/12/2019 08:40	12/12/2019 11:43	12/12/2019 08:40	12/12/2019 11:43	3,04	1	3,04	CHI
20191289329	MORRINHOS	MR12335174RE	MORRINHOS	12/12/2019 08:40	12/12/2019 11:47	12/12/2019 08:40	12/12/2019 11:47	3,10	75	232,71	CHI
20191289319	ANICUNS	AC12091322	ANICUNS	12/12/2019 08:41	12/12/2019 18:00	12/12/2019 08:41	12/12/2019 18:00	9,31	7	65,20	CHI
20191289602	ABADIANIA	AN12258829	ANAPOLIS UNIVERSITARIO S2	12/12/2019 08:41	12/12/2019 09:56	12/12/2019 08:41	12/12/2019 09:56	1,24	16	19,77	CHI
20191289325	GOIANIA	17274771	GOYA S2	12/12/2019 08:42	12/12/2019 10:05	12/12/2019 08:42	12/12/2019 10:05	1,38	1	1,38	CHI
20191289330	PIRES DO RIO	PR21000059	PIRES DO RIO S1	12/12/2019 08:42	12/12/2019 10:50	12/12/2019 08:42	12/12/2019 10:50	2,13	1	2,13	CHI
20191289331	NOVO BRASIL	NB21237286	JUSSARA	12/12/2019 08:42	12/12/2019 15:23	12/12/2019 08:42	12/12/2019 15:23	6,68	1	6,68	CHI
20191289333	SANTO ANTONIO DO DESCOBERTO	10012918588	ALEXANIA	12/12/2019 08:42	12/12/2019 10:04	12/12/2019 08:42	12/12/2019 10:04	1,36	1	1,36	CHI
20191289346	NOVA VENEZA	NV21280958	INHUMAS S1	12/12/2019 08:42	12/12/2019 10:38	12/12/2019 08:42	12/12/2019 10:38	1,92	11	21,09	CHI
20191289344	PALMEIRAS DE GOIAS	TV21299134	FIRMINOPOLIS S2	12/12/2019 08:43	12/12/2019 10:50	12/12/2019 08:43	12/12/2019 10:50	2,12	1	2,12	CHI
20191289347	CRISTALINA	KR21163141	CRISTALINA S1	12/12/2019 08:43	12/12/2019 11:59	12/12/2019 08:43	12/12/2019 11:59	3,25	1	3,25	CHI
20191291563	PIRANHAS	PH12342187	PIRANHAS	12/12/2019 08:43	12/12/2019 16:51	12/12/2019 08:43	12/12/2019 16:51	8,13	2	16,26	CHI
20191285537	SAO SIMAO	10028116281	CACHOEIRA ALTA	12/12/2019 08:44	12/12/2019 15:08	12/12/2019 08:44	12/12/2019 15:08	6,39	1	6,39	CHI
20191289349	QUIRINOPOLIS	80074443	QUIRINOPOLIS	12/12/2019 08:44	12/12/2019 09:34	12/12/2019 08:44	12/12/2019 09:34	0,83	1	0,83	CHI
20191291091	SAO SIMAO	SO12381306	CACHOEIRA ALTA	12/12/2019 08:44	12/12/2019 16:16	12/12/2019 08:44	12/12/2019 16:16	7,52	2	15,04	CHI
20191289377	CRISTALINA	KR12383072	CRISTALINA S2	12/12/2019 08:46	12/12/2019 09:59	12/12/2019 08:46	12/12/2019 09:59	1,21	3	3,64	CHI
20191289381	ITAPIRAPUA	RN13091462	BRITANIA	12/12/2019 08:46	13/12/2019 12:23	13/12/2019 11:01	13/12/2019 11:44	0,72	2	1,44	CHI
20191289381	SANTA FE DE GOIAS	RN13091462	BRITANIA	12/12/2019 08:46	13/12/2019 12:23	13/12/2019 11:01	13/12/2019 11:44	0,72	34	24,42	CHI
20191289381	JUSSARA	RN13119557	BRITANIA	12/12/2019 08:46	13/12/2019 12:23	13/12/2019 12:15	13/12/2019 12:23	0,14	6	0,81	CHI
20191289381	SANTA FE DE GOIAS	RN13119557	BRITANIA	12/12/2019 08:46	13/12/2019 12:23	13/12/2019 12:15	13/12/2019 12:23	0,14	37	5,03	CHI
20191289383	SANTO ANTONIO DO DESCOBERTO	SN21314252	MARAJOARA	12/12/2019 08:46	12/12/2019 17:17	12/12/2019 08:46	12/12/2019 17:17	8,51	2	17,02	CHI
20191289385	PIRANHAS	PH21343590	PIRANHAS	12/12/2019 08:46	12/12/2019 14:53	12/12/2019 08:46	12/12/2019 14:53	6,11	1	6,11	CHI
20191289392	VALPARAISO DE GOIAS	10014964056	PACAEMBU S1	12/12/2019 08:48	12/12/2019 11:40	12/12/2019 08:48	12/12/2019 11:40	2,86	1	2,86	CHI
20191289395	PIRACANJUBA	PJ21029639	MORRINHOS	12/12/2019 08:48	12/12/2019 17:35	12/12/2019 08:48	12/12/2019 17:35	8,78	1	8,78	CHI
20191289397	RIO VERDE	RV21355122	QUIRINOPOLIS	12/12/2019 08:48	12/12/2019 12:58	12/12/2019 08:48	12/12/2019 12:58	4,15	1	4,15	CHI

20191289604	NOVO PLANALTO	SM12099146	SAO MIGUEL DO ARAGUAIA	12/12/2019 08:48	12/12/2019 10:12	12/12/2019 08:48	12/12/2019 10:12	1,40	0	0,00	CHI
20191289604	SAO MIGUEL DO ARAGUAIA	SM12099146	SAO MIGUEL DO ARAGUAIA	12/12/2019 08:48	12/12/2019 10:12	12/12/2019 08:48	12/12/2019 10:12	1,40	52	72,57	CHI
20191289617	CALDAS NOVAS	CN12298650	SERRA DE CALDAS	12/12/2019 08:49	12/12/2019 12:25	12/12/2019 08:49	12/12/2019 12:25	3,59	5	17,94	CHI
20191289691	CALDAS NOVAS	CN12122123	SERRA DE CALDAS	12/12/2019 08:49	12/12/2019 10:34	12/12/2019 08:49	12/12/2019 10:34	1,74	4	6,95	CHI
20191289507	ITUMBIARA	10029571136	ITUMBIARA VELHA S1	12/12/2019 08:50	12/12/2019 09:40	12/12/2019 08:50	12/12/2019 09:40	0,82	1	0,82	CHI
20191289519	MONTE ALEGRE DE GOIAS	MA12282328	SAO DOMINGOS	12/12/2019 08:52	12/12/2019 13:26	12/12/2019 08:52	12/12/2019 13:26	4,56	2	9,12	CHI
20191289524	OUIDOR	CT21203172	CATALAO S1	12/12/2019 08:52	12/12/2019 17:55	12/12/2019 08:52	12/12/2019 17:55	9,04	3	27,11	CHI
20191289528	CALDAS NOVAS	CN12082136RE	SERRA DE CALDAS	12/12/2019 08:53	14/12/2019 08:00	12/12/2019 08:53	13/12/2019 11:20	26,45	2	52,90	CHI
20191289528	CALDAS NOVAS	CN12082136RE	SERRA DE CALDAS	12/12/2019 08:53	14/12/2019 08:00	12/12/2019 08:53	13/12/2019 15:53	31,00	3	92,99	CHI
20191289528	CALDAS NOVAS	CN12082136RE	SERRA DE CALDAS	12/12/2019 08:53	14/12/2019 08:00	13/12/2019 14:59	13/12/2019 15:53	0,90	2	1,80	CHI
20191289528	CALDAS NOVAS	CN12082136RE	SERRA DE CALDAS	12/12/2019 08:53	14/12/2019 08:00	12/12/2019 08:53	13/12/2019 19:29	34,60	14	484,44	CHI
20191289528	CALDAS NOVAS	CN12082136RE	SERRA DE CALDAS	12/12/2019 08:53	14/12/2019 08:00	12/12/2019 08:53	14/12/2019 08:00	47,13	10	471,25	CHI
20191289529	EDEIA	EA21033875	EDEIA	12/12/2019 08:53	12/12/2019 19:10	12/12/2019 08:53	12/12/2019 19:10	10,29	2	20,57	CHI
20191292000	PIRES DO RIO	PR12082799	PIRES DO RIO S1	12/12/2019 08:53	12/12/2019 17:00	12/12/2019 08:53	12/12/2019 17:00	8,11	6	48,66	CHI
20191289700	GOIATUBA	GT11000061	GOIATUBA S2	12/12/2019 08:54	12/12/2019 15:15	12/12/2019 08:54	12/12/2019 15:15	6,35	151	958,22	CHI
20191289542	SANTA HELENA DE GOIAS	SH21000226	IPEGUARI	12/12/2019 08:55	12/12/2019 11:45	12/12/2019 08:55	12/12/2019 11:45	2,83	2	5,66	CHI
20191289543	JATAI	10024791030	JATAI S2	12/12/2019 08:55	12/12/2019 14:57	12/12/2019 08:55	12/12/2019 14:57	6,04	1	6,04	CHI
20191289550	AMARALINA	LC12189854	MARA ROSA	12/12/2019 08:56	12/12/2019 21:45	12/12/2019 08:56	12/12/2019 21:45	12,81	7	89,65	CHI
20191289550	MARA ROSA	LC12189854	MARA ROSA	12/12/2019 08:56	12/12/2019 21:45	12/12/2019 08:56	12/12/2019 21:45	12,81	2	25,61	CHI
20191291806	EDEIA	EA12160412	EDEIA	12/12/2019 08:57	12/12/2019 20:09	12/12/2019 08:57	12/12/2019 20:09	11,20	18	201,55	CHI
20191289565	ITARUMA	IM21122642	CACHOEIRA ALTA	12/12/2019 08:58	12/12/2019 21:07	12/12/2019 08:58	12/12/2019 21:07	12,16	1	12,16	CHI
20191289566	SAO LUIS DE MONTES BELOS	SL21308586	FIRMINOPOLIS S2	12/12/2019 08:58	12/12/2019 09:59	12/12/2019 08:58	12/12/2019 09:59	1,03	1	1,03	CHI
20191289567	PARAUNA	PU12301132	ACREUNA	12/12/2019 08:58	12/12/2019 10:55	12/12/2019 08:58	12/12/2019 10:55	1,96	2	3,91	CHI
20191289582	MONTES CLAROS DE GOIAS	1440024781	BRITANIA	12/12/2019 08:59	12/12/2019 18:10	12/12/2019 08:59	12/12/2019 18:10	9,18	1	9,18	CHI
20191289576	JATAI	RV12040452	CABRIUVA S1	12/12/2019 09:00	12/12/2019 12:47	12/12/2019 09:00	12/12/2019 12:47	3,78	2	7,57	CHI
20191289576	RIO VERDE	RV12040452	CABRIUVA S1	12/12/2019 09:00	12/12/2019 12:47	12/12/2019 09:00	12/12/2019 12:47	3,78	6	22,70	CHI
20191289581	MATRINCHA	MP21231926	MATRINCHA	12/12/2019 09:00	12/12/2019 18:48	12/12/2019 09:00	12/12/2019 18:48	9,78	1	9,78	CHI
20191289586	URUACU	640049977	URUACU	12/12/2019 09:01	12/12/2019 14:45	12/12/2019 09:01	12/12/2019 14:45	5,72	1	5,72	CHI
20191289727	PONTALINA	AD12060078	GOIATUBA S1	12/12/2019 09:01	12/12/2019 16:00	12/12/2019 09:01	12/12/2019 16:00	6,98	12	83,74	CHI
20191289590	LEOPOLDO DE BULHOES	870008948	DAIA S2	12/12/2019 09:02	12/12/2019 11:21	12/12/2019 09:02	12/12/2019 11:21	2,30	1	2,30	CHI
20191289601	GOUVELANDIA	GB21296636	QUIRINOPOLIS	12/12/2019 09:05	12/12/2019 17:34	12/12/2019 09:05	12/12/2019 17:34	8,50	1	8,50	CHI
20191289606	PORANGATU	PO11202591	PORANGATU	12/12/2019 09:05	12/12/2019 11:25	12/12/2019 09:05	12/12/2019 11:25	2,32	2	4,64	CHI
20191289610	ALOANDIA	AD21000007	GOIATUBA S1	12/12/2019 09:06	12/12/2019 17:16	12/12/2019 09:06	12/12/2019 17:16	8,16	1	8,16	CHI

20191289618	PONTALINA	PK21268163	VICENTINOPOLIS	12/12/2019 09:07	12/12/2019 13:40	12/12/2019 09:07	12/12/2019 13:40	4,53	1	4,53	CHI
20191289619	BELA VISTA DE GOIAS	BV21357959	BELA VISTA S1	12/12/2019 09:08	12/12/2019 14:07	12/12/2019 09:08	12/12/2019 14:07	4,98	1	4,98	CHI
20191289621	LUZIANIA	LZ21153865	MARAJOARA	12/12/2019 09:08	12/12/2019 10:55	12/12/2019 09:08	12/12/2019 10:55	1,77	2	3,55	CHI
20191289628	CUMARI	10014689772	CATALAO S1	12/12/2019 09:10	12/12/2019 11:29	12/12/2019 09:10	12/12/2019 11:29	2,31	1	2,31	CHI
20191289629	ITAPURANGA	170020186	ITAPURANGA	12/12/2019 09:10	12/12/2019 10:29	12/12/2019 09:10	12/12/2019 10:29	1,33	1	1,33	CHI
20191289631	ANAPOLIS	20455872	JUNDIAI S2	12/12/2019 09:10	12/12/2019 10:46	12/12/2019 09:10	12/12/2019 10:46	1,60	1	1,60	CHI
20191289782	FAINA	MP12096007	MATRINCHA	12/12/2019 09:10	12/12/2019 19:00	12/12/2019 09:10	12/12/2019 19:00	9,83	8	78,66	CHI
20191289634	AGUA FRIA DE GOIAS	TL12330541	SAO JOAO D ALIANCA	12/12/2019 09:11	12/12/2019 13:30	12/12/2019 09:11	12/12/2019 13:30	4,31	3	12,94	CHI
20191289636	QUIRINOPOLIS	QI12029078	QUIRINOPOLIS	12/12/2019 09:11	12/12/2019 10:23	12/12/2019 09:11	12/12/2019 10:23	1,19	5	5,97	CHI
20191289416	CRISTALINA	KR12351414	PAMPLONA	12/12/2019 09:12	12/12/2019 18:02	12/12/2019 09:12	12/12/2019 18:02	8,83	6	52,96	CHI
20191289637	GOIATUBA	JV12208118	GOIATUBA S1	12/12/2019 09:12	12/12/2019 11:55	12/12/2019 09:12	12/12/2019 11:55	2,71	4	10,84	CHI
20191289637	JOVIANIA	JV12208118	GOIATUBA S1	12/12/2019 09:12	12/12/2019 11:55	12/12/2019 09:12	12/12/2019 11:55	2,71	15	40,65	CHI
20191289643	GOIANIA	GN21265192	GOIANIA LESTE S1	12/12/2019 09:13	12/12/2019 19:41	12/12/2019 15:58	12/12/2019 19:00	3,03	1	3,03	CHI
20191289643	GOIANIA	GN11140811	GOIANIA LESTE S1	12/12/2019 09:13	12/12/2019 19:41	12/12/2019 16:52	12/12/2019 19:41	2,82	111	313,36	CHI
20191291030	SERRANOPOLIS	SX12216620	JATAI S1	12/12/2019 09:15	12/12/2019 14:10	12/12/2019 09:15	12/12/2019 14:10	4,90	3	14,71	CHI
20191289661	PIRES DO RIO	PR11166945	PIRES DO RIO S1	12/12/2019 09:17	12/12/2019 12:00	12/12/2019 09:17	12/12/2019 12:00	2,71	33	89,57	CHI
20191289663	SAO MIGUEL DO ARAGUAIA	SM21128995	SAO MIGUEL DO ARAGUAIA	12/12/2019 09:18	12/12/2019 12:54	12/12/2019 09:18	12/12/2019 12:54	3,59	1	3,59	CHI
20191289478	GUAPO	GA21052083	TRINDADE	12/12/2019 09:19	12/12/2019 14:26	12/12/2019 09:19	12/12/2019 14:26	5,11	2	10,23	CHI
20191289677	INDIARA	CZ21233504	CEZARINA	12/12/2019 09:19	12/12/2019 12:01	12/12/2019 09:19	12/12/2019 12:01	2,69	1	2,69	CHI
20191289678	IPORA	IR12172534	IPORA	12/12/2019 09:19	12/12/2019 16:00	12/12/2019 09:19	12/12/2019 16:00	6,67	9	60,04	CHI
20191289678	IVOLANDIA	IR12172534	IPORA	12/12/2019 09:19	12/12/2019 16:00	12/12/2019 09:19	12/12/2019 16:00	6,67	1	6,67	CHI
20191289435	IPORA	IR21381033	ARENOPOLIS	12/12/2019 09:22	12/12/2019 10:57	12/12/2019 09:22	12/12/2019 10:57	1,58	1	1,58	CHI
20191290622	NOVO GAMA	LZ12082801	MARAJOARA	12/12/2019 09:22	12/12/2019 10:52	12/12/2019 09:22	12/12/2019 10:52	1,50	27	40,49	CHI
20191289696	BELA VISTA DE GOIAS	BV12020443	BELA VISTA S2	12/12/2019 09:23	12/12/2019 11:06	12/12/2019 09:23	12/12/2019 11:06	1,71	424	726,57	CHI
20191289698	FORMOSA	FA11344414	ITUIQUIRA	12/12/2019 09:23	12/12/2019 12:00	12/12/2019 09:23	12/12/2019 12:00	2,61	7	18,24	CHI
20191289703	JARAGUA	JA12278914	JARAGUA	12/12/2019 09:24	12/12/2019 13:00	12/12/2019 09:24	12/12/2019 13:00	3,59	2	7,17	CHI
20191290613	CATALAO	IO12363431	CATALAO S1	12/12/2019 09:24	12/12/2019 17:55	12/12/2019 09:24	12/12/2019 17:55	8,51	1	8,51	CHI
20191290613	DAVINOPOLIS	IO12363431	CATALAO S1	12/12/2019 09:24	12/12/2019 17:55	12/12/2019 09:24	12/12/2019 17:55	8,51	15	127,62	CHI
20191290613	OUVIDOR	IO12363431	CATALAO S1	12/12/2019 09:24	12/12/2019 17:55	12/12/2019 09:24	12/12/2019 17:55	8,51	4	34,03	CHI
20191289708	MINEIROS	MY12324528	PARQUE DAS EMAS	12/12/2019 09:25	12/12/2019 14:55	12/12/2019 09:25	12/12/2019 14:55	5,49	4	21,96	CHI
20191289710	NAZARIO	NZ12000046	ANICUNS	12/12/2019 09:26	12/12/2019 14:35	12/12/2019 09:26	12/12/2019 14:35	5,15	1	5,15	CHI
20191289714	MINACU	IH21236110	MINACU	12/12/2019 09:26	12/12/2019 16:17	12/12/2019 09:26	12/12/2019 16:17	6,85	1	6,85	CHI
20191289765	MATRINCHA	MP11073658	MATRINCHA	12/12/2019 09:26	12/12/2019 16:31	12/12/2019 09:26	12/12/2019 16:31	7,08	105	743,17	CHI

20191290789	AMERICANO DO BRASIL	KB12391521	ANICUNS	12/12/2019 09:26	12/12/2019 12:40	12/12/2019 09:26	12/12/2019 12:40	3,23	10	32,26	CHI
20191290789	MOSSAMEDES	KB12391521	ANICUNS	12/12/2019 09:26	12/12/2019 12:40	12/12/2019 09:26	12/12/2019 12:40	3,23	11	35,49	CHI
20191289715	CAMPOS VERDES	VD12380750	SANTA TEREZINHA	12/12/2019 09:27	12/12/2019 15:39	12/12/2019 09:27	12/12/2019 15:39	6,20	3	18,59	CHI
20191289718	ANAPOLIS	20857512	ANAPOLIS UNIVERSITARIO S2	12/12/2019 09:27	12/12/2019 12:27	12/12/2019 09:27	12/12/2019 12:27	3,00	1	3,00	CHI
20191289719	CAIAPONIA	PH12221148	PIRANHAS	12/12/2019 09:28	13/12/2019 10:20	12/12/2019 09:28	13/12/2019 10:20	24,86	3	74,57	CHI
20191289720	PIRES DO RIO	10008708973	PIRES DO RIO S1	12/12/2019 09:28	12/12/2019 16:40	12/12/2019 09:28	12/12/2019 16:40	7,20	1	7,20	CHI
20191289427	CAIAPONIA	CP11161698	CAIAPONIA	12/12/2019 09:29	12/12/2019 18:59	12/12/2019 09:29	12/12/2019 18:59	9,50	75	712,31	CHI
20191289728	VIANOPOLIS	VN21103819	VIANOPOLIS	12/12/2019 09:29	12/12/2019 11:56	12/12/2019 09:29	12/12/2019 11:56	2,43	1	2,43	CHI
20191289730	BOM JESUS DE GOIAS	BJ12062924	BOM JESUS DE GOIAS	12/12/2019 09:29	12/12/2019 12:24	12/12/2019 09:29	12/12/2019 12:24	2,90	1	2,90	CHI
20191289734	MORRINHOS	MR21000338	MORRINHOS	12/12/2019 09:30	12/12/2019 11:27	12/12/2019 09:30	12/12/2019 11:27	1,94	1	1,94	CHI
20191289735	ITABERAI	IB11183165	ITABERAI S2	12/12/2019 09:30	12/12/2019 10:58	12/12/2019 09:30	12/12/2019 10:58	1,45	59	85,68	CHI
20191289751	GAMELEIRA DE GOIAS	SV21197297	DAIA S2	12/12/2019 09:31	12/12/2019 15:10	12/12/2019 09:31	12/12/2019 15:10	5,63	1	5,63	CHI
20191296961	SANTA CRUZ DE GOIAS	BC21221800	PIRACANJUBA	12/12/2019 09:31	13/12/2019 11:58	12/12/2019 09:31	13/12/2019 11:58	26,44	1	26,44	CHI
20191289750	PADRE BERNARDO	PB12152732	PADRE BERNARDO	12/12/2019 09:32	12/12/2019 12:40	12/12/2019 09:32	12/12/2019 12:40	3,13	14	43,76	CHI
20191289755	MONTIVIDIU	MV12214245	MONTIVIDIU T	12/12/2019 09:33	12/12/2019 15:05	12/12/2019 09:33	12/12/2019 15:05	5,52	14	77,34	CHI
20191291139	CAIAPONIA	PY12040163	PALESTINA	12/12/2019 09:33	12/12/2019 14:29	12/12/2019 09:33	12/12/2019 14:29	4,93	45	221,69	CHI
20191291139	PALESTINA DE GOIAS	PY12040163	PALESTINA	12/12/2019 09:33	12/12/2019 14:29	12/12/2019 09:33	12/12/2019 14:29	4,93	102	502,49	CHI
20191289758	SANTO ANTONIO DO DESCOBERTO	SN21305094	ALEXANIA	12/12/2019 09:34	12/12/2019 13:21	12/12/2019 09:34	12/12/2019 13:21	3,78	2	7,56	CHI
20191289762	SAO LUIS DE MONTES BELOS	10003402205	SAO LUIZ DOS MONTES BELOS	12/12/2019 09:34	12/12/2019 12:54	12/12/2019 09:34	12/12/2019 12:54	3,34	1	3,34	CHI
20191289771	PONTALINA	PK21181908	PONTALINA	12/12/2019 09:37	12/12/2019 17:14	12/12/2019 09:37	12/12/2019 17:14	7,62	1	7,62	CHI
20191289772	RIO VERDE	SH12273765	SANTA HELENA S1	12/12/2019 09:37	12/12/2019 18:55	12/12/2019 09:37	12/12/2019 18:55	9,30	3	27,90	CHI
20191289772	SANTA HELENA DE GOIAS	SH12273765	SANTA HELENA S1	12/12/2019 09:37	12/12/2019 18:55	12/12/2019 09:37	12/12/2019 18:55	9,30	15	139,52	CHI
20191289773	DAMIANOPOLIS	MB12180672	IACIARA S2	12/12/2019 09:37	12/12/2019 16:12	12/12/2019 09:37	12/12/2019 16:12	6,58	9	59,18	CHI
20191289774	NIQUELANDIA	NQ12371132	SAO JOAO D ALIANCA	12/12/2019 09:37	12/12/2019 17:05	12/12/2019 09:37	12/12/2019 17:05	7,46	8	59,67	CHI
20191289775	COCALZINHO DE GOIAS	CB12051789	GOIANESIA S1	12/12/2019 09:37	12/12/2019 13:53	12/12/2019 09:37	12/12/2019 13:53	4,26	7	29,80	CHI
20191289780	CACU	CC11241789	CACHOEIRA ALTA	12/12/2019 09:38	13/12/2019 15:06	12/12/2019 09:38	13/12/2019 15:06	29,45	1	29,45	CHI
20191289786	BELA VISTA DE GOIAS	240066650	BELA VISTA S2	12/12/2019 09:40	12/12/2019 11:23	12/12/2019 09:40	12/12/2019 11:23	1,71	1	1,71	CHI
20191289787	URUTAI	UT21283586	URUTAI	12/12/2019 09:40	12/12/2019 16:43	12/12/2019 09:40	12/12/2019 16:43	7,05	1	7,05	CHI
20191289789	AGUAS LINDAS DE GOIAS	10008879190	AGUAS LINDAS DE GOIAS S1	12/12/2019 09:41	12/12/2019 11:39	12/12/2019 09:41	12/12/2019 11:39	1,96	1	1,96	CHI
20191289790	RUBIATABA	RB21312107	RUBIATABA	12/12/2019 09:41	12/12/2019 11:01	12/12/2019 09:41	12/12/2019 11:01	1,33	1	1,33	CHI
20191289793	ITABERAI	IB12307606	ITABERAI S2	12/12/2019 09:41	12/12/2019 13:18	12/12/2019 09:41	12/12/2019 13:18	3,61	1	3,61	CHI
20191289794	CAMPOS BELOS	CH21218580	SAO DOMINGOS	12/12/2019 09:41	12/12/2019 11:01	12/12/2019 09:41	12/12/2019 11:01	1,32	1	1,32	CHI
20191289795	GOIANDIRA	GD21237097	CATALAO S1	12/12/2019 09:41	13/12/2019 15:58	12/12/2019 09:41	13/12/2019 15:58	30,28	2	60,57	CHI

20191289798	CRISTALINA	KR11032695	CRISTALINA S1	12/12/2019 09:42	12/12/2019 11:56	12/12/2019 09:42	12/12/2019 11:56	2,23	53	118,19	CHI
20191290760	JANDAIA	JD12308464	PALMEIRAS	12/12/2019 09:42	12/12/2019 12:50	12/12/2019 09:42	12/12/2019 12:50	3,13	12	37,60	CHI
20191289804	SAO MIGUEL DO ARAGUAIA	SM12151000	SAO MIGUEL DO ARAGUAIA	12/12/2019 09:43	12/12/2019 14:01	12/12/2019 09:43	12/12/2019 14:01	4,30	16	68,74	CHI
20191289806	MATRINCHA	MP21098500	MATRINCHA	12/12/2019 09:44	13/12/2019 00:53	12/12/2019 09:44	13/12/2019 00:53	15,15	1	15,15	CHI
20191289811	ANAPOLIS	20206409	ANAPOLIS UNIVERSITARIO S2	12/12/2019 09:44	12/12/2019 11:48	12/12/2019 09:44	12/12/2019 11:48	2,05	1	2,05	CHI
20191289813	AGUAS LINDAS DE GOIAS	10009635090	AGUAS LINDAS DE GOIAS S1	12/12/2019 09:44	12/12/2019 14:42	12/12/2019 09:44	12/12/2019 14:42	4,95	1	4,95	CHI
20191290631	MONTES CLAROS DE GOIAS	ME21004029	IPORA	12/12/2019 09:45	12/12/2019 13:19	12/12/2019 09:45	12/12/2019 13:19	3,56	1	3,56	CHI
20191289818	IACIARA	IA12062299	IACIARA S2	12/12/2019 09:46	12/12/2019 16:34	12/12/2019 09:46	12/12/2019 16:34	6,81	10	68,13	CHI
20191289818	IACIARA	IA12062299	IACIARA S2	12/12/2019 09:46	12/12/2019 16:34	12/12/2019 15:04	12/12/2019 16:34	1,51	4	6,06	CHI
20191289818	POSSE	IA12062299	IACIARA S2	12/12/2019 09:46	12/12/2019 16:34	12/12/2019 15:04	12/12/2019 16:34	1,51	1	1,51	CHI
20191289824	CALDAS NOVAS	CN12060249	RIO QUENTE	12/12/2019 09:47	12/12/2019 16:40	12/12/2019 09:47	12/12/2019 16:40	6,88	3	20,65	CHI
20191289824	MORRINHOS	CN12060249	RIO QUENTE	12/12/2019 09:47	12/12/2019 16:40	12/12/2019 09:47	12/12/2019 16:40	6,88	1	6,88	CHI
20191289827	OUVIDOR	OU21166887	CATALAO S1	12/12/2019 09:47	13/12/2019 11:02	12/12/2019 09:47	13/12/2019 11:02	25,25	1	25,25	CHI
20191289828	CORUMBAIBA	CI12062859	VILA CORUMBA	12/12/2019 09:47	12/12/2019 17:17	12/12/2019 09:47	12/12/2019 17:17	7,48	20	149,68	CHI
20191289830	PALESTINA DE GOIAS	PY12342623	PALESTINA	12/12/2019 09:48	12/12/2019 12:48	12/12/2019 09:48	12/12/2019 12:48	3,00	2	6,01	CHI
20191289834	CRISTALINA	KR21305017	CRISTALINA S2	12/12/2019 09:48	12/12/2019 14:54	12/12/2019 09:48	12/12/2019 14:54	5,09	1	5,09	CHI
20191289835	PALMINOPOLIS	PP21006950	PALMEIRAS	12/12/2019 09:48	12/12/2019 11:44	12/12/2019 09:48	12/12/2019 11:44	1,93	1	1,93	CHI
20191289836	LUZIANIA	LZ21082910	MARAJOARA	12/12/2019 09:49	12/12/2019 12:19	12/12/2019 09:49	12/12/2019 12:19	2,49	1	2,49	CHI
20191290101	CACU	CC12030077	CACHOEIRA ALTA	12/12/2019 09:50	12/12/2019 13:36	12/12/2019 09:50	12/12/2019 13:36	3,75	2	7,50	CHI
20191290639	OUVIDOR	OU12061242RE	CATALAO S1	12/12/2019 09:50	12/12/2019 13:59	12/12/2019 09:50	12/12/2019 13:59	4,13	13	53,74	CHI
20191290402	JATAI	290126642	JATAI S2	12/12/2019 09:51	12/12/2019 11:58	12/12/2019 09:51	12/12/2019 11:58	2,11	1	2,11	CHI
20191290404	AGUAS LINDAS DE GOIAS	4830428595	AGUAS LINDAS DE GOIAS S1	12/12/2019 09:51	12/12/2019 13:05	12/12/2019 09:51	12/12/2019 13:05	3,22	1	3,22	CHI
20191290415	CACHOEIRA DOURADA	CD21296958	CACHOEIRA DOURADA	12/12/2019 09:54	12/12/2019 18:41	12/12/2019 09:54	12/12/2019 18:41	8,78	1	8,78	CHI
20191290416	INHUMAS	IN21024454	INHUMAS S2	12/12/2019 09:54	12/12/2019 15:32	12/12/2019 09:54	12/12/2019 15:32	5,64	1	5,64	CHI
20191290427	CALDAS NOVAS	760377704	SERRA DE CALDAS	12/12/2019 09:56	13/12/2019 08:31	12/12/2019 09:56	13/12/2019 08:31	22,59	1	22,59	CHI
20191290430	GOIATUBA	GT21208001	GOIATUBA S1	12/12/2019 09:57	12/12/2019 11:10	12/12/2019 09:57	12/12/2019 11:10	1,22	2	2,44	CHI
20191290433	PLANALTINA	PI21379176	PLANALTINA	12/12/2019 09:57	12/12/2019 12:57	12/12/2019 09:57	12/12/2019 12:57	2,99	1	2,99	CHI
20191290767	CALDAS NOVAS	CN12246588	CALDAS NOVAS S2	12/12/2019 10:00	12/12/2019 13:59	12/12/2019 10:00	12/12/2019 13:59	3,97	7	27,78	CHI
20191290823	NIQUELANDIA	NQ12290031	NIQUELANDIA SUBTRANSMISSAO	12/12/2019 10:00	12/12/2019 14:03	12/12/2019 10:00	12/12/2019 14:03	4,04	20	80,80	CHI
20191290445	SANTO ANTONIO DE GOIAS	10007722484	NEROPOLIS S1	12/12/2019 10:01	12/12/2019 18:40	12/12/2019 10:01	12/12/2019 18:40	8,65	1	8,65	CHI
20191290446	PALMEIRAS DE GOIAS	PL21197888	PALMEIRAS	12/12/2019 10:01	12/12/2019 18:08	12/12/2019 10:01	12/12/2019 18:08	8,12	1	8,12	CHI
20191290448	GOIAS	GS21183459	GOIAS	12/12/2019 10:01	12/12/2019 16:42	12/12/2019 10:01	12/12/2019 16:42	6,68	1	6,68	CHI
20191290450	ITABERAÍ	IB12000032	ITABERAÍ S2	12/12/2019 10:01	12/12/2019 20:31	12/12/2019 13:00	12/12/2019 20:31	7,53	2	15,06	CHI

20191290453	ARAGARCAS	AG12334804	ARAGARCAS	12/12/2019 10:02	12/12/2019 21:20	12/12/2019 10:02	12/12/2019 21:12	11,17	5	55,87	CHI
20191290453	ARAGARCAS	AG21140103	ARAGARCAS	12/12/2019 10:02	12/12/2019 21:20	12/12/2019 10:02	12/12/2019 21:20	11,31	1	11,31	CHI
20191290454	ITAPURANGA	IK12063175	ITAPURANGA	12/12/2019 10:02	12/12/2019 10:22	12/12/2019 10:02	12/12/2019 10:22	0,32	8	2,55	CHI
20191290455	GOIANIA	14288590	REAL S2	12/12/2019 10:02	12/12/2019 11:11	12/12/2019 10:02	12/12/2019 11:11	1,14	1	1,14	CHI
20191290472	CRISTALINA	03470454	CRISTALINA S2	12/12/2019 10:02	12/12/2019 21:41	12/12/2019 10:02	12/12/2019 11:51	1,82	14	25,44	CHI
20191290472	CRISTALINA	03470454	CRISTALINA S2	12/12/2019 10:02	12/12/2019 21:41	12/12/2019 10:02	12/12/2019 19:48	9,77	21	205,08	CHI
20191290472	CRISTALINA	KR13401323	CRISTALINA S2	12/12/2019 10:02	12/12/2019 21:41	12/12/2019 10:02	12/12/2019 19:48	9,77	43	419,93	CHI
20191290472	IPAMERI	KR13401323	CRISTALINA S2	12/12/2019 10:02	12/12/2019 21:41	12/12/2019 10:02	12/12/2019 19:48	9,77	5	48,83	CHI
20191290472	CRISTALINA	IP13401324	CRISTALINA S2	12/12/2019 10:02	12/12/2019 21:41	12/12/2019 10:02	12/12/2019 20:27	10,41	33	343,37	CHI
20191290472	IPAMERI	IP13401324	CRISTALINA S2	12/12/2019 10:02	12/12/2019 21:41	12/12/2019 10:02	12/12/2019 20:27	10,41	105	1092,53	CHI
20191290472	CRISTALINA	03470454	CRISTALINA S2	12/12/2019 10:02	12/12/2019 21:41	12/12/2019 10:02	12/12/2019 21:41	11,64	5	58,20	CHI
20191290464	APARECIDA DE GOIANIA	15979994	INDEPENDENCIA S1	12/12/2019 10:04	12/12/2019 11:26	12/12/2019 10:04	12/12/2019 11:26	1,36	1	1,36	CHI
20191290603	ARACU	AR11019227	ARACU	12/12/2019 10:04	12/12/2019 15:16	12/12/2019 10:04	12/12/2019 15:16	5,20	81	421,56	CHI
20191290475	VICENTINOPOLIS	VI12218178	VICENTINOPOLIS	12/12/2019 10:06	12/12/2019 19:31	12/12/2019 10:06	12/12/2019 19:31	9,41	5	47,04	CHI
20191290477	ABADIANIA	AN21059668	ANAPOLIS UNIVERSITARIO S2	12/12/2019 10:06	12/12/2019 16:15	12/12/2019 10:06	12/12/2019 16:15	6,14	1	6,14	CHI
20191290478	ORIZONA	2060047700	PIRES DO RIO S2	12/12/2019 10:06	12/12/2019 17:26	12/12/2019 10:06	12/12/2019 17:26	7,32	1	7,32	CHI
20191290479	MINACU	IH21208464	MINACU	12/12/2019 10:06	12/12/2019 12:08	12/12/2019 10:06	12/12/2019 12:08	2,02	1	2,02	CHI
20191290480	SANTO ANTONIO DO DESCOBERTO	10028046828	ALEXANIA	12/12/2019 10:07	12/12/2019 11:18	12/12/2019 10:07	12/12/2019 11:18	1,18	1	1,18	CHI
20191290481	NIQUELANDIA	2750104884	NIQUELANDIA SUBTRANSMISSAO	12/12/2019 10:07	12/12/2019 17:29	12/12/2019 10:07	12/12/2019 17:29	7,37	1	7,37	CHI
20191290491	SERRANOPOLIS	8046837	JATAI S1	12/12/2019 10:09	12/12/2019 12:19	12/12/2019 10:09	12/12/2019 12:19	2,16	1	2,16	CHI
20191290492	JUSSARA	1290041304	JUSSARA	12/12/2019 10:09	12/12/2019 18:00	12/12/2019 10:09	12/12/2019 18:00	7,84	1	7,84	CHI
20191290496	JATAI	290110506	JATAI S3	12/12/2019 10:09	12/12/2019 16:06	12/12/2019 10:09	12/12/2019 16:06	5,94	1	5,94	CHI
20191290497	NEROPOLIS	160073856	NEROPOLIS S2	12/12/2019 10:09	12/12/2019 11:47	12/12/2019 10:09	12/12/2019 11:47	1,62	1	1,62	CHI
20191290501	CALDAS NOVAS	CN12000057	CALDAS NOVAS S2	12/12/2019 10:10	12/12/2019 20:00	12/12/2019 10:10	12/12/2019 20:00	9,83	31	304,59	CHI
20191291159	ITAPIRAPUA	IU12073519	MATRINCHA	12/12/2019 10:10	12/12/2019 14:59	12/12/2019 10:10	12/12/2019 14:59	4,81	2	9,62	CHI
20191290506	CRISTALINA	KR21212055	CRISTALINA S1	12/12/2019 10:11	12/12/2019 13:03	12/12/2019 10:11	12/12/2019 13:03	2,86	1	2,86	CHI
20191290507	SANTA FE DE GOIAS	RN21292747	BRITANIA	12/12/2019 10:11	12/12/2019 15:48	12/12/2019 10:11	12/12/2019 15:48	5,62	1	5,62	CHI
20191290511	PIRES DO RIO	460102151	PIRES DO RIO S1	12/12/2019 10:12	12/12/2019 22:40	12/12/2019 10:12	12/12/2019 22:40	12,46	1	12,46	CHI
20191290512	PADRE BERNARDO	PB12382939	PADRE BERNARDO	12/12/2019 10:13	12/12/2019 15:45	12/12/2019 10:13	12/12/2019 15:45	5,53	7	38,69	CHI
20191290513	GOIANIA	10000234069	GOYA S2	12/12/2019 10:13	12/12/2019 11:59	12/12/2019 10:13	12/12/2019 11:59	1,76	1	1,76	CHI
20191290519	MOSSAMEDES	1310005440	FIRMINOPOLIS S2	12/12/2019 10:14	12/12/2019 13:49	12/12/2019 10:14	12/12/2019 13:49	3,57	1	3,57	CHI
20191290523	CALDAS NOVAS	CN12182603	SERRA DE CALDAS	12/12/2019 10:15	12/12/2019 18:00	12/12/2019 10:15	12/12/2019 18:00	7,75	15	116,22	CHI
20191290607	CAMPO ALEGRE DE GOIAS	CM21231580	CAMPO ALEGRE DE GOIAS	12/12/2019 10:17	12/12/2019 22:49	12/12/2019 10:17	12/12/2019 22:49	12,53	1	12,53	CHI

20191290612	SENADOR CANEDO	190076021	SENADOR CANEDO	12/12/2019 10:18	12/12/2019 12:12	12/12/2019 10:18	12/12/2019 12:12	1,90	1	1,90	CHI
20191290614	JUSSARA	JR21093794	BRITANIA	12/12/2019 10:18	12/12/2019 12:12	12/12/2019 10:18	12/12/2019 12:12	1,91	1	1,91	CHI
20191290626	BURITI ALEGRE	BG21000197	GOIATUBA S2	12/12/2019 10:20	12/12/2019 17:40	12/12/2019 10:20	12/12/2019 17:40	7,33	1	7,33	CHI
20191290628	CATALAO	TH21067845	CATALAO S1	12/12/2019 10:20	13/12/2019 15:01	12/12/2019 10:20	13/12/2019 15:01	28,68	1	28,68	CHI
20191290640	GOUVELANDIA	GB12261016	QUIRINOPOLIS	12/12/2019 10:24	12/12/2019 13:45	12/12/2019 10:24	12/12/2019 13:45	3,34	4	13,38	CHI
20191290647	IPORA	IR21102685	IPORA	12/12/2019 10:25	12/12/2019 13:18	12/12/2019 10:25	12/12/2019 13:18	2,87	1	2,87	CHI
20191290649	NIQUELANDIA	NQ11352334	NIQUELANDIA SUBTRANSMISSAO	12/12/2019 10:26	12/12/2019 15:22	12/12/2019 10:26	12/12/2019 15:22	4,92	5	24,62	CHI
20191290650	CACU	CC21216761	CACHOEIRA ALTA	12/12/2019 10:26	12/12/2019 14:23	12/12/2019 10:26	12/12/2019 14:23	3,94	1	3,94	CHI
20191290651	EDEIA	EA21329066	VICENTINOPOLIS	12/12/2019 10:26	12/12/2019 21:46	12/12/2019 10:26	12/12/2019 21:46	11,33	1	11,33	CHI
20191290653	GOUVELANDIA	QI12326803	QUIRINOPOLIS	12/12/2019 10:27	12/12/2019 22:27	12/12/2019 10:27	12/12/2019 22:27	12,00	2	23,99	CHI
20191290656	TRINDADE	14236175	GOYA S2	12/12/2019 10:28	12/12/2019 11:48	12/12/2019 10:28	12/12/2019 11:48	1,34	1	1,34	CHI
20191290658	PIRACANJUBA	PJ21105767	MORRINHOS	12/12/2019 10:28	12/12/2019 15:31	12/12/2019 10:28	12/12/2019 15:31	5,04	1	5,04	CHI
20191290660	SANTO ANTONIO DA BARRA	EU12260943LD	ACREUNA	12/12/2019 10:29	12/12/2019 19:40	12/12/2019 10:29	12/12/2019 19:40	9,18	1	9,18	CHI
20191290660	ACREUNA	EU12260943LD	ACREUNA	12/12/2019 10:29	12/12/2019 19:40	12/12/2019 17:35	12/12/2019 19:40	2,08	1	2,08	CHI
20191290670	SANTA HELENA DE GOIAS	400095312	IPEGUARI	12/12/2019 10:32	12/12/2019 11:40	12/12/2019 10:32	12/12/2019 11:40	1,13	1	1,13	CHI
20191290671	EDEIA	1120021793	EDEIA	12/12/2019 10:32	13/12/2019 10:41	12/12/2019 10:32	13/12/2019 10:41	24,15	1	24,15	CHI
20191290676	LUZIANIA	LZ11128900	MARAJOARA	12/12/2019 10:34	12/12/2019 14:11	12/12/2019 10:34	12/12/2019 14:11	3,61	14	50,49	CHI
20191290681	MAURILANDIA	ML12301541	RIO DOS BOIS	12/12/2019 10:34	12/12/2019 14:10	12/12/2019 10:34	12/12/2019 14:10	3,59	20	71,87	CHI
20191290679	NOVA CRIXAS	NA12115792	NOVA CRIXAS	12/12/2019 10:35	12/12/2019 15:40	12/12/2019 10:35	12/12/2019 15:40	5,08	4	20,32	CHI
20191290696	GAMELEIRA DE GOIAS	SV12214543	DAIA S2	12/12/2019 10:39	12/12/2019 17:22	12/12/2019 10:39	12/12/2019 17:22	6,72	7	47,01	CHI
20191290699	CALDAS NOVAS	CN21000085	CALDAS NOVAS S2	12/12/2019 10:39	12/12/2019 17:19	12/12/2019 10:39	12/12/2019 17:19	6,66	2	13,33	CHI
20191290708	GOIATUBA	GT21326068	GOIATUBA S2	12/12/2019 10:39	12/12/2019 15:36	12/12/2019 10:39	12/12/2019 15:36	4,93	2	9,87	CHI
20191290715	CORUMBA DE GOIAS	CB21287812	ALEXANIA	12/12/2019 10:40	12/12/2019 17:00	12/12/2019 10:40	12/12/2019 17:00	6,33	1	6,33	CHI
20191290718	GOIANIA	13359769	CAMPINAS S1	12/12/2019 10:41	12/12/2019 12:44	12/12/2019 10:41	12/12/2019 12:44	2,05	1	2,05	CHI
20191290731	CABECEIRAS	CW21157354	ITUIQUIRA	12/12/2019 10:42	12/12/2019 13:52	12/12/2019 10:42	12/12/2019 13:52	3,15	1	3,15	CHI
20191291176	BRITANIA	BT12040203	BRITANIA	12/12/2019 10:42	13/12/2019 06:36	12/12/2019 10:42	13/12/2019 06:36	19,89	6	119,34	CHI
20191290733	ITUMBIARA	CD12097345RE	CACHOEIRA DOURADA	12/12/2019 10:43	12/12/2019 14:38	12/12/2019 10:43	12/12/2019 14:38	3,90	9	35,11	CHI
20191290735	RIO VERDE	630472919	RIO VERDE S2	12/12/2019 10:44	13/12/2019 10:00	12/12/2019 10:44	13/12/2019 10:00	23,26	1	23,26	CHI
20191290738	SANTO ANTONIO DO DESCOBERTO	SN21249504	ALEXANIA	12/12/2019 10:44	12/12/2019 17:53	12/12/2019 10:44	12/12/2019 17:53	7,14	1	7,14	CHI
20191290742	FAINA	FC12038664	GOIAS	12/12/2019 10:45	12/12/2019 16:11	12/12/2019 10:45	12/12/2019 16:11	5,43	10	54,27	CHI
20191290744	NOVO GAMA	4990008419	PACAEMBU S1	12/12/2019 10:45	12/12/2019 12:03	12/12/2019 10:45	12/12/2019 12:03	1,28	1	1,28	CHI
20191290745	MOZARLANDIA	AZ12326097	MOZARLANDIA	12/12/2019 10:46	12/12/2019 16:26	12/12/2019 10:46	12/12/2019 16:26	5,67	1	5,67	CHI
20191290748	OUVIDOR	OU21140986	CATALAO S1	12/12/2019 10:46	13/12/2019 14:08	12/12/2019 10:46	13/12/2019 14:08	27,36	1	27,36	CHI

20191290748	OUVIDOR	OU21195360	CATALAO S1	12/12/2019 10:46	13/12/2019 14:08	13/12/2019 14:04	13/12/2019 14:08	0,07	1	0,07	CHI
20191290752	MONTES CLAROS DE GOIAS	ME21062853	IPORA	12/12/2019 10:46	12/12/2019 13:30	12/12/2019 10:46	12/12/2019 13:30	2,72	2	5,44	CHI
20191290753	PALMEIRAS DE GOIAS	590031624	PALMEIRAS	12/12/2019 10:47	12/12/2019 12:40	12/12/2019 10:47	12/12/2019 12:40	1,87	1	1,87	CHI
20191290768	ANAPOLIS	AN11129366	ANAPOLIS UNIVERSITARIO S2	12/12/2019 10:50	12/12/2019 12:33	12/12/2019 10:50	12/12/2019 12:33	1,71	161	274,86	CHI
20191290778	CIDADE OCIDENTAL	DH12333803	MARAJOARA	12/12/2019 10:52	12/12/2019 14:15	12/12/2019 10:52	12/12/2019 14:15	3,38	2	6,76	CHI
20191290785	CATURAI	CK21229276	INHUMAS S1	12/12/2019 10:54	13/12/2019 07:45	12/12/2019 10:54	13/12/2019 07:45	20,85	1	20,85	CHI
20191290786	JATAI	10028241663	JATAI S2	12/12/2019 10:54	12/12/2019 13:19	12/12/2019 10:54	12/12/2019 13:19	2,41	1	2,41	CHI
20191290788	MORRINHOS	MR21212265	MORRINHOS	12/12/2019 10:54	12/12/2019 16:51	12/12/2019 10:54	12/12/2019 16:51	5,94	1	5,94	CHI
20191290792	ANAPOLIS	20776184	ANAPOLIS UNIVERSITARIO S2	12/12/2019 10:55	12/12/2019 13:00	12/12/2019 10:55	12/12/2019 13:00	2,09	1	2,09	CHI
20191290795	ANAPOLIS	10003013713	ANAPOLIS UNIVERSITARIO S1	12/12/2019 10:55	12/12/2019 14:09	12/12/2019 10:55	12/12/2019 14:09	3,23	1	3,23	CHI
20191290799	CATALAO	5840000170	CATALAO S1	12/12/2019 10:56	12/12/2019 15:15	12/12/2019 10:56	12/12/2019 15:15	4,31	1	4,31	CHI
20191290800	APARECIDA DE GOIANIA	200186231	INDEPENDENCIA S1	12/12/2019 10:56	12/12/2019 15:35	12/12/2019 10:56	12/12/2019 15:35	4,64	1	4,64	CHI
20191290806	ANAPOLIS	20752003	ANAPOLIS UNIVERSITARIO S1	12/12/2019 10:57	12/12/2019 15:21	12/12/2019 10:57	12/12/2019 15:21	4,40	0	0,00	CHI
20191290809	GOIAS	GS12310531	GOIAS	12/12/2019 10:57	12/12/2019 13:47	12/12/2019 10:57	12/12/2019 13:47	2,82	17	47,98	CHI
20191290809	GUARAITA	GS12310531	GOIAS	12/12/2019 10:57	12/12/2019 13:47	12/12/2019 10:57	12/12/2019 13:47	2,82	2	5,64	CHI
20191290809	ITAPURANGA	GS12310531	GOIAS	12/12/2019 10:57	12/12/2019 13:47	12/12/2019 10:57	12/12/2019 13:47	2,82	2	5,64	CHI
20191290816	PONTALINA	PK21050362	GOIATUBA S1	12/12/2019 10:59	12/12/2019 20:19	12/12/2019 10:59	12/12/2019 20:19	9,32	1	9,32	CHI
20191290818	MINEIROS	MY12325793	PARQUE DAS EMAS	12/12/2019 10:59	12/12/2019 12:34	12/12/2019 10:59	12/12/2019 12:34	1,57	3	4,71	CHI
20191291008	SAO DOMINGOS	SD12035858	SAO DOMINGOS	12/12/2019 10:59	12/12/2019 13:28	12/12/2019 10:59	12/12/2019 13:28	2,47	906	2242,10	CHI
20191290826	IPAMERI	IP21000069	IPAMERI	12/12/2019 11:00	12/12/2019 20:44	12/12/2019 11:00	12/12/2019 20:44	9,73	1	9,73	CHI
20191290827	SERRANOPOLIS	SX12123303	ITAJA S1	12/12/2019 11:00	13/12/2019 17:58	12/12/2019 11:00	13/12/2019 17:58	30,96	35	1083,57	CHI
20191291143	HIDROLINA	SZ12262918	ITAPACI	12/12/2019 11:02	12/12/2019 15:46	12/12/2019 11:02	12/12/2019 15:46	4,73	11	51,99	CHI
20191291302	AMARALINA	LC12182362	MARA ROSA	12/12/2019 11:07	14/12/2019 03:54	12/12/2019 11:07	13/12/2019 01:33	14,43	73	1053,37	CHI
20191291302	MARA ROSA	LC12182362	MARA ROSA	12/12/2019 11:07	14/12/2019 03:54	12/12/2019 11:07	13/12/2019 01:33	14,43	8	115,44	CHI
20191291302	AMARALINA	LC12182362	MARA ROSA	12/12/2019 11:07	14/12/2019 03:54	12/12/2019 11:07	13/12/2019 12:08	25,03	13	325,36	CHI
20191291302	AMARALINA	LC12182362	MARA ROSA	12/12/2019 11:07	14/12/2019 03:54	12/12/2019 11:07	14/12/2019 03:54	40,79	19	775,00	CHI
20191291302	MUTUNOPOLIS	LC12182362	MARA ROSA	12/12/2019 11:07	14/12/2019 03:54	12/12/2019 11:07	14/12/2019 03:54	40,79	2	81,58	CHI
20191290925	PIRACANJUBA	PJ12000015	CALDAS NOVAS S1	12/12/2019 11:08	12/12/2019 15:00	12/12/2019 11:08	12/12/2019 15:00	3,86	3	11,59	CHI
20191290928	URUACU	UR11056781	URUACU	12/12/2019 11:09	12/12/2019 12:40	12/12/2019 11:09	12/12/2019 12:40	1,51	69	104,31	CHI
20191290932	BOM JESUS DE GOIAS	BJ11150140	VICENTINOPOLIS	12/12/2019 11:09	12/12/2019 18:29	12/12/2019 11:09	12/12/2019 18:29	7,32	1	7,32	CHI
20191290935	MINEIROS	10002210361	PARQUE DAS EMAS	12/12/2019 11:10	12/12/2019 13:39	12/12/2019 11:10	12/12/2019 13:39	2,49	1	2,49	CHI
20191290943	SAO MIGUEL DO ARAGUAIA	830069331	SAO MIGUEL DO ARAGUAIA	12/12/2019 11:11	12/12/2019 15:10	12/12/2019 11:11	12/12/2019 15:10	3,98	1	3,98	CHI
20191292405	NIQUELANDIA	NQ21146920	URUACU	12/12/2019 11:16	13/12/2019 10:30	12/12/2019 11:16	13/12/2019 10:30	23,23	1	23,23	CHI

20191290962	IPORA	IR21112686	ARENOPOLIS	12/12/2019 11:17	12/12/2019 14:12	12/12/2019 11:17	12/12/2019 14:12	2,91	1	2,91	CHI
20191290965	GOIANIA	16671946	GOYA S2	12/12/2019 11:18	12/12/2019 16:30	12/12/2019 11:18	12/12/2019 16:30	5,19	1	5,19	CHI
20191290967	IPAMERI	IP12404717	IPAMERI	12/12/2019 11:18	12/12/2019 18:59	12/12/2019 11:18	12/12/2019 18:59	7,67	2	15,35	CHI
20191290972	GOIATUBA	140043718	GOIATUBA S2	12/12/2019 11:19	12/12/2019 13:52	12/12/2019 11:19	12/12/2019 13:52	2,54	1	2,54	CHI
20191290973	NIQUELANDIA	NQ21213114	NIQUELANDIA SUBTRANSMISSAO	12/12/2019 11:19	12/12/2019 15:39	12/12/2019 11:19	12/12/2019 15:39	4,32	2	8,65	CHI
20191290976	INHUMAS	IN21244938	INHUMAS S2	12/12/2019 11:20	12/12/2019 16:39	12/12/2019 11:20	12/12/2019 16:39	5,32	1	5,32	CHI
20191290978	GOIANIA	14484195	GOYA S2	12/12/2019 11:21	12/12/2019 14:14	12/12/2019 11:21	12/12/2019 14:14	2,88	1	2,88	CHI
20191290989	NIQUELANDIA	NQ21317723	NIQUELANDIA SUBTRANSMISSAO	12/12/2019 11:23	12/12/2019 15:48	12/12/2019 11:23	12/12/2019 15:48	4,41	1	4,41	CHI
20191290996	JATAI	JT12196015	JATAI S1	12/12/2019 11:25	12/12/2019 15:57	12/12/2019 11:25	12/12/2019 15:57	4,52	8	36,17	CHI
20191290997	GOIANIRA	390036067	GOIANIRA	12/12/2019 11:26	12/12/2019 14:52	12/12/2019 11:26	12/12/2019 14:52	3,43	1	3,43	CHI
20191291002	ANAPOLIS	10006846740	ANAPOLIS UNIVERSITARIO S1	12/12/2019 11:27	12/12/2019 16:01	12/12/2019 11:27	12/12/2019 16:01	4,56	1	4,56	CHI
20191291005	GOUVELANDIA	QI21015009	QUIRINOPOLIS	12/12/2019 11:29	12/12/2019 20:12	12/12/2019 11:29	12/12/2019 20:12	8,72	1	8,72	CHI
20191291007	BURITI ALEGRE	BG21000186	ITUMBIARA VELHA S2	12/12/2019 11:29	12/12/2019 17:33	12/12/2019 11:29	12/12/2019 17:33	6,06	1	6,06	CHI
20191291025	CAIAPONIA	CP12252503	CAIAPONIA	12/12/2019 11:30	13/12/2019 09:12	12/12/2019 11:30	13/12/2019 09:12	21,69	6	130,16	CHI
20191291016	ABADIA DE GOIAS	GN32052059	CARAJAS S1	12/12/2019 11:31	12/12/2019 17:42	12/12/2019 11:31	12/12/2019 17:42	6,17	2	12,34	CHI
20191291017	MUNDO NOVO DE GOIAS	MH21041801	NOVA CRIXAS	12/12/2019 11:31	12/12/2019 12:52	12/12/2019 11:31	12/12/2019 12:52	1,34	1	1,34	CHI
20191291020	LUZIANIA	LZ11405491	RIO VERMELHO	12/12/2019 11:32	12/12/2019 12:52	12/12/2019 11:32	12/12/2019 12:52	1,32	3	3,95	CHI
20191291022	PIRENOPOLIS	PV21211804	CORUMBA	12/12/2019 11:33	12/12/2019 14:31	12/12/2019 11:33	12/12/2019 14:31	2,96	1	2,96	CHI
20191291040	ALEXANIA	AX21318552	ALEXANIA	12/12/2019 11:36	12/12/2019 14:24	12/12/2019 11:36	12/12/2019 14:24	2,79	1	2,79	CHI
20191291048	CAIAPONIA	CP12377303	JATAI S1	12/12/2019 11:38	12/12/2019 18:40	12/12/2019 11:38	12/12/2019 18:40	7,02	3	21,05	CHI
20191291057	DAVINOPOLIS	IO21151432	CATALAO S1	12/12/2019 11:38	12/12/2019 13:48	12/12/2019 11:38	12/12/2019 13:48	2,16	3	6,47	CHI
20191291373	BARRO ALTO	BA12210736	GOIANESIA S1	12/12/2019 11:38	12/12/2019 16:49	12/12/2019 11:38	12/12/2019 16:49	5,18	20	103,66	CHI
20191291049	URUACU	UR12317135	URUACU	12/12/2019 11:39	12/12/2019 17:11	12/12/2019 11:39	12/12/2019 17:11	5,53	11	60,82	CHI
20191291051	IPORA	IR21014082	IPORA	12/12/2019 11:39	12/12/2019 15:13	12/12/2019 11:39	12/12/2019 15:13	3,55	1	3,55	CHI
20191291335	MINEIROS	MY12260337	PARQUE DAS EMAS	12/12/2019 11:42	12/12/2019 14:40	12/12/2019 11:42	12/12/2019 14:40	2,96	518	1532,70	CHI
20191294501	IPAMERI	IP21137526	PIRES DO RIO S2	12/12/2019 11:42	12/12/2019 19:48	12/12/2019 11:42	12/12/2019 19:48	8,09	1	8,09	CHI
20191291101	NOVA CRIXAS	NA12321950	NOVA CRIXAS	12/12/2019 11:43	12/12/2019 14:05	12/12/2019 11:43	12/12/2019 14:05	2,36	7	16,54	CHI
20191291073	NOVA CRIXAS	10030490217	NOVA CRIXAS	12/12/2019 11:44	12/12/2019 16:50	12/12/2019 11:44	12/12/2019 16:50	5,09	1	5,09	CHI
20191291342	ALTO PARAISO DE GOIAS	BF12155974	SAO JOAO D ALIANCA	12/12/2019 11:46	12/12/2019 14:30	12/12/2019 11:46	12/12/2019 14:30	2,73	154	419,82	CHI
20191291587	DAVINOPOLIS	IO12000011RE	CATALAO S1	12/12/2019 11:47	12/12/2019 19:36	12/12/2019 17:33	12/12/2019 19:36	2,04	33	67,48	CHI
20191291587	DISTRITO FEDERAL	IO12000011RE	CATALAO S1	12/12/2019 11:47	12/12/2019 19:36	12/12/2019 17:33	12/12/2019 19:36	2,04	3	6,13	CHI
20191291587	OUVIDOR	IO12000011RE	CATALAO S1	12/12/2019 11:47	12/12/2019 19:36	12/12/2019 17:33	12/12/2019 19:36	2,04	12	24,54	CHI
20191291587	TRES RANCOS	IO12000011RE	CATALAO S1	12/12/2019 11:47	12/12/2019 19:36	12/12/2019 17:33	12/12/2019 19:36	2,04	4	8,18	CHI

20191291082	URUTAI	UT21300819	URUTAI	12/12/2019 11:48	12/12/2019 16:55	12/12/2019 11:48	12/12/2019 16:55	5,13	1	5,13	CHI
20191291083	URUACU	UR21298825	URUACU	12/12/2019 11:48	12/12/2019 15:01	12/12/2019 11:48	12/12/2019 15:01	3,20	2	6,41	CHI
20191291087	GUAPO	10016307257	GUAPO S1	12/12/2019 11:50	12/12/2019 15:57	12/12/2019 11:50	12/12/2019 15:57	4,11	1	4,11	CHI
20191289466	MUTUNOPOLIS	MU12291186	MARA ROSA	12/12/2019 11:51	12/12/2019 12:05	12/12/2019 11:51	12/12/2019 12:05	0,23	1	0,23	CHI
20191292011	CATALAO	CT21344538	CATALAO S1	12/12/2019 11:54	13/12/2019 14:49	12/12/2019 11:54	13/12/2019 14:49	26,92	1	26,92	CHI
20191292190	IPAMERI	IP12337216	IPAMERI	12/12/2019 11:54	12/12/2019 16:38	12/12/2019 11:54	12/12/2019 16:38	4,72	4	18,89	CHI
20191292190	NOVA AURORA	IP12337216	IPAMERI	12/12/2019 11:54	12/12/2019 16:38	12/12/2019 11:54	12/12/2019 16:38	4,72	2	9,44	CHI
20191291107	ITAGUARI	770010192	ITABERAI S1	12/12/2019 11:57	12/12/2019 13:45	12/12/2019 11:57	12/12/2019 13:45	1,79	1	1,79	CHI
20191293364	ITUMBIARA	IT12000414	ITUMBIARA NOVA	12/12/2019 11:58	12/12/2019 23:06	12/12/2019 11:58	12/12/2019 23:06	11,13	7	77,88	CHI
20191291113	APARECIDA DE GOIANIA	AP11003034	INDEPENDENCIA S1	12/12/2019 11:59	12/12/2019 16:09	12/12/2019 11:59	12/12/2019 16:09	4,17	76	316,71	CHI
20191291192	CRIXAS	CX12162721	SANTA TEREZINHA	12/12/2019 12:00	12/12/2019 17:16	12/12/2019 12:00	12/12/2019 17:16	5,26	5	26,30	CHI
20191291125	ITARUMA	IM21239534	CACHOEIRA ALTA	12/12/2019 12:01	13/12/2019 07:30	12/12/2019 12:01	13/12/2019 07:30	19,49	1	19,49	CHI
20191292324	CATALAO	GD12039654	CATALAO S1	12/12/2019 12:01	12/12/2019 18:40	12/12/2019 12:01	12/12/2019 18:40	6,65	4	26,62	CHI
20191292324	GOIANDIRA	GD12039654	CATALAO S1	12/12/2019 12:01	12/12/2019 18:40	12/12/2019 12:01	12/12/2019 18:40	6,65	6	39,93	CHI
20191291129	NOVA CRIXAS	NA21259716	MOZARLANDIA	12/12/2019 12:02	12/12/2019 16:35	12/12/2019 12:02	12/12/2019 16:35	4,54	1	4,54	CHI
20191291130	SENADOR CANEDO	190018641	SENADOR CANEDO	12/12/2019 12:02	12/12/2019 14:43	12/12/2019 12:02	12/12/2019 14:43	2,67	1	2,67	CHI
20191291131	VALPARAISO DE GOIAS	VA11162821	MARAJOARA	12/12/2019 12:03	12/12/2019 14:36	12/12/2019 12:03	12/12/2019 14:36	2,55	19	48,44	CHI
20191291144	MINEIROS	02420214	PARQUE DAS EMAS	12/12/2019 12:06	12/12/2019 14:34	12/12/2019 12:06	12/12/2019 14:34	2,45	187	458,41	CHI
20191291144	PORTELANDIA	02420214	PARQUE DAS EMAS	12/12/2019 12:06	12/12/2019 14:34	12/12/2019 12:06	12/12/2019 14:34	2,45	115	281,91	CHI
20191291144	SANTA RITA DO ARAGUAIA	02420214	PARQUE DAS EMAS	12/12/2019 12:06	12/12/2019 14:34	12/12/2019 12:06	12/12/2019 14:34	2,45	17	41,67	CHI
20191291150	GOIANESIA	550039193	GOIANESIA S2	12/12/2019 12:08	12/12/2019 13:49	12/12/2019 12:08	12/12/2019 13:49	1,69	1	1,69	CHI
20191291156	CALDAS NOVAS	760055816	SERRA DE CALDAS	12/12/2019 12:09	12/12/2019 19:13	12/12/2019 12:09	12/12/2019 19:13	7,07	1	7,07	CHI
20191293302	RIO VERDE	RV12249024	SANTA HELENA S1	12/12/2019 12:09	13/12/2019 10:39	12/12/2019 12:09	13/12/2019 10:39	22,50	6	134,99	CHI
20191291162	FAZENDA NOVA	FN21113483	JUSSARA	12/12/2019 12:11	12/12/2019 16:56	12/12/2019 12:11	12/12/2019 16:56	4,77	1	4,77	CHI
20191291165	ANAPOLIS	AN11059036	ANAPOLIS UNIVERSITARIO S2	12/12/2019 12:11	12/12/2019 14:24	12/12/2019 12:11	12/12/2019 14:24	2,21	20	44,17	CHI
20191291170	CAIAPONIA	CP12054806	CAIAPONIA	12/12/2019 12:14	13/12/2019 08:59	12/12/2019 12:14	13/12/2019 08:59	20,74	3	62,23	CHI
20191291173	ITABERAI	IB12220162	ITABERAI S1	12/12/2019 12:15	12/12/2019 15:57	12/12/2019 12:15	12/12/2019 15:57	3,70	4	14,79	CHI
20191291174	IPAMERI	6930000305	PIRES DO RIO S2	12/12/2019 12:15	12/12/2019 15:52	12/12/2019 12:15	12/12/2019 15:52	3,61	1	3,61	CHI
20191299745	APORE	AE12234187	ITAJA S2	12/12/2019 12:19	13/12/2019 18:34	12/12/2019 12:19	13/12/2019 18:34	30,24	2	60,48	CHI
20191291184	BONFINOPOLIS	LB12258821	DAIA S2	12/12/2019 12:20	12/12/2019 15:05	12/12/2019 12:20	12/12/2019 15:05	2,75	1	2,75	CHI
20191291184	LEOPOLDO DE BULHOES	LB12258821	DAIA S2	12/12/2019 12:20	12/12/2019 15:05	12/12/2019 12:20	12/12/2019 15:05	2,75	6	16,48	CHI
2019121200009	CHAPADAO DO CEU	02430214	CHAPADAO DO CEU	12/12/2019 12:20	12/12/2019 12:32	12/12/2019 12:20	12/12/2019 12:32	0,20	1994	398,80	CHI
2019121200009	MINEIROS	02430214	CHAPADAO DO CEU	12/12/2019 12:20	12/12/2019 12:32	12/12/2019 12:20	12/12/2019 12:32	0,20	9	1,80	CHI

2019121200010	CHAPADAO DO CEU	02430424	CHAPADAO DO CEU	12/12/2019 12:20	12/12/2019 12:33	12/12/2019 12:20	12/12/2019 12:33	0,22	82	17,77	CHI
2019121200011	CHAPADAO DO CEU	02430224	CHAPADAO DO CEU	12/12/2019 12:20	12/12/2019 12:32	12/12/2019 12:20	12/12/2019 12:32	0,20	2336	467,20	CHI
2019121200011	CHAPADAO DO CEU	02430414	CHAPADAO DO CEU	12/12/2019 12:20	12/12/2019 12:32	12/12/2019 12:20	12/12/2019 12:32	0,20	11	2,20	CHI
2019121200011	MINEIROS	02430414	CHAPADAO DO CEU	12/12/2019 12:20	12/12/2019 12:32	12/12/2019 12:20	12/12/2019 12:32	0,20	25	5,00	CHI
2019121200011	SERRANOPOLIS	02430414	CHAPADAO DO CEU	12/12/2019 12:20	12/12/2019 12:32	12/12/2019 12:20	12/12/2019 12:32	0,20	82	16,40	CHI
20191291193	SANTO ANTONIO DO DESCOBERTO	10010917665	ALEXANIA	12/12/2019 12:21	12/12/2019 14:23	12/12/2019 12:21	12/12/2019 14:23	2,02	1	2,02	CHI
20191291303	LUZIANIA	120399702	RIO VERMELHO	12/12/2019 12:24	12/12/2019 13:33	12/12/2019 12:24	12/12/2019 13:33	1,14	1	1,14	CHI
20191291315	MORRINHOS	MR21105597	MORRINHOS	12/12/2019 12:27	12/12/2019 16:20	12/12/2019 12:27	12/12/2019 16:20	3,87	1	3,87	CHI
20191293204	MORRINHOS	MR12102432	MORRINHOS	12/12/2019 12:27	12/12/2019 19:03	12/12/2019 12:27	12/12/2019 19:03	6,60	14	92,33	CHI
20191291318	MINEIROS	1390147682	PARQUE DAS EMAS	12/12/2019 12:28	12/12/2019 14:30	12/12/2019 12:28	12/12/2019 14:30	2,03	1	2,03	CHI
20191291329	PROFESSOR JAMIL SAFADY	JS12000112	ROCHEDO	12/12/2019 12:30	14/12/2019 12:30	12/12/2019 12:30	14/12/2019 12:30	48,00	11	527,98	CHI
20191291331	NOVO BRASIL	NB11289174	JUSSARA	12/12/2019 12:30	12/12/2019 15:39	12/12/2019 12:30	12/12/2019 15:39	3,13	118	369,83	CHI
20191289672	GUAPO	TR12006367	GUAPO S1	12/12/2019 12:32	12/12/2019 13:42	12/12/2019 12:32	12/12/2019 13:42	1,16	38	44,16	CHI
20191289672	TRINDADE	TR12006367	GUAPO S1	12/12/2019 12:32	12/12/2019 13:42	12/12/2019 12:32	12/12/2019 13:42	1,16	5	5,81	CHI
20191291337	FAZENDA NOVA	IS12381080	IPORA	12/12/2019 12:32	12/12/2019 17:52	12/12/2019 12:32	12/12/2019 17:52	5,34	9	48,02	CHI
20191291337	ISRAELANDIA	IS12381080	IPORA	12/12/2019 12:32	12/12/2019 17:52	12/12/2019 12:32	12/12/2019 17:52	5,34	2	10,67	CHI
20191291343	CAMPOS VERDES	VD12201662	SANTA TEREZINHA	12/12/2019 12:33	12/12/2019 22:37	12/12/2019 12:33	12/12/2019 22:37	10,06	5	50,30	CHI
20191291345	SAO MIGUEL DO ARAGUAIA	SM21282205	SAO MIGUEL DO ARAGUAIA	12/12/2019 12:33	12/12/2019 14:50	12/12/2019 12:33	12/12/2019 14:50	2,27	1	2,27	CHI
20191291346	PIRES DO RIO	460039611	PIRES DO RIO S1	12/12/2019 12:33	12/12/2019 16:01	12/12/2019 12:33	12/12/2019 16:01	3,45	1	3,45	CHI
20191291349	ANICUNS	910075876	ANICUNS	12/12/2019 12:34	12/12/2019 14:44	12/12/2019 12:34	12/12/2019 14:44	2,16	1	2,16	CHI
20191291353	PIRACANJUBA	PJ21106669	PIRACANJUBA	12/12/2019 12:35	13/12/2019 16:58	12/12/2019 12:35	13/12/2019 16:58	28,37	1	28,37	CHI
20191289480	PORANGATU	PO10391977	PORANGATU	12/12/2019 12:36	12/12/2019 18:42	12/12/2019 12:38	12/12/2019 13:53	1,25	212	265,29	CHI
20191289480	PORANGATU	PO12057986	PORANGATU	12/12/2019 12:36	12/12/2019 18:42	12/12/2019 12:38	12/12/2019 16:23	3,75	10	37,54	CHI
20191289480	PORANGATU	PO13057987	PORANGATU	12/12/2019 12:36	12/12/2019 18:42	12/12/2019 12:38	12/12/2019 17:34	4,94	126	622,69	CHI
20191289480	PORANGATU	PO12252122	PORANGATU	12/12/2019 12:36	12/12/2019 18:42	12/12/2019 12:38	12/12/2019 18:25	5,78	12	69,40	CHI
20191289480	PORANGATU	PO13320936	PORANGATU	12/12/2019 12:36	12/12/2019 18:42	12/12/2019 12:38	12/12/2019 18:42	6,07	6	36,43	CHI
20191291362	PARAUNA	PU21326807	ACREUNA	12/12/2019 12:38	12/12/2019 22:19	12/12/2019 12:38	12/12/2019 22:19	9,68	1	9,68	CHI
20191291399	BALIZA	BH12334535	BOM JARDIM	12/12/2019 12:38	12/12/2019 17:51	12/12/2019 12:38	12/12/2019 17:51	5,20	18	93,62	CHI
20191291367	JATAI	JT21267497	JATAI S1	12/12/2019 12:40	13/12/2019 16:13	12/12/2019 12:40	13/12/2019 16:13	27,54	1	27,54	CHI
20191291391	GOIANIA	GN11041888	SENADOR CANEDO	12/12/2019 12:41	12/12/2019 14:11	12/12/2019 12:41	12/12/2019 14:11	1,49	133	197,62	CHI
20191291377	VIANOPOLIS	VN21286054	CRISTIANOPOLIS	12/12/2019 12:43	12/12/2019 17:58	12/12/2019 12:43	12/12/2019 17:58	5,24	3	15,73	CHI
20191291381	FORMOSA	FA21306769	ITIQUEIRA	12/12/2019 12:43	12/12/2019 15:14	12/12/2019 12:43	12/12/2019 15:14	2,50	1	2,50	CHI
20191292121	CRISTALINA	KR11032674	CRISTALINA S1	12/12/2019 12:43	12/12/2019 15:26	12/12/2019 12:43	12/12/2019 15:26	2,71	63	170,43	CHI

20191291393	GOIANIA	12297045	ATLANTICO S1	12/12/2019 12:46	12/12/2019 17:10	12/12/2019 12:46	12/12/2019 17:10	4,40	1	4,40	CHI
20191291451	GOIANIA	GN12000442	GOIANIA LESTE S3	12/12/2019 12:46	12/12/2019 17:07	12/12/2019 12:46	12/12/2019 16:56	4,17	84	349,98	CHI
20191291451	GOIANIA	GN11000746	GOIANIA LESTE S3	12/12/2019 12:46	12/12/2019 17:07	12/12/2019 12:46	12/12/2019 17:07	4,35	110	478,62	CHI
20191291414	MONTIVIDIU	2840010040	MONTIVIDIU T	12/12/2019 12:51	12/12/2019 15:55	12/12/2019 12:51	12/12/2019 15:55	3,06	1	3,06	CHI
20191291415	PIRENOPOLIS	PV21297987	SAO FRANCISCO DE GOIAS	12/12/2019 12:51	12/12/2019 16:50	12/12/2019 12:51	12/12/2019 16:50	3,98	2	7,96	CHI
20191291420	SANTA HELENA DE GOIAS	400055594	IPEGUARI	12/12/2019 12:54	13/12/2019 00:00	12/12/2019 12:54	13/12/2019 00:00	11,10	1	11,10	CHI
20191291423	ALTO PARAISO DE GOIAS	BF21129910	FLORES DE GOIAS	12/12/2019 12:55	12/12/2019 17:52	12/12/2019 12:55	12/12/2019 17:52	4,94	1	4,94	CHI
20191291424	CORUMBAIBA	CI21000482	VILA CORUMBA	12/12/2019 12:55	12/12/2019 20:20	12/12/2019 12:55	12/12/2019 20:20	7,41	1	7,41	CHI
20191291426	MORRINHOS	MR21121141	MORRINHOS	12/12/2019 12:55	12/12/2019 15:52	12/12/2019 12:55	12/12/2019 15:52	2,94	1	2,94	CHI
20191291438	JATAI	JT21092377	JATAI S3	12/12/2019 12:58	13/12/2019 08:28	12/12/2019 12:58	13/12/2019 08:28	19,49	1	19,49	CHI
20191291439	APORE	AE12234188	ITAJA S1	12/12/2019 12:58	13/12/2019 16:48	12/12/2019 12:58	13/12/2019 16:48	27,83	2	55,67	CHI
20191291440	TRINDADE	TR21127452	GUAPO S1	12/12/2019 12:59	12/12/2019 15:25	12/12/2019 12:59	12/12/2019 15:25	2,43	1	2,43	CHI
20191293690	MORRINHOS	MR12212245	MORRINHOS	12/12/2019 12:59	15/12/2019 12:45	12/12/2019 12:59	14/12/2019 12:00	47,02	3	141,07	CHI
20191293690	MORRINHOS	MR12335174RE	MORRINHOS	12/12/2019 12:59	15/12/2019 12:45	14/12/2019 12:01	14/12/2019 14:12	2,19	36	78,93	CHI
20191293690	MORRINHOS	MR12335174RE	MORRINHOS	12/12/2019 12:59	15/12/2019 12:45	14/12/2019 14:13	14/12/2019 17:10	2,95	33	97,42	CHI
20191293690	MORRINHOS	MR12000194	MORRINHOS	12/12/2019 12:59	15/12/2019 12:45	14/12/2019 12:01	15/12/2019 01:18	13,29	36	478,32	CHI
20191293690	MORRINHOS	MR12335174RE	MORRINHOS	12/12/2019 12:59	15/12/2019 12:45	14/12/2019 17:11	15/12/2019 04:58	11,77	1	11,77	CHI
20191293690	MORRINHOS	MR12335174RE	MORRINHOS	12/12/2019 12:59	15/12/2019 12:45	15/12/2019 02:41	15/12/2019 04:58	2,27	68	154,45	CHI
20191293690	MORRINHOS	MR13243779	MORRINHOS	12/12/2019 12:59	15/12/2019 12:45	15/12/2019 05:07	15/12/2019 09:15	4,15	1	4,15	CHI
20191293690	MORRINHOS	MR12212245	MORRINHOS	12/12/2019 12:59	15/12/2019 12:45	14/12/2019 14:13	15/12/2019 11:30	21,28	3	63,85	CHI
20191293690	MORRINHOS	MR12212245	MORRINHOS	12/12/2019 12:59	15/12/2019 12:45	12/12/2019 12:59	15/12/2019 12:40	71,70	1	71,70	CHI
20191293690	MORRINHOS	MR12212245	MORRINHOS	12/12/2019 12:59	15/12/2019 12:45	12/12/2019 12:59	15/12/2019 12:45	71,77	2	143,54	CHI
20191291463	MONTIVIDIU	MV12054362	MONTIVIDIU T	12/12/2019 13:00	12/12/2019 18:05	12/12/2019 13:00	12/12/2019 18:05	5,08	6	30,49	CHI
20191291453	APARECIDA DE GOIANIA	AP11161647	INDEPENDENCIA S1	12/12/2019 13:01	12/12/2019 17:38	12/12/2019 13:01	12/12/2019 17:38	4,62	66	304,70	CHI
20191291459	ALEXANIA	AX12061853	ALEXANIA	12/12/2019 13:03	12/12/2019 15:58	12/12/2019 13:03	12/12/2019 15:58	2,91	5	14,57	CHI
20191291461	IPORA	IR12112737	IPORA	12/12/2019 13:03	13/12/2019 12:06	12/12/2019 13:03	12/12/2019 16:43	3,66	2	7,32	CHI
20191291461	IPORA	IR12112737	IPORA	12/12/2019 13:03	13/12/2019 12:06	12/12/2019 13:03	13/12/2019 12:06	23,04	9	207,36	CHI
20191291462	AGUAS LINDAS DE GOIAS	10004580654	AGUAS LINDAS DE GOIAS S1	12/12/2019 13:03	12/12/2019 13:59	12/12/2019 13:03	12/12/2019 13:59	0,92	1	0,92	CHI
20191291727	MORRINHOS	MR12352559	MORRINHOS	12/12/2019 13:04	12/12/2019 16:15	12/12/2019 13:04	12/12/2019 16:15	3,18	10	31,77	CHI
20191294203	IPORA	IR12112737	IPORA	12/12/2019 13:04	13/12/2019 12:06	13/12/2019 11:34	13/12/2019 12:06	0,53	2	1,06	CHI
20191291470	SERRANOPOLIS	SX21350273	CHAPADAO DO CEU	12/12/2019 13:05	15/12/2019 20:00	12/12/2019 13:05	15/12/2019 20:00	78,91	1	78,91	CHI
20191291472	JATAI	JT12202635	JATAI S3	12/12/2019 13:05	12/12/2019 17:50	12/12/2019 13:05	12/12/2019 17:50	4,73	1	4,73	CHI
20191291494	VICENTINOPOLIS	VI12071025	VICENTINOPOLIS	12/12/2019 13:06	12/12/2019 17:51	12/12/2019 13:06	12/12/2019 17:16	4,16	412	1714,03	CHI

20191291494	VICENTINOPOLIS	VI11064595	VICENTINOPOLIS	12/12/2019 13:06	12/12/2019 17:51	12/12/2019 13:06	12/12/2019 17:51	4,74	142	673,32	CHI
20191291513	MINEIROS	MY12193782	PARQUE DAS EMAS	12/12/2019 13:10	12/12/2019 15:43	12/12/2019 13:10	12/12/2019 15:43	2,55	4	10,19	CHI
20191291490	CABECEIRAS	CW21150014	ITUIQUIRA	12/12/2019 13:11	12/12/2019 14:42	12/12/2019 13:11	12/12/2019 14:42	1,51	1	1,51	CHI
20191291497	UIRAPURU	UP21119083	NOVA CRIXAS	12/12/2019 13:14	12/12/2019 17:59	12/12/2019 13:14	12/12/2019 17:59	4,73	1	4,73	CHI
20191291526	PADRE BERNARDO	PB12000008	PADRE BERNARDO	12/12/2019 13:16	12/12/2019 15:09	12/12/2019 13:16	12/12/2019 15:09	1,87	16	29,92	CHI
20191291506	NIQUELANDIA	NQ21282380	NIQUELANDIA SUBTRANSMISSAO	12/12/2019 13:17	12/12/2019 20:59	12/12/2019 13:17	12/12/2019 20:59	7,70	12	92,36	CHI
20191291514	AMORINOPOLIS	AM11000001	IPORA	12/12/2019 13:18	12/12/2019 16:11	12/12/2019 13:18	12/12/2019 16:11	2,87	122	350,21	CHI
20191291821	LUZIANIA	LZ12351401RE	MARAJOARA	12/12/2019 13:18	12/12/2019 17:30	12/12/2019 13:18	12/12/2019 17:30	4,20	28	117,50	CHI
20191291520	COCALZINHO DE GOIAS	ZN12394290	COCALZINHO	12/12/2019 13:19	13/12/2019 13:35	12/12/2019 13:19	13/12/2019 13:35	24,26	4	97,03	CHI
20191291522	PIRENOPOLIS	PV21008502	CORUMBA	12/12/2019 13:19	12/12/2019 16:56	12/12/2019 13:19	12/12/2019 16:56	3,60	1	3,60	CHI
20191295400	IPAMERI	IP12041051	IPAMERI	12/12/2019 13:19	13/12/2019 21:41	12/12/2019 13:19	13/12/2019 21:41	32,37	7	226,57	CHI
20191291957	SAO DOMINGOS	SD12389183	SAO DOMINGOS	12/12/2019 13:20	12/12/2019 18:27	12/12/2019 13:20	12/12/2019 18:27	5,11	21	107,21	CHI
20191293052	QUIRINOPOLIS	QI12096888	QUIRINOPOLIS	12/12/2019 13:20	13/12/2019 11:25	12/12/2019 13:20	13/12/2019 11:25	22,07	20	441,37	CHI
20191291536	QUIRINOPOLIS	80107370	QUIRINOPOLIS	12/12/2019 13:22	12/12/2019 14:30	12/12/2019 13:22	12/12/2019 14:30	1,12	1	1,12	CHI
20191291538	NIQUELANDIA	NQ11252066	NIQUELANDIA SUBTRANSMISSAO	12/12/2019 13:22	12/12/2019 15:11	12/12/2019 13:22	12/12/2019 15:11	1,80	31	55,89	CHI
20191291546	PIRENOPOLIS	PV21318117	CORUMBA	12/12/2019 13:23	12/12/2019 15:47	12/12/2019 13:23	12/12/2019 15:47	2,39	1	2,39	CHI
20191291548	VILA PROPICIO	NP11228389	GOIANESIA S1	12/12/2019 13:23	13/12/2019 09:12	12/12/2019 13:23	13/12/2019 09:12	19,80	1	19,80	CHI
20191293832	RIO VERDE	RV12260178	RIO VERDE S2	12/12/2019 13:23	13/12/2019 07:45	12/12/2019 13:23	13/12/2019 07:45	18,37	10	183,66	CHI
20191291552	CIDADE OCIDENTAL	10003817200	MARAJOARA	12/12/2019 13:24	12/12/2019 20:37	12/12/2019 13:24	12/12/2019 20:37	7,21	1	7,21	CHI
20191291553	BALIZA	BH12334823	BOM JARDIM	12/12/2019 13:25	12/12/2019 16:57	12/12/2019 13:25	12/12/2019 16:57	3,52	205	722,40	CHI
20191291559	CACU	CC21125606	CACHOEIRA ALTA	12/12/2019 13:27	12/12/2019 16:26	12/12/2019 13:27	12/12/2019 16:26	2,97	2	5,94	CHI
20191291570	GOIANIRA	GR11241328	GOIANIRA	12/12/2019 13:28	12/12/2019 15:28	12/12/2019 13:28	12/12/2019 15:28	2,00	131	262,55	CHI
20191289492	SERRANOPOLIS	SX21216632	CACHOEIRA ALTA	12/12/2019 13:30	12/12/2019 16:49	12/12/2019 13:30	12/12/2019 16:49	3,31	1	3,31	CHI
20191291574	RIO VERDE	RV12322315	CABRIUVA S2	12/12/2019 13:30	12/12/2019 16:01	12/12/2019 13:30	12/12/2019 16:01	2,52	1	2,52	CHI
20191291580	JATAI	JT12184049	JATAI S1	12/12/2019 13:31	12/12/2019 19:06	12/12/2019 13:31	12/12/2019 19:06	5,57	64	356,59	CHI
20191291580	SERRANOPOLIS	JT12184049	JATAI S1	12/12/2019 13:31	12/12/2019 19:06	12/12/2019 13:31	12/12/2019 19:06	5,57	32	178,29	CHI
20191291581	NOVA CRIXAS	7940685	MOZARLANDIA	12/12/2019 13:31	12/12/2019 17:40	12/12/2019 13:31	12/12/2019 17:40	4,14	1	4,14	CHI
20191291589	IPAMERI	CM21231440	CAMPO ALEGRE DE GOIAS	12/12/2019 13:33	12/12/2019 16:45	12/12/2019 13:33	12/12/2019 16:45	3,21	1	3,21	CHI
20191291592	ANAPOLIS	20402144	ANAPOLIS UNIVERSITARIO S2	12/12/2019 13:33	12/12/2019 15:52	12/12/2019 13:33	12/12/2019 15:52	2,33	1	2,33	CHI
20191291596	GOIANIA	10490966	GOIANIA LESTE S3	12/12/2019 13:33	12/12/2019 14:55	12/12/2019 13:33	12/12/2019 14:55	1,36	1	1,36	CHI
20191291599	LUZIANIA	LZ11253543	VIANOPOLIS	12/12/2019 13:33	12/12/2019 19:35	12/12/2019 13:33	12/12/2019 19:35	6,03	1	6,03	CHI
20191291600	QUIRINOPOLIS	QI21018030	QUIRINOPOLIS	12/12/2019 13:33	12/12/2019 15:01	12/12/2019 13:33	12/12/2019 15:01	1,46	1	1,46	CHI
20191291604	GOIANESIA	GE21140616	GOIANESIA S2	12/12/2019 13:33	12/12/2019 15:15	12/12/2019 13:33	12/12/2019 15:15	1,70	1	1,70	CHI

20191291605	ANAPOLIS	20289364	ANAPOLIS UNIVERSITARIO S2	12/12/2019 13:33	12/12/2019 17:16	12/12/2019 13:33	12/12/2019 17:16	3,71	1	3,71	CHI
20191291606	COCALZINHO DE GOIAS	10022580059	COCALZINHO	12/12/2019 13:33	13/12/2019 13:54	12/12/2019 13:33	13/12/2019 13:54	24,34	1	24,34	CHI
20191291610	SANTA CRUZ DE GOIAS	BC21300793	PIRES DO RIO S2	12/12/2019 13:33	12/12/2019 17:18	12/12/2019 13:33	12/12/2019 17:18	3,75	1	3,75	CHI
20191291611	SANTA CRUZ DE GOIAS	BC21221712	PIRES DO RIO S2	12/12/2019 13:33	12/12/2019 16:20	12/12/2019 13:33	12/12/2019 16:20	2,78	1	2,78	CHI
20191291707	IPAMERI	IP21071405	IPAMERI	12/12/2019 13:33	12/12/2019 18:44	12/12/2019 13:33	12/12/2019 18:44	5,17	1	5,17	CHI
20191291714	GOIATUBA	140015190	GOIATUBA S2	12/12/2019 13:33	12/12/2019 14:39	12/12/2019 13:33	12/12/2019 14:39	1,09	1	1,09	CHI
20191291715	LUZIANIA	LZ12313611	VIANOPOLIS	12/12/2019 13:33	12/12/2019 15:55	12/12/2019 13:33	12/12/2019 15:55	2,35	11	25,90	CHI
20191291717	GOIANIA	16884863	CARAJAS S1	12/12/2019 13:33	12/12/2019 16:10	12/12/2019 13:33	12/12/2019 16:10	2,60	1	2,60	CHI
20191292162	RIO VERDE	RV12260179	RIO VERDE S2	12/12/2019 13:33	13/12/2019 07:22	12/12/2019 13:33	13/12/2019 07:22	17,82	30	534,51	CHI
20191291723	RIO VERDE	RV12322325	MONTIVIDIU T	12/12/2019 13:35	13/12/2019 08:02	12/12/2019 13:35	13/12/2019 08:02	18,46	3	55,37	CHI
20191291805	CIDADE OCIDENTAL	2680161525	MARAJOARA	12/12/2019 13:38	12/12/2019 19:58	12/12/2019 13:38	12/12/2019 19:58	6,32	1	6,32	CHI
20191292170	MOZARLANDIA	MZ11250763	MOZARLANDIA	12/12/2019 13:38	13/12/2019 11:53	12/12/2019 13:38	13/12/2019 11:53	22,25	74	1646,85	CHI
20191291807	MOSSAMEDES	MD21295002	ITABERAI S2	12/12/2019 13:39	12/12/2019 16:11	12/12/2019 13:39	12/12/2019 16:11	2,54	1	2,54	CHI
20191289496	CRISTALINA	03470434	CRISTALINA S1	12/12/2019 13:40	12/12/2019 20:35	12/12/2019 13:40	12/12/2019 20:35	6,91	13	89,79	CHI
20191289496	CRISTALINA	03470434	CRISTALINA S1	12/12/2019 13:40	12/12/2019 20:35	12/12/2019 13:40	12/12/2019 20:35	6,92	29	200,69	CHI
20191289496	CRISTALINA	KR13251592	CRISTALINA S1	12/12/2019 13:40	12/12/2019 20:35	12/12/2019 13:40	12/12/2019 20:35	6,92	244	1688,55	CHI
20191289496	IPAMERI	KR13251592	CRISTALINA S1	12/12/2019 13:40	12/12/2019 20:35	12/12/2019 13:40	12/12/2019 20:35	6,92	6	41,52	CHI
20191291817	ALTO PARAISO DE GOIAS	BF21129911	FLORES DE GOIAS	12/12/2019 13:40	12/12/2019 18:20	12/12/2019 13:40	12/12/2019 18:20	4,66	1	4,66	CHI
20191291819	POSSE	10000484812	IACIARA S2	12/12/2019 13:40	12/12/2019 14:46	12/12/2019 13:40	12/12/2019 14:46	1,09	1	1,09	CHI
20191291823	APARECIDA DE GOIANIA	AP12000049	CEPAIGO S1	12/12/2019 13:41	12/12/2019 21:15	12/12/2019 13:41	12/12/2019 21:15	7,56	39	294,86	CHI
20191291826	PILAR DE GOIAS	GG12293454	URUACU	12/12/2019 13:41	13/12/2019 14:16	12/12/2019 13:41	13/12/2019 14:16	24,57	3	73,72	CHI
20191291827	BARRO ALTO	BA21064551	BARRO ALTO	12/12/2019 13:41	12/12/2019 19:54	12/12/2019 13:41	12/12/2019 19:54	6,20	1	6,20	CHI
20191291830	QUIRINOPOLIS	QI21276327	QUIRINOPOLIS	12/12/2019 13:43	12/12/2019 16:58	12/12/2019 13:43	12/12/2019 16:58	3,25	1	3,25	CHI
20191291953	RIO VERDE	RV12111052	CABRIUVA S2	12/12/2019 13:45	12/12/2019 15:35	12/12/2019 13:45	12/12/2019 15:35	1,82	29	52,88	CHI
20191291845	CATALAO	1990247821	CATALAO S2	12/12/2019 13:46	13/12/2019 02:37	12/12/2019 13:46	13/12/2019 02:37	12,85	1	12,85	CHI
20191291846	CAMPOS BELOS	MA21233143	SAO DOMINGOS	12/12/2019 13:46	12/12/2019 16:14	12/12/2019 13:46	12/12/2019 16:14	2,46	2	4,91	CHI
20191291852	LUZIANIA	LZ21138106	PIRES DO RIO S2	12/12/2019 13:47	13/12/2019 22:11	12/12/2019 13:47	13/12/2019 22:11	32,38	1	32,38	CHI
20191292503	RIO VERDE	RV12322198	RIO VERDE S1	12/12/2019 13:47	12/12/2019 16:15	12/12/2019 13:47	12/12/2019 16:15	2,45	472	1157,19	CHI
20191291856	GAMELEIRA DE GOIAS	AN12165598	DAIA S2	12/12/2019 13:48	14/12/2019 12:41	12/12/2019 13:48	13/12/2019 14:48	25,01	1	25,01	CHI
20191291856	GAMELEIRA DE GOIAS	AN12165598	DAIA S2	12/12/2019 13:48	14/12/2019 12:41	12/12/2019 13:48	13/12/2019 17:18	27,50	2	55,01	CHI
20191291856	GAMELEIRA DE GOIAS	AN12165598	DAIA S2	12/12/2019 13:48	14/12/2019 12:41	12/12/2019 13:48	14/12/2019 12:10	46,36	1	46,36	CHI
20191291856	SILVANIA	AN12165598	DAIA S2	12/12/2019 13:48	14/12/2019 12:41	12/12/2019 13:48	14/12/2019 12:10	46,36	1	46,36	CHI
20191291856	GAMELEIRA DE GOIAS	AN12165598	DAIA S2	12/12/2019 13:48	14/12/2019 12:41	14/12/2019 12:11	14/12/2019 12:41	0,51	4	2,02	CHI

20191291856	SILVANIA	AN12165598	DAIA S2	12/12/2019 13:48	14/12/2019 12:41	14/12/2019 12:11	14/12/2019 12:41	0,51	1	0,51	CHI
20191291860	BOM JARDIM DE GOIAS	BM12065617	BOM JARDIM	12/12/2019 13:48	12/12/2019 17:32	12/12/2019 13:48	12/12/2019 17:32	3,72	2	7,44	CHI
20191292300	RIO VERDE	RV11241410	RIO VERDE S2	12/12/2019 13:48	12/12/2019 16:42	12/12/2019 13:48	12/12/2019 16:42	2,90	168	486,69	CHI
20191291862	SANTO ANTONIO DO DESCOBERTO	SN12078141	MARAJOARA	12/12/2019 13:50	12/12/2019 19:38	12/12/2019 13:50	12/12/2019 19:38	5,79	617	3573,63	CHI
20191291865	GUARAITA	GK21156678	ITAPURANGA	12/12/2019 13:51	12/12/2019 16:10	12/12/2019 13:51	12/12/2019 16:10	2,32	1	2,32	CHI
20191291940	RIO VERDE	RV10371479	RIO VERDE S1	12/12/2019 13:51	13/12/2019 05:36	12/12/2019 13:51	13/12/2019 05:36	15,75	379	5970,93	CHI
20191291940	SANTA HELENA DE GOIAS	RV10371479	RIO VERDE S1	12/12/2019 13:51	13/12/2019 05:36	12/12/2019 13:51	13/12/2019 05:36	15,75	56	882,25	CHI
20191291867	CAMPO ALEGRE DE GOIAS	CM21066210	CAMPO ALEGRE DE GOIAS	12/12/2019 13:52	13/12/2019 08:01	12/12/2019 13:52	13/12/2019 08:01	18,15	1	18,15	CHI
20191291868	NAZARIO	NZ21307000	ANICUNS	12/12/2019 13:52	12/12/2019 15:25	12/12/2019 13:52	12/12/2019 15:25	1,55	1	1,55	CHI
20191291870	GOIANIA	14128202	ATLANTICO S3	12/12/2019 13:52	12/12/2019 18:49	12/12/2019 13:52	12/12/2019 18:49	4,95	1	4,95	CHI
20191291873	CRIXAS	SG12291237	SANTA TEREZINHA	12/12/2019 13:54	12/12/2019 20:22	12/12/2019 13:54	12/12/2019 20:22	6,46	13	83,95	CHI
20191291873	GUARINOS	SG12291237	SANTA TEREZINHA	12/12/2019 13:54	12/12/2019 20:22	12/12/2019 13:54	12/12/2019 20:22	6,46	6	38,75	CHI
20191291875	BOM JARDIM DE GOIAS	BM12334813	IPORA	12/12/2019 13:54	12/12/2019 18:00	12/12/2019 13:54	12/12/2019 18:00	4,09	14	57,25	CHI
20191291876	SAO LUIZ DO NORTE	DF21272180	BARRO ALTO	12/12/2019 13:55	13/12/2019 15:27	12/12/2019 13:55	13/12/2019 15:27	25,53	1	25,53	CHI
20191292103	JATAI	JT12209712	JATAI S1	12/12/2019 13:55	12/12/2019 18:00	12/12/2019 13:55	12/12/2019 18:00	4,08	109	445,14	CHI
20191292103	PEROLANDIA	JT12209712	JATAI S1	12/12/2019 13:55	12/12/2019 18:00	12/12/2019 13:55	12/12/2019 18:00	4,08	9	36,75	CHI
20191291880	LUZIANIA	LZ21230092	PACAEMBU S1	12/12/2019 13:56	12/12/2019 16:34	12/12/2019 13:56	12/12/2019 16:34	2,62	1	2,62	CHI
20191291884	LUZIANIA	LZ21209621	PACAEMBU S1	12/12/2019 13:57	12/12/2019 15:47	12/12/2019 13:57	12/12/2019 15:47	1,83	1	1,83	CHI
20191291892	RIO VERDE	RV12098515	MONTIVIDIU T	12/12/2019 13:58	13/12/2019 12:00	12/12/2019 13:58	13/12/2019 12:00	22,02	1	22,02	CHI
20191291893	SANTA RITA DO NOVO DESTINO	DF11315600	BARRO ALTO	12/12/2019 13:58	13/12/2019 14:43	12/12/2019 13:58	13/12/2019 14:43	24,74	1	24,74	CHI
20191291896	PLANALTINA	PI12099511	PLANALTINA	12/12/2019 13:59	13/12/2019 12:32	12/12/2019 13:59	13/12/2019 12:32	22,55	15	338,19	CHI
20191291898	IPAMERI	IP21332307	IPAMERI	12/12/2019 13:59	13/12/2019 07:56	12/12/2019 13:59	13/12/2019 07:56	17,94	1	17,94	CHI
20191291915	RIO VERDE	RV12327024	CABRIUVA S2	12/12/2019 14:00	13/12/2019 07:52	12/12/2019 14:00	13/12/2019 07:52	17,85	3	53,56	CHI
20191291990	SAO LUIS DE MONTES BELOS	SL11312558	SAO LUIZ DOS MONTES BELOS	12/12/2019 14:00	12/12/2019 19:46	12/12/2019 14:00	12/12/2019 19:46	5,75	181	1040,85	CHI
20191291908	ITAJA	IM21202749	ITAJA S2	12/12/2019 14:01	13/12/2019 15:19	12/12/2019 14:01	13/12/2019 15:19	25,30	1	25,30	CHI
20191291925	IACIARA	IA11018374	IACIARA S1	12/12/2019 14:03	12/12/2019 16:45	12/12/2019 15:00	12/12/2019 16:45	1,74	129	224,46	CHI
20191291921	NOVA VENEZA	NV21280958	INHUMAS S1	12/12/2019 14:04	12/12/2019 16:18	12/12/2019 14:04	12/12/2019 16:18	2,22	11	24,46	CHI
20191291927	POSSE	PS12180840	IACIARA S1	12/12/2019 14:06	12/12/2019 16:21	12/12/2019 14:06	12/12/2019 16:21	2,24	1	2,24	CHI
20191291931	JATAI	JT21241256	JATAI S1	12/12/2019 14:06	13/12/2019 10:32	12/12/2019 14:06	13/12/2019 10:32	20,42	2	40,83	CHI
20191291939	AGUAS LINDAS DE GOIAS	LA21290653	AGUAS LINDAS DE GOIAS S1	12/12/2019 14:08	12/12/2019 15:06	12/12/2019 14:08	12/12/2019 15:06	0,95	1	0,95	CHI
20191293237	BALIZA	BH12331413	CAIAPONIA	12/12/2019 14:08	13/12/2019 10:40	12/12/2019 14:08	13/12/2019 10:40	20,53	12	246,39	CHI
20191291942	JATAI	JT12241750	JATAI S1	12/12/2019 14:09	14/12/2019 21:40	12/12/2019 14:09	14/12/2019 21:40	55,51	1	55,51	CHI
20191291949	NOVO GAMA	2460199813	PACAEMBU S1	12/12/2019 14:10	12/12/2019 17:28	12/12/2019 14:10	12/12/2019 17:28	3,29	1	3,29	CHI

20191291950	GOIANIA	GN11162750	XAVANTES	12/12/2019 14:10	12/12/2019 15:49	12/12/2019 14:10	12/12/2019 15:49	1,64	162	265,14	CHI
20191291964	LUZIANIA	LZ12203332	VIANOPOLIS	12/12/2019 14:14	12/12/2019 16:36	12/12/2019 14:14	12/12/2019 16:36	2,36	12	28,37	CHI
20191292134	BOM JARDIM DE GOIAS	BM12155744	BOM JARDIM	12/12/2019 14:15	12/12/2019 18:00	12/12/2019 14:15	12/12/2019 18:00	3,75	4	14,99	CHI
20191291979	JATAI	JT21324786	JATAI S3	12/12/2019 14:16	12/12/2019 17:44	12/12/2019 14:16	12/12/2019 17:44	3,45	1	3,45	CHI
20191291983	JARAGUA	JA21331945	JARAGUA	12/12/2019 14:17	12/12/2019 17:30	12/12/2019 14:17	12/12/2019 17:30	3,22	2	6,43	CHI
20191291986	SAO MIGUEL DO PASSA QUATRO	SQ21199349	CRISTIANOPOLIS	12/12/2019 14:18	12/12/2019 17:04	12/12/2019 14:18	12/12/2019 17:04	2,76	1	2,76	CHI
20191291989	ITAGUARI	II12217216	ITABERAI S1	12/12/2019 14:18	12/12/2019 18:10	12/12/2019 14:18	12/12/2019 18:10	3,86	230	887,03	CHI
20191291989	ITABERAI	O3020214	ITABERAI S1	12/12/2019 14:18	12/12/2019 18:10	12/12/2019 17:57	12/12/2019 18:10	0,22	14	3,02	CHI
20191291989	ITAGUARI	O3020214	ITABERAI S1	12/12/2019 14:18	12/12/2019 18:10	12/12/2019 17:57	12/12/2019 18:10	0,22	685	147,85	CHI
20191291989	TAQUARAL DE GOIAS	O3020214	ITABERAI S1	12/12/2019 14:18	12/12/2019 18:10	12/12/2019 17:57	12/12/2019 18:10	0,22	43	9,28	CHI
20191292288	RIO VERDE	RV13338639	RIO VERDE S1	12/12/2019 14:18	13/12/2019 09:14	12/12/2019 14:18	12/12/2019 17:00	2,70	1174	3166,54	CHI
20191292288	RIO VERDE	RV10406836	RIO VERDE S1	12/12/2019 14:18	13/12/2019 09:14	12/12/2019 14:18	13/12/2019 09:14	18,93	131	2480,41	CHI
20191291997	SAO LUIS DE MONTES BELOS	SL21125623	FIRMINOPOLIS S1	12/12/2019 14:20	12/12/2019 16:15	12/12/2019 14:20	12/12/2019 16:15	1,92	1	1,92	CHI
20191291999	JUSSARA	JR12118238	JUSSARA	12/12/2019 14:20	12/12/2019 17:20	12/12/2019 14:20	12/12/2019 17:20	2,99	1	2,99	CHI
20191292102	URUACU	UR12000054	CAMPINORTE	12/12/2019 14:21	12/12/2019 22:50	12/12/2019 14:21	12/12/2019 18:11	3,84	77	295,57	CHI
20191292102	NOVA IGUACU DE GOIAS	UR12000054	CAMPINORTE	12/12/2019 14:21	12/12/2019 22:50	12/12/2019 14:21	12/12/2019 20:49	6,47	5	32,36	CHI
20191292102	URUACU	UR12000054	CAMPINORTE	12/12/2019 14:21	12/12/2019 22:50	12/12/2019 14:21	12/12/2019 20:49	6,47	9	58,24	CHI
20191292102	NOVA IGUACU DE GOIAS	UR12000054	CAMPINORTE	12/12/2019 14:21	12/12/2019 22:50	12/12/2019 14:21	12/12/2019 22:50	8,47	10	84,74	CHI
20191292102	URUACU	UR12000054	CAMPINORTE	12/12/2019 14:21	12/12/2019 22:50	12/12/2019 14:21	12/12/2019 22:50	8,47	4	33,90	CHI
20191292106	CORREGO DO OURO	CO21216965	FIRMINOPOLIS S2	12/12/2019 14:22	12/12/2019 18:37	12/12/2019 14:22	12/12/2019 18:37	4,24	1	4,24	CHI
20191292107	CROMINIA	CQ21060277	PONTALINA	12/12/2019 14:22	12/12/2019 17:59	12/12/2019 14:22	12/12/2019 17:59	3,61	3	10,83	CHI
20191292109	JATAI	JT12226592	JATAI S1	12/12/2019 14:22	13/12/2019 07:37	12/12/2019 14:22	13/12/2019 07:37	17,23	8	137,88	CHI
20191292111	VIANOPOLIS	SV21137417	VIANOPOLIS	12/12/2019 14:23	12/12/2019 15:38	12/12/2019 14:23	12/12/2019 15:38	1,24	1	1,24	CHI
20191292115	ALEXANIA	AX21319808	ALEXANIA	12/12/2019 14:24	12/12/2019 18:33	12/12/2019 14:24	12/12/2019 18:33	4,15	1	4,15	CHI
20191292119	FORMOSO	FO21185340	PORANGATU	12/12/2019 14:24	12/12/2019 17:00	12/12/2019 14:24	12/12/2019 17:00	2,60	1	2,60	CHI
20191292143	RIO VERDE	RV11160741	RIO VERDE S1	12/12/2019 14:24	12/12/2019 23:30	12/12/2019 14:24	12/12/2019 23:30	9,10	104	945,91	CHI
20191292167	RIO VERDE	RV12092000	RIO VERDE S1	12/12/2019 14:24	12/12/2019 15:45	12/12/2019 14:24	12/12/2019 15:45	1,34	563	756,77	CHI
20191292229	JATAI	SX12013892	JATAI S1	12/12/2019 14:25	12/12/2019 16:19	12/12/2019 14:25	12/12/2019 16:19	1,88	14	26,37	CHI
20191292229	SERRANOPOLIS	SX12013892	JATAI S1	12/12/2019 14:25	12/12/2019 16:19	12/12/2019 14:25	12/12/2019 16:19	1,88	141	265,63	CHI
20191292129	ITARUMA	IM21058481	CACHOEIRA ALTA	12/12/2019 14:26	12/12/2019 21:01	12/12/2019 14:26	12/12/2019 21:01	6,59	1	6,59	CHI
20191292138	CRISTALINA	KR21171567	CRISTALINA S2	12/12/2019 14:27	12/12/2019 23:06	12/12/2019 14:27	12/12/2019 23:06	8,64	1	8,64	CHI
20191292145	HIDROLANDIA	HD21350095	CEPAIGO S2	12/12/2019 14:28	12/12/2019 17:15	12/12/2019 14:28	12/12/2019 17:15	2,77	1	2,77	CHI
20191292146	SANTA HELENA DE GOIAS	10011862058	IPEGUARI	12/12/2019 14:28	12/12/2019 20:20	12/12/2019 14:28	12/12/2019 20:20	5,86	1	5,86	CHI

20191292158	RUBIATABA	RB21227130	RUBIATABA	12/12/2019 14:30	13/12/2019 09:19	12/12/2019 14:30	13/12/2019 09:19	18,81	1	18,81	CHI
20191292165	AGUAS LINDAS DE GOIAS	4830316768	AGUAS LINDAS DE GOIAS S1	12/12/2019 14:32	12/12/2019 16:34	12/12/2019 14:32	12/12/2019 16:34	2,03	1	2,03	CHI
20191292169	SILVANIA	SV12400022	VIANOPOLIS	12/12/2019 14:32	12/12/2019 16:55	12/12/2019 14:32	12/12/2019 16:55	2,37	27	63,99	CHI
20191292266	CACU	CC21264172	CACHOEIRA ALTA	12/12/2019 14:32	12/12/2019 15:45	12/12/2019 14:32	12/12/2019 15:45	1,21	36	43,50	CHI
20191292174	SAO LUIS DE MONTES BELOS	SL32248940	SAO LUIZ DOS MONTES BELOS	12/12/2019 14:33	12/12/2019 20:28	12/12/2019 14:33	12/12/2019 20:28	5,93	3	17,79	CHI
20191292176	FORMOSA	FA21218499	ITIQUEIRA	12/12/2019 14:33	12/12/2019 15:45	12/12/2019 14:33	12/12/2019 15:45	1,19	1	1,19	CHI
20191292181	ITARUMA	IM21122550	CACHOEIRA ALTA	12/12/2019 14:34	12/12/2019 21:05	12/12/2019 14:34	12/12/2019 21:05	6,51	1	6,51	CHI
20191292184	NIQUELANDIA	NQ12398048	URUACU	12/12/2019 14:35	12/12/2019 20:48	12/12/2019 14:35	12/12/2019 20:48	6,21	102	632,94	CHI
20191292185	SAO LUIS DE MONTES BELOS	10004127488	SAO LUIZ DOS MONTES BELOS	12/12/2019 14:36	12/12/2019 17:04	12/12/2019 14:36	12/12/2019 17:04	2,48	1	2,48	CHI
20191294692	BOM JARDIM DE GOIAS	BM12260019	BOM JARDIM	12/12/2019 14:38	13/12/2019 08:19	12/12/2019 14:38	13/12/2019 08:19	17,67	4	70,69	CHI
20191292205	CAVALCANTE	CJ21389783	MINACU	12/12/2019 14:40	12/12/2019 18:45	12/12/2019 14:40	12/12/2019 18:45	4,08	1	4,08	CHI
20191292207	CATALAO	9580009277	CATALAO S1	12/12/2019 14:40	12/12/2019 23:16	12/12/2019 14:40	12/12/2019 23:16	8,59	1	8,59	CHI
20191292219	ITUMBIARA	CD21154320	CACHOEIRA DOURADA	12/12/2019 14:40	12/12/2019 18:48	12/12/2019 14:40	12/12/2019 18:48	4,13	1	4,13	CHI
20191292211	BOM JESUS DE GOIAS	BJ11263765	VICENTINOPOLIS	12/12/2019 14:41	12/12/2019 19:13	12/12/2019 14:41	12/12/2019 19:13	4,53	1	4,53	CHI
20191292214	IPAMERI	IP12107642	IPAMERI	12/12/2019 14:41	12/12/2019 17:45	12/12/2019 14:41	12/12/2019 17:45	3,06	7	21,43	CHI
20191292215	SILVANIA	SV21135875	VIANOPOLIS	12/12/2019 14:41	12/12/2019 18:00	12/12/2019 14:41	12/12/2019 18:00	3,31	1	3,31	CHI
20191292710	PARAUNA	BZ10407792	ACREUNA	12/12/2019 14:41	12/12/2019 22:19	12/12/2019 14:41	12/12/2019 22:19	7,62	156	1189,20	CHI
20191292710	RIO VERDE	BZ10407792	ACREUNA	12/12/2019 14:41	12/12/2019 22:19	12/12/2019 14:41	12/12/2019 22:19	7,62	142	1082,47	CHI
20191292710	SANTO ANTONIO DA BARRA	BZ10407792	ACREUNA	12/12/2019 14:41	12/12/2019 22:19	12/12/2019 14:41	12/12/2019 22:19	7,62	94	716,57	CHI
20191292710	SANTO ANTONIO DA BARRA	BZ10407792	ACREUNA	12/12/2019 14:41	12/12/2019 22:19	12/12/2019 22:11	12/12/2019 22:19	0,12	101	12,48	CHI
20191292225	GOIANIA	14125201	GOYA S2	12/12/2019 14:43	12/12/2019 17:28	12/12/2019 14:43	12/12/2019 17:28	2,75	1	2,75	CHI
20191292228	FORMOSA	10003216991	ITIQUEIRA	12/12/2019 14:43	12/12/2019 16:16	12/12/2019 14:43	12/12/2019 16:16	1,56	1	1,56	CHI
20191292230	FORMOSA	610278617	ITIQUEIRA	12/12/2019 14:43	12/12/2019 16:04	12/12/2019 14:43	12/12/2019 16:04	1,34	1	1,34	CHI
20191295015	SERRANOPOLIS	SX12216620	JATAI S1	12/12/2019 14:43	13/12/2019 15:18	12/12/2019 14:43	13/12/2019 15:18	24,58	5	122,88	CHI
20191292231	CATALAO	CT21127856	CATALAO S1	12/12/2019 14:44	12/12/2019 17:21	12/12/2019 14:44	12/12/2019 17:21	2,62	1	2,62	CHI
20191292248	CORUMBAIBA	IP21242507	IPAMERI	12/12/2019 14:46	12/12/2019 19:43	12/12/2019 14:46	12/12/2019 19:43	4,94	1	4,94	CHI
20191292252	MOSSAMEDES	1310003248	FIRMINOPOLIS S2	12/12/2019 14:46	12/12/2019 18:45	12/12/2019 14:46	12/12/2019 18:45	3,97	1	3,97	CHI
20191292253	CUMARI	CT21192585	CATALAO S2	12/12/2019 14:46	13/12/2019 15:26	12/12/2019 14:46	13/12/2019 15:26	24,66	1	24,66	CHI
20191292306	PARANAIGUARA	PC12047562	QUIRINOPOLIS	12/12/2019 14:46	12/12/2019 23:28	12/12/2019 14:46	12/12/2019 23:28	8,69	5	43,43	CHI
20191292267	CACU	CC12202629	CACHOEIRA ALTA	12/12/2019 14:49	12/12/2019 17:02	12/12/2019 14:49	12/12/2019 17:02	2,20	4	8,82	CHI
20191292271	NOVA CRIXAS	NA12321950	NOVA CRIXAS	12/12/2019 14:50	12/12/2019 21:08	12/12/2019 14:50	12/12/2019 21:08	6,29	7	44,02	CHI
20191292272	PIRENOPOLIS	PV12080569	CORUMBA	12/12/2019 14:50	13/12/2019 18:15	12/12/2019 14:50	13/12/2019 18:15	27,40	6	164,43	CHI
20191292274	CACHOEIRA ALTA	CA21191611	CACHOEIRA ALTA	12/12/2019 14:50	12/12/2019 17:19	12/12/2019 14:50	12/12/2019 17:19	2,48	1	2,48	CHI

20191293283	ACREUNA	JD12255748	ACREUNA	12/12/2019 14:50	12/12/2019 21:35	12/12/2019 14:50	12/12/2019 21:35	6,73	5	33,67	CHI
20191293283	JANDAIA	JD12255748	ACREUNA	12/12/2019 14:50	12/12/2019 21:35	12/12/2019 14:50	12/12/2019 21:35	6,73	1	6,73	CHI
20191292281	RIO VERDE	RV21104929	CABRIUVA S1	12/12/2019 14:52	13/12/2019 12:17	12/12/2019 14:52	13/12/2019 12:17	21,42	1	21,42	CHI
20191290440	IPAMERI	IP21231632	PIRES DO RIO S2	12/12/2019 14:53	12/12/2019 18:20	12/12/2019 14:53	12/12/2019 18:20	3,44	1	3,44	CHI
20191292287	NOVO GAMA	10026167890	MARAJOARA	12/12/2019 14:53	12/12/2019 17:02	12/12/2019 14:53	12/12/2019 17:02	2,15	1	2,15	CHI
20191292293	VIANOPOLIS	510045893	VIANOPOLIS	12/12/2019 14:53	12/12/2019 18:17	12/12/2019 14:53	12/12/2019 18:17	3,38	1	3,38	CHI
20191292294	JATAI	10029985968	JATAI S2	12/12/2019 14:54	12/12/2019 18:40	12/12/2019 14:54	12/12/2019 18:40	3,77	1	3,77	CHI
20191292297	LUZIANIA	LZ11372271	MARAJOARA	12/12/2019 14:54	12/12/2019 19:13	12/12/2019 14:54	12/12/2019 19:13	4,32	127	548,08	CHI
20191292298	SILVANIA	SV21063561	VIANOPOLIS	12/12/2019 14:55	12/12/2019 18:34	12/12/2019 14:55	12/12/2019 18:34	3,65	1	3,65	CHI
20191292305	ITAPACI	100001993	ITAPACI	12/12/2019 14:56	13/12/2019 10:35	12/12/2019 14:56	13/12/2019 10:35	19,65	1	19,65	CHI
20191292307	MOSSAMEDES	MD12089231	ITABERAI S2	12/12/2019 14:56	12/12/2019 17:02	12/12/2019 14:56	12/12/2019 17:02	2,08	10	20,84	CHI
20191293296	RIO VERDE	RV12018224	CABRIUVA S2	12/12/2019 14:59	12/12/2019 17:37	12/12/2019 14:59	12/12/2019 17:37	2,62	5	13,10	CHI
20191292371	GOIANIA	GN11000630	CAMPINAS S1	12/12/2019 15:00	12/12/2019 16:41	12/12/2019 15:00	12/12/2019 16:41	1,67	166	277,59	CHI
20191293400	SANTA CRUZ DE GOIAS	BC12300692	PIRES DO RIO S2	12/12/2019 15:00	13/12/2019 01:40	12/12/2019 15:00	13/12/2019 01:40	10,65	9	95,89	CHI
20191292335	RIO VERDE	RV12106528	MONTIVIDIU T	12/12/2019 15:02	12/12/2019 19:05	12/12/2019 15:02	12/12/2019 19:05	4,05	4	16,21	CHI
20191292349	ITUMBIARA	IT11062962	PARANAIBA	12/12/2019 15:03	12/12/2019 18:05	12/12/2019 15:03	12/12/2019 18:05	3,02	143	431,82	CHI
20191292345	SILVANIA	SV21166457	VIANOPOLIS	12/12/2019 15:04	13/12/2019 04:05	12/12/2019 15:04	13/12/2019 04:05	13,02	1	13,02	CHI
20191292350	COCALZINHO DE GOIAS	ZN21201259	COCALZINHO	12/12/2019 15:04	12/12/2019 15:51	12/12/2019 15:04	12/12/2019 15:51	0,78	1	0,78	CHI
20191292353	GOUVELANDIA	2250002272	QUIRINOPOLIS	12/12/2019 15:04	13/12/2019 08:36	12/12/2019 15:04	13/12/2019 08:36	17,52	1	17,52	CHI
20191295364	ITAJA	IM12202616	ITAJA S2	12/12/2019 15:04	13/12/2019 02:48	12/12/2019 15:04	13/12/2019 02:48	11,73	11	129,05	CHI
20191295364	ITARUMA	IM12202616	ITAJA S2	12/12/2019 15:04	13/12/2019 02:48	12/12/2019 15:04	13/12/2019 02:48	11,73	31	363,69	CHI
20191292357	GOIANIA	13434974	GOIANIA LESTE S1	12/12/2019 15:06	12/12/2019 18:36	12/12/2019 15:06	12/12/2019 18:36	3,49	1	3,49	CHI
20191292362	PIRACANJUBA	PJ21032499	MORRINHOS	12/12/2019 15:08	12/12/2019 17:20	12/12/2019 15:08	12/12/2019 17:20	2,19	1	2,19	CHI
20191294663	QUIRINOPOLIS	QI12065837	CACHOEIRA ALTA	12/12/2019 15:10	13/12/2019 13:06	12/12/2019 15:10	13/12/2019 13:06	21,92	11	241,15	CHI
20191292376	ALTO PARAISO DE GOIAS	BF21048003	SAO JOAO D ALIANCA	12/12/2019 15:13	12/12/2019 16:52	12/12/2019 15:13	12/12/2019 16:52	1,65	1	1,65	CHI
20191292378	QUIRINOPOLIS	QI12226698	SANTA HELENA S1	12/12/2019 15:13	13/12/2019 12:03	12/12/2019 15:13	13/12/2019 12:03	20,83	6	124,98	CHI
20191292382	JATAI	JT21248507	JATAI S3	12/12/2019 15:14	13/12/2019 11:23	12/12/2019 15:14	13/12/2019 11:23	20,14	2	40,27	CHI
20191292387	MINEIROS	10013803571	PARQUE DAS EMAS	12/12/2019 15:15	12/12/2019 18:28	12/12/2019 15:15	12/12/2019 18:28	3,21	1	3,21	CHI
20191292390	BURITINOPOLIS	SU12248425	SANTA RITA DO ARAGUAIA	12/12/2019 15:16	13/12/2019 09:16	12/12/2019 15:16	13/12/2019 09:16	17,99	1	17,99	CHI
20191292390	MINEIROS	SU12248425	SANTA RITA DO ARAGUAIA	12/12/2019 15:16	13/12/2019 09:16	12/12/2019 15:16	13/12/2019 09:16	17,99	11	197,87	CHI
20191292390	SANTA RITA DO ARAGUAIA	SU12248425	SANTA RITA DO ARAGUAIA	12/12/2019 15:16	13/12/2019 09:16	12/12/2019 15:16	13/12/2019 09:16	17,99	130	2338,41	CHI
20191292396	GOIANIA	GN21000747	AEROPORTO S3	12/12/2019 15:17	12/12/2019 17:52	12/12/2019 15:17	12/12/2019 17:52	2,58	1	2,58	CHI
20191292398	CALDAS NOVAS	760112241	CALDAS NOVAS S1	12/12/2019 15:17	12/12/2019 19:45	12/12/2019 15:17	12/12/2019 19:45	4,46	1	4,46	CHI

20191292502	SAO DOMINGOS	SD12384774	SAO DOMINGOS	12/12/2019 15:18	12/12/2019 20:14	12/12/2019 15:18	12/12/2019 20:14	4,92	39	191,90	CHI
20191292504	AGUA FRIA DE GOIAS	TL12206197	SAO JOAO D ALIANCA	12/12/2019 15:18	12/12/2019 18:00	12/12/2019 15:18	12/12/2019 18:00	2,69	9	24,17	CHI
20191292507	TURVELANDIA	EU21153963	RIO DOS BOIS	12/12/2019 15:19	13/12/2019 08:20	12/12/2019 15:19	13/12/2019 08:20	17,01	1	17,01	CHI
20191292531	COCALZINHO DE GOIAS	ZN11155154	COCALZINHO	12/12/2019 15:19	12/12/2019 17:03	12/12/2019 15:19	12/12/2019 17:03	1,73	124	214,62	CHI
20191293392	IPAMERI	IP12000088	IPAMERI	12/12/2019 15:19	12/12/2019 20:36	12/12/2019 15:19	12/12/2019 20:36	5,28	14	73,91	CHI
20191292513	NIQUELANDIA	NQ21317695	NIQUELANDIA SUBTRANSMISSAO	12/12/2019 15:20	12/12/2019 19:49	12/12/2019 15:20	12/12/2019 19:49	4,48	2	8,96	CHI
20191292517	PIRACANJUBA	60068590	PIRACANJUBA	12/12/2019 15:20	13/12/2019 15:35	12/12/2019 15:20	13/12/2019 15:35	24,25	1	24,25	CHI
20191292595	MINEIROS	MY12274100	PARQUE DAS EMAS	12/12/2019 15:21	12/12/2019 17:05	12/12/2019 15:21	12/12/2019 17:05	1,73	16	27,62	CHI
20191292601	MORRO AGUDO DE GOIAS	MS12239817	ITAPURANGA	12/12/2019 15:21	12/12/2019 20:10	12/12/2019 15:21	12/12/2019 20:10	4,83	3	14,50	CHI
20191292530	FORMOSA	10027281696	ITUIQUIRA	12/12/2019 15:22	12/12/2019 18:32	12/12/2019 15:22	12/12/2019 18:32	3,17	1	3,17	CHI
20191292532	JAUPACI	JP12193319	IPORA	12/12/2019 15:22	12/12/2019 23:53	12/12/2019 15:22	12/12/2019 23:53	8,50	4	34,00	CHI
20191292534	TRINDADE	40317237	TRINDADE	12/12/2019 15:23	12/12/2019 18:44	12/12/2019 15:23	12/12/2019 18:44	3,34	1	3,34	CHI
20191292536	IPAMERI	IP21159575	IPAMERI	12/12/2019 15:23	13/12/2019 07:20	12/12/2019 15:23	13/12/2019 07:20	15,94	1	15,94	CHI
20191292551	GOIAS	GS12162480LD	GOIAS	12/12/2019 15:26	13/12/2019 14:35	12/12/2019 15:26	13/12/2019 14:35	23,14	43	995,07	CHI
20191292554	ARENOPOLIS	AY12000013	ARENOPOLIS	12/12/2019 15:26	12/12/2019 21:57	12/12/2019 15:26	12/12/2019 21:57	6,51	16	104,09	CHI
20191292555	MINEIROS	MY12197151	PARQUE DAS EMAS	12/12/2019 15:26	13/12/2019 12:33	12/12/2019 15:26	13/12/2019 12:33	21,10	1	21,10	CHI
20191292561	APORE	AE12202620	ITAJA S2	12/12/2019 15:26	14/12/2019 15:20	12/12/2019 15:26	14/12/2019 15:20	47,90	4	191,58	CHI
20191293057	SANTA HELENA DE GOIAS	SH11000043	IPEGUARI	12/12/2019 15:26	12/12/2019 17:15	12/12/2019 15:26	12/12/2019 17:15	1,80	51	92,04	CHI
20191292557	SANTA FE DE GOIAS	RN21298935	BRITANIA	12/12/2019 15:27	12/12/2019 21:35	12/12/2019 15:27	12/12/2019 21:35	6,13	1	6,13	CHI
20191292560	GOIANESIA	PV21097006	GOIANESIA S2	12/12/2019 15:27	12/12/2019 16:43	12/12/2019 15:27	12/12/2019 16:43	1,27	1	1,27	CHI
20191292562	POSSE	PS11180899	IACIARA S2	12/12/2019 15:27	12/12/2019 16:28	12/12/2019 15:27	12/12/2019 16:28	1,00	12	12,03	CHI
20191292778	PARANAIGUARA	PC12035750	CACHOEIRA ALTA	12/12/2019 15:27	12/12/2019 22:00	12/12/2019 15:27	12/12/2019 18:18	2,84	35	99,54	CHI
20191292778	PARANAIGUARA	PC21035760	CACHOEIRA ALTA	12/12/2019 15:27	12/12/2019 22:00	12/12/2019 15:27	12/12/2019 21:10	5,72	1	5,72	CHI
20191292778	PARANAIGUARA	PC21295753	CACHOEIRA ALTA	12/12/2019 15:27	12/12/2019 22:00	12/12/2019 15:27	12/12/2019 21:20	5,87	1	5,87	CHI
20191292778	PARANAIGUARA	PC21035759	CACHOEIRA ALTA	12/12/2019 15:27	12/12/2019 22:00	12/12/2019 15:27	12/12/2019 22:00	6,54	1	6,54	CHI
20191292568	AURILANDIA	AI11000009	FIRMINOPOLIS S2	12/12/2019 15:29	12/12/2019 22:21	12/12/2019 15:29	12/12/2019 22:21	6,86	94	645,23	CHI
20191292570	IACIARA	IA21286083	IACIARA S2	12/12/2019 15:29	12/12/2019 18:09	12/12/2019 15:29	12/12/2019 18:09	2,65	1	2,65	CHI
20191293073	GOIANIRA	GR11241328	GOIANIRA	12/12/2019 15:30	13/12/2019 04:30	12/12/2019 15:30	13/12/2019 04:30	13,00	131	1702,60	CHI
20191294335	CHAPADAO DO CEU	DJ12164750	CHAPADAO DO CEU	12/12/2019 15:33	13/12/2019 15:38	12/12/2019 15:33	13/12/2019 15:38	24,08	38	915,20	CHI
20191295083	CAIAPONIA	MV12030666	MONTIVIDIU T	12/12/2019 15:33	12/12/2019 22:25	12/12/2019 15:33	12/12/2019 22:25	6,86	16	109,72	CHI
20191295083	MONTIVIDIU	MV12030666	MONTIVIDIU T	12/12/2019 15:33	12/12/2019 22:25	12/12/2019 15:33	12/12/2019 22:25	6,86	23	157,72	CHI
20191295542	CAIAPONIA	CP12097751	CAIAPONIA	12/12/2019 15:34	13/12/2019 07:30	12/12/2019 15:34	13/12/2019 07:30	15,92	101	1608,06	CHI
20191291099	CALDAS NOVAS	CN12123546	SERRA DE CALDAS	12/12/2019 15:35	12/12/2019 20:14	12/12/2019 15:35	12/12/2019 20:14	4,65	68	315,90	CHI

20191292600	NAZARIO	PL12000127LD	PALMEIRAS	12/12/2019 15:35	12/12/2019 17:00	12/12/2019 15:35	12/12/2019 17:00	1,41	3	4,24	CHI
20191292600	PALMEIRAS DE GOIAS	PL12000127LD	PALMEIRAS	12/12/2019 15:35	12/12/2019 17:00	12/12/2019 15:35	12/12/2019 17:00	1,41	136	192,36	CHI
20191292704	AGUA FRIA DE GOIAS	4140000029	SAO JOAO D ALIANCA	12/12/2019 15:35	12/12/2019 18:07	12/12/2019 15:35	12/12/2019 18:07	2,52	1	2,52	CHI
20191292706	MARA ROSA	MQ11072701	MARA ROSA	12/12/2019 15:35	12/12/2019 19:29	12/12/2019 15:35	12/12/2019 19:29	3,89	152	591,03	CHI
20191297854	TURVELANDIA	TD31191571	IPEGUARI	12/12/2019 15:35	13/12/2019 11:00	12/12/2019 15:35	13/12/2019 11:00	19,40	3	58,20	CHI
20191292715	URUACU	UR21327252	MARA ROSA	12/12/2019 15:36	13/12/2019 13:20	12/12/2019 15:36	13/12/2019 13:20	21,72	1	21,72	CHI
20191292716	CEZARINA	1650019339	CEZARINA	12/12/2019 15:37	12/12/2019 18:12	12/12/2019 15:37	12/12/2019 18:12	2,58	1	2,58	CHI
20191292718	ALTO PARAISO DE GOIAS	BF11129977	FLORES DE GOIAS	12/12/2019 15:37	12/12/2019 16:28	12/12/2019 15:37	12/12/2019 16:28	0,85	143	121,23	CHI
20191292725	RIO VERDE	10009237419	RIO VERDE S1	12/12/2019 15:37	12/12/2019 18:20	12/12/2019 15:37	12/12/2019 18:20	2,71	0	0,00	CHI
20191293019	SANCLERLANDIA	SL12388893	SAO LUIZ DOS MONTES BELOS	12/12/2019 15:37	12/12/2019 21:51	12/12/2019 15:37	12/12/2019 21:51	6,22	9	55,96	CHI
20191292730	ABADIA DE GOIAS	TR31053694	GUAPU S1	12/12/2019 15:38	13/12/2019 08:50	12/12/2019 15:38	13/12/2019 08:50	17,19	1	17,19	CHI
20191292732	MINEIROS	MY12166286	CHAPADAO DO CEU	12/12/2019 15:38	13/12/2019 14:41	12/12/2019 15:38	13/12/2019 14:41	23,04	5	115,21	CHI
20191292732	SERRANOPOLIS	MY12166286	CHAPADAO DO CEU	12/12/2019 15:38	13/12/2019 14:41	12/12/2019 15:38	13/12/2019 14:41	23,04	9	207,37	CHI
20191293861	BALIZA	BH12331250	CAIAPONIA	12/12/2019 15:38	13/12/2019 11:04	12/12/2019 15:38	13/12/2019 11:04	19,42	99	1922,36	CHI
20191292747	ITARUMA	IM12107446	CACHOEIRA ALTA	12/12/2019 15:41	13/12/2019 11:15	12/12/2019 15:41	13/12/2019 11:15	19,55	1	19,55	CHI
20191292748	SANTA CRUZ DE GOIAS	BC21124193	PIRES DO RIO S2	12/12/2019 15:41	12/12/2019 20:41	12/12/2019 15:41	12/12/2019 20:41	4,99	3	14,96	CHI
20191293810	MAURILANDIA	ML12301541	RIO DOS BOIS	12/12/2019 15:41	13/12/2019 07:33	12/12/2019 15:41	13/12/2019 07:33	15,86	20	317,29	CHI
20191294334	CACU	CC11194916	CACHOEIRA ALTA	12/12/2019 15:42	13/12/2019 03:00	12/12/2019 15:42	13/12/2019 03:00	11,29	130	1467,09	CHI
20191292753	SAO JOAO DA PARAUNA	FR12299252	FIRMINOPOLIS S2	12/12/2019 15:43	12/12/2019 17:36	12/12/2019 15:43	12/12/2019 17:36	1,89	3	5,68	CHI
20191292758	GUARANI DE GOIAS	GY12267340	IACIARA S2	12/12/2019 15:44	12/12/2019 16:53	12/12/2019 15:44	12/12/2019 16:53	1,15	61	70,00	CHI
20191292766	PLANALTINA	PI21262260	PLANALTINA	12/12/2019 15:45	13/12/2019 08:34	12/12/2019 15:45	13/12/2019 08:34	16,81	1	16,81	CHI
20191292782	VILA PROPICIO	GE21196943	GOIANESIA S1	12/12/2019 15:48	13/12/2019 01:33	12/12/2019 15:48	13/12/2019 01:33	9,74	1	9,74	CHI
20191293040	CORUMBA DE GOIAS	CB12377443	CORUMBA	12/12/2019 15:49	12/12/2019 21:41	12/12/2019 15:49	12/12/2019 21:41	5,86	10	58,56	CHI
20191292792	MORRINHOS	MR21092097	MORRINHOS	12/12/2019 15:50	13/12/2019 11:23	12/12/2019 15:50	13/12/2019 11:23	19,55	1	19,55	CHI
20191292794	IPAMERI	580072915	IPAMERI	12/12/2019 15:50	12/12/2019 17:34	12/12/2019 15:50	12/12/2019 17:34	1,72	1	1,72	CHI
20191292797	NOVA CRIXAS	NA12040307	NOVA CRIXAS	12/12/2019 15:50	12/12/2019 23:09	12/12/2019 15:50	12/12/2019 23:09	7,30	5	36,51	CHI
20191293013	CACU	CC12191736	CACHOEIRA ALTA	12/12/2019 15:50	12/12/2019 17:32	12/12/2019 15:50	12/12/2019 17:32	1,69	6	10,13	CHI
20191292798	PONTALINA	6461578	PONTALINA	12/12/2019 15:51	12/12/2019 17:52	12/12/2019 15:51	12/12/2019 17:52	2,02	3	6,05	CHI
20191292800	FORMOSA	FA21218261	SAO JOAO D ALIANCA	12/12/2019 15:51	12/12/2019 18:37	12/12/2019 15:51	12/12/2019 18:37	2,77	1	2,77	CHI
20191293003	CAIAPONIA	CP12357554	CAIAPONIA	12/12/2019 15:51	12/12/2019 21:31	12/12/2019 15:51	12/12/2019 21:31	5,65	1	5,65	CHI
20191293005	RIO VERDE	RV12303838	MONTIVIDIU T	12/12/2019 15:52	13/12/2019 10:05	12/12/2019 15:52	13/12/2019 10:05	18,22	1	18,22	CHI
20191293006	GOIANIA	12663918	MEIA PONTE	12/12/2019 15:52	12/12/2019 18:13	12/12/2019 15:52	12/12/2019 18:13	2,34	1	2,34	CHI
20191293009	CORUMBA DE GOIAS	CB12061922	ANAPOLIS UNIVERSITARIO S1	12/12/2019 15:52	12/12/2019 18:15	12/12/2019 15:52	12/12/2019 18:15	2,37	11	26,06	CHI

20191293012	PORANGATU	PO11349914	MARA ROSA	12/12/2019 15:53	12/12/2019 23:50	12/12/2019 15:53	12/12/2019 23:50	7,94	1	7,94	CHI
20191293014	LUZIANIA	LZ21156965	MARAJOARA	12/12/2019 15:53	12/12/2019 17:42	12/12/2019 15:53	12/12/2019 17:42	1,81	2	3,63	CHI
20191293015	CAMPINORTE	UR12231336	MARA ROSA	12/12/2019 15:53	12/12/2019 22:21	12/12/2019 15:53	12/12/2019 22:21	6,45	2	12,90	CHI
20191293015	URUACU	UR12231336	MARA ROSA	12/12/2019 15:53	12/12/2019 22:21	12/12/2019 15:53	12/12/2019 22:21	6,45	22	141,92	CHI
20191293021	ORIZONA	OZ21186672	PIRES DO RIO S2	12/12/2019 15:55	12/12/2019 21:35	12/12/2019 15:55	12/12/2019 21:35	5,66	1	5,66	CHI
20191293022	PANAMA	PX21263936	GOIATUBA S1	12/12/2019 15:55	13/12/2019 07:52	12/12/2019 15:55	13/12/2019 07:52	15,94	1	15,94	CHI
20191293023	SERRANOPOLIS	JT12205191	JATAI S1	12/12/2019 15:55	13/12/2019 16:27	12/12/2019 15:55	13/12/2019 16:27	24,52	2	49,05	CHI
20191293024	CALDAZINHA	SV21270647	DAIA S2	12/12/2019 15:55	12/12/2019 18:24	12/12/2019 15:55	12/12/2019 18:24	2,47	1	2,47	CHI
20191293044	CHAPADAO DO CEU	02430414	CHAPADAO DO CEU	12/12/2019 15:56	16/12/2019 00:35	12/12/2019 15:56	12/12/2019 17:16	1,33	11	14,65	CHI
20191293044	SERRANOPOLIS	02430414	CHAPADAO DO CEU	12/12/2019 15:56	16/12/2019 00:35	12/12/2019 15:56	12/12/2019 17:16	1,33	10	13,32	CHI
20191293044	MINEIROS	SX10400642	CHAPADAO DO CEU	12/12/2019 15:56	16/12/2019 00:35	12/12/2019 15:56	12/12/2019 18:58	3,03	20	60,68	CHI
20191293044	SERRANOPOLIS	SX10400642	CHAPADAO DO CEU	12/12/2019 15:56	16/12/2019 00:35	12/12/2019 15:56	12/12/2019 18:58	3,03	55	166,86	CHI
20191293044	SERRANOPOLIS	DJ13164076	CHAPADAO DO CEU	12/12/2019 15:56	16/12/2019 00:35	12/12/2019 15:56	12/12/2019 19:13	3,28	6	19,68	CHI
20191293044	MINEIROS	SX10400642	CHAPADAO DO CEU	12/12/2019 15:56	16/12/2019 00:35	12/12/2019 19:12	13/12/2019 08:22	13,17	20	263,35	CHI
20191293044	SERRANOPOLIS	SX10400642	CHAPADAO DO CEU	12/12/2019 15:56	16/12/2019 00:35	12/12/2019 19:12	13/12/2019 08:22	13,17	43	566,20	CHI
20191293044	SERRANOPOLIS	DJ13164073	CHAPADAO DO CEU	12/12/2019 15:56	16/12/2019 00:35	12/12/2019 19:12	13/12/2019 08:45	13,54	12	162,43	CHI
20191293044	MINEIROS	SX10400642	CHAPADAO DO CEU	12/12/2019 15:56	16/12/2019 00:35	13/12/2019 08:25	13/12/2019 09:39	1,23	20	24,66	CHI
20191293044	SERRANOPOLIS	SX10400642	CHAPADAO DO CEU	12/12/2019 15:56	16/12/2019 00:35	13/12/2019 08:25	13/12/2019 09:39	1,23	35	43,16	CHI
20191293044	MINEIROS	SX10400642	CHAPADAO DO CEU	12/12/2019 15:56	16/12/2019 00:35	13/12/2019 09:43	13/12/2019 10:39	0,94	20	18,72	CHI
20191293044	SERRANOPOLIS	SX10400642	CHAPADAO DO CEU	12/12/2019 15:56	16/12/2019 00:35	13/12/2019 09:43	13/12/2019 10:39	0,94	5	4,68	CHI
20191293044	SERRANOPOLIS	SX13166013	CHAPADAO DO CEU	12/12/2019 15:56	16/12/2019 00:35	13/12/2019 09:43	13/12/2019 10:57	1,24	30	37,12	CHI
20191293044	JATAI	JT10400238	JATAI S1	12/12/2019 15:56	16/12/2019 00:35	13/12/2019 13:18	13/12/2019 17:49	4,52	20	90,34	CHI
20191293044	JATAI	JT10400238	JATAI S1	12/12/2019 15:56	16/12/2019 00:35	13/12/2019 17:51	13/12/2019 18:13	0,36	5	1,82	CHI
20191293044	JATAI	JT10400238	JATAI S1	12/12/2019 15:56	16/12/2019 00:35	13/12/2019 19:21	13/12/2019 19:35	0,23	5	1,15	CHI
20191293044	JATAI	JT13184074	JATAI S1	12/12/2019 15:56	16/12/2019 00:35	13/12/2019 17:51	13/12/2019 21:16	3,41	1	3,41	CHI
20191293044	JATAI	JT10400238	JATAI S1	12/12/2019 15:56	16/12/2019 00:35	13/12/2019 13:18	13/12/2019 21:35	8,28	10	82,84	CHI
20191293044	SERRANOPOLIS	JT10400238	JATAI S1	12/12/2019 15:56	16/12/2019 00:35	13/12/2019 13:18	13/12/2019 21:35	8,28	6	49,70	CHI
20191293044	JATAI	JT10400238	JATAI S1	12/12/2019 15:56	16/12/2019 00:35	13/12/2019 13:18	13/12/2019 21:40	8,36	7	58,51	CHI
20191293044	JATAI	JT12182138	JATAI S1	12/12/2019 15:56	16/12/2019 00:35	13/12/2019 17:51	13/12/2019 21:56	4,08	10	40,76	CHI
20191293044	JATAI	JT13402474	JATAI S1	12/12/2019 15:56	16/12/2019 00:35	13/12/2019 17:51	13/12/2019 22:30	4,64	4	18,57	CHI
20191293044	MINEIROS	SX10400642	CHAPADAO DO CEU	12/12/2019 15:56	16/12/2019 00:35	13/12/2019 13:18	14/12/2019 05:53	16,58	20	331,51	CHI
20191293044	SERRANOPOLIS	SX10400642	CHAPADAO DO CEU	12/12/2019 15:56	16/12/2019 00:35	13/12/2019 13:18	14/12/2019 05:53	16,58	35	580,13	CHI
20191293044	SERRANOPOLIS	DJ13164066	CHAPADAO DO CEU	12/12/2019 15:56	16/12/2019 00:35	13/12/2019 08:25	16/12/2019 00:35	64,16	8	513,28	CHI

20191293315	CASTELANDIA	QI12370150	QUIRINOPOLIS	12/12/2019 15:57	13/12/2019 06:09	12/12/2019 15:57	13/12/2019 06:09	14,20	19	269,76	CHI
20191293315	QUIRINOPOLIS	QI12370150	QUIRINOPOLIS	12/12/2019 15:57	13/12/2019 06:09	12/12/2019 15:57	13/12/2019 06:09	14,20	57	809,27	CHI
20191293315	RIO VERDE	QI12370150	QUIRINOPOLIS	12/12/2019 15:57	13/12/2019 06:09	12/12/2019 15:57	13/12/2019 06:09	14,20	1	14,20	CHI
20191293032	SAO MIGUEL DO ARAGUAIA	SM21096098	SAO MIGUEL DO ARAGUAIA	12/12/2019 15:58	12/12/2019 17:00	12/12/2019 15:58	12/12/2019 17:00	1,04	1	1,04	CHI
20191293036	ARAGARCAS	AG21341787	ARAGARCAS	12/12/2019 15:58	12/12/2019 23:05	12/12/2019 15:58	12/12/2019 23:05	7,10	1	7,10	CHI
20191293043	PALMEIRAS DE GOIAS	PL12346577	PALMEIRAS	12/12/2019 15:59	12/12/2019 18:10	12/12/2019 15:59	12/12/2019 18:10	2,19	22	48,12	CHI
20191293047	PALESTINA DE GOIAS	PY12040193	PALESTINA	12/12/2019 16:00	12/12/2019 19:17	12/12/2019 16:00	12/12/2019 19:17	3,27	81	265,07	CHI
20191293695	MORRINHOS	MR12000194	MORRINHOS	12/12/2019 16:00	12/12/2019 18:43	12/12/2019 16:00	12/12/2019 18:43	2,71	36	97,42	CHI
20191293050	CEZARINA	6283689	EDEIA	12/12/2019 16:01	12/12/2019 19:20	12/12/2019 16:01	12/12/2019 19:20	3,31	6	19,87	CHI
20191293050	INDIARA	6283689	EDEIA	12/12/2019 16:01	12/12/2019 19:20	12/12/2019 16:01	12/12/2019 19:20	3,31	5	16,56	CHI
20191293051	BOM JESUS DE GOIAS	1250052364	BOM JESUS DE GOIAS	12/12/2019 16:02	12/12/2019 20:59	12/12/2019 16:02	12/12/2019 20:59	4,95	1	4,95	CHI
20191293068	QUIRINOPOLIS	QI32007538	QUIRINOPOLIS	12/12/2019 16:02	13/12/2019 14:03	12/12/2019 16:02	13/12/2019 14:03	22,00	39	858,18	CHI
20191293066	RIO QUENTE	2530025764	RIO QUENTE	12/12/2019 16:04	13/12/2019 10:00	12/12/2019 16:04	13/12/2019 10:00	17,93	1	17,93	CHI
20191293069	CALDAS NOVAS	CN21271018	CALDAS NOVAS S2	12/12/2019 16:05	13/12/2019 07:42	12/12/2019 16:05	13/12/2019 07:42	15,62	1	15,62	CHI
20191293075	PLANALTINA	10000666988	PLANALTINA	12/12/2019 16:06	12/12/2019 18:08	12/12/2019 16:06	12/12/2019 18:08	2,03	1	2,03	CHI
20191293077	PLANALTINA	PI21281774	PADRE BERNARDO	12/12/2019 16:06	12/12/2019 18:10	12/12/2019 16:06	12/12/2019 18:10	2,06	1	2,06	CHI
20191293078	PARAUNA	PU12205939	PARAUNA	12/12/2019 16:06	12/12/2019 18:22	12/12/2019 16:06	12/12/2019 18:22	2,27	8	18,18	CHI
20191293269	ANAPOLIS	AN12191350	JUNDIAI S2	12/12/2019 16:06	13/12/2019 00:30	12/12/2019 16:06	12/12/2019 20:10	4,06	126	511,95	CHI
20191293269	ANAPOLIS	AN11043605	JUNDIAI S2	12/12/2019 16:06	13/12/2019 00:30	12/12/2019 16:06	13/12/2019 00:30	8,41	177	1488,27	CHI
20191293083	JATAI	10006194816	JATAI S3	12/12/2019 16:07	13/12/2019 09:33	12/12/2019 16:07	13/12/2019 09:33	17,43	1	17,43	CHI
20191293085	AGUAS LINDAS DE GOIAS	4830170798	AGUAS LINDAS DE GOIAS S1	12/12/2019 16:07	12/12/2019 17:18	12/12/2019 16:07	12/12/2019 17:18	1,17	1	1,17	CHI
20191293091	SENADOR CANEDO	16477169	GOIANIA LESTE S2	12/12/2019 16:09	12/12/2019 17:27	12/12/2019 16:09	12/12/2019 17:27	1,29	1	1,29	CHI
20191296147	CROMINIA	HD12000151	PONTALINA	12/12/2019 16:09	13/12/2019 01:03	12/12/2019 16:09	13/12/2019 01:03	8,89	2	17,78	CHI
20191296147	HIDROLANDIA	HD12000151	PONTALINA	12/12/2019 16:09	13/12/2019 01:03	12/12/2019 16:09	13/12/2019 01:03	8,89	37	328,93	CHI
20191296147	MAIRIPOTABA	HD12000151	PONTALINA	12/12/2019 16:09	13/12/2019 01:03	12/12/2019 16:09	13/12/2019 01:03	8,89	9	80,01	CHI
20191296147	VARJAO	HD12000151	PONTALINA	12/12/2019 16:09	13/12/2019 01:03	12/12/2019 16:09	13/12/2019 01:03	8,89	1	8,89	CHI
20191293094	PALMEIRAS DE GOIAS	PL12098934	PALMEIRAS	12/12/2019 16:10	12/12/2019 19:48	12/12/2019 16:10	12/12/2019 19:48	3,63	6	21,76	CHI
20191293096	PIRES DO RIO	PR21300702	PIRES DO RIO S1	12/12/2019 16:11	12/12/2019 19:18	12/12/2019 16:11	12/12/2019 19:18	3,13	1	3,13	CHI
20191293203	VIANOPOLIS	VN21385052	VIANOPOLIS	12/12/2019 16:12	13/12/2019 12:06	12/12/2019 16:12	13/12/2019 12:06	19,89	1	19,89	CHI
20191293205	IPAMERI	IP21315242	IPAMERI	12/12/2019 16:12	12/12/2019 22:00	12/12/2019 16:12	12/12/2019 22:00	5,79	1	5,79	CHI
20191293208	CACU	CC21026103	CACHOEIRA ALTA	12/12/2019 16:12	12/12/2019 18:29	12/12/2019 16:12	12/12/2019 18:29	2,27	1	2,27	CHI
20191293209	GOIANESIA	GE12040930	GOIANESIA S2	12/12/2019 16:12	12/12/2019 17:05	12/12/2019 16:12	12/12/2019 17:05	0,88	131	115,57	CHI
20191293398	QUIRINOPOLIS	QI12271537	QUIRINOPOLIS	12/12/2019 16:12	13/12/2019 06:54	12/12/2019 16:12	13/12/2019 06:54	14,69	89	1307,58	CHI

20191293214	ITAJA	IJ12321777	CACHOEIRA ALTA	12/12/2019 16:13	13/12/2019 09:59	12/12/2019 16:13	13/12/2019 09:59	17,76	24	426,23	CHI
20191293214	LAGOA SANTA	IJ12321777	CACHOEIRA ALTA	12/12/2019 16:13	13/12/2019 09:59	12/12/2019 16:13	13/12/2019 09:59	17,76	8	142,08	CHI
20191293215	QUIRINOPOLIS	QI11296617	QUIRINOPOLIS	12/12/2019 16:13	13/12/2019 10:46	13/12/2019 07:59	13/12/2019 10:46	2,78	18	50,04	CHI
20191293244	GOIAS	GS12310430	ITABERAI S1	12/12/2019 16:13	12/12/2019 19:23	12/12/2019 16:13	12/12/2019 19:23	3,16	1	3,16	CHI
20191293244	ITABERAI	GS12310430	ITABERAI S1	12/12/2019 16:13	12/12/2019 19:23	12/12/2019 16:13	12/12/2019 19:23	3,16	2	6,33	CHI
20191293224	LUZIANIA	3200038911	MARAJOARA	12/12/2019 16:15	12/12/2019 17:11	12/12/2019 16:15	12/12/2019 17:11	0,93	1	0,93	CHI
20191293231	BELA VISTA DE GOIAS	BV12185857	CEPAIGO S2	12/12/2019 16:16	12/12/2019 20:56	12/12/2019 16:16	12/12/2019 20:56	4,66	3	13,98	CHI
20191293236	RIO VERDE	RV11246853	RIO VERDE S1	12/12/2019 16:16	13/12/2019 00:02	12/12/2019 19:20	13/12/2019 00:02	4,70	135	635,10	CHI
20191293238	URUACU	UR13243294	MARA ROSA	12/12/2019 16:17	13/12/2019 16:09	13/12/2019 11:36	13/12/2019 16:09	4,55	12	54,60	CHI
20191293238	URUACU	UR21243234	MARA ROSA	12/12/2019 16:17	13/12/2019 16:09	12/12/2019 16:17	13/12/2019 16:09	23,87	1	23,87	CHI
20191293242	CORUMBAIBA	560011179	VILA CORUMBA	12/12/2019 16:17	12/12/2019 21:18	12/12/2019 16:17	12/12/2019 21:18	5,01	1	5,01	CHI
20191294098	MONTIVIDIU	MV12267634	MONTIVIDIU T	12/12/2019 16:17	12/12/2019 19:15	12/12/2019 16:17	12/12/2019 19:15	2,97	17	50,47	CHI
20191293248	LUZIANIA	LZ21000492	MARAJOARA	12/12/2019 16:18	12/12/2019 20:20	12/12/2019 16:18	12/12/2019 20:20	4,03	1	4,03	CHI
20191293250	TURVELANDIA	TD21342213	SANTA HELENA S1	12/12/2019 16:18	13/12/2019 12:00	12/12/2019 16:18	13/12/2019 12:00	19,68	1	19,68	CHI
20191293252	AGUA FRIA DE GOIAS	TL21218562	SAO JOAO D ALIANCA	12/12/2019 16:19	12/12/2019 22:00	12/12/2019 16:19	12/12/2019 22:00	5,68	1	5,68	CHI
20191293253	CACU	1140027351	CACHOEIRA ALTA	12/12/2019 16:19	12/12/2019 19:43	12/12/2019 16:19	12/12/2019 19:43	3,39	1	3,39	CHI
20191293259	GOIAS	GS12250581	GOIAS	12/12/2019 16:20	12/12/2019 17:44	12/12/2019 16:20	12/12/2019 17:44	1,39	53	73,51	CHI
20191293261	QUIRINOPOLIS	QI12296553	QUIRINOPOLIS	12/12/2019 16:20	13/12/2019 10:53	12/12/2019 16:20	13/12/2019 10:53	18,53	1	18,53	CHI
20191293263	GOIANIA	GN11189935	CARAJAS S2	12/12/2019 16:21	13/12/2019 09:49	12/12/2019 16:21	13/12/2019 09:49	17,45	96	1675,41	CHI
20191293267	GOIANIA	14525173	XAVANTES	12/12/2019 16:21	13/12/2019 09:41	12/12/2019 16:21	13/12/2019 09:41	17,32	1	17,32	CHI
20191293274	PONTALINA	PK21316603	PONTALINA	12/12/2019 16:23	13/12/2019 02:36	12/12/2019 16:23	13/12/2019 02:36	10,20	1	10,20	CHI
20191293276	AMORINOPOLIS	IR12014477	IPORA	12/12/2019 16:23	13/12/2019 00:26	12/12/2019 16:23	13/12/2019 00:26	8,04	37	297,37	CHI
20191293622	UIRAPURU	UP12391835	SANTA TEREZINHA	12/12/2019 16:27	12/12/2019 20:30	12/12/2019 16:27	12/12/2019 20:30	4,04	11	44,48	CHI
20191294030	ARAGOIANIA	AO32060885	GUAPU S2	12/12/2019 16:28	13/12/2019 08:34	12/12/2019 16:28	13/12/2019 08:34	16,09	28	450,52	CHI
20191293297	ITABERAI	IB12000038	ITABERAI S2	12/12/2019 16:29	12/12/2019 19:44	12/12/2019 16:29	12/12/2019 19:44	3,25	34	110,38	CHI
20191293305	ALTO PARAISO DE GOIAS	8183514	FLORES DE GOIAS	12/12/2019 16:30	12/12/2019 18:15	12/12/2019 16:30	12/12/2019 18:15	1,75	78	136,20	CHI
20191293311	PIRACANJUBA	PJ21403657	ROCHEDO	12/12/2019 16:31	13/12/2019 16:28	12/12/2019 16:31	13/12/2019 16:28	23,94	1	23,94	CHI
20191295181	RIO VERDE	RV21260625	CABRIUVA S1	12/12/2019 16:31	12/12/2019 17:41	12/12/2019 16:31	12/12/2019 17:41	1,17	1	1,17	CHI
20191293319	APARECIDA DE GOIANIA	200186231	INDEPENDENCIA S1	12/12/2019 16:32	12/12/2019 19:46	12/12/2019 16:32	12/12/2019 19:46	3,22	1	3,22	CHI
20191293326	OUVIDOR	OU12061242RE	CATALAO S1	12/12/2019 16:32	12/12/2019 18:15	12/12/2019 16:32	12/12/2019 18:15	1,71	13	22,27	CHI
20191293323	HIDROLANDIA	HD12015868	CEPAIGO S2	12/12/2019 16:34	12/12/2019 21:00	12/12/2019 16:34	12/12/2019 21:00	4,43	2	8,86	CHI
20191293336	POSSE	IA12035179	IACIARA S2	12/12/2019 16:37	13/12/2019 14:25	12/12/2019 16:37	13/12/2019 14:25	21,79	9	196,08	CHI
20191293674	ANAPOLIS	AN12384291	ANAPOLIS UNIVERSITARIO S2	12/12/2019 16:37	13/12/2019 00:12	12/12/2019 16:37	13/12/2019 00:12	7,57	45	340,60	CHI

20191293343	VIANOPOLIS	510019640	VIANOPOLIS	12/12/2019 16:38	13/12/2019 07:58	12/12/2019 16:38	13/12/2019 07:58	15,32	1	15,32	CHI
20191296127	JATAI	JT12230959	JATAI S1	12/12/2019 16:38	13/12/2019 07:46	12/12/2019 16:38	13/12/2019 07:46	15,13	2	30,26	CHI
20191293344	CIDADE OCIDENTAL	2680142660	MARAJOARA	12/12/2019 16:39	12/12/2019 22:22	12/12/2019 16:39	12/12/2019 22:22	5,72	1	5,72	CHI
20191293346	APORE	AE12205143	ITAJA S2	12/12/2019 16:39	13/12/2019 14:30	12/12/2019 16:39	13/12/2019 14:30	21,85	1	21,85	CHI
20191293347	ITAPURANGA	IK12364710	ITAPURANGA	12/12/2019 16:39	13/12/2019 12:15	12/12/2019 16:39	13/12/2019 12:15	19,59	9	176,34	CHI
20191293668	APARECIDA DE GOIANIA	AP11057257	INDEPENDENCIA S1	12/12/2019 16:39	12/12/2019 19:23	12/12/2019 16:39	12/12/2019 19:23	2,72	179	487,18	CHI
20191295145	BONOPOLIS	BX12246493	SAO MIGUEL DO ARAGUAIA	12/12/2019 16:40	12/12/2019 20:35	12/12/2019 16:40	12/12/2019 20:35	3,91	4	15,63	CHI
20191293360	ANICUNS	AC21000085	ANICUNS	12/12/2019 16:41	12/12/2019 20:54	12/12/2019 16:41	12/12/2019 20:54	4,22	2	8,44	CHI
20191293362	ANAPOLIS	10026742142	ANAPOLIS UNIVERSITARIO S1	12/12/2019 16:41	12/12/2019 20:52	12/12/2019 16:41	12/12/2019 20:52	4,17	1	4,17	CHI
20191293365	GOUVELANDIA	QI12301482	QUIRINOPOLIS	12/12/2019 16:41	12/12/2019 22:53	12/12/2019 16:41	12/12/2019 22:53	6,19	2	12,37	CHI
20191293381	AGUAS LINDAS DE GOIAS	LA12219645	AGUAS LINDAS DE GOIAS S2	12/12/2019 16:41	12/12/2019 17:53	12/12/2019 16:41	12/12/2019 17:53	1,19	32	38,03	CHI
20191293609	QUIRINOPOLIS	QI12303092LD	QUIRINOPOLIS	12/12/2019 16:41	13/12/2019 00:08	12/12/2019 16:41	13/12/2019 00:08	7,45	132	983,22	CHI
20191293367	LUZIANIA	3200119650	MARAJOARA	12/12/2019 16:42	12/12/2019 17:58	12/12/2019 16:42	12/12/2019 17:58	1,27	1	1,27	CHI
20191293370	FORMOSA	FA12042622	ITIQUEIRA	12/12/2019 16:42	12/12/2019 18:15	12/12/2019 16:42	12/12/2019 18:15	1,54	3	4,62	CHI
20191293375	ABADIANIA	AA21190621	CORUMBA	12/12/2019 16:43	13/12/2019 08:29	12/12/2019 16:43	13/12/2019 08:29	15,76	1	15,76	CHI
20191294488	JUSSARA	JR12023506	IPORA	12/12/2019 16:44	12/12/2019 20:40	12/12/2019 16:44	12/12/2019 20:40	3,92	7	27,46	CHI
20191293382	COCALZINHO DE GOIAS	ZN12377411	COCALZINHO	12/12/2019 16:45	13/12/2019 12:50	12/12/2019 16:45	13/12/2019 12:50	20,07	17	341,23	CHI
20191293390	SERRANOPOLIS	SX21216681	JATAI S1	12/12/2019 16:48	12/12/2019 21:50	12/12/2019 16:48	12/12/2019 21:50	5,02	1	5,02	CHI
20191293391	URUTAI	UT121275790	PIRES DO RIO S2	12/12/2019 16:48	12/12/2019 21:02	12/12/2019 16:48	12/12/2019 21:02	4,23	1	4,23	CHI
20191293393	SERRANOPOLIS	SX12196170	JATAI S1	12/12/2019 16:48	12/12/2019 23:10	12/12/2019 16:48	12/12/2019 21:50	5,02	1451	7280,39	CHI
20191293393	SERRANOPOLIS	SX11049359	JATAI S1	12/12/2019 16:48	12/12/2019 23:10	12/12/2019 20:58	12/12/2019 22:20	1,36	151	204,69	CHI
20191293393	JATAI	SX12196170	JATAI S1	12/12/2019 16:48	12/12/2019 23:10	12/12/2019 16:48	12/12/2019 23:10	6,35	14	88,91	CHI
20191293393	SERRANOPOLIS	SX12196170	JATAI S1	12/12/2019 16:48	12/12/2019 23:10	12/12/2019 16:48	12/12/2019 23:10	6,35	141	895,47	CHI
20191295115	CASTELANDIA	ML12303542	RIO DOS BOIS	12/12/2019 16:48	13/12/2019 10:42	12/12/2019 16:48	13/12/2019 10:42	17,89	5	89,46	CHI
20191295115	MAURILANDIA	ML12303542	RIO DOS BOIS	12/12/2019 16:48	13/12/2019 10:42	12/12/2019 16:48	13/12/2019 10:42	17,89	15	268,38	CHI
20191293394	MAURILANDIA	ML21360631	RIO DOS BOIS	12/12/2019 16:49	13/12/2019 11:55	12/12/2019 16:49	13/12/2019 11:55	19,10	1	19,10	CHI
20191293396	AGUAS LINDAS DE GOIAS	LA11290502	AGUAS LINDAS DE GOIAS S1	12/12/2019 16:49	12/12/2019 18:06	12/12/2019 16:49	12/12/2019 18:06	1,27	147	186,81	CHI
20191293869	MATRINCHA	MP12299738	MATRINCHA	12/12/2019 16:52	12/12/2019 20:01	12/12/2019 16:52	12/12/2019 20:01	3,15	12	37,76	CHI
20191293614	PIRENOPOLIS	PV12000030	CORUMBA	12/12/2019 16:53	12/12/2019 20:32	12/12/2019 16:53	12/12/2019 20:32	3,64	21	76,48	CHI
20191295707	GOUVELANDIA	QI12000140	QUIRINOPOLIS	12/12/2019 16:53	12/12/2019 23:34	12/12/2019 16:53	12/12/2019 23:34	6,68	12	80,11	CHI
20191294422	CORUMBA DE GOIAS	CB12155979	CORUMBA	12/12/2019 16:54	12/12/2019 22:41	12/12/2019 16:54	12/12/2019 22:41	5,78	14	80,91	CHI
20191293623	LUZIANIA	120311483	RIO VERMELHO	12/12/2019 16:55	12/12/2019 18:25	12/12/2019 16:55	12/12/2019 18:25	1,50	1	1,50	CHI
20191293625	LUZIANIA	120346990	RIO VERMELHO	12/12/2019 16:55	12/12/2019 18:06	12/12/2019 16:55	12/12/2019 18:06	1,17	0	0,00	CHI

20191293633	NIQUELANDIA	NQ12256621	NIQUELANDIA SUBTRANSMISSAO	12/12/2019 16:57	12/12/2019 23:22	12/12/2019 16:57	12/12/2019 23:22	6,41	8	51,25	CHI
20191293635	SANTA HELENA DE GOIAS	SH21000092	IPEGUARI	12/12/2019 16:57	12/12/2019 18:35	12/12/2019 16:57	12/12/2019 18:35	1,62	1	1,62	CHI
20191294413	CALDAS NOVAS	CN12404773	CALDAS NOVAS S1	12/12/2019 16:57	12/12/2019 21:51	12/12/2019 16:57	12/12/2019 21:51	4,89	4	19,57	CHI
20191293887	TRINDADE	TR11101119	GOYA S2	12/12/2019 16:59	12/12/2019 21:00	12/12/2019 16:59	12/12/2019 21:00	4,01	221	886,70	CHI
20191293643	PONTALINA	PK21102294	PONTALINA	12/12/2019 17:00	13/12/2019 07:58	12/12/2019 17:00	13/12/2019 07:58	14,97	1	14,97	CHI
20191293649	CATURAI	AV12019656	ANICUNS	12/12/2019 17:01	13/12/2019 12:09	12/12/2019 17:01	13/12/2019 09:07	16,11	2	32,21	CHI
20191293649	CATURAI	AV12019656	ANICUNS	12/12/2019 17:01	13/12/2019 12:09	13/12/2019 09:24	13/12/2019 12:09	2,75	8	22,03	CHI
20191293652	ANAPOLIS	AN11391693	ANAPOLIS UNIVERSITARIO S1	12/12/2019 17:01	12/12/2019 18:30	12/12/2019 17:01	12/12/2019 18:30	1,48	51	75,24	CHI
20191293657	POSSE	PS21235423	IACIARA S2	12/12/2019 17:02	12/12/2019 18:21	12/12/2019 17:02	12/12/2019 18:21	1,32	1	1,32	CHI
20191293659	SANTA HELENA DE GOIAS	SH12301752	IPEGUARI	12/12/2019 17:02	12/12/2019 18:03	12/12/2019 17:02	12/12/2019 18:03	1,01	12	12,09	CHI
20191293664	MORRINHOS	MR21381192	PONTALINA	12/12/2019 17:02	12/12/2019 22:59	12/12/2019 17:02	12/12/2019 22:59	5,94	1	5,94	CHI
20191293671	AGUA FRIA DE GOIAS	NQ12140180	SAO JOAO D ALIANCA	12/12/2019 17:03	13/12/2019 09:47	12/12/2019 17:03	13/12/2019 09:47	16,72	2	33,44	CHI
20191294421	CALDAS NOVAS	CN12098245	RIO QUENTE	12/12/2019 17:03	12/12/2019 21:30	12/12/2019 17:03	12/12/2019 21:30	4,45	2	8,91	CHI
20191293676	GOIANESIA	550118070	GOIANESIA S2	12/12/2019 17:04	12/12/2019 18:20	12/12/2019 17:04	12/12/2019 18:20	1,27	1	1,27	CHI
20191293888	GOIANIRA	GR11232183	GOIANIRA	12/12/2019 17:04	12/12/2019 20:40	12/12/2019 17:04	12/12/2019 20:40	3,60	96	345,57	CHI
20191293681	LUZIANIA	120226170	RIO VERMELHO	12/12/2019 17:05	12/12/2019 18:42	12/12/2019 17:05	12/12/2019 18:42	1,61	1	1,61	CHI
20191293682	CRISTALINA	10011784251	CRISTALINA S1	12/12/2019 17:05	13/12/2019 00:27	12/12/2019 17:05	13/12/2019 00:27	7,36	1	7,36	CHI
20191293683	IPAMERI	IP21352236	IPAMERI	12/12/2019 17:05	13/12/2019 17:05	12/12/2019 17:05	13/12/2019 17:05	24,00	1	24,00	CHI
20191293686	COLINAS DO SUL	TI21236623	MINACU	12/12/2019 17:05	12/12/2019 19:35	12/12/2019 17:05	12/12/2019 19:35	2,49	1	2,49	CHI
20191293703	MINEIROS	MY12248429	PARQUE DAS EMAS	12/12/2019 17:05	12/12/2019 18:57	12/12/2019 17:05	12/12/2019 18:57	1,86	16	29,69	CHI
20191293697	CACHOEIRA ALTA	CA12024254	CACHOEIRA ALTA	12/12/2019 17:06	12/12/2019 20:32	12/12/2019 17:06	12/12/2019 20:32	3,42	21	71,89	CHI
20191293697	QUIRINOPOLIS	CA12024254	CACHOEIRA ALTA	12/12/2019 17:06	12/12/2019 20:32	12/12/2019 17:06	12/12/2019 20:32	3,42	7	23,96	CHI
20191293699	ITABERAI	IB12206926	ITABERAI S2	12/12/2019 17:07	12/12/2019 19:24	12/12/2019 17:07	12/12/2019 19:24	2,28	146	332,68	CHI
20191294018	CAMPINACU	IH12132432	MINACU	12/12/2019 17:07	12/12/2019 20:33	12/12/2019 17:07	12/12/2019 20:33	3,43	22	75,50	CHI
20191294018	MINACU	IH12132432	MINACU	12/12/2019 17:07	12/12/2019 20:33	12/12/2019 17:07	12/12/2019 20:33	3,43	106	363,76	CHI
20191293811	ANAPOLIS	10003205680	JUNDIAI S2	12/12/2019 17:10	13/12/2019 08:13	12/12/2019 17:10	13/12/2019 08:13	15,05	1	15,05	CHI
20191293815	IACIARA	PS12268226	IACIARA S2	12/12/2019 17:10	12/12/2019 19:25	12/12/2019 17:10	12/12/2019 19:25	2,24	4	8,96	CHI
20191295750	NEROPOLIS	NR11347312	NEROPOLIS S2	12/12/2019 17:10	12/12/2019 22:20	12/12/2019 17:10	12/12/2019 22:20	5,16	82	422,98	CHI
20191293818	ANAPOLIS	20296964	JUNDIAI S1	12/12/2019 17:11	12/12/2019 19:35	12/12/2019 17:11	12/12/2019 19:35	2,40	1	2,40	CHI
20191294089	COCALZINHO DE GOIAS	PB12060341RE	PADRE BERNARDO	12/12/2019 17:11	12/12/2019 18:59	12/12/2019 17:11	12/12/2019 18:59	1,79	7	12,56	CHI
20191294089	PADRE BERNARDO	PB12060341RE	PADRE BERNARDO	12/12/2019 17:11	12/12/2019 18:59	12/12/2019 17:11	12/12/2019 18:59	1,79	15	26,92	CHI
20191293823	MINEIROS	MY12149310	PARQUE DAS EMAS	12/12/2019 17:12	13/12/2019 10:21	13/12/2019 07:16	13/12/2019 10:21	3,08	73	224,92	CHI
201912100263	MINEIROS	10007815598	PARQUE DAS EMAS	12/12/2019 17:12	13/12/2019 07:16	12/12/2019 17:12	13/12/2019 07:16	14,06	1	14,06	CHI

20191293828	CACHOEIRA ALTA	CA12196143	CACHOEIRA ALTA	12/12/2019 17:13	12/12/2019 22:10	12/12/2019 17:13	12/12/2019 22:10	4,94	2	9,88	CHI
20191293838	LUZIANIA	LZ12114519	PIRES DO RIO S2	12/12/2019 17:14	12/12/2019 20:27	12/12/2019 17:14	12/12/2019 20:27	3,20	23	73,61	CHI
20191293838	ORIZONA	LZ12114519	PIRES DO RIO S2	12/12/2019 17:14	12/12/2019 20:27	12/12/2019 17:14	12/12/2019 20:27	3,20	36	115,21	CHI
20191294083	CROMINIA	CQ11108120	PONTALINA	12/12/2019 17:14	12/12/2019 18:24	12/12/2019 17:14	12/12/2019 18:24	1,17	164	191,06	CHI
20191294920	ANAPOLIS	AN16401596	JUNDIAI S2	12/12/2019 17:14	12/12/2019 17:17	12/12/2019 17:14	12/12/2019 17:17	0,05	5122	278,86	CHI
20191294920	CAMPO LIMPO	AN16401596	JUNDIAI S2	12/12/2019 17:14	12/12/2019 17:17	12/12/2019 17:14	12/12/2019 17:17	0,05	2	0,11	CHI
20191294920	TEREZOPOLIS DE GOIAS	AN16401596	JUNDIAI S2	12/12/2019 17:14	12/12/2019 17:17	12/12/2019 17:14	12/12/2019 17:17	0,05	43	2,34	CHI
20191293842	HIDROLANDIA	03660214	PONTALINA	12/12/2019 17:15	13/12/2019 00:37	12/12/2019 17:15	13/12/2019 00:37	7,37	145	1068,13	CHI
20191293843	ARAGARCAS	BM12372350	BOM JARDIM	12/12/2019 17:15	12/12/2019 21:14	12/12/2019 17:15	12/12/2019 21:14	3,97	1	3,97	CHI
20191293843	BOM JARDIM DE GOIAS	BM12372350	BOM JARDIM	12/12/2019 17:15	12/12/2019 21:14	12/12/2019 17:15	12/12/2019 21:14	3,97	1	3,97	CHI
20191293844	CAIAPONIA	CP12338830	CAIAPONIA	12/12/2019 17:16	14/12/2019 12:23	12/12/2019 17:16	13/12/2019 12:04	18,80	2	37,59	CHI
20191293844	CAIAPONIA	CP12338830	CAIAPONIA	12/12/2019 17:16	14/12/2019 12:23	12/12/2019 17:16	14/12/2019 00:02	30,77	3	92,30	CHI
20191293844	CAIAPONIA	CP12338830	CAIAPONIA	12/12/2019 17:16	14/12/2019 12:23	12/12/2019 17:16	14/12/2019 12:23	43,12	5	215,62	CHI
20191293852	HIDROLANDIA	HD21269343	PONTALINA	12/12/2019 17:16	13/12/2019 11:37	12/12/2019 17:16	13/12/2019 11:37	18,34	1	18,34	CHI
20191293865	SILVANIA	660036988	VIANOPOLIS	12/12/2019 17:19	13/12/2019 09:39	12/12/2019 17:19	13/12/2019 09:39	16,33	1	16,33	CHI
20191295088	ITUMBIARA	IT12222577	ITUMBIARA VELHA S1	12/12/2019 17:20	12/12/2019 21:56	12/12/2019 17:20	12/12/2019 21:56	4,59	58	266,19	CHI
20191293878	NIQUELANDIA	NQ21203463	NIQUELANDIA SUBTRANSMISSAO	12/12/2019 17:22	12/12/2019 20:43	12/12/2019 17:22	12/12/2019 20:43	3,35	2	6,69	CHI
20191293886	SILVANIA	SV21100438	VIANOPOLIS	12/12/2019 17:23	13/12/2019 10:43	12/12/2019 17:23	13/12/2019 10:43	17,32	2	34,64	CHI
20191293895	LUZIANIA	120028967	RIO VERMELHO	12/12/2019 17:25	12/12/2019 20:14	12/12/2019 17:25	12/12/2019 20:14	2,80	1	2,80	CHI
20191294026	JATAI	RV12222009	CABRIUVA S2	12/12/2019 17:25	13/12/2019 08:10	12/12/2019 17:25	13/12/2019 08:10	14,75	6	88,50	CHI
20191294026	RIO VERDE	RV12222009	CABRIUVA S2	12/12/2019 17:25	13/12/2019 08:10	12/12/2019 17:25	13/12/2019 08:10	14,75	21	309,74	CHI
20191293900	JATAI	JT21358123	JATAI S1	12/12/2019 17:26	13/12/2019 16:23	12/12/2019 17:26	13/12/2019 16:23	22,93	1	22,93	CHI
20191294001	PIRES DO RIO	PZ12000510	PIRES DO RIO S2	12/12/2019 17:27	12/12/2019 20:56	12/12/2019 17:27	12/12/2019 20:56	3,49	1	3,49	CHI
20191294001	SANTA CRUZ DE GOIAS	PZ12000510	PIRES DO RIO S2	12/12/2019 17:27	12/12/2019 20:56	12/12/2019 17:27	12/12/2019 20:56	3,49	16	55,82	CHI
20191294003	CRISTALINA	1060039920	CRISTALINA S1	12/12/2019 17:27	13/12/2019 01:31	12/12/2019 17:27	13/12/2019 01:31	8,06	1	8,06	CHI
20191294009	NIQUELANDIA	2750109687	NIQUELANDIA SUBTRANSMISSAO	12/12/2019 17:28	12/12/2019 18:31	12/12/2019 17:28	12/12/2019 18:31	1,03	1	1,03	CHI
20191294010	ABADIANIA	AA21302298	ANAPOLIS UNIVERSITARIO S1	12/12/2019 17:29	12/12/2019 20:52	12/12/2019 17:29	12/12/2019 20:52	3,38	1	3,38	CHI
20191294011	PORTELANDIA	PW12205299	PARQUE DAS EMAS	12/12/2019 17:29	14/12/2019 16:30	12/12/2019 17:29	14/12/2019 16:30	47,01	10	470,09	CHI
20191294019	NIQUELANDIA	NQ21239311	NIQUELANDIA SUBTRANSMISSAO	12/12/2019 17:31	12/12/2019 19:22	12/12/2019 17:31	12/12/2019 19:22	1,85	1	1,85	CHI
20191295178	QUIRINOPOLIS	QI11018008	QUIRINOPOLIS	12/12/2019 17:32	13/12/2019 05:26	12/12/2019 17:32	13/12/2019 05:26	11,90	83	987,58	CHI
20191294029	ESTRELA DO NORTE	ET12256551	MARA ROSA	12/12/2019 17:33	13/12/2019 09:48	12/12/2019 17:33	13/12/2019 09:48	16,24	9	146,20	CHI
20191294036	GUARANI DE GOIAS	GY11242637	SAO DOMINGOS	12/12/2019 17:34	13/12/2019 08:41	12/12/2019 17:34	13/12/2019 08:41	15,11	2	30,22	CHI
20191294040	SAO SIMAO	SO21000015	CACHOEIRA ALTA	12/12/2019 17:35	13/12/2019 00:05	12/12/2019 17:35	13/12/2019 00:05	6,50	1	6,50	CHI

20191294064	VICENTINOPOLIS	VI12263852	VICENTINOPOLIS	12/12/2019 17:35	13/12/2019 19:00	12/12/2019 17:35	12/12/2019 22:31	4,92	8	39,35	CHI
20191294064	VICENTINOPOLIS	VI12263852	VICENTINOPOLIS	12/12/2019 17:35	13/12/2019 19:00	12/12/2019 22:32	13/12/2019 19:00	20,47	8	163,78	CHI
20191294046	ANAPOLIS	AN21258610	ANAPOLIS UNIVERSITARIO S2	12/12/2019 17:36	12/12/2019 20:09	12/12/2019 17:36	12/12/2019 20:09	2,54	1	2,54	CHI
20191294047	CHAPADAO DO CEU	DJ21205184	CHAPADAO DO CEU	12/12/2019 17:36	13/12/2019 17:03	12/12/2019 17:36	13/12/2019 17:03	23,44	1	23,44	CHI
20191294053	GOIANIA	13121900	CARAJAS S1	12/12/2019 17:37	13/12/2019 08:51	12/12/2019 17:37	13/12/2019 08:51	15,23	1	15,23	CHI
20191294056	GOIANIA	GN11244786	FERROVIARIO S1	12/12/2019 17:37	13/12/2019 09:30	12/12/2019 17:37	13/12/2019 09:30	15,87	12	190,49	CHI
20191294696	HIDROLANDIA	6421705	PIRACANJUBA	12/12/2019 17:37	13/12/2019 02:17	12/12/2019 17:37	13/12/2019 02:17	8,68	15	130,17	CHI
20191294696	PIRACANJUBA	6421705	PIRACANJUBA	12/12/2019 17:37	13/12/2019 02:17	12/12/2019 17:37	13/12/2019 02:17	8,68	277	2403,90	CHI
20191294696	PROFESSOR JAMIL SAFADY	6421705	PIRACANJUBA	12/12/2019 17:37	13/12/2019 02:17	12/12/2019 17:37	13/12/2019 02:17	8,68	13	112,82	CHI
20191295326	AGUA FRIA DE GOIAS	NQ12140182	SAO JOAO D ALIANCA	12/12/2019 17:37	12/12/2019 23:00	12/12/2019 17:37	12/12/2019 23:00	5,38	69	371,28	CHI
20191295326	NIQUELANDIA	NQ12140182	SAO JOAO D ALIANCA	12/12/2019 17:37	12/12/2019 23:00	12/12/2019 17:37	12/12/2019 23:00	5,38	6	32,29	CHI
20191294059	RIO VERDE	RV21361093	RIO VERDE S1	12/12/2019 17:38	13/12/2019 08:59	12/12/2019 17:38	13/12/2019 08:59	15,35	1	15,35	CHI
20191294060	PADRE BERNARDO	PI12099216	PLANALTINA	12/12/2019 17:38	12/12/2019 22:17	12/12/2019 17:38	12/12/2019 22:17	4,65	14	65,08	CHI
20191294060	PLANALTINA	PI12099216	PLANALTINA	12/12/2019 17:38	12/12/2019 22:17	12/12/2019 17:38	12/12/2019 22:17	4,65	109	506,67	CHI
20191295322	COLINAS DO SUL	TI11116081	MINACU	12/12/2019 17:38	13/12/2019 00:00	12/12/2019 17:38	13/12/2019 00:00	6,36	57	362,42	CHI
20191295450	MINEIROS	MY12360840	PARQUE DAS EMAS	12/12/2019 17:38	13/12/2019 15:36	12/12/2019 17:38	13/12/2019 15:36	21,96	20	439,11	CHI
20191293008	MAURILANDIA	ML21046731	RIO DOS BOIS	12/12/2019 17:39	13/12/2019 09:16	12/12/2019 17:39	13/12/2019 09:16	15,60	1	15,60	CHI
20191294387	PORTELANDIA	PW11045395	PARQUE DAS EMAS	12/12/2019 17:39	13/12/2019 14:00	13/12/2019 02:08	13/12/2019 14:00	11,87	111	1317,23	CHI
20191294074	PARANAIGUARA	PC21214453	QUIRINOPOLIS	12/12/2019 17:40	13/12/2019 11:00	12/12/2019 17:40	13/12/2019 11:00	17,33	1	17,33	CHI
20191294079	CUMARI	CT21266250	CATALAO S2	12/12/2019 17:41	13/12/2019 15:35	12/12/2019 17:41	13/12/2019 15:35	21,91	2	43,81	CHI
20191294084	CATALAO	CT21215505	CATALAO S1	12/12/2019 17:42	12/12/2019 23:54	12/12/2019 17:42	12/12/2019 23:54	6,19	2	12,38	CHI
20191294088	BOM JESUS DE GOIAS	10020967126	BOM JESUS DE GOIAS	12/12/2019 17:43	12/12/2019 23:43	12/12/2019 17:43	12/12/2019 23:43	5,99	1	5,99	CHI
20191294090	SILVANIA	SV12205351	VIANOPOLIS	12/12/2019 17:43	12/12/2019 21:30	12/12/2019 17:44	12/12/2019 21:30	3,78	64	241,60	CHI
20191294099	NEROPOLIS	NR21010105	NEROPOLIS S2	12/12/2019 17:45	13/12/2019 07:10	12/12/2019 17:45	13/12/2019 07:10	13,41	6	80,43	CHI
20191294202	ANAPOLIS	00050244	ANAPOLIS UNIVERSITARIO S2	12/12/2019 17:45	13/12/2019 04:07	12/12/2019 17:45	12/12/2019 17:50	0,08	3180	269,42	CHI
20191294202	ANAPOLIS	00050244	ANAPOLIS UNIVERSITARIO S2	12/12/2019 17:45	13/12/2019 04:07	12/12/2019 17:45	12/12/2019 17:52	0,11	3690	394,63	CHI
20191294202	CAMPO LIMPO	00050244	ANAPOLIS UNIVERSITARIO S2	12/12/2019 17:45	13/12/2019 04:07	12/12/2019 17:45	12/12/2019 17:52	0,11	7	0,75	CHI
20191294202	ANAPOLIS	00050244	ANAPOLIS UNIVERSITARIO S2	12/12/2019 17:45	13/12/2019 04:07	12/12/2019 17:45	12/12/2019 17:53	0,13	1279	172,31	CHI
20191294202	CAMPO LIMPO	00050244	ANAPOLIS UNIVERSITARIO S2	12/12/2019 17:45	13/12/2019 04:07	12/12/2019 17:45	12/12/2019 17:53	0,13	10	1,35	CHI
20191294202	PIRENOPOLIS	00050244	ANAPOLIS UNIVERSITARIO S2	12/12/2019 17:45	13/12/2019 04:07	12/12/2019 17:45	12/12/2019 17:53	0,13	54	7,28	CHI
20191294202	ANAPOLIS	AN16407972	ANAPOLIS UNIVERSITARIO S2	12/12/2019 17:45	13/12/2019 04:07	12/12/2019 17:54	12/12/2019 19:09	1,25	133	165,70	CHI
20191294202	CAMPO LIMPO	AN16407972	ANAPOLIS UNIVERSITARIO S2	12/12/2019 17:45	13/12/2019 04:07	12/12/2019 17:54	12/12/2019 19:09	1,25	2	2,49	CHI
20191294202	ANAPOLIS	00050244	ANAPOLIS UNIVERSITARIO S2	12/12/2019 17:45	13/12/2019 04:07	12/12/2019 19:20	12/12/2019 19:24	0,07	6730	448,67	CHI

20191294202	CAMPO LIMPO	00050244	ANAPOLIS UNIVERSITARIO S2	12/12/2019 17:45	13/12/2019 04:07	12/12/2019 19:20	12/12/2019 19:24	0,07	5	0,33	CHI
20191294202	ABADIANIA	00050244	ANAPOLIS UNIVERSITARIO S2	12/12/2019 17:45	13/12/2019 04:07	12/12/2019 17:45	12/12/2019 20:03	2,29	17	38,88	CHI
20191294202	ANAPOLIS	00050244	ANAPOLIS UNIVERSITARIO S2	12/12/2019 17:45	13/12/2019 04:07	12/12/2019 17:45	12/12/2019 20:03	2,29	162	370,49	CHI
20191294202	PIRENOPOLIS	00050244	ANAPOLIS UNIVERSITARIO S2	12/12/2019 17:45	13/12/2019 04:07	12/12/2019 17:45	12/12/2019 20:03	2,29	29	66,32	CHI
20191294202	ANAPOLIS	AN16407972	ANAPOLIS UNIVERSITARIO S2	12/12/2019 17:45	13/12/2019 04:07	12/12/2019 17:54	12/12/2019 20:03	2,14	1146	2447,35	CHI
20191294202	CAMPO LIMPO	AN16407972	ANAPOLIS UNIVERSITARIO S2	12/12/2019 17:45	13/12/2019 04:07	12/12/2019 17:54	12/12/2019 20:03	2,14	8	17,08	CHI
20191294202	PIRENOPOLIS	AN16407972	ANAPOLIS UNIVERSITARIO S2	12/12/2019 17:45	13/12/2019 04:07	12/12/2019 17:54	12/12/2019 20:03	2,14	54	115,32	CHI
20191294202	ANAPOLIS	AN16407972	ANAPOLIS UNIVERSITARIO S2	12/12/2019 17:45	13/12/2019 04:07	12/12/2019 19:20	12/12/2019 20:03	0,72	57	40,95	CHI
20191294202	ANAPOLIS	AN12370313LD	ANAPOLIS UNIVERSITARIO S2	12/12/2019 17:45	13/12/2019 04:07	12/12/2019 19:20	13/12/2019 04:07	8,78	76	667,55	CHI
20191294202	CAMPO LIMPO	AN12370313LD	ANAPOLIS UNIVERSITARIO S2	12/12/2019 17:45	13/12/2019 04:07	12/12/2019 19:20	13/12/2019 04:07	8,78	2	17,57	CHI
20191294305	RIO VERDE	RV12032004	RIO VERDE S1	12/12/2019 17:46	13/12/2019 09:02	12/12/2019 17:46	13/12/2019 09:02	15,25	2	30,51	CHI
20191295159	ITABERAI	IB12304486	ANICUNS	12/12/2019 17:46	12/12/2019 20:26	12/12/2019 17:46	12/12/2019 20:26	2,66	56	149,08	CHI
20191295159	MOSSAMEDES	IB12304486	ANICUNS	12/12/2019 17:46	12/12/2019 20:26	12/12/2019 17:46	12/12/2019 20:26	2,66	4	10,65	CHI
20191294308	APARECIDA DE GOIANIA	14110131	REAL S1	12/12/2019 17:47	12/12/2019 19:14	12/12/2019 17:47	12/12/2019 19:14	1,44	1	1,44	CHI
20191294310	ARAGUAPAZ	AZ21042940	MOZARLANDIA	12/12/2019 17:47	12/12/2019 22:00	12/12/2019 17:47	12/12/2019 22:00	4,21	1	4,21	CHI
20191294396	CATALAO	CT12215632	CATALAO S1	12/12/2019 17:47	13/12/2019 14:41	12/12/2019 17:47	13/12/2019 14:41	20,90	6	125,38	CHI
20191294316	RIO VERDE	RV21213395	MONTIVIDIU T	12/12/2019 17:48	13/12/2019 08:32	12/12/2019 17:48	13/12/2019 08:32	14,74	1	14,74	CHI
20191294348	ITABERAI	IB12116148	ITABERAI S1	12/12/2019 17:48	12/12/2019 21:19	12/12/2019 17:48	12/12/2019 21:19	3,51	7	24,59	CHI
20191294366	ANICUNS	AC12000067	ANICUNS	12/12/2019 17:48	12/12/2019 20:56	12/12/2019 17:48	12/12/2019 20:56	3,12	15	46,75	CHI
20191294618	GOIANESIA	GE12357338	GOIANESIA S2	12/12/2019 17:48	12/12/2019 20:05	12/12/2019 17:48	12/12/2019 20:05	2,28	14	31,90	CHI
20191294450	NEROPOLIS	NR11271853	NEROPOLIS S2	12/12/2019 17:49	13/12/2019 00:33	12/12/2019 17:49	13/12/2019 00:33	6,73	154	1036,81	CHI
20191294333	TAQUARAL DE GOIAS	I121222094	ITABERAI S1	12/12/2019 17:50	12/12/2019 22:47	12/12/2019 17:50	12/12/2019 22:47	4,94	2	9,89	CHI
20191294346	CAMPOS VERDES	VD12253107	SANTA TEREZINHA	12/12/2019 17:52	12/12/2019 21:12	12/12/2019 17:52	12/12/2019 21:12	3,32	4	13,29	CHI
20191294412	CAMPO LIMPO	AN10395369	NEROPOLIS S1	12/12/2019 17:52	13/12/2019 05:46	12/12/2019 17:52	12/12/2019 19:53	2,01	10	20,06	CHI
20191294412	CAMPO LIMPO	AN10395369	NEROPOLIS S1	12/12/2019 17:52	13/12/2019 05:46	12/12/2019 20:03	12/12/2019 20:23	0,33	10	3,31	CHI
20191294412	CAMPO LIMPO	AN10395369	NEROPOLIS S1	12/12/2019 17:52	13/12/2019 05:46	12/12/2019 22:49	12/12/2019 23:17	0,47	10	4,66	CHI
20191294412	ANAPOLIS	AN10395369	NEROPOLIS S1	12/12/2019 17:52	13/12/2019 05:46	12/12/2019 17:52	13/12/2019 05:46	11,88	441	5240,79	CHI
20191294412	CAMPO LIMPO	AN10395369	NEROPOLIS S1	12/12/2019 17:52	13/12/2019 05:46	12/12/2019 17:52	13/12/2019 05:46	11,88	74	879,41	CHI
20191294412	NEROPOLIS	AN10395369	NEROPOLIS S1	12/12/2019 17:52	13/12/2019 05:46	12/12/2019 17:52	13/12/2019 05:46	11,88	1	11,88	CHI
20191294412	TEREZOPOLIS DE GOIAS	AN10395369	NEROPOLIS S1	12/12/2019 17:52	13/12/2019 05:46	12/12/2019 17:52	13/12/2019 05:46	11,88	10	118,84	CHI
20191294349	IVOLANDIA	IV12026654LD	IPORA	12/12/2019 17:53	13/12/2019 10:43	12/12/2019 17:53	13/12/2019 10:43	16,83	18	302,96	CHI
20191294351	ANICUNS	AC21251393	ANICUNS	12/12/2019 17:53	12/12/2019 21:33	12/12/2019 17:53	12/12/2019 21:33	3,66	2	7,32	CHI
20191294353	BALIZA	BH12331446	CAIAPONIA	12/12/2019 17:53	13/12/2019 11:34	12/12/2019 17:53	13/12/2019 11:34	17,68	9	159,08	CHI

20191295825	SERRANOPOLIS	SX12071498	JATAI S1	12/12/2019 17:53	12/12/2019 22:05	12/12/2019 17:53	12/12/2019 22:05	4,20	669	2807,01	CHI
20191294363	VILA BOA	FA21120361	ITIQUEIRA	12/12/2019 17:54	13/12/2019 12:30	12/12/2019 17:54	13/12/2019 12:30	18,59	1	18,59	CHI
20191294365	MINEIROS	MY12348865	PARQUE DAS EMAS	12/12/2019 17:54	13/12/2019 13:00	12/12/2019 17:54	13/12/2019 13:00	19,08	1	19,08	CHI
20191294434	GOIAS	IK12250614	ITAPURANGA	12/12/2019 17:55	13/12/2019 20:55	12/12/2019 17:55	13/12/2019 14:25	20,51	1	20,51	CHI
20191294434	GUARAITA	IK12250614	ITAPURANGA	12/12/2019 17:55	13/12/2019 20:55	12/12/2019 17:55	13/12/2019 14:25	20,51	4	82,02	CHI
20191294434	ITAPURANGA	IK12250614	ITAPURANGA	12/12/2019 17:55	13/12/2019 20:55	12/12/2019 17:55	13/12/2019 14:25	20,51	5	102,53	CHI
20191294434	ITAPURANGA	IK12250614	ITAPURANGA	12/12/2019 17:55	13/12/2019 20:55	13/12/2019 10:56	13/12/2019 14:25	3,49	1	3,49	CHI
20191294434	GOIAS	IK12250614	ITAPURANGA	12/12/2019 17:55	13/12/2019 20:55	12/12/2019 17:55	13/12/2019 20:55	26,99	1	26,99	CHI
20191294434	GUARAITA	IK12250614	ITAPURANGA	12/12/2019 17:55	13/12/2019 20:55	12/12/2019 17:55	13/12/2019 20:55	26,99	13	350,87	CHI
20191294434	ITAPURANGA	IK12250614	ITAPURANGA	12/12/2019 17:55	13/12/2019 20:55	12/12/2019 17:55	13/12/2019 20:55	26,99	14	377,86	CHI
20191294434	GOIAS	IK12250614	ITAPURANGA	12/12/2019 17:55	13/12/2019 20:55	13/12/2019 19:15	13/12/2019 20:55	1,67	1	1,67	CHI
20191294434	GUARAITA	IK12250614	ITAPURANGA	12/12/2019 17:55	13/12/2019 20:55	13/12/2019 19:15	13/12/2019 20:55	1,67	4	6,66	CHI
20191294434	ITAPURANGA	IK12250614	ITAPURANGA	12/12/2019 17:55	13/12/2019 20:55	13/12/2019 19:15	13/12/2019 20:55	1,67	6	10,00	CHI
20191296932	ITAPURANGA	IK12157850	ITAPURANGA	12/12/2019 17:55	13/12/2019 10:08	12/12/2019 17:55	13/12/2019 10:08	16,21	7	113,48	CHI
20191294376	IVOLANDIA	IV12223012	IPORA	12/12/2019 17:56	13/12/2019 12:55	12/12/2019 17:56	13/12/2019 12:55	18,98	11	208,79	CHI
20191295314	GOIANIA	GN11041777	FERROVIARIO S1	12/12/2019 17:57	12/12/2019 21:17	12/12/2019 17:57	12/12/2019 21:17	3,32	36	119,49	CHI
20191294392	CACU	CC21193943	CACHOEIRA ALTA	12/12/2019 17:58	13/12/2019 13:27	12/12/2019 17:58	13/12/2019 13:27	19,48	1	19,48	CHI
20191294399	PALESTINA DE GOIAS	PY21087139	PALESTINA	12/12/2019 17:59	13/12/2019 10:23	12/12/2019 17:59	13/12/2019 10:23	16,40	1	16,40	CHI
20191294405	ITUMBIARA	IT11263771	ITUMBIARA NOVA	12/12/2019 18:00	13/12/2019 02:01	12/12/2019 18:00	13/12/2019 02:01	8,03	151	1212,78	CHI
20191294409	GOIATUBA	140054145	GOIATUBA S2	12/12/2019 18:00	12/12/2019 19:59	12/12/2019 18:00	12/12/2019 19:59	1,97	1	1,97	CHI
20191294410	CRISTALINA	10029179970	CRISTALINA S1	12/12/2019 18:00	13/12/2019 00:55	12/12/2019 18:00	13/12/2019 00:55	6,90	1	6,90	CHI
20191295139	SENADOR CANEDO	SW12055861	CEPAIGO S1	12/12/2019 18:00	12/12/2019 19:43	12/12/2019 18:00	12/12/2019 19:43	1,71	103	176,16	CHI
20191294424	ACREUNA	2440046390	ACREUNA	12/12/2019 18:02	13/12/2019 00:14	12/12/2019 18:02	13/12/2019 00:14	6,19	1	6,19	CHI
20191294427	NIQUELANDIA	2750054420	NIQUELANDIA SUBTRANSMISSAO	12/12/2019 18:02	12/12/2019 19:13	12/12/2019 18:02	12/12/2019 19:13	1,17	1	1,17	CHI
20191294432	COLINAS DO SUL	TI21138256	MINACU	12/12/2019 18:03	13/12/2019 08:36	12/12/2019 18:03	13/12/2019 08:36	14,54	1	14,54	CHI
20191295323	GOIAS	IK12274567	GOIAS	12/12/2019 18:03	14/12/2019 20:19	12/12/2019 18:03	14/12/2019 20:19	50,25	5	251,25	CHI
20191294439	SAO LUIS DE MONTES BELOS	SL12259113	SAO LUIZ DOS MONTES BELOS	12/12/2019 18:04	12/12/2019 21:50	12/12/2019 18:04	12/12/2019 21:50	3,76	3	11,29	CHI
20191294445	NOVO GAMA	4990063042	PACAEMBU S1	12/12/2019 18:05	12/12/2019 20:02	12/12/2019 18:05	12/12/2019 20:02	1,95	1	1,95	CHI
20191297186	INACIOLANDIA	ID32128272	QUIRINOPOLIS	12/12/2019 18:05	13/12/2019 09:58	12/12/2019 18:05	13/12/2019 09:58	15,87	8	126,97	CHI
20191294455	SANTA HELENA DE GOIAS	SH21213489	RIO DOS BOIS	12/12/2019 18:06	13/12/2019 08:50	12/12/2019 18:06	13/12/2019 08:50	14,73	1	14,73	CHI
20191294461	GUAPO	GA12000016	GUAPO S1	12/12/2019 18:06	13/12/2019 10:30	12/12/2019 18:06	13/12/2019 10:30	16,40	15	246,00	CHI
20191297713	QUIRINOPOLIS	QI21230973	QUIRINOPOLIS	12/12/2019 18:06	14/12/2019 10:37	12/12/2019 18:06	14/12/2019 10:37	40,51	1	40,51	CHI
20191294464	INHUMAS	30103861	INHUMAS S2	12/12/2019 18:07	13/12/2019 08:17	12/12/2019 18:07	13/12/2019 08:17	14,18	1	14,18	CHI

20191294465	MORRINHOS	MR21128641	MORRINHOS	12/12/2019 18:07	13/12/2019 07:59	12/12/2019 18:07	13/12/2019 07:59	13,86	1	13,86	CHI
20191294472	NAZARIO	440020300	ANICUNS	12/12/2019 18:08	13/12/2019 07:51	12/12/2019 18:08	13/12/2019 07:51	13,72	1	13,72	CHI
20191295416	PORTELANDIA	PW11234349	PARQUE DAS EMAS	12/12/2019 18:08	13/12/2019 04:12	12/12/2019 18:08	13/12/2019 04:12	10,05	80	804,13	CHI
20191294477	GOIANIA	10030732105	GOYA S2	12/12/2019 18:09	13/12/2019 12:40	12/12/2019 18:09	13/12/2019 12:40	18,50	0	0,00	CHI
20191294479	CATALAO	CT21268400	CATALAO S1	12/12/2019 18:10	12/12/2019 20:26	12/12/2019 18:10	12/12/2019 20:26	2,27	1	2,27	CHI
20191294481	ITUMBIARA	10011024591	ITUMBIARA NOVA	12/12/2019 18:10	12/12/2019 20:59	12/12/2019 18:10	12/12/2019 20:59	2,81	1	2,81	CHI
20191295032	CAMPO LIMPO	AN12011924	NEROPOLIS S1	12/12/2019 18:13	12/12/2019 21:55	12/12/2019 18:13	12/12/2019 21:55	3,69	47	173,39	CHI
20191294497	PALESTINA DE GOIAS	PY12374893	PALESTINA	12/12/2019 18:14	13/12/2019 11:51	12/12/2019 18:14	13/12/2019 11:51	17,61	8	140,88	CHI
20191294601	ITABERAI	IB12099042	ITABERAI S1	12/12/2019 18:14	12/12/2019 20:54	12/12/2019 18:14	12/12/2019 20:54	2,66	1	2,66	CHI
20191294605	ITABERAI	IB21105967	ITABERAI S1	12/12/2019 18:15	13/12/2019 08:54	12/12/2019 18:15	13/12/2019 08:54	14,64	1	14,64	CHI
20191294654	ITAPURANGA	IK12220544	ITAPURANGA	12/12/2019 18:15	13/12/2019 08:50	12/12/2019 18:15	13/12/2019 08:50	14,58	27	393,55	CHI
20191295184	JATAI	JT11092388	JATAI S2	12/12/2019 18:15	13/12/2019 04:05	12/12/2019 18:15	13/12/2019 04:05	9,82	13	127,70	CHI
20191294611	BALIZA	BH12210020	BOM JARDIM	12/12/2019 18:16	12/12/2019 21:46	12/12/2019 18:16	12/12/2019 21:46	3,49	93	324,83	CHI
20191294614	MINEIROS	10006205478	PARQUE DAS EMAS	12/12/2019 18:16	13/12/2019 00:08	12/12/2019 18:16	13/12/2019 00:08	5,85	0	0,00	CHI
20191294615	CAIAPONIA	DP21182186	JATAI S1	12/12/2019 18:16	14/12/2019 12:45	12/12/2019 18:16	14/12/2019 12:45	42,47	1	42,47	CHI
201912100269	MINEIROS	10022537528	PARQUE DAS EMAS	12/12/2019 18:16	13/12/2019 07:16	12/12/2019 18:16	13/12/2019 07:16	12,99	1	12,99	CHI
20191294620	DAVINOPOLIS	IO21127842	CATALAO S1	12/12/2019 18:17	13/12/2019 10:48	12/12/2019 18:17	13/12/2019 10:48	16,52	1	16,52	CHI
20191294625	AGUAS LINDAS DE GOIAS	LA11305234	AGUAS LINDAS DE GOIAS S2	12/12/2019 18:18	12/12/2019 19:00	12/12/2019 18:18	12/12/2019 19:00	0,69	215	149,31	CHI
20191294632	BALIZA	BH12142110	BOM JARDIM	12/12/2019 18:19	12/12/2019 21:22	12/12/2019 18:19	12/12/2019 21:22	3,03	84	254,82	CHI
20191294635	PETROLINA DE GOIAS	320000448	PETROLINA	12/12/2019 18:20	13/12/2019 09:30	12/12/2019 18:20	13/12/2019 09:30	15,17	1	15,17	CHI
20191294807	GOIANIA	GN11167866	CARAJAS S2	12/12/2019 18:22	12/12/2019 19:10	12/12/2019 18:22	12/12/2019 19:10	0,78	99	77,63	CHI
20191294658	PLANALTINA	PI11071308	PLANALTINA	12/12/2019 18:23	12/12/2019 19:37	12/12/2019 18:23	12/12/2019 19:37	1,22	27	32,92	CHI
20191294672	ANAPOLIS	21379531	JUNDIAI S2	12/12/2019 18:25	12/12/2019 20:35	12/12/2019 18:25	12/12/2019 20:35	2,16	1	2,16	CHI
20191294673	ARACU	AV12020305	ANICUNS	12/12/2019 18:25	12/12/2019 21:20	12/12/2019 18:25	12/12/2019 21:20	2,90	4	11,62	CHI
20191294673	ITABERAI	AV12020305	ANICUNS	12/12/2019 18:25	12/12/2019 21:20	12/12/2019 18:25	12/12/2019 21:20	2,90	17	49,38	CHI
20191294673	ARACU	AV12020305	ANICUNS	12/12/2019 18:25	12/12/2019 21:20	12/12/2019 19:04	12/12/2019 21:20	2,27	9	20,40	CHI
20191294673	AVELINOPOLIS	AV12020305	ANICUNS	12/12/2019 18:25	12/12/2019 21:20	12/12/2019 19:04	12/12/2019 21:20	2,27	176	398,98	CHI
20191294673	ITABERAI	AV12020305	ANICUNS	12/12/2019 18:25	12/12/2019 21:20	12/12/2019 19:04	12/12/2019 21:20	2,27	2	4,53	CHI
20191294673	SANTA BARBARA DE GOIAS	AV12020305	ANICUNS	12/12/2019 18:25	12/12/2019 21:20	12/12/2019 19:04	12/12/2019 21:20	2,27	8	18,14	CHI
20191295014	IPAMERI	IP12027099RE	PIRES DO RIO S2	12/12/2019 18:25	13/12/2019 10:09	12/12/2019 18:25	13/12/2019 10:09	15,73	12	188,80	CHI
20191294674	MINEIROS	PW12045348	PARQUE DAS EMAS	12/12/2019 18:26	13/12/2019 13:45	12/12/2019 18:26	13/12/2019 13:45	19,31	5	96,57	CHI
20191294674	PORTELANDIA	PW12045348	PARQUE DAS EMAS	12/12/2019 18:26	13/12/2019 13:45	12/12/2019 18:26	13/12/2019 13:45	19,31	12	231,76	CHI
20191294679	JATAI	JT12182064	JATAI S1	12/12/2019 18:27	13/12/2019 08:52	12/12/2019 18:27	13/12/2019 08:52	14,42	5	72,08	CHI

20191294686	PARANAIGUARA	PC21204116	QUIRINOPOLIS	12/12/2019 18:27	13/12/2019 09:45	12/12/2019 18:27	13/12/2019 09:45	15,28	1	15,28	CHI
20191294849	INHUMAS	IN11146598	INHUMAS S2	12/12/2019 18:27	13/12/2019 05:26	12/12/2019 18:27	13/12/2019 05:26	10,99	90	989,42	CHI
20191294690	DAVINOPOLIS	IO21085111	CATALAO S1	12/12/2019 18:28	13/12/2019 10:49	12/12/2019 18:28	13/12/2019 10:49	16,36	1	16,36	CHI
20191294838	GAMELEIRA DE GOIAS	SV12070048	DAIA S2	12/12/2019 18:28	12/12/2019 23:31	12/12/2019 18:28	12/12/2019 23:31	5,04	1	5,04	CHI
20191294838	SILVANIA	SV12070048	DAIA S2	12/12/2019 18:28	12/12/2019 23:31	12/12/2019 18:28	12/12/2019 23:31	5,04	15	75,59	CHI
20191295077	POSSE	PS11000007	IACIARA S2	12/12/2019 18:28	12/12/2019 21:33	12/12/2019 18:28	12/12/2019 21:33	3,08	155	477,31	CHI
20191294698	GOIANIA	GN12043700	GOIANIA LESTE S3	12/12/2019 18:29	12/12/2019 20:41	12/12/2019 18:29	12/12/2019 20:41	2,19	15	32,92	CHI
20191294700	CALDAZINHA	DE21279279	CEPAIGO S2	12/12/2019 18:29	13/12/2019 10:46	12/12/2019 18:29	13/12/2019 10:46	16,27	2	32,53	CHI
20191294802	GOIANIA	10629051	AEROPORTO S2	12/12/2019 18:30	13/12/2019 11:31	12/12/2019 18:30	13/12/2019 11:31	17,02	1	17,02	CHI
20191294805	CAMPINACU	UC12285921	PORANGATU	12/12/2019 18:30	12/12/2019 22:20	12/12/2019 18:30	12/12/2019 22:20	3,83	39	149,21	CHI
20191294806	QUIRINOPOLIS	QI12000060	QUIRINOPOLIS	12/12/2019 18:30	13/12/2019 15:59	12/12/2019 18:30	13/12/2019 15:59	21,47	8	171,77	CHI
20191294810	MONTES CLAROS DE GOIAS	ME12204928	IPORA	12/12/2019 18:31	12/12/2019 20:44	12/12/2019 18:31	12/12/2019 20:44	2,21	3	6,64	CHI
20191294812	SANTO ANTONIO DO DESCOBERTO	2210195105	AGUAS LINDAS DE GOIAS S2	12/12/2019 18:31	12/12/2019 21:40	12/12/2019 18:31	12/12/2019 21:40	3,15	1	3,15	CHI
20191294813	INHUMAS	IN21047643	INHUMAS S2	12/12/2019 18:31	13/12/2019 12:13	12/12/2019 18:31	13/12/2019 12:13	17,70	1	17,70	CHI
20191294814	MORRINHOS	150098947	MORRINHOS	12/12/2019 18:31	13/12/2019 11:38	12/12/2019 18:31	13/12/2019 11:38	17,10	1	17,10	CHI
20191294816	GOIATUBA	GT12049677	GOIATUBA S2	12/12/2019 18:31	12/12/2019 22:50	12/12/2019 18:31	12/12/2019 22:50	4,30	2	8,61	CHI
20191294816	MORRINHOS	GT12049677	GOIATUBA S2	12/12/2019 18:31	12/12/2019 22:50	12/12/2019 18:31	12/12/2019 22:50	4,30	4	17,21	CHI
20191294820	TRINDADE	40320224	GOYA S1	12/12/2019 18:33	12/12/2019 20:30	12/12/2019 18:33	12/12/2019 20:30	1,95	1	1,95	CHI
20191294823	ANAPOLIS	AN21267876	ANAPOLIS UNIVERSITARIO S2	12/12/2019 18:33	13/12/2019 01:25	12/12/2019 18:33	13/12/2019 01:25	6,86	5	34,28	CHI
20191294825	CALDAS NOVAS	CN21354119	VILA CORUMBA	12/12/2019 18:33	13/12/2019 10:25	12/12/2019 18:33	13/12/2019 10:25	15,85	1	15,85	CHI
20191294829	URUACU	UR12405401	MARA ROSA	12/12/2019 18:34	13/12/2019 03:54	12/12/2019 18:34	13/12/2019 03:54	9,33	1	9,33	CHI
20191294833	JATAI	290201925	JATAI S2	12/12/2019 18:35	13/12/2019 11:09	12/12/2019 18:35	13/12/2019 11:09	16,56	1	16,56	CHI
20191294836	MINACU	4020004421	MINACU	12/12/2019 18:35	12/12/2019 21:10	12/12/2019 18:35	12/12/2019 21:10	2,57	1	2,57	CHI
20191294837	SANTA RITA DO NOVO DESTINO	BA21070652	BARRO ALTO	12/12/2019 18:36	12/12/2019 23:20	12/12/2019 18:36	12/12/2019 23:20	4,73	1	4,73	CHI
20191294842	CORUMBA DE GOIAS	CB11351483	CORUMBA	12/12/2019 18:36	12/12/2019 22:35	12/12/2019 18:36	12/12/2019 22:35	3,97	47	186,69	CHI
20191294845	MINEIROS	10015818797	PARQUE DAS EMAS	12/12/2019 18:37	13/12/2019 11:42	12/12/2019 18:37	13/12/2019 11:42	17,08	1	17,08	CHI
20191294847	PLANALTINA	PI21149426	PLANALTINA	12/12/2019 18:37	13/12/2019 10:49	12/12/2019 18:37	13/12/2019 10:49	16,20	1	16,20	CHI
20191294855	RIO VERDE	RV12303492	MONTIVIDIU T	12/12/2019 18:38	13/12/2019 12:37	12/12/2019 18:38	13/12/2019 12:37	17,98	19	341,59	CHI
20191294856	RIO VERDE	RV21402292	ACREUNA	12/12/2019 18:38	13/12/2019 08:17	12/12/2019 18:38	13/12/2019 08:17	13,64	1	13,64	CHI
20191295016	JATAI	JT12109029	JATAI S1	12/12/2019 18:38	14/12/2019 14:11	12/12/2019 18:38	12/12/2019 21:09	2,52	28	70,44	CHI
20191295016	JATAI	JT12260426	JATAI S1	12/12/2019 18:38	14/12/2019 14:11	13/12/2019 10:49	13/12/2019 11:26	0,61	18	11,05	CHI
20191295016	JATAI	JT12109029	JATAI S1	12/12/2019 18:38	14/12/2019 14:11	12/12/2019 21:10	14/12/2019 14:11	41,01	24	984,29	CHI
20191295016	JATAI	JT12260426	JATAI S1	12/12/2019 18:38	14/12/2019 14:11	12/12/2019 21:10	14/12/2019 14:11	41,01	4	164,05	CHI

20191295016	JATAI	JT12260426	JATAI S1	12/12/2019 18:38	14/12/2019 14:11	13/12/2019 10:49	14/12/2019 14:11	27,35	35	957,39	CHI
20191295016	JATAI	JT12260426	JATAI S1	12/12/2019 18:38	14/12/2019 14:11	14/12/2019 12:48	14/12/2019 14:11	1,38	23	31,71	CHI
20191295016	JATAI	JT12260426	JATAI S1	12/12/2019 18:38	14/12/2019 14:11	14/12/2019 13:12	14/12/2019 14:11	0,98	29	28,52	CHI
20191294866	APARECIDA DE GOIANIA	10016818049	INDEPENDENCIA S1	12/12/2019 18:39	13/12/2019 03:21	12/12/2019 18:39	13/12/2019 03:21	8,70	1	8,70	CHI
20191295137	MORRINHOS	MR12120828	MORRINHOS	12/12/2019 18:39	12/12/2019 21:37	12/12/2019 18:39	12/12/2019 21:37	2,96	8	23,72	CHI
20191294874	BARRO ALTO	BA12210722	GOIANESIA S1	12/12/2019 18:41	13/12/2019 02:56	12/12/2019 18:41	13/12/2019 02:56	8,24	3	24,73	CHI
20191294876	SANTO ANTONIO DO DESCOBERTO	10001739695	ALEXANIA	12/12/2019 18:42	12/12/2019 20:06	12/12/2019 18:42	12/12/2019 20:06	1,39	1	1,39	CHI
20191294903	GOIANIA	GN11002460	XAVANTES	12/12/2019 18:42	13/12/2019 05:34	12/12/2019 21:15	13/12/2019 01:46	4,50	1	4,50	CHI
20191294903	GOIANIA	GN13394640B	XAVANTES	12/12/2019 18:42	13/12/2019 05:34	12/12/2019 18:42	13/12/2019 05:34	10,86	1365	14825,42	CHI
20191294903	SANTO ANTONIO DE GOIAS	GN13394640B	XAVANTES	12/12/2019 18:42	13/12/2019 05:34	12/12/2019 18:42	13/12/2019 05:34	10,86	16	173,78	CHI
20191294880	QUIRINOPOLIS	QI21100535	QUIRINOPOLIS	12/12/2019 18:43	13/12/2019 12:01	12/12/2019 18:43	13/12/2019 12:01	17,30	1	17,30	CHI
20191294881	MONTES CLAROS DE GOIAS	ME12088949	IPORA	12/12/2019 18:43	12/12/2019 22:40	12/12/2019 18:43	12/12/2019 22:40	3,95	49	193,36	CHI
20191294885	ITARUMA	IJ21143252	ITAJA S2	12/12/2019 18:43	13/12/2019 15:34	12/12/2019 18:43	13/12/2019 15:34	20,84	1	20,84	CHI
20191294886	CUMARI	CY21000307	CATALAO S1	12/12/2019 18:43	13/12/2019 15:46	12/12/2019 18:43	13/12/2019 15:46	21,04	1	21,04	CHI
20191295035	APARECIDA DE GOIANIA	AP11081451	ANHANGUERA	12/12/2019 18:44	12/12/2019 21:01	12/12/2019 18:44	12/12/2019 21:01	2,27	105	238,41	CHI
20191294899	CATALAO	CT12061266	CATALAO S1	12/12/2019 18:45	13/12/2019 14:27	12/12/2019 18:45	13/12/2019 14:27	19,70	3	59,11	CHI
20191295002	CATALAO	CT21286301	CATALAO S1	12/12/2019 18:45	12/12/2019 20:55	12/12/2019 18:45	12/12/2019 20:55	2,16	2	4,32	CHI
20191295030	NEROPOLIS	NR12000048	NEROPOLIS S2	12/12/2019 18:45	12/12/2019 21:07	12/12/2019 18:45	12/12/2019 21:07	2,36	16	37,68	CHI
20191295310	GOIANIA	GN11052725	XAVANTES	12/12/2019 18:45	12/12/2019 23:34	12/12/2019 18:45	12/12/2019 23:34	4,81	140	673,56	CHI
20191295404	CAMPO LIMPO	CV11237591	NEROPOLIS S1	12/12/2019 18:45	13/12/2019 05:01	12/12/2019 18:45	13/12/2019 05:01	10,27	98	1006,08	CHI
20191295008	SANTO ANTONIO DO DESCOBERTO	10006303534	AGUAS LINDAS DE GOIAS S2	12/12/2019 18:46	12/12/2019 22:04	12/12/2019 18:46	12/12/2019 22:04	3,30	1	3,30	CHI
20191295256	IPORA	IR12070185	IPORA	12/12/2019 18:47	12/12/2019 21:24	12/12/2019 18:47	12/12/2019 21:24	2,60	218	567,41	CHI
20191295597	BRAZABRANTES	BR12282906	INHUMAS S2	12/12/2019 18:47	13/12/2019 18:15	12/12/2019 18:47	13/12/2019 18:15	23,47	4	93,87	CHI
20191295597	INHUMAS	BR12282906	INHUMAS S2	12/12/2019 18:47	13/12/2019 18:15	12/12/2019 18:47	13/12/2019 18:15	23,47	4	93,87	CHI
20191295024	QUIRINOPOLIS	QI21291985	QUIRINOPOLIS	12/12/2019 18:48	13/12/2019 10:07	12/12/2019 18:48	13/12/2019 10:07	15,30	1	15,30	CHI
20191295025	FORMOSA	FA12106823	ITIQUEIRA	12/12/2019 18:49	13/12/2019 14:05	12/12/2019 18:49	13/12/2019 14:05	19,27	2	38,53	CHI
20191295031	NOVA AURORA	2220007723	CATALAO S1	12/12/2019 18:49	13/12/2019 08:49	12/12/2019 18:49	13/12/2019 08:49	13,99	1	13,99	CHI
20191295866	COCALZINHO DE GOIAS	ZN12273292	COCALZINHO	12/12/2019 18:49	13/12/2019 10:52	12/12/2019 18:49	13/12/2019 10:52	16,05	4	64,18	CHI
20191295299	ANICUNS	AC12019279	ANICUNS	12/12/2019 18:52	12/12/2019 22:56	12/12/2019 18:52	12/12/2019 22:56	4,05	22	89,14	CHI
20191296009	QUIRINOPOLIS	QI32052820	QUIRINOPOLIS	12/12/2019 18:52	13/12/2019 07:38	12/12/2019 18:52	13/12/2019 07:38	12,78	9	114,98	CHI
20191295058	NOVO BRASIL	NB12396218	JUSSARA	12/12/2019 18:53	12/12/2019 22:50	12/12/2019 18:53	12/12/2019 22:50	3,94	2	7,88	CHI
20191295059	TEREZOPOLIS DE GOIAS	TJ21353279	DAIA S2	12/12/2019 18:53	13/12/2019 08:30	12/12/2019 18:53	13/12/2019 08:30	13,61	1	13,61	CHI
20191295060	GOIANDIRA	GD21237110	CATALAO S1	12/12/2019 18:53	13/12/2019 16:08	12/12/2019 18:53	13/12/2019 16:08	21,24	1	21,24	CHI

20191295066	NIQUELANDIA	NQ21264249	URUACU	12/12/2019 18:55	12/12/2019 22:36	12/12/2019 18:55	12/12/2019 22:36	3,68	1	3,68	CHI
20191295067	CACHOEIRA DOURADA	130012506	CACHOEIRA DOURADA	12/12/2019 18:55	13/12/2019 08:40	12/12/2019 18:55	13/12/2019 08:40	13,75	1	13,75	CHI
20191295283	GOIANIA	GN11271021	XAVANTES	12/12/2019 18:56	12/12/2019 23:28	12/12/2019 18:56	12/12/2019 23:28	4,53	86	389,32	CHI
20191295343	CATURAI	CK12326309	INHUMAS S1	12/12/2019 18:56	12/12/2019 20:20	12/12/2019 18:56	12/12/2019 20:20	1,39	26	36,01	CHI
20191295343	INHUMAS	CK12326309	INHUMAS S1	12/12/2019 18:56	12/12/2019 20:20	12/12/2019 18:56	12/12/2019 20:20	1,39	3	4,16	CHI
20191295294	CAMPO LIMPO	CV11272951	NEROPOLIS S1	12/12/2019 18:57	13/12/2019 03:35	12/12/2019 18:57	13/12/2019 03:35	8,62	155	1335,88	CHI
20191295092	MINEIROS	MY21252744	PARQUE DAS EMAS	12/12/2019 18:58	14/12/2019 00:10	12/12/2019 18:58	14/12/2019 00:10	29,20	1	29,20	CHI
20191295120	FORMOSA	FA12248883	ITUIQUIRA	12/12/2019 18:58	12/12/2019 21:36	12/12/2019 18:58	12/12/2019 21:36	2,63	17	44,64	CHI
20191295170	RIO VERDE	RV12191082	RIO VERDE S1	12/12/2019 18:58	13/12/2019 00:13	12/12/2019 18:58	13/12/2019 00:13	5,24	429	2248,79	CHI
20191295106	SAO MIGUEL DO ARAGUAIA	SM11000015	SAO MIGUEL DO ARAGUAIA	12/12/2019 18:59	12/12/2019 22:10	12/12/2019 18:59	12/12/2019 22:10	3,17	87	276,10	CHI
20191295110	CATALAO	CT21281466	CATALAO S1	12/12/2019 18:59	13/12/2019 08:53	12/12/2019 18:59	13/12/2019 08:53	13,89	1	13,89	CHI
20191295216	ANAPOLIS	AN11247606	JUNDIAI S2	12/12/2019 19:00	12/12/2019 20:25	12/12/2019 19:00	12/12/2019 20:25	1,42	101	143,00	CHI
20191295265	GOIANIA	GN11040772	XAVANTES	12/12/2019 19:00	13/12/2019 01:38	12/12/2019 19:00	13/12/2019 01:38	6,63	146	968,30	CHI
20191295121	JATAI	290176657	JATAI S3	12/12/2019 19:01	13/12/2019 11:34	12/12/2019 19:01	13/12/2019 11:34	16,55	1	16,55	CHI
20191295124	JATAI	JT12226497	PARQUE DAS EMAS	12/12/2019 19:02	13/12/2019 11:09	12/12/2019 19:02	13/12/2019 11:09	16,11	23	370,63	CHI
20191295124	MINEIROS	JT12226497	PARQUE DAS EMAS	12/12/2019 19:02	13/12/2019 11:09	12/12/2019 19:02	13/12/2019 11:09	16,11	1	16,11	CHI
20191295124	PEROLANDIA	JT12226497	PARQUE DAS EMAS	12/12/2019 19:02	13/12/2019 11:09	12/12/2019 19:02	13/12/2019 11:09	16,11	17	273,94	CHI
20191295191	NEROPOLIS	NR11060064	NEROPOLIS S2	12/12/2019 19:02	13/12/2019 00:33	12/12/2019 19:02	13/12/2019 00:33	5,51	113	622,91	CHI
20191295135	CATURAI	GR12033390	GOIANIRA	12/12/2019 19:03	13/12/2019 02:30	12/12/2019 19:03	13/12/2019 02:30	7,44	159	1183,05	CHI
20191295135	GOIANIRA	GR12033390	GOIANIRA	12/12/2019 19:03	13/12/2019 02:30	12/12/2019 19:03	13/12/2019 02:30	7,44	21	156,25	CHI
20191295135	INHUMAS	GR12033390	GOIANIRA	12/12/2019 19:03	13/12/2019 02:30	12/12/2019 19:03	13/12/2019 02:30	7,44	6	44,64	CHI
20191294369	GUARAITA	IK12023097	ITAPURANGA	12/12/2019 19:04	13/12/2019 08:46	12/12/2019 19:04	13/12/2019 08:46	13,69	36	492,97	CHI
20191294369	ITAPURANGA	IK12023097	ITAPURANGA	12/12/2019 19:04	13/12/2019 08:46	12/12/2019 19:04	13/12/2019 08:46	13,69	5	68,47	CHI
20191295138	CABECEIRAS	CW12108823	ITUIQUIRA	12/12/2019 19:04	12/12/2019 21:38	12/12/2019 19:04	12/12/2019 21:38	2,56	9	23,07	CHI
20191295143	FORMOSA	610163929	ITUIQUIRA	12/12/2019 19:04	12/12/2019 21:48	12/12/2019 19:04	12/12/2019 21:48	2,73	1	2,73	CHI
20191295252	GOIANIA	GN11001342	XAVANTES	12/12/2019 19:04	13/12/2019 18:03	12/12/2019 19:04	13/12/2019 18:03	22,97	102	2342,66	CHI
20191295157	ABADIANIA	AA21125344	ANAPOLIS UNIVERSITARIO S1	12/12/2019 19:06	13/12/2019 07:49	12/12/2019 19:06	13/12/2019 07:49	12,71	1	12,71	CHI
20191295197	CALDAS NOVAS	CN11160322	SERRA DE CALDAS	12/12/2019 19:07	12/12/2019 20:25	12/12/2019 19:07	12/12/2019 20:25	1,29	267	344,80	CHI
20191295174	BOM JESUS DE GOIAS	BJ21068964	BOM JESUS DE GOIAS	12/12/2019 19:09	12/12/2019 22:58	12/12/2019 19:09	12/12/2019 22:58	3,81	1	3,81	CHI
20191295728	JATAI	JT12354963	JATAI S1	12/12/2019 19:10	13/12/2019 11:14	12/12/2019 19:10	13/12/2019 11:14	16,06	8	128,47	CHI
20191295190	PADRE BERNARDO	PB21313549	PADRE BERNARDO	12/12/2019 19:11	12/12/2019 20:24	12/12/2019 19:11	12/12/2019 20:24	1,21	1	1,21	CHI
20191295193	ITABERAI	IB12000047	ITABERAI S2	12/12/2019 19:12	12/12/2019 22:14	12/12/2019 19:12	12/12/2019 22:14	3,03	9	27,29	CHI
20191295196	IVOLANDIA	AM21000016	IPORA	12/12/2019 19:12	13/12/2019 09:10	12/12/2019 19:12	13/12/2019 09:10	13,97	1	13,97	CHI

20191295204	CACU	CC21191707	CACHOEIRA ALTA	12/12/2019 19:13	13/12/2019 00:25	12/12/2019 19:13	13/12/2019 00:25	5,18	1	5,18	CHI
20191295467	RIO VERDE	RV11054044	RIO VERDE S1	12/12/2019 19:13	13/12/2019 08:23	12/12/2019 19:13	13/12/2019 08:23	13,16	78	1026,33	CHI
20191295207	GOIANIA	10006612405	MEIA PONTE	12/12/2019 19:14	13/12/2019 02:13	12/12/2019 19:14	13/12/2019 02:13	6,98	1	6,98	CHI
20191295217	JATAI	JT12331838	JATAI S2	12/12/2019 19:15	13/12/2019 10:15	12/12/2019 19:15	13/12/2019 10:15	15,01	5	75,03	CHI
20191295222	NIQUELANDIA	2750109687	NIQUELANDIA SUBTRANSMISSAO	12/12/2019 19:15	12/12/2019 20:15	12/12/2019 19:15	12/12/2019 20:15	0,99	1	0,99	CHI
20191295692	GOIANIA	GN11180108	XAVANTES	12/12/2019 19:15	13/12/2019 10:48	12/12/2019 19:15	13/12/2019 10:48	15,54	87	1351,79	CHI
20191295704	TRINDADE	TR11144789	TRINDADE	12/12/2019 19:15	13/12/2019 12:00	12/12/2019 19:15	13/12/2019 12:00	16,75	204	3417,57	CHI
20191295293	APARECIDA DE GOIANIA	AP11004883	ATLANTICO S1	12/12/2019 19:16	12/12/2019 21:55	12/12/2019 19:16	12/12/2019 21:55	2,64	80	211,38	CHI
20191295307	GOIANIA	GN12077158	GOIANIA LESTE S2	12/12/2019 19:16	12/12/2019 21:01	12/12/2019 19:16	12/12/2019 21:01	1,74	56	97,16	CHI
20191295307	SENADOR CANEDO	GN12077158	GOIANIA LESTE S2	12/12/2019 19:16	12/12/2019 21:01	12/12/2019 19:16	12/12/2019 21:01	1,74	23	39,91	CHI
20191295231	SILVANIA	660066725	VIANOPOLIS	12/12/2019 19:17	13/12/2019 08:09	12/12/2019 19:17	13/12/2019 08:09	12,85	1	12,85	CHI
20191295232	VIANOPOLIS	VN21072136	VIANOPOLIS	12/12/2019 19:17	13/12/2019 10:30	12/12/2019 19:17	13/12/2019 10:30	15,20	1	15,20	CHI
20191295234	GOIAS	GS12065881	GOIAS	12/12/2019 19:18	12/12/2019 21:55	12/12/2019 19:18	12/12/2019 21:55	2,62	1	2,62	CHI
20191295240	PIRACANJUBA	60067500	PIRACANJUBA	12/12/2019 19:18	13/12/2019 10:40	12/12/2019 19:18	13/12/2019 10:40	15,36	1	15,36	CHI
20191295245	ALTO PARAISO DE GOIAS	BF21163462	FLORES DE GOIAS	12/12/2019 19:19	12/12/2019 21:06	12/12/2019 19:19	12/12/2019 21:06	1,78	1	1,78	CHI
20191295319	GOIANIA	GN11043787	CARAJAS S2	12/12/2019 19:20	12/12/2019 23:04	12/12/2019 19:20	12/12/2019 23:04	3,73	121	451,63	CHI
20191295360	TRINDADE	TR11134052	GOYA S2	12/12/2019 19:20	13/12/2019 01:13	12/12/2019 19:20	13/12/2019 01:13	5,88	124	729,22	CHI
20191295273	IPAMERI	IP21348263	IPAMERI	12/12/2019 19:21	13/12/2019 07:22	12/12/2019 19:21	13/12/2019 07:22	12,01	1	12,01	CHI
20191295401	OUVIDOR	OU12061242RE	CATALAO S1	12/12/2019 19:22	13/12/2019 11:18	12/12/2019 19:22	13/12/2019 11:18	15,93	13	207,12	CHI
20191295287	INHUMAS	10028311629	INHUMAS S2	12/12/2019 19:23	13/12/2019 19:59	12/12/2019 19:23	13/12/2019 19:59	24,60	1	24,60	CHI
20191295295	BALIZA	BH12395431	CAIAPONIA	12/12/2019 19:23	13/12/2019 12:14	12/12/2019 19:23	13/12/2019 12:14	16,84	1	16,84	CHI
20191296557	COCALZINHO DE GOIAS	CB12060039	COCALZINHO	12/12/2019 19:24	13/12/2019 11:08	12/12/2019 19:24	13/12/2019 11:08	15,73	22	346,06	CHI
20191296557	CORUMBA DE GOIAS	CB12060039	COCALZINHO	12/12/2019 19:24	13/12/2019 11:08	12/12/2019 19:24	13/12/2019 11:08	15,73	4	62,92	CHI
20191295305	ORIZONA	OZ11241872	VIANOPOLIS	12/12/2019 19:25	13/12/2019 11:58	12/12/2019 19:25	13/12/2019 11:58	16,54	9	148,90	CHI
20191295306	NOVO GAMA	10008406535	PACAEMBU S1	12/12/2019 19:25	12/12/2019 20:48	12/12/2019 19:25	12/12/2019 20:48	1,37	1	1,37	CHI
20191295311	CAMPO LIMPO	CV12252265	NEROPOLIS S1	12/12/2019 19:26	13/12/2019 08:38	12/12/2019 19:26	13/12/2019 08:38	13,18	2	26,37	CHI
20191295318	ITABERAI	IB21057863	ITABERAI S2	12/12/2019 19:26	13/12/2019 00:03	12/12/2019 19:26	13/12/2019 00:03	4,60	2	9,21	CHI
20191295600	GUARAITA	GK12299349	ITAPURANGA	12/12/2019 19:27	13/12/2019 07:11	12/12/2019 19:27	13/12/2019 07:11	11,73	25	293,15	CHI
20191295475	MONTIVIDIU	MV12267611	MONTIVIDIU T	12/12/2019 19:28	13/12/2019 09:41	12/12/2019 19:28	13/12/2019 09:41	14,22	5	71,10	CHI
20191295559	CATURAI	CK11107746	INHUMAS S1	12/12/2019 19:28	13/12/2019 03:19	12/12/2019 19:28	13/12/2019 03:19	7,83	135	1057,57	CHI
20191295546	GOIANIA	GN12251812	MEIA PONTE	12/12/2019 19:29	12/12/2019 21:57	12/12/2019 19:29	12/12/2019 21:57	2,46	340	837,63	CHI
20191295341	AGUAS LINDAS DE GOIAS	4830144600	AGUAS LINDAS DE GOIAS S1	12/12/2019 19:30	12/12/2019 20:56	12/12/2019 19:30	12/12/2019 20:56	1,43	1	1,43	CHI
20191295342	INDIARA	2710048894	EDEIA	12/12/2019 19:30	12/12/2019 22:07	12/12/2019 19:30	12/12/2019 22:07	2,62	1	2,62	CHI

20191295347	PALMEIRAS DE GOIAS	PL12100447	PALMEIRAS	12/12/2019 19:31	13/12/2019 01:01	12/12/2019 19:31	13/12/2019 01:01	5,50	5	27,48	CHI
20191295348	FAINA	FC12061009	GOIAS	12/12/2019 19:31	12/12/2019 21:59	12/12/2019 19:31	12/12/2019 21:59	2,46	61	150,20	CHI
20191296121	MUTUNOPOLIS	MU12076698	MARA ROSA	12/12/2019 19:31	13/12/2019 09:43	12/12/2019 19:31	13/12/2019 09:43	14,19	10	141,94	CHI
20191295447	GOIANIA	GN11001609	ATLANTICO S1	12/12/2019 19:32	13/12/2019 07:24	12/12/2019 19:32	13/12/2019 07:24	11,86	84	996,24	CHI
20191295576	BONFINOPOLIS	LB12029184	GOIANIA LESTE S2	12/12/2019 19:32	13/12/2019 08:19	12/12/2019 19:32	13/12/2019 08:19	12,78	55	702,96	CHI
20191295368	INHUMAS	IN11365566	INHUMAS S2	12/12/2019 19:33	12/12/2019 22:27	12/12/2019 19:33	12/12/2019 22:27	2,89	48	138,55	CHI
20191295413	VICENTINOPOLIS	VI11064595	VICENTINOPOLIS	12/12/2019 19:33	12/12/2019 21:32	12/12/2019 19:33	12/12/2019 21:32	1,97	142	280,41	CHI
20191295386	CATALAO	CT11000027	CATALAO S2	12/12/2019 19:34	12/12/2019 23:11	12/12/2019 19:34	12/12/2019 23:11	3,61	117	422,34	CHI
20191295396	GOIAS	GS12220498	GOIAS	12/12/2019 19:34	13/12/2019 10:10	12/12/2019 19:34	13/12/2019 10:10	14,61	46	671,96	CHI
20191295379	QUIRINOPOLIS	QI12000279	QUIRINOPOLIS	12/12/2019 19:35	13/12/2019 14:26	12/12/2019 19:35	13/12/2019 14:26	18,84	4	75,38	CHI
20191295534	GOIANIA	GN11050963	MEIA PONTE	12/12/2019 19:35	13/12/2019 10:30	12/12/2019 19:35	13/12/2019 10:30	14,91	122	1819,43	CHI
20191295395	RIO VERDE	RV21322288	CABRIUVA S2	12/12/2019 19:38	13/12/2019 10:24	12/12/2019 19:38	13/12/2019 10:24	14,75	1	14,75	CHI
20191295398	JATAI	290041910	JATAI S2	12/12/2019 19:39	13/12/2019 11:11	12/12/2019 19:39	13/12/2019 11:11	15,54	1	15,54	CHI
20191295406	CALDAS NOVAS	CN11163531	CALDAS NOVAS S2	12/12/2019 19:39	12/12/2019 22:15	12/12/2019 19:39	12/12/2019 22:15	2,59	196	508,29	CHI
20191295554	PLANALTINA	PI11164700	PLANALTINA	12/12/2019 19:39	12/12/2019 21:37	12/12/2019 19:39	12/12/2019 21:37	1,97	176	345,94	CHI
20191295415	INHUMAS	30181847	INHUMAS S2	12/12/2019 19:41	13/12/2019 08:00	12/12/2019 19:41	13/12/2019 08:00	12,31	1	12,31	CHI
20191295428	CALDAS NOVAS	10007312235	SERRA DE CALDAS	12/12/2019 19:43	13/12/2019 00:20	12/12/2019 19:43	13/12/2019 00:20	4,60	1	4,60	CHI
20191295507	AVELINOPOLIS	NZ12186359	ANICUNS	12/12/2019 19:43	12/12/2019 21:48	12/12/2019 19:43	12/12/2019 21:48	2,08	11	22,90	CHI
20191295507	NAZARIO	NZ12186359	ANICUNS	12/12/2019 19:43	12/12/2019 21:48	12/12/2019 19:43	12/12/2019 21:48	2,08	340	707,77	CHI
20191295432	ITARUMA	IM21219294	CACHOEIRA ALTA	12/12/2019 19:44	13/12/2019 08:52	12/12/2019 19:44	13/12/2019 08:52	13,14	1	13,14	CHI
20191295439	IPAMERI	IP21112309	IPAMERI	12/12/2019 19:44	13/12/2019 11:40	12/12/2019 19:44	13/12/2019 11:40	15,94	1	15,94	CHI
20191295440	GOIANIA	15738802	XAVANTES	12/12/2019 19:44	13/12/2019 00:30	12/12/2019 19:44	13/12/2019 00:30	4,75	1	4,75	CHI
20191295441	INHUMAS	30083886	INHUMAS S2	12/12/2019 19:44	13/12/2019 08:54	12/12/2019 19:44	13/12/2019 08:54	13,17	1	13,17	CHI
20191295451	APARECIDA DE GOIANIA	AP11377665	INDEPENDENCIA S2	12/12/2019 19:44	12/12/2019 21:38	12/12/2019 19:44	12/12/2019 21:38	1,89	106	200,22	CHI
20191295464	CORUMBAIBA	CI12000463RE	VILA CORUMBA	12/12/2019 19:44	12/12/2019 22:02	12/12/2019 19:44	12/12/2019 22:02	2,30	120	275,77	CHI
20191295488	GOIANIA	GN11274985	CARAJAS S2	12/12/2019 19:45	13/12/2019 09:29	12/12/2019 19:45	13/12/2019 09:29	13,72	76	1042,68	CHI
20191296139	GOIANIA	GN11271025	XAVANTES	12/12/2019 19:46	13/12/2019 00:20	12/12/2019 19:46	13/12/2019 00:20	4,56	114	520,31	CHI
20191295452	BOM JESUS DE GOIAS	BJ12305405	BOM JESUS DE GOIAS	12/12/2019 19:47	13/12/2019 10:43	12/12/2019 19:47	13/12/2019 10:43	14,93	9	134,38	CHI
20191295466	ANAPOLIS	20909329	ANAPOLIS UNIVERSITARIO S2	12/12/2019 19:48	13/12/2019 10:00	12/12/2019 19:48	13/12/2019 10:00	14,19	1	14,19	CHI
20191295474	PORANGATU	PO12187950	PORANGATU	12/12/2019 19:51	13/12/2019 12:08	12/12/2019 19:51	13/12/2019 12:08	16,29	1	16,29	CHI
20191295479	LUZIANIA	LZ21304730	RIO VERMELHO	12/12/2019 19:51	12/12/2019 21:31	12/12/2019 19:51	12/12/2019 21:31	1,65	2	3,31	CHI
20191295480	SANCLERLANDIA	SC21068257	FIRMINOPOLIS S2	12/12/2019 19:51	13/12/2019 06:52	12/12/2019 19:51	13/12/2019 06:52	11,00	1	11,00	CHI
20191295481	NOVA VENEZA	NV21188803	INHUMAS S1	12/12/2019 19:52	13/12/2019 03:58	12/12/2019 19:52	13/12/2019 03:58	8,09	2	16,19	CHI

20191295487	MIMOSO DE GOIAS	MJ12313852	PADRE BERNARDO	12/12/2019 19:52	12/12/2019 22:46	12/12/2019 19:52	12/12/2019 22:46	2,89	33	95,23	CHI
20191295490	VICENTINOPOLIS	1970005893	VICENTINOPOLIS	12/12/2019 19:53	13/12/2019 13:30	12/12/2019 19:53	13/12/2019 13:30	17,62	1	17,62	CHI
20191295506	BELA VISTA DE GOIAS	BV31010067	BELA VISTA S1	12/12/2019 19:55	13/12/2019 09:14	12/12/2019 19:55	13/12/2019 09:14	13,30	1	13,30	CHI
20191295541	GOIANIA	GN11001426	FERROVIARIO S3	12/12/2019 19:55	13/12/2019 04:42	12/12/2019 19:55	13/12/2019 04:42	8,78	195	1712,59	CHI
20191295721	GOIANIRA	IN12015974	INHUMAS S2	12/12/2019 19:55	13/12/2019 10:46	12/12/2019 19:55	13/12/2019 10:46	14,84	2	29,68	CHI
20191295721	INHUMAS	IN12015974	INHUMAS S2	12/12/2019 19:55	13/12/2019 10:46	12/12/2019 19:55	13/12/2019 10:46	14,84	1	14,84	CHI
20191295836	ITUMBIARA	IT11000151	ITUMBIARA NOVA	12/12/2019 19:55	12/12/2019 22:28	12/12/2019 19:55	12/12/2019 22:28	2,55	139	354,53	CHI
20191295514	FORMOSA	2870003141	ITUIQUIRA	12/12/2019 19:56	13/12/2019 11:10	12/12/2019 19:56	13/12/2019 11:10	15,23	1	15,23	CHI
20191297241	BRAZABRANTES	BR12026094	INHUMAS S2	12/12/2019 19:56	13/12/2019 13:19	12/12/2019 19:56	13/12/2019 13:19	17,37	6	104,22	CHI
20191295516	AMARALINA	MU12269538	MARA ROSA	12/12/2019 19:57	12/12/2019 23:05	12/12/2019 19:57	12/12/2019 23:05	3,13	40	125,10	CHI
20191295516	MUTUNOPOLIS	MU12269538	MARA ROSA	12/12/2019 19:57	12/12/2019 23:05	12/12/2019 19:57	12/12/2019 23:05	3,13	35	109,46	CHI
20191295904	BRAZABRANTES	BR11282776	NEROPOLIS S1	12/12/2019 19:58	13/12/2019 02:14	12/12/2019 19:58	13/12/2019 02:14	6,26	155	971,03	CHI
20191295526	CATURAI	CK12030119	INHUMAS S1	12/12/2019 19:59	13/12/2019 09:46	12/12/2019 19:59	13/12/2019 09:46	13,77	2	27,54	CHI
20191296117	PALMEIRAS DE GOIAS	PL12046351	PALMEIRAS	12/12/2019 19:59	13/12/2019 01:20	12/12/2019 19:59	13/12/2019 01:20	5,33	4	21,34	CHI
20191295563	CRISTALINA	KR12171519	CRISTALINA S1	12/12/2019 20:00	13/12/2019 08:07	12/12/2019 20:00	13/12/2019 08:07	12,11	12	145,33	CHI
20191295535	APARECIDA DE GOIANIA	12957586	INDEPENDENCIA S1	12/12/2019 20:01	13/12/2019 03:52	12/12/2019 20:01	13/12/2019 03:52	7,83	1	7,83	CHI
20191295544	TRINDADE	10010717410	TRINDADE	12/12/2019 20:03	12/12/2019 22:38	12/12/2019 20:03	12/12/2019 22:38	2,58	1	2,58	CHI
20191295558	AGUAS LINDAS DE GOIAS	LA11305234	AGUAS LINDAS DE GOIAS S2	12/12/2019 20:03	12/12/2019 21:55	12/12/2019 20:03	12/12/2019 21:55	1,87	215	402,59	CHI
20191296708	ALTO PARAISO DE GOIAS	JL12257606	SAO JOAO D ALIANCA	12/12/2019 20:05	13/12/2019 09:57	12/12/2019 20:05	13/12/2019 09:57	13,87	2	27,73	CHI
20191296708	SAO JOAO D ALIANCA	JL12257606	SAO JOAO D ALIANCA	12/12/2019 20:05	13/12/2019 09:57	12/12/2019 20:05	13/12/2019 09:57	13,87	81	1123,09	CHI
20191295568	GOIANIA	11448910	XAVANTES	12/12/2019 20:09	13/12/2019 06:13	12/12/2019 20:09	13/12/2019 06:13	10,06	1	10,06	CHI
20191295602	GOIANIA	GN16407745	GOYA S2	12/12/2019 20:09	13/12/2019 11:57	12/12/2019 20:10	12/12/2019 20:31	0,35	1	0,35	CHI
20191295602	GOIANIA	GN16407987	GOYA S2	12/12/2019 20:09	13/12/2019 11:57	12/12/2019 20:10	12/12/2019 21:21	1,19	349	413,86	CHI
20191295602	GOIANIA	GN21374182	GOYA S2	12/12/2019 20:09	13/12/2019 11:57	12/12/2019 20:10	13/12/2019 11:57	15,80	1	15,80	CHI
20191295948	SENADOR CANEDO	SW12150440	GOIANIA LESTE S1	12/12/2019 20:12	12/12/2019 22:07	12/12/2019 20:12	12/12/2019 22:07	1,91	13	24,82	CHI
20191295581	GOIANIA	10000607841	FERROVIARIO S3	12/12/2019 20:14	13/12/2019 07:21	12/12/2019 20:14	13/12/2019 07:21	11,10	1	11,10	CHI
20191295583	IPAMERI	IP11107625	IPAMERI	12/12/2019 20:14	13/12/2019 10:23	12/12/2019 20:14	13/12/2019 10:23	14,13	45	636,06	CHI
20191295989	GOIANIA	GN11140222	CAMPINAS S2	12/12/2019 20:14	13/12/2019 15:59	12/12/2019 20:14	13/12/2019 15:59	19,73	216	4262,52	CHI
20191295588	ITUMBIARA	690151172	ITUMBIARA NOVA	12/12/2019 20:16	12/12/2019 23:44	12/12/2019 20:16	12/12/2019 23:44	3,45	1	3,45	CHI
20191295591	GOIAS	GS12124232	GOIAS	12/12/2019 20:17	13/12/2019 09:00	12/12/2019 20:17	13/12/2019 09:00	12,72	10	127,16	CHI
20191295595	PORANGATU	PO12265802	PORANGATU	12/12/2019 20:17	12/12/2019 22:18	12/12/2019 20:17	12/12/2019 22:18	2,01	117	235,36	CHI
20191295814	CALDAS NOVAS	CN11114789	SERRA DE CALDAS	12/12/2019 20:17	12/12/2019 22:20	12/12/2019 20:17	12/12/2019 22:20	2,04	76	154,72	CHI
20191296187	GOIANIA	GN11199223	MEIA PONTE	12/12/2019 20:18	13/12/2019 09:12	12/12/2019 20:18	13/12/2019 09:12	12,90	119	1534,80	CHI

20191295701	CRISTALINA	KR21133578	CRISTALINA S2	12/12/2019 20:19	13/12/2019 08:11	12/12/2019 20:19	13/12/2019 08:11	11,86	1	11,86	CHI
20191295703	DAVINOPOLIS	IO21085203	CATALAO S1	12/12/2019 20:19	13/12/2019 10:54	12/12/2019 20:19	13/12/2019 10:54	14,57	1	14,57	CHI
20191295840	GUAPO	GA11000010	GUAPO S1	12/12/2019 20:19	13/12/2019 17:16	12/12/2019 20:19	13/12/2019 17:16	20,94	76	1591,50	CHI
20191295706	PORTELANDIA	PW21301981	PARQUE DAS EMAS	12/12/2019 20:20	14/12/2019 11:10	12/12/2019 20:20	14/12/2019 11:10	38,83	1	38,83	CHI
20191295711	FAZENDA NOVA	FN12250532	JUSSARA	12/12/2019 20:21	13/12/2019 03:29	12/12/2019 20:21	13/12/2019 03:29	7,12	11	78,31	CHI
20191295712	GOIANIA	10006256838	GOYA S2	12/12/2019 20:21	13/12/2019 10:53	12/12/2019 20:21	13/12/2019 10:53	14,52	1	14,52	CHI
20191295715	NIQUELANDIA	NQ21342830	NIQUELANDIA SUBTRANSMISSAO	12/12/2019 20:23	12/12/2019 22:11	12/12/2019 20:23	12/12/2019 22:11	1,79	1	1,79	CHI
20191295722	LUZIANIA	LZ11065874	RIO VERMELHO	12/12/2019 20:23	12/12/2019 21:27	12/12/2019 20:23	12/12/2019 21:27	1,06	145	153,86	CHI
20191295766	GOIANIA	GN12162074	REAL S2	12/12/2019 20:23	13/12/2019 12:52	12/12/2019 20:23	13/12/2019 12:52	16,48	54	890,10	CHI
20191295720	CATALAO	CT21399066	CATALAO S1	12/12/2019 20:24	13/12/2019 14:31	12/12/2019 20:24	13/12/2019 14:31	18,12	1	18,12	CHI
20191295723	BOM JARDIM DE GOIAS	BM21064178	BOM JARDIM	12/12/2019 20:24	13/12/2019 10:51	12/12/2019 20:24	13/12/2019 10:51	14,44	1	14,44	CHI
20191295725	ITABERAI	IB12310476	ITABERAI S2	12/12/2019 20:24	13/12/2019 08:30	12/12/2019 20:24	13/12/2019 08:30	12,08	3	36,25	CHI
20191296437	INHUMAS	IN12092619	INHUMAS S2	12/12/2019 20:25	13/12/2019 09:49	12/12/2019 20:25	13/12/2019 09:49	13,39	4	53,56	CHI
20191295797	CEZARINA	PL12304466	PALMEIRAS	12/12/2019 20:26	12/12/2019 23:40	12/12/2019 20:26	12/12/2019 23:40	3,22	1	3,22	CHI
20191295797	PALMEIRAS DE GOIAS	PL12304466	PALMEIRAS	12/12/2019 20:26	12/12/2019 23:40	12/12/2019 20:26	12/12/2019 23:40	3,22	12	38,64	CHI
20191295809	ITAPIRAPUA	IU12018852	MATRINCHA	12/12/2019 20:26	13/12/2019 10:31	12/12/2019 20:26	13/12/2019 10:31	14,08	35	492,72	CHI
20191295733	NOVO GAMA	NJ11165093	PACAEMBU S1	12/12/2019 20:27	12/12/2019 22:23	12/12/2019 20:27	12/12/2019 22:23	1,93	102	197,03	CHI
20191295743	CORUMBAIBA	CI12000533	VILA CORUMBA	12/12/2019 20:28	13/12/2019 17:07	12/12/2019 20:28	13/12/2019 17:07	20,63	3	61,90	CHI
20191295852	GOIANIA	GN11165707	GOYA S2	12/12/2019 20:28	13/12/2019 00:00	12/12/2019 20:28	13/12/2019 00:00	3,53	33	116,38	CHI
20191296438	JATAI	SX12080854	JATAI S1	12/12/2019 20:28	13/12/2019 12:50	12/12/2019 20:28	13/12/2019 12:50	16,35	48	784,92	CHI
20191296438	SERRANOPOLIS	SX12080854	JATAI S1	12/12/2019 20:28	13/12/2019 12:50	12/12/2019 20:28	13/12/2019 12:50	16,35	25	408,81	CHI
20191295807	ABADIA DE GOIAS	AO11007316	INDEPENDENCIA S2	12/12/2019 20:29	13/12/2019 02:27	12/12/2019 20:29	13/12/2019 02:27	5,96	74	441,12	CHI
20191295763	BALIZA	BH12358780	BOM JARDIM	12/12/2019 20:31	13/12/2019 10:00	12/12/2019 20:31	13/12/2019 10:00	13,48	19	256,04	CHI
20191295756	NOVO GAMA	10013970516	PACAEMBU S1	12/12/2019 20:32	12/12/2019 23:54	12/12/2019 20:32	12/12/2019 23:54	3,37	1	3,37	CHI
20191295759	CATALAO	GD12064004	CATALAO S1	12/12/2019 20:32	13/12/2019 14:55	12/12/2019 20:32	13/12/2019 14:55	18,37	4	73,50	CHI
20191295759	GOIANDIRA	GD12064004	CATALAO S1	12/12/2019 20:32	13/12/2019 14:55	12/12/2019 20:32	13/12/2019 14:55	18,37	1	18,37	CHI
20191295760	CAIAPONIA	CP12359444	CAIAPONIA	12/12/2019 20:32	13/12/2019 07:32	12/12/2019 20:32	13/12/2019 07:32	10,99	7	76,92	CHI
20191295765	GOIANIA	GN21000264	XAVANTES	12/12/2019 20:34	13/12/2019 00:45	12/12/2019 20:34	13/12/2019 00:45	4,17	1	4,17	CHI
20191295767	NOVO PLANALTO	TA12369993	NOVO PLANALTO	12/12/2019 20:35	13/12/2019 00:14	12/12/2019 20:35	13/12/2019 00:14	3,65	51	186,06	CHI
20191296198	GOIANIA	GN11164383	MEIA PONTE	12/12/2019 20:35	13/12/2019 06:34	12/12/2019 20:35	13/12/2019 06:34	9,98	159	1586,91	CHI
20191296583	DISTRITO FEDERAL	IJ12958044	ITAJA S2	12/12/2019 20:37	13/12/2019 13:50	12/12/2019 20:37	13/12/2019 13:50	17,20	1	17,20	CHI
20191296583	LAGOA SANTA	IJ12958044	ITAJA S2	12/12/2019 20:37	13/12/2019 13:50	12/12/2019 20:37	13/12/2019 13:50	17,20	8	137,62	CHI
20191295783	PORANGATU	PO12390255	PORANGATU	12/12/2019 20:38	13/12/2019 00:53	12/12/2019 20:38	13/12/2019 00:53	4,24	4	16,97	CHI

20191296403	PIRACANJUBA	PJ12249833	PIRACANJUBA	12/12/2019 20:38	13/12/2019 17:13	12/12/2019 20:38	13/12/2019 17:13	20,58	81	1667,11	CHI
20191296041	GUAPO	VJ13000011	GUAPO S2	12/12/2019 20:39	13/12/2019 01:35	12/12/2019 20:39	13/12/2019 01:15	4,59	127	583,07	CHI
20191296041	VARJAO	VJ13000011	GUAPO S2	12/12/2019 20:39	13/12/2019 01:35	12/12/2019 20:39	13/12/2019 01:15	4,59	97	445,34	CHI
20191296041	GUAPO	VJ13312879	GUAPO S2	12/12/2019 20:39	13/12/2019 01:35	12/12/2019 20:39	13/12/2019 01:35	4,93	3	14,79	CHI
20191296041	VARJAO	VJ13312879	GUAPO S2	12/12/2019 20:39	13/12/2019 01:35	12/12/2019 20:39	13/12/2019 01:35	4,93	103	507,85	CHI
20191295603	GOIANIA	GN10383648	CAMPINAS S1	12/12/2019 20:41	13/12/2019 04:42	12/12/2019 20:41	12/12/2019 21:24	0,72	3559	2577,31	CHI
20191295603	GOIANIA	GN12000069LD	CAMPINAS S1	12/12/2019 20:41	13/12/2019 04:42	12/12/2019 20:41	13/12/2019 04:42	8,02	1417	11358,04	CHI
20191295800	APARECIDA DE GOIANIA	AP11240465	INDEPENDENCIA S2	12/12/2019 20:43	12/12/2019 21:51	12/12/2019 20:43	12/12/2019 21:51	1,12	215	240,98	CHI
20191296196	GOIANIA	GN12163706	MEIA PONTE	12/12/2019 20:44	13/12/2019 02:21	12/12/2019 20:44	13/12/2019 02:21	5,61	205	1150,28	CHI
20191295815	LEOPOLDO DE BULHOES	LB12068299	DAIA S2	12/12/2019 20:47	13/12/2019 11:40	12/12/2019 20:47	13/12/2019 11:40	14,88	1	14,88	CHI
20191295891	GOIANIA	GN11166698	REAL S2	12/12/2019 20:47	13/12/2019 01:12	12/12/2019 20:47	13/12/2019 01:12	4,40	56	246,48	CHI
20191295829	CATURAI	CK12326309	INHUMAS S1	12/12/2019 20:48	13/12/2019 05:19	12/12/2019 20:48	13/12/2019 05:19	8,50	26	221,05	CHI
20191295829	INHUMAS	CK12326309	INHUMAS S1	12/12/2019 20:48	13/12/2019 05:19	12/12/2019 20:48	13/12/2019 05:19	8,50	3	25,51	CHI
20191295853	CATALAO	CT11333594	CATALAO S2	12/12/2019 20:48	12/12/2019 22:12	12/12/2019 20:48	12/12/2019 22:12	1,40	193	270,20	CHI
20191295841	ARUANA	MP13170271	MOZARLANDIA	12/12/2019 20:51	13/12/2019 14:40	13/12/2019 10:07	13/12/2019 14:12	4,08	2	8,15	CHI
20191295841	MATRINCHA	MP13170271	MOZARLANDIA	12/12/2019 20:51	13/12/2019 14:40	13/12/2019 10:07	13/12/2019 14:12	4,08	8	32,60	CHI
20191295841	ARUANA	MP12274498	MOZARLANDIA	12/12/2019 20:51	13/12/2019 14:40	12/12/2019 20:51	13/12/2019 14:40	17,82	5	89,10	CHI
20191295841	MATRINCHA	MP12274498	MOZARLANDIA	12/12/2019 20:51	13/12/2019 14:40	12/12/2019 20:51	13/12/2019 14:40	17,82	3	53,46	CHI
20191295842	GOIANIA	GN11164466	REAL S2	12/12/2019 20:52	13/12/2019 09:08	12/12/2019 20:52	13/12/2019 09:08	12,27	19	233,05	CHI
20191295843	IPAMERI	IP21112306	IPAMERI	12/12/2019 20:52	13/12/2019 12:59	12/12/2019 20:52	13/12/2019 12:59	16,13	1	16,13	CHI
20191295857	ANAPOLIS	AN21221401	DAIA S1	12/12/2019 20:55	13/12/2019 05:55	12/12/2019 20:55	13/12/2019 05:55	8,99	1	8,99	CHI
20191295916	ANAPOLIS	AN11003272	JUNDIAI S1	12/12/2019 20:55	12/12/2019 22:02	12/12/2019 20:55	12/12/2019 22:02	1,10	140	154,27	CHI
20191296079	NEROPOLIS	NR11060062	NEROPOLIS S2	12/12/2019 20:58	13/12/2019 01:20	12/12/2019 20:58	13/12/2019 01:20	4,36	108	471,30	CHI
20191296145	GOIANIA	GN11240969	CAMPINAS S1	12/12/2019 20:59	13/12/2019 04:45	12/12/2019 20:59	13/12/2019 04:45	7,75	98	759,83	CHI
20191295884	BONOPOLIS	BX12292422	SAO MIGUEL DO ARAGUAIA	12/12/2019 21:00	13/12/2019 00:12	12/12/2019 21:00	13/12/2019 00:12	3,19	33	105,13	CHI
20191295884	PORANGATU	BX12292422	SAO MIGUEL DO ARAGUAIA	12/12/2019 21:00	13/12/2019 00:12	12/12/2019 21:00	13/12/2019 00:12	3,19	1	3,19	CHI
20191295887	SILVANIA	SV21324247	VIANOPOLIS	12/12/2019 21:01	13/12/2019 12:15	12/12/2019 21:01	13/12/2019 12:15	15,22	5	76,10	CHI
20191295889	RIO VERDE	RV21076186	CABRIUVA S2	12/12/2019 21:02	13/12/2019 12:30	12/12/2019 21:02	13/12/2019 12:30	15,46	1	15,46	CHI
20191295894	JATAI	JT21363405	JATAI S1	12/12/2019 21:03	13/12/2019 11:07	12/12/2019 21:03	13/12/2019 11:07	14,06	1	14,06	CHI
20191295897	CATALAO	CT12266138	CATALAO S1	12/12/2019 21:04	13/12/2019 14:36	12/12/2019 21:04	13/12/2019 14:36	17,53	7	122,74	CHI
20191295906	GOIANIA	10661098	AEROPORTO S2	12/12/2019 21:07	13/12/2019 08:42	12/12/2019 21:07	13/12/2019 08:42	11,58	1	11,58	CHI
20191295999	APARECIDA DE GOIANIA	AP11000016	INDEPENDENCIA S1	12/12/2019 21:07	12/12/2019 23:50	12/12/2019 21:07	12/12/2019 23:50	2,71	121	327,88	CHI
20191295912	ITAPIRAPUA	IU12030155	JUSSARA	12/12/2019 21:08	13/12/2019 00:43	12/12/2019 21:08	13/12/2019 00:43	3,57	42	150,10	CHI

20191295912	NOVO BRASIL	IU12030155	JUSSARA	12/12/2019 21:08	13/12/2019 00:43	12/12/2019 21:08	13/12/2019 00:43	3,57	1	3,57	CHI
20191295915	APARECIDA DE GOIANIA	10003785465	INDEPENDENCIA S2	12/12/2019 21:08	12/12/2019 22:58	12/12/2019 21:08	12/12/2019 22:58	1,82	1	1,82	CHI
20191295920	PONTALINA	AD12060078	GOIATUBA S1	12/12/2019 21:10	13/12/2019 10:05	12/12/2019 21:10	13/12/2019 10:05	12,91	12	154,95	CHI
20191295982	LEOPOLDO DE BULHOES	LB12151171	DAIA S2	12/12/2019 21:10	13/12/2019 01:52	12/12/2019 21:10	13/12/2019 01:52	4,70	148	694,98	CHI
20191295925	PONTALINA	PK12047371RE	VICENTINOPOLIS	12/12/2019 21:12	13/12/2019 10:38	12/12/2019 21:12	13/12/2019 10:38	13,43	47	631,28	CHI
20191296377	FORMOSO	FO12391992	PORANGATU	12/12/2019 21:12	13/12/2019 07:45	12/12/2019 21:12	13/12/2019 07:45	10,55	3	31,65	CHI
20191295928	IPAMERI	IP12404742	IPAMERI	12/12/2019 21:13	13/12/2019 12:46	12/12/2019 21:13	13/12/2019 12:46	15,55	4	62,20	CHI
20191295931	IPORA	IR21358532	ARENOPOLIS	12/12/2019 21:13	13/12/2019 09:40	12/12/2019 21:13	13/12/2019 09:40	12,45	1	12,45	CHI
20191296057	MONTIVIDIU	MV12260799	MONTIVIDIU T	12/12/2019 21:13	13/12/2019 07:43	12/12/2019 21:13	13/12/2019 07:43	10,49	8	83,95	CHI
20191295933	NEROPOLIS	NR12272390	NEROPOLIS S2	12/12/2019 21:14	13/12/2019 09:12	12/12/2019 21:14	13/12/2019 09:12	11,97	1	11,97	CHI
20191295643	BELA VISTA DE GOIAS	SW10406913	SENADOR CANEDO	12/12/2019 21:18	13/12/2019 19:50	12/12/2019 21:18	13/12/2019 19:50	22,53	28	630,96	CHI
20191295643	CALDAZINHA	SW10406913	SENADOR CANEDO	12/12/2019 21:18	13/12/2019 19:50	12/12/2019 21:18	13/12/2019 19:50	22,53	59	1329,52	CHI
20191295643	SENADOR CANEDO	SW10406913	SENADOR CANEDO	12/12/2019 21:18	13/12/2019 19:50	12/12/2019 21:18	13/12/2019 19:50	22,53	15	338,01	CHI
20191295943	MOSSAMEDES	MD12005317	FIRMINOPOLIS S2	12/12/2019 21:21	13/12/2019 07:30	12/12/2019 21:21	13/12/2019 07:30	10,15	16	162,39	CHI
20191295945	BELA VISTA DE GOIAS	BV12067601LD	BELA VISTA S1	12/12/2019 21:21	13/12/2019 07:06	12/12/2019 21:21	13/12/2019 07:06	9,74	158	1538,88	CHI
20191295644	GOIANIA	00612224	CAMPINAS S3	12/12/2019 21:23	13/12/2019 06:00	12/12/2019 21:23	12/12/2019 22:30	1,11	159	175,96	CHI
20191295644	GOIANIA	00612224	CAMPINAS S3	12/12/2019 21:23	13/12/2019 06:00	12/12/2019 21:23	12/12/2019 22:37	1,22	654	797,34	CHI
20191295644	GOIANIA	00612224	CAMPINAS S3	12/12/2019 21:23	13/12/2019 06:00	12/12/2019 21:23	12/12/2019 22:38	1,24	1068	1322,24	CHI
20191295644	GOIANIA	00612224	CAMPINAS S3	12/12/2019 21:23	13/12/2019 06:00	12/12/2019 21:23	13/12/2019 06:00	8,60	525	4516,31	CHI
20191295957	BURITI DE GOIAS	BS21019833	FIRMINOPOLIS S2	12/12/2019 21:25	13/12/2019 07:07	12/12/2019 21:25	13/12/2019 07:07	9,69	2	19,38	CHI
20191295962	LEOPOLDO DE BULHOES	LB12012179	DAIA S2	12/12/2019 21:26	13/12/2019 10:26	12/12/2019 21:26	13/12/2019 10:26	12,99	10	129,91	CHI
20191295963	SAO LUIS DE MONTES BELOS	SL21222084	SAO LUIZ DOS MONTES BELOS	12/12/2019 21:26	12/12/2019 22:57	12/12/2019 21:26	12/12/2019 22:57	1,51	1	1,51	CHI
20191296026	CACU	CA12080196	CACHOEIRA ALTA	12/12/2019 21:27	13/12/2019 08:43	12/12/2019 21:27	13/12/2019 08:43	11,27	7	78,86	CHI
20191295972	NIQUELANDIA	NQ12253797	URUACU	12/12/2019 21:30	13/12/2019 05:49	12/12/2019 21:30	13/12/2019 05:49	8,31	20	166,24	CHI
20191295977	GOIANIA	13982175	MEIA PONTE	12/12/2019 21:31	13/12/2019 08:12	12/12/2019 21:31	13/12/2019 08:12	10,67	1	10,67	CHI
20191295978	SENADOR CANEDO	190126371	CEPAIGO S2	12/12/2019 21:31	12/12/2019 23:49	12/12/2019 21:31	12/12/2019 23:49	2,29	1	2,29	CHI
20191296061	CALDAS NOVAS	CN11000046	CALDAS NOVAS S1	12/12/2019 21:35	13/12/2019 01:19	12/12/2019 21:35	13/12/2019 01:19	3,72	118	438,66	CHI
20191295991	VIANOPOLIS	VN21346883	VIANOPOLIS	12/12/2019 21:37	13/12/2019 13:33	12/12/2019 21:37	13/12/2019 13:33	15,93	1	15,93	CHI
20191295997	QUIRINOPOLIS	RV12301218	SANTA HELENA S1	12/12/2019 21:37	13/12/2019 09:39	12/12/2019 21:37	13/12/2019 09:39	12,02	37	444,83	CHI
20191295997	RIO VERDE	RV12301218	SANTA HELENA S1	12/12/2019 21:37	13/12/2019 09:39	12/12/2019 21:37	13/12/2019 09:39	12,02	18	216,40	CHI
20191296380	PIRENOPOLIS	PV12355148	CORUMBA	12/12/2019 21:37	13/12/2019 07:38	12/12/2019 21:37	13/12/2019 07:38	10,01	24	240,25	CHI
20191295996	TEREZOPOLIS DE GOIAS	TJ12353440	DAIA S2	12/12/2019 21:38	13/12/2019 08:51	12/12/2019 21:38	13/12/2019 08:51	11,21	6	67,27	CHI
20191296001	SAO MIGUEL DO ARAGUAIA	SM12236306	SAO MIGUEL DO ARAGUAIA	12/12/2019 21:41	13/12/2019 14:09	12/12/2019 21:41	13/12/2019 14:09	16,46	2	32,93	CHI

20191296082	ALEXANIA	AX12061983	ALEXANIA	12/12/2019 21:50	13/12/2019 07:13	12/12/2019 21:50	13/12/2019 07:13	9,38	12	112,50	CHI
20191296082	CORUMBA DE GOIAS	AX12061983	ALEXANIA	12/12/2019 21:50	13/12/2019 07:13	12/12/2019 21:50	13/12/2019 07:13	9,38	1	9,38	CHI
20191296093	APARECIDA DE GOIANIA	AP11377665	INDEPENDENCIA S2	12/12/2019 21:50	13/12/2019 09:35	12/12/2019 21:50	13/12/2019 09:35	11,74	106	1243,97	CHI
20191296022	JATAI	JT21334234	JATAI S1	12/12/2019 21:51	14/12/2019 01:55	12/12/2019 21:51	14/12/2019 01:55	28,06	1	28,06	CHI
20191296029	GOIANIA	12393757	GOYA S2	12/12/2019 21:58	13/12/2019 11:19	12/12/2019 21:58	13/12/2019 11:19	13,34	1	13,34	CHI
20191296034	LUZIANIA	LZ11253543	VIANOPOLIS	12/12/2019 22:00	12/12/2019 23:45	12/12/2019 22:00	12/12/2019 23:45	1,74	1	1,74	CHI
20191296043	APARECIDA DE GOIANIA	AP21024121	CEPAIGO S1	12/12/2019 22:03	13/12/2019 10:05	12/12/2019 22:03	13/12/2019 10:05	12,03	1	12,03	CHI
20191296720	SANTA RITA DO NOVO DESTINO	BA12152774	BARRO ALTO	12/12/2019 22:04	13/12/2019 14:19	12/12/2019 22:04	13/12/2019 14:19	16,26	71	1154,18	CHI
20191296181	GOIANIA	GN11040689	CAMPINAS S2	12/12/2019 22:05	13/12/2019 11:50	12/12/2019 22:05	13/12/2019 11:50	13,75	118	1621,91	CHI
20191296050	BOM JARDIM DE GOIAS	BM11369907	BOM JARDIM	12/12/2019 22:07	13/12/2019 08:21	12/12/2019 22:07	13/12/2019 08:21	10,23	1	10,23	CHI
20191296052	LUZIANIA	LZ11149779	MARAJOARA	12/12/2019 22:09	12/12/2019 22:55	12/12/2019 22:09	12/12/2019 22:55	0,77	174	133,40	CHI
20191296053	CARMO DO RIO VERDE	IK21286664	ITAPURANGA	12/12/2019 22:09	13/12/2019 15:57	12/12/2019 22:09	13/12/2019 15:57	17,79	1	17,79	CHI
20191296054	DAMIANOPOLIS	MB12180640	IACIARA S2	12/12/2019 22:10	13/12/2019 09:11	12/12/2019 22:10	13/12/2019 09:11	11,01	7	77,10	CHI
20191296651	MORRINHOS	MR12128508	MORRINHOS	12/12/2019 22:11	13/12/2019 09:30	12/12/2019 22:11	13/12/2019 09:30	11,31	4	45,23	CHI
20191296058	BURITI DE GOIAS	BS12099750	FIRMINOPOLIS S2	12/12/2019 22:18	13/12/2019 07:43	12/12/2019 22:18	13/12/2019 07:43	9,41	3	28,22	CHI
20191296060	BELA VISTA DE GOIAS	240087574	BELA VISTA S1	12/12/2019 22:19	13/12/2019 07:41	12/12/2019 22:19	13/12/2019 07:41	9,36	1	9,36	CHI
20191295648	GOIANIA	00610244	CAMPINAS S1	12/12/2019 22:20	12/12/2019 23:22	12/12/2019 22:20	12/12/2019 22:25	0,08	5620	421,50	CHI
20191295648	GOIANIA	00610244	CAMPINAS S1	12/12/2019 22:20	12/12/2019 23:22	12/12/2019 22:20	12/12/2019 22:25	0,08	4131	309,83	CHI
20191295648	GOIANIA	00610244	CAMPINAS S1	12/12/2019 22:20	12/12/2019 23:22	12/12/2019 22:20	12/12/2019 23:22	1,03	1907	1966,86	CHI
20191296065	GOIAS	90020807	GOIAS	12/12/2019 22:22	13/12/2019 08:10	12/12/2019 22:22	13/12/2019 08:10	9,80	1	9,80	CHI
20191296761	URUACU	UR12181375	URUACU	12/12/2019 22:24	13/12/2019 14:32	12/12/2019 22:24	13/12/2019 14:32	16,13	2	32,26	CHI
20191296075	PORANGATU	PO12020611	NOVO PLANALTO	12/12/2019 22:27	13/12/2019 02:16	12/12/2019 22:27	13/12/2019 02:16	3,81	8	30,46	CHI
20191296086	NOVO GAMA	2460095448	PACAEMBU S1	12/12/2019 22:31	12/12/2019 23:28	12/12/2019 22:31	12/12/2019 23:28	0,95	1	0,95	CHI
20191296090	CAIAPONIA	CP21357550	CAIAPONIA	12/12/2019 22:31	13/12/2019 06:47	12/12/2019 22:31	13/12/2019 06:47	8,25	1	8,25	CHI
20191296220	MINEIROS	MY12341125LD	PARQUE DAS EMAS	12/12/2019 22:31	13/12/2019 11:26	12/12/2019 22:31	13/12/2019 11:26	12,91	203	2620,39	CHI
20191296088	GOIAS	GS21243754	ITABERAI S1	12/12/2019 22:32	13/12/2019 08:58	12/12/2019 22:32	13/12/2019 08:58	10,43	1	10,43	CHI
20191296202	GOIANIA	GN12144781	ATLANTICO S3	12/12/2019 22:32	13/12/2019 01:58	12/12/2019 22:32	13/12/2019 01:58	3,43	852	2922,12	CHI
20191296105	APARECIDA DE GOIANIA	AP11003034	INDEPENDENCIA S1	12/12/2019 22:33	13/12/2019 00:57	12/12/2019 22:33	13/12/2019 00:57	2,39	76	181,89	CHI
20191296884	CALDAZINHA	BO12400523	CEPAIGO S2	12/12/2019 22:33	13/12/2019 09:01	12/12/2019 22:33	13/12/2019 09:01	10,47	2	20,93	CHI
20191296884	LEOPOLDO DE BULHOES	BO12400523	CEPAIGO S2	12/12/2019 22:33	13/12/2019 09:01	12/12/2019 22:33	13/12/2019 09:01	10,47	33	345,38	CHI
20191296102	BALIZA	BH11334486	BOM JARDIM	12/12/2019 22:40	13/12/2019 08:18	12/12/2019 22:40	13/12/2019 08:18	9,63	1	9,63	CHI
20191295650	GOIANIA	GN10396877	CAMPINAS S2	12/12/2019 22:41	13/12/2019 10:12	12/12/2019 22:41	13/12/2019 10:12	11,52	691	7958,40	CHI
20191296115	BURITI DE GOIAS	SC12052751	FIRMINOPOLIS S2	12/12/2019 22:44	13/12/2019 08:50	12/12/2019 22:44	13/12/2019 08:50	10,09	3	30,27	CHI

20191296115	SANCLERLANDIA	SC12052751	FIRMINOPOLIS S2	12/12/2019 22:44	13/12/2019 08:50	12/12/2019 22:44	13/12/2019 08:50	10,09	19	191,70	CHI
20191296122	GOIANDIRA	2010001420	CATALAO S1	12/12/2019 22:50	13/12/2019 08:03	12/12/2019 22:50	13/12/2019 08:03	9,21	1	9,21	CHI
20191297650	SANTA RITA DO NOVO DESTINO	SZ12242779	BARRO ALTO	12/12/2019 22:58	14/12/2019 03:22	12/12/2019 22:58	14/12/2019 03:22	28,39	1	28,39	CHI
20191297650	SAO LUIZ DO NORTE	SZ12242779	BARRO ALTO	12/12/2019 22:58	14/12/2019 03:22	12/12/2019 22:58	14/12/2019 03:22	28,39	8	227,10	CHI
20191296133	INHUMAS	10017974613	INHUMAS S2	12/12/2019 23:00	13/12/2019 04:00	12/12/2019 23:00	13/12/2019 04:00	5,01	1	5,01	CHI
20191296135	CRISTALINA	10006938831	CRISTALINA S1	12/12/2019 23:00	12/12/2019 23:58	12/12/2019 23:00	12/12/2019 23:58	0,96	1	0,96	CHI
20191296141	PORANGATU	PO21145210	PORANGATU	12/12/2019 23:05	13/12/2019 02:09	12/12/2019 23:05	13/12/2019 02:09	3,06	1	3,06	CHI
20191296151	BOM JESUS DE GOIAS	BJ12068991	BOM JESUS DE GOIAS	12/12/2019 23:11	13/12/2019 08:21	12/12/2019 23:11	13/12/2019 08:21	9,16	10	91,65	CHI
20191296152	GOIANIA	11446158	XAVANTES	12/12/2019 23:11	13/12/2019 05:59	12/12/2019 23:11	13/12/2019 05:59	6,80	1	6,80	CHI
20191296154	NOVA VENEZA	NV21010117	INHUMAS S1	12/12/2019 23:12	13/12/2019 04:27	12/12/2019 23:12	13/12/2019 04:27	5,23	2	10,47	CHI
20191295651	NOVA IGUACU DE GOIAS	UR12266002LD	CAMPINORTE	12/12/2019 23:19	13/12/2019 12:48	12/12/2019 23:19	13/12/2019 08:58	9,65	6	57,90	CHI
20191295651	URUACU	UR12266002LD	CAMPINORTE	12/12/2019 23:19	13/12/2019 12:48	12/12/2019 23:19	13/12/2019 08:58	9,65	3	28,95	CHI
20191295651	NOVA IGUACU DE GOIAS	UR12266002LD	CAMPINORTE	12/12/2019 23:19	13/12/2019 12:48	13/12/2019 09:05	13/12/2019 12:30	3,41	6	20,49	CHI
20191295651	URUACU	UR12266002LD	CAMPINORTE	12/12/2019 23:19	13/12/2019 12:48	13/12/2019 09:05	13/12/2019 12:30	3,41	3	10,24	CHI
20191295651	NOVA IGUACU DE GOIAS	NH13333086	CAMPINORTE	12/12/2019 23:19	13/12/2019 12:48	12/12/2019 23:19	13/12/2019 12:48	13,47	4	53,90	CHI
20191295651	URUACU	NH13333086	CAMPINORTE	12/12/2019 23:19	13/12/2019 12:48	12/12/2019 23:19	13/12/2019 12:48	13,47	1	13,47	CHI
20191296300	NOVA AMERICA	NM12199851	RUBIATABA	12/12/2019 23:23	14/12/2019 12:10	12/12/2019 23:23	14/12/2019 12:10	36,78	7	257,45	CHI
20191296167	VALPARAISO DE GOIAS	3350116952	PACAEMBU S1	12/12/2019 23:25	13/12/2019 00:04	12/12/2019 23:25	13/12/2019 00:04	0,64	1	0,64	CHI
20191296168	LUZIANIA	120283931	RIO VERMELHO	12/12/2019 23:27	13/12/2019 00:27	12/12/2019 23:27	13/12/2019 00:27	1,00	1	1,00	CHI
20191296443	HIDROLINA	SZ12190057	ITAPACI	12/12/2019 23:28	13/12/2019 10:05	12/12/2019 23:28	13/12/2019 10:05	10,61	32	339,63	CHI
20191296443	SAO LUIZ DO NORTE	SZ12190057	ITAPACI	12/12/2019 23:28	13/12/2019 10:05	12/12/2019 23:28	13/12/2019 10:05	10,61	2	21,23	CHI
20191296171	GOIANIA	13944307	MEIA PONTE	12/12/2019 23:30	13/12/2019 10:11	12/12/2019 23:30	13/12/2019 10:11	10,68	1	10,68	CHI
20191296176	TRINDADE	TR32004733	TRINDADE	12/12/2019 23:34	13/12/2019 09:21	12/12/2019 23:34	13/12/2019 09:21	9,77	1	9,77	CHI
20191296182	FIRMINOPOLIS	FR12000070	FIRMINOPOLIS S1	12/12/2019 23:40	13/12/2019 07:25	12/12/2019 23:40	13/12/2019 07:25	7,75	6	46,50	CHI
20191296184	APARECIDA DE GOIANIA	AP11210875	INDEPENDENCIA S2	12/12/2019 23:42	13/12/2019 05:03	12/12/2019 23:42	13/12/2019 05:03	5,34	129	688,43	CHI
20191295652	SAO MIGUEL DO ARAGUAIA	SM10388763	SAO MIGUEL DO ARAGUAIA	12/12/2019 23:45	13/12/2019 00:11	12/12/2019 23:45	13/12/2019 00:10	0,43	312	132,77	CHI
20191295652	SAO MIGUEL DO ARAGUAIA	SM10388763	SAO MIGUEL DO ARAGUAIA	12/12/2019 23:45	13/12/2019 00:11	12/12/2019 23:45	13/12/2019 00:11	0,43	12	5,21	CHI
20191296189	GOIANIA	GN11001635	XAVANTES	12/12/2019 23:47	13/12/2019 11:04	12/12/2019 23:47	13/12/2019 11:04	11,28	107	1207,23	CHI
20191296191	CIDADE OCIDENTAL	DH11033837	MARAJOARA	12/12/2019 23:52	13/12/2019 01:51	12/12/2019 23:52	13/12/2019 01:51	1,97	92	181,55	CHI
20191296199	CRIXAS	CX12202134	SERRA DO OURO	13/12/2019 00:02	13/12/2019 11:00	13/12/2019 00:02	13/12/2019 11:00	10,97	46	504,65	CHI
20191297076	CALDAZINHA	SV12089946	DAIA S2	13/12/2019 00:05	13/12/2019 12:38	13/12/2019 00:05	13/12/2019 12:38	12,54	5	62,69	CHI
20191297076	SILVANIA	SV12089946	DAIA S2	13/12/2019 00:05	13/12/2019 12:38	13/12/2019 00:05	13/12/2019 12:38	12,54	2	25,08	CHI
20191296737	ALTO PARAISO DE GOIAS	BF12264707	FLORES DE GOIAS	13/12/2019 00:19	13/12/2019 11:17	13/12/2019 00:19	13/12/2019 11:17	10,96	21	230,16	CHI

20191296212	TRINDADE	GN11348651	TRINDADE	13/12/2019 00:39	13/12/2019 09:58	13/12/2019 00:39	13/12/2019 09:58	9,32	1	9,32	CHI
20191296214	CATALAO	CT21215505	CATALAO S1	13/12/2019 00:39	13/12/2019 10:01	13/12/2019 00:39	13/12/2019 10:01	9,35	2	18,70	CHI
20191296215	CACU	CC21347252	CACHOEIRA ALTA	13/12/2019 00:40	13/12/2019 09:35	13/12/2019 00:40	13/12/2019 09:35	8,91	1	8,91	CHI
20191296218	BALIZA	BH11334513	BOM JARDIM	13/12/2019 00:45	13/12/2019 10:21	13/12/2019 00:45	13/12/2019 10:21	9,60	1	9,60	CHI
20191296223	ALEXANIA	AX21329597	ALEXANIA	13/12/2019 00:52	13/12/2019 08:13	13/12/2019 00:52	13/12/2019 08:13	7,34	1	7,34	CHI
20191296224	SAO MIGUEL DO ARAGUAIA	SM12000063	SAO MIGUEL DO ARAGUAIA	13/12/2019 00:59	13/12/2019 09:26	13/12/2019 00:59	13/12/2019 09:26	8,45	35	295,75	CHI
20191296227	CRIXAS	CX21151560	SERRA DO OURO	13/12/2019 01:07	14/12/2019 02:00	13/12/2019 01:07	14/12/2019 02:00	24,88	1	24,88	CHI
20191296229	HIDROLINA	UR12048650	URUACU	13/12/2019 01:12	13/12/2019 07:21	13/12/2019 01:12	13/12/2019 07:21	6,15	15	92,19	CHI
20191296229	URUACU	UR12048650	URUACU	13/12/2019 01:12	13/12/2019 07:21	13/12/2019 01:12	13/12/2019 07:21	6,15	34	208,96	CHI
20191296231	BELA VISTA DE GOIAS	BV31167353	BELA VISTA S1	13/12/2019 01:40	13/12/2019 09:33	13/12/2019 01:40	13/12/2019 09:33	7,88	3	23,65	CHI
20191296233	FLORES DE GOIAS	FB12250123	FLORES DE GOIAS	13/12/2019 01:44	13/12/2019 13:15	13/12/2019 01:44	13/12/2019 13:15	11,51	81	932,20	CHI
20191296233	SAO JOAO D ALIANCA	FB12250123	FLORES DE GOIAS	13/12/2019 01:44	13/12/2019 13:15	13/12/2019 01:44	13/12/2019 13:15	11,51	20	230,17	CHI
20191296738	CRIXAS	IW12032522	RUBIATABA	13/12/2019 01:44	13/12/2019 13:20	13/12/2019 01:44	13/12/2019 13:20	11,59	12	139,11	CHI
20191296738	GUARINOS	IW12032522	RUBIATABA	13/12/2019 01:44	13/12/2019 13:20	13/12/2019 01:44	13/12/2019 13:20	11,59	11	127,52	CHI
20191296738	ITAPACI	IW12032522	RUBIATABA	13/12/2019 01:44	13/12/2019 13:20	13/12/2019 01:44	13/12/2019 13:20	11,59	33	382,56	CHI
20191296238	MOZARLANDIA	MZ10400707	MOZARLANDIA	13/12/2019 01:59	15/12/2019 13:46	13/12/2019 01:59	13/12/2019 03:22	1,39	35	48,61	CHI
20191296238	NOVA CRIXAS	MZ10400707	MOZARLANDIA	13/12/2019 01:59	15/12/2019 13:46	13/12/2019 01:59	13/12/2019 03:22	1,39	31	43,06	CHI
20191296238	CRIXAS	MZ10400707	MOZARLANDIA	13/12/2019 01:59	15/12/2019 13:46	13/12/2019 01:59	13/12/2019 09:44	7,75	2	15,49	CHI
20191296238	NOVA CRIXAS	MZ10400707	MOZARLANDIA	13/12/2019 01:59	15/12/2019 13:46	13/12/2019 01:59	13/12/2019 09:44	7,75	61	472,48	CHI
20191296238	NOVA CRIXAS	MZ10400707	MOZARLANDIA	13/12/2019 01:59	15/12/2019 13:46	13/12/2019 01:59	13/12/2019 11:43	9,74	20	194,83	CHI
20191296238	NOVA CRIXAS	NA12057420LD	MOZARLANDIA	13/12/2019 01:59	15/12/2019 13:46	13/12/2019 01:59	13/12/2019 13:17	11,30	18	203,31	CHI
20191296238	CRIXAS	MZ10400707	MOZARLANDIA	13/12/2019 01:59	15/12/2019 13:46	13/12/2019 01:59	13/12/2019 19:05	17,09	1	17,09	CHI
20191296238	NOVA CRIXAS	MZ10400707	MOZARLANDIA	13/12/2019 01:59	15/12/2019 13:46	13/12/2019 01:59	13/12/2019 19:05	17,09	6	102,56	CHI
20191296238	MOZARLANDIA	MZ10400707	MOZARLANDIA	13/12/2019 01:59	15/12/2019 13:46	14/12/2019 06:54	14/12/2019 09:53	2,99	21	62,71	CHI
20191296238	MOZARLANDIA	MZ10400707	MOZARLANDIA	13/12/2019 01:59	15/12/2019 13:46	14/12/2019 09:54	14/12/2019 10:28	0,58	7	4,04	CHI
20191296238	CRIXAS	MZ12055630LD	MOZARLANDIA	13/12/2019 01:59	15/12/2019 13:46	14/12/2019 06:54	14/12/2019 12:26	5,54	3	16,61	CHI
20191296238	MOZARLANDIA	MZ12055630LD	MOZARLANDIA	13/12/2019 01:59	15/12/2019 13:46	14/12/2019 06:54	14/12/2019 12:26	5,54	14	77,53	CHI
20191296238	NOVA CRIXAS	MZ12055630LD	MOZARLANDIA	13/12/2019 01:59	15/12/2019 13:46	14/12/2019 06:54	14/12/2019 12:26	5,54	136	753,18	CHI
20191296238	MOZARLANDIA	MZ12055630LD	MOZARLANDIA	13/12/2019 01:59	15/12/2019 13:46	14/12/2019 09:54	14/12/2019 12:26	2,54	13	33,08	CHI
20191296238	NOVA CRIXAS	NA12193695	MOZARLANDIA	13/12/2019 01:59	15/12/2019 13:46	13/12/2019 01:59	14/12/2019 14:23	36,41	6	218,44	CHI
20191296238	NOVA CRIXAS	NA12325050	MOZARLANDIA	13/12/2019 01:59	15/12/2019 13:46	13/12/2019 01:59	14/12/2019 15:00	37,02	9	333,15	CHI
20191296238	NOVA CRIXAS	NA12325050	NOVA CRIXAS	13/12/2019 01:59	15/12/2019 13:46	13/12/2019 01:59	14/12/2019 15:00	37,02	1	37,02	CHI
20191296238	NOVA CRIXAS	NA12193695	MOZARLANDIA	13/12/2019 01:59	15/12/2019 13:46	14/12/2019 14:28	14/12/2019 22:40	8,19	6	49,14	CHI

20191296238	MOZARLANDIA	MZ21334726	MOZARLANDIA	13/12/2019 01:59	15/12/2019 13:46	14/12/2019 09:54	15/12/2019 03:37	17,73	1	17,73	CHI
20191296238	NOVA CRIXAS	NA12325050	MOZARLANDIA	13/12/2019 01:59	15/12/2019 13:46	14/12/2019 15:05	15/12/2019 11:41	20,60	2	41,20	CHI
20191296238	NOVA CRIXAS	NA12022049	MOZARLANDIA	13/12/2019 01:59	15/12/2019 13:46	14/12/2019 15:05	15/12/2019 12:46	21,68	7	151,78	CHI
20191296238	NOVA CRIXAS	NA13038840	NOVA CRIXAS	13/12/2019 01:59	15/12/2019 13:46	14/12/2019 15:05	15/12/2019 13:46	22,68	1	22,68	CHI
20191296239	POSSE	1480015961	IACIARA S2	13/12/2019 02:04	13/12/2019 07:49	13/12/2019 02:04	13/12/2019 07:49	5,75	1	5,75	CHI
20191296532	GOIANESIA	GE12352313	GOIANESIA S1	13/12/2019 02:05	15/12/2019 00:10	13/12/2019 02:05	13/12/2019 13:47	11,71	15	175,59	CHI
20191296532	GOIANESIA	GE12352313	GOIANESIA S1	13/12/2019 02:05	15/12/2019 00:10	13/12/2019 02:05	15/12/2019 00:10	46,08	8	368,63	CHI
20191296532	SAO LUIZ DO NORTE	GE12352313	GOIANESIA S1	13/12/2019 02:05	15/12/2019 00:10	13/12/2019 02:05	15/12/2019 00:10	46,08	21	967,65	CHI
20191296532	GOIANESIA	GE12352313	GOIANESIA S1	13/12/2019 02:05	15/12/2019 00:10	14/12/2019 21:42	15/12/2019 00:10	2,47	15	37,00	CHI
20191295676	ALTO PARAISO DE GOIAS	BF10395392	NIQUELANDIA SUBTRANSMISSAO	13/12/2019 02:06	13/12/2019 02:43	13/12/2019 02:06	13/12/2019 02:16	0,15	522	80,47	CHI
20191295676	ALTO PARAISO DE GOIAS	O1290434	NIQUELANDIA SUBTRANSMISSAO	13/12/2019 02:06	13/12/2019 02:43	13/12/2019 02:06	13/12/2019 02:42	0,59	12	7,06	CHI
20191295676	COLINAS DO SUL	O1290434	NIQUELANDIA SUBTRANSMISSAO	13/12/2019 02:06	13/12/2019 02:43	13/12/2019 02:06	13/12/2019 02:42	0,59	18	10,58	CHI
20191295676	NIQUELANDIA	O1290434	NIQUELANDIA SUBTRANSMISSAO	13/12/2019 02:06	13/12/2019 02:43	13/12/2019 02:06	13/12/2019 02:42	0,59	1928	1133,77	CHI
20191295676	SAO JOAO D ALIANCA	O1290434	NIQUELANDIA SUBTRANSMISSAO	13/12/2019 02:06	13/12/2019 02:43	13/12/2019 02:06	13/12/2019 02:42	0,59	1	0,59	CHI
20191295676	ALTO PARAISO DE GOIAS	TI10400728	NIQUELANDIA SUBTRANSMISSAO	13/12/2019 02:06	13/12/2019 02:43	13/12/2019 02:06	13/12/2019 02:43	0,60	24	14,51	CHI
20191295676	CAVALCANTE	TI10400728	NIQUELANDIA SUBTRANSMISSAO	13/12/2019 02:06	13/12/2019 02:43	13/12/2019 02:06	13/12/2019 02:43	0,60	55	33,26	CHI
20191295676	COLINAS DO SUL	TI10400728	NIQUELANDIA SUBTRANSMISSAO	13/12/2019 02:06	13/12/2019 02:43	13/12/2019 02:06	13/12/2019 02:43	0,60	1168	706,32	CHI
20191295676	NIQUELANDIA	TI10400728	NIQUELANDIA SUBTRANSMISSAO	13/12/2019 02:06	13/12/2019 02:43	13/12/2019 02:06	13/12/2019 02:43	0,60	4	2,42	CHI
20191296241	ANAPOLIS	AN12026164	ANAPOLIS UNIVERSITARIO S2	13/12/2019 02:06	13/12/2019 07:43	13/12/2019 02:06	13/12/2019 07:43	5,61	2	11,22	CHI
20191296378	ALTO HORIZONTE	NH12202112RE	SANTA TEREZINHA	13/12/2019 02:24	13/12/2019 09:12	13/12/2019 02:24	13/12/2019 09:12	6,80	56	380,55	CHI
20191296378	CAMPOS VERDES	NH12202112RE	SANTA TEREZINHA	13/12/2019 02:24	13/12/2019 09:12	13/12/2019 02:24	13/12/2019 09:12	6,80	8	54,36	CHI
20191296378	NOVA IGUACU DE GOIAS	NH12202112RE	SANTA TEREZINHA	13/12/2019 02:24	13/12/2019 09:12	13/12/2019 02:24	13/12/2019 09:12	6,80	5	33,98	CHI
20191296378	PILAR DE GOIAS	NH12202112RE	SANTA TEREZINHA	13/12/2019 02:24	13/12/2019 09:12	13/12/2019 02:24	13/12/2019 09:12	6,80	1	6,80	CHI
20191296250	ITAGUARI	IC12035368	ITABERAI S1	13/12/2019 02:56	13/12/2019 07:24	13/12/2019 02:56	13/12/2019 07:24	4,45	27	120,22	CHI
20191296250	JARAGUA	IC12035368	ITABERAI S1	13/12/2019 02:56	13/12/2019 07:24	13/12/2019 02:56	13/12/2019 07:24	4,45	8	35,62	CHI
20191296253	GOIAS	GS12362376	MATRINCHA	13/12/2019 03:09	13/12/2019 07:40	13/12/2019 03:09	13/12/2019 07:40	4,50	2	9,01	CHI
20191296253	ITAPIRAPUA	GS12362376	MATRINCHA	13/12/2019 03:09	13/12/2019 07:40	13/12/2019 03:09	13/12/2019 07:40	4,50	61	274,67	CHI
20191296373	APARECIDA DE GOIANIA	AP11003034	INDEPENDENCIA S1	13/12/2019 03:17	13/12/2019 12:56	13/12/2019 03:17	13/12/2019 12:56	9,65	76	733,19	CHI
20191296258	ITABERAI	IB12250751	ITABERAI S1	13/12/2019 03:31	13/12/2019 07:36	13/12/2019 03:31	13/12/2019 07:36	4,08	5	20,39	CHI
20191296262	NIQUELANDIA	NQ12035673	NIQUELANDIA SUBTRANSMISSAO	13/12/2019 03:53	13/12/2019 06:01	13/12/2019 03:53	13/12/2019 06:01	2,12	414	876,76	CHI
20191296263	NOVA CRIXAS	NA12091692	NOVA CRIXAS	13/12/2019 03:54	13/12/2019 09:46	13/12/2019 03:54	13/12/2019 09:46	5,85	22	128,71	CHI
20191296637	ALTO HORIZONTE	MQ12181177	MARA ROSA	13/12/2019 04:15	13/12/2019 11:38	13/12/2019 04:15	13/12/2019 11:38	7,38	1	7,38	CHI
20191296637	MARA ROSA	MQ12181177	MARA ROSA	13/12/2019 04:15	13/12/2019 11:38	13/12/2019 04:15	13/12/2019 11:38	7,38	28	206,59	CHI

20191296637	URUACU	MQ12181177	MARA ROSA	13/12/2019 04:15	13/12/2019 11:38	13/12/2019 04:15	13/12/2019 11:38	7,38	1	7,38	CHI
20191296268	MOZARLANDIA	MZ12238850	MOZARLANDIA	13/12/2019 04:16	13/12/2019 08:45	13/12/2019 04:16	13/12/2019 08:45	4,48	4	17,90	CHI
20191296271	CEZARINA	CZ21010840	CEZARINA	13/12/2019 04:23	13/12/2019 07:33	13/12/2019 04:23	13/12/2019 07:33	3,17	1	3,17	CHI
20191296273	APORE	AE10396071	ITAJA S1	13/12/2019 04:24	13/12/2019 20:40	13/12/2019 04:24	13/12/2019 08:42	4,30	133	572,31	CHI
20191296273	ITARUMA	AE10396071	ITAJA S1	13/12/2019 04:24	13/12/2019 20:40	13/12/2019 04:24	13/12/2019 08:42	4,30	1	4,30	CHI
20191296273	APORE	AE13209674	ITAJA S1	13/12/2019 04:24	13/12/2019 20:40	13/12/2019 04:24	13/12/2019 20:18	15,89	31	492,62	CHI
20191296273	APORE	AE13209676	ITAJA S1	13/12/2019 04:24	13/12/2019 20:40	13/12/2019 15:37	13/12/2019 20:40	5,05	15	75,68	CHI
20191296275	TRINDADE	TR12134047	GOYA S2	13/12/2019 04:28	13/12/2019 07:30	13/12/2019 04:28	13/12/2019 07:30	3,02	124	374,20	CHI
20191296462	SANTA HELENA DE GOIAS	SH11000043	IPEGUARI	13/12/2019 04:30	13/12/2019 08:40	13/12/2019 04:30	13/12/2019 08:40	4,18	51	213,10	CHI
20191295679	FLORES DE GOIAS	FB10401476	FLORES DE GOIAS	13/12/2019 04:35	13/12/2019 12:09	13/12/2019 04:35	13/12/2019 07:41	3,10	212	656,61	CHI
20191295679	FORMOSA	FB10401476	FLORES DE GOIAS	13/12/2019 04:35	13/12/2019 12:09	13/12/2019 04:35	13/12/2019 07:41	3,10	137	424,32	CHI
20191295679	FORMOSO	FB10401476	FLORES DE GOIAS	13/12/2019 04:35	13/12/2019 12:09	13/12/2019 04:35	13/12/2019 07:41	3,10	1	3,10	CHI
20191295679	SAO JOAO D ALIANCA	FB10401476	FLORES DE GOIAS	13/12/2019 04:35	13/12/2019 12:09	13/12/2019 04:35	13/12/2019 07:41	3,10	5	15,49	CHI
20191295679	ALVORADA DO NORTE	FB10401476	FLORES DE GOIAS	13/12/2019 04:35	13/12/2019 12:09	13/12/2019 04:35	13/12/2019 11:50	7,26	54	391,90	CHI
20191295679	FLORES DE GOIAS	FB10401476	FLORES DE GOIAS	13/12/2019 04:35	13/12/2019 12:09	13/12/2019 04:35	13/12/2019 11:50	7,26	59	428,19	CHI
20191295679	IACIARA	FB10401476	FLORES DE GOIAS	13/12/2019 04:35	13/12/2019 12:09	13/12/2019 04:35	13/12/2019 11:50	7,26	20	145,15	CHI
20191295679	POSSE	FB10401476	FLORES DE GOIAS	13/12/2019 04:35	13/12/2019 12:09	13/12/2019 04:35	13/12/2019 11:50	7,26	2	14,51	CHI
20191295679	FLORES DE GOIAS	FB13257796	FLORES DE GOIAS	13/12/2019 04:35	13/12/2019 12:09	13/12/2019 11:58	13/12/2019 12:09	0,20	212	41,63	CHI
20191295679	FORMOSA	FB13257796	FLORES DE GOIAS	13/12/2019 04:35	13/12/2019 12:09	13/12/2019 11:58	13/12/2019 12:09	0,20	137	26,91	CHI
20191295679	FORMOSO	FB13257796	FLORES DE GOIAS	13/12/2019 04:35	13/12/2019 12:09	13/12/2019 11:58	13/12/2019 12:09	0,20	1	0,20	CHI
20191295679	SAO JOAO D ALIANCA	FB13257796	FLORES DE GOIAS	13/12/2019 04:35	13/12/2019 12:09	13/12/2019 11:58	13/12/2019 12:09	0,20	5	0,98	CHI
20191296290	GOIAS	GS12206865	MATRINCHA	13/12/2019 04:36	14/12/2019 12:21	13/12/2019 04:36	13/12/2019 08:49	4,21	1	4,21	CHI
20191296290	GOIAS	GS12206865	MATRINCHA	13/12/2019 04:36	14/12/2019 12:21	13/12/2019 04:36	13/12/2019 09:16	4,66	34	158,57	CHI
20191296290	GOIAS	GS12206865	MATRINCHA	13/12/2019 04:36	14/12/2019 12:21	13/12/2019 04:36	13/12/2019 10:32	5,93	14	83,08	CHI
20191296290	GOIAS	GS12206865	MATRINCHA	13/12/2019 04:36	14/12/2019 12:21	13/12/2019 12:46	13/12/2019 13:30	0,73	49	35,80	CHI
20191296290	GOIAS	GS12206865	MATRINCHA	13/12/2019 04:36	14/12/2019 12:21	14/12/2019 00:31	14/12/2019 01:33	1,03	49	50,23	CHI
20191296290	GOIAS	GS12206865	MATRINCHA	13/12/2019 04:36	14/12/2019 12:21	13/12/2019 04:36	14/12/2019 11:07	30,52	3	91,56	CHI
20191296290	GOIAS	GS12206865	MATRINCHA	13/12/2019 04:36	14/12/2019 12:21	13/12/2019 04:36	14/12/2019 11:52	31,26	15	468,93	CHI
20191296290	GOIAS	GS12206865	MATRINCHA	13/12/2019 04:36	14/12/2019 12:21	13/12/2019 04:36	14/12/2019 12:21	31,74	1	31,74	CHI
20191296287	SENADOR CANEDO	SW32025792	GOIANIA LESTE S1	13/12/2019 04:40	13/12/2019 10:52	13/12/2019 04:40	13/12/2019 10:52	6,19	4	24,78	CHI
20191296279	NOVA CRIXAS	NA12158761	NOVA CRIXAS	13/12/2019 04:41	13/12/2019 10:55	13/12/2019 04:41	13/12/2019 10:55	6,23	6	37,38	CHI
20191296280	FAINA	FC12299779	MATRINCHA	13/12/2019 04:41	13/12/2019 07:43	13/12/2019 04:41	13/12/2019 07:43	3,03	15	45,41	CHI
20191296280	MATRINCHA	FC12299779	MATRINCHA	13/12/2019 04:41	13/12/2019 07:43	13/12/2019 04:41	13/12/2019 07:43	3,03	38	115,03	CHI

20191296281	PIRENOPOLIS	PV12034069	CORUMBA	13/12/2019 04:41	13/12/2019 14:09	13/12/2019 04:41	13/12/2019 12:31	7,83	27	211,50	CHI
20191296281	PIRENOPOLIS	PV12382173LD	CORUMBA	13/12/2019 04:41	13/12/2019 14:09	13/12/2019 04:41	13/12/2019 13:29	8,81	18	158,55	CHI
20191296281	PIRENOPOLIS	PV12392221	CORUMBA	13/12/2019 04:41	13/12/2019 14:09	13/12/2019 04:41	13/12/2019 14:09	9,47	31	293,45	CHI
20191296361	NOVA CRIXAS	NA12334349	NOVA CRIXAS	13/12/2019 04:45	13/12/2019 07:53	13/12/2019 04:45	13/12/2019 07:53	3,12	83	259,17	CHI
20191296693	GOIANIA	GN12151986	MEIA PONTE	13/12/2019 04:45	13/12/2019 09:02	13/12/2019 04:45	13/12/2019 09:02	4,27	546	2330,96	CHI
20191296644	ARENOPOLIS	PH12024549LD	PIRANHAS	13/12/2019 04:47	13/12/2019 08:05	13/12/2019 04:47	13/12/2019 08:05	3,28	1	3,28	CHI
20191296644	PIRANHAS	PH12024549LD	PIRANHAS	13/12/2019 04:47	13/12/2019 08:05	13/12/2019 04:47	13/12/2019 08:05	3,28	108	354,69	CHI
20191296546	GOIANESIA	GE12384153	GOIANESIA S2	13/12/2019 04:50	13/12/2019 12:24	13/12/2019 04:50	13/12/2019 12:24	7,56	9	68,00	CHI
20191296288	PORANGATU	TB12208457	PORANGATU	13/12/2019 04:55	13/12/2019 12:52	13/12/2019 04:55	13/12/2019 12:52	7,95	1	7,95	CHI
20191296288	TROMBAS	TB12208457	PORANGATU	13/12/2019 04:55	13/12/2019 12:52	13/12/2019 04:55	13/12/2019 12:52	7,95	16	127,14	CHI
20191296292	NOVA CRIXAS	NA12397103	NOVA CRIXAS	13/12/2019 04:56	13/12/2019 11:40	13/12/2019 04:56	13/12/2019 11:40	6,73	7	47,08	CHI
20191296293	QUIRINOPOLIS	QI12303092LD	QUIRINOPOLIS	13/12/2019 04:56	13/12/2019 10:49	13/12/2019 04:56	13/12/2019 10:49	5,87	37	217,28	CHI
20191296609	FIRMINOPOLIS	SL12306929	SAO LUIZ DOS MONTES BELOS	13/12/2019 04:56	13/12/2019 08:19	13/12/2019 04:56	13/12/2019 08:19	3,39	12	40,69	CHI
20191296609	SAO LUIS DE MONTES BELOS	SL12306929	SAO LUIZ DOS MONTES BELOS	13/12/2019 04:56	13/12/2019 08:19	13/12/2019 04:56	13/12/2019 08:19	3,39	20	67,81	CHI
20191296294	SAO FRANCISCO DE GOIAS	SF12370404	SAO FRANCISCO DE GOIAS	13/12/2019 04:58	13/12/2019 09:00	13/12/2019 04:58	13/12/2019 09:00	4,02	10	40,22	CHI
20191296297	GOIAS	GS12378858	MATRINCHA	13/12/2019 04:59	13/12/2019 10:00	13/12/2019 04:59	13/12/2019 10:00	5,02	2	10,03	CHI
20191296542	GOIANIRA	GR11241328	GOIANIRA	13/12/2019 05:00	13/12/2019 10:06	13/12/2019 05:00	13/12/2019 10:06	5,09	131	666,86	CHI
20191297307	SERRANOPOLIS	SX12296496	JATAI S1	13/12/2019 05:02	13/12/2019 08:53	13/12/2019 05:02	13/12/2019 08:53	3,84	66	253,29	CHI
20191296301	ARENOPOLIS	AY12390169	ARENOPOLIS	13/12/2019 05:06	13/12/2019 08:09	13/12/2019 05:06	13/12/2019 08:09	3,04	24	73,07	CHI
20191296301	DIORAMA	AY12390169	ARENOPOLIS	13/12/2019 05:06	13/12/2019 08:09	13/12/2019 05:06	13/12/2019 08:09	3,04	3	9,13	CHI
20191296304	CATURAI	CK12015709LD	INHUMAS S1	13/12/2019 05:09	13/12/2019 12:01	13/12/2019 05:09	13/12/2019 12:01	6,86	1	6,86	CHI
20191296304	GOIANIRA	CK12015709LD	INHUMAS S1	13/12/2019 05:09	13/12/2019 12:01	13/12/2019 05:09	13/12/2019 12:01	6,86	1	6,86	CHI
20191296895	ANICUNS	AR12326204	ARACU	13/12/2019 05:09	13/12/2019 22:12	13/12/2019 05:09	13/12/2019 22:12	17,05	4	68,20	CHI
20191296895	ITABERAI	AR12326204	ARACU	13/12/2019 05:09	13/12/2019 22:12	13/12/2019 05:09	13/12/2019 22:12	17,05	3	51,15	CHI
20191297265	ITAPURANGA	MS10400600	ITAPURANGA	13/12/2019 05:13	13/12/2019 17:10	13/12/2019 05:13	13/12/2019 17:10	11,94	38	453,69	CHI
20191297265	MORRO AGUDO DE GOIAS	MS10400600	ITAPURANGA	13/12/2019 05:13	13/12/2019 17:10	13/12/2019 05:13	13/12/2019 17:10	11,94	59	704,41	CHI
20191296522	MUNDO NOVO DE GOIAS	NA12035650	NOVA CRIXAS	13/12/2019 05:14	13/12/2019 09:22	13/12/2019 05:14	13/12/2019 09:22	4,12	8	32,99	CHI
20191296522	NOVA CRIXAS	NA12035650	NOVA CRIXAS	13/12/2019 05:14	13/12/2019 09:22	13/12/2019 05:14	13/12/2019 09:22	4,12	24	98,98	CHI
20191296649	MUTUNOPOLIS	PO12374520	PORANGATU	13/12/2019 05:16	13/12/2019 08:22	13/12/2019 05:16	13/12/2019 08:22	3,09	18	55,70	CHI
20191296649	PORANGATU	PO12374520	PORANGATU	13/12/2019 05:16	13/12/2019 08:22	13/12/2019 05:16	13/12/2019 08:22	3,09	19	58,79	CHI
20191296311	SANTA HELENA DE GOIAS	SH12296117	IPEGUARI	13/12/2019 05:24	13/12/2019 10:23	13/12/2019 05:24	13/12/2019 10:23	4,97	5	24,85	CHI
20191298626	PORANGATU	PO12100815	NOVO PLANALTO	13/12/2019 05:24	13/12/2019 18:20	13/12/2019 05:24	13/12/2019 18:20	12,92	3	38,75	CHI
20191296485	EDEIA	EA12044037	EDEIA	13/12/2019 05:25	13/12/2019 11:39	13/12/2019 05:25	13/12/2019 11:39	6,23	37	230,62	CHI

201912219302	SAO MIGUEL DO ARAGUAIA	SM13220856	SAO MIGUEL DO ARAGUAIA	13/12/2019 05:26	13/12/2019 17:08	13/12/2019 05:26	13/12/2019 17:08	11,70	11	128,72	CHI
20191296321	INDIARA	IY12081489	EDEIA	13/12/2019 05:29	13/12/2019 07:40	13/12/2019 05:29	13/12/2019 07:40	2,18	52	113,37	CHI
20191296321	PALMEIRAS DE GOIAS	IY12081489	EDEIA	13/12/2019 05:29	13/12/2019 07:40	13/12/2019 05:29	13/12/2019 07:40	2,18	1	2,18	CHI
20191296327	URUACU	UR21340218	MARA ROSA	13/12/2019 05:32	13/12/2019 17:08	13/12/2019 05:32	13/12/2019 17:08	11,59	1	11,59	CHI
20191296330	NIQUELANDIA	NQ12262821	URUACU	13/12/2019 05:33	13/12/2019 09:05	13/12/2019 05:33	13/12/2019 09:05	3,53	8	28,22	CHI
20191296332	CATURAI	CK12326309	INHUMAS S1	13/12/2019 05:33	13/12/2019 12:44	13/12/2019 05:33	13/12/2019 08:02	2,47	8	19,77	CHI
20191296332	INHUMAS	CK12326309	INHUMAS S1	13/12/2019 05:33	13/12/2019 12:44	13/12/2019 05:33	13/12/2019 08:02	2,47	2	4,94	CHI
20191296332	CATURAI	CK12326309	INHUMAS S1	13/12/2019 05:33	13/12/2019 12:44	13/12/2019 05:33	13/12/2019 12:44	7,17	16	114,75	CHI
20191296332	INHUMAS	CK12326309	INHUMAS S1	13/12/2019 05:33	13/12/2019 12:44	13/12/2019 05:33	13/12/2019 12:44	7,17	1	7,17	CHI
20191296333	BALIZA	BH21228520	BOM JARDIM	13/12/2019 05:33	13/12/2019 11:22	13/12/2019 05:33	13/12/2019 11:22	5,80	2	11,61	CHI
20191297057	NOVA CRIXAS	NA12086286	NOVA CRIXAS	13/12/2019 05:33	13/12/2019 12:20	13/12/2019 05:33	13/12/2019 12:20	6,79	9	61,09	CHI
20191297699	ITAUCU	IX12016756	INHUMAS S1	13/12/2019 05:33	13/12/2019 15:30	13/12/2019 05:33	13/12/2019 15:30	9,94	7	69,61	CHI
20191296334	CAMPINACU	UC11208536	PORANGATU	13/12/2019 05:34	13/12/2019 10:07	13/12/2019 05:34	13/12/2019 10:07	4,55	43	195,44	CHI
20191296393	CAMPINACU	IH12132432	MINACU	13/12/2019 05:34	13/12/2019 08:28	13/12/2019 05:34	13/12/2019 08:28	2,88	22	63,45	CHI
20191296393	MINACU	IH12132432	MINACU	13/12/2019 05:34	13/12/2019 08:28	13/12/2019 05:34	13/12/2019 08:28	2,88	106	305,72	CHI
20191296337	BOM JARDIM DE GOIAS	BM11231854	BOM JARDIM	13/12/2019 05:35	13/12/2019 12:17	13/12/2019 05:35	13/12/2019 12:17	6,70	1	6,70	CHI
20191296339	CEZARINA	CZ21348766	CEZARINA	13/12/2019 05:36	13/12/2019 08:08	13/12/2019 05:36	13/12/2019 08:08	2,54	1	2,54	CHI
20191296340	SAO FRANCISCO DE GOIAS	SF21236652	SAO FRANCISCO DE GOIAS	13/12/2019 05:36	13/12/2019 09:35	13/12/2019 05:36	13/12/2019 09:35	3,98	1	3,98	CHI
20191296355	MORRINHOS	MR12121217	MORRINHOS	13/12/2019 05:36	13/12/2019 07:55	13/12/2019 05:36	13/12/2019 07:55	2,31	15	34,68	CHI
20191296343	ESTRELA DO NORTE	ET12012492	MARA ROSA	13/12/2019 05:38	13/12/2019 14:23	13/12/2019 05:38	13/12/2019 14:23	8,75	8	69,96	CHI
20191297664	SAO JOAO D ALIANCA	JL12218373	SAO JOAO D ALIANCA	13/12/2019 05:39	13/12/2019 10:38	13/12/2019 05:39	13/12/2019 10:38	4,97	134	665,76	CHI
20191298117	SERRANOPOLIS	SX12260526	JATAI S1	13/12/2019 05:40	13/12/2019 11:12	13/12/2019 05:40	13/12/2019 11:12	5,52	10	55,21	CHI
20191296353	CAMPINACU	UC12055175	PORANGATU	13/12/2019 05:41	13/12/2019 11:33	13/12/2019 05:41	13/12/2019 07:47	2,11	15	31,58	CHI
20191296353	CAMPINACU	UC12294016LD	PORANGATU	13/12/2019 05:41	13/12/2019 11:33	13/12/2019 05:41	13/12/2019 11:33	5,86	2	11,73	CHI
20191296356	CRIXAS	NA12126913	NOVA CRIXAS	13/12/2019 05:42	14/12/2019 17:10	13/12/2019 05:42	13/12/2019 11:26	5,75	3	17,24	CHI
20191296356	NOVA CRIXAS	NA12126913	NOVA CRIXAS	13/12/2019 05:42	14/12/2019 17:10	13/12/2019 05:42	13/12/2019 11:26	5,75	5	28,73	CHI
20191296356	CRIXAS	NA12126913	NOVA CRIXAS	13/12/2019 05:42	14/12/2019 17:10	13/12/2019 11:41	14/12/2019 17:10	29,48	3	88,43	CHI
20191296356	NOVA CRIXAS	NA12126913	NOVA CRIXAS	13/12/2019 05:42	14/12/2019 17:10	13/12/2019 11:41	14/12/2019 17:10	29,48	5	147,38	CHI
20191297108	GOIAS	IK12250721	GOIAS	13/12/2019 05:42	13/12/2019 17:51	13/12/2019 05:42	13/12/2019 17:51	12,14	14	169,98	CHI
20191297108	ITABERAI	IK12250721	GOIAS	13/12/2019 05:42	13/12/2019 17:51	13/12/2019 05:42	13/12/2019 17:51	12,14	2	24,28	CHI
20191297108	ITAPURANGA	IK12250721	GOIAS	13/12/2019 05:42	13/12/2019 17:51	13/12/2019 05:42	13/12/2019 17:51	12,14	3	36,42	CHI
20191297263	FORMOSA	FA12254301	ITUIQUIRA	13/12/2019 05:43	13/12/2019 19:02	13/12/2019 05:43	13/12/2019 19:02	13,32	8	106,52	CHI
20191296369	FORMOSA	FA12309175	ITUIQUIRA	13/12/2019 05:46	13/12/2019 11:00	13/12/2019 05:46	13/12/2019 11:00	5,22	3	15,67	CHI

20191296381	NOVO PLANALTO	TA12391925	SAO MIGUEL DO ARAGUAIA	13/12/2019 05:49	13/12/2019 10:34	13/12/2019 05:49	13/12/2019 10:34	4,75	8	37,98	CHI
20191296384	BRAZABRANTES	BR21015988	INHUMAS S2	13/12/2019 05:50	13/12/2019 18:29	13/12/2019 05:50	13/12/2019 18:29	12,67	2	25,33	CHI
20191296566	URUACU	UR12066508	URUACU	13/12/2019 05:51	13/12/2019 10:39	13/12/2019 05:51	13/12/2019 10:39	4,79	13	62,21	CHI
20191295927	CORUMBA DE GOIAS	CB12297694	CORUMBA	13/12/2019 05:52	13/12/2019 10:07	13/12/2019 05:52	13/12/2019 10:07	4,24	36	152,58	CHI
20191296785	CAIAPONIA	CP12200875	CAIAPONIA	13/12/2019 05:54	13/12/2019 10:40	13/12/2019 05:54	13/12/2019 10:40	4,76	9	42,87	CHI
20191296396	ARAGUAPAZ	AZ12188220	MOZARLANDIA	13/12/2019 05:55	13/12/2019 07:20	13/12/2019 05:55	13/12/2019 07:20	1,40	35	49,13	CHI
20191296396	MOZARLANDIA	AZ12188220	MOZARLANDIA	13/12/2019 05:55	13/12/2019 07:20	13/12/2019 05:55	13/12/2019 07:20	1,40	7	9,83	CHI
20191296399	ARUANA	AK12307445	MOZARLANDIA	13/12/2019 05:57	13/12/2019 08:04	13/12/2019 05:57	13/12/2019 08:04	2,10	12	25,25	CHI
20191296408	CATURAI	CK11093363	GOIANIRA	13/12/2019 05:59	13/12/2019 08:41	13/12/2019 05:59	13/12/2019 08:41	2,71	59	159,69	CHI
20191296409	MARA ROSA	MQ12263046	MARA ROSA	13/12/2019 05:59	14/12/2019 16:17	13/12/2019 05:59	14/12/2019 16:17	34,29	7	240,06	CHI
20191296724	ALTO PARAISO DE GOIAS	BF12096495	SAO JOAO D ALIANCA	13/12/2019 05:59	13/12/2019 13:46	13/12/2019 05:59	13/12/2019 13:46	7,77	8	62,17	CHI
20191296415	ARENOPOLIS	AY12345509	ARENOPOLIS	13/12/2019 06:00	13/12/2019 16:20	13/12/2019 06:00	13/12/2019 16:20	10,33	9	92,99	CHI
20191296758	NOVA AMERICA	NM12075610	RUBIATABA	13/12/2019 06:00	13/12/2019 10:38	13/12/2019 06:00	13/12/2019 10:38	4,62	13	60,11	CHI
20191296246	CRIXAS	MZ12055628	MOZARLANDIA	13/12/2019 06:01	13/12/2019 13:50	13/12/2019 06:01	13/12/2019 13:50	7,83	26	203,59	CHI
20191296246	MOZARLANDIA	MZ12055628	MOZARLANDIA	13/12/2019 06:01	13/12/2019 13:50	13/12/2019 06:01	13/12/2019 13:50	7,83	38	297,55	CHI
20191297136	NOVA VENEZA	NV12111337	INHUMAS S1	13/12/2019 06:01	13/12/2019 18:43	13/12/2019 06:01	13/12/2019 18:43	12,70	18	228,56	CHI
20191296247	MINEIROS	MY12153327RE	PARQUE DAS EMAS	13/12/2019 06:02	13/12/2019 14:20	13/12/2019 06:02	13/12/2019 14:20	8,29	167	1385,22	CHI
20191296247	SANTA RITA DO ARAGUAIA	MY12153327RE	PARQUE DAS EMAS	13/12/2019 06:02	13/12/2019 14:20	13/12/2019 06:02	13/12/2019 14:20	8,29	4	33,18	CHI
20191296428	SANTA FE DE GOIAS	RN12009765	BRITANIA	13/12/2019 06:02	13/12/2019 08:11	13/12/2019 06:02	13/12/2019 08:11	2,16	23	49,59	CHI
20191297004	GOIANIA	AP12048793	REAL S2	13/12/2019 06:02	13/12/2019 10:46	13/12/2019 06:02	13/12/2019 10:46	4,73	160	756,49	CHI
20191297073	IACIARA	IA12262079	IACIARA S1	13/12/2019 06:04	13/12/2019 10:55	13/12/2019 06:04	13/12/2019 10:55	4,84	21	101,72	CHI
20191296439	AURILANDIA	AI21346541	FIRMINOPOLIS S2	13/12/2019 06:06	13/12/2019 09:23	13/12/2019 06:06	13/12/2019 09:23	3,29	1	3,29	CHI
20191296446	SENADOR CANEDO	190043015	SENADOR CANEDO	13/12/2019 06:07	13/12/2019 07:26	13/12/2019 06:07	13/12/2019 07:26	1,30	1	1,30	CHI
20191296464	MINEIROS	MY10394758	PARQUE DAS EMAS	13/12/2019 06:07	14/12/2019 11:52	13/12/2019 06:07	13/12/2019 09:00	2,90	18	52,12	CHI
20191296464	MINEIROS	MY10394758	PARQUE DAS EMAS	13/12/2019 06:07	14/12/2019 11:52	13/12/2019 09:01	13/12/2019 10:11	1,18	13	15,36	CHI
20191296464	CAIAPONIA	MY10394758	PARQUE DAS EMAS	13/12/2019 06:07	14/12/2019 11:52	13/12/2019 06:07	13/12/2019 10:54	4,80	5	23,99	CHI
20191296464	MINEIROS	MY10394758	PARQUE DAS EMAS	13/12/2019 06:07	14/12/2019 11:52	13/12/2019 06:07	13/12/2019 10:54	4,80	69	331,07	CHI
20191296464	PEROLANDIA	MY10394758	PARQUE DAS EMAS	13/12/2019 06:07	14/12/2019 11:52	13/12/2019 06:07	13/12/2019 10:54	4,80	8	38,38	CHI
20191296464	MINEIROS	MY10394758	PARQUE DAS EMAS	13/12/2019 06:07	14/12/2019 11:52	13/12/2019 09:01	13/12/2019 10:54	1,90	3	5,69	CHI
20191296464	MINEIROS	MY10394758	PARQUE DAS EMAS	13/12/2019 06:07	14/12/2019 11:52	13/12/2019 10:16	13/12/2019 10:54	0,64	13	8,35	CHI
20191296464	MINEIROS	MY13296326	PARQUE DAS EMAS	13/12/2019 06:07	14/12/2019 11:52	13/12/2019 09:01	13/12/2019 11:59	2,97	1	2,97	CHI
20191296464	MINEIROS	MY12011374	PARQUE DAS EMAS	13/12/2019 06:07	14/12/2019 11:52	13/12/2019 09:01	14/12/2019 11:52	26,85	2	53,71	CHI
20191296476	ALTO PARAISO DE GOIAS	ND12302636	IACIARA S2	13/12/2019 06:07	13/12/2019 09:38	13/12/2019 06:07	13/12/2019 09:38	3,52	18	63,29	CHI

20191296476	NOVA ROMA	ND12302636	IACIARA S2	13/12/2019 06:07	13/12/2019 09:38	13/12/2019 06:07	13/12/2019 09:38	3,52	96	337,55	CHI
20191296476	SAO JOAO D ALIANCA	ND12302636	IACIARA S2	13/12/2019 06:07	13/12/2019 09:38	13/12/2019 06:07	13/12/2019 09:38	3,52	12	42,19	CHI
20191296748	MARA ROSA	MQ12249312	SANTA TEREZINHA	13/12/2019 06:07	14/12/2019 13:47	13/12/2019 06:07	14/12/2019 13:47	31,66	10	316,56	CHI
20191296451	CAIAPONIA	CP12245300	CAIAPONIA	13/12/2019 06:08	13/12/2019 12:33	13/12/2019 06:08	13/12/2019 12:33	6,40	38	243,33	CHI
20191296453	CRISTALINA	KR21348837	CRISTALINA S2	13/12/2019 06:08	13/12/2019 09:19	13/12/2019 06:08	13/12/2019 09:19	3,17	2	6,34	CHI
20191296454	GOIANIA	10024748	GOIANIA LESTE S1	13/12/2019 06:09	13/12/2019 10:39	13/12/2019 06:09	13/12/2019 10:39	4,50	1	4,50	CHI
20191296456	QUIRINOPOLIS	QI12370085	QUIRINOPOLIS	13/12/2019 06:09	13/12/2019 19:39	13/12/2019 06:09	13/12/2019 19:39	13,49	2	26,97	CHI
20191297028	CAMPOS VERDES	VD12251082	SANTA TEREZINHA	13/12/2019 06:10	13/12/2019 16:52	13/12/2019 06:10	13/12/2019 16:52	10,69	4	42,74	CHI
20191297028	SANTA TEREZINHA DE GOIAS	VD12251082	SANTA TEREZINHA	13/12/2019 06:10	13/12/2019 16:52	13/12/2019 06:10	13/12/2019 16:52	10,69	17	181,65	CHI
20191296458	SAO MIGUEL DO ARAGUAIA	SM12013036	SAO MIGUEL DO ARAGUAIA	13/12/2019 06:11	13/12/2019 10:02	13/12/2019 06:11	13/12/2019 10:02	3,85	20	77,08	CHI
20191296467	PIRES DO RIO	PR12000071	PIRES DO RIO S1	13/12/2019 06:14	13/12/2019 15:35	13/12/2019 06:14	13/12/2019 15:35	9,35	71	663,77	CHI
20191297007	GOIANIA	GN12000477	FERROVIARIO S1	13/12/2019 06:14	13/12/2019 08:12	13/12/2019 06:14	13/12/2019 08:12	1,96	551	1078,12	CHI
20191296473	BONOPOLIS	BX12013030	SAO MIGUEL DO ARAGUAIA	13/12/2019 06:15	13/12/2019 07:55	13/12/2019 06:15	13/12/2019 07:55	1,66	5	8,32	CHI
20191298643	CATURAI	CK12326309	INHUMAS S1	13/12/2019 06:15	13/12/2019 12:44	13/12/2019 06:15	13/12/2019 12:44	6,48	1	6,48	CHI
20191296480	ITAJA	IM12296705	ITAJA S2	13/12/2019 06:16	13/12/2019 16:03	13/12/2019 06:16	13/12/2019 16:03	9,78	1	9,78	CHI
20191296480	ITARUMA	IM12296705	ITAJA S2	13/12/2019 06:16	13/12/2019 16:03	13/12/2019 06:16	13/12/2019 16:03	9,78	14	136,87	CHI
20191296482	PORANGATU	PO12137591	PORANGATU	13/12/2019 06:16	13/12/2019 15:25	13/12/2019 06:16	13/12/2019 15:25	9,15	3	27,45	CHI
20191296488	CAMPOS VERDES	VD12243626	SANTA TEREZINHA	13/12/2019 06:17	13/12/2019 11:32	13/12/2019 06:17	13/12/2019 11:32	5,25	20	105,10	CHI
20191296491	SAO FRANCISCO DE GOIAS	SF12319829	SAO FRANCISCO DE GOIAS	13/12/2019 06:17	13/12/2019 11:00	13/12/2019 06:17	13/12/2019 11:00	4,70	20	94,01	CHI
20191297091	MUTUNOPOLIS	MU12214693	MARA ROSA	13/12/2019 06:17	13/12/2019 13:57	13/12/2019 06:17	13/12/2019 13:57	7,66	9	68,92	CHI
20191296500	CAMPO ALEGRE DE GOIAS	CM12029641	CAMPO ALEGRE DE GOIAS	13/12/2019 06:19	13/12/2019 12:41	13/12/2019 06:19	13/12/2019 12:41	6,36	8	50,90	CHI
20191296500	CATALAO	CM12029641	CAMPO ALEGRE DE GOIAS	13/12/2019 06:19	13/12/2019 12:41	13/12/2019 06:19	13/12/2019 12:41	6,36	8	50,90	CHI
20191296502	DAMIANOPOLIS	DA21309347	IACIARA S2	13/12/2019 06:19	13/12/2019 09:53	13/12/2019 06:19	13/12/2019 09:53	3,56	1	3,56	CHI
20191296503	CACHOEIRA ALTA	CA12200034	CACHOEIRA ALTA	13/12/2019 06:19	13/12/2019 12:28	13/12/2019 06:19	13/12/2019 12:28	6,15	3	18,46	CHI
20191296622	AMARALINA	MU12257886	MARA ROSA	13/12/2019 06:20	13/12/2019 10:02	13/12/2019 06:20	13/12/2019 10:02	3,69	36	133,01	CHI
20191296622	MUTUNOPOLIS	MU12257886	MARA ROSA	13/12/2019 06:20	13/12/2019 10:02	13/12/2019 06:20	13/12/2019 10:02	3,69	1	3,69	CHI
20191297085	GOIANIA	GN11215971	GOYA S1	13/12/2019 06:20	13/12/2019 09:22	13/12/2019 06:20	13/12/2019 09:22	3,03	131	396,68	CHI
20191296512	NOVA IGUACU DE GOIAS	UR12407359	URUACU	13/12/2019 06:21	13/12/2019 10:02	13/12/2019 06:21	13/12/2019 10:02	3,67	20	73,49	CHI
20191296512	PILAR DE GOIAS	UR12407359	URUACU	13/12/2019 06:21	13/12/2019 10:02	13/12/2019 06:21	13/12/2019 10:02	3,67	1	3,67	CHI
20191296512	URUACU	UR12407359	URUACU	13/12/2019 06:21	13/12/2019 10:02	13/12/2019 06:21	13/12/2019 10:02	3,67	30	110,23	CHI
20191296513	FAINA	FC12378894	MATRINCHA	13/12/2019 06:21	13/12/2019 16:28	13/12/2019 06:21	13/12/2019 16:28	10,11	13	131,41	CHI
20191296513	MATRINCHA	FC12378894	MATRINCHA	13/12/2019 06:21	13/12/2019 16:28	13/12/2019 06:21	13/12/2019 16:28	10,11	7	70,76	CHI
20191296518	GOIANESIA	GE11043767	GOIANESIA S1	13/12/2019 06:22	13/12/2019 12:07	13/12/2019 06:22	13/12/2019 12:07	5,75	119	683,79	CHI

20191296872	ALEXANIA	AX12000099	ALEXANIA	13/12/2019 06:23	13/12/2019 13:02	13/12/2019 06:23	13/12/2019 13:02	6,65	12	79,79	CHI
20191296523	EDEIA	EA21091317	EDEIA	13/12/2019 06:24	13/12/2019 12:15	13/12/2019 06:24	13/12/2019 12:15	5,85	1	5,85	CHI
20191296530	QUIRINOPOLIS	QI12239488	QUIRINOPOLIS	13/12/2019 06:25	15/12/2019 13:16	13/12/2019 06:25	14/12/2019 14:00	31,58	2	63,16	CHI
20191296530	QUIRINOPOLIS	QI12239488	QUIRINOPOLIS	13/12/2019 06:25	15/12/2019 13:16	13/12/2019 06:25	14/12/2019 15:40	33,25	1	33,25	CHI
20191296530	QUIRINOPOLIS	QI12239488	QUIRINOPOLIS	13/12/2019 06:25	15/12/2019 13:16	13/12/2019 06:25	15/12/2019 13:16	54,85	1	54,85	CHI
20191296533	AMERICANO DO BRASIL	KB12065194	ANICUNS	13/12/2019 06:25	13/12/2019 07:46	13/12/2019 06:25	13/12/2019 07:46	1,35	29	39,06	CHI
20191296533	MOSSAMEDES	KB12065194	ANICUNS	13/12/2019 06:25	13/12/2019 07:46	13/12/2019 06:25	13/12/2019 07:46	1,35	14	18,86	CHI
20191296534	ITAPIRAPUA	MP12299736	MATRINCHA	13/12/2019 06:25	13/12/2019 10:25	13/12/2019 06:25	13/12/2019 10:25	3,99	3	11,97	CHI
20191296534	MATRINCHA	MP12299736	MATRINCHA	13/12/2019 06:25	13/12/2019 10:25	13/12/2019 06:25	13/12/2019 10:25	3,99	178	710,37	CHI
20191296672	GOIANIA	GN11241445	INDEPENDENCIA S2	13/12/2019 06:26	13/12/2019 10:48	13/12/2019 06:26	13/12/2019 10:48	4,35	128	556,94	CHI
20191296543	MARZAGAO	MG21113189	VILA CORUMBA	13/12/2019 06:27	13/12/2019 10:10	13/12/2019 06:27	13/12/2019 10:10	3,70	1	3,70	CHI
20191296545	CAIAPONIA	CP12076264	MONTIVIDIU T	13/12/2019 06:27	13/12/2019 10:41	13/12/2019 06:27	13/12/2019 10:41	4,22	78	328,94	CHI
20191296545	JATAI	CP12076264	MONTIVIDIU T	13/12/2019 06:27	13/12/2019 10:41	13/12/2019 06:27	13/12/2019 10:41	4,22	6	25,30	CHI
20191296545	MONTIVIDIU	CP12076264	MONTIVIDIU T	13/12/2019 06:27	13/12/2019 10:41	13/12/2019 06:27	13/12/2019 10:41	4,22	2	8,43	CHI
20191296545	RIO VERDE	CP12076264	MONTIVIDIU T	13/12/2019 06:27	13/12/2019 10:41	13/12/2019 06:27	13/12/2019 10:41	4,22	12	50,61	CHI
20191296548	RIO QUENTE	2530025545	RIO QUENTE	13/12/2019 06:28	13/12/2019 14:10	13/12/2019 06:28	13/12/2019 14:10	7,69	1	7,69	CHI
20191296551	ARAGUAPAZ	AZ12329923	MOZARLANDIA	13/12/2019 06:29	13/12/2019 10:04	13/12/2019 06:29	13/12/2019 10:04	3,58	3	10,75	CHI
20191296555	JATAI	JT12337049	JATAI S1	13/12/2019 06:29	13/12/2019 20:00	13/12/2019 06:29	13/12/2019 20:00	13,53	8	108,20	CHI
20191296555	JATAI	JT12131457	JATAI S1	13/12/2019 06:29	13/12/2019 20:00	13/12/2019 18:00	13/12/2019 20:00	2,00	5	9,99	CHI
20191297045	GOIANIA	GN12098425	CEPAIGO S1	13/12/2019 06:29	13/12/2019 09:03	13/12/2019 06:29	13/12/2019 09:03	2,57	114	292,41	CHI
20191296570	QUIRINOPOLIS	QI31052461	QUIRINOPOLIS	13/12/2019 06:31	13/12/2019 13:43	13/12/2019 06:31	13/12/2019 13:43	7,19	1	7,19	CHI
20191296571	APARECIDA DE GOIANIA	AP11004878	ATLANTICO S1	13/12/2019 06:31	13/12/2019 13:43	13/12/2019 06:31	13/12/2019 13:43	7,19	81	582,03	CHI
20191296789	EDEALINA	ED12007679	PONTALINA	13/12/2019 06:31	13/12/2019 10:38	13/12/2019 06:31	13/12/2019 10:38	4,11	16	65,78	CHI
20191296716	BURITI DE GOIAS	BS12304459	FIRMINOPOLIS S2	13/12/2019 06:33	13/12/2019 08:30	13/12/2019 06:33	13/12/2019 08:30	1,94	9	17,49	CHI
20191296716	MOSSAMEDES	BS12304459	FIRMINOPOLIS S2	13/12/2019 06:33	13/12/2019 08:30	13/12/2019 06:33	13/12/2019 08:30	1,94	5	9,72	CHI
20191296716	SANCLERLANDIA	BS12304459	FIRMINOPOLIS S2	13/12/2019 06:33	13/12/2019 08:30	13/12/2019 06:33	13/12/2019 08:30	1,94	1	1,94	CHI
20191296881	URUACU	UR12117983	URUACU	13/12/2019 06:34	13/12/2019 13:10	13/12/2019 06:34	13/12/2019 13:10	6,59	4	26,34	CHI
20191296584	ANAPOLIS	AN21146864	ANAPOLIS UNIVERSITARIO S2	13/12/2019 06:35	13/12/2019 08:28	13/12/2019 06:35	13/12/2019 08:28	1,87	1	1,87	CHI
20191296801	CAMPOS VERDES	VD12253107	SANTA TEREZINHA	13/12/2019 06:35	13/12/2019 09:14	13/12/2019 06:35	13/12/2019 09:14	2,64	4	10,54	CHI
20191296586	BARRO ALTO	BA12328283	BARRO ALTO	13/12/2019 06:36	14/12/2019 11:58	13/12/2019 06:36	14/12/2019 11:58	29,36	5	146,82	CHI
20191296595	MARA ROSA	MQ12028228	MARA ROSA	13/12/2019 06:37	13/12/2019 09:20	13/12/2019 06:37	13/12/2019 09:20	2,71	13	35,18	CHI
20191296730	GOIANESIA	GE12384196	GOIANESIA S1	13/12/2019 06:37	13/12/2019 15:01	13/12/2019 06:37	13/12/2019 15:01	8,38	4	33,53	CHI
20191296770	SAO MIGUEL DO ARAGUAIA	SM12208936	SAO MIGUEL DO ARAGUAIA	13/12/2019 06:37	15/12/2019 13:30	13/12/2019 06:37	15/12/2019 09:27	50,83	8	406,62	CHI

20191296770	SAO MIGUEL DO ARAGUAIA	SM12298990LD	SAO MIGUEL DO ARAGUAIA	13/12/2019 06:37	15/12/2019 13:30	13/12/2019 06:37	15/12/2019 13:30	54,88	2	109,75	CHI
20191296889	ANAPOLIS	AN12370313LD	ANAPOLIS UNIVERSITARIO S2	13/12/2019 06:37	13/12/2019 17:14	13/12/2019 13:13	13/12/2019 17:14	4,02	31	124,52	CHI
20191296889	ANAPOLIS	8144879	ANAPOLIS UNIVERSITARIO S2	13/12/2019 06:37	13/12/2019 17:14	13/12/2019 06:37	13/12/2019 17:14	10,62	43	456,62	CHI
20191296889	CAMPO LIMPO	8144879	ANAPOLIS UNIVERSITARIO S2	13/12/2019 06:37	13/12/2019 17:14	13/12/2019 06:37	13/12/2019 17:14	10,62	2	21,24	CHI
20191297002	CRIXAS	CX12162721	SANTA TEREZINHA	13/12/2019 06:37	13/12/2019 09:56	13/12/2019 06:37	13/12/2019 09:56	3,31	5	16,55	CHI
20191296601	CRIXAS	CX12221633	RUBIATABA	13/12/2019 06:38	13/12/2019 10:48	13/12/2019 06:38	13/12/2019 10:48	4,16	131	545,11	CHI
20191296601	NOVA CRIXAS	CX12221633	RUBIATABA	13/12/2019 06:38	13/12/2019 10:48	13/12/2019 06:38	13/12/2019 10:48	4,16	1	4,16	CHI
20191296604	CRIXAS	CX12392063	SANTA TEREZINHA	13/12/2019 06:38	13/12/2019 09:02	13/12/2019 06:38	13/12/2019 09:02	2,38	27	64,37	CHI
20191296604	ITAPACI	CX12392063	SANTA TEREZINHA	13/12/2019 06:38	13/12/2019 09:02	13/12/2019 06:38	13/12/2019 09:02	2,38	4	9,54	CHI
20191296783	GOIANIA	GN12163706	MEIA PONTE	13/12/2019 06:38	13/12/2019 09:01	13/12/2019 06:38	13/12/2019 09:01	2,38	364	866,22	CHI
20191297637	GOIANAPOLIS	GP12000087	DAIA S2	13/12/2019 06:38	13/12/2019 10:42	13/12/2019 06:38	13/12/2019 10:42	4,05	6	24,30	CHI
20191297637	TEREZOPOLIS DE GOIAS	GP12000087	DAIA S2	13/12/2019 06:38	13/12/2019 10:42	13/12/2019 06:38	13/12/2019 10:42	4,05	9	36,46	CHI
201912100191	SAO MIGUEL DO ARAGUAIA	SM11276061	SAO MIGUEL DO ARAGUAIA	13/12/2019 06:38	13/12/2019 17:25	13/12/2019 06:38	13/12/2019 17:25	10,77	1	10,77	CHI
20191296607	AVELINOPOLIS	AV21020302	ANICUNS	13/12/2019 06:39	13/12/2019 13:05	13/12/2019 06:39	13/12/2019 13:05	6,42	1	6,42	CHI
20191296608	ITAPIRAPUA	IU12030155	JUSSARA	13/12/2019 06:40	13/12/2019 10:40	13/12/2019 06:40	13/12/2019 10:40	3,99	42	167,60	CHI
20191296608	NOVO BRASIL	IU12030155	JUSSARA	13/12/2019 06:40	13/12/2019 10:40	13/12/2019 06:40	13/12/2019 10:40	3,99	1	3,99	CHI
20191296610	COCALZINHO DE GOIAS	ZN21125098	AGUAS LINDAS DE GOIAS S2	13/12/2019 06:40	13/12/2019 15:01	13/12/2019 06:40	13/12/2019 15:01	8,34	1	8,34	CHI
20191296615	RIO VERDE	RV21296258	CABRIUVA S2	13/12/2019 06:41	13/12/2019 09:40	13/12/2019 06:41	13/12/2019 09:40	2,98	1	2,98	CHI
20191296747	CORREGO DO OURO	CO12300423	SAO LUIZ DOS MONTES BELOS	13/12/2019 06:41	13/12/2019 08:31	13/12/2019 06:41	13/12/2019 08:31	1,83	4	7,31	CHI
20191296625	QUIRINOPOLIS	QI21099298	QUIRINOPOLIS	13/12/2019 06:43	13/12/2019 10:34	13/12/2019 06:43	13/12/2019 10:34	3,85	1	3,85	CHI
20191296626	ITAJA	IJ12110360	ITAJA S2	13/12/2019 06:43	14/12/2019 03:26	13/12/2019 06:43	14/12/2019 03:26	20,71	1	20,71	CHI
20191296630	ALTO HORIZONTE	AJ12321045	SANTA TEREZINHA	13/12/2019 06:44	13/12/2019 10:19	13/12/2019 06:44	13/12/2019 10:19	3,58	15	53,67	CHI
20191296632	LUZIANIA	LZ21360112	RIO VERMELHO	13/12/2019 06:44	13/12/2019 08:48	13/12/2019 06:44	13/12/2019 08:48	2,06	1	2,06	CHI
20191296633	FORMOSO	10025637485	PORANGATU	13/12/2019 06:44	14/12/2019 18:02	13/12/2019 06:44	14/12/2019 18:02	35,30	1	35,30	CHI
20191296662	PORANGATU	PO12192371	PORANGATU	13/12/2019 06:44	13/12/2019 12:05	13/12/2019 06:44	13/12/2019 12:05	5,34	12	64,13	CHI
20191296641	PIRANHAS	1930039417	PIRANHAS	13/12/2019 06:45	13/12/2019 13:57	13/12/2019 06:45	13/12/2019 13:57	7,18	1	7,18	CHI
20191296642	NIQUELANDIA	NQ12232485	URUACU	13/12/2019 06:46	13/12/2019 16:12	13/12/2019 06:46	13/12/2019 16:12	9,43	3	28,30	CHI
20191296647	NIQUELANDIA	NQ12235367	NIQUELANDIA SUBTRANSMISSAO	13/12/2019 06:46	13/12/2019 14:40	13/12/2019 06:46	13/12/2019 14:40	7,90	9	71,08	CHI
20191297220	GOIATUBA	JV12208118	GOIATUBA S1	13/12/2019 06:46	13/12/2019 11:20	13/12/2019 06:46	13/12/2019 11:20	4,55	3	13,66	CHI
20191297220	JOVIANIA	JV12208118	GOIATUBA S1	13/12/2019 06:46	13/12/2019 11:20	13/12/2019 06:46	13/12/2019 11:20	4,55	15	68,28	CHI
20191296653	MATRINCHA	MP11223764	MATRINCHA	13/12/2019 06:47	13/12/2019 12:14	13/12/2019 06:47	13/12/2019 12:14	5,44	1	5,44	CHI
20191297225	GOIANIA	GN11282014	CAMPINAS S2	13/12/2019 06:48	13/12/2019 14:01	13/12/2019 06:48	13/12/2019 14:01	7,21	97	699,53	CHI
20191297110	PIRES DO RIO	PR12000079RE	PIRES DO RIO S1	13/12/2019 06:49	13/12/2019 13:03	13/12/2019 06:49	13/12/2019 13:03	6,22	16	99,54	CHI

20191296671	SANCLERLANDIA	SC21164049	FIRMINOPOLIS S2	13/12/2019 06:50	13/12/2019 09:20	13/12/2019 06:50	13/12/2019 09:20	2,50	1	2,50	CHI
20191296680	PADRE BERNARDO	10012089956	PADRE BERNARDO	13/12/2019 06:51	13/12/2019 10:02	13/12/2019 06:51	13/12/2019 10:02	3,17	1	3,17	CHI
20191297869	BELA VISTA DE GOIAS	SQ12318949	CRISTIANOPOLIS	13/12/2019 06:51	13/12/2019 11:14	13/12/2019 06:51	13/12/2019 11:14	4,38	20	87,61	CHI
20191297869	SAO MIGUEL DO PASSA QUATRO	SQ12318949	CRISTIANOPOLIS	13/12/2019 06:51	13/12/2019 11:14	13/12/2019 06:51	13/12/2019 11:14	4,38	5	21,90	CHI
20191296681	CATALAO	9580009277	CATALAO S1	13/12/2019 06:52	13/12/2019 08:14	13/12/2019 06:52	13/12/2019 08:14	1,37	1	1,37	CHI
20191296691	MATRINCHA	MP21299772	MATRINCHA	13/12/2019 06:53	13/12/2019 12:20	13/12/2019 06:53	13/12/2019 12:20	5,44	1	5,44	CHI
20191297462	GOIANIRA	GR12016215	GOIANIRA	13/12/2019 06:53	13/12/2019 12:55	13/12/2019 06:53	13/12/2019 12:55	6,03	16	96,52	CHI
20191297462	TRINDADE	GR12016215	GOIANIRA	13/12/2019 06:53	13/12/2019 12:55	13/12/2019 06:53	13/12/2019 12:55	6,03	3	18,10	CHI
20191296699	CORUMBAIBA	CI12247835	VILA CORUMBA	13/12/2019 06:54	14/12/2019 11:05	13/12/2019 06:54	14/12/2019 11:05	28,17	40	1126,77	CHI
20191296887	CAIAPONIA	CP12334323	PIRANHAS	13/12/2019 06:54	13/12/2019 10:13	13/12/2019 06:54	13/12/2019 10:13	3,30	8	26,40	CHI
20191296701	GOIANIA	15066400	XAVANTES	13/12/2019 06:55	13/12/2019 15:58	13/12/2019 06:55	13/12/2019 15:58	9,05	1	9,05	CHI
20191296704	CAMPINACU	FO12197186	PORANGATU	13/12/2019 06:56	13/12/2019 12:20	13/12/2019 06:56	13/12/2019 12:20	5,40	3	16,21	CHI
20191296704	CAMPINORTE	FO12197186	PORANGATU	13/12/2019 06:56	13/12/2019 12:20	13/12/2019 06:56	13/12/2019 12:20	5,40	24	129,64	CHI
20191296707	MOSSAMEDES	MD21172601	FIRMINOPOLIS S2	13/12/2019 06:57	13/12/2019 08:50	13/12/2019 06:57	13/12/2019 08:50	1,88	1	1,88	CHI
20191296712	PIRES DO RIO	PR12095256LD	PIRES DO RIO S1	13/12/2019 06:57	13/12/2019 16:11	13/12/2019 09:30	13/12/2019 16:11	6,69	19	127,10	CHI
20191296713	ITUMBIARA	IT12304205	PARANAIBA	13/12/2019 06:57	13/12/2019 12:19	13/12/2019 06:57	13/12/2019 12:19	5,35	10	53,52	CHI
20191296765	CAMPO LIMPO	CV11272951	NEROPOLIS S1	13/12/2019 06:57	13/12/2019 15:15	13/12/2019 06:57	13/12/2019 15:15	8,30	155	1285,81	CHI
20191296816	SAO MIGUEL DO ARAGUAIA	SM12276216	SAO MIGUEL DO ARAGUAIA	13/12/2019 06:57	13/12/2019 14:11	13/12/2019 06:57	13/12/2019 14:11	7,23	13	94,05	CHI
20191296721	IPAMERI	IP21000050	IPAMERI	13/12/2019 06:59	13/12/2019 22:44	13/12/2019 06:59	13/12/2019 22:44	15,74	1	15,74	CHI
20191296725	INDIARA	2710040019	EDEIA	13/12/2019 07:00	13/12/2019 11:30	13/12/2019 07:00	13/12/2019 11:30	4,49	1	4,49	CHI
20191296726	COLINAS DO SUL	TI21288517	MINACU	13/12/2019 07:00	13/12/2019 10:31	13/12/2019 07:00	13/12/2019 10:31	3,51	1	3,51	CHI
20191296727	URUACU	UR11237494	URUACU	13/12/2019 07:00	13/12/2019 11:55	13/12/2019 07:00	13/12/2019 11:55	4,91	5	24,57	CHI
20191296731	ITARUMA	IM21271703	CACHOEIRA ALTA	13/12/2019 07:01	13/12/2019 12:40	13/12/2019 07:01	13/12/2019 12:40	5,64	2	11,28	CHI
20191296732	COCALZINHO DE GOIAS	ZN21290613	AGUAS LINDAS DE GOIAS S2	13/12/2019 07:01	13/12/2019 08:14	13/12/2019 07:01	13/12/2019 08:14	1,20	1	1,20	CHI
20191296734	CRIXAS	CX12252981	SERRA DO OURO	13/12/2019 07:01	13/12/2019 12:40	13/12/2019 07:01	13/12/2019 12:40	5,63	5	28,17	CHI
20191296763	URUACU	UR12364091	URUACU	13/12/2019 07:01	13/12/2019 09:33	13/12/2019 07:01	13/12/2019 09:33	2,52	12	30,21	CHI
20191296736	MONTIVIDIU	MV12214243	MONTIVIDIU T	13/12/2019 07:02	13/12/2019 10:08	13/12/2019 07:02	13/12/2019 10:08	3,10	2	6,20	CHI
20191296739	MAIRIPOTABA	MI21000410	PONTALINA	13/12/2019 07:02	13/12/2019 09:24	13/12/2019 07:02	13/12/2019 09:24	2,36	2	4,71	CHI
20191296746	GUARAITA	3140001410	ITAPURANGA	13/12/2019 07:03	14/12/2019 11:15	13/12/2019 07:03	14/12/2019 11:15	28,20	1	28,20	CHI
20191296752	SANTA TEREZA DE GOIAS	SE12262714	PORANGATU	13/12/2019 07:03	13/12/2019 10:43	13/12/2019 07:03	13/12/2019 10:43	3,66	15	54,92	CHI
20191296820	PORTELANDIA	PW12302970	PARQUE DAS EMAS	13/12/2019 07:03	14/12/2019 10:05	13/12/2019 07:03	14/12/2019 10:05	27,03	4	108,11	CHI
20191296753	IPORA	IR21074004	IPORA	13/12/2019 07:04	13/12/2019 11:30	13/12/2019 07:04	13/12/2019 11:30	4,44	1	4,44	CHI
20191296762	ARAGARCAS	AG12092426	ARAGARCAS	13/12/2019 07:04	13/12/2019 11:24	13/12/2019 07:04	13/12/2019 11:24	4,33	4	17,30	CHI

20191297227	CAIAPONIA	RV12030683	MONTIVIDIU T	13/12/2019 07:04	13/12/2019 11:45	13/12/2019 07:04	13/12/2019 11:45	4,68	199	931,43	CHI
20191297227	RIO VERDE	RV12030683	MONTIVIDIU T	13/12/2019 07:04	13/12/2019 11:45	13/12/2019 07:04	13/12/2019 11:45	4,68	3	14,04	CHI
20191297450	BARRO ALTO	BA12210736	GOIANESIA S1	13/12/2019 07:04	14/12/2019 10:36	13/12/2019 07:04	14/12/2019 10:36	27,53	20	550,60	CHI
20191296773	GAMELEIRA DE GOIAS	SV21084695	DAIA S2	13/12/2019 07:05	13/12/2019 16:52	13/12/2019 07:05	13/12/2019 16:52	9,78	1	9,78	CHI
20191297427	AGUA FRIA DE GOIAS	NQ12140182	SAO JOAO D ALIANCA	13/12/2019 07:05	14/12/2019 20:21	13/12/2019 07:05	14/12/2019 20:21	37,25	69	2570,50	CHI
20191297427	NIQUELANDIA	NQ12140182	SAO JOAO D ALIANCA	13/12/2019 07:05	14/12/2019 20:21	13/12/2019 07:05	14/12/2019 20:21	37,25	6	223,52	CHI
20191296775	NOVA CRIXAS	NA21158703	NOVA CRIXAS	13/12/2019 07:06	13/12/2019 11:43	13/12/2019 07:06	13/12/2019 11:43	4,62	1	4,62	CHI
20191296780	GOIANESIA	10024629527	GOIANESIA S1	13/12/2019 07:06	13/12/2019 10:15	13/12/2019 07:06	13/12/2019 10:15	3,15	1	3,15	CHI
20191296781	CRIXAS	NA21257892	SANTA TEREZINHA	13/12/2019 07:06	13/12/2019 20:46	13/12/2019 07:06	13/12/2019 20:46	13,65	1	13,65	CHI
20191296784	FORMOSO	FO12151052	PORANGATU	13/12/2019 07:07	13/12/2019 14:11	13/12/2019 07:07	13/12/2019 14:11	7,07	6	42,42	CHI
20191296797	SILVANIA	SV12389473	VIANOPOLIS	13/12/2019 07:10	13/12/2019 20:08	13/12/2019 07:10	13/12/2019 18:33	11,39	9	102,49	CHI
20191296797	SILVANIA	SV12389473	VIANOPOLIS	13/12/2019 07:10	13/12/2019 20:08	13/12/2019 07:10	13/12/2019 20:08	12,98	1	12,98	CHI
20191296805	SAO LUIS DE MONTES BELOS	SL11006852	SAO LUIZ DOS MONTES BELOS	13/12/2019 07:10	13/12/2019 08:48	13/12/2019 07:10	13/12/2019 08:48	1,62	29	46,99	CHI
20191297081	FAZENDA NOVA	FN12022382	IPORA	13/12/2019 07:10	13/12/2019 17:34	13/12/2019 07:10	13/12/2019 17:34	10,39	54	561,05	CHI
20191296809	CORUMBA DE GOIAS	CB21401148	CORUMBA	13/12/2019 07:11	13/12/2019 21:34	13/12/2019 07:11	13/12/2019 21:34	14,38	1	14,38	CHI
20191296812	ANAPOLIS	AN21362293	NEROPOLIS S1	13/12/2019 07:12	13/12/2019 08:08	13/12/2019 07:12	13/12/2019 08:08	0,93	2	1,86	CHI
20191296813	CALDAZINHA	LB12270644	DAIA S2	13/12/2019 07:12	13/12/2019 18:13	13/12/2019 07:12	13/12/2019 18:13	11,00	5	55,02	CHI
20191296813	SILVANIA	LB12270644	DAIA S2	13/12/2019 07:12	13/12/2019 18:13	13/12/2019 07:12	13/12/2019 18:13	11,00	2	22,01	CHI
20191296818	GOIAS	GS12220079	GOIAS	13/12/2019 07:13	13/12/2019 11:49	13/12/2019 07:13	13/12/2019 11:49	4,60	2	9,19	CHI
20191296824	JATAI	JT21036758	JATAI S2	13/12/2019 07:14	13/12/2019 12:15	13/12/2019 07:14	13/12/2019 12:15	5,03	1	5,03	CHI
20191296827	AMORINOPOLIS	AM12201860	IPORA	13/12/2019 07:14	13/12/2019 09:30	13/12/2019 07:14	13/12/2019 09:30	2,26	8	18,05	CHI
20191296829	CALDAS NOVAS	760055816	SERRA DE CALDAS	13/12/2019 07:15	14/12/2019 10:04	13/12/2019 07:15	14/12/2019 10:04	26,82	1	26,82	CHI
20191296832	URUACU	UR21059832	URUACU	13/12/2019 07:15	13/12/2019 10:15	13/12/2019 07:15	13/12/2019 10:15	2,99	1	2,99	CHI
20191297098	GOIANESIA	GE12006474	BARRO ALTO	13/12/2019 07:16	14/12/2019 09:26	13/12/2019 07:16	14/12/2019 09:26	26,18	3	78,53	CHI
20191297098	SANTA RITA DO NOVO DESTINO	GE12006474	BARRO ALTO	13/12/2019 07:16	14/12/2019 09:26	13/12/2019 07:16	14/12/2019 09:26	26,18	6	157,06	CHI
20191297098	SAO LUIZ DO NORTE	GE12006474	BARRO ALTO	13/12/2019 07:16	14/12/2019 09:26	13/12/2019 07:16	14/12/2019 09:26	26,18	1	26,18	CHI
20191296845	GOIANIA	10020076132	XAVANTES	13/12/2019 07:17	13/12/2019 11:31	13/12/2019 07:17	13/12/2019 11:31	4,23	1	4,23	CHI
20191296847	NIQUELANDIA	10009885879	NIQUELANDIA SUBTRANSMISSAO	13/12/2019 07:17	13/12/2019 11:30	13/12/2019 07:17	13/12/2019 11:30	4,20	1	4,20	CHI
20191296848	TAQUARAL DE GOIAS	TQ11162738	ITABERAI S1	13/12/2019 07:18	13/12/2019 09:21	13/12/2019 07:18	13/12/2019 09:21	2,05	44	90,15	CHI
20191296854	CRIXAS	CX12244484	SANTA TEREZINHA	13/12/2019 07:18	13/12/2019 15:03	13/12/2019 07:18	13/12/2019 15:03	7,74	4	30,94	CHI
20191296860	VARJAO	VJ21358040	GUAPAO S2	13/12/2019 07:19	13/12/2019 16:34	13/12/2019 07:19	13/12/2019 16:34	9,24	1	9,24	CHI
20191297665	CAMPOS VERDES	VD11055150	SANTA TEREZINHA	13/12/2019 07:19	13/12/2019 10:26	13/12/2019 07:19	13/12/2019 10:26	3,11	125	388,33	CHI
20191296863	NIQUELANDIA	NQ12232332	NIQUELANDIA SUBTRANSMISSAO	13/12/2019 07:20	13/12/2019 11:28	13/12/2019 07:20	13/12/2019 11:28	4,13	81	334,17	CHI

20191296869	BELA VISTA DE GOIAS	BV21230579	BELA VISTA S1	13/12/2019 07:21	13/12/2019 14:32	13/12/2019 07:21	13/12/2019 14:32	7,18	4	28,73	CHI
20191296871	GOIANIA	GN11161733	ATLANTICO S2	13/12/2019 07:21	13/12/2019 11:15	13/12/2019 07:21	13/12/2019 11:15	3,90	102	397,55	CHI
20191296874	FAZENDA NOVA	NB12396255	JUSSARA	13/12/2019 07:21	13/12/2019 16:00	13/12/2019 07:21	13/12/2019 16:00	8,64	12	103,73	CHI
20191296874	NOVO BRASIL	NB12396255	JUSSARA	13/12/2019 07:21	13/12/2019 16:00	13/12/2019 07:21	13/12/2019 16:00	8,64	1	8,64	CHI
20191296877	URUACU	UR12352102	URUACU	13/12/2019 07:21	13/12/2019 12:15	13/12/2019 07:21	13/12/2019 12:15	4,90	1	4,90	CHI
20191297160	URUACU	UR12210930	URUACU	13/12/2019 07:21	13/12/2019 12:38	13/12/2019 07:21	13/12/2019 12:38	5,28	11	58,03	CHI
20191296885	DAMIANOPOLIS	DA12196513	IACIARA S2	13/12/2019 07:23	13/12/2019 10:47	13/12/2019 07:23	13/12/2019 10:47	3,39	58	196,72	CHI
20191296890	LEOPOLDO DE BULHOES	LB21155167	DAIA S2	13/12/2019 07:23	13/12/2019 10:00	13/12/2019 07:23	13/12/2019 10:00	2,61	1	2,61	CHI
20191297620	CALDAS NOVAS	RQ12100189	RIO QUENTE	13/12/2019 07:23	13/12/2019 12:14	13/12/2019 07:23	13/12/2019 12:14	4,84	105	508,05	CHI
20191297620	MORRINHOS	RQ12100189	RIO QUENTE	13/12/2019 07:23	13/12/2019 12:14	13/12/2019 07:23	13/12/2019 12:14	4,84	8	38,71	CHI
20191297620	PIRACANJUBA	RQ12100189	RIO QUENTE	13/12/2019 07:23	13/12/2019 12:14	13/12/2019 07:23	13/12/2019 12:14	4,84	1	4,84	CHI
20191297620	RIO QUENTE	RQ12100189	RIO QUENTE	13/12/2019 07:23	13/12/2019 12:14	13/12/2019 07:23	13/12/2019 12:14	4,84	93	449,99	CHI
20191296896	MARA ROSA	MQ12220792	MARA ROSA	13/12/2019 07:24	14/12/2019 11:33	13/12/2019 07:24	14/12/2019 11:33	28,14	5	140,72	CHI
20191296899	FAZENDA NOVA	FN12250853	FIRMINOPOLIS S2	13/12/2019 07:24	13/12/2019 15:30	13/12/2019 07:24	13/12/2019 15:30	8,09	4	32,36	CHI
20191297023	INHUMAS	IN12000127	INHUMAS S1	13/12/2019 07:24	13/12/2019 12:04	13/12/2019 07:24	13/12/2019 12:04	4,66	7	32,65	CHI
20191297013	ARAGUAPAZ	CX12058576	RUBIATABA	13/12/2019 07:26	15/12/2019 12:40	13/12/2019 07:26	15/12/2019 12:40	53,23	6	319,38	CHI
20191297013	CRIXAS	CX12058576	RUBIATABA	13/12/2019 07:26	15/12/2019 12:40	13/12/2019 07:26	15/12/2019 12:40	53,23	1	53,23	CHI
20191297018	FLORES DE GOIAS	FB21044975	IACIARA S2	13/12/2019 07:26	13/12/2019 10:42	13/12/2019 07:26	13/12/2019 10:42	3,26	1	3,26	CHI
20191297025	NEROPOLIS	NR21317423	NEROPOLIS S2	13/12/2019 07:27	13/12/2019 15:28	13/12/2019 07:27	13/12/2019 15:28	8,01	1	8,01	CHI
20191297557	SILVANIA	SV12027332	BELA VISTA S2	13/12/2019 07:27	13/12/2019 11:10	13/12/2019 07:27	13/12/2019 11:10	3,71	11	40,79	CHI
20191297030	GOIANESIA	GE21000209	GOIANESIA S2	13/12/2019 07:28	13/12/2019 10:24	13/12/2019 07:28	13/12/2019 10:24	2,94	1	2,94	CHI
20191297032	CALDAZINHA	SV12202383	CEPAIGO S2	13/12/2019 07:28	13/12/2019 16:32	13/12/2019 07:28	13/12/2019 16:32	9,05	12	108,63	CHI
20191297033	URUACU	UR12317135	URUACU	13/12/2019 07:28	13/12/2019 10:42	13/12/2019 07:28	13/12/2019 10:42	3,22	11	35,47	CHI
20191297035	URUACU	UR12320928	URUACU	13/12/2019 07:28	13/12/2019 14:32	13/12/2019 07:28	13/12/2019 14:32	7,05	15	105,77	CHI
20191297576	ARAGUAPAZ	AZ12188220	MOZARLANDIA	13/12/2019 07:28	13/12/2019 10:35	13/12/2019 07:28	13/12/2019 10:35	3,11	34	105,82	CHI
20191297576	MOZARLANDIA	AZ12188220	MOZARLANDIA	13/12/2019 07:28	13/12/2019 10:35	13/12/2019 07:28	13/12/2019 10:35	3,11	6	18,67	CHI
20191297039	CORUMBA DE GOIAS	CB12412801	CORUMBA	13/12/2019 07:29	14/12/2019 04:49	13/12/2019 07:29	14/12/2019 04:49	21,33	1	21,33	CHI
20191298056	SERRANOPOLIS	SX12260528	JATAI S1	13/12/2019 07:29	13/12/2019 12:24	13/12/2019 07:29	13/12/2019 12:24	4,91	4	19,65	CHI
20191297048	EDEIA	EA13263401	EDEIA	13/12/2019 07:30	13/12/2019 23:21	13/12/2019 18:18	13/12/2019 19:02	0,73	9	6,59	CHI
20191297048	EDEIA	EA13263401	EDEIA	13/12/2019 07:30	13/12/2019 23:21	13/12/2019 20:57	13/12/2019 23:21	2,39	9	21,52	CHI
20191297051	FORMOSA	FA21120050	ITIQUEIRA	13/12/2019 07:30	13/12/2019 14:05	13/12/2019 07:30	13/12/2019 14:05	6,57	1	6,57	CHI
20191297053	SENADOR CANEDO	SW12060130	GOIANIA LESTE S1	13/12/2019 07:30	13/12/2019 10:15	13/12/2019 07:30	13/12/2019 10:15	2,74	1	2,74	CHI
20191297054	BELA VISTA DE GOIAS	BV21324940	BELA VISTA S2	13/12/2019 07:30	13/12/2019 11:28	13/12/2019 07:30	13/12/2019 11:28	3,95	1	3,95	CHI

20191297059	SILVANIA	SV21199926	VIANOPOLIS	13/12/2019 07:31	13/12/2019 14:51	13/12/2019 07:31	13/12/2019 14:51	7,33	1	7,33	CHI
20191297061	JATAI	290259617	JATAI S2	13/12/2019 07:31	13/12/2019 14:30	13/12/2019 07:31	13/12/2019 14:30	6,98	1	6,98	CHI
20191297063	EDEIA	EA12084043	VICENTINOPOLIS	13/12/2019 07:31	13/12/2019 13:00	13/12/2019 07:31	13/12/2019 13:00	5,49	2	10,98	CHI
20191297070	PORANGATU	TB12262770	PORANGATU	13/12/2019 07:32	13/12/2019 10:34	13/12/2019 07:32	13/12/2019 10:34	3,02	1	3,02	CHI
20191297070	SANTA TEREZA DE GOIAS	TB12262770	PORANGATU	13/12/2019 07:32	13/12/2019 10:34	13/12/2019 07:32	13/12/2019 10:34	3,02	5	15,11	CHI
20191297070	TROMBAS	TB12262770	PORANGATU	13/12/2019 07:32	13/12/2019 10:34	13/12/2019 07:32	13/12/2019 10:34	3,02	13	39,29	CHI
20191297074	CAMPO LIMPO	AN12261235	NEROPOLIS S1	13/12/2019 07:32	13/12/2019 11:11	13/12/2019 07:32	13/12/2019 11:11	3,64	13	47,28	CHI
20191297088	GOIANAPOLIS	GP12000050	DAIA S2	13/12/2019 07:32	13/12/2019 09:26	13/12/2019 07:32	13/12/2019 09:26	1,90	2	3,80	CHI
20191297078	ACREUNA	EU21213342	ACREUNA	13/12/2019 07:33	13/12/2019 10:18	13/12/2019 07:33	13/12/2019 10:18	2,74	1	2,74	CHI
20191297084	APARECIDA DE GOIANIA	AP11038687	INDEPENDENCIA S2	13/12/2019 07:33	13/12/2019 09:44	13/12/2019 07:33	13/12/2019 09:44	2,18	183	398,64	CHI
20191297287	GOIANIA	GN11037015	FERROVIARIO S1	13/12/2019 07:33	13/12/2019 08:42	13/12/2019 07:33	13/12/2019 08:42	1,14	20	22,84	CHI
20191297089	ALTO PARAISO DE GOIAS	BF21302829	FLORES DE GOIAS	13/12/2019 07:34	13/12/2019 14:48	13/12/2019 07:34	13/12/2019 14:48	7,22	1	7,22	CHI
20191297090	URUACU	640102967	URUACU	13/12/2019 07:34	13/12/2019 11:44	13/12/2019 07:34	13/12/2019 11:44	4,15	1	4,15	CHI
20191297413	ALTO PARAISO DE GOIAS	BF12385529	NIQUELANDIA SUBTRANSMISSAO	13/12/2019 07:34	13/12/2019 11:54	13/12/2019 07:34	13/12/2019 11:54	4,32	2	8,64	CHI
20191297761	INHUMAS	IN11251732	INHUMAS S2	13/12/2019 07:34	13/12/2019 12:35	13/12/2019 07:34	13/12/2019 12:35	5,01	41	205,39	CHI
20191297100	PORANGATU	PO12300981	PORANGATU	13/12/2019 07:35	13/12/2019 09:50	13/12/2019 07:35	13/12/2019 09:50	2,26	1	2,26	CHI
20191297101	CALDAS NOVAS	CN21142360	SERRA DE CALDAS	13/12/2019 07:35	13/12/2019 11:24	13/12/2019 07:35	13/12/2019 11:24	3,81	1	3,81	CHI
20191297106	INDIARA	IY16404020	EDEIA	13/12/2019 07:36	13/12/2019 14:11	13/12/2019 07:55	13/12/2019 08:42	0,79	1447	1146,75	CHI
20191297106	INDIARA	IY16404020	EDEIA	13/12/2019 07:36	13/12/2019 14:11	13/12/2019 08:46	13/12/2019 14:09	5,38	503	2706,42	CHI
20191297106	INDIARA	IY16407338	EDEIA	13/12/2019 07:36	13/12/2019 14:11	13/12/2019 14:06	13/12/2019 14:09	0,05	937	48,15	CHI
20191297106	EDEIA	IY16404023	EDEIA	13/12/2019 07:36	13/12/2019 14:11	13/12/2019 14:06	13/12/2019 14:10	0,07	5	0,34	CHI
20191297106	INDIARA	IY16404023	EDEIA	13/12/2019 07:36	13/12/2019 14:11	13/12/2019 14:06	13/12/2019 14:10	0,07	1721	117,12	CHI
20191297106	JANDAIA	IY16404023	EDEIA	13/12/2019 07:36	13/12/2019 14:11	13/12/2019 14:06	13/12/2019 14:10	0,07	1	0,07	CHI
20191297106	INDIARA	IY10396906	EDEIA	13/12/2019 07:36	13/12/2019 14:11	13/12/2019 14:06	13/12/2019 14:11	0,08	42	3,21	CHI
20191297114	GOIATUBA	GT12056534	GOIATUBA S1	13/12/2019 07:37	13/12/2019 09:50	13/12/2019 07:37	13/12/2019 09:50	2,21	5	11,03	CHI
20191296155	GOIANIA	GN12373691	XAVANTES	13/12/2019 07:38	13/12/2019 14:59	13/12/2019 07:38	13/12/2019 14:59	7,35	39	286,49	CHI
20191296155	NEROPOLIS	GN12373691	XAVANTES	13/12/2019 07:38	13/12/2019 14:59	13/12/2019 07:38	13/12/2019 14:59	7,35	12	88,15	CHI
20191297123	ITUMBIARA	IT12007799	ITUMBIARA VELHA S1	13/12/2019 07:38	13/12/2019 22:05	13/12/2019 07:38	13/12/2019 22:05	14,45	1	14,45	CHI
20191297127	SANTO ANTONIO DO DESCOBERTO	SN12188742	ALEXANIA	13/12/2019 07:39	13/12/2019 10:04	13/12/2019 07:39	13/12/2019 10:04	2,41	22	53,01	CHI
20191297128	COLINAS DO SUL	TI21288515	MINACU	13/12/2019 07:39	13/12/2019 10:23	13/12/2019 07:39	13/12/2019 10:23	2,72	1	2,72	CHI
20191297698	ARACU	AV12083933	ANICUNS	13/12/2019 07:40	13/12/2019 12:51	13/12/2019 07:40	13/12/2019 12:51	5,17	2	10,35	CHI
20191297698	AVELINOPOLIS	AV12083933	ANICUNS	13/12/2019 07:40	13/12/2019 12:51	13/12/2019 07:40	13/12/2019 12:51	5,17	11	56,92	CHI
20191297253	NIQUELANDIA	NQ12257262	URUACU	13/12/2019 07:41	13/12/2019 13:17	13/12/2019 07:41	13/12/2019 13:17	5,60	6	33,58	CHI

20191297143	JATAI	JT12099233	JATAI S1	13/12/2019 07:42	13/12/2019 11:59	13/12/2019 07:42	13/12/2019 11:59	4,28	2	8,57	CHI
20191297147	CRISTALINA	KR21170316	PAMPLONA	13/12/2019 07:42	13/12/2019 09:57	13/12/2019 07:42	13/12/2019 09:57	2,24	1	2,24	CHI
20191297148	MINEIROS	MY12194461	PARQUE DAS EMAS	13/12/2019 07:42	13/12/2019 16:50	13/12/2019 07:42	13/12/2019 16:50	9,12	2	18,24	CHI
20191297152	PIRENOPOLIS	PV31111228	SAO FRANCISCO DE GOIAS	13/12/2019 07:42	13/12/2019 16:40	13/12/2019 07:42	13/12/2019 16:40	8,95	2	17,90	CHI
20191297233	GOIANIA	GN11220964	MEIA PONTE	13/12/2019 07:43	13/12/2019 14:01	13/12/2019 07:43	13/12/2019 14:01	6,29	135	849,52	CHI
20191297165	PROFESSOR JAMIL SAFADY	PJ12293365	PIRACANJUBA	13/12/2019 07:44	13/12/2019 18:03	13/12/2019 07:44	13/12/2019 18:03	10,31	3	30,93	CHI
20191297168	GOIANIA	13374450	ATLANTICO S1	13/12/2019 07:44	13/12/2019 15:38	13/12/2019 07:44	13/12/2019 15:38	7,89	1	7,89	CHI
20191297174	GOIANIA	10016154485	XAVANTES	13/12/2019 07:44	13/12/2019 11:28	13/12/2019 07:44	13/12/2019 11:28	3,72	1	3,72	CHI
20191299808	GOIANIA	13183758	GOIANIA LESTE S2	13/12/2019 07:44	13/12/2019 11:04	13/12/2019 07:44	13/12/2019 11:04	3,32	1	3,32	CHI
20191297177	PIRES DO RIO	PR12409073	PIRES DO RIO S2	13/12/2019 07:45	13/12/2019 21:59	13/12/2019 07:45	13/12/2019 21:59	14,22	2	28,44	CHI
201912102744	PIRES DO RIO	PR21409079	PIRES DO RIO S2	13/12/2019 07:45	14/12/2019 03:47	13/12/2019 07:45	14/12/2019 03:47	20,02	1	20,02	CHI
20191297181	CRISTALINA	KR12383072	CRISTALINA S2	13/12/2019 07:46	13/12/2019 12:08	13/12/2019 07:46	13/12/2019 12:08	4,36	21	91,62	CHI
20191297184	CACU	CC21191644	CACHOEIRA ALTA	13/12/2019 07:46	14/12/2019 11:03	13/12/2019 07:46	14/12/2019 11:03	27,27	1	27,27	CHI
20191297286	INDIARA	03300434	PALMEIRAS	13/12/2019 07:47	13/12/2019 15:32	13/12/2019 07:47	13/12/2019 07:57	0,17	138	23,00	CHI
20191297286	JANDAIA	03300434	PALMEIRAS	13/12/2019 07:47	13/12/2019 15:32	13/12/2019 07:47	13/12/2019 07:57	0,17	2108	351,33	CHI
20191297286	JANDAIA	03300434	PALMEIRAS	13/12/2019 07:47	13/12/2019 15:32	13/12/2019 07:47	13/12/2019 07:57	0,17	949	158,17	CHI
20191297286	JANDAIA	03300434	PALMEIRAS	13/12/2019 07:47	13/12/2019 15:32	13/12/2019 07:47	13/12/2019 07:57	0,17	27	4,50	CHI
20191297286	PALESTINA DE GOIAS	03300434	PALMEIRAS	13/12/2019 07:47	13/12/2019 15:32	13/12/2019 07:47	13/12/2019 07:57	0,17	1	0,17	CHI
20191297286	PALMEIRAS DE GOIAS	03300434	PALMEIRAS	13/12/2019 07:47	13/12/2019 15:32	13/12/2019 07:47	13/12/2019 07:57	0,17	38	6,33	CHI
20191297286	PALMEIRAS DE GOIAS	03300434	PALMEIRAS	13/12/2019 07:47	13/12/2019 15:32	13/12/2019 07:47	13/12/2019 07:57	0,17	97	16,17	CHI
20191297286	PALMEIRAS DE GOIAS	03300434	PALMEIRAS	13/12/2019 07:47	13/12/2019 15:32	13/12/2019 07:47	13/12/2019 07:57	0,17	29	4,83	CHI
20191297286	PALMINOPOLIS	03300434	PALMEIRAS	13/12/2019 07:47	13/12/2019 15:32	13/12/2019 07:47	13/12/2019 07:57	0,17	14	2,33	CHI
20191297286	PARAUNA	03300434	PALMEIRAS	13/12/2019 07:47	13/12/2019 15:32	13/12/2019 07:47	13/12/2019 07:57	0,17	51	8,50	CHI
20191297286	PALMEIRAS DE GOIAS	03300444	PALMEIRAS	13/12/2019 07:47	13/12/2019 15:32	13/12/2019 07:55	13/12/2019 09:58	2,05	5	10,25	CHI
20191297286	PALMEIRAS DE GOIAS	03300444	PALMEIRAS	13/12/2019 07:47	13/12/2019 15:32	13/12/2019 07:55	13/12/2019 10:19	2,40	32	76,70	CHI
20191297286	PALMINOPOLIS	03300444	PALMEIRAS	13/12/2019 07:47	13/12/2019 15:32	13/12/2019 07:55	13/12/2019 10:19	2,40	85	203,74	CHI
20191297286	PALMEIRAS DE GOIAS	03300444	PALMEIRAS	13/12/2019 07:47	13/12/2019 15:32	13/12/2019 07:55	13/12/2019 10:52	2,94	52	152,68	CHI
20191297286	PALMINOPOLIS	03300444	PALMEIRAS	13/12/2019 07:47	13/12/2019 15:32	13/12/2019 07:55	13/12/2019 10:52	2,94	1471	4319,02	CHI
20191297286	PALMINOPOLIS	03300444	PALMEIRAS	13/12/2019 07:47	13/12/2019 15:32	13/12/2019 07:55	13/12/2019 11:06	3,17	50	158,50	CHI
20191297286	PALMEIRAS DE GOIAS	PL12118643	PALMEIRAS	13/12/2019 07:47	13/12/2019 15:32	13/12/2019 12:32	13/12/2019 14:40	2,13	4	8,51	CHI
20191297286	PALMEIRAS DE GOIAS	03300444	PALMEIRAS	13/12/2019 07:47	13/12/2019 15:32	13/12/2019 07:55	13/12/2019 14:57	7,03	1	7,03	CHI
20191297286	PALMINOPOLIS	03300444	PALMEIRAS	13/12/2019 07:47	13/12/2019 15:32	13/12/2019 07:55	13/12/2019 14:57	7,03	1	7,03	CHI
20191297286	PALMEIRAS DE GOIAS	03300444	PALMEIRAS	13/12/2019 07:47	13/12/2019 15:32	13/12/2019 09:59	13/12/2019 14:57	4,97	5	24,86	CHI

20191297286	PALMINOPOLIS	03300444	PALMEIRAS	13/12/2019 07:47	13/12/2019 15:32	13/12/2019 07:55	13/12/2019 15:18	7,38	45	332,21	CHI
20191297286	JANDAIA	03300444	PALMEIRAS	13/12/2019 07:47	13/12/2019 15:32	13/12/2019 07:55	13/12/2019 15:19	7,39	56	413,95	CHI
20191297286	PALMINOPOLIS	03300444	PALMEIRAS	13/12/2019 07:47	13/12/2019 15:32	13/12/2019 07:55	13/12/2019 15:19	7,39	162	1197,49	CHI
20191297286	PALMEIRAS DE GOIAS	PL13000015	PALMEIRAS	13/12/2019 07:47	13/12/2019 15:32	13/12/2019 15:27	13/12/2019 15:32	0,09	79	7,40	CHI
20191297286	PALMINOPOLIS	PL13000015	PALMEIRAS	13/12/2019 07:47	13/12/2019 15:32	13/12/2019 15:27	13/12/2019 15:32	0,09	83	7,77	CHI
20191297865	NIQUELANDIA	NQ12235663	URUACU	13/12/2019 07:47	13/12/2019 14:25	13/12/2019 07:47	13/12/2019 14:25	6,62	8	52,98	CHI
2019121300054	JANDAIA	01901	PARAUNA	13/12/2019 07:47	13/12/2019 07:56	13/12/2019 07:47	13/12/2019 07:56	0,15	3	0,45	CHI
2019121300054	PARAUNA	01901	PARAUNA	13/12/2019 07:47	13/12/2019 07:56	13/12/2019 07:47	13/12/2019 07:56	0,15	30	4,50	CHI
20191297191	ITAPURANGA	IK21124268	ITAPURANGA	13/12/2019 07:48	13/12/2019 18:00	13/12/2019 07:48	13/12/2019 18:00	10,20	1	10,20	CHI
20191297194	HIDROLANDIA	HD21007601	PONTALINA	13/12/2019 07:48	13/12/2019 12:06	13/12/2019 07:48	13/12/2019 12:06	4,29	1	4,29	CHI
20191297197	SAO MIGUEL DO ARAGUAIA	830085361	SAO MIGUEL DO ARAGUAIA	13/12/2019 07:49	13/12/2019 14:00	13/12/2019 07:49	13/12/2019 14:00	6,18	1	6,18	CHI
20191297199	PORANGATU	PO12230431	PORANGATU	13/12/2019 07:49	14/12/2019 20:01	13/12/2019 07:49	14/12/2019 20:01	36,21	2	72,42	CHI
20191297202	MORRINHOS	MR21212265	MORRINHOS	13/12/2019 07:49	13/12/2019 11:37	13/12/2019 07:49	13/12/2019 11:37	3,79	1	3,79	CHI
20191297208	AMARALINA	MQ21373927	MARA ROSA	13/12/2019 07:50	14/12/2019 12:19	13/12/2019 07:50	14/12/2019 12:19	28,47	1	28,47	CHI
20191297209	NOVO PLANALTO	TA12192345	SAO MIGUEL DO ARAGUAIA	13/12/2019 07:51	13/12/2019 11:35	13/12/2019 07:51	13/12/2019 11:35	3,73	6	22,37	CHI
20191297214	GOIANIA	16818283	CARAJAS S2	13/12/2019 07:52	13/12/2019 13:06	13/12/2019 07:52	13/12/2019 13:06	5,23	1	5,23	CHI
20191297224	LUZIANIA	LZ12162291	CRISTALINA S1	13/12/2019 07:53	13/12/2019 12:01	13/12/2019 07:53	13/12/2019 12:01	4,13	16	66,05	CHI
20191297229	PORTELANDIA	1470014959	PARQUE DAS EMAS	13/12/2019 07:53	13/12/2019 15:57	13/12/2019 07:53	13/12/2019 15:57	8,05	1	8,05	CHI
20191297231	GOIANIA	14420089	CAMPINAS S2	13/12/2019 07:54	13/12/2019 15:19	13/12/2019 07:54	13/12/2019 15:19	7,42	1	7,42	CHI
20191297232	APARECIDA DE GOIANIA	10009271170	INDEPENDENCIA S2	13/12/2019 07:54	13/12/2019 10:08	13/12/2019 07:54	13/12/2019 10:08	2,22	1	2,22	CHI
20191297238	FORMOSA	FA12318517	ITUIQUIRA	13/12/2019 07:54	14/12/2019 11:57	13/12/2019 07:54	14/12/2019 11:57	28,04	4	112,14	CHI
20191297570	PADRE BERNARDO	PB12152732	PADRE BERNARDO	13/12/2019 07:54	13/12/2019 15:05	13/12/2019 07:54	13/12/2019 15:05	7,18	14	100,56	CHI
20191297244	IPAMERI	IP12272800	IPAMERI	13/12/2019 07:55	13/12/2019 11:28	13/12/2019 07:55	13/12/2019 11:28	3,54	2	7,09	CHI
20191297248	NOVA ROMA	ND21302759	IACIARA S2	13/12/2019 07:55	13/12/2019 11:40	13/12/2019 07:55	13/12/2019 11:40	3,74	1	3,74	CHI
20191297317	CORUMBA DE GOIAS	CB12089104	ALEXANIA	13/12/2019 07:55	13/12/2019 10:59	13/12/2019 07:55	13/12/2019 10:59	3,06	4	12,22	CHI
20191297252	GOIANIA	10612798	AEROPORTO S2	13/12/2019 07:56	13/12/2019 09:17	13/12/2019 07:56	13/12/2019 09:17	1,35	1	1,35	CHI
20191297255	JATAI	JT21152636	JATAI S2	13/12/2019 07:56	13/12/2019 14:37	13/12/2019 07:56	13/12/2019 14:37	6,68	1	6,68	CHI
20191297256	SILVANIA	SV21209077	VIANOPOLIS	13/12/2019 07:56	13/12/2019 10:11	13/12/2019 07:56	13/12/2019 10:11	2,24	1	2,24	CHI
20191297257	NOVO GAMA	NJ21171635	PACAEMBU S1	13/12/2019 07:56	13/12/2019 09:19	13/12/2019 07:56	13/12/2019 09:19	1,37	2	2,75	CHI
20191297267	TRINDADE	TR11180156	GOYA S2	13/12/2019 07:57	13/12/2019 13:00	13/12/2019 07:57	13/12/2019 13:00	5,04	41	206,77	CHI
20191297271	ANAPOLIS	AN11394297	JUNDIAI S1	13/12/2019 07:58	14/12/2019 00:05	13/12/2019 07:58	14/12/2019 00:05	16,10	23	370,38	CHI
20191297793	ALEXANIA	AX12061983	ALEXANIA	13/12/2019 07:59	13/12/2019 12:02	13/12/2019 07:59	13/12/2019 12:02	4,03	12	48,41	CHI
20191297793	CORUMBA DE GOIAS	AX12061983	ALEXANIA	13/12/2019 07:59	13/12/2019 12:02	13/12/2019 07:59	13/12/2019 12:02	4,03	1	4,03	CHI

20191297289	GOIATUBA	BJ21029034	BOM JESUS DE GOIAS	13/12/2019 08:00	13/12/2019 13:30	13/12/2019 08:00	13/12/2019 13:30	5,49	1	5,49	CHI
20191297293	QUIRINOPOLIS	QI32058080	QUIRINOPOLIS	13/12/2019 08:01	13/12/2019 12:09	13/12/2019 08:01	13/12/2019 12:09	4,14	9	37,23	CHI
20191297301	PIRENOPOLIS	220008942	CORUMBA	13/12/2019 08:02	13/12/2019 10:04	13/12/2019 08:02	13/12/2019 10:04	2,02	1	2,02	CHI
20191297302	PARANAIGUARA	PC21209774	QUIRINOPOLIS	13/12/2019 08:02	13/12/2019 20:50	13/12/2019 08:02	13/12/2019 20:50	12,79	1	12,79	CHI
20191297303	SANCLERLANDIA	SL12388893	SAO LUIZ DOS MONTES BELOS	13/12/2019 08:02	13/12/2019 10:24	13/12/2019 08:02	13/12/2019 10:24	2,35	9	21,17	CHI
20191297305	RUBIATABA	RB21287148	RUBIATABA	13/12/2019 08:03	13/12/2019 16:16	13/12/2019 08:03	13/12/2019 16:16	8,23	1	8,23	CHI
20191297532	QUIRINOPOLIS	QI11018008	QUIRINOPOLIS	13/12/2019 08:03	13/12/2019 17:32	13/12/2019 08:03	13/12/2019 17:32	9,47	83	786,08	CHI
20191297788	CRIXAS	CX12283275	SERRA DO OURO	13/12/2019 08:03	13/12/2019 12:20	13/12/2019 08:03	13/12/2019 12:20	4,30	2	8,59	CHI
20191297315	INDIARA	IY21327607	EDEIA	13/12/2019 08:04	13/12/2019 09:10	13/12/2019 08:04	13/12/2019 09:10	1,09	1	1,09	CHI
20191297318	COLINAS DO SUL	TI11116081	MINACU	13/12/2019 08:04	13/12/2019 12:11	13/12/2019 08:04	13/12/2019 12:11	4,11	57	234,18	CHI
20191297319	MORRINHOS	150027874	MORRINHOS	13/12/2019 08:04	13/12/2019 09:49	13/12/2019 08:04	13/12/2019 09:49	1,75	1	1,75	CHI
20191297320	VALPARAISO DE GOIAS	10019329316	MARAJOARA	13/12/2019 08:04	13/12/2019 11:09	13/12/2019 08:04	13/12/2019 11:09	3,08	1	3,08	CHI
20191297323	ANAPOLIS	AN12258234	NEROPOLIS S1	13/12/2019 08:04	13/12/2019 10:30	13/12/2019 08:04	13/12/2019 10:30	2,42	3	7,26	CHI
20191297323	CAMPO LIMPO	AN12258234	NEROPOLIS S1	13/12/2019 08:04	13/12/2019 10:30	13/12/2019 08:04	13/12/2019 10:30	2,42	28	67,73	CHI
20191297330	CORUMBA DE GOIAS	ZN21297575	COCALZINHO	13/12/2019 08:05	13/12/2019 14:45	13/12/2019 08:05	13/12/2019 14:45	6,66	1	6,66	CHI
20191297332	INHUMAS	IN12098348	INHUMAS S2	13/12/2019 08:05	13/12/2019 15:47	13/12/2019 08:05	13/12/2019 15:47	7,69	78	599,52	CHI
20191297335	FORMOSA	610321705	ITUIQUIRA	13/12/2019 08:06	13/12/2019 15:05	13/12/2019 08:06	13/12/2019 15:05	6,98	1	6,98	CHI
20191297342	GOIATUBA	BJ21309891	BOM JESUS DE GOIAS	13/12/2019 08:06	13/12/2019 17:20	13/12/2019 08:06	13/12/2019 17:20	9,22	2	18,44	CHI
20191297343	ANAPOLIS	GP21000253	JUNDIAI S2	13/12/2019 08:07	13/12/2019 11:21	13/12/2019 08:07	13/12/2019 11:21	3,23	1	3,23	CHI
20191297346	NOVA ROMA	ND21159882	IACIARA S2	13/12/2019 08:07	13/12/2019 12:40	13/12/2019 08:07	13/12/2019 12:40	4,55	1	4,55	CHI
20191297621	BARRO ALTO	BA12382485	BARRO ALTO	13/12/2019 08:07	13/12/2019 17:15	13/12/2019 08:07	13/12/2019 17:15	9,13	9	82,17	CHI
20191297349	ITUMBIARA	10000599660	ITUMBIARA NOVA	13/12/2019 08:08	13/12/2019 09:40	13/12/2019 08:08	13/12/2019 09:40	1,54	1	1,54	CHI
20191297350	ARAGARCAS	AG21234232	ARAGARCAS	13/12/2019 08:08	13/12/2019 17:03	13/12/2019 08:08	13/12/2019 17:03	8,92	1	8,92	CHI
20191297352	CRISTALINA	1060091036	CRISTALINA S1	13/12/2019 08:08	13/12/2019 11:03	13/12/2019 08:08	13/12/2019 11:03	2,91	1	2,91	CHI
20191297356	ANAPOLIS	20638644	JUNDIAI S1	13/12/2019 08:08	13/12/2019 18:42	13/12/2019 08:08	13/12/2019 18:42	10,55	1	10,55	CHI
20191297360	RIO VERDE	10003207704	RIO VERDE S2	13/12/2019 08:09	13/12/2019 10:42	13/12/2019 08:09	13/12/2019 10:42	2,54	1	2,54	CHI
201912100193	SAO MIGUEL DO ARAGUAIA	SM11276099	SAO MIGUEL DO ARAGUAIA	13/12/2019 08:09	13/12/2019 17:45	13/12/2019 08:09	13/12/2019 17:45	9,60	1	9,60	CHI
20191297362	PARAUNA	PU12295907	ACREUNA	13/12/2019 08:10	13/12/2019 20:12	13/12/2019 08:10	13/12/2019 20:12	12,03	6	72,19	CHI
20191297363	AGUA FRIA DE GOIAS	TL11164598	SAO JOAO D ALIANCA	13/12/2019 08:10	13/12/2019 17:27	13/12/2019 08:10	13/12/2019 17:27	9,28	126	1169,32	CHI
20191297373	GOIANIA	10027828326	XAVANTES	13/12/2019 08:11	13/12/2019 13:19	13/12/2019 08:11	13/12/2019 13:19	5,12	1	5,12	CHI
20191297374	EDEIA	EA12146600	VICENTINOPOLIS	13/12/2019 08:11	13/12/2019 14:10	13/12/2019 08:11	13/12/2019 14:10	5,98	2	11,96	CHI
20191297376	ITUMBIARA	IT21309825	ITUMBIARA NOVA	13/12/2019 08:11	13/12/2019 09:22	13/12/2019 08:11	13/12/2019 09:22	1,17	1	1,17	CHI
20191297543	GOIANIA	GN11132319	REAL S2	13/12/2019 08:11	13/12/2019 11:20	13/12/2019 08:11	13/12/2019 11:20	3,14	108	338,94	CHI

20191297716	PILAR DE GOIAS	GG12181616	SANTA TEREZINHA	13/12/2019 08:11	13/12/2019 12:37	13/12/2019 08:11	13/12/2019 12:37	4,42	3	13,26	CHI
20191297716	SANTA TEREZINHA DE GOIAS	GG12181616	SANTA TEREZINHA	13/12/2019 08:11	13/12/2019 12:37	13/12/2019 08:11	13/12/2019 12:37	4,42	6	26,51	CHI
20191298817	SANTA TEREZINHA DE GOIAS	GG12181600	SANTA TEREZINHA	13/12/2019 08:11	13/12/2019 19:53	13/12/2019 08:11	13/12/2019 19:53	11,69	7	81,85	CHI
20191297378	CAMPINACU	6482211	PORANGATU	13/12/2019 08:12	13/12/2019 14:27	13/12/2019 08:12	13/12/2019 14:27	6,24	1	6,24	CHI
20191297379	NIQUELANDIA	2750038814	NIQUELANDIA SUBTRANSMISSAO	13/12/2019 08:12	13/12/2019 16:19	13/12/2019 08:12	13/12/2019 16:19	8,12	1	8,12	CHI
20191297380	CAMPINACU	UC12236229	PORANGATU	13/12/2019 08:12	13/12/2019 10:47	13/12/2019 08:12	13/12/2019 10:47	2,58	27	69,57	CHI
20191297381	DIORAMA	1530010655	IPORA	13/12/2019 08:12	13/12/2019 11:00	13/12/2019 08:12	13/12/2019 11:00	2,80	1	2,80	CHI
20191297384	FAZENDA NOVA	FN12060693	IPORA	13/12/2019 08:12	13/12/2019 18:25	13/12/2019 08:12	13/12/2019 18:25	10,21	11	112,26	CHI
20191297903	PORTELANDIA	PW12234346	PARQUE DAS EMAS	13/12/2019 08:12	13/12/2019 15:13	13/12/2019 08:12	13/12/2019 15:13	7,00	80	560,07	CHI
20191297396	URUACU	UR12281005	URUACU	13/12/2019 08:13	13/12/2019 17:51	13/12/2019 08:13	13/12/2019 17:51	9,62	4	38,48	CHI
20191297668	CAMPO LIMPO	AN21255932	NEROPOLIS S1	13/12/2019 08:13	13/12/2019 12:25	13/12/2019 08:13	13/12/2019 12:25	4,19	3	12,56	CHI
20191297399	FAINA	MP13355885	MATRINCHA	13/12/2019 08:14	14/12/2019 14:15	13/12/2019 08:14	14/12/2019 14:15	30,02	8	240,12	CHI
20191297399	ARAGUAPAZ	MP13355885	MATRINCHA	13/12/2019 08:14	14/12/2019 14:15	14/12/2019 11:59	14/12/2019 14:15	2,27	1	2,27	CHI
20191297399	FAINA	MP13355885	MATRINCHA	13/12/2019 08:14	14/12/2019 14:15	14/12/2019 11:59	14/12/2019 14:15	2,27	59	133,68	CHI
20191297399	MATRINCHA	MP13355885	MATRINCHA	13/12/2019 08:14	14/12/2019 14:15	14/12/2019 11:59	14/12/2019 14:15	2,27	43	97,43	CHI
20191297400	GOIANIA	10017324309	CARAJAS S1	13/12/2019 08:14	13/12/2019 11:43	13/12/2019 08:14	13/12/2019 11:43	3,48	1	3,48	CHI
20191297402	JARAGUA	JA12298122	JARAGUA	13/12/2019 08:14	13/12/2019 10:15	13/12/2019 08:14	13/12/2019 10:15	2,01	1	2,01	CHI
20191297405	TURVELANDIA	SH12301062	RIO DOS BOIS	13/12/2019 08:14	15/12/2019 01:32	13/12/2019 08:14	15/12/2019 01:32	41,29	1	41,29	CHI
20191297405	SANTA HELENA DE GOIAS	SH12301062	RIO DOS BOIS	13/12/2019 08:14	15/12/2019 01:32	14/12/2019 21:51	15/12/2019 01:32	3,68	3	11,05	CHI
20191297405	TURVELANDIA	SH12301062	RIO DOS BOIS	13/12/2019 08:14	15/12/2019 01:32	14/12/2019 21:51	15/12/2019 01:32	3,68	2	7,37	CHI
20191297453	CAMPINACU	IH12192447	MINACU	13/12/2019 08:14	13/12/2019 11:01	13/12/2019 08:14	13/12/2019 11:01	2,78	5	13,91	CHI
20191297453	MINACU	IH12192447	MINACU	13/12/2019 08:14	13/12/2019 11:01	13/12/2019 08:14	13/12/2019 11:01	2,78	24	66,75	CHI
20191297407	NIQUELANDIA	NQ11057936	NIQUELANDIA SUBTRANSMISSAO	13/12/2019 08:15	13/12/2019 09:42	13/12/2019 08:15	13/12/2019 09:42	1,44	93	134,28	CHI
20191297418	CALDAS NOVAS	760108651	SERRA DE CALDAS	13/12/2019 08:16	13/12/2019 11:40	13/12/2019 08:16	13/12/2019 11:40	3,40	1	3,40	CHI
20191297424	PALMEIRAS DE GOIAS	PL21274646	PALMEIRAS	13/12/2019 08:17	13/12/2019 09:20	13/12/2019 08:17	13/12/2019 09:20	1,05	1	1,05	CHI
20191297430	CATURAI	TR12045912	TRINDADE	13/12/2019 08:17	14/12/2019 08:50	13/12/2019 08:17	14/12/2019 08:50	24,54	1	24,54	CHI
20191297430	TRINDADE	TR12045912	TRINDADE	13/12/2019 08:17	14/12/2019 08:50	13/12/2019 08:17	14/12/2019 08:50	24,54	2	49,07	CHI
20191297431	JATAI	JT11354986	JATAI S1	13/12/2019 08:17	13/12/2019 11:54	13/12/2019 08:17	13/12/2019 11:54	3,60	1	3,60	CHI
20191297435	BONOPOLIS	BX12292422	SAO MIGUEL DO ARAGUAIA	13/12/2019 08:18	14/12/2019 16:37	13/12/2019 08:18	14/12/2019 16:37	32,31	33	1066,31	CHI
20191297435	PORANGATU	BX12292422	SAO MIGUEL DO ARAGUAIA	13/12/2019 08:18	14/12/2019 16:37	13/12/2019 08:18	14/12/2019 16:37	32,31	1	32,31	CHI
20191297438	SERRANOPOLIS	3000008984	JATAI S1	13/12/2019 08:18	14/12/2019 14:16	13/12/2019 08:18	14/12/2019 14:16	29,96	1	29,96	CHI
20191297441	PORANGATU	840076710	PORANGATU	13/12/2019 08:18	13/12/2019 11:27	13/12/2019 08:18	13/12/2019 11:27	3,14	1	3,14	CHI
20191297442	CATALAO	CT21266242	CATALAO S1	13/12/2019 08:18	13/12/2019 09:30	13/12/2019 08:18	13/12/2019 09:30	1,20	5	6,00	CHI

20191297443	BELA VISTA DE GOIAS	BV21043562	BELA VISTA S1	13/12/2019 08:18	13/12/2019 15:13	13/12/2019 08:18	13/12/2019 15:13	6,90	1	6,90	CHI
20191297446	MINACU	IH12396740	MINACU	13/12/2019 08:19	13/12/2019 10:55	13/12/2019 08:19	13/12/2019 10:55	2,59	182	472,19	CHI
20191297447	JATAI	JT21061477	JATAI S1	13/12/2019 08:19	13/12/2019 11:40	13/12/2019 08:19	13/12/2019 11:40	3,34	1	3,34	CHI
20191297449	GOUVELANDIA	QI21014263	QUIRINOPOLIS	13/12/2019 08:19	13/12/2019 12:54	13/12/2019 08:19	13/12/2019 12:54	4,58	1	4,58	CHI
20191297452	MINEIROS	MY21358847	PARQUE DAS EMAS	13/12/2019 08:20	13/12/2019 22:36	13/12/2019 08:20	13/12/2019 22:36	14,27	1	14,27	CHI
20191297455	URUACU	UR21136330	CAMPINORTE	13/12/2019 08:20	13/12/2019 11:28	13/12/2019 08:20	13/12/2019 11:28	3,12	1	3,12	CHI
20191297457	EDEIA	EA12026650	EDEIA	13/12/2019 08:20	13/12/2019 12:01	13/12/2019 08:20	13/12/2019 12:01	3,67	7	25,68	CHI
20191297460	JAUPACI	JP12028023	IPORA	13/12/2019 08:21	13/12/2019 11:00	13/12/2019 08:21	13/12/2019 11:00	2,65	7	18,54	CHI
20191297461	JUSSARA	JR21139609	JUSSARA	13/12/2019 08:21	13/12/2019 10:55	13/12/2019 08:21	13/12/2019 10:55	2,58	3	7,73	CHI
20191297472	EDEIA	EA12160413	VICENTINOPOLIS	13/12/2019 08:22	13/12/2019 16:49	13/12/2019 08:22	13/12/2019 16:49	8,44	2	16,88	CHI
20191297476	ITUMBIARA	CD12097345RE	CACHOEIRA DOURADA	13/12/2019 08:22	13/12/2019 14:00	13/12/2019 08:22	13/12/2019 14:00	5,62	8	44,96	CHI
20191297478	PORANGATU	PO11239660	MARA ROSA	13/12/2019 08:23	13/12/2019 12:21	13/12/2019 08:23	13/12/2019 12:21	3,96	1	3,96	CHI
20191297479	ALEXANIA	AX12061991	ALEXANIA	13/12/2019 08:23	13/12/2019 11:24	13/12/2019 08:23	13/12/2019 11:24	3,01	2	6,01	CHI
20191297479	CORUMBA DE GOIAS	AX12061991	ALEXANIA	13/12/2019 08:23	13/12/2019 11:24	13/12/2019 08:23	13/12/2019 11:24	3,01	1	3,01	CHI
20191297480	CATURAI	CK21325157	ARACU	13/12/2019 08:23	14/12/2019 09:30	13/12/2019 08:23	14/12/2019 09:30	25,11	2	50,22	CHI
20191297482	GOIANIA	GN21340727	XAVANTES	13/12/2019 08:23	13/12/2019 11:29	13/12/2019 08:23	13/12/2019 11:29	3,08	1	3,08	CHI
20191297483	ITABERAI	IB21172569	ITABERAI S1	13/12/2019 08:24	13/12/2019 10:15	13/12/2019 08:24	13/12/2019 10:15	1,85	2	3,69	CHI
20191297487	PANAMA	PX31060114	GOIATUBA S1	13/12/2019 08:24	13/12/2019 18:14	13/12/2019 08:24	13/12/2019 18:14	9,82	1	9,82	CHI
20191297498	GOIANIRA	IN12188645	INHUMAS S2	13/12/2019 08:24	13/12/2019 15:36	13/12/2019 08:24	13/12/2019 15:36	7,19	2	14,38	CHI
20191297492	VICENTINOPOLIS	VI12218216	VICENTINOPOLIS	13/12/2019 08:25	13/12/2019 11:57	13/12/2019 08:25	13/12/2019 11:57	3,53	3	10,60	CHI
20191297501	ITAPURANGA	IK12027162	ITAPURANGA	13/12/2019 08:26	13/12/2019 16:25	13/12/2019 08:26	13/12/2019 16:25	7,98	6	47,87	CHI
20191297508	CRIXAS	CX21070612	SERRA DO OURO	13/12/2019 08:26	13/12/2019 14:06	13/12/2019 08:26	13/12/2019 14:06	5,65	2	11,30	CHI
20191296947	ABADIANIA	AA21146846	CORUMBA	13/12/2019 08:27	13/12/2019 08:45	13/12/2019 08:27	13/12/2019 08:45	0,29	1	0,29	CHI
20191297511	GOIANIA	10017887141	CAMPINAS S2	13/12/2019 08:27	13/12/2019 11:51	13/12/2019 08:27	13/12/2019 11:51	3,40	1	3,40	CHI
20191297518	CAMPINORTE	CR12050832	CAMPINORTE	13/12/2019 08:28	13/12/2019 11:10	13/12/2019 08:28	13/12/2019 11:10	2,70	5	13,50	CHI
20191297523	APARECIDA DE GOIANIA	14256162	ANHANGUERA	13/12/2019 08:28	13/12/2019 10:29	13/12/2019 08:28	13/12/2019 10:29	2,00	1	2,00	CHI
20191297527	CRIXAS	CX12252911	SANTA TEREZINHA	13/12/2019 08:28	13/12/2019 19:28	13/12/2019 08:28	13/12/2019 19:28	10,98	13	142,79	CHI
20191298032	RIO VERDE	RV21260538	RIO VERDE S2	13/12/2019 08:28	13/12/2019 11:14	13/12/2019 08:28	13/12/2019 11:14	2,76	1	2,76	CHI
20191298505	SANTA BARBARA DE GOIAS	SB12277716	TRINDADE	13/12/2019 08:28	13/12/2019 15:53	13/12/2019 08:28	13/12/2019 15:53	7,41	10	74,14	CHI
20191296950	PORTEIRAO	BJ11310061	RIO DOS BOIS	13/12/2019 08:29	14/12/2019 07:10	13/12/2019 08:29	14/12/2019 07:10	22,68	1	22,68	CHI
20191297530	CAMPOS VERDES	VD12257334	SANTA TEREZINHA	13/12/2019 08:29	13/12/2019 13:10	13/12/2019 08:29	13/12/2019 13:10	4,68	6	28,06	CHI
20191297531	AGUAS LINDAS DE GOIAS	10011948157	AGUAS LINDAS DE GOIAS S1	13/12/2019 08:29	13/12/2019 09:42	13/12/2019 08:29	13/12/2019 09:42	1,21	1	1,21	CHI
20191297535	RIO VERDE	RV12322315	CABRIUVA S2	13/12/2019 08:29	13/12/2019 16:36	13/12/2019 08:29	13/12/2019 16:36	8,10	1	8,10	CHI

20191297545	FAZENDA NOVA	NB12099386	JUSSARA	13/12/2019 08:31	13/12/2019 13:02	13/12/2019 08:31	13/12/2019 13:02	4,52	4	18,06	CHI
20191297548	CAMPOS VERDES	3790015748	SANTA TEREZINHA	13/12/2019 08:31	13/12/2019 21:44	13/12/2019 08:31	13/12/2019 21:44	13,21	1	13,21	CHI
20191297550	CORUMBA DE GOIAS	CB21311768	CORUMBA	13/12/2019 08:32	13/12/2019 16:57	13/12/2019 08:32	13/12/2019 16:57	8,41	1	8,41	CHI
20191297561	ITABERAI	IB12382593	ANICUNS	13/12/2019 08:33	13/12/2019 13:20	13/12/2019 08:33	13/12/2019 13:20	4,78	7	33,43	CHI
20191297562	GOIANIA	GN11066009	XAVANTES	13/12/2019 08:33	13/12/2019 10:42	13/12/2019 08:33	13/12/2019 10:42	2,14	8	17,11	CHI
20191297564	LEOPOLDO DE BULHOES	LB12092183	DAIA S2	13/12/2019 08:34	13/12/2019 13:19	13/12/2019 08:34	13/12/2019 13:19	4,75	4	18,98	CHI
20191297568	CAIAPONIA	CP12207862	PALESTINA	13/12/2019 08:34	14/12/2019 00:58	13/12/2019 08:34	14/12/2019 00:58	16,39	7	114,72	CHI
20191297568	PALESTINA DE GOIAS	CP12207862	PALESTINA	13/12/2019 08:34	14/12/2019 00:58	13/12/2019 08:34	14/12/2019 00:58	16,39	9	147,50	CHI
20191297575	CAIAPONIA	CP21267732	MONTIVIDIU T	13/12/2019 08:35	13/12/2019 21:04	13/12/2019 08:35	13/12/2019 21:04	12,48	1	12,48	CHI
20191297581	APORE	AE21205149	ITAJA S2	13/12/2019 08:36	13/12/2019 14:44	13/12/2019 08:36	13/12/2019 14:44	6,13	2	12,26	CHI
20191297582	RIO VERDE	RV21260981	RIO VERDE S1	13/12/2019 08:36	13/12/2019 12:25	13/12/2019 08:36	13/12/2019 12:25	3,81	1	3,81	CHI
20191297583	CAMPO ALEGRE DE GOIAS	CM12280944	CAMPO ALEGRE DE GOIAS	13/12/2019 08:36	13/12/2019 18:25	13/12/2019 08:36	13/12/2019 18:25	9,81	29	284,53	CHI
20191297584	JATAI	JT21274155	JATAI S2	13/12/2019 08:36	13/12/2019 15:09	13/12/2019 08:36	13/12/2019 15:09	6,54	2	13,08	CHI
20191297588	INDIARA	IY21312419	CEZARINA	13/12/2019 08:37	13/12/2019 10:20	13/12/2019 08:37	13/12/2019 10:20	1,71	1	1,71	CHI
20191297594	NIQUELANDIA	NQ12292649	NIQUELANDIA SUBTRANSMISSAO	13/12/2019 08:38	13/12/2019 13:29	13/12/2019 08:38	13/12/2019 13:29	4,84	2	9,69	CHI
20191296954	ARUANA	AK12078438	MOZARLANDIA	13/12/2019 08:39	13/12/2019 09:07	13/12/2019 08:39	13/12/2019 09:07	0,45	80	36,16	CHI
20191297599	GOIANIA	GN21066331	ATLANTICO S1	13/12/2019 08:39	13/12/2019 10:48	13/12/2019 08:39	13/12/2019 10:48	2,16	2	4,32	CHI
20191297604	NOVA CRIXAS	NA21342060	NOVA CRIXAS	13/12/2019 08:39	13/12/2019 17:40	13/12/2019 08:39	13/12/2019 17:40	9,01	2	18,02	CHI
20191298367	GAMELEIRA DE GOIAS	SV12197293	VIANOPOLIS	13/12/2019 08:39	14/12/2019 16:12	13/12/2019 08:39	14/12/2019 16:12	31,55	16	504,72	CHI
20191298367	SILVANIA	SV12197293	VIANOPOLIS	13/12/2019 08:39	14/12/2019 16:12	13/12/2019 08:39	14/12/2019 16:12	31,55	3	94,64	CHI
20191297609	RIO VERDE	10030703920	RIO VERDE S2	13/12/2019 08:40	13/12/2019 12:25	13/12/2019 08:40	13/12/2019 12:25	3,76	1	3,76	CHI
20191297610	MAURILANDIA	DM21306311	RIO DOS BOIS	13/12/2019 08:40	14/12/2019 10:00	13/12/2019 08:40	14/12/2019 10:00	25,33	1	25,33	CHI
20191297611	ANAPOLIS	10013770894	DAIA S1	13/12/2019 08:40	13/12/2019 12:27	13/12/2019 08:40	13/12/2019 12:27	3,77	1	3,77	CHI
20191297807	APARECIDA DE GOIANIA	AP11347787	INDEPENDENCIA S2	13/12/2019 08:40	13/12/2019 15:40	13/12/2019 08:40	13/12/2019 15:40	6,98	126	880,04	CHI
20191297615	VALPARAISO DE GOIAS	2860375734	MARAJOARA	13/12/2019 08:41	13/12/2019 10:30	13/12/2019 08:41	13/12/2019 10:30	1,81	1	1,81	CHI
20191297618	MOSSAMEDES	MD21204368	FIRMINOPOLIS S2	13/12/2019 08:41	13/12/2019 13:06	13/12/2019 08:41	13/12/2019 13:06	4,40	1	4,40	CHI
20191297625	CATALAO	1990134595	CATALAO S2	13/12/2019 08:43	14/12/2019 08:26	13/12/2019 08:43	14/12/2019 08:26	23,72	1	23,72	CHI
20191297627	PALMEIRAS DE GOIAS	TV31186340	ANICUNS	13/12/2019 08:43	13/12/2019 10:15	13/12/2019 08:43	13/12/2019 10:15	1,53	1	1,53	CHI
20191297633	GUAPO	GA21081175	GUAPO S2	13/12/2019 08:44	14/12/2019 10:00	13/12/2019 08:44	14/12/2019 10:00	25,27	1	25,27	CHI
20191297635	MONTES CLAROS DE GOIAS	ME12198229	IPORA	13/12/2019 08:45	13/12/2019 13:12	13/12/2019 08:45	13/12/2019 13:12	4,45	7	31,14	CHI
20191297639	GOIANIA	GN21366080	GOYA S1	13/12/2019 08:45	13/12/2019 11:44	13/12/2019 08:45	13/12/2019 11:44	2,98	1	2,98	CHI
20191297649	BRITANIA	9870000052	BRITANIA	13/12/2019 08:46	14/12/2019 01:10	13/12/2019 08:46	14/12/2019 01:10	16,40	1	16,40	CHI
20191297653	AMERICANO DO BRASIL	KB12391521	ANICUNS	13/12/2019 08:46	13/12/2019 12:27	13/12/2019 08:46	13/12/2019 12:27	3,68	11	40,52	CHI

20191297653	MOSSAMEDES	KB12391521	ANICUNS	13/12/2019 08:46	13/12/2019 12:27	13/12/2019 08:46	13/12/2019 12:27	3,68	11	40,52	CHI
20191297658	CRISTALINA	KR21313605	CRISTALINA S2	13/12/2019 08:47	13/12/2019 10:12	13/12/2019 08:47	13/12/2019 10:12	1,41	1	1,41	CHI
20191297660	RIO VERDE	630389767	CABRIUVA S1	13/12/2019 08:48	13/12/2019 10:40	13/12/2019 08:48	13/12/2019 10:40	1,87	1	1,87	CHI
20191297666	RIO VERDE	630021466	RIO VERDE S2	13/12/2019 08:48	13/12/2019 12:19	13/12/2019 08:48	13/12/2019 12:19	3,51	1	3,51	CHI
20191297673	GUARANI DE GOIAS	GY12093540	IACIARA S1	13/12/2019 08:49	13/12/2019 18:42	13/12/2019 08:49	13/12/2019 12:15	3,43	2	6,86	CHI
20191297673	GUARANI DE GOIAS	IA12085621LD	IACIARA S1	13/12/2019 08:49	13/12/2019 18:42	13/12/2019 08:49	13/12/2019 18:42	9,89	33	326,38	CHI
20191297673	IACIARA	IA12085621LD	IACIARA S1	13/12/2019 08:49	13/12/2019 18:42	13/12/2019 08:49	13/12/2019 18:42	9,89	31	306,60	CHI
20191297681	VILA PROPICIO	NP21328476	GOIANESIA S2	13/12/2019 08:50	13/12/2019 13:25	13/12/2019 08:50	13/12/2019 13:25	4,59	1	4,59	CHI
20191297690	GOIANIA	GN21000068	AEROPORTO S3	13/12/2019 08:50	13/12/2019 10:22	13/12/2019 08:50	13/12/2019 10:22	1,52	1	1,52	CHI
20191297721	NIQUELANDIA	NQ12255371	NIQUELANDIA SUBTRANSMISSAO	13/12/2019 08:50	13/12/2019 14:05	13/12/2019 08:50	13/12/2019 14:05	5,24	19	99,62	CHI
20191298488	PORANGATU	PO12390257	PORANGATU	13/12/2019 08:50	14/12/2019 11:25	13/12/2019 08:50	14/12/2019 11:25	26,57	4	106,29	CHI
20191297695	SAO MIGUEL DO ARAGUAIA	SM21147579	SAO MIGUEL DO ARAGUAIA	13/12/2019 08:51	13/12/2019 13:40	13/12/2019 08:51	13/12/2019 13:40	4,82	1	4,82	CHI
20191297697	QUIRINOPOLIS	QI21096905	QUIRINOPOLIS	13/12/2019 08:51	13/12/2019 12:22	13/12/2019 08:51	13/12/2019 12:22	3,50	1	3,50	CHI
20191298637	NIQUELANDIA	NQ12197750	URUACU	13/12/2019 08:52	13/12/2019 12:50	13/12/2019 08:52	13/12/2019 12:50	3,97	18	71,52	CHI
20191297707	RIO VERDE	RV12371358	RIO VERDE S1	13/12/2019 08:53	13/12/2019 13:02	13/12/2019 08:53	13/12/2019 13:02	4,15	6	24,89	CHI
20191297710	ITUMBIARA	IT12000255	ITUMBIARA NOVA	13/12/2019 08:53	13/12/2019 11:09	13/12/2019 08:53	13/12/2019 11:09	2,26	1	2,26	CHI
20191297710	PANAMA	IT12000255	ITUMBIARA NOVA	13/12/2019 08:53	13/12/2019 11:09	13/12/2019 08:53	13/12/2019 11:09	2,26	4	9,02	CHI
20191297711	AVELINOPOLIS	AV12383535	ANICUNS	13/12/2019 08:53	13/12/2019 10:28	13/12/2019 08:53	13/12/2019 10:28	1,58	5	7,90	CHI
20191297712	VALPARAISO DE GOIAS	10004644059	MARAJOARA	13/12/2019 08:53	13/12/2019 10:23	13/12/2019 08:53	13/12/2019 10:23	1,49	1	1,49	CHI
20191297715	GOIANIA	10008125030	CAMPINAS S1	13/12/2019 08:54	13/12/2019 14:07	13/12/2019 08:54	13/12/2019 14:07	5,21	1	5,21	CHI
20191297875	MAURILANDIA	ML21303533	RIO DOS BOIS	13/12/2019 08:55	13/12/2019 11:56	13/12/2019 08:55	13/12/2019 11:56	3,00	1	3,00	CHI
20191297726	NIQUELANDIA	2750103971	NIQUELANDIA SUBTRANSMISSAO	13/12/2019 08:56	13/12/2019 11:47	13/12/2019 08:56	13/12/2019 11:47	2,84	1	2,84	CHI
20191297732	NIQUELANDIA	NQ11269788	NIQUELANDIA SUBTRANSMISSAO	13/12/2019 08:57	13/12/2019 11:35	13/12/2019 08:57	13/12/2019 11:35	2,63	55	144,42	CHI
20191297734	CAVALCANTE	10003434662	FLORES DE GOIAS	13/12/2019 08:57	13/12/2019 15:49	13/12/2019 08:57	13/12/2019 15:49	6,85	1	6,85	CHI
201912209637	SAO MIGUEL DO ARAGUAIA	SM12371095	SAO MIGUEL DO ARAGUAIA	13/12/2019 08:57	13/12/2019 17:18	13/12/2019 08:57	13/12/2019 17:18	8,35	1	8,35	CHI
20191297744	GOIANIA	14966463	MEIA PONTE	13/12/2019 08:58	13/12/2019 12:07	13/12/2019 08:58	13/12/2019 12:07	3,14	1	3,14	CHI
20191297748	PARAUNA	980024924	PARAUNA	13/12/2019 08:59	13/12/2019 10:09	13/12/2019 08:59	13/12/2019 10:09	1,16	1	1,16	CHI

Plotagem das Ocorrências conforme a Espacialização das Chuvas

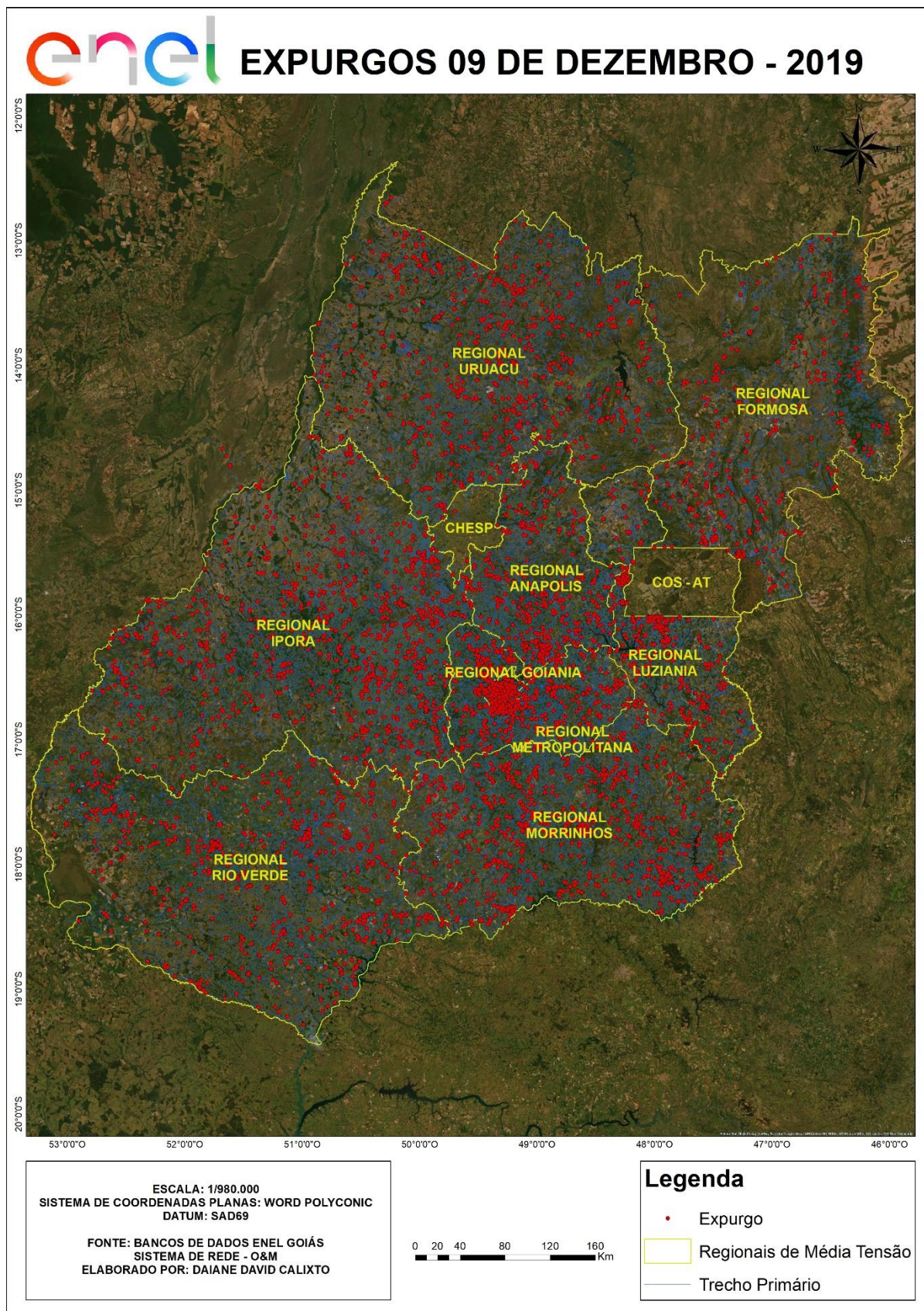

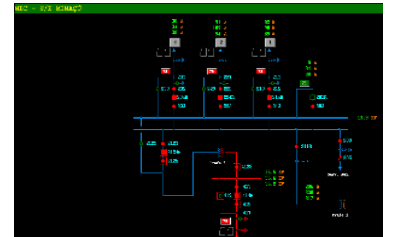
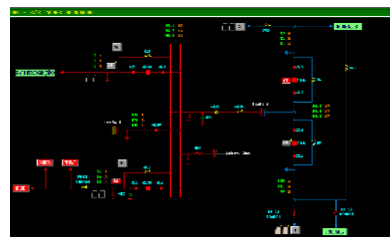
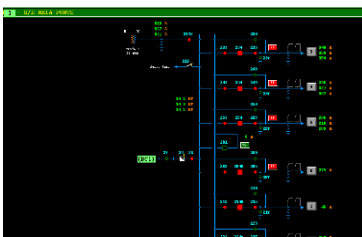
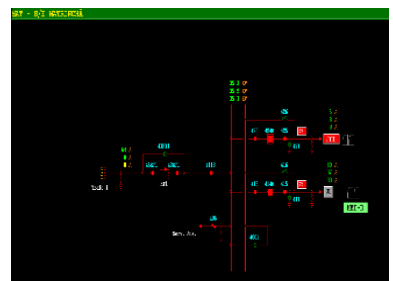
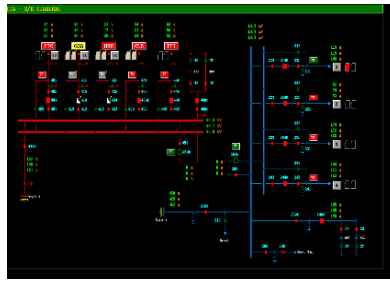
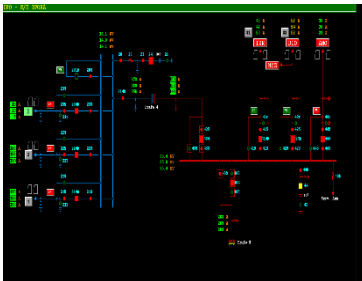
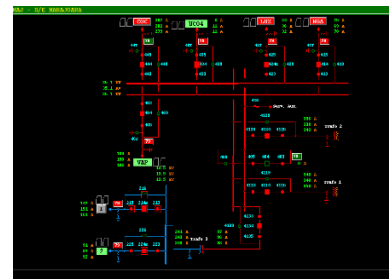
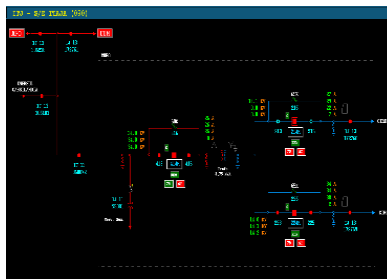
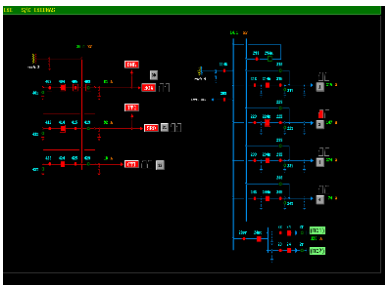
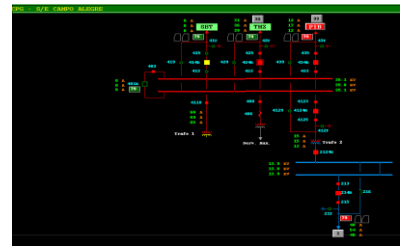
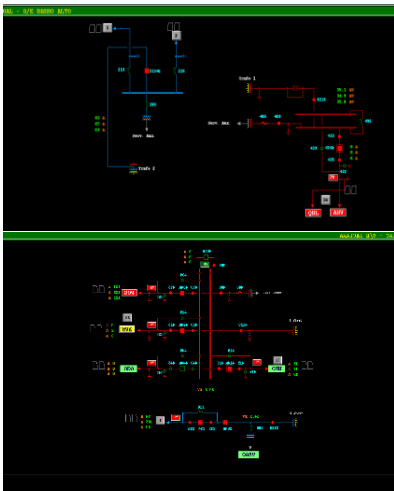
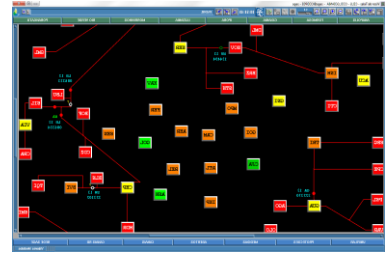
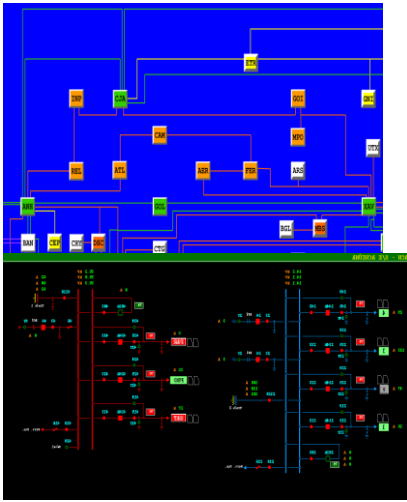

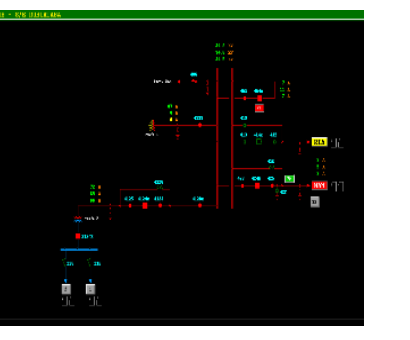
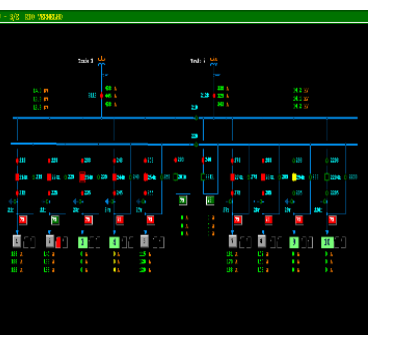
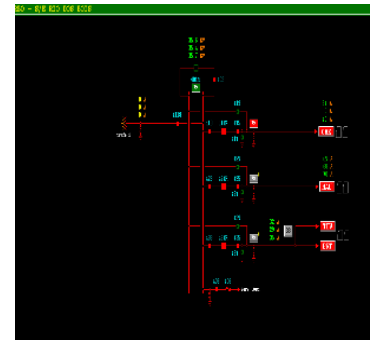
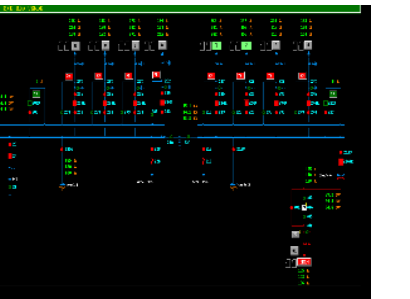
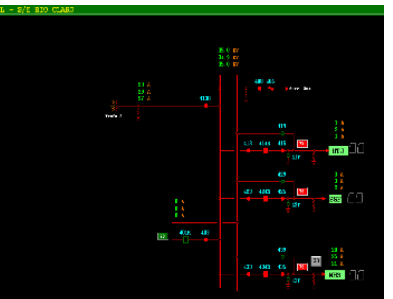
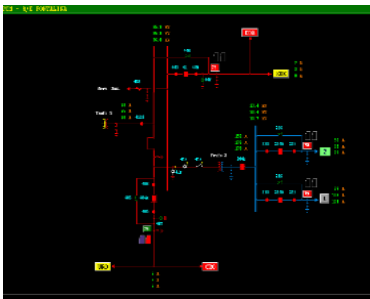
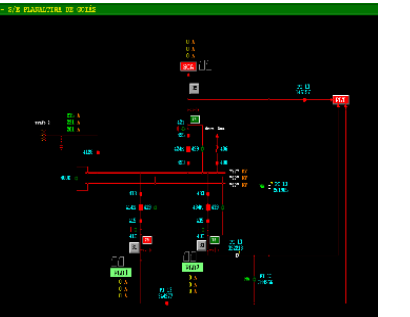
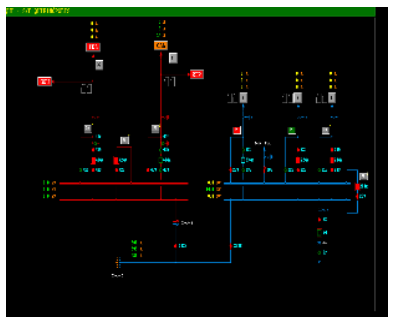
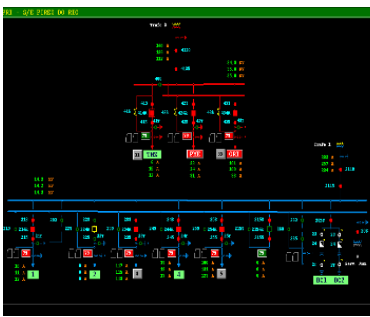
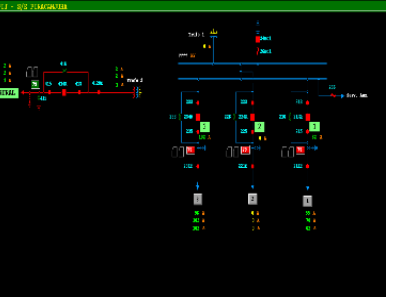
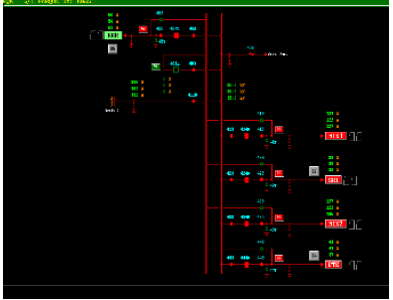
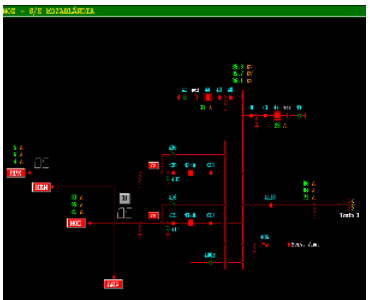
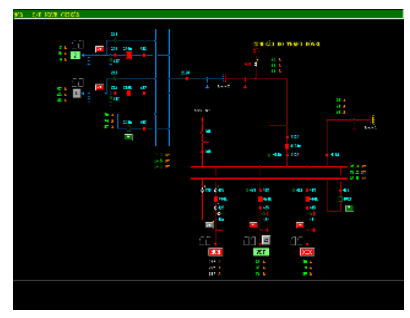
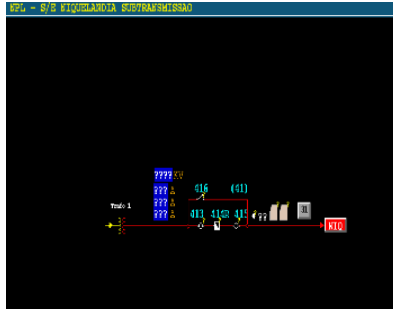

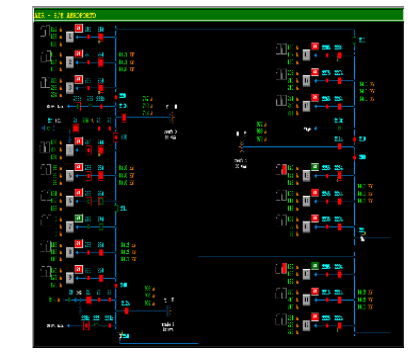
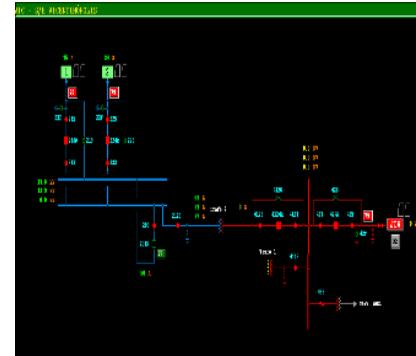
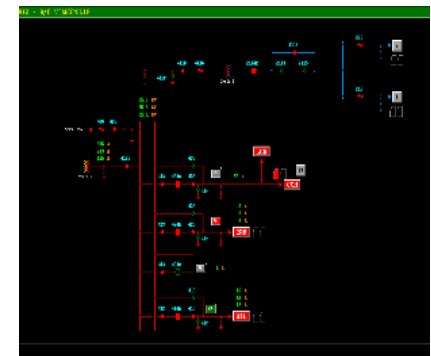
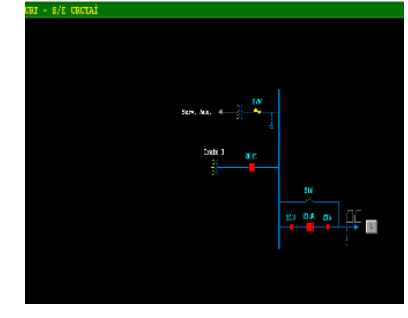
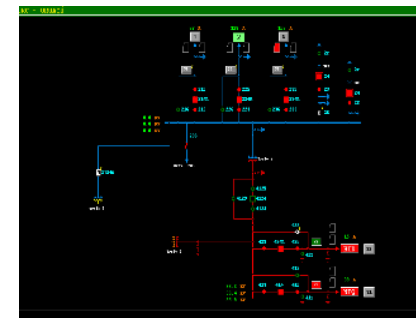
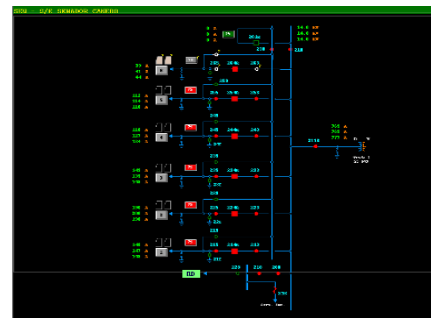
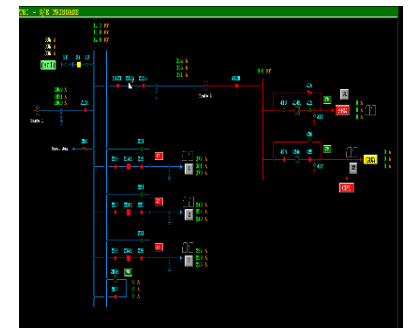
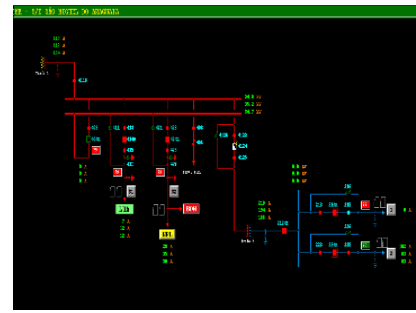
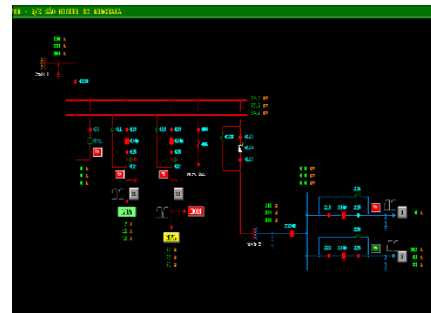
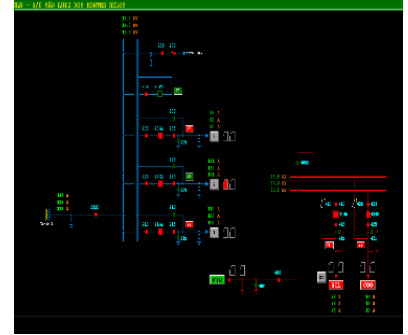
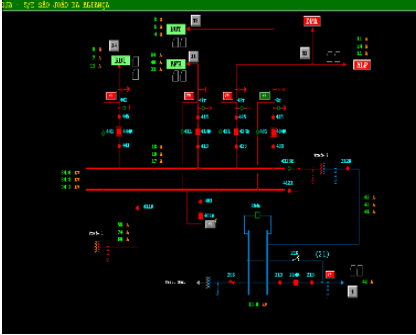
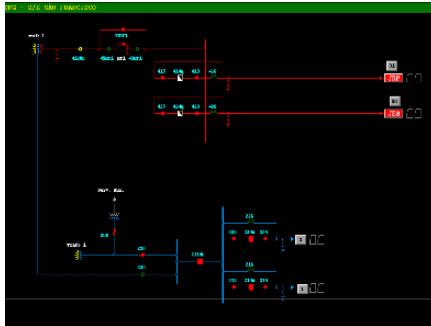
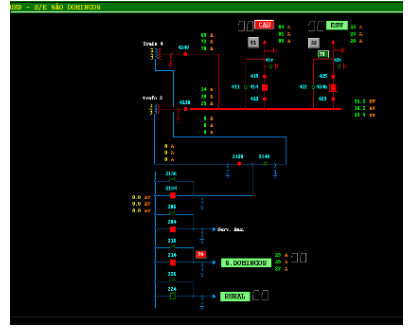
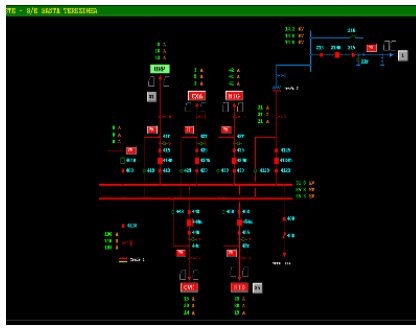
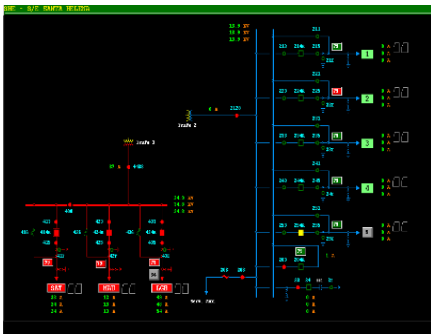

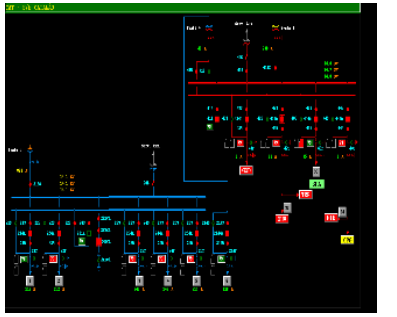
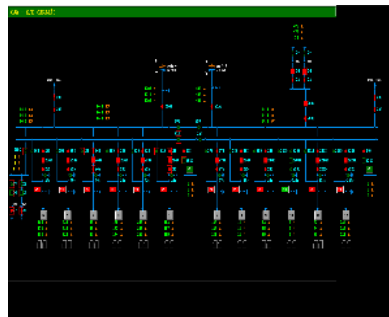
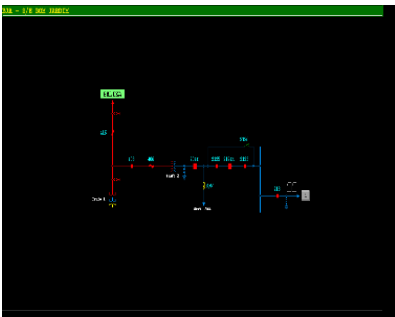
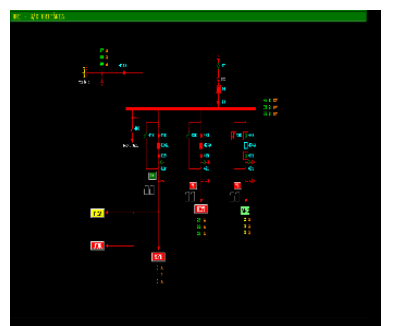
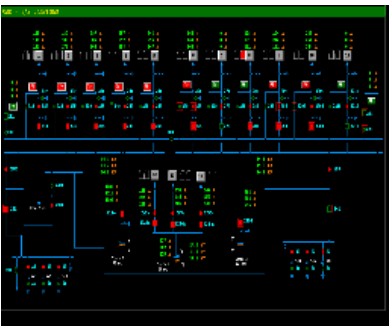
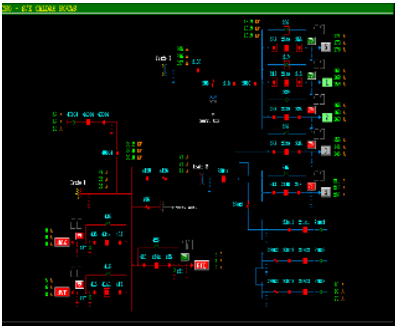
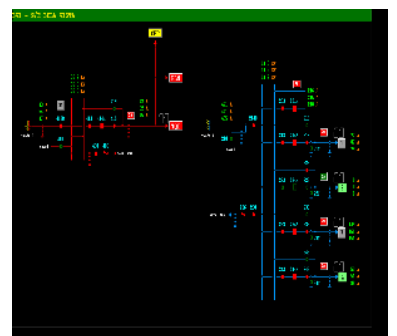
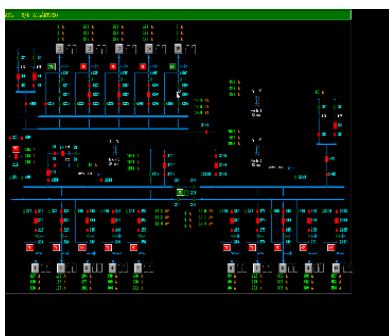
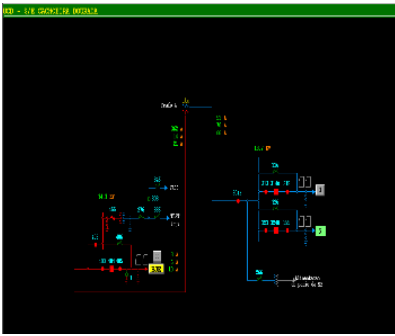
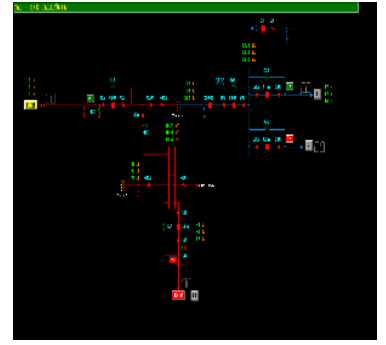
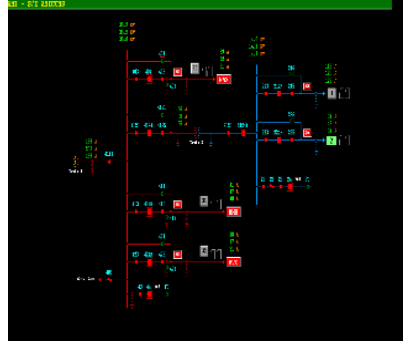
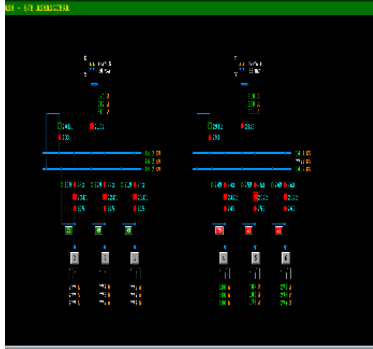
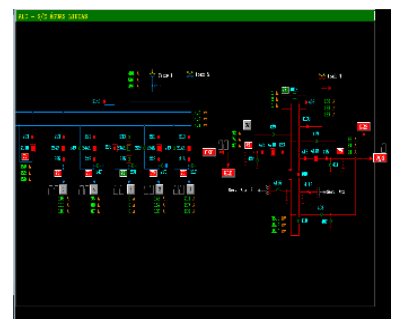
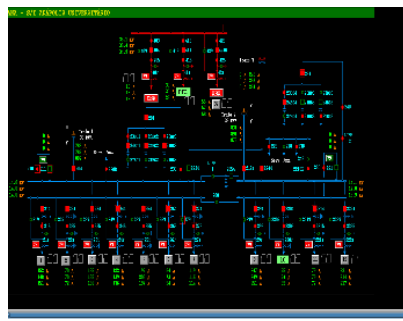
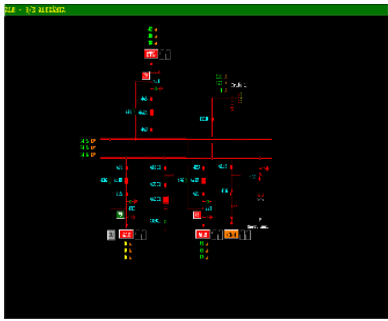

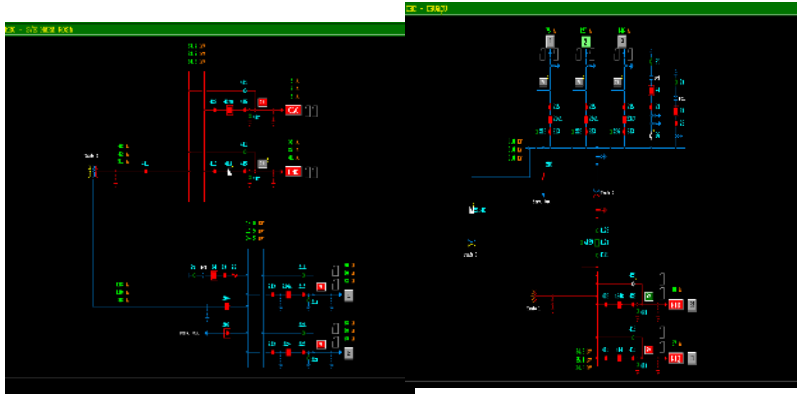
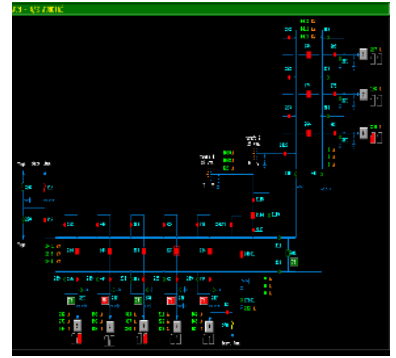
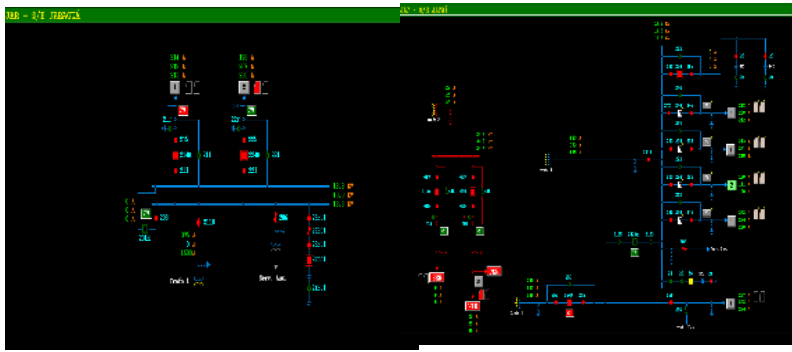

DEMAIS EVIDÊNCIAS

DADOS TÉCNICO - OPERACIONAIS ENEL GO

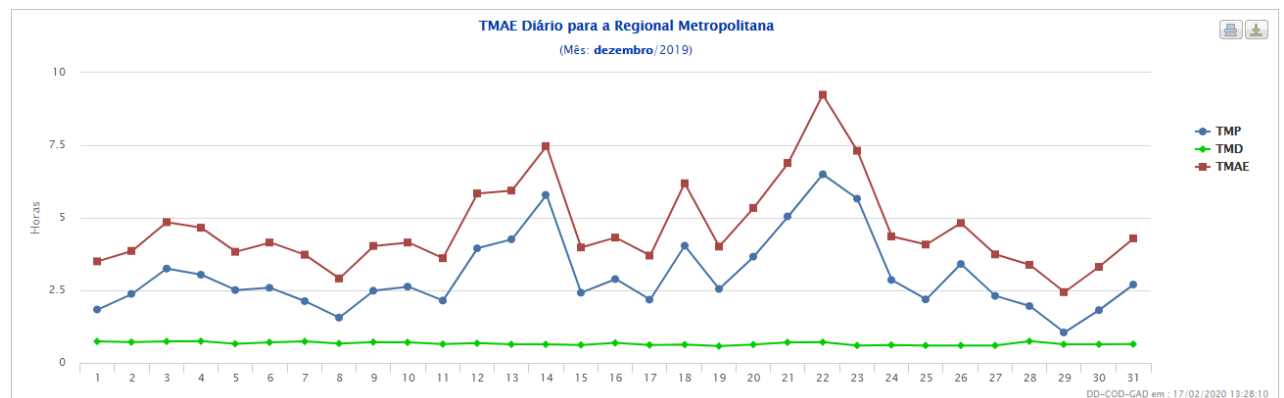
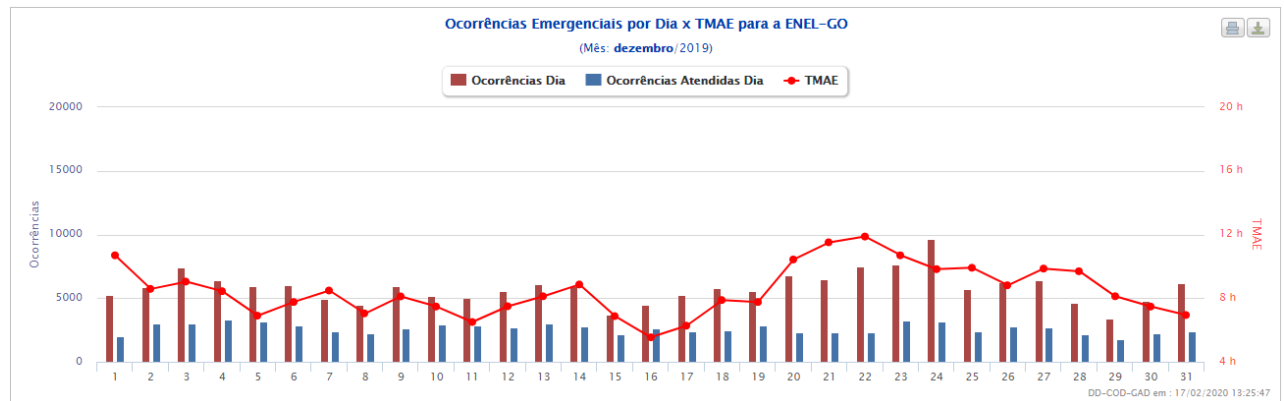
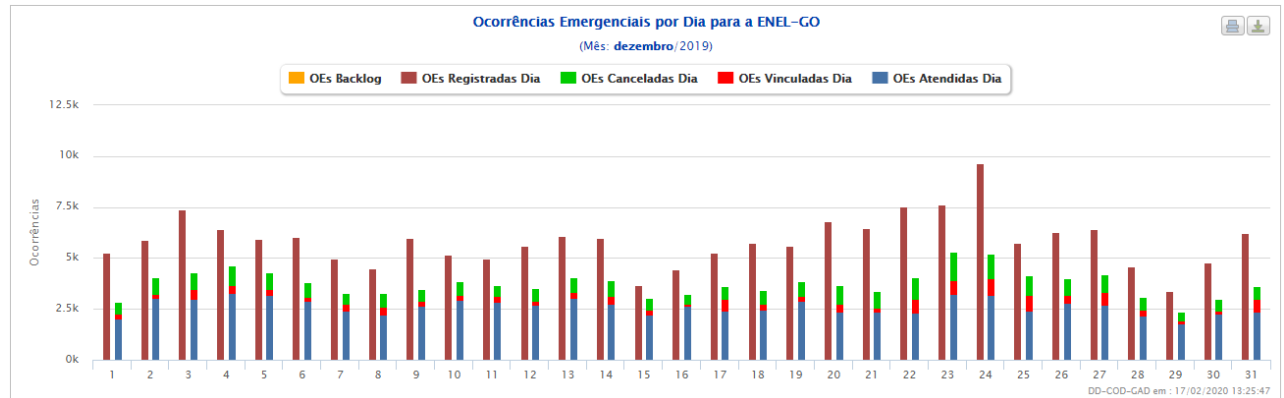
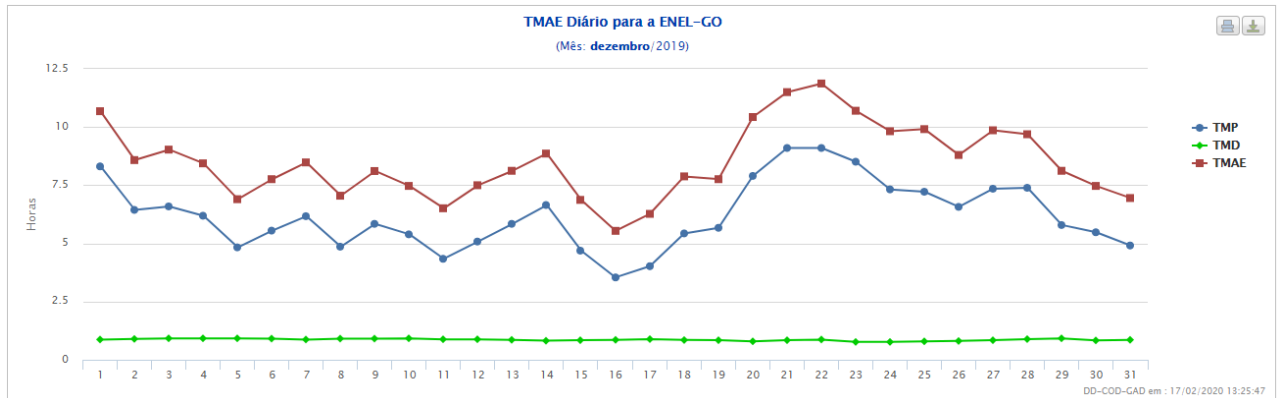

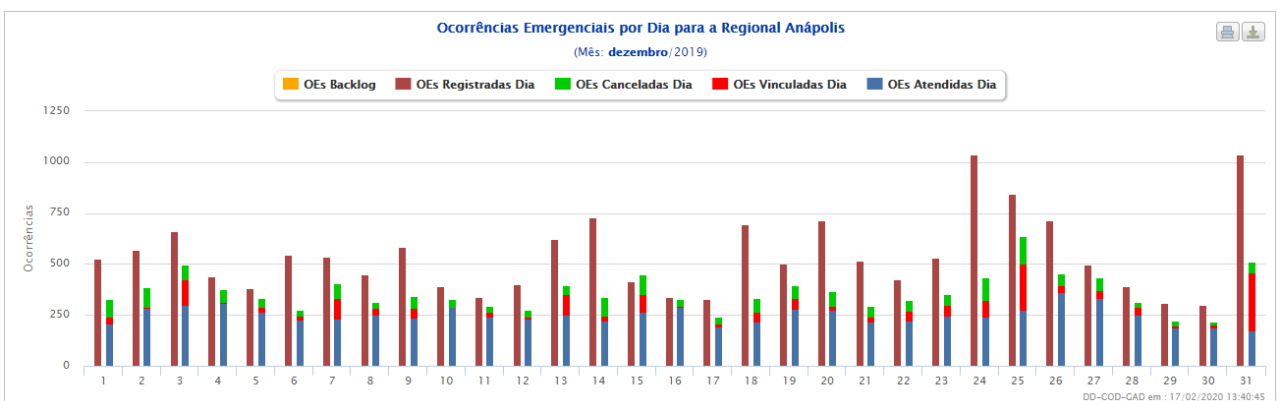
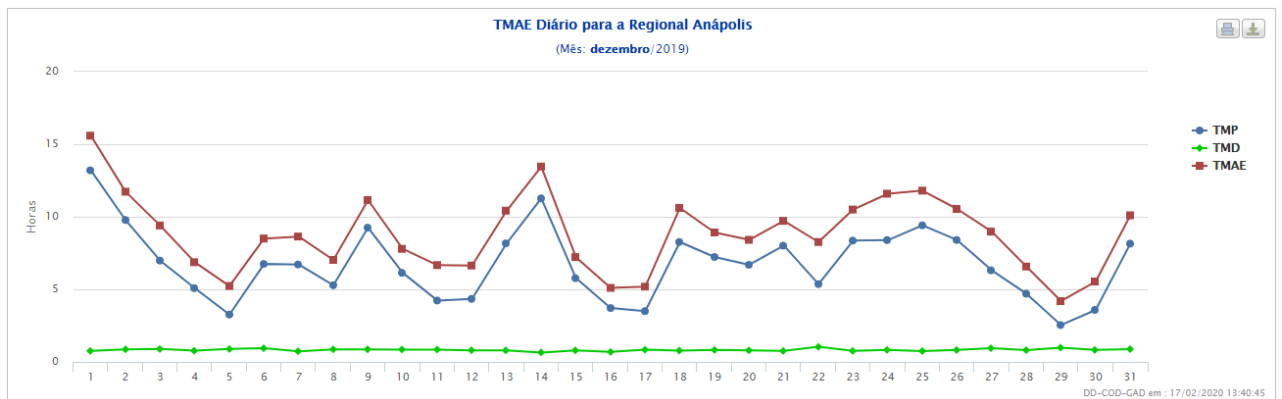
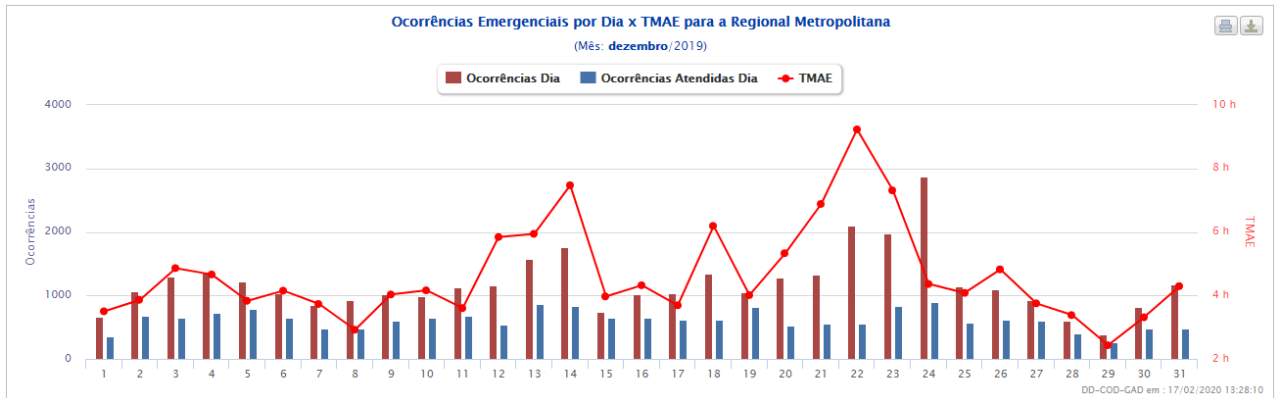

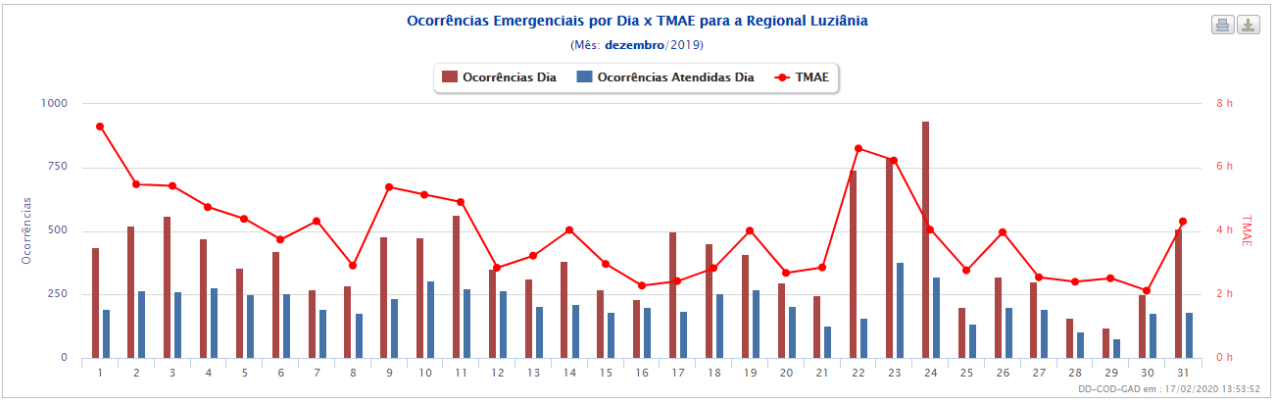
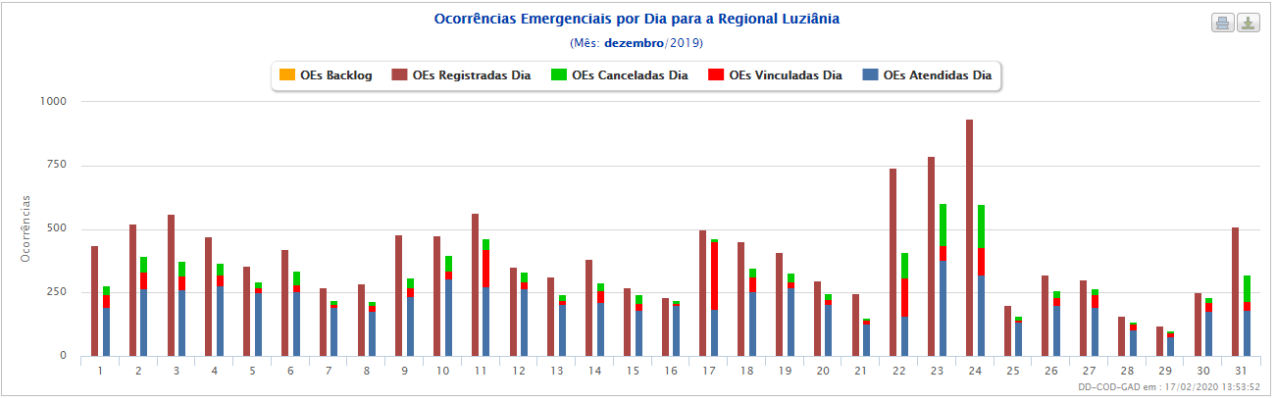
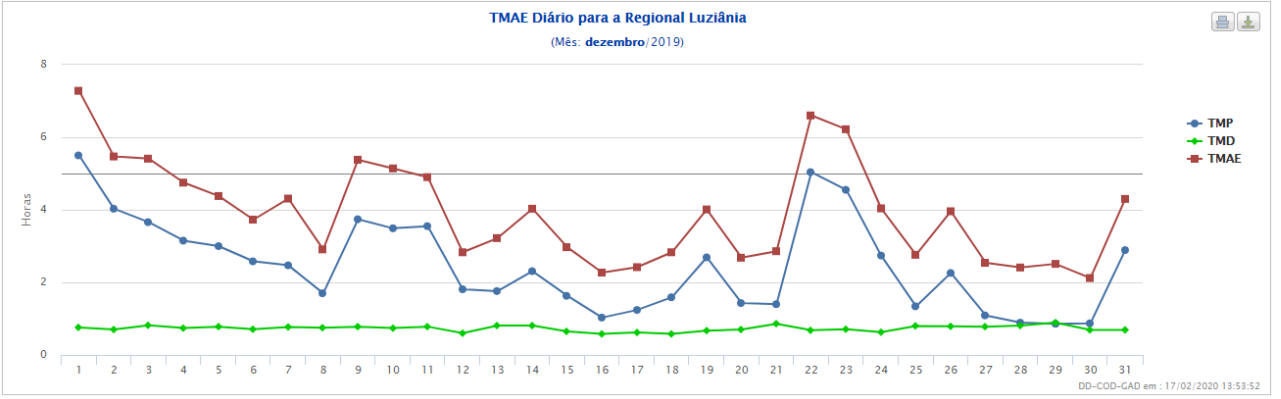
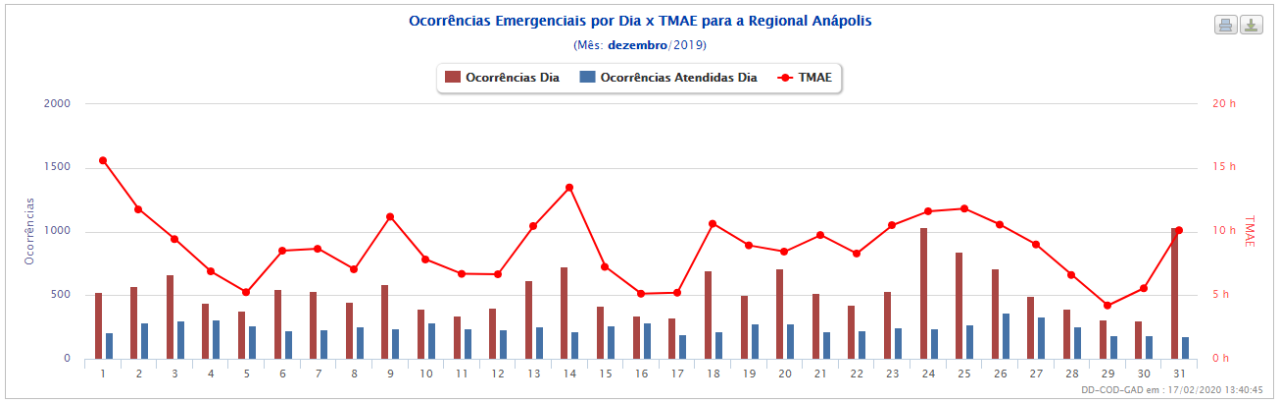

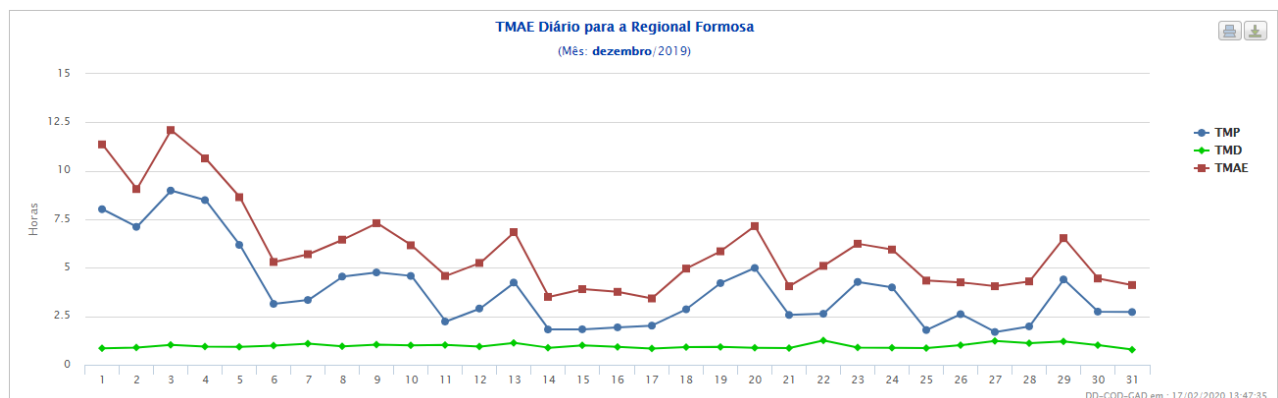
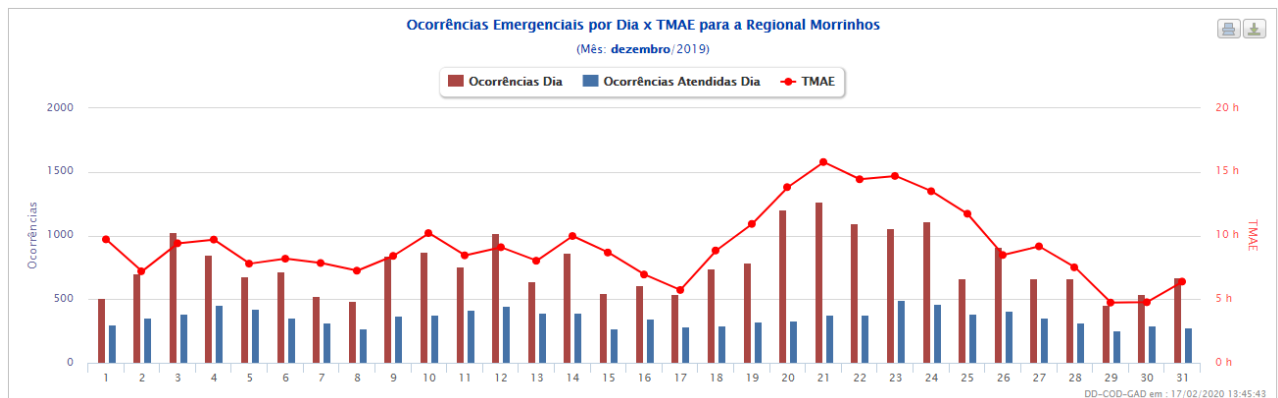
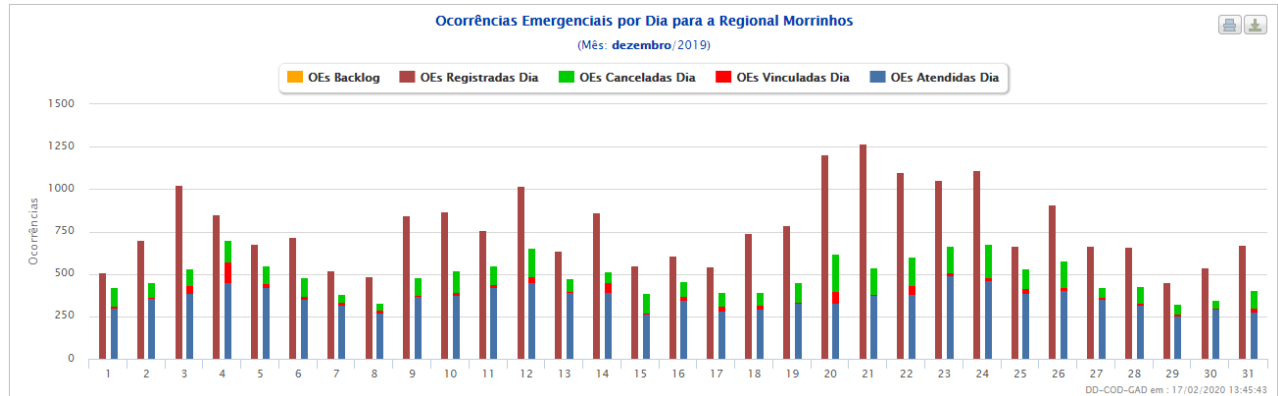
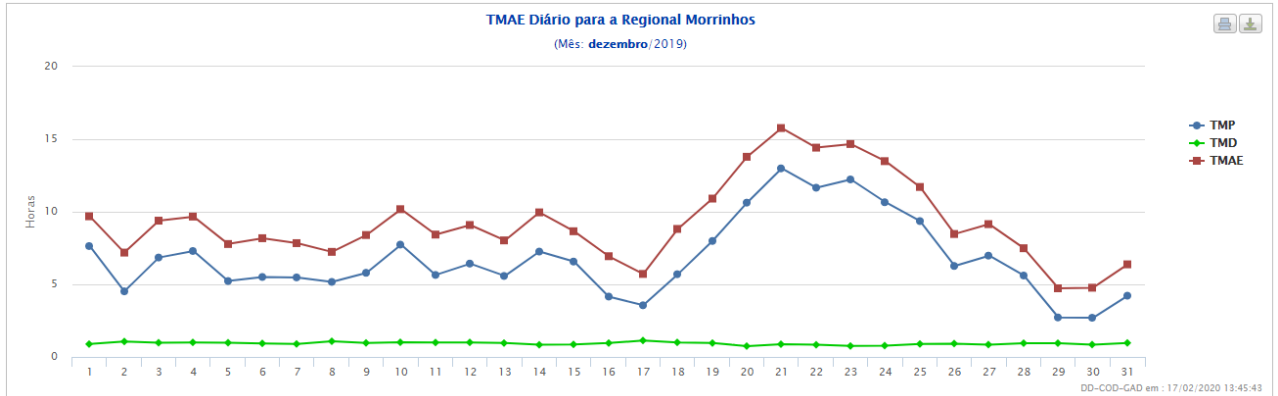

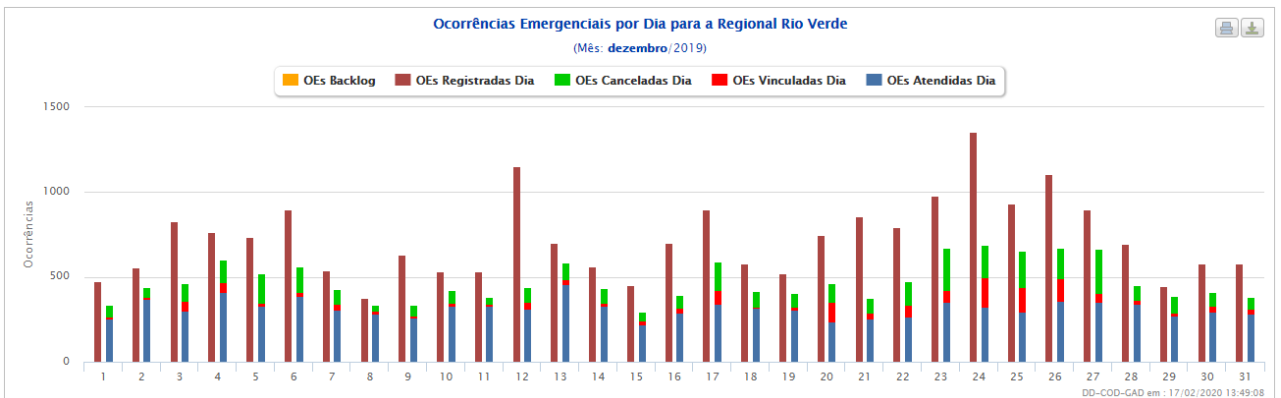
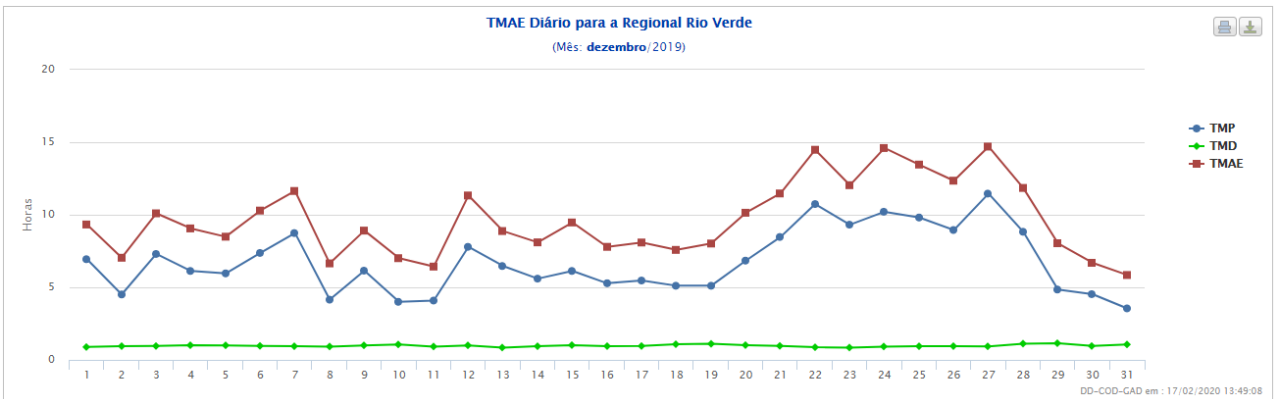
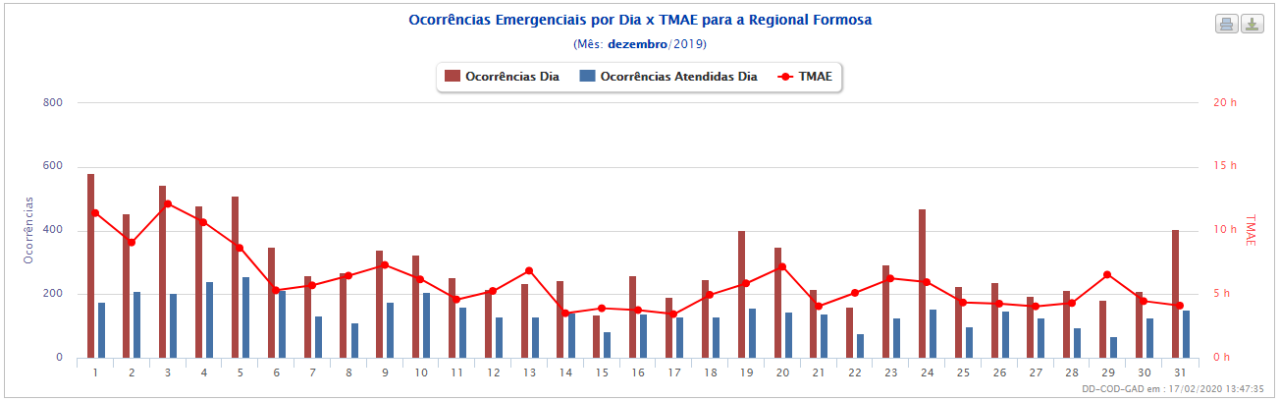
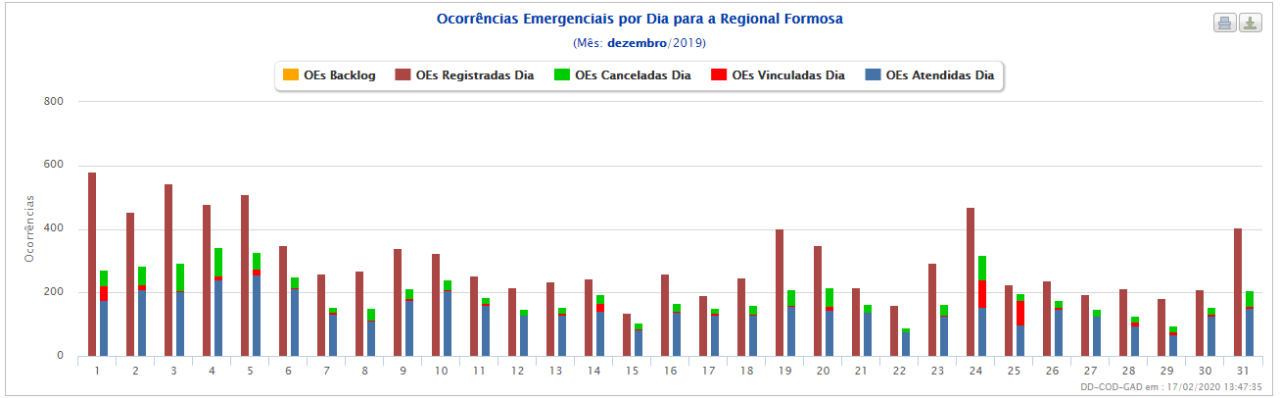

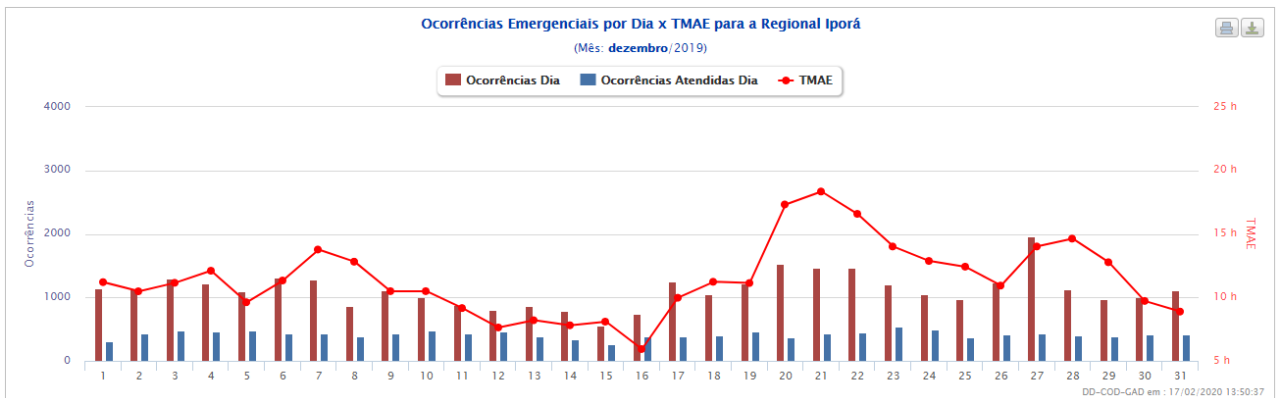
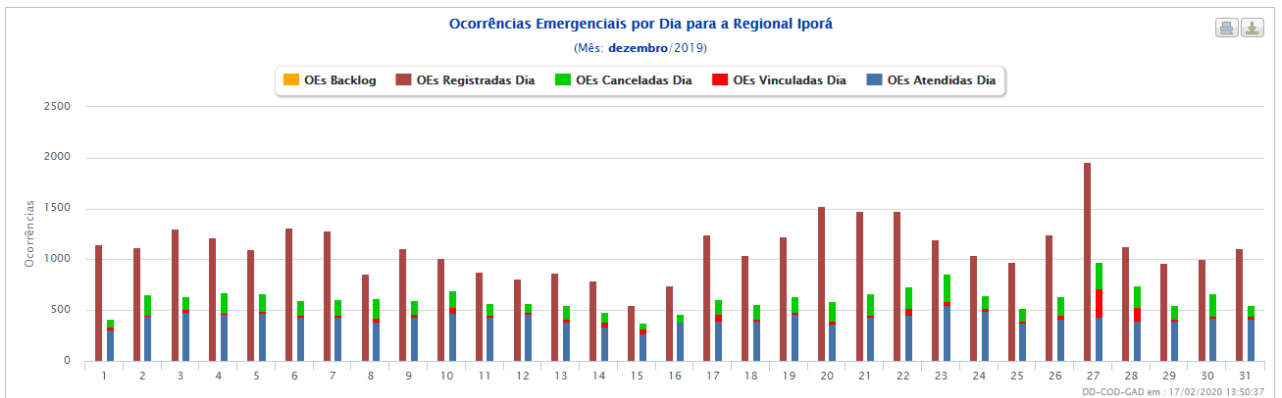
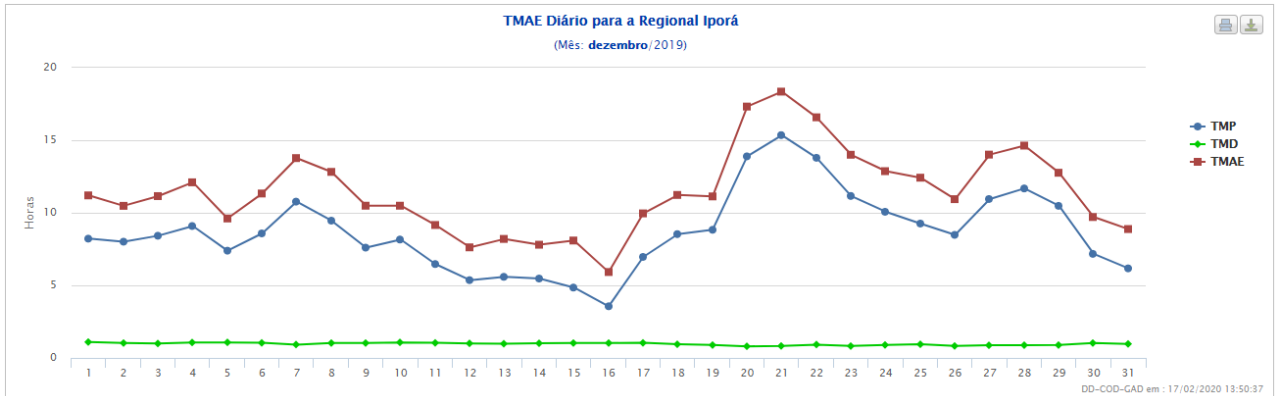
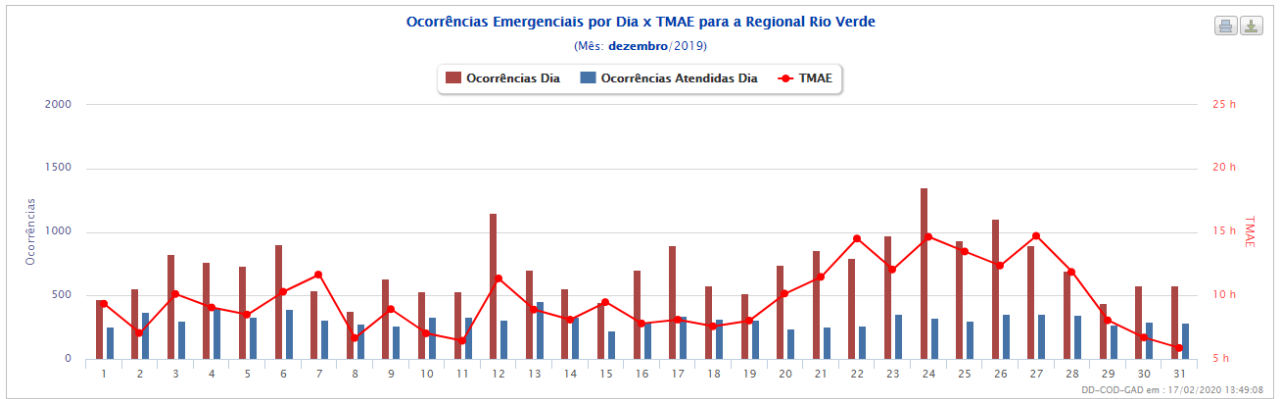

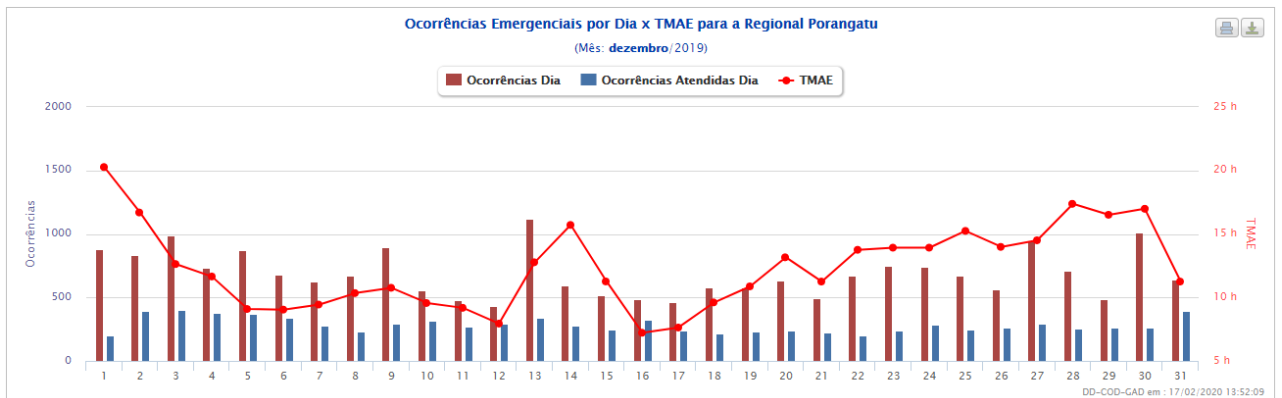
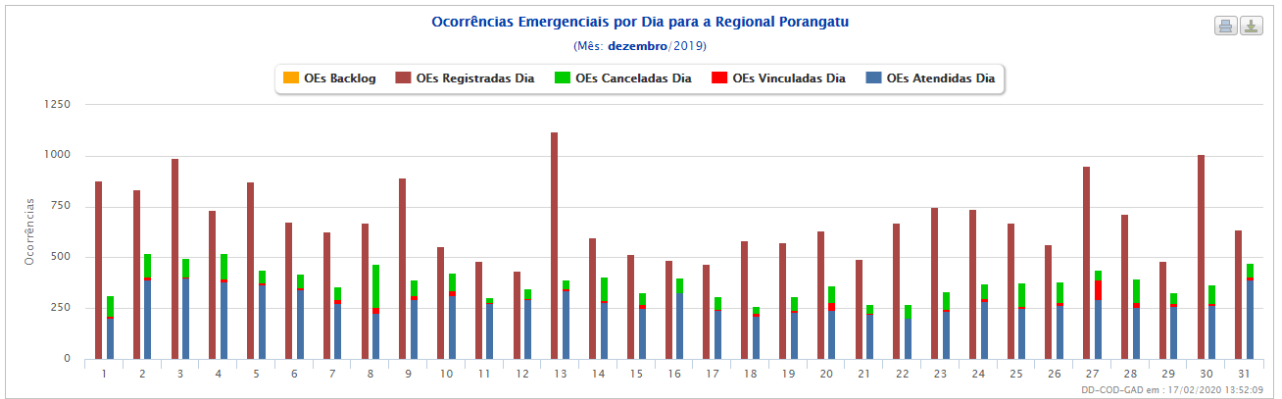
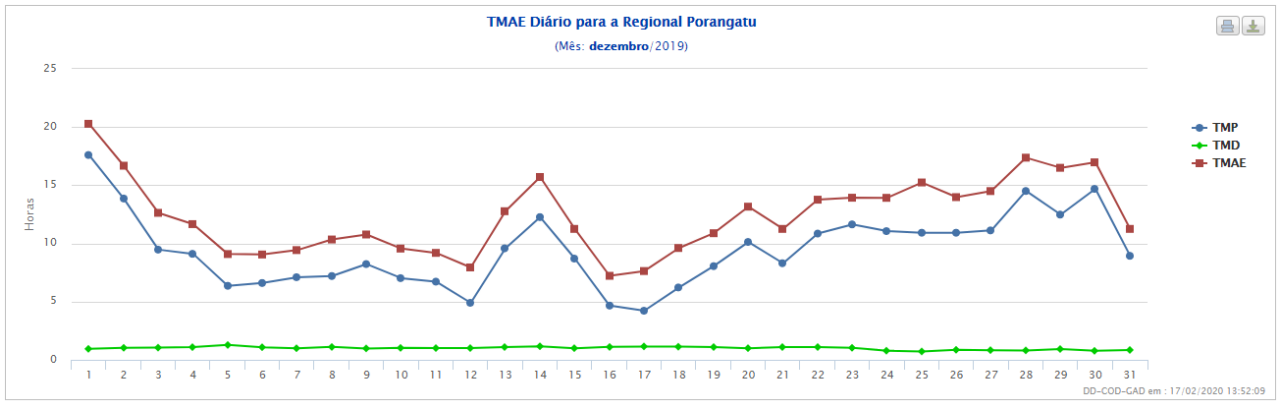

CLIMATEMPO

**Laudo Meteorológico de Evento
Climático - CELG Distribuição S.A. - 09
de dezembro de 2019**

São Paulo, SP,
Brasil Janeiro de
2020

Sumário

1	ANÁLISE DE EVENTO METEOROLÓGICO	2
1.1	Descrição do Evento.....	2
1.2	Abrangência do Evento	7
2	CLASSIFICAÇÃO COBRADE	16
3	RESUMO DO EVENTO	17
4	REFERÊNCIAS.....	21

1 Análise de Evento Meteorológico

1.1 Descrição do Evento

Na figura a seguir é apresentada a área de concessão da CELG Distribuição, dividida em regiões, a serem analisadas neste relatório.



Figura 1 – Regiões de Goiás atendidas pela CELG Distribuição.

A chegada de uma nova frente fria favoreceu a organização de um novo canal de umidade sobre o país e as condições se mantiveram favoráveis à formação de instabilidades sobre o estado de Goiás entre os dias 09 e 13 de dezembro de 2019.

Nas Figuras 2 e 3 são apresentadas as descargas atmosféricas nuvem-solo (raios) e nuvem-nuvem detectadas pelo sistema Earth Networks. Entre as 09h00 do dia 09 e 08h00 do dia 13 de dezembro foram registrados 48250 raios nuvem-solo e 95733 descargas nuvem-nuvem sobre a área da CELG Distribuição em Goiás.

Estações do Instituto Nacional de Meteorologia (INMET), representativas da área de concessão da CELG Distribuição Goiás, registraram chuva forte (segundo a American Meteorological Society - Sociedade Meteorológica Americana -, chuvas com taxa entre 2,5mm a 7,6 mm por hora são consideradas moderadas e aquelas com taxa superior a

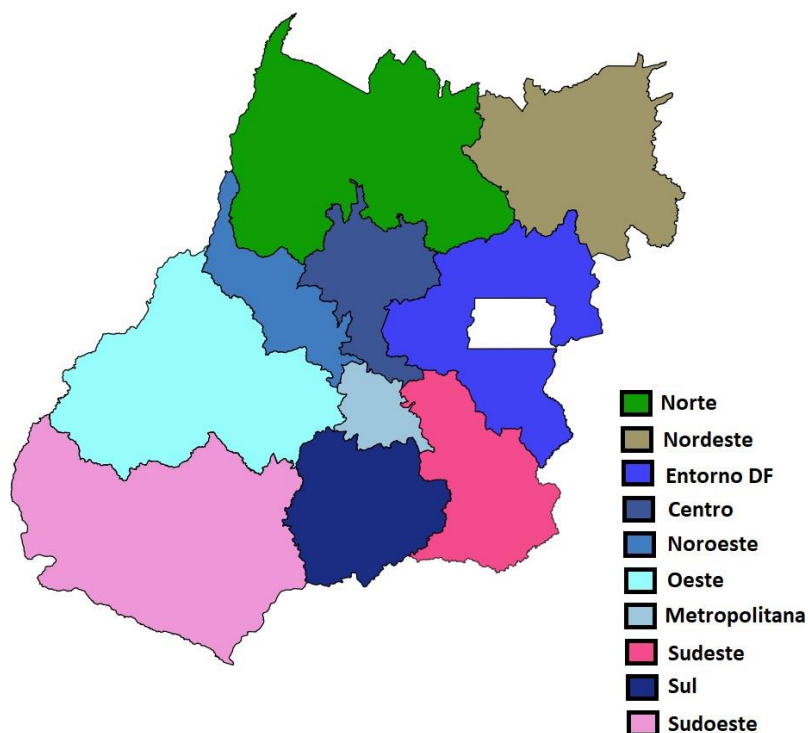
7,6 mm por hora são consideradas chuva forte). Na tabela 1 são apresentados os registros de acumulados horários superiores a 7,6 mm. Nas tabelas de 2 a 5 são apresentados os maiores acumulados diários registrados pelo INMET em estações no estado de Goiás entre os dias 09 e 13 de dezembro de 2019.

A chuva acumulada entre as 09h00 do dia 09 e 09h00 do dia 10 de dezembro em Formosa corresponde a aproximadamente 25% da média climatológica (1981-2010) para o mês de dezembro na região, em Cristalina a chuva acumulada entre as 09h00 do dia 10 e 09h00 do dia 11 corresponde a 16% da média para o mês, em Ipameri a chuva acumulada entre as 09h do dia 11 e as 09h00 do dia 12 corresponde a cerca de 29% da climatologia para o mês e em Mineiros o acumulado de chuva entre 09h00 do dia 12 e 09h00 do dia 13 corresponde a aproximadamente 20% da média climatológica.

Na tabela 6 são apresentadas as rajadas de vento maiores ou iguais a 50 km/h registradas pelo INMET entre os dias 09 e 13 de dezembro. O maior valor de rajada registrado foi de 59,8 km/h entre as 12h e 14h do dia 09 na estação de Mineiros. Segundo a escala Beaufort, ventos com tal intensidade podem ser classificados como vento forte.



Figura 2 – Descargas atmosféricas nuvem-solo (em preto) detectadas pelo sistema Earth Networks entre 09h00 do dia 09 e 08h00 do dia 13 de dezembro de 2019 sobre a área de concessão da CELG Distribuição.



Figura 3 – Descargas atmosféricas nuvem-nuvem (em vermelho) detectadas pelo sistema Earth Networks entre 09h00 do dia 09 e 08h00 do dia 13 de dezembro de 2019 sobre a área de concessão da CELG Distribuição.

Tabela 1 – Acumulado horário de chuva registrada pelo INMET.

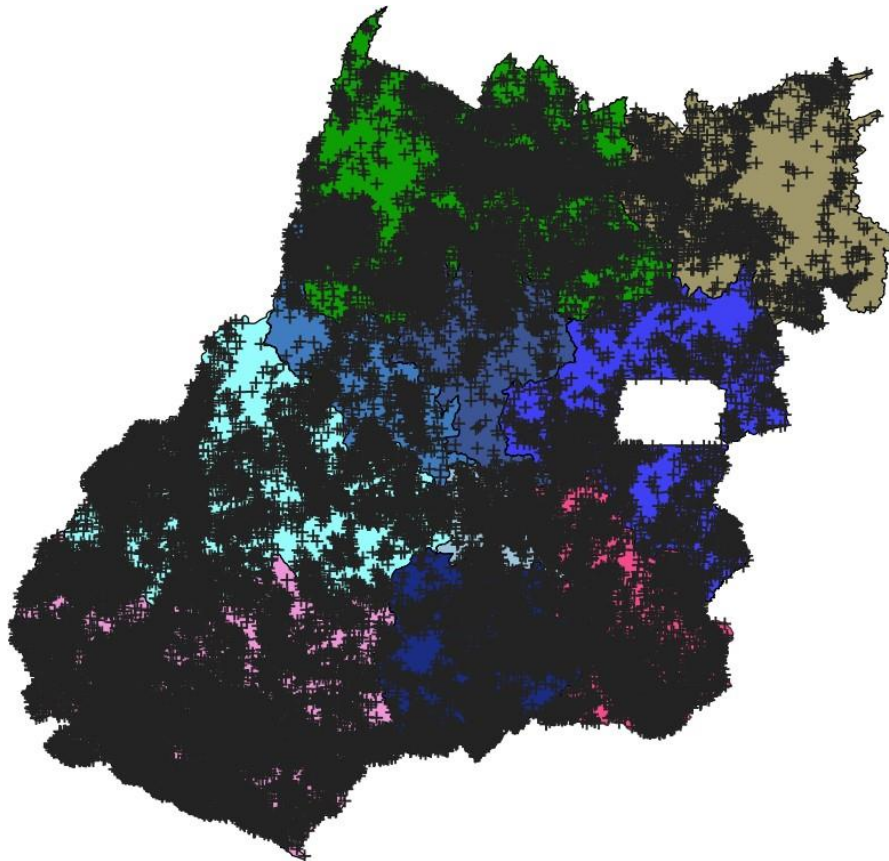
Estação	Horário	Precipitação (mm)
Alto Araguaia	Entre 11h e 12h do dia 9/12/2019	17.6
Alto Araguaia	Entre 12h e 13h do dia 9/12/2019	12.4
Alto Araguaia	Entre 13h e 14h do dia 9/12/2019	20.4
Alto Paraíso de Goiás	Entre 13h e 14h do dia 10/12/2019	15.
Aragarças	Entre 20h e 21h do dia 11/12/2019	8.2
Catalão	Entre 17h e 18h do dia 10/12/2019	8.0
Catalão	Entre 19h e 20h do dia 11/12/2019	9.0
Catalão	Entre 20h e 21h do dia 11/12/2019	9.0
Catalão	Entre 4h e 5h do dia 12/12/2019	11.0
Cristalina	Entre 15h e 16h do dia 9/12/2019	10.0
Cristalina	Entre 20h e 21h do dia 9/12/2019	33.4
Cristalina	Entre 16h e 17h do dia 10/12/2019	27.4
Cristalina	Entre 17h e 18h do dia 10/12/2019	22.0
Goiânia	Entre 14h e 15h do dia 9/12/2019	10.4
Goiânia	Entre 11h e 12h do dia 10/12/2019	12.4
Goiás	Entre 16h e 17h do dia 9/12/2019	8.0

Goiás	Entre 10h e 11h do dia 10/12/2019	13.2
Itumbiara	Entre 11h e 12h do dia 9/12/2019	14.6
Itumbiara	Entre 12h e 13h do dia 9/12/2019	14.0
Itumbiara	Entre 16h e 17h do dia 10/12/2019	20.0
Itumbiara	Entre 1h e 2h do dia 12/12/2019	9.2
Itumbiara	Entre 4h e 5h do dia 12/12/2019	24.6
Jataí	Entre 4h e 5h do dia 12/12/2019	22.2
Jataí	Entre 5h e 6h do dia 12/12/2019	12.2
Mineiros	Entre 13h e 14h do dia 9/12/2019	12.8
Mineiros	Entre 14h e 15h do dia 9/12/2019	8.8
Mineiros	Entre 17h e 18h do dia 10/12/2019	16.0
Mineiros	Entre 4h e 5h do dia 13/12/2019	27.4
Morrinhos	Entre 16h e 17h do dia 9/12/2019	11.0
Morrinhos	Entre 18h e 19h do dia 9/12/2019	11.0
Morrinhos	Entre 17h e 18h do dia 11/12/2019	9.6
Morrinhos	Entre 8h e 9h do dia 12/12/2019	37.8
Paraúna	Entre 22h e 23h do dia 9/12/2019	19.4
Paraúna	Entre 11h e 12h do dia 12/12/2019	13.4
Pires do Rio	Entre 21h e 22h do dia 9/12/2019	16.0
Pires do Rio	Entre 17h e 18h do dia 11/12/2019	11.2
Pires do Rio	Entre 23h e 0h do dia 12/12/2019	14.2
Pires do Rio	Entre 4h e 5h do dia 13/12/2019	16.4
Silvânia	Entre 19h e 20h do dia 9/12/2019	32.2

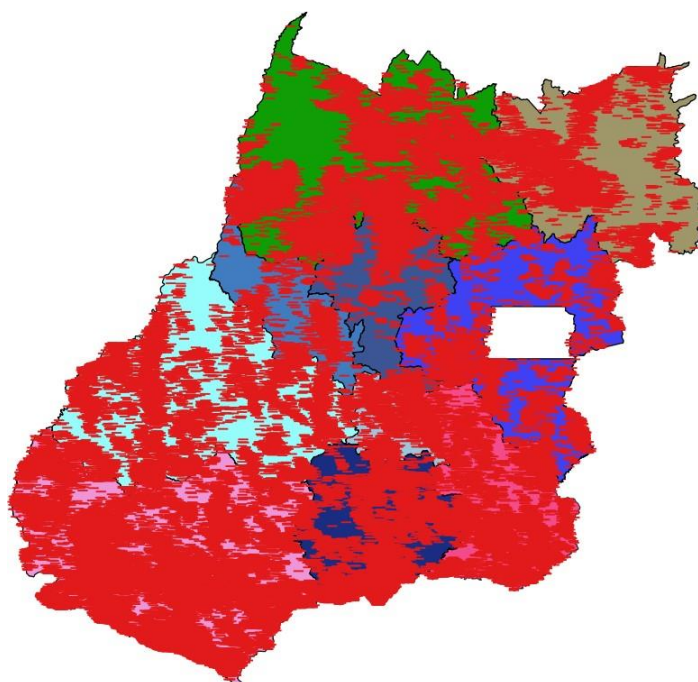
Tabela 2 – Precipitação acumulada entre 09h do dia 09 e 09h do dia 10 de dezembro de 2019. FONTE: INMET

Estação	Precipitação Acumulada(mm)
FORMOSA	61,7
CRISTALINA	53,4
ITUMBIARA	39,0
SILVANIA	34,4
MORRINHOS	33,8

Tabela 3 – Precipitação acumulada entre 09h do dia 10 e 09h do dia 11 de dezembro de 2019. FONTE: INMET

Estação	Precipitação Acumulada(mm)
CRISTALINA	50,2

Tabela 4 – Precipitação acumulada entre 09h do dia 11 e 09h do dia 12 de dezembro de 2019. FONTE: INMET

Estação	Precipitação Acumulada(mm)
IPAMERI	87,5
MORRINHOS	65,4
JATAI	56,3
ITUMBIARA	47,0
CATALÃO	45,2
PIRES DO RIO	35,8

Tabela 5 – Precipitação acumulada entre 09h do dia 12 e 09h do dia 13 de dezembro de 2019. FONTE: INMET

Estação	Precipitação Acumulada(mm)
MINEIROS	49,8
JATAÍ	33,6

Tabela 6 – Rajadas de vento maiores ou iguais a 50 km/h registradas pelo INMET. Segundo a escala Beaufort, ventos entre 50 e 61 km/h são classificados como vento forte.

Estação	Horário	Rajada (km/h)
Goiás	Entre 10h e 11h do dia 10/12/2019	54.0
Itumbiara	Entre 11h e 12h do dia 9/12/2019	51.8
Itumbiara	Entre 20h e 21h do dia 9/12/2019	53.3
Mineiros	Entre 12h e 13h do dia 9/12/2019	59.8
Mineiros	Entre 13h e 14h do dia 9/12/2019	59.8
Mineiros	Entre 17h e 18h do dia 10/12/2019	58.0
Mineiros	Entre 17h e 18h do dia 12/12/2019	55.4
Morrinhos	Entre 16h e 17h do dia 9/12/2019	54.7
Morrinhos	Entre 17h e 18h do dia 9/12/2019	53.6
Morrinhos	Entre 15h e 16h do dia 10/12/2019	50.0

1.2 Abrangência do Evento

A seguir são apresentadas as imagens realçadas do satélite GOES-16 entre as 09h00 do dia 09 e 09h00 do dia 13 de dezembro de 2019. Os tons em vermelho e preto indicam a presença de nuvens de grande desenvolvimento vertical, geralmente associadas à ocorrência de tempo severo.

09h00 - 09 de dezembro de 2019



Figura 4 – Imagens realçadas do satélite GOES-16 das 09h00 do dia 09 de dezembro de 2019. FONTE: Cptec/INPE.

13h00 - 09 de dezembro de 2019

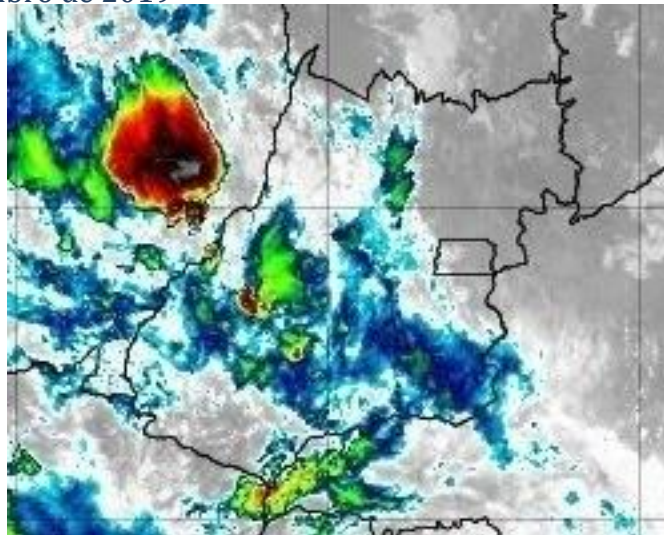

Figura 5 – Imagens realçadas do satélite GOES-16 das 13h00 do dia 09 de dezembro de 2019. FONTE: Cptec/INPE.

17h00 - 09 de dezembro de 2019

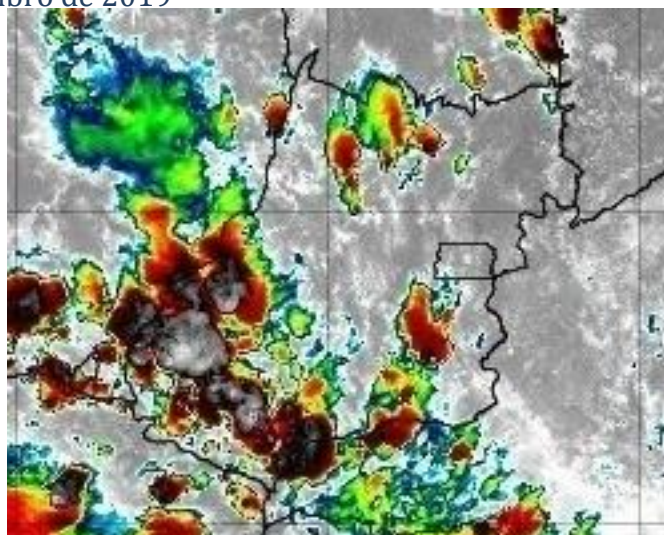

Figura 6 – Imagens realçadas do satélite GOES-16 das 17h00 do dia 09 de dezembro de 2019.
FONTE: Cptec/INPE.

21h00 - 09 de dezembro de 2019

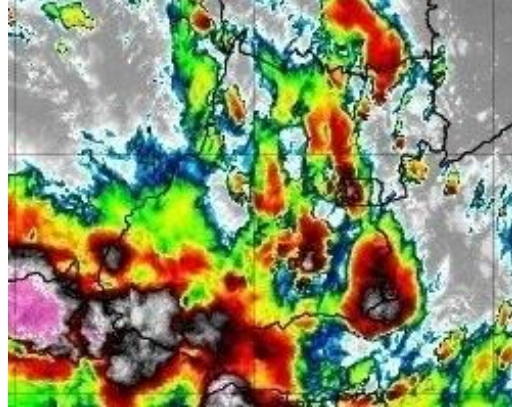

Figura 7 – Imagens realçadas do satélite GOES-16 das 21h00 do dia 09 de dezembro de 2019.
FONTE: Cptec/INPE.

01h00 - 10 de dezembro de 2019

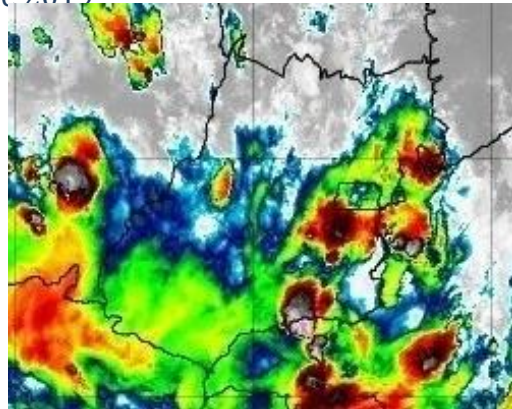

Figura 8 – Imagens realçadas do satélite GOES-16 das 01h00 do dia 10 de dezembro de 2019.
FONTE: Cptec/INPE.

05h00 - 10 de dezembro de 2019

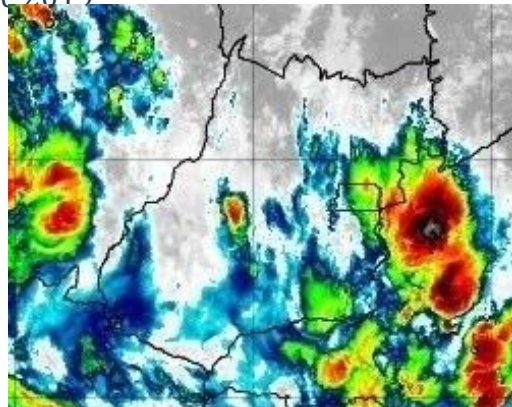

Figura 9 – Imagens realçadas do satélite GOES-16 das 05h00 do dia 10 de dezembro de 2019. FONTE: Cptec/INPE.

09h00 - 10 de dezembro de 2019



Figura 10 – Imagens realçadas do satélite GOES-16 das 09h00 do dia 10 de dezembro de 2019. FONTE: Cptec/INPE.

13h00 - 10 de dezembro de 2019

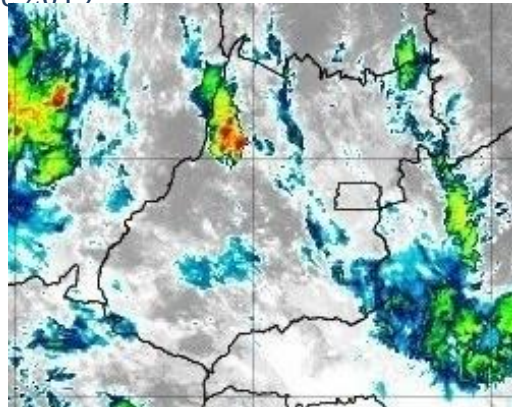

Figura 11 – Imagens realçadas do satélite GOES-16 das 13h00 do dia 10 de dezembro de 2019. FONTE: Cptec/INPE.

17h00 - 10 de dezembro de 2019

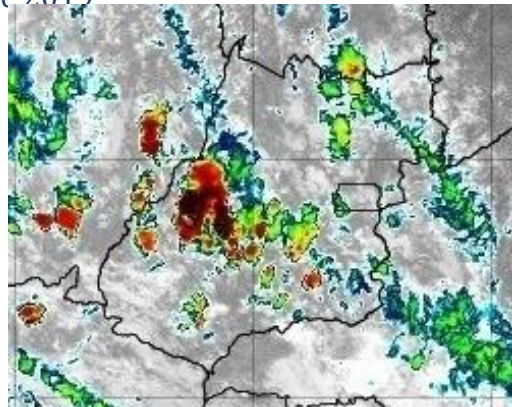

Figura 12 – Imagens realçadas do satélite GOES-16 das 17h00 do dia 10 de dezembro de 2019.
FONTE: Cptec/INPE.

21h00 - 10 de dezembro de 2019

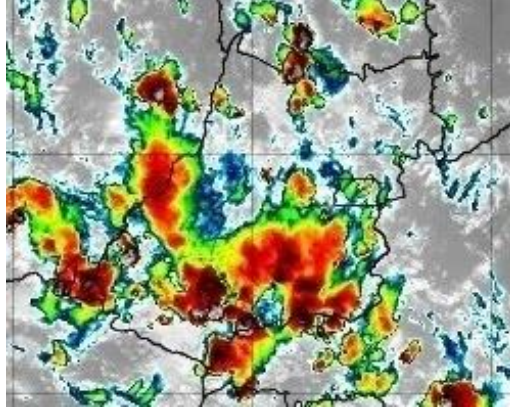

Figura 13 – Imagens realçadas do satélite GOES-16 das 21h00 do dia 10 de dezembro de 2019.
FONTE: Cptec/INPE.

01h00 - 11 de dezembro de 2019

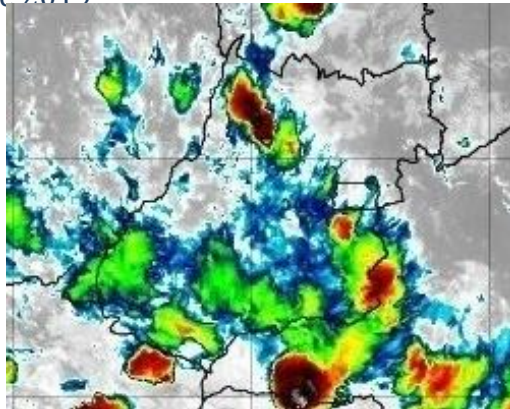

Figura 14 – Imagens realçadas do satélite GOES-16 das 01h00 do dia 11 de dezembro de 2019.
FONTE: Cptec/INPE.

05h00 - 11 de dezembro de 2019

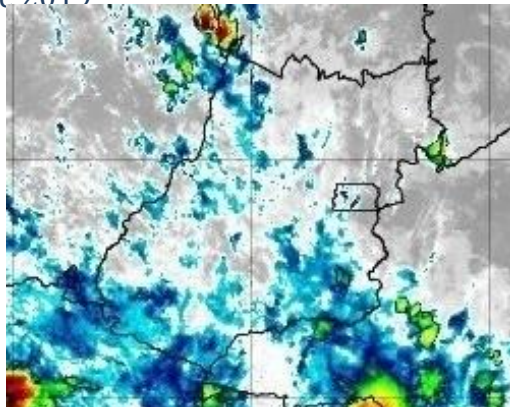

Figura 15 – Imagens realçadas do satélite GOES-16 das 05h00 do dia 11 de dezembro de 2019.
FONTE: Cptec/INPE.

09h00 - 11 de dezembro de 2019

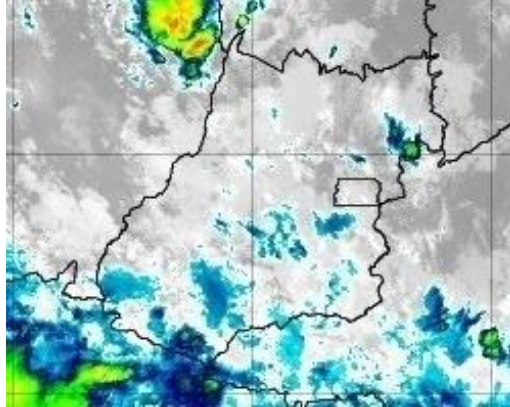

Figura 16 – Imagens realçadas do satélite GOES-16 das 09h00 do dia 11 de dezembro de 2019.
FONTE: Cptec/INPE.

13h00 - 11 de dezembro de 2019

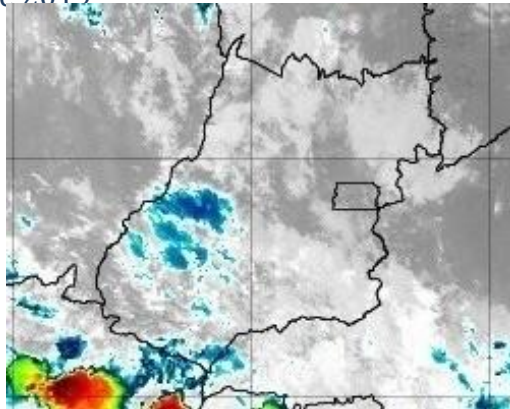

Figura 17 – Imagens realçadas do satélite GOES-16 das 13h00 do dia 11 de dezembro de 2019.
FONTE: Cptec/INPE.

17h00 - 11 de dezembro de 2019

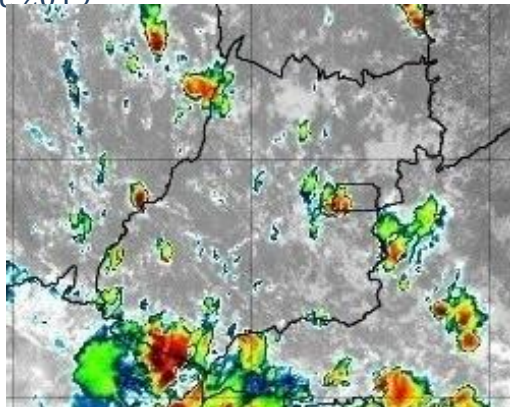

Figura 18 – Imagens realçadas do satélite GOES-16 das 17h00 do dia 11 de dezembro de 2019.
FONTE: Cptec/INPE.

21h00 - 11 de dezembro de 2019

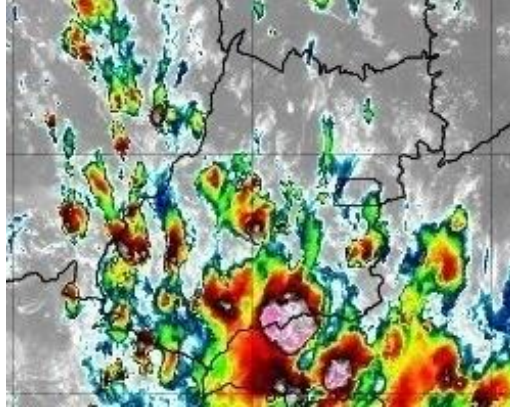

Figura 19 – Imagens realçadas do satélite GOES-16 das 21h00 do dia 11 de dezembro de 2019.
FONTE: Cptec/INPE.

01h00 - 12 de dezembro de 2019

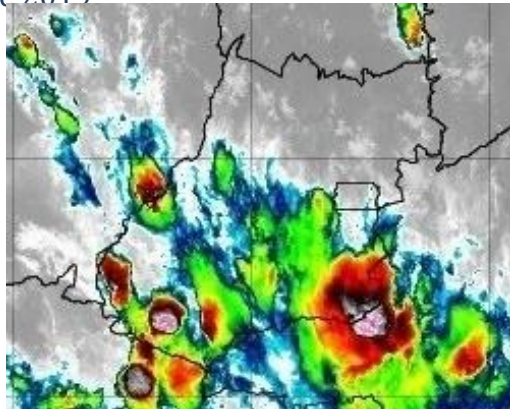

Figura 20 – Imagens realçadas do satélite GOES-16 das 01h00 do dia 12 de dezembro de 2019. FONTE:
Cptec/INPE.

05h00 - 12 de dezembro de 2019

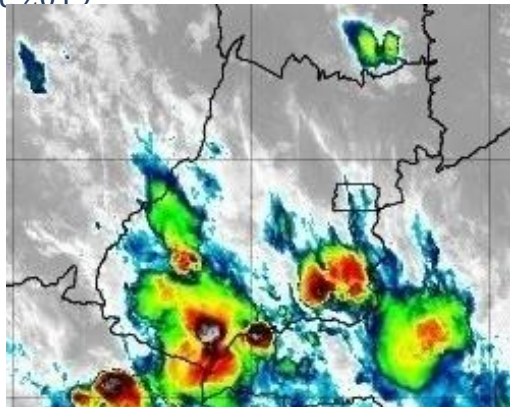

Figura 21 – Imagens realçadas do satélite GOES-16 das 05h00 do dia 12 de dezembro de 2019.
FONTE: Cptec/INPE.

09h00 - 12 de dezembro de 2019

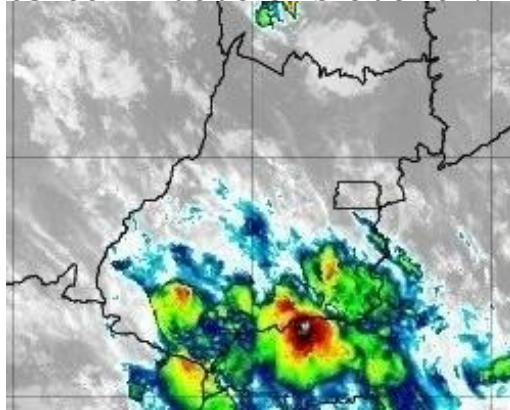

Figura 22 – Imagens realçadas do satélite GOES-16 das 09h00 do dia 12 de dezembro de 2019. FONTE:
Cptec/INPE.

13h00 - 12 de dezembro de 2019

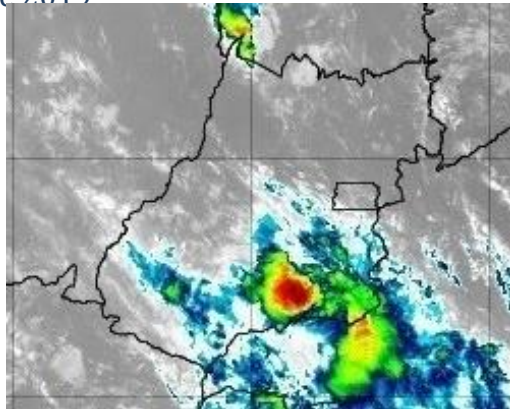

Figura 23 – Imagens realçadas do satélite GOES-16 das 13h00 do dia 12 de dezembro de 2019.
FONTE: Cptec/INPE.

17h00 - 12 de dezembro de 2019

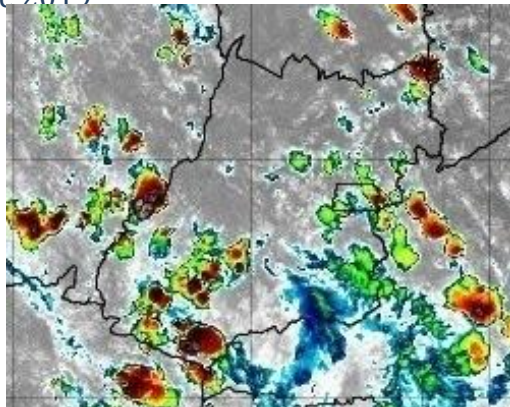

Figura 24 – Imagens realçadas do satélite GOES-16 das 17h00 do dia 12 de dezembro de 2019.
FONTE: Cptec/INPE.

21h00 - 12 de dezembro de 2019

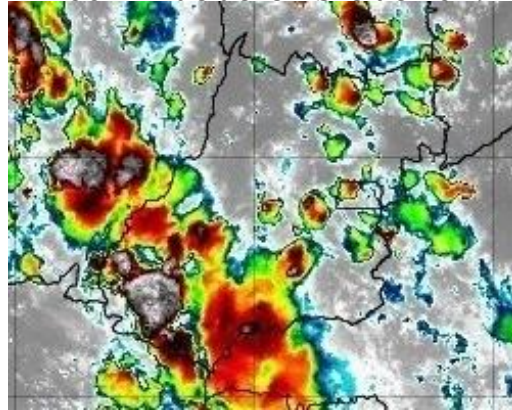

Figura 25 – Imagens realçadas do satélite GOES-16 das 21h00 do dia 12 de dezembro de 2019.
FONTE: Cptec/INPE.

01h00 - 13 de dezembro de 2019



Figura 26 – Imagens realçadas do satélite GOES-16 das 01h00 do dia 13 de dezembro de 2019.
FONTE: Cptec/INPE.

05h00 - 13 de dezembro de 2019

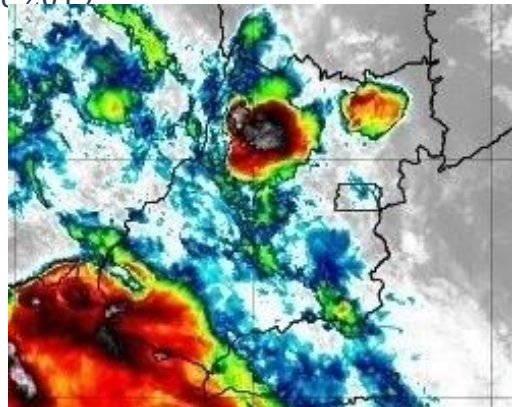

Figura 27 – Imagens realçadas do satélite GOES-16 das 05h00 do dia 13 de dezembro de 2019. FONTE: Cptec/INPE.

09h00 - 13 de dezembro de 2019



Figura 28 – Imagens realçadas do satélite GOES-16 das 09h00 do dia 13 de dezembro de 2019. FONTE: Cptec/INPE.

2 Classificação COBRADE

O COBRADE (Classificação e Codificação Brasileira de Desastres) foi criado com o intuito de adequar a classificação brasileira à classificação utilizada pela ONU na classificação de desastres e nivelar o país aos demais organismos de gestão de desastres do mundo.

Baseados nos dados analisados nos itens anteriores, podemos classificar o evento ocorrido na CELG Distribuição como Zona de Convergência (Código COBRADE 1.3.1.2.0).

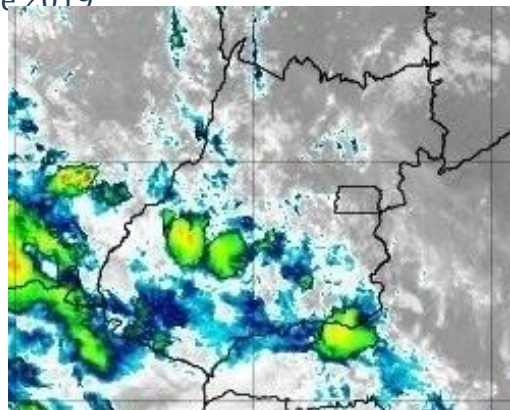
3 Resumo do Evento

Uma Zona de Convergência de Umidade ajudou a organizar áreas de instabilidade sobre o estado de Goiás entre os dias 09 e 13 de dezembro de 2019.

Entre as 09h00 do dia 09 e as 08h00 do dia 13 de dezembro de 2019 foram detectados 143983 descargas atmosféricas sobre a área de concessão da CELG Distribuição Goiás. Estações do INMET representativas da região de interesse registraram chuva e vento forte durante o período.

Segundo dados do INMET, a chuva acumulada entre as 09h00 do dia 09 e 09h00 do dia 10 de dezembro em Formosa corresponde a aproximadamente 25% da média climatológica (1981-2010) para o mês de dezembro na região, em Cristalina a chuva acumulada entre as 09h00 do dia 10 e 09h00 do dia 11 corresponde a 16% da média para o mês, em Ipameri a chuva acumulada entre as 09h do dia 11 e as 09h00 do dia 12 corresponde a cerca de 29% da climatologia para o mês e em Mineiros o acumulado de chuva entre 09h00 do dia 12 e 09h00 do dia 13 corresponde a aproximadamente 20% da média climatológica.

Tabela 7 – Resumo do evento Região Sudoeste

Número/Código do Evento	
Número/Código do Relatório	
Descrição	Região ligada à tempestade causada por uma zona de baixa pressão atmosférica, provocando forte deslocamento de massas de ar, vendavais, chuvas intensa e possível queda de granizo.
Código COBRADE	1.3.1.2.0 – Zona de Convergência
Hora início do evento	09h00 do dia 09 de dezembro de 2019
Hora de fim do evento	07h10 do dia 13 de dezembro de 2019
Abrangência	Região Sudoeste da CELG Distribuição S.A.

Tabela 8 – Resumo do evento Região Sul

Número/Código do Evento	
Número/Código do Relatório	
Descrição	Região ligada à tempestade causada por uma zona de baixa pressão atmosférica, provocando forte deslocamento de massas de ar, vendavais, chuvas intensa e possível queda de granizo.
Código COBRADE	1.3.1.2.0 – Zona de Convergência
Hora início do evento	10h00 do dia 09 de dezembro de 2019
Hora de fim do evento	07h15 do dia 13 de dezembro de 2019
Abrangência	Região Sul da CELG Distribuição S.A.

Tabela 9 – Resumo do evento Região Sudeste

Número/Código do Evento	
Número/Código do Relatório	
Descrição	Região ligada à tempestade causada por uma zona de baixa pressão atmosférica, provocando forte deslocamento de massas de ar, vendavais, chuvas intensa e possível queda de granizo.
Código COBRADE	1.3.1.2.0 – Zona de Convergência
Hora início do evento	10h30 do dia 09 de dezembro de 2019
Hora de fim do evento	07h30 do dia 13 de dezembro de 2019
Abrangência	Região Sudeste da CELG Distribuição S.A.

Tabela 10 – Resumo do evento Região Metropolitana

Número/Código do Evento	
Número/Código do Relatório	
Descrição	Região ligada à tempestade causada por uma zona de baixa pressão atmosférica, provocando forte deslocamento de massas de ar, vendavais, chuvas intensa e possível queda de granizo.
Código COBRADE	1.3.1.2.0 – Zona de Convergência
Hora início do evento	11h00 do dia 09 de dezembro de 2019
Hora de fim do evento	06h30 do dia 13 de dezembro de 2019
Abrangência	Região Metropolitana da CELG Distribuição S.A.

Tabela 11 – Resumo do evento Região Oeste

Número/Código do Evento	
Número/Código do Relatório	
Descrição	Região ligada à tempestade causada por uma zona de baixa pressão atmosférica, provocando forte deslocamento de massas de ar, vendavais, chuvas intensa e possível queda de granizo.
Código COBRADE	1.3.1.2.0 – Zona de Convergência
Hora início do evento	09h00 do dia 09 de dezembro de 2019
Hora de fim do evento	08h00 do dia 13 de dezembro de 2019
Abrangência	Região Oeste da CELG Distribuição S.A.

Tabela 12 – Resumo do evento Região Entorno DF

Número/Código do Evento	
Número/Código do Relatório	
Descrição	Região ligada à tempestade causada por uma zona de baixa pressão atmosférica, provocando forte deslocamento de massas de ar, vendavais, chuvas intensa e possível queda de granizo.
Código COBRADE	1.3.1.2.0 – Zona de Convergência
Hora início do evento	12h00 do dia 09 de dezembro de 2019
Hora de fim do evento	03h45 do dia 13 de dezembro de 2019
Abrangência	Região Entorno DF da CELG Distribuição S.A.

Tabela 13 – Resumo do evento Região Centro

Número/Código do Evento	
Número/Código do Relatório	
Descrição	Região ligada à tempestade causada por uma zona de baixa pressão atmosférica, provocando forte deslocamento de massas de ar, vendavais, chuvas intensa e possível queda de granizo.
Código COBRADE	1.3.1.2.0 – Zona de Convergência
Hora início do evento	12h15 do dia 09 de dezembro de 2019
Hora de fim do evento	05h15 do dia 13 de dezembro de 2019
Abrangência	Região Centro da CELG Distribuição S.A.

Tabela 14 – Resumo do evento Região Noroeste

Número/Código do Evento	
Número/Código do Relatório	
Descrição	Região ligada à tempestade causada por uma zona de baixa pressão atmosférica, provocando forte deslocamento de massas de ar, vendavais, chuvas intensa e possível queda de granizo.
Código COBRADE	1.3.1.2.0 – Zona de Convergência
Hora início do evento	13h45 do dia 09 de dezembro de 2019
Hora de fim do evento	04h15 do dia 13 de dezembro de 2019
Abrangência	Região Noroeste da CELG Distribuição S.A.

Tabela 15 – Resumo do evento Região Norte

Número/Código do Evento	
Número/Código do Relatório	
Descrição	Região ligada à tempestade causada por uma zona de baixa pressão atmosférica, provocando forte deslocamento de massas de ar, vendavais, chuvas intensa e possível queda de granizo.
Código COBRADE	1.3.1.2.0 – Zona de Convergência
Hora início do evento	10h00 do dia 09 de dezembro de 2019
Hora de fim do evento	06h00 do dia 13 de dezembro de 2019
Abrangência	Região Norte da CELG Distribuição S.A.

Tabela 16 – Resumo do evento Região Nordeste

Número/Código do Evento	
Número/Código do Relatório	
Descrição	Região ligada à tempestade causada por uma zona de baixa pressão atmosférica, provocando forte deslocamento de massas de ar, vendavais, chuvas intensa e possível queda de granizo.
Código COBRADE	1.3.1.2.0 – Zona de Convergência
Hora início do evento	11h15 do dia 09 de dezembro de 2019
Hora de fim do evento	07h15 do dia 13 de dezembro de 2019
Abrangência	Região Norte da CELG Distribuição S.A.

4 Referências

- RMetS Royal Meteorological Society – Beaufort Scale - <https://www.rmets.org/weather-and-climate/observing/beaufort-scale>

- Instituto Nacional de Meteorologia (INMET) - <http://www.inmet.gov.br>

- Cptec/INPE- <https://www.cptec.inpe.br/>

- Centro de Hidrografia da Marinha do Brasil - <https://www.marinha.mil.br/chm/>

- Meteorology Glossary - American Meteorological Society -

<http://glossary.ametsoc.org/>

Anexos

A.1 Carta Sinótica



Figura A1 - Carta sinótica da Marinha do Brasil para as 0000Z do dia 10 de dezembro de 2019 (21h00 do dia 09 de dezembro de 2019, hora local. FONTE: Marinha do Brasil).



LEGENDA			
	Frente Fria	A	Alta Pressão
	Frente Quente	B	Baixa Pressão
	Instabilidade		Zona de Convergência

Figura A2 - Carta sinótica da Marinha do Brasil para as 1200Z do dia 10 de dezembro de 2019 (09h00 do dia 10 de dezembro de 2019, hora local). FONTE: Marinha do Brasil).

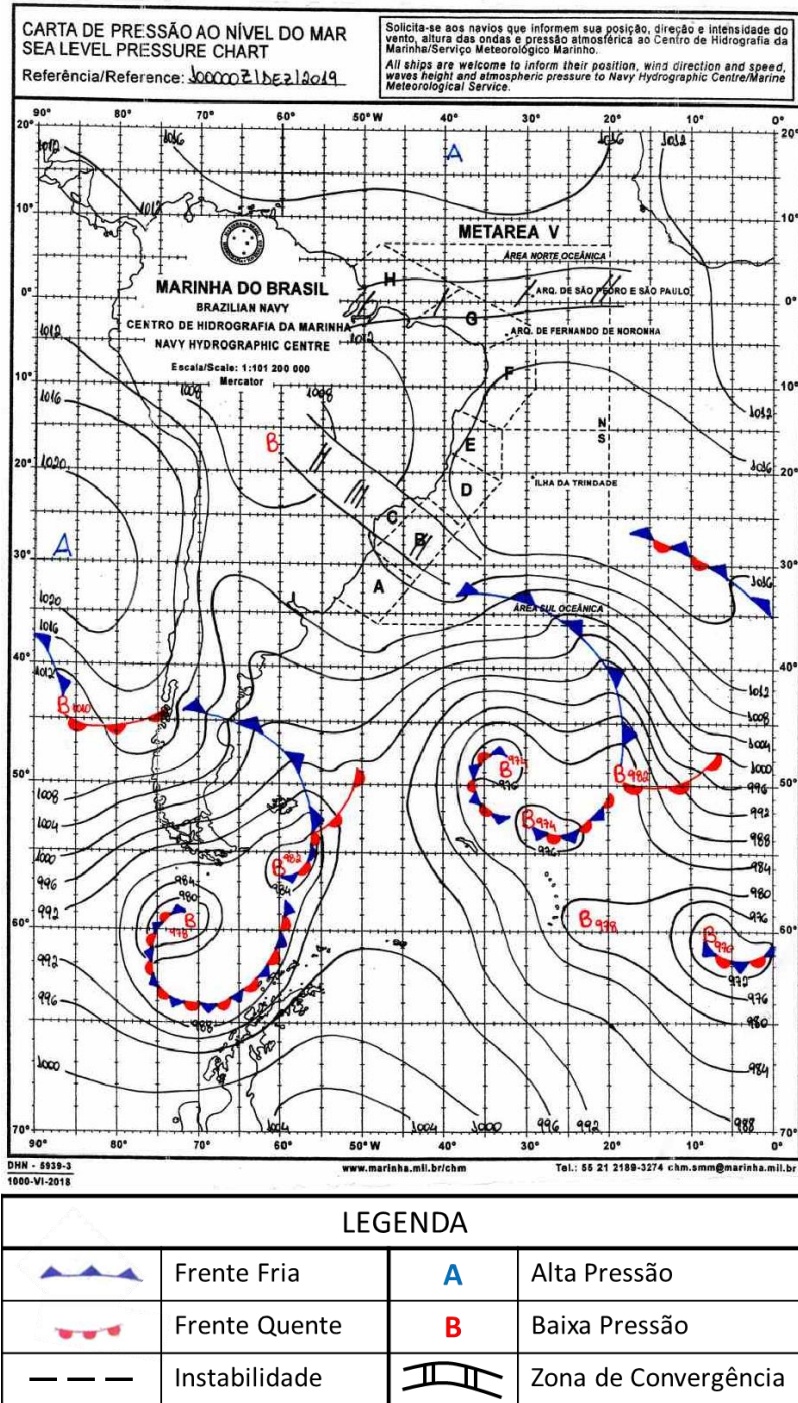
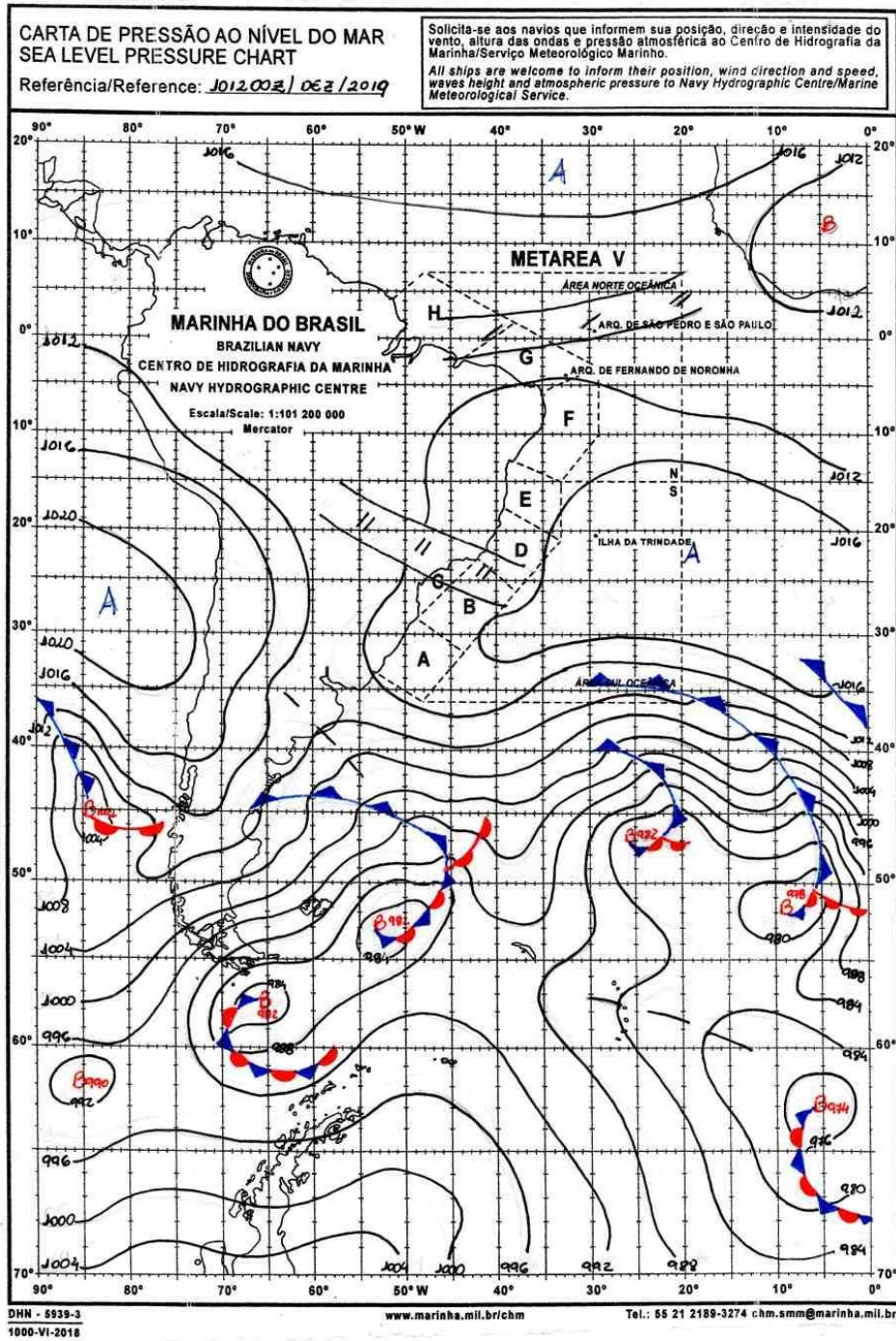
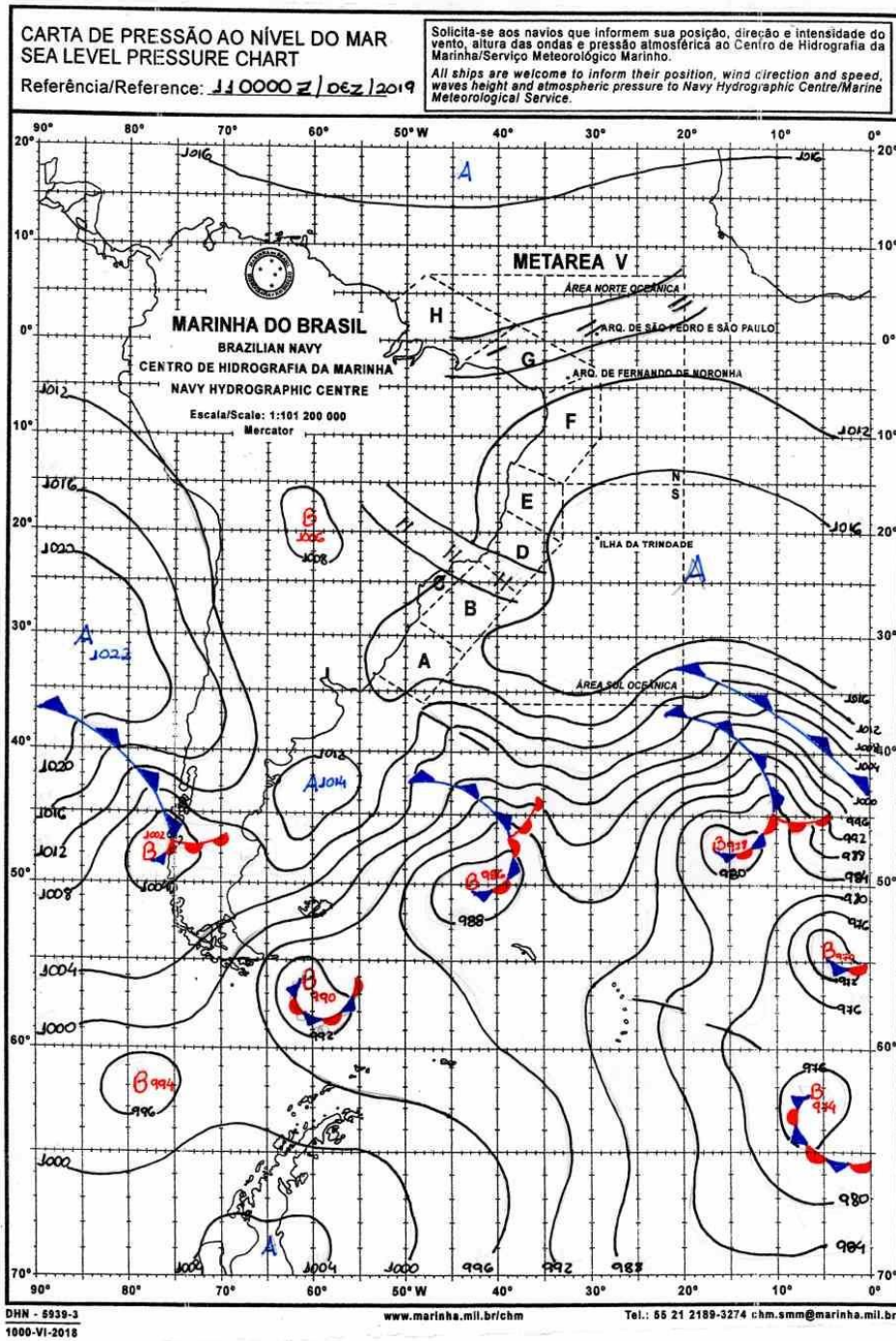

LEGENDA			
	Frente Fria	A	Alta Pressão
	Frente Quente	B	Baixa Pressão
	Instabilidade		Zona de Convergência

Figura A3 - Carta sinótica da Marinha do Brasil para as 0000Z do dia 11 de dezembro de 2019 (21h00 do dia 10 de dezembro de 2019, hora local. FONTE: Marinha do Brasil).



Figura A4 - Carta sinótica da Marinha do Brasil para as 1200Z do dia 11 de dezembro de 2019 (0900 do dia 11 de dezembro de 2019, hora local). FONTE: Marinha do Brasil).



LEGENDA			
	Frente Fria	A	Alta Pressão
	Frente Quente	B	Baixa Pressão
	Instabilidade		Zona de Convergência

Figura A5 - Carta sinótica da Marinha do Brasil para as 0000Z do dia 12 de dezembro de 2019 (21h00 do dia 11 de dezembro de 2019, hora local). FONTE: Marinha do Brasil).

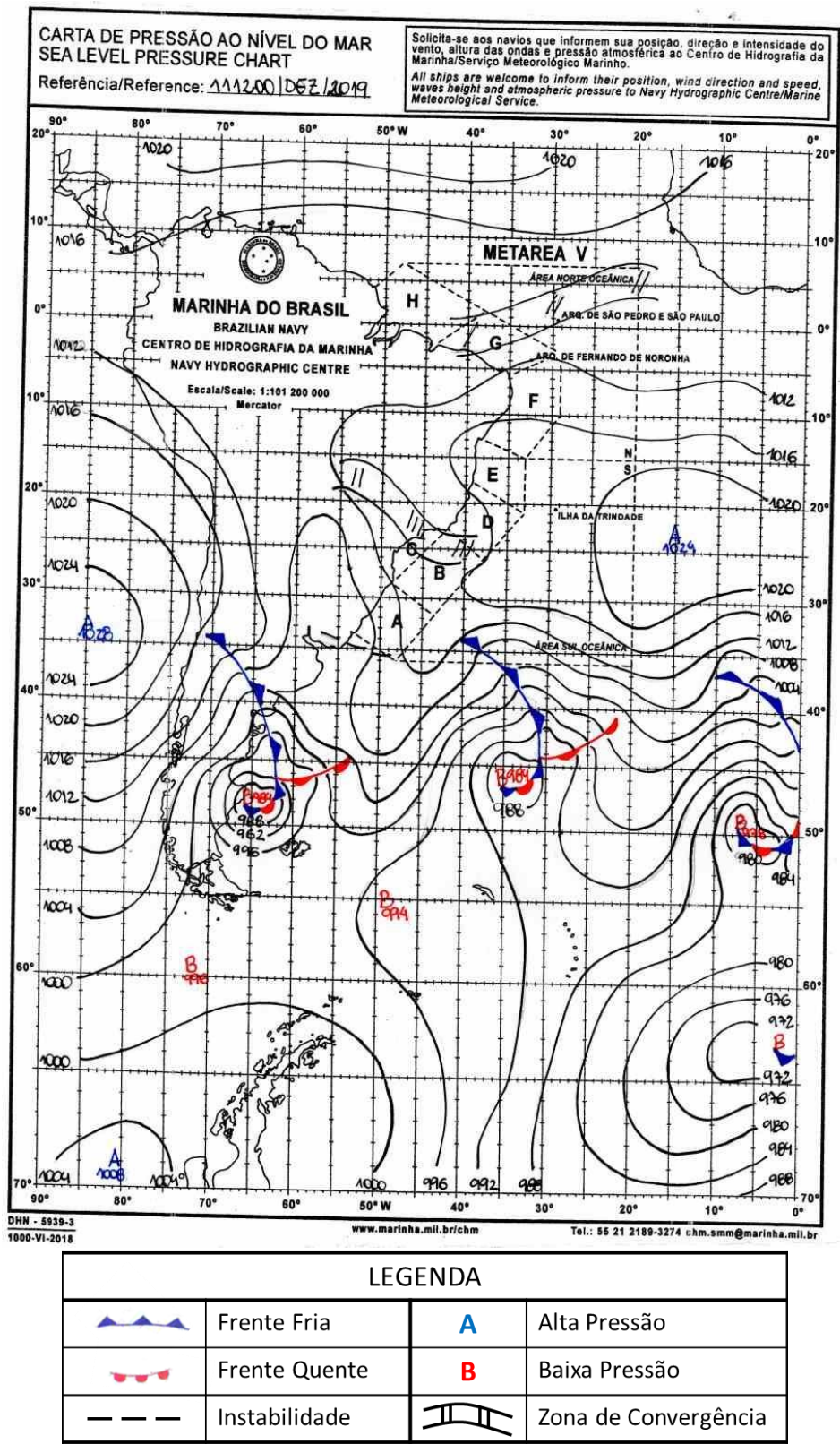
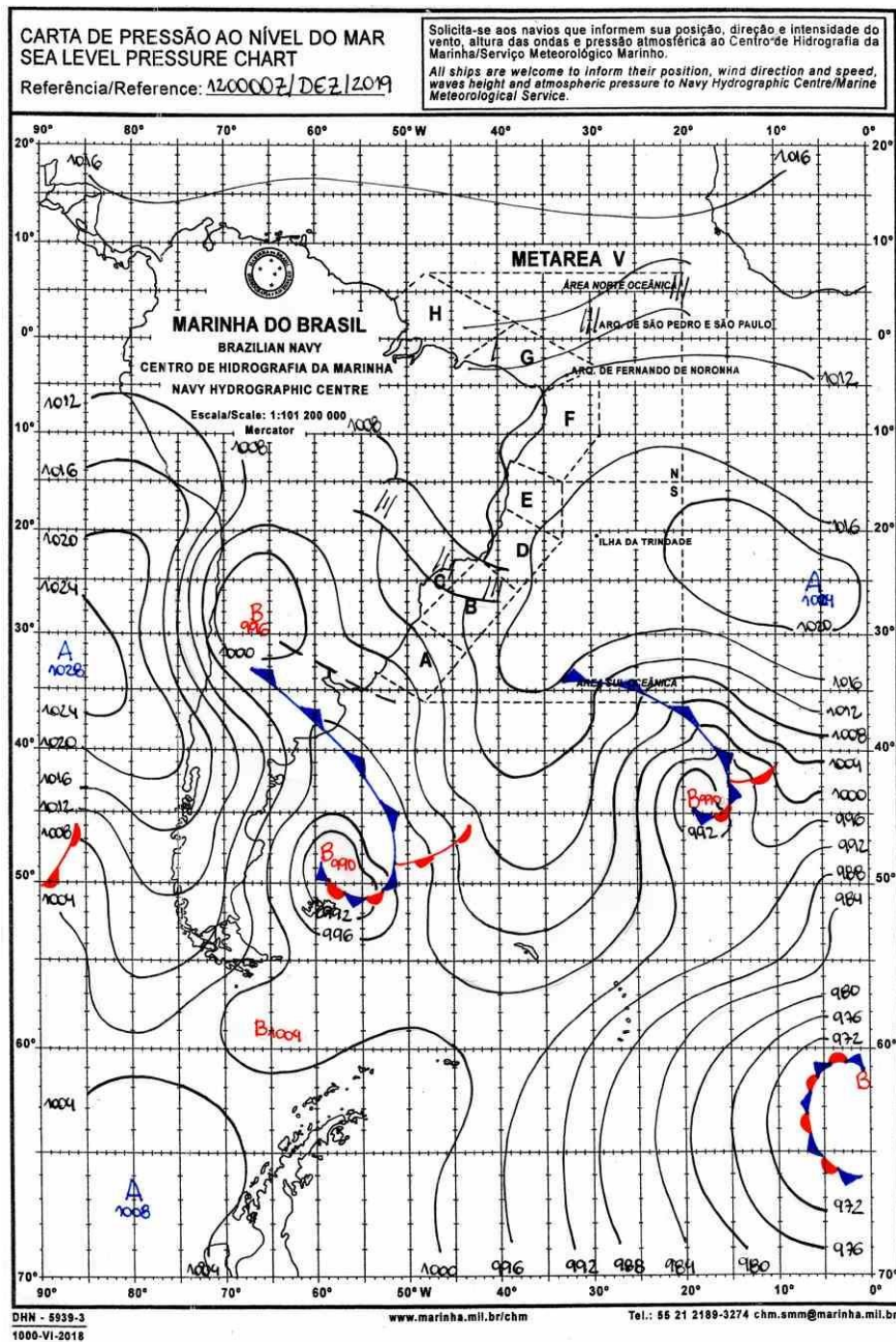
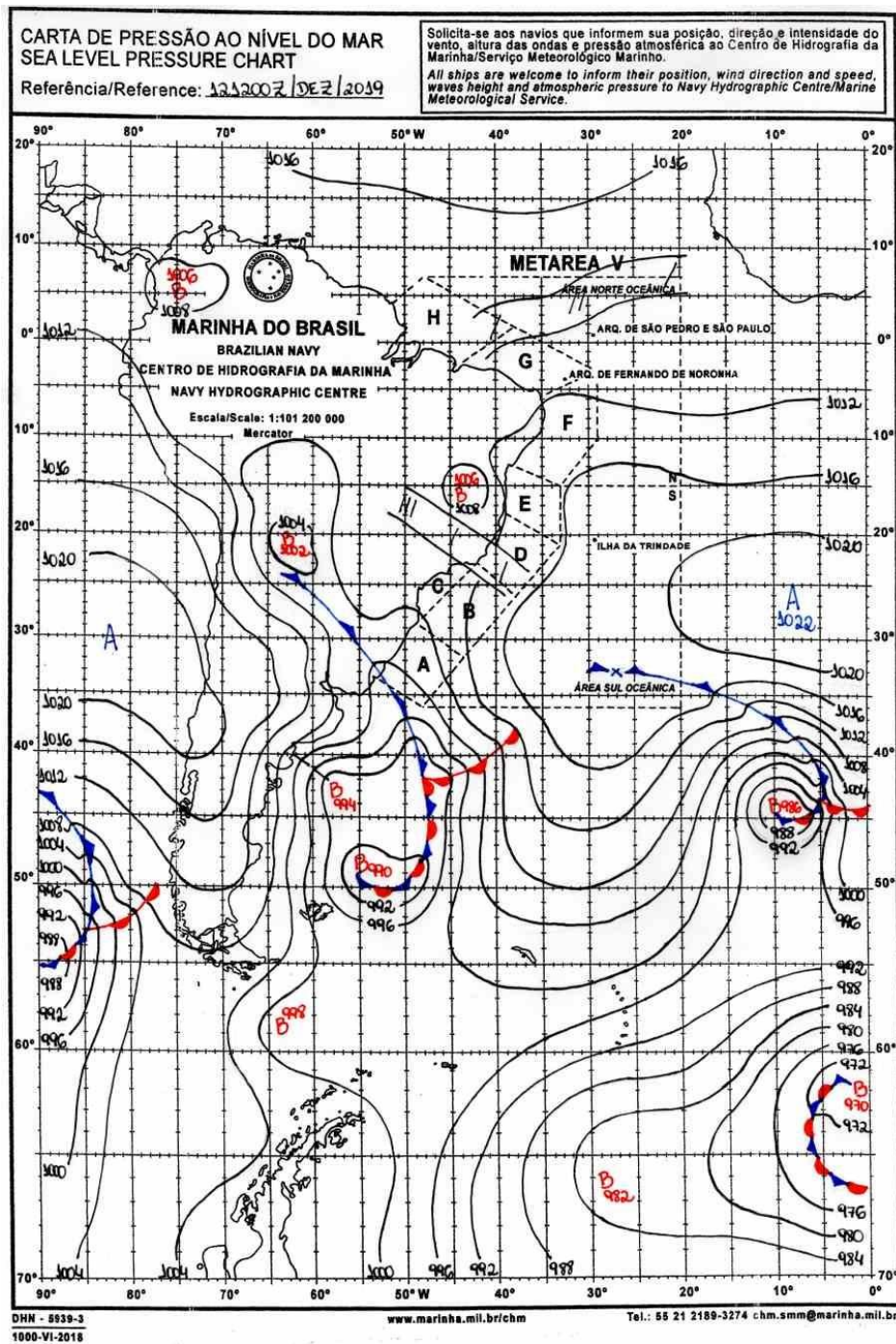

LEGENDA			
	Frente Fria	A	Alta Pressão
	Frente Quente	B	Baixa Pressão
	Instabilidade		Zona de Convergência

Figura A6 - Carta sinótica da Marinha do Brasil para as 1200Z do dia 12 de dezembro de 2019 (09h00 do dia 12 de dezembro de 2019, hora local. FONTE: Marinha do Brasil).

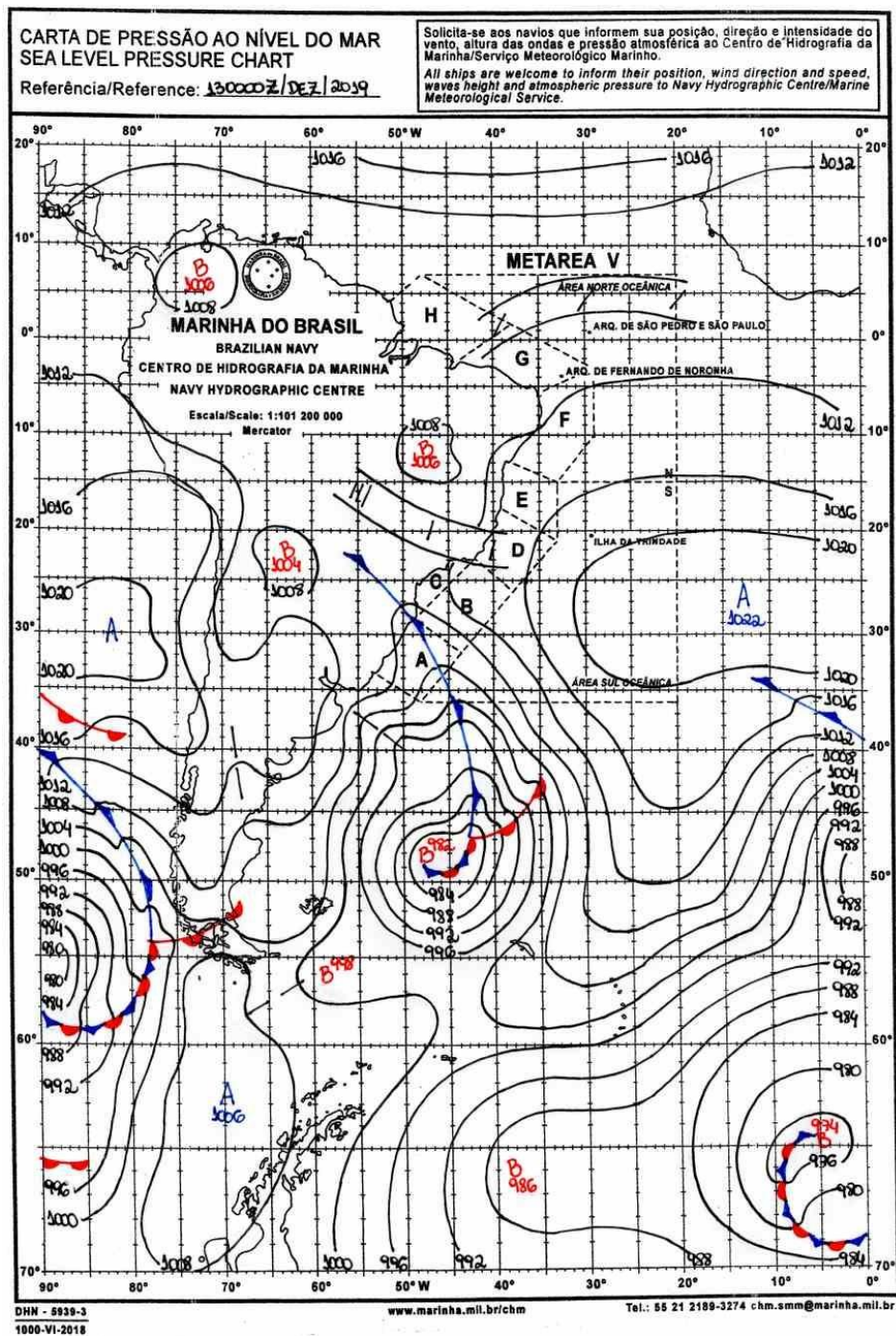

LEGENDA			
	Frente Fria	A	Alta Pressão
	Frente Quente	B	Baixa Pressão
	Instabilidade		Zona de Convergência

Figura A7 - Carta sinótica da Marinha do Brasil para as 0000Z do dia 13 de dezembro de 2019 (21h00 do dia 12 de dezembro de 2019, hora local. FONTE: Marinha do Brasil).

A.2 Média climatológica (1981-2010) de precipitação acumulada para o mês de dezembro



Figura A8 - Média climatológica (1981-2010) de precipitação acumulada para o mês de dezembro. Fonte: INMET).

A.3 Notícias associadas

- Chuva alaga ruas de Caldas Novas

<https://globoplay.globo.com/v/8156247>

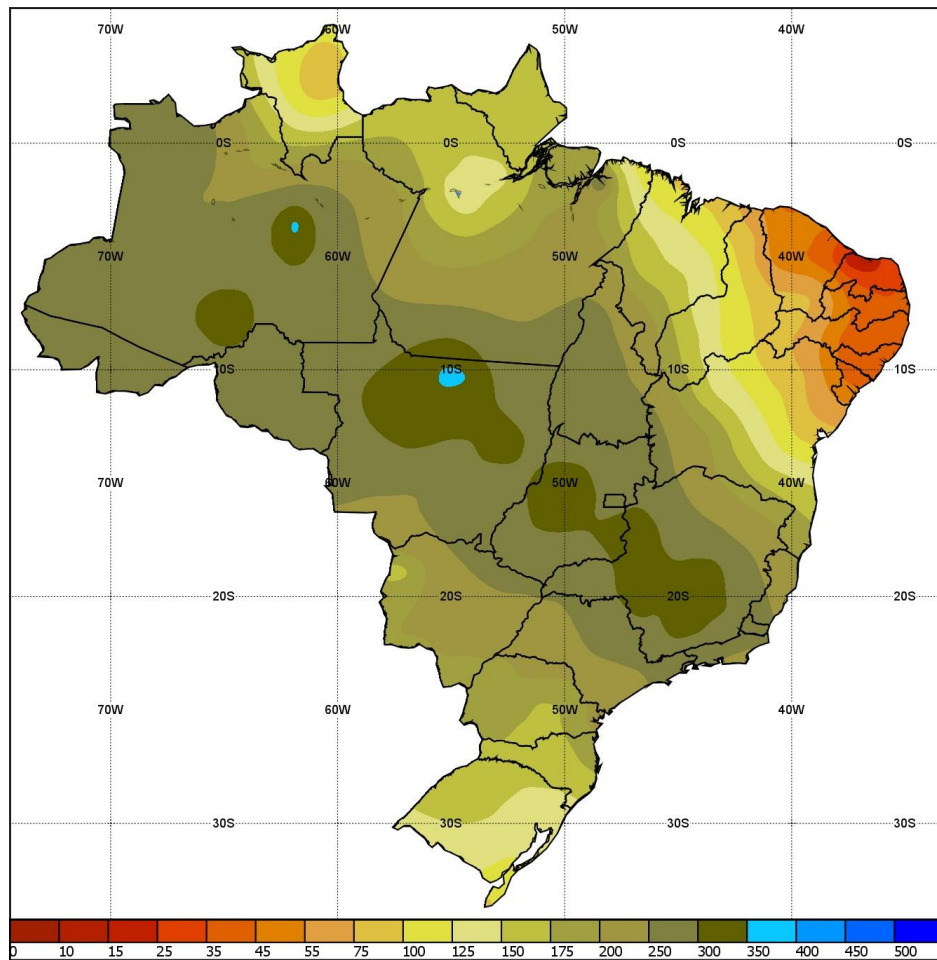
/

- Chuvas voltam a assustar cidades do Sudoeste goiano

<http://jornalsomos.com.br/sudoeste/detalhe/chuvas-voltam-a-assustar-cidades-do-sudoeste-goiano>

- Casa de idosos é invadida por forte enxurrada em Fazenda Nova. Confira vídeo

<https://www.emaisgoias.com.br/casa-de-idosos-e-invadida-por-forte-enxurrada-em-fazenda-nova-confira-video/>

- Chuva provoca acidente e deixa três pessoas feridas, na BR 153 em Morrinhos

<https://www.emaisgoias.com.br/chuva-provoca-acidente-e-deixa-tres-pessoas-feridas-na-br-153-em-morrinhos/>

- Chuva alaga pontos de Rio Verde

<https://globoplay.globo.com/v/8161554>

/

- Jovem é resgatada após carro ser arrastado por enxurrada, em Caldas Novas

<https://www.opopular.com.br/noticias/cidades/jovem-e-resgatada-apos-carro-ser-arrastado-por-enxurrada-em-caldas-novas-1.1950797>

Bianca Lobo
Silva
Meteorologista
CREA
5063840461

Instituto Nacional de Meteorologia - INMET

Umidade Relativa do Ar 00h UTC
Estação: ARAGARCAS (GO) - 12/2019

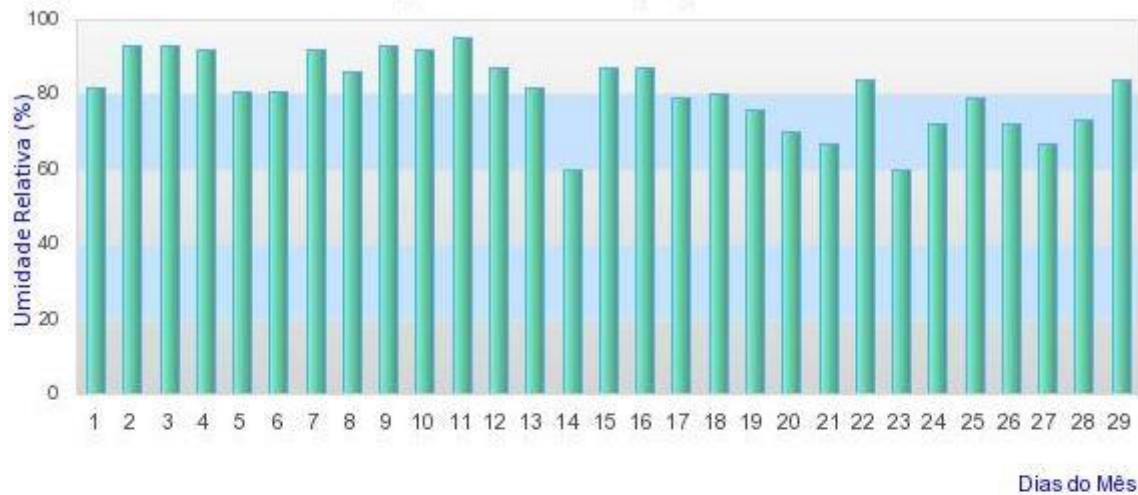

Instituto Nacional de Meteorologia - INMET

Chuva Acumulada 24h
Estação: ARAGARCAS - 12/2019

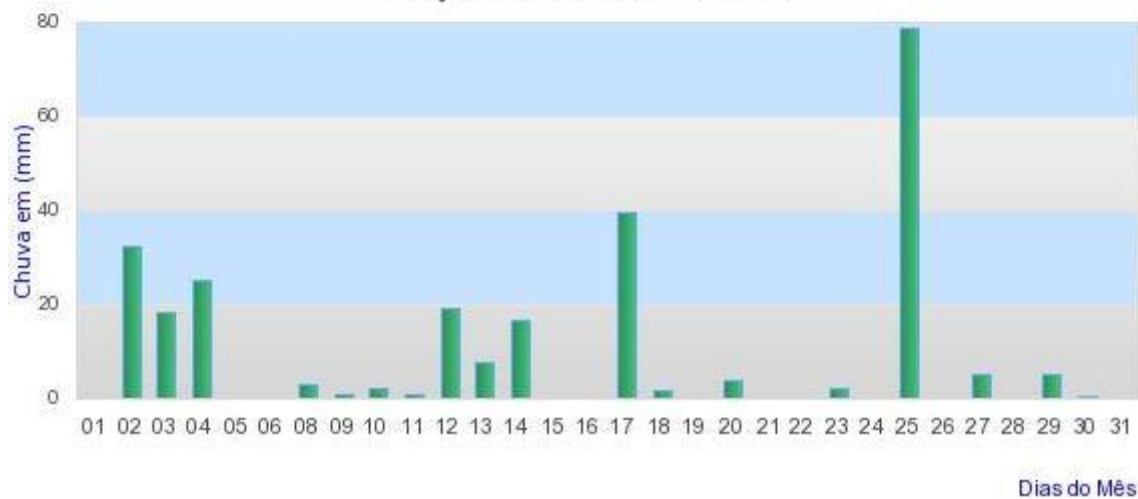

Instituto Nacional de Meteorologia - INMET

Umidade Relativa do Ar 00h UTC
Estação: CATALAO (GO) - 12/2019

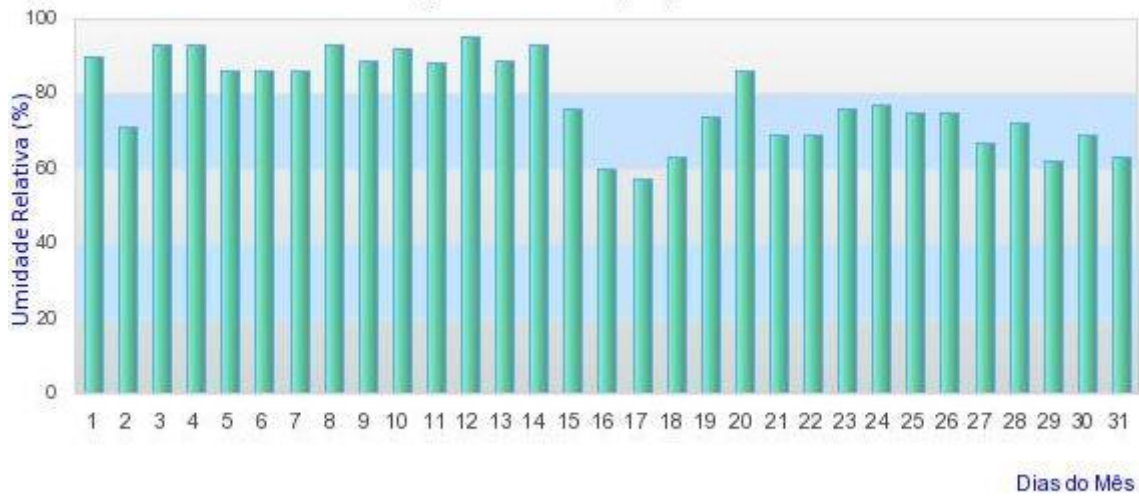

Instituto Nacional de Meteorologia - INMET

Chuva Acumulada 24h
Estação: CATALAO - 12/2019

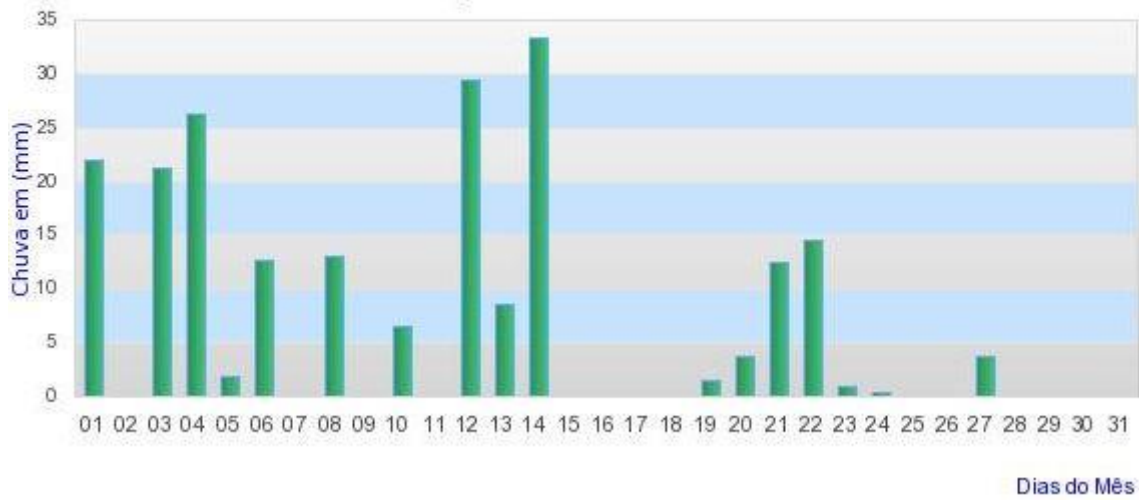

Instituto Nacional de Meteorologia - INMET

Umidade Relativa do Ar 00h UTC
Estação: FORMOSA (GO) - 12/2019

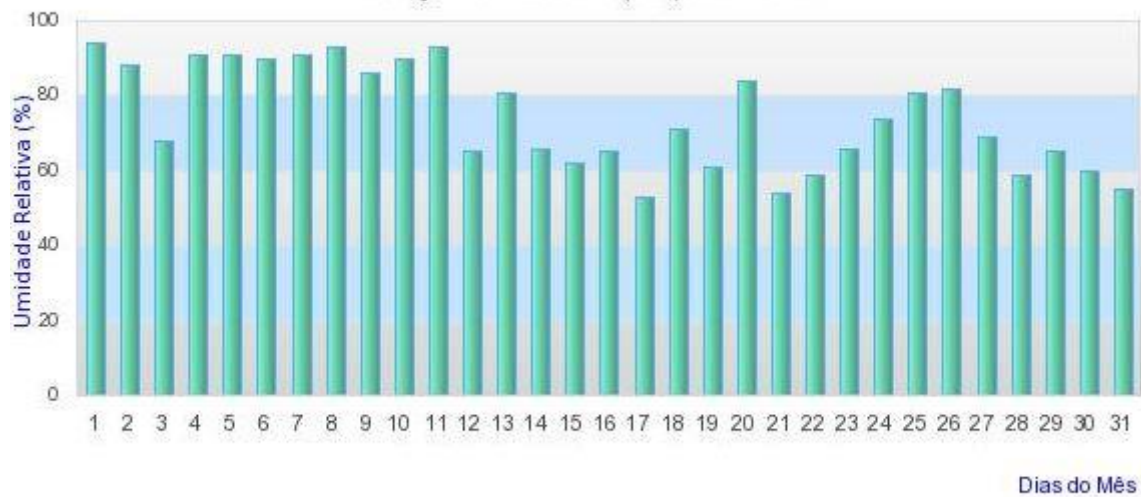

Instituto Nacional de Meteorologia - INMET

Chuva Acumulada 24h
Estação: FORMOSA - 12/2019



Instituto Nacional de Meteorologia - INMET

Umidade Relativa do Ar 00h UTC

Estação: GOIANIA (GO) - 12/2019

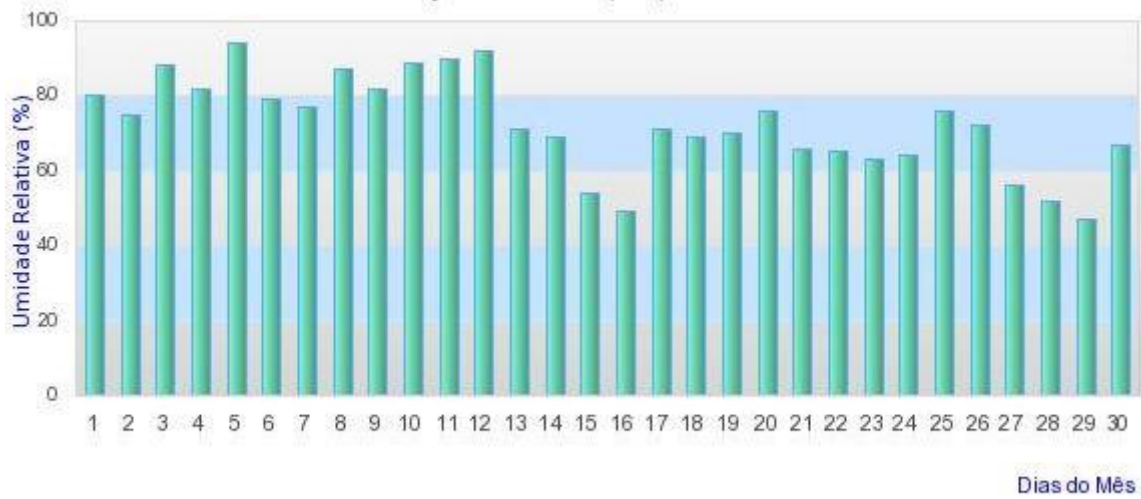

Instituto Nacional de Meteorologia - INMET

Chuva Acumulada 24h

Estação: GOIANIA - 12/2019



Instituto Nacional de Meteorologia - INMET

Umidade Relativa do Ar 00h UTC
Estação: IPAMERI (GO) - 12/2019

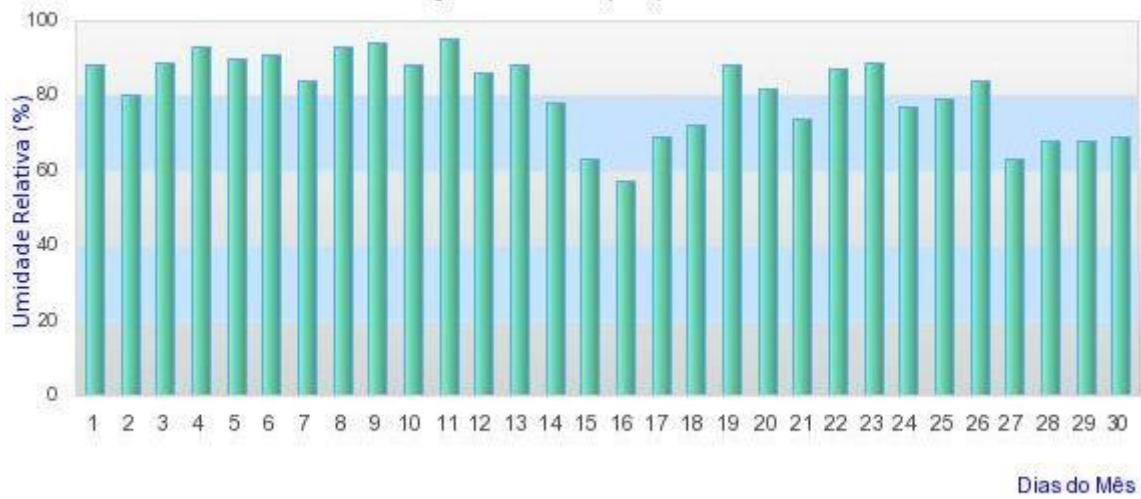

Instituto Nacional de Meteorologia - INMET

Chuva Acumulada 24h
Estação: IPAMERI - 12/2019

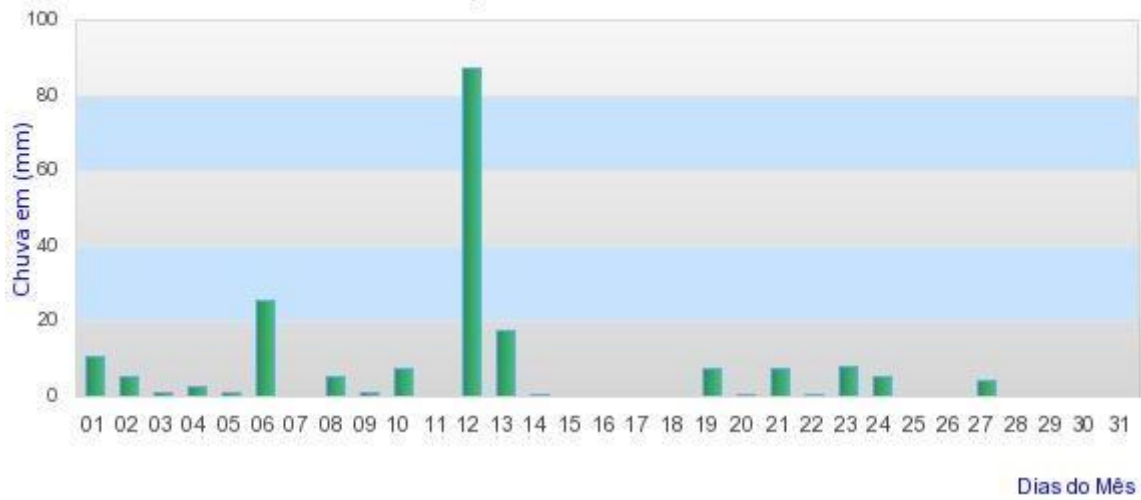

Instituto Nacional de Meteorologia - INMET

Umidade Relativa do Ar 00h UTC

Estação: JATAI (GO) - 12/2019

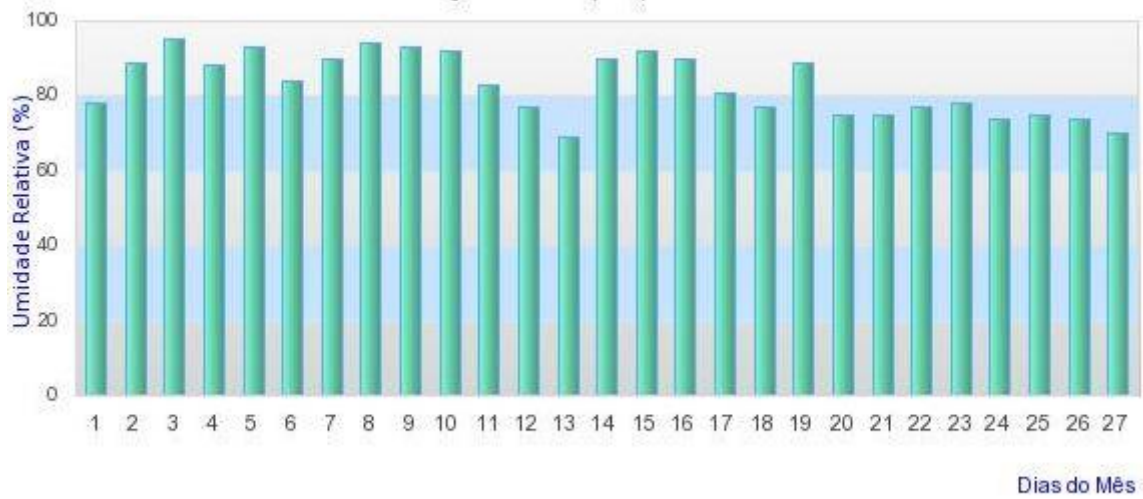

Instituto Nacional de Meteorologia - INMET

Chuva Acumulada 24h

Estação: JATAI - 12/2019

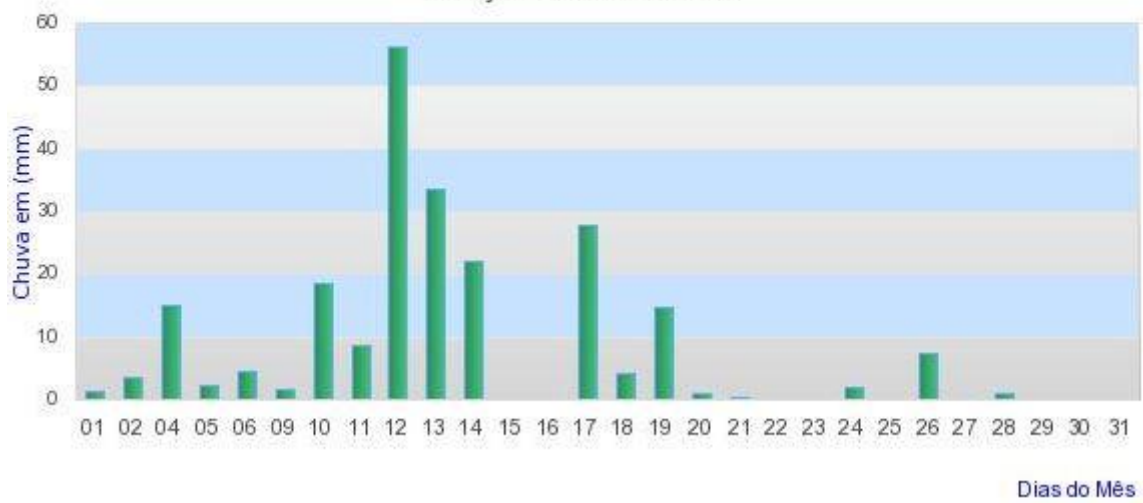

Instituto Nacional de Meteorologia - INMET

Umidade Relativa do Ar 00h UTC
Estação: PIRENOPOLIS (GO) - 12/2019

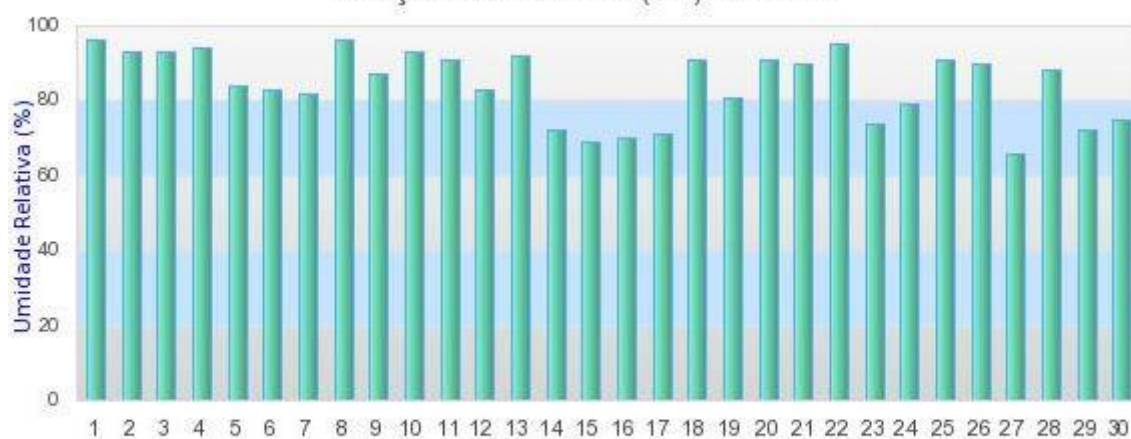

Dias do Mês

Instituto Nacional de Meteorologia - INMET

Chuva Acumulada 24h
Estação: PIRENOPOLIS - 12/2019



Dias do Mês

Instituto Nacional de Meteorologia - INMET

Umidade Relativa do Ar 00h UTC

Estação: POSSE (GO) - 12/2019



Instituto Nacional de Meteorologia - INMET

Chuva Acumulada 24h

Estação: POSSE - 12/2019

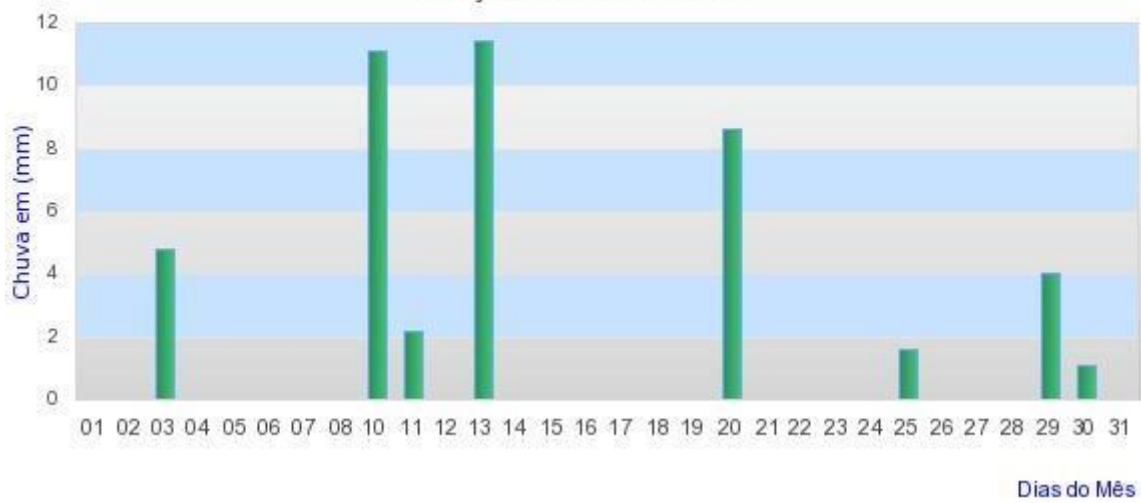

Instituto Nacional de Meteorologia - INMET

Umidade Relativa do Ar 00h UTC
Estação: RIO VERDE (GO) - 12/2019

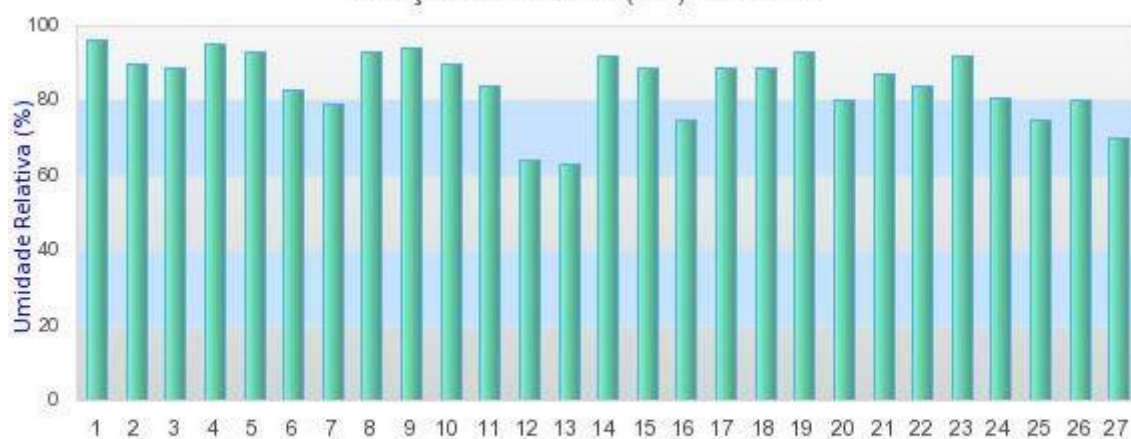

Dias do Mês

Instituto Nacional de Meteorologia - INMET

Chuva Acumulada 24h
Estação: RIO VERDE - 12/2019



Dias do Mês

NOTÍCIAS RELACIONADAS

<https://globoplay.globo.com/v/8156247/>

globoplay Agora na Globo Novelas Séries Cinema Infantil Mais ▾

#BomDiaGoias



GO 7:36 **CHUVARADA NO SUL DO ESTADO** Teve carro arrastado em Caldas e acidente em Itumbiara **AO VIVO**

Bom Dia GO >

Chuva alaga ruas de Caldas Novas

3 min Exibição em 11 Dez 2019

Em Itumbiara, temporal causou um acidente.

Chuvas voltam a assustar cidades do Sudoeste goiano

POR JORNAL SOMOS | 12/12/2019



Reprodução de vídeo

O dia de hoje, quinta feira (12/12), ainda estava incluído entre os dias de alerta amarelo, emitido pelo Instituto Nacional de Meteorologia do Brasil (INMET), através do Centro de Previsão de Tempo e Estudos Climáticos (CPTEC). O que assustou mais uma vez foi o volume de água e os ventos que acompanharam o clima.

<https://www.emaisgoias.com.br/casa-de-idosos-e-invadida-por-forte-enxurrada-em-fazenda-nova-confira-video/>

MENU  maisgoiás

últimas notícias [bbb20](#) [blog](#) [brasil](#) [carnaval](#) [cidades](#) [divirta-se](#) [economia](#) [entretê](#)



CHUVA

Casa de idosos é invadida por forte enxurrada em Fazenda Nova. Confira vídeo

Imagens foram feitas por neto do casal, que informou que problema é recorrente. Apesar do susto, ninguém se feriu

<https://www.emaisgoias.com.br/chuva-provoca-acidente-e-deixa-tres-pessoas-feridas-na-br-153-em-morrinhos/>



TEMPORAL

Chuva provoca acidente e deixa três pessoas feridas, na BR 153 em Morrinhos

Carro de passeio saiu da pista e capotou durante um forte temporal; as três vítimas do acidente foram levadas para o hospital de Morrinhos

<https://globoplay.globo.com/v/8161554/>

globoplay Agora na Globo Novelas Séries Cinema Infantil Mais ▾

#JornalAnhanguera



JAN RIO VERDE

JA 2ª Edição >

Chuva alaga pontos de Rio Verde

22 seg Exibição em 12 Dez 2019

Choveu forte no sudoeste de Goiás.



Carol Almeida
carol.almeida@
opopular.com.br



Jovem é resgatada após carro ser arrastado por enxurrada, em Caldas Novas



De acordo com o Corpo de Bombeiros, motorista não conseguiu sair do veículo após entrar em área alagada, na Avenida das Brisas, e acionou o resgate

10/12/2019 - 16:04



Encontro da Avenida das Brisas com a Rua B4, no Parque das Brisas, onde foi registrada a ocorrência, segundo o Corpo de Bombeiros (Foto: Google Street View)

Uma jovem, de 27 anos, foi resgatada pelo Corpo de Bombeiros após o carro em que estava ser arrastado pela enxurrada, na tarde desta terça-feira (10), no Setor Parque das Brisas, em Caldas Novas. O caso ocorreu por volta das 14h, quando a motorista trafegava pela Avenida das Brisas. De acordo com informações da corporação, ela conseguiu acionar o resgate após o veículo ser invadido pela água e foi retirada do automóvel em segurança.

Segundo os bombeiros, uma forte chuva ocorreu entre 13h30 e 15h. Durante esse tempo, 70 milímetros de precipitação foram registrados pelo pluviômetro da corporação, segundo esta informou. Vários pontos de alagamento foram identificados, sendo um deles o local em que houve a ocorrência, que foi a única recebida pela corporação, apesar da intensidade do temporal.