

## Resumo Executivo

O Presente Relatório tem como objetivo a incorporação de informações que sejam relevantes para que se possa fazer a devida associação aos dados contidos no corpo do documento objeto da classificação de Situação de Emergência caracterizada pelo Módulo 8 do Prodist, que tem como foco o impacto do evento sobre determinada rede geelétrica e cuja denominação é definida como CHI (Consumidor hora interrompido). O parâmetro para enquadramento nesta classificação de expurgo tem como premissa inicial o limite de Consumidor hora interrompido definido pela fórmula descrita no Módulo 01 do Prodist (Revisão - 9), acrescido de todos os outros informes e dados listados no Módulo 08 (Revisão 10) do Prodist. Este enquadramento se apresenta na maioria das vezes em condições climáticas adversas com severidade dos fatores inerentes a situação, caracterizado na maioria dos casos por fortes ventos e chuvas de grande intensidade e continuidade.

Entre a manhã do dia 22/12/2019 – domingo – e a madrugada de 25/12/2019 – quarta-feira – Houve a formação de nuvens de tempestade, do tipo Cumulonimbus, que avançaram sobre o continente e ajudaram a organizar áreas de instabilidade sobre as Regiões da Enel Distribuição Goiás.

Conforme informações do Climatempo Meteorologia, o Instituto Nacional de Meteorologia (INMET) detectou rajadas de vento acima de 50km/h entre a manhã do dia 22 e a madrugada do dia 25 de dezembro de 2019. A máxima rajada registrada foi de 64,4km/h, sendo esse vento classificado como ventania pela escala Beaufort.

Entre as 11h30 do dia 22 e 06h do dia 25 de dezembro de 2019 tivemos, em todo o Estado de Goiás, incidências de 259.244 descargas atmosféricas (55.630 raios nuvem-solo e 203.614 descargas nuvem-nuvem) sobre a região, o que causou grande instabilidade na rede.

**Após forte chuva, Prefeitura, defesa civil e bombeiros executam ações emergenciais pelas ruas da cidade** - Morrinhos registrou uma forte chuva neste domingo (22/12) de cerca de 30 milímetros e um forte vento. A tempestade causou muita sujeira em ruas, derrubou árvores, telhados, painéis, tendas e muros em vários bairros da cidade fez com que equipes da Prefeitura, defesa civil e corpo de bombeiros, trabalhassem intensamente durante o início da noite para reparar alguns danos e remover árvores do meio das ruas. Acesso em: [<https://morrinhos.go.gov.br/site/2019/12/apos-forte-chuva-prefeitura-defesa-civil-e-bombeiros-executam-acoes-emergenciais-pelas-ruas-da-cidade/>](https://morrinhos.go.gov.br/site/2019/12/apos-forte-chuva-prefeitura-defesa-civil-e-bombeiros-executam-acoes-emergenciais-pelas-ruas-da-cidade/)

## Relatório de Ocorrências do período

Em todo o Estado de Goiás verificou-se também que a intensidade da chuva e dos ventos danificaram a rede de distribuição de energia elétrica em diversos pontos, registrando aproximadamente 751 mil clientes com interrupção no fornecimento de energia elétrica devido a eventos relacionados ao temporal.

Para otimizar o volume de atendimentos e reduzir os tempos de interrupção foram mobilizados os recursos extras da empresa que aumentou o contingente em relação a situação normal de operação. O acompanhamento da quantidade de equipes e o Tempo Médio de Atendimento podem ser consultados na Pág.02 do Relatório em anexo.

O impacto e severidade do evento estão relatados em artigos de mídia, como fotos e reportagens que demonstram os danos na Rede de Distribuição, oriundos dos eventos climáticos no período. Eventos estes que afetaram 751.195 consumidores com CHI de 2.492.361,84 superior ao de 482.391,86 estabelecido como limite para definição de Situação de Emergência, conforme resumo das informações obrigatórias.

<b>Empresa</b>	ENEL DISTRIBUIÇÃO GOIÁS				
<b>Código do Relatório</b>	CHI-036 - ENEL DISTRIBUIÇÃO GOIÁS				
<b>Evento:</b>	TEMPORAL NA AREA DE CONCESSÃO DA ENEL DISTRIBUIÇÃO GOIAS				
<b>Código COBRADE:</b>	1.3.2.1.2 e 1.3.2.1.5	<b>Data Início</b>	22/12/2019	<b>Hora início</b>	11h30
<b>Código do Evento:</b>	CHI-036-ENEL GO	<b>Data Término</b>	25/12/2019	<b>Hora Término</b>	08h59
<b>Valor CHI (Limite e Real)</b>	482.391,86		2.492.361,84		
<b>Código do Decreto (Se Houver):</b>					
<b>Quantidade de Interrupções (Evento)</b>	6.759				
<b>Início 1ª Incidência (Data e Hora)</b>	22/12/2019 11:30		<b>Subestações Atingidas</b>	<p>ABADIANIA / ABC / ACREUNA / ADELANDIA / AEROPORTO / AGUA LIMPA (MARZAGAO) / AGUAS LINDAS / ALEXANIA / ALEXANIA TRANSMISSAO / ALMERINDONOPOLIS / ALOANDIA / ALPHAVILLE / ALTO BURITI / ALVORADA DO NORTE / AMERICANO ( RIO VERDE ) / AMERICANO DO BRASIL / AMORINOPOLIS / ANAPOLIS UNIVERSITARIA / ANHANGUERA / ANICUNS / ANTONIO DO VITTO / APARECIDA DO RIO DOCE / APORE / ARACU / ARAGARCAS / ARAGOIANIA / ARAGUAPAZ / ARARAS / AREIAS / ARENOPSIS / ARUANA / ARUANA (TRANSMISSAO) / ASA BRANCA / ATLANTICO / AURILANDIA / AVELINOPOLIS / BACURI (RIO VERDE) / BARBOSELANDIA / BARCELONA / BARREIRO (PORANGATU) / BARRO ALTO / BELA VISTA (TRANSMISSAO) / BOA VISTA / BOM JARDIM / BOM JESUS DE GOIAS / BONFINOPOLIS / BONITO / BONOPOLIS / BRAZABRANTES / BRITANIA / BRITANIA (TRANSMISSAO) / BURITI ALEGRE / BURITI DE GOIAS / BURITIZINHO / CABRIUVA (RIO VERDE) / CACHOEIRA ALTA / CACHOEIRA DOURADA / CACHOEIRA NOVA / CACHOEIRINHA (ITARUMA) / CACU / CAIAPONIA / CALCILANDIA / CALDAS NOVAS / CALDAZINHA / CAMPESTRE / CAMPINAS / CAMPINORTE / CAMPO ALEGRE DE GOIAS / CAMPO LIMPO DE GOIAS / CAMPO NOVO / CAMPOS BELOS / CAMPOS VERDES / CARAIBAS / CARAJAS / CARAMURU VICENTINOPOLIS / CASTELANDIA / CATALAO / CATURAI / CEBRASA FABRICA DA AMBEV / CEPAIGO / CEZARINA / CHAPADAO DO CEU / CIDADE ECLETICA / CIDADE OCIDENTAL / COCALZINHO / COLINACU / CORREGO ALEGRE / CORREGO DO OURO / CORUMBA / CORUMBAIBA / CRISTALINA / CRISTALINA TRANSMISSAO / CRISTIANOPOLIS / CRIXAS / CROMINIA / CUMARI / DAIA - ANAPOLIS / DAMOLANDIA / DAVINOPOLIS / DESFECHO / DESTILARIA BRASIL CENTRAL / DIMIC / DIORAMA / DORCELINO PEIXOTO DE MORAES / DOVERLANDIA / EDEALINA / EDEIA / ENERSUL / ESTANIFERA / ESTRELA DO NORTE / FAINA / FAZENDA CANADA / FAZENDA NOVA / FERROVIARIO / FIRMINOPOLIS / FLORES DE GOIAS / FORMIGA / FORMOSO / FRONTEIRA / GAMELEIRA / GIRASSOL / GOIANAPOLIS / GOIANDIRA / GOIANESIA / GOIANIA LESTE / GOIANIRA / GOIAS / GOIATUBA / GOUVERLANDIA / GOYA / GUAPO / HEITORAI / HIDROLANDIA / HIDROLINA / IACIARA / INACIOLANDIA / INDEPENDENCIA / INDIARA / INHUMAS / IPAMERI / IPEGUARI / IPORA / ISRAELANDIA / ITABERAI / ITAGUARI / ITAGUARU / ITAJA / ITAPACI / ITAPACI (TRANSMISSAO) / ITAPIRAPUA / ITAPURANGA / ITARUMA / ITAUCU / ITIQUIRA (FORMOSA) / ITUMBIARA NOVA / ITUMBIARA VELHA / JACILANDIA / JANDAIA / JARAGUA / JARANAPOLIS / JATAI / JAUPACI / JESUPOLIS / JOVIANIA / JUNDIAI / JURUMIRIM / JUSCELANDIA / JUSSARA / LAGES / LAGOA DA SERRA / LAGOA DO BAUZINHO (RIO VERDE) / LEOPOLDO DE BULHOES / LUZIANIA / LUZIANIA INDUSTRIAL / MAIRIPOTABA / MAMBAI / MARA ROSA / MARAJOARA / MARCIANOPOLIS / MARIAPOLIS (PADRE BERNARDO) / MARZAGAO / MATO GRANDE / MATRINCHA / MAURILANDIA / MEIA PONTE / MINACU / MINEIROS / MOIPORA / MONTE ALEGRE / MONTES CLAROS DE GOIAS / MONTIVIDIU T / MORRINHOS / MORRO AGUDO / MOSSAMEDES / MOZARLANDIA / MOZARLANDIA (TRANSMISSAO) / MUNDO NOVO DE GOIAS / MUTUNOPOLIS / NAVESLANDIA ( JATAI ) / NAZARIO / NEROPOLIS / NIQUELANDIA / NOVA AMERICA / NOVA AURORA / NOVA CRIXAS (TRANSMISSAO) / NOVA IGUAQU / NOVA PONTE / NOVA VENEZA / NOVO BRASIL / NOVO GAMA / NOVO PLANALTO / OLHOS DAGUA / ORIZONA / OURO VERDE DE GOIAS / OUVIDOR / PACAEMBU (NOVO GAMA) / PADRE BERNARDO / PALESTINA / PALMEIRAS / PALMEIRAS DE GOIAS / PALMELO / PALMINOPOLIS / PAMPLONA / PANAMA / PARANA / PARANAIBA / PARANAIGUARA / PARAUNA SE ALTA TENSAO / PARQUE DAS EMAS (MINEIROS) / PARQUE DAS NACOES / PEROLANDIA / PETROLINA / PILAR / PILOANDIA / PIRACANJUBA / PIRANHAS T / PIRENOPSIS / PIRES BELO / PIRES DO RIO / PLANALTINA / PLANALTINA (TRANSMISSAO) / PLANALTO / PONTALINA / PORANGATU / PORTEIRAO / PORTELANDIA / POSSE / POSSELANDIA / PROFESSOR JAMIL / QUEBRA LINHA / QUIRINOPOLIS / REAL / RETIRO / GOIAS / RIO CLARO JATAI MONTIVIDIU / RIO DO PEIXE / RIO DOS BOIS (MAURILANDIA) / RIO PRETO / RIO QUENTE / RIO VERDE / RIO VERMELHO / RIVERLANDIA (RIO VERDE) / ROCHEDO (UEH) / RUBIATABA / SANCLERLANDIA / SANTA BARBARA / SANTA FE DE GOIAS / SANTA HELENA / SANTA RITA DO ARAGUAIA / SANTA ROSA / SANTA ROSA DE GOIAS / SANTA ROSA DO MEIA PONTE / SANTA TEREZA DE GOIAS / SANTA TEREZINHA / SANTO ANTONIO DA BARRA / SANTO ANTONIO DE GOIAS / SANTO ANTONIO DO DESCOBERTO / SAO BARTOLOMEU / SAO DOMINGOS / SAO FRANCISCO DE GOIAS / SAO JOAO D ALIANCA / SAO JOAO DA PARAUNA / SAO JUDAS TADEU / SAO LUIZ DOS MONTES BELOS</p>	

			/SAO MIGUEL DO ARAGUAIA /SAO MIGUEL DO PASSA QUATRO / SENADOR CANEDO TRANSMISSAO /SERRA AZUL (JATAI) / SERRA DE CALDAS / SERRANOPOLIS / SILVANIA / SOUZALANDIA / SUCURI / TAIOBA / TAQUARAL / TAQUARI / TEREZOPOLIS / TERRA VERMELHA / TRES BARRAS / TRES RANCHOS / TRINDADE / TUCUNARE / TURVANIA / TURVELANDIA / URU / URUACU / URUTAI / USINA DE ACUCAR DE GOIANESIA / USINA MAMBAI / VALPARAISO / VARJAO / VENDA SECA / VIANOPOLIS / VICENTINOPOLIS / VILA CORUMBA / VILA PROPICIO / XAVANTES / XIXA / ZELANDIA / ALTO HORIZONTE / SANTANA / MINEIROS TRANSMISSAO
<b>Início Última Incidência (Data e Hora)</b>	25/12/2019 08:59:00		<b>Municípios Atingidos</b> ABADIA DE GOIAS / ABADIANIA / ACREUNA / ADELANDIA / AGUA FRIA DE GOIAS / AGUA LIMPA / AGUAS LINDAS DE GOIAS / ALEXANIA / ALOANDIA / ALTO HORIZONTE / ALTO PARAISO DE GOIAS / ALVORADA DO NORTE / AMARALINA / AMERICANO DO BRASIL / AMORINOPOLIS / ANAPOLIS / ANHANGUERA / ANICUNS / APARECIDA DE GOIANIA / APARECIDA DO RIO DOCE / APORE / ARACU / ARAGARCAS / ARAGOIANIA / ARAGUAPAZ / ARENOPOLIS / ARUANA / AURILANDIA / AVELINOPOLIS / BALIZA / BARRO ALTO / BELA VISTA DE GOIAS / BOM JARDIM DE GOIAS / BOM JESUS DE GOIAS / BONFINOPOLIS / BONOPOLIS / BRAZABRANTES / BRITANIA / BURITI ALEGRE / BURITI DE GOIAS / BURITINOPOLIS / CABECEIRAS / CACHOEIRA ALTA / CACHOEIRA DE GOIAS / CACHOEIRA DOURADA / CACU / CAIAPONIA / CALDAS NOVAS / CALDAZINHA / CAMPESTRE DE GOIAS / CAMPINACU / CAMPINORTE / CAMPO ALEGRE DE GOIAS / CAMPO LIMPO / CAMPOS BELOS / CAMPOS VERDES / CARMO DO RIO VERDE / CASTELANDIA / CATALAO / CATURAI / CAVALCANTE / CERES / CEZARINA / CHAPADAO DO CEU / CIDADE OCIDENTAL / COCALZINHO DE GOIAS / COLINAS DO SUL / CORREGO DO OURO / CORUMBA DE GOIAS / CORUMBAIBA / CRISTALINA / CRISTIANOPOLIS / CRIXAS / CROMINIA / CUMARI / DAMIANOPOLIS / DAMOLANDIA / DAVINOPOLIS / DIORAMA / DISTRITO FEDERAL / DIVINOPOLIS DE GOIAS / DOVERLANDIA / EDEALINA / EDEIA / ESTRELA DO NORTE / FAINA / FAZENDA NOVA / FIRMINOPOLIS / FLORES DE GOIAS / FORMOSA / FORMOSO / GAMELEIRA DE GOIAS / GOIANAPOLIS / GOIANDIRA / GOIANESIA / GOIANIA / GOIANIRA / GOIAS / GOIATUBA / GOUVELANDIA / GUAPO / GUARAITA / GUARANI DE GOIAS / GUARINOS / HEITORAI / HIDROLANDIA / HIDROLINA / IACIARA / INACIOLANDIA / INDIARA / INHUMAS / IPAMERI / IPIRANGA DE GOIAS / IPORA / ISRAELANDIA / ITABERAI / ITAGUARI / ITAGUARU / ITAJA / ITAPACI / ITAPIRAPUA / ITAPURANGA / ITARUMA / ITAUCU / ITUMBIARA / IVOLANDIA / JANDAIA / JARAGUA / JATAI / JAUPACI / JESUPOLIS / JOVIANIA / JUSSARA / LAGOA SANTA / LEOPOLDO DE BULHOES / LUZIANIA / MAIRIPOTABA / MAMBAI / MARA ROSA / MARZAGAO / MATRINCHA / MAURILANDIA / MIMOSO DE GOIAS / MINACU / MINEIROS / MOIPORA / MONTE ALEGRE DE GOIAS / MONTES CLAROS DE GOIAS / MONTIVIDIU / MONTIVIDIU DO NORTE / MORRINHOS / MORRO AGUDO DE GOIAS / MOSSAMEDES / MOZARLANDIA / MUNDO NOVO DE GOIAS / MUTUNOPOLIS / NAZARIO / NEROPOLIS / NIQUELANDIA / NOVA AMERICA / NOVA AURORA / NOVA CRIXAS / NOVA GLORIA / NOVA IGUACU DE GOIAS / NOVA ROMA / NOVA VENEZA / NOVO BRASIL / NOVO GAMA / NOVO PLANALTO / ORIZONA / OURO VERDE DE GOIAS / OUVIDOR / PADRE BERNARDO / PALESTINA DE GOIAS / PALMEIRAS DE GOIAS / PALMINOPOLIS / PANAMA / PARANAIGUARA / PARAUNA / PEROLANDIA / PETROLINA DE GOIAS / PILAR DE GOIAS / PIRACANJUBA / PIRANHAS / PIRENOPOLIS / PIRES DO RIO / PLANALTINA / PONTALINA / PORANGATU / PORTEIRAO / PORTELANDIA / POSSE / PROFESSOR JAMIL SAFADY / QUIRINOPOLIS / RIO QUENTE / RIO VERDE / RUBIATABA / SANCLERLANDIA / SANTA BARBARA DE GOIAS / SANTA CRUZ DE GOIAS / SANTA FE DE GOIAS / SANTA HELENA DE GOIAS / SANTA ISABEL / SANTA RITA DO ARAGUAIA / SANTA RITA DO NOVO DESTINO / SANTA ROSA DE GOIAS / SANTA TEREZA DE GOIAS / SANTA TEREZINHA DE GOIAS / SANTO ANTONIO DA BARRA / SANTO ANTONIO DE GOIAS / SANTO ANTONIO DO DESCOBERTO / SAO DOMINGOS / SAO FRANCISCO DE GOIAS / SAO JOAO D ALIANCA / SAO JOAO DA PARAUNA / SAO LUIS DE MONTES BELOS / SAO LUIZ DO NORTE / SAO MIGUEL DO ARAGUAIA / SAO MIGUEL DO PASSA QUATRO / SAO PATRICIO / SAO SIMAO / SENADOR CANEDO / SERRANOPOLIS / SILVANIA / SIMOLANDIA / SITIO D ABADIA / TAQUARAL DE GOIAS / TEREZOPOLIS DE GOIAS / TRES RANCHOS / TRINDADE / TROMBAS / TURVANIA / TURVELANDIA / UIRAPURU / URUACU / URUANA / URUTAI / VALPARAISO DE GOIAS / VARJAO / VIANOPOLIS / VICENTINOPOLIS / VILA BOA / VILA PROPICIO
<b>Média de Duração das Incidências (h)</b>	11,48		
<b>Duração da Incidência mais longa (h)</b>	134,10		
<b>Total de Clientes afetados</b>	751.195		

<b>DANOS CAUSADOS</b>			
<b>Equipamentos Danificado</b>	<b>Importância para o Sistema</b>	<b>Local</b>	<b>Quantidade</b>
Disjuntor/Religador Operado	Proteção do Alimentador	Área de Concessão	186
Chaves Fusíveis Operada	Proteção de Ramais de Alimentadores	Área de Concessão	2.020
Transformador Operado	Proteção do Transformador	Área de Concessão	1.671

<b>Relato técnico sobre a Intervenção realizada em Goiânia e Região Metropolitana</b>				
<b>Informações sobre Equipes</b>	22/12	23/12	24/12	
<b>Quantidade Usual</b>	595	773	773	turmas
<b>Quantidade Adicional</b>	38	39	15	turmas
<b>Quantidade Total</b>	633	812	788	turmas
<b>Tempos Médios</b>				
<b>Preparação</b>	9,06	8,49	7,27	Horas
<b>Deslocamento</b>	0,86	0,76	0,76	Horas
<b>Execução</b>	1,99	1,44	1,80	Horas
<b>TMAE</b>	11,90	10,70	9,83	Horas

### **Principais Dificuldades Encontradas:**

Chuvas com ventos fortes provocaram muitos pontos de alagamento e enxurrada, trânsito impedido por vários semáforos desligados dificultando a chegada ao atendimento das ocorrências emergenciais. Em determinadas regiões, decorrente dos fortes ventos, houve o tombamento de árvores nas estruturas de alimentação de média tensão, danos em ramais de ligação dos clientes, impedimentos de acesso e atolamentos em estradas rurais.

<b>Empresa</b>	ENEL DISTRIBUIÇÃO GOIAS		
<b>Valor CHI (Limite e Real)</b>	<b>482.391,86</b>		<b>2.492.361,84</b>



DOC ORIGEM	MIUNICIPIO	EQP_ORIGEM	CONJUNTO	INI_OCORRENC	FIM_OCORRENC	DT_INI_EVENTO	DT_FIM_EVENTO	DURAÇ	UC INT	CHI	EXPURGO
201912164332	DOVERLANDIA	DV21253679	CAIAPONIA	22/12/2019 16:23	23/12/2019 11:40	20/12/2019 11:10	23/12/2019 11:40	72,50	1	72,50	CHI
201912167017	DOVERLANDIA	DV11227943	CAIAPONIA	22/12/2019 20:11	23/12/2019 03:57	22/12/2019 10:23	23/12/2019 03:57	17,57	1	17,57	CHI
201912177033	BELA VISTA DE GOIAS	BV21130326	BELA VISTA S1	23/12/2019 11:34	24/12/2019 10:08	22/12/2019 11:22	24/12/2019 10:08	46,75	1	46,75	CHI
201912162746	SANTA HELENA DE GOIAS	SH11048890	IPEGUARI	22/12/2019 11:30	22/12/2019 17:36	22/12/2019 11:30	22/12/2019 17:36	6,10	108	658,98	CHI
201912162641	PARAUNA	JD12377478	PALMEIRAS	22/12/2019 11:35	22/12/2019 15:22	22/12/2019 11:35	22/12/2019 15:22	3,78	8	30,23	CHI
201912162642	BOM JARDIM DE GOIAS	BM12358489	BOM JARDIM	22/12/2019 11:35	22/12/2019 21:04	22/12/2019 11:35	22/12/2019 21:04	9,48	3	28,43	CHI
201912162648	IPORA	IR21112680	IPORA	22/12/2019 11:38	22/12/2019 17:14	22/12/2019 11:38	22/12/2019 17:14	5,60	1	5,60	CHI
201912162738	PALMEIRAS DE GOIAS	PL12276902	PALMEIRAS	22/12/2019 11:40	23/12/2019 16:10	22/12/2019 11:40	23/12/2019 16:10	28,49	67	1909,05	CHI
201912162656	GOUVELANDIA	QI21014261	QUIRINOPOLIS	22/12/2019 11:41	23/12/2019 09:58	22/12/2019 11:41	23/12/2019 09:58	22,28	1	22,28	CHI
201912165293	CHAPADAO DO CEU	DJ12309002	CHAPADAO DO CEU	22/12/2019 11:43	23/12/2019 07:24	22/12/2019 11:43	23/12/2019 07:24	19,68	4	78,72	CHI
201912162677	ANICUNS	AC10396902	ANICUNS	22/12/2019 11:45	23/12/2019 22:15	22/12/2019 11:45	22/12/2019 21:11	9,44	13	122,72	CHI
201912162677	ANICUNS	AC12228150LD	ANICUNS	22/12/2019 11:45	23/12/2019 22:15	22/12/2019 11:45	23/12/2019 22:15	34,50	109	3760,41	CHI
201912162677	AVELINOPOLIS	AC12228150LD	ANICUNS	22/12/2019 11:45	23/12/2019 22:15	22/12/2019 11:45	23/12/2019 22:15	34,50	1	34,50	CHI
201912162679	APARECIDA DO RIO DOCE	AW12191577	CACHOEIRA ALTA	22/12/2019 11:45	23/12/2019 11:41	22/12/2019 11:45	23/12/2019 11:41	23,92	10	239,24	CHI
201912182678	ARAGUAPAZ	AZ12193702	GOIAS	22/12/2019 11:48	24/12/2019 04:00	22/12/2019 11:48	24/12/2019 04:00	40,20	1	40,20	CHI
201912162700	SAO LUIS DE MONTES BELOS	SL31145796	SAO LUIZ DOS MONTES BELOS	22/12/2019 11:51	22/12/2019 16:49	22/12/2019 11:51	22/12/2019 16:49	4,95	1	4,95	CHI
201912162701	PARAUNA	PU11000005	PARAUNA	22/12/2019 11:52	22/12/2019 18:03	22/12/2019 11:52	22/12/2019 18:03	6,17	63	388,85	CHI
201912162718	FIRMINOPOLIS	FR12096828	FIRMINOPOLIS S1	22/12/2019 11:54	22/12/2019 20:05	22/12/2019 11:54	22/12/2019 20:05	8,18	8	65,45	CHI
201912162736	GOIAS	GS12393212	GOIAS	22/12/2019 12:03	22/12/2019 16:17	22/12/2019 12:03	22/12/2019 16:17	4,23	1	4,23	CHI
201912162752	JANDAIA	1180026874	PALMEIRAS	22/12/2019 12:06	23/12/2019 07:55	22/12/2019 12:06	23/12/2019 07:55	19,81	1	19,81	CHI
201912163290	SAO LUIS DE MONTES BELOS	6859280	SAO LUIZ DOS MONTES BELOS	22/12/2019 12:07	23/12/2019 10:10	22/12/2019 12:07	23/12/2019 10:10	22,04	5	110,18	CHI
201912162769	FAINA	MP12299729	MATRINCHA	22/12/2019 12:13	23/12/2019 17:33	22/12/2019 12:13	23/12/2019 17:33	29,34	2	58,69	CHI
201912162769	MATRINCHA	MP12299729	MATRINCHA	22/12/2019 12:13	23/12/2019 17:33	22/12/2019 12:13	23/12/2019 17:33	29,34	1	29,34	CHI
201912162783	MINEIROS	MY12184176	PARQUE DAS EMAS	22/12/2019 12:16	22/12/2019 14:32	22/12/2019 12:16	22/12/2019 14:32	2,27	7	15,86	CHI
201912162794	MINEIROS	MY12195578	PARQUE DAS EMAS	22/12/2019 12:20	22/12/2019 15:00	22/12/2019 12:20	22/12/2019 15:00	2,66	10	26,63	CHI
201912163014	JUSSARA	JR12022269	BRITANIA	22/12/2019 12:23	22/12/2019 18:02	22/12/2019 12:23	22/12/2019 18:02	5,65	30	169,38	CHI
201912163014	MONTES CLAROS DE GOIAS	JR12022269	BRITANIA	22/12/2019 12:23	22/12/2019 18:02	22/12/2019 12:23	22/12/2019 18:02	5,65	261	1473,63	CHI
201912162810	ADELANDIA	DN21304506	FIRMINOPOLIS S2	22/12/2019 12:24	23/12/2019 07:08	22/12/2019 12:24	23/12/2019 07:08	18,75	2	37,50	CHI
201912162847	ITABERAI	IB21058638	ITABERAI S2	22/12/2019 12:30	22/12/2019 20:02	22/12/2019 12:30	22/12/2019 20:02	7,53	3	22,59	CHI
201912162852	APORE	AE12000033	ITAJA S1	22/12/2019 12:30	22/12/2019 14:37	22/12/2019 12:30	22/12/2019 14:37	2,10	49	103,09	CHI
201912162865	ANICUNS	AC12020336	ANICUNS	22/12/2019 12:33	23/12/2019 07:29	22/12/2019 12:33	23/12/2019 07:29	18,93	23	435,29	CHI
201912162882	NIQUELANDIA	NQ21359862	NIQUELANDIA SUBTRANSMISSAO	22/12/2019 12:37	22/12/2019 15:58	22/12/2019 12:37	22/12/2019 15:58	3,34	1	3,34	CHI

201912162904	ITABERAÍ	IB21000141	ITABERAÍ S2	22/12/2019 12:41	22/12/2019 21:13	22/12/2019 12:41	22/12/2019 21:13	8,53	3	25,58	CHI
201912162906	SANTA HELENA DE GOÍAS	400130373	IPEGUARI	22/12/2019 12:42	22/12/2019 19:20	22/12/2019 12:42	22/12/2019 19:20	6,63	1	6,63	CHI
201912162909	SAO LUIS DE MONTES BELOS	500062286	SAO LUIZ DOS MONTES BELOS	22/12/2019 12:43	23/12/2019 08:06	22/12/2019 12:43	23/12/2019 08:06	19,38	1	19,38	CHI
201912163009	MOZARLANDIA	MZ12015614	MOZARLANDIA	22/12/2019 12:45	23/12/2019 17:11	22/12/2019 12:45	23/12/2019 17:11	28,43	13	369,62	CHI
201912162928	MOSSAMEDES	MD12037744	FIRMINOPOLIS S2	22/12/2019 12:46	23/12/2019 12:18	22/12/2019 12:46	23/12/2019 12:18	23,52	11	258,74	CHI
201912162935	CIDADE OCIDENTAL	2680184112	MARAJOARA	22/12/2019 12:48	22/12/2019 15:06	22/12/2019 12:48	22/12/2019 15:06	2,29	1	2,29	CHI
201912162940	MONTES CLAROS DE GOÍAS	ME12074392	IPORA	22/12/2019 12:49	22/12/2019 19:16	22/12/2019 12:49	22/12/2019 19:16	6,44	4	25,74	CHI
201912162942	FORMOSO	FO12072579	PORANGATU	22/12/2019 12:50	22/12/2019 20:26	22/12/2019 12:50	22/12/2019 20:26	7,60	4	30,39	CHI
201912162974	BOM JARDIM DE GOÍAS	BM11209240	BOM JARDIM	22/12/2019 12:50	23/12/2019 11:29	22/12/2019 12:50	23/12/2019 11:29	22,66	2	45,32	CHI
201912162955	PORANGATU	PO12240727	PORANGATU	22/12/2019 12:51	23/12/2019 11:35	22/12/2019 12:51	23/12/2019 11:35	22,72	1	22,72	CHI
201912162973	POSSE	PS21232219	IACIARA S2	22/12/2019 12:55	22/12/2019 16:10	22/12/2019 12:55	22/12/2019 16:10	3,24	1	3,24	CHI
201912162976	CAVALCANTE	CJ21033265	FLORES DE GOÍAS	22/12/2019 12:57	22/12/2019 15:26	22/12/2019 12:57	22/12/2019 15:26	2,48	1	2,48	CHI
201912160457	MINEIROS	SX10400642	CHAPADAO DO CEU	22/12/2019 13:00	22/12/2019 21:49	22/12/2019 13:00	22/12/2019 15:52	2,85	17	48,49	CHI
201912160457	SERRANOPOLIS	SX10400642	CHAPADAO DO CEU	22/12/2019 13:00	22/12/2019 21:49	22/12/2019 13:00	22/12/2019 15:52	2,85	47	134,07	CHI
201912160457	CHAPADAO DO CEU	02430414	CHAPADAO DO CEU	22/12/2019 13:00	22/12/2019 21:49	22/12/2019 13:00	22/12/2019 16:58	3,95	11	43,47	CHI
201912160457	SERRANOPOLIS	02430414	CHAPADAO DO CEU	22/12/2019 13:00	22/12/2019 21:49	22/12/2019 13:00	22/12/2019 16:58	3,95	12	47,43	CHI
201912160457	SERRANOPOLIS	02430414	CHAPADAO DO CEU	22/12/2019 13:00	22/12/2019 21:49	22/12/2019 13:00	22/12/2019 19:02	6,02	1	6,02	CHI
201912160457	CHAPADAO DO CEU	02430414	CHAPADAO DO CEU	22/12/2019 13:00	22/12/2019 21:49	22/12/2019 18:49	22/12/2019 19:02	0,21	11	2,34	CHI
201912160457	SERRANOPOLIS	02430414	CHAPADAO DO CEU	22/12/2019 13:00	22/12/2019 21:49	22/12/2019 18:49	22/12/2019 19:02	0,21	12	2,55	CHI
201912160457	MINEIROS	02430414	CHAPADAO DO CEU	22/12/2019 13:00	22/12/2019 21:49	22/12/2019 13:00	22/12/2019 19:26	6,42	5	32,12	CHI
201912160457	SERRANOPOLIS	02430414	CHAPADAO DO CEU	22/12/2019 13:00	22/12/2019 21:49	22/12/2019 13:00	22/12/2019 19:26	6,42	10	64,24	CHI
201912160457	SERRANOPOLIS	02430414	CHAPADAO DO CEU	22/12/2019 13:00	22/12/2019 21:49	22/12/2019 13:00	22/12/2019 20:36	7,59	4	30,36	CHI
201912160457	SERRANOPOLIS	02430414	CHAPADAO DO CEU	22/12/2019 13:00	22/12/2019 21:49	22/12/2019 13:00	22/12/2019 21:18	8,30	8	66,40	CHI
201912160457	MINEIROS	DJ13164068	CHAPADAO DO CEU	22/12/2019 13:00	22/12/2019 21:49	22/12/2019 21:39	22/12/2019 21:49	0,17	19	3,21	CHI
201912160457	SERRANOPOLIS	DJ13164068	CHAPADAO DO CEU	22/12/2019 13:00	22/12/2019 21:49	22/12/2019 21:39	22/12/2019 21:49	0,17	47	7,94	CHI
201912162991	PARAUNA	PU12163951	PARAUNA	22/12/2019 13:00	22/12/2019 20:39	22/12/2019 13:00	22/12/2019 20:39	7,63	1	7,63	CHI
201912164273	MINEIROS	MY21324400	CHAPADAO DO CEU	22/12/2019 13:00	23/12/2019 10:23	22/12/2019 13:00	23/12/2019 10:23	21,37	1	21,37	CHI
201912162996	MONTIVIDIU	MV12075512	MONTIVIDIU T	22/12/2019 13:01	22/12/2019 22:59	22/12/2019 13:01	22/12/2019 22:59	9,95	1	9,95	CHI
201912163204	MONTIVIDIU	MV12214244	MONTIVIDIU T	22/12/2019 13:01	22/12/2019 21:54	22/12/2019 13:01	22/12/2019 21:54	8,88	15	133,22	CHI
201912163204	RIO VERDE	MV12214244	MONTIVIDIU T	22/12/2019 13:01	22/12/2019 21:54	22/12/2019 13:01	22/12/2019 21:54	8,88	2	17,76	CHI
201912163005	URUTAI	UT21274689	PIRES DO RIO S2	22/12/2019 13:03	22/12/2019 15:38	22/12/2019 13:03	22/12/2019 15:38	2,57	1	2,57	CHI
201912163006	MORRINHOS	MR21128641	MORRINHOS	22/12/2019 13:04	22/12/2019 16:06	22/12/2019 13:04	22/12/2019 16:06	3,03	1	3,03	CHI
201912163033	NOVA CRIXAS	NA11061589	NOVA CRIXAS	22/12/2019 13:13	23/12/2019 10:57	22/12/2019 13:13	23/12/2019 10:57	21,72	61	1324,92	CHI

201912163035	CACHOEIRA ALTA	1090029874	CACHOEIRA ALTA	22/12/2019 13:14	22/12/2019 22:57	22/12/2019 13:14	22/12/2019 22:57	9,70	1	9,70	CHI
201912163778	MINACU	IH12392288	MINACU	22/12/2019 13:14	22/12/2019 20:35	22/12/2019 13:14	22/12/2019 20:35	7,34	5	36,71	CHI
201912163040	CRIXAS	RB12170307	RUBIATABA	22/12/2019 13:16	23/12/2019 13:28	22/12/2019 13:16	23/12/2019 13:28	24,19	1	24,19	CHI
201912163040	NOVA AMERICA	RB12170307	RUBIATABA	22/12/2019 13:16	23/12/2019 13:28	22/12/2019 13:16	23/12/2019 13:28	24,19	19	459,64	CHI
201912163040	RUBIATABA	RB12170307	RUBIATABA	22/12/2019 13:16	23/12/2019 13:28	22/12/2019 13:16	23/12/2019 13:28	24,19	56	1354,72	CHI
201912164301	CORUMBAIBA	CI12120810	VILA CORUMBA	22/12/2019 13:16	26/12/2019 20:23	22/12/2019 13:16	24/12/2019 15:55	50,66	51	2583,67	CHI
201912164301	CORUMBAIBA	CI12120810	VILA CORUMBA	22/12/2019 13:16	26/12/2019 20:23	24/12/2019 15:56	24/12/2019 17:36	1,67	50	83,68	CHI
201912164301	CORUMBAIBA	CI12081014LD	VILA CORUMBA	22/12/2019 13:16	26/12/2019 20:23	24/12/2019 15:56	26/12/2019 20:23	52,45	1	52,45	CHI
201912163041	CRIXAS	NA12229644	NOVA CRIXAS	22/12/2019 13:17	23/12/2019 14:01	22/12/2019 13:17	23/12/2019 14:01	24,73	1	24,73	CHI
201912163056	CAMPOS BELOS	CH11261948	SAO DOMINGOS	22/12/2019 13:23	22/12/2019 15:21	22/12/2019 13:23	22/12/2019 15:21	1,95	103	201,05	CHI
201912163066	NOVA CRIXAS	NA21057225	MOZARLANDIA	22/12/2019 13:29	24/12/2019 15:38	22/12/2019 13:29	24/12/2019 15:38	50,15	1	50,15	CHI
201912163113	JATAI	JT12219503	JATAI S3	22/12/2019 13:30	22/12/2019 15:01	22/12/2019 13:30	22/12/2019 15:01	1,51	5	7,54	CHI
201912163076	APARECIDA DE GOIANIA	13012101	REAL S1	22/12/2019 13:31	22/12/2019 17:31	22/12/2019 13:31	22/12/2019 17:31	3,99	1	3,99	CHI
201912163077	PLANALTINA	PI21281776	PADRE BERNARDO	22/12/2019 13:32	23/12/2019 11:02	22/12/2019 13:32	23/12/2019 11:02	21,49	4	85,97	CHI
201912167647	SAO MIGUEL DO ARAGUAIA	SM12000063	SAO MIGUEL DO ARAGUAIA	22/12/2019 13:36	23/12/2019 01:31	22/12/2019 13:36	23/12/2019 01:31	11,92	35	417,23	CHI
201912163089	CUMARI	CY21000322	CATALAO S1	22/12/2019 13:37	23/12/2019 11:10	22/12/2019 13:37	23/12/2019 11:10	21,55	1	21,55	CHI
201912163354	AURILANDIA	CG12391407	FIRMINOPOLIS S2	22/12/2019 13:38	22/12/2019 19:23	22/12/2019 13:38	22/12/2019 19:23	5,74	2	11,47	CHI
201912163354	CACHOEIRA DE GOIAS	CG12391407	FIRMINOPOLIS S2	22/12/2019 13:38	22/12/2019 19:23	22/12/2019 13:38	22/12/2019 19:23	5,74	66	378,55	CHI
201912163354	PARAUNA	CG12391407	FIRMINOPOLIS S2	22/12/2019 13:38	22/12/2019 19:23	22/12/2019 13:38	22/12/2019 19:23	5,74	32	183,54	CHI
201912163093	HIDROLANDIA	HD21283368	GUAPO S2	22/12/2019 13:39	22/12/2019 16:43	22/12/2019 13:39	22/12/2019 16:43	3,06	1	3,06	CHI
201912166774	VILA PROPICIO	NP12339454	GOIANESIA S1	22/12/2019 13:43	22/12/2019 22:50	22/12/2019 13:43	22/12/2019 22:50	9,13	103	940,50	CHI
201912164003	NOVO PLANALTO	TA12139159	NOVO PLANALTO	22/12/2019 13:45	22/12/2019 19:36	22/12/2019 13:45	22/12/2019 19:36	5,84	9	52,52	CHI
201912164003	PORANGATU	TA12139159	NOVO PLANALTO	22/12/2019 13:45	22/12/2019 19:36	22/12/2019 13:45	22/12/2019 19:36	5,84	15	87,53	CHI
201912163117	NEROPOLIS	NR21322371	NEROPOLIS S2	22/12/2019 13:46	23/12/2019 07:53	22/12/2019 13:46	23/12/2019 07:53	18,11	1	18,11	CHI
201912167273	SAO MIGUEL DO ARAGUAIA	SM12401695	SAO MIGUEL DO ARAGUAIA	22/12/2019 13:48	23/12/2019 13:48	22/12/2019 13:48	23/12/2019 13:48	24,00	3	72,00	CHI
201912163124	CASTELANDIA	ML12064391	RIO DOS BOIS	22/12/2019 13:49	23/12/2019 13:09	22/12/2019 13:49	23/12/2019 13:09	23,33	1	23,33	CHI
201912163124	MAURILANDIA	ML12064391	RIO DOS BOIS	22/12/2019 13:49	23/12/2019 13:09	22/12/2019 13:49	23/12/2019 13:09	23,33	3	69,98	CHI
201912163144	AGUAS LINDAS DE GOIAS	03730234	AGUAS LINDAS DE GOIAS S1	22/12/2019 13:49	22/12/2019 18:17	22/12/2019 13:49	22/12/2019 13:53	0,07	1969	131,27	CHI
201912163144	AGUAS LINDAS DE GOIAS	LA16413330	AGUAS LINDAS DE GOIAS S1	22/12/2019 13:49	22/12/2019 18:17	22/12/2019 13:49	22/12/2019 13:54	0,07	7786	573,14	CHI
201912163144	AGUAS LINDAS DE GOIAS	LA16408343	AGUAS LINDAS DE GOIAS S1	22/12/2019 13:49	22/12/2019 18:17	22/12/2019 13:49	22/12/2019 13:54	0,08	1047	87,25	CHI
201912163144	AGUAS LINDAS DE GOIAS	LA16413247	AGUAS LINDAS DE GOIAS S1	22/12/2019 13:49	22/12/2019 18:17	22/12/2019 13:49	22/12/2019 13:55	0,09	841	75,92	CHI
201912163144	AGUAS LINDAS DE GOIAS	LA16413330	AGUAS LINDAS DE GOIAS S1	22/12/2019 13:49	22/12/2019 18:17	22/12/2019 14:00	22/12/2019 14:08	0,14	4242	577,38	CHI
201912163144	AGUAS LINDAS DE GOIAS	LA16413333	AGUAS LINDAS DE GOIAS S1	22/12/2019 13:49	22/12/2019 18:17	22/12/2019 13:56	22/12/2019 14:12	0,26	3544	916,52	CHI

201912163144	AGUAS LINDAS DE GOIAS	LA16407112	AGUAS LINDAS DE GOIAS S1	22/12/2019 13:49	22/12/2019 18:17	22/12/2019 14:00	22/12/2019 14:13	0,21	1888	395,96	CHI
201912163144	AGUAS LINDAS DE GOIAS	LA16413240	AGUAS LINDAS DE GOIAS S1	22/12/2019 13:49	22/12/2019 18:17	22/12/2019 14:21	22/12/2019 14:41	0,34	3544	1206,93	CHI
201912163144	AGUAS LINDAS DE GOIAS	03730234	AGUAS LINDAS DE GOIAS S1	22/12/2019 13:49	22/12/2019 18:17	22/12/2019 14:23	22/12/2019 15:04	0,68	1969	1341,65	CHI
201912163144	AGUAS LINDAS DE GOIAS	LA16413333	AGUAS LINDAS DE GOIAS S1	22/12/2019 13:49	22/12/2019 18:17	22/12/2019 14:21	22/12/2019 15:40	1,32	2668	3512,87	CHI
201912163144	AGUAS LINDAS DE GOIAS	LA13149081	AGUAS LINDAS DE GOIAS S1	22/12/2019 13:49	22/12/2019 18:17	22/12/2019 14:21	22/12/2019 18:17	3,94	1574	6203,31	CHI
201912163128	INACIOLANDIA	ID21128163	QUIRINOPOLIS	22/12/2019 13:50	22/12/2019 16:47	22/12/2019 13:50	22/12/2019 16:47	2,95	1	2,95	CHI
201912163129	AGUAS LINDAS DE GOIAS	LA11370826	AGUAS LINDAS DE GOIAS S1	22/12/2019 13:50	22/12/2019 20:37	22/12/2019 13:50	22/12/2019 20:37	6,78	138	935,68	CHI
201912163136	CRISTALINA	KR12290773	CRISTALINA S2	22/12/2019 13:51	22/12/2019 15:13	22/12/2019 13:51	22/12/2019 15:13	1,36	5	6,80	CHI
201912163136	LUZIANIA	KR12290773	CRISTALINA S2	22/12/2019 13:51	22/12/2019 15:13	22/12/2019 13:51	22/12/2019 15:13	1,36	3	4,08	CHI
2019122200147	AGUAS LINDAS DE GOIAS	03730244	AGUAS LINDAS DE GOIAS S1	22/12/2019 13:55	22/12/2019 14:00	22/12/2019 13:55	22/12/2019 14:00	0,08	8391	699,25	CHI
2019122200147	AGUAS LINDAS DE GOIAS	03730254	AGUAS LINDAS DE GOIAS S1	22/12/2019 13:55	22/12/2019 14:00	22/12/2019 13:55	22/12/2019 14:00	0,08	9595	799,58	CHI
2019122200147	COCALZINHO DE GOIAS	03730244	AGUAS LINDAS DE GOIAS S1	22/12/2019 13:55	22/12/2019 14:00	22/12/2019 13:55	22/12/2019 14:00	0,08	1	0,08	CHI
2019122200147	SANTO ANTONIO DO DESCOBERTO	03730244	AGUAS LINDAS DE GOIAS S1	22/12/2019 13:55	22/12/2019 14:00	22/12/2019 13:55	22/12/2019 14:00	0,08	18	1,50	CHI
201912163147	ABADIANIA	AN12379943	ANAPOLIS UNIVERSITARIO S2	22/12/2019 13:56	22/12/2019 16:27	22/12/2019 13:56	22/12/2019 16:27	2,51	6	15,05	CHI
201912163148	SAO JOAO D ALIANCA	JL21297170	SAO JOAO D ALIANCA	22/12/2019 13:57	22/12/2019 19:28	22/12/2019 13:57	22/12/2019 19:28	5,52	1	5,52	CHI
201912164297	SAO FRANCISCO DE GOIAS	SF12079156	SAO FRANCISCO DE GOIAS	22/12/2019 13:58	22/12/2019 18:30	22/12/2019 13:58	22/12/2019 18:30	4,52	10	45,17	CHI
201912163345	PONTALINA	PK12074058	VICENTINOPOLIS	22/12/2019 14:00	22/12/2019 20:13	22/12/2019 14:00	22/12/2019 20:13	6,21	19	117,94	CHI
201912163200	SANTA RITA DO NOVO DESTINO	BA12152774	BARRO ALTO	22/12/2019 14:02	22/12/2019 17:54	22/12/2019 14:02	22/12/2019 17:54	3,86	71	274,02	CHI
201912163172	ALOANDIA	AD12394185	GOIATUBA S1	22/12/2019 14:04	23/12/2019 10:59	22/12/2019 14:04	23/12/2019 10:59	20,90	3	62,70	CHI
201912163172	JOVIANIA	AD12394185	GOIATUBA S1	22/12/2019 14:04	23/12/2019 10:59	22/12/2019 14:04	23/12/2019 10:59	20,90	2	41,80	CHI
201912163175	NOVO PLANALTO	SM12079722	SAO MIGUEL DO ARAGUAIA	22/12/2019 14:06	24/12/2019 08:30	22/12/2019 14:06	24/12/2019 08:30	42,40	3	127,20	CHI
201912163375	GUAPO	VJ13000011	GUAPO S2	22/12/2019 14:06	22/12/2019 19:05	22/12/2019 14:06	22/12/2019 18:50	4,73	127	600,11	CHI
201912163375	VARJAO	VJ13000011	GUAPO S2	22/12/2019 14:06	22/12/2019 19:05	22/12/2019 14:06	22/12/2019 18:50	4,73	97	458,35	CHI
201912163375	GUAPO	VJ13312879	GUAPO S2	22/12/2019 14:06	22/12/2019 19:05	22/12/2019 14:06	22/12/2019 19:05	4,97	3	14,91	CHI
201912163375	VARJAO	VJ13312879	GUAPO S2	22/12/2019 14:06	22/12/2019 19:05	22/12/2019 14:06	22/12/2019 19:05	4,97	103	511,88	CHI
201912166989	CORUMBAIBA	CI12110161	VILA CORUMBA	22/12/2019 14:07	22/12/2019 20:57	22/12/2019 14:07	22/12/2019 20:57	6,82	44	300,21	CHI
201912163240	CRIXAS	CX12405291	SANTA TEREZINHA	22/12/2019 14:08	23/12/2019 22:06	22/12/2019 14:08	23/12/2019 09:26	19,30	65	1254,28	CHI
201912163240	CRIXAS	CX12405291	SANTA TEREZINHA	22/12/2019 14:08	23/12/2019 22:06	22/12/2019 14:08	23/12/2019 17:05	26,95	9	242,52	CHI
201912163240	CRIXAS	CX12405291	SANTA TEREZINHA	22/12/2019 14:08	23/12/2019 22:06	22/12/2019 14:08	23/12/2019 22:06	31,97	16	511,48	CHI
201912163276	AGUAS LINDAS DE GOIAS	LA12219645	AGUAS LINDAS DE GOIAS S2	22/12/2019 14:09	22/12/2019 16:26	22/12/2019 14:09	22/12/2019 16:26	2,28	32	72,91	CHI
201912163198	JESUPOLIS	JE21124548	SAO FRANCISCO DE GOIAS	22/12/2019 14:10	22/12/2019 17:23	22/12/2019 14:10	22/12/2019 17:23	3,21	1	3,21	CHI
201912163201	ITAPURANGA	IK12274272	ITAPURANGA	22/12/2019 14:10	23/12/2019 16:43	22/12/2019 14:10	23/12/2019 16:43	26,54	1	26,54	CHI
201912163225	GOIAS	GS10405754	ITABERAI S1	22/12/2019 14:10	22/12/2019 19:00	22/12/2019 14:10	22/12/2019 19:00	4,83	53	255,99	CHI

201912163206	TURVELANDIA	TD12384565	RIO DOS BOIS	22/12/2019 14:11	22/12/2019 23:00	22/12/2019 14:11	22/12/2019 23:00	8,82	5	44,08	CHI
201912163212	LUZIANIA	LZ21237886	RIO VERMELHO	22/12/2019 14:11	22/12/2019 16:45	22/12/2019 14:11	22/12/2019 16:45	2,56	2	5,11	CHI
201912163635	JANDAIA	JD12308464	PALMEIRAS	22/12/2019 14:11	23/12/2019 09:24	22/12/2019 14:11	23/12/2019 09:24	19,20	12	230,42	CHI
201912163223	SAO LUIS DE MONTES BELOS	500014220	SAO LUIZ DOS MONTES BELOS	22/12/2019 14:13	22/12/2019 16:25	22/12/2019 14:13	22/12/2019 16:25	2,19	1	2,19	CHI
201912163224	CORUMBAIBA	CI12000529	VILA CORUMBA	22/12/2019 14:13	24/12/2019 15:18	22/12/2019 14:13	24/12/2019 15:18	49,07	2	98,14	CHI
201912163243	BURITI ALEGRE	BG12000103	ITUMBIARA VELHA S2	22/12/2019 14:13	23/12/2019 09:08	22/12/2019 14:13	23/12/2019 09:08	18,92	40	756,66	CHI
201912163238	CORUMBAIBA	CI12298710	VILA CORUMBA	22/12/2019 14:14	23/12/2019 15:57	22/12/2019 14:14	23/12/2019 15:57	25,71	14	359,91	CHI
201912163229	CATALAO	1990165154	CATALAO S2	22/12/2019 14:15	22/12/2019 17:18	22/12/2019 14:15	22/12/2019 17:18	3,05	1	3,05	CHI
201912163231	CALDAS NOVAS	CN21200087	CALDAS NOVAS S1	22/12/2019 14:16	23/12/2019 18:53	22/12/2019 14:16	23/12/2019 18:53	28,62	1	28,62	CHI
201912163244	ALEXANIA	10027220204	ALEXANIA	22/12/2019 14:19	22/12/2019 16:49	22/12/2019 14:19	22/12/2019 16:49	2,49	1	2,49	CHI
201912163247	SAO JOAO D ALIANCA	JL21325736	SAO JOAO D ALIANCA	22/12/2019 14:20	22/12/2019 21:52	22/12/2019 14:20	22/12/2019 21:52	7,53	1	7,53	CHI
201912163248	GOIATUBA	GT12041937	GOIATUBA S2	22/12/2019 14:20	23/12/2019 11:59	22/12/2019 14:20	23/12/2019 11:59	21,64	2	43,29	CHI
201912163260	SAO JOAO DA PARAUNA	RP21185264	FIRMINOPOLIS S2	22/12/2019 14:22	22/12/2019 19:15	22/12/2019 14:22	22/12/2019 19:15	4,89	1	4,89	CHI
201912163261	APARECIDA DE GOIANIA	14056914	ATLANTICO S2	22/12/2019 14:22	23/12/2019 09:57	22/12/2019 14:22	23/12/2019 09:57	19,57	1	19,57	CHI
201912163262	AGUAS LINDAS DE GOIAS	LA11377286	AGUAS LINDAS DE GOIAS S1	22/12/2019 14:22	22/12/2019 16:28	22/12/2019 14:22	22/12/2019 16:28	2,09	53	110,74	CHI
201912163263	AGUAS LINDAS DE GOIAS	10020864726	AGUAS LINDAS DE GOIAS S1	22/12/2019 14:23	22/12/2019 18:00	22/12/2019 14:23	22/12/2019 18:00	3,61	1	3,61	CHI
201912163264	CAMPO ALEGRE DE GOIAS	CM21333412	CAMPO ALEGRE DE GOIAS	22/12/2019 14:23	22/12/2019 15:22	22/12/2019 14:23	22/12/2019 15:22	0,98	2	1,95	CHI
201912163267	PONTALINA	PK12150856	PONTALINA	22/12/2019 14:23	22/12/2019 14:40	22/12/2019 14:23	22/12/2019 14:40	0,27	1	0,27	CHI
201912163275	MORRINHOS	MR11275828	GOIATUBA S1	22/12/2019 14:24	24/12/2019 00:28	22/12/2019 14:24	24/12/2019 00:28	34,05	1	34,05	CHI
201912163743	ANAPOLIS	AN12340035	DAIA S1	22/12/2019 14:24	22/12/2019 17:32	22/12/2019 14:24	22/12/2019 17:32	3,12	27	84,37	CHI
201912166054	CATURAI	CK12032824	ARACU	22/12/2019 14:24	23/12/2019 13:04	22/12/2019 14:24	23/12/2019 13:04	22,66	12	271,94	CHI
201912163307	PIRENOPOLIS	PV12185526	CORUMBA	22/12/2019 14:26	22/12/2019 16:01	22/12/2019 14:26	22/12/2019 16:01	1,57	9	14,11	CHI
201912163351	CAMPO ALEGRE DE GOIAS	CM12266783	CAMPO ALEGRE DE GOIAS	22/12/2019 14:26	22/12/2019 15:14	22/12/2019 14:26	22/12/2019 15:14	0,79	39	30,70	CHI
201912163288	NIQUELANDIA	NQ12256602	URUACU	22/12/2019 14:27	22/12/2019 18:00	22/12/2019 14:27	22/12/2019 18:00	3,55	6	21,29	CHI
201912163295	CALDAS NOVAS	760090841	CALDAS NOVAS S1	22/12/2019 14:28	23/12/2019 11:33	22/12/2019 14:28	23/12/2019 11:33	21,07	1	21,07	CHI
201912163296	AGUAS LINDAS DE GOIAS	LA11382933	AGUAS LINDAS DE GOIAS S1	22/12/2019 14:28	22/12/2019 23:35	22/12/2019 14:28	22/12/2019 23:35	9,12	136	1239,87	CHI
201912163297	PLANALTINA	PI12211502	PLANALTINA	22/12/2019 14:28	22/12/2019 18:45	22/12/2019 14:28	22/12/2019 18:45	4,27	174	743,22	CHI
201912163298	MINEIROS	MY21126518	PARQUE DAS EMAS	22/12/2019 14:28	23/12/2019 09:58	22/12/2019 14:28	23/12/2019 09:58	19,50	1	19,50	CHI
201912163301	TURVELANDIA	TD21280622	RIO DOS BOIS	22/12/2019 14:29	23/12/2019 18:20	22/12/2019 14:29	23/12/2019 18:20	27,85	1	27,85	CHI
201912163302	CRIXAS	CX12201679	SERRA DO OURO	22/12/2019 14:29	22/12/2019 14:46	22/12/2019 14:29	22/12/2019 14:46	0,27	4	1,10	CHI
201912163303	AGUAS LINDAS DE GOIAS	LA11172224	AGUAS LINDAS DE GOIAS S1	22/12/2019 14:29	22/12/2019 17:27	22/12/2019 14:29	22/12/2019 17:27	2,96	335	990,76	CHI
201912163308	AGUAS LINDAS DE GOIAS	LA11375276	AGUAS LINDAS DE GOIAS S1	22/12/2019 14:30	22/12/2019 15:55	22/12/2019 14:30	22/12/2019 15:55	1,42	76	107,56	CHI
201912165509	CORUMBAIBA	IP12167965	IPAMERI	22/12/2019 14:31	22/12/2019 19:45	22/12/2019 14:31	22/12/2019 19:45	5,23	2	10,46	CHI

201912165509	IPAMERI	IP12167965	IPAMERI	22/12/2019 14:31	22/12/2019 19:45	22/12/2019 14:31	22/12/2019 19:45	5,23	1	5,23	CHI
201912163329	AGUAS LINDAS DE GOIAS	LA11136690	AGUAS LINDAS DE GOIAS S1	22/12/2019 14:32	22/12/2019 20:36	22/12/2019 14:32	22/12/2019 20:36	6,06	36	218,27	CHI
201912163335	CAMPOS VERDES	SG12203146	SANTA TEREZINHA	22/12/2019 14:32	22/12/2019 20:34	22/12/2019 14:32	22/12/2019 20:34	6,02	8	48,17	CHI
201912163335	SANTA TEREZINHA DE GOIAS	SG12203146	SANTA TEREZINHA	22/12/2019 14:32	22/12/2019 20:34	22/12/2019 14:32	22/12/2019 20:34	6,02	8	48,17	CHI
201912163348	TRINDADE	TR11000039	TRINDADE	22/12/2019 14:32	22/12/2019 18:28	22/12/2019 14:32	22/12/2019 18:28	3,93	171	671,84	CHI
201912163651	AGUAS LINDAS DE GOIAS	LA12224038	AGUAS LINDAS DE GOIAS S1	22/12/2019 14:36	22/12/2019 17:48	22/12/2019 14:36	22/12/2019 17:48	3,19	677	2160,38	CHI
201912163814	PIRENOPOLIS	PV12008488	CORUMBA	22/12/2019 14:36	22/12/2019 16:03	22/12/2019 14:36	22/12/2019 16:03	1,44	6	8,63	CHI
201912170257	CORUMBAIBA	CI12085840	VILA CORUMBA	22/12/2019 14:36	24/12/2019 15:18	22/12/2019 14:36	24/12/2019 15:18	48,69	1	48,69	CHI
201912163356	AGUAS LINDAS DE GOIAS	10015794650	AGUAS LINDAS DE GOIAS S1	22/12/2019 14:38	22/12/2019 18:01	22/12/2019 14:38	22/12/2019 18:01	3,37	1	3,37	CHI
201912164014	NIQUELANDIA	NQ12221620	URUACU	22/12/2019 14:39	22/12/2019 19:31	22/12/2019 14:39	22/12/2019 19:31	4,85	146	708,46	CHI
201912163366	AGUAS LINDAS DE GOIAS	LA11137096	AGUAS LINDAS DE GOIAS S1	22/12/2019 14:40	22/12/2019 23:35	22/12/2019 14:40	22/12/2019 23:35	8,93	122	1089,05	CHI
201912163374	MAIRIPOTABA	MI21000457	PONTALINA	22/12/2019 14:42	23/12/2019 09:33	22/12/2019 14:42	23/12/2019 09:33	18,85	2	37,69	CHI
201912165301	BURITI ALEGRE	MR12048456	GOIATUBA S2	22/12/2019 14:43	23/12/2019 14:19	22/12/2019 14:46	23/12/2019 14:19	23,55	2	47,10	CHI
201912165301	GOIATUBA	MR12048456	GOIATUBA S2	22/12/2019 14:43	23/12/2019 14:19	22/12/2019 14:46	23/12/2019 14:19	23,55	4	94,20	CHI
201912165301	GOIATUBA	MR12048456	GOIATUBA S2	22/12/2019 14:43	23/12/2019 14:19	22/12/2019 17:39	23/12/2019 14:19	20,66	1	20,66	CHI
201912163387	BOM JARDIM DE GOIAS	BM12064233	BOM JARDIM	22/12/2019 14:44	23/12/2019 16:03	22/12/2019 14:44	23/12/2019 16:03	25,31	5	126,55	CHI
201912163399	PETROLINA DE GOIAS	PG21191014	INHUMAS S1	22/12/2019 14:47	22/12/2019 19:07	22/12/2019 14:47	22/12/2019 19:07	4,32	2	8,65	CHI
201912163820	MAIRIPOTABA	PK13389892	PONTALINA	22/12/2019 14:49	23/12/2019 22:43	22/12/2019 14:49	23/12/2019 12:10	21,35	9	192,13	CHI
201912163820	PONTALINA	PK13389892	PONTALINA	22/12/2019 14:49	23/12/2019 22:43	22/12/2019 14:49	23/12/2019 12:10	21,35	202	4312,31	CHI
201912163820	PONTALINA	PK13389892	PONTALINA	22/12/2019 14:49	23/12/2019 22:43	23/12/2019 11:35	23/12/2019 12:10	0,58	509	296,78	CHI
201912163820	PONTALINA	PK32045985RE	PONTALINA	22/12/2019 14:49	23/12/2019 22:43	22/12/2019 14:49	23/12/2019 20:09	29,33	14	410,67	CHI
201912163820	MAIRIPOTABA	PK32045985RE	PONTALINA	22/12/2019 14:49	23/12/2019 22:43	23/12/2019 16:01	23/12/2019 20:09	4,14	1	4,14	CHI
201912163820	PONTALINA	PK32045985RE	PONTALINA	22/12/2019 14:49	23/12/2019 22:43	23/12/2019 16:01	23/12/2019 20:09	4,14	23	95,12	CHI
201912163820	MAIRIPOTABA	PK13390269	PONTALINA	22/12/2019 14:49	23/12/2019 22:43	22/12/2019 14:49	23/12/2019 22:43	31,90	74	2360,50	CHI
201912163820	PONTALINA	PK13390269	PONTALINA	22/12/2019 14:49	23/12/2019 22:43	22/12/2019 14:49	23/12/2019 22:43	31,90	17	542,28	CHI
201912163820	PROFESSOR JAMIL SAFADY	PK13390269	PONTALINA	22/12/2019 14:49	23/12/2019 22:43	22/12/2019 14:49	23/12/2019 22:43	31,90	1	31,90	CHI
201912163820	MAIRIPOTABA	PK13390269	PONTALINA	22/12/2019 14:49	23/12/2019 22:43	23/12/2019 16:00	23/12/2019 22:43	6,72	1	6,72	CHI
201912163820	PROFESSOR JAMIL SAFADY	PK13390269	PONTALINA	22/12/2019 14:49	23/12/2019 22:43	23/12/2019 16:00	23/12/2019 22:43	6,72	14	94,04	CHI
201912163518	CROMINIA	MI12249916RE	PONTALINA	22/12/2019 14:52	23/12/2019 11:28	22/12/2019 14:52	23/12/2019 11:28	20,59	13	267,65	CHI
201912163518	MAIRIPOTABA	MI12249916RE	PONTALINA	22/12/2019 14:52	23/12/2019 11:28	22/12/2019 14:52	23/12/2019 11:28	20,59	57	1173,53	CHI
201912163649	MIMOSO DE GOIAS	PV12152505	BARRO ALTO	22/12/2019 14:52	23/12/2019 04:00	22/12/2019 14:52	23/12/2019 04:00	13,12	9	118,08	CHI
201912163649	NIQUELANDIA	PV12152505	BARRO ALTO	22/12/2019 14:52	23/12/2019 04:00	22/12/2019 14:52	23/12/2019 04:00	13,12	12	157,44	CHI
201912163649	VILA PROPICIO	PV12152505	BARRO ALTO	22/12/2019 14:52	23/12/2019 04:00	22/12/2019 14:52	23/12/2019 04:00	13,12	22	288,64	CHI

201912163419	EDEALINA	01510444	PONTALINA	22/12/2019 14:53	22/12/2019 17:32	22/12/2019 14:53	22/12/2019 17:32	2,65	21	55,65	CHI
201912163419	PONTALINA	01510444	PONTALINA	22/12/2019 14:53	22/12/2019 17:32	22/12/2019 14:53	22/12/2019 17:32	2,65	241	638,65	CHI
201912163521	AGUAS LINDAS DE GOIAS	LA12050951	AGUAS LINDAS DE GOIAS S1	22/12/2019 14:53	22/12/2019 19:42	22/12/2019 14:53	22/12/2019 19:42	4,83	741	3576,77	CHI
201912163420	PONTALINA	01510224	PONTALINA	22/12/2019 14:55	22/12/2019 16:29	22/12/2019 14:55	22/12/2019 15:01	0,10	3840	389,33	CHI
201912163420	PONTALINA	01510224	PONTALINA	22/12/2019 14:55	22/12/2019 16:29	22/12/2019 15:03	22/12/2019 15:18	0,24	3840	938,67	CHI
201912163420	PONTALINA	01510224	PONTALINA	22/12/2019 14:55	22/12/2019 16:29	22/12/2019 15:19	22/12/2019 16:29	1,17	3840	4505,60	CHI
201912163530	PADRE BERNARDO	PB12216115	PADRE BERNARDO	22/12/2019 14:55	22/12/2019 17:01	22/12/2019 14:55	22/12/2019 17:01	2,08	13	27,10	CHI
201912163534	AMERICANO DO BRASIL	KB12000027	ANICUNS	22/12/2019 14:56	22/12/2019 17:45	22/12/2019 14:56	22/12/2019 17:45	2,81	39	109,63	CHI
201912163534	ANICUNS	KB12000027	ANICUNS	22/12/2019 14:56	22/12/2019 17:45	22/12/2019 14:56	22/12/2019 17:45	2,81	188	528,49	CHI
201912163534	ITABERAÍ	KB12000027	ANICUNS	22/12/2019 14:56	22/12/2019 17:45	22/12/2019 14:56	22/12/2019 17:45	2,81	2	5,62	CHI
201912163537	FORMOSA	FA21116873	ITIQUEIRA	22/12/2019 14:56	22/12/2019 21:04	22/12/2019 14:56	22/12/2019 21:04	6,12	1	6,12	CHI
201912163694	RIO VERDE	RV12222616	RIO VERDE S2	22/12/2019 14:56	22/12/2019 17:33	22/12/2019 14:56	22/12/2019 17:33	2,61	13	33,91	CHI
201912163414	RIO VERDE	02450434	CABRIUVA S2	22/12/2019 14:57	23/12/2019 20:19	22/12/2019 14:57	22/12/2019 21:47	6,83	88	601,31	CHI
201912163414	RIO VERDE	02450434	CABRIUVA S2	22/12/2019 14:57	23/12/2019 20:19	22/12/2019 14:57	22/12/2019 21:47	6,83	1	6,83	CHI
201912163414	APARECIDA DO RIO DOCE	02450434	CABRIUVA S2	22/12/2019 14:57	23/12/2019 20:19	22/12/2019 14:57	22/12/2019 22:31	7,57	6	45,41	CHI
201912163414	QUIRINOPOLIS	02450434	CABRIUVA S2	22/12/2019 14:57	23/12/2019 20:19	22/12/2019 14:57	22/12/2019 22:31	7,57	4	30,27	CHI
201912163414	RIO VERDE	02450434	CABRIUVA S2	22/12/2019 14:57	23/12/2019 20:19	22/12/2019 14:57	22/12/2019 22:31	7,57	115	870,39	CHI
201912163414	RIO VERDE	02450434	CABRIUVA S2	22/12/2019 14:57	23/12/2019 20:19	22/12/2019 14:57	22/12/2019 22:31	7,57	214	1619,68	CHI
201912163414	RIO VERDE	02450434	CABRIUVA S2	22/12/2019 14:57	23/12/2019 20:19	22/12/2019 14:57	22/12/2019 22:31	7,57	131	991,49	CHI
201912163414	RIO VERDE	02450434	CABRIUVA S2	22/12/2019 14:57	23/12/2019 20:19	22/12/2019 14:57	22/12/2019 22:31	7,56	1	7,56	CHI
201912163414	RIO VERDE	02450434	CABRIUVA S2	22/12/2019 14:57	23/12/2019 20:19	22/12/2019 14:57	22/12/2019 23:11	8,24	14	115,39	CHI
201912163414	RIO VERDE	02450434	CABRIUVA S2	22/12/2019 14:57	23/12/2019 20:19	22/12/2019 14:57	23/12/2019 20:19	29,36	14	411,10	CHI
201912163414	RIO VERDE	RV13191199	CABRIUVA S2	22/12/2019 14:57	23/12/2019 20:19	22/12/2019 17:09	23/12/2019 20:19	27,17	2	54,33	CHI
201912163540	COCALZINHO DE GOIAS	ZN21321418	COCALZINHO	22/12/2019 14:57	22/12/2019 19:38	22/12/2019 14:57	22/12/2019 19:38	4,68	1	4,68	CHI
201912164225	INHUMAS	IN12011990	INHUMAS S1	22/12/2019 14:57	22/12/2019 18:25	22/12/2019 14:57	22/12/2019 18:25	3,46	53	183,42	CHI
201912162018	BOM JESUS DE GOIAS	JV12222565RE	VICENTINOPOLIS	22/12/2019 14:58	23/12/2019 15:58	22/12/2019 14:58	23/12/2019 15:58	25,00	3	75,01	CHI
201912162018	GOIATUBA	JV12222565RE	VICENTINOPOLIS	22/12/2019 14:58	23/12/2019 15:58	22/12/2019 14:58	23/12/2019 15:58	25,00	10	250,03	CHI
201912162018	JOVIANIA	JV12222565RE	VICENTINOPOLIS	22/12/2019 14:58	23/12/2019 15:58	22/12/2019 14:58	23/12/2019 15:58	25,00	4	100,01	CHI
201912163545	PIRENOPOLIS	PV12297744	CORUMBA	22/12/2019 14:58	22/12/2019 16:34	22/12/2019 14:58	22/12/2019 16:34	1,60	30	47,99	CHI
201912163643	APORE	09929511	ITAJA S1	22/12/2019 14:58	23/12/2019 19:18	22/12/2019 14:59	22/12/2019 15:05	0,10	1567	156,70	CHI
201912163643	DISTRITO FEDERAL	09929511	ITAJA S1	22/12/2019 14:58	23/12/2019 19:18	22/12/2019 14:59	22/12/2019 15:05	0,10	2	0,20	CHI
201912163643	ITARUMA	09929511	ITAJA S1	22/12/2019 14:58	23/12/2019 19:18	22/12/2019 14:59	22/12/2019 15:05	0,10	1	0,10	CHI
201912163643	JATAÍ	09929511	ITAJA S1	22/12/2019 14:58	23/12/2019 19:18	22/12/2019 14:59	22/12/2019 15:05	0,10	1	0,10	CHI

201912163643	APORE	IM10401499	ITAJA S2	22/12/2019 14:58	23/12/2019 19:18	22/12/2019 14:59	22/12/2019 15:07	0,15	4	0,58	CHI
201912163643	DISTRITO FEDERAL	09929511	ITAJA S2	22/12/2019 14:58	23/12/2019 19:18	22/12/2019 14:59	22/12/2019 15:07	0,15	10	1,46	CHI
201912163643	ITAJA	09929511	ITAJA S2	22/12/2019 14:58	23/12/2019 19:18	22/12/2019 14:59	22/12/2019 15:07	0,15	45	6,56	CHI
201912163643	ITAJA	09929511	ITAJA S2	22/12/2019 14:58	23/12/2019 19:18	22/12/2019 14:59	22/12/2019 15:07	0,15	1743	254,19	CHI
201912163643	ITAJA	IM10401499	ITAJA S2	22/12/2019 14:58	23/12/2019 19:18	22/12/2019 14:59	22/12/2019 15:07	0,15	92	13,42	CHI
201912163643	ITARUMA	IM10401499	ITAJA S2	22/12/2019 14:58	23/12/2019 19:18	22/12/2019 14:59	22/12/2019 15:07	0,15	99	14,44	CHI
201912163643	LAGOA SANTA	09929511	ITAJA S2	22/12/2019 14:58	23/12/2019 19:18	22/12/2019 14:59	22/12/2019 15:07	0,15	756	110,25	CHI
201912163643	ITAJA	09929511	ITAJA S2	22/12/2019 14:58	23/12/2019 19:18	22/12/2019 14:59	22/12/2019 16:15	1,28	11	14,06	CHI
201912163643	ITAJA	09929511	ITAJA S2	22/12/2019 14:58	23/12/2019 19:18	22/12/2019 16:16	22/12/2019 16:50	0,57	2	1,13	CHI
201912163643	APORE	09929511	ITAJA S1	22/12/2019 14:58	23/12/2019 19:18	22/12/2019 14:59	22/12/2019 17:37	2,65	93	246,06	CHI
201912163643	APORE	09929511	ITAJA S1	22/12/2019 14:58	23/12/2019 19:18	22/12/2019 14:59	22/12/2019 17:37	2,65	55	145,52	CHI
201912163643	APORE	09929511	ITAJA S1	22/12/2019 14:58	23/12/2019 19:18	22/12/2019 14:59	22/12/2019 17:37	2,65	7	18,52	CHI
201912163643	SERRANOPOLIS	09929511	ITAJA S1	22/12/2019 14:58	23/12/2019 19:18	22/12/2019 14:59	22/12/2019 17:37	2,65	46	121,71	CHI
201912163643	APORE	09929511	ITAJA S2	22/12/2019 14:58	23/12/2019 19:18	22/12/2019 14:59	22/12/2019 17:37	2,65	116	306,92	CHI
201912163643	DISTRITO FEDERAL	09929511	ITAJA S2	22/12/2019 14:58	23/12/2019 19:18	22/12/2019 14:59	22/12/2019 17:37	2,65	3	7,94	CHI
201912163643	ITAJA	09929511	ITAJA S2	22/12/2019 14:58	23/12/2019 19:18	22/12/2019 14:59	22/12/2019 17:37	2,65	16	42,33	CHI
201912163643	ITAJA	IJ10400571	ITAJA S2	22/12/2019 14:58	23/12/2019 19:18	22/12/2019 16:16	22/12/2019 18:27	2,19	9	19,70	CHI
201912163643	ITAJA	09929511	ITAJA S2	22/12/2019 14:58	23/12/2019 19:18	23/12/2019 17:38	23/12/2019 18:21	0,72	2	1,43	CHI
201912163643	ITAJA	IJ13214500	ITAJA S2	22/12/2019 14:58	23/12/2019 19:18	23/12/2019 17:18	23/12/2019 18:50	1,53	9	13,78	CHI
201912163643	APORE	09929511	ITAJA S2	22/12/2019 14:58	23/12/2019 19:18	23/12/2019 17:38	23/12/2019 19:10	1,54	22	33,77	CHI
201912163643	DISTRITO FEDERAL	09929511	ITAJA S2	22/12/2019 14:58	23/12/2019 19:18	23/12/2019 17:38	23/12/2019 19:10	1,54	2	3,07	CHI
201912163643	ITAJA	09929511	ITAJA S2	22/12/2019 14:58	23/12/2019 19:18	23/12/2019 17:38	23/12/2019 19:10	1,54	15	23,03	CHI
201912163643	APORE	09929511	ITAJA S1	22/12/2019 14:58	23/12/2019 19:18	23/12/2019 17:38	23/12/2019 19:18	1,68	95	159,57	CHI
201912163643	APORE	09929511	ITAJA S1	22/12/2019 14:58	23/12/2019 19:18	23/12/2019 17:38	23/12/2019 19:18	1,68	55	92,38	CHI
201912163643	APORE	09929511	ITAJA S1	22/12/2019 14:58	23/12/2019 19:18	23/12/2019 17:38	23/12/2019 19:18	1,68	7	11,76	CHI
201912163643	SERRANOPOLIS	09929511	ITAJA S1	22/12/2019 14:58	23/12/2019 19:18	23/12/2019 17:38	23/12/2019 19:18	1,68	46	77,27	CHI
201912163643	APORE	09929511	ITAJA S2	22/12/2019 14:58	23/12/2019 19:18	23/12/2019 17:38	23/12/2019 19:18	1,68	94	157,89	CHI
201912163643	APORE	09929511	ITAJA S1	22/12/2019 14:58	23/12/2019 19:18	23/12/2019 17:49	23/12/2019 19:18	1,50	1	1,50	CHI
201912165797	NOVO PLANALTO	TA12243601	NOVO PLANALTO	22/12/2019 14:58	22/12/2019 19:14	22/12/2019 14:58	22/12/2019 19:14	4,25	40	170,18	CHI
201912163556	CRIXAS	GF12243493	SANTA TEREZINHA	22/12/2019 14:59	23/12/2019 11:33	22/12/2019 14:59	23/12/2019 11:33	20,56	3	61,67	CHI
201912163556	GUARINOS	GF12243493	SANTA TEREZINHA	22/12/2019 14:59	23/12/2019 11:33	22/12/2019 14:59	23/12/2019 11:33	20,56	13	267,25	CHI
201912163559	URUACU	UR12390448	URUACU	22/12/2019 14:59	22/12/2019 17:11	22/12/2019 14:59	22/12/2019 17:11	2,18	95	207,55	CHI
201912163563	TRINDADE	TR11401100	TRINDADE	22/12/2019 15:00	22/12/2019 22:55	22/12/2019 15:00	22/12/2019 22:55	7,91	1	7,91	CHI



201912163566	ARAGUAPAZ	AZ12311301	MOZARLANDIA	22/12/2019 15:00	23/12/2019 08:54	22/12/2019 15:00	23/12/2019 08:54	17,89	2	35,77	CHI
201912164060	ITARUMA	IM12087819	CACHOEIRA ALTA	22/12/2019 15:00	23/12/2019 16:54	22/12/2019 15:00	23/12/2019 16:54	25,90	7	181,27	CHI
201912163573	RIO VERDE	10014679530	CABRIUVA S1	22/12/2019 15:01	22/12/2019 18:33	22/12/2019 15:01	22/12/2019 18:33	3,52	1	3,52	CHI
201912167143	AGUAS LINDAS DE GOIAS	LA11155449	AGUAS LINDAS DE GOIAS S1	22/12/2019 15:01	22/12/2019 21:32	22/12/2019 15:01	22/12/2019 21:32	6,50	233	1514,63	CHI
201912163578	GOIANIA	GN11293516	INDEPENDENCIA S2	22/12/2019 15:02	22/12/2019 17:27	22/12/2019 15:02	22/12/2019 17:27	2,42	87	210,15	CHI
201912163579	GOIANIA	10020935305	MEIA PONTE	22/12/2019 15:02	22/12/2019 16:42	22/12/2019 15:02	22/12/2019 16:42	1,66	1	1,66	CHI
201912163878	AGUAS LINDAS DE GOIAS	LA11348559	AGUAS LINDAS DE GOIAS S1	22/12/2019 15:02	22/12/2019 18:43	22/12/2019 15:02	22/12/2019 18:43	3,67	200	733,83	CHI
201912163594	GOIANIA	16289900	CARAJAS S1	22/12/2019 15:03	22/12/2019 15:59	22/12/2019 15:03	22/12/2019 15:59	0,92	1	0,92	CHI
201912163872	CROMINIA	CQ12060616	ROCHEDO	22/12/2019 15:03	23/12/2019 11:13	22/12/2019 15:03	23/12/2019 11:13	20,17	20	403,32	CHI
201912166237	ANICUNS	AC21304635	ANICUNS	22/12/2019 15:03	23/12/2019 06:33	22/12/2019 15:03	23/12/2019 06:33	15,50	1	15,50	CHI
201912176799	CROMINIA	CQ21109233	ROCHEDO	22/12/2019 15:03	23/12/2019 17:41	22/12/2019 15:03	23/12/2019 17:41	26,62	1	26,62	CHI
201912163602	GOUVELANDIA	GB12303158	QUIRINOPOLIS	22/12/2019 15:04	23/12/2019 14:46	22/12/2019 15:04	23/12/2019 14:46	23,69	1	23,69	CHI
201912163605	RIO VERDE	RV12371510	RIO VERDE S1	22/12/2019 15:04	22/12/2019 18:58	22/12/2019 15:04	22/12/2019 18:58	3,89	54	209,82	CHI
201912163691	PONTALINA	PK12389889	PONTALINA	22/12/2019 15:04	22/12/2019 20:30	22/12/2019 15:04	22/12/2019 20:30	5,43	90	488,47	CHI
201912163841	ITARUMA	IM12086918	CACHOEIRA ALTA	22/12/2019 15:04	23/12/2019 07:09	22/12/2019 15:04	23/12/2019 07:09	16,08	6	96,49	CHI
201912163611	BALIZA	BH11331341	CAIAPONIA	22/12/2019 15:05	22/12/2019 22:05	22/12/2019 15:05	22/12/2019 22:05	6,99	1	6,99	CHI
201912164229	GOIANIRA	GR11117279	GOIANIRA	22/12/2019 15:05	22/12/2019 22:40	22/12/2019 15:05	22/12/2019 22:40	7,58	171	1295,61	CHI
201912183623	SERRANOPOLIS	SX12390576	JATAI S1	22/12/2019 15:05	24/12/2019 09:59	22/12/2019 15:05	24/12/2019 09:59	42,88	9	385,96	CHI
201912163615	NIQUELANDIA	NQ12317176	NIQUELANDIA SUBTRANSMISSAO	22/12/2019 15:06	22/12/2019 18:34	22/12/2019 15:06	22/12/2019 18:34	3,46	75	259,71	CHI
201912163632	SERRANOPOLIS	SX12226484	JATAI S1	22/12/2019 15:07	22/12/2019 17:28	22/12/2019 15:07	22/12/2019 17:28	2,34	14	32,78	CHI
201912163630	RIO VERDE	10003564469	RIO VERDE S2	22/12/2019 15:08	23/12/2019 04:20	22/12/2019 15:08	23/12/2019 04:20	13,20	1	13,20	CHI
201912163633	RIO VERDE	RV12200055LD	RIO VERDE S1	22/12/2019 15:08	22/12/2019 21:15	22/12/2019 15:08	22/12/2019 21:15	6,10	18	109,82	CHI
201912163640	JATAI	JT12260433	JATAI S1	22/12/2019 15:10	23/12/2019 09:00	22/12/2019 15:10	23/12/2019 09:00	17,83	1	17,83	CHI
201912163640	PEROLANDIA	JT12260433	JATAI S1	22/12/2019 15:10	23/12/2019 09:00	22/12/2019 15:10	23/12/2019 09:00	17,83	5	89,16	CHI
201912163641	MORRINHOS	MR21263628	MORRINHOS	22/12/2019 15:10	23/12/2019 09:14	22/12/2019 15:10	23/12/2019 09:14	18,06	1	18,06	CHI
201912164903	AGUA LIMPA	02660414	VILA CORUMBA	22/12/2019 15:10	22/12/2019 23:23	22/12/2019 15:10	22/12/2019 23:23	8,22	483	3968,78	CHI
201912164903	AGUA LIMPA	02660414	VILA CORUMBA	22/12/2019 15:10	22/12/2019 23:23	22/12/2019 15:10	22/12/2019 23:23	8,22	127	1043,55	CHI
201912164903	AGUA LIMPA	02660414	VILA CORUMBA	22/12/2019 15:10	22/12/2019 23:23	22/12/2019 15:10	22/12/2019 23:23	8,22	7	57,52	CHI
201912164903	MARZAGAO	02660414	VILA CORUMBA	22/12/2019 15:10	22/12/2019 23:23	22/12/2019 15:10	22/12/2019 23:23	8,22	4	32,87	CHI
201912164903	MARZAGAO	02660414	VILA CORUMBA	22/12/2019 15:10	22/12/2019 23:23	22/12/2019 15:10	22/12/2019 23:23	8,22	35	287,59	CHI
201912164903	MORRINHOS	02660414	VILA CORUMBA	22/12/2019 15:10	22/12/2019 23:23	22/12/2019 15:10	22/12/2019 23:23	8,22	52	427,28	CHI
201912163552	NOVO PLANALTO	TA12369993	NOVO PLANALTO	22/12/2019 15:11	22/12/2019 19:06	22/12/2019 15:11	22/12/2019 19:06	3,91	51	199,51	CHI
201912163612	SERRANOPOLIS	SX12182120	JATAI S1	22/12/2019 15:11	24/12/2019 09:45	22/12/2019 15:11	24/12/2019 09:45	42,55	16	680,82	CHI

201912163668	VARJAO	VJ12362485	GUAPO S2	22/12/2019 15:12	22/12/2019 21:15	22/12/2019 15:12	22/12/2019 21:15	6,05	40	241,90	CHI
201912163665	BELA VISTA DE GOIAS	BV12000046	CEPAIGO S2	22/12/2019 15:13	22/12/2019 18:02	22/12/2019 15:13	22/12/2019 18:02	2,82	30	84,51	CHI
201912163669	BURITI ALEGRE	BG21316688	ITUMBIARA VELHA S2	22/12/2019 15:13	23/12/2019 13:50	22/12/2019 15:13	23/12/2019 13:50	22,61	1	22,61	CHI
201912163676	MORRINHOS	150138090	MORRINHOS	22/12/2019 15:14	23/12/2019 11:49	22/12/2019 15:14	23/12/2019 11:49	20,58	1	20,58	CHI
201912163677	ANICUNS	910070672	ANICUNS	22/12/2019 15:14	23/12/2019 10:07	22/12/2019 15:14	23/12/2019 10:07	18,88	1	18,88	CHI
201912163418	NOVO GAMA	NJ16403878	PACAEMBU S1	22/12/2019 15:15	22/12/2019 23:35	22/12/2019 21:32	22/12/2019 23:02	1,51	4097	6169,40	CHI
201912163418	ALEXANIA	01350424	MARAJOARA	22/12/2019 15:15	22/12/2019 23:35	22/12/2019 15:15	22/12/2019 23:35	8,33	5	41,65	CHI
201912163418	DISTRITO FEDERAL	01350424	MARAJOARA	22/12/2019 15:15	22/12/2019 23:35	22/12/2019 15:15	22/12/2019 23:35	8,33	3	24,99	CHI
201912163418	NOVO GAMA	01350424	MARAJOARA	22/12/2019 15:15	22/12/2019 23:35	22/12/2019 15:15	22/12/2019 23:35	8,33	10	83,30	CHI
201912163418	NOVO GAMA	NJ13297254	MARAJOARA	22/12/2019 15:15	22/12/2019 23:35	22/12/2019 15:15	22/12/2019 23:35	8,33	1	8,33	CHI
201912163418	SANTO ANTONIO DO DESCOBERTO	01350424	MARAJOARA	22/12/2019 15:15	22/12/2019 23:35	22/12/2019 15:15	22/12/2019 23:35	8,33	510	4248,16	CHI
201912163418	SANTO ANTONIO DO DESCOBERTO	NJ13297254	MARAJOARA	22/12/2019 15:15	22/12/2019 23:35	22/12/2019 15:15	22/12/2019 23:35	8,33	21	174,92	CHI
201912163681	CACU	CC21193954	CACHOEIRA ALTA	22/12/2019 15:15	23/12/2019 03:05	22/12/2019 15:15	23/12/2019 03:05	11,85	1	11,85	CHI
201912163686	ANAPOLIS	AN21302133	ANAPOLIS UNIVERSITARIO S2	22/12/2019 15:15	22/12/2019 17:57	22/12/2019 15:15	22/12/2019 17:57	2,69	115	309,22	CHI
201912163687	ANAPOLIS	21385440	ANAPOLIS UNIVERSITARIO S2	22/12/2019 15:15	22/12/2019 17:16	22/12/2019 15:15	22/12/2019 17:16	2,00	1	2,00	CHI
201912163693	MORRINHOS	MR21236053	GOIATUBA S1	22/12/2019 15:17	23/12/2019 15:56	22/12/2019 15:17	23/12/2019 15:56	24,65	1	24,65	CHI
201912163697	RIO VERDE	RV21210326	MONTIVIDIU T	22/12/2019 15:17	23/12/2019 11:47	22/12/2019 15:17	23/12/2019 11:47	20,49	1	20,49	CHI
201912163735	ANICUNS	AC12304664	FIRMINOPOLIS S2	22/12/2019 15:17	23/12/2019 13:40	22/12/2019 15:17	23/12/2019 13:40	22,37	12	268,44	CHI
201912177597	ANICUNS	AC21304679	FIRMINOPOLIS S2	22/12/2019 15:17	24/12/2019 06:58	22/12/2019 15:17	24/12/2019 06:58	39,68	2	79,36	CHI
201912163713	HIDROLANDIA	HD31156920	CEPAIGO S2	22/12/2019 15:18	22/12/2019 20:46	22/12/2019 15:18	22/12/2019 20:46	5,46	2	10,92	CHI
201912164434	AGUAS LINDAS DE GOIAS	LA11149831	AGUAS LINDAS DE GOIAS S1	22/12/2019 15:18	22/12/2019 18:56	22/12/2019 15:18	22/12/2019 18:00	2,69	342	921,21	CHI
201912164434	AGUAS LINDAS DE GOIAS	LA12377247	AGUAS LINDAS DE GOIAS S1	22/12/2019 15:18	22/12/2019 18:56	22/12/2019 18:15	22/12/2019 18:56	0,69	874	600,63	CHI
201912165633	JARAGUA	JA11144544	JARAGUA	22/12/2019 15:19	23/12/2019 01:29	22/12/2019 15:19	23/12/2019 01:29	10,17	148	1504,58	CHI
201912163753	BELA VISTA DE GOIAS	BV11000113	CEPAIGO S2	22/12/2019 15:22	22/12/2019 18:40	22/12/2019 15:22	22/12/2019 18:40	3,29	6	19,74	CHI
201912164666	AGUAS LINDAS DE GOIAS	LA11133115	AGUAS LINDAS DE GOIAS S2	22/12/2019 15:22	22/12/2019 18:36	22/12/2019 15:22	22/12/2019 18:36	3,22	120	386,90	CHI
201912163431	CAMPO ALEGRE DE GOIAS	02250434	CAMPO ALEGRE DE GOIAS	22/12/2019 15:24	22/12/2019 23:31	22/12/2019 15:24	22/12/2019 17:17	1,89	98	185,17	CHI
201912163431	CAMPO ALEGRE DE GOIAS	02250434	CAMPO ALEGRE DE GOIAS	22/12/2019 15:24	22/12/2019 23:31	22/12/2019 15:26	22/12/2019 17:17	1,84	1	1,84	CHI
201912163431	CAMPO ALEGRE DE GOIAS	02250434	CAMPO ALEGRE DE GOIAS	22/12/2019 15:24	22/12/2019 23:31	22/12/2019 15:24	22/12/2019 19:33	4,16	120	498,77	CHI
201912163431	CAMPO ALEGRE DE GOIAS	02250434	CAMPO ALEGRE DE GOIAS	22/12/2019 15:24	22/12/2019 23:31	22/12/2019 15:24	22/12/2019 21:24	6,00	4	24,01	CHI
201912163431	CATALAO	02250434	CAMPO ALEGRE DE GOIAS	22/12/2019 15:24	22/12/2019 23:31	22/12/2019 15:24	22/12/2019 21:24	6,00	33	198,10	CHI
201912163431	CATALAO	02250434	CAMPO ALEGRE DE GOIAS	22/12/2019 15:24	22/12/2019 23:31	22/12/2019 15:24	22/12/2019 23:31	8,12	27	219,37	CHI
201912163467	SAO MIGUEL DO ARAGUAIA	SM10391487	SAO MIGUEL DO ARAGUAIA	22/12/2019 15:24	23/12/2019 00:47	22/12/2019 15:24	22/12/2019 23:19	7,91	43	339,94	CHI
201912163467	SAO MIGUEL DO ARAGUAIA	SM10404193	SAO MIGUEL DO ARAGUAIA	22/12/2019 15:24	23/12/2019 00:47	22/12/2019 15:24	22/12/2019 23:43	8,31	12	99,74	CHI

201912163467	SAO MIGUEL DO ARAGUAIA	SM12016662	SAO MIGUEL DO ARAGUAIA	22/12/2019 15:24	23/12/2019 00:47	22/12/2019 15:24	23/12/2019 00:47	9,37	2	18,74	CHI
201912163763	AGUAS LINDAS DE GOIAS	LA11203799	AGUAS LINDAS DE GOIAS S1	22/12/2019 15:25	22/12/2019 18:53	22/12/2019 15:25	22/12/2019 18:53	3,46	129	446,38	CHI
201912163802	CACHOEIRA ALTA	CA12306204	CACHOEIRA ALTA	22/12/2019 15:25	22/12/2019 18:45	22/12/2019 16:10	22/12/2019 16:43	0,54	78	42,40	CHI
201912163802	CACHOEIRA ALTA	CA11041741	CACHOEIRA ALTA	22/12/2019 15:25	22/12/2019 18:45	22/12/2019 15:25	22/12/2019 18:45	3,32	61	202,37	CHI
201912163803	CROMINIA	CQ12293021	PONTALINA	22/12/2019 15:25	23/12/2019 10:10	22/12/2019 15:25	23/12/2019 10:10	18,74	5	93,69	CHI
201912165049	AGUAS LINDAS DE GOIAS	LA12097107	AGUAS LINDAS DE GOIAS S1	22/12/2019 15:25	22/12/2019 18:23	22/12/2019 15:25	22/12/2019 18:23	2,96	25	73,92	CHI
201912163433	MORRINHOS	MR10406639	MORRINHOS	22/12/2019 15:26	25/12/2019 14:15	22/12/2019 15:26	23/12/2019 01:03	9,61	53	509,55	CHI
201912163433	MORRINHOS	MR10406639	MORRINHOS	22/12/2019 15:26	25/12/2019 14:15	22/12/2019 15:26	23/12/2019 08:27	17,01	11	187,07	CHI
201912163433	MORRINHOS	MR10406639	MORRINHOS	22/12/2019 15:26	25/12/2019 14:15	23/12/2019 08:27	23/12/2019 08:33	0,11	53	5,76	CHI
201912163433	MORRINHOS	MR10406639	MORRINHOS	22/12/2019 15:26	25/12/2019 14:15	22/12/2019 15:26	25/12/2019 14:15	70,81	76	5381,33	CHI
201912163831	CALDAZINHA	DE12233222	CEPAIGO S2	22/12/2019 15:26	22/12/2019 16:40	22/12/2019 15:26	22/12/2019 16:40	1,22	6	7,31	CHI
201912163771	GOIANIA	10739099	CAMPINAS S1	22/12/2019 15:27	22/12/2019 16:26	22/12/2019 15:27	22/12/2019 16:26	0,98	1	0,98	CHI
201912163777	NOVO GAMA	2460086083	PACAEMBU S1	22/12/2019 15:28	23/12/2019 10:22	22/12/2019 15:28	23/12/2019 10:22	18,91	1	18,91	CHI
201912163779	JATAI	290318191	JATAI S3	22/12/2019 15:28	22/12/2019 17:25	22/12/2019 15:28	22/12/2019 17:25	1,94	1	1,94	CHI
201912163873	GOIANIA	GN11002651	CARAJAS S1	22/12/2019 15:29	22/12/2019 18:34	22/12/2019 15:29	22/12/2019 18:34	3,07	136	417,71	CHI
201912165121	NOVO PLANALTO	SM12074646	SAO MIGUEL DO ARAGUAIA	22/12/2019 15:29	22/12/2019 21:55	22/12/2019 15:29	22/12/2019 21:55	6,43	1	6,43	CHI
201912165121	SAO MIGUEL DO ARAGUAIA	SM12074646	SAO MIGUEL DO ARAGUAIA	22/12/2019 15:29	22/12/2019 21:55	22/12/2019 15:29	22/12/2019 21:55	6,43	200	1286,17	CHI
201912164202	PORANGATU	PO12141124	NOVO PLANALTO	22/12/2019 15:30	22/12/2019 22:11	22/12/2019 15:30	22/12/2019 22:11	6,68	20	133,61	CHI
201912163799	ITUMBIARA	690374800	ITUMBIARA NOVA	22/12/2019 15:31	22/12/2019 19:37	22/12/2019 15:31	22/12/2019 19:37	4,10	1	4,10	CHI
201912165652	NOVO GAMA	LZ12089559	PACAEMBU S1	22/12/2019 15:32	23/12/2019 10:50	22/12/2019 15:32	23/12/2019 10:50	19,29	150	2894,08	CHI
201912165701	BRAZABRANTES	BR12402705	NEROPOLIS S1	22/12/2019 15:32	23/12/2019 10:31	22/12/2019 15:32	23/12/2019 10:31	18,98	8	151,86	CHI
201912163817	SENADOR CANEDO	190063786	SENADOR CANEDO	22/12/2019 15:33	22/12/2019 17:06	22/12/2019 15:33	22/12/2019 17:06	1,54	1	1,54	CHI
201912163818	CAMPO LIMPO	AN12267847	NEROPOLIS S1	22/12/2019 15:33	22/12/2019 17:16	22/12/2019 15:33	22/12/2019 17:16	1,70	62	105,57	CHI
201912163822	GOIANIA	13945695	CAMPINAS S1	22/12/2019 15:34	22/12/2019 20:44	22/12/2019 15:34	22/12/2019 20:44	5,15	1	5,15	CHI
201912163830	INHUMAS	IN12325091	INHUMAS S1	22/12/2019 15:36	22/12/2019 19:53	22/12/2019 15:36	22/12/2019 19:53	4,28	15	64,19	CHI
201912163833	DAVINOPOLIS	IO12266860RE	CATALAO S1	22/12/2019 15:36	22/12/2019 20:55	22/12/2019 15:36	22/12/2019 20:55	5,30	49	259,74	CHI
201912163833	DISTRITO FEDERAL	IO12266860RE	CATALAO S1	22/12/2019 15:36	22/12/2019 20:55	22/12/2019 15:36	22/12/2019 20:55	5,30	8	42,41	CHI
201912163848	VALPARAISO DE GOIAS	2860067262	PACAEMBU S1	22/12/2019 15:39	22/12/2019 16:50	22/12/2019 15:39	22/12/2019 16:50	1,17	1	1,17	CHI
201912164132	MAIRIPOTABA	MI12078688	PONTALINA	22/12/2019 15:39	23/12/2019 00:14	22/12/2019 15:39	23/12/2019 00:14	8,59	8	68,68	CHI
201912163851	RIO VERDE	RV12116151	RIO VERDE S1	22/12/2019 15:40	22/12/2019 19:20	22/12/2019 15:40	22/12/2019 19:20	3,66	255	933,72	CHI
201912164147	NOVO GAMA	NJ11201130	PACAEMBU S1	22/12/2019 15:40	22/12/2019 18:56	22/12/2019 15:40	22/12/2019 18:56	3,25	278	903,89	CHI
201912164077	SANTA BARBARA DE GOIAS	03510216	TRINDADE	22/12/2019 15:41	22/12/2019 22:00	22/12/2019 15:42	22/12/2019 18:06	2,42	479	1157,18	CHI
201912164077	TRINDADE	03510216	TRINDADE	22/12/2019 15:41	22/12/2019 22:00	22/12/2019 15:42	22/12/2019 18:06	2,42	3	7,25	CHI

201912164077	SANTA BARBARA DE GOIAS	03510214	TRINDADE	22/12/2019 15:41	22/12/2019 22:00	22/12/2019 15:47	22/12/2019 18:06	2,33	153	355,94	CHI
201912164077	SANTA BARBARA DE GOIAS	03510216	TRINDADE	22/12/2019 15:41	22/12/2019 22:00	22/12/2019 15:42	22/12/2019 18:48	3,11	295	917,12	CHI
201912164077	AVELINOPOLIS	03510216	TRINDADE	22/12/2019 15:41	22/12/2019 22:00	22/12/2019 15:42	22/12/2019 22:00	6,31	10	63,08	CHI
201912164077	NAZARIO	03510216	TRINDADE	22/12/2019 15:41	22/12/2019 22:00	22/12/2019 15:42	22/12/2019 22:00	6,31	11	69,39	CHI
201912164077	SANTA BARBARA DE GOIAS	03510216	TRINDADE	22/12/2019 15:41	22/12/2019 22:00	22/12/2019 15:42	22/12/2019 22:00	6,31	37	233,41	CHI
201912164369	NOVO GAMA	NJ11290169	PACAEMBU S1	22/12/2019 15:41	22/12/2019 19:25	22/12/2019 15:41	22/12/2019 19:25	3,72	99	368,09	CHI
201912164990	BONOPOLIS	TA12139136	SAO MIGUEL DO ARAGUAIA	22/12/2019 15:41	23/12/2019 17:25	22/12/2019 15:41	23/12/2019 17:25	25,73	3	77,19	CHI
201912164990	NOVO PLANALTO	TA12139136	SAO MIGUEL DO ARAGUAIA	22/12/2019 15:41	23/12/2019 17:25	22/12/2019 15:41	23/12/2019 17:25	25,73	17	437,40	CHI
201912163862	VIANOPOLIS	510002183	VIANOPOLIS	22/12/2019 15:42	22/12/2019 17:45	22/12/2019 15:42	22/12/2019 17:45	2,05	1	2,05	CHI
201912163863	CAMPINORTE	CR12051895	MARA ROSA	22/12/2019 15:42	22/12/2019 19:05	22/12/2019 15:42	22/12/2019 19:05	3,38	17	57,47	CHI
201912163863	NOVA IGUACU DE GOIAS	CR12051895	MARA ROSA	22/12/2019 15:42	22/12/2019 19:05	22/12/2019 15:42	22/12/2019 19:05	3,38	15	50,71	CHI
201912163864	BALIZA	BH21359283	BOM JARDIM	22/12/2019 15:42	22/12/2019 18:24	22/12/2019 15:42	22/12/2019 18:24	2,70	1	2,70	CHI
201912163868	SAO MIGUEL DO ARAGUAIA	SM12211095	SAO MIGUEL DO ARAGUAIA	22/12/2019 15:42	22/12/2019 20:20	22/12/2019 15:42	22/12/2019 20:20	4,63	128	593,07	CHI
201912164098	GOIANIA	GN11001016	CAMPINAS S1	22/12/2019 15:42	22/12/2019 16:55	22/12/2019 15:42	22/12/2019 16:55	1,21	140	169,75	CHI
201912165092	NAZARIO	NZ11018619	ANICUNS	22/12/2019 15:42	22/12/2019 19:50	22/12/2019 15:42	22/12/2019 19:50	4,14	109	450,96	CHI
201912164691	NEROPOLIS	NR11347312	NEROPOLIS S2	22/12/2019 15:43	23/12/2019 14:14	22/12/2019 15:43	23/12/2019 14:14	22,51	82	1845,80	CHI
201912163754	AGUAS LINDAS DE GOIAS	4830024411	AGUAS LINDAS DE GOIAS S1	22/12/2019 15:44	22/12/2019 17:43	22/12/2019 15:44	22/12/2019 17:43	1,98	1	1,98	CHI
201912163883	GOIANIA	13144492	FERROVIARIO S1	22/12/2019 15:44	22/12/2019 18:36	22/12/2019 15:44	22/12/2019 18:36	2,85	1	2,85	CHI
201912164400	NOVO PLANALTO	TA12354751	SAO MIGUEL DO ARAGUAIA	22/12/2019 15:44	22/12/2019 21:22	22/12/2019 15:44	22/12/2019 21:22	5,62	17	95,51	CHI
201912163890	ITABERAI	IB21300327	ITABERAI S2	22/12/2019 15:45	22/12/2019 19:23	22/12/2019 15:45	22/12/2019 19:23	3,63	1	3,63	CHI
201912163892	NOVO GAMA	NJ12219814	PACAEMBU S1	22/12/2019 15:45	22/12/2019 19:35	22/12/2019 15:45	22/12/2019 19:35	3,82	140	535,31	CHI
201912166948	PORTELANDIA	PW11000033	PARQUE DAS EMAS	22/12/2019 15:46	23/12/2019 04:30	22/12/2019 15:46	23/12/2019 04:30	12,72	80	1017,44	CHI
201912164342	NAZARIO	NZ11205986	ANICUNS	22/12/2019 15:48	22/12/2019 18:35	22/12/2019 15:48	22/12/2019 18:35	2,79	99	276,18	CHI
201912163924	MINEIROS	MY21324393	PARQUE DAS EMAS	22/12/2019 15:49	23/12/2019 10:23	22/12/2019 15:49	23/12/2019 10:23	18,55	1	18,55	CHI
201912163926	CALDAS NOVAS	CN11213965	SERRA DE CALDAS	22/12/2019 15:49	23/12/2019 09:00	22/12/2019 15:49	23/12/2019 09:00	17,17	7	120,18	CHI
201912164115	NOVO GAMA	NJ11390038	PACAEMBU S1	22/12/2019 15:49	22/12/2019 18:20	22/12/2019 15:49	22/12/2019 18:20	2,51	134	336,30	CHI
201912164272	PONTALINA	PK12257244	PONTALINA	22/12/2019 15:49	22/12/2019 19:11	22/12/2019 15:49	22/12/2019 19:11	3,37	15	50,50	CHI
201912166024	NOVO GAMA	NJ12219815	PACAEMBU S1	22/12/2019 15:49	22/12/2019 20:40	22/12/2019 15:49	22/12/2019 20:40	4,84	209	1012,08	CHI
201912163938	PLANALTINA	PI12375541	PLANALTINA	22/12/2019 15:51	22/12/2019 23:34	22/12/2019 15:51	22/12/2019 23:34	7,72	179	1381,08	CHI
201912163953	NOVO GAMA	LZ12040416	PACAEMBU S1	22/12/2019 15:51	23/12/2019 10:30	22/12/2019 15:51	23/12/2019 10:30	18,64	18	335,53	CHI
201912163987	PROFESSOR JAMIL SAFADY	JS21083309	ROCHEDO	22/12/2019 15:51	23/12/2019 10:27	22/12/2019 15:51	23/12/2019 10:27	18,60	1	18,60	CHI
201912164263	GOIANIA	GN12198269	CAMPINAS S2	22/12/2019 15:51	22/12/2019 17:38	22/12/2019 15:51	22/12/2019 17:38	1,77	362	642,45	CHI
2019122200076	BURITI ALEGRE	01242118	MORRINHOS	22/12/2019 15:51	22/12/2019 16:11	22/12/2019 15:51	22/12/2019 16:11	0,33	1	0,33	CHI

2019122200076	CALDAS NOVAS	01242118	MORRINHOS	22/12/2019 15:51	22/12/2019 16:11	22/12/2019 15:51	22/12/2019 16:11	0,33	2	0,65	CHI
2019122200076	CALDAS NOVAS	01242118	MORRINHOS	22/12/2019 15:51	22/12/2019 16:11	22/12/2019 15:51	22/12/2019 16:11	0,33	6	1,95	CHI
2019122200076	MAIRIPOTABA	01242118	MORRINHOS	22/12/2019 15:51	22/12/2019 16:11	22/12/2019 15:51	22/12/2019 16:11	0,33	12	3,90	CHI
2019122200076	MORRINHOS	01242118	MORRINHOS	22/12/2019 15:51	22/12/2019 16:11	22/12/2019 15:51	22/12/2019 16:11	0,33	278	90,43	CHI
2019122200076	MORRINHOS	01242118	MORRINHOS	22/12/2019 15:51	22/12/2019 16:11	22/12/2019 15:51	22/12/2019 16:11	0,33	50	16,26	CHI
2019122200076	MORRINHOS	01242118	MORRINHOS	22/12/2019 15:51	22/12/2019 16:11	22/12/2019 15:51	22/12/2019 16:11	0,33	236	76,77	CHI
2019122200076	MORRINHOS	01242118	MORRINHOS	22/12/2019 15:51	22/12/2019 16:11	22/12/2019 15:51	22/12/2019 16:11	0,33	190	61,80	CHI
2019122200076	MORRINHOS	01242118	MORRINHOS	22/12/2019 15:51	22/12/2019 16:11	22/12/2019 15:51	22/12/2019 16:11	0,33	362	117,75	CHI
2019122200076	MORRINHOS	01242118	MORRINHOS	22/12/2019 15:51	22/12/2019 16:11	22/12/2019 15:51	22/12/2019 16:11	0,33	24	7,81	CHI
2019122200076	MORRINHOS	01242118	MORRINHOS	22/12/2019 15:51	22/12/2019 16:11	22/12/2019 15:51	22/12/2019 16:11	0,33	8278	2692,65	CHI
2019122200076	MORRINHOS	01242118	MORRINHOS	22/12/2019 15:51	22/12/2019 16:11	22/12/2019 15:51	22/12/2019 16:11	0,33	12465	4054,59	CHI
2019122200076	MORRINHOS	01242118	MORRINHOS	22/12/2019 15:51	22/12/2019 16:11	22/12/2019 15:51	22/12/2019 16:11	0,33	86	27,97	CHI
2019122200076	MORRINHOS	01242118	MORRINHOS	22/12/2019 15:51	22/12/2019 16:11	22/12/2019 15:51	22/12/2019 16:11	0,33	19	6,18	CHI
2019122200076	PIRACANJUBA	01242118	MORRINHOS	22/12/2019 15:51	22/12/2019 16:11	22/12/2019 15:51	22/12/2019 16:11	0,33	40	13,01	CHI
2019122200076	PIRACANJUBA	01242118	MORRINHOS	22/12/2019 15:51	22/12/2019 16:11	22/12/2019 15:51	22/12/2019 16:11	0,33	127	41,31	CHI
2019122200076	PIRACANJUBA	01242118	MORRINHOS	22/12/2019 15:51	22/12/2019 16:11	22/12/2019 15:51	22/12/2019 16:11	0,33	2	0,65	CHI
2019122200076	PIRACANJUBA	01242118	MORRINHOS	22/12/2019 15:51	22/12/2019 16:11	22/12/2019 15:51	22/12/2019 16:11	0,33	3	0,98	CHI
2019122200076	PONTALINA	01242118	MORRINHOS	22/12/2019 15:51	22/12/2019 16:11	22/12/2019 15:51	22/12/2019 16:11	0,33	15	4,88	CHI
2019122200076	RIO QUENTE	01242118	MORRINHOS	22/12/2019 15:51	22/12/2019 16:11	22/12/2019 15:51	22/12/2019 16:11	0,33	19	6,18	CHI
2019122200080	PIRACANJUBA	01620514	MORRINHOS	22/12/2019 15:51	22/12/2019 16:11	22/12/2019 15:51	22/12/2019 15:55	0,07	33	2,20	CHI
2019122200080	CROMINIA	36301	ROCHEDO	22/12/2019 15:51	22/12/2019 16:11	22/12/2019 15:51	22/12/2019 15:55	0,07	21	1,40	CHI
2019122200080	PIRACANJUBA	01620514	ROCHEDO	22/12/2019 15:51	22/12/2019 16:11	22/12/2019 15:51	22/12/2019 15:55	0,07	48	3,20	CHI
2019122200080	PIRACANJUBA	36302	ROCHEDO	22/12/2019 15:51	22/12/2019 16:11	22/12/2019 15:51	22/12/2019 15:55	0,07	14	0,93	CHI
2019122200080	PIRACANJUBA	01620514	ROCHEDO	22/12/2019 15:51	22/12/2019 16:11	22/12/2019 15:51	22/12/2019 15:55	0,07	311	20,73	CHI
2019122200080	PIRACANJUBA	01620514	ROCHEDO	22/12/2019 15:51	22/12/2019 16:11	22/12/2019 15:51	22/12/2019 15:55	0,07	1	0,07	CHI
2019122200080	PROFESSOR JAMIL SAFADY	01620514	ROCHEDO	22/12/2019 15:51	22/12/2019 16:11	22/12/2019 15:51	22/12/2019 15:55	0,07	25	1,67	CHI
2019122200080	PROFESSOR JAMIL SAFADY	36301	ROCHEDO	22/12/2019 15:51	22/12/2019 16:11	22/12/2019 15:51	22/12/2019 15:55	0,07	837	55,80	CHI
2019122200080	PROFESSOR JAMIL SAFADY	36302	ROCHEDO	22/12/2019 15:51	22/12/2019 16:11	22/12/2019 15:51	22/12/2019 15:55	0,07	487	32,47	CHI
2019122200080	PROFESSOR JAMIL SAFADY	01620514	ROCHEDO	22/12/2019 15:51	22/12/2019 16:11	22/12/2019 15:51	22/12/2019 15:55	0,07	6	0,40	CHI
2019122200080	PIRACANJUBA	01620514	MORRINHOS	22/12/2019 15:51	22/12/2019 16:11	22/12/2019 15:51	22/12/2019 16:11	0,33	3	1,00	CHI
201912163960	PADRE BERNARDO	PB12389380	PADRE BERNARDO	22/12/2019 15:53	22/12/2019 19:30	22/12/2019 15:53	22/12/2019 19:30	3,61	12	43,30	CHI
201912163963	FAINA	FC12147796	GOIAS	22/12/2019 15:53	23/12/2019 16:18	22/12/2019 15:53	23/12/2019 16:18	24,40	6	146,43	CHI
201912164213	VALPARAISO DE GOIAS	VA11149873	PACAEMBU S1	22/12/2019 15:53	22/12/2019 21:08	22/12/2019 15:53	22/12/2019 21:08	5,24	282	1476,35	CHI

201912164617	MOZARLANDIA	MZ12058536	MOZARLANDIA	22/12/2019 15:53	26/12/2019 02:24	22/12/2019 15:53	24/12/2019 01:14	33,35	15	500,22	CHI
201912164617	MOZARLANDIA	MZ12058536	MOZARLANDIA	22/12/2019 15:53	26/12/2019 02:24	22/12/2019 15:53	26/12/2019 02:24	82,50	1	82,50	CHI
201912164617	MOZARLANDIA	MZ12058536	MOZARLANDIA	22/12/2019 15:53	26/12/2019 02:24	25/12/2019 18:33	26/12/2019 02:24	7,84	15	117,63	CHI
201912165114	NOVO GAMA	NJ11183906	PACAEMBU S1	22/12/2019 15:53	23/12/2019 00:47	22/12/2019 15:53	23/12/2019 00:47	8,90	90	801,00	CHI
201912163973	PROFESSOR JAMIL SAFADY	10014369107	ROCHEDO	22/12/2019 15:54	23/12/2019 10:31	22/12/2019 15:54	23/12/2019 10:31	18,61	1	18,61	CHI
201912167056	ITAPACI	IW11267263	ITAPACI	22/12/2019 15:54	23/12/2019 10:43	22/12/2019 15:54	23/12/2019 10:43	18,81	84	1579,67	CHI
201912164255	TRINDADE	TR11095981	MEIA PONTE	22/12/2019 15:55	23/12/2019 04:50	22/12/2019 15:55	23/12/2019 04:50	12,91	169	2181,37	CHI
201912164389	NOVO GAMA	NJ11203782	MARAJOARA	22/12/2019 15:55	22/12/2019 19:02	22/12/2019 15:55	22/12/2019 19:02	3,11	225	699,63	CHI
201912163989	AGUAS LINDAS DE GOIAS	LA11209462	AGUAS LINDAS DE GOIAS S1	22/12/2019 15:56	22/12/2019 16:38	22/12/2019 15:56	22/12/2019 16:38	0,70	108	75,48	CHI
201912164580	VALPARAISO DE GOIAS	VA11192843	PACAEMBU S1	22/12/2019 15:56	22/12/2019 19:15	22/12/2019 15:56	22/12/2019 19:15	3,31	191	632,10	CHI
201912164002	NOVO GAMA	NJ12408328	PACAEMBU S1	22/12/2019 15:57	23/12/2019 11:21	22/12/2019 15:57	23/12/2019 11:21	19,40	11	213,39	CHI
201912164252	CORUMBAIBA	CI12049729	VILA CORUMBA	22/12/2019 15:57	23/12/2019 13:08	22/12/2019 15:57	23/12/2019 13:08	21,18	6	127,06	CHI
201912164749	MONTIVIDIU	MV11301689	MONTIVIDIU T	22/12/2019 15:57	22/12/2019 23:15	22/12/2019 15:57	22/12/2019 23:15	7,30	62	452,32	CHI
201912165819	NOVO GAMA	NJ11201195	PACAEMBU S1	22/12/2019 15:57	22/12/2019 22:24	22/12/2019 15:57	22/12/2019 22:24	6,44	208	1338,54	CHI
201912164012	NOVO GAMA	10000627664	PACAEMBU S1	22/12/2019 15:58	22/12/2019 18:08	22/12/2019 15:58	22/12/2019 18:08	2,16	1	2,16	CHI
201912164142	VALPARAISO DE GOIAS	VA11192928	PACAEMBU S1	22/12/2019 15:58	22/12/2019 22:44	22/12/2019 15:58	22/12/2019 22:44	6,75	181	1222,50	CHI
201912165705	AGUAS LINDAS DE GOIAS	LA12148937	AGUAS LINDAS DE GOIAS S1	22/12/2019 15:58	22/12/2019 21:08	22/12/2019 15:58	22/12/2019 21:08	5,15	292	1503,96	CHI
201912164020	TRINDADE	40136978	TRINDADE	22/12/2019 15:59	22/12/2019 19:34	22/12/2019 15:59	22/12/2019 19:34	3,59	1	3,59	CHI
201912164022	GOIANIA	GN11072323	ATLANTICO S1	22/12/2019 15:59	22/12/2019 19:20	22/12/2019 15:59	22/12/2019 19:20	3,35	149	498,90	CHI
201912164089	BARRO ALTO	BA12035658	BARRO ALTO	22/12/2019 15:59	22/12/2019 19:55	22/12/2019 15:59	22/12/2019 19:55	3,92	14	54,94	CHI
201912164089	NIQUELANDIA	BA12035658	BARRO ALTO	22/12/2019 15:59	22/12/2019 19:55	22/12/2019 15:59	22/12/2019 19:55	3,92	4	15,70	CHI
201912164553	PALMEIRAS DE GOIAS	PL12092997	PALMEIRAS	22/12/2019 15:59	23/12/2019 13:27	22/12/2019 15:59	23/12/2019 13:27	21,47	33	708,40	CHI
201912164036	JATAI	JT121374213	JATAI S1	22/12/2019 16:00	23/12/2019 15:14	22/12/2019 16:00	23/12/2019 15:14	23,23	1	23,23	CHI
201912164042	APARECIDA DE GOIANIA	10023032500	REAL S1	22/12/2019 16:00	22/12/2019 21:45	22/12/2019 16:00	22/12/2019 21:45	5,75	1	5,75	CHI
201912164044	ITAPURANGA	IK21227386	ITAPURANGA	22/12/2019 16:00	23/12/2019 16:52	22/12/2019 16:00	23/12/2019 16:52	24,86	1	24,86	CHI
201912164046	APARECIDA DE GOIANIA	200341303	INDEPENDENCIA S2	22/12/2019 16:00	23/12/2019 00:07	22/12/2019 16:00	23/12/2019 00:07	8,10	1	8,10	CHI
201912164053	IACIARA	IA21180875	IACIARA S2	22/12/2019 16:01	22/12/2019 17:36	22/12/2019 16:01	22/12/2019 17:36	1,58	1	1,58	CHI
201912164117	CEZARINA	PL10404073	PALMEIRAS	22/12/2019 16:02	23/12/2019 13:52	22/12/2019 16:02	22/12/2019 16:05	0,05	4	0,21	CHI
201912164117	PALMEIRAS DE GOIAS	PL10404073	PALMEIRAS	22/12/2019 16:02	23/12/2019 13:52	22/12/2019 16:02	22/12/2019 16:05	0,05	199	10,23	CHI
201912164117	CEZARINA	PL13260014	PALMEIRAS	22/12/2019 16:02	23/12/2019 13:52	22/12/2019 16:08	22/12/2019 19:38	3,51	1	3,51	CHI
201912164117	INDIARA	PL13260014	PALMEIRAS	22/12/2019 16:02	23/12/2019 13:52	22/12/2019 16:08	22/12/2019 19:38	3,51	3	10,54	CHI
201912164117	PALMEIRAS DE GOIAS	PL13260014	PALMEIRAS	22/12/2019 16:02	23/12/2019 13:52	22/12/2019 16:08	22/12/2019 19:38	3,51	126	442,68	CHI
201912164117	PALMEIRAS DE GOIAS	PL13145886	PALMEIRAS	22/12/2019 16:02	23/12/2019 13:52	22/12/2019 16:08	22/12/2019 20:56	4,81	99	475,72	CHI

201912164117	PALMEIRAS DE GOIAS	PL13145886	PALMEIRAS	22/12/2019 16:02	23/12/2019 13:52	22/12/2019 18:12	22/12/2019 20:56	2,73	19	51,96	CHI
201912164117	CEZARINA	CZ13031806	PALMEIRAS	22/12/2019 16:02	23/12/2019 13:52	22/12/2019 16:08	22/12/2019 22:34	6,45	4	25,78	CHI
201912164117	PALMEIRAS DE GOIAS	CZ13031806	PALMEIRAS	22/12/2019 16:02	23/12/2019 13:52	22/12/2019 16:08	22/12/2019 22:34	6,45	78	502,73	CHI
201912164117	PALMEIRAS DE GOIAS	PL13308410	PALMEIRAS	22/12/2019 16:02	23/12/2019 13:52	22/12/2019 21:15	22/12/2019 23:48	2,55	21	53,56	CHI
201912164117	PALMEIRAS DE GOIAS	PL13260014	PALMEIRAS	22/12/2019 16:02	23/12/2019 13:52	22/12/2019 16:08	23/12/2019 08:03	15,92	3	47,75	CHI
201912164117	CEZARINA	PL13260014	PALMEIRAS	22/12/2019 16:02	23/12/2019 13:52	23/12/2019 07:55	23/12/2019 08:03	0,13	1	0,13	CHI
201912164117	INDIARA	PL13260014	PALMEIRAS	22/12/2019 16:02	23/12/2019 13:52	23/12/2019 07:55	23/12/2019 08:03	0,13	3	0,39	CHI
201912164117	PALMEIRAS DE GOIAS	PL13260014	PALMEIRAS	22/12/2019 16:02	23/12/2019 13:52	23/12/2019 07:55	23/12/2019 08:03	0,13	132	17,20	CHI
201912164117	CEZARINA	04880216	PALMEIRAS	22/12/2019 16:02	23/12/2019 13:52	23/12/2019 08:59	23/12/2019 09:21	0,36	1	0,36	CHI
201912164117	INDIARA	04880216	PALMEIRAS	22/12/2019 16:02	23/12/2019 13:52	23/12/2019 08:59	23/12/2019 09:21	0,36	3	1,07	CHI
201912164117	PALMEIRAS DE GOIAS	04880216	PALMEIRAS	22/12/2019 16:02	23/12/2019 13:52	23/12/2019 08:59	23/12/2019 09:21	0,36	105	37,60	CHI
201912164117	PALMEIRAS DE GOIAS	PL10404073	PALMEIRAS	22/12/2019 16:02	23/12/2019 13:52	22/12/2019 21:15	23/12/2019 13:11	15,95	2	31,89	CHI
201912164117	PALMEIRAS DE GOIAS	PL13145886	PALMEIRAS	22/12/2019 16:02	23/12/2019 13:52	22/12/2019 23:50	23/12/2019 13:11	13,36	21	280,63	CHI
201912164117	PALMEIRAS DE GOIAS	PL12011091LD	PALMEIRAS	22/12/2019 16:02	23/12/2019 13:52	22/12/2019 21:15	23/12/2019 13:23	16,14	98	1581,53	CHI
201912164117	CEZARINA	PL13308410	PALMEIRAS	22/12/2019 16:02	23/12/2019 13:52	23/12/2019 13:46	23/12/2019 13:52	0,10	4	0,39	CHI
201912164117	PALMEIRAS DE GOIAS	PL13308410	PALMEIRAS	22/12/2019 16:02	23/12/2019 13:52	23/12/2019 13:46	23/12/2019 13:52	0,10	78	7,63	CHI
201912165323	NOVO GAMA	NJ11103511	PACAEMBU S1	22/12/2019 16:02	22/12/2019 22:19	22/12/2019 16:02	22/12/2019 22:19	6,28	186	1168,70	CHI
201912165472	ESTRELA DO NORTE	MU12391986	MARA ROSA	22/12/2019 16:02	22/12/2019 21:01	22/12/2019 16:02	22/12/2019 21:01	4,97	1	4,97	CHI
201912165472	MUTUNOPOLIS	MU12391986	MARA ROSA	22/12/2019 16:02	22/12/2019 21:01	22/12/2019 16:02	22/12/2019 21:01	4,97	101	501,86	CHI
201912168042	PALMEIRAS DE GOIAS	PL121276671	PALMEIRAS	22/12/2019 16:02	23/12/2019 19:40	22/12/2019 16:08	23/12/2019 19:40	27,55	1	27,55	CHI
201912177017	ITARUMA	IM12064122	CACHOEIRA ALTA	22/12/2019 16:03	24/12/2019 08:01	23/12/2019 01:54	24/12/2019 08:01	30,11	13	391,47	CHI
201912177017	JATAI	IM12064122	CACHOEIRA ALTA	22/12/2019 16:03	24/12/2019 08:01	23/12/2019 01:54	24/12/2019 08:01	30,11	12	361,36	CHI
201912177910	SERRANOPOLIS	SX21216608	CACHOEIRA ALTA	22/12/2019 16:03	24/12/2019 10:52	23/12/2019 01:54	24/12/2019 10:52	32,96	1	32,96	CHI
201912164083	GOIANIA	GN12042878	FERROVIARIO S2	22/12/2019 16:04	22/12/2019 18:03	22/12/2019 16:04	22/12/2019 18:03	1,98	144	285,20	CHI
201912164084	NOVO GAMA	NJ11183945	MARAJOARA	22/12/2019 16:04	22/12/2019 18:06	22/12/2019 16:04	22/12/2019 18:06	2,03	158	320,78	CHI
201912164086	GOIANIRA	10018640000	GOIANIRA	22/12/2019 16:04	23/12/2019 02:43	22/12/2019 16:04	23/12/2019 02:43	10,65	1	10,65	CHI
201912164088	GOIANIA	GN12000056	CAMPINAS S1	22/12/2019 16:04	22/12/2019 17:27	22/12/2019 16:04	22/12/2019 17:27	1,38	319	438,80	CHI
201912164091	PROFESSOR JAMIL SAFADY	PJ21157033	ROCHEDO	22/12/2019 16:04	23/12/2019 10:23	22/12/2019 16:04	23/12/2019 10:23	18,30	1	18,30	CHI
201912164092	GOIANIA	GN11068951	ATLANTICO S1	22/12/2019 16:04	22/12/2019 17:32	22/12/2019 16:04	22/12/2019 17:32	1,45	103	149,44	CHI
201912164700	APARECIDA DE GOIANIA	AP12147249	ATLANTICO S2	22/12/2019 16:04	22/12/2019 18:56	22/12/2019 16:04	22/12/2019 18:56	2,86	324	927,90	CHI
201912164858	RIO VERDE	RV11241410	RIO VERDE S2	22/12/2019 16:04	22/12/2019 19:00	22/12/2019 16:04	22/12/2019 19:00	2,92	168	490,89	CHI
201912164101	IPAMERI	IP21152351	IPAMERI	22/12/2019 16:05	22/12/2019 20:20	22/12/2019 16:05	22/12/2019 20:20	4,23	1	4,23	CHI
201912164106	GOIANIA	14597950	ATLANTICO S2	22/12/2019 16:06	22/12/2019 18:18	22/12/2019 16:06	22/12/2019 18:18	2,21	1	2,21	CHI

201912183614	NOVA CRIXAS	NA21203624	NOVA CRIXAS	22/12/2019 16:06	24/12/2019 10:06	22/12/2019 16:06	24/12/2019 10:06	41,99	1	41,99	CHI
201912164729	SAO MIGUEL DO ARAGUAIA	SM12208578	SAO MIGUEL DO ARAGUAIA	22/12/2019 16:07	22/12/2019 18:50	22/12/2019 16:07	22/12/2019 18:50	2,71	509	1377,27	CHI
201912164136	AMARALINA	MQ12208443	NOVA CRIXAS	22/12/2019 16:08	22/12/2019 20:34	22/12/2019 16:08	22/12/2019 20:34	4,42	1	4,42	CHI
201912164136	MARA ROSA	MQ12208443	NOVA CRIXAS	22/12/2019 16:08	22/12/2019 20:34	22/12/2019 16:08	22/12/2019 20:34	4,42	1	4,42	CHI
201912164140	AGUAS LINDAS DE GOIAS	LA21294628	AGUAS LINDAS DE GOIAS S1	22/12/2019 16:08	23/12/2019 11:58	22/12/2019 16:08	23/12/2019 11:58	19,82	1	19,82	CHI
201912164602	GOIANIA	GN12002508	ATLANTICO S3	22/12/2019 16:08	22/12/2019 19:05	22/12/2019 16:08	22/12/2019 19:05	2,94	984	2892,41	CHI
201912166219	GOIANIA	GN11001823	ATLANTICO S3	22/12/2019 16:08	23/12/2019 10:22	22/12/2019 16:08	23/12/2019 10:22	18,22	87	1585,38	CHI
201912167496	JATAI	JT12260447	JATAI S1	22/12/2019 16:08	24/12/2019 08:39	22/12/2019 16:08	23/12/2019 11:25	19,29	10	192,88	CHI
201912167496	JATAI	JT12260447	JATAI S1	22/12/2019 16:08	24/12/2019 08:39	23/12/2019 10:08	23/12/2019 11:25	1,29	28	36,11	CHI
201912167496	JATAI	JT12260447	JATAI S1	22/12/2019 16:08	24/12/2019 08:39	23/12/2019 14:26	23/12/2019 15:16	0,82	38	31,31	CHI
201912167496	JATAI	JT12260447	JATAI S1	22/12/2019 16:08	24/12/2019 08:39	22/12/2019 16:08	23/12/2019 15:29	23,35	3	70,06	CHI
201912167496	JATAI	JT12260447	JATAI S1	22/12/2019 16:08	24/12/2019 08:39	22/12/2019 16:08	23/12/2019 15:29	23,35	10	233,54	CHI
201912167496	JATAI	JT13264278	JATAI S1	22/12/2019 16:08	24/12/2019 08:39	23/12/2019 10:08	23/12/2019 15:29	5,36	4	21,42	CHI
201912167496	JATAI	JT13264278	JATAI S1	22/12/2019 16:08	24/12/2019 08:39	23/12/2019 10:08	23/12/2019 15:29	5,36	4	21,42	CHI
201912167496	JATAI	JT13337010	JATAI S1	22/12/2019 16:08	24/12/2019 08:39	23/12/2019 15:46	23/12/2019 18:39	2,88	3	8,63	CHI
201912167496	JATAI	JT13306513	JATAI S1	22/12/2019 16:08	24/12/2019 08:39	23/12/2019 15:46	24/12/2019 02:00	10,23	4	40,93	CHI
201912167496	JATAI	JT12260447	JATAI S1	22/12/2019 16:08	24/12/2019 08:39	22/12/2019 16:08	24/12/2019 02:07	34,00	17	577,93	CHI
201912167496	SERRANOPOLIS	JT12260447	JATAI S1	22/12/2019 16:08	24/12/2019 08:39	22/12/2019 16:08	24/12/2019 02:07	34,00	1	34,00	CHI
201912167496	JATAI	JT13306513	JATAI S1	22/12/2019 16:08	24/12/2019 08:39	23/12/2019 10:08	24/12/2019 02:07	16,00	30	479,93	CHI
201912167496	SERRANOPOLIS	JT13306513	JATAI S1	22/12/2019 16:08	24/12/2019 08:39	23/12/2019 10:08	24/12/2019 02:07	16,00	30	479,93	CHI
201912167496	JATAI	JT13306513	JATAI S1	22/12/2019 16:08	24/12/2019 08:39	23/12/2019 13:11	24/12/2019 02:07	12,94	4	51,75	CHI
201912167496	SERRANOPOLIS	JT13306513	JATAI S1	22/12/2019 16:08	24/12/2019 08:39	23/12/2019 13:11	24/12/2019 02:07	12,94	1	12,94	CHI
201912167496	JATAI	JT13306513	JATAI S1	22/12/2019 16:08	24/12/2019 08:39	24/12/2019 02:01	24/12/2019 02:07	0,11	4	0,46	CHI
201912167496	JATAI	JT13248376	JATAI S1	22/12/2019 16:08	24/12/2019 08:39	23/12/2019 22:30	24/12/2019 08:39	10,14	41	415,72	CHI
201912164146	SANTA HELENA DE GOIAS	SH12271341	ACREUNA	22/12/2019 16:09	24/12/2019 12:38	22/12/2019 16:09	23/12/2019 20:10	28,01	6	168,06	CHI
201912164146	SANTA HELENA DE GOIAS	SH12279485LD	ACREUNA	22/12/2019 16:09	24/12/2019 12:38	22/12/2019 16:09	24/12/2019 12:38	44,48	3	133,45	CHI
201912164177	APARECIDA DE GOIANIA	GN12035162	ATLANTICO S3	22/12/2019 16:09	23/12/2019 03:10	22/12/2019 16:09	23/12/2019 03:10	11,02	45	495,73	CHI
201912164177	GOIANIA	GN12035162	ATLANTICO S3	22/12/2019 16:09	23/12/2019 03:10	22/12/2019 16:09	23/12/2019 03:10	11,02	914	10068,73	CHI
201912164741	VALPARAISO DE GOIAS	VA11345877	PACAEMBU S1	22/12/2019 16:09	22/12/2019 19:39	22/12/2019 16:09	22/12/2019 19:39	3,50	133	465,39	CHI
201912165521	MOSSAMEDES	MD12024167	FIRMINOPOLIS S2	22/12/2019 16:09	22/12/2019 19:08	22/12/2019 16:09	22/12/2019 19:08	2,97	46	136,63	CHI
201912165521	SANCLERLANDIA	MD12024167	FIRMINOPOLIS S2	22/12/2019 16:09	22/12/2019 19:08	22/12/2019 16:09	22/12/2019 19:08	2,97	8	23,76	CHI
201912164154	ITAJA	IJ12226576	ITAJA S2	22/12/2019 16:10	23/12/2019 15:42	22/12/2019 16:10	23/12/2019 15:42	23,53	6	141,17	CHI
201912164303	GOIANIA	GN12001434	FERROVIARIO S1	22/12/2019 16:10	22/12/2019 18:49	22/12/2019 16:10	22/12/2019 18:49	2,65	95	251,30	CHI



201912165453	ITAPACI	IW12221659	ITAPACI	22/12/2019 16:10	23/12/2019 17:01	22/12/2019 16:10	23/12/2019 17:01	24,85	4	99,38	CHI
201912164176	ITARUMA	IM12340018	CACHOEIRA ALTA	22/12/2019 16:11	23/12/2019 17:09	22/12/2019 16:11	23/12/2019 17:09	24,95	2	49,90	CHI
201912163589	ANICUNS	8686810	ANICUNS	22/12/2019 16:13	22/12/2019 21:23	22/12/2019 16:13	22/12/2019 21:23	5,16	12	61,94	CHI
201912164190	NOVO PLANALTO	SM12328903	SAO MIGUEL DO ARAGUAIA	22/12/2019 16:13	23/12/2019 17:00	22/12/2019 16:13	23/12/2019 17:00	24,78	10	247,82	CHI
201912164203	GOIANIA	14724170	XAVANTES	22/12/2019 16:13	22/12/2019 21:24	22/12/2019 16:13	22/12/2019 21:24	5,17	1	5,17	CHI
201912164206	CALDAS NOVAS	CN21090589	RIO QUENTE	22/12/2019 16:13	23/12/2019 10:30	22/12/2019 16:13	23/12/2019 10:30	18,27	1	18,27	CHI
201912164361	GOIANIA	GN12118598	ATLANTICO S1	22/12/2019 16:13	23/12/2019 10:25	22/12/2019 16:13	23/12/2019 10:25	18,19	70	1273,18	CHI
201912164381	GOIANIA	GN11001712	ATLANTICO S2	22/12/2019 16:13	23/12/2019 11:07	22/12/2019 16:13	23/12/2019 11:07	18,88	94	1775,11	CHI
201912165095	ITAPACI	IW12201725	ITAPACI	22/12/2019 16:13	22/12/2019 22:13	22/12/2019 16:13	22/12/2019 22:13	5,99	663	3968,79	CHI
201912164540	VALPARAISO DE GOIAS	VA11164968	PACAEMBU S1	22/12/2019 16:14	22/12/2019 19:21	22/12/2019 16:14	22/12/2019 19:21	3,10	138	428,34	CHI
201912165183	NOVO GAMA	NJ12261832	PACAEMBU S1	22/12/2019 16:14	22/12/2019 19:27	22/12/2019 16:14	22/12/2019 19:27	3,21	600	1927,17	CHI
201912164226	GOIANIA	GN11043933	GOYA S2	22/12/2019 16:15	22/12/2019 21:26	22/12/2019 16:15	22/12/2019 21:26	5,18	65	336,77	CHI
201912164235	CRISTALINA	KR12162511	CRISTALINA S2	22/12/2019 16:15	22/12/2019 17:31	22/12/2019 16:15	22/12/2019 17:31	1,25	5	6,27	CHI
201912164451	GAMELEIRA DE GOIAS	SV12033468	DAIA S2	22/12/2019 16:15	22/12/2019 18:26	22/12/2019 16:15	22/12/2019 18:26	2,17	14	30,38	CHI
201912164451	SILVANIA	SV12033468	DAIA S2	22/12/2019 16:15	22/12/2019 18:26	22/12/2019 16:15	22/12/2019 18:26	2,17	136	295,08	CHI
201912164543	NOVO GAMA	NJ12261840	PACAEMBU S1	22/12/2019 16:15	22/12/2019 21:10	22/12/2019 16:15	22/12/2019 21:10	4,92	221	1086,40	CHI
201912164910	ANICUNS	AC12024032	ANICUNS	22/12/2019 16:15	23/12/2019 08:43	22/12/2019 16:15	23/12/2019 08:43	16,46	24	395,04	CHI
201912164910	TURVANIA	AC12024032	ANICUNS	22/12/2019 16:15	23/12/2019 08:43	22/12/2019 16:15	23/12/2019 08:43	16,46	4	65,84	CHI
201912164382	GOIANIRA	GR12242159	GOIANIRA	22/12/2019 16:16	23/12/2019 03:26	22/12/2019 16:16	23/12/2019 03:26	11,17	84	937,86	CHI
201912164521	ITAPIRAPUA	IU12018810	MATRINCHA	22/12/2019 16:16	22/12/2019 20:40	22/12/2019 16:16	22/12/2019 20:40	4,40	27	118,73	CHI
201912181303	ITAJA	IJ21200694	ITAJA S2	22/12/2019 16:16	24/12/2019 10:59	22/12/2019 16:16	24/12/2019 10:59	42,72	1	42,72	CHI
201912163478	BONOPOLIS	BX10403942	SAO MIGUEL DO ARAGUAIA	22/12/2019 16:17	22/12/2019 23:19	22/12/2019 16:19	22/12/2019 19:15	2,93	12	35,19	CHI
201912163478	AMARALINA	LC13051072	SAO MIGUEL DO ARAGUAIA	22/12/2019 16:17	22/12/2019 23:19	22/12/2019 16:19	22/12/2019 20:45	4,42	81	358,29	CHI
201912163478	AMARALINA	LC12270112	SAO MIGUEL DO ARAGUAIA	22/12/2019 16:17	22/12/2019 23:19	22/12/2019 16:19	22/12/2019 21:24	5,08	62	315,20	CHI
201912163478	AMARALINA	LC12182475	SAO MIGUEL DO ARAGUAIA	22/12/2019 16:17	22/12/2019 23:19	22/12/2019 16:19	22/12/2019 22:50	6,51	37	240,78	CHI
201912163478	AMARALINA	LC13315123	SAO MIGUEL DO ARAGUAIA	22/12/2019 16:17	22/12/2019 23:19	22/12/2019 16:19	22/12/2019 23:19	7,00	39	273,00	CHI
201912164254	BALIZA	BH12396561	BOM JARDIM	22/12/2019 16:17	23/12/2019 19:31	22/12/2019 16:17	23/12/2019 19:31	27,22	1	27,22	CHI
201912165196	ANICUNS	AC12304663	FIRMINOPOLIS S2	22/12/2019 16:17	23/12/2019 13:12	22/12/2019 16:17	23/12/2019 13:12	20,92	11	230,08	CHI
201912164261	SAO FRANCISCO DE GOIAS	SF12039051	SAO FRANCISCO DE GOIAS	22/12/2019 16:18	22/12/2019 20:25	22/12/2019 16:18	22/12/2019 20:25	4,11	34	139,76	CHI
201912164636	APARECIDA DE GOIANIA	AP12258426	INDEPENDENCIA S2	22/12/2019 16:18	22/12/2019 18:22	22/12/2019 16:18	22/12/2019 18:22	2,07	1073	2216,94	CHI
201912164463	GOIANIA	GN11169634	ATLANTICO S3	22/12/2019 16:19	22/12/2019 20:09	22/12/2019 16:19	22/12/2019 20:09	3,83	85	325,72	CHI
201912165497	GOIANIA	GN11037422	ATLANTICO S2	22/12/2019 16:19	22/12/2019 21:49	22/12/2019 16:19	22/12/2019 21:49	5,50	106	582,94	CHI
201912164283	OUVIDOR	OU12061245RE	CATALAO S1	22/12/2019 16:20	24/12/2019 11:33	22/12/2019 16:20	22/12/2019 20:01	3,69	16	59,00	CHI

201912164283	OUVIDOR	OU12061245RE	CATALAO S1	22/12/2019 16:20	24/12/2019 11:33	22/12/2019 16:20	23/12/2019 00:07	7,78	41	319,09	CHI
201912164283	OUVIDOR	OU12061245RE	CATALAO S1	22/12/2019 16:20	24/12/2019 11:33	23/12/2019 12:24	23/12/2019 20:23	7,99	16	127,92	CHI
201912164283	OUVIDOR	OU12061245RE	CATALAO S1	22/12/2019 16:20	24/12/2019 11:33	22/12/2019 16:20	24/12/2019 11:33	43,23	3	129,68	CHI
201912164283	OUVIDOR	OU12061245RE	CATALAO S1	22/12/2019 16:20	24/12/2019 11:33	23/12/2019 12:24	24/12/2019 11:33	23,16	41	949,67	CHI
201912164307	ITAPURANGA	IK21133446	GOIAS	22/12/2019 16:21	23/12/2019 16:19	22/12/2019 16:21	23/12/2019 16:19	23,95	2	47,90	CHI
201912164408	GOIANIA	GN11000705	ATLANTICO S2	22/12/2019 16:21	22/12/2019 22:42	22/12/2019 16:21	22/12/2019 22:42	6,35	167	1060,08	CHI
201912164712	GOIANIA	GN11002437	ATLANTICO S3	22/12/2019 16:21	22/12/2019 22:54	22/12/2019 16:21	22/12/2019 22:54	6,55	120	785,80	CHI
201912164873	APARECIDA DE GOIANIA	AP12067461	INDEPENDENCIA S2	22/12/2019 16:21	22/12/2019 19:07	22/12/2019 16:21	22/12/2019 19:07	2,77	839	2322,17	CHI
201912166065	TRINDADE	TR32027168	TRINDADE	22/12/2019 16:21	23/12/2019 00:04	22/12/2019 16:21	23/12/2019 00:04	7,71	42	323,68	CHI
201912164319	SERRANOPOLIS	SX12260528	JATAI S1	22/12/2019 16:22	23/12/2019 17:54	22/12/2019 16:22	23/12/2019 17:54	25,52	4	102,08	CHI
201912164569	VALPARAISO DE GOIAS	VA11090960	PACAEMBU S1	22/12/2019 16:22	22/12/2019 17:53	22/12/2019 16:22	22/12/2019 17:53	1,52	194	294,13	CHI
201912164957	CIDADE OCIDENTAL	DH12170612	MARAJOARA	22/12/2019 16:23	23/12/2019 00:51	22/12/2019 16:23	23/12/2019 00:51	8,45	14	118,34	CHI
201912166349	NOVO GAMA	NJ11128768	PACAEMBU S1	22/12/2019 16:23	23/12/2019 01:21	22/12/2019 16:23	23/12/2019 01:21	8,96	72	645,20	CHI
201912164334	CIDADE OCIDENTAL	LZ12031093	RIO VERMELHO	22/12/2019 16:24	22/12/2019 17:52	22/12/2019 16:24	22/12/2019 17:52	1,47	7	10,27	CHI
201912164334	LUZIANIA	LZ12031093	RIO VERMELHO	22/12/2019 16:24	22/12/2019 17:52	22/12/2019 16:24	22/12/2019 17:52	1,47	41	60,13	CHI
201912164343	NAZARIO	NZ21076353	ANICUNS	22/12/2019 16:24	23/12/2019 00:41	22/12/2019 16:24	22/12/2019 23:47	7,39	4	29,55	CHI
201912164343	NAZARIO	NZ12006961	ANICUNS	22/12/2019 16:24	23/12/2019 00:41	22/12/2019 16:24	23/12/2019 00:41	8,28	7	57,93	CHI
201912164393	APARECIDA DE GOIANIA	AP11241338	INDEPENDENCIA S1	22/12/2019 16:24	23/12/2019 00:58	22/12/2019 16:24	23/12/2019 00:58	8,56	182	1558,38	CHI
201912164996	VALPARAISO DE GOIAS	VA11163173	PACAEMBU S1	22/12/2019 16:24	22/12/2019 21:04	22/12/2019 16:24	22/12/2019 21:04	4,66	89	414,76	CHI
201912164702	APARECIDA DE GOIANIA	AP11041776	INDEPENDENCIA S2	22/12/2019 16:26	22/12/2019 18:31	22/12/2019 16:26	22/12/2019 18:31	2,07	106	219,74	CHI
201912164844	APARECIDA DE GOIANIA	AP12135358	INDEPENDENCIA S1	22/12/2019 16:26	23/12/2019 15:11	22/12/2019 16:26	23/12/2019 15:11	22,74	227	5162,99	CHI
201912179958	APARECIDA DE GOIANIA	AP11003034	INDEPENDENCIA S1	22/12/2019 16:26	23/12/2019 22:25	22/12/2019 16:26	23/12/2019 22:25	29,98	76	2278,31	CHI
201912164648	GOIANIA	GN11189680	ATLANTICO S1	22/12/2019 16:27	23/12/2019 05:27	22/12/2019 16:27	23/12/2019 05:27	12,99	69	896,54	CHI
201912164734	VALPARAISO DE GOIAS	VA11183582	PACAEMBU S1	22/12/2019 16:27	22/12/2019 20:30	22/12/2019 16:27	22/12/2019 20:30	4,06	143	580,22	CHI
201912164770	ITAPACI	01950214	ITAPACI	22/12/2019 16:27	23/12/2019 11:25	22/12/2019 16:27	23/12/2019 07:25	14,97	64	957,87	CHI
201912164770	NOVA GLORIA	01950214	ITAPACI	22/12/2019 16:27	23/12/2019 11:25	22/12/2019 16:27	23/12/2019 07:25	14,97	1	14,97	CHI
201912164770	GUARINOS	IW12048379LD	ITAPACI	22/12/2019 16:27	23/12/2019 11:25	22/12/2019 16:27	23/12/2019 11:25	18,97	14	265,51	CHI
201912164770	ITAPACI	01950214	ITAPACI	22/12/2019 16:27	23/12/2019 11:25	22/12/2019 16:27	23/12/2019 11:25	18,97	35	663,78	CHI
201912164770	ITAPACI	IW12048379LD	ITAPACI	22/12/2019 16:27	23/12/2019 11:25	22/12/2019 16:27	23/12/2019 11:25	18,97	72	1365,50	CHI
201912164770	ITAPACI	IW12048379LD	ITAPACI	22/12/2019 16:27	23/12/2019 11:25	22/12/2019 22:15	23/12/2019 11:25	13,17	2	26,33	CHI
201912165232	VALPARAISO DE GOIAS	VA11345914	PACAEMBU S1	22/12/2019 16:27	22/12/2019 21:49	22/12/2019 16:27	22/12/2019 21:49	5,36	87	466,49	CHI
201912171116	GUARINOS	IW12281203	ITAPACI	22/12/2019 16:27	23/12/2019 15:30	22/12/2019 16:27	23/12/2019 15:30	23,05	4	92,19	CHI
201912171116	ITAPACI	IW12281203	ITAPACI	22/12/2019 16:27	23/12/2019 15:30	22/12/2019 16:27	23/12/2019 15:30	23,05	2	46,10	CHI

201912171116	GUARINOS	IW12281203	ITAPACI	22/12/2019 16:27	23/12/2019 15:30	23/12/2019 08:55	23/12/2019 15:30	6,57	1	6,57	CHI
201912175712	GUARINOS	IW21099489	ITAPACI	22/12/2019 16:27	23/12/2019 22:17	22/12/2019 16:27	23/12/2019 22:17	29,83	1	29,83	CHI
201912164395	ITAPACI	10015830223	ITAPACI	22/12/2019 16:28	22/12/2019 22:12	22/12/2019 16:28	22/12/2019 22:12	5,72	1	5,72	CHI
201912164626	APARECIDA DE GOIANIA	AP12166603	ANHANGUERA	22/12/2019 16:28	22/12/2019 18:03	22/12/2019 16:28	22/12/2019 18:03	1,58	425	672,92	CHI
201912164420	APARECIDA DE GOIANIA	AP10383623	ANHANGUERA	22/12/2019 16:30	23/12/2019 11:12	22/12/2019 16:30	22/12/2019 18:35	2,08	675	1406,06	CHI
201912164420	APARECIDA DE GOIANIA	AP10383623	ANHANGUERA	22/12/2019 16:30	23/12/2019 11:12	22/12/2019 16:30	22/12/2019 18:55	2,40	2106	5063,76	CHI
201912164420	APARECIDA DE GOIANIA	AP10383623	ANHANGUERA	22/12/2019 16:30	23/12/2019 11:12	22/12/2019 16:30	22/12/2019 19:54	3,39	200	677,61	CHI
201912164420	HIDROLANDIA	AP10383623	ANHANGUERA	22/12/2019 16:30	23/12/2019 11:12	22/12/2019 16:30	22/12/2019 19:54	3,39	1829	6196,75	CHI
201912164420	APARECIDA DE GOIANIA	AP10383623	ANHANGUERA	22/12/2019 16:30	23/12/2019 11:12	22/12/2019 16:30	22/12/2019 21:47	5,27	1	5,27	CHI
201912164420	HIDROLANDIA	AP10383623	ANHANGUERA	22/12/2019 16:30	23/12/2019 11:12	22/12/2019 16:30	22/12/2019 21:47	5,27	4	21,09	CHI
201912164420	APARECIDA DE GOIANIA	AP10383623	ANHANGUERA	22/12/2019 16:30	23/12/2019 11:12	23/12/2019 01:55	23/12/2019 01:58	0,05	3437	172,80	CHI
201912164420	HIDROLANDIA	AP10383623	ANHANGUERA	22/12/2019 16:30	23/12/2019 11:12	23/12/2019 01:55	23/12/2019 01:58	0,05	1972	99,15	CHI
201912164420	APARECIDA DE GOIANIA	AP10383623	ANHANGUERA	22/12/2019 16:30	23/12/2019 11:12	22/12/2019 16:30	23/12/2019 11:12	18,69	1	18,69	CHI
201912164420	HIDROLANDIA	AP10383623	ANHANGUERA	22/12/2019 16:30	23/12/2019 11:12	22/12/2019 16:30	23/12/2019 11:12	18,69	40	747,51	CHI
201912164423	ANAPOLIS	20321892	JUNDIAI S2	22/12/2019 16:30	22/12/2019 18:04	22/12/2019 16:30	22/12/2019 18:04	1,55	1	1,55	CHI
201912164424	ABADIA DE GOIAS	LG31245589	GUAPO S1	22/12/2019 16:30	23/12/2019 22:30	22/12/2019 16:30	23/12/2019 22:30	29,98	12	359,82	CHI
201912164585	QUIRINOPOLIS	00270464	QUIRINOPOLIS	22/12/2019 16:30	22/12/2019 20:29	22/12/2019 16:30	22/12/2019 16:35	0,08	1	0,08	CHI
201912164585	QUIRINOPOLIS	00270464	QUIRINOPOLIS	22/12/2019 16:30	22/12/2019 20:29	22/12/2019 16:30	22/12/2019 16:35	0,08	2	0,17	CHI
201912164585	QUIRINOPOLIS	00270464	QUIRINOPOLIS	22/12/2019 16:30	22/12/2019 20:29	22/12/2019 16:30	22/12/2019 16:35	0,08	12	1,00	CHI
201912164585	RIO VERDE	00270464	QUIRINOPOLIS	22/12/2019 16:30	22/12/2019 20:29	22/12/2019 16:30	22/12/2019 16:35	0,08	1	0,08	CHI
201912164585	CACHOEIRA ALTA	00270464	QUIRINOPOLIS	22/12/2019 16:30	22/12/2019 20:29	22/12/2019 16:30	22/12/2019 16:35	0,08	37	2,98	CHI
201912164585	CACHOEIRA ALTA	00270464	QUIRINOPOLIS	22/12/2019 16:30	22/12/2019 20:29	22/12/2019 16:30	22/12/2019 16:35	0,08	3	0,24	CHI
201912164585	QUIRINOPOLIS	00270464	QUIRINOPOLIS	22/12/2019 16:30	22/12/2019 20:29	22/12/2019 16:30	22/12/2019 16:35	0,08	85	6,85	CHI
201912164585	QUIRINOPOLIS	00270464	QUIRINOPOLIS	22/12/2019 16:30	22/12/2019 20:29	22/12/2019 16:30	22/12/2019 16:35	0,08	283	22,80	CHI
201912164585	QUIRINOPOLIS	00270464	QUIRINOPOLIS	22/12/2019 16:30	22/12/2019 20:29	22/12/2019 16:30	22/12/2019 16:35	0,08	267	21,51	CHI
201912164585	RIO VERDE	00270464	QUIRINOPOLIS	22/12/2019 16:30	22/12/2019 20:29	22/12/2019 16:30	22/12/2019 16:35	0,08	110	8,86	CHI
201912164585	RIO VERDE	00270464	QUIRINOPOLIS	22/12/2019 16:30	22/12/2019 20:29	22/12/2019 16:30	22/12/2019 16:35	0,08	33	2,66	CHI
201912164585	CACHOEIRA ALTA	00270464	CACHOEIRA ALTA	22/12/2019 16:30	22/12/2019 20:29	22/12/2019 16:30	22/12/2019 18:26	1,93	67	129,55	CHI
201912164585	QUIRINOPOLIS	00270464	CACHOEIRA ALTA	22/12/2019 16:30	22/12/2019 20:29	22/12/2019 16:30	22/12/2019 18:26	1,93	38	73,48	CHI
201912164585	CACHOEIRA ALTA	00270464	CACHOEIRA ALTA	22/12/2019 16:30	22/12/2019 20:29	22/12/2019 16:30	22/12/2019 18:26	1,93	10	19,31	CHI
201912164585	QUIRINOPOLIS	00270464	CACHOEIRA ALTA	22/12/2019 16:30	22/12/2019 20:29	22/12/2019 16:30	22/12/2019 18:26	1,93	6	11,58	CHI
201912164585	CACHOEIRA ALTA	00270464	CACHOEIRA ALTA	22/12/2019 16:30	22/12/2019 20:29	22/12/2019 19:48	22/12/2019 20:29	0,67	77	51,46	CHI
201912164585	QUIRINOPOLIS	00270464	CACHOEIRA ALTA	22/12/2019 16:30	22/12/2019 20:29	22/12/2019 19:48	22/12/2019 20:29	0,67	45	30,08	CHI

201912165180	APARECIDA DE GOIANIA	AP12000025	INDEPENDENCIA S1	22/12/2019 16:30	22/12/2019 22:43	22/12/2019 16:30	22/12/2019 22:43	6,20	342	2120,78	CHI
201912166033	PORANGATU	PO12192281	PORANGATU	22/12/2019 16:30	23/12/2019 11:57	22/12/2019 16:30	23/12/2019 11:57	19,43	2	38,87	CHI
201912164427	DOVERLANDIA	MY12390600	PARQUE DAS EMAS	22/12/2019 16:31	23/12/2019 21:50	22/12/2019 16:31	23/12/2019 21:50	29,32	1	29,32	CHI
201912164427	MINEIROS	MY12390600	PARQUE DAS EMAS	22/12/2019 16:31	23/12/2019 21:50	22/12/2019 16:31	23/12/2019 21:50	29,32	24	703,61	CHI
201912164440	CATALAO	CT12134367	CATALAO S1	22/12/2019 16:31	23/12/2019 12:40	22/12/2019 16:31	23/12/2019 12:40	20,14	10	201,39	CHI
201912165265	MONTIVIDIU	MV12207149	MONTIVIDIU T	22/12/2019 16:31	23/12/2019 10:41	22/12/2019 16:31	23/12/2019 10:41	18,17	33	599,61	CHI
201912165406	APARECIDA DE GOIANIA	AP11127135	INDEPENDENCIA S1	22/12/2019 16:31	22/12/2019 22:40	22/12/2019 16:31	22/12/2019 22:40	6,15	227	1394,98	CHI
201912167125	VARJAO	VJ12350683	GUAPO S2	22/12/2019 16:31	24/12/2019 00:40	22/12/2019 16:31	24/12/2019 00:40	32,15	43	1382,26	CHI
201912169591	CATALAO	CT21149279	CATALAO S1	22/12/2019 16:31	23/12/2019 13:23	22/12/2019 16:31	23/12/2019 13:23	20,86	1	20,86	CHI
201912164457	MORRINHOS	MR21000281	MORRINHOS	22/12/2019 16:32	23/12/2019 16:30	22/12/2019 16:32	23/12/2019 16:30	23,95	1	23,95	CHI
201912164713	GOIANIA	GN11000665	ATLANTICO S3	22/12/2019 16:32	22/12/2019 21:38	22/12/2019 16:32	22/12/2019 21:38	5,09	198	1008,53	CHI
201912164509	GOIANIA	GN11097701	GOYA S2	22/12/2019 16:33	22/12/2019 19:40	22/12/2019 16:33	22/12/2019 19:25	2,87	152	436,58	CHI
201912164509	GOIANIA	GN12038186	GOYA S2	22/12/2019 16:33	22/12/2019 19:40	22/12/2019 16:33	22/12/2019 19:40	3,11	147	457,86	CHI
201912165309	APARECIDA DE GOIANIA	AP11000021	INDEPENDENCIA S1	22/12/2019 16:33	23/12/2019 18:27	22/12/2019 16:33	23/12/2019 18:27	25,90	216	5594,16	CHI
201912166059	APARECIDA DE GOIANIA	AP11048700	INDEPENDENCIA S1	22/12/2019 16:33	23/12/2019 15:20	22/12/2019 16:33	23/12/2019 15:20	22,78	138	3143,29	CHI
201912164474	MONTIVIDIU	MV11191877	MONTIVIDIU T	22/12/2019 16:34	22/12/2019 20:20	22/12/2019 17:40	22/12/2019 20:20	2,67	167	445,33	CHI
201912164650	APARECIDA DE GOIANIA	AP11094806	INDEPENDENCIA S1	22/12/2019 16:34	23/12/2019 15:28	22/12/2019 16:34	23/12/2019 15:28	22,90	226	5174,46	CHI
201912164747	APARECIDA DE GOIANIA	AP12208899	INDEPENDENCIA S1	22/12/2019 16:34	23/12/2019 08:47	22/12/2019 16:34	23/12/2019 08:47	16,20	141	2284,63	CHI
201912163464	JUSSARA	JR12093790	JUSSARA	22/12/2019 16:35	22/12/2019 18:59	22/12/2019 16:35	22/12/2019 18:59	2,39	2	4,77	CHI
201912164483	MORRINHOS	MR12033683	MORRINHOS	22/12/2019 16:35	22/12/2019 20:02	22/12/2019 16:35	22/12/2019 20:02	3,45	143	493,35	CHI
201912164493	ITUMBIARA	IT12404221	PARANAIBA	22/12/2019 16:35	22/12/2019 21:34	22/12/2019 18:58	22/12/2019 21:34	2,61	26	67,80	CHI
201912164549	PONTALINA	PK12340362RE	PONTALINA	22/12/2019 16:35	22/12/2019 18:28	22/12/2019 16:35	22/12/2019 18:28	1,88	78	146,66	CHI
201912164733	APARECIDA DE GOIANIA	AP11103823	INDEPENDENCIA S2	22/12/2019 16:35	22/12/2019 20:40	22/12/2019 16:35	22/12/2019 20:40	4,08	291	1186,96	CHI
201912164515	AGUAS LINDAS DE GOIAS	10020268295	AGUAS LINDAS DE GOIAS S1	22/12/2019 16:36	22/12/2019 18:19	22/12/2019 16:36	22/12/2019 18:19	1,70	1	1,70	CHI
201912164706	APARECIDA DE GOIANIA	AP11072666	INDEPENDENCIA S1	22/12/2019 16:36	23/12/2019 16:40	22/12/2019 16:36	23/12/2019 16:40	24,07	106	2551,21	CHI
201912164890	GOIANIA	GN11132347	ATLANTICO S1	22/12/2019 16:36	22/12/2019 20:18	22/12/2019 16:36	22/12/2019 20:18	3,69	124	457,39	CHI
201912165292	SAO MIGUEL DO ARAGUAIA	SM11315129	SAO MIGUEL DO ARAGUAIA	22/12/2019 16:36	22/12/2019 19:40	22/12/2019 16:36	22/12/2019 19:40	3,07	56	171,76	CHI
201912165384	APARECIDA DE GOIANIA	AP12058739	INDEPENDENCIA S1	22/12/2019 16:36	22/12/2019 19:37	22/12/2019 16:36	22/12/2019 19:37	3,01	340	1023,49	CHI
201912164523	PALMEIRAS DE GOIAS	PL12346577	PALMEIRAS	22/12/2019 16:37	24/12/2019 01:20	22/12/2019 16:37	23/12/2019 23:35	30,98	5	154,88	CHI
201912164523	PALMEIRAS DE GOIAS	PL12391021LD	PALMEIRAS	22/12/2019 16:37	24/12/2019 01:20	22/12/2019 16:37	23/12/2019 23:45	31,14	9	280,22	CHI
201912164523	PALMEIRAS DE GOIAS	PL12346582	PALMEIRAS	22/12/2019 16:37	24/12/2019 01:20	22/12/2019 16:37	23/12/2019 23:55	31,30	7	219,07	CHI
201912164523	PALMEIRAS DE GOIAS	PL12346577	PALMEIRAS	22/12/2019 16:37	24/12/2019 01:20	22/12/2019 16:37	24/12/2019 01:20	32,71	1	32,71	CHI
201912164523	PALMEIRAS DE GOIAS	PL12233432LD	PALMEIRAS	22/12/2019 16:37	24/12/2019 01:20	24/12/2019 00:04	24/12/2019 01:20	1,25	44	55,04	CHI

201912164524	GOIANIA	GN11037017	CAMPINAS S1	22/12/2019 16:37	22/12/2019 20:32	22/12/2019 16:37	22/12/2019 20:32	3,91	57	222,79	CHI
201912164769	GOIANIA	GN11002833	ATLANTICO S1	22/12/2019 16:37	22/12/2019 20:14	22/12/2019 16:37	22/12/2019 20:14	3,61	137	494,95	CHI
201912165189	NOVO GAMA	NJ11290165	PACAEMBU S1	22/12/2019 16:37	22/12/2019 19:00	22/12/2019 16:37	22/12/2019 19:00	2,37	147	348,68	CHI
201912165228	ITAPACI	IW11264925	ITAPACI	22/12/2019 16:37	23/12/2019 12:45	22/12/2019 16:37	23/12/2019 12:45	20,12	96	1931,81	CHI
201912165103	NOVO GAMA	NJ12148933	PACAEMBU S1	22/12/2019 16:38	23/12/2019 00:23	22/12/2019 16:38	23/12/2019 00:23	7,74	728	5632,29	CHI
201912165533	APARECIDA DE GOIANIA	AP12193733	INDEPENDENCIA S1	22/12/2019 16:38	22/12/2019 20:26	22/12/2019 16:38	22/12/2019 20:26	3,79	153	579,32	CHI
201912165804	APARECIDA DE GOIANIA	AP11282814	INDEPENDENCIA S1	22/12/2019 16:38	23/12/2019 14:00	22/12/2019 16:38	23/12/2019 14:00	21,37	51	1089,70	CHI
201912163461	MORRINHOS	MR12403761	MORRINHOS	22/12/2019 16:39	22/12/2019 18:40	22/12/2019 16:39	22/12/2019 18:40	2,01	215	432,99	CHI
201912164551	FORMOSA	FA12115645	ITUIQUIRA	22/12/2019 16:39	22/12/2019 20:01	22/12/2019 16:39	22/12/2019 20:01	3,37	39	131,25	CHI
201912164771	APARECIDA DE GOIANIA	AP11193212	INDEPENDENCIA S2	22/12/2019 16:39	23/12/2019 10:50	22/12/2019 16:39	23/12/2019 10:50	18,19	194	3529,24	CHI
201912164816	GOIANESIA	GE12352313	GOIANESIA S1	22/12/2019 16:39	23/12/2019 10:39	22/12/2019 16:39	23/12/2019 10:39	18,00	23	413,91	CHI
201912164816	SAO LUIZ DO NORTE	GE12352313	GOIANESIA S1	22/12/2019 16:39	23/12/2019 10:39	22/12/2019 16:39	23/12/2019 10:39	18,00	21	377,92	CHI
201912165164	APARECIDA DE GOIANIA	AP12160660	INDEPENDENCIA S1	22/12/2019 16:39	22/12/2019 20:10	22/12/2019 16:39	22/12/2019 20:10	3,51	308	1081,94	CHI
201912165479	GOIANIA	GN12168669	ATLANTICO S3	22/12/2019 16:39	22/12/2019 18:58	22/12/2019 16:39	22/12/2019 18:58	2,31	37	85,49	CHI
201912166207	GOIANIA	GN11169152	ATLANTICO S3	22/12/2019 16:39	23/12/2019 06:22	22/12/2019 16:39	23/12/2019 06:22	13,71	31	425,03	CHI
201912167267	NOVO GAMA	NJ12344854	PACAEMBU S1	22/12/2019 16:39	22/12/2019 23:08	22/12/2019 16:39	22/12/2019 23:08	6,48	232	1504,00	CHI
201912164584	VALPARAISO DE GOIAS	VA11330581	PACAEMBU S1	22/12/2019 16:40	22/12/2019 20:29	22/12/2019 16:40	22/12/2019 20:29	3,81	58	221,04	CHI
201912166448	NOVO GAMA	NJ11383084	PACAEMBU S1	22/12/2019 16:40	22/12/2019 20:38	22/12/2019 16:40	22/12/2019 20:38	3,96	146	578,40	CHI
201912164654	AGUAS LINDAS DE GOIAS	LA11382944	AGUAS LINDAS DE GOIAS S1	22/12/2019 16:41	22/12/2019 18:17	22/12/2019 16:41	22/12/2019 18:17	1,59	79	125,59	CHI
201912164913	APARECIDA DE GOIANIA	AP11207714	INDEPENDENCIA S2	22/12/2019 16:41	23/12/2019 03:00	22/12/2019 16:41	23/12/2019 03:00	10,31	306	3154,27	CHI
201912165112	FAINA	FC12376699	GOIAS	22/12/2019 16:41	23/12/2019 16:59	22/12/2019 16:41	23/12/2019 16:59	24,29	27	655,73	CHI
201912165112	GOIAS	FC12376699	GOIAS	22/12/2019 16:41	23/12/2019 16:59	22/12/2019 16:41	23/12/2019 16:59	24,29	2	48,57	CHI
201912164600	PADRE BERNARDO	PB12124272LD	PADRE BERNARDO	22/12/2019 16:42	23/12/2019 00:53	22/12/2019 16:42	22/12/2019 22:39	5,96	77	459,09	CHI
201912164600	PLANALTINA	PB12124272LD	PADRE BERNARDO	22/12/2019 16:42	23/12/2019 00:53	22/12/2019 16:42	22/12/2019 22:39	5,96	11	65,58	CHI
201912164600	PADRE BERNARDO	PB12124272LD	PADRE BERNARDO	22/12/2019 16:42	23/12/2019 00:53	22/12/2019 22:46	23/12/2019 00:53	2,13	80	170,24	CHI
201912164600	PLANALTINA	PB12124272LD	PADRE BERNARDO	22/12/2019 16:42	23/12/2019 00:53	22/12/2019 22:46	23/12/2019 00:53	2,13	11	23,41	CHI
201912164606	BRITANIA	BT21165649	BRITANIA	22/12/2019 16:42	23/12/2019 19:25	22/12/2019 16:42	23/12/2019 19:25	26,71	1	26,71	CHI
201912164614	JUSSARA	JR12241057	BRITANIA	22/12/2019 16:42	23/12/2019 13:08	22/12/2019 16:42	23/12/2019 13:08	20,42	1	20,42	CHI
201912165350	SANTO ANTONIO DO DESCOBERTO	SN12349049	ALEXANIA	22/12/2019 16:42	22/12/2019 21:15	22/12/2019 16:42	22/12/2019 21:15	4,54	9	40,86	CHI
201912165774	SAO MIGUEL DO ARAGUAIA	SM12384229	SAO MIGUEL DO ARAGUAIA	22/12/2019 16:42	23/12/2019 11:14	22/12/2019 16:42	23/12/2019 11:14	18,52	4	74,09	CHI
201912164616	JATAI	AW21308231	CACHOEIRA ALTA	22/12/2019 16:43	23/12/2019 14:42	22/12/2019 16:43	23/12/2019 14:42	21,98	1	21,98	CHI
201912164623	SANTA TEREZA DE GOIAS	SE12094689	MARA ROSA	22/12/2019 16:43	22/12/2019 21:06	22/12/2019 16:43	22/12/2019 21:06	4,37	1	4,37	CHI
201912165563	APARECIDA DE GOIANIA	AP12043971	INDEPENDENCIA S2	22/12/2019 16:43	23/12/2019 17:30	22/12/2019 16:43	23/12/2019 17:30	24,77	244	6044,96	CHI

201912164637	ANICUNS	AC21000080	ANICUNS	22/12/2019 16:44	23/12/2019 11:52	22/12/2019 16:44	23/12/2019 11:52	19,13	2	38,25	CHI
201912164728	APARECIDA DE GOIANIA	AP11166592	REAL S2	22/12/2019 16:44	22/12/2019 23:32	22/12/2019 16:44	22/12/2019 23:32	6,79	142	964,02	CHI
201912165256	APARECIDA DE GOIANIA	AP11389480	INDEPENDENCIA S2	22/12/2019 16:44	23/12/2019 11:29	22/12/2019 16:44	23/12/2019 11:29	18,75	79	1481,05	CHI
201912165503	GOIANIA	GN11110756	ATLANTICO S1	22/12/2019 16:44	22/12/2019 21:11	22/12/2019 16:44	22/12/2019 21:11	4,44	75	332,79	CHI
201912165149	APARECIDA DE GOIANIA	AP11053047	INDEPENDENCIA S1	22/12/2019 16:45	23/12/2019 08:55	22/12/2019 16:45	23/12/2019 08:55	16,16	257	4153,83	CHI
201912165481	APARECIDA DE GOIANIA	AP11240471	INDEPENDENCIA S2	22/12/2019 16:45	23/12/2019 08:59	22/12/2019 16:45	23/12/2019 08:59	16,22	84	1362,46	CHI
201912164678	SANTA HELENA DE GOIAS	SH21149494	ACREUNA	22/12/2019 16:46	24/12/2019 00:15	22/12/2019 16:46	24/12/2019 00:15	31,48	1	31,48	CHI
201912164684	PIRACANJUBA	PJ21106697	CALDAS NOVAS S1	22/12/2019 16:46	23/12/2019 10:01	22/12/2019 16:46	23/12/2019 10:01	17,23	1	17,23	CHI
201912165035	APARECIDA DE GOIANIA	AP11072158	INDEPENDENCIA S1	22/12/2019 16:46	23/12/2019 06:46	22/12/2019 16:46	23/12/2019 06:46	14,01	229	3208,04	CHI
201912166924	GOIANIA	GN11189337	CARAJAS S1	22/12/2019 16:46	23/12/2019 13:28	22/12/2019 16:46	23/12/2019 13:28	20,70	43	889,92	CHI
201912164696	APARECIDA DE GOIANIA	200345424	INDEPENDENCIA S2	22/12/2019 16:47	23/12/2019 10:55	22/12/2019 16:47	23/12/2019 10:55	18,13	1	18,13	CHI
201912165038	VALPARAISO DE GOIAS	VA11136667	PACAEMBU S2	22/12/2019 16:47	22/12/2019 19:34	22/12/2019 16:47	22/12/2019 19:34	2,78	176	489,28	CHI
201912164705	MUNDO NOVO DE GOIAS	4240002589	NOVA CRIXAS	22/12/2019 16:48	23/12/2019 08:35	22/12/2019 16:48	23/12/2019 08:35	15,78	1	15,78	CHI
201912165370	APARECIDA DE GOIANIA	AP12040976	INDEPENDENCIA S1	22/12/2019 16:48	22/12/2019 20:56	22/12/2019 16:48	22/12/2019 20:56	4,13	608	2512,39	CHI
201912163736	CAMPESTRE DE GOIAS	GA12011344	GUAPO S2	22/12/2019 16:49	23/12/2019 09:20	22/12/2019 16:49	23/12/2019 09:20	16,51	12	198,14	CHI
201912163736	GUAPO	GA12011344	GUAPO S2	22/12/2019 16:49	23/12/2019 09:20	22/12/2019 16:49	23/12/2019 09:20	16,51	54	891,62	CHI
201912164720	GOIANIA	GN11000468	CAMPINAS S3	22/12/2019 16:49	22/12/2019 19:19	22/12/2019 16:49	22/12/2019 19:19	2,49	41	102,17	CHI
201912164737	LEOPOLDO DE BULHOES	LB21277023	DAIA S2	22/12/2019 16:50	22/12/2019 18:54	22/12/2019 16:50	22/12/2019 18:54	2,06	10	20,64	CHI
201912165536	APARECIDA DE GOIANIA	AP11078319	INDEPENDENCIA S2	22/12/2019 16:51	23/12/2019 12:51	22/12/2019 16:51	23/12/2019 12:51	19,99	22	439,76	CHI
201912164763	AGUAS LINDAS DE GOIAS	LA12169519	AGUAS LINDAS DE GOIAS S1	22/12/2019 16:52	22/12/2019 19:50	22/12/2019 16:52	22/12/2019 19:50	2,97	61	180,97	CHI
201912164765	GOIANIA	GN11291397	ATLANTICO S1	22/12/2019 16:52	23/12/2019 04:45	22/12/2019 16:52	23/12/2019 04:45	11,88	33	391,99	CHI
201912164775	GOIANIA	16171573	MEIA PONTE	22/12/2019 16:53	22/12/2019 22:57	22/12/2019 16:53	22/12/2019 22:57	6,07	1	6,07	CHI
201912164778	ANICUNS	910060496	ANICUNS	22/12/2019 16:53	23/12/2019 15:05	22/12/2019 16:53	23/12/2019 15:05	22,19	1	22,19	CHI
201912166139	NOVO GAMA	NJ11201126	PACAEMBU S1	22/12/2019 16:53	22/12/2019 20:18	22/12/2019 16:53	22/12/2019 20:18	3,41	189	643,91	CHI
201912164797	APARECIDA DE GOIANIA	AP11170380	INDEPENDENCIA S2	22/12/2019 16:54	22/12/2019 19:40	22/12/2019 16:54	22/12/2019 19:40	2,75	130	357,54	CHI
201912164972	APARECIDA DE GOIANIA	AP11070531	INDEPENDENCIA S2	22/12/2019 16:54	23/12/2019 09:05	22/12/2019 16:54	23/12/2019 09:05	16,17	146	2361,47	CHI
201912164798	APARECIDA DE GOIANIA	AP11159208	INDEPENDENCIA S2	22/12/2019 16:55	22/12/2019 18:39	22/12/2019 16:55	22/12/2019 18:39	1,73	99	171,49	CHI
201912164813	PALMEIRAS DE GOIAS	PL12000219	PALMEIRAS	22/12/2019 16:55	23/12/2019 12:22	22/12/2019 16:55	23/12/2019 12:22	19,44	11	213,79	CHI
201912164818	SANTA HELENA DE GOIAS	SH21296164	IPEGUARI	22/12/2019 16:55	23/12/2019 23:15	22/12/2019 16:55	23/12/2019 23:15	30,32	1	30,32	CHI
201912164878	APARECIDA DE GOIANIA	AP11000018	INDEPENDENCIA S1	22/12/2019 16:55	23/12/2019 10:20	22/12/2019 16:55	23/12/2019 10:20	17,41	148	2576,52	CHI
201912164961	APARECIDA DE GOIANIA	AP11095596	INDEPENDENCIA S1	22/12/2019 16:55	23/12/2019 16:38	22/12/2019 16:55	23/12/2019 16:38	23,71	133	3152,95	CHI
201912166226	APARECIDA DE GOIANIA	AP11203380	INDEPENDENCIA S1	22/12/2019 16:55	23/12/2019 10:21	22/12/2019 16:55	23/12/2019 10:21	17,44	170	2965,27	CHI
201912163479	GOUVELANDIA	01560234	QUIRINOPOLIS	22/12/2019 16:56	23/12/2019 20:07	22/12/2019 17:15	22/12/2019 18:48	1,54	100	154,28	CHI

201912163479	QUIRINOPOLIS	01560234	QUIRINOPOLIS	22/12/2019 16:56	23/12/2019 20:07	22/12/2019 17:15	22/12/2019 18:48	1,54	13	20,06	CHI
201912163479	QUIRINOPOLIS	01560234	QUIRINOPOLIS	22/12/2019 16:56	23/12/2019 20:07	22/12/2019 17:15	22/12/2019 20:04	2,82	151	426,41	CHI
201912163479	GOUVELANDIA	01560234	QUIRINOPOLIS	22/12/2019 16:56	23/12/2019 20:07	22/12/2019 17:15	22/12/2019 20:47	3,53	208	734,01	CHI
201912163479	QUIRINOPOLIS	01560234	QUIRINOPOLIS	22/12/2019 16:56	23/12/2019 20:07	22/12/2019 17:15	22/12/2019 20:47	3,53	275	970,44	CHI
201912163479	CASTELANDIA	01560234	QUIRINOPOLIS	22/12/2019 16:56	23/12/2019 20:07	22/12/2019 17:15	22/12/2019 22:13	4,96	18	89,25	CHI
201912163479	QUIRINOPOLIS	01560234	QUIRINOPOLIS	22/12/2019 16:56	23/12/2019 20:07	22/12/2019 17:15	22/12/2019 22:13	4,96	188	932,22	CHI
201912163479	RIO VERDE	01560234	QUIRINOPOLIS	22/12/2019 16:56	23/12/2019 20:07	22/12/2019 17:15	22/12/2019 22:13	4,96	1	4,96	CHI
201912163479	GOUVELANDIA	01560234	QUIRINOPOLIS	22/12/2019 16:56	23/12/2019 20:07	22/12/2019 17:15	22/12/2019 22:15	4,99	2	9,98	CHI
201912163479	QUIRINOPOLIS	01560234	QUIRINOPOLIS	22/12/2019 16:56	23/12/2019 20:07	22/12/2019 17:15	22/12/2019 22:15	4,99	50	249,54	CHI
201912163479	QUIRINOPOLIS	01560234	QUIRINOPOLIS	22/12/2019 16:56	23/12/2019 20:07	22/12/2019 17:15	23/12/2019 07:31	14,27	17	242,51	CHI
201912163479	QUIRINOPOLIS	01560234	QUIRINOPOLIS	22/12/2019 16:56	23/12/2019 20:07	22/12/2019 17:15	23/12/2019 07:33	14,30	60	857,90	CHI
201912163479	QUIRINOPOLIS	01560234	QUIRINOPOLIS	22/12/2019 16:56	23/12/2019 20:07	22/12/2019 17:15	23/12/2019 07:39	14,40	7	100,82	CHI
201912163479	QUIRINOPOLIS	QI12303068	QUIRINOPOLIS	22/12/2019 16:56	23/12/2019 20:07	22/12/2019 19:58	23/12/2019 07:39	11,68	4	46,72	CHI
201912163479	QUIRINOPOLIS	QI12296596	QUIRINOPOLIS	22/12/2019 16:56	23/12/2019 20:07	23/12/2019 07:40	23/12/2019 10:23	2,72	23	62,59	CHI
201912163479	QUIRINOPOLIS	QI13360938	QUIRINOPOLIS	22/12/2019 16:56	23/12/2019 20:07	23/12/2019 07:40	23/12/2019 14:14	6,57	38	249,78	CHI
201912163479	GOUVELANDIA	GB10402438	QUIRINOPOLIS	22/12/2019 16:56	23/12/2019 20:07	23/12/2019 19:59	23/12/2019 20:07	0,13	101	13,16	CHI
201912163479	QUIRINOPOLIS	GB10402438	QUIRINOPOLIS	22/12/2019 16:56	23/12/2019 20:07	23/12/2019 19:59	23/12/2019 20:07	0,13	13	1,69	CHI
201912165836	ITAPACI	IW12051740	ITAPACI	22/12/2019 16:56	24/12/2019 00:34	22/12/2019 16:56	24/12/2019 00:34	31,62	4	126,49	CHI
201912165836	GUARINOS	IW12201636	ITAPACI	22/12/2019 16:56	24/12/2019 00:34	23/12/2019 19:48	24/12/2019 00:34	4,77	7	33,39	CHI
201912165836	ITAPACI	IW12201636	ITAPACI	22/12/2019 16:56	24/12/2019 00:34	23/12/2019 19:48	24/12/2019 00:34	4,77	240	1144,67	CHI
201912165836	PILAR DE GOIAS	IW12201636	ITAPACI	22/12/2019 16:56	24/12/2019 00:34	23/12/2019 19:48	24/12/2019 00:34	4,77	1	4,77	CHI
201912167077	JATAI	JT12000147	JATAI S2	22/12/2019 16:56	23/12/2019 08:50	22/12/2019 16:56	23/12/2019 08:50	15,89	4	63,55	CHI
201912163480	IPIRANGA DE GOIAS	01630414	RUBIATABA	22/12/2019 16:57	24/12/2019 02:03	22/12/2019 16:57	22/12/2019 18:20	1,38	3	4,14	CHI
201912163480	ITAPACI	01630414	RUBIATABA	22/12/2019 16:57	24/12/2019 02:03	22/12/2019 16:57	22/12/2019 18:20	1,38	10	13,79	CHI
201912163480	RUBIATABA	01630414	RUBIATABA	22/12/2019 16:57	24/12/2019 02:03	22/12/2019 16:57	22/12/2019 18:20	1,38	149	205,54	CHI
201912163480	IPIRANGA DE GOIAS	01630414	RUBIATABA	22/12/2019 16:57	24/12/2019 02:03	23/12/2019 04:13	23/12/2019 04:25	0,21	3	0,62	CHI
201912163480	ITAPACI	01630414	RUBIATABA	22/12/2019 16:57	24/12/2019 02:03	23/12/2019 04:13	23/12/2019 04:25	0,21	10	2,05	CHI
201912163480	RUBIATABA	01630414	RUBIATABA	22/12/2019 16:57	24/12/2019 02:03	23/12/2019 04:13	23/12/2019 04:25	0,21	149	30,59	CHI
201912163480	IPIRANGA DE GOIAS	RB13095552	RUBIATABA	22/12/2019 16:57	24/12/2019 02:03	22/12/2019 16:57	23/12/2019 08:33	15,60	7	109,23	CHI
201912163480	IPIRANGA DE GOIAS	RB13272934	RUBIATABA	22/12/2019 16:57	24/12/2019 02:03	22/12/2019 16:57	23/12/2019 16:31	23,58	21	495,08	CHI
201912163480	IPIRANGA DE GOIAS	RB13272934	RUBIATABA	22/12/2019 16:57	24/12/2019 02:03	22/12/2019 16:57	24/12/2019 02:03	33,10	9	297,87	CHI
201912164938	APARECIDA DE GOIANIA	AP11240439	INDEPENDENCIA S2	22/12/2019 16:57	22/12/2019 19:10	22/12/2019 16:57	22/12/2019 19:10	2,21	157	346,27	CHI
201912164974	APARECIDA DE GOIANIA	AP11000058	INDEPENDENCIA S1	22/12/2019 16:57	23/12/2019 08:20	22/12/2019 16:57	23/12/2019 08:20	15,39	198	3047,55	CHI

201912184129	NOVA IGUACU DE GOIAS	NH12371949	SANTA TEREZINHA	22/12/2019 16:57	24/12/2019 09:40	22/12/2019 16:57	24/12/2019 09:40	40,70	1	40,70	CHI
201912184129	PILAR DE GOIAS	NH12371949	SANTA TEREZINHA	22/12/2019 16:57	24/12/2019 09:40	22/12/2019 16:57	24/12/2019 09:40	40,70	2	81,41	CHI
201912164981	GOIANIA	GN11042201	FERROVIARIO S1	22/12/2019 16:58	22/12/2019 19:31	22/12/2019 16:58	22/12/2019 19:31	2,55	167	425,15	CHI
201912164851	MORRINHOS	MR21000317	MORRINHOS	22/12/2019 16:59	22/12/2019 19:02	22/12/2019 16:59	22/12/2019 19:02	2,05	1	2,05	CHI
201912164855	GOIANIA	11815279	REAL S1	22/12/2019 16:59	22/12/2019 20:46	22/12/2019 16:59	22/12/2019 20:46	3,78	1	3,78	CHI
201912164874	TRINDADE	TR31024882	TRINDADE	22/12/2019 16:59	23/12/2019 09:56	22/12/2019 16:59	23/12/2019 09:56	16,93	1	16,93	CHI
201912167180	CIDADE OCIDENTAL	DH11370634	MARAJOARA	22/12/2019 16:59	22/12/2019 22:47	22/12/2019 16:59	22/12/2019 22:47	5,79	100	579,22	CHI
201912163481	CAIAPONIA	JT10400621	JATAI S1	22/12/2019 17:00	22/12/2019 21:25	22/12/2019 17:00	22/12/2019 17:03	0,05	20	1,04	CHI
201912163481	CAIAPONIA	JT10400621	JATAI S1	22/12/2019 17:00	22/12/2019 21:25	22/12/2019 17:00	22/12/2019 17:03	0,05	38	1,97	CHI
201912163481	JATAI	JT10400621	JATAI S1	22/12/2019 17:00	22/12/2019 21:25	22/12/2019 17:00	22/12/2019 17:03	0,05	301	15,64	CHI
201912163481	JATAI	JT10400621	JATAI S1	22/12/2019 17:00	22/12/2019 21:25	22/12/2019 17:00	22/12/2019 17:03	0,05	12	0,62	CHI
201912163481	MINEIROS	JT10400621	JATAI S1	22/12/2019 17:00	22/12/2019 21:25	22/12/2019 17:00	22/12/2019 17:03	0,05	2	0,10	CHI
201912163481	MINEIROS	JT10400621	JATAI S1	22/12/2019 17:00	22/12/2019 21:25	22/12/2019 17:00	22/12/2019 17:03	0,05	3	0,16	CHI
201912163481	PEROLANDIA	JT10400621	JATAI S1	22/12/2019 17:00	22/12/2019 21:25	22/12/2019 17:00	22/12/2019 17:03	0,05	1034	53,71	CHI
201912163481	PEROLANDIA	JT10400621	JATAI S1	22/12/2019 17:00	22/12/2019 21:25	22/12/2019 17:00	22/12/2019 17:03	0,05	41	2,13	CHI
201912163481	PEROLANDIA	JT10400621	JATAI S1	22/12/2019 17:00	22/12/2019 21:25	22/12/2019 17:00	22/12/2019 17:03	0,05	131	6,80	CHI
201912163481	PEROLANDIA	JT10400621	JATAI S1	22/12/2019 17:00	22/12/2019 21:25	22/12/2019 17:00	22/12/2019 17:03	0,05	36	1,87	CHI
201912163481	JATAI	JT10400621	JATAI S1	22/12/2019 17:00	22/12/2019 21:25	22/12/2019 17:04	22/12/2019 19:13	2,15	1	2,15	CHI
201912163481	JATAI	JT10400565	JATAI S1	22/12/2019 17:00	22/12/2019 21:25	22/12/2019 17:00	22/12/2019 19:17	2,27	38	86,44	CHI
201912163481	JATAI	JT10400621	JATAI S1	22/12/2019 17:00	22/12/2019 21:25	22/12/2019 17:04	22/12/2019 20:33	3,49	11	38,38	CHI
201912163481	PEROLANDIA	JT10400621	JATAI S1	22/12/2019 17:00	22/12/2019 21:25	22/12/2019 17:04	22/12/2019 20:33	3,49	11	38,38	CHI
201912163481	CAIAPONIA	JT10400621	JATAI S1	22/12/2019 17:00	22/12/2019 21:25	22/12/2019 17:04	22/12/2019 21:25	4,35	20	87,00	CHI
201912163481	CAIAPONIA	JT10400621	JATAI S1	22/12/2019 17:00	22/12/2019 21:25	22/12/2019 17:04	22/12/2019 21:25	4,35	38	165,30	CHI
201912163481	JATAI	JT10400621	JATAI S1	22/12/2019 17:00	22/12/2019 21:25	22/12/2019 17:04	22/12/2019 21:25	4,35	301	1309,35	CHI
201912163481	MINEIROS	JT10400621	JATAI S1	22/12/2019 17:00	22/12/2019 21:25	22/12/2019 17:04	22/12/2019 21:25	4,35	2	8,70	CHI
201912163481	MINEIROS	JT10400621	JATAI S1	22/12/2019 17:00	22/12/2019 21:25	22/12/2019 17:04	22/12/2019 21:25	4,35	3	13,05	CHI
201912163481	PEROLANDIA	JT10400621	JATAI S1	22/12/2019 17:00	22/12/2019 21:25	22/12/2019 17:04	22/12/2019 21:25	4,35	1034	4497,90	CHI
201912163481	PEROLANDIA	JT10400621	JATAI S1	22/12/2019 17:00	22/12/2019 21:25	22/12/2019 17:04	22/12/2019 21:25	4,35	41	178,35	CHI
201912163481	PEROLANDIA	JT10400621	JATAI S1	22/12/2019 17:00	22/12/2019 21:25	22/12/2019 17:04	22/12/2019 21:25	4,35	131	569,85	CHI
201912163481	PEROLANDIA	DP13210124	JATAI S1	22/12/2019 17:00	22/12/2019 21:25	22/12/2019 17:04	22/12/2019 21:25	4,35	25	108,75	CHI
201912164883	APARECIDA DE GOIANIA	AP11402895	INDEPENDENCIA S1	22/12/2019 17:00	23/12/2019 10:33	22/12/2019 17:00	23/12/2019 10:33	17,54	102	1789,39	CHI
201912164895	CORUMBAIBA	CI21098627	VILA CORUMBA	22/12/2019 17:01	23/12/2019 16:45	22/12/2019 17:01	23/12/2019 16:45	23,73	1	23,73	CHI
201912167162	JOVIANIA	JV12000007	GOIATUBA S1	22/12/2019 17:01	22/12/2019 23:25	22/12/2019 17:01	22/12/2019 23:25	6,39	308	1967,44	CHI



201912169471	NOVO PLANALTO	TA12293689	SAO MIGUEL DO ARAGUAIA	22/12/2019 17:01	23/12/2019 12:52	22/12/2019 17:01	23/12/2019 12:52	19,83	10	198,35	CHI
201912164930	SILVANIA	SV12205354	DAIA S2	22/12/2019 17:03	22/12/2019 23:54	22/12/2019 17:03	22/12/2019 23:54	6,84	38	259,77	CHI
201912167399	APARECIDA DE GOIANIA	AP12265052	INDEPENDENCIA S1	22/12/2019 17:03	23/12/2019 15:03	22/12/2019 17:03	23/12/2019 15:03	21,99	64	1407,32	CHI
201912178999	APARECIDA DE GOIANIA	AP11137018	INDEPENDENCIA S1	22/12/2019 17:03	23/12/2019 19:39	22/12/2019 17:03	23/12/2019 19:39	26,59	56	1488,99	CHI
201912164933	APARECIDA DE GOIANIA	10007992457	ATLANTICO S3	22/12/2019 17:04	23/12/2019 11:18	22/12/2019 17:04	23/12/2019 11:18	18,22	1	18,22	CHI
201912164935	IVOLANDIA	IV21221049	IPORA	22/12/2019 17:04	23/12/2019 15:18	22/12/2019 17:04	23/12/2019 15:18	22,22	2	44,45	CHI
201912165574	MINEIROS	MY12303391	PARQUE DAS EMAS	22/12/2019 17:04	22/12/2019 20:50	22/12/2019 17:04	22/12/2019 20:50	3,77	138	520,60	CHI
201912165704	JOVIANIA	JV11000004	GOIATUBA S1	22/12/2019 17:05	23/12/2019 11:10	22/12/2019 17:05	23/12/2019 11:10	18,08	116	2097,51	CHI
201912166844	RIO VERDE	RV12327024	CABRIUVA S2	22/12/2019 17:05	23/12/2019 11:10	22/12/2019 17:05	23/12/2019 11:10	18,07	3	54,21	CHI
201912164951	PROFESSOR JAMIL SAFADY	JS21307921	PIRACANJUBA	22/12/2019 17:06	23/12/2019 10:23	22/12/2019 17:06	23/12/2019 10:23	17,28	1	17,28	CHI
201912164953	MORRINHOS	10024747732	MORRINHOS	22/12/2019 17:06	23/12/2019 04:23	22/12/2019 17:06	23/12/2019 04:23	11,28	1	11,28	CHI
201912164955	GOIANIA	GN11034219	ATLANTICO S2	22/12/2019 17:06	22/12/2019 22:13	22/12/2019 17:06	22/12/2019 22:13	5,11	176	899,16	CHI
201912165146	GOIANIA	GN12077158	GOIANIA LESTE S2	22/12/2019 17:09	23/12/2019 15:23	22/12/2019 17:09	23/12/2019 13:10	20,01	46	920,65	CHI
201912165146	SENADOR CANEDO	GN12077158	GOIANIA LESTE S2	22/12/2019 17:09	23/12/2019 15:23	22/12/2019 17:09	23/12/2019 13:10	20,01	16	320,23	CHI
201912165146	GOIANIA	GN12077158	GOIANIA LESTE S2	22/12/2019 17:09	23/12/2019 15:23	23/12/2019 13:11	23/12/2019 14:27	1,27	46	58,43	CHI
201912165146	SENADOR CANEDO	GN12077158	GOIANIA LESTE S2	22/12/2019 17:09	23/12/2019 15:23	23/12/2019 13:11	23/12/2019 14:27	1,27	16	20,32	CHI
201912165146	GOIANIA	GN12077158	GOIANIA LESTE S2	22/12/2019 17:09	23/12/2019 15:23	22/12/2019 17:09	23/12/2019 15:23	22,22	10	222,17	CHI
201912165146	SENADOR CANEDO	GN12077158	GOIANIA LESTE S2	22/12/2019 17:09	23/12/2019 15:23	22/12/2019 17:09	23/12/2019 15:23	22,22	7	155,52	CHI
201912167065	LEOPOLDO DE BULHOES	LB12012193	DAIA S2	22/12/2019 17:09	23/12/2019 11:44	22/12/2019 17:09	23/12/2019 11:44	18,57	189	3510,36	CHI
201912164993	IPAMERI	00830204	IPAMERI	22/12/2019 17:10	23/12/2019 00:33	22/12/2019 20:59	23/12/2019 00:33	3,56	3238	11520,98	CHI
201912164993	IPAMERI	IP13202854	IPAMERI	22/12/2019 17:10	23/12/2019 00:33	22/12/2019 21:00	23/12/2019 00:33	3,53	5	17,67	CHI
201912166862	NOVO GAMA	NJ11201181	PACAEMBU S1	22/12/2019 17:10	23/12/2019 18:26	22/12/2019 17:10	23/12/2019 18:26	25,26	8	202,09	CHI
201912165001	TEREZOPOLIS DE GOIAS	TJ12389766	DAIA S2	22/12/2019 17:11	23/12/2019 17:39	22/12/2019 17:11	23/12/2019 17:39	24,47	9	220,27	CHI
201912165007	CRIXAS	CX12063689LD	MOZARLANDIA	22/12/2019 17:11	23/12/2019 18:44	22/12/2019 17:11	23/12/2019 18:44	25,55	7	178,88	CHI
201912165007	MOZARLANDIA	CX12063689LD	MOZARLANDIA	22/12/2019 17:11	23/12/2019 18:44	22/12/2019 17:11	23/12/2019 18:44	25,55	5	127,77	CHI
201912165451	VALPARAISO DE GOIAS	VA11169041	MARAJOARA	22/12/2019 17:11	22/12/2019 18:58	22/12/2019 17:11	22/12/2019 18:58	1,77	219	386,96	CHI
201912167043	BONFINOPOLIS	03030224	CEPAIGO S2	22/12/2019 17:11	25/12/2019 16:40	22/12/2019 17:11	24/12/2019 03:29	34,30	4	137,20	CHI
201912167043	LEOPOLDO DE BULHOES	03030224	CEPAIGO S2	22/12/2019 17:11	25/12/2019 16:40	22/12/2019 17:11	24/12/2019 03:29	34,30	42	1440,55	CHI
201912167043	BONFINOPOLIS	03030224	CEPAIGO S2	22/12/2019 17:11	25/12/2019 16:40	22/12/2019 20:16	24/12/2019 03:29	31,22	18	561,88	CHI
201912167043	LEOPOLDO DE BULHOES	03030224	CEPAIGO S2	22/12/2019 17:11	25/12/2019 16:40	22/12/2019 20:16	24/12/2019 03:29	31,22	9	280,94	CHI
201912167043	BONFINOPOLIS	03030224	CEPAIGO S2	22/12/2019 17:11	25/12/2019 16:40	22/12/2019 17:11	25/12/2019 16:40	71,48	1	71,48	CHI
201912167043	LEOPOLDO DE BULHOES	03030224	CEPAIGO S2	22/12/2019 17:11	25/12/2019 16:40	22/12/2019 17:11	25/12/2019 16:40	71,48	4	285,91	CHI
201912167043	LEOPOLDO DE BULHOES	03030224	CEPAIGO S2	22/12/2019 17:11	25/12/2019 16:40	22/12/2019 20:16	25/12/2019 16:40	68,39	4	273,58	CHI

201912165446	JOVIANIA	JV12000001	GOIATUBA S1	22/12/2019 17:12	22/12/2019 21:09	22/12/2019 17:12	22/12/2019 21:09	3,95	91	359,45	CHI
201912165446	PONTALINA	JV12000001	GOIATUBA S1	22/12/2019 17:12	22/12/2019 21:09	22/12/2019 17:12	22/12/2019 21:09	3,95	16	63,20	CHI
201912165027	ARUANA	2380007683	ARUANA	22/12/2019 17:13	22/12/2019 21:03	22/12/2019 17:13	22/12/2019 21:03	3,83	1	3,83	CHI
201912165030	ANAPOLIS	AN11008938	JUNDIAI S1	22/12/2019 17:13	22/12/2019 18:09	22/12/2019 17:13	22/12/2019 18:09	0,92	133	122,80	CHI
201912165034	ITUMBIARA	690095235	ITUMBIARA NOVA	22/12/2019 17:13	23/12/2019 14:26	22/12/2019 17:13	23/12/2019 14:26	21,21	1	21,21	CHI
201912165041	NOVA AURORA	NE21150937	CATALAO S1	22/12/2019 17:14	23/12/2019 14:49	22/12/2019 17:14	23/12/2019 14:49	21,57	2	43,14	CHI
201912165056	FIRMINOPOLIS	FR21342989	FIRMINOPOLIS S1	22/12/2019 17:16	22/12/2019 19:21	22/12/2019 17:16	22/12/2019 19:21	2,08	1	2,08	CHI
201912165068	SILVANIA	SV21011724	VIANOPOLIS	22/12/2019 17:17	22/12/2019 18:31	22/12/2019 17:17	22/12/2019 18:31	1,22	1	1,22	CHI
201912165681	NOVO GAMA	NJ11383086	PACAEMBU S1	22/12/2019 17:17	23/12/2019 00:25	22/12/2019 17:17	23/12/2019 00:25	7,13	65	463,61	CHI
201912166829	MORRINHOS	MR12263655	MORRINHOS	22/12/2019 17:17	23/12/2019 16:02	22/12/2019 17:17	23/12/2019 16:02	22,75	7	159,23	CHI
201912165075	CAMPESTRE DE GOIAS	GC31053752	GUAPO S1	22/12/2019 17:18	23/12/2019 12:07	22/12/2019 17:18	23/12/2019 12:07	18,81	1	18,81	CHI
201912163487	QUIRINOPOLIS	01560214	QUIRINOPOLIS	22/12/2019 17:19	23/12/2019 03:34	22/12/2019 17:27	22/12/2019 17:36	0,15	2712	395,50	CHI
201912163487	QUIRINOPOLIS	QI13380618	QUIRINOPOLIS	22/12/2019 17:19	23/12/2019 03:34	22/12/2019 17:27	22/12/2019 18:24	0,95	200	189,67	CHI
201912163487	QUIRINOPOLIS	QI16409325	QUIRINOPOLIS	22/12/2019 17:19	23/12/2019 03:34	22/12/2019 17:27	22/12/2019 18:36	1,15	1970	2270,42	CHI
201912163487	QUIRINOPOLIS	QI16409330	QUIRINOPOLIS	22/12/2019 17:19	23/12/2019 03:34	22/12/2019 17:27	22/12/2019 19:11	1,72	658	1134,50	CHI
201912163487	QUIRINOPOLIS	QI13000010	QUIRINOPOLIS	22/12/2019 17:19	23/12/2019 03:34	22/12/2019 17:27	22/12/2019 19:12	1,75	1207	2110,91	CHI
201912163487	QUIRINOPOLIS	QI10406833	QUIRINOPOLIS	22/12/2019 17:19	23/12/2019 03:34	22/12/2019 17:27	22/12/2019 20:04	2,61	1693	4418,26	CHI
201912163487	QUIRINOPOLIS	QI16409340	QUIRINOPOLIS	22/12/2019 17:19	23/12/2019 03:34	22/12/2019 18:44	22/12/2019 20:06	1,36	64	86,93	CHI
201912163487	QUIRINOPOLIS	QI13000020	QUIRINOPOLIS	22/12/2019 17:19	23/12/2019 03:34	22/12/2019 17:27	23/12/2019 03:28	10,01	365	3652,64	CHI
201912163487	QUIRINOPOLIS	QI10396885	QUIRINOPOLIS	22/12/2019 17:19	23/12/2019 03:34	22/12/2019 18:44	23/12/2019 03:34	8,82	1906	16809,86	CHI
201912165083	GOIANIA	13025326	ATLANTICO S1	22/12/2019 17:19	22/12/2019 21:46	22/12/2019 17:19	22/12/2019 21:46	4,45	1	4,45	CHI
201912165512	JARAGUA	JA12297841	JARAGUA	22/12/2019 17:19	22/12/2019 23:25	22/12/2019 17:19	22/12/2019 23:25	6,09	47	286,10	CHI
201912165761	MOSSAMEDES	MD12188234	FIRMINOPOLIS S2	22/12/2019 17:19	22/12/2019 20:45	22/12/2019 17:19	22/12/2019 20:45	3,42	34	116,41	CHI
201912165104	BELA VISTA DE GOIAS	BV21131429	BELA VISTA S1	22/12/2019 17:20	23/12/2019 10:33	22/12/2019 17:20	23/12/2019 10:33	17,20	2	34,41	CHI
201912165442	GOIANIA	GN11169568	ATLANTICO S1	22/12/2019 17:20	22/12/2019 21:55	22/12/2019 17:20	22/12/2019 21:55	4,57	63	287,89	CHI
201912165605	APARECIDA DE GOIANIA	AP11168981	INDEPENDENCIA S2	22/12/2019 17:21	23/12/2019 05:08	22/12/2019 17:21	23/12/2019 05:08	11,77	93	1094,74	CHI
201912167265	RUBIATABA	RB11000022	RUBIATABA	22/12/2019 17:21	22/12/2019 23:19	22/12/2019 17:21	22/12/2019 23:19	5,95	80	476,36	CHI
201912165128	COCALZINHO DE GOIAS	1200031900	COCALZINHO	22/12/2019 17:23	22/12/2019 18:21	22/12/2019 17:23	22/12/2019 18:21	0,97	1	0,97	CHI
201912165129	SANCLERLANDIA	SC12376377	FIRMINOPOLIS S2	22/12/2019 17:23	23/12/2019 07:43	22/12/2019 17:23	23/12/2019 07:43	14,33	2	28,66	CHI
201912165133	MINEIROS	PW12219564	PARQUE DAS EMAS	22/12/2019 17:23	23/12/2019 15:15	22/12/2019 17:23	23/12/2019 15:15	21,86	7	153,04	CHI
201912165133	PORTELANDIA	PW12219564	PARQUE DAS EMAS	22/12/2019 17:23	23/12/2019 15:15	22/12/2019 17:23	23/12/2019 15:15	21,86	12	262,35	CHI
201912165135	FORMOSA	FA11236422	ITIQUEIRA	22/12/2019 17:23	23/12/2019 08:17	22/12/2019 17:23	23/12/2019 08:17	14,89	1	14,89	CHI
201912165136	ORIZONA	OZ12216069	PIRES DO RIO S2	22/12/2019 17:23	22/12/2019 18:50	22/12/2019 17:23	22/12/2019 18:50	1,44	10	14,42	CHI

201912165139	ABADIANIA	AA12221505LD	DAIA S2	22/12/2019 17:23	23/12/2019 00:35	22/12/2019 17:23	23/12/2019 00:35	7,18	121	869,32	CHI
201912165636	APARECIDA DE GOIANIA	AP11251667	INDEPENDENCIA S2	22/12/2019 17:23	23/12/2019 08:57	22/12/2019 17:23	23/12/2019 08:57	15,57	166	2584,99	CHI
201912166129	VALPARAISO DE GOIAS	VA11084536	PACAEMBU S2	22/12/2019 17:23	22/12/2019 22:47	22/12/2019 17:23	22/12/2019 22:47	5,40	32	172,68	CHI
201912165151	SAO JOAO DA PARAUNA	RP12027674	FIRMINOPOLIS S2	22/12/2019 17:25	23/12/2019 08:35	22/12/2019 17:25	23/12/2019 08:35	15,17	3	45,50	CHI
201912165156	LUZIANIA	10006656933	MARAJOARA	22/12/2019 17:25	23/12/2019 08:04	22/12/2019 17:25	23/12/2019 08:04	14,64	1	14,64	CHI
201912165163	GOIANESIA	GE12353996	GOIANESIA S1	22/12/2019 17:25	23/12/2019 02:48	22/12/2019 17:25	23/12/2019 02:48	9,37	9	84,32	CHI
201912165565	APARECIDA DE GOIANIA	AP11095597	INDEPENDENCIA S1	22/12/2019 17:25	23/12/2019 01:21	22/12/2019 17:25	23/12/2019 01:21	7,93	90	713,97	CHI
201912165165	RIO VERDE	630394891	RIO VERDE S1	22/12/2019 17:26	23/12/2019 13:39	22/12/2019 17:26	23/12/2019 13:39	20,22	1	20,22	CHI
201912165171	INHUMAS	IN11049760	INHUMAS S2	22/12/2019 17:26	23/12/2019 12:28	22/12/2019 17:26	23/12/2019 12:28	19,03	153	2910,99	CHI
201912165172	CATALAO	10017031271	CATALAO S2	22/12/2019 17:26	22/12/2019 18:35	22/12/2019 17:26	22/12/2019 18:35	1,14	1	1,14	CHI
201912165191	ARAGOIANIA	AO32000020	GUAPO S2	22/12/2019 17:28	23/12/2019 12:04	22/12/2019 17:28	23/12/2019 12:04	18,59	26	483,41	CHI
201912176715	ARAGOIANIA	AO21239149	GUAPO S2	22/12/2019 17:28	23/12/2019 19:40	22/12/2019 17:28	23/12/2019 19:40	26,19	1	26,19	CHI
201912165201	GOIANIA	16485865	FERROVIARIO S1	22/12/2019 17:29	23/12/2019 05:36	22/12/2019 17:29	23/12/2019 05:36	12,11	1	12,11	CHI
201912165202	CRIXAS	CX12392063	SANTA TEREZINHA	22/12/2019 17:29	23/12/2019 02:36	22/12/2019 17:29	23/12/2019 02:36	9,11	28	255,04	CHI
201912165202	ITAPACI	CX12392063	SANTA TEREZINHA	22/12/2019 17:29	23/12/2019 02:36	22/12/2019 17:29	23/12/2019 02:36	9,11	4	36,43	CHI
201912166714	INHUMAS	IN11012219	INHUMAS S2	22/12/2019 17:29	23/12/2019 04:52	22/12/2019 17:29	23/12/2019 04:52	11,38	191	2174,06	CHI
201912170281	MONTIVIDIU	MV12260796	MONTIVIDIU T	22/12/2019 17:29	23/12/2019 23:57	22/12/2019 17:29	23/12/2019 23:57	30,46	2	60,91	CHI
201912170281	RIO VERDE	MV12260796	MONTIVIDIU T	22/12/2019 17:29	23/12/2019 23:57	22/12/2019 17:29	23/12/2019 23:57	30,46	2	60,91	CHI
201912165227	BONOPOLIS	BX12229976	SAO MIGUEL DO ARAGUAIA	22/12/2019 17:31	23/12/2019 13:40	22/12/2019 17:31	23/12/2019 13:40	20,14	1	20,14	CHI
201912165494	GOIANIA	GN11169118	ATLANTICO S3	22/12/2019 17:31	22/12/2019 21:55	22/12/2019 17:31	22/12/2019 21:55	4,40	111	487,94	CHI
201912165776	VALPARAISO DE GOIAS	VA11097135	PACAEMBU S2	22/12/2019 17:33	22/12/2019 21:51	22/12/2019 17:33	22/12/2019 21:51	4,29	78	334,32	CHI
201912167359	APARECIDA DE GOIANIA	AP11054889	INDEPENDENCIA S2	22/12/2019 17:33	23/12/2019 17:37	22/12/2019 17:33	23/12/2019 17:37	24,06	238	5726,28	CHI
201912162168	CEZARINA	CZ12000015	CEZARINA	22/12/2019 17:34	23/12/2019 10:05	22/12/2019 17:34	22/12/2019 22:42	5,15	59	303,60	CHI
201912162168	INDIARA	CZ12000015	CEZARINA	22/12/2019 17:34	23/12/2019 10:05	22/12/2019 17:34	22/12/2019 22:42	5,15	36	185,25	CHI
201912162168	INDIARA	CZ12000015	CEZARINA	22/12/2019 17:34	23/12/2019 10:05	22/12/2019 17:34	23/12/2019 10:05	16,52	1	16,52	CHI
201912166478	CEZARINA	CZ21384875	CEZARINA	22/12/2019 17:34	22/12/2019 23:35	22/12/2019 17:34	22/12/2019 23:35	6,02	2	12,03	CHI
201912165262	APARECIDA DE GOIANIA	200051775	ANHANGUERA	22/12/2019 17:35	22/12/2019 19:28	22/12/2019 17:35	22/12/2019 19:28	1,88	1	1,88	CHI
201912165266	APARECIDA DE GOIANIA	13444165	INDEPENDENCIA S1	22/12/2019 17:35	23/12/2019 11:59	22/12/2019 17:35	23/12/2019 11:59	18,39	1	18,39	CHI
201912165466	JOVIANIA	JV11024944	GOIATUBA S1	22/12/2019 17:35	24/12/2019 13:56	22/12/2019 17:35	24/12/2019 13:56	44,35	122	5410,46	CHI
201912165275	NOVO GAMA	NJ12219816	PACAEMBU S1	22/12/2019 17:36	22/12/2019 20:21	22/12/2019 17:36	22/12/2019 20:21	2,75	182	499,79	CHI
201912166731	CALDAS NOVAS	MR12392164	MORRINHOS	22/12/2019 17:36	23/12/2019 04:05	22/12/2019 17:36	23/12/2019 04:05	10,48	1	10,48	CHI
201912166731	MORRINHOS	MR12392164	MORRINHOS	22/12/2019 17:36	23/12/2019 04:05	22/12/2019 17:36	23/12/2019 04:05	10,48	29	303,91	CHI
201912166731	RIO QUENTE	MR12392164	MORRINHOS	22/12/2019 17:36	23/12/2019 04:05	22/12/2019 17:36	23/12/2019 04:05	10,48	19	199,11	CHI

201912165284	APARECIDA DE GOIANIA	200078549	INDEPENDENCIA S1	22/12/2019 17:37	23/12/2019 13:08	22/12/2019 17:37	23/12/2019 13:08	19,51	1	19,51	CHI
201912165285	MOZARLANDIA	410014011	MOZARLANDIA	22/12/2019 17:37	23/12/2019 16:15	22/12/2019 17:37	23/12/2019 16:15	22,64	1	22,64	CHI
201912165286	SAO JOAO DA PARAUNA	RP21008027	FIRMINOPOLIS S1	22/12/2019 17:37	22/12/2019 20:54	22/12/2019 17:37	22/12/2019 20:54	3,28	1	3,28	CHI
201912165752	HIDROLANDIA	HD12058800	CEPAIGO S2	22/12/2019 17:38	23/12/2019 13:03	22/12/2019 17:38	23/12/2019 13:03	19,41	5	97,03	CHI
201912165300	CACU	CC12170574	CACHOEIRA ALTA	22/12/2019 17:39	24/12/2019 16:13	22/12/2019 17:39	23/12/2019 11:41	18,03	65	1172,09	CHI
201912165300	CACU	CC12170574	CACHOEIRA ALTA	22/12/2019 17:39	24/12/2019 16:13	22/12/2019 17:39	24/12/2019 16:13	46,58	19	885,06	CHI
201912165303	NOVO GAMA	NJ12183577	PACAEMBU S1	22/12/2019 17:39	23/12/2019 10:23	22/12/2019 17:39	23/12/2019 10:23	16,73	17	284,39	CHI
201912165306	AURILANDIA	AI12206461	FIRMINOPOLIS S2	22/12/2019 17:39	22/12/2019 22:05	22/12/2019 17:39	22/12/2019 22:05	4,43	14	61,99	CHI
201912165306	FIRMINOPOLIS	AI12206461	FIRMINOPOLIS S2	22/12/2019 17:39	22/12/2019 22:05	22/12/2019 17:39	22/12/2019 22:05	4,43	15	66,42	CHI
201912165311	CRISTALINA	KR12405473	CRISTALINA S1	22/12/2019 17:40	22/12/2019 19:25	22/12/2019 17:40	22/12/2019 19:25	1,75	1	1,75	CHI
201912165335	PONTALINA	PK12090553	VICENTINOPOLIS	22/12/2019 17:42	23/12/2019 16:15	22/12/2019 17:42	23/12/2019 16:15	22,54	16	360,58	CHI
201912165343	CORUMBAIBA	CI21114791	VILA CORUMBA	22/12/2019 17:43	24/12/2019 13:11	22/12/2019 17:43	24/12/2019 13:11	43,45	9	391,09	CHI
201912165351	MOSSAMEDES	MD21343869	ITABERAI S1	22/12/2019 17:44	24/12/2019 07:54	22/12/2019 17:44	24/12/2019 07:54	38,16	1	38,16	CHI
201912165357	GOIANIA	10021559072	GOIANIA LESTE S1	22/12/2019 17:44	22/12/2019 23:53	22/12/2019 17:44	22/12/2019 23:53	6,14	1	6,14	CHI
201912165358	GOIANESIA	GE21234248	GOIANESIA S1	22/12/2019 17:44	23/12/2019 10:46	22/12/2019 17:44	23/12/2019 10:46	17,02	1	17,02	CHI
201912165364	ITAUCU	IX21320342	INHUMAS S1	22/12/2019 17:45	23/12/2019 13:04	22/12/2019 17:45	23/12/2019 13:04	19,31	2	38,62	CHI
201912165368	GOIANIA	16693097	ATLANTICO S3	22/12/2019 17:45	22/12/2019 21:09	22/12/2019 17:45	22/12/2019 21:09	3,39	1	3,39	CHI
201912165369	MOZARLANDIA	410004856	MOZARLANDIA	22/12/2019 17:45	26/12/2019 10:08	22/12/2019 17:45	26/12/2019 10:08	88,37	1	88,37	CHI
201912165491	APARECIDA DE GOIANIA	AP11130319	INDEPENDENCIA S1	22/12/2019 17:45	23/12/2019 22:19	22/12/2019 17:45	23/12/2019 22:19	28,56	28	799,70	CHI
201912165379	MONTIVIDIU	2840019614	MONTIVIDIU T	22/12/2019 17:46	23/12/2019 13:14	22/12/2019 17:46	23/12/2019 13:14	19,46	1	19,46	CHI
201912165389	CATALAO	CT12267107	CATALAO S1	22/12/2019 17:47	23/12/2019 11:56	22/12/2019 17:47	23/12/2019 11:56	18,14	3	54,43	CHI
201912165391	NOVO GAMA	NJ12401781	PACAEMBU S1	22/12/2019 17:48	23/12/2019 15:30	22/12/2019 17:48	23/12/2019 15:30	21,70	4	86,79	CHI
201912165393	MORRINHOS	10000386241	MORRINHOS	22/12/2019 17:48	23/12/2019 11:38	22/12/2019 17:48	23/12/2019 11:38	17,84	1	17,84	CHI
201912165789	APARECIDA DE GOIANIA	AP11169181	INDEPENDENCIA S2	22/12/2019 17:48	22/12/2019 20:53	22/12/2019 17:48	22/12/2019 20:53	3,07	94	288,32	CHI
201912166094	APARECIDA DE GOIANIA	AP11169618	INDEPENDENCIA S2	22/12/2019 17:48	23/12/2019 08:47	22/12/2019 17:48	23/12/2019 08:47	14,98	115	1722,54	CHI
201912166034	GOIANIA	GN11291440	INDEPENDENCIA S2	22/12/2019 17:49	22/12/2019 21:54	22/12/2019 17:49	22/12/2019 21:54	4,07	106	431,48	CHI
201912165413	POSSE	PS12298947	FLORES DE GOIAS	22/12/2019 17:50	22/12/2019 21:40	22/12/2019 17:50	22/12/2019 21:40	3,82	1	3,82	CHI
201912165723	PALMEIRAS DE GOIAS	PL11252059	PALMEIRAS	22/12/2019 17:50	22/12/2019 19:30	22/12/2019 17:50	22/12/2019 19:30	1,66	100	165,86	CHI
201912165420	ITAPURANGA	IK21023686	ITAPURANGA	22/12/2019 17:51	24/12/2019 14:16	22/12/2019 17:51	24/12/2019 14:16	44,42	1	44,42	CHI
201912165425	PALMEIRAS DE GOIAS	PL11158606	PALMEIRAS	22/12/2019 17:51	22/12/2019 19:00	22/12/2019 17:51	22/12/2019 19:00	1,14	64	72,98	CHI
201912165433	CALDAZINHA	LB12270662	DAIA S2	22/12/2019 17:52	23/12/2019 14:00	22/12/2019 17:52	23/12/2019 14:00	20,13	14	281,75	CHI
201912165433	LEOPOLDO DE BULHOES	LB12270662	DAIA S2	22/12/2019 17:52	23/12/2019 14:00	22/12/2019 17:52	23/12/2019 14:00	20,13	3	60,38	CHI
201912165433	SILVANIA	LB12270662	DAIA S2	22/12/2019 17:52	23/12/2019 14:00	22/12/2019 17:52	23/12/2019 14:00	20,13	15	301,88	CHI

201912166472	APARECIDA DE GOIANIA	AP11076555	INDEPENDENCIA S2	22/12/2019 17:52	23/12/2019 10:15	22/12/2019 17:52	23/12/2019 10:15	16,38	177	2899,75	CHI
201912165454	SAO JOAO DA PARAUNA	RP12294284	FIRMINOPOLIS S2	22/12/2019 17:54	23/12/2019 17:24	22/12/2019 17:54	23/12/2019 17:24	23,49	1	23,49	CHI
201912165534	APARECIDA DE GOIANIA	AP11076034	INDEPENDENCIA S2	22/12/2019 17:54	23/12/2019 00:11	22/12/2019 17:54	23/12/2019 00:11	6,27	58	363,69	CHI
201912165679	APARECIDA DE GOIANIA	AP11091761	INDEPENDENCIA S1	22/12/2019 17:54	23/12/2019 14:22	23/12/2019 07:31	23/12/2019 14:22	6,86	174	1192,92	CHI
201912166462	TRES RANCHOS	TH12068477	CATALAO S1	22/12/2019 17:54	22/12/2019 23:55	22/12/2019 17:54	22/12/2019 23:55	6,01	19	114,13	CHI
201912260831	APARECIDA DE GOIANIA	10005679310	INDEPENDENCIA S2	22/12/2019 17:54	23/12/2019 07:31	22/12/2019 17:54	23/12/2019 07:31	13,60	1	13,60	CHI
201912165470	ESTRELA DO NORTE	ET12372080	MARA ROSA	22/12/2019 17:55	22/12/2019 22:15	22/12/2019 17:55	22/12/2019 22:15	4,32	2	8,64	CHI
201912167223	CAIAPONIA	CP12207985	CAIAPONIA	22/12/2019 17:55	23/12/2019 03:45	22/12/2019 17:55	23/12/2019 03:45	9,82	231	2268,04	CHI
201912165475	SAO MIGUEL DO ARAGUAIA	SM12104528	SAO MIGUEL DO ARAGUAIA	22/12/2019 17:56	24/12/2019 11:50	22/12/2019 17:56	24/12/2019 11:50	41,89	2	83,78	CHI
201912165480	PIRENOPOLIS	PV21031579	CORUMBA	22/12/2019 17:56	23/12/2019 15:42	22/12/2019 17:56	23/12/2019 15:42	21,76	3	65,29	CHI
201912167095	VALPARAISO DE GOIAS	VA11165063	PACAEMBU S1	22/12/2019 17:56	22/12/2019 21:25	22/12/2019 17:56	22/12/2019 21:25	3,48	183	636,28	CHI
201912165486	RIO VERDE	RV21370293	MONTIVIDIU T	22/12/2019 17:57	23/12/2019 11:21	22/12/2019 17:57	23/12/2019 11:21	17,39	1	17,39	CHI
201912166171	GUARAITA	GK12234058	ITAPURANGA	22/12/2019 17:58	23/12/2019 10:04	22/12/2019 17:58	23/12/2019 10:04	16,09	8	128,74	CHI
201912165501	GOIANIA	11143654	ATLANTICO S2	22/12/2019 17:59	23/12/2019 03:38	22/12/2019 17:59	23/12/2019 03:38	9,65	1	9,65	CHI
201912165507	RIO VERDE	RV21246813	RIO VERDE S1	22/12/2019 17:59	23/12/2019 11:10	22/12/2019 17:59	23/12/2019 11:10	17,17	1	17,17	CHI
201912165513	AMERICANO DO BRASIL	KB21119445	ANICUNS	22/12/2019 18:00	23/12/2019 11:29	22/12/2019 18:00	23/12/2019 11:29	17,49	2	34,98	CHI
201912167082	ADELANDIA	SC12323567	FIRMINOPOLIS S2	22/12/2019 18:00	23/12/2019 12:39	22/12/2019 18:00	23/12/2019 12:39	18,64	12	223,71	CHI
201912167082	SANCLERLANDIA	SC12323567	FIRMINOPOLIS S2	22/12/2019 18:00	23/12/2019 12:39	22/12/2019 18:00	23/12/2019 12:39	18,64	1	18,64	CHI
201912165523	LEOPOLDO DE BULHOES	LB21030118	DAIA S2	22/12/2019 18:01	23/12/2019 13:29	22/12/2019 18:01	23/12/2019 13:29	19,47	1	19,47	CHI
201912165567	GOIAS	GS12206887	GOIAS	22/12/2019 18:01	23/12/2019 15:56	22/12/2019 18:01	23/12/2019 15:56	21,90	21	459,96	CHI
201912166070	APARECIDA DE GOIANIA	AP11072265	INDEPENDENCIA S2	22/12/2019 18:01	22/12/2019 21:25	22/12/2019 18:01	22/12/2019 21:25	3,39	204	692,41	CHI
201912166815	INHUMAS	IN11378278	INHUMAS S2	22/12/2019 18:01	23/12/2019 08:33	22/12/2019 18:01	23/12/2019 08:33	14,53	69	1002,32	CHI
201912165735	CRIXAS	NM12270333	RUBIATABA	22/12/2019 18:02	23/12/2019 09:04	22/12/2019 18:02	23/12/2019 09:04	15,03	5	75,13	CHI
201912165735	NOVA AMERICA	NM12270333	RUBIATABA	22/12/2019 18:02	23/12/2019 09:04	22/12/2019 18:02	23/12/2019 09:04	15,03	8	120,21	CHI
201912165544	APARECIDA DE GOIANIA	200181634	INDEPENDENCIA S2	22/12/2019 18:03	23/12/2019 13:19	22/12/2019 18:03	23/12/2019 13:19	19,25	1	19,25	CHI
201912165554	ANAPOLIS	AN21302133	ANAPOLIS UNIVERSITARIO S2	22/12/2019 18:04	22/12/2019 19:29	22/12/2019 18:04	22/12/2019 19:29	1,41	115	161,96	CHI
201912166151	AGUAS LINDAS DE GOIAS	LA12108724	AGUAS LINDAS DE GOIAS S1	22/12/2019 18:04	22/12/2019 20:22	22/12/2019 18:04	22/12/2019 20:22	2,30	927	2128,24	CHI
201912165559	VIANOPOLIS	VN12012821	VIANOPOLIS	22/12/2019 18:05	23/12/2019 08:24	22/12/2019 18:05	23/12/2019 08:24	14,33	13	186,31	CHI
201912165852	LEOPOLDO DE BULHOES	LB12270649	DAIA S2	22/12/2019 18:05	23/12/2019 13:20	22/12/2019 18:05	23/12/2019 13:20	19,26	62	1194,07	CHI
201912166256	CAMPINORTE	04690224	MARA ROSA	22/12/2019 18:05	24/12/2019 01:36	22/12/2019 18:05	23/12/2019 19:04	24,98	88	2198,02	CHI
201912166256	URUACU	04690224	MARA ROSA	22/12/2019 18:05	24/12/2019 01:36	22/12/2019 18:05	23/12/2019 19:04	24,98	122	3047,26	CHI
201912166256	CAMPINORTE	04690224	MARA ROSA	22/12/2019 18:05	24/12/2019 01:36	22/12/2019 18:05	23/12/2019 22:48	28,71	1	28,71	CHI
201912166256	CAMPINACU	CR13269871	MARA ROSA	22/12/2019 18:05	24/12/2019 01:36	22/12/2019 18:05	23/12/2019 23:52	29,79	257	7655,03	CHI

201912166256	CAMPINORTE	04690224	MARA ROSA	22/12/2019 18:05	24/12/2019 01:36	22/12/2019 18:05	23/12/2019 23:52	29,79	87	2591,39	CHI
201912166256	CAMPINORTE	CR13269871	MARA ROSA	22/12/2019 18:05	24/12/2019 01:36	22/12/2019 18:05	23/12/2019 23:52	29,79	25	744,65	CHI
201912166256	URUACU	04690224	MARA ROSA	22/12/2019 18:05	24/12/2019 01:36	22/12/2019 18:05	23/12/2019 23:52	29,79	186	5540,22	CHI
201912166256	URUACU	CR13269871	MARA ROSA	22/12/2019 18:05	24/12/2019 01:36	22/12/2019 18:05	23/12/2019 23:52	29,79	60	1787,17	CHI
201912166256	URUACU	CR13269871	MARA ROSA	22/12/2019 18:05	24/12/2019 01:36	23/12/2019 13:12	23/12/2019 23:52	10,66	3	31,99	CHI
201912166256	CAMPINORTE	CR12317711LD	MARA ROSA	22/12/2019 18:05	24/12/2019 01:36	24/12/2019 00:49	24/12/2019 01:36	0,78	88	68,79	CHI
201912166256	URUACU	CR12317711LD	MARA ROSA	22/12/2019 18:05	24/12/2019 01:36	24/12/2019 00:49	24/12/2019 01:36	0,78	122	95,36	CHI
201912166353	CAMPINORTE	CR12282384	MARA ROSA	22/12/2019 18:05	22/12/2019 23:37	22/12/2019 18:05	22/12/2019 23:37	5,53	1	5,53	CHI
201912185338	CAMPINACU	UC13341459	MARA ROSA	22/12/2019 18:05	24/12/2019 17:23	22/12/2019 18:05	24/12/2019 17:23	47,30	6	283,79	CHI
201912165562	INHUMAS	IN21033529	INHUMAS S1	22/12/2019 18:06	23/12/2019 15:59	22/12/2019 18:06	23/12/2019 15:59	21,88	2	43,76	CHI
201912165568	ACREUNA	EU12000002	ACREUNA	22/12/2019 18:06	22/12/2019 22:13	22/12/2019 18:06	22/12/2019 22:13	4,11	6	24,63	CHI
201912165578	CORUMBAIBA	CI12035399	VILA CORUMBA	22/12/2019 18:07	23/12/2019 14:50	22/12/2019 18:07	23/12/2019 14:50	20,70	7	144,92	CHI
201912166938	APARECIDA DE GOIANIA	AP12156206	INDEPENDENCIA S2	22/12/2019 18:07	22/12/2019 23:19	22/12/2019 18:07	22/12/2019 23:19	5,19	458	2378,55	CHI
201912165580	ANAPOLIS	AN12273056	ANAPOLIS UNIVERSITARIO S2	22/12/2019 18:08	22/12/2019 20:57	22/12/2019 18:08	22/12/2019 20:57	2,81	14	39,36	CHI
201912165585	CHAPADAO DO CEU	DJ12387167	CHAPADAO DO CEU	22/12/2019 18:08	23/12/2019 09:41	22/12/2019 18:08	23/12/2019 09:41	15,54	60	932,23	CHI
201912165587	FAINA	FC12378894	MATRINCHA	22/12/2019 18:08	23/12/2019 15:06	22/12/2019 18:08	23/12/2019 15:06	20,96	13	272,48	CHI
201912165587	MATRINCHA	FC12378894	MATRINCHA	22/12/2019 18:08	23/12/2019 15:06	22/12/2019 18:08	23/12/2019 15:06	20,96	7	146,72	CHI
201912165590	SAO MIGUEL DO ARAGUAIA	6636476	SAO MIGUEL DO ARAGUAIA	22/12/2019 18:09	24/12/2019 11:47	22/12/2019 18:09	24/12/2019 11:47	41,63	1	41,63	CHI
201912165604	CATALAO	CT12363448RE	CATALAO S1	22/12/2019 18:10	23/12/2019 02:18	22/12/2019 18:10	23/12/2019 02:18	8,12	8	64,97	CHI
201912165604	TRES RANCHOS	CT12363448RE	CATALAO S1	22/12/2019 18:10	23/12/2019 02:18	22/12/2019 18:10	23/12/2019 02:18	8,12	26	211,16	CHI
201912165606	ITAJA	2300021591	ITAJA S2	22/12/2019 18:10	22/12/2019 22:55	22/12/2019 18:10	22/12/2019 22:55	4,74	1	4,74	CHI
201912165848	CATALAO	CT11032135	CATALAO S2	22/12/2019 18:11	22/12/2019 19:56	22/12/2019 18:11	22/12/2019 19:56	1,74	101	176,13	CHI
201912167434	RIO VERDE	RV12249020	CABRIUVA S2	22/12/2019 18:11	24/12/2019 05:02	22/12/2019 18:11	24/12/2019 05:02	34,84	18	627,15	CHI
201912165622	URUACU	10020164643	URUACU	22/12/2019 18:12	22/12/2019 19:11	22/12/2019 18:12	22/12/2019 19:11	0,97	1	0,97	CHI
201912166792	LEOPOLDO DE BULHOES	LB12057538	DAIA S1	22/12/2019 18:13	23/12/2019 09:23	22/12/2019 18:13	23/12/2019 09:23	15,16	11	166,74	CHI
201912166792	SILVANIA	LB12057538	DAIA S1	22/12/2019 18:13	23/12/2019 09:23	22/12/2019 18:13	23/12/2019 09:23	15,16	24	363,80	CHI
201912165630	ANAPOLIS	20167120	ANAPOLIS UNIVERSITARIO S2	22/12/2019 18:14	22/12/2019 20:51	22/12/2019 18:14	22/12/2019 20:51	2,61	1	2,61	CHI
201912166637	GOIANIA	GN11001541	CAMPINAS S3	22/12/2019 18:15	23/12/2019 01:36	22/12/2019 18:15	23/12/2019 01:36	7,34	82	601,72	CHI
201912165655	GOIANIA	14461961	ATLANTICO S2	22/12/2019 18:17	23/12/2019 03:31	22/12/2019 18:17	23/12/2019 03:31	9,23	1	9,23	CHI
201912165659	JATAI	JT21136072	JATAI S1	22/12/2019 18:17	23/12/2019 09:05	22/12/2019 18:17	23/12/2019 09:05	14,79	1	14,79	CHI
201912165663	PIRENOPOLIS	ZN21258991	COCALZINHO	22/12/2019 18:17	22/12/2019 19:32	22/12/2019 18:17	22/12/2019 19:32	1,24	1	1,24	CHI
201912165664	MORRINHOS	10007743759	MORRINHOS	22/12/2019 18:17	24/12/2019 10:19	22/12/2019 18:17	24/12/2019 10:19	40,02	1	40,02	CHI
201912165666	SILVANIA	660044304	VIANOPOLIS	22/12/2019 18:18	22/12/2019 19:40	22/12/2019 18:18	22/12/2019 19:40	1,37	1	1,37	CHI

201912165667	CATALAO	7429658	CATALAO S2	22/12/2019 18:18	22/12/2019 21:31	22/12/2019 18:18	22/12/2019 21:31	3,22	42	135,10	CHI
201912165677	SAO MIGUEL DO ARAGUAIA	SM12253876	SAO MIGUEL DO ARAGUAIA	22/12/2019 18:18	23/12/2019 16:59	22/12/2019 18:18	23/12/2019 16:59	22,67	3	68,01	CHI
201912166481	ANICUNS	AC12075338	FIRMINOPOLIS S2	22/12/2019 18:18	23/12/2019 11:57	22/12/2019 18:18	23/12/2019 11:57	17,64	16	282,28	CHI
201912165691	BONOPOLIS	BX12321724	SAO MIGUEL DO ARAGUAIA	22/12/2019 18:19	23/12/2019 12:55	22/12/2019 18:19	23/12/2019 12:55	18,59	5	92,94	CHI
201912165694	CABECEIRAS	CW12398925	ITIQUEIRA	22/12/2019 18:19	23/12/2019 15:25	22/12/2019 18:19	23/12/2019 10:08	15,80	10	158,02	CHI
201912165694	CABECEIRAS	CW13049283	ITIQUEIRA	22/12/2019 18:19	23/12/2019 15:25	22/12/2019 18:19	23/12/2019 11:52	17,53	10	175,35	CHI
201912165694	CABECEIRAS	CW13181821	ITIQUEIRA	22/12/2019 18:19	23/12/2019 15:25	22/12/2019 18:19	23/12/2019 15:25	21,08	8	168,68	CHI
201912166670	APARECIDA DE GOIANIA	AP11126424	INDEPENDENCIA S1	22/12/2019 18:19	23/12/2019 09:35	22/12/2019 18:19	23/12/2019 09:35	15,27	115	1756,24	CHI
201912165697	LUZIANIA	120315245	RIO VERMELHO	22/12/2019 18:20	23/12/2019 07:29	22/12/2019 18:20	23/12/2019 07:29	13,15	1	13,15	CHI
201912166463	NOVO GAMA	NJ11305081	PACAEMBU S1	22/12/2019 18:20	22/12/2019 21:36	22/12/2019 18:20	22/12/2019 21:36	3,25	39	126,80	CHI
201912165707	NOVO GAMA	NJ11128866	PACAEMBU S1	22/12/2019 18:21	23/12/2019 08:01	22/12/2019 18:21	23/12/2019 08:01	13,66	47	642,18	CHI
201912166179	ANAPOLIS	AN12000617	DAIA S1	22/12/2019 18:21	23/12/2019 07:36	22/12/2019 18:21	23/12/2019 07:36	13,24	34	450,18	CHI
201912166350	CIDADE OCIDENTAL	DH11169047	MARAJOARA	22/12/2019 18:21	22/12/2019 23:00	22/12/2019 18:21	22/12/2019 23:00	4,64	203	941,58	CHI
201912166642	CALDAZINHA	LB12270648	DAIA S2	22/12/2019 18:21	23/12/2019 18:06	22/12/2019 18:21	23/12/2019 18:06	23,74	1	23,74	CHI
201912166642	LEOPOLDO DE BULHOES	LB12270648	DAIA S2	22/12/2019 18:21	23/12/2019 18:06	22/12/2019 18:21	23/12/2019 18:06	23,74	18	427,25	CHI
201912167007	INHUMAS	IX12355994	INHUMAS S1	22/12/2019 18:21	23/12/2019 10:08	22/12/2019 18:21	23/12/2019 10:08	15,78	12	189,38	CHI
201912165718	VALPARAISO DE GOIAS	VA11041588	PACAEMBU S1	22/12/2019 18:22	22/12/2019 22:04	22/12/2019 18:22	22/12/2019 22:04	3,69	151	557,65	CHI
201912165722	APARECIDA DO RIO DOCE	AW12189038	CACHOEIRA ALTA	22/12/2019 18:22	23/12/2019 13:54	22/12/2019 18:22	23/12/2019 13:54	19,52	25	487,97	CHI
201912165724	GOIANIA	GN11002011	AEROPORTO S3	22/12/2019 18:22	22/12/2019 21:20	22/12/2019 18:22	22/12/2019 21:20	2,95	90	265,58	CHI
201912165725	SILVANIA	SV21166990	VIANOPOLIS	22/12/2019 18:23	23/12/2019 10:29	22/12/2019 18:23	23/12/2019 10:29	16,09	1	16,09	CHI
201912165738	SAO MIGUEL DO ARAGUAIA	SM11073065	SAO MIGUEL DO ARAGUAIA	22/12/2019 18:24	23/12/2019 15:25	22/12/2019 18:24	23/12/2019 15:25	21,00	2	42,01	CHI
201912166807	ITAPURANGA	IK12220328	ITAPURANGA	22/12/2019 18:24	22/12/2019 22:35	22/12/2019 18:24	22/12/2019 22:35	4,17	231	963,78	CHI
201912167740	MINEIROS	PW12219569	PARQUE DAS EMAS	22/12/2019 18:24	23/12/2019 22:26	22/12/2019 18:24	23/12/2019 22:26	28,02	94	2633,80	CHI
201912167740	PORTELANDIA	PW12219569	PARQUE DAS EMAS	22/12/2019 18:24	23/12/2019 22:26	22/12/2019 18:24	23/12/2019 22:26	28,02	5	140,10	CHI
201912163498	AGUAS LINDAS DE GOIAS	LA11164940	AGUAS LINDAS DE GOIAS S1	22/12/2019 18:25	22/12/2019 20:00	22/12/2019 18:25	22/12/2019 20:00	1,58	63	99,31	CHI
201912165743	APORE	SX12153265	JATAI S1	22/12/2019 18:25	23/12/2019 12:45	22/12/2019 18:25	23/12/2019 12:45	18,33	7	128,28	CHI
201912165743	ITARUMA	SX12153265	JATAI S1	22/12/2019 18:25	23/12/2019 12:45	22/12/2019 18:25	23/12/2019 12:45	18,33	1	18,33	CHI
201912165743	SERRANOPOLIS	SX12153265	JATAI S1	22/12/2019 18:25	23/12/2019 12:45	22/12/2019 18:25	23/12/2019 12:45	18,33	4	73,30	CHI
201912165747	FIRMINOPOLIS	FR12323491	FIRMINOPOLIS S2	22/12/2019 18:26	23/12/2019 15:32	22/12/2019 18:26	23/12/2019 15:32	21,10	3	63,30	CHI
201912165754	ANAPOLIS	AN21000695	ANAPOLIS UNIVERSITARIO S2	22/12/2019 18:26	23/12/2019 09:12	22/12/2019 18:26	23/12/2019 09:12	14,75	1	14,75	CHI
201912166451	APARECIDA DE GOIANIA	AP11077151	INDEPENDENCIA S2	22/12/2019 18:26	23/12/2019 10:20	22/12/2019 18:26	23/12/2019 10:20	15,89	190	3019,26	CHI
201912165756	JARAGUA	JA21006454	JARAGUA	22/12/2019 18:27	23/12/2019 13:30	22/12/2019 18:27	23/12/2019 13:30	19,05	2	38,10	CHI
201912165763	APARECIDA DE GOIANIA	AP12166603	ANHANGUERA	22/12/2019 18:28	23/12/2019 11:00	22/12/2019 18:28	23/12/2019 11:00	16,53	425	7025,25	CHI

201912165768	ALVORADA DO NORTE	SA12221147	IACIARA S2	22/12/2019 18:28	22/12/2019 21:08	22/12/2019 18:28	22/12/2019 21:08	2,67	3	8,01	CHI
201912165768	SIMOLANDIA	SA12221147	IACIARA S2	22/12/2019 18:28	22/12/2019 21:08	22/12/2019 18:28	22/12/2019 21:08	2,67	65	173,48	CHI
201912165780	MOSSAMEDES	MD21307420	ITABERAI S1	22/12/2019 18:29	24/12/2019 08:04	22/12/2019 18:29	24/12/2019 08:04	37,57	1	37,57	CHI
201912165781	HIDROLINA	HL12190112	URUACU	22/12/2019 18:29	23/12/2019 13:23	22/12/2019 18:29	23/12/2019 13:23	18,89	6	113,33	CHI
201912165781	PILAR DE GOIAS	HL12190112	URUACU	22/12/2019 18:29	23/12/2019 13:23	22/12/2019 18:29	23/12/2019 13:23	18,89	1	18,89	CHI
201912166461	APARECIDA DE GOIANIA	AP11254436	INDEPENDENCIA S2	22/12/2019 18:29	23/12/2019 10:46	22/12/2019 18:29	23/12/2019 10:46	16,29	123	2003,26	CHI
201912165786	CATALAO	3580002294	CATALAO S1	22/12/2019 18:30	23/12/2019 10:54	22/12/2019 18:30	23/12/2019 10:54	16,40	1	16,40	CHI
201912166234	APARECIDA DE GOIANIA	AP11244846	INDEPENDENCIA S2	22/12/2019 18:31	23/12/2019 18:19	22/12/2019 18:31	23/12/2019 18:19	23,81	105	2500,34	CHI
201912167589	GOIANIA	GN12042155	GOIANIA LESTE S3	22/12/2019 18:31	23/12/2019 04:00	22/12/2019 18:31	23/12/2019 04:00	9,47	81	767,20	CHI
201912165820	IPAMERI	IP21311862	IPAMERI	22/12/2019 18:32	22/12/2019 22:29	22/12/2019 18:32	22/12/2019 22:29	3,94	1	3,94	CHI
201912165822	MUTUNOPOLIS	MU12372636	MARA ROSA	22/12/2019 18:33	22/12/2019 22:04	22/12/2019 18:33	22/12/2019 22:04	3,51	3	10,54	CHI
201912165824	ANICUNS	10027117071	ANICUNS	22/12/2019 18:33	23/12/2019 13:02	22/12/2019 18:33	23/12/2019 13:02	18,49	1	18,49	CHI
201912165829	ABADIANIA	AA21413028	ANAPOLIS UNIVERSITARIO S2	22/12/2019 18:33	23/12/2019 07:48	22/12/2019 18:33	23/12/2019 07:48	13,24	1	13,24	CHI
201912165842	MORRINHOS	MR12000084	MORRINHOS	22/12/2019 18:34	23/12/2019 23:00	22/12/2019 18:34	23/12/2019 23:00	28,42	3	85,27	CHI
201912166235	APARECIDA DE GOIANIA	AP11004669	INDEPENDENCIA S2	22/12/2019 18:34	23/12/2019 15:47	22/12/2019 18:34	23/12/2019 15:47	21,22	138	2928,74	CHI
201912165855	ALEXANIA	AX11382894	ALEXANIA	22/12/2019 18:36	22/12/2019 19:46	22/12/2019 18:36	22/12/2019 19:46	1,16	8	9,32	CHI
201912166027	SAO LUIS DE MONTES BELOS	SL31145767	SAO LUIZ DOS MONTES BELOS	22/12/2019 18:39	23/12/2019 15:52	22/12/2019 18:39	23/12/2019 15:52	21,23	1	21,23	CHI
201912167639	BONOPOLIS	BX11208621	SAO MIGUEL DO ARAGUAIA	22/12/2019 18:39	23/12/2019 07:41	22/12/2019 18:39	23/12/2019 07:41	13,03	94	1224,35	CHI
201912166037	GOIANDIRA	2010009612	CATALAO S1	22/12/2019 18:40	22/12/2019 21:58	22/12/2019 18:40	22/12/2019 21:58	3,30	1	3,30	CHI
201912166896	CATALAO	OU12195337	CATALAO S1	22/12/2019 18:40	22/12/2019 23:02	22/12/2019 18:40	22/12/2019 23:02	4,35	5	21,76	CHI
201912166896	OUVIDOR	OU12195337	CATALAO S1	22/12/2019 18:40	22/12/2019 23:02	22/12/2019 18:40	22/12/2019 23:02	4,35	12	52,23	CHI
201912166896	TRES RANCHOS	OU12195337	CATALAO S1	22/12/2019 18:40	22/12/2019 23:02	22/12/2019 18:40	22/12/2019 23:02	4,35	1	4,35	CHI
201912168335	CEZARINA	CZ12010864	CEZARINA	22/12/2019 18:40	23/12/2019 11:32	22/12/2019 18:40	23/12/2019 11:32	16,88	11	185,70	CHI
201912260850	INHUMAS	IN12047634	INHUMAS S2	22/12/2019 18:42	23/12/2019 04:13	22/12/2019 18:42	23/12/2019 04:13	9,51	170	1617,46	CHI
201912166236	APARECIDA DE GOIANIA	AP11169538	INDEPENDENCIA S2	22/12/2019 18:43	23/12/2019 09:49	22/12/2019 18:43	23/12/2019 09:49	15,10	170	2566,76	CHI
201912166068	AGUAS LINDAS DE GOIAS	10012494370	AGUAS LINDAS DE GOIAS S1	22/12/2019 18:44	22/12/2019 23:22	22/12/2019 18:44	22/12/2019 23:22	4,63	1	4,63	CHI
201912166073	GOIANIA	10008516390	GOIANIA LESTE S3	22/12/2019 18:44	23/12/2019 06:19	22/12/2019 18:44	23/12/2019 06:19	11,58	1	11,58	CHI
201912166074	PIRENOPOLIS	PV12056014	CORUMBA	22/12/2019 18:44	23/12/2019 12:15	22/12/2019 18:44	23/12/2019 12:15	17,51	40	700,29	CHI
201912167555	LUZIANIA	LZ11383814	MARAJOARA	22/12/2019 18:44	22/12/2019 23:42	22/12/2019 18:44	22/12/2019 23:42	4,96	67	332,39	CHI
201912176613	PIRENOPOLIS	PV21285521	CORUMBA	22/12/2019 18:44	24/12/2019 04:54	22/12/2019 18:44	24/12/2019 04:54	34,16	1	34,16	CHI
201912176839	PIRENOPOLIS	PV21339415	CORUMBA	22/12/2019 18:44	23/12/2019 20:29	22/12/2019 18:44	23/12/2019 20:29	25,74	2	51,48	CHI
201912176462	PIRENOPOLIS	PV21155397	CORUMBA	22/12/2019 18:44	23/12/2019 17:43	22/12/2019 18:44	23/12/2019 17:43	22,97	1	22,97	CHI
201912176928	PIRENOPOLIS	PV21054412	CORUMBA	22/12/2019 18:44	23/12/2019 22:30	22/12/2019 18:44	23/12/2019 22:30	27,76	1	27,76	CHI



201912177016	PIRENOPOLIS	PV21350842	CORUMBA	22/12/2019 18:44	23/12/2019 21:41	22/12/2019 18:44	23/12/2019 21:41	26,94	1	26,94	CHI
201912166843	AGUAS LINDAS DE GOIAS	LA11313885	AGUAS LINDAS DE GOIAS S1	22/12/2019 18:45	23/12/2019 02:11	22/12/2019 18:45	23/12/2019 02:11	7,43	219	1627,23	CHI
201912166087	ORIZONA	IP21213682	PIRES DO RIO S2	22/12/2019 18:46	22/12/2019 20:21	22/12/2019 18:46	22/12/2019 20:21	1,59	1	1,59	CHI
201912166093	MARA ROSA	MQ12028228	MARA ROSA	22/12/2019 18:46	23/12/2019 00:13	22/12/2019 18:46	23/12/2019 00:13	5,44	14	76,19	CHI
201912166098	APARECIDA DE GOIANIA	200374965	INDEPENDENCIA S1	22/12/2019 18:47	23/12/2019 17:15	22/12/2019 18:47	23/12/2019 17:15	22,46	1	22,46	CHI
201912166099	ALTO HORIZONTE	AJ12295205	SANTA TEREZINHA	22/12/2019 18:47	23/12/2019 00:10	22/12/2019 18:47	22/12/2019 23:58	5,19	151	783,14	CHI
201912166099	ALTO HORIZONTE	AJ11295221	SANTA TEREZINHA	22/12/2019 18:47	23/12/2019 00:10	22/12/2019 18:47	23/12/2019 00:10	5,38	245	1318,17	CHI
201912166107	GAMELEIRA DE GOIAS	SV21216198	DAIA S2	22/12/2019 18:48	23/12/2019 10:35	22/12/2019 18:48	23/12/2019 10:35	15,78	1	15,78	CHI
201912166109	MOSSAMEDES	SC12068211	FIRMINOPOLIS S2	22/12/2019 18:48	23/12/2019 10:54	22/12/2019 18:48	23/12/2019 10:54	16,09	1	16,09	CHI
201912166109	SANCLERLANDIA	SC12068211	FIRMINOPOLIS S2	22/12/2019 18:48	23/12/2019 10:54	22/12/2019 18:48	23/12/2019 10:54	16,09	14	225,22	CHI
201912176223	SANCLERLANDIA	SC21144842	FIRMINOPOLIS S2	22/12/2019 18:48	23/12/2019 14:06	22/12/2019 18:48	23/12/2019 14:06	19,29	1	19,29	CHI
201912166112	PIRES DO RIO	PR12000071	PIRES DO RIO S1	22/12/2019 18:49	22/12/2019 21:28	22/12/2019 18:49	22/12/2019 21:28	2,65	19	50,34	CHI
201912166113	URUTAI	UT21230592	URUTAI	22/12/2019 18:49	22/12/2019 21:13	22/12/2019 18:49	22/12/2019 21:13	2,40	1	2,40	CHI
201912167325	PIRES DO RIO	PR21203223	PIRES DO RIO S1	22/12/2019 18:49	23/12/2019 01:06	22/12/2019 18:49	23/12/2019 01:06	6,28	1	6,28	CHI
201912166126	MORRINHOS	MR12128686RE	MORRINHOS	22/12/2019 18:50	23/12/2019 17:35	22/12/2019 18:50	23/12/2019 17:35	22,74	24	545,69	CHI
201912166534	VICENTINOPOLIS	VI11354719	VICENTINOPOLIS	22/12/2019 18:50	22/12/2019 22:37	22/12/2019 18:50	22/12/2019 22:37	3,77	59	222,46	CHI
201912166336	APARECIDA DE GOIANIA	AP11081166	INDEPENDENCIA S2	22/12/2019 18:51	23/12/2019 11:04	22/12/2019 18:51	23/12/2019 11:04	16,21	194	3145,28	CHI
201912166745	BELA VISTA DE GOIAS	SV12172117	DAIA S2	22/12/2019 18:51	23/12/2019 13:30	22/12/2019 18:51	23/12/2019 13:30	18,64	1	18,64	CHI
201912166745	SILVANIA	SV12172117	DAIA S2	22/12/2019 18:51	23/12/2019 13:30	22/12/2019 18:51	23/12/2019 13:30	18,64	43	801,47	CHI
201912166148	MORRINHOS	MR21256855	MORRINHOS	22/12/2019 18:52	23/12/2019 16:55	22/12/2019 18:52	23/12/2019 16:55	22,03	1	22,03	CHI
201912166913	SANTA HELENA DE GOIAS	SH12214104	ACREUNA	22/12/2019 18:54	23/12/2019 21:05	22/12/2019 18:54	23/12/2019 21:05	26,18	4	104,70	CHI
201912166176	CEZARINA	CZ12026704	GUAPO S2	22/12/2019 18:56	23/12/2019 14:29	22/12/2019 18:56	23/12/2019 14:29	19,54	4	78,18	CHI
201912166176	INDIARA	CZ12026704	GUAPO S2	22/12/2019 18:56	23/12/2019 14:29	22/12/2019 18:56	23/12/2019 14:29	19,54	1	19,54	CHI
201912166177	BONOPOLIS	BX12262762	SAO MIGUEL DO ARAGUAIA	22/12/2019 18:56	23/12/2019 10:38	22/12/2019 18:56	23/12/2019 10:38	15,69	5	78,46	CHI
201912166183	GOIANIA	GN11053333	FERROVIARIO S2	22/12/2019 18:57	23/12/2019 13:19	22/12/2019 18:57	23/12/2019 13:19	18,37	38	698,17	CHI
201912166186	SANTA CRUZ DE GOIAS	BC12023183	CRISTIANOPOLIS	22/12/2019 18:57	23/12/2019 20:09	22/12/2019 18:57	22/12/2019 23:11	4,24	44	186,72	CHI
201912166186	SANTA CRUZ DE GOIAS	BC12023183	CRISTIANOPOLIS	22/12/2019 18:57	23/12/2019 20:09	22/12/2019 23:12	23/12/2019 20:09	20,95	44	921,70	CHI
201912166190	CAMPOS VERDES	VD12056599	SANTA TEREZINHA	22/12/2019 18:57	24/12/2019 19:39	22/12/2019 18:57	24/12/2019 17:36	46,65	12	559,83	CHI
201912166190	CAMPOS VERDES	VD12056599	SANTA TEREZINHA	22/12/2019 18:57	24/12/2019 19:39	22/12/2019 18:57	24/12/2019 17:58	47,02	20	940,39	CHI
201912166190	CAMPOS VERDES	VD12056599	SANTA TEREZINHA	22/12/2019 18:57	24/12/2019 19:39	22/12/2019 18:57	24/12/2019 18:45	47,80	9	430,24	CHI
201912166190	ALTO HORIZONTE	VD13330122	SANTA TEREZINHA	22/12/2019 18:57	24/12/2019 19:39	22/12/2019 18:57	24/12/2019 19:39	48,71	9	438,38	CHI
201912166190	CAMPOS VERDES	VD13330122	SANTA TEREZINHA	22/12/2019 18:57	24/12/2019 19:39	22/12/2019 18:57	24/12/2019 19:39	48,71	55	2678,97	CHI
201912166190	MARA ROSA	VD13330122	SANTA TEREZINHA	22/12/2019 18:57	24/12/2019 19:39	22/12/2019 18:57	24/12/2019 19:39	48,71	67	3263,48	CHI

201912166408	FAZENDA NOVA	01050434	JUSSARA	22/12/2019 18:57	24/12/2019 17:42	22/12/2019 18:57	22/12/2019 20:04	1,13	100	112,61	CHI
201912166408	FAZENDA NOVA	01050434	JUSSARA	22/12/2019 18:57	24/12/2019 17:42	22/12/2019 18:57	22/12/2019 20:04	1,13	47	52,93	CHI
201912166408	ITAPIRAPUA	01050434	JUSSARA	22/12/2019 18:57	24/12/2019 17:42	22/12/2019 18:57	22/12/2019 20:04	1,13	55	61,94	CHI
201912166408	NOVO BRASIL	01050434	JUSSARA	22/12/2019 18:57	24/12/2019 17:42	22/12/2019 18:57	22/12/2019 20:04	1,13	489	550,67	CHI
201912166408	NOVO BRASIL	01050434	JUSSARA	22/12/2019 18:57	24/12/2019 17:42	22/12/2019 18:57	22/12/2019 20:04	1,13	1203	1354,71	CHI
201912166408	NOVO BRASIL	01050434	JUSSARA	22/12/2019 18:57	24/12/2019 17:42	22/12/2019 18:57	22/12/2019 20:04	1,13	50	56,31	CHI
201912166408	ITAPIRAPUA	01050434	JUSSARA	22/12/2019 18:57	24/12/2019 17:42	22/12/2019 18:57	23/12/2019 08:54	13,96	15	209,34	CHI
201912166408	NOVO BRASIL	01050434	JUSSARA	22/12/2019 18:57	24/12/2019 17:42	22/12/2019 18:57	23/12/2019 08:54	13,96	24	334,94	CHI
201912166408	ITAPIRAPUA	01050434	JUSSARA	22/12/2019 18:57	24/12/2019 17:42	22/12/2019 18:57	23/12/2019 16:01	21,08	10	210,76	CHI
201912166408	ITAPIRAPUA	01050434	JUSSARA	22/12/2019 18:57	24/12/2019 17:42	22/12/2019 18:57	24/12/2019 17:23	46,44	1	46,44	CHI
201912166408	ITAPIRAPUA	01050434	JUSSARA	22/12/2019 18:57	24/12/2019 17:42	22/12/2019 18:57	24/12/2019 17:42	46,75	1	46,75	CHI
201912166198	URUACU	640055540	URUACU	22/12/2019 18:58	22/12/2019 20:48	22/12/2019 18:58	22/12/2019 20:48	1,83	1	1,83	CHI
201912166905	APARECIDA DE GOIANIA	AP11135155	INDEPENDENCIA S2	22/12/2019 18:58	23/12/2019 03:55	22/12/2019 18:58	23/12/2019 03:55	8,95	112	1001,84	CHI
201912166356	GOIANIA	GN11274920	GOYA S1	22/12/2019 18:59	22/12/2019 21:46	22/12/2019 18:59	22/12/2019 21:46	2,78	110	305,31	CHI
201912167452	ITAPURANGA	IK11124726	ITAPURANGA	22/12/2019 18:59	23/12/2019 08:27	22/12/2019 18:59	23/12/2019 08:27	13,46	33	444,09	CHI
201912166309	PADRE BERNARDO	PB21363400	PADRE BERNARDO	22/12/2019 19:00	22/12/2019 20:30	22/12/2019 19:00	22/12/2019 20:30	1,50	1	1,50	CHI
201912166315	APARECIDA DE GOIANIA	AP11068175	INDEPENDENCIA S2	22/12/2019 19:00	23/12/2019 11:15	22/12/2019 19:00	23/12/2019 11:15	16,25	249	4046,53	CHI
201912167041	APARECIDA DE GOIANIA	AP11140144	INDEPENDENCIA S2	22/12/2019 19:00	23/12/2019 00:20	22/12/2019 19:00	23/12/2019 00:20	5,32	233	1240,72	CHI
201912167240	CAIAPONIA	00300214	CAIAPONIA	22/12/2019 19:00	23/12/2019 12:23	23/12/2019 06:09	23/12/2019 06:34	0,43	191	81,49	CHI
201912167240	CAIAPONIA	CP12036958	CAIAPONIA	22/12/2019 19:00	23/12/2019 12:23	22/12/2019 19:00	23/12/2019 12:23	17,38	74	1286,43	CHI
201912167240	CAIAPONIA	CP12036958	CAIAPONIA	22/12/2019 19:00	23/12/2019 12:23	23/12/2019 06:09	23/12/2019 12:23	6,24	5	31,22	CHI
201912166326	PIRENOPOLIS	10027177848	COCALZINHO	22/12/2019 19:01	23/12/2019 09:55	22/12/2019 19:01	23/12/2019 09:55	14,89	1	14,89	CHI
201912166327	CIDADE OCIDENTAL	DH21093768	MARAJOARA	22/12/2019 19:01	23/12/2019 09:26	22/12/2019 19:01	23/12/2019 09:26	14,40	1	14,40	CHI
201912166653	APARECIDA DE GOIANIA	AP11168045	INDEPENDENCIA S2	22/12/2019 19:02	23/12/2019 19:18	22/12/2019 19:02	23/12/2019 19:18	24,26	41	994,82	CHI
201912166704	VIANOPOLIS	VN11103039	VIANOPOLIS	22/12/2019 19:02	23/12/2019 08:15	22/12/2019 19:02	23/12/2019 08:15	13,21	148	1954,34	CHI
201912168344	PIRENOPOLIS	PV12008488	CORUMBA	22/12/2019 19:02	23/12/2019 15:42	22/12/2019 19:02	23/12/2019 15:42	20,67	8	165,36	CHI
201912166338	CATALAO	CT21166895	CATALAO S1	22/12/2019 19:03	23/12/2019 14:27	22/12/2019 19:03	23/12/2019 14:27	19,40	1	19,40	CHI
201912166341	BURITI ALEGRE	BG21110223	ITUMBIARA VELHA S2	22/12/2019 19:03	23/12/2019 20:34	22/12/2019 19:03	23/12/2019 20:34	25,51	1	25,51	CHI
201912166343	ANICUNS	AC21278689	ANICUNS	22/12/2019 19:03	23/12/2019 07:39	22/12/2019 19:03	23/12/2019 07:39	12,59	1	12,59	CHI
201912166346	CATALAO	CT12024110	CATALAO S1	22/12/2019 19:04	23/12/2019 10:27	22/12/2019 19:04	23/12/2019 10:27	15,38	3	46,13	CHI
201912166357	LUZIANIA	LZ11059643	RIO VERMELHO	22/12/2019 19:05	23/12/2019 10:29	22/12/2019 19:05	23/12/2019 10:29	15,39	7	107,74	CHI
201912166367	OUVIDOR	OU12061240	CATALAO S1	22/12/2019 19:06	23/12/2019 09:37	22/12/2019 19:06	23/12/2019 09:37	14,51	1	14,51	CHI
201912166664	APARECIDA DE GOIANIA	AP11127972	INDEPENDENCIA S2	22/12/2019 19:07	22/12/2019 22:37	22/12/2019 19:07	22/12/2019 22:37	3,49	164	571,59	CHI

201912166382	FORMOSA	FA11131890	ITIQUEIRA	22/12/2019 19:08	22/12/2019 20:17	22/12/2019 19:08	22/12/2019 20:17	1,14	79	90,41	CHI
201912166387	NOVO GAMA	LZ11013938	PACAEMBU S1	22/12/2019 19:08	23/12/2019 02:25	22/12/2019 19:08	23/12/2019 02:25	7,27	12	87,22	CHI
201912166398	VALPARAISO DE GOIAS	LZ12000138	MARAJOARA	22/12/2019 19:09	23/12/2019 08:54	22/12/2019 19:09	23/12/2019 08:54	13,75	6	82,49	CHI
201912166410	PALMEIRAS DE GOIAS	PL12000058	PALMEIRAS	22/12/2019 19:10	23/12/2019 08:50	22/12/2019 19:10	23/12/2019 08:50	13,66	6	81,97	CHI
201912167209	NOVO GAMA	NJ11165076	PACAEMBU S1	22/12/2019 19:10	22/12/2019 22:46	22/12/2019 19:10	22/12/2019 22:46	3,59	91	326,72	CHI
201912166419	ISRAELANDIA	IS21139425	IPORA	22/12/2019 19:11	23/12/2019 14:29	22/12/2019 19:11	23/12/2019 14:29	19,30	1	19,30	CHI
201912166425	PARAUNA	PU12186430	ACREUNA	22/12/2019 19:11	22/12/2019 21:47	22/12/2019 19:11	22/12/2019 21:47	2,59	7	18,12	CHI
201912166846	JESUPOLIS	SF12021521	SAO FRANCISCO DE GOIAS	22/12/2019 19:11	23/12/2019 09:54	22/12/2019 19:11	23/12/2019 09:54	14,71	2	29,42	CHI
201912166846	SAO FRANCISCO DE GOIAS	SF12021521	SAO FRANCISCO DE GOIAS	22/12/2019 19:11	23/12/2019 09:54	22/12/2019 19:11	23/12/2019 09:54	14,71	2	29,42	CHI
201912166436	NIQUELANDIA	2750121705	NIQUELANDIA SUBTRANSMISSAO	22/12/2019 19:12	22/12/2019 22:24	22/12/2019 19:12	22/12/2019 22:24	3,19	1	3,19	CHI
201912166439	JARAGUA	JA12072746	JARAGUA	22/12/2019 19:13	23/12/2019 02:56	22/12/2019 19:13	23/12/2019 02:56	7,71	39	300,88	CHI
201912166442	NIQUELANDIA	NQ21125304	URUACU	22/12/2019 19:13	22/12/2019 22:41	22/12/2019 19:13	22/12/2019 22:41	3,46	1	3,46	CHI
201912166446	NOVO GAMA	NJ11283925	MARAJOARA	22/12/2019 19:13	23/12/2019 10:05	22/12/2019 19:13	23/12/2019 10:05	14,86	31	460,61	CHI
201912166453	PIRENOPOLIS	PV21055381	CORUMBA	22/12/2019 19:14	22/12/2019 22:53	22/12/2019 19:14	22/12/2019 22:53	3,65	1	3,65	CHI
201912167285	ITAPIRAPUA	IU11000006	MATRINCHA	22/12/2019 19:14	23/12/2019 02:38	22/12/2019 19:14	23/12/2019 02:38	7,39	67	495,43	CHI
201912166465	PIRENOPOLIS	220041155	CORUMBA	22/12/2019 19:15	23/12/2019 07:37	22/12/2019 19:15	23/12/2019 07:37	12,36	1	12,36	CHI
201912166859	MORRINHOS	MR11000004	MORRINHOS	22/12/2019 19:15	23/12/2019 05:36	22/12/2019 19:15	23/12/2019 05:36	10,34	198	2046,88	CHI
201912166470	GOIANDIRA	GD12078364	CATALAO S1	22/12/2019 19:16	23/12/2019 15:34	22/12/2019 19:16	23/12/2019 15:34	20,29	9	182,59	CHI
201912166474	CALDAZINHA	SV12202383	CEPAIGO S2	22/12/2019 19:17	24/12/2019 00:02	22/12/2019 19:17	24/12/2019 00:02	28,75	12	344,97	CHI
201912166474	SILVANIA	SV12202383	CEPAIGO S2	22/12/2019 19:17	24/12/2019 00:02	22/12/2019 19:17	24/12/2019 00:02	28,75	1	28,75	CHI
201912166476	GUAPO	GA21006364	GUAPO S1	22/12/2019 19:17	23/12/2019 12:53	22/12/2019 19:17	23/12/2019 12:53	17,60	2	35,19	CHI
201912167157	VALPARAISO DE GOIAS	VA11172187	PACAEMBU S1	22/12/2019 19:17	22/12/2019 22:40	22/12/2019 19:17	22/12/2019 22:40	3,37	87	293,29	CHI
201912166491	SAO FRANCISCO DE GOIAS	SF12072320	SAO FRANCISCO DE GOIAS	22/12/2019 19:18	22/12/2019 22:53	22/12/2019 19:18	22/12/2019 22:53	3,57	216	771,36	CHI
201912166840	ABADIANIA	AA12261204	ANAPOLIS UNIVERSITARIO S1	22/12/2019 19:18	23/12/2019 17:59	22/12/2019 19:18	23/12/2019 17:59	22,68	22	498,98	CHI
201912166494	URUTAI	UT12337239	PIRES DO RIO S2	22/12/2019 19:19	23/12/2019 08:20	22/12/2019 19:19	23/12/2019 08:15	12,95	6	77,68	CHI
201912166494	URUTAI	UT21382048	PIRES DO RIO S2	22/12/2019 19:19	23/12/2019 08:20	22/12/2019 19:19	23/12/2019 08:20	13,03	1	13,03	CHI
201912166497	ANICUNS	AC12304649	ANICUNS	22/12/2019 19:19	23/12/2019 14:09	22/12/2019 19:19	23/12/2019 14:09	18,83	5	94,13	CHI
201912166501	JARAGUA	10023640675	JARAGUA	22/12/2019 19:20	22/12/2019 23:41	22/12/2019 19:20	22/12/2019 23:41	4,35	1	4,35	CHI
201912166755	VALPARAISO DE GOIAS	VA11169041	MARAJOARA	22/12/2019 19:21	22/12/2019 21:18	22/12/2019 19:21	22/12/2019 21:18	1,94	219	425,47	CHI
201912166517	VIANOPOLIS	VN12105501	VIANOPOLIS	22/12/2019 19:22	23/12/2019 07:49	22/12/2019 19:22	23/12/2019 07:49	12,45	230	2862,73	CHI
201912166522	NIQUELANDIA	NQ21141622	SAO JOAO D ALIANCA	22/12/2019 19:22	23/12/2019 15:54	22/12/2019 19:22	23/12/2019 15:54	20,52	2	41,04	CHI
201912166762	AGUAS LINDAS DE GOIAS	LA11348559	AGUAS LINDAS DE GOIAS S1	22/12/2019 19:22	22/12/2019 21:52	22/12/2019 19:22	22/12/2019 21:52	2,49	200	497,17	CHI
201912167151	LUZIANIA	LZ11376269	MARAJOARA	22/12/2019 19:22	22/12/2019 21:40	22/12/2019 19:22	22/12/2019 21:40	2,30	88	202,20	CHI

201912166527	GOIANDIRA	2010001698	CATALAO S1	22/12/2019 19:23	23/12/2019 09:15	22/12/2019 19:23	23/12/2019 09:15	13,86	1	13,86	CHI
201912166528	GOIANIA	10271235	CAMPINAS S3	22/12/2019 19:23	22/12/2019 21:01	22/12/2019 19:23	22/12/2019 21:01	1,62	1	1,62	CHI
201912166673	JARAGUA	JA12000236	JARAGUA	22/12/2019 19:23	24/12/2019 09:00	22/12/2019 19:23	24/12/2019 08:53	37,50	7	262,52	CHI
201912166673	JARAGUA	JA12000236	JARAGUA	22/12/2019 19:23	24/12/2019 09:00	22/12/2019 19:23	24/12/2019 09:00	37,61	19	714,51	CHI
201912166894	APARECIDA DE GOIANIA	AP11065081	INDEPENDENCIA S1	22/12/2019 19:23	23/12/2019 12:53	22/12/2019 19:23	23/12/2019 12:53	17,50	182	3184,85	CHI
201912166968	VALPARAISO DE GOIAS	VA11169042	MARAJOARA	22/12/2019 19:23	22/12/2019 21:28	22/12/2019 19:23	22/12/2019 21:28	2,07	181	375,07	CHI
201912166540	MINEIROS	1390144164	PARQUE DAS EMAS	22/12/2019 19:24	23/12/2019 12:38	22/12/2019 19:24	23/12/2019 12:38	17,23	1	17,23	CHI
201912166543	APARECIDA DE GOIANIA	AP11168598	INDEPENDENCIA S1	22/12/2019 19:24	23/12/2019 14:35	22/12/2019 19:24	23/12/2019 14:35	19,17	58	1111,83	CHI
201912166833	TRINDADE	TR11180169	TRINDADE	22/12/2019 19:24	23/12/2019 01:51	22/12/2019 19:24	23/12/2019 01:51	6,44	97	624,36	CHI
201912167051	NOVO GAMA	NJ11183662	PACAEMBU S1	22/12/2019 19:24	22/12/2019 22:17	22/12/2019 19:24	22/12/2019 22:17	2,88	190	546,78	CHI
201912177629	DOVERLANDIA	DV12324390	PARQUE DAS EMAS	22/12/2019 19:24	24/12/2019 14:15	22/12/2019 19:24	24/12/2019 14:15	42,85	11	471,30	CHI
201912166545	CATALAO	1990289633	CATALAO S2	22/12/2019 19:25	22/12/2019 20:44	22/12/2019 19:25	22/12/2019 20:44	1,31	1	1,31	CHI
201912166546	APARECIDA DE GOIANIA	AP11376803	INDEPENDENCIA S1	22/12/2019 19:25	23/12/2019 17:14	22/12/2019 19:25	23/12/2019 17:14	21,81	84	1832,27	CHI
201912166553	PLANALTINA	2960125790	PLANALTINA	22/12/2019 19:25	23/12/2019 01:13	22/12/2019 19:25	23/12/2019 01:13	5,79	1	5,79	CHI
201912166559	PIRES DO RIO	PR21332315	PIRES DO RIO S2	22/12/2019 19:26	22/12/2019 22:18	22/12/2019 19:26	22/12/2019 22:18	2,87	2	5,74	CHI
201912166694	JARAGUA	JA11273155	JARAGUA	22/12/2019 19:27	23/12/2019 01:51	22/12/2019 19:27	23/12/2019 01:51	6,39	87	556,29	CHI
201912167045	GOIANIA	GN11001821	ATLANTICO S3	22/12/2019 19:27	22/12/2019 22:52	22/12/2019 19:27	22/12/2019 22:52	3,41	134	456,64	CHI
201912166655	GUARAITA	GK12234057	ITAPURANGA	22/12/2019 19:28	24/12/2019 09:03	22/12/2019 19:28	24/12/2019 09:03	37,58	4	150,33	CHI
201912166668	ORIZONA	OZ12404781	PIRES DO RIO S1	22/12/2019 19:29	22/12/2019 22:49	22/12/2019 19:29	22/12/2019 22:49	3,32	15	49,77	CHI
201912167044	APARECIDA DE GOIANIA	AP11157736	INDEPENDENCIA S1	22/12/2019 19:30	23/12/2019 17:51	22/12/2019 19:30	23/12/2019 17:51	22,35	62	1385,87	CHI
201912166684	HIDROLANDIA	HD11282653	CEPAIGO S2	22/12/2019 19:31	22/12/2019 22:47	22/12/2019 19:31	22/12/2019 22:47	3,26	21	68,51	CHI
201912166812	APARECIDA DE GOIANIA	AP11251716	INDEPENDENCIA S1	22/12/2019 19:31	23/12/2019 14:00	22/12/2019 19:31	23/12/2019 14:00	18,47	147	2715,25	CHI
201912166690	NEROPOLIS	10009562050	NEROPOLIS S2	22/12/2019 19:32	23/12/2019 06:42	22/12/2019 19:32	23/12/2019 06:42	11,16	1	11,16	CHI
201912166703	JATAI	JT12230959	JATAI S1	22/12/2019 19:33	23/12/2019 12:12	22/12/2019 19:33	23/12/2019 12:12	16,64	2	33,27	CHI
201912166882	APARECIDA DE GOIANIA	AP11091373	INDEPENDENCIA S1	22/12/2019 19:34	23/12/2019 10:10	22/12/2019 19:34	23/12/2019 10:10	14,60	159	2321,18	CHI
201912166891	APARECIDA DE GOIANIA	AP11251490	INDEPENDENCIA S1	22/12/2019 19:34	23/12/2019 19:00	22/12/2019 19:34	23/12/2019 19:00	23,43	172	4030,49	CHI
201912167299	PONTALINA	PK32046001	PONTALINA	22/12/2019 19:34	23/12/2019 19:38	22/12/2019 19:34	23/12/2019 19:38	24,06	19	457,21	CHI
201912166809	APARECIDA DE GOIANIA	AP11167714	INDEPENDENCIA S1	22/12/2019 19:35	23/12/2019 08:30	22/12/2019 19:35	23/12/2019 08:30	12,91	134	1730,35	CHI
201912167136	APARECIDA DE GOIANIA	AP11046363	INDEPENDENCIA S1	22/12/2019 19:35	23/12/2019 09:59	22/12/2019 19:35	23/12/2019 09:59	14,39	177	2546,59	CHI
201912167572	ITAPIRAPUA	IU12072503	JUSSARA	22/12/2019 19:36	23/12/2019 15:35	22/12/2019 19:36	23/12/2019 15:35	19,98	11	219,83	CHI
201912166739	CALDAS NOVAS	CN12060250	CALDAS NOVAS S1	22/12/2019 19:37	24/12/2019 10:56	22/12/2019 19:37	24/12/2019 10:56	39,31	2	78,63	CHI
201912166739	PIRACANJUBA	CN12060250	CALDAS NOVAS S1	22/12/2019 19:37	24/12/2019 10:56	22/12/2019 19:37	24/12/2019 10:56	39,31	6	235,88	CHI
201912166739	SANTA CRUZ DE GOIAS	CN12060250	CALDAS NOVAS S1	22/12/2019 19:37	24/12/2019 10:56	22/12/2019 19:37	24/12/2019 10:56	39,31	6	235,88	CHI

201912167185	APARECIDA DE GOIANIA	AP11000066	INDEPENDENCIA S1	22/12/2019 19:37	23/12/2019 12:41	22/12/2019 19:37	23/12/2019 12:41	17,05	142	2421,42	CHI
201912166747	DIORAMA	DI21139441	IPORA	22/12/2019 19:38	24/12/2019 10:06	22/12/2019 19:38	24/12/2019 10:06	38,46	1	38,46	CHI
201912170843	INHUMAS	IX12016046	INHUMAS S1	22/12/2019 19:38	23/12/2019 14:00	22/12/2019 19:38	23/12/2019 14:00	18,36	6	110,19	CHI
201912170843	ITAUCU	IX12016046	INHUMAS S1	22/12/2019 19:38	23/12/2019 14:00	22/12/2019 19:38	23/12/2019 14:00	18,36	3	55,09	CHI
201912166751	PLANALTINA	10009392414	PLANALTINA	22/12/2019 19:39	22/12/2019 21:38	22/12/2019 19:39	22/12/2019 21:38	1,98	1	1,98	CHI
201912166758	GUARAITA	IK21023114	ITAPURANGA	22/12/2019 19:39	23/12/2019 13:47	22/12/2019 19:39	23/12/2019 13:47	18,12	1	18,12	CHI
201912166769	PIRES DO RIO	UT12300798	URUTAI	22/12/2019 19:39	22/12/2019 22:45	22/12/2019 19:39	22/12/2019 22:45	3,09	2	6,19	CHI
201912166769	URUTAI	UT12300798	URUTAI	22/12/2019 19:39	22/12/2019 22:45	22/12/2019 19:39	22/12/2019 22:45	3,09	25	77,33	CHI
201912166871	PANAMA	GT12000140	GOIATUBA S1	22/12/2019 19:39	23/12/2019 18:11	22/12/2019 19:39	23/12/2019 18:11	22,53	3	67,59	CHI
201912167049	CATALAO	TH12394023RE	CATALAO S1	22/12/2019 19:39	23/12/2019 17:43	22/12/2019 19:39	23/12/2019 10:05	14,42	72	1038,30	CHI
201912167049	CUMARI	TH12394023RE	CATALAO S1	22/12/2019 19:39	23/12/2019 17:43	22/12/2019 19:39	23/12/2019 10:05	14,42	1	14,42	CHI
201912167049	DISTRITO FEDERAL	TH12394023RE	CATALAO S1	22/12/2019 19:39	23/12/2019 17:43	22/12/2019 19:39	23/12/2019 10:05	14,42	1	14,42	CHI
201912167049	TRES RANCHOS	TH12394023RE	CATALAO S1	22/12/2019 19:39	23/12/2019 17:43	22/12/2019 19:39	23/12/2019 10:05	14,42	1	14,42	CHI
201912167049	CATALAO	TH12394023RE	CATALAO S2	22/12/2019 19:39	23/12/2019 17:43	22/12/2019 19:39	23/12/2019 10:05	14,42	28	403,78	CHI
201912167049	CUMARI	TH12394023RE	CATALAO S2	22/12/2019 19:39	23/12/2019 17:43	22/12/2019 19:39	23/12/2019 10:05	14,42	33	475,89	CHI
201912167049	CATALAO	TH12394023RE	CATALAO S1	22/12/2019 19:39	23/12/2019 17:43	22/12/2019 19:39	23/12/2019 17:43	22,05	66	1455,59	CHI
201912167138	NEROPOLIS	NR11167731	NEROPOLIS S2	22/12/2019 19:39	22/12/2019 21:58	22/12/2019 19:39	22/12/2019 21:58	2,31	142	328,18	CHI
201912166764	CATALAO	CT12318674	CATALAO S1	22/12/2019 19:40	22/12/2019 22:52	22/12/2019 19:40	22/12/2019 22:52	3,19	2	6,38	CHI
201912166764	DAVINOPOLIS	CT12318674	CATALAO S1	22/12/2019 19:40	22/12/2019 22:52	22/12/2019 19:40	22/12/2019 22:52	3,19	3	9,57	CHI
201912166767	GUAPO	GA12400521	GUAPO S1	22/12/2019 19:40	23/12/2019 03:58	22/12/2019 19:40	23/12/2019 03:58	8,29	11	91,14	CHI
201912171830	APARECIDA DE GOIANIA	AP11168963	INDEPENDENCIA S1	22/12/2019 19:40	24/12/2019 04:45	22/12/2019 19:40	24/12/2019 04:45	33,07	59	1951,28	CHI
201912166771	PIRENOPOLIS	PV21155069	SAO FRANCISCO DE GOIAS	22/12/2019 19:41	23/12/2019 09:34	22/12/2019 19:41	23/12/2019 09:34	13,87	1	13,87	CHI
201912166773	UIRAPURU	UP12281045LD	SANTA TEREZINHA	22/12/2019 19:41	23/12/2019 13:25	22/12/2019 19:41	23/12/2019 13:25	17,72	9	159,46	CHI
201912167474	NOVA AURORA	NE12143243	CATALAO S1	22/12/2019 19:41	23/12/2019 09:00	22/12/2019 19:41	23/12/2019 09:00	13,30	5	66,51	CHI
201912166218	NOVO PLANALTO	TA12354457	NOVO PLANALTO	22/12/2019 19:42	22/12/2019 20:40	22/12/2019 19:42	22/12/2019 20:40	0,95	12	11,46	CHI
201912166776	ANICUNS	910021077	ANICUNS	22/12/2019 19:42	23/12/2019 09:35	22/12/2019 19:42	23/12/2019 09:35	13,88	1	13,88	CHI
201912166778	GOIANIA	12750372	CARAJAS S1	22/12/2019 19:42	22/12/2019 23:25	22/12/2019 19:42	22/12/2019 23:25	3,71	1	3,71	CHI
201912166782	INHUMAS	IN11000055	INHUMAS S2	22/12/2019 19:43	23/12/2019 16:07	22/12/2019 19:43	23/12/2019 16:07	20,40	8	163,19	CHI
201912166785	INHUMAS	30028048	INHUMAS S2	22/12/2019 19:43	23/12/2019 16:04	22/12/2019 19:43	23/12/2019 16:04	20,35	1	20,35	CHI
201912166787	NAZARIO	440010901	ANICUNS	22/12/2019 19:43	23/12/2019 10:26	22/12/2019 19:43	23/12/2019 10:26	14,71	1	14,71	CHI
201912168020	CAMPO ALEGRE DE GOIAS	CM12358430RE	CAMPO ALEGRE DE GOIAS	22/12/2019 19:43	23/12/2019 06:55	22/12/2019 19:43	23/12/2019 06:55	11,19	7	78,35	CHI
201912168020	IPAMERI	CM12358430RE	CAMPO ALEGRE DE GOIAS	22/12/2019 19:43	23/12/2019 06:55	22/12/2019 19:43	23/12/2019 06:55	11,19	14	156,70	CHI
201912166795	GOIAS	GS21353052	GOIAS	22/12/2019 19:44	23/12/2019 11:05	22/12/2019 19:44	23/12/2019 11:05	15,35	3	46,05	CHI

201912166796	GOIANIA	GN11167771	GOIANIA LESTE S2	22/12/2019 19:44	23/12/2019 10:23	22/12/2019 19:44	23/12/2019 10:23	14,65	42	615,11	CHI
201912166801	GOIATUBA	GT12296902	BOM JESUS DE GOIAS	22/12/2019 19:44	23/12/2019 16:45	22/12/2019 19:44	23/12/2019 16:45	21,00	8	168,02	CHI
201912166802	GOUVELANDIA	GB21296636	QUIRINOPOLIS	22/12/2019 19:44	23/12/2019 11:17	22/12/2019 19:44	23/12/2019 11:17	15,53	1	15,53	CHI
201912166803	PLANALTINA	PI21125296	SAO JOAO D ALIANCA	22/12/2019 19:44	23/12/2019 08:00	22/12/2019 19:44	23/12/2019 08:00	12,25	1	12,25	CHI
201912166804	PALMEIRAS DE GOIAS	PL21341642	PALMEIRAS	22/12/2019 19:45	22/12/2019 20:51	22/12/2019 19:45	22/12/2019 20:51	1,11	1	1,11	CHI
201912166817	ALEXANIA	AX21319859	ALEXANIA	22/12/2019 19:46	22/12/2019 22:05	22/12/2019 19:46	22/12/2019 22:05	2,30	1	2,30	CHI
201912166220	GOIANIA	GN11002607	ATLANTICO S3	22/12/2019 19:47	23/12/2019 12:10	22/12/2019 19:47	23/12/2019 12:10	16,37	93	1522,57	CHI
201912166823	GOIANIA	14305720	GOIANIA LESTE S1	22/12/2019 19:47	23/12/2019 08:41	22/12/2019 19:47	23/12/2019 08:41	12,90	1	12,90	CHI
201912166826	MARZAGAO	MG21098250	VILA CORUMBA	22/12/2019 19:47	23/12/2019 17:54	22/12/2019 19:47	23/12/2019 17:54	22,11	1	22,11	CHI
201912166851	FORMOSA	FA11129972	ITUIQUIRA	22/12/2019 19:47	22/12/2019 20:40	22/12/2019 19:47	22/12/2019 20:40	0,87	111	97,03	CHI
201912166839	CAMPO ALEGRE DE GOIAS	CT12338757	CATALAO S1	22/12/2019 19:48	23/12/2019 14:13	22/12/2019 19:48	23/12/2019 14:13	18,41	2	36,82	CHI
201912166839	CATALAO	CT12338757	CATALAO S1	22/12/2019 19:48	23/12/2019 14:13	22/12/2019 19:48	23/12/2019 14:13	18,41	12	220,90	CHI
201912166842	GOIANIA	11390451	ATLANTICO S1	22/12/2019 19:48	23/12/2019 02:46	22/12/2019 19:48	23/12/2019 02:46	6,95	1	6,95	CHI
201912167148	ABADIANIA	AA11043940	ANAPOLIS UNIVERSITARIO S1	22/12/2019 19:48	23/12/2019 14:57	22/12/2019 19:48	23/12/2019 14:57	19,14	119	2278,12	CHI
201912166853	IACIARA	IA12302810	FLORES DE GOIAS	22/12/2019 19:49	23/12/2019 01:25	22/12/2019 19:49	23/12/2019 01:25	5,59	16	89,47	CHI
201912166854	SAO MIGUEL DO ARAGUAIA	SM21083886	SAO MIGUEL DO ARAGUAIA	22/12/2019 19:49	23/12/2019 16:40	22/12/2019 19:49	23/12/2019 16:40	20,86	1	20,86	CHI
201912167085	NOVO GAMA	NJ11162840	PACAEMBU S1	22/12/2019 19:50	22/12/2019 23:40	22/12/2019 19:50	22/12/2019 23:40	3,83	214	818,67	CHI
201912167236	APARECIDA DE GOIANIA	AP11144357	INDEPENDENCIA S1	22/12/2019 19:51	23/12/2019 09:38	22/12/2019 19:51	23/12/2019 09:38	13,77	132	1817,31	CHI
201912166879	RIO VERDE	630233482	RIO VERDE S1	22/12/2019 19:53	23/12/2019 11:39	22/12/2019 19:53	23/12/2019 11:39	15,76	1	15,76	CHI
201912168093	ITAPIRAPUA	IU12259757	MATRINCHA	22/12/2019 19:55	23/12/2019 16:48	22/12/2019 19:55	23/12/2019 16:48	20,87	25	521,80	CHI
201912168093	SANTA FE DE GOIAS	IU12259757	MATRINCHA	22/12/2019 19:55	23/12/2019 16:48	22/12/2019 19:55	23/12/2019 16:48	20,87	12	250,46	CHI
201912167165	APARECIDA DE GOIANIA	AP11157734	INDEPENDENCIA S1	22/12/2019 19:57	23/12/2019 17:36	22/12/2019 19:57	23/12/2019 17:36	21,65	73	1580,17	CHI
201912166921	BONOPOLIS	BX12165447	SAO MIGUEL DO ARAGUAIA	22/12/2019 19:58	23/12/2019 21:49	22/12/2019 19:58	23/12/2019 21:49	25,84	3	77,52	CHI
201912166923	VALPARAISO DE GOIAS	VA11162791	PACAEMBU S2	22/12/2019 19:58	23/12/2019 09:33	22/12/2019 19:58	23/12/2019 09:33	13,57	65	882,09	CHI
201912166928	GOIANESIA	10012256275	GOIANESIA S2	22/12/2019 19:59	23/12/2019 03:57	22/12/2019 19:59	23/12/2019 03:57	7,96	1	7,96	CHI
201912166929	MONTIVIDIU	2840032357	MONTIVIDIU T	22/12/2019 19:59	23/12/2019 14:07	22/12/2019 19:59	23/12/2019 14:07	18,13	1	18,13	CHI
201912166939	IPORA	730136220	IPORA	22/12/2019 20:00	22/12/2019 21:17	22/12/2019 20:00	22/12/2019 21:17	1,27	1	1,27	CHI
201912166959	PIRES DO RIO	PR12337227	PIRES DO RIO S1	22/12/2019 20:01	23/12/2019 00:15	22/12/2019 20:01	23/12/2019 00:15	4,22	39	164,69	CHI
201912166959	SANTA CRUZ DE GOIAS	PR12337227	PIRES DO RIO S1	22/12/2019 20:01	23/12/2019 00:15	22/12/2019 20:01	23/12/2019 00:15	4,22	1	4,22	CHI
201912166959	URUTAI	PR12337227	PIRES DO RIO S1	22/12/2019 20:01	23/12/2019 00:15	22/12/2019 20:01	23/12/2019 00:15	4,22	1	4,22	CHI
201912171831	APARECIDA DE GOIANIA	AP11043245	INDEPENDENCIA S1	22/12/2019 20:01	23/12/2019 17:11	22/12/2019 20:01	23/12/2019 17:11	21,15	76	1607,55	CHI
201912166949	BONOPOLIS	BX11391600	SAO MIGUEL DO ARAGUAIA	22/12/2019 20:02	23/12/2019 08:05	22/12/2019 20:02	23/12/2019 08:05	12,04	22	264,87	CHI
201912166951	JANDAIA	JD12008673	PALMEIRAS	22/12/2019 20:02	23/12/2019 10:46	22/12/2019 20:02	23/12/2019 10:46	14,72	9	132,49	CHI

201912167693	AGUAS LINDAS DE GOIAS	LA11148902	AGUAS LINDAS DE GOIAS S1	22/12/2019 20:02	22/12/2019 23:51	22/12/2019 20:02	22/12/2019 23:51	3,80	103	391,43	CHI
201912176627	JANDAIA	JD21017305	PALMEIRAS	22/12/2019 20:02	24/12/2019 08:18	22/12/2019 20:02	24/12/2019 08:18	36,25	2	72,51	CHI
201912166958	SAO JOAO DA PARAUNA	RP21185264	FIRMINOPOLIS S2	22/12/2019 20:03	23/12/2019 09:55	22/12/2019 20:03	23/12/2019 09:55	13,86	1	13,86	CHI
201912167402	MOZARLANDIA	MZ11307539	MOZARLANDIA	22/12/2019 20:03	23/12/2019 11:16	22/12/2019 20:03	23/12/2019 11:16	15,21	89	1353,84	CHI
201912167654	CATALAO	CT12039946RE	CATALAO S1	22/12/2019 20:03	23/12/2019 08:48	22/12/2019 20:03	23/12/2019 08:48	12,74	17	216,58	CHI
201912166960	BELA VISTA DE GOIAS	240101005	BELA VISTA S1	22/12/2019 20:04	23/12/2019 06:37	22/12/2019 20:04	23/12/2019 06:37	10,55	1	10,55	CHI
201912166962	GOIANIA	11054529	FERROVIARIO S3	22/12/2019 20:04	23/12/2019 01:42	22/12/2019 20:04	23/12/2019 01:42	5,63	1	5,63	CHI
201912166967	CRIXAS	CX12321023	SANTA TEREZINHA	22/12/2019 20:05	23/12/2019 09:58	22/12/2019 20:05	23/12/2019 09:58	13,87	11	152,60	CHI
201912166971	PILAR DE GOIAS	GG12181616	SANTA TEREZINHA	22/12/2019 20:06	23/12/2019 09:38	22/12/2019 20:06	23/12/2019 09:38	13,53	3	40,58	CHI
201912166971	SANTA TEREZINHA DE GOIAS	GG12181616	SANTA TEREZINHA	22/12/2019 20:06	23/12/2019 09:38	22/12/2019 20:06	23/12/2019 09:38	13,53	6	81,17	CHI
201912167371	AGUAS LINDAS DE GOIAS	LA11377274	AGUAS LINDAS DE GOIAS S1	22/12/2019 20:06	22/12/2019 22:36	22/12/2019 20:06	22/12/2019 22:36	2,49	99	246,02	CHI
201912169195	APARECIDA DE GOIANIA	AP11340701	INDEPENDENCIA S1	22/12/2019 20:06	23/12/2019 12:17	22/12/2019 20:06	23/12/2019 12:17	16,18	217	3511,78	CHI
201912166981	RIO VERDE	630516340	RIO VERDE S1	22/12/2019 20:07	23/12/2019 15:30	22/12/2019 20:07	23/12/2019 15:30	19,38	1	19,38	CHI
201912167328	APARECIDA DE GOIANIA	AP11168978	INDEPENDENCIA S1	22/12/2019 20:08	23/12/2019 17:24	22/12/2019 20:08	23/12/2019 17:24	21,27	85	1808,16	CHI
201912166997	APARECIDA DE GOIANIA	10014445237	CEPAIGO S1	22/12/2019 20:09	23/12/2019 12:28	22/12/2019 20:09	23/12/2019 12:28	16,31	1	16,31	CHI
201912167001	PARAUNA	PU12007910	PARAUNA	22/12/2019 20:09	23/12/2019 07:01	22/12/2019 20:09	23/12/2019 07:01	10,86	3	32,57	CHI
201912167658	CRIXAS	CX12230553	RUBIATABA	22/12/2019 20:09	23/12/2019 14:44	22/12/2019 20:09	23/12/2019 14:44	18,58	15	278,67	CHI
201912167658	NOVA CRIXAS	CX12230553	RUBIATABA	22/12/2019 20:09	23/12/2019 14:44	22/12/2019 20:09	23/12/2019 14:44	18,58	1	18,58	CHI
201912167793	ANAPOLIS	AN12382480	ANAPOLIS UNIVERSITARIO S2	22/12/2019 20:10	23/12/2019 07:31	22/12/2019 20:10	23/12/2019 01:25	5,24	22	115,32	CHI
201912167793	GAMELEIRA DE GOIAS	AN12382480	ANAPOLIS UNIVERSITARIO S2	22/12/2019 20:10	23/12/2019 07:31	22/12/2019 20:10	23/12/2019 01:25	5,24	41	214,92	CHI
201912167793	SILVANIA	AN12382480	ANAPOLIS UNIVERSITARIO S2	22/12/2019 20:10	23/12/2019 07:31	22/12/2019 20:10	23/12/2019 01:25	5,24	39	204,44	CHI
201912167793	SILVANIA	AN12285353	ANAPOLIS UNIVERSITARIO S2	22/12/2019 20:10	23/12/2019 07:31	23/12/2019 05:27	23/12/2019 07:31	2,07	18	37,28	CHI
201912167012	LUZIANIA	LZ12320196	RIO VERMELHO	22/12/2019 20:11	23/12/2019 09:23	22/12/2019 20:11	23/12/2019 09:23	13,20	11	145,18	CHI
201912167068	NEROPOLIS	NR11201595	NEROPOLIS S2	22/12/2019 20:11	22/12/2019 22:38	22/12/2019 20:11	22/12/2019 22:38	2,44	99	242,00	CHI
201912167354	ITAPIRAPUA	IU11172036	MATRINCHA	22/12/2019 20:11	23/12/2019 13:00	22/12/2019 20:11	23/12/2019 13:00	16,81	105	1765,55	CHI
201912168305	ITAUCU	PV12271945	CORUMBA	22/12/2019 20:11	23/12/2019 10:47	22/12/2019 20:11	23/12/2019 10:47	14,60	1	14,60	CHI
201912168305	PIRENOPOLIS	PV12271945	CORUMBA	22/12/2019 20:11	23/12/2019 10:47	22/12/2019 20:11	23/12/2019 10:47	14,60	12	175,19	CHI
201912167021	CAMPO ALEGRE DE GOIAS	CM12376048	CAMPO ALEGRE DE GOIAS	22/12/2019 20:13	23/12/2019 08:09	22/12/2019 20:13	23/12/2019 08:09	11,93	13	155,05	CHI
201912167021	CATALAO	CM12376048	CAMPO ALEGRE DE GOIAS	22/12/2019 20:13	23/12/2019 08:09	22/12/2019 20:13	23/12/2019 08:09	11,93	14	166,98	CHI
201912167021	DISTRITO FEDERAL	CM12376048	CAMPO ALEGRE DE GOIAS	22/12/2019 20:13	23/12/2019 08:09	22/12/2019 20:13	23/12/2019 08:09	11,93	1	11,93	CHI
201912165594	AGUAS LINDAS DE GOIAS	LA11119097	AGUAS LINDAS DE GOIAS S1	22/12/2019 20:14	22/12/2019 22:26	22/12/2019 20:14	22/12/2019 22:26	2,19	189	413,59	CHI
201912167475	ARUANA	04300224	MOZARLANDIA	22/12/2019 20:14	23/12/2019 13:04	22/12/2019 20:14	23/12/2019 13:04	16,83	34	572,25	CHI
201912167475	MOZARLANDIA	04300224	MOZARLANDIA	22/12/2019 20:14	23/12/2019 13:04	22/12/2019 20:14	23/12/2019 13:04	16,83	13	218,80	CHI

201912167475	NOVA CRIXAS	04300224	MOZARLANDIA	22/12/2019 20:14	23/12/2019 13:04	22/12/2019 20:14	23/12/2019 13:04	16,83	32	538,59	CHI
201912167032	SANTA CRUZ DE GOIAS	BC21012531	PIRES DO RIO S2	22/12/2019 20:15	23/12/2019 08:19	22/12/2019 20:15	23/12/2019 08:19	12,05	1	12,05	CHI
201912168598	MUNDO NOVO DE GOIAS	MH12291176	NOVA CRIXAS	22/12/2019 20:15	23/12/2019 13:58	22/12/2019 20:15	23/12/2019 13:58	17,71	8	141,67	CHI
201912167338	ITAGUARU	IC11159957	ITABERAI S1	22/12/2019 20:17	23/12/2019 14:55	22/12/2019 20:17	23/12/2019 14:55	18,62	47	875,10	CHI
201912167057	MINEIROS	MY12210139	PARQUE DAS EMAS	22/12/2019 20:19	23/12/2019 10:48	22/12/2019 20:19	23/12/2019 10:48	14,48	2	28,95	CHI
201912167641	ITAPIRAPUA	IU10400394	MATRINCHA	22/12/2019 20:19	24/12/2019 13:00	24/12/2019 12:37	24/12/2019 12:46	0,15	12	1,85	CHI
201912167641	ITAPIRAPUA	IU10400394	MATRINCHA	22/12/2019 20:19	24/12/2019 13:00	24/12/2019 12:55	24/12/2019 12:58	0,05	12	0,65	CHI
201912167641	ITAPIRAPUA	IU10400394	MATRINCHA	22/12/2019 20:19	24/12/2019 13:00	24/12/2019 12:37	24/12/2019 13:00	0,38	1389	533,22	CHI
201912167641	ITAPIRAPUA	IU10400394	MATRINCHA	22/12/2019 20:19	24/12/2019 13:00	24/12/2019 12:44	24/12/2019 13:00	0,26	1	0,26	CHI
201912167641	GOIAS	IU10400394	MATRINCHA	22/12/2019 20:19	24/12/2019 13:00	24/12/2019 12:37	24/12/2019 13:00	0,39	553	215,36	CHI
201912167641	ITAPIRAPUA	IU10400394	MATRINCHA	22/12/2019 20:19	24/12/2019 13:00	24/12/2019 12:37	24/12/2019 13:00	0,39	1659	646,09	CHI
201912167641	NOVO BRASIL	IU10400394	MATRINCHA	22/12/2019 20:19	24/12/2019 13:00	24/12/2019 12:37	24/12/2019 13:00	0,39	6	2,34	CHI
201912167641	GOIAS	IU10400394	MATRINCHA	22/12/2019 20:19	24/12/2019 13:00	24/12/2019 12:44	24/12/2019 13:00	0,27	1	0,27	CHI
201912167641	ITAPIRAPUA	IU10400394	MATRINCHA	22/12/2019 20:19	24/12/2019 13:00	24/12/2019 12:44	24/12/2019 13:00	0,27	2	0,53	CHI
201912168364	COCALZINHO DE GOIAS	PV12227808	COCALZINHO	22/12/2019 20:19	23/12/2019 12:32	22/12/2019 20:19	23/12/2019 12:32	16,20	1	16,20	CHI
201912168364	PIRENOPOLIS	PV12227808	COCALZINHO	22/12/2019 20:19	23/12/2019 12:32	22/12/2019 20:19	23/12/2019 12:32	16,20	8	129,62	CHI
201912166227	GOIANIA	10009607712	ATLANTICO S1	22/12/2019 20:20	22/12/2019 21:30	22/12/2019 20:20	22/12/2019 21:30	1,17	1	1,17	CHI
201912167190	APARECIDA DE GOIANIA	AP11350614	INDEPENDENCIA S1	22/12/2019 20:21	23/12/2019 12:47	22/12/2019 20:21	23/12/2019 12:47	16,44	100	1643,58	CHI
201912167081	ANAPOLIS	AN21258413	JUNDIAI S1	22/12/2019 20:23	23/12/2019 11:07	22/12/2019 20:23	23/12/2019 11:07	14,73	1	14,73	CHI
201912168457	LUZIANIA	LZ12313611	VIANOPOLIS	22/12/2019 20:23	23/12/2019 08:02	22/12/2019 20:23	23/12/2019 08:02	11,65	11	128,15	CHI
201912167086	BOM JESUS DE GOIAS	BJ12323661	BOM JESUS DE GOIAS	22/12/2019 20:24	24/12/2019 08:52	22/12/2019 20:24	24/12/2019 08:52	36,46	1	36,46	CHI
201912167091	GOIANESIA	GE11336602	GOIANESIA S2	22/12/2019 20:24	22/12/2019 23:44	22/12/2019 20:24	22/12/2019 23:44	3,32	85	282,13	CHI
201912167463	CORUMBA DE GOIAS	CB12078301	CORUMBA	22/12/2019 20:24	23/12/2019 13:08	22/12/2019 20:24	23/12/2019 13:08	16,73	4	66,91	CHI
201912167458	ABADIANIA	AA12388855LD	DAIA S2	22/12/2019 20:25	26/12/2019 19:15	22/12/2019 20:25	23/12/2019 10:30	14,07	5	70,35	CHI
201912167458	ABADIANIA	AA12258349LD	DAIA S2	22/12/2019 20:25	26/12/2019 19:15	22/12/2019 20:25	23/12/2019 10:35	14,15	9	127,38	CHI
201912167458	ABADIANIA	AA12297632	DAIA S2	22/12/2019 20:25	26/12/2019 19:15	22/12/2019 20:25	23/12/2019 13:26	17,01	2	34,01	CHI
201912167458	GAMELEIRA DE GOIAS	AA12297632	DAIA S2	22/12/2019 20:25	26/12/2019 19:15	22/12/2019 20:25	26/12/2019 19:15	94,82	1	94,82	CHI
201912167467	NOVO PLANALTO	TA12293622	SAO MIGUEL DO ARAGUAIA	22/12/2019 20:28	23/12/2019 12:31	22/12/2019 20:28	23/12/2019 12:31	16,04	19	304,77	CHI
201912169007	GOIANESIA	GE12093160	GOIANESIA S2	22/12/2019 20:28	23/12/2019 23:02	22/12/2019 20:28	23/12/2019 23:02	26,56	47	1248,55	CHI
201912167128	ARUANA	AK11124731	ARUANA	22/12/2019 20:31	24/12/2019 00:05	22/12/2019 20:31	24/12/2019 00:05	27,56	71	1956,46	CHI
201912167134	MORRINHOS	MR21000083	MORRINHOS	22/12/2019 20:32	23/12/2019 12:27	22/12/2019 20:32	23/12/2019 12:27	15,90	1	15,90	CHI
201912167145	CALDAZINHA	DE21217256	CEPAIGO S2	22/12/2019 20:33	23/12/2019 13:46	22/12/2019 20:33	23/12/2019 13:46	17,21	1	17,21	CHI
201912167147	ITAPURANGA	IK21310383	ITAPURANGA	22/12/2019 20:33	23/12/2019 11:23	22/12/2019 20:33	23/12/2019 11:23	14,84	1	14,84	CHI



201912168849	CEZARINA	VJ12405985	GUAPO S2	22/12/2019 20:33	23/12/2019 15:34	22/12/2019 20:33	23/12/2019 15:34	19,01	38	722,41	CHI
201912168849	VARJAO	VJ12405985	GUAPO S2	22/12/2019 20:33	23/12/2019 15:34	22/12/2019 20:33	23/12/2019 15:34	19,01	2	38,02	CHI
201912167150	SANTO ANTONIO DA BARRA	BZ21196645	SANTA HELENA S1	22/12/2019 20:34	23/12/2019 09:20	22/12/2019 20:34	23/12/2019 09:20	12,76	1	12,76	CHI
201912167160	COCALZINHO DE GOIAS	ZN12326371	COCALZINHO	22/12/2019 20:35	23/12/2019 21:12	22/12/2019 20:35	23/12/2019 21:12	24,61	7	172,27	CHI
201912167161	SANTA CRUZ DE GOIAS	BC21012528	PIRES DO RIO S2	22/12/2019 20:35	23/12/2019 08:42	22/12/2019 20:35	23/12/2019 08:42	12,10	1	12,10	CHI
201912167164	BALIZA	BH21207586	BOM JARDIM	22/12/2019 20:37	23/12/2019 01:02	22/12/2019 20:37	23/12/2019 01:02	4,42	1	4,42	CHI
201912167167	APARECIDA DE GOIANIA	13337981	INDEPENDENCIA S1	22/12/2019 20:37	23/12/2019 10:59	22/12/2019 20:37	23/12/2019 10:59	14,36	1	14,36	CHI
201912169150	SAO MIGUEL DO ARAGUAIA	SM12031421	SAO MIGUEL DO ARAGUAIA	22/12/2019 20:37	23/12/2019 18:05	22/12/2019 20:37	23/12/2019 18:05	21,46	17	364,82	CHI
201912167173	GUAPO	VJ12000056LD	GUAPO S2	22/12/2019 20:39	23/12/2019 15:51	22/12/2019 20:39	23/12/2019 15:51	19,19	46	882,92	CHI
201912167173	VARJAO	VJ12000056LD	GUAPO S2	22/12/2019 20:39	23/12/2019 15:51	22/12/2019 20:39	23/12/2019 15:51	19,19	75	1439,54	CHI
201912167178	PIRENOPOLIS	PV12000046	CORUMBA	22/12/2019 20:39	23/12/2019 13:36	22/12/2019 20:39	23/12/2019 13:36	16,94	50	846,81	CHI
201912167179	PALMEIRAS DE GOIAS	PL12051402	PALMEIRAS	22/12/2019 20:39	23/12/2019 07:38	22/12/2019 20:39	23/12/2019 07:38	10,98	3	32,95	CHI
201912167289	RIO VERDE	RV12296137LD	CABRIUVA S1	22/12/2019 20:41	23/12/2019 12:55	22/12/2019 20:41	23/12/2019 12:55	16,22	25	405,55	CHI
201912167356	PETROLINA DE GOIAS	PV12062894	SAO FRANCISCO DE GOIAS	22/12/2019 20:41	23/12/2019 16:08	22/12/2019 20:41	23/12/2019 16:08	19,44	3	58,32	CHI
201912167356	PIRENOPOLIS	PV12062894	SAO FRANCISCO DE GOIAS	22/12/2019 20:41	23/12/2019 16:08	22/12/2019 20:41	23/12/2019 16:08	19,44	20	388,80	CHI
201912167202	HIDROLANDIA	HD31117890	CEPAIGO S2	22/12/2019 20:43	24/12/2019 12:33	22/12/2019 20:43	24/12/2019 12:33	39,83	1	39,83	CHI
201912167297	APARECIDA DE GOIANIA	AP12000065	ANHANGUERA	22/12/2019 20:44	22/12/2019 23:40	22/12/2019 20:44	22/12/2019 23:40	2,94	732	2150,86	CHI
201912167215	GOIATUBA	GT21000179	BOM JESUS DE GOIAS	22/12/2019 20:45	24/12/2019 07:48	22/12/2019 20:45	24/12/2019 07:48	35,05	1	35,05	CHI
201912167216	CATURAI	IN21033213	ARACU	22/12/2019 20:45	23/12/2019 12:40	22/12/2019 20:45	23/12/2019 12:40	15,92	2	31,84	CHI
201912167672	SANTA RITA DO ARAGUAIA	SU11148199	SANTA RITA DO ARAGUAIA	22/12/2019 20:45	23/12/2019 12:02	22/12/2019 20:45	23/12/2019 12:02	15,28	39	595,89	CHI
201912166228	EDEALINA	EA10394609	EDEIA	22/12/2019 20:46	22/12/2019 22:43	22/12/2019 20:46	22/12/2019 22:43	1,95	1	1,95	CHI
201912166228	EDEIA	EA10394609	EDEIA	22/12/2019 20:46	22/12/2019 22:43	22/12/2019 20:46	22/12/2019 22:43	1,95	187	364,03	CHI
201912167220	CRISTALINA	KR21248637	CRISTALINA S2	22/12/2019 20:46	22/12/2019 21:34	22/12/2019 20:46	22/12/2019 21:34	0,80	1	0,80	CHI
201912167222	BARRO ALTO	GE12006481	BARRO ALTO	22/12/2019 20:46	23/12/2019 02:02	22/12/2019 20:46	23/12/2019 02:02	5,26	21	110,39	CHI
201912167222	SANTA RITA DO NOVO DESTINO	GE12006481	BARRO ALTO	22/12/2019 20:46	23/12/2019 02:02	22/12/2019 20:46	23/12/2019 02:02	5,26	10	52,57	CHI
201912167226	MONTES CLAROS DE GOIAS	ME12074392	IPORA	22/12/2019 20:47	24/12/2019 18:03	22/12/2019 20:47	24/12/2019 18:03	45,27	4	181,10	CHI
201912167232	ANICUNS	AC12304642	ANICUNS	22/12/2019 20:47	23/12/2019 22:27	22/12/2019 20:47	23/12/2019 22:27	25,65	7	179,56	CHI
201912167239	SANTA RITA DO ARAGUAIA	SU12306464	SANTA RITA DO ARAGUAIA	22/12/2019 20:49	23/12/2019 08:56	22/12/2019 20:49	23/12/2019 08:56	12,11	1	12,11	CHI
201912167241	NOVA CRIXAS	8570038126	NOVA CRIXAS	22/12/2019 20:49	23/12/2019 18:15	22/12/2019 20:49	23/12/2019 18:15	21,43	1	21,43	CHI
201912167412	APARECIDA DE GOIANIA	AP11101601	ANHANGUERA	22/12/2019 20:49	23/12/2019 01:05	22/12/2019 20:49	23/12/2019 01:05	4,26	455	1939,31	CHI
201912167492	SANTA RITA DO ARAGUAIA	SU11271643	SANTA RITA DO ARAGUAIA	22/12/2019 20:49	23/12/2019 16:36	22/12/2019 20:49	23/12/2019 16:36	19,78	33	652,76	CHI
201912167274	APARECIDA DE GOIANIA	AP16401542	INDEPENDENCIA S1	22/12/2019 20:50	23/12/2019 00:16	22/12/2019 20:50	22/12/2019 22:10	1,33	2293	3057,33	CHI
201912167274	ARAGOIANIA	AP16401542	INDEPENDENCIA S1	22/12/2019 20:50	23/12/2019 00:16	22/12/2019 20:50	22/12/2019 22:10	1,33	31	41,33	CHI

201912167274	HIDROLANDIA	AP16401542	INDEPENDENCIA S1	22/12/2019 20:50	23/12/2019 00:16	22/12/2019 20:50	22/12/2019 22:10	1,33	546	728,00	CHI
201912167274	APARECIDA DE GOIANIA	AP13383602B	INDEPENDENCIA S1	22/12/2019 20:50	23/12/2019 00:16	22/12/2019 20:50	22/12/2019 23:20	2,49	5240	13031,59	CHI
201912167274	APARECIDA DE GOIANIA	AP16401542	INDEPENDENCIA S1	22/12/2019 20:50	23/12/2019 00:16	22/12/2019 20:50	23/12/2019 00:16	3,42	447	1530,60	CHI
201912167260	ITUMBIARA	IT12263732	CACHOEIRA DOURADA	22/12/2019 20:53	23/12/2019 10:43	22/12/2019 20:53	23/12/2019 10:43	13,83	3	41,49	CHI
201912168528	ITUMBIARA	IT21039587	CACHOEIRA DOURADA	22/12/2019 20:53	23/12/2019 10:43	22/12/2019 20:53	23/12/2019 10:43	13,83	1	13,83	CHI
201912167268	AGUAS LINDAS DE GOIAS	LA11164940	AGUAS LINDAS DE GOIAS S1	22/12/2019 20:54	23/12/2019 13:06	22/12/2019 20:54	23/12/2019 13:06	16,19	63	1020,00	CHI
201912167282	MOZARLANDIA	10027772363	MOZARLANDIA	22/12/2019 20:56	23/12/2019 13:03	22/12/2019 20:56	23/12/2019 13:03	16,11	1	16,11	CHI
201912166229	QUIRINOPOLIS	QI11160805	QUIRINOPOLIS	22/12/2019 20:59	23/12/2019 05:54	22/12/2019 20:59	23/12/2019 05:54	8,90	118	1050,76	CHI
201912167293	CRISTALINA	KR12170191	CRISTALINA S1	22/12/2019 20:59	22/12/2019 22:11	22/12/2019 20:59	22/12/2019 22:11	1,18	56	66,34	CHI
201912167407	AGUAS LINDAS DE GOIAS	LA11148928	AGUAS LINDAS DE GOIAS S1	22/12/2019 20:59	22/12/2019 22:47	22/12/2019 20:59	22/12/2019 22:47	1,79	200	358,56	CHI
201912167464	JUSSARA	IU12292910	JUSSARA	22/12/2019 20:59	23/12/2019 09:23	22/12/2019 20:59	23/12/2019 09:23	12,39	27	334,41	CHI
201912167300	BARRO ALTO	BA12068485	BARRO ALTO	22/12/2019 21:00	23/12/2019 08:04	22/12/2019 21:00	23/12/2019 08:04	11,05	1	11,05	CHI
201912167300	SANTA RITA DO NOVO DESTINO	BA12068485	BARRO ALTO	22/12/2019 21:00	23/12/2019 08:04	22/12/2019 21:00	23/12/2019 08:04	11,05	30	331,57	CHI
201912169452	SANTA RITA DO NOVO DESTINO	BA21155560	BARRO ALTO	22/12/2019 21:00	24/12/2019 02:46	22/12/2019 21:00	24/12/2019 02:46	29,75	1	29,75	CHI
201912167308	CACHOEIRA DOURADA	CD21000053	CACHOEIRA DOURADA	22/12/2019 21:02	23/12/2019 10:26	22/12/2019 21:02	23/12/2019 10:26	13,40	1	13,40	CHI
201912167309	MOZARLANDIA	MZ12181621	MOZARLANDIA	22/12/2019 21:02	23/12/2019 16:14	22/12/2019 21:02	23/12/2019 16:14	19,20	9	172,76	CHI
201912167318	PIRACANJUBA	PJ21070780	PIRACANJUBA	22/12/2019 21:03	23/12/2019 09:10	22/12/2019 21:03	23/12/2019 09:10	12,10	1	12,10	CHI
201912167320	NOVO PLANALTO	TA12020801	NOVO PLANALTO	22/12/2019 21:03	24/12/2019 07:54	22/12/2019 21:03	24/12/2019 07:54	34,84	1	34,84	CHI
201912169202	NOVO PLANALTO	TA12354463	NOVO PLANALTO	22/12/2019 21:06	23/12/2019 18:32	22/12/2019 21:06	23/12/2019 18:32	21,45	6	128,67	CHI
201912167343	PILAR DE GOIAS	GG11034413	SANTA TEREZINHA	22/12/2019 21:09	23/12/2019 11:58	22/12/2019 21:09	23/12/2019 11:58	14,81	73	1081,01	CHI
201912167345	AGUAS LINDAS DE GOIAS	LA11060646	AGUAS LINDAS DE GOIAS S1	22/12/2019 21:09	22/12/2019 23:38	22/12/2019 21:09	22/12/2019 23:38	2,47	129	318,63	CHI
201912167346	MOSSAMEDES	8080000167	FIRMINOPOLIS S2	22/12/2019 21:09	23/12/2019 10:08	22/12/2019 21:09	23/12/2019 10:08	12,97	1	12,97	CHI
201912167350	PIRES DO RIO	PR21216091	PIRES DO RIO S1	22/12/2019 21:11	23/12/2019 01:46	22/12/2019 21:11	23/12/2019 01:46	4,58	1	4,58	CHI
201912167351	LUZIANIA	LZ12370861	MARAJOARA	22/12/2019 21:12	23/12/2019 09:42	22/12/2019 21:12	23/12/2019 09:42	12,50	19	237,48	CHI
201912167888	CAMPO LIMPO	AN12084795	NEROPOLIS S1	22/12/2019 21:13	23/12/2019 10:45	22/12/2019 21:13	23/12/2019 10:45	13,52	11	148,77	CHI
201912167367	ITAJA	IJ10352433	ITAJA S2	22/12/2019 21:15	23/12/2019 11:16	22/12/2019 21:15	23/12/2019 11:16	14,01	12	168,09	CHI
201912175016	ITAJA	IJ21202624	ITAJA S2	22/12/2019 21:15	23/12/2019 13:20	22/12/2019 21:15	23/12/2019 13:20	16,08	1	16,08	CHI
201912167538	APARECIDA DE GOIANIA	AP11103823	INDEPENDENCIA S2	22/12/2019 21:16	23/12/2019 00:50	22/12/2019 21:16	23/12/2019 00:50	3,56	291	1035,96	CHI
201912167369	SANTA TEREZINHA DE GOIAS	SG12242338	SANTA TEREZINHA	22/12/2019 21:17	23/12/2019 13:17	22/12/2019 21:17	23/12/2019 13:17	16,00	13	207,96	CHI
201912167377	BARRO ALTO	NQ12243457	URUACU	22/12/2019 21:19	23/12/2019 00:24	22/12/2019 21:19	23/12/2019 00:24	3,07	1	3,07	CHI
201912167377	NIQUELANDIA	NQ12243457	URUACU	22/12/2019 21:19	23/12/2019 00:24	22/12/2019 21:19	23/12/2019 00:24	3,07	2	6,15	CHI
201912167381	SILVANIA	SV12287460	VIANOPOLIS	22/12/2019 21:20	23/12/2019 05:01	22/12/2019 21:20	23/12/2019 05:01	7,67	86	659,50	CHI
201912167382	AGUAS LINDAS DE GOIAS	10005417129	AGUAS LINDAS DE GOIAS S1	22/12/2019 21:21	23/12/2019 11:18	22/12/2019 21:21	23/12/2019 11:18	13,95	1	13,95	CHI

201912167384	PIRANHAS	PH12307515	PIRANHAS	22/12/2019 21:21	23/12/2019 21:32	22/12/2019 21:21	23/12/2019 21:32	24,18	3	72,54	CHI
201912168606	MORRINHOS	MR12242419	GOIATUBA S1	22/12/2019 21:22	23/12/2019 12:36	22/12/2019 21:22	23/12/2019 12:36	15,22	12	182,65	CHI
201912176614	FAZENDA NOVA	FN11246060	IPORA	22/12/2019 21:24	23/12/2019 15:54	22/12/2019 21:24	23/12/2019 15:54	18,49	1	18,49	CHI
201912167405	MOSSAMEDES	MD12091062	FIRMINOPOLIS S2	22/12/2019 21:27	23/12/2019 09:28	22/12/2019 21:27	23/12/2019 09:28	12,00	1	12,00	CHI
201912167410	GOIANIA	10472265	GOIANIA LESTE S1	22/12/2019 21:28	23/12/2019 00:49	22/12/2019 21:28	23/12/2019 00:49	3,34	1	3,34	CHI
201912167411	CRIXAS	IW12031351	RUBIATABA	22/12/2019 21:28	24/12/2019 08:27	22/12/2019 21:28	24/12/2019 08:27	34,98	7	244,83	CHI
201912167411	ITAPACI	IW12031351	RUBIATABA	22/12/2019 21:28	24/12/2019 08:27	22/12/2019 21:28	24/12/2019 08:27	34,98	1	34,98	CHI
201912166239	LUZIANIA	LZ13401757	RIO VERMELHO	22/12/2019 21:31	23/12/2019 04:38	22/12/2019 21:31	23/12/2019 04:38	7,13	626	4460,25	CHI
201912166239	LUZIANIA	LZ13401757	RIO VERMELHO	22/12/2019 21:31	23/12/2019 04:38	23/12/2019 02:57	23/12/2019 04:38	1,68	840	1411,90	CHI
201912167417	LUZIANIA	LZ12330887	RIO VERMELHO	22/12/2019 21:31	23/12/2019 09:47	22/12/2019 21:31	23/12/2019 09:47	12,27	36	441,60	CHI
201912167528	CORREGO DO OURO	CO12048088	SAO LUIZ DOS MONTES BELOS	22/12/2019 21:31	23/12/2019 21:40	22/12/2019 21:31	23/12/2019 21:40	24,15	7	169,04	CHI
201912167424	CACHOEIRA ALTA	10005934654	CACHOEIRA ALTA	22/12/2019 21:32	23/12/2019 01:01	22/12/2019 21:32	23/12/2019 01:01	3,49	1	3,49	CHI
201912167425	ITAPURANGA	IK12236860	ITAPURANGA	22/12/2019 21:32	25/12/2019 14:39	22/12/2019 21:32	25/12/2019 14:39	65,12	1	65,12	CHI
201912167438	BARRO ALTO	BA12035658	BARRO ALTO	22/12/2019 21:32	23/12/2019 10:58	22/12/2019 21:32	23/12/2019 10:58	13,43	8	107,45	CHI
201912169278	PILAR DE GOIAS	GG12166527	SANTA TEREZINHA	22/12/2019 21:32	24/12/2019 08:17	22/12/2019 21:32	24/12/2019 08:17	34,74	12	416,83	CHI
201912169278	SANTA TEREZINHA DE GOIAS	GG12166527	SANTA TEREZINHA	22/12/2019 21:32	24/12/2019 08:17	22/12/2019 21:32	24/12/2019 08:17	34,74	7	243,15	CHI
201912167430	IPAMERI	IP21216224	IPAMERI	22/12/2019 21:33	23/12/2019 09:21	22/12/2019 21:33	23/12/2019 09:21	11,80	1	11,80	CHI
201912167542	GUAPO	GA12053739	GUAPO S1	22/12/2019 21:35	23/12/2019 10:12	22/12/2019 21:35	23/12/2019 10:12	12,61	7	88,24	CHI
201912167451	BALIZA	BH12356956	BOM JARDIM	22/12/2019 21:40	23/12/2019 10:11	22/12/2019 21:40	23/12/2019 10:11	12,51	2	25,02	CHI
201912167456	SIMOLANDIA	SA21366209	IACIARA S2	22/12/2019 21:40	22/12/2019 23:00	22/12/2019 21:40	22/12/2019 23:00	1,32	1	1,32	CHI
201912167503	NOVO GAMA	NJ11305083	MARAJOARA	22/12/2019 21:41	23/12/2019 01:02	22/12/2019 21:41	23/12/2019 01:02	3,34	365	1219,00	CHI
201912167461	PALMEIRAS DE GOIAS	PL21215283	PALMEIRAS	22/12/2019 21:43	23/12/2019 07:31	22/12/2019 21:43	23/12/2019 07:31	9,80	1	9,80	CHI
201912167536	NOVA CRIXAS	NA12086286	NOVA CRIXAS	22/12/2019 21:44	23/12/2019 16:39	22/12/2019 21:44	23/12/2019 16:39	18,90	9	170,12	CHI
201912167473	SANTA HELENA DE GOIAS	SH12023761	RIO DOS BOIS	22/12/2019 21:47	23/12/2019 17:17	22/12/2019 21:47	23/12/2019 17:17	19,49	2	38,99	CHI
201912167480	VALPARAISO DE GOIAS	VA21379010	PACAEMBU S2	22/12/2019 21:49	22/12/2019 23:48	22/12/2019 21:49	22/12/2019 23:48	1,97	1	1,97	CHI
201912167481	ITUMBIARA	IT21304266	CACHOEIRA DOURADA	22/12/2019 21:49	23/12/2019 00:01	22/12/2019 21:49	23/12/2019 00:01	2,19	1	2,19	CHI
201912167483	MOSSAMEDES	MD21198885	FIRMINOPOLIS S2	22/12/2019 21:50	23/12/2019 07:14	22/12/2019 21:50	23/12/2019 07:14	9,39	1	9,39	CHI
201912167485	LUZIANIA	LZ11041555	RIO VERMELHO	22/12/2019 21:50	23/12/2019 07:13	22/12/2019 21:50	23/12/2019 07:13	9,37	175	1639,70	CHI
201912167804	JUSSARA	JR12341198	JUSSARA	22/12/2019 21:50	23/12/2019 17:14	22/12/2019 21:50	23/12/2019 17:14	19,41	7	135,88	CHI
201912167495	PIRES DO RIO	PR12255829	PIRES DO RIO S1	22/12/2019 21:53	23/12/2019 19:20	22/12/2019 21:53	23/12/2019 19:20	21,45	7	150,15	CHI
201912176432	PIRES DO RIO	PR21186509	PIRES DO RIO S1	22/12/2019 21:53	23/12/2019 20:36	22/12/2019 21:53	23/12/2019 20:36	22,72	1	22,72	CHI
201912167498	PLANALTINA	PI21326714	SAO JOAO D ALIANCA	22/12/2019 21:54	25/12/2019 08:00	22/12/2019 21:54	25/12/2019 08:00	58,10	1	58,10	CHI
201912168109	LUZIANIA	LZ12304995	VIANOPOLIS	22/12/2019 21:54	23/12/2019 09:40	22/12/2019 21:54	23/12/2019 09:40	11,75	8	94,04	CHI

201912168109	ORIZONA	LZ12304995	VIANOPOLIS	22/12/2019 21:54	23/12/2019 09:40	22/12/2019 21:54	23/12/2019 09:40	11,75	90	1057,90	CHI
201912167531	LUZIANIA	LZ12086797	VIANOPOLIS	22/12/2019 21:59	23/12/2019 10:12	22/12/2019 21:59	23/12/2019 10:12	12,21	33	403,02	CHI
201912167606	GOIANESIA	GE12291463LD	GOIANESIA S2	22/12/2019 22:01	23/12/2019 00:22	22/12/2019 22:01	23/12/2019 00:22	2,33	361	842,93	CHI
201912167526	CRISTALINA	KR21199528	PAMPLONA	22/12/2019 22:02	23/12/2019 00:21	22/12/2019 22:02	23/12/2019 00:21	2,31	1	2,31	CHI
201912167527	GOUVELANDIA	GB31207162	QUIRINOPOLIS	22/12/2019 22:02	23/12/2019 11:09	22/12/2019 22:02	23/12/2019 11:09	13,11	4	52,44	CHI
201912168642	CRIXAS	CX12397647	SANTA TEREZINHA	22/12/2019 22:02	23/12/2019 13:50	22/12/2019 22:02	23/12/2019 13:50	15,79	4	63,17	CHI
201912167533	MARA ROSA	MQ12192427	MARA ROSA	22/12/2019 22:03	23/12/2019 11:25	22/12/2019 22:03	23/12/2019 11:25	13,37	3	40,12	CHI
201912167535	PADRE BERNARDO	PB21363400	PADRE BERNARDO	22/12/2019 22:03	22/12/2019 23:45	22/12/2019 22:03	22/12/2019 23:45	1,69	1	1,69	CHI
201912167539	RUBIATABA	RB21316856	RUBIATABA	22/12/2019 22:04	23/12/2019 16:44	22/12/2019 22:04	23/12/2019 16:44	18,67	1	18,67	CHI
201912167545	CIDADE OCIDENTAL	10015350159	MARAJOARA	22/12/2019 22:07	23/12/2019 01:51	22/12/2019 22:07	23/12/2019 01:51	3,72	1	3,72	CHI
201912167547	ACREUNA	EU12037883	ACREUNA	22/12/2019 22:07	23/12/2019 02:06	22/12/2019 22:07	23/12/2019 02:06	3,98	6	23,88	CHI
201912167561	LUZIANIA	LZ12383059	CRISTALINA S2	22/12/2019 22:11	24/12/2019 01:04	22/12/2019 22:11	24/12/2019 01:04	26,89	136	3656,62	CHI
201912167564	GOIANIA	16061111	MEIA PONTE	22/12/2019 22:13	22/12/2019 23:56	22/12/2019 22:13	22/12/2019 23:56	1,72	1	1,72	CHI
201912167624	PIRENOPOLIS	PV12311868	CORUMBA	22/12/2019 22:15	23/12/2019 08:53	22/12/2019 22:15	23/12/2019 08:53	10,62	35	371,82	CHI
201912167579	EDEIA	10023367529	EDEIA	22/12/2019 22:21	23/12/2019 08:20	22/12/2019 22:21	23/12/2019 08:20	9,98	1	9,98	CHI
201912167585	CATALAO	CT12067749	CATALAO S1	22/12/2019 22:26	23/12/2019 12:27	22/12/2019 22:26	23/12/2019 12:27	14,01	4	56,04	CHI
201912168301	NIQUELANDIA	NQ12292585	NIQUELANDIA SUBTRANSMISSAO	22/12/2019 22:27	23/12/2019 07:43	22/12/2019 22:27	23/12/2019 07:43	9,26	98	907,78	CHI
201912168406	LUZIANIA	OZ12195112	PIRES DO RIO S2	22/12/2019 22:31	23/12/2019 10:48	22/12/2019 22:31	23/12/2019 10:48	12,28	72	884,32	CHI
201912168025	BURITI DE GOIAS	SC12052751	FIRMINOPOLIS S2	22/12/2019 22:32	23/12/2019 18:58	22/12/2019 22:32	23/12/2019 18:58	20,42	3	61,27	CHI
201912168025	SANCLERLANDIA	SC12052751	FIRMINOPOLIS S2	22/12/2019 22:32	23/12/2019 18:58	22/12/2019 22:32	23/12/2019 18:58	20,42	19	388,01	CHI
201912167595	FORMOSA	FA12254248	ITIQUEIRA	22/12/2019 22:33	22/12/2019 23:37	22/12/2019 22:33	22/12/2019 23:37	1,06	6	6,38	CHI
201912167600	CRISTALINA	KR12110413	CRISTALINA S2	22/12/2019 22:34	23/12/2019 07:46	22/12/2019 22:34	23/12/2019 07:46	9,19	6	55,16	CHI
201912167601	CALDAS NOVAS	10000982430	SERRA DE CALDAS	22/12/2019 22:34	24/12/2019 07:20	22/12/2019 22:34	24/12/2019 07:20	32,76	1	32,76	CHI
201912167602	IPORA	IR12091540	IPORA	22/12/2019 22:34	23/12/2019 09:15	22/12/2019 22:34	23/12/2019 09:15	10,67	5	53,37	CHI
201912167610	IPAMERI	IP12216237	IPAMERI	22/12/2019 22:39	23/12/2019 08:42	22/12/2019 22:39	23/12/2019 08:42	10,04	21	210,94	CHI
201912167611	JARAGUA	10017340240	JARAGUA	22/12/2019 22:39	23/12/2019 00:33	22/12/2019 22:39	23/12/2019 00:33	1,89	1	1,89	CHI
201912163343	SANCLERLANDIA	SL12323580	SAO LUIZ DOS MONTES BELOS	22/12/2019 22:40	23/12/2019 16:50	22/12/2019 22:40	23/12/2019 11:09	12,47	28	349,18	CHI
201912163343	SAO LUIS DE MONTES BELOS	SL12323580	SAO LUIZ DOS MONTES BELOS	22/12/2019 22:40	23/12/2019 16:50	22/12/2019 22:40	23/12/2019 11:09	12,47	103	1284,50	CHI
201912163343	SAO LUIS DE MONTES BELOS	SL12323580	SAO LUIZ DOS MONTES BELOS	22/12/2019 22:40	23/12/2019 16:50	22/12/2019 22:40	23/12/2019 16:50	18,16	8	145,26	CHI
201912168120	BURITI DE GOIAS	BS12076542	FIRMINOPOLIS S2	22/12/2019 22:42	23/12/2019 16:04	22/12/2019 22:42	23/12/2019 16:04	17,36	38	659,75	CHI
201912167760	JUSSARA	JR12008743	BRITANIA	22/12/2019 22:47	23/12/2019 13:05	22/12/2019 22:47	23/12/2019 13:05	14,29	38	543,20	CHI
201912167638	ACREUNA	8577415	ACREUNA	22/12/2019 22:53	23/12/2019 01:41	22/12/2019 22:53	23/12/2019 01:41	2,79	7	19,53	CHI
201912167646	ACREUNA	EU12301057	ACREUNA	22/12/2019 22:57	26/12/2019 14:43	22/12/2019 22:57	23/12/2019 12:28	13,52	29	392,08	CHI

201912167646	ACREUNA	EU12301057	ACREUNA	22/12/2019 22:57	26/12/2019 14:43	23/12/2019 13:39	25/12/2019 23:13	57,56	16	920,99	CHI
201912167646	ACREUNA	EU12301439LD	ACREUNA	22/12/2019 22:57	26/12/2019 14:43	23/12/2019 13:39	26/12/2019 14:43	73,07	13	949,95	CHI
201912166458	JATAI	6606860	JATAI S1	22/12/2019 22:58	24/12/2019 09:31	22/12/2019 22:58	24/12/2019 09:31	34,54	14	483,58	CHI
201912166458	SERRANOPOLIS	6606860	JATAI S1	22/12/2019 22:58	24/12/2019 09:31	22/12/2019 22:58	24/12/2019 09:31	34,54	2	69,08	CHI
201912167650	CAIAPONIA	JT21254666	JATAI S1	22/12/2019 22:58	23/12/2019 11:03	22/12/2019 22:58	23/12/2019 11:03	12,08	1	12,08	CHI
201912167674	CUMARI	CY12078706	CATALAO S1	22/12/2019 23:10	23/12/2019 14:53	22/12/2019 23:10	23/12/2019 14:53	15,71	9	141,38	CHI
201912167863	MOSSAMEDES	MD12206495	FIRMINOPOLIS S2	22/12/2019 23:10	23/12/2019 10:34	22/12/2019 23:10	23/12/2019 10:34	11,39	19	216,50	CHI
201912167863	SANCLERLANDIA	MD12206495	FIRMINOPOLIS S2	22/12/2019 23:10	23/12/2019 10:34	22/12/2019 23:10	23/12/2019 10:34	11,39	7	79,76	CHI
201912167676	RIO VERDE	RV11018077	SANTA HELENA S1	22/12/2019 23:11	23/12/2019 13:11	22/12/2019 23:11	23/12/2019 13:11	13,99	94	1315,27	CHI
201912167685	ANAPOLIS	21128029	JUNDIAI S2	22/12/2019 23:14	23/12/2019 09:07	22/12/2019 23:14	23/12/2019 09:07	9,88	1	9,88	CHI
201912168856	SAO MIGUEL DO ARAGUAIA	SM12099146	SAO MIGUEL DO ARAGUAIA	22/12/2019 23:15	25/12/2019 21:34	22/12/2019 23:15	24/12/2019 20:22	45,12	44	1985,07	CHI
201912168856	SAO MIGUEL DO ARAGUAIA	SM12238245	SAO MIGUEL DO ARAGUAIA	22/12/2019 23:15	25/12/2019 21:34	24/12/2019 20:24	24/12/2019 20:49	0,41	17	7,04	CHI
201912168856	NOVO PLANALTO	SM12099146	SAO MIGUEL DO ARAGUAIA	22/12/2019 23:15	25/12/2019 21:34	22/12/2019 23:15	25/12/2019 21:34	70,31	0	0,00	CHI
201912168856	SAO MIGUEL DO ARAGUAIA	SM12099146	SAO MIGUEL DO ARAGUAIA	22/12/2019 23:15	25/12/2019 21:34	22/12/2019 23:15	25/12/2019 21:34	70,31	8	562,49	CHI
201912168856	SAO MIGUEL DO ARAGUAIA	SM12099146	SAO MIGUEL DO ARAGUAIA	22/12/2019 23:15	25/12/2019 21:34	25/12/2019 18:34	25/12/2019 21:34	3,01	44	132,38	CHI
201912167691	ANAPOLIS	10015259992	ANAPOLIS UNIVERSITARIO S2	22/12/2019 23:18	23/12/2019 08:11	22/12/2019 23:18	23/12/2019 08:11	8,87	1	8,87	CHI
201912167692	PONTALINA	PK21095490	GOIATUBA S1	22/12/2019 23:19	24/12/2019 13:25	22/12/2019 23:19	24/12/2019 13:25	38,10	1	38,10	CHI
201912167694	INHUMAS	10006962490	INHUMAS S2	22/12/2019 23:20	23/12/2019 15:45	22/12/2019 23:20	23/12/2019 15:45	16,40	1	16,40	CHI
201912167881	PORANGATU	PO12343307	PORANGATU	22/12/2019 23:23	23/12/2019 11:24	22/12/2019 23:23	23/12/2019 11:24	12,01	22	264,29	CHI
201912169229	FIRMINOPOLIS	SL12306929	SAO LUIZ DOS MONTES BELOS	22/12/2019 23:26	23/12/2019 16:46	22/12/2019 23:26	23/12/2019 16:46	17,32	39	675,60	CHI
201912169229	SAO LUIS DE MONTES BELOS	SL12306929	SAO LUIZ DOS MONTES BELOS	22/12/2019 23:26	23/12/2019 16:46	22/12/2019 23:26	23/12/2019 16:46	17,32	20	346,46	CHI
201912177006	SAO LUIS DE MONTES BELOS	SL21343012	SAO LUIZ DOS MONTES BELOS	22/12/2019 23:26	24/12/2019 10:00	22/12/2019 23:26	24/12/2019 10:00	34,56	2	69,11	CHI
201912167867	ALTO HORIZONTE	MQ10400799	MARA ROSA	22/12/2019 23:27	23/12/2019 23:21	22/12/2019 23:27	23/12/2019 11:25	11,97	11	131,66	CHI
201912167867	MARA ROSA	MQ10400799	MARA ROSA	22/12/2019 23:27	23/12/2019 23:21	22/12/2019 23:27	23/12/2019 11:25	11,97	27	323,17	CHI
201912167867	URUACU	MQ10400799	MARA ROSA	22/12/2019 23:27	23/12/2019 23:21	22/12/2019 23:27	23/12/2019 11:25	11,97	1	11,97	CHI
201912167867	ALTO HORIZONTE	AJ12384910	MARA ROSA	22/12/2019 23:27	23/12/2019 23:21	22/12/2019 23:27	23/12/2019 11:54	12,46	36	448,42	CHI
201912167867	MARA ROSA	AJ12384910	MARA ROSA	22/12/2019 23:27	23/12/2019 23:21	22/12/2019 23:27	23/12/2019 11:54	12,46	5	62,28	CHI
201912167867	ALTO HORIZONTE	AJ12143571	MARA ROSA	22/12/2019 23:27	23/12/2019 23:21	22/12/2019 23:27	23/12/2019 23:21	23,90	37	884,38	CHI
201912167867	MARA ROSA	AJ12143571	MARA ROSA	22/12/2019 23:27	23/12/2019 23:21	22/12/2019 23:27	23/12/2019 23:21	23,90	5	119,51	CHI
201912167867	NOVA IGUACU DE GOIAS	AJ12143571	MARA ROSA	22/12/2019 23:27	23/12/2019 23:21	22/12/2019 23:27	23/12/2019 23:21	23,90	12	286,83	CHI
201912167703	DIORAMA	1530003237	IPORA	22/12/2019 23:29	23/12/2019 16:18	22/12/2019 23:29	23/12/2019 16:18	16,80	1	16,80	CHI
201912167709	ALOANDIA	AD12013446	GOIATUBA S1	22/12/2019 23:36	23/12/2019 18:10	22/12/2019 23:36	23/12/2019 18:10	18,56	9	167,03	CHI
201912167709	PONTALINA	AD12013446	GOIATUBA S1	22/12/2019 23:36	23/12/2019 18:10	22/12/2019 23:36	23/12/2019 18:10	18,56	13	241,26	CHI

201912168323	NOVA AURORA	NE12127548	CATALAO S1	22/12/2019 23:37	23/12/2019 07:53	22/12/2019 23:37	23/12/2019 07:53	8,26	39	322,17	CHI
201912167730	MINEIROS	MY21287500	PARQUE DAS EMAS	22/12/2019 23:42	23/12/2019 18:30	22/12/2019 23:42	23/12/2019 18:30	18,80	1	18,80	CHI
201912167733	VALPARAISO DE GOIAS	10005516160	PACAEMBU S1	22/12/2019 23:46	23/12/2019 10:20	22/12/2019 23:46	23/12/2019 10:20	10,56	1	10,56	CHI
201912167734	SAO JOAO D ALIANCA	JL21403796	SAO JOAO D ALIANCA	22/12/2019 23:46	24/12/2019 13:52	22/12/2019 23:46	24/12/2019 13:52	38,11	2	76,22	CHI
201912167735	PARAUNA	PU12295868	ACREUNA	22/12/2019 23:48	23/12/2019 07:48	22/12/2019 23:48	23/12/2019 07:48	8,00	10	80,02	CHI
201912167748	SAO LUIS DE MONTES BELOS	SL12167229	SAO LUIZ DOS MONTES BELOS	23/12/2019 00:03	23/12/2019 07:22	23/12/2019 00:03	23/12/2019 07:22	7,33	4	29,31	CHI
201912167750	GOIANIA	13716207	INDEPENDENCIA S2	23/12/2019 00:05	23/12/2019 01:52	23/12/2019 00:05	23/12/2019 01:52	1,77	1	1,77	CHI
201912169021	ALEXANIA	SN12389385	MARAJOARA	23/12/2019 00:05	23/12/2019 20:15	23/12/2019 00:05	23/12/2019 13:12	13,12	4	52,49	CHI
201912169021	SANTO ANTONIO DO DESCOBERTO	SN12389385	MARAJOARA	23/12/2019 00:05	23/12/2019 20:15	23/12/2019 00:05	23/12/2019 13:12	13,12	51	669,21	CHI
201912169021	DISTRITO FEDERAL	SN12389385	MARAJOARA	23/12/2019 00:05	23/12/2019 20:15	23/12/2019 00:05	23/12/2019 20:15	20,18	3	60,53	CHI
201912169021	SANTO ANTONIO DO DESCOBERTO	SN12389385	MARAJOARA	23/12/2019 00:05	23/12/2019 20:15	23/12/2019 00:05	23/12/2019 20:15	20,18	30	605,32	CHI
201912169021	ALEXANIA	SN12389385	MARAJOARA	23/12/2019 00:05	23/12/2019 20:15	23/12/2019 13:13	23/12/2019 20:15	7,04	4	28,18	CHI
201912169021	SANTO ANTONIO DO DESCOBERTO	SN12389385	MARAJOARA	23/12/2019 00:05	23/12/2019 20:15	23/12/2019 13:13	23/12/2019 20:15	7,04	51	359,24	CHI
201912167751	AURILANDIA	AI21247539	FIRMINOPOLIS S2	23/12/2019 00:06	23/12/2019 03:28	23/12/2019 00:06	23/12/2019 03:28	3,37	1	3,37	CHI
201912167751	AURILANDIA	AI120574043LD	FIRMINOPOLIS S2	23/12/2019 00:06	23/12/2019 03:28	23/12/2019 00:06	23/12/2019 03:28	3,36	11	36,95	CHI
201912167759	NIQUELANDIA	NQ12233554	BARRO ALTO	23/12/2019 00:14	23/12/2019 11:35	23/12/2019 00:14	23/12/2019 11:35	11,34	2	22,69	CHI
201912167759	VILA PROPICIO	NQ12233554	BARRO ALTO	23/12/2019 00:14	23/12/2019 11:35	23/12/2019 00:14	23/12/2019 11:35	11,34	11	124,79	CHI
201912167761	TRINDADE	40293531	TRINDADE	23/12/2019 00:16	23/12/2019 11:26	23/12/2019 00:16	23/12/2019 11:26	11,16	1	11,16	CHI
201912169137	JARAGUA	SF12050973	SAO FRANCISCO DE GOIAS	23/12/2019 00:26	23/12/2019 11:49	23/12/2019 00:26	23/12/2019 11:49	11,38	5	56,89	CHI
201912169137	SAO FRANCISCO DE GOIAS	SF12050973	SAO FRANCISCO DE GOIAS	23/12/2019 00:26	23/12/2019 11:49	23/12/2019 00:26	23/12/2019 11:49	11,38	32	364,10	CHI
201912176587	SAO FRANCISCO DE GOIAS	SF21343971	SAO FRANCISCO DE GOIAS	23/12/2019 00:26	23/12/2019 17:12	23/12/2019 00:26	23/12/2019 17:12	16,76	1	16,76	CHI
201912167832	PIRANHAS	PH12079503	PIRANHAS	23/12/2019 00:27	23/12/2019 15:44	23/12/2019 00:27	23/12/2019 13:01	12,55	14	175,72	CHI
201912167832	PIRANHAS	PH12079503	PIRANHAS	23/12/2019 00:27	23/12/2019 15:44	23/12/2019 00:27	23/12/2019 13:49	13,35	5	66,76	CHI
201912167832	PIRANHAS	PH12079503	PIRANHAS	23/12/2019 00:27	23/12/2019 15:44	23/12/2019 00:27	23/12/2019 15:19	14,85	20	297,03	CHI
201912167832	CAIAPONIA	PH13349754	PIRANHAS	23/12/2019 00:27	23/12/2019 15:44	23/12/2019 00:27	23/12/2019 15:44	15,27	1	15,27	CHI
201912167832	PIRANHAS	PH13349754	PIRANHAS	23/12/2019 00:27	23/12/2019 15:44	23/12/2019 00:27	23/12/2019 15:44	15,27	85	1297,83	CHI
201912167773	CAMPO ALEGRE DE GOIAS	CM21333412	CAMPO ALEGRE DE GOIAS	23/12/2019 00:31	23/12/2019 13:47	23/12/2019 00:31	23/12/2019 13:47	13,26	2	26,52	CHI
201912167777	FAZENDA NOVA	FN21387559	IPORA	23/12/2019 00:35	23/12/2019 01:04	23/12/2019 00:35	23/12/2019 01:04	0,47	1	0,47	CHI
201912167778	SANTO ANTONIO DO DESCOBERTO	SN12010404	MARAJOARA	23/12/2019 00:37	23/12/2019 14:18	23/12/2019 00:37	23/12/2019 14:18	13,68	64	875,56	CHI
201912167779	APARECIDA DE GOIANIA	AP11043248	REAL S1	23/12/2019 00:38	24/12/2019 00:02	23/12/2019 00:38	24/12/2019 00:02	23,39	127	2970,39	CHI
201912167415	ITAGUARI	7279077	ITABERAI S1	23/12/2019 00:40	23/12/2019 12:10	23/12/2019 00:40	23/12/2019 12:10	11,50	10	115,01	CHI
201912167415	ITAGUARU	7279077	ITABERAI S1	23/12/2019 00:40	23/12/2019 12:10	23/12/2019 00:40	23/12/2019 12:10	11,50	18	207,01	CHI
201912167415	JARAGUA	7279077	ITABERAI S1	23/12/2019 00:40	23/12/2019 12:10	23/12/2019 00:40	23/12/2019 12:10	11,50	77	885,56	CHI

201912176639	ITAGUARI	JA12063000	ITABERAI S1	23/12/2019 00:40	23/12/2019 14:31	23/12/2019 00:40	23/12/2019 14:31	13,84	5	69,21	CHI
201912176639	ITAGUARU	JA12063000	ITABERAI S1	23/12/2019 00:40	23/12/2019 14:31	23/12/2019 00:40	23/12/2019 14:31	13,84	3	41,52	CHI
201912176639	JARAGUA	JA12063000	ITABERAI S1	23/12/2019 00:40	23/12/2019 14:31	23/12/2019 00:40	23/12/2019 14:31	13,84	17	235,30	CHI
201912167783	ARENOPOLIS	AY12139436	ARENOPOLIS	23/12/2019 00:45	23/12/2019 13:02	23/12/2019 00:45	23/12/2019 13:02	12,28	16	196,47	CHI
201912167783	IPORA	AY12139436	ARENOPOLIS	23/12/2019 00:45	23/12/2019 13:02	23/12/2019 00:45	23/12/2019 13:02	12,28	11	135,07	CHI
201912167787	ANAPOLIS	21315220	ANAPOLIS UNIVERSITARIO S2	23/12/2019 00:47	23/12/2019 09:07	23/12/2019 00:47	23/12/2019 09:07	8,32	1	8,32	CHI
201912167790	SAO MIGUEL DO ARAGUAIA	SM12016662	SAO MIGUEL DO ARAGUAIA	23/12/2019 00:48	24/12/2019 15:20	23/12/2019 00:48	24/12/2019 15:20	38,52	2	77,04	CHI
201912167789	AGUA LIMPA	AL21000273	VILA CORUMBA	23/12/2019 00:49	23/12/2019 11:45	23/12/2019 00:49	23/12/2019 11:45	10,93	1	10,93	CHI
201912167791	ARAGUAPAZ	FC12299833	GOIAS	23/12/2019 00:50	23/12/2019 07:30	23/12/2019 00:50	23/12/2019 07:30	6,68	16	106,91	CHI
201912167791	FAINA	FC12299833	GOIAS	23/12/2019 00:50	23/12/2019 07:30	23/12/2019 00:50	23/12/2019 07:30	6,68	9	60,13	CHI
201912167794	MUNDO NOVO DE GOIAS	NA12035650	NOVA CRIXAS	23/12/2019 00:57	23/12/2019 19:56	23/12/2019 00:57	23/12/2019 19:56	18,98	8	151,85	CHI
201912167794	NOVA CRIXAS	NA12035650	NOVA CRIXAS	23/12/2019 00:57	23/12/2019 19:56	23/12/2019 00:57	23/12/2019 19:56	18,98	24	455,55	CHI
201912167797	BOM JARDIM DE GOIAS	BM12201959	BOM JARDIM	23/12/2019 01:01	23/12/2019 06:28	23/12/2019 01:01	23/12/2019 06:28	5,44	85	462,49	CHI
201912167798	EDEIA	10028441050	EDEIA	23/12/2019 01:02	23/12/2019 07:47	23/12/2019 01:02	23/12/2019 07:47	6,75	1	6,75	CHI
201912167800	IPAMERI	IP21275752	IPAMERI	23/12/2019 01:06	23/12/2019 16:42	23/12/2019 01:06	23/12/2019 16:42	15,59	3	46,78	CHI
201912167901	JATAI	JT10394711	JATAI S3	23/12/2019 01:11	23/12/2019 14:50	23/12/2019 01:13	23/12/2019 04:03	2,84	35	99,31	CHI
201912167901	JATAI	JT13234317	JATAI S3	23/12/2019 01:11	23/12/2019 14:50	23/12/2019 01:13	23/12/2019 10:50	9,62	144	1385,84	CHI
201912167901	RIO VERDE	JT13234317	JATAI S3	23/12/2019 01:11	23/12/2019 14:50	23/12/2019 01:13	23/12/2019 10:50	9,62	3	28,87	CHI
201912167901	JATAI	JT13234430	JATAI S3	23/12/2019 01:11	23/12/2019 14:50	23/12/2019 01:13	23/12/2019 12:10	10,95	16	175,21	CHI
201912167901	RIO VERDE	JT13234430	JATAI S3	23/12/2019 01:11	23/12/2019 14:50	23/12/2019 01:13	23/12/2019 12:10	10,95	2	21,90	CHI
201912167901	JATAI	JT13241755	JATAI S3	23/12/2019 01:11	23/12/2019 14:50	23/12/2019 01:13	23/12/2019 13:20	12,12	12	145,40	CHI
201912167901	RIO VERDE	JT13241755	JATAI S3	23/12/2019 01:11	23/12/2019 14:50	23/12/2019 01:13	23/12/2019 13:20	12,12	2	24,23	CHI
201912167901	JATAI	JT12219320LD	JATAI S3	23/12/2019 01:11	23/12/2019 14:50	23/12/2019 01:13	23/12/2019 14:50	13,61	13	176,95	CHI
201912167806	CACU	CC12384080	CACHOEIRA ALTA	23/12/2019 01:28	23/12/2019 09:35	23/12/2019 01:28	23/12/2019 09:35	8,11	5	40,57	CHI
201912167806	ITARUMA	CC12384080	CACHOEIRA ALTA	23/12/2019 01:28	23/12/2019 09:35	23/12/2019 01:28	23/12/2019 09:35	8,11	3	24,34	CHI
201912167885	IPORA	IR12014024	IPORA	23/12/2019 01:31	23/12/2019 05:33	23/12/2019 01:31	23/12/2019 05:33	4,03	17	68,53	CHI
201912167810	JUSSARA	JR11292896	JUSSARA	23/12/2019 01:37	23/12/2019 08:24	23/12/2019 01:37	23/12/2019 08:24	6,78	85	575,90	CHI
201912167813	TURVANIA	TV12005582	FIRMINOPOLIS S2	23/12/2019 01:46	23/12/2019 12:18	23/12/2019 01:46	23/12/2019 12:18	10,53	49	515,89	CHI
201912176334	TURVANIA	TV21299094	FIRMINOPOLIS S2	23/12/2019 01:46	23/12/2019 19:19	23/12/2019 01:46	23/12/2019 19:19	17,54	1	17,54	CHI
201912167817	GOIANIA	GN11211468	GOYA S2	23/12/2019 01:55	23/12/2019 05:56	23/12/2019 01:55	23/12/2019 05:56	4,01	6	24,07	CHI
201912167820	ORIZONA	OZ21056870	PIRES DO RIO S2	23/12/2019 01:59	23/12/2019 07:44	23/12/2019 01:59	23/12/2019 07:44	5,74	2	11,48	CHI
201912167821	CASTELANDIA	DM12305932	RIO DOS BOIS	23/12/2019 02:04	23/12/2019 11:53	23/12/2019 02:04	23/12/2019 11:53	9,80	3	29,41	CHI
201912167821	QUIRINOPOLIS	DM12305932	RIO DOS BOIS	23/12/2019 02:04	23/12/2019 11:53	23/12/2019 02:04	23/12/2019 11:53	9,80	13	127,44	CHI

201912168761	CASTELANDIA	DM21295917	RIO DOS BOIS	23/12/2019 02:04	23/12/2019 13:20	23/12/2019 02:04	23/12/2019 13:20	11,25	1	11,25	CHI
201912167828	APARECIDA DE GOIANIA	200064587	INDEPENDENCIA S1	23/12/2019 02:25	23/12/2019 22:07	23/12/2019 02:25	23/12/2019 22:07	19,70	1	19,70	CHI
201912167829	JUSSARA	JR12220060	JUSSARA	23/12/2019 02:30	23/12/2019 16:55	23/12/2019 02:30	23/12/2019 16:55	14,41	22	317,10	CHI
201912167830	GUARINOS	GF12380720	SANTA TEREZINHA	23/12/2019 02:31	23/12/2019 12:05	23/12/2019 02:31	23/12/2019 12:05	9,56	16	152,97	CHI
201912176491	GUARINOS	GF21262897	SANTA TEREZINHA	23/12/2019 02:31	23/12/2019 14:14	23/12/2019 02:31	23/12/2019 14:14	11,71	1	11,71	CHI
201912167831	IPAMERI	IP12287085	IPAMERI	23/12/2019 02:34	26/12/2019 00:17	23/12/2019 02:34	23/12/2019 10:04	7,49	25	187,34	CHI
201912167831	IPAMERI	IP12287083LD	IPAMERI	23/12/2019 02:34	26/12/2019 00:17	23/12/2019 02:34	23/12/2019 13:00	10,43	4	41,72	CHI
201912167831	IPAMERI	IP12287083LD	IPAMERI	23/12/2019 02:34	26/12/2019 00:17	23/12/2019 13:14	23/12/2019 14:13	0,97	4	3,89	CHI
201912167831	IPAMERI	GD12075517	IPAMERI	23/12/2019 02:34	26/12/2019 00:17	23/12/2019 02:34	26/12/2019 00:17	69,71	14	976,00	CHI
201912167566	SANCLERLANDIA	SC12213411	FIRMINOPOLIS S2	23/12/2019 02:40	23/12/2019 09:50	23/12/2019 02:40	23/12/2019 09:10	6,50	2	13,01	CHI
201912167566	SANCLERLANDIA	SC12005400	FIRMINOPOLIS S2	23/12/2019 02:40	23/12/2019 09:50	23/12/2019 02:40	23/12/2019 09:50	7,16	42	300,88	CHI
201912167566	SAO LUIS DE MONTES BELOS	SC12005400	FIRMINOPOLIS S2	23/12/2019 02:40	23/12/2019 09:50	23/12/2019 02:40	23/12/2019 09:50	7,16	2	14,33	CHI
201912167838	BOM JARDIM DE GOIAS	BM12201516	BOM JARDIM	23/12/2019 02:59	23/12/2019 07:33	23/12/2019 02:59	23/12/2019 07:33	4,57	38	173,79	CHI
201912167844	CAIAPONIA	CP21164301	IPORA	23/12/2019 03:25	24/12/2019 09:33	23/12/2019 03:25	24/12/2019 09:33	30,13	1	30,13	CHI
201912168469	LUZIANIA	SV12013810	VIANOPOLIS	23/12/2019 03:26	23/12/2019 11:07	23/12/2019 03:26	23/12/2019 11:07	7,68	62	476,25	CHI
201912168469	ORIZONA	SV12013810	VIANOPOLIS	23/12/2019 03:26	23/12/2019 11:07	23/12/2019 03:26	23/12/2019 11:07	7,68	68	522,33	CHI
201912168469	SILVANIA	SV12013810	VIANOPOLIS	23/12/2019 03:26	23/12/2019 11:07	23/12/2019 03:26	23/12/2019 11:07	7,68	16	122,90	CHI
201912167850	HIDROLINA	UR12048650	URUACU	23/12/2019 03:38	23/12/2019 09:51	23/12/2019 03:38	23/12/2019 09:51	6,22	15	93,24	CHI
201912167850	URUACU	UR12048650	URUACU	23/12/2019 03:38	23/12/2019 09:51	23/12/2019 03:38	23/12/2019 09:51	6,22	34	211,35	CHI
201912168375	APARECIDA DE GOIANIA	AP11207714	INDEPENDENCIA S2	23/12/2019 03:48	23/12/2019 12:31	23/12/2019 03:48	23/12/2019 12:31	8,71	306	2666,36	CHI
201912167858	ARAGARCAS	BM12204856	BOM JARDIM	23/12/2019 03:51	23/12/2019 10:50	23/12/2019 03:51	23/12/2019 10:50	6,98	24	167,50	CHI
201912167858	BALIZA	BM12204856	BOM JARDIM	23/12/2019 03:51	23/12/2019 10:50	23/12/2019 03:51	23/12/2019 10:50	6,98	50	348,96	CHI
201912168044	ITAPACI	IW12181402	ITAPACI	23/12/2019 03:57	23/12/2019 13:44	23/12/2019 03:57	23/12/2019 13:44	9,77	51	498,34	CHI
201912168044	NOVA GLORIA	IW12181402	ITAPACI	23/12/2019 03:57	23/12/2019 13:44	23/12/2019 03:57	23/12/2019 13:44	9,77	26	254,06	CHI
201912167864	SANTA CRUZ DE GOIAS	BC21207699	PIRES DO RIO S2	23/12/2019 03:59	23/12/2019 11:11	23/12/2019 03:59	23/12/2019 11:11	7,20	2	14,39	CHI
201912168031	CACU	CC12058477	CACHOEIRA ALTA	23/12/2019 03:59	24/12/2019 08:06	23/12/2019 03:59	24/12/2019 08:06	28,11	12	337,34	CHI
201912177504	ITAPACI	IW12078035	ITAPACI	23/12/2019 04:02	23/12/2019 17:54	23/12/2019 04:02	23/12/2019 17:54	13,86	21	291,12	CHI
201912177504	NOVA GLORIA	IW12078035	ITAPACI	23/12/2019 04:02	23/12/2019 17:54	23/12/2019 04:02	23/12/2019 17:54	13,86	1	13,86	CHI
201912167873	BURITINOPOLIS	MB12361385	IACIARA S2	23/12/2019 04:11	23/12/2019 10:17	23/12/2019 04:11	23/12/2019 10:17	6,09	18	109,57	CHI
201912167874	MARA ROSA	NQ12243364	URUACU	23/12/2019 04:11	23/12/2019 09:56	23/12/2019 04:11	23/12/2019 09:56	5,73	1	5,73	CHI
201912167874	NIQUELANDIA	NQ12243364	URUACU	23/12/2019 04:11	23/12/2019 09:56	23/12/2019 04:11	23/12/2019 09:56	5,73	27	154,84	CHI
201912169499	INHUMAS	IN11000054	INHUMAS S2	23/12/2019 04:12	23/12/2019 11:09	23/12/2019 04:12	23/12/2019 11:09	6,94	215	1492,64	CHI
201912172555	EDEIA	EA12160385	VICENTINOPOLIS	23/12/2019 04:14	23/12/2019 15:00	23/12/2019 04:14	23/12/2019 15:00	10,76	10	107,64	CHI



201912167878	SAO DOMINGOS	SD11046237	SAO DOMINGOS	23/12/2019 04:21	23/12/2019 07:32	23/12/2019 04:21	23/12/2019 07:32	3,18	282	896,37	CHI
201912168540	GOIANESIA	GE12291463LD	GOIANESIA S2	23/12/2019 04:24	23/12/2019 10:48	23/12/2019 04:24	23/12/2019 10:48	6,40	361	2308,80	CHI
201912168545	ALTO HORIZONTE	AJ12040664	SANTA TEREZINHA	23/12/2019 04:25	23/12/2019 11:40	23/12/2019 04:25	23/12/2019 11:40	7,24	5	36,21	CHI
201912168545	NOVA IGUAÇU DE GOIAS	AJ12040664	SANTA TEREZINHA	23/12/2019 04:25	23/12/2019 11:40	23/12/2019 04:25	23/12/2019 11:40	7,24	2	14,48	CHI
201912168164	SANTA RITA DO ARAGUAIA	SU12306507	SANTA RITA DO ARAGUAIA	23/12/2019 04:26	23/12/2019 22:54	23/12/2019 04:26	23/12/2019 22:54	18,46	15	276,84	CHI
201912167887	IVOLANDIA	IV12390185	IPORA	23/12/2019 04:28	23/12/2019 19:02	23/12/2019 04:28	23/12/2019 19:02	14,55	13	189,16	CHI
201912167890	CEZARINA	IY12010391	EDEIA	23/12/2019 04:33	23/12/2019 08:01	23/12/2019 04:33	23/12/2019 08:01	3,48	3	10,43	CHI
201912167890	INDIARA	IY12010391	EDEIA	23/12/2019 04:33	23/12/2019 08:01	23/12/2019 04:33	23/12/2019 08:01	3,48	1	3,48	CHI
201912170861	MIMOSO DE GOIAS	NQ12371855	BARRO ALTO	23/12/2019 04:34	23/12/2019 17:14	23/12/2019 04:34	23/12/2019 17:14	12,65	4	50,60	CHI
201912170861	NIQUELANDIA	NQ12371855	BARRO ALTO	23/12/2019 04:34	23/12/2019 17:14	23/12/2019 04:34	23/12/2019 17:14	12,65	243	3074,08	CHI
201912168380	BURITINOPOLIS	BQ12344370RE	IACIARA S2	23/12/2019 04:37	23/12/2019 08:19	23/12/2019 04:37	23/12/2019 08:19	3,68	206	758,82	CHI
201912167895	LUZIANIA	LZ12245978	CRISTALINA S2	23/12/2019 04:38	24/12/2019 14:51	23/12/2019 04:38	24/12/2019 14:51	34,21	8	273,67	CHI
201912167899	MONTES CLAROS DE GOIAS	ME12212902	IPORA	23/12/2019 04:39	23/12/2019 11:08	23/12/2019 04:39	23/12/2019 11:08	6,47	10	64,72	CHI
201912168013	URUACU	UR12229447	URUACU	23/12/2019 04:49	23/12/2019 08:47	23/12/2019 04:49	23/12/2019 08:47	3,95	7	27,67	CHI
201912168012	SAO MIGUEL DO ARAGUAIA	SM12083962	SAO MIGUEL DO ARAGUAIA	23/12/2019 04:50	23/12/2019 16:15	23/12/2019 04:50	23/12/2019 16:15	11,41	11	125,54	CHI
201912168014	PIRES DO RIO	PR12092027	PIRES DO RIO S1	23/12/2019 04:51	23/12/2019 09:00	23/12/2019 04:51	23/12/2019 09:00	4,15	6	24,90	CHI
201912168015	RUBIATABA	RB21232730	RUBIATABA	23/12/2019 04:56	23/12/2019 17:07	23/12/2019 04:56	23/12/2019 17:07	12,18	1	12,18	CHI
201912168599	APARECIDA DE GOIANIA	AP11095597	INDEPENDENCIA S1	23/12/2019 04:58	23/12/2019 09:28	23/12/2019 04:58	23/12/2019 09:28	4,49	90	404,20	CHI
201912168196	CAIAPONIA	PY12244702	PALESTINA	23/12/2019 05:07	23/12/2019 13:28	23/12/2019 05:07	23/12/2019 13:28	8,34	49	408,50	CHI
201912168196	PALESTINA DE GOIAS	PY12244702	PALESTINA	23/12/2019 05:07	23/12/2019 13:28	23/12/2019 05:07	23/12/2019 13:28	8,34	2	16,67	CHI
201912168026	CALDAS NOVAS	CN12022653	CALDAS NOVAS S2	23/12/2019 05:09	23/12/2019 18:27	23/12/2019 05:09	23/12/2019 18:27	13,29	84	1116,64	CHI
201912164313	COCALZINHO DE GOIAS	ZN11330877	AGUAS LINDAS DE GOIAS S2	23/12/2019 05:12	23/12/2019 11:40	23/12/2019 05:12	23/12/2019 11:40	6,46	58	374,78	CHI
201912168029	BONOPOLIS	BX12391936	SAO MIGUEL DO ARAGUAIA	23/12/2019 05:12	23/12/2019 23:20	23/12/2019 05:12	23/12/2019 23:20	18,13	29	525,83	CHI
201912168033	CORUMBAIBA	CI12021432	VILA CORUMBA	23/12/2019 05:14	24/12/2019 14:01	23/12/2019 05:14	24/12/2019 14:01	32,78	2	65,56	CHI
201912169643	SAO MIGUEL DO ARAGUAIA	SM12000018	SAO MIGUEL DO ARAGUAIA	23/12/2019 05:14	23/12/2019 17:39	23/12/2019 05:14	23/12/2019 17:39	12,42	4	49,67	CHI
201912168034	RIO VERDE	RV12260296	CACHOEIRA ALTA	23/12/2019 05:15	23/12/2019 13:41	23/12/2019 05:15	23/12/2019 13:41	8,43	37	311,94	CHI
201912168171	PIRENOPOLIS	ZN12273387	COCALZINHO	23/12/2019 05:15	23/12/2019 09:01	23/12/2019 05:15	23/12/2019 09:01	3,76	14	52,68	CHI
201912169667	SANTA CRUZ DE GOIAS	BC12126991	PIRACANJUBA	23/12/2019 05:15	23/12/2019 23:20	23/12/2019 05:15	23/12/2019 23:20	18,07	21	379,51	CHI
201912168589	BURITI DE GOIAS	BS12055345LD	FIRMINOPOLIS S2	23/12/2019 05:19	23/12/2019 13:23	23/12/2019 05:19	23/12/2019 13:23	8,07	519	4187,90	CHI
201912168047	IACIARA	IA12262204	IACIARA S2	23/12/2019 05:24	23/12/2019 07:21	23/12/2019 05:24	23/12/2019 07:21	1,94	10	19,42	CHI
201912168146	VILA PROPICIO	NP12307145	BARRO ALTO	23/12/2019 05:24	23/12/2019 11:54	23/12/2019 05:24	23/12/2019 11:54	6,48	15	97,26	CHI
201912168358	MOSSAMEDES	MD12089245	ITABERAÍ S2	23/12/2019 05:24	23/12/2019 17:25	23/12/2019 05:24	23/12/2019 17:25	12,00	4	48,01	CHI
201912168050	MAMBAI	1570007140	IACIARA S2	23/12/2019 05:25	23/12/2019 07:32	23/12/2019 05:25	23/12/2019 07:32	2,12	1	2,12	CHI

201912169490	CRIXAS	NA12171143	NOVA CRIXAS	23/12/2019 05:25	23/12/2019 14:26	23/12/2019 05:25	23/12/2019 14:26	9,01	3	27,04	CHI
201912168052	DOVERLANDIA	DV12207962	CAIAPONIA	23/12/2019 05:26	23/12/2019 09:15	23/12/2019 05:26	23/12/2019 09:15	3,82	7	26,71	CHI
201912168054	CAMPO ALEGRE DE GOIAS	CM12376046	CAMPO ALEGRE DE GOIAS	23/12/2019 05:26	23/12/2019 09:03	23/12/2019 05:26	23/12/2019 09:03	3,61	7	25,24	CHI
201912168054	CATALAO	CM12376046	CAMPO ALEGRE DE GOIAS	23/12/2019 05:26	23/12/2019 09:03	23/12/2019 05:26	23/12/2019 09:03	3,61	3	10,82	CHI
201912168056	CAMPOS VERDES	VD12251079	SANTA TEREZINHA	23/12/2019 05:27	23/12/2019 12:19	23/12/2019 05:27	23/12/2019 12:19	6,86	3	20,58	CHI
201912168056	SANTA TEREZINHA DE GOIAS	VD12251079	SANTA TEREZINHA	23/12/2019 05:27	23/12/2019 12:19	23/12/2019 05:27	23/12/2019 12:19	6,86	3	20,58	CHI
201912168612	BONOPOLIS	TA12263013	NOVO PLANALTO	23/12/2019 05:27	24/12/2019 00:37	23/12/2019 05:27	24/12/2019 00:37	19,16	31	594,07	CHI
201912174603	GOIATUBA	BJ12015318	BOM JESUS DE GOIAS	23/12/2019 05:27	23/12/2019 22:27	23/12/2019 05:27	23/12/2019 22:27	16,99	5	84,93	CHI
201912168060	AGUA FRIA DE GOIAS	MJ12040650	PADRE BERNARDO	23/12/2019 05:28	23/12/2019 07:47	23/12/2019 05:28	23/12/2019 07:47	2,31	9	20,83	CHI
201912168060	MIMOSO DE GOIAS	MJ12040650	PADRE BERNARDO	23/12/2019 05:28	23/12/2019 07:47	23/12/2019 05:28	23/12/2019 07:47	2,31	12	27,77	CHI
201912168061	FORMOSA	FA21202295	ITUIQUIRA	23/12/2019 05:28	23/12/2019 12:09	23/12/2019 05:28	23/12/2019 12:09	6,68	1	6,68	CHI
201912169169	NOVO GAMA	NJ11183776	PACAEMBU S1	23/12/2019 05:28	23/12/2019 08:55	23/12/2019 05:28	23/12/2019 08:55	3,45	161	555,36	CHI
201912168063	SAO DOMINGOS	SD12384774	SAO DOMINGOS	23/12/2019 05:29	23/12/2019 10:00	23/12/2019 05:29	23/12/2019 10:00	4,51	40	180,58	CHI
201912168064	IPORA	IR21014054	IPORA	23/12/2019 05:29	23/12/2019 15:14	23/12/2019 05:29	23/12/2019 15:14	9,74	1	9,74	CHI
201912168067	CAMPO ALEGRE DE GOIAS	CM21294568	CAMPO ALEGRE DE GOIAS	23/12/2019 05:29	23/12/2019 12:19	23/12/2019 05:29	23/12/2019 12:19	6,82	1	6,82	CHI
201912169104	IPORA	IR12091286	IPORA	23/12/2019 05:29	23/12/2019 12:09	23/12/2019 05:29	23/12/2019 12:09	6,66	17	113,30	CHI
201912168536	FORMOSA	FA12106874	ITUIQUIRA	23/12/2019 05:31	23/12/2019 08:30	23/12/2019 05:31	23/12/2019 08:30	2,98	19	56,57	CHI
201912168074	RIO VERDE	RV12024714	RIO VERDE S1	23/12/2019 05:33	23/12/2019 22:30	23/12/2019 05:33	23/12/2019 22:30	16,94	25	423,40	CHI
201912168075	SILVANIA	SV21012805	BELA VISTA S2	23/12/2019 05:33	24/12/2019 11:33	23/12/2019 05:33	24/12/2019 11:33	29,99	1	29,99	CHI
201912168076	GUARANI DE GOIAS	GY12180835	IACIARA S1	23/12/2019 05:34	23/12/2019 12:43	23/12/2019 05:34	23/12/2019 08:43	3,15	265	834,60	CHI
201912168076	IACIARA	GY12180835	IACIARA S1	23/12/2019 05:34	23/12/2019 12:43	23/12/2019 05:34	23/12/2019 08:43	3,15	2	6,30	CHI
201912168076	GUARANI DE GOIAS	GY12180835	IACIARA S1	23/12/2019 05:34	23/12/2019 12:43	23/12/2019 05:34	23/12/2019 12:43	7,15	50	357,47	CHI
201912168080	SANTA CRUZ DE GOIAS	BC12110027RE	PIRES DO RIO S2	23/12/2019 05:35	23/12/2019 12:02	23/12/2019 05:35	23/12/2019 09:00	3,40	17	57,81	CHI
201912168080	SANTA CRUZ DE GOIAS	BC12110027RE	PIRES DO RIO S2	23/12/2019 05:35	23/12/2019 12:02	23/12/2019 05:35	23/12/2019 12:02	6,43	10	64,34	CHI
201912168574	RUBIATABA	RB12114263	RUBIATABA	23/12/2019 05:35	23/12/2019 15:08	23/12/2019 05:35	23/12/2019 15:08	9,54	92	877,86	CHI
201912168085	RIO VERDE	RV12303875	ACREUNA	23/12/2019 05:36	23/12/2019 14:55	23/12/2019 05:36	23/12/2019 14:55	9,30	29	269,84	CHI
201912168767	RIO VERDE	RV11361098	CABRIUVA S1	23/12/2019 05:36	23/12/2019 08:40	23/12/2019 05:36	23/12/2019 08:40	3,07	39	119,86	CHI
201912168087	PALMINOPOLIS	PP12008241	PALMEIRAS	23/12/2019 05:37	23/12/2019 18:44	23/12/2019 05:37	23/12/2019 18:44	13,11	22	288,34	CHI
201912168089	MARA ROSA	MQ12295258	MARA ROSA	23/12/2019 05:38	23/12/2019 16:11	23/12/2019 05:38	23/12/2019 16:11	10,55	2	21,10	CHI
201912168090	ITUMBIARA	IT12000215	ITUMBIARA NOVA	23/12/2019 05:38	23/12/2019 23:23	23/12/2019 05:38	23/12/2019 11:10	5,53	31	171,31	CHI
201912168090	ITUMBIARA	IT12000215	ITUMBIARA NOVA	23/12/2019 05:38	23/12/2019 23:23	23/12/2019 05:38	23/12/2019 23:23	17,74	7	124,20	CHI
201912168092	PARAUNA	PU12205939	PARAUNA	23/12/2019 05:39	23/12/2019 23:43	23/12/2019 05:39	23/12/2019 23:43	18,06	8	144,48	CHI
201912168100	ARAGARCAS	AG11207811	ARAGARCAS	23/12/2019 05:41	23/12/2019 10:51	23/12/2019 05:41	23/12/2019 10:51	5,16	109	562,02	CHI

201912168131	SAO LUIS DE MONTES BELOS	SL32145964	SAO LUIZ DOS MONTES BELOS	23/12/2019 05:41	23/12/2019 15:52	23/12/2019 05:41	23/12/2019 15:52	10,20	35	356,93	CHI
201912167825	BELA VISTA DE GOIAS	BV12291753	BELA VISTA S1	23/12/2019 05:42	23/12/2019 08:41	23/12/2019 05:42	23/12/2019 08:41	2,98	86	256,09	CHI
201912168104	ABADIANIA	AA12382488	ANAPOLIS UNIVERSITARIO S1	23/12/2019 05:42	23/12/2019 09:45	23/12/2019 05:42	23/12/2019 09:45	4,04	5	20,18	CHI
201912178285	CACHOEIRA ALTA	CA12200630	CACHOEIRA ALTA	23/12/2019 05:42	24/12/2019 12:46	23/12/2019 05:42	24/12/2019 12:46	31,06	16	497,04	CHI
201912168108	ARENOPOLIS	AY12000042	ARENOPOLIS	23/12/2019 05:43	23/12/2019 08:14	23/12/2019 05:43	23/12/2019 08:14	2,50	22	55,01	CHI
201912168116	CAIAPONIA	CP12200873	PALESTINA	23/12/2019 05:45	24/12/2019 07:30	23/12/2019 05:45	24/12/2019 07:30	25,74	54	1389,73	CHI
201912168117	GOIANIA	GN11169118	ATLANTICO S3	23/12/2019 05:45	23/12/2019 14:36	23/12/2019 05:45	23/12/2019 14:36	8,84	111	980,72	CHI
201912169142	APARECIDA DE GOIANIA	AP11137108	INDEPENDENCIA S1	23/12/2019 05:45	23/12/2019 12:56	23/12/2019 05:45	23/12/2019 12:56	7,17	268	1922,83	CHI
201912168119	MORRINHOS	MR12308001	MORRINHOS	23/12/2019 05:47	23/12/2019 11:16	23/12/2019 05:47	23/12/2019 11:16	5,48	12	65,73	CHI
201912168168	CRISTALINA	LZ12383044	CRISTALINA S2	23/12/2019 05:47	23/12/2019 12:05	23/12/2019 05:47	23/12/2019 12:05	6,29	21	132,00	CHI
201912168168	LUZIANIA	LZ12383044	CRISTALINA S2	23/12/2019 05:47	23/12/2019 12:05	23/12/2019 05:47	23/12/2019 12:05	6,29	101	634,87	CHI
201912168332	CAMPINORTE	MQ12370551LD	MARA ROSA	23/12/2019 05:48	23/12/2019 06:53	23/12/2019 05:48	23/12/2019 06:53	1,07	5	5,35	CHI
201912168332	MARA ROSA	MQ12370551LD	MARA ROSA	23/12/2019 05:48	23/12/2019 06:53	23/12/2019 05:48	23/12/2019 06:53	1,07	20	21,41	CHI
201912168126	FORMOSO	FO12170963	MARA ROSA	23/12/2019 05:49	23/12/2019 11:40	23/12/2019 05:49	23/12/2019 11:40	5,83	11	64,17	CHI
201912168129	PIRANHAS	PH12343597	PIRANHAS	23/12/2019 05:50	23/12/2019 15:22	23/12/2019 05:50	23/12/2019 15:22	9,53	18	171,48	CHI
201912169462	CRISTIANOPOLIS	PJ12212204	PIRACANJUBA	23/12/2019 05:50	23/12/2019 23:44	23/12/2019 05:50	23/12/2019 23:44	17,89	4	71,56	CHI
201912169462	PIRACANJUBA	PJ12212204	PIRACANJUBA	23/12/2019 05:50	23/12/2019 23:44	23/12/2019 05:50	23/12/2019 23:44	17,89	5	89,44	CHI
201912169462	SANTA CRUZ DE GOIAS	PJ12212204	PIRACANJUBA	23/12/2019 05:50	23/12/2019 23:44	23/12/2019 05:50	23/12/2019 23:44	17,89	4	71,56	CHI
201912168135	AMARALINA	LC21200470	SAO MIGUEL DO ARAGUAIA	23/12/2019 05:52	24/12/2019 00:09	23/12/2019 05:52	24/12/2019 00:09	18,28	4	73,11	CHI
201912168136	GOIANESIA	GE21185718	GOIANESIA S2	23/12/2019 05:52	23/12/2019 14:27	23/12/2019 05:52	23/12/2019 14:27	8,57	2	17,15	CHI
201912168138	RIO VERDE	RV12260699	CABRIUVA S1	23/12/2019 05:52	23/12/2019 18:29	23/12/2019 05:52	23/12/2019 18:29	12,61	19	239,61	CHI
201912168140	ITUMBIARA	IT12208124	PARANAIBA	23/12/2019 05:54	23/12/2019 10:38	23/12/2019 05:54	23/12/2019 10:38	4,73	143	676,87	CHI
201912168142	FAZENDA NOVA	JR12086356	BRITANIA	23/12/2019 05:54	23/12/2019 12:33	23/12/2019 05:54	23/12/2019 12:33	6,64	8	53,15	CHI
201912168142	JUSSARA	JR12086356	BRITANIA	23/12/2019 05:54	23/12/2019 12:33	23/12/2019 05:54	23/12/2019 12:33	6,64	1	6,64	CHI
201912168865	APARECIDA DE GOIANIA	AP11065083	INDEPENDENCIA S1	23/12/2019 05:54	23/12/2019 23:00	23/12/2019 05:54	23/12/2019 23:00	17,09	291	4973,51	CHI
201912168627	SENADOR CANEDO	SW11158378	SENADOR CANEDO	23/12/2019 05:55	23/12/2019 08:50	23/12/2019 05:55	23/12/2019 08:50	2,92	177	516,00	CHI
201912168152	SAO LUIS DE MONTES BELOS	SL12304619	FIRMINOPOLIS S2	23/12/2019 05:56	23/12/2019 12:20	23/12/2019 05:56	23/12/2019 12:20	6,40	2	12,79	CHI
201912168153	ITAPIRAPUA	IU12018840	MATRINCHA	23/12/2019 05:57	23/12/2019 14:36	23/12/2019 05:57	23/12/2019 14:36	8,66	18	155,89	CHI
201912168154	ANICUNS	AC12266584	ANICUNS	23/12/2019 05:57	23/12/2019 11:17	23/12/2019 05:57	23/12/2019 11:17	5,33	1	5,33	CHI
201912168154	TURVANIA	AC12266584	ANICUNS	23/12/2019 05:57	23/12/2019 11:17	23/12/2019 05:57	23/12/2019 11:17	5,33	6	31,96	CHI
201912168156	PETROLINA DE GOIAS	PG12025388	SAO FRANCISCO DE GOIAS	23/12/2019 05:58	23/12/2019 09:09	23/12/2019 05:58	23/12/2019 09:09	3,17	10	31,71	CHI
201912168156	PIRENOPOLIS	PG12025388	SAO FRANCISCO DE GOIAS	23/12/2019 05:58	23/12/2019 09:09	23/12/2019 05:58	23/12/2019 09:09	3,17	38	120,50	CHI
201912168157	ITAPACI	IW21275245	ITAPACI	23/12/2019 05:59	23/12/2019 16:03	23/12/2019 05:59	23/12/2019 16:03	10,07	1	10,07	CHI

201912168163	CEZARINA	IY12010807	EDEIA	23/12/2019 05:59	23/12/2019 09:17	23/12/2019 05:59	23/12/2019 09:17	3,29	1	3,29	CHI
201912168163	INDIARA	IY12010807	EDEIA	23/12/2019 05:59	23/12/2019 09:17	23/12/2019 05:59	23/12/2019 09:17	3,29	31	101,96	CHI
201912168166	FAZENDA NOVA	FN12073183	BRITANIA	23/12/2019 05:59	23/12/2019 11:36	23/12/2019 05:59	23/12/2019 11:36	5,60	66	369,62	CHI
201912173211	INDIARA	IY21154083	EDEIA	23/12/2019 05:59	23/12/2019 17:25	23/12/2019 05:59	23/12/2019 17:25	11,43	1	11,43	CHI
201912168393	INDIARA	IY21010815	EDEIA	23/12/2019 05:59	23/12/2019 16:24	23/12/2019 05:59	23/12/2019 16:24	10,42	1	10,42	CHI
201912176592	FAZENDA NOVA	FN21074226	BRITANIA	23/12/2019 05:59	23/12/2019 19:57	23/12/2019 05:59	23/12/2019 19:57	13,95	1	13,95	CHI
201912168167	QUIRINOPOLIS	Q1560224	QUIRINOPOLIS	23/12/2019 06:00	23/12/2019 10:07	23/12/2019 09:38	23/12/2019 09:59	0,35	9923	3462,02	CHI
201912168167	QUIRINOPOLIS	Q13370059	QUIRINOPOLIS	23/12/2019 06:00	23/12/2019 10:07	23/12/2019 09:23	23/12/2019 10:07	0,73	2876	2105,87	CHI
201912168170	URUACU	UR12003395	URUACU	23/12/2019 06:00	23/12/2019 08:45	23/12/2019 06:00	23/12/2019 08:45	2,74	8	21,94	CHI
201912171901	ITAPURANGA	IK12220328	ITAPURANGA	23/12/2019 06:01	23/12/2019 14:14	23/12/2019 06:01	23/12/2019 14:14	8,22	231	1897,79	CHI
201912168176	FAINA	FC12299837	GOIAS	23/12/2019 06:02	23/12/2019 09:15	23/12/2019 06:02	23/12/2019 09:15	3,20	6	19,23	CHI
201912169008	JATAI	JT12303380	JATAI S1	23/12/2019 06:02	23/12/2019 10:54	23/12/2019 06:02	23/12/2019 10:54	4,85	25	121,33	CHI
201912168177	CASTELANDIA	DM21028093	RIO DOS BOIS	23/12/2019 06:03	23/12/2019 20:44	23/12/2019 06:03	23/12/2019 20:44	14,69	1	14,69	CHI
201912168827	CATALAO	CT12363448RE	CATALAO S1	23/12/2019 06:03	23/12/2019 17:43	23/12/2019 06:03	23/12/2019 13:09	7,10	6	42,62	CHI
201912168827	TRES RANCHOS	CT12363448RE	CATALAO S1	23/12/2019 06:03	23/12/2019 17:43	23/12/2019 06:03	23/12/2019 13:09	7,10	24	170,47	CHI
201912168827	CATALAO	CT12363448RE	CATALAO S1	23/12/2019 06:03	23/12/2019 17:43	23/12/2019 06:03	23/12/2019 17:43	11,66	1	11,66	CHI
201912168827	TRES RANCHOS	CT12363448RE	CATALAO S1	23/12/2019 06:03	23/12/2019 17:43	23/12/2019 06:03	23/12/2019 17:43	11,66	2	23,32	CHI
201912168187	CAMPO ALEGRE DE GOIAS	CM21166722	CAMPO ALEGRE DE GOIAS	23/12/2019 06:05	23/12/2019 13:11	23/12/2019 06:05	23/12/2019 13:11	7,10	1	7,10	CHI
201912168193	ITAPURANGA	IK11387473	ITAPURANGA	23/12/2019 06:06	23/12/2019 11:13	23/12/2019 06:06	23/12/2019 11:13	5,10	3	15,31	CHI
201912169004	BOM JARDIM DE GOIAS	BM12243912	BOM JARDIM	23/12/2019 06:06	23/12/2019 19:06	23/12/2019 06:06	23/12/2019 19:06	12,99	11	142,86	CHI
201912169004	PIRANHAS	BM12243912	BOM JARDIM	23/12/2019 06:06	23/12/2019 19:06	23/12/2019 06:06	23/12/2019 19:06	12,99	9	116,89	CHI
201912168199	LUZIANIA	120069337	RIO VERMELHO	23/12/2019 06:09	23/12/2019 09:28	23/12/2019 06:09	23/12/2019 09:28	3,33	1	3,33	CHI
201912168338	DISTRITO FEDERAL	05410224	MARAJOARA	23/12/2019 06:09	23/12/2019 09:25	23/12/2019 06:09	23/12/2019 09:25	3,26	48	156,47	CHI
201912168338	NOVO GAMA	05410224	MARAJOARA	23/12/2019 06:09	23/12/2019 09:25	23/12/2019 06:09	23/12/2019 09:25	3,26	10	32,60	CHI
201912168338	SANTO ANTONIO DO DESCOBERTO	05410224	MARAJOARA	23/12/2019 06:09	23/12/2019 09:25	23/12/2019 06:09	23/12/2019 09:25	3,26	782	2549,10	CHI
201912168434	GOIANIA	GN11001828	ATLANTICO S3	23/12/2019 06:09	23/12/2019 10:32	23/12/2019 06:09	23/12/2019 10:32	4,38	176	770,20	CHI
201912168308	IPAMERI	IP12335846	IPAMERI	23/12/2019 06:10	23/12/2019 15:34	23/12/2019 06:10	23/12/2019 15:34	9,39	4	37,58	CHI
201912168314	NIQUELANDIA	NQ11353891	NIQUELANDIA SUBTRANSMISSAO	23/12/2019 06:11	23/12/2019 11:02	23/12/2019 06:11	23/12/2019 11:02	4,84	39	188,69	CHI
201912168319	IPAMERI	IP12265555	CAMPO ALEGRE DE GOIAS	23/12/2019 06:12	23/12/2019 15:43	23/12/2019 06:12	23/12/2019 15:43	9,51	7	66,59	CHI
201912168320	FLORES DE GOIAS	FB12106993	FLORES DE GOIAS	23/12/2019 06:12	23/12/2019 07:10	23/12/2019 06:12	23/12/2019 07:10	0,95	15	14,30	CHI
201912168320	FORMOSA	FB12106993	FLORES DE GOIAS	23/12/2019 06:12	23/12/2019 07:10	23/12/2019 06:12	23/12/2019 07:10	0,95	9	8,58	CHI
201912168320	SAO JOAO D ALIANCA	FB12106993	FLORES DE GOIAS	23/12/2019 06:12	23/12/2019 07:10	23/12/2019 06:12	23/12/2019 07:10	0,95	5	4,77	CHI
201912168506	ITAJA	04400224	CACHOEIRA ALTA	23/12/2019 06:15	23/12/2019 10:45	23/12/2019 06:15	23/12/2019 10:45	4,49	75	337,04	CHI

201912168506	LAGOA SANTA	04400224	CACHOEIRA ALTA	23/12/2019 06:15	23/12/2019 10:45	23/12/2019 06:15	23/12/2019 10:45	4,49	59	265,14	CHI
201912168506	LAGOA SANTA	04400224	ITAJA S2	23/12/2019 06:15	23/12/2019 10:45	23/12/2019 06:15	23/12/2019 10:45	4,49	2	8,99	CHI
201912169707	ANICUNS	AC12000068	ANICUNS	23/12/2019 06:15	23/12/2019 17:39	23/12/2019 06:15	23/12/2019 17:39	11,40	33	376,09	CHI
201912175002	ITAJA	IJ21388261	CACHOEIRA ALTA	23/12/2019 06:15	24/12/2019 15:01	23/12/2019 06:15	24/12/2019 15:01	32,75	1	32,75	CHI
201912168347	MINACU	IH12242192	MINACU	23/12/2019 06:17	23/12/2019 07:52	23/12/2019 06:17	23/12/2019 07:52	1,58	49	77,20	CHI
201912168348	GOIANESIA	GE12000150	GOIANESIA S1	23/12/2019 06:17	23/12/2019 11:52	23/12/2019 06:17	23/12/2019 11:52	5,57	3	16,72	CHI
201912168349	CHAPADAO DO CEU	DJ12248365	CHAPADAO DO CEU	23/12/2019 06:17	23/12/2019 13:59	23/12/2019 06:17	23/12/2019 13:59	7,69	4	30,76	CHI
201912168362	MARA ROSA	MQ12390474	MARA ROSA	23/12/2019 06:19	23/12/2019 09:35	23/12/2019 06:19	23/12/2019 09:35	3,26	3	9,77	CHI
201912169524	APARECIDA DE GOIANIA	AP11091374	INDEPENDENCIA S1	23/12/2019 06:19	23/12/2019 15:18	23/12/2019 06:19	23/12/2019 15:18	8,98	188	1688,34	CHI
201912176786	INHUMAS	IN12031534	INHUMAS S1	23/12/2019 06:19	23/12/2019 17:46	23/12/2019 06:19	23/12/2019 17:46	11,45	7	80,12	CHI
201912176882	PALMEIRAS DE GOIAS	PL12038678	PALMEIRAS	23/12/2019 06:19	23/12/2019 18:18	23/12/2019 06:19	23/12/2019 18:18	11,98	11	131,76	CHI
201912168367	AMARALINA	LC12182362	MARA ROSA	23/12/2019 06:20	23/12/2019 10:41	23/12/2019 06:20	23/12/2019 10:41	4,34	103	446,82	CHI
201912168367	MARA ROSA	LC12182362	MARA ROSA	23/12/2019 06:20	23/12/2019 10:41	23/12/2019 06:20	23/12/2019 10:41	4,34	8	34,70	CHI
201912168367	MUTUNOPOLIS	LC12182362	MARA ROSA	23/12/2019 06:20	23/12/2019 10:41	23/12/2019 06:20	23/12/2019 10:41	4,34	2	8,68	CHI
201912177701	JANDAIA	JD12005424	PALMEIRAS	23/12/2019 06:20	23/12/2019 19:36	23/12/2019 06:20	23/12/2019 19:36	13,25	4	53,01	CHI
201912177701	PALMEIRAS DE GOIAS	JD12005424	PALMEIRAS	23/12/2019 06:20	23/12/2019 19:36	23/12/2019 06:20	23/12/2019 19:36	13,25	4	53,01	CHI
201912174648	AMARALINA	MU21240606	MARA ROSA	23/12/2019 06:20	23/12/2019 17:05	23/12/2019 06:20	23/12/2019 17:05	10,74	1	10,74	CHI
201912168384	SAO LUIS DE MONTES BELOS	SL21125650	FIRMINOPOLIS S1	23/12/2019 06:24	23/12/2019 09:24	23/12/2019 06:24	23/12/2019 09:24	2,99	1	2,99	CHI
201912168386	SILVANIA	SV12247192	VIANOPOLIS	23/12/2019 06:24	24/12/2019 11:50	23/12/2019 06:24	23/12/2019 17:50	11,43	2	22,86	CHI
201912168386	SILVANIA	SV12247190LD	VIANOPOLIS	23/12/2019 06:24	24/12/2019 11:50	23/12/2019 06:24	24/12/2019 11:50	29,42	6	176,53	CHI
201912168205	GOUVELANDIA	QI13349498	QUIRINOPOLIS	23/12/2019 06:25	23/12/2019 07:36	23/12/2019 06:25	23/12/2019 07:36	1,18	12	14,16	CHI
201912168205	INACIOLANDIA	QI13349498	QUIRINOPOLIS	23/12/2019 06:25	23/12/2019 07:36	23/12/2019 06:25	23/12/2019 07:36	1,18	14	16,52	CHI
201912168205	QUIRINOPOLIS	QI13349498	QUIRINOPOLIS	23/12/2019 06:25	23/12/2019 07:36	23/12/2019 06:25	23/12/2019 07:36	1,18	23	27,15	CHI
201912168388	GUAPO	GA12400521	GUAPO S1	23/12/2019 06:25	24/12/2019 12:10	23/12/2019 06:25	23/12/2019 14:02	7,63	3	22,88	CHI
201912168388	GUAPO	GA32098734LD	GUAPO S1	23/12/2019 06:25	24/12/2019 12:10	23/12/2019 06:25	24/12/2019 12:10	29,75	8	238,00	CHI
201912168663	ANAPOLIS	AN12262491	ANAPOLIS UNIVERSITARIO S1	23/12/2019 06:26	23/12/2019 10:24	23/12/2019 06:26	23/12/2019 10:24	3,95	39	154,06	CHI
201912168398	CATALAO	CT12165146	CATALAO S1	23/12/2019 06:27	23/12/2019 11:58	23/12/2019 06:27	23/12/2019 11:58	5,51	11	60,66	CHI
201912176087	CATALAO	CT21266708	CATALAO S1	23/12/2019 06:27	23/12/2019 13:05	23/12/2019 06:27	23/12/2019 13:05	6,63	2	13,26	CHI
201912176973	CATALAO	CT21127667	CATALAO S1	23/12/2019 06:27	24/12/2019 10:42	23/12/2019 06:27	24/12/2019 10:42	28,25	1	28,25	CHI
201912168409	ITUMBIARA	690384385	ITUMBIARA NOVA	23/12/2019 06:29	24/12/2019 08:05	23/12/2019 06:29	24/12/2019 08:05	25,60	1	25,60	CHI
201912168415	APARECIDA DE GOIANIA	AP11006236	INDEPENDENCIA S2	23/12/2019 06:30	23/12/2019 12:53	23/12/2019 06:30	23/12/2019 12:53	6,38	150	956,50	CHI
201912168416	PALMEIRAS DE GOIAS	PL21287687	PALMEIRAS	23/12/2019 06:30	23/12/2019 13:47	23/12/2019 06:30	23/12/2019 13:47	7,28	1	7,28	CHI
201912168418	FORMOSO	FO12243348	MARA ROSA	23/12/2019 06:30	23/12/2019 14:57	23/12/2019 06:30	23/12/2019 14:57	8,43	1	8,43	CHI

201912168788	PIRES DO RIO	BC12027014RE	PIRES DO RIO S2	23/12/2019 06:30	23/12/2019 09:35	23/12/2019 06:30	23/12/2019 09:35	3,07	10	30,69	CHI
201912168788	SANTA CRUZ DE GOIAS	BC12027014RE	PIRES DO RIO S2	23/12/2019 06:30	23/12/2019 09:35	23/12/2019 06:30	23/12/2019 09:35	3,07	40	122,76	CHI
201912170871	SANTO ANTONIO DO DESCOBERTO	SN12037170	MARAJOARA	23/12/2019 06:30	23/12/2019 16:45	23/12/2019 06:30	23/12/2019 16:45	10,24	38	389,30	CHI
201912168426	NOVA CRIXAS	NA12034763	NOVA CRIXAS	23/12/2019 06:31	24/12/2019 11:15	23/12/2019 06:31	24/12/2019 11:15	28,73	6	172,35	CHI
201912168431	ORIZONA	OZ21185951	PIRES DO RIO S2	23/12/2019 06:32	23/12/2019 15:08	23/12/2019 06:32	23/12/2019 15:08	8,60	1	8,60	CHI
201912168436	JUSSARA	JR12204918	IPORA	23/12/2019 06:33	24/12/2019 10:55	23/12/2019 06:33	24/12/2019 10:55	28,35	35	992,41	CHI
201912168436	MONTES CLAROS DE GOIAS	JR12204918	IPORA	23/12/2019 06:33	24/12/2019 10:55	23/12/2019 06:33	24/12/2019 10:55	28,35	17	482,03	CHI
201912176901	CACU	CC12202629	CACHOEIRA ALTA	23/12/2019 06:33	23/12/2019 22:41	23/12/2019 06:33	23/12/2019 22:41	16,12	5	80,60	CHI
201912168713	PIRACANJUBA	PJ12039733	PIRACANJUBA	23/12/2019 06:34	23/12/2019 17:23	23/12/2019 06:34	23/12/2019 17:23	10,81	28	302,56	CHI
201912168450	APORE	AE21241895	ITAJA S1	23/12/2019 06:35	24/12/2019 15:32	23/12/2019 06:35	24/12/2019 15:32	32,94	1	32,94	CHI
201912168452	SAO MIGUEL DO ARAGUAIA	SM21208440	SAO MIGUEL DO ARAGUAIA	23/12/2019 06:35	24/12/2019 11:22	23/12/2019 06:35	24/12/2019 11:22	28,77	1	28,77	CHI
201912169445	APARECIDA DE GOIANIA	AP11034428	INDEPENDENCIA S1	23/12/2019 06:35	23/12/2019 09:51	23/12/2019 06:35	23/12/2019 09:51	3,26	143	466,66	CHI
201912170500	ACREUNA	EU12246749	ACREUNA	23/12/2019 06:35	26/12/2019 23:00	23/12/2019 06:35	24/12/2019 14:38	32,05	3	96,15	CHI
201912170500	EDEIA	EU12246749	ACREUNA	23/12/2019 06:35	26/12/2019 23:00	23/12/2019 06:35	25/12/2019 12:35	53,99	13	701,82	CHI
201912170500	TURVANIA	EU12246749	ACREUNA	23/12/2019 06:35	26/12/2019 23:00	23/12/2019 06:35	25/12/2019 12:35	53,99	1	53,99	CHI
201912170500	TURVELANDIA	EU12246749	ACREUNA	23/12/2019 06:35	26/12/2019 23:00	23/12/2019 06:35	25/12/2019 12:35	53,99	23	1241,68	CHI
201912170500	ACREUNA	EU12246749	ACREUNA	23/12/2019 06:35	26/12/2019 23:00	23/12/2019 06:35	26/12/2019 12:20	77,73	1	77,73	CHI
201912170500	ACREUNA	EU12246749	ACREUNA	23/12/2019 06:35	26/12/2019 23:00	23/12/2019 06:35	26/12/2019 23:00	88,40	7	618,81	CHI
201912179099	CEZARINA	CZ12228898	CEZARINA	23/12/2019 06:36	23/12/2019 18:40	23/12/2019 06:36	23/12/2019 18:40	12,07	10	120,69	CHI
201912168463	PIRES DO RIO	PR12337227	PIRES DO RIO S1	23/12/2019 06:37	23/12/2019 12:16	23/12/2019 06:37	23/12/2019 12:16	5,65	37	208,95	CHI
201912168463	SANTA CRUZ DE GOIAS	PR12337227	PIRES DO RIO S1	23/12/2019 06:37	23/12/2019 12:16	23/12/2019 06:37	23/12/2019 12:16	5,65	1	5,65	CHI
201912168463	URUTAI	PR12337227	PIRES DO RIO S1	23/12/2019 06:37	23/12/2019 12:16	23/12/2019 06:37	23/12/2019 12:16	5,65	1	5,65	CHI
201912168464	AURILANDIA	AI12194035	FIRMINOPOLIS S2	23/12/2019 06:37	23/12/2019 11:15	23/12/2019 06:37	23/12/2019 11:15	4,63	3	13,89	CHI
201912168467	INHUMAS	IN12000222	INHUMAS S2	23/12/2019 06:38	23/12/2019 11:20	23/12/2019 06:38	23/12/2019 11:20	4,71	1222	5753,58	CHI
201912168481	GOIATUBA	GT12332186	BOM JESUS DE GOIAS	23/12/2019 06:38	23/12/2019 18:21	23/12/2019 06:38	23/12/2019 18:21	11,70	2	23,40	CHI
201912168477	SANTA BARBARA DE GOIAS	1030006602	TRINDADE	23/12/2019 06:39	23/12/2019 09:59	23/12/2019 06:39	23/12/2019 09:59	3,33	1	3,33	CHI
201912169410	INHUMAS	IN11000019	INHUMAS S2	23/12/2019 06:39	23/12/2019 09:07	23/12/2019 06:39	23/12/2019 09:07	2,46	96	236,35	CHI
201912168482	CRISTALINA	KR21381877	CRISTALINA S2	23/12/2019 06:40	23/12/2019 12:22	23/12/2019 06:40	23/12/2019 12:22	5,70	1	5,70	CHI
201912168485	CRISTALINA	IP21168495	CRISTALINA S2	23/12/2019 06:40	23/12/2019 08:10	23/12/2019 06:40	23/12/2019 08:10	1,49	1	1,49	CHI
201912168487	VALPARAISO DE GOIAS	2860269119	PACAEMBU S1	23/12/2019 06:40	23/12/2019 09:30	23/12/2019 06:40	23/12/2019 09:30	2,83	1	2,83	CHI
201912177001	CALDAZINHA	SW12217284	CEPAIGO S2	23/12/2019 06:40	23/12/2019 18:14	23/12/2019 06:40	23/12/2019 18:14	11,55	6	69,33	CHI
201912177001	LEOPOLDO DE BULHOES	SW12217284	CEPAIGO S2	23/12/2019 06:40	23/12/2019 18:14	23/12/2019 06:40	23/12/2019 18:14	11,55	27	311,98	CHI
201912168491	AGUAS LINDAS DE GOIAS	4830009604	AGUAS LINDAS DE GOIAS S1	23/12/2019 06:41	23/12/2019 12:30	23/12/2019 06:41	23/12/2019 12:30	5,81	1	5,81	CHI

201912168492	ALTO PARAISO DE GOIAS	ND12302636	IACIARA S2	23/12/2019 06:41	23/12/2019 11:24	23/12/2019 06:41	23/12/2019 11:24	4,71	18	84,80	CHI
201912168492	NOVA ROMA	ND12302636	IACIARA S2	23/12/2019 06:41	23/12/2019 11:24	23/12/2019 06:41	23/12/2019 11:24	4,71	96	452,24	CHI
201912168492	SAO JOAO D ALIANCA	ND12302636	IACIARA S2	23/12/2019 06:41	23/12/2019 11:24	23/12/2019 06:41	23/12/2019 11:24	4,71	12	56,53	CHI
201912168496	ISRAELANDIA	IS12018686	IPORA	23/12/2019 06:42	23/12/2019 08:37	23/12/2019 06:42	23/12/2019 08:37	1,91	3	5,74	CHI
201912168496	JAUPACI	IS12018686	IPORA	23/12/2019 06:42	23/12/2019 08:37	23/12/2019 06:42	23/12/2019 08:37	1,91	7	13,40	CHI
201912168628	NOVO PLANALTO	TA12139137	NOVO PLANALTO	23/12/2019 06:42	24/12/2019 03:10	23/12/2019 06:42	24/12/2019 03:10	20,45	3	61,35	CHI
201912170883	GOIANESIA	GE12373995	GOIANESIA S2	23/12/2019 06:42	24/12/2019 11:32	23/12/2019 06:42	24/12/2019 11:32	28,82	18	518,84	CHI
201912170932	EDEIA	EA12086939	EDEIA	23/12/2019 06:44	24/12/2019 15:07	23/12/2019 06:44	24/12/2019 15:07	32,38	9	291,38	CHI
201912168511	ITAPIRAPUA	IU21073756	MATRINCHA	23/12/2019 06:45	23/12/2019 09:35	23/12/2019 06:45	23/12/2019 09:35	2,83	1	2,83	CHI
201912168512	RIO VERDE	RV12296050	RIO VERDE S1	23/12/2019 06:45	23/12/2019 11:17	23/12/2019 06:45	23/12/2019 11:17	4,53	10	45,30	CHI
201912168514	ACREUNA	EU21247384	ACREUNA	23/12/2019 06:45	23/12/2019 11:17	23/12/2019 06:45	23/12/2019 11:17	4,52	1	4,52	CHI
201912168516	JARAGUA	JA21114641	JARAGUA	23/12/2019 06:45	23/12/2019 14:20	23/12/2019 06:45	23/12/2019 14:20	7,57	1	7,57	CHI
201912168520	IPAMERI	IP12042440	IPAMERI	23/12/2019 06:46	23/12/2019 18:54	23/12/2019 06:46	23/12/2019 18:54	12,13	2	24,27	CHI
201912168521	BURITI ALEGRE	BG21000114	ITUMBIARA VELHA S2	23/12/2019 06:46	23/12/2019 17:47	23/12/2019 06:46	23/12/2019 17:47	11,01	1	11,01	CHI
201912168527	URUACU	UR12256445	URUACU	23/12/2019 06:46	23/12/2019 09:15	23/12/2019 06:46	23/12/2019 09:15	2,47	11	27,14	CHI
201912168771	MUTUNOPOLIS	MU12391657	MARA ROSA	23/12/2019 06:46	23/12/2019 13:25	23/12/2019 06:46	23/12/2019 13:25	6,64	15	99,63	CHI
201912168533	ISRAELANDIA	IS12184272	IPORA	23/12/2019 06:49	24/12/2019 01:00	23/12/2019 06:49	24/12/2019 01:00	18,17	6	109,04	CHI
201912168535	GOIANDIRA	GD12281470	CATALAO S1	23/12/2019 06:50	23/12/2019 10:09	23/12/2019 06:50	23/12/2019 10:09	3,31	4	13,24	CHI
201912168538	ITUMBIARA	IT21310050	ITUMBIARA NOVA	23/12/2019 06:50	23/12/2019 11:22	23/12/2019 06:50	23/12/2019 11:22	4,52	1	4,52	CHI
201912177569	PALMINOPOLIS	RP12156223	FIRMINOPOLIS S2	23/12/2019 06:50	23/12/2019 16:31	23/12/2019 06:50	23/12/2019 16:31	9,68	2	19,36	CHI
201912177569	SAO JOAO DA PARAUNA	RP12156223	FIRMINOPOLIS S2	23/12/2019 06:50	23/12/2019 16:31	23/12/2019 06:50	23/12/2019 16:31	9,68	24	232,35	CHI
201912168542	ACREUNA	SH12246720	ACREUNA	23/12/2019 06:51	23/12/2019 12:26	23/12/2019 06:51	23/12/2019 12:26	5,58	5	27,92	CHI
201912168542	SANTA HELENA DE GOIAS	SH12246720	ACREUNA	23/12/2019 06:51	23/12/2019 12:26	23/12/2019 06:51	23/12/2019 12:26	5,58	61	340,67	CHI
201912168542	SANTO ANTONIO DA BARRA	SH12246720	ACREUNA	23/12/2019 06:51	23/12/2019 12:26	23/12/2019 06:51	23/12/2019 12:26	5,58	16	89,36	CHI
201912168793	MORRINHOS	MR12033683	MORRINHOS	23/12/2019 06:51	23/12/2019 08:35	23/12/2019 06:51	23/12/2019 08:35	1,73	143	247,51	CHI
201912176237	SANTA HELENA DE GOIAS	SH21345996	ACREUNA	23/12/2019 06:51	24/12/2019 00:30	23/12/2019 06:51	24/12/2019 00:30	17,64	1	17,64	CHI
201912169622	JATAI	JT12182157	JATAI S2	23/12/2019 06:52	23/12/2019 14:45	23/12/2019 06:52	23/12/2019 14:45	7,87	98	771,67	CHI
201912168556	PETROLINA DE GOIAS	PG12298074	PETROLINA	23/12/2019 06:54	23/12/2019 19:24	23/12/2019 06:54	23/12/2019 19:24	12,50	11	137,46	CHI
201912168559	MORRINHOS	MR32092108	MORRINHOS	23/12/2019 06:54	23/12/2019 13:20	23/12/2019 06:54	23/12/2019 13:20	6,42	3	19,27	CHI
201912168561	GOIANESIA	JA12297398	GOIANESIA S2	23/12/2019 06:54	23/12/2019 13:21	23/12/2019 06:54	23/12/2019 13:21	6,44	2	12,88	CHI
201912168561	JARAGUA	JA12297398	GOIANESIA S2	23/12/2019 06:54	23/12/2019 13:21	23/12/2019 06:54	23/12/2019 13:21	6,44	10	64,40	CHI
201912169440	PORTELANDIA	PW12209812	PARQUE DAS EMAS	23/12/2019 06:54	23/12/2019 14:38	23/12/2019 06:54	23/12/2019 14:38	7,73	84	649,44	CHI
201912176913	FAINA	FC12160891	GOIAS	23/12/2019 06:54	23/12/2019 19:45	23/12/2019 06:54	23/12/2019 19:45	12,84	14	179,79	CHI

201912176913	ITAPURANGA	FC12160891	GOIAS	23/12/2019 06:54	23/12/2019 19:45	23/12/2019 06:54	23/12/2019 19:45	12,84	2	25,68	CHI
201912176913	MORRO AGUDO DE GOIAS	FC12160891	GOIAS	23/12/2019 06:54	23/12/2019 19:45	23/12/2019 06:54	23/12/2019 19:45	12,84	2	25,68	CHI
201912168565	ITAPIRAPUA	IU12250540	MATRINCHA	23/12/2019 06:55	23/12/2019 14:40	23/12/2019 06:55	23/12/2019 14:40	7,75	1	7,75	CHI
201912169319	APORE	AE21107341	ITAJA S1	23/12/2019 06:56	23/12/2019 10:35	23/12/2019 06:56	23/12/2019 10:35	3,63	1	3,63	CHI
201912168581	SAO MIGUEL DO ARAGUAIA	SM12208634	SAO MIGUEL DO ARAGUAIA	23/12/2019 06:57	23/12/2019 11:11	23/12/2019 06:57	23/12/2019 11:11	4,23	1	4,23	CHI
201912168596	APARECIDA DE GOIANIA	AP11158201	INDEPENDENCIA S1	23/12/2019 06:58	23/12/2019 09:19	23/12/2019 06:58	23/12/2019 09:19	2,34	155	362,10	CHI
201912167626	LUZIANIA	LZ21161311	MARAJOARA	23/12/2019 07:00	23/12/2019 10:51	23/12/2019 07:00	23/12/2019 10:51	3,84	1	3,84	CHI
201912168609	CATALAO	CT12011250LD	CATALAO S2	23/12/2019 07:00	23/12/2019 08:46	23/12/2019 07:00	23/12/2019 08:46	1,75	4	7,01	CHI
201912168609	CUMARI	CT12011250LD	CATALAO S2	23/12/2019 07:00	23/12/2019 08:46	23/12/2019 07:00	23/12/2019 08:46	1,75	8	14,03	CHI
201912168611	NIQUELANDIA	NQ12213092	NIQUELANDIA SUBTRANSMISSAO	23/12/2019 07:00	23/12/2019 09:49	23/12/2019 07:00	23/12/2019 09:49	2,80	1	2,80	CHI
201912169235	CORREGO DO OURO	CO12169770	FIRMINOPOLIS S2	23/12/2019 07:00	23/12/2019 15:19	23/12/2019 07:00	23/12/2019 15:19	8,31	6	49,89	CHI
201912168614	PIRACANJUBA	PJ21106680	PIRACANJUBA	23/12/2019 07:01	24/12/2019 07:50	23/12/2019 07:01	24/12/2019 07:50	24,81	1	24,81	CHI
201912168616	PLANALTINA	PI11391155	PLANALTINA	23/12/2019 07:02	23/12/2019 12:57	23/12/2019 07:02	23/12/2019 12:57	5,92	9	53,32	CHI
201912168620	NOVO PLANALTO	TA12141118	NOVO PLANALTO	23/12/2019 07:02	24/12/2019 03:15	23/12/2019 07:02	24/12/2019 03:15	20,20	1	20,20	CHI
201912168620	PORANGATU	TA12141118	NOVO PLANALTO	23/12/2019 07:02	24/12/2019 03:15	23/12/2019 07:02	24/12/2019 03:15	20,20	1	20,20	CHI
201912168624	NIQUELANDIA	NQ12239307	NIQUELANDIA SUBTRANSMISSAO	23/12/2019 07:03	23/12/2019 09:15	23/12/2019 07:03	23/12/2019 09:15	2,19	297	651,26	CHI
201912168631	GOIATUBA	GT21263921	GOIATUBA S1	23/12/2019 07:04	24/12/2019 18:15	23/12/2019 07:04	24/12/2019 18:15	35,18	1	35,18	CHI
201912168632	CEZARINA	CZ21314846	CEZARINA	23/12/2019 07:04	24/12/2019 10:06	23/12/2019 07:04	24/12/2019 10:06	27,03	2	54,05	CHI
201912168730	APARECIDA DE GOIANIA	AP11054997	INDEPENDENCIA S2	23/12/2019 07:04	23/12/2019 18:10	23/12/2019 07:04	23/12/2019 18:10	11,09	193	2141,17	CHI
201912169074	PIRACANJUBA	PJ12035476	PIRACANJUBA	23/12/2019 07:04	23/12/2019 12:15	23/12/2019 07:04	23/12/2019 12:15	5,18	17	88,05	CHI
201912183430	HIDROLANDIA	HD12138931	INDEPENDENCIA S1	23/12/2019 07:04	24/12/2019 02:18	23/12/2019 07:04	24/12/2019 02:18	19,22	15	288,35	CHI
201912168644	APARECIDA DE GOIANIA	10020903160	INDEPENDENCIA S2	23/12/2019 07:05	23/12/2019 11:46	23/12/2019 07:05	23/12/2019 11:46	4,68	1	4,68	CHI
201912168650	CAMPO ALEGRE DE GOIAS	CM12358430RE	CAMPO ALEGRE DE GOIAS	23/12/2019 07:06	23/12/2019 17:37	23/12/2019 07:06	23/12/2019 17:37	10,51	11	115,58	CHI
201912168650	IPAMERI	CM12358430RE	CAMPO ALEGRE DE GOIAS	23/12/2019 07:06	23/12/2019 17:37	23/12/2019 07:06	23/12/2019 17:37	10,51	20	210,14	CHI
201912168651	CIDADE OCIDENTAL	LZ12072636	MARAJOARA	23/12/2019 07:06	23/12/2019 20:02	23/12/2019 07:06	23/12/2019 20:02	12,92	20	258,47	CHI
201912178503	GOIANESIA	PV12312048RE	CORUMBA	23/12/2019 07:07	23/12/2019 16:10	23/12/2019 07:07	23/12/2019 16:10	9,05	10	90,48	CHI
201912178503	JARAGUA	PV12312048RE	CORUMBA	23/12/2019 07:07	23/12/2019 16:10	23/12/2019 07:07	23/12/2019 16:10	9,05	4	36,19	CHI
201912178503	PIRENOPOLIS	PV12312048RE	CORUMBA	23/12/2019 07:07	23/12/2019 16:10	23/12/2019 07:07	23/12/2019 16:10	9,05	58	524,77	CHI
201912178503	VILA PROPICIO	PV12312048RE	CORUMBA	23/12/2019 07:07	23/12/2019 16:10	23/12/2019 07:07	23/12/2019 16:10	9,05	3	27,14	CHI
201912179058	CORREGO DO OURO	CO12040666	FIRMINOPOLIS S2	23/12/2019 07:07	23/12/2019 16:21	23/12/2019 07:07	23/12/2019 16:21	9,23	12	110,74	CHI
201912179058	FAZENDA NOVA	CO12040666	FIRMINOPOLIS S2	23/12/2019 07:07	23/12/2019 16:21	23/12/2019 07:07	23/12/2019 16:21	9,23	8	73,82	CHI
201912168664	VILA BOA	FA21042042	IACIARA S2	23/12/2019 07:08	23/12/2019 08:32	23/12/2019 07:08	23/12/2019 08:32	1,39	1	1,39	CHI
201912168672	TAQUARAL DE GOIAS	TQ12019064	INHUMAS S1	23/12/2019 07:09	23/12/2019 14:30	23/12/2019 07:09	23/12/2019 14:30	7,35	11	80,87	CHI



201912168676	CAMPO ALEGRE DE GOIAS	CM21294385	CAMPO ALEGRE DE GOIAS	23/12/2019 07:09	23/12/2019 10:27	23/12/2019 07:09	23/12/2019 10:27	3,29	3	9,87	CHI
201912168685	AGUA FRIA DE GOIAS	JL21270091	SAO JOAO D ALIANCA	23/12/2019 07:10	23/12/2019 12:47	23/12/2019 07:10	23/12/2019 12:47	5,61	1	5,61	CHI
201912168688	RIO VERDE	RV21191970	SANTA HELENA S1	23/12/2019 07:10	23/12/2019 14:49	23/12/2019 07:10	23/12/2019 14:49	7,64	1	7,64	CHI
201912168689	PORANGATU	TA12227060	NOVO PLANALTO	23/12/2019 07:10	24/12/2019 02:16	23/12/2019 07:10	24/12/2019 02:16	19,08	1	19,08	CHI
201912168695	CIDADE OCIDENTAL	DH21170614	MARAJOARA	23/12/2019 07:11	23/12/2019 16:02	23/12/2019 07:11	23/12/2019 15:22	8,18	2	16,36	CHI
201912168695	CIDADE OCIDENTAL	DH12170612	MARAJOARA	23/12/2019 07:11	23/12/2019 16:02	23/12/2019 13:23	23/12/2019 16:02	2,64	12	31,68	CHI
201912168699	SANTO ANTONIO DO DESCOBERTO	2210011699	AGUAS LINDAS DE GOIAS S2	23/12/2019 07:11	23/12/2019 09:48	23/12/2019 07:11	23/12/2019 09:48	2,60	1	2,60	CHI
201912168706	CAMPO ALEGRE DE GOIAS	CM12321694	CAMPO ALEGRE DE GOIAS	23/12/2019 07:12	23/12/2019 12:29	23/12/2019 07:12	23/12/2019 12:29	5,28	2	10,56	CHI
201912168791	ANAPOLIS	AN12270373	ANAPOLIS UNIVERSITARIO S2	23/12/2019 07:12	23/12/2019 10:26	23/12/2019 07:12	23/12/2019 10:26	3,23	16	51,60	CHI
201912169705	APARECIDA DE GOIANIA	AP11091370	INDEPENDENCIA S1	23/12/2019 07:12	23/12/2019 12:16	23/12/2019 07:12	23/12/2019 12:16	5,07	255	1292,64	CHI
201912168717	SAO MIGUEL DO ARAGUAIA	SM21334356	SAO MIGUEL DO ARAGUAIA	23/12/2019 07:13	23/12/2019 22:30	23/12/2019 07:13	23/12/2019 22:30	15,29	1	15,29	CHI
201912168723	CALDAS NOVAS	MR12000394RE	RIO QUENTE	23/12/2019 07:13	24/12/2019 11:50	23/12/2019 07:13	24/12/2019 11:50	28,60	36	1029,65	CHI
201912168723	PIRACANJUBA	MR12000394RE	RIO QUENTE	23/12/2019 07:13	24/12/2019 11:50	23/12/2019 07:13	24/12/2019 11:50	28,60	1	28,60	CHI
201912169510	CAMPO ALEGRE DE GOIAS	CM12127511	CAMPO ALEGRE DE GOIAS	23/12/2019 07:13	23/12/2019 19:01	23/12/2019 07:13	23/12/2019 19:01	11,79	7	82,53	CHI
201912169510	IPAMERI	CM12127511	CAMPO ALEGRE DE GOIAS	23/12/2019 07:13	23/12/2019 19:01	23/12/2019 07:13	23/12/2019 19:01	11,79	3	35,37	CHI
201912176724	ITABERAI	IX12016074	INHUMAS S1	23/12/2019 07:13	23/12/2019 14:30	23/12/2019 07:13	23/12/2019 14:30	7,28	18	131,00	CHI
201912176724	ITAUCU	IX12016074	INHUMAS S1	23/12/2019 07:13	23/12/2019 14:30	23/12/2019 07:13	23/12/2019 14:30	7,28	12	87,34	CHI
201912168727	ANAPOLIS	10029131136	JUNDIAI S2	23/12/2019 07:15	23/12/2019 11:57	23/12/2019 07:15	23/12/2019 11:57	4,70	1	4,70	CHI
201912168728	BOM JARDIM DE GOIAS	BM12365303	BOM JARDIM	23/12/2019 07:15	24/12/2019 02:30	23/12/2019 07:15	24/12/2019 02:30	19,25	1	19,25	CHI
201912169149	LEOPOLDO DE BULHOES	LB12382365	DAIA S2	23/12/2019 07:15	23/12/2019 10:18	23/12/2019 07:15	23/12/2019 10:18	3,04	17	51,67	CHI
201912168744	NOVO GAMA	4990081810	PACAEMBU S1	23/12/2019 07:16	23/12/2019 10:29	23/12/2019 07:16	23/12/2019 10:29	3,22	1	3,22	CHI
201912168747	LEOPOLDO DE BULHOES	20528565	DAIA S1	23/12/2019 07:16	23/12/2019 10:55	23/12/2019 07:16	23/12/2019 10:55	3,64	1	3,64	CHI
201912168758	LUZIANIA	LZ21209515	RIO VERMELHO	23/12/2019 07:17	23/12/2019 10:58	23/12/2019 07:17	23/12/2019 10:58	3,67	1	3,67	CHI
201912168759	SILVANIA	SV21137437	DAIA S2	23/12/2019 07:17	23/12/2019 11:17	23/12/2019 07:17	23/12/2019 11:17	3,99	1	3,99	CHI
201912170995	PORANGATU	PO12047528	PORANGATU	23/12/2019 07:18	23/12/2019 15:10	23/12/2019 07:18	23/12/2019 15:10	7,87	28	220,34	CHI
201912168773	PIRES DO RIO	PR21203223	PIRES DO RIO S1	23/12/2019 07:19	23/12/2019 09:20	23/12/2019 07:19	23/12/2019 09:20	2,03	1	2,03	CHI
201912168779	ANAPOLIS	AN11000166	JUNDIAI S2	23/12/2019 07:19	23/12/2019 08:28	23/12/2019 07:19	23/12/2019 08:28	1,14	127	144,71	CHI
201912168792	ORIZONA	OZ12000353	PIRES DO RIO S1	23/12/2019 07:20	23/12/2019 14:00	23/12/2019 07:20	23/12/2019 14:00	6,67	33	220,06	CHI
201912169720	JESUPOLIS	SR12033942	INHUMAS S1	23/12/2019 07:20	23/12/2019 13:07	23/12/2019 07:20	23/12/2019 13:07	5,78	1	5,78	CHI
201912169720	SANTA ROSA DE GOIAS	SR12033942	INHUMAS S1	23/12/2019 07:20	23/12/2019 13:07	23/12/2019 07:20	23/12/2019 13:07	5,78	9	52,04	CHI
201912168795	ABADIA DE GOIAS	10012724600	INDEPENDENCIA S2	23/12/2019 07:21	23/12/2019 12:42	23/12/2019 07:21	23/12/2019 12:42	5,35	1	5,35	CHI
201912168798	SAO MIGUEL DO ARAGUAIA	SM11393958	SAO MIGUEL DO ARAGUAIA	23/12/2019 07:21	24/12/2019 11:00	23/12/2019 07:21	24/12/2019 11:00	27,64	1	27,64	CHI
201912168837	DIORAMA	DI12168628	IPORA	23/12/2019 07:21	23/12/2019 16:48	23/12/2019 07:21	23/12/2019 16:48	9,45	11	103,94	CHI

201912168266	ADELANDIA	SC12005458	FIRMINOPOLIS S2	23/12/2019 07:22	23/12/2019 13:46	23/12/2019 07:22	23/12/2019 13:46	6,41	2	12,81	CHI
201912168808	APARECIDA DE GOIANIA	AP11291318	ANHANGUERA	23/12/2019 07:22	23/12/2019 10:57	23/12/2019 07:22	23/12/2019 10:57	3,57	5	17,87	CHI
201912174111	APARECIDA DE GOIANIA	HD12346326	INDEPENDENCIA S1	23/12/2019 07:22	23/12/2019 13:23	23/12/2019 07:22	23/12/2019 13:23	6,01	12	72,16	CHI
201912193603	EDEIA	EA12040100	EDEIA	23/12/2019 07:22	24/12/2019 17:40	23/12/2019 07:22	24/12/2019 17:40	34,29	6	205,75	CHI
201912193603	INDIARA	EA12040100	EDEIA	23/12/2019 07:22	24/12/2019 17:40	23/12/2019 07:22	24/12/2019 17:40	34,29	4	137,17	CHI
201912193603	PONTALINA	EA12040100	EDEIA	23/12/2019 07:22	24/12/2019 17:40	23/12/2019 07:22	24/12/2019 17:40	34,29	1	34,29	CHI
201912168820	INDIARA	IY12158916	CEZARINA	23/12/2019 07:23	23/12/2019 10:30	23/12/2019 07:23	23/12/2019 10:30	3,11	3	9,32	CHI
201912168821	CORUMBA DE GOIAS	CB12312066	CORUMBA	23/12/2019 07:23	23/12/2019 13:52	23/12/2019 07:23	23/12/2019 13:52	6,47	2	12,94	CHI
201912168834	SANTO ANTONIO DO DESCOBERTO	SN21255134	MARAJOARA	23/12/2019 07:24	23/12/2019 15:31	23/12/2019 07:24	23/12/2019 15:31	8,11	1	8,11	CHI
201912169040	VILA PROPICIO	GE12258500	GOIANESIA S1	23/12/2019 07:24	23/12/2019 13:40	23/12/2019 07:24	23/12/2019 13:40	6,25	5	31,27	CHI
201912169481	SAO MIGUEL DO ARAGUAIA	SM12239670	SAO MIGUEL DO ARAGUAIA	23/12/2019 07:24	23/12/2019 19:25	23/12/2019 07:24	23/12/2019 19:25	12,01	11	132,16	CHI
201912168842	CRISTALINA	KR12383065	CRISTALINA S2	23/12/2019 07:25	23/12/2019 09:02	23/12/2019 07:25	23/12/2019 09:02	1,62	3	4,85	CHI
201912168843	MAIRIPOTABA	MI12068181	PONTALINA	23/12/2019 07:25	23/12/2019 10:35	23/12/2019 07:25	23/12/2019 10:35	3,16	7	22,15	CHI
201912168846	GOIANESIA	550175659	GOIANESIA S2	23/12/2019 07:25	23/12/2019 14:33	23/12/2019 07:25	23/12/2019 14:33	7,13	1	7,13	CHI
201912168847	NOVO GAMA	NJ11348202	PACAEMBU S1	23/12/2019 07:25	23/12/2019 13:03	23/12/2019 07:25	23/12/2019 13:03	5,63	64	360,30	CHI
201912168848	BARRO ALTO	BA21345792	BARRO ALTO	23/12/2019 07:25	24/12/2019 15:00	23/12/2019 07:25	24/12/2019 15:00	31,58	1	31,58	CHI
201912168858	GOIANIA	GN11162110	GOIANIA LESTE S1	23/12/2019 07:26	23/12/2019 10:30	23/12/2019 07:26	23/12/2019 10:30	3,05	17	51,92	CHI
201912168861	FORMOSA	FA12397719	ITIQUEIRA	23/12/2019 07:26	23/12/2019 12:29	23/12/2019 07:26	23/12/2019 12:29	5,04	44	221,56	CHI
201912170889	PALMINOPOLIS	PP12259174	PALMEIRAS	23/12/2019 07:26	24/12/2019 14:55	23/12/2019 07:26	24/12/2019 13:55	30,47	11	335,16	CHI
201912170889	PALMEIRAS DE GOIAS	PP12259174	PALMEIRAS	23/12/2019 07:26	24/12/2019 14:55	23/12/2019 07:26	24/12/2019 14:22	30,92	3	92,76	CHI
201912170889	PALMINOPOLIS	PP12259174	PALMEIRAS	23/12/2019 07:26	24/12/2019 14:55	23/12/2019 07:26	24/12/2019 14:22	30,92	4	123,67	CHI
201912170889	PALMINOPOLIS	PP12259174	PALMEIRAS	23/12/2019 07:26	24/12/2019 14:55	23/12/2019 07:26	24/12/2019 14:55	31,47	7	220,28	CHI
201912170889	PALMINOPOLIS	PP12259150	PALMEIRAS	23/12/2019 07:26	24/12/2019 14:55	23/12/2019 16:50	24/12/2019 14:55	22,08	1	22,08	CHI
201912168864	ANICUNS	AC12259933	FIRMINOPOLIS S2	23/12/2019 07:27	23/12/2019 23:27	23/12/2019 07:27	23/12/2019 23:27	16,00	9	143,99	CHI
201912168871	GOIANESIA	GE12255984	GOIANESIA S2	23/12/2019 07:27	23/12/2019 14:47	23/12/2019 07:27	23/12/2019 14:47	7,32	14	102,52	CHI
201912169238	GOIAS	GS12091169	MATRINCHA	23/12/2019 07:27	24/12/2019 14:17	23/12/2019 07:27	24/12/2019 14:17	30,83	9	277,43	CHI
201912169006	APARECIDA DE GOIANIA	200062839	INDEPENDENCIA S1	23/12/2019 07:28	23/12/2019 12:22	23/12/2019 07:28	23/12/2019 12:22	4,89	1	4,89	CHI
201912170296	NIQUELANDIA	NQ12221650LD	BARRO ALTO	23/12/2019 07:28	24/12/2019 03:00	23/12/2019 07:28	24/12/2019 03:00	19,54	66	1289,53	CHI
201912170296	NIQUELANDIA	NQ12221650LD	BARRO ALTO	23/12/2019 07:28	24/12/2019 03:00	24/12/2019 00:56	24/12/2019 03:00	2,07	3	6,20	CHI
201912182612	NIQUELANDIA	NQ11243529	BARRO ALTO	23/12/2019 07:28	24/12/2019 08:46	23/12/2019 07:28	24/12/2019 08:46	25,30	125	3162,12	CHI
201912169009	LUZIANIA	LZ12084127	PIRES DO RIO S2	23/12/2019 07:29	23/12/2019 10:29	23/12/2019 07:29	23/12/2019 10:29	3,00	8	24,02	CHI
201912169012	NIQUELANDIA	NQ12391782	NIQUELANDIA SUBTRANSMISSAO	23/12/2019 07:29	24/12/2019 09:58	23/12/2019 07:29	23/12/2019 14:26	6,95	55	381,99	CHI
201912169012	NIQUELANDIA	NQ12391782	NIQUELANDIA SUBTRANSMISSAO	23/12/2019 07:29	24/12/2019 09:58	23/12/2019 07:29	24/12/2019 00:22	16,89	3	50,67	CHI

201912169012	NIQUELANDIA	NQ12391782	NIQUELANDIA SUBTRANSMISSAO	23/12/2019 07:29	24/12/2019 09:58	23/12/2019 07:29	24/12/2019 09:58	26,49	17	450,37	CHI
201912176570	NIQUELANDIA	NQ12197661	BARRO ALTO	23/12/2019 07:29	23/12/2019 16:13	23/12/2019 07:29	23/12/2019 16:13	8,72	11	95,91	CHI
201912169020	JATAI	290253585	JATAI S3	23/12/2019 07:30	23/12/2019 12:22	23/12/2019 07:30	23/12/2019 12:22	4,88	1	4,88	CHI
201912170467	MONTIVIDIU	MV12207748	MONTIVIDIU T	23/12/2019 07:30	23/12/2019 21:32	23/12/2019 07:30	23/12/2019 21:32	14,03	8	112,24	CHI
201912169027	VILA PROPICIO	NP21388601	GOIANESIA S1	23/12/2019 07:31	23/12/2019 14:14	23/12/2019 07:31	23/12/2019 14:14	6,71	1	6,71	CHI
201912169029	GUAPO	GA12130533	GUAPO S1	23/12/2019 07:31	23/12/2019 09:22	23/12/2019 07:31	23/12/2019 09:22	1,85	187	345,22	CHI
201912169030	SANTA FE DE GOIAS	RN21275851	BRITANIA	23/12/2019 07:31	23/12/2019 11:04	23/12/2019 07:31	23/12/2019 11:04	3,54	1	3,54	CHI
201912169031	GOIANESIA	GE21107725	GOIANESIA S1	23/12/2019 07:31	23/12/2019 17:01	23/12/2019 07:31	23/12/2019 17:01	9,49	1	9,49	CHI
201912169037	BRITANIA	BT21124838	BRITANIA	23/12/2019 07:31	23/12/2019 21:23	23/12/2019 07:31	23/12/2019 21:23	13,85	1	13,85	CHI
201912172816	CORUMBAIBA	CI2000093RE	VILA CORUMBA	23/12/2019 07:31	24/12/2019 15:18	23/12/2019 07:31	24/12/2019 15:18	31,77	102	3240,29	CHI
201912169045	CATALAO	CT21150927	CATALAO S1	23/12/2019 07:32	23/12/2019 13:28	23/12/2019 07:32	23/12/2019 13:28	5,94	1	5,94	CHI
201912169047	BELA VISTA DE GOIAS	BV21380299	BELA VISTA S1	23/12/2019 07:32	23/12/2019 15:20	23/12/2019 07:32	23/12/2019 15:20	7,79	2	15,58	CHI
201912169050	NOVO GAMA	4990038989	PACAEMBU S1	23/12/2019 07:33	23/12/2019 11:08	23/12/2019 07:33	23/12/2019 11:08	3,59	1	3,59	CHI
201912169053	AGUAS LINDAS DE GOIAS	10011369602	AGUAS LINDAS DE GOIAS S1	23/12/2019 07:33	23/12/2019 08:45	23/12/2019 07:33	23/12/2019 08:45	1,19	1	1,19	CHI
201912169054	BELA VISTA DE GOIAS	BV21344899	BELA VISTA S1	23/12/2019 07:33	23/12/2019 12:15	23/12/2019 07:33	23/12/2019 12:15	4,69	1	4,69	CHI
201912169056	FORMOSA	FA12394724	ITIQUEIRA	23/12/2019 07:33	23/12/2019 09:43	23/12/2019 07:33	23/12/2019 09:43	2,15	27	58,13	CHI
201912169058	APARECIDA DE GOIANIA	AP11169496	INDEPENDENCIA S2	23/12/2019 07:34	23/12/2019 10:50	23/12/2019 07:34	23/12/2019 10:50	3,27	123	401,63	CHI
201912169063	GOIANIA	GN11104955	GOIANIA LESTE S3	23/12/2019 07:34	23/12/2019 09:52	23/12/2019 09:22	23/12/2019 09:52	0,49	81	39,55	CHI
201912169064	CATALAO	CT21265616	CAMPO ALEGRE DE GOIAS	23/12/2019 07:34	23/12/2019 10:56	23/12/2019 07:34	23/12/2019 10:56	3,35	1	3,35	CHI
201912169413	EDEIA	EA12000044	EDEIA	23/12/2019 07:34	24/12/2019 16:34	23/12/2019 07:34	24/12/2019 16:34	33,00	3	98,99	CHI
201912170294	JATAI	JT11090143	JATAI S2	23/12/2019 07:34	23/12/2019 11:46	23/12/2019 10:13	23/12/2019 11:46	1,55	117	181,38	CHI
201912169073	GOIATUBA	VI21263312	VICENTINOPOLIS	23/12/2019 07:35	24/12/2019 13:59	23/12/2019 07:35	24/12/2019 13:59	30,39	1	30,39	CHI
201912169075	GOIATUBA	VI21218164	VICENTINOPOLIS	23/12/2019 07:35	24/12/2019 14:33	23/12/2019 07:35	24/12/2019 14:33	30,96	1	30,96	CHI
201912169078	GOIATUBA	VI21166509	VICENTINOPOLIS	23/12/2019 07:35	24/12/2019 14:18	23/12/2019 07:35	24/12/2019 14:18	30,71	1	30,71	CHI
201912169081	PARAUNA	PU12361895	PARAUNA	23/12/2019 07:36	23/12/2019 12:02	23/12/2019 07:36	23/12/2019 12:02	4,44	1	4,44	CHI
201912169086	VIANOPOLIS	VN21159793	VIANOPOLIS	23/12/2019 07:37	23/12/2019 12:15	23/12/2019 07:37	23/12/2019 12:15	4,64	1	4,64	CHI
201912169091	ANAPOLIS	21312229	ANAPOLIS UNIVERSITARIO S2	23/12/2019 07:37	23/12/2019 09:09	23/12/2019 07:37	23/12/2019 09:09	1,52	1	1,52	CHI
201912169097	PONTALINA	PK21283468	PONTALINA	23/12/2019 07:38	23/12/2019 14:25	23/12/2019 07:38	23/12/2019 14:25	6,78	1	6,78	CHI
201912169099	PIRES DO RIO	PR21399738	PIRES DO RIO S1	23/12/2019 07:38	23/12/2019 08:40	23/12/2019 07:38	23/12/2019 08:40	1,04	1	1,04	CHI
201912169113	ORIZONA	OZ21338989	PIRES DO RIO S1	23/12/2019 07:38	23/12/2019 14:42	23/12/2019 07:38	23/12/2019 14:42	7,06	1	7,06	CHI
201912169244	PIRENOPOLIS	PV12355148	CORUMBA	23/12/2019 07:38	23/12/2019 09:45	23/12/2019 07:38	23/12/2019 09:45	2,11	24	50,71	CHI
201912176472	ITAPIRAPUA	IU12018846	MATRINCHA	23/12/2019 07:38	23/12/2019 14:49	23/12/2019 07:38	23/12/2019 14:49	7,19	4	28,76	CHI
201912174361	PIRENOPOLIS	PV21031647	CORUMBA	23/12/2019 07:38	23/12/2019 18:45	23/12/2019 07:38	23/12/2019 18:45	11,11	1	11,11	CHI

201912169120	NOVO GAMA	NJ11183772	PACAEMBU S1	23/12/2019 07:39	23/12/2019 10:35	23/12/2019 09:23	23/12/2019 10:35	1,20	218	261,66	CHI
201912169123	JUSSARA	1290054839	JUSSARA	23/12/2019 07:39	23/12/2019 11:26	23/12/2019 07:39	23/12/2019 11:26	3,78	1	3,78	CHI
201912169126	CACHOEIRA ALTA	CA12200034	CACHOEIRA ALTA	23/12/2019 07:39	23/12/2019 15:30	23/12/2019 07:39	23/12/2019 15:30	7,84	3	23,52	CHI
201912169127	RIO VERDE	RV21000200	RIO VERDE S1	23/12/2019 07:39	23/12/2019 16:18	23/12/2019 07:39	23/12/2019 16:18	8,64	1	8,64	CHI
201912169512	CORUMBAIBA	CI12363786	VILA CORUMBA	23/12/2019 07:39	23/12/2019 10:52	23/12/2019 07:39	23/12/2019 10:52	3,20	18	57,61	CHI
201912169771	CRISTALINA	KR12228851	CRISTALINA S2	23/12/2019 07:39	23/12/2019 10:53	23/12/2019 07:39	23/12/2019 10:53	3,22	2	6,44	CHI
201912171428	APARECIDA DE GOIANIA	AP11075371	INDEPENDENCIA S1	23/12/2019 07:39	23/12/2019 23:20	23/12/2019 07:39	23/12/2019 23:20	15,67	13	203,72	CHI
201912176451	PORANGATU	PO12228609	PORANGATU	23/12/2019 07:39	23/12/2019 23:52	23/12/2019 07:39	23/12/2019 23:52	16,21	16	259,36	CHI
201912172030	CRISTALINA	KR21228854	CRISTALINA S2	23/12/2019 07:39	23/12/2019 15:47	23/12/2019 07:39	23/12/2019 15:47	8,12	1	8,12	CHI
201912169136	JARAGUA	JA21298044	JARAGUA	23/12/2019 07:40	23/12/2019 23:17	23/12/2019 07:40	23/12/2019 23:17	15,61	1	15,61	CHI
201912169144	CAVALCANTE	CJ11071301	FLORES DE GOIAS	23/12/2019 07:40	23/12/2019 11:48	23/12/2019 07:40	23/12/2019 11:48	4,12	50	206,21	CHI
201912169268	FAZENDA NOVA	FN12242284	IPORA	23/12/2019 07:40	23/12/2019 13:29	23/12/2019 07:40	23/12/2019 13:29	5,80	7	40,63	CHI
201912179013	IPAMERI	IP12319009	URUTAI	23/12/2019 07:40	23/12/2019 17:35	23/12/2019 07:40	23/12/2019 17:35	9,91	8	79,29	CHI
201912169159	SANTO ANTONIO DA BARRA	BZ12301426	ACREUNA	23/12/2019 07:41	23/12/2019 09:56	23/12/2019 07:41	23/12/2019 09:56	2,25	1	2,25	CHI
201912177917	ITABERAI	IB12000038	ITABERAI S2	23/12/2019 07:41	24/12/2019 11:55	23/12/2019 07:41	24/12/2019 11:55	28,22	34	959,56	CHI
201912164810	INACIOLANDIA	ID12306349	CACHOEIRA DOURADA	23/12/2019 07:42	23/12/2019 13:56	23/12/2019 07:42	23/12/2019 13:56	6,23	43	267,95	CHI
201912169170	GOUVELANDIA	GB21130387	QUIRINOPOLIS	23/12/2019 07:42	23/12/2019 12:41	23/12/2019 07:42	23/12/2019 12:41	4,98	1	4,98	CHI
201912169174	SANTA HELENA DE GOIAS	SH21159373	IPEGUARI	23/12/2019 07:42	23/12/2019 19:11	23/12/2019 07:42	23/12/2019 19:11	11,48	3	34,43	CHI
201912169178	POSSE	PS21256118	IACIARA S2	23/12/2019 07:42	23/12/2019 16:28	23/12/2019 07:42	23/12/2019 16:28	8,76	1	8,76	CHI
201912169179	PIRES DO RIO	PR21372789	PIRES DO RIO S1	23/12/2019 07:42	23/12/2019 14:40	23/12/2019 07:42	23/12/2019 14:40	6,95	2	13,91	CHI
201912169182	NOVO GAMA	NJ12219815	PACAEMBU S1	23/12/2019 07:43	23/12/2019 10:42	23/12/2019 07:43	23/12/2019 10:42	2,98	209	623,05	CHI
201912169185	SAO JOAO D ALIANCA	JL21381413	SAO JOAO D ALIANCA	23/12/2019 07:43	23/12/2019 10:43	23/12/2019 07:43	23/12/2019 10:43	2,99	1	2,99	CHI
201912169186	FORMOSA	FA32058447	SAO JOAO D ALIANCA	23/12/2019 07:43	23/12/2019 12:40	23/12/2019 07:43	23/12/2019 12:40	4,93	2	9,87	CHI
201912169190	TRINDADE	TR31005154	TRINDADE	23/12/2019 07:44	23/12/2019 16:15	23/12/2019 07:44	23/12/2019 16:15	8,51	1	8,51	CHI
201912169192	CATALAO	CT12287025	CATALAO S1	23/12/2019 07:44	23/12/2019 10:09	23/12/2019 07:44	23/12/2019 10:09	2,42	5	12,12	CHI
201912169197	ANAPOLIS	20020624	ANAPOLIS UNIVERSITARIO S1	23/12/2019 07:44	23/12/2019 11:08	23/12/2019 07:44	23/12/2019 11:08	3,39	1	3,39	CHI
201912167522	EDEIA	EA12263391	EDEIA	23/12/2019 07:45	23/12/2019 11:49	23/12/2019 07:45	23/12/2019 11:49	4,07	19	77,32	CHI
201912169206	PARAUNA	PU12109627	PARAUNA	23/12/2019 07:45	23/12/2019 09:20	23/12/2019 07:45	23/12/2019 09:20	1,59	23	36,50	CHI
201912169212	PARANAIGUARA	PC21100295	CACHOEIRA ALTA	23/12/2019 07:45	23/12/2019 12:53	23/12/2019 07:45	23/12/2019 12:53	5,12	1	5,12	CHI
201912169214	GOIAS	GS12071259	GOIAS	23/12/2019 07:45	23/12/2019 17:09	23/12/2019 07:45	23/12/2019 17:09	9,39	3	28,16	CHI
201912169215	NOVO PLANALTO	TA12192342	NOVO PLANALTO	23/12/2019 07:45	23/12/2019 15:58	23/12/2019 07:45	23/12/2019 15:58	8,20	1	8,20	CHI
201912169215	PORANGATU	TA12192342	NOVO PLANALTO	23/12/2019 07:45	23/12/2019 15:58	23/12/2019 07:45	23/12/2019 15:58	8,20	9	73,81	CHI
201912171519	DAVINOPOLIS	IO12266778	CATALAO S1	23/12/2019 07:45	23/12/2019 17:26	23/12/2019 07:45	23/12/2019 17:26	9,68	13	125,79	CHI

201912171519	DISTRITO FEDERAL	IO12266778	CATALAO S1	23/12/2019 07:45	23/12/2019 17:26	23/12/2019 07:45	23/12/2019 17:26	9,68	1	9,68	CHI
201912169219	SANTA CRUZ DE GOIAS	450010302	PIRES DO RIO S2	23/12/2019 07:46	23/12/2019 10:39	23/12/2019 07:46	23/12/2019 10:39	2,87	1	2,87	CHI
201912169226	FIRMINOPOLIS	FR12096990	FIRMINOPOLIS S1	23/12/2019 07:47	23/12/2019 10:43	23/12/2019 07:47	23/12/2019 10:43	2,92	6	17,55	CHI
201912169234	CRISTALINA	KR12351414	PAMPLONA	23/12/2019 07:48	23/12/2019 10:54	23/12/2019 07:48	23/12/2019 10:54	3,10	6	18,59	CHI
201912169237	CATALAO	CT21061191	CATALAO S1	23/12/2019 07:48	23/12/2019 17:48	23/12/2019 07:48	23/12/2019 17:48	10,00	1	10,00	CHI
201912169239	PIRES DO RIO	PR21000014	PIRES DO RIO S1	23/12/2019 07:48	23/12/2019 14:43	23/12/2019 07:48	23/12/2019 14:43	6,91	3	20,73	CHI
201912169241	LUZIANIA	3200141308	MARAJOARA	23/12/2019 07:48	23/12/2019 09:34	23/12/2019 07:48	23/12/2019 09:34	1,76	1	1,76	CHI
201912169245	SANTA CRUZ DE GOIAS	BC21300794	PIRES DO RIO S2	23/12/2019 07:49	23/12/2019 09:39	23/12/2019 07:49	23/12/2019 09:39	1,83	1	1,83	CHI
201912169247	JATAI	JT21205255	JATAI S1	23/12/2019 07:49	23/12/2019 12:55	23/12/2019 07:49	23/12/2019 12:55	5,09	1	5,09	CHI
201912169248	TRINDADE	10018281816	TRINDADE	23/12/2019 07:49	23/12/2019 10:34	23/12/2019 07:49	23/12/2019 10:34	2,74	1	2,74	CHI
201912169251	GOIAS	GS12299709	GOIAS	23/12/2019 07:50	23/12/2019 10:46	23/12/2019 07:50	23/12/2019 10:46	2,93	13	38,08	CHI
201912169258	PIRENOPOLIS	10020697390	CORUMBA	23/12/2019 07:50	23/12/2019 12:01	23/12/2019 07:50	23/12/2019 12:01	4,17	1	4,17	CHI
201912169259	URUACU	UR12398066	CAMPINORTE	23/12/2019 07:50	23/12/2019 10:34	23/12/2019 07:50	23/12/2019 10:34	2,72	6	16,32	CHI
201912169260	GOIAS	GS21059821	ITABERAI S1	23/12/2019 07:50	23/12/2019 12:11	23/12/2019 07:50	23/12/2019 12:11	4,34	1	4,34	CHI
201912169264	IPAMERI	UT12016932RE	URUTAI	23/12/2019 07:51	24/12/2019 09:39	23/12/2019 07:51	24/12/2019 09:39	25,80	3	77,40	CHI
201912169264	URUTAI	UT12016932RE	URUTAI	23/12/2019 07:51	24/12/2019 09:39	23/12/2019 07:51	24/12/2019 09:39	25,80	5	129,00	CHI
201912169265	PIRENOPOLIS	PV12090408	CORUMBA	23/12/2019 07:51	23/12/2019 10:31	23/12/2019 07:51	23/12/2019 10:31	2,67	3	8,00	CHI
201912169267	MINACU	IH12207740	MINACU	23/12/2019 07:51	23/12/2019 12:19	23/12/2019 07:51	23/12/2019 12:19	4,46	99	441,60	CHI
201912169274	JARAGUA	70071780	JARAGUA	23/12/2019 07:51	24/12/2019 01:06	23/12/2019 07:51	24/12/2019 01:06	17,24	1	17,24	CHI
201912169275	APORE	AE21301899	ITAJA S1	23/12/2019 07:51	23/12/2019 11:13	23/12/2019 07:51	23/12/2019 11:13	3,35	1	3,35	CHI
201912171716	ARUANA	AK12310740	ARUANA	23/12/2019 07:51	24/12/2019 08:11	23/12/2019 07:51	24/12/2019 08:11	24,34	12	292,05	CHI
201912169402	SAO LUIS DE MONTES BELOS	500070982	SAO LUIZ DOS MONTES BELOS	23/12/2019 07:52	23/12/2019 09:40	23/12/2019 07:52	23/12/2019 09:40	1,79	1	1,79	CHI
201912169407	VARJAO	VJ11008894	GUAPO S2	23/12/2019 07:52	23/12/2019 12:48	23/12/2019 07:52	23/12/2019 12:48	4,92	6	29,53	CHI
201912169418	APARECIDA DE GOIANIA	10003647518	INDEPENDENCIA S2	23/12/2019 07:53	23/12/2019 11:05	23/12/2019 07:53	23/12/2019 11:05	3,19	1	3,19	CHI
201912169419	TRINDADE	GR31045839	MEIA PONTE	23/12/2019 07:53	23/12/2019 09:45	23/12/2019 07:53	23/12/2019 09:45	1,86	1	1,86	CHI
201912169428	FAINA	FC12362368	MATRINCHA	23/12/2019 07:54	24/12/2019 02:09	23/12/2019 07:54	24/12/2019 02:09	18,25	8	145,97	CHI
201912169428	MATRINCHA	FC12362368	MATRINCHA	23/12/2019 07:54	24/12/2019 02:09	23/12/2019 07:54	24/12/2019 02:09	18,25	2	36,49	CHI
201912169431	ANAPOLIS	21251228	DAIA S1	23/12/2019 07:54	23/12/2019 14:48	23/12/2019 07:54	23/12/2019 14:48	6,90	1	6,90	CHI
201912169434	CATALAO	IP12281428	IPAMERI	23/12/2019 07:54	23/12/2019 12:25	23/12/2019 07:54	23/12/2019 12:25	4,51	4	18,03	CHI
201912169436	TURVANIA	TV21055911	ANICUNS	23/12/2019 07:54	24/12/2019 07:20	23/12/2019 07:54	24/12/2019 07:20	23,42	1	23,42	CHI
201912169439	DIORAMA	DI21374929	IPORA	23/12/2019 07:54	23/12/2019 10:36	23/12/2019 07:54	23/12/2019 10:36	2,68	1	2,68	CHI
201912169446	VILA PROPICIO	NP21298241	GOIANESIA S1	23/12/2019 07:55	23/12/2019 23:10	23/12/2019 07:55	23/12/2019 23:10	15,24	1	15,24	CHI
201912169451	GOIANIRA	10010635406	MEIA PONTE	23/12/2019 07:55	23/12/2019 10:40	23/12/2019 07:55	23/12/2019 10:40	2,74	1	2,74	CHI

201912174109	SANTA HELENA DE GOIAS	SH12296170	IPEGUARI	23/12/2019 07:55	23/12/2019 15:53	23/12/2019 07:55	23/12/2019 15:53	7,96	8	63,66	CHI
201912169459	CATALAO	CT12042326	CATALAO S1	23/12/2019 07:56	24/12/2019 13:35	23/12/2019 07:56	24/12/2019 13:35	29,64	8	237,11	CHI
201912169480	TURVANIA	TV21171945	ANICUNS	23/12/2019 07:57	23/12/2019 18:59	23/12/2019 07:57	23/12/2019 18:59	11,02	1	11,02	CHI
201912170841	PORANGATU	PO12202569	PORANGATU	23/12/2019 07:57	23/12/2019 17:20	23/12/2019 07:57	23/12/2019 17:20	9,39	7	65,72	CHI
201912169485	APARECIDA DE GOIANIA	AP11350566	INDEPENDENCIA S1	23/12/2019 07:58	23/12/2019 17:48	23/12/2019 07:58	23/12/2019 17:48	9,83	104	1022,03	CHI
201912169486	APARECIDA DE GOIANIA	10018339547	ANHANGUERA	23/12/2019 07:58	23/12/2019 10:59	23/12/2019 07:58	23/12/2019 10:59	3,01	1	3,01	CHI
201912169487	ANAPOLIS	AN11319675	ANAPOLIS UNIVERSITARIO S2	23/12/2019 07:58	23/12/2019 16:59	23/12/2019 07:58	23/12/2019 16:59	9,02	79	712,29	CHI
201912169489	CRIXAS	CX12226949	SANTA TEREZINHA	23/12/2019 07:59	23/12/2019 18:17	23/12/2019 07:59	23/12/2019 18:17	10,30	10	102,97	CHI
201912169497	CRISTALINA	1060008728	CRISTALINA S1	23/12/2019 07:59	23/12/2019 09:28	23/12/2019 07:59	23/12/2019 09:28	1,47	1	1,47	CHI
201912172534	CRIXAS	NA21229640	SANTA TEREZINHA	23/12/2019 07:59	24/12/2019 10:54	23/12/2019 07:59	24/12/2019 10:54	26,91	1	26,91	CHI
201912176781	BELA VISTA DE GOIAS	BV32066370	BELA VISTA S1	23/12/2019 07:59	23/12/2019 16:32	23/12/2019 07:59	23/12/2019 16:32	8,55	3	25,66	CHI
201912169511	EDEIA	EA12394399	EDEIA	23/12/2019 08:00	23/12/2019 13:09	23/12/2019 08:00	23/12/2019 13:09	5,14	51	261,96	CHI
201912169519	GOIANESIA	GE21194473	GOIANESIA S1	23/12/2019 08:01	23/12/2019 16:06	23/12/2019 08:01	23/12/2019 16:06	8,08	1	8,08	CHI
201912169611	JATAI	JT12196090	JATAI S2	23/12/2019 08:01	24/12/2019 11:09	23/12/2019 08:01	24/12/2019 08:20	24,32	6	145,92	CHI
201912169611	JATAI	JT12196090	JATAI S2	23/12/2019 08:01	24/12/2019 11:09	23/12/2019 08:01	24/12/2019 09:36	25,60	4	102,39	CHI
201912169611	JATAI	JT12196090	JATAI S2	23/12/2019 08:01	24/12/2019 11:09	23/12/2019 08:01	24/12/2019 11:09	27,14	2	54,28	CHI
201912170275	VICENTINOPOLIS	VI12218216	VICENTINOPOLIS	23/12/2019 08:01	23/12/2019 16:29	23/12/2019 08:01	23/12/2019 16:29	8,46	3	25,39	CHI
201912169528	SAO DOMINGOS	SD11046237	SAO DOMINGOS	23/12/2019 08:02	23/12/2019 11:15	23/12/2019 08:02	23/12/2019 11:15	3,21	282	905,77	CHI
201912169534	NOVO GAMA	4990057285	PACAEMBU S1	23/12/2019 08:02	23/12/2019 17:18	23/12/2019 08:02	23/12/2019 17:18	9,25	1	9,25	CHI
201912169535	NOVA AURORA	NE21203102	CATALAO S1	23/12/2019 08:02	23/12/2019 10:31	23/12/2019 08:02	23/12/2019 10:31	2,47	1	2,47	CHI
201912179708	MORRINHOS	MR12171712	MORRINHOS	23/12/2019 08:02	24/12/2019 14:36	23/12/2019 08:02	24/12/2019 14:36	30,57	4	122,28	CHI
201912164914	CEZARINA	CZ12308499	CEZARINA	23/12/2019 08:03	23/12/2019 11:32	23/12/2019 08:03	23/12/2019 11:32	3,47	2	6,95	CHI
201912164914	INDIARA	CZ12308499	CEZARINA	23/12/2019 08:03	23/12/2019 11:32	23/12/2019 08:03	23/12/2019 11:32	3,47	10	34,75	CHI
201912169540	GOIANIA	12343900	ATLANTICO S1	23/12/2019 08:03	23/12/2019 09:16	23/12/2019 08:03	23/12/2019 09:16	1,22	1	1,22	CHI
201912164029	PORANGATU	PO12141125	NOVO PLANALTO	23/12/2019 08:04	23/12/2019 22:53	23/12/2019 08:04	23/12/2019 22:53	14,82	13	192,69	CHI
201912169552	ORIZONA	OZ21085073	PIRES DO RIO S2	23/12/2019 08:04	23/12/2019 10:30	23/12/2019 08:04	23/12/2019 10:30	2,44	1	2,44	CHI
201912169554	MUNDO NOVO DE GOIAS	MH12189540	NOVA CRIXAS	23/12/2019 08:04	23/12/2019 14:58	23/12/2019 08:04	23/12/2019 14:58	6,89	5	34,47	CHI
201912169557	GAMELEIRA DE GOIAS	SV21284479	DAIA S2	23/12/2019 08:04	23/12/2019 17:20	23/12/2019 08:04	23/12/2019 17:20	9,26	1	9,26	CHI
201912178511	SAO LUIS DE MONTES BELOS	SL12003981	SAO LUIZ DOS MONTES BELOS	23/12/2019 08:04	23/12/2019 15:52	23/12/2019 08:04	23/12/2019 15:52	7,81	177	1381,98	CHI
201912169561	ITABERAI	50045593	ITABERAI S2	23/12/2019 08:05	24/12/2019 08:40	23/12/2019 08:05	24/12/2019 08:40	24,58	1	24,58	CHI
201912170114	CRIXAS	CX12297042	SERRA DO OURO	23/12/2019 08:05	23/12/2019 16:20	23/12/2019 08:05	23/12/2019 16:20	8,24	1	8,24	CHI
201912169575	IPORA	730005537	IPORA	23/12/2019 08:06	23/12/2019 18:27	23/12/2019 08:06	23/12/2019 18:27	10,35	1	10,35	CHI
201912169586	EDEIA	1120006640	EDEIA	23/12/2019 08:06	23/12/2019 11:00	23/12/2019 08:06	23/12/2019 11:00	2,89	1	2,89	CHI

201912169587	NIQUELANDIA	NQ12140184	SAO JOAO D ALIANCA	23/12/2019 08:06	24/12/2019 13:40	23/12/2019 08:06	24/12/2019 13:40	29,56	60	1773,47	CHI
201912176763	CACHOEIRA DE GOIAS	CG12377182	FIRMINOPOLIS S2	23/12/2019 08:06	23/12/2019 18:18	23/12/2019 08:06	23/12/2019 18:18	10,20	10	101,96	CHI
201912177522	AGUA LIMPA	MG12120778	VILA CORUMBA	23/12/2019 08:06	24/12/2019 09:43	23/12/2019 08:06	24/12/2019 09:43	25,61	16	409,72	CHI
201912177522	MARZAGAO	MG12120778	VILA CORUMBA	23/12/2019 08:06	24/12/2019 09:43	23/12/2019 08:06	24/12/2019 09:43	25,61	2	51,22	CHI
201912169595	GOIANIRA	10015019541	GOIANIRA	23/12/2019 08:07	23/12/2019 18:09	23/12/2019 08:07	23/12/2019 18:09	10,03	1	10,03	CHI
201912169601	CATALAO	1990250911	CATALAO S2	23/12/2019 08:07	24/12/2019 07:33	23/12/2019 08:07	24/12/2019 07:33	23,42	1	23,42	CHI
201912169602	DISTRITO FEDERAL	2900005020	MARAJOARA	23/12/2019 08:07	23/12/2019 10:42	23/12/2019 08:07	23/12/2019 10:42	2,57	1	2,57	CHI
201912170493	APARECIDA DE GOIANIA	AP11193732	INDEPENDENCIA S1	23/12/2019 08:07	23/12/2019 13:56	23/12/2019 08:07	23/12/2019 13:56	5,81	148	860,37	CHI
201912171615	APARECIDA DE GOIANIA	AP11072158	INDEPENDENCIA S1	23/12/2019 08:07	23/12/2019 14:44	23/12/2019 08:07	23/12/2019 14:44	6,62	229	1515,41	CHI
201912169605	ITAGUARI	IC12038617	ITABERAI S1	23/12/2019 08:08	23/12/2019 13:44	23/12/2019 08:08	23/12/2019 13:44	5,60	19	106,34	CHI
201912169605	ITAGUARU	IC12038617	ITABERAI S1	23/12/2019 08:08	23/12/2019 13:44	23/12/2019 08:08	23/12/2019 13:44	5,60	11	61,57	CHI
201912169612	APARECIDA DE GOIANIA	16670449	REAL S1	23/12/2019 08:08	23/12/2019 11:29	23/12/2019 08:08	23/12/2019 11:29	3,33	1	3,33	CHI
201912169620	BONOPOLIS	BX12103386	SAO MIGUEL DO ARAGUAIA	23/12/2019 08:09	23/12/2019 19:29	23/12/2019 08:09	23/12/2019 19:29	11,33	1	11,33	CHI
201912169621	CUMARI	CY21231345	CATALAO S2	23/12/2019 08:09	23/12/2019 11:01	23/12/2019 08:09	23/12/2019 11:01	2,85	1	2,85	CHI
201912171436	APARECIDA DE GOIANIA	AP11167661	INDEPENDENCIA S1	23/12/2019 08:09	24/12/2019 02:37	23/12/2019 08:09	24/12/2019 02:37	18,48	84	1552,34	CHI
201912169448	JATAI	JT21378188	JATAI S3	23/12/2019 08:10	23/12/2019 11:32	23/12/2019 08:10	23/12/2019 11:32	3,36	1	3,36	CHI
201912169626	PORTEIRAO	2470021437	RIO DOS BOIS	23/12/2019 08:10	24/12/2019 14:30	23/12/2019 08:10	24/12/2019 14:30	30,34	1	30,34	CHI
201912169629	ANAPOLIS	20536252	ANAPOLIS UNIVERSITARIO S2	23/12/2019 08:10	23/12/2019 12:35	23/12/2019 08:10	23/12/2019 12:35	4,41	1	4,41	CHI
201912169631	CAMPOS VERDES	3790035061	SANTA TEREZINHA	23/12/2019 08:10	23/12/2019 16:01	23/12/2019 08:10	23/12/2019 16:01	7,84	1	7,84	CHI
201912169634	BONOPOLIS	PO12103385	NOVO PLANALTO	23/12/2019 08:10	24/12/2019 14:53	23/12/2019 08:10	24/12/2019 14:53	30,70	1	30,70	CHI
201912182661	NOVA CRIXAS	NA12328070	NOVA CRIXAS	23/12/2019 08:10	23/12/2019 20:42	23/12/2019 08:10	23/12/2019 20:42	12,53	114	1428,83	CHI
201912169636	MORRINHOS	MR21196309	GOIATUBA S1	23/12/2019 08:11	24/12/2019 13:55	23/12/2019 08:11	24/12/2019 13:55	29,73	1	29,73	CHI
201912169638	GOIANIA	GN11213533	GOYA S2	23/12/2019 08:11	23/12/2019 09:46	23/12/2019 08:11	23/12/2019 09:46	1,58	81	128,16	CHI
201912169640	ITUMBIARA	10007025244	ITUMBIARA VELHA S1	23/12/2019 08:11	23/12/2019 15:45	23/12/2019 08:11	23/12/2019 15:45	7,57	1	7,57	CHI
201912169641	NOVA AURORA	NE21311815	CATALAO S1	23/12/2019 08:11	23/12/2019 16:13	23/12/2019 08:11	23/12/2019 16:13	8,03	1	8,03	CHI
201912169642	SANTA BARBARA DE GOIAS	1030017338	TRINDADE	23/12/2019 08:11	23/12/2019 10:54	23/12/2019 08:11	23/12/2019 10:54	2,71	1	2,71	CHI
201912169647	JATAI	JT12244176	JATAI S1	23/12/2019 08:11	23/12/2019 17:50	23/12/2019 08:11	23/12/2019 17:50	9,64	3	28,92	CHI
201912169649	GOIANIA	GN11000627	AEROPORTO S1	23/12/2019 08:11	23/12/2019 11:36	23/12/2019 08:11	23/12/2019 11:36	3,40	50	170,01	CHI
201912176329	ITUMBIARA	IT12305607	ITUMBIARA NOVA	23/12/2019 08:11	23/12/2019 22:15	23/12/2019 08:11	23/12/2019 22:15	14,05	13	182,70	CHI
201912169652	RIO VERDE	RV21255787	RIO VERDE S1	23/12/2019 08:12	23/12/2019 17:00	23/12/2019 08:12	23/12/2019 17:00	8,80	3	26,39	CHI
201912170806	NOVO GAMA	NJ11313729	MARAJOARA	23/12/2019 08:12	23/12/2019 11:46	23/12/2019 08:12	23/12/2019 11:46	3,57	113	402,85	CHI
201912176813	ADELANDIA	SC12003889	FIRMINOPOLIS S2	23/12/2019 08:12	23/12/2019 17:00	23/12/2019 08:12	23/12/2019 17:00	8,79	23	202,10	CHI
201912176813	MOSSAMEDES	SC12003889	FIRMINOPOLIS S2	23/12/2019 08:12	23/12/2019 17:00	23/12/2019 08:12	23/12/2019 17:00	8,79	5	43,93	CHI

201912176813	SANCLERLANDIA	SC12003889	FIRMINOPOLIS S2	23/12/2019 08:12	23/12/2019 17:00	23/12/2019 08:12	23/12/2019 17:00	8,79	17	149,38	CHI
201912179942	SAO MIGUEL DO ARAGUAIA	SM12390459	SAO MIGUEL DO ARAGUAIA	23/12/2019 08:12	24/12/2019 09:45	23/12/2019 08:12	24/12/2019 09:45	25,53	4	102,13	CHI
201912168223	NEROPOLIS	160028000	NEROPOLIS S2	23/12/2019 08:13	23/12/2019 08:51	23/12/2019 08:13	23/12/2019 08:51	0,64	1	0,64	CHI
201912169690	CAMPINORTE	MQ12094074	MARA ROSA	23/12/2019 08:13	23/12/2019 12:53	23/12/2019 08:13	23/12/2019 12:53	4,66	9	41,97	CHI
201912170201	ESTRELA DO NORTE	SE12053814	MARA ROSA	23/12/2019 08:13	23/12/2019 13:30	23/12/2019 08:13	23/12/2019 13:30	5,28	3	15,84	CHI
201912170201	SANTA TEREZA DE GOIAS	SE12053814	MARA ROSA	23/12/2019 08:13	23/12/2019 13:30	23/12/2019 08:13	23/12/2019 13:30	5,28	5	26,41	CHI
201912169677	VIANOPOLIS	510020513	VIANOPOLIS	23/12/2019 08:14	23/12/2019 10:30	23/12/2019 08:14	23/12/2019 10:30	2,27	1	2,27	CHI
201912169681	JATAI	JT21248444	JATAI S1	23/12/2019 08:14	23/12/2019 12:27	23/12/2019 08:14	23/12/2019 12:27	4,21	1	4,21	CHI
201912169683	MINEIROS	10021136813	PARQUE DAS EMAS	23/12/2019 08:14	23/12/2019 23:30	23/12/2019 08:14	23/12/2019 23:30	15,26	1	15,26	CHI
201912169684	MONTIVIDIU DO NORTE	MX12364202	PORANGATU	23/12/2019 08:14	23/12/2019 11:16	23/12/2019 08:14	23/12/2019 11:16	3,02	24	72,51	CHI
201912169685	NOVO GAMA	NJ11320212	PACAEMBU S1	23/12/2019 08:14	23/12/2019 16:30	23/12/2019 08:14	23/12/2019 16:30	8,25	6	49,52	CHI
201912169692	PORTELANDIA	PW12248465	PARQUE DAS EMAS	23/12/2019 08:15	24/12/2019 10:38	23/12/2019 08:15	24/12/2019 10:38	26,37	11	290,05	CHI
201912176761	IVOLANDIA	IV12323743	IPORA	23/12/2019 08:15	23/12/2019 20:11	23/12/2019 08:15	23/12/2019 20:11	11,92	6	71,51	CHI
201912169694	ORIZONA	OZ21133336	PIRES DO RIO S2	23/12/2019 08:16	23/12/2019 14:08	23/12/2019 08:16	23/12/2019 14:08	5,88	1	5,88	CHI
201912169706	APARECIDA DE GOIANIA	AP11291450	INDEPENDENCIA S2	23/12/2019 08:17	23/12/2019 12:14	23/12/2019 08:17	23/12/2019 12:14	3,95	328	1294,87	CHI
201912169711	SANTA TEREZINHA DE GOIAS	GG12181600	SANTA TEREZINHA	23/12/2019 08:17	23/12/2019 10:41	23/12/2019 08:17	23/12/2019 10:41	2,39	7	16,76	CHI
201912169717	CALDAS NOVAS	CN11204581	SERRA DE CALDAS	23/12/2019 08:17	23/12/2019 10:30	23/12/2019 08:17	23/12/2019 10:30	2,20	49	107,83	CHI
201912169721	GOIANIA	10006777226	MEIA PONTE	23/12/2019 08:18	23/12/2019 10:33	23/12/2019 08:18	23/12/2019 10:33	2,25	1	2,25	CHI
201912169727	IVOLANDIA	IR21156193	IPORA	23/12/2019 08:18	23/12/2019 09:58	23/12/2019 08:18	23/12/2019 09:58	1,66	1	1,66	CHI
201912169728	AVELINOPOLIS	990011823	ANICUNS	23/12/2019 08:18	24/12/2019 07:55	23/12/2019 08:18	24/12/2019 07:55	23,61	1	23,61	CHI
201912169736	GOIAS	GS21220576	GOIAS	23/12/2019 08:18	23/12/2019 15:30	23/12/2019 08:18	23/12/2019 15:30	7,19	1	7,19	CHI
201912169741	VALPARAISO DE GOIAS	10012512662	MARAJOARA	23/12/2019 08:19	23/12/2019 09:33	23/12/2019 08:19	23/12/2019 09:33	1,23	1	1,23	CHI
201912169744	PONTALINA	MI12320239	PONTALINA	23/12/2019 08:19	24/12/2019 15:00	23/12/2019 08:19	24/12/2019 15:00	30,68	5	153,38	CHI
201912169745	RIO VERDE	RV11273565	SANTA HELENA S1	23/12/2019 08:19	24/12/2019 08:45	23/12/2019 08:19	24/12/2019 08:45	24,43	1	24,43	CHI
201912169748	MUNDO NOVO DE GOIAS	MH11274641	NOVA CRIXAS	23/12/2019 08:19	23/12/2019 16:04	23/12/2019 08:19	23/12/2019 16:04	7,75	1	7,75	CHI
201912169755	APARECIDA DE GOIANIA	200453361	INDEPENDENCIA S2	23/12/2019 08:19	23/12/2019 10:39	23/12/2019 08:19	23/12/2019 10:39	2,32	1	2,32	CHI
201912176765	APARECIDA DE GOIANIA	AP11128088	INDEPENDENCIA S1	23/12/2019 08:19	23/12/2019 15:31	23/12/2019 08:19	23/12/2019 15:31	7,19	167	1200,59	CHI
201912169759	AGUAS LINDAS DE GOIAS	10006475653	AGUAS LINDAS DE GOIAS S1	23/12/2019 08:20	23/12/2019 10:07	23/12/2019 08:20	23/12/2019 10:07	1,78	1	1,78	CHI
201912169760	IVOLANDIA	IV21231255	ARENOPOLIS	23/12/2019 08:20	23/12/2019 12:10	23/12/2019 08:20	23/12/2019 12:10	3,83	1	3,83	CHI
201912169762	LUZIANIA	LZ12330594	CRISTALINA S2	23/12/2019 08:20	23/12/2019 20:37	23/12/2019 08:20	23/12/2019 20:37	12,28	15	184,15	CHI
201912169767	PORANGATU	PO21136943	NOVO PLANALTO	23/12/2019 08:21	24/12/2019 11:02	23/12/2019 08:21	24/12/2019 11:02	26,68	1	26,68	CHI
201912170132	PALMEIRAS DE GOIAS	PL12109625	PALMEIRAS	23/12/2019 08:21	23/12/2019 19:14	23/12/2019 08:21	23/12/2019 19:14	10,88	31	337,15	CHI
201912170849	RIO VERDE	RV12296153	SANTA HELENA S1	23/12/2019 08:22	23/12/2019 11:50	23/12/2019 08:22	23/12/2019 11:50	3,46	20	69,20	CHI



201912171702	PIRACANJUBA	PJ12263257	CALDAS NOVAS S1	23/12/2019 08:22	23/12/2019 22:16	23/12/2019 08:22	23/12/2019 22:16	13,88	8	111,08	CHI
201912167513	CACHOEIRA ALTA	RV12051482	CACHOEIRA ALTA	23/12/2019 08:23	23/12/2019 17:20	23/12/2019 08:23	23/12/2019 17:20	8,95	4	35,79	CHI
201912167513	RIO VERDE	RV12051482	CACHOEIRA ALTA	23/12/2019 08:23	23/12/2019 17:20	23/12/2019 08:23	23/12/2019 17:20	8,95	4	35,79	CHI
201912169902	PROFESSOR JAMIL SAFADY	JS21384505	ROCHEDO	23/12/2019 08:23	23/12/2019 16:46	23/12/2019 08:23	23/12/2019 16:46	8,38	2	16,76	CHI
201912169657	GOIANIA	GN12044666	AEROPORTO S3	23/12/2019 08:24	23/12/2019 11:00	23/12/2019 08:24	23/12/2019 11:00	2,59	136	352,88	CHI
201912170101	CAMPINORTE	MQ12051960	MARA ROSA	23/12/2019 08:24	23/12/2019 14:42	23/12/2019 08:24	23/12/2019 14:42	6,30	2	12,60	CHI
201912170130	JARAGUA	JA12273193	JARAGUA	23/12/2019 08:24	23/12/2019 15:29	23/12/2019 08:24	23/12/2019 15:29	7,07	2	14,14	CHI
201912170136	POSSE	1480017738	IACIARA S2	23/12/2019 08:25	23/12/2019 10:00	23/12/2019 08:25	23/12/2019 10:00	1,58	1	1,58	CHI
201912170203	SAO LUIS DE MONTES BELOS	SL21222084	SAO LUIZ DOS MONTES BELOS	23/12/2019 08:25	23/12/2019 11:22	23/12/2019 08:25	23/12/2019 11:22	2,93	1	2,93	CHI
201912184526	MINEIROS	MY12114018	PARQUE DAS EMAS	23/12/2019 08:25	24/12/2019 10:42	23/12/2019 08:25	24/12/2019 10:42	26,28	47	1235,25	CHI
201912170206	URUTAI	UT12027071	URUTAI	23/12/2019 08:26	23/12/2019 11:00	23/12/2019 08:26	23/12/2019 11:00	2,58	3	7,74	CHI
201912170216	SANTO ANTONIO DA BARRA	BZ12295790	ACREUNA	23/12/2019 08:26	23/12/2019 12:05	23/12/2019 08:26	23/12/2019 12:05	3,63	6	21,81	CHI
201912179310	ARAGUAPAZ	AZ12198622	GOIAS	23/12/2019 08:26	23/12/2019 22:37	23/12/2019 08:26	23/12/2019 22:37	14,17	15	212,53	CHI
201912179310	FAINA	AZ12198622	GOIAS	23/12/2019 08:26	23/12/2019 22:37	23/12/2019 08:26	23/12/2019 22:37	14,17	1	14,17	CHI
201912170222	PORANGATU	PO21104339	PORANGATU	23/12/2019 08:27	24/12/2019 01:20	23/12/2019 08:27	24/12/2019 01:20	16,88	1	16,88	CHI
201912170232	SANCLERLANDIA	SC21163998	FIRMINOPOLIS S2	23/12/2019 08:27	23/12/2019 11:38	23/12/2019 08:27	23/12/2019 11:38	3,17	1	3,17	CHI
201912170233	ITABERAI	50020845	ITABERAI S2	23/12/2019 08:27	24/12/2019 12:45	23/12/2019 08:27	24/12/2019 12:45	28,29	1	28,29	CHI
201912170241	ANAPOLIS	AN12390630	DAIA S1	23/12/2019 08:28	23/12/2019 10:52	23/12/2019 08:28	23/12/2019 10:52	2,40	3	7,20	CHI
201912172411	VILA PROPICIO	NP12298239	GOIANESIA S1	23/12/2019 08:28	23/12/2019 13:48	23/12/2019 08:28	23/12/2019 13:48	5,32	6	31,92	CHI
201912179944	APARECIDA DE GOIANIA	AP11160858	INDEPENDENCIA S1	23/12/2019 08:28	24/12/2019 12:59	23/12/2019 08:28	24/12/2019 12:59	28,51	73	2081,09	CHI
201912170269	LUZIANIA	120366824	RIO VERMELHO	23/12/2019 08:29	23/12/2019 10:43	23/12/2019 08:29	23/12/2019 10:43	2,24	1	2,24	CHI
201912170289	CRISTALINA	KR12217277	CRISTALINA S1	23/12/2019 08:30	23/12/2019 12:47	23/12/2019 08:30	23/12/2019 12:47	4,28	13	55,63	CHI
201912170293	PALMEIRAS DE GOIAS	PL21341642	PALMEIRAS	23/12/2019 08:30	23/12/2019 11:38	23/12/2019 08:30	23/12/2019 11:38	3,12	1	3,12	CHI
201912170300	URUTAI	UT21311636	PIRES DO RIO S2	23/12/2019 08:31	23/12/2019 16:54	23/12/2019 08:31	23/12/2019 16:54	8,39	1	8,39	CHI
201912170302	JUSSARA	JR12222898	BRITANIA	23/12/2019 08:31	23/12/2019 13:37	23/12/2019 08:31	23/12/2019 13:37	5,10	2	10,19	CHI
201912170303	PLANALTINA	PI12375541	PLANALTINA	23/12/2019 08:31	23/12/2019 12:00	23/12/2019 08:31	23/12/2019 12:00	3,48	177	615,71	CHI
201912170307	INHUMAS	10004338365	INHUMAS S2	23/12/2019 08:31	23/12/2019 10:03	23/12/2019 08:31	23/12/2019 10:03	1,52	1	1,52	CHI
201912170308	INDIARA	2710019389	EDEIA	23/12/2019 08:31	23/12/2019 12:01	23/12/2019 08:31	23/12/2019 12:01	3,50	1	3,50	CHI
201912170312	MONTES CLAROS DE GOIAS	ME21039143	IPORA	23/12/2019 08:31	24/12/2019 21:29	23/12/2019 08:31	24/12/2019 21:29	36,95	1	36,95	CHI
201912179001	PIRES DO RIO	PR12051686	PIRES DO RIO S2	23/12/2019 08:31	23/12/2019 10:11	23/12/2019 08:31	23/12/2019 10:11	1,66	1	1,66	CHI
201912179001	SANTA CRUZ DE GOIAS	PR12051686	PIRES DO RIO S2	23/12/2019 08:31	23/12/2019 10:11	23/12/2019 08:31	23/12/2019 10:11	1,66	20	33,13	CHI
201912170407	GAMELEIRA DE GOIAS	SV21166972	DAIA S2	23/12/2019 08:33	23/12/2019 16:32	23/12/2019 08:33	23/12/2019 16:32	7,98	1	7,98	CHI
201912170408	MINEIROS	PW12296306	PARQUE DAS EMAS	23/12/2019 08:33	24/12/2019 21:25	23/12/2019 08:33	24/12/2019 21:25	36,87	27	995,38	CHI

201912170408	PORTELANDIA	PW12296306	PARQUE DAS EMAS	23/12/2019 08:33	24/12/2019 21:25	23/12/2019 08:33	24/12/2019 21:25	36,87	8	294,93	CHI
201912170412	SANTO ANTONIO DO DESCOBERTO	10005822350	ALEXANIA	23/12/2019 08:33	23/12/2019 11:10	23/12/2019 08:33	23/12/2019 11:10	2,61	1	2,61	CHI
201912170415	ITABERAÍ	IB12206921	ITABERAÍ S2	23/12/2019 08:33	24/12/2019 10:03	23/12/2019 08:33	24/12/2019 10:03	25,49	4	101,97	CHI
201912170416	CACHOEIRA ALTA	CA12301755	CACHOEIRA ALTA	23/12/2019 08:33	23/12/2019 16:29	23/12/2019 08:33	23/12/2019 16:29	7,92	14	110,91	CHI
201912170422	BOM JESUS DE GOIAS	BJ12000207	CACHOEIRA DOURADA	23/12/2019 08:33	24/12/2019 00:38	23/12/2019 08:33	24/12/2019 00:38	16,07	4	64,27	CHI
201912170422	GOIATUBA	BJ12000207	CACHOEIRA DOURADA	23/12/2019 08:33	24/12/2019 00:38	23/12/2019 08:33	24/12/2019 00:38	16,07	1	16,07	CHI
201912170422	PANAMA	BJ12000207	CACHOEIRA DOURADA	23/12/2019 08:33	24/12/2019 00:38	23/12/2019 08:33	24/12/2019 00:38	16,07	2	32,14	CHI
201912170423	CAMPOS BELOS	MA12163486	SAO DOMINGOS	23/12/2019 08:33	23/12/2019 11:50	23/12/2019 08:33	23/12/2019 11:50	3,27	3	9,81	CHI
201912170423	MONTE ALEGRE DE GOIAS	MA12163486	SAO DOMINGOS	23/12/2019 08:33	23/12/2019 11:50	23/12/2019 08:33	23/12/2019 11:50	3,27	17	55,57	CHI
201912171301	CORREGO DO OURO	CO12206021	FIRMINOPOLIS S2	23/12/2019 08:33	23/12/2019 12:10	23/12/2019 08:33	23/12/2019 12:10	3,60	36	129,73	CHI
201912179821	ITAJA	IJ21161295	ITAJA S2	23/12/2019 08:33	24/12/2019 16:04	23/12/2019 08:33	24/12/2019 16:04	31,50	1	31,50	CHI
201912170430	GOIAS	GS12064395	ITABERAÍ S1	23/12/2019 08:34	23/12/2019 11:47	23/12/2019 08:34	23/12/2019 11:47	3,21	2	6,42	CHI
201912170433	MONTES CLAROS DE GOIAS	ME12203472	IPORA	23/12/2019 08:34	23/12/2019 14:15	23/12/2019 08:34	23/12/2019 14:15	5,69	5	28,46	CHI
201912152841	GOIAS	NB12064413LD	MATRINCHA	23/12/2019 08:35	23/12/2019 12:20	23/12/2019 08:35	23/12/2019 12:20	3,74	1	3,74	CHI
201912152841	NOVO BRASIL	NB12064413LD	MATRINCHA	23/12/2019 08:35	23/12/2019 12:20	23/12/2019 08:35	23/12/2019 12:20	3,74	30	112,35	CHI
201912170443	SAO LUIS DE MONTES BELOS	SL21283962	FIRMINOPOLIS S2	23/12/2019 08:35	23/12/2019 12:00	23/12/2019 08:35	23/12/2019 12:00	3,42	1	3,42	CHI
201912170447	PIRENOPOLIS	PV21000624	SAO FRANCISCO DE GOIAS	23/12/2019 08:35	23/12/2019 14:31	23/12/2019 08:35	23/12/2019 14:31	5,92	1	5,92	CHI
201912170453	VALPARAISO DE GOIAS	2860216048	PACAEMBU S1	23/12/2019 08:35	23/12/2019 12:05	23/12/2019 08:35	23/12/2019 12:05	3,49	1	3,49	CHI
201912170504	FORMOSA	FA12042076	ITIQUEIRA	23/12/2019 08:35	23/12/2019 11:22	23/12/2019 08:35	23/12/2019 11:22	2,78	4	11,12	CHI
201912170454	JARAGUA	70059469	JARAGUA	23/12/2019 08:36	23/12/2019 20:40	23/12/2019 08:36	23/12/2019 20:40	12,07	1	12,07	CHI
201912170464	ITUMBIARA	IT12304205	PARANAIBA	23/12/2019 08:36	24/12/2019 14:10	23/12/2019 08:36	24/12/2019 14:10	29,56	10	295,64	CHI
201912175137	ITARUMA	IM12340999	CACHOEIRA ALTA	23/12/2019 08:36	23/12/2019 20:34	23/12/2019 08:36	23/12/2019 20:34	11,96	8	95,71	CHI
201912170466	CHAPADAO DO CEU	DJ11374205	CHAPADAO DO CEU	23/12/2019 08:37	23/12/2019 10:13	23/12/2019 08:37	23/12/2019 10:13	1,60	24	38,37	CHI
201912170469	GOIANDIRA	GD21157526	CATALAO S1	23/12/2019 08:37	23/12/2019 12:33	23/12/2019 08:37	23/12/2019 12:33	3,93	1	3,93	CHI
201912170471	SAO LUIS DE MONTES BELOS	500042135	SAO LUIZ DOS MONTES BELOS	23/12/2019 08:37	23/12/2019 10:25	23/12/2019 08:37	23/12/2019 10:25	1,79	1	1,79	CHI
201912170498	GOIANDIRA	GD21000010	CATALAO S1	23/12/2019 08:38	23/12/2019 14:20	23/12/2019 08:38	23/12/2019 14:20	5,69	1	5,69	CHI
201912176609	QUIRINOPOLIS	RV12301218	SANTA HELENA S1	23/12/2019 08:38	23/12/2019 19:15	23/12/2019 08:38	23/12/2019 19:15	10,62	37	393,12	CHI
201912176609	RIO VERDE	RV12301218	SANTA HELENA S1	23/12/2019 08:38	23/12/2019 19:15	23/12/2019 08:38	23/12/2019 19:15	10,62	18	191,25	CHI
201912177013	ITAJA	IJ21138064	ITAJA S2	23/12/2019 08:38	23/12/2019 17:39	23/12/2019 08:38	23/12/2019 17:39	9,01	1	9,01	CHI
201912170506	ITAPACI	NG21089699	ITAPACI	23/12/2019 08:39	23/12/2019 19:02	23/12/2019 08:39	23/12/2019 19:02	10,38	1	10,38	CHI
201912170509	CALDAS NOVAS	760301025	CALDAS NOVAS S2	23/12/2019 08:39	23/12/2019 17:06	23/12/2019 08:39	23/12/2019 17:06	8,44	1	8,44	CHI
201912170512	PANAMA	PX21134536	ITUMBIARA NOVA	23/12/2019 08:39	24/12/2019 09:37	23/12/2019 08:39	24/12/2019 09:37	24,96	2	49,92	CHI
201912170515	CACHOEIRA DE GOIAS	CG21321286	FIRMINOPOLIS S2	23/12/2019 08:39	23/12/2019 21:01	23/12/2019 08:39	23/12/2019 21:01	12,36	1	12,36	CHI

201912170520	VIANOPOLIS	VN12282490	PIRES DO RIO S2	23/12/2019 08:39	23/12/2019 13:51	23/12/2019 08:39	23/12/2019 13:51	5,19	2	10,37	CHI
201912170701	ORIZONA	OZ21186674	PIRES DO RIO S2	23/12/2019 08:40	23/12/2019 14:18	23/12/2019 08:40	23/12/2019 14:18	5,63	1	5,63	CHI
201912170809	AURILANDIA	AI12026583	SAO LUIZ DOS MONTES BELOS	23/12/2019 08:41	24/12/2019 00:25	23/12/2019 08:41	24/12/2019 00:25	15,73	2	31,45	CHI
201912170811	AGUAS LINDAS DE GOIAS	4830395607	AGUAS LINDAS DE GOIAS S1	23/12/2019 08:41	23/12/2019 12:29	23/12/2019 08:41	23/12/2019 12:29	3,79	1	3,79	CHI
201912170814	PARANAIGUARA	QI12054841	QUIRINOPOLIS	23/12/2019 08:41	23/12/2019 19:00	23/12/2019 08:41	23/12/2019 19:00	10,30	2	20,60	CHI
201912170814	QUIRINOPOLIS	QI12054841	QUIRINOPOLIS	23/12/2019 08:41	23/12/2019 19:00	23/12/2019 08:41	23/12/2019 19:00	10,30	17	175,14	CHI
201912170815	CATALAO	CT12266142RE	CATALAO S1	23/12/2019 08:41	24/12/2019 07:57	23/12/2019 08:41	24/12/2019 07:57	23,25	108	2511,21	CHI
201912170815	GOIANDIRA	CT12266142RE	CATALAO S1	23/12/2019 08:41	24/12/2019 07:57	23/12/2019 08:41	24/12/2019 07:57	23,25	43	999,83	CHI
201912170820	SAO MIGUEL DO ARAGUAIA	SM21262630	SAO MIGUEL DO ARAGUAIA	23/12/2019 08:42	24/12/2019 12:32	23/12/2019 08:42	24/12/2019 12:32	27,83	1	27,83	CHI
201912170825	CATALAO	CT12077408	CATALAO S1	23/12/2019 08:42	23/12/2019 12:20	23/12/2019 08:42	23/12/2019 12:20	3,62	7	25,35	CHI
201912170870	NOVO GAMA	LZ12149912	PACAEMBU S1	23/12/2019 08:43	23/12/2019 13:01	23/12/2019 08:43	23/12/2019 13:01	4,29	23	98,66	CHI
201912176900	INHUMAS	IN12034119	INHUMAS S2	23/12/2019 08:43	23/12/2019 16:00	23/12/2019 08:43	23/12/2019 16:00	7,27	7	50,92	CHI
201912170852	ACREUNA	EU12214051	ACREUNA	23/12/2019 08:44	24/12/2019 11:47	23/12/2019 08:44	24/12/2019 11:47	27,06	1	27,06	CHI
201912170858	FIRMINOPOLIS	FR12079711	FIRMINOPOLIS S1	23/12/2019 08:44	24/12/2019 07:02	23/12/2019 08:44	24/12/2019 07:02	22,29	1	22,29	CHI
201912170859	NIQUELANDIA	NQ12243473	BARRO ALTO	23/12/2019 08:44	23/12/2019 20:27	23/12/2019 08:44	23/12/2019 20:27	11,70	3	35,11	CHI
201912170879	PIRES DO RIO	PR12051693	PIRES DO RIO S2	23/12/2019 08:45	23/12/2019 14:15	23/12/2019 08:45	23/12/2019 14:15	5,50	12	66,05	CHI
201912170879	SANTA CRUZ DE GOIAS	PR12051693	PIRES DO RIO S2	23/12/2019 08:45	23/12/2019 14:15	23/12/2019 08:45	23/12/2019 14:15	5,50	2	11,01	CHI
201912176675	ESTRELA DO NORTE	ET12036513	MARA ROSA	23/12/2019 08:45	23/12/2019 15:32	23/12/2019 08:45	23/12/2019 15:32	6,78	3	20,33	CHI
201912176675	FORMOSO	ET12036513	MARA ROSA	23/12/2019 08:45	23/12/2019 15:32	23/12/2019 08:45	23/12/2019 15:32	6,78	1	6,78	CHI
201912176675	MARA ROSA	ET12036513	MARA ROSA	23/12/2019 08:45	23/12/2019 15:32	23/12/2019 08:45	23/12/2019 15:32	6,78	6	40,66	CHI
201912170882	APARECIDA DE GOIANIA	AP11401615	INDEPENDENCIA S1	23/12/2019 08:46	23/12/2019 17:46	23/12/2019 08:46	23/12/2019 17:46	9,01	112	1009,28	CHI
201912170886	APARECIDA DE GOIANIA	200463147	INDEPENDENCIA S2	23/12/2019 08:46	23/12/2019 13:03	23/12/2019 08:46	23/12/2019 13:03	4,28	1	4,28	CHI
201912170888	BRAZABRANTES	1110001311	INHUMAS S2	23/12/2019 08:46	23/12/2019 17:37	23/12/2019 08:46	23/12/2019 17:37	8,84	1	8,84	CHI
201912170890	GOIANESIA	GE21017485	GOIANESIA S1	23/12/2019 08:46	24/12/2019 00:01	23/12/2019 08:46	24/12/2019 00:01	15,24	1	15,24	CHI
201912170897	COCALZINHO DE GOIAS	CB12090420	COCALZINHO	23/12/2019 08:47	23/12/2019 14:02	23/12/2019 08:47	23/12/2019 14:02	5,23	14	73,27	CHI
201912170899	CACHOEIRA DE GOIAS	CG21158955	FIRMINOPOLIS S2	23/12/2019 08:48	23/12/2019 22:52	23/12/2019 08:48	23/12/2019 22:52	14,07	1	14,07	CHI
201912170900	GOIANIA	10730023	ATLANTICO S3	23/12/2019 08:48	23/12/2019 16:25	23/12/2019 08:48	23/12/2019 16:25	7,62	1	7,62	CHI
201912170908	AGUAS LINDAS DE GOIAS	4830012755	AGUAS LINDAS DE GOIAS S1	23/12/2019 08:48	23/12/2019 13:57	23/12/2019 08:48	23/12/2019 13:57	5,14	1	5,14	CHI
201912170909	CACHOEIRA ALTA	CA21315237	CACHOEIRA ALTA	23/12/2019 08:48	23/12/2019 11:09	23/12/2019 08:48	23/12/2019 11:09	2,34	1	2,34	CHI
201912170913	ITUMBIARA	IT21304266	CACHOEIRA DOURADA	23/12/2019 08:48	24/12/2019 11:15	23/12/2019 08:48	24/12/2019 11:15	26,44	1	26,44	CHI
201912170920	LUZIANIA	7618850	VIANOPOLIS	23/12/2019 08:48	23/12/2019 13:41	23/12/2019 08:48	23/12/2019 13:41	4,87	1	4,87	CHI
201912170926	TURVANIA	TV21215339	FIRMINOPOLIS S2	23/12/2019 08:49	23/12/2019 16:09	23/12/2019 08:49	23/12/2019 16:09	7,33	2	14,65	CHI
201912170927	GOIANIA	14180741	ATLANTICO S2	23/12/2019 08:49	23/12/2019 21:12	23/12/2019 08:49	23/12/2019 21:12	12,37	1	12,37	CHI

201912170929	HIDROLANDIA	HD21193786	CEPAIGO S2	23/12/2019 08:49	24/12/2019 15:20	23/12/2019 08:49	24/12/2019 15:20	30,51	2	61,01	CHI
201912170933	APARECIDA DE GOIANIA	200427623	INDEPENDENCIA S2	23/12/2019 08:50	23/12/2019 11:50	23/12/2019 08:50	23/12/2019 11:50	3,00	1	3,00	CHI
201912170937	INHUMAS	IN21098354	INHUMAS S2	23/12/2019 08:50	23/12/2019 18:30	23/12/2019 08:50	23/12/2019 18:30	9,66	1	9,66	CHI
201912170942	AGUA LIMPA	AL12000263RE	VILA CORUMBA	23/12/2019 08:50	23/12/2019 18:47	23/12/2019 08:50	23/12/2019 18:47	9,94	11	109,33	CHI
201912170951	MAURILANDIA	DM21279838	RIO DOS BOIS	23/12/2019 08:51	24/12/2019 08:40	23/12/2019 08:51	24/12/2019 08:40	23,82	1	23,82	CHI
201912170954	PALESTINA DE GOIAS	PY12268539	PALESTINA	23/12/2019 08:51	23/12/2019 14:07	23/12/2019 08:51	23/12/2019 14:07	5,27	5	26,34	CHI
201912170962	ALEXANIA	AX12319443	ALEXANIA	23/12/2019 08:51	23/12/2019 15:54	23/12/2019 08:51	23/12/2019 15:54	7,04	2	14,08	CHI
201912170965	NOVO GAMA	LZ11013938	PACAEMBU S1	23/12/2019 08:51	23/12/2019 13:28	23/12/2019 08:51	23/12/2019 13:28	4,60	12	55,25	CHI
201912170975	APARECIDA DE GOIANIA	200308002	ANHANGUERA	23/12/2019 08:52	24/12/2019 10:15	23/12/2019 08:52	24/12/2019 10:15	25,39	1	25,39	CHI
201912172026	APARECIDA DE GOIANIA	AP11160670	INDEPENDENCIA S1	23/12/2019 08:52	23/12/2019 16:59	23/12/2019 08:52	23/12/2019 16:59	8,12	105	852,34	CHI
201912170983	RIO VERDE	RV21123255	CABRIUVA S1	23/12/2019 08:53	23/12/2019 12:40	23/12/2019 08:53	23/12/2019 12:40	3,79	1	3,79	CHI
201912170988	ITABERAI	50070253	ITABERAI S2	23/12/2019 08:53	23/12/2019 15:47	23/12/2019 08:53	23/12/2019 15:47	6,88	1	6,88	CHI
201912170992	CATALAO	CT12333401	CATALAO S1	23/12/2019 08:54	23/12/2019 17:48	23/12/2019 08:54	23/12/2019 17:48	8,90	6	53,37	CHI
201912170994	GOIANIA	11390451	ATLANTICO S1	23/12/2019 08:54	23/12/2019 11:00	23/12/2019 08:54	23/12/2019 11:00	2,09	1	2,09	CHI
201912170996	SANTO ANTONIO DO DESCOBERTO	10022854795	AGUAS LINDAS DE GOIAS S2	23/12/2019 08:54	23/12/2019 12:18	23/12/2019 08:54	23/12/2019 12:18	3,39	1	3,39	CHI
201912171105	FAZENDA NOVA	FN11371912	IPORA	23/12/2019 08:55	23/12/2019 13:53	23/12/2019 08:55	23/12/2019 13:53	4,97	1	4,97	CHI
201912171106	CORUMBA DE GOIAS	AX12061914	CORUMBA	23/12/2019 08:55	23/12/2019 15:03	23/12/2019 08:55	23/12/2019 15:03	6,13	2	12,26	CHI
201912171108	AGUA LIMPA	AL12292925	VILA CORUMBA	23/12/2019 08:55	24/12/2019 10:14	23/12/2019 08:55	24/12/2019 10:14	25,32	5	126,58	CHI
201912171111	GOIANIA	16847842	GOYA S1	23/12/2019 08:55	23/12/2019 11:36	23/12/2019 08:55	23/12/2019 11:36	2,67	1	2,67	CHI
201912171113	ORIZONA	OZ21207530	VIANOPOLIS	23/12/2019 08:55	23/12/2019 14:11	23/12/2019 08:55	23/12/2019 14:11	5,26	1	5,26	CHI
201912171115	CATALAO	CT21104190	CATALAO S1	23/12/2019 08:55	23/12/2019 22:32	23/12/2019 08:55	23/12/2019 22:32	13,60	1	13,60	CHI
201912172825	JARAGUA	JA12297944	JARAGUA	23/12/2019 08:56	23/12/2019 13:48	23/12/2019 08:56	23/12/2019 13:48	4,86	11	53,51	CHI
201912176676	GOIANESIA	GE11185433	GOIANESIA S2	23/12/2019 08:56	23/12/2019 23:32	23/12/2019 08:56	23/12/2019 23:32	14,61	131	1913,87	CHI
201912171422	SAO JOAO D ALIANCA	6917878	SAO JOAO D ALIANCA	23/12/2019 08:57	23/12/2019 23:21	23/12/2019 08:57	23/12/2019 23:21	14,40	6	86,41	CHI
201912171422	SAO JOAO D ALIANCA	6917878	SAO JOAO D ALIANCA	23/12/2019 08:57	23/12/2019 23:21	23/12/2019 17:34	23/12/2019 23:21	5,79	85	491,75	CHI
201912171423	AGUAS LINDAS DE GOIAS	4830110066	AGUAS LINDAS DE GOIAS S1	23/12/2019 08:57	23/12/2019 11:30	23/12/2019 08:57	23/12/2019 11:30	2,55	1	2,55	CHI
201912171435	MORRINHOS	150120849	MORRINHOS	23/12/2019 08:57	25/12/2019 12:28	23/12/2019 08:57	25/12/2019 12:28	51,50	1	51,50	CHI
201912171504	ITABERAI	50094476	ITABERAI S2	23/12/2019 08:58	24/12/2019 08:23	23/12/2019 08:58	24/12/2019 08:23	23,42	1	23,42	CHI
201912171505	CATALAO	CM12063945	CAMPO ALEGRE DE GOIAS	23/12/2019 08:58	23/12/2019 14:36	23/12/2019 08:58	23/12/2019 14:36	5,63	2	11,26	CHI
201912171508	ITAJA	IJ12200688	ITAJA S2	23/12/2019 08:58	23/12/2019 16:25	23/12/2019 08:58	23/12/2019 16:25	7,45	1	7,45	CHI
201912171517	CATALAO	CT12287098	CAMPO ALEGRE DE GOIAS	23/12/2019 08:58	23/12/2019 17:00	23/12/2019 08:58	23/12/2019 17:00	8,02	22	176,49	CHI
201912173225	CAMPINACU	UC12318150	MARA ROSA	23/12/2019 08:59	24/12/2019 13:19	23/12/2019 08:59	24/12/2019 13:19	28,32	17	481,41	CHI
201912171701	CRIXAS	CX21291134	SANTA TEREZINHA	23/12/2019 09:00	24/12/2019 08:48	23/12/2019 09:00	24/12/2019 08:48	23,80	1	23,80	CHI

201912176695	BOM JARDIM DE GOIAS	BM12065606	BOM JARDIM	23/12/2019 09:00	23/12/2019 17:28	23/12/2019 09:00	23/12/2019 17:28	8,46	13	109,99	CHI
201912171708	URUACU	640008446	URUACU	23/12/2019 09:01	23/12/2019 14:28	23/12/2019 09:01	23/12/2019 14:28	5,45	1	5,45	CHI
201912171712	SERRANOPOLIS	DJ21365094	CHAPADAO DO CEU	23/12/2019 09:01	24/12/2019 11:27	23/12/2019 09:01	24/12/2019 11:27	26,43	1	26,43	CHI
201912171801	GOIAS	GS12027672	MATRINCHA	23/12/2019 09:01	24/12/2019 10:26	23/12/2019 09:01	24/12/2019 10:26	25,41	1	25,41	CHI
201912171812	DAVINOPOLIS	IO21195422	CATALAO S1	23/12/2019 09:02	24/12/2019 13:03	23/12/2019 09:02	24/12/2019 13:03	28,00	1	28,00	CHI
201912171813	GOIANIA	11093870	GOIANIA LESTE S2	23/12/2019 09:02	23/12/2019 12:24	23/12/2019 09:02	23/12/2019 12:24	3,35	1	3,35	CHI
201912172812	ITAPIRAPUA	IU12020125	MATRINCHA	23/12/2019 09:02	23/12/2019 14:30	23/12/2019 09:02	23/12/2019 14:30	5,47	14	76,62	CHI
201912180963	OUVIDOR	OU12063916	CATALAO S1	23/12/2019 09:02	23/12/2019 20:08	23/12/2019 09:02	23/12/2019 20:08	11,09	40	443,61	CHI
201912171815	MONTIVIDIU	2840035450	MONTIVIDIU T	23/12/2019 09:03	23/12/2019 15:58	23/12/2019 09:03	23/12/2019 15:58	6,92	1	6,92	CHI
201912171821	CRISTALINA	KR12405473	CRISTALINA S1	23/12/2019 09:03	23/12/2019 14:04	23/12/2019 09:03	23/12/2019 14:04	5,01	1	5,01	CHI
201912171826	CRISTALINA	KR12171525	PAMPLONA	23/12/2019 09:04	23/12/2019 15:00	23/12/2019 09:04	23/12/2019 13:12	4,13	14	57,86	CHI
201912171826	CRISTALINA	KR12171525	PAMPLONA	23/12/2019 09:04	23/12/2019 15:00	23/12/2019 09:04	23/12/2019 15:00	5,93	1	5,93	CHI
201912171827	SAO MIGUEL DO ARAGUAIA	SM21208479	NOVA CRIXAS	23/12/2019 09:04	24/12/2019 14:56	23/12/2019 09:04	24/12/2019 14:56	29,86	2	59,73	CHI
201912171834	APARECIDA DE GOIANIA	200649371	INDEPENDENCIA S1	23/12/2019 09:04	23/12/2019 12:35	23/12/2019 09:04	23/12/2019 12:35	3,51	1	3,51	CHI
201912171841	RIO VERDE	630229582	CABRIUVA S1	23/12/2019 09:04	23/12/2019 14:48	23/12/2019 09:04	23/12/2019 14:48	5,73	1	5,73	CHI
201912172003	NIQUELANDIA	NQ21262914	NIQUELANDIA SUBTRANSMISSAO	23/12/2019 09:04	23/12/2019 14:01	23/12/2019 09:04	23/12/2019 14:01	4,94	2	9,88	CHI
201912172005	GOIANIA	10022932338	ATLANTICO S1	23/12/2019 09:04	23/12/2019 12:17	23/12/2019 09:04	23/12/2019 12:17	3,20	1	3,20	CHI
201912176051	GOIANAPOLIS	GP11029286	JUNDIAI S1	23/12/2019 09:04	23/12/2019 16:09	23/12/2019 09:04	23/12/2019 16:09	7,07	42	296,88	CHI
201912172008	BELA VISTA DE GOIAS	BV21349135	BELA VISTA S1	23/12/2019 09:05	23/12/2019 16:22	23/12/2019 09:05	23/12/2019 16:22	7,28	2	14,56	CHI
201912172009	PARAUNA	980028164	PARAUNA	23/12/2019 09:05	23/12/2019 17:05	23/12/2019 09:05	23/12/2019 17:05	8,00	1	8,00	CHI
201912172016	POSSE	PS12180788	IACIARA S2	23/12/2019 09:05	23/12/2019 16:28	23/12/2019 09:05	23/12/2019 16:28	7,37	39	287,39	CHI
201912172031	GOIAS	02270406	ITABERAI S1	23/12/2019 09:06	25/12/2019 19:51	23/12/2019 09:06	25/12/2019 19:51	58,74	176	10338,44	CHI
201912172031	GOIAS	02270406	ITABERAI S1	23/12/2019 09:06	25/12/2019 19:51	23/12/2019 09:06	25/12/2019 19:51	58,74	75	4405,58	CHI
201912172031	ITABERAI	02270406	ITABERAI S1	23/12/2019 09:06	25/12/2019 19:51	23/12/2019 09:06	25/12/2019 19:51	58,74	3	176,22	CHI
201912172031	ITABERAI	02270406	ITABERAI S1	23/12/2019 09:06	25/12/2019 19:51	23/12/2019 09:06	25/12/2019 19:51	58,74	27	1586,01	CHI
201912172101	CRISTALINA	KR11287400	CRISTALINA S1	23/12/2019 09:07	23/12/2019 15:49	23/12/2019 09:07	23/12/2019 15:49	6,70	2	13,40	CHI
201912172107	NOVO GAMA	NJ11103511	PACAEMBU S1	23/12/2019 09:07	23/12/2019 13:05	23/12/2019 12:32	23/12/2019 13:05	0,55	186	102,40	CHI
201912172302	SAO LUIS DE MONTES BELOS	500055993	SAO LUIZ DOS MONTES BELOS	23/12/2019 09:08	23/12/2019 13:55	23/12/2019 09:08	23/12/2019 13:55	4,78	1	4,78	CHI
201912172303	SANTA HELENA DE GOIAS	SH21249424	RIO VERDE S2	23/12/2019 09:08	23/12/2019 16:40	23/12/2019 09:08	23/12/2019 16:40	7,53	2	15,06	CHI
201912172403	SANTA HELENA DE GOIAS	SH21260985	SANTA HELENA S1	23/12/2019 09:08	23/12/2019 16:35	23/12/2019 09:08	23/12/2019 16:35	7,44	1	7,44	CHI
201912172406	PIRENOPOLIS	PV21194630	CORUMBA	23/12/2019 09:08	24/12/2019 17:25	23/12/2019 09:08	24/12/2019 17:25	32,27	1	32,27	CHI
201912172412	PORANGATU	PO12391670	PORANGATU	23/12/2019 09:09	23/12/2019 18:20	23/12/2019 09:09	23/12/2019 18:20	9,18	4	36,70	CHI
201912172805	GOIAS	GS21203899	ITABERAI S2	23/12/2019 09:10	24/12/2019 09:48	23/12/2019 09:10	24/12/2019 09:48	24,62	2	49,24	CHI

201912176509	JATAI	JT12191107	JATAI S1	23/12/2019 09:10	23/12/2019 20:04	23/12/2019 09:10	23/12/2019 20:04	10,89	5	54,45	CHI
201912172808	VALPARAISO DE GOIAS	10018005533	MARAJOARA	23/12/2019 09:11	23/12/2019 13:50	23/12/2019 09:11	23/12/2019 13:50	4,66	1	4,66	CHI
201912172813	FAINA	MP12096007	MATRINCHA	23/12/2019 09:11	24/12/2019 00:35	23/12/2019 09:11	24/12/2019 00:35	15,39	8	123,15	CHI
201912172820	FAINA	FC12072196	GOIAS	23/12/2019 09:11	24/12/2019 08:17	23/12/2019 09:11	24/12/2019 08:17	23,09	6	138,53	CHI
201912173276	JUSSARA	JR12027532	BRITANIA	23/12/2019 09:11	23/12/2019 15:08	23/12/2019 09:11	23/12/2019 15:08	5,95	39	231,95	CHI
201912172823	RUBIATABA	780061779	RUBIATABA	23/12/2019 09:12	23/12/2019 15:11	23/12/2019 09:12	23/12/2019 15:11	5,98	1	5,98	CHI
201912173201	BALIZA	BH12358780	BOM JARDIM	23/12/2019 09:12	23/12/2019 19:31	23/12/2019 09:12	23/12/2019 19:31	10,30	18	185,44	CHI
201912173210	ARAGUAPAZ	10021347830	GOIAS	23/12/2019 09:13	24/12/2019 19:03	23/12/2019 09:13	24/12/2019 19:03	33,82	1	33,82	CHI
201912168256	ANAPOLIS	AN21132856	DAIA S1	23/12/2019 09:14	23/12/2019 11:13	23/12/2019 09:14	23/12/2019 11:13	1,98	1	1,98	CHI
201912173223	RIO VERDE	RV21191876	CABRIUVA S2	23/12/2019 09:14	24/12/2019 08:52	23/12/2019 09:14	24/12/2019 08:52	23,62	1	23,62	CHI
201912173232	SITIO D ABADIA	SI21242884	IACIARA S2	23/12/2019 09:16	23/12/2019 14:00	23/12/2019 09:16	23/12/2019 14:00	4,73	1	4,73	CHI
201912173233	SANTA HELENA DE GOIAS	SH21301287	IPEGUARI	23/12/2019 09:16	23/12/2019 20:40	23/12/2019 09:16	23/12/2019 20:40	11,40	1	11,40	CHI
201912173236	SAO LUIS DE MONTES BELOS	SL21206336	FIRMINOPOLIS S2	23/12/2019 09:16	23/12/2019 18:25	23/12/2019 09:16	23/12/2019 18:25	9,16	1	9,16	CHI
201912173244	GOIANIA	13644646	XAVANTES	23/12/2019 09:16	23/12/2019 12:42	23/12/2019 09:16	23/12/2019 12:42	3,42	1	3,42	CHI
201912173246	GOIANIA	10013766188	CARAJAS S1	23/12/2019 09:16	23/12/2019 15:32	23/12/2019 09:16	23/12/2019 15:32	6,25	1	6,25	CHI
201912173264	CRISTALINA	KR12219621	PAMPLONA	23/12/2019 09:18	23/12/2019 15:00	23/12/2019 09:18	23/12/2019 15:00	5,70	1	5,70	CHI
201912173266	TRINDADE	10002969708	GOYA S2	23/12/2019 09:18	23/12/2019 12:58	23/12/2019 09:18	23/12/2019 12:58	3,66	1	3,66	CHI
201912173268	TURVANIA	10022265110	FIRMINOPOLIS S2	23/12/2019 09:18	23/12/2019 16:04	23/12/2019 09:18	23/12/2019 16:04	6,76	1	6,76	CHI
201912173279	CALDAS NOVAS	CN21114794	VILA CORUMBA	23/12/2019 09:19	24/12/2019 08:37	23/12/2019 09:19	24/12/2019 08:37	23,30	1	23,30	CHI
201912173284	VIANOPOLIS	VN12282722	VIANOPOLIS	23/12/2019 09:19	23/12/2019 13:38	23/12/2019 09:19	23/12/2019 13:38	4,32	7	30,21	CHI
201912173291	PONTALINA	JV21134679	VICENTINOPOLIS	23/12/2019 09:19	24/12/2019 16:10	23/12/2019 09:19	24/12/2019 16:10	30,83	2	61,67	CHI
201912173292	CATURAI	CK21346343	INHUMAS S1	23/12/2019 09:19	23/12/2019 17:53	23/12/2019 09:19	23/12/2019 17:53	8,55	1	8,55	CHI
201912175127	JUSSARA	JR12090187	JUSSARA	23/12/2019 09:19	24/12/2019 07:44	23/12/2019 09:19	24/12/2019 07:44	22,42	3	67,26	CHI
201912173293	NOVO GAMA	10020536109	PACAEMBU S1	23/12/2019 09:20	23/12/2019 13:05	23/12/2019 09:20	23/12/2019 13:05	3,76	1	3,76	CHI
201912173503	VALPARAISO DE GOIAS	VA11162806	MARAJOARA	23/12/2019 09:20	23/12/2019 14:00	23/12/2019 09:20	23/12/2019 14:00	4,65	6	27,93	CHI
201912173509	AGUAS LINDAS DE GOIAS	10006994120	AGUAS LINDAS DE GOIAS S1	23/12/2019 09:21	23/12/2019 14:34	23/12/2019 09:21	23/12/2019 14:34	5,22	1	5,22	CHI
201912173701	MOZARLANDIA	10030785918	MOZARLANDIA	23/12/2019 09:21	24/12/2019 13:08	23/12/2019 09:21	24/12/2019 13:08	27,78	0	0,00	CHI
201912173716	BOM JESUS DE GOIAS	BJ12007756	BOM JESUS DE GOIAS	23/12/2019 09:22	24/12/2019 10:21	23/12/2019 09:22	24/12/2019 10:21	24,98	2	49,95	CHI
201912177725	CATALAO	TH12013600RE	CATALAO S1	23/12/2019 09:22	23/12/2019 17:43	23/12/2019 09:22	23/12/2019 17:43	8,35	58	484,17	CHI
201912177725	TRES RANCHOS	TH12013600RE	CATALAO S1	23/12/2019 09:22	23/12/2019 17:43	23/12/2019 09:22	23/12/2019 17:43	8,35	69	576,00	CHI
201912173724	GOIANIA	14336273	CARAJAS S2	23/12/2019 09:23	23/12/2019 12:38	23/12/2019 09:23	23/12/2019 12:38	3,25	1	3,25	CHI
201912173726	GOIANIA	10755299	CAMPINAS S1	23/12/2019 09:23	23/12/2019 12:42	23/12/2019 09:23	23/12/2019 12:42	3,31	1	3,31	CHI
201912173728	SAO FRANCISCO DE GOIAS	SF21008923	SAO FRANCISCO DE GOIAS	23/12/2019 09:23	23/12/2019 16:17	23/12/2019 09:23	23/12/2019 16:17	6,89	1	6,89	CHI

201912173733	MONTES CLAROS DE GOIAS	ME21062853	IPORA	23/12/2019 09:23	23/12/2019 19:03	23/12/2019 09:23	23/12/2019 19:03	9,65	2	19,31	CHI
201912173735	CATALAO	10018338710	CATALAO S2	23/12/2019 09:23	23/12/2019 14:57	23/12/2019 09:23	23/12/2019 14:57	5,55	1	5,55	CHI
201912175602	GOIANIA	GN12000819	FERROVIARIO S1	23/12/2019 09:23	23/12/2019 14:17	23/12/2019 09:23	23/12/2019 14:17	4,90	1354	6634,98	CHI
201912175636	NOVO GAMA	2460091418	MARAJOARA	23/12/2019 09:23	23/12/2019 15:01	23/12/2019 09:23	23/12/2019 15:01	5,64	1	5,64	CHI
201912173801	CACHOEIRA ALTA	CA21345345	CACHOEIRA ALTA	23/12/2019 09:24	23/12/2019 18:35	23/12/2019 09:24	23/12/2019 18:35	9,17	1	9,17	CHI
201912170474	MONTIVIDIU	MV11301689	MONTIVIDIU T	23/12/2019 09:25	23/12/2019 14:20	23/12/2019 12:05	23/12/2019 14:20	2,25	62	139,50	CHI
201912173803	FAINA	FC12026041	GOIAS	23/12/2019 09:25	24/12/2019 10:07	23/12/2019 09:25	24/12/2019 10:07	24,70	2	49,40	CHI
201912174103	PIRENOPOLIS	PV21360283	CORUMBA	23/12/2019 09:25	23/12/2019 23:38	23/12/2019 09:25	23/12/2019 23:38	14,21	3	42,62	CHI
201912174645	JATAI	JT11324813	JATAI S2	23/12/2019 09:25	23/12/2019 14:58	23/12/2019 09:25	23/12/2019 14:58	5,55	91	504,65	CHI
201912174110	DIORAMA	DI21126770	IPORA	23/12/2019 09:26	24/12/2019 11:16	23/12/2019 09:26	24/12/2019 11:16	25,83	1	25,83	CHI
201912174304	APARECIDA DE GOIANIA	10024864984	INDEPENDENCIA S1	23/12/2019 09:26	23/12/2019 13:23	23/12/2019 09:26	23/12/2019 13:23	3,93	1	3,93	CHI
201912174308	INACIOLANDIA	ID21128172	QUIRINOPOLIS	23/12/2019 09:27	23/12/2019 16:46	23/12/2019 09:27	23/12/2019 16:46	7,31	1	7,31	CHI
201912174310	PONTALINA	210031980	PONTALINA	23/12/2019 09:27	23/12/2019 16:12	23/12/2019 09:27	23/12/2019 16:12	6,75	1	6,75	CHI
201912174318	PIRENOPOLIS	PV12172930	CORUMBA	23/12/2019 09:28	24/12/2019 16:52	23/12/2019 09:28	24/12/2019 16:52	31,40	2	62,80	CHI
201912170505	APARECIDA DE GOIANIA	AP12000220	ANHANGUERA	23/12/2019 09:29	23/12/2019 10:10	23/12/2019 09:29	23/12/2019 10:10	0,68	595	402,29	CHI
201912174333	RIO QUENTE	RQ21103124	VILA CORUMBA	23/12/2019 09:29	24/12/2019 10:26	23/12/2019 09:29	24/12/2019 10:26	24,95	1	24,95	CHI
201912174335	ABADIANIA	AA21000036	ANAPOLIS UNIVERSITARIO S1	23/12/2019 09:29	23/12/2019 15:48	23/12/2019 09:29	23/12/2019 15:48	6,31	2	12,63	CHI
201912174344	SAO MIGUEL DO ARAGUAIA	SM12282233	SAO MIGUEL DO ARAGUAIA	23/12/2019 09:29	24/12/2019 13:30	23/12/2019 09:29	24/12/2019 13:30	28,01	2	56,02	CHI
201912174345	JATAI	JT12391181	JATAI S1	23/12/2019 09:29	23/12/2019 19:14	23/12/2019 09:29	23/12/2019 19:14	9,74	1	9,74	CHI
201912174351	LEOPOLDO DE BULHOES	LB31194750	DAIA S1	23/12/2019 09:30	23/12/2019 14:39	23/12/2019 09:30	23/12/2019 14:39	5,14	2	10,28	CHI
201912174354	CAMPESTRE DE GOIAS	GC12277038	TRINDADE	23/12/2019 09:30	23/12/2019 16:16	23/12/2019 09:30	23/12/2019 16:16	6,75	3	20,26	CHI
201912174354	PALMEIRAS DE GOIAS	GC12277038	TRINDADE	23/12/2019 09:30	23/12/2019 16:16	23/12/2019 09:30	23/12/2019 16:16	6,75	1	6,75	CHI
201912174356	GOIATUBA	GT21346922	GOIATUBA S2	23/12/2019 09:30	23/12/2019 19:36	23/12/2019 09:30	23/12/2019 19:36	10,09	1	10,09	CHI
201912174364	GOIANIA	10786375	CARAJAS S1	23/12/2019 09:31	23/12/2019 16:08	23/12/2019 09:31	23/12/2019 16:08	6,61	1	6,61	CHI
201912174370	EDEIA	EA12070748	EDEIA	23/12/2019 09:31	24/12/2019 20:12	23/12/2019 09:31	24/12/2019 20:12	34,68	3	104,05	CHI
201912174370	INDIARA	EA12070748	EDEIA	23/12/2019 09:31	24/12/2019 20:12	23/12/2019 09:31	24/12/2019 20:12	34,68	1	34,68	CHI
201912174371	FAZENDA NOVA	FN12355367	IPORA	23/12/2019 09:31	23/12/2019 21:21	23/12/2019 09:31	23/12/2019 21:21	11,82	20	236,43	CHI
201912174372	ARAGOIANIA	AO12094610	GUAPO S2	23/12/2019 09:32	23/12/2019 15:31	23/12/2019 09:32	23/12/2019 15:31	5,98	2	11,96	CHI
201912175615	PIRACANJUBA	PJ12025031	PIRACANJUBA	23/12/2019 09:32	24/12/2019 07:50	23/12/2019 09:32	24/12/2019 07:50	22,29	91	2028,64	CHI
201912174401	PIRENOPOLIS	PV21295584	CORUMBA	23/12/2019 09:33	23/12/2019 23:56	23/12/2019 09:33	23/12/2019 23:56	14,37	1	14,37	CHI
201912174501	GOIANIA	11877911	REAL S1	23/12/2019 09:33	23/12/2019 13:35	23/12/2019 09:33	23/12/2019 13:35	4,02	1	4,02	CHI
201912174503	INHUMAS	30027056	INHUMAS S2	23/12/2019 09:34	23/12/2019 15:09	23/12/2019 09:34	23/12/2019 15:09	5,58	1	5,58	CHI
201912174506	MINACU	10016037292	MINACU	23/12/2019 09:34	23/12/2019 17:33	23/12/2019 09:34	23/12/2019 17:33	7,98	1	7,98	CHI

201912174510	MONTES CLAROS DE GOIAS	ME21031575	ARENOPOLIS	23/12/2019 09:34	24/12/2019 08:15	23/12/2019 09:34	24/12/2019 08:15	22,67	1	22,67	CHI
201912174511	TROMBAS	TB12273728	PORANGATU	23/12/2019 09:34	24/12/2019 00:08	23/12/2019 09:34	24/12/2019 00:08	14,56	2	29,11	CHI
201912174512	VALPARAISO DE GOIAS	VA11351317	PACAEMBU S1	23/12/2019 09:34	23/12/2019 14:34	23/12/2019 09:34	23/12/2019 14:34	4,99	156	778,40	CHI
201912176653	VALPARAISO DE GOIAS	3350075240	PACAEMBU S1	23/12/2019 09:34	23/12/2019 19:16	23/12/2019 09:34	23/12/2019 19:16	9,69	1	9,69	CHI
201912179702	GOIATUBA	GT12052882	GOIATUBA S1	23/12/2019 09:34	23/12/2019 16:42	23/12/2019 09:34	23/12/2019 16:42	7,12	25	178,01	CHI
201912174601	GOIANIA	17092607	ATLANTICO S3	23/12/2019 09:35	23/12/2019 12:19	23/12/2019 09:35	23/12/2019 12:19	2,73	1	2,73	CHI
201912174613	APARECIDA DE GOIANIA	200417204	INDEPENDENCIA S2	23/12/2019 09:36	23/12/2019 14:34	23/12/2019 09:36	23/12/2019 14:34	4,95	1	4,95	CHI
201912168270	GOIANIA	GN11002463	GOIANIA LESTE S2	23/12/2019 09:37	23/12/2019 15:31	23/12/2019 09:37	23/12/2019 15:31	5,89	41	241,59	CHI
201912176128	BURITINOPOLIS	BQ12190586	IACIARA S2	23/12/2019 09:37	23/12/2019 17:52	23/12/2019 09:37	23/12/2019 17:52	8,24	14	115,30	CHI
201912174633	VALPARAISO DE GOIAS	3350086510	PACAEMBU S1	23/12/2019 09:38	23/12/2019 12:29	23/12/2019 09:38	23/12/2019 12:29	2,85	1	2,85	CHI
201912174640	GOIANIA	13494594	ATLANTICO S1	23/12/2019 09:39	23/12/2019 14:34	23/12/2019 09:39	23/12/2019 14:34	4,91	1	4,91	CHI
201912174653	APARECIDA DE GOIANIA	AP11051575	ANHANGUERA	23/12/2019 09:40	23/12/2019 14:15	23/12/2019 09:40	23/12/2019 14:15	4,58	128	585,96	CHI
201912174660	SAO LUIS DE MONTES BELOS	SL21125637	FIRMINOPOLIS S1	23/12/2019 09:40	24/12/2019 11:55	23/12/2019 09:40	24/12/2019 11:55	26,24	1	26,24	CHI
201912177630	APARECIDA DE GOIANIA	AP11378535	ANHANGUERA	23/12/2019 09:40	23/12/2019 17:51	23/12/2019 09:40	23/12/2019 17:51	8,18	5	40,89	CHI
201912174701	CASTELANDIA	1890000878	RIO DOS BOIS	23/12/2019 09:41	23/12/2019 16:06	23/12/2019 09:41	23/12/2019 16:06	6,42	1	6,42	CHI
201912175004	GOIANESIA	550199895	GOIANESIA S2	23/12/2019 09:41	24/12/2019 00:23	23/12/2019 09:41	24/12/2019 00:23	14,69	1	14,69	CHI
201912181248	MORRINHOS	GT12188828	GOIATUBA S2	23/12/2019 09:41	23/12/2019 22:13	23/12/2019 09:41	23/12/2019 22:13	12,52	8	100,14	CHI
201912175101	MINEIROS	1390077485	PARQUE DAS EMAS	23/12/2019 09:42	25/12/2019 18:44	23/12/2019 09:42	25/12/2019 18:44	57,02	1	57,02	CHI
201912176022	ARAGARCAS	AG11000019	ARAGARCAS	23/12/2019 09:42	23/12/2019 16:40	23/12/2019 09:42	23/12/2019 16:40	6,96	182	1266,92	CHI
201912179747	PONTALINA	PK12092021	PONTALINA	23/12/2019 09:42	24/12/2019 16:42	23/12/2019 09:42	24/12/2019 16:42	30,99	2	61,98	CHI
201912175107	QUIRINOPOLIS	QI21246834	QUIRINOPOLIS	23/12/2019 09:43	23/12/2019 18:30	23/12/2019 09:43	23/12/2019 18:30	8,77	1	8,77	CHI
201912175109	AMORINOPOLIS	IR12184420	IPORA	23/12/2019 09:43	23/12/2019 16:20	23/12/2019 09:43	23/12/2019 16:20	6,60	2	13,20	CHI
201912179767	GOIANIA	14407670	ATLANTICO S2	23/12/2019 09:44	23/12/2019 16:40	23/12/2019 09:44	23/12/2019 16:40	6,92	1	6,92	CHI
201912175128	CRIXAS	CX12262895	SERRA DO OURO	23/12/2019 09:45	23/12/2019 20:40	23/12/2019 09:45	23/12/2019 20:40	10,91	10	109,08	CHI
201912177201	SANTA FE DE GOIAS	RN12090835	BRITANIA	23/12/2019 09:45	23/12/2019 17:41	23/12/2019 09:45	23/12/2019 17:41	7,94	6	47,64	CHI
201912175503	SAO FRANCISCO DE GOIAS	SF21059108	SAO FRANCISCO DE GOIAS	23/12/2019 09:46	23/12/2019 16:11	23/12/2019 09:46	23/12/2019 16:11	6,40	1	6,40	CHI
201912175510	ARAGUAPAZ	AZ21143340	MOZARLANDIA	23/12/2019 09:47	24/12/2019 21:19	23/12/2019 09:47	24/12/2019 21:19	35,53	1	35,53	CHI
201912175607	GOIANIA	GN11200595	XAVANTES	23/12/2019 09:47	23/12/2019 16:24	23/12/2019 09:47	23/12/2019 16:24	6,60	54	356,43	CHI
201912175611	VILA PROPICIO	550089690	GOIANESIA S1	23/12/2019 09:48	25/12/2019 03:06	23/12/2019 09:48	25/12/2019 03:06	41,30	1	41,30	CHI
201912176433	ANAPOLIS	AN11121605	DAIA S1	23/12/2019 09:48	23/12/2019 14:50	23/12/2019 09:48	23/12/2019 14:50	5,02	144	722,56	CHI
201912175621	POSSE	PS11265881	IACIARA S2	23/12/2019 09:49	23/12/2019 14:00	23/12/2019 09:49	23/12/2019 14:00	4,18	164	685,93	CHI
201912175649	NOVO GAMA	4990013403	PACAEMBU S1	23/12/2019 09:50	23/12/2019 13:10	23/12/2019 09:50	23/12/2019 13:10	3,33	1	3,33	CHI
201912176044	GOIANIA	GN11209294	MEIA PONTE	23/12/2019 09:51	23/12/2019 15:09	23/12/2019 09:51	23/12/2019 15:09	5,30	124	656,92	CHI



201912175713	COCALZINHO DE GOIAS	4930000155	AGUAS LINDAS DE GOIAS S1	23/12/2019 09:52	23/12/2019 15:34	23/12/2019 09:52	23/12/2019 15:34	5,69	1	5,69	CHI
201912176155	RIO VERDE	RV12153892	RIO VERDE S2	23/12/2019 09:52	23/12/2019 19:40	23/12/2019 09:52	23/12/2019 19:40	9,80	9	88,20	CHI
201912177039	PARAUNA	PU12295865	ACREUNA	23/12/2019 09:52	23/12/2019 18:42	23/12/2019 09:52	23/12/2019 18:42	8,82	2	17,65	CHI
201912175901	HEITORAI	HE21158379	ITABERAI S1	23/12/2019 09:53	24/12/2019 11:01	23/12/2019 09:53	24/12/2019 11:01	25,12	1	25,12	CHI
201912176008	CEZARINA	CZ12027268	CEZARINA	23/12/2019 09:54	23/12/2019 23:20	23/12/2019 09:54	23/12/2019 23:20	13,44	1	13,44	CHI
201912176031	PIRES DO RIO	PR12075719	PIRES DO RIO S1	23/12/2019 09:54	23/12/2019 22:03	23/12/2019 09:54	23/12/2019 22:03	12,14	3	36,42	CHI
201912176024	JARAGUA	JA21059949	JARAGUA	23/12/2019 09:55	23/12/2019 14:29	23/12/2019 09:55	23/12/2019 14:29	4,56	1	4,56	CHI
201912178164	HIDROLANDIA	HD12058903	ANHANGUERA	23/12/2019 09:55	23/12/2019 22:02	23/12/2019 09:55	23/12/2019 22:02	12,10	168	2033,45	CHI
201912172562	APARECIDA DE GOIANIA	AP11137106	INDEPENDENCIA S1	23/12/2019 09:56	23/12/2019 15:18	23/12/2019 09:56	23/12/2019 15:18	5,36	169	906,03	CHI
201912176042	FAZENDA NOVA	FN12297339	IPORA	23/12/2019 09:57	23/12/2019 18:50	23/12/2019 09:57	23/12/2019 18:50	8,88	6	53,29	CHI
201912176048	IVOLANDIA	IV12396049	IPORA	23/12/2019 09:57	23/12/2019 17:49	23/12/2019 09:57	23/12/2019 17:49	7,87	6	47,21	CHI
201912176088	FAINA	FC12072193	GOIAS	23/12/2019 10:00	24/12/2019 07:37	23/12/2019 10:00	24/12/2019 07:37	21,61	12	259,31	CHI
201912176089	ALTO HORIZONTE	10005139730	SANTA TEREZINHA	23/12/2019 10:01	24/12/2019 11:40	23/12/2019 10:01	24/12/2019 11:40	25,65	1	25,65	CHI
201912176090	ANAPOLIS	21169974	ANAPOLIS UNIVERSITARIO S2	23/12/2019 10:01	23/12/2019 15:10	23/12/2019 10:01	23/12/2019 15:10	5,14	1	5,14	CHI
201912171001	SANTO ANTONIO DO DESCOBERTO	SN11313886	MARAJOARA	23/12/2019 10:02	23/12/2019 11:47	23/12/2019 10:02	23/12/2019 11:47	1,74	8	13,90	CHI
201912176095	SANTO ANTONIO DE GOIAS	BW12027240	NEROPOLIS S1	23/12/2019 10:02	24/12/2019 14:56	23/12/2019 10:02	23/12/2019 18:06	8,08	16	129,25	CHI
201912176095	SANTO ANTONIO DE GOIAS	GR12002121	NEROPOLIS S1	23/12/2019 10:02	24/12/2019 14:56	23/12/2019 10:02	24/12/2019 14:56	28,91	31	896,27	CHI
201912176097	RIO VERDE	RV21029071	SANTA HELENA S1	23/12/2019 10:02	24/12/2019 10:40	23/12/2019 10:02	24/12/2019 10:40	24,63	2	49,27	CHI
201912176100	APARECIDA DE GOIANIA	200055355	INDEPENDENCIA S1	23/12/2019 10:02	23/12/2019 17:36	23/12/2019 10:02	23/12/2019 17:36	7,56	1	7,56	CHI
201912176105	ITUMBIARA	690394366	ITUMBIARA VELHA S1	23/12/2019 10:02	23/12/2019 15:50	23/12/2019 10:02	23/12/2019 15:50	5,79	1	5,79	CHI
201912176121	AURILANDIA	10009564320	FIRMINOPOLIS S2	23/12/2019 10:04	23/12/2019 16:17	23/12/2019 10:04	23/12/2019 16:17	6,21	1	6,21	CHI
201912176139	CATALAO	CT11000022	CATALAO S2	23/12/2019 10:06	23/12/2019 13:54	23/12/2019 10:06	23/12/2019 13:54	3,80	58	220,30	CHI
201912176141	LUZIANIA	LZ12290798	MARAJOARA	23/12/2019 10:06	23/12/2019 19:17	23/12/2019 10:06	23/12/2019 19:17	9,18	3	27,53	CHI
201912176146	APARECIDA DE GOIANIA	10018350621	INDEPENDENCIA S1	23/12/2019 10:06	24/12/2019 09:34	23/12/2019 10:06	24/12/2019 09:34	23,45	1	23,45	CHI
201912176151	SAO SIMAO	SO21011412	CACHOEIRA ALTA	23/12/2019 10:07	23/12/2019 17:30	23/12/2019 10:07	23/12/2019 17:30	7,38	1	7,38	CHI
201912176152	PORTEIRAO	BJ12305324	RIO DOS BOIS	23/12/2019 10:07	24/12/2019 11:17	23/12/2019 10:07	24/12/2019 11:17	25,16	1	25,16	CHI
201912176154	MINACU	IH1234208	MINACU	23/12/2019 10:07	23/12/2019 18:27	23/12/2019 10:07	23/12/2019 18:27	8,33	1	8,33	CHI
201912176160	INDIARA	EA21128519	EDEIA	23/12/2019 10:08	24/12/2019 14:42	23/12/2019 10:08	24/12/2019 14:42	28,56	1	28,56	CHI
201912176161	NOVO GAMA	10009642569	PACAEMBU S1	23/12/2019 10:08	23/12/2019 16:50	23/12/2019 10:08	23/12/2019 16:50	6,69	1	6,69	CHI
201912176162	ARUANA	2380034285	ARUANA	23/12/2019 10:08	24/12/2019 09:54	23/12/2019 10:08	24/12/2019 09:54	23,76	1	23,76	CHI
201912176167	GOIANIA	10028640	ATLANTICO S3	23/12/2019 10:08	23/12/2019 13:36	23/12/2019 10:08	23/12/2019 13:36	3,45	1	3,45	CHI
201912176169	BELA VISTA DE GOIAS	BV21228834	BELA VISTA S1	23/12/2019 10:09	23/12/2019 15:14	23/12/2019 10:09	23/12/2019 15:14	5,08	2	10,17	CHI
201912176171	PIRENOPOLIS	PV21130442	SAO FRANCISCO DE GOIAS	23/12/2019 10:09	23/12/2019 15:00	23/12/2019 10:09	23/12/2019 15:00	4,85	1	4,85	CHI

201912176172	BOM JARDIM DE GOIAS	BM12065732	BOM JARDIM	23/12/2019 10:09	23/12/2019 21:25	23/12/2019 10:09	23/12/2019 21:25	11,27	1	11,27	CHI
201912176175	CORUMBAIBA	10007089048	VILA CORUMBA	23/12/2019 10:09	23/12/2019 17:00	23/12/2019 10:09	23/12/2019 17:00	6,85	1	6,85	CHI
201912176177	CALDAS NOVAS	CN21363801	SERRA DE CALDAS	23/12/2019 10:09	24/12/2019 08:15	23/12/2019 10:09	24/12/2019 08:15	22,09	1	22,09	CHI
201912176201	JATAI	290139582	JATAI S3	23/12/2019 10:09	23/12/2019 17:26	23/12/2019 10:09	23/12/2019 17:26	7,28	1	7,28	CHI
201912178591	BONFINOPOLIS	SW12084087	GOIANIA LESTE S2	23/12/2019 10:09	23/12/2019 16:21	23/12/2019 10:09	23/12/2019 16:21	6,19	2	12,39	CHI
201912176210	MORRO AGUDO DE GOIAS	MS21157493	ITAPURANGA	23/12/2019 10:10	24/12/2019 19:23	23/12/2019 10:10	24/12/2019 19:23	33,21	1	33,21	CHI
201912176211	CATURAI	IN21125345	ARACU	23/12/2019 10:10	23/12/2019 23:25	23/12/2019 10:10	23/12/2019 23:25	13,24	1	13,24	CHI
201912176219	VARJAO	VJ11329588	GUAPO S2	23/12/2019 10:11	23/12/2019 17:27	23/12/2019 10:11	23/12/2019 17:27	7,25	101	732,70	CHI
201912176222	VALPARAISO DE GOIAS	2860232236	PACAEMBU S1	23/12/2019 10:11	23/12/2019 14:37	23/12/2019 10:11	23/12/2019 14:37	4,42	1	4,42	CHI
201912176800	PLANALTINA	2960255830	PLANALTINA	23/12/2019 10:11	23/12/2019 16:45	23/12/2019 10:11	23/12/2019 16:45	6,56	1	6,56	CHI
201912176224	RIO VERDE	RV21232716	MONTIVIDIU T	23/12/2019 10:12	24/12/2019 09:45	23/12/2019 10:12	24/12/2019 09:45	23,54	1	23,54	CHI
201912176225	RIO VERDE	630579817	RIO VERDE S1	23/12/2019 10:12	23/12/2019 16:41	23/12/2019 10:12	23/12/2019 16:41	6,48	1	6,48	CHI
201912176229	GOIANIA	11870473	ATLANTICO S2	23/12/2019 10:12	23/12/2019 19:35	23/12/2019 10:12	23/12/2019 19:35	9,37	1	9,37	CHI
201912176230	FORMOSA	FA21051129	ITUIQUIRA	23/12/2019 10:12	23/12/2019 14:14	23/12/2019 10:12	23/12/2019 14:14	4,02	1	4,02	CHI
201912176238	MUNDO NOVO DE GOIAS	MH21087319	NOVA CRIXAS	23/12/2019 10:13	23/12/2019 15:15	23/12/2019 10:13	23/12/2019 15:15	5,03	1	5,03	CHI
201912176242	GOIANIA	10015928479	ATLANTICO S2	23/12/2019 10:13	23/12/2019 18:20	23/12/2019 10:13	23/12/2019 18:20	8,11	1	8,11	CHI
201912177050	GOIANIA	GN11187205	XAVANTES	23/12/2019 10:13	23/12/2019 15:00	23/12/2019 10:13	23/12/2019 15:00	4,78	57	272,38	CHI
201912176306	GOIAS	GS12068553	MATRINCHA	23/12/2019 10:14	24/12/2019 12:09	23/12/2019 10:14	24/12/2019 12:09	25,90	2	51,80	CHI
201912182819	MATRINCHA	MP12122362	MATRINCHA	23/12/2019 10:15	24/12/2019 03:28	23/12/2019 10:15	24/12/2019 03:28	17,21	67	1153,13	CHI
201912176320	ANICUNS	910063990	ANICUNS	23/12/2019 10:16	24/12/2019 08:23	23/12/2019 10:16	24/12/2019 08:23	22,11	1	22,11	CHI
201912176324	GOIAS	GS11220066	GOIAS	23/12/2019 10:16	23/12/2019 16:40	23/12/2019 10:16	23/12/2019 16:40	6,39	1	6,39	CHI
201912176325	MONTE ALEGRE DE GOIAS	MA21140160	SAO DOMINGOS	23/12/2019 10:16	23/12/2019 17:12	23/12/2019 10:16	23/12/2019 17:12	6,92	1	6,92	CHI
201912176333	BURITI ALEGRE	BG12161939	ITUMBIARA VELHA S2	23/12/2019 10:17	24/12/2019 13:31	23/12/2019 10:17	24/12/2019 13:31	27,24	1	27,24	CHI
201912176340	PANAMA	PX21099806	GOIATUBA S1	23/12/2019 10:17	24/12/2019 16:39	23/12/2019 10:17	24/12/2019 16:39	30,37	1	30,37	CHI
201912176342	BONOPOLIS	BX21334630	SAO MIGUEL DO ARAGUAIA	23/12/2019 10:17	23/12/2019 19:56	23/12/2019 10:17	23/12/2019 19:56	9,64	1	9,64	CHI
201912176411	PIRENOPOLIS	220039434	CORUMBA	23/12/2019 10:18	23/12/2019 16:45	23/12/2019 10:18	23/12/2019 16:45	6,44	1	6,44	CHI
201912176416	JATAI	10030326247	JATAI S2	23/12/2019 10:19	23/12/2019 16:05	23/12/2019 10:19	23/12/2019 16:05	5,77	1	5,77	CHI
201912176417	BURITI ALEGRE	BG21333094	ITUMBIARA VELHA S2	23/12/2019 10:19	23/12/2019 17:33	23/12/2019 10:19	23/12/2019 17:33	7,23	2	14,46	CHI
201912176434	ITAPACI	10025241166	ITAPACI	23/12/2019 10:20	24/12/2019 07:38	23/12/2019 10:20	24/12/2019 07:38	21,28	1	21,28	CHI
201912176552	GOIANIA	GN11047718	ATLANTICO S3	23/12/2019 10:20	23/12/2019 14:42	23/12/2019 10:20	23/12/2019 14:42	4,36	96	418,96	CHI
201912176438	GUAPO	710047691	GUAPO S1	23/12/2019 10:21	23/12/2019 13:59	23/12/2019 10:21	23/12/2019 13:59	3,63	1	3,63	CHI
201912176447	GOIANIA	10022416747	ATLANTICO S3	23/12/2019 10:21	23/12/2019 17:04	23/12/2019 10:21	23/12/2019 17:04	6,72	1	6,72	CHI
201912177652	CRISTALINA	KR12287383	CRISTALINA S1	23/12/2019 10:21	23/12/2019 17:35	23/12/2019 10:21	23/12/2019 17:35	7,22	78	563,20	CHI

201912176448	PIRACANJUBA	PJ21120691	PIRACANJUBA	23/12/2019 10:22	24/12/2019 17:10	23/12/2019 10:22	24/12/2019 17:10	30,80	1	30,80	CHI
201912176454	ANAPOLIS	AN21252257	ANAPOLIS UNIVERSITARIO S2	23/12/2019 10:22	23/12/2019 15:33	23/12/2019 10:22	23/12/2019 15:33	5,18	1	5,18	CHI
201912176460	JARAGUA	JA21027385	ITABERAI S1	23/12/2019 10:22	24/12/2019 06:54	23/12/2019 10:22	24/12/2019 06:54	20,52	1	20,52	CHI
201912178621	JATAI	JT12182089	JATAI S1	23/12/2019 10:22	23/12/2019 18:15	23/12/2019 10:22	23/12/2019 18:15	7,87	9	70,87	CHI
201912176461	CRIXAS	CX12181532	SERRA DO OURO	23/12/2019 10:23	23/12/2019 20:25	23/12/2019 10:23	23/12/2019 20:25	10,03	10	100,30	CHI
201912176464	APARECIDA DE GOIANIA	200153791	INDEPENDENCIA S1	23/12/2019 10:24	23/12/2019 18:35	23/12/2019 10:24	23/12/2019 18:35	8,18	1	8,18	CHI
201912176466	MORRINHOS	MR21000103	GOIATUBA S1	23/12/2019 10:24	24/12/2019 11:58	23/12/2019 10:24	24/12/2019 11:58	25,56	1	25,56	CHI
201912176473	ANAPOLIS	20304780	JUNDIAI S2	23/12/2019 10:24	23/12/2019 13:49	23/12/2019 10:24	23/12/2019 13:49	3,41	1	3,41	CHI
201912176474	CRIXAS	CX21181497	SANTA TEREZINHA	23/12/2019 10:24	24/12/2019 15:58	23/12/2019 10:24	24/12/2019 15:58	29,56	1	29,56	CHI
201912176476	LUZIANIA	3200018353	MARAJOARA	23/12/2019 10:24	23/12/2019 13:30	23/12/2019 10:24	23/12/2019 13:30	3,09	1	3,09	CHI
201912179737	BALIZA	BH12402901	CAIAPONIA	23/12/2019 10:24	24/12/2019 21:38	23/12/2019 10:24	24/12/2019 21:38	35,23	20	704,54	CHI
201912176480	ANAPOLIS	21270466	ANAPOLIS UNIVERSITARIO S2	23/12/2019 10:25	23/12/2019 21:24	23/12/2019 10:25	23/12/2019 21:24	10,98	1	10,98	CHI
201912176482	FAZENDA NOVA	FN12054011	BRITANIA	23/12/2019 10:25	23/12/2019 18:59	23/12/2019 10:25	23/12/2019 18:59	8,56	6	51,35	CHI
201912176485	APARECIDA DE GOIANIA	200599458	INDEPENDENCIA S2	23/12/2019 10:25	23/12/2019 17:55	23/12/2019 10:25	23/12/2019 17:55	7,49	1	7,49	CHI
201912178134	GOUVELANDIA	GB21199317	QUIRINOPOLIS	23/12/2019 10:25	23/12/2019 16:29	23/12/2019 10:25	23/12/2019 16:29	6,05	1	6,05	CHI
201912176489	CROMINIA	CQ21245187	PONTALINA	23/12/2019 10:26	24/12/2019 08:41	23/12/2019 10:26	24/12/2019 08:41	22,24	2	44,47	CHI
201912176492	MOSSAMEDES	MD21299601	ITABERAI S2	23/12/2019 10:26	23/12/2019 17:12	23/12/2019 10:26	23/12/2019 17:12	6,77	1	6,77	CHI
201912176493	SENADOR CANEDO	SW21281209	GOIANIA LESTE S2	23/12/2019 10:27	23/12/2019 15:29	23/12/2019 10:27	23/12/2019 15:29	5,03	1	5,03	CHI
201912176497	NOVA CRIXAS	8570024632	MOZARLANDIA	23/12/2019 10:27	24/12/2019 12:18	23/12/2019 10:27	24/12/2019 12:18	25,84	1	25,84	CHI
201912176515	BOM JESUS DE GOIAS	BJ21046718	BOM JESUS DE GOIAS	23/12/2019 10:29	23/12/2019 18:59	23/12/2019 10:29	23/12/2019 18:59	8,49	1	8,49	CHI
201912176518	GOIANIA	10026249349	CARAJAS S2	23/12/2019 10:30	23/12/2019 17:41	23/12/2019 10:30	23/12/2019 17:41	7,18	1	7,18	CHI
201912176519	CRISTALINA	KR21133543	CRISTALINA S1	23/12/2019 10:30	23/12/2019 15:58	23/12/2019 10:30	23/12/2019 15:58	5,46	1	5,46	CHI
201912176522	GOIANIA	GN11187579	FERROVIARIO S3	23/12/2019 10:30	23/12/2019 17:36	23/12/2019 10:30	23/12/2019 17:36	7,08	27	191,28	CHI
201912176937	SAO FRANCISCO DE GOIAS	SF12008967	SAO FRANCISCO DE GOIAS	23/12/2019 10:30	23/12/2019 15:44	23/12/2019 10:30	23/12/2019 15:44	5,22	16	83,56	CHI
201912176525	ANAPOLIS	20771400	ANAPOLIS UNIVERSITARIO S2	23/12/2019 10:31	23/12/2019 16:40	23/12/2019 10:31	23/12/2019 16:40	6,15	1	6,15	CHI
201912176527	ARENOPOLIS	AY21000031	ARENOPOLIS	23/12/2019 10:31	24/12/2019 15:57	23/12/2019 10:31	24/12/2019 15:57	29,43	1	29,43	CHI
201912176533	RIO VERDE	RV21200713	MONTIVIDIU T	23/12/2019 10:31	24/12/2019 09:40	23/12/2019 10:31	24/12/2019 09:40	23,14	1	23,14	CHI
201912176583	CRISTALINA	KR12162511	CRISTALINA S2	23/12/2019 10:31	23/12/2019 16:52	23/12/2019 10:31	23/12/2019 16:52	6,34	10	63,40	CHI
201912177441	JUSSARA	JR12198907	BRITANIA	23/12/2019 10:31	23/12/2019 21:27	23/12/2019 10:31	23/12/2019 21:27	10,92	36	393,25	CHI
201912177907	ITAPIRAPUA	IU12206883	MATRINCHA	23/12/2019 10:31	24/12/2019 09:07	23/12/2019 10:31	24/12/2019 09:07	22,59	13	293,66	CHI
201912178614	QUIRINOPOLIS	QI12000040	QUIRINOPOLIS	23/12/2019 10:31	23/12/2019 16:21	23/12/2019 10:31	23/12/2019 16:21	5,82	90	524,23	CHI
201912178903	PALMEIRAS DE GOIAS	GC12063009	TRINDADE	23/12/2019 10:32	24/12/2019 10:41	23/12/2019 10:32	24/12/2019 10:41	24,14	7	169,01	CHI
201912176543	MORRINHOS	MR21036226	GOIATUBA S2	23/12/2019 10:33	23/12/2019 18:06	23/12/2019 10:33	23/12/2019 18:06	7,55	1	7,55	CHI

201912176544	GUAPO	AO21171500	GUAPO S1	23/12/2019 10:33	23/12/2019 17:56	23/12/2019 10:33	23/12/2019 17:56	7,38	1	7,38	CHI
201912176546	SANCLERLANDIA	SC12299048	FIRMINOPOLIS S2	23/12/2019 10:33	23/12/2019 16:31	23/12/2019 10:33	23/12/2019 16:31	5,96	4	23,83	CHI
201912176563	FORMOSA	FA12392207	ITUIQUIRA	23/12/2019 10:34	23/12/2019 15:34	23/12/2019 10:34	23/12/2019 15:34	4,98	2	9,97	CHI
201912176569	CASTELANDIA	DM21303644	RIO DOS BOIS	23/12/2019 10:35	23/12/2019 14:40	23/12/2019 10:35	23/12/2019 14:40	4,07	1	4,07	CHI
201912176576	PORANGATU	840060361	PORANGATU	23/12/2019 10:37	23/12/2019 15:26	23/12/2019 10:37	23/12/2019 15:26	4,81	1	4,81	CHI
201912176794	APARECIDA DE GOIANIA	AP11091373	INDEPENDENCIA S1	23/12/2019 10:37	23/12/2019 14:40	23/12/2019 10:37	23/12/2019 14:40	4,04	159	642,76	CHI
201912176590	VALPARAISO DE GOIAS	10008483610	MARAJOARA	23/12/2019 10:38	23/12/2019 15:30	23/12/2019 10:38	23/12/2019 15:30	4,87	1	4,87	CHI
201912176593	PALMEIRAS DE GOIAS	PL21159052	PALMEIRAS	23/12/2019 10:39	23/12/2019 13:58	23/12/2019 10:39	23/12/2019 13:58	3,31	1	3,31	CHI
201912176596	GOIAS	GS21281679	ITABERAI S1	23/12/2019 10:39	24/12/2019 07:33	23/12/2019 10:39	24/12/2019 07:33	20,89	1	20,89	CHI
201912176597	BELA VISTA DE GOIAS	SQ21085447	CRISTIANOPOLIS	23/12/2019 10:40	23/12/2019 16:07	23/12/2019 10:40	23/12/2019 16:07	5,45	1	5,45	CHI
201912176602	ANICUNS	AC21232060	ANICUNS	23/12/2019 10:40	24/12/2019 08:29	23/12/2019 10:40	24/12/2019 08:29	21,83	1	21,83	CHI
201912176604	CATALAO	1990258399	CATALAO S2	23/12/2019 10:40	23/12/2019 14:23	23/12/2019 10:40	23/12/2019 14:23	3,70	1	3,70	CHI
201912176607	GOIATUBA	140051223	GOIATUBA S2	23/12/2019 10:41	23/12/2019 19:58	23/12/2019 10:41	23/12/2019 19:58	9,28	1	9,28	CHI
201912176616	GOIANIA	10299646	CAMPINAS S2	23/12/2019 10:42	23/12/2019 19:15	23/12/2019 10:42	23/12/2019 19:15	8,55	1	8,55	CHI
201912176624	RIO VERDE	10030715626	RIO VERDE S1	23/12/2019 10:42	23/12/2019 18:02	23/12/2019 10:42	23/12/2019 18:02	7,32	0	0,00	CHI
201912176629	ANAPOLIS	AN11000196	JUNDIAI S1	23/12/2019 10:43	23/12/2019 14:41	23/12/2019 10:43	23/12/2019 14:41	3,96	51	201,92	CHI
201912176637	CHAPADAO DO CEU	DJ21214403	CHAPADAO DO CEU	23/12/2019 10:44	23/12/2019 15:21	23/12/2019 10:44	23/12/2019 15:21	4,62	1	4,62	CHI
201912176670	BOM JARDIM DE GOIAS	BM12065721	BOM JARDIM	23/12/2019 10:44	23/12/2019 18:28	23/12/2019 10:44	23/12/2019 18:28	7,73	5	38,65	CHI
201912176654	VICENTINOPOLIS	VI12218196	VICENTINOPOLIS	23/12/2019 10:45	23/12/2019 18:12	23/12/2019 10:45	23/12/2019 18:12	7,44	5	37,20	CHI
201912176661	DISTRITO FEDERAL	AE21375078	ITAJA S2	23/12/2019 10:45	24/12/2019 00:08	23/12/2019 10:45	24/12/2019 00:08	13,37	1	13,37	CHI
201912177464	LEOPOLDO DE BULHOES	LB12281923	DAIA S2	23/12/2019 10:45	23/12/2019 18:29	23/12/2019 10:45	23/12/2019 18:29	7,72	90	694,70	CHI
201912176664	CORUMBAIBA	CI12035404	VILA CORUMBA	23/12/2019 10:46	24/12/2019 20:13	23/12/2019 10:46	24/12/2019 20:13	33,45	85	2842,97	CHI
201912176667	SANTA HELENA DE GOIAS	SH21301289	IPEGUARI	23/12/2019 10:46	23/12/2019 20:00	23/12/2019 10:46	23/12/2019 20:00	9,22	1	9,22	CHI
201912176677	NAZARIO	NZ21306997	ANICUNS	23/12/2019 10:47	24/12/2019 07:43	23/12/2019 10:47	24/12/2019 07:43	20,92	1	20,92	CHI
201912176690	ITAPURANGA	10030786132	ITAPURANGA	23/12/2019 10:49	26/12/2019 09:19	23/12/2019 10:49	26/12/2019 09:19	70,49	0	0,00	CHI
201912172508	CAMPO ALEGRE DE GOIAS	IP21275807	PIRES DO RIO S2	23/12/2019 10:51	23/12/2019 22:04	23/12/2019 10:51	23/12/2019 22:04	11,21	1	11,21	CHI
201912172807	NOVO GAMA	NJ11237835	PACAEMBU S1	23/12/2019 10:51	23/12/2019 11:54	23/12/2019 10:51	23/12/2019 11:54	1,03	7	7,24	CHI
201912176697	SANTO ANTONIO DO DESCOBERTO	SN21078102	MARAJOARA	23/12/2019 10:51	23/12/2019 16:38	23/12/2019 10:51	23/12/2019 16:38	5,78	1	5,78	CHI
201912176700	CORUMBA DE GOIAS	10014024754	CORUMBA	23/12/2019 10:51	24/12/2019 13:49	23/12/2019 10:51	24/12/2019 13:49	26,95	1	26,95	CHI
201912177589	GOIANIA	GN11001823	ATLANTICO S3	23/12/2019 10:51	23/12/2019 16:44	23/12/2019 10:51	23/12/2019 16:44	5,88	87	511,73	CHI
201912172818	NOVO GAMA	NJ11211976	PACAEMBU S1	23/12/2019 10:52	23/12/2019 11:43	23/12/2019 10:52	23/12/2019 11:43	0,83	15	12,52	CHI
201912176707	SAO MIGUEL DO ARAGUAIA	SM12139573	SAO MIGUEL DO ARAGUAIA	23/12/2019 10:53	24/12/2019 15:26	23/12/2019 10:53	24/12/2019 15:26	28,54	1	28,54	CHI
201912176998	APARECIDA DE GOIANIA	200430919	INDEPENDENCIA S1	23/12/2019 10:55	23/12/2019 15:49	23/12/2019 10:55	23/12/2019 15:49	4,90	1	4,90	CHI

201912172523	ITUMBIARA	IT21257111	ITUMBIARA VELHA S1	23/12/2019 10:57	23/12/2019 13:10	23/12/2019 10:57	23/12/2019 13:10	2,21	1	2,21	CHI
201912176727	SAO MIGUEL DO ARAGUAIA	SM11247003	SAO MIGUEL DO ARAGUAIA	23/12/2019 10:57	23/12/2019 15:45	23/12/2019 10:57	23/12/2019 15:45	4,80	1	4,80	CHI
201912176728	ITAPACI	100030040	ITAPACI	23/12/2019 10:57	24/12/2019 10:29	23/12/2019 10:57	24/12/2019 10:29	23,53	1	23,53	CHI
201912176732	APARECIDA DE GOIANIA	AP11038686	INDEPENDENCIA S2	23/12/2019 10:57	23/12/2019 18:10	23/12/2019 16:11	23/12/2019 18:00	1,81	82	148,01	CHI
201912176732	APARECIDA DE GOIANIA	AP11167780	INDEPENDENCIA S2	23/12/2019 10:57	23/12/2019 18:10	23/12/2019 10:57	23/12/2019 18:10	7,21	57	411,10	CHI
201912176818	GOIAS	GS12061668	ITABERAI S1	23/12/2019 10:57	24/12/2019 07:33	23/12/2019 10:57	24/12/2019 07:33	20,59	17	349,98	CHI
201912176742	LUZIANIA	7226447	MARAJOARA	23/12/2019 10:58	23/12/2019 17:41	23/12/2019 10:58	23/12/2019 17:41	6,70	11	73,73	CHI
201912176744	IPAMERI	IP12071023	IPAMERI	23/12/2019 10:59	23/12/2019 17:01	23/12/2019 10:59	23/12/2019 17:01	6,03	4	24,12	CHI
201912172524	ITAPIRAPUA	IU12378893	MATRINCHA	23/12/2019 11:00	23/12/2019 20:46	23/12/2019 11:00	23/12/2019 20:46	9,78	1	9,78	CHI
201912176499	GUARANI DE GOIAS	GY12271764	IACIARA S1	23/12/2019 11:00	23/12/2019 15:27	23/12/2019 11:00	23/12/2019 15:27	4,44	4	17,77	CHI
201912176757	ABADIANIA	AN12379437	ANAPOLIS UNIVERSITARIO S2	23/12/2019 11:00	23/12/2019 19:19	23/12/2019 11:00	23/12/2019 19:19	8,30	3	24,91	CHI
201912176758	VALPARAISO DE GOIAS	VA11136581	MARAJOARA	23/12/2019 11:01	23/12/2019 16:30	23/12/2019 11:01	23/12/2019 16:30	5,48	3	16,45	CHI
201912176767	SILVANIA	SV21318522	DAIA S2	23/12/2019 11:02	24/12/2019 10:37	23/12/2019 11:02	24/12/2019 10:37	23,59	2	47,18	CHI
201912179835	PIRES DO RIO	PR11186713	PIRES DO RIO S1	23/12/2019 11:02	23/12/2019 17:53	23/12/2019 11:02	23/12/2019 17:53	6,85	147	1006,42	CHI
201912176773	INHUMAS	IN12018528	INHUMAS S1	23/12/2019 11:03	23/12/2019 21:58	23/12/2019 11:03	23/12/2019 21:58	10,92	1	10,92	CHI
201912176789	FORMOSA	610132623	ITUIQUIRA	23/12/2019 11:05	23/12/2019 17:00	23/12/2019 11:05	23/12/2019 17:00	5,93	1	5,93	CHI
201912176791	CORREGO DO OURO	CO21111478	FIRMINOPOLIS S2	23/12/2019 11:05	23/12/2019 17:12	23/12/2019 11:05	23/12/2019 17:12	6,12	1	6,12	CHI
201912176796	CATALAO	CT11061205	CATALAO S1	23/12/2019 11:06	23/12/2019 19:39	23/12/2019 11:06	23/12/2019 19:39	8,55	124	1059,75	CHI
201912176802	VALPARAISO DE GOIAS	10004258329	PACAEMBU S1	23/12/2019 11:07	23/12/2019 20:22	23/12/2019 11:07	23/12/2019 20:22	9,25	1	9,25	CHI
201912176808	GOIANIA	17061854	INDEPENDENCIA S2	23/12/2019 11:07	23/12/2019 15:08	23/12/2019 11:07	23/12/2019 15:08	4,01	1	4,01	CHI
201912176810	CAMPESTRE DE GOIAS	GC11277362	TRINDADE	23/12/2019 11:07	23/12/2019 15:09	23/12/2019 11:07	23/12/2019 15:09	4,02	2	8,04	CHI
201912176814	MAIRIPOTABA	530004707	PONTALINA	23/12/2019 11:07	24/12/2019 11:31	23/12/2019 11:07	24/12/2019 11:31	24,38	1	24,38	CHI
201912177021	SANTA CRUZ DE GOIAS	BC12072311	CRISTIANOPOLIS	23/12/2019 11:07	23/12/2019 21:44	23/12/2019 11:07	23/12/2019 21:44	10,61	3	31,84	CHI
201912178161	RIO VERDE	RV12382619	RIO VERDE S2	23/12/2019 11:07	23/12/2019 18:16	23/12/2019 11:07	23/12/2019 18:16	7,16	48	343,55	CHI
201912178176	MOIPIORA	MO12374844	IPORA	23/12/2019 11:07	23/12/2019 23:57	23/12/2019 11:07	23/12/2019 23:57	12,82	10	128,19	CHI
201912176819	CRISTALINA	7514631	CRISTALINA S2	23/12/2019 11:08	23/12/2019 20:38	23/12/2019 11:08	23/12/2019 20:38	9,49	1	9,49	CHI
201912177489	ITAPIRAPUA	IU12209220	MATRINCHA	23/12/2019 11:08	24/12/2019 12:15	23/12/2019 11:08	24/12/2019 12:15	25,11	6	150,67	CHI
201912165767	CAMPO ALEGRE DE GOIAS	CM12077548	CAMPO ALEGRE DE GOIAS	23/12/2019 11:09	23/12/2019 16:18	23/12/2019 11:09	23/12/2019 16:18	5,14	6	30,81	CHI
201912176825	ANAPOLIS	AN21191461	DAIA S1	23/12/2019 11:09	23/12/2019 17:01	23/12/2019 11:09	23/12/2019 17:01	5,87	1	5,87	CHI
201912176826	CIDADE OCIDENTAL	2680110876	MARAJOARA	23/12/2019 11:09	23/12/2019 16:37	23/12/2019 11:09	23/12/2019 16:37	5,47	1	5,47	CHI
201912176834	ISRAELANDIA	IS12184270	IPORA	23/12/2019 11:10	23/12/2019 23:04	23/12/2019 11:10	23/12/2019 23:04	11,89	5	59,46	CHI
201912176834	MOIPIORA	IS12184270	IPORA	23/12/2019 11:10	23/12/2019 23:04	23/12/2019 11:10	23/12/2019 23:04	11,89	7	83,25	CHI
201912176846	CORUMBAIBA	CI12025125	VILA CORUMBA	23/12/2019 11:11	24/12/2019 13:04	23/12/2019 11:11	24/12/2019 13:04	25,87	4	103,47	CHI

201912176849	ARACU	AR12104723	ARACU	23/12/2019 11:12	23/12/2019 22:25	23/12/2019 11:12	23/12/2019 22:25	11,22	19	213,11	CHI
201912176849	ITAUCU	AR12104723	ARACU	23/12/2019 11:12	23/12/2019 22:25	23/12/2019 11:12	23/12/2019 22:25	11,22	10	112,16	CHI
201912176850	CRISTALINA	KR12209482	CRISTALINA S1	23/12/2019 11:12	23/12/2019 18:42	23/12/2019 11:12	23/12/2019 18:42	7,50	1	7,50	CHI
201912176855	SANTA ROSA DE GOIAS	SR21079758	INHUMAS S1	23/12/2019 11:12	23/12/2019 23:36	23/12/2019 11:12	23/12/2019 23:36	12,39	2	24,79	CHI
201912177046	GOIANIA	GN12001242	ATLANTICO S1	23/12/2019 11:12	23/12/2019 14:27	23/12/2019 11:12	23/12/2019 14:27	3,24	503	1630,00	CHI
201912177420	CAMPINACU	UC12283781	MARA ROSA	23/12/2019 11:12	24/12/2019 09:25	23/12/2019 11:12	24/12/2019 09:25	22,21	8	177,68	CHI
201912177420	CAMPINORTE	UC12283781	MARA ROSA	23/12/2019 11:12	24/12/2019 09:25	23/12/2019 11:12	24/12/2019 09:25	22,21	1	22,21	CHI
201912181902	PIRES DO RIO	PR11159538	PIRES DO RIO S1	23/12/2019 11:12	23/12/2019 19:37	23/12/2019 11:12	23/12/2019 19:37	8,41	109	916,72	CHI
201912176864	URUACU	10004980873	CAMPINORTE	23/12/2019 11:13	23/12/2019 23:03	23/12/2019 11:13	23/12/2019 23:03	11,84	1	11,84	CHI
201912176866	BONFINOPOLIS	BO21359983	CEPAIGO S2	23/12/2019 11:14	24/12/2019 10:31	23/12/2019 11:14	24/12/2019 10:31	23,28	1	23,28	CHI
201912176868	GOIANIA	10000506590	ATLANTICO S1	23/12/2019 11:14	23/12/2019 20:09	23/12/2019 11:14	23/12/2019 20:09	8,91	1	8,91	CHI
201912176887	CAMPESTRE DE GOIAS	10008481979	TRINDADE	23/12/2019 11:16	23/12/2019 17:36	23/12/2019 11:16	23/12/2019 17:36	6,33	1	6,33	CHI
201912176896	CACHOEIRA DOURADA	CD21000023	CACHOEIRA DOURADA	23/12/2019 11:17	23/12/2019 22:40	23/12/2019 11:17	23/12/2019 22:40	11,38	1	11,38	CHI
201912176904	EDEIA	EA21380549	EDEIA	23/12/2019 11:18	25/12/2019 17:21	23/12/2019 11:18	25/12/2019 17:21	54,04	1	54,04	CHI
201912177005	GOIANESIA	GE12241509	GOIANESIA S1	23/12/2019 11:18	24/12/2019 10:51	23/12/2019 11:18	24/12/2019 10:51	23,54	2	47,09	CHI
201912177005	NOVA GLORIA	GE12241509	GOIANESIA S1	23/12/2019 11:18	24/12/2019 10:51	23/12/2019 11:18	24/12/2019 10:51	23,54	2	47,09	CHI
201912177005	SANTA ISABEL	GE12241509	GOIANESIA S1	23/12/2019 11:18	24/12/2019 10:51	23/12/2019 11:18	24/12/2019 10:51	23,54	2	47,09	CHI
201912173511	RIO VERDE	RV21249068	RIO VERDE S1	23/12/2019 11:20	23/12/2019 12:00	23/12/2019 11:20	23/12/2019 12:00	0,65	1	0,65	CHI
201912176912	GOIAS	GS21157076	MATRINCHA	23/12/2019 11:20	23/12/2019 20:32	23/12/2019 11:20	23/12/2019 20:32	9,20	1	9,20	CHI
201912176914	GUARINOS	GG12237782	URUACU	23/12/2019 11:20	23/12/2019 16:43	23/12/2019 11:20	23/12/2019 16:43	5,38	4	21,52	CHI
201912176914	SANTA TEREZINHA DE GOIAS	GG12237782	URUACU	23/12/2019 11:20	23/12/2019 16:43	23/12/2019 11:20	23/12/2019 16:43	5,38	1	5,38	CHI
201912176917	AVELINOPOLIS	990008502	ANICUNS	23/12/2019 11:20	24/12/2019 08:45	23/12/2019 11:20	24/12/2019 08:45	21,41	1	21,41	CHI
201912176921	QUIRINOPOLIS	QI12013481	QUIRINOPOLIS	23/12/2019 11:20	23/12/2019 16:43	23/12/2019 11:20	23/12/2019 16:43	5,37	4	21,47	CHI
201912172535	PORANGATU	PO12339756	PORANGATU	23/12/2019 11:23	23/12/2019 12:22	23/12/2019 11:23	23/12/2019 12:22	0,97	1	0,97	CHI
201912176939	AGUAS LINDAS DE GOIAS	10016972404	AGUAS LINDAS DE GOIAS S1	23/12/2019 11:24	23/12/2019 14:55	23/12/2019 11:24	23/12/2019 14:55	3,52	1	3,52	CHI
201912176941	AGUAS LINDAS DE GOIAS	LA11164946	AGUAS LINDAS DE GOIAS S1	23/12/2019 11:24	23/12/2019 16:54	23/12/2019 11:24	23/12/2019 16:54	5,50	188	1033,43	CHI
201912176944	BELA VISTA DE GOIAS	SV12389455	DAIA S2	23/12/2019 11:24	23/12/2019 18:59	23/12/2019 11:24	23/12/2019 18:59	7,59	7	53,11	CHI
201912176944	SILVANIA	SV12389455	DAIA S2	23/12/2019 11:24	23/12/2019 18:59	23/12/2019 11:24	23/12/2019 18:59	7,59	114	864,97	CHI
201912176952	SANTA HELENA DE GOIAS	400057426	IPEGUARI	23/12/2019 11:24	24/12/2019 00:29	23/12/2019 11:24	24/12/2019 00:29	13,07	1	13,07	CHI
201912176954	CRISTALINA	KR21214871	CRISTALINA S2	23/12/2019 11:24	23/12/2019 16:42	23/12/2019 11:24	23/12/2019 16:42	5,28	1	5,28	CHI
201912172563	APARECIDA DE GOIANIA	AP11137105	INDEPENDENCIA S1	23/12/2019 11:25	23/12/2019 17:12	23/12/2019 11:25	23/12/2019 17:12	5,78	183	1058,15	CHI
201912176957	FAINA	FC12396534	ITAPURANGA	23/12/2019 11:25	24/12/2019 17:54	23/12/2019 11:25	24/12/2019 17:54	30,48	7	213,35	CHI
201912176984	MONTIVIDIU	MV12260895	MONTIVIDIU T	23/12/2019 11:25	23/12/2019 19:13	23/12/2019 11:25	23/12/2019 19:13	7,79	9	70,10	CHI

201912177615	IPAMERI	IP12000088	IPAMERI	23/12/2019 11:26	23/12/2019 18:15	23/12/2019 11:26	23/12/2019 18:15	6,81	15	102,12	CHI
201912176969	CROMINIA	CQ21249838	PONTALINA	23/12/2019 11:27	24/12/2019 09:12	23/12/2019 11:27	24/12/2019 09:12	21,75	1	21,75	CHI
201912176975	CRISTALINA	KR21245991	CRISTALINA S2	23/12/2019 11:27	23/12/2019 18:12	23/12/2019 11:27	23/12/2019 18:12	6,74	1	6,74	CHI
201912176978	NOVO GAMA	2900009980	MARAJOARA	23/12/2019 11:28	23/12/2019 15:09	23/12/2019 11:28	23/12/2019 15:09	3,68	1	3,68	CHI
201912176981	JOVIANIA	JV21398827	GOIATUBA S1	23/12/2019 11:28	24/12/2019 10:07	23/12/2019 11:28	24/12/2019 10:07	22,64	1	22,64	CHI
201912178943	BURITI ALEGRE	GT12263930	GOIATUBA S1	23/12/2019 11:28	24/12/2019 18:15	23/12/2019 11:28	24/12/2019 18:15	30,78	2	61,56	CHI
201912178943	GOIATUBA	GT12263930	GOIATUBA S1	23/12/2019 11:28	24/12/2019 18:15	23/12/2019 11:28	24/12/2019 18:15	30,78	34	1046,60	CHI
201912176985	TRINDADE	10000558913	TRINDADE	23/12/2019 11:29	24/12/2019 10:59	23/12/2019 11:29	24/12/2019 10:59	23,49	1	23,49	CHI
201912176987	SILVANIA	SV12317620	VIANOPOLIS	23/12/2019 11:29	23/12/2019 18:04	23/12/2019 11:29	23/12/2019 18:04	6,58	2	13,17	CHI
201912176997	CRISTALINA	KR21237813	CRISTALINA S2	23/12/2019 11:30	23/12/2019 17:07	23/12/2019 11:30	23/12/2019 17:07	5,60	1	5,60	CHI
201912177466	GOIANIA	GN11168562	CAMPINAS S1	23/12/2019 11:30	23/12/2019 16:15	23/12/2019 11:30	23/12/2019 16:15	4,74	49	232,45	CHI
201912177000	GOIANAPOLIS	GP21283828	DAIA S2	23/12/2019 11:31	23/12/2019 17:56	23/12/2019 11:31	23/12/2019 17:56	6,42	1	6,42	CHI
201912177008	URUACU	UR21294500	URUACU	23/12/2019 11:31	24/12/2019 07:49	23/12/2019 11:31	24/12/2019 07:49	20,29	1	20,29	CHI
201912177012	CRISTALINA	KR21261101	CRISTALINA S2	23/12/2019 11:32	23/12/2019 17:41	23/12/2019 11:32	23/12/2019 17:41	6,15	1	6,15	CHI
201912177020	APARECIDA DE GOIANIA	10003281017	INDEPENDENCIA S1	23/12/2019 11:32	23/12/2019 17:54	23/12/2019 11:32	23/12/2019 17:54	6,35	1	6,35	CHI
201912177023	VALPARAISO DE GOIAS	10017693550	PACAEMBU S1	23/12/2019 11:33	23/12/2019 22:44	23/12/2019 11:33	23/12/2019 22:44	11,18	1	11,18	CHI
201912179011	GOIANESIA	GE12126780	GOIANESIA S2	23/12/2019 11:34	23/12/2019 16:55	23/12/2019 11:34	23/12/2019 16:55	5,34	806	4307,17	CHI
201912177036	FORMOSA	FA11269959	ITIQUEIRA	23/12/2019 11:35	23/12/2019 20:03	23/12/2019 11:35	23/12/2019 20:03	8,46	1	8,46	CHI
201912177044	GOIANESIA	550070515	GOIANESIA S2	23/12/2019 11:36	24/12/2019 01:37	23/12/2019 11:36	24/12/2019 01:37	14,01	1	14,01	CHI
201912179837	PIRES DO RIO	PR11043805	PIRES DO RIO S1	23/12/2019 11:36	23/12/2019 18:07	23/12/2019 11:36	23/12/2019 18:07	6,53	102	666,26	CHI
201912177053	GOIANIA	11233850	CARAJAS S1	23/12/2019 11:37	23/12/2019 21:00	23/12/2019 11:37	23/12/2019 21:00	9,38	1	9,38	CHI
201912177054	GOIAS	GS11239253	GOIAS	23/12/2019 11:37	23/12/2019 18:05	23/12/2019 11:37	23/12/2019 18:05	6,46	1	6,46	CHI
201912177055	GOIANIA	GN11161521	FERROVIARIO S1	23/12/2019 11:37	23/12/2019 17:10	23/12/2019 11:37	23/12/2019 17:10	5,54	126	697,73	CHI
201912177058	CROMINIA	CQ21009389	PONTALINA	23/12/2019 11:38	24/12/2019 09:53	23/12/2019 11:38	24/12/2019 09:53	22,25	1	22,25	CHI
201912178005	BURITI ALEGRE	BG12000124	ITUMBIARA VELHA S2	23/12/2019 11:38	23/12/2019 16:13	23/12/2019 11:38	23/12/2019 16:13	4,57	5	22,86	CHI
201912177513	GOIANIA	GN12000075	CAMPINAS S1	23/12/2019 11:40	23/12/2019 14:55	23/12/2019 11:40	23/12/2019 14:55	3,24	264	854,33	CHI
201912177632	JUSSARA	RN12045571	BRITANIA	23/12/2019 11:40	23/12/2019 18:58	23/12/2019 11:40	23/12/2019 18:58	7,31	4	29,26	CHI
201912177632	SANTA FE DE GOIAS	RN12045571	BRITANIA	23/12/2019 11:40	23/12/2019 18:58	23/12/2019 11:40	23/12/2019 18:58	7,31	7	51,20	CHI
201912178561	DOVERLANDIA	DV12221021	CAIAPONIA	23/12/2019 11:40	23/12/2019 15:33	23/12/2019 11:40	23/12/2019 15:33	3,88	21	81,48	CHI
201912177408	PADRE BERNARDO	2760051001	PADRE BERNARDO	23/12/2019 11:42	23/12/2019 17:34	23/12/2019 11:42	23/12/2019 17:34	5,88	1	5,88	CHI
201912177413	MINEIROS	MY21202657	PARQUE DAS EMAS	23/12/2019 11:42	25/12/2019 11:18	23/12/2019 11:42	25/12/2019 11:18	47,59	1	47,59	CHI
201912177415	SAO LUIS DE MONTES BELOS	10002959680	SAO LUIZ DOS MONTES BELOS	23/12/2019 11:42	23/12/2019 14:42	23/12/2019 11:42	23/12/2019 14:42	2,99	1	2,99	CHI
201912177747	GOIANIA	GN12026286	REAL S1	23/12/2019 11:42	23/12/2019 15:42	23/12/2019 11:42	23/12/2019 15:42	3,99	1076	4291,45	CHI

201912177428	PIRES DO RIO	460105243	PIRES DO RIO S1	23/12/2019 11:45	23/12/2019 23:09	23/12/2019 11:45	23/12/2019 23:09	11,40	1	11,40	CHI
201912177445	SANTA HELENA DE GOIAS	SH21071638	SANTA HELENA S1	23/12/2019 11:47	24/12/2019 09:15	23/12/2019 11:47	24/12/2019 09:15	21,45	1	21,45	CHI
201912185204	ARENOPOLIS	PH12233032	PIRANHAS	23/12/2019 11:48	24/12/2019 06:48	23/12/2019 11:48	24/12/2019 06:48	19,00	3	56,99	CHI
201912185204	PIRANHAS	PH12233032	PIRANHAS	23/12/2019 11:48	24/12/2019 06:48	23/12/2019 11:48	24/12/2019 06:48	19,00	4	75,99	CHI
201912177454	PALMEIRAS DE GOIAS	590017615	PALMEIRAS	23/12/2019 11:49	24/12/2019 05:52	23/12/2019 11:49	24/12/2019 05:52	18,04	1	18,04	CHI
201912177455	CORUMBAIBA	CI21019703	VILA CORUMBA	23/12/2019 11:50	24/12/2019 17:54	23/12/2019 11:50	24/12/2019 17:54	30,06	1	30,06	CHI
201912177458	AGUAS LINDAS DE GOIAS	10009274250	AGUAS LINDAS DE GOIAS S1	23/12/2019 11:50	23/12/2019 19:43	23/12/2019 11:50	23/12/2019 19:43	7,88	1	7,88	CHI
201912179838	PIRES DO RIO	PR11000037	PIRES DO RIO S1	23/12/2019 11:50	23/12/2019 18:20	23/12/2019 11:50	23/12/2019 18:20	6,49	114	740,40	CHI
201912177461	ANAPOLIS	20792748	JUNDIAI S2	23/12/2019 11:51	23/12/2019 15:00	23/12/2019 11:51	23/12/2019 15:00	3,15	1	3,15	CHI
201912177473	MONTES CLAROS DE GOIAS	ME12184448	IPORA	23/12/2019 11:54	23/12/2019 17:31	23/12/2019 11:54	23/12/2019 17:31	5,61	7	39,30	CHI
201912177474	CUMARI	CY12000317	CATALAO S1	23/12/2019 11:54	24/12/2019 12:21	23/12/2019 11:54	24/12/2019 12:21	24,44	3	73,32	CHI
201912177478	GOIANIA	11285679	CAMPINAS S3	23/12/2019 11:55	23/12/2019 19:30	23/12/2019 11:55	23/12/2019 19:30	7,58	1	7,58	CHI
201912169423	APARECIDA DE GOIANIA	AP11164458	INDEPENDENCIA S2	23/12/2019 11:56	23/12/2019 19:36	23/12/2019 11:56	23/12/2019 19:36	7,66	152	1164,91	CHI
201912177484	LEOPOLDO DE BULHOES	LB21037888	DAIA S1	23/12/2019 12:00	23/12/2019 19:43	23/12/2019 12:00	23/12/2019 19:43	7,71	2	15,42	CHI
201912179038	ITABERAÍ	IX12321505	INHUMAS S1	23/12/2019 12:02	23/12/2019 19:10	23/12/2019 12:02	23/12/2019 19:10	7,13	1	7,13	CHI
201912179038	ITAUCU	IX12321505	INHUMAS S1	23/12/2019 12:02	23/12/2019 19:10	23/12/2019 12:02	23/12/2019 19:10	7,13	19	135,45	CHI
201912177497	NIQUELANDIA	NQ21146902	URUACU	23/12/2019 12:03	24/12/2019 11:17	23/12/2019 12:03	24/12/2019 11:17	23,23	1	23,23	CHI
201912177553	APARECIDA DE GOIANIA	AP11165711	INDEPENDENCIA S1	23/12/2019 12:04	23/12/2019 15:01	23/12/2019 12:04	23/12/2019 15:01	2,95	90	265,50	CHI
201912177521	GOIANIA	GN11002040	REAL S2	23/12/2019 12:08	23/12/2019 22:24	23/12/2019 12:08	23/12/2019 22:24	10,25	38	389,59	CHI
201912177534	RIO VERDE	RV21122022	MONTIVIDIU T	23/12/2019 12:10	24/12/2019 10:40	23/12/2019 12:10	24/12/2019 10:40	22,49	1	22,49	CHI
201912177542	NOVO GAMA	4990097660	PACAEMBU S1	23/12/2019 12:12	23/12/2019 16:20	23/12/2019 12:12	23/12/2019 16:20	4,13	1	4,13	CHI
201912177559	BELA VISTA DE GOIAS	BV21172634	BELA VISTA S2	23/12/2019 12:16	23/12/2019 18:33	23/12/2019 12:16	23/12/2019 18:33	6,28	1	6,28	CHI
201912185395	RUBIATABA	RB21114335	RUBIATABA	23/12/2019 12:16	24/12/2019 11:11	23/12/2019 12:16	24/12/2019 11:11	22,91	2	45,83	CHI
201912177570	NOVO GAMA	2460099041	PACAEMBU S1	23/12/2019 12:18	23/12/2019 16:26	23/12/2019 12:18	23/12/2019 16:26	4,15	1	4,15	CHI
201912177571	CACHOEIRA DE GOIAS	CG21156685	FIRMINOPOLIS S2	23/12/2019 12:18	23/12/2019 21:39	23/12/2019 12:18	23/12/2019 21:39	9,35	1	9,35	CHI
201912177575	CATALAO	CT11130164	CATALAO S1	23/12/2019 12:18	23/12/2019 16:42	23/12/2019 12:18	23/12/2019 16:42	4,39	12	52,69	CHI
201912177576	APARECIDA DO RIO DOCE	3650001297	CACHOEIRA ALTA	23/12/2019 12:18	24/12/2019 11:07	23/12/2019 12:18	24/12/2019 11:07	22,80	1	22,80	CHI
201912179110	APARECIDA DE GOIANIA	AP11204084	INDEPENDENCIA S2	23/12/2019 12:22	23/12/2019 17:19	23/12/2019 12:22	23/12/2019 17:19	4,95	130	643,36	CHI
201912183523	MAIRIPOTABA	MI12000420	PONTALINA	23/12/2019 12:22	24/12/2019 15:58	23/12/2019 12:22	24/12/2019 15:58	27,59	4	110,38	CHI
201912176091	RIO VERDE	RV21260629	RIO VERDE S1	23/12/2019 12:23	23/12/2019 13:00	23/12/2019 12:23	23/12/2019 13:00	0,61	1	0,61	CHI
201912177600	GOIANDIRA	GD21231398	CATALAO S1	23/12/2019 12:23	24/12/2019 10:37	23/12/2019 12:23	24/12/2019 10:37	22,22	1	22,22	CHI
201912177608	RIO VERDE	RV21260880	CABRIUVA S2	23/12/2019 12:25	24/12/2019 12:32	23/12/2019 12:25	24/12/2019 12:32	24,11	1	24,11	CHI
201912178174	GOIANESIA	GE12382313	GOIANESIA S2	23/12/2019 12:25	24/12/2019 01:54	23/12/2019 12:25	24/12/2019 01:54	13,49	18	242,87	CHI



201912177621	APARECIDA DE GOIANIA	12640992	REAL S1	23/12/2019 12:28	23/12/2019 20:03	23/12/2019 12:28	23/12/2019 20:03	7,58	1	7,58	CHI
201912177625	GOIANIA	GN11326522	ATLANTICO S3	23/12/2019 12:29	23/12/2019 21:52	23/12/2019 21:35	23/12/2019 21:52	0,28	9	2,55	CHI
201912177631	MORRINHOS	150021586	MORRINHOS	23/12/2019 12:30	24/12/2019 06:08	23/12/2019 12:30	24/12/2019 06:08	17,63	1	17,63	CHI
201912177633	NEROPOLIS	160017415	NEROPOLIS S2	23/12/2019 12:30	23/12/2019 17:19	23/12/2019 12:30	23/12/2019 17:19	4,81	1	4,81	CHI
201912177634	CACHOEIRA ALTA	CA21078883	CACHOEIRA ALTA	23/12/2019 12:30	24/12/2019 09:37	23/12/2019 12:30	24/12/2019 09:37	21,11	1	21,11	CHI
201912177635	ANAPOLIS	10001893015	JUNDIAI S2	23/12/2019 12:30	23/12/2019 18:18	23/12/2019 12:30	23/12/2019 18:18	5,79	1	5,79	CHI
201912177638	JATAI	290101360	JATAI S3	23/12/2019 12:30	23/12/2019 16:30	23/12/2019 12:30	23/12/2019 16:30	3,99	1	3,99	CHI
201912177639	NOVO GAMA	NJ21171635	PACAEMBU S1	23/12/2019 12:31	23/12/2019 17:00	23/12/2019 12:31	23/12/2019 17:00	4,48	2	8,96	CHI
201912177644	VALPARAISO DE GOIAS	3350000858	PACAEMBU S2	23/12/2019 12:31	23/12/2019 15:29	23/12/2019 12:31	23/12/2019 15:29	2,95	1	2,95	CHI
201912177686	LUZIANIA	LZ12390021	PIRES DO RIO S2	23/12/2019 12:31	23/12/2019 21:29	23/12/2019 12:31	23/12/2019 21:29	8,95	18	161,16	CHI
201912177649	GUAPO	710032377	GUAPO S1	23/12/2019 12:33	23/12/2019 15:07	23/12/2019 12:33	23/12/2019 15:07	2,56	1	2,56	CHI
201912177651	BURITI DE GOIAS	10011480686	FIRMINOPOLIS S2	23/12/2019 12:33	24/12/2019 10:28	23/12/2019 12:33	24/12/2019 10:28	21,91	1	21,91	CHI
201912178523	HIDROLANDIA	HD12372976	ANHANGUERA	23/12/2019 12:34	23/12/2019 18:49	23/12/2019 12:34	23/12/2019 18:49	6,25	14	87,50	CHI
201912177657	ANAPOLIS	AN11000017	ANAPOLIS UNIVERSITARIO S2	23/12/2019 12:36	23/12/2019 15:15	23/12/2019 12:36	23/12/2019 15:15	2,64	139	367,58	CHI
201912177662	SANTA RITA DO ARAGUAIA	SU12202817	SANTA RITA DO ARAGUAIA	23/12/2019 12:37	24/12/2019 13:26	23/12/2019 12:37	24/12/2019 13:26	24,81	1	24,81	CHI
201912177663	IPORA	IR21040130	IPORA	23/12/2019 12:37	24/12/2019 08:43	23/12/2019 12:37	24/12/2019 08:43	20,09	1	20,09	CHI
201912180094	LEOPOLDO DE BULHOES	LB12384849	DAIA S2	23/12/2019 12:38	23/12/2019 19:08	23/12/2019 12:38	23/12/2019 19:08	6,50	3	19,51	CHI
201912193005	CORUMBAIBA	CI12039772	VILA CORUMBA	23/12/2019 12:38	25/12/2019 13:37	23/12/2019 12:38	25/12/2019 13:37	48,97	7	342,77	CHI
201912177679	ITAUCU	IX12016886	INHUMAS S1	23/12/2019 12:41	24/12/2019 04:15	23/12/2019 12:41	24/12/2019 04:15	15,55	7	108,86	CHI
201912177682	AGUA LIMPA	AL12000265	VILA CORUMBA	23/12/2019 12:42	24/12/2019 13:41	23/12/2019 12:42	24/12/2019 13:41	24,97	1	24,97	CHI
201912183209	MUNDO NOVO DE GOIAS	MH12391957	NOVA CRIXAS	23/12/2019 12:43	24/12/2019 16:28	23/12/2019 12:43	24/12/2019 16:28	27,75	8	222,01	CHI
201912177687	QUIRINOPOLIS	QI21000100	QUIRINOPOLIS	23/12/2019 12:44	23/12/2019 18:19	23/12/2019 12:44	23/12/2019 18:19	5,58	1	5,58	CHI
201912177694	GOIAS	GS21250565	GOIAS	23/12/2019 12:45	23/12/2019 18:37	23/12/2019 12:45	23/12/2019 18:37	5,85	1	5,85	CHI
201912179098	RIO VERDE	RV12054358	MONTIVIDIU T	23/12/2019 12:46	23/12/2019 23:01	23/12/2019 12:46	23/12/2019 23:01	10,24	2	20,48	CHI
201912177704	LUZIANIA	LZ12389579	VIANOPOLIS	23/12/2019 12:48	23/12/2019 15:59	23/12/2019 12:48	23/12/2019 15:59	3,18	11	35,00	CHI
201912179092	MORRINHOS	MR11000004	MORRINHOS	23/12/2019 12:50	23/12/2019 17:23	23/12/2019 12:50	23/12/2019 17:23	4,53	198	897,71	CHI
201912179002	CALDAZINHA	LB12095842	CEPAIGO S2	23/12/2019 12:51	23/12/2019 19:31	23/12/2019 12:51	23/12/2019 19:31	6,66	2	13,32	CHI
201912177726	PALMEIRAS DE GOIAS	10018597007	PALMEIRAS	23/12/2019 12:54	23/12/2019 23:24	23/12/2019 12:54	23/12/2019 23:24	10,50	1	10,50	CHI
201912177566	GOIANIA	GN12001418	CAMPINAS S1	23/12/2019 12:55	23/12/2019 21:15	23/12/2019 12:55	23/12/2019 21:15	8,32	105	873,77	CHI
201912177735	CRISTALINA	KR12351414	PAMPLONA	23/12/2019 12:55	23/12/2019 19:27	23/12/2019 12:55	23/12/2019 19:27	6,53	6	39,19	CHI
201912177738	ITUMBIARA	IT12000367	ITUMBIARA NOVA	23/12/2019 12:55	23/12/2019 21:01	23/12/2019 12:55	23/12/2019 21:01	8,09	3	24,27	CHI
201912177742	PIRENOPOLIS	PV21000727	SAO FRANCISCO DE GOIAS	23/12/2019 12:56	23/12/2019 20:27	23/12/2019 12:56	23/12/2019 20:27	7,51	1	7,51	CHI
201912177902	URUTAI	UT21417471	PIRES DO RIO S2	23/12/2019 12:58	23/12/2019 21:40	23/12/2019 12:58	23/12/2019 21:40	8,70	0	0,00	CHI

201912178159	CALDAS NOVAS	CN11049916	CALDAS NOVAS S2	23/12/2019 12:58	23/12/2019 18:00	23/12/2019 12:58	23/12/2019 18:00	5,02	44	220,86	CHI
201912181158	BOM JESUS DE GOIAS	BJ12208042	BOM JESUS DE GOIAS	23/12/2019 12:58	23/12/2019 23:41	23/12/2019 12:58	23/12/2019 23:41	10,72	2	21,43	CHI
201912179043	POSSE	PS11104726	IACIARA S2	23/12/2019 13:00	23/12/2019 16:48	23/12/2019 13:00	23/12/2019 16:48	3,79	141	534,27	CHI
201912177915	LEOPOLDO DE BULHOES	LB21032428	DAIA S2	23/12/2019 13:01	24/12/2019 14:10	23/12/2019 13:01	24/12/2019 14:10	25,14	1	25,14	CHI
201912178002	PIRANHAS	PH21220935	CAIAPONIA	23/12/2019 13:02	24/12/2019 09:54	23/12/2019 13:02	24/12/2019 09:54	20,86	1	20,86	CHI
201912178004	GOIAS	GS21333995	GOIAS	23/12/2019 13:03	24/12/2019 15:46	23/12/2019 13:03	24/12/2019 15:46	26,71	2	53,43	CHI
201912178275	APARECIDA DE GOIANIA	AP11034423	INDEPENDENCIA S1	23/12/2019 13:03	23/12/2019 17:40	23/12/2019 13:03	23/12/2019 17:40	4,60	87	400,54	CHI
201912178011	SANTO ANTONIO DO DESCOBERTO	SN21078132	MARAJOARA	23/12/2019 13:04	23/12/2019 18:33	23/12/2019 13:04	23/12/2019 18:33	5,48	1	5,48	CHI
201912178018	NOVO GAMA	NJ11097136	PACAEMBU S1	23/12/2019 13:06	23/12/2019 16:13	23/12/2019 13:06	23/12/2019 16:13	3,11	250	777,85	CHI
201912178019	CAIAPONIA	930052950	CAIAPONIA	23/12/2019 13:06	24/12/2019 21:30	23/12/2019 13:06	24/12/2019 21:30	32,40	1	32,40	CHI
201912178102	QUIRINOPOLIS	80008975	QUIRINOPOLIS	23/12/2019 13:06	23/12/2019 16:08	23/12/2019 13:06	23/12/2019 16:08	3,02	1	3,02	CHI
201912178103	FORMOSA	FA21334132	SAO JOAO D ALIANCA	23/12/2019 13:07	23/12/2019 17:24	23/12/2019 13:07	23/12/2019 17:24	4,28	1	4,28	CHI
201912178106	ITUMBIARA	IT21097249	BOM JESUS DE GOIAS	23/12/2019 13:07	24/12/2019 09:37	23/12/2019 13:07	24/12/2019 09:37	20,49	1	20,49	CHI
201912178107	BOM JARDIM DE GOIAS	BM21155707	BOM JARDIM	23/12/2019 13:07	24/12/2019 15:45	23/12/2019 13:07	24/12/2019 15:45	26,62	1	26,62	CHI
201912178118	VILA BOA	2880014380	ITUIQUIRA	23/12/2019 13:09	23/12/2019 18:29	23/12/2019 13:09	23/12/2019 18:29	5,32	1	5,32	CHI
201912163621	ITUMBIARA	BG12000053	ITUMBIARA VELHA S2	23/12/2019 13:10	24/12/2019 11:40	23/12/2019 13:10	24/12/2019 11:40	22,50	10	225,03	CHI
201912178124	MINEIROS	MY12296347	PARQUE DAS EMAS	23/12/2019 13:10	24/12/2019 14:08	23/12/2019 13:10	24/12/2019 14:08	24,96	2	49,92	CHI
201912178126	CACHOEIRA ALTA	CA21084332	CACHOEIRA ALTA	23/12/2019 13:10	24/12/2019 01:04	23/12/2019 13:10	24/12/2019 01:04	11,89	1	11,89	CHI
201912178127	AGUA FRIA DE GOIAS	4140003997	SAO JOAO D ALIANCA	23/12/2019 13:10	24/12/2019 09:02	23/12/2019 13:10	24/12/2019 09:02	19,86	1	19,86	CHI
201912178133	JARAGUA	JA21062950	ITABERAI S1	23/12/2019 13:11	24/12/2019 08:56	23/12/2019 13:11	24/12/2019 08:56	19,74	1	19,74	CHI
201912178137	RIO VERDE	630592901	RIO VERDE S1	23/12/2019 13:12	23/12/2019 16:37	23/12/2019 13:12	23/12/2019 16:37	3,41	1	3,41	CHI
201912178546	MONTES CLAROS DE GOIAS	ME12380972	IPORA	23/12/2019 13:13	24/12/2019 08:39	23/12/2019 13:13	24/12/2019 08:39	19,43	8	155,42	CHI
201912178147	CATALAO	CT11363413	CATALAO S2	23/12/2019 13:14	23/12/2019 16:34	23/12/2019 13:14	23/12/2019 16:34	3,33	2	6,66	CHI
201912178148	BARRO ALTO	BA21342222	GOIANESIA S1	23/12/2019 13:14	27/12/2019 10:23	23/12/2019 13:14	27/12/2019 10:23	93,15	1	93,15	CHI
201912180965	IPAMERI	IP12068500	CRISTALINA S2	23/12/2019 13:14	23/12/2019 17:41	23/12/2019 13:14	23/12/2019 17:41	4,44	8	35,50	CHI
201912178704	GOIANIA	GN12383189	GOYA S2	23/12/2019 13:15	23/12/2019 16:15	23/12/2019 13:15	23/12/2019 16:15	3,00	162	485,37	CHI
201912178160	NOVA ROMA	ND21117607	IACIARA S2	23/12/2019 13:16	23/12/2019 15:59	23/12/2019 13:16	23/12/2019 15:59	2,71	1	2,71	CHI
201912178169	FORMOSA	610323738	ITUIQUIRA	23/12/2019 13:18	23/12/2019 15:48	23/12/2019 13:18	23/12/2019 15:48	2,49	1	2,49	CHI
201912178171	ITAPURANGA	IK21298445	ITAPURANGA	23/12/2019 13:18	26/12/2019 15:47	23/12/2019 13:18	26/12/2019 15:47	74,47	1	74,47	CHI
201912178178	MOSSAMEDES	MD21204368	FIRMINOPOLIS S2	23/12/2019 13:20	23/12/2019 17:02	23/12/2019 13:20	23/12/2019 17:02	3,70	1	3,70	CHI
201912178179	JARAGUA	JA21296998	JARAGUA	23/12/2019 13:20	23/12/2019 15:35	23/12/2019 13:20	23/12/2019 15:35	2,24	2	4,48	CHI
201912178181	QUIRINOPOLIS	QI31203948	QUIRINOPOLIS	23/12/2019 13:21	23/12/2019 17:55	23/12/2019 13:21	23/12/2019 17:55	4,55	1	4,55	CHI
201912178182	ITAPURANGA	10009620077	ITAPURANGA	23/12/2019 13:21	23/12/2019 16:08	23/12/2019 13:21	23/12/2019 16:08	2,77	1	2,77	CHI

201912178204	URUACU	10016392505	URUACU	23/12/2019 13:27	23/12/2019 18:55	23/12/2019 13:27	23/12/2019 18:55	5,47	1	5,47	CHI
201912178207	RIO VERDE	10016187707	RIO VERDE S2	23/12/2019 13:27	23/12/2019 17:27	23/12/2019 13:27	23/12/2019 17:27	3,99	1	3,99	CHI
201912178209	ORIZONA	2060007660	PIRES DO RIO S2	23/12/2019 13:28	23/12/2019 17:26	23/12/2019 13:28	23/12/2019 17:26	3,97	1	3,97	CHI
201912184536	ALTO HORIZONTE	AJ12210309LD	MARA ROSA	23/12/2019 13:28	24/12/2019 08:59	23/12/2019 13:28	24/12/2019 08:59	19,51	19	370,63	CHI
201912184536	MARA ROSA	AJ12210309LD	MARA ROSA	23/12/2019 13:28	24/12/2019 08:59	23/12/2019 13:28	24/12/2019 08:59	19,51	3	58,52	CHI
201912176970	ITAJA	IJ11252065	ITAJA S2	23/12/2019 13:29	23/12/2019 14:41	23/12/2019 13:29	23/12/2019 14:41	1,20	127	151,77	CHI
201912178219	GOIAS	IU12060535	MATRINCHA	23/12/2019 13:30	23/12/2019 20:43	23/12/2019 13:30	23/12/2019 20:43	7,22	1	7,22	CHI
201912178219	ITAPIRAPUA	IU12060535	MATRINCHA	23/12/2019 13:30	23/12/2019 20:43	23/12/2019 13:30	23/12/2019 20:43	7,22	11	79,38	CHI
201912178221	QUIRINOPOLIS	QI31035790	QUIRINOPOLIS	23/12/2019 13:30	24/12/2019 14:56	23/12/2019 13:30	24/12/2019 14:56	25,42	1	25,42	CHI
201912179037	APARECIDA DE GOIANIA	200260431	INDEPENDENCIA S1	23/12/2019 13:30	23/12/2019 16:01	23/12/2019 13:30	23/12/2019 16:01	2,52	1	2,52	CHI
201912178231	AMORINOPOLIS	1240016557	IPORA	23/12/2019 13:31	24/12/2019 10:34	23/12/2019 13:31	24/12/2019 10:34	21,04	1	21,04	CHI
201912178802	SAO MIGUEL DO PASSA QUATRO	SQ12077213	CRISTIANOPOLIS	23/12/2019 13:32	23/12/2019 17:00	23/12/2019 13:32	23/12/2019 17:00	3,46	40	138,53	CHI
201912178242	APARECIDA DE GOIANIA	200122368	INDEPENDENCIA S2	23/12/2019 13:33	23/12/2019 16:40	23/12/2019 13:33	23/12/2019 16:40	3,12	1	3,12	CHI
201912178244	APARECIDA DE GOIANIA	10020801953	INDEPENDENCIA S2	23/12/2019 13:33	23/12/2019 17:13	23/12/2019 13:33	23/12/2019 17:13	3,67	1	3,67	CHI
201912178246	JARAGUA	JA21354274	ITABERAI S1	23/12/2019 13:33	24/12/2019 09:28	23/12/2019 13:33	24/12/2019 09:28	19,91	1	19,91	CHI
201912178247	SANTA BARBARA DE GOIAS	SB21167113	TRINDADE	23/12/2019 13:33	23/12/2019 20:10	23/12/2019 13:33	23/12/2019 20:10	6,61	1	6,61	CHI
201912178249	CALDAS NOVAS	CN21186897	SERRA DE CALDAS	23/12/2019 13:33	24/12/2019 09:00	23/12/2019 13:33	24/12/2019 09:00	19,44	1	19,44	CHI
201912178255	URUACU	10005343788	URUACU	23/12/2019 13:34	23/12/2019 20:33	23/12/2019 13:34	23/12/2019 20:33	6,98	1	6,98	CHI
201912178256	MONTIVIDIU	MV12267623	MONTIVIDIU T	23/12/2019 13:34	23/12/2019 23:28	23/12/2019 13:34	23/12/2019 23:28	9,90	29	286,98	CHI
201912178259	CIDADE OCIDENTAL	2680101504	MARAJOARA	23/12/2019 13:34	23/12/2019 16:09	23/12/2019 13:34	23/12/2019 16:09	2,58	1	2,58	CHI
201912181288	MAIRIPOTABA	MI11293160	PONTALINA	23/12/2019 13:34	24/12/2019 12:08	23/12/2019 13:34	24/12/2019 12:08	22,55	13	293,17	CHI
201912178268	LUZIANIA	LZ21304790	PAMPLONA	23/12/2019 13:35	23/12/2019 20:44	23/12/2019 13:35	23/12/2019 20:44	7,14	1	7,14	CHI
201912178287	CRISTALINA	KR21163143	CRISTALINA S1	23/12/2019 13:37	23/12/2019 18:02	23/12/2019 13:37	23/12/2019 18:02	4,40	1	4,40	CHI
201912178294	GOIANIA	10201075	AEROPORTO S1	23/12/2019 13:38	24/12/2019 03:18	23/12/2019 13:38	24/12/2019 03:18	13,67	1	13,67	CHI
201912178303	APARECIDA DE GOIANIA	10006043230	INDEPENDENCIA S2	23/12/2019 13:40	23/12/2019 22:13	23/12/2019 13:40	23/12/2019 22:13	8,55	1	8,55	CHI
201912178401	ITAPURANGA	1690000512	ITAPURANGA	23/12/2019 13:41	24/12/2019 17:13	23/12/2019 13:41	24/12/2019 17:13	27,52	1	27,52	CHI
201912178940	FAINA	FC12211270	GOIAS	23/12/2019 13:41	26/12/2019 14:20	23/12/2019 13:41	25/12/2019 10:28	44,79	8	358,35	CHI
201912178940	FAINA	GS12042217	GOIAS	23/12/2019 13:41	26/12/2019 14:20	25/12/2019 10:29	25/12/2019 11:29	1,01	58	58,34	CHI
201912178940	FAINA	FC12211270	GOIAS	23/12/2019 13:41	26/12/2019 14:20	25/12/2019 10:29	25/12/2019 22:45	12,26	3	36,78	CHI
201912178940	FAINA	FC12211270	GOIAS	23/12/2019 13:41	26/12/2019 14:20	25/12/2019 10:29	26/12/2019 14:20	27,84	5	139,21	CHI
201912178940	FAINA	FC12211270	GOIAS	23/12/2019 13:41	26/12/2019 14:20	26/12/2019 13:43	26/12/2019 14:20	0,61	3	1,84	CHI
201912178508	GOIANIA	10952263	FERROVIARIO S1	23/12/2019 13:42	24/12/2019 03:38	23/12/2019 13:42	24/12/2019 03:38	13,93	1	13,93	CHI
201912178518	NOVO PLANALTO	TA21287449	SAO MIGUEL DO ARAGUAIA	23/12/2019 13:42	24/12/2019 03:45	23/12/2019 13:42	24/12/2019 03:45	14,04	1	14,04	CHI

201912179035	ALEXANIA	AX12066452	ALEXANIA	23/12/2019 13:43	23/12/2019 18:21	23/12/2019 13:43	23/12/2019 18:21	4,62	25	115,53	CHI
201912179914	SANTA TEREZINHA DE GOIAS	SG12242338	SANTA TEREZINHA	23/12/2019 13:43	23/12/2019 19:02	23/12/2019 13:43	23/12/2019 19:02	5,31	13	68,99	CHI
201912178545	FAINA	FC12299839	GOIAS	23/12/2019 13:47	23/12/2019 21:04	23/12/2019 13:47	23/12/2019 21:04	7,28	12	87,33	CHI
201912178547	APARECIDA DE GOIANIA	10020577468	INDEPENDENCIA S1	23/12/2019 13:47	23/12/2019 16:29	23/12/2019 13:47	23/12/2019 16:29	2,69	1	2,69	CHI
201912179729	SAO MIGUEL DO ARAGUAIA	SM12371801B	SAO MIGUEL DO ARAGUAIA	23/12/2019 13:47	23/12/2019 19:47	23/12/2019 13:47	23/12/2019 19:47	5,99	244	1461,70	CHI
201912178553	FORMOSA	FA12071400	SAO JOAO D ALIANCA	23/12/2019 13:48	23/12/2019 21:06	23/12/2019 13:48	23/12/2019 21:06	7,30	8	58,40	CHI
201912178555	GAMELEIRA DE GOIAS	SV31129462	ANAPOLIS UNIVERSITARIO S2	23/12/2019 13:48	24/12/2019 11:35	23/12/2019 13:48	24/12/2019 11:35	21,78	1	21,78	CHI
201912178563	APARECIDA DO RIO DOCE	AW12191577	CACHOEIRA ALTA	23/12/2019 13:49	23/12/2019 20:07	23/12/2019 13:49	23/12/2019 20:07	6,30	10	62,98	CHI
201912178574	ACREUNA	EU12257916	RIO DOS BOIS	23/12/2019 13:49	24/12/2019 10:52	23/12/2019 13:49	24/12/2019 10:52	21,04	2	42,09	CHI
201912178578	EDEIA	EA21108387	EDEIA	23/12/2019 13:49	24/12/2019 17:17	23/12/2019 13:49	24/12/2019 17:17	27,45	1	27,45	CHI
201912185657	PALMEIRAS DE GOIAS	PL12092997	PALMEIRAS	23/12/2019 13:49	24/12/2019 10:58	23/12/2019 13:49	24/12/2019 10:58	21,15	6	126,89	CHI
201912179931	CAMPO LIMPO	AN12084795	NEROPOLIS S1	23/12/2019 13:51	24/12/2019 22:47	23/12/2019 13:51	24/12/2019 22:47	32,94	9	296,46	CHI
201912179931	CAMPO LIMPO	AN12084795	NEROPOLIS S1	23/12/2019 13:51	24/12/2019 22:47	24/12/2019 19:25	24/12/2019 22:47	3,37	2	6,74	CHI
201912179931	CAMPO LIMPO	AN12011924	NEROPOLIS S1	23/12/2019 13:51	24/12/2019 22:47	24/12/2019 22:10	24/12/2019 22:47	0,62	33	20,62	CHI
201912178603	CALDAS NOVAS	CN21110312	RIO QUENTE	23/12/2019 13:53	24/12/2019 12:54	23/12/2019 13:53	24/12/2019 12:54	23,00	1	23,00	CHI
201912179977	EDEALINA	EA12257919RE	EDEIA	23/12/2019 13:53	25/12/2019 09:28	23/12/2019 13:53	25/12/2019 09:28	43,58	1	43,58	CHI
201912179977	EDEIA	EA12257919RE	EDEIA	23/12/2019 13:53	25/12/2019 09:28	23/12/2019 13:53	25/12/2019 09:28	43,58	46	2004,64	CHI
201912178608	CACU	IM12234538	CACHOEIRA ALTA	23/12/2019 13:54	24/12/2019 00:57	23/12/2019 13:54	24/12/2019 00:57	11,04	60	662,13	CHI
201912178608	ITARUMA	IM12234538	CACHOEIRA ALTA	23/12/2019 13:54	24/12/2019 00:57	23/12/2019 13:54	24/12/2019 00:57	11,04	35	386,24	CHI
201912178608	JATAI	IM12234538	CACHOEIRA ALTA	23/12/2019 13:54	24/12/2019 00:57	23/12/2019 13:54	24/12/2019 00:57	11,04	20	220,71	CHI
201912178613	CORUMBAIBA	CI21022146	VILA CORUMBA	23/12/2019 13:56	25/12/2019 10:20	23/12/2019 13:56	25/12/2019 10:20	44,39	1	44,39	CHI
201912179023	CAIAPONIA	CP12252503	CAIAPONIA	23/12/2019 13:56	24/12/2019 07:55	23/12/2019 13:56	24/12/2019 07:55	17,98	6	107,88	CHI
201912178615	EDEALINA	VI12381142	VICENTINOPOLIS	23/12/2019 13:58	24/12/2019 17:09	23/12/2019 13:58	24/12/2019 17:09	27,18	12	326,19	CHI
201912178623	MAURILANDIA	1040004183	RIO DOS BOIS	23/12/2019 13:59	23/12/2019 23:54	23/12/2019 13:59	23/12/2019 23:54	9,93	1	9,93	CHI
201912178706	NEROPOLIS	10003937800	NEROPOLIS S2	23/12/2019 14:00	23/12/2019 19:53	23/12/2019 14:00	23/12/2019 19:53	5,88	1	5,88	CHI
201912179784	ABADIANIA	AA12382362	CORUMBA	23/12/2019 14:01	23/12/2019 21:47	23/12/2019 14:01	23/12/2019 21:47	7,75	13	100,77	CHI
201912178718	BELA VISTA DE GOIAS	LB12270662	DAIA S2	23/12/2019 14:02	24/12/2019 08:57	23/12/2019 14:02	24/12/2019 08:57	18,91	1	18,91	CHI
201912178718	CALDAZINHA	LB12270662	DAIA S2	23/12/2019 14:02	24/12/2019 08:57	23/12/2019 14:02	24/12/2019 08:57	18,91	70	1323,56	CHI
201912178718	LEOPOLDO DE BULHOES	LB12270662	DAIA S2	23/12/2019 14:02	24/12/2019 08:57	23/12/2019 14:02	24/12/2019 08:57	18,91	6	113,45	CHI
201912178718	SILVANIA	LB12270662	DAIA S2	23/12/2019 14:02	24/12/2019 08:57	23/12/2019 14:02	24/12/2019 08:57	18,91	59	1115,58	CHI
201912178724	INHUMAS	IN12224002	INHUMAS S2	23/12/2019 14:04	23/12/2019 18:43	23/12/2019 14:04	23/12/2019 18:43	4,64	3	13,92	CHI
201912178804	TRINDADE	TR31055822	TRINDADE	23/12/2019 14:04	23/12/2019 18:07	23/12/2019 14:04	23/12/2019 18:07	4,03	1	4,03	CHI
201912179762	CATALAO	CT12338733	CATALAO S1	23/12/2019 14:04	23/12/2019 20:47	23/12/2019 14:04	23/12/2019 20:47	6,70	5	33,52	CHI

201912178805	ITABERAÍ	50106387	ITABERAÍ S2	23/12/2019 14:05	24/12/2019 10:57	23/12/2019 14:05	24/12/2019 10:57	20,86	1	20,86	CHI
201912178806	ANAPOLIS	10000431450	ANAPOLIS UNIVERSITARIO S1	23/12/2019 14:05	23/12/2019 22:45	23/12/2019 14:05	23/12/2019 22:45	8,66	1	8,66	CHI
201912182809	CRISTALINA	KR12305272	CRISTALINA S2	23/12/2019 14:05	23/12/2019 20:34	23/12/2019 14:05	23/12/2019 20:34	6,48	11	71,24	CHI
201912178915	CEZARINA	CZ21229167	CEZARINA	23/12/2019 14:09	23/12/2019 18:31	23/12/2019 14:09	23/12/2019 18:31	4,36	1	4,36	CHI
201912178918	MOSSAMEDES	MD21322813	FIRMINOPOLIS S2	23/12/2019 14:09	23/12/2019 19:27	23/12/2019 14:09	23/12/2019 19:27	5,29	1	5,29	CHI
201912179777	QUIRINOPOLIS	QI12017984	QUIRINOPOLIS	23/12/2019 14:10	23/12/2019 16:24	23/12/2019 14:10	23/12/2019 16:24	2,23	55	122,76	CHI
201912180183	APARECIDA DE GOIANIA	AP11169538	INDEPENDENCIA S2	23/12/2019 14:10	24/12/2019 09:45	23/12/2019 14:10	24/12/2019 09:45	19,57	170	3326,62	CHI
201912178926	QUIRINOPOLIS	QI21276327	QUIRINOPOLIS	23/12/2019 14:11	24/12/2019 15:38	23/12/2019 14:11	24/12/2019 15:38	25,45	1	25,45	CHI
201912183438	CAVALCANTE	MA12280267	SAO DOMINGOS	23/12/2019 14:11	24/12/2019 00:37	23/12/2019 14:11	24/12/2019 00:37	10,43	169	1762,72	CHI
201912183438	MONTE ALEGRE DE GOIAS	MA12280267	SAO DOMINGOS	23/12/2019 14:11	24/12/2019 00:37	23/12/2019 14:11	24/12/2019 00:37	10,43	13	135,59	CHI
201912178931	JOVIANIA	JV11164753	GOIATUBA S1	23/12/2019 14:12	24/12/2019 13:11	23/12/2019 14:12	24/12/2019 13:11	22,98	140	3216,81	CHI
201912178932	VALPARAISO DE GOIAS	VA11136580	MARAJOARA	23/12/2019 14:12	23/12/2019 16:23	23/12/2019 14:12	23/12/2019 16:23	2,19	4	8,75	CHI
201912178937	ANICUNS	AC31083711	ANICUNS	23/12/2019 14:13	24/12/2019 08:58	23/12/2019 14:13	24/12/2019 08:58	18,74	2	37,48	CHI
201912182160	MOSSAMEDES	MD12376367	ITABERAÍ S1	23/12/2019 14:13	24/12/2019 07:49	23/12/2019 14:13	24/12/2019 07:49	17,58	5	87,92	CHI
201912178938	ACREUNA	EU12219444	ACREUNA	23/12/2019 14:14	24/12/2019 12:16	23/12/2019 14:14	24/12/2019 12:16	22,04	2	44,08	CHI
201912178941	CUMARI	CT21061089	CATALAO S2	23/12/2019 14:14	24/12/2019 10:34	23/12/2019 14:14	24/12/2019 10:34	20,33	2	40,66	CHI
201912178951	OUVIDOR	TH12068476	CATALAO S1	23/12/2019 14:15	23/12/2019 21:31	23/12/2019 14:15	23/12/2019 21:31	7,26	3	21,78	CHI
201912178956	FLORES DE GOIAS	9620004303	IACIARA S2	23/12/2019 14:16	23/12/2019 21:27	23/12/2019 14:16	23/12/2019 21:27	7,18	1	7,18	CHI
201912179041	GOIANAPOLIS	GP11193050	DAIA S2	23/12/2019 14:16	23/12/2019 17:25	23/12/2019 14:16	23/12/2019 17:25	3,15	81	254,97	CHI
201912178961	CALDAS NOVAS	CN12298698	VILA CORUMBA	23/12/2019 14:17	24/12/2019 15:29	23/12/2019 14:17	24/12/2019 15:29	25,20	4	100,80	CHI
201912179990	SILVANIA	SV12389457	DAIA S2	23/12/2019 14:17	23/12/2019 19:45	23/12/2019 14:17	23/12/2019 19:45	5,48	9	49,28	CHI
201912182737	CATALAO	CT12141777	CATALAO S1	23/12/2019 14:17	24/12/2019 13:03	23/12/2019 14:17	24/12/2019 13:03	22,76	6	136,54	CHI
201912178968	GOUVELANDIA	QI21035316	QUIRINOPOLIS	23/12/2019 14:18	23/12/2019 15:33	23/12/2019 14:18	23/12/2019 15:33	1,25	1	1,25	CHI
201912178975	RIO VERDE	10026547838	RIO VERDE S2	23/12/2019 14:19	23/12/2019 17:37	23/12/2019 14:19	23/12/2019 17:37	3,29	1	3,29	CHI
201912178980	CRISTALINA	10030141077	CRISTALINA S1	23/12/2019 14:19	23/12/2019 16:02	23/12/2019 14:19	23/12/2019 16:02	1,71	1	1,71	CHI
201912178981	AGUAS LINDAS DE GOIAS	4830099563	AGUAS LINDAS DE GOIAS S1	23/12/2019 14:19	23/12/2019 16:01	23/12/2019 14:19	23/12/2019 16:01	1,69	1	1,69	CHI
201912181388	NOVA CRIXAS	NA12354849	NOVA CRIXAS	23/12/2019 14:20	24/12/2019 09:36	23/12/2019 14:20	24/12/2019 09:36	19,25	16	308,02	CHI
201912181177	MORRINHOS	150068062	MORRINHOS	23/12/2019 14:21	24/12/2019 13:37	23/12/2019 14:21	24/12/2019 13:37	23,27	1	23,27	CHI
201912179004	NOVA AURORA	NE21239761	CATALAO S1	23/12/2019 14:22	24/12/2019 15:17	23/12/2019 14:22	24/12/2019 15:17	24,91	1	24,91	CHI
201912179008	SANTA TEREZINHA DE GOIAS	10023168909	SANTA TEREZINHA	23/12/2019 14:22	23/12/2019 17:57	23/12/2019 14:22	23/12/2019 17:57	3,57	1	3,57	CHI
201912179022	CRISTIANOPOLIS	CF21112061	CRISTIANOPOLIS	23/12/2019 14:25	24/12/2019 07:28	23/12/2019 14:25	24/12/2019 07:28	17,05	1	17,05	CHI
201912179028	INACIOLANDIA	ID12304325	CACHOEIRA DOURADA	23/12/2019 14:25	24/12/2019 00:00	23/12/2019 14:25	24/12/2019 00:00	9,57	6	57,45	CHI
201912179042	SAO MIGUEL DO PASSA QUATRO	SQ21074847	CRISTIANOPOLIS	23/12/2019 14:28	24/12/2019 08:15	23/12/2019 14:28	24/12/2019 08:15	17,78	1	17,78	CHI

201912179044	GOIANIA	10585837	ATLANTICO S2	23/12/2019 14:28	23/12/2019 15:21	23/12/2019 14:28	23/12/2019 15:21	0,88	1	0,88	CHI
201912179046	CABECEIRAS	CW12233584	ITUIQUIRA	23/12/2019 14:28	23/12/2019 19:28	23/12/2019 14:28	23/12/2019 19:28	4,99	1	4,99	CHI
201912179049	MUNDO NOVO DE GOIAS	4240002188	NOVA CRIXAS	23/12/2019 14:29	24/12/2019 14:48	23/12/2019 14:29	24/12/2019 14:48	24,32	1	24,32	CHI
201912179065	CORREGO DO OURO	CO21200887	FIRMINOPOLIS S2	23/12/2019 14:29	24/12/2019 12:43	23/12/2019 14:29	24/12/2019 12:43	22,22	2	44,45	CHI
201912185878	APORE	SX12264389	JATAI S1	23/12/2019 14:29	24/12/2019 08:40	23/12/2019 14:29	24/12/2019 08:40	18,18	6	109,07	CHI
201912185878	ITARUMA	SX12264389	JATAI S1	23/12/2019 14:29	24/12/2019 08:40	23/12/2019 14:29	24/12/2019 08:40	18,18	1	18,18	CHI
201912185878	SERRANOPOLIS	SX12264389	JATAI S1	23/12/2019 14:29	24/12/2019 08:40	23/12/2019 14:29	24/12/2019 08:40	18,18	52	945,24	CHI
201912179074	TRINDADE	TR11180169	TRINDADE	23/12/2019 14:31	23/12/2019 16:53	23/12/2019 14:31	23/12/2019 16:53	2,37	97	229,43	CHI
201912179075	TRINDADE	15061760	GOYA S2	23/12/2019 14:31	23/12/2019 18:25	23/12/2019 14:31	23/12/2019 18:25	3,91	1	3,91	CHI
201912179079	BALIZA	BH11331475	CAIAPONIA	23/12/2019 14:31	24/12/2019 09:32	23/12/2019 14:31	24/12/2019 09:32	19,01	1	19,01	CHI
201912179085	CRISTALINA	KR21244625	CRISTALINA S1	23/12/2019 14:32	23/12/2019 19:37	23/12/2019 14:32	23/12/2019 19:37	5,07	1	5,07	CHI
201912179088	GOIANIA	10003921180	GOYA S1	23/12/2019 14:33	23/12/2019 16:35	23/12/2019 14:33	23/12/2019 16:35	2,03	1	2,03	CHI
201912183419	ACREUNA	EU11189128	ACREUNA	23/12/2019 14:33	24/12/2019 00:59	23/12/2019 14:33	24/12/2019 00:59	10,42	85	885,98	CHI
201912179113	RIO VERDE	RV12213437	SANTA HELENA S1	23/12/2019 14:37	23/12/2019 19:40	23/12/2019 14:37	23/12/2019 19:40	5,05	5	25,24	CHI
201912181162	ITABERAI	IB11018282	ITABERAI S2	23/12/2019 14:37	23/12/2019 19:56	23/12/2019 14:37	23/12/2019 19:56	5,31	132	700,44	CHI
201912185401	HIDROLANDIA	HD12188630	CEPAIGO S1	23/12/2019 14:38	24/12/2019 15:27	23/12/2019 14:38	24/12/2019 15:27	24,83	9	223,43	CHI
201912179123	PADRE BERNARDO	PB12377650	PADRE BERNARDO	23/12/2019 14:39	24/12/2019 12:54	23/12/2019 14:39	24/12/2019 12:54	22,25	6	133,50	CHI
201912179182	QUIRINOPOLIS	QI12013483	QUIRINOPOLIS	23/12/2019 14:39	23/12/2019 18:56	23/12/2019 14:39	23/12/2019 18:56	4,27	5	21,34	CHI
201912179136	BONFINOPOLIS	GP21188816	DAIA S2	23/12/2019 14:41	23/12/2019 18:44	23/12/2019 14:41	23/12/2019 18:44	4,05	8	32,40	CHI
201912179137	ANAPOLIS	10013532608	ANAPOLIS UNIVERSITARIO S1	23/12/2019 14:41	24/12/2019 04:04	23/12/2019 14:41	24/12/2019 04:04	13,38	1	13,38	CHI
201912179140	PORANGATU	PO12230423	NOVO PLANALTO	23/12/2019 14:41	24/12/2019 12:00	23/12/2019 14:41	24/12/2019 12:00	21,31	3	63,94	CHI
201912179142	MONTES CLAROS DE GOIAS	ME21332819	IPORA	23/12/2019 14:41	23/12/2019 18:42	23/12/2019 14:41	23/12/2019 18:42	4,01	1	4,01	CHI
201912179149	HIDROLANDIA	HD21340395	CEPAIGO S2	23/12/2019 14:43	24/12/2019 10:45	23/12/2019 14:43	24/12/2019 10:45	20,04	1	20,04	CHI
201912179156	NEROPOLIS	160011516	NEROPOLIS S2	23/12/2019 14:44	23/12/2019 19:20	23/12/2019 14:44	23/12/2019 19:20	4,59	1	4,59	CHI
201912179928	GOIANIA	GN11001823	ATLANTICO S3	23/12/2019 14:44	23/12/2019 18:52	23/12/2019 17:14	23/12/2019 18:52	1,62	87	140,84	CHI
201912179163	GOIANIA	10599927	AEROPORTO S1	23/12/2019 14:45	23/12/2019 23:58	23/12/2019 14:45	23/12/2019 23:58	9,21	1	9,21	CHI
201912179167	FORMOSA	610015308	ITUIQUIRA	23/12/2019 14:45	23/12/2019 16:27	23/12/2019 14:45	23/12/2019 16:27	1,68	1	1,68	CHI
201912179304	JUSSARA	JR12008743	BRITANIA	23/12/2019 14:45	24/12/2019 03:55	23/12/2019 14:45	24/12/2019 03:55	13,16	38	500,19	CHI
201912179169	PEROLANDIA	DP21166102	PARQUE DAS EMAS	23/12/2019 14:46	23/12/2019 17:20	23/12/2019 14:46	23/12/2019 17:20	2,56	1	2,56	CHI
201912179178	HIDROLANDIA	HD21149334	CEPAIGO S2	23/12/2019 14:48	24/12/2019 10:33	23/12/2019 14:48	24/12/2019 10:33	19,75	1	19,75	CHI
201912179997	GOIANIA	GN11001016	CAMPINAS S1	23/12/2019 14:48	23/12/2019 19:20	23/12/2019 14:48	23/12/2019 19:20	4,53	140	634,43	CHI
201912179306	PIRENOPOLIS	JA21059953	JARAGUA	23/12/2019 14:50	24/12/2019 17:56	23/12/2019 14:50	24/12/2019 17:56	27,09	1	27,09	CHI
201912179959	CASTELANDIA	QI12296614	QUIRINOPOLIS	23/12/2019 14:50	23/12/2019 16:58	23/12/2019 14:50	23/12/2019 16:58	2,12	1	2,12	CHI

201912179959	QUIRINOPOLIS	QI12296614	QUIRINOPOLIS	23/12/2019 14:50	23/12/2019 16:58	23/12/2019 14:50	23/12/2019 16:58	2,12	11	23,36	CHI
201912178967	BURITI DE GOIAS	BS12233417LD	FIRMINOPOLIS S2	23/12/2019 14:51	23/12/2019 18:47	23/12/2019 18:05	23/12/2019 18:47	0,71	260	183,81	CHI
201912178967	MOSSAMEDES	BS12233417LD	FIRMINOPOLIS S2	23/12/2019 14:51	23/12/2019 18:47	23/12/2019 18:05	23/12/2019 18:47	0,71	5	3,53	CHI
201912178967	SANCLERLANDIA	BS12233417LD	FIRMINOPOLIS S2	23/12/2019 14:51	23/12/2019 18:47	23/12/2019 18:05	23/12/2019 18:47	0,71	1	0,71	CHI
201912179313	ANAPOLIS	21252350	ANAPOLIS UNIVERSITARIO S1	23/12/2019 14:52	23/12/2019 19:43	23/12/2019 14:52	23/12/2019 19:43	4,84	1	4,84	CHI
201912179704	FAZENDA NOVA	FN21294829	JUSSARA	23/12/2019 14:53	24/12/2019 11:30	23/12/2019 14:53	24/12/2019 11:30	20,61	1	20,61	CHI
201912179705	CAMPO LIMPO	CV21289132	NEROPOLIS S1	23/12/2019 14:54	24/12/2019 09:45	23/12/2019 14:54	24/12/2019 09:45	18,85	3	56,55	CHI
201912179715	AGUAS LINDAS DE GOIAS	10029091320	AGUAS LINDAS DE GOIAS S1	23/12/2019 14:55	23/12/2019 16:54	23/12/2019 14:55	23/12/2019 16:54	1,97	1	1,97	CHI
201912191838	APARECIDA DE GOIANIA	200022945	INDEPENDENCIA S1	23/12/2019 14:55	24/12/2019 13:01	23/12/2019 14:55	24/12/2019 13:01	22,08	1	22,08	CHI
201912179922	GOIANIA	GN11133504	CAMPINAS S2	23/12/2019 14:57	23/12/2019 18:19	23/12/2019 14:57	23/12/2019 18:19	3,36	93	312,53	CHI
201912179740	ANAPOLIS	AN12270406	ANAPOLIS UNIVERSITARIO S2	23/12/2019 15:00	23/12/2019 19:15	23/12/2019 15:00	23/12/2019 19:15	4,24	6	25,41	CHI
201912179921	ITUMBIARA	IT11000014	ITUMBIARA VELHA S1	23/12/2019 15:00	23/12/2019 18:17	23/12/2019 15:00	23/12/2019 18:17	3,29	52	170,92	CHI
201912179920	CAIAPONIA	CP12308689	PALESTINA	23/12/2019 15:01	23/12/2019 18:22	23/12/2019 15:01	23/12/2019 18:22	3,34	7	23,41	CHI
201912179746	JARAGUA	JA21273410	JARAGUA	23/12/2019 15:02	24/12/2019 02:09	23/12/2019 15:02	24/12/2019 02:09	11,10	6	66,63	CHI
201912179759	BONOPOLIS	BX12193536	SAO MIGUEL DO ARAGUAIA	23/12/2019 15:04	25/12/2019 16:44	23/12/2019 15:04	24/12/2019 13:26	22,36	6	134,15	CHI
201912179759	BONOPOLIS	BX13182476	SAO MIGUEL DO ARAGUAIA	23/12/2019 15:04	25/12/2019 16:44	23/12/2019 15:04	25/12/2019 16:44	49,67	4	198,67	CHI
201912183765	ITABERAI	IB11000009	ITABERAI S2	23/12/2019 15:05	24/12/2019 08:56	23/12/2019 15:05	24/12/2019 08:56	17,84	120	2141,40	CHI
201912179768	SENADOR CANEDO	190157781	SENADOR CANEDO	23/12/2019 15:06	23/12/2019 17:41	23/12/2019 15:06	23/12/2019 17:41	2,58	1	2,58	CHI
201912179770	BURITI DE GOIAS	BS21319417	FIRMINOPOLIS S2	23/12/2019 15:07	24/12/2019 19:59	23/12/2019 15:07	24/12/2019 19:59	28,86	1	28,86	CHI
201912179774	BELA VISTA DE GOIAS	BV21207318	CEPAIGO S2	23/12/2019 15:08	24/12/2019 10:20	23/12/2019 15:08	24/12/2019 10:20	19,19	0	0,00	CHI
201912180168	APARECIDA DE GOIANIA	AP11340701	INDEPENDENCIA S1	23/12/2019 15:08	23/12/2019 16:23	23/12/2019 15:08	23/12/2019 16:23	1,25	217	271,25	CHI
201912179781	ANAPOLIS	20236670	ANAPOLIS UNIVERSITARIO S2	23/12/2019 15:09	23/12/2019 20:30	23/12/2019 15:09	23/12/2019 20:30	5,34	1	5,34	CHI
201912179782	APARECIDA DE GOIANIA	13746340	INDEPENDENCIA S2	23/12/2019 15:09	23/12/2019 17:37	23/12/2019 15:09	23/12/2019 17:37	2,46	1	2,46	CHI
201912179787	DOVERLANDIA	4220014872	CAIAPONIA	23/12/2019 15:09	23/12/2019 17:10	23/12/2019 15:09	23/12/2019 17:10	2,00	1	2,00	CHI
201912179796	RUBIATABA	RB21194743	RUBIATABA	23/12/2019 15:10	24/12/2019 00:38	23/12/2019 15:10	24/12/2019 00:38	9,45	1	9,45	CHI
201912179808	SANTA RITA DO ARAGUAIA	SU10400564	SANTA RITA DO ARAGUAIA	23/12/2019 15:11	23/12/2019 21:17	23/12/2019 15:11	23/12/2019 17:15	2,07	55	113,71	CHI
201912179808	MINEIROS	SU13209780	SANTA RITA DO ARAGUAIA	23/12/2019 15:11	23/12/2019 21:17	23/12/2019 15:11	23/12/2019 21:17	6,10	31	189,17	CHI
201912179808	SANTA RITA DO ARAGUAIA	SU13209780	SANTA RITA DO ARAGUAIA	23/12/2019 15:11	23/12/2019 21:17	23/12/2019 15:11	23/12/2019 21:17	6,10	14	85,43	CHI
201912179908	MONTES CLAROS DE GOIAS	ME12023298	IPORA	23/12/2019 15:12	24/12/2019 11:56	23/12/2019 15:12	24/12/2019 11:56	20,73	4	82,92	CHI
201912179909	IVOLANDIA	IV21231255	ARENOPOLIS	23/12/2019 15:12	24/12/2019 16:22	23/12/2019 15:12	24/12/2019 16:22	25,16	1	25,16	CHI
201912179910	INDIARA	IY21118759	EDEIA	23/12/2019 15:12	24/12/2019 08:07	23/12/2019 15:12	24/12/2019 08:07	16,90	1	16,90	CHI
201912179913	BONFINOPOLIS	10025487904	CEPAIGO S2	23/12/2019 15:13	23/12/2019 17:26	23/12/2019 15:13	23/12/2019 17:26	2,21	1	2,21	CHI
201912179924	MUTUNOPOLIS	PO12038770	PORANGATU	23/12/2019 15:16	23/12/2019 22:28	23/12/2019 15:16	23/12/2019 22:28	7,20	4	28,79	CHI

201912179924	PORANGATU	PO12038770	PORANGATU	23/12/2019 15:16	23/12/2019 22:28	23/12/2019 15:16	23/12/2019 22:28	7,20	12	86,37	CHI
201912179925	IPORA	IR11223072	IPORA	23/12/2019 15:16	23/12/2019 21:48	23/12/2019 15:16	23/12/2019 21:48	6,53	124	809,31	CHI
201912179932	PARAUNA	PU12159023	PARAUNA	23/12/2019 15:17	24/12/2019 07:57	23/12/2019 15:17	24/12/2019 07:57	16,66	4	66,63	CHI
201912179940	FORMOSA	610102618	ITUIQUIRA	23/12/2019 15:18	23/12/2019 17:12	23/12/2019 15:18	23/12/2019 17:12	1,89	1	1,89	CHI
201912179941	VARJAO	VJ31097659	GUAPO S2	23/12/2019 15:18	24/12/2019 10:40	23/12/2019 15:18	24/12/2019 10:40	19,36	1	19,36	CHI
201912179943	GOIANIA	11386034	ATLANTICO S2	23/12/2019 15:18	23/12/2019 19:10	23/12/2019 15:18	23/12/2019 19:10	3,85	1	3,85	CHI
201912179945	RIO VERDE	RV21260852	RIO VERDE S1	23/12/2019 15:19	24/12/2019 01:10	23/12/2019 15:19	24/12/2019 01:10	9,85	1	9,85	CHI
201912179947	GOIAS	GS21282560	GOIAS	23/12/2019 15:19	23/12/2019 19:27	23/12/2019 15:19	23/12/2019 19:27	4,12	1	4,12	CHI
201912179948	PORANGATU	840010424	PORANGATU	23/12/2019 15:19	24/12/2019 00:07	23/12/2019 15:19	24/12/2019 00:07	8,79	1	8,79	CHI
201912179961	CORREGO DO OURO	CO12229858	FIRMINOPOLIS S2	23/12/2019 15:23	23/12/2019 22:27	23/12/2019 15:23	23/12/2019 22:27	7,06	2	14,11	CHI
201912179964	APARECIDA DE GOIANIA	200089171	INDEPENDENCIA S2	23/12/2019 15:24	23/12/2019 18:52	23/12/2019 15:24	23/12/2019 18:52	3,46	1	3,46	CHI
201912179965	CRISTALINA	KR21219637	PAMPLONA	23/12/2019 15:24	23/12/2019 21:23	23/12/2019 15:24	23/12/2019 21:23	5,98	1	5,98	CHI
201912179968	SILVANIA	SV21078648	DAIA S2	23/12/2019 15:25	24/12/2019 14:03	23/12/2019 15:25	24/12/2019 14:03	22,65	2	45,29	CHI
201912179983	JUSSARA	JR12120641	JUSSARA	23/12/2019 15:27	24/12/2019 12:54	23/12/2019 15:27	24/12/2019 12:54	21,44	3	64,31	CHI
201912179985	CAMPO ALEGRE DE GOIAS	10003861331	CAMPO ALEGRE DE GOIAS	23/12/2019 15:28	24/12/2019 15:08	23/12/2019 15:28	24/12/2019 15:08	23,67	1	23,67	CHI
201912179986	AMORINOPOLIS	AM12285800	IPORA	23/12/2019 15:28	24/12/2019 11:49	23/12/2019 15:28	24/12/2019 11:49	20,35	3	61,04	CHI
201912179988	MORRINHOS	150023479	MORRINHOS	23/12/2019 15:28	23/12/2019 17:53	23/12/2019 15:28	23/12/2019 17:53	2,41	1	2,41	CHI
201912179989	CATURAI	IN21033213	ARACU	23/12/2019 15:28	23/12/2019 17:55	23/12/2019 15:28	23/12/2019 17:55	2,44	2	4,89	CHI
201912179992	SENADOR CANEDO	GN11283124	GOIANIA LESTE S2	23/12/2019 15:28	23/12/2019 18:21	23/12/2019 15:28	23/12/2019 18:21	2,87	9	25,81	CHI
201912179996	CRISTIANOPOLIS	CF21160508	CRISTIANOPOLIS	23/12/2019 15:30	23/12/2019 23:54	23/12/2019 15:30	23/12/2019 23:54	8,39	1	8,39	CHI
201912180002	VALPARAISO DE GOIAS	3350105140	PACAEMBU S1	23/12/2019 15:30	23/12/2019 20:00	23/12/2019 15:30	23/12/2019 20:00	4,49	1	4,49	CHI
201912180004	SANCLERLANDIA	SC21163974	FIRMINOPOLIS S2	23/12/2019 15:31	24/12/2019 15:40	23/12/2019 15:31	24/12/2019 15:40	24,14	2	48,29	CHI
201912180010	AGUA FRIA DE GOIAS	JL12261887	SAO JOAO D ALIANCA	23/12/2019 15:33	24/12/2019 00:39	23/12/2019 15:33	24/12/2019 00:39	9,10	4	36,40	CHI
201912180010	SAO JOAO D ALIANCA	JL12261887	SAO JOAO D ALIANCA	23/12/2019 15:33	24/12/2019 00:39	23/12/2019 15:33	24/12/2019 00:39	9,10	6	54,60	CHI
201912180071	SANTO ANTONIO DO DESCOBERTO	SN12078141	MARAJOARA	23/12/2019 15:33	23/12/2019 18:16	23/12/2019 15:33	23/12/2019 18:16	2,71	527	1428,46	CHI
201912180099	CALDAS NOVAS	CN12200060RE	CALDAS NOVAS S2	23/12/2019 15:34	25/12/2019 16:53	23/12/2019 15:34	23/12/2019 22:59	7,41	44	326,25	CHI
201912180099	CALDAS NOVAS	CN12200060RE	CALDAS NOVAS S2	23/12/2019 15:34	25/12/2019 16:53	23/12/2019 15:34	24/12/2019 18:52	27,30	1	27,30	CHI
201912180099	CALDAS NOVAS	CN12200060RE	CALDAS NOVAS S2	23/12/2019 15:34	25/12/2019 16:53	23/12/2019 15:34	24/12/2019 19:10	27,59	40	1103,56	CHI
201912180099	CALDAS NOVAS	CN12200060RE	CALDAS NOVAS S2	23/12/2019 15:34	25/12/2019 16:53	23/12/2019 15:34	24/12/2019 19:40	28,10	13	365,32	CHI
201912180099	CALDAS NOVAS	CN12200060RE	CALDAS NOVAS S2	23/12/2019 15:34	25/12/2019 16:53	23/12/2019 15:34	24/12/2019 20:02	28,46	39	1110,08	CHI
201912180099	PIRACANJUBA	CN12200060RE	CALDAS NOVAS S2	23/12/2019 15:34	25/12/2019 16:53	23/12/2019 15:34	24/12/2019 20:02	28,46	2	56,93	CHI
201912180099	CALDAS NOVAS	CN12200060RE	CALDAS NOVAS S2	23/12/2019 15:34	25/12/2019 16:53	24/12/2019 20:03	24/12/2019 20:35	0,54	116	62,80	CHI
201912180099	PIRACANJUBA	CN12200060RE	CALDAS NOVAS S2	23/12/2019 15:34	25/12/2019 16:53	24/12/2019 20:03	24/12/2019 20:35	0,54	2	1,08	CHI



201912180099	CALDAS NOVAS	CN12213872LD	CALDAS NOVAS S2	23/12/2019 15:34	25/12/2019 16:53	24/12/2019 19:41	25/12/2019 10:58	15,28	9	137,50	CHI
201912180099	CALDAS NOVAS	CN12213875LD	CALDAS NOVAS S2	23/12/2019 15:34	25/12/2019 16:53	24/12/2019 19:41	25/12/2019 16:53	21,20	4	84,79	CHI
201912182133	GOIANESIA	GE21258116	GOIANESIA S2	23/12/2019 15:35	24/12/2019 10:19	23/12/2019 15:35	24/12/2019 10:19	18,73	1	18,73	CHI
201912180031	MINACU	IH21230310	MINACU	23/12/2019 15:36	24/12/2019 09:01	23/12/2019 15:36	24/12/2019 09:01	17,40	1	17,40	CHI
201912180065	GOIANIA	GN11041883	CAMPINAS S1	23/12/2019 15:36	23/12/2019 20:00	23/12/2019 15:36	23/12/2019 20:00	4,39	98	430,06	CHI
201912180034	GOIANIA	10656273	CAMPINAS S3	23/12/2019 15:37	23/12/2019 20:43	23/12/2019 15:37	23/12/2019 20:43	5,10	1	5,10	CHI
201912180040	APARECIDA DE GOIANIA	10011590821	INDEPENDENCIA S1	23/12/2019 15:39	24/12/2019 01:12	23/12/2019 15:39	24/12/2019 01:12	9,55	1	9,55	CHI
201912180046	SILVANIA	SV21346579	VIANOPOLIS	23/12/2019 15:40	23/12/2019 17:44	23/12/2019 15:40	23/12/2019 17:44	2,05	1	2,05	CHI
201912180060	BURITI ALEGRE	BG12000136	ITUMBIARA VELHA S2	23/12/2019 15:43	24/12/2019 10:36	23/12/2019 15:43	24/12/2019 10:36	18,87	4	75,48	CHI
201912180072	TURVANIA	TV21083112	FIRMINOPOLIS S2	23/12/2019 15:45	23/12/2019 20:01	23/12/2019 15:45	23/12/2019 20:01	4,26	1	4,26	CHI
201912180073	MINACU	IH12088797	MINACU	23/12/2019 15:45	23/12/2019 17:17	23/12/2019 15:45	23/12/2019 17:17	1,53	165	252,17	CHI
201912180075	GOIANIA	11653796	ATLANTICO S3	23/12/2019 15:45	24/12/2019 01:30	23/12/2019 15:45	24/12/2019 01:30	9,74	1	9,74	CHI
201912180076	ANAPOLIS	AN31028679	JUNDIAI S2	23/12/2019 15:45	23/12/2019 19:36	23/12/2019 15:45	23/12/2019 19:36	3,84	2	7,68	CHI
201912180187	BELA VISTA DE GOIAS	BV12023147	CRISTIANOPOLIS	23/12/2019 15:46	23/12/2019 22:50	23/12/2019 15:46	23/12/2019 22:50	7,07	9	63,61	CHI
201912180187	SAO MIGUEL DO PASSA QUATRO	BV12023147	CRISTIANOPOLIS	23/12/2019 15:46	23/12/2019 22:50	23/12/2019 15:46	23/12/2019 22:50	7,07	1	7,07	CHI
201912180091	ORIZONA	10010001652	PIRES DO RIO S2	23/12/2019 15:47	23/12/2019 17:51	23/12/2019 15:47	23/12/2019 17:51	2,06	1	2,06	CHI
201912180092	ITAPURANGA	170022304	ITAPURANGA	23/12/2019 15:47	26/12/2019 18:42	23/12/2019 15:47	26/12/2019 18:42	74,91	1	74,91	CHI
201912180095	GOIANIA	14015067	ATLANTICO S2	23/12/2019 15:47	23/12/2019 18:16	23/12/2019 15:47	23/12/2019 18:16	2,47	1	2,47	CHI
201912180121	SAO LUIS DE MONTES BELOS	SL12404919	SAO LUIZ DOS MONTES BELOS	23/12/2019 15:48	24/12/2019 09:06	23/12/2019 15:48	24/12/2019 09:06	17,30	36	622,81	CHI
201912180106	SANTA RITA DO NOVO DESTINO	10002296959	GOIANESIA S1	23/12/2019 15:49	25/12/2019 00:02	23/12/2019 15:49	25/12/2019 00:02	32,21	1	32,21	CHI
201912182734	RUBIATABA	RB12060965	RUBIATABA	23/12/2019 15:49	24/12/2019 03:07	23/12/2019 15:49	24/12/2019 03:07	11,29	55	620,81	CHI
201912180119	ORIZONA	OZ21143503	VIANOPOLIS	23/12/2019 15:51	23/12/2019 23:21	23/12/2019 15:51	23/12/2019 23:21	7,49	1	7,49	CHI
201912180131	PARAUNA	PU21129718	PARAUNA	23/12/2019 15:54	24/12/2019 10:44	23/12/2019 15:54	24/12/2019 10:44	18,85	1	18,85	CHI
201912180134	PADRE BERNARDO	PB12376722	PADRE BERNARDO	23/12/2019 15:54	23/12/2019 18:50	23/12/2019 15:54	23/12/2019 18:50	2,93	7	20,52	CHI
201912180136	SANTA RITA DO ARAGUAIA	SU12202828	SANTA RITA DO ARAGUAIA	23/12/2019 15:54	24/12/2019 10:49	23/12/2019 15:54	24/12/2019 10:49	18,91	3	56,72	CHI
201912180139	SANCLERLANDIA	SC21005415	FIRMINOPOLIS S2	23/12/2019 15:55	23/12/2019 20:14	23/12/2019 15:55	23/12/2019 20:14	4,30	1	4,30	CHI
201912180141	NOVO GAMA	NJ11219823	PACAEMBU S1	23/12/2019 15:56	23/12/2019 17:40	23/12/2019 15:56	23/12/2019 17:40	1,73	34	58,86	CHI
201912180906	PLANALTINA	PI12015859	PLANALTINA	23/12/2019 15:56	23/12/2019 17:57	23/12/2019 15:56	23/12/2019 17:57	2,00	150	300,25	CHI
201912181255	CEZARINA	CZ12308499	CEZARINA	23/12/2019 15:57	24/12/2019 08:06	23/12/2019 15:57	24/12/2019 08:06	16,13	2	32,27	CHI
201912181255	INDIARA	CZ12308499	CEZARINA	23/12/2019 15:57	24/12/2019 08:06	23/12/2019 15:57	24/12/2019 08:06	16,13	10	161,34	CHI
201912180158	AMORINOPOLIS	AM12243769	IPORA	23/12/2019 15:59	24/12/2019 19:13	23/12/2019 15:59	24/12/2019 19:13	27,23	9	245,07	CHI
201912180165	IPORA	730114673	IPORA	23/12/2019 16:00	24/12/2019 04:37	23/12/2019 16:00	24/12/2019 04:37	12,61	1	12,61	CHI
201912180607	APARECIDA DE GOIANIA	AP11000052	INDEPENDENCIA S1	23/12/2019 16:02	23/12/2019 20:37	23/12/2019 16:02	23/12/2019 20:37	4,57	120	548,77	CHI

201912180174	GOIANIA	10682510	CAMPINAS S3	23/12/2019 16:03	24/12/2019 01:03	23/12/2019 16:03	24/12/2019 01:03	9,01	1	9,01	CHI
201912180184	CACHOEIRA ALTA	1090029503	CACHOEIRA ALTA	23/12/2019 16:04	23/12/2019 19:40	23/12/2019 16:04	23/12/2019 19:40	3,60	1	3,60	CHI
201912180191	SANTA CRUZ DE GOIAS	BC12012000	PIRES DO RIO S2	23/12/2019 16:05	24/12/2019 18:32	23/12/2019 16:05	24/12/2019 18:32	26,45	86	2275,08	CHI
201912180196	LUZIANIA	120083930	RIO VERMELHO	23/12/2019 16:06	24/12/2019 07:48	23/12/2019 16:06	24/12/2019 07:48	15,69	1	15,69	CHI
201912180302	CRISTIANOPOLIS	PJ13067540	PIRACANJUBA	23/12/2019 16:07	25/12/2019 14:28	25/12/2019 11:34	25/12/2019 14:28	2,89	4	11,58	CHI
201912180302	PIRACANJUBA	PJ13067540	PIRACANJUBA	23/12/2019 16:07	25/12/2019 14:28	25/12/2019 11:34	25/12/2019 14:28	2,89	64	185,28	CHI
201912180302	SANTA CRUZ DE GOIAS	PJ13067540	PIRACANJUBA	23/12/2019 16:07	25/12/2019 14:28	25/12/2019 11:34	25/12/2019 14:28	2,89	88	254,76	CHI
201912181390	GAMELEIRA DE GOIAS	AN12285354	ANAPOLIS UNIVERSITARIO S2	23/12/2019 16:07	23/12/2019 18:47	23/12/2019 16:07	23/12/2019 18:47	2,65	9	23,88	CHI
201912181390	SILVANIA	AN12285354	ANAPOLIS UNIVERSITARIO S2	23/12/2019 16:07	23/12/2019 18:47	23/12/2019 16:07	23/12/2019 18:47	2,65	19	50,42	CHI
201912180501	SANTO ANTONIO DA BARRA	10010804909	ACREUNA	23/12/2019 16:08	24/12/2019 08:08	23/12/2019 16:08	24/12/2019 08:08	16,00	1	16,00	CHI
201912180604	BALIZA	BH21228520	BOM JARDIM	23/12/2019 16:08	23/12/2019 20:17	23/12/2019 16:08	23/12/2019 20:17	4,14	2	8,27	CHI
201912181320	BELA VISTA DE GOIAS	BC12389811	PIRES DO RIO S2	23/12/2019 16:11	24/12/2019 09:57	23/12/2019 16:11	24/12/2019 09:57	17,76	2	35,53	CHI
201912181320	CRISTIANOPOLIS	BC12389811	PIRES DO RIO S2	23/12/2019 16:11	24/12/2019 09:57	23/12/2019 16:11	24/12/2019 09:57	17,76	3	53,29	CHI
201912181287	DOVERLANDIA	DV12169484	CAIAPONIA	23/12/2019 16:12	23/12/2019 22:15	23/12/2019 16:12	23/12/2019 22:15	6,04	45	271,61	CHI
201912180914	AGUAS LINDAS DE GOIAS	4830288086	AGUAS LINDAS DE GOIAS S1	23/12/2019 16:13	23/12/2019 17:07	23/12/2019 16:13	23/12/2019 17:07	0,89	1	0,89	CHI
201912180915	GOUVELANDIA	GB12402360	QUIRINOPOLIS	23/12/2019 16:13	23/12/2019 17:45	23/12/2019 16:13	23/12/2019 17:45	1,52	7	10,62	CHI
201912180915	QUIRINOPOLIS	GB12402360	QUIRINOPOLIS	23/12/2019 16:13	23/12/2019 17:45	23/12/2019 16:13	23/12/2019 17:45	1,52	4	6,07	CHI
201912181112	SAO LUIS DE MONTES BELOS	SL32145922	SAO LUIZ DOS MONTES BELOS	23/12/2019 16:13	24/12/2019 07:48	23/12/2019 16:13	24/12/2019 07:48	15,57	11	171,29	CHI
201912183817	GAMELEIRA DE GOIAS	SV12093659	DAIA S2	23/12/2019 16:14	24/12/2019 08:33	23/12/2019 16:14	24/12/2019 08:33	16,30	19	309,71	CHI
201912180921	COCALZINHO DE GOIAS	1200016881	COCALZINHO	23/12/2019 16:15	24/12/2019 09:10	23/12/2019 16:15	24/12/2019 09:10	16,91	1	16,91	CHI
201912180923	PIRES DO RIO	460069056	PIRES DO RIO S1	23/12/2019 16:15	23/12/2019 18:25	23/12/2019 16:15	23/12/2019 18:25	2,15	1	2,15	CHI
201912180928	APARECIDA DE GOIANIA	10024121760	INDEPENDENCIA S2	23/12/2019 16:17	23/12/2019 19:18	23/12/2019 16:17	23/12/2019 19:18	3,01	1	3,01	CHI
201912180930	LUZIANIA	10022647609	RIO VERMELHO	23/12/2019 16:17	24/12/2019 09:13	23/12/2019 16:17	24/12/2019 09:13	16,93	1	16,93	CHI
201912180935	VALPARAISO DE GOIAS	2860074242	MARAJOARA	23/12/2019 16:18	23/12/2019 21:10	23/12/2019 16:18	23/12/2019 21:10	4,85	0	0,00	CHI
201912180936	PALMEIRAS DE GOIAS	PL21287698	PALMEIRAS	23/12/2019 16:19	23/12/2019 17:16	23/12/2019 16:19	23/12/2019 17:16	0,97	1	0,97	CHI
201912181275	APARECIDA DE GOIANIA	AP11193236	ANHANGUERA	23/12/2019 16:19	23/12/2019 22:32	23/12/2019 16:19	23/12/2019 22:32	6,20	191	1185,00	CHI
201912180946	GOIANIA	15714470	XAVANTES	23/12/2019 16:20	24/12/2019 03:17	23/12/2019 16:20	24/12/2019 03:17	10,94	1	10,94	CHI
201912180947	CACHOEIRA ALTA	CA12294620	CACHOEIRA ALTA	23/12/2019 16:20	24/12/2019 13:22	23/12/2019 16:20	24/12/2019 13:22	21,02	2	42,05	CHI
201912180953	NOVA AURORA	2220005945	CATALAO S1	23/12/2019 16:21	24/12/2019 13:40	23/12/2019 16:21	24/12/2019 13:40	21,31	1	21,31	CHI
201912180958	PLANALTINA	2960076509	PLANALTINA	23/12/2019 16:22	23/12/2019 22:35	23/12/2019 16:22	23/12/2019 22:35	6,23	1	6,23	CHI
201912180967	MOSSAMEDES	1310004393	FIRMINOPOLIS S2	23/12/2019 16:25	24/12/2019 11:34	23/12/2019 16:25	24/12/2019 11:34	19,14	1	19,14	CHI
201912180969	GOIANIRA	390048215	GOIANIRA	23/12/2019 16:26	23/12/2019 19:52	23/12/2019 16:26	23/12/2019 19:52	3,43	1	3,43	CHI
201912181299	PIRES DO RIO	PR12051686	PIRES DO RIO S2	23/12/2019 16:26	24/12/2019 10:35	23/12/2019 16:26	24/12/2019 10:35	18,14	1	18,14	CHI

201912181299	SANTA CRUZ DE GOIAS	PR12051686	PIRES DO RIO S2	23/12/2019 16:26	24/12/2019 10:35	23/12/2019 16:26	24/12/2019 10:35	18,14	21	380,99	CHI
201912180974	PADRE BERNARDO	PB11376978	PADRE BERNARDO	23/12/2019 16:27	24/12/2019 13:17	23/12/2019 16:27	24/12/2019 13:17	20,83	38	791,39	CHI
201912180978	CORUMBAIBA	CI21376020	VILA CORUMBA	23/12/2019 16:28	24/12/2019 18:14	23/12/2019 16:28	24/12/2019 18:14	25,76	1	25,76	CHI
201912181101	VALPARAISO DE GOIAS	10011691350	MARAJOARA	23/12/2019 16:29	23/12/2019 19:24	23/12/2019 16:29	23/12/2019 19:24	2,92	1	2,92	CHI
201912181111	GOIANIRA	10021257858	MEIA PONTE	23/12/2019 16:30	23/12/2019 21:54	23/12/2019 16:30	23/12/2019 21:54	5,40	1	5,40	CHI
201912181116	SANTA HELENA DE GOIAS	SH21213360	SANTA HELENA S1	23/12/2019 16:30	23/12/2019 23:40	23/12/2019 16:30	23/12/2019 23:40	7,15	2	14,30	CHI
201912181128	MIMOSO DE GOIAS	MJ12377229	PADRE BERNARDO	23/12/2019 16:31	23/12/2019 20:47	23/12/2019 16:31	23/12/2019 20:47	4,25	7	29,78	CHI
201912183201	MORRINHOS	MR12160429RE	MORRINHOS	23/12/2019 16:31	23/12/2019 21:39	23/12/2019 16:31	23/12/2019 21:39	5,13	41	210,30	CHI
201912183590	MORRINHOS	MR21153619	MORRINHOS	23/12/2019 16:31	24/12/2019 09:18	23/12/2019 16:31	24/12/2019 09:18	16,78	1	16,78	CHI
201912181131	NOVO GAMA	2460192740	PACAEMBU S1	23/12/2019 16:32	23/12/2019 17:15	23/12/2019 16:32	23/12/2019 17:15	0,72	1	0,72	CHI
201912181134	CRIXAS	CX12285878LD	SERRA DO OURO	23/12/2019 16:32	26/12/2019 02:23	25/12/2019 20:58	26/12/2019 02:23	5,41	196	1060,96	CHI
201912181134	NOVA ROMA	CX12285878LD	SERRA DO OURO	23/12/2019 16:32	26/12/2019 02:23	25/12/2019 20:58	26/12/2019 02:23	5,41	1	5,41	CHI
201912181134	PORANGATU	CX12285878LD	SERRA DO OURO	23/12/2019 16:32	26/12/2019 02:23	25/12/2019 20:58	26/12/2019 02:23	5,41	1	5,41	CHI
201912181134	CRIXAS	CX21243631	SERRA DO OURO	23/12/2019 16:32	26/12/2019 02:23	23/12/2019 16:32	26/12/2019 02:23	57,84	1	57,84	CHI
201912181136	CORUMBA DE GOIAS	CB21374477	CORUMBA	23/12/2019 16:33	24/12/2019 12:46	23/12/2019 16:33	24/12/2019 12:46	20,21	1	20,21	CHI
201912181503	GOIANESIA	PV12312048RE	CORUMBA	23/12/2019 16:33	26/12/2019 13:52	23/12/2019 16:33	24/12/2019 14:28	21,92	10	219,23	CHI
201912181503	JARAGUA	PV12312048RE	CORUMBA	23/12/2019 16:33	26/12/2019 13:52	23/12/2019 16:33	24/12/2019 14:28	21,92	1	21,92	CHI
201912181503	PIRENOPOLIS	PV12312048RE	CORUMBA	23/12/2019 16:33	26/12/2019 13:52	23/12/2019 16:33	24/12/2019 14:28	21,92	57	1249,60	CHI
201912181503	VILA PROPICIO	PV12312048RE	CORUMBA	23/12/2019 16:33	26/12/2019 13:52	23/12/2019 16:33	24/12/2019 14:28	21,92	3	65,77	CHI
201912181503	PIRENOPOLIS	PV12312048RE	CORUMBA	23/12/2019 16:33	26/12/2019 13:52	23/12/2019 16:33	26/12/2019 12:56	68,39	1	68,39	CHI
201912181503	JARAGUA	PV12312048RE	CORUMBA	23/12/2019 16:33	26/12/2019 13:52	23/12/2019 16:33	26/12/2019 13:52	69,32	3	207,96	CHI
201912181139	QUIRINOPOLIS	20385745	QUIRINOPOLIS	23/12/2019 16:34	23/12/2019 19:20	23/12/2019 16:34	23/12/2019 19:20	2,77	6	16,60	CHI
201912181140	PIRES DO RIO	BC12027014RE	PIRES DO RIO S2	23/12/2019 16:34	25/12/2019 15:30	23/12/2019 16:34	24/12/2019 18:35	26,02	1	26,02	CHI
201912181140	SANTA CRUZ DE GOIAS	BC12027014RE	PIRES DO RIO S2	23/12/2019 16:34	25/12/2019 15:30	23/12/2019 16:34	24/12/2019 18:35	26,02	7	182,16	CHI
201912181140	SANTA CRUZ DE GOIAS	BC12027014RE	PIRES DO RIO S2	23/12/2019 16:34	25/12/2019 15:30	23/12/2019 16:34	25/12/2019 08:00	39,45	5	197,23	CHI
201912181140	PIRES DO RIO	BC12027014RE	PIRES DO RIO S2	23/12/2019 16:34	25/12/2019 15:30	23/12/2019 16:34	25/12/2019 13:51	45,28	7	316,99	CHI
201912181140	PIRES DO RIO	BC12027014RE	PIRES DO RIO S2	23/12/2019 16:34	25/12/2019 15:30	23/12/2019 16:34	25/12/2019 15:30	46,94	3	140,81	CHI
201912181140	SANTA CRUZ DE GOIAS	BC12027014RE	PIRES DO RIO S2	23/12/2019 16:34	25/12/2019 15:30	23/12/2019 16:34	25/12/2019 15:30	46,94	30	1408,12	CHI
201912181150	CRISTIANOPOLIS	CF11217008	CRISTIANOPOLIS	23/12/2019 16:35	23/12/2019 17:53	23/12/2019 16:35	23/12/2019 17:53	1,29	87	111,84	CHI
201912181155	IPAMERI	IP21373946	IPAMERI	23/12/2019 16:37	24/12/2019 07:50	23/12/2019 16:37	24/12/2019 07:50	15,22	2	30,43	CHI
201912181161	APARECIDA DE GOIANIA	10019638467	ANHANGUERA	23/12/2019 16:38	24/12/2019 00:30	23/12/2019 16:38	24/12/2019 00:30	7,86	1	7,86	CHI
201912181188	ORIZONA	OZ12337211	PIRES DO RIO S2	23/12/2019 16:38	23/12/2019 18:26	23/12/2019 16:38	23/12/2019 18:26	1,80	34	61,19	CHI
201912181164	SANTO ANTONIO DO DESCOBERTO	2210176901	AGUAS LINDAS DE GOIAS S2	23/12/2019 16:39	23/12/2019 18:23	23/12/2019 16:39	23/12/2019 18:23	1,73	1	1,73	CHI

201912181168	MAURILANDIA	1040012805	RIO DOS BOIS	23/12/2019 16:39	23/12/2019 22:50	23/12/2019 16:39	23/12/2019 22:50	6,18	1	6,18	CHI
201912181180	GOIANIA	SW21221318	GOIANIA LESTE S2	23/12/2019 16:41	23/12/2019 19:06	23/12/2019 16:41	23/12/2019 19:06	2,40	2	4,81	CHI
201912181183	PIRES DO RIO	PR11393430	PIRES DO RIO S1	23/12/2019 16:42	24/12/2019 10:24	23/12/2019 16:42	24/12/2019 10:24	17,70	12	212,40	CHI
201912181184	VARJAO	VJ21126533	GUAPO S2	23/12/2019 16:42	24/12/2019 11:59	23/12/2019 16:42	24/12/2019 11:59	19,28	1	19,28	CHI
201912183531	SILVANIA	SV12202389	DAIA S2	23/12/2019 16:43	24/12/2019 10:07	23/12/2019 16:43	24/12/2019 10:07	17,40	26	452,37	CHI
201912181407	ORIZONA	OZ12017053RE	PIRES DO RIO S2	23/12/2019 16:44	23/12/2019 19:39	23/12/2019 16:44	23/12/2019 19:39	2,90	11	31,91	CHI
201912181203	MAIRIPOTABA	10005734094	PONTALINA	23/12/2019 16:47	24/12/2019 10:28	23/12/2019 16:47	24/12/2019 10:28	17,67	1	17,67	CHI
201912182109	ORIZONA	OZ12022855	PIRES DO RIO S2	23/12/2019 16:48	23/12/2019 20:13	23/12/2019 16:48	23/12/2019 20:13	3,41	8	27,30	CHI
201912181217	OURO VERDE DE GOIAS	OV21168067	NEROPOLIS S1	23/12/2019 16:49	24/12/2019 14:35	23/12/2019 16:49	24/12/2019 14:35	21,77	1	21,77	CHI
201912181221	LUZIANIA	120437089	RIO VERMELHO	23/12/2019 16:49	23/12/2019 18:09	23/12/2019 16:49	23/12/2019 18:09	1,32	1	1,32	CHI
201912181224	ANAPOLIS	20620949	JUNDIAI S1	23/12/2019 16:50	23/12/2019 22:48	23/12/2019 16:50	23/12/2019 22:48	5,96	1	5,96	CHI
201912181231	SANTA TEREZA DE GOIAS	SE21017234	MARA ROSA	23/12/2019 16:52	24/12/2019 09:49	23/12/2019 16:52	24/12/2019 09:49	16,94	1	16,94	CHI
201912181233	PADRE BERNARDO	2800001611	PADRE BERNARDO	23/12/2019 16:52	23/12/2019 19:34	23/12/2019 16:52	23/12/2019 19:34	2,69	1	2,69	CHI
201912181296	AGUAS LINDAS DE GOIAS	LA12313875	AGUAS LINDAS DE GOIAS S1	23/12/2019 16:53	23/12/2019 18:09	23/12/2019 16:53	23/12/2019 18:09	1,26	94	118,81	CHI
201912181296	COCALZINHO DE GOIAS	LA12313875	AGUAS LINDAS DE GOIAS S1	23/12/2019 16:53	23/12/2019 18:09	23/12/2019 16:53	23/12/2019 18:09	1,26	1	1,26	CHI
201912181296	SANTO ANTONIO DO DESCOBERTO	LA12313875	AGUAS LINDAS DE GOIAS S1	23/12/2019 16:53	23/12/2019 18:09	23/12/2019 16:53	23/12/2019 18:09	1,26	18	22,75	CHI
201912181247	MATRINCHA	MP21183173	MATRINCHA	23/12/2019 16:55	24/12/2019 10:13	23/12/2019 16:55	24/12/2019 10:13	17,29	6	103,74	CHI
201912183550	CACHOEIRA ALTA	CA12301755	CACHOEIRA ALTA	23/12/2019 16:55	23/12/2019 22:30	23/12/2019 16:55	23/12/2019 22:30	5,57	5	27,84	CHI
201912185212	CALDAS NOVAS	CN11163575	CALDAS NOVAS S2	23/12/2019 16:55	23/12/2019 23:20	23/12/2019 16:55	23/12/2019 23:20	6,42	117	750,85	CHI
201912181252	CRISTALINA	KR21170452	CRISTALINA S2	23/12/2019 16:57	24/12/2019 12:39	23/12/2019 16:57	24/12/2019 12:39	19,70	1	19,70	CHI
201912182120	ORIZONA	OZ12081168	PIRES DO RIO S2	23/12/2019 16:58	24/12/2019 07:57	23/12/2019 16:58	24/12/2019 07:57	14,98	2	29,96	CHI
201912182120	VIANOPOLIS	OZ12081168	PIRES DO RIO S2	23/12/2019 16:58	24/12/2019 07:57	23/12/2019 16:58	24/12/2019 07:57	14,98	11	164,77	CHI
201912184190	VIANOPOLIS	VN11343146	VIANOPOLIS	23/12/2019 16:59	24/12/2019 14:30	23/12/2019 16:59	24/12/2019 14:30	21,52	59	1269,42	CHI
201912181268	NOVO GAMA	4990052500	PACAEMBU S1	23/12/2019 17:00	24/12/2019 11:21	23/12/2019 17:00	24/12/2019 11:21	18,36	1	18,36	CHI
201912181321	CALDAS NOVAS	CN12142352	CALDAS NOVAS S1	23/12/2019 17:00	24/12/2019 08:21	23/12/2019 17:00	24/12/2019 08:21	15,34	20	306,73	CHI
201912181323	ANAPOLIS	AN11072485	ANAPOLIS UNIVERSITARIO S2	23/12/2019 17:00	24/12/2019 00:21	23/12/2019 17:00	24/12/2019 00:21	7,34	38	278,88	CHI
201912186101	CACHOEIRA DOURADA	IT12088560	CACHOEIRA DOURADA	23/12/2019 17:05	24/12/2019 11:40	23/12/2019 17:05	24/12/2019 11:40	18,57	1	18,57	CHI
201912186101	ITUMBIARA	IT12088560	CACHOEIRA DOURADA	23/12/2019 17:05	24/12/2019 11:40	23/12/2019 17:05	24/12/2019 11:40	18,57	4	74,28	CHI
201912181804	MONTIVIDIU DO NORTE	MX12187845	PORANGATU	23/12/2019 17:06	24/12/2019 10:41	23/12/2019 17:06	24/12/2019 10:41	17,58	13	228,50	CHI
201912184136	PILAR DE GOIAS	GG12341538	SANTA TEREZINHA	23/12/2019 17:06	24/12/2019 10:41	23/12/2019 17:06	24/12/2019 10:41	17,57	14	245,97	CHI
201912181315	FAINA	FC12274380	GOIAS	23/12/2019 17:08	24/12/2019 11:31	23/12/2019 17:08	24/12/2019 11:31	18,38	2	36,77	CHI
201912181325	ANAPOLIS	20572670	JUNDIAI S1	23/12/2019 17:09	23/12/2019 20:40	23/12/2019 17:09	23/12/2019 20:40	3,51	1	3,51	CHI
201912182748	APARECIDA DE GOIANIA	AP11072265	INDEPENDENCIA S2	23/12/2019 17:09	23/12/2019 23:24	23/12/2019 17:09	23/12/2019 23:24	6,24	204	1273,70	CHI

201912181338	AGUA FRIA DE GOIAS	JL12117446	SAO JOAO D ALIANCA	23/12/2019 17:11	24/12/2019 10:52	23/12/2019 17:11	24/12/2019 10:52	17,67	19	335,74	CHI
201912181338	SAO JOAO D ALIANCA	JL12117446	SAO JOAO D ALIANCA	23/12/2019 17:11	24/12/2019 10:52	23/12/2019 17:11	24/12/2019 10:52	17,67	25	441,76	CHI
201912181704	SANTO ANTONIO DO DESCOBERTO	SN12091848	MARAJOARA	23/12/2019 17:11	23/12/2019 21:30	23/12/2019 17:11	23/12/2019 21:30	4,31	12	51,67	CHI
201912181339	SAO FRANCISCO DE GOIAS	SF21155629	SAO FRANCISCO DE GOIAS	23/12/2019 17:12	24/12/2019 09:23	23/12/2019 17:12	24/12/2019 09:23	16,19	3	48,56	CHI
201912182502	IPAMERI	IP12231489	IPAMERI	23/12/2019 17:12	23/12/2019 22:10	23/12/2019 17:12	23/12/2019 22:10	4,96	131	649,76	CHI
201912179832	MORRINHOS	VN13200254	VIANOPOLIS	23/12/2019 17:13	24/12/2019 14:07	23/12/2019 17:13	24/12/2019 03:08	9,91	1	9,91	CHI
201912179832	ORIZONA	VN13200254	VIANOPOLIS	23/12/2019 17:13	24/12/2019 14:07	23/12/2019 17:13	24/12/2019 03:08	9,91	50	495,61	CHI
201912179832	SILVANIA	VN13200254	VIANOPOLIS	23/12/2019 17:13	24/12/2019 14:07	23/12/2019 17:13	24/12/2019 03:08	9,91	5	49,56	CHI
201912179832	VIANOPOLIS	VN13200254	VIANOPOLIS	23/12/2019 17:13	24/12/2019 14:07	23/12/2019 17:13	24/12/2019 03:08	9,91	345	3419,72	CHI
201912179832	ORIZONA	03600224	VIANOPOLIS	23/12/2019 17:13	24/12/2019 14:07	23/12/2019 17:13	24/12/2019 08:24	15,19	7	106,32	CHI
201912179832	VIANOPOLIS	03600224	VIANOPOLIS	23/12/2019 17:13	24/12/2019 14:07	23/12/2019 17:13	24/12/2019 08:24	15,19	164	2490,98	CHI
201912179832	VIANOPOLIS	03600224	VIANOPOLIS	23/12/2019 17:13	24/12/2019 14:07	24/12/2019 08:26	24/12/2019 09:47	1,34	8	10,74	CHI
201912179832	ORIZONA	03600224	VIANOPOLIS	23/12/2019 17:13	24/12/2019 14:07	23/12/2019 17:13	24/12/2019 14:07	20,90	38	794,03	CHI
201912179832	VIANOPOLIS	03600224	VIANOPOLIS	23/12/2019 17:13	24/12/2019 14:07	23/12/2019 17:13	24/12/2019 14:07	20,90	152	3176,12	CHI
201912179832	ORIZONA	03600224	VIANOPOLIS	23/12/2019 17:13	24/12/2019 14:07	24/12/2019 08:26	24/12/2019 14:07	5,67	7	39,70	CHI
201912179832	VIANOPOLIS	03600224	VIANOPOLIS	23/12/2019 17:13	24/12/2019 14:07	24/12/2019 08:26	24/12/2019 14:07	5,67	156	884,82	CHI
201912179832	VIANOPOLIS	03600224	VIANOPOLIS	23/12/2019 17:13	24/12/2019 14:07	24/12/2019 13:54	24/12/2019 14:07	0,21	8	1,68	CHI
201912181415	FIRMINOPOLIS	SL12034655	SAO LUIZ DOS MONTES BELOS	23/12/2019 17:13	24/12/2019 01:27	23/12/2019 17:13	24/12/2019 01:27	8,23	27	222,18	CHI
201912181415	SAO LUIS DE MONTES BELOS	SL12034655	SAO LUIZ DOS MONTES BELOS	23/12/2019 17:13	24/12/2019 01:27	23/12/2019 17:13	24/12/2019 01:27	8,23	2	16,46	CHI
201912184109	SANTA CRUZ DE GOIAS	BC12075213	PIRES DO RIO S2	23/12/2019 17:13	23/12/2019 22:57	23/12/2019 17:13	23/12/2019 22:57	5,72	29	165,87	CHI
201912181360	URUACU	UR21310338	URUACU	23/12/2019 17:15	24/12/2019 08:35	23/12/2019 17:15	24/12/2019 08:35	15,32	1	15,32	CHI
201912182147	IPAMERI	IP12071023	IPAMERI	23/12/2019 17:15	23/12/2019 23:21	23/12/2019 17:15	23/12/2019 23:21	6,10	4	24,39	CHI
201912181361	SANTA TEREZINHA DE GOIAS	SG12330087	SANTA TEREZINHA	23/12/2019 17:16	23/12/2019 23:52	23/12/2019 17:16	23/12/2019 23:52	6,60	5	32,98	CHI
201912181363	APARECIDA DE GOIANIA	15725753	REAL S2	23/12/2019 17:16	24/12/2019 10:52	23/12/2019 17:16	24/12/2019 10:52	17,59	1	17,59	CHI
201912181367	PADRE BERNARDO	PB12375253	PADRE BERNARDO	23/12/2019 17:16	24/12/2019 13:16	23/12/2019 17:16	24/12/2019 13:16	19,99	1	19,99	CHI
201912182759	MONTIVIDIU DO NORTE	MX12168971	PORANGATU	23/12/2019 17:16	23/12/2019 21:42	23/12/2019 17:16	23/12/2019 21:42	4,42	253	1117,84	CHI
201912181373	POSSE	PS21195894	IACIARA S1	23/12/2019 17:17	23/12/2019 20:03	23/12/2019 17:17	23/12/2019 20:03	2,76	1	2,76	CHI
201912181377	JUSSARA	JR21118190	JUSSARA	23/12/2019 17:18	24/12/2019 09:34	23/12/2019 17:18	24/12/2019 09:34	16,27	1	16,27	CHI
201912181379	SANTO ANTONIO DO DESCOBERTO	SN12085981	MARAJOARA	23/12/2019 17:18	23/12/2019 23:09	23/12/2019 17:18	23/12/2019 23:09	5,84	24	140,15	CHI
201912181386	BONOPOLIS	SM16404040	SAO MIGUEL DO ARAGUAIA	23/12/2019 17:19	26/12/2019 19:17	25/12/2019 13:47	25/12/2019 14:20	0,55	93	51,46	CHI
201912181386	SAO MIGUEL DO ARAGUAIA	SM16404040	SAO MIGUEL DO ARAGUAIA	23/12/2019 17:19	26/12/2019 19:17	25/12/2019 13:47	25/12/2019 14:20	0,55	21	11,62	CHI
201912181386	BONOPOLIS	BX12262454LD	SAO MIGUEL DO ARAGUAIA	23/12/2019 17:19	26/12/2019 19:17	25/12/2019 13:47	26/12/2019 19:17	29,50	5	147,50	CHI
201912181386	BONOPOLIS	BX12202432	SAO MIGUEL DO ARAGUAIA	23/12/2019 17:19	26/12/2019 19:17	23/12/2019 17:19	26/12/2019 19:17	73,96	2	147,91	CHI

201912183501	SILVANIA	SV12205360	VIANOPOLIS	23/12/2019 17:19	24/12/2019 09:08	23/12/2019 17:19	24/12/2019 09:08	15,81	5	79,03	CHI
201912183733	ITABERAÍ	IB12000008	ITABERAÍ S2	23/12/2019 17:19	23/12/2019 19:56	23/12/2019 17:19	23/12/2019 19:56	2,62	282	737,66	CHI
201912181389	IACIARA	IA11302637	IACIARA S1	23/12/2019 17:20	23/12/2019 18:02	23/12/2019 17:20	23/12/2019 18:02	0,69	47	32,46	CHI
201912181397	GOIATUBA	BJ21123264	RIO DOS BOIS	23/12/2019 17:21	24/12/2019 09:35	23/12/2019 17:21	24/12/2019 09:35	16,22	1	16,22	CHI
201912181405	PIRENOPOLIS	PV21370121	CORUMBA	23/12/2019 17:24	24/12/2019 18:48	23/12/2019 17:24	24/12/2019 18:48	25,40	1	25,40	CHI
201912196315	GOIANDIRA	GD12078364	CATALAO S1	23/12/2019 17:24	25/12/2019 00:16	23/12/2019 17:24	25/12/2019 00:16	30,86	7	216,05	CHI
201912181420	JATAÍ	JT12209819	JATAÍ S1	23/12/2019 17:27	23/12/2019 17:58	23/12/2019 17:27	23/12/2019 17:58	0,51	10	5,11	CHI
201912184643	BALIZA	BH12331383	CAIAPONIA	23/12/2019 17:27	24/12/2019 06:47	23/12/2019 17:27	24/12/2019 06:47	13,32	3	39,96	CHI
201912181422	SERRANOPOLIS	SX21159416	CHAPADAO DO CEU	23/12/2019 17:28	24/12/2019 10:14	23/12/2019 17:28	24/12/2019 10:14	16,76	1	16,76	CHI
201912181423	GOIANIRA	10010181995	MEIA PONTE	23/12/2019 17:28	23/12/2019 23:11	23/12/2019 17:28	23/12/2019 23:11	5,71	1	5,71	CHI
201912181426	TRINDADE	40322762	TRINDADE	23/12/2019 17:28	24/12/2019 12:34	23/12/2019 17:28	24/12/2019 12:34	19,09	1	19,09	CHI
201912181720	AGUA FRIA DE GOIAS	TL10394719	SAO JOAO D ALIANCA	23/12/2019 17:28	24/12/2019 03:40	23/12/2019 17:28	23/12/2019 18:42	1,24	1615	2001,25	CHI
201912181720	MIMOSO DE GOIAS	TL10394719	SAO JOAO D ALIANCA	23/12/2019 17:28	24/12/2019 03:40	23/12/2019 17:28	23/12/2019 18:42	1,24	30	37,17	CHI
201912181720	PLANALTINA	TL10394719	SAO JOAO D ALIANCA	23/12/2019 17:28	24/12/2019 03:40	23/12/2019 17:28	23/12/2019 18:42	1,24	20	24,78	CHI
201912181720	AGUA FRIA DE GOIAS	TL12265501LD	SAO JOAO D ALIANCA	23/12/2019 17:28	24/12/2019 03:40	23/12/2019 17:28	23/12/2019 21:29	4,01	23	92,30	CHI
201912181720	AGUA FRIA DE GOIAS	TL10394719	SAO JOAO D ALIANCA	23/12/2019 17:28	24/12/2019 03:40	23/12/2019 17:28	24/12/2019 03:40	10,19	2	20,39	CHI
201912181720	AGUA FRIA DE GOIAS	TL12265501LD	SAO JOAO D ALIANCA	23/12/2019 17:28	24/12/2019 03:40	23/12/2019 17:28	24/12/2019 03:40	10,19	10	101,93	CHI
201912181720	PLANALTINA	TL10394719	SAO JOAO D ALIANCA	23/12/2019 17:28	24/12/2019 03:40	23/12/2019 17:28	24/12/2019 03:40	10,19	251	2558,53	CHI
201912181720	PLANALTINA	TL12265501LD	SAO JOAO D ALIANCA	23/12/2019 17:28	24/12/2019 03:40	23/12/2019 17:28	24/12/2019 03:40	10,19	5	50,97	CHI
201912186097	CATALAO	GD12127538	CATALAO S1	23/12/2019 17:28	24/12/2019 09:44	23/12/2019 17:28	24/12/2019 09:44	16,26	5	81,29	CHI
201912186097	GOIANDIRA	GD12127538	CATALAO S1	23/12/2019 17:28	24/12/2019 09:44	23/12/2019 17:28	24/12/2019 09:44	16,26	13	211,34	CHI
201912181706	TRINDADE	40025883	TRINDADE	23/12/2019 17:31	23/12/2019 19:53	23/12/2019 17:31	23/12/2019 19:53	2,36	1	2,36	CHI
201912182627	CALDAS NOVAS	CN11162476	CALDAS NOVAS S1	23/12/2019 17:31	23/12/2019 19:39	23/12/2019 17:31	23/12/2019 19:39	2,12	45	95,56	CHI
201912182677	APARECIDA DE GOIANIA	AP11254436	INDEPENDENCIA S2	23/12/2019 17:31	23/12/2019 22:27	23/12/2019 17:31	23/12/2019 22:27	4,92	123	605,16	CHI
201912185425	ANAPOLIS	AN12258563	ANAPOLIS UNIVERSITARIO S2	23/12/2019 17:31	24/12/2019 00:40	23/12/2019 17:31	24/12/2019 00:40	7,15	18	128,68	CHI
201912181713	CABECEIRAS	CW21233576	ITUIQUIRA	23/12/2019 17:33	23/12/2019 19:39	23/12/2019 17:33	23/12/2019 19:39	2,10	1	2,10	CHI
201912181717	GOIANIA	GN21002653	NEROPOLIS S2	23/12/2019 17:33	24/12/2019 06:34	23/12/2019 17:33	24/12/2019 06:34	13,00	3	39,01	CHI
201912181718	PIRENOPOLIS	PV21121858	CORUMBA	23/12/2019 17:33	24/12/2019 02:42	23/12/2019 17:33	24/12/2019 02:42	9,13	2	18,27	CHI
201912181719	ITUMBIARA	690022931	ITUMBIARA NOVA	23/12/2019 17:34	24/12/2019 10:14	23/12/2019 17:34	24/12/2019 10:14	16,66	1	16,66	CHI
201912181722	APARECIDA DE GOIANIA	10011563492	INDEPENDENCIA S1	23/12/2019 17:34	24/12/2019 10:33	23/12/2019 17:34	24/12/2019 10:33	16,97	1	16,97	CHI
201912185520	ANAPOLIS	AN12009341	NEROPOLIS S1	23/12/2019 17:34	24/12/2019 02:41	23/12/2019 17:34	24/12/2019 02:41	9,12	8	72,94	CHI
201912185520	PIRENOPOLIS	AN12009341	NEROPOLIS S1	23/12/2019 17:34	24/12/2019 02:41	23/12/2019 17:34	24/12/2019 02:41	9,12	18	164,11	CHI
201912181806	CIDADE OCIDENTAL	2680161446	MARAJOARA	23/12/2019 17:36	23/12/2019 19:10	23/12/2019 17:36	23/12/2019 19:10	1,56	1	1,56	CHI

201912181901	ORIZONA	OZ12052340	PIRES DO RIO S2	23/12/2019 17:36	23/12/2019 23:23	23/12/2019 17:36	23/12/2019 23:23	5,77	12	69,26	CHI
201912182151	IPAMERI	IP12000020	IPAMERI	23/12/2019 17:36	24/12/2019 12:05	23/12/2019 17:36	24/12/2019 12:05	18,48	99	1829,63	CHI
201912182693	IPAMERI	IP12203237	IPAMERI	23/12/2019 17:36	23/12/2019 20:12	23/12/2019 17:36	23/12/2019 20:12	2,59	170	440,58	CHI
201912184228	IPAMERI	IP12031890	IPAMERI	23/12/2019 17:37	25/12/2019 15:37	23/12/2019 17:37	25/12/2019 14:57	45,34	38	1722,82	CHI
201912184228	IPAMERI	IP12031890	IPAMERI	23/12/2019 17:37	25/12/2019 15:37	23/12/2019 17:37	25/12/2019 15:37	46,01	28	1288,16	CHI
201912182106	GOIANIA	AP12000205	INDEPENDENCIA S1	23/12/2019 17:39	23/12/2019 23:10	23/12/2019 17:39	23/12/2019 23:10	5,51	6	33,04	CHI
201912182645	VALPARAISO DE GOIAS	VA11163173	PACAEMBU S1	23/12/2019 17:40	23/12/2019 19:13	23/12/2019 17:40	23/12/2019 19:13	1,55	89	137,85	CHI
201912182115	FAZENDA NOVA	CO21148416	IPORA	23/12/2019 17:41	24/12/2019 15:02	23/12/2019 17:41	24/12/2019 15:02	21,35	1	21,35	CHI
201912182119	PIRENOPOLIS	10009285049	CORUMBA	23/12/2019 17:42	24/12/2019 20:58	23/12/2019 17:42	24/12/2019 20:58	27,27	1	27,27	CHI
201912182123	SANCLERLANDIA	SC21138098	FIRMINOPOLIS S2	23/12/2019 17:42	24/12/2019 11:05	23/12/2019 17:42	24/12/2019 11:05	17,38	1	17,38	CHI
201912182124	IPAMERI	580058931	IPAMERI	23/12/2019 17:42	24/12/2019 12:12	23/12/2019 17:42	24/12/2019 12:12	18,50	1	18,50	CHI
201912183543	PIRACANJUBA	PJ12068868	PIRACANJUBA	23/12/2019 17:42	24/12/2019 16:54	23/12/2019 17:42	24/12/2019 16:54	23,19	11	255,10	CHI
201912182132	PIRENOPOLIS	PV21185567	CORUMBA	23/12/2019 17:43	25/12/2019 10:49	23/12/2019 17:43	25/12/2019 10:49	41,09	1	41,09	CHI
201912183313	ITAJA	IJ11038949	ITAJA S2	23/12/2019 17:43	23/12/2019 21:07	23/12/2019 17:43	23/12/2019 21:07	3,40	48	162,97	CHI
201912184630	MIMOSO DE GOIAS	PB12095000	PADRE BERNARDO	23/12/2019 17:43	24/12/2019 01:13	23/12/2019 17:43	24/12/2019 01:13	7,50	46	345,08	CHI
201912184630	PADRE BERNARDO	PB12095000	PADRE BERNARDO	23/12/2019 17:43	24/12/2019 01:13	23/12/2019 17:43	24/12/2019 01:13	7,50	38	285,06	CHI
201912184630	VILA PROPICIO	PB12095000	PADRE BERNARDO	23/12/2019 17:43	24/12/2019 01:13	23/12/2019 17:43	24/12/2019 01:13	7,50	8	60,01	CHI
201912184102	ARAGOIANIA	AO32060885	GUAPO S2	23/12/2019 17:44	24/12/2019 08:20	23/12/2019 17:44	24/12/2019 08:20	14,61	28	409,11	CHI
201912182189	GOIANIA	GN11000717	REAL S2	23/12/2019 17:45	23/12/2019 22:10	23/12/2019 17:45	23/12/2019 22:05	4,32	83	358,56	CHI
201912182189	GOIANIA	GN11001565	REAL S2	23/12/2019 17:45	23/12/2019 22:10	23/12/2019 19:47	23/12/2019 22:10	2,37	106	251,43	CHI
201912182214	GOIANIA	GN11158148	GOYA S2	23/12/2019 17:45	23/12/2019 19:14	23/12/2019 17:45	23/12/2019 19:14	1,48	99	146,71	CHI
201912182628	LUZIANIA	LZ12290851	MARAJOARA	23/12/2019 17:45	23/12/2019 18:58	23/12/2019 17:45	23/12/2019 18:58	1,21	23	27,76	CHI
201912182152	GOIANIA	17430689	CARAJAS S2	23/12/2019 17:46	23/12/2019 18:57	23/12/2019 17:46	23/12/2019 18:57	1,17	1	1,17	CHI
201912182203	CRIXAS	NA12171143	NOVA CRIXAS	23/12/2019 17:47	24/12/2019 11:12	23/12/2019 17:47	24/12/2019 11:12	17,42	4	69,69	CHI
201912182171	PADRE BERNARDO	PB13411013	PADRE BERNARDO	23/12/2019 17:48	26/12/2019 17:34	23/12/2019 17:48	26/12/2019 17:34	71,76	1	71,76	CHI
201912182174	SAO MIGUEL DO ARAGUAIA	SM12208261	SAO MIGUEL DO ARAGUAIA	23/12/2019 17:49	24/12/2019 10:16	23/12/2019 17:49	24/12/2019 10:16	16,44	2	32,89	CHI
201912182181	ANAPOLIS	AN21258388	DAIA S1	23/12/2019 17:50	23/12/2019 19:46	23/12/2019 17:50	23/12/2019 19:46	1,93	2	3,86	CHI
201912183734	CORREGO DO OURO	CO12299163	FIRMINOPOLIS S2	23/12/2019 17:51	23/12/2019 21:04	23/12/2019 17:51	23/12/2019 21:04	3,22	13	41,80	CHI
201912182201	PILAR DE GOIAS	GG21309328	ITAPACI	23/12/2019 17:52	24/12/2019 09:57	23/12/2019 17:52	24/12/2019 09:57	16,07	1	16,07	CHI
201912183723	APARECIDA DE GOIANIA	AP12058739	INDEPENDENCIA S1	23/12/2019 17:52	23/12/2019 21:40	23/12/2019 17:52	23/12/2019 21:40	3,79	281	1064,37	CHI
201912182204	JARAGUA	JA12297944	JARAGUA	23/12/2019 17:53	24/12/2019 03:08	23/12/2019 17:53	24/12/2019 03:08	9,24	11	101,65	CHI
201912182212	PADRE BERNARDO	PB12104250	PADRE BERNARDO	23/12/2019 17:54	24/12/2019 00:09	23/12/2019 17:54	24/12/2019 00:09	6,24	22	137,22	CHI
201912184140	CEZARINA	VJ12066238	GUAPO S2	23/12/2019 17:54	24/12/2019 03:26	23/12/2019 17:54	24/12/2019 03:26	9,52	93	885,67	CHI

201912184140	VARJAO	VJ12066238	GUAPO S2	23/12/2019 17:54	24/12/2019 03:26	23/12/2019 17:54	24/12/2019 03:26	9,52	6	57,14	CHI
201912182217	ANAPOLIS	20311035	ANAPOLIS UNIVERSITARIO S2	23/12/2019 17:55	24/12/2019 01:28	23/12/2019 17:55	24/12/2019 01:28	7,54	1	7,54	CHI
201912182699	APARECIDA DE GOIANIA	AP11137105	INDEPENDENCIA S1	23/12/2019 17:55	24/12/2019 00:28	23/12/2019 17:55	24/12/2019 00:28	6,55	183	1198,29	CHI
201912176487	CAMPO ALEGRE DE GOIAS	CM12166728	CAMPO ALEGRE DE GOIAS	23/12/2019 17:56	23/12/2019 20:26	23/12/2019 17:56	23/12/2019 20:26	2,49	34	84,82	CHI
201912182220	CRISTALINA	KR12084389	PAMPLONA	23/12/2019 17:56	24/12/2019 11:10	23/12/2019 17:56	24/12/2019 11:10	17,24	4	68,96	CHI
201912182603	APARECIDA DE GOIANIA	200481332	INDEPENDENCIA S1	23/12/2019 17:56	24/12/2019 12:10	23/12/2019 17:56	24/12/2019 12:10	18,22	1	18,22	CHI
201912182604	IPORA	IR21223119	IPORA	23/12/2019 17:56	24/12/2019 09:15	23/12/2019 17:56	24/12/2019 09:15	15,31	1	15,31	CHI
201912182625	PIRES DO RIO	PR12092027	PIRES DO RIO S1	23/12/2019 17:59	24/12/2019 02:35	23/12/2019 17:59	24/12/2019 02:35	8,59	7	60,14	CHI
201912182626	PLANALTINA	2960068318	PLANALTINA	23/12/2019 17:59	23/12/2019 23:25	23/12/2019 17:59	23/12/2019 23:25	5,42	1	5,42	CHI
201912182629	FAZENDA NOVA	FN12383508	FIRMINOPOLIS S2	23/12/2019 18:00	25/12/2019 16:04	23/12/2019 18:00	25/12/2019 11:40	41,67	3	125,00	CHI
201912182629	FAZENDA NOVA	FN21159071	FIRMINOPOLIS S2	23/12/2019 18:00	25/12/2019 16:04	25/12/2019 11:47	25/12/2019 15:32	3,75	1	3,75	CHI
201912182629	FAZENDA NOVA	FN21119511	FIRMINOPOLIS S2	23/12/2019 18:00	25/12/2019 16:04	25/12/2019 11:47	25/12/2019 16:04	4,29	2	8,57	CHI
201912182632	VARJAO	VJ31011343	GUAPO S2	23/12/2019 18:00	24/12/2019 13:20	23/12/2019 18:00	24/12/2019 13:20	19,32	2	38,64	CHI
201912182633	PARAUNA	PU21299175	PARAUNA	23/12/2019 18:00	24/12/2019 09:04	23/12/2019 18:00	24/12/2019 09:04	15,05	1	15,05	CHI
201912182638	FORMOSO	FO12298166	MARA ROSA	23/12/2019 18:01	24/12/2019 10:25	23/12/2019 18:01	24/12/2019 10:25	16,39	6	98,35	CHI
201912182640	GOIANIA	14921364	CARAJAS S2	23/12/2019 18:01	23/12/2019 19:58	23/12/2019 18:01	23/12/2019 19:58	1,94	1	1,94	CHI
201912182641	LEOPOLDO DE BULHOES	LB21160620	DAIA S2	23/12/2019 18:01	24/12/2019 17:17	23/12/2019 18:01	24/12/2019 17:17	23,25	2	46,51	CHI
201912182644	ANICUNS	AC21283294	FIRMINOPOLIS S2	23/12/2019 18:01	24/12/2019 09:30	23/12/2019 18:01	24/12/2019 09:30	15,48	1	15,48	CHI
201912182646	ITABERAI	IB21310482	ITABERAI S2	23/12/2019 18:01	24/12/2019 15:15	23/12/2019 18:01	24/12/2019 15:15	21,22	1	21,22	CHI
201912182647	NIQUELANDIA	NQ12325450	SAO JOAO D ALIANCA	23/12/2019 18:02	25/12/2019 17:30	23/12/2019 18:02	25/12/2019 17:30	47,46	1	47,46	CHI
201912182668	URUACU	640004969	URUACU	23/12/2019 18:07	23/12/2019 20:45	23/12/2019 18:07	23/12/2019 20:45	2,63	1	2,63	CHI
201912182674	PONTALINA	PK12070376	PONTALINA	23/12/2019 18:07	24/12/2019 18:35	23/12/2019 18:07	24/12/2019 18:35	24,45	3	73,36	CHI
201912182675	SANTO ANTONIO DO DESCOBERTO	SN21071085	AGUAS LINDAS DE GOIAS S2	23/12/2019 18:08	23/12/2019 19:25	23/12/2019 18:08	23/12/2019 19:25	1,28	1	1,28	CHI
201912182676	CIDADE OCIDENTAL	DH11356116	MARAJOARA	23/12/2019 18:08	23/12/2019 20:00	23/12/2019 18:08	23/12/2019 20:00	1,86	62	115,03	CHI
201912184220	ANAPOLIS	20725073	ANAPOLIS UNIVERSITARIO S2	23/12/2019 18:08	24/12/2019 00:20	23/12/2019 18:08	24/12/2019 00:20	6,20	1	6,20	CHI
201912182691	ITAPACI	IW21379427	ITAPACI	23/12/2019 18:10	23/12/2019 23:37	23/12/2019 18:10	23/12/2019 23:37	5,44	1	5,44	CHI
201912182692	NOVO GAMA	LZ12000399	PACAEMBU S1	23/12/2019 18:10	23/12/2019 22:45	23/12/2019 18:10	23/12/2019 22:45	4,57	29	132,65	CHI
201912184121	MIMOSO DE GOIAS	NQ12371855	BARRO ALTO	23/12/2019 18:10	24/12/2019 07:56	23/12/2019 18:10	24/12/2019 07:56	13,75	4	55,02	CHI
201912184121	NIQUELANDIA	NQ12371855	BARRO ALTO	23/12/2019 18:10	24/12/2019 07:56	23/12/2019 18:10	24/12/2019 07:56	13,75	244	3355,95	CHI
201912182750	APARECIDA DE GOIANIA	AP10402777	REAL S1	23/12/2019 18:11	24/12/2019 09:50	23/12/2019 18:11	23/12/2019 18:16	0,09	4584	396,01	CHI
201912182750	APARECIDA DE GOIANIA	AP16409623	REAL S1	23/12/2019 18:11	24/12/2019 09:50	23/12/2019 18:11	23/12/2019 19:30	1,32	2781	3677,87	CHI
201912182750	APARECIDA DE GOIANIA	AP13393877	REAL S1	23/12/2019 18:11	24/12/2019 09:50	23/12/2019 18:11	23/12/2019 20:04	1,88	1337	2513,93	CHI
201912182750	APARECIDA DE GOIANIA	AP16409623	REAL S1	23/12/2019 18:11	24/12/2019 09:50	23/12/2019 18:11	23/12/2019 20:04	1,88	1	1,88	CHI



201912182750	APARECIDA DE GOIANIA	AP16409623	REAL S1	23/12/2019 18:11	24/12/2019 09:50	23/12/2019 18:11	23/12/2019 20:04	1,88	1392	2617,35	CHI
201912182750	GOIANIA	AP16409623	REAL S1	23/12/2019 18:11	24/12/2019 09:50	23/12/2019 18:11	23/12/2019 20:04	1,88	796	1496,70	CHI
201912182750	APARECIDA DE GOIANIA	AP12197278LD	REAL S1	23/12/2019 18:11	24/12/2019 09:50	23/12/2019 18:11	23/12/2019 20:50	2,65	366	968,68	CHI
201912182750	GOIANIA	AP12004146LD	REAL S1	23/12/2019 18:11	24/12/2019 09:50	23/12/2019 18:11	24/12/2019 09:50	15,65	7	109,53	CHI
201912184227	IPAMERI	IP12292701	IPAMERI	23/12/2019 18:11	24/12/2019 09:45	23/12/2019 18:11	24/12/2019 09:45	15,57	9	140,09	CHI
201912182705	ITUMBIARA	690211326	ITUMBIARA NOVA	23/12/2019 18:12	23/12/2019 22:10	23/12/2019 18:12	23/12/2019 22:10	3,97	1	3,97	CHI
201912182706	APARECIDA DE GOIANIA	10012822564	ANHANGUERA	23/12/2019 18:12	24/12/2019 10:03	23/12/2019 18:12	24/12/2019 10:03	15,84	1	15,84	CHI
201912182713	PIRACANJUBA	MR12000241	MORRINHOS	23/12/2019 18:13	24/12/2019 12:17	23/12/2019 18:13	24/12/2019 12:17	18,06	6	108,35	CHI
201912182720	NIQUELANDIA	NQ12274633	BARRO ALTO	23/12/2019 18:14	24/12/2019 03:35	23/12/2019 18:14	24/12/2019 03:35	9,34	1	9,34	CHI
201912182810	VALPARAISO DE GOIAS	VA11097135	PACAEMBU S2	23/12/2019 18:14	23/12/2019 20:42	23/12/2019 18:14	23/12/2019 20:42	2,47	78	192,40	CHI
201912185546	PLANALTINA	PI11194814	PLANALTINA	23/12/2019 18:14	24/12/2019 07:58	23/12/2019 18:14	24/12/2019 07:58	13,72	112	1536,33	CHI
201912182730	IPAMERI	IP12311771	IPAMERI	23/12/2019 18:15	24/12/2019 14:03	23/12/2019 18:15	24/12/2019 14:03	19,80	4	79,18	CHI
201912182814	TRINDADE	TR12051537	TRINDADE	23/12/2019 18:15	24/12/2019 09:19	23/12/2019 18:15	24/12/2019 09:19	15,06	6	90,36	CHI
201912182775	GOIANIRA	GR11095868	GOIANIRA	23/12/2019 18:16	24/12/2019 02:10	23/12/2019 18:16	24/12/2019 02:10	7,89	84	662,97	CHI
201912182792	GOIANIA	GN11216845	REAL S1	23/12/2019 18:16	23/12/2019 22:00	23/12/2019 18:16	23/12/2019 22:00	3,72	155	576,26	CHI
201912183325	NOVO GAMA	NJ12097523	PACAEMBU S1	23/12/2019 18:16	23/12/2019 19:09	23/12/2019 18:16	23/12/2019 19:09	0,88	401	352,43	CHI
201912184045	IPAMERI	IP11027105	IPAMERI	23/12/2019 18:16	23/12/2019 21:09	23/12/2019 18:16	23/12/2019 21:09	2,87	117	335,53	CHI
201912184546	LUZIANIA	LZ12000144	MARAJOARA	23/12/2019 18:16	23/12/2019 23:38	23/12/2019 18:16	23/12/2019 23:38	5,36	52	278,71	CHI
201912182756	RIO VERDE	RV21205437	MONTIVIDIU T	23/12/2019 18:17	24/12/2019 10:45	23/12/2019 18:17	24/12/2019 10:45	16,46	13	213,99	CHI
201912182761	RIO VERDE	RV12271475	CABRIUVA S2	23/12/2019 18:17	24/12/2019 13:42	23/12/2019 18:17	24/12/2019 13:42	19,40	2	38,80	CHI
201912185415	LUZIANIA	LZ12052711	VIANOPOLIS	23/12/2019 18:18	24/12/2019 03:06	23/12/2019 18:18	24/12/2019 03:06	8,79	5	43,95	CHI
201912182779	DAVINOPOLIS	IO21285615	CATALAO S1	23/12/2019 18:20	24/12/2019 14:41	23/12/2019 18:20	24/12/2019 14:41	20,34	1	20,34	CHI
201912182780	EDEIA	EA21044494	EDEIA	23/12/2019 18:20	24/12/2019 21:48	23/12/2019 18:20	24/12/2019 21:48	27,46	1	27,46	CHI
201912183425	PLANALTINA	PI12099511	PLANALTINA	23/12/2019 18:20	23/12/2019 21:59	23/12/2019 18:20	23/12/2019 21:59	3,65	17	62,03	CHI
201912182785	CATALAO	10002904304	CATALAO S2	23/12/2019 18:21	24/12/2019 02:25	23/12/2019 18:21	24/12/2019 02:25	8,06	1	8,06	CHI
201912182797	GOIANIA	17464791	GOIANIA LESTE S3	23/12/2019 18:24	23/12/2019 23:44	23/12/2019 18:24	23/12/2019 23:44	5,33	1	5,33	CHI
201912182800	ANAPOLIS	AN21167056	ANAPOLIS UNIVERSITARIO S2	23/12/2019 18:24	24/12/2019 07:45	23/12/2019 18:24	24/12/2019 07:45	13,34	1	13,34	CHI
201912182802	INHUMAS	IN21066359	INHUMAS S2	23/12/2019 18:25	24/12/2019 00:30	23/12/2019 18:25	24/12/2019 00:30	6,08	1	6,08	CHI
201912185656	PADRE BERNARDO	PB11349063	PADRE BERNARDO	23/12/2019 18:25	24/12/2019 04:09	23/12/2019 18:25	24/12/2019 04:09	9,72	5	48,60	CHI
201912184700	ITAJA	IM12296705	ITAJA S2	23/12/2019 18:26	24/12/2019 17:43	23/12/2019 18:26	24/12/2019 17:43	23,27	1	23,27	CHI
201912184700	ITARUMA	IM12296705	ITAJA S2	23/12/2019 18:26	24/12/2019 17:43	23/12/2019 18:26	24/12/2019 17:43	23,27	14	325,81	CHI
201912183701	DIVINOPOLIS DE GOIAS	GH12269345	SAO DOMINGOS	23/12/2019 18:27	23/12/2019 21:10	23/12/2019 18:27	23/12/2019 21:10	2,71	36	97,69	CHI
201912183722	ARACU	AV12020305	ANICUNS	23/12/2019 18:27	24/12/2019 00:37	23/12/2019 18:27	24/12/2019 00:37	6,15	11	67,69	CHI

201912183722	AVELINOPOLIS	AV12020305	ANICUNS	23/12/2019 18:27	24/12/2019 00:37	23/12/2019 18:27	24/12/2019 00:37	6,15	165	1015,30	CHI
201912183722	CATURAI	AV12020305	ANICUNS	23/12/2019 18:27	24/12/2019 00:37	23/12/2019 18:27	24/12/2019 00:37	6,15	8	49,23	CHI
201912183722	ITABERAÍ	AV12020305	ANICUNS	23/12/2019 18:27	24/12/2019 00:37	23/12/2019 18:27	24/12/2019 00:37	6,15	19	116,91	CHI
201912183722	SANTA BARBARA DE GOIAS	AV12020305	ANICUNS	23/12/2019 18:27	24/12/2019 00:37	23/12/2019 18:27	24/12/2019 00:37	6,15	8	49,23	CHI
201912182824	AMORINOPOLIS	AM12193255	IPORA	23/12/2019 18:29	24/12/2019 10:16	23/12/2019 18:29	24/12/2019 10:16	15,78	1	15,78	CHI
201912182825	LEOPOLDO DE BULHOES	LB21273354	DAIA S2	23/12/2019 18:29	24/12/2019 12:37	23/12/2019 18:29	24/12/2019 12:37	18,13	6	108,79	CHI
201912182828	ALTO HORIZONTE	AJ21100995	SANTA TEREZINHA	23/12/2019 18:29	24/12/2019 11:17	23/12/2019 18:29	24/12/2019 11:17	16,79	1	16,79	CHI
201912183105	CRIXAS	CX21319099	SERRA DO OURO	23/12/2019 18:29	24/12/2019 15:20	23/12/2019 18:29	24/12/2019 15:20	20,84	1	20,84	CHI
201912183592	SAO LUIS DE MONTES BELOS	SL32145963	SAO LUIZ DOS MONTES BELOS	23/12/2019 18:29	24/12/2019 07:12	23/12/2019 18:29	24/12/2019 07:12	12,71	4	50,83	CHI
201912183741	VALPARAISO DE GOIAS	VA12242135	MARAJOARA	23/12/2019 18:29	23/12/2019 20:20	23/12/2019 18:29	23/12/2019 20:20	1,84	102	187,51	CHI
201912184154	PADRE BERNARDO	PB12375242	PADRE BERNARDO	23/12/2019 18:29	24/12/2019 05:58	23/12/2019 18:29	24/12/2019 05:58	11,47	25	286,73	CHI
201912183202	GOIANDIRA	GD21000010	CATALAO S1	23/12/2019 18:30	24/12/2019 09:40	23/12/2019 18:30	24/12/2019 09:40	15,17	1	15,17	CHI
201912183203	SILVANIA	SV21209077	VIANOPOLIS	23/12/2019 18:31	24/12/2019 11:25	23/12/2019 18:31	24/12/2019 11:25	16,90	1	16,90	CHI
201912183204	MINACU	IH21288123	MINACU	23/12/2019 18:31	24/12/2019 09:15	23/12/2019 18:31	24/12/2019 09:15	14,73	1	14,73	CHI
201912183205	JATAI	290331158	JATAI S2	23/12/2019 18:31	24/12/2019 11:21	23/12/2019 18:31	24/12/2019 11:21	16,83	1	16,83	CHI
201912184081	ANAPOLIS	AN11329899	ANAPOLIS UNIVERSITARIO S2	23/12/2019 18:32	23/12/2019 20:42	23/12/2019 18:32	23/12/2019 20:42	2,16	83	179,63	CHI
201912183302	FIRMINOPOLIS	FR21339975	FIRMINOPOLIS S2	23/12/2019 18:33	24/12/2019 08:25	23/12/2019 18:33	24/12/2019 08:25	13,87	1	13,87	CHI
201912183308	GOIANIA	17132101	MEIA PONTE	23/12/2019 18:34	24/12/2019 00:02	23/12/2019 18:34	24/12/2019 00:02	5,46	1	5,46	CHI
201912183314	VALPARAISO DE GOIAS	VA12389550LD	PACAEMBU S1	23/12/2019 18:35	23/12/2019 22:55	23/12/2019 18:35	23/12/2019 22:55	4,33	10	43,31	CHI
201912183316	FORMOSA	10010918696	ITUIQUIRA	23/12/2019 18:35	23/12/2019 23:01	23/12/2019 18:35	23/12/2019 23:01	4,43	1	4,43	CHI
201912185305	VALPARAISO DE GOIAS	LZ11051979	PACAEMBU S1	23/12/2019 18:35	24/12/2019 13:49	23/12/2019 18:35	24/12/2019 11:54	17,32	6	103,92	CHI
201912185305	VALPARAISO DE GOIAS	VA12389551LD	PACAEMBU S1	23/12/2019 18:35	24/12/2019 13:49	24/12/2019 11:25	24/12/2019 12:29	1,07	0	0,00	CHI
201912185305	VALPARAISO DE GOIAS	LZ11051979	PACAEMBU S1	23/12/2019 18:35	24/12/2019 13:49	24/12/2019 12:29	24/12/2019 13:31	1,03	6	6,20	CHI
201912185305	VALPARAISO DE GOIAS	VA12389551LD	PACAEMBU S1	23/12/2019 18:35	24/12/2019 13:49	24/12/2019 13:10	24/12/2019 13:49	0,66	0	0,00	CHI
201912183320	NOVO BRASIL	NB21154738	JUSSARA	23/12/2019 18:36	24/12/2019 02:56	23/12/2019 18:36	24/12/2019 02:56	8,33	1	8,33	CHI
201912183330	MONTE ALEGRE DE GOIAS	MA12290191	SAO DOMINGOS	23/12/2019 18:38	23/12/2019 20:39	23/12/2019 18:38	23/12/2019 20:39	2,00	30	60,04	CHI
201912183331	GOIANIA	GN11168575	INDEPENDENCIA S2	23/12/2019 18:38	23/12/2019 23:28	23/12/2019 18:38	23/12/2019 23:28	4,82	36	173,43	CHI
201912183333	GUAPO	GA21000085	GUAPO S2	23/12/2019 18:39	24/12/2019 14:08	23/12/2019 18:39	24/12/2019 14:08	19,48	1	19,48	CHI
201912183336	APARECIDA DE GOIANIA	15880746	INDEPENDENCIA S2	23/12/2019 18:39	23/12/2019 20:52	23/12/2019 18:39	23/12/2019 20:52	2,21	1	2,21	CHI
201912183338	LEOPOLDO DE BULHOES	BO21195551	DAIA S2	23/12/2019 18:39	24/12/2019 14:13	23/12/2019 18:39	24/12/2019 14:13	19,55	2	39,11	CHI
201912183401	GUAPO	GA21027875	GUAPO S2	23/12/2019 18:40	24/12/2019 12:37	23/12/2019 18:40	24/12/2019 12:37	17,95	2	35,89	CHI
201912184054	HIDROLANDIA	HD11350570	ANHANGUERA	23/12/2019 18:40	24/12/2019 10:50	23/12/2019 18:40	24/12/2019 10:50	16,16	44	710,84	CHI
201912182137	SANTO ANTONIO DO DESCOBERTO	SN12275480	MARAJOARA	23/12/2019 18:41	24/12/2019 11:09	23/12/2019 18:41	24/12/2019 11:09	16,46	13	213,92	CHI

201912183423	LEOPOLDO DE BULHOES	LB21084062	DAIA S2	23/12/2019 18:41	24/12/2019 16:22	23/12/2019 18:41	24/12/2019 16:22	21,68	1	21,68	CHI
201912183431	VALPARAISO DE GOIAS	10004958622	PACAEMBU S1	23/12/2019 18:42	24/12/2019 11:07	23/12/2019 18:42	24/12/2019 11:07	16,42	1	16,42	CHI
201912183566	NOVO GAMA	NJ11183935	PACAEMBU S1	23/12/2019 18:42	23/12/2019 20:32	23/12/2019 18:42	23/12/2019 20:32	1,83	112	204,49	CHI
201912183437	SILVANIA	SV21043059	VIANOPOLIS	23/12/2019 18:43	24/12/2019 12:21	23/12/2019 18:43	24/12/2019 12:21	17,64	1	17,64	CHI
201912183440	PALMEIRAS DE GOIAS	PL21309222	PALMEIRAS	23/12/2019 18:44	24/12/2019 12:10	23/12/2019 18:44	24/12/2019 12:10	17,43	1	17,43	CHI
201912183441	VARJAO	VJ31089525	GUAPO S2	23/12/2019 18:44	24/12/2019 11:58	23/12/2019 18:44	24/12/2019 11:58	17,23	2	34,46	CHI
201912183449	NEROPOLIS	160007458	NEROPOLIS S2	23/12/2019 18:44	23/12/2019 21:25	23/12/2019 18:44	23/12/2019 21:25	2,67	1	2,67	CHI
201912183504	PADRE BERNARDO	PB12313643	PADRE BERNARDO	23/12/2019 18:45	24/12/2019 14:48	23/12/2019 18:45	24/12/2019 14:48	20,04	1	20,04	CHI
201912183505	INACIOLANDIA	ID12305562	CACHOEIRA DOURADA	23/12/2019 18:45	23/12/2019 23:04	23/12/2019 18:45	23/12/2019 23:04	4,30	4	17,21	CHI
201912183507	AGUAS LINDAS DE GOIAS	10003772223	AGUAS LINDAS DE GOIAS S1	23/12/2019 18:46	23/12/2019 22:26	23/12/2019 18:46	23/12/2019 22:26	3,66	1	3,66	CHI
201912183509	MORRINHOS	MR21041269	MORRINHOS	23/12/2019 18:46	24/12/2019 09:39	23/12/2019 18:46	24/12/2019 09:39	14,88	1	14,88	CHI
201912183518	VILA PROPICIO	NP21326105	GOIANESIA S1	23/12/2019 18:47	25/12/2019 08:58	23/12/2019 18:47	25/12/2019 08:58	38,18	1	38,18	CHI
201912183520	ORIZONA	OZ21043241	PIRES DO RIO S2	23/12/2019 18:47	23/12/2019 21:20	23/12/2019 18:47	23/12/2019 21:20	2,54	1	2,54	CHI
201912183521	FORMOSA	10030607769	ITUIQUIRA	23/12/2019 18:47	23/12/2019 20:28	23/12/2019 18:47	23/12/2019 20:28	1,67	0	0,00	CHI
201912183522	ORIZONA	OZ21114451	PIRES DO RIO S2	23/12/2019 18:48	24/12/2019 14:33	23/12/2019 18:48	24/12/2019 14:33	19,75	1	19,75	CHI
201912184537	ALEXANIA	AX12095958	CORUMBA	23/12/2019 18:48	25/12/2019 14:10	23/12/2019 18:48	25/12/2019 14:10	43,36	6	260,17	CHI
201912184537	CORUMBA DE GOIAS	AX12095958	CORUMBA	23/12/2019 18:48	25/12/2019 14:10	23/12/2019 18:48	25/12/2019 14:10	43,36	3	130,08	CHI
201912183540	NOVO GAMA	NJ11201167	PACAEMBU S1	23/12/2019 18:50	24/12/2019 15:00	23/12/2019 18:50	24/12/2019 15:00	20,17	43	867,13	CHI
201912183547	APARECIDA DE GOIANIA	14219785	REAL S1	23/12/2019 18:51	24/12/2019 08:25	23/12/2019 18:51	24/12/2019 08:25	13,56	1	13,56	CHI
201912183552	GOIANIA	10401738	GOIANIA LESTE S2	23/12/2019 18:52	23/12/2019 22:11	23/12/2019 18:52	23/12/2019 22:11	3,31	1	3,31	CHI
201912183553	LUZIANIA	LZ12041471	RIO VERMELHO	23/12/2019 18:52	24/12/2019 08:47	23/12/2019 18:52	24/12/2019 08:47	13,90	11	152,95	CHI
201912183555	MINEIROS	MY21156769	PARQUE DAS EMAS	23/12/2019 18:52	24/12/2019 11:17	23/12/2019 18:52	24/12/2019 11:17	16,40	1	16,40	CHI
201912183562	PIRES DO RIO	460008663	PIRES DO RIO S1	23/12/2019 18:53	24/12/2019 02:20	23/12/2019 18:53	24/12/2019 02:20	7,44	1	7,44	CHI
201912183563	MONTE ALEGRE DE GOIAS	MA21109512	SAO DOMINGOS	23/12/2019 18:53	23/12/2019 22:01	23/12/2019 18:53	23/12/2019 22:01	3,12	1	3,12	CHI
201912184401	CATALAO	CT12061265RE	CATALAO S1	23/12/2019 18:54	24/12/2019 09:52	23/12/2019 18:54	24/12/2019 09:52	14,96	15	224,41	CHI
201912184401	DAVINOPOLIS	CT12061265RE	CATALAO S1	23/12/2019 18:54	24/12/2019 09:52	23/12/2019 18:54	24/12/2019 09:52	14,96	71	1062,20	CHI
201912184401	OUVIDOR	CT12061265RE	CATALAO S1	23/12/2019 18:54	24/12/2019 09:52	23/12/2019 18:54	24/12/2019 09:52	14,96	53	792,91	CHI
201912183582	IPORA	730073683	IPORA	23/12/2019 18:57	24/12/2019 06:37	23/12/2019 18:57	24/12/2019 06:37	11,67	1	11,67	CHI
201912183583	APARECIDA DE GOIANIA	12599268	REAL S1	23/12/2019 18:57	24/12/2019 09:45	23/12/2019 18:57	24/12/2019 09:45	14,80	1	14,80	CHI
201912183586	QUIRINOPOLIS	QI32052457	QUIRINOPOLIS	23/12/2019 18:57	24/12/2019 12:51	23/12/2019 18:57	24/12/2019 12:51	17,89	9	161,04	CHI
201912183587	URUTAI	10030608145	PIRES DO RIO S2	23/12/2019 18:57	24/12/2019 08:09	23/12/2019 18:57	24/12/2019 08:09	13,19	0	0,00	CHI
201912183595	ITABERAI	IB11274360	ITABERAI S2	23/12/2019 18:59	24/12/2019 09:25	23/12/2019 18:59	24/12/2019 09:25	14,43	225	3246,50	CHI
201912183597	GOIANIA	10305221	CAMPINAS S2	23/12/2019 18:59	23/12/2019 21:48	23/12/2019 18:59	23/12/2019 21:48	2,81	1	2,81	CHI

201912183599	GOIANESIA	550124433	GOIANESIA S2	23/12/2019 19:00	24/12/2019 16:30	23/12/2019 19:00	24/12/2019 16:30	21,50	1	21,50	CHI
201912184049	GOIANIA	GN11065437	XAVANTES	23/12/2019 19:00	24/12/2019 01:09	23/12/2019 19:00	24/12/2019 01:09	6,14	141	866,21	CHI
201912184753	VALPARAISO DE GOIAS	VA11192788	MARAJOARA	23/12/2019 19:00	23/12/2019 22:55	23/12/2019 19:00	23/12/2019 22:55	3,90	42	163,96	CHI
201912183715	CATALAO	1990132331	CATALAO S2	23/12/2019 19:02	24/12/2019 03:32	23/12/2019 19:02	24/12/2019 03:32	8,49	1	8,49	CHI
201912183719	URUACU	640040287	URUACU	23/12/2019 19:02	24/12/2019 01:59	23/12/2019 19:02	24/12/2019 01:59	6,94	1	6,94	CHI
201912183727	DIVINOPOLIS DE GOIAS	GH12151252	SAO DOMINGOS	23/12/2019 19:03	24/12/2019 10:55	23/12/2019 19:03	24/12/2019 10:55	15,85	6	95,11	CHI
201912166347	RUBIATABA	RB12392306	RUBIATABA	23/12/2019 19:05	23/12/2019 21:21	23/12/2019 19:05	23/12/2019 21:21	2,26	5	11,31	CHI
201912183739	ARUANA	AK12250806	MOZARLANDIA	23/12/2019 19:06	24/12/2019 22:20	23/12/2019 19:06	24/12/2019 22:20	27,23	4	108,90	CHI
201912183746	GOIANIA	15101990	XAVANTES	23/12/2019 19:07	24/12/2019 02:18	23/12/2019 19:07	24/12/2019 02:18	7,17	1	7,17	CHI
201912183749	NEROPOLIS	160038121	NEROPOLIS S2	23/12/2019 19:08	23/12/2019 20:14	23/12/2019 19:08	23/12/2019 20:14	1,10	1	1,10	CHI
201912183750	APARECIDA DE GOIANIA	10024057140	INDEPENDENCIA S1	23/12/2019 19:08	24/12/2019 17:14	23/12/2019 19:08	24/12/2019 17:14	22,11	1	22,11	CHI
201912183751	AGUAS LINDAS DE GOIAS	LA11345843	AGUAS LINDAS DE GOIAS S1	23/12/2019 19:08	23/12/2019 20:19	23/12/2019 19:08	23/12/2019 20:19	1,18	71	83,46	CHI
201912184666	HIDROLANDIA	HD11000137	ANHANGUERA	23/12/2019 19:08	23/12/2019 22:03	23/12/2019 19:08	23/12/2019 22:03	2,90	56	162,54	CHI
201912183757	GOIANIA	14366125	MEIA PONTE	23/12/2019 19:09	24/12/2019 01:22	23/12/2019 19:09	24/12/2019 01:22	6,21	1	6,21	CHI
201912183763	APARECIDA DE GOIANIA	200261642	INDEPENDENCIA S1	23/12/2019 19:10	24/12/2019 12:20	23/12/2019 19:10	24/12/2019 12:20	17,16	1	17,16	CHI
201912183764	PIRES DO RIO	PR21300718	PIRES DO RIO S1	23/12/2019 19:10	24/12/2019 10:25	23/12/2019 19:10	24/12/2019 10:25	15,24	1	15,24	CHI
201912183767	GOIANIA	GN11338032	SENADOR CANEDO	23/12/2019 19:11	23/12/2019 19:47	23/12/2019 19:11	23/12/2019 19:47	0,60	57	34,17	CHI
201912183771	BURITINOPOLIS	SU12301950	SANTA RITA DO ARAGUAIA	23/12/2019 19:11	24/12/2019 09:01	23/12/2019 19:11	24/12/2019 09:01	13,82	1	13,82	CHI
201912183771	SANTA RITA DO ARAGUAIA	SU12301950	SANTA RITA DO ARAGUAIA	23/12/2019 19:11	24/12/2019 09:01	23/12/2019 19:11	24/12/2019 09:01	13,82	21	290,26	CHI
201912183802	LUZIANIA	LZ11136644	MARAJOARA	23/12/2019 19:11	23/12/2019 21:11	23/12/2019 19:11	23/12/2019 21:11	1,99	208	413,92	CHI
201912183782	GOIANIRA	390018740	GOIANIRA	23/12/2019 19:12	24/12/2019 07:46	23/12/2019 19:12	24/12/2019 07:46	12,56	1	12,56	CHI
201912183784	PETROLINA DE GOIAS	PG21070533	INHUMAS S1	23/12/2019 19:12	24/12/2019 01:34	23/12/2019 19:12	24/12/2019 01:34	6,35	1	6,35	CHI
201912184060	AMORINOPOLIS	IV12165613	IPORA	23/12/2019 19:12	24/12/2019 08:04	23/12/2019 19:12	24/12/2019 08:04	12,86	6	77,13	CHI
201912184060	IVOLANDIA	IV12165613	IPORA	23/12/2019 19:12	24/12/2019 08:04	23/12/2019 19:12	24/12/2019 08:04	12,86	6	77,13	CHI
201912184135	CAMPINACU	UC12197170	PORANGATU	23/12/2019 19:12	24/12/2019 01:47	23/12/2019 19:12	24/12/2019 01:47	6,57	13	85,46	CHI
201912184135	MINACU	UC12197170	PORANGATU	23/12/2019 19:12	24/12/2019 01:47	23/12/2019 19:12	24/12/2019 01:47	6,57	1	6,57	CHI
201912183786	ARENOPOLIS	IR12308228	ARENOPOLIS	23/12/2019 19:13	24/12/2019 13:10	23/12/2019 19:13	24/12/2019 13:10	17,94	1	17,94	CHI
201912183791	CAVALCANTE	CJ21404471	MINACU	23/12/2019 19:14	24/12/2019 15:15	23/12/2019 19:14	24/12/2019 15:15	20,01	1	20,01	CHI
201912183793	IPORA	730040070	IPORA	23/12/2019 19:14	24/12/2019 06:24	23/12/2019 19:14	24/12/2019 06:24	11,15	1	11,15	CHI
201912183807	NIQUELANDIA	NQ12264589	NIQUELANDIA SUBTRANSMISSAO	23/12/2019 19:16	23/12/2019 21:16	23/12/2019 19:16	23/12/2019 21:16	2,00	2	3,99	CHI
201912183809	APARECIDA DE GOIANIA	200576987	INDEPENDENCIA S1	23/12/2019 19:16	24/12/2019 12:05	23/12/2019 19:16	24/12/2019 12:05	16,81	1	16,81	CHI
201912183810	GOIANIA	17097484	INDEPENDENCIA S2	23/12/2019 19:16	23/12/2019 22:46	23/12/2019 19:16	23/12/2019 22:46	3,49	1	3,49	CHI
201912183812	ANAPOLIS	10008002175	JUNDIAI S2	23/12/2019 19:16	23/12/2019 20:35	23/12/2019 19:16	23/12/2019 20:35	1,31	1	1,31	CHI

201912184528	APARECIDA DE GOIANIA	AP12000026	INDEPENDENCIA S1	23/12/2019 19:16	23/12/2019 20:37	23/12/2019 19:16	23/12/2019 20:37	1,35	380	513,11	CHI
201912184715	CORREGO DO OURO	CO12079990	SAO LUIZ DOS MONTES BELOS	23/12/2019 19:16	24/12/2019 17:06	23/12/2019 19:16	24/12/2019 17:06	21,84	35	764,55	CHI
201912184715	MOIPORA	CO12079990	SAO LUIZ DOS MONTES BELOS	23/12/2019 19:16	24/12/2019 17:06	23/12/2019 19:16	24/12/2019 17:06	21,84	2	43,69	CHI
201912183737	MINEIROS	MY21322129	PARQUE DAS EMAS	23/12/2019 19:18	24/12/2019 14:49	23/12/2019 19:18	24/12/2019 14:49	19,50	1	19,50	CHI
201912183902	SAO LUIS DE MONTES BELOS	SL21020355	SAO LUIZ DOS MONTES BELOS	23/12/2019 19:18	24/12/2019 16:26	23/12/2019 19:18	24/12/2019 16:26	21,13	1	21,13	CHI
201912184001	CATALAO	CT12000107	CATALAO S1	23/12/2019 19:18	24/12/2019 10:04	23/12/2019 19:18	24/12/2019 10:04	14,76	16	236,14	CHI
201912184001	OUVIDOR	CT12000107	CATALAO S1	23/12/2019 19:18	24/12/2019 10:04	23/12/2019 19:18	24/12/2019 10:04	14,76	11	162,34	CHI
201912184011	PADRE BERNARDO	PB21250114	PADRE BERNARDO	23/12/2019 19:18	24/12/2019 17:13	23/12/2019 19:18	24/12/2019 17:13	21,90	1	21,90	CHI
201912184231	BOM JARDIM DE GOIAS	BM12201516	BOM JARDIM	23/12/2019 19:18	24/12/2019 07:49	23/12/2019 19:18	24/12/2019 07:49	12,50	38	475,13	CHI
201912184015	MOSSAMEDES	MD21283707	FIRMINOPOLIS S2	23/12/2019 19:19	24/12/2019 07:23	23/12/2019 19:19	24/12/2019 07:23	12,06	1	12,06	CHI
201912184018	APARECIDA DE GOIANIA	14907483	INDEPENDENCIA S2	23/12/2019 19:20	24/12/2019 09:41	23/12/2019 19:20	24/12/2019 09:41	14,35	1	14,35	CHI
201912184023	APARECIDA DE GOIANIA	200120347	INDEPENDENCIA S1	23/12/2019 19:20	24/12/2019 13:28	23/12/2019 19:20	24/12/2019 13:28	18,12	1	18,12	CHI
201912184028	IVOLANDIA	IV12221784	MONTIVIDIU T	23/12/2019 19:21	24/12/2019 10:52	23/12/2019 19:21	24/12/2019 10:52	15,50	19	294,54	CHI
201912184029	APARECIDA DE GOIANIA	200111000	INDEPENDENCIA S1	23/12/2019 19:22	24/12/2019 12:25	23/12/2019 19:22	24/12/2019 12:25	17,05	1	17,05	CHI
201912184033	ALEXANIA	480085134	ALEXANIA	23/12/2019 19:22	24/12/2019 15:34	23/12/2019 19:22	24/12/2019 15:34	20,19	1	20,19	CHI
201912184043	MIMOSO DE GOIAS	MJ12313849	PADRE BERNARDO	23/12/2019 19:23	24/12/2019 13:09	23/12/2019 19:23	24/12/2019 13:09	17,76	1	17,76	CHI
201912184195	VALPARAISO DE GOIAS	19964206	MARAJOARA	23/12/2019 19:23	24/12/2019 09:50	23/12/2019 19:23	24/12/2019 09:32	14,14	142	2007,88	CHI
201912184195	VALPARAISO DE GOIAS	VA11349004	MARAJOARA	23/12/2019 19:23	24/12/2019 09:50	23/12/2019 19:23	24/12/2019 09:42	14,31	86	1230,37	CHI
201912184195	VALPARAISO DE GOIAS	VA11128738	MARAJOARA	23/12/2019 19:23	24/12/2019 09:50	23/12/2019 19:23	24/12/2019 09:50	14,44	215	3104,60	CHI
201912185208	VALPARAISO DE GOIAS	VA11163173	PACAEMBU S1	23/12/2019 19:23	23/12/2019 22:06	23/12/2019 19:23	23/12/2019 22:06	2,71	89	241,44	CHI
201912184051	CATALAO	CT12215630RE	CATALAO S1	23/12/2019 19:24	24/12/2019 09:52	23/12/2019 19:24	24/12/2019 09:52	14,46	9	130,14	CHI
201912184051	DAVINOPOLIS	CT12215630RE	CATALAO S1	23/12/2019 19:24	24/12/2019 09:52	23/12/2019 19:24	24/12/2019 09:52	14,46	42	607,30	CHI
201912184051	OUVIDOR	CT12215630RE	CATALAO S1	23/12/2019 19:24	24/12/2019 09:52	23/12/2019 19:24	24/12/2019 09:52	14,46	26	375,95	CHI
201912183611	GOIAS	IB10394756	ITABERAI S2	23/12/2019 19:25	24/12/2019 04:26	23/12/2019 19:26	24/12/2019 03:23	7,95	1	7,95	CHI
201912183611	ITABERAI	IB10394756	ITABERAI S2	23/12/2019 19:25	24/12/2019 04:26	23/12/2019 19:26	24/12/2019 03:23	7,95	21	167,04	CHI
201912183611	ITABERAI	IB12124892	ITABERAI S2	23/12/2019 19:25	24/12/2019 04:26	23/12/2019 19:26	24/12/2019 03:43	8,29	11	91,22	CHI
201912183611	ITABERAI	IB10394756	ITABERAI S2	23/12/2019 19:25	24/12/2019 04:26	23/12/2019 19:26	24/12/2019 04:25	8,98	86	772,49	CHI
201912183611	ITABERAI	IB10394756	ITABERAI S2	23/12/2019 19:25	24/12/2019 04:26	23/12/2019 19:40	24/12/2019 04:25	8,74	1	8,74	CHI
201912183611	ITABERAI	IB10394756	ITABERAI S2	23/12/2019 19:25	24/12/2019 04:26	23/12/2019 21:15	24/12/2019 04:25	7,16	1	7,16	CHI
201912183611	GOIAS	IB10394756	ITABERAI S2	23/12/2019 19:25	24/12/2019 04:26	23/12/2019 19:26	24/12/2019 04:26	8,99	105	944,47	CHI
201912183611	ITABERAI	IB10394756	ITABERAI S2	23/12/2019 19:25	24/12/2019 04:26	23/12/2019 19:26	24/12/2019 04:26	8,99	87	782,56	CHI
201912183611	MOSSAMEDES	IB10394756	ITABERAI S2	23/12/2019 19:25	24/12/2019 04:26	23/12/2019 19:26	24/12/2019 04:26	8,99	256	2302,72	CHI
201912184056	SANTA CRUZ DE GOIAS	BC21280312	PIRES DO RIO S2	23/12/2019 19:25	25/12/2019 01:07	23/12/2019 19:25	25/12/2019 01:07	29,69	1	29,69	CHI

201912184064	NOVO PLANALTO	TA11293685	SAO MIGUEL DO ARAGUAIA	23/12/2019 19:26	24/12/2019 12:23	23/12/2019 19:26	24/12/2019 12:23	16,94	1	16,94	CHI
201912184068	CRISTALINA	KR21308777	CRISTALINA S1	23/12/2019 19:27	23/12/2019 20:19	23/12/2019 19:27	23/12/2019 20:19	0,87	1	0,87	CHI
201912184077	NOVA AURORA	2220002403	CATALAO S1	23/12/2019 19:27	24/12/2019 14:34	23/12/2019 19:27	24/12/2019 14:34	19,10	1	19,10	CHI
201912184625	NOVO GAMA	NJ12000104	PACAEMBU S1	23/12/2019 19:27	24/12/2019 13:18	23/12/2019 19:27	24/12/2019 13:18	17,83	23	410,19	CHI
201912185110	CEZARINA	CZ12064280	CEZARINA	23/12/2019 19:27	24/12/2019 08:06	23/12/2019 19:27	24/12/2019 08:06	12,65	44	556,38	CHI
201912185110	INDIARA	CZ12064280	CEZARINA	23/12/2019 19:27	24/12/2019 08:06	23/12/2019 19:27	24/12/2019 08:06	12,65	6	75,87	CHI
201912189124	SILVANIA	20914295	ANAPOLIS UNIVERSITARIO S2	23/12/2019 19:27	24/12/2019 15:09	23/12/2019 19:27	24/12/2019 15:09	19,68	1	19,68	CHI
201912184158	APARECIDA DE GOIANIA	AP11251490	INDEPENDENCIA S1	23/12/2019 19:28	23/12/2019 23:49	23/12/2019 19:28	23/12/2019 23:49	4,34	172	747,24	CHI
201912184105	GOIANIA	10994269	FERROVIARIO S2	23/12/2019 19:29	23/12/2019 23:06	23/12/2019 19:29	23/12/2019 23:06	3,62	1	3,62	CHI
201912184118	SANTO ANTONIO DO DESCOBERTO	SN12212041	AGUAS LINDAS DE GOIAS S2	23/12/2019 19:31	24/12/2019 11:01	23/12/2019 19:31	24/12/2019 11:01	15,49	1	15,49	CHI
201912184120	NIQUELANDIA	NQ21197688	URUACU	23/12/2019 19:31	24/12/2019 02:03	23/12/2019 19:31	24/12/2019 02:03	6,52	1	6,52	CHI
201912184126	JOVIANIA	570001262	GOIATUBA S1	23/12/2019 19:32	24/12/2019 11:49	23/12/2019 19:32	24/12/2019 11:49	16,27	1	16,27	CHI
201912184127	CALDAS NOVAS	CN12332905	CALDAS NOVAS S1	23/12/2019 19:32	24/12/2019 12:52	23/12/2019 19:32	24/12/2019 12:52	17,32	30	519,54	CHI
201912186258	CORUMBAIBA	IP12152359	IPAMERI	23/12/2019 19:32	24/12/2019 21:45	23/12/2019 19:32	24/12/2019 21:45	26,21	8	209,65	CHI
201912186258	IPAMERI	IP12152359	IPAMERI	23/12/2019 19:32	24/12/2019 21:45	23/12/2019 19:32	24/12/2019 21:45	26,21	8	209,65	CHI
201912184130	GOIANIA	10008800306	CAMPINAS S2	23/12/2019 19:33	23/12/2019 21:37	23/12/2019 19:33	23/12/2019 21:37	2,05	1	2,05	CHI
201912184134	APORE	04320224	ITAJA S1	23/12/2019 19:34	24/12/2019 08:32	23/12/2019 19:34	24/12/2019 08:32	12,96	53	687,12	CHI
201912184138	ITAPIRAPUA	IU12380825	MATRINCHA	23/12/2019 19:34	24/12/2019 17:50	23/12/2019 19:34	24/12/2019 17:50	22,26	1	22,26	CHI
201912184143	PALMEIRAS DE GOIAS	PL12405992	PALMEIRAS	23/12/2019 19:35	24/12/2019 14:54	24/12/2019 10:57	24/12/2019 14:54	3,96	33	130,52	CHI
201912184144	CALDAS NOVAS	CN12034233	CALDAS NOVAS S2	23/12/2019 19:36	24/12/2019 14:10	23/12/2019 19:36	24/12/2019 14:10	18,57	81	1503,88	CHI
201912184145	APARECIDA DE GOIANIA	AP11350625	INDEPENDENCIA S1	23/12/2019 19:36	24/12/2019 02:15	23/12/2019 19:36	24/12/2019 02:15	6,64	59	392,02	CHI
201912184148	GOIANIA	16017158	GOIANIA LESTE S1	23/12/2019 19:36	23/12/2019 22:04	23/12/2019 19:36	23/12/2019 22:04	2,46	1	2,46	CHI
201912184151	IPAMERI	IP21332871	IPAMERI	23/12/2019 19:36	24/12/2019 10:15	23/12/2019 19:36	24/12/2019 10:15	14,64	1	14,64	CHI
201912184548	ABADIA DE GOIAS	LG12355840	INDEPENDENCIA S2	23/12/2019 19:36	23/12/2019 20:41	23/12/2019 19:36	23/12/2019 20:41	1,08	435	468,47	CHI
201912184165	SAO MIGUEL DO ARAGUAIA	SM21135047	SAO MIGUEL DO ARAGUAIA	23/12/2019 19:38	24/12/2019 15:51	23/12/2019 19:38	24/12/2019 15:51	20,21	1	20,21	CHI
201912184512	DAVINOPOLIS	IO12085096	CATALAO S1	23/12/2019 19:38	24/12/2019 08:58	23/12/2019 19:38	24/12/2019 08:58	13,32	7	93,26	CHI
201912184512	OUVIDOR	IO12085096	CATALAO S1	23/12/2019 19:38	24/12/2019 08:58	23/12/2019 19:38	24/12/2019 08:58	13,32	2	26,64	CHI
201912184512	TRES RANCHOS	IO12085096	CATALAO S1	23/12/2019 19:38	24/12/2019 08:58	23/12/2019 19:38	24/12/2019 08:58	13,32	4	53,29	CHI
201912184171	NOVO GAMA	2460070180	PACAEMBU S1	23/12/2019 19:39	23/12/2019 21:36	23/12/2019 19:39	23/12/2019 21:36	1,94	1	1,94	CHI
201912184174	LUZIANIA	LZ21212000	MARAJOARA	23/12/2019 19:40	24/12/2019 10:20	23/12/2019 19:40	24/12/2019 10:20	14,66	1	14,66	CHI
201912184175	GOIANIA	GN21324980	CEPAIGO S1	23/12/2019 19:40	23/12/2019 21:55	23/12/2019 19:40	23/12/2019 21:55	2,24	1	2,24	CHI
201912184180	PIRACANJUBA	PJ21142450	PIRACANJUBA	23/12/2019 19:41	24/12/2019 18:40	23/12/2019 19:41	24/12/2019 18:40	22,98	1	22,98	CHI
201912184188	MONTIVIDIU	MV12260895	MONTIVIDIU T	23/12/2019 19:42	27/12/2019 09:35	23/12/2019 19:42	27/12/2019 09:35	85,89	9	772,99	CHI

201912184191	APARECIDA DE GOIANIA	200104019	INDEPENDENCIA S2	23/12/2019 19:42	24/12/2019 15:30	23/12/2019 19:42	24/12/2019 15:30	19,78	1	19,78	CHI
201912184192	APARECIDA DE GOIANIA	200435553	INDEPENDENCIA S1	23/12/2019 19:43	23/12/2019 21:52	23/12/2019 19:43	23/12/2019 21:52	2,15	1	2,15	CHI
201912184198	JATAI	290142118	JATAI S3	23/12/2019 19:44	24/12/2019 00:46	23/12/2019 19:44	24/12/2019 00:46	5,02	1	5,02	CHI
201912184200	GOIANIA	GN21118422	CEPAIGO S1	23/12/2019 19:45	23/12/2019 23:58	23/12/2019 19:45	23/12/2019 23:58	4,21	1	4,21	CHI
201912184201	IACIARA	IA12257653	IACIARA S1	23/12/2019 19:45	23/12/2019 21:23	23/12/2019 19:45	23/12/2019 21:23	1,62	6	9,74	CHI
201912184514	APARECIDA DE GOIANIA	10000740592	INDEPENDENCIA S2	23/12/2019 19:45	24/12/2019 07:54	23/12/2019 19:45	24/12/2019 07:54	12,14	1	12,14	CHI
201912184204	CRISTALINA	10002209312	PAMPLONA	23/12/2019 19:46	24/12/2019 04:23	23/12/2019 19:46	24/12/2019 04:23	8,61	1	8,61	CHI
201912185205	PORANGATU	PO12139169	PORANGATU	23/12/2019 19:46	24/12/2019 15:03	23/12/2019 19:46	24/12/2019 15:03	19,29	105	2024,98	CHI
201912184213	MONTE ALEGRE DE GOIAS	MA11397610	SAO DOMINGOS	23/12/2019 19:47	24/12/2019 08:54	23/12/2019 19:47	24/12/2019 08:54	13,11	1	13,11	CHI
201912184215	URUACU	640026412	URUACU	23/12/2019 19:48	24/12/2019 02:50	23/12/2019 19:48	24/12/2019 02:50	7,03	1	7,03	CHI
201912185215	APARECIDA DE GOIANIA	AP11107086	INDEPENDENCIA S1	23/12/2019 19:48	24/12/2019 09:05	23/12/2019 19:48	24/12/2019 09:05	13,27	38	504,24	CHI
201912184506	MONTES CLAROS DE GOIAS	ME12088949	IPORA	23/12/2019 19:49	24/12/2019 05:52	23/12/2019 19:49	24/12/2019 05:52	10,05	49	492,33	CHI
201912185441	CAIAPONIA	CP12390147	CAIAPONIA	23/12/2019 19:52	23/12/2019 22:54	23/12/2019 19:52	23/12/2019 22:54	3,03	8	24,26	CHI
201912184511	NIQUELANDIA	NQ11281231	NIQUELANDIA SUBTRANSMISSAO	23/12/2019 19:54	23/12/2019 22:41	23/12/2019 19:54	23/12/2019 22:41	2,78	1	2,78	CHI
201912185223	COCALZINHO DE GOIAS	ZN12377777	COCALZINHO	23/12/2019 19:56	24/12/2019 08:05	23/12/2019 19:56	24/12/2019 08:05	12,15	2	24,29	CHI
201912184531	ABADIANIA	CB12272931	CORUMBA	23/12/2019 19:58	24/12/2019 16:23	23/12/2019 19:58	24/12/2019 16:23	20,40	1	20,40	CHI
201912184531	CORUMBA DE GOIAS	CB12272931	CORUMBA	23/12/2019 19:58	24/12/2019 16:23	23/12/2019 19:58	24/12/2019 16:23	20,40	49	999,71	CHI
201912184553	DAVINOPOLIS	IO12028236	CATALAO S1	23/12/2019 19:58	24/12/2019 11:28	23/12/2019 19:58	24/12/2019 11:28	15,49	3	46,48	CHI
201912184553	OUVIDOR	IO12028236	CATALAO S1	23/12/2019 19:58	24/12/2019 11:28	23/12/2019 19:58	24/12/2019 11:28	15,49	25	387,32	CHI
201912184553	TRES RANCHOS	IO12028236	CATALAO S1	23/12/2019 19:58	24/12/2019 11:28	23/12/2019 19:58	24/12/2019 11:28	15,49	1	15,49	CHI
201912184533	RIO VERDE	RV12271286	CABRIUVA S2	23/12/2019 19:59	26/12/2019 21:39	23/12/2019 19:59	26/12/2019 21:39	73,67	2	147,33	CHI
201912184660	SENADOR CANEDO	SW12323299	SENADOR CANEDO	23/12/2019 19:59	23/12/2019 21:40	23/12/2019 19:59	23/12/2019 21:40	1,67	1145	1911,20	CHI
201912184646	JOVIANIA	JV11000009	GOIATUBA S1	23/12/2019 20:00	24/12/2019 00:14	23/12/2019 20:00	24/12/2019 00:14	4,22	143	603,06	CHI
201912184550	SIMOLANDIA	1940018514	IACIARA S2	23/12/2019 20:02	23/12/2019 21:22	23/12/2019 20:02	23/12/2019 21:22	1,33	1	1,33	CHI
201912184551	LUZIANIA	LZ21209525	RIO VERMELHO	23/12/2019 20:02	24/12/2019 09:40	23/12/2019 20:02	24/12/2019 09:40	13,62	1	13,62	CHI
201912184564	ANAPOLIS	20610713	JUNDIAI S1	23/12/2019 20:04	23/12/2019 21:50	23/12/2019 20:04	23/12/2019 21:50	1,75	1	1,75	CHI
201912184622	AGUA FRIA DE GOIAS	TL21248251	SAO JOAO D ALIANCA	23/12/2019 20:08	24/12/2019 17:30	23/12/2019 20:08	24/12/2019 17:30	21,36	1	21,36	CHI
201912184751	SENADOR CANEDO	SW21094947	SENADOR CANEDO	23/12/2019 20:08	24/12/2019 04:22	23/12/2019 20:08	24/12/2019 04:22	8,23	208	1711,44	CHI
201912184623	GOIANESIA	550147860	GOIANESIA S2	23/12/2019 20:09	24/12/2019 14:47	23/12/2019 20:09	24/12/2019 14:47	18,63	1	18,63	CHI
201912184624	GOIATUBA	140069940	GOIATUBA S2	23/12/2019 20:09	24/12/2019 06:55	23/12/2019 20:09	24/12/2019 06:55	10,76	1	10,76	CHI
201912184637	GOIANIA	14030524	CAMPINAS S2	23/12/2019 20:12	23/12/2019 23:48	23/12/2019 20:12	23/12/2019 23:48	3,60	1	3,60	CHI
201912184641	APORE	AE21154106	ITAJA S1	23/12/2019 20:12	24/12/2019 19:09	23/12/2019 20:12	24/12/2019 19:09	22,94	2	45,87	CHI
201912187622	IVOLANDIA	PU12349487	MONTIVIDIU T	23/12/2019 20:12	24/12/2019 12:48	23/12/2019 20:12	24/12/2019 12:48	16,60	6	99,57	CHI

201912188314	MONTIVIDIU DO NORTE	MX12088676	PORANGATU	23/12/2019 20:15	24/12/2019 14:43	23/12/2019 20:15	24/12/2019 14:43	18,46	2	36,91	CHI
201912183629	CALDAS NOVAS	01240414	MORRINHOS	23/12/2019 20:16	23/12/2019 20:37	23/12/2019 20:16	23/12/2019 20:37	0,34	2	0,69	CHI
201912183629	MORRINHOS	01240414	MORRINHOS	23/12/2019 20:16	23/12/2019 20:37	23/12/2019 20:16	23/12/2019 20:37	0,34	237	81,70	CHI
201912183629	MORRINHOS	01240414	MORRINHOS	23/12/2019 20:16	23/12/2019 20:37	23/12/2019 20:16	23/12/2019 20:37	0,34	258	88,94	CHI
201912183629	MORRINHOS	01240414	MORRINHOS	23/12/2019 20:16	23/12/2019 20:37	23/12/2019 20:16	23/12/2019 20:37	0,34	88	30,34	CHI
201912183629	RIO QUENTE	01240414	MORRINHOS	23/12/2019 20:16	23/12/2019 20:37	23/12/2019 20:16	23/12/2019 20:37	0,34	19	6,55	CHI
201912184670	CATALAO	CT12379370	CATALAO S2	23/12/2019 20:19	24/12/2019 07:51	23/12/2019 20:19	24/12/2019 07:51	11,52	48	552,93	CHI
201912184670	CUMARI	CT12379370	CATALAO S2	23/12/2019 20:19	24/12/2019 07:51	23/12/2019 20:19	24/12/2019 07:51	11,52	5	57,60	CHI
201912184675	CAMPINACU	UC11058960	PORANGATU	23/12/2019 20:20	23/12/2019 22:46	23/12/2019 20:20	23/12/2019 22:46	2,42	98	237,43	CHI
201912185264	CALDAS NOVAS	CN11052951	CALDAS NOVAS S2	23/12/2019 20:20	24/12/2019 13:00	23/12/2019 20:20	24/12/2019 13:00	16,65	68	1132,52	CHI
201912184680	LUZIANIA	10006053880	MARAJOARA	23/12/2019 20:21	23/12/2019 22:01	23/12/2019 20:21	23/12/2019 22:01	1,65	1	1,65	CHI
201912184698	NEROPOLIS	NR11167731	NEROPOLIS S2	23/12/2019 20:21	23/12/2019 22:43	23/12/2019 20:21	23/12/2019 22:43	2,35	142	334,33	CHI
201912184695	BURITINOPOLIS	BQ12149627	IACIARA S2	23/12/2019 20:26	23/12/2019 21:38	23/12/2019 20:26	23/12/2019 21:38	1,19	118	140,68	CHI
201912185125	BURITI ALEGRE	BG12000126	ITUMBIARA VELHA S2	23/12/2019 20:29	24/12/2019 17:11	23/12/2019 20:29	24/12/2019 17:11	20,69	6	124,16	CHI
201912184702	MINEIROS	MY21311789	PARQUE DAS EMAS	23/12/2019 20:30	24/12/2019 08:52	23/12/2019 20:30	24/12/2019 08:52	12,36	1	12,36	CHI
201912184703	FORMOSA	FA12383240	ITUIQUIRA	23/12/2019 20:30	23/12/2019 23:00	23/12/2019 20:30	23/12/2019 23:00	2,49	2	4,98	CHI
201912184716	CAMPOS BELOS	820015477	SAO DOMINGOS	23/12/2019 20:35	24/12/2019 04:30	23/12/2019 20:35	24/12/2019 04:30	7,90	1	7,90	CHI
201912184719	MORRINHOS	150076988	MORRINHOS	23/12/2019 20:36	23/12/2019 22:52	23/12/2019 20:36	23/12/2019 22:52	2,26	1	2,26	CHI
201912184723	ITARUMA	IM12340970	CACHOEIRA ALTA	23/12/2019 20:37	24/12/2019 12:31	23/12/2019 20:37	24/12/2019 12:31	15,89	3	47,68	CHI
201912184726	MUNDO NOVO DE GOIAS	MH21041801	NOVA CRIXAS	23/12/2019 20:37	24/12/2019 13:38	23/12/2019 20:37	24/12/2019 13:38	17,00	1	17,00	CHI
201912184727	SAO JOAO D ALIANCA	JL12144660	SAO JOAO D ALIANCA	23/12/2019 20:37	24/12/2019 09:20	23/12/2019 20:37	24/12/2019 09:20	12,71	2	25,41	CHI
201912184739	BOM JARDIM DE GOIAS	BM21188325	BOM JARDIM	23/12/2019 20:42	23/12/2019 23:11	23/12/2019 20:42	23/12/2019 23:11	2,47	1	2,47	CHI
201912184740	BONFINOPOLIS	10010560031	CEPAIGO S2	23/12/2019 20:42	24/12/2019 08:23	23/12/2019 20:42	24/12/2019 08:23	11,67	1	11,67	CHI
201912184741	CAMPINACU	10002557183	PORANGATU	23/12/2019 20:43	24/12/2019 00:48	23/12/2019 20:43	24/12/2019 00:48	4,08	1	4,08	CHI
201912185287	CRISTALINA	KR12376280	PAMPLONA	23/12/2019 20:44	24/12/2019 03:12	23/12/2019 20:44	24/12/2019 03:12	6,47	56	362,09	CHI
201912184745	ORIZONA	OZ21300557	PIRES DO RIO S2	23/12/2019 20:45	23/12/2019 23:53	23/12/2019 20:45	23/12/2019 23:53	3,13	1	3,13	CHI
201912184754	SAO SIMAO	SO21338612	CACHOEIRA ALTA	23/12/2019 20:45	23/12/2019 22:28	23/12/2019 20:45	23/12/2019 22:28	1,70	1	1,70	CHI
201912184756	GOIANIRA	10009013740	GOIANIRA	23/12/2019 20:46	24/12/2019 00:25	23/12/2019 20:46	24/12/2019 00:25	3,65	1	3,65	CHI
201912184757	MONTIVIDIU	MV21075308	MONTIVIDIU T	23/12/2019 20:46	24/12/2019 20:00	23/12/2019 20:46	24/12/2019 20:00	23,23	1	23,23	CHI
201912185001	PLANALTINA	PI12211502	PLANALTINA	23/12/2019 20:50	24/12/2019 03:32	23/12/2019 20:50	24/12/2019 03:32	6,69	174	1164,59	CHI
201912185103	AURILANDIA	AI12194035	FIRMINOPOLIS S2	23/12/2019 20:52	24/12/2019 17:11	23/12/2019 20:52	24/12/2019 17:11	20,31	3	60,94	CHI
201912185106	PARANAIGUARA	CA21081286	CACHOEIRA ALTA	23/12/2019 20:52	24/12/2019 12:25	23/12/2019 20:52	24/12/2019 12:25	15,54	1	15,54	CHI
201912185404	JATAI	CP12147712	CAIAPONIA	23/12/2019 20:52	24/12/2019 09:06	23/12/2019 20:52	24/12/2019 09:06	12,22	3	36,66	CHI



201912185404	RIO VERDE	CP12147712	CAIAPONIA	23/12/2019 20:52	24/12/2019 09:06	23/12/2019 20:52	24/12/2019 09:06	12,22	4	48,88	CHI
201912185121	APARECIDA DE GOIANIA	10006125458	INDEPENDENCIA S2	23/12/2019 20:54	24/12/2019 13:09	23/12/2019 20:54	24/12/2019 13:09	16,25	1	16,25	CHI
201912185122	ARUANA	AK21187700	MOZARLANDIA	23/12/2019 20:54	24/12/2019 19:59	23/12/2019 20:54	24/12/2019 19:59	23,08	1	23,08	CHI
201912185124	ITABERAÍ	IX12321507	INHUMAS S1	23/12/2019 20:55	24/12/2019 10:46	23/12/2019 20:55	24/12/2019 10:46	13,84	1	13,84	CHI
201912185124	ITAUCU	IX12321507	INHUMAS S1	23/12/2019 20:55	24/12/2019 10:46	23/12/2019 20:55	24/12/2019 10:46	13,84	5	69,22	CHI
201912185256	AMARALINA	LC12270112	SAO MIGUEL DO ARAGUAIA	23/12/2019 20:56	23/12/2019 23:18	23/12/2019 20:56	23/12/2019 23:18	2,36	62	146,11	CHI
201912186408	MORRINHOS	MR12040540RE	MORRINHOS	23/12/2019 20:57	24/12/2019 13:28	23/12/2019 20:57	24/12/2019 13:28	16,52	48	792,73	CHI
201912185136	RIO QUENTE	RQ21335217	MORRINHOS	23/12/2019 20:59	24/12/2019 14:42	23/12/2019 20:59	24/12/2019 14:42	17,71	11	194,79	CHI
201912185141	GOIANIRA	10001034837	MEIA PONTE	23/12/2019 21:00	24/12/2019 00:52	23/12/2019 21:00	24/12/2019 00:52	3,86	1	3,86	CHI
201912184545	CAIAPONIA	CP21238701	PALESTINA	23/12/2019 21:03	24/12/2019 03:46	23/12/2019 21:03	24/12/2019 03:46	6,72	1	6,72	CHI
201912185157	GOIANIA	10959282	GOIANIA LESTE S3	23/12/2019 21:05	24/12/2019 01:01	23/12/2019 21:05	24/12/2019 01:01	3,94	1	3,94	CHI
201912185158	FORMOSA	FA21122068	PLANALTINA	23/12/2019 21:05	23/12/2019 22:39	23/12/2019 21:05	23/12/2019 22:39	1,56	1	1,56	CHI
201912185210	MINEIROS	MY21329873	PARQUE DAS EMAS	23/12/2019 21:10	24/12/2019 02:50	23/12/2019 21:10	24/12/2019 02:50	5,65	1	5,65	CHI
201912185211	SAO MIGUEL DO ARAGUAIA	SM11393943	SAO MIGUEL DO ARAGUAIA	23/12/2019 21:11	24/12/2019 13:48	23/12/2019 21:11	24/12/2019 13:48	16,60	1	16,60	CHI
201912185217	FORMOSA	FA12042076	ITUIQUIRA	23/12/2019 21:13	24/12/2019 08:14	23/12/2019 21:13	24/12/2019 08:14	11,00	5	55,02	CHI
201912185255	CATALAO	CT11333352	CATALAO S2	23/12/2019 21:21	24/12/2019 16:47	23/12/2019 21:21	24/12/2019 16:47	19,42	32	621,50	CHI
201912185258	URUACU	NQ12268908	NIQUELANDIA SUBTRANSMISSAO	23/12/2019 21:22	24/12/2019 17:33	23/12/2019 21:22	24/12/2019 17:33	20,18	1	20,18	CHI
201912185260	MORRINHOS	MR11009620	MORRINHOS	23/12/2019 21:22	24/12/2019 03:30	23/12/2019 21:22	24/12/2019 03:15	5,88	11	64,64	CHI
201912185260	MORRINHOS	MR11009620	MORRINHOS	23/12/2019 21:22	24/12/2019 03:30	24/12/2019 03:20	24/12/2019 03:30	0,17	11	1,82	CHI
201912185261	GOIAS	GS12274373	GOIAS	23/12/2019 21:22	24/12/2019 08:31	23/12/2019 21:22	24/12/2019 08:31	11,14	12	133,67	CHI
201912185263	GOIAS	GS12250973	GOIAS	23/12/2019 21:22	24/12/2019 09:28	23/12/2019 21:22	24/12/2019 09:28	12,09	5	60,43	CHI
201912185266	CACU	SO12303104	CACHOEIRA ALTA	23/12/2019 21:23	23/12/2019 23:34	23/12/2019 21:23	23/12/2019 23:34	2,18	1	2,18	CHI
201912185266	SAO SIMAO	SO12303104	CACHOEIRA ALTA	23/12/2019 21:23	23/12/2019 23:34	23/12/2019 21:23	23/12/2019 23:34	2,18	2	4,37	CHI
201912185267	APARECIDA DE GOIANIA	200112831	INDEPENDENCIA S1	23/12/2019 21:23	24/12/2019 11:50	23/12/2019 21:23	24/12/2019 11:50	14,45	1	14,45	CHI
201912185297	MINEIROS	MY12360762	PARQUE DAS EMAS	23/12/2019 21:23	23/12/2019 22:34	23/12/2019 21:23	23/12/2019 22:34	1,17	30	35,22	CHI
201912185275	CORREGO DO OURO	CO21406121	SAO LUIZ DOS MONTES BELOS	23/12/2019 21:25	24/12/2019 23:06	23/12/2019 21:25	24/12/2019 23:06	25,68	2	51,35	CHI
201912185276	HIDROLINA	HL21286362	ITAPACI	23/12/2019 21:25	24/12/2019 16:02	23/12/2019 21:25	24/12/2019 16:02	18,60	1	18,60	CHI
201912187411	SANTO ANTONIO DO DESCOBERTO	SN12275494	MARAJOARA	23/12/2019 21:25	24/12/2019 10:58	23/12/2019 21:25	24/12/2019 10:58	13,54	8	108,36	CHI
201912185301	RIO VERDE	RV13383499	MONTIVIDIU T	23/12/2019 21:28	24/12/2019 21:02	23/12/2019 21:28	24/12/2019 21:02	23,56	5	117,78	CHI
201912185286	FORMOSA	FA21148940	PLANALTINA	23/12/2019 21:29	23/12/2019 23:50	23/12/2019 21:29	23/12/2019 23:50	2,34	2	4,69	CHI
201912185291	PIRENOPOLIS	PV21227820	CORUMBA	23/12/2019 21:32	24/12/2019 16:27	23/12/2019 21:32	24/12/2019 14:42	17,17	1	17,17	CHI
201912185291	PIRENOPOLIS	PV12384898LD	CORUMBA	23/12/2019 21:32	24/12/2019 16:27	24/12/2019 12:47	24/12/2019 16:27	3,67	8	29,34	CHI
201912185293	CACU	CC21048530	CACHOEIRA ALTA	23/12/2019 21:32	24/12/2019 02:14	23/12/2019 21:32	24/12/2019 02:14	4,69	1	4,69	CHI

201912185510	BARRO ALTO	BA12035658	BARRO ALTO	23/12/2019 21:32	24/12/2019 08:56	23/12/2019 21:32	24/12/2019 08:56	11,40	7	79,77	CHI
201912185298	LUZIANIA	LZ11288039	RIO VERMELHO	23/12/2019 21:33	24/12/2019 08:14	23/12/2019 21:33	24/12/2019 08:14	10,68	3	32,03	CHI
201912185299	DAMIANOPOLIS	DA12204799	IACIARA S2	23/12/2019 21:33	23/12/2019 23:51	23/12/2019 21:33	23/12/2019 23:51	2,29	115	263,70	CHI
201912185300	TRINDADE	40090279	MEIA PONTE	23/12/2019 21:33	24/12/2019 00:24	23/12/2019 21:33	24/12/2019 00:24	2,85	1	2,85	CHI
201912188160	CRISTALINA	KR12250016	PAMPLONA	23/12/2019 21:33	24/12/2019 12:46	23/12/2019 21:33	24/12/2019 12:46	15,21	26	395,58	CHI
201912185402	BONFINOPOLIS	GP21188816	DAIA S2	23/12/2019 21:35	24/12/2019 13:35	23/12/2019 21:35	24/12/2019 13:35	16,01	8	128,07	CHI
201912185403	PIRENOPOLIS	PV21379360	CORUMBA	23/12/2019 21:36	25/12/2019 13:57	23/12/2019 21:36	25/12/2019 13:57	40,35	1	40,35	CHI
201912185408	IPAMERI	IP11332985	IPAMERI	23/12/2019 21:40	24/12/2019 16:36	23/12/2019 21:40	24/12/2019 16:36	18,93	1	18,93	CHI
201912185413	LUZIANIA	120162350	RIO VERMELHO	23/12/2019 21:43	23/12/2019 23:58	23/12/2019 21:43	23/12/2019 23:58	2,25	1	2,25	CHI
201912185414	GOIANIA	10027360235	GOYA S1	23/12/2019 21:43	24/12/2019 02:23	23/12/2019 21:43	24/12/2019 02:23	4,65	1	4,65	CHI
201912185325	APARECIDA DE GOIANIA	AP11168978	INDEPENDENCIA S1	23/12/2019 21:45	24/12/2019 02:09	23/12/2019 21:45	24/12/2019 02:09	4,40	85	373,69	CHI
201912185417	VALPARAISO DE GOIAS	2860233459	PACAEMBU S1	23/12/2019 21:45	24/12/2019 11:10	23/12/2019 21:45	24/12/2019 11:10	13,41	1	13,41	CHI
201912185421	GOIANESIA	10008198100	GOIANESIA S2	23/12/2019 21:48	24/12/2019 19:41	23/12/2019 21:48	24/12/2019 19:41	21,88	1	21,88	CHI
201912185422	FORMOSA	610054880	ITUIQUIRA	23/12/2019 21:49	23/12/2019 23:59	23/12/2019 21:49	23/12/2019 23:59	2,17	1	2,17	CHI
201912185852	ALTO HORIZONTE	AJ12320992	SANTA TEREZINHA	23/12/2019 21:50	24/12/2019 08:27	23/12/2019 21:50	24/12/2019 08:27	10,60	46	487,77	CHI
201912185439	SANCLERLANDIA	1210000134	FIRMINOPOLIS S2	23/12/2019 21:52	24/12/2019 08:50	23/12/2019 21:52	24/12/2019 08:50	10,96	1	10,96	CHI
201912185588	VALPARAISO DE GOIAS	VA11192847	PACAEMBU S1	23/12/2019 21:52	23/12/2019 23:28	23/12/2019 21:52	23/12/2019 23:28	1,60	251	400,76	CHI
201912185442	SANTA CRUZ DE GOIAS	BC21257197	PIRACANJUBA	23/12/2019 21:53	24/12/2019 08:39	23/12/2019 21:53	24/12/2019 08:39	10,76	1	10,76	CHI
201912185502	NOVO GAMA	10010082180	PACAEMBU S1	23/12/2019 21:55	24/12/2019 02:51	23/12/2019 21:55	24/12/2019 02:51	4,92	1	4,92	CHI
201912185506	NIQUELANDIA	2750098094	NIQUELANDIA SUBTRANSMISSAO	23/12/2019 21:56	24/12/2019 00:29	23/12/2019 21:56	24/12/2019 00:29	2,53	1	2,53	CHI
201912185304	DIVINOPOLIS DE GOIAS	4620001285	SAO DOMINGOS	23/12/2019 21:57	24/12/2019 01:33	23/12/2019 21:57	24/12/2019 01:33	3,60	1	3,60	CHI
201912185507	APARECIDA DE GOIANIA	AP21004642	INDEPENDENCIA S2	23/12/2019 21:57	24/12/2019 16:50	23/12/2019 21:57	24/12/2019 16:50	18,87	1	18,87	CHI
201912185508	DOVERLANDIA	4220035231	PARQUE DAS EMAS	23/12/2019 21:58	25/12/2019 08:30	23/12/2019 21:58	25/12/2019 08:30	34,53	1	34,53	CHI
201912185513	APARECIDA DE GOIANIA	200224785	INDEPENDENCIA S2	23/12/2019 22:00	24/12/2019 09:34	23/12/2019 22:00	24/12/2019 09:34	11,56	1	11,56	CHI
2019122300015	BOM JESUS DE GOIAS	22201	QUIRINOPOLIS	23/12/2019 22:00	23/12/2019 22:03	23/12/2019 22:00	23/12/2019 22:03	0,05	69	3,45	CHI
2019122300015	CASTELANDIA	01560234	QUIRINOPOLIS	23/12/2019 22:00	23/12/2019 22:03	23/12/2019 22:00	23/12/2019 22:03	0,05	20	1,00	CHI
2019122300015	GOUVELANDIA	23101	QUIRINOPOLIS	23/12/2019 22:00	23/12/2019 22:03	23/12/2019 22:00	23/12/2019 22:03	0,05	1998	99,90	CHI
2019122300015	GOUVELANDIA	01560234	QUIRINOPOLIS	23/12/2019 22:00	23/12/2019 22:03	23/12/2019 22:00	23/12/2019 22:03	0,05	315	15,75	CHI
2019122300015	GOUVELANDIA	01560414	QUIRINOPOLIS	23/12/2019 22:00	23/12/2019 22:03	23/12/2019 22:00	23/12/2019 22:03	0,05	13	0,65	CHI
2019122300015	INACIOLANDIA	22201	QUIRINOPOLIS	23/12/2019 22:00	23/12/2019 22:03	23/12/2019 22:00	23/12/2019 22:03	0,05	2667	133,35	CHI
2019122300015	INACIOLANDIA	01560414	QUIRINOPOLIS	23/12/2019 22:00	23/12/2019 22:03	23/12/2019 22:00	23/12/2019 22:03	0,05	14	0,70	CHI
2019122300015	ITUMBIARA	22201	QUIRINOPOLIS	23/12/2019 22:00	23/12/2019 22:03	23/12/2019 22:00	23/12/2019 22:03	0,05	9	0,45	CHI
2019122300015	QUIRINOPOLIS	23101	QUIRINOPOLIS	23/12/2019 22:00	23/12/2019 22:03	23/12/2019 22:00	23/12/2019 22:03	0,05	89	4,45	CHI

2019122300015	QUIRINOPOLIS	01560234	QUIRINOPOLIS	23/12/2019 22:00	23/12/2019 22:03	23/12/2019 22:00	23/12/2019 22:03	0,05	762	38,10	CHI
2019122300015	QUIRINOPOLIS	01560414	QUIRINOPOLIS	23/12/2019 22:00	23/12/2019 22:03	23/12/2019 22:00	23/12/2019 22:03	0,05	23	1,15	CHI
2019122300015	RIO VERDE	01560234	QUIRINOPOLIS	23/12/2019 22:00	23/12/2019 22:03	23/12/2019 22:00	23/12/2019 22:03	0,05	1	0,05	CHI
201912185517	APARECIDA DE GOIANIA	200202212	INDEPENDENCIA S2	23/12/2019 22:01	24/12/2019 10:24	23/12/2019 22:01	24/12/2019 10:24	12,37	1	12,37	CHI
201912185534	ITAPURANGA	IK12060514	ITAPURANGA	23/12/2019 22:03	24/12/2019 07:23	23/12/2019 22:03	24/12/2019 07:23	9,33	64	597,32	CHI
201912185541	ANHANGUERA	CY12071523RE	CATALAO S1	23/12/2019 22:04	26/12/2019 20:40	23/12/2019 22:04	25/12/2019 12:09	38,07	3	114,22	CHI
201912185541	CUMARI	CY12071523RE	CATALAO S1	23/12/2019 22:04	26/12/2019 20:40	23/12/2019 22:04	25/12/2019 12:09	38,07	8	304,60	CHI
201912185541	ANHANGUERA	CY13071708	CATALAO S1	23/12/2019 22:04	26/12/2019 20:40	23/12/2019 22:04	25/12/2019 19:47	45,71	2	91,43	CHI
201912185541	CUMARI	CY13071708	CATALAO S1	23/12/2019 22:04	26/12/2019 20:40	23/12/2019 22:04	25/12/2019 19:47	45,71	9	411,43	CHI
201912185541	ANHANGUERA	CY13071708	CATALAO S1	23/12/2019 22:04	26/12/2019 20:40	25/12/2019 19:48	25/12/2019 19:56	0,13	2	0,27	CHI
201912185541	CUMARI	CY13071708	CATALAO S1	23/12/2019 22:04	26/12/2019 20:40	25/12/2019 19:48	25/12/2019 19:56	0,13	9	1,20	CHI
201912185541	CORUMBAIBA	CY13071709	CATALAO S1	23/12/2019 22:04	26/12/2019 20:40	23/12/2019 22:04	25/12/2019 22:20	48,27	2	96,53	CHI
201912185541	CUMARI	CY13071709	CATALAO S1	23/12/2019 22:04	26/12/2019 20:40	23/12/2019 22:04	25/12/2019 22:20	48,27	2	96,53	CHI
201912185541	NOVA AURORA	CY13071709	CATALAO S1	23/12/2019 22:04	26/12/2019 20:40	23/12/2019 22:04	25/12/2019 22:20	48,27	1	48,27	CHI
201912185541	ANHANGUERA	CY12071523RE	CATALAO S1	23/12/2019 22:04	26/12/2019 20:40	25/12/2019 23:00	26/12/2019 01:16	2,28	3	6,84	CHI
201912185541	CUMARI	CY12071523RE	CATALAO S1	23/12/2019 22:04	26/12/2019 20:40	25/12/2019 23:00	26/12/2019 01:16	2,28	8	18,24	CHI
201912185541	CORUMBAIBA	CY13071708	CATALAO S1	23/12/2019 22:04	26/12/2019 20:40	23/12/2019 22:04	26/12/2019 13:42	63,62	2	127,25	CHI
201912185541	ANHANGUERA	CY12071523RE	CATALAO S1	23/12/2019 22:04	26/12/2019 20:40	25/12/2019 23:00	26/12/2019 13:42	14,70	2	29,40	CHI
201912185541	CORUMBAIBA	CY12071523RE	CATALAO S1	23/12/2019 22:04	26/12/2019 20:40	25/12/2019 23:00	26/12/2019 13:42	14,70	2	29,40	CHI
201912185541	CUMARI	CY12071523RE	CATALAO S1	23/12/2019 22:04	26/12/2019 20:40	25/12/2019 23:00	26/12/2019 13:42	14,70	10	147,00	CHI
201912185541	NOVA AURORA	CY12071523RE	CATALAO S1	23/12/2019 22:04	26/12/2019 20:40	25/12/2019 23:00	26/12/2019 13:42	14,70	1	14,70	CHI
201912185541	CORUMBAIBA	CI12071508	CATALAO S1	23/12/2019 22:04	26/12/2019 20:40	26/12/2019 14:06	26/12/2019 15:54	1,81	2	3,61	CHI
201912185541	CUMARI	CY12071523RE	CATALAO S1	23/12/2019 22:04	26/12/2019 20:40	25/12/2019 23:00	26/12/2019 19:20	20,34	1	20,34	CHI
201912185541	CUMARI	CY12317584	CATALAO S1	23/12/2019 22:04	26/12/2019 20:40	23/12/2019 22:04	26/12/2019 20:40	70,60	1	70,60	CHI
201912186166	GAMELEIRA DE GOIAS	SV12270685	DAIA S2	23/12/2019 22:04	24/12/2019 11:09	23/12/2019 22:04	24/12/2019 11:09	13,08	20	261,60	CHI
201912185309	PALMINOPOLIS	03140224	PALMEIRAS	23/12/2019 22:05	24/12/2019 00:56	23/12/2019 22:05	24/12/2019 00:14	2,15	412	884,54	CHI
201912185309	JANDAIA	03140224	PALMEIRAS	23/12/2019 22:05	24/12/2019 00:56	23/12/2019 22:05	24/12/2019 00:56	2,84	56	159,10	CHI
201912185309	PALMEIRAS DE GOIAS	03140224	PALMEIRAS	23/12/2019 22:05	24/12/2019 00:56	23/12/2019 22:05	24/12/2019 00:56	2,84	49	139,21	CHI
201912185309	PALMINOPOLIS	03140224	PALMEIRAS	23/12/2019 22:05	24/12/2019 00:56	23/12/2019 22:05	24/12/2019 00:56	2,84	1294	3676,40	CHI
201912199683	GOIANIA	GN11144573	SENADOR CANEDO	23/12/2019 22:05	25/12/2019 00:20	24/12/2019 22:05	25/12/2019 00:20	2,24	36	80,72	CHI
201912199730	GOIANIA	GN11165748	SENADOR CANEDO	23/12/2019 22:05	24/12/2019 23:34	24/12/2019 22:05	24/12/2019 23:34	1,48	136	200,64	CHI
201912200122	GOIANIA	GN11151321	SENADOR CANEDO	23/12/2019 22:05	25/12/2019 00:08	24/12/2019 22:05	25/12/2019 00:08	2,04	107	218,49	CHI
201912201917	SENADOR CANEDO	SW11053061	SENADOR CANEDO	23/12/2019 22:05	25/12/2019 08:57	24/12/2019 22:05	25/12/2019 08:57	10,86	137	1487,63	CHI

201912202442	SENADOR CANEDO	SW11384961	SENADOR CANEDO	23/12/2019 22:05	25/12/2019 09:22	24/12/2019 22:05	25/12/2019 09:22	11,28	169	1906,13	CHI
2019122500064	SENADOR CANEDO	SW16401514	SENADOR CANEDO	23/12/2019 22:05	25/12/2019 06:51	24/12/2019 22:05	24/12/2019 22:42	0,61	413	251,70	CHI
2019122500064	GOIANIA	SW10378595	SENADOR CANEDO	23/12/2019 22:05	25/12/2019 06:51	24/12/2019 22:05	24/12/2019 22:42	0,62	3596	2236,51	CHI
2019122500064	SENADOR CANEDO	SW10378595	SENADOR CANEDO	23/12/2019 22:05	25/12/2019 06:51	24/12/2019 22:05	24/12/2019 22:42	0,62	6159	3830,56	CHI
2019122500064	SENADOR CANEDO	SW10378593	SENADOR CANEDO	23/12/2019 22:05	25/12/2019 06:51	24/12/2019 22:05	25/12/2019 03:05	5,00	5901	29521,39	CHI
2019122500064	BELA VISTA DE GOIAS	04982118	SENADOR CANEDO	23/12/2019 22:05	25/12/2019 06:51	24/12/2019 22:05	25/12/2019 06:51	8,76	17	148,90	CHI
2019122500064	CALDAZINHA	04982118	SENADOR CANEDO	23/12/2019 22:05	25/12/2019 06:51	24/12/2019 22:05	25/12/2019 06:51	8,76	104	910,90	CHI
2019122500064	CALDAZINHA	04982118	SENADOR CANEDO	23/12/2019 22:05	25/12/2019 06:51	24/12/2019 22:05	25/12/2019 06:51	8,76	59	516,76	CHI
2019122500064	GOIANIA	04982118	SENADOR CANEDO	23/12/2019 22:05	25/12/2019 06:51	24/12/2019 22:05	25/12/2019 06:51	8,76	7	61,31	CHI
2019122500064	SENADOR CANEDO	04982118	SENADOR CANEDO	23/12/2019 22:05	25/12/2019 06:51	24/12/2019 22:05	25/12/2019 06:51	8,76	2178	19076,25	CHI
2019122500064	SENADOR CANEDO	04982118	SENADOR CANEDO	23/12/2019 22:05	25/12/2019 06:51	24/12/2019 22:05	25/12/2019 06:51	8,76	9373	82094,46	CHI
2019122500064	SENADOR CANEDO	04982118	SENADOR CANEDO	23/12/2019 22:05	25/12/2019 06:51	24/12/2019 22:05	25/12/2019 06:51	8,76	6996	61275,24	CHI
2019122500064	SENADOR CANEDO	04982118	SENADOR CANEDO	23/12/2019 22:05	25/12/2019 06:51	24/12/2019 22:05	25/12/2019 06:51	8,76	8549	74877,37	CHI
2019122500064	SENADOR CANEDO	04982118	SENADOR CANEDO	23/12/2019 22:05	25/12/2019 06:51	24/12/2019 22:05	25/12/2019 06:51	8,76	3582	31373,34	CHI
201912185556	JUSSARA	RN12250752	BRITANIA	23/12/2019 22:10	24/12/2019 18:11	23/12/2019 22:10	24/12/2019 18:11	20,01	19	380,27	CHI
201912185556	SANTA FE DE GOIAS	RN12250752	BRITANIA	23/12/2019 22:10	24/12/2019 18:11	23/12/2019 22:10	24/12/2019 18:11	20,01	40	800,57	CHI
201912185575	ANICUNS	AC11399375	ANICUNS	23/12/2019 22:11	24/12/2019 09:06	23/12/2019 22:11	24/12/2019 09:06	10,91	51	556,37	CHI
201912185600	BURITI DE GOIAS	BS11055346	FIRMINOPOLIS S2	23/12/2019 22:11	24/12/2019 06:09	23/12/2019 22:11	24/12/2019 06:09	7,95	102	811,10	CHI
201912185318	FLORES DE GOIAS	FB10401476	FLORES DE GOIAS	23/12/2019 22:15	24/12/2019 05:09	23/12/2019 22:15	23/12/2019 23:58	1,71	232	397,17	CHI
201912185318	FORMOSA	FB10401476	FLORES DE GOIAS	23/12/2019 22:15	24/12/2019 05:09	23/12/2019 22:15	23/12/2019 23:58	1,71	137	234,54	CHI
201912185318	FORMOSO	FB10401476	FLORES DE GOIAS	23/12/2019 22:15	24/12/2019 05:09	23/12/2019 22:15	23/12/2019 23:58	1,71	1	1,71	CHI
201912185318	SAO JOAO D ALIANCA	FB10401476	FLORES DE GOIAS	23/12/2019 22:15	24/12/2019 05:09	23/12/2019 22:15	23/12/2019 23:58	1,71	5	8,56	CHI
201912185318	ALVORADA DO NORTE	FB12062290LD	FLORES DE GOIAS	23/12/2019 22:15	24/12/2019 05:09	23/12/2019 22:15	24/12/2019 05:09	6,89	53	365,29	CHI
201912185318	FLORES DE GOIAS	FB12062290LD	FLORES DE GOIAS	23/12/2019 22:15	24/12/2019 05:09	23/12/2019 22:15	24/12/2019 05:09	6,89	37	255,01	CHI
201912185318	IACIARA	FB12062290LD	FLORES DE GOIAS	23/12/2019 22:15	24/12/2019 05:09	23/12/2019 22:15	24/12/2019 05:09	6,89	20	137,84	CHI
201912185318	POSSE	FB12062290LD	FLORES DE GOIAS	23/12/2019 22:15	24/12/2019 05:09	23/12/2019 22:15	24/12/2019 05:09	6,89	2	13,78	CHI
201912187705	ABADIANIA	SV12265211	DAIA S2	23/12/2019 22:16	24/12/2019 09:09	23/12/2019 22:16	24/12/2019 09:09	10,88	4	43,53	CHI
201912187705	ANAPOLIS	SV12265211	DAIA S2	23/12/2019 22:16	24/12/2019 09:09	23/12/2019 22:16	24/12/2019 09:09	10,88	4	43,53	CHI
201912187705	GAMELEIRA DE GOIAS	SV12265211	DAIA S2	23/12/2019 22:16	24/12/2019 09:09	23/12/2019 22:16	24/12/2019 09:09	10,88	101	1099,16	CHI
201912185582	CATALAO	1990057291	CATALAO S2	23/12/2019 22:20	24/12/2019 12:16	23/12/2019 22:20	24/12/2019 12:16	13,92	1	13,92	CHI
201912185587	APARECIDA DE GOIANIA	200348760	INDEPENDENCIA S2	23/12/2019 22:21	24/12/2019 10:16	23/12/2019 22:21	24/12/2019 10:16	11,91	1	11,91	CHI
201912185590	LUZIANIA	LZ21192781	MARAJOARA	23/12/2019 22:22	24/12/2019 12:34	23/12/2019 22:22	24/12/2019 12:34	14,19	3	42,58	CHI
201912185633	INDIARA	IY12010960	EDEIA	23/12/2019 22:23	24/12/2019 15:08	23/12/2019 22:23	24/12/2019 15:08	16,76	19	318,43	CHI

201912185599	SERRANOPOLIS	SX12296482	JATAI S1	23/12/2019 22:28	24/12/2019 11:48	23/12/2019 22:28	24/12/2019 11:48	13,32	2	26,65	CHI
201912185602	EDEALINA	ED12007679	PONTALINA	23/12/2019 22:29	24/12/2019 15:32	23/12/2019 22:29	24/12/2019 15:32	17,05	16	272,77	CHI
201912185606	FAZENDA NOVA	FN21237252	IPORA	23/12/2019 22:30	24/12/2019 09:14	23/12/2019 22:30	24/12/2019 09:14	10,73	1	10,73	CHI
201912185608	PIRACANJUBA	PJ21000084	PIRACANJUBA	23/12/2019 22:30	24/12/2019 19:44	23/12/2019 22:30	24/12/2019 19:44	21,22	1	21,22	CHI
201912186047	MONTES CLAROS DE GOIAS	ME12066160	IPORA	23/12/2019 22:30	24/12/2019 07:13	23/12/2019 22:30	24/12/2019 07:13	8,71	80	696,62	CHI
201912185623	SAO DOMINGOS	8680010779	SAO DOMINGOS	23/12/2019 22:35	24/12/2019 08:45	23/12/2019 22:35	24/12/2019 08:45	10,16	1	10,16	CHI
201912185626	MOZARLANDIA	MZ12238850	MOZARLANDIA	23/12/2019 22:37	25/12/2019 18:00	23/12/2019 22:37	25/12/2019 18:00	43,38	4	173,52	CHI
201912185630	PALMEIRAS DE GOIAS	PL21287687	PALMEIRAS	23/12/2019 22:39	24/12/2019 13:03	23/12/2019 22:39	24/12/2019 13:03	14,39	1	14,39	CHI
201912185636	LUZIANIA	LZ11162869	RIO VERMELHO	23/12/2019 22:40	24/12/2019 08:42	23/12/2019 22:40	24/12/2019 08:42	10,02	104	1042,20	CHI
201912185640	POSSE	PS12124649	IACIARA S2	23/12/2019 22:41	24/12/2019 08:58	23/12/2019 22:41	24/12/2019 08:58	10,28	22	226,06	CHI
201912185815	GUARANI DE GOIAS	GY12180835	IACIARA S1	23/12/2019 22:45	24/12/2019 07:24	23/12/2019 22:45	24/12/2019 07:24	8,64	315	2720,03	CHI
201912185815	IACIARA	GY12180835	IACIARA S1	23/12/2019 22:45	24/12/2019 07:24	23/12/2019 22:45	24/12/2019 07:24	8,64	2	17,27	CHI
201912185647	AGUAS LINDAS DE GOIAS	LA11305234	AGUAS LINDAS DE GOIAS S2	23/12/2019 22:48	23/12/2019 23:50	23/12/2019 22:48	23/12/2019 23:50	1,02	215	219,78	CHI
201912185649	GOIANIA	GN21160881	CEPAIGO S1	23/12/2019 22:49	24/12/2019 02:09	23/12/2019 22:49	24/12/2019 02:09	3,32	1	3,32	CHI
201912185652	CABECEIRAS	CW21181828	ITIQUEIRA	23/12/2019 22:52	24/12/2019 08:52	23/12/2019 22:52	24/12/2019 08:52	10,00	1	10,00	CHI
201912185654	SILVANIA	SV12340735	VIANOPOLIS	23/12/2019 22:52	24/12/2019 09:51	23/12/2019 22:52	24/12/2019 09:51	10,98	46	504,90	CHI
201912185919	PIRANHAS	PH12374859	PIRANHAS	23/12/2019 23:01	24/12/2019 05:34	23/12/2019 23:01	24/12/2019 05:34	6,54	48	313,93	CHI
201912185664	JUSSARA	JR12114089	BRITANIA	23/12/2019 23:02	24/12/2019 10:47	23/12/2019 23:02	24/12/2019 10:47	11,75	4	46,98	CHI
201912185801	DOVERLANDIA	DV12207926	CAIAPONIA	23/12/2019 23:06	24/12/2019 02:35	23/12/2019 23:06	24/12/2019 02:35	3,47	58	201,49	CHI
201912188182	MUTUNOPOLIS	MU12240578	MARA ROSA	23/12/2019 23:07	24/12/2019 18:49	23/12/2019 23:07	24/12/2019 18:49	19,70	4	78,79	CHI
201912185808	ITAJA	IJ21191590	ITAJA S2	23/12/2019 23:08	24/12/2019 10:08	23/12/2019 23:08	24/12/2019 10:08	10,98	1	10,98	CHI
201912185810	GOIANESIA	GE21120472	GOIANESIA S1	23/12/2019 23:10	24/12/2019 14:43	23/12/2019 23:10	24/12/2019 14:43	15,54	1	15,54	CHI
201912185811	ANAPOLIS	21243256	ANAPOLIS UNIVERSITARIO S2	23/12/2019 23:11	24/12/2019 09:21	23/12/2019 23:11	24/12/2019 09:21	10,15	1	10,15	CHI
201912188284	DOVERLANDIA	MY12390600	PARQUE DAS EMAS	23/12/2019 23:14	25/12/2019 01:01	23/12/2019 23:14	25/12/2019 01:01	25,77	1	25,77	CHI
201912188284	MINEIROS	MY12390600	PARQUE DAS EMAS	23/12/2019 23:14	25/12/2019 01:01	23/12/2019 23:14	25/12/2019 01:01	25,77	24	618,51	CHI
201912185818	FORMOSA	FA11131872	ITIQUEIRA	23/12/2019 23:15	24/12/2019 11:17	23/12/2019 23:15	24/12/2019 11:17	12,04	155	1866,24	CHI
201912186035	MAIRIPOTABA	MI12019752	PONTALINA	23/12/2019 23:15	25/12/2019 22:06	23/12/2019 23:15	25/12/2019 22:06	46,86	4	187,43	CHI
201912185321	JATAI	03280434	MONTIVIDIU T	23/12/2019 23:17	24/12/2019 18:38	23/12/2019 23:17	24/12/2019 03:36	4,31	3	12,93	CHI
201912185321	RIO VERDE	03280434	MONTIVIDIU T	23/12/2019 23:17	24/12/2019 18:38	23/12/2019 23:17	24/12/2019 03:36	4,31	3	12,93	CHI
201912185321	JATAI	03280434	MONTIVIDIU T	23/12/2019 23:17	24/12/2019 18:38	23/12/2019 23:18	24/12/2019 03:36	4,31	1	4,31	CHI
201912185321	RIO VERDE	03280434	MONTIVIDIU T	23/12/2019 23:17	24/12/2019 18:38	23/12/2019 23:17	24/12/2019 18:38	19,35	7	135,46	CHI
201912186220	DAMIANOPOLIS	01110214	IACIARA S2	23/12/2019 23:18	24/12/2019 09:00	23/12/2019 23:18	24/12/2019 09:00	9,69	130	1259,84	CHI
201912186220	SITIO D ABADIA	01110214	IACIARA S2	23/12/2019 23:18	24/12/2019 09:00	23/12/2019 23:18	24/12/2019 09:00	9,69	378	3663,24	CHI

201912185322	FORMOSA	FA10396048	ITIQUEIRA	23/12/2019 23:27	24/12/2019 11:49	23/12/2019 23:27	24/12/2019 10:01	10,57	107	1130,78	CHI
201912185322	FORMOSA	FA10396048	ITIQUEIRA	23/12/2019 23:27	24/12/2019 11:49	23/12/2019 23:27	24/12/2019 11:49	12,37	348	4303,79	CHI
201912186153	BALIZA	BH12358780	BOM JARDIM	23/12/2019 23:28	24/12/2019 10:02	23/12/2019 23:28	24/12/2019 10:02	10,55	19	200,53	CHI
201912185834	APARECIDA DE GOIANIA	10021453550	INDEPENDENCIA S1	23/12/2019 23:30	24/12/2019 10:56	23/12/2019 23:30	24/12/2019 10:56	11,43	1	11,43	CHI
201912188916	BARRO ALTO	BA12156230	BARRO ALTO	23/12/2019 23:31	26/12/2019 13:54	23/12/2019 23:31	26/12/2019 13:54	62,38	45	2807,26	CHI
201912188916	SANTA RITA DO NOVO DESTINO	BA12156230	BARRO ALTO	23/12/2019 23:31	26/12/2019 13:54	23/12/2019 23:31	26/12/2019 13:54	62,38	13	810,99	CHI
201912186326	URUACU	UR12364104	URUACU	23/12/2019 23:32	24/12/2019 08:07	23/12/2019 23:32	24/12/2019 08:07	8,58	20	171,59	CHI
201912186326	URUACU	UR12364104	URUACU	23/12/2019 23:32	24/12/2019 08:07	23/12/2019 23:32	24/12/2019 08:07	8,58	67	574,82	CHI
201912186345	SANTA RITA DO NOVO DESTINO	DF12256464	BARRO ALTO	23/12/2019 23:33	24/12/2019 12:25	23/12/2019 23:33	24/12/2019 12:25	12,86	16	205,70	CHI
201912185841	IPAMERI	580038336	IPAMERI	23/12/2019 23:35	24/12/2019 09:42	23/12/2019 23:35	24/12/2019 09:42	10,11	1	10,11	CHI
201912185842	VALPARAISO DE GOIAS	2860006406	MARAJOARA	23/12/2019 23:36	24/12/2019 00:41	23/12/2019 23:36	24/12/2019 00:41	1,08	1	1,08	CHI
201912185853	GOIANIA	10000466989	GOIANIA LESTE S1	23/12/2019 23:40	24/12/2019 02:17	23/12/2019 23:40	24/12/2019 02:17	2,61	1	2,61	CHI
201912186214	ARUANA	MP12041292	MOZARLANDIA	23/12/2019 23:44	24/12/2019 17:40	23/12/2019 23:44	24/12/2019 17:40	17,94	3	53,82	CHI
201912186214	MATRINCHA	MP12041292	MOZARLANDIA	23/12/2019 23:44	24/12/2019 17:40	23/12/2019 23:44	24/12/2019 17:40	17,94	1	17,94	CHI
201912185862	ITUMBIARA	IT21000334	ITUMBIARA NOVA	23/12/2019 23:47	24/12/2019 12:46	23/12/2019 23:47	24/12/2019 12:46	12,97	2	25,95	CHI
201912185933	PIRENOPOLIS	PV12355148	CORUMBA	23/12/2019 23:50	24/12/2019 10:08	23/12/2019 23:50	24/12/2019 10:08	10,29	25	257,23	CHI
201912185870	ABADIANIA	10026483120	ANAPOLIS UNIVERSITARIO S1	23/12/2019 23:55	24/12/2019 13:57	23/12/2019 23:55	24/12/2019 13:57	14,03	1	14,03	CHI
201912185880	APARECIDA DE GOIANIA	200624829	INDEPENDENCIA S2	24/12/2019 00:05	24/12/2019 09:30	24/12/2019 00:05	24/12/2019 09:30	9,41	1	9,41	CHI
201912185883	BOM JARDIM DE GOIAS	BM12334813	IPORA	24/12/2019 00:06	24/12/2019 08:44	24/12/2019 00:06	24/12/2019 08:44	8,62	14	120,67	CHI
201912185901	FORMOSA	FA21261884	ITIQUEIRA	24/12/2019 00:11	24/12/2019 11:28	24/12/2019 00:11	24/12/2019 11:28	11,28	1	11,28	CHI
201912185908	NEROPOLIS	NR11167731	NEROPOLIS S2	24/12/2019 00:18	24/12/2019 02:00	24/12/2019 00:18	24/12/2019 02:00	1,68	142	239,19	CHI
201912185918	SANCLERLANDIA	SC12008814	FIRMINOPOLIS S2	24/12/2019 00:36	24/12/2019 10:13	24/12/2019 00:36	24/12/2019 10:13	9,61	19	182,68	CHI
201912185329	RIO VERDE	RV10396180	CABRIUVA S2	24/12/2019 00:40	26/12/2019 11:01	24/12/2019 00:40	24/12/2019 06:06	5,42	12	65,08	CHI
201912185329	RIO VERDE	RV10396180	CABRIUVA S2	24/12/2019 00:40	26/12/2019 11:01	24/12/2019 00:40	25/12/2019 21:15	44,57	7	311,99	CHI
201912185329	RIO VERDE	RV10396180	CABRIUVA S2	24/12/2019 00:40	26/12/2019 11:01	25/12/2019 16:11	25/12/2019 21:15	5,07	12	60,80	CHI
201912185329	RIO VERDE	RV13238313	CABRIUVA S2	24/12/2019 00:40	26/12/2019 11:01	24/12/2019 00:40	25/12/2019 23:07	46,45	10	464,49	CHI
201912185329	RIO VERDE	RV12279477	CABRIUVA S2	24/12/2019 00:40	26/12/2019 11:01	24/12/2019 00:40	26/12/2019 01:05	48,42	6	290,50	CHI
201912185329	RIO VERDE	RV10396180	CABRIUVA S2	24/12/2019 00:40	26/12/2019 11:01	24/12/2019 00:40	26/12/2019 08:58	56,29	14	787,99	CHI
201912185329	RIO VERDE	RV10396180	CABRIUVA S2	24/12/2019 00:40	26/12/2019 11:01	26/12/2019 02:18	26/12/2019 08:58	6,66	35	233,18	CHI
201912185329	RIO VERDE	RV13191246	CABRIUVA S2	24/12/2019 00:40	26/12/2019 11:01	24/12/2019 00:40	26/12/2019 10:10	57,49	3	172,46	CHI
201912185329	RIO VERDE	RV13191246	CABRIUVA S2	24/12/2019 00:40	26/12/2019 11:01	26/12/2019 09:55	26/12/2019 10:10	0,24	14	3,43	CHI
201912185329	APARECIDA DO RIO DOCE	RV10400562	CABRIUVA S2	24/12/2019 00:40	26/12/2019 11:01	26/12/2019 10:57	26/12/2019 11:01	0,06	6	0,36	CHI
201912185329	QUIRINOPOLIS	RV13190628	CABRIUVA S2	24/12/2019 00:40	26/12/2019 11:01	26/12/2019 10:57	26/12/2019 11:01	0,06	4	0,24	CHI

201912185329	RIO VERDE	RV13190628	CABRIUVA S2	24/12/2019 00:40	26/12/2019 11:01	26/12/2019 10:57	26/12/2019 11:01	0,06	163	9,83	CHI
201912185329	RIO VERDE	RV13190628	CABRIUVA S2	24/12/2019 00:40	26/12/2019 11:01	26/12/2019 10:57	26/12/2019 11:01	0,06	212	12,78	CHI
201912185329	RIO VERDE	RV10400562	CABRIUVA S2	24/12/2019 00:40	26/12/2019 11:01	26/12/2019 10:57	26/12/2019 11:01	0,06	126	7,59	CHI
201912185929	MOSSAMEDES	1310032650	FIRMINOPOLIS S2	24/12/2019 00:53	24/12/2019 12:36	24/12/2019 00:53	24/12/2019 12:36	11,70	1	11,70	CHI
201912185930	GOIANIA	14586976	INDEPENDENCIA S2	24/12/2019 00:53	24/12/2019 03:01	24/12/2019 00:53	24/12/2019 03:01	2,12	1	2,12	CHI
201912185931	AURILANDIA	SL12003839	SAO LUIZ DOS MONTES BELOS	24/12/2019 00:54	24/12/2019 20:39	24/12/2019 00:54	24/12/2019 20:39	19,75	14	276,43	CHI
201912185931	SAO LUIS DE MONTES BELOS	SL12003839	SAO LUIZ DOS MONTES BELOS	24/12/2019 00:54	24/12/2019 20:39	24/12/2019 00:54	24/12/2019 20:39	19,75	8	157,96	CHI
201912185932	PONTALINA	PK21307953	PONTALINA	24/12/2019 00:58	24/12/2019 08:41	24/12/2019 00:58	24/12/2019 08:41	7,70	1	7,70	CHI
201912179102	JATAI	JT12216740	JATAI S1	24/12/2019 01:09	29/12/2019 15:15	24/12/2019 01:09	27/12/2019 00:38	71,48	47	3359,43	CHI
201912179102	JATAI	JT12216740	JATAI S1	24/12/2019 01:09	29/12/2019 15:15	27/12/2019 21:44	27/12/2019 23:47	2,05	46	94,39	CHI
201912179102	JATAI	JT12216740	JATAI S1	24/12/2019 01:09	29/12/2019 15:15	24/12/2019 01:09	29/12/2019 15:15	134,10	2	268,20	CHI
201912179102	JATAI	JT12216740	JATAI S1	24/12/2019 01:09	29/12/2019 15:15	29/12/2019 11:56	29/12/2019 15:15	3,32	46	152,58	CHI
201912185335	MAURILANDIA	01660424	SANTA HELENA S1	24/12/2019 01:10	24/12/2019 01:33	24/12/2019 01:12	24/12/2019 01:33	0,35	4	1,40	CHI
201912185335	SANTA HELENA DE GOIAS	01660424	SANTA HELENA S1	24/12/2019 01:10	24/12/2019 01:33	24/12/2019 01:12	24/12/2019 01:33	0,35	18	6,31	CHI
201912186007	PARAUNA	PU12336678	PARAUNA	24/12/2019 01:14	24/12/2019 18:16	24/12/2019 01:14	24/12/2019 18:16	17,03	2	34,06	CHI
201912186010	ITAPACI	IW21308220	ITAPACI	24/12/2019 01:22	24/12/2019 12:50	24/12/2019 01:22	24/12/2019 12:50	11,48	1	11,48	CHI
201912179792	JUSSARA	JR12198421	BRITANIA	24/12/2019 01:30	24/12/2019 13:29	24/12/2019 01:30	24/12/2019 10:22	8,85	22	194,71	CHI
201912179792	JUSSARA	JR12198421	BRITANIA	24/12/2019 01:30	24/12/2019 13:29	24/12/2019 01:30	24/12/2019 13:29	11,97	1	11,97	CHI
201912186012	PALMINOPOLIS	PP21031809	PALMEIRAS	24/12/2019 01:30	24/12/2019 10:34	24/12/2019 01:30	24/12/2019 10:34	9,06	1	9,06	CHI
201912187631	ARACU	AR12104723	ARACU	24/12/2019 01:35	24/12/2019 13:03	24/12/2019 01:35	24/12/2019 13:03	11,47	22	252,25	CHI
201912187631	ITAUCU	AR12104723	ARACU	24/12/2019 01:35	24/12/2019 13:03	24/12/2019 01:35	24/12/2019 13:03	11,47	10	114,66	CHI
201912187503	JAUPACI	JP12045494	IPORA	24/12/2019 01:36	24/12/2019 10:58	24/12/2019 01:36	24/12/2019 10:58	9,35	10	93,51	CHI
201912186019	BELA VISTA DE GOIAS	BV12321565	CEPAIGO S2	24/12/2019 01:46	24/12/2019 11:19	24/12/2019 01:46	24/12/2019 11:19	9,54	3	28,62	CHI
201912188150	BELA VISTA DE GOIAS	BV31052929	CEPAIGO S2	24/12/2019 01:46	24/12/2019 11:38	24/12/2019 01:46	24/12/2019 11:38	9,86	4	39,43	CHI
201912186226	JANDAIA	03140224	PALMEIRAS	24/12/2019 01:49	24/12/2019 15:43	24/12/2019 09:51	24/12/2019 10:10	0,31	56	17,36	CHI
201912186226	PALMEIRAS DE GOIAS	03140224	PALMEIRAS	24/12/2019 01:49	24/12/2019 15:43	24/12/2019 09:51	24/12/2019 10:10	0,31	14	4,34	CHI
201912186226	PALMINOPOLIS	03140224	PALMEIRAS	24/12/2019 01:49	24/12/2019 15:43	24/12/2019 09:51	24/12/2019 10:10	0,31	1694	525,14	CHI
201912186226	PALMEIRAS DE GOIAS	PL12027206LD	PALMEIRAS	24/12/2019 01:49	24/12/2019 15:43	24/12/2019 09:51	24/12/2019 15:43	5,86	34	199,14	CHI
201912189349	CATALAO	CT12203060	CATALAO S1	24/12/2019 01:58	24/12/2019 14:24	24/12/2019 01:58	24/12/2019 14:24	12,42	16	198,72	CHI
201912187479	PORANGATU	PO12350106	PORANGATU	24/12/2019 02:02	24/12/2019 11:49	24/12/2019 02:02	24/12/2019 11:49	9,77	7	68,38	CHI
201912186531	VILA PROPICIO	NP12307145	BARRO ALTO	24/12/2019 02:04	24/12/2019 09:42	24/12/2019 02:04	24/12/2019 09:42	7,62	14	106,74	CHI
201912188157	PONTALINA	PK12047371RE	VICENTINOPOLIS	24/12/2019 02:16	25/12/2019 10:50	24/12/2019 02:16	25/12/2019 10:50	32,58	47	1531,17	CHI
201912186031	BRITANIA	BT11007821	BRITANIA	24/12/2019 02:20	24/12/2019 06:59	24/12/2019 02:20	24/12/2019 06:59	4,65	76	353,38	CHI

201912186032	ALTO HORIZONTE	MQ12181177	MARA ROSA	24/12/2019 02:22	24/12/2019 07:46	24/12/2019 02:22	24/12/2019 07:46	5,39	3	16,18	CHI
201912186032	MARA ROSA	MQ12181177	MARA ROSA	24/12/2019 02:22	24/12/2019 07:46	24/12/2019 02:22	24/12/2019 07:46	5,39	28	151,03	CHI
201912186032	URUACU	MQ12181177	MARA ROSA	24/12/2019 02:22	24/12/2019 07:46	24/12/2019 02:22	24/12/2019 07:46	5,39	1	5,39	CHI
201912188415	BOM JESUS DE GOIAS	DM12153969	RIO DOS BOIS	24/12/2019 02:31	24/12/2019 15:30	24/12/2019 02:31	24/12/2019 15:30	12,97	1	12,97	CHI
201912188415	CASTELANDIA	DM12153969	RIO DOS BOIS	24/12/2019 02:31	24/12/2019 15:30	24/12/2019 02:31	24/12/2019 15:30	12,97	5	64,84	CHI
201912188415	QUIRINOPOLIS	DM12153969	RIO DOS BOIS	24/12/2019 02:31	24/12/2019 15:30	24/12/2019 02:31	24/12/2019 15:30	12,97	9	116,72	CHI
201912185343	SANTA HELENA DE GOIAS	SH10394752	IPEGUARI	24/12/2019 02:43	24/12/2019 12:06	24/12/2019 02:43	24/12/2019 10:46	8,05	23	185,12	CHI
201912185343	SANTA HELENA DE GOIAS	SH12279533	IPEGUARI	24/12/2019 02:43	24/12/2019 12:06	24/12/2019 02:43	24/12/2019 11:26	8,71	33	287,46	CHI
201912185343	SANTA HELENA DE GOIAS	SH12296172	IPEGUARI	24/12/2019 02:43	24/12/2019 12:06	24/12/2019 02:43	24/12/2019 12:05	9,36	50	468,04	CHI
201912185343	SANTA HELENA DE GOIAS	SH12279534	IPEGUARI	24/12/2019 02:43	24/12/2019 12:06	24/12/2019 02:43	24/12/2019 12:06	9,38	2	18,76	CHI
201912186351	SANTA CRUZ DE GOIAS	BC12110028RE	PIRES DO RIO S2	24/12/2019 02:53	24/12/2019 11:08	24/12/2019 02:53	24/12/2019 11:08	8,26	19	156,87	CHI
201912188213	VILA PROPICIO	NP12221137	GOIANESIA S1	24/12/2019 02:56	24/12/2019 20:05	24/12/2019 02:56	24/12/2019 20:05	17,15	18	308,65	CHI
201912185346	BOM JESUS DE GOIAS	VI10400587	VICENTINOPOLIS	24/12/2019 03:01	24/12/2019 10:32	24/12/2019 03:01	24/12/2019 10:32	7,51	3	22,54	CHI
201912185346	GOIATUBA	VI10400587	VICENTINOPOLIS	24/12/2019 03:01	24/12/2019 10:32	24/12/2019 03:01	24/12/2019 10:32	7,51	14	105,19	CHI
201912185346	JOVIANIA	VI10400587	VICENTINOPOLIS	24/12/2019 03:01	24/12/2019 10:32	24/12/2019 03:01	24/12/2019 10:32	7,51	17	127,73	CHI
201912185346	VICENTINOPOLIS	VI10400587	VICENTINOPOLIS	24/12/2019 03:01	24/12/2019 10:32	24/12/2019 03:01	24/12/2019 10:32	7,51	9	67,62	CHI
201912174655	ARENOPOLIS	AY12123896	ARENOPOLIS	24/12/2019 03:18	24/12/2019 09:56	24/12/2019 03:18	24/12/2019 09:56	6,62	14	92,67	CHI
201912174655	DIORAMA	AY12123896	ARENOPOLIS	24/12/2019 03:18	24/12/2019 09:56	24/12/2019 03:18	24/12/2019 09:56	6,62	15	99,29	CHI
201912186050	VICENTINOPOLIS	VI12000145	VICENTINOPOLIS	24/12/2019 03:30	24/12/2019 11:32	24/12/2019 03:30	24/12/2019 11:32	8,03	3	24,10	CHI
201912186253	NOVA IGUACU DE GOIAS	UR12046188	URUACU	24/12/2019 03:35	24/12/2019 07:52	24/12/2019 03:35	24/12/2019 07:52	4,27	20	85,46	CHI
201912186253	PILAR DE GOIAS	UR12046188	URUACU	24/12/2019 03:35	24/12/2019 07:52	24/12/2019 03:35	24/12/2019 07:52	4,27	1	4,27	CHI
201912186253	URUACU	UR12046188	URUACU	24/12/2019 03:35	24/12/2019 07:52	24/12/2019 03:35	24/12/2019 07:52	4,27	160	683,69	CHI
201912186462	ITAPACI	IW12040081	ITAPACI	24/12/2019 03:35	24/12/2019 09:44	24/12/2019 03:35	24/12/2019 09:44	6,15	32	196,70	CHI
201912186541	CHAPADAO DO CEU	DJ12378153	CHAPADAO DO CEU	24/12/2019 03:35	24/12/2019 14:56	24/12/2019 03:35	24/12/2019 14:56	11,35	2	22,69	CHI
201912187662	URUACU	UR21237522	URUACU	24/12/2019 03:35	24/12/2019 09:27	24/12/2019 03:35	24/12/2019 09:27	5,86	1	5,86	CHI
201912186235	BONOPOLIS	BX12391936	SAO MIGUEL DO ARAGUAIA	24/12/2019 03:52	25/12/2019 16:15	24/12/2019 03:52	25/12/2019 16:15	36,37	29	1054,83	CHI
201912186067	URUTAI	UT12080724RE	URUTAI	24/12/2019 03:53	24/12/2019 11:11	24/12/2019 03:53	24/12/2019 11:11	7,30	80	583,62	CHI
201912186287	AURILANDIA	AI12126017	FIRMINOPOLIS S2	24/12/2019 03:55	24/12/2019 16:48	24/12/2019 03:55	24/12/2019 16:48	12,87	5	64,36	CHI
201912186287	CACHOEIRA DE GOIAS	AI12126017	FIRMINOPOLIS S2	24/12/2019 03:55	24/12/2019 16:48	24/12/2019 03:55	24/12/2019 16:48	12,87	4	51,49	CHI
201912187207	CRISTALINA	KR12162510	PAMPLONA	24/12/2019 03:57	24/12/2019 12:25	24/12/2019 03:57	24/12/2019 12:25	8,46	53	448,59	CHI
201912189495	CAMPO ALEGRE DE GOIAS	CM12166728	CAMPO ALEGRE DE GOIAS	24/12/2019 04:02	24/12/2019 14:31	24/12/2019 04:02	24/12/2019 14:31	10,48	34	356,41	CHI
201912186085	INACIOLANDIA	2810007142	QUIRINOPOLIS	24/12/2019 04:10	24/12/2019 07:48	24/12/2019 04:10	24/12/2019 07:48	3,63	1	3,63	CHI
201912186086	AMARALINA	MU12391653	MARA ROSA	24/12/2019 04:13	24/12/2019 10:44	24/12/2019 04:13	24/12/2019 10:44	6,51	20	130,13	CHI



201912188142	EDEIA	EA12068777	EDEIA	24/12/2019 04:18	24/12/2019 18:28	24/12/2019 04:18	24/12/2019 11:54	7,60	199	1511,74	CHI
201912188142	EDEIA	EA12068777	EDEIA	24/12/2019 04:18	24/12/2019 18:28	24/12/2019 11:55	24/12/2019 18:28	6,56	199	1305,61	CHI
201912187639	RIO VERDE	RV12000250	RIO VERDE S1	24/12/2019 04:21	24/12/2019 13:59	24/12/2019 04:21	24/12/2019 13:59	9,62	5	48,11	CHI
201912187639	SANTA HELENA DE GOIAS	RV12000250	RIO VERDE S1	24/12/2019 04:21	24/12/2019 13:59	24/12/2019 04:21	24/12/2019 13:59	9,62	14	134,70	CHI
201912186149	MORRINHOS	MR12098214	MORRINHOS	24/12/2019 04:24	25/12/2019 14:22	24/12/2019 04:24	25/12/2019 14:22	33,95	15	509,32	CHI
201912186095	PALMEIRAS DE GOIAS	8058692	PALMEIRAS	24/12/2019 04:31	24/12/2019 10:58	24/12/2019 04:32	24/12/2019 10:58	6,42	108	693,84	CHI
201912186099	ANAPOLIS	AN11226668	ANAPOLIS UNIVERSITARIO S2	24/12/2019 04:36	24/12/2019 08:08	24/12/2019 04:36	24/12/2019 08:08	3,52	78	274,82	CHI
201912186305	AURILANDIA	CG12391526	FIRMINOPOLIS S2	24/12/2019 04:37	24/12/2019 18:09	24/12/2019 04:37	24/12/2019 18:09	13,53	2	27,05	CHI
201912186305	CACHOEIRA DE GOIAS	CG12391526	FIRMINOPOLIS S2	24/12/2019 04:37	24/12/2019 18:09	24/12/2019 04:37	24/12/2019 18:09	13,53	11	148,80	CHI
201912186305	PARAUNA	CG12391526	FIRMINOPOLIS S2	24/12/2019 04:37	24/12/2019 18:09	24/12/2019 04:37	24/12/2019 18:09	13,53	32	432,87	CHI
201912186512	ARACU	AR12019445	ARACU	24/12/2019 04:39	24/12/2019 09:02	24/12/2019 04:39	24/12/2019 09:02	4,38	19	83,18	CHI
201912186512	ITABERAI	AR12019445	ARACU	24/12/2019 04:39	24/12/2019 09:02	24/12/2019 04:39	24/12/2019 09:02	4,38	12	52,54	CHI
201912186104	CUMARI	CT21267009	CATALAO S2	24/12/2019 04:42	24/12/2019 08:55	24/12/2019 04:42	24/12/2019 08:55	4,20	1	4,20	CHI
201912186108	NOVA IGUACU DE GOIAS	AJ21204039	MARA ROSA	24/12/2019 04:53	24/12/2019 12:18	24/12/2019 04:53	24/12/2019 12:18	7,41	1	7,41	CHI
201912188149	FORMOSA	FA12180826	SAO JOAO D ALIANCA	24/12/2019 04:53	24/12/2019 19:08	24/12/2019 04:53	24/12/2019 19:08	14,24	6	85,45	CHI
201912186112	CATALAO	1990114614	CATALAO S2	24/12/2019 04:55	24/12/2019 06:54	24/12/2019 04:55	24/12/2019 06:54	1,97	1	1,97	CHI
201912186113	MORRO AGUDO DE GOIAS	MS12113258	ITAPURANGA	24/12/2019 04:55	24/12/2019 10:09	24/12/2019 04:55	24/12/2019 10:09	5,22	29	151,42	CHI
201912186113	RUBIATABA	MS12113258	ITAPURANGA	24/12/2019 04:55	24/12/2019 10:09	24/12/2019 04:55	24/12/2019 10:09	5,22	2	10,44	CHI
201912189439	VILA PROPICIO	NP12339454	GOIANESIA S1	24/12/2019 05:02	24/12/2019 12:43	24/12/2019 05:02	24/12/2019 12:43	7,69	113	868,50	CHI
201912186123	MINEIROS	PW12219569	PARQUE DAS EMAS	24/12/2019 05:05	24/12/2019 14:12	24/12/2019 05:05	24/12/2019 14:12	9,10	94	855,82	CHI
201912186123	PORTELANDIA	PW12219569	PARQUE DAS EMAS	24/12/2019 05:05	24/12/2019 14:12	24/12/2019 05:05	24/12/2019 14:12	9,10	5	45,52	CHI
201912186127	SANTA HELENA DE GOIAS	SH21000048	IPEGUARI	24/12/2019 05:07	25/12/2019 09:26	24/12/2019 05:07	25/12/2019 09:26	28,30	1	28,30	CHI
201912186293	CAIAPONIA	PY12040163	PALESTINA	24/12/2019 05:09	24/12/2019 12:12	24/12/2019 05:09	24/12/2019 12:12	7,04	45	316,84	CHI
201912186293	PALESTINA DE GOIAS	PY12040163	PALESTINA	24/12/2019 05:09	24/12/2019 12:12	24/12/2019 05:09	24/12/2019 12:12	7,04	102	718,16	CHI
201912186139	AMORINOPOLIS	AM12000005	IPORA	24/12/2019 05:10	24/12/2019 08:18	24/12/2019 05:10	24/12/2019 08:18	3,12	32	99,99	CHI
201912186139	IVOLANDIA	AM12000005	IPORA	24/12/2019 05:10	24/12/2019 08:18	24/12/2019 05:10	24/12/2019 08:18	3,12	2	6,25	CHI
201912186133	JARAGUA	JA12000001LD	JARAGUA	24/12/2019 05:12	26/12/2019 11:00	24/12/2019 05:12	24/12/2019 08:57	3,75	219	822,16	CHI
201912186133	PIRENOPOLIS	JA12000001LD	JARAGUA	24/12/2019 05:12	26/12/2019 11:00	24/12/2019 05:12	24/12/2019 08:57	3,75	28	105,12	CHI
201912186133	JARAGUA	JA12000001LD	JARAGUA	24/12/2019 05:12	26/12/2019 11:00	24/12/2019 08:58	24/12/2019 11:32	2,56	39	99,99	CHI
201912186133	JARAGUA	JA13221538	JARAGUA	24/12/2019 05:12	26/12/2019 11:00	24/12/2019 05:12	24/12/2019 22:42	17,49	23	402,31	CHI
201912186133	PIRENOPOLIS	JA13221538	JARAGUA	24/12/2019 05:12	26/12/2019 11:00	24/12/2019 05:12	24/12/2019 22:42	17,49	7	122,44	CHI
201912186133	JARAGUA	JA13221538	JARAGUA	24/12/2019 05:12	26/12/2019 11:00	24/12/2019 08:58	24/12/2019 22:42	13,73	243	3335,18	CHI
201912186133	PIRENOPOLIS	JA13221538	JARAGUA	24/12/2019 05:12	26/12/2019 11:00	24/12/2019 08:58	24/12/2019 22:42	13,73	9	123,53	CHI

201912186133	JARAGUA	JA13221538	JARAGUA	24/12/2019 05:12	26/12/2019 11:00	24/12/2019 21:41	24/12/2019 22:42	1,01	2	2,01	CHI
201912186133	PIRENOPOLIS	JA13221538	JARAGUA	24/12/2019 05:12	26/12/2019 11:00	24/12/2019 21:41	24/12/2019 22:42	1,01	12	12,08	CHI
201912186133	JARAGUA	JA12392219LD	JARAGUA	24/12/2019 05:12	26/12/2019 11:00	24/12/2019 08:58	25/12/2019 15:18	30,33	2	60,66	CHI
201912186133	PIRENOPOLIS	JA12392219LD	JARAGUA	24/12/2019 05:12	26/12/2019 11:00	24/12/2019 08:58	25/12/2019 15:18	30,33	18	545,97	CHI
201912186133	JARAGUA	JA10394589	JARAGUA	24/12/2019 05:12	26/12/2019 11:00	26/12/2019 09:13	26/12/2019 09:24	0,20	347	67,67	CHI
201912186133	PIRENOPOLIS	JA10394589	JARAGUA	24/12/2019 05:12	26/12/2019 11:00	26/12/2019 09:13	26/12/2019 09:24	0,20	45	8,78	CHI
201912186133	PIRENOPOLIS	JA12298023	JARAGUA	24/12/2019 05:12	26/12/2019 11:00	24/12/2019 08:58	26/12/2019 10:05	49,10	8	392,84	CHI
201912186133	JARAGUA	JA12297925	JARAGUA	24/12/2019 05:12	26/12/2019 11:00	26/12/2019 10:10	26/12/2019 11:00	0,83	4	3,33	CHI
201912186133	PIRENOPOLIS	JA12297925	JARAGUA	24/12/2019 05:12	26/12/2019 11:00	26/12/2019 10:10	26/12/2019 11:00	0,83	7	5,83	CHI
201912186134	CRIXAS	RB12170307	RUBIATABA	24/12/2019 05:12	25/12/2019 16:47	24/12/2019 05:12	24/12/2019 12:10	6,97	1	6,97	CHI
201912186134	NOVA AMERICA	RB12170307	RUBIATABA	24/12/2019 05:12	25/12/2019 16:47	24/12/2019 05:12	24/12/2019 12:10	6,97	19	132,39	CHI
201912186134	RUBIATABA	RB12170307	RUBIATABA	24/12/2019 05:12	25/12/2019 16:47	24/12/2019 05:12	24/12/2019 12:10	6,97	56	390,20	CHI
201912186134	RUBIATABA	RB12114265	RUBIATABA	24/12/2019 05:12	25/12/2019 16:47	24/12/2019 22:30	25/12/2019 11:23	12,89	26	335,26	CHI
201912186134	CRIXAS	RB12170307	RUBIATABA	24/12/2019 05:12	25/12/2019 16:47	24/12/2019 12:11	25/12/2019 13:09	24,97	1	24,97	CHI
201912186134	RUBIATABA	RB12170307	RUBIATABA	24/12/2019 05:12	25/12/2019 16:47	24/12/2019 12:11	25/12/2019 13:09	24,97	53	1323,65	CHI
201912186134	NOVA AMERICA	RB12272716LD	RUBIATABA	24/12/2019 05:12	25/12/2019 16:47	24/12/2019 12:11	25/12/2019 16:47	28,61	19	543,65	CHI
201912186134	RUBIATABA	RB12272716LD	RUBIATABA	24/12/2019 05:12	25/12/2019 16:47	24/12/2019 12:11	25/12/2019 16:47	28,61	4	114,45	CHI
201912186304	INDIARA	IY12312488	CEZARINA	24/12/2019 05:12	24/12/2019 09:01	24/12/2019 05:12	24/12/2019 09:01	3,81	6	22,89	CHI
201912186136	AGUAS LINDAS DE GOIAS	10027730610	AGUAS LINDAS DE GOIAS S1	24/12/2019 05:13	24/12/2019 07:50	24/12/2019 05:13	24/12/2019 07:50	2,61	1	2,61	CHI
201912186137	PORANGATU	PO12020947	PORANGATU	24/12/2019 05:14	24/12/2019 08:40	24/12/2019 05:14	24/12/2019 08:40	3,42	44	150,41	CHI
201912187564	SANTA HELENA DE GOIAS	SH12295822	IPEGUARI	24/12/2019 05:18	24/12/2019 12:34	24/12/2019 05:18	24/12/2019 12:34	7,26	80	580,91	CHI
201912188349	SANTA TEREZINHA DE GOIAS	SG12242338	SANTA TEREZINHA	24/12/2019 05:19	24/12/2019 16:51	24/12/2019 05:19	24/12/2019 16:51	11,53	13	149,89	CHI
201912186154	CACU	CC21076242	CACHOEIRA ALTA	24/12/2019 05:25	25/12/2019 03:24	24/12/2019 05:25	25/12/2019 03:24	21,98	1	21,98	CHI
201912186157	MINEIROS	MY12156849	PARQUE DAS EMAS	24/12/2019 05:27	24/12/2019 12:55	24/12/2019 05:27	24/12/2019 12:55	7,47	11	82,14	CHI
201912187521	CAIAPONIA	CP12119577	CAIAPONIA	24/12/2019 05:33	24/12/2019 17:19	24/12/2019 05:33	24/12/2019 17:19	11,77	66	776,56	CHI
201912187521	DOVERLANDIA	CP12119577	CAIAPONIA	24/12/2019 05:33	24/12/2019 17:19	24/12/2019 05:33	24/12/2019 17:19	11,77	7	82,36	CHI
201912186164	FLORES DE GOIAS	FB21161681	FLORES DE GOIAS	24/12/2019 05:34	24/12/2019 09:49	24/12/2019 05:34	24/12/2019 09:49	4,25	1	4,25	CHI
201912186165	APARECIDA DE GOIANIA	AP11089717	REAL S1	24/12/2019 05:34	24/12/2019 07:18	24/12/2019 05:34	24/12/2019 07:18	1,73	237	409,15	CHI
201912186652	FORMOSA	FA12404372	ITIQUEIRA	24/12/2019 05:37	24/12/2019 08:57	24/12/2019 05:37	24/12/2019 08:57	3,32	155	514,77	CHI
201912192026	IPAMERI	NE12082774	CATALAO S1	24/12/2019 05:38	24/12/2019 12:48	24/12/2019 05:38	24/12/2019 12:48	7,17	14	100,34	CHI
201912192026	NOVA AURORA	NE12082774	CATALAO S1	24/12/2019 05:38	24/12/2019 12:48	24/12/2019 05:38	24/12/2019 12:48	7,17	16	114,67	CHI
201912185353	CACU	IM12371219	CACHOEIRA ALTA	24/12/2019 05:42	24/12/2019 14:48	24/12/2019 05:42	24/12/2019 11:08	5,42	4	21,69	CHI
201912185353	ITARUMA	IM12371219	CACHOEIRA ALTA	24/12/2019 05:42	24/12/2019 14:48	24/12/2019 05:42	24/12/2019 11:08	5,42	7	37,97	CHI

201912185353	CACU	CC13360878	CACHOEIRA ALTA	24/12/2019 05:42	24/12/2019 14:48	24/12/2019 05:42	24/12/2019 14:48	9,10	25	227,59	CHI
201912185353	ITARUMA	CC13360878	CACHOEIRA ALTA	24/12/2019 05:42	24/12/2019 14:48	24/12/2019 05:42	24/12/2019 14:48	9,10	14	127,45	CHI
201912185353	JATAI	CC13360878	CACHOEIRA ALTA	24/12/2019 05:42	24/12/2019 14:48	24/12/2019 05:42	24/12/2019 14:48	9,10	20	182,07	CHI
201912186182	JANDAIA	JD12102347	ACREUNA	24/12/2019 05:42	24/12/2019 21:31	24/12/2019 05:42	24/12/2019 21:08	15,43	1	15,43	CHI
201912186182	ACREUNA	JD12296090LD	ACREUNA	24/12/2019 05:42	24/12/2019 21:31	24/12/2019 18:05	24/12/2019 21:31	3,43	14	48,06	CHI
201912186182	JANDAIA	JD12296090LD	ACREUNA	24/12/2019 05:42	24/12/2019 21:31	24/12/2019 18:05	24/12/2019 21:31	3,43	5	17,17	CHI
201912188363	EDEIA	ED12000041	EDEIA	24/12/2019 05:43	25/12/2019 13:10	24/12/2019 05:43	25/12/2019 13:10	31,44	25	786,07	CHI
201912186414	MINEIROS	MY12043894	PARQUE DAS EMAS	24/12/2019 05:45	24/12/2019 13:01	24/12/2019 05:45	24/12/2019 13:01	7,25	102	739,87	CHI
201912186194	ITAPIRAPUA	IU12250542	MATRINCHA	24/12/2019 05:48	24/12/2019 17:40	24/12/2019 05:48	24/12/2019 17:40	11,87	9	106,79	CHI
201912186195	ITABERAI	IB12250593	ITABERAI S1	24/12/2019 05:48	24/12/2019 09:54	24/12/2019 05:48	24/12/2019 09:54	4,09	6	24,53	CHI
201912186196	CEZARINA	VJ12378550	GUAPO S2	24/12/2019 05:49	24/12/2019 08:12	24/12/2019 05:49	24/12/2019 08:12	2,39	8	19,14	CHI
201912186196	VARJAO	VJ12378550	GUAPO S2	24/12/2019 05:49	24/12/2019 08:12	24/12/2019 05:49	24/12/2019 08:12	2,39	43	102,87	CHI
201912186198	LUZIANIA	LZ21248639	VIANOPOLIS	24/12/2019 05:50	24/12/2019 10:28	24/12/2019 05:50	24/12/2019 10:28	4,63	3	13,90	CHI
201912186199	SAO DOMINGOS	8680008190	SAO DOMINGOS	24/12/2019 05:50	24/12/2019 07:48	24/12/2019 05:50	24/12/2019 07:48	1,96	1	1,96	CHI
201912188112	ITAPIRAPUA	IU12121510	MATRINCHA	24/12/2019 05:51	25/12/2019 08:38	24/12/2019 05:51	25/12/2019 08:38	26,80	3	80,39	CHI
201912188708	CEZARINA	CZ12271995	GUAPO S2	24/12/2019 05:51	24/12/2019 11:00	24/12/2019 05:51	24/12/2019 11:00	5,15	25	128,73	CHI
201912186208	CRISTALINA	KR21248615	CRISTALINA S2	24/12/2019 05:53	24/12/2019 16:37	24/12/2019 05:53	24/12/2019 16:37	10,74	1	10,74	CHI
201912186212	JARAGUA	JA12259973	JARAGUA	24/12/2019 05:53	24/12/2019 11:16	24/12/2019 05:53	24/12/2019 11:16	5,37	11	59,11	CHI
201912193612	SAO MIGUEL DO ARAGUAIA	SM12371801B	SAO MIGUEL DO ARAGUAIA	24/12/2019 05:53	24/12/2019 16:55	24/12/2019 05:53	24/12/2019 16:55	11,05	181	1999,55	CHI
201912186289	HIDROLANDIA	HD12058903	ANHANGUERA	24/12/2019 05:54	24/12/2019 12:54	24/12/2019 05:54	24/12/2019 12:54	6,99	168	1174,32	CHI
201912186218	MONTE ALEGRE DE GOIAS	MA12211597	SAO DOMINGOS	24/12/2019 05:55	24/12/2019 09:53	24/12/2019 05:55	24/12/2019 09:53	3,96	10	39,62	CHI
201912186657	ITUMBIARA	IT12033779RE	CACHOEIRA DOURADA	24/12/2019 05:55	24/12/2019 09:49	24/12/2019 05:55	24/12/2019 09:49	3,90	60	233,73	CHI
201912189461	GOUVELANDIA	QI12402335	QUIRINOPOLIS	24/12/2019 05:55	24/12/2019 17:01	24/12/2019 05:55	24/12/2019 17:01	11,10	14	155,40	CHI
201912186229	APARECIDA DE GOIANIA	200666885	CEPAIGO S1	24/12/2019 05:57	24/12/2019 15:53	24/12/2019 05:57	24/12/2019 15:53	9,92	1	9,92	CHI
201912186231	ANICUNS	AC12304607	FIRMINOPOLIS S2	24/12/2019 05:57	24/12/2019 10:24	24/12/2019 05:57	24/12/2019 10:24	4,43	3	13,30	CHI
201912189106	HEITORAI	HE12170839	ITAPURANGA	24/12/2019 05:57	24/12/2019 20:05	24/12/2019 05:57	24/12/2019 20:05	14,14	115	1625,94	CHI
201912189106	ITAGUARU	HE12170839	ITAPURANGA	24/12/2019 05:57	24/12/2019 20:05	24/12/2019 05:57	24/12/2019 20:05	14,14	35	494,85	CHI
201912189106	ITAPURANGA	HE12170839	ITAPURANGA	24/12/2019 05:57	24/12/2019 20:05	24/12/2019 05:57	24/12/2019 20:05	14,14	5	70,69	CHI
201912189106	URUANA	HE12170839	ITAPURANGA	24/12/2019 05:57	24/12/2019 20:05	24/12/2019 05:57	24/12/2019 20:05	14,14	1	14,14	CHI
201912186232	CRISTIANOPOLIS	PJ12242517	PIRACANJUBA	24/12/2019 05:58	24/12/2019 11:45	24/12/2019 05:58	24/12/2019 11:45	5,80	5	28,98	CHI
201912186232	PIRACANJUBA	PJ12242517	PIRACANJUBA	24/12/2019 05:58	24/12/2019 11:45	24/12/2019 05:58	24/12/2019 11:45	5,80	3	17,39	CHI
201912188205	CRIXAS	CX12243465	SERRA DO OURO	24/12/2019 05:58	24/12/2019 17:30	24/12/2019 05:58	24/12/2019 17:30	11,52	13	149,75	CHI
201912186251	MOSSAMEDES	IB12336421	ITABERAI S2	24/12/2019 05:59	24/12/2019 08:22	24/12/2019 05:59	24/12/2019 08:22	2,37	3	7,10	CHI

201912189532	PONTALINA	PK21092092	PONTALINA	24/12/2019 05:59	24/12/2019 17:27	24/12/2019 05:59	24/12/2019 17:27	11,45	1	11,45	CHI
201912186239	ARUANA	03960214	NOVA CRIXAS	24/12/2019 06:00	25/12/2019 20:52	25/12/2019 02:28	25/12/2019 10:40	8,20	25	204,99	CHI
201912186239	NOVA CRIXAS	03960214	NOVA CRIXAS	24/12/2019 06:00	25/12/2019 20:52	25/12/2019 02:28	25/12/2019 10:40	8,20	90	737,98	CHI
201912186239	ARUANA	03960214	NOVA CRIXAS	24/12/2019 06:00	25/12/2019 20:52	25/12/2019 10:41	25/12/2019 11:58	1,28	25	32,09	CHI
201912186239	NOVA CRIXAS	03960214	NOVA CRIXAS	24/12/2019 06:00	25/12/2019 20:52	25/12/2019 10:41	25/12/2019 11:58	1,28	43	55,20	CHI
201912186239	NOVA CRIXAS	NA12213163LD	NOVA CRIXAS	24/12/2019 06:00	25/12/2019 20:52	25/12/2019 10:41	25/12/2019 19:28	8,79	48	421,87	CHI
201912186239	ARUANA	NA13400051	NOVA CRIXAS	24/12/2019 06:00	25/12/2019 20:52	25/12/2019 11:59	25/12/2019 20:52	8,89	25	222,36	CHI
201912186239	NOVA CRIXAS	NA13400051	NOVA CRIXAS	24/12/2019 06:00	25/12/2019 20:52	25/12/2019 11:59	25/12/2019 20:52	8,89	42	373,57	CHI
201912186356	CAMPO ALEGRE DE GOIAS	CM12127511	CAMPO ALEGRE DE GOIAS	24/12/2019 06:00	24/12/2019 09:15	24/12/2019 06:00	24/12/2019 09:15	3,23	7	22,64	CHI
201912186356	IPAMERI	CM12127511	CAMPO ALEGRE DE GOIAS	24/12/2019 06:00	24/12/2019 09:15	24/12/2019 06:00	24/12/2019 09:15	3,23	3	9,70	CHI
201912186649	TURVANIA	TV12005720	FIRMINOPOLIS S2	24/12/2019 06:00	24/12/2019 20:29	24/12/2019 06:00	24/12/2019 20:29	14,47	14	202,58	CHI
201912260894	NOVA CRIXAS	8570035265	NOVA CRIXAS	24/12/2019 06:00	25/12/2019 02:28	24/12/2019 06:00	25/12/2019 02:28	20,47	1	20,47	CHI
201912186244	SAO SIMAO	SO12216668	CACHOEIRA ALTA	24/12/2019 06:01	24/12/2019 19:00	24/12/2019 06:01	24/12/2019 19:00	12,97	14	181,60	CHI
201912189771	GOIATUBA	GT12000178	BOM JESUS DE GOIAS	24/12/2019 06:01	24/12/2019 17:20	24/12/2019 06:01	24/12/2019 17:20	11,30	29	327,82	CHI
201912186617	ANAPOLIS	GP12346839	JUNDIAI S2	24/12/2019 06:02	24/12/2019 08:42	24/12/2019 06:02	24/12/2019 08:42	2,66	5	13,32	CHI
201912186617	TEREZOPOLIS DE GOIAS	GP12346839	JUNDIAI S2	24/12/2019 06:02	24/12/2019 08:42	24/12/2019 06:02	24/12/2019 08:42	2,66	16	42,64	CHI
201912189324	LEOPOLDO DE BULHOES	LB12322348	DAIA S2	24/12/2019 06:02	24/12/2019 12:39	24/12/2019 06:02	24/12/2019 12:39	6,61	15	99,12	CHI
201912186249	CACHOEIRA DOURADA	CD21035744	CACHOEIRA DOURADA	24/12/2019 06:03	24/12/2019 23:49	24/12/2019 06:03	24/12/2019 23:49	17,78	1	17,78	CHI
201912197250	CORUMBAIBA	IP12071442	IPAMERI	24/12/2019 06:05	24/12/2019 21:56	24/12/2019 06:05	24/12/2019 21:56	15,84	3	47,51	CHI
201912197250	IPAMERI	IP12071442	IPAMERI	24/12/2019 06:05	24/12/2019 21:56	24/12/2019 06:05	24/12/2019 21:56	15,84	14	221,70	CHI
201912186259	ANAPOLIS	AN12258718	JUNDIAI S2	24/12/2019 06:06	24/12/2019 10:26	24/12/2019 06:06	24/12/2019 10:26	4,33	21	90,92	CHI
201912186263	GOIANIA	GN12001697	AEROPORTO S2	24/12/2019 06:07	24/12/2019 08:12	24/12/2019 06:07	24/12/2019 08:12	2,08	462	960,58	CHI
201912187513	MUTUNOPOLIS	PO12242424	PORANGATU	24/12/2019 06:07	25/12/2019 14:42	24/12/2019 06:07	25/12/2019 14:42	32,59	1	32,59	CHI
201912187513	PORANGATU	PO12242424	PORANGATU	24/12/2019 06:07	25/12/2019 14:42	24/12/2019 06:07	25/12/2019 14:42	32,59	2	65,17	CHI
201912186267	FORMOSA	FA12042666	SAO JOAO D ALIANCA	24/12/2019 06:08	24/12/2019 15:46	24/12/2019 06:08	24/12/2019 11:00	4,88	15	73,20	CHI
201912186267	FORMOSA	FA12042666	SAO JOAO D ALIANCA	24/12/2019 06:08	24/12/2019 15:46	24/12/2019 11:01	24/12/2019 15:46	4,76	15	71,37	CHI
201912186273	BELA VISTA DE GOIAS	BV12011052	BELA VISTA S1	24/12/2019 06:08	24/12/2019 10:26	24/12/2019 06:08	24/12/2019 10:26	4,28	5	21,42	CHI
201912186423	GOIAS	GS12228460	GOIAS	24/12/2019 06:08	24/12/2019 17:24	24/12/2019 06:08	24/12/2019 17:24	11,27	3	33,82	CHI
201912187309	JATAI	JT12109029	JATAI S1	24/12/2019 06:08	24/12/2019 15:43	24/12/2019 06:08	24/12/2019 15:43	9,59	28	268,42	CHI
201912188561	PALMEIRAS DE GOIAS	PL12085269	PALMEIRAS	24/12/2019 06:08	24/12/2019 14:16	24/12/2019 06:08	24/12/2019 14:16	8,12	16	129,90	CHI
201912186278	FORMOSO	FO12071135	PORANGATU	24/12/2019 06:09	24/12/2019 14:55	24/12/2019 06:09	24/12/2019 13:20	7,18	4	28,70	CHI
201912186278	FORMOSO	FO12071135	PORANGATU	24/12/2019 06:09	24/12/2019 14:55	24/12/2019 13:21	24/12/2019 14:55	1,58	4	6,32	CHI
201912186279	GOIANIA	GN11265866	CEPAIGO S1	24/12/2019 06:09	24/12/2019 07:56	24/12/2019 06:09	24/12/2019 07:56	1,77	6	10,61	CHI

201912186280	PORANGATU	TB12262770	PORANGATU	24/12/2019 06:10	25/12/2019 15:37	24/12/2019 06:10	25/12/2019 15:37	33,44	1	33,44	CHI
201912186280	SANTA TEREZA DE GOIAS	TB12262770	PORANGATU	24/12/2019 06:10	25/12/2019 15:37	24/12/2019 06:10	25/12/2019 15:37	33,44	5	167,22	CHI
201912186280	TROMBAS	TB12262770	PORANGATU	24/12/2019 06:10	25/12/2019 15:37	24/12/2019 06:10	25/12/2019 15:37	33,44	13	434,76	CHI
201912186284	INDIARA	IY12391438	EDEIA	24/12/2019 06:10	24/12/2019 09:22	24/12/2019 06:10	24/12/2019 09:22	3,19	15	47,84	CHI
201912186284	PALMEIRAS DE GOIAS	IY12391438	EDEIA	24/12/2019 06:10	24/12/2019 09:22	24/12/2019 06:10	24/12/2019 09:22	3,19	1	3,19	CHI
201912260872	ACREUNA	TD12025737	RIO DOS BOIS	24/12/2019 06:10	27/12/2019 23:01	24/12/2019 06:10	24/12/2019 15:32	9,36	4	37,44	CHI
201912260872	SANTA HELENA DE GOIAS	TD12025737	RIO DOS BOIS	24/12/2019 06:10	27/12/2019 23:01	24/12/2019 06:10	24/12/2019 15:32	9,36	18	168,47	CHI
201912260872	TURVELANDIA	TD12025737	RIO DOS BOIS	24/12/2019 06:10	27/12/2019 23:01	24/12/2019 06:10	24/12/2019 15:32	9,36	32	299,50	CHI
201912260872	ACREUNA	TD12025721	RIO DOS BOIS	24/12/2019 06:10	27/12/2019 23:01	24/12/2019 06:10	25/12/2019 13:58	31,79	9	286,14	CHI
201912260872	TURVELANDIA	TD12025721	RIO DOS BOIS	24/12/2019 06:10	27/12/2019 23:01	24/12/2019 06:10	25/12/2019 13:58	31,79	19	604,07	CHI
201912260872	ACREUNA	TD12246829	RIO DOS BOIS	24/12/2019 06:10	27/12/2019 23:01	25/12/2019 13:59	26/12/2019 12:34	22,59	4	90,34	CHI
201912260872	SANTA HELENA DE GOIAS	TD12246829	RIO DOS BOIS	24/12/2019 06:10	27/12/2019 23:01	25/12/2019 13:59	26/12/2019 12:34	22,59	2	45,17	CHI
201912260872	TURVELANDIA	TD12246829	RIO DOS BOIS	24/12/2019 06:10	27/12/2019 23:01	25/12/2019 13:59	26/12/2019 12:34	22,59	16	361,38	CHI
201912260872	TURVELANDIA	TD12246829	RIO DOS BOIS	24/12/2019 06:10	27/12/2019 23:01	26/12/2019 13:48	26/12/2019 15:00	1,19	6	7,13	CHI
201912260872	SANTA HELENA DE GOIAS	EU12026832	RIO DOS BOIS	24/12/2019 06:10	27/12/2019 23:01	25/12/2019 13:59	26/12/2019 15:41	25,71	1	25,71	CHI
201912260872	TURVELANDIA	EU12026832	RIO DOS BOIS	24/12/2019 06:10	27/12/2019 23:01	25/12/2019 13:59	26/12/2019 15:41	25,71	5	128,54	CHI
201912260872	SANTA HELENA DE GOIAS	EU12026829	RIO DOS BOIS	24/12/2019 06:10	27/12/2019 23:01	26/12/2019 13:48	26/12/2019 15:41	1,88	2	3,76	CHI
201912260872	TURVELANDIA	EU12026829	RIO DOS BOIS	24/12/2019 06:10	27/12/2019 23:01	26/12/2019 13:48	26/12/2019 15:41	1,88	8	15,04	CHI
201912260872	SANTA HELENA DE GOIAS	TD12246741	RIO DOS BOIS	24/12/2019 06:10	27/12/2019 23:01	25/12/2019 13:59	27/12/2019 01:47	35,80	15	537,00	CHI
201912260872	TURVELANDIA	TD12246741	RIO DOS BOIS	24/12/2019 06:10	27/12/2019 23:01	25/12/2019 13:59	27/12/2019 01:47	35,80	4	143,20	CHI
201912260872	ACREUNA	TD12025737	RIO DOS BOIS	24/12/2019 06:10	27/12/2019 23:01	27/12/2019 16:00	27/12/2019 16:28	0,47	9	4,27	CHI
201912260872	SANTA HELENA DE GOIAS	TD12025737	RIO DOS BOIS	24/12/2019 06:10	27/12/2019 23:01	27/12/2019 16:00	27/12/2019 16:28	0,47	18	8,54	CHI
201912260872	TURVELANDIA	TD12025737	RIO DOS BOIS	24/12/2019 06:10	27/12/2019 23:01	27/12/2019 16:00	27/12/2019 16:28	0,47	49	23,25	CHI
201912260872	ACREUNA	EU12026747	RIO DOS BOIS	24/12/2019 06:10	27/12/2019 23:01	24/12/2019 06:10	27/12/2019 23:00	88,83	11	977,09	CHI
201912260872	TURVELANDIA	EU12026747	RIO DOS BOIS	24/12/2019 06:10	27/12/2019 23:01	24/12/2019 06:10	27/12/2019 23:00	88,83	15	1332,40	CHI
201912260872	ACREUNA	TD12303729	RIO DOS BOIS	24/12/2019 06:10	27/12/2019 23:01	26/12/2019 13:48	27/12/2019 23:01	33,21	4	132,82	CHI
201912260872	TURVELANDIA	TD12303729	RIO DOS BOIS	24/12/2019 06:10	27/12/2019 23:01	26/12/2019 13:48	27/12/2019 23:01	33,21	2	66,41	CHI
201912186285	PARAUNA	PU12301174	ACREUNA	24/12/2019 06:11	24/12/2019 16:33	24/12/2019 06:11	24/12/2019 16:33	10,36	13	134,63	CHI
201912186292	PORANGATU	PO21230368	PORANGATU	24/12/2019 06:12	24/12/2019 11:50	24/12/2019 06:12	24/12/2019 11:50	5,62	1	5,62	CHI
201912186298	SAO SIMAO	SO21000082	CACHOEIRA ALTA	24/12/2019 06:14	24/12/2019 10:16	24/12/2019 06:14	24/12/2019 10:16	4,03	1	4,03	CHI
201912186313	JANDAIA	JD12391449	PALMEIRAS	24/12/2019 06:17	24/12/2019 09:36	24/12/2019 06:17	24/12/2019 09:36	3,31	3	9,94	CHI
201912186403	ABADIANIA	AA12180462	DAIA S2	24/12/2019 06:17	24/12/2019 11:41	24/12/2019 06:17	24/12/2019 11:41	5,39	12	64,72	CHI
201912186320	BELA VISTA DE GOIAS	BV21117065	BELA VISTA S1	24/12/2019 06:18	24/12/2019 10:59	24/12/2019 06:18	24/12/2019 10:59	4,67	2	9,34	CHI

201912188188	GOIANIA	GN11041777	FERROVIARIO S1	24/12/2019 06:18	24/12/2019 11:58	24/12/2019 06:18	24/12/2019 11:58	5,66	36	203,60	CHI
201912186464	ITAPIRAPUA	NB12020254	JUSSARA	24/12/2019 06:19	24/12/2019 12:46	24/12/2019 06:19	24/12/2019 12:46	6,45	4	25,79	CHI
201912186464	NOVO BRASIL	NB12020254	JUSSARA	24/12/2019 06:19	24/12/2019 12:46	24/12/2019 06:19	24/12/2019 12:46	6,45	24	154,75	CHI
201912186325	ARAGARCAS	BM21251409	ARAGARCAS	24/12/2019 06:20	24/12/2019 16:28	24/12/2019 06:20	24/12/2019 16:28	10,13	1	10,13	CHI
201912186327	JATAI	JT12061503	JATAI S2	24/12/2019 06:20	24/12/2019 08:42	24/12/2019 06:20	24/12/2019 08:42	2,36	5	11,80	CHI
201912187537	BARRO ALTO	DF12194371	BARRO ALTO	24/12/2019 06:22	24/12/2019 11:41	24/12/2019 06:22	24/12/2019 11:41	5,30	67	355,12	CHI
201912187537	SANTA RITA DO NOVO DESTINO	DF12194371	BARRO ALTO	24/12/2019 06:22	24/12/2019 11:41	24/12/2019 06:22	24/12/2019 11:41	5,30	33	174,91	CHI
201912186337	JATAI	JT21155454	JATAI S1	24/12/2019 06:23	24/12/2019 17:04	24/12/2019 06:23	24/12/2019 17:04	10,70	2	21,39	CHI
201912186338	AGUAS LINDAS DE GOIAS	4830154598	AGUAS LINDAS DE GOIAS S2	24/12/2019 06:23	24/12/2019 10:20	24/12/2019 06:23	24/12/2019 10:20	3,94	1	3,94	CHI
201912186341	CAIAPONIA	CP12160847	PALESTINA	24/12/2019 06:23	24/12/2019 21:10	24/12/2019 06:23	24/12/2019 21:10	14,78	26	384,23	CHI
201912186349	FORMOSA	10019140574	ITIQUEIRA	24/12/2019 06:24	24/12/2019 12:03	24/12/2019 06:24	24/12/2019 12:03	5,64	1	5,64	CHI
201912186352	SILVANIA	SV21249983	DAIA S2	24/12/2019 06:24	24/12/2019 16:51	24/12/2019 06:24	24/12/2019 16:51	10,43	1	10,43	CHI
201912186355	URUTAI	UT21417471	PIRES DO RIO S2	24/12/2019 06:25	24/12/2019 08:44	24/12/2019 06:25	24/12/2019 08:44	2,31	0	0,00	CHI
201912186363	IPORA	IR12065120	IPORA	24/12/2019 06:26	24/12/2019 21:46	24/12/2019 06:26	24/12/2019 21:46	15,33	7	107,28	CHI
201912186624	CRISTIANOPOLIS	CF12112080	CRISTIANOPOLIS	24/12/2019 06:26	24/12/2019 08:23	24/12/2019 06:26	24/12/2019 08:23	1,94	17	32,95	CHI
201912186624	PIRACANJUBA	CF12112080	CRISTIANOPOLIS	24/12/2019 06:26	24/12/2019 08:23	24/12/2019 06:26	24/12/2019 08:23	1,94	58	112,41	CHI
201912187545	SILVANIA	VN12017544	VIANOPOLIS	24/12/2019 06:26	24/12/2019 11:23	24/12/2019 06:26	24/12/2019 11:23	4,94	114	563,10	CHI
201912187545	VIANOPOLIS	VN12017544	VIANOPOLIS	24/12/2019 06:26	24/12/2019 11:23	24/12/2019 06:26	24/12/2019 11:23	4,94	48	237,09	CHI
201912186366	PORANGATU	PO12079340	PORANGATU	24/12/2019 06:27	24/12/2019 10:28	24/12/2019 06:27	24/12/2019 10:28	4,02	6	24,10	CHI
201912186367	VARJAO	VJ21113934	GUAPO S2	24/12/2019 06:27	24/12/2019 11:06	24/12/2019 06:27	24/12/2019 11:06	4,65	1	4,65	CHI
201912186368	ITAPURANGA	IK12298363	ITAPURANGA	24/12/2019 06:27	24/12/2019 21:23	24/12/2019 06:27	24/12/2019 21:23	14,92	4	59,69	CHI
201912186369	JATAI	JT12184203	JATAI S2	24/12/2019 06:28	24/12/2019 11:27	24/12/2019 06:28	24/12/2019 11:27	4,98	1	4,98	CHI
201912186404	ITUMBIARA	IT12030720	BOM JESUS DE GOIAS	24/12/2019 06:29	24/12/2019 21:20	24/12/2019 06:29	24/12/2019 21:20	14,85	9	133,63	CHI
201912186413	GOIANIA	00590254	FERROVIARIO S1	24/12/2019 06:30	24/12/2019 09:14	24/12/2019 06:30	24/12/2019 06:34	0,08	544	44,58	CHI
201912186413	GOIANIA	00590254	FERROVIARIO S1	24/12/2019 06:30	24/12/2019 09:14	24/12/2019 06:30	24/12/2019 06:49	0,33	1382	456,06	CHI
201912186413	GOIANIA	GN16407273	FERROVIARIO S1	24/12/2019 06:30	24/12/2019 09:14	24/12/2019 06:36	24/12/2019 08:16	1,66	227	377,77	CHI
201912186413	GOIANIA	GN13000207	FERROVIARIO S1	24/12/2019 06:30	24/12/2019 09:14	24/12/2019 06:36	24/12/2019 09:14	2,63	317	833,62	CHI
201912186474	ABADIANIA	AA12050405	ANAPOLIS UNIVERSITARIO S1	24/12/2019 06:30	24/12/2019 09:11	24/12/2019 06:30	24/12/2019 09:11	2,67	15	40,09	CHI
201912187524	NIQUELANDIA	NQ11289994	NIQUELANDIA SUBTRANSMISSAO	24/12/2019 06:30	24/12/2019 11:40	24/12/2019 06:30	24/12/2019 11:40	5,15	24	123,67	CHI
201912196118	ACREUNA	EU12030223	ACREUNA	24/12/2019 06:30	25/12/2019 08:47	24/12/2019 06:30	25/12/2019 08:47	26,28	3	78,85	CHI
201912182766	CATALAO	00460406	IPAMERI	24/12/2019 06:31	24/12/2019 18:50	24/12/2019 06:31	24/12/2019 18:50	12,32	19	233,99	CHI
201912182766	IPAMERI	00460406	IPAMERI	24/12/2019 06:31	24/12/2019 18:50	24/12/2019 06:31	24/12/2019 18:50	12,32	41	504,93	CHI
201912186393	BONOPOLIS	BX12013030	SAO MIGUEL DO ARAGUAIA	24/12/2019 06:32	24/12/2019 16:20	24/12/2019 06:32	24/12/2019 16:20	9,79	5	48,96	CHI

201912186629	FORMOSA	FA12206251	ITUIQUIRA	24/12/2019 06:32	24/12/2019 10:34	24/12/2019 06:32	24/12/2019 10:34	4,02	10	40,24	CHI
201912188548	BOM JARDIM DE GOIAS	BM12349615	BOM JARDIM	24/12/2019 06:32	24/12/2019 19:51	24/12/2019 06:32	24/12/2019 19:51	13,31	16	212,96	CHI
201912186397	GOIANIA	17258558	MEIA PONTE	24/12/2019 06:33	24/12/2019 07:54	24/12/2019 06:33	24/12/2019 07:54	1,34	1	1,34	CHI
201912185354	ABADIANIA	00030414	DAIA S2	24/12/2019 06:34	24/12/2019 06:42	24/12/2019 06:38	24/12/2019 06:41	0,05	387	19,89	CHI
201912185354	ABADIANIA	00030414	DAIA S2	24/12/2019 06:34	24/12/2019 06:42	24/12/2019 06:38	24/12/2019 06:41	0,05	2	0,10	CHI
201912185354	ABADIANIA	00030414	DAIA S2	24/12/2019 06:34	24/12/2019 06:42	24/12/2019 06:38	24/12/2019 06:41	0,05	167	8,58	CHI
201912185354	ABADIANIA	00030414	DAIA S2	24/12/2019 06:34	24/12/2019 06:42	24/12/2019 06:38	24/12/2019 06:41	0,05	1	0,05	CHI
201912185354	BELA VISTA DE GOIAS	00030414	DAIA S2	24/12/2019 06:34	24/12/2019 06:42	24/12/2019 06:38	24/12/2019 06:41	0,05	1	0,05	CHI
201912185354	GAMELEIRA DE GOIAS	00030414	DAIA S2	24/12/2019 06:34	24/12/2019 06:42	24/12/2019 06:38	24/12/2019 06:41	0,05	857	44,04	CHI
201912185354	GAMELEIRA DE GOIAS	00030414	DAIA S2	24/12/2019 06:34	24/12/2019 06:42	24/12/2019 06:38	24/12/2019 06:41	0,05	158	8,12	CHI
201912185354	GAMELEIRA DE GOIAS	SV10401462	DAIA S2	24/12/2019 06:34	24/12/2019 06:42	24/12/2019 06:38	24/12/2019 06:41	0,05	218	11,20	CHI
201912185354	SILVANIA	00030414	DAIA S2	24/12/2019 06:34	24/12/2019 06:42	24/12/2019 06:38	24/12/2019 06:41	0,05	359	18,45	CHI
201912185354	ANAPOLIS	AN10384400	DAIA S2	24/12/2019 06:34	24/12/2019 06:42	24/12/2019 06:38	24/12/2019 06:42	0,07	2	0,14	CHI
201912185354	BELA VISTA DE GOIAS	00030414	DAIA S2	24/12/2019 06:34	24/12/2019 06:42	24/12/2019 06:38	24/12/2019 06:42	0,07	8	0,57	CHI
201912185354	CALDAZINHA	00030414	DAIA S2	24/12/2019 06:34	24/12/2019 06:42	24/12/2019 06:38	24/12/2019 06:42	0,07	1	0,07	CHI
201912185354	GAMELEIRA DE GOIAS	00030414	DAIA S2	24/12/2019 06:34	24/12/2019 06:42	24/12/2019 06:38	24/12/2019 06:42	0,07	26	1,85	CHI
201912185354	LEOPOLDO DE BULHOES	00030414	DAIA S2	24/12/2019 06:34	24/12/2019 06:42	24/12/2019 06:38	24/12/2019 06:42	0,07	1032	73,39	CHI
201912185354	LEOPOLDO DE BULHOES	00030414	DAIA S2	24/12/2019 06:34	24/12/2019 06:42	24/12/2019 06:38	24/12/2019 06:42	0,07	1846	131,27	CHI
201912185354	LEOPOLDO DE BULHOES	AN10384400	DAIA S2	24/12/2019 06:34	24/12/2019 06:42	24/12/2019 06:38	24/12/2019 06:42	0,07	21	1,49	CHI
201912185354	SILVANIA	00030414	DAIA S2	24/12/2019 06:34	24/12/2019 06:42	24/12/2019 06:38	24/12/2019 06:42	0,07	243	17,28	CHI
201912185354	SILVANIA	00030414	DAIA S2	24/12/2019 06:34	24/12/2019 06:42	24/12/2019 06:38	24/12/2019 06:42	0,07	216	15,36	CHI
201912185354	SILVANIA	AN10384400	DAIA S2	24/12/2019 06:34	24/12/2019 06:42	24/12/2019 06:38	24/12/2019 06:42	0,07	18	1,28	CHI
201912186420	PIRACANJUBA	PJ12083290	PIRACANJUBA	24/12/2019 06:34	24/12/2019 20:43	24/12/2019 06:34	24/12/2019 20:43	14,16	23	325,58	CHI
201912186447	CRISTALINA	03470474	CRISTALINA S2	24/12/2019 06:34	24/12/2019 19:15	24/12/2019 06:37	24/12/2019 06:41	0,07	2	0,14	CHI
201912186447	LUZIANIA	03470474	CRISTALINA S2	24/12/2019 06:34	24/12/2019 19:15	24/12/2019 06:37	24/12/2019 06:41	0,07	4	0,28	CHI
201912186447	CRISTALINA	03470474	CRISTALINA S2	24/12/2019 06:34	24/12/2019 19:15	24/12/2019 06:42	24/12/2019 08:39	1,96	1	1,96	CHI
201912186447	CRISTALINA	KR13313622	CRISTALINA S2	24/12/2019 06:34	24/12/2019 19:15	24/12/2019 06:42	24/12/2019 12:55	6,22	1	6,22	CHI
201912186447	LUZIANIA	LZ13313628	CRISTALINA S2	24/12/2019 06:34	24/12/2019 19:15	24/12/2019 06:42	24/12/2019 19:15	12,55	4	50,20	CHI
201912186401	ABADIA DE GOIAS	LG12385094	INDEPENDENCIA S2	24/12/2019 06:35	24/12/2019 13:19	24/12/2019 06:35	24/12/2019 13:19	6,73	79	532,00	CHI
201912186401	ARAGOIANIA	LG12385094	INDEPENDENCIA S2	24/12/2019 06:35	24/12/2019 13:19	24/12/2019 06:35	24/12/2019 13:19	6,73	4	26,94	CHI
201912186406	ANAPOLIS	AN11000166	JUNDIAI S2	24/12/2019 06:36	24/12/2019 08:53	24/12/2019 06:36	24/12/2019 08:53	2,28	127	288,96	CHI
201912186418	PLANALTINA	PI12099511	PLANALTINA	24/12/2019 06:37	24/12/2019 10:46	24/12/2019 06:37	24/12/2019 10:46	4,14	17	70,36	CHI
201912186502	BALIZA	BH12142110	BOM JARDIM	24/12/2019 06:37	24/12/2019 19:57	24/12/2019 06:37	24/12/2019 19:57	13,32	84	1118,83	CHI

201912187457	MAURILANDIA	ML12301060	RIO DOS BOIS	24/12/2019 06:37	24/12/2019 13:53	24/12/2019 06:37	24/12/2019 13:53	7,26	8	58,11	CHI
201912187457	SANTA HELENA DE GOIAS	ML12301060	RIO DOS BOIS	24/12/2019 06:37	24/12/2019 13:53	24/12/2019 06:37	24/12/2019 13:53	7,26	50	363,19	CHI
201912187457	TURVELANDIA	ML12301060	RIO DOS BOIS	24/12/2019 06:37	24/12/2019 13:53	24/12/2019 06:37	24/12/2019 13:53	7,26	17	123,49	CHI
201912189339	CAMPINACU	UC12237456	MARA ROSA	24/12/2019 06:38	24/12/2019 13:56	24/12/2019 06:38	24/12/2019 13:56	7,28	7	50,99	CHI
201912189339	URUACU	UC12237456	MARA ROSA	24/12/2019 06:38	24/12/2019 13:56	24/12/2019 06:38	24/12/2019 13:56	7,28	5	36,42	CHI
201912186426	SAO LUIS DE MONTES BELOS	SL12003840	SAO LUIZ DOS MONTES BELOS	24/12/2019 06:39	25/12/2019 07:30	24/12/2019 06:39	25/12/2019 07:30	24,84	1	24,84	CHI
201912186430	CACHOEIRA ALTA	CA12040332	CACHOEIRA ALTA	24/12/2019 06:40	24/12/2019 15:03	24/12/2019 06:40	24/12/2019 15:03	8,38	11	92,15	CHI
201912187368	JUSSARA	JR12396094	JUSSARA	24/12/2019 06:40	24/12/2019 09:38	24/12/2019 06:40	24/12/2019 09:38	2,96	25	73,94	CHI
201912187547	PORANGATU	PO12022073	PORANGATU	24/12/2019 06:41	26/12/2019 09:27	24/12/2019 06:41	24/12/2019 10:30	3,81	44	167,65	CHI
201912187547	PORANGATU	PO12022073	PORANGATU	24/12/2019 06:41	26/12/2019 09:27	24/12/2019 10:31	24/12/2019 16:28	5,96	26	155,01	CHI
201912187547	PORANGATU	PO13334436	PORANGATU	24/12/2019 06:41	26/12/2019 09:27	24/12/2019 10:31	25/12/2019 11:31	25,01	16	400,22	CHI
201912187547	PORANGATU	PO12022073	PORANGATU	24/12/2019 06:41	26/12/2019 09:27	25/12/2019 22:41	26/12/2019 03:06	4,42	43	189,87	CHI
201912187547	PORANGATU	PO21145209	PORANGATU	24/12/2019 06:41	26/12/2019 09:27	24/12/2019 10:31	26/12/2019 09:10	46,66	1	46,66	CHI
201912187547	PORANGATU	PO12292385	PORANGATU	24/12/2019 06:41	26/12/2019 09:27	24/12/2019 10:31	26/12/2019 09:27	46,93	1	46,93	CHI
201912202445	CATALAO	TH21127656	CATALAO S1	24/12/2019 06:41	25/12/2019 10:06	24/12/2019 06:41	25/12/2019 10:06	27,40	1	27,40	CHI
201912186442	TRINDADE	10028512594	MEIA PONTE	24/12/2019 06:42	24/12/2019 12:02	24/12/2019 06:42	24/12/2019 12:02	5,32	1	5,32	CHI
201912186449	IPORA	IR21354421	IPORA	24/12/2019 06:43	24/12/2019 10:40	24/12/2019 06:43	24/12/2019 10:40	3,94	1	3,94	CHI
201912186451	GOIANIA	14651683	CAMPINAS S2	24/12/2019 06:44	24/12/2019 08:19	24/12/2019 06:44	24/12/2019 08:19	1,58	1	1,58	CHI
201912186453	IACIARA	IA12302910	IACIARA S1	24/12/2019 06:44	24/12/2019 07:17	24/12/2019 06:44	24/12/2019 07:17	0,54	11	5,95	CHI
201912186454	ITUMBIARA	IT12257047	PARANAIBA	24/12/2019 06:44	24/12/2019 18:00	24/12/2019 06:44	24/12/2019 18:00	11,25	3	33,76	CHI
201912186456	CAMPO ALEGRE DE GOIAS	CM12266783	CAMPO ALEGRE DE GOIAS	24/12/2019 06:45	24/12/2019 12:04	24/12/2019 06:45	24/12/2019 12:04	5,32	7	37,21	CHI
201912186458	PILAR DE GOIAS	GG12318427	URUACU	24/12/2019 06:45	24/12/2019 11:22	24/12/2019 06:45	24/12/2019 11:22	4,61	10	46,13	CHI
201912186459	PORTEIRAO	CL12195968	RIO DOS BOIS	24/12/2019 06:45	25/12/2019 20:48	24/12/2019 06:45	25/12/2019 20:48	38,03	2	76,07	CHI
201912187481	ITAJA	IM12301779	CACHOEIRA ALTA	24/12/2019 06:45	24/12/2019 18:26	24/12/2019 06:45	24/12/2019 18:26	11,67	6	70,02	CHI
201912186471	MAIRIPOTABA	MI12166303	PONTALINA	24/12/2019 06:47	25/12/2019 16:59	24/12/2019 06:47	25/12/2019 16:59	34,19	1	34,19	CHI
201912186471	PONTALINA	MI12166303	PONTALINA	24/12/2019 06:47	25/12/2019 16:59	24/12/2019 06:47	25/12/2019 16:59	34,19	3	102,57	CHI
201912186472	CACHOEIRA ALTA	1090007313	CACHOEIRA ALTA	24/12/2019 06:47	24/12/2019 17:00	24/12/2019 06:47	24/12/2019 17:00	10,21	1	10,21	CHI
201912187471	FORMOSA	FA12364321	SAO JOAO D ALIANCA	24/12/2019 06:48	24/12/2019 16:48	24/12/2019 06:48	24/12/2019 16:48	9,99	9	89,94	CHI
201912186485	GOIANESIA	GE21185718	GOIANESIA S2	24/12/2019 06:49	24/12/2019 22:26	24/12/2019 06:49	24/12/2019 22:26	15,61	2	31,22	CHI
201912186486	NOVA AMERICA	NM21109080	RUBIATABA	24/12/2019 06:49	25/12/2019 11:10	24/12/2019 06:49	25/12/2019 11:10	28,34	1	28,34	CHI
201912186489	ARAGARCAS	AG12234261	ARAGARCAS	24/12/2019 06:49	24/12/2019 17:00	24/12/2019 06:49	24/12/2019 17:00	10,17	4	40,67	CHI
201912186490	JOVIANIA	JV21052910	GOIATUBA S1	24/12/2019 06:50	25/12/2019 08:11	24/12/2019 06:50	25/12/2019 08:11	25,35	2	50,70	CHI
201912186492	MONTIVIDIU	MV12267634	MONTIVIDIU T	24/12/2019 06:50	24/12/2019 23:10	24/12/2019 06:50	24/12/2019 23:10	16,33	17	277,57	CHI



201912188264	ITAPIRAPUA	IU12030155	JUSSARA	24/12/2019 06:50	24/12/2019 09:56	24/12/2019 06:50	24/12/2019 09:56	3,09	39	120,40	CHI
201912188264	NOVO BRASIL	IU12030155	JUSSARA	24/12/2019 06:50	24/12/2019 09:56	24/12/2019 06:50	24/12/2019 09:56	3,09	1	3,09	CHI
201912189311	APARECIDA DE GOIANIA	AP12079024	INDEPENDENCIA S1	24/12/2019 06:51	24/12/2019 13:20	24/12/2019 06:51	24/12/2019 13:20	6,48	83	537,86	CHI
201912186504	APARECIDA DE GOIANIA	200168319	INDEPENDENCIA S1	24/12/2019 06:52	24/12/2019 15:10	24/12/2019 06:52	24/12/2019 15:10	8,29	1	8,29	CHI
201912186508	FORMOSA	FA11254216	ITUIQUIRA	24/12/2019 06:54	24/12/2019 12:01	24/12/2019 06:54	24/12/2019 12:01	5,11	1	5,11	CHI
201912186520	NIQUELANDIA	NQ21141187	NIQUELANDIA SUBTRANSMISSAO	24/12/2019 06:55	24/12/2019 12:05	24/12/2019 06:55	24/12/2019 12:05	5,16	1	5,16	CHI
201912186523	BURITINOPOLIS	BQ12194634	IACIARA S2	24/12/2019 06:55	24/12/2019 08:40	24/12/2019 06:55	24/12/2019 08:40	1,74	50	86,86	CHI
201912186523	MAMBAI	BQ12194634	IACIARA S2	24/12/2019 06:55	24/12/2019 08:40	24/12/2019 06:55	24/12/2019 08:40	1,74	1	1,74	CHI
201912186528	JANDAIA	JD21008218	PALMEIRAS	24/12/2019 06:56	24/12/2019 11:17	24/12/2019 06:56	24/12/2019 11:17	4,33	2	8,67	CHI
201912187182	CAIAPONIA	CP12247462	IPORA	24/12/2019 06:57	25/12/2019 08:32	24/12/2019 06:57	25/12/2019 08:32	25,58	4	102,33	CHI
201912187189	GOIAS	GS12076722	GOIAS	24/12/2019 06:57	24/12/2019 10:25	24/12/2019 06:57	24/12/2019 10:25	3,47	14	48,52	CHI
201912189132	JUSSARA	JR12008743	BRITANIA	24/12/2019 06:57	24/12/2019 11:41	24/12/2019 06:57	24/12/2019 11:41	4,73	38	179,55	CHI
201912189503	CORUMBAIBA	CI12060033	CATALAO S1	24/12/2019 06:57	25/12/2019 09:17	24/12/2019 06:57	25/12/2019 09:17	26,32	14	368,52	CHI
201912189503	MORRINHOS	CI12060033	CATALAO S1	24/12/2019 06:57	25/12/2019 09:17	24/12/2019 06:57	25/12/2019 09:17	26,32	1	26,32	CHI
201912186544	ANAPOLIS	AN11319675	ANAPOLIS UNIVERSITARIO S2	24/12/2019 06:58	24/12/2019 18:35	24/12/2019 06:58	24/12/2019 18:35	11,60	79	916,49	CHI
201912187193	SERRANOPOLIS	SX12260467	JATAI S1	24/12/2019 06:58	24/12/2019 09:24	24/12/2019 06:58	24/12/2019 09:24	2,42	7	16,94	CHI
201912188158	FORMOSA	FA11131890	ITUIQUIRA	24/12/2019 06:58	24/12/2019 09:54	24/12/2019 06:58	24/12/2019 09:54	2,93	79	231,58	CHI
201912192644	AGUA LIMPA	AL12257036	VILA CORUMBA	24/12/2019 06:58	24/12/2019 16:21	24/12/2019 06:58	24/12/2019 16:21	9,38	47	440,95	CHI
201912192644	CORUMBAIBA	AL12257036	VILA CORUMBA	24/12/2019 06:58	24/12/2019 16:21	24/12/2019 06:58	24/12/2019 16:21	9,38	1	9,38	CHI
201912186549	PLANALTINA	PI12361252	PLANALTINA	24/12/2019 06:59	24/12/2019 12:05	24/12/2019 06:59	24/12/2019 12:05	5,10	32	163,06	CHI
201912187556	BURITI ALEGRE	BG12256778	ALTO BURITI	24/12/2019 06:59	24/12/2019 15:59	24/12/2019 06:59	24/12/2019 15:59	9,01	12	108,12	CHI
201912186648	BELA VISTA DE GOIAS	BV12000027	BELA VISTA S1	24/12/2019 07:00	24/12/2019 12:33	24/12/2019 07:00	24/12/2019 12:33	5,54	18	99,72	CHI
201912186554	ANICUNS	AC21123430	ANICUNS	24/12/2019 07:01	24/12/2019 14:07	24/12/2019 07:01	24/12/2019 14:07	7,10	1	7,10	CHI
201912186627	PARAUNA	PU12194221	ACREUNA	24/12/2019 07:01	24/12/2019 17:25	24/12/2019 07:01	24/12/2019 17:25	10,39	37	384,31	CHI
201912186641	RUBIATABA	RB12194366	RUBIATABA	24/12/2019 07:02	24/12/2019 14:14	24/12/2019 07:02	24/12/2019 14:14	7,19	8	57,53	CHI
201912187383	ABADIANIA	AA12261204	ANAPOLIS UNIVERSITARIO S1	24/12/2019 07:03	24/12/2019 10:25	24/12/2019 07:03	24/12/2019 10:25	3,35	22	73,75	CHI
201912191832	GOIATUBA	GT12052882	GOIATUBA S1	24/12/2019 07:03	26/12/2019 19:30	24/12/2019 07:03	24/12/2019 19:44	12,69	28	355,37	CHI
201912191832	GOIATUBA	GT13263766	GOIATUBA S1	24/12/2019 07:03	26/12/2019 19:30	24/12/2019 19:45	26/12/2019 19:30	47,76	3	143,28	CHI
201912186610	MIMOSO DE GOIAS	MJ12377213	PADRE BERNARDO	24/12/2019 07:04	24/12/2019 12:28	24/12/2019 07:04	24/12/2019 12:28	5,40	1	5,40	CHI
201912186614	JATAI	JT12226592	JATAI S1	24/12/2019 07:04	24/12/2019 10:25	24/12/2019 07:04	24/12/2019 10:25	3,34	7	23,37	CHI
201912186620	PLANALTINA	PI21257557	PLANALTINA	24/12/2019 07:05	24/12/2019 12:52	24/12/2019 07:05	24/12/2019 12:52	5,77	2	11,55	CHI
201912186621	MAIRIPOTABA	MI21060560	PONTALINA	24/12/2019 07:05	25/12/2019 10:18	24/12/2019 07:05	25/12/2019 10:18	27,20	1	27,20	CHI
201912187610	ARAGARCAS	BM12372332	BOM JARDIM	24/12/2019 07:05	24/12/2019 17:51	24/12/2019 07:05	24/12/2019 17:51	10,77	16	172,35	CHI

201912187610	BOM JARDIM DE GOIAS	BM12372332	BOM JARDIM	24/12/2019 07:05	24/12/2019 17:51	24/12/2019 07:05	24/12/2019 17:51	10,77	1	10,77	CHI
201912188167	SANTO ANTONIO DO DESCOBERTO	SN12078141	MARAJOARA	24/12/2019 07:05	24/12/2019 10:22	24/12/2019 07:05	24/12/2019 10:22	3,27	623	2039,29	CHI
201912186625	ITAPACI	IW12211865	RUBIATABA	24/12/2019 07:06	24/12/2019 13:44	24/12/2019 07:06	24/12/2019 13:44	6,63	10	66,30	CHI
201912186626	DIORAMA	DI12066071	ARENOPOLIS	24/12/2019 07:06	24/12/2019 11:24	24/12/2019 07:06	24/12/2019 11:24	4,29	28	120,26	CHI
201912187442	APARECIDA DE GOIANIA	AP11000021	INDEPENDENCIA S1	24/12/2019 07:07	24/12/2019 10:13	24/12/2019 07:07	24/12/2019 10:13	3,11	216	671,76	CHI
201912187494	GOIANAPOLIS	GP12285356	DAIA S2	24/12/2019 07:07	24/12/2019 11:41	24/12/2019 07:07	24/12/2019 11:41	4,57	8	36,53	CHI
201912186636	MARA ROSA	MQ12031345	MARA ROSA	24/12/2019 07:08	24/12/2019 14:56	24/12/2019 07:08	24/12/2019 14:56	7,79	5	38,95	CHI
201912189392	ANICUNS	AC12259088	ANICUNS	24/12/2019 07:08	24/12/2019 10:49	24/12/2019 07:08	24/12/2019 10:49	3,67	51	187,21	CHI
201912186643	PLANALTINA	PI12322780	SAO JOAO D ALIANCA	24/12/2019 07:09	24/12/2019 13:05	24/12/2019 07:09	24/12/2019 13:05	5,92	7	41,47	CHI
201912186655	SANTA HELENA DE GOIAS	SH12247775	SANTA HELENA S1	24/12/2019 07:11	25/12/2019 16:09	24/12/2019 07:11	25/12/2019 16:09	32,95	2	65,91	CHI
201912188922	SILVANIA	SV12317628	DAIA S2	24/12/2019 07:11	24/12/2019 11:22	24/12/2019 07:11	24/12/2019 11:22	4,17	72	300,26	CHI
201912186659	GOIANIA	GN11002011	AEROPORTO S3	24/12/2019 07:12	24/12/2019 11:03	24/12/2019 07:12	24/12/2019 11:03	3,84	90	345,33	CHI
201912187295	PALMEIRAS DE GOIAS	PL12061057	PALMEIRAS	24/12/2019 07:12	24/12/2019 16:09	24/12/2019 07:12	24/12/2019 16:09	8,94	4	35,74	CHI
201912186664	GAMELEIRA DE GOIAS	GL21331573	ANAPOLIS UNIVERSITARIO S2	24/12/2019 07:13	24/12/2019 09:47	24/12/2019 07:13	24/12/2019 09:47	2,57	1	2,57	CHI
201912186670	GOIANIA	10029463406	GOYA S1	24/12/2019 07:13	24/12/2019 10:01	24/12/2019 07:13	24/12/2019 10:01	2,80	1	2,80	CHI
201912186671	INHUMAS	IN21211012	INHUMAS S2	24/12/2019 07:13	24/12/2019 12:38	24/12/2019 07:13	24/12/2019 12:38	5,42	1	5,42	CHI
201912186674	LUZIANIA	120202256	RIO VERMELHO	24/12/2019 07:13	24/12/2019 07:51	24/12/2019 07:13	24/12/2019 07:51	0,64	1	0,64	CHI
201912186675	URUACU	UR21158463	MARA ROSA	24/12/2019 07:13	24/12/2019 16:52	24/12/2019 07:13	24/12/2019 16:52	9,65	1	9,65	CHI
201912186901	FIRMINOPOLIS	SL21043773	SAO LUIZ DOS MONTES BELOS	24/12/2019 07:13	24/12/2019 09:48	24/12/2019 07:13	24/12/2019 09:48	2,58	1	2,58	CHI
201912187105	APARECIDA DE GOIANIA	10005324538	INDEPENDENCIA S2	24/12/2019 07:13	24/12/2019 11:14	24/12/2019 07:13	24/12/2019 11:14	4,01	1	4,01	CHI
201912187122	BELA VISTA DE GOIAS	BV21357869	BELA VISTA S1	24/12/2019 07:13	24/12/2019 12:28	24/12/2019 07:13	24/12/2019 12:28	5,25	3	15,74	CHI
201912187137	APARECIDA DE GOIANIA	AP11054997	INDEPENDENCIA S2	24/12/2019 07:13	24/12/2019 10:43	24/12/2019 07:13	24/12/2019 10:43	3,49	193	674,48	CHI
201912187155	CRIXAS	CX21276695	SANTA TEREZINHA	24/12/2019 07:13	24/12/2019 11:49	24/12/2019 07:13	24/12/2019 11:49	4,59	2	9,18	CHI
201912187164	PIRACANJUBA	PJ21392645	PIRACANJUBA	24/12/2019 07:13	25/12/2019 19:11	24/12/2019 07:13	25/12/2019 19:11	35,96	2	71,92	CHI
201912187173	GOIANIA	14036034	CAMPINAS S1	24/12/2019 07:13	24/12/2019 08:07	24/12/2019 07:13	24/12/2019 08:07	0,89	1	0,89	CHI
201912187178	PETROLINA DE GOIAS	PG21281389	PETROLINA	24/12/2019 07:13	24/12/2019 08:42	24/12/2019 07:13	24/12/2019 08:42	1,47	1	1,47	CHI
201912187366	APARECIDA DE GOIANIA	AP11281938	INDEPENDENCIA S1	24/12/2019 07:13	24/12/2019 10:03	24/12/2019 07:13	24/12/2019 10:03	2,83	183	518,35	CHI
201912187415	APARECIDA DE GOIANIA	AP11254436	INDEPENDENCIA S2	24/12/2019 07:13	24/12/2019 08:34	24/12/2019 07:13	24/12/2019 08:34	1,35	123	165,81	CHI
201912187430	APARECIDA DE GOIANIA	AP11165711	INDEPENDENCIA S1	24/12/2019 07:13	24/12/2019 12:07	24/12/2019 07:13	24/12/2019 12:07	4,90	90	440,95	CHI
201912187509	APARECIDA DE GOIANIA	AP11137021	INDEPENDENCIA S1	24/12/2019 07:13	24/12/2019 13:54	24/12/2019 07:13	24/12/2019 13:54	6,69	64	428,28	CHI
201912187608	PIRES DO RIO	PR12337227	PIRES DO RIO S1	24/12/2019 07:13	24/12/2019 13:14	24/12/2019 07:13	24/12/2019 13:14	6,01	39	234,51	CHI
201912187608	SANTA CRUZ DE GOIAS	PR12337227	PIRES DO RIO S1	24/12/2019 07:13	24/12/2019 13:14	24/12/2019 07:13	24/12/2019 13:14	6,01	1	6,01	CHI
201912187608	URUTAI	PR12337227	PIRES DO RIO S1	24/12/2019 07:13	24/12/2019 13:14	24/12/2019 07:13	24/12/2019 13:14	6,01	1	6,01	CHI

201912188146	MUTUNOPOLIS	MU12086704	MARA ROSA	24/12/2019 07:13	24/12/2019 14:54	24/12/2019 07:13	24/12/2019 14:54	7,67	8	61,39	CHI
201912192516	CACHOEIRA ALTA	CA12053365	CACHOEIRA ALTA	24/12/2019 07:13	24/12/2019 16:26	24/12/2019 07:13	24/12/2019 16:26	9,20	8	73,61	CHI
201912202285	PALESTINA DE GOIAS	PY12121107	PALESTINA	24/12/2019 07:13	26/12/2019 11:20	24/12/2019 07:13	26/12/2019 00:51	41,64	33	1374,28	CHI
201912202285	CAIAPONIA	PY12244702	PALESTINA	24/12/2019 07:13	26/12/2019 11:20	24/12/2019 07:13	26/12/2019 11:20	52,12	49	2553,84	CHI
201912202285	PALESTINA DE GOIAS	PY12244702	PALESTINA	24/12/2019 07:13	26/12/2019 11:20	24/12/2019 07:13	26/12/2019 11:20	52,12	2	104,24	CHI
201912187187	GOIANIA	GN12217262LD	FERROVIARIO S1	24/12/2019 07:14	24/12/2019 10:52	24/12/2019 07:14	24/12/2019 10:52	3,63	2	7,25	CHI
201912187191	CORUMBAIBA	CI21098627	VILA CORUMBA	24/12/2019 07:14	25/12/2019 15:41	24/12/2019 07:14	25/12/2019 15:41	32,43	1	32,43	CHI
201912187199	SANCLERLANDIA	SC12299052	FIRMINOPOLIS S2	24/12/2019 07:15	24/12/2019 16:05	24/12/2019 07:15	24/12/2019 16:05	8,82	4	35,28	CHI
201912189110	CATALAO	CT12266191RE	CATALAO S1	24/12/2019 07:15	24/12/2019 12:52	24/12/2019 07:15	24/12/2019 12:52	5,61	29	162,81	CHI
201912195322	PIRACANJUBA	PJ12233807	ROCHEDO	24/12/2019 07:15	25/12/2019 16:42	24/12/2019 07:15	25/12/2019 16:42	33,43	8	267,48	CHI
201912187211	GOIANIA	12582797	GOIANIA LESTE S3	24/12/2019 07:16	24/12/2019 12:31	24/12/2019 07:16	24/12/2019 12:31	5,24	1	5,24	CHI
201912187215	SANTA CRUZ DE GOIAS	BC12332314LD	CRISTIANOPOLIS	24/12/2019 07:16	24/12/2019 11:50	24/12/2019 07:16	24/12/2019 11:50	4,57	1	4,57	CHI
201912187221	SANCLERLANDIA	SC21260007	FIRMINOPOLIS S2	24/12/2019 07:16	25/12/2019 06:59	24/12/2019 07:16	25/12/2019 06:59	23,71	1	23,71	CHI
201912187223	PIRES DO RIO	PR21083225	PIRES DO RIO S2	24/12/2019 07:16	24/12/2019 20:20	24/12/2019 07:16	24/12/2019 20:20	13,06	1	13,06	CHI
201912187235	INACIOLANDIA	CD21000114	CACHOEIRA DOURADA	24/12/2019 07:16	24/12/2019 12:15	24/12/2019 07:16	24/12/2019 12:15	4,97	1	4,97	CHI
201912187239	APARECIDA DE GOIANIA	13315511	INDEPENDENCIA S1	24/12/2019 07:16	24/12/2019 13:14	24/12/2019 07:16	24/12/2019 13:14	5,96	1	5,96	CHI
201912187243	APARECIDA DE GOIANIA	AP11137108	INDEPENDENCIA S1	24/12/2019 07:16	24/12/2019 09:30	24/12/2019 07:16	24/12/2019 09:30	2,23	268	598,91	CHI
201912187244	JATAI	10027189722	JATAI S3	24/12/2019 07:16	24/12/2019 09:20	24/12/2019 07:16	24/12/2019 09:20	2,07	1	2,07	CHI
201912187251	SANTA CRUZ DE GOIAS	BC21027145	CRISTIANOPOLIS	24/12/2019 07:16	24/12/2019 10:20	24/12/2019 07:16	24/12/2019 10:20	3,07	1	3,07	CHI
201912187268	MONTES CLAROS DE GOIAS	ME21317232	IPORA	24/12/2019 07:16	24/12/2019 12:46	24/12/2019 07:16	24/12/2019 12:46	5,49	1	5,49	CHI
201912188220	MONTES CLAROS DE GOIAS	ME12139989	IPORA	24/12/2019 07:16	24/12/2019 12:55	24/12/2019 07:16	24/12/2019 12:55	5,65	64	361,58	CHI
201912187277	CAIAPONIA	CP12395453	PALESTINA	24/12/2019 07:17	25/12/2019 17:11	24/12/2019 07:17	25/12/2019 17:11	33,90	6	203,41	CHI
201912187286	GOIANIA	15528844	AEROPORTO S1	24/12/2019 07:17	24/12/2019 09:31	24/12/2019 07:17	24/12/2019 09:31	2,23	1	2,23	CHI
201912187298	IPAMERI	580103316	IPAMERI	24/12/2019 07:17	24/12/2019 12:14	24/12/2019 07:17	24/12/2019 12:14	4,95	1	4,95	CHI
201912187300	CALDAS NOVAS	CN21186891	CALDAS NOVAS S1	24/12/2019 07:17	24/12/2019 11:30	24/12/2019 07:17	24/12/2019 11:30	4,21	1	4,21	CHI
201912187308	MORRINHOS	MR21044927	GOIATUBA S2	24/12/2019 07:17	25/12/2019 08:15	24/12/2019 07:17	25/12/2019 08:15	24,96	1	24,96	CHI
201912187323	TURVANIA	TV21186337	FIRMINOPOLIS S2	24/12/2019 07:17	25/12/2019 07:49	24/12/2019 07:17	25/12/2019 07:49	24,53	1	24,53	CHI
201912187351	INACIOLANDIA	CD21000087	CACHOEIRA DOURADA	24/12/2019 07:17	24/12/2019 11:26	24/12/2019 07:17	24/12/2019 11:26	4,14	1	4,14	CHI
201912187352	ANICUNS	AC31194173	ANICUNS	24/12/2019 07:17	24/12/2019 11:20	24/12/2019 07:17	24/12/2019 11:20	4,04	2	8,07	CHI
201912187378	GOIANIA	GN11131188	FERROVIARIO S1	24/12/2019 07:17	24/12/2019 10:10	24/12/2019 07:17	24/12/2019 10:10	2,88	100	288,17	CHI
201912187435	APARECIDA DE GOIANIA	AP11193236	ANHANGUERA	24/12/2019 07:17	24/12/2019 09:50	24/12/2019 07:17	24/12/2019 09:50	2,55	191	486,73	CHI
201912189926	LUZIANIA	LZ12000547	MARAJOARA	24/12/2019 07:17	24/12/2019 11:14	24/12/2019 07:17	24/12/2019 11:14	3,94	5	19,70	CHI
201912192545	CORUMBAIBA	CI12298710	VILA CORUMBA	24/12/2019 07:17	24/12/2019 16:31	24/12/2019 07:17	24/12/2019 16:31	9,23	14	129,24	CHI

201912192622	MATRINCHA	MP12221185	MATRINCHA	24/12/2019 07:17	24/12/2019 20:57	24/12/2019 07:17	24/12/2019 20:55	13,63	53	722,29	CHI
201912192622	MATRINCHA	MP11223818	MATRINCHA	24/12/2019 07:17	24/12/2019 20:57	24/12/2019 07:17	24/12/2019 20:57	13,66	3	40,98	CHI
201912185362	JATAI	JT21267583	JATAI S1	24/12/2019 07:18	24/12/2019 13:39	24/12/2019 07:18	24/12/2019 13:39	6,34	1	6,34	CHI
201912187372	BELA VISTA DE GOIAS	BV21092444	BELA VISTA S1	24/12/2019 07:18	24/12/2019 11:50	24/12/2019 07:18	24/12/2019 11:50	4,53	1	4,53	CHI
201912187375	BELA VISTA DE GOIAS	BV21380299	BELA VISTA S1	24/12/2019 07:18	24/12/2019 12:13	24/12/2019 07:18	24/12/2019 12:13	4,91	2	9,83	CHI
201912187387	PALMEIRAS DE GOIAS	PL11276820	PALMEIRAS	24/12/2019 07:18	24/12/2019 17:02	24/12/2019 07:18	24/12/2019 17:02	9,73	1	9,73	CHI
201912187394	CRIXAS	CX12239577	SANTA TEREZINHA	24/12/2019 07:18	24/12/2019 18:05	24/12/2019 07:18	24/12/2019 18:05	10,77	16	172,32	CHI
201912187397	CATALAO	TH21149273	CATALAO S1	24/12/2019 07:18	25/12/2019 09:32	24/12/2019 07:18	25/12/2019 09:32	26,22	1	26,22	CHI
201912188235	SILVANIA	SV12032728	DAIA S2	24/12/2019 07:18	24/12/2019 12:09	24/12/2019 07:18	24/12/2019 12:09	4,84	17	82,36	CHI
201912187404	GOIANIA	16380794	CAMPINAS S1	24/12/2019 07:19	24/12/2019 08:50	24/12/2019 07:19	24/12/2019 08:50	1,51	1	1,51	CHI
201912187406	MONTES CLAROS DE GOIAS	ME12038311	IPORA	24/12/2019 07:19	24/12/2019 23:48	24/12/2019 07:19	24/12/2019 23:48	16,47	9	148,22	CHI
201912187620	MONTES CLAROS DE GOIAS	ME12155653	IPORA	24/12/2019 07:19	25/12/2019 08:20	24/12/2019 07:19	25/12/2019 08:20	25,02	37	925,61	CHI
201912187636	APARECIDA DE GOIANIA	AP12043971	INDEPENDENCIA S2	24/12/2019 07:19	24/12/2019 09:58	24/12/2019 07:19	24/12/2019 09:58	2,64	244	645,11	CHI
201912185393	AMARALINA	LC21200486	SAO MIGUEL DO ARAGUAIA	24/12/2019 07:20	24/12/2019 10:57	24/12/2019 07:20	24/12/2019 10:57	3,61	2	7,22	CHI
201912187412	TAQUARAL DE GOIAS	TQ21343648	INHUMAS S1	24/12/2019 07:20	24/12/2019 13:29	24/12/2019 07:20	24/12/2019 13:29	6,15	1	6,15	CHI
201912187425	ANAPOLIS	20672032	DAIA S1	24/12/2019 07:20	24/12/2019 10:51	24/12/2019 07:20	24/12/2019 10:51	3,51	1	3,51	CHI
201912187426	COCALZINHO DE GOIAS	ZN21201262	COCALZINHO	24/12/2019 07:20	24/12/2019 18:01	24/12/2019 07:20	24/12/2019 18:01	10,68	1	10,68	CHI
201912187427	PALMEIRAS DE GOIAS	PL21366262	TRINDADE	24/12/2019 07:20	24/12/2019 16:11	24/12/2019 07:20	24/12/2019 16:11	8,84	1	8,84	CHI
201912188179	BURITI ALEGRE	BG12229309	ITUMBIARA VELHA S2	24/12/2019 07:20	24/12/2019 17:45	24/12/2019 07:20	24/12/2019 17:45	10,41	3	31,24	CHI
201912189101	ABADIANIA	AA12382362	CORUMBA	24/12/2019 07:20	24/12/2019 12:00	24/12/2019 07:20	24/12/2019 12:00	4,66	13	60,54	CHI
201912189791	PIRACANJUBA	PJ12082241	PIRACANJUBA	24/12/2019 07:20	24/12/2019 19:07	24/12/2019 07:20	24/12/2019 19:07	11,79	7	82,50	CHI
201912187450	PORANGATU	PO21104339	PORANGATU	24/12/2019 07:21	24/12/2019 16:25	24/12/2019 07:21	24/12/2019 16:25	9,07	1	9,07	CHI
201912187454	GOIATUBA	GT12388304	GOIATUBA S1	24/12/2019 07:21	25/12/2019 07:13	24/12/2019 07:21	25/12/2019 07:13	23,86	3	71,59	CHI
201912187460	TURVANIA	TV12005561	FIRMINOPOLIS S1	24/12/2019 07:21	24/12/2019 10:34	24/12/2019 07:21	24/12/2019 10:34	3,21	4	12,83	CHI
201912187656	CACHOEIRA ALTA	CA12191598	CACHOEIRA ALTA	24/12/2019 07:21	24/12/2019 16:13	24/12/2019 07:21	24/12/2019 16:13	8,87	28	248,25	CHI
201912187656	CACU	CA12191598	CACHOEIRA ALTA	24/12/2019 07:21	24/12/2019 16:13	24/12/2019 07:21	24/12/2019 16:13	8,87	5	44,33	CHI
201912193525	MINACU	10022750965	MINACU	24/12/2019 07:22	25/12/2019 00:07	24/12/2019 07:22	25/12/2019 00:07	16,74	1	16,74	CHI
201912187468	RIO VERDE	RV12147889	RIO VERDE S1	24/12/2019 07:23	24/12/2019 13:30	24/12/2019 07:23	24/12/2019 13:30	6,11	2	12,22	CHI
201912187469	SAO LUIS DE MONTES BELOS	SL21146026	SAO LUIZ DOS MONTES BELOS	24/12/2019 07:23	24/12/2019 10:50	24/12/2019 07:23	24/12/2019 10:50	3,44	1	3,44	CHI
201912187470	TURVANIA	TV21331648	FIRMINOPOLIS S2	24/12/2019 07:23	25/12/2019 07:24	24/12/2019 07:23	25/12/2019 07:24	24,01	2	48,02	CHI
201912187472	ITAUCU	IX21000065	INHUMAS S1	24/12/2019 07:23	24/12/2019 11:53	24/12/2019 07:23	24/12/2019 11:53	4,49	2	8,98	CHI
201912187476	SAO MIGUEL DO ARAGUAIA	SM12309562	SAO MIGUEL DO ARAGUAIA	24/12/2019 07:24	24/12/2019 13:37	24/12/2019 07:24	24/12/2019 13:37	6,21	2	12,42	CHI
201912187486	SAO LUIS DE MONTES BELOS	SL12388875	SAO LUIZ DOS MONTES BELOS	24/12/2019 07:25	24/12/2019 21:26	24/12/2019 07:25	24/12/2019 21:26	14,01	6	84,04	CHI

201912187723	GAMELEIRA DE GOIAS	SV12056396	DAIA S2	24/12/2019 07:25	24/12/2019 09:48	24/12/2019 07:25	24/12/2019 09:48	2,37	104	246,97	CHI
201912187723	SILVANIA	SV12056396	DAIA S2	24/12/2019 07:25	24/12/2019 09:48	24/12/2019 07:25	24/12/2019 09:48	2,37	1	2,37	CHI
201912195649	RIO VERDE	SH12296215	IPEGUARI	24/12/2019 07:25	25/12/2019 09:26	24/12/2019 07:25	25/12/2019 09:26	26,00	3	78,00	CHI
201912195649	SANTA HELENA DE GOIAS	SH12296215	IPEGUARI	24/12/2019 07:25	25/12/2019 09:26	24/12/2019 07:25	25/12/2019 09:26	26,00	38	988,03	CHI
201912193949	BALIZA	BH12204858	BOM JARDIM	24/12/2019 07:26	24/12/2019 20:21	24/12/2019 07:26	24/12/2019 20:21	12,91	6	77,44	CHI
201912187498	BOM JESUS DE GOIAS	IT12352670	CACHOEIRA DOURADA	24/12/2019 07:27	25/12/2019 07:44	24/12/2019 07:27	25/12/2019 07:44	24,28	2	48,55	CHI
201912187498	ITUMBIARA	IT12352670	CACHOEIRA DOURADA	24/12/2019 07:27	25/12/2019 07:44	24/12/2019 07:27	25/12/2019 07:44	24,28	5	121,38	CHI
201912188562	LUZIANIA	LZ12315949	CRISTALINA S2	24/12/2019 07:27	24/12/2019 09:58	24/12/2019 07:27	24/12/2019 09:58	2,50	6	15,00	CHI
201912193201	GAMELEIRA DE GOIAS	SV12027617	DAIA S2	24/12/2019 07:27	24/12/2019 19:44	24/12/2019 07:27	24/12/2019 19:44	12,27	22	269,95	CHI
201912188446	QUIRINOPOLIS	RV12301218	SANTA HELENA S1	24/12/2019 07:28	24/12/2019 11:40	24/12/2019 07:28	24/12/2019 11:40	4,21	37	155,73	CHI
201912188446	RIO VERDE	RV12301218	SANTA HELENA S1	24/12/2019 07:28	24/12/2019 11:40	24/12/2019 07:28	24/12/2019 11:40	4,21	18	75,76	CHI
201912187514	LEOPOLDO DE BULHOES	LB12384849	DAIA S2	24/12/2019 07:29	26/12/2019 14:55	24/12/2019 07:29	26/12/2019 14:55	55,42	3	166,27	CHI
201912188183	INDIARA	IY12010924	PALMEIRAS	24/12/2019 07:29	24/12/2019 13:00	24/12/2019 07:29	24/12/2019 13:00	5,51	14	77,13	CHI
201912188183	JANDAIA	IY12010924	PALMEIRAS	24/12/2019 07:29	24/12/2019 13:00	24/12/2019 07:29	24/12/2019 13:00	5,51	1	5,51	CHI
201912187520	RIO VERDE	RV12000254	RIO VERDE S1	24/12/2019 07:30	25/12/2019 10:37	24/12/2019 07:30	25/12/2019 10:37	27,11	9	243,97	CHI
201912187522	RIO VERDE	630323604	CABRIUVA S1	24/12/2019 07:31	24/12/2019 16:56	24/12/2019 07:31	24/12/2019 16:56	9,42	1	9,42	CHI
201912187528	AMARALINA	LC12308828	MARA ROSA	24/12/2019 07:31	24/12/2019 13:44	24/12/2019 07:31	24/12/2019 13:44	6,21	2	12,41	CHI
201912187528	MARA ROSA	LC12308828	MARA ROSA	24/12/2019 07:31	24/12/2019 13:44	24/12/2019 07:31	24/12/2019 13:44	6,21	1	6,21	CHI
201912187750	ANAPOLIS	AN12009341	NEROPOLIS S1	24/12/2019 07:31	24/12/2019 18:26	24/12/2019 07:31	24/12/2019 18:26	10,91	8	87,31	CHI
201912187750	PIRENOPOLIS	AN12009341	NEROPOLIS S1	24/12/2019 07:31	24/12/2019 18:26	24/12/2019 07:31	24/12/2019 18:26	10,91	18	196,45	CHI
201912187532	AMORINOPOLIS	AM21104125	IPORA	24/12/2019 07:32	24/12/2019 09:53	24/12/2019 07:32	24/12/2019 09:53	2,34	1	2,34	CHI
201912188294	DAVINOPOLIS	IO12281488	CATALAO S1	24/12/2019 07:32	25/12/2019 12:32	24/12/2019 07:32	25/12/2019 12:32	29,01	2	58,01	CHI
201912188294	OUVIDOR	IO12281488	CATALAO S1	24/12/2019 07:32	25/12/2019 12:32	24/12/2019 07:32	25/12/2019 12:32	29,01	3	87,02	CHI
201912189493	DIVINOPOLIS DE GOIAS	GH12211210	SAO DOMINGOS	24/12/2019 07:32	24/12/2019 12:29	24/12/2019 07:32	24/12/2019 12:29	4,94	18	88,96	CHI
201912187538	TRINDADE	TR11180018	TRINDADE	24/12/2019 07:33	24/12/2019 09:58	24/12/2019 07:33	24/12/2019 09:58	2,41	79	190,57	CHI
201912187539	GOIATUBA	JV12222364	GOIATUBA S1	24/12/2019 07:33	25/12/2019 12:10	24/12/2019 07:33	25/12/2019 12:10	28,61	2	57,22	CHI
201912187540	RIO VERDE	RV21049043	RIO VERDE S2	24/12/2019 07:33	24/12/2019 11:13	24/12/2019 07:33	24/12/2019 11:13	3,67	1	3,67	CHI
201912187541	PADRE BERNARDO	PB12375242	PADRE BERNARDO	24/12/2019 07:33	24/12/2019 15:49	24/12/2019 07:33	24/12/2019 15:49	8,26	25	206,45	CHI
201912187543	MATRINCHA	MP12206785LD	MATRINCHA	24/12/2019 07:33	24/12/2019 12:53	24/12/2019 07:33	24/12/2019 12:53	5,32	61	324,62	CHI
201912192584	VIANOPOLIS	VN11346102	VIANOPOLIS	24/12/2019 07:33	24/12/2019 14:31	24/12/2019 07:33	24/12/2019 14:31	6,97	21	146,28	CHI
201912187549	CAMPINORTE	UR12231322	MARA ROSA	24/12/2019 07:34	24/12/2019 12:39	24/12/2019 07:34	24/12/2019 12:39	5,08	4	20,32	CHI
201912187558	ITUMBIARA	CD21222294	CACHOEIRA DOURADA	24/12/2019 07:34	25/12/2019 10:39	24/12/2019 07:34	25/12/2019 10:39	27,07	1	27,07	CHI
201912188194	BARRO ALTO	GE12255886	GOIANESIA S1	24/12/2019 07:34	25/12/2019 11:06	24/12/2019 07:34	25/12/2019 11:06	27,53	1	27,53	CHI

201912188194	GOIANESIA	GE12255886	GOIANESIA S1	24/12/2019 07:34	25/12/2019 11:06	24/12/2019 07:34	25/12/2019 11:06	27,53	4	110,10	CHI
201912188400	MORRINHOS	MR12000135RE	GOIATUBA S1	24/12/2019 07:34	24/12/2019 13:55	24/12/2019 07:34	24/12/2019 13:55	6,35	132	838,09	CHI
201912187572	IPAMERI	IP12319009	URUTAI	24/12/2019 07:35	24/12/2019 11:50	24/12/2019 07:35	24/12/2019 11:50	4,24	7	29,66	CHI
201912187573	ITAPACI	IW21171158	ITAPACI	24/12/2019 07:35	24/12/2019 16:01	24/12/2019 07:35	24/12/2019 16:01	8,43	1	8,43	CHI
201912188460	LAGOA SANTA	IJ12200621	ITAJA S2	24/12/2019 07:35	24/12/2019 19:06	24/12/2019 07:35	24/12/2019 19:06	11,52	9	103,64	CHI
201912188570	VILA PROPICIO	NP12249481	BARRO ALTO	24/12/2019 07:35	24/12/2019 15:48	24/12/2019 07:35	24/12/2019 15:48	8,22	3	24,65	CHI
201912192559	PONTALINA	PK12063358	PONTALINA	24/12/2019 07:35	25/12/2019 11:38	24/12/2019 07:35	25/12/2019 11:38	28,04	6	168,24	CHI
201912193190	CORUMBAIBA	CI12062859	VILA CORUMBA	24/12/2019 07:35	25/12/2019 11:51	24/12/2019 07:35	25/12/2019 11:51	28,25	20	565,02	CHI
201912187582	VARJAO	VJ21363535	GUAPO S2	24/12/2019 07:36	24/12/2019 17:02	24/12/2019 07:36	24/12/2019 17:02	9,44	1	9,44	CHI
201912187584	NIQUELANDIA	NQ21233553	BARRO ALTO	24/12/2019 07:36	24/12/2019 09:31	24/12/2019 07:36	24/12/2019 09:31	1,92	1	1,92	CHI
201912187585	GOIANIA	10011189086	TRINDADE	24/12/2019 07:36	24/12/2019 15:32	24/12/2019 07:36	24/12/2019 15:32	7,93	1	7,93	CHI
201912187598	TURVELANDIA	TD21303641	RIO DOS BOIS	24/12/2019 07:37	24/12/2019 17:17	24/12/2019 07:37	24/12/2019 17:17	9,65	1	9,65	CHI
201912187601	CAMPO ALEGRE DE GOIAS	CM21042352	CAMPO ALEGRE DE GOIAS	24/12/2019 07:38	24/12/2019 18:57	24/12/2019 07:38	24/12/2019 18:57	11,31	1	11,31	CHI
201912187603	BONOPOLIS	BX21189509	NOVO PLANALTO	24/12/2019 07:38	25/12/2019 09:59	24/12/2019 07:38	25/12/2019 09:59	26,34	1	26,34	CHI
201912187612	GUAPO	GA21327581	GUAPO S2	24/12/2019 07:39	24/12/2019 14:45	24/12/2019 07:39	24/12/2019 14:45	7,10	2	14,19	CHI
201912187616	MOSSAMEDES	MD21299601	ITABERAI S2	24/12/2019 07:39	24/12/2019 17:48	24/12/2019 07:39	24/12/2019 17:48	10,14	1	10,14	CHI
201912190408	GOIATUBA	GT32048521	GOIATUBA S2	24/12/2019 07:39	24/12/2019 20:30	24/12/2019 07:39	24/12/2019 20:30	12,84	8	102,71	CHI
201912195586	SANCLERLANDIA	SC21005427	FIRMINOPOLIS S2	24/12/2019 07:39	25/12/2019 07:08	24/12/2019 07:39	25/12/2019 07:08	23,47	1	23,47	CHI
201912187624	ARAGARCAS	10004581006	ARAGARCAS	24/12/2019 07:40	24/12/2019 13:54	24/12/2019 07:40	24/12/2019 13:54	6,22	1	6,22	CHI
201912187627	APARECIDA DE GOIANIA	200435073	INDEPENDENCIA S2	24/12/2019 07:41	24/12/2019 10:41	24/12/2019 07:41	24/12/2019 10:41	3,00	1	3,00	CHI
201912187635	PIRANHAS	PH12023593	PIRANHAS	24/12/2019 07:42	25/12/2019 06:42	24/12/2019 07:42	25/12/2019 06:42	22,99	25	574,87	CHI
201912187637	BALIZA	BH12207583	BOM JARDIM	24/12/2019 07:42	25/12/2019 10:11	24/12/2019 07:42	25/12/2019 10:11	26,48	11	291,25	CHI
201912187648	VICENTINOPOLIS	VI12000156	VICENTINOPOLIS	24/12/2019 07:43	25/12/2019 08:57	24/12/2019 07:43	25/12/2019 08:57	25,23	1	25,23	CHI
201912187651	AGUA LIMPA	AL12000251	VILA CORUMBA	24/12/2019 07:43	25/12/2019 10:34	24/12/2019 07:43	25/12/2019 10:34	26,84	51	1368,85	CHI
201912187651	BURITI ALEGRE	AL12000251	VILA CORUMBA	24/12/2019 07:43	25/12/2019 10:34	24/12/2019 07:43	25/12/2019 10:34	26,84	3	80,52	CHI
201912187651	MORRINHOS	AL12000251	VILA CORUMBA	24/12/2019 07:43	25/12/2019 10:34	24/12/2019 07:43	25/12/2019 10:34	26,84	2	53,68	CHI
201912187658	CRISTALINA	KR12183725	CRISTALINA S2	24/12/2019 07:43	24/12/2019 16:23	24/12/2019 07:43	24/12/2019 16:23	8,65	1	8,65	CHI
201912189455	MINACU	IH12377674	MINACU	24/12/2019 07:43	24/12/2019 20:17	24/12/2019 07:43	24/12/2019 20:17	12,56	18	226,05	CHI
201912187660	ARAGUAPAZ	AZ12404519	MOZARLANDIA	24/12/2019 07:44	25/12/2019 10:07	24/12/2019 07:44	25/12/2019 10:07	26,37	8	210,97	CHI
201912187663	BOM JARDIM DE GOIAS	BM12074235	PIRANHAS	24/12/2019 07:44	25/12/2019 12:30	24/12/2019 07:44	25/12/2019 12:30	28,75	12	345,05	CHI
201912188914	GOIAS	GS12198785	GOIAS	24/12/2019 07:44	24/12/2019 17:40	24/12/2019 07:44	24/12/2019 17:40	9,92	8	79,36	CHI
201912188914	GUARAITA	GS12198785	GOIAS	24/12/2019 07:44	24/12/2019 17:40	24/12/2019 07:44	24/12/2019 17:40	9,92	2	19,84	CHI
201912188914	ITAPURANGA	GS12198785	GOIAS	24/12/2019 07:44	24/12/2019 17:40	24/12/2019 07:44	24/12/2019 17:40	9,92	2	19,84	CHI

201912192602	ITARUMA	IM12096941	CACHOEIRA ALTA	24/12/2019 07:44	24/12/2019 20:06	24/12/2019 07:44	24/12/2019 20:06	12,36	2	24,72	CHI
201912187669	GOIANIA	10007520695	INDEPENDENCIA S2	24/12/2019 07:45	24/12/2019 09:36	24/12/2019 07:45	24/12/2019 09:36	1,85	1	1,85	CHI
201912187671	JOVIANIA	VI12218238	VICENTINOPOLIS	24/12/2019 07:45	25/12/2019 22:45	24/12/2019 07:45	25/12/2019 22:45	38,99	1	38,99	CHI
201912187671	VICENTINOPOLIS	VI12218238	VICENTINOPOLIS	24/12/2019 07:45	25/12/2019 22:45	24/12/2019 07:45	25/12/2019 22:45	38,99	17	662,87	CHI
201912188365	CACU	CA12196122	CACHOEIRA ALTA	24/12/2019 07:45	24/12/2019 17:30	24/12/2019 07:45	24/12/2019 17:30	9,74	39	379,77	CHI
201912192672	CRISTALINA	KR12313666	CRISTALINA S2	24/12/2019 07:45	24/12/2019 13:14	24/12/2019 07:45	24/12/2019 13:14	5,47	6	32,85	CHI
201912192967	MORRINHOS	MR12254377	MORRINHOS	24/12/2019 07:45	24/12/2019 18:47	24/12/2019 07:45	24/12/2019 18:47	11,02	3	33,06	CHI
201912187704	BOM JESUS DE GOIAS	BJ12000040	BOM JESUS DE GOIAS	24/12/2019 07:46	24/12/2019 18:12	24/12/2019 07:46	24/12/2019 18:12	10,44	4	41,76	CHI
201912187719	APARECIDA DE GOIANIA	AP11391479	INDEPENDENCIA S1	24/12/2019 07:48	24/12/2019 10:40	24/12/2019 07:48	24/12/2019 10:40	2,86	12	34,35	CHI
201912187720	MONTES CLAROS DE GOIAS	ME21086430	IPORA	24/12/2019 07:48	25/12/2019 00:36	24/12/2019 07:48	25/12/2019 00:36	16,79	1	16,79	CHI
201912187726	VALPARAISO DE GOIAS	VA11163844	MARAJOARA	24/12/2019 07:48	24/12/2019 12:39	24/12/2019 07:48	24/12/2019 12:39	4,84	131	634,26	CHI
201912187727	ORIZONA	OZ12114508	PIRES DO RIO S2	24/12/2019 07:49	24/12/2019 10:16	24/12/2019 07:49	24/12/2019 10:16	2,45	11	26,95	CHI
201912187739	GOIANIA	GN12051055	CAMPINAS S2	24/12/2019 07:49	24/12/2019 09:43	24/12/2019 07:49	24/12/2019 09:43	1,89	93	175,80	CHI
201912190427	LUZIANIA	OZ12402562RE	PIRES DO RIO S2	24/12/2019 07:49	24/12/2019 12:51	24/12/2019 07:49	24/12/2019 12:51	5,03	122	613,19	CHI
201912190427	ORIZONA	OZ12402562RE	PIRES DO RIO S2	24/12/2019 07:49	24/12/2019 12:51	24/12/2019 07:49	24/12/2019 12:51	5,03	7	35,18	CHI
201912187746	APARECIDA DE GOIANIA	10000036500	ANHANGUERA	24/12/2019 07:50	24/12/2019 10:35	24/12/2019 07:50	24/12/2019 10:35	2,75	1	2,75	CHI
201912187747	PALMEIRAS DE GOIAS	PL21000228	PALMEIRAS	24/12/2019 07:50	24/12/2019 17:33	24/12/2019 07:50	24/12/2019 17:33	9,72	1	9,72	CHI
201912187748	ARAGUAPAZ	AZ12193702	GOIAS	24/12/2019 07:50	25/12/2019 15:32	24/12/2019 07:50	25/12/2019 15:32	31,70	2	63,39	CHI
201912188102	AGUA LIMPA	AL21292929	VILA CORUMBA	24/12/2019 07:50	24/12/2019 17:15	24/12/2019 07:50	24/12/2019 17:15	9,40	1	9,40	CHI
201912188103	QUIRINOPOLIS	QI21255785	QUIRINOPOLIS	24/12/2019 07:50	24/12/2019 23:20	24/12/2019 07:50	24/12/2019 23:20	15,48	1	15,48	CHI
201912188107	RIO VERDE	RV21260264	RIO VERDE S1	24/12/2019 07:51	24/12/2019 11:10	24/12/2019 07:51	24/12/2019 11:10	3,31	1	3,31	CHI
201912201855	PETROLINA DE GOIAS	220082753	NEROPOLIS S1	24/12/2019 07:51	25/12/2019 13:10	24/12/2019 07:51	25/12/2019 13:10	29,32	1	29,32	CHI
201912188125	TRINDADE	40247570	GOYA S1	24/12/2019 07:52	24/12/2019 12:58	24/12/2019 07:52	24/12/2019 12:58	5,08	1	5,08	CHI
201912188159	FORMOSA	FA12269989	ITUIQUIRA	24/12/2019 07:52	24/12/2019 10:23	24/12/2019 07:52	24/12/2019 10:23	2,51	13	32,60	CHI
201912188126	SAO JOAO D ALIANCA	JL12404385	SAO JOAO D ALIANCA	24/12/2019 07:53	24/12/2019 13:04	24/12/2019 07:53	24/12/2019 13:04	5,18	56	289,94	CHI
201912188129	ITAJA	IJ21110370	ITAJA S2	24/12/2019 07:53	24/12/2019 17:11	24/12/2019 07:53	24/12/2019 17:11	9,29	1	9,29	CHI
201912188135	GUAPO	GA21052083	TRINDADE	24/12/2019 07:54	25/12/2019 04:24	24/12/2019 07:54	25/12/2019 04:24	20,49	2	40,98	CHI
201912188136	CACHOEIRA DOURADA	CD12222525	CACHOEIRA DOURADA	24/12/2019 07:54	24/12/2019 19:14	24/12/2019 07:54	24/12/2019 19:14	11,32	1	11,32	CHI
201912188137	PARANAIGUARA	PC12370045	CACHOEIRA ALTA	24/12/2019 07:54	24/12/2019 19:24	24/12/2019 07:54	24/12/2019 19:24	11,49	5	57,44	CHI
201912188140	ITUMBIARA	IT12273841	PARANAIBA	24/12/2019 07:54	25/12/2019 09:00	24/12/2019 07:54	25/12/2019 09:00	25,08	3	75,25	CHI
201912188141	GOIANIRA	10026902417	MEIA PONTE	24/12/2019 07:55	24/12/2019 11:30	24/12/2019 07:55	24/12/2019 11:30	3,58	1	3,58	CHI
201912188152	JATAI	JT12267525	JATAI S2	24/12/2019 07:55	24/12/2019 11:00	24/12/2019 07:55	24/12/2019 11:00	3,07	6	18,41	CHI
201912188942	CORUMBA DE GOIAS	CB12377443	CORUMBA	24/12/2019 07:55	24/12/2019 11:25	24/12/2019 07:55	24/12/2019 11:25	3,50	10	34,95	CHI

201912188161	BURITI ALEGRE	BG21000172	ITUMBIARA VELHA S2	24/12/2019 07:56	24/12/2019 17:45	24/12/2019 07:56	24/12/2019 17:45	9,81	1	9,81	CHI
201912188165	APARECIDA DE GOIANIA	10015471649	ANHANGUERA	24/12/2019 07:57	24/12/2019 09:46	24/12/2019 07:57	24/12/2019 09:46	1,82	1	1,82	CHI
201912188166	PARAUNA	PU12388915	PARAUNA	24/12/2019 07:57	24/12/2019 21:16	24/12/2019 07:57	24/12/2019 21:16	13,31	3	39,94	CHI
201912188168	ANAPOLIS	21284726	ANAPOLIS UNIVERSITARIO S2	24/12/2019 07:57	24/12/2019 09:16	24/12/2019 07:57	24/12/2019 09:16	1,31	1	1,31	CHI
201912188174	FAINA	GS12030249	GOIAS	24/12/2019 07:58	26/12/2019 08:02	24/12/2019 07:58	26/12/2019 08:02	48,07	5	240,34	CHI
201912188231	GUAPO	GA12008568	GUAPO S2	24/12/2019 07:58	24/12/2019 10:36	24/12/2019 07:58	24/12/2019 10:36	2,62	60	157,28	CHI
201912192978	PLANALTINA	PI21109497	PLANALTINA	24/12/2019 07:58	24/12/2019 13:56	24/12/2019 07:58	24/12/2019 13:56	5,95	1	5,95	CHI
201912188185	GOIANIA	12182205	XAVANTES	24/12/2019 07:59	24/12/2019 11:26	24/12/2019 07:59	24/12/2019 11:26	3,45	1	3,45	CHI
201912188189	APORE	AE21191631	ITAJA S1	24/12/2019 07:59	24/12/2019 17:41	24/12/2019 07:59	24/12/2019 17:41	9,69	1	9,69	CHI
201912188190	MOIPIORA	MO32259058	SAO LUIZ DOS MONTES BELOS	24/12/2019 07:59	24/12/2019 13:58	24/12/2019 07:59	24/12/2019 13:58	5,97	5	29,87	CHI
201912188191	CACU	CC21017493	CACHOEIRA ALTA	24/12/2019 07:59	25/12/2019 08:39	24/12/2019 07:59	25/12/2019 08:39	24,65	1	24,65	CHI
201912188391	AMERICANO DO BRASIL	KB12000059	ANICUNS	24/12/2019 08:00	24/12/2019 11:18	24/12/2019 08:00	24/12/2019 11:18	3,30	2	6,60	CHI
201912195363	PLANALTINA	PI12214338	PLANALTINA	24/12/2019 08:01	24/12/2019 20:45	24/12/2019 08:01	24/12/2019 20:45	12,73	12	152,75	CHI
201912188216	PROFESSOR JAMIL SAFADY	JS21392641	ROCHEDO	24/12/2019 08:02	25/12/2019 10:12	24/12/2019 08:02	25/12/2019 10:12	26,15	1	26,15	CHI
201912188243	BELA VISTA DE GOIAS	BV32051409	BELA VISTA S2	24/12/2019 08:02	24/12/2019 11:10	24/12/2019 08:02	24/12/2019 11:10	3,13	293	916,19	CHI
201912188223	ITUMBIARA	IT21273956	CACHOEIRA DOURADA	24/12/2019 08:03	25/12/2019 09:24	24/12/2019 08:03	25/12/2019 09:24	25,34	1	25,34	CHI
201912188229	GOIANIRA	XX09269812	TRINDADE	24/12/2019 08:03	24/12/2019 15:30	24/12/2019 08:03	24/12/2019 15:30	7,44	1	7,44	CHI
201912188238	MONTES CLAROS DE GOIAS	ME12212911	IPORA	24/12/2019 08:04	25/12/2019 09:47	24/12/2019 08:04	25/12/2019 09:47	25,71	36	925,46	CHI
201912188247	ANAPOLIS	10009136698	ANAPOLIS UNIVERSITARIO S2	24/12/2019 08:05	24/12/2019 17:18	24/12/2019 08:05	24/12/2019 17:18	9,22	1	9,22	CHI
201912194636	MAIRIPOTABA	PK12390276	PONTALINA	24/12/2019 08:05	25/12/2019 22:06	24/12/2019 08:05	25/12/2019 22:06	38,02	52	1976,95	CHI
201912188258	SILVANIA	SV12072588	VIANOPOLIS	24/12/2019 08:06	24/12/2019 11:29	24/12/2019 08:06	24/12/2019 11:29	3,38	6	20,29	CHI
201912188272	PORTEIRAO	TD21213458	RIO DOS BOIS	24/12/2019 08:06	26/12/2019 15:31	24/12/2019 08:06	26/12/2019 15:31	55,40	1	55,40	CHI
201912188273	MUTUNOPOLIS	SE12352924	MARA ROSA	24/12/2019 08:06	24/12/2019 16:27	24/12/2019 08:06	24/12/2019 16:27	8,33	6	50,01	CHI
201912188273	SANTA TEREZA DE GOIAS	SE12352924	MARA ROSA	24/12/2019 08:06	24/12/2019 16:27	24/12/2019 08:06	24/12/2019 16:27	8,33	1	8,33	CHI
201912188280	JUSSARA	JR12022269	BRITANIA	24/12/2019 08:07	25/12/2019 11:33	24/12/2019 08:07	25/12/2019 11:33	27,43	30	822,85	CHI
201912188280	MONTES CLAROS DE GOIAS	JR12022269	BRITANIA	24/12/2019 08:07	25/12/2019 11:33	24/12/2019 08:07	25/12/2019 11:33	27,43	261	7158,79	CHI
201912188283	PIRACANJUBA	PJ21153494	PIRACANJUBA	24/12/2019 08:07	24/12/2019 16:15	24/12/2019 08:07	24/12/2019 16:15	8,12	1	8,12	CHI
201912188331	FORMOSA	FA12218278	SAO JOAO D ALIANCA	24/12/2019 08:07	24/12/2019 16:22	24/12/2019 08:07	24/12/2019 16:22	8,24	3	24,73	CHI
201912188490	SAO JOAO DA PARAUNA	FR12040685	FIRMINOPOLIS S2	24/12/2019 08:07	24/12/2019 14:25	24/12/2019 08:07	24/12/2019 14:25	6,29	6	37,72	CHI
201912189352	CORREGO DO OURO	CO12237607	SAO LUIZ DOS MONTES BELOS	24/12/2019 08:07	25/12/2019 08:26	24/12/2019 08:07	25/12/2019 08:26	24,30	3	72,91	CHI
201912190716	LUZIANIA	LZ12390018	MARAJOARA	24/12/2019 08:07	24/12/2019 11:19	24/12/2019 08:07	24/12/2019 11:19	3,20	9	28,79	CHI
201912193092	ITARUMA	IM12087819	CACHOEIRA ALTA	24/12/2019 08:07	24/12/2019 20:55	24/12/2019 08:07	24/12/2019 20:55	12,79	5	63,95	CHI
201912188291	RIO VERDE	RV21189053	CABRIUVA S2	24/12/2019 08:08	25/12/2019 12:00	24/12/2019 08:08	25/12/2019 12:00	27,86	1	27,86	CHI



201912190836	SILVANIA	SV12281886	VIANOPOLIS	24/12/2019 08:09	24/12/2019 12:14	24/12/2019 08:09	24/12/2019 12:14	4,07	116	471,86	CHI
201912188316	ORIZONA	OZ21300752	PIRES DO RIO S2	24/12/2019 08:10	24/12/2019 10:30	24/12/2019 08:10	24/12/2019 10:30	2,33	1	2,33	CHI
201912188322	CABECEIRAS	CW12218489	ITUIQUIRA	24/12/2019 08:10	24/12/2019 12:10	24/12/2019 08:10	24/12/2019 12:10	3,99	3	11,97	CHI
201912188325	SAO LUIS DE MONTES BELOS	SL21180337	SAO LUIZ DOS MONTES BELOS	24/12/2019 08:10	24/12/2019 10:18	24/12/2019 08:10	24/12/2019 10:18	2,12	1	2,12	CHI
201912188328	QUIRINOPOLIS	QI12163457	QUIRINOPOLIS	24/12/2019 08:11	24/12/2019 12:00	24/12/2019 08:11	24/12/2019 12:00	3,81	1	3,81	CHI
201912188333	INDIARA	IY21312447	CEZARINA	24/12/2019 08:11	25/12/2019 10:53	24/12/2019 08:11	25/12/2019 10:53	26,69	1	26,69	CHI
201912191501	JATAI	JT11036335	JATAI S3	24/12/2019 08:11	24/12/2019 11:02	24/12/2019 08:11	24/12/2019 11:02	2,85	94	267,77	CHI
201912188337	ITAPIRAPUA	IU12089730	MATRINCHA	24/12/2019 08:12	24/12/2019 16:25	24/12/2019 08:12	24/12/2019 16:25	8,20	4	32,81	CHI
201912189113	JARAGUA	JE13248834	SAO FRANCISCO DE GOIAS	24/12/2019 08:13	27/12/2019 16:41	24/12/2019 08:13	27/12/2019 16:41	80,45	17	1367,66	CHI
201912189113	JESUPOLIS	JE13248834	SAO FRANCISCO DE GOIAS	24/12/2019 08:13	27/12/2019 16:41	24/12/2019 08:13	27/12/2019 16:41	80,45	5	402,25	CHI
201912189113	JESUPOLIS	JE13248834	SAO FRANCISCO DE GOIAS	24/12/2019 08:13	27/12/2019 16:41	25/12/2019 08:04	27/12/2019 16:41	56,62	1	56,62	CHI
201912189757	GOIANIA	TR12082347	GOYA S2	24/12/2019 08:13	24/12/2019 15:21	24/12/2019 08:13	24/12/2019 11:38	3,41	51	173,92	CHI
201912189757	TRINDADE	GN11086876	GOYA S2	24/12/2019 08:13	24/12/2019 15:21	24/12/2019 08:13	24/12/2019 15:21	7,13	109	776,66	CHI
201912192616	BOM JESUS DE GOIAS	BJ12000133	BOM JESUS DE GOIAS	24/12/2019 08:13	25/12/2019 18:00	24/12/2019 08:13	25/12/2019 18:00	33,78	3	101,35	CHI
201912188346	MONTIVIDIU	MV21065033	MONTIVIDIU T	24/12/2019 08:14	24/12/2019 11:57	24/12/2019 08:14	24/12/2019 11:57	3,72	1	3,72	CHI
201912188348	APARECIDA DO RIO DOCE	JT12264386	JATAI S1	24/12/2019 08:14	25/12/2019 08:53	24/12/2019 08:14	25/12/2019 08:53	24,64	4	98,58	CHI
201912188354	GOIANIA	10010582558	XAVANTES	24/12/2019 08:14	24/12/2019 10:44	24/12/2019 08:14	24/12/2019 10:44	2,48	1	2,48	CHI
201912188360	INACIOLANDIA	ID12305562	CACHOEIRA DOURADA	24/12/2019 08:15	25/12/2019 17:45	24/12/2019 08:15	25/12/2019 17:30	33,25	1	33,25	CHI
201912188360	INACIOLANDIA	CD12000351LD	CACHOEIRA DOURADA	24/12/2019 08:15	25/12/2019 17:45	24/12/2019 08:15	25/12/2019 17:45	33,50	3	100,49	CHI
201912188361	PONTALINA	210012444	PONTALINA	24/12/2019 08:15	24/12/2019 12:50	24/12/2019 08:15	24/12/2019 12:50	4,58	1	4,58	CHI
201912188367	SERRANOPOLIS	SX12260314	JATAI S1	24/12/2019 08:15	24/12/2019 16:26	24/12/2019 08:15	24/12/2019 16:26	8,17	4	32,69	CHI
201912188369	ISRAELANDIA	IS12228356	IPORA	24/12/2019 08:15	24/12/2019 22:53	24/12/2019 08:15	24/12/2019 22:53	14,62	2	29,24	CHI
201912190406	ITAPURANGA	IK12220328	ITAPURANGA	24/12/2019 08:15	24/12/2019 16:34	24/12/2019 08:15	24/12/2019 16:34	8,31	231	1918,65	CHI
201912188385	CRISTALINA	KR12316249	PAMPLONA	24/12/2019 08:17	24/12/2019 17:25	24/12/2019 08:17	24/12/2019 17:25	9,14	1	9,14	CHI
201912188389	ORIZONA	OZ21022894	PIRES DO RIO S2	24/12/2019 08:17	24/12/2019 11:55	24/12/2019 08:17	24/12/2019 11:55	3,62	2	7,24	CHI
201912188439	ANAPOLIS	GP12382871	JUNDIAI S2	24/12/2019 08:17	24/12/2019 15:38	24/12/2019 08:17	24/12/2019 15:38	7,35	5	36,74	CHI
201912188439	TEREZOPOLIS DE GOIAS	GP12382871	JUNDIAI S2	24/12/2019 08:17	24/12/2019 15:38	24/12/2019 08:17	24/12/2019 15:38	7,35	2	14,70	CHI
201912188392	SENADOR CANEDO	190003364	SENADOR CANEDO	24/12/2019 08:18	24/12/2019 10:19	24/12/2019 08:18	24/12/2019 10:19	2,01	1	2,01	CHI
201912188396	NIQUELANDIA	NQ21239306	URUACU	24/12/2019 08:19	24/12/2019 10:54	24/12/2019 08:19	24/12/2019 10:54	2,58	33	85,19	CHI
201912188939	JATAI	JT12211164	JATAI S2	24/12/2019 08:19	24/12/2019 12:07	24/12/2019 08:19	24/12/2019 12:07	3,79	10	37,87	CHI
201912188403	ANAPOLIS	20146413	JUNDIAI S2	24/12/2019 08:20	24/12/2019 11:19	24/12/2019 08:20	24/12/2019 11:19	2,98	1	2,98	CHI
201912188414	PLANALTINA	PI12365307	PLANALTINA	24/12/2019 08:21	25/12/2019 09:28	24/12/2019 08:21	25/12/2019 09:28	25,11	12	301,34	CHI
201912189518	MONTIVIDIU	MV12065978	MONTIVIDIU T	24/12/2019 08:21	24/12/2019 18:36	24/12/2019 08:21	24/12/2019 18:36	10,25	21	215,27	CHI

201912189742	ACREUNA	BZ12302017LD	ACREUNA	24/12/2019 08:21	24/12/2019 15:23	24/12/2019 08:21	24/12/2019 15:23	7,02	2	14,05	CHI
201912189742	SANTO ANTONIO DA BARRA	BZ12302017LD	ACREUNA	24/12/2019 08:21	24/12/2019 15:23	24/12/2019 08:21	24/12/2019 15:23	7,02	9	63,22	CHI
201912190414	ORIZONA	OZ12372377	PIRES DO RIO S2	24/12/2019 08:21	24/12/2019 12:19	24/12/2019 08:21	24/12/2019 12:19	3,96	3	11,89	CHI
201912188423	NOVO PLANALTO	TA21170063	NOVO PLANALTO	24/12/2019 08:22	25/12/2019 15:25	24/12/2019 08:22	25/12/2019 15:25	31,05	1	31,05	CHI
201912188427	PETROLINA DE GOIAS	PG21070533	INHUMAS S1	24/12/2019 08:22	24/12/2019 09:46	24/12/2019 08:22	24/12/2019 09:46	1,39	1	1,39	CHI
201912188574	PLANALTINA	PI12085617RE	PLANALTINA	24/12/2019 08:22	24/12/2019 11:03	24/12/2019 08:22	24/12/2019 11:03	2,67	390	1041,19	CHI
201912188430	MINEIROS	MY21101983	PARQUE DAS EMAS	24/12/2019 08:23	24/12/2019 17:03	24/12/2019 08:23	24/12/2019 17:03	8,67	1	8,67	CHI
201912188432	ALVORADA DO NORTE	1510003890	IACIARA S2	24/12/2019 08:23	24/12/2019 10:49	24/12/2019 08:23	24/12/2019 10:49	2,43	1	2,43	CHI
201912188444	FIRMINOPOLIS	FR21186488	FIRMINOPOLIS S2	24/12/2019 08:24	24/12/2019 15:48	24/12/2019 08:24	24/12/2019 15:48	7,39	1	7,39	CHI
201912185367	CRISTALINA	KR16410079	CRISTALINA S1	24/12/2019 08:25	24/12/2019 11:50	24/12/2019 08:25	24/12/2019 08:46	0,35	1570	543,39	CHI
201912185367	CRISTALINA	00430234	CRISTALINA S1	24/12/2019 08:25	24/12/2019 11:50	24/12/2019 08:25	24/12/2019 09:40	1,26	101	126,95	CHI
201912185367	CRISTALINA	KR13410082B	CRISTALINA S1	24/12/2019 08:25	24/12/2019 11:50	24/12/2019 08:25	24/12/2019 09:59	1,56	757	1179,45	CHI
201912185367	CRISTALINA	KR10400552	CRISTALINA S1	24/12/2019 08:25	24/12/2019 11:50	24/12/2019 08:25	24/12/2019 11:50	3,41	20	68,27	CHI
201912188300	CRISTALINA	03470424	CRISTALINA S1	24/12/2019 08:25	24/12/2019 11:42	24/12/2019 08:25	24/12/2019 11:41	3,27	35	114,56	CHI
201912188300	CRISTALINA	KR10395377	CRISTALINA S1	24/12/2019 08:25	24/12/2019 11:42	24/12/2019 08:25	24/12/2019 11:42	3,28	164	538,38	CHI
201912188458	MOSSAMEDES	MD21332921	ITABERAI S1	24/12/2019 08:25	24/12/2019 14:15	24/12/2019 08:25	24/12/2019 14:15	5,82	1	5,82	CHI
201912191871	JARAGUA	JA12297944	JARAGUA	24/12/2019 08:25	26/12/2019 09:02	24/12/2019 08:25	26/12/2019 09:02	48,60	11	534,65	CHI
201912188464	POSSE	PS12287891	IACIARA S2	24/12/2019 08:26	24/12/2019 10:55	24/12/2019 08:26	24/12/2019 10:55	2,47	1	2,47	CHI
201912188467	ITAPACI	10022415660	ITAPACI	24/12/2019 08:27	24/12/2019 16:18	24/12/2019 08:27	24/12/2019 16:18	7,85	1	7,85	CHI
201912188471	JATAI	JT12337052	JATAI S1	24/12/2019 08:27	24/12/2019 14:17	24/12/2019 08:27	24/12/2019 14:17	5,82	3	17,46	CHI
201912188473	GOIAS	NB12064413LD	MATRINCHA	24/12/2019 08:27	25/12/2019 02:08	24/12/2019 08:27	25/12/2019 02:08	17,67	1	17,67	CHI
201912188473	NOVO BRASIL	NB12064413LD	MATRINCHA	24/12/2019 08:27	25/12/2019 02:08	24/12/2019 08:27	25/12/2019 02:08	17,67	30	530,07	CHI
201912192621	ARAGUAPAZ	AZ12031001	MOZARLANDIA	24/12/2019 08:27	24/12/2019 23:45	24/12/2019 08:27	24/12/2019 23:45	15,29	5	76,43	CHI
201912188478	GOIANIA	GN12100381	XAVANTES	24/12/2019 08:28	24/12/2019 11:44	24/12/2019 08:28	24/12/2019 11:44	3,26	2	6,53	CHI
201912188479	QUIRINOPOLIS	80017186	QUIRINOPOLIS	24/12/2019 08:28	24/12/2019 17:58	24/12/2019 08:28	24/12/2019 17:58	9,51	1	9,51	CHI
201912188482	PIRACANJUBA	PJ31048687	MORRINHOS	24/12/2019 08:28	26/12/2019 18:22	24/12/2019 08:28	26/12/2019 18:00	57,53	1	57,53	CHI
201912188482	PIRACANJUBA	PJ32048686	MORRINHOS	24/12/2019 08:28	26/12/2019 18:22	26/12/2019 17:05	26/12/2019 18:22	1,27	1	1,27	CHI
201912188485	BOM JESUS DE GOIAS	1250009306	BOM JESUS DE GOIAS	24/12/2019 08:28	24/12/2019 13:35	24/12/2019 08:28	24/12/2019 13:35	5,10	1	5,10	CHI
201912192201	HIDROLANDIA	HD12007397	CEPAIGO S2	24/12/2019 08:28	24/12/2019 11:20	24/12/2019 08:28	24/12/2019 11:20	2,86	3	8,57	CHI
201912192608	MONTES CLAROS DE GOIAS	ME12124936	IPORA	24/12/2019 08:28	25/12/2019 08:11	24/12/2019 08:28	25/12/2019 08:11	23,72	10	237,16	CHI
201912188491	SILVANIA	SV21085398	VIANOPOLIS	24/12/2019 08:29	24/12/2019 15:36	24/12/2019 08:29	24/12/2019 15:36	7,12	1	7,12	CHI
201912188492	URUACU	UR12201688	URUACU	24/12/2019 08:29	24/12/2019 10:25	24/12/2019 08:29	24/12/2019 10:25	1,93	4	7,72	CHI
201912188497	GOIANIRA	390020400	GOIANIRA	24/12/2019 08:29	24/12/2019 13:01	24/12/2019 08:29	24/12/2019 13:01	4,52	1	4,52	CHI

201912192655	ITAGUARU	JA12068865	JARAGUA	24/12/2019 08:29	24/12/2019 20:01	24/12/2019 08:29	24/12/2019 20:01	11,52	9	103,70	CHI
201912192655	JARAGUA	JA12068865	JARAGUA	24/12/2019 08:29	24/12/2019 20:01	24/12/2019 08:29	24/12/2019 20:01	11,52	1	11,52	CHI
201912188516	APARECIDA DE GOIANIA	10027747970	INDEPENDENCIA S2	24/12/2019 08:31	24/12/2019 12:43	24/12/2019 08:31	24/12/2019 12:43	4,19	1	4,19	CHI
201912188521	TURVELANDIA	TD21363370	RIO DOS BOIS	24/12/2019 08:32	25/12/2019 01:10	24/12/2019 08:32	25/12/2019 01:10	16,63	4	66,51	CHI
201912188523	ANAPOLIS	20017522	JUNDIAI S2	24/12/2019 08:32	24/12/2019 10:17	24/12/2019 08:32	24/12/2019 10:17	1,74	1	1,74	CHI
201912188525	ORIZONA	VN12250208	VIANOPOLIS	24/12/2019 08:32	24/12/2019 11:36	24/12/2019 08:32	24/12/2019 11:36	3,07	5	15,37	CHI
201912188525	VIANOPOLIS	VN12250208	VIANOPOLIS	24/12/2019 08:32	24/12/2019 11:36	24/12/2019 08:32	24/12/2019 11:36	3,07	1	3,07	CHI
201912188534	QUIRINOPOLIS	QI31053172	QUIRINOPOLIS	24/12/2019 08:33	24/12/2019 10:36	24/12/2019 08:33	24/12/2019 10:36	2,04	1	2,04	CHI
201912189387	GAMELEIRA DE GOIAS	GL12383829	DAIA S2	24/12/2019 08:33	24/12/2019 15:10	24/12/2019 08:33	24/12/2019 15:10	6,60	1	6,60	CHI
201912189387	SILVANIA	GL12383829	DAIA S2	24/12/2019 08:33	24/12/2019 15:10	24/12/2019 08:33	24/12/2019 15:10	6,60	25	165,02	CHI
201912189490	COCALZINHO DE GOIAS	ZN12312225	COCALZINHO	24/12/2019 08:33	24/12/2019 13:11	24/12/2019 08:33	24/12/2019 13:11	4,63	8	37,05	CHI
201912189490	VILA PROPICIO	ZN12312225	COCALZINHO	24/12/2019 08:33	24/12/2019 13:11	24/12/2019 08:33	24/12/2019 13:11	4,63	1	4,63	CHI
201912188537	RIO VERDE	RV21000264	RIO VERDE S1	24/12/2019 08:34	24/12/2019 12:41	24/12/2019 08:34	24/12/2019 12:41	4,12	1	4,12	CHI
201912188547	GOIANIA	10013638210	CARAJAS S1	24/12/2019 08:34	24/12/2019 12:30	24/12/2019 08:34	24/12/2019 12:30	3,92	1	3,92	CHI
201912188551	MOSSAMEDES	MD21291570	ITABERAI S2	24/12/2019 08:35	24/12/2019 16:28	24/12/2019 08:35	24/12/2019 16:28	7,87	1	7,87	CHI
201912188554	SANCLERLANDIA	SL21361940	SAO LUIZ DOS MONTES BELOS	24/12/2019 08:35	25/12/2019 08:46	24/12/2019 08:35	25/12/2019 08:46	24,17	1	24,17	CHI
201912188560	NIQUELANDIA	NQ21256605	BARRO ALTO	24/12/2019 08:36	24/12/2019 10:23	24/12/2019 08:36	24/12/2019 10:23	1,78	1	1,78	CHI
201912197254	IPAMERI	IP12107642	IPAMERI	24/12/2019 08:36	24/12/2019 22:29	24/12/2019 08:36	24/12/2019 22:29	13,88	7	97,16	CHI
201912188571	ANAPOLIS	20270884	JUNDIAI S1	24/12/2019 08:38	24/12/2019 12:58	24/12/2019 08:38	24/12/2019 12:58	4,33	1	4,33	CHI
201912188579	APARECIDA DE GOIANIA	12920060	ANHANGUERA	24/12/2019 08:39	24/12/2019 14:11	24/12/2019 08:39	24/12/2019 14:11	5,53	1	5,53	CHI
201912188581	ANAPOLIS	AN21270372	ANAPOLIS UNIVERSITARIO S2	24/12/2019 08:39	24/12/2019 15:24	24/12/2019 08:39	24/12/2019 15:24	6,74	1	6,74	CHI
201912188582	GOIANIA	13908030	FERROVIARIO S3	24/12/2019 08:39	24/12/2019 12:55	24/12/2019 08:39	24/12/2019 12:55	4,26	1	4,26	CHI
201912188701	NOVO BRASIL	NB12396218	JUSSARA	24/12/2019 08:39	25/12/2019 09:45	24/12/2019 08:39	25/12/2019 09:45	25,08	2	50,17	CHI
201912189452	GOIANIA	GN11042201	FERROVIARIO S1	24/12/2019 08:39	24/12/2019 12:44	24/12/2019 08:39	24/12/2019 12:44	4,07	167	679,88	CHI
201912188705	APARECIDA DE GOIANIA	10007903144	INDEPENDENCIA S1	24/12/2019 08:40	24/12/2019 16:26	24/12/2019 08:40	24/12/2019 16:26	7,76	1	7,76	CHI
201912189343	INDIARA	CZ12308499	CEZARINA	24/12/2019 08:40	25/12/2019 13:43	24/12/2019 08:40	24/12/2019 21:35	12,92	5	64,60	CHI
201912189343	CEZARINA	CZ12186284	CEZARINA	24/12/2019 08:40	25/12/2019 13:43	24/12/2019 08:40	24/12/2019 22:00	13,33	2	26,65	CHI
201912189343	INDIARA	CZ12186284	CEZARINA	24/12/2019 08:40	25/12/2019 13:43	24/12/2019 08:40	24/12/2019 22:00	13,33	3	39,98	CHI
201912189343	INDIARA	7605112	CEZARINA	24/12/2019 08:40	25/12/2019 13:43	24/12/2019 08:40	25/12/2019 13:43	29,05	1	29,05	CHI
201912188710	URUACU	UR21313083	URUACU	24/12/2019 08:41	24/12/2019 10:50	24/12/2019 08:41	24/12/2019 10:50	2,15	1	2,15	CHI
201912188712	APARECIDA DE GOIANIA	200424038	INDEPENDENCIA S1	24/12/2019 08:41	24/12/2019 14:43	24/12/2019 08:41	24/12/2019 14:43	6,03	1	6,03	CHI
201912188714	ARENOPOLIS	AY12390169	ARENOPOLIS	24/12/2019 08:41	24/12/2019 16:48	24/12/2019 08:41	24/12/2019 16:48	8,11	24	194,67	CHI
201912188714	DIORAMA	AY12390169	ARENOPOLIS	24/12/2019 08:41	24/12/2019 16:48	24/12/2019 08:41	24/12/2019 16:48	8,11	3	24,33	CHI

201912188906	QUIRINOPOLIS	QI21306148	QUIRINOPOLIS	24/12/2019 08:43	24/12/2019 12:02	24/12/2019 08:43	24/12/2019 12:02	3,31	1	3,31	CHI
201912188907	PORTELANDIA	PW21205286	PARQUE DAS EMAS	24/12/2019 08:43	25/12/2019 09:10	24/12/2019 08:43	25/12/2019 09:10	24,44	1	24,44	CHI
201912188911	CORREGO DO OURO	CO21003958	FIRMINOPOLIS S2	24/12/2019 08:44	25/12/2019 01:51	24/12/2019 08:44	25/12/2019 01:51	17,11	1	17,11	CHI
201912193214	CASTELANDIA	QI12303068	QUIRINOPOLIS	24/12/2019 08:44	25/12/2019 08:32	24/12/2019 08:44	25/12/2019 08:32	23,79	1	23,79	CHI
201912193214	QUIRINOPOLIS	QI12303068	QUIRINOPOLIS	24/12/2019 08:44	25/12/2019 08:32	24/12/2019 08:44	25/12/2019 08:32	23,79	22	523,45	CHI
201912188924	LUZIANIA	LZ21250034	MARAJOARA	24/12/2019 08:45	24/12/2019 10:24	24/12/2019 08:45	24/12/2019 10:24	1,64	1	1,64	CHI
201912188936	GOIANESIA	10005724021	GOIANESIA S2	24/12/2019 08:47	25/12/2019 03:28	24/12/2019 08:47	25/12/2019 03:28	18,68	1	18,68	CHI
201912188941	BONOPOLIS	BX12165447	SAO MIGUEL DO ARAGUAIA	24/12/2019 08:47	24/12/2019 16:50	24/12/2019 08:47	24/12/2019 16:50	8,04	3	24,11	CHI
201912189335	BARRO ALTO	DF12205803	GOIANESIA S1	24/12/2019 08:47	25/12/2019 00:38	24/12/2019 08:47	25/12/2019 00:38	15,85	7	110,92	CHI
201912189335	SANTA RITA DO NOVO DESTINO	DF12205803	GOIANESIA S1	24/12/2019 08:47	25/12/2019 00:38	24/12/2019 08:47	25/12/2019 00:38	15,85	9	142,61	CHI
201912188943	NIQUELANDIA	NQ12398048	URUACU	24/12/2019 08:48	24/12/2019 12:00	24/12/2019 08:48	24/12/2019 12:00	3,20	102	326,32	CHI
201912188944	IPAMERI	IP21149947	URUTAI	24/12/2019 08:48	24/12/2019 12:54	24/12/2019 08:48	24/12/2019 12:54	4,10	1	4,10	CHI
201912188949	PALMEIRAS DE GOIAS	TV21280060	FIRMINOPOLIS S2	24/12/2019 08:49	25/12/2019 08:32	24/12/2019 08:49	25/12/2019 08:32	23,72	1	23,72	CHI
201912188951	MONTES CLAROS DE GOIAS	ME21118708	IPORA	24/12/2019 08:49	25/12/2019 12:28	24/12/2019 08:49	25/12/2019 12:28	27,65	1	27,65	CHI
201912188952	CAMPO ALEGRE DE GOIAS	CM12009357	CAMPO ALEGRE DE GOIAS	24/12/2019 08:49	25/12/2019 21:04	24/12/2019 08:49	24/12/2019 22:22	13,56	3	40,68	CHI
201912188952	CAMPO ALEGRE DE GOIAS	CM12009357	CAMPO ALEGRE DE GOIAS	24/12/2019 08:49	25/12/2019 21:04	24/12/2019 22:23	25/12/2019 17:43	19,33	2	38,66	CHI
201912188952	CAMPO ALEGRE DE GOIAS	CM21231696	CAMPO ALEGRE DE GOIAS	24/12/2019 08:49	25/12/2019 21:04	24/12/2019 22:23	25/12/2019 21:04	22,69	1	22,69	CHI
201912188953	URUACU	UR21281579	URUACU	24/12/2019 08:49	24/12/2019 12:01	24/12/2019 08:49	24/12/2019 12:01	3,18	2	6,37	CHI
201912188956	PIRENOPOLIS	PV12000135	CORUMBA	24/12/2019 08:50	24/12/2019 17:51	24/12/2019 08:50	24/12/2019 17:51	9,01	3	27,03	CHI
201912188965	GOIANIA	10643631	AEROPORTO S3	24/12/2019 08:51	24/12/2019 10:24	24/12/2019 08:51	24/12/2019 10:24	1,55	1	1,55	CHI
201912188968	GOIATUBA	BJ21062727	RIO DOS BOIS	24/12/2019 08:51	26/12/2019 17:38	24/12/2019 08:51	26/12/2019 17:38	56,79	1	56,79	CHI
201912193951	IPORA	IR12289241	IPORA	24/12/2019 08:51	25/12/2019 06:55	24/12/2019 08:51	25/12/2019 06:55	22,06	5	110,30	CHI
201912189102	BOM JARDIM DE GOIAS	1880016129	BOM JARDIM	24/12/2019 08:52	24/12/2019 16:05	24/12/2019 08:52	24/12/2019 16:05	7,22	1	7,22	CHI
201912188536	MONTE ALEGRE DE GOIAS	MA21240181	SAO DOMINGOS	24/12/2019 08:53	24/12/2019 09:04	24/12/2019 08:53	24/12/2019 09:04	0,17	1	0,17	CHI
201912189117	PIRENOPOLIS	PV21227818	CORUMBA	24/12/2019 08:53	24/12/2019 16:00	24/12/2019 08:53	24/12/2019 16:00	7,10	1	7,10	CHI
201912189128	SANTO ANTONIO DO DESCOBERTO	SN21070946	MARAJOARA	24/12/2019 08:54	24/12/2019 13:24	24/12/2019 08:54	24/12/2019 13:24	4,49	1	4,49	CHI
201912189130	GOIANIA	10732986	ATLANTICO S2	24/12/2019 08:54	24/12/2019 13:27	24/12/2019 08:54	24/12/2019 13:27	4,54	1	4,54	CHI
201912190802	ORIZONA	OZ12073391	PIRES DO RIO S2	24/12/2019 08:54	24/12/2019 11:16	24/12/2019 08:54	24/12/2019 11:16	2,37	10	23,67	CHI
201912189133	DIVINOPOLIS DE GOIAS	GH12256132	SAO DOMINGOS	24/12/2019 08:55	24/12/2019 17:45	24/12/2019 08:55	24/12/2019 17:45	8,83	19	167,71	CHI
201912189135	MINACU	IH21230297	MINACU	24/12/2019 08:55	25/12/2019 01:26	24/12/2019 08:55	25/12/2019 01:26	16,51	1	16,51	CHI
201912189147	INHUMAS	IN11000055	INHUMAS S2	24/12/2019 08:56	24/12/2019 15:57	24/12/2019 08:56	24/12/2019 15:57	7,00	8	56,01	CHI
201912195358	EDEIA	CL12214130RE	RIO DOS BOIS	24/12/2019 08:56	25/12/2019 20:48	24/12/2019 08:56	25/12/2019 20:48	35,86	2	71,72	CHI
201912195358	GOIATUBA	CL12214130RE	RIO DOS BOIS	24/12/2019 08:56	25/12/2019 20:48	24/12/2019 08:56	25/12/2019 20:48	35,86	18	645,52	CHI

201912195358	PORTEIRAO	CL12214130RE	RIO DOS BOIS	24/12/2019 08:56	25/12/2019 20:48	24/12/2019 08:56	25/12/2019 20:48	35,86	29	1040,01	CHI
201912195358	VICENTINOPOLIS	CL12214130RE	RIO DOS BOIS	24/12/2019 08:56	25/12/2019 20:48	24/12/2019 08:56	25/12/2019 20:48	35,86	4	143,45	CHI
201912189155	NOVO GAMA	10002628153	PACAEMBU S1	24/12/2019 08:57	24/12/2019 16:03	24/12/2019 08:57	24/12/2019 16:03	7,09	1	7,09	CHI
201912189156	APARECIDA DE GOIANIA	14509787	REAL S1	24/12/2019 08:57	24/12/2019 09:57	24/12/2019 08:57	24/12/2019 09:57	0,99	1	0,99	CHI
201912189301	CRISTALINA	KR12210364	CRISTALINA S2	24/12/2019 08:57	24/12/2019 15:19	24/12/2019 08:57	24/12/2019 15:19	6,36	2	12,72	CHI
201912189303	APORE	AE12061471	ITAJA S1	24/12/2019 08:58	24/12/2019 23:28	24/12/2019 08:58	24/12/2019 18:44	9,78	5	48,88	CHI
201912189303	APORE	AE12061471	ITAJA S1	24/12/2019 08:58	24/12/2019 23:28	24/12/2019 08:58	24/12/2019 23:28	14,50	1	14,50	CHI
201912189309	ARUANA	AK21066597	ARUANA	24/12/2019 08:58	24/12/2019 17:06	24/12/2019 08:58	24/12/2019 17:06	8,12	1	8,12	CHI
201912189795	BELA VISTA DE GOIAS	LB12270662	DAIA S2	24/12/2019 08:58	25/12/2019 18:30	24/12/2019 08:58	24/12/2019 16:11	7,21	1	7,21	CHI
201912189795	CALDAZINHA	LB12270662	DAIA S2	24/12/2019 08:58	25/12/2019 18:30	24/12/2019 08:58	24/12/2019 16:11	7,21	45	324,54	CHI
201912189795	LEOPOLDO DE BULHOES	LB12270662	DAIA S2	24/12/2019 08:58	25/12/2019 18:30	24/12/2019 08:58	24/12/2019 16:11	7,21	4	28,85	CHI
201912189795	SILVANIA	LB12270662	DAIA S2	24/12/2019 08:58	25/12/2019 18:30	24/12/2019 08:58	24/12/2019 16:11	7,21	59	425,50	CHI
201912189795	CALDAZINHA	LB12012180	DAIA S2	24/12/2019 08:58	25/12/2019 18:30	24/12/2019 08:58	25/12/2019 16:09	31,18	19	592,49	CHI
201912189795	LEOPOLDO DE BULHOES	LB12012180	DAIA S2	24/12/2019 08:58	25/12/2019 18:30	24/12/2019 08:58	25/12/2019 16:09	31,18	2	62,37	CHI
201912189795	CALDAZINHA	LB12008844	DAIA S2	24/12/2019 08:58	25/12/2019 18:30	24/12/2019 08:58	25/12/2019 18:01	33,05	3	99,14	CHI
201912189795	CALDAZINHA	LB12012180	DAIA S2	24/12/2019 08:58	25/12/2019 18:30	24/12/2019 08:58	25/12/2019 18:30	33,53	3	100,59	CHI
201912189316	APARECIDA DE GOIANIA	12422599	REAL S1	24/12/2019 08:59	24/12/2019 10:26	24/12/2019 08:59	24/12/2019 10:26	1,44	1	1,44	CHI
201912189318	VALPARAISO DE GOIAS	10019779729	PACAEMBU S2	24/12/2019 08:59	24/12/2019 11:35	24/12/2019 08:59	24/12/2019 11:35	2,59	1	2,59	CHI
201912189319	APARECIDA DE GOIANIA	200138947	INDEPENDENCIA S2	24/12/2019 08:59	24/12/2019 13:26	24/12/2019 08:59	24/12/2019 13:26	4,44	1	4,44	CHI
201912189331	QUIRINOPOLIS	QI12315189	QUIRINOPOLIS	24/12/2019 09:00	24/12/2019 13:02	24/12/2019 09:00	24/12/2019 13:02	4,03	3	12,10	CHI
201912185392	BELA VISTA DE GOIAS	240082011	SENADOR CANEDO	24/12/2019 09:01	24/12/2019 18:03	24/12/2019 09:01	24/12/2019 18:03	9,03	1	9,03	CHI
201912189341	MIMOSO DE GOIAS	MJ12282532	PADRE BERNARDO	24/12/2019 09:02	24/12/2019 18:39	24/12/2019 09:02	24/12/2019 18:39	9,61	2	19,23	CHI
201912189345	ITABERAÍ	IB21059794	ITABERAÍ S2	24/12/2019 09:02	24/12/2019 11:58	24/12/2019 09:02	24/12/2019 11:58	2,92	1	2,92	CHI
201912189346	NIQUELANDIA	NQ21310108	BARRO ALTO	24/12/2019 09:02	24/12/2019 13:07	24/12/2019 09:02	24/12/2019 13:07	4,07	4	16,28	CHI
201912189358	EDEIA	1120051748	EDEIA	24/12/2019 09:04	24/12/2019 16:00	24/12/2019 09:04	24/12/2019 16:00	6,93	1	6,93	CHI
201912191917	BELA VISTA DE GOIAS	20303534	SENADOR CANEDO	24/12/2019 09:04	25/12/2019 06:51	24/12/2019 09:04	25/12/2019 06:51	21,78	11	239,59	CHI
201912189366	CRISTALINA	KR11165540	CRISTALINA S2	24/12/2019 09:05	24/12/2019 12:59	24/12/2019 09:05	24/12/2019 12:59	3,89	1	3,89	CHI
201912189388	VIANOPOLIS	VN12033292	VIANOPOLIS	24/12/2019 09:05	24/12/2019 12:14	24/12/2019 09:05	24/12/2019 12:14	3,14	21	65,96	CHI
201912189508	ANAPOLIS	GP12384837	JUNDIAI S2	24/12/2019 09:05	24/12/2019 16:52	24/12/2019 09:05	24/12/2019 16:52	7,78	2	15,57	CHI
201912189508	TEREZOPOLIS DE GOIAS	GP12384837	JUNDIAI S2	24/12/2019 09:05	24/12/2019 16:52	24/12/2019 09:05	24/12/2019 16:52	7,78	5	38,91	CHI
201912189371	ITUMBIARA	BG12000180	PARANAIBA	24/12/2019 09:06	24/12/2019 12:41	24/12/2019 09:06	24/12/2019 12:41	3,58	4	14,33	CHI
201912189373	PIRACANJUBA	PJ21082270	CRISTIANOPOLIS	24/12/2019 09:06	24/12/2019 17:47	24/12/2019 09:06	24/12/2019 17:47	8,68	1	8,68	CHI
201912189376	LUZIANIA	LZ12376178	CRISTALINA S2	24/12/2019 09:06	24/12/2019 17:33	24/12/2019 09:06	24/12/2019 17:33	8,44	9	75,97	CHI

201912189377	URUACU	CR21135668	MARA ROSA	24/12/2019 09:06	24/12/2019 15:40	24/12/2019 09:06	24/12/2019 15:40	6,56	2	13,11	CHI
201912189380	GOIATUBA	GT12392084	GOIATUBA S2	24/12/2019 09:06	25/12/2019 08:44	24/12/2019 09:06	25/12/2019 08:44	23,62	2	47,24	CHI
201912189383	DISTRITO FEDERAL	PI12131789	PLANALTINA	24/12/2019 09:07	24/12/2019 12:58	24/12/2019 09:07	24/12/2019 12:58	3,85	5	19,25	CHI
201912189383	PLANALTINA	PI12131789	PLANALTINA	24/12/2019 09:07	24/12/2019 12:58	24/12/2019 09:07	24/12/2019 12:58	3,85	10	38,49	CHI
201912189384	GOIANIA	GN11000667	ATLANTICO S2	24/12/2019 09:07	24/12/2019 10:14	24/12/2019 09:07	24/12/2019 10:14	1,11	72	80,16	CHI
201912189399	GOIANIA	14991834	XAVANTES	24/12/2019 09:08	24/12/2019 10:45	24/12/2019 09:08	24/12/2019 10:45	1,60	1	1,60	CHI
201912189404	CACU	1140001118	CACHOEIRA ALTA	24/12/2019 09:09	24/12/2019 19:10	24/12/2019 09:09	24/12/2019 19:10	10,01	1	10,01	CHI
201912189450	GOIANIA	GN11034219	ATLANTICO S2	24/12/2019 09:09	24/12/2019 11:00	24/12/2019 09:09	24/12/2019 11:00	1,85	176	325,06	CHI
201912189410	PILAR DE GOIAS	GG21350033	SANTA TEREZINHA	24/12/2019 09:10	24/12/2019 15:35	24/12/2019 09:10	24/12/2019 15:35	6,41	1	6,41	CHI
201912189411	SANTA CRUZ DE GOIAS	BC21268863	PIRES DO RIO S2	24/12/2019 09:10	24/12/2019 11:40	24/12/2019 09:10	24/12/2019 11:40	2,51	1	2,51	CHI
201912190815	LUZIANIA	LZ11162869	RIO VERMELHO	24/12/2019 09:10	24/12/2019 14:21	24/12/2019 09:10	24/12/2019 14:21	5,18	104	538,95	CHI
201912191874	IACIARA	IA12242614	IACIARA S1	24/12/2019 09:10	24/12/2019 13:44	24/12/2019 09:10	24/12/2019 13:44	4,55	2	9,11	CHI
201912189416	GOIAS	IU12060535	MATRINCHA	24/12/2019 09:11	24/12/2019 19:05	24/12/2019 09:11	24/12/2019 19:05	9,89	1	9,89	CHI
201912189416	ITAPIRAPUA	IU12060535	MATRINCHA	24/12/2019 09:11	24/12/2019 19:05	24/12/2019 09:11	24/12/2019 19:05	9,89	11	108,84	CHI
201912189418	PADRE BERNARDO	PB11044244	PADRE BERNARDO	24/12/2019 09:11	24/12/2019 12:31	24/12/2019 09:11	24/12/2019 12:31	3,33	15	49,88	CHI
201912189422	NOVO GAMA	NJ12219816	PACAEMBU S1	24/12/2019 09:12	24/12/2019 16:33	24/12/2019 09:12	24/12/2019 16:33	7,34	182	1336,79	CHI
201912189423	BRITANIA	BT11284762	BRITANIA	24/12/2019 09:12	24/12/2019 17:25	24/12/2019 09:12	24/12/2019 17:25	8,21	92	755,42	CHI
201912196581	APORE	SX12264389	JATAI S1	24/12/2019 09:12	25/12/2019 09:20	24/12/2019 09:12	25/12/2019 09:20	24,12	7	168,85	CHI
201912196581	ITARUMA	SX12264389	JATAI S1	24/12/2019 09:12	25/12/2019 09:20	24/12/2019 09:12	25/12/2019 09:20	24,12	1	24,12	CHI
201912196581	SERRANOPOLIS	SX12264389	JATAI S1	24/12/2019 09:12	25/12/2019 09:20	24/12/2019 09:12	25/12/2019 09:20	24,12	53	1278,43	CHI
201912189432	PIRACANJUBA	PJ21042786	PIRACANJUBA	24/12/2019 09:13	25/12/2019 17:52	24/12/2019 09:13	25/12/2019 17:52	32,64	1	32,64	CHI
201912189437	JATAI	JT21267537	JATAI S1	24/12/2019 09:14	25/12/2019 07:46	24/12/2019 09:14	25/12/2019 07:46	22,53	1	22,53	CHI
201912189444	TRINDADE	10020339613	GOYA S1	24/12/2019 09:15	24/12/2019 12:43	24/12/2019 09:15	24/12/2019 12:43	3,47	0	0,00	CHI
201912189445	CATALAO	1990199966	CATALAO S2	24/12/2019 09:15	24/12/2019 12:47	24/12/2019 09:15	24/12/2019 12:47	3,53	1	3,53	CHI
201912189448	PLANALTINA	PI12375539	PLANALTINA	24/12/2019 09:15	24/12/2019 12:18	24/12/2019 09:15	24/12/2019 12:18	3,04	41	124,54	CHI
201912189451	CALDAS NOVAS	CN21000065	CALDAS NOVAS S2	24/12/2019 09:16	24/12/2019 15:25	24/12/2019 09:16	24/12/2019 15:25	6,14	1	6,14	CHI
201912189459	MORRINHOS	MR31076820	MORRINHOS	24/12/2019 09:16	24/12/2019 11:52	24/12/2019 09:16	24/12/2019 11:52	2,59	1	2,59	CHI
201912189463	GOIANIA	10703573	ATLANTICO S2	24/12/2019 09:17	24/12/2019 11:34	24/12/2019 09:17	24/12/2019 11:34	2,28	1	2,28	CHI
201912189466	CATALAO	CT21280756	CATALAO S1	24/12/2019 09:17	25/12/2019 10:06	24/12/2019 09:17	25/12/2019 10:06	24,81	1	24,81	CHI
201912189473	JATAI	10004902260	JATAI S3	24/12/2019 09:18	24/12/2019 12:08	24/12/2019 09:18	24/12/2019 12:08	2,83	1	2,83	CHI
201912189476	JATAI	JT12167855	JATAI S1	24/12/2019 09:18	24/12/2019 11:20	24/12/2019 09:18	24/12/2019 11:20	2,02	1	2,02	CHI
201912189481	ANAPOLIS	AN12258779	JUNDIAI S1	24/12/2019 09:18	24/12/2019 15:49	24/12/2019 09:18	24/12/2019 15:49	6,50	4	26,00	CHI
201912190204	MONTIVIDIU	MV11099792	MONTIVIDIU T	24/12/2019 09:18	24/12/2019 16:44	24/12/2019 09:18	24/12/2019 16:44	7,42	95	705,22	CHI

201912189482	PARAUNA	PU12304549	PARAUNA	24/12/2019 09:19	24/12/2019 13:44	24/12/2019 09:19	24/12/2019 13:44	4,42	14	61,95	CHI
201912189486	APARECIDA DE GOIANIA	200062610	INDEPENDENCIA S1	24/12/2019 09:19	24/12/2019 13:43	24/12/2019 09:19	24/12/2019 13:43	4,39	1	4,39	CHI
201912189489	TRINDADE	TR11193148	GOYA S1	24/12/2019 09:19	24/12/2019 23:01	24/12/2019 09:19	24/12/2019 23:01	13,69	32	437,94	CHI
201912189494	CACHOEIRA ALTA	CA12301755	CACHOEIRA ALTA	24/12/2019 09:20	26/12/2019 21:26	24/12/2019 09:20	24/12/2019 19:14	9,89	4	39,58	CHI
201912189494	CACHOEIRA ALTA	CA12301755	CACHOEIRA ALTA	24/12/2019 09:20	26/12/2019 21:26	26/12/2019 09:06	26/12/2019 09:37	0,51	4	2,05	CHI
201912189494	CACHOEIRA ALTA	CA12301755	CACHOEIRA ALTA	24/12/2019 09:20	26/12/2019 21:26	24/12/2019 09:20	26/12/2019 13:13	51,88	5	259,38	CHI
201912189494	CACHOEIRA ALTA	CA12301755	CACHOEIRA ALTA	24/12/2019 09:20	26/12/2019 21:26	24/12/2019 09:20	26/12/2019 21:26	60,10	5	300,50	CHI
201912189494	CACHOEIRA ALTA	CA12081284	CACHOEIRA ALTA	24/12/2019 09:20	26/12/2019 21:26	26/12/2019 21:03	26/12/2019 21:26	0,38	5	1,91	CHI
201912189497	COCALZINHO DE GOIAS	ZN11388043	GOIANESIA S1	24/12/2019 09:21	25/12/2019 11:44	24/12/2019 09:21	25/12/2019 11:44	26,38	1	26,38	CHI
201912189500	FORMOSA	FA12383240	ITUIQUIRA	24/12/2019 09:21	24/12/2019 14:39	24/12/2019 09:21	24/12/2019 14:39	5,28	2	10,57	CHI
201912189504	APARECIDA DE GOIANIA	200391410	INDEPENDENCIA S2	24/12/2019 09:22	24/12/2019 13:24	24/12/2019 09:22	24/12/2019 13:24	4,03	1	4,03	CHI
201912189507	TRINDADE	TR11072664	TRINDADE	24/12/2019 09:22	24/12/2019 14:13	24/12/2019 09:22	24/12/2019 14:13	4,85	138	668,76	CHI
201912189512	PIRES DO RIO	460111589	PIRES DO RIO S1	24/12/2019 09:22	24/12/2019 15:49	24/12/2019 09:22	24/12/2019 15:49	6,44	1	6,44	CHI
201912190719	CAMPESTRE DE GOIAS	GA12011344	GUAPO S2	24/12/2019 09:22	24/12/2019 12:25	24/12/2019 09:22	24/12/2019 12:25	3,04	12	36,50	CHI
201912190719	GUAPO	GA12011344	GUAPO S2	24/12/2019 09:22	24/12/2019 12:25	24/12/2019 09:22	24/12/2019 12:25	3,04	54	164,25	CHI
201912189515	APARECIDA DE GOIANIA	AP11160860	INDEPENDENCIA S2	24/12/2019 09:23	24/12/2019 13:34	24/12/2019 09:23	24/12/2019 13:34	4,18	72	301,22	CHI
201912189516	FAINA	FC21073649	MATRINCHA	24/12/2019 09:23	26/12/2019 20:12	24/12/2019 09:23	26/12/2019 20:12	58,82	1	58,82	CHI
201912190708	PIRENOPOLIS	PV12381252	CORUMBA	24/12/2019 09:24	24/12/2019 19:25	24/12/2019 09:24	24/12/2019 19:25	10,00	8	80,00	CHI
201912189787	GOIANIA	GN12059752	GOYA S1	24/12/2019 09:25	24/12/2019 11:26	24/12/2019 09:25	24/12/2019 11:26	2,01	70	140,74	CHI
201912189534	SILVANIA	SV21357095	VIANOPOLIS	24/12/2019 09:26	24/12/2019 14:27	24/12/2019 09:26	24/12/2019 14:27	5,02	1	5,02	CHI
201912191308	NOVA CRIXAS	NA12228222	MOZARLANDIA	24/12/2019 09:26	26/12/2019 13:34	24/12/2019 09:26	26/12/2019 13:34	52,14	7	364,99	CHI
201912189706	ARENOPOLIS	PH12201801	PIRANHAS	24/12/2019 09:27	25/12/2019 07:18	24/12/2019 09:27	25/12/2019 07:18	21,84	1	21,84	CHI
201912189706	PIRANHAS	PH12201801	PIRANHAS	24/12/2019 09:27	25/12/2019 07:18	24/12/2019 09:27	25/12/2019 07:18	21,84	12	262,09	CHI
201912189356	MONTIVIDIU DO NORTE	MX11203493	PORANGATU	24/12/2019 09:28	24/12/2019 12:56	24/12/2019 09:28	24/12/2019 12:56	3,46	3	10,39	CHI
201912189716	JUSSARA	JR12101970RE	BRITANIA	24/12/2019 09:28	24/12/2019 20:09	24/12/2019 09:28	24/12/2019 20:09	10,67	11	117,38	CHI
201912189718	GOIANIA	12311765	XAVANTES	24/12/2019 09:28	24/12/2019 13:18	24/12/2019 09:28	24/12/2019 13:18	3,82	1	3,82	CHI
201912190828	LUZIANIA	LZ12290851	MARAJOARA	24/12/2019 09:28	24/12/2019 21:43	24/12/2019 09:28	24/12/2019 21:43	12,25	23	281,78	CHI
201912189725	CACU	CC12371316	CACHOEIRA ALTA	24/12/2019 09:30	25/12/2019 10:27	24/12/2019 09:30	25/12/2019 10:27	24,94	4	99,77	CHI
201912189728	PIRACANJUBA	PJ12154709	CALDAS NOVAS S1	24/12/2019 09:30	24/12/2019 12:27	24/12/2019 09:30	24/12/2019 12:27	2,94	2	5,88	CHI
201912192503	APARECIDA DE GOIANIA	AP12000026	INDEPENDENCIA S1	24/12/2019 09:30	24/12/2019 12:50	24/12/2019 09:30	24/12/2019 12:50	3,33	380	1266,67	CHI
201912189729	MIMOSO DE GOIAS	MJ12288360	PADRE BERNARDO	24/12/2019 09:31	24/12/2019 14:45	24/12/2019 09:31	24/12/2019 14:45	5,23	1	5,23	CHI
201912189732	FORMOSA	FA12394724	ITUIQUIRA	24/12/2019 09:31	24/12/2019 12:40	24/12/2019 09:31	24/12/2019 12:40	3,14	26	81,76	CHI
201912189734	VILA BOA	FA21106990	ITUIQUIRA	24/12/2019 09:32	24/12/2019 14:42	24/12/2019 09:32	24/12/2019 14:42	5,17	1	5,17	CHI

201912189736	AGUAS LINDAS DE GOIAS	4830233590	AGUAS LINDAS DE GOIAS S1	24/12/2019 09:32	24/12/2019 12:48	24/12/2019 09:32	24/12/2019 12:48	3,26	1	3,26	CHI
201912189753	NOVO BRASIL	1460013193	JUSSARA	24/12/2019 09:32	25/12/2019 18:22	24/12/2019 09:32	25/12/2019 18:22	32,82	1	32,82	CHI
201912189739	CRISTALINA	KR21171572	CRISTALINA S2	24/12/2019 09:33	24/12/2019 18:17	24/12/2019 09:33	24/12/2019 18:17	8,73	1	8,73	CHI
201912189746	TRINDADE	TR31026470	TRINDADE	24/12/2019 09:34	24/12/2019 14:58	24/12/2019 09:34	24/12/2019 14:58	5,39	1	5,39	CHI
201912189754	CACHOEIRA ALTA	CA21357917	CACHOEIRA ALTA	24/12/2019 09:35	24/12/2019 15:23	24/12/2019 09:35	24/12/2019 15:23	5,79	1	5,79	CHI
201912189755	CEZARINA	CZ21310227	GUAPO S2	24/12/2019 09:35	24/12/2019 19:15	24/12/2019 09:35	24/12/2019 19:15	9,66	1	9,66	CHI
201912189766	APARECIDA DE GOIANIA	AP11169724	INDEPENDENCIA S1	24/12/2019 09:37	24/12/2019 15:15	24/12/2019 09:37	24/12/2019 15:15	5,63	119	669,94	CHI
201912192794	PLANALTINA	PI12355798	PLANALTINA	24/12/2019 09:37	24/12/2019 15:51	24/12/2019 09:37	24/12/2019 15:51	6,23	55	342,45	CHI
201912189776	ALTO HORIZONTE	AJ12210309LD	MARA ROSA	24/12/2019 09:38	24/12/2019 14:04	24/12/2019 09:38	24/12/2019 14:04	4,42	19	84,04	CHI
201912189776	MARA ROSA	AJ12210309LD	MARA ROSA	24/12/2019 09:38	24/12/2019 14:04	24/12/2019 09:38	24/12/2019 14:04	4,42	3	13,27	CHI
201912189777	CRIXAS	CX21214521	SERRA DO OURO	24/12/2019 09:38	25/12/2019 15:12	24/12/2019 09:38	25/12/2019 15:12	29,57	1	29,57	CHI
201912189780	BELA VISTA DE GOIAS	BV21172633	BELA VISTA S2	24/12/2019 09:39	24/12/2019 12:40	24/12/2019 09:39	24/12/2019 12:40	3,01	1	3,01	CHI
201912189782	PORANGATU	PO21139173	PORANGATU	24/12/2019 09:39	24/12/2019 16:16	24/12/2019 09:39	24/12/2019 16:16	6,61	2	13,21	CHI
201912189783	CRISTALINA	KR21000012	CRISTALINA S2	24/12/2019 09:39	24/12/2019 15:47	24/12/2019 09:39	24/12/2019 15:47	6,12	3	18,37	CHI
201912189918	GOIANIA	GN11001086	GOIANIA LESTE S2	24/12/2019 09:40	24/12/2019 12:49	24/12/2019 09:40	24/12/2019 12:49	3,15	18	56,68	CHI
201912189793	CATALAO	1990223385	CATALAO S2	24/12/2019 09:41	24/12/2019 17:16	24/12/2019 09:41	24/12/2019 17:16	7,58	1	7,58	CHI
201912189903	APARECIDA DE GOIANIA	10018063843	ANHANGUERA	24/12/2019 09:43	24/12/2019 12:06	24/12/2019 09:43	24/12/2019 12:06	2,38	1	2,38	CHI
201912189904	ALTO HORIZONTE	AJ21086203	SANTA TEREZINHA	24/12/2019 09:43	24/12/2019 11:26	24/12/2019 09:43	24/12/2019 11:26	1,71	1	1,71	CHI
201912189908	LUZIANIA	LZ12320207	CRISTALINA S2	24/12/2019 09:44	24/12/2019 19:06	24/12/2019 09:44	24/12/2019 19:06	9,36	2	18,72	CHI
201912196312	MONTIVIDIU	MV10398076	MONTIVIDIU T	24/12/2019 09:44	25/12/2019 20:35	24/12/2019 17:20	24/12/2019 22:34	5,24	18	94,29	CHI
201912196312	RIO VERDE	RV13322228	MONTIVIDIU T	24/12/2019 09:44	25/12/2019 20:35	24/12/2019 17:20	25/12/2019 02:49	9,50	12	113,94	CHI
201912196312	MONTIVIDIU	MV10398076	MONTIVIDIU T	24/12/2019 09:44	25/12/2019 20:35	24/12/2019 17:20	25/12/2019 20:35	27,26	12	327,13	CHI
201912196312	RIO VERDE	MV10398076	MONTIVIDIU T	24/12/2019 09:44	25/12/2019 20:35	24/12/2019 17:20	25/12/2019 20:35	27,26	30	817,82	CHI
201912189912	ITAPIRAPUA	IU12038173	MATRINCHA	24/12/2019 09:45	25/12/2019 21:53	24/12/2019 09:45	25/12/2019 21:53	36,13	1	36,13	CHI
201912189915	FAINA	MP12194509	MATRINCHA	24/12/2019 09:45	25/12/2019 23:24	24/12/2019 09:45	25/12/2019 23:24	37,64	3	112,93	CHI
201912189915	MATRINCHA	MP12194509	MATRINCHA	24/12/2019 09:45	25/12/2019 23:24	24/12/2019 09:45	25/12/2019 23:24	37,64	3	112,93	CHI
201912189917	SANTA CRUZ DE GOIAS	BC21152758	PIRES DO RIO S2	24/12/2019 09:45	24/12/2019 14:50	24/12/2019 09:45	24/12/2019 14:50	5,08	1	5,08	CHI
201912189921	PIRENOPOLIS	10019776347	CORUMBA	24/12/2019 09:45	24/12/2019 16:31	24/12/2019 09:45	24/12/2019 16:31	6,76	1	6,76	CHI
201912189922	PONTALINA	210032558	PONTALINA	24/12/2019 09:45	24/12/2019 10:28	24/12/2019 09:45	24/12/2019 10:28	0,70	1	0,70	CHI
201912190303	GOIANIA	GN11203354	GOYA S2	24/12/2019 09:45	24/12/2019 11:57	24/12/2019 09:45	24/12/2019 11:57	2,20	244	536,80	CHI
201912194312	CATALAO	CT12287098	CAMPO ALEGRE DE GOIAS	24/12/2019 09:45	25/12/2019 08:29	24/12/2019 09:45	25/12/2019 08:29	22,73	22	500,07	CHI
201912189925	CRISTALINA	KR21237968	PAMPLONA	24/12/2019 09:46	24/12/2019 16:09	24/12/2019 09:46	24/12/2019 16:09	6,38	1	6,38	CHI
201912190201	GOIANIA	GN11374103	FERROVIARIO S3	24/12/2019 09:46	24/12/2019 13:57	24/12/2019 09:46	24/12/2019 13:57	4,17	49	204,40	CHI



201912190202	NOVO GAMA	4990069202	PACAEMBU S1	24/12/2019 09:46	24/12/2019 12:34	24/12/2019 09:46	24/12/2019 12:34	2,79	1	2,79	CHI
201912190307	CRISTALINA	KR12168277	PAMPLONA	24/12/2019 09:47	24/12/2019 14:46	24/12/2019 09:47	24/12/2019 14:46	4,97	5	24,85	CHI
201912190401	CRISTALINA	KR12273433	CRISTALINA S2	24/12/2019 09:48	24/12/2019 16:29	24/12/2019 09:48	24/12/2019 16:29	6,68	41	274,02	CHI
201912190404	APARECIDA DE GOIANIA	200128632	INDEPENDENCIA S1	24/12/2019 09:48	24/12/2019 16:34	24/12/2019 09:48	24/12/2019 16:34	6,75	1	6,75	CHI
201912190405	ITUMBIARA	690376753	PARANAIBA	24/12/2019 09:48	24/12/2019 11:27	24/12/2019 09:48	24/12/2019 11:27	1,63	1	1,63	CHI
201912190410	QUIRINOPOLIS	80047488	QUIRINOPOLIS	24/12/2019 09:49	24/12/2019 14:28	24/12/2019 09:49	24/12/2019 14:28	4,64	1	4,64	CHI
201912190413	ANAPOLIS	20138003	JUNDIAI S1	24/12/2019 09:50	24/12/2019 18:38	24/12/2019 09:50	24/12/2019 18:38	8,80	1	8,80	CHI
201912190415	BOM JESUS DE GOIAS	BJ12062924	BOM JESUS DE GOIAS	24/12/2019 09:50	24/12/2019 13:37	24/12/2019 09:50	24/12/2019 13:37	3,78	1	3,78	CHI
201912190421	MINACU	4020075622	MINACU	24/12/2019 09:51	24/12/2019 11:38	24/12/2019 09:51	24/12/2019 11:38	1,78	1	1,78	CHI
201912190424	ANAPOLIS	AN11003263	ANAPOLIS UNIVERSITARIO S2	24/12/2019 09:51	24/12/2019 11:09	24/12/2019 09:51	24/12/2019 11:09	1,29	7	9,02	CHI
201912192647	MORRINHOS	MR12000077RE	MORRINHOS	24/12/2019 09:53	24/12/2019 16:11	24/12/2019 09:53	24/12/2019 16:11	6,29	101	635,54	CHI
201912190706	JUSSARA	JR21206803	JUSSARA	24/12/2019 09:56	24/12/2019 15:17	24/12/2019 09:56	24/12/2019 15:17	5,33	1	5,33	CHI
201912190717	GOIANIA	10202470	AEROPORTO S3	24/12/2019 09:59	24/12/2019 11:11	24/12/2019 09:59	24/12/2019 11:11	1,19	1	1,19	CHI
201912190727	GOIAS	GS12172051	GOIAS	24/12/2019 10:00	24/12/2019 18:50	24/12/2019 10:00	24/12/2019 18:50	8,82	6	52,92	CHI
201912190729	IPORA	IR21231135	ARENOPOLIS	24/12/2019 10:01	24/12/2019 18:35	24/12/2019 10:01	24/12/2019 18:35	8,56	1	8,56	CHI
201912190732	CRISTALINA	KR11032819	PAMPLONA	24/12/2019 10:01	24/12/2019 11:33	24/12/2019 10:01	24/12/2019 11:33	1,53	69	105,32	CHI
201912192002	ANAPOLIS	AN12351048	ANAPOLIS UNIVERSITARIO S2	24/12/2019 10:01	24/12/2019 12:02	24/12/2019 10:01	24/12/2019 12:02	2,01	17	34,23	CHI
201912190808	ANAPOLIS	AN11000329	JUNDIAI S1	24/12/2019 10:04	24/12/2019 12:03	24/12/2019 10:04	24/12/2019 12:03	1,97	105	206,91	CHI
201912190816	CRIXAS	CX21190098	RUBIATABA	24/12/2019 10:05	25/12/2019 23:09	24/12/2019 10:05	25/12/2019 23:09	37,05	1	37,05	CHI
201912190817	LUZIANIA	LZ12333210	CRISTALINA S2	24/12/2019 10:06	24/12/2019 19:06	24/12/2019 10:06	24/12/2019 19:06	9,00	13	116,95	CHI
201912190818	INDIARA	IY12323655	EDEIA	24/12/2019 10:06	24/12/2019 17:48	24/12/2019 10:06	24/12/2019 17:48	7,70	4	30,81	CHI
201912190822	APARECIDA DE GOIANIA	AP11072158	INDEPENDENCIA S1	24/12/2019 10:07	24/12/2019 15:19	24/12/2019 10:07	24/12/2019 15:19	5,19	229	1189,27	CHI
201912193509	PADRE BERNARDO	PB12376777	PADRE BERNARDO	24/12/2019 10:07	24/12/2019 15:40	24/12/2019 10:07	24/12/2019 15:40	5,54	15	83,17	CHI
201912190831	COCALZINHO DE GOIAS	ZN21345323	COCALZINHO	24/12/2019 10:08	25/12/2019 18:59	24/12/2019 10:08	25/12/2019 18:59	32,85	1	32,85	CHI
201912190833	APARECIDA DE GOIANIA	200201130	INDEPENDENCIA S1	24/12/2019 10:08	24/12/2019 12:43	24/12/2019 10:08	24/12/2019 12:43	2,57	1	2,57	CHI
201912190837	ANAPOLIS	20915524	ANAPOLIS UNIVERSITARIO S2	24/12/2019 10:09	24/12/2019 16:09	24/12/2019 10:09	24/12/2019 16:09	6,00	1	6,00	CHI
201912190842	APARECIDA DE GOIANIA	200373006	INDEPENDENCIA S1	24/12/2019 10:09	24/12/2019 14:26	24/12/2019 10:09	24/12/2019 14:26	4,28	1	4,28	CHI
201912190848	APARECIDA DE GOIANIA	200453361	INDEPENDENCIA S2	24/12/2019 10:10	24/12/2019 11:06	24/12/2019 10:10	24/12/2019 11:06	0,93	1	0,93	CHI
201912190901	APARECIDA DE GOIANIA	200083661	INDEPENDENCIA S1	24/12/2019 10:10	24/12/2019 12:33	24/12/2019 10:10	24/12/2019 12:33	2,37	1	2,37	CHI
201912187661	GOIANDIRA	CT12075551	CATALAO S1	24/12/2019 10:11	25/12/2019 08:15	24/12/2019 10:11	25/12/2019 08:15	22,05	2	44,11	CHI
201912190905	VALPARAISO DE GOIAS	3350048132	PACAEMBU S1	24/12/2019 10:11	24/12/2019 10:59	24/12/2019 10:11	24/12/2019 10:59	0,79	1	0,79	CHI
201912190910	PIRES DO RIO	PR21186578	PIRES DO RIO S1	24/12/2019 10:11	24/12/2019 14:00	24/12/2019 10:11	24/12/2019 14:00	3,81	1	3,81	CHI
201912191846	GOIANIA	GN11274985	CARAJAS S2	24/12/2019 10:11	24/12/2019 11:50	24/12/2019 10:11	24/12/2019 11:50	1,64	76	124,62	CHI

201912191803	APARECIDA DE GOIANIA	AP11132554	REAL S1	24/12/2019 10:13	24/12/2019 15:24	24/12/2019 10:13	24/12/2019 15:24	5,19	160	830,04	CHI
201912191207	SAO LUIS DE MONTES BELOS	SL31111640	FIRMINOPOLIS S1	24/12/2019 10:14	24/12/2019 11:25	24/12/2019 10:14	24/12/2019 11:25	1,18	2	2,37	CHI
201912191302	VIANOPOLIS	VN21247342	VIANOPOLIS	24/12/2019 10:14	24/12/2019 15:57	24/12/2019 10:14	24/12/2019 15:57	5,71	1	5,71	CHI
201912191305	INHUMAS	10014972024	INHUMAS S2	24/12/2019 10:15	24/12/2019 16:07	24/12/2019 10:15	24/12/2019 16:07	5,87	1	5,87	CHI
201912191310	BOM JESUS DE GOIAS	1250028301	BOM JESUS DE GOIAS	24/12/2019 10:15	24/12/2019 16:17	24/12/2019 10:15	24/12/2019 16:17	6,03	1	6,03	CHI
201912191314	APARECIDA DE GOIANIA	10002602375	INDEPENDENCIA S1	24/12/2019 10:16	24/12/2019 12:23	24/12/2019 10:16	24/12/2019 12:23	2,11	1	2,11	CHI
201912191318	NOVO BRASIL	NB12246495	JUSSARA	24/12/2019 10:17	24/12/2019 14:20	24/12/2019 10:17	24/12/2019 14:20	4,05	5	20,25	CHI
201912191866	FAINA	FC12299839	GOIAS	24/12/2019 10:17	25/12/2019 08:14	24/12/2019 10:17	25/12/2019 08:14	21,94	12	263,34	CHI
201912191324	AURILANDIA	AI12000002	FIRMINOPOLIS S2	24/12/2019 10:18	24/12/2019 14:30	24/12/2019 10:18	24/12/2019 14:30	4,20	30	125,97	CHI
201912191324	FIRMINOPOLIS	AI12000002	FIRMINOPOLIS S2	24/12/2019 10:18	24/12/2019 14:30	24/12/2019 10:18	24/12/2019 14:30	4,20	17	71,38	CHI
201912191328	ARUANA	2380035289	ARUANA	24/12/2019 10:18	24/12/2019 14:48	24/12/2019 10:18	24/12/2019 14:48	4,49	1	4,49	CHI
201912191346	APARECIDA DE GOIANIA	17441316	INDEPENDENCIA S2	24/12/2019 10:22	24/12/2019 11:47	24/12/2019 10:22	24/12/2019 11:47	1,41	1	1,41	CHI
201912191347	MORRINHOS	150015460	MORRINHOS	24/12/2019 10:22	24/12/2019 15:28	24/12/2019 10:22	24/12/2019 15:28	5,09	1	5,09	CHI
201912191348	AGUAS LINDAS DE GOIAS	4830189539	AGUAS LINDAS DE GOIAS S2	24/12/2019 10:22	24/12/2019 12:10	24/12/2019 10:22	24/12/2019 12:10	1,79	1	1,79	CHI
201912191849	JUSSARA	JR12076133	BRITANIA	24/12/2019 10:22	24/12/2019 13:29	24/12/2019 10:22	24/12/2019 13:29	3,11	2	6,23	CHI
201912191353	ITAJA	IJ21191590	ITAJA S2	24/12/2019 10:23	24/12/2019 22:17	24/12/2019 10:23	24/12/2019 22:17	11,89	1	11,89	CHI
201912191357	AMARALINA	LC21266011	MARA ROSA	24/12/2019 10:24	24/12/2019 14:25	24/12/2019 10:24	24/12/2019 14:25	4,01	1	4,01	CHI
201912191361	CAMPINACU	UC124000346	MARA ROSA	24/12/2019 10:24	25/12/2019 14:59	24/12/2019 10:24	25/12/2019 10:24	24,00	1	24,00	CHI
201912191361	CAMPINACU	20376194	MARA ROSA	24/12/2019 10:24	25/12/2019 14:59	25/12/2019 14:55	25/12/2019 14:59	0,07	1	0,07	CHI
201912191362	CALDAS NOVAS	CN21118548	CALDAS NOVAS S1	24/12/2019 10:25	24/12/2019 14:00	24/12/2019 10:25	24/12/2019 14:00	3,58	1	3,58	CHI
201912191373	ORIZONA	OZ21085084	PIRES DO RIO S2	24/12/2019 10:26	24/12/2019 15:20	24/12/2019 10:26	24/12/2019 15:20	4,89	1	4,89	CHI
201912191375	APARECIDA DE GOIANIA	200186140	INDEPENDENCIA S1	24/12/2019 10:27	24/12/2019 13:35	24/12/2019 10:27	24/12/2019 13:35	3,13	1	3,13	CHI
201912189920	PIRACANJUBA	PJ12242517	PIRACANJUBA	24/12/2019 10:28	24/12/2019 11:45	24/12/2019 10:28	24/12/2019 11:45	1,30	2	2,59	CHI
201912191606	APARECIDA DE GOIANIA	200467761	INDEPENDENCIA S2	24/12/2019 10:28	24/12/2019 15:38	24/12/2019 10:28	24/12/2019 15:38	5,16	1	5,16	CHI
201912191801	JESUPOLIS	SF12021521	SAO FRANCISCO DE GOIAS	24/12/2019 10:28	25/12/2019 10:42	24/12/2019 10:28	25/12/2019 10:42	24,22	4	96,87	CHI
201912191801	SAO FRANCISCO DE GOIAS	SF12021521	SAO FRANCISCO DE GOIAS	24/12/2019 10:28	25/12/2019 10:42	24/12/2019 10:28	25/12/2019 10:42	24,22	2	48,44	CHI
201912191703	CRISTALINA	KR12372294	CRISTALINA S2	24/12/2019 10:29	24/12/2019 19:20	24/12/2019 10:29	24/12/2019 19:20	8,85	1	8,85	CHI
201912191704	AGUAS LINDAS DE GOIAS	4830279942	AGUAS LINDAS DE GOIAS S1	24/12/2019 10:29	24/12/2019 14:04	24/12/2019 10:29	24/12/2019 14:04	3,58	1	3,58	CHI
201912191802	ARENOPOLIS	AY21147815	ARENOPOLIS	24/12/2019 10:30	24/12/2019 17:29	24/12/2019 10:30	24/12/2019 17:29	6,98	1	6,98	CHI
201912191804	GAMELEIRA DE GOIAS	SV21056374	DAIA S2	24/12/2019 10:31	24/12/2019 12:19	24/12/2019 10:31	24/12/2019 12:19	1,80	1	1,80	CHI
201912191807	GOIANIA	14473628	CAMPINAS S1	24/12/2019 10:31	24/12/2019 12:50	24/12/2019 10:31	24/12/2019 12:50	2,31	1	2,31	CHI
201912191814	RIO VERDE	RV12295090	RIO VERDE S1	24/12/2019 10:32	24/12/2019 12:25	24/12/2019 10:32	24/12/2019 12:25	1,88	447	838,75	CHI
201912191816	CAMPOS VERDES	VD11023477	SANTA TEREZINHA	24/12/2019 10:32	25/12/2019 21:16	24/12/2019 10:32	25/12/2019 21:16	34,75	74	2571,17	CHI

201912191829	SERRANOPOLIS	SX21216585	JATAI S1	24/12/2019 10:35	25/12/2019 14:34	24/12/2019 10:35	25/12/2019 14:34	27,97	1	27,97	CHI
201912192531	ANAPOLIS	AN11394297	JUNDIAI S1	24/12/2019 10:35	24/12/2019 13:47	24/12/2019 10:35	24/12/2019 13:47	3,19	23	73,43	CHI
201912191833	GOIANIA	10629336	AEROPORTO S2	24/12/2019 10:36	24/12/2019 11:36	24/12/2019 10:36	24/12/2019 11:36	1,00	1	1,00	CHI
201912191834	GOIANIRA	390039410	GOIANIRA	24/12/2019 10:36	24/12/2019 14:07	24/12/2019 10:36	24/12/2019 14:07	3,51	1	3,51	CHI
201912191840	AGUAS LINDAS DE GOIAS	4830084602	AGUAS LINDAS DE GOIAS S1	24/12/2019 10:37	24/12/2019 12:57	24/12/2019 10:37	24/12/2019 12:57	2,32	1	2,32	CHI
201912191847	TRINDADE	TR21119079	TRINDADE	24/12/2019 10:38	24/12/2019 18:53	24/12/2019 10:38	24/12/2019 18:53	8,25	1	8,25	CHI
201912191852	CRISTALINA	KR12237900	CRISTALINA S2	24/12/2019 10:39	24/12/2019 17:47	24/12/2019 10:39	24/12/2019 17:47	7,12	3	21,37	CHI
201912191854	ALTO HORIZONTE	AJ21136870	MARA ROSA	24/12/2019 10:39	24/12/2019 12:57	24/12/2019 10:39	24/12/2019 12:57	2,29	1	2,29	CHI
201912191855	AMARALINA	LC21288788	MARA ROSA	24/12/2019 10:39	26/12/2019 07:50	24/12/2019 10:39	26/12/2019 07:50	45,17	1	45,17	CHI
201912191857	BALIZA	BM12390150	BOM JARDIM	24/12/2019 10:39	25/12/2019 10:11	24/12/2019 10:39	25/12/2019 10:11	23,52	40	940,68	CHI
201912191857	BOM JARDIM DE GOIAS	BM12390150	BOM JARDIM	24/12/2019 10:39	25/12/2019 10:11	24/12/2019 10:39	25/12/2019 10:11	23,52	9	211,65	CHI
201912191861	BOM JARDIM DE GOIAS	BM21362481	BOM JARDIM	24/12/2019 10:40	24/12/2019 17:10	24/12/2019 10:40	24/12/2019 17:10	6,50	1	6,50	CHI
201912191864	PORANGATU	6473336	PORANGATU	24/12/2019 10:40	24/12/2019 16:39	24/12/2019 10:40	24/12/2019 16:39	5,97	6	35,81	CHI
201912192909	VICENTINOPOLIS	VI12263804	VICENTINOPOLIS	24/12/2019 10:41	26/12/2019 16:35	24/12/2019 10:41	24/12/2019 18:59	8,29	7	58,04	CHI
201912192909	VICENTINOPOLIS	VI12263852	VICENTINOPOLIS	24/12/2019 10:41	26/12/2019 16:35	24/12/2019 10:41	26/12/2019 16:35	53,89	8	431,08	CHI
201912195341	PADRE BERNARDO	PB12163248	PADRE BERNARDO	24/12/2019 10:42	24/12/2019 20:43	24/12/2019 10:42	24/12/2019 20:43	10,01	16	160,17	CHI
201912192004	PIRENOPOLIS	4310000485	SAO FRANCISCO DE GOIAS	24/12/2019 10:43	24/12/2019 17:29	24/12/2019 10:43	24/12/2019 17:29	6,76	1	6,76	CHI
201912192012	PIRACANJUBA	PJ21199391	CALDAS NOVAS S1	24/12/2019 10:44	24/12/2019 20:06	24/12/2019 10:44	24/12/2019 20:06	9,36	1	9,36	CHI
201912192592	CRIXAS	CX12151609	SANTA TEREZINHA	24/12/2019 10:44	24/12/2019 16:57	24/12/2019 10:44	24/12/2019 16:57	6,21	36	223,50	CHI
201912204374	ALOANDIA	AD12394185	GOIATUBA S1	24/12/2019 10:44	25/12/2019 14:22	24/12/2019 10:44	25/12/2019 14:22	27,62	3	82,86	CHI
201912204374	JOVIANIA	AD12394185	GOIATUBA S1	24/12/2019 10:44	25/12/2019 14:22	24/12/2019 10:44	25/12/2019 14:22	27,62	2	55,24	CHI
201912192017	NOVO GAMA	2900023756	MARAJOARA	24/12/2019 10:45	24/12/2019 13:18	24/12/2019 10:45	24/12/2019 13:18	2,55	1	2,55	CHI
201912192018	GOIANIA	10029823160	CAMPINAS S3	24/12/2019 10:45	24/12/2019 14:10	24/12/2019 10:45	24/12/2019 14:10	3,41	1	3,41	CHI
201912192025	MINACU	IH11207707	MINACU	24/12/2019 10:46	25/12/2019 03:43	24/12/2019 10:46	25/12/2019 03:43	16,94	1	16,94	CHI
201912192203	CRISTALINA	KR21245993	CRISTALINA S2	24/12/2019 10:48	24/12/2019 18:26	24/12/2019 10:48	24/12/2019 18:26	7,63	1	7,63	CHI
201912192207	NOVO GAMA	NJ12401782	PACAEMBU S1	24/12/2019 10:49	24/12/2019 14:15	24/12/2019 10:49	24/12/2019 14:15	3,43	4	13,72	CHI
201912192208	TRINDADE	40203761	TRINDADE	24/12/2019 10:49	24/12/2019 14:13	24/12/2019 10:49	24/12/2019 14:13	3,39	1	3,39	CHI
201912191904	LUZIANIA	3200180648	MARAJOARA	24/12/2019 10:50	24/12/2019 13:04	24/12/2019 10:50	24/12/2019 13:04	2,22	1	2,22	CHI
201912192210	NOVO BRASIL	NB12216880	JUSSARA	24/12/2019 10:50	25/12/2019 08:19	24/12/2019 10:50	25/12/2019 08:19	21,48	2	42,95	CHI
201912192211	HIDROLANDIA	HD11313034	CEPAIGO S2	24/12/2019 10:50	24/12/2019 12:53	24/12/2019 10:50	24/12/2019 12:53	2,04	3	6,13	CHI
201912192213	GOIATUBA	GT12295929	RIO DOS BOIS	24/12/2019 10:50	25/12/2019 12:52	24/12/2019 10:50	25/12/2019 12:52	26,02	2	52,05	CHI
201912200805	JATAI	JT12260493	JATAI S1	24/12/2019 10:50	25/12/2019 09:05	24/12/2019 10:50	25/12/2019 09:05	22,24	18	400,26	CHI
201912192218	PIRENOPOLIS	220059263	CORUMBA	24/12/2019 10:51	24/12/2019 17:50	24/12/2019 10:51	24/12/2019 17:50	6,98	1	6,98	CHI

201912192224	CACU	CC21198054	CACHOEIRA ALTA	24/12/2019 10:51	24/12/2019 17:30	24/12/2019 10:51	24/12/2019 17:30	6,65	1	6,65	CHI
201912192225	BOM JESUS DE GOIAS	BJ21218246	BOM JESUS DE GOIAS	24/12/2019 10:52	24/12/2019 15:00	24/12/2019 10:52	24/12/2019 15:00	4,12	1	4,12	CHI
201912192625	ITABERAÍ	IB11183163	ITABERAÍ S2	24/12/2019 10:53	24/12/2019 14:08	24/12/2019 10:53	24/12/2019 14:08	3,24	39	126,32	CHI
201912192502	PADRE BERNARDO	PB11349063	PADRE BERNARDO	24/12/2019 10:54	24/12/2019 14:18	24/12/2019 10:54	24/12/2019 14:18	3,40	5	17,00	CHI
201912192509	SANTO ANTONIO DE GOIAS	GR12002136	NEROPOLIS S1	24/12/2019 10:55	24/12/2019 13:07	24/12/2019 10:55	24/12/2019 13:07	2,20	3	6,59	CHI
201912192510	CRISTALINA	KR21399485	CRISTALINA S1	24/12/2019 10:55	24/12/2019 15:16	24/12/2019 10:55	24/12/2019 15:16	4,34	1	4,34	CHI
201912192517	FORMOSA	FA11270015	ITIQUEIRA	24/12/2019 10:57	24/12/2019 21:38	24/12/2019 10:57	24/12/2019 21:38	10,69	1	10,69	CHI
201912192566	FORMOSA	03740454	ITIQUEIRA	24/12/2019 10:57	24/12/2019 15:16	24/12/2019 10:57	24/12/2019 11:02	0,08	5	0,39	CHI
201912192566	FORMOSA	03740454	ITIQUEIRA	24/12/2019 10:57	24/12/2019 15:16	24/12/2019 10:57	24/12/2019 13:10	2,22	38	84,43	CHI
201912192566	CABECEIRAS	03740454	ITIQUEIRA	24/12/2019 10:57	24/12/2019 15:16	24/12/2019 10:57	24/12/2019 14:59	4,04	5	20,18	CHI
201912192566	FORMOSA	03740454	ITIQUEIRA	24/12/2019 10:57	24/12/2019 15:16	24/12/2019 10:57	24/12/2019 14:59	4,04	327	1319,72	CHI
201912192566	FORMOSA	03740454	ITIQUEIRA	24/12/2019 10:57	24/12/2019 15:16	24/12/2019 10:59	24/12/2019 14:59	4,01	2	8,01	CHI
201912192566	FORMOSA	03740454	ITIQUEIRA	24/12/2019 10:57	24/12/2019 15:16	24/12/2019 10:57	24/12/2019 15:16	4,32	73	315,66	CHI
201912192566	VILA BOA	03740454	ITIQUEIRA	24/12/2019 10:57	24/12/2019 15:16	24/12/2019 10:57	24/12/2019 15:16	4,32	15	64,86	CHI
201912192566	FORMOSA	03740454	ITIQUEIRA	24/12/2019 10:57	24/12/2019 15:16	24/12/2019 10:59	24/12/2019 15:16	4,29	4	17,18	CHI
201912192566	VILA BOA	03740454	ITIQUEIRA	24/12/2019 10:57	24/12/2019 15:16	24/12/2019 10:59	24/12/2019 15:16	4,29	1	4,29	CHI
201912191908	ORIZONA	OZ21339354	PIRES DO RIO S2	24/12/2019 10:58	24/12/2019 14:26	24/12/2019 10:58	24/12/2019 14:26	3,46	0	0,00	CHI
201912192523	NIQUELANDIA	NQ21136449	NIQUELANDIA SUBTRANSMISSAO	24/12/2019 10:59	24/12/2019 15:18	24/12/2019 10:59	24/12/2019 15:18	4,31	2	8,62	CHI
201912192525	RUBIATABA	RB21287152	RUBIATABA	24/12/2019 10:59	26/12/2019 10:19	24/12/2019 10:59	26/12/2019 10:19	47,32	1	47,32	CHI
201912192535	LUZIANIA	10000338840	RIO VERMELHO	24/12/2019 11:01	24/12/2019 13:04	24/12/2019 11:01	24/12/2019 13:04	2,04	1	2,04	CHI
201912192536	FORMOSA	FA11233647	SAO JOAO D ALIANCA	24/12/2019 11:01	25/12/2019 11:02	24/12/2019 11:01	25/12/2019 11:02	24,02	1	24,02	CHI
201912192540	CEZARINA	MI12402581	PONTALINA	24/12/2019 11:02	25/12/2019 18:27	24/12/2019 11:02	25/12/2019 12:12	25,15	16	402,44	CHI
201912192540	MAIRIPOTABA	MI12402581	PONTALINA	24/12/2019 11:02	25/12/2019 18:27	24/12/2019 11:02	25/12/2019 12:12	25,15	14	352,13	CHI
201912192540	CEZARINA	MI12402581	PONTALINA	24/12/2019 11:02	25/12/2019 18:27	24/12/2019 11:02	25/12/2019 18:27	31,40	1	31,40	CHI
201912192540	MAIRIPOTABA	MI12402581	PONTALINA	24/12/2019 11:02	25/12/2019 18:27	24/12/2019 11:02	25/12/2019 18:27	31,40	8	251,22	CHI
201912192543	APORE	AE12061469	ITAJA S1	24/12/2019 11:03	24/12/2019 23:28	24/12/2019 11:03	24/12/2019 23:28	12,41	1	12,41	CHI
201912192544	ABADIANIA	AN21297749	ANAPOLIS UNIVERSITARIO S1	24/12/2019 11:03	24/12/2019 13:07	24/12/2019 11:03	24/12/2019 13:07	2,05	1	2,05	CHI
201912192546	CRISTALINA	KR12305252	PAMPLONA	24/12/2019 11:03	24/12/2019 16:20	24/12/2019 11:03	24/12/2019 16:20	5,27	6	31,61	CHI
201912192550	NOVA CRIXAS	NA21077101	NOVA CRIXAS	24/12/2019 11:04	25/12/2019 12:57	24/12/2019 11:04	25/12/2019 12:57	25,87	1	25,87	CHI
201912192555	ACREUNA	EU21189129	ACREUNA	24/12/2019 11:05	26/12/2019 00:17	24/12/2019 11:05	26/12/2019 00:17	37,20	1	37,20	CHI
201912192564	GOIANIA	10030500425	GOIANIA LESTE S2	24/12/2019 11:06	24/12/2019 13:06	24/12/2019 11:06	24/12/2019 13:06	2,00	1	2,00	CHI
201912192568	GOIAS	IU21154740	MATRINCHA	24/12/2019 11:06	25/12/2019 07:25	24/12/2019 11:06	25/12/2019 07:25	20,31	1	20,31	CHI
201912192578	NIQUELANDIA	NQ21360524	NIQUELANDIA SUBTRANSMISSAO	24/12/2019 11:08	24/12/2019 15:35	24/12/2019 11:08	24/12/2019 15:35	4,44	1	4,44	CHI

201912192583	LUZIANIA	LZ21156976	VIANOPOLIS	24/12/2019 11:08	24/12/2019 22:39	24/12/2019 11:08	24/12/2019 22:39	11,50	1	11,50	CHI
201912192585	NIQUELANDIA	NQ12271070	BARRO ALTO	24/12/2019 11:09	24/12/2019 21:24	24/12/2019 11:09	24/12/2019 21:24	10,24	9	92,15	CHI
201912192588	JATAI	290031874	JATAI S3	24/12/2019 11:10	24/12/2019 16:19	24/12/2019 11:10	24/12/2019 16:19	5,14	1	5,14	CHI
201912192589	BELA VISTA DE GOIAS	BV21286545	BELA VISTA S1	24/12/2019 11:10	24/12/2019 15:49	24/12/2019 11:10	24/12/2019 15:49	4,65	1	4,65	CHI
201912192596	GOIANIA	GN21236385	REAL S1	24/12/2019 11:13	24/12/2019 13:50	24/12/2019 11:13	24/12/2019 13:50	2,60	5	13,02	CHI
201912192597	LUZIANIA	LZ21128446	PIRES DO RIO S2	24/12/2019 11:14	24/12/2019 14:14	24/12/2019 11:14	24/12/2019 14:14	3,00	1	3,00	CHI
201912192598	RIO VERDE	RV21249095	CABRIUVA S2	24/12/2019 11:14	25/12/2019 09:25	24/12/2019 11:14	25/12/2019 09:25	22,17	1	22,17	CHI
201912192924	INACIOLANDIA	ID12359397	QUIRINOPOLIS	24/12/2019 11:16	24/12/2019 14:46	24/12/2019 11:16	24/12/2019 14:46	3,49	57	198,93	CHI
201912192924	ITUMBIARA	ID12359397	QUIRINOPOLIS	24/12/2019 11:16	24/12/2019 14:46	24/12/2019 11:16	24/12/2019 14:46	3,49	4	13,96	CHI
201912192619	CATALAO	1990277229	CATALAO S2	24/12/2019 11:20	24/12/2019 15:50	24/12/2019 11:20	24/12/2019 15:50	4,50	1	4,50	CHI
201912192620	CALDAS NOVAS	MG12000353	VILA CORUMBA	24/12/2019 11:20	25/12/2019 08:50	24/12/2019 11:20	25/12/2019 08:50	21,49	4	85,97	CHI
201912192631	IVOLANDIA	IV12231164	IPORA	24/12/2019 11:21	24/12/2019 13:15	24/12/2019 11:21	24/12/2019 13:15	1,89	2	3,78	CHI
201912192632	NOVO PLANALTO	TA12391923	SAO MIGUEL DO ARAGUAIA	24/12/2019 11:23	25/12/2019 10:45	24/12/2019 11:23	25/12/2019 10:45	23,37	1	23,37	CHI
201912193065	POSSE	PS12212366	IACIARA S1	24/12/2019 11:26	24/12/2019 14:49	24/12/2019 11:26	24/12/2019 14:49	3,37	37	124,63	CHI
201912192652	AGUAS LINDAS DE GOIAS	4830108930	AGUAS LINDAS DE GOIAS S1	24/12/2019 11:27	24/12/2019 15:20	24/12/2019 11:27	24/12/2019 15:20	3,88	1	3,88	CHI
201912192653	GOIANIRA	10006859508	GOIANIRA	24/12/2019 11:27	24/12/2019 19:05	24/12/2019 11:27	24/12/2019 19:05	7,63	1	7,63	CHI
201912192654	AGUA LIMPA	AL21263204	VILA CORUMBA	24/12/2019 11:27	25/12/2019 11:18	24/12/2019 11:27	25/12/2019 11:18	23,84	1	23,84	CHI
201912192656	NOVO GAMA	10007363360	PACAEMBU S1	24/12/2019 11:27	24/12/2019 13:35	24/12/2019 11:27	24/12/2019 13:35	2,13	1	2,13	CHI
201912192658	CRISTALINA	KR12209482	CRISTALINA S1	24/12/2019 11:27	24/12/2019 21:26	24/12/2019 11:27	24/12/2019 21:26	9,97	1	9,97	CHI
201912192659	BURITI ALEGRE	MR12041248	GOIATUBA S2	24/12/2019 11:28	25/12/2019 16:40	24/12/2019 11:28	25/12/2019 16:40	29,19	3	87,58	CHI
201912192659	GOIATUBA	MR12041248	GOIATUBA S2	24/12/2019 11:28	25/12/2019 16:40	24/12/2019 11:28	25/12/2019 16:40	29,19	1	29,19	CHI
201912192661	ISRAELANDIA	IS12138487	IPORA	24/12/2019 11:28	24/12/2019 23:53	24/12/2019 11:28	24/12/2019 23:53	12,41	1	12,41	CHI
201912192663	SILVANIA	660059642	VIANOPOLIS	24/12/2019 11:29	24/12/2019 14:48	24/12/2019 11:29	24/12/2019 14:48	3,31	1	3,31	CHI
201912193066	GOIANESIA	GE12000255	GOIANESIA S2	24/12/2019 11:30	25/12/2019 13:06	24/12/2019 11:30	25/12/2019 13:06	25,59	3	76,76	CHI
201912193066	JARAGUA	GE12000255	GOIANESIA S2	24/12/2019 11:30	25/12/2019 13:06	24/12/2019 11:30	25/12/2019 13:06	25,59	5	127,93	CHI
201912192675	APARECIDA DE GOIANIA	10013075185	INDEPENDENCIA S1	24/12/2019 11:31	24/12/2019 15:56	24/12/2019 11:31	24/12/2019 15:56	4,41	1	4,41	CHI
201912192680	CACU	CC21076567	CACHOEIRA ALTA	24/12/2019 11:33	25/12/2019 11:46	24/12/2019 11:33	25/12/2019 11:46	24,22	1	24,22	CHI
201912192682	CATALAO	CT21250462	CATALAO S1	24/12/2019 11:33	24/12/2019 22:39	24/12/2019 11:33	24/12/2019 22:39	11,09	1	11,09	CHI
201912192683	GOIANIA	10014693273	XAVANTES	24/12/2019 11:33	24/12/2019 18:52	24/12/2019 11:33	24/12/2019 18:52	7,31	1	7,31	CHI
201912192691	IPAMERI	IP21234081	URUTAI	24/12/2019 11:35	24/12/2019 16:20	24/12/2019 11:35	24/12/2019 16:20	4,75	1	4,75	CHI
201912168831	CRIXAS	MZ12055628	MOZARLANDIA	24/12/2019 11:36	24/12/2019 15:35	24/12/2019 11:36	24/12/2019 15:35	3,97	26	103,16	CHI
201912168831	MOZARLANDIA	MZ12055628	MOZARLANDIA	24/12/2019 11:36	24/12/2019 15:35	24/12/2019 11:36	24/12/2019 15:35	3,97	38	150,77	CHI
201912192694	FAZENDA NOVA	FN21227645	IPORA	24/12/2019 11:36	25/12/2019 10:34	24/12/2019 11:36	25/12/2019 10:34	22,97	1	22,97	CHI

201912192695	NEROPOLIS	160048485	NEROPOLIS S2	24/12/2019 11:36	24/12/2019 17:43	24/12/2019 11:36	24/12/2019 17:43	6,12	1	6,12	CHI
201912192697	SERRANOPOLIS	SX21314489	CHAPADAO DO CEU	24/12/2019 11:36	25/12/2019 18:16	24/12/2019 11:36	25/12/2019 18:16	30,66	1	30,66	CHI
201912192699	GOIANIA	10354086	CAMPINAS S1	24/12/2019 11:36	24/12/2019 14:48	24/12/2019 11:36	24/12/2019 14:48	3,19	1	3,19	CHI
201912192701	SENADOR CANEDO	10023161491	SENADOR CANEDO	24/12/2019 11:36	24/12/2019 13:31	24/12/2019 11:36	24/12/2019 13:31	1,90	1	1,90	CHI
201912192704	BOM JESUS DE GOIAS	BJ12000300	BOM JESUS DE GOIAS	24/12/2019 11:37	24/12/2019 14:37	24/12/2019 11:37	24/12/2019 14:37	3,00	3	9,00	CHI
201912192706	BURITI ALEGRE	BG21090572	ITUMBIARA VELHA S2	24/12/2019 11:37	24/12/2019 18:45	24/12/2019 11:37	24/12/2019 18:45	7,12	1	7,12	CHI
201912192707	PADRE BERNARDO	PB12377292	PADRE BERNARDO	24/12/2019 11:38	24/12/2019 14:41	24/12/2019 11:38	24/12/2019 14:41	3,05	25	76,13	CHI
201912192709	PEROLANDIA	DP12285778	JATAI S1	24/12/2019 11:38	24/12/2019 15:28	24/12/2019 11:38	24/12/2019 15:28	3,82	5	19,12	CHI
201912191919	CAMPO ALEGRE DE GOIAS	02250424	CAMPO ALEGRE DE GOIAS	24/12/2019 11:39	24/12/2019 20:25	24/12/2019 11:39	24/12/2019 15:19	3,67	83	304,89	CHI
201912191919	IPAMERI	02250424	CAMPO ALEGRE DE GOIAS	24/12/2019 11:39	24/12/2019 20:25	24/12/2019 11:39	24/12/2019 15:19	3,67	16	58,77	CHI
201912191919	CAMPO ALEGRE DE GOIAS	02250424	CAMPO ALEGRE DE GOIAS	24/12/2019 11:39	24/12/2019 20:25	24/12/2019 11:40	24/12/2019 15:19	3,65	20	72,97	CHI
201912191919	IPAMERI	02250424	CAMPO ALEGRE DE GOIAS	24/12/2019 11:39	24/12/2019 20:25	24/12/2019 11:40	24/12/2019 15:19	3,65	20	72,97	CHI
201912191919	CAMPO ALEGRE DE GOIAS	02250424	CAMPO ALEGRE DE GOIAS	24/12/2019 11:39	24/12/2019 20:25	24/12/2019 11:39	24/12/2019 17:01	5,38	43	231,18	CHI
201912191919	CAMPO ALEGRE DE GOIAS	CM13266893	CAMPO ALEGRE DE GOIAS	24/12/2019 11:39	24/12/2019 20:25	24/12/2019 11:39	24/12/2019 17:01	5,38	123	661,30	CHI
201912191919	CATALAO	CM13266893	CAMPO ALEGRE DE GOIAS	24/12/2019 11:39	24/12/2019 20:25	24/12/2019 11:39	24/12/2019 17:01	5,38	18	96,77	CHI
201912191919	DISTRITO FEDERAL	CM13266893	CAMPO ALEGRE DE GOIAS	24/12/2019 11:39	24/12/2019 20:25	24/12/2019 11:39	24/12/2019 17:01	5,38	1	5,38	CHI
201912191919	IPAMERI	CM13266893	CAMPO ALEGRE DE GOIAS	24/12/2019 11:39	24/12/2019 20:25	24/12/2019 11:39	24/12/2019 17:01	5,38	11	59,14	CHI
201912191919	CAMPO ALEGRE DE GOIAS	02250424	CAMPO ALEGRE DE GOIAS	24/12/2019 11:39	24/12/2019 20:25	24/12/2019 11:39	24/12/2019 18:43	7,08	28	198,26	CHI
201912191919	CAMPO ALEGRE DE GOIAS	CM13166769	CAMPO ALEGRE DE GOIAS	24/12/2019 11:39	24/12/2019 20:25	24/12/2019 11:40	24/12/2019 18:43	7,06	1	7,06	CHI
201912191919	CAMPO ALEGRE DE GOIAS	02250424	CAMPO ALEGRE DE GOIAS	24/12/2019 11:39	24/12/2019 20:25	24/12/2019 11:39	24/12/2019 19:51	8,21	4	32,84	CHI
201912191919	CAMPO ALEGRE DE GOIAS	02250424	CAMPO ALEGRE DE GOIAS	24/12/2019 11:39	24/12/2019 20:25	24/12/2019 11:39	24/12/2019 20:25	8,78	51	447,60	CHI
201912196818	GAMELEIRA DE GOIAS	SV12068676	DAIA S2	24/12/2019 11:41	25/12/2019 14:43	24/12/2019 11:41	25/12/2019 14:43	27,03	2	54,06	CHI
201912192722	GUAPO	GA21000067	GUAPO S2	24/12/2019 11:42	24/12/2019 15:51	24/12/2019 11:42	24/12/2019 15:51	4,14	1	4,14	CHI
201912192726	APARECIDA DE GOIANIA	200024668	INDEPENDENCIA S1	24/12/2019 11:43	24/12/2019 15:45	24/12/2019 11:43	24/12/2019 15:45	4,03	1	4,03	CHI
201912192727	CAMPOS VERDES	VD12266622	SANTA TEREZINHA	24/12/2019 11:43	25/12/2019 11:51	24/12/2019 11:43	25/12/2019 11:51	24,13	1	24,13	CHI
201912192728	RIO VERDE	RV21284344	CABRIUVA S2	24/12/2019 11:43	25/12/2019 12:11	24/12/2019 11:43	25/12/2019 12:11	24,45	2	48,90	CHI
201912192733	AGUAS LINDAS DE GOIAS	LA11149831	AGUAS LINDAS DE GOIAS S1	24/12/2019 11:44	24/12/2019 17:00	24/12/2019 11:44	24/12/2019 17:00	5,25	342	1796,73	CHI
201912192737	AGUA LIMPA	MG12039743	VILA CORUMBA	24/12/2019 11:45	24/12/2019 12:22	24/12/2019 11:45	24/12/2019 12:22	0,60	1	0,60	CHI
201912192739	BURITINOPOLIS	BQ12228969	IACIARA S2	24/12/2019 11:46	24/12/2019 15:48	24/12/2019 11:46	24/12/2019 15:48	4,02	1	4,02	CHI
201912192740	FORMOSO	FO12185308	PORANGATU	24/12/2019 11:46	24/12/2019 21:06	24/12/2019 11:46	24/12/2019 21:06	9,34	4	37,35	CHI
201912192745	ITABERAI	IB21000061	ITABERAI S2	24/12/2019 11:47	24/12/2019 15:51	24/12/2019 11:47	24/12/2019 15:51	4,05	1	4,05	CHI
201912192748	GUAPO	GA11381320	GUAPO S2	24/12/2019 11:48	24/12/2019 16:10	24/12/2019 11:48	24/12/2019 16:10	4,36	2	8,71	CHI
201912192754	CRISTALINA	KR12170191	CRISTALINA S1	24/12/2019 11:49	24/12/2019 16:38	24/12/2019 11:49	24/12/2019 16:38	4,80	56	269,02	CHI

201912192814	CRISTALINA	KR12365895	PAMPLONA	24/12/2019 11:49	24/12/2019 13:10	24/12/2019 11:49	24/12/2019 13:10	1,34	102	136,91	CHI
201912193413	GOIATUBA	JV12263416	GOIATUBA S1	24/12/2019 11:49	26/12/2019 17:50	24/12/2019 11:49	26/12/2019 17:50	54,02	3	162,05	CHI
201912192758	GOIANIA	16047746	ATLANTICO S3	24/12/2019 11:50	24/12/2019 13:21	24/12/2019 11:50	24/12/2019 13:21	1,51	1	1,51	CHI
201912192767	URUTAI	UT21231343	URUTAI	24/12/2019 11:51	25/12/2019 11:41	24/12/2019 11:51	25/12/2019 11:41	23,83	1	23,83	CHI
201912193278	PALMEIRAS DE GOIAS	PL12346577	PALMEIRAS	24/12/2019 11:51	24/12/2019 20:56	24/12/2019 11:51	24/12/2019 20:56	9,09	22	199,89	CHI
201912193905	CEZARINA	CZ12071567	GUAPO S2	24/12/2019 11:51	25/12/2019 09:01	24/12/2019 11:51	25/12/2019 09:01	21,16	7	148,10	CHI
201912192770	CEZARINA	CZ21116980	GUAPO S2	24/12/2019 11:52	24/12/2019 15:56	24/12/2019 11:52	24/12/2019 15:56	4,06	1	4,06	CHI
201912192784	LUZIANIA	LZ11103550	PACAEMBU S1	24/12/2019 11:54	24/12/2019 16:54	24/12/2019 11:54	24/12/2019 16:54	5,01	11	55,14	CHI
201912192791	PARAUNA	PU21215404	PARAUNA	24/12/2019 11:55	24/12/2019 18:51	24/12/2019 11:55	24/12/2019 18:51	6,92	1	6,92	CHI
201912193521	QUIRINOPOLIS	QI12303196	RIO DOS BOIS	24/12/2019 11:55	25/12/2019 12:24	24/12/2019 11:55	25/12/2019 12:24	24,48	5	122,41	CHI
201912192801	AGUAS LINDAS DE GOIAS	4830208900	AGUAS LINDAS DE GOIAS S1	24/12/2019 11:59	24/12/2019 14:03	24/12/2019 11:59	24/12/2019 14:03	2,07	1	2,07	CHI
201912192803	RIO VERDE	630449430	RIO VERDE S2	24/12/2019 11:59	25/12/2019 09:21	24/12/2019 11:59	25/12/2019 09:21	21,36	1	21,36	CHI
201912192804	FORMOSA	FA11202296	SAO JOAO D ALIANCA	24/12/2019 11:59	24/12/2019 18:30	24/12/2019 11:59	24/12/2019 18:30	6,51	9	58,58	CHI
201912192807	PARAUNA	PU21136889	PARAUNA	24/12/2019 11:59	24/12/2019 19:45	24/12/2019 11:59	24/12/2019 19:45	7,75	2	15,50	CHI
201912192808	SAO MIGUEL DO ARAGUAIA	SM12334354	SAO MIGUEL DO ARAGUAIA	24/12/2019 11:59	24/12/2019 14:32	24/12/2019 11:59	24/12/2019 14:32	2,55	1	2,55	CHI
201912192811	TURVANIA	TV21233516	FIRMINOPOLIS S2	24/12/2019 12:00	24/12/2019 17:11	24/12/2019 12:00	24/12/2019 17:11	5,19	1	5,19	CHI
201912192813	GOIANIA	GN11001190	AEROPORTO S2	24/12/2019 12:00	24/12/2019 17:57	24/12/2019 12:00	24/12/2019 13:14	1,23	125	154,24	CHI
201912192813	GOIANIA	GN11001190	AEROPORTO S2	24/12/2019 12:00	24/12/2019 17:57	24/12/2019 13:19	24/12/2019 17:57	4,63	125	578,26	CHI
201912192815	GOIANIA	GN11034219	ATLANTICO S2	24/12/2019 12:01	24/12/2019 15:02	24/12/2019 12:01	24/12/2019 15:02	3,00	176	528,10	CHI
201912192821	VALPARAISO DE GOIAS	2860029467	PACAEMBU S2	24/12/2019 12:02	24/12/2019 13:31	24/12/2019 12:02	24/12/2019 13:31	1,47	1	1,47	CHI
201912192822	ABADIANIA	AA21301025	ANAPOLIS UNIVERSITARIO S1	24/12/2019 12:03	24/12/2019 20:32	24/12/2019 12:03	24/12/2019 20:32	8,48	1	8,48	CHI
201912193106	ORIZONA	OZ12300755	PIRES DO RIO S2	24/12/2019 12:03	24/12/2019 18:45	24/12/2019 12:03	24/12/2019 18:45	6,69	4	26,75	CHI
201912193589	ABADIANIA	AN12001134	ANAPOLIS UNIVERSITARIO S2	24/12/2019 12:03	24/12/2019 18:03	24/12/2019 12:03	24/12/2019 18:03	6,00	15	89,93	CHI
201912192826	JATAI	JT21267581	JATAI S1	24/12/2019 12:04	24/12/2019 18:57	24/12/2019 12:04	24/12/2019 18:57	6,89	1	6,89	CHI
201912192887	URUACU	UR12390448	URUACU	24/12/2019 12:06	24/12/2019 15:10	24/12/2019 12:06	24/12/2019 15:10	3,06	95	290,41	CHI
201912192839	ITAPIRAPUA	IU21198531	MATRINCHA	24/12/2019 12:07	25/12/2019 10:00	24/12/2019 12:07	25/12/2019 10:00	21,88	1	21,88	CHI
201912192905	INDIARA	IY12312488	CEZARINA	24/12/2019 12:10	25/12/2019 09:00	24/12/2019 12:10	25/12/2019 09:00	20,85	6	125,07	CHI
201912192868	GOIANIA	17352034	CARAJAS S1	24/12/2019 12:13	24/12/2019 15:42	24/12/2019 12:13	24/12/2019 15:42	3,48	0	0,00	CHI
201912192871	JATAI	SX12139578	JATAI S1	24/12/2019 12:14	25/12/2019 13:29	24/12/2019 12:14	25/12/2019 13:29	25,24	14	353,41	CHI
201912192871	SERRANOPOLIS	SX12139578	JATAI S1	24/12/2019 12:14	25/12/2019 13:29	24/12/2019 12:14	25/12/2019 13:29	25,24	33	833,03	CHI
201912193562	ITABERAI	IB11000007	ITABERAI S2	24/12/2019 12:14	24/12/2019 15:06	24/12/2019 12:14	24/12/2019 15:06	2,85	103	293,98	CHI
201912192877	LUZIANIA	LZ21199602	VIANOPOLIS	24/12/2019 12:15	25/12/2019 02:17	24/12/2019 12:15	25/12/2019 02:17	14,03	1	14,03	CHI
201912192885	NIQUELANDIA	NQ12262954	NIQUELANDIA SUBTRANSMISSAO	24/12/2019 12:15	25/12/2019 11:23	24/12/2019 12:15	25/12/2019 11:23	23,12	3	69,37	CHI

201912192888	VALPARAISO DE GOIAS	10003633150	PACAEMBU S1	24/12/2019 12:16	24/12/2019 16:05	24/12/2019 12:16	24/12/2019 16:05	3,80	1	3,80	CHI
201912192889	AGUAS LINDAS DE GOIAS	LA11164948	AGUAS LINDAS DE GOIAS S1	24/12/2019 12:17	24/12/2019 14:28	24/12/2019 12:17	24/12/2019 14:28	2,18	141	307,77	CHI
201912192891	ANICUNS	AC21304655	FIRMINOPOLIS S2	24/12/2019 12:17	24/12/2019 13:44	24/12/2019 12:17	24/12/2019 13:44	1,44	3	4,31	CHI
201912192892	SILVANIA	SV12282736	VIANOPOLIS	24/12/2019 12:18	24/12/2019 16:25	24/12/2019 12:18	24/12/2019 16:25	4,12	3	12,36	CHI
201912192893	APARECIDA DE GOIANIA	10002676999	INDEPENDENCIA S2	24/12/2019 12:18	24/12/2019 13:22	24/12/2019 12:18	24/12/2019 13:22	1,06	1	1,06	CHI
201912193008	CORUMBAIBA	CI21025128	VILA CORUMBA	24/12/2019 12:18	25/12/2019 11:23	24/12/2019 12:18	25/12/2019 11:23	23,08	1	23,08	CHI
201912192896	NOVO BRASIL	FN12220513	JUSSARA	24/12/2019 12:19	25/12/2019 10:54	24/12/2019 12:19	25/12/2019 10:54	22,58	2	45,16	CHI
201912192898	CAMPINORTE	CR21339928	MARA ROSA	24/12/2019 12:19	25/12/2019 00:19	24/12/2019 12:19	25/12/2019 00:19	12,00	1	12,00	CHI
201912193029	EDEALINA	ED12390279	PONTALINA	24/12/2019 12:19	24/12/2019 18:47	24/12/2019 12:19	24/12/2019 18:47	6,46	17	109,86	CHI
201912192903	BOM JARDIM DE GOIAS	BM12065725	BOM JARDIM	24/12/2019 12:20	25/12/2019 02:39	24/12/2019 12:20	25/12/2019 02:39	14,31	102	1459,59	CHI
201912192903	PIRANHAS	BM12065725	BOM JARDIM	24/12/2019 12:20	25/12/2019 02:39	24/12/2019 12:20	25/12/2019 02:39	14,31	9	128,79	CHI
201912203245	SAO MIGUEL DO ARAGUAIA	SM21147677	SAO MIGUEL DO ARAGUAIA	24/12/2019 12:20	25/12/2019 11:14	24/12/2019 12:20	25/12/2019 11:14	22,89	1	22,89	CHI
201912192908	BOM JESUS DE GOIAS	BJ21305370	BOM JESUS DE GOIAS	24/12/2019 12:22	24/12/2019 23:07	24/12/2019 12:22	24/12/2019 23:07	10,75	1	10,75	CHI
201912192912	RIO VERDE	RV12000243	RIO VERDE S1	24/12/2019 12:24	25/12/2019 12:42	24/12/2019 12:24	25/12/2019 12:42	24,30	5	121,48	CHI
201912192916	CAIAPONIA	CP11292238	CAIAPONIA	24/12/2019 12:25	24/12/2019 22:30	24/12/2019 12:25	24/12/2019 22:30	10,07	1	10,07	CHI
201912192927	BOM JESUS DE GOIAS	BJ21143978	BOM JESUS DE GOIAS	24/12/2019 12:28	24/12/2019 23:53	24/12/2019 12:28	24/12/2019 23:53	11,40	1	11,40	CHI
201912192933	VALPARAISO DE GOIAS	2860125390	PACAEMBU S1	24/12/2019 12:29	24/12/2019 17:18	24/12/2019 12:29	24/12/2019 17:18	4,82	1	4,82	CHI
201912193758	PLANALTINA	PI12324322	SAO JOAO D ALIANCA	24/12/2019 12:30	24/12/2019 19:38	24/12/2019 12:30	24/12/2019 19:38	7,13	7	49,88	CHI
201912194996	MONTIVIDIU DO NORTE	MX21146585	PORANGATU	24/12/2019 12:31	25/12/2019 22:19	24/12/2019 12:31	25/12/2019 22:19	33,79	2	67,59	CHI
201912192941	SILVANIA	LB21067402	DAIA S2	24/12/2019 12:32	24/12/2019 16:26	24/12/2019 12:32	24/12/2019 16:26	3,90	1	3,90	CHI
201912192942	RIO VERDE	630151453	RIO VERDE S2	24/12/2019 12:32	24/12/2019 19:16	24/12/2019 12:32	24/12/2019 19:16	6,73	1	6,73	CHI
201912192943	CIDADE OCIDENTAL	2680013895	MARAJOARA	24/12/2019 12:33	24/12/2019 14:18	24/12/2019 12:33	24/12/2019 14:18	1,75	1	1,75	CHI
201912192944	FLORES DE GOIAS	10006613444	FLORES DE GOIAS	24/12/2019 12:33	24/12/2019 15:03	24/12/2019 12:33	24/12/2019 15:03	2,50	1	2,50	CHI
201912192946	APARECIDA DE GOIANIA	200343762	INDEPENDENCIA S2	24/12/2019 12:34	24/12/2019 16:52	24/12/2019 12:34	24/12/2019 16:52	4,30	1	4,30	CHI
201912192949	PLANALTINA	PI11391155	PLANALTINA	24/12/2019 12:35	24/12/2019 17:47	24/12/2019 12:35	24/12/2019 17:47	5,20	9	46,80	CHI
201912195371	RIO VERDE	RV11251861	RIO VERDE S1	24/12/2019 12:36	24/12/2019 21:16	24/12/2019 12:36	24/12/2019 21:16	8,66	114	987,53	CHI
201912192959	PALESTINA DE GOIAS	PY12342701	PALESTINA	24/12/2019 12:37	25/12/2019 00:06	24/12/2019 12:37	25/12/2019 00:06	11,47	2	22,94	CHI
201912192963	JUSSARA	JR12204918	IPORA	24/12/2019 12:39	25/12/2019 04:18	24/12/2019 12:39	25/12/2019 04:18	15,65	35	547,73	CHI
201912192963	MONTES CLAROS DE GOIAS	JR12204918	IPORA	24/12/2019 12:39	25/12/2019 04:18	24/12/2019 12:39	25/12/2019 04:18	15,65	17	266,04	CHI
201912192964	JATAI	JT21104679	JATAI S1	24/12/2019 12:39	24/12/2019 18:56	24/12/2019 12:39	24/12/2019 18:56	6,28	1	6,28	CHI
201912192965	CRISTALINA	KR12351414	PAMPLONA	24/12/2019 12:39	24/12/2019 14:50	24/12/2019 12:39	24/12/2019 14:50	2,17	6	13,04	CHI
201912192968	JOVIANIA	JV12025428	GOIATUBA S1	24/12/2019 12:41	25/12/2019 13:50	24/12/2019 12:41	25/12/2019 13:50	25,14	5	125,69	CHI
201912192968	PONTALINA	JV12025428	GOIATUBA S1	24/12/2019 12:41	25/12/2019 13:50	24/12/2019 12:41	25/12/2019 13:50	25,14	19	477,62	CHI



201912192969	INHUMAS	IN12011980	INHUMAS S1	24/12/2019 12:41	24/12/2019 14:03	24/12/2019 12:41	24/12/2019 14:03	1,35	8	10,84	CHI
201912192976	TURVELANDIA	1760011207	RIO DOS BOIS	24/12/2019 12:42	26/12/2019 17:00	24/12/2019 12:42	26/12/2019 17:00	52,29	1	52,29	CHI
201912192981	APARECIDA DE GOIANIA	10029678186	CEPAIGO S1	24/12/2019 12:43	24/12/2019 15:06	24/12/2019 12:43	24/12/2019 15:06	2,37	1	2,37	CHI
201912192982	ANAPOLIS	10005290820	ANAPOLIS UNIVERSITARIO S2	24/12/2019 12:43	24/12/2019 17:20	24/12/2019 12:43	24/12/2019 17:20	4,60	1	4,60	CHI
201912191924	SANTA HELENA DE GOIAS	SH12279534	IPEGUARI	24/12/2019 12:45	26/12/2019 15:01	24/12/2019 12:45	26/12/2019 14:37	49,87	2	99,73	CHI
201912191924	SANTA HELENA DE GOIAS	SH12387441	SANTA HELENA S1	24/12/2019 12:45	26/12/2019 15:01	26/12/2019 10:19	26/12/2019 15:01	4,70	3	14,10	CHI
201912192992	CRISTALINA	KR12031672	CRISTALINA S1	24/12/2019 12:45	24/12/2019 18:08	24/12/2019 12:45	24/12/2019 18:08	5,37	1	5,37	CHI
201912192993	FAINA	FC21220900	GOIAS	24/12/2019 12:45	25/12/2019 16:32	24/12/2019 12:45	25/12/2019 16:32	27,77	1	27,77	CHI
201912192994	LUZIANIA	LZ21120160	MARAJOARA	24/12/2019 12:46	24/12/2019 13:53	24/12/2019 12:46	24/12/2019 13:53	1,11	1	1,11	CHI
201912193009	JATAI	JT21244714	JATAI S1	24/12/2019 12:48	24/12/2019 16:22	24/12/2019 12:48	24/12/2019 16:22	3,56	1	3,56	CHI
201912195589	SANCLERLANDIA	SC21250589	FIRMINOPOLIS S2	24/12/2019 12:48	25/12/2019 08:51	24/12/2019 12:48	25/12/2019 08:51	20,04	1	20,04	CHI
201912193011	GOUVELANDIA	QI10394709	QUIRINOPOLIS	24/12/2019 12:49	27/12/2019 12:41	24/12/2019 16:53	24/12/2019 20:50	3,96	3	11,88	CHI
201912193011	QUIRINOPOLIS	QI10394709	QUIRINOPOLIS	24/12/2019 12:49	27/12/2019 12:41	24/12/2019 16:53	24/12/2019 20:50	3,96	263	1041,85	CHI
201912193011	GOUVELANDIA	QI13370068	QUIRINOPOLIS	24/12/2019 12:49	27/12/2019 12:41	24/12/2019 12:49	25/12/2019 10:17	21,46	3	64,38	CHI
201912193011	GOUVELANDIA	QI13370068	QUIRINOPOLIS	24/12/2019 12:49	27/12/2019 12:41	24/12/2019 16:53	25/12/2019 10:17	17,40	73	1270,20	CHI
201912193011	GOUVELANDIA	QI13370068	QUIRINOPOLIS	24/12/2019 12:49	27/12/2019 12:41	25/12/2019 10:50	25/12/2019 16:44	5,91	1	5,91	CHI
201912193011	GOUVELANDIA	QI10394709	QUIRINOPOLIS	24/12/2019 12:49	27/12/2019 12:41	26/12/2019 13:36	26/12/2019 17:18	3,70	3	11,10	CHI
201912193011	QUIRINOPOLIS	QI10394709	QUIRINOPOLIS	24/12/2019 12:49	27/12/2019 12:41	26/12/2019 13:36	26/12/2019 17:18	3,70	263	972,95	CHI
201912193011	GOUVELANDIA	QI10394709	QUIRINOPOLIS	24/12/2019 12:49	27/12/2019 12:41	25/12/2019 10:50	26/12/2019 20:37	33,79	75	2534,52	CHI
201912193011	GOUVELANDIA	QI10394709	QUIRINOPOLIS	24/12/2019 12:49	27/12/2019 12:41	26/12/2019 13:36	26/12/2019 20:37	7,01	1	7,01	CHI
201912193011	GOUVELANDIA	QI10394709	QUIRINOPOLIS	24/12/2019 12:49	27/12/2019 12:41	24/12/2019 16:53	27/12/2019 12:10	67,29	7	471,02	CHI
201912193011	GOUVELANDIA	QI10394709	QUIRINOPOLIS	24/12/2019 12:49	27/12/2019 12:41	24/12/2019 16:53	27/12/2019 12:41	67,81	126	8543,99	CHI
201912193012	IPAMERI	IP11027105	IPAMERI	24/12/2019 12:49	24/12/2019 17:08	24/12/2019 12:49	24/12/2019 17:08	4,31	117	503,94	CHI
201912193018	APARECIDA DE GOIANIA	14897283	REAL S1	24/12/2019 12:50	24/12/2019 13:38	24/12/2019 12:50	24/12/2019 13:38	0,79	1	0,79	CHI
201912193020	ITUMBIARA	BG21000044	ITUMBIARA VELHA S2	24/12/2019 12:50	24/12/2019 16:12	24/12/2019 12:50	24/12/2019 16:12	3,36	1	3,36	CHI
201912193022	PALMEIRAS DE GOIAS	PL21167186	PALMEIRAS	24/12/2019 12:50	25/12/2019 08:00	24/12/2019 12:50	25/12/2019 08:00	19,16	1	19,16	CHI
201912193024	MINEIROS	SU12184123	SANTA RITA DO ARAGUAIA	24/12/2019 12:51	24/12/2019 23:03	24/12/2019 12:51	24/12/2019 23:03	10,20	15	152,97	CHI
201912193024	SANTA RITA DO ARAGUAIA	SU12184123	SANTA RITA DO ARAGUAIA	24/12/2019 12:51	24/12/2019 23:03	24/12/2019 12:51	24/12/2019 23:03	10,20	5	50,99	CHI
201912193031	ARUANA	AK21158199	ARUANA	24/12/2019 12:52	24/12/2019 16:12	24/12/2019 12:52	24/12/2019 16:12	3,32	1	3,32	CHI
201912193047	CALDAS NOVAS	BC12352288	CALDAS NOVAS S1	24/12/2019 12:57	25/12/2019 16:32	24/12/2019 12:57	25/12/2019 16:32	27,58	1	27,58	CHI
201912193121	BELA VISTA DE GOIAS	05240214	CRISTIANOPOLIS	24/12/2019 12:57	24/12/2019 15:32	24/12/2019 12:57	24/12/2019 14:55	1,98	80	158,02	CHI
201912193121	CRISTIANOPOLIS	05240214	CRISTIANOPOLIS	24/12/2019 12:57	24/12/2019 15:32	24/12/2019 12:57	24/12/2019 14:55	1,98	22	43,46	CHI
201912193121	SAO MIGUEL DO PASSA QUATRO	05240214	CRISTIANOPOLIS	24/12/2019 12:57	24/12/2019 15:32	24/12/2019 12:57	24/12/2019 14:55	1,98	93	183,70	CHI

201912193121	VIANOPOLIS	05240214	CRISTIANOPOLIS	24/12/2019 12:57	24/12/2019 15:32	24/12/2019 12:57	24/12/2019 14:55	1,98	3	5,93	CHI
201912193121	BELA VISTA DE GOIAS	SQ13257336	CRISTIANOPOLIS	24/12/2019 12:57	24/12/2019 15:32	24/12/2019 12:57	24/12/2019 15:32	2,59	4	10,36	CHI
201912193121	SAO MIGUEL DO PASSA QUATRO	SQ13257336	CRISTIANOPOLIS	24/12/2019 12:57	24/12/2019 15:32	24/12/2019 12:57	24/12/2019 15:32	2,59	182	471,33	CHI
201912193048	APARECIDA DE GOIANIA	11904860	REAL S1	24/12/2019 12:58	24/12/2019 13:33	24/12/2019 12:58	24/12/2019 13:33	0,58	1	0,58	CHI
201912193713	HIDROLINA	SZ12190052	ITAPACI	24/12/2019 12:59	24/12/2019 16:49	24/12/2019 12:59	24/12/2019 16:49	3,83	51	195,50	CHI
201912193713	SAO LUIZ DO NORTE	SZ12190052	ITAPACI	24/12/2019 12:59	24/12/2019 16:49	24/12/2019 12:59	24/12/2019 16:49	3,83	21	80,50	CHI
201912193059	CATALAO	CT21286342	CATALAO S1	24/12/2019 13:00	24/12/2019 14:45	24/12/2019 13:00	24/12/2019 14:45	1,75	1	1,75	CHI
201912193060	CATALAO	CT11000061	CATALAO S2	24/12/2019 13:00	24/12/2019 16:40	24/12/2019 13:00	24/12/2019 16:40	3,66	106	387,61	CHI
201912193443	PALESTINA DE GOIAS	PY12040193	PALESTINA	24/12/2019 13:00	24/12/2019 16:10	24/12/2019 13:00	24/12/2019 16:10	3,16	81	256,36	CHI
201912193406	AURILANDIA	AI11000004	FIRMINOPOLIS S2	24/12/2019 13:04	24/12/2019 15:06	24/12/2019 13:04	24/12/2019 15:06	2,02	114	230,22	CHI
201912193080	DAMOLANDIA	DL21014210	INHUMAS S1	24/12/2019 13:05	24/12/2019 17:07	24/12/2019 13:05	24/12/2019 17:07	4,03	2	8,06	CHI
201912193089	ABADIANIA	AA21370544	CORUMBA	24/12/2019 13:06	24/12/2019 21:16	24/12/2019 13:06	24/12/2019 21:16	8,17	1	8,17	CHI
201912193097	TEREZOPOLIS DE GOIAS	AN21258448	JUNDIAI S2	24/12/2019 13:07	24/12/2019 18:29	24/12/2019 13:07	24/12/2019 18:29	5,35	1	5,35	CHI
201912196566	GUARAITA	GK12299446	ITAPURANGA	24/12/2019 13:08	25/12/2019 10:57	24/12/2019 13:08	25/12/2019 10:57	21,82	11	240,01	CHI
201912193108	GOIANIA	12570631	ATLANTICO S3	24/12/2019 13:09	24/12/2019 14:46	24/12/2019 13:09	24/12/2019 14:46	1,61	1	1,61	CHI
201912193109	FORMOSA	610195013	ITUIQUIRA	24/12/2019 13:10	24/12/2019 15:48	24/12/2019 13:10	24/12/2019 15:48	2,63	1	2,63	CHI
201912193110	RIO VERDE	630528020	RIO VERDE S1	24/12/2019 13:10	24/12/2019 15:50	24/12/2019 13:10	24/12/2019 15:50	2,66	1	2,66	CHI
201912193112	DAVINOPOLIS	2950002920	CATALAO S1	24/12/2019 13:10	24/12/2019 15:43	24/12/2019 13:10	24/12/2019 15:43	2,54	1	2,54	CHI
201912193449	MUTUNOPOLIS	MU12291187	MARA ROSA	24/12/2019 13:11	25/12/2019 01:35	24/12/2019 13:11	25/12/2019 01:35	12,39	2	24,78	CHI
201912193127	RIO VERDE	630296431	RIO VERDE S1	24/12/2019 13:13	25/12/2019 15:26	24/12/2019 13:13	25/12/2019 15:26	26,21	1	26,21	CHI
201912193145	ABADIANIA	AA21291877	ANAPOLIS UNIVERSITARIO S1	24/12/2019 13:17	24/12/2019 14:28	24/12/2019 13:17	24/12/2019 14:28	1,18	1	1,18	CHI
201912193148	APARECIDA DE GOIANIA	12455878	REAL S1	24/12/2019 13:17	24/12/2019 13:53	24/12/2019 13:17	24/12/2019 13:53	0,59	1	0,59	CHI
201912193152	DAVINOPOLIS	IO21077554	CATALAO S1	24/12/2019 13:17	24/12/2019 15:42	24/12/2019 13:17	24/12/2019 15:42	2,41	1	2,41	CHI
201912193155	GOIANIA	11968552	FERROVIARIO S1	24/12/2019 13:17	24/12/2019 14:40	24/12/2019 13:17	24/12/2019 14:40	1,38	1	1,38	CHI
201912193160	SANCLERLANDIA	SC21164049	FIRMINOPOLIS S2	24/12/2019 13:17	25/12/2019 08:26	24/12/2019 13:17	25/12/2019 08:26	19,14	1	19,14	CHI
201912193164	NIQUELANDIA	NQ21371959	BARRO ALTO	24/12/2019 13:17	25/12/2019 04:38	24/12/2019 13:17	25/12/2019 04:38	15,34	1	15,34	CHI
201912193170	AGUAS LINDAS DE GOIAS	10023236130	AGUAS LINDAS DE GOIAS S2	24/12/2019 13:17	24/12/2019 15:00	24/12/2019 13:17	24/12/2019 15:00	1,72	1	1,72	CHI
201912193173	APARECIDA DE GOIANIA	AP11000052	INDEPENDENCIA S1	24/12/2019 13:17	24/12/2019 15:32	24/12/2019 13:17	24/12/2019 15:32	2,25	120	269,57	CHI
201912193176	GOIANIA	14995529	FERROVIARIO S1	24/12/2019 13:17	24/12/2019 15:06	24/12/2019 13:17	24/12/2019 15:06	1,80	1	1,80	CHI
201912193178	FIRMINOPOLIS	FR21102785	SAO LUIZ DOS MONTES BELOS	24/12/2019 13:17	24/12/2019 17:45	24/12/2019 13:17	24/12/2019 17:45	4,45	1	4,45	CHI
201912193179	URUACU	UR21202053	URUACU	24/12/2019 13:18	24/12/2019 15:31	24/12/2019 13:18	24/12/2019 15:31	2,22	1	2,22	CHI
201912193181	PLANALTINA	PI21109463	PLANALTINA	24/12/2019 13:18	24/12/2019 18:41	24/12/2019 13:18	24/12/2019 18:41	5,38	1	5,38	CHI
201912193183	LEOPOLDO DE BULHOES	BO21072846	DAIA S2	24/12/2019 13:18	24/12/2019 18:18	24/12/2019 13:18	24/12/2019 18:18	5,00	1	5,00	CHI

201912193197	APARECIDA DE GOIANIA	200403515	ANHANGUERA	24/12/2019 13:20	24/12/2019 17:04	24/12/2019 13:20	24/12/2019 17:04	3,73	1	3,73	CHI
201912193438	ANICUNS	AC12020338	ANICUNS	24/12/2019 13:20	24/12/2019 16:30	24/12/2019 13:20	24/12/2019 16:30	3,16	21	66,44	CHI
201912193205	BARRO ALTO	BA21165593	BARRO ALTO	24/12/2019 13:21	25/12/2019 08:15	24/12/2019 13:21	25/12/2019 08:15	18,88	1	18,88	CHI
201912193209	CABECEIRAS	CW12218489	ITUIQUIRA	24/12/2019 13:22	24/12/2019 18:50	24/12/2019 13:22	24/12/2019 18:50	5,46	3	16,37	CHI
201912193213	SAO MIGUEL DO ARAGUAIA	SM12064129	SAO MIGUEL DO ARAGUAIA	24/12/2019 13:23	25/12/2019 15:32	24/12/2019 13:23	25/12/2019 15:32	26,14	4	104,57	CHI
201912193218	CATALAO	CT12288065	CATALAO S1	24/12/2019 13:24	25/12/2019 16:10	24/12/2019 13:24	25/12/2019 16:10	26,76	5	133,81	CHI
201912193221	MORRINHOS	10029831812	MORRINHOS	24/12/2019 13:25	25/12/2019 05:36	24/12/2019 13:25	25/12/2019 05:36	16,19	1	16,19	CHI
201912193529	CAVALCANTE	TI12162624	NIQUELANDIA SUBTRANSMISSAO	24/12/2019 13:26	24/12/2019 18:21	24/12/2019 13:26	24/12/2019 18:21	4,91	55	270,13	CHI
201912193529	COLINAS DO SUL	TI12162624	NIQUELANDIA SUBTRANSMISSAO	24/12/2019 13:26	24/12/2019 18:21	24/12/2019 13:26	24/12/2019 18:21	4,91	17	83,49	CHI
201912193228	GOUVELANDIA	GB12261016	QUIRINOPOLIS	24/12/2019 13:27	24/12/2019 15:29	24/12/2019 13:27	24/12/2019 15:29	2,03	3	6,08	CHI
201912193230	GOIAS	GS11274470	GOIAS	24/12/2019 13:28	26/12/2019 11:35	24/12/2019 13:28	26/12/2019 11:35	46,11	5	230,57	CHI
201912193231	VALPARAISO DE GOIAS	2860116030	PACAEMBU S1	24/12/2019 13:28	24/12/2019 18:03	24/12/2019 13:28	24/12/2019 18:03	4,58	1	4,58	CHI
201912193235	NOVO PLANALTO	TA11253751	NOVO PLANALTO	24/12/2019 13:29	24/12/2019 20:05	24/12/2019 13:29	24/12/2019 20:05	6,60	121	798,43	CHI
201912193238	AGUAS LINDAS DE GOIAS	10010134164	AGUAS LINDAS DE GOIAS S1	24/12/2019 13:29	24/12/2019 14:54	24/12/2019 13:29	24/12/2019 14:54	1,40	1	1,40	CHI
201912194228	RIO VERDE	RV12240417	CABRIUVA S2	24/12/2019 13:29	25/12/2019 10:12	24/12/2019 13:29	25/12/2019 10:12	20,71	5	103,55	CHI
201912193241	BONOPOLIS	4350004854	SAO MIGUEL DO ARAGUAIA	24/12/2019 13:31	25/12/2019 17:55	24/12/2019 13:31	25/12/2019 17:55	28,41	1	28,41	CHI
201912193243	APARECIDA DE GOIANIA	13601386	INDEPENDENCIA S2	24/12/2019 13:31	24/12/2019 14:58	24/12/2019 13:31	24/12/2019 14:58	1,44	1	1,44	CHI
201912193245	ORIZONA	OZ21408043	PIRES DO RIO S2	24/12/2019 13:32	24/12/2019 16:50	24/12/2019 13:32	24/12/2019 16:50	3,30	1	3,30	CHI
201912193806	FAZENDA NOVA	FN12390152	IPORA	24/12/2019 13:32	25/12/2019 08:24	24/12/2019 13:32	25/12/2019 08:24	18,86	12	226,30	CHI
201912193806	ISRAELANDIA	FN12390152	IPORA	24/12/2019 13:32	25/12/2019 08:24	24/12/2019 13:32	25/12/2019 08:24	18,86	2	37,72	CHI
201912193247	CATURAI	CK21029150	ARACU	24/12/2019 13:33	24/12/2019 18:43	24/12/2019 13:33	24/12/2019 18:43	5,17	1	5,17	CHI
201912193255	CRISTALINA	KR11032674	CRISTALINA S1	24/12/2019 13:33	24/12/2019 15:27	24/12/2019 13:33	24/12/2019 15:27	1,89	63	118,86	CHI
201912194987	VILA PROPICIO	PV11326334	GOIANESIA S1	24/12/2019 13:33	25/12/2019 00:01	24/12/2019 13:33	25/12/2019 00:01	10,47	113	1183,02	CHI
201912193258	NIQUELANDIA	NQ12295506	NIQUELANDIA SUBTRANSMISSAO	24/12/2019 13:34	24/12/2019 15:43	24/12/2019 13:34	24/12/2019 15:43	2,14	19	40,75	CHI
201912193263	TRINDADE	TR12000048	TRINDADE	24/12/2019 13:35	24/12/2019 14:55	24/12/2019 13:35	24/12/2019 14:55	1,32	5	6,59	CHI
201912193495	PIRES DO RIO	PR12051686	PIRES DO RIO S2	24/12/2019 13:36	24/12/2019 18:27	24/12/2019 13:36	24/12/2019 18:27	4,84	1	4,84	CHI
201912193495	SANTA CRUZ DE GOIAS	PR12051686	PIRES DO RIO S2	24/12/2019 13:36	24/12/2019 18:27	24/12/2019 13:36	24/12/2019 18:27	4,84	20	96,83	CHI
201912193274	MONTES CLAROS DE GOIAS	ME12270281	IPORA	24/12/2019 13:38	25/12/2019 10:11	24/12/2019 13:38	25/12/2019 10:11	20,54	1	20,54	CHI
201912193701	NAZARIO	PL12000127LD	PALMEIRAS	24/12/2019 13:38	24/12/2019 17:05	24/12/2019 13:38	24/12/2019 17:05	3,46	3	10,38	CHI
201912193701	PALMEIRAS DE GOIAS	PL12000127LD	PALMEIRAS	24/12/2019 13:38	24/12/2019 17:05	24/12/2019 13:38	24/12/2019 17:05	3,46	136	470,45	CHI
201912195435	VILA PROPICIO	NP12339454	GOIANESIA S1	24/12/2019 13:39	24/12/2019 19:47	24/12/2019 13:39	24/12/2019 19:47	6,13	113	692,66	CHI
201912193283	LUZIANIA	LZ21060643	MARAJOARA	24/12/2019 13:41	24/12/2019 15:19	24/12/2019 13:41	24/12/2019 15:19	1,62	1	1,62	CHI
201912193285	SANTA HELENA DE GOIAS	400147543	IPEGUARI	24/12/2019 13:43	25/12/2019 14:27	24/12/2019 13:43	25/12/2019 14:27	24,73	1	24,73	CHI

201912193287	ANICUNS	AC12020336	ANICUNS	24/12/2019 13:44	24/12/2019 16:30	24/12/2019 13:44	24/12/2019 16:30	2,77	2	5,53	CHI
201912193292	LUZIANIA	LZ21209550	RIO VERMELHO	24/12/2019 13:45	24/12/2019 15:39	24/12/2019 13:45	24/12/2019 15:39	1,89	1	1,89	CHI
201912193298	CALDAS NOVAS	CN21292320	CALDAS NOVAS S1	24/12/2019 13:45	24/12/2019 14:26	24/12/2019 13:45	24/12/2019 14:26	0,67	1	0,67	CHI
201912193401	APARECIDA DE GOIANIA	10016818677	INDEPENDENCIA S2	24/12/2019 13:46	24/12/2019 16:01	24/12/2019 13:46	24/12/2019 16:01	2,24	1	2,24	CHI
201912193405	JATAI	JT11386915	JATAI S2	24/12/2019 13:46	24/12/2019 15:49	24/12/2019 13:46	24/12/2019 15:49	2,04	28	57,00	CHI
201912193469	PIRANHAS	PH12201811RE	PIRANHAS	24/12/2019 13:46	25/12/2019 09:19	24/12/2019 13:46	25/12/2019 09:19	19,53	52	1015,75	CHI
201912197202	JUSSARA	JR12008743	BRITANIA	24/12/2019 13:46	24/12/2019 23:06	24/12/2019 13:46	24/12/2019 23:06	9,32	38	354,22	CHI
201912201326	SANTA ISABEL	1380000996	GOIANESIA S1	24/12/2019 13:46	26/12/2019 23:11	24/12/2019 13:46	26/12/2019 23:11	57,41	1	57,41	CHI
201912193316	PONTALINA	PK13160437	PONTALINA	24/12/2019 13:48	25/12/2019 12:30	24/12/2019 13:48	25/12/2019 12:30	22,69	69	1565,59	CHI
201912193411	OUVIDOR	OU12358276RE	CATALAO S1	24/12/2019 13:48	25/12/2019 11:06	24/12/2019 13:48	25/12/2019 11:06	21,30	23	489,86	CHI
201912196573	SAO JOAO D ALIANCA	JL12404385	SAO JOAO D ALIANCA	24/12/2019 13:49	25/12/2019 15:01	24/12/2019 13:49	25/12/2019 15:01	25,19	56	1410,44	CHI
201912193421	APARECIDA DE GOIANIA	AP12058868	INDEPENDENCIA S1	24/12/2019 13:51	24/12/2019 15:50	24/12/2019 13:51	24/12/2019 15:50	1,98	4	7,93	CHI
201912193425	APARECIDA DE GOIANIA	200292742	INDEPENDENCIA S1	24/12/2019 13:52	24/12/2019 14:46	24/12/2019 13:52	24/12/2019 14:46	0,89	1	0,89	CHI
201912193516	APARECIDA DE GOIANIA	AP11079021	INDEPENDENCIA S1	24/12/2019 13:53	24/12/2019 18:35	24/12/2019 13:53	24/12/2019 18:35	4,68	83	388,79	CHI
201912193566	INHUMAS	IN12294040	INHUMAS S1	24/12/2019 13:53	24/12/2019 16:30	24/12/2019 13:53	24/12/2019 16:30	2,60	2	5,20	CHI
201912193437	ALVORADA DO NORTE	AQ11071370	IACIARA S2	24/12/2019 13:55	24/12/2019 15:21	24/12/2019 13:55	24/12/2019 15:21	1,43	191	272,76	CHI
201912200804	IPAMERI	10013344437	URUTAI	24/12/2019 13:57	25/12/2019 16:53	24/12/2019 13:57	25/12/2019 16:53	26,92	1	26,92	CHI
201912193448	QUIRINOPOLIS	QI21246834	QUIRINOPOLIS	24/12/2019 13:58	24/12/2019 22:37	24/12/2019 13:58	24/12/2019 22:37	8,65	1	8,65	CHI
201912193470	PADRE BERNARDO	PB12097184	PADRE BERNARDO	24/12/2019 13:58	24/12/2019 17:46	24/12/2019 13:58	24/12/2019 17:46	3,79	7	26,56	CHI
201912193317	RIO VERDE	RV10400679	RIO VERDE S1	24/12/2019 14:01	25/12/2019 11:55	24/12/2019 14:01	24/12/2019 18:43	4,70	71	333,96	CHI
201912193317	RIO VERDE	RV12024714	RIO VERDE S1	24/12/2019 14:01	25/12/2019 11:55	24/12/2019 14:01	25/12/2019 11:55	21,90	15	328,49	CHI
201912193461	NIQUELANDIA	NQ21197663	BARRO ALTO	24/12/2019 14:01	24/12/2019 19:14	24/12/2019 14:01	24/12/2019 19:14	5,21	1	5,21	CHI
201912193462	SANCLERLANDIA	SL12323584	SAO LUIZ DOS MONTES BELOS	24/12/2019 14:01	24/12/2019 17:40	24/12/2019 14:01	24/12/2019 17:40	3,66	18	65,88	CHI
201912193464	APARECIDA DE GOIANIA	10022951880	INDEPENDENCIA S1	24/12/2019 14:01	24/12/2019 16:06	24/12/2019 14:01	24/12/2019 16:06	2,07	1	2,07	CHI
201912193466	GOIANIA	GN11001054	XAVANTES	24/12/2019 14:01	24/12/2019 16:57	24/12/2019 14:01	24/12/2019 16:57	2,92	33	96,27	CHI
201912193468	APARECIDA DE GOIANIA	200247311	INDEPENDENCIA S1	24/12/2019 14:03	24/12/2019 17:28	24/12/2019 14:03	24/12/2019 17:28	3,40	1	3,40	CHI
201912193474	SAO DOMINGOS	SD21317916	SAO DOMINGOS	24/12/2019 14:05	24/12/2019 16:58	24/12/2019 14:05	24/12/2019 16:58	2,87	1	2,87	CHI
201912193480	PETROLINA DE GOIAS	PV31054471	SAO FRANCISCO DE GOIAS	24/12/2019 14:07	24/12/2019 18:41	24/12/2019 14:07	24/12/2019 18:41	4,56	5	22,82	CHI
201912193482	COCALZINHO DE GOIAS	ZN12302256	COCALZINHO	24/12/2019 14:08	25/12/2019 09:21	24/12/2019 14:08	25/12/2019 09:21	19,21	2	38,43	CHI
201912193484	ITUMBIARA	690036395	ITUMBIARA VELHA S1	24/12/2019 14:08	25/12/2019 08:05	24/12/2019 14:08	25/12/2019 08:05	17,95	1	17,95	CHI
201912193493	NOVO GAMA	4990066596	PACAEMBU S1	24/12/2019 14:10	24/12/2019 17:37	24/12/2019 14:10	24/12/2019 17:37	3,43	1	3,43	CHI
201912193506	GOIANIA	10009309754	CARAJAS S1	24/12/2019 14:12	24/12/2019 15:54	24/12/2019 14:12	24/12/2019 15:54	1,69	1	1,69	CHI
201912193507	URUACU	UR21243282	MARA ROSA	24/12/2019 14:12	25/12/2019 14:08	24/12/2019 14:12	25/12/2019 14:08	23,93	1	23,93	CHI

201912193511	NOVA CRIXAS	NA11250089	NOVA CRIXAS	24/12/2019 14:14	24/12/2019 15:20	24/12/2019 14:14	24/12/2019 15:20	1,10	73	80,02	CHI
201912193561	GOIANIA	GN11199197	ATLANTICO S1	24/12/2019 14:14	24/12/2019 15:35	24/12/2019 14:14	24/12/2019 15:35	1,34	92	123,43	CHI
201912193517	APARECIDA DE GOIANIA	200479489	INDEPENDENCIA S2	24/12/2019 14:16	25/12/2019 14:00	24/12/2019 14:16	25/12/2019 14:00	23,73	1	23,73	CHI
201912193527	GOIANIA	GN11374103	FERROVIARIO S3	24/12/2019 14:16	24/12/2019 15:12	24/12/2019 14:16	24/12/2019 15:12	0,93	49	45,47	CHI
201912193518	SENADOR CANEDO	10026970153	SENADOR CANEDO	24/12/2019 14:17	24/12/2019 15:56	24/12/2019 14:17	24/12/2019 15:56	1,65	1	1,65	CHI
201912193534	PIRANHAS	PH11374802	PIRANHAS	24/12/2019 14:20	24/12/2019 16:08	24/12/2019 14:20	24/12/2019 16:08	1,79	54	96,57	CHI
201912193537	ITUMBIARA	10007025244	ITUMBIARA VELHA S1	24/12/2019 14:21	25/12/2019 07:30	24/12/2019 14:21	25/12/2019 07:30	17,15	1	17,15	CHI
201912193539	EDEIA	EA21026653	EDEIA	24/12/2019 14:22	25/12/2019 15:29	24/12/2019 14:22	25/12/2019 15:29	25,11	1	25,11	CHI
201912193540	PARAUNA	PU12159023	PARAUNA	24/12/2019 14:22	24/12/2019 22:56	24/12/2019 14:22	24/12/2019 22:56	8,55	4	34,21	CHI
201912193544	LUZIANIA	LZ12085964	PACAEMBU S1	24/12/2019 14:24	24/12/2019 20:02	24/12/2019 14:24	24/12/2019 20:02	5,63	29	163,36	CHI
201912193544	NOVO GAMA	LZ12085964	PACAEMBU S1	24/12/2019 14:24	24/12/2019 20:02	24/12/2019 14:24	24/12/2019 20:02	5,63	18	101,39	CHI
201912193547	MINEIROS	MY21216304	PARQUE DAS EMAS	24/12/2019 14:24	24/12/2019 18:37	24/12/2019 14:24	24/12/2019 18:37	4,20	1	4,20	CHI
201912193749	LUZIANIA	LZ12351393	MARAJOARA	24/12/2019 14:25	24/12/2019 17:07	24/12/2019 14:25	24/12/2019 17:07	2,69	12	32,23	CHI
201912193555	PADRE BERNARDO	PB21275036	PADRE BERNARDO	24/12/2019 14:26	24/12/2019 18:19	24/12/2019 14:26	24/12/2019 18:19	3,88	1	3,88	CHI
201912193557	SAO DOMINGOS	8680006429	SAO DOMINGOS	24/12/2019 14:26	24/12/2019 22:10	24/12/2019 14:26	24/12/2019 22:10	7,72	1	7,72	CHI
201912193564	ITUMBIARA	690346992	ITUMBIARA NOVA	24/12/2019 14:27	24/12/2019 16:57	24/12/2019 14:27	24/12/2019 16:57	2,49	1	2,49	CHI
201912193567	CRISTALINA	KR12261531	CRISTALINA S1	24/12/2019 14:28	24/12/2019 21:47	24/12/2019 14:28	24/12/2019 21:47	7,31	4	29,24	CHI
201912193570	ITAPIRAPUA	IU12341188	JUSSARA	24/12/2019 14:28	24/12/2019 21:09	24/12/2019 14:28	24/12/2019 21:09	6,67	6	40,03	CHI
201912193574	HIDROLANDIA	10004794697	ANHANGUERA	24/12/2019 14:29	24/12/2019 18:13	24/12/2019 14:29	24/12/2019 18:13	3,72	1	3,72	CHI
201912195530	MUTUNOPOLIS	MU12391658	MARA ROSA	24/12/2019 14:29	25/12/2019 02:49	24/12/2019 14:29	25/12/2019 02:49	12,32	21	258,80	CHI
201912193587	GOIANIA	GN12000671	CARAJAS S2	24/12/2019 14:30	24/12/2019 16:18	24/12/2019 14:30	24/12/2019 16:18	1,79	751	1345,75	CHI
201912193591	PORTEIRAO	CL12338603	RIO DOS BOIS	24/12/2019 14:34	25/12/2019 00:55	24/12/2019 19:53	25/12/2019 00:55	5,03	1	5,03	CHI
201912193596	FLORES DE GOIAS	FB11255046	FLORES DE GOIAS	24/12/2019 14:36	24/12/2019 19:57	24/12/2019 14:36	24/12/2019 19:57	5,35	13	69,51	CHI
201912193611	NIQUELANDIA	10004786392	NIQUELANDIA SUBTRANSMISSAO	24/12/2019 14:36	24/12/2019 16:55	24/12/2019 14:36	24/12/2019 16:55	2,31	0	0,00	CHI
201912193599	VALPARAISO DE GOIAS	2860148419	MARAJOARA	24/12/2019 14:38	24/12/2019 15:43	24/12/2019 14:38	24/12/2019 15:43	1,08	1	1,08	CHI
201912193804	PORANGATU	PO12102916	PORANGATU	24/12/2019 14:38	27/12/2019 00:36	24/12/2019 14:38	25/12/2019 02:05	11,44	5	57,22	CHI
201912193804	PORANGATU	PO12102916	PORANGATU	24/12/2019 14:38	27/12/2019 00:36	24/12/2019 14:38	25/12/2019 10:08	19,49	3	58,48	CHI
201912193804	PORANGATU	PO12102916	PORANGATU	24/12/2019 14:38	27/12/2019 00:36	24/12/2019 14:38	25/12/2019 12:15	21,61	2	43,22	CHI
201912193804	PORANGATU	PO12102916	PORANGATU	24/12/2019 14:38	27/12/2019 00:36	26/12/2019 18:46	26/12/2019 19:58	1,19	10	11,86	CHI
201912193804	PORANGATU	PO12102916	PORANGATU	24/12/2019 14:38	27/12/2019 00:36	24/12/2019 14:38	26/12/2019 21:03	54,41	17	924,96	CHI
201912193804	PORANGATU	PO12192315	PORANGATU	24/12/2019 14:38	27/12/2019 00:36	26/12/2019 22:46	27/12/2019 00:36	1,84	19	34,90	CHI
201912193708	PLANALTINA	10001403743	SAO JOAO D ALIANCA	24/12/2019 14:39	24/12/2019 19:55	24/12/2019 14:39	24/12/2019 19:55	5,27	1	5,27	CHI
201912193709	SAO LUIS DE MONTES BELOS	SL12391408	FIRMINOPOLIS S2	24/12/2019 14:39	25/12/2019 06:28	24/12/2019 14:39	25/12/2019 06:28	15,81	2	31,62	CHI

201912193718	COCALZINHO DE GOIAS	ZN21290613	AGUAS LINDAS DE GOIAS S2	24/12/2019 14:41	24/12/2019 17:45	24/12/2019 14:41	24/12/2019 17:45	3,06	1	3,06	CHI
201912193720	ORIZONA	VN10406899	VIANOPOLIS	24/12/2019 14:41	24/12/2019 17:40	24/12/2019 14:41	24/12/2019 17:40	2,97	23	68,32	CHI
201912193720	VIANOPOLIS	VN10406899	VIANOPOLIS	24/12/2019 14:41	24/12/2019 17:40	24/12/2019 14:41	24/12/2019 17:40	2,97	141	418,85	CHI
201912193729	APARECIDA DE GOIANIA	12114893	CARAJAS S1	24/12/2019 14:43	25/12/2019 13:29	24/12/2019 14:43	25/12/2019 13:29	22,77	1	22,77	CHI
201912193731	JATAI	JT11083489	JATAI S2	24/12/2019 14:43	24/12/2019 18:05	24/12/2019 14:43	24/12/2019 18:05	3,35	1	3,35	CHI
201912195523	PORANGATU	PO12391666	PORANGATU	24/12/2019 14:44	24/12/2019 21:14	24/12/2019 14:44	24/12/2019 21:14	6,51	15	97,65	CHI
201912193747	PLANALTINA	PI21125290	SAO JOAO D ALIANCA	24/12/2019 14:45	24/12/2019 22:31	24/12/2019 14:45	24/12/2019 22:31	7,75	1	7,75	CHI
201912193752	AGUA FRIA DE GOIAS	TL21205629	SAO JOAO D ALIANCA	24/12/2019 14:46	25/12/2019 08:32	24/12/2019 14:46	25/12/2019 08:32	17,76	1	17,76	CHI
201912193757	APARECIDA DE GOIANIA	200515100	INDEPENDENCIA S2	24/12/2019 14:48	24/12/2019 19:02	24/12/2019 14:48	24/12/2019 19:02	4,23	1	4,23	CHI
201912193762	DAVINOPOLIS	IO21223950	CATALAO S1	24/12/2019 14:48	24/12/2019 17:37	24/12/2019 14:48	24/12/2019 17:37	2,80	1	2,80	CHI
201912193766	GOIANIA	12235003	ATLANTICO S1	24/12/2019 14:49	24/12/2019 16:27	24/12/2019 14:49	24/12/2019 16:27	1,62	1	1,62	CHI
201912194304	CAMPINORTE	MQ12094074	MARA ROSA	24/12/2019 14:50	24/12/2019 21:27	24/12/2019 14:50	24/12/2019 21:27	6,61	9	59,52	CHI
201912193772	ABADIANIA	AA21291877	ANAPOLIS UNIVERSITARIO S1	24/12/2019 14:51	24/12/2019 18:26	24/12/2019 14:51	24/12/2019 18:26	3,58	1	3,58	CHI
201912193778	APARECIDA DE GOIANIA	200111012	INDEPENDENCIA S1	24/12/2019 14:52	24/12/2019 20:43	24/12/2019 14:52	24/12/2019 20:43	5,84	1	5,84	CHI
201912193785	APARECIDA DE GOIANIA	200110238	INDEPENDENCIA S2	24/12/2019 14:54	24/12/2019 19:10	24/12/2019 14:54	24/12/2019 19:10	4,26	1	4,26	CHI
201912193788	AMERICANO DO BRASIL	AC12019282	ANICUNS	24/12/2019 14:56	24/12/2019 17:45	24/12/2019 14:56	24/12/2019 17:45	2,82	4	11,29	CHI
201912193788	ANICUNS	AC12019282	ANICUNS	24/12/2019 14:56	24/12/2019 17:45	24/12/2019 14:56	24/12/2019 17:45	2,82	2	5,65	CHI
201912193791	QUIRINOPOLIS	QI21116504	QUIRINOPOLIS	24/12/2019 14:57	24/12/2019 21:22	24/12/2019 14:57	24/12/2019 21:22	6,41	1	6,41	CHI
201912193794	FAZENDA NOVA	FN21183430	IPORA	24/12/2019 14:58	25/12/2019 07:18	24/12/2019 14:58	25/12/2019 07:18	16,33	1	16,33	CHI
201912193801	FORMOSA	FA12020054	ITUIQUIRA	24/12/2019 15:00	25/12/2019 21:16	24/12/2019 15:00	25/12/2019 21:16	30,26	8	242,06	CHI
201912193901	URUACU	UR21247222	MARA ROSA	24/12/2019 15:05	25/12/2019 09:25	24/12/2019 15:05	25/12/2019 09:25	18,33	1	18,33	CHI
201912193936	NOVO GAMA	NJ12212105	PACAEMBU S1	24/12/2019 15:05	24/12/2019 17:50	24/12/2019 15:05	24/12/2019 17:50	2,75	247	678,91	CHI
201912193936	SANTO ANTONIO DO DESCOBERTO	NJ12212105	PACAEMBU S1	24/12/2019 15:05	24/12/2019 17:50	24/12/2019 15:05	24/12/2019 17:50	2,75	26	71,46	CHI
201912194939	MINACU	IH12208345	MINACU	24/12/2019 15:07	24/12/2019 22:08	24/12/2019 15:07	24/12/2019 22:08	7,01	95	665,55	CHI
201912193917	INACIOLANDIA	ID21134544	QUIRINOPOLIS	24/12/2019 15:09	25/12/2019 08:08	24/12/2019 15:09	25/12/2019 08:08	16,98	2	33,96	CHI
201912193918	VALPARAISO DE GOIAS	2860374936	PACAEMBU S1	24/12/2019 15:09	24/12/2019 17:07	24/12/2019 15:09	24/12/2019 17:07	1,96	1	1,96	CHI
201912193922	SENADOR CANEDO	SW11406595	SENADOR CANEDO	24/12/2019 15:10	24/12/2019 17:25	24/12/2019 15:10	24/12/2019 17:25	2,23	0	0,00	CHI
201912193924	NOVA CRIXAS	7939486	MOZARLANDIA	24/12/2019 15:10	26/12/2019 17:23	24/12/2019 15:10	26/12/2019 17:22	50,18	1	50,18	CHI
201912193924	NOVA CRIXAS	NA12055690	MOZARLANDIA	24/12/2019 15:10	26/12/2019 17:23	24/12/2019 15:10	26/12/2019 17:23	50,21	12	602,56	CHI
201912193014	SANTO ANTONIO DO DESCOBERTO	SN21082875	MARAJOARA	24/12/2019 15:12	24/12/2019 18:23	24/12/2019 15:12	24/12/2019 18:23	3,18	3	9,53	CHI
201912193928	APARECIDA DE GOIANIA	200371009	INDEPENDENCIA S1	24/12/2019 15:12	24/12/2019 17:52	24/12/2019 15:12	24/12/2019 17:52	2,66	1	2,66	CHI
201912193929	RIO VERDE	10011607856	RIO VERDE S1	24/12/2019 15:12	25/12/2019 10:41	24/12/2019 15:12	25/12/2019 10:41	19,47	1	19,47	CHI
201912186197	BRITANIA	04750224	MATRINCHA	24/12/2019 15:13	24/12/2019 19:35	24/12/2019 15:13	24/12/2019 19:35	4,38	6	26,27	CHI

201912186197	ITAPIRAPUA	04750224	MATRINCHA	24/12/2019 15:13	24/12/2019 19:35	24/12/2019 15:13	24/12/2019 19:35	4,38	91	398,48	CHI
201912193938	ANAPOLIS	AN12008937	JUNDIAI S1	24/12/2019 15:14	24/12/2019 16:28	24/12/2019 15:14	24/12/2019 16:28	1,22	282	344,98	CHI
201912193941	GOIANIA	AP21002093	REAL S1	24/12/2019 15:14	24/12/2019 21:01	24/12/2019 15:14	24/12/2019 21:01	5,77	1	5,77	CHI
201912193944	CRISTALINA	KR12305054	PAMPLONA	24/12/2019 15:15	25/12/2019 08:56	24/12/2019 15:15	25/12/2019 08:56	17,67	108	1908,48	CHI
201912193948	VILA BOA	VB11265316	ITIQUEIRA	24/12/2019 15:17	24/12/2019 22:10	24/12/2019 15:17	24/12/2019 22:10	6,88	6	41,25	CHI
201912193953	SAO JOAO DA PARAUNA	FR21215370	FIRMINOPOLIS S2	24/12/2019 15:19	24/12/2019 16:11	24/12/2019 15:19	24/12/2019 16:11	0,86	1	0,86	CHI
201912193957	NIQUELANDIA	NQ21371114	SAO JOAO D ALIANCA	24/12/2019 15:19	24/12/2019 22:16	24/12/2019 15:19	24/12/2019 22:16	6,94	1	6,94	CHI
201912194967	QUIRINOPOLIS	RV12301218	SANTA HELENA S1	24/12/2019 15:19	25/12/2019 10:08	24/12/2019 15:19	25/12/2019 10:08	18,81	37	696,01	CHI
201912194967	RIO VERDE	RV12301218	SANTA HELENA S1	24/12/2019 15:19	25/12/2019 10:08	24/12/2019 15:19	25/12/2019 10:08	18,81	18	338,60	CHI
201912193971	PARAUNA	EU21295890	ACREUNA	24/12/2019 15:23	25/12/2019 10:20	24/12/2019 15:23	25/12/2019 10:20	18,95	2	37,90	CHI
201912193972	RIO VERDE	RV12303556	RIO VERDE S1	24/12/2019 15:23	25/12/2019 18:00	24/12/2019 15:23	25/12/2019 18:00	26,61	1	26,61	CHI
201912193976	CRISTALINA	KR12228852	CRISTALINA S2	24/12/2019 15:23	24/12/2019 18:20	24/12/2019 15:23	24/12/2019 18:20	2,94	3	8,82	CHI
201912193988	CRISTALINA	KR12209473	CRISTALINA S2	24/12/2019 15:27	24/12/2019 17:39	24/12/2019 15:27	24/12/2019 17:39	2,19	8	17,55	CHI
201912193989	ABADIANIA	AA12382362	CORUMBA	24/12/2019 15:28	24/12/2019 21:16	24/12/2019 15:28	24/12/2019 21:16	5,81	12	69,75	CHI
201912193992	CAMPINACU	IH12192447	MINACU	24/12/2019 15:28	24/12/2019 22:17	24/12/2019 15:28	24/12/2019 22:17	6,81	5	34,03	CHI
201912193992	MINACU	IH12192447	MINACU	24/12/2019 15:28	24/12/2019 22:17	24/12/2019 15:28	24/12/2019 22:17	6,81	24	163,37	CHI
201912194201	AGUAS LINDAS DE GOIAS	10020539698	AGUAS LINDAS DE GOIAS S1	24/12/2019 15:30	24/12/2019 16:42	24/12/2019 15:30	24/12/2019 16:42	1,19	1	1,19	CHI
201912194103	RIO VERDE	RV10394866	RIO VERDE S2	24/12/2019 15:31	27/12/2019 17:16	24/12/2019 15:31	24/12/2019 15:35	0,06	24	1,51	CHI
201912194103	RIO VERDE	RV10394866	RIO VERDE S2	24/12/2019 15:31	27/12/2019 17:16	24/12/2019 16:48	24/12/2019 17:00	0,20	27	5,41	CHI
201912194103	RIO VERDE	RV10394844	CABRIUVA S2	24/12/2019 15:31	27/12/2019 17:16	24/12/2019 15:31	24/12/2019 18:37	3,10	114	353,81	CHI
201912194103	RIO VERDE	RV10394844	MONTIVIDIU T	24/12/2019 15:31	27/12/2019 17:16	24/12/2019 15:31	24/12/2019 18:37	3,10	63	195,53	CHI
201912194103	RIO VERDE	RV13213414	CABRIUVA S2	24/12/2019 15:31	27/12/2019 17:16	24/12/2019 18:39	24/12/2019 21:34	2,92	26	75,88	CHI
201912194103	RIO VERDE	MV13213455	MONTIVIDIU T	24/12/2019 15:31	27/12/2019 17:16	24/12/2019 23:00	25/12/2019 00:14	1,24	69	85,71	CHI
201912194103	RIO VERDE	RV10394844	CABRIUVA S2	24/12/2019 15:31	27/12/2019 17:16	24/12/2019 18:39	25/12/2019 04:03	9,40	12	112,82	CHI
201912194103	RIO VERDE	RV10394844	CABRIUVA S2	24/12/2019 15:31	27/12/2019 17:16	24/12/2019 18:39	25/12/2019 04:35	9,93	10	99,27	CHI
201912194103	RIO VERDE	RV10394844	CABRIUVA S2	24/12/2019 15:31	27/12/2019 17:16	24/12/2019 18:39	25/12/2019 09:55	15,27	67	1023,11	CHI
201912194103	RIO VERDE	01600404	CABRIUVA S2	24/12/2019 15:31	27/12/2019 17:16	25/12/2019 12:45	25/12/2019 13:13	0,47	89	42,08	CHI
201912194103	RIO VERDE	01600404	RIO VERDE S2	24/12/2019 15:31	27/12/2019 17:16	25/12/2019 12:45	25/12/2019 13:13	0,47	28	13,24	CHI
201912194103	RIO VERDE	RV10394844	CABRIUVA S2	24/12/2019 15:31	27/12/2019 17:16	24/12/2019 15:31	25/12/2019 19:30	27,98	2	55,96	CHI
201912194103	RIO VERDE	RV10394844	MONTIVIDIU T	24/12/2019 15:31	27/12/2019 17:16	24/12/2019 18:39	25/12/2019 20:24	25,74	8	205,96	CHI
201912194103	RIO VERDE	RV10394866	RIO VERDE S2	24/12/2019 15:31	27/12/2019 17:16	25/12/2019 20:38	25/12/2019 20:41	0,05	18	0,93	CHI
201912194103	RIO VERDE	RV10394866	RIO VERDE S2	24/12/2019 15:31	27/12/2019 17:16	25/12/2019 20:38	25/12/2019 20:45	0,11	9	0,96	CHI
201912194103	RIO VERDE	RV10394844	MONTIVIDIU T	24/12/2019 15:31	27/12/2019 17:16	24/12/2019 18:39	25/12/2019 21:32	26,89	5	134,45	CHI

201912194103	MONTIVIDIU	MV10400618	MONTIVIDIU T	24/12/2019 15:31	27/12/2019 17:16	25/12/2019 22:40	26/12/2019 01:04	2,39	15	35,81	CHI
201912194103	RIO VERDE	MV10400618	MONTIVIDIU T	24/12/2019 15:31	27/12/2019 17:16	25/12/2019 22:40	26/12/2019 01:04	2,39	68	162,33	CHI
201912194103	RIO VERDE	RV10394844	MONTIVIDIU T	24/12/2019 15:31	27/12/2019 17:16	24/12/2019 18:39	26/12/2019 02:05	31,43	31	974,42	CHI
201912194103	RIO VERDE	RV12260132	CABRIUVA S2	24/12/2019 15:31	27/12/2019 17:16	26/12/2019 09:02	26/12/2019 11:08	2,10	2	4,19	CHI
201912194103	RIO VERDE	RV10394844	CABRIUVA S2	24/12/2019 15:31	27/12/2019 17:16	24/12/2019 15:31	26/12/2019 11:09	43,63	17	741,68	CHI
201912194103	RIO VERDE	RV10394844	CABRIUVA S2	24/12/2019 15:31	27/12/2019 17:16	26/12/2019 18:02	26/12/2019 22:07	4,09	89	364,28	CHI
201912194103	RIO VERDE	RV10394844	MONTIVIDIU T	24/12/2019 15:31	27/12/2019 17:16	24/12/2019 18:39	27/12/2019 00:21	53,69	19	1020,18	CHI
201912194103	RIO VERDE	RV10394866	RIO VERDE S2	24/12/2019 15:31	27/12/2019 17:16	26/12/2019 13:40	27/12/2019 11:15	21,58	25	539,44	CHI
201912194103	MONTIVIDIU	MV10400618	MONTIVIDIU T	24/12/2019 15:31	27/12/2019 17:16	27/12/2019 14:20	27/12/2019 14:46	0,44	15	6,57	CHI
201912194103	RIO VERDE	MV10400618	MONTIVIDIU T	24/12/2019 15:31	27/12/2019 17:16	27/12/2019 14:20	27/12/2019 14:46	0,44	93	40,74	CHI
201912194103	RIO VERDE	RV10394844	MONTIVIDIU T	24/12/2019 15:31	27/12/2019 17:16	26/12/2019 18:02	27/12/2019 17:16	23,23	31	720,28	CHI
201912194204	SANTA ROSA DE GOIAS	SR21000042	INHUMAS S1	24/12/2019 15:31	25/12/2019 07:28	24/12/2019 15:31	25/12/2019 07:28	15,94	1	15,94	CHI
201912194206	MONTIVIDIU DO NORTE	MX12270910	PORANGATU	24/12/2019 15:31	26/12/2019 15:24	24/12/2019 15:31	26/12/2019 15:24	47,87	7	335,12	CHI
201912194766	RIO VERDE	RV12123367	RIO VERDE S1	24/12/2019 15:31	24/12/2019 18:53	24/12/2019 15:31	24/12/2019 18:53	3,35	67	224,71	CHI
201912194244	PIRENOPOLIS	PV12273035	SAO FRANCISCO DE GOIAS	24/12/2019 15:32	24/12/2019 19:09	24/12/2019 15:32	24/12/2019 19:09	3,60	12	43,22	CHI
201912194217	CALDAS NOVAS	CN12213917	CALDAS NOVAS S1	24/12/2019 15:33	24/12/2019 17:10	24/12/2019 15:33	24/12/2019 17:10	1,61	37	59,65	CHI
201912194278	APARECIDA DE GOIANIA	04200224	INDEPENDENCIA S1	24/12/2019 15:33	24/12/2019 15:43	24/12/2019 15:33	24/12/2019 15:36	0,05	1065	56,21	CHI
201912194278	APARECIDA DE GOIANIA	AP10383617	INDEPENDENCIA S1	24/12/2019 15:33	24/12/2019 15:43	24/12/2019 15:33	24/12/2019 15:37	0,07	3405	250,65	CHI
201912194278	GOIANIA	AP10396189	INDEPENDENCIA S1	24/12/2019 15:33	24/12/2019 15:43	24/12/2019 15:36	24/12/2019 15:43	0,10	1576	159,79	CHI
201912195346	RIO VERDE	RV12000199	RIO VERDE S1	24/12/2019 15:35	25/12/2019 08:12	24/12/2019 15:35	25/12/2019 08:12	16,62	32	531,99	CHI
201912195346	SANTA HELENA DE GOIAS	RV12000199	RIO VERDE S1	24/12/2019 15:35	25/12/2019 08:12	24/12/2019 15:35	25/12/2019 08:12	16,62	11	182,87	CHI
201912194232	BONFINOPOLIS	920005135	CEPAIGO S2	24/12/2019 15:36	24/12/2019 17:27	24/12/2019 15:36	24/12/2019 17:27	1,84	1	1,84	CHI
201912194233	MUNDO NOVO DE GOIAS	MH12391968	NOVA CRIXAS	24/12/2019 15:36	25/12/2019 13:15	24/12/2019 15:36	25/12/2019 13:15	21,64	5	108,21	CHI
201912194236	ITUMBIARA	IT12034470	CACHOEIRA DOURADA	24/12/2019 15:36	25/12/2019 08:34	24/12/2019 15:36	25/12/2019 08:34	16,95	3	50,85	CHI
201912194102	ANAPOLIS	20425818	ANAPOLIS UNIVERSITARIO S2	24/12/2019 15:37	24/12/2019 18:23	24/12/2019 15:37	24/12/2019 18:23	2,76	1	2,76	CHI
201912194243	GOIANIRA	10027634971	GOIANIRA	24/12/2019 15:37	24/12/2019 20:31	24/12/2019 15:37	24/12/2019 20:31	4,90	1	4,90	CHI
201912194273	FORMOSA	FA21151650	ITUIQUIRA	24/12/2019 15:40	24/12/2019 17:22	24/12/2019 15:40	24/12/2019 17:22	1,69	1	1,69	CHI
201912196602	JATAI	JT12214374	JATAI S3	24/12/2019 15:40	25/12/2019 12:32	24/12/2019 15:40	25/12/2019 12:32	20,88	6	125,29	CHI
201912194212	MONTIVIDIU DO NORTE	MX12226413	PORANGATU	24/12/2019 15:42	24/12/2019 22:11	24/12/2019 15:42	24/12/2019 22:11	6,48	41	265,60	CHI
201912194311	ORIZONA	OZ12205496	VIANOPOLIS	24/12/2019 15:43	24/12/2019 23:20	24/12/2019 15:43	24/12/2019 23:20	7,62	1	7,62	CHI
201912194321	GOIANIA	10000151147	GOYA S2	24/12/2019 15:43	24/12/2019 18:10	24/12/2019 15:43	24/12/2019 18:10	2,44	1	2,44	CHI
201912260885	QUIRINOPOLIS	01560214	QUIRINOPOLIS	24/12/2019 15:43	25/12/2019 00:01	24/12/2019 15:44	24/12/2019 17:33	1,82	353	641,09	CHI
201912260885	QUIRINOPOLIS	QI10404159	QUIRINOPOLIS	24/12/2019 15:43	25/12/2019 00:01	24/12/2019 15:43	24/12/2019 17:37	1,91	645	1230,87	CHI



201912260885	QUIRINOPOLIS	QI16409338	QUIRINOPOLIS	24/12/2019 15:43	25/12/2019 00:01	24/12/2019 15:43	24/12/2019 18:08	2,43	1041	2527,89	CHI
201912260885	QUIRINOPOLIS	QI16409330	QUIRINOPOLIS	24/12/2019 15:43	25/12/2019 00:01	24/12/2019 15:44	24/12/2019 19:25	3,68	2993	11026,71	CHI
201912260885	QUIRINOPOLIS	QI16409340	QUIRINOPOLIS	24/12/2019 15:43	25/12/2019 00:01	24/12/2019 15:44	24/12/2019 19:26	3,70	2901	10744,18	CHI
201912260885	QUIRINOPOLIS	QI13370012	QUIRINOPOLIS	24/12/2019 15:43	25/12/2019 00:01	24/12/2019 15:43	25/12/2019 00:01	8,31	873	7254,39	CHI
201912194331	INACIOLANDIA	ID21283944	QUIRINOPOLIS	24/12/2019 15:44	25/12/2019 16:47	24/12/2019 15:44	25/12/2019 16:47	25,04	1	25,04	CHI
201912194341	MUNDO NOVO DE GOIAS	MH21092751	NOVA CRIXAS	24/12/2019 15:45	25/12/2019 16:43	24/12/2019 15:45	25/12/2019 16:43	24,96	1	24,96	CHI
201912194345	GOIANESIA	550087837	GOIANESIA S2	24/12/2019 15:45	24/12/2019 23:04	24/12/2019 15:45	24/12/2019 23:04	7,30	1	7,30	CHI
201912194364	FORMOSA	FA21329694	ITIQUEIRA	24/12/2019 15:48	25/12/2019 09:36	24/12/2019 15:48	25/12/2019 09:36	17,80	1	17,80	CHI
201912208203	SANTA HELENA DE GOIAS	SH13085693	SANTA HELENA S1	24/12/2019 15:49	27/12/2019 04:08	25/12/2019 08:58	27/12/2019 04:08	43,16	1	43,16	CHI
201912260902	SANTA HELENA DE GOIAS	01660434	SANTA HELENA S1	24/12/2019 15:49	25/12/2019 23:50	24/12/2019 15:49	24/12/2019 18:11	2,36	14	33,04	CHI
201912260902	MAURILANDIA	01660434	SANTA HELENA S1	24/12/2019 15:49	25/12/2019 23:50	24/12/2019 15:49	24/12/2019 22:40	6,84	6	41,05	CHI
201912260902	QUIRINOPOLIS	01660434	SANTA HELENA S1	24/12/2019 15:49	25/12/2019 23:50	24/12/2019 15:49	24/12/2019 22:40	6,84	5	34,21	CHI
201912260902	QUIRINOPOLIS	01660434	SANTA HELENA S1	24/12/2019 15:49	25/12/2019 23:50	24/12/2019 15:49	24/12/2019 22:40	6,84	10	68,41	CHI
201912260902	RIO VERDE	01660434	SANTA HELENA S1	24/12/2019 15:49	25/12/2019 23:50	24/12/2019 15:49	24/12/2019 22:40	6,84	385	2633,93	CHI
201912260902	RIO VERDE	01660434	SANTA HELENA S1	24/12/2019 15:49	25/12/2019 23:50	24/12/2019 15:49	24/12/2019 22:40	6,84	620	4241,66	CHI
201912260902	RIO VERDE	01660434	SANTA HELENA S1	24/12/2019 15:49	25/12/2019 23:50	24/12/2019 15:49	24/12/2019 22:40	6,84	26	177,88	CHI
201912260902	SANTA HELENA DE GOIAS	01660434	SANTA HELENA S1	24/12/2019 15:49	25/12/2019 23:50	24/12/2019 15:49	24/12/2019 22:40	6,84	1	6,84	CHI
201912260902	RIO VERDE	01660434	SANTA HELENA S1	24/12/2019 15:49	25/12/2019 23:50	24/12/2019 15:52	24/12/2019 22:40	6,79	4	27,16	CHI
201912260902	SANTA HELENA DE GOIAS	01660424	SANTA HELENA S1	24/12/2019 15:49	25/12/2019 23:50	24/12/2019 16:22	25/12/2019 05:29	13,11	9	117,97	CHI
201912260902	SANTA HELENA DE GOIAS	01660424	SANTA HELENA S1	24/12/2019 15:49	25/12/2019 23:50	25/12/2019 09:55	25/12/2019 10:08	0,22	8	1,76	CHI
201912260902	MAURILANDIA	01660424	SANTA HELENA S1	24/12/2019 15:49	25/12/2019 23:50	24/12/2019 16:22	25/12/2019 16:09	23,78	5	118,92	CHI
201912260902	SANTA HELENA DE GOIAS	01660424	SANTA HELENA S1	24/12/2019 15:49	25/12/2019 23:50	24/12/2019 16:22	25/12/2019 16:09	23,78	8	190,28	CHI
201912260902	MAURILANDIA	ML12214185LD	SANTA HELENA S1	24/12/2019 15:49	25/12/2019 23:50	25/12/2019 12:01	25/12/2019 16:09	4,14	5	20,70	CHI
201912260902	QUIRINOPOLIS	ML12214185LD	SANTA HELENA S1	24/12/2019 15:49	25/12/2019 23:50	25/12/2019 12:01	25/12/2019 16:09	4,14	42	173,86	CHI
201912260902	QUIRINOPOLIS	ML12214185LD	SANTA HELENA S1	24/12/2019 15:49	25/12/2019 23:50	25/12/2019 12:01	25/12/2019 16:09	4,14	10	41,39	CHI
201912260902	RIO VERDE	ML12214185LD	SANTA HELENA S1	24/12/2019 15:49	25/12/2019 23:50	25/12/2019 12:01	25/12/2019 16:09	4,14	385	1593,69	CHI
201912260902	RIO VERDE	ML12214185LD	SANTA HELENA S1	24/12/2019 15:49	25/12/2019 23:50	25/12/2019 12:01	25/12/2019 16:09	4,14	552	2284,97	CHI
201912260902	RIO VERDE	ML12214185LD	SANTA HELENA S1	24/12/2019 15:49	25/12/2019 23:50	25/12/2019 12:01	25/12/2019 16:09	4,14	19	78,65	CHI
201912260902	SANTA HELENA DE GOIAS	ML12214185LD	SANTA HELENA S1	24/12/2019 15:49	25/12/2019 23:50	25/12/2019 12:01	25/12/2019 16:09	4,14	1	4,14	CHI
201912260902	SANTA HELENA DE GOIAS	01660434	SANTA HELENA S1	24/12/2019 15:49	25/12/2019 23:50	24/12/2019 15:49	25/12/2019 21:33	29,73	2	59,47	CHI
201912260902	MAURILANDIA	01660434	SANTA HELENA S1	24/12/2019 15:49	25/12/2019 23:50	24/12/2019 15:49	25/12/2019 21:57	30,13	4	120,53	CHI
201912260902	MAURILANDIA	01660434	SANTA HELENA S1	24/12/2019 15:49	25/12/2019 23:50	24/12/2019 15:49	25/12/2019 22:43	30,90	28	865,23	CHI
201912260902	RIO VERDE	01660434	SANTA HELENA S1	24/12/2019 15:49	25/12/2019 23:50	24/12/2019 15:49	25/12/2019 22:43	30,90	593	18324,36	CHI

201912260902	RIO VERDE	01660434	SANTA HELENA S1	24/12/2019 15:49	25/12/2019 23:50	24/12/2019 15:49	25/12/2019 22:43	30,90	1	30,90	CHI
201912260902	SANTA HELENA DE GOIAS	01660434	SANTA HELENA S1	24/12/2019 15:49	25/12/2019 23:50	24/12/2019 15:49	25/12/2019 22:43	30,90	3	92,70	CHI
201912260902	RIO VERDE	01660434	SANTA HELENA S1	24/12/2019 15:49	25/12/2019 23:50	24/12/2019 15:52	25/12/2019 22:43	30,85	3	92,55	CHI
201912260902	RIO VERDE	01660434	SANTA HELENA S1	24/12/2019 15:49	25/12/2019 23:50	24/12/2019 15:49	25/12/2019 22:50	31,02	30	930,53	CHI
201912260902	SANTA HELENA DE GOIAS	01660434	SANTA HELENA S1	24/12/2019 15:49	25/12/2019 23:50	24/12/2019 15:49	25/12/2019 22:50	31,02	50	1550,88	CHI
201912260902	MAURILANDIA	ML13402294	SANTA HELENA S1	24/12/2019 15:49	25/12/2019 23:50	25/12/2019 23:40	25/12/2019 23:50	0,16	6	0,98	CHI
201912260902	QUIRINOPOLIS	ML13402294	SANTA HELENA S1	24/12/2019 15:49	25/12/2019 23:50	25/12/2019 23:40	25/12/2019 23:50	0,16	10	1,64	CHI
201912260902	RIO VERDE	ML13402294	SANTA HELENA S1	24/12/2019 15:49	25/12/2019 23:50	25/12/2019 23:40	25/12/2019 23:50	0,16	385	62,99	CHI
201912260902	RIO VERDE	ML13402294	SANTA HELENA S1	24/12/2019 15:49	25/12/2019 23:50	25/12/2019 23:40	25/12/2019 23:50	0,16	132	21,60	CHI
201912260902	RIO VERDE	ML13402294	SANTA HELENA S1	24/12/2019 15:49	25/12/2019 23:50	25/12/2019 23:40	25/12/2019 23:50	0,16	19	3,11	CHI
201912194392	PORANGATU	PO21115471	PORANGATU	24/12/2019 15:50	25/12/2019 11:38	24/12/2019 15:50	25/12/2019 11:38	19,78	3	59,35	CHI
201912194410	MINACU	IH12182309	MINACU	24/12/2019 15:52	24/12/2019 23:08	24/12/2019 15:52	24/12/2019 23:08	7,26	17	123,49	CHI
201912194419	NIQUELANDIA	2750064874	NIQUELANDIA SUBTRANSMISSAO	24/12/2019 15:53	24/12/2019 18:35	24/12/2019 15:53	24/12/2019 18:35	2,69	1	2,69	CHI
201912194424	FORMOSO	FO10328897	PORANGATU	24/12/2019 15:53	26/12/2019 18:47	24/12/2019 23:58	25/12/2019 10:45	10,79	5	53,93	CHI
201912194424	CAMPINORTE	FO10328897	PORANGATU	24/12/2019 15:53	26/12/2019 18:47	24/12/2019 23:58	25/12/2019 11:30	11,53	3	34,59	CHI
201912194424	FORMOSO	FO10328897	PORANGATU	24/12/2019 15:53	26/12/2019 18:47	24/12/2019 23:58	25/12/2019 11:30	11,53	36	415,04	CHI
201912194424	CAMPINORTE	FO10328897	PORANGATU	24/12/2019 15:53	26/12/2019 18:47	25/12/2019 12:12	25/12/2019 12:49	0,60	3	1,80	CHI
201912194424	FORMOSO	FO10328897	PORANGATU	24/12/2019 15:53	26/12/2019 18:47	25/12/2019 12:12	25/12/2019 12:49	0,60	41	24,65	CHI
201912194424	CAMPINACU	FO10328897	PORANGATU	24/12/2019 15:53	26/12/2019 18:47	24/12/2019 23:58	25/12/2019 15:12	15,23	46	700,57	CHI
201912194424	CAMPINORTE	FO10328897	PORANGATU	24/12/2019 15:53	26/12/2019 18:47	24/12/2019 23:58	25/12/2019 15:12	15,23	75	1142,23	CHI
201912194424	FORMOSO	FO10328897	PORANGATU	24/12/2019 15:53	26/12/2019 18:47	24/12/2019 23:58	25/12/2019 15:12	15,23	3	45,69	CHI
201912194424	CAMPINACU	FO10328897	PORANGATU	24/12/2019 15:53	26/12/2019 18:47	24/12/2019 23:58	25/12/2019 16:10	16,21	1417	22964,06	CHI
201912194424	MINACU	FO10328897	PORANGATU	24/12/2019 15:53	26/12/2019 18:47	24/12/2019 23:58	25/12/2019 16:10	16,21	1	16,21	CHI
201912194424	PORANGATU	FO10328897	PORANGATU	24/12/2019 15:53	26/12/2019 18:47	24/12/2019 23:58	25/12/2019 16:10	16,21	1	16,21	CHI
201912194424	CAMPINACU	UC13351144	PORANGATU	24/12/2019 15:53	26/12/2019 18:47	25/12/2019 12:12	25/12/2019 16:10	3,97	25	99,14	CHI
201912194424	CAMPINACU	UC12236229	PORANGATU	24/12/2019 15:53	26/12/2019 18:47	24/12/2019 15:53	25/12/2019 16:11	24,29	28	680,14	CHI
201912194424	CAMPINORTE	FO10328897	PORANGATU	24/12/2019 15:53	26/12/2019 18:47	25/12/2019 16:53	26/12/2019 01:27	8,56	46	393,95	CHI
201912194424	FORMOSO	FO10328897	PORANGATU	24/12/2019 15:53	26/12/2019 18:47	25/12/2019 16:53	26/12/2019 01:27	8,56	41	351,13	CHI
201912194424	CAMPINACU	FO10328897	PORANGATU	24/12/2019 15:53	26/12/2019 18:47	25/12/2019 16:53	26/12/2019 04:40	11,78	130	1531,26	CHI
201912194424	CAMPINORTE	FO10328897	PORANGATU	24/12/2019 15:53	26/12/2019 18:47	25/12/2019 16:53	26/12/2019 04:40	11,78	32	376,92	CHI
201912194424	FORMOSO	FO10328897	PORANGATU	24/12/2019 15:53	26/12/2019 18:47	25/12/2019 16:53	26/12/2019 04:40	11,78	3	35,34	CHI
201912194424	MINACU	FO10328897	PORANGATU	24/12/2019 15:53	26/12/2019 18:47	25/12/2019 16:53	26/12/2019 04:40	11,78	1	11,78	CHI
201912194424	CAMPINACU	FO10328897	PORANGATU	24/12/2019 15:53	26/12/2019 18:47	25/12/2019 16:53	26/12/2019 09:01	16,12	1136	18314,53	CHI

201912194424	CAMPINACU	FO10328897	PORANGATU	24/12/2019 15:53	26/12/2019 18:47	25/12/2019 16:53	26/12/2019 13:15	20,36	8	162,91	CHI
201912194424	CAMPINACU	FO10328897	PORANGATU	24/12/2019 15:53	26/12/2019 18:47	25/12/2019 16:53	26/12/2019 16:43	23,83	23	548,10	CHI
201912194424	CAMPINORTE	FO12182459	PORANGATU	24/12/2019 15:53	26/12/2019 18:47	24/12/2019 23:58	26/12/2019 17:22	41,40	67	2773,48	CHI
201912194424	MINACU	FO12182459	PORANGATU	24/12/2019 15:53	26/12/2019 18:47	24/12/2019 23:58	26/12/2019 17:22	41,40	41	1697,21	CHI
201912194424	MINACU	FO12182459	PORANGATU	24/12/2019 15:53	26/12/2019 18:47	25/12/2019 12:12	26/12/2019 17:22	29,15	1	29,15	CHI
201912194424	CAMPINACU	FO10328897	PORANGATU	24/12/2019 15:53	26/12/2019 18:47	25/12/2019 16:53	26/12/2019 18:47	25,89	65	1683,08	CHI
201912194434	SERRANOPOLIS	SX12267588	JATAI S1	24/12/2019 15:53	24/12/2019 18:58	24/12/2019 15:53	24/12/2019 18:58	3,07	6	18,41	CHI
201912195058	SANTO ANTONIO DA BARRA	BZ12301385	ACREUNA	24/12/2019 15:53	25/12/2019 10:36	24/12/2019 15:53	25/12/2019 10:36	18,71	7	130,94	CHI
201912205658	CAMPINACU	UC12208537	PORANGATU	24/12/2019 15:53	28/12/2019 18:00	25/12/2019 16:53	26/12/2019 10:00	17,10	19	324,94	CHI
201912205658	PORANGATU	UC12208537	PORANGATU	24/12/2019 15:53	28/12/2019 18:00	25/12/2019 16:53	26/12/2019 10:00	17,10	1	17,10	CHI
201912205658	CAMPINACU	UC12197189	PORANGATU	24/12/2019 15:53	28/12/2019 18:00	25/12/2019 16:53	26/12/2019 10:23	17,48	68	1188,96	CHI
201912205658	CAMPINACU	UC12285921	PORANGATU	24/12/2019 15:53	28/12/2019 18:00	25/12/2019 16:53	26/12/2019 14:51	21,97	39	856,65	CHI
201912205658	CAMPINACU	FO10328897	PORANGATU	24/12/2019 15:53	28/12/2019 18:00	26/12/2019 19:42	26/12/2019 21:11	1,48	61	90,48	CHI
201912205658	CAMPINORTE	FO10328897	PORANGATU	24/12/2019 15:53	28/12/2019 18:00	26/12/2019 19:42	26/12/2019 21:11	1,48	145	215,08	CHI
201912205658	FORMOSO	FO10328897	PORANGATU	24/12/2019 15:53	28/12/2019 18:00	26/12/2019 19:42	26/12/2019 21:11	1,48	44	65,27	CHI
201912205658	MINACU	FO10328897	PORANGATU	24/12/2019 15:53	28/12/2019 18:00	26/12/2019 19:42	26/12/2019 21:11	1,48	43	63,78	CHI
201912205658	CAMPINACU	UC10398402	PORANGATU	24/12/2019 15:53	28/12/2019 18:00	26/12/2019 19:42	26/12/2019 21:11	1,49	1427	2122,66	CHI
201912205658	PORANGATU	UC10398402	PORANGATU	24/12/2019 15:53	28/12/2019 18:00	26/12/2019 19:42	26/12/2019 21:11	1,49	1	1,49	CHI
201912205658	CAMPINACU	UC12236229	PORANGATU	24/12/2019 15:53	28/12/2019 18:00	25/12/2019 16:53	26/12/2019 23:30	30,61	3	91,83	CHI
201912205658	CAMPINACU	UC12236229	PORANGATU	24/12/2019 15:53	28/12/2019 18:00	25/12/2019 16:53	27/12/2019 12:09	43,26	15	648,87	CHI
201912205658	CAMPINACU	UC12236229	PORANGATU	24/12/2019 15:53	28/12/2019 18:00	25/12/2019 16:53	27/12/2019 15:57	47,06	8	376,49	CHI
201912205658	CAMPINACU	UC12236229	PORANGATU	24/12/2019 15:53	28/12/2019 18:00	25/12/2019 16:53	28/12/2019 18:00	73,11	2	146,22	CHI
201912194435	MINACU	4020096960	MINACU	24/12/2019 15:54	24/12/2019 20:41	24/12/2019 15:54	24/12/2019 20:41	4,78	1	4,78	CHI
201912194438	SAO DOMINGOS	10010793265	SAO DOMINGOS	24/12/2019 15:54	25/12/2019 11:08	24/12/2019 15:54	25/12/2019 11:08	19,23	1	19,23	CHI
201912194516	ORIZONA	OZ21231569	VIANOPOLIS	24/12/2019 15:55	24/12/2019 18:22	24/12/2019 15:55	24/12/2019 18:22	2,44	1	2,44	CHI
201912194517	SENADOR CANEDO	10030292954	SENADOR CANEDO	24/12/2019 15:55	24/12/2019 18:47	24/12/2019 15:55	24/12/2019 18:47	2,86	1	2,86	CHI
201912194594	PIRACANJUBA	BV32051418	BELA VISTA S1	24/12/2019 15:55	24/12/2019 19:13	24/12/2019 15:55	24/12/2019 19:13	3,28	18	59,11	CHI
201912194540	GOIANIA	13977714	GOYA S2	24/12/2019 15:56	24/12/2019 17:28	24/12/2019 15:56	24/12/2019 17:28	1,52	1	1,52	CHI
201912194565	GOIANIA	GN12035915	GOYA S1	24/12/2019 15:56	24/12/2019 18:13	24/12/2019 15:56	24/12/2019 18:13	2,27	126	286,09	CHI
201912195418	RIO VERDE	RV12306400	CABRIUVA S2	24/12/2019 15:57	25/12/2019 11:12	24/12/2019 15:57	25/12/2019 11:12	19,25	5	96,24	CHI
201912194564	MOSSAMEDES	1310000648	FIRMINOPOLIS S2	24/12/2019 15:58	25/12/2019 09:04	24/12/2019 15:58	25/12/2019 09:04	17,09	1	17,09	CHI
201912195114	PORANGATU	PO12139169	PORANGATU	24/12/2019 15:58	25/12/2019 00:52	24/12/2019 15:58	25/12/2019 00:52	8,89	105	933,36	CHI
201912195198	MONTIVIDIU	MV11301689	MONTIVIDIU T	24/12/2019 15:58	24/12/2019 19:07	24/12/2019 15:58	24/12/2019 19:07	3,14	62	194,71	CHI

201912195443	JARAGUA	JA11000027	JARAGUA	24/12/2019 15:58	25/12/2019 11:41	24/12/2019 15:58	25/12/2019 11:41	19,71	79	1556,85	CHI
2019122400119	BOM JESUS DE GOIAS	22201	QUIRINOPOLIS	24/12/2019 15:58	24/12/2019 16:02	24/12/2019 15:58	24/12/2019 16:02	0,07	69	4,60	CHI
2019122400119	CACHOEIRA ALTA	48601	QUIRINOPOLIS	24/12/2019 15:58	24/12/2019 16:02	24/12/2019 15:58	24/12/2019 16:02	0,07	37	2,47	CHI
2019122400119	CACHOEIRA ALTA	48602	QUIRINOPOLIS	24/12/2019 15:58	24/12/2019 16:02	24/12/2019 15:58	24/12/2019 16:02	0,07	3	0,20	CHI
2019122400119	GOUVELANDIA	23101	QUIRINOPOLIS	24/12/2019 15:58	24/12/2019 16:02	24/12/2019 15:58	24/12/2019 16:02	0,07	1998	133,20	CHI
2019122400119	GOUVELANDIA	01560414	QUIRINOPOLIS	24/12/2019 15:58	24/12/2019 16:02	24/12/2019 15:58	24/12/2019 16:02	0,07	13	0,87	CHI
2019122400119	INACIOLANDIA	22201	QUIRINOPOLIS	24/12/2019 15:58	24/12/2019 16:02	24/12/2019 15:58	24/12/2019 16:02	0,07	2665	177,67	CHI
2019122400119	INACIOLANDIA	01560414	QUIRINOPOLIS	24/12/2019 15:58	24/12/2019 16:02	24/12/2019 15:58	24/12/2019 16:02	0,07	13	0,87	CHI
2019122400119	ITUMBIARA	22201	QUIRINOPOLIS	24/12/2019 15:58	24/12/2019 16:02	24/12/2019 15:58	24/12/2019 16:02	0,07	9	0,60	CHI
2019122400119	QUIRINOPOLIS	23101	QUIRINOPOLIS	24/12/2019 15:58	24/12/2019 16:02	24/12/2019 15:58	24/12/2019 16:02	0,07	89	5,93	CHI
2019122400119	QUIRINOPOLIS	42301	QUIRINOPOLIS	24/12/2019 15:58	24/12/2019 16:02	24/12/2019 15:58	24/12/2019 16:02	0,07	61	4,07	CHI
2019122400119	QUIRINOPOLIS	48601	QUIRINOPOLIS	24/12/2019 15:58	24/12/2019 16:02	24/12/2019 15:58	24/12/2019 16:02	0,07	86	5,73	CHI
2019122400119	QUIRINOPOLIS	48602	QUIRINOPOLIS	24/12/2019 15:58	24/12/2019 16:02	24/12/2019 15:58	24/12/2019 16:02	0,07	86	5,73	CHI
2019122400119	QUIRINOPOLIS	01560414	QUIRINOPOLIS	24/12/2019 15:58	24/12/2019 16:02	24/12/2019 15:58	24/12/2019 16:02	0,07	23	1,53	CHI
2019122400119	RIO VERDE	48601	QUIRINOPOLIS	24/12/2019 15:58	24/12/2019 16:02	24/12/2019 15:58	24/12/2019 16:02	0,07	111	7,40	CHI
2019122400119	RIO VERDE	48602	QUIRINOPOLIS	24/12/2019 15:58	24/12/2019 16:02	24/12/2019 15:58	24/12/2019 16:02	0,07	43	2,87	CHI
201912194577	SANTA HELENA DE GOIAS	SH31134283	IPEGUARI	24/12/2019 15:59	25/12/2019 12:05	24/12/2019 15:59	25/12/2019 12:05	20,10	1	20,10	CHI
201912194590	LUZIANIA	LZ21244338	VIANOPOLIS	24/12/2019 16:00	25/12/2019 02:43	24/12/2019 16:00	25/12/2019 02:43	10,71	1	10,71	CHI
201912194726	CAMPO ALEGRE DE GOIAS	1160007734	CAMPO ALEGRE DE GOIAS	24/12/2019 16:03	24/12/2019 18:18	24/12/2019 16:03	24/12/2019 18:18	2,24	1	2,24	CHI
201912195431	VIANOPOLIS	VN12026005	VIANOPOLIS	24/12/2019 16:04	25/12/2019 03:50	24/12/2019 16:04	25/12/2019 03:50	11,76	5	58,82	CHI
201912194754	RIO VERDE	RV12000118	RIO VERDE S2	24/12/2019 16:06	26/12/2019 14:02	24/12/2019 16:06	26/12/2019 14:02	45,93	63	2893,78	CHI
201912194754	SANTA HELENA DE GOIAS	RV12000118	RIO VERDE S2	24/12/2019 16:06	26/12/2019 14:02	24/12/2019 16:06	26/12/2019 14:02	45,93	70	3215,31	CHI
201912194961	GOIATUBA	GT11218098	GOIATUBA S2	24/12/2019 16:08	24/12/2019 19:10	24/12/2019 16:08	24/12/2019 19:10	3,03	73	221,13	CHI
201912194992	MINEIROS	MY12360839	PARQUE DAS EMAS	24/12/2019 16:09	25/12/2019 11:35	24/12/2019 16:09	25/12/2019 11:35	19,43	32	621,77	CHI
201912194937	RIO VERDE	RV11241410	RIO VERDE S2	24/12/2019 16:10	24/12/2019 18:17	24/12/2019 16:10	24/12/2019 18:17	2,11	168	354,62	CHI
201912194932	APARECIDA DE GOIANIA	200093812	INDEPENDENCIA S1	24/12/2019 16:12	24/12/2019 17:49	24/12/2019 16:12	24/12/2019 17:49	1,61	1	1,61	CHI
201912194948	JATAI	JT21000197	JATAI S2	24/12/2019 16:14	25/12/2019 08:37	24/12/2019 16:14	25/12/2019 08:37	16,37	1	16,37	CHI
201912194951	PORANGATU	PO12020618	PORANGATU	24/12/2019 16:14	25/12/2019 08:42	24/12/2019 16:14	25/12/2019 08:42	16,46	24	394,93	CHI
201912195000	MUNDO NOVO DE GOIAS	MH12252129	NOVA CRIXAS	24/12/2019 16:15	24/12/2019 19:25	24/12/2019 16:15	24/12/2019 19:25	3,15	97	305,90	CHI
201912195233	FORMOSO	FO11300972	PORANGATU	24/12/2019 16:15	24/12/2019 18:54	24/12/2019 16:15	24/12/2019 18:54	2,65	85	225,01	CHI
201912194966	SANTA TEREZINHA DE GOIAS	SG12171145	SANTA TEREZINHA	24/12/2019 16:17	25/12/2019 01:00	24/12/2019 16:17	25/12/2019 01:00	8,72	13	113,41	CHI
201912194980	NOVO PLANALTO	TA12141118	NOVO PLANALTO	24/12/2019 16:19	26/12/2019 13:22	24/12/2019 16:19	26/12/2019 13:22	45,06	1	45,06	CHI
201912194980	PORANGATU	TA12141118	NOVO PLANALTO	24/12/2019 16:19	26/12/2019 13:22	24/12/2019 16:19	26/12/2019 13:22	45,06	1	45,06	CHI

201912195043	ACREUNA	EU12260948	ACREUNA	24/12/2019 16:19	25/12/2019 11:34	24/12/2019 16:19	25/12/2019 11:34	19,25	24	461,97	CHI
201912195063	RIO VERDE	RV12360613	RIO VERDE S2	24/12/2019 16:19	25/12/2019 21:30	24/12/2019 16:19	25/12/2019 21:30	29,17	75	2187,79	CHI
201912195072	QUIRINOPOLIS	QI32052820	QUIRINOPOLIS	24/12/2019 16:19	24/12/2019 19:30	24/12/2019 16:19	24/12/2019 19:30	3,18	34	108,03	CHI
201912202595	MONTIVIDIU DO NORTE	MX21236225	PORANGATU	24/12/2019 16:22	25/12/2019 10:07	24/12/2019 16:22	25/12/2019 10:07	17,74	2	35,48	CHI
201912194999	ALTO HORIZONTE	AJ12210309LD	MARA ROSA	24/12/2019 16:23	25/12/2019 09:29	24/12/2019 16:23	25/12/2019 09:29	17,11	19	325,11	CHI
201912194999	MARA ROSA	AJ12210309LD	MARA ROSA	24/12/2019 16:23	25/12/2019 09:29	24/12/2019 16:23	25/12/2019 09:29	17,11	3	51,33	CHI
201912195003	PONTALINA	PK21284876	PONTALINA	24/12/2019 16:23	25/12/2019 17:50	24/12/2019 16:23	25/12/2019 17:50	25,44	1	25,44	CHI
201912195076	RIO VERDE	RV11249015	RIO VERDE S2	24/12/2019 16:23	24/12/2019 22:40	24/12/2019 16:23	24/12/2019 22:40	6,28	97	609,51	CHI
201912195008	FORMOSO	FO12151052	PORANGATU	24/12/2019 16:24	25/12/2019 00:19	24/12/2019 16:24	25/12/2019 00:19	7,91	6	47,47	CHI
201912195020	TROMBAS	TB12247392	PORANGATU	24/12/2019 16:27	26/12/2019 12:35	24/12/2019 16:27	26/12/2019 12:35	44,14	13	573,79	CHI
201912195572	ESTRELA DO NORTE	MQ12150566	MARA ROSA	24/12/2019 16:27	24/12/2019 19:41	24/12/2019 16:27	24/12/2019 19:41	3,25	7	22,72	CHI
201912195572	MARA ROSA	MQ12150566	MARA ROSA	24/12/2019 16:27	24/12/2019 19:41	24/12/2019 16:27	24/12/2019 19:41	3,25	7	22,72	CHI
201912195027	CAIAPONIA	930017596	CAIAPONIA	24/12/2019 16:28	24/12/2019 21:01	24/12/2019 16:28	24/12/2019 21:01	4,55	1	4,55	CHI
201912201496	ACREUNA	EU12045005	ACREUNA	24/12/2019 16:28	25/12/2019 08:43	24/12/2019 16:28	25/12/2019 08:43	16,25	25	406,20	CHI
201912195039	QUIRINOPOLIS	QI21100570	QUIRINOPOLIS	24/12/2019 16:29	24/12/2019 20:15	24/12/2019 16:29	24/12/2019 20:15	3,76	1	3,76	CHI
201912195368	BRITANIA	BT11005984	BRITANIA	24/12/2019 16:29	24/12/2019 21:51	24/12/2019 16:29	24/12/2019 21:51	5,36	131	702,34	CHI
201912195047	AGUAS LINDAS DE GOIAS	4830279991	AGUAS LINDAS DE GOIAS S1	24/12/2019 16:30	24/12/2019 19:25	24/12/2019 16:30	24/12/2019 19:25	2,91	1	2,91	CHI
201912195292	ITUMBIARA	IT12222530	PARANAIBA	24/12/2019 16:30	24/12/2019 21:48	24/12/2019 16:30	24/12/2019 21:48	5,28	101	533,78	CHI
201912195622	EDEIA	ED12000020	PONTALINA	24/12/2019 16:31	25/12/2019 18:13	24/12/2019 16:31	25/12/2019 18:13	25,68	7	179,79	CHI
201912195057	CORUMBAIBA	CI12392071	VILA CORUMBA	24/12/2019 16:32	26/12/2019 17:01	24/12/2019 16:32	25/12/2019 16:46	24,23	5	121,17	CHI
201912195057	CORUMBAIBA	CI12307796LD	VILA CORUMBA	24/12/2019 16:32	26/12/2019 17:01	24/12/2019 16:32	26/12/2019 17:01	48,48	2	96,95	CHI
201912195398	MORRINHOS	MR12389875	MORRINHOS	24/12/2019 16:32	25/12/2019 18:39	24/12/2019 16:32	25/12/2019 18:39	26,12	7	182,84	CHI
201912195664	MUNDO NOVO DE GOIAS	MH11035549	NOVA CRIXAS	24/12/2019 16:32	24/12/2019 18:45	24/12/2019 16:32	24/12/2019 18:45	2,22	126	279,75	CHI
201912195061	QUIRINOPOLIS	80042259	QUIRINOPOLIS	24/12/2019 16:33	24/12/2019 19:58	24/12/2019 16:33	24/12/2019 19:58	3,42	1	3,42	CHI
201912195108	MONTIVIDIU	MV12029219	MONTIVIDIU T	24/12/2019 16:35	24/12/2019 18:28	24/12/2019 16:35	24/12/2019 18:28	1,88	237	445,23	CHI
201912195108	RIO VERDE	MV12029219	MONTIVIDIU T	24/12/2019 16:35	24/12/2019 18:28	24/12/2019 16:35	24/12/2019 18:28	1,88	1	1,88	CHI
201912195109	ITAJA	IJ21398798	ITAJA S2	24/12/2019 16:37	24/12/2019 23:02	24/12/2019 16:37	24/12/2019 23:02	6,42	1	6,42	CHI
201912195116	APARECIDA DE GOIANIA	200156135	INDEPENDENCIA S1	24/12/2019 16:37	24/12/2019 20:47	24/12/2019 16:37	24/12/2019 20:47	4,15	1	4,15	CHI
201912196713	MONTIVIDIU	MV11106466	MONTIVIDIU T	24/12/2019 16:37	24/12/2019 20:50	24/12/2019 16:37	24/12/2019 20:50	4,21	60	252,43	CHI
201912194607	BURITI ALEGRE	BG16408159	ITUMBIARA VELHA S2	24/12/2019 16:38	24/12/2019 19:20	24/12/2019 16:38	24/12/2019 17:10	0,52	79	41,30	CHI
201912194607	GOIATUBA	BG16408159	ITUMBIARA VELHA S2	24/12/2019 16:38	24/12/2019 19:20	24/12/2019 16:38	24/12/2019 17:10	0,52	2	1,05	CHI
201912194607	ITUMBIARA	BG16408159	ITUMBIARA VELHA S2	24/12/2019 16:38	24/12/2019 19:20	24/12/2019 16:38	24/12/2019 17:10	0,52	238	124,42	CHI
201912194607	BURITI ALEGRE	BG16408494	ITUMBIARA VELHA S2	24/12/2019 16:38	24/12/2019 19:20	24/12/2019 16:38	24/12/2019 17:10	0,53	958	506,14	CHI

201912194607	AGUA LIMPA	BG16408494	VILA CORUMBA	24/12/2019 16:38	24/12/2019 19:20	24/12/2019 16:38	24/12/2019 17:10	0,53	7	3,70	CHI
201912194607	BURITI ALEGRE	IT13218243	ITUMBIARA VELHA S2	24/12/2019 16:38	24/12/2019 19:20	24/12/2019 16:38	24/12/2019 19:20	2,69	6	16,14	CHI
201912194607	ITUMBIARA	IT13218243	ITUMBIARA VELHA S2	24/12/2019 16:38	24/12/2019 19:20	24/12/2019 16:38	24/12/2019 19:20	2,69	80	215,16	CHI
201912195121	APARECIDA DE GOIANIA	AP11079717	INDEPENDENCIA S2	24/12/2019 16:39	24/12/2019 18:47	24/12/2019 16:39	24/12/2019 18:47	2,13	317	676,18	CHI
201912195123	AGUAS LINDAS DE GOIAS	10006681113	AGUAS LINDAS DE GOIAS S1	24/12/2019 16:39	24/12/2019 18:48	24/12/2019 16:39	24/12/2019 18:48	2,15	1	2,15	CHI
201912195562	CRIXAS	UP12171176	SANTA TEREZINHA	24/12/2019 16:40	25/12/2019 09:41	24/12/2019 16:40	25/12/2019 09:41	17,03	12	204,33	CHI
201912195562	UIRAPURU	UP12171176	SANTA TEREZINHA	24/12/2019 16:40	25/12/2019 09:41	24/12/2019 16:40	25/12/2019 09:41	17,03	11	187,30	CHI
201912195138	JATAI	JT12219503	JATAI S3	24/12/2019 16:41	24/12/2019 19:14	24/12/2019 16:41	24/12/2019 19:14	2,55	5	12,74	CHI
201912195143	SANTA TEREZA DE GOIAS	SE12060934	PORANGATU	24/12/2019 16:42	27/12/2019 17:51	24/12/2019 16:42	25/12/2019 19:44	27,04	1	27,04	CHI
201912195143	SANTA TEREZA DE GOIAS	SE12053783LD	PORANGATU	24/12/2019 16:42	27/12/2019 17:51	24/12/2019 16:42	27/12/2019 17:51	73,16	5	365,82	CHI
201912195144	RIO VERDE	10016527362	RIO VERDE S2	24/12/2019 16:42	25/12/2019 12:06	24/12/2019 16:42	25/12/2019 12:06	19,40	1	19,40	CHI
201912195145	JOVIANIA	JV12071445	GOIATUBA S1	24/12/2019 16:42	25/12/2019 14:22	24/12/2019 16:42	25/12/2019 14:22	21,66	2	43,33	CHI
201912195151	PALMEIRAS DE GOIAS	PL21024199	PALMEIRAS	24/12/2019 16:42	25/12/2019 00:46	24/12/2019 16:42	25/12/2019 00:46	8,05	1	8,05	CHI
201912195154	ITUMBIARA	690371627	ITUMBIARA NOVA	24/12/2019 16:42	25/12/2019 09:07	24/12/2019 16:42	25/12/2019 09:07	16,40	1	16,40	CHI
201912195155	CALDAS NOVAS	CN21118548	CALDAS NOVAS S1	24/12/2019 16:43	25/12/2019 21:32	24/12/2019 16:43	25/12/2019 21:32	28,82	1	28,82	CHI
201912195156	TURVELANDIA	TD21384562	RIO DOS BOIS	24/12/2019 16:43	26/12/2019 11:25	24/12/2019 16:43	26/12/2019 11:25	42,70	1	42,70	CHI
201912195170	LUZIANIA	10007755846	RIO VERMELHO	24/12/2019 16:44	24/12/2019 18:00	24/12/2019 16:44	24/12/2019 18:00	1,25	1	1,25	CHI
201912195175	DAVINOPOLIS	IO21077554	CATALAO S1	24/12/2019 16:45	25/12/2019 09:19	24/12/2019 16:45	25/12/2019 09:19	16,55	1	16,55	CHI
201912195177	CORUMBA DE GOIAS	CB21292230	CORUMBA	24/12/2019 16:45	24/12/2019 20:33	24/12/2019 16:45	24/12/2019 20:33	3,79	1	3,79	CHI
201912195186	PALMINOPOLIS	PP12013318	PALMEIRAS	24/12/2019 16:46	24/12/2019 19:12	24/12/2019 16:46	24/12/2019 19:12	2,42	2	4,84	CHI
201912195188	GUAPO	GA21216295	GUAPO S1	24/12/2019 16:47	25/12/2019 07:22	24/12/2019 16:47	25/12/2019 07:22	14,58	1	14,58	CHI
201912195190	APARECIDA DE GOIANIA	10022951880	INDEPENDENCIA S1	24/12/2019 16:47	24/12/2019 19:31	24/12/2019 16:47	24/12/2019 19:31	2,73	1	2,73	CHI
201912195195	AGUAS LINDAS DE GOIAS	LA11148906	AGUAS LINDAS DE GOIAS S1	24/12/2019 16:48	24/12/2019 17:42	24/12/2019 16:48	24/12/2019 17:42	0,90	216	193,98	CHI
201912195204	NIQUELANDIA	NQ12274633	BARRO ALTO	24/12/2019 16:48	24/12/2019 20:19	24/12/2019 16:48	24/12/2019 20:19	3,50	1	3,50	CHI
201912195886	RIO VERDE	RV12051746	MONTIVIDIU T	24/12/2019 16:48	25/12/2019 09:05	24/12/2019 16:48	25/12/2019 09:05	16,27	76	1236,84	CHI
201912195207	SILVANIA	SV21277322	VIANOPOLIS	24/12/2019 16:49	25/12/2019 09:28	24/12/2019 16:49	25/12/2019 09:28	16,65	2	33,30	CHI
201912195211	GOIANIA	11299447	CAMPINAS S2	24/12/2019 16:49	24/12/2019 18:36	24/12/2019 16:49	24/12/2019 18:36	1,78	1	1,78	CHI
201912195213	OUVIDOR	10020883640	CATALAO S1	24/12/2019 16:49	25/12/2019 09:03	24/12/2019 16:49	25/12/2019 09:03	16,22	1	16,22	CHI
201912197802	GOIANIA	GN11000739	GOIANIA LESTE S2	24/12/2019 16:49	24/12/2019 22:10	24/12/2019 16:49	24/12/2019 22:10	5,35	80	427,96	CHI
201912195223	MARA ROSA	MQ21247514	MARA ROSA	24/12/2019 16:50	25/12/2019 11:13	24/12/2019 16:50	25/12/2019 11:13	18,39	1	18,39	CHI
201912195227	APARECIDA DO RIO DOCE	CC12170574	CACHOEIRA ALTA	24/12/2019 16:50	25/12/2019 11:30	24/12/2019 16:50	25/12/2019 11:30	18,65	10	186,51	CHI
201912195227	CACU	CC12170574	CACHOEIRA ALTA	24/12/2019 16:50	25/12/2019 11:30	24/12/2019 16:50	25/12/2019 11:30	18,65	84	1566,65	CHI
201912195228	PEROLANDIA	DP11254586	JATAI S1	24/12/2019 16:51	24/12/2019 18:10	24/12/2019 16:51	24/12/2019 18:10	1,32	1	1,32	CHI

201912195632	JATAI	JT12061503	JATAI S2	24/12/2019 16:51	25/12/2019 01:34	24/12/2019 16:51	25/12/2019 01:34	8,71	5	43,54	CHI
201912195259	CAMPINORTE	UR12243278	MARA ROSA	24/12/2019 16:52	25/12/2019 22:38	24/12/2019 16:52	25/12/2019 22:38	29,77	7	208,37	CHI
201912195259	URUACU	UR12243278	MARA ROSA	24/12/2019 16:52	25/12/2019 22:38	24/12/2019 16:52	25/12/2019 22:38	29,77	15	446,50	CHI
201912195242	SAO LUIS DE MONTES BELOS	500055993	SAO LUIZ DOS MONTES BELOS	24/12/2019 16:53	24/12/2019 19:10	24/12/2019 16:53	24/12/2019 19:10	2,27	1	2,27	CHI
201912195245	AGUA LIMPA	AL12263113	VILA CORUMBA	24/12/2019 16:54	25/12/2019 12:28	24/12/2019 16:54	25/12/2019 12:28	19,57	14	273,93	CHI
201912195245	CORUMBAIBA	AL12263113	VILA CORUMBA	24/12/2019 16:54	25/12/2019 12:28	24/12/2019 16:54	25/12/2019 12:28	19,57	1	19,57	CHI
201912195287	GOUVELANDIA	QI12000340	QUIRINOPOLIS	24/12/2019 16:55	25/12/2019 11:35	24/12/2019 16:55	25/12/2019 11:35	18,67	17	317,34	CHI
2019122400120	BOM JESUS DE GOIAS	22201	QUIRINOPOLIS	24/12/2019 16:55	24/12/2019 16:59	24/12/2019 16:55	24/12/2019 16:59	0,07	69	4,60	CHI
2019122400120	CACHOEIRA ALTA	48601	QUIRINOPOLIS	24/12/2019 16:55	24/12/2019 16:59	24/12/2019 16:55	24/12/2019 16:59	0,07	37	2,47	CHI
2019122400120	CACHOEIRA ALTA	48602	QUIRINOPOLIS	24/12/2019 16:55	24/12/2019 16:59	24/12/2019 16:55	24/12/2019 16:59	0,07	3	0,20	CHI
2019122400120	GOUVELANDIA	23101	QUIRINOPOLIS	24/12/2019 16:55	24/12/2019 16:59	24/12/2019 16:55	24/12/2019 16:59	0,07	1981	132,07	CHI
2019122400120	GOUVELANDIA	01560414	QUIRINOPOLIS	24/12/2019 16:55	24/12/2019 16:59	24/12/2019 16:55	24/12/2019 16:59	0,07	13	0,87	CHI
2019122400120	INACIOLANDIA	22201	QUIRINOPOLIS	24/12/2019 16:55	24/12/2019 16:59	24/12/2019 16:55	24/12/2019 16:59	0,07	2665	177,67	CHI
2019122400120	INACIOLANDIA	01560414	QUIRINOPOLIS	24/12/2019 16:55	24/12/2019 16:59	24/12/2019 16:55	24/12/2019 16:59	0,07	13	0,87	CHI
2019122400120	ITUMBIARA	22201	QUIRINOPOLIS	24/12/2019 16:55	24/12/2019 16:59	24/12/2019 16:55	24/12/2019 16:59	0,07	9	0,60	CHI
2019122400120	QUIRINOPOLIS	23101	QUIRINOPOLIS	24/12/2019 16:55	24/12/2019 16:59	24/12/2019 16:55	24/12/2019 16:59	0,07	89	5,93	CHI
2019122400120	QUIRINOPOLIS	42301	QUIRINOPOLIS	24/12/2019 16:55	24/12/2019 16:59	24/12/2019 16:55	24/12/2019 16:59	0,07	61	4,07	CHI
2019122400120	QUIRINOPOLIS	48601	QUIRINOPOLIS	24/12/2019 16:55	24/12/2019 16:59	24/12/2019 16:55	24/12/2019 16:59	0,07	86	5,73	CHI
2019122400120	QUIRINOPOLIS	48602	QUIRINOPOLIS	24/12/2019 16:55	24/12/2019 16:59	24/12/2019 16:55	24/12/2019 16:59	0,07	86	5,73	CHI
2019122400120	QUIRINOPOLIS	01560414	QUIRINOPOLIS	24/12/2019 16:55	24/12/2019 16:59	24/12/2019 16:55	24/12/2019 16:59	0,07	23	1,53	CHI
2019122400120	RIO VERDE	48601	QUIRINOPOLIS	24/12/2019 16:55	24/12/2019 16:59	24/12/2019 16:55	24/12/2019 16:59	0,07	111	7,40	CHI
2019122400120	RIO VERDE	48602	QUIRINOPOLIS	24/12/2019 16:55	24/12/2019 16:59	24/12/2019 16:55	24/12/2019 16:59	0,07	43	2,87	CHI
201912195261	VIANOPOLIS	VN12052243	VIANOPOLIS	24/12/2019 16:57	25/12/2019 09:22	24/12/2019 16:57	25/12/2019 09:22	16,41	4	65,66	CHI
201912195263	SAO MIGUEL DO ARAGUAIA	SM21187907	SAO MIGUEL DO ARAGUAIA	24/12/2019 16:57	26/12/2019 14:23	24/12/2019 16:57	26/12/2019 14:23	45,42	1	45,42	CHI
201912195285	SILVANIA	SV21366208	VIANOPOLIS	24/12/2019 16:58	25/12/2019 17:25	24/12/2019 16:58	25/12/2019 16:55	23,94	1	23,94	CHI
201912195285	SILVANIA	SV12372234	VIANOPOLIS	24/12/2019 16:58	25/12/2019 17:25	24/12/2019 16:58	25/12/2019 17:25	24,45	3	73,35	CHI
201912195300	RIO VERDE	RV11136154	RIO VERDE S2	24/12/2019 16:58	24/12/2019 19:32	24/12/2019 16:58	24/12/2019 19:32	2,55	289	737,11	CHI
201912195289	PALMINOPOLIS	PP21000038	PALMEIRAS	24/12/2019 16:59	24/12/2019 19:39	24/12/2019 16:59	24/12/2019 19:39	2,67	1	2,67	CHI
201912195291	MUTUNOPOLIS	MU12291031	MARA ROSA	24/12/2019 16:59	25/12/2019 03:21	24/12/2019 16:59	25/12/2019 03:21	10,37	10	103,68	CHI
201912195293	GOIANIA	16345204	CAMPINAS S2	24/12/2019 16:59	24/12/2019 22:45	24/12/2019 16:59	24/12/2019 22:45	5,75	1	5,75	CHI
201912195453	AGUA LIMPA	AL12392132	VILA CORUMBA	24/12/2019 17:00	25/12/2019 15:05	24/12/2019 17:00	25/12/2019 15:05	22,07	5	110,36	CHI
201912195360	RIO VERDE	RV11231013	RIO VERDE S2	24/12/2019 17:01	25/12/2019 00:39	24/12/2019 17:01	25/12/2019 00:39	7,62	207	1576,82	CHI
201912194645	ITABERAÍ	IB16407963	ITABERAÍ S2	24/12/2019 17:04	25/12/2019 04:30	24/12/2019 17:04	24/12/2019 17:48	0,73	1419	1032,32	CHI

201912194645	ITABERAI	IB16407963	ITABERAI S2	24/12/2019 17:04	25/12/2019 04:30	24/12/2019 17:49	24/12/2019 17:56	0,12	1277	148,98	CHI
201912194645	ITABERAI	IB10406890	ITABERAI S2	24/12/2019 17:04	25/12/2019 04:30	24/12/2019 17:04	24/12/2019 18:34	1,50	813	1223,11	CHI
201912194645	ITABERAI	IB16409255	ITABERAI S2	24/12/2019 17:04	25/12/2019 04:30	24/12/2019 17:04	24/12/2019 22:06	5,03	607	3051,86	CHI
201912194645	ITABERAI	IB11000008	ITABERAI S2	24/12/2019 17:04	25/12/2019 04:30	24/12/2019 17:49	25/12/2019 04:30	10,68	142	1516,09	CHI
201912195311	MARA ROSA	MQ12208523	MARA ROSA	24/12/2019 17:04	26/12/2019 10:02	24/12/2019 17:04	26/12/2019 10:02	40,95	1	40,95	CHI
201912195313	GOUVELANDIA	2250005388	QUIRINOPOLIS	24/12/2019 17:05	25/12/2019 05:15	24/12/2019 17:05	25/12/2019 05:15	12,17	1	12,17	CHI
201912195314	MONTIVIDIU	RV10400629	MONTIVIDIU T	24/12/2019 17:05	25/12/2019 11:33	24/12/2019 17:05	25/12/2019 11:33	18,47	31	572,58	CHI
201912195314	RIO VERDE	RV10400629	MONTIVIDIU T	24/12/2019 17:05	25/12/2019 11:33	24/12/2019 17:05	25/12/2019 11:33	18,47	39	720,34	CHI
201912195314	RIO VERDE	RV10400629	MONTIVIDIU T	24/12/2019 17:05	25/12/2019 11:33	24/12/2019 17:05	25/12/2019 11:33	18,47	60	1108,22	CHI
201912195643	URUACU	CR12375637	CAMPINORTE	24/12/2019 17:07	24/12/2019 21:03	24/12/2019 17:07	24/12/2019 21:03	3,93	117	459,97	CHI
201912195329	FAINA	MP12187690	MATRINCHA	24/12/2019 17:08	25/12/2019 02:20	24/12/2019 17:08	25/12/2019 02:20	9,20	1	9,20	CHI
201912195331	APARECIDA DE GOIANIA	200517946	INDEPENDENCIA S1	24/12/2019 17:08	24/12/2019 21:27	24/12/2019 17:08	24/12/2019 21:27	4,30	1	4,30	CHI
201912195338	SANTA FE DE GOIAS	RN12089667	BRITANIA	24/12/2019 17:10	25/12/2019 09:59	24/12/2019 17:10	25/12/2019 09:59	16,82	1	16,82	CHI
201912195349	CALDAZINHA	DE21378488	CEPAIGO S2	24/12/2019 17:11	24/12/2019 18:57	24/12/2019 17:11	24/12/2019 18:57	1,76	2	3,52	CHI
201912195357	TRES RANCHOS	TH21127704	CATALAO S1	24/12/2019 17:12	25/12/2019 11:36	24/12/2019 17:12	25/12/2019 11:36	18,40	5	91,99	CHI
201912195365	ITUMBIARA	IT12305618	PARANAIBA	24/12/2019 17:12	25/12/2019 09:59	24/12/2019 17:12	25/12/2019 09:59	16,77	2	33,54	CHI
201912196142	MUTUNOPOLIS	PO12084869	PORANGATU	24/12/2019 17:12	25/12/2019 10:40	24/12/2019 17:12	25/12/2019 10:40	17,47	4	69,88	CHI
201912196142	PORANGATU	PO12084869	PORANGATU	24/12/2019 17:12	25/12/2019 10:40	24/12/2019 17:12	25/12/2019 10:40	17,47	3	52,41	CHI
201912195370	CATALAO	CT11333352	CATALAO S2	24/12/2019 17:13	24/12/2019 20:08	24/12/2019 17:13	24/12/2019 20:08	2,91	32	93,12	CHI
201912195376	GOIANIA	11322950	MEIA PONTE	24/12/2019 17:14	24/12/2019 20:40	24/12/2019 17:14	24/12/2019 20:40	3,43	1	3,43	CHI
201912195377	MINACU	IH12328091	MINACU	24/12/2019 17:14	25/12/2019 02:03	24/12/2019 17:14	25/12/2019 02:03	8,81	8	70,46	CHI
201912195379	MARA ROSA	MQ12156002	MARA ROSA	24/12/2019 17:14	24/12/2019 23:31	24/12/2019 17:14	24/12/2019 23:31	6,27	19	119,15	CHI
201912196401	RIO VERDE	RV11240547	RIO VERDE S1	24/12/2019 17:14	24/12/2019 22:20	24/12/2019 17:14	24/12/2019 22:20	5,09	106	539,33	CHI
201912196513	IPAMERI	IP12252560	IPAMERI	24/12/2019 17:14	26/12/2019 08:21	24/12/2019 17:14	26/12/2019 08:21	39,10	8	312,83	CHI
201912195386	IVOLANDIA	IV21222937	IPORA	24/12/2019 17:15	24/12/2019 22:51	24/12/2019 17:15	24/12/2019 22:51	5,60	1	5,60	CHI
201912195491	CALDAS NOVAS	CN12099537RE	RIO QUENTE	24/12/2019 17:15	25/12/2019 02:45	24/12/2019 17:15	25/12/2019 02:45	9,49	98	930,40	CHI
201912195491	MORRINHOS	CN12099537RE	RIO QUENTE	24/12/2019 17:15	25/12/2019 02:45	24/12/2019 17:15	25/12/2019 02:45	9,49	8	75,95	CHI
201912195491	PIRACANJUBA	CN12099537RE	RIO QUENTE	24/12/2019 17:15	25/12/2019 02:45	24/12/2019 17:15	25/12/2019 02:45	9,49	1	9,49	CHI
201912195491	RIO QUENTE	CN12099537RE	RIO QUENTE	24/12/2019 17:15	25/12/2019 02:45	24/12/2019 17:15	25/12/2019 02:45	9,49	2	18,99	CHI
201912195395	ESTRELA DO NORTE	ET12136395	MARA ROSA	24/12/2019 17:16	25/12/2019 09:25	24/12/2019 17:16	25/12/2019 09:25	16,15	11	177,62	CHI
201912195395	MARA ROSA	ET12136395	MARA ROSA	24/12/2019 17:16	25/12/2019 09:25	24/12/2019 17:16	25/12/2019 09:25	16,15	8	129,18	CHI
201912197497	JATAI	JT12234429	JATAI S3	24/12/2019 17:17	25/12/2019 12:50	24/12/2019 17:17	24/12/2019 22:00	4,71	1	4,71	CHI
201912197497	JATAI	JT11182182	JATAI S3	24/12/2019 17:17	25/12/2019 12:50	24/12/2019 17:17	25/12/2019 12:50	19,54	4	78,14	CHI



201912195417	CALDAS NOVAS	10002631294	SERRA DE CALDAS	24/12/2019 17:18	24/12/2019 21:27	24/12/2019 17:18	24/12/2019 21:27	4,14	1	4,14	CHI
201912196143	RIO VERDE	RV11249014	RIO VERDE S2	24/12/2019 17:18	24/12/2019 21:35	24/12/2019 17:18	24/12/2019 21:35	4,27	87	371,32	CHI
201912195429	INACIOLANDIA	ID31128286	QUIRINOPOLIS	24/12/2019 17:20	25/12/2019 08:42	24/12/2019 17:20	25/12/2019 08:42	15,35	1	15,35	CHI
201912195433	CROMINIA	CQ12079876	ROCHEDO	24/12/2019 17:20	25/12/2019 17:25	24/12/2019 17:20	25/12/2019 17:25	24,08	15	361,15	CHI
201912195436	CRISTALINA	KR21214920	CRISTALINA S1	24/12/2019 17:21	24/12/2019 19:14	24/12/2019 17:21	24/12/2019 19:14	1,88	1	1,88	CHI
201912195873	MORRINHOS	MR11264047	MORRINHOS	24/12/2019 17:21	25/12/2019 00:19	24/12/2019 17:21	25/12/2019 00:19	6,96	159	1107,21	CHI
201912195441	CRIXAS	CX12190207	SANTA TEREZINHA	24/12/2019 17:22	26/12/2019 09:41	24/12/2019 17:22	26/12/2019 09:41	40,32	8	322,52	CHI
201912195446	PORANGATU	PO21166515	PORANGATU	24/12/2019 17:22	25/12/2019 12:21	24/12/2019 17:22	25/12/2019 12:21	18,97	2	37,94	CHI
201912195447	CUMARI	CY12064051	CATALAO S2	24/12/2019 17:23	25/12/2019 12:06	24/12/2019 17:23	25/12/2019 12:06	18,71	2	37,42	CHI
201912195463	APARECIDA DE GOIANIA	16892707	REAL S1	24/12/2019 17:24	24/12/2019 18:43	24/12/2019 17:24	24/12/2019 18:43	1,30	1	1,30	CHI
201912196139	RIO VERDE	RV11269457	RIO VERDE S1	24/12/2019 17:24	24/12/2019 22:09	24/12/2019 17:24	24/12/2019 22:09	4,73	167	790,65	CHI
201912196304	AGUAS LINDAS DE GOIAS	4830083026	AGUAS LINDAS DE GOIAS S1	24/12/2019 17:24	24/12/2019 23:18	24/12/2019 17:24	24/12/2019 23:18	5,90	1	5,90	CHI
201912195676	SAO MIGUEL DO ARAGUAIA	SM12228636	SAO MIGUEL DO ARAGUAIA	24/12/2019 17:25	24/12/2019 20:24	24/12/2019 17:25	24/12/2019 20:24	2,97	56	166,54	CHI
201912195533	JATAI	JT11025995	JATAI S2	24/12/2019 17:26	24/12/2019 19:39	24/12/2019 17:26	24/12/2019 19:39	2,21	164	361,80	CHI
201912196752	MINACU	IH12220680	MINACU	24/12/2019 17:26	25/12/2019 08:11	24/12/2019 17:26	25/12/2019 08:11	14,74	13	191,57	CHI
201912195483	GOIANIRA	10005872802	GOIANIRA	24/12/2019 17:27	24/12/2019 19:34	24/12/2019 17:27	24/12/2019 19:34	2,11	1	2,11	CHI
201912195494	MINEIROS	1390061891	PARQUE DAS EMAS	24/12/2019 17:28	24/12/2019 20:34	24/12/2019 17:28	24/12/2019 20:34	3,09	1	3,09	CHI
201912195699	SAO MIGUEL DO ARAGUAIA	SM12276125	SAO MIGUEL DO ARAGUAIA	24/12/2019 17:28	25/12/2019 11:20	24/12/2019 17:28	25/12/2019 11:20	17,85	45	803,30	CHI
201912196521	TROMBAS	TB12240756	PORANGATU	24/12/2019 17:28	26/12/2019 17:02	24/12/2019 17:28	26/12/2019 17:02	47,55	47	2235,05	CHI
201912195498	VIANOPOLIS	VN21151144	VIANOPOLIS	24/12/2019 17:29	25/12/2019 12:53	24/12/2019 17:29	25/12/2019 12:53	19,41	2	38,81	CHI
201912195499	JATAI	JT12359179	JATAI S1	24/12/2019 17:29	25/12/2019 12:03	24/12/2019 17:29	25/12/2019 12:03	18,56	3	55,69	CHI
201912195575	RIO VERDE	RV12222616	RIO VERDE S2	24/12/2019 17:29	25/12/2019 10:44	24/12/2019 17:29	25/12/2019 10:44	17,24	13	224,15	CHI
201912195049	GOIANESIA	PV12384873	CORUMBA	24/12/2019 17:30	24/12/2019 21:33	24/12/2019 17:30	24/12/2019 21:33	4,03	8	32,28	CHI
201912195049	PIRENOPOLIS	PV12384873	CORUMBA	24/12/2019 17:30	24/12/2019 21:33	24/12/2019 17:30	24/12/2019 21:33	4,03	26	104,90	CHI
201912195049	VILA PROPICIO	PV12384873	CORUMBA	24/12/2019 17:30	24/12/2019 21:33	24/12/2019 17:30	24/12/2019 21:33	4,03	3	12,10	CHI
201912195508	APARECIDA DO RIO DOCE	AW12341096	CACHOEIRA ALTA	24/12/2019 17:30	25/12/2019 09:55	24/12/2019 17:30	25/12/2019 09:55	16,40	2	32,80	CHI
201912195628	TAQUARAL DE GOIAS	TQ12170668	ITABERAI S1	24/12/2019 17:30	24/12/2019 20:07	24/12/2019 17:30	24/12/2019 20:07	2,62	95	248,53	CHI
201912195513	ITUMBIARA	IT21166467	ITUMBIARA VELHA S2	24/12/2019 17:31	25/12/2019 12:32	24/12/2019 17:31	25/12/2019 12:32	19,01	1	19,01	CHI
201912195519	SANTO ANTONIO DO DESCOBERTO	SN12168727	ALEXANIA	24/12/2019 17:33	24/12/2019 18:40	24/12/2019 17:33	24/12/2019 18:40	1,11	74	81,87	CHI
201912195646	NOVO GAMA	NJ11165091	PACAEMBU S1	24/12/2019 17:33	24/12/2019 18:48	24/12/2019 17:33	24/12/2019 18:48	1,25	141	176,02	CHI
201912195522	CATALAO	CT11333518	CATALAO S2	24/12/2019 17:34	24/12/2019 19:08	24/12/2019 17:34	24/12/2019 19:08	1,57	26	40,72	CHI
201912195525	MORRINHOS	MR21066517	MORRINHOS	24/12/2019 17:34	25/12/2019 16:18	24/12/2019 17:34	25/12/2019 16:18	22,73	1	22,73	CHI
201912195528	SANTA TEREZINHA DE GOIAS	SG11049778	SANTA TEREZINHA	24/12/2019 17:34	24/12/2019 22:19	24/12/2019 17:34	24/12/2019 22:19	4,74	123	582,44	CHI

201912195534	CIDADE OCIDENTAL	10027335729	MARAJOARA	24/12/2019 17:36	25/12/2019 12:32	24/12/2019 17:36	25/12/2019 12:32	18,92	1	18,92	CHI
201912195548	CRISTALINA	KR21248615	CRISTALINA S2	24/12/2019 17:38	25/12/2019 00:00	24/12/2019 17:38	25/12/2019 00:00	6,36	1	6,36	CHI
201912195552	GOIANESIA	GE12017484	GOIANESIA S1	24/12/2019 17:38	25/12/2019 13:01	24/12/2019 17:38	25/12/2019 13:01	19,37	1	19,37	CHI
201912197630	URUACU	UR12136315	CAMPINORTE	24/12/2019 17:39	25/12/2019 10:20	24/12/2019 17:39	25/12/2019 10:20	16,68	3	50,04	CHI
201912195556	GOIANIA	13970483	MEIA PONTE	24/12/2019 17:40	24/12/2019 19:23	24/12/2019 17:40	24/12/2019 19:23	1,71	1	1,71	CHI
201912195637	GOIANIA	GN11001340	XAVANTES	24/12/2019 17:40	24/12/2019 19:37	24/12/2019 17:40	24/12/2019 19:37	1,95	84	163,43	CHI
201912195573	RIO VERDE	630532060	CABRIUVA S1	24/12/2019 17:41	25/12/2019 12:40	24/12/2019 17:41	25/12/2019 12:40	18,97	1	18,97	CHI
201912196165	GOIANIA	GN12035286	GOIANIA LESTE S2	24/12/2019 17:42	25/12/2019 03:14	24/12/2019 17:42	25/12/2019 03:14	9,54	542	5168,27	CHI
201912195610	GOIANIA	GN11144573	SENADOR CANEDO	24/12/2019 17:43	24/12/2019 19:52	24/12/2019 17:43	24/12/2019 19:52	2,14	36	77,16	CHI
201912195594	SAO MIGUEL DO ARAGUAIA	10018491640	SAO MIGUEL DO ARAGUAIA	24/12/2019 17:44	24/12/2019 19:29	24/12/2019 17:44	24/12/2019 19:29	1,74	1	1,74	CHI
201912195596	NOVO GAMA	NJ11183762	PACAEMBU S1	24/12/2019 17:44	24/12/2019 19:20	24/12/2019 17:44	24/12/2019 19:20	1,59	96	152,77	CHI
201912195617	EDEALINA	ED12007679	PONTALINA	24/12/2019 17:44	25/12/2019 11:47	24/12/2019 17:44	25/12/2019 11:47	18,04	16	288,69	CHI
201912195607	CATALAO	TH21067845	CATALAO S1	24/12/2019 17:45	25/12/2019 10:51	24/12/2019 17:45	25/12/2019 10:51	17,09	1	17,09	CHI
201912199426	JARAGUA	SF12297981	SAO FRANCISCO DE GOIAS	24/12/2019 17:46	25/12/2019 04:18	24/12/2019 17:46	25/12/2019 04:18	10,53	107	1126,62	CHI
201912199426	JESUPOLIS	SF12297981	SAO FRANCISCO DE GOIAS	24/12/2019 17:46	25/12/2019 04:18	24/12/2019 17:46	25/12/2019 04:18	10,53	5	52,65	CHI
201912199426	SAO FRANCISCO DE GOIAS	SF12297981	SAO FRANCISCO DE GOIAS	24/12/2019 17:46	25/12/2019 04:18	24/12/2019 17:46	25/12/2019 04:18	10,53	2	21,06	CHI
201912195635	JOVIANIA	JV21203256	GOIATUBA S1	24/12/2019 17:48	25/12/2019 09:45	24/12/2019 17:48	25/12/2019 09:45	15,94	1	15,94	CHI
201912196137	MARA ROSA	MQ11243552	MARA ROSA	24/12/2019 17:48	24/12/2019 21:02	24/12/2019 17:48	24/12/2019 21:02	3,23	127	410,35	CHI
201912195885	GOIANIA	GN11170721	GOIANIA LESTE S2	24/12/2019 17:49	24/12/2019 20:23	24/12/2019 17:49	24/12/2019 20:00	2,17	40	86,80	CHI
201912195885	GOIANIA	GN12170695	GOIANIA LESTE S2	24/12/2019 17:49	24/12/2019 20:23	24/12/2019 17:49	24/12/2019 20:23	2,56	52	133,37	CHI
201912195644	NIQUELANDIA	NQ11280414	NIQUELANDIA SUBTRANSMISSAO	24/12/2019 17:50	24/12/2019 19:56	24/12/2019 17:50	24/12/2019 19:56	2,10	1	2,10	CHI
201912195648	MAIRIPOTABA	MI21051348	PONTALINA	24/12/2019 17:50	25/12/2019 16:19	24/12/2019 17:50	25/12/2019 16:19	22,48	1	22,48	CHI
201912195653	AMARALINA	MU12391672	MARA ROSA	24/12/2019 17:51	25/12/2019 10:11	24/12/2019 17:51	25/12/2019 10:11	16,33	100	1632,86	CHI
201912195653	MUTUNOPOLIS	MU12391672	MARA ROSA	24/12/2019 17:51	25/12/2019 10:11	24/12/2019 17:51	25/12/2019 10:11	16,33	7	114,30	CHI
201912195654	BELA VISTA DE GOIAS	BV12097969	BELA VISTA S1	24/12/2019 17:51	24/12/2019 21:07	24/12/2019 17:51	24/12/2019 21:07	3,26	3	9,77	CHI
201912195655	GOIANIA	GN11221767	GOYA S2	24/12/2019 17:51	24/12/2019 18:52	24/12/2019 17:51	24/12/2019 18:52	1,01	125	125,66	CHI
201912195656	ARAGOIANIA	AO31133285	GUAPO S2	24/12/2019 17:51	24/12/2019 19:39	24/12/2019 17:51	24/12/2019 19:39	1,79	1	1,79	CHI
201912195870	CACU	CA12196122	CACHOEIRA ALTA	24/12/2019 17:52	24/12/2019 21:15	24/12/2019 17:52	24/12/2019 21:15	3,37	39	131,45	CHI
201912195670	PADRE BERNARDO	10016350764	PADRE BERNARDO	24/12/2019 17:53	24/12/2019 20:22	24/12/2019 17:53	24/12/2019 20:22	2,48	1	2,48	CHI
201912195673	GOIANIA	GN11240456	GOIANIA LESTE S1	24/12/2019 17:53	24/12/2019 22:28	24/12/2019 17:53	24/12/2019 22:28	4,57	51	233,07	CHI
201912197422	MONTIVIDIU	MV10226416	MONTIVIDIU T	24/12/2019 17:53	27/12/2019 18:06	24/12/2019 17:53	24/12/2019 18:36	0,72	67	48,52	CHI
201912197422	RIO VERDE	MV10226416	MONTIVIDIU T	24/12/2019 17:53	27/12/2019 18:06	24/12/2019 17:53	24/12/2019 18:36	0,72	139	100,66	CHI
201912197422	CAIAPONIA	MV10400640	MONTIVIDIU T	24/12/2019 17:53	27/12/2019 18:06	24/12/2019 17:53	24/12/2019 18:40	0,78	28	21,75	CHI

201912197422	MONTIVIDIU	MV10400640	MONTIVIDIU T	24/12/2019 17:53	27/12/2019 18:06	24/12/2019 17:53	24/12/2019 18:40	0,78	56	43,49	CHI
201912197422	RIO VERDE	MV10400640	MONTIVIDIU T	24/12/2019 17:53	27/12/2019 18:06	24/12/2019 17:53	24/12/2019 18:40	0,78	50	38,83	CHI
201912197422	CAIAPONIA	RV10400619	MONTIVIDIU T	24/12/2019 17:53	27/12/2019 18:06	24/12/2019 17:53	24/12/2019 18:43	0,83	32	26,44	CHI
201912197422	IVOLANDIA	RV10400619	MONTIVIDIU T	24/12/2019 17:53	27/12/2019 18:06	24/12/2019 17:53	24/12/2019 18:43	0,83	25	20,66	CHI
201912197422	MONTIVIDIU	RV10400619	MONTIVIDIU T	24/12/2019 17:53	27/12/2019 18:06	24/12/2019 17:53	24/12/2019 18:43	0,83	34	28,10	CHI
201912197422	PARAUNA	RV10400619	MONTIVIDIU T	24/12/2019 17:53	27/12/2019 18:06	24/12/2019 17:53	24/12/2019 18:43	0,83	148	122,31	CHI
201912197422	RIO VERDE	RV10400619	MONTIVIDIU T	24/12/2019 17:53	27/12/2019 18:06	24/12/2019 17:53	24/12/2019 18:43	0,83	136	112,39	CHI
201912197422	CAIAPONIA	RV10400619	MONTIVIDIU T	24/12/2019 17:53	27/12/2019 18:06	24/12/2019 17:53	24/12/2019 18:43	0,82	3	2,45	CHI
201912197422	RIO VERDE	MV10400640	MONTIVIDIU T	24/12/2019 17:53	27/12/2019 18:06	24/12/2019 18:42	25/12/2019 10:31	15,82	9	142,38	CHI
201912197422	MONTIVIDIU	MV10400640	MONTIVIDIU T	24/12/2019 17:53	27/12/2019 18:06	24/12/2019 18:42	25/12/2019 13:46	19,07	13	247,95	CHI
201912197422	MONTIVIDIU	MV13305650	MONTIVIDIU T	24/12/2019 17:53	27/12/2019 18:06	24/12/2019 18:42	25/12/2019 13:46	19,07	5	95,37	CHI
201912197422	RIO VERDE	MV10400640	MONTIVIDIU T	24/12/2019 17:53	27/12/2019 18:06	24/12/2019 18:42	25/12/2019 13:46	19,07	29	553,13	CHI
201912197422	RIO VERDE	MV13305650	MONTIVIDIU T	24/12/2019 17:53	27/12/2019 18:06	24/12/2019 18:42	25/12/2019 13:46	19,07	11	209,81	CHI
201912197422	CAIAPONIA	MV12054336	MONTIVIDIU T	24/12/2019 17:53	27/12/2019 18:06	24/12/2019 18:42	25/12/2019 15:25	20,72	6	124,33	CHI
201912197422	MONTIVIDIU	MV12054336	MONTIVIDIU T	24/12/2019 17:53	27/12/2019 18:06	24/12/2019 18:42	25/12/2019 15:25	20,72	24	497,33	CHI
201912197422	RIO VERDE	MV12054336	MONTIVIDIU T	24/12/2019 17:53	27/12/2019 18:06	24/12/2019 18:42	25/12/2019 15:25	20,72	1	20,72	CHI
201912197422	MONTIVIDIU	MV12054328	MONTIVIDIU T	24/12/2019 17:53	27/12/2019 18:06	24/12/2019 18:42	25/12/2019 19:46	25,07	14	351,05	CHI
201912197422	CAIAPONIA	CP12260986	MONTIVIDIU T	24/12/2019 17:53	27/12/2019 18:06	24/12/2019 18:42	26/12/2019 17:29	46,79	15	701,81	CHI
201912197422	CAIAPONIA	CP12260986	MONTIVIDIU T	24/12/2019 17:53	27/12/2019 18:06	24/12/2019 18:42	27/12/2019 18:06	71,41	8	571,27	CHI
201912196583	GOIANIA	GN11001392	GOIANIA LESTE S1	24/12/2019 17:54	24/12/2019 20:56	24/12/2019 17:54	24/12/2019 20:56	3,02	16	48,39	CHI
201912195882	GOUVELANDIA	QI12035777	QUIRINOPOLIS	24/12/2019 17:55	25/12/2019 14:38	24/12/2019 17:55	25/12/2019 14:38	20,71	8	165,64	CHI
201912195900	BOM JESUS DE GOIAS	01810424	VICENTINOPOLIS	24/12/2019 17:55	25/12/2019 00:07	24/12/2019 17:55	24/12/2019 18:01	0,11	1	0,11	CHI
201912195900	GOIATUBA	01810424	VICENTINOPOLIS	24/12/2019 17:55	25/12/2019 00:07	24/12/2019 17:55	24/12/2019 18:01	0,11	15	1,67	CHI
201912195900	JOVIANIA	01810424	VICENTINOPOLIS	24/12/2019 17:55	25/12/2019 00:07	24/12/2019 17:55	24/12/2019 18:01	0,11	17	1,89	CHI
201912195900	VICENTINOPOLIS	01810424	VICENTINOPOLIS	24/12/2019 17:55	25/12/2019 00:07	24/12/2019 17:55	24/12/2019 18:01	0,11	9	1,00	CHI
201912195900	ALOANDIA	01040424	GOIATUBA S1	24/12/2019 17:55	25/12/2019 00:07	24/12/2019 18:27	24/12/2019 21:42	3,25	212	689,00	CHI
201912195900	ALOANDIA	01040424	GOIATUBA S1	24/12/2019 17:55	25/12/2019 00:07	24/12/2019 18:27	24/12/2019 21:42	3,25	309	1004,25	CHI
201912195900	ALOANDIA	01040424	GOIATUBA S1	24/12/2019 17:55	25/12/2019 00:07	24/12/2019 18:27	24/12/2019 21:42	3,25	1	3,25	CHI
201912195900	JOVIANIA	01040424	GOIATUBA S1	24/12/2019 17:55	25/12/2019 00:07	24/12/2019 18:27	24/12/2019 21:42	3,25	15	48,75	CHI
201912195900	JOVIANIA	01040424	GOIATUBA S1	24/12/2019 17:55	25/12/2019 00:07	24/12/2019 18:27	24/12/2019 21:42	3,25	6	19,50	CHI
201912195900	MORRINHOS	01040424	GOIATUBA S1	24/12/2019 17:55	25/12/2019 00:07	24/12/2019 18:27	24/12/2019 21:42	3,25	22	71,50	CHI
201912195900	MORRINHOS	01040424	GOIATUBA S1	24/12/2019 17:55	25/12/2019 00:07	24/12/2019 18:27	24/12/2019 21:42	3,25	218	708,50	CHI
201912195900	PONTALINA	01040424	GOIATUBA S1	24/12/2019 17:55	25/12/2019 00:07	24/12/2019 18:27	24/12/2019 21:42	3,25	71	230,75	CHI

201912195900	EDEALINA	01810424	VICENTINOPOLIS	24/12/2019 17:55	25/12/2019 00:07	24/12/2019 17:55	24/12/2019 22:43	4,79	15	71,92	CHI
201912195900	EDEALINA	01810424	VICENTINOPOLIS	24/12/2019 17:55	25/12/2019 00:07	24/12/2019 17:55	24/12/2019 22:43	4,79	34	163,02	CHI
201912195900	EDEIA	01810424	VICENTINOPOLIS	24/12/2019 17:55	25/12/2019 00:07	24/12/2019 17:55	24/12/2019 22:43	4,79	11	52,74	CHI
201912195900	EDEIA	01810424	VICENTINOPOLIS	24/12/2019 17:55	25/12/2019 00:07	24/12/2019 17:55	24/12/2019 22:43	4,79	31	148,64	CHI
201912195900	EDEIA	01810424	VICENTINOPOLIS	24/12/2019 17:55	25/12/2019 00:07	24/12/2019 17:55	24/12/2019 22:43	4,79	10	47,95	CHI
201912195900	GOIATUBA	01810424	VICENTINOPOLIS	24/12/2019 17:55	25/12/2019 00:07	24/12/2019 17:55	24/12/2019 22:43	4,79	13	62,33	CHI
201912195900	PONTALINA	01810424	VICENTINOPOLIS	24/12/2019 17:55	25/12/2019 00:07	24/12/2019 17:55	24/12/2019 22:43	4,79	126	604,14	CHI
201912195900	PONTALINA	01810424	VICENTINOPOLIS	24/12/2019 17:55	25/12/2019 00:07	24/12/2019 17:55	24/12/2019 22:43	4,79	1	4,79	CHI
201912195900	PONTALINA	01810424	VICENTINOPOLIS	24/12/2019 17:55	25/12/2019 00:07	24/12/2019 17:55	24/12/2019 22:43	4,79	17	81,51	CHI
201912195900	VICENTINOPOLIS	01810424	VICENTINOPOLIS	24/12/2019 17:55	25/12/2019 00:07	24/12/2019 17:55	24/12/2019 22:43	4,79	13	62,33	CHI
201912195900	VICENTINOPOLIS	01810424	VICENTINOPOLIS	24/12/2019 17:55	25/12/2019 00:07	24/12/2019 17:55	24/12/2019 22:43	4,79	1	4,79	CHI
201912195900	VICENTINOPOLIS	01810424	VICENTINOPOLIS	24/12/2019 17:55	25/12/2019 00:07	24/12/2019 17:55	24/12/2019 22:43	4,79	1	4,79	CHI
201912195900	VICENTINOPOLIS	01810424	VICENTINOPOLIS	24/12/2019 17:55	25/12/2019 00:07	24/12/2019 17:55	24/12/2019 22:43	4,79	2	9,59	CHI
201912195900	VICENTINOPOLIS	01810424	VICENTINOPOLIS	24/12/2019 17:55	25/12/2019 00:07	24/12/2019 17:55	24/12/2019 22:43	4,79	449	2152,83	CHI
201912195900	BOM JESUS DE GOIAS	VI10400587	VICENTINOPOLIS	24/12/2019 17:55	25/12/2019 00:07	24/12/2019 18:27	25/12/2019 00:07	5,68	3	17,04	CHI
201912195900	GOIATUBA	VI10400587	VICENTINOPOLIS	24/12/2019 17:55	25/12/2019 00:07	24/12/2019 18:27	25/12/2019 00:07	5,68	15	85,22	CHI
201912195900	JOVIANIA	VI10400587	VICENTINOPOLIS	24/12/2019 17:55	25/12/2019 00:07	24/12/2019 18:27	25/12/2019 00:07	5,68	17	96,58	CHI
201912195900	VICENTINOPOLIS	VI10400587	VICENTINOPOLIS	24/12/2019 17:55	25/12/2019 00:07	24/12/2019 18:27	25/12/2019 00:07	5,68	9	51,13	CHI
201912200321	PORANGATU	PO21290124	PORANGATU	24/12/2019 17:55	25/12/2019 16:58	24/12/2019 17:55	25/12/2019 16:58	23,04	1	23,04	CHI
2019122400067	JOVIANIA	01810214	VICENTINOPOLIS	24/12/2019 17:55	24/12/2019 17:58	24/12/2019 17:55	24/12/2019 17:58	0,05	30	1,50	CHI
2019122400067	PONTALINA	01810214	VICENTINOPOLIS	24/12/2019 17:55	24/12/2019 17:58	24/12/2019 17:55	24/12/2019 17:58	0,05	24	1,20	CHI
2019122400067	VICENTINOPOLIS	01810214	VICENTINOPOLIS	24/12/2019 17:55	24/12/2019 17:58	24/12/2019 17:55	24/12/2019 17:58	0,05	1983	99,15	CHI
2019122400067	VICENTINOPOLIS	01810224	VICENTINOPOLIS	24/12/2019 17:55	24/12/2019 17:58	24/12/2019 17:55	24/12/2019 17:58	0,05	1140	57,00	CHI
201912195685	CAMPINORTE	CR12282384	MARA ROSA	24/12/2019 17:56	25/12/2019 11:01	24/12/2019 17:56	25/12/2019 11:01	17,08	1	17,08	CHI
201912195685	URUACU	CR12282384	MARA ROSA	24/12/2019 17:56	25/12/2019 11:01	24/12/2019 17:56	25/12/2019 11:01	17,08	4	68,33	CHI
201912196227	JATAI	JT11036270	JATAI S2	24/12/2019 17:56	25/12/2019 09:08	24/12/2019 20:23	25/12/2019 09:08	12,75	79	1007,27	CHI
201912195693	APARECIDA DE GOIANIA	10002788266	INDEPENDENCIA S1	24/12/2019 17:57	24/12/2019 19:39	24/12/2019 17:57	24/12/2019 19:39	1,69	1	1,69	CHI
201912193744	CORUMBAIBA	CI12025149	VILA CORUMBA	24/12/2019 17:58	26/12/2019 16:25	24/12/2019 17:58	26/12/2019 16:25	46,43	12	557,22	CHI
201912195811	COLINAS DO SUL	9700003005	NIQUELANDIA SUBTRANSMISSAO	24/12/2019 17:59	24/12/2019 20:22	24/12/2019 17:59	24/12/2019 20:22	2,37	1	2,37	CHI
201912195836	INHUMAS	IN21066359	INHUMAS S2	24/12/2019 18:00	25/12/2019 07:51	24/12/2019 18:00	25/12/2019 07:51	13,84	1	13,84	CHI
201912196519	SANTA HELENA DE GOIAS	SH11226305	IPEGUARI	24/12/2019 18:00	25/12/2019 18:40	24/12/2019 18:00	25/12/2019 18:40	24,66	54	1331,70	CHI
201912195840	ITUMBIARA	BG21277063	ITUMBIARA VELHA S2	24/12/2019 18:01	25/12/2019 15:29	24/12/2019 18:01	25/12/2019 15:29	21,48	1	21,48	CHI
201912196135	MUNDO NOVO DE GOIAS	MH12269270	NOVA CRIXAS	24/12/2019 18:01	25/12/2019 10:28	24/12/2019 18:01	25/12/2019 10:28	16,45	39	641,41	CHI

201912196924	SAO MIGUEL DO ARAGUAIA	SM12151000	SAO MIGUEL DO ARAGUAIA	24/12/2019 18:03	25/12/2019 12:40	24/12/2019 18:03	25/12/2019 12:40	18,61	19	353,66	CHI
201912196131	RIO VERDE	RV11241416	RIO VERDE S2	24/12/2019 18:04	24/12/2019 19:52	24/12/2019 18:04	24/12/2019 19:52	1,79	98	175,23	CHI
201912196212	GOIANIA	GN11162240	GOIANIA LESTE S1	24/12/2019 18:04	25/12/2019 01:04	24/12/2019 18:04	25/12/2019 01:04	7,00	109	762,97	CHI
201912196717	MAIRIPOTABA	MI12025436	PONTALINA	24/12/2019 18:04	25/12/2019 10:49	24/12/2019 18:04	25/12/2019 10:49	16,74	253	4234,52	CHI
201912195860	MORRINHOS	10000386241	MORRINHOS	24/12/2019 18:05	25/12/2019 07:49	24/12/2019 18:05	25/12/2019 07:49	13,73	1	13,73	CHI
201912195864	URUACU	UR21117931	URUACU	24/12/2019 18:05	25/12/2019 11:31	24/12/2019 18:05	25/12/2019 11:31	17,42	1	17,42	CHI
201912195866	URUACU	640129730	URUACU	24/12/2019 18:05	24/12/2019 19:33	24/12/2019 18:05	24/12/2019 19:33	1,46	1	1,46	CHI
201912195878	MINACU	IH11207299	MINACU	24/12/2019 18:06	26/12/2019 12:16	24/12/2019 18:06	26/12/2019 12:16	42,16	1	42,16	CHI
201912195879	RIO VERDE	RV21034827	RIO VERDE S1	24/12/2019 18:07	26/12/2019 12:35	24/12/2019 18:07	26/12/2019 12:35	42,46	4	169,86	CHI
201912195881	GOIANIA	12312757	GOYA S2	24/12/2019 18:07	24/12/2019 20:22	24/12/2019 18:07	24/12/2019 20:22	2,24	1	2,24	CHI
201912196639	SAO MIGUEL DO ARAGUAIA	SM12000063	SAO MIGUEL DO ARAGUAIA	24/12/2019 18:07	25/12/2019 02:23	24/12/2019 18:07	25/12/2019 02:23	8,26	35	289,12	CHI
201912195897	CAIAPONIA	CP12054805	CAIAPONIA	24/12/2019 18:08	25/12/2019 12:01	24/12/2019 18:08	25/12/2019 12:01	17,87	32	571,76	CHI
201912195897	PIRANHAS	CP12054805	CAIAPONIA	24/12/2019 18:08	25/12/2019 12:01	24/12/2019 18:08	25/12/2019 12:01	17,87	77	1375,80	CHI
201912196031	PARAUNA	PU12252901	PARAUNA	24/12/2019 18:08	25/12/2019 07:42	24/12/2019 18:08	25/12/2019 07:42	13,55	3	40,65	CHI
201912196031	SAO JOAO DA PARAUNA	PU12252901	PARAUNA	24/12/2019 18:08	25/12/2019 07:42	24/12/2019 18:08	25/12/2019 07:42	13,55	1	13,55	CHI
201912197468	RIO VERDE	RV11230851	RIO VERDE S2	24/12/2019 18:08	25/12/2019 12:04	24/12/2019 18:08	25/12/2019 12:04	17,93	89	1595,70	CHI
201912195898	PIRACANJUBA	PJ21131240	BELA VISTA S1	24/12/2019 18:09	25/12/2019 10:57	24/12/2019 18:09	25/12/2019 10:57	16,81	1	16,81	CHI
201912196006	BONFINOPOLIS	BO21209906	CEPAIGO S2	24/12/2019 18:09	25/12/2019 12:40	24/12/2019 18:09	25/12/2019 12:40	18,51	2	37,02	CHI
201912196905	GOIANIA	GN11048166	GOIANIA LESTE S3	24/12/2019 18:09	24/12/2019 22:58	24/12/2019 18:09	24/12/2019 22:58	4,81	52	249,93	CHI
201912196010	ITUMBIARA	IT21208056	PARANAIBA	24/12/2019 18:10	25/12/2019 09:00	24/12/2019 18:10	25/12/2019 09:00	14,83	2	29,66	CHI
201912196015	PEROLANDIA	20114503	PARQUE DAS EMAS	24/12/2019 18:10	25/12/2019 12:32	24/12/2019 18:10	25/12/2019 12:32	18,36	1	18,36	CHI
201912196129	GOIANIA	GN11180063	GOIANIA LESTE S2	24/12/2019 18:10	24/12/2019 23:05	24/12/2019 18:10	24/12/2019 23:05	4,90	79	387,14	CHI
201912199970	AURILANDIA	CG12391526	FIRMINOPOLIS S2	24/12/2019 18:10	25/12/2019 11:00	24/12/2019 18:10	25/12/2019 11:00	16,84	2	33,67	CHI
201912199970	CACHOEIRA DE GOIAS	CG12391526	FIRMINOPOLIS S2	24/12/2019 18:10	25/12/2019 11:00	24/12/2019 18:10	25/12/2019 11:00	16,84	11	185,19	CHI
201912199970	PARAUNA	CG12391526	FIRMINOPOLIS S2	24/12/2019 18:10	25/12/2019 11:00	24/12/2019 18:10	25/12/2019 11:00	16,84	32	538,75	CHI
201912196020	ALTO HORIZONTE	AJ12320992	SANTA TEREZINHA	24/12/2019 18:11	25/12/2019 02:43	24/12/2019 18:11	25/12/2019 02:43	8,53	46	392,37	CHI
201912196653	RIO VERDE	RV12123226	RIO VERDE S1	24/12/2019 18:11	26/12/2019 09:56	24/12/2019 18:11	26/12/2019 09:56	39,74	61	2424,26	CHI
201912196102	RIO VERDE	RV21000135	RIO VERDE S1	24/12/2019 18:12	25/12/2019 14:55	24/12/2019 18:12	25/12/2019 14:55	20,72	1	20,72	CHI
201912196103	URUACU	UR12398011	URUACU	24/12/2019 18:13	25/12/2019 08:23	24/12/2019 18:13	25/12/2019 08:23	14,17	3	42,50	CHI
201912196105	GOIANIRA	390023516	GOIANIRA	24/12/2019 18:13	24/12/2019 20:29	24/12/2019 18:13	24/12/2019 20:29	2,26	1	2,26	CHI
201912195905	NOVA IGUACU DE GOIAS	NH10400425	SANTA TEREZINHA	24/12/2019 18:15	27/12/2019 06:50	24/12/2019 18:15	25/12/2019 01:40	7,41	6	44,49	CHI
201912195905	NOVA IGUACU DE GOIAS	NH10400425	SANTA TEREZINHA	24/12/2019 18:15	27/12/2019 06:50	25/12/2019 10:56	25/12/2019 11:22	0,43	20	8,65	CHI
201912195905	PILAR DE GOIAS	NH10400425	SANTA TEREZINHA	24/12/2019 18:15	27/12/2019 06:50	25/12/2019 10:56	25/12/2019 11:22	0,43	1	0,43	CHI

201912195905	NOVA IGUACU DE GOIAS	NH10400425	SANTA TEREZINHA	24/12/2019 18:15	27/12/2019 06:50	25/12/2019 15:47	25/12/2019 16:15	0,46	20	9,28	CHI
201912195905	PILAR DE GOIAS	NH10400425	SANTA TEREZINHA	24/12/2019 18:15	27/12/2019 06:50	25/12/2019 15:47	25/12/2019 16:15	0,46	1	0,46	CHI
201912195905	NOVA IGUACU DE GOIAS	NH10400425	SANTA TEREZINHA	24/12/2019 18:15	27/12/2019 06:50	25/12/2019 17:00	25/12/2019 17:35	0,59	20	11,85	CHI
201912195905	PILAR DE GOIAS	NH10400425	SANTA TEREZINHA	24/12/2019 18:15	27/12/2019 06:50	25/12/2019 17:00	25/12/2019 17:35	0,59	1	0,59	CHI
201912195905	PILAR DE GOIAS	GG13034410	SANTA TEREZINHA	24/12/2019 18:15	27/12/2019 06:50	24/12/2019 18:15	26/12/2019 13:46	43,52	133	5787,53	CHI
201912195905	SANTA TEREZINHA DE GOIAS	GG13034410	SANTA TEREZINHA	24/12/2019 18:15	27/12/2019 06:50	24/12/2019 18:15	26/12/2019 13:46	43,52	38	1653,58	CHI
201912195905	PILAR DE GOIAS	GG13034410	SANTA TEREZINHA	24/12/2019 18:15	27/12/2019 06:50	25/12/2019 10:56	26/12/2019 13:46	26,82	1	26,82	CHI
201912195905	PILAR DE GOIAS	GG12070823LD	SANTA TEREZINHA	24/12/2019 18:15	27/12/2019 06:50	24/12/2019 18:15	26/12/2019 16:41	46,43	1	46,43	CHI
201912195905	NOVA IGUACU DE GOIAS	GG12375656	SANTA TEREZINHA	24/12/2019 18:15	27/12/2019 06:50	24/12/2019 18:15	26/12/2019 18:07	47,87	5	239,33	CHI
201912195905	PILAR DE GOIAS	GG12375656	SANTA TEREZINHA	24/12/2019 18:15	27/12/2019 06:50	24/12/2019 18:15	26/12/2019 18:07	47,87	11	526,52	CHI
201912195905	NOVA IGUACU DE GOIAS	GG12375656	SANTA TEREZINHA	24/12/2019 18:15	27/12/2019 06:50	25/12/2019 10:56	26/12/2019 18:07	31,17	1	31,17	CHI
201912195905	PILAR DE GOIAS	GG12375656	SANTA TEREZINHA	24/12/2019 18:15	27/12/2019 06:50	25/12/2019 10:56	26/12/2019 18:07	31,17	3	93,52	CHI
201912195905	PILAR DE GOIAS	GG12325153LD	SANTA TEREZINHA	24/12/2019 18:15	27/12/2019 06:50	24/12/2019 18:15	27/12/2019 06:50	60,58	2	121,17	CHI
201912197129	GOIANIA	GN11030495	MEIA PONTE	24/12/2019 18:15	24/12/2019 21:41	24/12/2019 18:15	24/12/2019 21:41	3,42	105	359,48	CHI
201912197482	PIRENOPOLIS	PV12334718	CORUMBA	24/12/2019 18:15	25/12/2019 13:19	24/12/2019 18:15	25/12/2019 13:19	19,06	4	76,25	CHI
201912196140	VICENTINOPOLIS	VI12047267	VICENTINOPOLIS	24/12/2019 18:17	25/12/2019 14:20	24/12/2019 18:17	25/12/2019 14:20	20,06	5	100,30	CHI
201912196141	SANTA CRUZ DE GOIAS	BC12012502	PIRES DO RIO S2	24/12/2019 18:17	24/12/2019 20:36	24/12/2019 18:17	24/12/2019 20:36	2,31	3	6,94	CHI
201912196150	SANTA CRUZ DE GOIAS	BC21300713	PIRES DO RIO S2	24/12/2019 18:18	24/12/2019 21:39	24/12/2019 18:18	24/12/2019 21:39	3,34	2	6,68	CHI
201912196151	APARECIDA DE GOIANIA	10010195856	INDEPENDENCIA S1	24/12/2019 18:18	25/12/2019 05:12	24/12/2019 18:18	25/12/2019 05:12	10,89	1	10,89	CHI
201912196575	VIANOPOLIS	VN12060945	VIANOPOLIS	24/12/2019 18:18	25/12/2019 07:54	24/12/2019 18:18	25/12/2019 07:54	13,58	11	149,43	CHI
201912197016	JATAI	JT12286459	CABRIUVA S2	24/12/2019 18:19	25/12/2019 12:14	24/12/2019 18:19	25/12/2019 12:14	17,90	10	179,02	CHI
201912198929	SAO MIGUEL DO ARAGUAIA	SM11216319	SAO MIGUEL DO ARAGUAIA	24/12/2019 18:20	25/12/2019 01:54	24/12/2019 18:20	25/12/2019 01:54	7,55	93	702,31	CHI
201912196698	SAO MIGUEL DO ARAGUAIA	SM11216322	SAO MIGUEL DO ARAGUAIA	24/12/2019 18:21	24/12/2019 20:47	24/12/2019 18:21	24/12/2019 20:47	2,43	142	344,39	CHI
201912196174	SAO MIGUEL DO ARAGUAIA	SM12083962	SAO MIGUEL DO ARAGUAIA	24/12/2019 18:22	25/12/2019 12:15	24/12/2019 18:22	25/12/2019 12:15	17,88	11	196,69	CHI
201912196187	CRIXAS	CX21252993	SANTA TEREZINHA	24/12/2019 18:26	25/12/2019 00:32	24/12/2019 18:26	25/12/2019 00:32	6,10	1	6,10	CHI
201912196189	NOVA AMERICA	NM21307819	RUBIATABA	24/12/2019 18:26	25/12/2019 09:25	24/12/2019 18:26	25/12/2019 09:25	14,98	2	29,96	CHI
201912196190	CRIXAS	CX12213200	SANTA TEREZINHA	24/12/2019 18:26	25/12/2019 13:43	24/12/2019 18:26	25/12/2019 13:43	19,27	11	211,98	CHI
201912196670	CRIXAS	CX11201755	SERRA DO OURO	24/12/2019 18:28	25/12/2019 09:07	24/12/2019 18:28	25/12/2019 09:07	14,64	104	1522,16	CHI
201912196211	CATALAO	CT12000061	CATALAO S1	24/12/2019 18:29	26/12/2019 11:12	24/12/2019 18:29	26/12/2019 11:12	40,71	8	325,70	CHI
201912196215	CATALAO	1990207835	CATALAO S2	24/12/2019 18:29	24/12/2019 21:49	24/12/2019 18:29	24/12/2019 21:49	3,32	1	3,32	CHI
201912196720	GOIANIA	GN11000677	GOIANIA LESTE S2	24/12/2019 18:30	24/12/2019 22:45	24/12/2019 18:30	24/12/2019 22:45	4,23	101	427,68	CHI
201912197867	SAO MIGUEL DO ARAGUAIA	SM11038964	SAO MIGUEL DO ARAGUAIA	24/12/2019 18:30	25/12/2019 01:28	24/12/2019 18:30	25/12/2019 01:28	6,96	177	1231,72	CHI
201912196237	INACIOLANDIA	ID11305487	CACHOEIRA DOURADA	24/12/2019 18:31	25/12/2019 09:15	24/12/2019 18:31	25/12/2019 09:15	14,72	1	14,72	CHI

201912196241	ESTRELA DO NORTE	ET21249303	MARA ROSA	24/12/2019 18:32	26/12/2019 12:12	24/12/2019 18:32	26/12/2019 12:12	41,66	1	41,66	CHI
201912196245	PARAUNA	PU21279829	PARAUNA	24/12/2019 18:32	24/12/2019 20:22	24/12/2019 18:32	24/12/2019 20:22	1,82	1	1,82	CHI
201912196501	CRIXAS	GF12146937	SANTA TEREZINHA	24/12/2019 18:32	24/12/2019 22:53	24/12/2019 18:32	24/12/2019 22:53	4,35	239	1038,99	CHI
201912196501	GUARINOS	GF12146937	SANTA TEREZINHA	24/12/2019 18:32	24/12/2019 22:53	24/12/2019 18:32	24/12/2019 22:53	4,35	12	52,17	CHI
201912196506	SANTA CRUZ DE GOIAS	BC12309602	CRISTIANOPOLIS	24/12/2019 18:33	24/12/2019 21:52	24/12/2019 18:33	24/12/2019 21:52	3,31	51	168,97	CHI
201912196511	IPAMERI	10002348800	IPAMERI	24/12/2019 18:33	25/12/2019 01:51	24/12/2019 18:33	25/12/2019 01:51	7,29	1	7,29	CHI
201912196690	ARACU	AV12020305	ANICUNS	24/12/2019 18:33	25/12/2019 17:50	24/12/2019 18:33	24/12/2019 21:50	3,27	5	16,37	CHI
201912196690	AVELINOPOLIS	AV12020305	ANICUNS	24/12/2019 18:33	25/12/2019 17:50	24/12/2019 18:33	24/12/2019 21:50	3,27	45	147,30	CHI
201912196690	ITABERAI	AV12020305	ANICUNS	24/12/2019 18:33	25/12/2019 17:50	24/12/2019 18:33	24/12/2019 21:50	3,27	2	6,55	CHI
201912196690	AVELINOPOLIS	AV12020305	ANICUNS	24/12/2019 18:33	25/12/2019 17:50	24/12/2019 18:33	24/12/2019 22:08	3,57	126	450,24	CHI
201912196690	SANTA BARBARA DE GOIAS	AV12020305	ANICUNS	24/12/2019 18:33	25/12/2019 17:50	24/12/2019 18:33	24/12/2019 22:08	3,57	8	28,59	CHI
201912196690	ARACU	AV12020305	ANICUNS	24/12/2019 18:33	25/12/2019 17:50	25/12/2019 00:38	25/12/2019 02:53	2,25	5	11,24	CHI
201912196690	AVELINOPOLIS	AV12020305	ANICUNS	24/12/2019 18:33	25/12/2019 17:50	25/12/2019 00:38	25/12/2019 02:53	2,25	169	380,02	CHI
201912196690	ITABERAI	AV12020305	ANICUNS	24/12/2019 18:33	25/12/2019 17:50	25/12/2019 00:38	25/12/2019 02:53	2,25	2	4,50	CHI
201912196690	SANTA BARBARA DE GOIAS	AV12020305	ANICUNS	24/12/2019 18:33	25/12/2019 17:50	25/12/2019 00:38	25/12/2019 02:53	2,25	8	17,99	CHI
201912196690	ARACU	AV12020305	ANICUNS	24/12/2019 18:33	25/12/2019 17:50	24/12/2019 18:33	25/12/2019 17:50	23,27	8	186,19	CHI
201912196690	AVELINOPOLIS	AV12020305	ANICUNS	24/12/2019 18:33	25/12/2019 17:50	24/12/2019 18:33	25/12/2019 17:50	23,27	5	116,37	CHI
201912196690	CATURAI	AV12020305	ANICUNS	24/12/2019 18:33	25/12/2019 17:50	24/12/2019 18:33	25/12/2019 17:50	23,27	8	186,19	CHI
201912196690	ITABERAI	AV12020305	ANICUNS	24/12/2019 18:33	25/12/2019 17:50	24/12/2019 18:33	25/12/2019 17:50	23,27	17	395,65	CHI
201912196800	ARAGOIANIA	AO32000020	GUAPO S2	24/12/2019 18:35	24/12/2019 21:27	24/12/2019 18:35	24/12/2019 21:27	2,87	27	77,37	CHI
201912196531	PORANGATU	PO21267432	NOVO PLANALTO	24/12/2019 18:36	25/12/2019 16:17	24/12/2019 18:36	25/12/2019 16:17	21,70	1	21,70	CHI
201912196532	NOVA AURORA	2220001745	CATALAO S1	24/12/2019 18:36	24/12/2019 20:11	24/12/2019 18:36	24/12/2019 20:11	1,58	1	1,58	CHI
201912198281	SERRANOPOLIS	SX12166076	JATAI S1	24/12/2019 18:36	25/12/2019 10:19	24/12/2019 18:36	25/12/2019 10:19	15,71	11	172,77	CHI
201912196699	NOVO PLANALTO	TA12293622	SAO MIGUEL DO ARAGUAIA	24/12/2019 18:37	25/12/2019 12:20	24/12/2019 18:37	25/12/2019 12:20	17,72	19	336,60	CHI
201912196710	NOVO GAMA	NJ11041536	MARAJOARA	24/12/2019 18:37	24/12/2019 20:32	24/12/2019 18:37	24/12/2019 20:32	1,92	24	45,98	CHI
201912196917	HIDROLINA	HL11253146	URUACU	24/12/2019 18:37	25/12/2019 08:46	24/12/2019 18:37	25/12/2019 08:46	14,14	37	523,03	CHI
201912197383	MARA ROSA	MQ12062677	MARA ROSA	24/12/2019 18:37	25/12/2019 02:54	24/12/2019 18:37	25/12/2019 02:54	8,28	260	2152,87	CHI
201912196551	SANTA CRUZ DE GOIAS	BC12311723	PIRES DO RIO S2	24/12/2019 18:38	26/12/2019 09:49	24/12/2019 18:38	26/12/2019 09:49	39,18	3	117,54	CHI
201912196558	SANTA CRUZ DE GOIAS	BC21300864	CRISTIANOPOLIS	24/12/2019 18:39	24/12/2019 23:00	24/12/2019 18:39	24/12/2019 23:00	4,35	1	4,35	CHI
201912196564	AGUAS LINDAS DE GOIAS	10006713368	AGUAS LINDAS DE GOIAS S2	24/12/2019 18:39	24/12/2019 19:31	24/12/2019 18:39	24/12/2019 19:31	0,86	1	0,86	CHI
201912196210	ALTO HORIZONTE	AJ21136868	SANTA TEREZINHA	24/12/2019 18:40	24/12/2019 23:23	24/12/2019 18:40	24/12/2019 23:23	4,70	1	4,70	CHI
201912196591	CAMPINORTE	CR12347099	MARA ROSA	24/12/2019 18:41	25/12/2019 12:14	24/12/2019 18:41	25/12/2019 12:14	17,54	16	280,69	CHI
201912196591	URUACU	CR12347099	MARA ROSA	24/12/2019 18:41	25/12/2019 12:14	24/12/2019 18:41	25/12/2019 12:14	17,54	12	210,52	CHI

201912196608	APARECIDA DE GOIANIA	10017607866	ANHANGUERA	24/12/2019 18:42	24/12/2019 20:05	24/12/2019 18:42	24/12/2019 20:05	1,37	1	1,37	CHI
201912196627	NOVO GAMA	NJ12163860	PACAEMBU S1	24/12/2019 18:42	24/12/2019 19:20	24/12/2019 18:42	24/12/2019 19:20	0,63	767	485,34	CHI
201912196316	BONOPOLIS	04950224	SAO MIGUEL DO ARAGUAIA	24/12/2019 18:43	25/12/2019 08:49	24/12/2019 18:43	24/12/2019 18:53	0,16	514	83,67	CHI
201912196316	PORANGATU	04950224	SAO MIGUEL DO ARAGUAIA	24/12/2019 18:43	25/12/2019 08:49	24/12/2019 18:43	24/12/2019 18:53	0,16	1	0,16	CHI
201912196316	BONOPOLIS	04950224	SAO MIGUEL DO ARAGUAIA	24/12/2019 18:43	25/12/2019 08:49	24/12/2019 18:54	24/12/2019 21:38	2,74	181	495,04	CHI
201912196316	BONOPOLIS	04950224	SAO MIGUEL DO ARAGUAIA	24/12/2019 18:43	25/12/2019 08:49	24/12/2019 18:54	25/12/2019 00:33	5,64	15	84,57	CHI
201912196316	BONOPOLIS	04950224	SAO MIGUEL DO ARAGUAIA	24/12/2019 18:43	25/12/2019 08:49	24/12/2019 18:54	25/12/2019 02:12	7,30	45	328,45	CHI
201912196316	PORANGATU	04950224	SAO MIGUEL DO ARAGUAIA	24/12/2019 18:43	25/12/2019 08:49	24/12/2019 18:54	25/12/2019 02:12	7,30	1	7,30	CHI
201912196316	BONOPOLIS	04950224	SAO MIGUEL DO ARAGUAIA	24/12/2019 18:43	25/12/2019 08:49	24/12/2019 18:54	25/12/2019 08:49	13,91	9	125,16	CHI
201912196616	PIRACANJUBA	PJ21161201	PIRACANJUBA	24/12/2019 18:43	24/12/2019 23:59	24/12/2019 18:43	24/12/2019 23:59	5,25	2	10,51	CHI
201912196617	GOIANIA	15948699	MEIA PONTE	24/12/2019 18:44	25/12/2019 00:44	24/12/2019 18:44	25/12/2019 00:44	6,00	1	6,00	CHI
201912196618	ANICUNS	AC12391422	ANICUNS	24/12/2019 18:44	25/12/2019 06:22	24/12/2019 18:44	25/12/2019 06:22	11,64	4	46,56	CHI
201912197373	SAO MIGUEL DO ARAGUAIA	SM11030537	SAO MIGUEL DO ARAGUAIA	24/12/2019 18:44	25/12/2019 01:21	24/12/2019 18:44	25/12/2019 01:21	6,61	200	1322,06	CHI
201912196641	GOIANIA	15661945	GOIANIA LESTE S1	24/12/2019 18:46	25/12/2019 03:09	24/12/2019 18:46	25/12/2019 03:09	8,38	1	8,38	CHI
201912196317	CRIXAS	CX10394718	SERRA DO OURO	24/12/2019 18:47	27/12/2019 00:58	24/12/2019 19:03	24/12/2019 20:05	1,04	80	83,44	CHI
201912196317	CRIXAS	CX12201615LD	SERRA DO OURO	24/12/2019 18:47	27/12/2019 00:58	24/12/2019 19:03	25/12/2019 00:28	5,41	84	454,67	CHI
201912196317	CRIXAS	CX12201615LD	SERRA DO OURO	24/12/2019 18:47	27/12/2019 00:58	25/12/2019 00:58	25/12/2019 08:43	7,75	9	69,75	CHI
201912196317	CRIXAS	CX12132683LD	SERRA DO OURO	24/12/2019 18:47	27/12/2019 00:58	25/12/2019 00:58	25/12/2019 09:59	9,01	75	675,85	CHI
201912196317	CRIXAS	CX12132683LD	SERRA DO OURO	24/12/2019 18:47	27/12/2019 00:58	25/12/2019 10:07	25/12/2019 12:39	2,52	43	108,54	CHI
201912196317	CRIXAS	CX12132683LD	SERRA DO OURO	24/12/2019 18:47	27/12/2019 00:58	25/12/2019 10:07	25/12/2019 19:37	9,49	10	94,94	CHI
201912196317	CRIXAS	CX12132683LD	SERRA DO OURO	24/12/2019 18:47	27/12/2019 00:58	25/12/2019 16:48	25/12/2019 19:37	2,81	43	120,85	CHI
201912196317	CRIXAS	CX12132683LD	SERRA DO OURO	24/12/2019 18:47	27/12/2019 00:58	25/12/2019 10:07	26/12/2019 22:37	36,50	8	292,03	CHI
201912196317	CRIXAS	CX12132683LD	SERRA DO OURO	24/12/2019 18:47	27/12/2019 00:58	26/12/2019 21:58	26/12/2019 22:37	0,65	53	34,51	CHI
201912196317	CRIXAS	CX12132683LD	SERRA DO OURO	24/12/2019 18:47	27/12/2019 00:58	25/12/2019 10:07	26/12/2019 23:52	37,75	9	339,77	CHI
201912196317	CRIXAS	CX12132683LD	SERRA DO OURO	24/12/2019 18:47	27/12/2019 00:58	25/12/2019 10:07	27/12/2019 00:21	38,23	5	191,17	CHI
201912196317	CRIXAS	CX13243673	SERRA DO OURO	24/12/2019 18:47	27/12/2019 00:58	24/12/2019 19:03	27/12/2019 00:58	53,92	57	3073,34	CHI
201912196317	NOVA CRIXAS	CX13243673	SERRA DO OURO	24/12/2019 18:47	27/12/2019 00:58	24/12/2019 19:03	27/12/2019 00:58	53,92	3	161,75	CHI
201912196317	CRIXAS	CX13243673	SERRA DO OURO	24/12/2019 18:47	27/12/2019 00:58	26/12/2019 08:11	27/12/2019 00:58	16,78	2	33,56	CHI
201912196317	NOVA CRIXAS	CX13243673	SERRA DO OURO	24/12/2019 18:47	27/12/2019 00:58	26/12/2019 08:11	27/12/2019 00:58	16,78	2	33,56	CHI
201912196645	GOIATUBA	MR12161814	GOIATUBA S2	24/12/2019 18:47	25/12/2019 10:48	24/12/2019 18:47	25/12/2019 10:48	16,02	1	16,02	CHI
201912196652	MONTIVIDIU	MV12326811	MONTIVIDIU T	24/12/2019 18:47	24/12/2019 19:59	24/12/2019 18:47	24/12/2019 19:59	1,19	62	73,57	CHI
201912197795	CRIXAS	CX12190201RE	SANTA TEREZINHA	24/12/2019 18:47	26/12/2019 19:44	24/12/2019 18:47	26/12/2019 11:47	40,99	42	1721,71	CHI
201912197795	CRIXAS	CX12252974LD	SANTA TEREZINHA	24/12/2019 18:47	26/12/2019 19:44	24/12/2019 18:47	26/12/2019 19:44	48,95	8	391,58	CHI



201912196655	ARAGOIANIA	AO21032715	INDEPENDENCIA S2	24/12/2019 18:48	25/12/2019 09:27	24/12/2019 18:48	25/12/2019 09:27	14,65	4	58,59	CHI
201912196657	APARECIDA DE GOIANIA	13442028	REAL S1	24/12/2019 18:48	24/12/2019 20:14	24/12/2019 18:48	24/12/2019 20:14	1,43	1	1,43	CHI
201912196665	AURILANDIA	AI12194035	FIRMINOPOLIS S2	24/12/2019 18:49	25/12/2019 10:24	24/12/2019 18:49	25/12/2019 10:24	15,58	3	46,73	CHI
201912196676	LEOPOLDO DE BULHOES	LB21310172	DAIA S2	24/12/2019 18:49	25/12/2019 13:28	24/12/2019 18:49	25/12/2019 13:28	18,64	1	18,64	CHI
201912201575	FORMOSO	FO12115548	MARA ROSA	24/12/2019 18:49	25/12/2019 17:16	24/12/2019 18:49	25/12/2019 17:16	22,44	53	1189,54	CHI
201912201575	MARA ROSA	FO12115548	MARA ROSA	24/12/2019 18:49	25/12/2019 17:16	24/12/2019 18:49	25/12/2019 17:16	22,44	56	1256,87	CHI
201912197037	PIRENOPOLIS	PV12289643	CORUMBA	24/12/2019 18:50	24/12/2019 21:04	24/12/2019 18:50	24/12/2019 21:04	2,23	319	710,04	CHI
201912196688	ISRAELANDIA	1270001933	IPORA	24/12/2019 18:51	25/12/2019 07:55	24/12/2019 18:51	25/12/2019 07:55	13,07	1	13,07	CHI
201912196691	GOIAS	GS21299682	GOIAS	24/12/2019 18:51	24/12/2019 22:57	24/12/2019 18:51	24/12/2019 22:57	4,09	4	16,37	CHI
201912197420	ALTO HORIZONTE	NH12202110	SANTA TEREZINHA	24/12/2019 18:52	25/12/2019 10:51	24/12/2019 18:52	25/12/2019 10:51	15,97	13	207,67	CHI
201912197420	PILAR DE GOIAS	NH12202110	SANTA TEREZINHA	24/12/2019 18:52	25/12/2019 10:51	24/12/2019 18:52	25/12/2019 10:51	15,97	10	159,75	CHI
201912197420	SANTA TEREZINHA DE GOIAS	NH12202110	SANTA TEREZINHA	24/12/2019 18:52	25/12/2019 10:51	24/12/2019 18:52	25/12/2019 10:51	15,97	23	367,42	CHI
201912196941	SANTA CRUZ DE GOIAS	BC12023183	CRISTIANOPOLIS	24/12/2019 18:54	24/12/2019 22:25	24/12/2019 18:54	24/12/2019 22:25	3,50	44	154,01	CHI
201912196738	AVELINOPOLIS	10010712052	ANICUNS	24/12/2019 18:55	25/12/2019 07:50	24/12/2019 18:55	25/12/2019 07:50	12,91	1	12,91	CHI
201912196739	SAO LUIS DE MONTES BELOS	SL21304422	SAO LUIZ DOS MONTES BELOS	24/12/2019 18:55	25/12/2019 07:45	24/12/2019 18:55	25/12/2019 07:45	12,84	1	12,84	CHI
201912196741	LUZIANIA	LZ21084474	MARAJOARA	24/12/2019 18:55	25/12/2019 12:20	24/12/2019 18:55	25/12/2019 12:20	17,40	3	52,21	CHI
201912196778	CEZARINA	CZ21099646	PONTALINA	24/12/2019 18:55	25/12/2019 09:36	24/12/2019 18:55	25/12/2019 09:36	14,68	1	14,68	CHI
201912196785	EDEALINA	EA12232936	PONTALINA	24/12/2019 18:55	25/12/2019 10:30	24/12/2019 18:55	25/12/2019 10:30	15,58	37	576,58	CHI
201912196785	EDEIA	EA12232936	PONTALINA	24/12/2019 18:55	25/12/2019 10:30	24/12/2019 18:55	25/12/2019 10:30	15,58	21	327,25	CHI
2019122400045	EDEALINA	00500414	EDEIA	24/12/2019 18:55	24/12/2019 19:00	24/12/2019 18:55	24/12/2019 19:00	0,08	3	0,25	CHI
2019122400045	EDEIA	00500414	EDEIA	24/12/2019 18:55	24/12/2019 19:00	24/12/2019 18:55	24/12/2019 19:00	0,08	20	1,67	CHI
2019122400045	CEZARINA	04101	PONTALINA	24/12/2019 18:55	24/12/2019 19:00	24/12/2019 18:55	24/12/2019 19:00	0,08	3	0,25	CHI
2019122400045	EDEALINA	04101	PONTALINA	24/12/2019 18:55	24/12/2019 19:00	24/12/2019 18:55	24/12/2019 19:00	0,08	1950	162,50	CHI
2019122400045	EDEIA	04101	PONTALINA	24/12/2019 18:55	24/12/2019 19:00	24/12/2019 18:55	24/12/2019 19:00	0,08	103	8,58	CHI
2019122400045	INDIARA	04101	PONTALINA	24/12/2019 18:55	24/12/2019 19:00	24/12/2019 18:55	24/12/2019 19:00	0,08	2	0,17	CHI
2019122400045	PONTALINA	04101	PONTALINA	24/12/2019 18:55	24/12/2019 19:00	24/12/2019 18:55	24/12/2019 19:00	0,08	22	1,83	CHI
201912196742	MONTES CLAROS DE GOIAS	ME21245897	IPORA	24/12/2019 18:56	25/12/2019 17:40	24/12/2019 18:56	25/12/2019 17:40	22,73	1	22,73	CHI
201912207691	RIO VERDE	RV21010590	RIO VERDE S1	24/12/2019 18:56	26/12/2019 13:30	24/12/2019 18:56	26/12/2019 13:30	42,56	1	42,56	CHI
201912196758	RIO VERDE	630268745	RIO VERDE S1	24/12/2019 18:58	25/12/2019 01:05	24/12/2019 18:58	25/12/2019 01:05	6,13	1	6,13	CHI
201912196764	EDEALINA	1130001900	PONTALINA	24/12/2019 18:58	25/12/2019 11:18	24/12/2019 18:58	25/12/2019 11:18	16,32	1	16,32	CHI
201912196766	SILVANIA	SV12400020	VIANOPOLIS	24/12/2019 18:58	25/12/2019 11:02	24/12/2019 18:58	25/12/2019 11:02	16,05	42	674,29	CHI
201912196766	VIANOPOLIS	SV12400020	VIANOPOLIS	24/12/2019 18:58	25/12/2019 11:02	24/12/2019 18:58	25/12/2019 11:02	16,05	1	16,05	CHI
201912197915	INHUMAS	IN11378278	INHUMAS S2	24/12/2019 18:59	24/12/2019 22:36	24/12/2019 18:59	24/12/2019 22:36	3,60	69	248,74	CHI

201912196961	CATURAI	GR12033390	GOIANIRA	24/12/2019 19:01	25/12/2019 05:11	24/12/2019 19:01	25/12/2019 05:11	10,17	157	1596,12	CHI
201912196961	GOIANIRA	GR12033390	GOIANIRA	24/12/2019 19:01	25/12/2019 05:11	24/12/2019 19:01	25/12/2019 05:11	10,17	19	193,16	CHI
201912196961	INHUMAS	GR12033390	GOIANIRA	24/12/2019 19:01	25/12/2019 05:11	24/12/2019 19:01	25/12/2019 05:11	10,17	6	61,00	CHI
201912196820	EDEIA	EA12068777	EDEIA	24/12/2019 19:02	24/12/2019 22:26	24/12/2019 19:02	24/12/2019 22:26	3,39	148	501,97	CHI
201912198306	RIO VERDE	RV12022474	RIO VERDE S1	24/12/2019 19:02	25/12/2019 21:45	24/12/2019 19:02	25/12/2019 21:45	26,71	7	186,94	CHI
201912203296	EDEIA	EA11257914	EDEIA	24/12/2019 19:02	25/12/2019 13:43	24/12/2019 19:02	25/12/2019 13:43	18,67	51	952,04	CHI
201912196802	JARAGUA	70070325	JARAGUA	24/12/2019 19:03	25/12/2019 14:50	24/12/2019 19:03	25/12/2019 14:50	19,78	1	19,78	CHI
201912198761	INHUMAS	IN12049761	INHUMAS S2	24/12/2019 19:05	24/12/2019 23:51	24/12/2019 19:05	24/12/2019 23:51	4,75	807	3833,70	CHI
201912196821	ITAPIRAPUA	IU12378890	MATRINCHA	24/12/2019 19:06	25/12/2019 08:55	24/12/2019 19:06	25/12/2019 08:55	13,81	1	13,81	CHI
201912196823	EDEIA	1120030319	EDEIA	24/12/2019 19:06	24/12/2019 22:53	24/12/2019 19:06	24/12/2019 22:53	3,77	1	3,77	CHI
201912196824	MORRINHOS	MR12000273	MORRINHOS	24/12/2019 19:06	25/12/2019 19:54	24/12/2019 19:06	25/12/2019 11:04	15,96	7	111,70	CHI
201912196824	MORRINHOS	MR12000273	MORRINHOS	24/12/2019 19:06	25/12/2019 19:54	24/12/2019 19:06	25/12/2019 19:54	24,79	2	49,58	CHI
201912196824	MORRINHOS	MR12000273	MORRINHOS	24/12/2019 19:06	25/12/2019 19:54	25/12/2019 19:40	25/12/2019 19:54	0,23	7	1,63	CHI
201912197405	EDEIA	EA12044472	EDEIA	24/12/2019 19:06	25/12/2019 15:12	24/12/2019 19:06	25/12/2019 15:12	20,08	12	241,01	CHI
201912196827	VALPARAISO DE GOIAS	VA11325529	MARAJOARA	24/12/2019 19:07	24/12/2019 20:05	24/12/2019 19:07	24/12/2019 20:05	0,97	91	87,97	CHI
201912196835	ANAPOLIS	AN12000168	JUNDIAI S2	24/12/2019 19:08	24/12/2019 20:39	24/12/2019 19:08	24/12/2019 20:39	1,51	442	668,28	CHI
201912196839	NOVA CRIXAS	NA11380416	NOVA CRIXAS	24/12/2019 19:08	24/12/2019 21:10	24/12/2019 19:08	24/12/2019 21:10	2,02	48	97,12	CHI
201912196842	URUACU	640006735	URUACU	24/12/2019 19:08	25/12/2019 09:10	24/12/2019 19:08	25/12/2019 09:10	14,02	1	14,02	CHI
201912196843	NIQUELANDIA	NQ12239315	NIQUELANDIA SUBTRANSMISSAO	24/12/2019 19:08	24/12/2019 22:06	24/12/2019 19:08	24/12/2019 22:06	2,95	15	44,28	CHI
201912196955	EDEIA	EA12000039	EDEIA	24/12/2019 19:08	25/12/2019 14:33	24/12/2019 19:08	25/12/2019 14:33	19,40	20	388,10	CHI
201912201993	CALDAS NOVAS	PJ12263230	CALDAS NOVAS S1	24/12/2019 19:08	25/12/2019 19:48	24/12/2019 19:08	25/12/2019 19:48	24,66	1	24,66	CHI
201912201993	PIRACANJUBA	PJ12263230	CALDAS NOVAS S1	24/12/2019 19:08	25/12/2019 19:48	24/12/2019 19:08	25/12/2019 19:48	24,66	17	419,16	CHI
201912196859	EDEIA	EA21043988	EDEIA	24/12/2019 19:09	25/12/2019 22:27	24/12/2019 19:09	25/12/2019 22:27	27,29	1	27,29	CHI
201912196883	CRIXAS	NA12171143	NOVA CRIXAS	24/12/2019 19:09	26/12/2019 10:58	24/12/2019 19:09	26/12/2019 10:58	39,80	4	159,21	CHI
201912197147	LUZIANIA	LZ11312368	MARAJOARA	24/12/2019 19:09	24/12/2019 20:39	24/12/2019 19:09	24/12/2019 20:39	1,50	11	16,45	CHI
201912197231	CORUMBA DE GOIAS	O1680424	ALEXANIA	24/12/2019 19:09	24/12/2019 20:24	24/12/2019 19:09	24/12/2019 19:35	0,44	13	5,66	CHI
201912197231	SANTO ANTONIO DO DESCOBERTO	O1680424	ALEXANIA	24/12/2019 19:09	24/12/2019 20:24	24/12/2019 19:09	24/12/2019 19:35	0,44	8684	3777,54	CHI
201912197231	SANTO ANTONIO DO DESCOBERTO	SN10404168	ALEXANIA	24/12/2019 19:09	24/12/2019 20:24	24/12/2019 19:44	24/12/2019 20:24	0,66	2123	1408,26	CHI
201912197614	AGUAS LINDAS DE GOIAS	LA11097547	AGUAS LINDAS DE GOIAS S1	24/12/2019 19:09	24/12/2019 21:02	24/12/2019 19:09	24/12/2019 21:02	1,88	287	538,44	CHI
201912196868	ITAPURANGA	IK12093412	ITAPURANGA	24/12/2019 19:10	25/12/2019 18:08	24/12/2019 19:10	25/12/2019 18:08	22,96	11	252,56	CHI
201912196873	TRINDADE	TR31034671	TRINDADE	24/12/2019 19:10	24/12/2019 21:03	24/12/2019 19:10	24/12/2019 21:03	1,87	5	9,36	CHI
201912197372	SENADOR CANEDO	SW11265443	GOIANIA LESTE S1	24/12/2019 19:10	25/12/2019 03:15	24/12/2019 19:10	25/12/2019 03:15	8,08	106	856,39	CHI
201912197375	GOIANIA	GN11041124	XAVANTES	24/12/2019 19:10	24/12/2019 23:48	24/12/2019 19:10	24/12/2019 23:48	4,62	193	891,93	CHI

201912196882	NOVA CRIXAS	NA11158874	NOVA CRIXAS	24/12/2019 19:11	24/12/2019 22:59	24/12/2019 19:11	24/12/2019 22:59	3,80	131	497,55	CHI
201912196886	ARACU	AR21019621	ARACU	24/12/2019 19:11	25/12/2019 09:55	24/12/2019 19:11	25/12/2019 09:55	14,73	2	29,46	CHI
201912196901	NOVA IGUACU DE GOIAS	NH12136479	SANTA TEREZINHA	24/12/2019 19:12	25/12/2019 10:32	24/12/2019 19:12	25/12/2019 10:32	15,33	2	30,66	CHI
201912197549	ALEXANIA	AX12221351	ALEXANIA	24/12/2019 19:12	24/12/2019 22:45	24/12/2019 19:12	24/12/2019 22:45	3,54	221	781,54	CHI
201912197062	GOIANIA	GN11280924	CARAJAS S2	24/12/2019 19:12	24/12/2019 19:58	24/12/2019 19:12	24/12/2019 19:58	0,76	125	94,86	CHI
201912197081	GOIANIA	GN11329317	CARAJAS S2	24/12/2019 19:12	24/12/2019 19:47	24/12/2019 19:12	24/12/2019 19:47	0,58	81	46,60	CHI
2019122400047	RIO VERDE	36702	SANTA HELENA S1	24/12/2019 19:13	24/12/2019 19:16	24/12/2019 19:13	24/12/2019 19:16	0,05	9	0,45	CHI
2019122400047	SANTA HELENA DE GOIAS	01660434	SANTA HELENA S1	24/12/2019 19:13	24/12/2019 19:16	24/12/2019 19:13	24/12/2019 19:16	0,05	14	0,70	CHI
201912196937	GOIANIA	10023667379	CARAJAS S2	24/12/2019 19:14	24/12/2019 20:24	24/12/2019 19:14	24/12/2019 20:24	1,16	1	1,16	CHI
201912196958	MONTIVIDIU DO NORTE	MX12182383	PORANGATU	24/12/2019 19:15	26/12/2019 18:43	24/12/2019 19:15	26/12/2019 18:43	47,46	1	47,46	CHI
201912197339	GOIANIA	GN12378780	CARAJAS S2	24/12/2019 19:15	24/12/2019 23:21	24/12/2019 19:15	24/12/2019 23:21	4,10	557	2282,62	CHI
201912197349	CEZARINA	CZ10406616	CEZARINA	24/12/2019 19:15	24/12/2019 20:54	24/12/2019 19:15	24/12/2019 20:54	1,66	358	594,68	CHI
201912197349	INDIARA	CZ10406616	CEZARINA	24/12/2019 19:15	24/12/2019 20:54	24/12/2019 19:15	24/12/2019 20:54	1,66	36	59,80	CHI
201912197349	INDIARA	CZ10406616	CEZARINA	24/12/2019 19:15	24/12/2019 20:54	24/12/2019 20:49	24/12/2019 20:54	0,08	1	0,08	CHI
201912197435	ABADIANIA	AX12221526	ALEXANIA	24/12/2019 19:15	24/12/2019 23:54	24/12/2019 19:15	24/12/2019 23:54	4,64	13	60,35	CHI
201912197435	ALEXANIA	AX12221526	ALEXANIA	24/12/2019 19:15	24/12/2019 23:54	24/12/2019 19:15	24/12/2019 23:54	4,64	189	877,33	CHI
201912198268	JATAI	JT12306448	JATAI S1	24/12/2019 19:15	24/12/2019 23:38	24/12/2019 19:15	24/12/2019 23:38	4,38	16	70,11	CHI
201912199521	GOIAS	GS12054690	GOIAS	24/12/2019 19:15	25/12/2019 09:26	24/12/2019 19:15	25/12/2019 09:26	14,19	14	198,59	CHI
201912198911	CEZARINA	CZ21358230	CEZARINA	24/12/2019 19:15	25/12/2019 09:57	24/12/2019 19:15	25/12/2019 09:57	14,70	1	14,70	CHI
201912196982	SAO MIGUEL DO ARAGUAIA	830003538	SAO MIGUEL DO ARAGUAIA	24/12/2019 19:16	24/12/2019 21:42	24/12/2019 19:16	24/12/2019 21:42	2,43	1	2,43	CHI
201912197444	EDEALINA	ED12103817	EDEIA	24/12/2019 19:16	25/12/2019 13:53	24/12/2019 19:16	25/12/2019 13:53	18,61	3	55,82	CHI
201912197444	INDIARA	ED12103817	EDEIA	24/12/2019 19:16	25/12/2019 13:53	24/12/2019 19:16	25/12/2019 13:53	18,61	4	74,42	CHI
201912197012	TEREZOPOLIS DE GOIAS	TJ21027301	JUNDIAI S2	24/12/2019 19:17	24/12/2019 23:10	24/12/2019 19:17	24/12/2019 23:10	3,88	1	3,88	CHI
201912197573	GOIANIA	GN11039226	GOIANIA LESTE S2	24/12/2019 19:18	24/12/2019 20:31	24/12/2019 19:18	24/12/2019 20:31	1,21	138	167,44	CHI
201912197093	PIRENOPOLIS	PV21056006	CORUMBA	24/12/2019 19:19	25/12/2019 12:44	24/12/2019 19:19	25/12/2019 12:44	17,41	1	17,41	CHI
201912197107	CATALAO	9580012136	CATALAO S1	24/12/2019 19:20	25/12/2019 07:30	24/12/2019 19:20	25/12/2019 07:30	12,16	1	12,16	CHI
201912197494	PARAUNA	PU12000022	PARAUNA	24/12/2019 19:20	24/12/2019 21:58	24/12/2019 19:20	24/12/2019 21:58	2,63	182	479,12	CHI
201912197751	SENADOR CANEDO	SW12323299	SENADOR CANEDO	24/12/2019 19:20	25/12/2019 06:51	24/12/2019 19:20	25/12/2019 06:51	11,51	1146	13189,50	CHI
201912197150	RIO VERDE	RV12260699	CABRIUVA S1	24/12/2019 19:21	25/12/2019 10:11	24/12/2019 19:21	25/12/2019 10:11	14,82	19	281,66	CHI
201912197162	NIQUELANDIA	NQ12262679	URUACU	24/12/2019 19:22	24/12/2019 21:36	24/12/2019 19:22	24/12/2019 21:36	2,24	17	38,01	CHI
201912197165	PONTALINA	AD21320773	GOIATUBA S1	24/12/2019 19:22	25/12/2019 11:31	24/12/2019 19:22	25/12/2019 11:31	16,15	1	16,15	CHI
201912197315	GOIANIA	13130109	ATLANTICO S1	24/12/2019 19:24	24/12/2019 21:42	24/12/2019 19:24	24/12/2019 21:42	2,29	1	2,29	CHI
201912197351	GUARINOS	GF21164839	SANTA TEREZINHA	24/12/2019 19:25	25/12/2019 14:41	24/12/2019 19:25	25/12/2019 14:41	19,26	1	19,26	CHI

201912197352	EDEIA	EA21142930	EDEIA	24/12/2019 19:25	25/12/2019 16:44	24/12/2019 19:25	25/12/2019 16:44	21,31	1	21,31	CHI
201912197550	GOIANIA	GN11167794	MEIA PONTE	24/12/2019 19:25	24/12/2019 20:26	24/12/2019 19:25	24/12/2019 20:26	1,00	313	313,52	CHI
201912197986	NOVO GAMA	NJ11084529	PACAEMBU S1	24/12/2019 19:25	24/12/2019 21:06	24/12/2019 19:25	24/12/2019 21:06	1,67	244	407,01	CHI
201912197363	CRIXAS	SG21142134	SANTA TEREZINHA	24/12/2019 19:26	26/12/2019 04:40	24/12/2019 19:26	26/12/2019 04:40	33,23	1	33,23	CHI
201912197411	ALTO HORIZONTE	MQ12181177	MARA ROSA	24/12/2019 19:28	25/12/2019 11:03	24/12/2019 19:28	25/12/2019 11:03	15,58	3	46,74	CHI
201912197411	MARA ROSA	MQ12181177	MARA ROSA	24/12/2019 19:28	25/12/2019 11:03	24/12/2019 19:28	25/12/2019 11:03	15,58	28	436,24	CHI
201912197411	URUACU	MQ12181177	MARA ROSA	24/12/2019 19:28	25/12/2019 11:03	24/12/2019 19:28	25/12/2019 11:03	15,58	1	15,58	CHI
201912197672	LUZIANIA	LZ11061777	MARAJOARA	24/12/2019 19:28	24/12/2019 21:10	24/12/2019 19:28	24/12/2019 21:10	1,68	25	42,10	CHI
201912197780	GOIANIA	GN11275002	CARAJAS S1	24/12/2019 19:32	24/12/2019 21:07	24/12/2019 19:32	24/12/2019 21:07	1,57	75	117,83	CHI
201912197841	SAO LUIS DE MONTES BELOS	SL12383600	SAO LUIZ DOS MONTES BELOS	24/12/2019 19:32	25/12/2019 07:18	24/12/2019 19:32	25/12/2019 07:18	11,75	9	105,77	CHI
201912197515	ABADIA DE GOIAS	10013072623	INDEPENDENCIA S2	24/12/2019 19:33	25/12/2019 10:18	24/12/2019 19:33	25/12/2019 10:18	14,74	1	14,74	CHI
201912197524	SANTA HELENA DE GOIAS	SH21295819	IPEGUARI	24/12/2019 19:33	25/12/2019 17:12	24/12/2019 19:33	25/12/2019 17:12	21,64	1	21,64	CHI
201912197594	CIDADE OCIDENTAL	DH12068392	MARAJOARA	24/12/2019 19:33	24/12/2019 20:57	24/12/2019 19:33	24/12/2019 20:57	1,40	332	464,80	CHI
201912197706	GOIANIA	GN11144783	XAVANTES	24/12/2019 19:33	24/12/2019 21:44	24/12/2019 19:33	24/12/2019 21:44	2,17	234	507,33	CHI
201912197689	GOIAS	GS11219972	GOIAS	24/12/2019 19:34	24/12/2019 21:29	24/12/2019 19:34	24/12/2019 21:29	1,92	218	417,53	CHI
201912197741	PONTALINA	PK12049724	PONTALINA	24/12/2019 19:34	25/12/2019 16:38	24/12/2019 19:34	25/12/2019 16:38	21,05	3	63,16	CHI
201912197567	PARANAIGUARA	2230028814	CACHOEIRA ALTA	24/12/2019 19:35	24/12/2019 23:03	24/12/2019 19:35	24/12/2019 23:03	3,46	1	3,46	CHI
201912197570	LUZIANIA	LZ11351417	RIO VERMELHO	24/12/2019 19:35	24/12/2019 20:48	24/12/2019 19:35	24/12/2019 20:48	1,21	84	101,52	CHI
201912197585	RIO VERDE	630216381	RIO VERDE S2	24/12/2019 19:36	25/12/2019 09:05	24/12/2019 19:36	25/12/2019 09:05	13,48	1	13,48	CHI
201912197589	APARECIDA DE GOIANIA	AP12000199	CEPAIGO S1	24/12/2019 19:36	25/12/2019 14:49	24/12/2019 19:36	25/12/2019 14:49	19,21	18	345,80	CHI
201912197598	ALEXANIA	AX21000071	MARAJOARA	24/12/2019 19:36	25/12/2019 11:00	24/12/2019 19:36	25/12/2019 11:00	15,39	2	30,77	CHI
201912197617	TRINDADE	10010097544	TRINDADE	24/12/2019 19:37	24/12/2019 22:04	24/12/2019 19:37	24/12/2019 22:04	2,43	1	2,43	CHI
201912197618	GOIANIA	10701205	ATLANTICO S3	24/12/2019 19:38	24/12/2019 21:35	24/12/2019 19:38	24/12/2019 21:35	1,95	1	1,95	CHI
201912198053	ANAPOLIS	AN12068097	ANAPOLIS UNIVERSITARIO S2	24/12/2019 19:38	24/12/2019 23:27	24/12/2019 19:38	24/12/2019 23:27	3,81	142	541,18	CHI
201912197791	ANAPOLIS	AN12210756	JUNDIAI S1	24/12/2019 19:39	24/12/2019 21:02	24/12/2019 19:39	24/12/2019 21:02	1,38	1092	1507,57	CHI
201912197671	VIANOPOLIS	VN21105515	VIANOPOLIS	24/12/2019 19:40	25/12/2019 11:44	24/12/2019 19:40	25/12/2019 11:44	16,06	1	16,06	CHI
201912197675	CACHOEIRA ALTA	CA12327414	CACHOEIRA ALTA	24/12/2019 19:40	24/12/2019 22:22	24/12/2019 19:40	24/12/2019 22:22	2,68	5	13,42	CHI
201912197863	APARECIDA DE GOIANIA	AP11079717	INDEPENDENCIA S2	24/12/2019 19:40	25/12/2019 03:53	24/12/2019 19:40	25/12/2019 03:53	8,20	317	2599,84	CHI
201912197690	PARANAIGUARA	2230014773	CACHOEIRA ALTA	24/12/2019 19:42	25/12/2019 00:29	24/12/2019 19:42	25/12/2019 00:29	4,78	1	4,78	CHI
201912197718	JARAGUA	70006453	JARAGUA	24/12/2019 19:43	25/12/2019 15:10	24/12/2019 19:43	25/12/2019 15:10	19,45	1	19,45	CHI
201912200676	INHUMAS	IN12326218	INHUMAS S2	24/12/2019 19:43	25/12/2019 04:32	24/12/2019 19:43	25/12/2019 04:32	8,80	3	26,40	CHI
201912197856	NOVO GAMA	NJ11097526	PACAEMBU S1	24/12/2019 19:45	24/12/2019 21:37	24/12/2019 19:45	24/12/2019 21:37	1,85	248	459,35	CHI
201912197816	CIDADE OCIDENTAL	DH11199687	MARAJOARA	24/12/2019 19:46	24/12/2019 23:56	24/12/2019 19:46	24/12/2019 23:56	4,17	29	120,82	CHI

201912198082	PIRENOPOLIS	PV11000022	CORUMBA	24/12/2019 19:47	24/12/2019 21:54	24/12/2019 19:47	24/12/2019 21:54	2,11	216	456,30	CHI
201912197786	CATALAO	CT12077474	CATALAO S1	24/12/2019 19:48	25/12/2019 09:14	24/12/2019 19:48	25/12/2019 09:14	13,42	4	53,70	CHI
201912197818	ABADIANIA	CB12317749	CORUMBA	24/12/2019 19:49	25/12/2019 10:26	24/12/2019 19:49	25/12/2019 10:26	14,60	3	43,81	CHI
201912197818	CORUMBA DE GOIAS	CB12317749	CORUMBA	24/12/2019 19:49	25/12/2019 10:26	24/12/2019 19:49	25/12/2019 10:26	14,60	5	73,01	CHI
201912197602	GOIANIA	GN10407676	CARAJAS S2	24/12/2019 19:50	24/12/2019 22:36	24/12/2019 19:50	24/12/2019 20:11	0,35	1183	414,71	CHI
201912197602	GOIANIA	GN10407676	CARAJAS S2	24/12/2019 19:50	24/12/2019 22:36	24/12/2019 20:14	24/12/2019 22:36	2,37	1501	3564,46	CHI
201912197832	SANTA FE DE GOIAS	RN12206843	BRITANIA	24/12/2019 19:50	25/12/2019 00:52	24/12/2019 19:50	25/12/2019 00:52	5,03	20	100,63	CHI
201912197940	INHUMAS	IN11012239	INHUMAS S2	24/12/2019 19:50	25/12/2019 01:59	24/12/2019 19:50	25/12/2019 01:59	6,14	142	872,35	CHI
201912197854	VILA PROPICIO	NP21298242	GOIANESIA S1	24/12/2019 19:51	25/12/2019 11:02	24/12/2019 19:51	25/12/2019 11:02	15,17	1	15,17	CHI
201912200941	CRIXAS	CX11210910	SERRA DO OURO	24/12/2019 19:51	25/12/2019 05:57	24/12/2019 19:51	25/12/2019 05:57	10,10	100	1009,89	CHI
201912201182	TRINDADE	TR12043728	TRINDADE	24/12/2019 19:51	25/12/2019 03:01	24/12/2019 19:51	25/12/2019 03:01	7,18	85	610,49	CHI
201912197960	GOIANIA	GN11211467	FERROVIARIO S1	24/12/2019 19:52	24/12/2019 22:21	24/12/2019 19:52	24/12/2019 22:21	2,48	214	531,31	CHI
201912198167	PIRENOPOLIS	PV12381250	CORUMBA	24/12/2019 19:53	26/12/2019 10:31	24/12/2019 19:53	26/12/2019 10:31	38,63	8	309,04	CHI
201912198278	APARECIDA DE GOIANIA	AP16401590	INDEPENDENCIA S2	24/12/2019 19:53	25/12/2019 03:23	24/12/2019 19:54	24/12/2019 21:39	1,74	1602	2786,59	CHI
201912198278	APARECIDA DE GOIANIA	AP13363107	INDEPENDENCIA S2	24/12/2019 19:53	25/12/2019 03:23	24/12/2019 19:54	24/12/2019 23:08	3,24	1271	4116,27	CHI
201912198278	APARECIDA DE GOIANIA	AP16401539	INDEPENDENCIA S2	24/12/2019 19:53	25/12/2019 03:23	24/12/2019 19:54	25/12/2019 03:10	7,26	607	4406,31	CHI
201912198278	APARECIDA DE GOIANIA	AP13401540B	INDEPENDENCIA S2	24/12/2019 19:53	25/12/2019 03:23	24/12/2019 19:54	25/12/2019 03:23	7,47	521	3893,32	CHI
201912197897	AGUAS LINDAS DE GOIAS	4830165201	AGUAS LINDAS DE GOIAS S1	24/12/2019 19:54	24/12/2019 22:49	24/12/2019 19:54	24/12/2019 22:49	2,91	1	2,91	CHI
201912197904	AVELINOPOLIS	10008323745	ANICUNS	24/12/2019 19:54	25/12/2019 07:13	24/12/2019 19:54	25/12/2019 07:13	11,30	1	11,30	CHI
201912197906	BONOPOLIS	BX11168256	SAO MIGUEL DO ARAGUAIA	24/12/2019 19:54	25/12/2019 07:00	24/12/2019 19:54	25/12/2019 07:00	11,08	74	820,25	CHI
201912197933	ESTRELA DO NORTE	MQ12150566	MARA ROSA	24/12/2019 19:56	25/12/2019 13:16	24/12/2019 19:56	25/12/2019 13:16	17,33	7	121,29	CHI
201912197933	MARA ROSA	MQ12150566	MARA ROSA	24/12/2019 19:56	25/12/2019 13:16	24/12/2019 19:56	25/12/2019 13:16	17,33	7	121,29	CHI
201912197966	MORRINHOS	MR12000113	MORRINHOS	24/12/2019 19:57	25/12/2019 14:52	24/12/2019 19:57	25/12/2019 14:52	18,91	11	207,99	CHI
201912197972	NAZARIO	NZ12034145	ANICUNS	24/12/2019 19:57	25/12/2019 07:00	24/12/2019 19:57	25/12/2019 07:00	11,05	2	22,10	CHI
201912199405	CALDAS NOVAS	CN12213873	CALDAS NOVAS S2	24/12/2019 19:57	25/12/2019 03:57	24/12/2019 19:57	25/12/2019 03:57	7,98	8	63,88	CHI
201912197228	PETROLINA DE GOIAS	PV13370486	SAO FRANCISCO DE GOIAS	24/12/2019 19:58	26/12/2019 20:24	24/12/2019 20:12	25/12/2019 02:42	6,50	3	19,50	CHI
201912197228	PIRENOPOLIS	PV13370486	SAO FRANCISCO DE GOIAS	24/12/2019 19:58	26/12/2019 20:24	24/12/2019 20:12	25/12/2019 02:42	6,50	329	2138,96	CHI
201912197228	PIRENOPOLIS	05390214	SAO FRANCISCO DE GOIAS	24/12/2019 19:58	26/12/2019 20:24	24/12/2019 19:59	25/12/2019 10:39	14,67	435	6381,21	CHI
201912197228	PIRENOPOLIS	05390214	SAO FRANCISCO DE GOIAS	24/12/2019 19:58	26/12/2019 20:24	24/12/2019 20:00	25/12/2019 10:39	14,65	1	14,65	CHI
201912197228	PIRENOPOLIS	05390214	SAO FRANCISCO DE GOIAS	24/12/2019 19:58	26/12/2019 20:24	24/12/2019 19:59	25/12/2019 10:50	14,85	79	1173,54	CHI
201912197228	PETROLINA DE GOIAS	05390214	SAO FRANCISCO DE GOIAS	24/12/2019 19:58	26/12/2019 20:24	24/12/2019 19:59	25/12/2019 11:11	15,21	6	91,24	CHI
201912197228	PIRENOPOLIS	05390214	SAO FRANCISCO DE GOIAS	24/12/2019 19:58	26/12/2019 20:24	24/12/2019 19:59	25/12/2019 11:11	15,21	14	212,90	CHI
201912197228	PIRENOPOLIS	05390214	SAO FRANCISCO DE GOIAS	24/12/2019 19:58	26/12/2019 20:24	24/12/2019 19:59	25/12/2019 11:16	15,29	68	1039,51	CHI

201912197228	PETROLINA DE GOIAS	05390214	SAO FRANCISCO DE GOIAS	24/12/2019 19:58	26/12/2019 20:24	24/12/2019 19:59	25/12/2019 11:40	15,68	6	94,08	CHI
201912197228	PIRENOPOLIS	05390214	SAO FRANCISCO DE GOIAS	24/12/2019 19:58	26/12/2019 20:24	24/12/2019 19:59	25/12/2019 11:40	15,68	248	3888,71	CHI
201912197228	SAO FRANCISCO DE GOIAS	05390214	SAO FRANCISCO DE GOIAS	24/12/2019 19:58	26/12/2019 20:24	24/12/2019 19:59	25/12/2019 11:40	15,68	19	297,93	CHI
201912197228	PIRENOPOLIS	PV13093293	SAO FRANCISCO DE GOIAS	24/12/2019 19:58	26/12/2019 20:24	24/12/2019 19:59	25/12/2019 12:08	16,16	337	5445,36	CHI
201912197228	PIRENOPOLIS	05390214	SAO FRANCISCO DE GOIAS	24/12/2019 19:58	26/12/2019 20:24	24/12/2019 19:59	26/12/2019 20:24	48,42	3	145,26	CHI
201912197975	FAINA	MP12096007	MATRINCHA	24/12/2019 19:58	25/12/2019 11:58	24/12/2019 19:58	25/12/2019 11:58	16,00	8	127,99	CHI
201912198089	CUMARI	CY11000063	CATALAO S1	24/12/2019 19:58	25/12/2019 08:14	24/12/2019 19:58	25/12/2019 08:14	12,27	110	1349,21	CHI
201912197232	ITABERAI	IB10395409	ITABERAI S2	24/12/2019 19:59	24/12/2019 20:22	24/12/2019 20:05	24/12/2019 20:22	0,29	79	22,73	CHI
201912197232	TAQUARAL DE GOIAS	IB10395409	ITABERAI S2	24/12/2019 19:59	24/12/2019 20:22	24/12/2019 20:05	24/12/2019 20:22	0,29	3	0,86	CHI
201912197723	QUIRINOPOLIS	QI11091105	QUIRINOPOLIS	24/12/2019 19:59	24/12/2019 20:46	24/12/2019 19:59	24/12/2019 20:46	0,79	128	100,55	CHI
201912198011	AGUAS LINDAS DE GOIAS	LA11348439	AGUAS LINDAS DE GOIAS S2	24/12/2019 19:59	24/12/2019 21:53	24/12/2019 19:59	24/12/2019 21:53	1,89	36	67,97	CHI
201912199187	AGUAS LINDAS DE GOIAS	LA12165006	AGUAS LINDAS DE GOIAS S2	24/12/2019 19:59	24/12/2019 22:07	24/12/2019 19:59	24/12/2019 22:07	2,13	1451	3095,87	CHI
201912198026	AGUAS LINDAS DE GOIAS	LA12389408	AGUAS LINDAS DE GOIAS S2	24/12/2019 20:00	24/12/2019 21:49	24/12/2019 20:00	24/12/2019 21:49	1,81	126	227,50	CHI
201912202555	PONTALINA	PK12109412	PONTALINA	24/12/2019 20:00	25/12/2019 11:15	24/12/2019 20:00	25/12/2019 11:15	15,24	14	213,41	CHI
201912198044	VALPARAISO DE GOIAS	VA11335928	PACAEMBU S2	24/12/2019 20:01	24/12/2019 23:23	24/12/2019 20:01	24/12/2019 23:23	3,36	139	467,04	CHI
201912197226	ITABERAI	00880404	ITABERAI S1	24/12/2019 20:02	25/12/2019 14:21	24/12/2019 20:02	24/12/2019 20:07	0,08	3	0,25	CHI
201912197226	ITABERAI	IX10400372	ITABERAI S1	24/12/2019 20:02	25/12/2019 14:21	24/12/2019 20:02	24/12/2019 20:07	0,08	2	0,17	CHI
201912197226	ITAUCU	IX10400372	ITABERAI S1	24/12/2019 20:02	25/12/2019 14:21	24/12/2019 20:02	24/12/2019 20:07	0,08	93	7,75	CHI
201912197226	TAQUARAL DE GOIAS	00880404	ITABERAI S1	24/12/2019 20:02	25/12/2019 14:21	24/12/2019 20:02	24/12/2019 20:07	0,08	1492	124,33	CHI
201912197226	TAQUARAL DE GOIAS	00880404	ITABERAI S1	24/12/2019 20:02	25/12/2019 14:21	24/12/2019 20:02	24/12/2019 20:07	0,08	125	10,42	CHI
201912197226	TAQUARAL DE GOIAS	IX10400372	ITABERAI S1	24/12/2019 20:02	25/12/2019 14:21	24/12/2019 20:02	24/12/2019 20:07	0,08	2	0,17	CHI
201912197226	ITABERAI	00880404	ITABERAI S1	24/12/2019 20:02	25/12/2019 14:21	24/12/2019 20:02	24/12/2019 22:52	2,83	50	141,33	CHI
201912197226	ITAUCU	00880404	ITABERAI S1	24/12/2019 20:02	25/12/2019 14:21	24/12/2019 20:02	24/12/2019 22:52	2,83	2	5,65	CHI
201912197226	ITABERAI	00880404	ITABERAI S1	24/12/2019 20:02	25/12/2019 14:21	24/12/2019 20:02	24/12/2019 23:14	3,20	28	89,55	CHI
201912197226	ITABERAI	00880404	ITABERAI S1	24/12/2019 20:02	25/12/2019 14:21	24/12/2019 20:02	25/12/2019 14:21	18,30	17	311,16	CHI
201912197226	ITABERAI	IB13376371	ITABERAI S1	24/12/2019 20:02	25/12/2019 14:21	25/12/2019 08:26	25/12/2019 14:21	5,91	50	295,33	CHI
201912197226	ITAUCU	IB13376371	ITABERAI S1	24/12/2019 20:02	25/12/2019 14:21	25/12/2019 08:26	25/12/2019 14:21	5,91	2	11,81	CHI
201912198061	AGUAS LINDAS DE GOIAS	LA11261061	AGUAS LINDAS DE GOIAS S1	24/12/2019 20:02	24/12/2019 20:48	24/12/2019 20:02	24/12/2019 20:48	0,77	128	98,06	CHI
201912198363	VALPARAISO DE GOIAS	VA11214925	PACAEMBU S1	24/12/2019 20:02	24/12/2019 22:02	24/12/2019 20:02	24/12/2019 22:02	2,00	127	253,72	CHI
201912198352	COCALZINHO DE GOIAS	ZN11302179	COCALZINHO	24/12/2019 20:03	25/12/2019 12:26	24/12/2019 20:03	25/12/2019 12:26	16,38	97	1588,54	CHI
201912198210	ANAPOLIS	AN11297556	JUNDIAI S2	24/12/2019 20:04	24/12/2019 22:40	24/12/2019 20:04	24/12/2019 22:40	2,59	56	144,87	CHI
201912198117	GOIANESIA	GE21229505	GOIANESIA S2	24/12/2019 20:05	25/12/2019 11:21	24/12/2019 20:05	25/12/2019 11:21	15,26	2	30,51	CHI
201912198135	TRINDADE	TR11005163	TRINDADE	24/12/2019 20:05	24/12/2019 23:39	24/12/2019 20:05	24/12/2019 23:39	3,56	128	455,93	CHI

201912202026	ARACU	AR12104723	ARACU	24/12/2019 20:05	26/12/2019 18:30	24/12/2019 20:05	26/12/2019 16:50	44,74	11	492,19	CHI
201912202026	ARACU	AR12320408	ARACU	24/12/2019 20:05	26/12/2019 18:30	24/12/2019 20:05	26/12/2019 18:02	45,95	6	275,67	CHI
201912202026	ITAUCU	AR12320408	ARACU	24/12/2019 20:05	26/12/2019 18:30	24/12/2019 20:05	26/12/2019 18:02	45,95	1	45,95	CHI
201912202026	ARACU	AR12320407	ARACU	24/12/2019 20:05	26/12/2019 18:30	24/12/2019 20:05	26/12/2019 18:03	45,96	5	229,81	CHI
201912202026	ITAUCU	AR12376846	ARACU	24/12/2019 20:05	26/12/2019 18:30	24/12/2019 20:05	26/12/2019 18:30	46,41	8	371,29	CHI
201912198122	ITABERAI	IB11352473	ITABERAI S2	24/12/2019 20:06	25/12/2019 06:46	24/12/2019 20:06	25/12/2019 06:46	10,67	123	1311,93	CHI
201912198128	MINEIROS	1390117914	PARQUE DAS EMAS	24/12/2019 20:06	24/12/2019 22:59	24/12/2019 20:06	24/12/2019 22:59	2,88	1	2,88	CHI
201912198156	ANICUNS	IB12172694	ARACU	24/12/2019 20:08	25/12/2019 13:26	24/12/2019 20:08	25/12/2019 13:26	17,31	1	17,31	CHI
201912198156	ITABERAI	IB12172694	ARACU	24/12/2019 20:08	25/12/2019 13:26	24/12/2019 20:08	25/12/2019 13:26	17,31	7	121,15	CHI
201912198158	APARECIDA DE GOIANIA	200251107	INDEPENDENCIA S1	24/12/2019 20:08	24/12/2019 21:52	24/12/2019 20:08	24/12/2019 21:52	1,72	1	1,72	CHI
201912200394	SANTA TEREZA DE GOIAS	SE12182470	MARA ROSA	24/12/2019 20:09	25/12/2019 16:55	24/12/2019 20:09	25/12/2019 16:55	20,76	7	145,29	CHI
201912198174	ABADIANIA	AA12199755	ANAPOLIS UNIVERSITARIO S1	24/12/2019 20:10	25/12/2019 14:30	24/12/2019 20:10	25/12/2019 14:30	18,33	12	219,98	CHI
201912198178	LUZIANIA	LZ11169066	RIO VERMELHO	24/12/2019 20:10	24/12/2019 21:32	24/12/2019 20:10	24/12/2019 21:32	1,36	142	193,24	CHI
201912198185	NOVA CRIXAS	8570012010	NOVA CRIXAS	24/12/2019 20:10	25/12/2019 00:00	24/12/2019 20:10	25/12/2019 00:00	3,82	1	3,82	CHI
201912198186	BOM JARDIM DE GOIAS	BM21135320	BOM JARDIM	24/12/2019 20:11	25/12/2019 07:40	24/12/2019 20:11	25/12/2019 07:40	11,49	1	11,49	CHI
201912198247	VILA PROPICIO	BA12248765	BARRO ALTO	24/12/2019 20:12	25/12/2019 10:59	24/12/2019 20:12	25/12/2019 10:59	14,77	22	324,93	CHI
201912198220	SANTO ANTONIO DO DESCOBERTO	10001926320	ALEXANIA	24/12/2019 20:13	25/12/2019 00:18	24/12/2019 20:13	25/12/2019 00:18	4,07	1	4,07	CHI
201912198934	VALPARAISO DE GOIAS	VA11060575	MARAJOARA	24/12/2019 20:13	24/12/2019 22:17	24/12/2019 20:13	24/12/2019 22:17	2,06	122	251,29	CHI
201912199246	GOIATUBA	GT12052886	GOIATUBA S1	24/12/2019 20:13	25/12/2019 07:53	24/12/2019 20:13	25/12/2019 07:53	11,67	1	11,67	CHI
201912199246	MORRINHOS	GT12052886	GOIATUBA S1	24/12/2019 20:13	25/12/2019 07:53	24/12/2019 20:13	25/12/2019 07:53	11,67	25	291,63	CHI
201912198236	PARANAIGUARA	PC12370045	CACHOEIRA ALTA	24/12/2019 20:15	25/12/2019 03:34	24/12/2019 20:15	25/12/2019 03:34	7,31	5	36,56	CHI
201912198241	GOIATUBA	GT12044907	GOIATUBA S2	24/12/2019 20:15	25/12/2019 10:16	24/12/2019 20:15	25/12/2019 10:16	14,01	11	154,07	CHI
201912198243	COCALZINHO DE GOIAS	ZN11285368	COCALZINHO	24/12/2019 20:15	25/12/2019 10:37	24/12/2019 20:15	25/12/2019 10:37	14,35	87	1248,81	CHI
201912198244	CATALAO	10011280865	CATALAO S2	24/12/2019 20:15	25/12/2019 04:18	24/12/2019 20:15	25/12/2019 04:18	8,04	1	8,04	CHI
201912198246	ITABERAI	IB11317841	ITABERAI S2	24/12/2019 20:16	25/12/2019 06:55	24/12/2019 20:16	25/12/2019 06:55	10,65	97	1032,97	CHI
201912198248	ITAUCU	AR21168383	INHUMAS S1	24/12/2019 20:16	26/12/2019 04:03	24/12/2019 20:16	26/12/2019 04:03	31,78	1	31,78	CHI
201912198250	TAQUARAL DE GOIAS	TQ12170668	ITABERAI S1	24/12/2019 20:16	24/12/2019 21:36	24/12/2019 20:16	24/12/2019 21:36	1,32	95	125,69	CHI
201912197959	QUIRINOPOLIS	QI11000030	QUIRINOPOLIS	24/12/2019 20:17	24/12/2019 20:32	24/12/2019 20:17	24/12/2019 20:32	0,25	65	16,09	CHI
201912199173	PETROLINA DE GOIAS	PG12101826	PETROLINA	24/12/2019 20:17	25/12/2019 10:17	24/12/2019 20:17	25/12/2019 10:17	14,00	10	139,97	CHI
201912198263	NEROPOLIS	10013867987	NEROPOLIS S1	24/12/2019 20:18	24/12/2019 21:55	24/12/2019 20:18	24/12/2019 21:55	1,61	1	1,61	CHI
201912198406	LUZIANIA	LZ11183942	MARAJOARA	24/12/2019 20:18	24/12/2019 21:41	24/12/2019 20:18	24/12/2019 21:41	1,38	290	399,88	CHI
201912198271	APARECIDA DE GOIANIA	200323866	INDEPENDENCIA S2	24/12/2019 20:19	25/12/2019 08:18	24/12/2019 20:19	25/12/2019 08:18	11,98	1	11,98	CHI
201912198280	GOIANDIRA	GD21081402	CATALAO S1	24/12/2019 20:19	25/12/2019 09:01	24/12/2019 20:19	25/12/2019 09:01	12,69	1	12,69	CHI

201912198295	GOIANIA	GN12059752	GOYA S1	24/12/2019 20:21	24/12/2019 22:08	24/12/2019 20:21	24/12/2019 22:08	1,78	70	124,74	CHI
201912198307	CALDAS NOVAS	760109035	CALDAS NOVAS S1	24/12/2019 20:22	25/12/2019 07:01	24/12/2019 20:22	25/12/2019 07:01	10,64	1	10,64	CHI
201912198311	SANTA TEREZINHA DE GOIAS	SG21067427	SANTA TEREZINHA	24/12/2019 20:22	25/12/2019 16:49	24/12/2019 20:22	25/12/2019 16:49	20,43	1	20,43	CHI
201912199245	VALPARAISO DE GOIAS	VA12261805	PACAEMBU S2	24/12/2019 20:23	24/12/2019 22:26	24/12/2019 20:23	24/12/2019 22:26	2,04	619	1260,70	CHI
201912198333	NIQUELANDIA	4760001233	NIQUELANDIA SUBTRANSMISSAO	24/12/2019 20:24	25/12/2019 02:00	24/12/2019 20:24	25/12/2019 02:00	5,59	1	5,59	CHI
201912200386	NOVA CRIXAS	NA11282180	NOVA CRIXAS	24/12/2019 20:24	25/12/2019 06:59	24/12/2019 20:24	25/12/2019 06:59	10,58	34	359,68	CHI
201912198432	AGUAS LINDAS DE GOIAS	LA11261311	AGUAS LINDAS DE GOIAS S1	24/12/2019 20:25	24/12/2019 22:22	24/12/2019 20:25	24/12/2019 22:22	1,94	114	221,48	CHI
201912198371	VICENTINOPOLIS	VI21009223	VICENTINOPOLIS	24/12/2019 20:26	25/12/2019 16:13	24/12/2019 20:26	25/12/2019 16:13	19,77	1	19,77	CHI
201912198719	ITABERAI	IB11221786	ITABERAI S2	24/12/2019 20:26	25/12/2019 10:54	24/12/2019 20:26	25/12/2019 10:54	14,45	73	1055,03	CHI
201912200434	ITAGUARI	II11049701	ITABERAI S1	24/12/2019 20:26	25/12/2019 06:41	24/12/2019 20:26	25/12/2019 06:41	10,24	196	2007,42	CHI
201912198374	SANTO ANTONIO DO DESCOBERTO	SN12375212	ALEXANIA	24/12/2019 20:27	24/12/2019 21:58	24/12/2019 20:27	24/12/2019 21:58	1,52	543	823,25	CHI
201912198923	GOIANIA	GN11329317	CARAJAS S2	24/12/2019 20:27	24/12/2019 23:58	24/12/2019 20:27	24/12/2019 23:58	3,51	81	284,31	CHI
201912198990	GOIANIA	GN12200020	GOYA S2	24/12/2019 20:28	24/12/2019 21:55	24/12/2019 20:28	24/12/2019 21:55	1,43	612	878,22	CHI
201912198403	CALDAS NOVAS	CN21182616	SERRA DE CALDAS	24/12/2019 20:29	25/12/2019 10:55	24/12/2019 20:29	25/12/2019 10:55	14,43	1	14,43	CHI
201912198429	ABADIANIA	AA12377766	ANAPOLIS UNIVERSITARIO S1	24/12/2019 20:29	25/12/2019 15:18	24/12/2019 20:29	25/12/2019 15:18	18,80	9	169,24	CHI
201912198417	GOIANIA	10066871	GOIANIA LESTE S3	24/12/2019 20:31	24/12/2019 22:31	24/12/2019 20:31	24/12/2019 22:31	2,00	1	2,00	CHI
201912198419	CAIAPONIA	CP12119577	CAIAPONIA	24/12/2019 20:31	25/12/2019 08:11	24/12/2019 20:31	25/12/2019 08:11	11,66	66	769,41	CHI
201912198419	DOVERLANDIA	CP12119577	CAIAPONIA	24/12/2019 20:31	25/12/2019 08:11	24/12/2019 20:31	25/12/2019 08:11	11,66	7	81,60	CHI
201912198439	SAO MIGUEL DO ARAGUAIA	830075471	SAO MIGUEL DO ARAGUAIA	24/12/2019 20:34	24/12/2019 23:18	24/12/2019 20:34	24/12/2019 23:18	2,73	1	2,73	CHI
201912198451	CRIXAS	CX21040904	SANTA TEREZINHA	24/12/2019 20:36	26/12/2019 16:59	24/12/2019 20:36	26/12/2019 16:59	44,38	1	44,38	CHI
201912198456	INHUMAS	IN31066335	INHUMAS S2	24/12/2019 20:36	25/12/2019 11:29	24/12/2019 20:36	25/12/2019 11:29	14,87	1	14,87	CHI
201912198464	PADRE BERNARDO	PB11377629	PADRE BERNARDO	24/12/2019 20:37	24/12/2019 22:12	24/12/2019 20:37	24/12/2019 22:12	1,58	28	44,18	CHI
201912198469	JATAI	JT12219503	JATAI S3	24/12/2019 20:37	25/12/2019 09:42	24/12/2019 20:37	25/12/2019 09:42	13,07	5	65,34	CHI
201912198473	VALPARAISO DE GOIAS	VA12373786	MARAJOARA	24/12/2019 20:38	24/12/2019 23:07	24/12/2019 20:38	24/12/2019 23:07	2,48	730	1807,76	CHI
201912198701	GOIANIA	10022208931	XAVANTES	24/12/2019 20:39	24/12/2019 23:41	24/12/2019 20:39	24/12/2019 23:41	3,03	1	3,03	CHI
201912198709	COCALZINHO DE GOIAS	1200003989	COCALZINHO	24/12/2019 20:39	25/12/2019 12:05	24/12/2019 20:39	25/12/2019 12:05	15,42	1	15,42	CHI
201912199075	CAMPO LIMPO	CV11352323	NEROPOLIS S1	24/12/2019 20:39	25/12/2019 01:13	24/12/2019 20:39	25/12/2019 01:13	4,56	130	592,69	CHI
201912198722	PIRACANJUBA	PJ12212150RE	PIRACANJUBA	24/12/2019 20:41	25/12/2019 06:52	24/12/2019 20:41	25/12/2019 06:52	10,17	66	671,22	CHI
201912198723	SENADOR CANEDO	190073160	SENADOR CANEDO	24/12/2019 20:41	24/12/2019 23:42	24/12/2019 20:41	24/12/2019 23:42	3,01	1	3,01	CHI
201912198724	GOIANIA	GN12071558	XAVANTES	24/12/2019 20:41	24/12/2019 23:58	24/12/2019 20:41	24/12/2019 23:58	3,27	2	6,54	CHI
201912198727	MORRINHOS	MR21076970	GOIATUBA S2	24/12/2019 20:42	25/12/2019 12:40	24/12/2019 20:42	25/12/2019 12:40	15,97	1	15,97	CHI
201912198734	TAQUARAL DE GOIAS	TQ11000031	ITABERAI S1	24/12/2019 20:42	25/12/2019 00:25	24/12/2019 20:42	25/12/2019 00:25	3,70	128	473,71	CHI
201912201619	ITABERAI	II12217217	ITABERAI S1	24/12/2019 20:42	25/12/2019 14:27	24/12/2019 20:42	25/12/2019 14:27	17,75	22	390,49	CHI



201912201619	ITAGUARI	II12217217	ITABERAI S1	24/12/2019 20:42	25/12/2019 14:27	24/12/2019 20:42	25/12/2019 14:27	17,75	42	745,48	CHI
201912201619	TAQUARAL DE GOIAS	II12217217	ITABERAI S1	24/12/2019 20:42	25/12/2019 14:27	24/12/2019 20:42	25/12/2019 14:27	17,75	46	816,47	CHI
201912198739	ITUMBIARA	IT12000091	PARANAIBA	24/12/2019 20:44	25/12/2019 08:33	24/12/2019 20:44	25/12/2019 08:33	11,82	10	118,17	CHI
201912199102	TAQUARAL DE GOIAS	TQ12000087	ITABERAI S1	24/12/2019 20:44	25/12/2019 15:05	24/12/2019 20:44	25/12/2019 15:05	18,35	44	807,35	CHI
201912200322	ITAPURANGA	IK12220328	ITAPURANGA	24/12/2019 20:44	25/12/2019 09:37	24/12/2019 20:44	25/12/2019 09:37	12,88	231	2975,02	CHI
201912199101	APARECIDA DE GOIANIA	AP11144595	INDEPENDENCIA S2	24/12/2019 20:46	25/12/2019 04:01	24/12/2019 20:46	25/12/2019 04:01	7,23	248	1794,07	CHI
201912198916	CAIAPONIA	CP12254646	JATAI S1	24/12/2019 20:48	25/12/2019 09:08	24/12/2019 20:48	25/12/2019 09:08	12,32	5	61,59	CHI
201912200644	RIO VERDE	RV11241416	RIO VERDE S2	24/12/2019 20:48	25/12/2019 01:30	24/12/2019 20:48	25/12/2019 01:30	4,70	98	460,22	CHI
201912202314	ARAGARCAS	BM11372371	BOM JARDIM	24/12/2019 20:48	25/12/2019 17:02	24/12/2019 20:48	25/12/2019 17:02	20,22	1	20,22	CHI
201912198927	CACHOEIRA ALTA	CA12034602	CACHOEIRA ALTA	24/12/2019 20:50	25/12/2019 01:23	24/12/2019 20:50	25/12/2019 01:23	4,54	1	4,54	CHI
201912198928	PETROLINA DE GOIAS	PG11335028	PETROLINA	24/12/2019 20:51	25/12/2019 19:42	24/12/2019 20:51	25/12/2019 19:42	22,84	37	845,22	CHI
201912198936	LUZIANIA	LZ11029350	RIO VERMELHO	24/12/2019 20:52	24/12/2019 21:58	24/12/2019 20:52	24/12/2019 21:58	1,10	205	224,93	CHI
201912198937	PARANAIGUARA	CA21081286	CACHOEIRA ALTA	24/12/2019 20:52	25/12/2019 01:38	24/12/2019 20:52	25/12/2019 01:38	4,76	1	4,76	CHI
201912198956	ORIZONA	OZ12022855	PIRES DO RIO S2	24/12/2019 20:55	24/12/2019 22:50	24/12/2019 20:55	24/12/2019 22:50	1,91	8	15,24	CHI
201912198960	INDIARA	IY21315340	EDEIA	24/12/2019 20:55	25/12/2019 08:59	24/12/2019 20:55	25/12/2019 08:59	12,05	1	12,05	CHI
201912199841	JARAGUA	O3160224	SAO FRANCISCO DE GOIAS	24/12/2019 20:55	25/12/2019 15:50	24/12/2019 20:55	25/12/2019 04:18	7,38	123	907,64	CHI
201912199841	SAO FRANCISCO DE GOIAS	O3160224	SAO FRANCISCO DE GOIAS	24/12/2019 20:55	25/12/2019 15:50	24/12/2019 20:55	25/12/2019 04:18	7,38	599	4420,12	CHI
201912199841	JARAGUA	SF12203675LD	SAO FRANCISCO DE GOIAS	24/12/2019 20:55	25/12/2019 15:50	24/12/2019 20:55	25/12/2019 04:38	7,71	2	15,42	CHI
201912199841	SAO FRANCISCO DE GOIAS	SF12203675LD	SAO FRANCISCO DE GOIAS	24/12/2019 20:55	25/12/2019 15:50	24/12/2019 20:55	25/12/2019 04:38	7,71	81	624,71	CHI
201912199841	SAO FRANCISCO DE GOIAS	SF12000155LD	SAO FRANCISCO DE GOIAS	24/12/2019 20:55	25/12/2019 15:50	24/12/2019 20:55	25/12/2019 15:50	18,91	5	94,56	CHI
201912198964	CAIAPONIA	CP12160772	MONTIVIDIU T	24/12/2019 20:56	25/12/2019 12:01	24/12/2019 20:56	25/12/2019 12:01	15,07	22	331,53	CHI
201912198964	JATAI	CP12160772	MONTIVIDIU T	24/12/2019 20:56	25/12/2019 12:01	24/12/2019 20:56	25/12/2019 12:01	15,07	7	105,49	CHI
201912198964	RIO VERDE	CP12160772	MONTIVIDIU T	24/12/2019 20:56	25/12/2019 12:01	24/12/2019 20:56	25/12/2019 12:01	15,07	11	165,77	CHI
201912199029	BONOPOLIS	BX12202593	SAO MIGUEL DO ARAGUAIA	24/12/2019 20:57	25/12/2019 17:52	24/12/2019 20:57	25/12/2019 17:52	20,92	4	83,69	CHI
201912198991	RUBIATABA	RB12255942	RUBIATABA	24/12/2019 20:58	25/12/2019 18:13	24/12/2019 20:58	25/12/2019 18:13	21,25	46	977,58	CHI
201912201843	PONTALINA	PK12074058	VICENTINOPOLIS	24/12/2019 20:58	25/12/2019 16:00	24/12/2019 20:58	25/12/2019 16:00	19,03	19	361,50	CHI
201912202654	SAO FRANCISCO DE GOIAS	SF12000106	SAO FRANCISCO DE GOIAS	24/12/2019 20:58	25/12/2019 13:41	24/12/2019 20:58	25/12/2019 13:41	16,71	9	150,38	CHI
2019122400158	ARAGUAPAZ	13333	RUBIATABA	24/12/2019 20:58	24/12/2019 21:04	24/12/2019 20:58	24/12/2019 21:04	0,10	103	10,30	CHI
2019122400158	CARMO DO RIO VERDE	01635114	RUBIATABA	24/12/2019 20:58	24/12/2019 21:04	24/12/2019 20:58	24/12/2019 21:04	0,10	3	0,30	CHI
2019122400158	CERES	01635114	RUBIATABA	24/12/2019 20:58	24/12/2019 21:04	24/12/2019 20:58	24/12/2019 21:04	0,10	28	2,80	CHI
2019122400158	CRIXAS	13301	RUBIATABA	24/12/2019 20:58	24/12/2019 21:04	24/12/2019 20:58	24/12/2019 21:04	0,10	30	3,00	CHI
2019122400158	CRIXAS	13333	RUBIATABA	24/12/2019 20:58	24/12/2019 21:04	24/12/2019 20:58	24/12/2019 21:04	0,10	581	58,10	CHI
2019122400158	GUARINOS	13301	RUBIATABA	24/12/2019 20:58	24/12/2019 21:04	24/12/2019 20:58	24/12/2019 21:04	0,10	11	1,10	CHI

2019122400158	IPIRANGA DE GOIAS	01635114	RUBIATABA	24/12/2019 20:58	24/12/2019 21:04	24/12/2019 20:58	24/12/2019 21:04	0,10	3	0,30	CHI
2019122400158	IPIRANGA DE GOIAS	01635114	RUBIATABA	24/12/2019 20:58	24/12/2019 21:04	24/12/2019 20:58	24/12/2019 21:04	0,10	33	3,30	CHI
2019122400158	ITAPACI	13301	RUBIATABA	24/12/2019 20:58	24/12/2019 21:04	24/12/2019 20:58	24/12/2019 21:04	0,10	162	16,20	CHI
2019122400158	ITAPACI	01635114	RUBIATABA	24/12/2019 20:58	24/12/2019 21:04	24/12/2019 20:58	24/12/2019 21:04	0,10	10	1,00	CHI
2019122400158	MORRO AGUDO DE GOIAS	01635114	RUBIATABA	24/12/2019 20:58	24/12/2019 21:04	24/12/2019 20:58	24/12/2019 21:04	0,10	14	1,40	CHI
2019122400158	MOZARLANDIA	13333	RUBIATABA	24/12/2019 20:58	24/12/2019 21:04	24/12/2019 20:58	24/12/2019 21:04	0,10	4	0,40	CHI
2019122400158	NOVA AMERICA	13301	RUBIATABA	24/12/2019 20:58	24/12/2019 21:04	24/12/2019 20:58	24/12/2019 21:04	0,10	806	80,60	CHI
2019122400158	NOVA AMERICA	01635114	RUBIATABA	24/12/2019 20:58	24/12/2019 21:04	24/12/2019 20:58	24/12/2019 21:04	0,10	3	0,30	CHI
2019122400158	NOVA AMERICA	01635114	RUBIATABA	24/12/2019 20:58	24/12/2019 21:04	24/12/2019 20:58	24/12/2019 21:04	0,10	41	4,10	CHI
2019122400158	NOVA AMERICA	13333	RUBIATABA	24/12/2019 20:58	24/12/2019 21:04	24/12/2019 20:58	24/12/2019 21:04	0,10	206	20,60	CHI
2019122400158	NOVA CRIXAS	13333	RUBIATABA	24/12/2019 20:58	24/12/2019 21:04	24/12/2019 20:58	24/12/2019 21:04	0,10	1	0,10	CHI
2019122400158	NOVA IGUACU DE GOIAS	13333	RUBIATABA	24/12/2019 20:58	24/12/2019 21:04	24/12/2019 20:58	24/12/2019 21:04	0,10	1	0,10	CHI
2019122400158	RUBIATABA	01635114	RUBIATABA	24/12/2019 20:58	24/12/2019 21:04	24/12/2019 20:58	24/12/2019 21:04	0,10	4407	440,70	CHI
2019122400158	RUBIATABA	01635114	RUBIATABA	24/12/2019 20:58	24/12/2019 21:04	24/12/2019 20:58	24/12/2019 21:04	0,10	4647	464,70	CHI
2019122400158	RUBIATABA	01635114	RUBIATABA	24/12/2019 20:58	24/12/2019 21:04	24/12/2019 20:58	24/12/2019 21:04	0,10	149	14,90	CHI
2019122400158	RUBIATABA	01635114	RUBIATABA	24/12/2019 20:58	24/12/2019 21:04	24/12/2019 20:58	24/12/2019 21:04	0,10	109	10,90	CHI
2019122400158	RUBIATABA	13333	RUBIATABA	24/12/2019 20:58	24/12/2019 21:04	24/12/2019 20:58	24/12/2019 21:04	0,10	8	0,80	CHI
2019122400158	SAO PATRICIO	01635114	RUBIATABA	24/12/2019 20:58	24/12/2019 21:04	24/12/2019 20:58	24/12/2019 21:04	0,10	20	2,00	CHI
201912198980	CAMPO LIMPO	AN21146759	NEROPOLIS S1	24/12/2019 20:59	25/12/2019 17:51	24/12/2019 20:59	25/12/2019 17:51	20,86	2	41,72	CHI
201912199090	SAO FRANCISCO DE GOIAS	SF11000031	SAO FRANCISCO DE GOIAS	24/12/2019 20:59	25/12/2019 15:50	24/12/2019 20:59	25/12/2019 15:50	18,84	113	2128,95	CHI
201912197261	GUARAITA	IK10396063	ITAPURANGA	24/12/2019 21:00	25/12/2019 19:46	24/12/2019 21:00	25/12/2019 19:46	22,77	7	159,38	CHI
201912197261	ITAPURANGA	IK10396063	ITAPURANGA	24/12/2019 21:00	25/12/2019 19:46	24/12/2019 21:00	25/12/2019 19:46	22,77	413	9403,32	CHI
201912197261	ITAPURANGA	IK12300200LD	ITAPURANGA	24/12/2019 21:00	25/12/2019 19:46	24/12/2019 21:00	25/12/2019 19:46	22,78	31	706,14	CHI
201912199000	RUBIATABA	780071384	RUBIATABA	24/12/2019 21:01	26/12/2019 12:57	24/12/2019 21:01	26/12/2019 12:57	39,92	1	39,92	CHI
201912199197	INHUMAS	IN11000045	INHUMAS S2	24/12/2019 21:01	24/12/2019 22:33	24/12/2019 21:01	24/12/2019 22:33	1,52	104	158,25	CHI
201912199016	ITABERAI	IB12274270	ITABERAI S1	24/12/2019 21:03	25/12/2019 10:58	24/12/2019 21:03	25/12/2019 10:58	13,91	55	764,78	CHI
201912199023	NOVA VENEZA	NV21188803	INHUMAS S1	24/12/2019 21:04	24/12/2019 23:24	24/12/2019 21:04	24/12/2019 23:24	2,33	2	4,65	CHI
201912199057	BELA VISTA DE GOIAS	05240214	CRISTIANOPOLIS	24/12/2019 21:04	25/12/2019 00:55	24/12/2019 21:04	24/12/2019 21:12	0,13	85	11,22	CHI
201912199057	CRISTIANOPOLIS	05240214	CRISTIANOPOLIS	24/12/2019 21:04	25/12/2019 00:55	24/12/2019 21:04	24/12/2019 21:12	0,13	22	2,90	CHI
201912199057	SAO MIGUEL DO PASSA QUATRO	05240214	CRISTIANOPOLIS	24/12/2019 21:04	25/12/2019 00:55	24/12/2019 21:04	24/12/2019 21:12	0,13	275	36,28	CHI
201912199057	VIANOPOLIS	05240214	CRISTIANOPOLIS	24/12/2019 21:04	25/12/2019 00:55	24/12/2019 21:04	24/12/2019 21:12	0,13	3	0,40	CHI
201912199057	BELA VISTA DE GOIAS	05240214	CRISTIANOPOLIS	24/12/2019 21:04	25/12/2019 00:55	24/12/2019 21:13	25/12/2019 00:06	2,88	81	233,12	CHI
201912199057	CRISTIANOPOLIS	05240214	CRISTIANOPOLIS	24/12/2019 21:04	25/12/2019 00:55	24/12/2019 21:13	25/12/2019 00:06	2,88	22	63,32	CHI

201912199057	SAO MIGUEL DO PASSA QUATRO	05240214	CRISTIANOPOLIS	24/12/2019 21:04	25/12/2019 00:55	24/12/2019 21:13	25/12/2019 00:06	2,88	93	267,66	CHI
201912199057	VIANOPOLIS	05240214	CRISTIANOPOLIS	24/12/2019 21:04	25/12/2019 00:55	24/12/2019 21:13	25/12/2019 00:06	2,88	1	2,88	CHI
201912199057	BELA VISTA DE GOIAS	SQ13257336	CRISTIANOPOLIS	24/12/2019 21:04	25/12/2019 00:55	24/12/2019 21:13	25/12/2019 00:55	3,69	4	14,75	CHI
201912199057	SAO MIGUEL DO PASSA QUATRO	SQ13257336	CRISTIANOPOLIS	24/12/2019 21:04	25/12/2019 00:55	24/12/2019 21:13	25/12/2019 00:55	3,69	182	670,92	CHI
201912199259	ITAPURANGA	IK12316147	ITAPURANGA	24/12/2019 21:04	26/12/2019 11:38	24/12/2019 21:04	26/12/2019 11:38	38,57	8	308,53	CHI
201912202596	MONTIVIDIU DO NORTE	MX21134739	PORANGATU	24/12/2019 21:04	26/12/2019 17:32	24/12/2019 21:04	26/12/2019 17:32	44,46	2	88,91	CHI
201912199032	NOVA VENEZA	NV12272400	INHUMAS S1	24/12/2019 21:05	24/12/2019 22:49	24/12/2019 21:05	24/12/2019 22:49	1,72	51	87,86	CHI
201912199059	BONFINOPOLIS	PO12315103	NOVO PLANALTO	24/12/2019 21:08	25/12/2019 12:34	24/12/2019 21:08	25/12/2019 12:34	15,42	1	15,42	CHI
201912199059	BONOPOLIS	PO12315103	NOVO PLANALTO	24/12/2019 21:08	25/12/2019 12:34	24/12/2019 21:08	25/12/2019 12:34	15,42	1	15,42	CHI
201912199059	PORANGATU	PO12315103	NOVO PLANALTO	24/12/2019 21:08	25/12/2019 12:34	24/12/2019 21:08	25/12/2019 12:34	15,42	2	30,84	CHI
201912199211	CAMPO LIMPO	AN11055165	NEROPOLIS S1	24/12/2019 21:09	24/12/2019 23:18	24/12/2019 21:09	24/12/2019 23:18	2,14	140	300,26	CHI
201912199079	CALDAS NOVAS	CN11022655	CALDAS NOVAS S2	24/12/2019 21:11	25/12/2019 10:52	24/12/2019 21:11	25/12/2019 10:52	13,68	19	259,84	CHI
201912199985	GUARINOS	IW12330115	ITAPACI	24/12/2019 21:11	25/12/2019 05:20	24/12/2019 21:11	25/12/2019 05:20	8,15	6	48,87	CHI
201912199985	ITAPACI	IW12330115	ITAPACI	24/12/2019 21:11	25/12/2019 05:20	24/12/2019 21:11	25/12/2019 05:20	8,15	117	953,03	CHI
201912199985	PILAR DE GOIAS	IW12330115	ITAPACI	24/12/2019 21:11	25/12/2019 05:20	24/12/2019 21:11	25/12/2019 05:20	8,15	1	8,15	CHI
201912199849	ITAGUARU	IC11134132	ITABERAI S1	24/12/2019 21:12	25/12/2019 21:51	24/12/2019 21:12	25/12/2019 21:51	24,64	103	2538,35	CHI
201912201884	PETROLINA DE GOIAS	SF12009988	SAO FRANCISCO DE GOIAS	24/12/2019 21:12	25/12/2019 16:46	24/12/2019 21:12	25/12/2019 16:46	19,57	26	508,91	CHI
201912201884	PIRENOPOLIS	SF12009988	SAO FRANCISCO DE GOIAS	24/12/2019 21:12	25/12/2019 16:46	24/12/2019 21:12	25/12/2019 16:46	19,57	5	97,87	CHI
201912201884	SAO FRANCISCO DE GOIAS	SF12009988	SAO FRANCISCO DE GOIAS	24/12/2019 21:12	25/12/2019 16:46	24/12/2019 21:12	25/12/2019 16:46	19,57	93	1820,32	CHI
201912201884	PETROLINA DE GOIAS	SF12009988	SAO FRANCISCO DE GOIAS	24/12/2019 21:12	25/12/2019 16:46	25/12/2019 01:52	25/12/2019 16:46	14,91	62	924,63	CHI
201912201884	PIRENOPOLIS	SF12009988	SAO FRANCISCO DE GOIAS	24/12/2019 21:12	25/12/2019 16:46	25/12/2019 01:52	25/12/2019 16:46	14,91	39	581,62	CHI
201912201884	SAO FRANCISCO DE GOIAS	SF12009988	SAO FRANCISCO DE GOIAS	24/12/2019 21:12	25/12/2019 16:46	25/12/2019 01:52	25/12/2019 16:46	14,91	49	730,75	CHI
201912203385	PIRENOPOLIS	SF13297555	SAO FRANCISCO DE GOIAS	24/12/2019 21:12	25/12/2019 13:41	24/12/2019 21:12	25/12/2019 13:41	16,48	13	214,18	CHI
201912203385	SAO FRANCISCO DE GOIAS	SF13297555	SAO FRANCISCO DE GOIAS	24/12/2019 21:12	25/12/2019 13:41	24/12/2019 21:12	25/12/2019 13:41	16,48	1250	20594,10	CHI
201912201107	SAO FRANCISCO DE GOIAS	SF11055356	SAO FRANCISCO DE GOIAS	24/12/2019 21:12	26/12/2019 00:27	24/12/2019 21:12	26/12/2019 00:27	27,24	82	2233,86	CHI
201912204329	SAO FRANCISCO DE GOIAS	SF11074693	SAO FRANCISCO DE GOIAS	24/12/2019 21:12	25/12/2019 20:40	24/12/2019 21:12	25/12/2019 20:40	23,46	224	5255,35	CHI
201912199184	NEROPOLIS	NR11282954	NEROPOLIS S2	24/12/2019 21:13	25/12/2019 01:05	24/12/2019 21:13	25/12/2019 01:05	3,86	37	142,70	CHI
201912199265	PIRACANJUBA	PJ12040800	PIRACANJUBA	24/12/2019 21:14	25/12/2019 07:38	24/12/2019 21:14	25/12/2019 07:38	10,40	42	436,64	CHI
201912200761	IPORA	IR12202000	ARENOPOLIS	24/12/2019 21:14	25/12/2019 08:07	24/12/2019 21:14	25/12/2019 08:07	10,88	8	87,04	CHI
201912199104	INHUMAS	30131935	INHUMAS S2	24/12/2019 21:15	25/12/2019 10:28	24/12/2019 21:15	25/12/2019 10:28	13,23	1	13,23	CHI
201912199107	FAINA	FC12038664	GOIAS	24/12/2019 21:15	25/12/2019 12:22	24/12/2019 21:15	25/12/2019 12:22	15,11	10	151,07	CHI
201912199112	EDEALINA	ED21037913	PONTALINA	24/12/2019 21:16	25/12/2019 19:16	24/12/2019 21:16	25/12/2019 19:16	21,98	1	21,98	CHI
201912199114	SAO LUIS DE MONTES BELOS	SL12021470	SAO LUIZ DOS MONTES BELOS	24/12/2019 21:17	25/12/2019 08:40	24/12/2019 21:17	25/12/2019 08:40	11,37	36	409,33	CHI

201912199126	LUZIANIA	LZ11061777	MARAJOARA	24/12/2019 21:17	24/12/2019 22:57	24/12/2019 21:17	24/12/2019 22:57	1,65	25	41,31	CHI
201912199128	ALEXANIA	AX21318552	ALEXANIA	24/12/2019 21:21	25/12/2019 07:28	24/12/2019 21:21	25/12/2019 07:28	10,12	1	10,12	CHI
201912199142	PETROLINA DE GOIAS	PG12017366	PETROLINA	24/12/2019 21:21	25/12/2019 10:51	24/12/2019 21:21	25/12/2019 10:51	13,50	33	445,51	CHI
201912199142	SAO FRANCISCO DE GOIAS	PG12017366	PETROLINA	24/12/2019 21:21	25/12/2019 10:51	24/12/2019 21:21	25/12/2019 10:51	13,50	8	108,00	CHI
201912200387	GOIANIA	GN11000871	FERROVIARIO S1	24/12/2019 21:23	25/12/2019 09:25	24/12/2019 21:23	25/12/2019 09:25	12,04	47	565,84	CHI
201912199146	CRISTALINA	KR21320124	PAMPLONA	24/12/2019 21:24	25/12/2019 09:09	24/12/2019 21:24	25/12/2019 09:09	11,74	13	152,67	CHI
201912199273	MUNDO NOVO DE GOIAS	MH12391951	NOVA CRIXAS	24/12/2019 21:24	25/12/2019 11:42	24/12/2019 21:24	25/12/2019 11:42	14,30	18	257,48	CHI
201912199181	GOIANIA	GN11000598	AEROPORTO S2	24/12/2019 21:25	25/12/2019 00:43	24/12/2019 21:25	25/12/2019 00:43	3,30	68	224,32	CHI
201912199204	TRINDADE	TR11002505	TRINDADE	24/12/2019 21:25	25/12/2019 01:40	24/12/2019 21:25	25/12/2019 01:40	4,23	197	834,24	CHI
201912202521	JARAGUA	JA12029022	JARAGUA	24/12/2019 21:25	25/12/2019 09:28	24/12/2019 21:25	25/12/2019 09:28	12,05	152	1831,60	CHI
2019122400142	ITAGUARU	O1020214	JARAGUA	24/12/2019 21:25	24/12/2019 21:34	24/12/2019 21:25	24/12/2019 21:34	0,15	26	3,90	CHI
2019122400142	JARAGUA	O1020214	JARAGUA	24/12/2019 21:25	24/12/2019 21:34	24/12/2019 21:25	24/12/2019 21:34	0,15	8658	1298,70	CHI
2019122400142	PIRENOPOLIS	O1020214	JARAGUA	24/12/2019 21:25	24/12/2019 21:34	24/12/2019 21:25	24/12/2019 21:34	0,15	95	14,25	CHI
2019122400142	URUANA	O1020214	JARAGUA	24/12/2019 21:25	24/12/2019 21:34	24/12/2019 21:25	24/12/2019 21:34	0,15	8	1,20	CHI
201912199157	SAO FRANCISCO DE GOIAS	10007629336	SAO FRANCISCO DE GOIAS	24/12/2019 21:27	26/12/2019 09:50	24/12/2019 21:27	26/12/2019 09:50	36,38	1	36,38	CHI
201912199165	BOM JESUS DE GOIAS	BJ21198586	RIO DOS BOIS	24/12/2019 21:29	25/12/2019 13:38	24/12/2019 21:29	25/12/2019 13:38	16,15	1	16,15	CHI
201912199172	INHUMAS	30026027	INHUMAS S2	24/12/2019 21:30	25/12/2019 09:21	24/12/2019 21:30	25/12/2019 09:21	11,84	1	11,84	CHI
201912203261	MINEIROS	MY10396070	PARQUE DAS EMAS	24/12/2019 21:30	25/12/2019 10:49	24/12/2019 21:30	25/12/2019 10:49	13,30	96	1277,25	CHI
201912203070	JOVIANIA	JV12000001	GOIATUBA S1	24/12/2019 21:31	25/12/2019 10:58	24/12/2019 21:31	25/12/2019 10:58	13,44	68	913,69	CHI
201912203070	PONTALINA	JV12000001	GOIATUBA S1	24/12/2019 21:31	25/12/2019 10:58	24/12/2019 21:31	25/12/2019 10:58	13,44	16	214,99	CHI
201912199236	MORRINHOS	MR31060316	VILA CORUMBA	24/12/2019 21:38	25/12/2019 23:11	24/12/2019 21:38	25/12/2019 23:11	25,54	1	25,54	CHI
201912201486	ANAPOLIS	AN12096740	JUNDIAI S2	24/12/2019 21:38	25/12/2019 08:44	24/12/2019 21:38	25/12/2019 08:44	11,09	21	232,91	CHI
201912199250	SAO FRANCISCO DE GOIAS	SF11273263	SAO FRANCISCO DE GOIAS	24/12/2019 21:39	26/12/2019 05:06	24/12/2019 21:39	26/12/2019 05:06	31,43	70	2200,41	CHI
201912199239	JARAGUA	70034527	JARAGUA	24/12/2019 21:40	25/12/2019 15:30	24/12/2019 21:40	25/12/2019 15:30	17,83	1	17,83	CHI
201912199247	JARAGUA	70142506	JARAGUA	24/12/2019 21:42	26/12/2019 04:42	24/12/2019 21:42	26/12/2019 04:42	30,99	1	30,99	CHI
201912197284	AMERICANO DO BRASIL	IB10395408	ITABERAI S2	24/12/2019 21:45	26/12/2019 23:57	24/12/2019 21:45	26/12/2019 18:40	44,91	12	538,95	CHI
201912197284	ITABERAI	IB10395408	ITABERAI S2	24/12/2019 21:45	26/12/2019 23:57	24/12/2019 21:45	26/12/2019 18:40	44,91	221	9925,60	CHI
201912197284	ITABERAI	IB13404109B	ITABERAI S2	24/12/2019 21:45	26/12/2019 23:57	24/12/2019 21:45	26/12/2019 19:04	45,31	26	1178,07	CHI
201912197284	ITABERAI	IB13021959	ITABERAI S2	24/12/2019 21:45	26/12/2019 23:57	24/12/2019 21:45	26/12/2019 23:57	50,19	106	5320,46	CHI
201912199262	CORUMBAIBA	CI12110161	VILA CORUMBA	24/12/2019 21:47	25/12/2019 09:23	24/12/2019 21:47	25/12/2019 09:23	11,59	44	510,17	CHI
201912201366	MUNDO NOVO DE GOIAS	MH12391952	NOVA CRIXAS	24/12/2019 21:47	25/12/2019 12:05	24/12/2019 21:47	25/12/2019 12:05	14,30	29	414,58	CHI
201912199625	INHUMAS	IN11012219	INHUMAS S2	24/12/2019 21:48	25/12/2019 02:35	24/12/2019 21:48	25/12/2019 02:35	4,78	191	912,66	CHI
201912202395	ITAGUARI	IC12353098	ITABERAI S1	24/12/2019 21:48	25/12/2019 11:52	24/12/2019 21:48	25/12/2019 11:52	14,07	47	661,09	CHI

201912202395	ITAGUARU	IC12353098	ITABERAI S1	24/12/2019 21:48	25/12/2019 11:52	24/12/2019 21:48	25/12/2019 11:52	14,07	81	1139,33	CHI
201912202395	JARAGUA	IC12353098	ITABERAI S1	24/12/2019 21:48	25/12/2019 11:52	24/12/2019 21:48	25/12/2019 11:52	14,07	127	1786,36	CHI
201912199473	ITAPURANGA	IK11000027	ITAPURANGA	24/12/2019 21:49	25/12/2019 06:55	24/12/2019 21:49	25/12/2019 06:55	9,09	123	1117,59	CHI
201912202674	AGUA LIMPA	AL12263355	VILA CORUMBA	24/12/2019 21:49	25/12/2019 19:35	24/12/2019 21:49	25/12/2019 19:35	21,76	12	261,16	CHI
201912202674	MORRINHOS	AL12263355	VILA CORUMBA	24/12/2019 21:49	25/12/2019 19:35	24/12/2019 21:49	25/12/2019 19:35	21,76	1	21,76	CHI
201912199274	GOIANIA	16774164	INDEPENDENCIA S2	24/12/2019 21:50	24/12/2019 23:06	24/12/2019 21:50	24/12/2019 23:06	1,26	1	1,26	CHI
201912199276	ITAPURANGA	IK12387485	ITAPURANGA	24/12/2019 21:51	26/12/2019 15:08	24/12/2019 21:51	26/12/2019 15:08	41,28	3	123,85	CHI
201912199805	APARECIDA DE GOIANIA	AP11111850	INDEPENDENCIA S2	24/12/2019 21:53	25/12/2019 03:10	24/12/2019 21:53	25/12/2019 03:10	5,28	126	665,07	CHI
201912199414	NEROPOLIS	NR12282952	NEROPOLIS S2	24/12/2019 21:54	25/12/2019 01:05	24/12/2019 21:54	25/12/2019 01:05	3,18	39	124,12	CHI
201912200685	JARAGUA	JA11096564	JARAGUA	24/12/2019 21:55	25/12/2019 11:38	24/12/2019 21:55	25/12/2019 11:38	13,71	46	630,83	CHI
201912200986	ITAPACI	IW11136320	ITAPACI	24/12/2019 21:55	25/12/2019 09:47	24/12/2019 21:55	25/12/2019 09:47	11,86	130	1542,09	CHI
201912202020	CAIAPONIA	MV12305995	MONTIVIDIU T	24/12/2019 21:56	25/12/2019 22:20	24/12/2019 21:56	25/12/2019 22:20	24,38	35	853,43	CHI
201912202020	IVOLANDIA	MV12305995	MONTIVIDIU T	24/12/2019 21:56	25/12/2019 22:20	24/12/2019 21:56	25/12/2019 22:20	24,38	29	707,12	CHI
201912202020	MONTIVIDIU	MV12305995	MONTIVIDIU T	24/12/2019 21:56	25/12/2019 22:20	24/12/2019 21:56	25/12/2019 22:20	24,38	27	658,36	CHI
201912202020	PARAUNA	MV12305995	MONTIVIDIU T	24/12/2019 21:56	25/12/2019 22:20	24/12/2019 21:56	25/12/2019 22:20	24,38	58	1414,25	CHI
201912197288	BALIZA	BH21359269	BOM JARDIM	24/12/2019 21:58	24/12/2019 22:01	24/12/2019 21:58	24/12/2019 22:01	0,05	1	0,05	CHI
201912199435	MORRINHOS	MR21244645	MORRINHOS	24/12/2019 21:58	25/12/2019 16:21	24/12/2019 21:58	25/12/2019 16:21	18,37	1	18,37	CHI
201912202089	GOIANESIA	GE12000035	GOIANESIA S2	24/12/2019 22:01	25/12/2019 10:02	24/12/2019 22:01	25/12/2019 10:02	12,01	2	24,02	CHI
201912202089	VILA PROPICIO	GE12000035	GOIANESIA S2	24/12/2019 22:01	25/12/2019 10:02	24/12/2019 22:01	25/12/2019 10:02	12,01	8	96,07	CHI
201912199457	OURO VERDE DE GOIAS	NR21217747	NEROPOLIS S2	24/12/2019 22:03	25/12/2019 09:53	24/12/2019 22:03	25/12/2019 09:53	11,83	1	11,83	CHI
201912199465	NIQUELANDIA	NQ12257262	URUACU	24/12/2019 22:04	25/12/2019 00:34	24/12/2019 22:04	25/12/2019 00:34	2,51	8	20,05	CHI
201912199481	LEOPOLDO DE BULHOES	LB11067572	DAIA S2	24/12/2019 22:05	25/12/2019 14:45	24/12/2019 22:05	25/12/2019 14:45	16,67	11	183,33	CHI
201912200053	LEOPOLDO DE BULHOES	LB21187239	DAIA S2	24/12/2019 22:05	25/12/2019 15:30	24/12/2019 22:05	25/12/2019 15:30	17,42	1	17,42	CHI
201912200231	PIRENOPOLIS	PV21101840	CORUMBA	24/12/2019 22:05	25/12/2019 11:12	24/12/2019 22:05	25/12/2019 11:12	13,12	1	13,12	CHI
201912200306	PIRENOPOLIS	PV21382859	CORUMBA	24/12/2019 22:05	25/12/2019 10:05	24/12/2019 22:05	25/12/2019 10:05	12,00	1	12,00	CHI
2019122400143	ABADIANIA	19801	ALEXANIA	24/12/2019 22:05	24/12/2019 22:45	24/12/2019 22:05	24/12/2019 22:45	0,67	4	2,67	CHI
2019122400143	ALEXANIA	19801	ALEXANIA	24/12/2019 22:05	24/12/2019 22:45	24/12/2019 22:05	24/12/2019 22:45	0,67	3993	2662,00	CHI
2019122400143	ALEXANIA	36501	ALEXANIA	24/12/2019 22:05	24/12/2019 22:45	24/12/2019 22:05	24/12/2019 22:45	0,67	408	272,00	CHI
2019122400143	ALEXANIA	19802	ALEXANIA	24/12/2019 22:05	24/12/2019 22:45	24/12/2019 22:05	24/12/2019 22:45	0,67	1666	1110,67	CHI
2019122400143	ALEXANIA	36502	ALEXANIA	24/12/2019 22:05	24/12/2019 22:45	24/12/2019 22:05	24/12/2019 22:45	0,67	65	43,33	CHI
2019122400143	ALEXANIA	19803	ALEXANIA	24/12/2019 22:05	24/12/2019 22:45	24/12/2019 22:05	24/12/2019 22:45	0,67	4516	3010,67	CHI
2019122400143	ALEXANIA	36503	ALEXANIA	24/12/2019 22:05	24/12/2019 22:45	24/12/2019 22:05	24/12/2019 22:45	0,67	758	505,33	CHI
2019122400143	ALEXANIA	03195114	ALEXANIA	24/12/2019 22:05	24/12/2019 22:45	24/12/2019 22:05	24/12/2019 22:45	0,67	39	26,00	CHI

2019122400143	ALEXANIA	03195114	ALEXANIA	24/12/2019 22:05	24/12/2019 22:45	24/12/2019 22:05	24/12/2019 22:45	0,67	3	2,00	CHI
2019122400143	ALEXANIA	03195114	ALEXANIA	24/12/2019 22:05	24/12/2019 22:45	24/12/2019 22:05	24/12/2019 22:45	0,67	283	188,67	CHI
2019122400143	ALEXANIA	03195114	ALEXANIA	24/12/2019 22:05	24/12/2019 22:45	24/12/2019 22:05	24/12/2019 22:45	0,67	25	16,67	CHI
2019122400143	BARRO ALTO	36501	ALEXANIA	24/12/2019 22:05	24/12/2019 22:45	24/12/2019 22:05	24/12/2019 22:45	0,67	2	1,33	CHI
2019122400143	CORUMBA DE GOIAS	19801	ALEXANIA	24/12/2019 22:05	24/12/2019 22:45	24/12/2019 22:05	24/12/2019 22:45	0,67	121	80,67	CHI
2019122400143	CORUMBA DE GOIAS	16802	ALEXANIA	24/12/2019 22:05	24/12/2019 22:45	24/12/2019 22:05	24/12/2019 22:45	0,67	13	8,67	CHI
2019122400143	CORUMBA DE GOIAS	19802	ALEXANIA	24/12/2019 22:05	24/12/2019 22:45	24/12/2019 22:05	24/12/2019 22:45	0,67	7	4,67	CHI
2019122400143	CORUMBA DE GOIAS	03195114	ALEXANIA	24/12/2019 22:05	24/12/2019 22:45	24/12/2019 22:05	24/12/2019 22:45	0,67	15	10,00	CHI
2019122400143	JARAGUA	19801	ALEXANIA	24/12/2019 22:05	24/12/2019 22:45	24/12/2019 22:05	24/12/2019 22:45	0,67	74	49,33	CHI
2019122400143	SANTO ANTONIO DO DESCOBERTO	36501	ALEXANIA	24/12/2019 22:05	24/12/2019 22:45	24/12/2019 22:05	24/12/2019 22:45	0,67	1	0,67	CHI
2019122400143	SANTO ANTONIO DO DESCOBERTO	16802	ALEXANIA	24/12/2019 22:05	24/12/2019 22:45	24/12/2019 22:05	24/12/2019 22:45	0,67	12310	8206,67	CHI
2019122400143	SANTO ANTONIO DO DESCOBERTO	19802	ALEXANIA	24/12/2019 22:05	24/12/2019 22:45	24/12/2019 22:05	24/12/2019 22:45	0,67	4	2,67	CHI
2019122400143	SANTO ANTONIO DO DESCOBERTO	36502	ALEXANIA	24/12/2019 22:05	24/12/2019 22:45	24/12/2019 22:05	24/12/2019 22:45	0,67	178	118,67	CHI
2019122400143	SANTO ANTONIO DO DESCOBERTO	19803	ALEXANIA	24/12/2019 22:05	24/12/2019 22:45	24/12/2019 22:05	24/12/2019 22:45	0,67	1	0,67	CHI
2019122400143	SANTO ANTONIO DO DESCOBERTO	03195114	ALEXANIA	24/12/2019 22:05	24/12/2019 22:45	24/12/2019 22:05	24/12/2019 22:45	0,67	34	22,67	CHI
2019122400143	COCALZINHO DE GOIAS	05745114	COCALZINHO	24/12/2019 22:05	24/12/2019 22:45	24/12/2019 22:05	24/12/2019 22:45	0,67	3130	2086,67	CHI
2019122400143	COCALZINHO DE GOIAS	05745114	COCALZINHO	24/12/2019 22:05	24/12/2019 22:45	24/12/2019 22:05	24/12/2019 22:45	0,67	1618	1078,67	CHI
2019122400143	CORUMBA DE GOIAS	05745114	COCALZINHO	24/12/2019 22:05	24/12/2019 22:45	24/12/2019 22:05	24/12/2019 22:45	0,67	19	12,67	CHI
2019122400143	CORUMBA DE GOIAS	05745114	COCALZINHO	24/12/2019 22:05	24/12/2019 22:45	24/12/2019 22:05	24/12/2019 22:45	0,67	316	210,67	CHI
2019122400143	PADRE BERNARDO	05745114	COCALZINHO	24/12/2019 22:05	24/12/2019 22:45	24/12/2019 22:05	24/12/2019 22:45	0,67	1	0,67	CHI
2019122400143	PIRENOPOLIS	05745114	COCALZINHO	24/12/2019 22:05	24/12/2019 22:45	24/12/2019 22:05	24/12/2019 22:45	0,67	34	22,67	CHI
2019122400143	PIRENOPOLIS	05745114	COCALZINHO	24/12/2019 22:05	24/12/2019 22:45	24/12/2019 22:05	24/12/2019 22:45	0,67	49	32,67	CHI
2019122400143	VILA PROPICIO	05745114	COCALZINHO	24/12/2019 22:05	24/12/2019 22:45	24/12/2019 22:05	24/12/2019 22:45	0,67	1	0,67	CHI
2019122400143	ABADIANIA	00400604	CORUMBA	24/12/2019 22:05	24/12/2019 22:45	24/12/2019 22:05	24/12/2019 22:45	0,67	86	57,33	CHI
2019122400143	ABADIANIA	20404	CORUMBA	24/12/2019 22:05	24/12/2019 22:45	24/12/2019 22:05	24/12/2019 22:45	0,67	675	450,00	CHI
2019122400143	ALEXANIA	32401	CORUMBA	24/12/2019 22:05	24/12/2019 22:45	24/12/2019 22:05	24/12/2019 22:45	0,67	846	564,00	CHI
2019122400143	ANAPOLIS	20402	CORUMBA	24/12/2019 22:05	24/12/2019 22:45	24/12/2019 22:05	24/12/2019 22:45	0,67	1	0,67	CHI
2019122400143	CORUMBA DE GOIAS	32401	CORUMBA	24/12/2019 22:05	24/12/2019 22:45	24/12/2019 22:05	24/12/2019 22:45	0,67	358	238,67	CHI
2019122400143	CORUMBA DE GOIAS	00400604	CORUMBA	24/12/2019 22:05	24/12/2019 22:45	24/12/2019 22:05	24/12/2019 22:45	0,67	3330	2220,00	CHI
2019122400143	CORUMBA DE GOIAS	20404	CORUMBA	24/12/2019 22:05	24/12/2019 22:45	24/12/2019 22:05	24/12/2019 22:45	0,67	39	26,00	CHI
2019122400143	CORUMBA DE GOIAS	00400604	CORUMBA	24/12/2019 22:05	24/12/2019 22:45	24/12/2019 22:05	24/12/2019 22:45	0,67	281	187,33	CHI
2019122400143	GOIANESIA	20402	CORUMBA	24/12/2019 22:05	24/12/2019 22:45	24/12/2019 22:05	24/12/2019 22:45	0,67	10	6,67	CHI
2019122400143	ITAUCU	20403	CORUMBA	24/12/2019 22:05	24/12/2019 22:45	24/12/2019 22:05	24/12/2019 22:45	0,67	1	0,67	CHI

2019122400143	JARAGUA	20402	CORUMBA	24/12/2019 22:05	24/12/2019 22:45	24/12/2019 22:05	24/12/2019 22:45	0,67	14	9,33	CHI
2019122400143	PIRENOPOLIS	20401	CORUMBA	24/12/2019 22:05	24/12/2019 22:45	24/12/2019 22:05	24/12/2019 22:45	0,67	2534	1689,33	CHI
2019122400143	PIRENOPOLIS	20402	CORUMBA	24/12/2019 22:05	24/12/2019 22:45	24/12/2019 22:05	24/12/2019 22:45	0,67	3807	2538,00	CHI
2019122400143	PIRENOPOLIS	20403	CORUMBA	24/12/2019 22:05	24/12/2019 22:45	24/12/2019 22:05	24/12/2019 22:45	0,67	3585	2390,00	CHI
2019122400143	PIRENOPOLIS	20404	CORUMBA	24/12/2019 22:05	24/12/2019 22:45	24/12/2019 22:05	24/12/2019 22:45	0,67	605	403,33	CHI
2019122400143	PIRENOPOLIS	00400604	CORUMBA	24/12/2019 22:05	24/12/2019 22:45	24/12/2019 22:05	24/12/2019 22:45	0,67	124	82,67	CHI
2019122400143	SAO FRANCISCO DE GOIAS	20402	CORUMBA	24/12/2019 22:05	24/12/2019 22:45	24/12/2019 22:05	24/12/2019 22:45	0,67	2	1,33	CHI
2019122400143	VILA PROPICIO	20402	CORUMBA	24/12/2019 22:05	24/12/2019 22:45	24/12/2019 22:05	24/12/2019 22:45	0,67	16	10,67	CHI
2019122400144	ANAPOLIS	00030618	DAIA S1	24/12/2019 22:05	24/12/2019 22:32	24/12/2019 22:05	24/12/2019 22:32	0,45	8	3,60	CHI
2019122400144	ANAPOLIS	00030618	DAIA S1	24/12/2019 22:05	24/12/2019 22:32	24/12/2019 22:05	24/12/2019 22:32	0,45	15	6,75	CHI
2019122400144	ANAPOLIS	00030618	DAIA S1	24/12/2019 22:05	24/12/2019 22:32	24/12/2019 22:05	24/12/2019 22:32	0,45	81	36,45	CHI
2019122400144	ANAPOLIS	00030618	DAIA S1	24/12/2019 22:05	24/12/2019 22:32	24/12/2019 22:05	24/12/2019 22:32	0,45	19	8,55	CHI
2019122400144	ANAPOLIS	00030618	DAIA S1	24/12/2019 22:05	24/12/2019 22:32	24/12/2019 22:05	24/12/2019 22:32	0,45	456	205,20	CHI
2019122400144	ANAPOLIS	00030618	DAIA S1	24/12/2019 22:05	24/12/2019 22:32	24/12/2019 22:05	24/12/2019 22:32	0,45	7	3,15	CHI
2019122400144	ANAPOLIS	00030618	DAIA S1	24/12/2019 22:05	24/12/2019 22:32	24/12/2019 22:05	24/12/2019 22:32	0,45	4	1,80	CHI
2019122400144	ANAPOLIS	00030618	DAIA S1	24/12/2019 22:05	24/12/2019 22:32	24/12/2019 22:05	24/12/2019 22:32	0,45	3359	1511,55	CHI
2019122400144	ANAPOLIS	00030618	DAIA S1	24/12/2019 22:05	24/12/2019 22:32	24/12/2019 22:05	24/12/2019 22:32	0,45	12	5,40	CHI
2019122400144	ANAPOLIS	00030618	DAIA S1	24/12/2019 22:05	24/12/2019 22:32	24/12/2019 22:05	24/12/2019 22:32	0,45	1	0,45	CHI
2019122400144	GAMELEIRA DE GOIAS	00030618	DAIA S1	24/12/2019 22:05	24/12/2019 22:32	24/12/2019 22:05	24/12/2019 22:32	0,45	149	67,05	CHI
2019122400144	LEOPOLDO DE BULHOES	00030618	DAIA S1	24/12/2019 22:05	24/12/2019 22:32	24/12/2019 22:05	24/12/2019 22:32	0,45	2	0,90	CHI
2019122400144	LEOPOLDO DE BULHOES	00030618	DAIA S1	24/12/2019 22:05	24/12/2019 22:32	24/12/2019 22:05	24/12/2019 22:32	0,45	71	31,95	CHI
2019122400144	SILVANIA	00030618	DAIA S1	24/12/2019 22:05	24/12/2019 22:32	24/12/2019 22:05	24/12/2019 22:32	0,45	24	10,80	CHI
2019122400144	SILVANIA	00030618	DAIA S1	24/12/2019 22:05	24/12/2019 22:32	24/12/2019 22:05	24/12/2019 22:32	0,45	22	9,90	CHI
2019122400144	ABADIANIA	31001	DAIA S2	24/12/2019 22:05	24/12/2019 22:32	24/12/2019 22:05	24/12/2019 22:32	0,45	4	1,80	CHI
2019122400144	ABADIANIA	57301	DAIA S2	24/12/2019 22:05	24/12/2019 22:32	24/12/2019 22:05	24/12/2019 22:32	0,45	387	174,15	CHI
2019122400144	ABADIANIA	57202	DAIA S2	24/12/2019 22:05	24/12/2019 22:32	24/12/2019 22:05	24/12/2019 22:32	0,45	2	0,90	CHI
2019122400144	ABADIANIA	57302	DAIA S2	24/12/2019 22:05	24/12/2019 22:32	24/12/2019 22:05	24/12/2019 22:32	0,45	181	81,45	CHI
2019122400144	ANAPOLIS	31001	DAIA S2	24/12/2019 22:05	24/12/2019 22:32	24/12/2019 22:05	24/12/2019 22:32	0,45	4	1,80	CHI
2019122400144	ANAPOLIS	33801	DAIA S2	24/12/2019 22:05	24/12/2019 22:32	24/12/2019 22:05	24/12/2019 22:32	0,45	8	3,60	CHI
2019122400144	ANAPOLIS	38801	DAIA S2	24/12/2019 22:05	24/12/2019 22:32	24/12/2019 22:05	24/12/2019 22:32	0,45	1	0,45	CHI
2019122400144	ANAPOLIS	00030618	DAIA S2	24/12/2019 22:05	24/12/2019 22:32	24/12/2019 22:05	24/12/2019 22:32	0,45	18	8,10	CHI
2019122400144	ANAPOLIS	00030618	DAIA S2	24/12/2019 22:05	24/12/2019 22:32	24/12/2019 22:05	24/12/2019 22:32	0,45	1	0,45	CHI
2019122400144	BELA VISTA DE GOIAS	10701	DAIA S2	24/12/2019 22:05	24/12/2019 22:32	24/12/2019 22:05	24/12/2019 22:32	0,45	1	0,45	CHI

2019122400144	BELA VISTA DE GOIAS	31001	DAIA S2	24/12/2019 22:05	24/12/2019 22:32	24/12/2019 22:05	24/12/2019 22:32	0,45	1	0,45	CHI
2019122400144	BELA VISTA DE GOIAS	10702	DAIA S2	24/12/2019 22:05	24/12/2019 22:32	24/12/2019 22:05	24/12/2019 22:32	0,45	8	3,60	CHI
2019122400144	BONFINOPOLIS	33801	DAIA S2	24/12/2019 22:05	24/12/2019 22:32	24/12/2019 22:05	24/12/2019 22:32	0,45	52	23,40	CHI
2019122400144	BONFINOPOLIS	33832	DAIA S2	24/12/2019 22:05	24/12/2019 22:32	24/12/2019 22:05	24/12/2019 22:32	0,45	1	0,45	CHI
2019122400144	CALDAZINHA	10701	DAIA S2	24/12/2019 22:05	24/12/2019 22:32	24/12/2019 22:05	24/12/2019 22:32	0,45	46	20,70	CHI
2019122400144	GAMELEIRA DE GOIAS	10701	DAIA S2	24/12/2019 22:05	24/12/2019 22:32	24/12/2019 22:05	24/12/2019 22:32	0,45	26	11,70	CHI
2019122400144	GAMELEIRA DE GOIAS	31001	DAIA S2	24/12/2019 22:05	24/12/2019 22:32	24/12/2019 22:05	24/12/2019 22:32	0,45	995	447,75	CHI
2019122400144	GAMELEIRA DE GOIAS	33801	DAIA S2	24/12/2019 22:05	24/12/2019 22:32	24/12/2019 22:05	24/12/2019 22:32	0,45	2	0,90	CHI
2019122400144	GAMELEIRA DE GOIAS	57202	DAIA S2	24/12/2019 22:05	24/12/2019 22:32	24/12/2019 22:05	24/12/2019 22:32	0,45	158	71,10	CHI
2019122400144	GAMELEIRA DE GOIAS	00030618	DAIA S2	24/12/2019 22:05	24/12/2019 22:32	24/12/2019 22:05	24/12/2019 22:32	0,45	230	103,50	CHI
2019122400144	GOIANAPOLIS	33801	DAIA S2	24/12/2019 22:05	24/12/2019 22:32	24/12/2019 22:05	24/12/2019 22:32	0,45	3529	1588,05	CHI
2019122400144	GOIANAPOLIS	38801	DAIA S2	24/12/2019 22:05	24/12/2019 22:32	24/12/2019 22:05	24/12/2019 22:32	0,45	2	0,90	CHI
2019122400144	GOIANAPOLIS	33802	DAIA S2	24/12/2019 22:05	24/12/2019 22:32	24/12/2019 22:05	24/12/2019 22:32	0,45	1043	469,35	CHI
2019122400144	GOIANAPOLIS	38802	DAIA S2	24/12/2019 22:05	24/12/2019 22:32	24/12/2019 22:05	24/12/2019 22:32	0,45	330	148,50	CHI
2019122400144	GOIANAPOLIS	00030618	DAIA S2	24/12/2019 22:05	24/12/2019 22:32	24/12/2019 22:05	24/12/2019 22:32	0,45	2	0,90	CHI
2019122400144	GOIANAPOLIS	33832	DAIA S2	24/12/2019 22:05	24/12/2019 22:32	24/12/2019 22:05	24/12/2019 22:32	0,45	3	1,35	CHI
2019122400144	GOIANIA	38802	DAIA S2	24/12/2019 22:05	24/12/2019 22:32	24/12/2019 22:05	24/12/2019 22:32	0,45	1	0,45	CHI
2019122400144	LEOPOLDO DE BULHOES	10701	DAIA S2	24/12/2019 22:05	24/12/2019 22:32	24/12/2019 22:05	24/12/2019 22:32	0,45	1043	469,35	CHI
2019122400144	LEOPOLDO DE BULHOES	33801	DAIA S2	24/12/2019 22:05	24/12/2019 22:32	24/12/2019 22:05	24/12/2019 22:32	0,45	601	270,45	CHI
2019122400144	LEOPOLDO DE BULHOES	10702	DAIA S2	24/12/2019 22:05	24/12/2019 22:32	24/12/2019 22:05	24/12/2019 22:32	0,45	1845	830,25	CHI
2019122400144	LEOPOLDO DE BULHOES	33802	DAIA S2	24/12/2019 22:05	24/12/2019 22:32	24/12/2019 22:05	24/12/2019 22:32	0,45	511	229,95	CHI
2019122400144	LEOPOLDO DE BULHOES	00030618	DAIA S2	24/12/2019 22:05	24/12/2019 22:32	24/12/2019 22:05	24/12/2019 22:32	0,45	21	9,45	CHI
2019122400144	LEOPOLDO DE BULHOES	00030618	DAIA S2	24/12/2019 22:05	24/12/2019 22:32	24/12/2019 22:05	24/12/2019 22:32	0,45	1	0,45	CHI
2019122400144	NEROPOLIS	38801	DAIA S2	24/12/2019 22:05	24/12/2019 22:32	24/12/2019 22:05	24/12/2019 22:32	0,45	48	21,60	CHI
2019122400144	NEROPOLIS	38802	DAIA S2	24/12/2019 22:05	24/12/2019 22:32	24/12/2019 22:05	24/12/2019 22:32	0,45	2	0,90	CHI
2019122400144	SILVANIA	10701	DAIA S2	24/12/2019 22:05	24/12/2019 22:32	24/12/2019 22:05	24/12/2019 22:32	0,45	304	136,80	CHI
2019122400144	SILVANIA	31001	DAIA S2	24/12/2019 22:05	24/12/2019 22:32	24/12/2019 22:05	24/12/2019 22:32	0,45	361	162,45	CHI
2019122400144	SILVANIA	10702	DAIA S2	24/12/2019 22:05	24/12/2019 22:32	24/12/2019 22:05	24/12/2019 22:32	0,45	244	109,80	CHI
2019122400144	SILVANIA	00030618	DAIA S2	24/12/2019 22:05	24/12/2019 22:32	24/12/2019 22:05	24/12/2019 22:32	0,45	19	8,55	CHI
2019122400144	TEREZOPOLIS DE GOIAS	33801	DAIA S2	24/12/2019 22:05	24/12/2019 22:32	24/12/2019 22:05	24/12/2019 22:32	0,45	47	21,15	CHI
2019122400144	TEREZOPOLIS DE GOIAS	38801	DAIA S2	24/12/2019 22:05	24/12/2019 22:32	24/12/2019 22:05	24/12/2019 22:32	0,45	2249	1012,05	CHI
2019122400144	TEREZOPOLIS DE GOIAS	38802	DAIA S2	24/12/2019 22:05	24/12/2019 22:32	24/12/2019 22:05	24/12/2019 22:32	0,45	698	314,10	CHI
2019122400144	TEREZOPOLIS DE GOIAS	33832	DAIA S2	24/12/2019 22:05	24/12/2019 22:32	24/12/2019 22:05	24/12/2019 22:32	0,45	2	0,90	CHI



2019122400144	ANAPOLIS	02370605	JUNDIAI S1	24/12/2019 22:05	24/12/2019 22:32	24/12/2019 22:05	24/12/2019 22:32	0,45	9249	4162,05	CHI
2019122400144	ANAPOLIS	02370605	JUNDIAI S1	24/12/2019 22:05	24/12/2019 22:32	24/12/2019 22:05	24/12/2019 22:32	0,45	2944	1324,80	CHI
2019122400144	ANAPOLIS	02370605	JUNDIAI S1	24/12/2019 22:05	24/12/2019 22:32	24/12/2019 22:05	24/12/2019 22:32	0,45	5608	2523,60	CHI
2019122400144	ANAPOLIS	02370605	JUNDIAI S1	24/12/2019 22:05	24/12/2019 22:32	24/12/2019 22:05	24/12/2019 22:32	0,45	6873	3092,85	CHI
2019122400144	ANAPOLIS	02370605	JUNDIAI S1	24/12/2019 22:05	24/12/2019 22:32	24/12/2019 22:05	24/12/2019 22:32	0,45	13830	6223,50	CHI
2019122400144	CAMPO LIMPO	02370605	JUNDIAI S1	24/12/2019 22:05	24/12/2019 22:32	24/12/2019 22:05	24/12/2019 22:32	0,45	10	4,50	CHI
2019122400144	GOIANAPOLIS	02370605	JUNDIAI S1	24/12/2019 22:05	24/12/2019 22:32	24/12/2019 22:05	24/12/2019 22:32	0,45	189	85,05	CHI
2019122400144	LEOPOLDO DE BULHOES	02370605	JUNDIAI S1	24/12/2019 22:05	24/12/2019 22:32	24/12/2019 22:05	24/12/2019 22:32	0,45	5	2,25	CHI
2019122400144	TEREZOPOLIS DE GOIAS	02370605	JUNDIAI S1	24/12/2019 22:05	24/12/2019 22:32	24/12/2019 22:05	24/12/2019 22:32	0,45	54	24,30	CHI
2019122400144	ANAPOLIS	02370605	JUNDIAI S2	24/12/2019 22:05	24/12/2019 22:32	24/12/2019 22:05	24/12/2019 22:32	0,45	11000	4950,00	CHI
2019122400144	ANAPOLIS	02370605	JUNDIAI S2	24/12/2019 22:05	24/12/2019 22:32	24/12/2019 22:05	24/12/2019 22:32	0,45	10965	4934,25	CHI
2019122400144	CAMPO LIMPO	02370605	JUNDIAI S2	24/12/2019 22:05	24/12/2019 22:32	24/12/2019 22:05	24/12/2019 22:32	0,45	2	0,90	CHI
2019122400144	TEREZOPOLIS DE GOIAS	02370605	JUNDIAI S2	24/12/2019 22:05	24/12/2019 22:32	24/12/2019 22:05	24/12/2019 22:32	0,45	41	18,45	CHI
2019122400144	ANAPOLIS	02370605	NEROPOLIS S1	24/12/2019 22:05	24/12/2019 22:32	24/12/2019 22:05	24/12/2019 22:32	0,45	3	1,35	CHI
2019122400144	CAMPO LIMPO	02370605	NEROPOLIS S1	24/12/2019 22:05	24/12/2019 22:32	24/12/2019 22:05	24/12/2019 22:32	0,45	136	61,20	CHI
2019122400145	ABADIA DE GOIAS	02002	ANAPOLIS UNIVERSITARIO S1	24/12/2019 22:05	24/12/2019 22:32	24/12/2019 22:05	24/12/2019 22:32	0,45	1	0,45	CHI
2019122400145	ABADIANIA	00201	ANAPOLIS UNIVERSITARIO S1	24/12/2019 22:05	24/12/2019 22:32	24/12/2019 22:05	24/12/2019 22:32	0,45	66	29,70	CHI
2019122400145	ABADIANIA	02001	ANAPOLIS UNIVERSITARIO S1	24/12/2019 22:05	24/12/2019 22:32	24/12/2019 22:05	24/12/2019 22:32	0,45	1473	662,85	CHI
2019122400145	ABADIANIA	00202	ANAPOLIS UNIVERSITARIO S1	24/12/2019 22:05	24/12/2019 22:32	24/12/2019 22:05	24/12/2019 22:32	0,45	133	59,85	CHI
2019122400145	ABADIANIA	02002	ANAPOLIS UNIVERSITARIO S1	24/12/2019 22:05	24/12/2019 22:32	24/12/2019 22:05	24/12/2019 22:32	0,45	3499	1574,55	CHI
2019122400145	ABADIANIA	00050604	ANAPOLIS UNIVERSITARIO S1	24/12/2019 22:05	24/12/2019 22:32	24/12/2019 22:05	24/12/2019 22:32	0,45	22	9,90	CHI
2019122400145	ABADIANIA	00232	ANAPOLIS UNIVERSITARIO S1	24/12/2019 22:05	24/12/2019 22:32	24/12/2019 22:05	24/12/2019 22:32	0,45	27	12,15	CHI
2019122400145	ABADIANIA	00050604	ANAPOLIS UNIVERSITARIO S1	24/12/2019 22:05	24/12/2019 22:32	24/12/2019 22:05	24/12/2019 22:32	0,45	16	7,20	CHI
2019122400145	ANAPOLIS	00201	ANAPOLIS UNIVERSITARIO S1	24/12/2019 22:05	24/12/2019 22:32	24/12/2019 22:05	24/12/2019 22:32	0,45	428	192,60	CHI
2019122400145	ANAPOLIS	00202	ANAPOLIS UNIVERSITARIO S1	24/12/2019 22:05	24/12/2019 22:32	24/12/2019 22:05	24/12/2019 22:32	0,45	365	164,25	CHI
2019122400145	ANAPOLIS	00050604	ANAPOLIS UNIVERSITARIO S1	24/12/2019 22:05	24/12/2019 22:32	24/12/2019 22:05	24/12/2019 22:32	0,45	16644	7489,80	CHI
2019122400145	ANAPOLIS	00050604	ANAPOLIS UNIVERSITARIO S1	24/12/2019 22:05	24/12/2019 22:32	24/12/2019 22:05	24/12/2019 22:32	0,45	1	0,45	CHI
2019122400145	ANAPOLIS	00050604	ANAPOLIS UNIVERSITARIO S1	24/12/2019 22:05	24/12/2019 22:32	24/12/2019 22:05	24/12/2019 22:32	0,45	61	27,45	CHI
2019122400145	ANAPOLIS	00050604	ANAPOLIS UNIVERSITARIO S1	24/12/2019 22:05	24/12/2019 22:32	24/12/2019 22:05	24/12/2019 22:32	0,45	93	41,85	CHI
2019122400145	CORUMBA DE GOIAS	02001	ANAPOLIS UNIVERSITARIO S1	24/12/2019 22:05	24/12/2019 22:32	24/12/2019 22:05	24/12/2019 22:32	0,45	61	27,45	CHI
2019122400145	CORUMBA DE GOIAS	02002	ANAPOLIS UNIVERSITARIO S1	24/12/2019 22:05	24/12/2019 22:32	24/12/2019 22:05	24/12/2019 22:32	0,45	4	1,80	CHI
2019122400145	GAMELEIRA DE GOIAS	00202	ANAPOLIS UNIVERSITARIO S1	24/12/2019 22:05	24/12/2019 22:32	24/12/2019 22:05	24/12/2019 22:32	0,45	33	14,85	CHI
2019122400145	GAMELEIRA DE GOIAS	02002	ANAPOLIS UNIVERSITARIO S1	24/12/2019 22:05	24/12/2019 22:32	24/12/2019 22:05	24/12/2019 22:32	0,45	11	4,95	CHI

2019122400145	ABADIANIA	00050604	ANAPOLIS UNIVERSITARIO S2	24/12/2019 22:05	24/12/2019 22:32	24/12/2019 22:05	24/12/2019 22:32	0,45	17	7,65	CHI
2019122400145	ABADIANIA	00050604	ANAPOLIS UNIVERSITARIO S2	24/12/2019 22:05	24/12/2019 22:32	24/12/2019 22:05	24/12/2019 22:32	0,45	365	164,25	CHI
2019122400145	ANAPOLIS	00050604	ANAPOLIS UNIVERSITARIO S2	24/12/2019 22:05	24/12/2019 22:32	24/12/2019 22:05	24/12/2019 22:32	0,45	1757	790,65	CHI
2019122400145	ANAPOLIS	00050604	ANAPOLIS UNIVERSITARIO S2	24/12/2019 22:05	24/12/2019 22:32	24/12/2019 22:05	24/12/2019 22:32	0,45	2626	1181,70	CHI
2019122400145	ANAPOLIS	00050604	ANAPOLIS UNIVERSITARIO S2	24/12/2019 22:05	24/12/2019 22:32	24/12/2019 22:05	24/12/2019 22:32	0,45	8613	3875,85	CHI
2019122400145	ANAPOLIS	00050604	ANAPOLIS UNIVERSITARIO S2	24/12/2019 22:05	24/12/2019 22:32	24/12/2019 22:05	24/12/2019 22:32	0,45	8373	3767,85	CHI
2019122400145	ANAPOLIS	00050604	ANAPOLIS UNIVERSITARIO S2	24/12/2019 22:05	24/12/2019 22:32	24/12/2019 22:05	24/12/2019 22:32	0,45	1992	896,40	CHI
2019122400145	ANAPOLIS	00050604	ANAPOLIS UNIVERSITARIO S2	24/12/2019 22:05	24/12/2019 22:32	24/12/2019 22:05	24/12/2019 22:32	0,45	10202	4590,90	CHI
2019122400145	ANAPOLIS	00050604	ANAPOLIS UNIVERSITARIO S2	24/12/2019 22:05	24/12/2019 22:32	24/12/2019 22:05	24/12/2019 22:32	0,45	2507	1128,15	CHI
2019122400145	ANAPOLIS	00050604	ANAPOLIS UNIVERSITARIO S2	24/12/2019 22:05	24/12/2019 22:32	24/12/2019 22:05	24/12/2019 22:32	0,45	6304	2836,80	CHI
2019122400145	ANAPOLIS	00050604	ANAPOLIS UNIVERSITARIO S2	24/12/2019 22:05	24/12/2019 22:32	24/12/2019 22:05	24/12/2019 22:32	0,45	1491	670,95	CHI
2019122400145	ANAPOLIS	00050604	ANAPOLIS UNIVERSITARIO S2	24/12/2019 22:05	24/12/2019 22:32	24/12/2019 22:05	24/12/2019 22:32	0,45	13468	6060,60	CHI
2019122400145	CAMPO LIMPO	00050604	ANAPOLIS UNIVERSITARIO S2	24/12/2019 22:05	24/12/2019 22:32	24/12/2019 22:05	24/12/2019 22:32	0,45	17	7,65	CHI
2019122400145	CORUMBA DE GOIAS	00050604	ANAPOLIS UNIVERSITARIO S2	24/12/2019 22:05	24/12/2019 22:32	24/12/2019 22:05	24/12/2019 22:32	0,45	1	0,45	CHI
2019122400145	PIRENOPOLIS	00050604	ANAPOLIS UNIVERSITARIO S2	24/12/2019 22:05	24/12/2019 22:32	24/12/2019 22:05	24/12/2019 22:32	0,45	83	37,35	CHI
201912199469	PILAR DE GOIAS	GG12190086	URUACU	24/12/2019 22:06	25/12/2019 16:10	24/12/2019 22:06	25/12/2019 16:10	18,07	4	72,26	CHI
201912199474	MORRINHOS	MR21182695	MORRINHOS	24/12/2019 22:06	25/12/2019 19:29	24/12/2019 22:06	25/12/2019 19:29	21,37	1	21,37	CHI
201912199476	MOSSAMEDES	MD21299601	ITABERAI S2	24/12/2019 22:06	25/12/2019 10:13	24/12/2019 22:06	25/12/2019 10:13	12,10	1	12,10	CHI
201912206352	JARAGUA	JA11054614	JARAGUA	24/12/2019 22:07	26/12/2019 16:48	24/12/2019 22:07	26/12/2019 16:48	42,68	120	5121,63	CHI
201912199534	GOIANIA	GN11056120	FERROVIARIO S1	24/12/2019 22:10	25/12/2019 03:25	24/12/2019 22:10	25/12/2019 03:25	5,25	107	561,69	CHI
201912199599	JARAGUA	JA11006451	JARAGUA	24/12/2019 22:12	25/12/2019 15:17	24/12/2019 22:12	25/12/2019 15:17	17,09	89	1521,03	CHI
201912199680	PALMEIRAS DE GOIAS	PL21294861	PALMEIRAS	24/12/2019 22:14	25/12/2019 09:13	24/12/2019 22:14	25/12/2019 09:13	10,97	1	10,97	CHI
201912197294	PIRACANJUBA	04220214	CALDAS NOVAS S1	24/12/2019 22:19	24/12/2019 23:26	24/12/2019 22:19	24/12/2019 23:26	1,12	152	169,94	CHI
201912197294	PIRACANJUBA	04220214	PIRACANJUBA	24/12/2019 22:19	24/12/2019 23:26	24/12/2019 22:19	24/12/2019 23:26	1,12	90	100,63	CHI
201912199817	AVELINOPOLIS	AV21071791	ANICUNS	24/12/2019 22:19	25/12/2019 08:35	24/12/2019 22:19	25/12/2019 08:35	10,26	2	20,53	CHI
201912200630	ITAPIRAPUA	IU12030155	JUSSARA	24/12/2019 22:20	25/12/2019 14:27	24/12/2019 22:20	25/12/2019 14:27	16,12	42	677,13	CHI
201912200630	NOVO BRASIL	IU12030155	JUSSARA	24/12/2019 22:20	25/12/2019 14:27	24/12/2019 22:20	25/12/2019 14:27	16,12	1	16,12	CHI
201912200926	ITABERAI	IB11071373	ITABERAI S2	24/12/2019 22:22	25/12/2019 09:09	24/12/2019 22:22	25/12/2019 09:09	10,78	56	603,68	CHI
201912199973	MORRINHOS	MR31134509	GOIATUBA S1	24/12/2019 22:23	25/12/2019 17:20	24/12/2019 22:23	25/12/2019 17:20	18,94	5	94,68	CHI
201912200049	SANTA HELENA DE GOIAS	SH21126145	ACREUNA	24/12/2019 22:26	25/12/2019 15:30	24/12/2019 22:26	25/12/2019 15:30	17,05	1	17,05	CHI
201912200740	NOVO BRASIL	NB12378819	JUSSARA	24/12/2019 22:28	26/12/2019 01:00	24/12/2019 22:28	26/12/2019 01:00	26,52	4	106,09	CHI
201912200651	ESTRELA DO NORTE	ET12168852	MARA ROSA	24/12/2019 22:29	25/12/2019 21:13	24/12/2019 22:29	25/12/2019 21:13	22,73	4	90,92	CHI
201912200651	FORMOSO	ET12168852	MARA ROSA	24/12/2019 22:29	25/12/2019 21:13	24/12/2019 22:29	25/12/2019 21:13	22,73	2	45,46	CHI

201912200200	INHUMAS	30179609	INHUMAS S2	24/12/2019 22:32	25/12/2019 09:45	24/12/2019 22:32	25/12/2019 09:45	11,21	1	11,21	CHI
201912200206	PIRES DO RIO	PR21100004	PIRES DO RIO S2	24/12/2019 22:33	25/12/2019 15:07	24/12/2019 22:33	25/12/2019 15:07	16,57	1	16,57	CHI
201912200211	GOIANIA	GN11001775	FERROVIARIO S3	24/12/2019 22:33	25/12/2019 01:21	24/12/2019 22:33	25/12/2019 01:21	2,79	12	33,51	CHI
201912200483	SANTO ANTONIO DO DESCOBERTO	SN21328450	MARAJOARA	24/12/2019 22:33	25/12/2019 10:53	25/12/2019 07:01	25/12/2019 10:52	3,84	11	42,24	CHI
201912200483	SANTO ANTONIO DO DESCOBERTO	SN12010404	MARAJOARA	24/12/2019 22:33	25/12/2019 10:53	24/12/2019 22:33	25/12/2019 10:53	12,33	53	653,61	CHI
201912200979	ITABERAI	IB11071381	ITABERAI S2	24/12/2019 22:36	25/12/2019 07:13	24/12/2019 22:36	25/12/2019 07:13	8,60	142	1221,55	CHI
201912201549	ITAPACI	IW12308199	ITAPACI	24/12/2019 22:38	25/12/2019 08:39	24/12/2019 22:38	25/12/2019 08:39	10,01	6	60,08	CHI
201912200391	INHUMAS	IN31066334	INHUMAS S2	24/12/2019 22:43	25/12/2019 13:53	24/12/2019 22:43	25/12/2019 13:53	15,15	1	15,15	CHI
201912200459	ITAPACI	IW12287954	ITAPACI	24/12/2019 22:44	25/12/2019 10:38	24/12/2019 22:44	25/12/2019 10:38	11,90	9	107,08	CHI
201912200415	DOVERLANDIA	DV11160584	CAIAPONIA	24/12/2019 22:45	25/12/2019 16:04	24/12/2019 22:45	25/12/2019 16:04	17,32	94	1627,85	CHI
201912200428	LEOPOLDO DE BULHOES	LB31078535	DAIA S2	24/12/2019 22:46	25/12/2019 10:58	24/12/2019 22:46	25/12/2019 10:58	12,20	1	12,20	CHI
201912200570	GOIAS	GS12206865	MATRINCHA	24/12/2019 22:49	26/12/2019 07:05	24/12/2019 22:49	26/12/2019 07:05	32,26	67	2161,46	CHI
201912202514	PETROLINA DE GOIAS	PG12015831RE	PETROLINA	24/12/2019 22:49	25/12/2019 10:51	24/12/2019 22:49	25/12/2019 10:51	12,02	198	2379,74	CHI
201912202514	SAO FRANCISCO DE GOIAS	PG12015831RE	PETROLINA	24/12/2019 22:49	25/12/2019 10:51	24/12/2019 22:49	25/12/2019 10:51	12,02	26	312,49	CHI
201912200492	APARECIDA DE GOIANIA	AP11004883	ATLANTICO S1	24/12/2019 22:51	25/12/2019 07:40	24/12/2019 22:51	25/12/2019 07:40	8,81	80	704,78	CHI
201912200730	GOIANIA	GN11169114	CAMPINAS S1	24/12/2019 22:54	25/12/2019 05:34	24/12/2019 22:54	25/12/2019 05:34	6,67	62	413,26	CHI
201912202234	ITAGUARI	IC12219941	ITABERAI S1	24/12/2019 22:54	25/12/2019 08:38	24/12/2019 22:54	25/12/2019 08:38	9,74	31	302,07	CHI
201912202234	ITAGUARU	IC12219941	ITABERAI S1	24/12/2019 22:54	25/12/2019 08:38	24/12/2019 22:54	25/12/2019 08:38	9,74	21	204,63	CHI
201912204046	LEOPOLDO DE BULHOES	LB12000008	DAIA S2	24/12/2019 22:55	25/12/2019 12:12	24/12/2019 22:55	25/12/2019 12:12	13,27	127	1685,18	CHI
201912200564	NEROPOLIS	NR12200309	NEROPOLIS S2	24/12/2019 22:58	25/12/2019 05:36	24/12/2019 22:58	25/12/2019 05:36	6,63	20	132,56	CHI
201912200564	TEREZOPOLIS DE GOIAS	NR12200309	NEROPOLIS S2	24/12/2019 22:58	25/12/2019 05:36	24/12/2019 22:58	25/12/2019 05:36	6,63	1	6,63	CHI
201912200919	ARAGARCAS	00242124	BOM JARDIM	24/12/2019 23:01	25/12/2019 00:36	24/12/2019 23:01	25/12/2019 00:36	1,58	102	161,07	CHI
201912200919	BALIZA	00242124	BOM JARDIM	24/12/2019 23:01	25/12/2019 00:36	24/12/2019 23:01	25/12/2019 00:36	1,58	277	437,43	CHI
201912200919	BOM JARDIM DE GOIAS	00242124	BOM JARDIM	24/12/2019 23:01	25/12/2019 00:36	24/12/2019 23:01	25/12/2019 00:36	1,58	3817	6027,68	CHI
201912200919	PIRANHAS	00242124	BOM JARDIM	24/12/2019 23:01	25/12/2019 00:36	24/12/2019 23:01	25/12/2019 00:36	1,58	33	52,11	CHI
201912201573	JARAGUA	JA12040435	SAO FRANCISCO DE GOIAS	24/12/2019 23:03	25/12/2019 15:59	24/12/2019 23:03	25/12/2019 15:59	16,92	3	50,77	CHI
201912201573	JESUPOLIS	JA12040435	SAO FRANCISCO DE GOIAS	24/12/2019 23:03	25/12/2019 15:59	24/12/2019 23:03	25/12/2019 15:59	16,92	19	321,56	CHI
201912200620	AGUAS LINDAS DE GOIAS	LA11305234	AGUAS LINDAS DE GOIAS S2	24/12/2019 23:04	25/12/2019 07:49	24/12/2019 23:04	25/12/2019 07:49	8,73	215	1877,79	CHI
201912201125	ITAPURANGA	IK11021601	ITAPURANGA	24/12/2019 23:06	25/12/2019 09:06	25/12/2019 07:11	25/12/2019 09:06	1,91	110	209,70	CHI
201912202660	GOIAS	GS12071258	GOIAS	24/12/2019 23:07	25/12/2019 18:15	24/12/2019 23:07	25/12/2019 18:15	19,12	88	1682,61	CHI
201912202820	CAIAPONIA	DV12332038	CAIAPONIA	24/12/2019 23:07	25/12/2019 17:21	24/12/2019 23:07	25/12/2019 17:21	18,23	22	400,95	CHI
201912202820	DOVERLANDIA	DV12332038	CAIAPONIA	24/12/2019 23:07	25/12/2019 17:21	24/12/2019 23:07	25/12/2019 17:21	18,23	28	510,30	CHI
201912203411	CARMO DO RIO VERDE	IK12311305	ITAPURANGA	24/12/2019 23:07	25/12/2019 16:36	24/12/2019 23:07	25/12/2019 16:36	17,48	27	471,97	CHI

201912203411	ITAPURANGA	IK12311305	ITAPURANGA	24/12/2019 23:07	25/12/2019 16:36	24/12/2019 23:07	25/12/2019 16:36	17,48	117	2045,19	CHI
201912202617	JARAGUA	JA12278881	JARAGUA	24/12/2019 23:08	26/12/2019 00:01	24/12/2019 23:08	26/12/2019 00:01	24,89	12	298,67	CHI
201912200673	CIDADE OCIDENTAL	DH11292249	MARAJOARA	24/12/2019 23:12	25/12/2019 00:56	24/12/2019 23:12	25/12/2019 00:56	1,72	123	211,32	CHI
201912200682	RIO VERDE	RV21068336	CABRIUVA S2	24/12/2019 23:14	25/12/2019 11:13	24/12/2019 23:14	25/12/2019 11:13	11,97	1	11,97	CHI
201912203278	MORRINHOS	MR12000183	MORRINHOS	24/12/2019 23:17	25/12/2019 15:07	24/12/2019 23:17	25/12/2019 15:07	15,84	7	110,88	CHI
201912200711	ARUANA	MP12102504	MATRINCHA	24/12/2019 23:18	25/12/2019 10:05	24/12/2019 23:18	25/12/2019 10:05	10,77	1	10,77	CHI
201912200717	ITABERAI	IB21000034	ITABERAI S2	24/12/2019 23:20	25/12/2019 17:19	24/12/2019 23:20	25/12/2019 17:19	17,98	2	35,96	CHI
201912202985	ALOANDIA	AD12402547	GOIATUBA S1	24/12/2019 23:20	25/12/2019 12:02	24/12/2019 23:20	25/12/2019 12:02	12,69	5	63,47	CHI
201912202985	JOVIANIA	AD12402547	GOIATUBA S1	24/12/2019 23:20	25/12/2019 12:02	24/12/2019 23:20	25/12/2019 12:02	12,69	10	126,94	CHI
201912200801	PIRES DO RIO	01480234	PIRES DO RIO S1	24/12/2019 23:21	25/12/2019 03:44	24/12/2019 23:21	25/12/2019 00:01	0,67	5411	3649,42	CHI
201912200801	PIRES DO RIO	PR13231380	PIRES DO RIO S1	24/12/2019 23:21	25/12/2019 03:44	24/12/2019 23:21	25/12/2019 03:44	4,38	1067	4675,83	CHI
201912204478	PIRENOPOLIS	PV12360316	CORUMBA	24/12/2019 23:22	25/12/2019 14:58	24/12/2019 23:22	25/12/2019 14:58	15,60	19	296,31	CHI
201912200792	JARAGUA	JA12273085	JARAGUA	24/12/2019 23:30	25/12/2019 16:50	24/12/2019 23:30	25/12/2019 14:55	15,41	2	30,81	CHI
201912200792	JARAGUA	JA12104703	JARAGUA	24/12/2019 23:30	25/12/2019 16:50	24/12/2019 23:30	25/12/2019 16:50	17,32	3	51,97	CHI
201912200794	JATAI	JT12210073	JATAI S1	24/12/2019 23:33	25/12/2019 08:59	24/12/2019 23:33	25/12/2019 08:59	9,42	23	216,74	CHI
201912201127	ITAPACI	IW11162607	ITAPACI	24/12/2019 23:35	25/12/2019 04:13	24/12/2019 23:35	25/12/2019 04:13	4,62	160	739,29	CHI
201912201114	GOIANESIA	BA12163310	GOIANESIA S1	24/12/2019 23:36	25/12/2019 10:44	24/12/2019 23:36	25/12/2019 10:44	11,12	2	22,24	CHI
201912201114	VILA PROPICIO	BA12163310	GOIANESIA S1	24/12/2019 23:36	25/12/2019 10:44	24/12/2019 23:36	25/12/2019 10:44	11,12	11	122,31	CHI
201912202801	CRIXAS	NM12172927	RUBIATABA	24/12/2019 23:38	25/12/2019 14:18	24/12/2019 23:38	25/12/2019 14:18	14,66	1	14,66	CHI
201912202801	NOVA AMERICA	NM12172927	RUBIATABA	24/12/2019 23:38	25/12/2019 14:18	24/12/2019 23:38	25/12/2019 14:18	14,66	44	644,88	CHI
201912200937	CRIXAS	GF12243492	SANTA TEREZINHA	24/12/2019 23:42	25/12/2019 14:37	24/12/2019 23:42	25/12/2019 14:37	14,90	36	536,45	CHI
201912200937	GUARINOS	GF12243492	SANTA TEREZINHA	24/12/2019 23:42	25/12/2019 14:37	24/12/2019 23:42	25/12/2019 14:37	14,90	73	1087,80	CHI
201912200937	ITAPACI	GF12243492	SANTA TEREZINHA	24/12/2019 23:42	25/12/2019 14:37	24/12/2019 23:42	25/12/2019 14:37	14,90	6	89,41	CHI
201912200945	IPAMERI	IP12107641LD	IPAMERI	24/12/2019 23:45	25/12/2019 09:26	24/12/2019 23:45	25/12/2019 09:26	9,68	19	183,93	CHI
201912202675	JESUPOLIS	SF12000165	SAO FRANCISCO DE GOIAS	24/12/2019 23:45	25/12/2019 11:15	24/12/2019 23:45	25/12/2019 11:15	11,49	12	137,88	CHI
201912202028	MORRINHOS	MR12329056	MORRINHOS	24/12/2019 23:48	25/12/2019 20:49	24/12/2019 23:48	25/12/2019 20:49	21,01	12	252,14	CHI
201912202587	SANTA HELENA DE GOIAS	SH12394803	IPEGUARI	24/12/2019 23:54	26/12/2019 00:42	24/12/2019 23:54	26/12/2019 00:42	24,79	18	446,30	CHI
201912202587	TURVELANDIA	SH12394803	IPEGUARI	24/12/2019 23:54	26/12/2019 00:42	24/12/2019 23:54	26/12/2019 00:42	24,79	4	99,18	CHI
201912200996	CATALAO	10000312647	CATALAO S2	24/12/2019 23:56	25/12/2019 03:21	24/12/2019 23:56	25/12/2019 03:21	3,41	1	3,41	CHI
201912202854	JARAGUA	JA12297841	JARAGUA	24/12/2019 23:56	25/12/2019 11:13	24/12/2019 23:56	25/12/2019 11:13	11,27	47	529,57	CHI
201912201014	DOVERLANDIA	DV11204060	CAIAPONIA	24/12/2019 23:59	25/12/2019 22:20	24/12/2019 23:59	25/12/2019 22:20	22,35	1	22,35	CHI
201912201023	PALMEIRAS DE GOIAS	PL12022483	PALMEIRAS	25/12/2019 00:02	25/12/2019 08:37	25/12/2019 00:02	25/12/2019 08:37	8,58	2	17,16	CHI
201912201918	IPAMERI	IP12300933	IPAMERI	25/12/2019 00:04	25/12/2019 10:45	25/12/2019 00:04	25/12/2019 10:45	10,67	51	544,20	CHI

201912201110	APORE	AE12063740	ITAJA S1	25/12/2019 00:09	25/12/2019 10:32	25/12/2019 00:09	25/12/2019 10:32	10,38	369	3830,32	CHI
201912201145	AMORINOPOLIS	AM12000032	IPORA	25/12/2019 00:10	25/12/2019 15:26	25/12/2019 00:10	25/12/2019 15:26	15,26	6	91,55	CHI
201912201145	IVOLANDIA	AM12000032	IPORA	25/12/2019 00:10	25/12/2019 15:26	25/12/2019 00:10	25/12/2019 15:26	15,26	11	167,84	CHI
201912201952	JESUPOLIS	JE12298004	SAO FRANCISCO DE GOIAS	25/12/2019 00:15	25/12/2019 11:32	25/12/2019 00:15	25/12/2019 11:32	11,28	14	157,91	CHI
201912201225	ITAPACI	IW12167977	ITAPACI	25/12/2019 00:18	25/12/2019 10:27	25/12/2019 00:18	25/12/2019 10:27	10,16	20	203,17	CHI
201912201153	ITARUMA	IM12058060	CACHOEIRA ALTA	25/12/2019 00:23	25/12/2019 10:06	25/12/2019 00:23	25/12/2019 10:06	9,71	8	77,72	CHI
201912201156	JUSSARA	JR12259832	BRITANIA	25/12/2019 00:25	25/12/2019 08:41	25/12/2019 00:25	25/12/2019 08:41	8,27	44	363,73	CHI
201912201156	SANTA FE DE GOIAS	JR12259832	BRITANIA	25/12/2019 00:25	25/12/2019 08:41	25/12/2019 00:25	25/12/2019 08:41	8,27	6	49,60	CHI
201912201977	DOVERLANDIA	DV12138342	CAIAPONIA	25/12/2019 00:29	26/12/2019 02:01	25/12/2019 00:29	26/12/2019 02:01	25,53	8	204,20	CHI
201912202098	GOIANESIA	GE12255999	GOIANESIA S2	25/12/2019 00:37	25/12/2019 15:23	25/12/2019 00:37	25/12/2019 15:23	14,76	26	383,64	CHI
201912201170	GAMELEIRA DE GOIAS	AN11264488	DAIA S1	25/12/2019 00:38	25/12/2019 13:58	25/12/2019 00:38	25/12/2019 13:58	13,33	18	239,92	CHI
201912201178	ANAPOLIS	AN12001176	ANAPOLIS UNIVERSITARIO S2	25/12/2019 00:43	25/12/2019 07:50	25/12/2019 00:43	25/12/2019 07:50	7,11	2	14,23	CHI
201912201188	NIQUELANDIA	NQ12378056	NIQUELANDIA SUBTRANSMISSAO	25/12/2019 00:44	25/12/2019 02:33	25/12/2019 00:44	25/12/2019 02:33	1,80	5	9,02	CHI
201912201197	SANTO ANTONIO DO DESCOBERTO	10030331607	ALEXANIA	25/12/2019 00:48	25/12/2019 10:01	25/12/2019 00:48	25/12/2019 10:01	9,20	0	0,00	CHI
201912201220	PIRES DO RIO	PR21255825	PIRES DO RIO S1	25/12/2019 00:59	25/12/2019 08:16	25/12/2019 00:59	25/12/2019 08:16	7,27	1	7,27	CHI
201912201223	ANAPOLIS	AN12090702	ANAPOLIS UNIVERSITARIO S2	25/12/2019 01:01	25/12/2019 07:49	25/12/2019 01:01	25/12/2019 07:49	6,78	5	33,92	CHI
201912209151	MINEIROS	MY12048095	PARQUE DAS EMAS	25/12/2019 01:03	26/12/2019 10:56	25/12/2019 01:03	26/12/2019 10:56	33,88	22	745,30	CHI
201912201227	BOM JARDIM DE GOIAS	BM11212784	BOM JARDIM	25/12/2019 01:05	25/12/2019 05:45	25/12/2019 01:05	25/12/2019 05:45	4,66	85	395,75	CHI
201912201237	PARAUNA	PU12079039	PARAUNA	25/12/2019 01:11	25/12/2019 09:10	25/12/2019 01:11	25/12/2019 09:10	7,98	22	175,61	CHI
201912260789	JARAGUA	10016381627	JARAGUA	25/12/2019 01:12	25/12/2019 13:57	25/12/2019 01:12	25/12/2019 13:57	12,76	1	12,76	CHI
201912260790	JARAGUA	JA12205735	JARAGUA	25/12/2019 01:12	25/12/2019 20:35	25/12/2019 13:57	25/12/2019 20:35	6,63	365	2419,34	CHI
201912202254	ARAGUAPAZ	FC12299833	GOIAS	25/12/2019 01:16	25/12/2019 14:35	25/12/2019 01:16	25/12/2019 14:35	13,32	16	213,16	CHI
201912202254	FAINA	FC12299833	GOIAS	25/12/2019 01:16	25/12/2019 14:35	25/12/2019 01:16	25/12/2019 14:35	13,32	9	119,90	CHI
201912201267	AMARALINA	LC12308828	MARA ROSA	25/12/2019 01:29	25/12/2019 16:15	25/12/2019 01:29	25/12/2019 16:15	14,77	2	29,53	CHI
201912201267	MARA ROSA	LC12308828	MARA ROSA	25/12/2019 01:29	25/12/2019 16:15	25/12/2019 01:29	25/12/2019 16:15	14,77	1	14,77	CHI
201912201269	NOVO GAMA	NJ12212105	PACAEMBU S1	25/12/2019 01:29	25/12/2019 03:23	25/12/2019 01:29	25/12/2019 03:23	1,89	235	444,28	CHI
201912201269	SANTO ANTONIO DO DESCOBERTO	NJ12212105	PACAEMBU S1	25/12/2019 01:29	25/12/2019 03:23	25/12/2019 01:29	25/12/2019 03:23	1,89	26	49,15	CHI
201912201270	MOZARLANDIA	MZ12066086	MOZARLANDIA	25/12/2019 01:29	25/12/2019 09:46	25/12/2019 01:29	25/12/2019 09:46	8,28	5	41,40	CHI
201912201304	JUSSARA	JR10394757	JUSSARA	25/12/2019 01:31	25/12/2019 19:37	25/12/2019 01:31	25/12/2019 02:59	1,46	59	86,30	CHI
201912201304	NOVO BRASIL	JR10394757	JUSSARA	25/12/2019 01:31	25/12/2019 19:37	25/12/2019 01:31	25/12/2019 02:59	1,46	11	16,09	CHI
201912201304	ITAPIRAPUA	JR13292891	JUSSARA	25/12/2019 01:31	25/12/2019 19:37	25/12/2019 01:31	25/12/2019 04:39	3,13	13	40,65	CHI
201912201304	JUSSARA	JR13292891	JUSSARA	25/12/2019 01:31	25/12/2019 19:37	25/12/2019 01:31	25/12/2019 04:39	3,13	39	121,96	CHI
201912201304	ITAPIRAPUA	IU12020180LD	JUSSARA	25/12/2019 01:31	25/12/2019 19:37	25/12/2019 01:31	25/12/2019 08:59	7,46	10	74,64	CHI

201912201304	ITAPIRAPUA	IU12015133LD	JUSSARA	25/12/2019 01:31	25/12/2019 19:37	25/12/2019 01:31	25/12/2019 18:02	16,50	10	165,03	CHI
201912201304	ITAPIRAPUA	IU12054519LD	JUSSARA	25/12/2019 01:31	25/12/2019 19:37	25/12/2019 01:31	25/12/2019 18:34	17,05	23	392,07	CHI
201912201304	ITAPIRAPUA	IU12015133LD	JUSSARA	25/12/2019 01:31	25/12/2019 19:37	25/12/2019 01:31	25/12/2019 19:04	17,54	10	175,37	CHI
201912201304	ITAPIRAPUA	IU12015133LD	JUSSARA	25/12/2019 01:31	25/12/2019 19:37	25/12/2019 01:31	25/12/2019 19:37	18,09	37	669,21	CHI
201912201303	APORE	AE10396071	ITAJA S1	25/12/2019 01:39	25/12/2019 10:25	25/12/2019 01:39	25/12/2019 07:25	5,77	134	772,96	CHI
201912201303	ITARUMA	AE10396071	ITAJA S1	25/12/2019 01:39	25/12/2019 10:25	25/12/2019 01:39	25/12/2019 07:25	5,77	1	5,77	CHI
201912201303	APORE	AE13209674	ITAJA S1	25/12/2019 01:39	25/12/2019 10:25	25/12/2019 01:39	25/12/2019 09:20	7,68	3	23,03	CHI
201912201303	APORE	AE12122767	ITAJA S1	25/12/2019 01:39	25/12/2019 10:25	25/12/2019 01:39	25/12/2019 10:25	8,76	31	271,60	CHI
201912202412	ARAGARCAS	AG11207811	ARAGARCAS	25/12/2019 01:48	25/12/2019 16:00	25/12/2019 01:48	25/12/2019 16:00	14,19	109	1547,16	CHI
201912201401	COCALZINHO DE GOIAS	ZN11326572	GOIANESIA S1	25/12/2019 01:51	25/12/2019 12:10	25/12/2019 01:51	25/12/2019 12:10	10,32	31	319,80	CHI
201912201402	MONTES CLAROS DE GOIAS	ME12334949	IPORA	25/12/2019 01:51	25/12/2019 19:15	25/12/2019 01:51	25/12/2019 19:15	17,39	7	121,72	CHI
201912201411	MATRINCHA	MP12010442	MOZARLANDIA	25/12/2019 01:56	25/12/2019 07:52	25/12/2019 01:56	25/12/2019 07:52	5,92	4	23,68	CHI
201912201418	ANAPOLIS	20821207	JUNDIAI S1	25/12/2019 02:00	25/12/2019 09:28	25/12/2019 02:00	25/12/2019 09:28	7,46	1	7,46	CHI
201912201420	ARAGARCAS	AG11138459	ARAGARCAS	25/12/2019 02:01	25/12/2019 06:58	25/12/2019 02:01	25/12/2019 06:58	4,95	51	252,41	CHI
201912201421	JANDAIA	JD21126229	PALMEIRAS	25/12/2019 02:01	25/12/2019 11:15	25/12/2019 02:01	25/12/2019 11:15	9,23	1	9,23	CHI
201912201305	VICENTINOPOLIS	VI11128634	VICENTINOPOLIS	25/12/2019 02:04	25/12/2019 10:54	25/12/2019 02:04	25/12/2019 10:54	8,83	148	1306,88	CHI
201912202261	RIO VERDE	RV12104444	RIO VERDE S1	25/12/2019 02:04	25/12/2019 11:30	25/12/2019 02:04	25/12/2019 11:30	9,42	72	678,16	CHI
201912201442	PIRANHAS	1930044656	PIRANHAS	25/12/2019 02:16	25/12/2019 13:25	25/12/2019 02:16	25/12/2019 13:25	11,16	1	11,16	CHI
201912201469	GOIAS	GS21145728	GOIAS	25/12/2019 02:45	25/12/2019 10:10	25/12/2019 02:45	25/12/2019 10:10	7,42	1	7,42	CHI
201912201480	ALEXANIA	AX21071311	ALEXANIA	25/12/2019 03:07	25/12/2019 08:39	25/12/2019 03:07	25/12/2019 08:39	5,52	1	5,52	CHI
201912202275	ALTO HORIZONTE	VD12056599	SANTA TEREZINHA	25/12/2019 03:07	25/12/2019 10:34	25/12/2019 03:07	25/12/2019 10:34	7,45	9	67,02	CHI
201912202275	CAMPOS VERDES	VD12056599	SANTA TEREZINHA	25/12/2019 03:07	25/12/2019 10:34	25/12/2019 03:07	25/12/2019 10:34	7,45	95	707,43	CHI
201912202275	MARA ROSA	VD12056599	SANTA TEREZINHA	25/12/2019 03:07	25/12/2019 10:34	25/12/2019 03:07	25/12/2019 10:34	7,45	67	498,93	CHI
201912201482	CRIXAS	IW12211868	RUBIATABA	25/12/2019 03:09	25/12/2019 13:15	25/12/2019 03:09	25/12/2019 13:15	10,10	12	121,22	CHI
201912201482	GUARINOS	IW12211868	RUBIATABA	25/12/2019 03:09	25/12/2019 13:15	25/12/2019 03:09	25/12/2019 13:15	10,10	5	50,51	CHI
201912201482	ITAPACI	IW12211868	RUBIATABA	25/12/2019 03:09	25/12/2019 13:15	25/12/2019 03:09	25/12/2019 13:15	10,10	19	191,93	CHI
201912201497	RIO VERDE	RV12064609	CABRIUVA S1	25/12/2019 03:26	25/12/2019 21:19	25/12/2019 03:26	25/12/2019 20:42	17,26	57	983,84	CHI
201912201497	RIO VERDE	RV12064609	CABRIUVA S1	25/12/2019 03:26	25/12/2019 21:19	25/12/2019 03:26	25/12/2019 20:49	17,38	1	17,38	CHI
201912201497	RIO VERDE	RV12064609	CABRIUVA S1	25/12/2019 03:26	25/12/2019 21:19	25/12/2019 03:26	25/12/2019 20:57	17,51	66	1155,68	CHI
201912201497	RIO VERDE	RV12064609	CABRIUVA S1	25/12/2019 03:26	25/12/2019 21:19	25/12/2019 03:26	25/12/2019 21:10	17,73	25	443,17	CHI
201912201497	RIO VERDE	RV12064609	CABRIUVA S1	25/12/2019 03:26	25/12/2019 21:19	25/12/2019 03:26	25/12/2019 21:19	17,88	35	625,68	CHI
201912201497	RIO VERDE	RV12064609	CABRIUVA S1	25/12/2019 03:26	25/12/2019 21:19	25/12/2019 03:26	25/12/2019 21:19	17,88	40	715,09	CHI
201912202008	CRIXAS	MZ12055628	MOZARLANDIA	25/12/2019 03:37	25/12/2019 16:47	25/12/2019 03:37	25/12/2019 16:47	13,16	26	342,25	CHI

201912202008	MOZARLANDIA	MZ12055628	MOZARLANDIA	25/12/2019 03:37	25/12/2019 16:47	25/12/2019 03:37	25/12/2019 16:47	13,16	37	487,04	CHI
201912203039	MAIRIPOTABA	CQ12028525RE	PONTALINA	25/12/2019 03:40	25/12/2019 15:29	25/12/2019 03:40	25/12/2019 15:29	11,81	40	472,30	CHI
201912203039	PONTALINA	CQ12028525RE	PONTALINA	25/12/2019 03:40	25/12/2019 15:29	25/12/2019 03:40	25/12/2019 15:29	11,81	34	401,46	CHI
201912201508	JUSSARA	RN12250752	BRITANIA	25/12/2019 03:42	25/12/2019 10:27	25/12/2019 03:42	25/12/2019 10:27	6,73	17	114,48	CHI
201912201508	SANTA FE DE GOIAS	RN12250752	BRITANIA	25/12/2019 03:42	25/12/2019 10:27	25/12/2019 03:42	25/12/2019 10:27	6,73	40	269,36	CHI
201912201319	DIORAMA	IR10403921	ARENOPOLIS	25/12/2019 03:43	25/12/2019 13:17	25/12/2019 03:43	25/12/2019 07:30	3,77	27	101,84	CHI
201912201319	IPORA	IR10403921	ARENOPOLIS	25/12/2019 03:43	25/12/2019 13:17	25/12/2019 03:43	25/12/2019 07:30	3,77	10	37,72	CHI
201912201319	MONTES CLAROS DE GOIAS	IR10403921	ARENOPOLIS	25/12/2019 03:43	25/12/2019 13:17	25/12/2019 03:43	25/12/2019 07:30	3,77	8	30,18	CHI
201912201319	DIORAMA	DI12231269	ARENOPOLIS	25/12/2019 03:43	25/12/2019 13:17	25/12/2019 03:43	25/12/2019 09:02	5,31	38	201,63	CHI
201912201319	MONTES CLAROS DE GOIAS	DI12231269	ARENOPOLIS	25/12/2019 03:43	25/12/2019 13:17	25/12/2019 03:43	25/12/2019 09:02	5,31	14	74,29	CHI
201912201319	DIORAMA	DI12231254LD	ARENOPOLIS	25/12/2019 03:43	25/12/2019 13:17	25/12/2019 03:43	25/12/2019 10:19	6,58	17	111,94	CHI
201912201319	MONTES CLAROS DE GOIAS	DI12231254LD	ARENOPOLIS	25/12/2019 03:43	25/12/2019 13:17	25/12/2019 03:43	25/12/2019 10:19	6,58	1	6,58	CHI
201912201319	DIORAMA	DI13231246	ARENOPOLIS	25/12/2019 03:43	25/12/2019 13:17	25/12/2019 03:43	25/12/2019 12:19	8,59	3	25,76	CHI
201912201319	MONTES CLAROS DE GOIAS	DI13231246	ARENOPOLIS	25/12/2019 03:43	25/12/2019 13:17	25/12/2019 03:43	25/12/2019 12:19	8,59	1	8,59	CHI
201912201319	DIORAMA	ME13193427	ARENOPOLIS	25/12/2019 03:43	25/12/2019 13:17	25/12/2019 03:43	25/12/2019 13:17	9,57	28	267,87	CHI
201912201319	MONTES CLAROS DE GOIAS	ME13193427	ARENOPOLIS	25/12/2019 03:43	25/12/2019 13:17	25/12/2019 03:43	25/12/2019 13:17	9,57	14	133,93	CHI
201912201318	MINEIROS	MY10406634	PARQUE DAS EMAS	25/12/2019 03:49	27/12/2019 21:47	25/12/2019 03:49	25/12/2019 09:37	5,80	17	98,56	CHI
201912201318	PORTELANDIA	MY10406634	PARQUE DAS EMAS	25/12/2019 03:49	27/12/2019 21:47	25/12/2019 03:49	25/12/2019 09:37	5,80	1	5,80	CHI
201912201318	MINEIROS	MY12024312	PARQUE DAS EMAS	25/12/2019 03:49	27/12/2019 21:47	25/12/2019 03:49	26/12/2019 07:48	27,99	14	391,84	CHI
201912201318	MINEIROS	MY12153046LD	PARQUE DAS EMAS	25/12/2019 03:49	27/12/2019 21:47	25/12/2019 03:49	26/12/2019 10:50	31,03	9	279,23	CHI
201912201318	SANTA RITA DO ARAGUAIA	MY12153046LD	PARQUE DAS EMAS	25/12/2019 03:49	27/12/2019 21:47	25/12/2019 03:49	26/12/2019 10:50	31,03	3	93,08	CHI
201912201318	MINEIROS	MY12195578	PARQUE DAS EMAS	25/12/2019 03:49	27/12/2019 21:47	26/12/2019 11:42	26/12/2019 12:01	0,32	9	2,91	CHI
201912201318	MINEIROS	MY10406634	PARQUE DAS EMAS	25/12/2019 03:49	27/12/2019 21:47	26/12/2019 12:55	26/12/2019 14:04	1,16	32	37,24	CHI
201912201318	PORTELANDIA	MY10406634	PARQUE DAS EMAS	25/12/2019 03:49	27/12/2019 21:47	26/12/2019 12:55	26/12/2019 14:04	1,16	1	1,16	CHI
201912201318	MINEIROS	MY12153046LD	PARQUE DAS EMAS	25/12/2019 03:49	27/12/2019 21:47	26/12/2019 12:55	27/12/2019 08:20	19,42	1	19,42	CHI
201912201318	SANTA RITA DO ARAGUAIA	MY12153046LD	PARQUE DAS EMAS	25/12/2019 03:49	27/12/2019 21:47	26/12/2019 12:55	27/12/2019 08:20	19,42	3	58,25	CHI
201912201318	MINEIROS	MY10406634	PARQUE DAS EMAS	25/12/2019 03:49	27/12/2019 21:47	27/12/2019 09:28	27/12/2019 10:11	0,72	33	23,73	CHI
201912201318	PORTELANDIA	MY10406634	PARQUE DAS EMAS	25/12/2019 03:49	27/12/2019 21:47	27/12/2019 09:28	27/12/2019 10:11	0,72	1	0,72	CHI
201912201318	SANTA RITA DO ARAGUAIA	MY10406634	PARQUE DAS EMAS	25/12/2019 03:49	27/12/2019 21:47	27/12/2019 09:28	27/12/2019 10:11	0,72	3	2,16	CHI
201912201318	MINEIROS	MY10406634	PARQUE DAS EMAS	25/12/2019 03:49	27/12/2019 21:47	27/12/2019 13:46	27/12/2019 14:15	0,48	33	15,78	CHI
201912201318	PORTELANDIA	MY10406634	PARQUE DAS EMAS	25/12/2019 03:49	27/12/2019 21:47	27/12/2019 13:46	27/12/2019 14:15	0,48	1	0,48	CHI
201912201318	SANTA RITA DO ARAGUAIA	MY10406634	PARQUE DAS EMAS	25/12/2019 03:49	27/12/2019 21:47	27/12/2019 13:46	27/12/2019 14:15	0,48	3	1,43	CHI
201912201318	MINEIROS	MY10406634	PARQUE DAS EMAS	25/12/2019 03:49	27/12/2019 21:47	27/12/2019 14:22	27/12/2019 14:26	0,08	33	2,62	CHI

201912201318	PORTELANDIA	MY10406634	PARQUE DAS EMAS	25/12/2019 03:49	27/12/2019 21:47	27/12/2019 14:22	27/12/2019 14:26	0,08	1	0,08	CHI
201912201318	SANTA RITA DO ARAGUAIA	MY10406634	PARQUE DAS EMAS	25/12/2019 03:49	27/12/2019 21:47	27/12/2019 14:22	27/12/2019 14:26	0,08	3	0,24	CHI
201912201318	MINEIROS	MY10406634	PARQUE DAS EMAS	25/12/2019 03:49	27/12/2019 21:47	27/12/2019 15:28	27/12/2019 18:34	3,10	18	55,81	CHI
201912201318	PORTELANDIA	MY10406634	PARQUE DAS EMAS	25/12/2019 03:49	27/12/2019 21:47	27/12/2019 15:28	27/12/2019 18:34	3,10	1	3,10	CHI
201912201318	MINEIROS	MY12024312	PARQUE DAS EMAS	25/12/2019 03:49	27/12/2019 21:47	27/12/2019 15:28	27/12/2019 18:44	3,27	15	49,02	CHI
201912201318	SANTA RITA DO ARAGUAIA	MY12024312	PARQUE DAS EMAS	25/12/2019 03:49	27/12/2019 21:47	27/12/2019 15:28	27/12/2019 18:44	3,27	3	9,80	CHI
201912201318	MINEIROS	MY12195578	PARQUE DAS EMAS	25/12/2019 03:49	27/12/2019 21:47	26/12/2019 12:11	27/12/2019 19:31	31,32	9	281,88	CHI
201912201318	MINEIROS	MY10406634	PARQUE DAS EMAS	25/12/2019 03:49	27/12/2019 21:47	27/12/2019 19:37	27/12/2019 20:30	0,89	18	15,99	CHI
201912201318	PORTELANDIA	MY10406634	PARQUE DAS EMAS	25/12/2019 03:49	27/12/2019 21:47	27/12/2019 19:37	27/12/2019 20:30	0,89	1	0,89	CHI
201912201318	MINEIROS	MY10406634	PARQUE DAS EMAS	25/12/2019 03:49	27/12/2019 21:47	27/12/2019 20:51	27/12/2019 21:06	0,25	18	4,48	CHI
201912201318	PORTELANDIA	MY10406634	PARQUE DAS EMAS	25/12/2019 03:49	27/12/2019 21:47	27/12/2019 20:51	27/12/2019 21:06	0,25	1	0,25	CHI
201912201318	MINEIROS	MY12024312	PARQUE DAS EMAS	25/12/2019 03:49	27/12/2019 21:47	27/12/2019 19:37	27/12/2019 21:29	1,86	15	27,90	CHI
201912201318	SANTA RITA DO ARAGUAIA	MY12024312	PARQUE DAS EMAS	25/12/2019 03:49	27/12/2019 21:47	27/12/2019 19:37	27/12/2019 21:29	1,86	3	5,58	CHI
201912201318	MINEIROS	MY12195578	PARQUE DAS EMAS	25/12/2019 03:49	27/12/2019 21:47	27/12/2019 19:37	27/12/2019 21:45	2,13	10	21,30	CHI
201912201318	MINEIROS	PW12301783LD	PARQUE DAS EMAS	25/12/2019 03:49	27/12/2019 21:47	25/12/2019 03:49	27/12/2019 21:47	65,97	44	2902,46	CHI
201912201318	SANTA RITA DO ARAGUAIA	PW12301783LD	PARQUE DAS EMAS	25/12/2019 03:49	27/12/2019 21:47	25/12/2019 03:49	27/12/2019 21:47	65,97	12	791,58	CHI
201912201318	MINEIROS	MY12153057LD	PARQUE DAS EMAS	25/12/2019 03:49	27/12/2019 21:47	27/12/2019 09:28	27/12/2019 21:47	12,32	2	24,63	CHI
201912201318	SANTA RITA DO ARAGUAIA	PW12301783LD	PARQUE DAS EMAS	25/12/2019 03:49	27/12/2019 21:47	27/12/2019 09:28	27/12/2019 21:47	12,32	2	24,63	CHI
201912201986	SANTA RITA DO NOVO DESTINO	BA12021220	BARRO ALTO	25/12/2019 03:57	26/12/2019 09:42	25/12/2019 03:57	26/12/2019 09:42	29,74	6	178,42	CHI
201912201520	ARAGARCAS	AG11000008	ARAGARCAS	25/12/2019 04:00	25/12/2019 16:45	25/12/2019 04:00	25/12/2019 16:45	12,74	39	496,97	CHI
201912201522	QUIRINOPOLIS	QI11091315	QUIRINOPOLIS	25/12/2019 04:01	25/12/2019 06:23	25/12/2019 04:01	25/12/2019 06:23	2,36	65	153,58	CHI
201912202951	CACHOEIRA ALTA	6516617	QUIRINOPOLIS	25/12/2019 04:02	25/12/2019 17:20	25/12/2019 04:02	25/12/2019 17:20	13,30	26	345,80	CHI
201912202951	QUIRINOPOLIS	6516617	QUIRINOPOLIS	25/12/2019 04:02	25/12/2019 17:20	25/12/2019 04:02	25/12/2019 17:20	13,30	19	252,70	CHI
201912202951	QUIRINOPOLIS	6516617	QUIRINOPOLIS	25/12/2019 04:02	25/12/2019 17:20	25/12/2019 04:02	25/12/2019 17:20	13,30	11	146,30	CHI
201912202951	QUIRINOPOLIS	QI13245784	QUIRINOPOLIS	25/12/2019 04:02	25/12/2019 17:20	25/12/2019 04:02	25/12/2019 17:20	13,30	44	585,20	CHI
201912202951	RIO VERDE	6516617	QUIRINOPOLIS	25/12/2019 04:02	25/12/2019 17:20	25/12/2019 04:02	25/12/2019 17:20	13,30	31	412,30	CHI
201912202951	QUIRINOPOLIS	QI13245784	QUIRINOPOLIS	25/12/2019 04:02	25/12/2019 17:20	25/12/2019 16:41	25/12/2019 17:20	0,65	2	1,30	CHI
201912201524	SAO MIGUEL DO ARAGUAIA	SM12000050	SAO MIGUEL DO ARAGUAIA	25/12/2019 04:04	25/12/2019 16:06	25/12/2019 04:04	25/12/2019 16:06	12,03	28	336,90	CHI
201912201527	ARAGUAPAZ	AZ12064165	GOIAS	25/12/2019 04:07	25/12/2019 18:37	25/12/2019 04:07	25/12/2019 18:37	14,50	4	57,98	CHI
201912201587	ORIZONA	PR12000082RE	PIRES DO RIO S1	25/12/2019 04:11	26/12/2019 13:04	25/12/2019 04:11	25/12/2019 10:37	6,43	5	32,17	CHI
201912201587	PIRES DO RIO	PR12000082RE	PIRES DO RIO S1	25/12/2019 04:11	26/12/2019 13:04	25/12/2019 04:11	25/12/2019 10:37	6,43	23	148,00	CHI
201912201587	SANTA CRUZ DE GOIAS	PR12000082RE	PIRES DO RIO S1	25/12/2019 04:11	26/12/2019 13:04	25/12/2019 04:11	25/12/2019 10:37	6,43	1	6,43	CHI
201912201587	PIRES DO RIO	PR12000082RE	PIRES DO RIO S1	25/12/2019 04:11	26/12/2019 13:04	25/12/2019 10:38	25/12/2019 19:12	8,58	6	51,46	CHI



201912201587	PIRES DO RIO	PR12404703	PIRES DO RIO S1	25/12/2019 04:11	26/12/2019 13:04	25/12/2019 10:38	25/12/2019 20:50	10,21	4	40,85	CHI
201912201587	SANTA CRUZ DE GOIAS	PR12404703	PIRES DO RIO S1	25/12/2019 04:11	26/12/2019 13:04	25/12/2019 10:38	25/12/2019 20:50	10,21	1	10,21	CHI
201912201587	PIRES DO RIO	PR12064871LD	PIRES DO RIO S1	25/12/2019 04:11	26/12/2019 13:04	25/12/2019 04:11	25/12/2019 22:14	18,04	13	234,54	CHI
201912201587	ORIZONA	PR12000082RE	PIRES DO RIO S1	25/12/2019 04:11	26/12/2019 13:04	25/12/2019 10:38	26/12/2019 13:04	26,43	5	132,17	CHI
201912201587	PIRES DO RIO	PR12000082RE	PIRES DO RIO S1	25/12/2019 04:11	26/12/2019 13:04	25/12/2019 10:38	26/12/2019 13:04	26,43	13	343,63	CHI
201912203452	APORE	AE12000052	ITAJA S1	25/12/2019 04:22	25/12/2019 22:26	25/12/2019 04:22	25/12/2019 22:26	18,06	13	234,79	CHI
201912201539	HIDROLINA	UR12374716	URUACU	25/12/2019 04:28	25/12/2019 14:28	25/12/2019 04:28	25/12/2019 14:28	10,00	9	89,97	CHI
201912200455	ESTRELA DO NORTE	MU12076698	MARA ROSA	25/12/2019 04:34	25/12/2019 08:01	25/12/2019 04:34	25/12/2019 08:01	3,45	1	3,45	CHI
201912200455	MUTUNOPOLIS	MU12076698	MARA ROSA	25/12/2019 04:34	25/12/2019 08:01	25/12/2019 04:34	25/12/2019 08:01	3,45	32	110,38	CHI
201912201873	DOVERLANDIA	DV12380977	CAIAPONIA	25/12/2019 04:36	25/12/2019 17:10	25/12/2019 04:36	25/12/2019 17:10	12,55	93	1167,49	CHI
201912201545	MARA ROSA	MQ12208423	MARA ROSA	25/12/2019 04:37	25/12/2019 12:12	25/12/2019 04:37	25/12/2019 12:12	7,58	12	90,98	CHI
201912202360	BONOPOLIS	BX12168258	SAO MIGUEL DO ARAGUAIA	25/12/2019 04:39	25/12/2019 18:23	25/12/2019 04:39	25/12/2019 18:23	13,73	20	274,51	CHI
201912202360	CACU	BX12168258	SAO MIGUEL DO ARAGUAIA	25/12/2019 04:39	25/12/2019 18:23	25/12/2019 04:39	25/12/2019 18:23	13,73	1	13,73	CHI
201912201554	SANTO ANTONIO DA BARRA	O1690214	ACREUNA	25/12/2019 04:46	27/12/2019 16:40	25/12/2019 04:46	25/12/2019 08:15	3,49	1443	5040,48	CHI
201912201554	SANTO ANTONIO DA BARRA	BZ10407792	ACREUNA	25/12/2019 04:46	27/12/2019 16:40	25/12/2019 04:46	25/12/2019 09:27	4,69	101	473,55	CHI
201912201554	PARAUNA	BZ12000006LD	ACREUNA	25/12/2019 04:46	27/12/2019 16:40	25/12/2019 04:46	25/12/2019 11:49	7,06	19	134,12	CHI
201912201554	RIO VERDE	BZ12000006LD	ACREUNA	25/12/2019 04:46	27/12/2019 16:40	25/12/2019 04:46	25/12/2019 11:49	7,06	43	303,53	CHI
201912201554	SANTO ANTONIO DA BARRA	BZ12000006LD	ACREUNA	25/12/2019 04:46	27/12/2019 16:40	25/12/2019 04:46	25/12/2019 11:49	7,06	94	663,54	CHI
201912201554	PARAUNA	BZ13189087	ACREUNA	25/12/2019 04:46	27/12/2019 16:40	25/12/2019 04:46	25/12/2019 15:13	10,46	110	1150,57	CHI
201912201554	RIO VERDE	BZ13189087	ACREUNA	25/12/2019 04:46	27/12/2019 16:40	25/12/2019 04:46	25/12/2019 15:13	10,46	70	732,18	CHI
201912201554	PARAUNA	RV13303774	ACREUNA	25/12/2019 04:46	27/12/2019 16:40	25/12/2019 04:46	25/12/2019 23:51	19,09	28	534,42	CHI
201912201554	RIO VERDE	RV13303774	ACREUNA	25/12/2019 04:46	27/12/2019 16:40	25/12/2019 04:46	25/12/2019 23:51	19,09	2	38,17	CHI
201912201554	PARAUNA	BZ13394760B	ACREUNA	25/12/2019 04:46	27/12/2019 16:40	26/12/2019 09:45	26/12/2019 12:55	3,17	157	498,04	CHI
201912201554	RIO VERDE	BZ13394760B	ACREUNA	25/12/2019 04:46	27/12/2019 16:40	26/12/2019 09:45	26/12/2019 12:55	3,17	116	367,98	CHI
201912201554	SANTO ANTONIO DA BARRA	BZ13394760B	ACREUNA	25/12/2019 04:46	27/12/2019 16:40	26/12/2019 09:45	26/12/2019 12:55	3,17	94	298,19	CHI
201912201554	RIO VERDE	RV13303726LD	ACREUNA	25/12/2019 04:46	27/12/2019 16:40	25/12/2019 04:46	27/12/2019 16:35	59,82	18	1076,82	CHI
201912201554	RIO VERDE	RV12306632	ACREUNA	25/12/2019 04:46	27/12/2019 16:40	25/12/2019 04:46	27/12/2019 16:40	59,89	8	479,15	CHI
201912202036	BARRO ALTO	PV12069121	GOIANESIA S1	25/12/2019 04:47	26/12/2019 11:34	25/12/2019 04:47	26/12/2019 11:34	30,78	1	30,78	CHI
201912202036	VILA PROPICIO	PV12069121	GOIANESIA S1	25/12/2019 04:47	26/12/2019 11:34	25/12/2019 04:47	26/12/2019 11:34	30,78	34	1046,54	CHI
201912202482	ALTO HORIZONTE	NH12396799	SANTA TEREZINHA	25/12/2019 05:00	25/12/2019 11:34	25/12/2019 05:00	25/12/2019 11:34	6,57	56	367,64	CHI
201912202482	CAMPOS VERDES	NH12396799	SANTA TEREZINHA	25/12/2019 05:00	25/12/2019 11:34	25/12/2019 05:00	25/12/2019 11:34	6,57	8	52,52	CHI
201912202482	PILAR DE GOIAS	NH12396799	SANTA TEREZINHA	25/12/2019 05:00	25/12/2019 11:34	25/12/2019 05:00	25/12/2019 11:34	6,57	1	6,57	CHI
201912201578	MINEIROS	PW12336959	PARQUE DAS EMAS	25/12/2019 05:09	25/12/2019 12:20	25/12/2019 05:09	25/12/2019 12:20	7,18	5	35,91	CHI

201912202436	DOVERLANDIA	DV12358445	CAIAPONIA	25/12/2019 05:11	25/12/2019 19:44	25/12/2019 05:11	25/12/2019 19:44	14,54	21	305,30	CHI
201912201711	ARAGARCAS	AG11207761	ARAGARCAS	25/12/2019 05:14	25/12/2019 12:33	25/12/2019 05:14	25/12/2019 12:33	7,31	106	774,39	CHI
201912201593	GOIAS	GS12162479	GOIAS	25/12/2019 05:16	25/12/2019 14:25	25/12/2019 05:16	25/12/2019 14:25	9,15	3	27,45	CHI
201912203423	MORRINHOS	MR12133255	MORRINHOS	25/12/2019 05:20	25/12/2019 23:09	25/12/2019 05:20	25/12/2019 23:09	17,82	12	213,79	CHI
201912202293	ARENOPOLIS	AY12390169	ARENOPOLIS	25/12/2019 05:22	26/12/2019 21:47	25/12/2019 05:22	25/12/2019 20:13	14,85	7	103,93	CHI
201912202293	ARENOPOLIS	AY12196437LD	ARENOPOLIS	25/12/2019 05:22	26/12/2019 21:47	25/12/2019 05:22	25/12/2019 22:08	16,77	8	134,12	CHI
201912202293	ARENOPOLIS	AY12331916	ARENOPOLIS	25/12/2019 05:22	26/12/2019 21:47	25/12/2019 05:22	26/12/2019 17:03	35,67	3	107,01	CHI
201912202293	ARENOPOLIS	AY12331916	ARENOPOLIS	25/12/2019 05:22	26/12/2019 21:47	25/12/2019 05:22	26/12/2019 21:47	40,40	6	242,41	CHI
201912202293	DIORAMA	AY12331916	ARENOPOLIS	25/12/2019 05:22	26/12/2019 21:47	25/12/2019 05:22	26/12/2019 21:47	40,40	3	121,20	CHI
201912202293	ARENOPOLIS	AY12331916	ARENOPOLIS	25/12/2019 05:22	26/12/2019 21:47	26/12/2019 20:56	26/12/2019 21:47	0,84	3	2,52	CHI
201912201596	ITUMBIARA	IT21263999	PARANAIBA	25/12/2019 05:25	25/12/2019 09:58	25/12/2019 05:25	25/12/2019 09:58	4,55	1	4,55	CHI
201912201597	PIRACANJUBA	PJ12082228	CRISTIANOPOLIS	25/12/2019 05:25	25/12/2019 08:42	25/12/2019 05:25	25/12/2019 08:42	3,28	5	16,41	CHI
201912201598	AMORINOPOLIS	AM21362178	IPORA	25/12/2019 05:25	25/12/2019 09:21	25/12/2019 05:25	25/12/2019 09:21	3,93	1	3,93	CHI
201912202297	JARAGUA	JA12221418	JARAGUA	25/12/2019 05:25	26/12/2019 09:58	25/12/2019 05:25	26/12/2019 09:58	28,54	17	485,19	CHI
201912201609	DOVERLANDIA	DV12207926	CAIAPONIA	25/12/2019 05:29	25/12/2019 18:38	25/12/2019 05:29	25/12/2019 18:38	13,15	58	762,65	CHI
201912201755	CALDAS NOVAS	CN12263786	RIO QUENTE	25/12/2019 05:29	25/12/2019 09:06	25/12/2019 05:29	25/12/2019 09:06	3,61	32	115,52	CHI
201912201755	RIO QUENTE	CN12263786	RIO QUENTE	25/12/2019 05:29	25/12/2019 09:06	25/12/2019 05:29	25/12/2019 09:06	3,61	1	3,61	CHI
201912201612	BOM JESUS DE GOIAS	BJ12000088RE	BOM JESUS DE GOIAS	25/12/2019 05:30	25/12/2019 14:12	25/12/2019 05:30	25/12/2019 14:12	8,69	10	86,94	CHI
201912201612	GOIATUBA	BJ12000088RE	BOM JESUS DE GOIAS	25/12/2019 05:30	25/12/2019 14:12	25/12/2019 05:30	25/12/2019 14:12	8,69	45	391,21	CHI
201912201834	CATALAO	00460214	IPAMERI	25/12/2019 05:31	26/12/2019 14:27	25/12/2019 05:31	25/12/2019 19:04	13,55	2	27,11	CHI
201912201834	IPAMERI	00460214	IPAMERI	25/12/2019 05:31	26/12/2019 14:27	25/12/2019 05:31	25/12/2019 19:04	13,55	38	515,04	CHI
201912201834	IPAMERI	IP13344939	IPAMERI	25/12/2019 05:31	26/12/2019 14:27	25/12/2019 05:31	25/12/2019 19:48	14,28	3	42,84	CHI
201912201834	CATALAO	IP12272796LD	IPAMERI	25/12/2019 05:31	26/12/2019 14:27	25/12/2019 05:31	26/12/2019 00:05	18,58	16	297,24	CHI
201912201834	IPAMERI	IP12272796LD	IPAMERI	25/12/2019 05:31	26/12/2019 14:27	25/12/2019 05:31	26/12/2019 00:05	18,58	2	37,16	CHI
201912201834	CATALAO	IP12272796LD	IPAMERI	25/12/2019 05:31	26/12/2019 14:27	25/12/2019 05:31	26/12/2019 14:27	32,94	2	65,88	CHI
201912201834	IPAMERI	IP12272796LD	IPAMERI	25/12/2019 05:31	26/12/2019 14:27	25/12/2019 05:31	26/12/2019 14:27	32,94	1	32,94	CHI
201912201834	CATALAO	IP12272796LD	IPAMERI	25/12/2019 05:31	26/12/2019 14:27	26/12/2019 12:39	26/12/2019 14:27	1,80	16	28,81	CHI
201912201834	IPAMERI	IP12272796LD	IPAMERI	25/12/2019 05:31	26/12/2019 14:27	26/12/2019 12:39	26/12/2019 14:27	1,80	2	3,60	CHI
201912202214	GOIANESIA	GE12321377	GOIANESIA S2	25/12/2019 05:31	25/12/2019 13:07	25/12/2019 05:31	25/12/2019 13:07	7,59	15	113,87	CHI
201912202214	VILA PROPICIO	GE12321377	GOIANESIA S2	25/12/2019 05:31	25/12/2019 13:07	25/12/2019 05:31	25/12/2019 13:07	7,59	9	68,32	CHI
201912201635	MUTUNOPOLIS	MU12291031	MARA ROSA	25/12/2019 05:40	27/12/2019 12:33	25/12/2019 05:40	26/12/2019 12:28	30,81	3	92,42	CHI
201912201635	MUTUNOPOLIS	MU12342062LD	MARA ROSA	25/12/2019 05:40	27/12/2019 12:33	25/12/2019 05:40	27/12/2019 12:33	54,90	7	384,29	CHI
201912201641	ITAPACI	IW12210234	ITAPACI	25/12/2019 05:44	25/12/2019 09:57	25/12/2019 05:44	25/12/2019 09:57	4,21	21	88,32	CHI

201912201641	NOVA GLORIA	IW12210234	ITAPACI	25/12/2019 05:44	25/12/2019 09:57	25/12/2019 05:44	25/12/2019 09:57	4,21	26	109,35	CHI
201912201668	ITARUMA	IM13296707	ITAJA S2	25/12/2019 05:52	25/12/2019 21:19	25/12/2019 18:34	25/12/2019 20:53	2,31	19	43,95	CHI
201912201668	ITARUMA	IM12160235	ITAJA S2	25/12/2019 05:52	25/12/2019 21:19	25/12/2019 05:52	25/12/2019 21:19	15,45	13	200,85	CHI
201912201669	CAMPO ALEGRE DE GOIAS	6939890	CAMPO ALEGRE DE GOIAS	25/12/2019 05:52	25/12/2019 20:20	25/12/2019 05:52	25/12/2019 20:20	14,46	10	144,57	CHI
201912201669	IPAMERI	6939890	CAMPO ALEGRE DE GOIAS	25/12/2019 05:52	25/12/2019 20:20	25/12/2019 05:52	25/12/2019 20:20	14,46	3	43,37	CHI
201912201689	CORUMBA DE GOIAS	CB21382197	CORUMBA	25/12/2019 05:52	25/12/2019 08:19	25/12/2019 05:52	25/12/2019 08:19	2,44	1	2,44	CHI
201912201697	GOIANESIA	GE21332698	GOIANESIA S2	25/12/2019 05:52	26/12/2019 08:12	25/12/2019 05:52	26/12/2019 08:12	26,32	1	26,32	CHI
201912201709	PIRACANJUBA	PJ12384538	MORRINHOS	25/12/2019 05:58	25/12/2019 18:40	25/12/2019 05:58	25/12/2019 18:40	12,69	21	266,50	CHI
201912201715	QUIRINOPOLIS	QI21013484	QUIRINOPOLIS	25/12/2019 05:59	25/12/2019 09:52	25/12/2019 05:59	25/12/2019 09:52	3,87	1	3,87	CHI
201912202349	DOVERLANDIA	DV12395475	CAIAPONIA	25/12/2019 05:59	26/12/2019 06:45	25/12/2019 05:59	26/12/2019 06:45	24,78	11	272,53	CHI
201912201720	GOIAS	GS12058298	MATRINCHA	25/12/2019 06:00	25/12/2019 11:42	25/12/2019 06:00	25/12/2019 11:42	5,69	27	153,71	CHI
201912202267	RIO VERDE	RV12135958	CABRIUVA S2	25/12/2019 06:05	26/12/2019 09:01	25/12/2019 06:05	26/12/2019 09:01	26,92	33	888,52	CHI
201912202123	CRIXAS	MZ12055650	MOZARLANDIA	25/12/2019 06:07	26/12/2019 10:04	25/12/2019 06:07	26/12/2019 10:04	27,94	76	2123,25	CHI
201912202123	MOZARLANDIA	MZ12055650	MOZARLANDIA	25/12/2019 06:07	26/12/2019 10:04	25/12/2019 06:07	26/12/2019 10:04	27,94	5	139,69	CHI
201912202123	NOVA CRIXAS	MZ12055650	MOZARLANDIA	25/12/2019 06:07	26/12/2019 10:04	25/12/2019 06:07	26/12/2019 10:04	27,94	28	782,25	CHI
201912201751	TURVANIA	TV12259072	FIRMINOPOLIS S2	25/12/2019 06:09	25/12/2019 09:51	25/12/2019 06:09	25/12/2019 09:51	3,71	3	11,13	CHI
201912201996	JARAGUA	JA12247688	JARAGUA	25/12/2019 06:11	25/12/2019 12:30	25/12/2019 06:11	25/12/2019 12:30	6,31	8	50,50	CHI
201912201767	PIRENOPOLIS	PV21123738	CORUMBA	25/12/2019 06:15	25/12/2019 09:29	25/12/2019 06:15	25/12/2019 09:29	3,23	1	3,23	CHI
201912201769	SAO MIGUEL DO ARAGUAIA	SM11038964	SAO MIGUEL DO ARAGUAIA	25/12/2019 06:15	25/12/2019 12:43	25/12/2019 06:15	25/12/2019 12:43	6,46	177	1143,08	CHI
201912201772	ABADIANIA	AA12126647	CORUMBA	25/12/2019 06:17	25/12/2019 13:43	25/12/2019 06:17	25/12/2019 13:43	7,43	37	274,98	CHI
201912202497	PIRACANJUBA	CF12300660	CRISTIANOPOLIS	25/12/2019 06:17	26/12/2019 00:44	25/12/2019 06:17	26/12/2019 00:44	18,44	65	1198,73	CHI
201912204089	BELA VISTA DE GOIAS	SQ12340634	CRISTIANOPOLIS	25/12/2019 06:17	25/12/2019 17:58	25/12/2019 06:17	25/12/2019 17:58	11,68	14	163,55	CHI
201912203048	ABADIANIA	CB12089823	ALEXANIA	25/12/2019 06:21	25/12/2019 12:57	25/12/2019 06:21	25/12/2019 12:57	6,59	4	26,36	CHI
201912203048	CORUMBA DE GOIAS	CB12089823	ALEXANIA	25/12/2019 06:21	25/12/2019 12:57	25/12/2019 06:21	25/12/2019 12:57	6,59	11	72,48	CHI
201912201799	ITAPIRAPUA	IU12018752	MATRINCHA	25/12/2019 06:24	25/12/2019 12:03	25/12/2019 06:24	25/12/2019 12:03	5,66	7	39,60	CHI
201912202460	TEREZOPOLIS DE GOIAS	TJ12389766	DAIA S2	25/12/2019 06:25	25/12/2019 10:59	25/12/2019 06:25	25/12/2019 10:59	4,56	9	41,07	CHI
201912203609	SAO MIGUEL DO PASSA QUATRO	SV12049996	CRISTIANOPOLIS	25/12/2019 06:26	25/12/2019 12:15	25/12/2019 06:26	25/12/2019 12:15	5,81	5	29,03	CHI
201912202658	PIRENOPOLIS	PV12008487	CORUMBA	25/12/2019 06:28	25/12/2019 11:24	25/12/2019 06:28	25/12/2019 11:24	4,92	74	364,02	CHI
201912202391	SILVANIA	SV12202389	DAIA S2	25/12/2019 06:29	25/12/2019 09:23	25/12/2019 06:29	25/12/2019 09:23	2,88	27	77,89	CHI
201912202875	GUARINOS	GG12318452	URUACU	25/12/2019 06:29	25/12/2019 13:17	25/12/2019 06:29	25/12/2019 13:17	6,81	1	6,81	CHI
201912202875	PILAR DE GOIAS	GG12318452	URUACU	25/12/2019 06:29	25/12/2019 13:17	25/12/2019 06:29	25/12/2019 13:17	6,81	82	558,76	CHI
201912202875	SANTA TEREZINHA DE GOIAS	GG12318452	URUACU	25/12/2019 06:29	25/12/2019 13:17	25/12/2019 06:29	25/12/2019 13:17	6,81	3	20,44	CHI
201912201828	CRIXAS	CX12380727	SANTA TEREZINHA	25/12/2019 06:31	27/12/2019 09:29	25/12/2019 06:31	27/12/2019 09:29	50,96	6	305,76	CHI

201912201829	TEREZOPOLIS DE GOIAS	TJ12000124	DAIA S2	25/12/2019 06:31	25/12/2019 09:24	25/12/2019 06:32	25/12/2019 09:24	2,87	4	11,47	CHI
201912201965	PONTALINA	PK12080022	PONTALINA	25/12/2019 06:31	25/12/2019 22:59	25/12/2019 06:31	25/12/2019 22:59	16,46	5	82,28	CHI
201912203220	MORRINHOS	MR12394199	MORRINHOS	25/12/2019 06:32	25/12/2019 20:41	25/12/2019 06:32	25/12/2019 20:41	14,15	7	99,04	CHI
201912202211	NIQUELANDIA	NQ12378056	NIQUELANDIA SUBTRANSMISSAO	25/12/2019 06:36	25/12/2019 14:48	25/12/2019 06:36	25/12/2019 14:48	8,20	5	41,01	CHI
201912202433	CRIXAS	CX12190247	SANTA TEREZINHA	25/12/2019 06:36	25/12/2019 16:56	25/12/2019 06:36	25/12/2019 16:56	10,33	5	51,64	CHI
201912201862	FAZENDA NOVA	JR12139962	JUSSARA	25/12/2019 06:37	25/12/2019 11:41	25/12/2019 06:37	25/12/2019 11:41	5,07	6	30,40	CHI
201912201862	JUSSARA	JR12139962	JUSSARA	25/12/2019 06:37	25/12/2019 11:41	25/12/2019 06:37	25/12/2019 11:41	5,07	131	663,81	CHI
201912201867	CORUMBAIBA	CI12000093RE	VILA CORUMBA	25/12/2019 06:38	25/12/2019 14:22	25/12/2019 06:38	25/12/2019 14:22	7,73	35	270,42	CHI
201912202720	SAO MIGUEL DO PASSA QUATRO	SQ12231382	CRISTIANOPOLIS	25/12/2019 06:38	25/12/2019 09:59	25/12/2019 06:38	25/12/2019 09:59	3,34	44	147,08	CHI
201912201871	SAO MIGUEL DO ARAGUAIA	SM12020625	SAO MIGUEL DO ARAGUAIA	25/12/2019 06:39	25/12/2019 12:17	25/12/2019 06:39	25/12/2019 12:17	5,62	6	33,74	CHI
201912201879	GOIAS	GS12073710	MATRINCHA	25/12/2019 06:41	26/12/2019 14:06	25/12/2019 06:41	25/12/2019 17:11	10,52	11	115,67	CHI
201912201879	GOIAS	GS12073710	MATRINCHA	25/12/2019 06:41	26/12/2019 14:06	25/12/2019 06:41	26/12/2019 14:06	31,42	2	62,84	CHI
201912201879	GOIAS	GS12073710	MATRINCHA	25/12/2019 06:41	26/12/2019 14:06	26/12/2019 09:54	26/12/2019 14:06	4,19	11	46,08	CHI
201912206128	PIRACANJUBA	PJ12363983	CRISTIANOPOLIS	25/12/2019 06:41	26/12/2019 10:30	25/12/2019 06:41	26/12/2019 10:30	27,82	4	111,26	CHI
201912201888	PORANGATU	PO12240217	MARA ROSA	25/12/2019 06:42	27/12/2019 12:53	25/12/2019 06:42	27/12/2019 12:53	54,18	4	216,74	CHI
201912201325	ANICUNS	910063461	ANICUNS	25/12/2019 06:43	25/12/2019 08:01	25/12/2019 06:43	25/12/2019 08:01	1,29	0	0,00	CHI
201912201898	EDEALINA	ED12000017	PONTALINA	25/12/2019 06:43	26/12/2019 16:15	25/12/2019 06:43	26/12/2019 16:15	33,52	2	67,05	CHI
201912201900	NIQUELANDIA	NQ12171080	BARRO ALTO	25/12/2019 06:44	25/12/2019 10:12	25/12/2019 06:44	25/12/2019 10:12	3,47	11	38,12	CHI
201912202886	FAINA	FC12211092	GOIAS	25/12/2019 06:44	26/12/2019 11:56	25/12/2019 06:44	26/12/2019 11:56	29,20	24	700,75	CHI
201912201914	SAO MIGUEL DO ARAGUAIA	SM12013036	SAO MIGUEL DO ARAGUAIA	25/12/2019 06:46	25/12/2019 17:39	25/12/2019 06:46	25/12/2019 17:39	10,88	16	174,05	CHI
201912201206	IPAMERI	NE12086750	CATALAO S1	25/12/2019 06:47	25/12/2019 13:22	25/12/2019 06:47	25/12/2019 13:22	6,57	13	85,44	CHI
201912201206	NOVA AURORA	NE12086750	CATALAO S1	25/12/2019 06:47	25/12/2019 13:22	25/12/2019 06:47	25/12/2019 13:22	6,57	2	13,14	CHI
201912201916	NEROPOLIS	NR12353484	DAIA S2	25/12/2019 06:47	25/12/2019 10:49	25/12/2019 06:47	25/12/2019 10:49	4,03	42	169,24	CHI
201912201932	IVOLANDIA	IV21158487	IPORA	25/12/2019 06:50	25/12/2019 11:26	25/12/2019 06:50	25/12/2019 11:26	4,60	1	4,60	CHI
201912201933	CRISTIANOPOLIS	CF12300616	CRISTIANOPOLIS	25/12/2019 06:50	25/12/2019 09:46	25/12/2019 06:50	25/12/2019 09:46	2,93	8	23,45	CHI
201912201934	JATAI	JT12264349	JATAI S1	25/12/2019 06:50	28/12/2019 12:23	25/12/2019 06:50	25/12/2019 18:27	11,61	19	220,67	CHI
201912201934	JATAI	JT12264349	JATAI S1	25/12/2019 06:50	28/12/2019 12:23	25/12/2019 17:40	25/12/2019 18:27	0,78	1	0,78	CHI
201912201934	JATAI	JT12264349	JATAI S1	25/12/2019 06:50	28/12/2019 12:23	25/12/2019 23:29	27/12/2019 18:19	42,85	20	856,91	CHI
201912201934	JATAI	JT12264349	JATAI S1	25/12/2019 06:50	28/12/2019 12:23	25/12/2019 06:50	28/12/2019 12:23	77,55	39	3024,49	CHI
201912201934	JATAI	JT13219247	JATAI S1	25/12/2019 06:50	28/12/2019 12:23	25/12/2019 06:50	28/12/2019 12:23	77,55	1	77,55	CHI
201912201940	ITABERAI	IB11307602	ITABERAI S2	25/12/2019 06:52	25/12/2019 09:49	25/12/2019 06:52	25/12/2019 09:49	2,94	275	809,42	CHI
201912201943	INDIARA	IY12391437	EDEIA	25/12/2019 06:53	25/12/2019 11:01	25/12/2019 06:53	25/12/2019 11:01	4,13	3	12,40	CHI
201912202792	BALIZA	BH12331413	CAIAPONIA	25/12/2019 06:53	25/12/2019 23:12	25/12/2019 06:53	25/12/2019 23:12	16,31	12	195,69	CHI

201912201953	ITAPACI	RB12161662	RUBIATABA	25/12/2019 06:55	25/12/2019 11:59	25/12/2019 06:55	25/12/2019 11:59	5,05	10	50,54	CHI
201912201953	RUBIATABA	RB12161662	RUBIATABA	25/12/2019 06:55	25/12/2019 11:59	25/12/2019 06:55	25/12/2019 11:59	5,05	30	151,62	CHI
201912202340	PORANGATU	PO12391671	PORANGATU	25/12/2019 06:56	25/12/2019 12:40	25/12/2019 06:56	25/12/2019 12:40	5,73	24	137,42	CHI
201912202584	ITAPURANGA	IK11051548	ITAPURANGA	25/12/2019 06:57	25/12/2019 10:27	25/12/2019 06:57	25/12/2019 10:27	3,49	165	575,90	CHI
201912201972	PALESTINA DE GOIAS	PY21161680	PALESTINA	25/12/2019 06:58	25/12/2019 15:58	25/12/2019 06:58	25/12/2019 15:58	9,00	1	9,00	CHI
201912201975	JATAI	JT12402412	JATAI S2	25/12/2019 06:58	25/12/2019 09:05	25/12/2019 06:58	25/12/2019 09:05	2,11	448	946,15	CHI
201912201976	TEREZOPOLIS DE GOIAS	TJ12353440	DAIA S2	25/12/2019 06:58	25/12/2019 09:04	25/12/2019 06:58	25/12/2019 09:04	2,09	6	12,52	CHI
201912202439	BOM JARDIM DE GOIAS	BM12253664	BOM JARDIM	25/12/2019 06:59	25/12/2019 10:25	25/12/2019 06:59	25/12/2019 10:25	3,44	8	27,53	CHI
201912201983	NOVA IGUACU DE GOIAS	NH21051101	SANTA TEREZINHA	25/12/2019 07:00	25/12/2019 09:29	25/12/2019 07:00	25/12/2019 09:29	2,48	2	4,96	CHI
201912201988	BONOPOLIS	BX11391600	SAO MIGUEL DO ARAGUAIA	25/12/2019 07:00	25/12/2019 12:54	25/12/2019 07:00	25/12/2019 12:54	5,89	22	129,51	CHI
201912201990	PIRACANJUBA	PJ11171390	PIRACANJUBA	25/12/2019 07:00	25/12/2019 20:24	25/12/2019 07:00	25/12/2019 20:24	13,39	1	13,39	CHI
201912202597	ITAPURANGA	IK11124735	ITAPURANGA	25/12/2019 07:01	25/12/2019 10:46	25/12/2019 07:01	25/12/2019 10:46	3,74	61	228,39	CHI
201912201997	GOIANAPOLIS	GP12285356	DAIA S2	25/12/2019 07:02	25/12/2019 13:49	25/12/2019 07:02	25/12/2019 13:49	6,77	8	54,18	CHI
201912202312	MORRINHOS	MR12263657	GOIATUBA S1	25/12/2019 07:02	25/12/2019 18:06	25/12/2019 07:02	25/12/2019 18:06	11,06	13	143,79	CHI
201912203344	PEROLANDIA	DP12260465	JATAI S1	25/12/2019 07:02	25/12/2019 13:41	25/12/2019 07:02	25/12/2019 13:41	6,64	10	66,37	CHI
201912202002	GOIANAPOLIS	GP21353319	DAIA S2	25/12/2019 07:03	25/12/2019 15:18	25/12/2019 07:03	25/12/2019 15:18	8,24	2	16,48	CHI
201912202005	PORTELANDIA	PW21303439	PARQUE DAS EMAS	25/12/2019 07:03	26/12/2019 13:51	25/12/2019 07:03	26/12/2019 13:51	30,79	1	30,79	CHI
201912202015	PIRACANJUBA	PJ12381140	PIRACANJUBA	25/12/2019 07:06	25/12/2019 22:17	25/12/2019 07:06	25/12/2019 22:17	15,17	9	136,53	CHI
201912202032	QUIRINOPOLIS	QI12144242	QUIRINOPOLIS	25/12/2019 07:06	25/12/2019 08:48	25/12/2019 07:06	25/12/2019 08:48	1,71	4	6,83	CHI
201912202893	ITAPACI	IW12078035	ITAPACI	25/12/2019 07:07	25/12/2019 10:26	25/12/2019 07:07	25/12/2019 10:26	3,31	21	69,43	CHI
201912202893	NOVA GLORIA	IW12078035	ITAPACI	25/12/2019 07:07	25/12/2019 10:26	25/12/2019 07:07	25/12/2019 10:26	3,31	1	3,31	CHI
201912202027	ITAPIRAPUA	IU12008889	MATRINCHA	25/12/2019 07:08	25/12/2019 09:30	25/12/2019 07:08	25/12/2019 09:30	2,37	9	21,30	CHI
201912202034	JARAGUA	JA12328516	JARAGUA	25/12/2019 07:09	25/12/2019 16:45	25/12/2019 07:09	25/12/2019 16:45	9,59	19	182,17	CHI
201912202039	ANICUNS	AC11000022	ANICUNS	25/12/2019 07:10	25/12/2019 13:09	25/12/2019 07:10	25/12/2019 13:09	5,98	48	287,13	CHI
201912202056	QUIRINOPOLIS	10013114130	QUIRINOPOLIS	25/12/2019 07:13	25/12/2019 14:04	25/12/2019 07:13	25/12/2019 14:04	6,84	1	6,84	CHI
201912202057	CACHOEIRA ALTA	CA12371227	CACHOEIRA ALTA	25/12/2019 07:13	25/12/2019 22:31	25/12/2019 07:13	25/12/2019 22:31	15,30	10	152,99	CHI
201912202058	FORMOSO	FO12151052	PORANGATU	25/12/2019 07:13	26/12/2019 16:00	25/12/2019 07:13	26/12/2019 16:00	32,78	6	196,65	CHI
201912202061	CAIAPONIA	CP21151496	CAIAPONIA	25/12/2019 07:14	26/12/2019 07:00	25/12/2019 07:14	25/12/2019 13:25	6,18	1	6,18	CHI
201912202061	CAIAPONIA	CP12207986	CAIAPONIA	25/12/2019 07:14	26/12/2019 07:00	25/12/2019 07:14	26/12/2019 07:00	23,77	9	213,93	CHI
201912202062	NIQUELANDIA	NQ21257260	URUACU	25/12/2019 07:14	25/12/2019 12:09	25/12/2019 07:14	25/12/2019 12:09	4,90	1	4,90	CHI
201912202637	ABADIANIA	AA12258352	ANAPOLIS UNIVERSITARIO S1	25/12/2019 07:15	25/12/2019 09:31	25/12/2019 07:15	25/12/2019 09:31	2,27	9	20,40	CHI
201912202637	CORUMBA DE GOIAS	AA12258352	ANAPOLIS UNIVERSITARIO S1	25/12/2019 07:15	25/12/2019 09:31	25/12/2019 07:15	25/12/2019 09:31	2,27	2	4,53	CHI
201912203924	INDIARA	IY12312482	CEZARINA	25/12/2019 07:16	25/12/2019 11:36	25/12/2019 07:16	25/12/2019 11:36	4,33	11	47,68	CHI

201912203437	HEITORAI	HE12099418	ITAPURANGA	25/12/2019 07:17	25/12/2019 19:45	25/12/2019 07:17	25/12/2019 19:45	12,45	38	473,19	CHI
201912202078	MAIRIPOTABA	PK12263491	PONTALINA	25/12/2019 07:18	29/12/2019 11:12	25/12/2019 07:18	26/12/2019 16:09	32,85	5	164,27	CHI
201912202078	PONTALINA	PK12263491	PONTALINA	25/12/2019 07:18	29/12/2019 11:12	25/12/2019 07:18	26/12/2019 16:09	32,85	30	985,61	CHI
201912202078	MAIRIPOTABA	PK12263491	PONTALINA	25/12/2019 07:18	29/12/2019 11:12	26/12/2019 18:50	27/12/2019 21:39	26,83	1	26,83	CHI
201912202078	PONTALINA	PK12263491	PONTALINA	25/12/2019 07:18	29/12/2019 11:12	26/12/2019 18:50	27/12/2019 21:39	26,83	17	456,04	CHI
201912202078	MAIRIPOTABA	PK12076875LD	PONTALINA	25/12/2019 07:18	29/12/2019 11:12	26/12/2019 18:50	28/12/2019 12:25	41,60	1	41,60	CHI
201912202078	PONTALINA	PK12076875LD	PONTALINA	25/12/2019 07:18	29/12/2019 11:12	26/12/2019 18:50	28/12/2019 12:25	41,60	9	374,38	CHI
201912202078	MAIRIPOTABA	PK12076875LD	PONTALINA	25/12/2019 07:18	29/12/2019 11:12	26/12/2019 18:50	28/12/2019 13:32	42,70	3	128,10	CHI
201912202078	PONTALINA	PK12076875LD	PONTALINA	25/12/2019 07:18	29/12/2019 11:12	26/12/2019 18:50	28/12/2019 13:32	42,70	4	170,80	CHI
201912202078	MAIRIPOTABA	PK12076875LD	PONTALINA	25/12/2019 07:18	29/12/2019 11:12	28/12/2019 12:26	28/12/2019 13:32	1,09	1	1,09	CHI
201912202078	PONTALINA	PK12076875LD	PONTALINA	25/12/2019 07:18	29/12/2019 11:12	28/12/2019 12:26	28/12/2019 13:32	1,09	4	4,38	CHI
201912202078	MAIRIPOTABA	PK12076875LD	PONTALINA	25/12/2019 07:18	29/12/2019 11:12	28/12/2019 13:33	28/12/2019 19:10	5,61	1	5,61	CHI
201912202078	PONTALINA	PK12076875LD	PONTALINA	25/12/2019 07:18	29/12/2019 11:12	28/12/2019 13:33	28/12/2019 19:10	5,61	4	22,45	CHI
201912202078	PONTALINA	PK12041942	PONTALINA	25/12/2019 07:18	29/12/2019 11:12	28/12/2019 12:26	28/12/2019 19:40	7,24	5	36,19	CHI
201912202078	MAIRIPOTABA	PK12263491	PONTALINA	25/12/2019 07:18	29/12/2019 11:12	28/12/2019 20:05	28/12/2019 22:55	2,83	1	2,83	CHI
201912202078	PONTALINA	PK12263491	PONTALINA	25/12/2019 07:18	29/12/2019 11:12	28/12/2019 20:05	28/12/2019 22:55	2,83	17	48,19	CHI
201912202078	MAIRIPOTABA	PK12076875LD	PONTALINA	25/12/2019 07:18	29/12/2019 11:12	28/12/2019 20:05	29/12/2019 09:50	13,76	1	13,76	CHI
201912202078	PONTALINA	PK12076875LD	PONTALINA	25/12/2019 07:18	29/12/2019 11:12	28/12/2019 20:05	29/12/2019 09:50	13,76	4	55,04	CHI
201912202078	MAIRIPOTABA	PK12263504	PONTALINA	25/12/2019 07:18	29/12/2019 11:12	28/12/2019 13:33	29/12/2019 10:55	21,37	3	64,10	CHI
201912202078	PONTALINA	PK12263504	PONTALINA	25/12/2019 07:18	29/12/2019 11:12	28/12/2019 13:33	29/12/2019 10:55	21,37	4	85,47	CHI
201912202078	PONTALINA	PK12041942	PONTALINA	25/12/2019 07:18	29/12/2019 11:12	28/12/2019 20:05	29/12/2019 11:12	15,12	5	75,58	CHI
201912202087	CAMPINORTE	CR12221640	MARA ROSA	25/12/2019 07:19	25/12/2019 16:45	25/12/2019 07:19	25/12/2019 15:54	8,59	1	8,59	CHI
201912202087	URUACU	CR12221640	MARA ROSA	25/12/2019 07:19	25/12/2019 16:45	25/12/2019 07:19	25/12/2019 15:54	8,59	28	240,54	CHI
201912202087	CAMPINORTE	UR12231321	MARA ROSA	25/12/2019 07:19	25/12/2019 16:45	25/12/2019 16:40	25/12/2019 16:45	0,09	1	0,09	CHI
201912202087	URUACU	UR12231321	MARA ROSA	25/12/2019 07:19	25/12/2019 16:45	25/12/2019 16:40	25/12/2019 16:45	0,09	31	2,71	CHI
201912202093	DOVERLANDIA	DV11253347	CAIAPONIA	25/12/2019 07:20	25/12/2019 23:10	25/12/2019 07:20	25/12/2019 23:10	15,84	1	15,84	CHI
201912202095	BONOPOLIS	BX12266004	NOVO PLANALTO	25/12/2019 07:20	25/12/2019 11:50	25/12/2019 07:20	25/12/2019 11:50	4,49	3	13,48	CHI
201912202672	TEREZOPOLIS DE GOIAS	TJ12193124	DAIA S2	25/12/2019 07:20	25/12/2019 10:41	25/12/2019 07:20	25/12/2019 10:41	3,33	302	1007,09	CHI
201912202106	LUZIANIA	LZ21092852	MARAJOARA	25/12/2019 07:21	25/12/2019 13:08	25/12/2019 07:21	25/12/2019 13:08	5,78	1	5,78	CHI
201912202486	BURITI ALEGRE	BG12229309	ITUMBIARA VELHA S2	25/12/2019 07:21	25/12/2019 10:08	25/12/2019 07:21	25/12/2019 10:08	2,78	3	8,33	CHI
201912202917	ITAPURANGA	IK11000010	ITAPURANGA	25/12/2019 07:21	25/12/2019 09:52	25/12/2019 07:21	25/12/2019 09:52	2,52	210	528,27	CHI
201912204904	PONTALINA	PK12080054	PONTALINA	25/12/2019 07:21	25/12/2019 17:19	25/12/2019 07:21	25/12/2019 17:19	9,96	95	946,67	CHI
201912202111	PANAMA	PX12057616	GOIATUBA S1	25/12/2019 07:22	25/12/2019 11:22	25/12/2019 07:22	25/12/2019 11:22	4,00	45	179,90	CHI

201912202114	JAUPACI	JP12380852	IPORA	25/12/2019 07:22	25/12/2019 11:15	25/12/2019 07:22	25/12/2019 11:15	3,88	5	19,39	CHI
201912202115	PROFESSOR JAMIL SAFADY	JS21307968	ROCHEDO	25/12/2019 07:22	25/12/2019 11:38	25/12/2019 07:22	25/12/2019 11:38	4,25	1	4,25	CHI
201912202117	MINEIROS	SU12184123	SANTA RITA DO ARAGUAIA	25/12/2019 07:23	25/12/2019 21:20	25/12/2019 07:23	25/12/2019 20:06	12,71	15	190,72	CHI
201912202117	SANTA RITA DO ARAGUAIA	SU12184123	SANTA RITA DO ARAGUAIA	25/12/2019 07:23	25/12/2019 21:20	25/12/2019 07:23	25/12/2019 20:06	12,71	3	38,14	CHI
201912202117	SANTA RITA DO ARAGUAIA	SU12202820LD	SANTA RITA DO ARAGUAIA	25/12/2019 07:23	25/12/2019 21:20	25/12/2019 07:23	25/12/2019 21:12	13,81	1	13,81	CHI
201912202117	SANTA RITA DO ARAGUAIA	SU12202821LD	SANTA RITA DO ARAGUAIA	25/12/2019 07:23	25/12/2019 21:20	25/12/2019 07:23	25/12/2019 21:20	13,95	1	13,95	CHI
201912202850	SANTA HELENA DE GOIAS	SH12279545	IPEGUARI	25/12/2019 07:23	25/12/2019 17:32	25/12/2019 07:23	25/12/2019 17:32	10,15	10	101,50	CHI
201912202122	CATALAO	CT21042314	CATALAO S1	25/12/2019 07:24	25/12/2019 12:28	25/12/2019 07:24	25/12/2019 12:28	5,06	1	5,06	CHI
201912202128	NIQUELANDIA	NQ12330279	NIQUELANDIA SUBTRANSMISSAO	25/12/2019 07:25	25/12/2019 14:37	25/12/2019 07:25	25/12/2019 14:37	7,20	4	28,79	CHI
201912202207	SANTA CRUZ DE GOIAS	CF12103816	CRISTIANOPOLIS	25/12/2019 07:25	25/12/2019 10:53	25/12/2019 07:25	25/12/2019 10:53	3,46	10	34,65	CHI
201912202142	ARAGUAPAZ	AZ12271926LD	MOZARLANDIA	25/12/2019 07:27	26/12/2019 05:22	25/12/2019 07:27	26/12/2019 05:22	21,91	7	153,39	CHI
201912202780	AMARALINA	MU12087485	MARA ROSA	25/12/2019 07:27	26/12/2019 09:27	25/12/2019 07:27	26/12/2019 09:27	25,98	5	129,92	CHI
201912202780	MUTUNOPOLIS	MU12087485	MARA ROSA	25/12/2019 07:27	26/12/2019 09:27	25/12/2019 07:27	26/12/2019 09:27	25,98	11	285,82	CHI
201912202203	ANAPOLIS	AN21285312	ANAPOLIS UNIVERSITARIO S2	25/12/2019 07:28	25/12/2019 21:48	25/12/2019 07:28	25/12/2019 21:48	14,32	2	28,65	CHI
201912202400	MINEIROS	MY12324344	PARQUE DAS EMAS	25/12/2019 07:28	25/12/2019 11:42	25/12/2019 07:28	25/12/2019 11:42	4,23	7	29,61	CHI
201912198021	PONTALINA	PK12182928	PONTALINA	25/12/2019 07:29	25/12/2019 10:06	25/12/2019 07:29	25/12/2019 10:06	2,61	15	39,19	CHI
201912202210	PIRENOPOLIS	PV21194533	SAO FRANCISCO DE GOIAS	25/12/2019 07:29	25/12/2019 15:12	25/12/2019 07:29	25/12/2019 15:12	7,71	2	15,43	CHI
201912202218	FIRMINOPOLIS	FR12000070	FIRMINOPOLIS S1	25/12/2019 07:30	25/12/2019 09:40	25/12/2019 07:30	25/12/2019 09:40	2,16	6	12,98	CHI
201912202284	BALIZA	BH12331465	CAIAPONIA	25/12/2019 07:32	25/12/2019 22:37	25/12/2019 07:32	25/12/2019 22:37	15,08	26	392,17	CHI
201912202295	JATAI	JT12214347	JATAI S2	25/12/2019 07:32	25/12/2019 10:34	25/12/2019 07:32	25/12/2019 10:34	3,02	10	30,19	CHI
201912202852	CRIXAS	CX11210910	SERRA DO OURO	25/12/2019 07:32	25/12/2019 10:01	25/12/2019 07:32	25/12/2019 10:01	2,48	100	248,03	CHI
201912202244	LUZIANIA	LZ21209594	CRISTALINA S2	25/12/2019 07:33	25/12/2019 09:56	25/12/2019 07:33	25/12/2019 09:56	2,37	1	2,37	CHI
201912202798	MUNDO NOVO DE GOIAS	NA12035650	NOVA CRIXAS	25/12/2019 07:33	25/12/2019 16:26	25/12/2019 07:33	25/12/2019 16:26	8,87	8	70,99	CHI
201912202798	NOVA CRIXAS	NA12035650	NOVA CRIXAS	25/12/2019 07:33	25/12/2019 16:26	25/12/2019 07:33	25/12/2019 16:26	8,87	24	212,98	CHI
201912202249	CORUMBA DE GOIAS	260016305	CORUMBA	25/12/2019 07:34	25/12/2019 11:16	25/12/2019 07:34	25/12/2019 11:16	3,70	1	3,70	CHI
201912202251	TEREZOPOLIS DE GOIAS	TJ21327815	JUNDIAI S2	25/12/2019 07:34	25/12/2019 09:21	25/12/2019 07:34	25/12/2019 09:21	1,78	1	1,78	CHI
201912203047	SANTA HELENA DE GOIAS	SH12159472	IPEGUARI	25/12/2019 07:35	25/12/2019 12:50	25/12/2019 07:35	25/12/2019 12:50	5,25	203	1064,96	CHI
201912202266	MORRINHOS	MR21265934	VILA CORUMBA	25/12/2019 07:36	25/12/2019 15:38	25/12/2019 07:36	25/12/2019 15:38	8,02	1	8,02	CHI
201912202278	BOM JESUS DE GOIAS	VI13151722	VICENTINOPOLIS	25/12/2019 07:37	25/12/2019 21:45	25/12/2019 19:00	25/12/2019 21:45	2,75	1	2,75	CHI
201912202278	GOIATUBA	VI13151722	VICENTINOPOLIS	25/12/2019 07:37	25/12/2019 21:45	25/12/2019 19:00	25/12/2019 21:45	2,75	13	35,75	CHI
201912202278	JOVIANIA	VI13151722	VICENTINOPOLIS	25/12/2019 07:37	25/12/2019 21:45	25/12/2019 19:00	25/12/2019 21:45	2,75	17	46,75	CHI
201912202278	VICENTINOPOLIS	VI13151722	VICENTINOPOLIS	25/12/2019 07:37	25/12/2019 21:45	25/12/2019 19:00	25/12/2019 21:45	2,75	7	19,25	CHI
201912202291	CAIAPONIA	CP12410631	CAIAPONIA	25/12/2019 07:40	26/12/2019 19:02	25/12/2019 07:40	25/12/2019 20:51	13,18	11	144,99	CHI

201912202291	CAIAPONIA	CP12410631	CAIAPONIA	25/12/2019 07:40	26/12/2019 19:02	25/12/2019 20:59	26/12/2019 13:27	16,48	11	181,31	CHI
201912202291	CAIAPONIA	CP12410631	CAIAPONIA	25/12/2019 07:40	26/12/2019 19:02	26/12/2019 13:28	26/12/2019 15:33	2,10	7	14,69	CHI
201912202291	CAIAPONIA	CP12219461LD	CAIAPONIA	25/12/2019 07:40	26/12/2019 19:02	26/12/2019 13:28	26/12/2019 16:15	2,80	3	8,39	CHI
201912202291	CAIAPONIA	CP12301797LD	CAIAPONIA	25/12/2019 07:40	26/12/2019 19:02	25/12/2019 07:40	26/12/2019 18:16	34,61	6	207,63	CHI
201912202291	CAIAPONIA	CP12163956LD	CAIAPONIA	25/12/2019 07:40	26/12/2019 19:02	26/12/2019 13:28	26/12/2019 18:38	5,18	1	5,18	CHI
201912202291	CAIAPONIA	CP21158370	CAIAPONIA	25/12/2019 07:40	26/12/2019 19:02	26/12/2019 13:28	26/12/2019 19:02	5,57	0	0,00	CHI
201912202292	ITAJA	XX13422194	CACHOEIRA ALTA	25/12/2019 07:40	26/12/2019 10:59	25/12/2019 07:40	26/12/2019 10:59	27,31	3	81,92	CHI
201912202304	LUZIANIA	LZ12320068	CRISTALINA S2	25/12/2019 07:41	25/12/2019 10:43	25/12/2019 07:41	25/12/2019 10:43	3,02	4	12,09	CHI
201912202308	PONTALINA	PK11307878	PONTALINA	25/12/2019 07:42	25/12/2019 09:00	25/12/2019 07:42	25/12/2019 09:00	1,30	25	32,50	CHI
201912203355	TAQUARAL DE GOIAS	TQ12074928	ITABERAI S1	25/12/2019 07:42	25/12/2019 23:54	25/12/2019 07:42	25/12/2019 23:54	16,20	25	404,90	CHI
201912202317	PORANGATU	PO12137591	PORANGATU	25/12/2019 07:43	25/12/2019 13:40	25/12/2019 07:43	25/12/2019 13:40	5,94	3	17,82	CHI
201912202319	MORRINHOS	RQ12063040	RIO QUENTE	25/12/2019 07:44	25/12/2019 12:19	25/12/2019 07:44	25/12/2019 12:19	4,58	10	45,79	CHI
201912202319	RIO QUENTE	RQ12063040	RIO QUENTE	25/12/2019 07:44	25/12/2019 12:19	25/12/2019 07:44	25/12/2019 12:19	4,58	1	4,58	CHI
201912202744	ITAGUARI	II11068202	ITABERAI S1	25/12/2019 07:44	26/12/2019 15:35	25/12/2019 07:44	26/12/2019 15:35	31,85	49	1560,66	CHI
201912202806	RIO VERDE	RV11241416	RIO VERDE S2	25/12/2019 07:44	25/12/2019 20:24	25/12/2019 07:44	25/12/2019 20:24	12,65	98	1239,92	CHI
201912202958	ITAGUARI	II11049703	ITABERAI S1	25/12/2019 07:45	25/12/2019 23:20	25/12/2019 07:45	25/12/2019 23:20	15,58	116	1807,18	CHI
201912202339	JARAGUA	JA21293926	JARAGUA	25/12/2019 07:46	25/12/2019 12:53	25/12/2019 07:46	25/12/2019 12:53	5,11	2	10,21	CHI
201912202345	GOIAS	GS12325824	GOIAS	25/12/2019 07:46	25/12/2019 09:10	25/12/2019 07:46	25/12/2019 09:10	1,40	2	2,79	CHI
201912204355	JUSSARA	JR12011813	BRITANIA	25/12/2019 07:46	26/12/2019 19:19	25/12/2019 07:46	25/12/2019 18:17	10,52	29	305,15	CHI
201912204355	JUSSARA	JR12011813	BRITANIA	25/12/2019 07:46	26/12/2019 19:19	25/12/2019 13:35	25/12/2019 18:17	4,71	1	4,71	CHI
201912204355	JUSSARA	JR12011813	BRITANIA	25/12/2019 07:46	26/12/2019 19:19	25/12/2019 18:43	25/12/2019 22:27	3,74	7	26,18	CHI
201912204355	JUSSARA	JR12011813	BRITANIA	25/12/2019 07:46	26/12/2019 19:19	25/12/2019 18:43	26/12/2019 16:03	21,33	23	490,67	CHI
201912204355	JUSSARA	JR12011813	BRITANIA	25/12/2019 07:46	26/12/2019 19:19	26/12/2019 16:36	26/12/2019 16:54	0,30	7	2,11	CHI
201912204355	JUSSARA	JR13162413	BRITANIA	25/12/2019 07:46	26/12/2019 19:19	26/12/2019 16:36	26/12/2019 19:19	2,71	23	62,38	CHI
201912202371	EDEIA	EA21084061	VICENTINOPOLIS	25/12/2019 07:50	26/12/2019 10:36	25/12/2019 07:50	26/12/2019 10:36	26,76	1	26,76	CHI
201912202374	NOVA CRIXAS	NA21313350	NOVA CRIXAS	25/12/2019 07:50	25/12/2019 11:36	25/12/2019 07:50	25/12/2019 11:36	3,75	1	3,75	CHI
201912202375	PORTELANDIA	PW12303429	PARQUE DAS EMAS	25/12/2019 07:50	26/12/2019 16:10	25/12/2019 07:50	26/12/2019 16:10	32,32	2	64,64	CHI
201912202380	MINEIROS	MY12210139	PARQUE DAS EMAS	25/12/2019 07:51	25/12/2019 20:24	25/12/2019 07:51	25/12/2019 20:24	12,55	2	25,10	CHI
201912202382	PIRACANJUBA	PJ21282980	PIRACANJUBA	25/12/2019 07:51	25/12/2019 16:58	25/12/2019 07:51	25/12/2019 16:58	9,11	1	9,11	CHI
201912202392	PIRANHAS	PH12038593	PIRANHAS	25/12/2019 07:51	26/12/2019 00:20	25/12/2019 07:51	26/12/2019 00:20	16,47	23	378,77	CHI
201912203701	AGUA LIMPA	AL12391591RE	VILA CORUMBA	25/12/2019 07:51	26/12/2019 08:59	25/12/2019 07:51	26/12/2019 08:59	25,13	7	175,91	CHI
201912203701	MORRINHOS	AL12391591RE	VILA CORUMBA	25/12/2019 07:51	26/12/2019 08:59	25/12/2019 07:51	26/12/2019 08:59	25,13	8	201,04	CHI
201912202394	CAIAPONIA	CP11292020	CAIAPONIA	25/12/2019 07:52	25/12/2019 13:04	25/12/2019 07:52	25/12/2019 13:04	5,20	1	5,20	CHI



201912202405	MORRINHOS	MR21121919	MORRINHOS	25/12/2019 07:52	25/12/2019 12:15	25/12/2019 07:52	25/12/2019 12:15	4,37	1	4,37	CHI
201912202406	BOM JESUS DE GOIAS	BJ12030804	RIO DOS BOIS	25/12/2019 07:52	25/12/2019 17:45	25/12/2019 07:52	25/12/2019 17:45	9,87	4	39,48	CHI
201912202406	GOIATUBA	BJ12030804	RIO DOS BOIS	25/12/2019 07:52	25/12/2019 17:45	25/12/2019 07:52	25/12/2019 17:45	9,87	1	9,87	CHI
201912203989	BALIZA	DV12133496	CAIAPONIA	25/12/2019 07:52	25/12/2019 20:33	25/12/2019 07:52	25/12/2019 20:33	12,68	48	608,53	CHI
201912203989	DOVERLANDIA	DV12133496	CAIAPONIA	25/12/2019 07:52	25/12/2019 20:33	25/12/2019 07:52	25/12/2019 20:33	12,68	1	12,68	CHI
201912203265	ITABERAI	IB12000034	ITABERAI S2	25/12/2019 07:54	25/12/2019 11:15	25/12/2019 07:54	25/12/2019 11:15	3,33	163	543,42	CHI
201912203364	ITABERAI	IB11325060	ITABERAI S2	25/12/2019 07:54	25/12/2019 11:53	25/12/2019 07:54	25/12/2019 11:53	3,97	27	107,11	CHI
201912202447	TEREZOPOLIS DE GOIAS	TJ12353479	DAIA S2	25/12/2019 07:57	25/12/2019 13:09	25/12/2019 07:57	25/12/2019 13:09	5,20	13	67,57	CHI
201912202943	ANAPOLIS	AN12261182	JUNDIAI S1	25/12/2019 07:57	25/12/2019 10:08	25/12/2019 07:57	25/12/2019 10:08	2,17	148	320,95	CHI
201912202943	GOIANAPOLIS	AN12261182	JUNDIAI S1	25/12/2019 07:57	25/12/2019 10:08	25/12/2019 07:57	25/12/2019 10:08	2,17	9	19,52	CHI
201912202943	LEOPOLDO DE BULHOES	AN12261182	JUNDIAI S1	25/12/2019 07:57	25/12/2019 10:08	25/12/2019 07:57	25/12/2019 10:08	2,17	5	10,84	CHI
201912204614	JANDAIA	JD12008652	PALMEIRAS	25/12/2019 07:57	25/12/2019 19:03	25/12/2019 07:57	25/12/2019 19:03	11,09	8	88,68	CHI
201912202457	CALDAS NOVAS	760048976	SERRA DE CALDAS	25/12/2019 07:58	25/12/2019 11:53	25/12/2019 07:58	25/12/2019 11:53	3,92	1	3,92	CHI
201912202533	PIRES DO RIO	OZ12022847	PIRES DO RIO S2	25/12/2019 07:58	25/12/2019 10:50	25/12/2019 07:58	25/12/2019 10:50	2,86	8	22,91	CHI
201912202465	JARAGUA	70111390	JARAGUA	25/12/2019 07:59	25/12/2019 15:49	25/12/2019 07:59	25/12/2019 15:49	7,84	1	7,84	CHI
201912202511	JOVIANIA	JV11024944	GOIATUBA S1	25/12/2019 07:59	25/12/2019 11:06	25/12/2019 07:59	25/12/2019 11:06	3,10	122	378,57	CHI
201912202476	PIRACANJUBA	PJ12082194	PIRACANJUBA	25/12/2019 08:00	26/12/2019 08:18	25/12/2019 08:00	26/12/2019 08:18	24,29	2	48,57	CHI
201912203250	APORE	AE12061471	ITAJA S1	25/12/2019 08:01	25/12/2019 17:50	25/12/2019 08:01	25/12/2019 17:50	9,81	7	68,68	CHI
201912204438	CALDAS NOVAS	CN12363765	CALDAS NOVAS S1	25/12/2019 08:01	25/12/2019 17:23	25/12/2019 08:01	25/12/2019 17:23	9,36	19	177,78	CHI
201912202490	PARAUNA	PU21118504	PARAUNA	25/12/2019 08:02	25/12/2019 11:09	25/12/2019 08:02	25/12/2019 11:09	3,11	1	3,11	CHI
201912202493	CAIAPONIA	CP12200873	PALESTINA	25/12/2019 08:02	26/12/2019 15:19	25/12/2019 08:02	26/12/2019 15:19	31,27	54	1688,56	CHI
201912202499	PADRE BERNARDO	PB12376752	PADRE BERNARDO	25/12/2019 08:03	25/12/2019 09:22	25/12/2019 08:03	25/12/2019 09:22	1,31	6	7,85	CHI
201912202503	EDEIA	EA21308026	EDEIA	25/12/2019 08:03	26/12/2019 11:17	25/12/2019 08:03	26/12/2019 11:17	27,22	1	27,22	CHI
201912203007	JARAGUA	JA11222186	JARAGUA	25/12/2019 08:03	25/12/2019 11:52	25/12/2019 08:03	25/12/2019 11:52	3,80	126	479,12	CHI
201912204805	CORUMBA DE GOIAS	CB12381201	CORUMBA	25/12/2019 08:03	25/12/2019 15:55	25/12/2019 08:03	25/12/2019 15:55	7,86	5	39,29	CHI
201912202510	BOM JARDIM DE GOIAS	BM12064234	BOM JARDIM	25/12/2019 08:04	25/12/2019 21:58	25/12/2019 08:04	25/12/2019 21:58	13,89	4	55,56	CHI
201912202516	ANICUNS	AV12020503	ANICUNS	25/12/2019 08:05	25/12/2019 09:38	25/12/2019 08:05	25/12/2019 09:38	1,54	7	10,75	CHI
201912203054	CEZARINA	CZ12116977	CEZARINA	25/12/2019 08:05	25/12/2019 12:27	25/12/2019 08:05	25/12/2019 12:27	4,37	10	43,69	CHI
201912202525	PORANGATU	PO21288215	PORANGATU	25/12/2019 08:07	25/12/2019 17:25	25/12/2019 08:07	25/12/2019 17:25	9,30	1	9,30	CHI
201912202530	JATAI	JT21150955	JATAI S1	25/12/2019 08:07	25/12/2019 19:20	25/12/2019 08:07	25/12/2019 19:20	11,21	1	11,21	CHI
201912202535	GOUVELANDIA	GB12402307	QUIRINOPOLIS	25/12/2019 08:07	25/12/2019 15:43	25/12/2019 08:07	25/12/2019 15:43	7,59	3	22,78	CHI
201912202536	ANAPOLIS	20306258	JUNDIAI S1	25/12/2019 08:07	25/12/2019 11:37	25/12/2019 08:07	25/12/2019 11:37	3,49	1	3,49	CHI
201912202699	ANAPOLIS	AN12390204	ANAPOLIS UNIVERSITARIO S1	25/12/2019 08:07	25/12/2019 14:37	25/12/2019 08:07	25/12/2019 14:37	6,50	2	13,00	CHI

201912202547	CORUMBAIBA	CI21234673	VILA CORUMBA	25/12/2019 08:08	26/12/2019 10:59	25/12/2019 08:08	26/12/2019 10:59	26,84	1	26,84	CHI
201912202548	CRISTALINA	KR12305272	CRISTALINA S2	25/12/2019 08:08	25/12/2019 11:09	25/12/2019 08:08	25/12/2019 11:09	3,00	11	33,03	CHI
201912198988	IPORA	IR12207857	IPORA	25/12/2019 08:09	25/12/2019 09:45	25/12/2019 08:09	25/12/2019 09:45	1,60	12	19,23	CHI
201912202568	TURVELANDIA	TD21075423	RIO DOS BOIS	25/12/2019 08:10	26/12/2019 16:44	25/12/2019 08:10	26/12/2019 16:44	32,56	2	65,12	CHI
201912202665	JATAI	CP12147712	CAIAPONIA	25/12/2019 08:10	26/12/2019 07:32	25/12/2019 08:10	26/12/2019 07:32	23,35	3	70,05	CHI
201912202665	RIO VERDE	CP12147712	CAIAPONIA	25/12/2019 08:10	26/12/2019 07:32	25/12/2019 08:10	26/12/2019 07:32	23,35	4	93,41	CHI
201912202580	MORRINHOS	MR32076989	GOIATUBA S1	25/12/2019 08:11	25/12/2019 20:24	25/12/2019 08:11	25/12/2019 20:24	12,20	6	73,21	CHI
201912202760	GOIANESIA	GE12373995	GOIANESIA S2	25/12/2019 08:11	26/12/2019 07:44	25/12/2019 08:11	26/12/2019 07:44	23,54	18	423,74	CHI
201912202592	JARAGUA	JA21278912	JARAGUA	25/12/2019 08:13	25/12/2019 18:43	25/12/2019 08:13	25/12/2019 18:43	10,49	1	10,49	CHI
201912202604	PALMEIRAS DE GOIAS	PP12233536	PALMEIRAS	25/12/2019 08:15	25/12/2019 11:00	25/12/2019 08:15	25/12/2019 11:00	2,75	11	30,24	CHI
201912202604	PALMINOPOLIS	PP12233536	PALMEIRAS	25/12/2019 08:15	25/12/2019 11:00	25/12/2019 08:15	25/12/2019 11:00	2,75	1	2,75	CHI
201912202616	CATALAO	CT21333685	CATALAO S1	25/12/2019 08:16	25/12/2019 12:41	25/12/2019 08:16	25/12/2019 12:41	4,41	1	4,41	CHI
201912202620	DOVERLANDIA	4220014422	CAIAPONIA	25/12/2019 08:16	26/12/2019 11:21	25/12/2019 08:16	26/12/2019 11:21	27,07	1	27,07	CHI
201912202621	CATALAO	CT12075553LD	CATALAO S1	25/12/2019 08:17	25/12/2019 12:02	25/12/2019 08:17	25/12/2019 12:02	3,75	28	105,00	CHI
201912202621	GOIANDIRA	CT12075553LD	CATALAO S1	25/12/2019 08:17	25/12/2019 12:02	25/12/2019 08:17	25/12/2019 12:02	3,75	5	18,75	CHI
201912202629	MINACU	IH21187806	MINACU	25/12/2019 08:17	25/12/2019 14:04	25/12/2019 08:17	25/12/2019 14:04	5,78	1	5,78	CHI
201912202809	MONTES CLAROS DE GOIAS	ME12260033	IPORA	25/12/2019 08:17	25/12/2019 20:23	25/12/2019 08:17	25/12/2019 20:23	12,10	4	48,38	CHI
201912203284	JARAGUA	JA12273177	JARAGUA	25/12/2019 08:17	25/12/2019 11:14	25/12/2019 08:17	25/12/2019 11:14	2,94	7	20,60	CHI
201912202635	INDIARA	IY12010814	EDEIA	25/12/2019 08:18	25/12/2019 12:48	25/12/2019 08:18	25/12/2019 12:48	4,49	9	40,45	CHI
201912205396	CAIAPONIA	PH12170753	PIRANHAS	25/12/2019 08:18	26/12/2019 11:59	25/12/2019 08:18	26/12/2019 11:59	27,67	11	304,42	CHI
201912205396	PIRANHAS	PH12170753	PIRANHAS	25/12/2019 08:18	26/12/2019 11:59	25/12/2019 08:18	26/12/2019 11:59	27,67	1	27,67	CHI
201912202647	GOIANDIRA	550016340	CATALAO S1	25/12/2019 08:19	25/12/2019 20:30	25/12/2019 08:19	25/12/2019 20:30	12,18	1	12,18	CHI
201912203243	ITAPURANGA	FC12237749	ITAPURANGA	25/12/2019 08:19	25/12/2019 16:23	25/12/2019 08:19	25/12/2019 16:23	8,06	2	16,12	CHI
201912204079	PONTALINA	PK32046032	PONTALINA	25/12/2019 08:19	25/12/2019 18:21	25/12/2019 08:19	25/12/2019 18:21	10,03	15	150,44	CHI
201912202653	MONTES CLAROS DE GOIAS	ME12139989	IPORA	25/12/2019 08:20	25/12/2019 11:25	25/12/2019 08:20	25/12/2019 11:25	3,08	64	197,07	CHI
201912202656	PALMEIRAS DE GOIAS	PL12194014	PALMEIRAS	25/12/2019 08:20	25/12/2019 10:32	25/12/2019 08:20	25/12/2019 10:32	2,20	60	131,93	CHI
201912202659	CRIXAS	CX12062047	SANTA TEREZINHA	25/12/2019 08:20	26/12/2019 23:21	25/12/2019 08:20	26/12/2019 19:32	35,19	1	35,19	CHI
201912202659	CRIXAS	CX12239136LD	SANTA TEREZINHA	25/12/2019 08:20	26/12/2019 23:21	25/12/2019 08:20	26/12/2019 21:05	36,76	5	183,78	CHI
201912202659	CRIXAS	CX12239136LD	SANTA TEREZINHA	25/12/2019 08:20	26/12/2019 23:21	25/12/2019 08:20	26/12/2019 23:21	39,02	3	117,05	CHI
201912202659	CRIXAS	CX12239136LD	SANTA TEREZINHA	25/12/2019 08:20	26/12/2019 23:21	26/12/2019 21:06	26/12/2019 23:21	2,26	5	11,29	CHI
201912202815	JANDAIA	JD12308457	PALMEIRAS	25/12/2019 08:20	25/12/2019 16:30	25/12/2019 08:20	25/12/2019 16:30	8,17	18	146,98	CHI
201912202666	PORANGATU	PO12253874	PORANGATU	25/12/2019 08:21	25/12/2019 15:50	25/12/2019 08:21	25/12/2019 15:50	7,47	4	29,87	CHI
201912203177	RIO VERDE	RV11052129	SANTA HELENA S1	25/12/2019 08:21	26/12/2019 03:20	25/12/2019 08:21	26/12/2019 03:20	18,97	90	1707,40	CHI

201912202673	PIRENOPOLIS	PV12355915	CORUMBA	25/12/2019 08:22	25/12/2019 12:52	25/12/2019 08:22	25/12/2019 12:52	4,49	21	94,23	CHI
201912202676	CORUMBAIBA	CI12392156	VILA CORUMBA	25/12/2019 08:22	27/12/2019 09:37	25/12/2019 08:22	27/12/2019 09:37	49,24	8	393,89	CHI
201912202677	CACHOEIRA DE GOIAS	CG11215429	FIRMINOPOLIS S2	25/12/2019 08:22	25/12/2019 13:16	25/12/2019 08:22	25/12/2019 13:16	4,89	78	381,12	CHI
201912202680	EDEALINA	EA12257971	EDEIA	25/12/2019 08:22	26/12/2019 12:15	25/12/2019 08:22	26/12/2019 12:15	27,87	7	195,08	CHI
201912202680	INDIARA	EA12257971	EDEIA	25/12/2019 08:22	26/12/2019 12:15	25/12/2019 08:22	26/12/2019 12:15	27,87	2	55,74	CHI
201912202683	AMERICANO DO BRASIL	KB12322827	ANICUNS	25/12/2019 08:23	25/12/2019 11:26	25/12/2019 08:23	25/12/2019 11:26	3,05	2	6,10	CHI
201912202686	VICENTINOPOLIS	VI21093017	VICENTINOPOLIS	25/12/2019 08:23	26/12/2019 16:07	25/12/2019 08:23	26/12/2019 16:07	31,72	1	31,72	CHI
201912204399	JATAI	290346265	JATAI S1	25/12/2019 08:23	25/12/2019 14:20	25/12/2019 08:23	25/12/2019 14:20	5,94	1	5,94	CHI
201912198435	HIDROLANDIA	PJ12000117	PIRACANJUBA	25/12/2019 08:25	25/12/2019 19:00	25/12/2019 08:25	25/12/2019 19:00	10,57	8	84,57	CHI
201912198435	PIRACANJUBA	PJ12000117	PIRACANJUBA	25/12/2019 08:25	25/12/2019 19:00	25/12/2019 08:25	25/12/2019 19:00	10,57	58	613,11	CHI
201912198435	PROFESSOR JAMIL SAFADY	PJ12000117	PIRACANJUBA	25/12/2019 08:25	25/12/2019 19:00	25/12/2019 08:25	25/12/2019 19:00	10,57	13	137,42	CHI
201912202703	SAO LUIS DE MONTES BELOS	SL12011302	FIRMINOPOLIS S2	25/12/2019 08:25	25/12/2019 10:25	25/12/2019 08:25	25/12/2019 10:25	2,00	11	21,96	CHI
201912202709	CRISTALINA	KR12209473	CRISTALINA S2	25/12/2019 08:25	25/12/2019 11:36	25/12/2019 08:25	25/12/2019 11:36	3,18	5	15,88	CHI
201912204116	SAO MIGUEL DO PASSA QUATRO	SQ12111653	CRISTIANOPOLIS	25/12/2019 08:25	25/12/2019 14:30	25/12/2019 08:25	25/12/2019 14:30	6,07	6	36,45	CHI
201912204132	PORTELANDIA	PW11045395	PARQUE DAS EMAS	25/12/2019 08:25	25/12/2019 22:58	25/12/2019 08:25	25/12/2019 22:58	14,55	111	1614,56	CHI
201912202722	CRISTALINA	KR12248743	CRISTALINA S2	25/12/2019 08:26	26/12/2019 13:11	25/12/2019 08:26	26/12/2019 13:11	28,75	8	230,00	CHI
201912202725	EDEIA	EA12086939	EDEIA	25/12/2019 08:26	26/12/2019 12:33	25/12/2019 08:26	26/12/2019 12:33	28,10	8	224,81	CHI
201912202728	SILVANIA	SV21141398	DAIA S2	25/12/2019 08:27	25/12/2019 17:02	25/12/2019 08:27	25/12/2019 17:02	8,58	1	8,58	CHI
201912202736	CAIAPONIA	CP12338830	CAIAPONIA	25/12/2019 08:28	25/12/2019 11:20	25/12/2019 08:28	25/12/2019 11:20	2,85	10	28,54	CHI
201912203260	MINEIROS	MY12348865	PARQUE DAS EMAS	25/12/2019 08:28	25/12/2019 12:00	25/12/2019 08:28	25/12/2019 12:00	3,53	2	7,06	CHI
201912203479	ITAPURANGA	IK12387482	ITAPURANGA	25/12/2019 08:28	25/12/2019 18:11	25/12/2019 08:28	25/12/2019 18:11	9,70	25	242,54	CHI
201912202742	JARAGUA	3850000240	JARAGUA	25/12/2019 08:29	25/12/2019 15:35	25/12/2019 08:29	25/12/2019 15:35	7,09	1	7,09	CHI
201912202743	MINEIROS	MY12360754	PARQUE DAS EMAS	25/12/2019 08:29	25/12/2019 12:42	25/12/2019 08:29	25/12/2019 12:42	4,20	1	4,20	CHI
201912202755	SAO MIGUEL DO ARAGUAIA	SM12240639	SAO MIGUEL DO ARAGUAIA	25/12/2019 08:29	25/12/2019 11:50	25/12/2019 08:29	25/12/2019 11:50	3,33	3	10,00	CHI
201912204112	SANTA HELENA DE GOIAS	SH12279869	IPEGUARI	25/12/2019 08:29	25/12/2019 13:40	25/12/2019 08:29	25/12/2019 13:40	5,18	167	864,87	CHI
201912203171	ITAPIRAPUA	IU12018840	MATRINCHA	25/12/2019 08:30	25/12/2019 14:50	25/12/2019 08:30	25/12/2019 14:50	6,32	18	113,72	CHI
201912203319	JARAGUA	JA11140540	JARAGUA	25/12/2019 08:30	25/12/2019 11:58	25/12/2019 08:30	25/12/2019 11:58	3,46	111	384,15	CHI
201912202765	QUIRINOPOLIS	80034871	QUIRINOPOLIS	25/12/2019 08:31	25/12/2019 11:21	25/12/2019 08:31	25/12/2019 11:21	2,83	1	2,83	CHI
201912202771	HEITORAI	HE21023874	ITABERAI S1	25/12/2019 08:32	25/12/2019 17:04	25/12/2019 08:32	25/12/2019 17:04	8,53	1	8,53	CHI
201912204182	ESTRELA DO NORTE	ET12143710	MARA ROSA	25/12/2019 08:32	25/12/2019 22:24	25/12/2019 08:32	25/12/2019 22:24	13,87	4	55,46	CHI
201912204182	SANTA TEREZA DE GOIAS	ET12143710	MARA ROSA	25/12/2019 08:32	25/12/2019 22:24	25/12/2019 08:32	25/12/2019 22:24	13,87	4	55,46	CHI
201912202781	CATALAO	CT11384535	CATALAO S1	25/12/2019 08:33	25/12/2019 09:58	25/12/2019 08:33	25/12/2019 09:58	1,41	24	33,92	CHI
201912202784	PIRACANJUBA	PJ21111807	PIRACANJUBA	25/12/2019 08:33	26/12/2019 12:43	25/12/2019 08:33	26/12/2019 12:43	28,17	1	28,17	CHI

201912202963	ABADIANIA	AA12335610	ANAPOLIS UNIVERSITARIO S1	25/12/2019 08:33	26/12/2019 01:17	25/12/2019 08:33	26/12/2019 01:17	16,73	9	150,55	CHI
201912202802	PORTELANDIA	PW21303405	PARQUE DAS EMAS	25/12/2019 08:34	26/12/2019 16:23	25/12/2019 08:34	26/12/2019 16:23	31,80	1	31,80	CHI
201912202919	GOIANESIA	GE12384160	GOIANESIA S2	25/12/2019 08:34	26/12/2019 10:33	25/12/2019 08:34	26/12/2019 10:33	25,98	13	337,71	CHI
201912203033	RIO QUENTE	RQ12063401	RIO QUENTE	25/12/2019 08:34	25/12/2019 11:13	25/12/2019 08:34	25/12/2019 11:13	2,65	6	15,89	CHI
201912203365	ANAPOLIS	AN12000433	ANAPOLIS UNIVERSITARIO S2	25/12/2019 08:35	25/12/2019 11:30	25/12/2019 08:35	25/12/2019 11:30	2,91	16	46,52	CHI
201912203365	PIRENOPOLIS	AN12000433	ANAPOLIS UNIVERSITARIO S2	25/12/2019 08:35	25/12/2019 11:30	25/12/2019 08:35	25/12/2019 11:30	2,91	12	34,89	CHI
201912202812	PIRENOPOLIS	PV11239227	CORUMBA	25/12/2019 08:36	25/12/2019 12:15	25/12/2019 08:36	25/12/2019 12:15	3,65	44	160,44	CHI
201912202814	FAINA	FC21226868	GOIAS	25/12/2019 08:36	25/12/2019 11:11	25/12/2019 08:36	25/12/2019 11:11	2,58	1	2,58	CHI
201912202830	BONOPOLIS	BX21168232	SAO MIGUEL DO ARAGUAIA	25/12/2019 08:37	25/12/2019 21:52	25/12/2019 08:37	25/12/2019 21:52	13,24	1	13,24	CHI
201912203097	GOIANAPOLIS	GP12357383	DAIA S2	25/12/2019 08:37	25/12/2019 11:49	25/12/2019 08:37	25/12/2019 11:49	3,20	15	47,98	CHI
201912203097	GOIANIA	GP12357383	DAIA S2	25/12/2019 08:37	25/12/2019 11:49	25/12/2019 08:37	25/12/2019 11:49	3,20	1	3,20	CHI
201912203621	BONOPOLIS	BX12013030	SAO MIGUEL DO ARAGUAIA	25/12/2019 08:37	26/12/2019 01:09	25/12/2019 08:37	26/12/2019 01:09	16,53	4	66,10	CHI
201912205946	HIDROLINA	HL12068284	URUACU	25/12/2019 08:37	26/12/2019 09:00	25/12/2019 08:37	26/12/2019 09:00	24,39	21	512,25	CHI
201912202837	IPAMERI	UT12016932RE	URUTAI	25/12/2019 08:38	25/12/2019 09:45	25/12/2019 08:38	25/12/2019 09:45	1,11	3	3,33	CHI
201912202837	URUTAI	UT12016932RE	URUTAI	25/12/2019 08:38	25/12/2019 09:45	25/12/2019 08:38	25/12/2019 09:45	1,11	5	5,55	CHI
201912202844	MONTIVIDIU	RV12305784	MONTIVIDIU T	25/12/2019 08:38	26/12/2019 17:32	25/12/2019 08:38	26/12/2019 17:32	32,89	1	32,89	CHI
201912202844	RIO VERDE	RV12305784	MONTIVIDIU T	25/12/2019 08:38	26/12/2019 17:32	25/12/2019 08:38	26/12/2019 17:32	32,89	7	230,25	CHI
201912202845	RIO VERDE	RV21207167	RIO VERDE S1	25/12/2019 08:38	25/12/2019 11:29	25/12/2019 08:38	25/12/2019 11:29	2,84	1	2,84	CHI
201912202859	NOVO GAMA	2460093579	PACAEMBU S1	25/12/2019 08:40	25/12/2019 11:00	25/12/2019 08:40	25/12/2019 11:00	2,33	1	2,33	CHI
201912203031	EDEIA	EA12043985	EDEIA	25/12/2019 08:40	25/12/2019 22:11	25/12/2019 08:40	25/12/2019 22:11	13,51	4	54,03	CHI
201912203461	ITAPURANGA	IK12298409	ITAPURANGA	25/12/2019 08:41	25/12/2019 18:53	25/12/2019 08:41	25/12/2019 18:53	10,19	14	142,70	CHI
201912202885	AGUAS LINDAS DE GOIAS	4830031142	AGUAS LINDAS DE GOIAS S1	25/12/2019 08:42	25/12/2019 10:15	25/12/2019 08:42	25/12/2019 10:15	1,54	1	1,54	CHI
201912203182	GOIANAPOLIS	GP12273038	DAIA S2	25/12/2019 08:42	25/12/2019 15:19	25/12/2019 08:42	25/12/2019 15:19	6,62	7	46,31	CHI
201912202940	JARAGUA	JA12221349	JARAGUA	25/12/2019 08:43	25/12/2019 10:53	25/12/2019 08:43	25/12/2019 10:53	2,16	6	12,93	CHI
201912203467	ANAPOLIS	AN12026162	ANAPOLIS UNIVERSITARIO S2	25/12/2019 08:43	25/12/2019 14:48	25/12/2019 08:43	25/12/2019 14:48	6,08	6	36,49	CHI
201912203912	CACHOEIRA DOURADA	CD12222456	CACHOEIRA DOURADA	25/12/2019 08:43	25/12/2019 14:00	25/12/2019 08:43	25/12/2019 14:00	5,28	4	21,13	CHI
201912202904	JARAGUA	70122805	JARAGUA	25/12/2019 08:44	25/12/2019 13:30	25/12/2019 08:44	25/12/2019 13:30	4,76	1	4,76	CHI
201912199113	ITAPURANGA	IK12300342	ITAPURANGA	25/12/2019 08:46	25/12/2019 16:54	25/12/2019 08:46	25/12/2019 16:54	8,14	38	309,21	CHI
201912202912	JARAGUA	JA12112518	JARAGUA	25/12/2019 08:46	25/12/2019 12:44	25/12/2019 08:46	25/12/2019 12:44	3,96	16	63,40	CHI
201912202918	SILVANIA	SV21078661	DAIA S2	25/12/2019 08:46	25/12/2019 11:20	25/12/2019 08:46	25/12/2019 11:20	2,57	1	2,57	CHI
201912202920	MAIRIPOTABA	7555290	PONTALINA	25/12/2019 08:46	26/12/2019 14:24	25/12/2019 08:46	26/12/2019 14:24	29,62	1	29,62	CHI
201912205854	GOIATUBA	GT12352741RE	BOM JESUS DE GOIAS	25/12/2019 08:47	26/12/2019 16:22	25/12/2019 08:47	25/12/2019 18:40	9,87	58	572,32	CHI
201912205854	GOIATUBA	GT12352741RE	BOM JESUS DE GOIAS	25/12/2019 08:47	26/12/2019 16:22	25/12/2019 18:41	25/12/2019 19:12	0,52	36	18,80	CHI

201912205854	GOIATUBA	GT12352741RE	BOM JESUS DE GOIAS	25/12/2019 08:47	26/12/2019 16:22	25/12/2019 20:30	25/12/2019 20:58	0,47	36	16,79	CHI
201912205854	GOIATUBA	GT12190946 LD	BOM JESUS DE GOIAS	25/12/2019 08:47	26/12/2019 16:22	25/12/2019 18:41	26/12/2019 16:22	21,68	22	476,94	CHI
201912205931	SANTA RITA DO NOVO DESTINO	BA12211709	BARRO ALTO	25/12/2019 08:47	26/12/2019 02:02	25/12/2019 08:47	26/12/2019 02:02	17,23	98	1689,00	CHI
201912202929	GOIATUBA	GT12008206	BOM JESUS DE GOIAS	25/12/2019 08:48	25/12/2019 17:31	25/12/2019 08:48	25/12/2019 17:31	8,71	15	130,70	CHI
201912202955	ITAPURANGA	IK12250609	ITAPURANGA	25/12/2019 08:48	26/12/2019 10:14	25/12/2019 08:48	26/12/2019 10:14	25,43	22	559,50	CHI
201912202937	PIRANHAS	PH12381017	PIRANHAS	25/12/2019 08:49	26/12/2019 07:06	25/12/2019 08:49	26/12/2019 07:06	22,28	12	267,34	CHI
201912202947	ITABERAI	50002922	ITABERAI S2	25/12/2019 08:50	25/12/2019 11:49	25/12/2019 08:50	25/12/2019 11:49	2,98	1	2,98	CHI
201912202957	PIRENOPOLIS	PV21245637	SAO FRANCISCO DE GOIAS	25/12/2019 08:51	25/12/2019 15:14	25/12/2019 08:51	25/12/2019 15:14	6,37	2	12,74	CHI
201912202959	MORRINHOS	10029831812	MORRINHOS	25/12/2019 08:52	25/12/2019 16:05	25/12/2019 08:52	25/12/2019 16:05	7,21	1	7,21	CHI
201912202971	MORRINHOS	MR21000293	GOIATUBA S1	25/12/2019 08:53	25/12/2019 19:13	25/12/2019 08:53	25/12/2019 19:13	10,32	1	10,32	CHI
201912202974	MONTES CLAROS DE GOIAS	ME12085895	IPORA	25/12/2019 08:54	25/12/2019 13:19	25/12/2019 08:54	25/12/2019 13:19	4,41	21	92,69	CHI
201912203078	COCALZINHO DE GOIAS	ZN12297780	COCALZINHO	25/12/2019 08:54	25/12/2019 16:57	25/12/2019 08:54	25/12/2019 16:57	8,04	1	8,04	CHI
201912202991	BALIZA	BH12380942	BOM JARDIM	25/12/2019 08:55	25/12/2019 20:33	25/12/2019 08:55	25/12/2019 20:33	11,62	7	81,32	CHI
201912203020	RIO VERDE	RV12249024	SANTA HELENA S1	25/12/2019 08:55	26/12/2019 12:49	25/12/2019 08:55	26/12/2019 12:49	27,89	7	195,25	CHI
201912203232	DOVERLANDIA	DV11193282	CAIAPONIA	25/12/2019 08:55	25/12/2019 12:35	25/12/2019 08:55	25/12/2019 12:35	3,66	39	142,86	CHI
201912203001	PONTALINA	PK12057749	VICENTINOPOLIS	25/12/2019 08:56	26/12/2019 08:45	25/12/2019 08:56	26/12/2019 08:45	23,80	3	71,41	CHI
201912203002	VALPARAISO DE GOIAS	VA11089618	PACAEMBU S1	25/12/2019 08:57	25/12/2019 11:42	25/12/2019 08:57	25/12/2019 11:42	2,75	84	231,33	CHI
201912203006	MONTES CLAROS DE GOIAS	ME12204928	IPORA	25/12/2019 08:57	25/12/2019 14:39	25/12/2019 08:57	25/12/2019 14:39	5,69	5	28,47	CHI
201912203132	GOIAS	GS12220496	MATRINCHA	25/12/2019 08:57	27/12/2019 12:07	25/12/2019 08:57	27/12/2019 12:07	51,16	4	204,66	CHI
201912204584	COCALZINHO DE GOIAS	ZN12402010RE	COCALZINHO	25/12/2019 08:57	25/12/2019 16:57	25/12/2019 08:57	25/12/2019 16:57	8,00	93	743,92	CHI
201912204584	VILA PROPICIO	ZN12402010RE	COCALZINHO	25/12/2019 08:57	25/12/2019 16:57	25/12/2019 08:57	25/12/2019 16:57	8,00	1	8,00	CHI
201912203980	GOIANESIA	JA12297408	GOIANESIA S2	25/12/2019 08:58	25/12/2019 11:58	25/12/2019 08:58	25/12/2019 11:58	3,00	1	3,00	CHI
201912203980	JARAGUA	JA12297408	GOIANESIA S2	25/12/2019 08:58	25/12/2019 11:58	25/12/2019 08:58	25/12/2019 11:58	3,00	13	38,97	CHI
201912203032	MINEIROS	1390145612	PARQUE DAS EMAS	25/12/2019 08:59	25/12/2019 22:53	25/12/2019 08:59	25/12/2019 22:53	13,89	1	13,89	CHI
201912204397	JANDAIA	JD12289833	PALMEIRAS	25/12/2019 08:59	25/12/2019 16:30	25/12/2019 08:59	25/12/2019 16:30	7,52	91	683,87	CHI
201912204397	PARAUNA	JD12289833	PALMEIRAS	25/12/2019 08:59	25/12/2019 16:30	25/12/2019 08:59	25/12/2019 16:30	7,52	23	172,85	CHI
201912204397	JANDAIA	JD12289833	PARAUNA	25/12/2019 08:59	25/12/2019 16:30	25/12/2019 08:59	25/12/2019 16:30	7,52	3	22,55	CHI
201912204397	PARAUNA	JD12289833	PARAUNA	25/12/2019 08:59	25/12/2019 16:30	25/12/2019 08:59	25/12/2019 16:30	7,52	23	172,85	CHI



# Plotagem das Ocorrências conforme a Espacialização das Chuvas

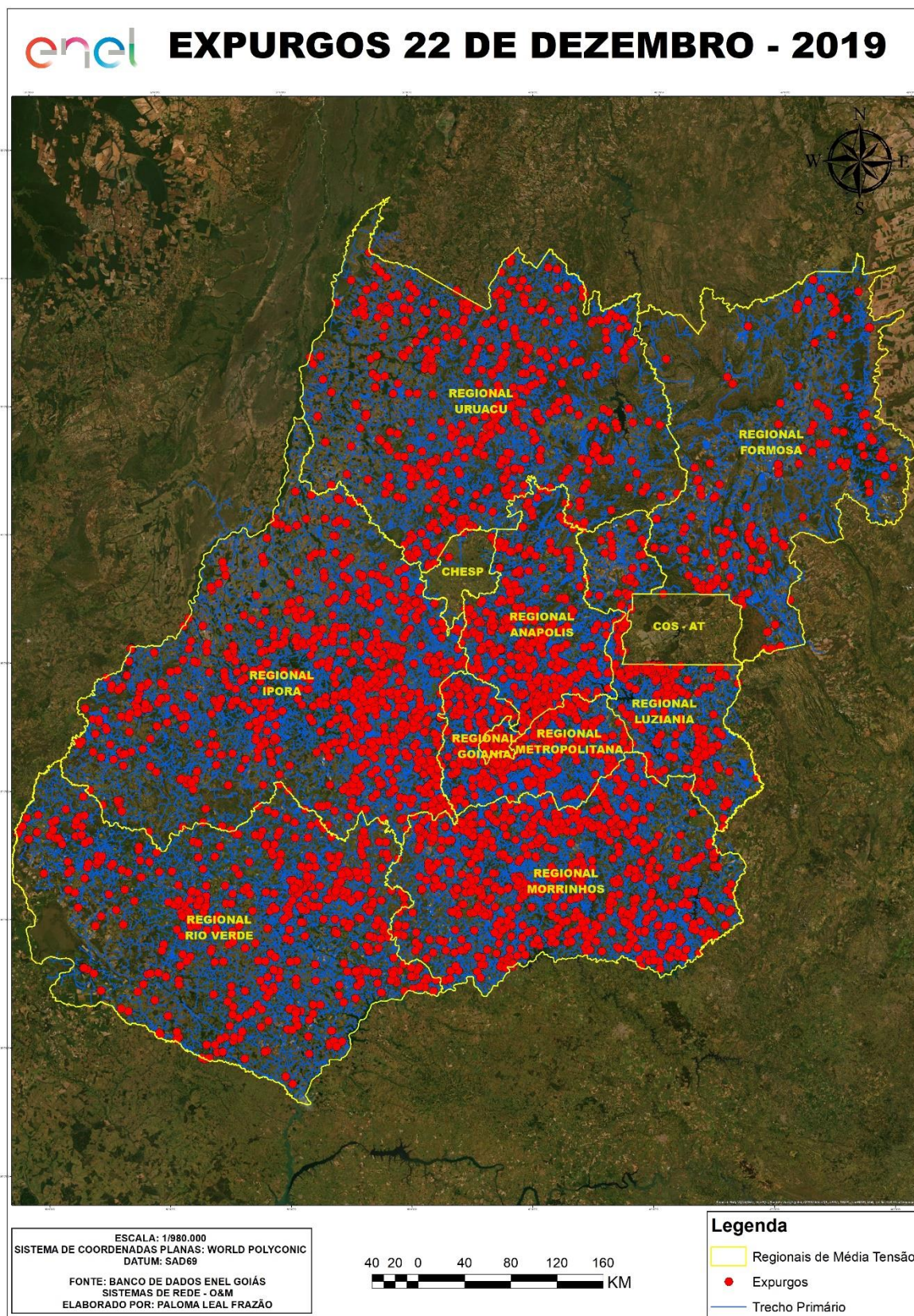

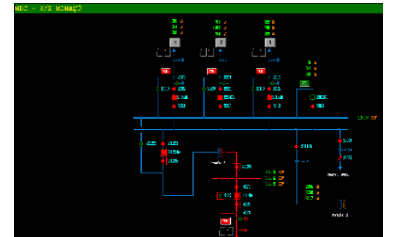
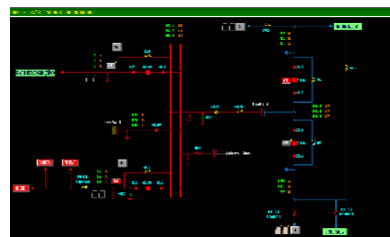
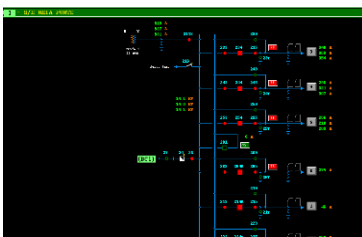
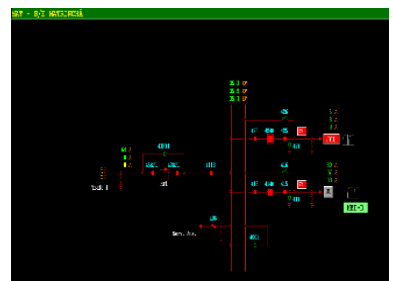
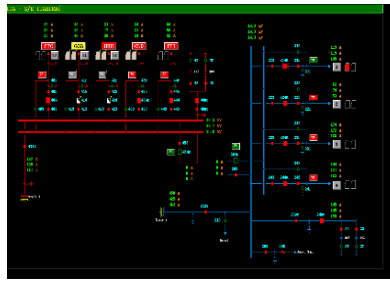
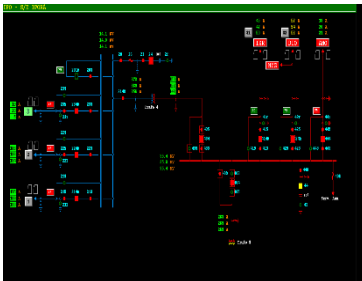
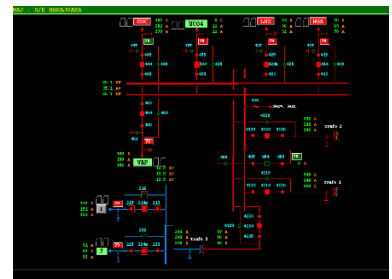
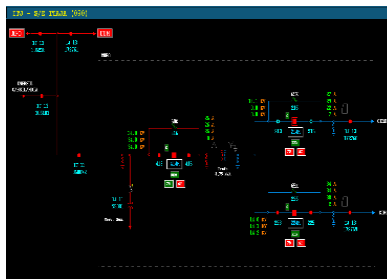
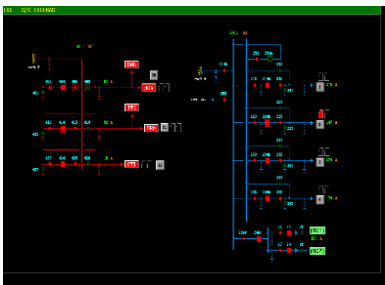
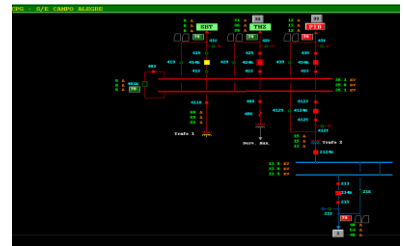
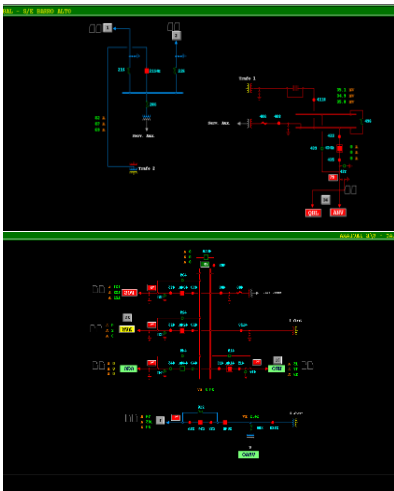
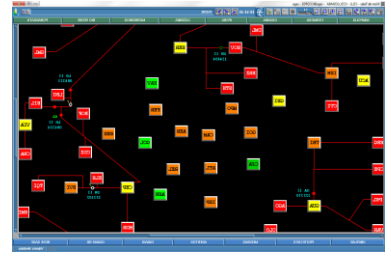
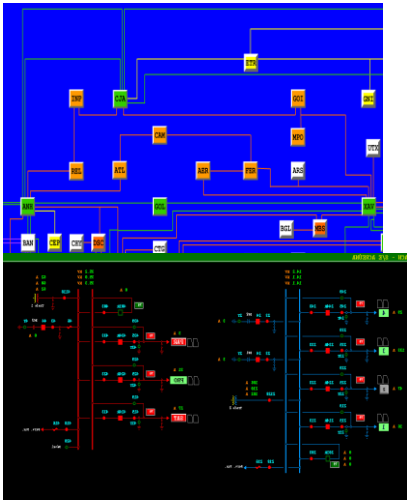

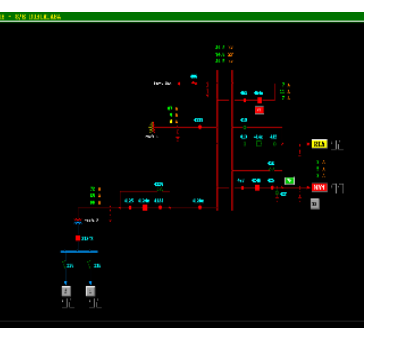
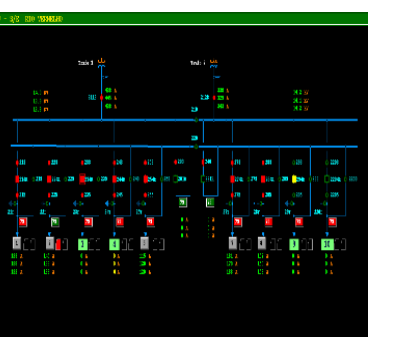
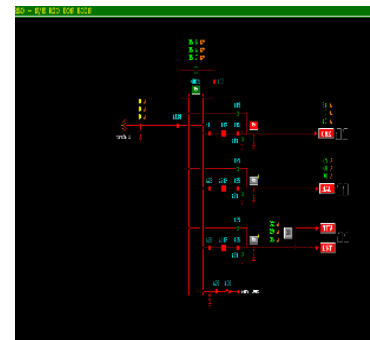
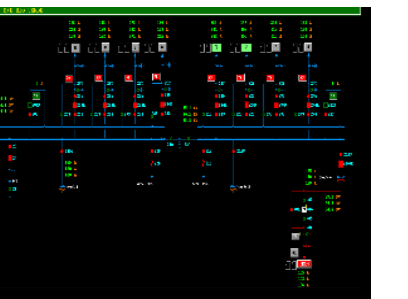
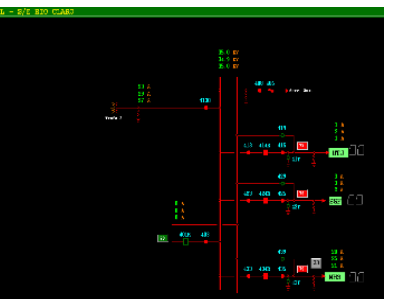
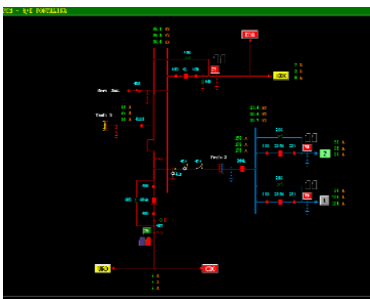
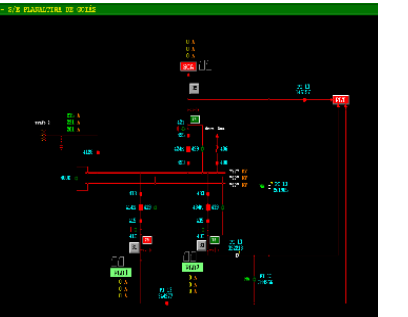
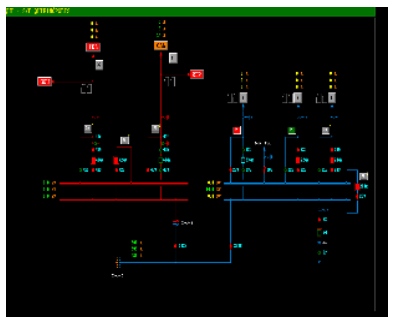
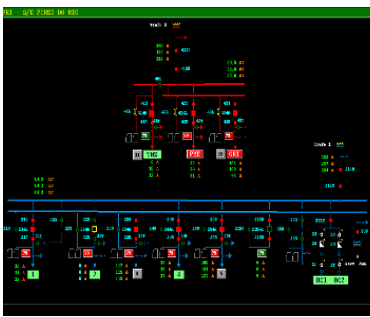
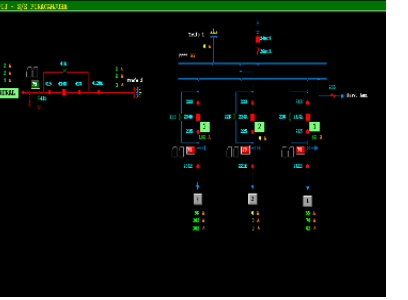
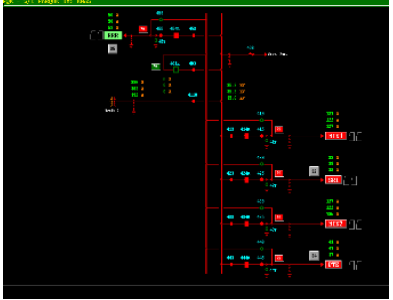
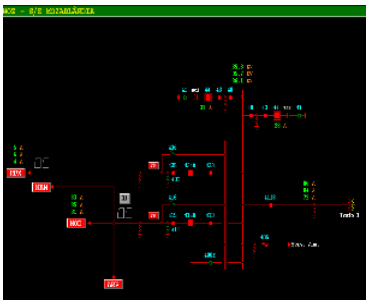
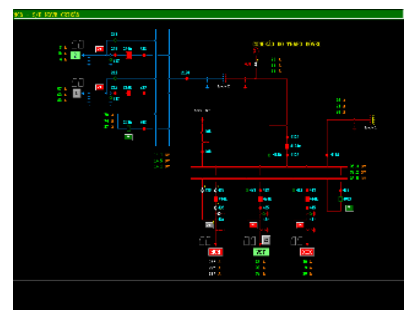
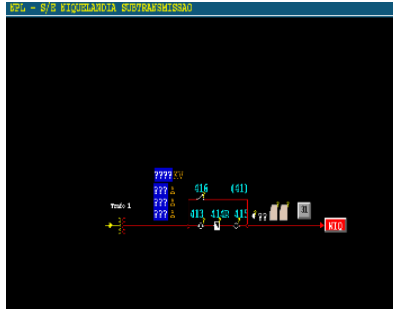



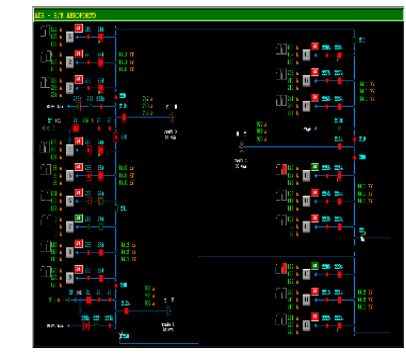
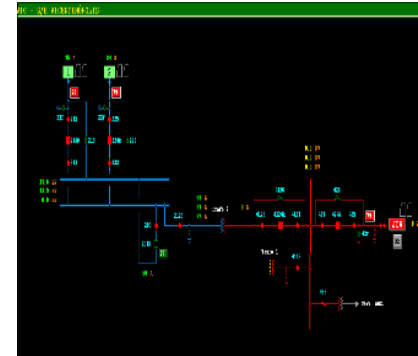
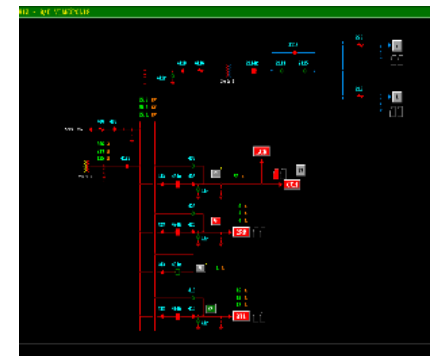
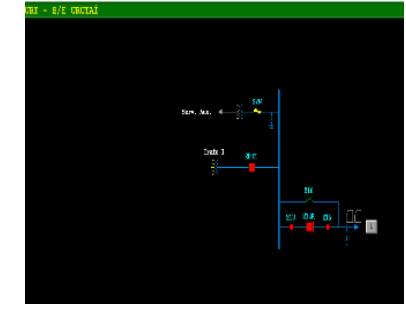
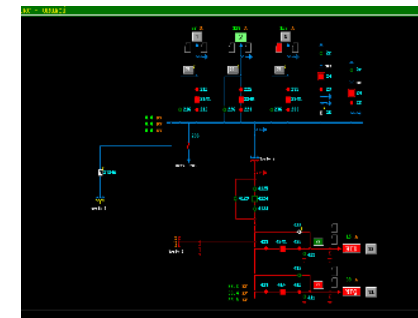
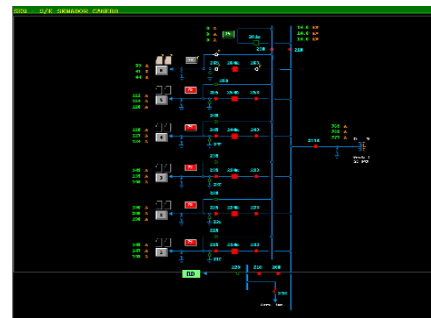
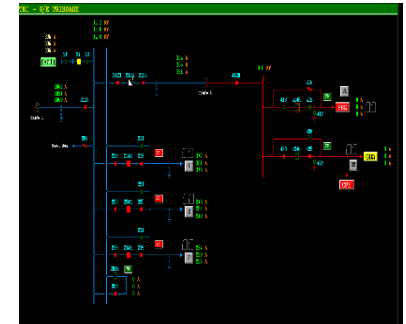
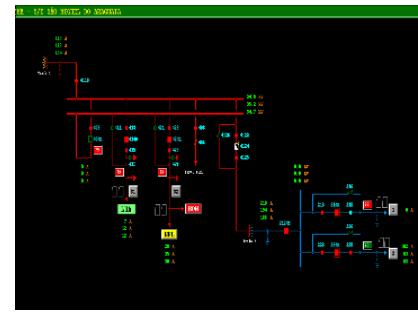
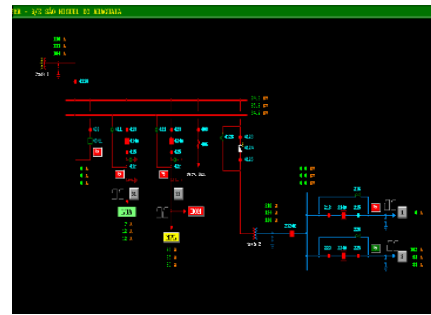
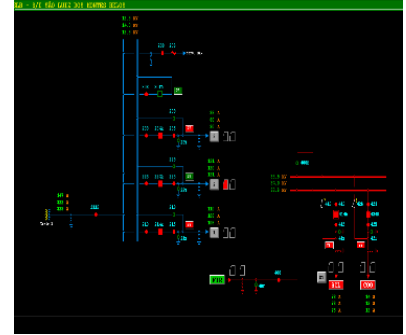
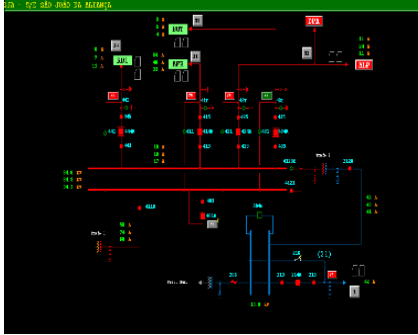
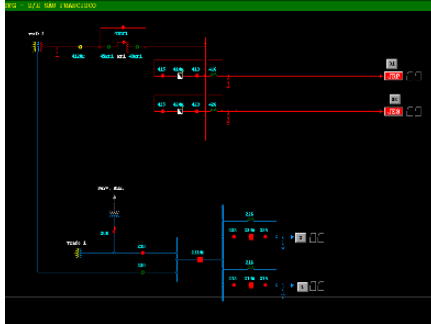
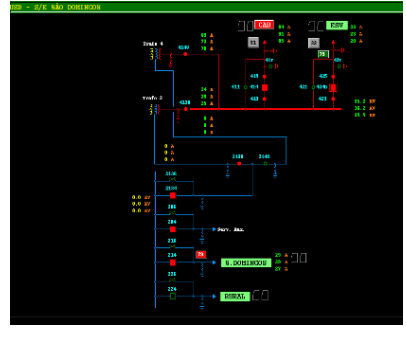
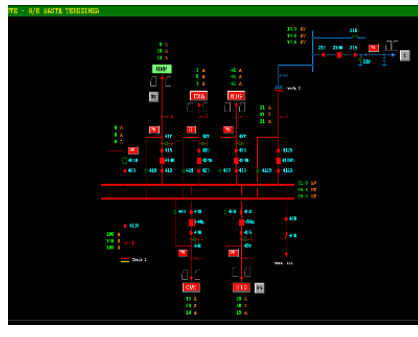
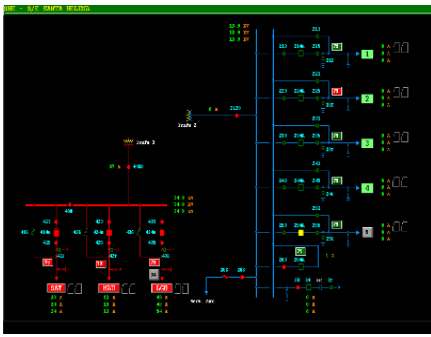

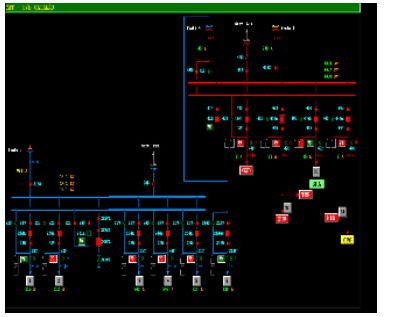
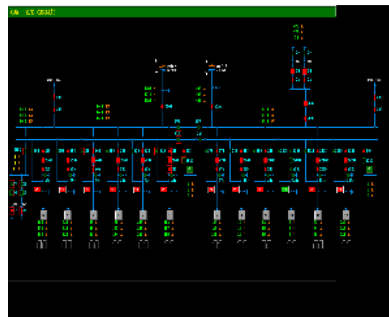
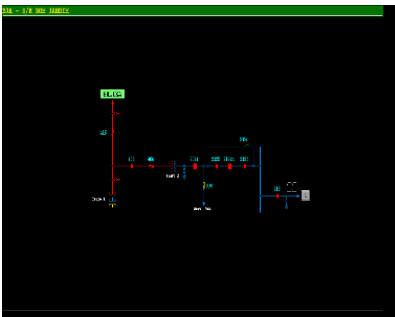
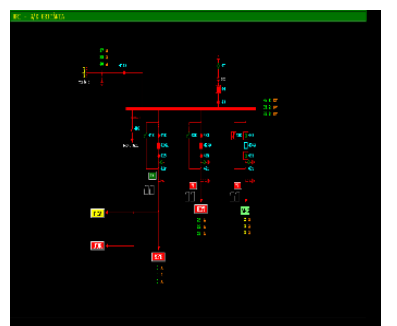
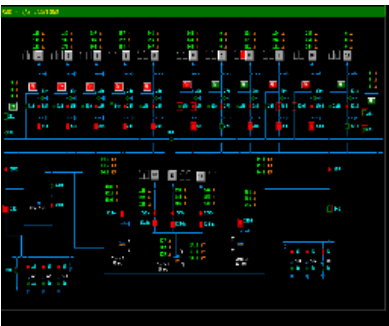
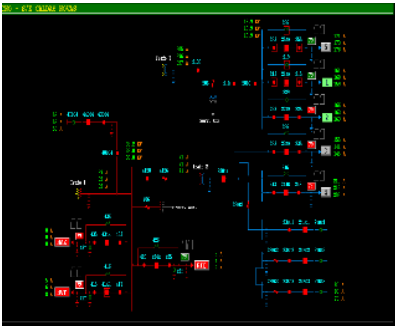
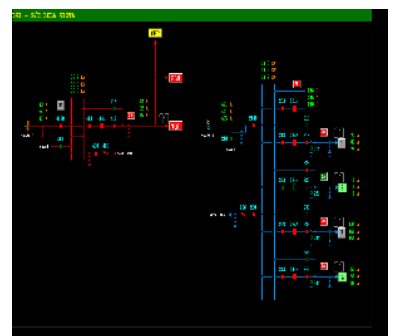
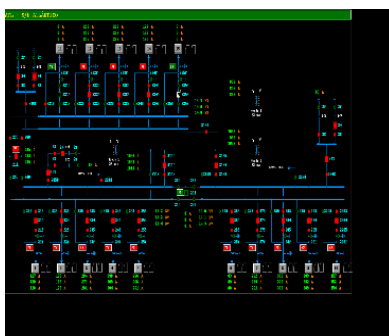
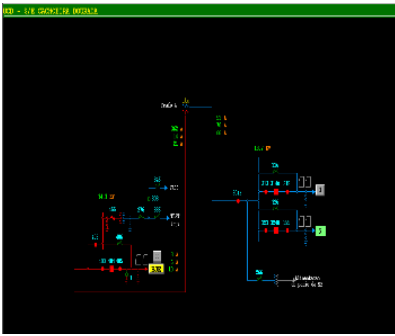
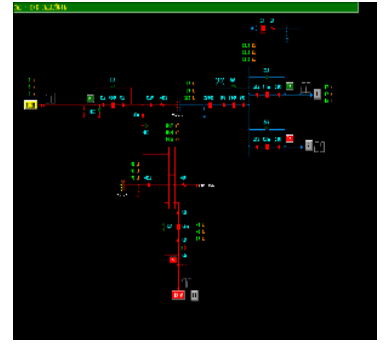
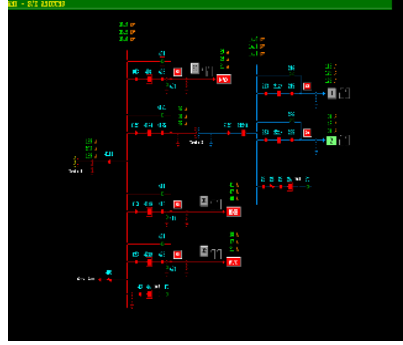
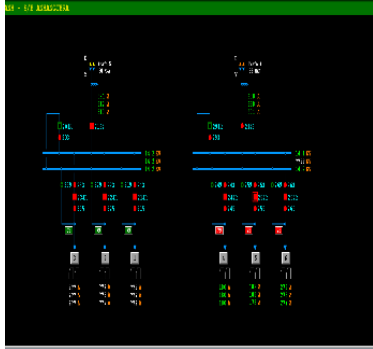
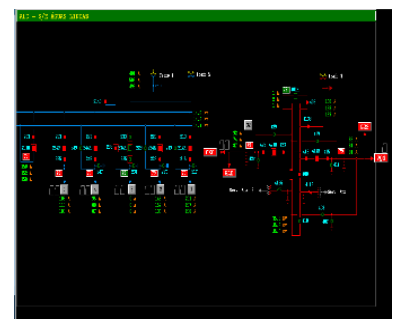
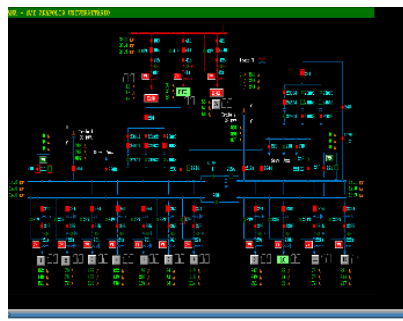
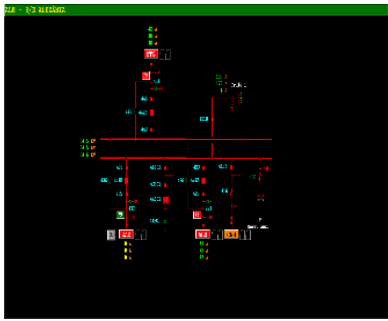



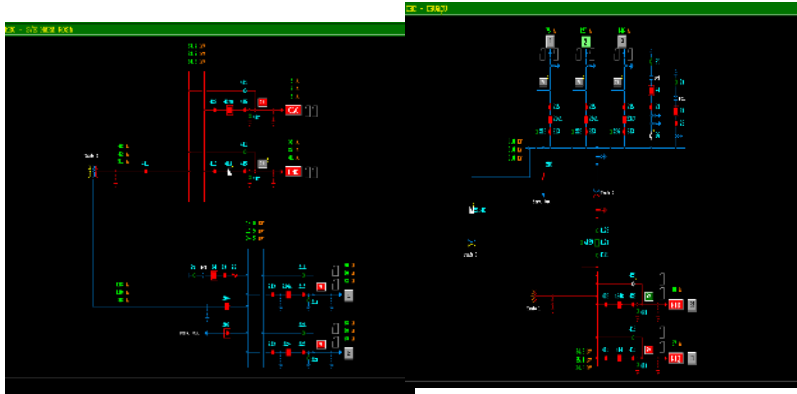
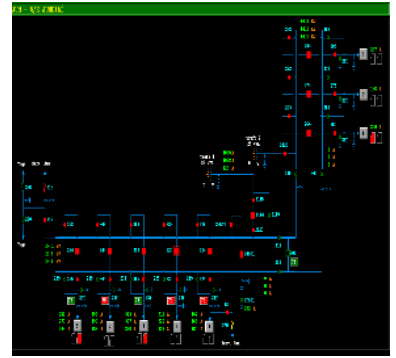
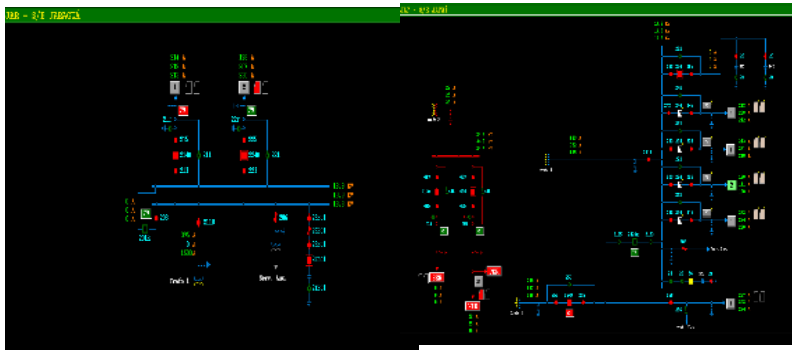

# DEMAIS EVIDÊNCIAS

## DADOS TÉCNICO - OPERACIONAIS ENEL GO

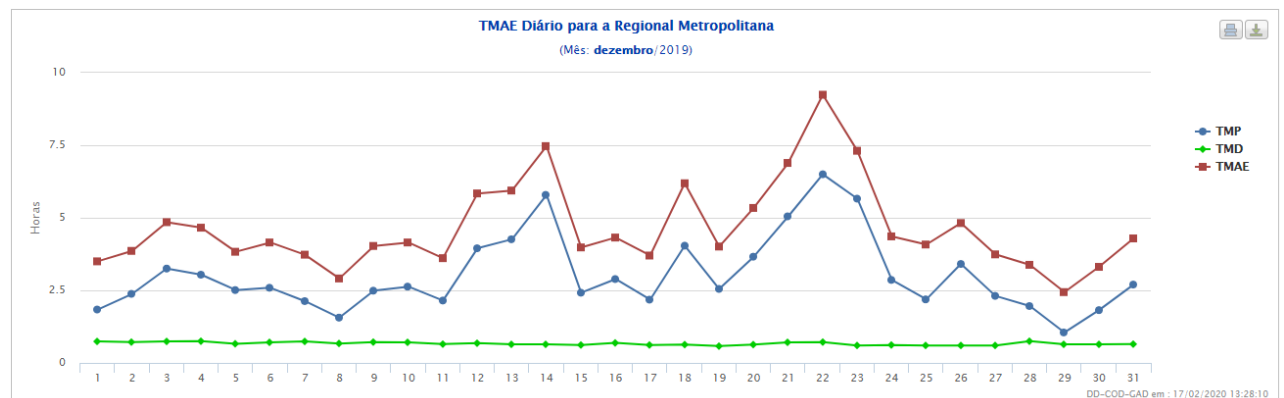
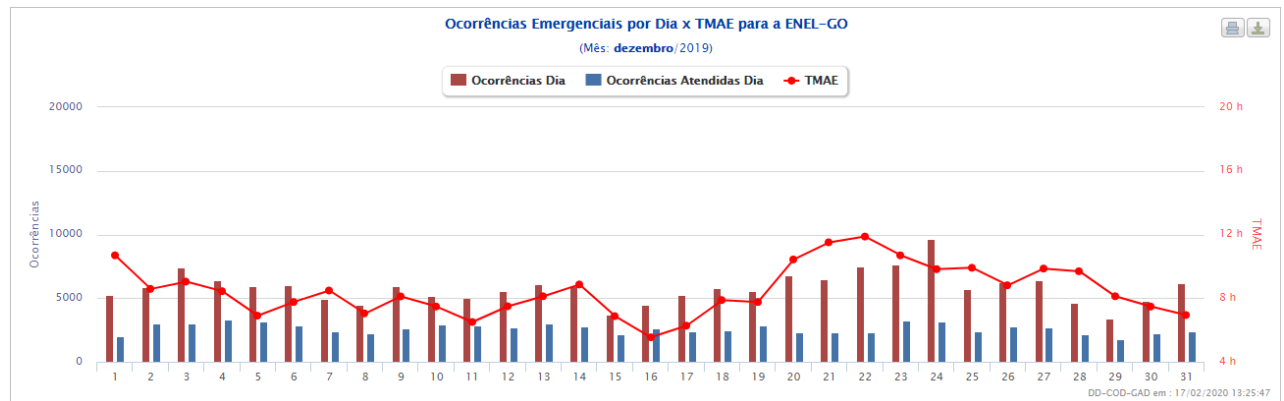
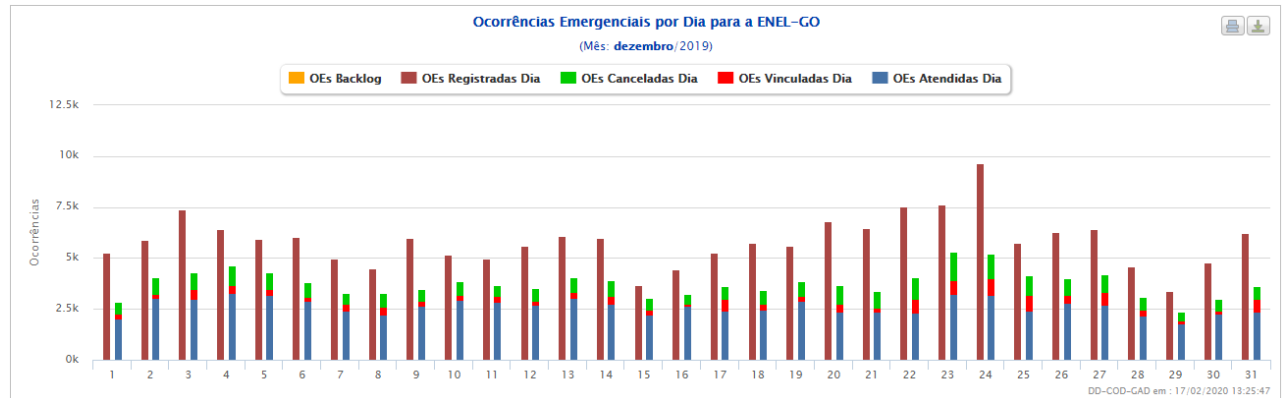
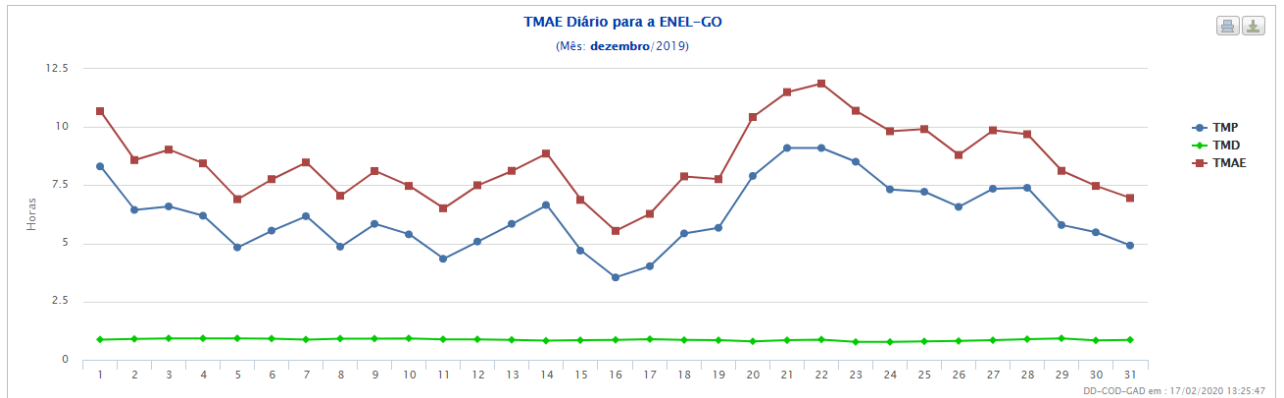

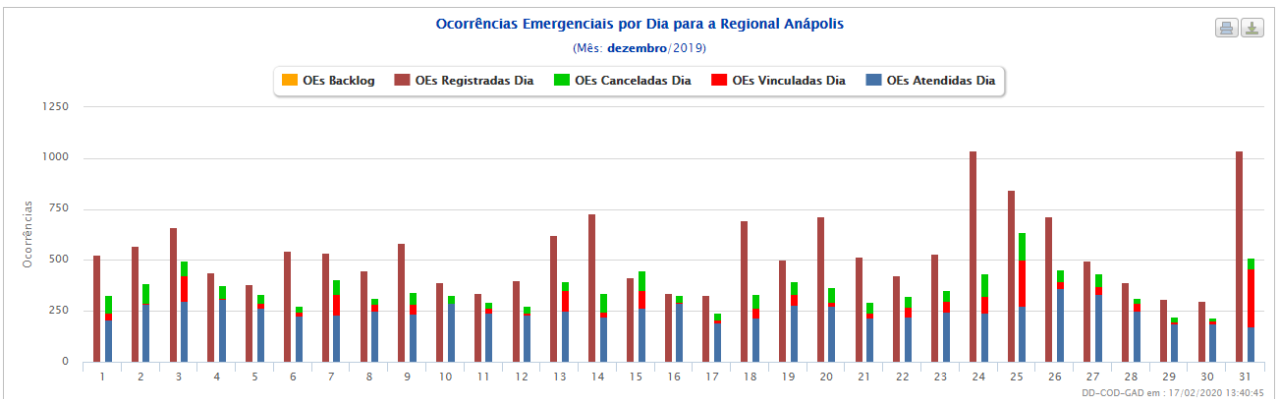
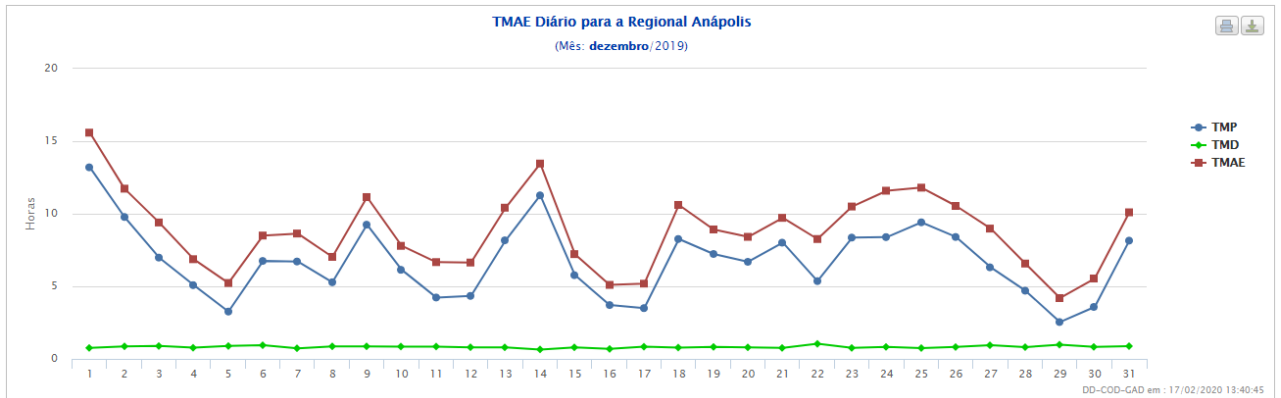
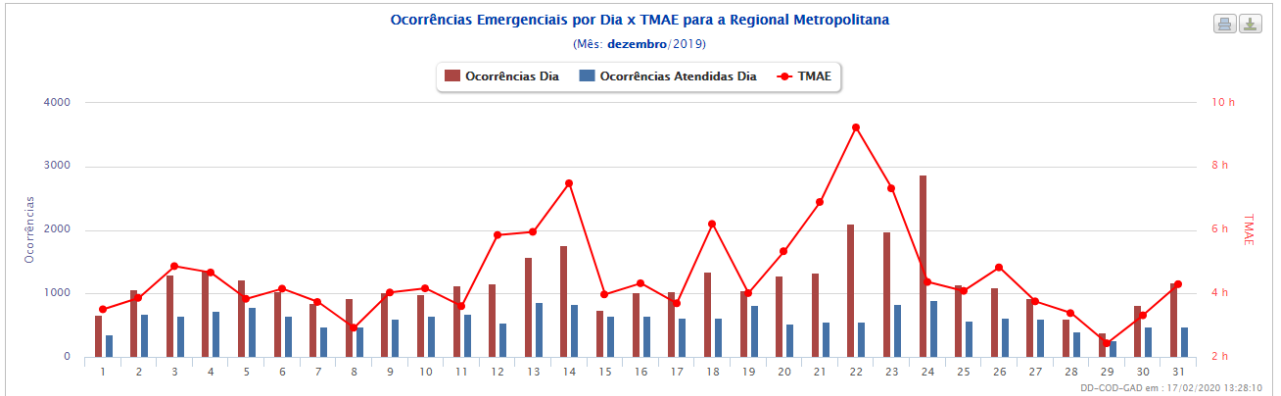
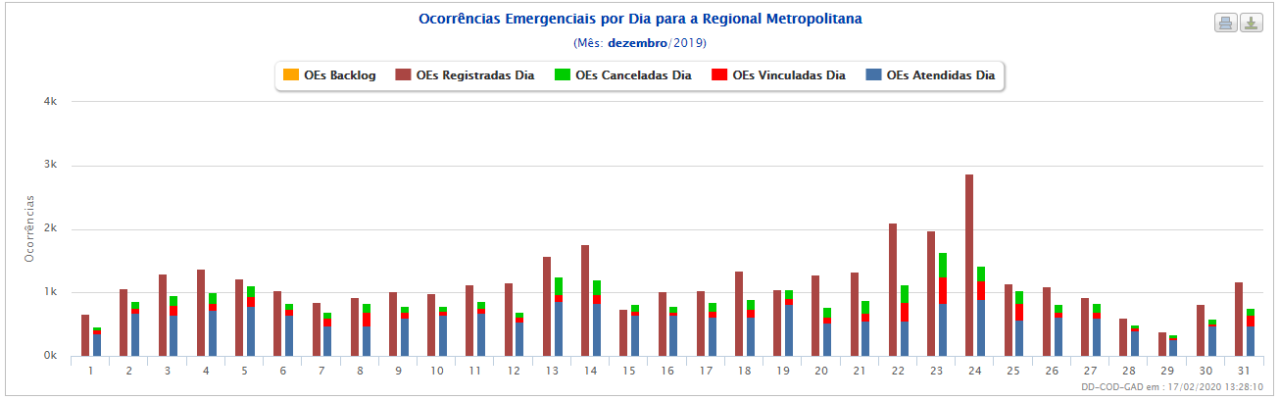

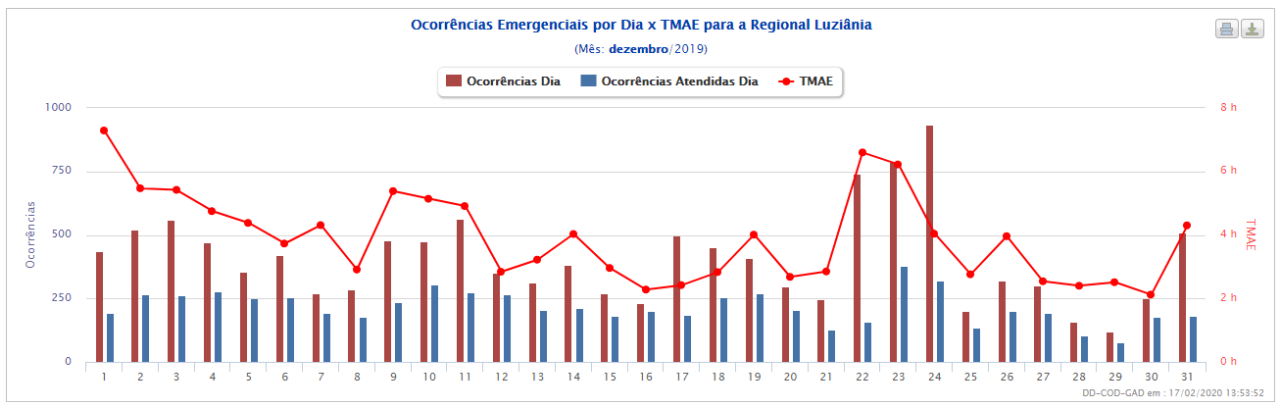
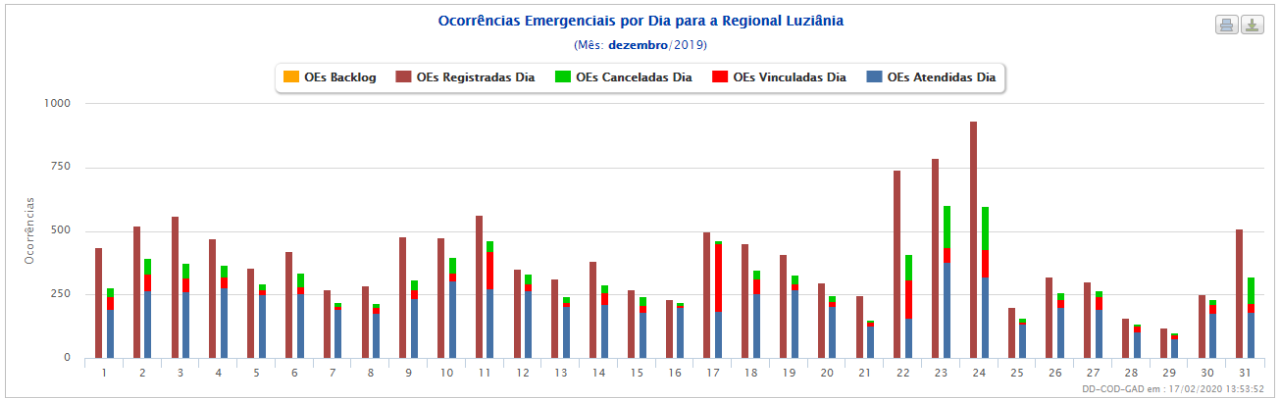
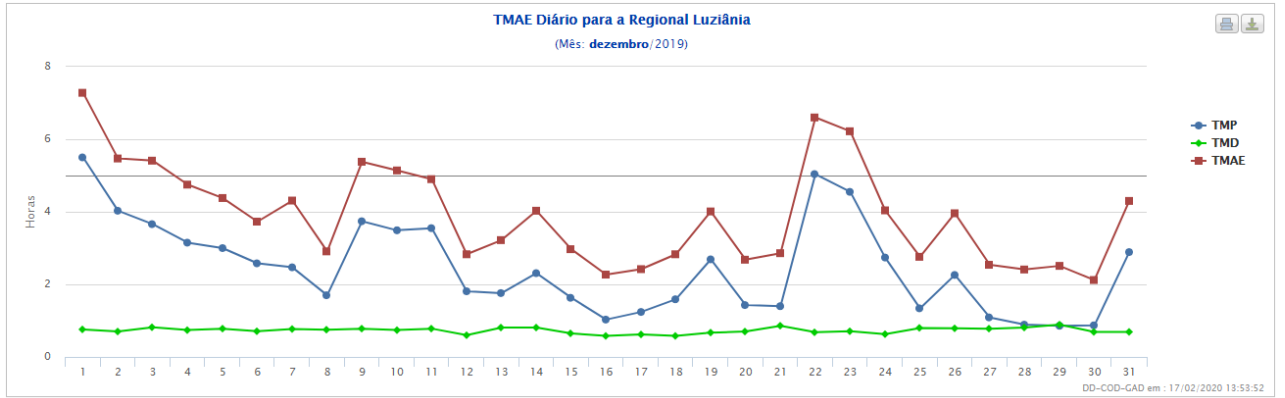
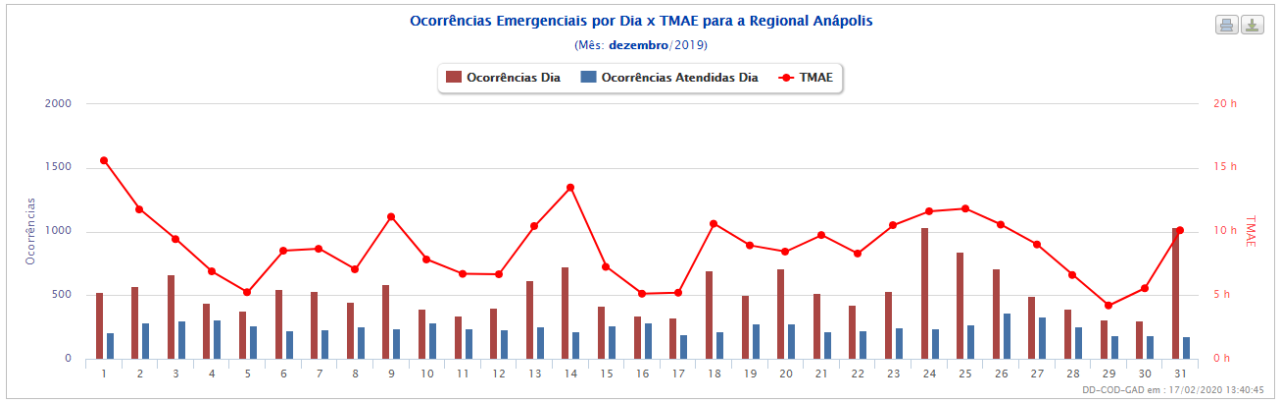

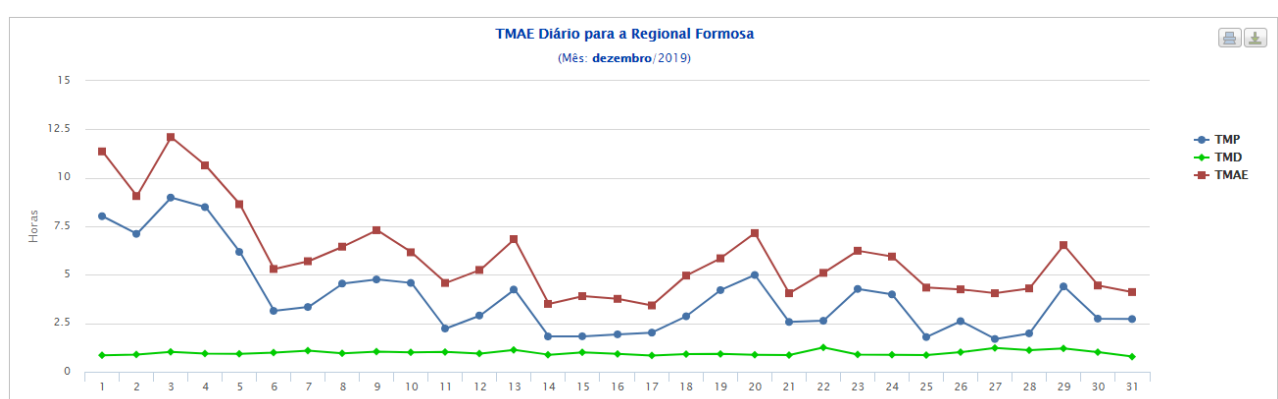
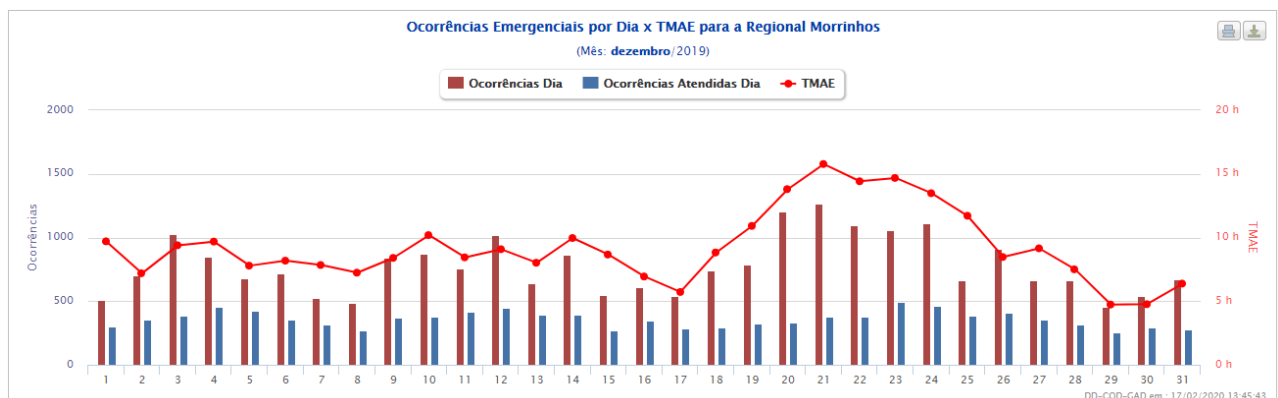
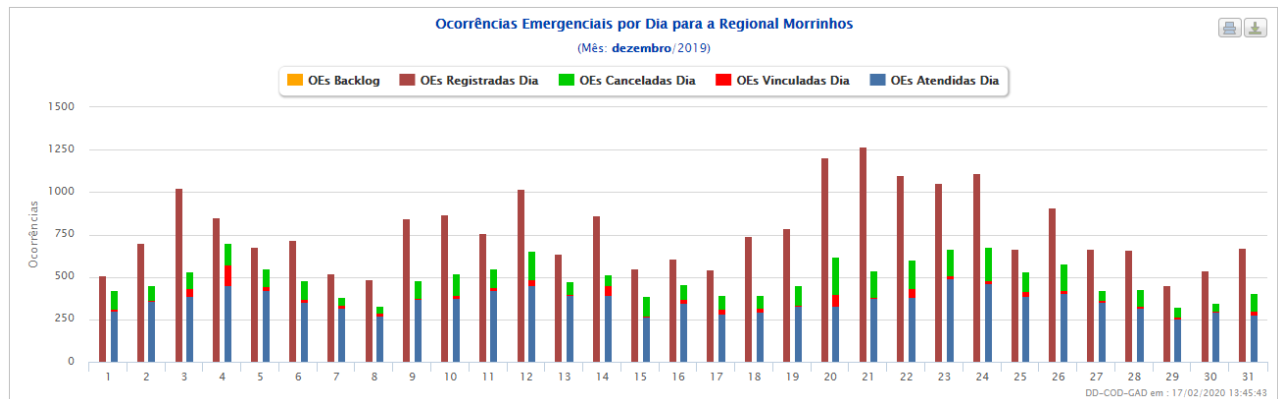
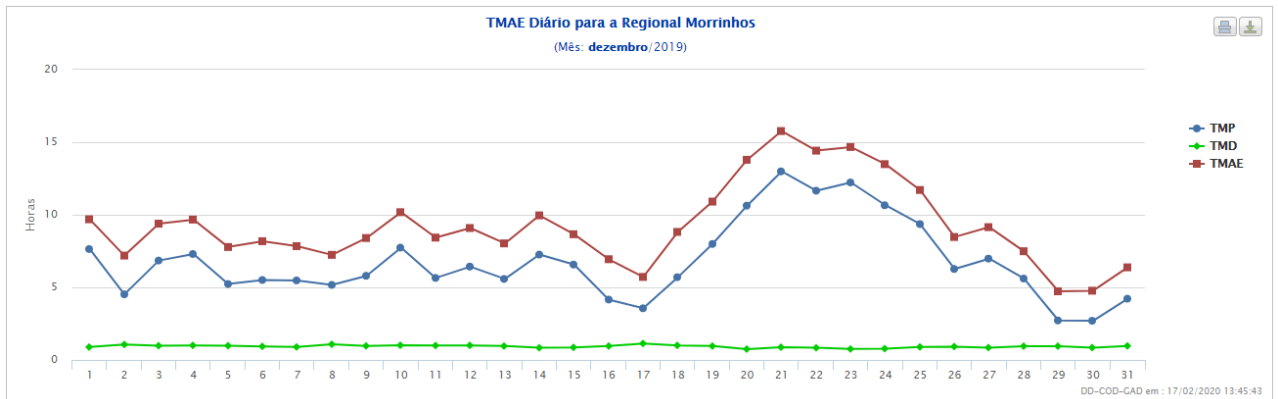



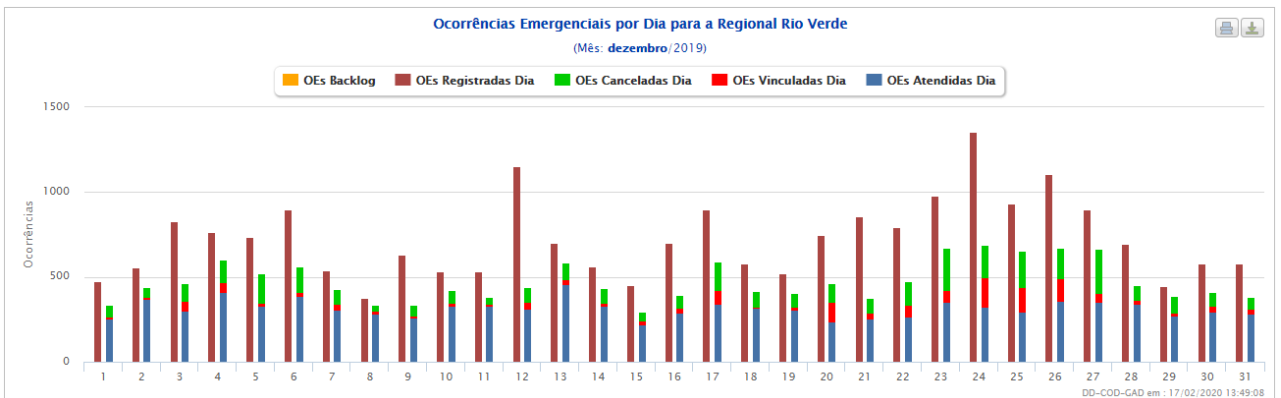
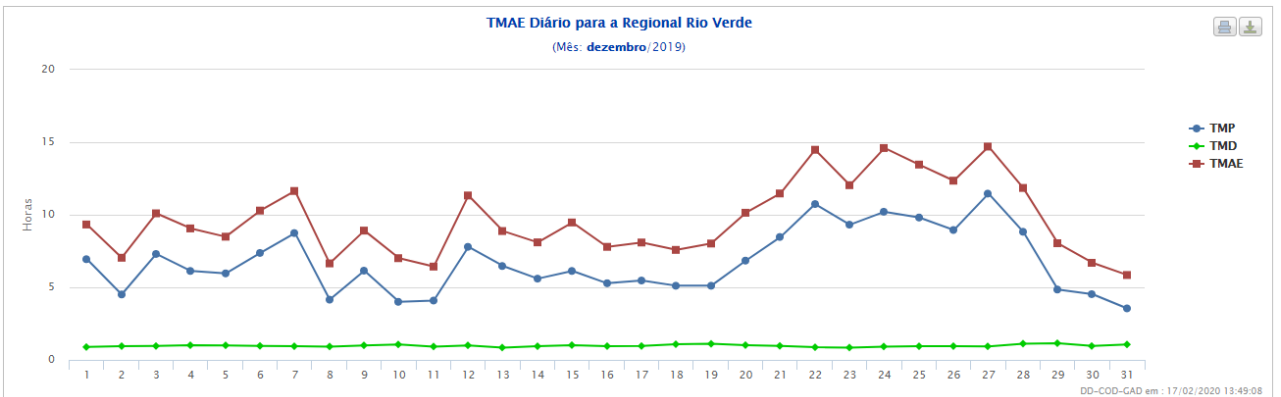
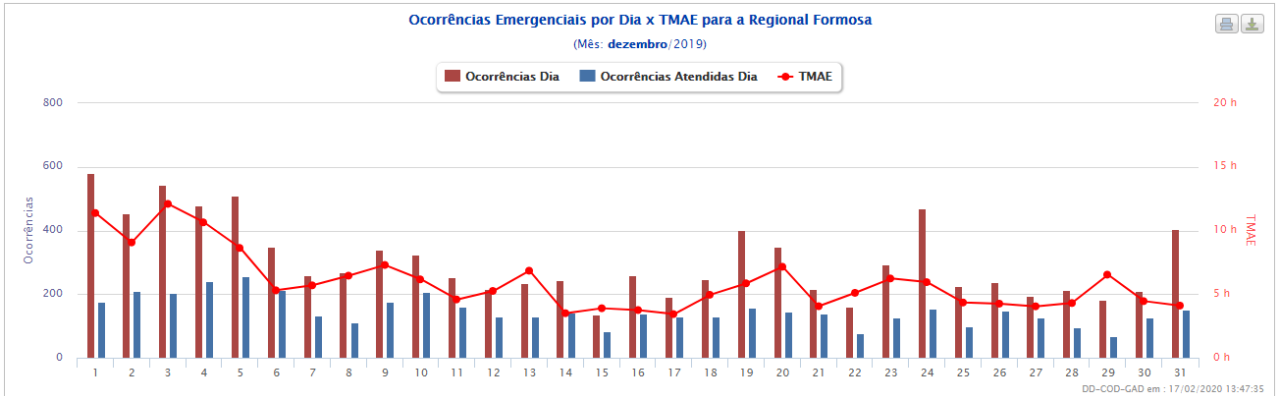
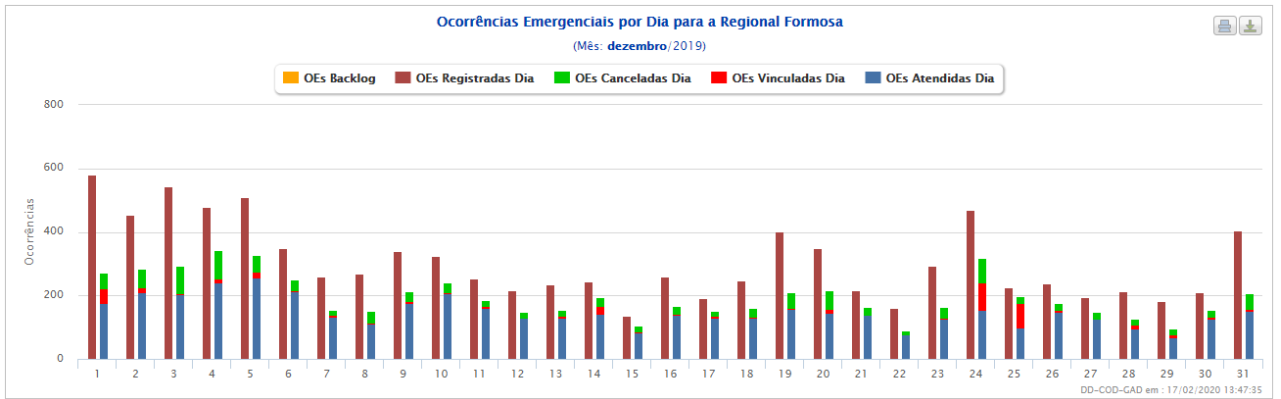

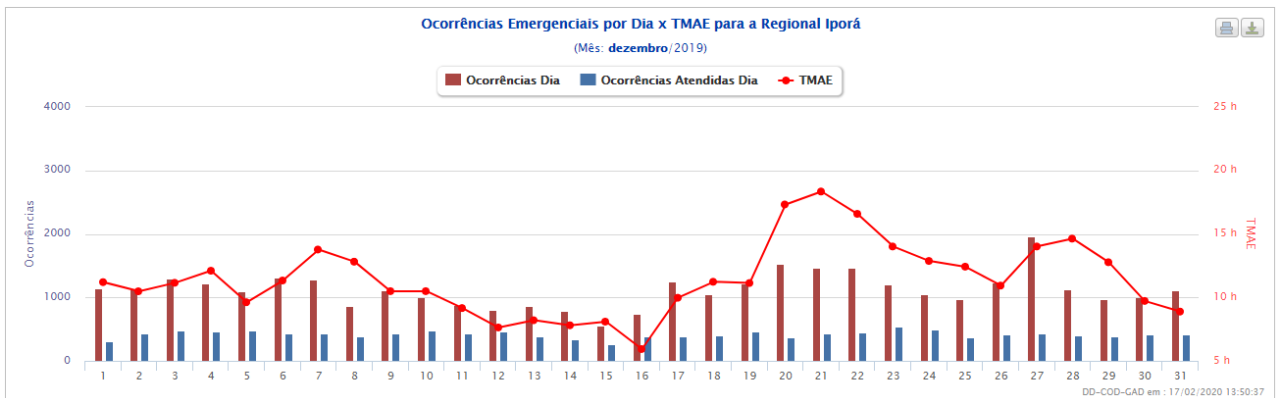
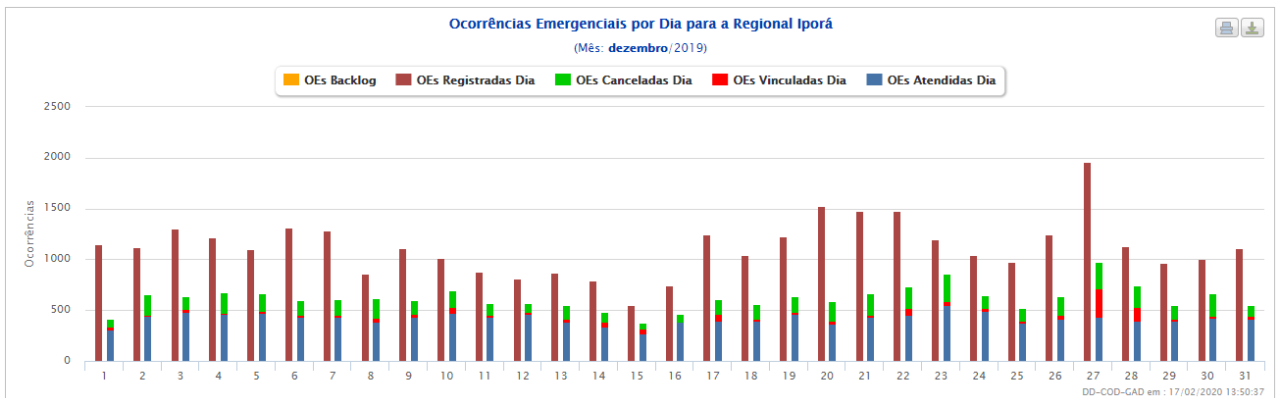
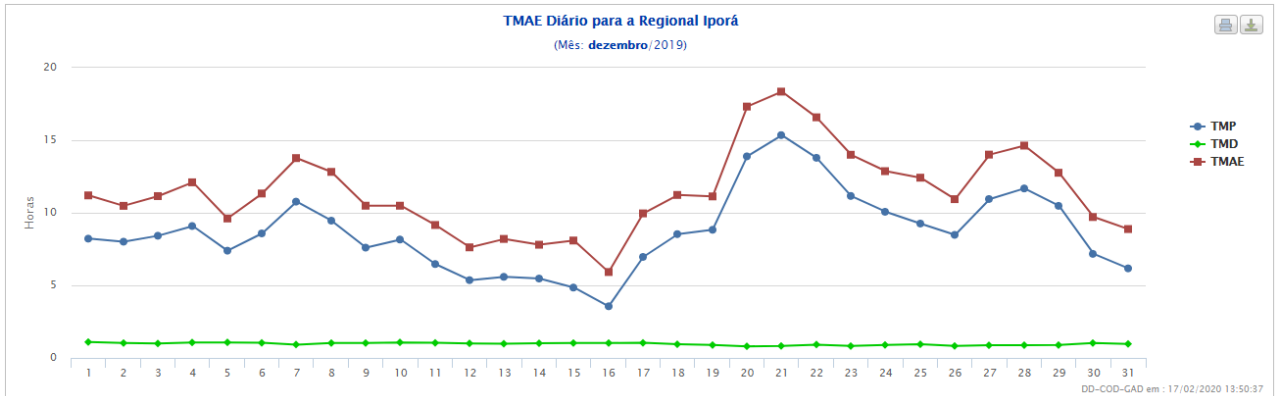
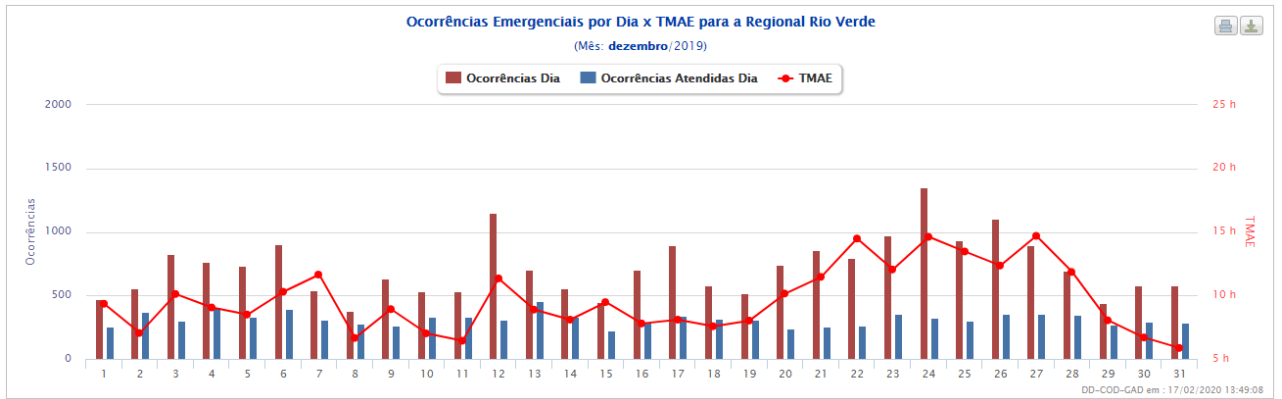

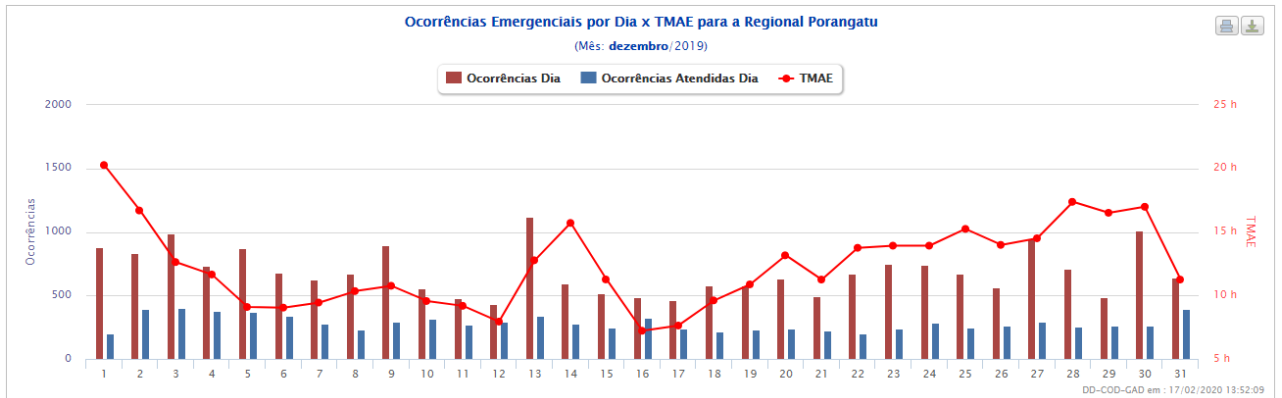
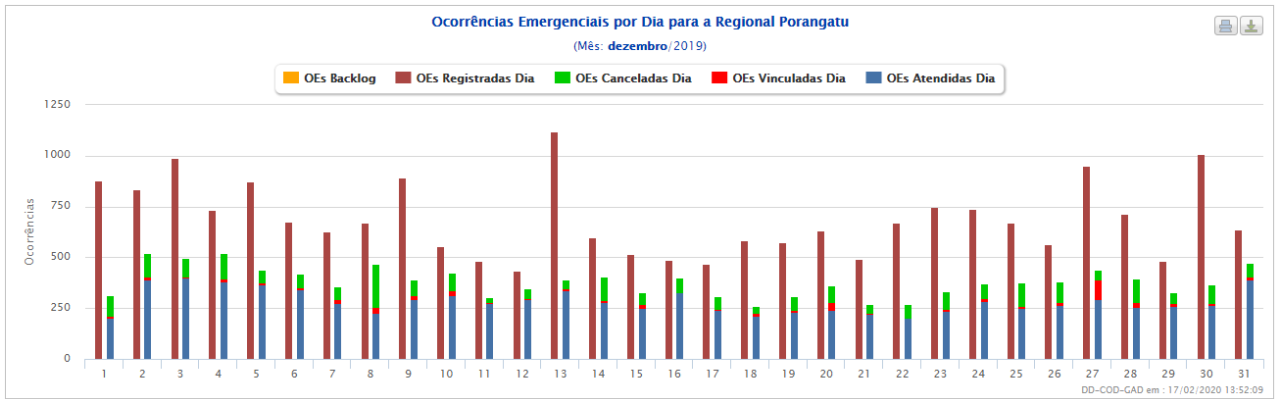
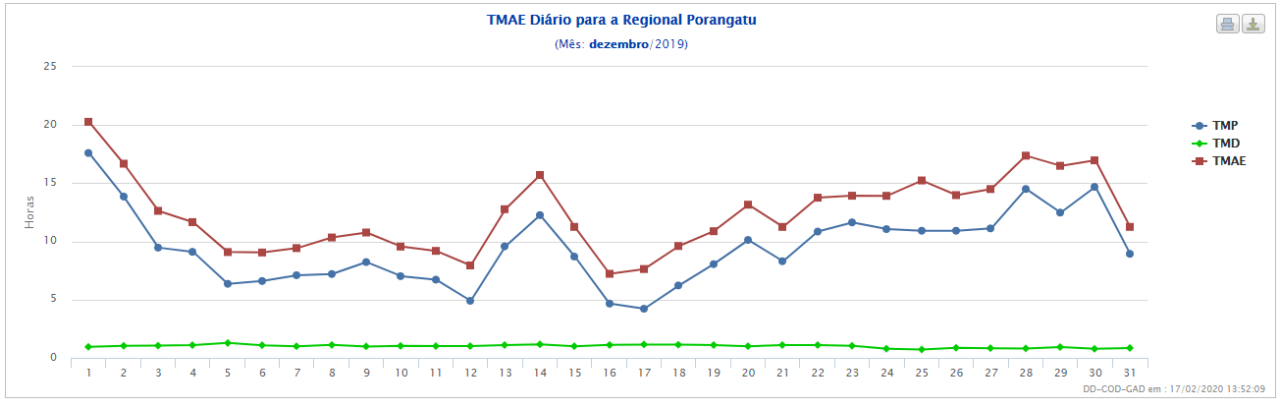

CLIMATEMPO

**Laudo Meteorológico de Evento Climático  
- CELG Distribuição S.A. - 22 de  
dezembro de 2019**

São Paulo, SP,  
Brasil Janeiro de  
2020

## Sumário

<b>1</b>	<b>ANÁLISE DE EVENTO METEOROLÓGICO .....</b>	<b>2</b>
<b>1.1</b>	<b>Descrição do Evento.....</b>	<b>2</b>
<b>1.2</b>	<b>Abrangência do Evento .....</b>	<b>5</b>
<b>2</b>	<b>CLASSIFICAÇÃO COBRADE .....</b>	<b>22</b>
<b>3</b>	<b>RESUMO DO EVENTO .....</b>	<b>23</b>
<b>4</b>	<b>REFERÊNCIAS.....</b>	<b>29</b>

# 1 Análise de Evento Meteorológico

## 1.1 Descrição do Evento

Na figura a seguir é apresentada a área de concessão da CELG Distribuição, dividida em regiões, a serem analisadas neste relatório.



Figura 1 – Regiões de Goiás atendidas pela CELG Distribuição.

O ar quente e úmido e a passagem de uma frente fria pela costa do Brasil favoreceram a formação de nuvens de tempestade, do tipo Cumulonimbus, que avançaram sobre o estado de Goiás entre os dias 22 e 25 de dezembro de 2019.

Nas Figuras 2 e 3 são apresentadas as descargas atmosféricas nuvem-solo (raios) e nuvem-nuvem detectadas pelo sistema Earth Networks. Entre as 11h30 do dia 22 e 06h00 do dia 25 de dezembro foram registrados 55630 raios nuvem-solo e 203614 descargas nuvem-nuvem sobre a área da CELG Distribuição em Goiás.

Estações do Instituto Nacional de Meteorologia (INMET), representativas da área de concessão da CELG Distribuição Goiás, registraram chuva forte (segundo a American Meteorological Society - Sociedade Meteorológica Americana -, chuvas com taxa entre 2,5mm a 7,6 mm por hora são consideradas moderadas e aquelas com taxa superior a 7,6

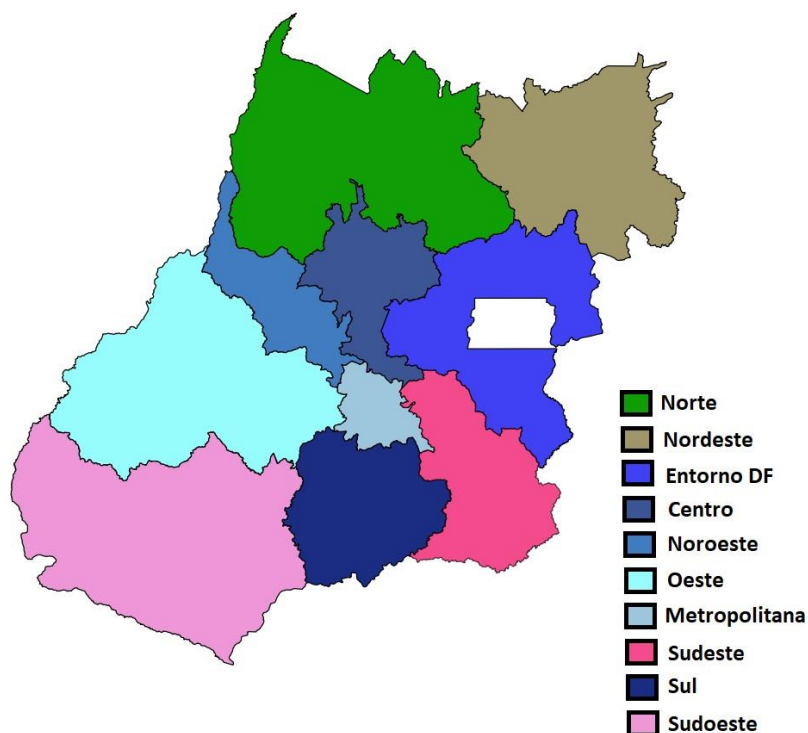
mm por hora são consideradas chuva forte). Na tabela 1 são apresentados os registros de acumulados horários superiores a 7,6 mm. Entre as 09h00 do dia 24 e as 09h00 do dia 25 de dezembro foram acumulados 78,6 mm de chuva na estação de Aragarças (INMET), o que corresponde a aproximadamente 29% da média climatológica (1981-2010) para um mês de dezembro na região.

Na tabela 2 são apresentadas as rajadas de vento maiores ou iguais a 50 km/h registradas pelo INMET entre a manhã do dia 22 e a madrugada do dia 25 de dezembro de 2019. Como é possível observar, o maior valor de rajada registrado foi de 64,4 km/h na estação de Goiás entre as 13h e 14h do dia 22 de dezembro, vento classificado como ventania pela escala Beaufort.



Figura 2 – Descargas atmosféricas nuvem-solo (em preto) detectadas pelo sistema Earth Networks entre 11h30 do dia 22 e 06h00 do dia 24 de dezembro de 2019 sobre a área de concessão da CELG Distribuição.



Figura 3 – Descargas atmosféricas nuvem-nuvem (em vermelho) detectadas pelo sistema Earth Networks entre 11h30 do dia 22 e 06h00 do dia 24 de dezembro de 2019 sobre a área de concessão da CELG Distribuição.

Tabela 1 – Acumulado horário de chuva registrada pelo INMET.

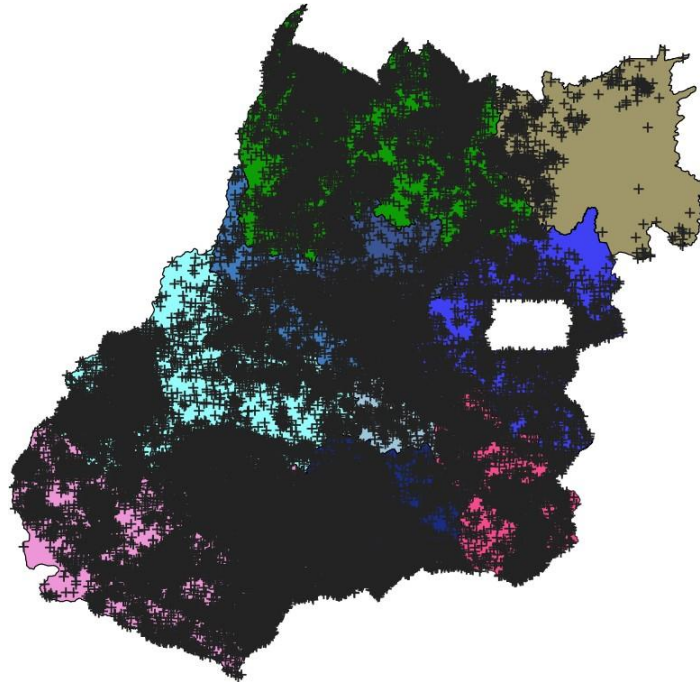
Estação	Horário	Precipitação (mm)
Alto Araguaia	Entre 18h e 19h do dia 24/12/2019	28.2
Cristalina	Entre 22h e 23h do dia 22/12/2019	25.8
Cristalina	Entre 7h e 8h do dia 24/12/2019	8.0
Iporá	Entre 1h e 2h do dia 23/12/2019	21.8
Itumbiara	Entre 15h e 16h do dia 22/12/2019	22.4
Itumbiara	Entre 1h e 2h do dia 24/12/2019	33.0
Luziânia	Entre 18h e 19h do dia 23/12/2019	18.8
Morrinhos	Entre 16h e 17h do dia 22/12/2019	15.4
Morrinhos	Entre 19h e 20h do dia 24/12/2019	8.4
Silvânia	Entre 5h e 6h do dia 24/12/2019	16.2
Silvânia	Entre 6h e 7h do dia 24/12/2019	9.2

Tabela 2 – Rajadas de vento maiores ou iguais a 50 km/h registradas pelo INMET. Segundo a escala Beaufort, ventos entre 50 e 61 km/h são classificados como vento forte e entre 62 e 74 km/h como ventania.

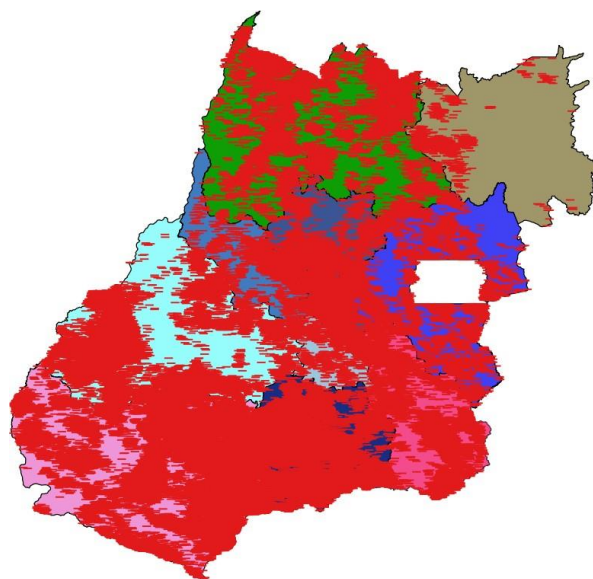
Estação	Horário	Rajada (km/h)
Goiás	Entre 13h e 14h do dia 22/12/2019	64.4
Jataí	Entre 16h e 17h do dia 22/12/2019	53.3
Morrinhos	Entre 16h e 17h do dia 22/12/2019	58.7
Morrinhos	Entre 19h e 20h do dia 24/12/2019	54.7



## 1.2 Abrangência do Evento

A seguir são apresentadas as imagens realçadas do satélite GOES-16 entre as 13h00 do dia 22 e 03h00 do dia 23 de dezembro de 2019. Os tons em vermelho e preto indicam a presença de nuvens de grande desenvolvimento vertical, geralmente associadas à ocorrência de tempo severo.

13h00 - 22 de dezembro de 2019



Figura 4 – Imagens realçadas do satélite GOES-16 das 13h00 do dia 22 de dezembro de 2019.  
FONTE: Cptec/INPE.

15h00 - 22 de dezembro de 2019



Figura 5 – Imagens realçadas do satélite GOES-16 das 15h00 do dia 22 de dezembro de 2019.  
FONTE: Cptec/INPE.

17h00 - 22 de dezembro de 2019

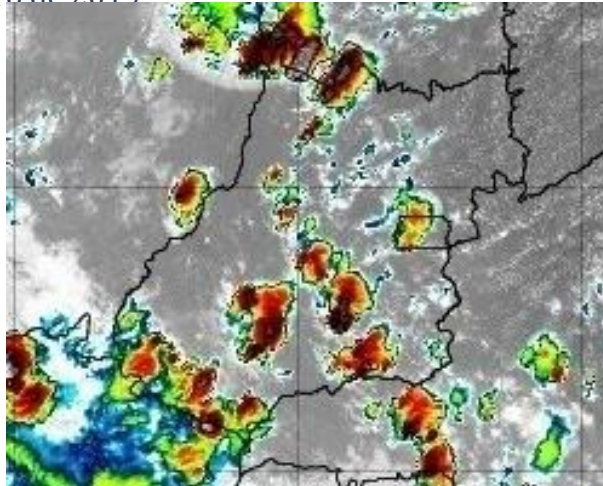

Figura 6 – Imagens realçadas do satélite GOES-16 das 17h00 do dia 22 de dezembro de 2019.  
FONTE: Cptec/INPE.

19h00 - 22 de dezembro de 2019

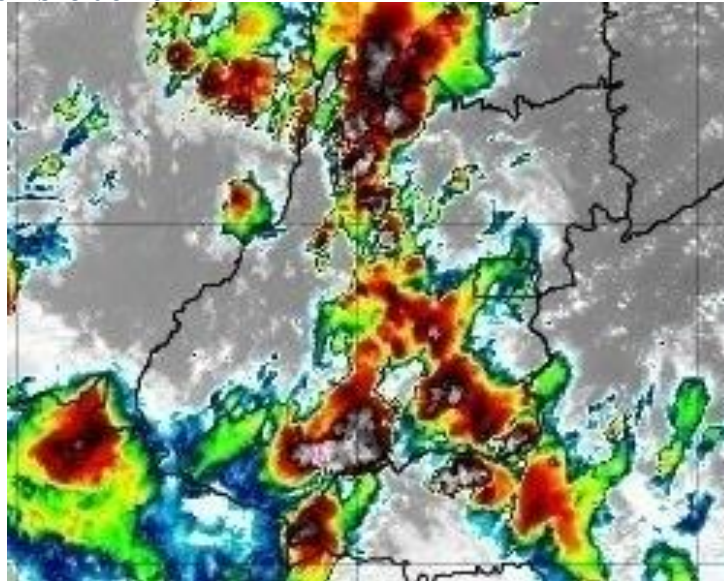

Figura 7 – Imagens realçadas do satélite GOES-16 das 19h00 do dia 22 de dezembro de 2019.  
FONTE: Cptec/INPE.

21h00 - 23 de dezembro de 2019

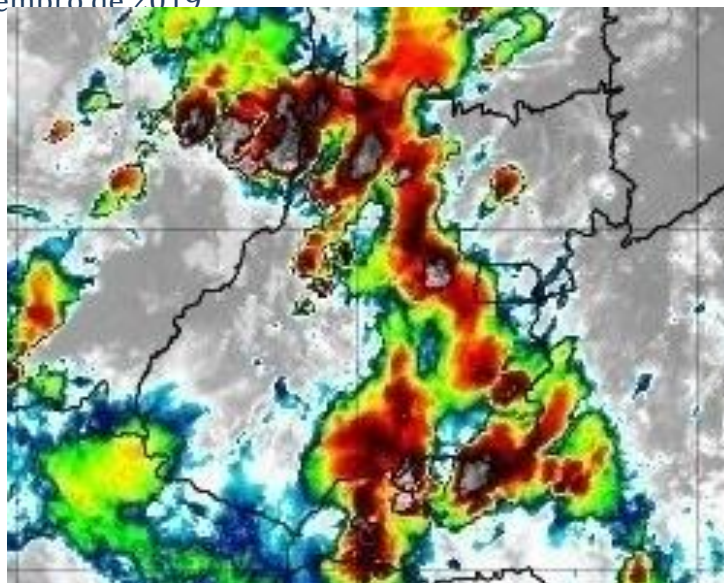

Figura 8 – Imagens realçadas do satélite GOES-16 das 21h00 do dia 22 de dezembro de 2019. FONTE: Cptec/INPE.

23h00 - 22 de dezembro de 2019



Figura 9 – Imagens realçadas do satélite GOES-16 das 23h00 do dia 22 de dezembro de 2019. FONTE: Cptec/INPE.

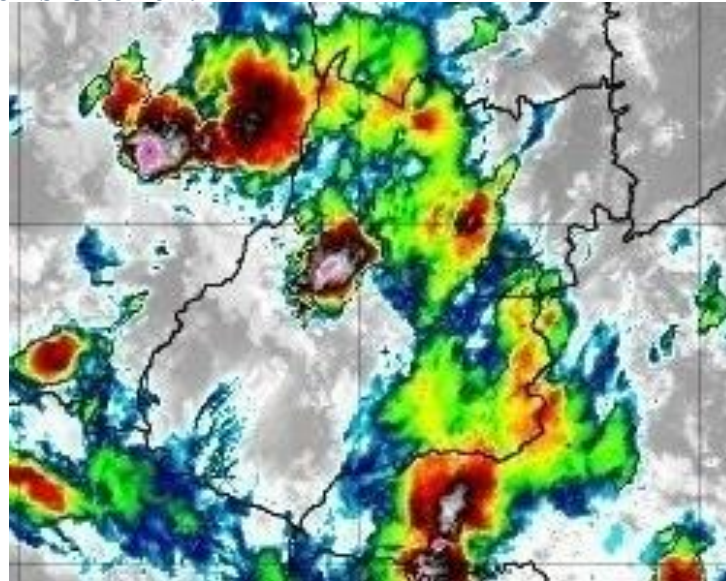

01h00 - 23 de dezembro de 2019

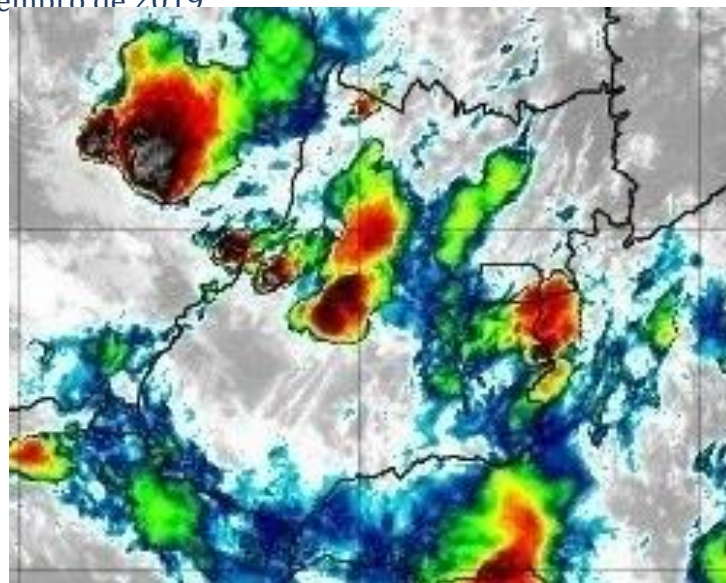

Figura 10 – Imagens realçadas do satélite GOES-16 das 01h00 do dia 23 de dezembro de 2019. FONTE: Cptec/INPE.

03h00 - 23 de dezembro de 2019

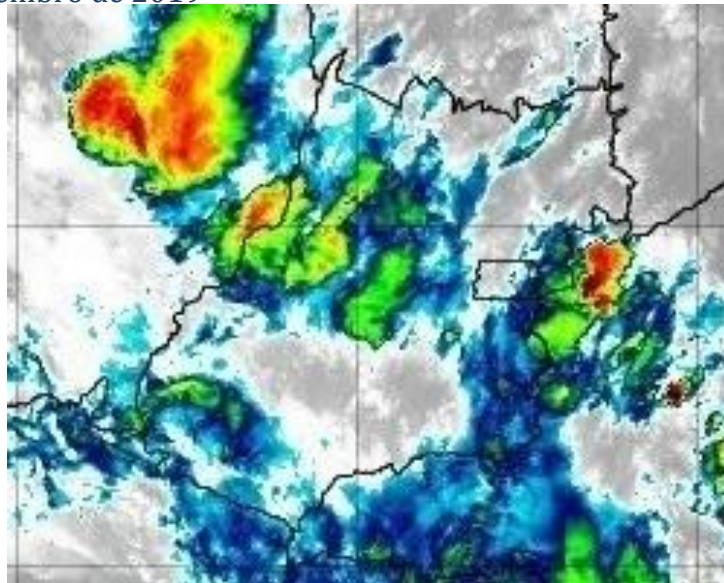

Figura 11 – Imagens realçadas do satélite GOES-16 das 03h00 do dia 23 de dezembro de 2019. FONTE: Cptec/INPE.

05h00 - 23 de dezembro de 2019

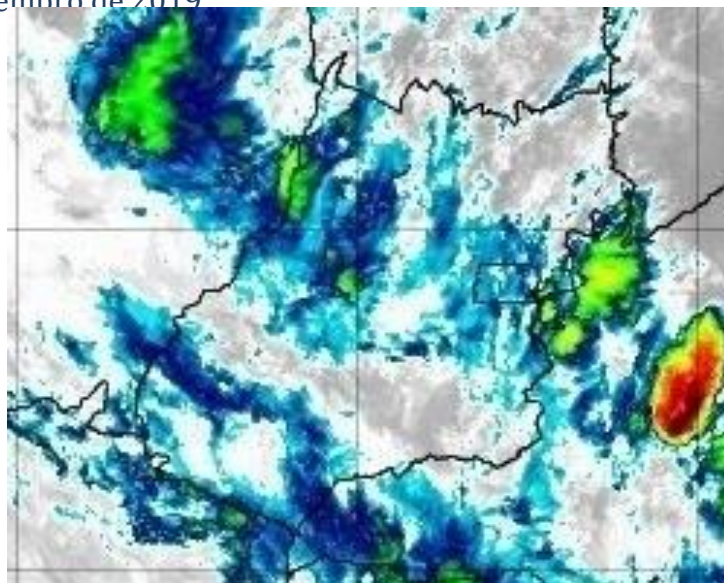

Figura 12 – Imagens realçadas do satélite GOES-16 das 05h00 do dia 23 de dezembro de 2019. FONTE: Cptec/INPE.

07h00 - 23 de dezembro de 2019

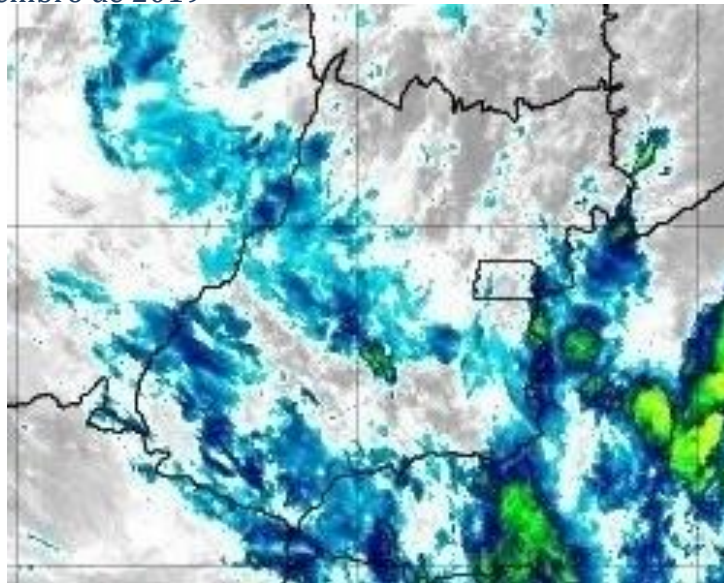

Figura 13 – Imagens realçadas do satélite GOES-16 das 07h00 do dia 23 de dezembro de 2019. FONTE: Cptec/INPE.

09h00 - 23 de dezembro de 2019

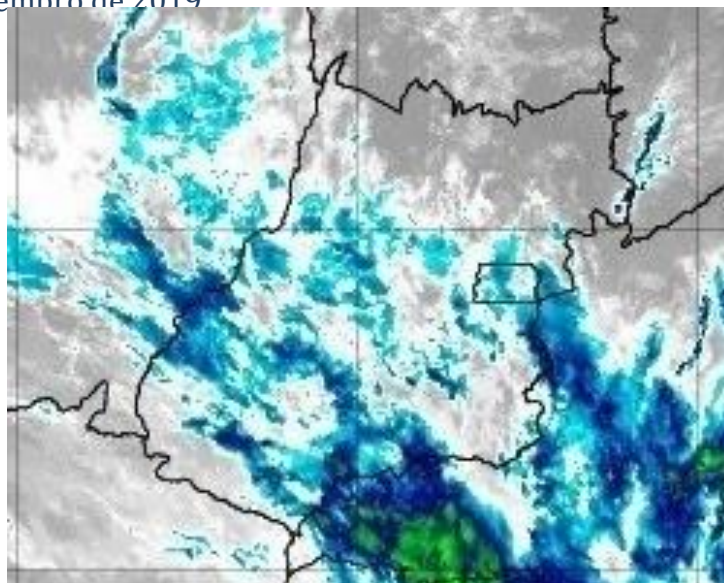

Figura 14 – Imagens realçadas do satélite GOES-16 das 09h00 do dia 23 de dezembro de 2019. FONTE: Cptec/INPE.

11h00 - 23 de dezembro de 2019



Figura 15 – Imagens realçadas do satélite GOES-16 das 11h00 do dia 23 de dezembro de 2019. FONTE: Cptec/INPE.

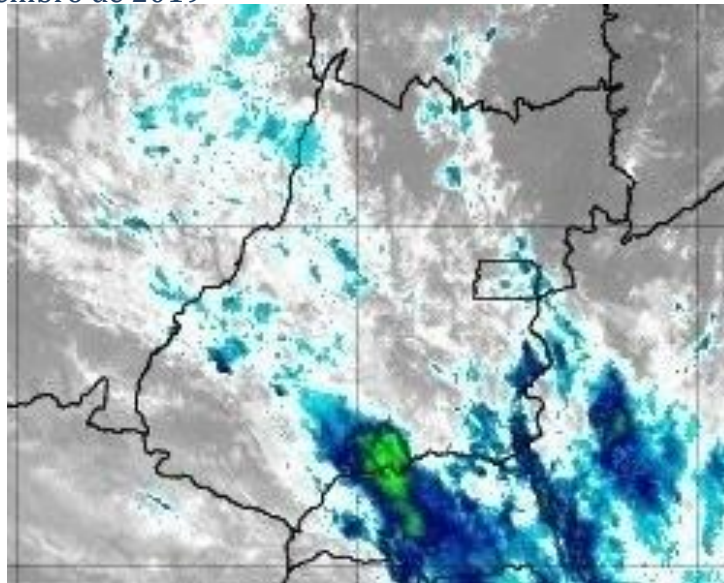

13h00 - 23 de dezembro de 2019



Figura 16 – Imagens realçadas do satélite GOES-16 das 13h00 do dia 23 de dezembro de 2019.  
FONTE: Cptec/INPE.

15h00 - 23 de dezembro de 2019



Figura 17 – Imagens realçadas do satélite GOES-16 das 15h00 do dia 23 de dezembro de 2019.  
FONTE: Cptec/INPE.

17h00 - 23 de dezembro de 2019



Figura 18 – Imagens realçadas do satélite GOES-16 das 17h00 do dia 23 de dezembro de 2019.  
FONTE: Cptec/INPE.

19h00 - 23 de dezembro de 2019



Figura 19 – Imagens realçadas do satélite GOES-16 das 19h00 do dia 23 de dezembro de 2019.  
FONTE: Cptec/INPE.

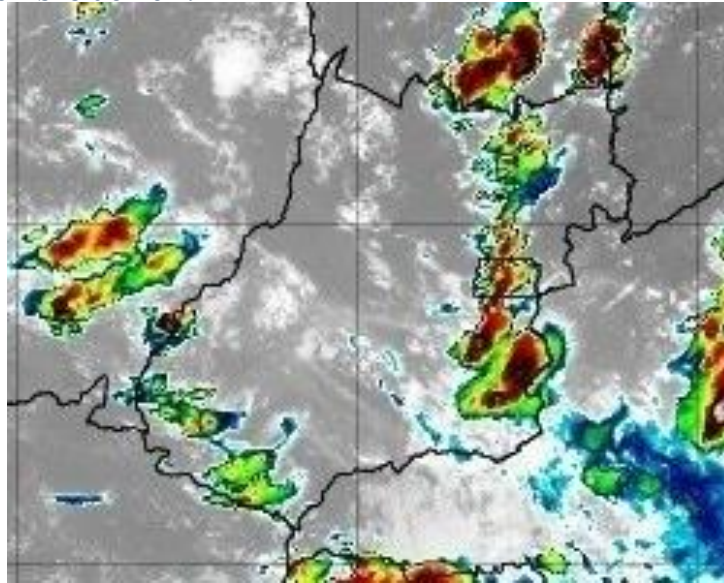

21h00 - 23 de dezembro de 2019

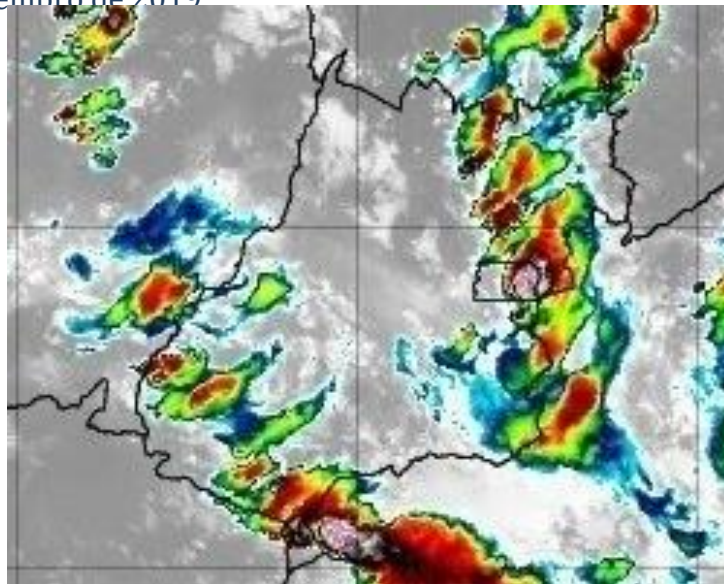

Figura 20 – Imagens realçadas do satélite GOES-16 das 21h00 do dia 23 de dezembro de 2019. FONTE: Cptec/INPE.

23h00 - 23 de dezembro de 2019

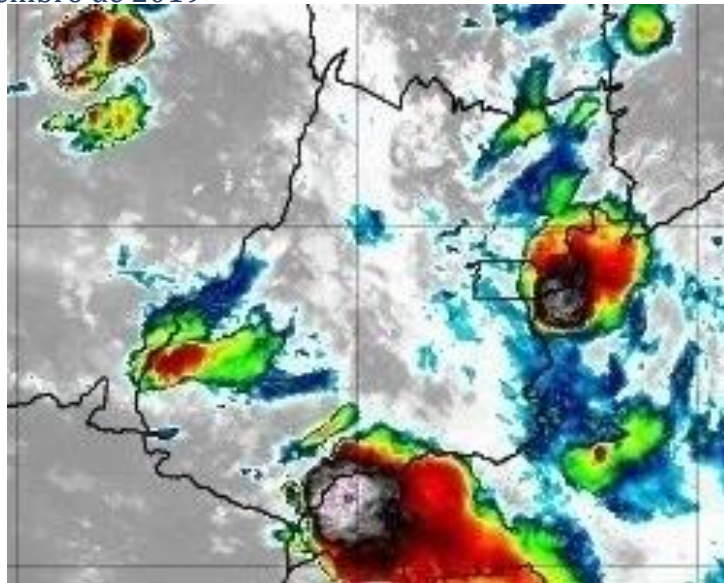

Figura 21 – Imagens realçadas do satélite GOES-16 das 23h00 do dia 23 de dezembro de 2019. FONTE: Cptec/INPE.

01h00 - 24 de dezembro de 2019

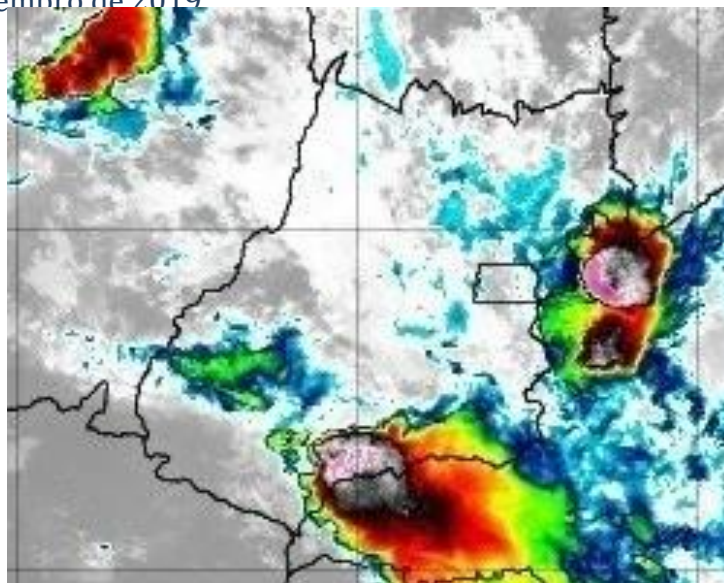

Figura 22 – Imagens realçadas do satélite GOES-16 das 01h00 do dia 24 de dezembro de 2019. FONTE: Cptec/INPE.

03h00 - 24 de dezembro de 2019



Figura 23 – Imagens realçadas do satélite GOES-16 das 03h00 do dia 24 de dezembro de 2019. FONTE: Cptec/INPE.

05h00 - 24 de dezembro de 2019



Figura 24 – Imagens realçadas do satélite GOES-16 das 05h00 do dia 24 de dezembro de 2019. FONTE: Cptec/INPE.

07h00 - 24 de dezembro de 2019



Figura 25 – Imagens realçadas do satélite GOES-16 das 07h00 do dia 24 de dezembro de 2019. FONTE: Cptec/INPE.

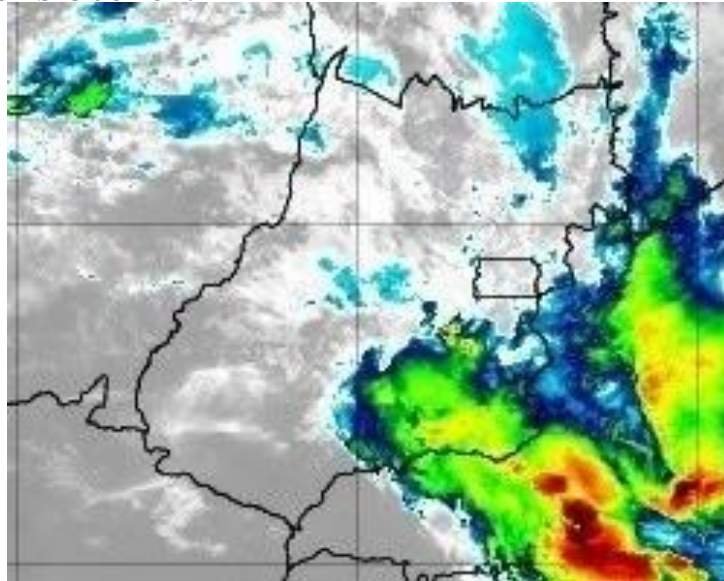

09h00 - 24 de dezembro de 2019

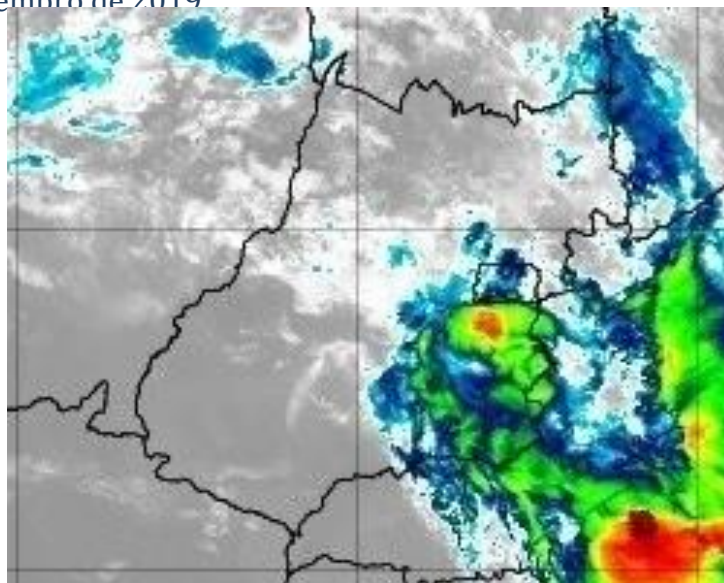

Figura 26 – Imagens realçadas do satélite GOES-16 das 09h00 do dia 24 de dezembro de 2019. FONTE: Cptec/INPE.

11h00 - 24 de dezembro de 2019

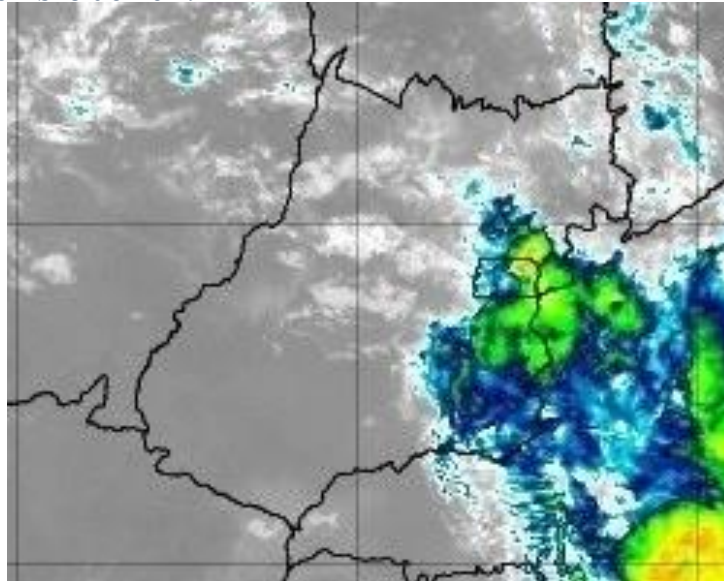

Figura 27 – Imagens realçadas do satélite GOES-16 das 11h00 do dia 24 de dezembro de 2019. FONTE: Cptec/INPE.

13h00 - 24 de dezembro de 2019

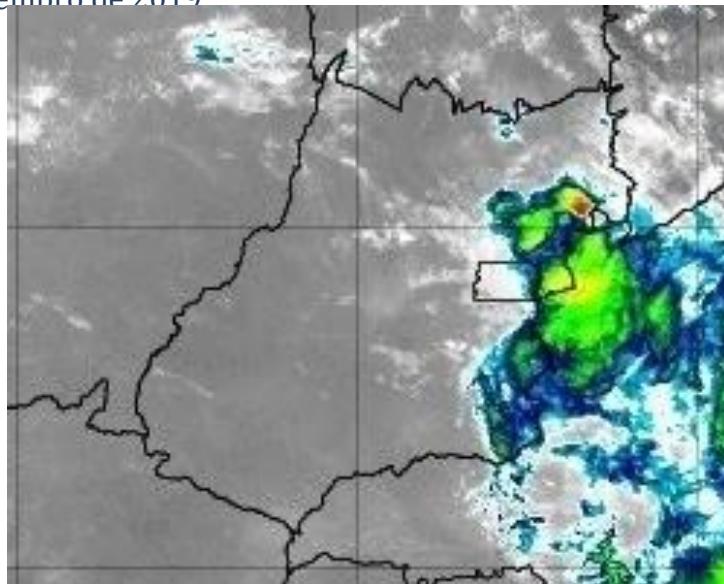

Figura 28 – Imagens realçadas do satélite GOES-16 das 13h00 do dia 24 de dezembro de 2019. FONTE: Cptec/INPE.

15h00 - 24 de dezembro de 2019

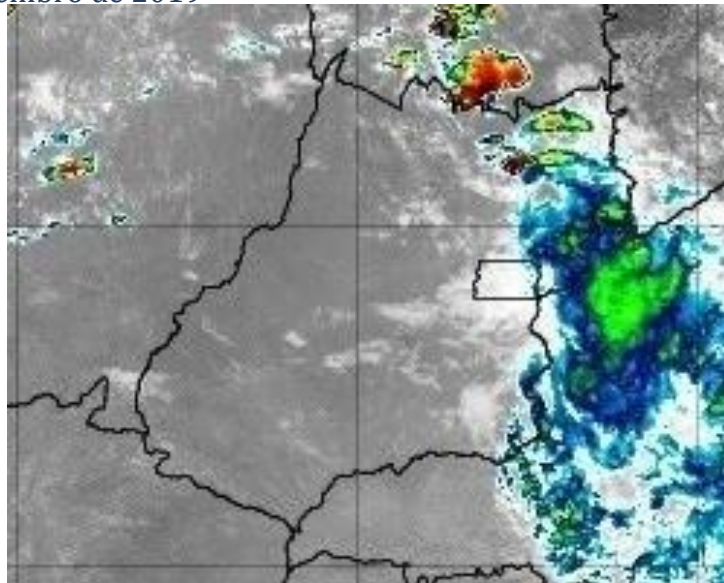

Figura 29 – Imagens realçadas do satélite GOES-16 das 15h00 do dia 24 de dezembro de 2019. FONTE: Cptec/INPE.

17h00 - 24 de dezembro de 2019

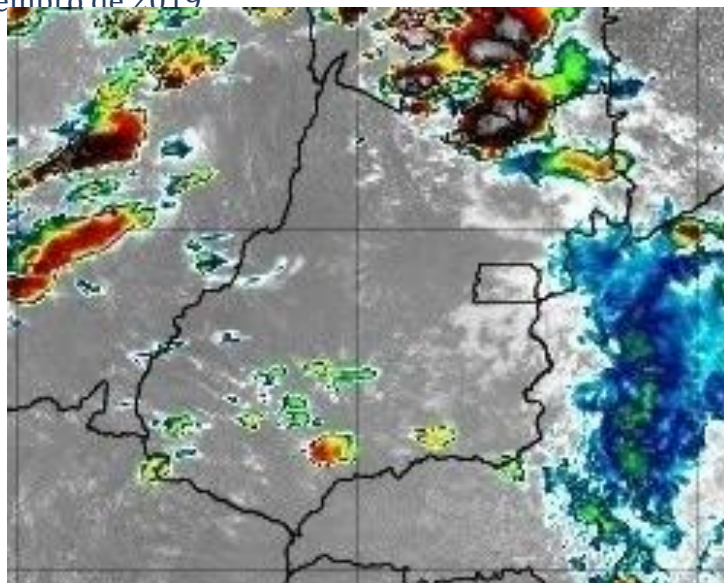

Figura 30 – Imagens realçadas do satélite GOES-16 das 17h00 do dia 24 de dezembro de 2019. FONTE: Cptec/INPE.

19h00 - 24 de dezembro de 2019



Figura 31 – Imagens realçadas do satélite GOES-16 das 19h00 do dia 24 de dezembro de 2019. FONTE: Cptec/INPE.



21h00 - 24 de dezembro de 2019

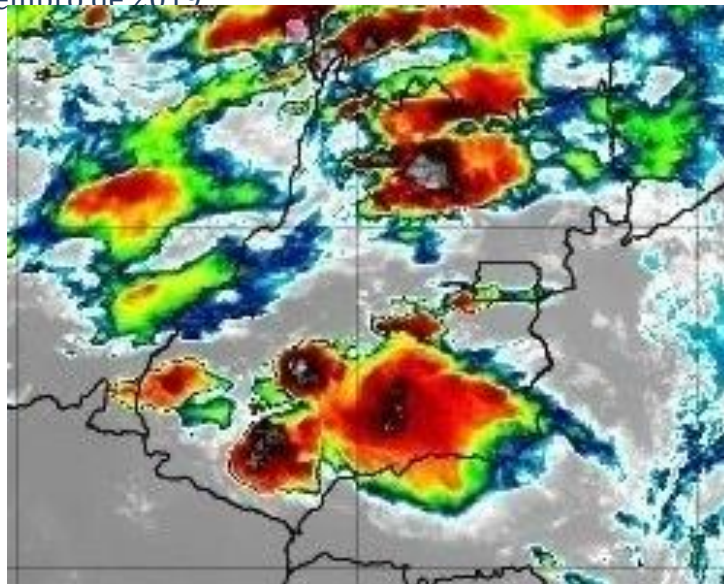

Figura 32 – Imagens realçadas do satélite GOES-16 das 21h00 do dia 24 de dezembro de 2019. FONTE: Cptec/INPE.

23h00 - 24 de dezembro de 2019

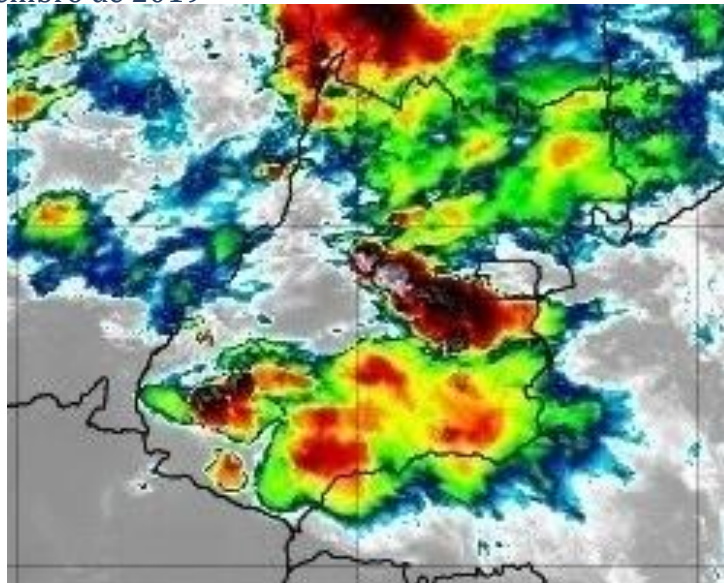

Figura 33 – Imagens realçadas do satélite GOES-16 das 23h00 do dia 24 de dezembro de 2019. FONTE: Cptec/INPE.

01h00 - 25 de dezembro de 2019

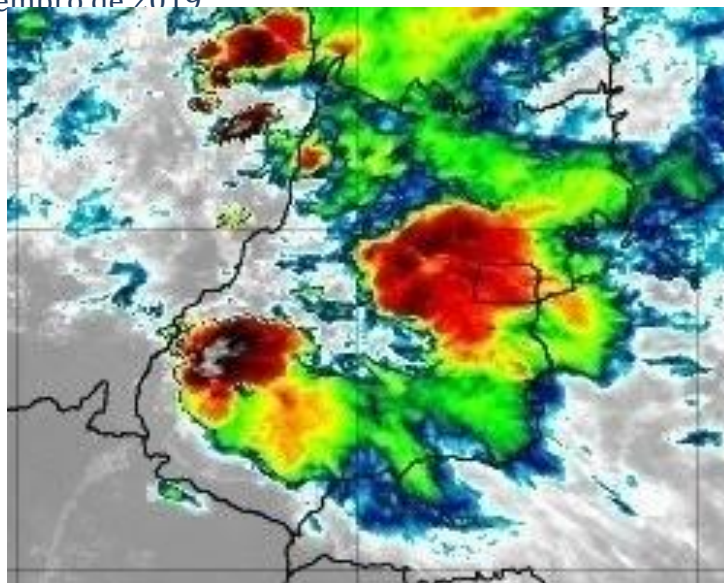

Figura 34 – Imagens realçadas do satélite GOES-16 das 01h00 do dia 25 de dezembro de 2019. FONTE: Cptec/INPE.

03h00 - 25 de dezembro de 2019



Figura 35 – Imagens realçadas do satélite GOES-16 das 03h00 do dia 25 de dezembro de 2019. FONTE: Cptec/INPE.

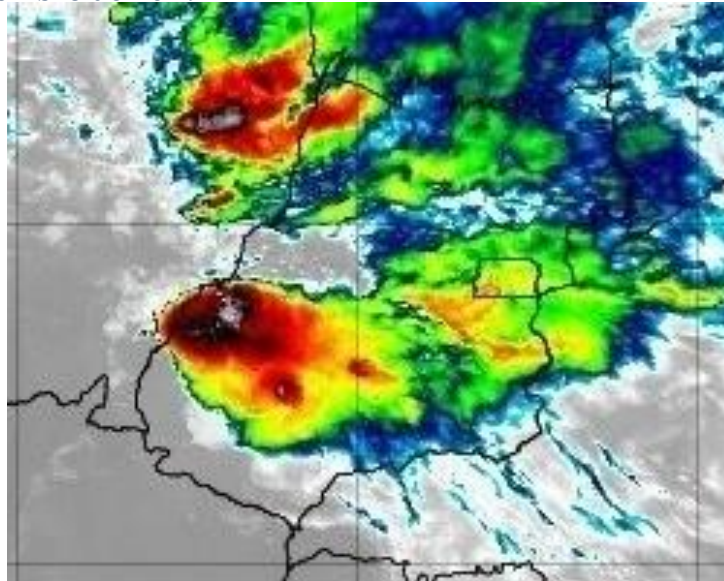

05h00 - 25 de dezembro de 2019

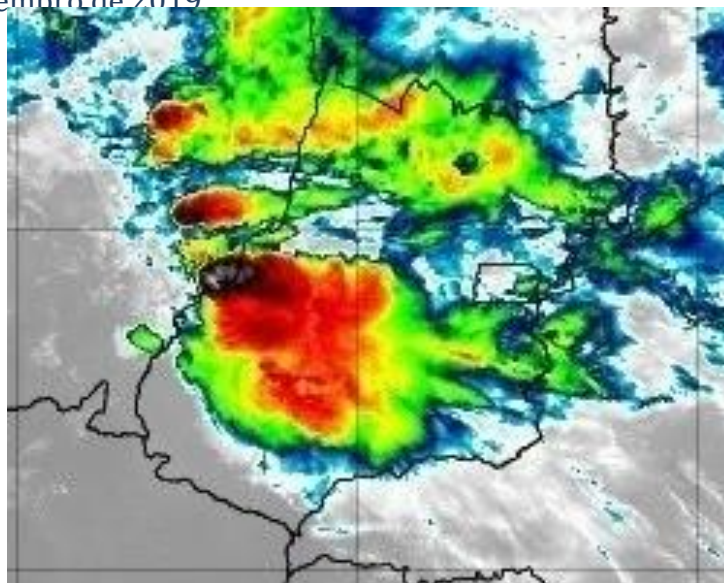

Figura 36 – Imagens realçadas do satélite GOES-16 das 05h00 do dia 25 de dezembro de 2019. FONTE: Cptec/INPE.

## 2 Classificação COBRADE

O COBRADE (Classificação e Codificação Brasileira de Desastres) foi criado com o intuito de adequar a classificação brasileira à classificação utilizada pela ONU na classificação de desastres e nivelar o país aos demais organismos de gestão de desastres do mundo.

Baseados nos dados analisados nos itens anteriores, podemos classificar o evento ocorrido na CELG Distribuição como Vendaval (Código 1.3.2.1.5), Tempestade de raios (Código 1.3.2.1.2) e Chuvas intensas (Código 1.3.2.1.4).

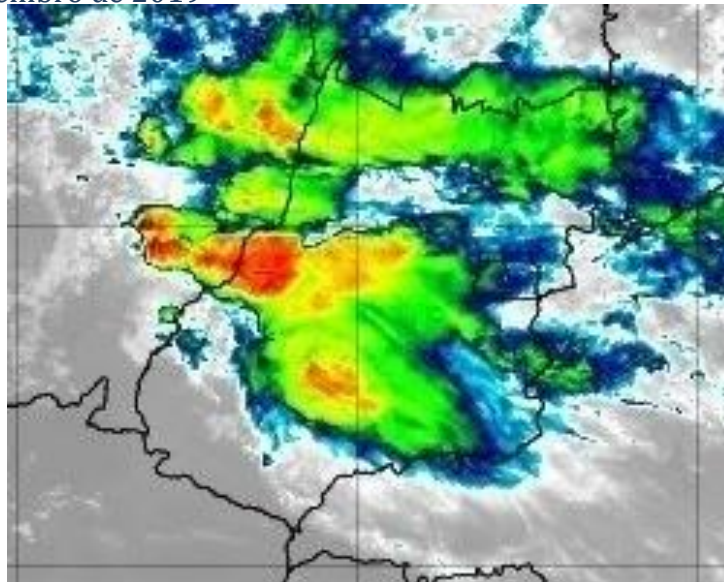
### 3 Resumo do Evento

O ar quente e úmido e a presença de uma frente fria na costa organizaram a formação de nuvens de tempestade sobre o estado de Goiás entre a manhã do dia 22 e a madrugada do dia 25 de dezembro de 2019.

Entre as 11h30 do dia 22 e 06h00 do dia 25 de dezembro foram detectadas 259244 descargas atmosféricas sobre a área de concessão da CELG Distribuição Goiás (sendo 55630 raios nuvem-solo e 203614 descargas nuvem-nuvem).

Estações do INMET representativas da região de interesse registraram chuva e vento forte durante o período. Na estação de Goiás ventos de até 64,4 km/h, classificados como ventania pela escala Beaufort, foram registrados entre 13h00 e 14h00 do dia 22 de dezembro. Entre as 09h00 do dia 24 e as 09h00 do dia 25 de dezembro foram acumulados 78,6 mm de chuva na estação de Aragarças (INMET), o que corresponde a aproximadamente 29% da média climatológica (1981-2010) para um mês de dezembro na região.

Tabela 3 – Resumo do evento Região Sudoeste

Número/Código do Evento	
Número/Código do Relatório	
Descrição	Forte deslocamento de uma massa de ar em uma região. Tempestade com intensa atividade elétrica no interior das nuvens, com grande desenvolvimento vertical. Chuvas com acumulados significativos.
Código COBRADE	1.3.2.1.5 - Vendaval e 1.3.2.1.2 - Tempestade de raios e 1.3.2.1.4 - Chuvas intensas
Hora início do evento	11h30 do dia 22 de dezembro de 2019
Hora de fim do evento	04h40 do dia 25 de dezembro de 2019
Abrangência	Região Sudoeste da CELG Distribuição S.A.

Tabela 4 – Resumo do evento Região Sul

Número/Código do Evento	
Número/Código do Relatório	
Descrição	Forte deslocamento de uma massa de ar em uma região. Tempestade com intensa atividade elétrica no interior das nuvens, com grande desenvolvimento vertical. Chuvas com acumulados significativos.
Código COBRADE	1.3.2.1.5 - Vendaval e 1.3.2.1.2 - Tempestade de raios e 1.3.2.1.4 - Chuvas intensas
Hora início do evento	13h00 do dia 22 de dezembro de 2019
Hora de fim do evento	03h00 do dia 25 de dezembro de 2019
Abrangência	Região Sul da CELG Distribuição S.A.

Tabela 5 – Resumo do evento Região Sudeste

Número/Código do Evento	
Número/Código do Relatório	
Descrição	Forte deslocamento de uma massa de ar em uma região. Tempestade com intensa atividade elétrica no interior das nuvens, com grande desenvolvimento vertical. Chuvas com acumulados significativos.
Código COBRADE	1.3.2.1.5 - Vendaval e 1.3.2.1.2 - Tempestade de raios e 1.3.2.1.4 - Chuvas intensas
Hora início do evento	13h30 do dia 22 de dezembro de 2019
Hora de fim do evento	23h30 do dia 24 de dezembro de 2019
Abrangência	Região Sudeste da CELG Distribuição S.A.

Tabela 6 – Resumo do evento Região Metropolitana

Número/Código do Evento	
Número/Código do Relatório	
Descrição	Forte deslocamento de uma massa de ar em uma região. Tempestade com intensa atividade elétrica no interior das nuvens, com grande desenvolvimento vertical. Chuvas com acumulados significativos.
Código COBRADE	1.3.2.1.5 - Vendaval e 1.3.2.1.2 - Tempestade de raios e 1.3.2.1.4 - Chuvas intensas
Hora início do evento	13h30 do dia 22 de dezembro de 2019
Hora de fim do evento	23h00 do dia 24 de dezembro de 2019
Abrangência	Região Metropolitana da CELG Distribuição S.A.

Tabela 7 – Resumo do evento Região Oeste

Número/Código do Evento	
Número/Código do Relatório	
Descrição	Forte deslocamento de uma massa de ar em uma região. Tempestade com intensa atividade elétrica no interior das nuvens, com grande desenvolvimento vertical. Chuvas com acumulados significativos.
Código COBRADE	1.3.2.1.5 - Vendaval e 1.3.2.1.2 - Tempestade de raios e 1.3.2.1.4 - Chuvas intensas
Hora início do evento	11h30 do dia 22 de dezembro de 2019
Hora de fim do evento	06h00 do dia 25 de dezembro de 2019
Abrangência	Região Oeste da CELG Distribuição S.A.

Tabela 8 – Resumo do evento Região EDF

Número/Código do Evento	
Número/Código do Relatório	
Descrição	Forte deslocamento de uma massa de ar em uma região. Tempestade com intensa atividade elétrica no interior das nuvens, com grande desenvolvimento vertical. Chuvas com acumulados significativos.
Código COBRADE	1.3.2.1.5 - Vendaval e 1.3.2.1.2 - Tempestade de raios e 1.3.2.1.4 - Chuvas intensas
Hora início do evento	12h30 do dia 22 de dezembro de 2019
Hora de fim do evento	00h00 do dia 25 de dezembro de 2019
Abrangência	Região EDF da CELG Distribuição S.A.

Tabela 9 – Resumo do evento Região Centro

Número/Código do Evento	
Número/Código do Relatório	
Descrição	Forte deslocamento de uma massa de ar em uma região. Tempestade com intensa atividade elétrica no interior das nuvens, com grande desenvolvimento vertical. Chuvas com acumulados significativos.
Código COBRADE	1.3.2.1.5 - Vendaval e 1.3.2.1.2 - Tempestade de raios e 1.3.2.1.4 - Chuvas intensas
Hora início do evento	13h30 do dia 22 de dezembro de 2019
Hora de fim do evento	01h00 do dia 25 de dezembro de 2019
Abrangência	Região Centro da CELG Distribuição S.A.

Tabela 10 – Resumo do evento Região Noroeste

Número/Código do Evento	
Número/Código do Relatório	
Descrição	Forte deslocamento de uma massa de ar em uma região. Tempestade com intensa atividade elétrica no interior das nuvens, com grande desenvolvimento vertical. Chuvas com acumulados significativos.
Código COBRADE	1.3.2.1.5 - Vendaval e 1.3.2.1.2 - Tempestade de raios e 1.3.2.1.4 - Chuvas intensas
Hora início do evento	13h00 do dia 22 de dezembro de 2019
Hora de fim do evento	01h00 do dia 25 de dezembro de 2019
Abrangência	Região Noroeste da CELG Distribuição S.A.

Tabela 11 – Resumo do evento Região Norte

Número/Código do Evento	
Número/Código do Relatório	
Descrição	Forte deslocamento de uma massa de ar em uma região. Tempestade com intensa atividade elétrica no interior das nuvens, com grande desenvolvimento vertical. Chuvas com acumulados significativos.
Código COBRADE	1.3.2.1.5 - Vendaval e 1.3.2.1.2 - Tempestade de raios e 1.3.2.1.4 - Chuvas intensas
Hora início do evento	12h30 do dia 22 de dezembro de 2019
Hora de fim do evento	00h00 do dia 25 de dezembro de 2019
Abrangência	Região Norte da CELG Distribuição S.A.

Tabela 12 – Resumo do evento Região Nordeste

Número/Código do Evento	
Número/Código do Relatório	
Descrição	Forte deslocamento de uma massa de ar em uma região. Tempestade com intensa atividade elétrica no interior das nuvens, com grande desenvolvimento vertical. Chuvas com acumulados significativos.
Código COBRADE	1.3.2.1.5 - Vendaval e 1.3.2.1.2 - Tempestade de raios e 1.3.2.1.4 - Chuvas intensas
Hora início do evento	12h30 do dia 23 de dezembro de 2019
Hora de fim do evento	17h00 do dia 24 de dezembro de 2019
Abrangência	Região Nordeste da CELG Distribuição S.A.



#### 4 Referências

- RMetS Royal Meteorological Society – Beaufort Scale - <https://www.rmets.org/weather-and-climate/observing/beaufort-scale>

- Instituto Nacional de Meteorologia (INMET) - <http://www.inmet.gov.br>

- Cptec/INPE- <https://www.cptec.inpe.br/>

- Centro de Hidrografia da Marinha do Brasil - <https://www.marinha.mil.br/chm/>

- Meteorology Glossary - American Meteorological Society -  
<http://glossary.ametsoc.org/>

Anexos

A.1 Carta Sinótica

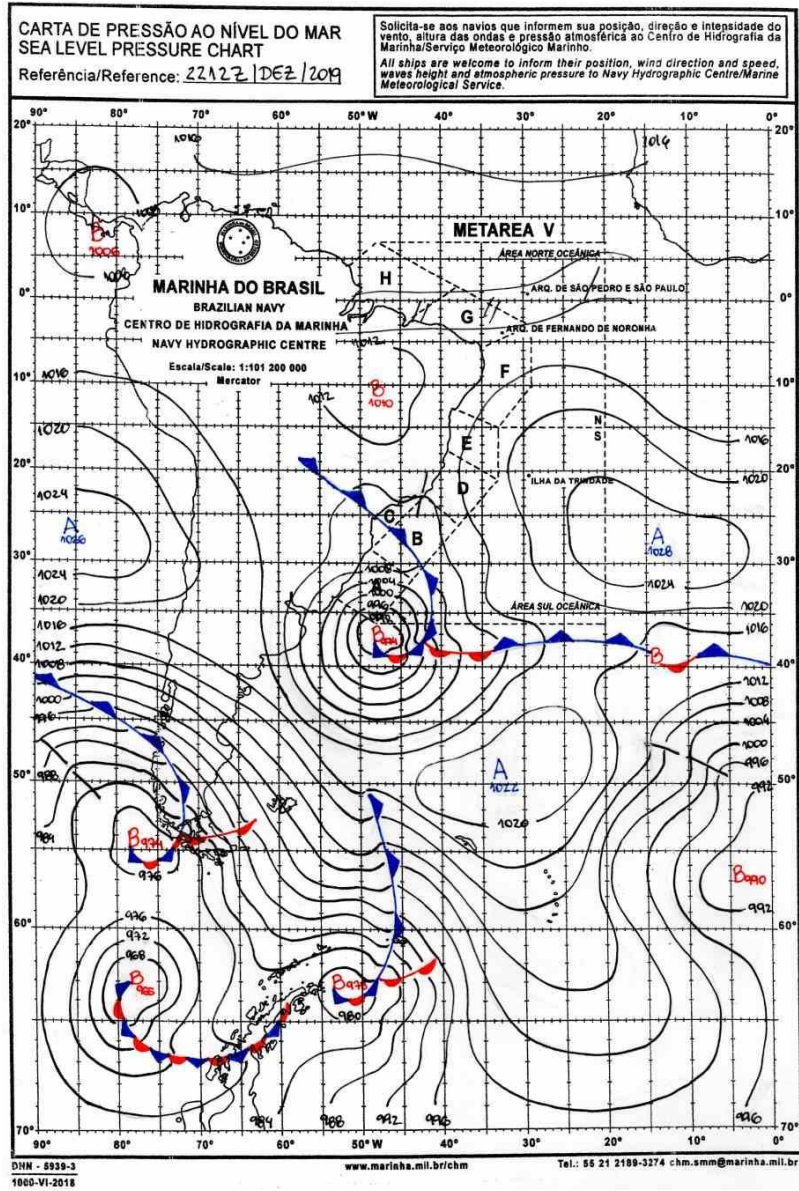

LEGENDA			
	Frente Fria	<b>A</b>	Alta Pressão
	Frente Quente	<b>B</b>	Baixa Pressão
	Instabilidade		Zona de Convergência

Figura A1 - Carta sinótica da Marinha do Brasil para as 1200Z do dia 22 de dezembro de 2019 (09h00 do dia 22 de dezembro de 2019, hora local. FONTE: Marinha do Brasil).

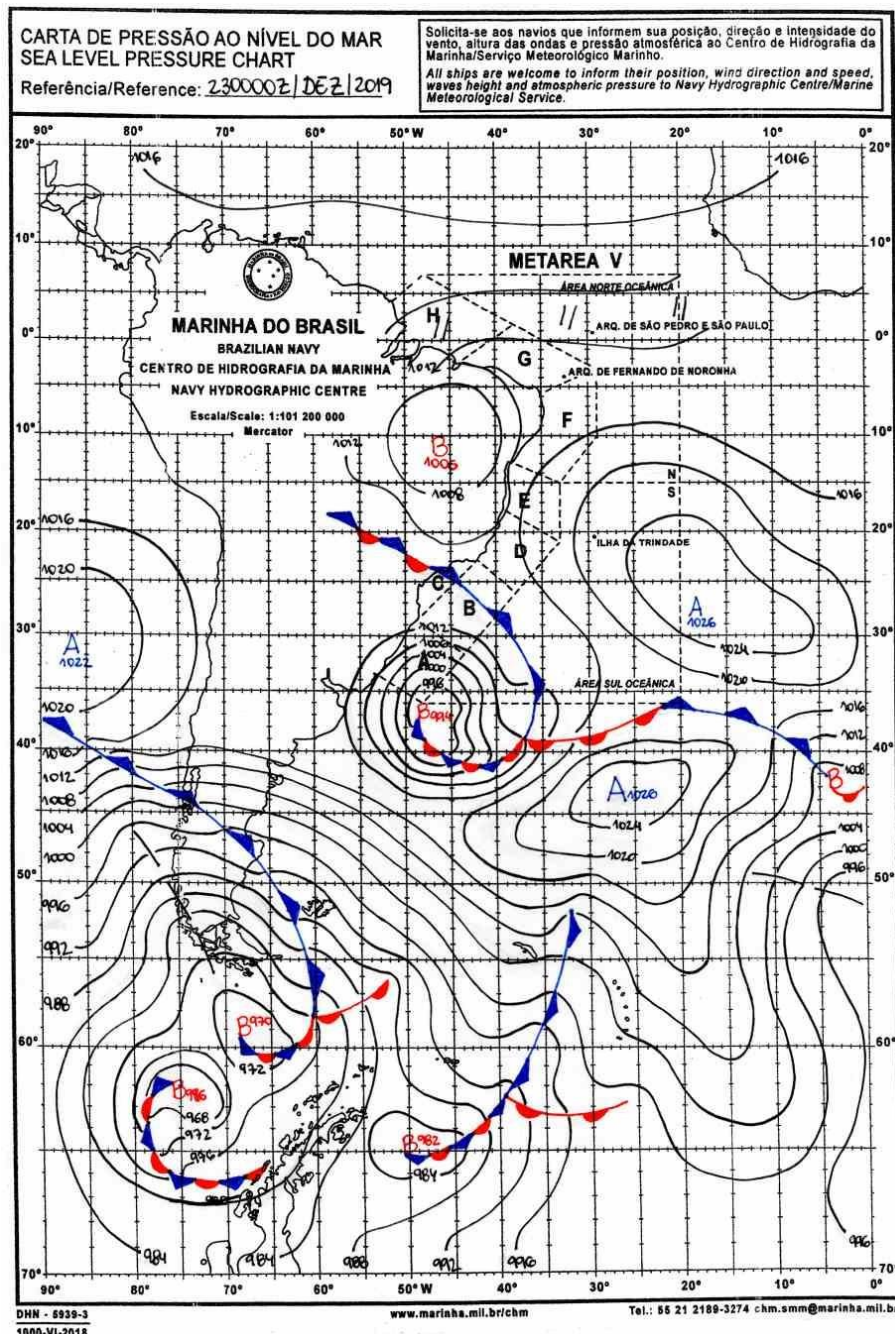

LEGENDA			
	Frente Fria	<b>A</b>	Alta Pressão
	Frente Quente	<b>B</b>	Baixa Pressão
	Instabilidade		Zona de Convergência

Figura A2 - Carta sinótica da Marinha do Brasil para as 0000Z do dia 23 de dezembro de 2019 (21h00 do dia 22 de dezembro de 2019, hora local. FONTE: Marinha do Brasil).



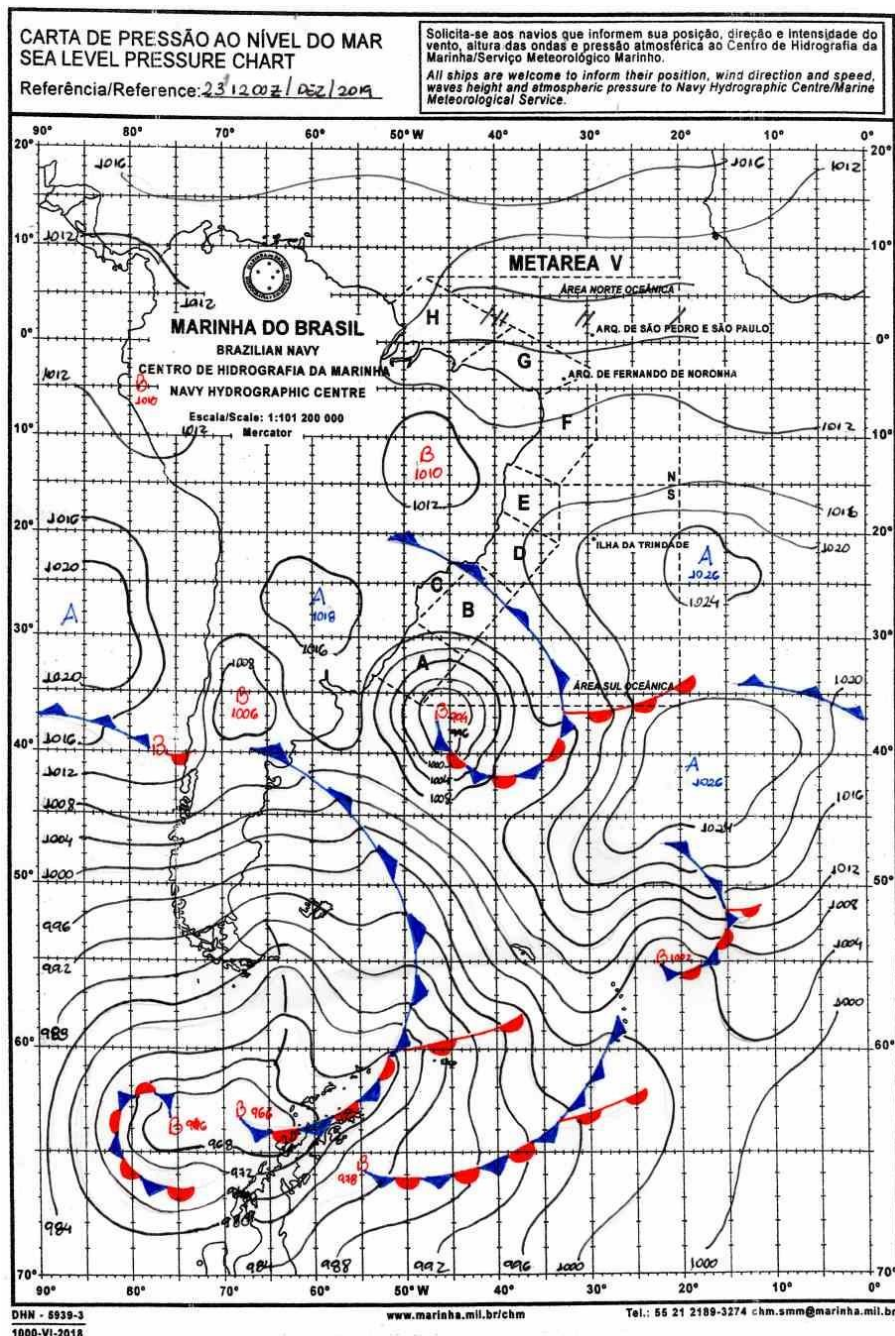

LEGENDA			
	Frente Fria	<b>A</b>	Alta Pressão
	Frente Quente	<b>B</b>	Baixa Pressão
	Instabilidade		Zona de Convergência

Figura A3 - Carta sinótica da Marinha do Brasil para as 1200Z do dia 23 de dezembro de 2019 (09h00 do dia 23 de dezembro de 2019, hora local. FONTE: Marinha do Brasil).

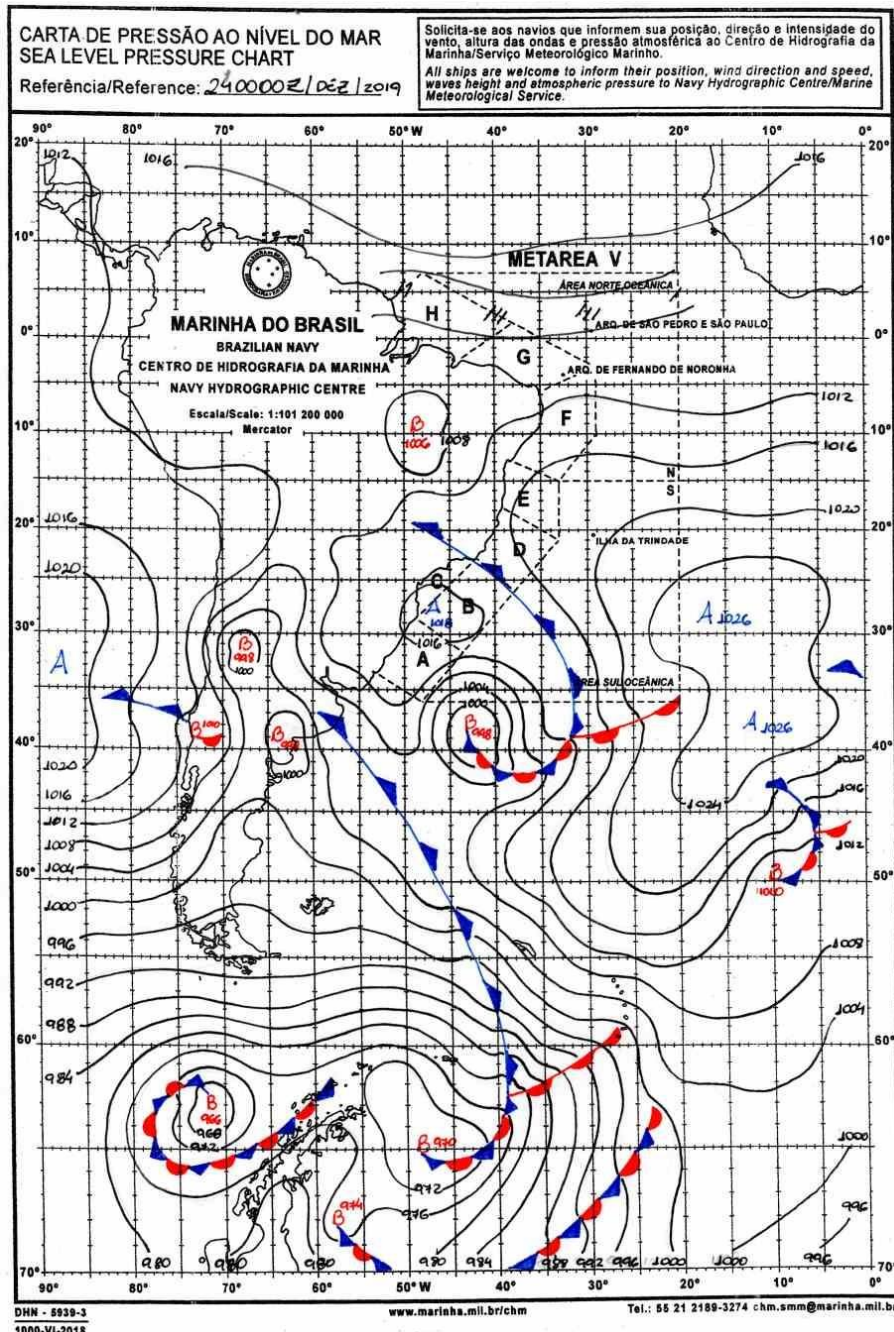

LEGENDA			
	Frente Fria	<b>A</b>	Alta Pressão
	Frente Quente	<b>B</b>	Baixa Pressão
	Instabilidade		Zona de Convergência

Figura A4 - Carta sinótica da Marinha do Brasil para as 0000Z do dia 24 de dezembro de 2019 (21h00 do dia 23 de dezembro de 2019, hora local. FONTE: Marinha do Brasil).



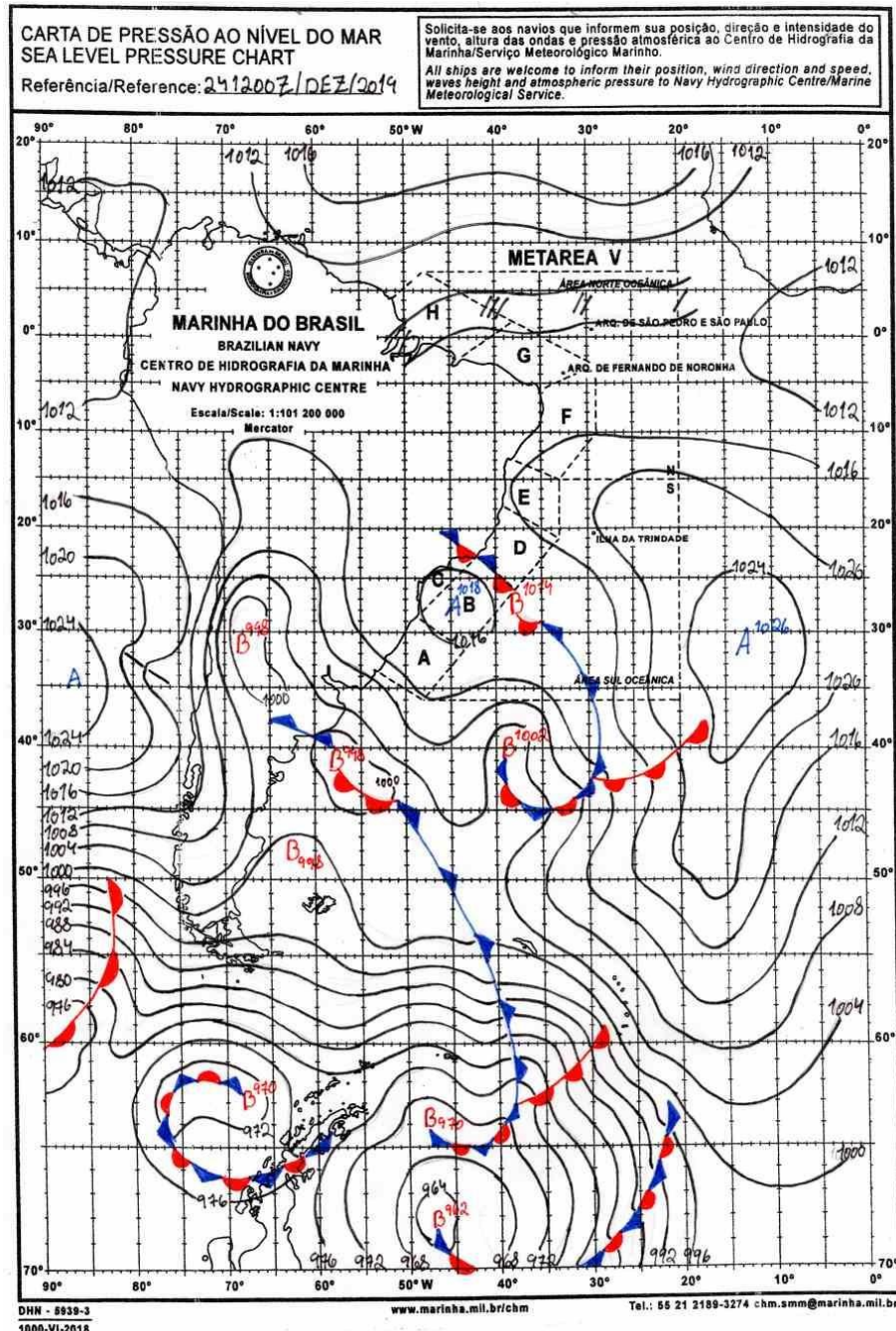

LEGENDA			
	Frente Fria	<b>A</b>	Alta Pressão
	Frente Quente	<b>B</b>	Baixa Pressão
	Instabilidade		Zona de Convergência

Figura A5 - Carta sinótica da Marinha do Brasil para as 1200Z do dia 24 de dezembro de 2019 (09h00 do dia 24 de dezembro de 2019, hora local. FONTE: Marinha do Brasil).

---

## A.2 Notícias relacionadas

- Temporal faz igreja desabar, mas fiés agradecem por ninguém se ferir: 'Livramento'  
<https://g1.globo.com/go/goias/noticia/2019/12/23/temporal-faz-igreja-desabar-mas-fieis-agradecem-por-ninguem-se-ferir-livramento.ghtml>

- Chuva castiga Aparecida de Goiânia no final da tarde deste Domingo (22)

<https://www.jornalgoiasemfoco.com.br/noticia/chuva-castiga-aparecida-de-goiania-no-final-da-tarde-deste-domingo-22>

- Após forte chuva, Prefeitura, defesa civil e bombeiros executam ações emergenciais pelas ruas da cidade

<https://morrinhos.go.gov.br/site/2019/12/apos-forte-chuva-prefeitura-defesa-civil-e-bombeiros-executam-acoes-emergenciais-pelas-ruas-da-cidade/>

- Árvore cai em cima de carro após forte chuva em Morrinhos

<https://www.morrinhosagora.com.br/arvore-cai-em-cima-de-carro-apos-forte-chuva-em-morrinhos/>

- Teto de posto de combustíveis desaba após forte chuva, em Aparecida de Goiânia

<https://globoplay.globo.com/v/8185096/>

- Tempestade causa estragos em Águas Lindas

<https://aguaslindasnews.com.br/2019/12/23/aguas-lindas/tempestade-causa-estragos-em-aguas-lindas/>

Bianca Lobo

Silva

Meteorologista

CREA

5063840461

## Instituto Nacional de Meteorologia - INMET

Umidade Relativa do Ar 00h UTC  
Estação: ARAGARCAS (GO) - 12/2019

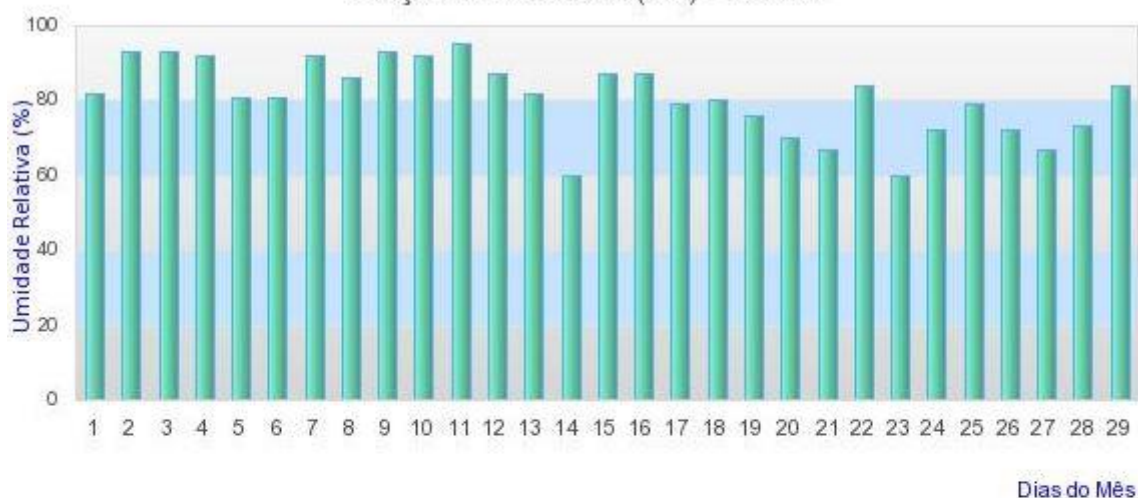

## Instituto Nacional de Meteorologia - INMET

Chuva Acumulada 24h  
Estação: ARAGARCAS - 12/2019





## Instituto Nacional de Meteorologia - INMET

Umidade Relativa do Ar 00h UTC  
Estação: CATALAO (GO) - 12/2019

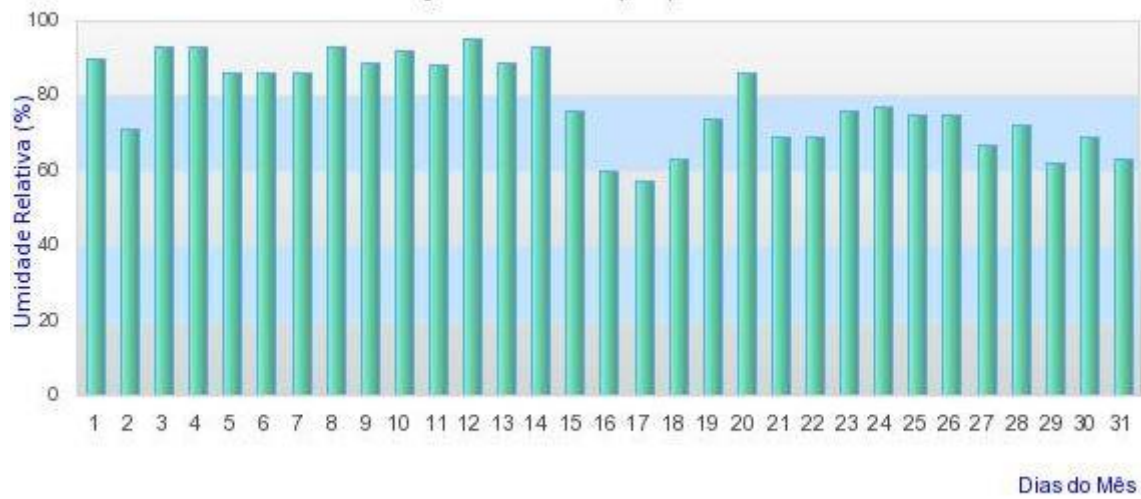

## Instituto Nacional de Meteorologia - INMET

Chuva Acumulada 24h  
Estação: CATALAO - 12/2019

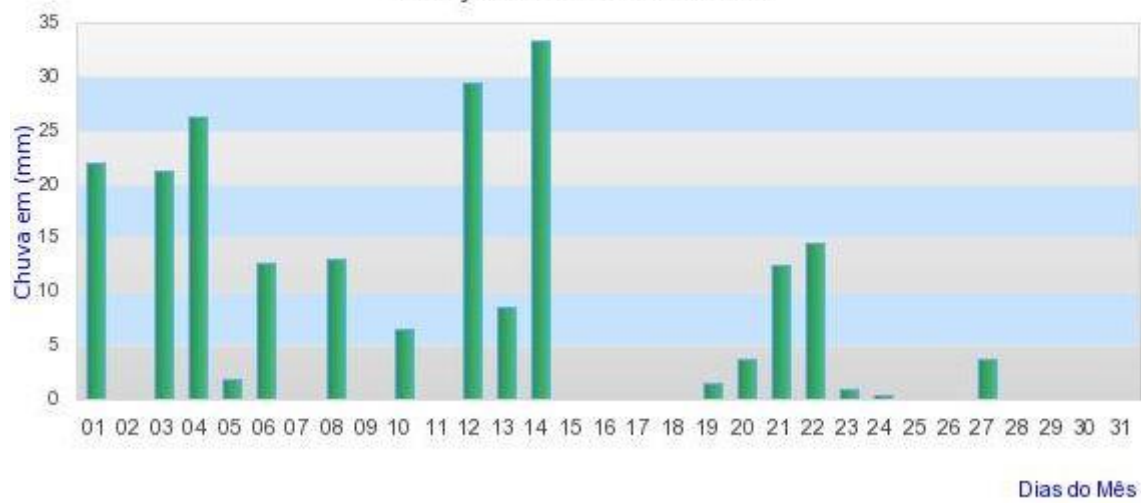

## Instituto Nacional de Meteorologia - INMET

Umidade Relativa do Ar 00h UTC  
Estação: FORMOSA (GO) - 12/2019

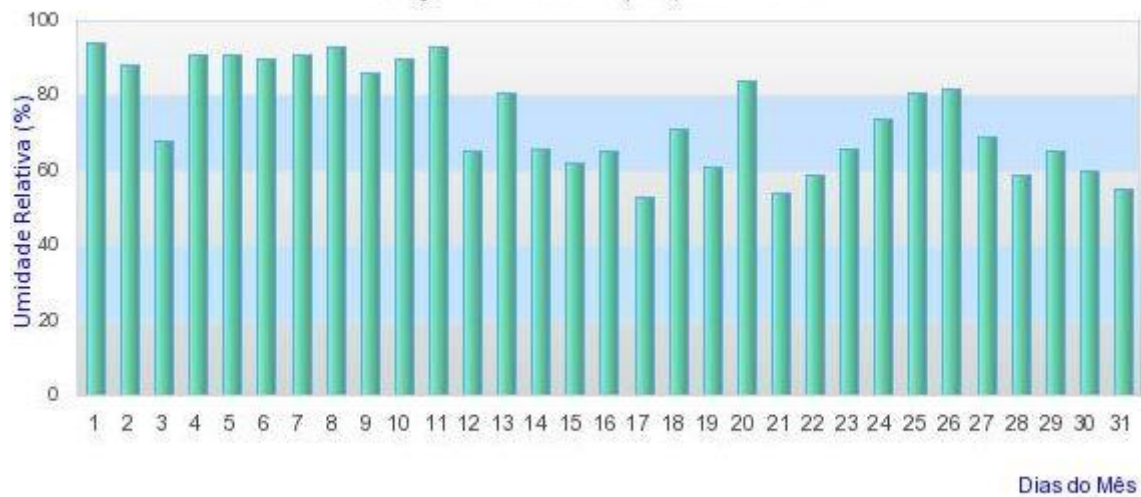

## Instituto Nacional de Meteorologia - INMET

Chuva Acumulada 24h  
Estação: FORMOSA - 12/2019



### Instituto Nacional de Meteorologia - INMET

Umidade Relativa do Ar 00h UTC  
Estação: IPAMERI (GO) - 12/2019

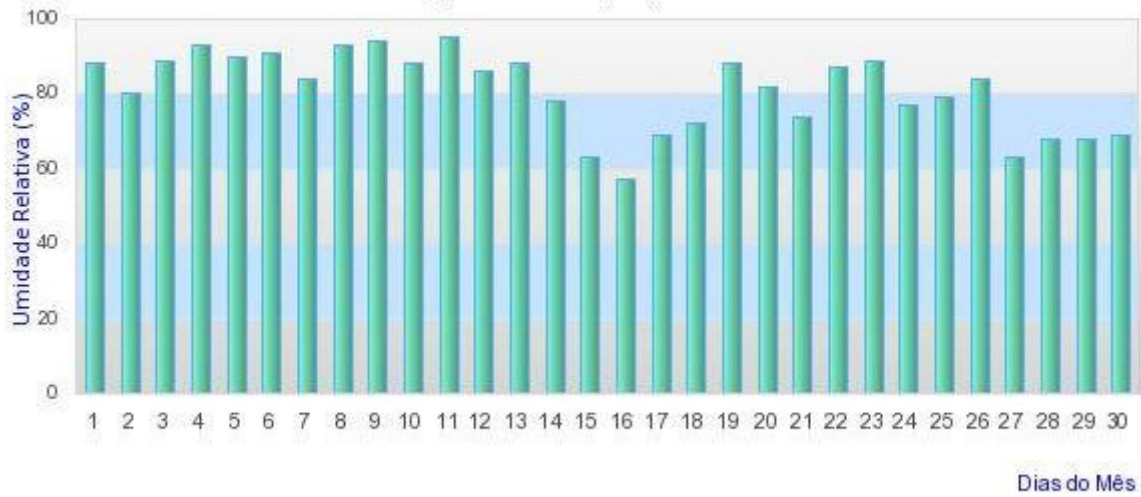

### Instituto Nacional de Meteorologia - INMET

Chuva Acumulada 24h  
Estação: IPAMERI - 12/2019

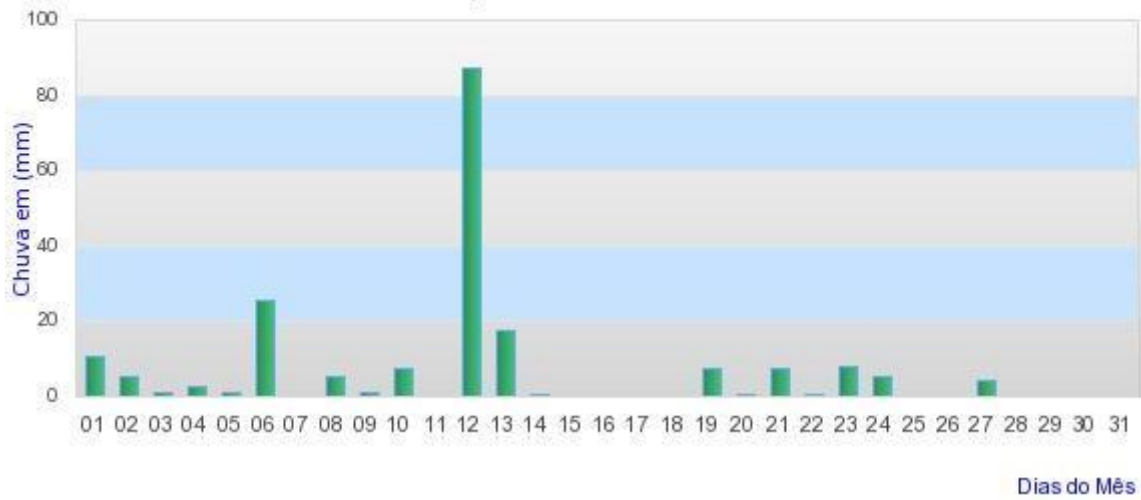

## Instituto Nacional de Meteorologia - INMET

Umidade Relativa do Ar 00h UTC  
Estação: PIRENOPOLIS (GO) - 12/2019

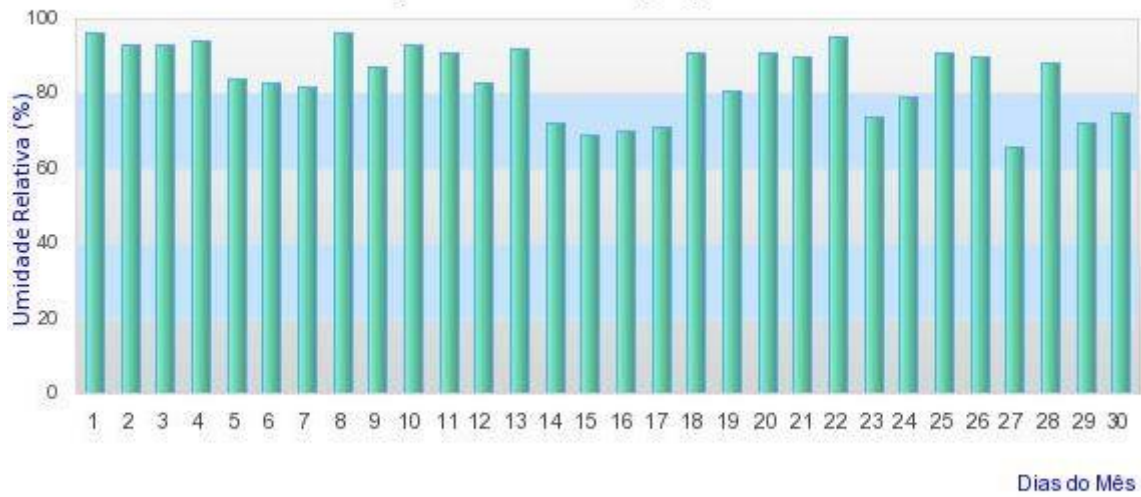

## Instituto Nacional de Meteorologia - INMET

Chuva Acumulada 24h  
Estação: PIRENOPOLIS - 12/2019

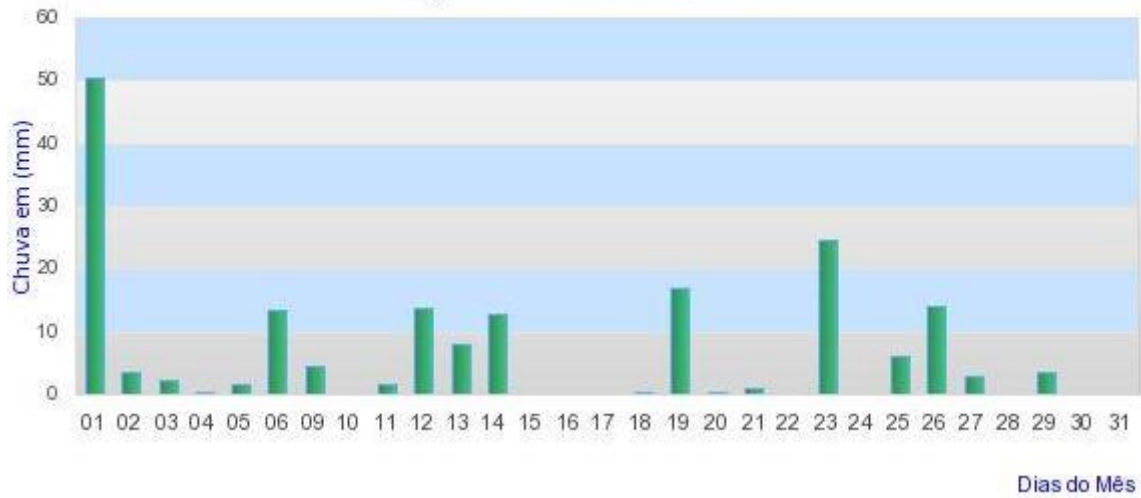

### Instituto Nacional de Meteorologia - INMET

Umidade Relativa do Ar 00h UTC

Estação: POSSE (GO) - 12/2019



### Instituto Nacional de Meteorologia - INMET

Chuva Acumulada 24h

Estação: POSSE - 12/2019

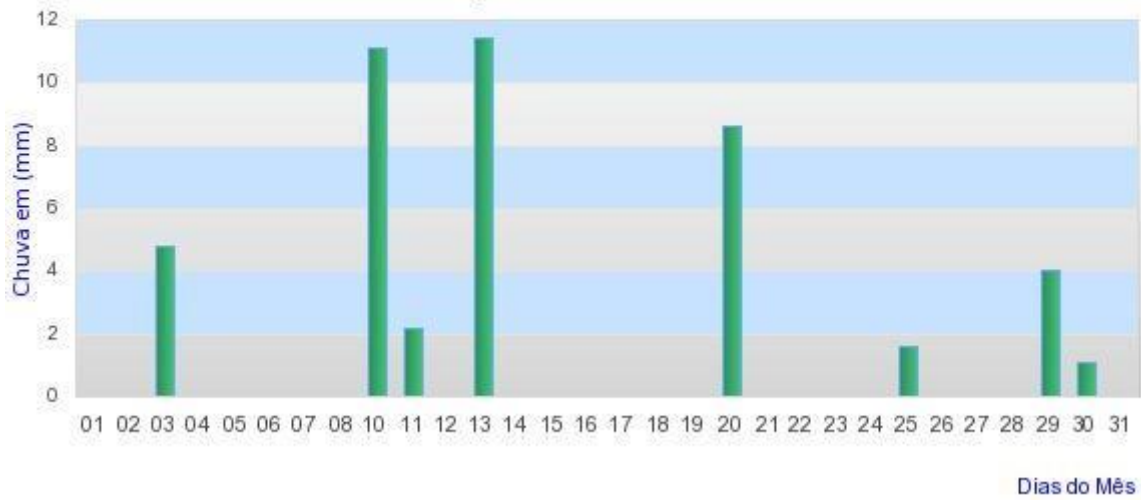

## Instituto Nacional de Meteorologia - INMET

Umidade Relativa do Ar 00h UTC  
Estação: RIO VERDE (GO) - 12/2019

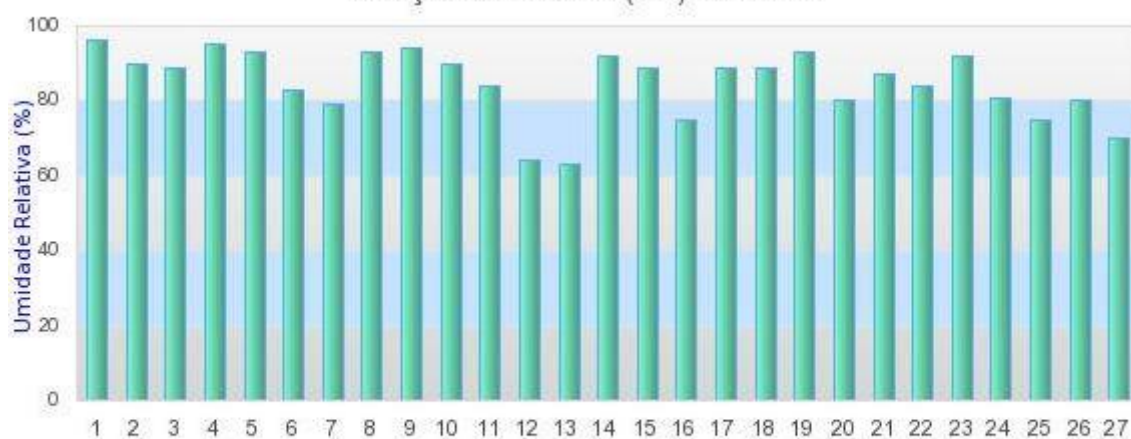

Dias do Mês

## Instituto Nacional de Meteorologia - INMET

Chuva Acumulada 24h  
Estação: RIO VERDE - 12/2019



Dias do Mês



## NOTÍCIAS RELACIONADAS

<https://g1.globo.com/go/goias/noticia/2019/12/23/temporal-faz-igreja-desabar-mas-fieis-agradecem-por-ninguem-se-ferir-livramento.ghtml>

G1

GOIÁS

# Temporal faz igreja desabar, mas fiéis agradecem por ninguém se ferir: 'Livramento'

Chuva forte fez templo ir ao chão em Aparecida de Goiânia quando local estava vazio, cerca de 3h antes de culto. Prédio onde celebrações eram realizadas e nova sede anexa foram abaixo, mas comunidade já se mexe para fazer reconstrução.

Por **Sílvio Túlio e João Vítor Guedes**, G1 GO e TV Anhanguera

23/12/2019 07h39 - Atualizado há 2 meses



<https://www.jornalgoiasemfoco.com.br/noticia/chuva-castiga-aparecida-de-goiania-no-final-da-tarde-deste-domingo-22>

JORNAL  
**GOIÁS EM FOCO**  
TV, RÁDIO, WEB

HOME CATEGORIAS ▾ VÍDEOS EVENTOS ALBUNS EMPREGOS ▾ CLASSIFICADOS COLUNA SOCIAL FUTEBOL ▾ CONTATO

≡ NOTÍCIAS / CIDADES

## Chuva castiga Aparecida de Goiânia no final da tarde deste Domingo (22)

Casas destelhadas, árvores caídas e fios de alta tensão rompidos.



JORNAL GOIÁS EM FOCO

<https://morrinhos.go.gov.br/site/2019/12/apos-forte-chuva-prefeitura-defesa-civil-e-bombeiros-executam-acoes-emergenciais-pelas-ruas-da-cidade/>

## Após forte chuva, Prefeitura, defesa civil e bombeiros executam ações emergenciais pelas ruas da cidade

Ascom Notícias dezembro 22, 2019 | 0

MEIAS ELITE

Morrinhos registrou uma forte chuva neste domingo (22/12) de cerca de 30 milímetros e um forte vento. A tempestade causou muita sujeira em ruas, derrubou árvores, telhados, painéis, tendas e muros em vários bairros da cidade fez com que equipes da Prefeitura, defesa civil e corpo de bombeiros, trabalhassem intensamente durante o início da noite para reparar alguns danos e remover árvores do meio das ruas.

### ARQUIVOS

fevereiro 2020  
janeiro 2020  
dezembro 2019  
novembro 2019  
outubro 2019  
setembro 2019  
agosto 2019

<https://www.morrinhosagora.com.br/arvore-cai-em-cima-de-carro-apos-forte-chuva-em-morrinhos/>



## Árvore cai em cima de carro após forte chuva em Morrinhos

Morrinhos Agora 22 de dezembro de 2019 Morrinhos

Compartilhar no Facebook Compartilhar no Twitter

Espalhe por ai:





<https://globoplay.globo.com/v/8185096/>

globoplay

Agora na Globo

Novelas

Séries

Cinema

Infantil

Mais ▾



imagens

SITE MAIS GOIAS



Bom Dia GO >

# Teto de posto de combustíveis desaba após forte chuva, em Aparecida de Goiânia

<https://aguaslindasnews.com.br/2019/12/23/aguas-lindas/tempestade-causa-estragos-em-aguas-lindas/>

Águas Lindas, Últimas notícias

# Tempestade causa estragos em Águas Lindas

23/12/2019 às 19:56

[Curtir 109](#) [Compartilhar](#) [Tweet](#)



*Tempestade causa estragos em Águas Lindas – Foto: TVCMN*