

Resumo Executivo

O Presente Relatório tem como objetivo a incorporação de informações que sejam relevantes para que se possa fazer a devida associação aos dados contidos no corpo do documento objeto da classificação de Situação de Emergência caracterizada pelo Módulo 8 do Prodist, que tem como foco o impacto do evento sobre determinada rede geelétrica e cuja denominação é definida como CHI (Consumidor hora interrompido). O parâmetro para enquadramento nesta classificação de expurgo tem como premissa inicial o limite de Consumidor hora interrompido definido pela fórmula descrita no Módulo 01 do Prodist (Revisão - 9), acrescido de todos os outros informes e dados listados no Módulo 08 (Revisão 10) do Prodist. Este enquadramento se apresenta na maioria das vezes em condições climáticas adversas com severidade dos fatores inerentes a situação, caracterizado na maioria dos casos por fortes ventos e chuvas de grande intensidade e continuidade.

No dia 12/01/2019 – sábado – ocorreu chuva forte, raios e rajadas de vento sobre as Regiões da Enel Distribuição Goiás, provocando um número elevado de ocorrências.

Conforme informações do Climatempo Meteorologia, o aeroporto de Goiânia registrou rajadas de vento de aproximadamente 77,7 km/h às 17h08 do dia 12 de janeiro de 2019, e a estação de Aragarças registrou rajadas de 72,0 km/h as 22:00 do dia 12/01/2019, vento classificado como ventania forte pela escala Beaufort. Outras oito estações registraram rajadas superiores a 50 km/h, de acordo com laudo em anexo.

Entre as 10h00 do dia 12 e as 04h00 do dia 13 de janeiro de 2019 - domingo – Tivemos em todo o Estado de Goiás a incidências de 39.867 raios que poderão ser evidenciados no relatório. A estação do Instituto Nacional de Meteorologia (INMET) em Pirenópolis registrou 37,3 mm de chuva entre as 10h00 do dia 12 e as 10h00 do dia 13 de janeiro de 2019. Esse acumulado de chuva corresponde a aproximadamente 13% da média climatológica do mês de janeiro (1981-2010) para a região.

Áreas de instabilidade formadas pelo ar quente e úmido foram responsáveis pelo desenvolvimento de nuvens de tempestade, responsáveis pela ocorrência de chuva moderada a forte, raios e rajadas de vento de até 77 km/h sobre a área de concessão da ENEL DISTRIBUIÇÃO GOIÁS entre o dia 12 e o dia 13 de janeiro de 2019. As condições eram favoráveis à ocorrência de granizo.

Trechos de reportagens sobre o evento climático

Forte chuva com ventania em Anápolis causa estragos e assusta moradores. Corpo de Bombeiros também precisou socorrer vítima que caiu no Córrego das Antas. <https://portal6.com.br/2019/01/12/forte-chuva-com-ventania-em-anapolis-causa-estragos-e-assusta-moradores/>

Temporal derruba barracas de feira e causa alagamentos em Goiânia. Imagens mostram ainda parte do telhado e uma empresa que desabou, em Jaraguá, e chuva de granizo, em Formosa. Segundo a Comurg, há registro de nove árvores que caíram na capital. <https://g1.globo.com/go/goias/noticia/2019/01/12/temporal-derruba-barracas-de-feira-e-causa-alagamentos-em-goiania.ghtml>

Chuva e ventos forte provoca estragos e falta de energia em Anápolis. Quedas de árvores, e falta de energia foram registradas em vários bairros da cidade. <http://www.anapolisnoticias24h.com.br/chuva-e-ventos-forte-provoca-estragos-e-falta-de-energia-em-anapolis/>

Temporal e ventos fortes causam estragos na empresa FVO em Rialma. <http://www.jornalpopulacional.com.br/noticia/9471-temporal-e-ventos-fortes-causam-estragos-na-empresa-fvo-em-rialma.html>

Vendaval deixa Rubiataba e Nova América 18 horas sem energia. <http://www.jornalpopulacional.com.br/noticia/9469-vendaval-deixa-rubiataba-e-nova-america-18-horas-sem-energia.html>

Relatório de Ocorrências do período

Em todo o Estado de Goiás verificou-se também que a intensidade da chuva e dos ventos danificaram a rede de distribuição de energia elétrica em diversos pontos, registrando aproximadamente 246 mil clientes com interrupção no fornecimento de energia elétrica devido a eventos relacionados ao temporal.

Para otimizar o volume de atendimentos e reduzir os tempos de interrupção foram mobilizados os recursos extras da empresa que aumentou o contingente em relação a situação normal de operação. O acompanhamento da quantidade de equipes e o Tempo Médio de Atendimento podem ser consultados na Pág.02 do Relatório em anexo.

O impacto e severidade do evento estão relatados em artigos de mídia, como foto e reportagens que demonstram os danos na Rede de Distribuição, oriundos dos eventos climáticos no período. Eventos estes que afetaram 487.615 consumidores com CHI de 1.920.998,43, superior ao de 476.777,69 estabelecido como limite para definição de Situação de Emergência, conforme resumo das informações obrigatórias.

Empresa		ENEL DISTRIBUIÇÃO GOIÁS			
Código do Relatório		CHI-010 - ENEL DISTRIBUIÇÃO GOIÁS			
Evento:		TEMPORAL NA AREA DE CONCESSÃO DA ENEL DISTRIBUIÇÃO GOIÁS			
Código COBRADE:	1.3.2.1.2, 1.3.2.1.3, 1.3.2.1.3.4, 1.3.2.1.5	Data Inicio	12/01/2019	Hora início	10:00
Código do Evento:	CHI-010-ENEL GO	Data Término	13/01/2019	Hora Término	22:50
Valor CHI (Limite e Real)	476.777,69	1.920.998,43	<p>Subestações Atingidas</p> <p>ACREUNA / AEROPORTO / AGUAS LINDAS / GIRASSOL / PARQUE DAS NACOES / SANTO ANTONIO DO DESCOBERTO / ANAPOLIS UNIVERSITARIA / AMERICANO DO BRASIL / ANICUNS / NAZARIO / AVELINOPOLIS / ARAGARCAS / ARENOPOLIS / ARUANA / ATLANTICO / BOM JARDIM / BOM JESUS DE GOIAS / VENDA SECA / BRITANIA / JURUMIRIM / CABRIUVA (RIO VERDE) / BACURI (RIO VERDE) / CACU / CACHOEIRA ALTA / PARANAIGUARA / ITARUMA / APARECIDA DO RIO DOCE / SAO SIMAO / CACHOEIRA DOURADA / ALMERINDONOPOLIS / CAIAPONIA / DOVERLANDIA / CALDAS NOVAS / BOA VISTA / CAMPINORTE / CAMPO ALEGRE DE GOIAS / CARAJAS / CUMARI / PIRES BELO / CATALAO / NOVA AURORA / GOIANDIRA / OUVIDOR / DIMIC / CALDAZINHA / CEZARINA / CHAPADAO DO CEU / COCALZINHO / CRISTALINA / CRISTALINA TRANSMISSAO / SAO BARTOLOMEU / SAO MIGUEL DO PASSA QUATRO / CRISTIANOPOLIS / TEREZOPOLIS / EDEIA / INDIARA / FERROVIARIO / FIRMINOPOLIS / TURVANIA / ADELANDIA / AURILANDIA / CORREGO DO OURO / BURITI DE GOIAS / MOSSAMEDES / SAO JOAO DA PARAUNA / SANCLERLANDIA / FLORES DE GOIAS / GOIANIA LESTE / FAINA / GOIAS / RETIRO / GOIAS / ALOANDIA / GOIATUBA / ARAGOIANIA / POSSELANDIA / VARJAO / IACIARA / ALVORADA DO NORTE / MAMBAI / POSSE / BARBOSELANDIA / USINA MAMBAI / SITO DABADIA / INDEPENDENCIA / IPAMERI / IPEGUARI / AMORINOPOLIS / AREIAS / MONTES CLAROS DE GOIAS / DIORAMA / JAUPACI / IPORA / ISRAELANDIA / MOIPORA / URU / CALCILANDIA / ITABERAI / ITAGUARI / ITAGUARI / APORE / CAMPO NOVO / ENERSUL / ITAPACI / ITAPACI (TRANSMISSAO) / NOVA PONTE / MORRO AGUDO / HEITORAI / ITAPURANGA (TRANSMISSAO) / ITAPURANGA / ITIQUIRA (FORMOSA) / ITUMBIARA NOVA / ITUMBIARA VELHA / BURITI ALEGRE / SERRANOPOLIS / SERRA AZUL (JATAI) / PEROLANDIA / JATAI / JUNDIAI / FAZENDA NOVA / NOVO BRASIL / JUSSARA / MUTUNOPOLIS / MARA ROSA / COLINACU / ESTRELA DO NORTE / SANTA TEREZA DE GOIAS / ABC / CIDADE OCIDENTAL / LAGES / DESFECHO / MARAJOARA / NOVO GAMA / VALPARAISO / MATRINCHA / ITAPIRAPUA / JACILANDIA / MINACU / MONTVIDIU T / FORMIGA / MORRINHOS / ARAGUAPAZ / RIO DO PEIXE / MOZARLANDIA / MOZARLANDIA (TRANSMISSAO) / NIQUELANDIA / NOVA CRIXAS (TRANSMISSAO) / XIXA / MUNDO NOVO DE GOIAS / NOVO PLANALTO / PACAEMBU (NOVO GAMA) / PADRE BERNARDO (PADRE BERNARDO) / PALESTINA / SUCURI / JANDAIA / PALMEIRAS DE GOIAS / PALMINOPOLIS / PALMEIRAS / PAMPLONA / PARAUNA SE ALTA TENSAO / MINEIROS / PORTELANDIA / PARQUE DAS EMAS (MINEIROS) / PIRACANJUBA / PIRANHAS T / PIRES DO RIO / ORIZONA / PALMELO / SAO GABRIEL DE GOIAS / PLANALTINA / PLANALTINA (TRANSMISSAO) / PONTALINA / EDEALINA / MAIRIPOTABA / PORANGATU / FORMOSO / BARREIRO (PORANGATU) / RIO PRETO / QUIRINOPOLIS / REAL / RIO VERDE / RIO VERMELHO / PROFESSOR JAMIL / RUBIATABA / NOVA AMERICA / NOVA IGUAU / CAMPOS VERDES / SANTA TEREZINHA / SAO JOAO D ALIANCA / SAO LUIZ DOS MONTES BELOS / BONOPOLIS / SAO MIGUEL DO ARAGUAIA / SERRA DE CALDAS / CRIXAS / URUAU / PILAR / HIDROLINA / BONITO / VICENTINOPOLIS / CORUMBAIBA / ALEXANIA / MATO GRANDE / ALEXANIA TRANSMISSAO / CEBRASA FABRICA DA AMBEV / ABADIANIA / ANHANGUERA / BARRO ALTO / QUEBRA LINHA / BELA VISTA (TRANSMISSAO) / TAQUARI / CAMPINAS / CEPAIGO / HIDROLANDIA / BARCELONA / BONFINOPOLIS / DAIA - ANAPOLIS / DORCELINO PEIXOTO DE MORAES / GOIANAPOLIS / GAMELEIRA / LEOPOLDO DE BULHOES / JUSCELANDIA / GOIANESIA / GUAPO / NOVA VENEZA / CATURAI / DAMOLANDIA / ITAUUCU / SANTA ROSA DE GOIAS / INHUMAS / JARAGUA / NEROPOLIS / SENADOR CANEDO TRANSMISSAO / CACHOEIRA NOVA / LAGOA DA SERRA / VIANOPOLIS / ARACU / SANTA FE DE GOIAS / TRES RANCHOS / DAVINOPOLIS / PIRENOPOLIS / OLHOS DAGUA / CORUMBA / GOIANIRA / GOYA / MEIA PONTE / CAMPO LIMPO DE GOIAS / BRAZABRANTES / SANTO ANTONIO DE GOIAS / OURO VERDE DE GOIAS / PETROLINA / JESUPOLIS / SAO FRANCISCO DE GOIAS / JARANAPOLIS / SANTA BARBARA / CAMPESTRE / TRINDADE / MARZAGAO / AGUA LIMPA (MARZAGAO) / VILA CORUMBA / XAVANTES</p>		
Código do Decreto (Se Houver):					
Quantidade de Interrupções (Evento)	2535				
Início 1ª Incidência (Data e Hora)	12/01/2019 10:02				
Início Última Incidência (Data e Hora)	13/01/2019 22:44				
Média de Duração das Incidências (h)	11,11				
Duração da Incidência mais longa (h)	163,20				
Total de Clientes afetados	487.615		<p>Municípios Atingidos</p> <p>ACREUNA / EDEIA / TURVELANDIA / GOIANIA / AGUAS LINDAS DE GOIAS / COCALZINHO DE GOIAS / PADRE BERNARDO / SANTO ANTONIO DO DESCOBERTO / CORUMBA DE GOIAS / ANAPOLIS / ADELANDIA / AMERICANO DO BRASIL / ANICUNS / AVELINOPOLIS / ITABERAI / MOSSAMEDES / NAZARIO / PALMEIRAS DE GOIAS / SANTA BARBARA DE GOIAS / TURVANIA / ARAGARCAS / BOM JARDIM DE GOIAS / ARENOPOLIS / DIORAMA / MONTES CLAROS DE GOIAS / ARUANA / BALIZA / PIRANHAS / BOM JESUS DE GOIAS / GOIATUBA / BRITANIA / JUSSARA / RIO VERDE / JATAI / APARECIDA DO RIO DOCE / CACHOEIRA ALTA / CACU / ITARUMA / PARANAIGUARA / SAO SIMAO / CACHOEIRA DOURADA / INACIOLANDIA / ITUMBIARA / CAIAPONIA / DOVERLANDIA / CALDAS NOVAS / PIRACANJUBA / SANTA CRUZ DE GOIAS / CAMPINORTE / URUAU / CAMPO ALEGRE DE GOIAS / ABADIA DE GOIAS / ANHANGUERA / CATALAO / CORUMBAIBA / GOIANDIRA / IPAMERI / NOVA AURORA / OUVIDOR / CUMARI / CALDAZINHA / CEZARINA / INDIARA / MINEIROS / SERRANOPOLIS / CRISTALINA / LUZIANIA / BELA VISTA DE GOIAS / CRISTIANOPOLIS / SAO MIGUEL DO PASSA QUATRO / TEREZOPOLIS DE GOIAS / EDEALINA / JANDAIA / FIRMINOPOLIS / PALMINOPOLIS / SAO JOAO DA PARAUNA / AURILANDIA / BURITI DE GOIAS / CACHOEIRA DE GOIAS / CORREGO DO OURO / FAZENDA NOVA / PARAUNA / SANCLERLANDIA / SAO LUIS DE MONTES BELOS / ALVORADA DO NORTE / FLORES DE GOIAS / FORMOSA / FORMOSO / IACIARA / NOVA ROMA / POSSE / SAO JOAO D ALIANCA / ARAGUAPAZ / FAINA / GOIAS / GUARAITA / ITAPURANGA / MORRO AGUDO DE GOIAS / PONTALINA / MORRINHOS / ARAGOIANIA / CAMPESTRE DE GOIAS / GUAPO / VARJAO / DAMIANOPOLIS / MAMBAI / SIMOLANDIA / SITO D ABADIA / APARECIDA DE GOIANIA / SANTA HELENA DE GOIAS / AMORINOPOLIS / IPORA / ISRAELANDIA / IVOLANDIA / JAUPACI / MOIPORA / HEITORAI / ITAGUARI / ITAGUARI / JARAGUA / TAQUARAL DE GOIAS / APORE / ITAJA / GUARINOS / HIDROLINA / ITAPACI / NOVA GLORIA / PILAR DE GOIAS / SAO LUIZ DO NORTE / URUANA / VILA BOA / BURITI ALEGRE / PEROLANDIA / ITAPIRAPUA / NOVO BRASIL / SANTA FE DE GOIAS / AMARALINA / BONOPOLIS / CAMPINACU / ESTRELA DO NORTE / MARA ROSA / MUTUNOPOLIS / PORANGATU / SANTA TEREZA DE GOIAS / CIDADE OCIDENTAL / DISTRITO FEDERAL / NOVO GAMA / VALPARAISO DE GOIAS / MATRINCHA / CAVALCANTE / COLINAS DO SUL / MINACU / TROMBAS / MONTVIDIU / CRIXAS / MOZARLANDIA / NOVA CRIXAS / NIQUELANDIA / MUNDO NOVO DE GOIAS / SAO MIGUEL DO ARAGUAIA / UIRAPURU / NOVO PLANALTO / MIMOSO DE GOIAS / PLANALTINA / PALESTINA DE GOIAS / PORTELANDIA / SANTA RITA DO ARAGUAIA / PIRES DO RIO / URUTAI / ORIZONA / PALMELO / VIANOPOLIS / CROMINIA / MAIRIPOTABA / PROFESSOR JAMIL SAFADY / MONTVIDIU DO NORTE / QUIRINOPOLIS / CERES / NOVA AMERICA / RUBIATABA / ALTO HORIZONTE / CAMPOS VERDES / NOVA IGUAU DE GOIAS / SANTA TEREZINHA DE GOIAS / AGUA FRIA DE GOIAS / ALTO PARAISO DE GOIAS / BARRO ALTO / VICENTINOPOLIS / ABADIANIA / ALEXANIA / GAMELEIRA DE GOIAS / CAMPO LIMPO / PIRENOPOLIS / HIDROLANDIA / SANTA RITA DO NOVO DESTINO / VILA PROPICIO / SENADOR CANEDO / BONFINOPOLIS / LEOPOLDO DE BULHOES / SILVANIA / GOIANAPOLIS / GOIANESIA / TRINDADE / BRAZABRANTES / CATURAI / DAMOLANDIA / GOIANIRA / INHUMAS / ITAUUCU / NOVA VENEZA / PETROLINA DE GOIAS / SANTA ROSA DE GOIAS / NEROPOLIS / OURO VERDE DE GOIAS / SANTO ANTONIO DE GOIAS / ARACU / TRES RANCHOS / JESUPOLIS / SAO FRANCISCO DE GOIAS / AGUA LIMPA / MARZAGAO / RIO QUENTE</p>		

DANOS CAUSADOS			
Equipamentos Danificado	Importância para o Sistema	Local	Quantidade
Disjuntor/Religador Operado	Proteção do Alimentador	Área de Concessão	67
Chaves Fusíveis Operada	Proteção de Ramais de Alimentadores	Área de Concessão	837
Transformador Operado	Proteção do Transformador	Área de Concessão	663

Relato técnico sobre a Intervenção realizada em Goiânia e Região Metropolitana				
Informações sobre Equipes	12/01	13/01		
Quantidade Usual	644	521		turmas
Quantidade Adicional	12	40		turmas
Quantidade Total	656	561		turmas
Tempos Médios				
Preparação	12,78	13,26		Horas
Deslocamento	0,66	0,68		Horas
Execução	1,55	1,28		Horas
TMAE	14,99	15,22		Horas

Principais Dificuldades Encontradas:

Chuvas com ventos fortes provocaram muitos pontos de alagamento e enxurrada, trânsito impedido por vários semáforos desligados dificultando a chegada ao atendimento das ocorrências emergenciais. Em determinadas regiões, decorrente dos fortes ventos, houve o tombamento de árvores nas estruturas de alimentação de média tensão, danos em ramais de ligação dos clientes, impedimentos de acesso e atolamentos em estradas rurais.

Empresa	ENEL DISTRIBUIÇÃO GOIAS		
Valor CHI (Limite e Real)	476.777,69		1.920.998,43

DOC ORIGEM	MUNICIPIO	EQP_ORIGEM	CONJUNTO	INI_OCORRENC	FIM_OCORRENC	DT_INI_EVENTO	DT_FIM_EVENTO	DURAÇ	UC INT	ΣCHI	EXPURGO
20190141681	PETROLINA DE GOIAS	SR12018993	INHUMAS S1	12/01/2019 14:35	12/01/2019 17:33	12/01/2019 14:35	12/01/2019 17:33	2,97	78	231,40	CHI
20190141681	SANTA ROSA DE GOIAS	SR12018993	INHUMAS S1	12/01/2019 14:35	12/01/2019 17:33	12/01/2019 14:35	12/01/2019 17:33	2,97	1	2,97	CHI
20190144066	CATALAO	CT12266207LD	CATALAO S1	12/01/2019 10:31	12/01/2019 12:08	12/01/2019 10:31	12/01/2019 12:08	1,62	3	4,85	DIA CRITICO
20190144080	SANTA CRUZ DE GOIAS	BC21140741	PIRES DO RIO S2	12/01/2019 11:37	12/01/2019 12:57	12/01/2019 11:37	12/01/2019 12:57	1,33	1	1,33	CHI
20190144094	AGUAS LINDAS DE GOIAS	03730224	AGUAS LINDAS DE GOIAS S1	12/01/2019 13:12	12/01/2019 13:15	12/01/2019 13:12	12/01/2019 13:15	0,05	12287	614,35	CHI
20190144094	COCALZINHO DE GOIAS	03730224	AGUAS LINDAS DE GOIAS S1	12/01/2019 13:12	12/01/2019 13:15	12/01/2019 13:12	12/01/2019 13:15	0,05	274	13,70	CHI
20190144095	AGUAS LINDAS DE GOIAS	LA13326259	AGUAS LINDAS DE GOIAS S2	12/01/2019 13:18	14/01/2019 10:51	12/01/2019 13:18	12/01/2019 16:25	3,12	4695	14632,75	CHI
20190144095	COCALZINHO DE GOIAS	LA13326259	AGUAS LINDAS DE GOIAS S2	12/01/2019 13:18	14/01/2019 10:51	12/01/2019 13:18	12/01/2019 16:25	3,12	48	149,60	CHI
20190144095	PADRE BERNARDO	LA13326259	AGUAS LINDAS DE GOIAS S2	12/01/2019 13:18	14/01/2019 10:51	12/01/2019 13:18	12/01/2019 16:25	3,12	1	3,12	CHI
20190144095	AGUAS LINDAS DE GOIAS	04540214	AGUAS LINDAS DE GOIAS S2	12/01/2019 13:18	14/01/2019 10:51	12/01/2019 19:50	12/01/2019 20:03	0,22	8948	1938,73	CHI
20190144095	AGUAS LINDAS DE GOIAS	04540214	AGUAS LINDAS DE GOIAS S2	12/01/2019 13:18	14/01/2019 10:51	12/01/2019 19:50	12/01/2019 20:03	0,22	4696	1017,47	CHI
20190144095	COCALZINHO DE GOIAS	04540214	AGUAS LINDAS DE GOIAS S2	12/01/2019 13:18	14/01/2019 10:51	12/01/2019 19:50	12/01/2019 20:03	0,22	3	0,65	CHI
20190144095	COCALZINHO DE GOIAS	04540214	AGUAS LINDAS DE GOIAS S2	12/01/2019 13:18	14/01/2019 10:51	12/01/2019 19:50	12/01/2019 20:03	0,22	63	13,65	CHI
20190144095	PADRE BERNARDO	04540214	AGUAS LINDAS DE GOIAS S2	12/01/2019 13:18	14/01/2019 10:51	12/01/2019 19:50	12/01/2019 20:03	0,22	1	0,22	CHI
20190144095	AGUAS LINDAS DE GOIAS	04540214	AGUAS LINDAS DE GOIAS S2	12/01/2019 13:18	14/01/2019 10:51	12/01/2019 20:09	12/01/2019 20:13	0,07	8674	578,27	CHI
20190144095	AGUAS LINDAS DE GOIAS	04540214	AGUAS LINDAS DE GOIAS S2	12/01/2019 13:18	14/01/2019 10:51	12/01/2019 20:09	12/01/2019 20:13	0,07	4694	312,93	CHI
20190144095	AGUAS LINDAS DE GOIAS	LA10400754	AGUAS LINDAS DE GOIAS S2	12/01/2019 13:18	14/01/2019 10:51	12/01/2019 20:09	12/01/2019 20:46	0,62	707	435,98	CHI
20190144095	COCALZINHO DE GOIAS	LA10400754	AGUAS LINDAS DE GOIAS S2	12/01/2019 13:18	14/01/2019 10:51	12/01/2019 20:09	12/01/2019 20:46	0,62	3	1,85	CHI
20190144095	AGUAS LINDAS DE GOIAS	04540214	AGUAS LINDAS DE GOIAS S2	12/01/2019 13:18	14/01/2019 10:51	12/01/2019 20:30	12/01/2019 20:46	0,27	8674	2313,07	CHI
20190144095	AGUAS LINDAS DE GOIAS	LA13377226	AGUAS LINDAS DE GOIAS S2	12/01/2019 13:18	14/01/2019 10:51	12/01/2019 20:30	12/01/2019 22:00	1,50	3783	5674,50	CHI
20190144095	AGUAS LINDAS DE GOIAS	LA13326259	AGUAS LINDAS DE GOIAS S2	12/01/2019 13:18	14/01/2019 10:51	12/01/2019 20:30	12/01/2019 22:25	1,92	911	1746,08	CHI
20190144095	AGUAS LINDAS DE GOIAS	LA10394645	AGUAS LINDAS DE GOIAS S2	12/01/2019 13:18	14/01/2019 10:51	12/01/2019 20:07	12/01/2019 22:26	2,32	2	4,63	CHI
20190144095	COCALZINHO DE GOIAS	LA10394645	AGUAS LINDAS DE GOIAS S2	12/01/2019 13:18	14/01/2019 10:51	12/01/2019 20:07	12/01/2019 22:26	2,32	63	145,95	CHI
20190144095	PADRE BERNARDO	LA10394645	AGUAS LINDAS DE GOIAS S2	12/01/2019 13:18	14/01/2019 10:51	12/01/2019 20:07	12/01/2019 22:26	2,32	1	2,32	CHI
20190144095	AGUAS LINDAS DE GOIAS	04540214	AGUAS LINDAS DE GOIAS S2	12/01/2019 13:18	14/01/2019 10:51	14/01/2019 04:32	14/01/2019 04:47	0,25	912	228,00	CHI
20190144095	COCALZINHO DE GOIAS	04540214	AGUAS LINDAS DE GOIAS S2	12/01/2019 13:18	14/01/2019 10:51	14/01/2019 04:32	14/01/2019 04:47	0,25	63	15,75	CHI
20190144095	PADRE BERNARDO	04540214	AGUAS LINDAS DE GOIAS S2	12/01/2019 13:18	14/01/2019 10:51	14/01/2019 04:32	14/01/2019 04:47	0,25	1	0,25	CHI
20190144095	AGUAS LINDAS DE GOIAS	LA13164983	AGUAS LINDAS DE GOIAS S1	12/01/2019 13:18	14/01/2019 10:51	14/01/2019 08:46	14/01/2019 08:49	0,05	2611	130,55	CHI
20190144095	AGUAS LINDAS DE GOIAS	LA12386805	AGUAS LINDAS DE GOIAS S2	12/01/2019 13:18	14/01/2019 10:51	12/01/2019 22:26	14/01/2019 10:51	36,42	1	36,42	CHI
20190144904	ALTO HORIZONTE	AJ12375644	SANTA TEREZINHA	12/01/2019 10:02	12/01/2019 11:41	12/01/2019 10:02	12/01/2019 11:41	1,65	9	14,85	CHI
20190144904	PILAR DE GOIAS	AJ12375644	SANTA TEREZINHA	12/01/2019 10:02	12/01/2019 11:41	12/01/2019 10:02	12/01/2019 11:41	1,65	1	1,65	CHI
20190144916	MORRINHOS	MR11000056	MORRINHOS	12/01/2019 10:05	12/01/2019 11:15	12/01/2019 10:05	12/01/2019 11:15	1,17	97	113,17	CHI

20190144931	BOM JESUS DE GOIAS	BJ12000078	BOM JESUS DE GOIAS	12/01/2019 12:03	12/01/2019 13:34	12/01/2019 12:03	12/01/2019 13:34	1,52	5	7,58	CHI
20190144952	PORANGATU	PO12182396	PORANGATU	12/01/2019 10:15	12/01/2019 11:39	12/01/2019 10:15	12/01/2019 11:39	1,40	28	39,20	CHI
20190144962	NIQUELANDIA	NQ12317176	NIQUELANDIA SUBTRANSMISSÃO	12/01/2019 10:18	12/01/2019 15:11	12/01/2019 10:18	12/01/2019 15:11	4,88	78	380,90	CHI
20190144965	CACHOEIRA DE GOIAS	AI21349335	FIRMINOPOLIS S2	12/01/2019 10:19	12/01/2019 16:50	12/01/2019 10:19	12/01/2019 16:50	6,52	1	6,52	CHI
20190144969	MORRINHOS	MR12223447	MORRINHOS	12/01/2019 10:19	12/01/2019 13:55	12/01/2019 10:19	12/01/2019 13:55	3,60	5	18,00	CHI
20190144981	BALIZA	BH12396127	BOM JARDIM	12/01/2019 10:21	12/01/2019 19:10	12/01/2019 10:21	12/01/2019 19:10	8,82	1	8,82	CHI
20190144981	BOM JARDIM DE GOIAS	BH12396127	BOM JARDIM	12/01/2019 10:21	12/01/2019 19:10	12/01/2019 10:21	12/01/2019 19:10	8,82	1	8,82	CHI
20190144984	ALTO HORIZONTE	10004091750	SANTA TEREZINHA	12/01/2019 10:21	12/01/2019 12:41	12/01/2019 10:21	12/01/2019 12:41	2,33	1	2,33	CHI
20190145004	HEITORAI	HE12220534	ITAPURANGA	12/01/2019 10:27	14/01/2019 11:00	12/01/2019 10:27	12/01/2019 12:15	1,80	4	7,20	CHI
20190145004	HEITORAI	HE12220534	ITAPURANGA	12/01/2019 10:27	14/01/2019 11:00	12/01/2019 10:27	14/01/2019 11:00	48,55	2	97,10	CHI
20190145004	HEITORAI	HE12220534	ITAPURANGA	12/01/2019 10:27	14/01/2019 11:00	14/01/2019 09:46	14/01/2019 11:00	1,23	4	4,93	CHI
20190145024	MARA ROSA	MQ12360395	MARA ROSA	12/01/2019 10:33	12/01/2019 14:31	12/01/2019 10:33	12/01/2019 14:31	3,97	1	3,97	CHI
20190145042	SERRANOPOLIS	SX12241857	JATAI S1	12/01/2019 14:19	12/01/2019 20:27	12/01/2019 14:19	12/01/2019 20:27	6,13	6	36,80	CHI
20190145055	CORUMBAIBA	CI12377064	CATALAO S1	12/01/2019 10:41	12/01/2019 12:13	12/01/2019 10:41	12/01/2019 12:13	1,53	12	18,40	DIA CRITICO
20190145060	ITUMBIARA	IT12257058	ITUMBIARA NOVA	12/01/2019 10:42	12/01/2019 14:09	12/01/2019 10:42	12/01/2019 14:09	3,45	2	6,90	CHI
20190145065	GOIANDIRA	CT21267153	CATALAO S1	12/01/2019 10:43	13/01/2019 11:41	12/01/2019 10:43	13/01/2019 11:41	24,97	1	24,97	DIA CRITICO
20190145094	TRES RANCHOS	TH21195262	CATALAO S1	12/01/2019 10:58	12/01/2019 14:47	12/01/2019 10:58	12/01/2019 14:47	3,82	2	7,63	DIA CRITICO
20190145107	BONOPOLIS	BX12325674	SAO MIGUEL DO ARAGUAIA	12/01/2019 11:02	12/01/2019 15:39	12/01/2019 11:02	12/01/2019 15:39	4,62	1	4,62	DIA CRITICO
20190145110	CUMARI	CY21000307	CATALAO S1	12/01/2019 11:03	13/01/2019 16:41	12/01/2019 11:03	13/01/2019 16:41	29,63	1	29,63	DIA CRITICO
20190145113	CORUMBAIBA	CI21211124	VILA CORUMBA	12/01/2019 11:04	12/01/2019 13:00	12/01/2019 11:04	12/01/2019 13:00	1,93	1	1,93	CHI
20190145114	CEZARINA	CZ21215295	CEZARINA	12/01/2019 11:04	12/01/2019 17:29	12/01/2019 11:04	12/01/2019 17:29	6,42	1	6,42	CHI
20190145118	GOIAS	GS12198785	GOIAS	12/01/2019 11:06	13/01/2019 08:43	12/01/2019 11:06	13/01/2019 08:43	21,62	8	172,93	CHI
20190145118	GUARAITA	GS12198785	GOIAS	12/01/2019 11:06	13/01/2019 08:43	12/01/2019 11:06	13/01/2019 08:43	21,62	2	43,23	CHI
20190145118	ITAPURANGA	GS12198785	GOIAS	12/01/2019 11:06	13/01/2019 08:43	12/01/2019 11:06	13/01/2019 08:43	21,62	2	43,23	CHI
20190145138	OUVIDOR	IO12077557	CATALAO S1	12/01/2019 11:10	14/01/2019 15:20	12/01/2019 11:10	14/01/2019 15:20	52,17	2	104,33	DIA CRITICO
20190145149	GOIATUBA	GT21296875	BOM JESUS DE GOIAS	12/01/2019 11:14	12/01/2019 17:52	12/01/2019 11:14	12/01/2019 17:52	6,63	1	6,63	CHI
20190145153	SANTA FE DE GOIAS	RN12213784	JUSSARA	12/01/2019 11:15	12/01/2019 14:05	12/01/2019 11:15	12/01/2019 13:29	2,23	1	2,23	CHI
20190145153	SANTA FE DE GOIAS	RN12213784	JUSSARA	12/01/2019 11:15	12/01/2019 14:05	12/01/2019 13:50	12/01/2019 14:05	0,25	1	0,25	CHI
20190145154	AMARALINA	MQ12288718LD	NOVA CRIXAS	12/01/2019 11:16	12/01/2019 13:04	12/01/2019 11:16	12/01/2019 13:04	1,80	2	3,60	CHI
20190145155	ITUMBIARA	BG12000084	ITUMBIARA VELHA S2	12/01/2019 11:16	12/01/2019 18:20	12/01/2019 11:16	12/01/2019 18:20	7,07	1	7,07	CHI
20190145161	SANTA FE DE GOIAS	RN12252451	JUSSARA	12/01/2019 11:20	12/01/2019 15:37	12/01/2019 11:20	12/01/2019 15:37	4,28	7	29,98	CHI
20190145162	IVOLANDIA	IV12207910	IPORA	12/01/2019 11:21	12/01/2019 15:20	12/01/2019 11:21	12/01/2019 15:20	3,98	6	23,90	CHI
20190145173	PIRES DO RIO	PR21040826	PIRES DO RIO S1	12/01/2019 11:23	12/01/2019 12:39	12/01/2019 11:23	12/01/2019 12:39	1,27	1	1,27	CHI

20190145176	FAINA	FC12188057	GOIAS	12/01/2019 11:26	12/01/2019 17:26	12/01/2019 11:26	12/01/2019 17:26	6,00	2	12,00	CHI
20190145182	HIDROLINA	SZ12262852	ITAPACI	12/01/2019 11:28	12/01/2019 13:38	12/01/2019 11:28	12/01/2019 13:38	2,17	31	67,17	CHI
20190145196	DOVERLANDIA	DV21144443	CAIAPONIA	12/01/2019 11:34	12/01/2019 18:32	12/01/2019 11:34	12/01/2019 18:32	6,97	1	6,97	CHI
20190145211	GOIAS	GS12162481	GOIAS	12/01/2019 10:14	12/01/2019 15:21	12/01/2019 10:14	12/01/2019 15:21	5,12	10	51,17	CHI
20190145212	GOIANDIRA	GD12081490	CATALAO S1	12/01/2019 11:39	14/01/2019 09:40	12/01/2019 11:39	14/01/2019 09:40	46,02	2	92,03	DIA CRITICO
20190145221	MOSSAMEDES	MD11274191	FIRMINOPOLIS S2	12/01/2019 11:44	12/01/2019 12:45	12/01/2019 11:44	12/01/2019 12:45	1,02	88	89,47	CHI
20190145222	GOIAS	GS12073702	MATRINCHA	12/01/2019 11:44	13/01/2019 16:16	12/01/2019 11:44	13/01/2019 16:16	28,53	2	57,07	CHI
20190145228	PARAUNA	RP21033834	FIRMINOPOLIS S2	12/01/2019 11:47	12/01/2019 18:12	12/01/2019 11:47	12/01/2019 18:12	6,42	2	12,83	CHI
20190145231	GOIAS	GS12220469	GOIAS	12/01/2019 11:48	12/01/2019 16:49	12/01/2019 11:48	12/01/2019 16:49	5,02	1	5,02	CHI
20190145251	BONOPOLIS	BX12364670	SAO MIGUEL DO ARAGUAIA	12/01/2019 11:56	13/01/2019 12:00	12/01/2019 11:56	13/01/2019 12:00	24,07	2	48,13	DIA CRITICO
20190145258	BONOPOLIS	PO12090602	MARA ROSA	12/01/2019 11:36	12/01/2019 18:46	12/01/2019 11:36	12/01/2019 18:46	7,17	2	14,33	CHI
20190145258	PORANGATU	PO12090602	MARA ROSA	12/01/2019 11:36	12/01/2019 18:46	12/01/2019 11:36	12/01/2019 18:46	7,17	66	473,00	CHI
20190145264	SANTA TEREZA DE GOIAS	2430003930	MARA ROSA	12/01/2019 12:01	12/01/2019 20:53	12/01/2019 12:01	12/01/2019 20:53	8,87	1	8,87	CHI
20190145266	CRIXAS	CX11398116	SERRA DO OURO	12/01/2019 12:02	12/01/2019 13:43	12/01/2019 12:02	12/01/2019 13:43	1,68	2	3,37	CHI
20190145267	INDIARA	IY21057309	EDEIA	12/01/2019 12:03	13/01/2019 13:42	12/01/2019 12:03	13/01/2019 13:42	25,65	1	25,65	CHI
20190145268	CRISTALINA	KR21331933	PAMPLONA	12/01/2019 12:03	12/01/2019 18:10	12/01/2019 12:03	12/01/2019 18:10	6,12	1	6,12	CHI
20190145269	AURILANDIA	AI12033027	FIRMINOPOLIS S2	12/01/2019 10:52	12/01/2019 15:19	12/01/2019 10:52	12/01/2019 15:19	4,45	2	8,90	CHI
20190145276	CRISTALINA	KR21245536	CRISTALINA S1	12/01/2019 12:06	12/01/2019 13:43	12/01/2019 12:06	12/01/2019 13:43	1,62	1	1,62	CHI
20190145280	CATALAO	CT12270789	CATALAO S2	12/01/2019 11:57	12/01/2019 16:58	12/01/2019 11:57	12/01/2019 16:58	5,02	3	15,05	CHI
20190145280	CUMARI	CT12270789	CATALAO S2	12/01/2019 11:57	12/01/2019 16:58	12/01/2019 11:57	12/01/2019 16:58	5,02	8	40,13	CHI
20190145281	CATALAO	CT12078822	CATALAO S1	12/01/2019 11:44	13/01/2019 08:32	12/01/2019 11:44	13/01/2019 08:32	20,80	5	104,00	DIA CRITICO
20190145285	CORUMBAIBA	CI12092137	CATALAO S1	12/01/2019 12:09	12/01/2019 18:04	12/01/2019 12:09	12/01/2019 18:04	5,92	7	41,42	DIA CRITICO
20190145301	INDIARA	EA21086969	EDEIA	12/01/2019 12:14	12/01/2019 18:10	12/01/2019 12:14	12/01/2019 18:10	5,93	1	5,93	CHI
20190145302	PADRE BERNARDO	PB12305257	PADRE BERNARDO	12/01/2019 12:15	12/01/2019 17:45	12/01/2019 12:15	12/01/2019 17:45	5,50	5	27,50	CHI
20190145302	PLANALTINA	PB12305257	PADRE BERNARDO	12/01/2019 12:15	12/01/2019 17:45	12/01/2019 12:15	12/01/2019 17:45	5,50	71	390,50	CHI
20190145310	JARAGUA	JA12297444	JARAGUA	12/01/2019 12:19	12/01/2019 14:09	12/01/2019 12:19	12/01/2019 14:09	1,83	8	14,67	CHI
20190145319	GOIATUBA	BJ12062735	BOM JESUS DE GOIAS	12/01/2019 12:22	12/01/2019 14:57	12/01/2019 12:22	12/01/2019 14:57	2,58	3	7,75	CHI
20190145332	PIRES DO RIO	460122095	PIRES DO RIO S1	12/01/2019 12:26	12/01/2019 14:35	12/01/2019 12:26	12/01/2019 14:35	2,15	1	2,15	CHI
20190145337	GOIAS	GS12188236	ITABERAI S2	12/01/2019 10:39	12/01/2019 15:48	12/01/2019 10:39	12/01/2019 15:48	5,15	12	61,80	CHI
20190145342	PALMEIRAS DE GOIAS	PL12071444	PALMEIRAS	12/01/2019 12:29	14/01/2019 12:13	12/01/2019 12:29	14/01/2019 12:13	47,73	2	95,47	CHI
20190145344	PORANGATU	PO21208395	PORANGATU	12/01/2019 12:30	12/01/2019 15:17	12/01/2019 12:30	12/01/2019 15:17	2,78	1	2,78	CHI
20190145350	LUZIANIA	LZ12261780	RIO VERMELHO	12/01/2019 12:32	12/01/2019 13:41	12/01/2019 12:32	12/01/2019 13:41	1,15	26	29,90	CHI
20190145352	LUZIANIA	LZ12000149	MARAJOARA	12/01/2019 12:24	12/01/2019 14:26	12/01/2019 12:24	12/01/2019 14:26	2,03	55	111,83	CHI

20190145360	POSSE	PS21180786	IACIARA S2	12/01/2019 12:37	12/01/2019 17:42	12/01/2019 12:37	12/01/2019 17:42	5,08	1	5,08	CHI
20190145378	ANICUNS	NZ12299085	ANICUNS	12/01/2019 12:45	12/01/2019 15:32	12/01/2019 12:45	12/01/2019 15:32	2,78	3	8,35	CHI
20190145378	NAZARIO	NZ12299085	ANICUNS	12/01/2019 12:45	12/01/2019 15:32	12/01/2019 12:45	12/01/2019 15:32	2,78	8	22,27	CHI
20190145393	RIO VERDE	RV12350909	CACHOEIRA ALTA	12/01/2019 12:50	12/01/2019 20:25	12/01/2019 12:50	12/01/2019 20:25	7,58	2	15,17	CHI
20190145396	PEROLANDIA	DP21216540	JATAI S1	12/01/2019 12:53	13/01/2019 14:41	12/01/2019 12:53	13/01/2019 14:41	25,80	1	25,80	CHI
20190145398	CRISTALINA	KR21321839	PAMPLONA	12/01/2019 12:53	12/01/2019 22:52	12/01/2019 12:53	12/01/2019 22:52	9,98	1	9,98	CHI
20190145399	CORUMBA DE GOIAS	CB12382152	CORUMBA	12/01/2019 12:48	12/01/2019 16:19	12/01/2019 12:48	12/01/2019 16:19	3,52	5	17,58	DIA CRITICO
20190145404	GOIAS	GS12071467	MATRINCHA	12/01/2019 11:57	12/01/2019 18:31	12/01/2019 11:57	12/01/2019 18:31	6,57	2	13,13	CHI
20190145404	MATRINCHA	GS12071467	MATRINCHA	12/01/2019 11:57	12/01/2019 18:31	12/01/2019 11:57	12/01/2019 18:31	6,57	8	52,53	CHI
20190145408	MINACU	IH11135600	MINACU	12/01/2019 13:01	12/01/2019 21:34	12/01/2019 13:01	12/01/2019 21:34	8,55	56	478,80	CHI
20190145410	RIO VERDE	RV21384362	RIO VERDE S1	12/01/2019 13:01	12/01/2019 20:00	12/01/2019 13:01	12/01/2019 20:00	6,98	2	13,97	CHI
20190145416	GOIANIA	10002644787	GOIANIA LESTE S3	12/01/2019 13:02	12/01/2019 14:54	12/01/2019 13:02	12/01/2019 14:54	1,87	1	1,87	DIA CRITICO
20190145419	URUACU	UR12340195	CAMPINORTE	12/01/2019 13:02	12/01/2019 16:20	12/01/2019 13:02	12/01/2019 16:20	3,30	1	3,30	CHI
20190145428	SAO SIMAO	SO12000105	CACHOEIRA ALTA	12/01/2019 13:02	12/01/2019 15:40	12/01/2019 13:02	12/01/2019 15:40	2,63	78	205,40	CHI
20190145432	CAMPOS VERDES	VD12049791	SANTA TEREZINHA	12/01/2019 13:08	13/01/2019 11:00	12/01/2019 13:08	13/01/2019 11:00	21,87	20	437,33	CHI
20190145438	GOIANESIA	GE21186002	GOIANESIA S2	12/01/2019 13:11	12/01/2019 14:40	12/01/2019 13:11	12/01/2019 14:40	1,48	1	1,48	CHI
20190145439	IPAMERI	IP21231637	IPAMERI	12/01/2019 13:11	12/01/2019 17:52	12/01/2019 13:11	12/01/2019 17:52	4,68	1	4,68	CHI
20190145440	AGUAS LINDAS DE GOIAS	LA11330520	AGUAS LINDAS DE GOIAS S1	12/01/2019 13:11	12/01/2019 21:16	12/01/2019 13:11	12/01/2019 21:16	8,08	33	266,75	CHI
20190145441	PIRES DO RIO	PR12000076	PIRES DO RIO S1	12/01/2019 13:11	12/01/2019 16:38	12/01/2019 13:11	12/01/2019 16:38	3,45	1	3,45	CHI
20190145454	LUZIANIA	LZ12376189	RIO VERMELHO	12/01/2019 13:17	12/01/2019 15:16	12/01/2019 13:17	12/01/2019 15:16	1,98	2	3,97	CHI
20190145464	SAO MIGUEL DO ARAGUAIA	SM21147704	SAO MIGUEL DO ARAGUAIA	12/01/2019 13:21	13/01/2019 08:29	12/01/2019 13:21	13/01/2019 08:29	19,13	1	19,13	DIA CRITICO
20190145467	ARAGUAPAZ	AZ12234927	GOIAS	12/01/2019 13:22	12/01/2019 16:30	12/01/2019 13:22	12/01/2019 16:30	3,13	1	3,13	CHI
20190145477	MONTIVIDIU	RV12384572B	MONTIVIDIU T	12/01/2019 13:25	12/01/2019 22:10	12/01/2019 13:25	12/01/2019 22:10	8,75	1	8,75	CHI
20190145482	GOIAS	GS12211445	GOIAS	12/01/2019 13:26	12/01/2019 15:56	12/01/2019 13:26	12/01/2019 15:21	1,92	548	1050,33	CHI
20190145482	GOIAS	GS10396204	GOIAS	12/01/2019 13:26	12/01/2019 15:56	12/01/2019 13:26	12/01/2019 15:56	2,50	312	780,00	CHI
20190145483	MINEIROS	MY11068368	PARQUE DAS EMAS	12/01/2019 13:26	12/01/2019 20:26	12/01/2019 13:26	12/01/2019 20:26	7,00	169	1183,00	CHI
20190145486	NOVA CRIXAS	NA12263044LD	NOVA CRIXAS	13/01/2019 10:40	13/01/2019 13:51	13/01/2019 10:40	13/01/2019 13:51	3,18	82	261,03	CHI
20190145490	MOSSAMEDES	MD12066158	FIRMINOPOLIS S2	12/01/2019 13:03	12/01/2019 16:34	12/01/2019 13:03	12/01/2019 16:34	3,52	21	73,85	CHI
20190145493	PETROLINA DE GOIAS	PG21117025	PETROLINA	12/01/2019 13:31	12/01/2019 17:26	12/01/2019 13:31	12/01/2019 17:26	3,92	1	3,92	DIA CRITICO
20190145494	CRIXAS	CX21040904	SANTA TEREZINHA	12/01/2019 13:31	12/01/2019 16:43	12/01/2019 13:31	12/01/2019 16:43	3,20	1	3,20	CHI
20190145499	MINACU	IH12220707	MINACU	12/01/2019 10:02	12/01/2019 15:05	12/01/2019 10:02	12/01/2019 15:05	5,05	10	50,50	CHI
20190145501	GOIAS	GS12067665	GOIAS	12/01/2019 13:10	12/01/2019 14:51	12/01/2019 13:10	12/01/2019 14:51	1,68	267	449,45	CHI
20190145504	CACHOEIRA ALTA	CA12095029	CACHOEIRA ALTA	12/01/2019 13:23	12/01/2019 19:34	12/01/2019 13:23	12/01/2019 19:34	6,18	6	37,10	CHI

20190145509	NOVA CRIXAS	NA21117482	MOZARLANDIA	12/01/2019 13:35	12/01/2019 19:11	12/01/2019 13:35	12/01/2019 19:11	5,60	1	5,60	CHI
20190145523	SAO MIGUEL DO ARAGUAIA	SM12220658	SAO MIGUEL DO ARAGUAIA	12/01/2019 13:41	13/01/2019 11:15	12/01/2019 13:41	13/01/2019 11:15	21,57	4	86,27	DIA CRITICO
20190145525	ACREUNA	EU12246749	ACREUNA	12/01/2019 13:33	12/01/2019 15:45	12/01/2019 13:33	12/01/2019 15:45	2,20	11	24,20	CHI
20190145525	EDEIA	EU12246749	ACREUNA	12/01/2019 13:33	12/01/2019 15:45	12/01/2019 13:33	12/01/2019 15:45	2,20	12	26,40	CHI
20190145525	TURVELANDIA	EU12246749	ACREUNA	12/01/2019 13:33	12/01/2019 15:45	12/01/2019 13:33	12/01/2019 15:45	2,20	26	57,20	CHI
20190145530	CAMPESTRE DE GOIAS	GC21202400	TRINDADE	12/01/2019 13:44	12/01/2019 14:52	12/01/2019 13:44	12/01/2019 14:52	1,13	1	1,13	DIA CRITICO
20190145532	AGUAS LINDAS DE GOIAS	03730224	AGUAS LINDAS DE GOIAS S1	12/01/2019 13:39	12/01/2019 20:33	12/01/2019 13:39	12/01/2019 14:37	0,97	812	784,93	CHI
20190145532	AGUAS LINDAS DE GOIAS	LA13224060	AGUAS LINDAS DE GOIAS S1	12/01/2019 13:39	12/01/2019 20:33	12/01/2019 13:39	12/01/2019 14:52	1,22	9006	10957,30	CHI
20190145532	COCALZINHO DE GOIAS	LA13224060	AGUAS LINDAS DE GOIAS S1	12/01/2019 13:39	12/01/2019 20:33	12/01/2019 13:39	12/01/2019 14:52	1,22	275	334,58	CHI
20190145532	AGUAS LINDAS DE GOIAS	7642899	AGUAS LINDAS DE GOIAS S1	12/01/2019 13:39	12/01/2019 20:33	12/01/2019 14:53	12/01/2019 15:20	0,45	10739	4832,55	CHI
20190145532	AGUAS LINDAS DE GOIAS	7642899	AGUAS LINDAS DE GOIAS S1	12/01/2019 13:39	12/01/2019 20:33	12/01/2019 14:53	12/01/2019 15:20	0,45	300	135,00	CHI
20190145532	COCALZINHO DE GOIAS	7642899	AGUAS LINDAS DE GOIAS S1	12/01/2019 13:39	12/01/2019 20:33	12/01/2019 14:53	12/01/2019 15:20	0,45	275	123,75	CHI
20190145532	AGUAS LINDAS DE GOIAS	LA10394622	AGUAS LINDAS DE GOIAS S1	12/01/2019 13:39	12/01/2019 20:33	12/01/2019 15:24	12/01/2019 15:33	0,15	3916	587,40	CHI
20190145532	COCALZINHO DE GOIAS	LA10394622	AGUAS LINDAS DE GOIAS S1	12/01/2019 13:39	12/01/2019 20:33	12/01/2019 15:24	12/01/2019 15:33	0,15	59	8,85	CHI
20190145532	AGUAS LINDAS DE GOIAS	LA10394622	AGUAS LINDAS DE GOIAS S1	12/01/2019 13:39	12/01/2019 20:33	12/01/2019 15:34	12/01/2019 15:40	0,10	3916	391,60	CHI
20190145532	COCALZINHO DE GOIAS	LA10394622	AGUAS LINDAS DE GOIAS S1	12/01/2019 13:39	12/01/2019 20:33	12/01/2019 15:34	12/01/2019 15:40	0,10	59	5,90	CHI
20190145532	AGUAS LINDAS DE GOIAS	03730224	AGUAS LINDAS DE GOIAS S1	12/01/2019 13:39	12/01/2019 20:33	12/01/2019 13:39	12/01/2019 16:09	2,50	1933	4832,50	CHI
20190145532	AGUAS LINDAS DE GOIAS	LA10394644	AGUAS LINDAS DE GOIAS S1	12/01/2019 13:39	12/01/2019 20:33	12/01/2019 15:24	12/01/2019 17:13	1,82	3055	5549,92	CHI
20190145532	COCALZINHO DE GOIAS	LA10394644	AGUAS LINDAS DE GOIAS S1	12/01/2019 13:39	12/01/2019 20:33	12/01/2019 15:24	12/01/2019 17:13	1,82	215	390,58	CHI
20190145532	COCALZINHO DE GOIAS	LA10394644	AGUAS LINDAS DE GOIAS S1	12/01/2019 13:39	12/01/2019 20:33	12/01/2019 15:34	12/01/2019 17:13	1,65	1	1,65	CHI
20190145532	AGUAS LINDAS DE GOIAS	03730224	AGUAS LINDAS DE GOIAS S1	12/01/2019 13:39	12/01/2019 20:33	12/01/2019 13:39	12/01/2019 18:00	4,35	475	2066,25	CHI
20190145532	AGUAS LINDAS DE GOIAS	03730224	AGUAS LINDAS DE GOIAS S1	12/01/2019 13:39	12/01/2019 20:33	12/01/2019 13:39	12/01/2019 18:13	4,57	21	95,90	CHI
20190145532	AGUAS LINDAS DE GOIAS	03730224	AGUAS LINDAS DE GOIAS S1	12/01/2019 13:39	12/01/2019 20:33	12/01/2019 13:39	12/01/2019 20:33	6,90	40	276,00	CHI
20190145541	RIO VERDE	630385099	RIO VERDE S2	12/01/2019 13:47	12/01/2019 14:58	12/01/2019 13:47	12/01/2019 14:58	1,18	1	1,18	CHI
20190145545	CATALAO	1990288616	CATALAO S2	12/01/2019 13:48	12/01/2019 23:54	12/01/2019 13:48	12/01/2019 23:54	10,10	1	10,10	CHI
20190145548	CATALAO	CT21195442	CATALAO S1	12/01/2019 13:53	12/01/2019 20:13	12/01/2019 13:53	12/01/2019 20:13	6,33	1	6,33	DIA CRITICO
20190145552	APARECIDA DE GOIANIA	AP11254436	INDEPENDENCIA S2	12/01/2019 13:54	12/01/2019 15:38	12/01/2019 13:54	12/01/2019 15:38	1,73	125	216,67	CHI
20190145554	JARAGUA	PV12000071	CORUMBA	12/01/2019 13:55	12/01/2019 16:07	12/01/2019 13:55	12/01/2019 16:07	2,20	13	28,60	DIA CRITICO
20190145554	PIRENOPOLIS	PV12000071	CORUMBA	12/01/2019 13:55	12/01/2019 16:07	12/01/2019 13:55	12/01/2019 16:07	2,20	323	710,60	DIA CRITICO
20190145556	GOIAS	GS21156657	ITABERAI S1	12/01/2019 13:56	12/01/2019 15:51	12/01/2019 13:56	12/01/2019 15:51	1,92	1	1,92	CHI
20190145558	JARAGUA	JA21098908	JARAGUA	12/01/2019 13:57	12/01/2019 16:37	12/01/2019 13:57	12/01/2019 16:37	2,67	2	5,33	CHI
20190145559	NOVO GAMA	LZ12040416	PACAEMBU S1	12/01/2019 13:57	12/01/2019 17:24	12/01/2019 13:57	12/01/2019 17:24	3,45	16	55,20	CHI
20190145565	NOVA CRIXAS	SM12089299	SAO MIGUEL DO ARAGUAIA	12/01/2019 13:59	12/01/2019 19:00	12/01/2019 13:59	12/01/2019 19:00	5,02	1	5,02	DIA CRITICO

20190145565	SAO MIGUEL DO ARAGUAIA	SM12089299	SAO MIGUEL DO ARAGUAIA	12/01/2019 13:59	12/01/2019 19:00	12/01/2019 13:59	12/01/2019 19:00	5,02	89	446,48	DIA CRITICO
20190145566	APARECIDA DE GOIANIA	AP12149479	INDEPENDENCIA S2	12/01/2019 13:36	12/01/2019 15:15	12/01/2019 13:36	12/01/2019 15:15	1,65	508	838,20	CHI
20190145571	NOVA CRIXAS	NA11354873	NOVA CRIXAS	12/01/2019 14:01	13/01/2019 14:21	12/01/2019 14:01	13/01/2019 14:21	24,33	1	24,33	CHI
20190145578	ANICUNS	AC12391423	ANICUNS	12/01/2019 14:04	12/01/2019 17:57	12/01/2019 14:04	12/01/2019 17:57	3,88	16	62,13	CHI
20190145580	MORRINHOS	MR21246575	MORRINHOS	12/01/2019 14:06	12/01/2019 17:25	12/01/2019 14:06	12/01/2019 17:25	3,32	1	3,32	CHI
20190145595	AGUAS LINDAS DE GOIAS	LA12165006	AGUAS LINDAS DE GOIAS S2	12/01/2019 13:40	12/01/2019 15:39	12/01/2019 13:40	12/01/2019 15:39	1,98	1507	2988,88	CHI
20190145596	DOVERLANDIA	DV12217563	CAIAPONIA	12/01/2019 14:08	12/01/2019 15:40	12/01/2019 14:08	12/01/2019 15:40	1,53	128	196,27	CHI
20190145602	PADRE BERNARDO	PB12375253	PADRE BERNARDO	12/01/2019 14:11	12/01/2019 15:59	12/01/2019 14:11	12/01/2019 15:59	1,80	2	3,60	CHI
20190145605	SAO MIGUEL DO ARAGUAIA	SM21360511	SAO MIGUEL DO ARAGUAIA	12/01/2019 14:13	13/01/2019 10:53	12/01/2019 14:13	13/01/2019 10:53	20,67	1	20,67	DIA CRITICO
20190145610	PIRENOPOLIS	PV12381257	CORUMBA	12/01/2019 12:21	12/01/2019 15:30	12/01/2019 12:21	12/01/2019 15:30	3,15	119	374,85	DIA CRITICO
20190145617	MONTIVIDIU	MV12230885	MONTIVIDIU T	12/01/2019 14:17	12/01/2019 23:49	12/01/2019 14:17	12/01/2019 23:49	9,53	9	85,80	CHI
20190145617	RIO VERDE	MV12230885	MONTIVIDIU T	12/01/2019 14:17	12/01/2019 23:49	12/01/2019 14:17	12/01/2019 23:49	9,53	37	352,73	CHI
20190145625	JUSSARA	JR12022269	BRITANIA	12/01/2019 10:05	12/01/2019 18:51	12/01/2019 10:05	12/01/2019 18:51	8,77	29	254,23	CHI
20190145625	MONTES CLAROS DE GOIAS	JR12022269	BRITANIA	12/01/2019 10:05	12/01/2019 18:51	12/01/2019 10:05	12/01/2019 18:51	8,77	255	2235,50	CHI
20190145627	VIANOPOLIS	VN21289086	VIANOPOLIS	12/01/2019 14:19	12/01/2019 14:52	12/01/2019 14:19	12/01/2019 14:52	0,55	1	0,55	CHI
20190145629	PORANGATU	PO12182396	PORANGATU	12/01/2019 14:19	13/01/2019 10:45	12/01/2019 14:19	13/01/2019 10:45	20,43	28	572,13	CHI
20190145633	PORANGATU	PO12241996	PORANGATU	12/01/2019 14:22	12/01/2019 18:24	12/01/2019 14:22	12/01/2019 18:24	4,03	79	318,63	CHI
20190145641	LUZIANIA	LZ21214945	VIANOPOLIS	12/01/2019 14:25	12/01/2019 17:27	12/01/2019 14:25	12/01/2019 17:27	3,03	1	3,03	CHI
20190145643	MINEIROS	MY12322128	PARQUE DAS EMAS	12/01/2019 14:27	13/01/2019 10:26	12/01/2019 14:27	13/01/2019 10:26	19,98	4	79,93	CHI
20190145644	AMORINOPOLIS	AM21090270	IPORA	12/01/2019 14:27	12/01/2019 17:01	12/01/2019 14:27	12/01/2019 17:01	2,57	1	2,57	CHI
20190145654	ALTO HORIZONTE	10005957247	SANTA TEREZINHA	12/01/2019 14:28	12/01/2019 15:22	12/01/2019 14:28	12/01/2019 15:22	0,90	1	0,90	CHI
20190145657	NOVA CRIXAS	NA21291259	NOVA CRIXAS	12/01/2019 14:29	12/01/2019 22:19	12/01/2019 14:29	12/01/2019 22:19	7,83	1	7,83	CHI
20190145658	CAMPO ALEGRE DE GOIAS	CM12042424	CAMPO ALEGRE DE GOIAS	12/01/2019 14:29	12/01/2019 17:39	12/01/2019 14:29	12/01/2019 17:39	3,17	25	79,17	CHI
20190145661	SANTO ANTONIO DO DESCOBERTO	SN12313466	MARAJOARA	12/01/2019 14:30	12/01/2019 16:17	12/01/2019 14:30	12/01/2019 16:17	1,78	27	48,15	CHI
20190145663	SAO SIMAO	2240018465	CACHOEIRA ALTA	12/01/2019 14:31	12/01/2019 22:08	12/01/2019 14:31	12/01/2019 22:08	7,62	1	7,62	CHI
20190145666	CRIXAS	CX12190125	SANTA TEREZINHA	12/01/2019 14:31	12/01/2019 17:34	12/01/2019 14:31	12/01/2019 17:34	3,05	10	30,50	CHI
20190145678	IPAMERI	IP21292706	IPAMERI	12/01/2019 14:34	12/01/2019 18:00	12/01/2019 14:34	12/01/2019 18:00	3,43	2	6,87	CHI
20190145681	HIDROLANDIA	HD21193786	CEPAIGO S2	12/01/2019 14:35	12/01/2019 18:10	12/01/2019 14:35	12/01/2019 18:10	3,58	2	7,17	CHI
20190145688	SAO LUIS DE MONTES BELOS	SL21314882	FIRMINOPOLIS S2	12/01/2019 14:36	12/01/2019 16:38	12/01/2019 14:36	12/01/2019 16:38	2,03	1	2,03	CHI
20190145695	AGUAS LINDAS DE GOIAS	LA12345961	AGUAS LINDAS DE GOIAS S2	12/01/2019 14:37	13/01/2019 12:37	12/01/2019 14:37	13/01/2019 12:37	22,00	2	44,00	CHI
20190145704	CATALAO	7458455	CATALAO S1	12/01/2019 14:38	12/01/2019 21:15	12/01/2019 14:38	12/01/2019 21:15	6,62	1	6,62	DIA CRITICO
20190145706	MUNDO NOVO DE GOIAS	MH10400729	NOVA CRIXAS	12/01/2019 14:30	13/01/2019 01:04	12/01/2019 14:30	12/01/2019 14:40	0,17	103	17,17	CHI
20190145706	SAO MIGUEL DO ARAGUAIA	MH10400729	NOVA CRIXAS	12/01/2019 14:30	13/01/2019 01:04	12/01/2019 14:30	12/01/2019 14:40	0,17	21	3,50	CHI

20190145706	MUNDO NOVO DE GOIAS	MH10400729	NOVA CRIXAS	12/01/2019 14:30	13/01/2019 01:04	12/01/2019 14:44	12/01/2019 17:31	2,78	8	22,27	CHI
20190145706	MUNDO NOVO DE GOIAS	MH10400729	NOVA CRIXAS	12/01/2019 14:30	13/01/2019 01:04	12/01/2019 18:00	12/01/2019 18:28	0,47	8	3,73	CHI
20190145706	SAO MIGUEL DO ARAGUAIA	MH13262750	NOVA CRIXAS	12/01/2019 14:30	13/01/2019 01:04	12/01/2019 14:44	12/01/2019 19:17	4,55	21	95,55	CHI
20190145706	MUNDO NOVO DE GOIAS	MH10400729	NOVA CRIXAS	12/01/2019 14:30	13/01/2019 01:04	12/01/2019 19:15	12/01/2019 19:41	0,43	8	3,47	CHI
20190145706	MUNDO NOVO DE GOIAS	MH13262750	NOVA CRIXAS	12/01/2019 14:30	13/01/2019 01:04	12/01/2019 14:44	12/01/2019 21:33	6,82	70	477,17	CHI
20190145706	MUNDO NOVO DE GOIAS	MH12391956LD	NOVA CRIXAS	12/01/2019 14:30	13/01/2019 01:04	12/01/2019 14:44	12/01/2019 22:30	7,77	1	7,77	CHI
20190145706	SAO MIGUEL DO ARAGUAIA	SM10401470	NOVA CRIXAS	12/01/2019 14:30	13/01/2019 01:04	12/01/2019 19:18	12/01/2019 22:51	3,55	21	74,55	CHI
20190145706	MUNDO NOVO DE GOIAS	MH13262750	NOVA CRIXAS	12/01/2019 14:30	13/01/2019 01:04	12/01/2019 14:44	13/01/2019 01:04	10,33	24	248,00	CHI
20190145707	JATAI	01030224	JATAI S2	12/01/2019 15:01	12/01/2019 20:40	12/01/2019 15:01	12/01/2019 15:55	0,90	3072	2764,80	CHI
20190145707	JATAI	01030224	JATAI S2	12/01/2019 15:01	12/01/2019 20:40	12/01/2019 15:58	12/01/2019 16:10	0,20	3072	614,40	CHI
20190145707	JATAI	01030224	JATAI S2	12/01/2019 15:01	12/01/2019 20:40	12/01/2019 15:01	12/01/2019 16:59	1,97	5	9,83	CHI
20190145707	JATAI	01030224	JATAI S2	12/01/2019 15:01	12/01/2019 20:40	12/01/2019 16:55	12/01/2019 16:59	0,07	3072	204,80	CHI
20190145707	JATAI	01030224	JATAI S2	12/01/2019 15:01	12/01/2019 20:40	12/01/2019 15:01	12/01/2019 20:40	5,65	72	406,80	CHI
20190145710	GOIANIA	GN21000829	GOIANIA LESTE S3	12/01/2019 15:09	12/01/2019 16:22	12/01/2019 15:09	12/01/2019 16:22	1,22	1	1,22	DIA CRITICO
20190145713	NOVA CRIXAS	NA12291260	NOVA CRIXAS	12/01/2019 15:25	12/01/2019 17:02	12/01/2019 15:25	12/01/2019 17:02	1,62	7	11,32	CHI
20190145717	ITUMBIARA	IT10404103	ITUMBIARA VELHA S1	12/01/2019 15:45	12/01/2019 19:24	12/01/2019 15:45	12/01/2019 19:24	3,65	1643	5996,95	CHI
20190145723	ANAPOLIS	00050214	ANAPOLIS UNIVERSITARIO S2	12/01/2019 16:03	13/01/2019 10:15	12/01/2019 16:03	12/01/2019 17:20	1,28	388	497,93	CHI
20190145723	ANAPOLIS	AN13000192	ANAPOLIS UNIVERSITARIO S2	12/01/2019 16:03	13/01/2019 10:15	12/01/2019 16:03	12/01/2019 19:28	3,42	342	1168,50	CHI
20190145723	ANAPOLIS	AN13352352	ANAPOLIS UNIVERSITARIO S2	12/01/2019 16:03	13/01/2019 10:15	12/01/2019 16:03	12/01/2019 19:28	3,42	423	1445,25	CHI
20190145723	ANAPOLIS	AN13000140	ANAPOLIS UNIVERSITARIO S2	12/01/2019 16:03	13/01/2019 10:15	12/01/2019 17:30	12/01/2019 20:38	3,13	388	1215,73	CHI
20190145723	ANAPOLIS	AN13000119	ANAPOLIS UNIVERSITARIO S2	12/01/2019 16:03	13/01/2019 10:15	12/01/2019 16:03	12/01/2019 22:39	6,60	644	4250,40	CHI
20190145723	ANAPOLIS	AN13370350	ANAPOLIS UNIVERSITARIO S2	12/01/2019 16:03	13/01/2019 10:15	13/01/2019 10:12	13/01/2019 10:15	0,05	342	17,10	CHI
20190145726	DOVERLANDIA	DV13395384S	CAIAPONIA	12/01/2019 16:01	13/01/2019 01:53	12/01/2019 16:01	12/01/2019 16:52	0,85	40	34,00	CHI
20190145726	DOVERLANDIA	DV13217562	CAIAPONIA	12/01/2019 16:01	13/01/2019 01:53	12/01/2019 16:01	12/01/2019 17:29	1,47	14	20,53	CHI
20190145726	DOVERLANDIA	DV13217569	CAIAPONIA	12/01/2019 16:01	13/01/2019 01:53	12/01/2019 16:01	12/01/2019 18:26	2,42	20	48,33	CHI
20190145726	DOVERLANDIA	DV13217569	CAIAPONIA	12/01/2019 16:01	13/01/2019 01:53	12/01/2019 18:35	12/01/2019 19:58	1,38	3	4,15	CHI
20190145726	DOVERLANDIA	DV12217563	CAIAPONIA	12/01/2019 16:01	13/01/2019 01:53	12/01/2019 16:01	12/01/2019 21:25	5,40	128	691,20	CHI
20190145726	DOVERLANDIA	8739038	CAIAPONIA	12/01/2019 16:01	13/01/2019 01:53	12/01/2019 18:35	13/01/2019 01:53	7,30	17	124,10	CHI
20190145727	ANAPOLIS	00052204	ANAPOLIS UNIVERSITARIO S2	12/01/2019 16:11	12/01/2019 21:25	12/01/2019 16:11	12/01/2019 17:41	1,50	3464	5196,00	CHI
20190145727	ANAPOLIS	AN13000066	ANAPOLIS UNIVERSITARIO S2	12/01/2019 16:11	12/01/2019 21:25	12/01/2019 16:11	12/01/2019 18:10	1,98	1449	2873,85	CHI
20190145727	ANAPOLIS	00052204	ANAPOLIS UNIVERSITARIO S2	12/01/2019 16:11	12/01/2019 21:25	12/01/2019 18:32	12/01/2019 18:37	0,08	3464	288,67	CHI
20190145727	ANAPOLIS	AN13077950	ANAPOLIS UNIVERSITARIO S2	12/01/2019 16:11	12/01/2019 21:25	12/01/2019 16:11	12/01/2019 19:40	3,48	283	985,78	CHI
20190145727	ANAPOLIS	AN13077950	ANAPOLIS UNIVERSITARIO S2	12/01/2019 16:11	12/01/2019 21:25	12/01/2019 16:11	12/01/2019 21:25	5,23	1006	5264,73	CHI

20190145728	ITAPURANGA	IK10395419	ITAPURANGA	12/01/2019 16:15	12/01/2019 23:10	12/01/2019 16:15	12/01/2019 17:15	1,00	23	23,00	CHI
20190145728	ITAPURANGA	IK13404518	ITAPURANGA	12/01/2019 16:15	12/01/2019 23:10	12/01/2019 16:15	12/01/2019 17:47	1,53	101	154,87	CHI
20190145728	HEITORAI	IK10395419	ITAPURANGA	12/01/2019 16:15	12/01/2019 23:10	12/01/2019 16:15	12/01/2019 22:49	6,57	1442	9469,13	CHI
20190145728	ITAGUARU	IK10395419	ITAPURANGA	12/01/2019 16:15	12/01/2019 23:10	12/01/2019 16:15	12/01/2019 22:49	6,57	58	380,87	CHI
20190145728	ITAPURANGA	IK10395419	ITAPURANGA	12/01/2019 16:15	12/01/2019 23:10	12/01/2019 16:15	12/01/2019 22:49	6,57	77	505,63	CHI
20190145728	URUANA	IK10395419	ITAPURANGA	12/01/2019 16:15	12/01/2019 23:10	12/01/2019 16:15	12/01/2019 22:49	6,57	1	6,57	CHI
20190145728	HEITORAI	IK13307408	ITAPURANGA	12/01/2019 16:15	12/01/2019 23:10	12/01/2019 16:15	12/01/2019 23:10	6,92	32	221,33	CHI
20190145728	ITAPURANGA	IK13307408	ITAPURANGA	12/01/2019 16:15	12/01/2019 23:10	12/01/2019 16:15	12/01/2019 23:10	6,92	55	380,42	CHI
20190145732	GOIAS	GS12029627	GOIAS	12/01/2019 16:53	12/01/2019 17:08	12/01/2019 16:53	12/01/2019 17:08	0,25	10	2,50	CHI
20190145733	ALTO HORIZONTE	03400224	SANTA TEREZINHA	12/01/2019 16:34	12/01/2019 16:56	12/01/2019 16:34	12/01/2019 16:56	0,37	48	17,60	CHI
20190145733	CAMPOS VERDES	03400224	SANTA TEREZINHA	12/01/2019 16:34	12/01/2019 16:56	12/01/2019 16:34	12/01/2019 16:56	0,37	7	2,57	CHI
20190145733	NOVA IGUACU DE GOIAS	03400224	SANTA TEREZINHA	12/01/2019 16:34	12/01/2019 16:56	12/01/2019 16:34	12/01/2019 16:56	0,37	361	132,37	CHI
20190145742	GOIANIA	GN16401524	XAVANTES	12/01/2019 16:50	13/01/2019 16:45	12/01/2019 20:20	13/01/2019 06:44	10,40	262	2724,80	DIA CRITICO
20190145742	GOIANIA	GN11002836	XAVANTES	12/01/2019 16:50	13/01/2019 16:45	12/01/2019 16:50	13/01/2019 10:00	17,17	32	549,33	DIA CRITICO
20190145742	GOIANIA	GN13394640B	XAVANTES	12/01/2019 16:50	13/01/2019 16:45	12/01/2019 16:50	13/01/2019 14:30	21,67	1320	28600,00	DIA CRITICO
20190145742	SANTO ANTONIO DE GOIAS	GN13394640B	XAVANTES	12/01/2019 16:50	13/01/2019 16:45	12/01/2019 16:50	13/01/2019 14:30	21,67	16	346,67	DIA CRITICO
20190145742	GOIANIA	GN12383183	XAVANTES	12/01/2019 16:50	13/01/2019 16:45	13/01/2019 15:42	13/01/2019 16:20	0,63	63	39,90	DIA CRITICO
20190145742	GOIANIA	GN12159195	XAVANTES	12/01/2019 16:50	13/01/2019 16:45	12/01/2019 16:50	13/01/2019 16:39	23,82	30	714,50	DIA CRITICO
20190145742	GOIANIA	GN13394640B	XAVANTES	12/01/2019 16:50	13/01/2019 16:45	12/01/2019 16:50	13/01/2019 16:45	23,92	17	406,58	DIA CRITICO
20190145743	GOIANIA	GN10380021	XAVANTES	12/01/2019 16:51	12/01/2019 22:50	12/01/2019 16:51	12/01/2019 20:44	3,88	97	376,68	DIA CRITICO
20190145743	GOIANIA	GN13000870	XAVANTES	12/01/2019 16:51	12/01/2019 22:50	12/01/2019 16:51	12/01/2019 22:50	5,98	69	412,85	DIA CRITICO
20190145744	MARA ROSA	MQ12208528	MARA ROSA	12/01/2019 15:37	12/01/2019 18:56	12/01/2019 15:37	12/01/2019 18:56	3,32	1	3,32	CHI
20190145745	GOIANIA	00582014	GOIANIA LESTE S2	12/01/2019 17:06	12/01/2019 22:45	12/01/2019 17:06	12/01/2019 18:43	1,62	876	1416,20	DIA CRITICO
20190145745	GOIANIA	XX00054896	GOIANIA LESTE S2	12/01/2019 17:06	12/01/2019 22:45	12/01/2019 17:06	12/01/2019 19:20	2,23	2359	5268,43	DIA CRITICO
20190145745	GOIANIA	GN12405677LD	GOIANIA LESTE S2	12/01/2019 17:06	12/01/2019 22:45	12/01/2019 17:06	12/01/2019 22:45	5,65	647	3655,55	DIA CRITICO
20190145746	GOIANIA	GN10380012	GOIANIA LESTE S3	12/01/2019 16:46	13/01/2019 06:22	12/01/2019 16:46	12/01/2019 20:15	3,48	863	3006,12	DIA CRITICO
20190145746	GOIANIA	GN13000068	GOIANIA LESTE S3	12/01/2019 16:46	13/01/2019 06:22	12/01/2019 16:46	12/01/2019 23:49	7,05	1	7,05	DIA CRITICO
20190145746	GOIANAPOLIS	GN13390523	GOIANIA LESTE S3	12/01/2019 16:46	13/01/2019 06:22	12/01/2019 16:46	13/01/2019 06:22	13,60	10	136,00	DIA CRITICO
20190145746	GOIANIA	GN13390523	GOIANIA LESTE S3	12/01/2019 16:46	13/01/2019 06:22	12/01/2019 16:46	13/01/2019 06:22	13,60	938	12756,80	DIA CRITICO
20190145747	GOIANIA	GN10380003	GOIANIA LESTE S1	12/01/2019 17:05	13/01/2019 14:41	12/01/2019 17:05	12/01/2019 19:33	2,47	105	259,00	CHI
20190145747	GOIANIA	GN10380008	GOIANIA LESTE S1	12/01/2019 17:05	13/01/2019 14:41	12/01/2019 17:05	12/01/2019 19:44	2,65	71	188,15	CHI
20190145747	SENADOR CANEDO	GN10380008	GOIANIA LESTE S1	12/01/2019 17:05	13/01/2019 14:41	12/01/2019 17:05	12/01/2019 19:44	2,65	3929	10411,85	CHI
20190145747	GOIANIA	GN13384245	GOIANIA LESTE S1	12/01/2019 17:05	13/01/2019 14:41	12/01/2019 17:05	12/01/2019 23:27	6,37	289	1839,97	CHI

20190145747	SENADOR CANEDO	GN13000385	GOIANIA LESTE S1	12/01/2019 17:05	13/01/2019 14:41	12/01/2019 23:43	12/01/2019 23:48	0,08	2281	190,08	CHI
20190145747	GOIANIA	SW10404124	GOIANIA LESTE S1	12/01/2019 17:05	13/01/2019 14:41	12/01/2019 23:43	13/01/2019 10:35	10,87	67	728,07	CHI
20190145747	SENADOR CANEDO	SW10404124	GOIANIA LESTE S1	12/01/2019 17:05	13/01/2019 14:41	12/01/2019 23:43	13/01/2019 11:03	11,33	609	6902,00	CHI
20190145747	GOIANIA	SW10404124	GOIANIA LESTE S1	12/01/2019 17:05	13/01/2019 14:41	12/01/2019 23:43	13/01/2019 11:24	11,68	1	11,68	CHI
20190145747	SENADOR CANEDO	SW10404124	GOIANIA LESTE S1	12/01/2019 17:05	13/01/2019 14:41	12/01/2019 23:43	13/01/2019 11:24	11,68	97	1133,28	CHI
20190145747	SENADOR CANEDO	GN12391536LD	GOIANIA LESTE S1	12/01/2019 17:05	13/01/2019 14:41	12/01/2019 23:43	13/01/2019 12:22	12,65	940	11891,00	CHI
20190145747	SENADOR CANEDO	SW10404124	GOIANIA LESTE S1	12/01/2019 17:05	13/01/2019 14:41	13/01/2019 14:29	13/01/2019 14:40	0,18	609	111,65	CHI
20190145747	GOIANIA	SW10404124	GOIANIA LESTE S1	12/01/2019 17:05	13/01/2019 14:41	13/01/2019 14:30	13/01/2019 14:40	0,17	68	11,33	CHI
20190145747	SENADOR CANEDO	SW10404124	GOIANIA LESTE S1	12/01/2019 17:05	13/01/2019 14:41	13/01/2019 14:30	13/01/2019 14:40	0,17	1037	172,83	CHI
20190145747	GOIANIA	SW12395816	GOIANIA LESTE S1	12/01/2019 17:05	13/01/2019 14:41	12/01/2019 23:43	13/01/2019 14:41	14,97	3	44,90	CHI
20190145747	SENADOR CANEDO	SW12395816	GOIANIA LESTE S1	12/01/2019 17:05	13/01/2019 14:41	12/01/2019 23:43	13/01/2019 14:41	14,97	2	29,93	CHI
20190145748	GOIANIA	00610284	CAMPINAS S2	12/01/2019 16:56	13/01/2019 14:35	12/01/2019 16:56	12/01/2019 16:59	0,05	7784	389,20	DIA CRITICO
20190145748	GOIANIA	00610284	XAVANTES	12/01/2019 16:56	13/01/2019 14:35	12/01/2019 16:56	12/01/2019 16:59	0,05	9	0,45	DIA CRITICO
20190145748	GOIANIA	00610284	CAMPINAS S2	12/01/2019 16:56	13/01/2019 14:35	12/01/2019 17:00	12/01/2019 17:19	0,32	4929	1560,85	DIA CRITICO
20190145748	GOIANIA	GN10380036	CAMPINAS S2	12/01/2019 16:56	13/01/2019 14:35	12/01/2019 17:00	13/01/2019 02:01	9,02	3027	27293,45	DIA CRITICO
20190145748	GOIANIA	GN10380036	XAVANTES	12/01/2019 16:56	13/01/2019 14:35	12/01/2019 17:00	13/01/2019 02:01	9,02	9	81,15	DIA CRITICO
20190145748	GOIANIA	GN12312957	CAMPINAS S2	12/01/2019 16:56	13/01/2019 14:35	13/01/2019 10:34	13/01/2019 14:35	4,02	1	4,02	DIA CRITICO
20190145749	GOIANIA	GN12347717	FERROVIARIO S3	12/01/2019 17:19	12/01/2019 21:58	12/01/2019 17:19	12/01/2019 21:58	4,65	261	1213,65	DIA CRITICO
20190145750	GOIANIA	00612244	CAMPINAS S3	12/01/2019 16:57	12/01/2019 22:16	12/01/2019 16:57	12/01/2019 18:29	1,53	3629	5564,47	DIA CRITICO
20190145750	GOIANIA	GN12401388LD	CAMPINAS S3	12/01/2019 16:57	12/01/2019 22:16	12/01/2019 16:57	12/01/2019 22:16	5,32	1123	5970,62	DIA CRITICO
20190145760	GOIANESIA	GE11372621	GOIANESIA S1	12/01/2019 16:29	12/01/2019 18:21	12/01/2019 16:29	12/01/2019 18:21	1,87	1	1,87	CHI
20190145762	GOIANESIA	GE11297291	GOIANESIA S1	12/01/2019 16:35	12/01/2019 18:24	12/01/2019 16:35	12/01/2019 18:24	1,82	1	1,82	CHI
20190145763	GOIANIA	GN10380330	GOIANIA LESTE S1	12/01/2019 17:06	13/01/2019 01:39	12/01/2019 17:06	12/01/2019 19:07	2,02	1325	2672,08	CHI
20190145763	GOIANIA	GN10380330	GOIANIA LESTE S1	12/01/2019 17:06	13/01/2019 01:39	12/01/2019 17:06	12/01/2019 19:34	2,47	1473	3633,40	CHI
20190145763	GOIANIA	GN13000419	GOIANIA LESTE S1	12/01/2019 17:06	13/01/2019 01:39	12/01/2019 17:06	12/01/2019 19:45	2,65	636	1685,40	CHI
20190145763	GOIANIA	GN10400448	FERROVIARIO S3	12/01/2019 17:06	13/01/2019 01:39	12/01/2019 17:06	12/01/2019 22:13	5,12	512	2619,73	CHI
20190145763	GOIANIA	GN10400446	FERROVIARIO S3	12/01/2019 17:06	13/01/2019 01:39	12/01/2019 17:06	13/01/2019 01:39	8,55	445	3804,75	CHI
20190145768	JANDAIA	03300414	PALMEIRAS	12/01/2019 17:58	14/01/2019 03:55	12/01/2019 17:58	12/01/2019 19:15	1,28	1	1,28	CHI
20190145768	NAZARIO	03300414	PALMEIRAS	12/01/2019 17:58	14/01/2019 03:55	12/01/2019 17:58	12/01/2019 19:15	1,28	2	2,57	CHI
20190145768	PALMEIRAS DE GOIAS	03300414	PALMEIRAS	12/01/2019 17:58	14/01/2019 03:55	12/01/2019 17:58	12/01/2019 19:15	1,28	5930	7610,17	CHI
20190145768	PALMEIRAS DE GOIAS	03300414	PALMEIRAS	12/01/2019 17:58	14/01/2019 03:55	12/01/2019 17:58	12/01/2019 19:15	1,28	47	60,32	CHI
20190145768	PALMEIRAS DE GOIAS	03300414	PALMEIRAS	12/01/2019 17:58	14/01/2019 03:55	12/01/2019 17:58	12/01/2019 19:15	1,28	6330	8123,50	CHI
20190145768	PALMEIRAS DE GOIAS	03300414	PALMEIRAS	12/01/2019 17:58	14/01/2019 03:55	12/01/2019 17:58	12/01/2019 19:15	1,28	509	653,22	CHI

20190145768	PALMEIRAS DE GOIAS	03300414	PALMEIRAS	12/01/2019 17:58	14/01/2019 03:55	12/01/2019 17:58	12/01/2019 19:15	1,28	229	293,88	CHI
20190145768	PALMEIRAS DE GOIAS	03300414	PALMEIRAS	12/01/2019 17:58	14/01/2019 03:55	12/01/2019 17:58	12/01/2019 19:15	1,28	6	7,70	CHI
20190145768	PALMINOPOLIS	03300414	PALMEIRAS	12/01/2019 17:58	14/01/2019 03:55	12/01/2019 17:58	12/01/2019 19:15	1,28	1	1,28	CHI
20190145768	PALMEIRAS DE GOIAS	03300414	PALMEIRAS	12/01/2019 17:58	14/01/2019 03:55	12/01/2019 17:58	12/01/2019 19:55	1,95	3	5,85	CHI
20190145768	JANDAIA	03300414	PALMEIRAS	12/01/2019 17:58	14/01/2019 03:55	12/01/2019 20:59	12/01/2019 21:04	0,08	1	0,08	CHI
20190145768	NAZARIO	03300414	PALMEIRAS	12/01/2019 17:58	14/01/2019 03:55	12/01/2019 20:59	12/01/2019 21:04	0,08	2	0,17	CHI
20190145768	PALMEIRAS DE GOIAS	03300414	PALMEIRAS	12/01/2019 17:58	14/01/2019 03:55	12/01/2019 20:59	12/01/2019 21:04	0,08	5911	492,58	CHI
20190145768	PALMEIRAS DE GOIAS	03300414	PALMEIRAS	12/01/2019 17:58	14/01/2019 03:55	12/01/2019 20:59	12/01/2019 21:04	0,08	47	3,92	CHI
20190145768	PALMEIRAS DE GOIAS	03300414	PALMEIRAS	12/01/2019 17:58	14/01/2019 03:55	12/01/2019 20:59	12/01/2019 21:04	0,08	6330	527,50	CHI
20190145768	PALMEIRAS DE GOIAS	03300414	PALMEIRAS	12/01/2019 17:58	14/01/2019 03:55	12/01/2019 20:59	12/01/2019 21:04	0,08	506	42,17	CHI
20190145768	PALMEIRAS DE GOIAS	03300414	PALMEIRAS	12/01/2019 17:58	14/01/2019 03:55	12/01/2019 20:59	12/01/2019 21:04	0,08	229	19,08	CHI
20190145768	PALMEIRAS DE GOIAS	03300414	PALMEIRAS	12/01/2019 17:58	14/01/2019 03:55	12/01/2019 20:59	12/01/2019 21:04	0,08	9	0,75	CHI
20190145768	PALMINOPOLIS	03300414	PALMEIRAS	12/01/2019 17:58	14/01/2019 03:55	12/01/2019 20:59	12/01/2019 21:04	0,08	1	0,08	CHI
20190145768	NAZARIO	03300414	PALMEIRAS	12/01/2019 17:58	14/01/2019 03:55	12/01/2019 17:58	12/01/2019 21:08	3,17	3	9,50	CHI
20190145768	PALMEIRAS DE GOIAS	PL12000095	PALMEIRAS	12/01/2019 17:58	14/01/2019 03:55	14/01/2019 00:01	14/01/2019 03:20	3,32	12	39,80	CHI
20190145768	PALMEIRAS DE GOIAS	03300414	PALMEIRAS	12/01/2019 17:58	14/01/2019 03:55	12/01/2019 17:58	14/01/2019 03:55	33,95	21	712,95	CHI
20190145769	GOIANIA	GN10383780	ATLANTICO S3	12/01/2019 18:10	13/01/2019 00:38	12/01/2019 18:10	12/01/2019 19:38	1,47	1462	2144,27	CHI
20190145769	GOIANIA	GN13040240	ATLANTICO S3	12/01/2019 18:10	13/01/2019 00:38	12/01/2019 18:10	12/01/2019 22:20	4,17	1125	4687,50	CHI
20190145769	GOIANIA	GN13000841	ATLANTICO S3	12/01/2019 18:10	13/01/2019 00:38	12/01/2019 18:10	13/01/2019 00:38	6,47	2666	17240,13	CHI
20190145772	PADRE BERNARDO	PB21330821	PADRE BERNARDO	12/01/2019 18:15	12/01/2019 23:20	12/01/2019 18:15	12/01/2019 23:20	5,08	1	5,08	CHI
20190145773	JANDAIA	03300444	PALMEIRAS	12/01/2019 18:21	12/01/2019 23:46	12/01/2019 18:21	12/01/2019 18:24	0,05	57	2,85	CHI
20190145773	PALMEIRAS DE GOIAS	03300444	PALMEIRAS	12/01/2019 18:21	12/01/2019 23:46	12/01/2019 18:21	12/01/2019 18:24	0,05	51	2,55	CHI
20190145773	PALMINOPOLIS	03300444	PALMEIRAS	12/01/2019 18:21	12/01/2019 23:46	12/01/2019 18:21	12/01/2019 18:24	0,05	750	37,50	CHI
20190145773	PALMEIRAS DE GOIAS	03300444	PALMEIRAS	12/01/2019 18:21	12/01/2019 23:46	12/01/2019 18:21	12/01/2019 20:04	1,72	5	8,58	CHI
20190145773	PALMEIRAS DE GOIAS	03300444	PALMEIRAS	12/01/2019 18:21	12/01/2019 23:46	12/01/2019 18:21	12/01/2019 21:43	3,37	1	3,37	CHI
20190145773	PALMINOPOLIS	03300444	PALMEIRAS	12/01/2019 18:21	12/01/2019 23:46	12/01/2019 18:21	12/01/2019 23:25	5,07	1	5,07	CHI
20190145773	JANDAIA	03300444	PALMEIRAS	12/01/2019 18:21	12/01/2019 23:46	12/01/2019 18:21	12/01/2019 23:46	5,42	2	10,83	CHI
20190145773	PALMEIRAS DE GOIAS	03300444	PALMEIRAS	12/01/2019 18:21	12/01/2019 23:46	12/01/2019 18:21	12/01/2019 23:46	5,42	30	162,50	CHI
20190145773	PALMEIRAS DE GOIAS	03300444	PALMEIRAS	12/01/2019 18:21	12/01/2019 23:46	12/01/2019 18:21	12/01/2019 23:46	5,42	1	5,42	CHI
20190145773	PALMINOPOLIS	03300444	PALMEIRAS	12/01/2019 18:21	12/01/2019 23:46	12/01/2019 18:21	12/01/2019 23:46	5,42	86	465,83	CHI
20190145773	PALMINOPOLIS	03300444	PALMEIRAS	12/01/2019 18:21	12/01/2019 23:46	12/01/2019 18:21	12/01/2019 23:46	5,42	968	5243,33	CHI
20190145774	GOIANIA	NR10400766	NEROPOLIS S2	12/01/2019 16:43	13/01/2019 11:00	12/01/2019 16:43	12/01/2019 23:02	6,32	230	1452,83	CHI
20190145774	NEROPOLIS	NR10400766	NEROPOLIS S2	12/01/2019 16:43	13/01/2019 11:00	12/01/2019 16:43	12/01/2019 23:02	6,32	74	467,43	CHI

20190145774	SANTO ANTONIO DE GOIAS	NR10400766	NEROPOLIS S2	12/01/2019 16:43	13/01/2019 11:00	12/01/2019 16:43	12/01/2019 23:02	6,32	69	435,85	CHI
20190145774	TEREZOPOLIS DE GOIAS	NR10400766	NEROPOLIS S2	12/01/2019 16:43	13/01/2019 11:00	12/01/2019 16:43	12/01/2019 23:02	6,32	1	6,32	CHI
20190145774	GOIANIA	GN13212629	NEROPOLIS S2	12/01/2019 16:43	13/01/2019 11:00	12/01/2019 16:43	13/01/2019 11:00	18,28	9	164,55	CHI
20190145774	SANTO ANTONIO DE GOIAS	GN13212629	NEROPOLIS S2	12/01/2019 16:43	13/01/2019 11:00	12/01/2019 16:43	13/01/2019 11:00	18,28	1	18,28	CHI
20190145776	ALTO HORIZONTE	03400224	SANTA TEREZINHA	12/01/2019 18:05	13/01/2019 15:22	12/01/2019 18:05	12/01/2019 22:15	4,17	58	241,67	CHI
20190145776	CAMPOS VERDES	03400224	SANTA TEREZINHA	12/01/2019 18:05	13/01/2019 15:22	12/01/2019 18:05	12/01/2019 22:15	4,17	7	29,17	CHI
20190145776	NOVA IGUACU DE GOIAS	03400224	SANTA TEREZINHA	12/01/2019 18:05	13/01/2019 15:22	12/01/2019 18:05	12/01/2019 22:15	4,17	269	1120,83	CHI
20190145776	PILAR DE GOIAS	03400224	SANTA TEREZINHA	12/01/2019 18:05	13/01/2019 15:22	12/01/2019 18:05	12/01/2019 22:15	4,17	1	4,17	CHI
20190145776	NOVA IGUACU DE GOIAS	NH12243422	SANTA TEREZINHA	12/01/2019 18:05	13/01/2019 15:22	12/01/2019 18:05	13/01/2019 02:21	8,27	7	57,87	CHI
20190145776	NOVA IGUACU DE GOIAS	NH12181043	SANTA TEREZINHA	12/01/2019 18:05	13/01/2019 15:22	13/01/2019 11:15	13/01/2019 15:21	4,10	1	4,10	CHI
20190145776	NOVA IGUACU DE GOIAS	19696899	SANTA TEREZINHA	12/01/2019 18:05	13/01/2019 15:22	12/01/2019 18:05	13/01/2019 15:22	21,28	26	553,37	CHI
20190145777	FIRMINOPOLIS	FR13194157	FIRMINOPOLIS S1	12/01/2019 18:38	13/01/2019 14:25	12/01/2019 18:38	12/01/2019 23:20	4,70	188	883,60	CHI
20190145777	FIRMINOPOLIS	FR13215421	FIRMINOPOLIS S1	12/01/2019 18:38	13/01/2019 14:25	12/01/2019 18:38	13/01/2019 00:07	5,48	38	208,37	CHI
20190145777	FIRMINOPOLIS	TV13005528	FIRMINOPOLIS S1	12/01/2019 18:38	13/01/2019 14:25	12/01/2019 18:38	13/01/2019 01:20	6,70	87	582,90	CHI
20190145777	TURVANIA	TV13005528	FIRMINOPOLIS S1	12/01/2019 18:38	13/01/2019 14:25	12/01/2019 18:38	13/01/2019 01:20	6,70	72	482,40	CHI
20190145777	FIRMINOPOLIS	FR13215421	FIRMINOPOLIS S1	12/01/2019 18:38	13/01/2019 14:25	12/01/2019 18:38	13/01/2019 01:30	6,87	96	659,20	CHI
20190145777	FIRMINOPOLIS	FR13194157	FIRMINOPOLIS S1	12/01/2019 18:38	13/01/2019 14:25	12/01/2019 23:30	13/01/2019 01:30	2,00	3	6,00	CHI
20190145777	FIRMINOPOLIS	FR13096969	FIRMINOPOLIS S1	12/01/2019 18:38	13/01/2019 14:25	13/01/2019 00:08	13/01/2019 03:10	3,03	38	115,27	CHI
20190145777	FIRMINOPOLIS	FR13096969	FIRMINOPOLIS S1	12/01/2019 18:38	13/01/2019 14:25	13/01/2019 12:56	13/01/2019 13:57	1,02	38	38,63	CHI
20190145777	FIRMINOPOLIS	FR13215421	FIRMINOPOLIS S1	12/01/2019 18:38	13/01/2019 14:25	12/01/2019 18:38	13/01/2019 14:25	19,78	3	59,35	CHI
20190145777	FIRMINOPOLIS	FR13215421	FIRMINOPOLIS S1	12/01/2019 18:38	13/01/2019 14:25	12/01/2019 23:30	13/01/2019 14:25	14,92	1	14,92	CHI
20190145778	BELA VISTA DE GOIAS	02200234	CEPAIGO S2	12/01/2019 18:37	13/01/2019 00:10	12/01/2019 18:37	12/01/2019 20:52	2,25	1	2,25	CHI
20190145778	HIDROLANDIA	02200234	CEPAIGO S2	12/01/2019 18:37	13/01/2019 00:10	12/01/2019 18:37	12/01/2019 20:52	2,25	639	1437,75	CHI
20190145778	BELA VISTA DE GOIAS	HD13402815	CEPAIGO S2	12/01/2019 18:37	13/01/2019 00:10	12/01/2019 18:37	13/01/2019 00:10	5,55	7	38,85	CHI
20190145778	HIDROLANDIA	HD13402815	CEPAIGO S2	12/01/2019 18:37	13/01/2019 00:10	12/01/2019 18:37	13/01/2019 00:10	5,55	272	1509,60	CHI
20190145783	JAUPACI	030902214	IPORA	12/01/2019 19:04	13/01/2019 03:56	12/01/2019 19:04	12/01/2019 21:23	2,32	673	1559,12	CHI
20190145783	JAUPACI	030902214	IPORA	12/01/2019 19:04	13/01/2019 03:56	12/01/2019 21:24	12/01/2019 22:05	0,68	516	352,60	CHI
20190145783	DIORAMA	030902214	IPORA	12/01/2019 19:04	13/01/2019 03:56	12/01/2019 19:04	12/01/2019 22:56	3,87	11	42,53	CHI
20190145783	FAZENDA NOVA	030902214	IPORA	12/01/2019 19:04	13/01/2019 03:56	12/01/2019 19:04	12/01/2019 22:56	3,87	21	81,20	CHI
20190145783	JAUPACI	030902214	IPORA	12/01/2019 19:04	13/01/2019 03:56	12/01/2019 19:04	12/01/2019 22:56	3,87	349	1349,47	CHI
20190145783	JAUPACI	JP12089960LD	IPORA	12/01/2019 19:04	13/01/2019 03:56	12/01/2019 21:24	12/01/2019 23:26	2,03	124	252,13	CHI
20190145783	DIORAMA	030902214	IPORA	12/01/2019 19:04	13/01/2019 03:56	12/01/2019 23:46	13/01/2019 00:02	0,27	11	2,93	CHI
20190145783	FAZENDA NOVA	030902214	IPORA	12/01/2019 19:04	13/01/2019 03:56	12/01/2019 23:46	13/01/2019 00:02	0,27	21	5,60	CHI

20190145783	JAUPACI	030902214	IPORA	12/01/2019 19:04	13/01/2019 03:56	12/01/2019 23:46	13/01/2019 00:02	0,27	992	264,53	CHI
20190145783	DIORAMA	030902214	IPORA	12/01/2019 19:04	13/01/2019 03:56	13/01/2019 00:46	13/01/2019 01:23	0,62	11	6,78	CHI
20190145783	FAZENDA NOVA	030902214	IPORA	12/01/2019 19:04	13/01/2019 03:56	13/01/2019 00:46	13/01/2019 01:23	0,62	21	12,95	CHI
20190145783	JAUPACI	030902214	IPORA	12/01/2019 19:04	13/01/2019 03:56	13/01/2019 00:46	13/01/2019 01:23	0,62	992	611,73	CHI
20190145783	JAUPACI	JP12187452LD	IPORA	12/01/2019 19:04	13/01/2019 03:56	12/01/2019 21:24	13/01/2019 03:56	6,53	33	215,60	CHI
20190145784	RUBIATABA	RB11111533	RUBIATABA	12/01/2019 19:14	13/01/2019 00:23	12/01/2019 19:14	13/01/2019 00:23	5,15	140	721,00	CHI
20190145785	GOIANIA	GN10400631	AEROPORTO S2	12/01/2019 19:24	12/01/2019 23:07	12/01/2019 19:24	12/01/2019 19:54	0,50	2303	1151,50	DIA CRITICO
20190145785	GOIANIA	GN10400631	GOIANIA LESTE S3	12/01/2019 19:24	12/01/2019 23:07	12/01/2019 19:24	12/01/2019 19:54	0,50	1	0,50	DIA CRITICO
20190145785	GOIANIA	GN10380044	AEROPORTO S2	12/01/2019 19:24	12/01/2019 23:07	12/01/2019 19:35	12/01/2019 20:57	1,37	2132	2913,73	DIA CRITICO
20190145785	GOIANIA	GN10380320	AEROPORTO S2	12/01/2019 19:24	12/01/2019 23:07	12/01/2019 21:06	12/01/2019 21:50	0,73	261	191,40	DIA CRITICO
20190145785	GOIANIA	GN13001156	AEROPORTO S2	12/01/2019 19:24	12/01/2019 23:07	12/01/2019 21:06	12/01/2019 23:07	2,02	613	1236,22	DIA CRITICO
20190145786	MOZARLANDIA	03370434	MOZARLANDIA	12/01/2019 19:14	14/01/2019 09:40	12/01/2019 19:14	12/01/2019 19:17	0,05	1	0,05	CHI
20190145786	ARUANA	03370434	MOZARLANDIA	12/01/2019 19:14	14/01/2019 09:40	12/01/2019 19:14	12/01/2019 22:52	3,63	124	450,53	CHI
20190145786	MOZARLANDIA	03370434	MOZARLANDIA	12/01/2019 19:14	14/01/2019 09:40	12/01/2019 19:14	12/01/2019 22:52	3,63	13	47,23	CHI
20190145786	NOVA CRIXAS	03370434	MOZARLANDIA	12/01/2019 19:14	14/01/2019 09:40	12/01/2019 19:14	12/01/2019 22:52	3,63	30	109,00	CHI
20190145786	ARUANA	03370434	MOZARLANDIA	12/01/2019 19:14	14/01/2019 09:40	12/01/2019 19:14	13/01/2019 00:30	5,27	8	42,13	CHI
20190145786	MOZARLANDIA	03370434	MOZARLANDIA	12/01/2019 19:14	14/01/2019 09:40	12/01/2019 19:14	13/01/2019 00:30	5,27	101	531,93	CHI
20190145786	NOVA CRIXAS	03370434	MOZARLANDIA	12/01/2019 19:14	14/01/2019 09:40	12/01/2019 19:14	13/01/2019 00:30	5,27	35	184,33	CHI
20190145786	ARUANA	MZ10404259	MOZARLANDIA	12/01/2019 19:14	14/01/2019 09:40	13/01/2019 00:22	13/01/2019 00:30	0,13	124	16,53	CHI
20190145786	MOZARLANDIA	MZ10404259	MOZARLANDIA	12/01/2019 19:14	14/01/2019 09:40	13/01/2019 00:22	13/01/2019 00:30	0,13	2222	296,27	CHI
20190145786	MOZARLANDIA	MZ10404259	MOZARLANDIA	12/01/2019 19:14	14/01/2019 09:40	13/01/2019 00:22	13/01/2019 00:30	0,13	1	0,13	CHI
20190145786	MOZARLANDIA	MZ10404259	MOZARLANDIA	12/01/2019 19:14	14/01/2019 09:40	13/01/2019 00:22	13/01/2019 00:30	0,13	13	1,73	CHI
20190145786	NOVA CRIXAS	MZ10404259	MOZARLANDIA	12/01/2019 19:14	14/01/2019 09:40	13/01/2019 00:22	13/01/2019 00:30	0,13	30	4,00	CHI
20190145786	ARUANA	MZ10404259	MOZARLANDIA	12/01/2019 19:14	14/01/2019 09:40	13/01/2019 14:01	13/01/2019 14:04	0,05	124	6,20	CHI
20190145786	MOZARLANDIA	MZ10404259	MOZARLANDIA	12/01/2019 19:14	14/01/2019 09:40	13/01/2019 14:01	13/01/2019 14:04	0,05	2222	111,10	CHI
20190145786	MOZARLANDIA	MZ10404259	MOZARLANDIA	12/01/2019 19:14	14/01/2019 09:40	13/01/2019 14:01	13/01/2019 14:04	0,05	88	4,40	CHI
20190145786	MOZARLANDIA	MZ10404259	MOZARLANDIA	12/01/2019 19:14	14/01/2019 09:40	13/01/2019 14:01	13/01/2019 14:04	0,05	13	0,65	CHI
20190145786	NOVA CRIXAS	MZ10404259	MOZARLANDIA	12/01/2019 19:14	14/01/2019 09:40	13/01/2019 14:01	13/01/2019 14:04	0,05	34	1,70	CHI
20190145786	NOVA CRIXAS	MZ10404259	MOZARLANDIA	12/01/2019 19:14	14/01/2019 09:40	13/01/2019 14:01	13/01/2019 14:04	0,05	30	1,50	CHI
20190145786	ARUANA	MZ10404259	MOZARLANDIA	12/01/2019 19:14	14/01/2019 09:40	13/01/2019 21:52	13/01/2019 22:04	0,20	8	1,60	CHI
20190145786	ARUANA	MZ10404259	MOZARLANDIA	12/01/2019 19:14	14/01/2019 09:40	13/01/2019 21:52	13/01/2019 22:04	0,20	108	21,60	CHI
20190145786	MOZARLANDIA	MZ10404259	MOZARLANDIA	12/01/2019 19:14	14/01/2019 09:40	13/01/2019 21:52	13/01/2019 22:04	0,20	2222	444,40	CHI
20190145786	MOZARLANDIA	MZ10404259	MOZARLANDIA	12/01/2019 19:14	14/01/2019 09:40	13/01/2019 21:52	13/01/2019 22:04	0,20	97	19,40	CHI

20190145786	MOZARLANDIA	MZ10404259	MOZARLANDIA	12/01/2019 19:14	14/01/2019 09:40	13/01/2019 21:52	13/01/2019 22:04	0,20	13	2,60	CHI
20190145786	NOVA CRIXAS	MZ10404259	MOZARLANDIA	12/01/2019 19:14	14/01/2019 09:40	13/01/2019 21:52	13/01/2019 22:04	0,20	34	6,80	CHI
20190145786	NOVA CRIXAS	MZ10404259	MOZARLANDIA	12/01/2019 19:14	14/01/2019 09:40	13/01/2019 21:52	13/01/2019 22:04	0,20	30	6,00	CHI
20190145786	ARUANA	MZ10404259	MOZARLANDIA	12/01/2019 19:14	14/01/2019 09:40	13/01/2019 22:14	13/01/2019 22:28	0,23	8	1,87	CHI
20190145786	ARUANA	MZ10404259	MOZARLANDIA	12/01/2019 19:14	14/01/2019 09:40	13/01/2019 22:14	13/01/2019 22:28	0,23	108	25,20	CHI
20190145786	MOZARLANDIA	MZ10404259	MOZARLANDIA	12/01/2019 19:14	14/01/2019 09:40	13/01/2019 22:14	13/01/2019 22:28	0,23	2222	518,47	CHI
20190145786	MOZARLANDIA	MZ10404259	MOZARLANDIA	12/01/2019 19:14	14/01/2019 09:40	13/01/2019 22:14	13/01/2019 22:28	0,23	76	17,73	CHI
20190145786	MOZARLANDIA	MZ10404259	MOZARLANDIA	12/01/2019 19:14	14/01/2019 09:40	13/01/2019 22:14	13/01/2019 22:28	0,23	13	3,03	CHI
20190145786	NOVA CRIXAS	MZ10404259	MOZARLANDIA	12/01/2019 19:14	14/01/2019 09:40	13/01/2019 22:14	13/01/2019 22:28	0,23	1	0,23	CHI
20190145786	NOVA CRIXAS	MZ10404259	MOZARLANDIA	12/01/2019 19:14	14/01/2019 09:40	13/01/2019 22:14	13/01/2019 22:28	0,23	30	7,00	CHI
20190145786	MOZARLANDIA	03370434	MOZARLANDIA	12/01/2019 19:14	14/01/2019 09:40	12/01/2019 19:14	14/01/2019 05:00	33,77	4	135,07	CHI
20190145786	ARUANA	MZ13329944	MOZARLANDIA	12/01/2019 19:14	14/01/2019 09:40	14/01/2019 08:39	14/01/2019 09:11	0,53	108	57,60	CHI
20190145786	MOZARLANDIA	MZ13329944	MOZARLANDIA	12/01/2019 19:14	14/01/2019 09:40	14/01/2019 08:39	14/01/2019 09:11	0,53	13	6,93	CHI
20190145786	NOVA CRIXAS	MZ13329944	MOZARLANDIA	12/01/2019 19:14	14/01/2019 09:40	14/01/2019 08:39	14/01/2019 09:11	0,53	30	16,00	CHI
20190145786	MOZARLANDIA	MZ10404259	MOZARLANDIA	12/01/2019 19:14	14/01/2019 09:40	13/01/2019 22:14	14/01/2019 09:40	11,43	21	240,10	CHI
20190145786	NOVA CRIXAS	MZ10404259	MOZARLANDIA	12/01/2019 19:14	14/01/2019 09:40	13/01/2019 22:14	14/01/2019 09:40	11,43	33	377,30	CHI
20190145786	ARUANA	MZ10404259	MOZARLANDIA	12/01/2019 19:14	14/01/2019 09:40	14/01/2019 09:24	14/01/2019 09:40	0,27	8	2,13	CHI
20190145786	MOZARLANDIA	MZ10404259	MOZARLANDIA	12/01/2019 19:14	14/01/2019 09:40	14/01/2019 09:24	14/01/2019 09:40	0,27	76	20,27	CHI
20190145786	NOVA CRIXAS	MZ10404259	MOZARLANDIA	12/01/2019 19:14	14/01/2019 09:40	14/01/2019 09:24	14/01/2019 09:40	0,27	1	0,27	CHI
20190145789	MAMBAI	MB11120560	IACIARA S2	12/01/2019 19:43	12/01/2019 19:55	12/01/2019 19:43	12/01/2019 19:55	0,20	6	1,20	CHI
20190145792	RIO VERDE	RV10212406	CABRIUVA S2	12/01/2019 19:59	14/01/2019 12:59	12/01/2019 19:59	12/01/2019 22:44	2,75	29	79,75	CHI
20190145792	RIO VERDE	RV13076249	CABRIUVA S2	12/01/2019 19:59	14/01/2019 12:59	12/01/2019 19:59	13/01/2019 08:46	12,78	26	332,37	CHI
20190145792	MONTIVIDIU	05700414	MONTIVIDIU T	12/01/2019 19:59	14/01/2019 12:59	13/01/2019 09:09	13/01/2019 09:24	0,25	1	0,25	CHI
20190145792	RIO VERDE	05700414	MONTIVIDIU T	12/01/2019 19:59	14/01/2019 12:59	13/01/2019 09:09	13/01/2019 09:24	0,25	36	9,00	CHI
20190145792	RIO VERDE	RV13357270	CABRIUVA S2	12/01/2019 19:59	14/01/2019 12:59	12/01/2019 19:59	13/01/2019 11:08	15,15	1	15,15	CHI
20190145792	RIO VERDE	RV13076246	CABRIUVA S2	12/01/2019 19:59	14/01/2019 12:59	12/01/2019 19:59	13/01/2019 11:16	15,28	1	15,28	CHI
20190145792	RIO VERDE	RV10212406	CABRIUVA S2	12/01/2019 19:59	14/01/2019 12:59	13/01/2019 11:50	13/01/2019 11:58	0,13	60	8,00	CHI
20190145792	RIO VERDE	RV12205429	CABRIUVA S2	12/01/2019 19:59	14/01/2019 12:59	12/01/2019 19:59	13/01/2019 17:20	21,35	2	42,70	CHI
20190145792	RIO VERDE	RV12205429	CABRIUVA S2	12/01/2019 19:59	14/01/2019 12:59	12/01/2019 19:59	14/01/2019 12:10	40,18	7	281,28	CHI
20190145792	RIO VERDE	RV12205429	CABRIUVA S2	12/01/2019 19:59	14/01/2019 12:59	13/01/2019 17:21	14/01/2019 12:10	18,82	2	37,63	CHI
20190145792	RIO VERDE	RV13076246	CABRIUVA S2	12/01/2019 19:59	14/01/2019 12:59	12/01/2019 19:59	14/01/2019 12:59	41,00	31	1271,00	CHI
20190145792	RIO VERDE	RV13207004	CABRIUVA S2	12/01/2019 19:59	14/01/2019 12:59	13/01/2019 09:09	14/01/2019 12:59	27,83	1	27,83	CHI
20190145794	URUACU	UR12339041	URUACU	12/01/2019 18:06	13/01/2019 22:41	12/01/2019 18:06	13/01/2019 22:41	28,58	28	800,33	CHI

20190145794	URUACU	UR12339041	URUACU	12/01/2019 18:06	13/01/2019 22:41	13/01/2019 10:34	13/01/2019 22:41	12,12	5	60,58	CHI
20190145798	ANICUNS	AC21294330	ANICUNS	12/01/2019 18:00	13/01/2019 10:20	12/01/2019 18:00	13/01/2019 10:20	16,33	1	16,33	CHI
20190145800	BONOPOLIS	TA12247490	NOVO PLANALTO	12/01/2019 20:29	12/01/2019 21:06	12/01/2019 20:29	12/01/2019 21:06	0,62	10	6,17	CHI
20190145800	PORANGATU	TA12247490	NOVO PLANALTO	12/01/2019 20:29	12/01/2019 21:06	12/01/2019 20:29	12/01/2019 21:06	0,62	2	1,23	CHI
20190145813	PIRENOPOLIS	ZN21371793	COCALZINHO	12/01/2019 14:39	12/01/2019 16:18	12/01/2019 14:39	12/01/2019 16:18	1,65	2	3,30	CHI
20190145820	CAMPESTRE DE GOIAS	GC11276776	TRINDADE	12/01/2019 14:41	12/01/2019 17:54	12/01/2019 14:41	12/01/2019 17:54	3,22	1	3,22	DIA CRITICO
20190145828	RIO VERDE	RV12305777	CABRIUVA S2	12/01/2019 14:39	12/01/2019 16:10	12/01/2019 14:39	12/01/2019 16:10	1,52	2	3,03	CHI
20190145841	SANTO ANTONIO DO DESCOBERTO	SN12192799	AGUAS LINDAS DE GOIAS S2	12/01/2019 14:43	12/01/2019 16:23	12/01/2019 14:43	12/01/2019 16:23	1,67	233	388,33	CHI
20190145844	FORMOSA	FA12233558	ITIQUEIRA	12/01/2019 14:44	12/01/2019 18:19	12/01/2019 14:44	12/01/2019 18:19	3,58	2	7,17	CHI
20190145845	ARUANA	03960416	NOVA CRIXAS	12/01/2019 14:44	13/01/2019 00:40	12/01/2019 14:44	13/01/2019 00:40	9,93	25	248,33	CHI
20190145845	NOVA CRIXAS	03960416	NOVA CRIXAS	12/01/2019 14:44	13/01/2019 00:40	12/01/2019 14:44	13/01/2019 00:40	9,93	88	874,13	CHI
20190145845	NOVA CRIXAS	03960416	NOVA CRIXAS	12/01/2019 14:44	13/01/2019 00:40	12/01/2019 14:44	13/01/2019 00:40	9,93	16	158,93	CHI
20190145857	HIDROLANDIA	HD21072708	CEPAIGO S2	12/01/2019 14:45	12/01/2019 16:32	12/01/2019 14:45	12/01/2019 16:32	1,78	1	1,78	CHI
20190145863	DISTRITO FEDERAL	PB12163215	PADRE BERNARDO	12/01/2019 14:46	12/01/2019 17:23	12/01/2019 14:46	12/01/2019 17:23	2,62	3	7,85	CHI
20190145863	PADRE BERNARDO	PB12163215	PADRE BERNARDO	12/01/2019 14:46	12/01/2019 17:23	12/01/2019 14:46	12/01/2019 17:23	2,62	291	761,45	CHI
20190145865	DISTRITO FEDERAL	05410224	MARAJOARA	12/01/2019 13:34	12/01/2019 17:15	12/01/2019 13:34	12/01/2019 17:15	3,68	27	99,45	CHI
20190145865	SANTO ANTONIO DO DESCOBERTO	05410224	MARAJOARA	12/01/2019 13:34	12/01/2019 17:15	12/01/2019 13:34	12/01/2019 17:15	3,68	671	2471,52	CHI
20190145866	BELA VISTA DE GOIAS	BV12360000	BELA VISTA S2	12/01/2019 14:47	12/01/2019 17:52	12/01/2019 14:47	12/01/2019 17:52	3,08	2	6,17	CHI
20190145869	VILA BOA	FA21146154	ITIQUEIRA	12/01/2019 14:47	12/01/2019 23:44	12/01/2019 14:47	12/01/2019 23:44	8,95	5	44,75	CHI
20190145871	CAMPO ALEGRE DE GOIAS	CM12252408	CAMPO ALEGRE DE GOIAS	12/01/2019 14:32	12/01/2019 17:55	12/01/2019 14:32	12/01/2019 17:55	3,38	4	13,53	CHI
20190145874	ANICUNS	NZ12147519	ANICUNS	12/01/2019 14:45	12/01/2019 16:20	12/01/2019 14:45	12/01/2019 16:20	1,58	102	161,50	CHI
20190145874	NAZARIO	NZ12147519	ANICUNS	12/01/2019 14:45	12/01/2019 16:20	12/01/2019 14:45	12/01/2019 16:20	1,58	3	4,75	CHI
20190145874	TURVANIA	NZ12147519	ANICUNS	12/01/2019 14:45	12/01/2019 16:20	12/01/2019 14:45	12/01/2019 16:20	1,58	10	15,83	CHI
20190145880	CRIXAS	CX12201610	SANTA TEREZINHA	12/01/2019 14:50	12/01/2019 19:00	12/01/2019 14:50	12/01/2019 19:00	4,17	161	670,83	CHI
20190145881	SANTA TEREZINHA DE GOIAS	SG21067427	SANTA TEREZINHA	12/01/2019 14:50	12/01/2019 18:29	12/01/2019 14:50	12/01/2019 18:29	3,65	1	3,65	CHI
20190145882	DOVERLANDIA	DV11053612	CAIAPONIA	12/01/2019 14:39	12/01/2019 16:15	12/01/2019 14:39	12/01/2019 16:15	1,60	165	264,00	CHI
20190145889	MINEIROS	MY21296308	PARQUE DAS EMAS	12/01/2019 14:52	12/01/2019 17:33	12/01/2019 14:52	12/01/2019 17:33	2,68	1	2,68	CHI
20190145891	JUSSARA	1290048980	JUSSARA	12/01/2019 14:52	12/01/2019 16:05	12/01/2019 14:52	12/01/2019 16:05	1,22	1	1,22	CHI
20190145899	AGUAS LINDAS DE GOIAS	LA11261304	AGUAS LINDAS DE GOIAS S1	12/01/2019 14:45	12/01/2019 15:42	12/01/2019 14:45	12/01/2019 15:42	0,95	150	142,50	CHI
20190145917	JATAI	JT11108719	JATAI S2	12/01/2019 14:56	12/01/2019 18:48	12/01/2019 14:56	12/01/2019 18:48	3,87	173	668,93	CHI
20190145920	ANICUNS	AR12384485	ARACU	12/01/2019 14:57	12/01/2019 17:35	12/01/2019 14:57	12/01/2019 17:35	2,63	14	36,87	DIA CRITICO
20190145920	ARACU	AR12384485	ARACU	12/01/2019 14:57	12/01/2019 17:35	12/01/2019 14:57	12/01/2019 17:35	2,63	1	2,63	DIA CRITICO
20190145920	ITABERAI	AR12384485	ARACU	12/01/2019 14:57	12/01/2019 17:35	12/01/2019 14:57	12/01/2019 17:35	2,63	6	15,80	DIA CRITICO

20190145926	COCALZINHO DE GOIAS	ZN12330505	AGUAS LINDAS DE GOIAS S2	12/01/2019 13:45	13/01/2019 11:25	12/01/2019 13:45	13/01/2019 11:25	21,67	29	628,33	CHI
20190145926	PADRE BERNARDO	ZN12330505	AGUAS LINDAS DE GOIAS S2	12/01/2019 13:45	13/01/2019 11:25	12/01/2019 13:45	13/01/2019 11:25	21,67	4	86,67	CHI
20190145927	PADRE BERNARDO	PB12163212	PADRE BERNARDO	12/01/2019 14:55	12/01/2019 16:45	12/01/2019 14:55	12/01/2019 16:45	1,83	30	55,00	CHI
20190145928	SANTO ANTONIO DO DESCOBERTO	10004453199	ALEXANIA	12/01/2019 14:58	12/01/2019 20:30	12/01/2019 14:58	12/01/2019 20:30	5,53	1	5,53	CHI
20190145942	PORTELANDIA	PW11045395	PARQUE DAS EMAS	12/01/2019 14:59	12/01/2019 18:03	12/01/2019 14:59	12/01/2019 18:03	3,07	112	343,47	CHI
20190145953	GOIANIA	GN11001804	ATLANTICO S3	12/01/2019 15:00	12/01/2019 17:19	12/01/2019 15:00	12/01/2019 17:19	2,32	104	240,93	CHI
20190145961	SANTA TEREZA DE GOIAS	SE21000019	MARA ROSA	12/01/2019 15:01	12/01/2019 21:45	12/01/2019 15:01	12/01/2019 21:45	6,73	1	6,73	CHI
20190145963	PADRE BERNARDO	PB12313957	PADRE BERNARDO	12/01/2019 15:01	12/01/2019 20:28	12/01/2019 15:01	12/01/2019 20:28	5,45	33	179,85	CHI
20190145965	MORRINHOS	MR12128631	MORRINHOS	12/01/2019 15:01	12/01/2019 17:56	12/01/2019 15:01	12/01/2019 17:56	2,92	13	37,92	CHI
20190145968	GOIANIA	GN11066503	AEROPORTO S3	12/01/2019 15:02	12/01/2019 16:18	12/01/2019 15:02	12/01/2019 16:18	1,27	7	8,87	CHI
20190145980	COCALZINHO DE GOIAS	CB12060039	COCALZINHO	12/01/2019 15:03	12/01/2019 17:18	12/01/2019 15:03	12/01/2019 17:18	2,25	23	51,75	CHI
20190145980	CORUMBA DE GOIAS	CB12060039	COCALZINHO	12/01/2019 15:03	12/01/2019 17:18	12/01/2019 15:03	12/01/2019 17:18	2,25	3	6,75	CHI
20190145982	SAO SIMAO	10000193400	CACHOEIRA ALTA	12/01/2019 15:04	12/01/2019 23:00	12/01/2019 15:04	12/01/2019 23:00	7,93	1	7,93	CHI
20190145988	GOIAS	GS21140296	MATRINCHA	12/01/2019 13:26	12/01/2019 22:15	12/01/2019 13:26	12/01/2019 22:15	8,82	2	17,63	CHI
20190145989	VARJAO	940007083	GUAPU S2	12/01/2019 15:05	12/01/2019 16:59	12/01/2019 15:05	12/01/2019 16:59	1,90	1	1,90	CHI
20190146003	ANICUNS	IX12200037	ARACU	12/01/2019 15:06	13/01/2019 14:39	12/01/2019 15:06	13/01/2019 14:39	23,55	1	23,55	DIA CRITICO
20190146003	ITABERAI	IX12200037	ARACU	12/01/2019 15:06	13/01/2019 14:39	12/01/2019 15:06	13/01/2019 14:39	23,55	12	282,60	DIA CRITICO
20190146010	CUMARI	CY21000311	CATALAO S1	12/01/2019 15:06	13/01/2019 19:05	12/01/2019 15:06	13/01/2019 19:05	27,98	1	27,98	DIA CRITICO
20190146021	PIRENOPOLIS	PV21227840	COCALZINHO	12/01/2019 15:08	12/01/2019 19:03	12/01/2019 15:08	12/01/2019 19:03	3,92	2	7,83	CHI
20190146029	TRINDADE	TR11365570	TRINDADE	12/01/2019 14:58	12/01/2019 16:41	12/01/2019 14:58	12/01/2019 16:41	1,72	128	219,73	DIA CRITICO
20190146033	ALEXANIA	AX21370363	ALEXANIA	12/01/2019 15:09	13/01/2019 15:22	12/01/2019 15:09	13/01/2019 15:22	24,22	1	24,22	CHI
20190146037	ALEXANIA	AX10397586	ALEXANIA	12/01/2019 15:11	12/01/2019 17:42	12/01/2019 15:11	12/01/2019 16:04	0,88	163	143,98	CHI
20190146037	ABADIANIA	AX13351021	ALEXANIA	12/01/2019 15:11	12/01/2019 17:42	12/01/2019 15:11	12/01/2019 17:15	2,07	13	26,87	CHI
20190146037	ALEXANIA	AX13351021	ALEXANIA	12/01/2019 15:11	12/01/2019 17:42	12/01/2019 15:11	12/01/2019 17:15	2,07	215	444,33	CHI
20190146037	ABADIANIA	AX13221527	ALEXANIA	12/01/2019 15:11	12/01/2019 17:42	12/01/2019 15:11	12/01/2019 17:42	2,52	6	15,10	CHI
20190146037	ALEXANIA	AX13221527	ALEXANIA	12/01/2019 15:11	12/01/2019 17:42	12/01/2019 15:11	12/01/2019 17:42	2,52	2	5,03	CHI
20190146037	CORUMBA DE GOIAS	AX13221527	ALEXANIA	12/01/2019 15:11	12/01/2019 17:42	12/01/2019 15:11	12/01/2019 17:42	2,52	117	294,45	CHI
20190146041	MOSSAMEDES	MD21091061	FIRMINOPOLIS S2	12/01/2019 15:11	17/01/2019 19:00	12/01/2019 15:11	17/01/2019 19:00	123,82	1	123,82	CHI
20190146048	CALDAS NOVAS	760105753	CALDAS NOVAS S1	12/01/2019 15:12	12/01/2019 16:39	12/01/2019 15:12	12/01/2019 16:39	1,45	1	1,45	CHI
20190146050	FAZENDA NOVA	NB12116362	JUSSARA	12/01/2019 15:12	12/01/2019 20:21	12/01/2019 15:12	12/01/2019 20:21	5,15	4	20,60	CHI
20190146050	NOVO BRASIL	NB12116362	JUSSARA	12/01/2019 15:12	12/01/2019 20:21	12/01/2019 15:12	12/01/2019 20:21	5,15	15	77,25	CHI
20190146057	JATAI	JT12374278	JATAI S2	12/01/2019 14:55	12/01/2019 16:44	12/01/2019 14:55	12/01/2019 16:44	1,82	575	1044,58	CHI
20190146068	JARAGUA	JA12029022	JARAGUA	12/01/2019 15:14	12/01/2019 17:30	12/01/2019 15:14	12/01/2019 17:30	2,27	151	342,27	CHI

20190146071	LUZIANIA	LZ21248639	VIANOPOLIS	12/01/2019 15:19	13/01/2019 02:00	12/01/2019 15:19	13/01/2019 02:00	10,68	3	32,05	CHI
20190146085	CAMPO ALEGRE DE GOIAS	1160027149	CAMPO ALEGRE DE GOIAS	12/01/2019 15:16	12/01/2019 17:14	12/01/2019 15:16	12/01/2019 17:14	1,97	1	1,97	CHI
20190146094	NIQUELANDIA	NQ12359232	NIQUELANDIA SUBTRANSMISSÃO	12/01/2019 15:17	12/01/2019 20:40	12/01/2019 15:17	12/01/2019 20:40	5,38	3	16,15	CHI
20190146095	ALEXANIA	AX12185636	ALEXANIA	12/01/2019 15:18	13/01/2019 17:06	12/01/2019 15:18	13/01/2019 17:06	25,80	1	25,80	CHI
20190146097	ITAPACI	RB12146830	RUBIATABA	12/01/2019 15:12	12/01/2019 16:02	12/01/2019 15:12	12/01/2019 16:02	0,83	10	8,33	CHI
20190146097	RUBIATABA	RB12146830	RUBIATABA	12/01/2019 15:12	12/01/2019 16:02	12/01/2019 15:12	12/01/2019 16:02	0,83	98	81,67	CHI
20190146105	LUZIANIA	LZ12376129	CRISTALINA S2	12/01/2019 15:18	12/01/2019 17:19	12/01/2019 15:18	12/01/2019 17:19	2,02	59	118,98	CHI
20190146107	CUMARI	CY12071522	CATALAO S1	12/01/2019 12:04	12/01/2019 16:50	12/01/2019 12:04	12/01/2019 16:50	4,77	6	28,60	DIA CRITICO
20190146107	GOIANDIRA	CY12071522	CATALAO S1	12/01/2019 12:04	12/01/2019 16:50	12/01/2019 12:04	12/01/2019 16:50	4,77	8	38,13	DIA CRITICO
20190146111	GOIATUBA	GT11087235	GOIATUBA S2	12/01/2019 15:18	12/01/2019 16:08	12/01/2019 15:18	12/01/2019 16:08	0,83	179	149,17	CHI
20190146116	PIRENOPOLIS	PV21339446	CORUMBA	12/01/2019 15:20	13/01/2019 12:48	12/01/2019 15:20	13/01/2019 12:48	21,47	1	21,47	DIA CRITICO
20190146120	CACHOEIRA ALTA	1090034158	CACHOEIRA ALTA	12/01/2019 15:20	12/01/2019 18:02	12/01/2019 15:20	12/01/2019 18:02	2,70	1	2,70	CHI
20190146125	JARAGUA	JA12000144	JARAGUA	12/01/2019 15:21	12/01/2019 16:38	12/01/2019 15:21	12/01/2019 16:38	1,28	212	272,07	CHI
20190146128	PIRENOPOLIS	PV11264950	CORUMBA	12/01/2019 15:03	12/01/2019 19:09	12/01/2019 15:03	12/01/2019 19:09	4,10	33	135,30	DIA CRITICO
20190146133	COCALZINHO DE GOIAS	PV12185533	COCALZINHO	12/01/2019 15:14	12/01/2019 16:10	12/01/2019 15:14	12/01/2019 16:10	0,93	1	0,93	CHI
20190146133	PIRENOPOLIS	PV12185533	COCALZINHO	12/01/2019 15:14	12/01/2019 16:10	12/01/2019 15:14	12/01/2019 16:10	0,93	19	17,73	CHI
20190146141	PIRENOPOLIS	PV12084565	CORUMBA	12/01/2019 15:15	12/01/2019 17:05	12/01/2019 15:15	12/01/2019 17:05	1,83	10	18,33	DIA CRITICO
20190146144	URUACU	640112626	URUACU	12/01/2019 15:25	12/01/2019 16:48	12/01/2019 15:25	12/01/2019 16:48	1,38	1	1,38	CHI
20190146156	CRIXAS	CX12202134	SERRA DO OURO	12/01/2019 15:25	12/01/2019 19:20	12/01/2019 15:25	12/01/2019 19:20	3,92	43	168,42	CHI
20190146174	ITABERAI	IB21171750	ITABERAI S2	12/01/2019 15:29	12/01/2019 17:13	12/01/2019 15:29	12/01/2019 17:13	1,73	1	1,73	CHI
20190146179	BONOPOLIS	BX12198524	SAO MIGUEL DO ARAGUAIA	12/01/2019 15:30	13/01/2019 15:30	12/01/2019 15:30	13/01/2019 15:30	24,00	6	144,00	DIA CRITICO
20190146182	MINEIROS	MY12358901	PARQUE DAS EMAS	12/01/2019 15:31	13/01/2019 09:54	12/01/2019 15:31	13/01/2019 09:54	18,38	53	974,32	CHI
20190146182	SANTA RITA DO ARAGUAIA	MY12358901	PARQUE DAS EMAS	12/01/2019 15:31	13/01/2019 09:54	12/01/2019 15:31	13/01/2019 09:54	18,38	2	36,77	CHI
20190146193	MUTUNOPOLIS	PO12297103	PORANGATU	12/01/2019 15:32	12/01/2019 18:35	12/01/2019 15:32	12/01/2019 18:35	3,05	4	12,20	CHI
20190146193	PORANGATU	PO12297103	PORANGATU	12/01/2019 15:32	12/01/2019 18:35	12/01/2019 15:32	12/01/2019 18:35	3,05	31	94,55	CHI
20190146194	ALEXANIA	03240214	CORUMBA	12/01/2019 14:38	12/01/2019 18:00	12/01/2019 14:38	12/01/2019 18:00	3,37	276	929,20	DIA CRITICO
20190146194	CORUMBA DE GOIAS	03240214	CORUMBA	12/01/2019 14:38	12/01/2019 18:00	12/01/2019 14:38	12/01/2019 18:00	3,37	32	107,73	DIA CRITICO
20190146197	GAMELEIRA DE GOIAS	SV12056334	DAIA S2	12/01/2019 15:32	12/01/2019 18:15	12/01/2019 15:32	12/01/2019 18:15	2,72	14	38,03	CHI
20190146197	SILVANIA	SV12056334	DAIA S2	12/01/2019 15:32	12/01/2019 18:15	12/01/2019 15:32	12/01/2019 18:15	2,72	23	62,48	CHI
20190146211	CAIAPONIA	CP21207117	MONTIVIDIU T	12/01/2019 15:34	13/01/2019 09:35	12/01/2019 15:34	13/01/2019 09:35	18,02	1	18,02	CHI
20190146218	GOIANESIA	GE12255984	GOIANESIA S2	12/01/2019 15:33	12/01/2019 18:43	12/01/2019 15:33	12/01/2019 18:43	3,17	13	41,17	CHI
20190146219	ITAGUARI	IC12219937	ITABERAI S1	12/01/2019 15:36	12/01/2019 16:51	12/01/2019 15:36	12/01/2019 16:51	1,25	26	32,50	CHI
20190146219	ITAGUARU	IC12219937	ITABERAI S1	12/01/2019 15:36	12/01/2019 16:51	12/01/2019 15:36	12/01/2019 16:51	1,25	2	2,50	CHI

20190146223	NIQUELANDIA	04560224	BARRO ALTO	12/01/2019 15:13	12/01/2019 16:49	12/01/2019 15:13	12/01/2019 16:49	1,60	138	220,80	CHI
20190146233	PIRENOPOLIS	10020944622	CORUMBA	12/01/2019 15:38	13/01/2019 16:51	12/01/2019 15:38	13/01/2019 16:51	25,22	1	25,22	DIA CRITICO
20190146234	PETROLINA DE GOIAS	PG12298074	PETROLINA	12/01/2019 15:38	12/01/2019 18:16	12/01/2019 15:38	12/01/2019 18:16	2,63	13	34,23	DIA CRITICO
20190146235	CUMARI	CY21063821	CATALAO S1	12/01/2019 15:38	14/01/2019 08:30	12/01/2019 15:38	14/01/2019 08:30	40,87	1	40,87	DIA CRITICO
20190146245	PARANAIGUARA	01410406	CACHOEIRA ALTA	12/01/2019 15:31	12/01/2019 20:52	12/01/2019 15:31	12/01/2019 16:54	1,38	2468	3414,07	CHI
20190146245	SAO SIMAO	01410406	CACHOEIRA ALTA	12/01/2019 15:31	12/01/2019 20:52	12/01/2019 15:31	12/01/2019 16:54	1,38	5	6,92	CHI
20190146245	PARANAIGUARA	01410406	CACHOEIRA ALTA	12/01/2019 15:31	12/01/2019 20:52	12/01/2019 15:31	12/01/2019 16:57	1,43	1289	1847,57	CHI
20190146245	PARANAIGUARA	01410406	CACHOEIRA ALTA	12/01/2019 15:31	12/01/2019 20:52	12/01/2019 16:44	12/01/2019 17:41	0,95	39	37,05	CHI
20190146245	SAO SIMAO	01410406	CACHOEIRA ALTA	12/01/2019 15:31	12/01/2019 20:52	12/01/2019 16:44	12/01/2019 17:41	0,95	2	1,90	CHI
20190146245	CACHOEIRA ALTA	PC12000018	CACHOEIRA ALTA	12/01/2019 15:31	12/01/2019 20:52	12/01/2019 16:44	12/01/2019 18:10	1,43	8	11,47	CHI
20190146245	PARANAIGUARA	PC12000018	CACHOEIRA ALTA	12/01/2019 15:31	12/01/2019 20:52	12/01/2019 16:44	12/01/2019 18:10	1,43	27	38,70	CHI
20190146245	SAO SIMAO	PC12000018	CACHOEIRA ALTA	12/01/2019 15:31	12/01/2019 20:52	12/01/2019 16:44	12/01/2019 18:10	1,43	3	4,30	CHI
20190146245	PARANAIGUARA	01410406	CACHOEIRA ALTA	12/01/2019 15:31	12/01/2019 20:52	12/01/2019 15:31	12/01/2019 19:14	3,72	1	3,72	CHI
20190146245	SAO SIMAO	01410406	CACHOEIRA ALTA	12/01/2019 15:31	12/01/2019 20:52	12/01/2019 15:31	12/01/2019 19:14	3,72	1	3,72	CHI
20190146245	PARANAIGUARA	01410406	CACHOEIRA ALTA	12/01/2019 15:31	12/01/2019 20:52	12/01/2019 16:44	12/01/2019 19:14	2,50	57	142,50	CHI
20190146245	SAO SIMAO	01410406	CACHOEIRA ALTA	12/01/2019 15:31	12/01/2019 20:52	12/01/2019 16:44	12/01/2019 19:14	2,50	603	1507,50	CHI
20190146245	PARANAIGUARA	SO13000029	CACHOEIRA ALTA	12/01/2019 15:31	12/01/2019 20:52	12/01/2019 17:24	12/01/2019 19:14	1,83	3	5,50	CHI
20190146245	SAO SIMAO	SO13000029	CACHOEIRA ALTA	12/01/2019 15:31	12/01/2019 20:52	12/01/2019 17:24	12/01/2019 19:14	1,83	4	7,33	CHI
20190146245	CACU	01410406	CACHOEIRA ALTA	12/01/2019 15:31	12/01/2019 20:52	12/01/2019 15:31	12/01/2019 20:52	5,35	3	16,05	CHI
20190146245	SAO SIMAO	01410406	CACHOEIRA ALTA	12/01/2019 15:31	12/01/2019 20:52	12/01/2019 15:31	12/01/2019 20:52	5,35	1	5,35	CHI
20190146245	CACHOEIRA ALTA	01410406	CACHOEIRA ALTA	12/01/2019 15:31	12/01/2019 20:52	12/01/2019 16:44	12/01/2019 20:52	4,13	6	24,80	CHI
20190146245	CACU	01410406	CACHOEIRA ALTA	12/01/2019 15:31	12/01/2019 20:52	12/01/2019 16:44	12/01/2019 20:52	4,13	28	115,73	CHI
20190146245	SAO SIMAO	01410406	CACHOEIRA ALTA	12/01/2019 15:31	12/01/2019 20:52	12/01/2019 16:44	12/01/2019 20:52	4,13	21	86,80	CHI
20190146245	SAO SIMAO	01410406	CACHOEIRA ALTA	12/01/2019 15:31	12/01/2019 20:52	12/01/2019 16:44	12/01/2019 20:52	4,13	1	4,13	CHI
20190146245	CACU	SO13000228	CACHOEIRA ALTA	12/01/2019 15:31	12/01/2019 20:52	12/01/2019 17:24	12/01/2019 20:52	3,47	70	242,67	CHI
20190146245	SAO SIMAO	SO13000228	CACHOEIRA ALTA	12/01/2019 15:31	12/01/2019 20:52	12/01/2019 17:24	12/01/2019 20:52	3,47	1	3,47	CHI
20190146247	PADRE BERNARDO	PB11375255	PADRE BERNARDO	12/01/2019 15:40	12/01/2019 17:45	12/01/2019 15:40	12/01/2019 17:45	2,08	12	25,00	CHI
20190146254	CAIAPONIA	PY12040163	PALESTINA	12/01/2019 15:39	12/01/2019 17:34	12/01/2019 15:39	12/01/2019 17:34	1,92	47	90,08	CHI
20190146254	PALESTINA DE GOIAS	PY12040163	PALESTINA	12/01/2019 15:39	12/01/2019 17:34	12/01/2019 15:39	12/01/2019 17:34	1,92	103	197,42	CHI
20190146262	GOIANDIRA	GD21323410	CATALAO S1	12/01/2019 15:43	13/01/2019 17:05	12/01/2019 15:43	13/01/2019 17:05	25,37	1	25,37	DIA CRITICO
20190146265	ALEXANIA	AX21318552	ALEXANIA	12/01/2019 15:43	12/01/2019 21:53	12/01/2019 15:43	12/01/2019 21:53	6,17	1	6,17	CHI
20190146277	ALTO HORIZONTE	AJ12375644	SANTA TEREZINHA	12/01/2019 15:37	12/01/2019 17:09	12/01/2019 15:37	12/01/2019 17:09	1,53	9	13,80	CHI
20190146277	PILAR DE GOIAS	AJ12375644	SANTA TEREZINHA	12/01/2019 15:37	12/01/2019 17:09	12/01/2019 15:37	12/01/2019 17:09	1,53	1	1,53	CHI

20190146279	PORANGATU	PO12297140	PORANGATU	12/01/2019 15:45	12/01/2019 18:30	12/01/2019 15:45	12/01/2019 18:30	2,75	16	44,00	CHI
20190146279	SANTA TEREZA DE GOIAS	PO12297140	PORANGATU	12/01/2019 15:45	12/01/2019 18:30	12/01/2019 15:45	12/01/2019 18:30	2,75	11	30,25	CHI
20190146279	TROMBAS	PO12297140	PORANGATU	12/01/2019 15:45	12/01/2019 18:30	12/01/2019 15:45	12/01/2019 18:30	2,75	171	470,25	CHI
20190146289	PONTALINA	PK12293006	PONTALINA	12/01/2019 15:46	12/01/2019 17:36	12/01/2019 15:46	12/01/2019 17:36	1,83	3	5,50	CHI
20190146303	AGUA FRIA DE GOIAS	TL21096461	SAO JOAO D ALIANCA	12/01/2019 15:48	12/01/2019 18:33	12/01/2019 15:48	12/01/2019 18:33	2,75	1	2,75	CHI
20190146309	AURILANDIA	CG12018656LD	FIRMINOPOLIS S2	12/01/2019 14:53	12/01/2019 21:34	12/01/2019 14:53	12/01/2019 21:34	6,68	3	20,05	CHI
20190146309	CACHOEIRA DE GOIAS	CG12018656LD	FIRMINOPOLIS S2	12/01/2019 14:53	12/01/2019 21:34	12/01/2019 14:53	12/01/2019 21:34	6,68	91	608,18	CHI
20190146309	PARAUNA	CG12018656LD	FIRMINOPOLIS S2	12/01/2019 14:53	12/01/2019 21:34	12/01/2019 14:53	12/01/2019 21:34	6,68	32	213,87	CHI
20190146313	SANTO ANTONIO DO DESCOBERTO	SN21214788	AGUAS LINDAS DE GOIAS S2	12/01/2019 15:49	13/01/2019 00:34	12/01/2019 15:49	13/01/2019 00:34	8,75	2	17,50	CHI
20190146321	PETROLINA DE GOIAS	PG12050987	PETROLINA	12/01/2019 15:50	13/01/2019 00:38	12/01/2019 15:50	13/01/2019 00:38	8,80	6	52,80	DIA CRITICO
20190146324	AGUAS LINDAS DE GOIAS	ZN12124947	AGUAS LINDAS DE GOIAS S2	12/01/2019 15:18	13/01/2019 11:36	12/01/2019 15:18	13/01/2019 11:36	20,30	3	60,90	CHI
20190146324	COCALZINHO DE GOIAS	ZN12124947	AGUAS LINDAS DE GOIAS S2	12/01/2019 15:18	13/01/2019 11:36	12/01/2019 15:18	13/01/2019 11:36	20,30	13	263,90	CHI
20190146330	ANAPOLIS	AN12000585	ANAPOLIS UNIVERSITARIO S2	12/01/2019 15:50	13/01/2019 10:25	12/01/2019 15:50	13/01/2019 10:25	18,58	167	3103,42	CHI
20190146339	CACHOEIRA DOURADA	CD21000148	CACHOEIRA DOURADA	12/01/2019 15:52	13/01/2019 08:56	12/01/2019 15:52	13/01/2019 08:56	17,07	1	17,07	CHI
20190146348	SAO MIGUEL DO ARAGUAIA	SM12208506	SAO MIGUEL DO ARAGUAIA	12/01/2019 15:54	13/01/2019 09:44	12/01/2019 15:54	13/01/2019 09:44	17,83	9	160,50	DIA CRITICO
20190146349	CRISTALINA	KR12210364	CRISTALINA S2	12/01/2019 15:54	12/01/2019 17:00	12/01/2019 15:54	12/01/2019 17:00	1,10	2	2,20	CHI
20190146351	MUTUNOPOLIS	PO12374520	PORANGATU	12/01/2019 15:54	13/01/2019 11:14	12/01/2019 15:54	13/01/2019 11:14	19,33	18	348,00	CHI
20190146351	PORANGATU	PO12374520	PORANGATU	12/01/2019 15:54	13/01/2019 11:14	12/01/2019 15:54	13/01/2019 11:14	19,33	19	367,33	CHI
20190146357	APARECIDA DE GOIANIA	200309274	INDEPENDENCIA S2	12/01/2019 15:55	12/01/2019 17:39	12/01/2019 15:55	12/01/2019 17:39	1,73	1	1,73	CHI
20190146364	JATAI	JT12260447	JATAI S1	12/01/2019 15:56	12/01/2019 18:34	12/01/2019 15:56	12/01/2019 18:34	2,63	12	31,60	CHI
20190146366	PIRES DO RIO	PR21000059	PIRES DO RIO S1	12/01/2019 13:11	12/01/2019 17:50	12/01/2019 13:11	12/01/2019 17:50	4,65	1	4,65	CHI
20190146377	FORMOSA	FA12042622	ITIQUEIRA	12/01/2019 15:57	12/01/2019 23:14	12/01/2019 15:57	12/01/2019 23:14	7,28	3	21,85	CHI
20190146380	PIRENOPOLIS	PV12355148	CORUMBA	12/01/2019 15:54	12/01/2019 23:46	12/01/2019 15:54	12/01/2019 23:46	7,87	24	188,80	DIA CRITICO
20190146393	PIRENOPOLIS	PV12295641	SAO FRANCISCO DE GOIAS	12/01/2019 15:50	13/01/2019 04:41	12/01/2019 15:50	13/01/2019 04:41	12,85	183	2351,55	DIA CRITICO
20190146408	PETROLINA DE GOIAS	PG21286283	PETROLINA	12/01/2019 16:00	12/01/2019 21:45	12/01/2019 16:00	12/01/2019 21:45	5,75	1	5,75	DIA CRITICO
20190146415	SAO MIGUEL DO PASSA QUATRO	VN12311677	PIRES DO RIO S2	12/01/2019 15:49	13/01/2019 13:09	12/01/2019 15:49	13/01/2019 13:09	21,33	2	42,67	CHI
20190146415	VIANOPOLIS	VN12311677	PIRES DO RIO S2	12/01/2019 15:49	13/01/2019 13:09	12/01/2019 15:49	13/01/2019 13:09	21,33	8	170,67	CHI
20190146418	BOM JESUS DE GOIAS	BJ21309859	BOM JESUS DE GOIAS	12/01/2019 16:03	12/01/2019 17:26	12/01/2019 16:03	12/01/2019 17:26	1,38	1	1,38	CHI
20190146421	ITAGUARU	IC11159958	ITABERAI S1	12/01/2019 15:53	12/01/2019 20:04	12/01/2019 15:53	12/01/2019 20:04	4,18	43	179,88	CHI
20190146436	CAMPINORTE	CR12398058	CAMPINORTE	12/01/2019 16:03	12/01/2019 20:57	12/01/2019 16:03	12/01/2019 20:57	4,90	3	14,70	CHI
20190146437	PIRENOPOLIS	PV12000067	CORUMBA	12/01/2019 14:15	12/01/2019 18:18	12/01/2019 14:15	12/01/2019 18:18	4,05	18	72,90	DIA CRITICO
20190146446	JATAI	290348456	JATAI S2	12/01/2019 16:07	13/01/2019 10:48	12/01/2019 16:07	13/01/2019 10:48	18,68	1	18,68	CHI
20190146450	ANAPOLIS	AN21000223	JUNDIAI S1	12/01/2019 16:07	13/01/2019 10:51	12/01/2019 16:07	13/01/2019 10:51	18,73	1	18,73	CHI

20190146451	COCALZINHO DE GOIAS	ZN21297499	COCALZINHO	12/01/2019 15:03	15/01/2019 15:00	12/01/2019 15:03	15/01/2019 15:00	71,95	1	71,95	CHI
20190146452	LUZIANIA	LZ12065466	MARAJOARA	12/01/2019 16:07	12/01/2019 23:29	12/01/2019 16:07	12/01/2019 23:29	7,37	14	103,13	CHI
20190146456	PORANGATU	PO13365599	PORANGATU	12/01/2019 16:08	13/01/2019 09:25	12/01/2019 16:08	13/01/2019 09:25	17,28	20	345,67	CHI
20190146459	PETROLINA DE GOIAS	SF12273257	SAO FRANCISCO DE GOIAS	12/01/2019 15:59	12/01/2019 18:29	12/01/2019 15:59	12/01/2019 18:29	2,50	60	150,00	DIA CRITICO
20190146459	PIRENOPOLIS	SF12273257	SAO FRANCISCO DE GOIAS	12/01/2019 15:59	12/01/2019 18:29	12/01/2019 15:59	12/01/2019 18:29	2,50	38	95,00	DIA CRITICO
20190146459	SAO FRANCISCO DE GOIAS	SF12273257	SAO FRANCISCO DE GOIAS	12/01/2019 15:59	12/01/2019 18:29	12/01/2019 15:59	12/01/2019 18:29	2,50	36	90,00	DIA CRITICO
20190146462	CAIAPONIA	CP12200873	PALESTINA	12/01/2019 16:09	12/01/2019 20:15	12/01/2019 16:09	12/01/2019 20:15	4,10	32	131,20	CHI
20190146463	ITAGUARU	JA12062998	ITABERAI S1	12/01/2019 15:56	13/01/2019 02:48	12/01/2019 15:56	13/01/2019 02:48	10,87	9	97,80	CHI
20190146463	JARAGUA	JA12062998	ITABERAI S1	12/01/2019 15:56	13/01/2019 02:48	12/01/2019 15:56	13/01/2019 02:48	10,87	5	54,33	CHI
20190146464	AGUAS LINDAS DE GOIAS	LA11199566	AGUAS LINDAS DE GOIAS S1	12/01/2019 16:07	12/01/2019 18:25	12/01/2019 16:07	12/01/2019 18:25	2,30	192	441,60	CHI
20190146468	ITAGUARI	IC21251066	ITABERAI S1	12/01/2019 16:09	13/01/2019 09:20	12/01/2019 16:09	13/01/2019 09:20	17,18	1	17,18	CHI
20190146469	SILVANIA	SV12389456	VIANOPOLIS	12/01/2019 16:04	13/01/2019 10:34	12/01/2019 16:04	13/01/2019 10:34	18,50	107	1979,50	CHI
20190146473	FORMOSO	ET12143681	MARA ROSA	12/01/2019 15:37	13/01/2019 09:22	12/01/2019 15:37	13/01/2019 09:22	17,75	12	213,00	CHI
20190146475	AGUAS LINDAS DE GOIAS	LA12165006	AGUAS LINDAS DE GOIAS S2	12/01/2019 16:00	12/01/2019 17:44	12/01/2019 16:00	12/01/2019 17:44	1,73	1507	2612,13	CHI
20190146495	PETROLINA DE GOIAS	PG21255976	PETROLINA	12/01/2019 16:12	12/01/2019 19:09	12/01/2019 16:12	12/01/2019 19:09	2,95	2	5,90	DIA CRITICO
20190146497	OUVIDOR	OU21140986	CATALAO S1	12/01/2019 16:13	14/01/2019 09:59	12/01/2019 16:13	14/01/2019 09:59	41,77	1	41,77	DIA CRITICO
20190146501	CALDAS NOVAS	CN11164890	CALDAS NOVAS S1	12/01/2019 16:07	12/01/2019 17:42	12/01/2019 16:07	12/01/2019 17:42	1,58	70	110,83	CHI
20190146503	RUBIATABA	RB12246313	RUBIATABA	12/01/2019 15:34	12/01/2019 17:11	12/01/2019 15:34	12/01/2019 17:11	1,62	416	672,53	CHI
20190146504	NEROPOLIS	NR12029257	NEROPOLIS S2	12/01/2019 16:14	13/01/2019 13:43	12/01/2019 16:14	13/01/2019 13:43	21,48	10	214,83	CHI
20190146508	GOIANESIA	GE12000230	GOIANESIA S2	12/01/2019 16:14	12/01/2019 19:29	12/01/2019 16:14	12/01/2019 19:29	3,25	10	32,50	CHI
20190146515	COCALZINHO DE GOIAS	ZN21063260	AGUAS LINDAS DE GOIAS S2	12/01/2019 16:15	14/01/2019 09:15	12/01/2019 16:15	14/01/2019 09:15	41,00	2	82,00	CHI
20190146517	ARAGOIANIA	AO11164767	GUAPO S2	12/01/2019 16:15	13/01/2019 09:21	12/01/2019 16:15	13/01/2019 09:21	17,10	16	273,60	CHI
20190146520	AGUAS LINDAS DE GOIAS	LA21083373	AGUAS LINDAS DE GOIAS S2	12/01/2019 16:16	12/01/2019 21:19	12/01/2019 16:16	12/01/2019 21:19	5,05	2	10,10	CHI
20190146525	NIQUELANDIA	NQ12070622	URUACU	12/01/2019 16:16	12/01/2019 18:44	12/01/2019 16:16	12/01/2019 18:44	2,47	138	340,40	CHI
20190146528	LUZIANIA	LZ11210880	RIO VERMELHO	12/01/2019 16:16	12/01/2019 20:00	12/01/2019 16:16	12/01/2019 20:00	3,73	24	89,60	CHI
20190146529	CORUMBA DE GOIAS	CB12297791	CORUMBA	12/01/2019 16:16	13/01/2019 09:25	12/01/2019 16:16	13/01/2019 09:25	17,15	3	51,45	DIA CRITICO
20190146532	MORRINHOS	MR12232914	GOIATUBA S2	12/01/2019 16:15	12/01/2019 20:20	12/01/2019 16:15	12/01/2019 20:20	4,08	3	12,25	CHI
20190146534	PIRENOPOLIS	PV21122025	CORUMBA	12/01/2019 16:16	13/01/2019 12:56	12/01/2019 16:16	13/01/2019 12:56	20,67	1	20,67	DIA CRITICO
20190146537	ANAPOLIS	AN12239275	ANAPOLIS UNIVERSITARIO S2	12/01/2019 15:57	12/01/2019 23:10	12/01/2019 15:57	12/01/2019 23:10	7,22	224	1616,53	CHI
20190146538	HIDROLINA	HL21218964	ITAPACI	12/01/2019 16:16	14/01/2019 15:06	12/01/2019 16:16	14/01/2019 15:06	46,83	1	46,83	CHI
20190146539	CUMARI	CY12195494	CATALAO S1	12/01/2019 16:16	14/01/2019 10:02	12/01/2019 16:16	14/01/2019 10:02	41,77	4	167,07	DIA CRITICO
20190146559	COCALZINHO DE GOIAS	ZN12312225	COCALZINHO	12/01/2019 15:50	13/01/2019 08:58	12/01/2019 15:50	13/01/2019 08:58	17,13	9	154,20	CHI
20190146559	VILA PROPICIO	ZN12312225	COCALZINHO	12/01/2019 15:50	13/01/2019 08:58	12/01/2019 15:50	13/01/2019 08:58	17,13	1	17,13	CHI

20190146566	INHUMAS	IN12282891	INHUMAS S2	12/01/2019 16:19	12/01/2019 19:16	12/01/2019 16:19	12/01/2019 19:16	2,95	30	88,50	CHI
20190146566	ITAUCU	IN12282891	INHUMAS S2	12/01/2019 16:19	12/01/2019 19:16	12/01/2019 16:19	12/01/2019 19:16	2,95	1	2,95	CHI
20190146571	PORANGATU	PO11371815	PORANGATU	12/01/2019 16:19	12/01/2019 19:46	12/01/2019 16:19	12/01/2019 19:46	3,45	9	31,05	CHI
20190146574	PIRENOPOLIS	PV12017586	CORUMBA	12/01/2019 15:52	12/01/2019 22:39	12/01/2019 15:52	12/01/2019 22:39	6,78	56	379,87	DIA CRITICO
20190146577	JARAGUA	SF12297981	SAO FRANCISCO DE GOIAS	12/01/2019 16:19	12/01/2019 18:10	12/01/2019 16:19	12/01/2019 18:10	1,85	104	192,40	DIA CRITICO
20190146577	JESUPOLIS	SF12297981	SAO FRANCISCO DE GOIAS	12/01/2019 16:19	12/01/2019 18:10	12/01/2019 16:19	12/01/2019 18:10	1,85	5	9,25	DIA CRITICO
20190146577	SAO FRANCISCO DE GOIAS	SF12297981	SAO FRANCISCO DE GOIAS	12/01/2019 16:19	12/01/2019 18:10	12/01/2019 16:19	12/01/2019 18:10	1,85	2	3,70	DIA CRITICO
20190146579	ANAPOLIS	AN11012274	ANAPOLIS UNIVERSITARIO S2	12/01/2019 16:19	13/01/2019 09:40	12/01/2019 16:19	13/01/2019 09:40	17,35	13	225,55	CHI
20190146585	CRIXAS	CX11201611	RUBIATABA	12/01/2019 16:10	13/01/2019 14:54	12/01/2019 16:10	13/01/2019 14:54	22,73	50	1136,67	CHI
20190146590	AMARALINA	LC12270112	SAO MIGUEL DO ARAGUAIA	12/01/2019 16:22	13/01/2019 00:11	12/01/2019 16:22	13/01/2019 00:11	7,82	62	484,63	DIA CRITICO
20190146597	CRIXAS	NM21154980	RUBIATABA	12/01/2019 16:22	13/01/2019 18:25	12/01/2019 16:22	13/01/2019 18:25	26,05	1	26,05	CHI
20190146608	PIRENOPOLIS	PV12000046	CORUMBA	12/01/2019 15:34	12/01/2019 23:28	12/01/2019 15:34	12/01/2019 23:28	7,90	50	395,00	DIA CRITICO
20190146609	RIO VERDE	RV12301246	MONTIVIDIU T	12/01/2019 16:18	12/01/2019 18:09	12/01/2019 16:18	12/01/2019 18:09	1,85	14	25,90	CHI
20190146610	PETROLINA DE GOIAS	PG12100309	PETROLINA	12/01/2019 16:20	12/01/2019 18:48	12/01/2019 16:20	12/01/2019 18:48	2,47	5	12,33	DIA CRITICO
20190146612	SILVANIA	LZ12168079	VIANOPOLIS	12/01/2019 15:25	12/01/2019 19:35	12/01/2019 15:25	12/01/2019 19:35	4,17	47	195,83	CHI
20190146614	ANAPOLIS	AN11135792	ANAPOLIS UNIVERSITARIO S1	12/01/2019 16:23	13/01/2019 06:22	12/01/2019 16:23	13/01/2019 06:22	13,98	130	1817,83	CHI
20190146619	ANAPOLIS	AN21258903	ANAPOLIS UNIVERSITARIO S2	12/01/2019 16:24	13/01/2019 13:18	12/01/2019 16:24	13/01/2019 13:18	20,90	2	41,80	CHI
20190146631	ALEXANIA	AX12258528	ALEXANIA	12/01/2019 15:37	12/01/2019 20:28	12/01/2019 15:37	12/01/2019 20:28	4,85	44	213,40	CHI
20190146632	CORUMBA DE GOIAS	CB11000004	CORUMBA	12/01/2019 16:25	12/01/2019 22:33	12/01/2019 16:25	12/01/2019 22:33	6,13	69	423,20	DIA CRITICO
20190146638	NEROPOLIS	NR12322425	NEROPOLIS S2	12/01/2019 16:26	13/01/2019 00:10	12/01/2019 16:26	13/01/2019 00:10	7,73	36	278,40	CHI
20190146638	SANTO ANTONIO DE GOIAS	NR12322425	NEROPOLIS S2	12/01/2019 16:26	13/01/2019 00:10	12/01/2019 16:26	13/01/2019 00:10	7,73	3	23,20	CHI
20190146653	PIRENOPOLIS	PV21185604	COCALZINHO	12/01/2019 16:27	12/01/2019 21:11	12/01/2019 16:27	12/01/2019 21:11	4,73	2	9,47	CHI
20190146654	GOIANESIA	GE11372408	GOIANESIA S1	12/01/2019 16:28	12/01/2019 18:15	12/01/2019 16:28	12/01/2019 18:15	1,78	1	1,78	CHI
20190146655	SILVANIA	SV12024318	DAIA S2	12/01/2019 16:28	12/01/2019 19:38	12/01/2019 16:28	12/01/2019 19:38	3,17	5	15,83	CHI
20190146669	ITAJA	IJ21298877	ITAJA S2	12/01/2019 16:29	13/01/2019 20:40	12/01/2019 16:29	13/01/2019 20:40	28,18	2	56,37	CHI
20190146677	URUACU	UR21190082	URUACU	12/01/2019 16:30	12/01/2019 19:00	12/01/2019 16:30	12/01/2019 19:00	2,50	1	2,50	CHI
20190146680	LUZIANIA	LZ12304862	VIANOPOLIS	12/01/2019 15:22	13/01/2019 09:15	12/01/2019 15:22	13/01/2019 09:15	17,88	4	71,53	CHI
20190146686	PADRE BERNARDO	PB11206724	PADRE BERNARDO	12/01/2019 16:30	12/01/2019 20:48	12/01/2019 16:30	12/01/2019 20:48	4,30	18	77,40	CHI
20190146688	SAO LUIS DE MONTES BELOS	10006155861	SAO LUIZ DOS MONTES BELOS	12/01/2019 16:31	13/01/2019 12:14	12/01/2019 16:31	13/01/2019 12:14	19,72	1	19,72	CHI
20190146702	ABADIANIA	AA12205050	ANAPOLIS UNIVERSITARIO S1	12/01/2019 16:32	13/01/2019 16:47	12/01/2019 16:32	13/01/2019 16:47	24,25	1	24,25	CHI
20190146716	ALVORADA DO NORTE	SI12211393	IACIARA S2	12/01/2019 16:31	12/01/2019 17:32	12/01/2019 16:31	12/01/2019 17:32	1,02	3	3,05	CHI
20190146716	SITIO D ABADIA	SI12211393	IACIARA S2	12/01/2019 16:31	12/01/2019 17:32	12/01/2019 16:31	12/01/2019 17:32	1,02	1	1,02	CHI
20190146722	GOIANAPOLIS	GP21381454	JUNDIAI S1	12/01/2019 16:33	13/01/2019 09:55	12/01/2019 16:33	13/01/2019 09:55	17,37	1	17,37	CHI

20190146726	CIDADE OCIDENTAL	DH12255591	MARAJOARA	12/01/2019 16:34	12/01/2019 19:27	12/01/2019 16:34	12/01/2019 19:27	2,88	1	2,88	CHI
20190146729	IPAMERI	IP11373040	CRISTALINA S1	12/01/2019 16:34	13/01/2019 07:31	12/01/2019 16:34	13/01/2019 07:31	14,95	12	179,40	CHI
20190146737	ANAPOLIS	AN12259031	ANAPOLIS UNIVERSITARIO S2	12/01/2019 16:11	13/01/2019 10:26	12/01/2019 16:11	13/01/2019 10:26	18,25	13	237,25	CHI
20190146746	AMERICANO DO BRASIL	KB12000028	ANICUNS	12/01/2019 16:35	12/01/2019 23:10	12/01/2019 16:35	12/01/2019 23:10	6,58	147	967,75	CHI
20190146746	ANICUNS	KB12000028	ANICUNS	12/01/2019 16:35	12/01/2019 23:10	12/01/2019 16:35	12/01/2019 23:10	6,58	191	1257,42	CHI
20190146746	ITABERAI	KB12000028	ANICUNS	12/01/2019 16:35	12/01/2019 23:10	12/01/2019 16:35	12/01/2019 23:10	6,58	2	13,17	CHI
20190146759	JARAGUA	JA12040435	SAO FRANCISCO DE GOIAS	12/01/2019 16:32	12/01/2019 19:34	12/01/2019 16:32	12/01/2019 19:34	3,03	3	9,10	DIA CRITICO
20190146759	JESUPOLIS	JA12040435	SAO FRANCISCO DE GOIAS	12/01/2019 16:32	12/01/2019 19:34	12/01/2019 16:32	12/01/2019 19:34	3,03	19	57,63	DIA CRITICO
20190146764	ABADIANIA	AA21291796	CORUMBA	12/01/2019 16:37	13/01/2019 08:26	12/01/2019 16:37	13/01/2019 08:26	15,82	1	15,82	DIA CRITICO
20190146767	ABADIANIA	AA12221505	DAIA S2	12/01/2019 16:37	12/01/2019 19:52	12/01/2019 16:37	12/01/2019 19:52	3,25	109	354,25	CHI
20190146768	PIRENOPOLIS	PV12000030	CORUMBA	12/01/2019 16:37	12/01/2019 21:20	12/01/2019 16:37	12/01/2019 21:20	4,72	23	108,48	DIA CRITICO
20190146770	ANAPOLIS	GP12382434	DAIA S2	12/01/2019 16:37	13/01/2019 04:23	12/01/2019 16:37	13/01/2019 04:23	11,77	8	94,13	CHI
20190146770	GOIANAPOLIS	GP12382434	DAIA S2	12/01/2019 16:37	13/01/2019 04:23	12/01/2019 16:37	13/01/2019 04:23	11,77	1	11,77	CHI
20190146770	LEOPOLDO DE BULHOES	GP12382434	DAIA S2	12/01/2019 16:37	13/01/2019 04:23	12/01/2019 16:37	13/01/2019 04:23	11,77	119	1400,23	CHI
20190146771	CACU	CC12191702	CACHOEIRA ALTA	12/01/2019 16:37	13/01/2019 17:42	12/01/2019 16:37	13/01/2019 17:42	25,08	5	125,42	CHI
20190146772	GAMELEIRA DE GOIAS	SV12075804	DAIA S2	12/01/2019 16:25	13/01/2019 02:28	12/01/2019 16:25	13/01/2019 02:28	10,05	571	5738,55	CHI
20190146773	RIO VERDE	04150224	CABRIUVA S2	12/01/2019 16:37	12/01/2019 21:15	12/01/2019 16:37	12/01/2019 21:15	4,63	14	64,87	CHI
20190146775	LUZIANIA	LZ12336006	VIANOPOLIS	12/01/2019 15:18	13/01/2019 08:36	12/01/2019 15:18	13/01/2019 08:36	17,30	94	1626,20	CHI
20190146776	MUTUNOPOLIS	MU12391658	MARA ROSA	13/01/2019 10:00	13/01/2019 13:21	13/01/2019 10:00	13/01/2019 13:21	3,35	31	103,85	CHI
20190146778	CORUMBA DE GOIAS	SN12376780	ALEXANIA	12/01/2019 16:38	12/01/2019 21:46	12/01/2019 16:38	12/01/2019 21:46	5,13	14	71,87	CHI
20190146778	SANTO ANTONIO DO DESCOBERTO	SN12376780	ALEXANIA	12/01/2019 16:38	12/01/2019 21:46	12/01/2019 16:38	12/01/2019 21:46	5,13	18	92,40	CHI
20190146782	FAINA	FC12218092	GOIAS	12/01/2019 16:38	13/01/2019 08:25	12/01/2019 16:38	13/01/2019 08:25	15,78	4	63,13	CHI
20190146785	CAIAPONIA	CP12269004	CAIAPONIA	12/01/2019 16:38	13/01/2019 07:18	12/01/2019 16:38	13/01/2019 07:18	14,67	4	58,67	CHI
20190146787	PORANGATU	PO12022073	PORANGATU	12/01/2019 16:34	13/01/2019 14:12	12/01/2019 16:34	13/01/2019 02:56	10,37	5	51,83	CHI
20190146787	PORANGATU	PO12071683LD	PORANGATU	12/01/2019 16:34	13/01/2019 14:12	12/01/2019 16:34	13/01/2019 05:04	12,50	21	262,50	CHI
20190146787	PORANGATU	PO12071683LD	PORANGATU	12/01/2019 16:34	13/01/2019 14:12	12/01/2019 16:34	13/01/2019 14:12	21,63	18	389,40	CHI
20190146787	PORANGATU	PO12071683LD	PORANGATU	12/01/2019 16:34	13/01/2019 14:12	13/01/2019 08:51	13/01/2019 14:12	5,35	21	112,35	CHI
20190146792	PORANGATU	PO12282160	PORANGATU	12/01/2019 16:39	12/01/2019 19:00	12/01/2019 16:39	12/01/2019 19:00	2,35	10	23,50	CHI
20190146796	SAO FRANCISCO DE GOIAS	SF12319826	SAO FRANCISCO DE GOIAS	12/01/2019 16:38	12/01/2019 18:55	12/01/2019 16:38	12/01/2019 18:55	2,28	6	13,70	DIA CRITICO
20190146799	ORIZONA	OZ12306688	PIRES DO RIO S2	12/01/2019 16:40	12/01/2019 19:33	12/01/2019 16:40	12/01/2019 19:33	2,88	5	14,42	CHI
20190146816	HEITORAI	IC12376461	ITABERAI S1	12/01/2019 15:54	12/01/2019 20:29	12/01/2019 15:54	12/01/2019 20:29	4,58	7	32,08	CHI
20190146816	ITAGUARU	IC12376461	ITABERAI S1	12/01/2019 15:54	12/01/2019 20:29	12/01/2019 15:54	12/01/2019 20:29	4,58	46	210,83	CHI
20190146831	LUZIANIA	LZ12200111	VIANOPOLIS	12/01/2019 16:44	13/01/2019 11:04	12/01/2019 16:44	13/01/2019 11:04	18,33	11	201,67	CHI

20190146837	SANTO ANTONIO DO DESCOBERTO	SN12345965	AGUAS LINDAS DE GOIAS S2	12/01/2019 15:16	12/01/2019 18:14	12/01/2019 15:16	12/01/2019 18:14	2,97	2	5,93	CHI
20190146846	MUNDO NOVO DE GOIAS	MH12391971LD	NOVA CRIXAS	12/01/2019 15:14	12/01/2019 18:37	12/01/2019 15:14	12/01/2019 18:37	3,38	21	71,05	CHI
20190146852	CRIXAS	GF12243492	SANTA TEREZINHA	12/01/2019 16:02	12/01/2019 18:39	12/01/2019 16:02	12/01/2019 18:39	2,62	33	86,35	CHI
20190146852	GUARINOS	GF12243492	SANTA TEREZINHA	12/01/2019 16:02	12/01/2019 18:39	12/01/2019 16:02	12/01/2019 18:39	2,62	69	180,55	CHI
20190146852	ITAPACI	GF12243492	SANTA TEREZINHA	12/01/2019 16:02	12/01/2019 18:39	12/01/2019 16:02	12/01/2019 18:39	2,62	6	15,70	CHI
20190146853	MORRINHOS	MR12102435	MORRINHOS	12/01/2019 16:07	12/01/2019 19:28	12/01/2019 16:07	12/01/2019 19:28	3,35	9	30,15	CHI
20190146857	JESUPOLIS	SF21170301	SAO FRANCISCO DE GOIAS	12/01/2019 16:46	13/01/2019 16:11	12/01/2019 16:46	13/01/2019 16:11	23,42	1	23,42	DIA CRITICO
20190146859	JUSSARA	JR21148852	JUSSARA	12/01/2019 16:46	12/01/2019 17:50	12/01/2019 16:46	12/01/2019 17:50	1,07	1	1,07	CHI
20190146860	ITAGUARI	IC21253199	ITABERAI S1	12/01/2019 16:46	13/01/2019 09:40	12/01/2019 16:46	13/01/2019 09:40	16,90	1	16,90	CHI
20190146863	FORMOSA	610295238	ITUIQUIRA	12/01/2019 16:46	12/01/2019 18:48	12/01/2019 16:46	12/01/2019 18:48	2,03	1	2,03	CHI
20190146867	AMARALINA	LC12182475	SAO MIGUEL DO ARAGUAIA	12/01/2019 16:21	12/01/2019 23:45	12/01/2019 16:21	12/01/2019 23:45	7,40	78	577,20	DIA CRITICO
20190146870	GOIANIRA	GR11016212	GOIANIRA	12/01/2019 16:47	12/01/2019 18:31	12/01/2019 16:47	12/01/2019 18:31	1,73	127	220,13	DIA CRITICO
20190146876	PETROLINA DE GOIAS	PG12297879	PETROLINA	12/01/2019 16:45	12/01/2019 19:54	12/01/2019 16:45	12/01/2019 19:54	3,15	7	22,05	DIA CRITICO
20190146879	ITAPACI	IW12078035	ITAPACI	12/01/2019 16:48	13/01/2019 07:30	12/01/2019 16:48	13/01/2019 07:30	14,70	22	323,40	CHI
20190146879	NOVA GLORIA	IW12078035	ITAPACI	12/01/2019 16:48	13/01/2019 07:30	12/01/2019 16:48	13/01/2019 07:30	14,70	1	14,70	CHI
20190146882	MORRO AGUDO DE GOIAS	MS12113277	ITAPURANGA	12/01/2019 17:44	12/01/2019 20:36	12/01/2019 17:44	12/01/2019 20:36	2,87	17	48,73	CHI
20190146883	ANAPOLIS	AN11135756	ANAPOLIS UNIVERSITARIO S2	12/01/2019 16:43	13/01/2019 08:45	12/01/2019 16:43	13/01/2019 08:45	16,03	116	1859,87	CHI
20190146885	ARENOPOLIS	AY21139369	IPORA	12/01/2019 16:49	12/01/2019 21:50	12/01/2019 16:49	12/01/2019 21:50	5,02	1	5,02	CHI
20190146891	TEREZOPOLIS DE GOIAS	GP31017509	JUNDIAI S1	12/01/2019 16:49	13/01/2019 14:15	12/01/2019 16:49	13/01/2019 14:15	21,43	3	64,30	CHI
20190146892	PETROLINA DE GOIAS	PG12033256	PETROLINA	12/01/2019 16:30	12/01/2019 18:43	12/01/2019 16:30	12/01/2019 18:43	2,22	28	62,07	DIA CRITICO
20190146895	ANAPOLIS	AN21352385	JUNDIAI S1	12/01/2019 16:45	12/01/2019 22:20	12/01/2019 16:45	12/01/2019 22:20	5,58	195	1088,75	CHI
20190146898	ITAUCU	IX12000067	INHUMAS S1	12/01/2019 16:50	13/01/2019 12:19	12/01/2019 16:50	13/01/2019 12:19	19,48	14	272,77	CHI
20190146899	ITABERAI	II12217217	ITABERAI S1	12/01/2019 16:50	12/01/2019 21:14	12/01/2019 16:50	12/01/2019 21:14	4,40	23	101,20	CHI
20190146899	ITAGUARI	II12217217	ITABERAI S1	12/01/2019 16:50	12/01/2019 21:14	12/01/2019 16:50	12/01/2019 21:14	4,40	42	184,80	CHI
20190146899	TAQUARAL DE GOIAS	II12217217	ITABERAI S1	12/01/2019 16:50	12/01/2019 21:14	12/01/2019 16:50	12/01/2019 21:14	4,40	48	211,20	CHI
20190146904	ALTO HORIZONTE	AJ21136376	SANTA TEREZINHA	12/01/2019 16:51	14/01/2019 07:32	12/01/2019 16:51	14/01/2019 07:32	38,68	1	38,68	CHI
20190146906	PADRE BERNARDO	PB12389380	PADRE BERNARDO	12/01/2019 16:51	13/01/2019 11:12	12/01/2019 16:51	13/01/2019 11:12	18,35	12	220,20	CHI
20190146913	NEROPOLIS	GR12133315	NEROPOLIS S1	12/01/2019 16:51	12/01/2019 18:07	12/01/2019 16:51	12/01/2019 18:07	1,27	17	21,53	DIA CRITICO
20190146913	SANTO ANTONIO DE GOIAS	GR12133315	NEROPOLIS S1	12/01/2019 16:51	12/01/2019 18:07	12/01/2019 16:51	12/01/2019 18:07	1,27	5	6,33	DIA CRITICO
20190146917	APARECIDA DO RIO DOCE	AW21248472	CACHOEIRA ALTA	12/01/2019 16:51	13/01/2019 09:34	12/01/2019 16:51	13/01/2019 09:34	16,72	1	16,72	CHI
20190146918	PIRENOPOLIS	PV11240432	CORUMBA	12/01/2019 16:27	12/01/2019 18:26	12/01/2019 16:27	12/01/2019 18:26	1,98	99	196,35	DIA CRITICO
20190146928	CAMPO ALEGRE DE GOIAS	CM12192738	CAMPO ALEGRE DE GOIAS	12/01/2019 16:52	13/01/2019 12:09	12/01/2019 16:52	13/01/2019 12:09	19,28	53	1022,02	CHI
20190146931	RUBIATABA	RB11185021	RUBIATABA	12/01/2019 16:52	12/01/2019 19:38	12/01/2019 16:52	12/01/2019 19:38	2,77	94	260,07	CHI

20190146935	INHUMAS	IN12352128	INHUMAS S2	12/01/2019 16:49	12/01/2019 17:28	12/01/2019 16:49	12/01/2019 17:28	0,65	177	115,05	CHI
20190146937	ANAPOLIS	AN12374625	JUNDIAI S2	12/01/2019 16:21	13/01/2019 02:43	12/01/2019 16:21	13/01/2019 02:43	10,37	138	1430,60	CHI
20190146939	EDEALINA	ED21049307	PONTALINA	12/01/2019 16:53	12/01/2019 19:50	12/01/2019 16:53	12/01/2019 19:50	2,95	1	2,95	CHI
20190146940	PIRENOPOLIS	PV12248872	CORUMBA	12/01/2019 16:53	12/01/2019 20:55	12/01/2019 16:53	12/01/2019 20:55	4,03	176	709,87	DIA CRITICO
20190146953	ANAPOLIS	AN11129424	JUNDIAI S2	12/01/2019 16:53	12/01/2019 22:24	12/01/2019 16:53	12/01/2019 22:24	5,52	120	662,00	CHI
20190146958	SAO MIGUEL DO ARAGUAIA	SM12113573	SAO MIGUEL DO ARAGUAIA	12/01/2019 14:07	12/01/2019 19:35	12/01/2019 14:07	12/01/2019 19:35	5,47	7	38,27	DIA CRITICO
20190146962	GOIANIA	10018614700	XAVANTES	12/01/2019 16:55	14/01/2019 16:57	12/01/2019 16:55	14/01/2019 16:57	48,03	1	48,03	DIA CRITICO
20190146964	PADRE BERNARDO	PB12066279	PADRE BERNARDO	12/01/2019 16:56	12/01/2019 23:27	12/01/2019 18:06	12/01/2019 20:29	2,38	6	14,30	CHI
20190146964	PADRE BERNARDO	PB21199708	PADRE BERNARDO	12/01/2019 16:56	12/01/2019 23:27	12/01/2019 16:56	12/01/2019 23:27	6,52	1	6,52	CHI
20190146976	ABADIANIA	AA12390214	ANAPOLIS UNIVERSITARIO S1	12/01/2019 16:16	13/01/2019 10:07	12/01/2019 16:16	13/01/2019 10:07	17,85	9	160,65	CHI
20190146982	MUNDO NOVO DE GOIAS	MH11254826	NOVA CRIXAS	12/01/2019 18:05	12/01/2019 18:45	12/01/2019 18:05	12/01/2019 18:45	0,67	184	122,67	CHI
20190146992	GOIANIA	GN21001836	FERROVIARIO S1	12/01/2019 16:57	14/01/2019 13:32	12/01/2019 16:57	14/01/2019 13:32	44,58	1	44,58	DIA CRITICO
20190146995	GOIANIA	14496379	MEIA PONTE	12/01/2019 16:58	15/01/2019 02:42	12/01/2019 16:58	15/01/2019 02:42	57,73	1	57,73	DIA CRITICO
20190147004	SERRANOPOLIS	SX12266486	JATAI S1	12/01/2019 16:58	13/01/2019 12:31	12/01/2019 16:58	13/01/2019 12:31	19,55	7	136,85	CHI
20190147010	BONOPOLIS	BX12291268	SAO MIGUEL DO ARAGUAIA	12/01/2019 16:58	13/01/2019 09:27	12/01/2019 16:58	13/01/2019 09:27	16,48	1	16,48	DIA CRITICO
20190147011	CIDADE OCIDENTAL	DH12370609	MARAJOARA	12/01/2019 16:07	12/01/2019 18:27	12/01/2019 16:07	12/01/2019 18:27	2,33	23	53,67	CHI
20190147030	CORUMBA DE GOIAS	CB12382397	CORUMBA	12/01/2019 16:29	12/01/2019 20:27	12/01/2019 16:29	12/01/2019 20:27	3,97	32	126,93	DIA CRITICO
20190147042	PORANGATU	PO12064911	NOVO PLANALTO	12/01/2019 16:40	13/01/2019 02:12	12/01/2019 16:40	13/01/2019 02:12	9,53	137	1306,07	CHI
20190147047	GOIANIA	GN11168042	MEIA PONTE	12/01/2019 17:00	12/01/2019 19:18	12/01/2019 17:00	12/01/2019 19:18	2,30	66	151,80	DIA CRITICO
20190147048	GOIANIA	10305830	CAMPINAS S2	12/01/2019 17:00	14/01/2019 18:07	12/01/2019 17:00	14/01/2019 18:07	49,12	1	49,12	DIA CRITICO
20190147050	PORANGATU	PO21038728	PORANGATU	12/01/2019 17:00	13/01/2019 09:35	12/01/2019 17:00	13/01/2019 09:35	16,58	3	49,75	CHI
20190147055	PIRENOPOLIS	PV21185145	CORUMBA	12/01/2019 17:01	14/01/2019 15:20	12/01/2019 17:01	14/01/2019 15:20	46,32	1	46,32	DIA CRITICO
20190147065	BARRO ALTO	BA12185125	BARRO ALTO	12/01/2019 17:01	12/01/2019 18:20	12/01/2019 17:01	12/01/2019 18:20	1,32	41	53,98	CHI
20190147069	CALDAZINHA	10007273540	CEPAIGO S2	12/01/2019 17:01	12/01/2019 18:32	12/01/2019 17:01	12/01/2019 18:32	1,52	1	1,52	CHI
20190147083	ABADIANIA	00020224	ANAPOLIS UNIVERSITARIO S1	12/01/2019 16:00	13/01/2019 00:40	12/01/2019 16:00	12/01/2019 17:04	1,07	91	97,07	CHI
20190147083	ANAPOLIS	00020224	ANAPOLIS UNIVERSITARIO S1	12/01/2019 16:00	13/01/2019 00:40	12/01/2019 16:00	12/01/2019 17:04	1,07	180	192,00	CHI
20190147083	GAMELEIRA DE GOIAS	00020224	ANAPOLIS UNIVERSITARIO S1	12/01/2019 16:00	13/01/2019 00:40	12/01/2019 16:00	12/01/2019 17:04	1,07	14	14,93	CHI
20190147083	ANAPOLIS	00020224	ANAPOLIS UNIVERSITARIO S1	12/01/2019 16:00	13/01/2019 00:40	12/01/2019 17:05	12/01/2019 19:39	2,57	260	667,33	CHI
20190147083	ANAPOLIS	00020414	ANAPOLIS UNIVERSITARIO S1	12/01/2019 16:00	13/01/2019 00:40	12/01/2019 19:43	13/01/2019 00:37	4,90	260	1274,00	CHI
20190147083	ABADIANIA	AN13376523	ANAPOLIS UNIVERSITARIO S1	12/01/2019 16:00	13/01/2019 00:40	12/01/2019 17:05	13/01/2019 00:39	7,57	135	1021,50	CHI
20190147083	ANAPOLIS	AN13376523	ANAPOLIS UNIVERSITARIO S1	12/01/2019 16:00	13/01/2019 00:40	12/01/2019 17:05	13/01/2019 00:39	7,57	59	446,43	CHI
20190147083	GAMELEIRA DE GOIAS	AN13376523	ANAPOLIS UNIVERSITARIO S1	12/01/2019 16:00	13/01/2019 00:40	12/01/2019 17:05	13/01/2019 00:39	7,57	34	257,27	CHI
20190147083	ANAPOLIS	AN13394333	ANAPOLIS UNIVERSITARIO S1	12/01/2019 16:00	13/01/2019 00:40	12/01/2019 17:05	13/01/2019 00:40	7,58	52	394,33	CHI

20190147087	IPAMERI	580061474	IPAMERI	12/01/2019 17:02	12/01/2019 17:53	12/01/2019 17:02	12/01/2019 17:53	0,85	1	0,85	CHI
20190147113	GOIANIA	GN11167372	XAVANTES	12/01/2019 16:46	13/01/2019 16:36	12/01/2019 16:46	13/01/2019 16:36	23,83	47	1120,17	DIA CRITICO
20190147124	GOIAS	GS12391962	GOIAS	12/01/2019 17:04	13/01/2019 11:28	12/01/2019 17:04	13/01/2019 11:28	18,40	2	36,80	CHI
20190147125	GOIANIRA	TR12016263	GOIANIRA	12/01/2019 17:04	13/01/2019 14:37	12/01/2019 17:04	13/01/2019 14:37	21,55	1157	24933,35	DIA CRITICO
20190147125	TRINDADE	TR12016263	GOIANIRA	12/01/2019 17:04	13/01/2019 14:37	12/01/2019 17:04	13/01/2019 14:37	21,55	43	926,65	DIA CRITICO
20190147144	GOIANIA	GN11383167	XAVANTES	12/01/2019 17:04	14/01/2019 10:43	12/01/2019 17:04	14/01/2019 10:43	41,65	52	2165,80	DIA CRITICO
20190147148	IPORA	MO12223037	IPORA	12/01/2019 16:51	12/01/2019 19:20	12/01/2019 16:51	12/01/2019 19:20	2,48	1	2,48	CHI
20190147148	MOIPORA	MO12223037	IPORA	12/01/2019 16:51	12/01/2019 19:20	12/01/2019 16:51	12/01/2019 19:20	2,48	3	7,45	CHI
20190147154	GOIANIA	GN11128068	MEIA PONTE	12/01/2019 17:06	13/01/2019 10:55	12/01/2019 17:06	13/01/2019 10:55	17,82	220	3919,67	DIA CRITICO
20190147164	MUNDO NOVO DE GOIAS	MH12391949	NOVA CRIXAS	12/01/2019 17:06	13/01/2019 09:01	12/01/2019 17:06	13/01/2019 09:01	15,92	43	684,42	CHI
20190147167	PORANGATU	PO12349236	MARA ROSA	12/01/2019 17:06	13/01/2019 03:57	12/01/2019 17:06	13/01/2019 03:57	10,85	7	75,95	CHI
20190147174	PIRENOPOLIS	PV12000073	CORUMBA	12/01/2019 16:40	13/01/2019 15:18	12/01/2019 16:40	13/01/2019 15:18	22,63	10	226,33	DIA CRITICO
20190147176	GOIANIA	GN11002408	FERROVIARIO S1	12/01/2019 17:04	13/01/2019 13:48	12/01/2019 17:04	13/01/2019 13:48	20,73	107	2218,47	DIA CRITICO
20190147178	LUZIANIA	LZ12304718	RIO VERMELHO	12/01/2019 17:07	13/01/2019 00:10	12/01/2019 17:07	13/01/2019 00:10	7,05	9	63,45	CHI
20190147183	ARAGOIANIA	AO12034433	GUAPU S2	12/01/2019 17:07	12/01/2019 18:58	12/01/2019 17:07	12/01/2019 18:58	1,85	12	22,20	CHI
20190147184	GOIANIA	GN12000838	FERROVIARIO S2	12/01/2019 16:52	12/01/2019 19:59	12/01/2019 16:52	12/01/2019 19:59	3,12	592	1845,07	DIA CRITICO
20190147190	GOIANIA	GN11168581	FERROVIARIO S1	12/01/2019 17:00	13/01/2019 20:30	12/01/2019 17:00	13/01/2019 20:30	27,50	71	1952,50	DIA CRITICO
20190147207	ANAPOLIS	AN12000150	JUNDIAI S2	12/01/2019 16:30	13/01/2019 10:16	12/01/2019 16:30	13/01/2019 10:16	17,77	23	408,63	CHI
20190147212	CAMPO LIMPO	AN11130904	NEROPOLIS S1	12/01/2019 16:49	12/01/2019 18:34	12/01/2019 16:49	12/01/2019 18:34	1,75	115	201,25	DIA CRITICO
20190147228	GOIANIA	16359112	GOYA S1	12/01/2019 17:10	15/01/2019 05:00	12/01/2019 17:10	15/01/2019 05:00	59,83	1	59,83	DIA CRITICO
20190147229	GOIANIA	GN12000643	CAMPINAS S2	12/01/2019 17:00	12/01/2019 20:05	12/01/2019 17:00	12/01/2019 20:05	3,08	414	1276,50	DIA CRITICO
20190147264	GOIANIA	GN11358020	XAVANTES	12/01/2019 17:11	15/01/2019 04:31	12/01/2019 17:11	15/01/2019 04:31	59,33	72	4272,00	DIA CRITICO
20190147274	PIRES DO RIO	PR12064872	PIRES DO RIO S1	12/01/2019 16:49	13/01/2019 13:10	12/01/2019 16:49	13/01/2019 00:16	7,45	54	402,30	CHI
20190147274	SANTA CRUZ DE GOIAS	PR12064872	PIRES DO RIO S1	12/01/2019 16:49	13/01/2019 13:10	12/01/2019 16:49	13/01/2019 00:16	7,45	1	7,45	CHI
20190147274	URUTAI	PR12064872	PIRES DO RIO S1	12/01/2019 16:49	13/01/2019 13:10	12/01/2019 16:49	13/01/2019 00:16	7,45	1	7,45	CHI
20190147274	PIRES DO RIO	PR12275729	PIRES DO RIO S1	12/01/2019 16:49	13/01/2019 13:10	13/01/2019 00:17	13/01/2019 13:10	12,88	54	695,70	CHI
20190147274	SANTA CRUZ DE GOIAS	PR12275729	PIRES DO RIO S1	12/01/2019 16:49	13/01/2019 13:10	13/01/2019 00:17	13/01/2019 13:10	12,88	1	12,88	CHI
20190147274	URUTAI	PR12275729	PIRES DO RIO S1	12/01/2019 16:49	13/01/2019 13:10	13/01/2019 00:17	13/01/2019 13:10	12,88	1	12,88	CHI
20190147275	GOIANIA	11543190	CAMPINAS S2	12/01/2019 17:11	15/01/2019 11:11	12/01/2019 17:11	15/01/2019 11:11	66,00	1	66,00	DIA CRITICO
20190147276	LUZIANIA	LZ21000487	PACAEMBU S1	12/01/2019 17:11	13/01/2019 09:40	12/01/2019 17:11	13/01/2019 09:40	16,48	1	16,48	CHI
20190147281	GOIANIA	GN11058021	XAVANTES	12/01/2019 16:51	13/01/2019 12:18	12/01/2019 16:51	13/01/2019 12:18	19,45	93	1808,85	DIA CRITICO
20190147293	GOIANIA	GN11173030	AEROPORTO S3	12/01/2019 17:07	12/01/2019 19:46	12/01/2019 17:07	12/01/2019 19:46	2,65	12	31,80	CHI
20190147295	GOIANIA	GN11043869	CAMPINAS S2	12/01/2019 17:09	13/01/2019 17:05	12/01/2019 17:09	13/01/2019 17:05	23,93	136	3254,93	DIA CRITICO

20190147298	URUACU	UR12136315	CAMPINORTE	12/01/2019 16:07	12/01/2019 19:42	12/01/2019 16:07	12/01/2019 19:42	3,58	3	10,75	CHI
20190147306	SENADOR CANEDO	SW11065499	SENADOR CANEDO	12/01/2019 17:08	12/01/2019 19:02	12/01/2019 17:08	12/01/2019 19:02	1,90	90	171,00	CHI
20190147308	GOIANIA	GN11195733	XAVANTES	12/01/2019 17:04	14/01/2019 11:51	12/01/2019 17:04	14/01/2019 11:51	42,78	63	2695,35	DIA CRITICO
20190147316	GOIANIA	GN12164390	XAVANTES	12/01/2019 16:52	13/01/2019 01:22	12/01/2019 16:52	13/01/2019 01:22	8,50	741	6298,50	DIA CRITICO
20190147318	MINACU	IH12317057	MINACU	12/01/2019 17:13	12/01/2019 18:37	12/01/2019 17:13	12/01/2019 18:37	1,40	6	8,40	CHI
20190147323	GOIANIA	GN11193208	CAMPINAS S2	12/01/2019 17:07	13/01/2019 18:58	12/01/2019 17:07	13/01/2019 18:58	25,85	129	3334,65	DIA CRITICO
20190147338	PIRENOPOLIS	PV12265425	CORUMBA	12/01/2019 16:07	12/01/2019 17:59	12/01/2019 16:07	12/01/2019 17:59	1,87	202	377,07	DIA CRITICO
20190147346	PILAR DE GOIAS	GG12181185	SANTA TEREZINHA	12/01/2019 17:15	13/01/2019 16:10	12/01/2019 17:15	13/01/2019 16:10	22,92	27	618,75	CHI
20190147355	MINEIROS	1390018079	PARQUE DAS EMAS	12/01/2019 17:15	12/01/2019 22:08	12/01/2019 17:15	12/01/2019 22:08	4,88	1	4,88	CHI
20190147363	GOIANIA	GN11167769	CAMPINAS S2	12/01/2019 17:05	13/01/2019 14:30	12/01/2019 17:05	13/01/2019 14:30	21,42	76	1627,67	DIA CRITICO
20190147369	GOIANIA	GN11000909	CAMPINAS S2	12/01/2019 17:14	13/01/2019 16:32	12/01/2019 17:14	13/01/2019 16:32	23,30	137	3192,10	DIA CRITICO
20190147376	AMARALINA	LC12230319	NOVA CRIXAS	12/01/2019 17:01	12/01/2019 20:49	12/01/2019 17:01	12/01/2019 20:49	3,80	3	11,40	CHI
20190147377	GOIANIRA	XX17041351	NEROPOLIS S1	12/01/2019 17:15	14/01/2019 10:27	12/01/2019 17:15	14/01/2019 10:27	41,20	5	206,00	DIA CRITICO
20190147379	GOIANIA	GN11000798	GOIANIA LESTE S3	12/01/2019 17:06	13/01/2019 11:04	12/01/2019 17:06	13/01/2019 11:04	17,97	84	1509,20	DIA CRITICO
20190147381	SAO FRANCISCO DE GOIAS	SF12008967	SAO FRANCISCO DE GOIAS	12/01/2019 16:36	13/01/2019 09:35	12/01/2019 16:36	13/01/2019 09:35	16,98	20	339,67	DIA CRITICO
20190147385	GAMELEIRA DE GOIAS	AN12285354	JUNDIAI S1	13/01/2019 18:01	15/01/2019 11:50	13/01/2019 18:01	14/01/2019 12:15	18,23	5	91,17	CHI
20190147385	SILVANIA	AN12285354	JUNDIAI S1	13/01/2019 18:01	15/01/2019 11:50	13/01/2019 18:01	14/01/2019 12:15	18,23	2	36,47	CHI
20190147385	GAMELEIRA DE GOIAS	7015209	JUNDIAI S1	13/01/2019 18:01	15/01/2019 11:50	13/01/2019 18:01	14/01/2019 15:22	21,35	2	42,70	CHI
20190147385	SILVANIA	7015209	JUNDIAI S1	13/01/2019 18:01	15/01/2019 11:50	13/01/2019 18:01	14/01/2019 15:22	21,35	16	341,60	CHI
20190147385	GAMELEIRA DE GOIAS	7012910	JUNDIAI S1	13/01/2019 18:01	15/01/2019 11:50	13/01/2019 18:01	15/01/2019 11:50	41,82	1	41,82	CHI
20190147385	SILVANIA	7012910	JUNDIAI S1	13/01/2019 18:01	15/01/2019 11:50	13/01/2019 18:01	15/01/2019 11:50	41,82	1	41,82	CHI
20190147401	SANTO ANTONIO DE GOIAS	BW21118552	NEROPOLIS S1	12/01/2019 17:16	12/01/2019 18:11	12/01/2019 17:16	12/01/2019 18:11	0,92	1	0,92	DIA CRITICO
20190147402	BONOPOLIS	TA12390366	NOVO PLANALTO	12/01/2019 14:29	12/01/2019 20:03	12/01/2019 14:29	12/01/2019 20:03	5,57	49	272,77	CHI
20190147402	PORANGATU	TA12390366	NOVO PLANALTO	12/01/2019 14:29	12/01/2019 20:03	12/01/2019 14:29	12/01/2019 20:03	5,57	2	11,13	CHI
20190147405	BARRO ALTO	NQ12146903	URUACU	12/01/2019 17:08	12/01/2019 19:28	12/01/2019 17:08	12/01/2019 19:28	2,33	1	2,33	CHI
20190147405	NIQUELANDIA	NQ12146903	URUACU	12/01/2019 17:08	12/01/2019 19:28	12/01/2019 17:08	12/01/2019 19:28	2,33	97	226,33	CHI
20190147425	LUZIANIA	LZ12031093	RIO VERMELHO	12/01/2019 17:18	12/01/2019 23:38	12/01/2019 17:18	12/01/2019 23:38	6,33	40	253,33	CHI
20190147427	GOIANIA	GN10385857	CAMPINAS S1	12/01/2019 17:04	12/01/2019 23:06	12/01/2019 17:04	12/01/2019 23:06	6,03	563	3396,77	DIA CRITICO
20190147427	GOIANIA	GN10385857	CAMPINAS S1	12/01/2019 17:04	12/01/2019 23:06	12/01/2019 23:01	12/01/2019 23:06	0,08	3747	312,25	DIA CRITICO
20190147430	FORMOSO	FO12200415	MARA ROSA	12/01/2019 17:18	13/01/2019 08:56	12/01/2019 17:18	13/01/2019 08:56	15,63	19	297,03	CHI
20190147431	GOIANIA	GN12000545	CAMPINAS S3	12/01/2019 17:12	13/01/2019 08:54	12/01/2019 17:12	13/01/2019 08:54	15,70	313	4914,10	DIA CRITICO
20190147436	GOIANIA	GN11214750	MEIA PONTE	12/01/2019 17:17	13/01/2019 08:54	12/01/2019 17:17	13/01/2019 08:54	15,62	142	2217,57	DIA CRITICO
20190147442	ARAGUAPAZ	AZ12042979	MOZARLANDIA	12/01/2019 17:18	12/01/2019 18:21	12/01/2019 17:18	12/01/2019 18:21	1,05	10	10,50	CHI

20190147443	RUBIATABA	RB12111534	RUBIATABA	12/01/2019 17:18	12/01/2019 18:39	12/01/2019 17:18	12/01/2019 18:39	1,35	326	440,10	CHI
20190147450	PIRENOPOLIS	PV12360268	CORUMBA	12/01/2019 16:48	13/01/2019 10:51	12/01/2019 16:48	13/01/2019 10:51	18,05	38	685,90	DIA CRITICO
20190147453	GOIANIA	GN11001383	CAMPINAS S2	12/01/2019 16:13	13/01/2019 21:50	12/01/2019 16:13	13/01/2019 21:50	29,62	145	4294,42	DIA CRITICO
20190147473	GAMELEIRA DE GOIAS	SV12056396	DAIA S2	12/01/2019 16:56	13/01/2019 03:39	12/01/2019 16:56	13/01/2019 03:39	10,72	104	1114,53	CHI
20190147473	SILVANIA	SV12056396	DAIA S2	12/01/2019 16:56	13/01/2019 03:39	12/01/2019 16:56	13/01/2019 03:39	10,72	1	10,72	CHI
20190147483	NIQUELANDIA	NQ12280978	URUACU	12/01/2019 17:20	12/01/2019 22:44	12/01/2019 17:20	12/01/2019 22:44	5,40	89	480,60	CHI
20190147486	PORANGATU	PO12349234	MARA ROSA	12/01/2019 17:20	13/01/2019 03:16	12/01/2019 17:20	13/01/2019 03:16	9,93	16	158,93	CHI
20190147490	ANAPOLIS	NR12268437	NEROPOLIS S2	12/01/2019 17:01	12/01/2019 19:54	12/01/2019 17:01	12/01/2019 19:54	2,88	13	37,48	CHI
20190147490	NEROPOLIS	NR12268437	NEROPOLIS S2	12/01/2019 17:01	12/01/2019 19:54	12/01/2019 17:01	12/01/2019 19:54	2,88	18	51,90	CHI
20190147490	OURO VERDE DE GOIAS	NR12268437	NEROPOLIS S2	12/01/2019 17:01	12/01/2019 19:54	12/01/2019 17:01	12/01/2019 19:54	2,88	1	2,88	CHI
20190147493	CORUMBA DE GOIAS	CB12161727	CORUMBA	12/01/2019 16:17	12/01/2019 19:30	12/01/2019 16:17	12/01/2019 19:30	3,22	295	948,92	DIA CRITICO
20190147497	GOIANIA	GN12000915	XAVANTES	12/01/2019 16:58	13/01/2019 11:04	12/01/2019 16:58	13/01/2019 11:04	18,10	136	2461,60	DIA CRITICO
20190147501	PONTALINA	PK11076921	PONTALINA	12/01/2019 17:14	12/01/2019 19:10	12/01/2019 17:14	12/01/2019 19:10	1,93	49	94,73	CHI
20190147502	ITAGUARI	JA12038937	ITABERAI S1	12/01/2019 17:21	13/01/2019 12:25	12/01/2019 17:21	13/01/2019 12:25	19,07	3	57,20	CHI
20190147502	ITAGUARU	JA12038937	ITABERAI S1	12/01/2019 17:21	13/01/2019 12:25	12/01/2019 17:21	13/01/2019 12:25	19,07	1	19,07	CHI
20190147502	JARAGUA	JA12038937	ITABERAI S1	12/01/2019 17:21	13/01/2019 12:25	12/01/2019 17:21	13/01/2019 12:25	19,07	6	114,40	CHI
20190147510	GOIANIA	GN11059893	FERROVIARIO S2	12/01/2019 17:05	13/01/2019 00:05	12/01/2019 17:05	13/01/2019 00:05	7,00	86	602,00	DIA CRITICO
20190147520	GOIANIA	GN11151348	MEIA PONTE	12/01/2019 17:15	14/01/2019 10:58	12/01/2019 17:15	14/01/2019 10:58	41,72	108	4505,40	DIA CRITICO
20190147526	GOIANIA	GN11169133	CARAJAS S1	12/01/2019 17:20	13/01/2019 17:12	12/01/2019 17:20	13/01/2019 17:12	23,87	55	1312,67	CHI
20190147549	PIRENOPOLIS	ZN121216908	COCALZINHO	12/01/2019 17:24	13/01/2019 10:50	12/01/2019 17:24	13/01/2019 10:50	17,43	1	17,43	CHI
20190147556	SERRANOPOLIS	SX12014732	JATAI S1	12/01/2019 16:21	12/01/2019 19:45	12/01/2019 16:21	12/01/2019 19:45	3,40	743	2526,20	CHI
20190147559	GOIANIA	GN11002411	FERROVIARIO S1	12/01/2019 17:24	15/01/2019 07:52	12/01/2019 17:24	15/01/2019 07:52	62,47	51	3185,80	DIA CRITICO
20190147576	GOIANIA	GN11168570	FERROVIARIO S2	12/01/2019 17:25	14/01/2019 12:42	12/01/2019 17:25	14/01/2019 12:42	43,28	34	1471,63	DIA CRITICO
20190147584	APARECIDA DE GOIANIA	AP12002038	ANHANGUERA	12/01/2019 17:14	12/01/2019 19:33	12/01/2019 17:14	12/01/2019 19:33	2,32	321	743,65	CHI
20190147595	GOIANIA	GN11151324	MEIA PONTE	12/01/2019 16:59	13/01/2019 15:23	12/01/2019 16:59	13/01/2019 15:23	22,40	178	3987,20	DIA CRITICO
20190147603	BONOPOLIS	BX12198523	SAO MIGUEL DO ARAGUAIA	12/01/2019 17:26	13/01/2019 22:34	12/01/2019 17:26	13/01/2019 22:34	29,13	3	87,40	DIA CRITICO
20190147617	GOIANIA	GN12001048	CAMPINAS S1	12/01/2019 17:05	12/01/2019 18:45	12/01/2019 17:05	12/01/2019 18:45	1,67	529	881,67	DIA CRITICO
20190147618	ANAPOLIS	20998510	JUNDIAI S2	12/01/2019 17:27	13/01/2019 14:12	12/01/2019 17:27	13/01/2019 14:12	20,75	1	20,75	CHI
20190147625	APARECIDA DE GOIANIA	AP11077028	REAL S2	12/01/2019 17:18	12/01/2019 19:35	12/01/2019 17:18	12/01/2019 19:35	2,28	173	395,02	CHI
20190147640	ANAPOLIS	10001689043	ANAPOLIS UNIVERSITARIO S2	12/01/2019 17:27	13/01/2019 09:24	12/01/2019 17:27	13/01/2019 09:24	15,95	1	15,95	CHI
20190147664	GOIANIA	GN11000401	FERROVIARIO S2	12/01/2019 17:23	13/01/2019 03:04	12/01/2019 17:23	13/01/2019 03:04	9,68	109	1055,48	DIA CRITICO
20190147668	GOIANIA	GN11144784	XAVANTES	12/01/2019 17:26	13/01/2019 18:18	12/01/2019 17:26	13/01/2019 18:18	24,87	256	6365,87	DIA CRITICO
20190147669	GOIANIA	GN11043946	CARAJAS S1	12/01/2019 17:10	12/01/2019 21:35	12/01/2019 17:10	12/01/2019 21:35	4,42	241	1064,42	CHI

20190147670	GOIANIA	GN11378749	REAL S1	12/01/2019 17:15	13/01/2019 12:12	12/01/2019 17:15	13/01/2019 12:12	18,95	87	1648,65	CHI
20190147682	PETROLINA DE GOIAS	PG21015800	PETROLINA	12/01/2019 17:30	13/01/2019 22:01	12/01/2019 17:30	13/01/2019 22:01	28,52	1	28,52	DIA CRITICO
20190147684	ANAPOLIS	AN21317449	ANAPOLIS UNIVERSITARIO S1	12/01/2019 17:29	13/01/2019 14:03	12/01/2019 17:29	13/01/2019 14:03	20,57	1	20,57	CHI
20190147694	GOIANIA	GN12221766	GOYA S2	12/01/2019 16:59	13/01/2019 03:38	12/01/2019 16:59	13/01/2019 03:38	10,65	385	4100,25	DIA CRITICO
20190147696	TRINDADE	TR12110913	GOYA S2	12/01/2019 17:20	13/01/2019 08:09	12/01/2019 17:20	13/01/2019 08:09	14,82	114	1689,10	DIA CRITICO
20190147703	CALDAZINHA	BV12000065	CEPAIGO S2	12/01/2019 17:25	13/01/2019 12:25	12/01/2019 17:25	13/01/2019 12:25	19,00	9	171,00	CHI
20190147706	GOIANIA	GN11001767	FERROVIARIO S1	12/01/2019 17:06	13/01/2019 11:43	12/01/2019 17:06	13/01/2019 11:43	18,62	92	1712,73	DIA CRITICO
20190147713	GOIANIA	GN11056164	GOYA S2	12/01/2019 17:03	13/01/2019 12:22	12/01/2019 17:03	13/01/2019 12:22	19,32	100	1931,67	DIA CRITICO
20190147720	GOIANIA	GN12200568	CAMPINAS S2	12/01/2019 17:10	12/01/2019 22:26	12/01/2019 17:10	12/01/2019 22:26	5,27	561	2954,60	DIA CRITICO
20190147727	GOIANIA	GN13380025B	FERROVIARIO S1	12/01/2019 17:00	13/01/2019 00:05	12/01/2019 17:00	13/01/2019 00:05	7,08	1738	12310,83	DIA CRITICO
20190147737	GOIANIA	GN11002223	FERROVIARIO S3	12/01/2019 17:15	13/01/2019 11:20	12/01/2019 17:15	13/01/2019 11:20	18,08	27	488,25	DIA CRITICO
20190147739	SAO LUIZ DO NORTE	SZ10400555	ITAPACI	12/01/2019 17:32	14/01/2019 11:43	12/01/2019 17:32	12/01/2019 23:01	5,48	8	43,87	CHI
20190147739	SAO LUIZ DO NORTE	SZ10400555	ITAPACI	12/01/2019 17:32	14/01/2019 11:43	12/01/2019 20:26	12/01/2019 23:01	2,58	5	12,92	CHI
20190147739	HIDROLINA	SZ10400555	ITAPACI	12/01/2019 17:32	14/01/2019 11:43	12/01/2019 17:32	13/01/2019 01:27	7,92	9	71,25	CHI
20190147739	HIDROLINA	SZ13262851	ITAPACI	12/01/2019 17:32	14/01/2019 11:43	12/01/2019 20:26	13/01/2019 01:27	5,02	5	25,08	CHI
20190147739	HIDROLINA	HL12384345LD	ITAPACI	12/01/2019 17:32	14/01/2019 11:43	12/01/2019 17:32	13/01/2019 13:24	19,87	44	874,13	CHI
20190147739	HIDROLINA	HL12384345LD	ITAPACI	12/01/2019 17:32	14/01/2019 11:43	12/01/2019 20:26	13/01/2019 13:24	16,97	19	322,37	CHI
20190147739	HIDROLINA	SZ10400555	ITAPACI	12/01/2019 17:32	14/01/2019 11:43	13/01/2019 13:26	13/01/2019 14:12	0,77	100	76,67	CHI
20190147739	SAO LUIZ DO NORTE	SZ10400555	ITAPACI	12/01/2019 17:32	14/01/2019 11:43	13/01/2019 13:26	13/01/2019 14:12	0,77	13	9,97	CHI
20190147739	HIDROLINA	SZ10400555	ITAPACI	12/01/2019 17:32	14/01/2019 11:43	13/01/2019 14:13	13/01/2019 14:54	0,68	40	27,33	CHI
20190147739	SAO LUIZ DO NORTE	SZ10400555	ITAPACI	12/01/2019 17:32	14/01/2019 11:43	13/01/2019 14:13	13/01/2019 14:54	0,68	13	8,88	CHI
20190147739	SAO LUIZ DO NORTE	SZ10400555	ITAPACI	12/01/2019 17:32	14/01/2019 11:43	13/01/2019 14:56	13/01/2019 18:23	3,45	13	44,85	CHI
20190147739	HIDROLINA	SZ13262851	ITAPACI	12/01/2019 17:32	14/01/2019 11:43	13/01/2019 14:56	13/01/2019 20:46	5,83	7	40,83	CHI
20190147739	HIDROLINA	7139762	ITAPACI	12/01/2019 17:32	14/01/2019 11:43	13/01/2019 14:56	13/01/2019 20:59	6,05	33	199,65	CHI
20190147739	SAO LUIZ DO NORTE	SZ10400555	ITAPACI	12/01/2019 17:32	14/01/2019 11:43	13/01/2019 22:04	14/01/2019 00:27	2,38	13	30,98	CHI
20190147739	HIDROLINA	SZ13262851	ITAPACI	12/01/2019 17:32	14/01/2019 11:43	13/01/2019 22:04	14/01/2019 00:49	2,75	36	99,00	CHI
20190147739	HIDROLINA	SZ10400555	ITAPACI	12/01/2019 17:32	14/01/2019 11:43	14/01/2019 00:52	14/01/2019 01:39	0,78	36	28,20	CHI
20190147739	SAO LUIZ DO NORTE	SZ10400555	ITAPACI	12/01/2019 17:32	14/01/2019 11:43	14/01/2019 00:52	14/01/2019 01:39	0,78	13	10,18	CHI
20190147739	HIDROLINA	HL12384345LD	ITAPACI	12/01/2019 17:32	14/01/2019 11:43	13/01/2019 14:13	14/01/2019 04:10	13,95	63	878,85	CHI
20190147739	HIDROLINA	SZ10400555	ITAPACI	12/01/2019 17:32	14/01/2019 11:43	13/01/2019 21:01	14/01/2019 11:43	14,70	4	58,80	CHI
20190147739	HIDROLINA	SZ10400555	ITAPACI	12/01/2019 17:32	14/01/2019 11:43	14/01/2019 08:08	14/01/2019 11:43	3,58	98	351,17	CHI
20190147739	SAO LUIZ DO NORTE	SZ10400555	ITAPACI	12/01/2019 17:32	14/01/2019 11:43	14/01/2019 08:08	14/01/2019 11:43	3,58	13	46,58	CHI
20190147743	LUZIANIA	LZ12033418	RIO VERMELHO	12/01/2019 17:32	12/01/2019 19:12	12/01/2019 17:32	12/01/2019 19:12	1,67	16	26,67	CHI

20190147753	GOIANIA	GN11251445	GOYA S1	12/01/2019 17:31	14/01/2019 02:18	12/01/2019 17:31	14/01/2019 02:18	32,78	192	6294,40	DIA CRITICO
20190147757	FORMOSA	FA21265683	ITUIQUIRA	12/01/2019 17:33	12/01/2019 22:00	12/01/2019 17:33	12/01/2019 22:00	4,45	1	4,45	CHI
20190147769	HIDROLINA	00790416	URUACU	12/01/2019 17:24	12/01/2019 21:30	12/01/2019 17:24	12/01/2019 21:30	4,10	28	114,80	CHI
20190147769	PILAR DE GOIAS	00790416	URUACU	12/01/2019 17:24	12/01/2019 21:30	12/01/2019 17:24	12/01/2019 21:30	4,10	42	172,20	CHI
20190147776	GOIANIA	GN11000948	ATLANTICO S2	12/01/2019 17:31	13/01/2019 11:42	12/01/2019 17:31	13/01/2019 11:42	18,18	89	1618,32	CHI
20190147779	CAMPOS VERDES	VD12145521	SANTA TEREZINHA	12/01/2019 17:34	12/01/2019 20:40	12/01/2019 17:34	12/01/2019 20:40	3,10	2	6,20	CHI
20190147779	SANTA TEREZINHA DE GOIAS	VD12145521	SANTA TEREZINHA	12/01/2019 17:34	12/01/2019 20:40	12/01/2019 17:34	12/01/2019 20:40	3,10	28	86,80	CHI
20190147783	GOIANIA	GN11127468	MEIA PONTE	12/01/2019 17:10	14/01/2019 02:44	12/01/2019 17:10	14/01/2019 02:44	33,57	146	4900,73	DIA CRITICO
20190147785	SAO LUIZ DO NORTE	SZ12066095	ITAPACI	12/01/2019 17:34	13/01/2019 18:32	12/01/2019 17:34	13/01/2019 18:32	24,97	7	174,77	CHI
20190147789	ITAPURANGA	IK12022906	ITAPURANGA	12/01/2019 16:47	12/01/2019 18:50	12/01/2019 16:47	12/01/2019 18:50	2,05	38	77,90	CHI
20190147790	BONOPOLIS	BX12136924	SAO MIGUEL DO ARAGUAIA	12/01/2019 17:09	12/01/2019 22:11	12/01/2019 17:09	12/01/2019 22:11	5,03	5	25,17	DIA CRITICO
20190147794	SANTO ANTONIO DE GOIAS	BW11233006	NEROPOLIS S1	12/01/2019 17:29	13/01/2019 09:36	12/01/2019 17:29	13/01/2019 09:36	16,12	112	1805,07	DIA CRITICO
20190147799	SENADOR CANEDO	SW11074736	GOIANIA LESTE S2	12/01/2019 17:01	13/01/2019 03:13	12/01/2019 17:01	13/01/2019 03:13	10,20	115	1173,00	DIA CRITICO
20190147816	ANAPOLIS	20698320	ANAPOLIS UNIVERSITARIO S2	12/01/2019 17:37	13/01/2019 09:17	12/01/2019 17:37	13/01/2019 09:17	15,67	1	15,67	CHI
20190147820	ANAPOLIS	AN12000074	JUNDIAI S2	12/01/2019 16:13	12/01/2019 19:47	12/01/2019 16:13	12/01/2019 19:47	3,57	140	499,33	CHI
20190147821	BONFINOPOLIS	BO12400465	CEPAIGO S2	12/01/2019 16:53	13/01/2019 14:11	12/01/2019 16:53	13/01/2019 14:11	21,30	3	63,90	CHI
20190147821	LEOPOLDO DE BULHOES	BO12400465	CEPAIGO S2	12/01/2019 16:53	13/01/2019 14:11	12/01/2019 16:53	13/01/2019 14:11	21,30	13	276,90	CHI
20190147836	GOIANIA	GN11000646	CAMPINAS S3	12/01/2019 17:30	13/01/2019 09:33	12/01/2019 17:30	13/01/2019 09:33	16,05	119	1909,95	DIA CRITICO
20190147838	GOIANIA	GN12213540	XAVANTES	12/01/2019 17:04	12/01/2019 18:57	12/01/2019 17:04	12/01/2019 18:57	1,88	519	977,45	DIA CRITICO
20190147853	SENADOR CANEDO	SW11074735	GOIANIA LESTE S2	12/01/2019 17:17	13/01/2019 02:20	12/01/2019 17:17	13/01/2019 02:20	9,05	124	1122,20	DIA CRITICO
20190147858	GOIANIRA	GR11275527	MEIA PONTE	12/01/2019 17:04	13/01/2019 16:33	12/01/2019 17:04	13/01/2019 16:33	23,48	88	2066,53	DIA CRITICO
20190147861	APARECIDA DE GOIANIA	AP11003030	INDEPENDENCIA S1	12/01/2019 17:39	12/01/2019 18:55	12/01/2019 17:39	12/01/2019 18:55	1,27	108	136,80	CHI
20190147879	SANTA CRUZ DE GOIAS	BC12083189	PIRES DO RIO S2	12/01/2019 17:28	12/01/2019 19:47	12/01/2019 17:28	12/01/2019 19:47	2,32	8	18,53	CHI
20190147880	GOIANIA	GN12213654	XAVANTES	12/01/2019 16:55	13/01/2019 18:00	12/01/2019 16:55	13/01/2019 15:30	22,58	576	13008,00	DIA CRITICO
20190147880	GOIANIA	GN11213727	XAVANTES	12/01/2019 16:55	13/01/2019 18:00	12/01/2019 16:55	13/01/2019 18:00	25,08	117	2934,75	DIA CRITICO
20190147882	VALPARAISO DE GOIAS	VA11192929	PACAEMBU S2	12/01/2019 17:28	12/01/2019 19:22	12/01/2019 17:28	12/01/2019 19:22	1,90	210	399,00	CHI
20190147885	NOVO GAMA	LZ12082801	MARAJOARA	12/01/2019 16:58	12/01/2019 19:20	12/01/2019 16:58	12/01/2019 19:20	2,37	29	68,63	CHI
20190147889	GOIANIA	GN11168419	MEIA PONTE	12/01/2019 17:31	13/01/2019 11:37	12/01/2019 17:31	13/01/2019 11:37	18,10	200	3620,00	DIA CRITICO
20190147890	ANAPOLIS	AN12000547	JUNDIAI S1	12/01/2019 16:17	12/01/2019 21:25	12/01/2019 16:17	12/01/2019 21:25	5,13	485	2489,67	CHI
20190147893	AGUAS LINDAS DE GOIAS	LA12149756	AGUAS LINDAS DE GOIAS S2	12/01/2019 17:41	13/01/2019 07:45	12/01/2019 17:41	13/01/2019 07:45	14,07	44	618,93	CHI
20190147894	SANTA BARBARA DE GOIAS	SB11078308	TRINDADE	12/01/2019 17:36	14/01/2019 10:58	12/01/2019 17:36	14/01/2019 10:58	41,37	151	6246,37	DIA CRITICO
20190147898	GOIANIA	GN11002143	GOYA S1	12/01/2019 17:11	13/01/2019 12:16	12/01/2019 17:11	13/01/2019 12:16	19,08	44	839,67	DIA CRITICO
20190147900	APARECIDA DE GOIANIA	AP11168695	INDEPENDENCIA S1	12/01/2019 17:39	12/01/2019 18:30	12/01/2019 17:39	12/01/2019 18:30	0,85	27	22,95	CHI

20190147901	GOIANIA	GN12001353	GOIANIA LESTE S1	12/01/2019 17:10	12/01/2019 20:05	12/01/2019 17:10	12/01/2019 20:05	2,92	1035	3018,75	CHI
20190147902	PIRENOPOLIS	PV12060501	CORUMBA	12/01/2019 17:40	13/01/2019 17:06	12/01/2019 17:40	13/01/2019 17:06	23,43	5	117,17	DIA CRITICO
20190147908	GOIANIA	GN11001692	CAMPINAS S2	12/01/2019 17:12	13/01/2019 11:19	12/01/2019 17:12	13/01/2019 11:19	18,12	23	416,68	DIA CRITICO
20190147909	GOIANIRA	GR10396914	GOIANIRA	12/01/2019 17:22	12/01/2019 22:17	12/01/2019 17:22	12/01/2019 19:05	1,72	836	1435,13	DIA CRITICO
20190147909	TRINDADE	GR10396914	GOIANIRA	12/01/2019 17:22	12/01/2019 22:17	12/01/2019 17:22	12/01/2019 19:05	1,72	1	1,72	DIA CRITICO
20190147909	GOIANIRA	GR12247939LD	GOIANIRA	12/01/2019 17:22	12/01/2019 22:17	12/01/2019 17:22	12/01/2019 22:17	4,92	1313	6455,58	DIA CRITICO
20190147909	TRINDADE	GR12247939LD	GOIANIRA	12/01/2019 17:22	12/01/2019 22:17	12/01/2019 17:22	12/01/2019 22:17	4,92	1	4,92	DIA CRITICO
20190147923	SAO MIGUEL DO PASSA QUATRO	1490009891	CRISTIANOPOLIS	12/01/2019 17:41	13/01/2019 18:09	12/01/2019 17:41	13/01/2019 18:09	24,47	1	24,47	CHI
20190147929	PADRE BERNARDO	PB12330893	PADRE BERNARDO	12/01/2019 17:42	13/01/2019 01:26	12/01/2019 17:42	13/01/2019 01:26	7,73	3	23,20	CHI
20190147930	GOIANIA	GN12251812	MEIA PONTE	12/01/2019 17:09	13/01/2019 10:57	12/01/2019 17:09	13/01/2019 10:57	17,80	341	6069,80	DIA CRITICO
20190147936	TRINDADE	TR11132428	MEIA PONTE	12/01/2019 17:31	13/01/2019 15:41	12/01/2019 17:31	13/01/2019 15:41	22,17	145	3214,17	DIA CRITICO
20190147950	TRINDADE	TR21187615	TRINDADE	12/01/2019 17:40	14/01/2019 10:17	12/01/2019 17:40	14/01/2019 10:17	40,62	1	40,62	DIA CRITICO
20190147959	TRINDADE	TR12000262	GUAPO S1	12/01/2019 17:52	13/01/2019 14:09	12/01/2019 17:52	13/01/2019 14:09	20,28	16	324,53	CHI
20190147961	SANTA RITA DO NOVO DESTINO	DF11315662	BARRO ALTO	12/01/2019 17:44	13/01/2019 10:48	12/01/2019 17:44	13/01/2019 10:48	17,07	1	17,07	CHI
20190147964	APARECIDA DE GOIANIA	AP12147249	ATLANTICO S2	12/01/2019 17:18	12/01/2019 18:38	12/01/2019 17:18	12/01/2019 18:38	1,33	324	432,00	CHI
20190147965	RIO VERDE	QI21306090	QUIRINOPOLIS	12/01/2019 17:45	12/01/2019 22:54	12/01/2019 17:45	12/01/2019 22:54	5,15	3	15,45	CHI
20190147968	GOIANIRA	GR12394646	GOIANIRA	12/01/2019 17:03	12/01/2019 23:00	12/01/2019 17:03	12/01/2019 23:00	5,95	1199	7134,05	DIA CRITICO
20190147975	GOIANIA	GN11039978	CAMPINAS S1	12/01/2019 17:42	13/01/2019 12:09	12/01/2019 17:42	13/01/2019 12:09	18,45	140	2583,00	DIA CRITICO
20190147984	GOIANIA	GN11000630	CAMPINAS S1	12/01/2019 17:16	13/01/2019 14:00	12/01/2019 17:16	13/01/2019 14:00	20,73	177	3669,80	DIA CRITICO
20190147993	GOIANIA	GN11169933	GOYA S1	12/01/2019 17:31	14/01/2019 11:45	12/01/2019 17:31	14/01/2019 11:45	42,23	21	886,90	DIA CRITICO
20190147995	URUACU	UR21242671	URUACU	12/01/2019 17:46	12/01/2019 21:42	12/01/2019 17:46	12/01/2019 21:42	3,93	1	3,93	CHI
20190148020	GOIANIA	GN11140222	CAMPINAS S2	12/01/2019 17:03	13/01/2019 17:30	12/01/2019 17:03	13/01/2019 17:30	24,45	221	5403,45	DIA CRITICO
20190148027	GUARINOS	GF12117930	SANTA TEREZINHA	12/01/2019 17:41	12/01/2019 19:37	12/01/2019 17:41	12/01/2019 19:37	1,93	496	958,93	CHI
20190148031	TRINDADE	TR11378268	TRINDADE	12/01/2019 17:14	13/01/2019 17:00	12/01/2019 17:14	13/01/2019 17:00	23,77	70	1663,67	DIA CRITICO
20190148035	TRINDADE	TR12276767	TRINDADE	12/01/2019 17:32	12/01/2019 19:48	12/01/2019 17:32	12/01/2019 19:48	2,27	545	1235,33	DIA CRITICO
20190148037	TRINDADE	TR11111549	TRINDADE	12/01/2019 17:10	13/01/2019 18:17	12/01/2019 17:10	13/01/2019 18:17	25,12	135	3390,75	DIA CRITICO
20190148039	LUZIANIA	LZ13090045	MARAJOARA	12/01/2019 17:47	13/01/2019 14:08	12/01/2019 17:47	13/01/2019 14:08	20,35	2	40,70	CHI
20190148039	LUZIANIA	LZ13090045	MARAJOARA	12/01/2019 17:47	13/01/2019 14:08	13/01/2019 11:36	13/01/2019 14:08	2,53	8	20,27	CHI
20190148040	ITAPURANGA	IK12311323	ITAPURANGA	12/01/2019 17:13	13/01/2019 11:51	12/01/2019 17:13	13/01/2019 11:51	18,63	7	130,43	CHI
20190148056	GOIANIA	GN12383189	GOYA S2	12/01/2019 17:15	13/01/2019 08:18	12/01/2019 17:15	13/01/2019 08:18	15,05	354	5327,70	DIA CRITICO
20190148059	CAMPOS VERDES	SG12202098	SANTA TEREZINHA	12/01/2019 17:49	13/01/2019 08:45	12/01/2019 17:49	13/01/2019 08:45	14,93	41	612,27	CHI
20190148059	SANTA TEREZINHA DE GOIAS	SG12202098	SANTA TEREZINHA	12/01/2019 17:49	13/01/2019 08:45	12/01/2019 17:49	13/01/2019 08:45	14,93	129	1926,40	CHI
20190148059	UIRAPURU	SG12202098	SANTA TEREZINHA	12/01/2019 17:49	13/01/2019 08:45	12/01/2019 17:49	13/01/2019 08:45	14,93	58	866,13	CHI

20190148070	SANTA BARBARA DE GOIAS	SB11215433	TRINDADE	12/01/2019 17:44	14/01/2019 11:25	12/01/2019 17:44	14/01/2019 11:25	41,68	90	3751,50	DIA CRITICO
20190148071	GOIANIA	GN11003119	GOYA S1	12/01/2019 17:28	13/01/2019 13:57	12/01/2019 17:28	13/01/2019 13:57	20,48	116	2376,07	DIA CRITICO
20190148072	GOIANIA	GN10380349	GOYA S2	12/01/2019 16:46	12/01/2019 20:45	12/01/2019 16:46	12/01/2019 19:54	3,13	1204	3772,53	DIA CRITICO
20190148072	SENADOR CANEDO	GN10380349	GOYA S2	12/01/2019 16:46	12/01/2019 20:45	12/01/2019 16:46	12/01/2019 19:54	3,13	1	3,13	DIA CRITICO
20190148072	TRINDADE	GN10380349	GOYA S2	12/01/2019 16:46	12/01/2019 20:45	12/01/2019 16:46	12/01/2019 19:54	3,13	1790	5608,67	DIA CRITICO
20190148072	GOIANIA	TR16401523	GOYA S2	12/01/2019 16:46	12/01/2019 20:45	12/01/2019 16:46	12/01/2019 19:55	3,15	638	2009,70	DIA CRITICO
20190148072	TRINDADE	TR16401523	GOYA S2	12/01/2019 16:46	12/01/2019 20:45	12/01/2019 16:46	12/01/2019 19:55	3,15	4958	15617,70	DIA CRITICO
20190148072	GOIANIA	TR10394642	GOYA S2	12/01/2019 16:46	12/01/2019 20:45	12/01/2019 16:46	12/01/2019 19:58	3,20	52	166,40	DIA CRITICO
20190148072	TRINDADE	TR10394642	GOYA S2	12/01/2019 16:46	12/01/2019 20:45	12/01/2019 16:46	12/01/2019 19:58	3,20	2071	6627,20	DIA CRITICO
20190148072	GOIANIA	TR10403967	GOYA S2	12/01/2019 16:46	12/01/2019 20:45	12/01/2019 16:46	12/01/2019 20:03	3,28	152	499,07	DIA CRITICO
20190148072	TRINDADE	TR10403967	GOYA S2	12/01/2019 16:46	12/01/2019 20:45	12/01/2019 16:46	12/01/2019 20:03	3,28	3378	11091,10	DIA CRITICO
20190148072	GOIANIA	GN12161847	GOYA S2	12/01/2019 16:46	12/01/2019 20:45	12/01/2019 20:13	12/01/2019 20:45	0,53	14	7,47	DIA CRITICO
20190148073	RIO VERDE	RV12271471	CABRIUVA S2	12/01/2019 17:49	12/01/2019 18:55	12/01/2019 17:49	12/01/2019 18:55	1,10	2	2,20	CHI
20190148077	CRIXAS	NA21238089	NOVA CRIXAS	12/01/2019 17:50	14/01/2019 19:13	12/01/2019 17:50	14/01/2019 19:13	49,38	1	49,38	CHI
20190148078	HIDROLINA	HL12003219	URUACU	13/01/2019 08:45	13/01/2019 18:30	13/01/2019 08:45	13/01/2019 09:45	1,00	30	30,00	CHI
20190148078	HIDROLINA	HL12003219	URUACU	13/01/2019 08:45	13/01/2019 18:30	13/01/2019 09:46	13/01/2019 15:08	5,37	20	107,33	CHI
20190148078	HIDROLINA	HL12232432LD	URUACU	13/01/2019 08:45	13/01/2019 18:30	13/01/2019 09:46	13/01/2019 18:30	8,73	10	87,33	CHI
20190148079	TRINDADE	TR11044071	GOYA S2	12/01/2019 16:46	14/01/2019 04:20	12/01/2019 16:46	14/01/2019 04:20	35,57	107	3805,63	DIA CRITICO
20190148082	GOIANIA	GN12201566	GOYA S2	12/01/2019 17:24	13/01/2019 06:28	12/01/2019 17:24	13/01/2019 06:28	13,07	306	3998,40	DIA CRITICO
20190148085	GOIANIA	GN12211337	GOYA S2	12/01/2019 17:02	13/01/2019 10:21	12/01/2019 17:02	13/01/2019 10:21	17,32	362	6268,63	DIA CRITICO
20190148102	GOIANIA	GN11222101	CAMPINAS S2	12/01/2019 17:41	13/01/2019 16:48	12/01/2019 17:41	13/01/2019 16:48	23,12	87	2011,15	DIA CRITICO
20190148106	LUZIANIA	LZ12351428	PACAEMBU S1	12/01/2019 17:46	13/01/2019 14:09	12/01/2019 17:46	13/01/2019 14:09	20,38	1	20,38	CHI
20190148108	LUZIANIA	LZ21118914	RIO VERMELHO	12/01/2019 17:32	12/01/2019 19:28	12/01/2019 17:32	12/01/2019 19:28	1,93	4	7,73	CHI
20190148112	PIRENOPOLIS	PV12289876	SAO FRANCISCO DE GOIAS	12/01/2019 16:50	13/01/2019 12:03	12/01/2019 16:50	13/01/2019 12:03	19,22	15	288,25	DIA CRITICO
20190148114	ITAPURANGA	IK12364740	ITAPURANGA	12/01/2019 17:52	12/01/2019 22:42	12/01/2019 17:52	12/01/2019 22:42	4,83	12	58,00	CHI
20190148114	MORRO AGUDO DE GOIAS	IK12364740	ITAPURANGA	12/01/2019 17:52	12/01/2019 22:42	12/01/2019 17:52	12/01/2019 22:42	4,83	14	67,67	CHI
20190148124	MUNDO NOVO DE GOIAS	MH12035583	NOVA CRIXAS	12/01/2019 17:54	12/01/2019 23:20	12/01/2019 17:54	12/01/2019 23:20	5,43	57	309,70	CHI
20190148131	APARECIDA DE GOIANIA	AP11067637	REAL S2	12/01/2019 17:39	13/01/2019 10:48	12/01/2019 17:39	13/01/2019 10:48	17,15	145	2486,75	CHI
20190148147	APARECIDA DE GOIANIA	AP11127735	CEPAIGO S1	12/01/2019 17:48	13/01/2019 10:02	12/01/2019 17:48	13/01/2019 10:02	16,23	98	1590,87	CHI
20190148153	TRINDADE	TR12001811	GOYA S1	12/01/2019 17:15	13/01/2019 12:56	12/01/2019 17:15	13/01/2019 12:56	19,68	24	472,40	DIA CRITICO
20190148155	GOIANIA	GN11191076	XAVANTES	12/01/2019 17:28	13/01/2019 12:26	12/01/2019 17:28	13/01/2019 12:26	18,97	76	1441,47	DIA CRITICO
20190148159	GOIANIA	GN12205677	CARAJAS S2	12/01/2019 17:49	13/01/2019 12:50	12/01/2019 17:49	13/01/2019 12:50	19,02	87	1654,45	CHI
20190148163	GOIANIA	GN11001109	CAMPINAS S3	12/01/2019 17:48	13/01/2019 15:32	12/01/2019 17:48	13/01/2019 15:32	21,73	112	2434,13	DIA CRITICO

20190148174	NOVA GLORIA	NG21181344	RUBIATABA	12/01/2019 17:56	13/01/2019 15:19	12/01/2019 17:56	13/01/2019 15:19	21,38	1	21,38	CHI
20190148191	GOIANIA	GN11001483	CAMPINAS S1	12/01/2019 17:31	13/01/2019 12:24	12/01/2019 17:31	13/01/2019 12:24	18,88	101	1907,22	DIA CRITICO
20190148193	GOIAS	GS12071261	GOIAS	12/01/2019 16:42	13/01/2019 09:04	12/01/2019 16:42	13/01/2019 09:04	16,37	7	114,57	CHI
20190148196	PIRENOPOLIS	PV10219138	CORUMBA	12/01/2019 17:14	12/01/2019 21:55	12/01/2019 17:14	12/01/2019 19:04	1,83	158	289,67	DIA CRITICO
20190148196	PIRENOPOLIS	PV13000004	CORUMBA	12/01/2019 17:14	12/01/2019 21:55	12/01/2019 17:14	12/01/2019 21:00	3,77	102	384,20	DIA CRITICO
20190148196	PIRENOPOLIS	PV13000003	CORUMBA	12/01/2019 17:14	12/01/2019 21:55	12/01/2019 17:14	12/01/2019 21:40	4,43	91	403,43	DIA CRITICO
20190148196	ANAPOLIS	PV10397556	CORUMBA	12/01/2019 17:14	12/01/2019 21:55	12/01/2019 17:14	12/01/2019 21:55	4,68	1	4,68	DIA CRITICO
20190148196	GOIANESIA	PV10397556	CORUMBA	12/01/2019 17:14	12/01/2019 21:55	12/01/2019 17:14	12/01/2019 21:55	4,68	11	51,52	DIA CRITICO
20190148196	JARAGUA	PV10397556	CORUMBA	12/01/2019 17:14	12/01/2019 21:55	12/01/2019 17:14	12/01/2019 21:55	4,68	4	18,73	DIA CRITICO
20190148196	PIRENOPOLIS	PV10397556	CORUMBA	12/01/2019 17:14	12/01/2019 21:55	12/01/2019 17:14	12/01/2019 21:55	4,68	997	4669,28	DIA CRITICO
20190148196	VILA PROPICIO	PV10397556	CORUMBA	12/01/2019 17:14	12/01/2019 21:55	12/01/2019 17:14	12/01/2019 21:55	4,68	14	65,57	DIA CRITICO
20190148197	GOIANIA	GN11168927	GOYA S1	12/01/2019 17:46	13/01/2019 16:54	12/01/2019 17:46	13/01/2019 16:54	23,13	157	3631,93	DIA CRITICO
20190148198	LEOPOLDO DE BULHOES	LB12151171	DAIA S2	12/01/2019 16:30	12/01/2019 19:20	12/01/2019 16:30	12/01/2019 19:20	2,83	146	413,67	CHI
20190148201	SENADOR CANEDO	SW11054753	SENADOR CANEDO	12/01/2019 17:49	12/01/2019 22:19	12/01/2019 17:49	12/01/2019 22:19	4,50	143	643,50	CHI
20190148203	GOIANIA	GN12000446	GOIANIA LESTE S3	12/01/2019 17:14	12/01/2019 22:52	12/01/2019 17:14	12/01/2019 22:52	5,63	416	2343,47	DIA CRITICO
20190148208	ORIZONA	OZ12062411	PIRES DO RIO S2	12/01/2019 16:27	12/01/2019 21:32	12/01/2019 16:27	12/01/2019 21:32	5,08	12	61,00	CHI
20190148208	PIRES DO RIO	OZ12062411	PIRES DO RIO S2	12/01/2019 16:27	12/01/2019 21:32	12/01/2019 16:27	12/01/2019 21:32	5,08	11	55,92	CHI
20190148208	VIANOPOLIS	OZ12062411	PIRES DO RIO S2	12/01/2019 16:27	12/01/2019 21:32	12/01/2019 16:27	12/01/2019 21:32	5,08	23	116,92	CHI
20190148219	ALVORADA DO NORTE	FB12143258	IACIARA S2	12/01/2019 17:58	13/01/2019 21:41	12/01/2019 17:58	13/01/2019 21:41	27,72	29	803,78	CHI
20190148219	FLORES DE GOIAS	FB12143258	IACIARA S2	12/01/2019 17:58	13/01/2019 21:41	12/01/2019 17:58	13/01/2019 21:41	27,72	25	692,92	CHI
20190148220	CALDAS NOVAS	CN12000031LD	CALDAS NOVAS S1	12/01/2019 17:25	13/01/2019 00:59	12/01/2019 17:25	12/01/2019 20:07	2,70	11	29,70	CHI
20190148220	SANTA CRUZ DE GOIAS	CN12000031LD	CALDAS NOVAS S1	12/01/2019 17:25	13/01/2019 00:59	12/01/2019 17:25	12/01/2019 20:07	2,70	6	16,20	CHI
20190148220	CALDAS NOVAS	CN12000031LD	CALDAS NOVAS S1	12/01/2019 17:25	13/01/2019 00:59	12/01/2019 17:25	12/01/2019 21:52	4,45	623	2772,35	CHI
20190148220	CALDAS NOVAS	CN12000031LD	CALDAS NOVAS S1	12/01/2019 17:25	13/01/2019 00:59	12/01/2019 17:25	13/01/2019 00:59	7,57	2	15,13	CHI
20190148225	LUZIANIA	LZ12290724	MARAJOARA	12/01/2019 17:54	13/01/2019 10:05	12/01/2019 17:54	13/01/2019 10:05	16,18	10	161,83	CHI
20190148234	ALEXANIA	AX21353461	ALEXANIA	12/01/2019 17:59	12/01/2019 21:10	12/01/2019 17:59	12/01/2019 21:10	3,18	3	9,55	CHI
20190148240	LEOPOLDO DE BULHOES	LB12351059	DAIA S2	12/01/2019 18:00	13/01/2019 13:41	12/01/2019 18:00	13/01/2019 13:41	19,68	7	137,78	CHI
20190148243	GOIANIA	GN12000025	CAMPINAS S1	12/01/2019 17:12	12/01/2019 21:03	12/01/2019 17:12	12/01/2019 21:03	3,85	351	1351,35	DIA CRITICO
20190148247	CAMPOS VERDES	UP10398079	SANTA TEREZINHA	12/01/2019 17:09	15/01/2019 10:15	12/01/2019 17:09	13/01/2019 00:51	7,70	1	7,70	CHI
20190148247	MARA ROSA	UP10398079	SANTA TEREZINHA	12/01/2019 17:09	15/01/2019 10:15	12/01/2019 17:09	13/01/2019 00:51	7,70	76	585,20	CHI
20190148247	SANTA TEREZINHA DE GOIAS	UP10398079	SANTA TEREZINHA	12/01/2019 17:09	15/01/2019 10:15	12/01/2019 17:09	13/01/2019 00:51	7,70	119	916,30	CHI
20190148247	UIRAPURU	UP10398079	SANTA TEREZINHA	12/01/2019 17:09	15/01/2019 10:15	12/01/2019 17:09	13/01/2019 00:51	7,70	19	146,30	CHI
20190148247	UIRAPURU	UP10398079	SANTA TEREZINHA	12/01/2019 17:09	15/01/2019 10:15	13/01/2019 04:40	13/01/2019 09:24	4,73	10	47,33	CHI

20190148247	UIRAPURU	UP10398079	SANTA TEREZINHA	12/01/2019 17:09	15/01/2019 10:15	13/01/2019 04:40	13/01/2019 10:20	5,67	4	22,67	CHI
20190148247	SANTA TEREZINHA DE GOIAS	UP10398079	SANTA TEREZINHA	12/01/2019 17:09	15/01/2019 10:15	13/01/2019 04:40	13/01/2019 12:39	7,98	80	638,67	CHI
20190148247	UIRAPURU	UP10398079	SANTA TEREZINHA	12/01/2019 17:09	15/01/2019 10:15	13/01/2019 04:40	13/01/2019 12:39	7,98	5	39,92	CHI
20190148247	SANTA TEREZINHA DE GOIAS	UP10398079	SANTA TEREZINHA	12/01/2019 17:09	15/01/2019 10:15	13/01/2019 16:44	13/01/2019 16:55	0,18	80	14,67	CHI
20190148247	UIRAPURU	UP10398079	SANTA TEREZINHA	12/01/2019 17:09	15/01/2019 10:15	13/01/2019 16:44	13/01/2019 16:55	0,18	19	3,48	CHI
20190148247	CAMPOS VERDES	SG12323395LD	SANTA TEREZINHA	12/01/2019 17:09	15/01/2019 10:15	13/01/2019 04:40	14/01/2019 00:33	19,88	1	19,88	CHI
20190148247	MARA ROSA	SG12323395LD	SANTA TEREZINHA	12/01/2019 17:09	15/01/2019 10:15	13/01/2019 04:40	14/01/2019 00:33	19,88	16	318,13	CHI
20190148247	SANTA TEREZINHA DE GOIAS	SG12323395LD	SANTA TEREZINHA	12/01/2019 17:09	15/01/2019 10:15	13/01/2019 04:40	14/01/2019 00:33	19,88	39	775,45	CHI
20190148247	SANTA TEREZINHA DE GOIAS	UP10398079	SANTA TEREZINHA	12/01/2019 17:09	15/01/2019 10:15	14/01/2019 00:34	14/01/2019 01:12	0,63	80	50,67	CHI
20190148247	UIRAPURU	UP10398079	SANTA TEREZINHA	12/01/2019 17:09	15/01/2019 10:15	14/01/2019 00:34	14/01/2019 01:12	0,63	19	12,03	CHI
20190148247	SANTA TEREZINHA DE GOIAS	SG12323395LD	SANTA TEREZINHA	12/01/2019 17:09	15/01/2019 10:15	14/01/2019 00:34	14/01/2019 14:38	14,07	19	267,27	CHI
20190148247	SANTA TEREZINHA DE GOIAS	UP10398079	SANTA TEREZINHA	12/01/2019 17:09	15/01/2019 10:15	14/01/2019 16:21	14/01/2019 17:11	0,83	99	82,50	CHI
20190148247	UIRAPURU	UP10398079	SANTA TEREZINHA	12/01/2019 17:09	15/01/2019 10:15	14/01/2019 16:21	14/01/2019 17:11	0,83	19	15,83	CHI
20190148247	SANTA TEREZINHA DE GOIAS	UP10398079	SANTA TEREZINHA	12/01/2019 17:09	15/01/2019 10:15	14/01/2019 20:59	14/01/2019 21:12	0,22	99	21,45	CHI
20190148247	UIRAPURU	UP10398079	SANTA TEREZINHA	12/01/2019 17:09	15/01/2019 10:15	14/01/2019 20:59	14/01/2019 21:12	0,22	19	4,12	CHI
20190148247	MARA ROSA	UP10398079	SANTA TEREZINHA	12/01/2019 17:09	15/01/2019 10:15	13/01/2019 04:40	15/01/2019 10:15	53,58	60	3215,00	CHI
20190148247	CAMPOS VERDES	SG13323396	SANTA TEREZINHA	12/01/2019 17:09	15/01/2019 10:15	14/01/2019 00:34	15/01/2019 10:15	33,68	1	33,68	CHI
20190148247	MARA ROSA	SG13323396	SANTA TEREZINHA	12/01/2019 17:09	15/01/2019 10:15	14/01/2019 00:34	15/01/2019 10:15	33,68	16	538,93	CHI
20190148247	SANTA TEREZINHA DE GOIAS	SG13323396	SANTA TEREZINHA	12/01/2019 17:09	15/01/2019 10:15	14/01/2019 00:34	15/01/2019 10:15	33,68	20	673,67	CHI
20190148250	PALESTINA DE GOIAS	PY12187293	PALESTINA	12/01/2019 17:52	12/01/2019 21:40	12/01/2019 17:52	12/01/2019 21:40	3,80	22	83,60	CHI
20190148270	APARECIDA DE GOIANIA	AP12208899	INDEPENDENCIA S1	12/01/2019 17:45	12/01/2019 23:30	12/01/2019 17:45	12/01/2019 23:30	5,75	145	833,75	CHI
20190148291	LUZIANIA	LZ11078401	RIO VERMELHO	12/01/2019 18:02	12/01/2019 21:01	12/01/2019 18:02	12/01/2019 21:01	2,98	83	247,62	CHI
20190148298	GOIANIA	GN11040763	GOIANIA LESTE S3	12/01/2019 17:53	13/01/2019 19:05	12/01/2019 17:53	13/01/2019 19:05	25,20	168	4233,60	DIA CRITICO
20190148303	SANCLERLANDIA	SC11180176	FIRMINOPOLIS S2	12/01/2019 17:42	13/01/2019 03:30	12/01/2019 17:42	13/01/2019 03:30	9,80	63	617,40	CHI
20190148306	AGUAS LINDAS DE GOIAS	LA11370820	AGUAS LINDAS DE GOIAS S1	12/01/2019 17:51	12/01/2019 19:31	12/01/2019 17:51	12/01/2019 19:31	1,67	75	125,00	CHI
20190148309	SAO FRANCISCO DE GOIAS	SF12000106	SAO FRANCISCO DE GOIAS	12/01/2019 18:03	13/01/2019 09:32	12/01/2019 18:03	13/01/2019 09:32	15,48	9	139,35	DIA CRITICO
20190148319	LEOPOLDO DE BULHOES	LB21351046	DAIA S2	12/01/2019 18:03	13/01/2019 14:41	12/01/2019 18:03	13/01/2019 14:41	20,63	1	20,63	CHI
20190148321	GOIANIA	GN11162083	FERROVIARIO S3	12/01/2019 17:14	13/01/2019 09:55	12/01/2019 17:14	13/01/2019 09:55	16,68	81	1351,35	DIA CRITICO
20190148328	GOIANIA	GN21276737	GOIANIA LESTE S2	12/01/2019 17:53	13/01/2019 21:06	12/01/2019 17:53	13/01/2019 21:06	27,22	2	54,43	DIA CRITICO
20190148330	GOIANIA	GN12000153	REAL S2	12/01/2019 17:32	12/01/2019 19:34	12/01/2019 17:32	12/01/2019 19:34	2,03	545	1108,17	CHI
20190148331	SENADOR CANEDO	SW11167939	SENADOR CANEDO	12/01/2019 17:55	13/01/2019 00:33	12/01/2019 17:55	13/01/2019 00:33	6,63	69	457,70	CHI
20190148335	GOIAS	GS12250574	GOIAS	12/01/2019 17:56	13/01/2019 10:18	12/01/2019 17:56	13/01/2019 10:18	16,37	8	130,93	CHI
20190148350	ARAGUAPAZ	AZ12042978	MOZARLANDIA	12/01/2019 18:01	13/01/2019 08:40	12/01/2019 18:01	12/01/2019 21:47	3,77	1	3,77	CHI

20190148350	ARAGUAPAZ	AZ12042934LD	MOZARLANDIA	12/01/2019 18:01	13/01/2019 08:40	12/01/2019 18:01	12/01/2019 23:42	5,68	7	39,78	CHI
20190148350	ARAGUAPAZ	AZ13307476	MOZARLANDIA	12/01/2019 18:01	13/01/2019 08:40	12/01/2019 18:01	13/01/2019 08:40	14,65	9	131,85	CHI
20190148355	BURITI DE GOIAS	BS12169767	FIRMINOPOLIS S2	12/01/2019 18:02	12/01/2019 20:12	12/01/2019 18:02	12/01/2019 20:12	2,17	24	52,00	CHI
20190148355	SANCLERLANDIA	BS12169767	FIRMINOPOLIS S2	12/01/2019 18:02	12/01/2019 20:12	12/01/2019 18:02	12/01/2019 20:12	2,17	56	121,33	CHI
20190148355	SAO LUIS DE MONTES BELOS	BS12169767	FIRMINOPOLIS S2	12/01/2019 18:02	12/01/2019 20:12	12/01/2019 18:02	12/01/2019 20:12	2,17	4	8,67	CHI
20190148356	ANAPOLIS	AN11129052	JUNDIAI S2	12/01/2019 17:41	12/01/2019 21:55	12/01/2019 17:41	12/01/2019 21:55	4,23	190	804,33	CHI
20190148358	GOIANIA	GN12072714	GOYA S1	12/01/2019 17:16	12/01/2019 21:52	12/01/2019 17:16	12/01/2019 21:52	4,60	1414	6504,40	DIA CRITICO
20190148369	GOIANDIRA	GD21287053	CATALAO S1	12/01/2019 18:05	14/01/2019 15:55	12/01/2019 18:05	14/01/2019 15:55	45,83	1	45,83	DIA CRITICO
20190148378	GOIANAPOLIS	TJ12389754	DAIA S2	12/01/2019 16:36	13/01/2019 09:50	12/01/2019 16:36	13/01/2019 09:50	17,23	2	34,47	CHI
20190148378	TEREZOPOLIS DE GOIAS	TJ12389754	DAIA S2	12/01/2019 16:36	13/01/2019 09:50	12/01/2019 16:36	13/01/2019 09:50	17,23	16	275,73	CHI
20190148391	GUAPO	GA12000003LD	GUAPO S1	12/01/2019 17:46	12/01/2019 23:27	12/01/2019 19:58	12/01/2019 21:55	1,95	541	1054,95	CHI
20190148391	GUAPO	GA12000158LD	GUAPO S1	12/01/2019 17:46	12/01/2019 23:27	12/01/2019 17:46	12/01/2019 23:27	5,68	1535	8723,92	CHI
20190148392	TRINDADE	TR11000017	TRINDADE	12/01/2019 17:57	13/01/2019 12:39	12/01/2019 17:57	13/01/2019 12:39	18,70	162	3029,40	DIA CRITICO
20190148393	TRINDADE	TR10395417	TRINDADE	12/01/2019 17:10	13/01/2019 12:48	12/01/2019 17:10	12/01/2019 19:31	2,35	249	585,15	DIA CRITICO
20190148393	TRINDADE	TR13000018	TRINDADE	12/01/2019 17:10	13/01/2019 12:48	12/01/2019 17:10	12/01/2019 20:36	3,43	5217	17911,70	DIA CRITICO
20190148393	TRINDADE	TR10395417	TRINDADE	12/01/2019 17:10	13/01/2019 12:48	12/01/2019 21:34	12/01/2019 21:38	0,07	5466	364,40	DIA CRITICO
20190148393	TRINDADE	TR13346333	TRINDADE	12/01/2019 17:10	13/01/2019 12:48	12/01/2019 17:10	12/01/2019 22:06	4,93	101	498,27	DIA CRITICO
20190148393	TRINDADE	TR12005126LD	TRINDADE	12/01/2019 17:10	13/01/2019 12:48	12/01/2019 17:10	12/01/2019 22:10	5,00	420	2100,00	DIA CRITICO
20190148393	GOIANIA	TR12005126LD	TRINDADE	12/01/2019 17:10	13/01/2019 12:48	12/01/2019 17:10	13/01/2019 12:48	19,63	50	981,67	DIA CRITICO
20190148393	TRINDADE	TR12005126LD	TRINDADE	12/01/2019 17:10	13/01/2019 12:48	12/01/2019 17:10	13/01/2019 12:48	19,63	762	14960,60	DIA CRITICO
20190148394	GOIANIA	GN11168565	CARAJAS S1	12/01/2019 17:27	13/01/2019 11:45	12/01/2019 17:27	13/01/2019 11:45	18,30	64	1171,20	CHI
20190148399	HIDROLINA	HL11269818	URUACU	12/01/2019 18:05	13/01/2019 02:00	12/01/2019 18:05	13/01/2019 02:00	7,92	83	657,08	CHI
20190148401	MOSSAMEDES	KB12381762	ANICUNS	12/01/2019 18:05	13/01/2019 21:53	12/01/2019 18:05	13/01/2019 21:53	27,80	3	83,40	CHI
20190148408	GOIANIA	GN21031139	AEROPORTO S1	12/01/2019 18:08	13/01/2019 02:30	12/01/2019 18:08	13/01/2019 02:30	8,37	1	8,37	DIA CRITICO
20190148416	GOIANIA	GN11337834	XAVANTES	12/01/2019 18:02	14/01/2019 07:41	12/01/2019 18:02	14/01/2019 07:41	37,65	6	225,90	DIA CRITICO
20190148418	GOIANIA	GN11001143	GOIANIA LESTE S1	12/01/2019 17:46	13/01/2019 14:46	12/01/2019 17:46	13/01/2019 14:46	21,00	109	2289,00	CHI
20190148419	MIMOSO DE GOIAS	PB12333289	PADRE BERNARDO	12/01/2019 16:03	13/01/2019 15:20	12/01/2019 16:03	13/01/2019 15:20	23,28	42	977,90	CHI
20190148419	PADRE BERNARDO	PB12333289	PADRE BERNARDO	12/01/2019 16:03	13/01/2019 15:20	12/01/2019 16:03	13/01/2019 15:20	23,28	7	162,98	CHI
20190148420	GOIANIA	GN12155252	CAMPINAS S2	12/01/2019 17:24	13/01/2019 10:24	12/01/2019 17:24	13/01/2019 10:24	17,00	130	2210,00	DIA CRITICO
20190148424	GOIANIA	GN11201575	GOYA S1	12/01/2019 17:31	13/01/2019 19:47	12/01/2019 17:31	13/01/2019 19:47	26,27	101	2652,93	DIA CRITICO
20190148434	PETROLINA DE GOIAS	PG12031546	PETROLINA	12/01/2019 18:02	12/01/2019 20:29	12/01/2019 18:02	12/01/2019 20:29	2,45	24	58,80	DIA CRITICO
20190148435	SANTA ROSA DE GOIAS	SR21312810	INHUMAS S1	12/01/2019 18:08	13/01/2019 21:57	12/01/2019 18:08	13/01/2019 21:57	27,82	1	27,82	CHI
20190148436	PIRENOPOLIS	PV12273236	SAO FRANCISCO DE GOIAS	12/01/2019 17:49	13/01/2019 00:15	12/01/2019 17:49	13/01/2019 00:15	6,43	13	83,63	DIA CRITICO

20190148436	SAO FRANCISCO DE GOIAS	PV12273236	SAO FRANCISCO DE GOIAS	12/01/2019 17:49	13/01/2019 00:15	12/01/2019 17:49	13/01/2019 00:15	6,43	11	70,77	DIA CRITICO
20190148442	SANTA RITA DO NOVO DESTINO	DF21287209	BARRO ALTO	12/01/2019 18:09	13/01/2019 09:01	12/01/2019 18:09	13/01/2019 09:01	14,87	1	14,87	CHI
20190148446	AGUAS LINDAS DE GOIAS	4830015495	AGUAS LINDAS DE GOIAS S1	12/01/2019 18:09	12/01/2019 19:56	12/01/2019 18:09	12/01/2019 19:56	1,78	1	1,78	CHI
20190148448	GOIANIRA	GR11167473	GOIANIRA	12/01/2019 17:42	14/01/2019 11:17	12/01/2019 17:42	14/01/2019 11:17	41,58	248	10312,67	DIA CRITICO
20190148455	GOIANIA	GN11002033	GOIANIA LESTE S3	12/01/2019 17:31	12/01/2019 23:09	12/01/2019 17:31	12/01/2019 23:09	5,63	174	980,20	DIA CRITICO
20190148459	GOIANIA	GN11189337	CARAJAS S1	12/01/2019 17:35	13/01/2019 15:13	12/01/2019 17:35	13/01/2019 15:13	21,63	43	930,23	CHI
20190148467	BONOPOLIS	BX12202593	SAO MIGUEL DO ARAGUAIA	12/01/2019 17:11	13/01/2019 07:35	12/01/2019 17:11	13/01/2019 07:35	14,40	5	72,00	DIA CRITICO
20190148468	GOIANIA	GN11162159	MEIA PONTE	12/01/2019 17:46	13/01/2019 16:00	12/01/2019 17:46	13/01/2019 16:00	22,23	172	3824,13	DIA CRITICO
20190148472	JARAGUA	JA12000144	JARAGUA	12/01/2019 17:05	12/01/2019 20:34	12/01/2019 17:05	12/01/2019 20:34	3,48	212	738,47	CHI
20190148478	INACIOLANDIA	ID12371230	CACHOEIRA DOURADA	12/01/2019 18:12	12/01/2019 21:15	12/01/2019 18:12	12/01/2019 21:15	3,05	16	48,80	CHI
20190148478	ITUMBIARA	ID12371230	CACHOEIRA DOURADA	12/01/2019 18:12	12/01/2019 21:15	12/01/2019 18:12	12/01/2019 21:15	3,05	13	39,65	CHI
20190148486	GOIANIA	GN12220949	MEIA PONTE	12/01/2019 17:35	13/01/2019 09:47	12/01/2019 17:35	13/01/2019 09:47	16,20	276	4471,20	DIA CRITICO
20190148492	PIRACANJUBA	PJ12040801	PIRACANJUBA	12/01/2019 17:47	12/01/2019 23:43	12/01/2019 17:47	12/01/2019 23:43	5,93	33	195,80	CHI
20190148498	APARECIDA DE GOIANIA	AP11078319	INDEPENDENCIA S2	12/01/2019 18:13	12/01/2019 20:05	12/01/2019 18:13	12/01/2019 20:05	1,87	21	39,20	CHI
20190148501	CRIXAS	CX12392296	SANTA TEREZINHA	12/01/2019 18:14	13/01/2019 23:22	12/01/2019 18:14	13/01/2019 23:22	29,13	6	174,80	CHI
20190148501	SANTA TEREZINHA DE GOIAS	CX12392296	SANTA TEREZINHA	12/01/2019 18:14	13/01/2019 23:22	12/01/2019 18:14	13/01/2019 23:22	29,13	3	87,40	CHI
20190148502	APARECIDA DE GOIANIA	AP11085125	ATLANTICO S1	12/01/2019 18:01	12/01/2019 20:20	12/01/2019 18:01	12/01/2019 20:20	2,32	94	217,77	CHI
20190148505	JATAI	JT11377900	JATAI S1	12/01/2019 18:14	13/01/2019 10:17	12/01/2019 18:14	13/01/2019 10:17	16,05	1	16,05	CHI
20190148506	ABADIANIA	AA12285384	ANAPOLIS UNIVERSITARIO S1	12/01/2019 16:15	13/01/2019 09:21	12/01/2019 16:15	13/01/2019 09:21	17,10	95	1624,50	CHI
20190148506	GAMELEIRA DE GOIAS	AA12285384	ANAPOLIS UNIVERSITARIO S1	12/01/2019 16:15	13/01/2019 09:21	12/01/2019 16:15	13/01/2019 09:21	17,10	1	17,10	CHI
20190148508	ADELANDIA	DN21259961	ANICUNS	12/01/2019 18:14	13/01/2019 14:29	12/01/2019 18:14	13/01/2019 14:29	20,25	1	20,25	CHI
20190148510	GOIANIRA	GR12282901	INHUMAS S1	12/01/2019 18:15	13/01/2019 14:47	12/01/2019 18:15	13/01/2019 14:47	20,53	23	472,27	CHI
20190148510	TRINDADE	GR12282901	INHUMAS S1	12/01/2019 18:15	13/01/2019 14:47	12/01/2019 18:15	13/01/2019 14:47	20,53	64	1314,13	CHI
20190148519	ITAPURANGA	IK12311322	ITAPURANGA	12/01/2019 16:52	13/01/2019 17:15	12/01/2019 16:52	13/01/2019 13:45	20,88	4	83,53	CHI
20190148519	ITAPURANGA	19645058	ITAPURANGA	12/01/2019 16:52	13/01/2019 17:15	12/01/2019 16:52	13/01/2019 17:15	24,38	4	97,53	CHI
20190148521	SANTA BARBARA DE GOIAS	SB11049964	TRINDADE	12/01/2019 17:24	14/01/2019 12:55	12/01/2019 17:24	14/01/2019 12:55	43,52	111	4830,35	DIA CRITICO
20190148523	GOIANIA	10001116574	MEIA PONTE	12/01/2019 18:16	14/01/2019 19:54	12/01/2019 18:16	14/01/2019 19:54	49,63	1	49,63	DIA CRITICO
20190148527	ITAPURANGA	IK12073123	ITAPURANGA	12/01/2019 18:16	13/01/2019 09:59	12/01/2019 18:16	13/01/2019 09:59	15,72	35	550,08	CHI
20190148539	CEZARINA	04880224	PALMEIRAS	12/01/2019 20:44	13/01/2019 11:44	12/01/2019 20:44	12/01/2019 21:05	0,35	5	1,75	CHI
20190148539	INDIARA	04880224	PALMEIRAS	12/01/2019 20:44	13/01/2019 11:44	12/01/2019 20:44	12/01/2019 21:05	0,35	3	1,05	CHI
20190148539	PALMEIRAS DE GOIAS	04880224	PALMEIRAS	12/01/2019 20:44	13/01/2019 11:44	12/01/2019 20:44	12/01/2019 21:05	0,35	398	139,30	CHI
20190148539	PALMEIRAS DE GOIAS	04880224	PALMEIRAS	12/01/2019 20:44	13/01/2019 11:44	12/01/2019 20:44	12/01/2019 23:11	2,45	5	12,25	CHI
20190148539	PALMEIRAS DE GOIAS	04880224	PALMEIRAS	12/01/2019 20:44	13/01/2019 11:44	12/01/2019 20:44	13/01/2019 11:44	15,00	1	15,00	CHI

20190148539	PALMEIRAS DE GOIAS	04880224	PALMEIRAS	12/01/2019 20:44	13/01/2019 11:44	12/01/2019 20:44	13/01/2019 11:44	15,00	18	270,00	CHI
20190148539	PALMEIRAS DE GOIAS	PL13194026	PALMEIRAS	12/01/2019 20:44	13/01/2019 11:44	12/01/2019 20:44	13/01/2019 11:44	15,00	114	1710,00	CHI
20190148544	GOIANIA	GN12000243	XAVANTES	12/01/2019 17:22	13/01/2019 09:30	12/01/2019 17:22	13/01/2019 09:30	16,13	291	4694,80	DIA CRITICO
20190148556	LEOPOLDO DE BULHOES	LB12353350	DAIA S2	12/01/2019 18:15	13/01/2019 12:29	12/01/2019 18:15	13/01/2019 12:29	18,23	23	419,37	CHI
20190148561	GOIANIA	GN12275486	GOYA S2	12/01/2019 17:20	13/01/2019 09:00	12/01/2019 17:20	13/01/2019 09:00	15,67	228	3572,00	DIA CRITICO
20190148562	BRAZABRANTES	GR21016006	NEROPOLIS S1	12/01/2019 18:18	13/01/2019 21:47	12/01/2019 18:18	13/01/2019 21:47	27,48	2	54,97	DIA CRITICO
20190148563	GOIANIA	GN11167563	MEIA PONTE	12/01/2019 17:01	13/01/2019 12:45	12/01/2019 17:01	13/01/2019 12:45	19,73	117	2308,80	DIA CRITICO
20190148586	GOIANIA	GN11329504	INDEPENDENCIA S2	12/01/2019 18:19	13/01/2019 20:58	12/01/2019 18:19	13/01/2019 20:58	26,65	135	3597,75	CHI
20190148590	APARECIDA DE GOIANIA	AP11234809	ATLANTICO S2	12/01/2019 18:01	12/01/2019 21:13	12/01/2019 18:01	12/01/2019 21:13	3,20	48	153,60	CHI
20190148593	OURO VERDE DE GOIAS	OV11130758	NEROPOLIS S1	12/01/2019 18:02	13/01/2019 12:32	12/01/2019 18:02	13/01/2019 12:32	18,50	46	851,00	DIA CRITICO
20190148594	CAMPO LIMPO	AN12084813	NEROPOLIS S1	12/01/2019 16:58	13/01/2019 11:38	12/01/2019 16:58	13/01/2019 11:38	18,67	61	1138,67	DIA CRITICO
20190148594	OURO VERDE DE GOIAS	AN12084813	NEROPOLIS S1	12/01/2019 16:58	13/01/2019 11:38	12/01/2019 16:58	13/01/2019 11:38	18,67	1	18,67	DIA CRITICO
20190148596	ITAPIRAPUA	IU11220473	MATRINCHA	12/01/2019 18:20	12/01/2019 19:22	12/01/2019 18:20	12/01/2019 19:22	1,03	17	17,57	CHI
20190148599	GOIANIA	GN11205698	GOYA S2	12/01/2019 18:00	13/01/2019 10:01	12/01/2019 18:00	13/01/2019 10:01	16,02	163	2610,72	DIA CRITICO
20190148603	TRINDADE	TR12169662	TRINDADE	12/01/2019 17:19	12/01/2019 22:58	12/01/2019 17:19	12/01/2019 22:58	5,65	212	1197,80	DIA CRITICO
20190148606	TRINDADE	TR11207461	TRINDADE	12/01/2019 17:40	13/01/2019 13:15	12/01/2019 17:40	13/01/2019 13:15	19,58	50	979,17	DIA CRITICO
20190148615	GOIANIA	GN11002543	XAVANTES	12/01/2019 16:59	14/01/2019 10:13	12/01/2019 16:59	14/01/2019 10:13	41,23	39	1608,10	DIA CRITICO
20190148622	GOIANIA	GN11053208	XAVANTES	12/01/2019 17:33	14/01/2019 17:15	12/01/2019 17:33	14/01/2019 17:15	47,70	165	7870,50	DIA CRITICO
20190148633	ITAPURANGA	IK12387482	ITAPURANGA	12/01/2019 17:24	13/01/2019 09:25	12/01/2019 17:24	13/01/2019 09:25	16,02	22	352,37	CHI
20190148634	HIDROLANDIA	HD12000191	ANHANGUERA	12/01/2019 18:23	12/01/2019 19:00	12/01/2019 18:23	12/01/2019 19:00	0,62	25	15,42	CHI
20190148636	GOIANIA	GN12001389	CAMPINAS S2	12/01/2019 17:54	13/01/2019 11:39	12/01/2019 17:54	13/01/2019 11:39	17,75	276	4899,00	DIA CRITICO
20190148637	GOIANIA	GN12057812	ATLANTICO S2	12/01/2019 17:59	12/01/2019 22:45	12/01/2019 17:59	12/01/2019 22:45	4,77	327	1558,70	CHI
20190148650	ANAPOLIS	AN11086508	NEROPOLIS S1	12/01/2019 18:02	13/01/2019 09:05	12/01/2019 18:02	13/01/2019 09:05	15,05	175	2633,75	DIA CRITICO
20190148651	ITAGUARU	IC21037004	ITABERAI S1	12/01/2019 18:24	13/01/2019 15:31	12/01/2019 18:24	13/01/2019 15:31	21,12	2	42,23	CHI
20190148655	ARAGOIANIA	AO11251669	GUAPO S2	12/01/2019 18:16	12/01/2019 23:45	12/01/2019 18:16	12/01/2019 23:42	5,43	19	103,23	CHI
20190148655	ARAGOIANIA	AO32251689	GUAPO S2	12/01/2019 18:16	12/01/2019 23:45	12/01/2019 22:41	12/01/2019 23:45	1,07	7	7,47	CHI
20190148662	ARACU	AR12200075	ARACU	12/01/2019 17:53	12/01/2019 19:27	12/01/2019 17:53	12/01/2019 19:27	1,57	232	363,47	DIA CRITICO
20190148662	INHUMAS	AR12200075	ARACU	12/01/2019 17:53	12/01/2019 19:27	12/01/2019 17:53	12/01/2019 19:27	1,57	21	32,90	DIA CRITICO
20190148662	ITAUCU	AR12200075	ARACU	12/01/2019 17:53	12/01/2019 19:27	12/01/2019 17:53	12/01/2019 19:27	1,57	6	9,40	DIA CRITICO
20190148679	TRINDADE	TR12185497	GOYA S1	12/01/2019 17:52	13/01/2019 13:09	12/01/2019 17:52	13/01/2019 11:34	17,70	98	1734,60	DIA CRITICO
20190148679	TRINDADE	TR11185436	GOYA S1	12/01/2019 17:52	13/01/2019 13:09	13/01/2019 11:35	13/01/2019 13:09	1,57	98	153,53	DIA CRITICO
20190148686	GOIANIA	GN11002726	MEIA PONTE	12/01/2019 17:49	13/01/2019 21:31	12/01/2019 17:49	13/01/2019 21:31	27,70	225	6232,50	DIA CRITICO
20190148691	ANAPOLIS	AN12267843	ANAPOLIS UNIVERSITARIO S2	12/01/2019 18:28	13/01/2019 14:55	12/01/2019 18:28	13/01/2019 14:55	20,45	5	102,25	CHI

20190148698	NEROPOLIS	NR12329594	NEROPOLIS S2	12/01/2019 16:39	12/01/2019 19:44	12/01/2019 16:39	12/01/2019 19:44	3,08	1016	3132,67	CHI
20190148699	ITAPURANGA	IK11000023	ITAPURANGA	12/01/2019 17:06	13/01/2019 08:51	12/01/2019 17:06	13/01/2019 08:51	15,75	119	1874,25	CHI
20190148703	NOVA IGUACU DE GOIAS	GG12375656	SANTA TEREZINHA	13/01/2019 05:16	13/01/2019 10:30	13/01/2019 05:16	13/01/2019 10:30	5,23	6	31,40	DIA CRITICO
20190148703	PILAR DE GOIAS	GG12375656	SANTA TEREZINHA	13/01/2019 05:16	13/01/2019 10:30	13/01/2019 05:16	13/01/2019 10:30	5,23	14	73,27	DIA CRITICO
20190148709	SANTA BARBARA DE GOIAS	SB11215432	TRINDADE	12/01/2019 17:55	14/01/2019 12:05	12/01/2019 17:55	14/01/2019 12:05	42,17	116	4891,33	DIA CRITICO
20190148715	PORTELANDIA	PW11000033	PARQUE DAS EMAS	12/01/2019 18:30	12/01/2019 20:22	12/01/2019 18:30	12/01/2019 20:22	1,87	80	149,33	CHI
20190148717	TRINDADE	TR12050572	TRINDADE	12/01/2019 17:32	12/01/2019 21:59	12/01/2019 17:32	12/01/2019 21:59	4,45	287	1277,15	DIA CRITICO
20190148726	NIQUELANDIA	NQ12315971	BARRO ALTO	12/01/2019 18:29	12/01/2019 19:45	12/01/2019 18:29	12/01/2019 19:45	1,27	15	19,00	CHI
20190148726	VILA PROPICIO	NQ12315971	BARRO ALTO	12/01/2019 18:29	12/01/2019 19:45	12/01/2019 18:29	12/01/2019 19:45	1,27	1	1,27	CHI
20190148727	PIRES DO RIO	PR21082356	PIRES DO RIO S1	12/01/2019 18:29	13/01/2019 05:35	12/01/2019 18:29	13/01/2019 05:35	11,10	2	22,20	CHI
20190148735	SAO MIGUEL DO ARAGUAIA	SM12315127	SAO MIGUEL DO ARAGUAIA	12/01/2019 18:31	13/01/2019 12:30	12/01/2019 18:31	13/01/2019 12:30	17,98	2	35,97	DIA CRITICO
20190148739	GOIANIA	10194770	AEROPORTO S2	12/01/2019 18:31	14/01/2019 18:14	12/01/2019 18:31	14/01/2019 18:14	47,72	1	47,72	DIA CRITICO
20190148752	ARAGOIANIA	AO11167635	GUAPO S2	12/01/2019 18:31	13/01/2019 11:07	12/01/2019 18:31	13/01/2019 11:07	16,60	13	215,80	CHI
20190148754	APARECIDA DE GOIANIA	AP11201087	REAL S1	12/01/2019 17:58	12/01/2019 20:01	12/01/2019 17:58	12/01/2019 20:01	2,05	73	149,65	CHI
20190148767	PLANALTINA	02170406	PLANALTINA	12/01/2019 17:50	12/01/2019 23:05	12/01/2019 17:50	12/01/2019 23:05	5,25	299	1569,75	CHI
20190148773	ANICUNS	AC12304530	ANICUNS	12/01/2019 18:33	13/01/2019 09:40	12/01/2019 18:33	13/01/2019 09:40	15,12	1	15,12	CHI
20190148773	MOSSAMEDES	AC12304530	ANICUNS	12/01/2019 18:33	13/01/2019 09:40	12/01/2019 18:33	13/01/2019 09:40	15,12	5	75,58	CHI
20190148774	TRINDADE	TR11091345	TRINDADE	12/01/2019 18:12	13/01/2019 12:51	12/01/2019 18:12	13/01/2019 12:51	18,65	150	2797,50	DIA CRITICO
20190148778	GOIANIA	GN11213958	GOYA S1	12/01/2019 18:24	13/01/2019 11:37	12/01/2019 18:24	13/01/2019 11:37	17,22	93	1601,15	DIA CRITICO
20190148804	LUZIANIA	LZ12209094	RIO VERMELHO	12/01/2019 18:12	12/01/2019 20:15	12/01/2019 18:12	12/01/2019 20:15	2,05	59	120,95	CHI
20190148809	HIDROLINA	SZ12115033	BARRO ALTO	12/01/2019 18:33	13/01/2019 12:25	12/01/2019 18:33	13/01/2019 12:25	17,87	1	17,87	CHI
20190148809	SAO LUIZ DO NORTE	SZ12115033	BARRO ALTO	12/01/2019 18:33	13/01/2019 12:25	12/01/2019 18:33	13/01/2019 12:25	17,87	9	160,80	CHI
20190148812	ALEXANIA	AX11210817	CORUMBA	12/01/2019 18:36	12/01/2019 19:42	12/01/2019 18:36	12/01/2019 19:42	1,10	98	107,80	DIA CRITICO
20190148826	BELA VISTA DE GOIAS	BV12201455	BELA VISTA S2	12/01/2019 18:37	13/01/2019 10:15	12/01/2019 18:37	13/01/2019 10:15	15,63	3	46,90	CHI
20190148827	GOIANIA	GN12240918	GOYA S1	12/01/2019 18:15	13/01/2019 16:49	12/01/2019 18:15	13/01/2019 16:49	22,57	99	2234,10	DIA CRITICO
20190148831	TRINDADE	TR12000052	TRINDADE	12/01/2019 17:20	13/01/2019 14:45	12/01/2019 17:20	13/01/2019 14:45	21,42	102	2184,50	DIA CRITICO
20190148834	GOIANIA	GN11216354	CAMPINAS S2	12/01/2019 17:38	14/01/2019 03:13	12/01/2019 17:38	14/01/2019 03:13	33,58	83	2787,42	DIA CRITICO
20190148835	URUACU	640108076	URUACU	12/01/2019 18:38	12/01/2019 22:56	12/01/2019 18:38	12/01/2019 22:56	4,30	1	4,30	CHI
20190148836	ITAUCU	IX12032570	INHUMAS S1	12/01/2019 18:38	13/01/2019 18:16	12/01/2019 18:38	13/01/2019 18:16	23,63	5	118,17	CHI
20190148848	PIRENOPOLIS	PV12297714	CORUMBA	12/01/2019 17:53	12/01/2019 23:15	12/01/2019 17:53	12/01/2019 23:15	5,37	7	37,57	DIA CRITICO
20190148850	APARECIDA DE GOIANIA	AP12111849	INDEPENDENCIA S2	12/01/2019 18:00	12/01/2019 21:48	12/01/2019 18:00	12/01/2019 21:48	3,80	414	1573,20	CHI
20190148853	JARAGUA	SF12297981	SAO FRANCISCO DE GOIAS	12/01/2019 18:39	13/01/2019 16:24	12/01/2019 18:39	13/01/2019 16:24	21,75	104	2262,00	DIA CRITICO
20190148853	JESUPOLIS	SF12297981	SAO FRANCISCO DE GOIAS	12/01/2019 18:39	13/01/2019 16:24	12/01/2019 18:39	13/01/2019 16:24	21,75	5	108,75	DIA CRITICO

20190148853	SAO FRANCISCO DE GOIAS	SF12297981	SAO FRANCISCO DE GOIAS	12/01/2019 18:39	13/01/2019 16:24	12/01/2019 18:39	13/01/2019 16:24	21,75	2	43,50	DIA CRITICO
20190148854	TRINDADE	TR11156205	TRINDADE	12/01/2019 17:31	13/01/2019 14:09	12/01/2019 17:31	13/01/2019 14:09	20,63	165	3404,50	DIA CRITICO
20190148864	GUARINOS	GF12099271	SANTA TEREZINHA	12/01/2019 18:40	13/01/2019 18:38	12/01/2019 18:40	13/01/2019 18:38	23,97	41	982,63	CHI
20190148864	PILAR DE GOIAS	GF12099271	SANTA TEREZINHA	12/01/2019 18:40	13/01/2019 18:38	12/01/2019 18:40	13/01/2019 18:38	23,97	1	23,97	CHI
20190148872	ABADIANIA	00050244	ANAPOLIS UNIVERSITARIO S2	12/01/2019 16:14	12/01/2019 16:19	12/01/2019 16:14	12/01/2019 16:19	0,08	13	1,08	CHI
20190148872	ANAPOLIS	00050244	ANAPOLIS UNIVERSITARIO S2	12/01/2019 16:14	12/01/2019 16:19	12/01/2019 16:14	12/01/2019 16:19	0,08	7572	631,00	CHI
20190148872	CAMPO LIMPO	00050244	ANAPOLIS UNIVERSITARIO S2	12/01/2019 16:14	12/01/2019 16:19	12/01/2019 16:14	12/01/2019 16:19	0,08	13	1,08	CHI
20190148872	PIRENOPOLIS	00050244	ANAPOLIS UNIVERSITARIO S2	12/01/2019 16:14	12/01/2019 16:19	12/01/2019 16:14	12/01/2019 16:19	0,08	82	6,83	CHI
20190148874	GOIANIA	GN11337780	MEIA PONTE	12/01/2019 18:33	13/01/2019 14:06	12/01/2019 18:33	13/01/2019 14:06	19,55	55	1075,25	DIA CRITICO
20190148880	MUNDO NOVO DE GOIAS	MH12269270	NOVA CRIXAS	12/01/2019 17:38	13/01/2019 14:26	12/01/2019 17:38	12/01/2019 21:48	4,17	38	158,33	CHI
20190148880	MUNDO NOVO DE GOIAS	MH11269410	NOVA CRIXAS	12/01/2019 17:38	13/01/2019 14:26	12/01/2019 17:38	13/01/2019 14:26	20,80	1	20,80	CHI
20190148881	CRISTIANOPOLIS	BV12023166	CRISTIANOPOLIS	12/01/2019 18:42	13/01/2019 10:28	12/01/2019 18:42	13/01/2019 10:28	15,77	4	63,07	CHI
20190148883	GOIANIA	GN11004888	ATLANTICO S1	12/01/2019 18:37	13/01/2019 16:54	12/01/2019 18:37	13/01/2019 16:54	22,28	123	2740,85	CHI
20190148888	ANAPOLIS	AN10383660	ANAPOLIS UNIVERSITARIO S1	12/01/2019 16:01	13/01/2019 02:34	12/01/2019 16:01	12/01/2019 21:31	5,50	1043	5736,50	CHI
20190148888	ANAPOLIS	AN10383660	ANAPOLIS UNIVERSITARIO S1	12/01/2019 16:01	13/01/2019 02:34	12/01/2019 20:57	12/01/2019 21:31	0,57	2893	1639,37	CHI
20190148888	ANAPOLIS	AN10383660	ANAPOLIS UNIVERSITARIO S1	12/01/2019 16:01	13/01/2019 02:34	12/01/2019 21:32	12/01/2019 21:35	0,05	3936	196,80	CHI
20190148888	ANAPOLIS	AN10383660	ANAPOLIS UNIVERSITARIO S1	12/01/2019 16:01	13/01/2019 02:34	12/01/2019 16:01	12/01/2019 22:50	6,82	1402	9556,97	CHI
20190148888	ANAPOLIS	AN10383660	ANAPOLIS UNIVERSITARIO S1	12/01/2019 16:01	13/01/2019 02:34	12/01/2019 16:01	12/01/2019 23:55	7,90	1949	15397,10	CHI
20190148888	ANAPOLIS	AN10383660	ANAPOLIS UNIVERSITARIO S1	12/01/2019 16:01	13/01/2019 02:34	12/01/2019 16:01	13/01/2019 00:01	8,00	3065	24520,00	CHI
20190148888	ANAPOLIS	AN10383660	ANAPOLIS UNIVERSITARIO S1	12/01/2019 16:01	13/01/2019 02:34	12/01/2019 16:01	13/01/2019 02:34	10,55	141	1487,55	CHI
20190148890	GOIANIA	GN11162194	MEIA PONTE	12/01/2019 17:14	12/01/2019 23:43	12/01/2019 17:14	12/01/2019 23:43	6,48	232	1504,13	DIA CRITICO
20190148896	GOIANIA	GN11001594	GOIANIA LESTE S2	12/01/2019 17:16	14/01/2019 11:51	12/01/2019 17:16	14/01/2019 11:51	42,58	107	4556,42	DIA CRITICO
20190148897	BELA VISTA DE GOIAS	BV12366278	BELA VISTA S1	12/01/2019 18:26	13/01/2019 08:31	12/01/2019 18:26	13/01/2019 08:31	14,08	3	42,25	CHI
20190148897	PIRACANJUBA	BV12366278	BELA VISTA S1	12/01/2019 18:26	13/01/2019 08:31	12/01/2019 18:26	13/01/2019 08:31	14,08	79	1112,58	CHI
20190148908	TRINDADE	TR12193070	GOYA S1	12/01/2019 18:36	13/01/2019 11:49	12/01/2019 18:36	13/01/2019 11:49	17,22	35	602,58	DIA CRITICO
20190148910	GOIANIA	GN12000100	ATLANTICO S2	12/01/2019 17:30	12/01/2019 21:15	12/01/2019 17:30	12/01/2019 21:15	3,75	1033	3873,75	CHI
20190148911	GOIANIA	GN12057443	GOYA S2	12/01/2019 17:46	14/01/2019 06:53	12/01/2019 17:46	14/01/2019 06:53	37,12	125	4639,58	DIA CRITICO
20190148913	SANCLERLANDIA	SC12005282	FIRMINOPOLIS S2	12/01/2019 18:43	13/01/2019 08:41	12/01/2019 18:43	13/01/2019 08:41	13,97	17	237,43	CHI
20190148914	CIDADE OCIDENTAL	DH12060300	MARAJOARA	12/01/2019 18:43	12/01/2019 21:36	12/01/2019 18:43	12/01/2019 21:36	2,88	7	20,18	CHI
20190148918	CRIXAS	CX21075608	RUBIATABA	12/01/2019 18:42	14/01/2019 15:52	12/01/2019 18:42	14/01/2019 15:52	45,17	2	90,33	CHI
20190148921	RUBIATABA	RB21191311	RUBIATABA	12/01/2019 18:43	12/01/2019 23:27	12/01/2019 18:43	12/01/2019 23:27	4,73	1	4,73	CHI
20190148926	CRISTALINA	KR21245536	CRISTALINA S1	12/01/2019 18:44	12/01/2019 19:56	12/01/2019 18:44	12/01/2019 19:56	1,20	1	1,20	CHI
20190148929	GOIANIA	GN11162078	CAMPINAS S3	12/01/2019 17:14	13/01/2019 07:15	12/01/2019 17:14	13/01/2019 07:15	14,02	71	995,18	DIA CRITICO

20190148930	SANTA TEREZINHA DE GOIAS	SG12237481	SANTA TEREZINHA	12/01/2019 18:43	13/01/2019 02:27	12/01/2019 18:43	13/01/2019 02:27	7,73	14	108,27	CHI
20190148933	ANAPOLIS	AN11017762	ANAPOLIS UNIVERSITARIO S2	12/01/2019 17:39	13/01/2019 09:56	12/01/2019 17:39	13/01/2019 09:56	16,28	62	1009,57	CHI
20190148934	GOIANIA	GN11213713	XAVANTES	12/01/2019 18:24	14/01/2019 00:23	12/01/2019 18:24	14/01/2019 00:23	29,98	92	2758,47	DIA CRITICO
20190148939	GOIANESIA	GE12000231	GOIANESIA S2	12/01/2019 16:40	12/01/2019 19:50	12/01/2019 16:40	12/01/2019 19:50	3,17	4	12,67	CHI
20190148946	NAZARIO	NZ11205983	ANICUNS	12/01/2019 18:29	12/01/2019 23:17	12/01/2019 18:29	12/01/2019 23:17	4,80	107	513,60	CHI
20190148949	GOIANIA	GN11056252	GOYA S2	12/01/2019 18:18	13/01/2019 21:28	12/01/2019 18:18	13/01/2019 21:28	27,17	157	4265,17	DIA CRITICO
20190148950	CORUMBA DE GOIAS	CB21215003	CORUMBA	12/01/2019 18:46	13/01/2019 18:11	12/01/2019 18:46	13/01/2019 18:11	23,42	1	23,42	DIA CRITICO
20190148953	SITIO D ABADIA	SI12234157	IACIARA S2	12/01/2019 18:43	12/01/2019 20:41	12/01/2019 18:43	12/01/2019 20:41	1,97	12	23,60	CHI
20190148955	GOIANIA	GN11147728	MEIA PONTE	12/01/2019 18:36	12/01/2019 22:53	12/01/2019 18:36	12/01/2019 22:53	4,28	124	531,13	DIA CRITICO
20190148956	PIRES DO RIO	PR12159861	PIRES DO RIO S2	12/01/2019 18:48	13/01/2019 07:51	12/01/2019 18:48	13/01/2019 07:51	13,05	45	587,25	CHI
20190148957	GOIANIA	GN12164391	MEIA PONTE	12/01/2019 17:31	13/01/2019 05:17	12/01/2019 17:31	13/01/2019 05:17	11,77	240	2824,00	DIA CRITICO
20190148959	PONTALINA	PK12047217	PONTALINA	12/01/2019 18:43	12/01/2019 19:48	12/01/2019 18:43	12/01/2019 19:48	1,08	79	85,58	CHI
20190148965	CRIXAS	CX12166640	SANTA TEREZINHA	12/01/2019 18:45	16/01/2019 11:21	12/01/2019 18:45	13/01/2019 14:45	20,00	13	260,00	CHI
20190148965	CRIXAS	CX12166640	SANTA TEREZINHA	12/01/2019 18:45	16/01/2019 11:21	13/01/2019 15:15	13/01/2019 17:25	2,17	4	8,67	CHI
20190148965	CRIXAS	CX12166640	SANTA TEREZINHA	12/01/2019 18:45	16/01/2019 11:21	12/01/2019 18:45	13/01/2019 20:58	26,22	12	314,60	CHI
20190148965	CRIXAS	CX12166640	SANTA TEREZINHA	12/01/2019 18:45	16/01/2019 11:21	13/01/2019 15:15	13/01/2019 20:58	5,72	5	28,58	CHI
20190148965	CRIXAS	CX12166640	SANTA TEREZINHA	12/01/2019 18:45	16/01/2019 11:21	13/01/2019 19:14	13/01/2019 20:58	1,73	4	6,93	CHI
20190148965	CRIXAS	CX12166640	SANTA TEREZINHA	12/01/2019 18:45	16/01/2019 11:21	13/01/2019 15:15	16/01/2019 11:21	68,10	4	272,40	CHI
20190148965	CRIXAS	CX12166640	SANTA TEREZINHA	12/01/2019 18:45	16/01/2019 11:21	16/01/2019 09:23	16/01/2019 11:21	1,97	21	41,30	CHI
20190148966	GOIANIA	GN11051446	CARAJAS S1	12/01/2019 18:18	13/01/2019 11:24	12/01/2019 18:18	13/01/2019 11:24	17,10	178	3043,80	CHI
20190148976	GAMELEIRA DE GOIAS	AN11273366	DAIA S1	12/01/2019 18:49	13/01/2019 14:47	12/01/2019 18:49	13/01/2019 14:47	19,97	26	519,13	CHI
20190148979	ANAPOLIS	AN21288963	ANAPOLIS UNIVERSITARIO S2	12/01/2019 18:47	13/01/2019 12:44	12/01/2019 18:47	13/01/2019 12:44	17,95	4	71,80	CHI
20190148984	ANAPOLIS	AN12370313	ANAPOLIS UNIVERSITARIO S2	12/01/2019 16:24	13/01/2019 02:30	12/01/2019 16:24	13/01/2019 02:30	10,10	71	717,10	CHI
20190148984	CAMPO LIMPO	AN12370313	ANAPOLIS UNIVERSITARIO S2	12/01/2019 16:24	13/01/2019 02:30	12/01/2019 16:24	13/01/2019 02:30	10,10	2	20,20	CHI
20190149014	GOIANIA	GN11076705	MEIA PONTE	12/01/2019 18:26	13/01/2019 12:53	12/01/2019 18:26	13/01/2019 12:53	18,45	230	4243,50	DIA CRITICO
20190149017	FAINA	MS12036227	ITAPURANGA	12/01/2019 18:06	12/01/2019 21:35	12/01/2019 18:06	12/01/2019 21:35	3,48	11	38,32	CHI
20190149017	MORRO AGUDO DE GOIAS	MS12036227	ITAPURANGA	12/01/2019 18:06	12/01/2019 21:35	12/01/2019 18:06	12/01/2019 21:35	3,48	27	94,05	CHI
20190149034	GOIANIA	14036060	XAVANTES	12/01/2019 18:52	13/01/2019 16:35	12/01/2019 18:52	13/01/2019 16:35	21,72	1	21,72	DIA CRITICO
20190149040	GOIANIA	GN12001252	GOIANIA LESTE S1	12/01/2019 18:25	12/01/2019 22:36	12/01/2019 18:25	12/01/2019 22:36	4,18	159	665,15	CHI
20190149043	GOIANIA	10015109907	XAVANTES	12/01/2019 18:52	14/01/2019 22:33	12/01/2019 18:52	14/01/2019 22:33	51,68	1	51,68	DIA CRITICO
20190149046	PALMELO	PZ11216192	PIRES DO RIO S2	12/01/2019 18:50	12/01/2019 20:23	12/01/2019 18:50	12/01/2019 20:23	1,55	41	63,55	CHI
20190149055	TRINDADE	TR12000015	TRINDADE	12/01/2019 18:06	12/01/2019 23:55	12/01/2019 18:06	12/01/2019 23:55	5,82	180	1047,00	DIA CRITICO
20190149056	ITAPURANGA	IK12310867	ITAPURANGA	12/01/2019 18:06	13/01/2019 13:09	12/01/2019 18:06	13/01/2019 13:09	19,05	11	209,55	CHI

20190149058	ITAPURANGA	IK12250607	ITAPURANGA	12/01/2019 18:31	12/01/2019 23:33	12/01/2019 18:31	12/01/2019 23:33	5,03	14	70,47	CHI
20190149070	GOIANIA	GN11346268	CARAJAS S1	12/01/2019 18:41	13/01/2019 16:42	12/01/2019 18:41	13/01/2019 16:42	22,02	119	2619,98	CHI
20190149088	GOIANIA	GN11133701	GOYA S2	12/01/2019 18:24	14/01/2019 07:57	12/01/2019 18:24	14/01/2019 07:57	37,55	152	5707,60	DIA CRITICO
20190149092	ITABERAI	IB11000015	ITABERAI S2	12/01/2019 18:55	12/01/2019 21:05	12/01/2019 18:55	12/01/2019 21:05	2,17	96	208,00	CHI
20190149096	ANAPOLIS	AN11004583	ANAPOLIS UNIVERSITARIO S2	13/01/2019 11:29	13/01/2019 12:50	13/01/2019 11:29	13/01/2019 12:50	1,35	181	244,35	CHI
20190149098	TRINDADE	TR11193143	GOYA S1	12/01/2019 18:22	13/01/2019 09:30	12/01/2019 18:22	13/01/2019 09:30	15,13	137	2073,27	DIA CRITICO
20190149101	CATURAI	CK12241316	GOIANIRA	12/01/2019 17:50	13/01/2019 09:14	12/01/2019 17:50	13/01/2019 09:14	15,40	146	2248,40	DIA CRITICO
20190149101	INHUMAS	CK12241316	GOIANIRA	12/01/2019 17:50	13/01/2019 09:14	12/01/2019 17:50	13/01/2019 09:14	15,40	5	77,00	DIA CRITICO
20190149103	BELA VISTA DE GOIAS	BV12079681	BELA VISTA S1	12/01/2019 18:59	13/01/2019 13:54	12/01/2019 18:59	13/01/2019 13:54	18,92	12	227,00	CHI
20190149105	GOIANIA	GN11167619	MEIA PONTE	12/01/2019 18:08	14/01/2019 12:01	12/01/2019 18:08	14/01/2019 12:01	41,88	112	4690,93	DIA CRITICO
20190149108	APARECIDA DE GOIANIA	AP11313131	INDEPENDENCIA S2	12/01/2019 17:50	13/01/2019 09:57	12/01/2019 17:50	13/01/2019 09:57	16,12	71	1144,28	CHI
20190149112	GOIANIA	GN11068952	GOIANIA LESTE S3	12/01/2019 17:55	13/01/2019 13:53	12/01/2019 17:55	13/01/2019 13:53	19,97	194	3873,53	DIA CRITICO
20190149120	INDIARA	IY12158916	CEZARINA	12/01/2019 19:01	13/01/2019 21:08	12/01/2019 19:01	13/01/2019 21:08	26,12	3	78,35	CHI
20190149124	GOIANIA	13729391	REAL S1	12/01/2019 19:00	13/01/2019 16:06	12/01/2019 19:00	13/01/2019 16:06	21,10	1	21,10	CHI
20190149129	GOIANIA	GN11167644	XAVANTES	12/01/2019 18:51	14/01/2019 11:00	12/01/2019 18:51	14/01/2019 11:00	40,15	126	5058,90	DIA CRITICO
20190149130	CATURAI	IN12000128	INHUMAS S1	12/01/2019 19:02	13/01/2019 10:56	12/01/2019 19:02	13/01/2019 10:56	15,90	33	524,70	CHI
20190149130	INHUMAS	IN12000128	INHUMAS S1	12/01/2019 19:02	13/01/2019 10:56	12/01/2019 19:02	13/01/2019 10:56	15,90	1	15,90	CHI
20190149134	INDIARA	2710013855	EDEIA	12/01/2019 19:22	13/01/2019 18:35	12/01/2019 19:22	13/01/2019 18:35	23,22	1	23,22	CHI
20190149135	GOIANIA	GN11322882	FERROVIARIO S2	12/01/2019 17:01	13/01/2019 09:11	12/01/2019 17:01	13/01/2019 09:11	16,17	117	1891,50	DIA CRITICO
20190149137	TRINDADE	TR11377667	TRINDADE	12/01/2019 18:49	12/01/2019 23:29	12/01/2019 18:49	12/01/2019 23:29	4,67	151	704,67	DIA CRITICO
20190149138	MONTIVIDIU DO NORTE	MX12365604	PORANGATU	12/01/2019 18:59	13/01/2019 09:44	12/01/2019 18:59	13/01/2019 09:44	14,75	3	44,25	CHI
20190149139	GOIANIA	TR11132425	MEIA PONTE	12/01/2019 18:58	13/01/2019 16:39	12/01/2019 18:58	13/01/2019 16:39	21,68	111	2406,85	DIA CRITICO
20190149145	APARECIDA DE GOIANIA	AP11350625	INDEPENDENCIA S1	12/01/2019 18:33	12/01/2019 22:28	12/01/2019 18:33	12/01/2019 22:28	3,92	60	235,00	CHI
20190149148	INDIARA	JD12005508	PALMEIRAS	12/01/2019 19:05	13/01/2019 08:40	12/01/2019 19:05	13/01/2019 08:40	13,58	9	122,25	CHI
20190149148	JANDAIA	JD12005508	PALMEIRAS	12/01/2019 19:05	13/01/2019 08:40	12/01/2019 19:05	13/01/2019 08:40	13,58	9	122,25	CHI
20190149152	ALEXANIA	CB12114195	CORUMBA	12/01/2019 18:51	13/01/2019 12:20	12/01/2019 18:51	13/01/2019 12:20	17,48	12	209,80	DIA CRITICO
20190149152	CORUMBA DE GOIAS	CB12114195	CORUMBA	12/01/2019 18:51	13/01/2019 12:20	12/01/2019 18:51	13/01/2019 12:20	17,48	26	454,57	DIA CRITICO
20190149157	SANTA TEREZINHA DE GOIAS	SG21243475	SANTA TEREZINHA	12/01/2019 19:05	13/01/2019 09:40	12/01/2019 19:05	13/01/2019 09:40	14,58	1	14,58	CHI
20190149164	FORMOSA	FA11085644	ITIQUEIRA	12/01/2019 18:58	12/01/2019 20:29	12/01/2019 18:58	12/01/2019 20:29	1,52	209	316,98	CHI
20190149165	GOIANIA	GN11356882	MEIA PONTE	12/01/2019 18:16	13/01/2019 14:51	12/01/2019 18:16	13/01/2019 14:51	20,58	143	2943,42	DIA CRITICO
20190149168	CAMPESTRE DE GOIAS	GC21357209	TRINDADE	12/01/2019 19:06	14/01/2019 19:16	12/01/2019 19:06	14/01/2019 19:16	48,17	1	48,17	DIA CRITICO
20190149172	TRINDADE	TR12200194	TRINDADE	12/01/2019 17:23	13/01/2019 10:30	12/01/2019 17:23	13/01/2019 10:30	17,12	23	393,68	DIA CRITICO
20190149175	HIDROLINA	HL11269773	URUACU	12/01/2019 18:42	13/01/2019 14:28	12/01/2019 18:42	13/01/2019 14:28	19,77	68	1344,13	CHI

20190149179	NOVO PLANALTO	TA11293677	SAO MIGUEL DO ARAGUAIA	12/01/2019 19:09	13/01/2019 12:37	12/01/2019 19:09	13/01/2019 12:37	17,47	1	17,47	DIA CRITICO
20190149181	GOIANIA	GN11165722	CAMPINAS S2	12/01/2019 18:06	13/01/2019 21:58	12/01/2019 18:06	13/01/2019 21:58	27,87	42	1170,40	DIA CRITICO
20190149186	LUZIANIA	LZ12149936	MARAJOARA	12/01/2019 18:32	13/01/2019 02:00	12/01/2019 18:32	13/01/2019 02:00	7,47	13	97,07	CHI
20190149191	IPAMERI	IP12404712	IPAMERI	12/01/2019 18:56	12/01/2019 20:44	12/01/2019 18:56	12/01/2019 20:44	1,80	66	118,80	CHI
20190149192	GOIANIA	GN12214738	MEIA PONTE	12/01/2019 17:31	13/01/2019 07:39	12/01/2019 17:31	13/01/2019 07:39	14,13	217	3066,93	DIA CRITICO
20190149193	NOVO BRASIL	NB12047598	JUSSARA	12/01/2019 18:11	12/01/2019 21:50	12/01/2019 18:11	12/01/2019 21:50	3,65	13	47,45	CHI
20190149195	GOIANIA	GN12001665	CAMPINAS S2	12/01/2019 17:25	13/01/2019 13:41	12/01/2019 17:25	13/01/2019 12:32	19,12	121	2313,12	DIA CRITICO
20190149195	GOIANIA	GN11002079	CAMPINAS S2	12/01/2019 17:25	13/01/2019 13:41	12/01/2019 17:25	13/01/2019 13:41	20,27	82	1661,87	DIA CRITICO
20190149197	NIQUELANDIA	NQ12095916	URUACU	12/01/2019 19:11	12/01/2019 22:10	12/01/2019 19:11	12/01/2019 22:10	2,98	2	5,97	CHI
20190149205	BELA VISTA DE GOIAS	BV12020443	BELA VISTA S2	12/01/2019 17:36	13/01/2019 01:11	12/01/2019 17:36	13/01/2019 01:11	7,58	347	2631,42	CHI
20190149206	TRINDADE	TR12266490	TRINDADE	12/01/2019 17:45	13/01/2019 10:57	12/01/2019 17:45	13/01/2019 10:57	17,20	178	3061,60	DIA CRITICO
20190149212	TRINDADE	40279078	GOYA S1	12/01/2019 19:00	14/01/2019 12:19	12/01/2019 19:00	14/01/2019 12:19	41,32	1	41,32	DIA CRITICO
20190149217	NOVA AURORA	NE11306741	CATALAO S1	12/01/2019 18:08	13/01/2019 19:45	13/01/2019 18:32	13/01/2019 19:30	0,97	57	55,10	DIA CRITICO
20190149217	NOVA AURORA	NE12127530	CATALAO S1	12/01/2019 18:08	13/01/2019 19:45	12/01/2019 18:08	13/01/2019 19:45	25,62	176	4508,53	DIA CRITICO
20190149219	GOIANIA	GN11313255	GOYA S1	12/01/2019 19:07	13/01/2019 16:40	12/01/2019 19:07	13/01/2019 16:40	21,55	61	1314,55	DIA CRITICO
20190149221	SANTA RITA DO NOVO DESTINO	DF12315581	BARRO ALTO	12/01/2019 19:14	13/01/2019 10:38	12/01/2019 19:14	12/01/2019 21:30	2,27	20	45,33	CHI
20190149221	SANTA RITA DO NOVO DESTINO	DF12315581	BARRO ALTO	12/01/2019 19:14	13/01/2019 10:38	12/01/2019 21:31	13/01/2019 10:38	13,12	20	262,33	CHI
20190149223	RUBIATABA	RB12273121	RUBIATABA	12/01/2019 19:14	12/01/2019 20:26	12/01/2019 19:14	12/01/2019 20:26	1,20	150	180,00	CHI
20190149229	GOIANIA	12538425	ATLANTICO S3	12/01/2019 19:05	14/01/2019 18:39	12/01/2019 19:05	14/01/2019 18:39	47,57	1	47,57	CHI
20190149232	CATALAO	CT12333725	CATALAO S1	12/01/2019 19:09	13/01/2019 10:13	12/01/2019 19:09	13/01/2019 10:13	15,07	6	90,40	DIA CRITICO
20190149238	GOIANIA	GN11199195	CAMPINAS S2	12/01/2019 18:58	13/01/2019 00:19	12/01/2019 18:58	13/01/2019 00:19	5,35	66	353,10	DIA CRITICO
20190149245	SANCLERLANDIA	SC11194201	FIRMINOPOLIS S2	12/01/2019 18:26	12/01/2019 22:10	12/01/2019 18:26	12/01/2019 22:10	3,73	160	597,33	CHI
20190149246	GOIANIA	GN11059718	REAL S2	12/01/2019 18:20	13/01/2019 15:51	12/01/2019 18:20	13/01/2019 15:51	21,52	161	3464,18	CHI
20190149257	GOIANIA	GN12068692	MEIA PONTE	12/01/2019 17:27	13/01/2019 07:57	12/01/2019 17:27	13/01/2019 07:57	14,50	420	6090,00	DIA CRITICO
20190149260	GOIANIA	GN11265408	FERROVIARIO S3	12/01/2019 18:27	14/01/2019 10:55	12/01/2019 18:27	14/01/2019 10:55	40,47	56	2266,13	DIA CRITICO
20190149262	CATALAO	CT12000051	CATALAO S1	12/01/2019 17:45	12/01/2019 23:11	12/01/2019 17:45	12/01/2019 23:11	5,43	63	342,30	DIA CRITICO
20190149264	SENADOR CANEDO	SW11180046	GOIANIA LESTE S2	12/01/2019 17:03	12/01/2019 23:33	12/01/2019 17:03	12/01/2019 23:33	6,50	69	448,50	DIA CRITICO
20190149282	NOVO PLANALTO	TA21249546	SAO MIGUEL DO ARAGUAIA	12/01/2019 19:12	14/01/2019 12:04	12/01/2019 19:12	14/01/2019 12:04	40,87	1	40,87	DIA CRITICO
20190149284	ARUANA	AK11061608	ARUANA	12/01/2019 19:20	13/01/2019 14:37	12/01/2019 19:20	13/01/2019 14:37	19,28	39	752,05	CHI
20190149286	GOIANIA	GN11001415	FERROVIARIO S1	12/01/2019 17:39	14/01/2019 18:40	12/01/2019 17:39	14/01/2019 18:40	49,02	71	3480,18	DIA CRITICO
20190149288	GOIANIA	GN11052662	GOYA S2	12/01/2019 17:13	13/01/2019 04:56	12/01/2019 17:13	13/01/2019 03:50	10,62	160	1698,67	DIA CRITICO
20190149288	GOIANIA	GN11212493	GOYA S2	12/01/2019 17:13	13/01/2019 04:56	12/01/2019 18:16	13/01/2019 04:51	10,58	83	878,42	DIA CRITICO
20190149288	GOIANIA	GN11197045	GOYA S2	12/01/2019 17:13	13/01/2019 04:56	12/01/2019 18:16	13/01/2019 04:56	10,67	61	650,67	DIA CRITICO

20190149296	SAO FRANCISCO DE GOIAS	SF12205371	SAO FRANCISCO DE GOIAS	12/01/2019 18:47	12/01/2019 23:21	12/01/2019 18:47	12/01/2019 23:21	4,57	2	9,13	DIA CRITICO
20190149297	GOIANIA	GN11056819	XAVANTES	12/01/2019 17:35	12/01/2019 21:00	12/01/2019 17:35	12/01/2019 21:00	3,42	205	700,42	DIA CRITICO
20190149298	ALTO HORIZONTE	AJ12398008	SANTA TEREZINHA	13/01/2019 07:33	13/01/2019 13:15	13/01/2019 07:33	13/01/2019 13:15	5,70	139	792,30	DIA CRITICO
20190149298	MARA ROSA	AJ12398008	SANTA TEREZINHA	13/01/2019 07:33	13/01/2019 13:15	13/01/2019 07:33	13/01/2019 13:15	5,70	129	735,30	DIA CRITICO
20190149298	NOVA IGUAÇU DE GOIAS	AJ12398008	SANTA TEREZINHA	13/01/2019 07:33	13/01/2019 13:15	13/01/2019 07:33	13/01/2019 13:15	5,70	24	136,80	DIA CRITICO
20190149300	SAO MIGUEL DO ARAGUAIA	SM21153694	SAO MIGUEL DO ARAGUAIA	12/01/2019 19:06	13/01/2019 14:01	12/01/2019 19:06	13/01/2019 14:01	18,92	1	18,92	DIA CRITICO
20190149305	CORREGO DO OURO	CO21051876	FIRMINOPOLIS S2	12/01/2019 19:21	19/01/2019 14:33	12/01/2019 19:21	19/01/2019 14:33	163,20	1	163,20	CHI
20190149307	GOIANIA	GN11002311	CAMPINAS S2	12/01/2019 18:08	13/01/2019 21:26	12/01/2019 18:08	13/01/2019 21:26	27,30	109	2975,70	DIA CRITICO
20190149311	SAO LUIS DE MONTES BELOS	SL12388918	SAO LUIZ DOS MONTES BELOS	12/01/2019 19:11	13/01/2019 00:55	12/01/2019 19:11	13/01/2019 00:55	5,73	179	1026,27	CHI
20190149315	GOIANIA	GN11000205	AEROPORTO S1	12/01/2019 18:34	13/01/2019 12:34	12/01/2019 18:34	13/01/2019 12:34	18,00	126	2268,00	DIA CRITICO
20190149317	CEZARINA	03320214	GUAPO S2	12/01/2019 18:59	13/01/2019 01:47	12/01/2019 18:59	13/01/2019 01:47	6,80	2	13,60	CHI
20190149317	VARJAO	03320214	GUAPO S2	12/01/2019 18:59	13/01/2019 01:47	12/01/2019 18:59	13/01/2019 01:47	6,80	953	6480,40	CHI
20190149319	CRISTALINA	IP12100702	CRISTALINA S2	12/01/2019 19:16	12/01/2019 23:55	12/01/2019 19:16	12/01/2019 23:55	4,65	19	88,35	CHI
20190149319	IPAMERI	IP12100702	CRISTALINA S2	12/01/2019 19:16	12/01/2019 23:55	12/01/2019 19:16	12/01/2019 23:55	4,65	9	41,85	CHI
20190149321	GOIANIA	GN11001676	CAMPINAS S3	12/01/2019 17:03	13/01/2019 15:40	12/01/2019 17:03	13/01/2019 15:40	22,62	140	3166,33	DIA CRITICO
20190149323	GOIANIA	GN12133742	GOYA S1	12/01/2019 18:03	13/01/2019 21:40	12/01/2019 18:03	13/01/2019 21:40	27,62	89	2457,88	DIA CRITICO
20190149330	GOIANIA	GN11002582	MEIA PONTE	12/01/2019 17:46	13/01/2019 14:45	12/01/2019 17:46	13/01/2019 14:45	20,98	203	4259,62	DIA CRITICO
20190149331	CRISTIANOPOLIS	PJ12212176	PIRACANJUBA	12/01/2019 19:25	13/01/2019 10:22	12/01/2019 19:25	13/01/2019 10:22	14,95	4	59,80	CHI
20190149331	PIRACANJUBA	PJ12212176	PIRACANJUBA	12/01/2019 19:25	13/01/2019 10:22	12/01/2019 19:25	13/01/2019 10:22	14,95	15	224,25	CHI
20190149331	SANTA CRUZ DE GOIAS	PJ12212176	PIRACANJUBA	12/01/2019 19:25	13/01/2019 10:22	12/01/2019 19:25	13/01/2019 10:22	14,95	71	1061,45	CHI
20190149339	GOIANIA	GN11043266	CAMPINAS S1	12/01/2019 18:02	13/01/2019 16:40	12/01/2019 18:02	13/01/2019 16:40	22,63	122	2761,27	DIA CRITICO
20190149343	GOIANIA	GN11000750	GOIANIA LESTE S3	12/01/2019 18:59	13/01/2019 02:27	12/01/2019 18:59	13/01/2019 02:27	7,47	77	574,93	DIA CRITICO
20190149354	GOIANIA	GN11167919	FERROVIARIO S2	12/01/2019 18:55	13/01/2019 09:50	12/01/2019 18:55	13/01/2019 09:50	14,92	52	775,67	DIA CRITICO
20190149361	GOIANIA	GN11001562	GOIANIA LESTE S1	12/01/2019 18:07	13/01/2019 08:36	12/01/2019 18:07	13/01/2019 08:36	14,48	178	2578,03	CHI
20190149363	ITAPURANGA	IK12250509	ITAPURANGA	12/01/2019 19:24	13/01/2019 19:25	12/01/2019 19:24	13/01/2019 19:25	24,02	7	168,12	CHI
20190149373	MUTUNOPOLIS	MU12214693	MARA ROSA	12/01/2019 19:27	14/01/2019 09:34	12/01/2019 19:27	14/01/2019 09:34	38,12	9	343,05	CHI
20190149384	PIRACANJUBA	PJ21106632	CALDAS NOVAS S1	12/01/2019 19:28	15/01/2019 07:44	12/01/2019 19:28	15/01/2019 07:44	60,27	2	120,53	CHI
20190149385	PROFESSOR JAMIL SAFADY	PJ12084882	ROCHEDO	12/01/2019 19:28	13/01/2019 09:35	12/01/2019 19:28	13/01/2019 09:35	14,12	27	381,15	CHI
20190149386	URUACU	640088235	URUACU	12/01/2019 19:29	12/01/2019 20:45	12/01/2019 19:29	12/01/2019 20:45	1,27	1	1,27	CHI
20190149389	ANAPOLIS	AN11135819	ANAPOLIS UNIVERSITARIO S2	12/01/2019 17:46	13/01/2019 08:05	12/01/2019 17:46	13/01/2019 08:05	14,32	108	1546,20	CHI
20190149398	ALEXANIA	AX12190700	CORUMBA	12/01/2019 19:29	12/01/2019 20:06	12/01/2019 19:29	12/01/2019 20:06	0,62	4	2,47	DIA CRITICO
20190149408	CATURAI	IN21000184	ARACU	12/01/2019 19:23	13/01/2019 17:49	12/01/2019 19:23	13/01/2019 17:49	22,43	1	22,43	DIA CRITICO
20190149409	ANAPOLIS	10005451130	JUNDIAI S1	12/01/2019 19:29	13/01/2019 10:12	12/01/2019 19:29	13/01/2019 10:12	14,72	1	14,72	CHI

20190149412	GOIANIA	GN12338058	CAMPINAS S2	12/01/2019 17:13	13/01/2019 05:15	12/01/2019 17:13	13/01/2019 05:15	12,03	337	4055,23	DIA CRITICO
20190149414	APARECIDA DE GOIANIA	AP11134415	REAL S1	12/01/2019 17:36	13/01/2019 05:51	12/01/2019 17:36	13/01/2019 05:51	12,25	154	1886,50	CHI
20190149417	CAMPINORTE	04690224	MARA ROSA	12/01/2019 19:31	14/01/2019 03:02	12/01/2019 19:31	13/01/2019 10:10	14,65	1	14,65	CHI
20190149417	CAMPINORTE	04690224	MARA ROSA	12/01/2019 19:31	14/01/2019 03:02	12/01/2019 19:31	13/01/2019 10:10	14,65	1	14,65	CHI
20190149417	URUACU	04690224	MARA ROSA	12/01/2019 19:31	14/01/2019 03:02	12/01/2019 19:31	13/01/2019 10:10	14,65	3	43,95	CHI
20190149417	CAMPINORTE	CR13269871	MARA ROSA	12/01/2019 19:31	14/01/2019 03:02	12/01/2019 19:31	13/01/2019 12:10	16,65	1	16,65	CHI
20190149417	URUACU	CR13269871	MARA ROSA	12/01/2019 19:31	14/01/2019 03:02	12/01/2019 19:31	13/01/2019 12:10	16,65	59	982,35	CHI
20190149417	URUACU	UR13243266	MARA ROSA	12/01/2019 19:31	14/01/2019 03:02	12/01/2019 19:31	13/01/2019 13:40	18,15	1	18,15	CHI
20190149417	CAMPINORTE	04690224	MARA ROSA	12/01/2019 19:31	14/01/2019 03:02	13/01/2019 13:41	13/01/2019 14:46	1,08	36	39,00	CHI
20190149417	CAMPINORTE	04690224	MARA ROSA	12/01/2019 19:31	14/01/2019 03:02	13/01/2019 13:41	13/01/2019 14:46	1,08	111	120,25	CHI
20190149417	URUACU	04690224	MARA ROSA	12/01/2019 19:31	14/01/2019 03:02	13/01/2019 13:41	13/01/2019 14:46	1,08	203	219,92	CHI
20190149417	CAMPINACU	UR13243266	MARA ROSA	12/01/2019 19:31	14/01/2019 03:02	12/01/2019 19:31	14/01/2019 03:02	31,52	10	315,17	CHI
20190149417	URUACU	UR13243266	MARA ROSA	12/01/2019 19:31	14/01/2019 03:02	12/01/2019 19:31	14/01/2019 03:02	31,52	1	31,52	CHI
20190149417	CAMPINORTE	UR13243266	MARA ROSA	12/01/2019 19:31	14/01/2019 03:02	13/01/2019 13:41	14/01/2019 03:02	13,35	17	226,95	CHI
20190149417	URUACU	UR13243266	MARA ROSA	12/01/2019 19:31	14/01/2019 03:02	13/01/2019 13:41	14/01/2019 03:02	13,35	39	520,65	CHI
20190149419	GOIANIA	GN11025839	GOIANIA LESTE S2	12/01/2019 18:44	13/01/2019 17:10	12/01/2019 18:44	13/01/2019 17:10	22,43	179	4015,57	DIA CRITICO
20190149421	GOIANIA	GN11350199	MEIA PONTE	12/01/2019 18:54	14/01/2019 14:44	12/01/2019 18:54	14/01/2019 14:44	43,83	89	3901,17	DIA CRITICO
20190149424	GOIANESIA	GE12043766	GOIANESIA S1	12/01/2019 18:48	12/01/2019 21:29	12/01/2019 18:48	12/01/2019 21:29	2,68	3	8,05	CHI
20190149427	CATALAO	CT12013670	CATALAO S1	12/01/2019 19:21	13/01/2019 11:25	12/01/2019 19:21	13/01/2019 11:25	16,07	4	64,27	DIA CRITICO
20190149430	APARECIDA DE GOIANIA	AP11169621	ATLANTICO S3	12/01/2019 18:53	13/01/2019 10:17	12/01/2019 18:53	13/01/2019 10:17	15,40	74	1139,60	CHI
20190149431	GOIANIA	GN11226674	CARAJAS S1	12/01/2019 17:42	13/01/2019 12:05	12/01/2019 17:42	13/01/2019 12:05	18,38	158	2904,57	CHI
20190149438	GOIANIA	GN11002699	GOIANIA LESTE S3	12/01/2019 19:02	13/01/2019 14:59	12/01/2019 19:02	13/01/2019 14:59	19,95	96	1915,20	DIA CRITICO
20190149441	BARRO ALTO	BA21163332	BARRO ALTO	12/01/2019 19:21	13/01/2019 16:30	12/01/2019 19:21	13/01/2019 16:30	21,15	2	42,30	CHI
20190149445	FORMOSA	FA12195886	ITUIQUIRA	12/01/2019 19:33	13/01/2019 10:35	12/01/2019 19:33	13/01/2019 10:35	15,03	47	706,57	CHI
20190149446	INHUMAS	IN12000139	ARACU	12/01/2019 16:43	13/01/2019 09:48	12/01/2019 16:43	13/01/2019 09:48	17,08	13	222,08	DIA CRITICO
20190149452	ITUMBIARA	IT11065316	ITUMBIARA VELHA S1	12/01/2019 19:22	12/01/2019 21:51	12/01/2019 19:22	12/01/2019 21:51	2,48	117	290,55	CHI
20190149457	GOIANIA	GN12000077	CAMPINAS S1	12/01/2019 18:28	12/01/2019 21:52	12/01/2019 18:28	12/01/2019 21:52	3,40	266	904,40	DIA CRITICO
20190149460	SENADOR CANEDO	SW11168679	SENADOR CANEDO	12/01/2019 19:07	13/01/2019 00:22	12/01/2019 19:07	13/01/2019 00:22	5,25	59	309,75	CHI
20190149462	GOIAS	GS12378857	MATRINCHA	12/01/2019 19:31	13/01/2019 08:49	12/01/2019 19:31	13/01/2019 08:49	13,30	7	93,10	CHI
20190149464	APARECIDA DE GOIANIA	AP11291299	INDEPENDENCIA S2	12/01/2019 18:54	13/01/2019 02:03	12/01/2019 18:54	13/01/2019 02:03	7,15	110	786,50	CHI
20190149465	GOIANIA	GN11196700	GOIANIA LESTE S3	12/01/2019 18:52	13/01/2019 00:05	12/01/2019 18:52	13/01/2019 00:05	5,22	172	897,27	DIA CRITICO
20190149469	GOIANIA	GN12166248	MEIA PONTE	12/01/2019 17:18	12/01/2019 22:54	12/01/2019 17:18	12/01/2019 22:54	5,60	1288	7212,80	DIA CRITICO
20190149470	PIRACANJUBA	PJ11071516	ROCHEDO	12/01/2019 19:35	14/01/2019 16:20	12/01/2019 19:35	14/01/2019 16:20	44,75	40	1790,00	CHI

20190149471	GOIANIA	GN11000772	GOIANIA LESTE S3	12/01/2019 19:06	13/01/2019 12:43	12/01/2019 19:06	13/01/2019 12:43	17,62	22	387,57	DIA CRITICO
20190149471	GOIANIA	8354034	GOIANIA LESTE S3	12/01/2019 19:06	13/01/2019 12:43	12/01/2019 19:07	13/01/2019 12:43	17,60	2	35,20	DIA CRITICO
20190149474	GOIANIA	GN11003107	CAMPINAS S1	12/01/2019 19:25	13/01/2019 17:04	12/01/2019 19:25	13/01/2019 17:04	21,65	99	2143,35	DIA CRITICO
20190149485	SANTA CRUZ DE GOIAS	BC12110037	PIRACANJUBA	13/01/2019 08:53	13/01/2019 20:51	13/01/2019 08:53	13/01/2019 20:51	11,97	9	107,70	CHI
20190149488	GOIANIA	GN12000367	CAMPINAS S3	13/01/2019 07:24	13/01/2019 13:58	13/01/2019 07:24	13/01/2019 13:58	6,57	143	939,03	CHI
20190149490	GOIANIA	GN12170698	GOIANIA LESTE S2	12/01/2019 19:08	12/01/2019 22:02	12/01/2019 19:08	12/01/2019 22:02	2,90	253	733,70	DIA CRITICO
20190149491	MONTIVIDIU	MV21136224	MONTIVIDIU T	12/01/2019 19:37	13/01/2019 08:47	12/01/2019 19:37	13/01/2019 08:47	13,17	2	26,33	CHI
20190149492	NAZARIO	NZ12205985	ANICUNS	12/01/2019 18:29	12/01/2019 22:50	12/01/2019 18:29	12/01/2019 22:50	4,35	306	1331,10	CHI
20190149495	ABADIANIA	AA12349451	DAIA S2	12/01/2019 16:41	13/01/2019 13:11	12/01/2019 16:41	13/01/2019 13:11	20,50	25	512,50	CHI
20190149495	GAMELEIRA DE GOIAS	AA12349451	DAIA S2	12/01/2019 16:41	13/01/2019 13:11	12/01/2019 16:41	13/01/2019 13:11	20,50	1	20,50	CHI
20190149501	ABADIANIA	AA12017723	DAIA S2	12/01/2019 17:51	13/01/2019 16:41	12/01/2019 17:51	13/01/2019 16:41	22,83	11	251,17	CHI
20190149509	CATURAI	CK21281074	ARACU	12/01/2019 19:31	13/01/2019 14:20	12/01/2019 19:31	13/01/2019 14:20	18,82	1	18,82	DIA CRITICO
20190149510	GOIANIA	GN11160997	ATLANTICO S1	12/01/2019 19:18	13/01/2019 16:36	12/01/2019 19:18	13/01/2019 16:36	21,30	66	1405,80	CHI
20190149513	MUTUNOPOLIS	MU21147219	MARA ROSA	12/01/2019 19:30	13/01/2019 14:23	12/01/2019 19:30	13/01/2019 14:23	18,88	1	18,88	CHI
20190149518	BELA VISTA DE GOIAS	BV12242070	BELA VISTA S1	12/01/2019 19:05	13/01/2019 09:28	12/01/2019 19:05	13/01/2019 09:28	14,38	9	129,45	CHI
20190149520	ITUMBIARA	IT21349798	ITUMBIARA VELHA S1	12/01/2019 19:39	12/01/2019 20:44	12/01/2019 19:39	12/01/2019 20:44	1,08	16	17,33	CHI
20190149524	PETROLINA DE GOIAS	PG12333167	PETROLINA	12/01/2019 15:25	13/01/2019 10:18	12/01/2019 15:25	13/01/2019 10:18	18,88	18	339,90	DIA CRITICO
20190149527	SANTA RITA DO NOVO DESTINO	DF11287214	BARRO ALTO	12/01/2019 19:39	13/01/2019 08:59	12/01/2019 19:39	13/01/2019 08:59	13,33	3	40,00	CHI
20190149534	NOVA CRIXAS	NA12025131	NOVA CRIXAS	12/01/2019 19:33	13/01/2019 18:07	12/01/2019 19:33	13/01/2019 18:07	22,57	2	45,13	CHI
20190149539	GOIANIA	GN11255210	GOYA S1	12/01/2019 18:51	13/01/2019 12:32	12/01/2019 18:51	13/01/2019 12:32	17,68	169	2988,48	DIA CRITICO
20190149541	GOIANIA	GN11210431	GOIANIA LESTE S3	12/01/2019 18:40	13/01/2019 12:46	12/01/2019 18:40	13/01/2019 12:46	18,10	61	1104,10	DIA CRITICO
20190149543	GOIANIA	GN11129212	GOIANIA LESTE S1	12/01/2019 18:50	13/01/2019 10:08	12/01/2019 18:50	13/01/2019 10:08	15,30	166	2539,80	CHI
20190149549	APARECIDA DE GOIANIA	AP12210390	ATLANTICO S3	12/01/2019 18:41	12/01/2019 21:12	12/01/2019 18:41	12/01/2019 21:12	2,52	465	1170,25	CHI
20190149553	GOIANIA	GN12000081	ATLANTICO S1	12/01/2019 17:27	12/01/2019 22:10	12/01/2019 17:27	12/01/2019 22:10	4,72	117	551,85	CHI
20190149554	MONTIVIDIU	MV12249172	MONTIVIDIU T	12/01/2019 19:42	13/01/2019 07:57	12/01/2019 19:42	13/01/2019 07:57	12,25	3	36,75	CHI
20190149558	PARAUNA	PU11000019	PARAÚNA	12/01/2019 19:43	12/01/2019 23:48	12/01/2019 19:43	12/01/2019 23:48	4,08	79	322,58	CHI
20190149559	CAMPINACU	IH12360453	MINACU	12/01/2019 19:43	12/01/2019 22:46	12/01/2019 19:43	12/01/2019 22:46	3,05	5	15,25	CHI
20190149559	MINACU	IH12360453	MINACU	12/01/2019 19:43	12/01/2019 22:46	12/01/2019 19:43	12/01/2019 22:46	3,05	71	216,55	CHI
20190149561	AMARALINA	MH12037774	NOVA CRIXAS	13/01/2019 09:18	13/01/2019 11:18	13/01/2019 09:18	13/01/2019 11:18	2,00	1	2,00	CHI
20190149561	MARA ROSA	MH12037774	NOVA CRIXAS	13/01/2019 09:18	13/01/2019 11:18	13/01/2019 09:18	13/01/2019 11:18	2,00	4	8,00	CHI
20190149561	MUNDO NOVO DE GOIAS	MH12037774	NOVA CRIXAS	13/01/2019 09:18	13/01/2019 11:18	13/01/2019 09:18	13/01/2019 11:18	2,00	4	8,00	CHI
20190149561	UIRAPURU	MH12037774	NOVA CRIXAS	13/01/2019 09:18	13/01/2019 11:18	13/01/2019 09:18	13/01/2019 11:18	2,00	18	36,00	CHI
20190149568	MAIRIPOTABA	PK32045985	PONTALINA	12/01/2019 19:37	14/01/2019 12:20	12/01/2019 19:37	12/01/2019 23:36	3,98	1	3,98	CHI

20190149568	PONTALINA	PK32045985	PONTALINA	12/01/2019 19:37	14/01/2019 12:20	12/01/2019 19:37	12/01/2019 23:36	3,98	37	147,38	CHI
20190149568	MAIRIPOTABA	PK13390269	PONTALINA	12/01/2019 19:37	14/01/2019 12:20	12/01/2019 19:37	13/01/2019 08:32	12,92	8	103,33	CHI
20190149568	PONTALINA	PK13390269	PONTALINA	12/01/2019 19:37	14/01/2019 12:20	12/01/2019 19:37	13/01/2019 08:32	12,92	17	219,58	CHI
20190149568	MAIRIPOTABA	PK32045985	PONTALINA	12/01/2019 19:37	14/01/2019 12:20	13/01/2019 08:33	13/01/2019 09:37	1,07	1	1,07	CHI
20190149568	PONTALINA	PK32045985	PONTALINA	12/01/2019 19:37	14/01/2019 12:20	13/01/2019 08:33	13/01/2019 09:37	1,07	37	39,47	CHI
20190149568	MAIRIPOTABA	PK13390269	PONTALINA	12/01/2019 19:37	14/01/2019 12:20	13/01/2019 08:33	13/01/2019 12:10	3,62	2	7,23	CHI
20190149568	PONTALINA	PK13390269	PONTALINA	12/01/2019 19:37	14/01/2019 12:20	13/01/2019 08:33	13/01/2019 12:10	3,62	17	61,48	CHI
20190149568	MAIRIPOTABA	PK13390269	PONTALINA	12/01/2019 19:37	14/01/2019 12:20	13/01/2019 08:33	14/01/2019 09:15	24,70	6	148,20	CHI
20190149568	MAIRIPOTABA	PK13390269	PONTALINA	12/01/2019 19:37	14/01/2019 12:20	14/01/2019 08:06	14/01/2019 09:15	1,15	2	2,30	CHI
20190149568	PONTALINA	PK13390269	PONTALINA	12/01/2019 19:37	14/01/2019 12:20	14/01/2019 08:06	14/01/2019 09:15	1,15	17	19,55	CHI
20190149568	MAIRIPOTABA	MI13168904	PONTALINA	12/01/2019 19:37	14/01/2019 12:20	12/01/2019 19:37	14/01/2019 10:42	39,08	30	1172,50	CHI
20190149568	PROFESSOR JAMIL SAFADY	MI13168904	PONTALINA	12/01/2019 19:37	14/01/2019 12:20	12/01/2019 19:37	14/01/2019 10:42	39,08	15	586,25	CHI
20190149568	MAIRIPOTABA	PK12390276	PONTALINA	12/01/2019 19:37	14/01/2019 12:20	12/01/2019 19:37	14/01/2019 12:20	40,72	57	2320,85	CHI
20190149570	GOIANIA	GN12001000	GOYA S2	12/01/2019 18:36	13/01/2019 09:41	12/01/2019 18:36	13/01/2019 09:41	15,08	153	2307,75	DIA CRITICO
20190149577	GOIANIA	GN11199029	SENADOR CANEDO	12/01/2019 19:17	13/01/2019 12:43	12/01/2019 19:17	13/01/2019 12:43	17,43	80	1394,67	CHI
20190149579	JATAI	JT12226592	JATAI S1	12/01/2019 19:46	13/01/2019 11:30	12/01/2019 19:46	13/01/2019 11:30	15,73	8	125,87	CHI
20190149582	GAMELEIRA DE GOIAS	SV21151512	JUNDIAI S1	12/01/2019 19:41	13/01/2019 19:13	12/01/2019 19:41	13/01/2019 19:13	23,53	1	23,53	CHI
20190149586	FLORES DE GOIAS	FB12106993	FLORES DE GOIAS	12/01/2019 19:34	12/01/2019 22:45	12/01/2019 19:34	12/01/2019 22:45	3,18	16	50,93	CHI
20190149586	FORMOSA	FB12106993	FLORES DE GOIAS	12/01/2019 19:34	12/01/2019 22:45	12/01/2019 19:34	12/01/2019 22:45	3,18	136	432,93	CHI
20190149586	FORMOSO	FB12106993	FLORES DE GOIAS	12/01/2019 19:34	12/01/2019 22:45	12/01/2019 19:34	12/01/2019 22:45	3,18	1	3,18	CHI
20190149586	SAO JOAO D ALIANCA	FB12106993	FLORES DE GOIAS	12/01/2019 19:34	12/01/2019 22:45	12/01/2019 19:34	12/01/2019 22:45	3,18	5	15,92	CHI
20190149591	SANTA RITA DO NOVO DESTINO	DF21252393	BARRO ALTO	12/01/2019 19:47	13/01/2019 15:50	12/01/2019 19:47	13/01/2019 15:50	20,05	1	20,05	CHI
20190149592	PARAUNA	PU12205010	PARAÚNA	12/01/2019 19:47	12/01/2019 22:35	12/01/2019 19:47	12/01/2019 22:35	2,80	13	36,40	CHI
20190149596	GOIANIA	GN12074910	GOYA S1	12/01/2019 17:18	13/01/2019 08:34	12/01/2019 17:18	13/01/2019 08:34	15,27	340	5190,67	DIA CRITICO
20190149600	GOIANIA	GN11056171	GOYA S2	12/01/2019 17:42	14/01/2019 01:54	12/01/2019 17:42	14/01/2019 01:54	32,20	269	8661,80	DIA CRITICO
20190149601	GUARINOS	GF12099025	SANTA TEREZINHA	12/01/2019 19:38	12/01/2019 21:07	12/01/2019 19:38	12/01/2019 21:07	1,48	160	237,33	CHI
20190149602	ITAPACI	IW12093559	ITAPACI	12/01/2019 19:40	13/01/2019 10:18	12/01/2019 19:40	13/01/2019 10:18	14,63	3	43,90	CHI
20190149605	ANAPOLIS	AN11043969	ANAPOLIS UNIVERSITARIO S2	12/01/2019 18:46	13/01/2019 01:29	12/01/2019 18:46	13/01/2019 01:29	6,72	181	1215,72	CHI
20190149616	GOIANIA	GN11082039	MEIA PONTE	12/01/2019 18:41	14/01/2019 12:08	12/01/2019 18:41	14/01/2019 12:08	41,45	134	5554,30	DIA CRITICO
20190149624	GOIANIA	GN11131381	MEIA PONTE	12/01/2019 18:26	13/01/2019 10:06	12/01/2019 18:26	13/01/2019 10:06	15,67	152	2381,33	DIA CRITICO
20190149627	URUACU	CR21243717	CAMPINORTE	12/01/2019 19:53	13/01/2019 09:49	12/01/2019 19:53	13/01/2019 09:49	13,93	7	97,53	CHI
20190149629	GOIANIA	GN11134197	CAMPINAS S2	12/01/2019 17:10	14/01/2019 17:25	12/01/2019 17:10	14/01/2019 17:17	48,12	75	3608,75	DIA CRITICO
20190149629	GOIANIA	GN11166598	CAMPINAS S2	12/01/2019 17:10	14/01/2019 17:25	14/01/2019 16:24	14/01/2019 17:25	1,02	21	21,35	DIA CRITICO

20190149630	PETROLINA DE GOIAS	PG12322380	INHUMAS S1	12/01/2019 19:36	13/01/2019 10:48	12/01/2019 19:36	13/01/2019 10:48	15,20	20	304,00	CHI
20190149638	BELA VISTA DE GOIAS	BV12006339	CEPAIGO S2	12/01/2019 19:25	13/01/2019 08:38	12/01/2019 19:25	13/01/2019 08:38	13,22	13	171,82	CHI
20190149642	GOIANIA	GN12165692	CAMPINAS S2	12/01/2019 18:02	13/01/2019 02:14	12/01/2019 18:02	13/01/2019 02:14	8,20	94	770,80	DIA CRITICO
20190149643	CAMPINACU	UC12346900	PORANGATU	12/01/2019 19:46	13/01/2019 00:55	12/01/2019 19:46	13/01/2019 00:55	5,15	5	25,75	CHI
20190149644	AGUAS LINDAS DE GOIAS	LA11230161	AGUAS LINDAS DE GOIAS S1	12/01/2019 18:11	13/01/2019 02:43	12/01/2019 18:11	13/01/2019 02:43	8,53	21	179,20	CHI
20190149654	ANAPOLIS	AN11211796	JUNDIAI S2	12/01/2019 16:13	13/01/2019 18:45	12/01/2019 16:13	13/01/2019 18:45	26,53	51	1353,20	CHI
20190149665	ITAPACI	IW21361461	ITAPACI	12/01/2019 19:49	13/01/2019 12:26	12/01/2019 19:49	13/01/2019 12:26	16,62	1	16,62	CHI
20190149671	JATAI	SX12013892	JATAI S1	12/01/2019 16:20	12/01/2019 20:27	12/01/2019 16:20	12/01/2019 20:27	4,12	14	57,63	CHI
20190149671	SERRANOPOLIS	SX12013892	JATAI S1	12/01/2019 16:20	12/01/2019 20:27	12/01/2019 16:20	12/01/2019 20:27	4,12	135	555,75	CHI
20190149683	SANCLERLANDIA	SC12163921	FIRMINOPOLIS S2	12/01/2019 18:57	12/01/2019 20:35	12/01/2019 18:57	12/01/2019 20:35	1,63	11	17,97	CHI
20190149687	CORUMBA DE GOIAS	260023991	CORUMBA	12/01/2019 17:06	13/01/2019 10:50	12/01/2019 17:06	13/01/2019 10:50	17,73	1	17,73	DIA CRITICO
20190149692	GOIANIA	GN11035482	GOIANIA LESTE S2	12/01/2019 18:56	13/01/2019 09:22	12/01/2019 18:56	13/01/2019 09:22	14,43	205	2958,83	DIA CRITICO
20190149698	SERRANOPOLIS	SX12328785	JATAI S1	12/01/2019 19:21	13/01/2019 09:48	12/01/2019 19:21	13/01/2019 09:48	14,45	20	289,00	CHI
20190149700	PARAUNA	PU12205939	PARAUNA	12/01/2019 19:51	13/01/2019 15:28	12/01/2019 19:51	13/01/2019 15:28	19,62	8	156,93	CHI
20190149705	CALDAZINHA	DE21359318	CEPAIGO S2	12/01/2019 20:02	13/01/2019 14:28	12/01/2019 20:02	13/01/2019 14:28	18,43	2	36,87	CHI
20190149710	GOIANIA	GN12001197	CARAJAS S1	12/01/2019 18:55	13/01/2019 17:28	12/01/2019 18:55	13/01/2019 17:28	22,55	171	3856,05	CHI
20190149719	AGUAS LINDAS DE GOIAS	LA12164999	AGUAS LINDAS DE GOIAS S1	12/01/2019 19:53	12/01/2019 21:28	12/01/2019 19:53	12/01/2019 21:28	1,58	203	321,42	CHI
20190149722	GOIANIA	GN11131343	MEIA PONTE	12/01/2019 17:16	12/01/2019 23:36	12/01/2019 17:16	12/01/2019 23:36	6,33	204	1292,00	DIA CRITICO
20190149723	COCALZINHO DE GOIAS	LA12389399	AGUAS LINDAS DE GOIAS S1	12/01/2019 19:39	13/01/2019 12:31	12/01/2019 19:39	13/01/2019 12:31	16,87	10	168,67	CHI
20190149726	GOIANIA	GN11001041	CARAJAS S1	12/01/2019 19:49	13/01/2019 19:19	12/01/2019 19:49	13/01/2019 19:19	23,50	115	2702,50	CHI
20190149728	GOIANIA	15318230	CAMPINAS S2	12/01/2019 20:03	14/01/2019 10:52	12/01/2019 20:03	14/01/2019 10:52	38,82	1	38,82	DIA CRITICO
20190149733	CAIAPONIA	CP12241169	CAIAPONIA	12/01/2019 19:47	12/01/2019 22:16	12/01/2019 19:47	12/01/2019 22:16	2,48	17	42,22	CHI
20190149740	PROFESSOR JAMIL SAFADY	JS21317558	ROCHEDO	12/01/2019 20:06	13/01/2019 13:18	12/01/2019 20:06	13/01/2019 13:18	17,20	1	17,20	CHI
20190149746	GUAPO	GA21019863	GUAPO S2	12/01/2019 20:07	14/01/2019 14:24	12/01/2019 20:07	14/01/2019 14:24	42,28	3	126,85	CHI
20190149749	IPAMERI	IP12332967	IPAMERI	12/01/2019 19:55	13/01/2019 10:00	12/01/2019 19:55	13/01/2019 10:00	14,08	14	197,17	CHI
20190149763	ANAPOLIS	AN11000119	JUNDIAI S2	12/01/2019 19:15	12/01/2019 22:40	12/01/2019 19:15	12/01/2019 22:40	3,42	141	481,75	CHI
20190149766	ANICUNS	AC21278643	FIRMINOPOLIS S2	12/01/2019 20:11	13/01/2019 14:24	12/01/2019 20:11	13/01/2019 14:24	18,22	1	18,22	CHI
20190149771	GOIANIA	GN11000405	FERROVIARIO S3	12/01/2019 18:27	13/01/2019 13:45	12/01/2019 18:27	13/01/2019 13:25	18,97	95	1801,83	DIA CRITICO
20190149771	GOIANIA	GN12000508	FERROVIARIO S3	12/01/2019 18:27	13/01/2019 13:45	12/01/2019 18:27	13/01/2019 13:45	19,30	21	405,30	DIA CRITICO
20190149772	PETROLINA DE GOIAS	SF12273257	SAO FRANCISCO DE GOIAS	12/01/2019 19:18	13/01/2019 03:50	12/01/2019 19:18	13/01/2019 03:50	8,53	60	512,00	DIA CRITICO
20190149772	PIRENOPOLIS	SF12273257	SAO FRANCISCO DE GOIAS	12/01/2019 19:18	13/01/2019 03:50	12/01/2019 19:18	13/01/2019 03:50	8,53	38	324,27	DIA CRITICO
20190149772	SAO FRANCISCO DE GOIAS	SF12273257	SAO FRANCISCO DE GOIAS	12/01/2019 19:18	13/01/2019 03:50	12/01/2019 19:18	13/01/2019 03:50	8,53	36	307,20	DIA CRITICO
20190149787	ANICUNS	AC12304664	FIRMINOPOLIS S2	12/01/2019 20:13	13/01/2019 08:43	12/01/2019 20:13	13/01/2019 08:43	12,50	15	187,50	CHI

20190149797	GOIANIA	GN11002199	GOIANIA LESTE S2	12/01/2019 18:08	13/01/2019 10:56	12/01/2019 18:08	13/01/2019 10:56	16,80	80	1344,00	DIA CRITICO
20190149811	BELA VISTA DE GOIAS	BV12027552	BELA VISTA S1	12/01/2019 19:57	13/01/2019 10:56	12/01/2019 19:57	13/01/2019 10:56	14,98	15	224,75	CHI
20190149811	PIRACANJUBA	BV12027552	BELA VISTA S1	12/01/2019 19:57	13/01/2019 10:56	12/01/2019 19:57	13/01/2019 10:56	14,98	16	239,73	CHI
20190149817	CROMINIA	CQ12079876	ROCHEDO	12/01/2019 19:26	13/01/2019 03:58	12/01/2019 19:26	13/01/2019 03:58	8,53	15	128,00	CHI
20190149822	PONTALINA	AD12060078	GOIATUBA S1	12/01/2019 20:18	13/01/2019 10:08	12/01/2019 20:18	13/01/2019 10:08	13,83	11	152,17	CHI
20190149831	GOIAS	GS21299760	GOIAS	12/01/2019 20:19	13/01/2019 17:14	12/01/2019 20:19	13/01/2019 17:14	20,92	2	41,83	CHI
20190149836	GOIANIA	GN12001776	GOYA S1	12/01/2019 17:48	13/01/2019 14:25	12/01/2019 17:48	13/01/2019 14:25	20,62	261	5380,95	DIA CRITICO
20190149839	APARECIDA DE GOIANIA	AP11004615	REAL S2	12/01/2019 19:20	12/01/2019 23:19	12/01/2019 19:20	12/01/2019 23:19	3,98	105	418,25	CHI
20190149841	LEOPOLDO DE BULHOES	LB12057538	DAIA S1	12/01/2019 16:45	13/01/2019 12:35	12/01/2019 16:45	13/01/2019 12:35	19,83	11	218,17	CHI
20190149841	SILVANIA	LB12057538	DAIA S1	12/01/2019 16:45	13/01/2019 12:35	12/01/2019 16:45	13/01/2019 12:35	19,83	23	456,17	CHI
20190149842	SAO FRANCISCO DE GOIAS	SF11055356	SAO FRANCISCO DE GOIAS	12/01/2019 19:58	12/01/2019 23:25	12/01/2019 19:58	12/01/2019 23:25	3,45	84	289,80	DIA CRITICO
20190149844	GOIANIA	GN11189924	GOYA S2	12/01/2019 18:51	13/01/2019 11:54	12/01/2019 18:51	13/01/2019 11:54	17,05	86	1466,30	DIA CRITICO
20190149845	SANCLERLANDIA	10016153950	FIRMINOPOLIS S2	12/01/2019 20:21	13/01/2019 07:26	12/01/2019 20:21	13/01/2019 07:26	11,08	1	11,08	CHI
20190149849	PROFESSOR JAMIL SAFADY	JS11000008	ROCHEDO	12/01/2019 19:33	12/01/2019 22:22	12/01/2019 19:33	12/01/2019 22:22	2,82	95	267,58	CHI
20190149850	MORRO AGUDO DE GOIAS	MS12136795	ITAPURANGA	12/01/2019 16:48	12/01/2019 21:02	12/01/2019 16:48	12/01/2019 21:02	4,23	35	148,17	CHI
20190149855	AMERICANO DO BRASIL	KB12000021	ANICUNS	12/01/2019 20:22	13/01/2019 08:27	12/01/2019 20:22	13/01/2019 08:27	12,08	7	84,58	CHI
20190149855	ITABERAI	KB12000021	ANICUNS	12/01/2019 20:22	13/01/2019 08:27	12/01/2019 20:22	13/01/2019 08:27	12,08	3	36,25	CHI
20190149855	MOSSAMEDES	KB12000021	ANICUNS	12/01/2019 20:22	13/01/2019 08:27	12/01/2019 20:22	13/01/2019 08:27	12,08	1	12,08	CHI
20190149860	GOIANIA	GN21011428	GOYA S1	12/01/2019 20:23	15/01/2019 13:39	12/01/2019 20:23	15/01/2019 13:39	65,27	1	65,27	DIA CRITICO
20190149865	JUSSARA	JR11259814	JUSSARA	12/01/2019 20:23	13/01/2019 00:48	12/01/2019 20:23	13/01/2019 00:48	4,42	77	340,08	CHI
20190149872	GOIANIA	GN11002891	FERROVIARIO S2	12/01/2019 17:00	12/01/2019 21:34	12/01/2019 17:00	12/01/2019 21:34	4,57	13	59,37	DIA CRITICO
20190149909	JARAGUA	JA21277228	JARAGUA	12/01/2019 20:24	13/01/2019 02:30	12/01/2019 20:24	13/01/2019 02:30	6,10	1	6,10	CHI
20190149914	INDIARA	CZ21308501	CEZARINA	12/01/2019 20:25	14/01/2019 12:46	12/01/2019 20:25	14/01/2019 12:46	40,35	1	40,35	CHI
20190149915	ALEXANIA	AX21094515	ALEXANIA	12/01/2019 20:25	13/01/2019 18:28	12/01/2019 20:25	13/01/2019 18:28	22,05	1	22,05	CHI
20190149916	CRISTALINA	KR21243772	CRISTALINA S2	12/01/2019 20:25	13/01/2019 00:08	12/01/2019 20:25	13/01/2019 00:08	3,72	1	3,72	CHI
20190149918	PIRANHAS	PH21247791	PIRANHAS	12/01/2019 20:26	12/01/2019 21:20	12/01/2019 20:26	12/01/2019 21:20	0,90	2	1,80	CHI
20190149920	PROFESSOR JAMIL SAFADY	JS21317457	ROCHEDO	12/01/2019 20:05	13/01/2019 11:40	12/01/2019 20:05	13/01/2019 11:40	15,58	1	15,58	CHI
20190149923	ANAPOLIS	AN11000514	ANAPOLIS UNIVERSITARIO S1	12/01/2019 16:01	13/01/2019 12:36	12/01/2019 16:01	13/01/2019 12:36	20,58	157	3231,58	CHI
20190149938	GOIANIA	12150472	REAL S1	12/01/2019 20:28	14/01/2019 22:04	12/01/2019 20:28	14/01/2019 22:04	49,60	1	49,60	CHI
20190149945	APARECIDA DE GOIANIA	AP11004607	ANHANGUERA	12/01/2019 19:05	13/01/2019 13:11	12/01/2019 19:05	13/01/2019 13:11	18,10	24	434,40	CHI
20190149949	GOIANIA	GN12045528	MEIA PONTE	13/01/2019 07:08	15/01/2019 16:20	13/01/2019 07:08	14/01/2019 21:32	38,40	23	883,20	DIA CRITICO
20190149949	GOIANIRA	GN12045528	MEIA PONTE	13/01/2019 07:08	15/01/2019 16:20	13/01/2019 07:08	14/01/2019 21:32	38,40	1	38,40	DIA CRITICO
20190149949	GOIANIA	GN12270704LD	MEIA PONTE	13/01/2019 07:08	15/01/2019 16:20	13/01/2019 07:08	15/01/2019 16:20	57,20	2	114,40	DIA CRITICO

20190149949	GOIANIRA	GN12270704LD	MEIA PONTE	13/01/2019 07:08	15/01/2019 16:20	13/01/2019 07:08	15/01/2019 16:20	57,20	2	114,40	DIA CRITICO
20190149951	ITAPURANGA	IK12299963	ITAPURANGA	12/01/2019 18:05	13/01/2019 11:13	12/01/2019 18:05	13/01/2019 11:13	17,13	38	651,07	CHI
20190149953	ANICUNS	AC12382504	ANICUNS	12/01/2019 19:57	13/01/2019 07:13	12/01/2019 19:57	13/01/2019 07:13	11,27	29	326,73	CHI
20190149957	ARUANA	AK12183284	ARUANA	12/01/2019 20:12	13/01/2019 10:02	12/01/2019 20:12	13/01/2019 10:02	13,83	99	1369,50	CHI
20190149961	SAO LUIS DE MONTES BELOS	SL21237706	FIRMINOPOLIS S2	12/01/2019 20:13	14/01/2019 01:18	12/01/2019 20:13	14/01/2019 01:18	29,08	1	29,08	CHI
20190149962	ANAPOLIS	AN11205837	JUNDIAI S1	12/01/2019 20:28	13/01/2019 10:24	12/01/2019 20:28	13/01/2019 10:24	13,93	83	1156,47	CHI
20190149967	GOIANIA	GN11002301	CAMPINAS S2	12/01/2019 18:14	13/01/2019 03:36	12/01/2019 18:14	13/01/2019 03:36	9,37	105	983,50	DIA CRITICO
20190149968	GOIANIA	GN11002666	ATLANTICO S1	12/01/2019 19:08	13/01/2019 17:10	12/01/2019 19:08	13/01/2019 17:10	22,03	29	638,97	CHI
20190149969	CROMINIA	CQ12109249	PONTALINA	12/01/2019 19:56	13/01/2019 03:42	12/01/2019 19:56	13/01/2019 03:42	7,77	5	38,83	CHI
20190149973	ARACU	00120214	ARACU	12/01/2019 19:40	13/01/2019 12:13	12/01/2019 19:40	13/01/2019 10:05	14,42	1091	15728,58	DIA CRITICO
20190149973	ARACU	00120214	ARACU	12/01/2019 19:40	13/01/2019 12:13	12/01/2019 19:40	13/01/2019 10:05	14,42	30	432,50	DIA CRITICO
20190149973	CATURAI	00120214	ARACU	12/01/2019 19:40	13/01/2019 12:13	12/01/2019 19:40	13/01/2019 10:05	14,42	109	1571,42	DIA CRITICO
20190149973	CATURAI	00120214	ARACU	12/01/2019 19:40	13/01/2019 12:13	12/01/2019 19:40	13/01/2019 10:05	14,42	87	1254,25	DIA CRITICO
20190149973	GOIANIRA	00120214	ARACU	12/01/2019 19:40	13/01/2019 12:13	12/01/2019 19:40	13/01/2019 10:05	14,42	1	14,42	DIA CRITICO
20190149973	INHUMAS	00120214	ARACU	12/01/2019 19:40	13/01/2019 12:13	12/01/2019 19:40	13/01/2019 10:05	14,42	108	1557,00	DIA CRITICO
20190149973	INHUMAS	00120214	ARACU	12/01/2019 19:40	13/01/2019 12:13	12/01/2019 19:40	13/01/2019 10:05	14,42	5	72,08	DIA CRITICO
20190149973	ITABERAI	00120214	ARACU	12/01/2019 19:40	13/01/2019 12:13	12/01/2019 19:40	13/01/2019 10:05	14,42	11	158,58	DIA CRITICO
20190149973	ITABERAI	00120214	ARACU	12/01/2019 19:40	13/01/2019 12:13	12/01/2019 19:40	13/01/2019 10:05	14,42	10	144,17	DIA CRITICO
20190149973	ITAUCU	00120214	ARACU	12/01/2019 19:40	13/01/2019 12:13	12/01/2019 19:40	13/01/2019 10:05	14,42	6	86,50	DIA CRITICO
20190149973	ANICUNS	AR13019231	ARACU	12/01/2019 19:40	13/01/2019 12:13	12/01/2019 19:40	13/01/2019 12:13	16,55	67	1108,85	DIA CRITICO
20190149973	ARACU	AR13019231	ARACU	12/01/2019 19:40	13/01/2019 12:13	12/01/2019 19:40	13/01/2019 12:13	16,55	79	1307,45	DIA CRITICO
20190149973	ITABERAI	AR13019231	ARACU	12/01/2019 19:40	13/01/2019 12:13	12/01/2019 19:40	13/01/2019 12:13	16,55	38	628,90	DIA CRITICO
20190149973	ITAUCU	AR13019231	ARACU	12/01/2019 19:40	13/01/2019 12:13	12/01/2019 19:40	13/01/2019 12:13	16,55	10	165,50	DIA CRITICO
20190149973	ARACU	AR13019231	ARACU	12/01/2019 19:40	13/01/2019 12:13	13/01/2019 09:41	13/01/2019 12:13	2,53	15	38,00	DIA CRITICO
20190149973	ARACU	AR13019231	ARACU	12/01/2019 19:40	13/01/2019 12:13	13/01/2019 10:57	13/01/2019 12:13	1,27	253	320,47	DIA CRITICO
20190149976	PIRACANJUBA	PJ12326569	CRISTIANOPOLIS	12/01/2019 20:35	13/01/2019 09:30	12/01/2019 20:35	13/01/2019 09:30	12,92	28	361,67	CHI
20190149977	TRINDADE	TR11049496	GOYA S1	12/01/2019 18:50	13/01/2019 16:48	12/01/2019 18:50	13/01/2019 16:48	21,97	111	2438,30	DIA CRITICO
20190149979	AMARALINA	UP12390498	NOVA CRIXAS	12/01/2019 20:35	13/01/2019 10:06	12/01/2019 20:35	13/01/2019 10:06	13,52	22	297,37	CHI
20190149979	MARA ROSA	UP12390498	NOVA CRIXAS	12/01/2019 20:35	13/01/2019 10:06	12/01/2019 20:35	13/01/2019 10:06	13,52	1	13,52	CHI
20190149979	UIRAPURU	UP12390498	NOVA CRIXAS	12/01/2019 20:35	13/01/2019 10:06	12/01/2019 20:35	13/01/2019 10:06	13,52	5	67,58	CHI
20190149980	GOIANIA	13530586	XAVANTES	12/01/2019 20:34	15/01/2019 13:06	12/01/2019 20:34	15/01/2019 13:06	64,53	1	64,53	DIA CRITICO
20190149985	ALEXANIA	AX12000005	ALEXANIA	12/01/2019 18:48	13/01/2019 13:14	12/01/2019 18:48	13/01/2019 13:14	18,43	13	239,63	CHI
20190149987	GOIANIA	GN12170695	GOIANIA LESTE S2	12/01/2019 18:57	13/01/2019 08:03	12/01/2019 18:57	13/01/2019 08:03	13,10	94	1231,40	DIA CRITICO

20190149994	GOIANIA	GN11002405	XAVANTES	12/01/2019 19:00	13/01/2019 13:28	12/01/2019 19:00	13/01/2019 13:28	18,47	116	2142,13	DIA CRITICO
20190149995	GOIANIA	GN11002502	GOIANIA LESTE S3	12/01/2019 18:49	14/01/2019 00:30	12/01/2019 18:49	14/01/2019 00:30	29,68	206	6114,77	DIA CRITICO
20190149997	GOIANIA	GN12000625	CAMPINAS S2	12/01/2019 20:07	13/01/2019 10:49	12/01/2019 20:07	13/01/2019 10:49	14,70	124	1822,80	DIA CRITICO
20190150001	ITAGUARU	IC21089211	ITABERAI S1	12/01/2019 20:38	12/01/2019 20:44	12/01/2019 20:38	12/01/2019 20:44	0,10	1	0,10	CHI
20190150003	IPAMERI	IP11000020	IPAMERI	12/01/2019 18:56	13/01/2019 00:05	12/01/2019 18:56	13/01/2019 00:05	5,15	79	406,85	CHI
20190150004	MINEIROS	MY21303696	PARQUE DAS EMAS	12/01/2019 21:00	13/01/2019 13:06	12/01/2019 21:00	13/01/2019 13:06	16,10	1	16,10	CHI
20190150009	ITABERAI	IB11000015	ITABERAI S2	12/01/2019 21:13	12/01/2019 23:09	12/01/2019 21:13	12/01/2019 23:09	1,93	96	185,60	CHI
20190150016	FAZENDA NOVA	FN10400396	JUSSARA	12/01/2019 20:47	13/01/2019 10:28	12/01/2019 20:47	12/01/2019 20:50	0,05	1230	61,50	CHI
20190150016	FAZENDA NOVA	01340434	JUSSARA	12/01/2019 20:47	13/01/2019 10:28	12/01/2019 20:47	13/01/2019 01:17	4,50	46	207,00	CHI
20190150016	NOVO BRASIL	01340434	JUSSARA	12/01/2019 20:47	13/01/2019 10:28	12/01/2019 20:47	13/01/2019 01:17	4,50	48	216,00	CHI
20190150016	FAZENDA NOVA	FN10400396	JUSSARA	12/01/2019 20:47	13/01/2019 10:28	13/01/2019 01:18	13/01/2019 09:00	7,70	42	323,40	CHI
20190150016	NOVO BRASIL	FN10400396	JUSSARA	12/01/2019 20:47	13/01/2019 10:28	13/01/2019 01:18	13/01/2019 09:00	7,70	27	207,90	CHI
20190150016	FAZENDA NOVA	01050434	JUSSARA	12/01/2019 20:47	13/01/2019 10:28	13/01/2019 01:18	13/01/2019 09:51	8,55	4	34,20	CHI
20190150016	NOVO BRASIL	01050434	JUSSARA	12/01/2019 20:47	13/01/2019 10:28	13/01/2019 01:18	13/01/2019 09:51	8,55	21	179,55	CHI
20190150016	FAZENDA NOVA	NB13055186	JUSSARA	12/01/2019 20:47	13/01/2019 10:28	13/01/2019 10:17	13/01/2019 10:23	0,10	42	4,20	CHI
20190150016	NOVO BRASIL	NB13055186	JUSSARA	12/01/2019 20:47	13/01/2019 10:28	13/01/2019 10:17	13/01/2019 10:23	0,10	27	2,70	CHI
20190150016	FAZENDA NOVA	FN10400396	JUSSARA	12/01/2019 20:47	13/01/2019 10:28	12/01/2019 20:47	13/01/2019 10:28	13,68	672	9195,20	CHI
20190150017	MONTIVIDIU DO NORTE	MX12203419	PORANGATU	12/01/2019 19:10	13/01/2019 00:13	12/01/2019 19:10	13/01/2019 00:13	5,05	95	479,75	CHI
20190150020	MONTIVIDIU DO NORTE	MX12203484	PORANGATU	12/01/2019 21:01	13/01/2019 23:25	12/01/2019 21:01	13/01/2019 23:25	26,40	18	475,20	CHI
20190150021	MINACU	IH11135600	MINACU	12/01/2019 21:48	13/01/2019 01:00	12/01/2019 21:48	13/01/2019 01:00	3,20	56	179,20	CHI
20190150028	HIDROLINA	HL11136323	URUACU	12/01/2019 18:06	13/01/2019 03:48	12/01/2019 18:06	13/01/2019 03:48	9,70	85	824,50	CHI
20190150030	GOIANIA	GN11374155	MEIA PONTE	12/01/2019 17:01	14/01/2019 09:03	12/01/2019 17:01	14/01/2019 09:03	40,03	183	7326,10	DIA CRITICO
20190150031	GOIANIA	13458863	MEIA PONTE	12/01/2019 20:45	14/01/2019 18:37	12/01/2019 20:45	14/01/2019 18:37	45,87	1	45,87	DIA CRITICO
20190150038	CACHOEIRA ALTA	CA12327414	CACHOEIRA ALTA	12/01/2019 22:49	13/01/2019 00:04	12/01/2019 22:49	13/01/2019 00:04	1,25	5	6,25	CHI
20190150040	GOIANIA	GN11165737	CAMPINAS S2	12/01/2019 18:26	13/01/2019 20:31	12/01/2019 18:26	13/01/2019 20:31	26,08	122	3182,17	DIA CRITICO
20190150042	GOIANIA	GN11050821	CAMPINAS S2	12/01/2019 19:50	13/01/2019 18:26	12/01/2019 19:50	13/01/2019 18:26	22,60	70	1582,00	DIA CRITICO
20190150044	TRINDADE	TR11251737	TRINDADE	12/01/2019 18:30	14/01/2019 06:35	12/01/2019 18:30	14/01/2019 06:35	36,08	408	14722,00	DIA CRITICO
20190150046	GOIANIA	GN11162473	GOIANIA LESTE S3	12/01/2019 18:41	13/01/2019 07:40	12/01/2019 18:41	13/01/2019 07:40	12,98	171	2220,15	DIA CRITICO
20190150047	PIRENOPOLIS	PV10219138	CORUMBA	12/01/2019 23:48	13/01/2019 15:36	12/01/2019 23:48	13/01/2019 07:13	7,42	208	1542,67	DIA CRITICO
20190150047	PIRENOPOLIS	PV10219138	CORUMBA	12/01/2019 23:48	13/01/2019 15:36	12/01/2019 23:48	13/01/2019 08:25	8,62	102	878,90	DIA CRITICO
20190150047	PIRENOPOLIS	PV10219138	CORUMBA	12/01/2019 23:48	13/01/2019 15:36	12/01/2019 23:48	13/01/2019 14:05	14,28	91	1299,78	DIA CRITICO
20190150047	ANAPOLIS	PV10397556	CORUMBA	12/01/2019 23:48	13/01/2019 15:36	12/01/2019 23:48	13/01/2019 15:36	15,80	1	15,80	DIA CRITICO
20190150047	GOIANESIA	PV10397556	CORUMBA	12/01/2019 23:48	13/01/2019 15:36	12/01/2019 23:48	13/01/2019 15:36	15,80	11	173,80	DIA CRITICO

20190150047	JARAGUA	PV10397556	CORUMBA	12/01/2019 23:48	13/01/2019 15:36	12/01/2019 23:48	13/01/2019 15:36	15,80	4	63,20	DIA CRITICO
20190150047	PIRENOPOLIS	PV10397556	CORUMBA	12/01/2019 23:48	13/01/2019 15:36	12/01/2019 23:48	13/01/2019 15:36	15,80	997	15752,60	DIA CRITICO
20190150047	VILA PROPICIO	PV10397556	CORUMBA	12/01/2019 23:48	13/01/2019 15:36	12/01/2019 23:48	13/01/2019 15:36	15,80	14	221,20	DIA CRITICO
20190150056	ALVORADA DO NORTE	FB10401474	FLORES DE GOIAS	13/01/2019 00:53	13/01/2019 04:36	13/01/2019 00:53	13/01/2019 00:56	0,05	55	2,75	CHI
20190150056	FLORES DE GOIAS	FB10401474	FLORES DE GOIAS	13/01/2019 00:53	13/01/2019 04:36	13/01/2019 00:53	13/01/2019 00:56	0,05	231	11,55	CHI
20190150056	FORMOSA	FB10401474	FLORES DE GOIAS	13/01/2019 00:53	13/01/2019 04:36	13/01/2019 00:53	13/01/2019 00:56	0,05	136	6,80	CHI
20190150056	FORMOSO	FB10401474	FLORES DE GOIAS	13/01/2019 00:53	13/01/2019 04:36	13/01/2019 00:53	13/01/2019 00:56	0,05	1	0,05	CHI
20190150056	IACIARA	FB10401474	FLORES DE GOIAS	13/01/2019 00:53	13/01/2019 04:36	13/01/2019 00:53	13/01/2019 00:56	0,05	20	1,00	CHI
20190150056	POSSE	FB10401474	FLORES DE GOIAS	13/01/2019 00:53	13/01/2019 04:36	13/01/2019 00:53	13/01/2019 00:56	0,05	2	0,10	CHI
20190150056	SAO JOAO D ALIANCA	FB10401474	FLORES DE GOIAS	13/01/2019 00:53	13/01/2019 04:36	13/01/2019 00:53	13/01/2019 00:56	0,05	5	0,25	CHI
20190150056	FLORES DE GOIAS	02830414	FLORES DE GOIAS	13/01/2019 00:53	13/01/2019 04:36	13/01/2019 00:53	13/01/2019 02:57	2,07	1369	2829,27	CHI
20190150056	FLORES DE GOIAS	02830414	FLORES DE GOIAS	13/01/2019 00:53	13/01/2019 04:36	13/01/2019 00:53	13/01/2019 03:30	2,62	947	2477,98	CHI
20190150056	NOVA ROMA	02830414	FLORES DE GOIAS	13/01/2019 00:53	13/01/2019 04:36	13/01/2019 00:53	13/01/2019 03:30	2,62	2	5,23	CHI
20190150056	SAO JOAO D ALIANCA	02830414	FLORES DE GOIAS	13/01/2019 00:53	13/01/2019 04:36	13/01/2019 00:53	13/01/2019 03:30	2,62	107	279,98	CHI
20190150056	FLORES DE GOIAS	02830414	FLORES DE GOIAS	13/01/2019 00:53	13/01/2019 04:36	13/01/2019 02:58	13/01/2019 03:30	0,53	1	0,53	CHI
20190150056	FLORES DE GOIAS	FB12043489LD	FLORES DE GOIAS	13/01/2019 00:53	13/01/2019 04:36	13/01/2019 02:58	13/01/2019 04:36	1,63	1368	2234,40	CHI
20190150073	GOIANIA	14180935	AEROPORTO S1	12/01/2019 18:39	15/01/2019 02:32	12/01/2019 18:39	15/01/2019 02:32	55,88	1	55,88	DIA CRITICO
20190150085	JAUPACI	JP21008695	IPORA	13/01/2019 03:57	13/01/2019 04:26	13/01/2019 03:57	13/01/2019 04:26	0,48	1	0,48	CHI
20190150096	TRINDADE	TR11129065	TRINDADE	12/01/2019 20:17	13/01/2019 11:45	12/01/2019 20:17	13/01/2019 11:45	15,47	105	1624,00	DIA CRITICO
20190150101	GOIANIA	GN11037867	AEROPORTO S2	12/01/2019 20:13	13/01/2019 17:10	12/01/2019 20:13	13/01/2019 17:10	20,95	39	817,05	DIA CRITICO
20190150104	CALDAZINHA	BV21164318	CEPAIGO S2	12/01/2019 20:08	13/01/2019 15:56	12/01/2019 20:08	13/01/2019 15:56	19,80	1	19,80	CHI
20190150112	GOIANIA	GN11275706	CAMPINAS S2	12/01/2019 18:29	13/01/2019 15:27	12/01/2019 18:29	13/01/2019 15:27	20,97	178	3732,07	DIA CRITICO
20190150113	MORRINHOS	MR21223298	MORRINHOS	12/01/2019 20:42	12/01/2019 22:17	12/01/2019 20:42	12/01/2019 22:17	1,58	1	1,58	CHI
20190150116	SANTA RITA DO NOVO DESTINO	BF12287229	BARRO ALTO	12/01/2019 20:43	13/01/2019 09:55	12/01/2019 20:43	13/01/2019 09:55	13,20	7	92,40	CHI
20190150120	ANAPOLIS	AN11211786	ANAPOLIS UNIVERSITARIO S2	12/01/2019 19:02	12/01/2019 22:00	12/01/2019 19:02	12/01/2019 22:00	2,97	136	403,47	CHI
20190150123	GOIANIA	GN11203354	GOYA S2	12/01/2019 19:44	13/01/2019 20:39	12/01/2019 19:44	13/01/2019 20:39	24,92	248	6179,33	DIA CRITICO
20190150137	GOIANIA	GN11001056	XAVANTES	12/01/2019 18:50	14/01/2019 09:39	12/01/2019 18:50	14/01/2019 09:39	38,82	173	6715,28	DIA CRITICO
20190150140	ALEXANIA	AX12311876	ALEXANIA	12/01/2019 20:12	12/01/2019 22:41	12/01/2019 20:12	12/01/2019 22:41	2,48	106	263,23	CHI
20190150147	BRITANIA	BT11252614	BRITANIA	12/01/2019 20:24	13/01/2019 06:41	12/01/2019 20:24	13/01/2019 06:41	10,28	224	2303,47	CHI
20190150156	AGUAS LINDAS DE GOIAS	LA11087889	AGUAS LINDAS DE GOIAS S1	12/01/2019 20:18	12/01/2019 22:26	12/01/2019 20:18	12/01/2019 22:26	2,13	82	174,93	CHI
20190150159	ARAGOIANIA	680010750	GUAPO S2	12/01/2019 20:51	13/01/2019 14:03	12/01/2019 20:51	13/01/2019 14:03	17,20	1	17,20	CHI
20190150160	FAINA	FC12299779	MATRINCHA	12/01/2019 20:45	17/01/2019 13:00	12/01/2019 20:45	13/01/2019 00:19	3,57	12	42,80	CHI
20190150160	FAINA	MP13062750	MATRINCHA	12/01/2019 20:45	17/01/2019 13:00	12/01/2019 20:45	13/01/2019 15:52	19,12	1	19,12	CHI

20190150160	MATRINCHA	MP13062750	MATRINCHA	12/01/2019 20:45	17/01/2019 13:00	12/01/2019 20:45	13/01/2019 15:52	19,12	3	57,35	CHI
20190150160	FAINA	7381641	MATRINCHA	12/01/2019 20:45	17/01/2019 13:00	12/01/2019 20:45	13/01/2019 16:40	19,92	3	59,75	CHI
20190150160	MATRINCHA	7381641	MATRINCHA	12/01/2019 20:45	17/01/2019 13:00	12/01/2019 20:45	13/01/2019 16:40	19,92	20	398,33	CHI
20190150160	FAINA	FC12299779	MATRINCHA	12/01/2019 20:45	17/01/2019 13:00	16/01/2019 08:24	16/01/2019 09:43	1,32	4	5,27	CHI
20190150160	MATRINCHA	FC12299779	MATRINCHA	12/01/2019 20:45	17/01/2019 13:00	16/01/2019 08:24	16/01/2019 09:43	1,32	23	30,28	CHI
20190150160	FAINA	FC12299779	MATRINCHA	12/01/2019 20:45	17/01/2019 13:00	16/01/2019 08:59	16/01/2019 09:43	0,73	12	8,80	CHI
20190150160	FAINA	7387466	MATRINCHA	12/01/2019 20:45	17/01/2019 13:00	12/01/2019 20:45	16/01/2019 11:39	86,90	1	86,90	CHI
20190150160	MATRINCHA	7387466	MATRINCHA	12/01/2019 20:45	17/01/2019 13:00	12/01/2019 20:45	16/01/2019 11:39	86,90	2	173,80	CHI
20190150160	MATRINCHA	7387466	MATRINCHA	12/01/2019 20:45	17/01/2019 13:00	12/01/2019 20:45	17/01/2019 10:10	109,42	9	984,75	CHI
20190150160	MATRINCHA	MP12287507	MATRINCHA	12/01/2019 20:45	17/01/2019 13:00	12/01/2019 20:45	17/01/2019 11:52	111,12	2	222,23	CHI
20190150160	MATRINCHA	7387466	MATRINCHA	12/01/2019 20:45	17/01/2019 13:00	12/01/2019 20:45	17/01/2019 13:00	112,25	3	336,75	CHI
20190150165	TEREZOPOLIS DE GOIAS	1370000458	DAIA S2	12/01/2019 20:15	13/01/2019 10:50	12/01/2019 20:15	13/01/2019 10:50	14,58	1	14,58	CHI
20190150167	GOIANIA	10825745	GOIANIA LESTE S2	12/01/2019 20:23	13/01/2019 22:46	12/01/2019 20:23	13/01/2019 22:46	26,38	1	26,38	DIA CRITICO
20190150170	GOIANIA	GN11203806	CARAJAS S2	12/01/2019 18:47	13/01/2019 16:10	12/01/2019 18:47	13/01/2019 16:10	21,38	95	2031,42	CHI
20190150175	APARECIDA DE GOIANIA	AP12055193	INDEPENDENCIA S2	12/01/2019 20:46	12/01/2019 22:45	12/01/2019 20:46	12/01/2019 22:45	1,98	424	840,93	CHI
20190150183	ALTO PARAISO DE GOIAS	BF21232055	SAO JOAO D ALIANCA	12/01/2019 20:33	13/01/2019 10:35	12/01/2019 20:33	13/01/2019 10:35	14,03	2	28,07	CHI
20190150185	HIDROLINA	1020007403	URUACU	12/01/2019 20:58	13/01/2019 02:22	12/01/2019 20:58	13/01/2019 02:22	5,40	1	5,40	CHI
20190150191	MONTES CLAROS DE GOIAS	ME21154719	IPORA	12/01/2019 20:36	13/01/2019 09:24	12/01/2019 20:36	13/01/2019 09:24	12,80	1	12,80	CHI
20190150193	SENADOR CANEDO	SW11209072	SENADOR CANEDO	12/01/2019 18:28	12/01/2019 23:48	12/01/2019 18:28	12/01/2019 23:48	5,33	141	752,00	CHI
20190150194	SANTA TEREZINHA DE GOIAS	SG21337134	SANTA TEREZINHA	12/01/2019 20:29	14/01/2019 09:20	12/01/2019 20:29	14/01/2019 09:20	36,85	1	36,85	CHI
20190150206	SANTA BARBARA DE GOIAS	TR32048114	TRINDADE	12/01/2019 18:06	13/01/2019 11:25	12/01/2019 18:06	13/01/2019 11:25	17,32	141	2441,65	DIA CRITICO
20190150206	TRINDADE	TR32048114	TRINDADE	12/01/2019 18:06	13/01/2019 11:25	12/01/2019 18:06	13/01/2019 11:25	17,32	28	484,87	DIA CRITICO
20190150207	GOIANIA	GN11162032	CAMPINAS S2	12/01/2019 20:13	14/01/2019 10:46	12/01/2019 20:13	14/01/2019 10:46	38,55	79	3045,45	DIA CRITICO
20190150209	SANTA TEREZINHA DE GOIAS	GG12171180	SANTA TEREZINHA	12/01/2019 20:29	13/01/2019 14:34	12/01/2019 20:29	13/01/2019 14:34	18,08	44	795,67	CHI
20190150213	ARAGUAPAZ	AZ12274250	GOIAS	12/01/2019 21:04	14/01/2019 09:57	12/01/2019 21:04	14/01/2019 09:57	36,88	11	405,72	CHI
20190150219	ANICUNS	AC12304531	ANICUNS	12/01/2019 20:31	13/01/2019 13:35	12/01/2019 20:31	13/01/2019 13:35	17,07	5	85,33	CHI
20190150220	SAO LUIS DE MONTES BELOS	SL11259154	SAO LUIZ DOS MONTES BELOS	12/01/2019 20:13	13/01/2019 08:13	12/01/2019 20:13	13/01/2019 08:13	12,00	48	576,00	CHI
20190150222	LUZIANIA	LZ12016676	RIO VERMELHO	12/01/2019 20:45	13/01/2019 10:47	12/01/2019 20:45	13/01/2019 10:47	14,03	27	378,90	CHI
20190150224	BELA VISTA DE GOIAS	BV12011713	BELA VISTA S1	12/01/2019 20:36	13/01/2019 13:54	12/01/2019 20:36	13/01/2019 13:54	17,30	2	34,60	CHI
20190150227	GOIANIRA	GR11275300	MEIA PONTE	12/01/2019 18:36	14/01/2019 09:30	12/01/2019 18:36	14/01/2019 09:30	38,90	89	3462,10	DIA CRITICO
20190150228	GOIANIA	13507291	MEIA PONTE	12/01/2019 21:08	15/01/2019 12:35	12/01/2019 21:08	15/01/2019 12:35	63,45	1	63,45	DIA CRITICO
20190150235	GOIANIA	GN12001664	CAMPINAS S2	12/01/2019 19:12	13/01/2019 03:18	12/01/2019 19:12	13/01/2019 03:18	8,10	148	1198,80	DIA CRITICO
20190150237	GOIANIA	GN11313254	GOYA S1	12/01/2019 19:29	13/01/2019 18:19	12/01/2019 19:29	13/01/2019 18:19	22,83	98	2237,67	DIA CRITICO

20190150239	ARAGOIANIA	AO31025020	GUAPO S2	12/01/2019 20:33	15/01/2019 13:31	12/01/2019 20:33	15/01/2019 13:31	64,97	1	64,97	CHI
20190150241	APARECIDA DE GOIANIA	AP11201087	REAL S1	12/01/2019 20:36	13/01/2019 01:00	12/01/2019 20:36	13/01/2019 01:00	4,40	73	321,20	CHI
20190150243	FAINA	FC12220289	GOIAS	12/01/2019 18:19	13/01/2019 10:27	12/01/2019 18:19	13/01/2019 10:27	16,13	29	467,87	CHI
20190150243	ITAPURANGA	FC12220289	GOIAS	12/01/2019 18:19	13/01/2019 10:27	12/01/2019 18:19	13/01/2019 10:27	16,13	2	32,27	CHI
20190150243	MORRO AGUDO DE GOIAS	FC12220289	GOIAS	12/01/2019 18:19	13/01/2019 10:27	12/01/2019 18:19	13/01/2019 10:27	16,13	3	48,40	CHI
20190150247	BARRO ALTO	BA12035658	BARRO ALTO	12/01/2019 20:36	13/01/2019 11:11	12/01/2019 20:36	13/01/2019 11:11	14,58	4	58,33	CHI
20190150247	NIQUELANDIA	BA12035658	BARRO ALTO	12/01/2019 20:36	13/01/2019 11:11	12/01/2019 20:36	13/01/2019 11:11	14,58	1	14,58	CHI
20190150250	GOIANIA	GN11192098	GOYA S2	12/01/2019 19:55	14/01/2019 11:48	12/01/2019 19:55	14/01/2019 11:48	39,88	127	5065,18	DIA CRITICO
20190150254	CATALAO	CT21192707	CATALAO S1	12/01/2019 20:38	13/01/2019 22:20	12/01/2019 20:38	13/01/2019 22:20	25,70	1	25,70	DIA CRITICO
20190150265	CALDAS NOVAS	CN12000031LD	CALDAS NOVAS S1	12/01/2019 19:59	13/01/2019 00:59	12/01/2019 19:59	13/01/2019 00:59	5,00	4	20,00	CHI
20190150265	SANTA CRUZ DE GOIAS	CN12000031LD	CALDAS NOVAS S1	12/01/2019 19:59	13/01/2019 00:59	12/01/2019 19:59	13/01/2019 00:59	5,00	2	10,00	CHI
20190150274	JUSSARA	JR12019314	JUSSARA	12/01/2019 20:51	13/01/2019 07:08	12/01/2019 20:51	13/01/2019 07:08	10,28	83	853,52	CHI
20190150284	AGUAS LINDAS DE GOIAS	LA11149840	AGUAS LINDAS DE GOIAS S1	12/01/2019 20:59	12/01/2019 22:44	12/01/2019 20:59	12/01/2019 22:44	1,75	169	295,75	CHI
20190150285	SANTA FE DE GOIAS	IU12018758	MATRINCHA	13/01/2019 00:42	13/01/2019 14:07	13/01/2019 00:42	13/01/2019 14:07	13,42	12	161,00	CHI
20190150290	TROMBAS	TB12185402	PORANGATU	12/01/2019 20:30	13/01/2019 07:33	12/01/2019 20:30	13/01/2019 07:33	11,05	3	33,15	CHI
20190150291	JUSSARA	JR12027532	BRITANIA	12/01/2019 20:35	13/01/2019 10:16	12/01/2019 20:35	13/01/2019 10:16	13,68	7	95,78	CHI
20190150305	JUSSARA	JR21320018	BRITANIA	12/01/2019 20:36	13/01/2019 09:23	12/01/2019 20:36	13/01/2019 09:23	12,78	1	12,78	CHI
20190150313	CATALAO	CT21195442	CATALAO S1	12/01/2019 20:51	13/01/2019 15:24	12/01/2019 20:51	13/01/2019 15:24	18,55	1	18,55	DIA CRITICO
20190150315	PONTALINA	PK11000003	PONTALINA	12/01/2019 20:55	13/01/2019 07:54	12/01/2019 20:55	13/01/2019 07:54	10,98	97	1065,38	CHI
20190150323	TURVANIA	TV21055912	FIRMINOPOLIS S2	12/01/2019 21:29	13/01/2019 05:00	12/01/2019 21:29	13/01/2019 05:00	7,52	1	7,52	CHI
20190150336	RUBIATABA	RB12372523	RUBIATABA	12/01/2019 20:54	13/01/2019 09:48	12/01/2019 20:54	13/01/2019 09:48	12,90	2	25,80	CHI
20190150341	BELA VISTA DE GOIAS	BV21000047	BELA VISTA S1	12/01/2019 21:30	13/01/2019 10:50	12/01/2019 21:30	13/01/2019 10:50	13,33	3	40,00	CHI
20190150346	PETROLINA DE GOIAS	PG21200824	PETROLINA	12/01/2019 20:46	14/01/2019 09:22	12/01/2019 20:46	14/01/2019 09:22	36,60	2	73,20	DIA CRITICO
20190150350	SANCLERLANDIA	SC12058699	FIRMINOPOLIS S2	12/01/2019 20:46	13/01/2019 10:28	12/01/2019 20:46	13/01/2019 10:28	13,70	3	41,10	CHI
20190150351	EDEIA	EA21038799	EDEIA	12/01/2019 21:24	13/01/2019 10:20	12/01/2019 21:24	13/01/2019 10:20	12,93	1	12,93	CHI
20190150352	ARENOPOLIS	AY12259445	IPORA	12/01/2019 20:55	12/01/2019 23:04	12/01/2019 20:55	12/01/2019 23:04	2,15	4	8,60	CHI
20190150352	PIRANHAS	AY12259445	IPORA	12/01/2019 20:55	12/01/2019 23:04	12/01/2019 20:55	12/01/2019 23:04	2,15	1	2,15	CHI
20190150355	GOIANIA	GN11002011	AEROPORTO S3	12/01/2019 20:23	13/01/2019 17:15	12/01/2019 20:23	13/01/2019 17:15	20,87	98	2044,93	CHI
20190150360	CRISTALINA	KR12163890	CRISTALINA S2	12/01/2019 20:59	13/01/2019 07:49	12/01/2019 20:59	13/01/2019 07:49	10,83	97	1050,83	CHI
20190150360	LUZIANIA	KR12163890	CRISTALINA S2	12/01/2019 20:59	13/01/2019 07:49	12/01/2019 20:59	13/01/2019 07:49	10,83	8	86,67	CHI
20190150363	PETROLINA DE GOIAS	PG21211772	PETROLINA	12/01/2019 21:02	14/01/2019 09:19	12/01/2019 21:02	14/01/2019 09:19	36,28	1	36,28	DIA CRITICO
20190150368	ARAGOIANIA	HD13394662	CEPAIGO S2	12/01/2019 20:12	13/01/2019 13:58	12/01/2019 20:12	13/01/2019 13:58	17,77	14	248,73	CHI
20190150368	HIDROLANDIA	HD13394662	CEPAIGO S2	12/01/2019 20:12	13/01/2019 13:58	12/01/2019 20:12	13/01/2019 13:58	17,77	296	5258,93	CHI

20190150368	HIDROLANDIA	HD13394662	CEPAIGO S2	12/01/2019 20:12	13/01/2019 13:58	13/01/2019 11:13	13/01/2019 13:58	2,75	4	11,00	CHI
20190150372	MAIRIPOTABA	MI21357851	PONTALINA	12/01/2019 21:05	13/01/2019 11:45	12/01/2019 21:05	13/01/2019 11:45	14,67	1	14,67	CHI
20190150373	JUSSARA	JR12019908	JUSSARA	12/01/2019 21:06	13/01/2019 08:40	12/01/2019 21:06	13/01/2019 08:40	11,57	4	46,27	CHI
20190150374	JATAI	JT21274138	JATAI S2	12/01/2019 21:09	13/01/2019 08:50	12/01/2019 21:09	13/01/2019 08:50	11,68	1	11,68	CHI
20190150377	RIO VERDE	RV21271491	CABRIUVA S2	12/01/2019 21:06	14/01/2019 00:48	12/01/2019 21:06	14/01/2019 00:48	27,70	1	27,70	CHI
20190150380	CORUMBAIBA	CI21107549	VILA CORUMBA	12/01/2019 21:37	14/01/2019 11:55	12/01/2019 21:37	14/01/2019 11:55	38,30	1	38,30	CHI
20190150386	BELA VISTA DE GOIAS	BV21097926	BELA VISTA S2	12/01/2019 21:32	14/01/2019 04:24	12/01/2019 21:32	14/01/2019 04:24	30,87	2	61,73	CHI
20190150389	BELA VISTA DE GOIAS	BV11065432	BELA VISTA S2	12/01/2019 21:11	13/01/2019 15:35	12/01/2019 21:11	13/01/2019 15:35	18,40	80	1472,00	CHI
20190150391	PIRACANJUBA	PJ21403657	ROCHEDO	12/01/2019 20:52	13/01/2019 08:28	12/01/2019 20:52	13/01/2019 08:28	11,60	1	11,60	CHI
20190150396	JUSSARA	BT12124815	BRITANIA	12/01/2019 21:39	14/01/2019 18:35	12/01/2019 21:39	13/01/2019 16:55	19,27	5	96,33	CHI
20190150396	BRITANIA	BT12124815	BRITANIA	12/01/2019 21:39	14/01/2019 18:35	12/01/2019 21:39	14/01/2019 18:35	44,93	13	584,13	CHI
20190150396	JUSSARA	BT12124815	BRITANIA	12/01/2019 21:39	14/01/2019 18:35	14/01/2019 17:15	14/01/2019 18:35	1,33	5	6,67	CHI
20190150400	GOIANIA	GN11282958	GOYA S1	12/01/2019 18:50	14/01/2019 00:12	12/01/2019 18:50	14/01/2019 00:12	29,37	69	2026,30	DIA CRITICO
20190150403	GOIANIA	GN11340638	AEROPORTO S3	12/01/2019 20:46	13/01/2019 16:32	12/01/2019 20:46	13/01/2019 16:32	19,77	100	1976,67	CHI
20190150411	ANAPOLIS	AN21379426	ANAPOLIS UNIVERSITARIO S1	12/01/2019 20:57	13/01/2019 14:15	12/01/2019 20:57	13/01/2019 14:15	17,30	2	34,60	CHI
20190150415	TRINDADE	TR11002501	TRINDADE	12/01/2019 20:38	13/01/2019 19:23	12/01/2019 20:38	13/01/2019 19:23	22,75	54	1228,50	DIA CRITICO
20190150424	VIANOPOLIS	VN11291641	VIANOPOLIS	12/01/2019 21:02	13/01/2019 18:48	12/01/2019 21:02	13/01/2019 18:48	21,77	6	130,60	CHI
20190150427	PONTALINA	PK21074972	PONTALINA	12/01/2019 21:21	13/01/2019 09:29	12/01/2019 21:21	13/01/2019 09:29	12,13	1	12,13	CHI
20190150431	ARUANA	MP12102504	MATRINCHA	12/01/2019 21:24	14/01/2019 07:04	12/01/2019 21:24	14/01/2019 07:04	33,67	1	33,67	CHI
20190150441	DIORAMA	ME12184441	IPORA	13/01/2019 06:24	13/01/2019 13:20	13/01/2019 06:24	13/01/2019 13:20	6,93	11	76,27	CHI
20190150441	MONTES CLAROS DE GOIAS	ME12184441	IPORA	13/01/2019 06:24	13/01/2019 13:20	13/01/2019 06:24	13/01/2019 13:20	6,93	70	485,33	CHI
20190150444	ANAPOLIS	AN11004478	ANAPOLIS UNIVERSITARIO S2	12/01/2019 16:11	13/01/2019 04:15	12/01/2019 16:11	13/01/2019 04:15	12,07	166	2003,07	CHI
20190150445	GOIANIA	GN11083703	ATLANTICO S1	12/01/2019 18:55	13/01/2019 17:39	12/01/2019 18:55	13/01/2019 17:39	22,73	144	3273,60	CHI
20190150446	GOIAS	GS12093798	MATRINCHA	12/01/2019 21:25	13/01/2019 10:53	12/01/2019 21:25	13/01/2019 10:53	13,47	7	94,27	CHI
20190150450	BRAZABRANTES	NV12272430	INHUMAS S1	12/01/2019 20:50	13/01/2019 08:01	12/01/2019 20:50	13/01/2019 08:01	11,18	4	44,73	CHI
20190150450	NOVA VENEZA	NV12272430	INHUMAS S1	12/01/2019 20:50	13/01/2019 08:01	12/01/2019 20:50	13/01/2019 08:01	11,18	3	33,55	CHI
20190150454	ABADIA DE GOIAS	LG11251432	CARAJAS S1	12/01/2019 21:16	13/01/2019 03:14	12/01/2019 21:16	13/01/2019 03:14	5,97	135	805,50	CHI
20190150472	NIQUELANDIA	NQ12208518	NIQUELANDIA SUBTRANSMISSÃO	12/01/2019 21:22	13/01/2019 14:34	12/01/2019 21:22	13/01/2019 08:04	10,70	52	556,40	CHI
20190150472	NIQUELANDIA	NQ12208518	NIQUELANDIA SUBTRANSMISSÃO	12/01/2019 21:22	13/01/2019 14:34	13/01/2019 09:41	13/01/2019 10:21	0,67	52	34,67	CHI
20190150472	NIQUELANDIA	NQ13090398	NIQUELANDIA SUBTRANSMISSÃO	12/01/2019 21:22	13/01/2019 14:34	12/01/2019 21:22	13/01/2019 14:31	17,15	26	445,90	CHI
20190150472	NIQUELANDIA	NQ13202075	NIQUELANDIA SUBTRANSMISSÃO	12/01/2019 21:22	13/01/2019 14:34	12/01/2019 21:22	13/01/2019 14:34	17,20	25	430,00	CHI
20190150475	GUARINOS	GF21287089	SANTA TEREZINHA	12/01/2019 21:27	14/01/2019 09:59	12/01/2019 21:27	14/01/2019 09:59	36,53	1	36,53	CHI
20190150477	GOIANIA	GN12001353	GOIANIA LESTE S1	12/01/2019 20:11	13/01/2019 04:39	12/01/2019 20:11	13/01/2019 04:39	8,47	1035	8763,00	CHI

20190150481	GOIATUBA	VI12329055	VICENTINOPOLIS	12/01/2019 20:52	13/01/2019 07:50	12/01/2019 20:52	13/01/2019 07:50	10,97	13	142,57	CHI
20190150481	VICENTINOPOLIS	VI12329055	VICENTINOPOLIS	12/01/2019 20:52	13/01/2019 07:50	12/01/2019 20:52	13/01/2019 07:50	10,97	25	274,17	CHI
20190150484	JUSSARA	JR12011813	BRITANIA	12/01/2019 20:13	13/01/2019 21:00	12/01/2019 20:13	13/01/2019 12:35	16,37	7	114,57	CHI
20190150484	JUSSARA	JR12198421	BRITANIA	12/01/2019 20:13	13/01/2019 21:00	13/01/2019 12:36	13/01/2019 13:18	0,70	19	13,30	CHI
20190150484	JUSSARA	JR13162413	BRITANIA	12/01/2019 20:13	13/01/2019 21:00	12/01/2019 20:13	13/01/2019 14:56	18,72	1	18,72	CHI
20190150484	JUSSARA	JR12013107LD	BRITANIA	12/01/2019 20:13	13/01/2019 21:00	12/01/2019 20:13	13/01/2019 18:09	21,93	1	21,93	CHI
20190150484	JUSSARA	JR12013107LD	BRITANIA	12/01/2019 20:13	13/01/2019 21:00	13/01/2019 18:10	13/01/2019 19:53	1,72	1	1,72	CHI
20190150484	JUSSARA	JR13292725	BRITANIA	12/01/2019 20:13	13/01/2019 21:00	12/01/2019 20:13	13/01/2019 21:00	24,78	21	520,45	CHI
20190150485	PLANALTINA	PI12262322	PLANALTINA	12/01/2019 21:43	13/01/2019 03:54	12/01/2019 21:43	13/01/2019 03:54	6,18	14	86,57	CHI
20190150487	MAIRIPOTABA	MI21244379	PONTALINA	12/01/2019 21:48	13/01/2019 16:01	12/01/2019 21:48	13/01/2019 16:01	18,22	1	18,22	CHI
20190150491	CALDAS NOVAS	CN12011481LD	CALDAS NOVAS S1	12/01/2019 21:44	13/01/2019 00:59	12/01/2019 21:44	13/01/2019 00:59	3,25	198	643,50	CHI
20190150491	SANTA CRUZ DE GOIAS	CN12011481LD	CALDAS NOVAS S1	12/01/2019 21:44	13/01/2019 00:59	12/01/2019 21:44	13/01/2019 00:59	3,25	102	331,50	CHI
20190150496	BELA VISTA DE GOIAS	BV12360000	BELA VISTA S2	12/01/2019 21:13	13/01/2019 10:13	12/01/2019 21:13	13/01/2019 10:13	13,00	2	26,00	CHI
20190150511	GOIANIRA	GR11295091	MEIA PONTE	12/01/2019 21:21	14/01/2019 15:10	12/01/2019 21:21	14/01/2019 15:10	41,82	91	3805,32	DIA CRITICO
20190150512	ITAPACI	SZ12243712	ITAPACI	12/01/2019 18:02	13/01/2019 13:19	12/01/2019 18:02	13/01/2019 13:19	19,28	3	57,85	CHI
20190150512	SAO LUIZ DO NORTE	SZ12243712	ITAPACI	12/01/2019 18:02	13/01/2019 13:19	12/01/2019 18:02	13/01/2019 13:19	19,28	13	250,68	CHI
20190150513	GOIANIA	GN12001517	XAVANTES	12/01/2019 20:47	13/01/2019 01:31	12/01/2019 20:47	13/01/2019 01:31	4,73	782	3701,47	DIA CRITICO
20190150521	POSSE	PS12344417	IACIARA S1	12/01/2019 21:52	13/01/2019 10:45	12/01/2019 21:52	13/01/2019 10:45	12,88	144	1855,20	CHI
20190150522	GOIANIA	GN12130652	XAVANTES	12/01/2019 20:47	13/01/2019 01:30	12/01/2019 20:47	13/01/2019 01:30	4,72	599	2825,28	DIA CRITICO
20190150525	PORANGATU	TB12262770	PORANGATU	12/01/2019 19:54	13/01/2019 09:06	12/01/2019 19:54	13/01/2019 09:06	13,20	1	13,20	CHI
20190150525	SANTA TEREZA DE GOIAS	TB12262770	PORANGATU	12/01/2019 19:54	13/01/2019 09:06	12/01/2019 19:54	13/01/2019 09:06	13,20	5	66,00	CHI
20190150525	TROMBAS	TB12262770	PORANGATU	12/01/2019 19:54	13/01/2019 09:06	12/01/2019 19:54	13/01/2019 09:06	13,20	13	171,60	CHI
20190150529	PIRENOPOLIS	PV21155397	CORUMBA	12/01/2019 21:57	13/01/2019 17:54	12/01/2019 21:57	13/01/2019 17:54	19,95	1	19,95	DIA CRITICO
20190150536	GOIANIA	GN11043926	ATLANTICO S2	12/01/2019 21:42	13/01/2019 16:25	12/01/2019 21:42	13/01/2019 16:25	18,72	200	3743,33	CHI
20190150541	PIRENOPOLIS	PV11000022	CORUMBA	12/01/2019 21:44	12/01/2019 23:55	12/01/2019 21:44	12/01/2019 23:55	2,18	307	670,28	DIA CRITICO
20190150542	GOIANIA	GN12265400	GOIANIA LESTE S3	12/01/2019 19:32	13/01/2019 08:10	12/01/2019 19:32	13/01/2019 08:10	12,63	136	1718,13	DIA CRITICO
20190150545	ITAPACI	IW12141396	ITAPACI	12/01/2019 20:29	13/01/2019 08:12	12/01/2019 20:29	13/01/2019 08:12	11,72	9	105,45	CHI
20190150552	JARAGUA	JA12064317	JARAGUA	12/01/2019 20:53	13/01/2019 01:01	12/01/2019 20:53	13/01/2019 01:01	4,13	52	214,93	CHI
20190150556	SANTO ANTONIO DE GOIAS	BW11343452	NEROPOLIS S1	12/01/2019 18:43	13/01/2019 10:44	12/01/2019 18:43	13/01/2019 10:44	16,02	14	224,23	DIA CRITICO
20190150559	GUAPO	GA21000056	GUAPO S1	12/01/2019 21:59	14/01/2019 20:01	12/01/2019 21:59	14/01/2019 20:01	46,03	1	46,03	CHI
20190150565	ITUMBIARA	IT12222376	ITUMBIARA VELHA S1	12/01/2019 21:54	12/01/2019 23:52	12/01/2019 21:54	12/01/2019 23:52	1,97	8	15,73	CHI
20190150567	RUBIATABA	RB12000034	RUBIATABA	12/01/2019 21:35	13/01/2019 08:15	12/01/2019 21:35	13/01/2019 08:15	10,67	12	128,00	CHI
20190150569	ANAPOLIS	AN11392173	ANAPOLIS UNIVERSITARIO S2	12/01/2019 21:54	13/01/2019 11:12	12/01/2019 21:54	13/01/2019 11:12	13,30	88	1170,40	CHI

20190150572	ITAPIRAPUA	IU11018875	MATRINCHA	12/01/2019 20:15	12/01/2019 23:46	12/01/2019 20:15	12/01/2019 23:46	3,52	113	397,38	CHI
20190150576	PROFESSOR JAMIL SAFADY	JS12115433	ROCHEDO	12/01/2019 21:43	13/01/2019 02:56	12/01/2019 23:08	13/01/2019 00:43	1,58	106	167,83	CHI
20190150576	PROFESSOR JAMIL SAFADY	JS11115432	ROCHEDO	12/01/2019 21:43	13/01/2019 02:56	12/01/2019 21:43	13/01/2019 02:56	5,22	77	401,68	CHI
20190150577	FAZENDA NOVA	FN12073960	JUSSARA	12/01/2019 20:29	13/01/2019 20:27	12/01/2019 20:29	13/01/2019 20:27	23,97	24	575,20	CHI
20190150582	GOIAS	GS21319416	GOIAS	12/01/2019 22:07	13/01/2019 18:31	12/01/2019 22:07	13/01/2019 18:31	20,40	1	20,40	CHI
20190150588	RIO VERDE	RV12000118	RIO VERDE S2	12/01/2019 22:08	13/01/2019 01:15	12/01/2019 22:08	13/01/2019 01:15	3,12	63	196,35	CHI
20190150588	SANTA HELENA DE GOIAS	RV12000118	RIO VERDE S2	12/01/2019 22:08	13/01/2019 01:15	12/01/2019 22:08	13/01/2019 01:15	3,12	65	202,58	CHI
20190150597	RUBIATABA	RB11000009	RUBIATABA	12/01/2019 20:39	13/01/2019 02:18	12/01/2019 20:39	13/01/2019 02:18	5,65	116	655,40	CHI
20190150600	BELA VISTA DE GOIAS	BV12020243	BELA VISTA S2	12/01/2019 22:11	13/01/2019 12:11	12/01/2019 22:11	13/01/2019 12:11	14,00	1	14,00	CHI
20190150601	GOIANIA	14382283	MEIA PONTE	12/01/2019 22:11	15/01/2019 10:48	12/01/2019 22:11	15/01/2019 10:48	60,62	1	60,62	DIA CRITICO
20190150604	SENADOR CANEDO	SW11038332	SENADOR CANEDO	12/01/2019 22:13	13/01/2019 09:10	12/01/2019 22:13	13/01/2019 09:10	10,95	80	876,00	CHI
20190150607	ARUANA	AK11376419	ARUANA	12/01/2019 20:23	13/01/2019 11:58	12/01/2019 20:23	13/01/2019 11:58	15,58	60	935,00	CHI
20190150608	ALEXANIA	AX12000057	ALEXANIA	12/01/2019 18:12	13/01/2019 14:46	12/01/2019 18:12	13/01/2019 14:46	20,57	10	205,67	CHI
20190150608	SANTO ANTONIO DO DESCOBERTO	AX12000057	ALEXANIA	12/01/2019 18:12	13/01/2019 14:46	12/01/2019 18:12	13/01/2019 14:46	20,57	2	41,13	CHI
20190150610	GOIANIA	GN11002039	CAMPINAS S3	12/01/2019 19:27	13/01/2019 15:14	12/01/2019 19:27	13/01/2019 15:14	19,78	81	1602,45	DIA CRITICO
20190150614	ESTRELA DO NORTE	ET12168852	MARA ROSA	12/01/2019 19:12	13/01/2019 08:34	12/01/2019 19:12	13/01/2019 08:34	13,37	4	53,47	CHI
20190150614	FORMOSO	ET12168852	MARA ROSA	12/01/2019 19:12	13/01/2019 08:34	12/01/2019 19:12	13/01/2019 08:34	13,37	2	26,73	CHI
20190150617	GOIANIA	GN11229538	XAVANTES	12/01/2019 19:44	13/01/2019 11:50	12/01/2019 19:44	13/01/2019 11:50	16,10	72	1159,20	DIA CRITICO
20190150622	CRIXAS	UP12171789	SANTA TEREZINHA	12/01/2019 21:39	13/01/2019 10:03	12/01/2019 21:39	13/01/2019 10:03	12,40	15	186,00	CHI
20190150622	UIRAPURU	UP12171789	SANTA TEREZINHA	12/01/2019 21:39	13/01/2019 10:03	12/01/2019 21:39	13/01/2019 10:03	12,40	50	620,00	CHI
20190150630	GOIANESIA	GE12115135	GOIANESIA S1	12/01/2019 22:20	13/01/2019 18:16	12/01/2019 22:20	13/01/2019 18:16	19,93	2	39,87	CHI
20190150633	SAO FRANCISCO DE GOIAS	10022911489	SAO FRANCISCO DE GOIAS	12/01/2019 22:21	14/01/2019 07:49	12/01/2019 22:21	14/01/2019 07:49	33,47	1	33,47	DIA CRITICO
20190150635	QUIRINOPOLIS	QI21116446	QUIRINOPOLIS	12/01/2019 22:22	13/01/2019 00:07	12/01/2019 22:22	13/01/2019 00:07	1,75	2	3,50	CHI
20190150638	RIO VERDE	RV12000089	CABRIUVA S1	12/01/2019 22:22	12/01/2019 22:51	12/01/2019 22:22	12/01/2019 22:51	0,48	2	0,97	CHI
20190150641	ANAPOLIS	AN11121962	JUNDIAI S1	12/01/2019 21:57	13/01/2019 12:10	12/01/2019 21:57	13/01/2019 12:10	14,22	172	2445,27	CHI
20190150643	JATAI	JT11172264	JATAI S2	12/01/2019 22:17	13/01/2019 12:17	12/01/2019 22:17	13/01/2019 12:17	14,00	101	1414,00	CHI
20190150647	GOIANIA	GN11065517	MEIA PONTE	12/01/2019 18:39	14/01/2019 16:37	12/01/2019 18:39	14/01/2019 16:37	45,97	240	11032,00	DIA CRITICO
20190150654	GOIANIA	GN12001199	CARAJAS S1	12/01/2019 19:52	12/01/2019 23:55	12/01/2019 19:52	12/01/2019 23:55	4,05	285	1154,25	CHI
20190150657	GOIANIA	GN12000081	ATLANTICO S1	12/01/2019 22:27	13/01/2019 00:30	12/01/2019 22:27	13/01/2019 00:30	2,05	117	239,85	CHI
20190150661	TRINDADE	TR11129066	TRINDADE	12/01/2019 21:48	13/01/2019 09:35	12/01/2019 21:48	13/01/2019 09:35	11,78	169	1991,38	DIA CRITICO
20190150663	PONTALINA	PK21186005	GOIATUBA S1	12/01/2019 20:18	13/01/2019 10:40	12/01/2019 20:18	13/01/2019 10:40	14,37	1	14,37	CHI
20190150674	CRISTALINA	KR12401305LD	CRISTALINA S1	12/01/2019 22:35	13/01/2019 09:36	12/01/2019 22:35	13/01/2019 09:36	11,02	4	44,07	CHI
20190150676	CAMPO ALEGRE DE GOIAS	CT12306674	CATALAO S1	13/01/2019 05:32	13/01/2019 11:23	13/01/2019 05:32	13/01/2019 11:23	5,85	1	5,85	CHI

20190150676	CATALAO	CT12306674	CATALAO S1	13/01/2019 05:32	13/01/2019 11:23	13/01/2019 05:32	13/01/2019 11:23	5,85	334	1953,90	CHI
20190150678	ACREUNA	EU12296083LD	ACREUNA	12/01/2019 22:36	13/01/2019 00:56	12/01/2019 22:36	13/01/2019 00:56	2,33	6	14,00	CHI
20190150679	SERRANOPOLIS	SX11147545	JATAI S1	12/01/2019 21:03	13/01/2019 15:46	12/01/2019 21:03	13/01/2019 15:46	18,72	74	1385,03	CHI
20190150680	ALEXANIA	AX12374685	CORUMBA	12/01/2019 22:33	13/01/2019 08:20	12/01/2019 22:33	13/01/2019 08:20	9,78	29	283,72	DIA CRITICO
20190150683	NIQUELANDIA	NQ12171829	NIQUELANDIA SUBTRANSMISSÃO	12/01/2019 20:37	13/01/2019 02:43	12/01/2019 20:37	13/01/2019 02:43	6,10	380	2318,00	CHI
20190150686	NOVA IGUACU DE GOIAS	NH12232436	SANTA TEREZINHA	12/01/2019 18:17	13/01/2019 08:36	12/01/2019 18:17	13/01/2019 08:36	14,32	19	272,02	CHI
20190150689	FLORES DE GOIAS	FB21233550	FLORES DE GOIAS	12/01/2019 22:37	13/01/2019 22:41	12/01/2019 22:37	13/01/2019 22:41	24,07	1	24,07	CHI
20190150698	DIORAMA	DI12028436	ARENOPOLIS	12/01/2019 22:39	13/01/2019 15:04	12/01/2019 22:39	13/01/2019 15:04	16,42	3	49,25	CHI
20190150698	MONTES CLAROS DE GOIAS	DI12028436	ARENOPOLIS	12/01/2019 22:39	13/01/2019 15:04	12/01/2019 22:39	13/01/2019 15:04	16,42	14	229,83	CHI
20190150709	FAZENDA NOVA	FN11019359	JUSSARA	12/01/2019 20:05	13/01/2019 19:08	12/01/2019 20:05	13/01/2019 19:08	23,05	70	1613,50	CHI
20190150722	CIDADE OCIDENTAL	LZ12255588	RIO VERMELHO	12/01/2019 16:10	13/01/2019 08:43	12/01/2019 16:10	13/01/2019 08:43	16,55	9	148,95	CHI
20190150722	LUZIANIA	LZ12255588	RIO VERMELHO	12/01/2019 16:10	13/01/2019 08:43	12/01/2019 16:10	13/01/2019 08:43	16,55	1	16,55	CHI
20190150726	BELA VISTA DE GOIAS	BV12029817	BELA VISTA S1	12/01/2019 22:46	13/01/2019 10:51	12/01/2019 22:46	13/01/2019 10:51	12,08	11	132,92	CHI
20190150730	AGUAS LINDAS DE GOIAS	10012794099	AGUAS LINDAS DE GOIAS S1	12/01/2019 22:53	13/01/2019 14:58	12/01/2019 22:53	13/01/2019 14:58	16,08	1	16,08	CHI
20190150731	GOIAS	GS12259678	ITABERAI S2	12/01/2019 22:52	13/01/2019 08:43	12/01/2019 22:52	13/01/2019 08:43	9,85	49	482,65	CHI
20190150740	SENADOR CANEDO	SW11239215	SENADOR CANEDO	12/01/2019 22:49	13/01/2019 04:47	12/01/2019 22:49	13/01/2019 04:47	5,97	100	596,67	CHI
20190150748	AGUAS LINDAS DE GOIAS	LA11128741	AGUAS LINDAS DE GOIAS S1	12/01/2019 21:32	13/01/2019 03:19	12/01/2019 21:32	13/01/2019 03:19	5,78	88	508,93	CHI
20190150755	ARUANA	AK12341269	BRITANIA	12/01/2019 22:55	13/01/2019 18:19	12/01/2019 22:55	13/01/2019 18:19	19,40	2	38,80	CHI
20190150759	ARAGARCAS	AG12072894	ARAGARCAS	12/01/2019 22:52	13/01/2019 13:24	12/01/2019 22:52	13/01/2019 13:24	14,53	71	1031,87	CHI
20190150759	BOM JARDIM DE GOIAS	AG12072894	ARAGARCAS	12/01/2019 22:52	13/01/2019 13:24	12/01/2019 22:52	13/01/2019 13:24	14,53	35	508,67	CHI
20190150760	GOIANIA	GN11001631	XAVANTES	12/01/2019 21:03	14/01/2019 09:04	12/01/2019 21:03	14/01/2019 09:04	36,02	106	3817,77	DIA CRITICO
20190150765	PALMEIRAS DE GOIAS	PL11000005	PALMEIRAS	12/01/2019 21:47	13/01/2019 14:03	12/01/2019 21:47	13/01/2019 14:03	16,27	131	2130,93	CHI
20190150777	MONTES CLAROS DE GOIAS	AY12223209	IPORA	12/01/2019 23:04	13/01/2019 17:50	12/01/2019 23:04	13/01/2019 17:50	18,77	77	1445,03	CHI
20190150779	PALMEIRAS DE GOIAS	PL12000267	PALMEIRAS	12/01/2019 23:05	14/01/2019 10:21	12/01/2019 23:05	14/01/2019 10:21	35,27	3	105,80	CHI
20190150780	VALPARAISO DE GOIAS	VA11192785	MARAJOARA	12/01/2019 23:03	13/01/2019 01:28	12/01/2019 23:03	13/01/2019 01:28	2,42	92	222,33	CHI
20190150781	JUSSARA	JR11198836	JUSSARA	12/01/2019 23:04	13/01/2019 11:45	12/01/2019 23:04	13/01/2019 11:45	12,68	71	900,52	CHI
20190150783	JUSSARA	JR12114080	JUSSARA	12/01/2019 23:06	13/01/2019 09:11	12/01/2019 23:06	13/01/2019 09:11	10,08	2	20,17	CHI
20190150787	JATAI	JT12063435	JATAI S2	12/01/2019 21:13	13/01/2019 11:04	12/01/2019 21:13	13/01/2019 11:04	13,85	82	1135,70	CHI
20190150787	JATAI	JT12063435	JATAI S2	12/01/2019 21:13	13/01/2019 11:04	13/01/2019 09:59	13/01/2019 11:04	1,08	228	247,00	CHI
20190150792	GOIANIA	11591146	XAVANTES	12/01/2019 23:09	14/01/2019 17:57	12/01/2019 23:09	14/01/2019 17:57	42,80	1	42,80	DIA CRITICO
20190150799	BELA VISTA DE GOIAS	BV12347597	BELA VISTA S1	12/01/2019 17:54	13/01/2019 08:06	12/01/2019 17:54	13/01/2019 08:06	14,20	246	3493,20	CHI
20190150800	ARAGARCAS	1820035879	ARAGARCAS	12/01/2019 23:13	13/01/2019 08:49	12/01/2019 23:13	13/01/2019 08:49	9,60	1	9,60	CHI
20190150802	APARECIDA DE GOIANIA	AP11166584	INDEPENDENCIA S2	12/01/2019 22:25	13/01/2019 09:07	12/01/2019 22:25	13/01/2019 09:07	10,70	99	1059,30	CHI

20190150803	HIDROLANDIA	HD11282768	CEPAIGO S2	12/01/2019 20:40	13/01/2019 10:07	12/01/2019 20:40	13/01/2019 10:07	13,45	73	981,85	CHI
20190150904	ARAGARCAS	AG11138458	ARAGARCAS	12/01/2019 23:23	13/01/2019 04:07	12/01/2019 23:23	13/01/2019 04:07	4,73	33	156,20	CHI
20190150907	GOIANIA	GN12326311	GOYA S1	12/01/2019 17:43	13/01/2019 10:19	12/01/2019 17:43	13/01/2019 10:19	16,60	4	66,40	DIA CRITICO
20190150917	FAZENDA NOVA	FN12040966	JUSSARA	12/01/2019 20:47	14/01/2019 09:43	12/01/2019 20:47	14/01/2019 09:43	36,93	8	295,47	CHI
20190150917	FAZENDA NOVA	FN12040966	JUSSARA	12/01/2019 20:47	14/01/2019 09:43	12/01/2019 23:26	14/01/2019 09:43	34,28	2	68,57	CHI
20190150921	CATALAO	CT11078243	CATALAO S2	12/01/2019 23:27	13/01/2019 07:44	12/01/2019 23:27	13/01/2019 07:44	8,28	90	745,50	CHI
20190150929	GOIANIA	GN11003125	GOYA S1	12/01/2019 21:25	13/01/2019 10:18	12/01/2019 21:25	13/01/2019 10:18	12,88	45	579,75	DIA CRITICO
20190150930	IPAMERI	IP21359965	PIRES DO RIO S2	12/01/2019 23:32	14/01/2019 04:21	12/01/2019 23:32	14/01/2019 04:21	28,82	1	28,82	CHI
20190150939	SANTA BARBARA DE GOIAS	01760224	TRINDADE	13/01/2019 05:27	13/01/2019 05:30	13/01/2019 05:27	13/01/2019 05:30	0,05	15	0,75	DIA CRITICO
20190150939	TRINDADE	01760224	TRINDADE	13/01/2019 05:27	13/01/2019 05:30	13/01/2019 05:27	13/01/2019 05:30	0,05	13606	680,30	DIA CRITICO
20190150942	ITAGUARU	IC21250483	ITAPURANGA	12/01/2019 23:37	13/01/2019 16:43	12/01/2019 23:37	13/01/2019 16:43	17,10	1	17,10	CHI
20190150944	APARECIDA DE GOIANIA	AP11168048	REAL S2	12/01/2019 23:07	13/01/2019 11:40	12/01/2019 23:07	13/01/2019 11:40	12,55	84	1054,20	CHI
20190150949	GOIANIA	GN12002513	CAMPINAS S2	12/01/2019 21:52	13/01/2019 21:41	12/01/2019 21:52	13/01/2019 21:41	23,82	244	5811,27	DIA CRITICO
20190150956	AMERICANO DO BRASIL	KB12000027	ANICUNS	13/01/2019 04:06	15/01/2019 21:06	13/01/2019 04:06	13/01/2019 13:18	9,20	41	377,20	CHI
20190150956	ANICUNS	KB12000027	ANICUNS	13/01/2019 04:06	15/01/2019 21:06	13/01/2019 04:06	13/01/2019 13:18	9,20	191	1757,20	CHI
20190150956	ITABERAÍ	KB12000027	ANICUNS	13/01/2019 04:06	15/01/2019 21:06	13/01/2019 04:06	13/01/2019 13:18	9,20	2	18,40	CHI
20190150956	AMERICANO DO BRASIL	KB12000027	ANICUNS	13/01/2019 04:06	15/01/2019 21:06	13/01/2019 13:19	13/01/2019 17:41	4,37	41	179,03	CHI
20190150956	ANICUNS	KB12000027	ANICUNS	13/01/2019 04:06	15/01/2019 21:06	13/01/2019 13:19	13/01/2019 17:41	4,37	136	593,87	CHI
20190150956	ITABERAÍ	KB12000027	ANICUNS	13/01/2019 04:06	15/01/2019 21:06	13/01/2019 13:19	13/01/2019 17:41	4,37	2	8,73	CHI
20190150956	AMERICANO DO BRASIL	KB12000027	ANICUNS	13/01/2019 04:06	15/01/2019 21:06	14/01/2019 10:58	14/01/2019 21:30	10,53	34	358,13	CHI
20190150956	ANICUNS	KB12000027	ANICUNS	13/01/2019 04:06	15/01/2019 21:06	14/01/2019 10:58	14/01/2019 21:30	10,53	9	94,80	CHI
20190150956	ANICUNS	KB12000027	ANICUNS	13/01/2019 04:06	15/01/2019 21:06	13/01/2019 13:19	15/01/2019 21:06	55,78	55	3068,08	CHI
20190150956	AMERICANO DO BRASIL	KB12000027	ANICUNS	13/01/2019 04:06	15/01/2019 21:06	14/01/2019 10:58	15/01/2019 21:06	34,13	7	238,93	CHI
20190150956	ANICUNS	KB12000027	ANICUNS	13/01/2019 04:06	15/01/2019 21:06	14/01/2019 10:58	15/01/2019 21:06	34,13	127	4334,93	CHI
20190150956	ITABERAÍ	KB12000027	ANICUNS	13/01/2019 04:06	15/01/2019 21:06	14/01/2019 10:58	15/01/2019 21:06	34,13	2	68,27	CHI
20190150956	AMERICANO DO BRASIL	KB12000027	ANICUNS	13/01/2019 04:06	15/01/2019 21:06	15/01/2019 19:27	15/01/2019 21:06	1,65	34	56,10	CHI
20190150956	ANICUNS	KB12000027	ANICUNS	13/01/2019 04:06	15/01/2019 21:06	15/01/2019 19:27	15/01/2019 21:06	1,65	9	14,85	CHI
20190150959	GOIANIA	GN11201077	GOYA S2	12/01/2019 21:18	13/01/2019 19:00	12/01/2019 21:18	13/01/2019 19:00	21,70	101	2191,70	DIA CRITICO
20190150963	ANICUNS	AC12000068	ANICUNS	12/01/2019 20:29	13/01/2019 08:02	12/01/2019 20:29	13/01/2019 08:02	11,55	34	392,70	CHI
20190150980	ANAPOLIS	AN11211784	ANAPOLIS UNIVERSITARIO S2	12/01/2019 23:52	13/01/2019 15:21	12/01/2019 23:52	13/01/2019 15:21	15,48	145	2245,08	CHI
20190150982	GOIANIA	GN11168059	CAMPINAS S1	12/01/2019 23:48	13/01/2019 11:04	12/01/2019 23:48	13/01/2019 11:04	11,27	75	845,00	DIA CRITICO
20190150983	GOIANIA	GN11219016	GOIANIA LESTE S1	12/01/2019 23:54	13/01/2019 14:31	12/01/2019 23:54	13/01/2019 14:31	14,62	59	862,38	CHI
20190150987	APARECIDA DE GOIANIA	AP12000044	INDEPENDENCIA S2	12/01/2019 23:48	13/01/2019 10:35	12/01/2019 23:48	13/01/2019 10:35	10,78	151	1628,28	CHI

20190150989	GOIANIA	GN11002384	XAVANTES	12/01/2019 23:10	13/01/2019 17:20	12/01/2019 23:10	13/01/2019 17:20	18,17	69	1253,50	DIA CRITICO
20190150996	FAZENDA NOVA	FN12292739	JUSSARA	12/01/2019 19:33	13/01/2019 10:28	12/01/2019 19:33	13/01/2019 10:21	14,80	3	44,40	CHI
20190150996	FAZENDA NOVA	FN12292739	JUSSARA	12/01/2019 19:33	13/01/2019 10:28	12/01/2019 19:33	13/01/2019 10:28	14,92	39	581,75	CHI
20190150999	SANTO ANTONIO DE GOIAS	BW11219061	NEROPOLIS S1	12/01/2019 23:08	13/01/2019 10:00	12/01/2019 23:08	13/01/2019 10:00	10,87	111	1206,20	DIA CRITICO
20190151009	ANAPOLIS	AN11000234	ANAPOLIS UNIVERSITARIO S1	12/01/2019 22:53	13/01/2019 10:32	12/01/2019 22:53	13/01/2019 10:32	11,65	163	1898,95	CHI
20190151011	INDIARA	IY12205924	EDEIA	13/01/2019 08:35	13/01/2019 11:30	13/01/2019 08:35	13/01/2019 11:30	2,92	294	857,50	CHI
20190151011	JANDAIA	IY12205924	EDEIA	13/01/2019 08:35	13/01/2019 11:30	13/01/2019 08:35	13/01/2019 11:30	2,92	1	2,92	CHI
20190151013	ANAPOLIS	AN11203735	JUNDIAI S1	12/01/2019 23:57	13/01/2019 02:06	12/01/2019 23:57	13/01/2019 02:06	2,15	66	141,90	CHI
20190151014	RIO VERDE	RV11213463	RIO VERDE S2	13/01/2019 00:15	13/01/2019 11:30	13/01/2019 00:15	13/01/2019 11:30	11,25	134	1507,50	CHI
20190151025	CEZARINA	PL12304466	PALMEIRAS	13/01/2019 00:23	13/01/2019 23:36	13/01/2019 00:23	13/01/2019 23:36	23,22	1	23,22	DIA CRITICO
20190151025	PALMEIRAS DE GOIAS	PL12304466	PALMEIRAS	13/01/2019 00:23	13/01/2019 23:36	13/01/2019 00:23	13/01/2019 23:36	23,22	12	278,60	DIA CRITICO
20190151036	SAO LUIZ DO NORTE	SZ12236801	BARRO ALTO	12/01/2019 21:00	14/01/2019 19:45	12/01/2019 21:00	13/01/2019 14:19	17,32	13	225,12	CHI
20190151036	SAO LUIZ DO NORTE	6710628	BARRO ALTO	12/01/2019 21:00	14/01/2019 19:45	12/01/2019 21:00	14/01/2019 19:45	46,75	10	467,50	CHI
20190151038	GOIANIA	GN11200595	XAVANTES	13/01/2019 00:22	13/01/2019 13:58	13/01/2019 00:22	13/01/2019 13:58	13,60	57	775,20	DIA CRITICO
20190151041	APARECIDA DE GOIANIA	AP11111850	INDEPENDENCIA S2	12/01/2019 23:03	13/01/2019 08:37	12/01/2019 23:03	13/01/2019 08:37	9,57	125	1195,83	CHI
20190151043	ANAPOLIS	AN11000264	JUNDIAI S1	12/01/2019 22:10	13/01/2019 04:10	12/01/2019 22:10	13/01/2019 04:10	6,00	156	936,00	CHI
20190151047	SENADOR CANEDO	SW12161513	SENADOR CANEDO	12/01/2019 23:49	13/01/2019 18:25	12/01/2019 23:49	13/01/2019 18:25	18,60	275	5115,00	CHI
20190151050	EDEALINA	ED12284469	PONTALINA	12/01/2019 23:33	13/01/2019 09:10	12/01/2019 23:33	13/01/2019 09:10	9,62	4	38,47	CHI
20190151055	MINEIROS	MY21303460	PARQUE DAS EMAS	13/01/2019 00:43	13/01/2019 10:12	13/01/2019 00:43	13/01/2019 10:12	9,48	1	9,48	CHI
20190151062	GOIANIA	GN12001090	CARAJAS S1	13/01/2019 00:12	13/01/2019 04:14	13/01/2019 00:12	13/01/2019 04:14	4,03	823	3319,43	DIA CRITICO
20190151065	TRINDADE	TR12200181	TRINDADE	13/01/2019 00:52	14/01/2019 10:40	13/01/2019 00:52	14/01/2019 10:40	33,80	3	101,40	DIA CRITICO
20190151069	ANAPOLIS	AN11000024	ANAPOLIS UNIVERSITARIO S1	12/01/2019 22:39	13/01/2019 09:53	12/01/2019 22:39	13/01/2019 09:53	11,23	164	1842,27	CHI
20190151071	FAZENDA NOVA	FN12217148	JUSSARA	13/01/2019 00:06	13/01/2019 17:09	13/01/2019 00:06	13/01/2019 17:09	17,05	17	289,85	CHI
20190151075	ACREUNA	EA12257973	EDEIA	13/01/2019 01:03	13/01/2019 12:13	13/01/2019 01:03	13/01/2019 12:13	11,17	14	156,33	CHI
20190151075	EDEIA	EA12257973	EDEIA	13/01/2019 01:03	13/01/2019 12:13	13/01/2019 01:03	13/01/2019 12:13	11,17	22	245,67	CHI
20190151075	INDIARA	EA12257973	EDEIA	13/01/2019 01:03	13/01/2019 12:13	13/01/2019 01:03	13/01/2019 12:13	11,17	7	78,17	CHI
20190151077	POSSE	PS11067854	IACIARA S2	13/01/2019 01:04	13/01/2019 15:00	13/01/2019 01:04	13/01/2019 15:00	13,93	41	571,27	CHI
20190151079	CALDAS NOVAS	CN12363792	SERRA DE CALDAS	13/01/2019 01:07	13/01/2019 08:39	13/01/2019 01:07	13/01/2019 08:39	7,53	128	964,27	CHI
20190151083	CORUMBAIBA	CI12060020	CATALAO S1	13/01/2019 01:14	13/01/2019 09:14	13/01/2019 01:14	13/01/2019 09:14	8,00	118	944,00	CHI
20190151083	NOVA AURORA	CI12060020	CATALAO S1	13/01/2019 01:14	13/01/2019 09:14	13/01/2019 01:14	13/01/2019 09:14	8,00	9	72,00	CHI
20190151084	SANTA TEREZINHA DE GOIAS	SG12242338	SANTA TEREZINHA	13/01/2019 01:16	13/01/2019 16:30	13/01/2019 01:16	13/01/2019 16:30	15,23	13	198,03	DIA CRITICO
20190151087	JANDAIA	JD12391440	PALMEIRAS	13/01/2019 01:20	15/01/2019 11:00	13/01/2019 01:20	15/01/2019 11:00	57,67	23	1326,33	DIA CRITICO
20190151089	POSSE	PS12000018	IACIARA S2	13/01/2019 01:22	13/01/2019 07:33	13/01/2019 01:22	13/01/2019 07:33	6,18	280	1731,33	CHI

20190151097	CALDAS NOVAS	CN21204423	SERRA DE CALDAS	13/01/2019 01:07	13/01/2019 09:25	13/01/2019 01:07	13/01/2019 09:25	8,30	1	8,30	CHI
20190151104	SANTA RITA DO NOVO DESTINO	DF12163298	BARRO ALTO	12/01/2019 19:11	13/01/2019 15:05	12/01/2019 19:11	13/01/2019 15:05	19,90	1	19,90	CHI
20190151111	ARAGARCAS	AG11062874	ARAGARCAS	12/01/2019 23:26	13/01/2019 08:06	12/01/2019 23:26	13/01/2019 08:06	8,67	163	1412,67	CHI
20190151117	PALMEIRAS DE GOIAS	PL12349300	PALMEIRAS	12/01/2019 21:13	13/01/2019 13:13	12/01/2019 21:13	13/01/2019 11:00	13,78	129	1778,05	CHI
20190151117	PALMEIRAS DE GOIAS	PL12349300	PALMEIRAS	12/01/2019 21:13	13/01/2019 13:13	13/01/2019 09:58	13/01/2019 11:00	1,03	363	375,10	CHI
20190151117	PALMEIRAS DE GOIAS	PL12349300	PALMEIRAS	12/01/2019 21:13	13/01/2019 13:13	12/01/2019 21:13	13/01/2019 12:15	15,03	32	481,07	CHI
20190151117	PALMEIRAS DE GOIAS	PL12349300	PALMEIRAS	12/01/2019 21:13	13/01/2019 13:13	12/01/2019 21:13	13/01/2019 13:13	16,00	145	2320,00	CHI
20190151117	PALMEIRAS DE GOIAS	PL12349300	PALMEIRAS	12/01/2019 21:13	13/01/2019 13:13	13/01/2019 09:58	13/01/2019 13:13	3,25	110	357,50	CHI
20190151138	BURITI ALEGRE	BG12000103	ITUMBIARA VELHA S2	13/01/2019 02:23	13/01/2019 09:28	13/01/2019 02:23	13/01/2019 09:28	7,08	38	269,17	CHI
20190151139	GOIANIA	GN11196726	CARAJAS S1	13/01/2019 01:11	13/01/2019 19:29	13/01/2019 01:11	13/01/2019 19:29	18,30	118	2159,40	DIA CRITICO
20190151155	CALDAZINHA	BV12034389	CEPAIGO S2	13/01/2019 02:46	13/01/2019 11:13	13/01/2019 02:46	13/01/2019 11:13	8,45	46	388,70	CHI
20190151159	PALMEIRAS DE GOIAS	PL12000014	PALMEIRAS	13/01/2019 02:48	13/01/2019 08:05	13/01/2019 02:48	13/01/2019 08:05	5,28	667	3523,98	DIA CRITICO
20190151162	ANICUNS	AC12299011	FIRMINOPOLIS S2	13/01/2019 02:52	13/01/2019 14:39	13/01/2019 02:52	13/01/2019 14:39	11,78	10	117,83	CHI
20190151164	MINEIROS	MY12303356	PARQUE DAS EMAS	13/01/2019 02:54	13/01/2019 11:17	13/01/2019 02:54	13/01/2019 11:17	8,38	3	25,15	CHI
20190151170	GOIANIA	GN11214765	CAMPINAS S2	13/01/2019 02:39	13/01/2019 12:49	13/01/2019 02:39	13/01/2019 12:49	10,17	101	1026,83	DIA CRITICO
20190151177	GOIANIA	13760919	FERROVIARIO S2	13/01/2019 03:26	14/01/2019 15:08	13/01/2019 03:26	14/01/2019 15:08	35,70	1	35,70	DIA CRITICO
20190151184	LEOPOLDO DE BULHOES	BV21029215	CEPAIGO S2	13/01/2019 03:32	13/01/2019 20:57	13/01/2019 03:32	13/01/2019 20:57	17,42	1	17,42	CHI
20190151194	APARECIDA DE GOIANIA	AP11141231	INDEPENDENCIA S1	12/01/2019 19:29	13/01/2019 11:02	12/01/2019 19:29	13/01/2019 11:02	15,55	175	2721,25	CHI
20190151199	APARECIDA DE GOIANIA	AP11208896	INDEPENDENCIA S1	13/01/2019 01:56	13/01/2019 11:46	13/01/2019 01:56	13/01/2019 11:46	9,83	145	1425,83	CHI
20190151205	GOIANIA	GN11167773	GOIANIA LESTE S3	13/01/2019 04:28	13/01/2019 15:11	13/01/2019 04:28	13/01/2019 15:11	10,72	16	171,47	CHI
20190151210	PALMEIRAS DE GOIAS	PL12143287	PALMEIRAS	12/01/2019 23:35	13/01/2019 07:28	12/01/2019 23:35	13/01/2019 07:28	7,88	36	283,80	CHI
20190151216	CORUMBAIBA	CI12000459	VILA CORUMBA	13/01/2019 04:43	13/01/2019 10:50	13/01/2019 04:43	13/01/2019 10:50	6,12	32	195,73	DIA CRITICO
20190151218	CAMPINACU	IH12360453	MINACU	13/01/2019 04:45	13/01/2019 07:35	13/01/2019 04:45	13/01/2019 07:35	2,83	5	14,17	CHI
20190151218	MINACU	IH12360453	MINACU	13/01/2019 04:45	13/01/2019 07:35	13/01/2019 04:45	13/01/2019 07:35	2,83	71	201,17	CHI
20190151223	HIDROLANDIA	JS12000108	ROCHEDO	13/01/2019 04:46	13/01/2019 08:28	13/01/2019 04:46	13/01/2019 08:28	3,70	9	33,30	DIA CRITICO
20190151223	PIRACANJUBA	JS12000108	ROCHEDO	13/01/2019 04:46	13/01/2019 08:28	13/01/2019 04:46	13/01/2019 08:28	3,70	206	762,20	DIA CRITICO
20190151223	PROFESSOR JAMIL SAFADY	JS12000108	ROCHEDO	13/01/2019 04:46	13/01/2019 08:28	13/01/2019 04:46	13/01/2019 08:28	3,70	90	333,00	DIA CRITICO
20190151225	ACREUNA	EU12260946	ACREUNA	13/01/2019 07:35	13/01/2019 09:18	13/01/2019 07:35	13/01/2019 09:18	1,72	24	41,20	CHI
20190151238	ITAPIRAPUA	IU11000007	MATRINCHA	13/01/2019 05:02	13/01/2019 12:55	13/01/2019 05:02	13/01/2019 12:55	7,88	47	370,52	CHI
20190151243	MINEIROS	MY12149300	PARQUE DAS EMAS	13/01/2019 05:07	13/01/2019 08:30	13/01/2019 05:07	13/01/2019 08:30	3,38	90	304,50	CHI
20190151246	ITARUMA	IM21122619	ITAJA S2	13/01/2019 05:13	13/01/2019 17:51	13/01/2019 05:13	13/01/2019 17:51	12,63	1	12,63	CHI
20190151262	MINEIROS	MY12303402	PARQUE DAS EMAS	13/01/2019 01:18	13/01/2019 09:45	13/01/2019 01:18	13/01/2019 09:45	8,45	2	16,90	CHI
20190151269	RUBIATABA	RB12003316	RUBIATABA	13/01/2019 05:40	13/01/2019 11:20	13/01/2019 05:40	13/01/2019 11:20	5,67	40	226,67	CHI

20190151273	PROFESSOR JAMIL SAFADY	PJ12063207	ROCHEDO	13/01/2019 05:43	13/01/2019 10:52	13/01/2019 05:43	13/01/2019 10:52	5,15	16	82,40	DIA CRITICO
20190151299	JUSSARA	RN12250752	BRITANIA	13/01/2019 05:51	13/01/2019 11:05	13/01/2019 05:51	13/01/2019 11:05	5,23	19	99,43	DIA CRITICO
20190151299	SANTA FE DE GOIAS	RN12250752	BRITANIA	13/01/2019 05:51	13/01/2019 11:05	13/01/2019 05:51	13/01/2019 11:05	5,23	39	204,10	DIA CRITICO
20190151310	ABADIA DE GOIAS	AP10396921	INDEPENDENCIA S2	13/01/2019 02:00	13/01/2019 09:22	13/01/2019 02:00	13/01/2019 09:22	7,37	24	176,80	CHI
20190151310	APARECIDA DE GOIANIA	AP10396921	INDEPENDENCIA S2	13/01/2019 02:00	13/01/2019 09:22	13/01/2019 02:00	13/01/2019 09:22	7,37	2278	16781,27	CHI
20190151310	GOIANIA	AP10396921	INDEPENDENCIA S2	13/01/2019 02:00	13/01/2019 09:22	13/01/2019 02:00	13/01/2019 09:22	7,37	3187	23477,57	CHI
20190151321	BOM JESUS DE GOIAS	BJ12392128	BOM JESUS DE GOIAS	13/01/2019 06:09	13/01/2019 09:29	13/01/2019 06:09	13/01/2019 09:29	3,33	3	10,00	CHI
20190151321	GOIATUBA	BJ12392128	BOM JESUS DE GOIAS	13/01/2019 06:09	13/01/2019 09:29	13/01/2019 06:09	13/01/2019 09:29	3,33	1	3,33	CHI
20190151323	ORIZONA	OZ12022866	PIRES DO RIO S2	13/01/2019 06:10	13/01/2019 12:00	13/01/2019 06:10	13/01/2019 12:00	5,83	22	128,33	CHI
20190151326	MONTES CLAROS DE GOIAS	ME12023317	IPORA	13/01/2019 06:12	13/01/2019 07:57	13/01/2019 06:12	13/01/2019 07:57	1,75	3	5,25	CHI
20190151339	ACREUNA	EU12045029LD	ACREUNA	13/01/2019 06:20	13/01/2019 10:37	13/01/2019 06:20	13/01/2019 10:37	4,28	7	29,98	CHI
20190151340	CATALAO	CT12399850	CATALAO S1	13/01/2019 06:20	13/01/2019 13:40	13/01/2019 06:20	13/01/2019 13:40	7,33	53	388,67	CHI
20190151340	GOIANDIRA	CT12399850	CATALAO S1	13/01/2019 06:20	13/01/2019 13:40	13/01/2019 06:20	13/01/2019 13:40	7,33	40	293,33	CHI
20190151342	GOIANIA	GN11189626	GOIANIA LESTE S1	13/01/2019 06:22	13/01/2019 07:31	13/01/2019 06:22	13/01/2019 07:31	1,15	166	190,90	CHI
20190151350	GUARINOS	GF12317996	SANTA TEREZINHA	13/01/2019 06:27	13/01/2019 17:16	13/01/2019 06:27	13/01/2019 17:16	10,82	5	54,08	DIA CRITICO
20190151355	ORIZONA	OZ12231408	PIRES DO RIO S2	13/01/2019 06:32	13/01/2019 09:04	13/01/2019 06:32	13/01/2019 09:04	2,53	594	1504,80	CHI
20190151359	SAO MIGUEL DO ARAGUAIA	SM11246545	SAO MIGUEL DO ARAGUAIA	13/01/2019 05:17	13/01/2019 12:02	13/01/2019 05:17	13/01/2019 12:02	6,75	44	297,00	CHI
20190151362	PLANALTINA	PI11164700	PLANALTINA	13/01/2019 06:35	13/01/2019 08:03	13/01/2019 06:35	13/01/2019 08:03	1,47	183	268,40	CHI
20190151365	BELA VISTA DE GOIAS	240082370	BELA VISTA S2	13/01/2019 06:38	13/01/2019 12:42	13/01/2019 06:38	13/01/2019 12:42	6,07	1	6,07	CHI
20190151371	ITAPACI	IW12141722	ITAPACI	13/01/2019 02:47	13/01/2019 08:50	13/01/2019 02:47	13/01/2019 08:50	6,05	12	72,60	CHI
20190151377	PORANGATU	PO12048411	PORANGATU	13/01/2019 06:43	13/01/2019 11:08	13/01/2019 06:43	13/01/2019 11:08	4,42	17	75,08	CHI
20190151380	BALIZA	DV12212840LD	CAIAPONIA	13/01/2019 06:43	13/01/2019 18:01	13/01/2019 06:43	13/01/2019 18:01	11,30	183	2067,90	CHI
20190151381	ITAPACI	IW12201625	ITAPACI	13/01/2019 06:37	13/01/2019 11:32	13/01/2019 06:37	13/01/2019 11:32	4,92	7	34,42	CHI
20190151381	PILAR DE GOIAS	IW12201625	ITAPACI	13/01/2019 06:37	13/01/2019 11:32	13/01/2019 06:37	13/01/2019 11:32	4,92	21	103,25	CHI
20190151386	CALDAS NOVAS	CN12114775	CALDAS NOVAS S1	13/01/2019 06:45	13/01/2019 10:46	13/01/2019 06:45	13/01/2019 10:46	4,02	26	104,43	CHI
20190151386	SANTA CRUZ DE GOIAS	CN12114775	CALDAS NOVAS S1	13/01/2019 06:45	13/01/2019 10:46	13/01/2019 06:45	13/01/2019 10:46	4,02	95	381,58	CHI
20190151397	GOIANIA	GN11164444	CAMPINAS S2	13/01/2019 06:14	14/01/2019 04:31	13/01/2019 06:14	14/01/2019 04:31	22,28	145	3231,08	DIA CRITICO
20190151402	PONTALINA	PK12109373	PONTALINA	13/01/2019 06:51	13/01/2019 12:40	13/01/2019 06:51	13/01/2019 12:40	5,82	5	29,08	CHI
20190151404	PIRANHAS	PH12184391	PIRANHAS	13/01/2019 06:52	13/01/2019 09:50	13/01/2019 06:52	13/01/2019 09:50	2,97	44	130,53	CHI
20190151406	NIQUELANDIA	NQ12317176	NIQUELANDIA SUBTRANSMISSÃO	13/01/2019 06:52	13/01/2019 09:33	13/01/2019 06:52	13/01/2019 09:33	2,68	78	209,30	CHI
20190151413	GOIATUBA	GT12000285	BOM JESUS DE GOIAS	13/01/2019 06:51	13/01/2019 20:45	13/01/2019 06:51	13/01/2019 13:14	6,38	18	114,90	CHI
20190151413	GOIATUBA	GT12000285	BOM JESUS DE GOIAS	13/01/2019 06:51	13/01/2019 20:45	13/01/2019 06:51	13/01/2019 20:45	13,90	10	139,00	CHI
20190151413	GOIATUBA	GT12000285	BOM JESUS DE GOIAS	13/01/2019 06:51	13/01/2019 20:45	13/01/2019 19:19	13/01/2019 20:45	1,43	18	25,80	CHI

20190151414	GOIANDIRA	GD12131103	CATALAO S1	13/01/2019 05:14	13/01/2019 11:52	13/01/2019 05:14	13/01/2019 11:52	6,63	49	325,03	CHI
20190151414	NOVA AURORA	GD12131103	CATALAO S1	13/01/2019 05:14	13/01/2019 11:52	13/01/2019 05:14	13/01/2019 11:52	6,63	14	92,87	CHI
20190151421	IACIARA	IA12262204	IACIARA S2	13/01/2019 06:55	13/01/2019 19:31	13/01/2019 06:55	13/01/2019 14:30	7,58	2	15,17	CHI
20190151421	IACIARA	IA12160072LD	IACIARA S2	13/01/2019 06:55	13/01/2019 19:31	13/01/2019 06:55	13/01/2019 15:45	8,83	2	17,67	CHI
20190151421	IACIARA	IA12271731LD	IACIARA S2	13/01/2019 06:55	13/01/2019 19:31	13/01/2019 06:55	13/01/2019 19:31	12,60	6	75,60	CHI
20190151427	IPORA	IR12222977	IPORA	13/01/2019 06:57	13/01/2019 12:38	13/01/2019 06:57	13/01/2019 12:38	5,68	15	85,25	CHI
20190151427	ISRAELANDIA	IR12222977	IPORA	13/01/2019 06:57	13/01/2019 12:38	13/01/2019 06:57	13/01/2019 12:38	5,68	15	85,25	CHI
20190151427	MOIPORA	IR12222977	IPORA	13/01/2019 06:57	13/01/2019 12:38	13/01/2019 06:57	13/01/2019 12:38	5,68	60	341,00	CHI
20190151429	TRINDADE	TR32027908	TRINDADE	13/01/2019 06:59	14/01/2019 17:36	13/01/2019 06:59	14/01/2019 17:36	34,62	1	34,62	DIA CRITICO
20190151432	MARA ROSA	MQ21320750	SANTA TEREZINHA	13/01/2019 06:01	13/01/2019 14:23	13/01/2019 06:01	13/01/2019 14:23	8,37	1	8,37	DIA CRITICO
20190151440	CATALAO	CT12000081	CATALAO S1	13/01/2019 07:02	13/01/2019 09:42	13/01/2019 07:02	13/01/2019 09:42	2,67	5	13,33	CHI
20190151446	GOIANIA	GN11198301	CAMPINAS S2	13/01/2019 05:17	13/01/2019 15:00	13/01/2019 05:17	13/01/2019 15:00	9,72	136	1321,47	DIA CRITICO
20190151454	FORMOSO	FO12185315	PORANGATU	13/01/2019 07:05	13/01/2019 11:17	13/01/2019 07:05	13/01/2019 11:17	4,20	7	29,40	CHI
20190151460	CAMPO ALEGRE DE GOIAS	CM12192733	CAMPO ALEGRE DE GOIAS	13/01/2019 07:07	13/01/2019 10:15	13/01/2019 07:07	13/01/2019 10:15	3,13	18	56,40	CHI
20190151463	ALTO HORIZONTE	NH12202110	SANTA TEREZINHA	13/01/2019 07:07	13/01/2019 11:59	13/01/2019 07:07	13/01/2019 11:59	4,87	12	58,40	DIA CRITICO
20190151463	PILAR DE GOIAS	NH12202110	SANTA TEREZINHA	13/01/2019 07:07	13/01/2019 11:59	13/01/2019 07:07	13/01/2019 11:59	4,87	8	38,93	DIA CRITICO
20190151463	SANTA TEREZINHA DE GOIAS	NH12202110	SANTA TEREZINHA	13/01/2019 07:07	13/01/2019 11:59	13/01/2019 07:07	13/01/2019 11:59	4,87	23	111,93	DIA CRITICO
20190151472	CAIAPONIA	PY12126840	PALESTINA	13/01/2019 07:09	13/01/2019 12:20	13/01/2019 07:09	13/01/2019 12:20	5,18	4	20,73	DIA CRITICO
20190151472	PALESTINA DE GOIAS	PY12126840	PALESTINA	13/01/2019 07:09	13/01/2019 12:20	13/01/2019 07:09	13/01/2019 12:20	5,18	6	31,10	DIA CRITICO
20190151479	HIDROLINA	HL12003223	SANTA TEREZINHA	12/01/2019 19:39	13/01/2019 12:29	12/01/2019 19:39	13/01/2019 12:29	16,83	1	16,83	CHI
20190151479	PILAR DE GOIAS	HL12003223	SANTA TEREZINHA	12/01/2019 19:39	13/01/2019 12:29	12/01/2019 19:39	13/01/2019 12:29	16,83	49	824,83	CHI
20190151479	URUACU	HL12003223	SANTA TEREZINHA	12/01/2019 19:39	13/01/2019 12:29	12/01/2019 19:39	13/01/2019 12:29	16,83	4	67,33	CHI
20190151483	SENADOR CANEDO	SW12002157	SENADOR CANEDO	13/01/2019 07:11	13/01/2019 15:27	13/01/2019 07:11	13/01/2019 15:27	8,27	5	41,33	CHI
20190151496	FAZENDA NOVA	FN12220464	JUSSARA	13/01/2019 05:09	13/01/2019 16:21	13/01/2019 05:09	13/01/2019 16:21	11,20	30	336,00	CHI
20190151497	SILVANIA	SV21385040	VIANOPOLIS	13/01/2019 07:14	14/01/2019 18:33	13/01/2019 07:14	14/01/2019 18:33	35,32	1	35,32	CHI
20190151500	CORUMBAIBA	CI12025121	VILA CORUMBA	13/01/2019 07:14	13/01/2019 13:21	13/01/2019 07:14	13/01/2019 13:21	6,12	22	134,57	DIA CRITICO
20190151506	CORUMBAIBA	CI12060036	VILA CORUMBA	13/01/2019 06:44	13/01/2019 12:20	13/01/2019 06:44	13/01/2019 10:50	4,10	3	12,30	DIA CRITICO
20190151506	CORUMBAIBA	CI12060036	VILA CORUMBA	13/01/2019 06:44	13/01/2019 12:20	13/01/2019 10:54	13/01/2019 11:40	0,77	2	1,53	DIA CRITICO
20190151506	CORUMBAIBA	CI12104562LD	VILA CORUMBA	13/01/2019 06:44	13/01/2019 12:20	13/01/2019 06:44	13/01/2019 12:00	5,27	2	10,53	DIA CRITICO
20190151506	CORUMBAIBA	CI21060019	VILA CORUMBA	13/01/2019 06:44	13/01/2019 12:20	13/01/2019 10:54	13/01/2019 12:20	1,43	1	1,43	DIA CRITICO
20190151508	FAINA	MS12220561	ITAPURANGA	13/01/2019 07:15	13/01/2019 17:40	13/01/2019 07:15	13/01/2019 17:40	10,42	10	104,17	CHI
20190151515	BONFINOPOLIS	BO21360385	GOIANIA LESTE S2	13/01/2019 07:16	13/01/2019 12:34	13/01/2019 07:16	13/01/2019 12:34	5,30	2	10,60	CHI
20190151518	EDEALINA	EA12257919RE	EDEIA	13/01/2019 07:17	13/01/2019 08:26	13/01/2019 07:17	13/01/2019 08:26	1,15	1	1,15	CHI

20190151518	EDEIA	EA12257919RE	EDEIA	13/01/2019 07:17	13/01/2019 08:26	13/01/2019 07:17	13/01/2019 08:26	1,15	46	52,90	CHI
20190151520	GOIANIA	GN11041880	FERROVIARIO S1	13/01/2019 06:54	13/01/2019 22:13	13/01/2019 06:54	13/01/2019 22:13	15,32	100	1531,67	CHI
20190151527	FAZENDA NOVA	FN11138693	JUSSARA	12/01/2019 20:29	13/01/2019 23:02	12/01/2019 20:29	13/01/2019 23:02	26,55	87	2309,85	CHI
20190151528	CORUMBAIBA	CI12107485	VILA CORUMBA	13/01/2019 07:18	13/01/2019 11:40	13/01/2019 07:18	13/01/2019 11:40	4,37	20	87,33	DIA CRITICO
20190151531	AMARALINA	LC21220621	SAO MIGUEL DO ARAGUAIA	13/01/2019 07:18	14/01/2019 00:10	13/01/2019 07:18	14/01/2019 00:10	16,87	1	16,87	CHI
20190151533	BELA VISTA DE GOIAS	BV21340072	CEPAIGO S2	13/01/2019 07:19	13/01/2019 11:12	13/01/2019 07:19	13/01/2019 11:12	3,88	25	97,08	CHI
20190151539	GOIANIA	GN12001090	CARAJAS S1	13/01/2019 04:47	13/01/2019 08:54	13/01/2019 04:47	13/01/2019 08:54	4,12	823	3388,02	DIA CRITICO
20190151548	CAMPOS VERDES	VD12243665	SANTA TEREZINHA	13/01/2019 07:19	13/01/2019 11:01	13/01/2019 07:19	13/01/2019 11:01	3,70	7	25,90	DIA CRITICO
20190151551	JATAI	RV12222009	CABRIUVA S2	13/01/2019 07:22	13/01/2019 12:02	13/01/2019 07:22	13/01/2019 12:02	4,67	17	79,33	CHI
20190151551	RIO VERDE	RV12222009	CABRIUVA S2	13/01/2019 07:22	13/01/2019 12:02	13/01/2019 07:22	13/01/2019 12:02	4,67	21	98,00	CHI
20190151552	BALIZA	BH12331453	CAIAPONIA	13/01/2019 07:22	13/01/2019 15:45	13/01/2019 07:22	13/01/2019 15:45	8,38	5	41,92	CHI
20190151555	DAMIANOPOLIS	DA12204799	IACIARA S2	13/01/2019 01:52	13/01/2019 09:30	13/01/2019 01:52	13/01/2019 09:30	7,63	341	2602,97	CHI
20190151558	MONTIVIDIU DO NORTE	MX12270942	PORANGATU	13/01/2019 07:23	13/01/2019 13:10	13/01/2019 07:23	13/01/2019 13:10	5,78	51	294,95	CHI
20190151561	GOIANIA	10018449210	CAMPINAS S2	13/01/2019 07:23	13/01/2019 13:37	13/01/2019 07:23	13/01/2019 13:37	6,23	1	6,23	DIA CRITICO
20190151570	DIORAMA	DI12066071	ARENOPOLIS	13/01/2019 04:56	13/01/2019 14:42	13/01/2019 04:56	13/01/2019 14:42	9,77	28	273,47	CHI
20190151571	DAMOLANDIA	DL12272318	INHUMAS S1	13/01/2019 07:26	13/01/2019 12:21	13/01/2019 07:26	13/01/2019 12:21	4,92	3	14,75	CHI
20190151571	NOVA VENEZA	DL12272318	INHUMAS S1	13/01/2019 07:26	13/01/2019 12:21	13/01/2019 07:26	13/01/2019 12:21	4,92	27	132,75	CHI
20190151575	MINEIROS	MY12296345	PARQUE DAS EMAS	13/01/2019 07:27	13/01/2019 09:30	13/01/2019 07:27	13/01/2019 09:30	2,05	1	2,05	CHI
20190151581	APORE	AE12340781	ITAJA S1	13/01/2019 07:27	13/01/2019 16:59	13/01/2019 07:27	13/01/2019 16:59	9,53	1	9,53	CHI
20190151589	OUVIDOR	OU12077703	CATALAO S1	13/01/2019 07:29	13/01/2019 17:28	13/01/2019 07:29	13/01/2019 17:28	9,98	24	239,60	CHI
20190151592	BONOPOLIS	BX12079315	SAO MIGUEL DO ARAGUAIA	13/01/2019 07:29	13/01/2019 19:24	13/01/2019 07:29	13/01/2019 19:24	11,92	1	11,92	CHI
20190151593	GOIANIA	GN12001388	CAMPINAS S2	13/01/2019 06:41	13/01/2019 09:10	13/01/2019 06:41	13/01/2019 09:10	2,48	223	553,78	DIA CRITICO
20190151596	INHUMAS	IN21355873	INHUMAS S2	13/01/2019 07:31	14/01/2019 09:38	13/01/2019 07:31	14/01/2019 09:38	26,12	1	26,12	CHI
20190151607	SAO LUIS DE MONTES BELOS	SL12206033	SAO LUIZ DOS MONTES BELOS	13/01/2019 07:09	13/01/2019 09:35	13/01/2019 07:09	13/01/2019 09:35	2,43	12	29,20	CHI
20190151613	GOIANIA	GN11002279	AEROPORTO S3	13/01/2019 07:35	15/01/2019 08:46	13/01/2019 07:35	15/01/2019 08:46	49,18	18	885,30	CHI
20190151626	BURITI DE GOIAS	BS12308643	FIRMINOPOLIS S2	13/01/2019 07:13	13/01/2019 14:39	13/01/2019 07:13	13/01/2019 14:39	7,43	5	37,17	CHI
20190151635	GOIANIA	GN12000025	CAMPINAS S1	13/01/2019 05:48	13/01/2019 08:53	13/01/2019 05:48	13/01/2019 08:53	3,08	276	851,00	CHI
20190151641	PORANGATU	PO12320954	NOVO PLANALTO	13/01/2019 07:41	13/01/2019 12:25	13/01/2019 07:41	13/01/2019 12:25	4,73	11	52,07	DIA CRITICO
20190151642	EDEIA	EA12060899	EDEIA	13/01/2019 07:42	13/01/2019 11:35	13/01/2019 07:42	13/01/2019 11:35	3,88	5	19,42	CHI
20190151644	FORMOSA	FA11395031	FLORES DE GOIAS	13/01/2019 07:42	13/01/2019 19:27	13/01/2019 07:42	13/01/2019 19:27	11,75	1	11,75	CHI
20190151646	GUARINOS	GG12214355	URUACU	13/01/2019 07:42	13/01/2019 19:03	13/01/2019 07:42	13/01/2019 19:03	11,35	1	11,35	CHI
20190151646	PILAR DE GOIAS	GG12214355	URUACU	13/01/2019 07:42	13/01/2019 19:03	13/01/2019 07:42	13/01/2019 19:03	11,35	1	11,35	CHI
20190151663	ARUANA	MZ12250762	MOZARLANDIA	13/01/2019 07:46	13/01/2019 14:18	13/01/2019 07:46	13/01/2019 14:18	6,53	8	52,27	CHI

20190151663	MOZARLANDIA	MZ12250762	MOZARLANDIA	13/01/2019 07:46	13/01/2019 14:18	13/01/2019 07:46	13/01/2019 14:18	6,53	2	13,07	CHI
20190151664	GOIAS	90101273	GOIAS	13/01/2019 07:46	13/01/2019 10:30	13/01/2019 07:46	13/01/2019 10:30	2,73	1	2,73	CHI
20190151667	NIQUELANDIA	PO12378907	PORANGATU	13/01/2019 07:46	13/01/2019 10:03	13/01/2019 07:46	13/01/2019 10:03	2,28	1	2,28	CHI
20190151667	PORANGATU	PO12378907	PORANGATU	13/01/2019 07:46	13/01/2019 10:03	13/01/2019 07:46	13/01/2019 10:03	2,28	7	15,98	CHI
20190151669	CALDAZINHA	2340000343	CEPAIGO S2	13/01/2019 07:47	13/01/2019 12:17	13/01/2019 07:47	13/01/2019 12:17	4,50	1	4,50	CHI
20190151681	GOIAS	GS21220478	GOIAS	13/01/2019 07:50	13/01/2019 18:17	13/01/2019 07:50	13/01/2019 18:17	10,45	1	10,45	CHI
20190151685	IVOLANDIA	MO12374904	IPORA	13/01/2019 07:51	14/01/2019 16:03	13/01/2019 07:51	14/01/2019 16:03	32,20	1	32,20	CHI
20190151685	MOIPORA	MO12374904	IPORA	13/01/2019 07:51	14/01/2019 16:03	13/01/2019 07:51	14/01/2019 16:03	32,20	1	32,20	CHI
20190151687	DIORAMA	DI21193436	IPORA	13/01/2019 07:52	14/01/2019 02:45	13/01/2019 07:52	14/01/2019 02:45	18,88	1	18,88	CHI
20190151689	MUNDO NOVO DE GOIAS	MH12243667LD	NOVA CRIXAS	13/01/2019 07:52	13/01/2019 14:44	13/01/2019 07:52	13/01/2019 14:44	6,87	1	6,87	CHI
20190151703	CORUMBAIBA	CI21298741	VILA CORUMBA	13/01/2019 07:54	13/01/2019 10:30	13/01/2019 07:54	13/01/2019 10:30	2,60	14	36,40	DIA CRITICO
20190151706	PEROLANDIA	DP12260464	JATAI S1	13/01/2019 07:56	13/01/2019 14:12	13/01/2019 07:56	13/01/2019 14:12	6,27	16	100,27	CHI
20190151707	GOIANIA	GN12164393	MEIA PONTE	13/01/2019 07:31	13/01/2019 09:36	13/01/2019 07:31	13/01/2019 09:36	2,08	210	437,50	DIA CRITICO
20190151708	GOIANIA	GN11166114	FERROVIARIO S2	13/01/2019 07:23	14/01/2019 16:54	13/01/2019 07:23	14/01/2019 16:54	33,52	29	971,98	DIA CRITICO
20190151714	CAIAPONIA	CP12354285	CAIAPONIA	13/01/2019 07:56	13/01/2019 11:29	13/01/2019 07:56	13/01/2019 11:29	3,55	12	42,60	CHI
20190151716	EDEALINA	ED21044492	PONTALINA	13/01/2019 07:58	13/01/2019 13:20	13/01/2019 07:58	13/01/2019 13:20	5,37	2	10,73	CHI
20190151717	SANTO ANTONIO DO DESCOBERTO	SN12082917	MARAJOARA	13/01/2019 07:58	14/01/2019 08:24	13/01/2019 07:58	14/01/2019 08:24	24,43	35	855,17	CHI
20190151719	URUACU	UR21136330	CAMPINORTE	13/01/2019 07:58	13/01/2019 09:42	13/01/2019 07:58	13/01/2019 09:42	1,73	1	1,73	CHI
20190151726	RIO VERDE	RV12261024	CACHOEIRA ALTA	13/01/2019 07:59	13/01/2019 13:29	13/01/2019 07:59	13/01/2019 13:29	5,50	2	11,00	CHI
20190151729	ANHANGUERA	CY12092258	CATALAO S1	13/01/2019 08:00	14/01/2019 10:42	13/01/2019 08:00	14/01/2019 10:42	26,70	2	53,40	CHI
20190151736	PIRANHAS	PH12380878	PIRANHAS	13/01/2019 08:01	13/01/2019 19:23	13/01/2019 08:01	13/01/2019 19:23	11,37	11	125,03	CHI
20190151741	SITIO D ABADIA	SI12247434	IACIARA S2	12/01/2019 19:48	13/01/2019 18:05	12/01/2019 19:48	13/01/2019 18:05	22,28	17	378,82	CHI
20190151742	ANICUNS	AC21167197	FIRMINOPOLIS S2	13/01/2019 08:02	14/01/2019 20:42	13/01/2019 08:02	14/01/2019 20:42	36,67	1	36,67	CHI
20190151753	RIO VERDE	RV21213484	CABRIUVA S2	13/01/2019 08:02	14/01/2019 13:03	13/01/2019 08:02	14/01/2019 13:03	29,02	1	29,02	CHI
20190151760	CATALAO	CT21378498	CATALAO S2	13/01/2019 08:04	14/01/2019 17:40	13/01/2019 08:04	14/01/2019 17:40	33,60	2	67,20	CHI
20190151762	QUIRINOPOLIS	QI21050839	QUIRINOPOLIS	13/01/2019 08:05	13/01/2019 09:34	13/01/2019 08:05	13/01/2019 09:34	1,48	1	1,48	CHI
20190151763	ISRAELANDIA	IS12089375	IPORA	13/01/2019 07:06	13/01/2019 09:19	13/01/2019 07:06	13/01/2019 09:19	2,22	20	44,33	CHI
20190151773	INHUMAS	CK21318926	INHUMAS S2	13/01/2019 08:06	13/01/2019 15:40	13/01/2019 08:06	13/01/2019 15:40	7,57	3	22,70	CHI
20190151796	ITAPURANGA	IK21300427	ITAPURANGA	13/01/2019 08:09	14/01/2019 08:21	13/01/2019 08:09	14/01/2019 08:21	24,20	3	72,60	CHI
20190151800	NOVA AURORA	NE12337562	CATALAO S1	13/01/2019 08:09	13/01/2019 18:36	13/01/2019 08:09	13/01/2019 18:36	10,45	4	41,80	CHI
20190151803	SANTA TEREZINHA DE GOIAS	SG21087953	SANTA TEREZINHA	13/01/2019 08:09	13/01/2019 18:40	13/01/2019 08:09	13/01/2019 18:40	10,52	1	10,52	DIA CRITICO
20190151805	POSSE	PS12132045	IACIARA S2	13/01/2019 07:36	13/01/2019 11:24	13/01/2019 07:36	13/01/2019 11:24	3,80	200	760,00	CHI
20190151807	GOIANIA	GN12000353	GOIANIA LESTE S1	13/01/2019 06:43	13/01/2019 08:52	13/01/2019 06:43	13/01/2019 08:52	2,15	770	1655,50	CHI

20190151809	GOIANIA	10633510	AEROPORTO S2	13/01/2019 08:10	14/01/2019 11:57	13/01/2019 08:10	14/01/2019 11:57	27,78	1	27,78	CHI
20190151810	GOIANIA	GN11165697	CAMPINAS S2	13/01/2019 08:05	13/01/2019 17:47	13/01/2019 08:05	13/01/2019 17:47	9,70	65	630,50	DIA CRITICO
20190151815	GOIANIA	GN11161626	GOIANIA LESTE S3	13/01/2019 07:47	13/01/2019 16:45	13/01/2019 07:47	13/01/2019 16:45	8,97	127	1138,77	CHI
20190151820	GOIANIA	12898831	XAVANTES	13/01/2019 08:12	15/01/2019 11:26	13/01/2019 08:12	15/01/2019 11:26	51,23	1	51,23	DIA CRITICO
20190151839	SERRANOPOLIS	SX12216725	JATAI S1	13/01/2019 08:15	13/01/2019 16:30	13/01/2019 08:15	13/01/2019 16:30	8,25	18	148,50	CHI
20190151845	GOIANIRA	GR11141251	GOIANIRA	13/01/2019 07:42	13/01/2019 11:00	13/01/2019 07:42	13/01/2019 11:00	3,30	163	537,90	DIA CRITICO
20190151850	GOIANIA	GN11000871	FERROVIARIO S1	13/01/2019 06:55	13/01/2019 14:21	13/01/2019 06:55	13/01/2019 14:21	7,43	140	1040,67	CHI
20190151856	GOIANIA	GN12044690	CAMPINAS S2	13/01/2019 08:13	13/01/2019 15:10	13/01/2019 08:13	13/01/2019 15:10	6,95	108	750,60	DIA CRITICO
20190151858	LUZIANIA	LZ12086797	VIANOPOLIS	12/01/2019 15:44	13/01/2019 12:20	12/01/2019 15:44	13/01/2019 12:20	20,60	32	659,20	CHI
20190151866	ITARUMA	IM12239504	CACHOEIRA ALTA	13/01/2019 08:20	13/01/2019 16:31	13/01/2019 08:20	13/01/2019 16:31	8,18	29	237,32	CHI
20190151869	BRITANIA	BT12106205	BRITANIA	13/01/2019 08:20	14/01/2019 10:00	13/01/2019 08:20	14/01/2019 10:00	25,67	10	256,67	DIA CRITICO
20190151881	GOIANIA	GN11170721	GOIANIA LESTE S2	13/01/2019 08:23	13/01/2019 08:55	13/01/2019 08:23	13/01/2019 08:55	0,53	39	20,80	CHI
20190151882	BONOPOLIS	BX12391936	SAO MIGUEL DO ARAGUAIA	13/01/2019 08:24	13/01/2019 13:14	13/01/2019 08:24	13/01/2019 13:14	4,83	29	140,17	CHI
20190151885	PIRES DO RIO	PR21115582	PIRES DO RIO S1	13/01/2019 08:17	14/01/2019 00:32	13/01/2019 08:17	14/01/2019 00:32	16,25	1	16,25	CHI
20190151887	APORE	AE12241896	ITAJA S1	13/01/2019 08:25	13/01/2019 14:10	13/01/2019 08:25	13/01/2019 14:10	5,75	1	5,75	CHI
20190151896	GOIANIA	GN11198446	CARAJAS S2	13/01/2019 06:27	13/01/2019 14:21	13/01/2019 06:27	13/01/2019 14:21	7,90	107	845,30	CHI
20190151898	IPAMERI	NE12086750	CATALAO S1	13/01/2019 07:20	13/01/2019 14:16	13/01/2019 07:20	13/01/2019 14:16	6,93	14	97,07	CHI
20190151898	NOVA AURORA	NE12086750	CATALAO S1	13/01/2019 07:20	13/01/2019 14:16	13/01/2019 07:20	13/01/2019 14:16	6,93	2	13,87	CHI
20190151907	FORMOSO	FO12088777	MARA ROSA	12/01/2019 14:37	13/01/2019 09:25	12/01/2019 14:37	13/01/2019 09:25	18,80	37	695,60	CHI
20190151910	GOIANIA	GN11001657	GOIANIA LESTE S3	12/01/2019 19:51	13/01/2019 09:05	12/01/2019 19:51	13/01/2019 09:05	13,23	232	3070,13	DIA CRITICO
20190151917	CALDAS NOVAS	CN21100042	CALDAS NOVAS S1	13/01/2019 08:55	13/01/2019 14:30	13/01/2019 08:55	13/01/2019 14:30	5,58	1	5,58	CHI
20190151923	AGUAS LINDAS DE GOIAS	LA12050923	AGUAS LINDAS DE GOIAS S1	13/01/2019 08:50	13/01/2019 10:41	13/01/2019 08:50	13/01/2019 10:41	1,85	110	203,50	CHI
20190151926	GOIANIA	GN11221913	GOYA S2	12/01/2019 18:52	14/01/2019 14:34	12/01/2019 18:52	14/01/2019 14:34	43,70	40	1748,00	DIA CRITICO
20190151930	GOIANIA	GN11001690	FERROVIARIO S2	12/01/2019 21:02	13/01/2019 13:51	12/01/2019 21:02	13/01/2019 13:51	16,82	53	891,28	DIA CRITICO
20190151940	CAIAPONIA	CP12345397	CAIAPONIA	13/01/2019 08:02	13/01/2019 13:44	13/01/2019 08:02	13/01/2019 13:44	5,70	7	39,90	CHI
20190151961	TRINDADE	TR11207467	TRINDADE	12/01/2019 19:31	14/01/2019 10:57	12/01/2019 19:31	14/01/2019 10:57	39,43	56	2208,27	DIA CRITICO
20190151978	MINACU	IH21236286	MINACU	13/01/2019 14:00	13/01/2019 17:28	13/01/2019 14:00	13/01/2019 17:28	3,47	1	3,47	CHI
20190152001	NEROPOLIS	NR12317368	NEROPOLIS S2	13/01/2019 08:19	13/01/2019 14:55	13/01/2019 08:19	13/01/2019 14:55	6,60	1	6,60	CHI
20190152007	TRINDADE	TR11180211	GOYA S1	13/01/2019 07:09	13/01/2019 18:45	13/01/2019 07:09	13/01/2019 18:45	11,60	116	1345,60	DIA CRITICO
20190152012	ITABERAI	IB12379750	ITABERAI S2	13/01/2019 08:10	13/01/2019 11:30	13/01/2019 08:10	13/01/2019 11:30	3,33	5	16,67	CHI
20190152017	GOIANIA	GN21045633	GOYA S1	13/01/2019 08:30	13/01/2019 21:11	13/01/2019 08:30	13/01/2019 21:11	12,68	3	38,05	DIA CRITICO
20190152023	NOVA CRIXAS	NA12210258	NOVA CRIXAS	13/01/2019 08:21	13/01/2019 10:12	13/01/2019 08:21	13/01/2019 10:12	1,85	1	1,85	CHI
20190152024	GOIANIA	GN12198750	CARAJAS S1	13/01/2019 05:53	13/01/2019 12:06	13/01/2019 05:53	13/01/2019 12:06	6,22	622	3866,77	DIA CRITICO

20190152027	MINACU	IH12230530	MINACU	13/01/2019 08:30	13/01/2019 11:13	13/01/2019 08:30	13/01/2019 11:13	2,72	3	8,15	CHI
20190152030	FORMOSA	FA12071048	ITUIQUIRA	13/01/2019 08:32	13/01/2019 10:12	13/01/2019 08:32	13/01/2019 10:12	1,67	13	21,67	CHI
20190152037	EDEIA	EA12028603	VICENTINOPOLIS	13/01/2019 08:33	13/01/2019 12:33	13/01/2019 08:33	13/01/2019 12:33	4,00	3	12,00	CHI
20190152046	FAINA	FC11309246	GOIAS	13/01/2019 08:34	13/01/2019 13:21	13/01/2019 08:34	13/01/2019 13:21	4,78	11	52,62	CHI
20190152053	NOVA CRIXAS	NA12091692	NOVA CRIXAS	13/01/2019 07:16	13/01/2019 16:43	13/01/2019 07:16	13/01/2019 16:43	9,45	23	217,35	CHI
20190152055	FLORES DE GOIAS	FB12211535	IACIARA S2	13/01/2019 08:32	13/01/2019 11:32	13/01/2019 08:32	13/01/2019 11:32	3,00	52	156,00	CHI
20190152064	GOIANIA	GN11148300	MEIA PONTE	13/01/2019 07:16	13/01/2019 19:23	13/01/2019 07:16	13/01/2019 19:23	12,12	134	1623,63	DIA CRITICO
20190152065	RIO VERDE	RV21230876	RIO VERDE S2	13/01/2019 08:34	14/01/2019 08:20	13/01/2019 08:34	14/01/2019 08:20	23,77	1	23,77	CHI
20190152074	GOIANIA	GN11000401	FERROVIARIO S2	13/01/2019 08:10	13/01/2019 21:59	13/01/2019 08:10	13/01/2019 21:59	13,82	109	1506,02	DIA CRITICO
20190152075	ITABERAÍ	IB21080504	ANICUNS	13/01/2019 08:36	14/01/2019 17:54	13/01/2019 08:36	14/01/2019 17:54	33,30	2	66,60	CHI
20190152098	GOIANIA	GN11000926	CAMPINAS S2	13/01/2019 08:16	13/01/2019 17:17	13/01/2019 08:16	13/01/2019 17:17	9,02	135	1217,25	DIA CRITICO
20190152105	GOIANIA	GN12001199	CARAJAS S1	13/01/2019 07:06	13/01/2019 10:20	13/01/2019 07:06	13/01/2019 10:20	3,23	285	921,50	DIA CRITICO
20190152108	CATURAI	CK12386231	INHUMAS S1	13/01/2019 08:39	13/01/2019 13:03	13/01/2019 08:39	13/01/2019 13:03	4,40	6	26,40	CHI
20190152108	GOIANIRA	CK12386231	INHUMAS S1	13/01/2019 08:39	13/01/2019 13:03	13/01/2019 08:39	13/01/2019 13:03	4,40	6	26,40	CHI
20190152111	LUZIANIA	LZ21230104	RIO VERMELHO	13/01/2019 08:39	13/01/2019 12:18	13/01/2019 08:39	13/01/2019 12:18	3,65	2	7,30	CHI
20190152118	GOIANIA	GN11074904	GOYA S1	13/01/2019 08:39	13/01/2019 09:31	13/01/2019 08:39	13/01/2019 09:31	0,87	178	154,27	DIA CRITICO
20190152130	GOIANIA	GN11172731	CAMPINAS S3	13/01/2019 05:52	13/01/2019 18:41	13/01/2019 05:52	13/01/2019 18:41	12,82	51	653,65	CHI
20190152132	TRINDADE	TR11180018	TRINDADE	13/01/2019 08:03	14/01/2019 10:39	13/01/2019 08:03	14/01/2019 10:39	26,60	82	2181,20	DIA CRITICO
20190152133	JATAÍ	JT21136024	JATAÍ S2	13/01/2019 08:43	13/01/2019 14:29	13/01/2019 08:43	13/01/2019 14:29	5,77	2	11,53	CHI
20190152138	ANICUNS	TV12005585	FIRMINOPOLIS S2	13/01/2019 06:27	13/01/2019 12:32	13/01/2019 06:27	13/01/2019 12:32	6,08	22	133,83	CHI
20190152138	TURVANIA	TV12005585	FIRMINOPOLIS S2	13/01/2019 06:27	13/01/2019 12:32	13/01/2019 06:27	13/01/2019 12:32	6,08	16	97,33	CHI
20190152156	GOIANIA	10009368815	MEIA PONTE	13/01/2019 08:45	15/01/2019 11:34	13/01/2019 08:45	15/01/2019 11:34	50,82	1	50,82	DIA CRITICO
20190152164	GOIANIA	GN11211367	GOYA S2	13/01/2019 07:39	14/01/2019 12:04	13/01/2019 07:39	14/01/2019 12:04	28,42	145	4120,42	DIA CRITICO
20190152172	GOIANIA	10011878795	MEIA PONTE	13/01/2019 08:46	14/01/2019 20:38	13/01/2019 08:46	14/01/2019 20:38	35,87	1	35,87	DIA CRITICO
20190152178	SENADOR CANEDO	SW11291698	CEPAIGO S1	13/01/2019 08:07	13/01/2019 10:37	13/01/2019 08:07	13/01/2019 10:37	2,50	60	150,00	CHI
20190152190	GOIANIA	15209325	MEIA PONTE	13/01/2019 08:49	15/01/2019 17:27	13/01/2019 08:49	15/01/2019 17:27	56,63	1	56,63	DIA CRITICO
20190152191	ITAPURANGA	IK11249442	ITAPURANGA	13/01/2019 07:19	13/01/2019 09:36	13/01/2019 07:19	13/01/2019 09:36	2,28	82	187,23	CHI
20190152196	BONOPOLIS	BX12203505	SAO MIGUEL DO ARAGUAIA	13/01/2019 08:49	14/01/2019 09:28	13/01/2019 08:49	14/01/2019 09:28	24,65	2	49,30	CHI
20190152207	BOM JARDIM DE GOIAS	BM11212782	BOM JARDIM	13/01/2019 08:50	13/01/2019 10:32	13/01/2019 08:50	13/01/2019 10:32	1,70	159	270,30	DIA CRITICO
20190152209	ARENOPOLIS	AY12070195	ARENOPOLIS	13/01/2019 08:51	13/01/2019 20:30	13/01/2019 08:51	13/01/2019 20:30	11,65	9	104,85	CHI
20190152209	DIORAMA	AY12070195	ARENOPOLIS	13/01/2019 08:51	13/01/2019 20:30	13/01/2019 08:51	13/01/2019 20:30	11,65	3	34,95	CHI
20190152209	MONTES CLAROS DE GOIAS	AY12070195	ARENOPOLIS	13/01/2019 08:51	13/01/2019 20:30	13/01/2019 08:51	13/01/2019 20:30	11,65	24	279,60	CHI
20190152215	CALDAS NOVAS	CN12298773	VILA CORUMBA	13/01/2019 08:51	13/01/2019 16:41	13/01/2019 08:51	13/01/2019 13:04	4,22	44	185,53	DIA CRITICO

20190152215	CALDAS NOVAS	CN12298773	VILA CORUMBA	13/01/2019 08:51	13/01/2019 16:41	13/01/2019 08:51	13/01/2019 16:41	7,83	1	7,83	DIA CRITICO
20190152216	GOIAS	GS12250577	GOIAS	13/01/2019 07:45	13/01/2019 17:23	13/01/2019 07:45	13/01/2019 17:23	9,63	8	77,07	CHI
20190152217	PORANGATU	PO21189531	NOVO PLANALTO	13/01/2019 08:51	13/01/2019 16:29	13/01/2019 08:51	13/01/2019 16:29	7,63	1	7,63	DIA CRITICO
20190152227	PORANGATU	PO12021172	PORANGATU	13/01/2019 08:53	13/01/2019 11:49	13/01/2019 08:53	13/01/2019 11:49	2,93	5	14,67	CHI
20190152230	MINEIROS	PW12013857	PARQUE DAS EMAS	13/01/2019 08:53	13/01/2019 13:24	13/01/2019 08:53	13/01/2019 13:24	4,52	19	85,82	CHI
20190152238	PROFESSOR JAMIL SAFADY	PJ21079288	ROCHEDO	13/01/2019 08:54	13/01/2019 12:40	13/01/2019 08:54	13/01/2019 12:40	3,77	2	7,53	DIA CRITICO
20190152243	PORANGATU	PO12189557	NOVO PLANALTO	13/01/2019 08:55	13/01/2019 14:51	13/01/2019 08:55	13/01/2019 14:51	5,93	2	11,87	DIA CRITICO
20190152245	CRISTALINA	KR21261610	CRISTALINA S2	13/01/2019 08:55	13/01/2019 09:59	13/01/2019 08:55	13/01/2019 09:59	1,07	3	3,20	CHI
20190152254	POSSE	PS11325654	IACIARA S2	13/01/2019 08:40	13/01/2019 10:34	13/01/2019 08:40	13/01/2019 10:34	1,90	145	275,50	CHI
20190152262	DOVERLANDIA	DV11253347	CAIAPONIA	13/01/2019 08:58	13/01/2019 20:18	13/01/2019 08:58	13/01/2019 20:18	11,33	1	11,33	CHI
20190152266	ITABERAÍ	II12220461	ITABERAÍ S1	13/01/2019 08:58	13/01/2019 20:08	13/01/2019 08:58	13/01/2019 20:08	11,17	2	22,33	CHI
20190152266	ITAGUARI	II12220461	ITABERAÍ S1	13/01/2019 08:58	13/01/2019 20:08	13/01/2019 08:58	13/01/2019 20:08	11,17	1	11,17	CHI
20190152266	TAQUARAL DE GOIAS	II12220461	ITABERAÍ S1	13/01/2019 08:58	13/01/2019 20:08	13/01/2019 08:58	13/01/2019 20:08	11,17	28	312,67	CHI
20190152270	TRINDADE	TR11071654	TRINDADE	13/01/2019 07:49	14/01/2019 00:39	13/01/2019 07:49	14/01/2019 00:39	16,83	65	1094,17	DIA CRITICO
20190152271	GOIANIA	GN12090354	GOIANIA LESTE S1	13/01/2019 07:23	13/01/2019 09:59	13/01/2019 07:23	13/01/2019 09:59	2,60	247	642,20	CHI
20190152273	SANTA HELENA DE GOIAS	SH12085742	IPEGUARI	13/01/2019 08:59	13/01/2019 10:55	13/01/2019 08:59	13/01/2019 10:55	1,93	9	17,40	CHI
20190152273	SANTA HELENA DE GOIAS	SH12085742	SANTA HELENA S1	13/01/2019 08:59	13/01/2019 10:55	13/01/2019 08:59	13/01/2019 10:55	1,93	49	94,73	CHI
20190152279	CORUMBAIBA	CI12392144	VILA CORUMBA	13/01/2019 08:59	14/01/2019 12:10	13/01/2019 08:59	14/01/2019 12:10	27,18	2	54,37	DIA CRITICO
20190152284	ISRAELANDIA	IS12184684	IPORA	13/01/2019 07:05	13/01/2019 21:07	13/01/2019 07:05	13/01/2019 21:07	14,03	10	140,33	CHI
20190152287	PIRES DO RIO	PR12255837	PIRES DO RIO S1	13/01/2019 08:57	13/01/2019 13:57	13/01/2019 08:57	13/01/2019 13:57	5,00	30	150,00	CHI
20190152299	APARECIDA DE GOIANIA	AP11234804	INDEPENDENCIA S1	13/01/2019 08:09	13/01/2019 11:38	13/01/2019 08:09	13/01/2019 11:38	3,48	37	128,88	CHI
20190152338	PARAUNA	PU12010292	FIRMINOPOLIS S2	13/01/2019 08:30	13/01/2019 12:35	13/01/2019 08:30	13/01/2019 12:35	4,08	26	106,17	CHI
20190152349	ABADIA DE GOIAS	LG11251432	CARAJAS S1	13/01/2019 08:30	13/01/2019 13:20	13/01/2019 08:30	13/01/2019 13:20	4,83	135	652,50	DIA CRITICO
20190152353	SENADOR CANEDO	SW12092681	SENADOR CANEDO	13/01/2019 08:44	13/01/2019 11:23	13/01/2019 08:44	13/01/2019 11:23	2,65	45	119,25	CHI
20190152369	SANTA HELENA DE GOIAS	SH11000019	IPEGUARI	13/01/2019 08:22	13/01/2019 11:33	13/01/2019 08:22	13/01/2019 11:33	3,18	120	382,00	CHI
20190152391	GOIANIA	GN11346228	GOYA S2	13/01/2019 08:43	14/01/2019 13:32	13/01/2019 08:43	14/01/2019 13:32	28,82	131	3774,98	DIA CRITICO
20190152394	PORANGATU	PO21240721	PORANGATU	13/01/2019 09:11	13/01/2019 15:15	13/01/2019 09:11	13/01/2019 15:15	6,07	1	6,07	CHI
20190152395	AMARALINA	LC12216163	MARA ROSA	13/01/2019 09:14	13/01/2019 14:27	13/01/2019 09:14	13/01/2019 14:27	5,22	5	26,08	CHI
20190152398	PONTALINA	PK11223570	PONTALINA	13/01/2019 08:56	13/01/2019 10:25	13/01/2019 08:56	13/01/2019 10:25	1,48	68	100,87	CHI
20190152419	NIQUELANDIA	NQ21097485	NIQUELANDIA SUBTRANSMISSÃO	13/01/2019 09:16	14/01/2019 02:05	13/01/2019 09:16	14/01/2019 02:05	16,82	2	33,63	CHI
20190152422	ALVORADA DO NORTE	SA12168085	IACIARA S2	13/01/2019 08:45	13/01/2019 11:25	13/01/2019 08:45	13/01/2019 11:25	2,67	3	8,00	CHI
20190152422	POSSE	SA12168085	IACIARA S2	13/01/2019 08:45	13/01/2019 11:25	13/01/2019 08:45	13/01/2019 11:25	2,67	15	40,00	CHI
20190152422	SIMOLANDIA	SA12168085	IACIARA S2	13/01/2019 08:45	13/01/2019 11:25	13/01/2019 08:45	13/01/2019 11:25	2,67	91	242,67	CHI

20190152424	BELA VISTA DE GOIAS	BV12033454	CRISTIANOPOLIS	13/01/2019 08:40	13/01/2019 17:19	13/01/2019 08:40	13/01/2019 17:19	8,65	3	25,95	CHI
20190152424	SAO MIGUEL DO PASSA QUATRO	BV12033454	CRISTIANOPOLIS	13/01/2019 08:40	13/01/2019 17:19	13/01/2019 08:40	13/01/2019 17:19	8,65	6	51,90	CHI
20190152426	SITIO D ABADIA	SI12143367	IACIARA S2	13/01/2019 08:15	13/01/2019 10:22	13/01/2019 08:15	13/01/2019 10:22	2,12	23	48,68	CHI
20190152452	PORANGATU	PO12240217	MARA ROSA	13/01/2019 09:18	13/01/2019 19:24	13/01/2019 09:18	13/01/2019 19:24	10,10	4	40,40	CHI
20190152464	MUNDO NOVO DE GOIAS	MH21330152	NOVA CRIXAS	13/01/2019 09:21	13/01/2019 14:43	13/01/2019 09:21	13/01/2019 14:43	5,37	1	5,37	CHI
20190152470	NOVO PLANALTO	TA12192346	SAO MIGUEL DO ARAGUAIA	13/01/2019 07:27	13/01/2019 12:01	13/01/2019 07:27	13/01/2019 12:01	4,57	92	420,13	CHI
20190152474	MONTIVIDIU DO NORTE	MX21208434	PORANGATU	13/01/2019 09:20	13/01/2019 11:20	13/01/2019 09:20	13/01/2019 11:20	2,00	1	2,00	CHI
20190152479	RUBIATABA	RB21114295	RUBIATABA	13/01/2019 09:23	14/01/2019 14:25	13/01/2019 09:23	14/01/2019 14:25	29,03	1	29,03	CHI
20190152481	SENADOR CANEDO	SW11158437	GOIANIA LESTE S2	13/01/2019 07:57	13/01/2019 12:26	13/01/2019 07:57	13/01/2019 12:26	4,48	34	152,43	CHI
20190152490	SAO FRANCISCO DE GOIAS	SF21059954	SAO FRANCISCO DE GOIAS	12/01/2019 17:09	14/01/2019 17:38	12/01/2019 17:09	14/01/2019 17:38	48,48	1	48,48	DIA CRITICO
20190152538	PIRES DO RIO	PR21335349	PIRES DO RIO S1	13/01/2019 08:57	14/01/2019 07:49	13/01/2019 08:57	14/01/2019 07:49	22,87	3	68,60	CHI
20190152558	NOVA CRIXAS	NA21321948	NOVA CRIXAS	13/01/2019 09:30	13/01/2019 23:35	13/01/2019 09:30	13/01/2019 23:35	14,08	1	14,08	CHI
20190152582	PALMEIRAS DE GOIAS	PL11000039	PALMEIRAS	13/01/2019 07:58	13/01/2019 11:50	13/01/2019 07:58	13/01/2019 11:50	3,87	143	552,93	DIA CRITICO
20190152588	GOIANIA	TR12200065	GOYA S2	13/01/2019 08:28	13/01/2019 23:15	13/01/2019 08:28	13/01/2019 23:15	14,78	96	1419,20	DIA CRITICO
20190152594	CORREGO DO OURO	SL10400788	SAO LUIZ DOS MONTES BELOS	13/01/2019 05:48	13/01/2019 20:30	13/01/2019 05:48	13/01/2019 15:58	10,17	1	10,17	CHI
20190152594	SANCLERLANDIA	SL10400788	SAO LUIZ DOS MONTES BELOS	13/01/2019 05:48	13/01/2019 20:30	13/01/2019 05:48	13/01/2019 15:58	10,17	34	345,67	CHI
20190152594	SAO LUIS DE MONTES BELOS	SL10400788	SAO LUIZ DOS MONTES BELOS	13/01/2019 05:48	13/01/2019 20:30	13/01/2019 05:48	13/01/2019 15:58	10,17	23	233,83	CHI
20190152594	CORREGO DO OURO	SL10400788	SAO LUIZ DOS MONTES BELOS	13/01/2019 05:48	13/01/2019 20:30	13/01/2019 18:10	13/01/2019 18:22	0,20	1	0,20	CHI
20190152594	SANCLERLANDIA	SL10400788	SAO LUIZ DOS MONTES BELOS	13/01/2019 05:48	13/01/2019 20:30	13/01/2019 18:10	13/01/2019 18:22	0,20	34	6,80	CHI
20190152594	SAO LUIS DE MONTES BELOS	SL10400788	SAO LUIZ DOS MONTES BELOS	13/01/2019 05:48	13/01/2019 20:30	13/01/2019 18:10	13/01/2019 18:22	0,20	23	4,60	CHI
20190152594	CORREGO DO OURO	SL32233416LD	SAO LUIZ DOS MONTES BELOS	13/01/2019 05:48	13/01/2019 20:30	13/01/2019 05:48	13/01/2019 19:45	13,95	65	906,75	CHI
20190152594	CORREGO DO OURO	CO12003620LD	SAO LUIZ DOS MONTES BELOS	13/01/2019 05:48	13/01/2019 20:30	13/01/2019 05:48	13/01/2019 20:30	14,70	186	2734,20	CHI
20190152594	FIRMINOPOLIS	CO12003620LD	SAO LUIZ DOS MONTES BELOS	13/01/2019 05:48	13/01/2019 20:30	13/01/2019 05:48	13/01/2019 20:30	14,70	16	235,20	CHI
20190152594	MOIPORA	CO12003620LD	SAO LUIZ DOS MONTES BELOS	13/01/2019 05:48	13/01/2019 20:30	13/01/2019 05:48	13/01/2019 20:30	14,70	2	29,40	CHI
20190152600	URUACU	UR12361495	URUACU	13/01/2019 09:37	13/01/2019 12:59	13/01/2019 09:37	13/01/2019 12:59	3,37	5	16,83	CHI
20190152601	BELA VISTA DE GOIAS	BV12000235	BELA VISTA S1	13/01/2019 08:43	13/01/2019 13:25	13/01/2019 08:43	13/01/2019 13:25	4,70	12	56,40	CHI
20190152611	JARAGUA	SR12018998	INHUMAS S1	13/01/2019 07:45	13/01/2019 13:51	13/01/2019 07:45	13/01/2019 13:51	6,10	7	42,70	CHI
20190152611	SANTA ROSA DE GOIAS	SR12018998	INHUMAS S1	13/01/2019 07:45	13/01/2019 13:51	13/01/2019 07:45	13/01/2019 13:51	6,10	38	231,80	CHI
20190152614	PILAR DE GOIAS	GG12181017	SANTA TEREZINHA	13/01/2019 08:51	13/01/2019 16:55	13/01/2019 08:51	13/01/2019 16:55	8,07	8	64,53	DIA CRITICO
20190152616	SANTA TEREZA DE GOIAS	SE12000019	MARA ROSA	13/01/2019 09:37	13/01/2019 13:40	13/01/2019 09:37	13/01/2019 13:40	4,05	1	4,05	CHI
20190152640	JATAI	JT12219503	JATAI S3	13/01/2019 08:52	13/01/2019 14:30	13/01/2019 08:52	13/01/2019 14:30	5,63	5	28,17	CHI
20190152641	GOIANIA	GN11002564	CAMPINAS S2	13/01/2019 07:24	14/01/2019 12:58	13/01/2019 07:24	14/01/2019 12:58	29,57	98	2897,53	DIA CRITICO
20190152668	NOVA GLORIA	NG12181391	RUBIATABA	13/01/2019 09:43	13/01/2019 14:10	13/01/2019 09:43	13/01/2019 14:10	4,45	20	89,00	CHI

20190152682	CRIXAS	CX12390328	SANTA TEREZINHA	13/01/2019 09:47	14/01/2019 16:50	13/01/2019 09:47	14/01/2019 16:50	31,05	33	1024,65	DIA CRITICO
20190152695	PALMEIRAS DE GOIAS	PL12277423	PALMEIRAS	13/01/2019 07:14	13/01/2019 19:15	13/01/2019 07:14	13/01/2019 19:15	12,02	24	288,40	DIA CRITICO
20190152696	URUACU	UR12242674	URUACU	13/01/2019 09:49	13/01/2019 16:27	13/01/2019 09:49	13/01/2019 16:27	6,63	2	13,27	CHI
20190152718	POSSE	PS12124656	IACIARA S2	13/01/2019 05:39	13/01/2019 12:04	13/01/2019 05:39	13/01/2019 12:04	6,42	92	590,33	CHI
20190152719	CRIXAS	CX12318471	SERRA DO OURO	13/01/2019 09:51	14/01/2019 12:40	13/01/2019 09:51	14/01/2019 12:40	26,82	12	321,80	CHI
20190152726	ITABERAI	II12300400	ITABERAI S1	13/01/2019 08:36	13/01/2019 12:47	13/01/2019 08:36	13/01/2019 12:47	4,18	21	87,85	CHI
20190152726	ITAGUARI	II12300400	ITABERAI S1	13/01/2019 08:36	13/01/2019 12:47	13/01/2019 08:36	13/01/2019 12:47	4,18	24	100,40	CHI
20190152751	ITAPACI	IW12181521	ITAPACI	13/01/2019 09:53	13/01/2019 12:26	13/01/2019 09:53	13/01/2019 12:26	2,55	4	10,20	CHI
20190152764	JUSSARA	JR12220268	JUSSARA	13/01/2019 04:22	13/01/2019 17:39	13/01/2019 04:22	13/01/2019 14:31	10,15	10	101,50	CHI
20190152764	ITAPIRAPUA	JR13259755	JUSSARA	13/01/2019 04:22	13/01/2019 17:39	13/01/2019 04:22	13/01/2019 15:20	10,97	5	54,83	CHI
20190152764	ITAPIRAPUA	IU13018853	MATRINCHA	13/01/2019 04:22	13/01/2019 17:39	13/01/2019 04:22	13/01/2019 17:39	13,28	13	172,68	CHI
20190152765	PALMEIRAS DE GOIAS	PL12206047	PALMEIRAS	13/01/2019 08:08	13/01/2019 15:40	13/01/2019 08:08	13/01/2019 15:40	7,53	303	2282,60	DIA CRITICO
20190152784	PALMINOPOLIS	PP12312505	PALMEIRAS	13/01/2019 07:37	13/01/2019 19:04	13/01/2019 07:37	13/01/2019 19:04	11,45	9	103,05	DIA CRITICO
20190152787	HIDROLANDIA	HD12000136	CEPAIGO S2	13/01/2019 07:04	13/01/2019 12:30	13/01/2019 07:04	13/01/2019 12:30	5,43	31	168,43	CHI
20190152808	GOIANIA	10013235174	MEIA PONTE	13/01/2019 08:15	14/01/2019 09:21	13/01/2019 08:15	14/01/2019 09:21	25,10	1	25,10	DIA CRITICO
20190152813	MUNDO NOVO DE GOIAS	MH21087320	NOVA CRIXAS	13/01/2019 10:00	13/01/2019 14:04	13/01/2019 10:00	13/01/2019 14:04	4,07	1	4,07	CHI
20190152817	ITAPIRAPUA	IU12091645	MATRINCHA	13/01/2019 07:18	13/01/2019 13:54	13/01/2019 07:18	13/01/2019 13:54	6,60	8	52,80	CHI
20190152821	NIQUELANDIA	NQ12359847	NIQUELANDIA SUBTRANSMISSÃO	13/01/2019 10:01	13/01/2019 12:11	13/01/2019 10:01	13/01/2019 12:11	2,17	47	101,83	CHI
20190152870	IPAMERI	IP12266894	IPAMERI	13/01/2019 08:52	13/01/2019 14:01	13/01/2019 08:52	13/01/2019 14:01	5,15	14	72,10	CHI
20190152880	NIQUELANDIA	NQ12213022	NIQUELANDIA SUBTRANSMISSÃO	13/01/2019 10:01	13/01/2019 13:22	13/01/2019 10:01	13/01/2019 13:22	3,35	8	26,80	CHI
20190152887	SAO MIGUEL DO ARAGUAIA	SM12401695	SAO MIGUEL DO ARAGUAIA	13/01/2019 10:08	13/01/2019 14:31	13/01/2019 10:08	13/01/2019 14:31	4,38	2	8,77	CHI
20190152894	HIDROLINA	HL11269761	URUACU	13/01/2019 09:52	13/01/2019 13:54	13/01/2019 09:52	13/01/2019 13:54	4,03	68	274,27	CHI
20190152900	CRIXAS	IW12031351	RUBIATABA	13/01/2019 08:18	13/01/2019 16:56	13/01/2019 08:18	13/01/2019 16:56	8,63	5	43,17	CHI
20190152900	ITAPACI	IW12031351	RUBIATABA	13/01/2019 08:18	13/01/2019 16:56	13/01/2019 08:18	13/01/2019 16:56	8,63	1	8,63	CHI
20190152901	AVELINOPOLIS	AV12241071	ANICUNS	13/01/2019 05:26	13/01/2019 21:56	13/01/2019 05:26	13/01/2019 16:30	11,07	112	1239,47	CHI
20190152901	AVELINOPOLIS	AV12323554LD	ANICUNS	13/01/2019 05:26	13/01/2019 21:56	13/01/2019 05:26	13/01/2019 21:56	16,50	13	214,50	CHI
20190152901	SANTA BARBARA DE GOIAS	AV12323554LD	ANICUNS	13/01/2019 05:26	13/01/2019 21:56	13/01/2019 05:26	13/01/2019 21:56	16,50	8	132,00	CHI
20190152901	AVELINOPOLIS	AV12323554LD	ANICUNS	13/01/2019 05:26	13/01/2019 21:56	13/01/2019 20:40	13/01/2019 21:56	1,27	7	8,87	CHI
20190152934	PORANGATU	PO12349237	MARA ROSA	13/01/2019 11:12	13/01/2019 18:27	13/01/2019 11:12	13/01/2019 18:27	7,25	18	130,50	CHI
20190152939	URUACU	UR12135693	URUACU	13/01/2019 10:14	14/01/2019 17:21	13/01/2019 10:14	14/01/2019 14:55	28,68	10	286,83	CHI
20190152939	URUACU	UR12135693	URUACU	13/01/2019 10:14	14/01/2019 17:21	13/01/2019 10:14	14/01/2019 17:21	31,12	3	93,35	CHI
20190152966	GOIANIA	GN11076037	CAMPINAS S2	12/01/2019 18:44	13/01/2019 19:17	12/01/2019 18:44	13/01/2019 19:17	24,55	157	3854,35	DIA CRITICO
20190152988	GOIANIA	GN11094552	ATLANTICO S1	13/01/2019 08:35	14/01/2019 11:00	13/01/2019 08:35	14/01/2019 11:00	26,42	106	2800,17	CHI

20190153017	NIQUELANDIA	NQ21213125	NIQUELANDIA SUBTRANSMISSÃO	13/01/2019 10:22	13/01/2019 12:55	13/01/2019 10:22	13/01/2019 12:55	2,55	1	2,55	CHI
20190153036	CAMPOS VERDES	VD12332081	SANTA TEREZINHA	13/01/2019 07:48	13/01/2019 12:22	13/01/2019 07:48	13/01/2019 12:22	4,57	2	9,13	DIA CRITICO
20190153064	NIQUELANDIA	NQ12391958	NIQUELANDIA SUBTRANSMISSÃO	13/01/2019 10:24	13/01/2019 18:21	13/01/2019 10:24	13/01/2019 18:21	7,95	22	174,90	CHI
20190153070	GOIANDIRA	GD12250481	CATALAO S1	13/01/2019 08:07	13/01/2019 12:41	13/01/2019 08:07	13/01/2019 12:41	4,57	58	264,87	CHI
20190153090	ALVORADA DO NORTE	SI12281746LD	IACIARA S2	13/01/2019 08:17	13/01/2019 20:21	13/01/2019 08:17	13/01/2019 20:21	12,07	4	48,27	CHI
20190153092	BELA VISTA DE GOIAS	BV32000075	BELA VISTA S1	13/01/2019 08:50	13/01/2019 16:02	13/01/2019 08:50	13/01/2019 16:02	7,20	21	151,20	CHI
20190153107	MARA ROSA	MQ12120038	MARA ROSA	13/01/2019 10:33	13/01/2019 18:09	13/01/2019 10:33	13/01/2019 18:09	7,60	2	15,20	CHI
20190153123	CAMPOS VERDES	VD11037450	SANTA TEREZINHA	13/01/2019 10:34	13/01/2019 11:38	13/01/2019 10:34	13/01/2019 11:38	1,07	108	115,20	DIA CRITICO
20190153133	TURVANIA	TV12005554	FIRMINOPOLIS S1	13/01/2019 07:23	13/01/2019 13:13	13/01/2019 07:23	13/01/2019 13:13	5,83	10	58,33	CHI
20190153134	MONTIVIDIU DO NORTE	MX21153521	PORANGATU	13/01/2019 10:35	14/01/2019 13:22	13/01/2019 10:35	14/01/2019 13:22	26,78	2	53,57	CHI
20190153139	MINACU	IH21192473	MINACU	13/01/2019 10:36	13/01/2019 11:45	13/01/2019 10:36	13/01/2019 11:45	1,15	1	1,15	CHI
20190153155	CORREGO DO OURO	CO12383517	FIRMINOPOLIS S2	13/01/2019 08:53	13/01/2019 19:50	13/01/2019 08:53	13/01/2019 19:50	10,95	7	76,65	CHI
20190153160	LUZIANIA	LZ12013824	VIANOPOLIS	13/01/2019 07:52	13/01/2019 14:43	13/01/2019 07:52	13/01/2019 14:43	6,85	16	109,60	CHI
20190153164	ITAPIRAPUA	IU12121437	MATRINCHA	13/01/2019 04:59	13/01/2019 14:52	13/01/2019 04:59	13/01/2019 14:52	9,88	16	158,13	CHI
20190153187	MINACU	IH12236116	MINACU	13/01/2019 10:38	13/01/2019 15:49	13/01/2019 10:38	13/01/2019 15:49	5,18	2	10,37	CHI
20190153195	MONTIVIDIU DO NORTE	MX12203429	PORANGATU	13/01/2019 10:42	13/01/2019 22:00	13/01/2019 10:42	13/01/2019 22:00	11,30	25	282,50	CHI
20190153206	MINEIROS	SX12165993	CHAPADAO DO CEU	13/01/2019 08:08	13/01/2019 15:35	13/01/2019 08:08	13/01/2019 15:35	7,45	20	149,00	CHI
20190153206	SERRANOPOLIS	SX12165993	CHAPADAO DO CEU	13/01/2019 08:08	13/01/2019 15:35	13/01/2019 08:08	13/01/2019 15:35	7,45	1	7,45	CHI
20190153224	GUARINOS	GF21147950	SANTA TEREZINHA	13/01/2019 10:44	14/01/2019 10:00	13/01/2019 10:44	14/01/2019 10:00	23,27	1	23,27	DIA CRITICO
20190153263	PORANGATU	PO12202569	PORANGATU	13/01/2019 10:50	13/01/2019 13:11	13/01/2019 10:50	13/01/2019 13:11	2,35	7	16,45	CHI
20190153324	GOIANIA	GN11194305	FERROVIARIO S2	13/01/2019 08:46	14/01/2019 10:09	13/01/2019 08:46	14/01/2019 10:09	25,38	56	1421,47	DIA CRITICO
20190153354	CRIXAS	CX12209957	SANTA TEREZINHA	13/01/2019 09:51	14/01/2019 00:54	13/01/2019 09:51	14/01/2019 00:54	15,05	4	60,20	DIA CRITICO
20190153368	MINACU	IH12396734	MINACU	13/01/2019 11:02	13/01/2019 17:38	13/01/2019 11:02	13/01/2019 17:38	6,60	62	409,20	CHI
20190153368	TROMBAS	IH12396734	MINACU	13/01/2019 11:02	13/01/2019 17:38	13/01/2019 11:02	13/01/2019 17:38	6,60	6	39,60	CHI
20190153391	PORANGATU	PO12391645	NOVO PLANALTO	13/01/2019 09:25	13/01/2019 13:06	13/01/2019 09:25	13/01/2019 13:06	3,68	10	36,83	DIA CRITICO
20190153400	IPORA	IR11353741	IPORA	13/01/2019 08:05	14/01/2019 11:08	13/01/2019 08:05	14/01/2019 11:08	27,05	1	27,05	CHI
20190153436	CORUMBAIBA	IP12152359	IPAMERI	13/01/2019 08:05	13/01/2019 13:01	13/01/2019 08:05	13/01/2019 13:01	4,93	8	39,47	CHI
20190153436	IPAMERI	IP12152359	IPAMERI	13/01/2019 08:05	13/01/2019 13:01	13/01/2019 08:05	13/01/2019 13:01	4,93	7	34,53	CHI
20190153439	URUACU	UR12213102	URUACU	13/01/2019 11:03	13/01/2019 12:58	13/01/2019 11:03	13/01/2019 12:58	1,92	9	17,25	CHI
20190153458	ARAGUAPAZ	RB12372516	RUBIATABA	13/01/2019 09:42	13/01/2019 15:02	13/01/2019 09:42	13/01/2019 15:02	5,33	1	5,33	CHI
20190153458	MORRO AGUDO DE GOIAS	RB12372516	RUBIATABA	13/01/2019 09:42	13/01/2019 15:02	13/01/2019 09:42	13/01/2019 15:02	5,33	14	74,67	CHI
20190153458	RUBIATABA	RB12372516	RUBIATABA	13/01/2019 09:42	13/01/2019 15:02	13/01/2019 09:42	13/01/2019 15:02	5,33	150	800,00	CHI
20190153464	NOVA CRIXAS	NA12057386	NOVA CRIXAS	13/01/2019 11:14	14/01/2019 13:22	13/01/2019 11:14	14/01/2019 13:22	26,13	9	235,20	CHI

20190153468	PETROLINA DE GOIAS	PG12070554	INHUMAS S1	13/01/2019 08:27	13/01/2019 12:08	13/01/2019 08:27	13/01/2019 12:08	3,68	8	29,47	CHI
20190153477	CRIXAS	NM12322630	RUBIATABA	13/01/2019 09:41	13/01/2019 14:50	13/01/2019 09:41	13/01/2019 14:50	5,15	1	5,15	CHI
20190153477	NOVA AMERICA	NM12322630	RUBIATABA	13/01/2019 09:41	13/01/2019 14:50	13/01/2019 09:41	13/01/2019 14:50	5,15	64	329,60	CHI
20190153477	RUBIATABA	NM12322630	RUBIATABA	13/01/2019 09:41	13/01/2019 14:50	13/01/2019 09:41	13/01/2019 14:50	5,15	6	30,90	CHI
20190153489	RUBIATABA	RB21126610	RUBIATABA	13/01/2019 11:16	14/01/2019 00:57	13/01/2019 11:16	14/01/2019 00:57	13,68	1	13,68	CHI
20190153558	BELA VISTA DE GOIAS	BV12079678	BELA VISTA S1	13/01/2019 06:41	13/01/2019 14:32	13/01/2019 06:41	13/01/2019 14:32	7,85	118	926,30	CHI
20190153558	HIDROLANDIA	BV12079678	BELA VISTA S1	13/01/2019 06:41	13/01/2019 14:32	13/01/2019 06:41	13/01/2019 14:32	7,85	1	7,85	CHI
20190153563	NIQUELANDIA	NQ12146984LD	URUACU	13/01/2019 11:02	13/01/2019 16:50	13/01/2019 11:02	13/01/2019 16:50	5,80	80	464,00	CHI
20190153582	PORANGATU	PO12320970	NOVO PLANALTO	13/01/2019 11:27	13/01/2019 19:57	13/01/2019 11:27	13/01/2019 19:57	8,50	2	17,00	DIA CRITICO
20190153600	NOVA IGUACU DE GOIAS	NH21265978	SANTA TEREZINHA	13/01/2019 11:29	13/01/2019 16:07	13/01/2019 11:29	13/01/2019 16:07	4,63	1	4,63	DIA CRITICO
20190153622	CRIXAS	CX12297040	SERRA DO OURO	13/01/2019 11:32	15/01/2019 00:07	13/01/2019 11:32	15/01/2019 00:07	36,58	1	36,58	CHI
20190153659	CAMPINORTE	CR12101042	CAMPINORTE	13/01/2019 08:29	13/01/2019 13:19	13/01/2019 08:29	13/01/2019 13:19	4,83	7	33,83	CHI
20190153660	SAO MIGUEL DO ARAGUAIA	SM12390371	SAO MIGUEL DO ARAGUAIA	13/01/2019 11:36	13/01/2019 15:11	13/01/2019 11:36	13/01/2019 15:11	3,58	2	7,17	CHI
20190153669	PIRACANJUBA	PJ12040801	PIRACANJUBA	13/01/2019 08:07	13/01/2019 15:18	13/01/2019 08:07	13/01/2019 15:18	7,18	33	237,05	CHI
20190153670	MUNDO NOVO DE GOIAS	MH21117473	NOVA CRIXAS	13/01/2019 11:38	13/01/2019 13:20	13/01/2019 11:38	13/01/2019 13:20	1,70	1	1,70	CHI
20190153672	MAMBAI	MB11057996	IACIARA S2	13/01/2019 08:54	13/01/2019 16:02	13/01/2019 08:54	13/01/2019 16:02	7,13	31	221,13	CHI
20190153682	BOM JARDIM DE GOIAS	BM12297165	BOM JARDIM	13/01/2019 08:38	13/01/2019 16:38	13/01/2019 08:38	13/01/2019 16:38	8,00	6	48,00	DIA CRITICO
20190153695	URUACU	UR21213213	URUACU	13/01/2019 11:41	13/01/2019 18:56	13/01/2019 11:41	13/01/2019 18:56	7,25	1	7,25	CHI
20190153707	MINACU	IH12220835	MINACU	13/01/2019 11:43	13/01/2019 12:51	13/01/2019 11:43	13/01/2019 12:51	1,13	5	5,67	CHI
20190153720	ITAPACI	IW21167976	ITAPACI	13/01/2019 11:45	13/01/2019 16:14	13/01/2019 11:45	13/01/2019 16:14	4,48	1	4,48	CHI
20190153754	CRIXAS	UP12171789	SANTA TEREZINHA	13/01/2019 11:27	13/01/2019 18:29	13/01/2019 11:27	13/01/2019 18:29	7,03	15	105,50	DIA CRITICO
20190153754	UIRAPURU	UP12171789	SANTA TEREZINHA	13/01/2019 11:27	13/01/2019 18:29	13/01/2019 11:27	13/01/2019 18:29	7,03	50	351,67	DIA CRITICO
20190153841	ESTRELA DO NORTE	ET12391908	MARA ROSA	13/01/2019 12:07	13/01/2019 13:20	13/01/2019 12:07	13/01/2019 13:20	1,22	2	2,43	CHI
20190153842	URUACU	UR12229447	URUACU	13/01/2019 10:52	13/01/2019 17:27	13/01/2019 10:52	13/01/2019 17:27	6,58	7	46,08	CHI
20190153889	CRIXAS	CX21164842	SANTA TEREZINHA	13/01/2019 12:14	14/01/2019 16:11	13/01/2019 12:14	14/01/2019 16:11	27,95	1	27,95	DIA CRITICO
20190153898	NIQUELANDIA	NQ12262875	URUACU	13/01/2019 12:15	13/01/2019 16:43	13/01/2019 12:15	13/01/2019 16:43	4,47	1	4,47	CHI
20190153910	NIQUELANDIA	NQ12374578	URUACU	13/01/2019 12:17	13/01/2019 17:58	13/01/2019 12:17	13/01/2019 17:58	5,68	1	5,68	CHI
20190153930	CACHOEIRA DE GOIAS	CG12018660	FIRMINOPOLIS S2	13/01/2019 07:56	14/01/2019 10:09	13/01/2019 07:56	14/01/2019 10:09	26,22	38	996,23	CHI
20190153931	MINACU	IH12341446	MINACU	13/01/2019 12:20	13/01/2019 14:08	13/01/2019 12:20	13/01/2019 14:08	1,80	39	70,20	CHI
20190153933	GUAPO	TR12006367	GUAPO S1	12/01/2019 17:53	13/01/2019 12:53	12/01/2019 17:53	13/01/2019 12:53	19,00	40	760,00	CHI
20190153933	TRINDADE	TR12006367	GUAPO S1	12/01/2019 17:53	13/01/2019 12:53	12/01/2019 17:53	13/01/2019 12:53	19,00	5	95,00	CHI
20190153948	CRIXAS	GF12135520	SANTA TEREZINHA	13/01/2019 09:19	13/01/2019 15:42	13/01/2019 09:19	13/01/2019 15:42	6,38	3	19,15	DIA CRITICO
20190153948	GUARINOS	GF12135520	SANTA TEREZINHA	13/01/2019 09:19	13/01/2019 15:42	13/01/2019 09:19	13/01/2019 15:42	6,38	5	31,92	DIA CRITICO

20190153953	AMARALINA	LC12270117	SAO MIGUEL DO ARAGUAIA	13/01/2019 11:30	13/01/2019 21:41	13/01/2019 11:30	13/01/2019 21:41	10,18	9	91,65	CHI
20190153978	ABADIA DE GOIAS	TR32052049	CARAJAS S1	13/01/2019 08:40	13/01/2019 17:13	13/01/2019 08:40	13/01/2019 17:13	8,55	8	68,40	DIA CRITICO
20190153980	ITAPACI	IW12167969LD	ITAPACI	13/01/2019 12:28	13/01/2019 19:23	13/01/2019 12:28	13/01/2019 19:23	6,92	1	6,92	CHI
20190153986	NIQUELANDIA	NQ21067960	URUACU	13/01/2019 12:28	13/01/2019 20:09	13/01/2019 12:28	13/01/2019 20:09	7,68	1	7,68	CHI
20190154032	PORANGATU	PO12365601	NOVO PLANALTO	13/01/2019 12:36	13/01/2019 21:09	13/01/2019 12:36	13/01/2019 21:09	8,55	4	34,20	DIA CRITICO
20190154043	BELA VISTA DE GOIAS	BV32058331	BELA VISTA S1	13/01/2019 06:47	13/01/2019 16:38	13/01/2019 06:47	13/01/2019 16:38	9,85	33	325,05	CHI
20190154056	ARAGUAPAZ	RB10394723	RUBIATABA	13/01/2019 10:51	13/01/2019 23:22	13/01/2019 20:40	13/01/2019 20:46	0,10	1	0,10	CHI
20190154056	CRIXAS	RB10394723	RUBIATABA	13/01/2019 10:51	13/01/2019 23:22	13/01/2019 20:40	13/01/2019 20:46	0,10	1	0,10	CHI
20190154056	MORRO AGUDO DE GOIAS	RB10394723	RUBIATABA	13/01/2019 10:51	13/01/2019 23:22	13/01/2019 20:40	13/01/2019 20:46	0,10	14	1,40	CHI
20190154056	NOVA AMERICA	RB10394723	RUBIATABA	13/01/2019 10:51	13/01/2019 23:22	13/01/2019 20:40	13/01/2019 20:46	0,10	18	1,80	CHI
20190154056	RUBIATABA	RB10394723	RUBIATABA	13/01/2019 10:51	13/01/2019 23:22	13/01/2019 20:40	13/01/2019 20:46	0,10	482	48,20	CHI
20190154056	NOVA AMERICA	RB12114263	RUBIATABA	13/01/2019 10:51	13/01/2019 23:22	13/01/2019 10:51	13/01/2019 23:22	12,52	3	37,55	CHI
20190154056	RUBIATABA	RB12114263	RUBIATABA	13/01/2019 10:51	13/01/2019 23:22	13/01/2019 10:51	13/01/2019 23:22	12,52	25	312,92	CHI
20190154056	RUBIATABA	RB12114263	RUBIATABA	13/01/2019 10:51	13/01/2019 23:22	13/01/2019 20:40	13/01/2019 23:22	2,70	90	243,00	CHI
20190154057	GUAPO	GA12011344	GUAPO S2	13/01/2019 07:58	13/01/2019 17:19	13/01/2019 07:58	13/01/2019 16:07	8,15	1	8,15	CHI
20190154057	CAMPESTRE DE GOIAS	GA12011344	GUAPO S2	13/01/2019 07:58	13/01/2019 17:19	13/01/2019 07:58	13/01/2019 17:19	9,35	12	112,20	CHI
20190154057	GUAPO	GA12011344	GUAPO S2	13/01/2019 07:58	13/01/2019 17:19	13/01/2019 07:58	13/01/2019 17:19	9,35	53	495,55	CHI
20190154063	MONTES CLAROS DE GOIAS	ME12207822	IPORA	13/01/2019 07:15	13/01/2019 18:00	13/01/2019 07:15	13/01/2019 18:00	10,75	17	182,75	CHI
20190154074	MUTUNOPOLIS	PO12372640	PORANGATU	13/01/2019 10:57	13/01/2019 17:22	13/01/2019 10:57	13/01/2019 17:22	6,42	2	12,83	CHI
20190154074	PORANGATU	PO12372640	PORANGATU	13/01/2019 10:57	13/01/2019 17:22	13/01/2019 10:57	13/01/2019 17:22	6,42	1	6,42	CHI
20190154082	GUARINOS	GG21323903	ITAPACI	13/01/2019 12:44	14/01/2019 09:30	13/01/2019 12:44	14/01/2019 09:30	20,77	1	20,77	CHI
20190154157	SAO MIGUEL DO ARAGUAIA	SM21230613	SAO MIGUEL DO ARAGUAIA	13/01/2019 12:57	13/01/2019 16:08	13/01/2019 12:57	13/01/2019 16:08	3,18	1	3,18	CHI
20190154168	ARUANA	AK12341206	BRITANIA	13/01/2019 07:20	13/01/2019 18:42	13/01/2019 07:20	13/01/2019 18:42	11,37	6	68,20	DIA CRITICO
20190154261	SANTA TEREZINHA DE GOIAS	SG21190048	SANTA TEREZINHA	13/01/2019 13:13	14/01/2019 11:26	13/01/2019 13:13	14/01/2019 11:26	22,22	1	22,22	DIA CRITICO
20190154272	CATALAO	CT12270789	CATALAO S2	13/01/2019 07:22	13/01/2019 19:54	13/01/2019 07:22	13/01/2019 19:54	12,53	3	37,60	CHI
20190154272	CUMARI	CT12270789	CATALAO S2	13/01/2019 07:22	13/01/2019 19:54	13/01/2019 07:22	13/01/2019 19:54	12,53	8	100,27	CHI
20190154290	JAUPACI	JP12028023	IPORA	13/01/2019 07:54	13/01/2019 20:03	13/01/2019 07:54	13/01/2019 20:03	12,15	7	85,05	CHI
20190154330	SANTA TEREZINHA DE GOIAS	SG21210201	SANTA TEREZINHA	13/01/2019 13:26	14/01/2019 14:22	13/01/2019 13:26	14/01/2019 14:22	24,93	1	24,93	DIA CRITICO
20190154331	SANTA TEREZINHA DE GOIAS	SG21141134	SANTA TEREZINHA	13/01/2019 13:26	14/01/2019 15:15	13/01/2019 13:26	14/01/2019 15:15	25,82	1	25,82	DIA CRITICO
20190154342	FORMOSO	FO12145370	PORANGATU	13/01/2019 13:28	13/01/2019 14:24	13/01/2019 13:28	13/01/2019 14:24	0,93	58	54,13	CHI
20190154350	NIQUELANDIA	NQ11353861	URUACU	13/01/2019 13:29	14/01/2019 09:58	13/01/2019 13:29	14/01/2019 09:58	20,48	1	20,48	CHI
20190154358	BURITI DE GOIAS	CO12000058	FIRMINOPOLIS S2	13/01/2019 08:16	13/01/2019 17:28	13/01/2019 08:16	13/01/2019 17:28	9,20	31	285,20	CHI
20190154358	CORREGO DO OURO	CO12000058	FIRMINOPOLIS S2	13/01/2019 08:16	13/01/2019 17:28	13/01/2019 08:16	13/01/2019 17:28	9,20	55	506,00	CHI

20190154358	FAZENDA NOVA	CO12000058	FIRMINOPOLIS S2	13/01/2019 08:16	13/01/2019 17:28	13/01/2019 08:16	13/01/2019 17:28	9,20	2	18,40	CHI
20190154367	SANTA TEREZINHA DE GOIAS	SG21232422	SANTA TEREZINHA	13/01/2019 13:31	14/01/2019 08:18	13/01/2019 13:31	14/01/2019 08:18	18,78	1	18,78	DIA CRITICO
20190154393	PORANGATU	PO12199175	PORANGATU	13/01/2019 13:34	14/01/2019 13:32	13/01/2019 13:34	14/01/2019 13:32	23,97	1	23,97	CHI
20190154437	URUACU	UR12364064	URUACU	13/01/2019 12:59	13/01/2019 18:46	13/01/2019 12:59	13/01/2019 18:46	5,78	6	34,70	CHI
20190154439	SANTA TEREZINHA DE GOIAS	SG12321938	SANTA TEREZINHA	13/01/2019 09:42	13/01/2019 17:08	13/01/2019 09:42	13/01/2019 17:08	7,43	23	170,97	DIA CRITICO
20190154482	MOZARLANDIA	MZ12055628	MOZARLANDIA	12/01/2019 22:18	13/01/2019 21:32	12/01/2019 22:18	13/01/2019 21:32	23,23	2	46,47	CHI
20190154482	CRIXAS	MZ12055628	MOZARLANDIA	12/01/2019 22:18	13/01/2019 21:32	13/01/2019 06:48	13/01/2019 21:32	14,73	6	88,40	CHI
20190154482	MOZARLANDIA	MZ12055628	MOZARLANDIA	12/01/2019 22:18	13/01/2019 21:32	13/01/2019 06:48	13/01/2019 21:32	14,73	6	88,40	CHI
20190154500	HIDROLINA	HL21293481	URUACU	13/01/2019 13:50	14/01/2019 10:44	13/01/2019 13:50	14/01/2019 10:44	20,90	1	20,90	CHI
20190154513	SANTA TEREZINHA DE GOIAS	SG21252856	SANTA TEREZINHA	13/01/2019 13:53	15/01/2019 09:25	13/01/2019 13:53	15/01/2019 09:25	43,53	1	43,53	DIA CRITICO
20190154519	TROMBAS	TB21322543	PORANGATU	13/01/2019 13:55	14/01/2019 17:28	13/01/2019 13:55	14/01/2019 17:28	27,55	2	55,10	CHI
20190154540	ALVORADA DO NORTE	AQ12232934	IACIARA S2	13/01/2019 08:15	13/01/2019 16:36	13/01/2019 08:15	13/01/2019 16:36	8,35	10	83,50	CHI
20190154558	SANTA TEREZINHA DE GOIAS	SG21153350	SANTA TEREZINHA	13/01/2019 14:01	13/01/2019 15:40	13/01/2019 14:01	13/01/2019 15:40	1,65	2	3,30	DIA CRITICO
20190154572	MOZARLANDIA	MZ12230681	RUBIATABA	13/01/2019 14:03	13/01/2019 18:06	13/01/2019 14:03	13/01/2019 18:06	4,05	3	12,15	CHI
20190154653	SANTA TEREZINHA DE GOIAS	GG21320678	SANTA TEREZINHA	13/01/2019 14:21	13/01/2019 17:49	13/01/2019 14:21	13/01/2019 17:49	3,47	1	3,47	DIA CRITICO
20190154662	PORANGATU	PO12348288	PORANGATU	13/01/2019 13:51	13/01/2019 18:05	13/01/2019 13:51	13/01/2019 18:05	4,23	8	33,87	CHI
20190154667	BONOPOLIS	TA12263013	NOVO PLANALTO	13/01/2019 09:46	13/01/2019 18:04	13/01/2019 09:46	13/01/2019 18:04	8,30	30	249,00	DIA CRITICO
20190154682	ITAPACI	IW12362986	URUACU	13/01/2019 14:28	14/01/2019 08:04	13/01/2019 14:28	14/01/2019 08:04	17,60	1	17,60	CHI
20190154697	SANTA TEREZINHA DE GOIAS	SG12305627	SANTA TEREZINHA	13/01/2019 09:28	13/01/2019 20:04	13/01/2019 09:28	13/01/2019 20:04	10,60	4	42,40	DIA CRITICO
20190154699	MONTIVIDIU DO NORTE	MX12203419	PORANGATU	13/01/2019 13:57	14/01/2019 00:20	13/01/2019 13:57	14/01/2019 00:20	10,38	95	986,42	CHI
20190154714	MUTUNOPOLIS	MU12127951	MARA ROSA	13/01/2019 12:52	13/01/2019 18:04	13/01/2019 12:52	13/01/2019 18:04	5,20	4	20,80	CHI
20190154749	CAMPOS VERDES	SG12318464	SANTA TEREZINHA	13/01/2019 14:40	13/01/2019 18:13	13/01/2019 14:40	13/01/2019 18:13	3,55	11	39,05	DIA CRITICO
20190154749	SANTA TEREZINHA DE GOIAS	SG12318464	SANTA TEREZINHA	13/01/2019 14:40	13/01/2019 18:13	13/01/2019 14:40	13/01/2019 18:13	3,55	24	85,20	DIA CRITICO
20190154749	UIRAPURU	SG12318464	SANTA TEREZINHA	13/01/2019 14:40	13/01/2019 18:13	13/01/2019 14:40	13/01/2019 18:13	3,55	13	46,15	DIA CRITICO
20190154750	BONOPOLIS	BX12079317	SAO MIGUEL DO ARAGUAIA	13/01/2019 13:49	13/01/2019 18:53	13/01/2019 13:49	13/01/2019 18:53	5,07	38	192,53	CHI
20190154765	CRIXAS	NM21242775	RUBIATABA	13/01/2019 14:42	14/01/2019 19:54	13/01/2019 14:42	14/01/2019 19:54	29,20	1	29,20	CHI
20190154771	CRIXAS	CX12297041	SERRA DO OURO	13/01/2019 14:43	14/01/2019 01:43	13/01/2019 14:43	14/01/2019 01:43	11,00	1	11,00	CHI
20190154796	CRIXAS	CX12134848	SANTA TEREZINHA	13/01/2019 12:14	14/01/2019 18:30	13/01/2019 12:14	14/01/2019 18:30	30,27	3	90,80	DIA CRITICO
20190154825	ITAPIRAPUA	IU12018777	JUSSARA	13/01/2019 04:22	13/01/2019 21:48	13/01/2019 04:22	13/01/2019 21:48	17,43	1	17,43	CHI
20190154829	SANTA TEREZINHA DE GOIAS	SG21317240	SANTA TEREZINHA	13/01/2019 14:40	14/01/2019 15:18	13/01/2019 14:40	14/01/2019 15:18	24,63	1	24,63	DIA CRITICO
20190154831	URUACU	UR12384347	URUACU	13/01/2019 14:51	14/01/2019 07:32	13/01/2019 14:51	14/01/2019 07:32	16,68	25	417,08	CHI
20190154846	NOVA CRIXAS	NA12115792	NOVA CRIXAS	13/01/2019 14:54	14/01/2019 17:40	13/01/2019 14:54	14/01/2019 17:40	26,77	5	133,83	CHI
20190154873	HIDROLINA	1020004190	URUACU	13/01/2019 14:59	14/01/2019 00:29	13/01/2019 14:59	14/01/2019 00:29	9,50	1	9,50	CHI

20190154919	NOVO PLANALTO	TA12293689	SAO MIGUEL DO ARAGUAIA	13/01/2019 15:06	13/01/2019 20:11	13/01/2019 15:06	13/01/2019 20:11	5,08	11	55,92	CHI
20190154931	SAO MIGUEL DO ARAGUAIA	SM11317008	SAO MIGUEL DO ARAGUAIA	13/01/2019 15:08	13/01/2019 19:06	13/01/2019 15:08	13/01/2019 19:06	3,97	65	257,83	CHI
20190154968	CRIXAS	CX12215112	RUBIATABA	13/01/2019 10:00	14/01/2019 14:55	13/01/2019 10:00	14/01/2019 14:16	28,27	13	367,47	CHI
20190154968	CRIXAS	CX12201697LD	RUBIATABA	13/01/2019 10:00	14/01/2019 14:55	13/01/2019 10:00	14/01/2019 14:55	28,92	11	318,08	CHI
20190154970	GUARINOS	GF21280704	SANTA TEREZINHA	13/01/2019 06:27	14/01/2019 11:16	13/01/2019 06:27	14/01/2019 11:16	28,82	1	28,82	DIA CRITICO
20190154979	NOVO PLANALTO	TA12293622	SAO MIGUEL DO ARAGUAIA	13/01/2019 12:43	13/01/2019 19:29	13/01/2019 12:43	13/01/2019 19:29	6,77	19	128,57	CHI
20190155008	NIQUELANDIA	NQ12358165	NIQUELANDIA SUBTRANSMISSÃO	13/01/2019 15:19	13/01/2019 20:10	13/01/2019 15:19	13/01/2019 20:10	4,85	5	24,25	CHI
20190155042	URUACU	20122867	URUACU	13/01/2019 15:25	14/01/2019 03:16	13/01/2019 15:25	14/01/2019 03:16	11,85	1	11,85	CHI
20190155067	SAO MIGUEL DO ARAGUAIA	SM12013040	SAO MIGUEL DO ARAGUAIA	13/01/2019 15:31	14/01/2019 11:00	13/01/2019 15:31	14/01/2019 11:00	19,48	1	19,48	CHI
20190155071	HIDROLINA	SZ12190057	ITAPACI	13/01/2019 11:07	13/01/2019 20:00	13/01/2019 11:07	13/01/2019 20:00	8,88	29	257,62	CHI
20190155071	SAO LUIZ DO NORTE	SZ12190057	ITAPACI	13/01/2019 11:07	13/01/2019 20:00	13/01/2019 11:07	13/01/2019 20:00	8,88	2	17,77	CHI
20190155072	MUNDO NOVO DE GOIAS	MH12391968	NOVA CRIXAS	13/01/2019 15:32	13/01/2019 20:07	13/01/2019 15:32	13/01/2019 20:07	4,58	5	22,92	CHI
20190155124	CAMPINACU	UC12346900	PORANGATU	13/01/2019 15:44	13/01/2019 21:14	13/01/2019 15:44	13/01/2019 21:14	5,50	5	27,50	CHI
20190155125	PORANGATU	MU12391993	MARA ROSA	13/01/2019 15:21	13/01/2019 18:01	13/01/2019 15:21	13/01/2019 18:01	2,67	10	26,67	CHI
20190155129	NIQUELANDIA	NQ12235223	NIQUELANDIA SUBTRANSMISSÃO	13/01/2019 15:45	13/01/2019 17:21	13/01/2019 15:45	13/01/2019 17:21	1,60	31	49,60	CHI
20190155146	NIQUELANDIA	NQ21359895	URUACU	13/01/2019 15:47	14/01/2019 19:34	13/01/2019 15:47	14/01/2019 19:34	27,78	2	55,57	CHI
20190155165	AMARALINA	LC12245307	MARA ROSA	13/01/2019 15:50	13/01/2019 18:30	13/01/2019 15:50	13/01/2019 18:30	2,67	4	10,67	CHI
20190155210	NOVO PLANALTO	TA12139159	NOVO PLANALTO	13/01/2019 15:57	13/01/2019 17:29	13/01/2019 15:57	13/01/2019 17:29	1,53	2	3,07	DIA CRITICO
20190155210	PORANGATU	TA12139159	NOVO PLANALTO	13/01/2019 15:57	13/01/2019 17:29	13/01/2019 15:57	13/01/2019 17:29	1,53	1	1,53	DIA CRITICO
20190155216	AMARALINA	MU12192418	MARA ROSA	13/01/2019 15:57	13/01/2019 20:06	13/01/2019 15:57	13/01/2019 20:06	4,15	2	8,30	CHI
20190155216	PORANGATU	MU12192418	MARA ROSA	13/01/2019 15:57	13/01/2019 20:06	13/01/2019 15:57	13/01/2019 20:06	4,15	1	4,15	CHI
20190155262	PORANGATU	PO12100815	NOVO PLANALTO	13/01/2019 16:02	13/01/2019 21:14	13/01/2019 16:02	13/01/2019 21:14	5,20	3	15,60	DIA CRITICO
20190155266	ARAGUAPAZ	AZ11238807	RUBIATABA	13/01/2019 16:02	15/01/2019 07:50	13/01/2019 16:02	15/01/2019 07:50	39,80	1	39,80	CHI
20190155337	HIDROLINA	1020006873	URUACU	13/01/2019 16:09	13/01/2019 17:46	13/01/2019 16:09	13/01/2019 17:46	1,62	1	1,62	CHI
20190155409	MUTUNOPOLIS	MU12354547	MARA ROSA	13/01/2019 15:23	13/01/2019 18:48	13/01/2019 15:23	13/01/2019 18:48	3,42	12	41,00	CHI
20190155416	MONTIVIDIU DO NORTE	MX12143686	PORANGATU	13/01/2019 12:52	13/01/2019 18:06	13/01/2019 12:52	13/01/2019 18:06	5,23	105	549,50	CHI
20190155449	HIDROLINA	HL21068281	URUACU	13/01/2019 16:19	14/01/2019 16:34	13/01/2019 16:19	14/01/2019 16:34	24,25	2	48,50	CHI
20190155459	NIQUELANDIA	NQ12181071	NIQUELANDIA SUBTRANSMISSÃO	13/01/2019 15:45	13/01/2019 18:40	13/01/2019 15:45	13/01/2019 18:40	2,92	16	46,67	CHI
20190155461	ALTO HORIZONTE	AJ12210309	SANTA TEREZINHA	13/01/2019 16:21	14/01/2019 01:04	13/01/2019 16:21	14/01/2019 01:04	8,72	19	165,62	DIA CRITICO
20190155461	MARA ROSA	AJ12210309	SANTA TEREZINHA	13/01/2019 16:21	14/01/2019 01:04	13/01/2019 16:21	14/01/2019 01:04	8,72	2	17,43	DIA CRITICO
20190155490	MUTUNOPOLIS	PO12242441	PORANGATU	13/01/2019 14:24	14/01/2019 11:47	13/01/2019 14:24	14/01/2019 11:47	21,38	2	42,77	CHI
20190155500	BONOPOLIS	BX21198519	SAO MIGUEL DO ARAGUAIA	13/01/2019 16:25	13/01/2019 19:50	13/01/2019 16:25	13/01/2019 19:50	3,42	1	3,42	CHI
20190155528	TRINDADE	TR11072597	TRINDADE	13/01/2019 07:39	14/01/2019 10:38	13/01/2019 07:39	14/01/2019 10:38	26,98	93	2509,45	DIA CRITICO

20190155543	MONTIVIDIU DO NORTE	MX12361990	PORANGATU	13/01/2019 19:49	13/01/2019 20:20	13/01/2019 19:49	13/01/2019 20:20	0,52	11	5,68	CHI
20190155656	PORANGATU	PO11349874	MARA ROSA	13/01/2019 10:14	13/01/2019 18:55	13/01/2019 10:14	13/01/2019 18:55	8,68	1	8,68	CHI
20190155657	PORANGATU	MU12266017	MARA ROSA	13/01/2019 13:14	13/01/2019 23:43	13/01/2019 13:14	13/01/2019 23:43	10,48	2	20,97	CHI
20190155676	AMARALINA	MQ12391953	NOVA CRIXAS	13/01/2019 16:34	13/01/2019 20:22	13/01/2019 16:34	13/01/2019 20:22	3,80	8	30,40	CHI
20190155676	MARA ROSA	MQ12391953	NOVA CRIXAS	13/01/2019 16:34	13/01/2019 20:22	13/01/2019 16:34	13/01/2019 20:22	3,80	14	53,20	CHI
20190155772	NOVA CRIXAS	NA12091628	NOVA CRIXAS	13/01/2019 16:47	14/01/2019 10:49	13/01/2019 16:47	14/01/2019 10:49	18,03	16	288,53	CHI
20190155817	CRIXAS	CX12164857	SANTA TEREZINHA	13/01/2019 14:48	14/01/2019 15:57	13/01/2019 14:48	14/01/2019 15:57	25,15	9	226,35	DIA CRITICO
20190155832	CRIXAS	CX21040904	SANTA TEREZINHA	13/01/2019 17:01	14/01/2019 05:13	13/01/2019 17:01	14/01/2019 05:13	12,20	1	12,20	DIA CRITICO
20190155903	MONTIVIDIU DO NORTE	MX11254836	PORANGATU	13/01/2019 17:14	14/01/2019 08:38	13/01/2019 17:14	14/01/2019 08:38	15,40	1	15,40	CHI
20190155959	CAVALCANTE	TI12156216	MINACU	13/01/2019 17:17	14/01/2019 10:50	13/01/2019 17:17	14/01/2019 10:50	17,55	63	1105,65	CHI
20190155959	COLINAS DO SUL	TI12156216	MINACU	13/01/2019 17:17	14/01/2019 10:50	13/01/2019 17:17	14/01/2019 10:50	17,55	34	596,70	CHI
20190156060	NIQUELANDIA	NQ21197673	NIQUELANDIA SUBTRANSMISSÃO	13/01/2019 17:33	13/01/2019 20:02	13/01/2019 17:33	13/01/2019 20:02	2,48	1	2,48	CHI
20190156098	GOIANIA	GN12070847	MEIA PONTE	13/01/2019 07:59	14/01/2019 17:02	13/01/2019 07:59	14/01/2019 17:02	33,05	3	99,15	DIA CRITICO
20190156098	GOIANIRA	GN12070847	MEIA PONTE	13/01/2019 07:59	14/01/2019 17:02	13/01/2019 07:59	14/01/2019 17:02	33,05	8	264,40	DIA CRITICO
20190156118	MONTIVIDIU DO NORTE	MX12187943	PORANGATU	13/01/2019 17:41	14/01/2019 00:23	13/01/2019 17:41	14/01/2019 00:23	6,70	3	20,10	CHI
20190156124	ARUANA	MZ21124761	NOVA CRIXAS	13/01/2019 17:41	15/01/2019 11:53	13/01/2019 17:41	15/01/2019 11:53	42,20	1	42,20	CHI
20190156270	SAO MIGUEL DO ARAGUAIA	SM21328604	SAO MIGUEL DO ARAGUAIA	13/01/2019 18:02	13/01/2019 20:35	13/01/2019 18:02	13/01/2019 20:35	2,55	1	2,55	CHI
20190156271	PORANGATU	840044586	PORANGATU	13/01/2019 18:02	13/01/2019 23:45	13/01/2019 18:02	13/01/2019 23:45	5,72	1	5,72	CHI
20190156348	CAMPINORTE	MQ21055248	MARA ROSA	13/01/2019 18:14	14/01/2019 10:33	13/01/2019 18:14	14/01/2019 10:33	16,32	1	16,32	CHI
20190156353	PALMINOPOLIS	PL21226729	PALMEIRAS	12/01/2019 15:37	14/01/2019 10:45	12/01/2019 15:37	14/01/2019 10:45	43,13	1	43,13	CHI
20190156369	HIDROLINA	UR12048650	URUACU	13/01/2019 12:48	13/01/2019 20:01	13/01/2019 12:48	13/01/2019 20:01	7,22	15	108,25	CHI
20190156369	URUACU	UR12048650	URUACU	13/01/2019 12:48	13/01/2019 20:01	13/01/2019 12:48	13/01/2019 20:01	7,22	34	245,37	CHI
20190156384	NIQUELANDIA	NQ12396776	NIQUELANDIA SUBTRANSMISSÃO	13/01/2019 18:20	13/01/2019 19:56	13/01/2019 18:20	13/01/2019 19:56	1,60	4	6,40	CHI
20190156457	NOVA CRIXAS	NA11354881	NOVA CRIXAS	13/01/2019 18:30	14/01/2019 00:34	13/01/2019 18:30	14/01/2019 00:34	6,07	1	6,07	CHI
20190156507	ITAPACI	SZ12243712	ITAPACI	13/01/2019 15:33	13/01/2019 19:24	13/01/2019 15:33	13/01/2019 19:24	3,85	3	11,55	CHI
20190156507	SAO LUIZ DO NORTE	SZ12243712	ITAPACI	13/01/2019 15:33	13/01/2019 19:24	13/01/2019 15:33	13/01/2019 19:24	3,85	13	50,05	CHI
20190156557	NIQUELANDIA	NQ21256642	NIQUELANDIA SUBTRANSMISSÃO	13/01/2019 18:42	13/01/2019 22:20	13/01/2019 18:42	13/01/2019 22:20	3,63	1	3,63	CHI
20190156632	SAO LUIZ DO NORTE	SZ12356538	ITAPACI	13/01/2019 18:52	14/01/2019 12:20	13/01/2019 18:52	14/01/2019 12:20	17,47	3	52,40	CHI
20190156869	PORANGATU	PO12320943	NOVO PLANALTO	13/01/2019 19:31	14/01/2019 15:42	13/01/2019 19:31	14/01/2019 15:42	20,18	1	20,18	DIA CRITICO
20190156940	CERES	JA12273170	RUBIATABA	13/01/2019 19:43	14/01/2019 13:54	13/01/2019 19:43	14/01/2019 13:54	18,18	2	36,37	CHI
20190156941	MONTIVIDIU DO NORTE	MX12137628	PORANGATU	13/01/2019 18:39	13/01/2019 21:15	13/01/2019 18:39	13/01/2019 21:15	2,60	6	15,60	CHI
20190156978	NOVA AMERICA	NM21150064	RUBIATABA	13/01/2019 19:48	14/01/2019 15:58	13/01/2019 19:48	14/01/2019 15:58	20,17	2	40,33	CHI
20190156997	URUACU	UR12320928	URUACU	13/01/2019 19:51	14/01/2019 14:08	14/01/2019 10:58	14/01/2019 11:36	0,63	10	6,33	CHI

20190156997	URUACU	UR12190194	URUACU	13/01/2019 19:51	14/01/2019 14:08	13/01/2019 19:51	14/01/2019 13:31	17,67	2	35,33	CHI
20190156997	URUACU	UR12190194	URUACU	13/01/2019 19:51	14/01/2019 14:08	13/01/2019 19:51	14/01/2019 14:08	18,28	5	91,42	CHI
20190157041	GUARINOS	GF21164891	SANTA TEREZINHA	13/01/2019 19:59	14/01/2019 10:59	13/01/2019 19:59	14/01/2019 10:59	15,00	1	15,00	DIA CRITICO
20190157095	CRIXAS	CX12394450	SERRA DO OURO	13/01/2019 14:34	13/01/2019 22:44	13/01/2019 14:34	13/01/2019 22:44	8,17	11	89,83	CHI
20190157110	NOVA CRIXAS	NA12158762	NOVA CRIXAS	13/01/2019 16:03	14/01/2019 08:40	13/01/2019 16:03	14/01/2019 08:40	16,62	6	99,70	CHI
20190157232	ITAPACI	100011809	ITAPACI	13/01/2019 20:34	13/01/2019 21:24	13/01/2019 20:34	13/01/2019 21:24	0,83	1	0,83	CHI
20190157252	RUBIATABA	RB21054199	RUBIATABA	13/01/2019 20:38	14/01/2019 00:05	13/01/2019 20:38	14/01/2019 00:05	3,45	1	3,45	CHI
20190157298	SANTA TEREZINHA DE GOIAS	SG21143286	SANTA TEREZINHA	13/01/2019 20:47	15/01/2019 21:31	13/01/2019 20:47	15/01/2019 21:31	48,73	1	48,73	DIA CRITICO
20190157475	PORANGATU	PO12227072	PORANGATU	13/01/2019 21:50	14/01/2019 17:44	13/01/2019 21:50	14/01/2019 17:44	19,90	4	79,60	CHI
20190157573	URUACU	10006338419	URUACU	13/01/2019 22:44	14/01/2019 00:39	13/01/2019 22:44	14/01/2019 00:39	1,92	1	1,92	CHI
20190160322	BRITANIA	BT12259804	BRITANIA	13/01/2019 08:15	14/01/2019 10:53	13/01/2019 08:15	14/01/2019 10:53	26,63	2	53,27	DIA CRITICO
20190161967	CACHOEIRA DE GOIAS	PU12093868	FIRMINOPOLIS S2	13/01/2019 08:08	14/01/2019 21:28	13/01/2019 08:08	14/01/2019 21:28	37,33	3	112,00	CHI
20190161967	PARAUNA	PU12093868	FIRMINOPOLIS S2	13/01/2019 08:08	14/01/2019 21:28	13/01/2019 08:08	14/01/2019 21:28	37,33	5	186,67	CHI
201901119325	ANICUNS	AC13379312	ANICUNS	12/01/2019 17:45	12/01/2019 17:50	12/01/2019 17:45	12/01/2019 17:50	0,08	5	0,42	CHI
201901119325	NAZARIO	AC13379312	ANICUNS	12/01/2019 17:45	12/01/2019 17:50	12/01/2019 17:45	12/01/2019 17:50	0,08	2	0,17	CHI
201901126809	GOIANIA	00592204	FERROVIARIO S2	12/01/2019 19:42	12/01/2019 20:07	12/01/2019 19:42	12/01/2019 19:59	0,28	4015	1137,58	DIA CRITICO
201901126809	GOIANIA	00592204	FERROVIARIO S2	12/01/2019 19:42	12/01/2019 20:07	12/01/2019 19:42	12/01/2019 20:07	0,42	30	12,50	DIA CRITICO
201901132376	GOIANIA	GN12000371	FERROVIARIO S2	12/01/2019 17:27	12/01/2019 22:37	12/01/2019 17:27	12/01/2019 22:37	5,17	1946	10054,33	DIA CRITICO
201901151851	HIDROLANDIA	HD12120557	CEPAIGO S2	13/01/2019 07:06	13/01/2019 19:18	13/01/2019 07:06	13/01/2019 19:18	12,20	19	231,80	CHI
201901151852	GOIANIA	GN12058417	REAL S1	13/01/2019 08:27	13/01/2019 08:49	13/01/2019 08:27	13/01/2019 08:49	0,37	125	45,83	CHI
201901151853	PORANGATU	PO12020611	NOVO PLANALTO	13/01/2019 08:32	13/01/2019 15:26	13/01/2019 08:32	13/01/2019 15:26	6,90	8	55,20	DIA CRITICO
201901155926	BOM JARDIM DE GOIAS	BM21335413	BOM JARDIM	12/01/2019 21:21	12/01/2019 23:00	12/01/2019 21:21	12/01/2019 23:00	1,65	1	1,65	CHI
201901164366	GOIANIA	GN12167949	FERROVIARIO S1	12/01/2019 17:00	12/01/2019 21:10	12/01/2019 17:00	12/01/2019 21:10	4,17	159	662,50	DIA CRITICO
201901164396	GOIAS	00880434	ITABERAI S1	12/01/2019 16:25	13/01/2019 06:16	12/01/2019 16:25	12/01/2019 17:51	1,43	10	14,33	CHI
201901164396	ITABERAI	00880434	ITABERAI S1	12/01/2019 16:25	13/01/2019 06:16	12/01/2019 16:25	12/01/2019 17:51	1,43	50	71,67	CHI
201901164396	GOIAS	22702	ITABERAI S1	12/01/2019 16:25	13/01/2019 06:16	12/01/2019 16:25	13/01/2019 06:16	13,85	75	1038,75	CHI
201901164396	GOIAS	22731	ITABERAI S1	12/01/2019 16:25	13/01/2019 06:16	12/01/2019 16:25	13/01/2019 06:16	13,85	2	27,70	CHI
201901164396	GOIAS	00880434	ITABERAI S1	12/01/2019 16:25	13/01/2019 06:16	12/01/2019 16:25	13/01/2019 06:16	13,85	35	484,75	CHI
201901164396	ITABERAI	22702	ITABERAI S1	12/01/2019 16:25	13/01/2019 06:16	12/01/2019 16:25	13/01/2019 06:16	13,85	25	346,25	CHI
201901164396	ITABERAI	00880434	ITABERAI S1	12/01/2019 16:25	13/01/2019 06:16	12/01/2019 16:25	13/01/2019 06:16	13,85	12	166,20	CHI
201901164396	GOIAS	02270406	ITABERAI S1	12/01/2019 16:25	13/01/2019 06:16	12/01/2019 17:51	13/01/2019 06:16	12,42	176	2185,33	CHI
201901164396	ITABERAI	02270406	ITABERAI S1	12/01/2019 16:25	13/01/2019 06:16	12/01/2019 17:51	13/01/2019 06:16	12,42	3	37,25	CHI
2019011200067	GOIANIA	00600244	ATLANTICO S1	12/01/2019 16:58	12/01/2019 17:04	12/01/2019 16:58	12/01/2019 17:04	0,10	7098	709,80	CHI

2019011200079	GOIANIA	02400254	AEROPORTO S1	12/01/2019 17:21	12/01/2019 17:24	12/01/2019 17:21	12/01/2019 17:24	0,05	4019	200,95	DIA CRITICO
2019011200086	ANICUNS	12801	ANICUNS	12/01/2019 17:45	12/01/2019 17:50	12/01/2019 17:45	12/01/2019 17:50	0,08	147	12,25	CHI
2019011200086	ANICUNS	00090404	ANICUNS	12/01/2019 17:45	12/01/2019 17:50	12/01/2019 17:45	12/01/2019 17:50	0,08	9	0,75	CHI
2019011200086	AVELINOPOLIS	12802	ANICUNS	12/01/2019 17:45	12/01/2019 17:50	12/01/2019 17:45	12/01/2019 17:50	0,08	11	0,92	CHI
2019011200086	NAZARIO	12801	ANICUNS	12/01/2019 17:45	12/01/2019 17:50	12/01/2019 17:45	12/01/2019 17:50	0,08	3374	281,17	CHI
2019011200086	NAZARIO	12802	ANICUNS	12/01/2019 17:45	12/01/2019 17:50	12/01/2019 17:45	12/01/2019 17:50	0,08	562	46,83	CHI
2019011200086	NAZARIO	00090404	ANICUNS	12/01/2019 17:45	12/01/2019 17:50	12/01/2019 17:45	12/01/2019 17:50	0,08	5	0,42	CHI
2019011200086	NAZARIO	12830	ANICUNS	12/01/2019 17:45	12/01/2019 17:50	12/01/2019 17:45	12/01/2019 17:50	0,08	5	0,42	CHI
2019011200086	PALMEIRAS DE GOIAS	12801	ANICUNS	12/01/2019 17:45	12/01/2019 17:50	12/01/2019 17:45	12/01/2019 17:50	0,08	79	6,58	CHI
2019011200086	PALMEIRAS DE GOIAS	12802	ANICUNS	12/01/2019 17:45	12/01/2019 17:50	12/01/2019 17:45	12/01/2019 17:50	0,08	17	1,42	CHI
2019011200086	SANTA BARBARA DE GOIAS	12802	ANICUNS	12/01/2019 17:45	12/01/2019 17:50	12/01/2019 17:45	12/01/2019 17:50	0,08	7	0,58	CHI
2019011200086	TURVANIA	12801	ANICUNS	12/01/2019 17:45	12/01/2019 17:50	12/01/2019 17:45	12/01/2019 17:50	0,08	47	3,92	CHI
2019011200086	NAZARIO	12830	PALMEIRAS	12/01/2019 17:45	12/01/2019 17:50	12/01/2019 17:45	12/01/2019 17:50	0,08	3	0,25	CHI
2019011200086	PALMEIRAS DE GOIAS	12830	PALMEIRAS	12/01/2019 17:45	12/01/2019 17:50	12/01/2019 17:45	12/01/2019 17:50	0,08	21	1,75	CHI
2019011200089	AVELINOPOLIS	35101	TRINDADE	12/01/2019 17:55	12/01/2019 18:18	12/01/2019 17:55	12/01/2019 18:18	0,38	10	3,83	DIA CRITICO
2019011200089	NAZARIO	35101	TRINDADE	12/01/2019 17:55	12/01/2019 18:18	12/01/2019 17:55	12/01/2019 18:18	0,38	11	4,22	DIA CRITICO
2019011200089	SANTA BARBARA DE GOIAS	35101	TRINDADE	12/01/2019 17:55	12/01/2019 18:18	12/01/2019 17:55	12/01/2019 18:18	0,38	702	269,10	DIA CRITICO
2019011200089	SANTA BARBARA DE GOIAS	35102	TRINDADE	12/01/2019 17:55	12/01/2019 18:18	12/01/2019 17:55	12/01/2019 18:18	0,38	1343	514,82	DIA CRITICO
2019011200089	SANTA BARBARA DE GOIAS	01760414	TRINDADE	12/01/2019 17:55	12/01/2019 18:18	12/01/2019 17:55	12/01/2019 18:18	0,38	18	6,90	DIA CRITICO
2019011200089	TRINDADE	35101	TRINDADE	12/01/2019 17:55	12/01/2019 18:18	12/01/2019 17:55	12/01/2019 18:18	0,38	3	1,15	DIA CRITICO
2019011200089	TRINDADE	01760414	TRINDADE	12/01/2019 17:55	12/01/2019 18:18	12/01/2019 17:55	12/01/2019 18:18	0,38	9	3,45	DIA CRITICO
2019011200108	GOIAS	17901	ITABERAI S1	12/01/2019 18:55	12/01/2019 18:58	12/01/2019 18:55	12/01/2019 18:58	0,05	39	1,95	CHI
2019011200108	GOIAS	00880424	ITABERAI S1	12/01/2019 18:55	12/01/2019 18:58	12/01/2019 18:55	12/01/2019 18:58	0,05	38	1,90	CHI
2019011200108	HEITORAI	17901	ITABERAI S1	12/01/2019 18:55	12/01/2019 18:58	12/01/2019 18:55	12/01/2019 18:58	0,05	25	1,25	CHI
2019011200108	HEITORAI	00880424	ITABERAI S1	12/01/2019 18:55	12/01/2019 18:58	12/01/2019 18:55	12/01/2019 18:58	0,05	2	0,10	CHI
2019011200108	ITABERAI	17901	ITABERAI S1	12/01/2019 18:55	12/01/2019 18:58	12/01/2019 18:55	12/01/2019 18:58	0,05	223	11,15	CHI
2019011200108	ITABERAI	00880424	ITABERAI S1	12/01/2019 18:55	12/01/2019 18:58	12/01/2019 18:55	12/01/2019 18:58	0,05	544	27,20	CHI
2019011200135	CAMPESTRE DE GOIAS	00750224	GUAPO S1	12/01/2019 21:50	12/01/2019 21:55	12/01/2019 21:50	12/01/2019 21:55	0,08	22	1,83	CHI
2019011200135	GUAPO	00750224	GUAPO S1	12/01/2019 21:50	12/01/2019 21:55	12/01/2019 21:50	12/01/2019 21:55	0,08	484	40,33	CHI
2019011200135	TRINDADE	00750224	GUAPO S1	12/01/2019 21:50	12/01/2019 21:55	12/01/2019 21:50	12/01/2019 21:55	0,08	17	1,42	CHI
2019011200144	FIRMINOPOLIS	00490214	FIRMINOPOLIS S1	12/01/2019 23:30	12/01/2019 23:33	12/01/2019 23:30	12/01/2019 23:33	0,05	357	17,85	CHI
2019011200144	PALMINOPOLIS	00490214	FIRMINOPOLIS S1	12/01/2019 23:30	12/01/2019 23:33	12/01/2019 23:30	12/01/2019 23:33	0,05	1	0,05	CHI
2019011200144	SAO JOAO DA PARAUNA	00490214	FIRMINOPOLIS S1	12/01/2019 23:30	12/01/2019 23:33	12/01/2019 23:30	12/01/2019 23:33	0,05	18	0,90	CHI

2019011200160	ESTRELA DO NORTE	11030	MARA ROSA	12/01/2019 14:28	12/01/2019 15:17	12/01/2019 14:28	12/01/2019 15:17	0,82	48	39,20	CHI
2019011200160	FORMOSO	11030	MARA ROSA	12/01/2019 14:28	12/01/2019 15:17	12/01/2019 14:28	12/01/2019 15:17	0,82	7	5,72	CHI
2019011200160	SANTA TEREZA DE GOIAS	11030	MARA ROSA	12/01/2019 14:28	12/01/2019 15:17	12/01/2019 14:28	12/01/2019 15:17	0,82	22	17,97	CHI
2019011200160	NOVO PLANALTO	01520418	NOVO PLANALTO	12/01/2019 14:28	12/01/2019 15:17	12/01/2019 14:28	12/01/2019 15:17	0,82	2	1,63	CHI
2019011200160	PORANGATU	01520418	NOVO PLANALTO	12/01/2019 14:28	12/01/2019 15:17	12/01/2019 14:28	12/01/2019 15:17	0,82	21	17,15	CHI
2019011200160	CAMPINACU	01520438	PORANGATU	12/01/2019 14:28	12/01/2019 15:17	12/01/2019 14:28	12/01/2019 15:17	0,82	66	53,90	CHI
2019011200160	CAMPINORTE	01520438	PORANGATU	12/01/2019 14:28	12/01/2019 15:17	12/01/2019 14:28	12/01/2019 15:17	0,82	151	123,32	CHI
2019011200160	FORMOSO	11001	PORANGATU	12/01/2019 14:28	12/01/2019 15:17	12/01/2019 14:28	12/01/2019 15:17	0,82	1890	1543,50	CHI
2019011200160	FORMOSO	11030	PORANGATU	12/01/2019 14:28	12/01/2019 15:17	12/01/2019 14:28	12/01/2019 15:17	0,82	78	63,70	CHI
2019011200160	FORMOSO	01520438	PORANGATU	12/01/2019 14:28	12/01/2019 15:17	12/01/2019 14:28	12/01/2019 15:17	0,82	154	125,77	CHI
2019011200160	MINACU	01520438	PORANGATU	12/01/2019 14:28	12/01/2019 15:17	12/01/2019 14:28	12/01/2019 15:17	0,82	56	45,73	CHI
2019011200160	MONTIVIDIU DO NORTE	41402	PORANGATU	12/01/2019 14:28	12/01/2019 15:17	12/01/2019 14:28	12/01/2019 15:17	0,82	6	4,90	CHI
2019011200160	MONTIVIDIU DO NORTE	01520438	PORANGATU	12/01/2019 14:28	12/01/2019 15:17	12/01/2019 14:28	12/01/2019 15:17	0,82	1771	1446,32	CHI
2019011200160	PORANGATU	41401	PORANGATU	12/01/2019 14:28	12/01/2019 15:17	12/01/2019 14:28	12/01/2019 15:17	0,82	182	148,63	CHI
2019011200160	PORANGATU	41402	PORANGATU	12/01/2019 14:28	12/01/2019 15:17	12/01/2019 14:28	12/01/2019 15:17	0,82	1023	835,45	CHI
2019011200160	PORANGATU	01520418	PORANGATU	12/01/2019 14:28	12/01/2019 15:17	12/01/2019 14:28	12/01/2019 15:17	0,82	241	196,82	CHI
2019011200160	SANTA TEREZA DE GOIAS	41402	PORANGATU	12/01/2019 14:28	12/01/2019 15:17	12/01/2019 14:28	12/01/2019 15:17	0,82	11	8,98	CHI
2019011200160	SANTA TEREZA DE GOIAS	11030	PORANGATU	12/01/2019 14:28	12/01/2019 15:17	12/01/2019 14:28	12/01/2019 15:17	0,82	39	31,85	CHI
2019011200160	SANTA TEREZA DE GOIAS	01520438	PORANGATU	12/01/2019 14:28	12/01/2019 15:17	12/01/2019 14:28	12/01/2019 15:17	0,82	17	13,88	CHI
2019011200160	TROMBAS	41402	PORANGATU	12/01/2019 14:28	12/01/2019 15:17	12/01/2019 14:28	12/01/2019 15:17	0,82	171	139,65	CHI
2019011200160	TROMBAS	01520438	PORANGATU	12/01/2019 14:28	12/01/2019 15:17	12/01/2019 14:28	12/01/2019 15:17	0,82	1286	1050,23	CHI
2019011300037	BURITI ALEGRE	37501	ITUMBIARA VELHA S2	13/01/2019 00:31	13/01/2019 00:35	13/01/2019 00:31	13/01/2019 00:35	0,07	891	59,40	CHI
2019011300037	AGUA LIMPA	26601	VILA CORUMBA	13/01/2019 00:31	13/01/2019 00:35	13/01/2019 00:31	13/01/2019 00:35	0,07	16	1,07	DIA CRITICO
2019011300037	AGUA LIMPA	37501	VILA CORUMBA	13/01/2019 00:31	13/01/2019 00:35	13/01/2019 00:31	13/01/2019 00:35	0,07	880	58,67	DIA CRITICO
2019011300037	AGUA LIMPA	37502	VILA CORUMBA	13/01/2019 00:31	13/01/2019 00:35	13/01/2019 00:31	13/01/2019 00:35	0,07	137	9,13	DIA CRITICO
2019011300037	AGUA LIMPA	26631	VILA CORUMBA	13/01/2019 00:31	13/01/2019 00:35	13/01/2019 00:31	13/01/2019 00:35	0,07	7	0,47	DIA CRITICO
2019011300037	AGUA LIMPA	03856124	VILA CORUMBA	13/01/2019 00:31	13/01/2019 00:35	13/01/2019 00:31	13/01/2019 00:35	0,07	16	1,07	DIA CRITICO
2019011300037	BURITI ALEGRE	37501	VILA CORUMBA	13/01/2019 00:31	13/01/2019 00:35	13/01/2019 00:31	13/01/2019 00:35	0,07	3	0,20	DIA CRITICO
2019011300037	CALDAS NOVAS	26601	VILA CORUMBA	13/01/2019 00:31	13/01/2019 00:35	13/01/2019 00:31	13/01/2019 00:35	0,07	20	1,33	DIA CRITICO
2019011300037	CALDAS NOVAS	03856124	VILA CORUMBA	13/01/2019 00:31	13/01/2019 00:35	13/01/2019 00:31	13/01/2019 00:35	0,07	3	0,20	DIA CRITICO
2019011300037	CALDAS NOVAS	03856124	VILA CORUMBA	13/01/2019 00:31	13/01/2019 00:35	13/01/2019 00:31	13/01/2019 00:35	0,07	83	5,53	DIA CRITICO
2019011300037	CALDAS NOVAS	03856124	VILA CORUMBA	13/01/2019 00:31	13/01/2019 00:35	13/01/2019 00:31	13/01/2019 00:35	0,07	51	3,40	DIA CRITICO
2019011300037	CORUMBAIBA	08401	VILA CORUMBA	13/01/2019 00:31	13/01/2019 00:35	13/01/2019 00:31	13/01/2019 00:35	0,07	3399	226,60	DIA CRITICO

2019011300037	CORUMBAIBA	26601	VILA CORUMBA	13/01/2019 00:31	13/01/2019 00:35	13/01/2019 00:31	13/01/2019 00:35	0,07	38	2,53	DIA CRITICO
2019011300037	CORUMBAIBA	37501	VILA CORUMBA	13/01/2019 00:31	13/01/2019 00:35	13/01/2019 00:31	13/01/2019 00:35	0,07	1	0,07	DIA CRITICO
2019011300037	CORUMBAIBA	08402	VILA CORUMBA	13/01/2019 00:31	13/01/2019 00:35	13/01/2019 00:31	13/01/2019 00:35	0,07	1005	67,00	DIA CRITICO
2019011300037	CORUMBAIBA	03856124	VILA CORUMBA	13/01/2019 00:31	13/01/2019 00:35	13/01/2019 00:31	13/01/2019 00:35	0,07	58	3,87	DIA CRITICO
2019011300037	MARZAGAO	26601	VILA CORUMBA	13/01/2019 00:31	13/01/2019 00:35	13/01/2019 00:31	13/01/2019 00:35	0,07	1073	71,53	DIA CRITICO
2019011300037	MARZAGAO	37502	VILA CORUMBA	13/01/2019 00:31	13/01/2019 00:35	13/01/2019 00:31	13/01/2019 00:35	0,07	4	0,27	DIA CRITICO
2019011300037	MARZAGAO	26631	VILA CORUMBA	13/01/2019 00:31	13/01/2019 00:35	13/01/2019 00:31	13/01/2019 00:35	0,07	36	2,40	DIA CRITICO
2019011300037	MARZAGAO	03856124	VILA CORUMBA	13/01/2019 00:31	13/01/2019 00:35	13/01/2019 00:31	13/01/2019 00:35	0,07	41	2,73	DIA CRITICO
2019011300037	MORRINHOS	37501	VILA CORUMBA	13/01/2019 00:31	13/01/2019 00:35	13/01/2019 00:31	13/01/2019 00:35	0,07	2	0,13	DIA CRITICO
2019011300037	MORRINHOS	37502	VILA CORUMBA	13/01/2019 00:31	13/01/2019 00:35	13/01/2019 00:31	13/01/2019 00:35	0,07	52	3,47	DIA CRITICO
2019011300037	MORRINHOS	03856124	VILA CORUMBA	13/01/2019 00:31	13/01/2019 00:35	13/01/2019 00:31	13/01/2019 00:35	0,07	4	0,27	DIA CRITICO
2019011300037	NOVA AURORA	08401	VILA CORUMBA	13/01/2019 00:31	13/01/2019 00:35	13/01/2019 00:31	13/01/2019 00:35	0,07	7	0,47	DIA CRITICO
2019011300037	RIO QUENTE	26601	VILA CORUMBA	13/01/2019 00:31	13/01/2019 00:35	13/01/2019 00:31	13/01/2019 00:35	0,07	5	0,33	DIA CRITICO
2019011300037	RIO QUENTE	03856124	VILA CORUMBA	13/01/2019 00:31	13/01/2019 00:35	13/01/2019 00:31	13/01/2019 00:35	0,07	114	7,60	DIA CRITICO
2019011300060	ARAGARCAS	0024204E	BOM JARDIM	12/01/2019 21:58	13/01/2019 02:03	12/01/2019 21:58	12/01/2019 23:00	1,03	7	7,23	CHI
2019011300060	BALIZA	0024204E	BOM JARDIM	12/01/2019 21:58	13/01/2019 02:03	12/01/2019 21:58	12/01/2019 23:00	1,03	56	57,87	CHI
2019011300060	BOM JARDIM DE GOIAS	0024204E	BOM JARDIM	12/01/2019 21:58	13/01/2019 02:03	12/01/2019 21:58	12/01/2019 23:00	1,03	3915	4045,50	CHI
2019011300060	PIRANHAS	0024204E	BOM JARDIM	12/01/2019 21:58	13/01/2019 02:03	12/01/2019 21:58	12/01/2019 23:00	1,03	36	37,20	CHI
2019011300060	ARAGARCAS	00242124	BOM JARDIM	12/01/2019 21:58	13/01/2019 02:03	12/01/2019 23:01	13/01/2019 01:02	2,02	7	14,12	CHI
2019011300060	BOM JARDIM DE GOIAS	00242124	BOM JARDIM	12/01/2019 21:58	13/01/2019 02:03	12/01/2019 23:01	13/01/2019 01:02	2,02	2971	5991,52	CHI
2019011300060	PIRANHAS	00242124	BOM JARDIM	12/01/2019 21:58	13/01/2019 02:03	12/01/2019 23:01	13/01/2019 01:02	2,02	32	64,53	CHI
2019011300060	ARAGARCAS	0024204E	BOM JARDIM	12/01/2019 21:58	13/01/2019 02:03	12/01/2019 21:58	13/01/2019 01:30	3,53	110	388,67	CHI
2019011300060	BALIZA	0024204E	BOM JARDIM	12/01/2019 21:58	13/01/2019 02:03	12/01/2019 21:58	13/01/2019 01:30	3,53	278	982,27	CHI
2019011300060	BOM JARDIM DE GOIAS	0024204E	BOM JARDIM	12/01/2019 21:58	13/01/2019 02:03	12/01/2019 21:58	13/01/2019 01:30	3,53	112	395,73	CHI
2019011300060	BALIZA	00242124	BOM JARDIM	12/01/2019 21:58	13/01/2019 02:03	12/01/2019 23:01	13/01/2019 02:03	3,03	56	169,87	CHI
2019011300060	BOM JARDIM DE GOIAS	00242124	BOM JARDIM	12/01/2019 21:58	13/01/2019 02:03	12/01/2019 23:01	13/01/2019 02:03	3,03	945	2866,50	CHI
2019011300060	PIRANHAS	00242124	BOM JARDIM	12/01/2019 21:58	13/01/2019 02:03	12/01/2019 23:01	13/01/2019 02:03	3,03	4	12,13	CHI

Plotagem das Ocorrências conforme a Espacialização das Chuvas



EXPURGOS 12 DE JANEIRO - 2019

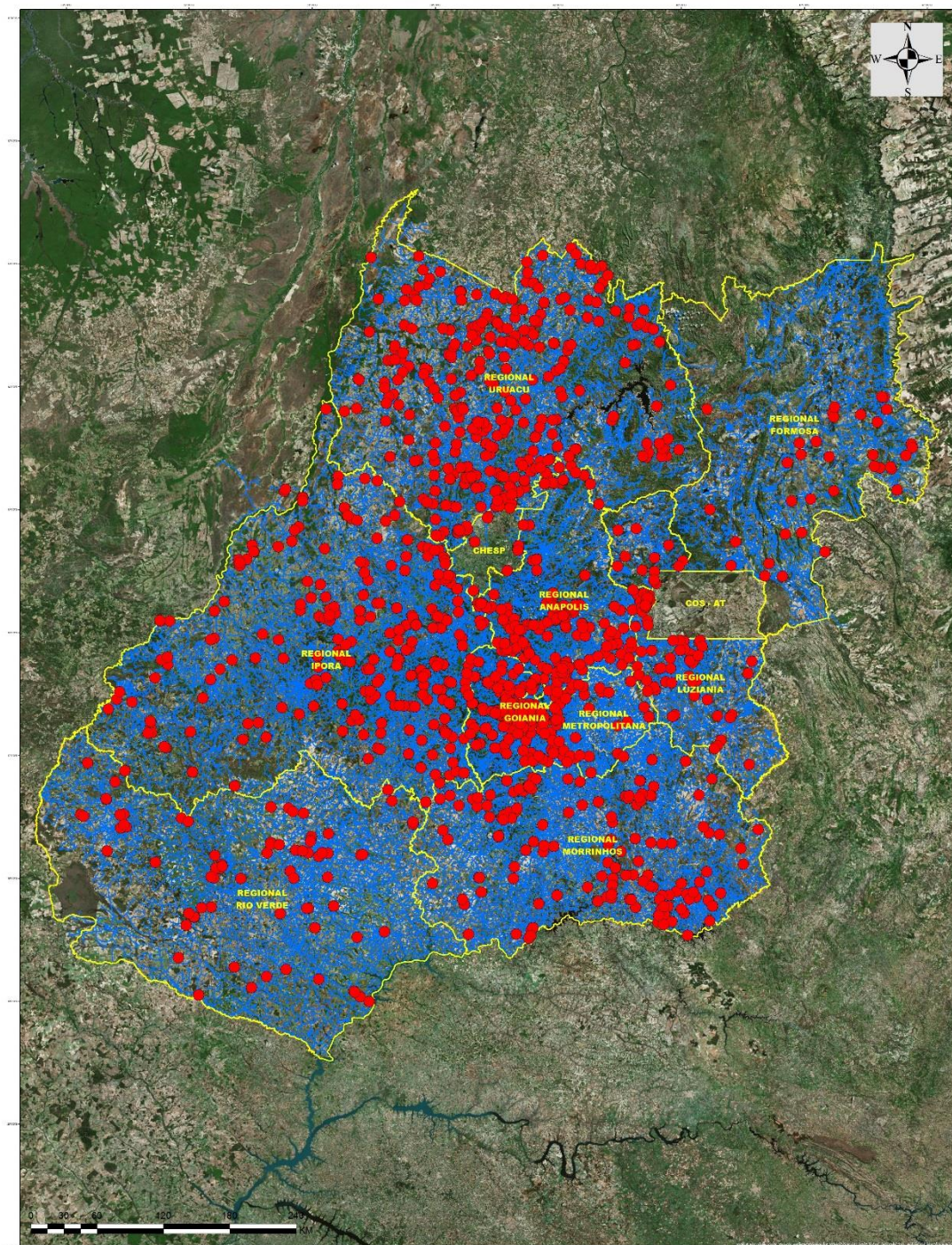

ESCALA: 1/1.110.000
SISTEMA DE COORDENADAS PLANAS: WORLD POLYCONIC
DATUM: SAD89
FONTE: BANCO DE DADOS ENEL GOIÁS
GESTÃO DA INFORMAÇÃO TÉCNICA E GEOPROCESSAMENTO
ELABORADO POR: DANIELLE DA SILVA PEREIRA

Legenda

- EXPURGO 12 DE JANEIRO - 2019
- UNIDADE TERRITORIAL ENEL GOIÁS
- TRECHO PRIMÁRIO

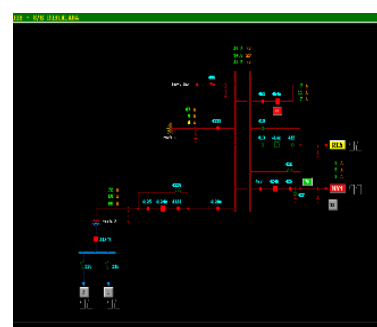
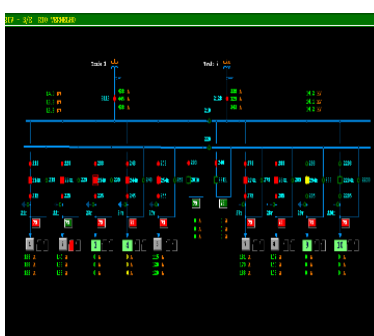
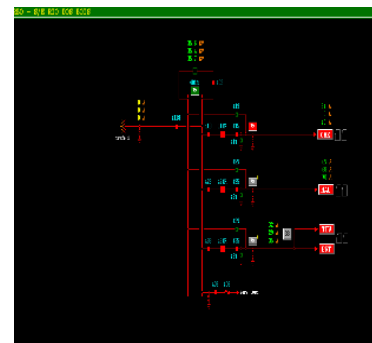
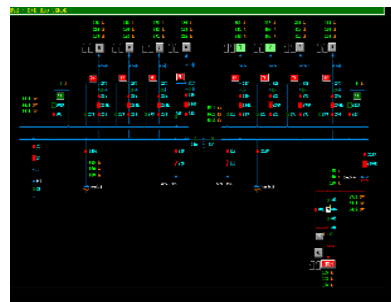
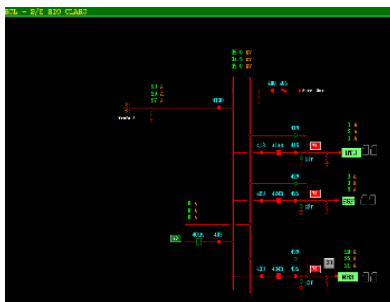
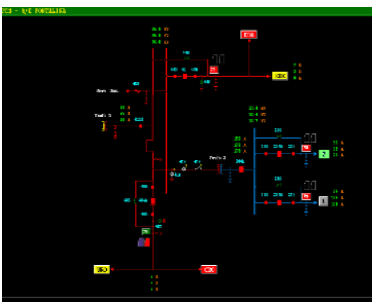
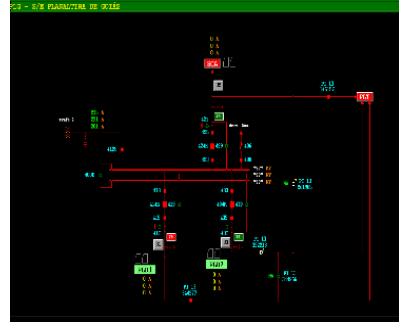
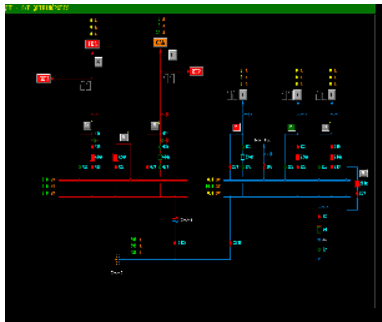
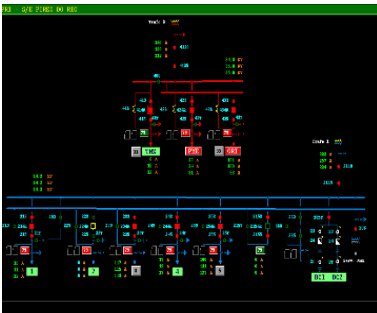
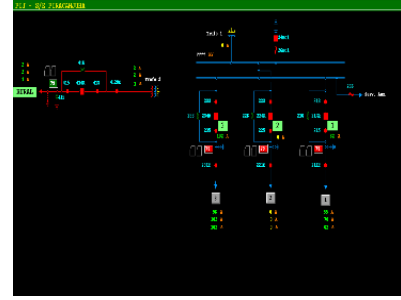
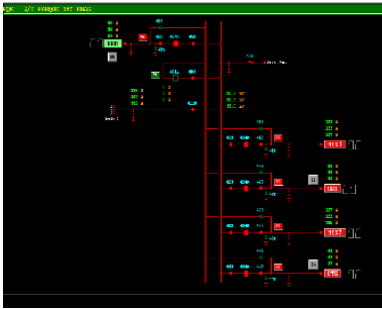
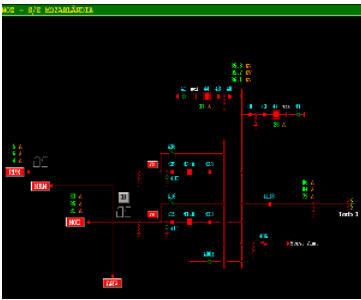
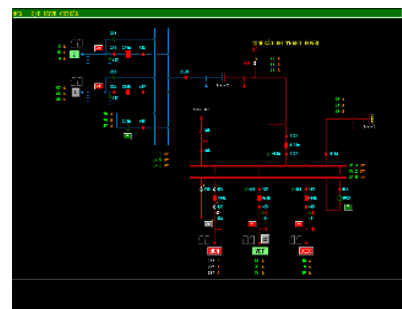
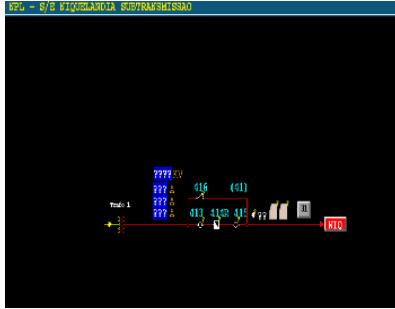

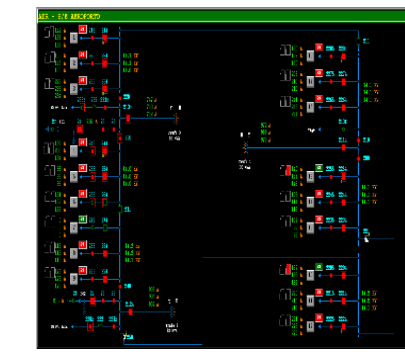
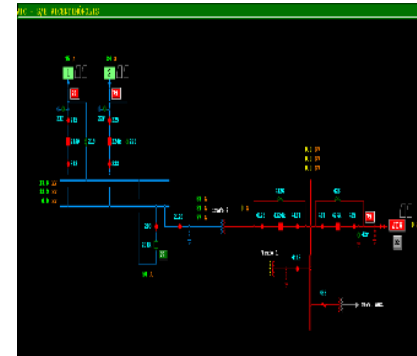
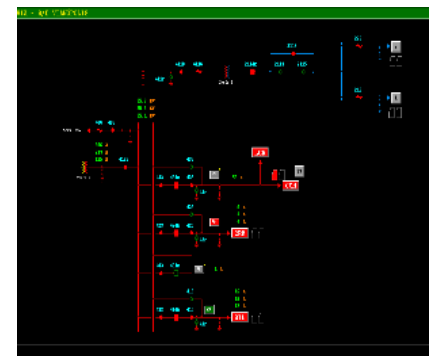
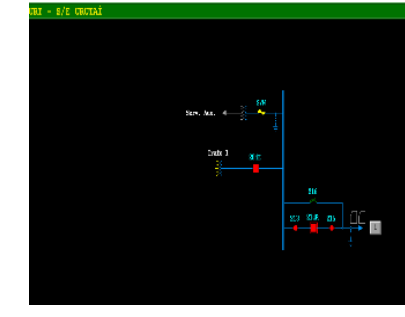
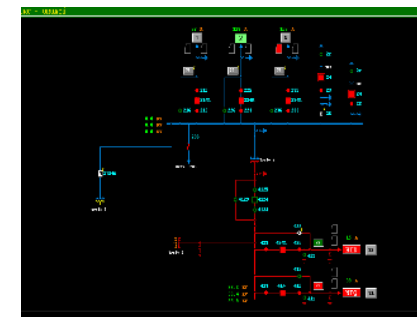
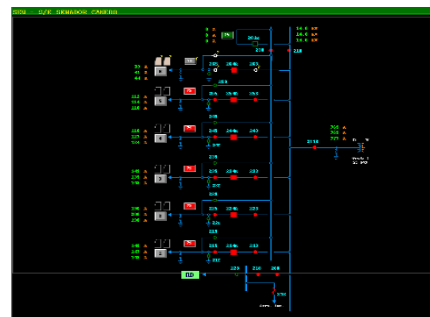
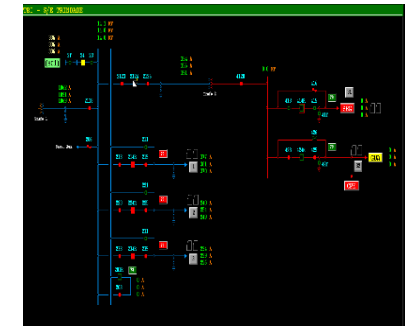
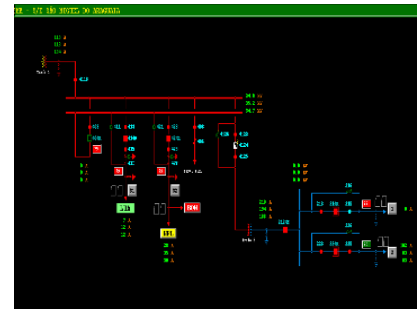
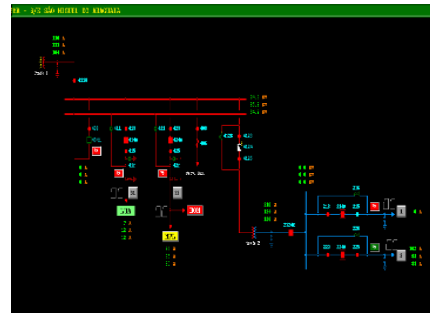
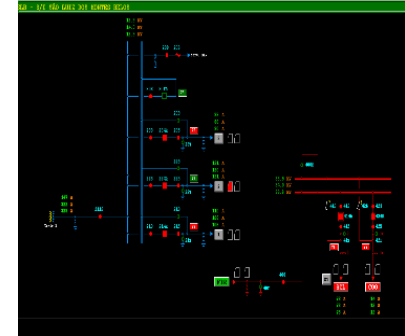
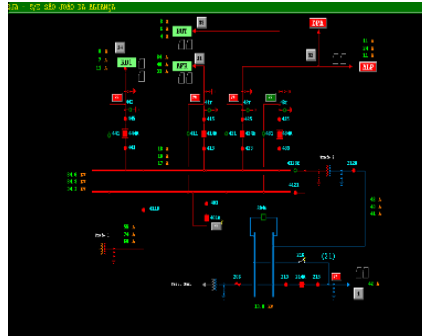
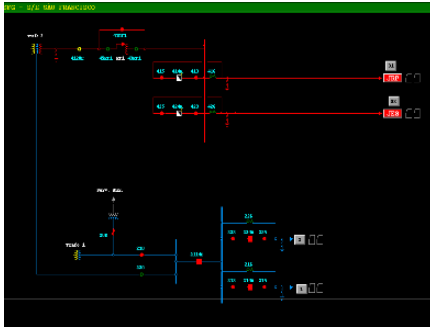
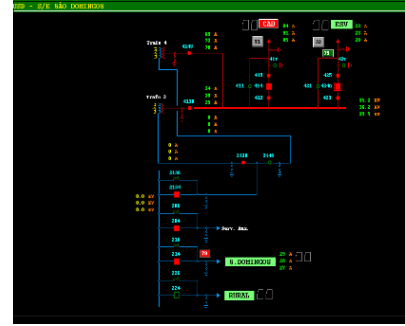
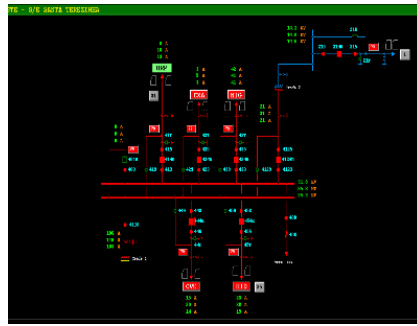
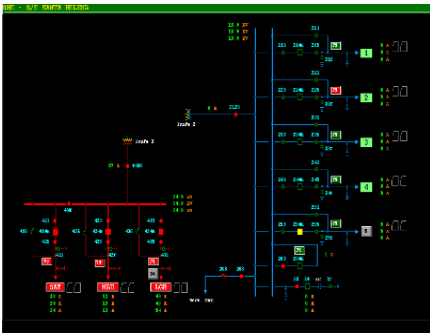

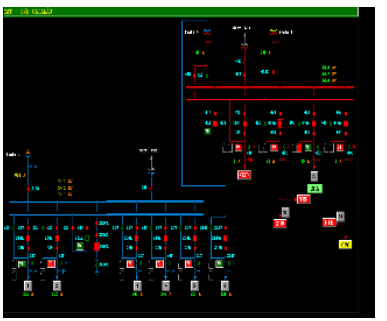
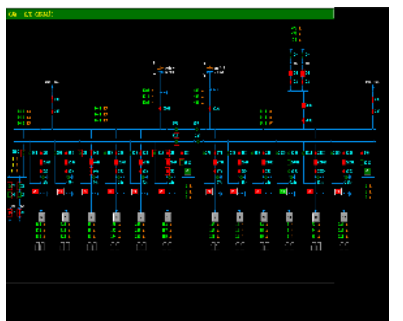
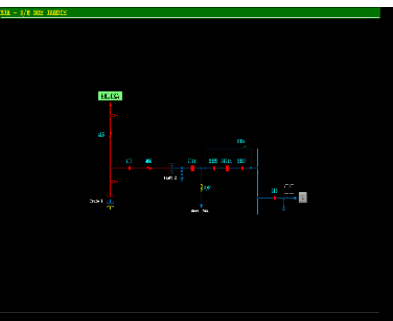
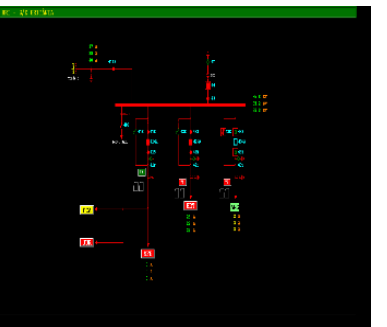
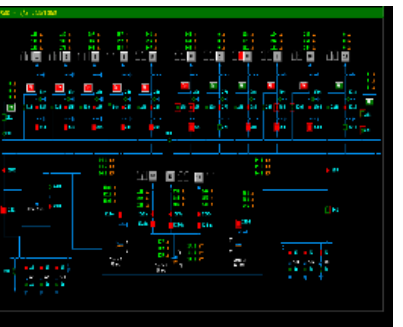
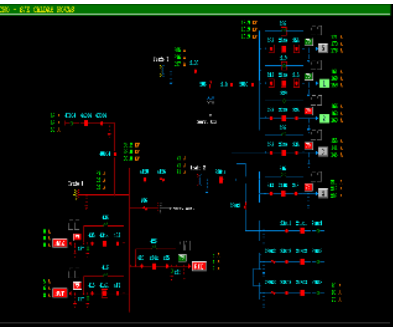
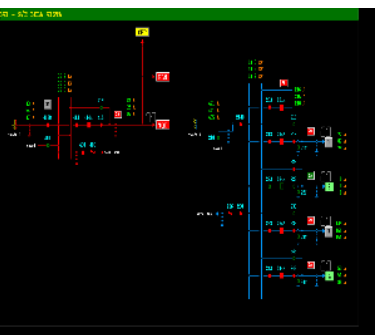
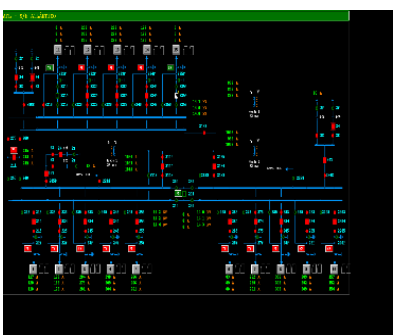
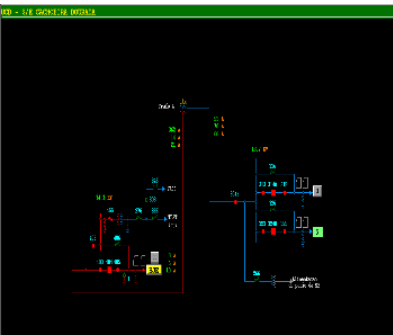
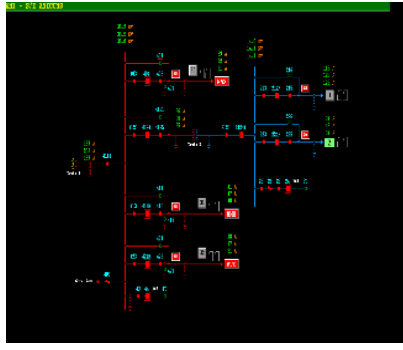
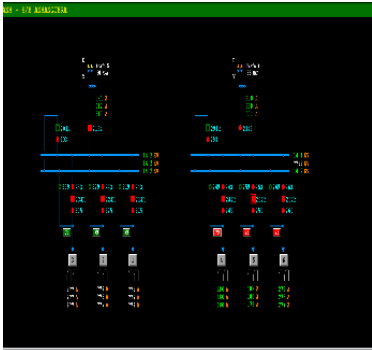
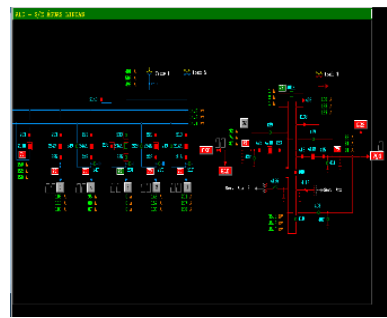
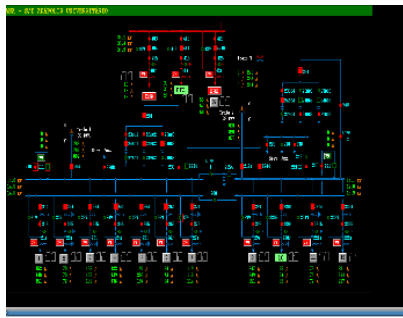
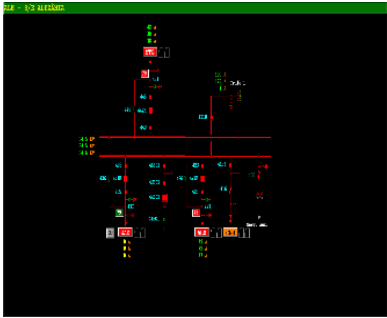

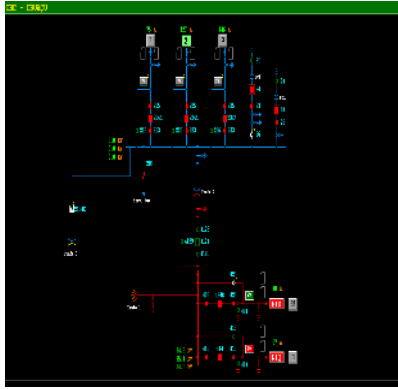
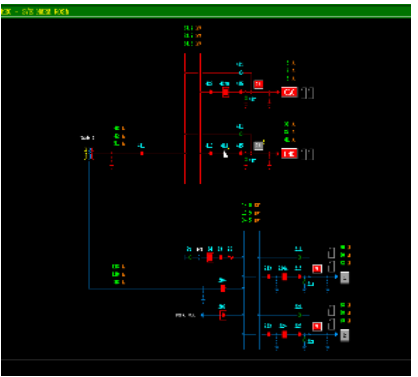
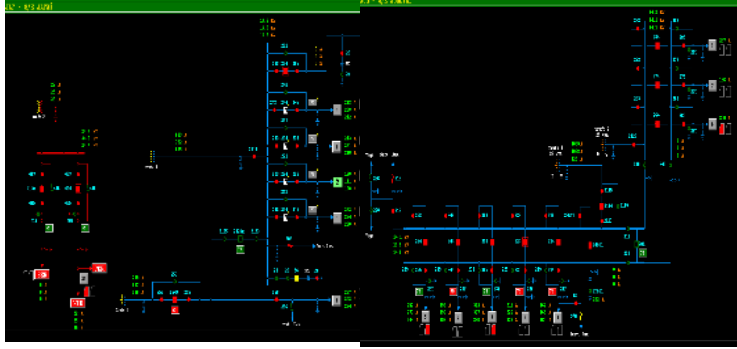
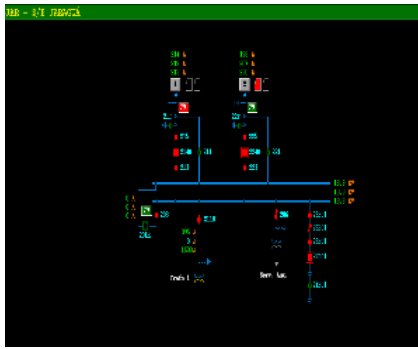

GO

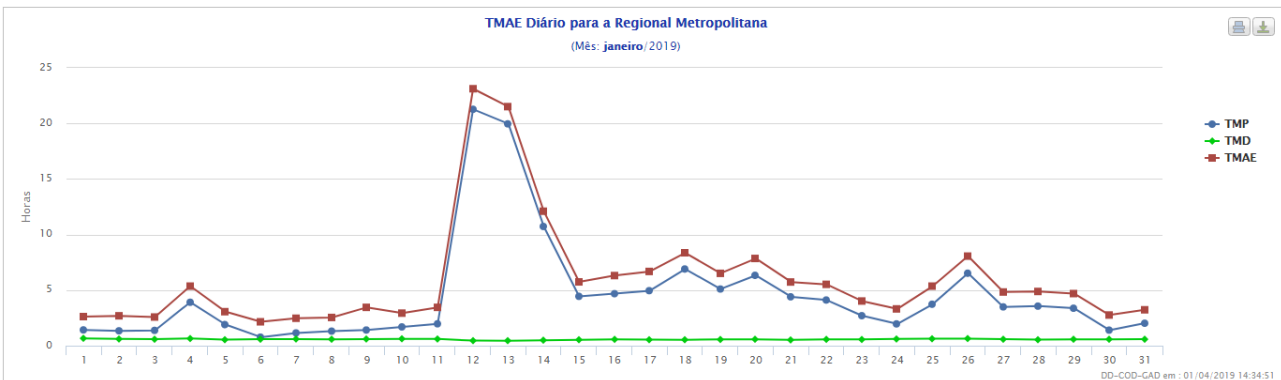
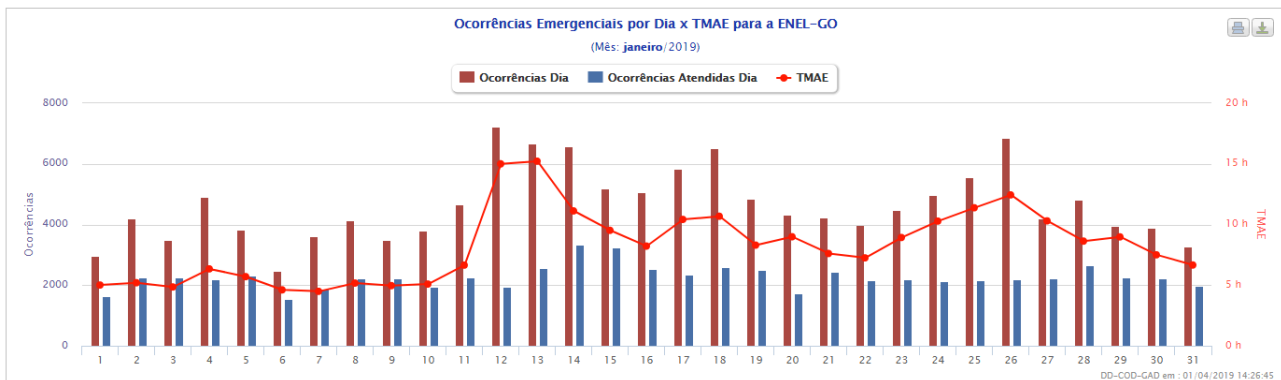
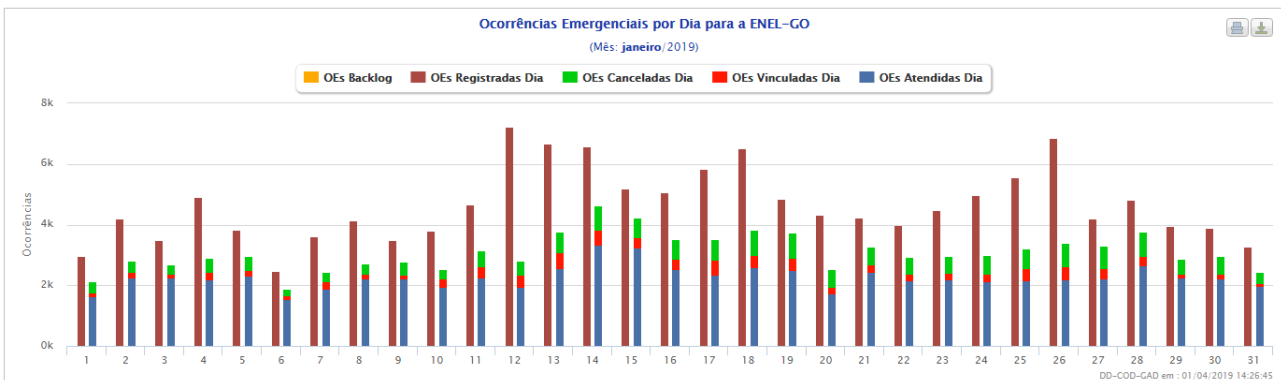
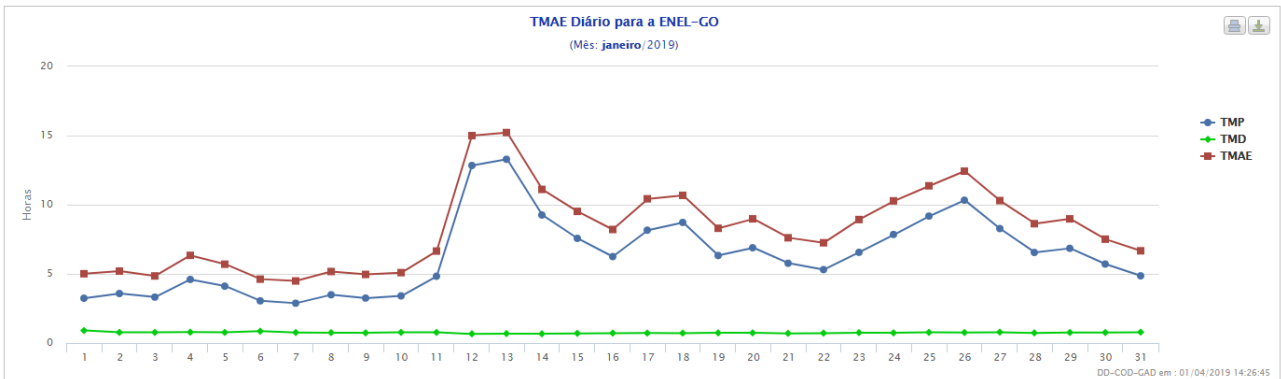

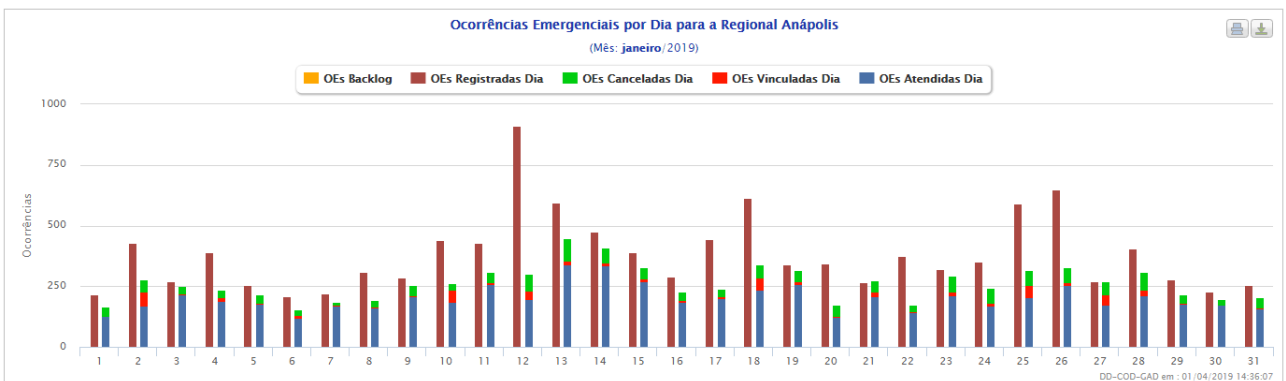
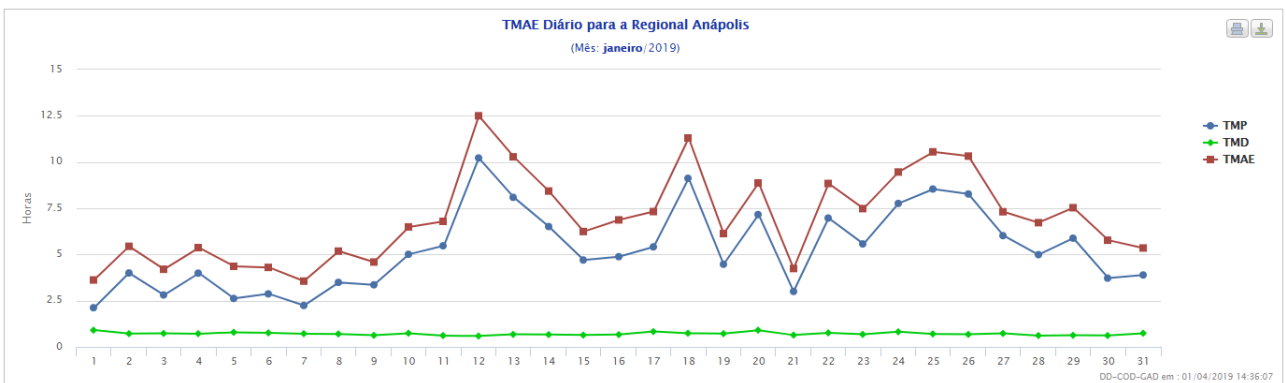
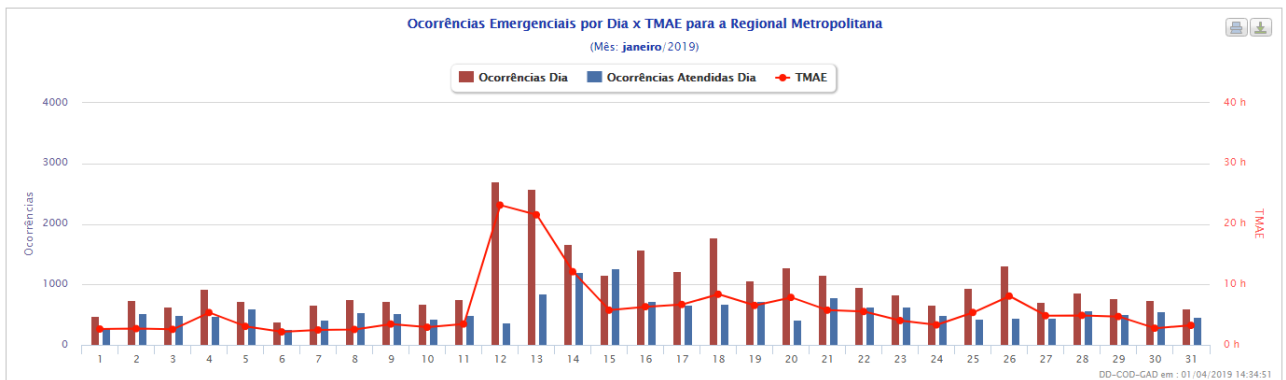

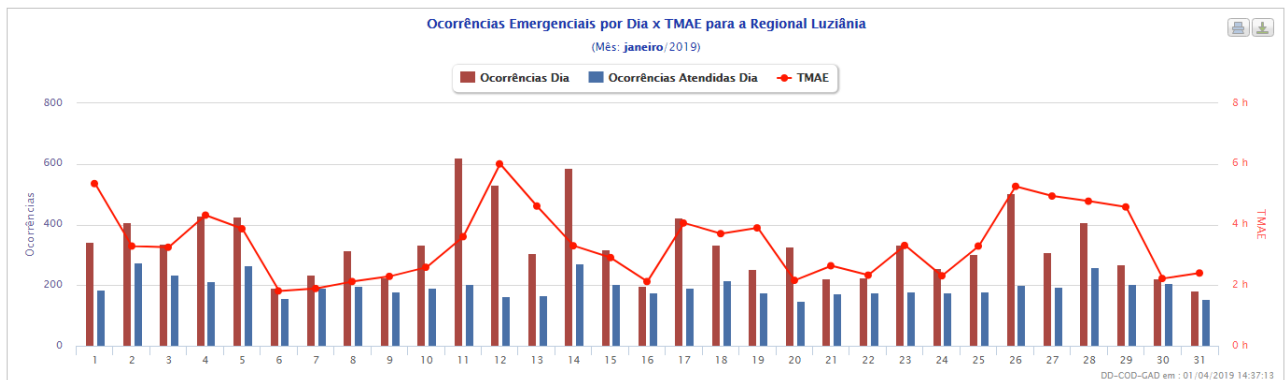
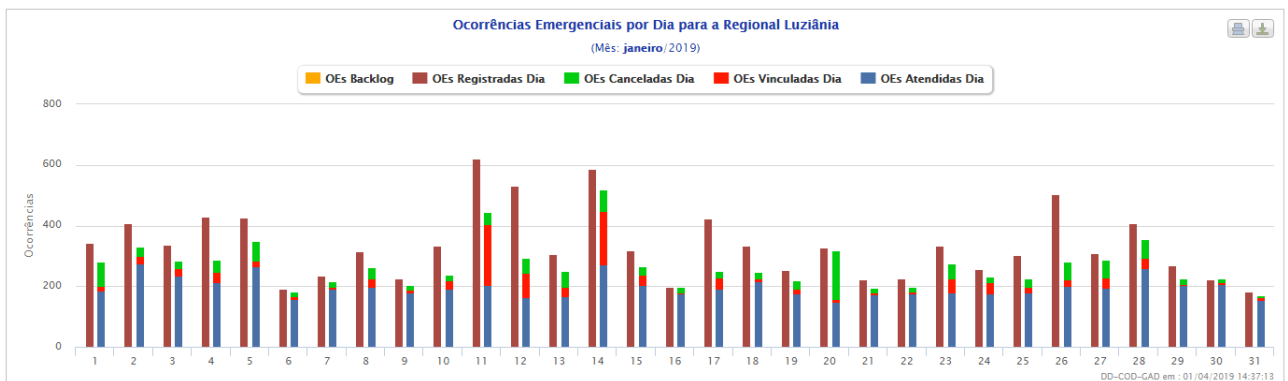
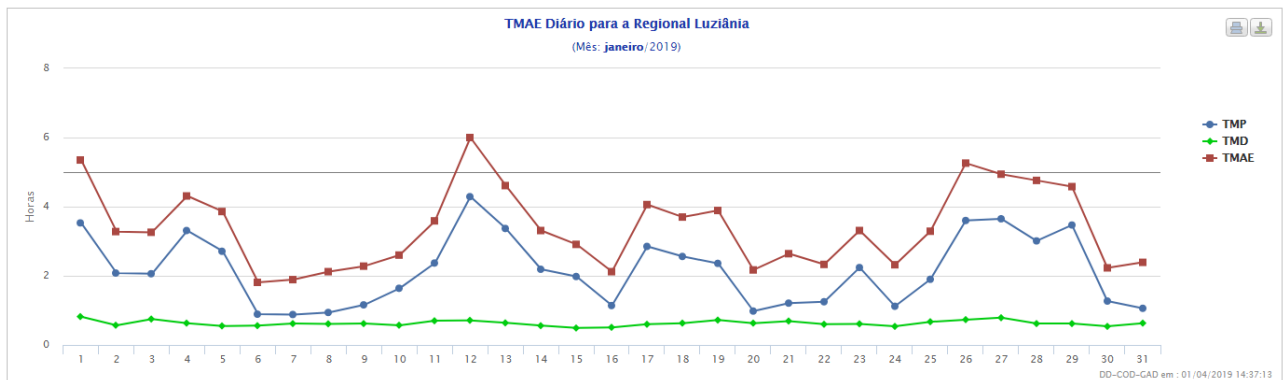
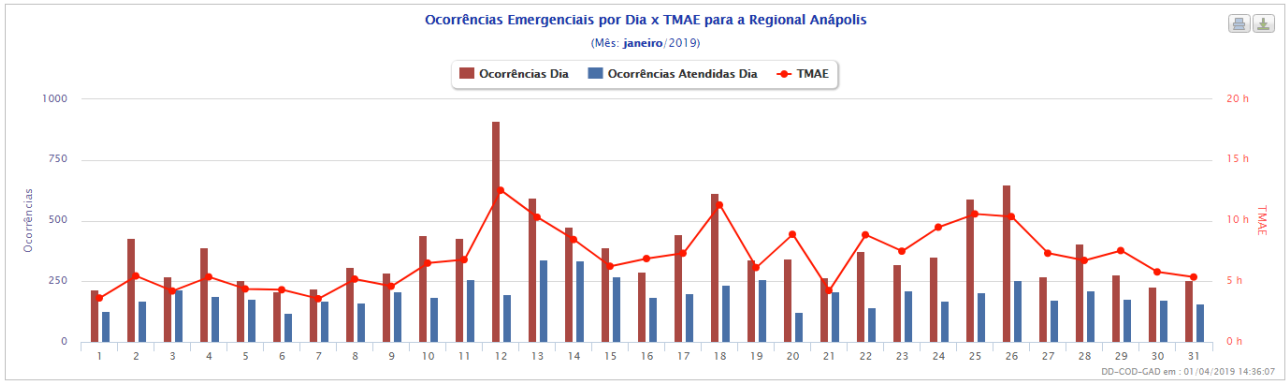

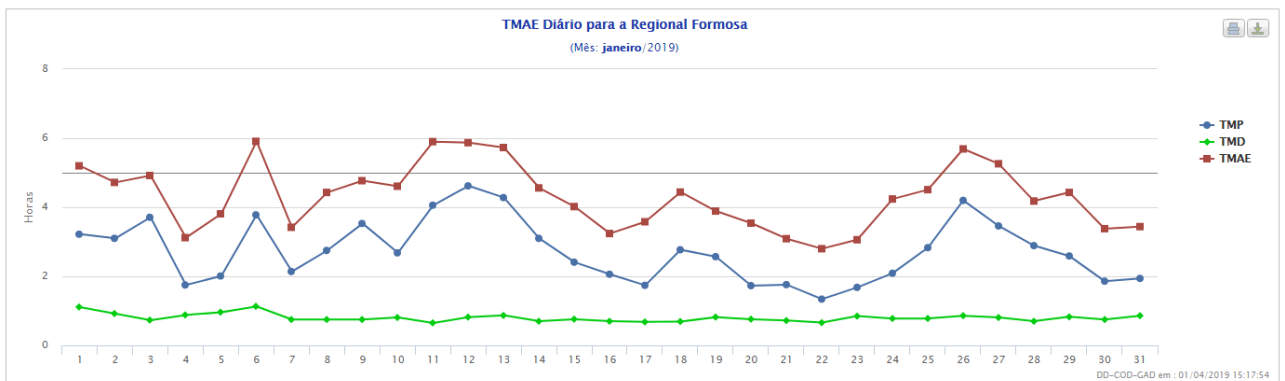
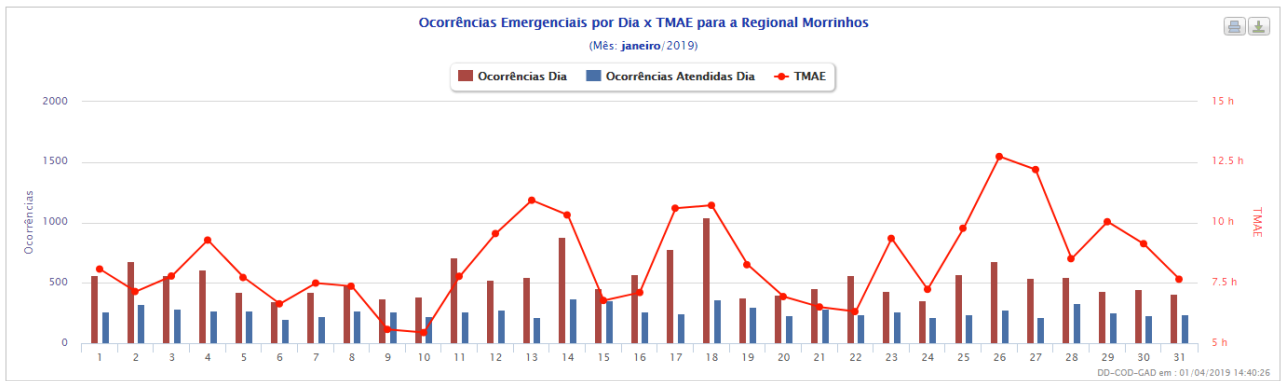
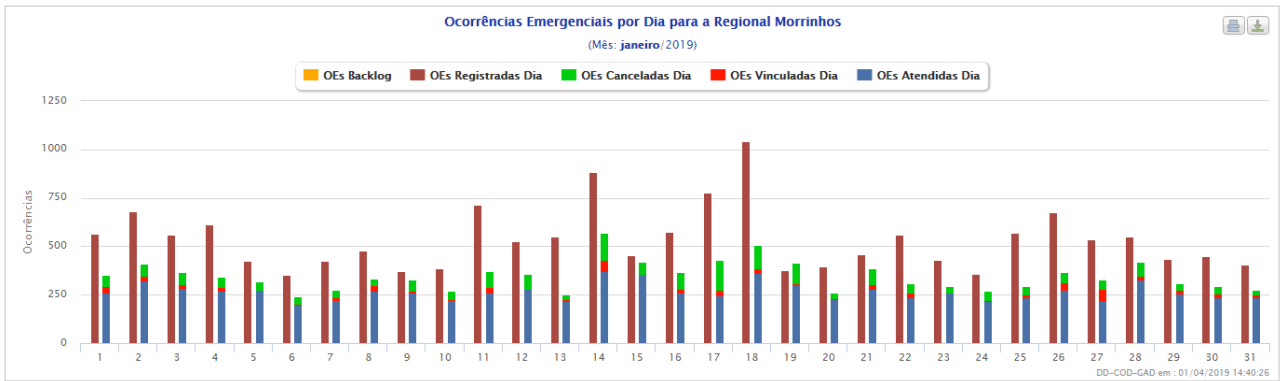
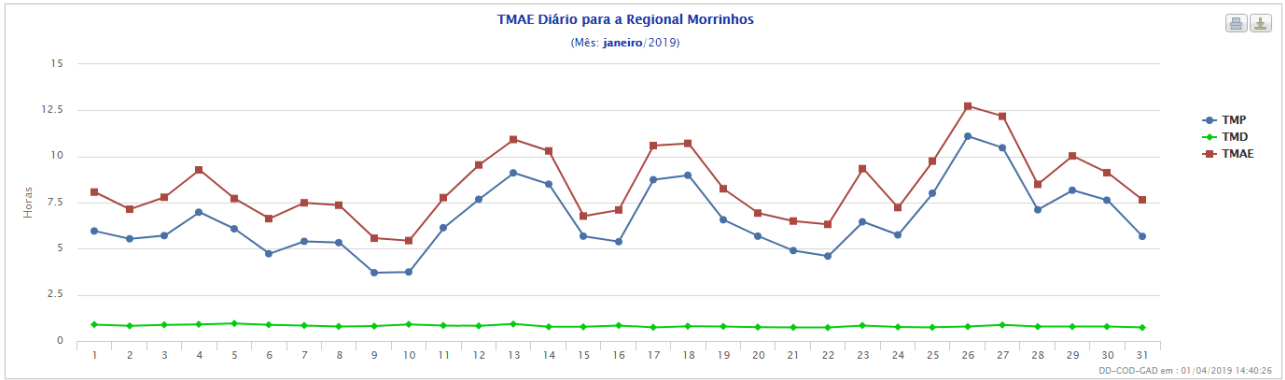

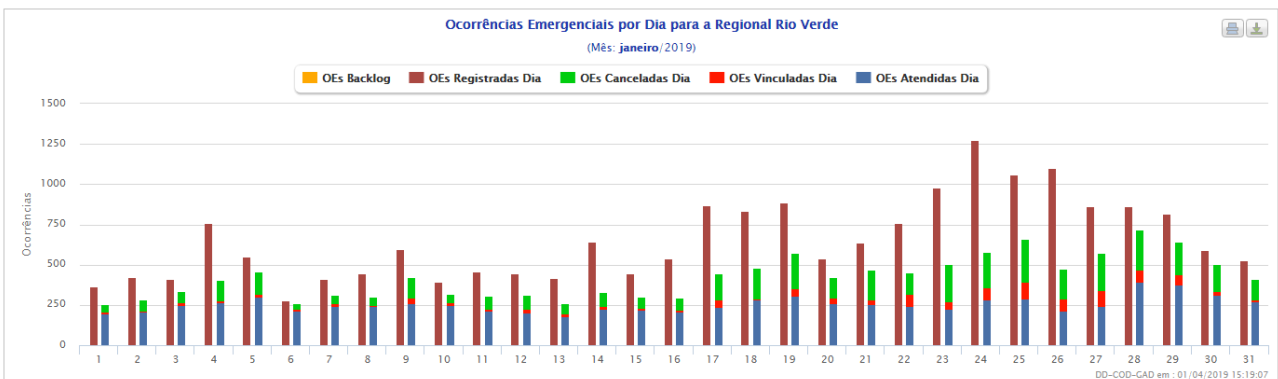
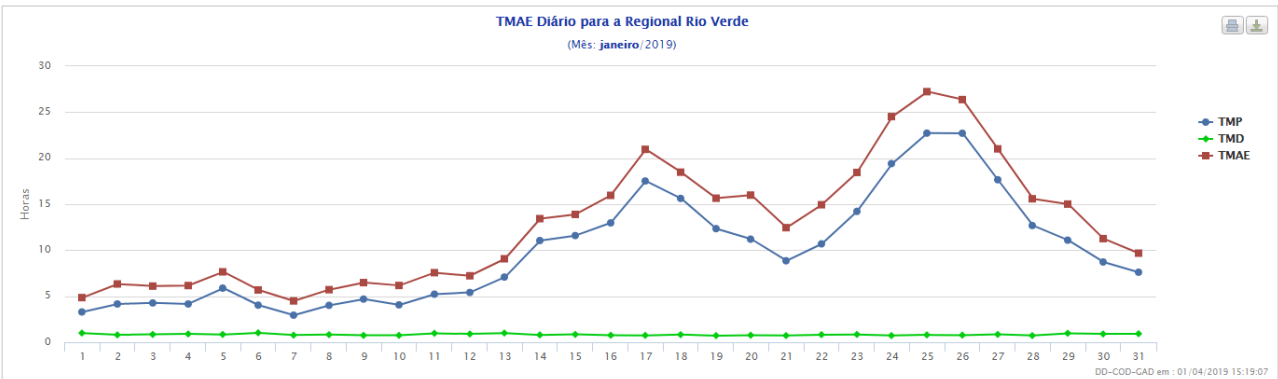
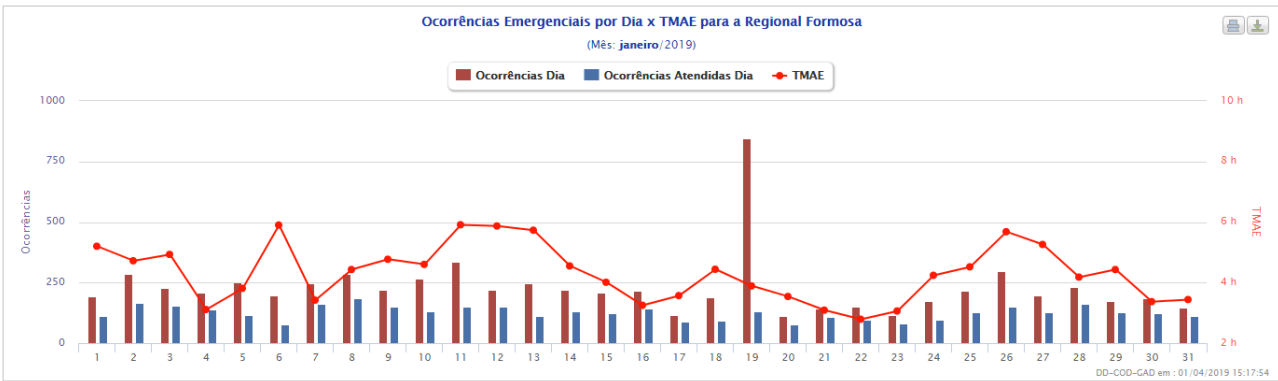
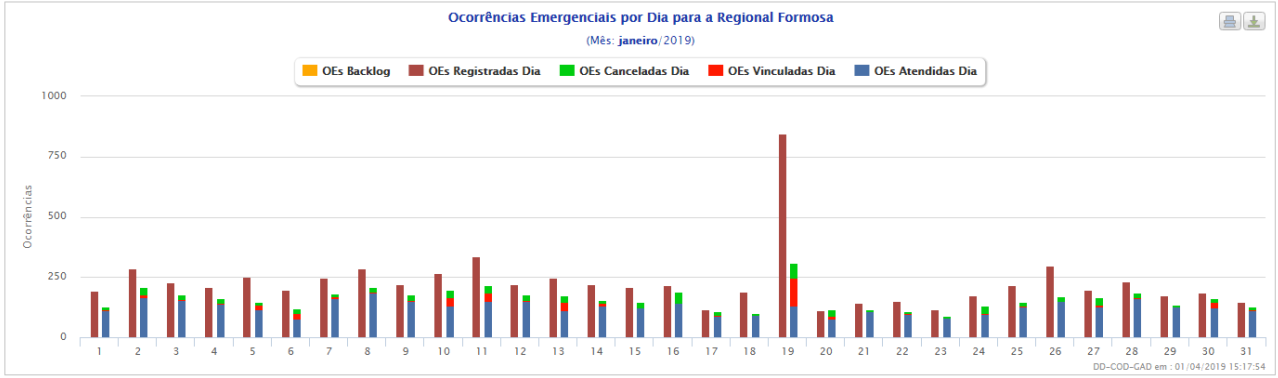

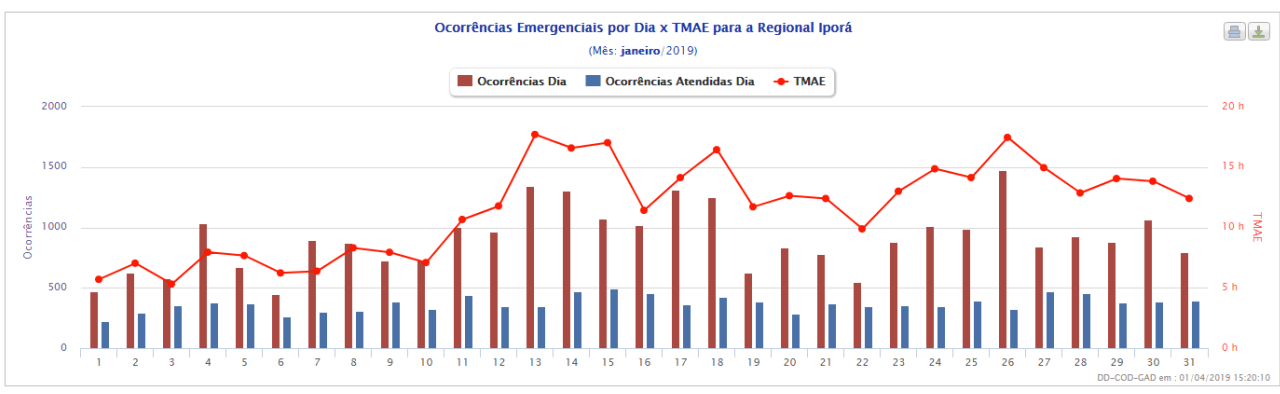
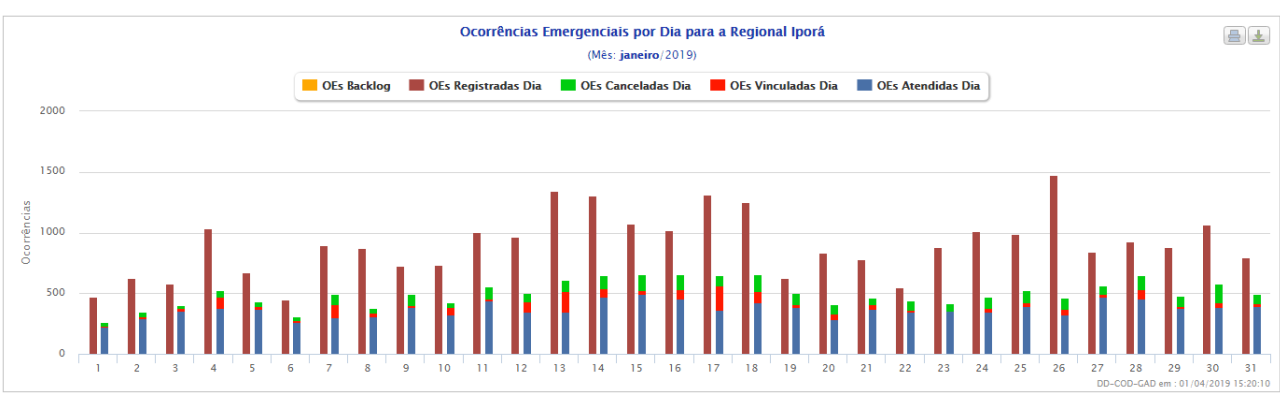
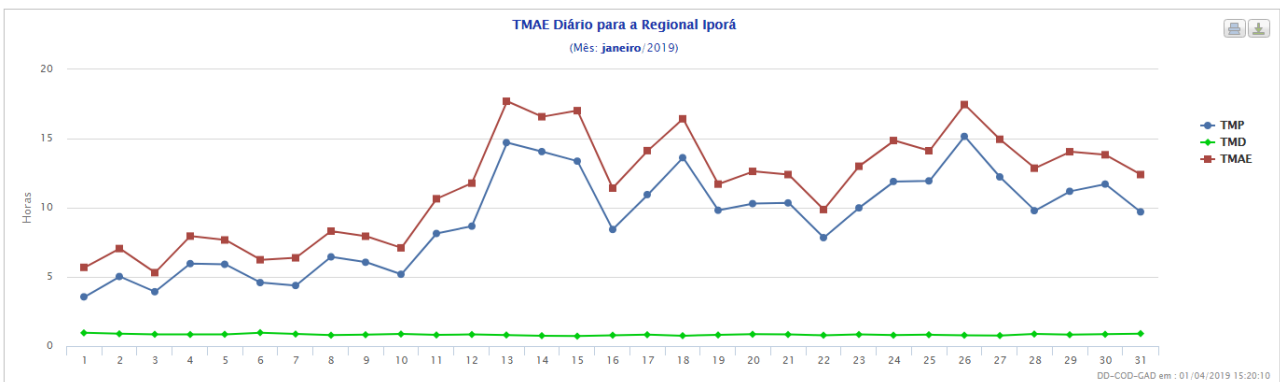
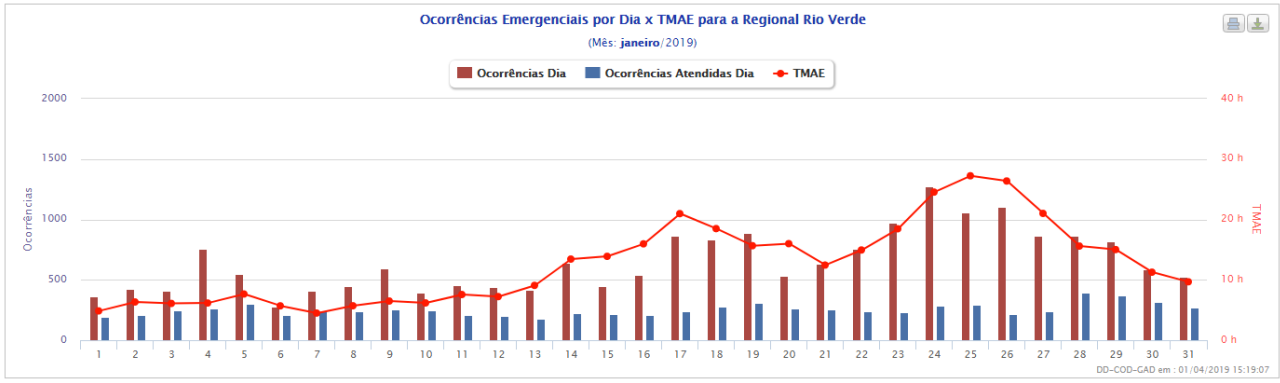

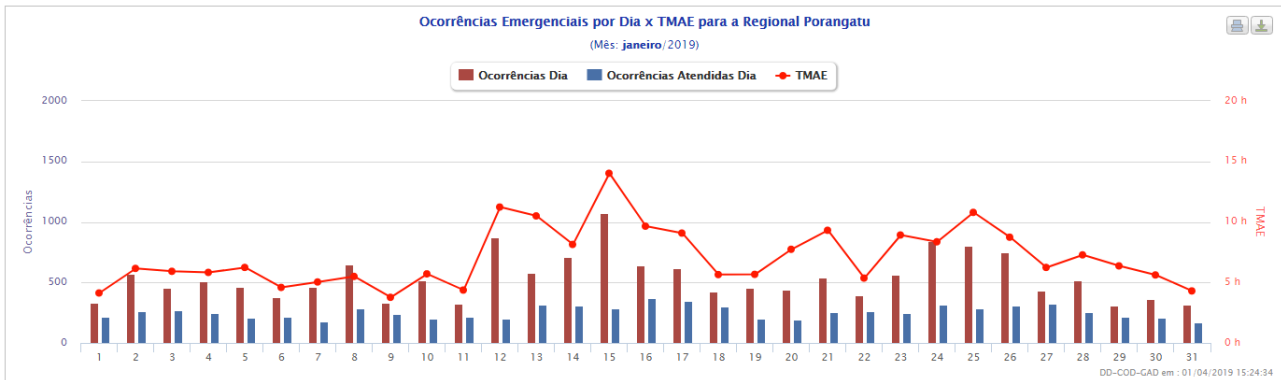
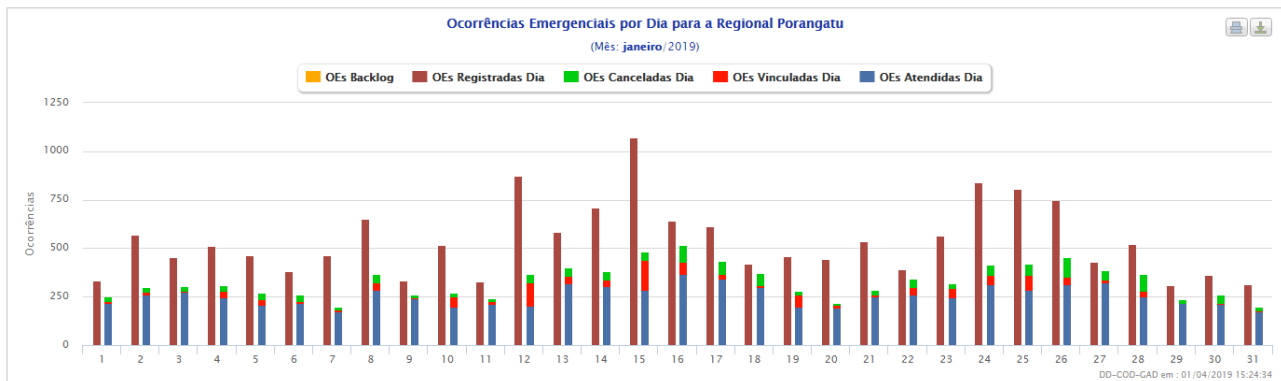
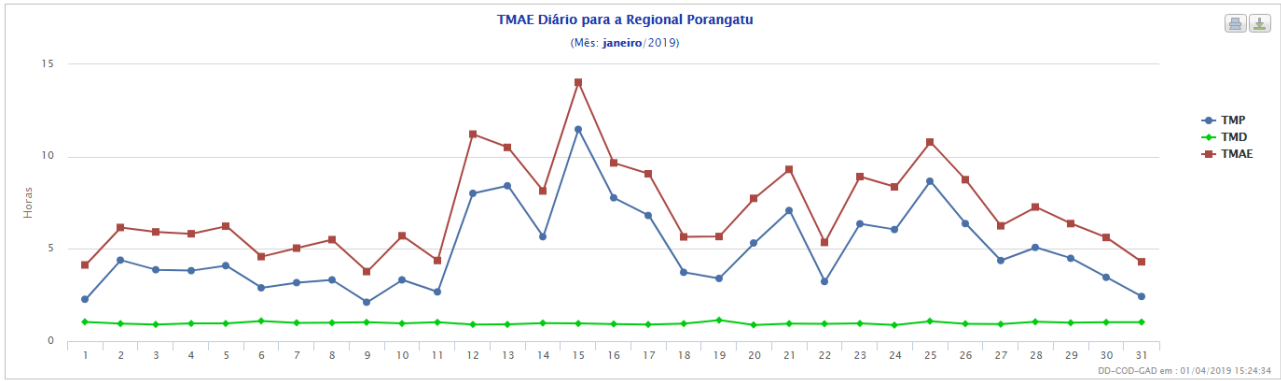

**Laudo Meteorológico de Evento
Climático – ENEL DISTRIBUIÇÃO
GOIÁS.: 12 de janeiro de 2019**

Climatempo Meteorologia

Janeiro de 2019

Sumário

1. Descrição do Evento	3
2. Abrangência do Evento	7
3. Classificação COBRADE.....	7
4. Resumo do Evento.....	7
5. Referências.....	11
Anexos	12
A.1 Carta Sinótica	12
A.2 Notícias associadas.....	13

1. Descrição do Evento

Na figura a seguir é apresentado as áreas de concessão da ENEL DISTRIBUIÇÃO GOIÁS divididos em regiões a serem analisadas neste relatório.



Figura 1 – Regiões de Goiás atendidas pela ENEL DISTRIBUIÇÃO GOIÁS.

Uma massa de ar quente e úmido sobre a região central do país favoreceu a formação de nuvens de tempestade, do tipo Cumulonimbus, sobre o estado de Goiás entre a manhã do dia 12 de janeiro e a madrugada do dia 13 de janeiro de 2019.

Na Figura 2 são apresentadas as descargas atmosféricas nuvem-solo (raios) e nuvem-nuvem detectadas pelo sistema Earth Networks. Entre as 10h00 do dia 12 e as 04h00 do dia 13 de janeiro de 2019 foram detectados 12421 raios nuvem-solo e 27446 descargas nuvem-nuvem sobre a área de concessão da ENEL DISTRIBUIÇÃO GOIÁS. Como é possível observar, todas as regiões de Goiás atendidas pela ENEL DISTRIBUIÇÃO GOIÁS tiveram registro de descargas atmosféricas durante o período.

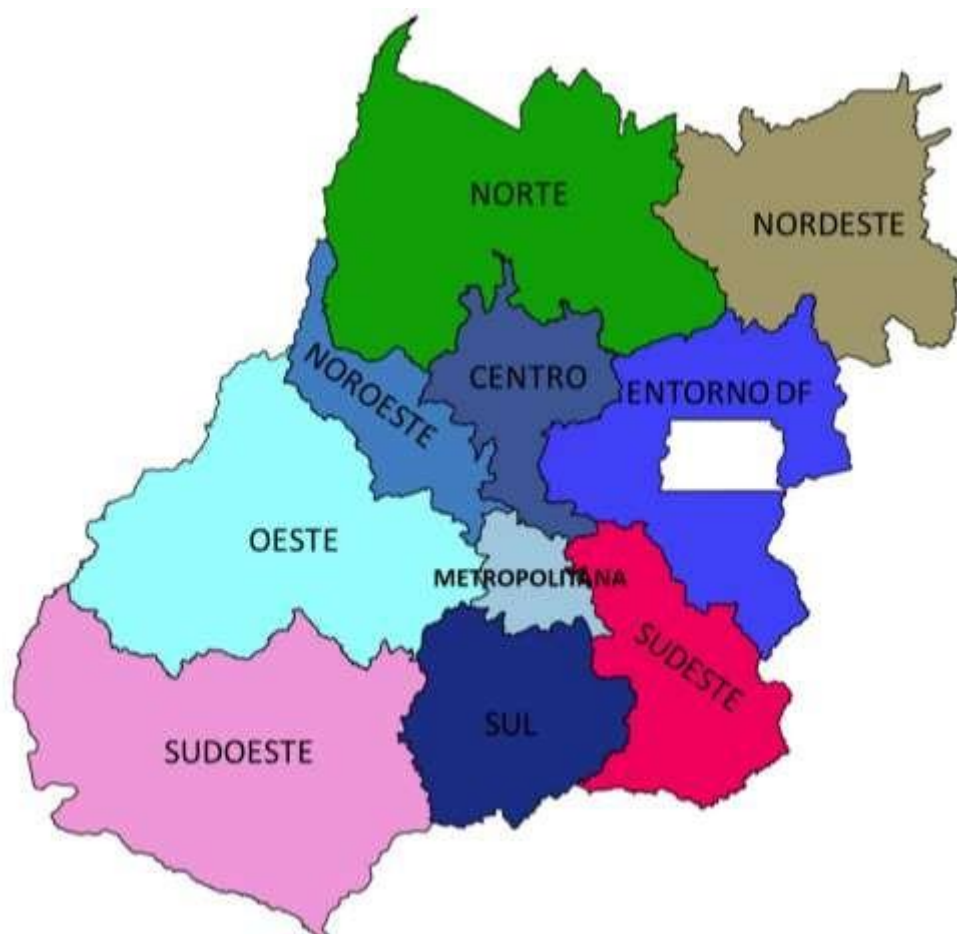

Figura 2 – Descargas atmosféricas nuvem-solo (em preto) e nuvem-nuvem (em vermelho) detectadas pelo sistema Earth Networks entre 10h00 do dia 12 e 04h00 do dia 13 de janeiro de 2019 sobre a área de concessão da ENEL DISTRIBUIÇÃO GOIÁS.

Segundo dados do Instituto Nacional de Meteorologia (INMET) entre as 10h00 do dia 12 e as 10h00 do dia 13 de janeiro de 2019 foram acumulados 37,3 mm de chuva em Pirenópolis (Região Entorno DF), o que corresponde a aproximadamente 13% da média climatológica (1981-2010) para o mês de janeiro na região.

Tabela 1 – Precipitação acumulada entre 10h00 do dia 12 e 10h00 do dia 13 de janeiro de 2019. Fonte: INMET

Estação	Precipitação (mm)
PIRENOPOLIS	37,3
ARAGARCAS	33,0
ARAGARÇAS	30,8
CAIAPÔNIA	25,4
IPORÁ	22,4
GOIANIA	22,2
FORMOSA	17,1
SÃO SIMÃO	16,2
PIRES DO RIO	14,4
MINEIROS	13,0

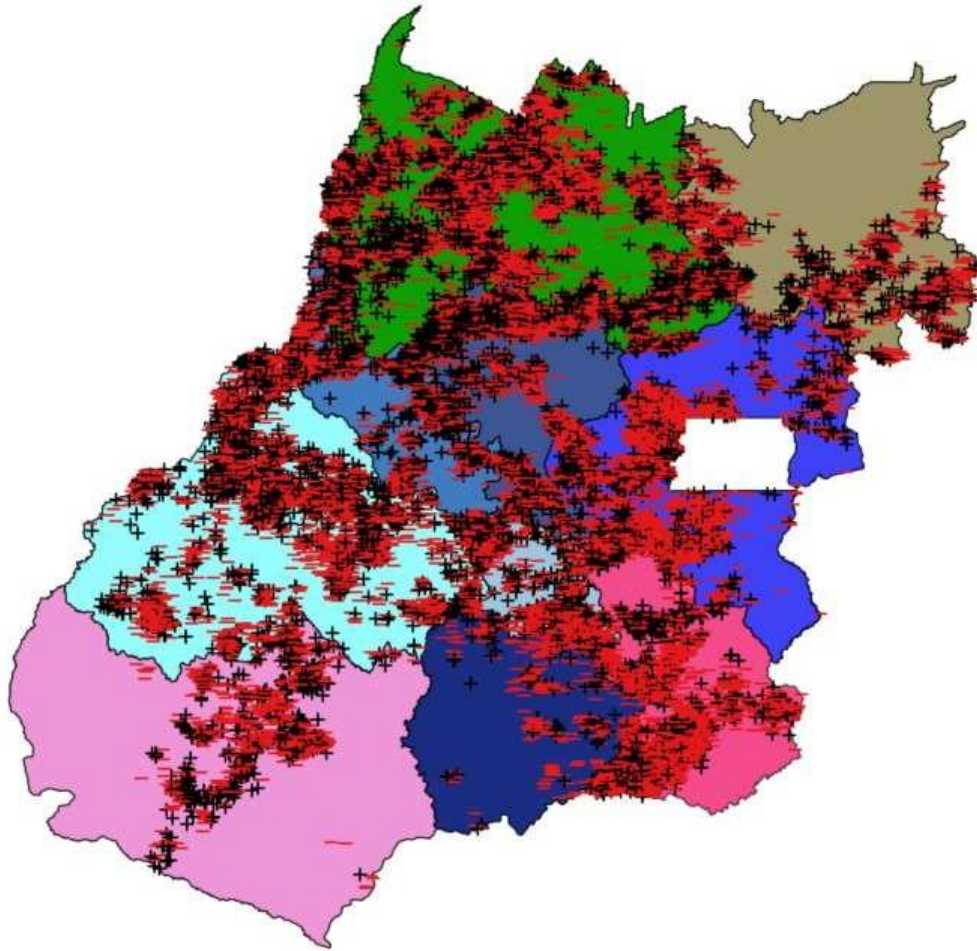
Na tabela a seguir são apresentadas as rajadas de vento superiores a 50 km/h registradas pelas estações do INMET representativas da área de interesse. O maior valor de rajada de vento registrada durante o período analisado foi de 72,0 km/h na noite do dia 12 de janeiro na estação de Aragarças (Região Oeste). Segundo a escala Beaufort, ventos entre 50 e 61 km/h são classificados como vento forte e entre 62 e 74 km/h como ventania.

Tabela 2 – Rajadas de vento superiores a 50 km/h registradas pelo INMET entre a manhã do dia 12 e a madrugada do dia 13 de janeiro de 2019.

Estação	Hora	Rajada (km/h)
Alto Araguaia	13/01/2019 00:00	56.5
Alto Araguaia	13/01/2019 01:00	56.5
Aragarças	12/01/2019 21:00	51.5
Aragarças	12/01/2019 22:00	72.0
Goiânia	12/01/2019 17:00	54.4
Itapaci	12/01/2019 17:00	53.3
Jataí	12/01/2019 23:00	50.4
Jataí	13/01/2019 00:00	58.7
Mineiros	13/01/2019 00:00	63.0
Paraúna	12/01/2019 19:00	64.4
Paraúna	12/01/2019 20:00	64.4
Posse	13/01/2019 00:00	62.6
Posse	13/01/2019 01:00	70.2

No aeroporto de Goiânia as rajadas de vento chegaram a aproximadamente 77,7 km/h, classificados como ventania forte pela escala Beaufort, às 17h08 do dia 12 de janeiro de 2019.

Na figura a seguir são apresentadas as imagens realçadas do satélite GOES-16 entre as 13h00 do dia 12 e as 04h00 do dia 13 de janeiro de 2019. Nestas imagens os tons em preto, vermelho e rosa indicam as áreas com nuvens de grande desenvolvimento vertical, geralmente associada à condição de mau tempo. Nestas imagens é possível acompanhar que as nuvens mais carregadas inicialmente se desenvolveram na parte norte de Goiás, depois se espalharam sobre as demais regiões do estado.



Figura 3 – Imagens realçadas do satélite GOES-16 entre as 13h00 do dia 12 e 04h00 do dia 13 de janeiro de 2019.

2. Abrangência do Evento

Áreas de instabilidade formadas pelo ar quente e úmido foram responsáveis pelo desenvolvimento de nuvens de tempestade, responsáveis pela ocorrência de chuva moderada a forte, raios e rajadas de vento sobre a área de concessão da ENEL DISTRIBUIÇÃO GOIÁS entre o dia 12 e a madrugada do dia 13 de janeiro de 2019. As condições eram favoráveis à ocorrência de granizo.

3. Classificação COBRADE

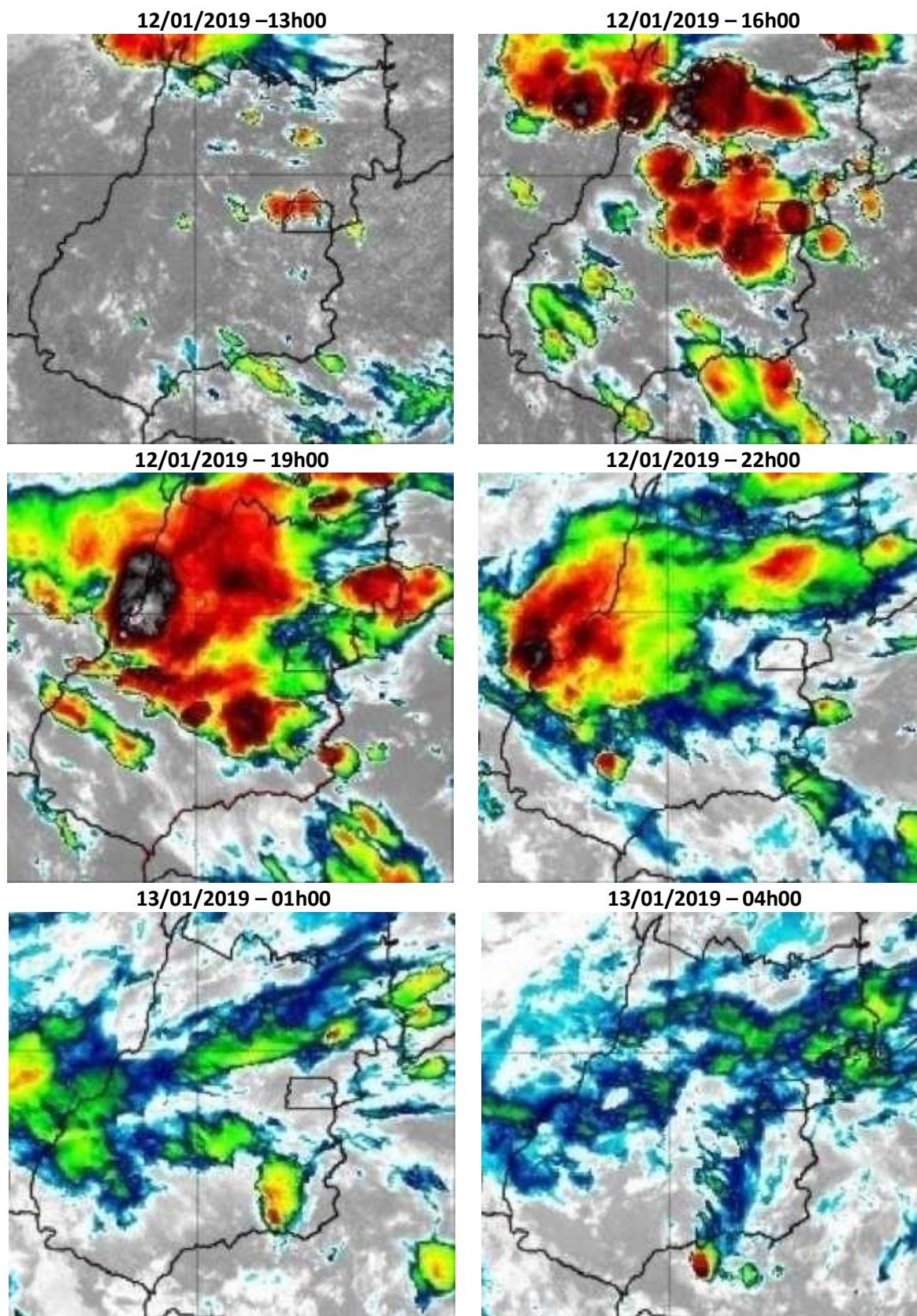
O COBRADE (Classificação e Codificação Brasileira de Desastres) foi criado com o intuito de adequar a classificação brasileira à classificação utilizada pela ONU na classificação de desastres e nivelar o país aos demais organismos de gestão de desastres do mundo.

Baseados nos dados analisados, podemos classificar o ocorrido como Natural – Meteorológico – Tempestade local/Convectiva:

- Tempestade de raios (Código COBRADE 1.3.2.1.2)
- Granizo (Código COBRADE 1.3.2.1.3)
- Chuvas intensas (Código COBRADE 1.3.2.1.3.4)
- Vendaval (Código COBRADE 1.3.2.1.5)

4. Resumo do Evento

A presença de uma massa de ar quente e úmido favoreceu a formação de nuvens carregadas, do tipo Cumulonimbus, associadas à condições de tempo severo, entre a manhã do dia 12 de janeiro e a madrugada do dia 13 de janeiro de 2019.

O aeroporto de Goiânia registrou rajadas de vento de aproximadamente 77,7 km/h às 17h08 do dia 12 de janeiro de 2019, vento classificado como ventania forte pela escala Beaufort.

Entre as 10h00 do dia 12 de janeiro e 04h00 do dia 13 de janeiro de 2019 foram registrados 12421 raios nuvem-solo e 27446 descargas nuvem-nuvem sobre a área de concessão da ENEL DISTRIBUIÇÃO GOIÁS.

Segundo dados do INMET entre as 10h00 do dia 12 e as 10h00 do dia 13 de janeiro de 2019 foram acumulados 37,3 mm de chuva em Pirenópolis, o que corresponde a aproximadamente 13% da média climatológica (1981-2010) para o mês de janeiro na região.

Tabela 3 – Resumo do Evento Região Nordeste

Número/Código do Evento	
Número / Código do Relatório	
Descrição	Vendavais, chuva intensa, raios e queda de granizo
Código COBRADE	1.3.2.1.2 – Tempestade de raios 1.3.2.1.3 – Granizo 1.3.2.1.4 – Chuvas intensas 1.3.2.1.5 - Vendaval
Hora início do evento	11h30 do dia 12 de janeiro de 2019
Hora de fim do evento	04h00 do dia 13 de janeiro de 2019
Abrangência	Região Nordeste da ENEL DISTRIBUIÇÃO GOIÁS

Tabela 4 – Resumo do Evento Região Norte

Número/Código do Evento	
Número / Código do Relatório	
Descrição	Vendavais, chuva intensa, raios e queda de granizo
Código COBRADE	1.3.2.1.2 – Tempestade de raios 1.3.2.1.3 – Granizo 1.3.2.1.4 – Chuvas intensas 1.3.2.1.5 - Vendaval
Hora início do evento	10h00 do dia 12 de janeiro de 2019
Hora de fim do evento	22h00 do dia 13 de janeiro de 2019
Abrangência	Região Norte da ENEL DISTRIBUIÇÃO GOIÁS

Tabela 5 – Resumo do Evento Região Noroeste

Número/Código do Evento	
Número / Código do Relatório	
Descrição	Vendavais, chuva intensa, raios e queda de granizo
Código COBRADE	1.3.2.1.2 – Tempestade de raios 1.3.2.1.3 – Granizo 1.3.2.1.4 – Chuvas intensas 1.3.2.1.5 - Vendaval
Hora início do evento	12h00 do dia 12 de janeiro de 2019
Hora de fim do evento	20h00 do dia 12 de janeiro de 2019
Abrangência	Região Noroeste da ENEL DISTRIBUIÇÃO GOIÁS

Tabela 6 – Resumo do Evento Região Centro

Número/Código do Evento	
Número / Código do Relatório	
Descrição	Vendavais, chuva intensa, raios e queda de granizo
Código COBRADE	1.3.2.1.2 – Tempestade de raios 1.3.2.1.3 – Granizo 1.3.2.1.4 – Chuvas intensas 1.3.2.1.5 - Vendaval
Hora início do evento	12h00 do dia 12 de janeiro de 2019
Hora de fim do evento	22h30 do dia 12 de janeiro de 2019
Abrangência	Região Centro da ENEL DISTRIBUIÇÃO GOIÁS

Tabela 7 – Resumo do Evento Região Entorno DF

Número/Código do Evento	
Número / Código do Relatório	
Descrição	Vendavais, chuva intensa, raios e queda de granizo
Código COBRADE	1.3.2.1.2 – Tempestade de raios 1.3.2.1.3 – Granizo 1.3.2.1.4 – Chuvas intensas 1.3.2.1.5 - Vendaval
Hora início do evento	11h30 do dia 12 de janeiro de 2019
Hora de fim do evento	02h00 do dia 13 de janeiro de 2019
Abrangência	Região Entorno DF da ENEL DISTRIBUIÇÃO GOIÁS

Tabela 8 – Resumo do Evento Região Oeste

Número/Código do Evento	
Número / Código do Relatório	
Descrição	Vendavais, chuva intensa, raios e queda de granizo
Código COBRADE	1.3.2.1.2 – Tempestade de raios 1.3.2.1.3 – Granizo 1.3.2.1.4 – Chuvas intensas 1.3.2.1.5 - Vendaval
Hora início do evento	10h00 do dia 12 de janeiro de 2019
Hora de fim do evento	01h00 do dia 13 de janeiro de 2019
Abrangência	Região Oeste da ENEL DISTRIBUIÇÃO GOIÁS

Tabela 9 – Resumo do Evento Região Metropolitana

Número/Código do Evento	
Número / Código do Relatório	
Descrição	Vendavais, chuva intensa, raios e queda de granizo
Código COBRADE	1.3.2.1.2 – Tempestade de raios 1.3.2.1.3 – Granizo 1.3.2.1.4 – Chuvas intensas 1.3.2.1.5 - Vendaval
Hora início do evento	13h00 do dia 12 de janeiro de 2019
Hora de fim do evento	04h00 do dia 13 de janeiro de 2019
Abrangência	Região Metropolitana da ENEL DISTRIBUIÇÃO GOIÁS

Tabela 10 – Resumo do Evento Região Sudeste

Número/Código do Evento	
Número / Código do Relatório	
Descrição	Vendavais, chuva intensa, raios e queda de granizo
Código COBRADE	1.3.2.1.2 – Tempestade de raios 1.3.2.1.3 – Granizo 1.3.2.1.4 – Chuvas intensas 1.3.2.1.5 - Vendaval
Hora início do evento	12h30 do dia 12 de janeiro de 2019
Hora de fim do evento	04h00 do dia 13 de janeiro de 2019
Abrangência	Região Sudeste da ENEL DISTRIBUIÇÃO GOIÁS

Tabela 11 – Resumo do Evento Região Sul

Número/Código do Evento	
Número / Código do Relatório	
Descrição	Vendavais, chuva intensa, raios e queda de granizo
Código COBRADE	1.3.2.1.2 – Tempestade de raios 1.3.2.1.3 – Granizo 1.3.2.1.4 – Chuvas intensas 1.3.2.1.5 - Vendaval
Hora início do evento	10h00 do dia 12 de janeiro de 2019
Hora de fim do evento	04h00 do dia 13 de janeiro de 2019
Abrangência	Região Sul da ENEL DISTRIBUIÇÃO GOIÁS

Tabela 12 – Resumo do Evento Região Sudoeste

Número/Código do Evento	
Número / Código do Relatório	
Descrição	Vendavais, chuva intensa, raios e queda de granizo
Código COBRADE	1.3.2.1.2 – Tempestade de raios 1.3.2.1.3 – Granizo 1.3.2.1.4 – Chuvas intensas 1.3.2.1.5 - Vendaval
Hora início do evento	12h30 do dia 12 de janeiro de 2019
Hora de fim do evento	00h30 do dia 13 de janeiro de 2019
Abrangência	Região Sudoeste da ENEL DISTRIBUIÇÃO GOIÁS

5. Referências

- Instituto Nacional de Meteorologia (INMET) - <http://www.inmet.gov.br>
- Centro de Hidrografia da Marinha - <https://www.marinha.mil.br/chm/>
- Rede de Meteorologia do Comando da Aeronáutica - www.redemet.aer.mil.br
- CPTEC - <https://www.cptec.inpe.br/>

Anexos

A.1 Carta Sinótica

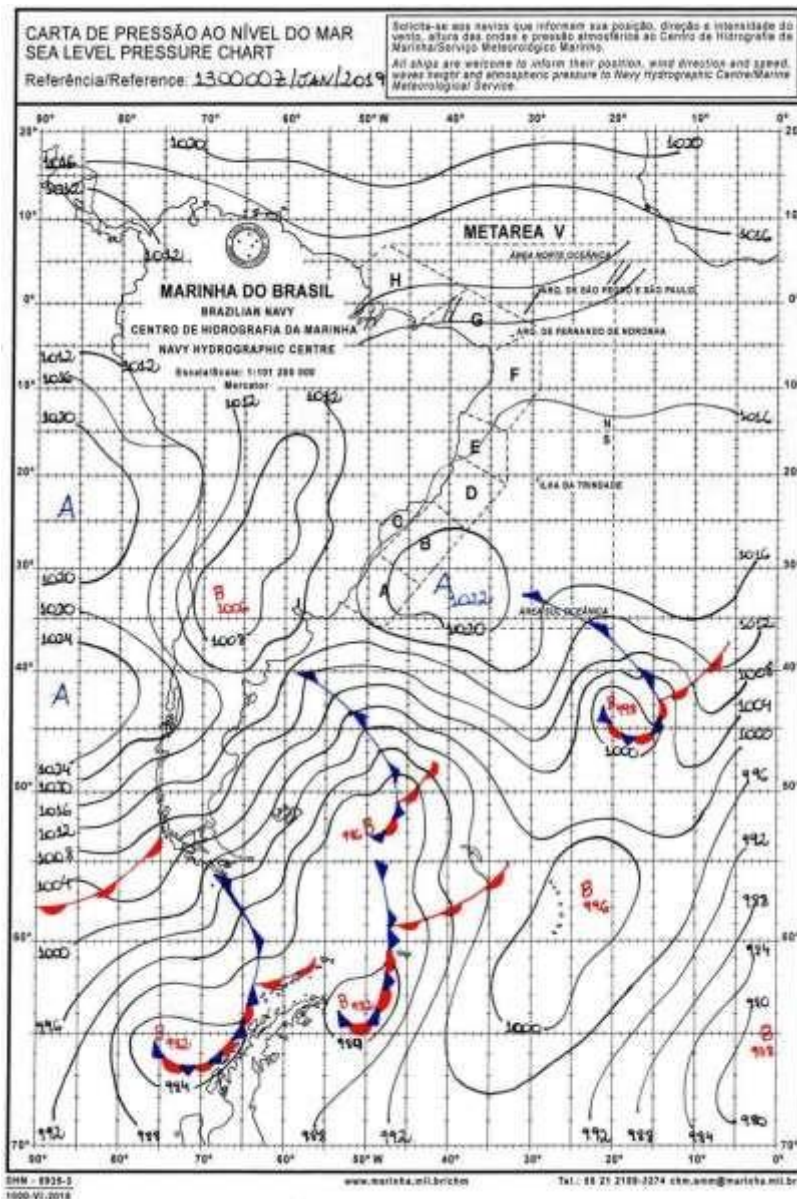

LEGENDA	
	Frente Fria
	Frente Quente
	Instabilidade
	Alta Pressão
	Baixa Pressão
	Zona de Convergência

Figura A1 – Carta sinótica da Marinha do Brasil para as 0000Z do dia 13 de janeiro de 2019 (22h00 do dia 12 de janeiro de 2019, hora local).

A.2 Notícias associadas

Temporal derruba barracas de feira e causa alagamentos em Goiânia -

<https://g1.globo.com/go/goias/noticia/2019/01/12/temporal-derruba-barracas-de-feira-e-causa-alagamentos-em-goiania.ghtml>



Barracas desfeitas por causa de forte chuva em Goiânia — Foto: Reprodução/TV Anhangüera

Vídeo mostra chuva de granizo em Formosa - <http://g1.globo.com/goias/videos/t/todos-os-videos/v/video-mostra-chuva-de-granizo-em-formosa/7295851/>

Chuva, raios e ventania de 78 km/h em Goiânia (GO) -

<https://www.climatempo.com.br/noticia/2019/01/12/chuva-raios-e-ventania-de-72-km-h-em-goiania-go--1013>

Bianca Lobo Silva
Meteorologista CREA
5063840461

Instituto Nacional de Meteorologia - INMET
Umidade Relativa do Ar 00h UTC
Estação: ARAGARCAS (GO) - 01/2019

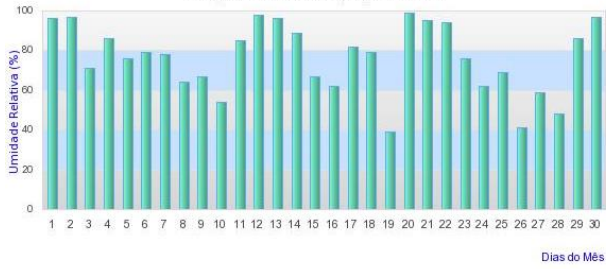

Instituto Nacional de Meteorologia - INMET
Umidade Relativa do Ar 00h UTC
Estação: FORMOSA (GO) - 01/2019

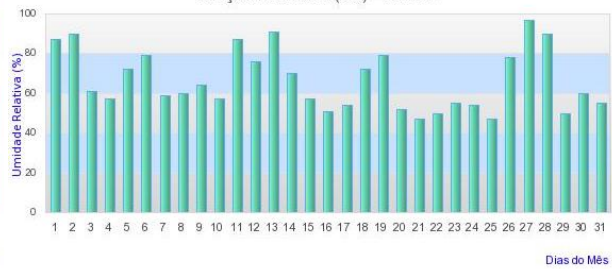

Instituto Nacional de Meteorologia - INMET
Chuva Acumulada 24h
Estação: ARAGARCAS (GO) - 01/2019



Instituto Nacional de Meteorologia - INMET
Chuva Acumulada 24h
Estação: FORMOSA (GO) - 01/2019



Instituto Nacional de Meteorologia - INMET
Umidade Relativa do Ar 00h UTC
Estação: GOIANIA (GO) - 01/2019

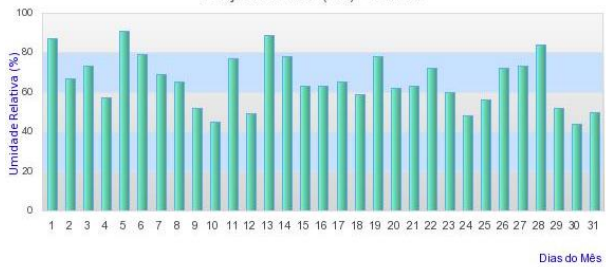

Instituto Nacional de Meteorologia - INMET
Umidade Relativa do Ar 00h UTC
Estação: IPAMERI (GO) - 01/2019

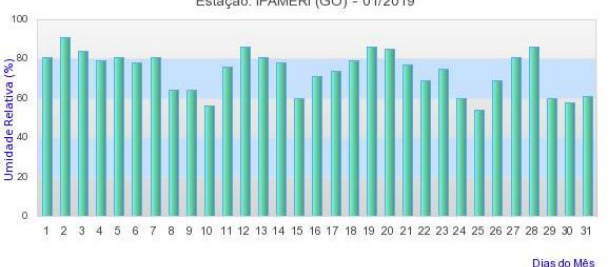

Instituto Nacional de Meteorologia - INMET
Chuva Acumulada 24h
Estação: GOIANIA (GO) - 01/2019

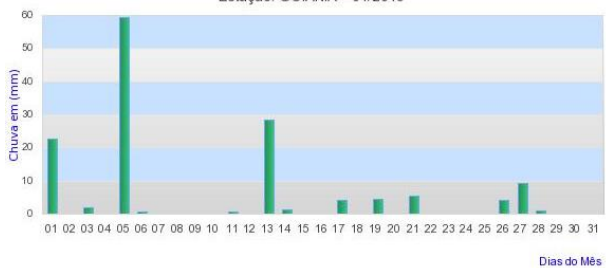

Instituto Nacional de Meteorologia - INMET
Chuva Acumulada 24h
Estação: IPAMERI (GO) - 01/2019

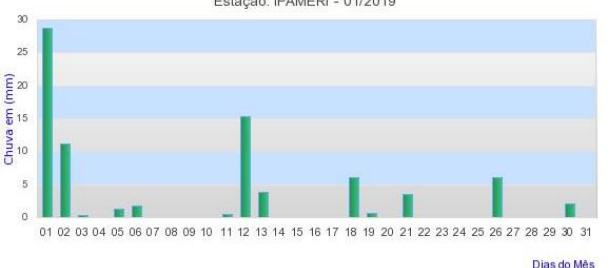

Instituto Nacional de Meteorologia - INMET

Umidade Relativa do Ar 00h UTC
Estação: JATAI (GO) - 01/2019

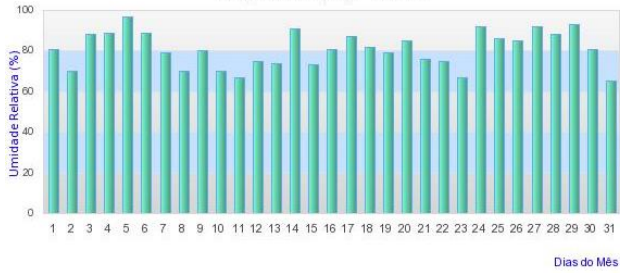

Instituto Nacional de Meteorologia - INMET

Umidade Relativa do Ar 00h UTC
Estação: PIRENOPOLIS (GO) - 01/2019

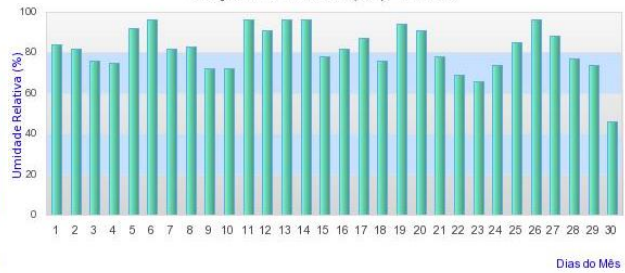

Instituto Nacional de Meteorologia - INMET

Chuva Acumulada 24h
Estação: JATAI - 01/2019

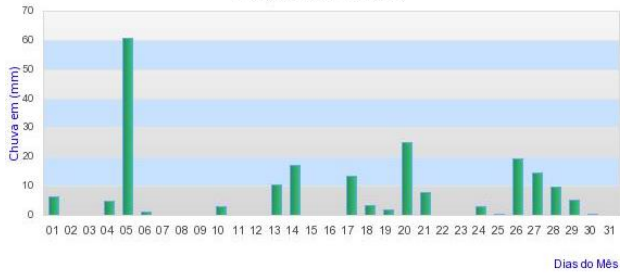

Instituto Nacional de Meteorologia - INMET

Chuva Acumulada 24h
Estação: PIRENOPOLIS - 01/2019

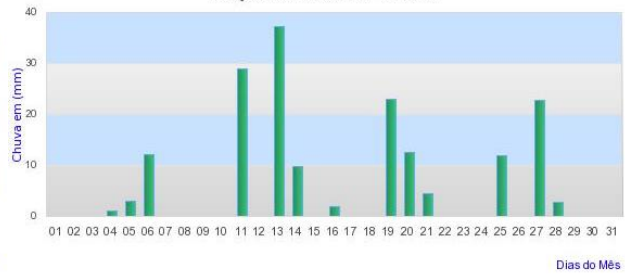

Instituto Nacional de Meteorologia - INMET

Umidade Relativa do Ar 00h UTC
Estação: POSSE (GO) - 01/2019

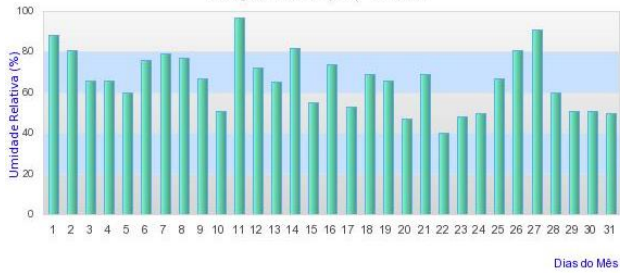

Instituto Nacional de Meteorologia - INMET

Chuva Acumulada 24h
Estação: POSSE - 01/2019

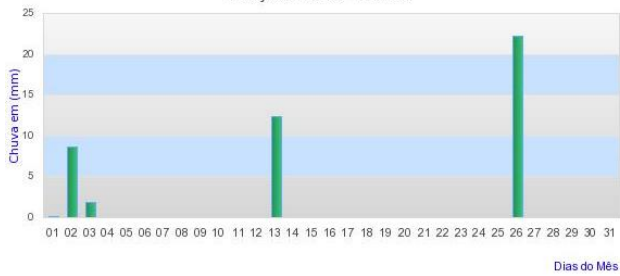

https://portal6.com.br/2019/01/12/forte-chuva-com-ventania-em-anapolis-causa-estragos-e-assusta-moradores/

Forte chuva com ventania em Anápolis causa estragos e assusta moradores



(Foto: Denilson Boaventura)



Denilson Boaventura

3 meses atrás

Corpo de Bombeiros também precisou socorrer vítima que caiu no Córrego das Antas

A forte chuva acompanhada de ventania na tarde deste sábado (12) assustou e deixou moradores de Anápolis em estado de alerta.

Houve quedas de árvores, paredes de residências estremecidas e falta de energia elétrica em diversos pontos da cidade.

O Corpo de Bombeiros também

Temporal derruba barracas de feira e causa alagamentos em Goiânia

Imagens mostram ainda parte do telhado e uma empresa que desabou, em Jaraguá, e chuva de granizo, em Formosa. Segundo a Comurg, há registro de nove árvores que caíram na capital.

Por Vanessa Martins, G1GO
12/01/2019 20:04 - Atualizado há 2 meses

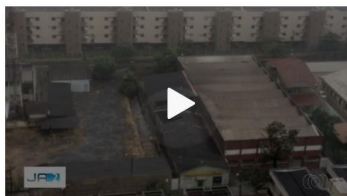

Temporal derruba barracas de feira e causa alagamentos em Goiânia

Chuva e ventos forte provoca estragos e falta de energia em Anápolis

Quedas de árvores, e falta de energia foram registradas em vários bairros da cidade



12 de janeiro de 2019

Moradores de Anápolis foram surpreendidos com uma forte chuva seguida de ventos forte na tarde deste sábado (12).

Quedas de árvores, e falta de energia foram registradas em vários bairros da cidade. Um homem foi levado pela chuva no córrego das Antas, os Bombeiros foi acionado e fizeram o resgate.

A previsão para este domingo (13) é de chuva durante a tarde e a noite na cidade.

Segunda-Feira, 01 de Abril de 2019

Segunda-Feira, 01 de Abril de 2019

JP Jornal Populacional

UM NOVO CONCEITO N HORAS MAIS DIFICEIS DA SU

INÍCIO LOCAIS NOTÍCIAS MODA & BELEZA OUÇA OS PODCASTS DO JORNAL DAS 11 DA LEGAL FM

Página Inicial / Notícias / Rialma / Notícia / Temporal e ventos fortes causam estragos na empresa FVO em Rialma

Temporal e ventos fortes causam estragos na empresa FVO em Rialma

Publicado em 25/01/2019 às 21:02

CLIQUE PARA AMPLIAR P



Na noite desta quinta-feira (24/1), um temporal e ventos fortes causam estragos na empresa FVO na cidade de Rialma, às margens da BR - 153.

De acordo com Lúcio, funcionário da empresa, telhas da fábrica foram arrancadas com a força do vento e arremessadas a cerca de 500 metros de distância.

Lúcio, relata ainda que uma área administrativa, onde fica o descanso dos motorista houve o desabamento do teto. Na região da FVO, árvores caíram com a força de vendaval.



Além da FVO, outras empresas como a Comprém e uma borracharia naquela localidade também foram atingidas pelo vento, onde as mesmas tiveram danos materiais. Apesar deste vendaval, ninguém ficou ferido.

JP Jornal Populacional

UM NOVO CONCEITO N HORAS MAIS DIFICEIS DA SU

INÍCIO LOCAIS NOTÍCIAS MODA & BELEZA OUÇA OS PODCASTS DO JORNAL DAS 11 DA LEGAL FM

Página Inicial / Notícias / Rubiataba / Notícia / Vendaval deixa Rubiataba e Nova América 18 horas sem energia

Vendaval deixa Rubiataba e Nova América 18 horas sem energia

Publicado em 24/01/2019 às 21:12

CLIQUE PARA AMPLIAR P



Na noite desta quarta-feira (23/1), por volta das 22h, um vendaval na cidade de Rubiataba, deixa um rastro de destruição. Inúmeras árvores foram derrubadas pela forte ventania.

De acordo com colaborador do Jornal Populacional em Rubiataba, Aurino Dias de Oliveira, (Ceará), um eucalipto de grande porte, caiu sobre um poste nas proximidades da subestação de energia da Enel que abastece a cidade de Rubiataba.

Nova América e Rubiataba ficaram sem energia desde ontem das 22h até hoje (quinta-feira (24) as

16h30.



De acordo com Aurino Dias, que esteve na subestação, equipes da Enel estiveram no local para reestabelecer a energia.

Aurino Dias, Ceará como é conhecido, informou que mora em Rubiataba há mais de 30 anos, nunca viu um vendaval tão forte como foi o de ontem (23).

Aurino, ressalta a todos que forem trafegar entre o tateral de leilões e o segundo trevo conhecido como trevo da aroeira, que dá acesso para Rubiataba, que tomem muito cuidado devido ao um eucalipto que caiu sobre a pista, apenas um lado da pista está tendo

Chuva, raios e ventania de 78 km/h em Goiânia (GO)

12/01/2019 às 17:21 por Marcelo Pinheiro

compartilhar

Atualizado 12/01/2019 às 17:44

SMAC Oferecimento

Nuvens carregadas formadas pelo tempo quente e úmido se espalharam pelo centro de Goiás neste final de tarde de sábado. Em Goiânia há registro de chuva moderada a forte, raios e rajadas de vento de até 78 km/h.

compartilhar



Leia mais

Temporal derruba barracas de feira e causa alagamentos em Goiânia

Imagens mostram ainda parte do telhado e uma empresa que desabou, em Jaraguá, e chuva de granizo, em Formosa. Segundo a Comurg, há registro de nove árvores que caíram na capital.

Por Vanessa Martins, G1GO
12/01/2019 20:04 - Atualizado há 2 meses

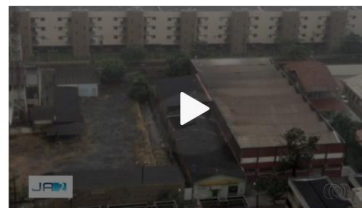

Temporal derruba barracas de feira e causa alagamentos em Goiânia

g1.globo.com/goias/videos/t/todos-os-videos/v/video-mostra-chuva-de-granizo-em-formosa/7295851/

globo.com | g1 | globoesporte | gshow | videos

MENU G1 GOIÁS TV ANHANGUERA

Video most
MAIS INFORMAÇÕES

12/01/2019 | 00:04
Temporal causou estragos em várias cidades de Goiás.



<https://portal6.com.br/2019/01/12/forte-chuva-com-ventania-em-anapolis-causa-estragos-e-assustam- moradores/>

<https://g1.globo.com/go/goias/noticia/2019/01/12/temporal-derruba-barracas-de-feira-e-causa- alagamentos-em-goiania.ghtml>

<http://www.anapolisnoticias24h.com.br/chuva-e-ventos-forte-provoca-estragos-e-falta-de-energia-em- anapolis/>

<http://www.jornalpopulacional.com.br/noticia/9471-temporal-e-ventos-fortes-causam-estragos-na- empresa-fvo-em--rialma.html>

<http://www.jornalpopulacional.com.br/noticia/9469-venda-val-deixa-rubiataba-e-nova-america-18-horas- sem-energia.html>

<https://g1.globo.com/go/goias/noticia/2019/01/12/temporal-derruba-barracas-de-feira-e-causa- alagamentos-em-goiania.ghtml>

<http://g1.globo.com/goias/videos/t/todos-os-videos/v/video-mostra-chuva-de-granizo-em- formosa/7295851/>

<https://www.climatempo.com.br/noticia/2019/01/12/chuva-raios-e-ventania-de-72-km- h-em- goiania-go--1013>