

## Resumo Executivo

O Presente Relatório tem como objetivo a incorporação de informações que sejam relevantes para que se possa fazer a devida associação aos dados contidos no corpo do documento objeto da classificação de Situação de Emergência caracterizada pelo Módulo 8 do Prodist, que tem como foco o impacto do evento sobre determinada rede geelétrica e cuja denominação é definida como CHI (Consumidor hora interrompido). O parâmetro para enquadramento nesta classificação de expurgo tem como premissa inicial o limite de Consumidor hora interrompido definido pela fórmula descrita no Módulo 01 do Prodist (Revisão - 9), acrescido de todos os outros informes e dados listados no Módulo 08 (Revisão 10) do Prodist. Este enquadramento se apresenta na maioria das vezes em condições climáticas adversas com severidade dos fatores inerentes a situação, caracterizado na maioria dos casos por fortes ventos e chuvas de grande intensidade e continuidade.

Entre a manhã do dia 02/01/2020 – quinta-feira – e a manhã de 07/01/2020 – terça-feira – Houve a formação de nuvens de tempestade, que avançaram sobre o continente e ajudaram a organizar áreas de instabilidade sobre as Regiões da Enel Distribuição Goiás.

Conforme informações do Climatempo Meteorologia, o Instituto Nacional de Meteorologia (INMET) detectou rajadas de vento acima de 50km/h entre a manhã do dia 02 e a manhã do dia 07 de janeiro de 2020. A máxima rajada registrada foi de 69,1km/h, sendo esse vento classificado como vento forte e ventania pela escala Beaufort.

Entre as 09h30 do dia 02 e 08h do dia 07 de janeiro de 2020 tivemos, em todo o Estado de Goiás, incidências de 78.869 descargas atmosféricas (27.057 raios nuvem-solo e 51.812 descargas nuvem-nuvem) sobre a região, o que causou grande instabilidade na rede.

### **Comerciantes e moradores contam prejuízos após forte chuva e rompimento de represa em Pontalina**

- Vídeos mostram ruas, casas e lojas completamente alagadas. Moradores de quatro casas precisam sair dos imóveis, que foram interditados. Acesso em:

<https://g1.globo.com/go/goias/noticia/2020/01/06/comerciantes-e-moradores-contam-prejuizos-apos-forte-chuva-e-rompimento-de-represa-em-pontalina.ghtml>

**Suspeita é que chuva causou rompimento de barragem em Goiás** - Segundo a prefeitura de Pontalina, pelo menos quatro residências da rua Padre Primo foram condenadas e interditadas pelos bombeiros por risco de desabamento. “O levantamento final de todos os danos ainda está sendo feito pela equipe técnica responsável e em breve será divulgado oficialmente pelos órgãos competentes”. Acesso em:

<https://www.metropoles.com/brasil/suspeita-e-que-chuva-causou-rompimento-de-barragem-em-goias>

## Relatório de Ocorrências do período

Em todo o Estado de Goiás verificou-se também que a intensidade da chuva e dos ventos danificaram a rede de distribuição de energia elétrica em diversos pontos, registrando aproximadamente 487 mil clientes com interrupção no fornecimento de energia elétrica devido a eventos relacionados ao temporal.

Para otimizar o volume de atendimentos e reduzir os tempos de interrupção foram mobilizados os recursos extras da empresa que aumentou o contingente em relação a situação normal de operação. O acompanhamento da quantidade de equipes e o Tempo Médio de Atendimento podem ser consultados na Pág.02 do Relatório em anexo.

O impacto e severidade do evento estão relatados em artigos de mídia, como fotos e reportagens que demonstram os danos na Rede de Distribuição, oriundos dos eventos climáticos no período. Eventos estes que afetaram 487.263 consumidores com CHI de 1.316.254,62 superior ao de 482.597,74 estabelecido como limite para definição de Situação de Emergência, conforme resumo das informações obrigatórias.

<b>Empresa</b>	ENEL DISTRIBUIÇÃO GOIÁS							
<b>Código do Relatório</b>	CHI-038 - ENEL DISTRIBUIÇÃO GOIÁS							
<b>Evento:</b>	TEMPORAL NA AREA DE CONCESSÃO DA ENEL DISTRIBUIÇÃO GOIAS							
<b>Código COBRADE:</b>	1.3.1.2.0	<b>Data Início</b>	02/01/2020	<b>Hora início</b>	09h30			
<b>Código do Evento:</b>	CHI-038-ENEL GO	<b>Data Término</b>	07/01/2020	<b>Hora Término</b>	08h59			
<b>Valor CHI (Limite e Real)</b>	482.391,86	1.316.254,62	<b>Subestações Atingidas</b> ABADIANIA / ABC / ACREUNA / ADELANDIA / AEROPORTO / AGUA LIMPA (MARZAGAO) / AGUAS LINDAS / ALEXANIA / ALEXANIA TRANSMISSAO / ALMERINDONOPOLIS / ALOANDIA / ALPHAVILLE / ALTO BURITI / ALTO PARAISO DE GOIAS / ALVORADA DO NORTE / AMERICANO ( RIO VERDE ) / AMERICANO DO BRASIL / AMORINOPOLIS / ANAPOLIS UNIVERSITARIA / ANHANGUERA / ANICUNS / ANTONIO DO VITTO / APARECIDA DO RIO DOCE / APORE / ARACU / ARAGARCAS / ARAGOIANIA / ARAGUAPAZ / ARARAS / AREIAS / ARENOPOLIS / ARUANA / ARUANA (TRANSMISSAO) / ASA BRANCA / ATLANTICO / AURILANDIA / AVELINOPOLIS / BACURI (RIO VERDE) / BARBOSELANDIA / BARCELONA / BARREIRO (PORANGATU) / BARRO ALTO / BELA VISTA (TRANSMISSAO) / BOA VISTA / BOM JARDIM / BOM JESUS DE GOIAS / BONFINOPOLIS / BONOPOLIS / BONSUCESSO (RIO VERDE) / BRAZABRANTES / BRITANIA / BRITANIA (TRANSMISSAO) / BURITI ALEGRE / BURITI DE GOIAS / BURITIZINHO / CABECEIRAS / CABRIUVA (RIO VERDE) / CACHOEIRA ALTA / CACHOEIRA DOURADA / CACHOEIRA NOVA / CACHOEIRINHA (ITARUMA) / CACU / CAIAPONIA / CALCILANDIA / CALDAS NOVAS / CALDAZINHA / CAMPESTRE / CAMPINAS / CAMPINORTE / CAMPO ALEGRE DE GOIAS / CAMPO LIMPO DE GOIAS / CAMPO NOVO / CAMPOS BELOS / CAMPOS VERDES / CARAIBAS / CARAJAS / CASTELANDIA / CATALAO / CATURAI / CEBRASA FABRICA DA AMBEV / CEMAT/BALIZA / CEPALGO / CEZARINA / CHAPADAO DO CEU / CIDADE OCIDENTAL / COCALZINHO / COLINACU / CORREGO ALEGRE / CORREGO DO OURO / CORUMBA / CORUMBAIBA / CRISTALINA / CRISTALINA TRANSMISSAO / CRISTIANOPOLIS / CRIXAS / CROMINIA / CUMARI / DAIA - ANAPOLIS / DAMOLANDIA / DAVINOPOLIS / DESFECHO / DESTILARIA BRASIL CENTRAL / DIMIC / DIORAMA / DORCELINO PEIXOTO DE MORAES / DOVERLANDIA / EDEALINA / EDEIA / ENERSUL / ESTANIFERA / ESTRELA DO NORTE / FAINA / FAZENDA CANADA / FAZENDA NOVA / FERROVIARIO / FIRMINOPOLIS / FLORES DE GOIAS / FORMIGA / FORMOSO / FRONTEIRA / GAMELEIRA / GIRASSOL / GOIANAPOLIS / GOIANDIRA / GOIANESIA / GOIANIA LESTE / GOIANIRA / GOIAS / GOIATUBA / GOUVERLANDIA / GOYA / GUAPO / HEITORAI / HIDROLANDIA / HIDROLINA / IACIARA / INACIOLANDIA / INDEPENDENCIA / INDIARA / INHUMAS / IPAMERI / IPEGUARI / IPORA / ISRAELANDIA / ITABERAI / ITAGUARI / ITAGUARU / ITAJA / ITAPACI / ITAPACI (TRANSMISSAO) / ITAPIRAPUA / ITAPURANGA / ITARUMA / ITAUCU / ITIQUIRA (FORMOSA) / ITUMBIARA NOVA / ITUMBIARA VELHA / JACILANDIA / JANDAIA / JARAGUA / JARANAPOLIS / JATAI / JAUPACI / JESUPOLIS / JOVIANIA / JUNDIAI / JURUMIRIM / JUSCELANDIA / JUSSARA / LAGES / LAGOA DA SERRA / LAGOA DO BAUZINHO (RIO VERDE) / LEOPOLDO DE BULHOES / LUZIANIA / LUZIANIA INDUSTRIAL / MAIRIPOTABA / MAMBAI / MARA ROSA / MARAJOARA / MARCIANOPOLIS / MARIAPOLIS (PADRE BERNARDO) / MARZAGAO / MATO GRANDE / MATRINCHA / MAURILANDIA / MEIA PONTE / MINACU / MINEIROS / MOIPORA / MONTE ALEGRE / MONTES CLAROS DE GOIAS / MONTIVIDIU T / MORRINHOS / MORRO AGUDO / MOSSAMEDES / MOZARLANDIA / MOZARLANDIA (TRANSMISSAO) / MUNDO NOVO DE GOIAS / MUTUNOPOLIS / NAVESLANDIA ( JATAI ) / NAZARIO / NEROPOLIS / NIQUELANDIA / NOVA AMERICA / NOVA AURORA / NOVA CRIXAS (TRANSMISSAO) / NOVA IGUACU / NOVA PONTE / NOVA VENEZA / NOVO BRASIL / NOVO GAMA / NOVO PLANALTO / OLHOS DAGUA / OLOANA / ORIZONA / OURO VERDE DE GOIAS / OUVIDOR / PACAEMBU (NOVO GAMA) / PADRE BERNARDO / PALESTINA / PALMEIRAS / PALMEIRAS DE GOIAS / PALMELO / PALMINOPOLIS / PAMPLONA / PANAMA / PARANA / PARANAIBA / PARANAIGUARA / PARAUNA SE ALTA TENSAO / PARQUE DAS EMAS (MINEIROS) / PARQUE DAS NACOES / PEROLANDIA / PETROLINA / PILAR / PILOANDIA / PIRACANJUBA / PIRANHAS T / PIRENOPOLIS / PIRES BELO / PIRES DO RIO / PLANALTINA / PLANALTINA (TRANSMISSAO) / PLANALTO / PONTALINA / PORANGATU / PORTEIRAO / PORTELANDIA / POSSE / POSSELANDIA / PROFESSOR JAMIL / QUEBRA LINHA / QUIRINOPOLIS / REAL / RETIRO / GOIAS / RIO CLARO JATAI MONTIVIDIU / RIO DO PEIXE / RIO DOS BOIS (MAURILANDIA) / RIO PRETO / RIO QUENTE / RIO VERDE / RIO VERMELHO / RIVERLANDIA (RIO VERDE) / RUBIATABA / SANCLERLANDIA / SANTA BARBARA / SANTA FE DE GOIAS / SANTA HELENA / SANTA RITA DO ARAGUAIA / SANTA ROSA / SANTA ROSA DE GOIAS / SANTA ROSA DO MEIA PONTE / SANTA TEREZA DE GOIAS / SANTA TEREZINHA / SANTO ANTONIO DA BARRA / SANTO ANTONIO DE GOIAS / SANTO ANTONIO DO DESCOBERTO / SAO BARTOLOMEU / SAO DOMINGOS / SAO FRANCISCO DE GOIAS / SAO GABRIEL DE GOIAS / SAO JOAO D					
<b>Código do Decreto (Se Houver):</b>								
<b>Quantidade de Interrupções (Evento)</b>	8.641							
<b>Início 1ª Incidência (Data e Hora)</b>	02/01/2020 09:30:00							

			ALIANCA / SAO JOAO DA PARAUNA / SAO LUIZ DOS MONTES BELOS / SAO MIGUEL DO ARAGUAIA / SAO MIGUEL DO PASSA QUATRO / SAO SIMAO / SENADOR CANEDO TRANSMISSAO / SERRA AZUL (JATAI) / SERRA DE CALDAS / SERRA DO OURO / SERRANOPOLIS / SILVANIA / SOUZALANDIA / SUCURI / TAIOBA / TAQUARAL / TAQUARI / TEREZOPOLIS / TERRA VERMELHA / TRAJANOPOLIS (PADRE BERNARDO) / TRES BARRAS / TRES RANCHOS / TRINDADE / TUCUNARE / TURVANIA / TURVELANDIA / URU / URUACU / URUTAI / USINA DE ACUCAR DE GOIANESIA / USINA MAMBAI / VALPARAISO / VARJAO / VENDA SECA / VIANOPOLIS / VICENTINOPOLIS / VILA BOA / VILA CORUMBA / VILA PROPICIO / XAVANTES / XIXA / ZELANDIA / SANTANA / ALTO HORIZONTE / MINEIROS TRANSMISSAO
<b>Início Última Incidência (Data e Hora)</b>	07/01/2020 08:58:00		
<b>Média de Duração das Incidências (h)</b>	7,84		
<b>Duração da Incidência mais longa (h)</b>	90,90		
<b>Total de Clientes afetados</b>	487.263	<b>Municípios Atingidos</b>	ABADIA DE GOIAS / ABADIANIA / ACREUNA / ADELANDIA / AGUA FRIA DE GOIAS / AGUA LIMPA / AGUAS LINDAS DE GOIAS / ALEXANIA / ALOANDIA / ALTO HORIZONTE / ALTO PARAISO DE GOIAS / ALVORADA DO NORTE / AMARALINA / AMERICANO DO BRASIL / AMORINOPOLIS / ANAPOLIS / ANICUNS / APARECIDA DE GOIANIA / APARECIDA DO RIO DOCE / APORE / ARACU / ARAGARCAS / ARAGOIANIA / ARAGUAPAZ / ARENOPOLIS / ARUANA / AURILANDIA / AVELINOPOLIS / BALIZA / BARRO ALTO / BELA VISTA DE GOIAS / BOM JARDIM DE GOIAS / BOM JESUS DE GOIAS / BONFINOPOLIS / BONOPOLIS / BRAZABRANTES / BRITANIA / BURITI ALEGRE / BURITI DE GOIAS / BURITINOPOLIS / CABECEIRAS / CACHOEIRA ALTA / CACHOEIRA DE GOIAS / CACHOEIRA DOURADA / CACU / CAIAPONIA / CALDAS NOVAS / CALDAZINHA / CAMPESTRE DE GOIAS / CAMPINACU / CAMPINORTE / CAMPO ALEGRE DE GOIAS / CAMPO LIMPO / CAMPOS BELOS / CAMPOS VERDES / CARMO DO RIO VERDE / CASTELANDIA / CATALAO / CATURAI / CAVALCANTE / CERES / CEZARINA / CHAPADAO DO CEU / CIDADE OCIDENTAL / COCALZINHO DE GOIAS / COLINAS DO SUL / CORREGO DO OURO / CORUMBA DE GOIAS / CORUMBAIBA / CRISTALINA / CRISTIANOPOLIS / CRIXAS / CROMINIA / CUMARI / DAMIANOPOLIS / DAMOLANDIA / DAVINOPOLIS / DIORAMA / DISTRITO FEDERAL / DIVINOPOLIS DE GOIAS / DOVERLANDIA / EDEALINA / EDEIA / ESTRELA DO NORTE / FAINA / FAZENDA NOVA / FIRMINOPOLIS / FLORES DE GOIAS / FORMOSA / FORMOSO / GAMELEIRA DE GOIAS / GOIANAPOLIS / GOIANDIRA / GOIANESIA / GOIANIA / GOIANIRA / GOIAS / GOIATUBA / GOUVELANDIA / GUAPO / GUARAITA / GUARANI DE GOIAS / GUARINOS / HEITORAI / HIDROLANDIA / HIDROLINA / IACIARA / INACIOLANDIA / INDIARA / INHUMAS / IPAMERI / IPIRANGA DE GOIAS / IPORA / ISRAELANDIA / ITABERAI / ITAGUARI / ITAGUARU / ITAJA / ITAPACI / ITAPIRAPUA / ITAPURANGA / ITARUMA / ITAUCU / ITUMBIARA / IVOLANDIA / JANDAIA / JARAGUA / JATAI / JAUPACI / JOVIANIA / JUSSARA / LAGOA SANTA / LEOPOLDO DE BULHOES / LUZIANIA / MAIRIPOTABA / MAMBAI / MARA ROSA / MARZAGAO / MATRINCHA / MAURILANDIA / MIMOSO DE GOIAS / MINACU / MINEIROS / MOIPORA / MONTE ALEGRE DE GOIAS / MONTES CLAROS DE GOIAS / MONTIVIDIU / MONTIVIDIU DO NORTE / MORRINHOS / MORRO AGUDO DE GOIAS / MOSSAMEDES / MOZARLANDIA / MUNDO NOVO DE GOIAS / MUTUNOPOLIS / NAZARIO / NEROPOLIS / NIQUELANDIA / NOVA AMERICA / NOVA AURORA / NOVA CRIXAS / NOVA GLORIA / NOVA IGUACU DE GOIAS / NOVA ROMA / NOVA VENEZA / NOVO BRASIL / NOVO GAMA / NOVO PLANALTO / ORIZONA / OURO VERDE DE GOIAS / OUIDOR / PADRE BERNARDO / PALESTINA DE GOIAS / PALMEIRAS DE GOIAS / PALMELO / PALMINOPOLIS / PANAMA / PARANAIGUARA / PARAUNA / PEROLANDIA / PETROLINA DE GOIAS / PILAR DE GOIAS / PIRACANJUBA / PIRANHAS / PIRENOPOLIS / PIRES DO RIO / PLANALTINA / PONTALINA / PORANGATU / PORTEIRAO / PORTELANDIA / POSSE / PROFESSOR JAMIL SAFADY / QUIRINOPOLIS / RIO QUENTE / RIO VERDE / RUBIATABA / SANCLERLANDIA / SANTA BARBARA DE GOIAS / SANTA CRUZ DE GOIAS / SANTA FE DE GOIAS / SANTA HELENA DE GOIAS / SANTA ISABEL / SANTA RITA DO ARAGUAIA / SANTA RITA DO NOVO DESTINO / SANTA ROSA DE GOIAS / SANTA TEREZA DE GOIAS / SANTA TEREZINHA DE GOIAS / SANTO ANTONIO DA BARRA / SANTO ANTONIO DE GOIAS / SANTO ANTONIO DO DESCOBERTO / SAO DOMINGOS / SAO FRANCISCO DE GOIAS / SAO JOAO D ALIANCA / SAO JOAO DA PARAUNA / SAO LUIS DE MONTES BELOS / SAO LUIZ DO NORTE / SAO MIGUEL DO ARAGUAIA / SAO MIGUEL DO PASSA QUATRO / SAO PATRICIO / SAO SIMAO / SENADOR CANEDO / SERRANOPOLIS / SILVANIA / SIMOLANDIA / SITIO D ABADIA / TAQUARAL DE GOIAS / TERESINA DE GOIAS / TEREZOPOLIS DE GOIAS / TRES RANCHOS / TRINDADE / TROMBAS / TURVANIA / TURVELANDIA / UIRAPURU / URUACU / URUANA / URUTAI / VALPARAISO DE GOIAS / VARJAO / VIANOPOLIS / VICENTINOPOLIS / VILA BOA / VILA PROPICIO

DANOS CAUSADOS			
Equipamentos Danificado	Importância para o Sistema	Local	Quantidade
Disjuntor/Religador Operado	Proteção do Alimentador	Área de Concessão	131
Chaves Fusíveis Operada	Proteção de Ramais de Alimentadores	Área de Concessão	2.642
Transformador Operado	Proteção do Transformador	Área de Concessão	2.005

Relato técnico sobre a Intervenção realizada em Goiânia e Região Metropolitana							
Informações sobre Equipes	02/01	03/01	04/01	05/01	06/01	07/01	
Quantidade Usual	738	738	738	738	738	738	turmas
Quantidade Adicional	47	31	0	0	65	47	turmas
Quantidade Total	785	769	675	629	803	785	turmas
Tempos Médios							
Preparação	4,01	4,65	6,09	5,79	4,58	4,11	Horas
Deslocamento	0,88	0,87	0,87	0,86	0,79	0,78	Horas
Execução	1,15	1,07	1,12	1,00	1,03	1,03	Horas
TMAE	6,04	6,59	8,08	7,65	6,40	5,92	Horas

### Principais Dificuldades Encontradas:

Chuvas com ventos fortes provocaram muitos pontos de alagamento e enxurrada, trânsito impedido por vários semáforos desligados dificultando a chegada ao atendimento das ocorrências emergenciais. Em determinadas regiões, decorrente dos fortes ventos, houve o tombamento de árvores nas estruturas de alimentação de média tensão, danos em ramais de ligação dos clientes, impedimentos de acesso e atolamentos em estradas rurais.

Empresa	ENEL DISTRIBUIÇÃO GOIAS		
Valor CHI (Limite e Real)	<b>482.391,86</b>		<b>1.316.254,62</b>



DOC ORIGEM	MIUNICIPIO	EQP_ORIGEM	CONJUNTO	INI_OCORRENC	FIM_OCORRENC	DT_INI_EVENTO	DT_FIM_EVENTO	DURAÇ	UC INT	CHI	EXPURGO
2020013846	BOM JARDIM DE GOIAS	BM12260019	BOM JARDIM	02/01/2020 12:43	03/01/2020 12:56	02/01/2020 12:43	03/01/2020 12:56	24,21	4	96,84	CHI
2020014782	JUSSARA	01050424	JUSSARA	02/01/2020 09:58	02/01/2020 16:59	02/01/2020 09:58	02/01/2020 12:25	2,44	24	58,61	CHI
2020014782	FAZENDA NOVA	JR13080950	JUSSARA	02/01/2020 09:58	02/01/2020 16:59	02/01/2020 09:58	02/01/2020 12:35	2,61	6	15,63	CHI
2020014782	JUSSARA	JR13080950	JUSSARA	02/01/2020 09:58	02/01/2020 16:59	02/01/2020 09:58	02/01/2020 12:35	2,61	152	396,00	CHI
2020014782	SANTA FE DE GOIAS	JR13080950	JUSSARA	02/01/2020 09:58	02/01/2020 16:59	02/01/2020 09:58	02/01/2020 12:35	2,61	5	13,03	CHI
2020014782	SANTA FE DE GOIAS	RN13259917	JUSSARA	02/01/2020 09:58	02/01/2020 16:59	02/01/2020 09:58	02/01/2020 16:09	6,18	22	136,03	CHI
2020014782	SANTA FE DE GOIAS	RN13378855	JUSSARA	02/01/2020 09:58	02/01/2020 16:59	02/01/2020 09:58	02/01/2020 16:59	7,01	1	7,01	CHI
2020014782	FAZENDA NOVA	01650424	BRITANIA	02/01/2020 09:58	02/01/2020 16:59	02/01/2020 16:52	02/01/2020 16:59	0,13	209	26,13	CHI
2020014782	JAUPACI	01650424	BRITANIA	02/01/2020 09:58	02/01/2020 16:59	02/01/2020 16:52	02/01/2020 16:59	0,13	2	0,25	CHI
2020014782	JUSSARA	01650424	BRITANIA	02/01/2020 09:58	02/01/2020 16:59	02/01/2020 16:52	02/01/2020 16:59	0,13	323	40,38	CHI
2020014782	JUSSARA	01650424	BRITANIA	02/01/2020 09:58	02/01/2020 16:59	02/01/2020 16:52	02/01/2020 16:59	0,13	12	1,50	CHI
2020014782	SANTA FE DE GOIAS	01650424	BRITANIA	02/01/2020 09:58	02/01/2020 16:59	02/01/2020 16:52	02/01/2020 16:59	0,13	411	51,38	CHI
2020014782	SANTA FE DE GOIAS	01650424	BRITANIA	02/01/2020 09:58	02/01/2020 16:59	02/01/2020 16:52	02/01/2020 16:59	0,13	1679	209,88	CHI
2020016139	CALDAS NOVAS	CN12363792	SERRA DE CALDAS	02/01/2020 11:37	02/01/2020 14:02	02/01/2020 11:37	02/01/2020 14:02	2,42	126	304,33	CHI
2020016244	SANTO ANTONIO DA BARRA	BZ21200051	ACREUNA	02/01/2020 12:39	02/01/2020 20:37	02/01/2020 12:39	02/01/2020 20:37	7,96	1	7,96	CHI
2020016477	JATAI	JT12109029	JATAI S1	02/01/2020 09:30	02/01/2020 16:20	02/01/2020 09:30	02/01/2020 16:20	6,83	28	191,33	CHI
2020016479	AMORINOPOLIS	1240008720	IPORA	02/01/2020 09:30	02/01/2020 13:43	02/01/2020 09:30	02/01/2020 13:43	4,22	1	4,22	CHI
2020016481	PALMEIRAS DE GOIAS	PL11276969	PALMEIRAS	02/01/2020 09:30	02/01/2020 10:38	02/01/2020 09:30	02/01/2020 10:38	1,12	1	1,12	CHI
2020016504	APARECIDA DO RIO DOCE	AW21296519	CACHOEIRA ALTA	02/01/2020 09:36	02/01/2020 15:00	02/01/2020 09:36	02/01/2020 15:00	5,40	1	5,40	CHI
2020016506	CHAPADAO DO CEU	DJ11223661	CHAPADAO DO CEU	02/01/2020 09:37	02/01/2020 11:22	02/01/2020 09:37	02/01/2020 11:22	1,75	1	1,75	CHI
2020016511	RIO VERDE	RV21301035	CABRIUVA S2	02/01/2020 09:38	02/01/2020 15:00	02/01/2020 09:38	02/01/2020 15:00	5,37	1	5,37	CHI
2020016519	ITARUMA	IM21198077	CACHOEIRA ALTA	02/01/2020 09:39	02/01/2020 13:05	02/01/2020 09:39	02/01/2020 13:05	3,42	1	3,42	CHI
2020016522	PORANGATU	PO12192371	PORANGATU	02/01/2020 09:40	02/01/2020 14:23	02/01/2020 09:40	02/01/2020 14:23	4,72	12	56,60	CHI
2020016530	CRIXAS	CX21266642	SERRA DO OURO	02/01/2020 09:41	02/01/2020 16:30	02/01/2020 09:41	02/01/2020 16:30	6,82	1	6,82	CHI
2020016531	SANTO ANTONIO DA BARRA	BZ21303295	ACREUNA	02/01/2020 09:41	02/01/2020 15:08	02/01/2020 09:41	02/01/2020 15:08	5,44	1	5,44	CHI
2020016536	JATAI	290287030	JATAI S2	02/01/2020 09:42	02/01/2020 11:24	02/01/2020 09:42	02/01/2020 11:24	1,69	1	1,69	CHI
2020016550	ITARUMA	IM12239506	CACHOEIRA ALTA	02/01/2020 09:44	02/01/2020 15:35	02/01/2020 09:44	02/01/2020 15:35	5,84	2	11,67	CHI
2020016555	URUACU	UR12398066	CAMPINORTE	02/01/2020 09:45	02/01/2020 12:21	02/01/2020 09:45	02/01/2020 12:21	2,60	6	15,57	CHI
2020016573	RIO VERDE	BZ21371529	ACREUNA	02/01/2020 09:47	03/01/2020 08:59	02/01/2020 09:47	03/01/2020 08:59	23,20	6	139,18	CHI
2020016579	PARAUNA	PU12332611	PARAUNA	02/01/2020 09:47	02/01/2020 16:50	02/01/2020 09:47	02/01/2020 16:50	7,05	6	42,28	CHI
2020016588	JATAI	JT12182138	JATAI S1	02/01/2020 09:49	02/01/2020 12:55	02/01/2020 09:49	02/01/2020 12:55	3,11	10	31,10	CHI
2020016601	PARAUNA	PU12299203	FIRMINOPOLIS S2	02/01/2020 09:51	02/01/2020 16:13	02/01/2020 09:51	02/01/2020 16:13	6,36	3	19,09	CHI

2020016612	SANTA FE DE GOIAS	RN12089667	BRITANIA	02/01/2020 09:46	03/01/2020 11:17	02/01/2020 09:46	03/01/2020 11:17	25,51	1	25,51	CHI
2020016616	TURVELANDIA	TD21326928	RIO DOS BOIS	02/01/2020 09:53	02/01/2020 12:56	02/01/2020 09:53	02/01/2020 12:56	3,05	4	12,18	CHI
2020016621	JANDAIA	JD21102063	PALMEIRAS	02/01/2020 09:54	02/01/2020 14:32	02/01/2020 09:54	02/01/2020 14:32	4,63	1	4,63	CHI
2020016622	MARA ROSA	MQ21251032	SANTA TEREZINHA	02/01/2020 09:54	02/01/2020 23:23	02/01/2020 09:54	02/01/2020 23:23	13,48	1	13,48	CHI
2020016623	JATAI	JT21104408	JATAI S3	02/01/2020 09:54	02/01/2020 12:49	02/01/2020 09:54	02/01/2020 12:49	2,91	1	2,91	CHI
2020016626	SANTA TEREZINHA DE GOIAS	2480031713	SANTA TEREZINHA	02/01/2020 09:54	02/01/2020 15:36	02/01/2020 09:54	02/01/2020 15:36	5,70	1	5,70	CHI
2020016659	CAMPINORTE	CR12101039	CAMPINORTE	02/01/2020 09:59	02/01/2020 11:46	02/01/2020 09:59	02/01/2020 11:46	1,78	3	5,34	CHI
2020016666	URUACU	UR12317135	URUACU	02/01/2020 10:00	02/01/2020 13:15	02/01/2020 10:00	02/01/2020 13:15	3,25	11	35,70	CHI
2020016667	JUSSARA	JR13292768	BRITANIA	02/01/2020 10:01	03/01/2020 16:01	03/01/2020 12:51	03/01/2020 16:00	3,15	4	12,60	CHI
2020016667	JUSSARA	JR21101100	BRITANIA	02/01/2020 10:01	03/01/2020 16:01	02/01/2020 10:01	03/01/2020 16:01	30,00	1	30,00	CHI
2020016677	SANTA TEREZA DE GOIAS	2430016893	MARA ROSA	02/01/2020 10:02	02/01/2020 14:38	02/01/2020 10:02	02/01/2020 14:38	4,60	1	4,60	CHI
2020016680	MONTIVIDIU	MV12267613	MONTIVIDIU T	02/01/2020 10:03	02/01/2020 15:18	02/01/2020 10:03	02/01/2020 15:18	5,24	4	20,95	CHI
2020016685	MORRO AGUDO DE GOIAS	MS12331530	ITAPURANGA	02/01/2020 10:03	03/01/2020 10:40	02/01/2020 10:03	03/01/2020 10:40	24,62	1	24,62	CHI
2020016686	DIORAMA	DI12245747	IPORA	02/01/2020 10:04	03/01/2020 12:57	02/01/2020 10:04	03/01/2020 12:57	26,90	1	26,90	CHI
2020016693	FIRMINOPOLIS	FR12186311	FIRMINOPOLIS S1	02/01/2020 10:05	02/01/2020 12:04	02/01/2020 10:05	02/01/2020 12:04	1,97	3	5,91	CHI
2020016700	TURVELANDIA	TD31191571	IPEGUARI	02/01/2020 10:07	02/01/2020 18:35	02/01/2020 10:07	02/01/2020 18:35	8,47	3	25,40	CHI
2020016702	UIRAPURU	UP12287175	SANTA TEREZINHA	02/01/2020 10:07	02/01/2020 16:46	02/01/2020 10:07	02/01/2020 16:46	6,64	2	13,28	CHI
2020016706	RIO VERDE	RV12296252	MONTIVIDIU T	02/01/2020 10:07	02/01/2020 11:20	02/01/2020 10:07	02/01/2020 11:20	1,20	1	1,20	CHI
2020016708	JANDAIA	1180029220	PALMEIRAS	02/01/2020 10:08	02/01/2020 15:54	02/01/2020 10:08	02/01/2020 15:54	5,76	1	5,76	CHI
2020016727	PORANGATU	PO12100811	PORANGATU	02/01/2020 09:39	02/01/2020 18:04	02/01/2020 09:39	02/01/2020 18:04	8,42	2	16,83	CHI
2020016732	QUIRINOPOLIS	QI21292359	QUIRINOPOLIS	02/01/2020 10:12	02/01/2020 14:58	02/01/2020 10:12	02/01/2020 14:58	4,76	1	4,76	CHI
2020016738	AURILANDIA	CG12391526	FIRMINOPOLIS S2	02/01/2020 10:13	02/01/2020 17:03	02/01/2020 10:13	02/01/2020 17:03	6,84	2	13,67	CHI
2020016738	CACHOEIRA DE GOIAS	CG12391526	FIRMINOPOLIS S2	02/01/2020 10:13	02/01/2020 17:03	02/01/2020 10:13	02/01/2020 17:03	6,84	11	75,21	CHI
2020016738	PARAUNA	CG12391526	FIRMINOPOLIS S2	02/01/2020 10:13	02/01/2020 17:03	02/01/2020 10:13	02/01/2020 17:03	6,84	32	218,78	CHI
2020016748	NIQUELANDIA	NQ12317684	NIQUELANDIA SUBTRANSMISSAO	02/01/2020 10:14	02/01/2020 14:00	02/01/2020 10:14	02/01/2020 14:00	3,76	1	3,76	CHI
2020016762	MINACU	IH21345561	MINACU	02/01/2020 10:17	02/01/2020 11:40	02/01/2020 10:17	02/01/2020 11:40	1,37	1	1,37	CHI
2020016770	RUBIATABA	RB21405365	RUBIATABA	02/01/2020 10:20	02/01/2020 14:42	02/01/2020 10:20	02/01/2020 14:42	4,37	1	4,37	CHI
2020016772	ARAGARCAS	BM12204862	IPORA	02/01/2020 10:20	02/01/2020 15:10	02/01/2020 10:20	02/01/2020 15:10	4,83	2	9,66	CHI
2020016777	ARAGARCAS	AG21223133	ARAGARCAS	02/01/2020 10:21	02/01/2020 14:11	02/01/2020 10:21	02/01/2020 14:11	3,83	1	3,83	CHI
2020016787	SANCLERLANDIA	SC21157800	FIRMINOPOLIS S2	02/01/2020 10:22	02/01/2020 11:48	02/01/2020 10:22	02/01/2020 11:48	1,42	1	1,42	CHI
2020016789	ITAJA	IJ21249677	ITAJA S2	02/01/2020 10:21	02/01/2020 16:01	02/01/2020 10:21	02/01/2020 16:01	5,65	1	5,65	CHI
2020016852	CRIXAS	CX12136473	SANTA TEREZINHA	02/01/2020 11:55	02/01/2020 23:43	02/01/2020 16:53	02/01/2020 23:43	6,83	9	61,51	CHI
2020016871	PONTALINA	VI10400585	VICENTINOPOLIS	02/01/2020 12:35	02/01/2020 17:49	02/01/2020 12:37	02/01/2020 15:35	2,97	176	523,36	CHI

2020016871	PONTALINA	VI10400585	VICENTINOPOLIS	02/01/2020 12:35	02/01/2020 17:49	02/01/2020 12:37	02/01/2020 15:35	2,97	14	41,63	CHI
2020016871	VICENTINOPOLIS	VI10400585	VICENTINOPOLIS	02/01/2020 12:35	02/01/2020 17:49	02/01/2020 12:37	02/01/2020 15:35	2,97	13	38,66	CHI
2020016871	VICENTINOPOLIS	VI10400585	VICENTINOPOLIS	02/01/2020 12:35	02/01/2020 17:49	02/01/2020 12:37	02/01/2020 15:35	2,97	2	5,95	CHI
2020016871	PONTALINA	VI10400585	VICENTINOPOLIS	02/01/2020 12:35	02/01/2020 17:49	02/01/2020 15:36	02/01/2020 16:27	0,86	5	4,29	CHI
2020016871	VICENTINOPOLIS	VI10400585	VICENTINOPOLIS	02/01/2020 12:35	02/01/2020 17:49	02/01/2020 15:36	02/01/2020 16:27	0,86	2	1,72	CHI
2020016871	PONTALINA	VI13157335	VICENTINOPOLIS	02/01/2020 12:35	02/01/2020 17:49	02/01/2020 12:37	02/01/2020 17:49	5,19	1	5,19	CHI
2020016871	PONTALINA	VI10400585	VICENTINOPOLIS	02/01/2020 12:35	02/01/2020 17:49	02/01/2020 15:36	02/01/2020 17:49	2,21	176	389,11	CHI
2020016871	PONTALINA	VI13157335	VICENTINOPOLIS	02/01/2020 12:35	02/01/2020 17:49	02/01/2020 15:36	02/01/2020 17:49	2,21	9	19,90	CHI
2020016871	VICENTINOPOLIS	VI10400585	VICENTINOPOLIS	02/01/2020 12:35	02/01/2020 17:49	02/01/2020 15:36	02/01/2020 17:49	2,21	13	28,74	CHI
2020016878	GOIANIA	GN11150420	XAVANTES	02/01/2020 13:06	02/01/2020 14:54	02/01/2020 13:06	02/01/2020 14:54	1,79	129	231,55	CHI
2020016903	MINACU	IH12236222	MINACU	02/01/2020 10:24	02/01/2020 16:05	02/01/2020 10:24	02/01/2020 16:05	5,68	19	107,85	CHI
2020016912	FAZENDA NOVA	FN21238184	IPORA	02/01/2020 10:25	03/01/2020 04:29	02/01/2020 10:25	03/01/2020 04:29	18,05	1	18,05	CHI
2020016934	ARUANA	AK11264955	ARUANA	02/01/2020 10:29	02/01/2020 13:04	02/01/2020 10:29	02/01/2020 13:04	2,57	108	277,80	CHI
2020016942	IACIARA	IA12046295	IACIARA S2	02/01/2020 10:30	03/01/2020 03:29	02/01/2020 10:30	02/01/2020 18:44	8,22	16	131,59	CHI
2020016942	FLORES DE GOIAS	IA12218804LD	IACIARA S2	02/01/2020 10:30	03/01/2020 03:29	02/01/2020 10:30	03/01/2020 03:29	16,98	1	16,98	CHI
2020016942	IACIARA	IA12218804LD	IACIARA S2	02/01/2020 10:30	03/01/2020 03:29	02/01/2020 10:30	03/01/2020 03:29	16,98	73	1239,66	CHI
2020016944	CATALAO	CT11061205	CATALAO S1	02/01/2020 10:31	02/01/2020 15:56	02/01/2020 10:31	02/01/2020 15:56	5,42	124	672,32	CHI
2020016947	SANTA FE DE GOIAS	RN21142926	BRITANIA	02/01/2020 10:31	02/01/2020 19:48	02/01/2020 10:31	02/01/2020 19:48	9,27	1	9,27	CHI
2020016949	MORRO AGUDO DE GOIAS	MS12335823	ITAPURANGA	02/01/2020 10:31	02/01/2020 17:13	02/01/2020 10:31	02/01/2020 17:13	6,70	2	13,39	CHI
2020016967	MUNDO NOVO DE GOIAS	10018471305	NOVA CRIXAS	02/01/2020 10:34	03/01/2020 07:34	02/01/2020 10:34	03/01/2020 07:34	21,00	1	21,00	CHI
2020016969	PIRES DO RIO	PR21286424	PIRES DO RIO S1	02/01/2020 10:34	02/01/2020 17:02	02/01/2020 10:34	02/01/2020 17:02	6,46	2	12,92	CHI
2020016971	IPAMERI	IP21287977	IPAMERI	02/01/2020 10:34	02/01/2020 18:56	02/01/2020 10:34	02/01/2020 18:56	8,35	1	8,35	CHI
2020016973	MINEIROS	1390095992	PARQUE DAS EMAS	02/01/2020 10:35	02/01/2020 16:47	02/01/2020 10:35	02/01/2020 16:47	6,19	1	6,19	CHI
2020016977	JATAI	JT21101411	JATAI S1	02/01/2020 10:36	02/01/2020 12:03	02/01/2020 10:36	02/01/2020 12:03	1,44	1	1,44	CHI
2020016978	RIO VERDE	630059445	RIO VERDE S1	02/01/2020 10:36	02/01/2020 15:45	02/01/2020 10:36	02/01/2020 15:45	5,16	1	5,16	CHI
2020016982	MORRINHOS	MR12333296	GOIATUBA S1	02/01/2020 10:37	02/01/2020 13:56	02/01/2020 10:37	02/01/2020 13:56	3,32	2	6,63	CHI
2020016995	CALDAS NOVAS	760040473	SERRA DE CALDAS	02/01/2020 10:40	02/01/2020 15:20	02/01/2020 10:40	02/01/2020 15:20	4,66	1	4,66	CHI
2020017002	DOVERLANDIA	DV12259940	CAIAPONIA	02/01/2020 10:42	02/01/2020 17:00	02/01/2020 10:42	02/01/2020 17:00	6,30	2	12,60	CHI
2020017026	MORRINHOS	MR12035104	GOIATUBA S1	02/01/2020 10:46	02/01/2020 17:00	02/01/2020 10:46	02/01/2020 17:00	6,23	4	24,92	CHI
2020017030	PORANGATU	PO21217375	PORANGATU	02/01/2020 10:47	02/01/2020 18:38	02/01/2020 10:47	02/01/2020 18:38	7,85	1	7,85	CHI
2020017032	MUNDO NOVO DE GOIAS	MH12269469	NOVA CRIXAS	02/01/2020 10:29	02/01/2020 13:14	02/01/2020 10:29	02/01/2020 13:14	2,74	3	8,21	CHI
2020017035	ACREUNA	TD12025737	RIO DOS BOIS	02/01/2020 10:48	02/01/2020 13:05	02/01/2020 10:48	02/01/2020 13:05	2,29	24	54,98	CHI
2020017035	SANTA HELENA DE GOIAS	TD12025737	RIO DOS BOIS	02/01/2020 10:48	02/01/2020 13:05	02/01/2020 10:48	02/01/2020 13:05	2,29	18	41,23	CHI

2020017035	TURVELANDIA	TD12025737	RIO DOS BOIS	02/01/2020 10:48	02/01/2020 13:05	02/01/2020 10:48	02/01/2020 13:05	2,29	66	151,19	CHI
2020017050	MARA ROSA	MQ12391677	MARA ROSA	02/01/2020 10:49	02/01/2020 16:13	02/01/2020 10:49	02/01/2020 16:13	5,40	2	10,79	CHI
2020017056	ITAGUARI	770003710	ITABERAI S1	02/01/2020 10:50	02/01/2020 14:27	02/01/2020 10:50	02/01/2020 14:27	3,62	1	3,62	CHI
2020017061	DOVERLANDIA	DV12139934	CAIAPONIA	02/01/2020 09:43	02/01/2020 21:18	02/01/2020 09:43	02/01/2020 21:18	11,58	4	46,30	CHI
2020017062	BOM JARDIM DE GOIAS	BM12208863	BOM JARDIM	02/01/2020 10:13	02/01/2020 17:20	02/01/2020 10:13	02/01/2020 17:20	7,11	6	42,65	CHI
2020017068	PORANGATU	PO12202569	PORANGATU	02/01/2020 10:51	03/01/2020 01:56	02/01/2020 10:51	03/01/2020 01:56	15,08	7	105,54	CHI
2020017073	FAINA	MP12299729	MATRINCHA	02/01/2020 10:52	03/01/2020 11:10	02/01/2020 10:52	03/01/2020 11:10	24,29	2	48,58	CHI
2020017073	MATRINCHA	MP12299729	MATRINCHA	02/01/2020 10:52	03/01/2020 11:10	02/01/2020 10:52	03/01/2020 11:10	24,29	1	24,29	CHI
2020017075	CAMPINORTE	CR12375665	MARA ROSA	02/01/2020 10:52	02/01/2020 13:36	02/01/2020 10:52	02/01/2020 13:36	2,72	1	2,72	CHI
2020017076	ITABERAI	50074829	ITABERAI S2	02/01/2020 10:52	02/01/2020 17:50	02/01/2020 10:52	02/01/2020 17:50	6,96	1	6,96	CHI
2020017078	FAZENDA NOVA	FN12217148	JUSSARA	02/01/2020 10:42	02/01/2020 14:10	02/01/2020 10:42	02/01/2020 14:10	3,45	16	55,22	CHI
2020017084	MOIPIORA	MO12015679	IPORA	02/01/2020 10:53	02/01/2020 15:27	02/01/2020 10:53	02/01/2020 15:27	4,56	5	22,78	CHI
2020017085	NIQUELANDIA	10023556097	NIQUELANDIA SUBTRANSMISSAO	02/01/2020 10:53	03/01/2020 09:40	02/01/2020 10:53	03/01/2020 09:40	22,79	1	22,79	CHI
2020017097	INDIARA	IY21312431	EDEIA	02/01/2020 10:55	02/01/2020 12:08	02/01/2020 10:55	02/01/2020 12:08	1,20	1	1,20	CHI
2020017104	RIO VERDE	RV12260643	CABRIUVA S2	02/01/2020 10:49	02/01/2020 12:04	02/01/2020 10:49	02/01/2020 12:04	1,25	8	10,03	CHI
2020017106	QUIRINOPOLIS	QI21295722	QUIRINOPOLIS	02/01/2020 10:57	02/01/2020 15:22	02/01/2020 10:57	02/01/2020 15:22	4,41	1	4,41	CHI
2020017108	ADELANDIA	DN21259059	FIRMINOPOLIS S2	02/01/2020 10:57	02/01/2020 14:34	02/01/2020 10:57	02/01/2020 14:34	3,61	1	3,61	CHI
2020017119	VILA BOA	FB13082135	IACIARA S2	02/01/2020 11:00	03/01/2020 02:13	02/01/2020 22:39	03/01/2020 02:13	3,56	1	3,56	CHI
2020017119	FLORES DE GOIAS	01890424	IACIARA S2	02/01/2020 11:00	03/01/2020 02:13	03/01/2020 01:45	03/01/2020 02:13	0,45	284	128,35	CHI
2020017119	FORMOSA	01890424	IACIARA S2	02/01/2020 11:00	03/01/2020 02:13	03/01/2020 01:45	03/01/2020 02:13	0,45	1	0,45	CHI
2020017119	IACIARA	01890424	IACIARA S2	02/01/2020 11:00	03/01/2020 02:13	03/01/2020 01:45	03/01/2020 02:13	0,45	1	0,45	CHI
2020017119	VILA BOA	01890424	IACIARA S2	02/01/2020 11:00	03/01/2020 02:13	03/01/2020 01:45	03/01/2020 02:13	0,45	4	1,81	CHI
2020017121	IPAMERI	IP12355196	IPAMERI	02/01/2020 11:01	02/01/2020 14:25	02/01/2020 11:01	02/01/2020 14:25	3,40	1	3,40	CHI
2020017146	LUZIANIA	3200027007	MARAJOARA	02/01/2020 11:05	02/01/2020 12:16	02/01/2020 11:05	02/01/2020 12:16	1,17	1	1,17	CHI
2020017147	SANTA TEREZINHA DE GOIAS	SG11403157	SANTA TEREZINHA	02/01/2020 11:05	03/01/2020 04:04	02/01/2020 11:05	03/01/2020 04:04	16,97	1	16,97	CHI
2020017163	MONTES CLAROS DE GOIAS	ME21066174	IPORA	02/01/2020 11:10	02/01/2020 17:24	02/01/2020 11:10	02/01/2020 17:24	6,23	1	6,23	CHI
2020017164	VALPARAISO DE GOIAS	10007562959	PACAEMBU S1	02/01/2020 11:10	02/01/2020 12:18	02/01/2020 11:10	02/01/2020 12:18	1,13	1	1,13	CHI
2020017170	MUNDO NOVO DE GOIAS	MH11269063	NOVA CRIXAS	02/01/2020 11:12	02/01/2020 23:44	02/01/2020 11:12	02/01/2020 23:44	12,53	1	12,53	CHI
2020017172	PALMEIRAS DE GOIAS	PL21124661	ANICUNS	02/01/2020 11:12	02/01/2020 16:43	02/01/2020 11:12	02/01/2020 16:43	5,52	1	5,52	CHI
2020017175	BONOPOLIS	MU12394938	MARA ROSA	02/01/2020 17:10	02/01/2020 21:13	02/01/2020 17:10	02/01/2020 21:13	4,05	2	8,10	CHI
2020017175	PORANGATU	MU12394938	MARA ROSA	02/01/2020 17:10	02/01/2020 21:13	02/01/2020 17:10	02/01/2020 21:13	4,05	66	267,21	CHI
2020017175	AMARALINA	MU12394938	MARA ROSA	02/01/2020 17:10	02/01/2020 21:13	02/01/2020 17:10	02/01/2020 21:13	4,05	7	28,34	CHI
2020017175	MUTUNOPOLIS	MU12394938	MARA ROSA	02/01/2020 17:10	02/01/2020 21:13	02/01/2020 17:10	02/01/2020 21:13	4,05	14	56,68	CHI

2020017175	PORANGATU	MU12394938	MARA ROSA	02/01/2020 17:10	02/01/2020 21:13	02/01/2020 17:10	02/01/2020 21:13	4,05	9	36,43	CHI
2020017179	IPORA	730003670	IPORA	02/01/2020 11:12	02/01/2020 17:56	02/01/2020 11:12	02/01/2020 17:56	6,72	1	6,72	CHI
2020017187	BONOPOLIS	BX12079317	SAO MIGUEL DO ARAGUAIA	02/01/2020 09:36	03/01/2020 09:23	02/01/2020 09:36	03/01/2020 09:23	23,79	37	880,08	CHI
2020017191	JUSSARA	JR12364553	BRITANIA	02/01/2020 11:04	02/01/2020 18:51	02/01/2020 11:04	02/01/2020 18:51	7,78	18	140,07	CHI
2020017198	FORMOSO	TB12372648	PORANGATU	02/01/2020 11:08	02/01/2020 14:43	02/01/2020 11:08	02/01/2020 14:43	3,57	1	3,57	CHI
2020017198	TROMBAS	TB12372648	PORANGATU	02/01/2020 11:08	02/01/2020 14:43	02/01/2020 11:08	02/01/2020 14:43	3,57	66	235,68	CHI
2020017206	LUZIANIA	10007686593	MARAJOARA	02/01/2020 11:17	02/01/2020 14:44	02/01/2020 11:17	02/01/2020 14:44	3,44	1	3,44	CHI
2020017234	IPORA	730117662	IPORA	02/01/2020 11:20	02/01/2020 14:52	02/01/2020 11:20	02/01/2020 14:52	3,52	1	3,52	CHI
2020017244	BURITI DE GOIAS	BS21125253	FIRMINOPOLIS S2	02/01/2020 11:26	02/01/2020 13:18	02/01/2020 11:26	02/01/2020 13:18	1,86	1	1,86	CHI
2020017246	RIO VERDE	QI21150107	QUIRINOPOLIS	02/01/2020 11:26	02/01/2020 20:34	02/01/2020 11:26	02/01/2020 20:34	9,12	1	9,12	CHI
2020017250	BONOPOLIS	BX12103386	SAO MIGUEL DO ARAGUAIA	02/01/2020 11:27	03/01/2020 15:23	02/01/2020 11:27	03/01/2020 15:23	27,92	1	27,92	CHI
2020017251	FAZENDA NOVA	FN12250532	JUSSARA	02/01/2020 11:27	03/01/2020 11:20	02/01/2020 11:27	03/01/2020 11:20	23,88	11	262,72	CHI
2020017253	INACIOLANDIA	ID12128174	QUIRINOPOLIS	02/01/2020 11:26	02/01/2020 20:33	02/01/2020 11:26	02/01/2020 20:33	9,11	2	18,23	CHI
2020017255	GOIAS	GS12073673	MATRINCHA	02/01/2020 11:28	02/01/2020 13:03	02/01/2020 11:28	02/01/2020 13:03	1,58	10	15,78	CHI
2020017260	ITAPIRAPUA	IU21089745	MATRINCHA	02/01/2020 11:29	02/01/2020 22:55	02/01/2020 11:29	02/01/2020 22:55	11,43	1	11,43	CHI
2020017269	URUACU	UR21339047	URUACU	02/01/2020 11:31	02/01/2020 16:21	02/01/2020 11:31	02/01/2020 16:21	4,83	2	9,65	CHI
2020017273	GOIANDIRA	GD12127622	CATALAO S1	02/01/2020 11:32	02/01/2020 18:08	02/01/2020 11:32	02/01/2020 18:08	6,59	2	13,19	CHI
2020017276	NOVA CRIXAS	NA21087042	NOVA CRIXAS	02/01/2020 11:32	02/01/2020 15:20	02/01/2020 11:32	02/01/2020 15:20	3,79	1	3,79	CHI
2020017279	FORMOSO	FO12328885	PORANGATU	02/01/2020 11:19	02/01/2020 15:50	02/01/2020 11:19	02/01/2020 15:50	4,51	4	18,04	CHI
2020017279	SANTA TEREZA DE GOIAS	FO12328885	PORANGATU	02/01/2020 11:19	02/01/2020 15:50	02/01/2020 11:19	02/01/2020 15:50	4,51	12	54,13	CHI
2020017292	LUZIANIA	120362338	RIO VERMELHO	02/01/2020 11:35	02/01/2020 12:16	02/01/2020 11:35	02/01/2020 12:16	0,68	1	0,68	CHI
2020017300	SANTA CRUZ DE GOIAS	BC12311644	PIRES DO RIO S2	02/01/2020 11:20	02/01/2020 15:37	02/01/2020 11:20	02/01/2020 15:37	4,27	3	12,80	CHI
2020017301	SAO JOAO D ALIANCA	JL12261887	SAO JOAO D ALIANCA	02/01/2020 11:37	02/01/2020 14:10	02/01/2020 11:37	02/01/2020 14:10	2,54	5	12,68	CHI
2020017307	PILAR DE GOIAS	GG12405274	ITAPACI	02/01/2020 11:39	02/01/2020 16:47	02/01/2020 11:39	02/01/2020 16:47	5,13	16	82,07	CHI
2020017328	RIO VERDE	MV21305755	MONTIVIDIU T	02/01/2020 11:44	02/01/2020 17:59	02/01/2020 11:44	02/01/2020 17:59	6,24	1	6,24	CHI
2020017329	ITABERAI	IB21336444	ITABERAI S1	02/01/2020 11:44	02/01/2020 16:22	02/01/2020 11:44	02/01/2020 16:22	4,62	2	9,24	CHI
2020017341	GOUVELANDIA	GB21296592	QUIRINOPOLIS	02/01/2020 11:47	02/01/2020 15:31	02/01/2020 11:47	02/01/2020 15:31	3,72	1	3,72	CHI
2020017352	CAMPOS BELOS	CH21130008	SAO DOMINGOS	02/01/2020 11:51	02/01/2020 14:24	02/01/2020 11:51	02/01/2020 14:24	2,54	1	2,54	CHI
2020017363	GUARANI DE GOIAS	GY12267993	IACIARA S1	02/01/2020 10:36	02/01/2020 14:12	02/01/2020 10:36	02/01/2020 14:12	3,58	50	179,21	CHI
2020017368	SANTA HELENA DE GOIAS	SH12279544	IPEGUARI	02/01/2020 11:55	02/01/2020 19:49	02/01/2020 11:55	02/01/2020 19:49	7,89	2	15,78	CHI
2020017372	CATALAO	CT12209404	CATALAO S1	02/01/2020 10:41	02/01/2020 18:35	02/01/2020 10:41	02/01/2020 18:35	7,90	3	23,70	CHI
2020017373	PLANALTINA	2960164022	PLANALTINA	02/01/2020 11:56	02/01/2020 14:08	02/01/2020 11:56	02/01/2020 14:08	2,19	1	2,19	CHI
2020017382	CIDADE OCIDENTAL	2680034679	MARAJOARA	02/01/2020 11:58	02/01/2020 14:27	02/01/2020 11:58	02/01/2020 14:27	2,48	1	2,48	CHI

2020017394	MINACU	4020114305	MINACU	02/01/2020 12:00	02/01/2020 15:46	02/01/2020 12:00	02/01/2020 15:46	3,76	1	3,76	CHI
2020017395	SANCLERLANDIA	SC21217506	FIRMINOPOLIS S2	02/01/2020 12:00	02/01/2020 14:07	02/01/2020 12:00	02/01/2020 14:07	2,11	1	2,11	CHI
2020017398	QUIRINOPOLIS	Q12355062	QUIRINOPOLIS	02/01/2020 12:01	02/01/2020 14:00	02/01/2020 12:01	02/01/2020 14:00	1,97	44	86,80	CHI
2020017400	CIDADE OCIDENTAL	2680034667	MARAJOARA	02/01/2020 12:01	02/01/2020 13:51	02/01/2020 12:01	02/01/2020 13:51	1,82	1	1,82	CHI
2020017401	ARUANA	AK21353720	BRITANIA	02/01/2020 12:01	02/01/2020 13:53	02/01/2020 12:01	02/01/2020 13:53	1,85	1	1,85	CHI
2020017404	PORANGATU	PO12391930	PORANGATU	02/01/2020 10:38	02/01/2020 15:39	02/01/2020 10:38	02/01/2020 15:39	5,00	57	285,17	CHI
2020017406	SANTO ANTONIO DA BARRA	BZ12301373	ACREUNA	02/01/2020 12:03	02/01/2020 16:12	02/01/2020 12:03	02/01/2020 16:12	4,15	3	12,44	CHI
2020017407	CHAPADAO DO CEU	DJ12309002	CHAPADAO DO CEU	02/01/2020 12:03	02/01/2020 16:00	02/01/2020 12:03	02/01/2020 16:00	3,94	4	15,77	CHI
2020017410	BONOPOLIS	BX21115495	SAO MIGUEL DO ARAGUAIA	02/01/2020 12:05	03/01/2020 15:33	02/01/2020 12:05	03/01/2020 15:33	27,46	1	27,46	CHI
2020017412	CRIXAS	CX21253776	SERRA DO OURO	02/01/2020 12:06	02/01/2020 18:20	02/01/2020 12:06	02/01/2020 18:20	6,23	1	6,23	CHI
2020017415	PIRES DO RIO	460008729	PIRES DO RIO S1	02/01/2020 12:07	02/01/2020 17:41	02/01/2020 12:07	02/01/2020 17:41	5,56	1	5,56	CHI
2020017418	GOIANIA	12691460	GOIANIA LESTE S1	02/01/2020 12:07	02/01/2020 17:09	02/01/2020 12:07	02/01/2020 17:09	5,03	1	5,03	CHI
2020017420	CATALAO	CT12338694	CATALAO S1	02/01/2020 12:07	02/01/2020 20:38	02/01/2020 12:07	02/01/2020 20:38	8,51	25	212,63	CHI
2020017427	PALMEIRAS DE GOIAS	PL11252059	PALMEIRAS	02/01/2020 12:08	02/01/2020 15:15	02/01/2020 12:08	02/01/2020 15:15	3,10	100	310,11	CHI
2020017429	GUARANI DE GOIAS	GY21195859	SAO DOMINGOS	02/01/2020 12:09	02/01/2020 15:11	02/01/2020 12:09	02/01/2020 15:11	3,03	1	3,03	CHI
2020017430	CRISTALINA	KR21209628	CRISTALINA S2	02/01/2020 12:09	02/01/2020 13:27	02/01/2020 12:09	02/01/2020 13:27	1,29	1	1,29	CHI
2020017436	SENADOR CANEDO	10010772160	GOIANIA LESTE S2	02/01/2020 12:11	02/01/2020 17:46	02/01/2020 12:11	02/01/2020 17:46	5,58	1	5,58	CHI
2020017443	APARECIDA DE GOIANIA	14857091	INDEPENDENCIA S2	02/01/2020 12:12	02/01/2020 16:41	02/01/2020 12:12	02/01/2020 16:41	4,48	1	4,48	CHI
2020017444	GOIAS	GS12070348	GOIAS	02/01/2020 12:13	02/01/2020 12:32	02/01/2020 12:13	02/01/2020 12:32	0,32	6	1,90	CHI
2020017446	POSSE	PS21256266	IACIARA S2	02/01/2020 12:12	02/01/2020 19:05	02/01/2020 12:12	02/01/2020 19:05	6,87	1	6,87	CHI
2020017448	AMARALINA	LC21320725	MARA ROSA	02/01/2020 12:13	02/01/2020 19:04	02/01/2020 12:13	02/01/2020 19:04	6,84	1	6,84	CHI
2020017452	CALDAS NOVAS	CN12246666	SERRA DE CALDAS	02/01/2020 12:13	02/01/2020 18:09	02/01/2020 12:13	02/01/2020 18:09	5,93	26	154,24	CHI
2020017453	GOIANIA	11763644	XAVANTES	02/01/2020 12:13	02/01/2020 16:16	02/01/2020 12:13	02/01/2020 16:16	4,03	1	4,03	CHI
2020017454	IPORA	730024404	IPORA	02/01/2020 12:14	02/01/2020 16:15	02/01/2020 12:14	02/01/2020 16:15	4,02	1	4,02	CHI
2020017458	PIRACANJUBA	PJ11000004	PIRACANJUBA	02/01/2020 12:15	02/01/2020 19:10	02/01/2020 12:15	02/01/2020 19:10	6,92	71	491,14	CHI
2020017460	ARAGARCAS	BM12155745	BOM JARDIM	02/01/2020 10:51	02/01/2020 14:47	02/01/2020 10:51	02/01/2020 14:47	3,94	86	338,65	CHI
2020017460	BOM JARDIM DE GOIAS	BM12155745	BOM JARDIM	02/01/2020 10:51	02/01/2020 14:47	02/01/2020 10:51	02/01/2020 14:47	3,94	55	216,58	CHI
2020017462	ITUMBIARA	IT12222527	PARANAIBA	02/01/2020 12:16	02/01/2020 18:40	02/01/2020 12:16	02/01/2020 18:40	6,40	14	89,57	CHI
2020017467	PIRES DO RIO	PR11202883	PIRES DO RIO S1	02/01/2020 12:17	03/01/2020 10:44	02/01/2020 12:17	03/01/2020 10:44	22,43	27	605,74	CHI
2020017468	SENADOR CANEDO	10017951150	GOIANIA LESTE S1	02/01/2020 12:17	02/01/2020 16:33	02/01/2020 12:17	02/01/2020 16:33	4,25	1	4,25	CHI
2020017472	ARACU	AR12320408	ARACU	02/01/2020 12:18	02/01/2020 12:32	02/01/2020 12:18	02/01/2020 12:32	0,23	6	1,38	CHI
2020017472	ITAUCU	AR12320408	ARACU	02/01/2020 12:18	02/01/2020 12:32	02/01/2020 12:18	02/01/2020 12:32	0,23	1	0,23	CHI
2020017474	CATALAO	1990196023	CATALAO S2	02/01/2020 12:19	02/01/2020 16:18	02/01/2020 12:19	02/01/2020 16:18	3,98	1	3,98	CHI

2020017483	AMARALINA	ET12000004	MARA ROSA	02/01/2020 12:12	02/01/2020 14:10	02/01/2020 12:12	02/01/2020 14:10	1,95	6	11,72	CHI
2020017483	MUTUNOPOLIS	ET12000004	MARA ROSA	02/01/2020 12:12	02/01/2020 14:10	02/01/2020 12:12	02/01/2020 14:10	1,95	3	5,86	CHI
2020017491	CATALAO	CY12064048	CATALAO S2	02/01/2020 12:22	02/01/2020 16:40	02/01/2020 12:22	02/01/2020 16:40	4,29	2	8,57	CHI
2020017491	CUMARI	CY12064048	CATALAO S2	02/01/2020 12:22	02/01/2020 16:40	02/01/2020 12:22	02/01/2020 16:40	4,29	3	12,86	CHI
2020017496	VALPARAISO DE GOIAS	3350051532	PACAEMBU S1	02/01/2020 12:25	02/01/2020 17:56	02/01/2020 12:25	02/01/2020 17:56	5,50	1	5,50	CHI
2020017498	CRISTALINA	KR13342495	CRISTALINA S2	02/01/2020 11:08	03/01/2020 16:38	02/01/2020 11:08	02/01/2020 16:31	5,38	3	16,14	CHI
2020017498	CRISTALINA	KR12087952	CRISTALINA S2	02/01/2020 11:08	03/01/2020 16:38	02/01/2020 11:08	03/01/2020 12:33	25,41	29	736,87	CHI
2020017498	CRISTALINA	KR12087952	CRISTALINA S2	02/01/2020 11:08	03/01/2020 16:38	02/01/2020 11:08	03/01/2020 14:58	27,82	2	55,65	CHI
2020017498	CRISTALINA	KR12087952	CRISTALINA S2	02/01/2020 11:08	03/01/2020 16:38	02/01/2020 11:08	03/01/2020 15:58	28,83	1	28,83	CHI
2020017498	CRISTALINA	KR12087952	CRISTALINA S2	02/01/2020 11:08	03/01/2020 16:38	02/01/2020 11:08	03/01/2020 16:38	29,50	1	29,50	CHI
2020017508	CAMPO ALEGRE DE GOIAS	CM21127611	CAMPO ALEGRE DE GOIAS	02/01/2020 12:28	02/01/2020 14:00	02/01/2020 12:28	02/01/2020 14:00	1,53	3	4,58	CHI
2020017512	CATALAO	CT12077605	CATALAO S1	02/01/2020 12:29	02/01/2020 18:41	02/01/2020 12:29	02/01/2020 18:41	6,20	9	55,78	CHI
2020017517	CALDAS NOVAS	760416618	SERRA DE CALDAS	02/01/2020 12:29	02/01/2020 18:47	02/01/2020 12:29	02/01/2020 18:47	6,29	1	6,29	CHI
2020017521	NOVO GAMA	4990063170	PACAEMBU S1	02/01/2020 12:30	02/01/2020 20:34	02/01/2020 12:30	02/01/2020 20:34	8,07	1	8,07	CHI
2020017522	NOVO GAMA	2460195923	PACAEMBU S1	02/01/2020 12:30	02/01/2020 16:49	02/01/2020 12:30	02/01/2020 16:49	4,31	1	4,31	CHI
2020017525	JATAI	290249387	JATAI S2	02/01/2020 12:30	02/01/2020 15:06	02/01/2020 12:30	02/01/2020 15:06	2,59	1	2,59	CHI
2020017533	ARAGOIANIA	AO11117266	GUAPO S2	02/01/2020 12:32	02/01/2020 19:26	02/01/2020 12:32	02/01/2020 19:26	6,90	24	165,59	CHI
2020017535	GOIANIA	10356265	CAMPINAS S1	02/01/2020 12:32	02/01/2020 15:37	02/01/2020 12:32	02/01/2020 15:37	3,07	1	3,07	CHI
2020017538	ALEXANIA	AX12319851	ALEXANIA	02/01/2020 12:32	02/01/2020 15:30	02/01/2020 12:32	02/01/2020 15:30	2,95	21	62,02	CHI
2020017545	HIDROLANDIA	AO12394650	GUAPO S2	02/01/2020 12:34	02/01/2020 16:14	02/01/2020 12:34	02/01/2020 16:14	3,67	3	11,01	CHI
2020017547	GOIANIA	10948296	GOIANIA LESTE S2	02/01/2020 12:34	02/01/2020 18:25	02/01/2020 12:34	02/01/2020 18:25	5,84	1	5,84	CHI
2020017555	GOIANIA	15040161	XAVANTES	02/01/2020 12:35	02/01/2020 14:26	02/01/2020 12:35	02/01/2020 14:26	1,85	1	1,85	CHI
2020017559	AGUAS LINDAS DE GOIAS	10030298421	AGUAS LINDAS DE GOIAS S1	02/01/2020 12:36	02/01/2020 14:10	02/01/2020 12:36	02/01/2020 14:10	1,55	1	1,55	CHI
2020017561	ALTO PARAISO DE GOIAS	BF12266419	NIQUELANDIA SUBTRANSMISSAO	02/01/2020 12:18	02/01/2020 15:41	02/01/2020 12:18	02/01/2020 15:41	3,37	5	16,86	CHI
2020017566	APARECIDA DE GOIANIA	AP21323263	REAL S1	02/01/2020 12:39	02/01/2020 15:45	02/01/2020 12:39	02/01/2020 15:45	3,09	1	3,09	CHI
2020017570	VALPARAISO DE GOIAS	10018196290	PACAEMBU S1	02/01/2020 12:40	02/01/2020 15:22	02/01/2020 12:40	02/01/2020 15:22	2,69	1	2,69	CHI
2020017572	PIRES DO RIO	BC21186552	PIRES DO RIO S1	02/01/2020 12:40	02/01/2020 22:12	02/01/2020 12:40	02/01/2020 22:12	9,52	1	9,52	CHI
2020017574	ITUMBIARA	10014458282	ITUMBIARA NOVA	02/01/2020 12:40	02/01/2020 14:16	02/01/2020 12:40	02/01/2020 14:16	1,59	1	1,59	CHI
2020017577	SANTA FE DE GOIAS	2070004552	BRITANIA	02/01/2020 12:41	02/01/2020 18:44	02/01/2020 12:41	02/01/2020 18:44	6,05	1	6,05	CHI
2020017580	MORRINHOS	150134204	MORRINHOS	02/01/2020 12:41	02/01/2020 16:14	02/01/2020 12:41	02/01/2020 16:14	3,54	1	3,54	CHI
2020017581	CABECEIRAS	CW12262301	ITUIQUIRA	02/01/2020 12:41	02/01/2020 14:56	02/01/2020 12:41	02/01/2020 14:56	2,24	43	96,38	CHI
2020017581	DISTRITO FEDERAL	CW12262301	ITUIQUIRA	02/01/2020 12:41	02/01/2020 14:56	02/01/2020 12:41	02/01/2020 14:56	2,24	1	2,24	CHI
2020017585	SILVANIA	SV12077010	VIANOPOLIS	02/01/2020 12:42	02/01/2020 18:22	02/01/2020 12:42	02/01/2020 18:22	5,66	5	28,29	CHI

2020017586	MONTIVIDIU	MV21189201	MONTIVIDIU T	02/01/2020 12:42	02/01/2020 18:55	02/01/2020 12:42	02/01/2020 18:55	6,20	1	6,20	CHI
2020017588	PADRE BERNARDO	9980012061	PADRE BERNARDO	02/01/2020 12:43	02/01/2020 13:49	02/01/2020 12:43	02/01/2020 13:49	1,10	1	1,10	CHI
2020017590	PALMEIRAS DE GOIAS	PL21259254	PALMEIRAS	02/01/2020 12:43	02/01/2020 14:45	02/01/2020 12:43	02/01/2020 14:45	2,04	1	2,04	CHI
2020017595	CATALAO	10018935450	CATALAO S2	02/01/2020 12:44	02/01/2020 15:40	02/01/2020 12:44	02/01/2020 15:40	2,93	1	2,93	CHI
2020017597	PORANGATU	PO21288221	MARA ROSA	02/01/2020 12:44	02/01/2020 22:00	02/01/2020 12:44	02/01/2020 22:00	9,26	1	9,26	CHI
2020017598	GOIANIA	16308402	REAL S2	02/01/2020 12:44	02/01/2020 15:49	02/01/2020 12:44	02/01/2020 15:49	3,07	1	3,07	CHI
2020017599	PILAR DE GOIAS	GG12341659	SANTA TEREZINHA	02/01/2020 12:44	02/01/2020 16:19	02/01/2020 12:44	02/01/2020 16:19	3,57	3	10,71	CHI
2020017600	GOIANIA	14916198	REAL S1	02/01/2020 12:45	02/01/2020 22:02	02/01/2020 12:45	02/01/2020 22:02	9,28	1	9,28	CHI
2020017603	GOIANIA	GN11000696	REAL S2	02/01/2020 12:33	02/01/2020 17:52	02/01/2020 12:33	02/01/2020 17:52	5,32	122	649,58	CHI
2020017607	IACIARA	IA12206170	IACIARA S1	02/01/2020 12:13	02/01/2020 14:38	02/01/2020 12:13	02/01/2020 14:38	2,41	79	190,00	CHI
2020017610	PIRES DO RIO	PR12265575	PIRES DO RIO S1	02/01/2020 12:46	02/01/2020 15:31	02/01/2020 12:46	02/01/2020 15:31	2,75	3	8,26	CHI
2020017616	AMORINOPOLIS	AM21284841	IPORA	02/01/2020 12:48	02/01/2020 18:25	02/01/2020 12:48	02/01/2020 18:25	5,61	2	11,22	CHI
2020017620	AMORINOPOLIS	IV12390141	IPORA	02/01/2020 11:00	02/01/2020 19:26	02/01/2020 11:00	02/01/2020 19:26	8,43	6	50,59	CHI
2020017620	IVOLANDIA	IV12390141	IPORA	02/01/2020 11:00	02/01/2020 19:26	02/01/2020 11:00	02/01/2020 19:26	8,43	60	505,88	CHI
2020017627	GOIANIA	GN11041880	FERROVIARIO S1	02/01/2020 12:50	02/01/2020 14:58	02/01/2020 14:00	02/01/2020 14:58	0,95	99	94,27	CHI
2020017629	RIO VERDE	RV21400993	MONTIVIDIU T	02/01/2020 12:51	02/01/2020 17:25	02/01/2020 12:51	02/01/2020 17:25	4,56	1	4,56	CHI
2020017630	CATALAO	CT12042393	CATALAO S1	02/01/2020 12:51	02/01/2020 18:41	02/01/2020 12:51	02/01/2020 18:41	5,82	2	11,64	CHI
2020017633	TRINDADE	40183440	MEIA PONTE	02/01/2020 12:51	02/01/2020 16:51	02/01/2020 12:51	02/01/2020 16:51	3,98	1	3,98	CHI
2020017636	PARANAIGUARA	QI12100493	QUIRINOPOLIS	02/01/2020 12:52	02/01/2020 21:14	02/01/2020 12:52	02/01/2020 21:14	8,36	3	25,07	CHI
2020017636	QUIRINOPOLIS	QI12100493	QUIRINOPOLIS	02/01/2020 12:52	02/01/2020 21:14	02/01/2020 12:52	02/01/2020 21:14	8,36	8	66,84	CHI
2020017641	GOIAS	GS21250832	MATRINCHA	02/01/2020 12:54	02/01/2020 17:22	02/01/2020 12:54	02/01/2020 17:22	4,45	1	4,45	CHI
2020017645	GOIANIA	GN12347705	GOYA S1	02/01/2020 12:56	02/01/2020 15:51	02/01/2020 12:56	02/01/2020 15:51	2,91	207	603,12	CHI
2020017646	IPORA	IR12091419	IPORA	02/01/2020 12:56	02/01/2020 17:11	02/01/2020 12:56	02/01/2020 17:11	4,25	1	4,25	CHI
2020017652	CRIXAS	CX12392063	SANTA TEREZINHA	02/01/2020 12:58	02/01/2020 21:05	02/01/2020 12:58	02/01/2020 21:05	8,11	27	219,06	CHI
2020017652	ITAPACI	CX12392063	SANTA TEREZINHA	02/01/2020 12:58	02/01/2020 21:05	02/01/2020 12:58	02/01/2020 21:05	8,11	4	32,45	CHI
2020017662	NOVO PLANALTO	TA12293689	SAO MIGUEL DO ARAGUAIA	02/01/2020 13:01	03/01/2020 09:33	02/01/2020 13:01	03/01/2020 09:33	20,53	10	205,34	CHI
2020017665	GOIANIA	13072328	MEIA PONTE	02/01/2020 13:02	02/01/2020 16:37	02/01/2020 13:02	02/01/2020 16:37	3,57	1	3,57	CHI
2020017669	ABADIANIA	SV12158398	ANAPOLIS UNIVERSITARIO S1	02/01/2020 13:03	02/01/2020 19:23	02/01/2020 13:03	02/01/2020 19:23	6,32	5	31,58	CHI
2020017669	GAMELEIRA DE GOIAS	SV12158398	ANAPOLIS UNIVERSITARIO S1	02/01/2020 13:03	02/01/2020 19:23	02/01/2020 13:03	02/01/2020 19:23	6,32	6	37,90	CHI
2020017672	ORIZONA	OZ12297216	PIRES DO RIO S2	02/01/2020 13:04	02/01/2020 18:36	02/01/2020 13:04	02/01/2020 18:36	5,52	4	22,09	CHI
2020017675	SAO FRANCISCO DE GOIAS	PV12289656	SAO FRANCISCO DE GOIAS	02/01/2020 13:04	02/01/2020 16:56	02/01/2020 13:04	02/01/2020 16:56	3,85	7	26,98	CHI
2020017676	PIRENOPOLIS	PV12370311	CORUMBA	02/01/2020 12:31	02/01/2020 16:34	02/01/2020 12:31	02/01/2020 16:34	4,04	3	12,13	CHI
2020017679	ABADIANIA	AA21297769	ANAPOLIS UNIVERSITARIO S1	02/01/2020 13:05	02/01/2020 20:16	02/01/2020 13:05	02/01/2020 20:16	7,18	1	7,18	CHI



2020017684	LUZIANIA	LZ12137225	VIANOPOLIS	02/01/2020 13:06	02/01/2020 16:55	02/01/2020 13:06	02/01/2020 16:55	3,81	14	53,39	CHI
2020017687	DOVERLANDIA	DV12207932	CAIAPONIA	02/01/2020 12:30	02/01/2020 22:19	02/01/2020 12:30	02/01/2020 22:19	9,81	6	58,83	CHI
2020017688	MINEIROS	MY21191129	PARQUE DAS EMAS	02/01/2020 13:07	02/01/2020 18:47	02/01/2020 13:07	02/01/2020 18:47	5,67	1	5,67	CHI
2020017692	FAZENDA NOVA	JR12362437	BRITANIA	02/01/2020 12:22	02/01/2020 17:50	02/01/2020 12:22	02/01/2020 17:50	5,46	3	16,39	CHI
2020017692	JUSSARA	JR12362437	BRITANIA	02/01/2020 12:22	02/01/2020 17:50	02/01/2020 12:22	02/01/2020 17:50	5,46	7	38,25	CHI
2020017695	SENADOR CANEDO	SW21334088	CEPAIGO S2	02/01/2020 13:10	02/01/2020 16:46	02/01/2020 13:10	02/01/2020 16:46	3,59	1	3,59	CHI
2020017698	AMARALINA	MH12037774	NOVA CRIXAS	02/01/2020 13:17	02/01/2020 22:55	02/01/2020 13:17	02/01/2020 22:55	9,62	1	9,62	CHI
2020017698	MUNDO NOVO DE GOIAS	MH12037774	NOVA CRIXAS	02/01/2020 13:17	02/01/2020 22:55	02/01/2020 13:17	02/01/2020 22:55	9,62	5	48,12	CHI
2020017698	UIRAPURU	MH12037774	NOVA CRIXAS	02/01/2020 13:17	02/01/2020 22:55	02/01/2020 13:17	02/01/2020 22:55	9,62	21	202,11	CHI
2020017700	SITIO D ABADIA	SI12235082	IACIARA S2	02/01/2020 13:11	02/01/2020 15:44	02/01/2020 13:11	02/01/2020 15:44	2,54	2	5,09	CHI
2020017703	ANICUNS	AC12031058	ANICUNS	02/01/2020 13:11	02/01/2020 15:53	02/01/2020 14:00	02/01/2020 15:45	1,75	4	7,00	CHI
2020017703	ANICUNS	AC21306994	ANICUNS	02/01/2020 13:11	02/01/2020 15:53	02/01/2020 13:11	02/01/2020 15:53	2,69	1	2,69	CHI
2020017704	PALESTINA DE GOIAS	PY12138375	PALESTINA	02/01/2020 11:16	03/01/2020 07:10	02/01/2020 11:16	03/01/2020 07:10	19,90	24	477,53	CHI
2020017705	CALDAS NOVAS	CN11114780	SERRA DE CALDAS	02/01/2020 13:12	02/01/2020 20:23	02/01/2020 13:12	02/01/2020 20:23	7,19	73	524,69	CHI
2020017708	GOIANESIA	GE21339790	GOIANESIA S2	02/01/2020 13:12	02/01/2020 20:10	02/01/2020 13:12	02/01/2020 20:10	6,96	1	6,96	CHI
2020017709	MORRINHOS	MR11031103	MORRINHOS	02/01/2020 12:37	02/01/2020 15:20	02/01/2020 12:37	02/01/2020 15:20	2,71	129	349,84	CHI
2020017710	FIRMINOPOLIS	10009451976	FIRMINOPOLIS S1	02/01/2020 13:13	02/01/2020 14:26	02/01/2020 13:13	02/01/2020 14:26	1,21	1	1,21	CHI
2020017723	GOIANIA	10004770518	REAL S1	02/01/2020 13:18	02/01/2020 19:44	02/01/2020 13:18	02/01/2020 19:44	6,43	1	6,43	CHI
2020017724	GOIANIA	GN11347531	AEROPORTO S2	02/01/2020 13:18	02/01/2020 15:59	02/01/2020 13:18	02/01/2020 15:59	2,67	62	165,38	CHI
2020017727	CRIXAS	NA12078447	NOVA CRIXAS	02/01/2020 09:49	02/01/2020 17:34	02/01/2020 09:49	02/01/2020 17:34	7,74	18	139,35	CHI
2020017727	NOVA CRIXAS	NA12078447	NOVA CRIXAS	02/01/2020 09:49	02/01/2020 17:34	02/01/2020 09:49	02/01/2020 17:34	7,74	19	147,09	CHI
2020017732	ARAGOIANIA	AO12033825LD	GUAPO S2	02/01/2020 13:20	02/01/2020 20:34	02/01/2020 13:20	02/01/2020 20:34	7,23	3	21,70	CHI
2020017732	ARAGOIANIA	AO12033825LD	GUAPO S2	02/01/2020 13:20	02/01/2020 20:34	02/01/2020 20:18	02/01/2020 20:34	0,26	977	257,01	CHI
2020017742	PADRE BERNARDO	PI12099216LD	PLANALTINA	02/01/2020 13:22	02/01/2020 15:53	02/01/2020 13:22	02/01/2020 15:53	2,51	16	40,22	CHI
2020017742	PLANALTINA	PI12099216LD	PLANALTINA	02/01/2020 13:22	02/01/2020 15:53	02/01/2020 13:22	02/01/2020 15:53	2,51	157	394,64	CHI
2020017747	UIRAPURU	UP12181266	SANTA TEREZINHA	02/01/2020 13:22	02/01/2020 22:07	02/01/2020 13:22	02/01/2020 22:07	8,74	8	69,92	CHI
2020017755	IPORA	730150768	IPORA	02/01/2020 13:23	02/01/2020 20:10	02/01/2020 13:23	02/01/2020 20:10	6,77	1	6,77	CHI
2020017756	ORIZONA	OZ21159625	PIRES DO RIO S1	02/01/2020 13:23	02/01/2020 16:46	02/01/2020 13:23	02/01/2020 16:46	3,37	1	3,37	CHI
2020017760	APARECIDA DE GOIANIA	10022691420	INDEPENDENCIA S1	02/01/2020 13:24	02/01/2020 15:41	02/01/2020 13:24	02/01/2020 15:41	2,28	1	2,28	CHI
2020017765	ARENOPOLIS	03830216	IPORA	02/01/2020 13:25	03/01/2020 10:26	02/01/2020 13:25	03/01/2020 10:26	21,02	107	2249,50	CHI
2020017765	MONTES CLAROS DE GOIAS	03830216	IPORA	02/01/2020 13:25	03/01/2020 10:26	02/01/2020 13:25	03/01/2020 10:26	21,02	83	1744,94	CHI
2020017765	PIRANHAS	03830216	IPORA	02/01/2020 13:25	03/01/2020 10:26	02/01/2020 13:25	03/01/2020 10:26	21,02	2	42,05	CHI
2020017769	PALESTINA DE GOIAS	PY12065854	PALESTINA	02/01/2020 10:50	02/01/2020 16:32	02/01/2020 10:50	02/01/2020 16:32	5,70	4	22,79	CHI

2020017778	CAVALCANTE	10029552930	MINACU	02/01/2020 13:26	03/01/2020 18:25	02/01/2020 13:26	03/01/2020 18:25	28,98	1	28,98	CHI
2020017781	PORANGATU	PO12137637	PORANGATU	02/01/2020 11:58	03/01/2020 09:15	02/01/2020 11:58	03/01/2020 09:15	21,28	6	127,66	CHI
2020017785	CAMPO ALEGRE DE GOIAS	CM21133621	CAMPO ALEGRE DE GOIAS	02/01/2020 13:28	03/01/2020 11:43	02/01/2020 13:28	03/01/2020 11:43	22,25	1	22,25	CHI
2020017795	CALDAS NOVAS	760038168	SERRA DE CALDAS	02/01/2020 13:30	03/01/2020 09:40	02/01/2020 13:30	03/01/2020 09:40	20,16	1	20,16	CHI
2020017797	URUACU	UR21082983	URUACU	02/01/2020 13:31	02/01/2020 14:49	02/01/2020 13:31	02/01/2020 14:49	1,30	1	1,30	CHI
2020017804	VICENTINOPOLIS	VI12352541	VICENTINOPOLIS	02/01/2020 13:32	02/01/2020 22:32	02/01/2020 13:32	02/01/2020 22:32	9,00	4	36,00	CHI
2020017812	GOIANIA	02400214	AEROPORTO S1	02/01/2020 13:31	02/01/2020 15:37	02/01/2020 13:31	02/01/2020 13:35	0,08	1290	96,75	CHI
2020017812	GOIANIA	02400214	AEROPORTO S1	02/01/2020 13:31	02/01/2020 15:37	02/01/2020 13:36	02/01/2020 14:35	0,99	1086	1070,61	CHI
2020017812	GOIANIA	GN12001618LD	AEROPORTO S1	02/01/2020 13:31	02/01/2020 15:37	02/01/2020 13:36	02/01/2020 15:37	2,03	204	413,89	CHI
2020017817	ITAGUARU	IC21145654	ITAPURANGA	02/01/2020 13:34	02/01/2020 15:58	02/01/2020 13:34	02/01/2020 15:58	2,40	1	2,40	CHI
2020017818	ITABERAI	IB21185765	INHUMAS S1	02/01/2020 13:34	02/01/2020 18:21	02/01/2020 13:34	02/01/2020 18:21	4,77	1	4,77	CHI
2020017820	GUARAITA	3140003594	ITAPURANGA	02/01/2020 13:35	03/01/2020 09:39	02/01/2020 13:35	03/01/2020 09:39	20,07	1	20,07	CHI
2020017821	JATAI	JT12101410	JATAI S1	02/01/2020 13:35	02/01/2020 17:54	02/01/2020 13:35	02/01/2020 17:54	4,31	2	8,62	CHI
2020017822	TEREZOPOLIS DE GOIAS	TJ12273160	JUNDIAI S2	02/01/2020 13:35	02/01/2020 17:12	02/01/2020 13:35	02/01/2020 17:12	3,61	1	3,61	CHI
2020017827	NIQUELANDIA	NQ11280420	NIQUELANDIA SUBTRANSMISSAO	02/01/2020 13:36	02/01/2020 16:30	02/01/2020 13:36	02/01/2020 16:30	2,90	1	2,90	CHI
2020017829	GOIANIA	10002444940	FERROVIARIO S1	02/01/2020 13:37	02/01/2020 16:11	02/01/2020 13:37	02/01/2020 16:11	2,56	1	2,56	CHI
2020017830	GOIANIA	11071692	REAL S1	02/01/2020 13:37	02/01/2020 15:47	02/01/2020 13:37	02/01/2020 15:47	2,16	1	2,16	CHI
2020017832	BELA VISTA DE GOIAS	BV21020408	BELA VISTA S2	02/01/2020 13:37	02/01/2020 16:04	02/01/2020 13:37	02/01/2020 16:04	2,44	1	2,44	CHI
2020017836	CIDADE OCIDENTAL	2680020772	MARAJOARA	02/01/2020 13:38	02/01/2020 16:37	02/01/2020 13:38	02/01/2020 16:37	2,98	1	2,98	CHI
2020017839	URUACU	640005585	URUACU	02/01/2020 13:38	02/01/2020 18:08	02/01/2020 13:38	02/01/2020 18:08	4,50	1	4,50	CHI
2020017840	CALDAS NOVAS	CN12104521	SERRA DE CALDAS	02/01/2020 12:31	02/01/2020 14:39	02/01/2020 12:31	02/01/2020 14:39	2,13	145	308,89	CHI
2020017842	SERRANOPOLIS	SX12166082	JATAI S1	02/01/2020 13:39	02/01/2020 17:10	02/01/2020 13:39	02/01/2020 17:10	3,51	19	66,77	CHI
2020017846	VALPARAISO DE GOIAS	3350098998	PACAEMBU S1	02/01/2020 13:40	02/01/2020 18:41	02/01/2020 13:40	02/01/2020 18:41	5,01	1	5,01	CHI
2020017849	ABADIANIA	AA21123839	DAIA S2	02/01/2020 13:40	02/01/2020 18:15	02/01/2020 13:40	02/01/2020 18:15	4,57	1	4,57	CHI
2020017853	ORIZONA	OZ12048939	PIRES DO RIO S1	02/01/2020 13:41	02/01/2020 16:32	02/01/2020 13:41	02/01/2020 16:32	2,84	7	19,89	CHI
2020017856	CHAPADAO DO CEU	DJ11223658	CHAPADAO DO CEU	02/01/2020 13:42	02/01/2020 17:04	02/01/2020 13:42	02/01/2020 17:04	3,36	1	3,36	CHI
2020017858	SANTA TEREZA DE GOIAS	SE12060934	PORANGATU	02/01/2020 12:30	02/01/2020 19:48	02/01/2020 12:30	02/01/2020 19:48	7,29	6	43,75	CHI
2020017863	PIRES DO RIO	PR12265574	PIRES DO RIO S1	02/01/2020 13:44	02/01/2020 16:52	02/01/2020 13:44	02/01/2020 16:52	3,15	3	9,44	CHI
2020017866	GOIANIA	12037035	ATLANTICO S3	02/01/2020 13:44	02/01/2020 14:54	02/01/2020 13:44	02/01/2020 14:54	1,16	1	1,16	CHI
2020017874	CAVALCANTE	MA12280212LD	SAO DOMINGOS	02/01/2020 13:46	02/01/2020 16:55	02/01/2020 13:46	02/01/2020 16:55	3,14	160	502,22	CHI
2020017874	MONTE ALEGRE DE GOIAS	MA12280212LD	SAO DOMINGOS	02/01/2020 13:46	02/01/2020 16:55	02/01/2020 13:46	02/01/2020 16:55	3,14	167	524,19	CHI
2020017876	GOIANIA	GN11040089	REAL S1	02/01/2020 13:47	02/01/2020 18:13	02/01/2020 13:47	02/01/2020 18:13	4,43	85	376,43	CHI
2020017886	GOIANIA	10627935	AEROPORTO S2	02/01/2020 13:49	02/01/2020 19:43	02/01/2020 13:49	02/01/2020 19:43	5,89	1	5,89	CHI

2020017890	ITAPURANGA	IK12220328	ITAPURANGA	02/01/2020 12:28	02/01/2020 15:04	02/01/2020 12:28	02/01/2020 15:04	2,60	231	599,57	CHI
2020017895	JATAI	JT12378192	JATAI S1	02/01/2020 13:51	02/01/2020 16:19	02/01/2020 13:51	02/01/2020 16:19	2,46	2	4,92	CHI
2020017898	POSSE	PS12124656	IACIARA S2	02/01/2020 13:11	02/01/2020 17:55	02/01/2020 13:11	02/01/2020 17:55	4,73	34	160,78	CHI
2020017902	CAIAPONIA	MV12054328	MONTIVIDIU T	02/01/2020 11:54	02/01/2020 20:11	02/01/2020 11:54	02/01/2020 20:11	8,27	23	190,18	CHI
2020017902	MONTIVIDIU	MV12054328	MONTIVIDIU T	02/01/2020 11:54	02/01/2020 20:11	02/01/2020 11:54	02/01/2020 20:11	8,27	14	115,76	CHI
2020017906	CACU	CC11000023	CACHOEIRA ALTA	02/01/2020 12:29	02/01/2020 17:01	02/01/2020 12:29	02/01/2020 17:01	4,53	95	430,35	CHI
2020017910	GOIANIA	GN11247739	XAVANTES	02/01/2020 13:42	02/01/2020 17:58	02/01/2020 13:42	02/01/2020 17:58	4,26	72	306,96	CHI
2020017913	CRISTALINA	KR12164788	PAMPLONA	02/01/2020 13:56	03/01/2020 05:54	02/01/2020 13:56	03/01/2020 05:54	15,97	20	319,34	CHI
2020017917	SAO LUIZ DO NORTE	DF12241242	BARRO ALTO	02/01/2020 13:57	03/01/2020 12:26	02/01/2020 13:57	03/01/2020 12:26	22,47	5	112,37	CHI
2020017921	ANAPOLIS	10015681104	ANAPOLIS UNIVERSITARIO S2	02/01/2020 13:58	02/01/2020 16:00	02/01/2020 13:58	02/01/2020 16:00	2,04	1	2,04	CHI
2020017922	PARAUNA	PU12044570	ACREUNA	02/01/2020 13:58	02/01/2020 18:45	02/01/2020 13:58	02/01/2020 18:45	4,78	24	114,69	CHI
2020017933	BRITANIA	2110020770	BRITANIA	02/01/2020 14:00	02/01/2020 17:26	02/01/2020 14:00	02/01/2020 17:26	3,43	1	3,43	CHI
2020017936	HEITORAI	HE11243974	ITAPURANGA	02/01/2020 14:00	02/01/2020 18:12	02/01/2020 14:00	02/01/2020 18:12	4,20	1	4,20	CHI
2020017937	ALTO PARAISO DE GOIAS	BF12105397	SAO JOAO D ALIANCA	02/01/2020 14:01	02/01/2020 16:09	02/01/2020 14:01	02/01/2020 16:09	2,13	211	449,96	CHI
2020017940	AGUA LIMPA	AL12000251	VILA CORUMBA	02/01/2020 14:01	02/01/2020 18:01	02/01/2020 14:01	02/01/2020 18:01	3,99	52	207,29	CHI
2020017940	BURITI ALEGRE	AL12000251	VILA CORUMBA	02/01/2020 14:01	02/01/2020 18:01	02/01/2020 14:01	02/01/2020 18:01	3,99	3	11,96	CHI
2020017940	MORRINHOS	AL12000251	VILA CORUMBA	02/01/2020 14:01	02/01/2020 18:01	02/01/2020 14:01	02/01/2020 18:01	3,99	2	7,97	CHI
2020017942	GOIANIA	10005101695	REAL S1	02/01/2020 14:02	02/01/2020 16:15	02/01/2020 14:02	02/01/2020 16:15	2,21	1	2,21	CHI
2020017948	BELA VISTA DE GOIAS	BV21099005	BELA VISTA S2	02/01/2020 14:04	02/01/2020 16:09	02/01/2020 14:04	02/01/2020 16:09	2,08	2	4,17	CHI
2020017950	DOVERLANDIA	DV12187350	CAIAPONIA	02/01/2020 13:58	02/01/2020 19:21	02/01/2020 13:58	02/01/2020 19:21	5,37	17	91,31	CHI
2020017955	SERRANOPOLIS	SX21318791	ITAJA S1	02/01/2020 14:05	03/01/2020 12:10	02/01/2020 14:05	02/01/2020 16:06	2,00	1	2,00	CHI
2020017955	SERRANOPOLIS	SX12318793	ITAJA S1	02/01/2020 14:05	03/01/2020 12:10	03/01/2020 10:44	03/01/2020 11:30	0,77	1	0,77	CHI
2020017955	SERRANOPOLIS	SX21318791	ITAJA S1	02/01/2020 14:05	03/01/2020 12:10	02/01/2020 16:07	03/01/2020 12:10	20,05	1	20,05	CHI
2020017956	IPORA	IR12024610	ARENOPOLIS	02/01/2020 14:06	02/01/2020 19:34	02/01/2020 14:06	02/01/2020 19:34	5,46	39	213,06	CHI
2020017958	ANAPOLIS	20575762	JUNDIAI S2	02/01/2020 14:06	02/01/2020 18:27	02/01/2020 14:06	02/01/2020 18:27	4,36	1	4,36	CHI
2020017961	JUSSARA	JR12331712	JUSSARA	02/01/2020 14:06	03/01/2020 12:41	02/01/2020 14:06	03/01/2020 12:41	22,57	2	45,14	CHI
2020017963	INDIARA	IY12158916	CEZARINA	02/01/2020 13:39	02/01/2020 14:52	02/01/2020 13:39	02/01/2020 14:52	1,23	3	3,69	CHI
2020017967	PADRE BERNARDO	PB12275509	PADRE BERNARDO	02/01/2020 14:08	02/01/2020 17:19	02/01/2020 14:08	02/01/2020 17:19	3,18	16	50,92	CHI
2020017971	CAMPOS VERDES	SG12202098	SANTA TEREZINHA	02/01/2020 14:03	02/01/2020 17:13	02/01/2020 14:03	02/01/2020 17:13	3,16	41	129,75	CHI
2020017971	SANTA TEREZINHA DE GOIAS	SG12202098	SANTA TEREZINHA	02/01/2020 14:03	02/01/2020 17:13	02/01/2020 14:03	02/01/2020 17:13	3,16	131	414,58	CHI
2020017971	UIRAPURU	SG12202098	SANTA TEREZINHA	02/01/2020 14:03	02/01/2020 17:13	02/01/2020 14:03	02/01/2020 17:13	3,16	55	174,06	CHI
2020017973	NIQUELANDIA	NQ21317727	NIQUELANDIA SUBTRANSMISSAO	02/01/2020 14:08	03/01/2020 03:48	02/01/2020 14:08	03/01/2020 03:48	13,66	1	13,66	CHI
2020017976	LUZIANIA	LZ11169001	MARAJOARA	02/01/2020 14:08	02/01/2020 18:47	02/01/2020 14:08	02/01/2020 18:47	4,64	13	60,30	CHI

2020017982	CACHOEIRA ALTA	PC12000018	CACHOEIRA ALTA	02/01/2020 14:09	02/01/2020 17:49	02/01/2020 14:09	02/01/2020 17:49	3,66	8	29,26	CHI
2020017982	PARANAIGUARA	PC12000018	CACHOEIRA ALTA	02/01/2020 14:09	02/01/2020 17:49	02/01/2020 14:09	02/01/2020 17:49	3,66	33	120,72	CHI
2020017982	SAO SIMAO	PC12000018	CACHOEIRA ALTA	02/01/2020 14:09	02/01/2020 17:49	02/01/2020 14:09	02/01/2020 17:49	3,66	10	36,58	CHI
2020017983	CATALAO	CT21152923	CATALAO S1	02/01/2020 14:09	02/01/2020 18:04	02/01/2020 14:09	02/01/2020 18:04	3,90	1	3,90	CHI
2020017988	GOIATUBA	10008555603	GOIATUBA S2	02/01/2020 14:10	03/01/2020 08:36	02/01/2020 14:10	03/01/2020 08:36	18,44	1	18,44	CHI
2020017989	GOIANDIRA	CT21077519	CATALAO S1	02/01/2020 14:10	03/01/2020 07:28	02/01/2020 14:10	03/01/2020 07:28	17,28	1	17,28	CHI
2020017994	CALDAS NOVAS	CN11163527	SERRA DE CALDAS	02/01/2020 14:11	03/01/2020 08:18	02/01/2020 14:11	03/01/2020 08:18	18,11	8	144,87	CHI
2020017996	MUNDO NOVO DE GOIAS	MH12391965	NOVA CRIXAS	02/01/2020 13:56	03/01/2020 18:31	02/01/2020 13:56	03/01/2020 18:00	28,06	2	56,12	CHI
2020017996	AMARALINA	MH12391965	NOVA CRIXAS	02/01/2020 13:56	03/01/2020 18:31	02/01/2020 13:56	03/01/2020 18:31	28,58	1	28,58	CHI
2020017996	MUNDO NOVO DE GOIAS	MH12391965	NOVA CRIXAS	02/01/2020 13:56	03/01/2020 18:31	02/01/2020 13:56	03/01/2020 18:31	28,58	10	285,81	CHI
2020017999	MINEIROS	10019335570	PARQUE DAS EMAS	02/01/2020 14:13	03/01/2020 15:16	02/01/2020 14:13	03/01/2020 15:16	25,06	1	25,06	CHI
2020018000	PIRACANJUBA	PJ21229199	CALDAS NOVAS S1	02/01/2020 14:13	02/01/2020 19:25	02/01/2020 14:13	02/01/2020 19:25	5,19	1	5,19	CHI
2020018001	FORMOSA	FA12000130	ITIQUEIRA	02/01/2020 14:13	02/01/2020 15:39	02/01/2020 14:13	02/01/2020 15:39	1,42	14	19,90	CHI
2020018002	ITUMBIARA	IT12000308RE	PARANAIBA	02/01/2020 13:59	02/01/2020 17:20	02/01/2020 13:59	02/01/2020 17:20	3,36	91	305,73	CHI
2020018003	SAO MIGUEL DO ARAGUAIA	SM12151000	SAO MIGUEL DO ARAGUAIA	02/01/2020 14:10	03/01/2020 14:49	02/01/2020 14:10	03/01/2020 12:59	22,82	5	114,11	CHI
2020018003	SAO MIGUEL DO ARAGUAIA	SM12151000	SAO MIGUEL DO ARAGUAIA	02/01/2020 14:10	03/01/2020 14:49	02/01/2020 16:00	03/01/2020 12:59	20,99	1	20,99	CHI
2020018003	SAO MIGUEL DO ARAGUAIA	SM12151000	SAO MIGUEL DO ARAGUAIA	02/01/2020 14:10	03/01/2020 14:49	02/01/2020 14:10	03/01/2020 14:19	24,15	7	169,08	CHI
2020018003	SAO MIGUEL DO ARAGUAIA	SM13391613	SAO MIGUEL DO ARAGUAIA	02/01/2020 14:10	03/01/2020 14:49	02/01/2020 16:00	03/01/2020 14:19	22,32	1	22,32	CHI
2020018003	SAO MIGUEL DO ARAGUAIA	SM12252458	SAO MIGUEL DO ARAGUAIA	02/01/2020 14:10	03/01/2020 14:49	02/01/2020 14:10	03/01/2020 14:49	24,66	5	123,29	CHI
2020018011	ARAGARCAS	1820047079	ARAGARCAS	02/01/2020 14:16	02/01/2020 19:19	02/01/2020 14:16	02/01/2020 19:19	5,04	1	5,04	CHI
2020018032	CHAPADAO DO CEU	9880006221	CHAPADAO DO CEU	02/01/2020 14:21	02/01/2020 16:08	02/01/2020 14:21	02/01/2020 16:08	1,79	1	1,79	CHI
2020018033	NOVA ROMA	ND12161820	IACIARA S2	02/01/2020 14:21	03/01/2020 18:40	02/01/2020 14:21	02/01/2020 18:20	3,98	25	99,59	CHI
2020018033	NOVA ROMA	ND13164499	IACIARA S2	02/01/2020 14:21	03/01/2020 18:40	02/01/2020 14:21	03/01/2020 18:40	28,32	104	2945,48	CHI
2020018059	BALIZA	BM12390150	BOM JARDIM	02/01/2020 13:44	02/01/2020 18:45	02/01/2020 13:44	02/01/2020 18:45	5,00	50	250,15	CHI
2020018059	BOM JARDIM DE GOIAS	BM12390150	BOM JARDIM	02/01/2020 13:44	02/01/2020 18:45	02/01/2020 13:44	02/01/2020 18:45	5,00	9	45,03	CHI
2020018062	IVOLANDIA	IV12206098	IPORA	02/01/2020 14:23	02/01/2020 18:40	02/01/2020 14:23	02/01/2020 18:40	4,27	2	8,55	CHI
2020018063	GOIANIA	12154775	INDEPENDENCIA S2	02/01/2020 14:24	02/01/2020 15:42	02/01/2020 14:24	02/01/2020 15:42	1,31	1	1,31	CHI
2020018064	IPAMERI	IP21195073	URUTAI	02/01/2020 14:24	02/01/2020 19:49	02/01/2020 14:24	02/01/2020 19:49	5,41	1	5,41	CHI
2020018066	ANICUNS	910041623	ANICUNS	02/01/2020 14:24	02/01/2020 17:02	02/01/2020 14:24	02/01/2020 17:02	2,62	1	2,62	CHI
2020018071	MAURILANDIA	1040011473	RIO DOS BOIS	02/01/2020 14:25	02/01/2020 23:57	02/01/2020 14:25	02/01/2020 23:57	9,53	1	9,53	CHI
2020018072	GOIANESIA	GE12040930	GOIANESIA S2	02/01/2020 13:05	02/01/2020 16:23	02/01/2020 13:05	02/01/2020 16:23	3,30	131	432,45	CHI
2020018073	POSSE	PS12375570	IACIARA S2	02/01/2020 13:36	02/01/2020 17:55	02/01/2020 13:36	02/01/2020 17:55	4,32	5	21,62	CHI
2020018074	CAVALCANTE	CJ21412224	MINACU	02/01/2020 14:26	02/01/2020 15:06	02/01/2020 14:26	02/01/2020 15:06	0,65	1	0,65	CHI

2020018077	MINACU	IH11208430	MINACU	02/01/2020 14:27	02/01/2020 18:48	02/01/2020 14:27	02/01/2020 18:48	4,34	45	195,29	CHI
2020018080	CATALAO	10012086183	CATALAO S2	02/01/2020 14:27	02/01/2020 17:08	02/01/2020 14:27	02/01/2020 17:08	2,67	1	2,67	CHI
2020018081	APARECIDA DO RIO DOCE	AW11163943	CACHOEIRA ALTA	02/01/2020 12:51	02/01/2020 16:10	02/01/2020 12:51	02/01/2020 16:10	3,30	133	439,12	CHI
2020018082	SAO LUIZ DO NORTE	SZ11054700	ITAPACI	02/01/2020 14:28	03/01/2020 04:00	03/01/2020 01:13	03/01/2020 04:00	2,78	88	244,93	CHI
2020018083	DOVERLANDIA	DV12354650	CAIAPONIA	02/01/2020 12:12	02/01/2020 17:31	02/01/2020 12:12	02/01/2020 17:31	5,31	130	690,01	CHI
2020018084	SANTA HELENA DE GOIAS	TD12246829	RIO DOS BOIS	02/01/2020 14:28	03/01/2020 23:58	02/01/2020 14:28	03/01/2020 11:36	21,12	18	380,14	CHI
2020018084	TURVELANDIA	TD12246829	RIO DOS BOIS	02/01/2020 14:28	03/01/2020 23:58	02/01/2020 14:28	03/01/2020 11:36	21,12	23	485,73	CHI
2020018084	SANTA HELENA DE GOIAS	EU12026829	RIO DOS BOIS	02/01/2020 14:28	03/01/2020 23:58	03/01/2020 11:37	03/01/2020 12:56	1,32	2	2,63	CHI
2020018084	TURVELANDIA	EU12026829	RIO DOS BOIS	02/01/2020 14:28	03/01/2020 23:58	03/01/2020 11:37	03/01/2020 12:56	1,32	8	10,53	CHI
2020018084	ACREUNA	TD12246829	RIO DOS BOIS	02/01/2020 14:28	03/01/2020 23:58	02/01/2020 14:28	03/01/2020 16:10	25,69	4	102,74	CHI
2020018084	TURVELANDIA	TD12246829	RIO DOS BOIS	02/01/2020 14:28	03/01/2020 23:58	02/01/2020 14:28	03/01/2020 16:10	25,69	2	51,37	CHI
2020018084	SANTA HELENA DE GOIAS	EU12026829	RIO DOS BOIS	02/01/2020 14:28	03/01/2020 23:58	03/01/2020 11:37	03/01/2020 23:58	12,36	16	197,76	CHI
2020018084	TURVELANDIA	EU12026829	RIO DOS BOIS	02/01/2020 14:28	03/01/2020 23:58	03/01/2020 11:37	03/01/2020 23:58	12,36	9	111,24	CHI
2020018086	ALEXANIA	AX21094727	ALEXANIA	02/01/2020 14:29	03/01/2020 22:34	02/01/2020 14:29	03/01/2020 20:52	30,38	1	30,38	CHI
2020018086	ALEXANIA	AX12379436	ALEXANIA	02/01/2020 14:29	03/01/2020 22:34	03/01/2020 20:51	03/01/2020 22:34	1,71	3	5,14	CHI
2020018094	AGUA LIMPA	AL21263210	VILA CORUMBA	02/01/2020 14:30	03/01/2020 09:59	02/01/2020 14:30	03/01/2020 09:59	19,48	1	19,48	CHI
2020018095	ITUMBIARA	IT12000033	ITUMBIARA VELHA S1	02/01/2020 14:30	03/01/2020 08:30	02/01/2020 14:30	03/01/2020 08:30	17,99	3	53,97	CHI
2020018098	DIORAMA	ME12062803	ARENOPOLIS	02/01/2020 14:31	03/01/2020 09:12	02/01/2020 14:31	03/01/2020 09:12	18,68	2	37,35	CHI
2020018098	MONTES CLAROS DE GOIAS	ME12062803	ARENOPOLIS	02/01/2020 14:31	03/01/2020 09:12	02/01/2020 14:31	03/01/2020 09:12	18,68	6	112,06	CHI
2020018099	PIRES DO RIO	PR12409073	PIRES DO RIO S2	02/01/2020 14:31	03/01/2020 00:30	02/01/2020 14:31	03/01/2020 00:30	9,98	3	29,93	CHI
2020018114	LUZIANIA	LZ11128864	RIO VERMELHO	02/01/2020 14:50	02/01/2020 17:20	02/01/2020 15:50	02/01/2020 17:20	1,50	169	253,50	CHI
2020018119	LUZIANIA	LZ21134458	PAMPLONA	02/01/2020 15:09	02/01/2020 16:30	02/01/2020 15:09	02/01/2020 16:30	1,35	1	1,35	CHI
2020018202	COCALZINHO DE GOIAS	ZN21121788	COCALZINHO	02/01/2020 14:31	02/01/2020 19:56	02/01/2020 14:31	02/01/2020 19:56	5,41	1	5,41	CHI
2020018210	CORUMBA DE GOIAS	AX12061965	CORUMBA	02/01/2020 14:33	02/01/2020 18:51	02/01/2020 14:33	02/01/2020 18:51	4,30	2	8,59	CHI
2020018213	GOIATUBA	10002905513	GOIATUBA S2	02/01/2020 14:34	03/01/2020 08:45	02/01/2020 14:34	03/01/2020 08:45	18,19	1	18,19	CHI
2020018216	QUIRINOPOLIS	QI32052485	QUIRINOPOLIS	02/01/2020 14:34	02/01/2020 17:36	02/01/2020 14:34	02/01/2020 17:36	3,03	8	24,24	CHI
2020018220	ESTRELA DO NORTE	ET12094692	MARA ROSA	02/01/2020 14:35	02/01/2020 21:49	02/01/2020 14:35	02/01/2020 21:49	7,23	13	93,94	CHI
2020018220	SANTA TEREZA DE GOIAS	ET12094692	MARA ROSA	02/01/2020 14:35	02/01/2020 21:49	02/01/2020 14:35	02/01/2020 21:49	7,23	4	28,90	CHI
2020018226	FAINA	FC12029561	GOIAS	02/01/2020 14:37	02/01/2020 16:21	02/01/2020 14:37	02/01/2020 16:21	1,73	4	6,94	CHI
2020018230	FORMOSA	610010165	ITUIQUIRA	02/01/2020 14:38	02/01/2020 16:17	02/01/2020 14:38	02/01/2020 16:17	1,65	1	1,65	CHI
2020018236	ORIZONA	OZ21000314	PIRES DO RIO S2	02/01/2020 14:39	02/01/2020 22:08	02/01/2020 14:39	02/01/2020 22:08	7,49	2	14,97	CHI
2020018237	MOZARLANDIA	410047478	MOZARLANDIA	02/01/2020 14:39	02/01/2020 16:20	02/01/2020 14:39	02/01/2020 16:20	1,67	1	1,67	CHI
2020018238	FAZENDA NOVA	FN12231182	IPORA	02/01/2020 12:34	03/01/2020 03:37	02/01/2020 12:34	03/01/2020 03:37	15,03	2	30,07	CHI

2020018248	ITUMBIARA	IT12000103	PARANAIBA	02/01/2020 14:42	03/01/2020 11:26	02/01/2020 14:42	03/01/2020 11:26	20,74	3	62,21	CHI
2020018255	SANCLERLANDIA	SC21343836	FIRMINOPOLIS S2	02/01/2020 14:45	02/01/2020 19:06	02/01/2020 14:45	02/01/2020 19:06	4,35	1	4,35	CHI
2020018257	GOIANIA	GN11000627	AEROPORTO S1	02/01/2020 14:47	02/01/2020 17:35	02/01/2020 14:47	02/01/2020 17:35	2,80	50	139,79	CHI
2020018259	RIO VERDE	630076777	RIO VERDE S2	02/01/2020 14:47	02/01/2020 22:10	02/01/2020 14:47	02/01/2020 22:10	7,37	1	7,37	CHI
2020018268	ITUMBIARA	IT12249852	PARANAIBA	02/01/2020 14:49	02/01/2020 17:14	02/01/2020 14:49	02/01/2020 16:14	1,42	221	314,56	CHI
2020018268	ITUMBIARA	IT11222286	PARANAIBA	02/01/2020 14:49	02/01/2020 17:14	02/01/2020 14:49	02/01/2020 17:14	2,41	57	137,34	CHI
2020018271	CAMPO ALEGRE DE GOIAS	CM12266790	CAMPO ALEGRE DE GOIAS	02/01/2020 14:36	02/01/2020 17:17	02/01/2020 14:36	02/01/2020 17:17	2,67	142	379,26	CHI
2020018271	CATALAO	CM12266790	CAMPO ALEGRE DE GOIAS	02/01/2020 14:36	02/01/2020 17:17	02/01/2020 14:36	02/01/2020 17:17	2,67	8	21,37	CHI
2020018271	IPAMERI	CM12266790	CAMPO ALEGRE DE GOIAS	02/01/2020 14:36	02/01/2020 17:17	02/01/2020 14:36	02/01/2020 17:17	2,67	14	37,39	CHI
2020018278	SANTA HELENA DE GOIAS	400068679	IPEGUARI	02/01/2020 14:50	02/01/2020 21:33	02/01/2020 14:50	02/01/2020 21:33	6,70	1	6,70	CHI
2020018281	URUTAI	UT12229762	URUTAI	02/01/2020 14:51	02/01/2020 18:25	02/01/2020 14:51	02/01/2020 18:25	3,56	1	3,56	CHI
2020018282	URUACU	UR11262790	URUACU	02/01/2020 14:51	02/01/2020 23:33	02/01/2020 14:51	02/01/2020 23:33	8,69	214	1859,72	CHI
2020018284	POSSE	PS12237063	IACIARA S2	02/01/2020 14:52	03/01/2020 10:33	02/01/2020 14:52	03/01/2020 10:33	19,68	3	59,05	CHI
2020018285	ALEXANIA	AX21279217	ALEXANIA	02/01/2020 14:52	02/01/2020 17:54	02/01/2020 14:52	02/01/2020 17:54	3,03	1	3,03	CHI
2020018289	PETROLINA DE GOIAS	PG21019053	PETROLINA	02/01/2020 14:53	02/01/2020 16:43	02/01/2020 14:53	02/01/2020 16:43	1,83	1	1,83	CHI
2020018293	CALDAS NOVAS	CN11114789	SERRA DE CALDAS	02/01/2020 14:54	02/01/2020 18:12	02/01/2020 14:54	02/01/2020 18:12	3,29	77	253,35	CHI
2020018295	PIRES DO RIO	460000949	PIRES DO RIO S1	02/01/2020 14:54	02/01/2020 16:14	02/01/2020 14:54	02/01/2020 16:14	1,32	1	1,32	CHI
2020018296	NIQUELANDIA	NQ12264564	BARRO ALTO	02/01/2020 12:32	02/01/2020 16:35	02/01/2020 12:32	02/01/2020 16:35	4,05	12	48,57	CHI
2020018298	CATALAO	CT21104190	CATALAO S1	02/01/2020 14:55	03/01/2020 08:45	02/01/2020 14:55	03/01/2020 08:45	17,85	1	17,85	CHI
2020018299	CRISTIANOPOLIS	CF21362232	CRISTIANOPOLIS	02/01/2020 14:55	02/01/2020 17:04	02/01/2020 14:55	02/01/2020 17:04	2,15	1	2,15	CHI
2020018305	ABADIANIA	AA12295550	ANAPOLIS UNIVERSITARIO S1	02/01/2020 14:56	02/01/2020 18:26	02/01/2020 14:56	02/01/2020 18:26	3,49	5	17,47	CHI
2020018308	ITUMBIARA	CD12000284	CACHOEIRA DOURADA	02/01/2020 14:56	03/01/2020 11:48	02/01/2020 14:56	03/01/2020 11:35	20,65	21	433,59	CHI
2020018308	ITUMBIARA	IT12263732	CACHOEIRA DOURADA	02/01/2020 14:56	03/01/2020 11:48	03/01/2020 11:36	03/01/2020 11:48	0,19	4	0,74	CHI
2020018317	ARUANA	AK12353719	BRITANIA	02/01/2020 14:59	02/01/2020 15:50	02/01/2020 14:59	02/01/2020 15:50	0,85	1	0,85	CHI
2020018318	SAO LUIS DE MONTES BELOS	SL12383600	SAO LUIZ DOS MONTES BELOS	02/01/2020 14:59	02/01/2020 17:00	02/01/2020 14:59	02/01/2020 17:00	2,00	9	18,00	CHI
2020018322	SENADOR CANEDO	SW12081185	CEPAIGO S2	02/01/2020 15:01	02/01/2020 18:15	02/01/2020 15:01	02/01/2020 18:15	3,22	1	3,22	CHI
2020018325	ITUMBIARA	IT10406885	PARANAIBA	02/01/2020 15:02	03/01/2020 09:12	02/01/2020 15:02	03/01/2020 09:12	18,18	63	1145,36	CHI
2020018327	ALTO HORIZONTE	AJ12375615	SANTA TEREZINHA	02/01/2020 15:02	02/01/2020 18:16	02/01/2020 15:02	02/01/2020 18:16	3,22	8	25,78	CHI
2020018328	SAO MIGUEL DO ARAGUAIA	830059453	SAO MIGUEL DO ARAGUAIA	02/01/2020 15:02	02/01/2020 17:35	02/01/2020 15:02	02/01/2020 17:35	2,55	1	2,55	CHI
2020018331	GOIANIA	16416624	REAL S1	02/01/2020 15:02	02/01/2020 17:31	02/01/2020 15:02	02/01/2020 17:31	2,48	1	2,48	CHI
2020018334	BOM JESUS DE GOIAS	BJ21222298	BOM JESUS DE GOIAS	02/01/2020 15:03	03/01/2020 11:20	02/01/2020 15:03	03/01/2020 11:20	20,27	1	20,27	CHI
2020018337	CRIXAS	6338392	RUBIATABA	02/01/2020 15:05	03/01/2020 11:20	02/01/2020 15:05	03/01/2020 11:20	20,26	6	121,55	CHI
2020018343	PIRENOPOLIS	PV21248866	CORUMBA	02/01/2020 15:06	02/01/2020 19:16	02/01/2020 15:06	02/01/2020 19:16	4,16	1	4,16	CHI

2020018347	MORRINHOS	MR12182577	MORRINHOS	02/01/2020 15:07	02/01/2020 17:40	02/01/2020 15:07	02/01/2020 17:40	2,54	1	2,54	CHI
2020018352	AGUA LIMPA	AL12263113	VILA CORUMBA	02/01/2020 14:39	03/01/2020 09:16	02/01/2020 14:39	03/01/2020 09:16	18,61	18	334,98	CHI
2020018352	CORUMBAIBA	AL12263113	VILA CORUMBA	02/01/2020 14:39	03/01/2020 09:16	02/01/2020 14:39	03/01/2020 09:16	18,61	1	18,61	CHI
2020018359	CRISTALINA	10002030371	CRISTALINA S1	02/01/2020 15:09	02/01/2020 16:19	02/01/2020 15:09	02/01/2020 16:19	1,16	1	1,16	CHI
2020018363	NIQUELANDIA	NQ11035206	NIQUELANDIA SUBTRANSMISSAO	02/01/2020 15:09	02/01/2020 21:52	02/01/2020 21:24	02/01/2020 21:52	0,45	125	56,60	CHI
2020018366	ITUMBIARA	BG12361148	ITUMBIARA VELHA S2	02/01/2020 15:10	03/01/2020 09:50	02/01/2020 15:10	03/01/2020 09:50	18,66	2	37,32	CHI
2020018368	FORMOSA	FA12000078	ITUIQUIRA	02/01/2020 15:10	02/01/2020 18:47	02/01/2020 15:10	02/01/2020 18:47	3,62	1	3,62	CHI
2020018369	PARAUNA	PU21308531	MONTIVIDIU T	02/01/2020 15:10	02/01/2020 20:22	02/01/2020 15:10	02/01/2020 20:22	5,19	1	5,19	CHI
2020018377	GOIANIA	13680286	CARAJAS S1	02/01/2020 15:12	02/01/2020 16:59	02/01/2020 15:12	02/01/2020 16:59	1,77	1	1,77	CHI
2020018382	CALDAS NOVAS	CN11111406	CALDAS NOVAS S1	02/01/2020 15:13	02/01/2020 18:17	02/01/2020 15:13	02/01/2020 18:17	3,05	136	415,06	CHI
2020018383	PLANALTINA	PI12100880	PLANALTINA	02/01/2020 13:15	02/01/2020 16:12	02/01/2020 13:15	02/01/2020 16:12	2,94	99	290,73	CHI
2020018389	CAIAPONIA	MV12305995	MONTIVIDIU T	02/01/2020 14:00	02/01/2020 19:23	02/01/2020 14:00	02/01/2020 19:23	5,37	35	187,84	CHI
2020018389	IVOLANDIA	MV12305995	MONTIVIDIU T	02/01/2020 14:00	02/01/2020 19:23	02/01/2020 14:00	02/01/2020 19:23	5,37	29	155,64	CHI
2020018389	MONTIVIDIU	MV12305995	MONTIVIDIU T	02/01/2020 14:00	02/01/2020 19:23	02/01/2020 14:00	02/01/2020 19:23	5,37	27	144,91	CHI
2020018389	PARAUNA	MV12305995	MONTIVIDIU T	02/01/2020 14:00	02/01/2020 19:23	02/01/2020 14:00	02/01/2020 19:23	5,37	58	311,28	CHI
2020018393	SANTA RITA DO ARAGUAIA	SU12374325	SANTA RITA DO ARAGUAIA	02/01/2020 15:16	02/01/2020 18:04	02/01/2020 15:16	02/01/2020 18:04	2,81	28	78,56	CHI
2020018398	GOIANIA	GN12395188	GOYA S2	02/01/2020 15:17	02/01/2020 16:40	02/01/2020 15:17	02/01/2020 16:40	1,39	1	1,39	CHI
2020018399	GOIATUBA	GT11000043	GOIATUBA S2	02/01/2020 14:37	02/01/2020 20:30	02/01/2020 14:37	02/01/2020 20:30	5,87	94	552,20	CHI
2020018401	VILA PROPICIO	NP21312746	GOIANESIA S1	02/01/2020 15:18	03/01/2020 00:40	02/01/2020 15:18	03/01/2020 00:40	9,36	1	9,36	CHI
2020018407	SANTA CRUZ DE GOIAS	BC12300693	PIRES DO RIO S2	02/01/2020 11:09	02/01/2020 17:29	02/01/2020 11:09	02/01/2020 17:29	6,33	5	31,65	CHI
2020018408	PIRES DO RIO	PR11186730	PIRES DO RIO S1	02/01/2020 15:19	02/01/2020 19:30	02/01/2020 15:19	02/01/2020 19:30	4,18	88	367,42	CHI
2020018411	CRIXAS	CX12250107	SANTA TEREZINHA	02/01/2020 15:20	03/01/2020 11:00	02/01/2020 15:20	03/01/2020 11:00	19,67	9	177,00	CHI
2020018414	ORIZONA	OZ12052340	PIRES DO RIO S2	02/01/2020 15:20	02/01/2020 17:20	02/01/2020 15:20	02/01/2020 17:20	1,99	12	23,93	CHI
2020018416	ARUANA	2380005017	ARUANA	02/01/2020 15:21	02/01/2020 16:46	02/01/2020 15:21	02/01/2020 16:46	1,41	1	1,41	CHI
2020018428	ITAJA	IJ12122658	ITAJA S2	02/01/2020 15:24	02/01/2020 17:09	02/01/2020 15:24	02/01/2020 17:09	1,75	4	6,98	CHI
2020018433	CALDAS NOVAS	CN21245965	VILA CORUMBA	02/01/2020 15:24	03/01/2020 12:23	02/01/2020 15:24	03/01/2020 12:23	20,97	1	20,97	CHI
2020018434	JARAGUA	10011740580	JARAGUA	02/01/2020 15:24	02/01/2020 20:14	02/01/2020 15:24	02/01/2020 20:14	4,82	1	4,82	CHI
2020018437	ITUMBIARA	IT12122250LD	ITUMBIARA VELHA S1	02/01/2020 14:09	02/01/2020 17:38	02/01/2020 14:09	02/01/2020 17:38	3,48	305	1061,57	CHI
2020018438	GOIANIA	14868532	GOIANIA LESTE S3	02/01/2020 15:25	02/01/2020 18:43	02/01/2020 15:25	02/01/2020 18:43	3,29	1	3,29	CHI
2020018439	CAVALCANTE	10030147660	MINACU	02/01/2020 15:25	02/01/2020 16:14	02/01/2020 15:25	02/01/2020 16:14	0,80	1	0,80	CHI
2020018440	COCALZINHO DE GOIAS	ZN12297574	COCALZINHO	02/01/2020 15:25	02/01/2020 23:25	02/01/2020 15:25	02/01/2020 23:25	7,98	1	7,98	CHI
2020018440	CORUMBA DE GOIAS	ZN12297574	COCALZINHO	02/01/2020 15:25	02/01/2020 23:25	02/01/2020 15:25	02/01/2020 23:25	7,98	2	15,97	CHI
2020018447	GOIANIA	GN31045285	GOYA S1	02/01/2020 15:27	02/01/2020 18:38	02/01/2020 15:27	02/01/2020 18:38	3,17	1	3,17	CHI

2020018449	FORMOSA	FA12062379	ITUIQUIRA	02/01/2020 15:28	02/01/2020 18:10	02/01/2020 15:28	02/01/2020 18:10	2,70	6	16,19	CHI
2020018458	ITUMBUIARA	10011568370	ITUMBUIARA VELHA S1	02/01/2020 15:30	02/01/2020 18:25	02/01/2020 15:30	02/01/2020 18:25	2,90	1	2,90	CHI
2020018459	IPAMERI	IP21286636	IPAMERI	02/01/2020 15:30	02/01/2020 16:44	02/01/2020 15:30	02/01/2020 16:44	1,22	1	1,22	CHI
2020018465	CALDAS NOVAS	10027163588	SERRA DE CALDAS	02/01/2020 15:32	03/01/2020 03:26	02/01/2020 15:32	03/01/2020 03:26	11,90	1	11,90	CHI
2020018467	HIDROLANDIA	HD12000305	CEPAIGO S2	02/01/2020 15:32	02/01/2020 19:12	02/01/2020 15:32	02/01/2020 19:12	3,66	1	3,66	CHI
2020018475	CORUMBA DE GOIAS	CB21111217	CORUMBA	02/01/2020 15:34	03/01/2020 18:57	02/01/2020 15:34	03/01/2020 18:57	27,38	1	27,38	CHI
2020018476	SAO MIGUEL DO PASSA QUATRO	SQ21116213	BELA VISTA S2	02/01/2020 15:34	02/01/2020 17:18	02/01/2020 15:34	02/01/2020 17:18	1,73	1	1,73	CHI
2020018480	PORANGATU	PO12145187	PORANGATU	02/01/2020 13:25	02/01/2020 23:07	02/01/2020 13:25	02/01/2020 23:07	9,69	8	77,53	CHI
2020018482	PLANALTINA	TL21206179	SAO JOAO D ALIANCA	02/01/2020 15:35	02/01/2020 19:50	02/01/2020 15:35	02/01/2020 19:50	4,25	1	4,25	CHI
2020018483	IPAMERI	IP21000053	IPAMERI	02/01/2020 15:36	02/01/2020 18:03	02/01/2020 15:36	02/01/2020 18:03	2,44	1	2,44	CHI
2020018489	CRIXAS	CX21207039	SERRA DO OURO	02/01/2020 15:37	02/01/2020 18:00	02/01/2020 15:37	02/01/2020 18:00	2,37	1	2,37	CHI
2020018501	LUZIANIA	10004162348	RIO VERMELHO	02/01/2020 15:40	02/01/2020 20:02	02/01/2020 15:40	02/01/2020 20:02	4,35	1	4,35	CHI
2020018508	ALTO PARAISO DE GOIAS	BF21245423	FLORES DE GOIAS	02/01/2020 15:43	02/01/2020 19:20	02/01/2020 15:43	02/01/2020 19:20	3,62	1	3,62	CHI
2020018509	RIO VERDE	630534070	RIO VERDE S2	02/01/2020 15:43	02/01/2020 17:32	02/01/2020 15:43	02/01/2020 17:32	1,83	1	1,83	CHI
2020018510	ANAPOLIS	AN21086629	ANAPOLIS UNIVERSITARIO S2	02/01/2020 15:43	02/01/2020 18:00	02/01/2020 15:43	02/01/2020 18:00	2,28	1	2,28	CHI
2020018511	MINEIROS	MY12043894	PARQUE DAS EMAS	02/01/2020 15:26	04/01/2020 23:49	02/01/2020 15:26	02/01/2020 19:18	3,87	16	61,95	CHI
2020018511	MINEIROS	MY12043894	PARQUE DAS EMAS	02/01/2020 15:26	04/01/2020 23:49	02/01/2020 15:26	02/01/2020 22:47	7,35	29	213,13	CHI
2020018511	MINEIROS	MY12043894	PARQUE DAS EMAS	02/01/2020 15:26	04/01/2020 23:49	02/01/2020 15:26	03/01/2020 09:52	18,44	36	663,92	CHI
2020018511	MINEIROS	MY12043894	PARQUE DAS EMAS	02/01/2020 15:26	04/01/2020 23:49	03/01/2020 12:25	03/01/2020 13:15	0,83	60	49,75	CHI
2020018511	MINEIROS	MY12043894	PARQUE DAS EMAS	02/01/2020 15:26	04/01/2020 23:49	03/01/2020 22:04	04/01/2020 00:12	2,12	60	127,30	CHI
2020018511	MINEIROS	MY12043894	PARQUE DAS EMAS	02/01/2020 15:26	04/01/2020 23:49	02/01/2020 15:26	04/01/2020 13:07	45,68	21	959,30	CHI
2020018511	MINEIROS	MY13196005	PARQUE DAS EMAS	02/01/2020 15:26	04/01/2020 23:49	03/01/2020 12:25	04/01/2020 13:07	24,68	19	469,00	CHI
2020018511	MINEIROS	MY13196005	PARQUE DAS EMAS	02/01/2020 15:26	04/01/2020 23:49	03/01/2020 12:25	04/01/2020 23:10	34,75	1	34,75	CHI
2020018511	MINEIROS	MY13196005	PARQUE DAS EMAS	02/01/2020 15:26	04/01/2020 23:49	03/01/2020 12:25	04/01/2020 23:49	35,39	1	35,39	CHI
2020018511	MINEIROS	MY21219359	PARQUE DAS EMAS	02/01/2020 15:26	04/01/2020 23:49	04/01/2020 23:13	04/01/2020 23:49	0,61	1	0,61	CHI
2020018516	CORUMBA DE GOIAS	CB21196904	CORUMBA	02/01/2020 15:44	02/01/2020 17:10	02/01/2020 15:44	02/01/2020 17:10	1,43	1	1,43	CHI
2020018525	FAINA	IK12305641	ITAPURANGA	02/01/2020 15:45	02/01/2020 21:03	02/01/2020 15:45	02/01/2020 21:03	5,28	1	5,28	CHI
2020018525	ITAPURANGA	IK12305641	ITAPURANGA	02/01/2020 15:45	02/01/2020 21:03	02/01/2020 15:45	02/01/2020 21:03	5,28	1	5,28	CHI
2020018535	VALPARAISO DE GOIAS	2860297917	MARAJOARA	02/01/2020 15:48	03/01/2020 16:42	02/01/2020 15:48	03/01/2020 16:42	24,90	1	24,90	CHI
2020018537	FLORES DE GOIAS	FB11085609	FLORES DE GOIAS	02/01/2020 15:48	02/01/2020 20:04	02/01/2020 15:48	02/01/2020 20:04	4,25	97	412,38	CHI
2020018541	GOIANIA	12018442	GOIANIA LESTE S3	02/01/2020 15:49	02/01/2020 17:23	02/01/2020 15:49	02/01/2020 17:23	1,56	1	1,56	CHI
2020018544	COCALZINHO DE GOIAS	ZN21194703	COCALZINHO	02/01/2020 15:49	02/01/2020 21:59	02/01/2020 15:49	02/01/2020 21:59	6,15	1	6,15	CHI
2020018550	DOVERLANDIA	DV12139906	CAIAPONIA	02/01/2020 13:58	02/01/2020 18:15	02/01/2020 13:58	02/01/2020 18:15	4,27	10	42,68	CHI



2020018552	AMARALINA	LC12168861	MARA ROSA	02/01/2020 15:51	03/01/2020 00:25	02/01/2020 15:51	03/01/2020 00:25	8,57	4	34,26	CHI
2020018558	CATALAO	CT21104207	CATALAO S1	02/01/2020 15:52	03/01/2020 12:57	02/01/2020 15:52	03/01/2020 12:57	21,07	1	21,07	CHI
2020018564	APORE	04320224	ITAJA S1	02/01/2020 15:54	03/01/2020 13:10	02/01/2020 15:54	02/01/2020 20:00	4,10	9	36,87	CHI
2020018564	APORE	04320224	ITAJA S1	02/01/2020 15:54	03/01/2020 13:10	02/01/2020 15:54	03/01/2020 08:05	16,18	21	339,79	CHI
2020018564	APORE	04320224	ITAJA S1	02/01/2020 15:54	03/01/2020 13:10	02/01/2020 15:54	03/01/2020 10:15	18,35	15	275,20	CHI
2020018564	APORE	04320224	ITAJA S1	02/01/2020 15:54	03/01/2020 13:10	02/01/2020 15:54	03/01/2020 13:10	21,27	33	702,02	CHI
2020018571	PORANGATU	7806431	PORANGATU	02/01/2020 15:55	03/01/2020 08:21	02/01/2020 15:55	03/01/2020 08:21	16,43	1	16,43	CHI
2020018572	GAMELEIRA DE GOIAS	SV12033468	DAIA S2	02/01/2020 15:30	02/01/2020 16:56	02/01/2020 15:30	02/01/2020 16:56	1,43	14	20,01	CHI
2020018572	SILVANIA	SV12033468	DAIA S2	02/01/2020 15:30	02/01/2020 16:56	02/01/2020 15:30	02/01/2020 16:56	1,43	134	191,55	CHI
2020018576	CAMPOS VERDES	VD12363564	SANTA TEREZINHA	02/01/2020 15:18	02/01/2020 21:23	02/01/2020 15:18	02/01/2020 21:23	6,08	33	200,54	CHI
2020018582	BARRO ALTO	DF12194371	BARRO ALTO	02/01/2020 15:08	04/01/2020 01:36	02/01/2020 15:08	03/01/2020 11:29	20,36	34	692,15	CHI
2020018582	SANTA RITA DO NOVO DESTINO	DF12194371	BARRO ALTO	02/01/2020 15:08	04/01/2020 01:36	02/01/2020 15:08	03/01/2020 11:29	20,36	2	40,71	CHI
2020018582	SANTA RITA DO NOVO DESTINO	DF12194371	BARRO ALTO	02/01/2020 15:08	04/01/2020 01:36	02/01/2020 15:08	03/01/2020 14:42	23,57	31	730,79	CHI
2020018582	BARRO ALTO	DF12194371	BARRO ALTO	02/01/2020 15:08	04/01/2020 01:36	03/01/2020 13:36	03/01/2020 14:42	1,11	34	37,65	CHI
2020018582	SANTA RITA DO NOVO DESTINO	DF12194371	BARRO ALTO	02/01/2020 15:08	04/01/2020 01:36	03/01/2020 13:36	03/01/2020 14:42	1,11	2	2,21	CHI
2020018582	BARRO ALTO	BA12168169LD	BARRO ALTO	02/01/2020 15:08	04/01/2020 01:36	02/01/2020 15:08	04/01/2020 01:36	34,46	33	1137,32	CHI
2020018585	URUACU	640100053	URUACU	02/01/2020 16:00	02/01/2020 19:28	02/01/2020 16:00	02/01/2020 19:28	3,47	1	3,47	CHI
2020018591	JARAGUA	JA11255159	JARAGUA	02/01/2020 15:37	02/01/2020 19:35	02/01/2020 15:37	02/01/2020 19:35	3,97	82	325,29	CHI
2020018596	JATAI	JT12234505	JATAI S1	02/01/2020 16:02	03/01/2020 00:37	02/01/2020 16:02	03/01/2020 00:37	8,57	1	8,57	CHI
2020018599	BONFINOPOLIS	920025080	CEPAIGO S2	02/01/2020 16:03	02/01/2020 17:44	02/01/2020 16:03	02/01/2020 17:44	1,68	1	1,68	CHI
2020018601	SAO LUIS DE MONTES BELOS	SL21125638	FIRMINOPOLIS S1	02/01/2020 15:59	02/01/2020 17:40	02/01/2020 15:59	02/01/2020 17:40	1,69	1	1,69	CHI
2020018603	APORE	AE11129743	ITAJA S1	02/01/2020 16:03	02/01/2020 16:08	02/01/2020 16:03	02/01/2020 16:08	0,08	35	2,64	CHI
2020018606	CAMPOS VERDES	UP10398079	SANTA TEREZINHA	02/01/2020 15:59	02/01/2020 18:15	02/01/2020 15:59	02/01/2020 18:15	2,26	1	2,26	CHI
2020018606	MARA ROSA	UP10398079	SANTA TEREZINHA	02/01/2020 15:59	02/01/2020 18:15	02/01/2020 15:59	02/01/2020 18:15	2,26	75	169,33	CHI
2020018606	SANTA TEREZINHA DE GOIAS	UP10398079	SANTA TEREZINHA	02/01/2020 15:59	02/01/2020 18:15	02/01/2020 15:59	02/01/2020 18:15	2,26	118	266,42	CHI
2020018606	UIRAPURU	UP10398079	SANTA TEREZINHA	02/01/2020 15:59	02/01/2020 18:15	02/01/2020 15:59	02/01/2020 18:15	2,26	17	38,38	CHI
2020018608	MONTIVIDIU	MV21200063	MONTIVIDIU T	02/01/2020 14:19	02/01/2020 17:44	02/01/2020 14:19	02/01/2020 17:44	3,42	1	3,42	CHI
2020018609	MONTE ALEGRE DE GOIAS	ND10401466	IACIARA S2	02/01/2020 16:20	02/01/2020 16:29	02/01/2020 16:20	02/01/2020 16:29	0,15	1	0,15	CHI
2020018609	NOVA ROMA	ND10401466	IACIARA S2	02/01/2020 16:20	02/01/2020 16:29	02/01/2020 16:20	02/01/2020 16:29	0,15	1023	149,47	CHI
2020018609	SAO DOMINGOS	ND10401466	IACIARA S2	02/01/2020 16:20	02/01/2020 16:29	02/01/2020 16:20	02/01/2020 16:29	0,15	4	0,58	CHI
2020018611	ANAPOLIS	10015681104	ANAPOLIS UNIVERSITARIO S2	02/01/2020 16:38	02/01/2020 19:06	02/01/2020 16:38	02/01/2020 19:06	2,46	1	2,46	CHI
2020018615	APARECIDA DE GOIANIA	AP11000015	INDEPENDENCIA S2	02/01/2020 16:08	02/01/2020 17:42	02/01/2020 16:08	02/01/2020 17:42	1,56	239	372,04	CHI
2020018628	EDEALINA	EA10394609	EDEIA	02/01/2020 18:01	03/01/2020 19:44	02/01/2020 18:01	02/01/2020 19:07	1,10	1	1,10	CHI

2020018628	EDEIA	EA10394609	EDEIA	02/01/2020 18:01	03/01/2020 19:44	02/01/2020 18:01	02/01/2020 19:07	1,10	160	176,40	CHI
2020018628	EDEIA	EA12000048LD	EDEIA	02/01/2020 18:01	03/01/2020 19:44	02/01/2020 18:01	03/01/2020 08:13	14,20	6	85,21	CHI
2020018628	EDEIA	EA10394609	EDEIA	02/01/2020 18:01	03/01/2020 19:44	02/01/2020 18:01	03/01/2020 19:44	25,73	25	643,22	CHI
2020018628	EDEALINA	EA10394609	EDEIA	02/01/2020 18:01	03/01/2020 19:44	03/01/2020 09:16	03/01/2020 19:44	10,47	1	10,47	CHI
2020018628	EDEIA	EA10394609	EDEIA	02/01/2020 18:01	03/01/2020 19:44	03/01/2020 09:16	03/01/2020 19:44	10,47	167	1748,49	CHI
2020018647	CUMARI	CY21127680	CATALAO S1	02/01/2020 19:15	02/01/2020 20:25	02/01/2020 19:15	02/01/2020 20:25	1,17	1	1,17	CHI
2020018670	DIORAMA	IR10403921	ARENOPOLIS	02/01/2020 19:57	03/01/2020 10:30	02/01/2020 19:57	02/01/2020 22:53	2,94	66	194,17	CHI
2020018670	IPORA	IR10403921	ARENOPOLIS	02/01/2020 19:57	03/01/2020 10:30	02/01/2020 19:57	02/01/2020 22:53	2,94	10	29,42	CHI
2020018670	MONTES CLAROS DE GOIAS	IR10403921	ARENOPOLIS	02/01/2020 19:57	03/01/2020 10:30	02/01/2020 19:57	02/01/2020 22:53	2,94	22	64,72	CHI
2020018670	DIORAMA	IR10403921	ARENOPOLIS	02/01/2020 19:57	03/01/2020 10:30	03/01/2020 00:24	03/01/2020 00:37	0,22	66	14,23	CHI
2020018670	IPORA	IR10403921	ARENOPOLIS	02/01/2020 19:57	03/01/2020 10:30	03/01/2020 00:24	03/01/2020 00:37	0,22	10	2,16	CHI
2020018670	MONTES CLAROS DE GOIAS	IR10403921	ARENOPOLIS	02/01/2020 19:57	03/01/2020 10:30	03/01/2020 00:24	03/01/2020 00:37	0,22	22	4,74	CHI
2020018670	DIORAMA	IR10403921	ARENOPOLIS	02/01/2020 19:57	03/01/2020 10:30	03/01/2020 01:34	03/01/2020 01:54	0,32	66	21,10	CHI
2020018670	IPORA	IR10403921	ARENOPOLIS	02/01/2020 19:57	03/01/2020 10:30	03/01/2020 01:34	03/01/2020 01:54	0,32	10	3,20	CHI
2020018670	MONTES CLAROS DE GOIAS	IR10403921	ARENOPOLIS	02/01/2020 19:57	03/01/2020 10:30	03/01/2020 01:34	03/01/2020 01:54	0,32	22	7,03	CHI
2020018670	DIORAMA	DI12231254LD	ARENOPOLIS	02/01/2020 19:57	03/01/2020 10:30	02/01/2020 19:57	03/01/2020 09:29	13,53	17	230,02	CHI
2020018670	MONTES CLAROS DE GOIAS	DI12231254LD	ARENOPOLIS	02/01/2020 19:57	03/01/2020 10:30	02/01/2020 19:57	03/01/2020 09:29	13,53	1	13,53	CHI
2020018670	DIORAMA	IR10403921	ARENOPOLIS	02/01/2020 19:57	03/01/2020 10:30	02/01/2020 19:57	03/01/2020 10:30	14,55	32	465,62	CHI
2020018670	MONTES CLAROS DE GOIAS	IR10403921	ARENOPOLIS	02/01/2020 19:57	03/01/2020 10:30	02/01/2020 19:57	03/01/2020 10:30	14,55	16	232,81	CHI
2020018673	AMORINOPOLIS	AM12390135	IPORA	02/01/2020 20:13	02/01/2020 20:37	02/01/2020 20:13	02/01/2020 20:37	0,39	8	3,11	CHI
2020018673	IVOLANDIA	AM12390135	IPORA	02/01/2020 20:13	02/01/2020 20:37	02/01/2020 20:13	02/01/2020 20:37	0,39	68	26,43	CHI
2020018678	RIO VERDE	MV10400640	MONTIVIDIU T	02/01/2020 20:45	03/01/2020 16:55	02/01/2020 20:50	02/01/2020 23:00	2,16	9	19,45	CHI
2020018678	MONTIVIDIU	RV13331677	MONTIVIDIU T	02/01/2020 20:45	03/01/2020 16:55	02/01/2020 20:50	02/01/2020 23:32	2,69	5	13,43	CHI
2020018678	RIO VERDE	RV13331677	MONTIVIDIU T	02/01/2020 20:45	03/01/2020 16:55	02/01/2020 20:50	02/01/2020 23:32	2,69	10	26,87	CHI
2020018678	RIO VERDE	MV10400640	MONTIVIDIU T	02/01/2020 20:45	03/01/2020 16:55	03/01/2020 01:05	03/01/2020 01:13	0,14	9	1,30	CHI
2020018678	MONTIVIDIU	MV10400640	MONTIVIDIU T	02/01/2020 20:45	03/01/2020 16:55	02/01/2020 20:50	03/01/2020 14:45	17,91	4	71,66	CHI
2020018678	RIO VERDE	MV10400640	MONTIVIDIU T	02/01/2020 20:45	03/01/2020 16:55	02/01/2020 20:50	03/01/2020 14:45	17,91	28	501,61	CHI
2020018678	RIO VERDE	MV10400640	MONTIVIDIU T	02/01/2020 20:45	03/01/2020 16:55	03/01/2020 14:33	03/01/2020 14:47	0,24	9	2,18	CHI
2020018678	CAIAPONIA	MV12054336	MONTIVIDIU T	02/01/2020 20:45	03/01/2020 16:55	02/01/2020 20:50	03/01/2020 16:25	19,57	29	567,67	CHI
2020018678	MONTIVIDIU	MV12054336	MONTIVIDIU T	02/01/2020 20:45	03/01/2020 16:55	02/01/2020 20:50	03/01/2020 16:25	19,57	37	724,26	CHI
2020018678	RIO VERDE	MV12054336	MONTIVIDIU T	02/01/2020 20:45	03/01/2020 16:55	02/01/2020 20:50	03/01/2020 16:25	19,57	1	19,57	CHI
2020018678	MONTIVIDIU	RV12060217	MONTIVIDIU T	02/01/2020 20:45	03/01/2020 16:55	02/01/2020 20:50	03/01/2020 16:55	20,07	8	160,56	CHI
2020018678	RIO VERDE	RV12060217	MONTIVIDIU T	02/01/2020 20:45	03/01/2020 16:55	02/01/2020 20:50	03/01/2020 16:55	20,07	1	20,07	CHI

2020018685	SANTA HELENA DE GOIAS	SH10394752	IPEGUARI	02/01/2020 22:53	04/01/2020 00:48	02/01/2020 22:53	03/01/2020 01:51	2,96	74	218,75	CHI
2020018685	SANTA HELENA DE GOIAS	20398971	IPEGUARI	02/01/2020 22:53	04/01/2020 00:48	02/01/2020 22:53	04/01/2020 00:03	25,16	1	25,16	CHI
2020018685	SANTA HELENA DE GOIAS	SH12279533	IPEGUARI	02/01/2020 22:53	04/01/2020 00:48	02/01/2020 22:53	04/01/2020 00:48	25,91	32	829,04	CHI
2020018688	RIO VERDE	RV10212406	CABRIUVA S2	02/01/2020 23:28	03/01/2020 23:10	02/01/2020 23:28	03/01/2020 03:17	3,83	2	7,65	CHI
2020018688	RIO VERDE	RV10212406	CABRIUVA S2	02/01/2020 23:28	03/01/2020 23:10	02/01/2020 23:28	03/01/2020 05:44	6,27	31	194,45	CHI
2020018688	RIO VERDE	RV12207053LD	CABRIUVA S2	02/01/2020 23:28	03/01/2020 23:10	02/01/2020 23:28	03/01/2020 09:30	10,03	1	10,03	CHI
2020018688	RIO VERDE	7108540	CABRIUVA S2	02/01/2020 23:28	03/01/2020 23:10	03/01/2020 09:47	03/01/2020 11:25	1,63	1	1,63	CHI
2020018688	RIO VERDE	RV10212406	CABRIUVA S2	02/01/2020 23:28	03/01/2020 23:10	02/01/2020 23:28	03/01/2020 12:33	13,09	8	104,76	CHI
2020018688	RIO VERDE	RV10212406	CABRIUVA S2	02/01/2020 23:28	03/01/2020 23:10	03/01/2020 12:37	03/01/2020 16:08	3,52	33	116,13	CHI
2020018688	RIO VERDE	RV12207053LD	CABRIUVA S2	02/01/2020 23:28	03/01/2020 23:10	03/01/2020 12:37	03/01/2020 21:52	9,25	1	9,25	CHI
2020018688	RIO VERDE	RV13402251	CABRIUVA S2	02/01/2020 23:28	03/01/2020 23:10	03/01/2020 12:37	03/01/2020 22:30	9,89	8	79,09	CHI
2020018688	RIO VERDE	RV12249020	CABRIUVA S2	02/01/2020 23:28	03/01/2020 23:10	02/01/2020 23:28	03/01/2020 23:10	23,71	18	426,76	CHI
2020018702	ALEXANIA	AX12313240	ALEXANIA	02/01/2020 15:58	02/01/2020 18:44	02/01/2020 15:58	02/01/2020 18:44	2,76	17	46,89	CHI
2020018705	NOVA ROMA	ND12392238	IACIARA S2	02/01/2020 15:15	02/01/2020 20:12	02/01/2020 15:15	02/01/2020 20:12	4,95	233	1153,41	CHI
2020018710	MONTIVIDIU DO NORTE	MX11275239	PORANGATU	02/01/2020 16:05	02/01/2020 17:51	02/01/2020 16:05	02/01/2020 17:51	1,76	1	1,76	CHI
2020018712	CALDAS NOVAS	CN11214015	SERRA DE CALDAS	02/01/2020 16:05	03/01/2020 11:41	02/01/2020 16:05	03/01/2020 11:41	19,59	2	39,17	CHI
2020018715	GUAPO	GA21000226	GUAPO S1	02/01/2020 16:06	03/01/2020 01:15	02/01/2020 16:06	03/01/2020 01:15	9,14	1	9,14	CHI
2020018716	NOVA CRIXAS	NA21201685	MOZARLANDIA	02/01/2020 16:06	03/01/2020 09:17	02/01/2020 16:06	03/01/2020 09:17	17,17	1	17,17	CHI
2020018717	CIDADE OCIDENTAL	10025824838	MARAJOARA	02/01/2020 16:07	03/01/2020 00:30	02/01/2020 16:07	03/01/2020 00:30	8,38	1	8,38	CHI
2020018718	ORIZONA	OZ21000303	PIRES DO RIO S1	02/01/2020 16:08	02/01/2020 17:30	02/01/2020 16:08	02/01/2020 17:30	1,36	1	1,36	CHI
2020018719	GOIANIA	GN11002630	CAMPINAS S1	02/01/2020 16:08	02/01/2020 18:17	02/01/2020 16:08	02/01/2020 18:17	2,14	102	218,34	CHI
2020018720	APARECIDA DE GOIANIA	AP11389480	INDEPENDENCIA S2	02/01/2020 16:08	02/01/2020 18:35	02/01/2020 16:08	02/01/2020 18:35	2,44	82	200,08	CHI
2020018721	BOM JESUS DE GOIAS	1250055900	BOM JESUS DE GOIAS	02/01/2020 16:08	03/01/2020 00:29	02/01/2020 16:08	03/01/2020 00:29	8,34	1	8,34	CHI
2020018734	GOIANIA	GN12201566	GOYA S2	02/01/2020 16:10	02/01/2020 17:08	02/01/2020 16:10	02/01/2020 17:08	0,95	300	285,58	CHI
2020018736	PIRACANJUBA	MR21120846	MORRINHOS	02/01/2020 16:11	02/01/2020 20:35	02/01/2020 16:11	02/01/2020 20:35	4,40	1	4,40	CHI
2020018739	PORANGATU	PO12192280	PORANGATU	02/01/2020 16:11	03/01/2020 00:09	02/01/2020 16:11	03/01/2020 00:09	7,96	5	39,81	CHI
2020018747	PORANGATU	PO21151008	PORANGATU	02/01/2020 16:14	02/01/2020 19:00	02/01/2020 16:14	02/01/2020 19:00	2,75	1	2,75	CHI
2020018752	TURVELANDIA	TD21303641	RIO DOS BOIS	02/01/2020 16:15	02/01/2020 19:35	02/01/2020 16:15	02/01/2020 19:35	3,34	1	3,34	CHI
2020018755	ANAPOLIS	AN11000366	ANAPOLIS UNIVERSITARIO S2	02/01/2020 15:49	02/01/2020 17:21	02/01/2020 15:49	02/01/2020 17:21	1,53	108	165,30	CHI
2020018766	ARENOPOLIS	AY12390170	ARENOPOLIS	02/01/2020 13:09	02/01/2020 21:00	02/01/2020 13:09	02/01/2020 21:00	7,84	8	62,74	CHI
2020018767	ITAPURANGA	IK21300212	ITAPURANGA	02/01/2020 16:16	03/01/2020 15:38	02/01/2020 16:16	03/01/2020 15:38	23,36	1	23,36	CHI
2020018768	NIQUELANDIA	NQ21146920	URUACU	02/01/2020 16:18	03/01/2020 09:05	02/01/2020 16:18	03/01/2020 09:05	16,77	1	16,77	CHI
2020018770	PIRANHAS	PH12170743	PIRANHAS	02/01/2020 11:44	02/01/2020 17:24	02/01/2020 11:44	02/01/2020 17:24	5,66	17	96,20	CHI

2020018771	ABADIANIA	AA21146320	DAIA S2	02/01/2020 16:19	03/01/2020 09:48	02/01/2020 16:19	03/01/2020 09:48	17,48	1	17,48	CHI
2020018772	MORRINHOS	PK12095164RE	PONTALINA	02/01/2020 16:19	03/01/2020 08:27	02/01/2020 16:19	03/01/2020 08:27	16,13	4	64,52	CHI
2020018772	PONTALINA	PK12095164RE	PONTALINA	02/01/2020 16:19	03/01/2020 08:27	02/01/2020 16:19	03/01/2020 08:27	16,13	13	209,70	CHI
2020018774	PIRES DO RIO	PR21000017	PIRES DO RIO S1	02/01/2020 16:19	02/01/2020 20:29	02/01/2020 16:19	02/01/2020 20:29	4,16	4	16,66	CHI
2020018778	SILVANIA	SV21105539	VIANOPOLIS	02/01/2020 16:20	02/01/2020 18:45	02/01/2020 16:20	02/01/2020 18:45	2,42	14	33,90	CHI
2020018783	APARECIDA DE GOIANIA	AP11004912	INDEPENDENCIA S2	02/01/2020 16:22	02/01/2020 18:45	02/01/2020 16:22	02/01/2020 18:45	2,38	121	288,05	CHI
2020018796	LUZIANIA	10006059978	MARAJOARA	02/01/2020 16:23	02/01/2020 19:57	02/01/2020 16:23	02/01/2020 19:57	3,56	1	3,56	CHI
2020018798	NOVA ROMA	SD12115759	SAO DOMINGOS	02/01/2020 16:23	02/01/2020 19:02	02/01/2020 16:23	02/01/2020 19:02	2,64	2	5,27	CHI
2020018798	SAO DOMINGOS	SD12115759	SAO DOMINGOS	02/01/2020 16:23	02/01/2020 19:02	02/01/2020 16:23	02/01/2020 19:02	2,64	44	116,00	CHI
2020018799	DOVERLANDIA	DV21151196	CAIAPONIA	02/01/2020 16:23	02/01/2020 22:08	02/01/2020 16:23	02/01/2020 22:08	5,73	1	5,73	CHI
2020018800	FORMOSA	610259880	ITUIQUIRA	02/01/2020 16:24	02/01/2020 18:14	02/01/2020 16:24	02/01/2020 18:14	1,83	1	1,83	CHI
2020018805	FAINA	MS12113246	ITAPURANGA	02/01/2020 16:25	03/01/2020 20:33	02/01/2020 16:25	02/01/2020 19:39	3,23	1	3,23	CHI
2020018805	MORRO AGUDO DE GOIAS	MS12113246	ITAPURANGA	02/01/2020 16:25	03/01/2020 20:33	02/01/2020 16:25	02/01/2020 19:39	3,23	5	16,14	CHI
2020018805	FAINA	MS12113246	ITAPURANGA	02/01/2020 16:25	03/01/2020 20:33	02/01/2020 16:25	03/01/2020 09:45	17,32	4	69,28	CHI
2020018805	MORRO AGUDO DE GOIAS	MS12113246	ITAPURANGA	02/01/2020 16:25	03/01/2020 20:33	02/01/2020 16:25	03/01/2020 09:45	17,32	2	34,64	CHI
2020018805	ARAGUAPAZ	MS12113246	ITAPURANGA	02/01/2020 16:25	03/01/2020 20:33	02/01/2020 16:25	03/01/2020 20:33	28,13	2	56,25	CHI
2020018805	FAINA	MS12113246	ITAPURANGA	02/01/2020 16:25	03/01/2020 20:33	02/01/2020 16:25	03/01/2020 20:33	28,13	2	56,25	CHI
2020018805	FAINA	MS12154382LD	ITAPURANGA	02/01/2020 16:25	03/01/2020 20:33	03/01/2020 19:27	03/01/2020 20:33	1,10	4	4,41	CHI
2020018805	MORRO AGUDO DE GOIAS	MS12154382LD	ITAPURANGA	02/01/2020 16:25	03/01/2020 20:33	03/01/2020 19:27	03/01/2020 20:33	1,10	2	2,21	CHI
2020018807	MARA ROSA	2260040129	MARA ROSA	02/01/2020 16:26	03/01/2020 09:45	02/01/2020 16:26	03/01/2020 09:45	17,32	1	17,32	CHI
2020018809	MONTES CLAROS DE GOIAS	ME21040230	BRITANIA	02/01/2020 16:26	03/01/2020 00:14	02/01/2020 16:26	03/01/2020 00:14	7,79	1	7,79	CHI
2020018811	CATALAO	1990006453	CATALAO S2	02/01/2020 16:27	02/01/2020 20:30	02/01/2020 16:27	02/01/2020 20:30	4,04	1	4,04	CHI
2020018814	BONOPOLIS	BX12079321	SAO MIGUEL DO ARAGUAIA	02/01/2020 15:46	03/01/2020 06:58	02/01/2020 15:46	03/01/2020 06:58	15,19	58	880,83	CHI
2020018818	PIRACANJUBA	PJ21000030	PIRACANJUBA	02/01/2020 16:28	02/01/2020 17:37	02/01/2020 16:28	02/01/2020 17:37	1,13	2	2,27	CHI
2020018819	TURVANIA	TV10400598	FIRMINOPOLIS S2	02/01/2020 16:29	02/01/2020 19:31	02/01/2020 16:29	02/01/2020 19:31	3,03	1	3,03	CHI
2020018820	CACU	SO12303104	CACHOEIRA ALTA	02/01/2020 16:30	02/01/2020 22:44	02/01/2020 16:30	02/01/2020 22:44	6,22	1	6,22	CHI
2020018820	SAO SIMAO	SO12303104	CACHOEIRA ALTA	02/01/2020 16:30	02/01/2020 22:44	02/01/2020 16:30	02/01/2020 22:44	6,22	2	12,45	CHI
2020018822	GOIANIRA	390088961	GOIANIRA	02/01/2020 16:30	02/01/2020 20:24	02/01/2020 16:30	02/01/2020 20:24	3,89	1	3,89	CHI
2020018828	AMARALINA	MQ13074152	MARA ROSA	03/01/2020 06:38	03/01/2020 18:46	03/01/2020 17:16	03/01/2020 17:44	0,47	742	346,06	CHI
2020018828	MARA ROSA	MQ13074152	MARA ROSA	03/01/2020 06:38	03/01/2020 18:46	03/01/2020 17:16	03/01/2020 17:44	0,47	72	33,58	CHI
2020018828	MUTUNOPOLIS	MQ13074152	MARA ROSA	03/01/2020 06:38	03/01/2020 18:46	03/01/2020 17:16	03/01/2020 17:44	0,47	2	0,93	CHI
2020018828	ALTO HORIZONTE	MQ10396038	MARA ROSA	03/01/2020 06:38	03/01/2020 18:46	03/01/2020 06:38	03/01/2020 18:12	11,57	2	23,13	CHI
2020018828	AMARALINA	MQ10396038	MARA ROSA	03/01/2020 06:38	03/01/2020 18:46	03/01/2020 06:38	03/01/2020 18:12	11,57	282	3261,96	CHI

2020018828	MARA ROSA	MQ10396038	MARA ROSA	03/01/2020 06:38	03/01/2020 18:46	03/01/2020 06:38	03/01/2020 18:12	11,57	263	3042,18	CHI
2020018828	MARA ROSA	MQ10396038	MARA ROSA	03/01/2020 06:38	03/01/2020 18:46	03/01/2020 12:49	03/01/2020 18:12	5,40	13	70,18	CHI
2020018828	AMARALINA	MQ10396038	MARA ROSA	03/01/2020 06:38	03/01/2020 18:46	03/01/2020 13:51	03/01/2020 18:12	4,36	22	95,93	CHI
2020018828	MARA ROSA	MQ10396038	MARA ROSA	03/01/2020 06:38	03/01/2020 18:46	03/01/2020 13:51	03/01/2020 18:12	4,36	3	13,08	CHI
2020018828	MARA ROSA	MQ21125483	MARA ROSA	03/01/2020 06:38	03/01/2020 18:46	03/01/2020 12:48	03/01/2020 18:28	5,66	1	5,66	CHI
2020018828	MARA ROSA	MQ12338264	MARA ROSA	03/01/2020 06:38	03/01/2020 18:46	03/01/2020 12:48	03/01/2020 18:46	5,98	1	5,98	CHI
2020018844	CRISTALINA	03460444	PAMPLONA	02/01/2020 16:29	03/01/2020 10:20	02/01/2020 16:29	02/01/2020 17:44	1,24	2103	2617,65	CHI
2020018844	CRISTALINA	03460444	PAMPLONA	02/01/2020 16:29	03/01/2020 10:20	02/01/2020 16:29	02/01/2020 17:44	1,24	196	243,97	CHI
2020018844	CRISTALINA	03460444	PAMPLONA	02/01/2020 16:29	03/01/2020 10:20	02/01/2020 17:46	02/01/2020 18:23	0,62	121	74,99	CHI
2020018844	CRISTALINA	03460444	PAMPLONA	02/01/2020 16:29	03/01/2020 10:20	02/01/2020 17:46	02/01/2020 18:24	0,64	2103	1344,17	CHI
2020018844	CRISTALINA	KR10400360	PAMPLONA	02/01/2020 16:29	03/01/2020 10:20	02/01/2020 17:46	02/01/2020 18:24	0,64	1	0,64	CHI
2020018844	CRISTALINA	KR13400832	PAMPLONA	02/01/2020 16:29	03/01/2020 10:20	02/01/2020 17:46	02/01/2020 19:17	1,52	22	33,37	CHI
2020018844	CRISTALINA	KR10400354	PAMPLONA	02/01/2020 16:29	03/01/2020 10:20	02/01/2020 17:46	02/01/2020 21:12	3,45	48	165,48	CHI
2020018844	CRISTALINA	RT00650415	PAMPLONA	02/01/2020 16:29	03/01/2020 10:20	02/01/2020 17:46	03/01/2020 04:11	10,42	4	41,70	CHI
2020018844	CRISTALINA	03460444	PAMPLONA	02/01/2020 16:29	03/01/2020 10:20	02/01/2020 16:29	03/01/2020 10:20	17,84	1	17,84	CHI
2020018844	LUZIANIA	03460444	PAMPLONA	02/01/2020 16:29	03/01/2020 10:20	02/01/2020 16:29	03/01/2020 10:20	17,84	5	89,19	CHI
2020018845	COCALZINHO DE GOIAS	CB12028344	COCALZINHO	02/01/2020 16:34	02/01/2020 21:26	02/01/2020 20:15	02/01/2020 20:28	0,20	3	0,60	CHI
2020018845	COCALZINHO DE GOIAS	ZN21201296	COCALZINHO	02/01/2020 16:34	02/01/2020 21:26	02/01/2020 16:34	02/01/2020 21:26	4,85	1	4,85	CHI
2020018855	AGUAS LINDAS DE GOIAS	LA12214978	AGUAS LINDAS DE GOIAS S1	02/01/2020 16:36	02/01/2020 18:02	02/01/2020 16:36	02/01/2020 18:02	1,42	364	518,60	CHI
2020018856	TRINDADE	10012903041	TRINDADE	02/01/2020 16:36	02/01/2020 19:14	02/01/2020 16:36	02/01/2020 19:14	2,62	1	2,62	CHI
2020018868	CABECEIRAS	CW10401455	ITIQUEIRA	02/01/2020 16:07	02/01/2020 19:00	02/01/2020 16:12	02/01/2020 16:18	0,09	1	0,09	CHI
2020018868	CABECEIRAS	CW10401455	ITIQUEIRA	02/01/2020 16:07	02/01/2020 19:00	02/01/2020 16:15	02/01/2020 19:00	2,75	7	19,25	CHI
2020018869	SANTA RITA DO ARAGUAIA	SU21245154	SANTA RITA DO ARAGUAIA	02/01/2020 16:40	02/01/2020 20:51	02/01/2020 16:40	02/01/2020 20:51	4,18	1	4,18	CHI
2020018872	GOIANIA	10010085287	SENADOR CANEDO	02/01/2020 16:40	02/01/2020 20:27	02/01/2020 16:40	02/01/2020 20:27	3,78	1	3,78	CHI
2020018877	BELA VISTA DE GOIAS	BV12291753	BELA VISTA S1	02/01/2020 16:41	02/01/2020 18:29	02/01/2020 16:41	02/01/2020 18:29	1,79	87	156,12	CHI
2020018879	JANDAIA	PL21087918	PALMEIRAS	02/01/2020 16:41	02/01/2020 21:03	02/01/2020 16:41	02/01/2020 21:03	4,35	1	4,35	CHI
2020018886	APARECIDA DE GOIANIA	10010580598	INDEPENDENCIA S1	02/01/2020 16:43	02/01/2020 17:39	02/01/2020 16:43	02/01/2020 17:39	0,93	1	0,93	CHI
2020018887	CAIAPONIA	CP12374977	PALESTINA	02/01/2020 19:18	03/01/2020 15:55	02/01/2020 19:18	03/01/2020 15:55	20,61	31	638,76	CHI
2020018889	AGUAS LINDAS DE GOIAS	4830163230	AGUAS LINDAS DE GOIAS S1	02/01/2020 16:43	02/01/2020 17:49	02/01/2020 16:43	02/01/2020 17:49	1,09	1	1,09	CHI
2020018899	PIRES DO RIO	PR21115582	PIRES DO RIO S1	02/01/2020 16:46	02/01/2020 21:31	02/01/2020 16:46	02/01/2020 21:31	4,75	1	4,75	CHI
2020018903	QUIRINOPOLIS	QI21129241	SANTA HELENA S1	02/01/2020 16:47	02/01/2020 22:30	02/01/2020 16:47	02/01/2020 22:30	5,71	1	5,71	CHI
2020018908	CASTELANDIA	1890012753	RIO DOS BOIS	02/01/2020 16:49	02/01/2020 22:55	02/01/2020 16:49	02/01/2020 22:55	6,10	1	6,10	CHI
2020018910	PALMEIRAS DE GOIAS	10022081761	PALMEIRAS	02/01/2020 16:49	02/01/2020 18:38	02/01/2020 16:49	02/01/2020 18:38	1,81	1	1,81	CHI

2020018912	SAO LUIZ DO NORTE	SZ21351564	ITAPACI	02/01/2020 16:49	02/01/2020 20:20	02/01/2020 16:49	02/01/2020 20:20	3,50	1	3,50	CHI
2020018922	GOIANIA	14160092	MEIA PONTE	02/01/2020 16:52	02/01/2020 18:40	02/01/2020 16:52	02/01/2020 18:40	1,80	1	1,80	CHI
2020018924	PIRES DO RIO	PR21099998	PIRES DO RIO S1	02/01/2020 16:52	03/01/2020 13:48	02/01/2020 16:52	03/01/2020 13:48	20,94	1	20,94	CHI
2020018930	LEOPOLDO DE BULHOES	LB31089096	DAIA S1	02/01/2020 16:54	02/01/2020 21:05	02/01/2020 16:54	02/01/2020 21:05	4,18	1	4,18	CHI
2020018932	SERRANOPOLIS	SX12137267	ITAJA S1	02/01/2020 16:54	03/01/2020 14:04	02/01/2020 16:54	03/01/2020 14:04	21,16	8	169,29	CHI
2020018934	LUZIANIA	LZ12313611	VIANOPOLIS	02/01/2020 16:55	02/01/2020 21:46	02/01/2020 16:55	02/01/2020 21:46	4,85	10	48,49	CHI
2020018936	IPAMERI	IP12247905	CRISTALINA S2	02/01/2020 16:23	03/01/2020 09:43	02/01/2020 16:23	03/01/2020 09:43	17,32	42	727,48	CHI
2020018937	MINEIROS	MY12303348	PARQUE DAS EMAS	02/01/2020 16:56	02/01/2020 23:54	02/01/2020 16:56	02/01/2020 23:54	6,97	9	62,69	CHI
2020018942	FLORES DE GOIAS	FB12250123	FLORES DE GOIAS	02/01/2020 16:19	02/01/2020 21:56	02/01/2020 16:19	02/01/2020 21:56	5,61	81	454,25	CHI
2020018942	SAO JOAO D ALIANCA	FB12250123	FLORES DE GOIAS	02/01/2020 16:19	02/01/2020 21:56	02/01/2020 16:19	02/01/2020 21:56	5,61	20	112,16	CHI
2020018948	MONTE ALEGRE DE GOIAS	MA12290214	SAO DOMINGOS	02/01/2020 16:57	02/01/2020 18:23	02/01/2020 16:57	02/01/2020 18:23	1,44	12	17,22	CHI
2020018949	CAVALCANTE	CJ12308270	MINACU	02/01/2020 16:58	03/01/2020 15:14	02/01/2020 16:58	03/01/2020 15:14	22,26	4	89,05	CHI
2020018951	GOIANIA	17015777	GOYA S2	02/01/2020 16:58	02/01/2020 19:10	02/01/2020 16:58	02/01/2020 19:10	2,19	1	2,19	CHI
2020018953	SAO MIGUEL DO ARAGUAIA	SM12321016	NOVA CRIXAS	02/01/2020 16:59	03/01/2020 08:56	02/01/2020 16:59	03/01/2020 08:56	15,95	7	111,63	CHI
2020018954	MONTES CLAROS DE GOIAS	ME121204885	BRITANIA	02/01/2020 16:59	03/01/2020 03:57	02/01/2020 16:59	03/01/2020 03:57	10,96	10	109,63	CHI
2020018957	GOIANIA	16652241	XAVANTES	02/01/2020 17:00	02/01/2020 18:40	02/01/2020 17:00	02/01/2020 18:40	1,67	1	1,67	CHI
2020018962	CRISTALINA	KR21348854	CRISTALINA S2	02/01/2020 17:01	03/01/2020 11:38	02/01/2020 17:01	03/01/2020 11:38	18,60	1	18,60	CHI
2020018966	PIRACANJUBA	60033617	PIRACANJUBA	02/01/2020 17:02	02/01/2020 22:49	02/01/2020 17:02	02/01/2020 22:49	5,77	1	5,77	CHI
2020018969	IACIARA	IA12206170	IACIARA S1	02/01/2020 16:10	02/01/2020 23:28	02/01/2020 16:10	02/01/2020 23:28	7,30	80	583,87	CHI
2020018973	SAO DOMINGOS	SD12389179	SAO DOMINGOS	02/01/2020 17:03	02/01/2020 22:45	02/01/2020 17:03	02/01/2020 22:45	5,69	10	56,89	CHI
2020018975	CUMARI	CY21149246	CATALAO S1	02/01/2020 17:04	02/01/2020 18:30	02/01/2020 17:04	02/01/2020 18:30	1,43	1	1,43	CHI
2020018980	APARECIDA DE GOIANIA	10010756580	REAL S1	02/01/2020 17:04	02/01/2020 18:51	02/01/2020 17:04	02/01/2020 18:51	1,77	1	1,77	CHI
2020018981	ALTO PARAISO DE GOIAS	BF21170296	FLORES DE GOIAS	02/01/2020 17:05	02/01/2020 19:45	02/01/2020 17:05	02/01/2020 19:45	2,66	1	2,66	CHI
2020018985	CATALAO	CT12316116	CATALAO S1	02/01/2020 16:19	02/01/2020 18:06	02/01/2020 16:19	02/01/2020 18:06	1,78	4	7,12	CHI
2020018996	IACIARA	1550026103	IACIARA S1	02/01/2020 17:08	03/01/2020 01:42	02/01/2020 17:08	03/01/2020 01:42	8,56	1	8,56	CHI
2020019000	PIRES DO RIO	PR21300577	PIRES DO RIO S1	02/01/2020 17:09	03/01/2020 02:15	02/01/2020 17:09	03/01/2020 02:15	9,09	1	9,09	CHI
2020019003	IPORA	IR21091536	IPORA	02/01/2020 17:10	02/01/2020 21:55	02/01/2020 17:10	02/01/2020 21:55	4,74	1	4,74	CHI
2020019006	ALEXANIA	AX11000006	ALEXANIA	02/01/2020 16:40	02/01/2020 18:35	02/01/2020 16:40	02/01/2020 18:35	1,91	74	141,50	CHI
2020019007	BURITINOPOLIS	BQ21386628	IACIARA S2	02/01/2020 17:11	03/01/2020 10:31	02/01/2020 17:11	03/01/2020 10:31	17,33	1	17,33	CHI
2020019009	SANTO ANTONIO DO DESCOBERTO	SN12399549	MARAJOARA	02/01/2020 17:11	03/01/2020 00:22	02/01/2020 17:11	03/01/2020 00:22	7,18	9	64,59	CHI
2020019010	TRINDADE	10010385078	TRINDADE	02/01/2020 17:11	02/01/2020 21:00	02/01/2020 17:11	02/01/2020 21:00	3,81	1	3,81	CHI
2020019013	GOIANIA	AP12040086	INDEPENDENCIA S2	02/01/2020 16:46	02/01/2020 18:01	02/01/2020 16:46	02/01/2020 18:01	1,24	232	286,58	CHI
2020019019	CATALAO	1990035532	CATALAO S2	02/01/2020 17:13	02/01/2020 22:26	02/01/2020 17:13	02/01/2020 22:26	5,22	1	5,22	CHI

2020019020	MORRINHOS	150151615	MORRINHOS	02/01/2020 17:13	02/01/2020 23:38	02/01/2020 17:13	02/01/2020 23:38	6,41	1	6,41	CHI
2020019021	IPORA	IR21014087	IPORA	02/01/2020 17:13	02/01/2020 20:52	02/01/2020 17:13	02/01/2020 20:52	3,64	1	3,64	CHI
2020019022	ACREUNA	EU11279445	ACREUNA	02/01/2020 17:12	02/01/2020 18:33	02/01/2020 17:12	02/01/2020 18:33	1,35	8	10,80	CHI
2020019025	GOIANESIA	550135510	GOIANESIA S2	02/01/2020 17:14	03/01/2020 01:35	02/01/2020 17:14	03/01/2020 01:35	8,36	1	8,36	CHI
2020019030	SANTO ANTONIO DO DESCOBERTO	SN12082917	MARAJOARA	02/01/2020 17:06	03/01/2020 08:42	02/01/2020 17:06	03/01/2020 08:42	15,61	31	483,92	CHI
2020019038	PALMINOPOLIS	PP12053922	PALMEIRAS	02/01/2020 17:16	02/01/2020 21:30	02/01/2020 17:16	02/01/2020 21:30	4,22	3	12,66	CHI
2020019040	CRISTALINA	KR12304800	CRISTALINA S2	02/01/2020 17:17	02/01/2020 22:45	02/01/2020 17:17	02/01/2020 22:45	5,47	66	360,74	CHI
2020019042	GOIANESIA	GE12004544	GOIANESIA S2	02/01/2020 17:02	03/01/2020 00:03	02/01/2020 17:02	03/01/2020 00:03	7,01	8	56,08	CHI
2020019042	VILA PROPICIO	GE12004544	GOIANESIA S2	02/01/2020 17:02	03/01/2020 00:03	02/01/2020 17:02	03/01/2020 00:03	7,01	29	203,28	CHI
2020019044	RIO VERDE	04150224	CABRIUVA S2	02/01/2020 17:18	03/01/2020 15:12	02/01/2020 17:18	03/01/2020 09:00	15,69	6	94,15	CHI
2020019044	QUIRINOPOLIS	04150224	CABRIUVA S2	02/01/2020 17:18	03/01/2020 15:12	02/01/2020 17:18	03/01/2020 15:12	21,90	4	87,59	CHI
2020019044	RIO VERDE	04150224	CABRIUVA S2	02/01/2020 17:18	03/01/2020 15:12	02/01/2020 17:18	03/01/2020 15:12	21,90	206	4510,66	CHI
2020019044	RIO VERDE	04150224	CABRIUVA S2	02/01/2020 17:18	03/01/2020 15:12	03/01/2020 09:01	03/01/2020 15:12	6,19	6	37,13	CHI
2020019046	FLORES DE GOIAS	FB12255011	FLORES DE GOIAS	03/01/2020 07:57	03/01/2020 12:45	03/01/2020 07:57	03/01/2020 12:45	4,78	413	1976,09	CHI
2020019046	NOVA ROMA	FB12255011	FLORES DE GOIAS	03/01/2020 07:57	03/01/2020 12:45	03/01/2020 07:57	03/01/2020 12:45	4,78	2	9,57	CHI
2020019046	SAO JOAO D ALIANCA	FB12255011	FLORES DE GOIAS	03/01/2020 07:57	03/01/2020 12:45	03/01/2020 07:57	03/01/2020 12:45	4,78	45	215,31	CHI
2020019060	CRISTALINA	KR12170191	CRISTALINA S1	02/01/2020 17:22	02/01/2020 18:22	02/01/2020 17:22	02/01/2020 18:22	0,99	57	56,70	CHI
2020019062	APARECIDA DE GOIANIA	10011627946	INDEPENDENCIA S1	02/01/2020 17:22	02/01/2020 18:46	02/01/2020 17:22	02/01/2020 18:46	1,39	1	1,39	CHI
2020019069	PORTELANDIA	PW12209812	PARQUE DAS EMAS	02/01/2020 16:44	03/01/2020 15:00	02/01/2020 16:44	02/01/2020 22:45	6,03	80	482,20	CHI
2020019069	PORTELANDIA	PW12048137LD	PARQUE DAS EMAS	02/01/2020 16:44	03/01/2020 15:00	02/01/2020 16:44	03/01/2020 15:00	22,26	4	89,05	CHI
2020019071	PORANGATU	PO21103383	NOVO PLANALTO	02/01/2020 17:24	03/01/2020 12:39	02/01/2020 17:24	03/01/2020 12:39	19,24	1	19,24	CHI
2020019073	CAVALCANTE	TI12162624	NIQUELANDIA SUBTRANSMISSAO	02/01/2020 16:22	02/01/2020 19:17	02/01/2020 16:22	02/01/2020 19:17	2,90	57	165,44	CHI
2020019073	COLINAS DO SUL	TI12162624	NIQUELANDIA SUBTRANSMISSAO	02/01/2020 16:22	02/01/2020 19:17	02/01/2020 16:22	02/01/2020 19:17	2,90	17	49,34	CHI
2020019079	CRISTALINA	KR12248700	CRISTALINA S2	02/01/2020 17:25	02/01/2020 19:57	02/01/2020 17:25	02/01/2020 19:57	2,53	18	45,51	CHI
2020019084	GOIANIA	14314850	MEIA PONTE	02/01/2020 17:26	02/01/2020 18:24	02/01/2020 17:26	02/01/2020 18:24	0,96	1	0,96	CHI
2020019086	JATAI	JT12303012	JATAI S1	02/01/2020 17:27	02/01/2020 21:31	02/01/2020 17:27	02/01/2020 21:31	4,06	3	12,18	CHI
2020019095	CATALAO	1990123081	CATALAO S2	02/01/2020 17:28	02/01/2020 22:00	02/01/2020 17:28	02/01/2020 22:00	4,52	1	4,52	CHI
2020019098	PORANGATU	PO21251037	PORANGATU	02/01/2020 17:29	03/01/2020 10:50	02/01/2020 17:29	03/01/2020 10:50	17,35	1	17,35	CHI
2020019100	PADRE BERNARDO	PB12382220	PADRE BERNARDO	02/01/2020 15:33	02/01/2020 19:41	02/01/2020 15:33	02/01/2020 19:41	4,14	45	186,33	CHI
2020019103	JATAI	290295142	JATAI S3	02/01/2020 17:29	02/01/2020 22:20	02/01/2020 17:29	02/01/2020 22:20	4,83	1	4,83	CHI
2020019108	CHAPADAO DO CEU	DJ12309002	CHAPADAO DO CEU	02/01/2020 17:30	02/01/2020 20:36	02/01/2020 17:30	02/01/2020 20:36	3,10	4	12,40	CHI
2020019110	NOVA CRIXAS	NA12380421	NOVA CRIXAS	02/01/2020 17:28	04/01/2020 13:28	03/01/2020 12:00	03/01/2020 20:53	8,89	34	302,37	CHI
2020019110	NOVA CRIXAS	NA12096364	NOVA CRIXAS	02/01/2020 17:28	04/01/2020 13:28	02/01/2020 17:28	04/01/2020 13:28	44,00	5	220,00	CHI

2020019116	FLORES DE GOIAS	FB12204157	FLORES DE GOIAS	02/01/2020 17:32	03/01/2020 08:02	02/01/2020 17:32	03/01/2020 08:02	14,49	13	188,41	CHI
2020019117	GOIANIA	GN11168566	REAL S2	02/01/2020 15:49	02/01/2020 19:13	02/01/2020 15:49	02/01/2020 19:13	3,39	104	353,02	CHI
2020019125	CRISTALINA	KR12405474LD	CRISTALINA S1	02/01/2020 17:34	03/01/2020 13:27	02/01/2020 17:34	03/01/2020 13:27	19,88	4	79,53	CHI
2020019130	CACHOEIRA DOURADA	CD21000023	CACHOEIRA DOURADA	02/01/2020 17:35	03/01/2020 12:14	02/01/2020 17:35	03/01/2020 12:14	18,65	1	18,65	CHI
2020019131	COCALZINHO DE GOIAS	CB12084585	COCALZINHO	02/01/2020 17:35	03/01/2020 08:58	02/01/2020 17:35	03/01/2020 08:58	15,38	4	61,53	CHI
2020019132	CRIXAS	CX12391833	RUBIATABA	02/01/2020 17:35	02/01/2020 21:55	02/01/2020 17:35	02/01/2020 21:55	4,33	7	30,33	CHI
2020019132	NOVA IGUACU DE GOIAS	CX12391833	RUBIATABA	02/01/2020 17:35	02/01/2020 21:55	02/01/2020 17:35	02/01/2020 21:55	4,33	1	4,33	CHI
2020019133	NOVO GAMA	2900103200	MARAJOARA	02/01/2020 17:35	03/01/2020 09:39	02/01/2020 17:35	03/01/2020 09:39	16,06	1	16,06	CHI
2020019138	FORMOSA	610211638	ITUIQUIRA	02/01/2020 17:36	02/01/2020 19:53	02/01/2020 17:36	02/01/2020 19:53	2,29	1	2,29	CHI
2020019141	RIO VERDE	QI21306090	QUIRINOPOLIS	02/01/2020 17:37	03/01/2020 08:24	02/01/2020 17:37	03/01/2020 08:24	14,78	3	44,33	CHI
2020019143	GOIANESIA	GE12373077LD	GOIANESIA S2	02/01/2020 14:58	02/01/2020 19:20	02/01/2020 14:58	02/01/2020 19:20	4,37	201	878,87	CHI
2020019143	SANTA ISABEL	GE12373077LD	GOIANESIA S2	02/01/2020 14:58	02/01/2020 19:20	02/01/2020 14:58	02/01/2020 19:20	4,37	1	4,37	CHI
2020019144	RIO VERDE	RV21403521	CABRIUVA S2	02/01/2020 17:38	02/01/2020 21:20	02/01/2020 17:38	02/01/2020 21:20	3,70	1	3,70	CHI
2020019145	BONOPOLIS	TA12263013	NOVO PLANALTO	02/01/2020 16:47	03/01/2020 08:26	02/01/2020 16:47	03/01/2020 08:26	15,65	31	485,13	CHI
2020019147	JATAI	JT12062161	JATAI S1	02/01/2020 17:38	04/01/2020 15:00	02/01/2020 17:38	02/01/2020 17:46	0,14	1	0,14	CHI
2020019147	JATAI	8045148	JATAI S1	02/01/2020 17:38	04/01/2020 15:00	02/01/2020 17:38	04/01/2020 15:00	45,36	1	45,36	CHI
2020019148	CAVALCANTE	CJ21404475	MINACU	02/01/2020 17:38	03/01/2020 18:34	02/01/2020 17:38	03/01/2020 18:34	24,93	1	24,93	CHI
2020019149	CAMPOS BELOS	CH11077830	SAO DOMINGOS	02/01/2020 17:38	02/01/2020 19:03	02/01/2020 17:38	02/01/2020 19:03	1,41	131	184,60	CHI
2020019153	IPORA	IR12008874	IPORA	02/01/2020 17:39	02/01/2020 23:01	02/01/2020 17:39	02/01/2020 23:01	5,36	2	10,73	CHI
2020019154	SANTA TEREZINHA DE GOIAS	SG21403433	SANTA TEREZINHA	02/01/2020 17:39	02/01/2020 19:25	02/01/2020 17:39	02/01/2020 19:25	1,76	1	1,76	CHI
2020019155	FAZENDA NOVA	FN12395473	IPORA	02/01/2020 15:40	03/01/2020 09:31	02/01/2020 15:40	03/01/2020 09:31	17,84	4	71,38	CHI
2020019165	GOIANIA	10003851786	XAVANTES	02/01/2020 17:41	03/01/2020 00:24	02/01/2020 17:41	03/01/2020 00:24	6,71	1	6,71	CHI
2020019166	CATALAO	CT21131044	CATALAO S1	02/01/2020 17:41	03/01/2020 07:55	02/01/2020 17:41	03/01/2020 07:55	14,23	1	14,23	CHI
2020019167	CRISTALINA	KR21245993	CRISTALINA S2	02/01/2020 17:41	03/01/2020 10:22	02/01/2020 17:41	03/01/2020 10:22	16,68	1	16,68	CHI
2020019170	ITARUMA	IM21303137	CACHOEIRA ALTA	02/01/2020 17:41	02/01/2020 21:20	02/01/2020 17:41	02/01/2020 21:20	3,64	1	3,64	CHI
2020019173	GOIANIA	11891853	GOIANIA LESTE S1	02/01/2020 17:42	02/01/2020 20:28	02/01/2020 17:42	02/01/2020 20:28	2,76	1	2,76	CHI
2020019179	SANTO ANTONIO DO DESCOBERTO	SN12275480	MARAJOARA	02/01/2020 18:12	03/01/2020 13:17	02/01/2020 18:12	03/01/2020 13:17	19,07	12	228,88	CHI
2020019180	GOIANIA	GN11001148	GOIANIA LESTE S2	02/01/2020 17:21	02/01/2020 19:01	02/01/2020 17:21	02/01/2020 19:01	1,66	190	316,35	CHI
2020019183	GOIAS	GS12042305	ITABERAI S1	02/01/2020 17:45	02/01/2020 19:07	02/01/2020 17:45	02/01/2020 19:07	1,36	11	14,97	CHI
2020019186	CRISTALINA	KR21323373	PAMPLONA	02/01/2020 17:46	02/01/2020 20:20	02/01/2020 17:46	02/01/2020 20:20	2,58	1	2,58	CHI
2020019194	GOIANESIA	10010204405	GOIANESIA S2	02/01/2020 17:47	03/01/2020 02:43	02/01/2020 17:47	03/01/2020 02:43	8,93	1	8,93	CHI
2020019195	TRINDADE	40028082	TRINDADE	02/01/2020 17:47	02/01/2020 20:29	02/01/2020 17:47	02/01/2020 20:29	2,69	1	2,69	CHI
2020019196	CRISTALINA	KR12209473LD	CRISTALINA S2	02/01/2020 17:47	03/01/2020 13:12	02/01/2020 17:47	03/01/2020 13:12	19,40	9	174,64	CHI



2020019197	RIO VERDE	RV21260147	RIO VERDE S2	02/01/2020 17:48	02/01/2020 20:47	02/01/2020 17:48	02/01/2020 20:47	2,98	1	2,98	CHI
2020019198	GOIANIA	13810352	CARAJAS S2	02/01/2020 17:48	02/01/2020 19:25	02/01/2020 17:48	02/01/2020 19:25	1,61	1	1,61	CHI
2020019200	MINEIROS	MY12241641	PARQUE DAS EMAS	02/01/2020 17:49	03/01/2020 14:12	02/01/2020 17:49	03/01/2020 14:12	20,39	3	61,18	CHI
2020019200	SANTA RITA DO ARAGUAIA	MY12241641	PARQUE DAS EMAS	02/01/2020 17:49	03/01/2020 14:12	02/01/2020 17:49	03/01/2020 14:12	20,39	2	40,78	CHI
2020019201	NOVA IGUACU DE GOIAS	NH12232436	SANTA TEREZINHA	02/01/2020 17:03	02/01/2020 22:02	02/01/2020 17:03	02/01/2020 22:02	4,97	19	94,52	CHI
2020019205	URUACU	640029371	URUACU	02/01/2020 17:50	02/01/2020 20:28	02/01/2020 17:50	02/01/2020 20:28	2,62	1	2,62	CHI
2020019206	CRISTALINA	KR21133543	CRISTALINA S1	02/01/2020 17:51	03/01/2020 09:49	02/01/2020 17:51	03/01/2020 09:49	15,96	1	15,96	CHI
2020019211	CABECEIRAS	CW21381539	ITUIQUIRA	02/01/2020 17:52	03/01/2020 10:14	02/01/2020 17:52	03/01/2020 10:14	16,36	2	32,72	CHI
2020019218	CACHOEIRA DOURADA	IT12088560	CACHOEIRA DOURADA	02/01/2020 17:49	03/01/2020 17:29	02/01/2020 17:49	03/01/2020 17:29	23,66	1	23,66	CHI
2020019218	ITUMBIARA	IT12088560	CACHOEIRA DOURADA	02/01/2020 17:49	03/01/2020 17:29	02/01/2020 17:49	03/01/2020 17:29	23,66	4	94,63	CHI
2020019221	TURVELANDIA	TD21205421	RIO DOS BOIS	02/01/2020 17:54	03/01/2020 08:55	02/01/2020 17:54	03/01/2020 08:55	15,01	1	15,01	CHI
2020019222	BOM JARDIM DE GOIAS	BM12155744	BOM JARDIM	02/01/2020 17:34	03/01/2020 07:12	02/01/2020 17:34	03/01/2020 07:12	13,63	4	54,51	CHI
2020019224	BELA VISTA DE GOIAS	BV32249964	BELA VISTA S1	02/01/2020 17:55	02/01/2020 19:10	02/01/2020 17:55	02/01/2020 19:10	1,24	44	54,74	CHI
2020019227	DISTRITO FEDERAL	PB12163215	PADRE BERNARDO	02/01/2020 17:55	02/01/2020 19:47	02/01/2020 17:55	02/01/2020 19:47	1,86	3	5,57	CHI
2020019227	PADRE BERNARDO	PB12163215	PADRE BERNARDO	02/01/2020 17:55	02/01/2020 19:47	02/01/2020 17:55	02/01/2020 19:47	1,86	278	516,46	CHI
2020019229	CRISTALINA	KR12248743	CRISTALINA S2	02/01/2020 17:55	03/01/2020 11:13	02/01/2020 17:55	03/01/2020 11:13	17,29	6	103,73	CHI
2020019240	EDEIA	EA21086956	EDEIA	02/01/2020 17:58	03/01/2020 13:53	02/01/2020 17:58	03/01/2020 13:53	19,90	1	19,90	CHI
2020019243	ITUMBIARA	IT12293044	PARANAIBA	02/01/2020 17:58	03/01/2020 00:19	02/01/2020 17:58	03/01/2020 00:19	6,35	5	31,73	CHI
2020019247	GAMELEIRA DE GOIAS	AN12285354	ANAPOLIS UNIVERSITARIO S2	02/01/2020 17:58	02/01/2020 20:21	02/01/2020 17:58	02/01/2020 20:21	2,38	9	21,45	CHI
2020019247	SILVANIA	AN12285354	ANAPOLIS UNIVERSITARIO S2	02/01/2020 17:58	02/01/2020 20:21	02/01/2020 17:58	02/01/2020 20:21	2,38	19	45,28	CHI
2020019253	BOM JARDIM DE GOIAS	BM12065611	BOM JARDIM	02/01/2020 18:01	03/01/2020 13:30	02/01/2020 18:01	03/01/2020 13:30	19,48	4	77,93	CHI
2020019254	CRISTALINA	KR12163117	CRISTALINA S1	02/01/2020 17:56	03/01/2020 08:38	02/01/2020 17:56	03/01/2020 08:38	14,69	7	102,84	CHI
2020019257	GOIANIA	10877241	GOIANIA LESTE S3	02/01/2020 18:02	02/01/2020 21:13	02/01/2020 18:02	02/01/2020 21:13	3,18	1	3,18	CHI
2020019259	ANAPOLIS	AN12048812	ANAPOLIS UNIVERSITARIO S1	02/01/2020 18:00	02/01/2020 20:26	02/01/2020 18:00	02/01/2020 20:26	2,43	29	70,37	CHI
2020019261	MONTIVIDIU DO NORTE	MX12187847	PORANGATU	02/01/2020 17:58	02/01/2020 20:36	02/01/2020 17:58	02/01/2020 20:36	2,63	29	76,23	CHI
2020019267	BARRO ALTO	3380004234	GOIANESIA S1	02/01/2020 18:04	03/01/2020 00:10	02/01/2020 18:04	03/01/2020 00:10	6,10	1	6,10	CHI
2020019271	FORMOSA	610009837	ITUIQUIRA	02/01/2020 18:05	02/01/2020 22:35	02/01/2020 18:05	02/01/2020 22:35	4,49	1	4,49	CHI
2020019272	IACIARA	4670001700	IACIARA S1	02/01/2020 18:05	03/01/2020 10:48	02/01/2020 18:05	03/01/2020 10:48	16,70	1	16,70	CHI
2020019275	CEZARINA	CZ21277708	CEZARINA	02/01/2020 18:06	02/01/2020 19:50	02/01/2020 18:06	02/01/2020 19:50	1,72	1	1,72	CHI
2020019279	LEOPOLDO DE BULHOES	DE21216510	CEPAIGO S2	02/01/2020 18:08	02/01/2020 21:03	02/01/2020 18:08	02/01/2020 21:03	2,91	1	2,91	CHI
2020019280	NOVO GAMA	NJ11073459	PACAEMBU S1	02/01/2020 18:04	02/01/2020 19:19	02/01/2020 18:04	02/01/2020 19:19	1,24	181	225,14	CHI
2020019285	BELA VISTA DE GOIAS	7355275	BELA VISTA S1	02/01/2020 18:09	03/01/2020 12:00	02/01/2020 18:09	03/01/2020 12:00	17,86	1	17,86	CHI
2020019290	PONTALINA	PK21184869	VICENTINOPOLIS	02/01/2020 18:10	02/01/2020 22:20	02/01/2020 18:10	02/01/2020 22:20	4,17	1	4,17	CHI

2020019293	GUAPO	GA11113836	GUAPO S1	02/01/2020 17:39	03/01/2020 00:20	02/01/2020 17:39	03/01/2020 00:20	6,67	105	700,76	CHI
2020019298	SILVANIA	SV12056199	DAIA S2	02/01/2020 17:44	02/01/2020 19:25	02/01/2020 17:44	02/01/2020 19:25	1,67	9	15,02	CHI
2020019303	ITABERAI	IB21000057	ITABERAI S2	02/01/2020 18:12	02/01/2020 19:58	02/01/2020 18:12	02/01/2020 19:58	1,76	1	1,76	CHI
2020019305	GOIATUBA	GT12000127	GOIATUBA S2	02/01/2020 18:13	02/01/2020 20:46	02/01/2020 18:13	02/01/2020 20:46	2,54	40	101,74	CHI
2020019307	ITUMBIARA	IT11003830	PARANAIBA	02/01/2020 15:54	03/01/2020 00:09	02/01/2020 15:54	03/01/2020 00:09	8,25	69	569,06	CHI
2020019309	CALDAZINHA	BV21049109	CEPAIGO S2	02/01/2020 18:13	02/01/2020 19:45	02/01/2020 18:13	02/01/2020 19:45	1,52	1	1,52	CHI
2020019310	DIORAMA	DI21063478	IPORA	02/01/2020 18:13	03/01/2020 17:11	02/01/2020 18:13	03/01/2020 17:11	22,96	1	22,96	CHI
2020019314	MONTE ALEGRE DE GOIAS	MA12264848	SAO DOMINGOS	02/01/2020 18:13	02/01/2020 21:50	02/01/2020 18:13	02/01/2020 21:50	3,61	2	7,21	CHI
2020019315	CRISTALINA	KR12404434	CRISTALINA S1	02/01/2020 18:15	03/01/2020 07:20	02/01/2020 18:15	03/01/2020 07:20	13,08	7	91,55	CHI
2020019316	ITAPIRAPUA	IU12259711	MATRINCHA	02/01/2020 17:58	02/01/2020 22:55	02/01/2020 17:58	02/01/2020 22:55	4,94	4	19,78	CHI
2020019321	ITARUMA	IM12107442	CACHOEIRA ALTA	02/01/2020 18:16	03/01/2020 08:39	02/01/2020 18:16	03/01/2020 08:39	14,37	8	114,94	CHI
2020019322	CRISTALINA	KR12336415	CRISTALINA S2	02/01/2020 18:18	03/01/2020 13:10	02/01/2020 18:18	03/01/2020 13:10	18,87	15	283,00	CHI
2020019323	APARECIDA DE GOIANIA	13058198	ATLANTICO S2	02/01/2020 18:18	02/01/2020 19:45	02/01/2020 18:18	02/01/2020 19:45	1,44	1	1,44	CHI
2020019330	CRISTALINA	KR21399485	CRISTALINA S1	02/01/2020 18:19	03/01/2020 08:10	02/01/2020 18:19	03/01/2020 08:10	13,85	1	13,85	CHI
2020019335	APARECIDA DE GOIANIA	14857091	INDEPENDENCIA S2	02/01/2020 18:19	02/01/2020 20:29	02/01/2020 18:19	02/01/2020 20:29	2,15	1	2,15	CHI
2020019341	SANTO ANTONIO DO DESCOBERTO	SN12345926	MARAJOARA	02/01/2020 18:20	02/01/2020 23:15	02/01/2020 18:20	02/01/2020 23:15	4,91	2	9,82	CHI
2020019342	GOIANIA	200300830	INDEPENDENCIA S2	02/01/2020 18:20	02/01/2020 22:20	02/01/2020 18:20	02/01/2020 22:20	3,99	1	3,99	CHI
2020019344	PORANGATU	PO12328865	PORANGATU	02/01/2020 18:19	02/01/2020 23:32	02/01/2020 18:19	02/01/2020 23:32	5,20	1	5,20	CHI
2020019348	BELA VISTA DE GOIAS	BV21134172	BELA VISTA S1	02/01/2020 18:21	02/01/2020 20:09	02/01/2020 18:21	02/01/2020 20:09	1,79	1	1,79	CHI
2020019363	SAO MIGUEL DO ARAGUAIA	SM12384276	SAO MIGUEL DO ARAGUAIA	02/01/2020 18:24	03/01/2020 16:32	02/01/2020 18:24	03/01/2020 15:05	20,69	2	41,37	CHI
2020019363	SAO MIGUEL DO ARAGUAIA	SM21220657	SAO MIGUEL DO ARAGUAIA	02/01/2020 18:24	03/01/2020 16:32	02/01/2020 18:24	03/01/2020 16:32	22,13	1	22,13	CHI
2020019366	CATALAO	IO12394028	CATALAO S1	02/01/2020 18:13	02/01/2020 20:15	02/01/2020 18:13	02/01/2020 20:15	2,02	13	26,26	CHI
2020019366	DAVINOPOLIS	IO12394028	CATALAO S1	02/01/2020 18:13	02/01/2020 20:15	02/01/2020 18:13	02/01/2020 20:15	2,02	6	12,12	CHI
2020019370	GOIANIA	10013765653	REAL S1	02/01/2020 18:27	02/01/2020 19:56	02/01/2020 18:27	02/01/2020 19:56	1,48	1	1,48	CHI
2020019372	SAO LUIS DE MONTES BELOS	SL21233459	FIRMINOPOLIS S2	02/01/2020 18:27	02/01/2020 20:14	02/01/2020 18:27	02/01/2020 20:14	1,77	1	1,77	CHI
2020019374	PARAUNA	PU21303777	ACREUNA	02/01/2020 18:28	02/01/2020 21:40	02/01/2020 18:28	02/01/2020 21:40	3,20	1	3,20	CHI
2020019378	GAMELEIRA DE GOIAS	SV12056396	DAIA S2	02/01/2020 18:19	03/01/2020 00:05	02/01/2020 18:19	03/01/2020 00:05	5,75	100	575,36	CHI
2020019378	SILVANIA	SV12056396	DAIA S2	02/01/2020 18:19	03/01/2020 00:05	02/01/2020 18:19	03/01/2020 00:05	5,75	1	5,75	CHI
2020019380	ALTO PARAISO DE GOIAS	BF11047999	FLORES DE GOIAS	02/01/2020 18:28	02/01/2020 19:27	02/01/2020 18:28	02/01/2020 19:27	0,97	132	127,86	CHI
2020019381	MARA ROSA	MQ12391677	MARA ROSA	02/01/2020 18:29	03/01/2020 09:42	02/01/2020 18:29	03/01/2020 09:42	15,22	2	30,43	CHI
2020019385	QUIRINOPOLIS	QI12000225	QUIRINOPOLIS	02/01/2020 18:20	03/01/2020 03:22	02/01/2020 18:20	03/01/2020 03:22	9,02	47	424,01	CHI
2020019387	JUSSARA	1290010290	JUSSARA	02/01/2020 18:30	03/01/2020 07:52	02/01/2020 18:30	03/01/2020 07:52	13,36	1	13,36	CHI
2020019389	CORREGO DO OURO	CO21311136	SAO LUIZ DOS MONTES BELOS	02/01/2020 18:30	02/01/2020 21:21	02/01/2020 18:30	02/01/2020 21:21	2,84	1	2,84	CHI

2020019390	ANAPOLIS	AN12353412	JUNDIAI S1	02/01/2020 18:28	02/01/2020 21:51	02/01/2020 18:28	02/01/2020 21:51	3,39	88	298,39	CHI
2020019395	AMORINOPOLIS	AM12285800	IPORA	02/01/2020 18:32	03/01/2020 10:50	02/01/2020 18:32	03/01/2020 10:50	16,30	3	48,89	CHI
2020019400	PONTALINA	PK21268163	VICENTINOPOLIS	02/01/2020 18:33	02/01/2020 21:08	02/01/2020 18:33	02/01/2020 21:08	2,58	1	2,58	CHI
2020019401	PIRACANJUBA	60086907	PIRACANJUBA	02/01/2020 18:33	02/01/2020 21:00	02/01/2020 18:33	02/01/2020 21:00	2,45	1	2,45	CHI
2020019404	ALTO HORIZONTE	AJ12375644	SANTA TEREZINHA	02/01/2020 18:25	03/01/2020 10:10	02/01/2020 18:25	03/01/2020 10:10	15,74	9	141,70	CHI
2020019404	PILAR DE GOIAS	AJ12375644	SANTA TEREZINHA	02/01/2020 18:25	03/01/2020 10:10	02/01/2020 18:25	03/01/2020 10:10	15,74	1	15,74	CHI
2020019407	COCALZINHO DE GOIAS	ZN12377435	COCALZINHO	02/01/2020 15:10	03/01/2020 04:45	02/01/2020 15:10	03/01/2020 04:45	13,58	54	733,12	CHI
2020019411	ITUMBIARA	IT12222390	ITUMBIARA NOVA	02/01/2020 18:35	03/01/2020 07:52	02/01/2020 18:35	03/01/2020 07:52	13,28	6	79,66	CHI
2020019412	LUZIANIA	LZ12149936	MARAJOARA	02/01/2020 18:10	03/01/2020 08:24	02/01/2020 18:10	03/01/2020 08:24	14,22	13	184,90	CHI
2020019414	GOIANESIA	BA12163310	GOIANESIA S1	02/01/2020 17:47	03/01/2020 16:03	02/01/2020 17:47	03/01/2020 16:03	22,27	2	44,53	CHI
2020019414	VILA PROPICIO	BA12163310	GOIANESIA S1	02/01/2020 17:47	03/01/2020 16:03	02/01/2020 17:47	03/01/2020 16:03	22,27	11	244,92	CHI
2020019418	VILA PROPICIO	GE12258997	GOIANESIA S2	02/01/2020 18:05	02/01/2020 20:22	02/01/2020 18:05	02/01/2020 20:22	2,28	10	22,80	CHI
2020019422	FORMOSA	FA12330238	ITIQUEIRA	02/01/2020 18:36	02/01/2020 22:41	02/01/2020 18:36	02/01/2020 22:41	4,07	2	8,14	CHI
2020019430	LEOPOLDO DE BULHOES	BO21249969	CEPAIGO S2	02/01/2020 18:39	02/01/2020 21:55	02/01/2020 18:39	02/01/2020 21:55	3,27	2	6,53	CHI
2020019431	NOVA IGUACU DE GOIAS	NH12202113	SANTA TEREZINHA	02/01/2020 18:38	03/01/2020 19:45	02/01/2020 18:38	03/01/2020 04:01	9,38	29	271,95	CHI
2020019431	NOVA IGUACU DE GOIAS	NH12202113	SANTA TEREZINHA	02/01/2020 18:38	03/01/2020 19:45	02/01/2020 18:38	03/01/2020 08:32	13,90	5	69,50	CHI
2020019431	NOVA IGUACU DE GOIAS	NH12202113	SANTA TEREZINHA	02/01/2020 18:38	03/01/2020 19:45	02/01/2020 18:38	03/01/2020 12:40	18,02	25	450,50	CHI
2020019431	ALTO HORIZONTE	NH10406905	SANTA TEREZINHA	02/01/2020 18:38	03/01/2020 19:45	03/01/2020 12:41	03/01/2020 13:20	0,65	86	55,83	CHI
2020019431	CAMPOS VERDES	NH10406905	SANTA TEREZINHA	02/01/2020 18:38	03/01/2020 19:45	03/01/2020 12:41	03/01/2020 13:20	0,65	7	4,54	CHI
2020019431	NOVA IGUACU DE GOIAS	NH10406905	SANTA TEREZINHA	02/01/2020 18:38	03/01/2020 19:45	03/01/2020 12:41	03/01/2020 13:20	0,65	50	32,46	CHI
2020019431	PILAR DE GOIAS	NH10406905	SANTA TEREZINHA	02/01/2020 18:38	03/01/2020 19:45	03/01/2020 12:41	03/01/2020 13:20	0,65	1	0,65	CHI
2020019431	NOVA IGUACU DE GOIAS	NH12202113	SANTA TEREZINHA	02/01/2020 18:38	03/01/2020 19:45	02/01/2020 18:38	03/01/2020 19:45	25,11	3	75,33	CHI
2020019438	GOIANIA	10001979319	CARAJAS S1	02/01/2020 18:40	02/01/2020 21:33	02/01/2020 18:40	02/01/2020 21:33	2,88	1	2,88	CHI
2020019443	CACU	CC12360934	CACHOEIRA ALTA	02/01/2020 18:41	02/01/2020 22:30	02/01/2020 18:41	02/01/2020 22:30	3,81	13	49,58	CHI
2020019443	ITARUMA	CC12360934	CACHOEIRA ALTA	02/01/2020 18:41	02/01/2020 22:30	02/01/2020 18:41	02/01/2020 22:30	3,81	7	26,70	CHI
2020019444	CAMPOS VERDES	VD12238510	SANTA TEREZINHA	02/01/2020 18:41	03/01/2020 11:14	02/01/2020 18:41	03/01/2020 11:14	16,54	6	99,27	CHI
2020019446	AGUAS LINDAS DE GOIAS	LA12214978	AGUAS LINDAS DE GOIAS S1	02/01/2020 18:41	02/01/2020 20:23	02/01/2020 18:41	02/01/2020 20:23	1,68	364	613,04	CHI
2020019449	SAO JOAO D ALIANCA	JL12098015	SAO JOAO D ALIANCA	02/01/2020 18:43	02/01/2020 20:18	02/01/2020 18:43	02/01/2020 20:18	1,59	7	11,15	CHI
2020019451	CALDAS NOVAS	CN11114784	CALDAS NOVAS S1	02/01/2020 18:43	02/01/2020 23:10	02/01/2020 18:43	02/01/2020 22:42	3,97	168	667,71	CHI
2020019451	CALDAS NOVAS	CN11114784	CALDAS NOVAS S1	02/01/2020 18:43	02/01/2020 23:10	02/01/2020 22:45	02/01/2020 23:10	0,42	168	69,91	CHI
2020019455	AMERICANO DO BRASIL	KB12382581	ANICUNS	02/01/2020 18:45	02/01/2020 21:27	02/01/2020 18:45	02/01/2020 21:27	2,70	9	24,27	CHI
2020019455	ANICUNS	KB12382581	ANICUNS	02/01/2020 18:45	02/01/2020 21:27	02/01/2020 18:45	02/01/2020 21:27	2,70	13	35,05	CHI
2020019456	NOVO GAMA	LZ12372231	PACAEMBU S1	02/01/2020 17:16	02/01/2020 22:10	02/01/2020 17:16	02/01/2020 22:10	4,89	10	48,94	CHI

2020019463	SILVANIA	SV12241257	VIANOPOLIS	02/01/2020 18:36	03/01/2020 07:54	02/01/2020 18:36	03/01/2020 07:54	13,29	6	79,73	CHI
2020019464	LUZIANIA	LZ16410100	RIO VERMELHO	02/01/2020 18:46	03/01/2020 03:42	02/01/2020 18:58	02/01/2020 19:47	0,82	314	257,13	CHI
2020019464	LUZIANIA	LZ16410100	RIO VERMELHO	02/01/2020 18:46	03/01/2020 03:42	02/01/2020 20:59	02/01/2020 21:02	0,05	193	9,65	CHI
2020019464	LUZIANIA	LZ16410100	MARAJOARA	02/01/2020 18:46	03/01/2020 03:42	02/01/2020 18:58	03/01/2020 00:32	5,57	351	1956,43	CHI
2020019464	LUZIANIA	LZ16410100	RIO VERMELHO	02/01/2020 18:46	03/01/2020 03:42	02/01/2020 18:58	03/01/2020 00:32	5,57	409	2279,72	CHI
2020019464	LUZIANIA	LZ16410100	RIO VERMELHO	02/01/2020 18:46	03/01/2020 03:42	02/01/2020 20:59	03/01/2020 00:32	3,55	121	429,52	CHI
2020019464	LUZIANIA	LZ12041476	RIO VERMELHO	02/01/2020 18:46	03/01/2020 03:42	02/01/2020 18:58	03/01/2020 01:16	6,29	21	132,19	CHI
2020019464	LUZIANIA	LZ16410100	MARAJOARA	02/01/2020 18:46	03/01/2020 03:42	03/01/2020 01:51	03/01/2020 03:42	1,85	364	674,51	CHI
2020019464	LUZIANIA	LZ16410100	RIO VERMELHO	02/01/2020 18:46	03/01/2020 03:42	03/01/2020 02:21	03/01/2020 03:42	1,34	568	761,28	CHI
2020019468	JATAI	JT11184025	JATAI S2	02/01/2020 18:31	02/01/2020 20:10	02/01/2020 18:31	02/01/2020 20:10	1,65	84	138,20	CHI
2020019469	URUACU	UR12243259	MARA ROSA	02/01/2020 18:25	02/01/2020 23:10	02/01/2020 18:25	02/01/2020 23:10	4,74	7	33,20	CHI
2020019470	CATALAO	CT21338739	CATALAO S1	02/01/2020 18:47	03/01/2020 10:12	02/01/2020 18:47	03/01/2020 10:12	15,40	1	15,40	CHI
2020019471	IPAMERI	IP21332847	URUTAI	02/01/2020 18:48	02/01/2020 20:54	02/01/2020 18:48	02/01/2020 20:54	2,09	1	2,09	CHI
2020019476	ANAPOLIS	AN12261182	JUNDIAI S1	02/01/2020 18:29	02/01/2020 19:38	02/01/2020 18:29	02/01/2020 19:38	1,15	61	69,95	CHI
2020019476	GOIANAPOLIS	AN12261182	JUNDIAI S1	02/01/2020 18:29	02/01/2020 19:38	02/01/2020 18:29	02/01/2020 19:38	1,15	9	10,32	CHI
2020019476	LEOPOLDO DE BULHOES	AN12261182	JUNDIAI S1	02/01/2020 18:29	02/01/2020 19:38	02/01/2020 18:29	02/01/2020 19:38	1,15	5	5,73	CHI
2020019478	FAZENDA NOVA	FN11358594	IPORA	02/01/2020 18:49	03/01/2020 05:09	02/01/2020 18:49	03/01/2020 05:09	10,32	24	247,68	CHI
2020019479	MONTES CLAROS DE GOIAS	ME12204928	IPORA	02/01/2020 18:50	02/01/2020 22:30	02/01/2020 18:50	02/01/2020 22:30	3,67	5	18,33	CHI
2020019481	CAMPO ALEGRE DE GOIAS	CM12042353	CAMPO ALEGRE DE GOIAS	02/01/2020 18:32	02/01/2020 20:29	02/01/2020 18:32	02/01/2020 20:29	1,95	5	9,73	CHI
2020019482	MONTIVIDIU	MV12010585	MONTIVIDIU T	02/01/2020 17:53	02/01/2020 19:30	02/01/2020 17:53	02/01/2020 19:30	1,60	25	40,12	CHI
2020019482	RIO VERDE	MV12010585	MONTIVIDIU T	02/01/2020 17:53	02/01/2020 19:30	02/01/2020 17:53	02/01/2020 19:30	1,60	20	32,09	CHI
2020019483	PROFESSOR JAMIL SAFADY	JS21321267	PONTALINA	02/01/2020 18:50	03/01/2020 09:25	02/01/2020 18:50	03/01/2020 09:25	14,58	1	14,58	CHI
2020019484	MAMBAI	MB12302924	IACIARA S2	02/01/2020 18:36	02/01/2020 20:44	02/01/2020 18:36	02/01/2020 20:44	2,13	31	66,00	CHI
2020019492	PIRANHAS	10005064200	PIRANHAS	02/01/2020 18:52	03/01/2020 09:03	02/01/2020 18:52	03/01/2020 09:03	14,17	1	14,17	CHI
2020019497	SIMOLANDIA	1940009744	IACIARA S2	02/01/2020 18:53	03/01/2020 12:00	02/01/2020 18:53	03/01/2020 12:00	17,11	1	17,11	CHI
2020019499	IPORA	IR12207942	ARENOPOLIS	02/01/2020 18:53	03/01/2020 13:06	02/01/2020 18:53	03/01/2020 13:06	18,21	1	18,21	CHI
2020019504	QUIRINOPOLIS	QI32025589	QUIRINOPOLIS	02/01/2020 18:54	02/01/2020 23:11	02/01/2020 18:54	02/01/2020 23:11	4,28	2	8,56	CHI
2020019506	BONFINOPOLIS	920019640	CEPAIGO S2	02/01/2020 18:54	02/01/2020 20:16	02/01/2020 18:54	02/01/2020 20:16	1,36	1	1,36	CHI
2020019510	CASTELANDIA	DM11000009	RIO DOS BOIS	02/01/2020 17:27	02/01/2020 21:00	02/01/2020 17:27	02/01/2020 21:00	3,54	71	251,24	CHI
2020019516	GOIANIA	GN11001637	GOIANIA LESTE S2	02/01/2020 18:34	02/01/2020 23:06	02/01/2020 18:34	02/01/2020 23:06	4,52	76	343,67	CHI
2020019518	RIO VERDE	RV21242592	CABRIUVA S2	02/01/2020 18:56	03/01/2020 08:29	02/01/2020 18:56	03/01/2020 08:29	13,54	1	13,54	CHI
2020019523	CRISTALINA	KR12245975	CRISTALINA S1	02/01/2020 18:57	03/01/2020 15:00	02/01/2020 18:57	03/01/2020 15:00	20,04	5	100,19	CHI
2020019524	PALMEIRAS DE GOIAS	PL21189748	PALMEIRAS	02/01/2020 18:57	02/01/2020 21:48	02/01/2020 18:57	02/01/2020 21:48	2,84	1	2,84	CHI

2020019529	CAIAPONIA	CP12204879	PIRANHAS	02/01/2020 18:59	03/01/2020 08:56	02/01/2020 18:59	03/01/2020 08:56	13,95	16	223,19	CHI
2020019530	CALDAS NOVAS	CN11114789	SERRA DE CALDAS	02/01/2020 18:20	02/01/2020 22:41	02/01/2020 18:20	02/01/2020 22:41	4,35	77	334,57	CHI
2020019535	DOVERLANDIA	DV12171957	CAIAPONIA	02/01/2020 19:00	02/01/2020 23:33	02/01/2020 19:00	02/01/2020 23:33	4,54	24	108,89	CHI
2020019546	ARUANA	NA13211079	NOVA CRIXAS	02/01/2020 19:03	03/01/2020 20:09	03/01/2020 17:57	03/01/2020 20:09	2,21	25	55,31	CHI
2020019546	NOVA CRIXAS	NA13211079	NOVA CRIXAS	02/01/2020 19:03	03/01/2020 20:09	03/01/2020 17:57	03/01/2020 20:09	2,21	42	92,91	CHI
2020019546	NOVA CRIXAS	NA12213163LD	NOVA CRIXAS	02/01/2020 19:03	03/01/2020 20:09	02/01/2020 19:03	03/01/2020 20:09	25,11	44	1104,79	CHI
2020019551	VALPARAISO DE GOIAS	VA11107069	MARAJOARA	02/01/2020 19:05	02/01/2020 20:51	02/01/2020 19:05	02/01/2020 20:51	1,76	82	144,23	CHI
2020019555	URUACU	10010257312	URUACU	02/01/2020 19:05	02/01/2020 21:25	02/01/2020 19:05	02/01/2020 21:25	2,32	1	2,32	CHI
2020019558	CAVALCANTE	740014821	FLORES DE GOIAS	02/01/2020 19:06	02/01/2020 19:53	02/01/2020 19:06	02/01/2020 19:53	0,78	1	0,78	CHI
2020019567	URUTAI	600003048	URUTAI	02/01/2020 19:07	02/01/2020 22:21	02/01/2020 19:07	02/01/2020 22:21	3,23	1	3,23	CHI
2020019575	SANTO ANTONIO DA BARRA	BZ21279805	ACREUNA	02/01/2020 19:08	03/01/2020 10:33	02/01/2020 19:08	03/01/2020 10:33	15,41	1	15,41	CHI
2020019579	APARECIDA DE GOIANIA	14603524	INDEPENDENCIA S2	02/01/2020 19:09	02/01/2020 20:18	02/01/2020 19:09	02/01/2020 20:18	1,14	1	1,14	CHI
2020019581	VILA PROPICIO	BA12248765	BARRO ALTO	02/01/2020 17:14	04/01/2020 13:09	02/01/2020 17:14	03/01/2020 13:12	19,97	7	139,77	CHI
2020019581	VILA PROPICIO	NP12307145	BARRO ALTO	02/01/2020 17:14	04/01/2020 13:09	02/01/2020 17:14	04/01/2020 13:09	43,92	15	658,81	CHI
2020019582	TRINDADE	40118496	GOYA S1	02/01/2020 19:09	02/01/2020 20:47	02/01/2020 19:09	02/01/2020 20:47	1,62	1	1,62	CHI
2020019584	ITAPIRAPUA	IU21073754	MATRINCHA	02/01/2020 19:10	02/01/2020 22:12	02/01/2020 19:10	02/01/2020 22:12	3,02	1	3,02	CHI
2020019589	FORMOSA	FA11131890	ITIQUEIRA	02/01/2020 19:06	03/01/2020 02:47	02/01/2020 19:06	03/01/2020 02:47	7,68	78	598,93	CHI
2020019594	PIRES DO RIO	PR21195125	PIRES DO RIO S2	02/01/2020 19:14	03/01/2020 00:59	02/01/2020 19:14	03/01/2020 00:59	5,75	1	5,75	CHI
2020019597	FORMOSA	FA21309079	ITIQUEIRA	02/01/2020 19:14	03/01/2020 09:02	02/01/2020 19:14	03/01/2020 09:02	13,79	1	13,79	CHI
2020019605	ITUMBIRA	IT12249852	PARANAIBA	02/01/2020 18:10	02/01/2020 20:33	02/01/2020 18:10	02/01/2020 20:33	2,38	278	660,71	CHI
2020019609	MONTES CLAROS DE GOIAS	ME21380916	IPORA	02/01/2020 19:16	02/01/2020 21:01	02/01/2020 19:16	02/01/2020 21:01	1,74	2	3,48	CHI
2020019617	CUMARI	2000000119	CATALAO S1	02/01/2020 19:18	02/01/2020 21:24	02/01/2020 19:18	02/01/2020 21:24	2,10	1	2,10	CHI
2020019623	ITAJA	2300010003	ITAJA S2	02/01/2020 19:18	02/01/2020 21:45	02/01/2020 19:18	02/01/2020 21:45	2,44	1	2,44	CHI
2020019628	PARAUNA	PU21239458	FIRMINOPOLIS S2	02/01/2020 19:20	03/01/2020 01:12	02/01/2020 19:20	03/01/2020 01:12	5,86	1	5,86	CHI
2020019633	MONTES CLAROS DE GOIAS	ME12334949	IPORA	02/01/2020 19:21	03/01/2020 11:36	02/01/2020 19:21	03/01/2020 11:36	16,25	8	129,98	CHI
2020019635	RIO VERDE	RV21279417	ACREUNA	02/01/2020 19:22	03/01/2020 11:37	02/01/2020 19:22	03/01/2020 11:37	16,24	1	16,24	CHI
2020019637	CIDADE OCIDENTAL	DH11277131	MARAJOARA	02/01/2020 19:23	03/01/2020 01:11	02/01/2020 19:23	03/01/2020 01:11	5,80	1	5,80	CHI
2020019638	GOIANIA	10028528148	CARAJAS S1	02/01/2020 19:23	02/01/2020 20:20	02/01/2020 19:23	02/01/2020 20:20	0,94	1	0,94	CHI
2020019639	URUACU	10005161132	URUACU	02/01/2020 19:24	03/01/2020 00:29	02/01/2020 19:24	03/01/2020 00:29	5,08	1	5,08	CHI
2020019643	SAO MIGUEL DO ARAGUAIA	830059453	SAO MIGUEL DO ARAGUAIA	02/01/2020 19:25	03/01/2020 03:05	02/01/2020 19:25	03/01/2020 03:05	7,67	1	7,67	CHI
2020019648	CALDAS NOVAS	10003152446	SERRA DE CALDAS	02/01/2020 19:25	02/01/2020 21:03	02/01/2020 19:25	02/01/2020 21:03	1,63	1	1,63	CHI
2020019649	RIO VERDE	RV21248260	CABRIUVA S2	02/01/2020 19:26	03/01/2020 10:43	02/01/2020 19:26	03/01/2020 10:43	15,28	1	15,28	CHI
2020019650	CATALAO	CT12229928	CATALAO S2	02/01/2020 19:26	03/01/2020 13:11	02/01/2020 19:26	03/01/2020 13:11	17,74	1	17,74	CHI

2020019655	BELA VISTA DE GOIAS	BV12201455	BELA VISTA S2	02/01/2020 19:27	02/01/2020 20:50	02/01/2020 19:27	02/01/2020 20:50	1,38	7	9,68	CHI
2020019658	CAMPINORTE	CR12247077	PORANGATU	02/01/2020 18:45	03/01/2020 00:03	02/01/2020 18:45	03/01/2020 00:03	5,29	6	31,76	CHI
2020019658	MINACU	CR12247077	PORANGATU	02/01/2020 18:45	03/01/2020 00:03	02/01/2020 18:45	03/01/2020 00:03	5,29	1	5,29	CHI
2020019659	GOIANIA	14463477	XAVANTES	02/01/2020 19:27	02/01/2020 23:37	02/01/2020 19:27	02/01/2020 23:37	4,16	1	4,16	CHI
2020019661	NIQUELANDIA	NQ21242302	URUACU	02/01/2020 19:27	03/01/2020 01:11	02/01/2020 19:27	03/01/2020 01:11	5,72	1	5,72	CHI
2020019664	URUACU	640029401	URUACU	02/01/2020 19:29	03/01/2020 00:38	02/01/2020 19:29	03/01/2020 00:38	5,15	1	5,15	CHI
2020019669	CALDAS NOVAS	CN12114775	CALDAS NOVAS S1	02/01/2020 19:06	03/01/2020 19:56	02/01/2020 19:06	03/01/2020 19:56	24,83	28	695,32	CHI
2020019669	SANTA CRUZ DE GOIAS	CN12114775	CALDAS NOVAS S1	02/01/2020 19:06	03/01/2020 19:56	02/01/2020 19:06	03/01/2020 19:56	24,83	94	2334,28	CHI
2020019670	BRAZABRANTES	380001883	NEROPOLIS S1	02/01/2020 19:30	02/01/2020 23:29	02/01/2020 19:30	02/01/2020 23:29	3,98	1	3,98	CHI
2020019679	CUMARI	CT12231652	CATALAO S2	02/01/2020 19:31	03/01/2020 09:28	02/01/2020 19:31	03/01/2020 09:28	13,93	5	69,67	CHI
2020019684	PADRE BERNARDO	PB21141200	PADRE BERNARDO	02/01/2020 19:33	02/01/2020 21:29	02/01/2020 19:33	02/01/2020 21:29	1,92	1	1,92	CHI
2020019685	GOIANIA	11334526	CAMPINAS S2	02/01/2020 19:34	02/01/2020 21:37	02/01/2020 19:34	02/01/2020 21:37	2,04	1	2,04	CHI
2020019691	MINACU	4020112643	MINACU	02/01/2020 19:35	02/01/2020 21:47	02/01/2020 19:35	02/01/2020 21:47	2,20	1	2,20	CHI
2020019692	CRISTALINA	KR11273452	CRISTALINA S2	02/01/2020 19:35	03/01/2020 13:07	02/01/2020 19:35	03/01/2020 13:07	17,53	1	17,53	CHI
2020019694	GOIATUBA	140012321	GOIATUBA S2	02/01/2020 19:36	03/01/2020 09:28	02/01/2020 19:36	03/01/2020 09:28	13,86	1	13,86	CHI
2020019697	MINEIROS	MY12148260	PARQUE DAS EMAS	02/01/2020 19:36	03/01/2020 14:44	02/01/2020 19:36	03/01/2020 14:44	19,12	6	114,71	CHI
2020019698	SAO MIGUEL DO ARAGUAIA	SM12032000	SAO MIGUEL DO ARAGUAIA	02/01/2020 19:37	03/01/2020 16:08	02/01/2020 19:37	03/01/2020 16:08	20,52	5	102,58	CHI
2020019699	ITUMBIARA	IT12399537	PARANAIBA	02/01/2020 17:40	02/01/2020 23:26	02/01/2020 17:40	02/01/2020 23:26	5,77	5	28,85	CHI
2020019705	JUSSARA	JR12073379	BRITANIA	02/01/2020 19:38	03/01/2020 12:00	02/01/2020 19:38	03/01/2020 12:00	16,36	9	147,24	CHI
2020019706	JATAI	10010744949	JATAI S2	02/01/2020 19:39	02/01/2020 21:05	02/01/2020 19:39	02/01/2020 21:05	1,43	1	1,43	CHI
2020019718	CALDAS NOVAS	760446738	SERRA DE CALDAS	02/01/2020 19:41	02/01/2020 23:49	02/01/2020 19:41	02/01/2020 23:49	4,13	1	4,13	CHI
2020019722	QUIRINOPOLIS	QI13213322	CACHOEIRA ALTA	03/01/2020 19:03	04/01/2020 13:21	03/01/2020 19:03	04/01/2020 13:21	18,31	22	402,86	CHI
2020019723	GOIATUBA	PX12047021	GOIATUBA S1	02/01/2020 19:14	02/01/2020 21:56	02/01/2020 19:14	02/01/2020 21:56	2,69	7	18,82	CHI
2020019723	PANAMA	PX12047021	GOIATUBA S1	02/01/2020 19:14	02/01/2020 21:56	02/01/2020 19:14	02/01/2020 21:56	2,69	2	5,38	CHI
2020019724	SANTA HELENA DE GOIAS	SH11228517	RIO VERDE S2	02/01/2020 19:43	02/01/2020 21:49	02/01/2020 19:43	02/01/2020 21:49	2,10	1	2,10	CHI
2020019725	NIQUELANDIA	NQ12135340	NIQUELANDIA SUBTRANSMISSAO	02/01/2020 19:43	02/01/2020 22:45	02/01/2020 19:43	02/01/2020 22:45	3,02	216	652,86	CHI
2020019734	FAZENDA NOVA	FN12013300	FIRMINOPOLIS S2	02/01/2020 19:47	03/01/2020 15:06	02/01/2020 19:47	03/01/2020 15:06	19,31	8	154,47	CHI
2020019740	SAO MIGUEL DO ARAGUAIA	SM21099599	SAO MIGUEL DO ARAGUAIA	02/01/2020 19:49	04/01/2020 19:04	02/01/2020 19:49	04/01/2020 18:33	46,73	3	140,19	CHI
2020019740	NOVA CRIXAS	SM13282154	SAO MIGUEL DO ARAGUAIA	02/01/2020 19:49	04/01/2020 19:04	04/01/2020 11:27	04/01/2020 19:04	7,60	1	7,60	CHI
2020019740	SAO MIGUEL DO ARAGUAIA	SM13282154	SAO MIGUEL DO ARAGUAIA	02/01/2020 19:49	04/01/2020 19:04	04/01/2020 11:27	04/01/2020 19:04	7,60	76	577,77	CHI
2020019747	PLANALTINA	PI12066045	PLANALTINA	02/01/2020 19:53	02/01/2020 21:45	02/01/2020 19:53	02/01/2020 21:45	1,87	5	9,34	CHI
2020019748	CRISTALINA	KR12383045	CRISTALINA S2	02/01/2020 19:53	03/01/2020 18:15	02/01/2020 19:53	03/01/2020 18:15	22,37	12	268,38	CHI
2020019751	CRISTALINA	KR11128711	CRISTALINA S1	02/01/2020 19:55	03/01/2020 00:09	02/01/2020 19:55	03/01/2020 00:09	4,23	132	558,29	CHI

2020019753	COLINAS DO SUL	TI12355503	MINACU	02/01/2020 19:56	02/01/2020 22:27	02/01/2020 19:56	02/01/2020 22:27	2,51	9	22,59	CHI
2020019755	IVOLANDIA	PU12090442	MONTIVIDIU T	02/01/2020 19:57	03/01/2020 08:33	02/01/2020 19:57	03/01/2020 08:33	12,60	3	37,79	CHI
2020019755	PARAUNA	PU12090442	MONTIVIDIU T	02/01/2020 19:57	03/01/2020 08:33	02/01/2020 19:57	03/01/2020 08:33	12,60	49	617,28	CHI
2020019758	PLANALTINA	PI21072292	PLANALTINA	02/01/2020 19:44	03/01/2020 11:06	02/01/2020 19:44	03/01/2020 11:06	15,36	1	15,36	CHI
2020019759	SANTA TEREZA DE GOIAS	SE21291078	MARA ROSA	02/01/2020 19:58	03/01/2020 10:49	02/01/2020 19:58	03/01/2020 10:49	14,84	2	29,68	CHI
2020019760	DOVERLANDIA	DV21137993	CAIAPONIA	02/01/2020 19:58	03/01/2020 06:35	02/01/2020 19:58	03/01/2020 06:35	10,60	1	10,60	CHI
2020019763	SERRANOPOLIS	SX21318838	JATAI S1	02/01/2020 20:00	03/01/2020 11:40	02/01/2020 20:00	03/01/2020 11:40	15,67	1	15,67	CHI
2020019766	INHUMAS	IN11049760	INHUMAS S2	02/01/2020 19:53	02/01/2020 22:18	02/01/2020 19:53	02/01/2020 22:18	2,40	154	369,99	CHI
2020019767	RIO VERDE	630509300	RIO VERDE S2	02/01/2020 20:01	02/01/2020 23:53	02/01/2020 20:01	02/01/2020 23:53	3,86	1	3,86	CHI
2020019768	ANAPOLIS	AN10383789	JUNDIAI S1	02/01/2020 19:59	03/01/2020 03:37	02/01/2020 19:59	02/01/2020 20:39	0,67	458	306,86	CHI
2020019768	ANAPOLIS	AN10383789	JUNDIAI S1	02/01/2020 19:59	03/01/2020 03:37	02/01/2020 19:59	02/01/2020 21:04	1,09	32	34,79	CHI
2020019768	ANAPOLIS	AN13085938	JUNDIAI S1	02/01/2020 19:59	03/01/2020 03:37	02/01/2020 19:59	02/01/2020 21:04	1,09	29	31,53	CHI
2020019768	CAMPO LIMPO	AN10383789	JUNDIAI S1	02/01/2020 19:59	03/01/2020 03:37	02/01/2020 19:59	02/01/2020 21:04	1,09	8	8,70	CHI
2020019768	CAMPO LIMPO	AN13085938	JUNDIAI S1	02/01/2020 19:59	03/01/2020 03:37	02/01/2020 19:59	02/01/2020 21:04	1,09	2	2,17	CHI
2020019768	ANAPOLIS	AN10383789	JUNDIAI S1	02/01/2020 19:59	03/01/2020 03:37	02/01/2020 21:08	02/01/2020 21:14	0,10	458	47,07	CHI
2020019768	ANAPOLIS	AN10383789	NEROPOLIS S1	02/01/2020 19:59	03/01/2020 03:37	02/01/2020 19:59	02/01/2020 22:22	2,39	3	7,16	CHI
2020019768	CAMPO LIMPO	AN10383789	NEROPOLIS S1	02/01/2020 19:59	03/01/2020 03:37	02/01/2020 19:59	02/01/2020 22:22	2,39	137	326,97	CHI
2020019768	ANAPOLIS	AN13085938	JUNDIAI S1	02/01/2020 19:59	03/01/2020 03:37	02/01/2020 21:08	03/01/2020 03:37	6,48	61	395,33	CHI
2020019768	CAMPO LIMPO	AN13085938	JUNDIAI S1	02/01/2020 19:59	03/01/2020 03:37	02/01/2020 21:08	03/01/2020 03:37	6,48	10	64,81	CHI
2020019769	CRISTALINA	KR12323260	CRISTALINA S1	02/01/2020 19:37	03/01/2020 09:52	02/01/2020 19:37	03/01/2020 09:52	14,24	10	142,43	CHI
2020019770	RIO VERDE	630135368	RIO VERDE S1	02/01/2020 20:03	02/01/2020 22:54	02/01/2020 20:03	02/01/2020 22:54	2,85	1	2,85	CHI
2020019787	IPAMERI	IP11089951	IPAMERI	02/01/2020 20:04	02/01/2020 21:03	02/01/2020 20:04	02/01/2020 21:03	0,97	217	210,67	CHI
2020019795	RIO VERDE	RV11085792	RIO VERDE S1	02/01/2020 20:07	03/01/2020 01:47	02/01/2020 20:07	03/01/2020 01:47	5,65	125	706,39	CHI
2020019796	LUZIANIA	LZ21357801	MARAJOARA	02/01/2020 20:11	03/01/2020 09:57	02/01/2020 20:11	03/01/2020 09:57	13,77	2	27,53	CHI
2020019797	GOIANIA	GN11196672	GOIANIA LESTE S2	02/01/2020 20:11	03/01/2020 00:43	02/01/2020 20:11	03/01/2020 00:43	4,52	103	465,93	CHI
2020019798	CEZARINA	CZ12010377	CEZARINA	02/01/2020 20:12	02/01/2020 20:39	02/01/2020 20:12	02/01/2020 20:39	0,45	10	4,51	CHI
2020019803	URUACU	UR21295413	URUACU	02/01/2020 20:14	03/01/2020 04:17	02/01/2020 20:14	03/01/2020 04:17	8,04	1	8,04	CHI
2020019806	PIRENOPOLIS	220033158	CORUMBA	02/01/2020 20:16	03/01/2020 09:34	02/01/2020 20:16	03/01/2020 09:34	13,30	1	13,30	CHI
2020019809	ARAGARCAS	AG12354636	ARAGARCAS	02/01/2020 20:17	03/01/2020 08:03	02/01/2020 20:17	03/01/2020 08:03	11,76	17	199,85	CHI
2020019812	INHUMAS	10016659439	INHUMAS S2	02/01/2020 20:18	03/01/2020 02:09	02/01/2020 20:18	03/01/2020 02:09	5,85	1	5,85	CHI
2020019813	ARENOPOLIS	AY12000029	ARENOPOLIS	02/01/2020 20:17	02/01/2020 22:52	02/01/2020 20:17	02/01/2020 22:52	2,57	7	18,00	CHI
2020019816	PADRE BERNARDO	PB11275517	PADRE BERNARDO	02/01/2020 18:32	02/01/2020 23:56	02/01/2020 18:32	02/01/2020 23:56	5,40	4	21,60	CHI
2020019818	SANTO ANTONIO DO DESCOBERTO	10002503431	MARAJOARA	02/01/2020 22:02	03/01/2020 03:54	02/01/2020 22:02	03/01/2020 03:54	5,87	1	5,87	CHI

2020019819	MONTIVIDIU	MV21260536	MONTIVIDIU T	02/01/2020 20:20	02/01/2020 23:45	02/01/2020 20:20	02/01/2020 23:45	3,41	1	3,41	CHI
2020019821	MONTIVIDIU	MV21030651	MONTIVIDIU T	02/01/2020 20:20	02/01/2020 23:14	02/01/2020 20:20	02/01/2020 23:14	2,89	1	2,89	CHI
2020019822	GOIATUBA	GT21296820	GOIATUBA S1	02/01/2020 20:20	03/01/2020 15:32	02/01/2020 20:20	03/01/2020 15:32	19,18	1	19,18	CHI
2020019825	PLANALTINA	PI21142684	PLANALTINA	02/01/2020 20:21	02/01/2020 22:19	02/01/2020 20:21	02/01/2020 22:19	1,95	1	1,95	CHI
2020019829	BURITI ALEGRE	BG21066352	ITUMBIARA VELHA S2	02/01/2020 20:22	03/01/2020 11:22	02/01/2020 20:22	03/01/2020 11:22	14,98	1	14,98	CHI
2020019832	CACHOEIRA DOURADA	10024341906	CACHOEIRA DOURADA	02/01/2020 20:23	03/01/2020 13:52	02/01/2020 20:23	03/01/2020 13:52	17,47	1	17,47	CHI
2020019837	GOIANIA	GN11053095	CAMPINAS S1	02/01/2020 20:24	02/01/2020 22:32	02/01/2020 20:58	02/01/2020 22:32	1,56	51	79,48	CHI
2020019838	GOIANIA	14602167	REAL S1	02/01/2020 20:25	03/01/2020 00:09	02/01/2020 20:25	03/01/2020 00:09	3,73	1	3,73	CHI
2020019840	GUARINOS	GG12318446	URUACU	02/01/2020 20:05	03/01/2020 00:40	02/01/2020 20:05	03/01/2020 00:40	4,58	1	4,58	CHI
2020019840	PILAR DE GOIAS	GG12318446	URUACU	02/01/2020 20:05	03/01/2020 00:40	02/01/2020 20:05	03/01/2020 00:40	4,58	113	517,45	CHI
2020019840	SANTA TEREZINHA DE GOIAS	GG12318446	URUACU	02/01/2020 20:05	03/01/2020 00:40	02/01/2020 20:05	03/01/2020 00:40	4,58	4	18,32	CHI
2020019842	QUIRINOPOLIS	QI32052513	QUIRINOPOLIS	02/01/2020 20:27	02/01/2020 21:53	02/01/2020 20:27	02/01/2020 21:53	1,43	5	7,13	CHI
2020019850	AMARALINA	LC12245307	MARA ROSA	02/01/2020 20:30	02/01/2020 22:52	02/01/2020 20:30	02/01/2020 22:52	2,35	5	11,77	CHI
2020019851	SANTA RITA DO ARAGUAIA	SU12142710	SANTA RITA DO ARAGUAIA	02/01/2020 20:32	03/01/2020 12:31	02/01/2020 20:32	03/01/2020 12:31	16,00	11	175,97	CHI
2020019856	ALEXANIA	AX12398552	ALEXANIA	02/01/2020 18:56	03/01/2020 10:47	02/01/2020 18:56	03/01/2020 10:47	15,84	5	79,21	CHI
2020019859	PIRES DO RIO	PR12255829	PIRES DO RIO S1	02/01/2020 20:31	02/01/2020 22:22	02/01/2020 20:31	02/01/2020 22:22	1,85	7	12,92	CHI
2020019860	FORMOSA	VB21207554	ITUIQUIRA	02/01/2020 20:35	02/01/2020 22:07	02/01/2020 20:35	02/01/2020 22:07	1,52	1	1,52	CHI
2020019863	ITAPIRAPUA	IU12250542	MATRINCHA	02/01/2020 20:37	03/01/2020 10:44	02/01/2020 20:37	03/01/2020 10:44	14,11	9	126,95	CHI
2020019864	FORMOSA	610049549	ITUIQUIRA	02/01/2020 20:38	02/01/2020 23:25	02/01/2020 20:38	02/01/2020 23:25	2,78	1	2,78	CHI
2020019875	PORTEIRAO	CL12301097	RIO DOS BOIS	02/01/2020 20:42	03/01/2020 12:54	02/01/2020 20:42	03/01/2020 12:54	16,20	1	16,20	CHI
2020019883	CABECEIRAS	CW12181804	ITUIQUIRA	02/01/2020 18:55	03/01/2020 09:16	02/01/2020 18:55	03/01/2020 09:16	14,35	8	114,76	CHI
2020019890	GOIANIA	10373871	CAMPINAS S1	02/01/2020 20:49	02/01/2020 22:37	02/01/2020 20:49	02/01/2020 22:37	1,79	1	1,79	CHI
2020019902	ANAPOLIS	AN11000269	JUNDIAI S1	02/01/2020 20:46	03/01/2020 00:04	02/01/2020 20:46	03/01/2020 00:04	3,29	98	322,34	CHI
2020019904	CORUMBA DE GOIAS	CB21111203	CORUMBA	02/01/2020 20:53	04/01/2020 09:59	02/01/2020 20:53	04/01/2020 09:59	37,10	1	37,10	CHI
2020019909	URUACU	UR12065508	URUACU	02/01/2020 20:53	03/01/2020 00:52	02/01/2020 20:53	03/01/2020 00:52	3,97	72	286,00	CHI
2020019910	MINEIROS	MY12043892	PARQUE DAS EMAS	02/01/2020 20:32	03/01/2020 01:21	02/01/2020 20:32	03/01/2020 01:21	4,80	13	62,44	CHI
2020019915	GOIANDIRA	GD21157961	CATALAO S1	02/01/2020 20:54	03/01/2020 01:29	02/01/2020 20:54	03/01/2020 01:29	4,57	1	4,57	CHI
2020019916	ITAPURANGA	170098746	ITAPURANGA	02/01/2020 20:55	02/01/2020 23:14	02/01/2020 20:55	02/01/2020 23:14	2,32	1	2,32	CHI
2020019921	MINEIROS	MY11055289	PARQUE DAS EMAS	02/01/2020 20:52	03/01/2020 01:09	02/01/2020 20:52	03/01/2020 01:09	4,27	122	520,94	CHI
2020019930	APARECIDA DE GOIANIA	200147407	INDEPENDENCIA S2	02/01/2020 21:01	02/01/2020 22:28	02/01/2020 21:01	02/01/2020 22:28	1,45	1	1,45	CHI
2020019933	APARECIDA DE GOIANIA	15089356	INDEPENDENCIA S2	02/01/2020 21:03	02/01/2020 22:39	02/01/2020 21:03	02/01/2020 22:39	1,60	1	1,60	CHI
2020019935	ANAPOLIS	AN12000133	JUNDIAI S1	02/01/2020 20:45	02/01/2020 22:40	02/01/2020 20:45	02/01/2020 22:40	1,90	110	209,40	CHI
2020019936	GOIANIA	GN11000202	FERROVIARIO S1	02/01/2020 21:04	02/01/2020 23:37	02/01/2020 21:04	02/01/2020 23:37	2,54	46	117,01	CHI



2020019940	ITARUMA	IM21122550	CACHOEIRA ALTA	02/01/2020 21:05	03/01/2020 08:08	02/01/2020 21:05	03/01/2020 08:08	11,04	1	11,04	CHI
2020019944	BRITANIA	BT12009771	BRITANIA	02/01/2020 21:08	03/01/2020 07:40	02/01/2020 21:08	03/01/2020 07:40	10,53	9	94,74	CHI
2020019948	ABADIANIA	AA12377766	ANAPOLIS UNIVERSITARIO S1	02/01/2020 20:59	03/01/2020 08:57	02/01/2020 20:59	03/01/2020 08:57	11,96	9	107,60	CHI
2020019950	ANAPOLIS	AN11211774	JUNDIAI S1	02/01/2020 20:41	03/01/2020 00:48	02/01/2020 20:41	03/01/2020 00:48	4,11	50	205,36	CHI
2020019956	SANTA CRUZ DE GOIAS	BC21332229	PIRACANJUBA	02/01/2020 21:15	02/01/2020 22:58	02/01/2020 21:15	02/01/2020 22:58	1,71	1	1,71	CHI
2020019966	FORMOSA	610190982	ITUIQUIRA	02/01/2020 21:21	03/01/2020 08:06	02/01/2020 21:21	03/01/2020 08:06	10,75	1	10,75	CHI
2020019969	DIORAMA	DI12070162	IPORA	02/01/2020 21:22	03/01/2020 10:17	02/01/2020 21:22	03/01/2020 10:17	12,91	1	12,91	CHI
2020019969	JAUPACI	DI12070162	IPORA	02/01/2020 21:22	03/01/2020 10:17	02/01/2020 21:22	03/01/2020 10:17	12,91	8	103,29	CHI
2020019972	TRINDADE	10002012004	GOYA S1	02/01/2020 21:24	03/01/2020 00:08	02/01/2020 21:24	03/01/2020 00:08	2,72	1	2,72	CHI
2020019974	JUSSARA	JR12364553	BRITANIA	02/01/2020 21:26	03/01/2020 16:06	02/01/2020 21:26	03/01/2020 16:06	18,66	18	335,84	CHI
2020019979	COCALZINHO DE GOIAS	ZN12297619	COCALZINHO	02/01/2020 21:32	03/01/2020 12:29	02/01/2020 21:32	03/01/2020 12:29	14,95	4	59,80	CHI
2020019983	ITUMBIARA	3910000482	ITUMBIARA NOVA	02/01/2020 21:32	03/01/2020 11:00	02/01/2020 21:32	03/01/2020 11:00	13,46	1	13,46	CHI
2020019988	LAGOA SANTA	IJ21063049	ITAJA S2	02/01/2020 21:37	03/01/2020 08:20	02/01/2020 21:37	03/01/2020 08:20	10,71	1	10,71	CHI
2020019989	MATRINCHA	MP12010442	MOZARLANDIA	02/01/2020 21:39	03/01/2020 01:45	02/01/2020 21:39	03/01/2020 01:45	4,11	4	16,42	CHI
2020019990	PLANALTINA	7366238	PLANALTINA	02/01/2020 21:40	03/01/2020 19:02	02/01/2020 21:40	03/01/2020 19:02	21,38	1	21,38	CHI
2020019992	GOIANIA	14970910	GOIANIA LESTE S1	02/01/2020 21:41	03/01/2020 01:34	02/01/2020 21:41	03/01/2020 01:34	3,88	1	3,88	CHI
2020019994	IPORA	IR12184346	ARENOPOLIS	02/01/2020 21:43	03/01/2020 12:03	02/01/2020 21:43	03/01/2020 12:03	14,33	5	71,63	CHI
2020019998	FORMOSA	10018768189	ITUIQUIRA	02/01/2020 21:48	03/01/2020 10:01	02/01/2020 21:48	03/01/2020 10:01	12,21	1	12,21	CHI
20200110007	COCALZINHO DE GOIAS	ZN12295671	COCALZINHO	02/01/2020 21:54	03/01/2020 12:00	02/01/2020 21:54	03/01/2020 12:00	14,09	11	154,97	CHI
20200110013	RIO VERDE	630437464	RIO VERDE S1	02/01/2020 21:58	03/01/2020 00:15	02/01/2020 21:58	03/01/2020 00:15	2,28	1	2,28	CHI
20200110016	GOIANESIA	GE21137460	GOIANESIA S1	02/01/2020 21:59	03/01/2020 23:38	02/01/2020 21:59	03/01/2020 23:38	25,64	1	25,64	CHI
20200110022	MOSSAMEDES	MD12188234	FIRMINOPOLIS S2	02/01/2020 22:02	03/01/2020 08:13	02/01/2020 22:02	03/01/2020 08:13	10,18	34	346,16	CHI
20200110026	SANTA HELENA DE GOIAS	SH12271563	IPEGUARI	02/01/2020 21:56	03/01/2020 08:42	02/01/2020 21:56	03/01/2020 08:42	10,76	28	301,15	CHI
20200110026	TURVELANDIA	SH12271563	IPEGUARI	02/01/2020 21:56	03/01/2020 08:42	02/01/2020 21:56	03/01/2020 08:42	10,76	12	129,06	CHI
20200110028	AGUAS LINDAS DE GOIAS	4830100796	AGUAS LINDAS DE GOIAS S1	02/01/2020 22:07	03/01/2020 06:55	02/01/2020 22:07	03/01/2020 06:55	8,80	1	8,80	CHI
20200110032	PIRENOPOLIS	PV12008488	CORUMBA	02/01/2020 22:07	03/01/2020 07:44	02/01/2020 22:07	03/01/2020 07:44	9,60	6	57,63	CHI
20200110036	AGUAS LINDAS DE GOIAS	LA11164956	AGUAS LINDAS DE GOIAS S1	02/01/2020 21:32	02/01/2020 23:53	02/01/2020 21:32	02/01/2020 23:53	2,35	177	415,51	CHI
20200110041	RIO VERDE	RV12098479	RIO VERDE S1	02/01/2020 18:37	03/01/2020 07:24	02/01/2020 18:37	03/01/2020 07:24	12,79	7	89,51	CHI
20200110042	BELA VISTA DE GOIAS	BV31197948	BELA VISTA S1	02/01/2020 22:18	03/01/2020 07:35	02/01/2020 22:18	03/01/2020 07:35	9,28	1	9,28	CHI
20200110044	SANTA HELENA DE GOIAS	SH12279542	SANTA HELENA S1	02/01/2020 22:18	03/01/2020 16:28	02/01/2020 22:18	03/01/2020 16:04	17,75	2	35,51	CHI
20200110044	SANTA HELENA DE GOIAS	SH12279542	SANTA HELENA S1	02/01/2020 22:18	03/01/2020 16:28	02/01/2020 23:43	03/01/2020 16:04	16,35	4	65,40	CHI
20200110044	SANTO ANTONIO DA BARRA	SH12279542	SANTA HELENA S1	02/01/2020 22:18	03/01/2020 16:28	02/01/2020 23:43	03/01/2020 16:04	16,35	1	16,35	CHI
20200110044	SANTA HELENA DE GOIAS	SH12279542	SANTA HELENA S1	02/01/2020 22:18	03/01/2020 16:28	02/01/2020 22:18	03/01/2020 16:28	18,15	1	18,15	CHI

20200110044	ACREUNA	SH12271266	SANTA HELENA S1	02/01/2020 22:18	03/01/2020 16:28	02/01/2020 23:43	03/01/2020 16:28	16,75	3	50,25	CHI
20200110044	SANTA HELENA DE GOIAS	SH12271266	SANTA HELENA S1	02/01/2020 22:18	03/01/2020 16:28	02/01/2020 23:43	03/01/2020 16:28	16,75	2	33,50	CHI
20200110047	GOIANIA	12621791	ATLANTICO S2	02/01/2020 22:20	03/01/2020 00:46	02/01/2020 22:20	03/01/2020 00:46	2,43	1	2,43	CHI
20200110053	QUIRINOPOLIS	QI21314411	QUIRINOPOLIS	02/01/2020 22:24	03/01/2020 02:33	02/01/2020 22:24	03/01/2020 02:33	4,14	1	4,14	CHI
20200110059	TRINDADE	10005695781	TRINDADE	02/01/2020 22:27	03/01/2020 00:29	02/01/2020 22:27	03/01/2020 00:29	2,03	1	2,03	CHI
20200110060	ARUANA	AK12353719	BRITANIA	02/01/2020 22:32	03/01/2020 02:02	02/01/2020 22:32	03/01/2020 02:02	3,50	1	3,50	CHI
20200110061	GOIANIA	10000666899	CARAJAS S1	02/01/2020 22:33	02/01/2020 23:49	02/01/2020 22:33	02/01/2020 23:49	1,25	1	1,25	CHI
20200110062	MOZARLANDIA	MZ12057146	MOZARLANDIA	03/01/2020 06:37	03/01/2020 23:32	03/01/2020 06:37	03/01/2020 23:32	16,92	6	101,51	CHI
20200110062	NOVA CRIXAS	MZ12057146	MOZARLANDIA	03/01/2020 06:37	03/01/2020 23:32	03/01/2020 06:37	03/01/2020 23:32	16,92	31	524,47	CHI
20200110062	NOVA CRIXAS	MZ12057146	MOZARLANDIA	03/01/2020 06:37	03/01/2020 23:32	03/01/2020 09:30	03/01/2020 23:32	14,04	1	14,04	CHI
20200110065	GOIANIRA	10015785058	GOIANIRA	02/01/2020 22:35	03/01/2020 00:37	02/01/2020 22:35	03/01/2020 00:37	2,04	1	2,04	CHI
20200110069	ALEXANIA	AX12313240	ALEXANIA	02/01/2020 19:27	03/01/2020 12:26	02/01/2020 19:27	03/01/2020 12:26	16,98	17	288,66	CHI
20200110073	MINEIROS	SX10400642	CHAPADAO DO CEU	02/01/2020 22:49	03/01/2020 14:26	03/01/2020 10:14	03/01/2020 11:47	1,55	25	38,78	CHI
20200110073	SERRANOPOLIS	SX10400642	CHAPADAO DO CEU	02/01/2020 22:49	03/01/2020 14:26	03/01/2020 10:14	03/01/2020 11:47	1,55	81	125,64	CHI
20200110073	CHAPADAO DO CEU	DJ13164074	CHAPADAO DO CEU	02/01/2020 22:49	03/01/2020 14:26	03/01/2020 10:14	03/01/2020 14:09	3,91	5	19,53	CHI
20200110073	CHAPADAO DO CEU	DJ13164077	CHAPADAO DO CEU	02/01/2020 22:49	03/01/2020 14:26	03/01/2020 14:20	03/01/2020 14:26	0,11	5	0,56	CHI
20200110073	MINEIROS	DJ13164077	CHAPADAO DO CEU	02/01/2020 22:49	03/01/2020 14:26	03/01/2020 14:20	03/01/2020 14:26	0,11	25	2,81	CHI
20200110073	SERRANOPOLIS	DJ13164077	CHAPADAO DO CEU	02/01/2020 22:49	03/01/2020 14:26	03/01/2020 14:20	03/01/2020 14:26	0,11	82	9,23	CHI
20200110074	GOIANIA	14790312	SENADOR CANEDO	02/01/2020 22:51	03/01/2020 00:36	02/01/2020 22:51	03/01/2020 00:36	1,74	1	1,74	CHI
20200110075	CRISTALINA	KR12352836	CRISTALINA S1	02/01/2020 22:54	03/01/2020 11:54	02/01/2020 22:54	03/01/2020 11:54	13,00	63	818,70	CHI
20200110081	ITUMBIARA	10030722053	ITUMBIARA NOVA	02/01/2020 23:01	03/01/2020 09:05	02/01/2020 23:01	03/01/2020 09:05	10,05	1	10,05	CHI
20200110088	ANICUNS	AC21251393	ANICUNS	02/01/2020 23:12	03/01/2020 06:43	02/01/2020 23:12	03/01/2020 06:43	7,52	2	15,03	CHI
20200110089	ANICUNS	AC12000067	ANICUNS	02/01/2020 23:11	03/01/2020 03:52	02/01/2020 23:11	03/01/2020 03:52	4,67	15	70,03	CHI
20200110090	PADRE BERNARDO	PB12377245	PADRE BERNARDO	02/01/2020 23:12	03/01/2020 09:43	02/01/2020 23:12	03/01/2020 09:43	10,50	3	31,51	CHI
20200110096	GOIANIA	GN11000241	AEROPORTO S1	02/01/2020 23:20	03/01/2020 02:43	02/01/2020 23:20	03/01/2020 02:43	3,38	32	108,14	CHI
20200110099	ANAPOLIS	AN11000093	ANAPOLIS UNIVERSITARIO S2	02/01/2020 23:03	03/01/2020 00:33	02/01/2020 23:03	03/01/2020 00:33	1,49	117	174,13	CHI
20200110100	PARAUNA	PU12081329	PARAUNA	02/01/2020 23:26	03/01/2020 03:08	02/01/2020 23:26	03/01/2020 03:08	3,70	64	236,73	CHI
20200110105	GOIANIA	GN11247760	CARAJAS S1	02/01/2020 23:25	03/01/2020 00:21	02/01/2020 23:25	03/01/2020 00:21	0,93	144	133,60	CHI
20200110106	GOIANIA	10006919047	CARAJAS S1	02/01/2020 23:31	03/01/2020 01:19	02/01/2020 23:31	03/01/2020 01:19	1,79	1	1,79	CHI
20200110112	ORIZONA	OZ12113013	PIRES DO RIO S2	02/01/2020 23:44	03/01/2020 08:21	02/01/2020 23:44	03/01/2020 08:21	8,61	11	94,66	CHI
20200110113	ANICUNS	AC12000051	ANICUNS	02/01/2020 23:46	03/01/2020 09:24	02/01/2020 23:47	03/01/2020 09:24	9,63	50	481,36	CHI
20200110113	AVELINOPOLIS	AC12000051	ANICUNS	02/01/2020 23:46	03/01/2020 09:24	02/01/2020 23:47	03/01/2020 09:24	9,63	1	9,63	CHI
20200110115	ITAGUARI	IC12219941	ITABERAI S1	02/01/2020 23:48	03/01/2020 02:48	02/01/2020 23:48	03/01/2020 02:48	2,99	31	92,70	CHI

20200110115	ITAGUARU	IC12219941	ITABERAÍ S1	02/01/2020 23:48	03/01/2020 02:48	02/01/2020 23:48	03/01/2020 02:48	2,99	19	56,82	CHI
20200110116	GOIANIA	GN21249526	GOIANIA LESTE S2	02/01/2020 23:50	03/01/2020 01:47	02/01/2020 23:50	03/01/2020 01:47	1,95	2	3,89	CHI
20200110120	RIO VERDE	RV12214126	RIO VERDE S1	02/01/2020 23:57	03/01/2020 12:06	02/01/2020 23:57	03/01/2020 12:06	12,14	71	862,04	CHI
20200110120	SANTA HELENA DE GOIAS	RV12214126	RIO VERDE S1	02/01/2020 23:57	03/01/2020 12:06	02/01/2020 23:57	03/01/2020 12:06	12,14	45	546,36	CHI
20200110128	GOIATUBA	GT12000127	GOIATUBA S2	03/01/2020 00:10	03/01/2020 12:56	03/01/2020 00:10	03/01/2020 12:56	12,76	40	510,43	CHI
20200110129	ITUMBIARA	IT12257151	ITUMBIARA NOVA	02/01/2020 23:30	03/01/2020 10:49	02/01/2020 23:30	03/01/2020 10:49	11,32	248	2806,33	CHI
20200110130	MORRINHOS	150151615	MORRINHOS	03/01/2020 00:17	03/01/2020 08:28	03/01/2020 00:17	03/01/2020 08:28	8,18	1	8,18	CHI
20200110131	BOM JARDIM DE GOIAS	PH12201913	PIRANHAS	03/01/2020 00:22	03/01/2020 10:05	03/01/2020 00:22	03/01/2020 10:05	9,72	2	19,43	CHI
20200110131	PIRANHAS	PH12201913	PIRANHAS	03/01/2020 00:22	03/01/2020 10:05	03/01/2020 00:22	03/01/2020 10:05	9,72	11	106,89	CHI
20200110138	FIRMINOPOLIS	FR12382556	FIRMINOPOLIS S1	03/01/2020 00:44	03/01/2020 08:13	03/01/2020 00:44	03/01/2020 08:13	7,47	22	164,31	CHI
20200110138	SAO LUIS DE MONTES BELOS	FR12382556	FIRMINOPOLIS S1	03/01/2020 00:44	03/01/2020 08:13	03/01/2020 00:44	03/01/2020 08:13	7,47	7	52,28	CHI
20200110139	INDIARA	IY12081489	EDEIA	03/01/2020 00:39	03/01/2020 07:36	03/01/2020 00:39	03/01/2020 07:36	6,94	51	353,83	CHI
20200110139	PALMEIRAS DE GOIAS	IY12081489	EDEIA	03/01/2020 00:39	03/01/2020 07:36	03/01/2020 00:39	03/01/2020 07:36	6,94	1	6,94	CHI
20200110140	RIO VERDE	RV12147889	RIO VERDE S1	03/01/2020 00:48	03/01/2020 11:07	03/01/2020 00:48	03/01/2020 11:07	10,30	2	20,61	CHI
20200110143	INDIARA	IY12205923	EDEIA	03/01/2020 01:15	03/01/2020 08:58	03/01/2020 01:15	03/01/2020 08:58	7,71	33	254,47	CHI
20200110143	PALMEIRAS DE GOIAS	IY12205923	EDEIA	03/01/2020 01:15	03/01/2020 08:58	03/01/2020 01:15	03/01/2020 08:58	7,71	5	38,56	CHI
20200110144	MINEIROS	MY11055289	PARQUE DAS EMAS	03/01/2020 01:27	03/01/2020 02:20	03/01/2020 01:27	03/01/2020 02:20	0,88	122	107,70	CHI
20200110145	ACREUNA	EU12026734	RIO DOS BOIS	03/01/2020 01:30	03/01/2020 10:46	03/01/2020 01:30	03/01/2020 10:46	9,26	18	166,73	CHI
20200110145	TURVELANDIA	EU12026734	RIO DOS BOIS	03/01/2020 01:30	03/01/2020 10:46	03/01/2020 01:30	03/01/2020 10:46	9,26	19	175,99	CHI
20200110147	BONFINOPOLIS	TA12247490	NOVO PLANALTO	03/01/2020 01:34	03/01/2020 08:59	03/01/2020 01:34	03/01/2020 08:59	7,41	1	7,41	CHI
20200110147	BONOPOLIS	TA12247490	NOVO PLANALTO	03/01/2020 01:34	03/01/2020 08:59	03/01/2020 01:34	03/01/2020 08:59	7,41	11	81,49	CHI
20200110147	PORANGATU	TA12247490	NOVO PLANALTO	03/01/2020 01:34	03/01/2020 08:59	03/01/2020 01:34	03/01/2020 08:59	7,41	2	14,82	CHI
20200110154	CATALAO	CT12267016	CATALAO S1	03/01/2020 01:42	03/01/2020 08:08	03/01/2020 01:42	03/01/2020 08:08	6,43	44	282,96	CHI
20200110155	ORIZONA	PR12272876	PIRES DO RIO S1	03/01/2020 01:44	03/01/2020 08:24	03/01/2020 01:44	03/01/2020 08:24	6,66	5	33,31	CHI
20200110155	PIRES DO RIO	PR12272876	PIRES DO RIO S1	03/01/2020 01:44	03/01/2020 08:24	03/01/2020 01:44	03/01/2020 08:24	6,66	8	53,29	CHI
20200110158	JANDAIA	PP10404111	PALMEIRAS	03/01/2020 01:47	03/01/2020 09:45	03/01/2020 01:47	03/01/2020 04:41	2,90	19	55,05	CHI
20200110158	PALMINOPOLIS	PP10404111	PALMEIRAS	03/01/2020 01:47	03/01/2020 09:45	03/01/2020 01:47	03/01/2020 04:41	2,90	84	243,39	CHI
20200110158	PALMINOPOLIS	PP10404111	PALMEIRAS	03/01/2020 01:47	03/01/2020 09:45	03/01/2020 01:47	03/01/2020 08:41	6,90	7	48,33	CHI
20200110158	JANDAIA	PP10404111	PALMEIRAS	03/01/2020 01:47	03/01/2020 09:45	03/01/2020 01:47	03/01/2020 09:06	7,32	8	58,53	CHI
20200110158	PALMINOPOLIS	PP10404111	PALMEIRAS	03/01/2020 01:47	03/01/2020 09:45	03/01/2020 01:47	03/01/2020 09:06	7,32	5	36,58	CHI
20200110158	JANDAIA	PP10404111	PALMEIRAS	03/01/2020 01:47	03/01/2020 09:45	03/01/2020 01:47	03/01/2020 09:45	7,96	29	230,94	CHI
20200110158	PALMINOPOLIS	PP10404111	PALMEIRAS	03/01/2020 01:47	03/01/2020 09:45	03/01/2020 01:47	03/01/2020 09:45	7,96	66	525,60	CHI
20200110160	DOVERLANDIA	DV12342553	PARQUE DAS EMAS	03/01/2020 01:54	03/01/2020 11:01	03/01/2020 01:54	03/01/2020 11:01	9,11	0	0,00	CHI

20200110161	MUTUNOPOLIS	MU12141105	MARA ROSA	03/01/2020 02:02	03/01/2020 10:02	03/01/2020 02:02	03/01/2020 10:02	8,00	25	200,10	CHI
20200110162	CALDAS NOVAS	CN11114789	SERRA DE CALDAS	02/01/2020 23:41	03/01/2020 04:55	02/01/2020 23:41	03/01/2020 04:55	5,22	77	401,90	CHI
20200110164	CEZARINA	CZ12000015	CEZARINA	03/01/2020 02:11	03/01/2020 07:56	03/01/2020 02:11	03/01/2020 07:56	5,74	61	350,29	CHI
20200110164	INDIARA	CZ12000015	CEZARINA	03/01/2020 02:11	03/01/2020 07:56	03/01/2020 02:11	03/01/2020 07:56	5,74	37	212,47	CHI
20200110169	IPAMERI	GD21034042	IPAMERI	03/01/2020 02:35	03/01/2020 06:46	03/01/2020 02:35	03/01/2020 06:46	4,17	1	4,17	CHI
20200110170	INACIOLANDIA	ID31128267	QUIRINOPOLIS	03/01/2020 02:41	03/01/2020 07:27	03/01/2020 02:41	03/01/2020 07:27	4,76	1	4,76	CHI
20200110186	GOIAS	GS12071258	GOIAS	03/01/2020 03:24	03/01/2020 14:32	03/01/2020 03:24	03/01/2020 14:32	11,12	91	1011,89	CHI
20200110188	CAMPINORTE	MQ12390480	MARA ROSA	03/01/2020 03:00	03/01/2020 08:41	03/01/2020 03:00	03/01/2020 08:41	5,68	1	5,68	CHI
20200110188	MARA ROSA	MQ12390480	MARA ROSA	03/01/2020 03:00	03/01/2020 08:41	03/01/2020 03:00	03/01/2020 08:41	5,68	4	22,70	CHI
20200110191	CORUMBAIBA	CI12027816	VILA CORUMBA	02/01/2020 22:54	03/01/2020 10:22	02/01/2020 22:54	03/01/2020 10:22	11,46	23	263,57	CHI
20200110193	ALTO HORIZONTE	MQ12181177	MARA ROSA	03/01/2020 03:47	03/01/2020 11:46	03/01/2020 03:47	03/01/2020 11:46	7,97	3	23,90	CHI
20200110193	MARA ROSA	MQ12181177	MARA ROSA	03/01/2020 03:47	03/01/2020 11:46	03/01/2020 03:47	03/01/2020 11:46	7,97	28	223,10	CHI
20200110193	URUACU	MQ12181177	MARA ROSA	03/01/2020 03:47	03/01/2020 11:46	03/01/2020 03:47	03/01/2020 11:46	7,97	1	7,97	CHI
20200110201	PALESTINA DE GOIAS	PY12395457	PALESTINA	02/01/2020 18:08	03/01/2020 11:27	02/01/2020 18:08	03/01/2020 11:27	17,30	4	69,21	CHI
20200110203	FAZENDA NOVA	RN10394715	BRITANIA	03/01/2020 01:01	05/01/2020 00:42	03/01/2020 01:01	03/01/2020 02:14	1,23	9	11,03	CHI
20200110203	JUSSARA	RN10394715	BRITANIA	03/01/2020 01:01	05/01/2020 00:42	03/01/2020 01:01	03/01/2020 02:14	1,23	276	338,41	CHI
20200110203	SANTA FE DE GOIAS	RN10394715	BRITANIA	03/01/2020 01:01	05/01/2020 00:42	03/01/2020 01:01	03/01/2020 02:14	1,23	25	30,65	CHI
20200110203	FAZENDA NOVA	JR13403067	BRITANIA	03/01/2020 01:01	05/01/2020 00:42	03/01/2020 01:01	03/01/2020 04:21	3,33	142	473,18	CHI
20200110203	JUSSARA	JR13403067	BRITANIA	03/01/2020 01:01	05/01/2020 00:42	03/01/2020 01:01	03/01/2020 04:21	3,33	20	66,64	CHI
20200110203	JUSSARA	RN10394715	BRITANIA	03/01/2020 01:01	05/01/2020 00:42	03/01/2020 04:26	03/01/2020 05:25	1,00	46	45,86	CHI
20200110203	SANTA FE DE GOIAS	RN10394715	BRITANIA	03/01/2020 01:01	05/01/2020 00:42	03/01/2020 04:26	03/01/2020 05:25	1,00	17	16,95	CHI
20200110203	JUSSARA	RN10394715	BRITANIA	03/01/2020 01:01	05/01/2020 00:42	03/01/2020 08:13	03/01/2020 09:04	0,86	46	39,46	CHI
20200110203	SANTA FE DE GOIAS	RN10394715	BRITANIA	03/01/2020 01:01	05/01/2020 00:42	03/01/2020 08:13	03/01/2020 09:04	0,86	17	14,58	CHI
20200110203	JUSSARA	JR13259542	BRITANIA	03/01/2020 01:01	05/01/2020 00:42	03/01/2020 04:26	03/01/2020 13:56	9,50	86	817,24	CHI
20200110203	SANTA FE DE GOIAS	JR13259542	BRITANIA	03/01/2020 01:01	05/01/2020 00:42	03/01/2020 04:26	03/01/2020 13:56	9,50	2	19,01	CHI
20200110203	FAZENDA NOVA	JR12033556	BRITANIA	03/01/2020 01:01	05/01/2020 00:42	03/01/2020 04:26	03/01/2020 14:32	10,11	9	90,95	CHI
20200110203	JUSSARA	JR12033556	BRITANIA	03/01/2020 01:01	05/01/2020 00:42	03/01/2020 04:26	03/01/2020 14:32	10,11	144	1455,12	CHI
20200110203	FAZENDA NOVA	JR13403067	BRITANIA	03/01/2020 01:01	05/01/2020 00:42	03/01/2020 04:26	03/01/2020 14:43	10,28	142	1460,31	CHI
20200110203	JUSSARA	JR13403067	BRITANIA	03/01/2020 01:01	05/01/2020 00:42	03/01/2020 04:26	03/01/2020 14:43	10,28	20	205,68	CHI
20200110203	SANTA FE DE GOIAS	JR12008748	BRITANIA	03/01/2020 01:01	05/01/2020 00:42	03/01/2020 04:26	03/01/2020 17:18	12,87	3	38,62	CHI
20200110203	SANTA FE DE GOIAS	RN10394715	BRITANIA	03/01/2020 01:01	05/01/2020 00:42	03/01/2020 04:26	03/01/2020 21:23	16,95	3	50,85	CHI
20200110203	FAZENDA NOVA	RN10394715	BRITANIA	03/01/2020 01:01	05/01/2020 00:42	03/01/2020 21:11	03/01/2020 21:23	0,19	151	28,52	CHI
20200110203	JUSSARA	RN10394715	BRITANIA	03/01/2020 01:01	05/01/2020 00:42	03/01/2020 21:11	03/01/2020 21:23	0,19	314	59,31	CHI

20200110203	SANTA FE DE GOIAS	RN10394715	BRITANIA	03/01/2020 01:01	05/01/2020 00:42	03/01/2020 21:11	03/01/2020 21:23	0,19	22	4,16	CHI
20200110203	SANTA FE DE GOIAS	RN12148859LD	BRITANIA	03/01/2020 01:01	05/01/2020 00:42	03/01/2020 21:24	03/01/2020 22:04	0,68	2	1,36	CHI
20200110203	FAZENDA NOVA	RN10394715	BRITANIA	03/01/2020 01:01	05/01/2020 00:42	03/01/2020 23:28	03/01/2020 23:51	0,38	151	57,97	CHI
20200110203	JUSSARA	RN10394715	BRITANIA	03/01/2020 01:01	05/01/2020 00:42	03/01/2020 23:28	03/01/2020 23:51	0,38	314	120,54	CHI
20200110203	SANTA FE DE GOIAS	RN10394715	BRITANIA	03/01/2020 01:01	05/01/2020 00:42	03/01/2020 23:28	03/01/2020 23:51	0,38	25	9,60	CHI
20200110203	FAZENDA NOVA	FN13362430	BRITANIA	03/01/2020 01:01	05/01/2020 00:42	03/01/2020 01:01	04/01/2020 04:56	27,92	45	1256,56	CHI
20200110203	JUSSARA	FN13362430	BRITANIA	03/01/2020 01:01	05/01/2020 00:42	03/01/2020 01:01	04/01/2020 04:56	27,92	11	307,16	CHI
20200110203	FAZENDA NOVA	FN13362430	BRITANIA	03/01/2020 01:01	05/01/2020 00:42	03/01/2020 01:01	05/01/2020 00:42	47,69	16	763,05	CHI
20200110203	JAUPACI	FN13362430	BRITANIA	03/01/2020 01:01	05/01/2020 00:42	03/01/2020 01:01	05/01/2020 00:42	47,69	2	95,38	CHI
20200110203	FAZENDA NOVA	FN13362430	BRITANIA	03/01/2020 01:01	05/01/2020 00:42	04/01/2020 23:44	05/01/2020 00:42	0,97	45	43,79	CHI
20200110203	JUSSARA	FN13362430	BRITANIA	03/01/2020 01:01	05/01/2020 00:42	04/01/2020 23:44	05/01/2020 00:42	0,97	11	10,70	CHI
20200110301	SAO JOAO DA PARAUNA	RP12294284	FIRMINOPOLIS S2	03/01/2020 03:55	03/01/2020 09:26	03/01/2020 03:55	03/01/2020 09:26	5,50	1	5,50	CHI
20200110305	PORANGATU	PO12192371	PORANGATU	03/01/2020 03:47	03/01/2020 09:26	03/01/2020 03:47	03/01/2020 09:26	5,63	12	67,61	CHI
20200110306	CRISTALINA	KR21385519	CRISTALINA S2	03/01/2020 04:00	03/01/2020 12:25	03/01/2020 04:00	03/01/2020 12:25	8,41	2	16,83	CHI
20200110308	CRIXAS	MZ12055628	MOZARLANDIA	03/01/2020 04:07	03/01/2020 17:15	03/01/2020 04:07	03/01/2020 12:00	7,88	2	15,75	CHI
20200110308	MOZARLANDIA	MZ12055628	MOZARLANDIA	03/01/2020 04:07	03/01/2020 17:15	03/01/2020 04:07	03/01/2020 12:00	7,88	31	244,13	CHI
20200110308	MOZARLANDIA	MZ12055628	MOZARLANDIA	03/01/2020 04:07	03/01/2020 17:15	03/01/2020 09:10	03/01/2020 12:00	2,83	2	5,67	CHI
20200110308	CRIXAS	MZ12055628	MOZARLANDIA	03/01/2020 04:07	03/01/2020 17:15	03/01/2020 04:07	03/01/2020 13:00	8,89	7	62,23	CHI
20200110308	MOZARLANDIA	MZ12055628	MOZARLANDIA	03/01/2020 04:07	03/01/2020 17:15	03/01/2020 04:07	03/01/2020 13:00	8,89	5	44,45	CHI
20200110308	CRIXAS	MZ12055628	MOZARLANDIA	03/01/2020 04:07	03/01/2020 17:15	03/01/2020 04:07	03/01/2020 17:08	13,01	12	156,17	CHI
20200110308	CRIXAS	MZ12055628	MOZARLANDIA	03/01/2020 04:07	03/01/2020 17:15	03/01/2020 04:07	03/01/2020 17:15	13,13	5	65,63	CHI
20200110310	FAINA	GS12042217	GOIAS	03/01/2020 04:10	03/01/2020 10:10	03/01/2020 04:10	03/01/2020 10:10	5,99	74	443,05	CHI
20200110311	SANTA HELENA DE GOIAS	400037350	IPEGUARI	03/01/2020 04:12	03/01/2020 10:22	03/01/2020 04:12	03/01/2020 10:22	6,16	1	6,16	CHI
20200110312	GOUVELANDIA	GB12303274	QUIRINOPOLIS	03/01/2020 04:18	03/01/2020 10:56	03/01/2020 04:18	03/01/2020 10:56	6,63	2	13,27	CHI
20200110314	MAURILANDIA	ML21054048	RIO DOS BOIS	03/01/2020 04:23	03/01/2020 15:39	03/01/2020 04:23	03/01/2020 15:39	11,26	1	11,26	CHI
20200110321	PADRE BERNARDO	PB12305108	PADRE BERNARDO	03/01/2020 04:34	03/01/2020 07:22	03/01/2020 04:34	03/01/2020 07:22	2,80	4	11,20	CHI
20200110324	SANCLERLANDIA	SC12163921	FIRMINOPOLIS S2	03/01/2020 04:39	03/01/2020 06:51	03/01/2020 04:39	03/01/2020 06:51	2,20	12	26,39	CHI
20200110330	SAO MIGUEL DO ARAGUAIA	SM12013063LD	SAO MIGUEL DO ARAGUAIA	03/01/2020 04:55	05/01/2020 12:08	03/01/2020 04:55	05/01/2020 12:08	55,22	3	165,65	CHI
20200110330	SAO MIGUEL DO ARAGUAIA	SM12013063LD	SAO MIGUEL DO ARAGUAIA	03/01/2020 04:55	05/01/2020 12:08	05/01/2020 07:46	05/01/2020 12:08	4,36	8	34,88	CHI
20200110336	CACU	CC11247562	CACHOEIRA ALTA	03/01/2020 05:03	03/01/2020 08:25	03/01/2020 05:03	03/01/2020 08:25	3,36	1	3,36	CHI
20200110340	ALEXANIA	AX12402045	ALEXANIA	03/01/2020 01:46	03/01/2020 09:35	03/01/2020 01:46	03/01/2020 09:35	7,81	178	1390,03	CHI
20200110340	SANTO ANTONIO DO DESCOBERTO	AX12402045	ALEXANIA	03/01/2020 01:46	03/01/2020 09:35	03/01/2020 01:46	03/01/2020 09:35	7,81	1	7,81	CHI
20200110342	ARENOPOLIS	AY12156761	ARENOPOLIS	03/01/2020 05:11	03/01/2020 11:25	03/01/2020 05:11	03/01/2020 11:25	6,22	5	31,12	CHI

20200110344	IPORA	IR12014004	IPORA	03/01/2020 05:12	03/01/2020 12:45	03/01/2020 05:12	03/01/2020 12:45	7,55	2	15,09	CHI
20200110346	ITARUMA	IM12096943	CACHOEIRA ALTA	03/01/2020 04:19	03/01/2020 06:38	03/01/2020 04:19	03/01/2020 06:38	2,30	12	27,61	CHI
20200110347	GOIATUBA	IT12257065	PARANAIBA	03/01/2020 04:55	03/01/2020 18:21	03/01/2020 04:55	03/01/2020 18:21	13,43	6	80,60	CHI
20200110347	ITUMBIARA	IT12257065	PARANAIBA	03/01/2020 04:55	03/01/2020 18:21	03/01/2020 04:55	03/01/2020 18:21	13,43	2	26,87	CHI
20200110347	PANAMA	IT12257065	PARANAIBA	03/01/2020 04:55	03/01/2020 18:21	03/01/2020 04:55	03/01/2020 18:21	13,43	9	120,91	CHI
20200110348	CABECEIRAS	CW12287236	ITUIQUIRA	03/01/2020 05:17	03/01/2020 11:30	03/01/2020 05:17	03/01/2020 11:30	6,20	17	105,43	CHI
20200110349	CEZARINA	PL12304466	PALMEIRAS	03/01/2020 05:19	03/01/2020 07:14	03/01/2020 05:19	03/01/2020 07:14	1,92	1	1,92	CHI
20200110349	PALMEIRAS DE GOIAS	PL12304466	PALMEIRAS	03/01/2020 05:19	03/01/2020 07:14	03/01/2020 05:19	03/01/2020 07:14	1,92	12	23,00	CHI
20200110350	GOIANIA	13008043	FERROVIARIO S3	03/01/2020 05:20	03/01/2020 06:28	03/01/2020 05:20	03/01/2020 06:28	1,12	1	1,12	CHI
20200110352	APARECIDA DE GOIANIA	10004731130	INDEPENDENCIA S1	03/01/2020 05:23	03/01/2020 07:44	03/01/2020 05:23	03/01/2020 07:44	2,34	1	2,34	CHI
20200110358	MORRINHOS	MR12119764RE	MORRINHOS	03/01/2020 05:26	03/01/2020 09:02	03/01/2020 05:26	03/01/2020 09:02	3,60	76	273,35	CHI
20200110359	MAMBAI	MB12302924	IACIARA S2	02/01/2020 21:10	03/01/2020 08:47	02/01/2020 21:10	03/01/2020 08:47	11,62	31	360,10	CHI
20200110360	AURILANDIA	CG12391526	FIRMINOPOLIS S2	03/01/2020 05:27	03/01/2020 21:17	03/01/2020 05:27	03/01/2020 11:16	5,81	2	11,62	CHI
20200110360	CACHOEIRA DE GOIAS	CG12391526	FIRMINOPOLIS S2	03/01/2020 05:27	03/01/2020 21:17	03/01/2020 05:27	03/01/2020 11:16	5,81	5	29,05	CHI
20200110360	PARAUNA	CG12391526	FIRMINOPOLIS S2	03/01/2020 05:27	03/01/2020 21:17	03/01/2020 05:27	03/01/2020 11:16	5,81	16	92,96	CHI
20200110360	PARAUNA	CG12391526	FIRMINOPOLIS S2	03/01/2020 05:27	03/01/2020 21:17	03/01/2020 05:27	03/01/2020 13:42	8,25	9	74,27	CHI
20200110360	CACHOEIRA DE GOIAS	CG12391526	FIRMINOPOLIS S2	03/01/2020 05:27	03/01/2020 21:17	03/01/2020 05:27	03/01/2020 18:03	12,60	3	37,81	CHI
20200110360	PARAUNA	CG12391526	FIRMINOPOLIS S2	03/01/2020 05:27	03/01/2020 21:17	03/01/2020 05:27	03/01/2020 18:03	12,60	2	25,21	CHI
20200110360	CACHOEIRA DE GOIAS	CG12391526	FIRMINOPOLIS S2	03/01/2020 05:27	03/01/2020 21:17	03/01/2020 05:27	03/01/2020 20:14	14,78	3	44,35	CHI
20200110360	PARAUNA	CG12391526	FIRMINOPOLIS S2	03/01/2020 05:27	03/01/2020 21:17	03/01/2020 05:27	03/01/2020 20:14	14,78	4	59,14	CHI
20200110360	PARAUNA	CG12391526	FIRMINOPOLIS S2	03/01/2020 05:27	03/01/2020 21:17	03/01/2020 05:27	03/01/2020 21:17	15,83	1	15,83	CHI
20200110363	DOVERLANDIA	DV12303682	PARQUE DAS EMAS	03/01/2020 05:31	03/01/2020 13:01	03/01/2020 05:31	03/01/2020 13:01	7,49	8	59,93	CHI
20200110365	ALTO HORIZONTE	NH12396799	SANTA TEREZINHA	02/01/2020 18:46	03/01/2020 10:10	02/01/2020 18:46	03/01/2020 10:10	15,40	49	754,52	CHI
20200110365	CAMPOS VERDES	NH12396799	SANTA TEREZINHA	02/01/2020 18:46	03/01/2020 10:10	02/01/2020 18:46	03/01/2020 10:10	15,40	7	107,79	CHI
20200110366	VIANOPOLIS	VN12026013	VIANOPOLIS	03/01/2020 05:34	03/01/2020 10:54	03/01/2020 05:34	03/01/2020 10:54	5,33	13	69,28	CHI
20200110374	AGUA LIMPA	AL11273798	VILA CORUMBA	03/01/2020 05:39	03/01/2020 09:38	03/01/2020 05:39	03/01/2020 09:38	3,98	23	91,48	CHI
20200110376	CATALAO	CT12317610	CATALAO S1	03/01/2020 05:39	03/01/2020 09:18	03/01/2020 05:39	03/01/2020 09:18	3,64	1	3,64	CHI
20200110377	PADRE BERNARDO	PB12275452	PADRE BERNARDO	03/01/2020 05:39	03/01/2020 13:05	03/01/2020 05:39	03/01/2020 13:05	7,43	29	215,51	CHI
20200110378	ESTRELA DO NORTE	MU12391986	MARA ROSA	03/01/2020 05:11	03/01/2020 10:20	03/01/2020 05:11	03/01/2020 10:20	5,14	1	5,14	CHI
20200110378	MUTUNOPOLIS	MU12391986	MARA ROSA	03/01/2020 05:11	03/01/2020 10:20	03/01/2020 05:11	03/01/2020 10:20	5,14	100	514,33	CHI
20200110381	ITAPACI	IW12081353	ITAPACI	03/01/2020 05:40	03/01/2020 07:34	03/01/2020 05:40	03/01/2020 07:34	1,89	23	43,43	CHI
20200110384	FIRMINOPOLIS	FR12061354	FIRMINOPOLIS S1	03/01/2020 04:50	03/01/2020 07:18	03/01/2020 04:50	03/01/2020 07:18	2,46	20	49,12	CHI
20200110385	FORMOSA	FA11131890	ITUIQUIRA	03/01/2020 03:26	03/01/2020 06:59	03/01/2020 03:26	03/01/2020 06:59	3,55	78	276,75	CHI

20200110386	ITAPURANGA	IK12298407LD	ITAPURANGA	03/01/2020 05:42	03/01/2020 13:22	03/01/2020 05:42	03/01/2020 13:22	7,68	35	268,68	CHI
20200110388	CAMPOS VERDES	VD12181203	SANTA TEREZINHA	03/01/2020 05:44	03/01/2020 13:07	03/01/2020 05:44	03/01/2020 13:07	7,37	12	88,42	CHI
20200110389	CUMARI	CT12266111	CATALAO S2	03/01/2020 05:45	03/01/2020 07:52	03/01/2020 05:45	03/01/2020 07:52	2,10	7	14,71	CHI
20200110390	BONOPOLIS	BX12168214	SAO MIGUEL DO ARAGUAIA	03/01/2020 05:46	03/01/2020 13:10	03/01/2020 05:46	03/01/2020 13:10	7,40	124	917,39	CHI
20200110392	PIRANHAS	PH12201916	BOM JARDIM	03/01/2020 05:47	03/01/2020 11:16	03/01/2020 05:47	03/01/2020 11:16	5,47	9	49,21	CHI
20200110397	BARRO ALTO	BA12035658	BARRO ALTO	03/01/2020 05:49	04/01/2020 07:54	03/01/2020 05:49	04/01/2020 07:54	26,07	14	365,02	CHI
20200110397	NIQUELANDIA	BA12035658	BARRO ALTO	03/01/2020 05:49	04/01/2020 07:54	03/01/2020 05:49	04/01/2020 07:54	26,07	4	104,29	CHI
20200110417	IPORA	IR12139399	IPORA	03/01/2020 07:04	03/01/2020 09:25	03/01/2020 07:04	03/01/2020 09:25	2,34	3	7,03	CHI
20200110427	ANAPOLIS	10018584002	JUNDIAI S1	03/01/2020 08:03	03/01/2020 08:53	03/01/2020 08:03	03/01/2020 08:53	0,82	0	0,00	CHI
20200110440	CACHOEIRA ALTA	CC10400649	CACHOEIRA ALTA	03/01/2020 08:29	03/01/2020 18:58	03/01/2020 08:29	03/01/2020 09:53	1,40	64	89,78	CHI
20200110440	CACU	CC10400649	CACHOEIRA ALTA	03/01/2020 08:29	03/01/2020 18:58	03/01/2020 08:29	03/01/2020 09:53	1,40	1	1,40	CHI
20200110440	CACHOEIRA ALTA	CC10400649	CACHOEIRA ALTA	03/01/2020 08:29	03/01/2020 18:58	03/01/2020 08:29	03/01/2020 11:46	3,28	52	170,56	CHI
20200110440	CACHOEIRA ALTA	CA13161863	CACHOEIRA ALTA	03/01/2020 08:29	03/01/2020 18:58	03/01/2020 08:30	03/01/2020 11:46	3,26	1	3,26	CHI
20200110440	CACHOEIRA ALTA	CC10400649	CACHOEIRA ALTA	03/01/2020 08:29	03/01/2020 18:58	03/01/2020 08:29	03/01/2020 14:03	5,56	31	172,51	CHI
20200110440	CACHOEIRA ALTA	CA12014743RE	CACHOEIRA ALTA	03/01/2020 08:29	03/01/2020 18:58	03/01/2020 08:29	03/01/2020 18:58	10,49	62	650,60	CHI
20200110440	CACHOEIRA ALTA	CA12014743RE	CACHOEIRA ALTA	03/01/2020 08:29	03/01/2020 18:58	03/01/2020 08:30	03/01/2020 18:58	10,47	1	10,47	CHI
20200110443	SANTO ANTONIO DO DESCOBERTO	AX21070952	MARAJOARA	02/01/2020 18:12	04/01/2020 03:09	02/01/2020 18:12	04/01/2020 02:30	32,29	1	32,29	CHI
20200110443	SANTO ANTONIO DO DESCOBERTO	AX21070928	MARAJOARA	02/01/2020 18:12	04/01/2020 03:09	03/01/2020 21:50	04/01/2020 03:09	5,32	2	10,63	CHI
20200110481	LUZIANIA	LZ12087444	VIANOPOLIS	03/01/2020 07:03	03/01/2020 11:50	03/01/2020 07:03	03/01/2020 11:50	4,77	16	76,35	CHI
20200110483	PARAUNA	PU12044570	ACREUNA	03/01/2020 06:33	03/01/2020 14:04	03/01/2020 06:33	03/01/2020 14:04	7,52	23	172,91	CHI
20200110501	ITUMBIARA	BG12363928	ITUMBIARA VELHA S2	03/01/2020 05:51	04/01/2020 08:22	03/01/2020 05:51	04/01/2020 08:22	26,53	5	132,63	CHI
20200110507	PIRANHAS	PH12307515	PIRANHAS	03/01/2020 05:52	03/01/2020 09:37	03/01/2020 05:52	03/01/2020 09:37	3,74	3	11,22	CHI
20200110510	ITAGUARI	IC12045481	ITABERAI S1	03/01/2020 05:54	03/01/2020 09:09	03/01/2020 05:54	03/01/2020 09:09	3,25	5	16,25	CHI
20200110510	ITAGUARU	IC12045481	ITABERAI S1	03/01/2020 05:54	03/01/2020 09:09	03/01/2020 05:54	03/01/2020 09:09	3,25	1	3,25	CHI
20200110515	EDEIA	IY12010954	EDEIA	03/01/2020 04:24	03/01/2020 07:23	03/01/2020 04:24	03/01/2020 07:23	2,98	5	14,91	CHI
20200110515	INDIARA	IY12010954	EDEIA	03/01/2020 04:24	03/01/2020 07:23	03/01/2020 04:24	03/01/2020 07:23	2,98	46	137,16	CHI
20200110516	CAVALCANTE	CJ12278451	NIQUELANDIA SUBTRANSMISSAO	03/01/2020 05:57	03/01/2020 17:00	03/01/2020 05:57	03/01/2020 17:00	11,04	56	618,47	CHI
20200110518	FLORES DE GOIAS	FB21252169	FLORES DE GOIAS	03/01/2020 05:57	03/01/2020 14:32	03/01/2020 05:57	03/01/2020 14:32	8,57	2	17,15	CHI
20200110522	FORMOSA	FA12195886	ITIQUEIRA	03/01/2020 05:58	03/01/2020 07:54	03/01/2020 05:58	03/01/2020 07:54	1,92	48	92,07	CHI
20200110523	IPORA	IR12024610	ARENOPOLIS	03/01/2020 05:58	03/01/2020 11:45	03/01/2020 05:58	03/01/2020 11:45	5,77	39	224,96	CHI
20200110525	JATAI	JT12036267	JATAI S2	03/01/2020 05:59	03/01/2020 08:30	03/01/2020 05:59	03/01/2020 08:30	2,50	2	5,01	CHI
20200110529	MIMOSO DE GOIAS	NQ12371855	BARRO ALTO	03/01/2020 04:27	03/01/2020 08:21	03/01/2020 04:27	03/01/2020 08:21	3,90	4	15,60	CHI
20200110529	NIQUELANDIA	NQ12371855	BARRO ALTO	03/01/2020 04:27	03/01/2020 08:21	03/01/2020 04:27	03/01/2020 08:21	3,90	243	947,70	CHI

20200110530	IPAMERI	IP12112779	IPAMERI	03/01/2020 04:32	03/01/2020 07:12	03/01/2020 04:32	03/01/2020 07:12	2,66	28	74,40	CHI
20200110533	ITARUMA	IM12219293	CACHOEIRA ALTA	03/01/2020 06:02	03/01/2020 10:39	03/01/2020 06:02	03/01/2020 10:39	4,60	1	4,60	CHI
20200110535	CALDAS NOVAS	CN12363792	SERRA DE CALDAS	03/01/2020 05:48	03/01/2020 09:06	03/01/2020 05:48	03/01/2020 09:06	3,29	110	362,27	CHI
20200110536	PADRE BERNARDO	PB12305256	PADRE BERNARDO	03/01/2020 06:03	03/01/2020 15:17	03/01/2020 06:03	03/01/2020 15:17	9,22	2	18,44	CHI
20200110537	MONTIVIDIU	MV12226282	MONTIVIDIU T	03/01/2020 06:04	03/01/2020 14:22	03/01/2020 06:04	03/01/2020 14:22	8,29	1	8,29	CHI
20200110542	RUBIATABA	RB12003316	RUBIATABA	03/01/2020 06:05	03/01/2020 07:43	03/01/2020 06:05	03/01/2020 07:43	1,63	45	73,29	CHI
20200110543	JATAI	SX12264387	JATAI S1	03/01/2020 06:06	03/01/2020 08:52	03/01/2020 06:06	03/01/2020 08:52	2,75	7	19,25	CHI
20200110543	SERRANOPOLIS	SX12264387	JATAI S1	03/01/2020 06:06	03/01/2020 08:52	03/01/2020 06:06	03/01/2020 08:52	2,75	22	60,51	CHI
20200110547	MARA ROSA	MQ12285530	MARA ROSA	03/01/2020 06:07	03/01/2020 14:42	03/01/2020 06:07	03/01/2020 14:42	8,58	1	8,58	CHI
20200110548	RIO VERDE	SH12271530	IPEGUARI	03/01/2020 01:35	03/01/2020 09:11	03/01/2020 01:35	03/01/2020 09:11	7,59	2	15,19	CHI
20200110548	SANTA HELENA DE GOIAS	SH12271530	IPEGUARI	03/01/2020 01:35	03/01/2020 09:11	03/01/2020 01:35	03/01/2020 09:11	7,59	36	273,40	CHI
20200110549	MORRINHOS	MR12000273	MORRINHOS	03/01/2020 06:07	03/01/2020 08:49	03/01/2020 06:07	03/01/2020 08:49	2,69	9	24,22	CHI
20200110554	ITAPIRAPUA	IU12089733	MATRINCHA	03/01/2020 05:51	03/01/2020 07:21	03/01/2020 05:51	03/01/2020 07:21	1,49	24	35,77	CHI
20200110556	RIO VERDE	10009070573	CABRIUVA S1	03/01/2020 06:10	03/01/2020 09:49	03/01/2020 06:10	03/01/2020 09:49	3,65	1	3,65	CHI
20200110557	URUANA	JA21216798	JARAGUA	03/01/2020 06:10	03/01/2020 09:20	03/01/2020 06:10	03/01/2020 09:20	3,16	1	3,16	CHI
20200110559	CAMPO ALEGRE DE GOIAS	CM12156359	CAMPO ALEGRE DE GOIAS	03/01/2020 05:39	03/01/2020 08:22	03/01/2020 05:39	03/01/2020 08:22	2,71	31	84,02	CHI
20200110560	GOIAS	IU12362402	MATRINCHA	02/01/2020 22:02	03/01/2020 08:40	02/01/2020 22:02	03/01/2020 08:40	10,63	32	340,07	CHI
20200110560	ITAPIRAPUA	IU12362402	MATRINCHA	02/01/2020 22:02	03/01/2020 08:40	02/01/2020 22:02	03/01/2020 08:40	10,63	12	127,53	CHI
20200110567	VALPARAISO DE GOIAS	3350095705	PACAEMBU S1	03/01/2020 06:12	03/01/2020 08:10	03/01/2020 06:12	03/01/2020 08:10	1,96	1	1,96	CHI
20200110569	GOIATUBA	JV12000030	GOIATUBA S1	03/01/2020 06:13	03/01/2020 10:36	03/01/2020 06:13	03/01/2020 10:36	4,38	17	74,43	CHI
20200110569	JOVIANIA	JV12000030	GOIATUBA S1	03/01/2020 06:13	03/01/2020 10:36	03/01/2020 06:13	03/01/2020 10:36	4,38	13	56,91	CHI
20200110569	VICENTINOPOLIS	JV12000030	GOIATUBA S1	03/01/2020 06:13	03/01/2020 10:36	03/01/2020 06:13	03/01/2020 10:36	4,38	14	61,29	CHI
20200110572	PLANALTINA	PI12072312	PLANALTINA	03/01/2020 00:43	03/01/2020 07:40	03/01/2020 00:43	03/01/2020 07:40	6,93	52	360,59	CHI
20200110579	IPAMERI	IP12287085	IPAMERI	03/01/2020 04:24	03/01/2020 07:11	03/01/2020 04:24	03/01/2020 07:11	2,78	53	147,49	CHI
20200110580	PIRES DO RIO	PR12404727	PIRES DO RIO S1	03/01/2020 06:16	03/01/2020 08:18	03/01/2020 06:16	03/01/2020 08:18	2,02	4	8,10	CHI
20200110581	ABADIANIA	AA12123838	DAIA S2	03/01/2020 06:16	03/01/2020 15:02	03/01/2020 06:16	03/01/2020 15:02	8,76	3	26,27	CHI
20200110582	CACHOEIRA ALTA	CC12013147RE	CACHOEIRA ALTA	03/01/2020 06:16	04/01/2020 21:35	03/01/2020 06:16	03/01/2020 18:11	11,91	14	166,73	CHI
20200110582	QUIRINOPOLIS	CC12013147RE	CACHOEIRA ALTA	03/01/2020 06:16	04/01/2020 21:35	03/01/2020 06:16	03/01/2020 18:11	11,91	5	59,55	CHI
20200110582	CACHOEIRA ALTA	CC12013147RE	CACHOEIRA ALTA	03/01/2020 06:16	04/01/2020 21:35	03/01/2020 16:41	03/01/2020 18:11	1,49	1	1,49	CHI
20200110582	CACHOEIRA ALTA	CC12013147RE	CACHOEIRA ALTA	03/01/2020 06:16	04/01/2020 21:35	03/01/2020 06:16	04/01/2020 17:44	35,46	11	390,03	CHI
20200110582	QUIRINOPOLIS	CC12013147RE	CACHOEIRA ALTA	03/01/2020 06:16	04/01/2020 21:35	03/01/2020 06:16	04/01/2020 17:44	35,46	11	390,03	CHI
20200110582	QUIRINOPOLIS	CC12041658LD	CACHOEIRA ALTA	03/01/2020 06:16	04/01/2020 21:35	03/01/2020 16:41	04/01/2020 17:44	25,03	1	25,03	CHI
20200110582	CACHOEIRA ALTA	CC12013147RE	CACHOEIRA ALTA	03/01/2020 06:16	04/01/2020 21:35	03/01/2020 06:16	04/01/2020 21:35	39,31	23	904,23	CHI



20200110582	QUIRINOPOLIS	CC12013147RE	CACHOEIRA ALTA	03/01/2020 06:16	04/01/2020 21:35	03/01/2020 06:16	04/01/2020 21:35	39,31	11	432,46	CHI
20200110583	AGUA LIMPA	AL21298682	VILA CORUMBA	03/01/2020 06:16	03/01/2020 10:44	03/01/2020 06:16	03/01/2020 10:44	4,45	1	4,45	CHI
20200110585	POSSE	SA12195795	IACIARA S2	03/01/2020 06:17	03/01/2020 20:49	03/01/2020 06:17	03/01/2020 20:49	14,53	5	72,63	CHI
20200110593	INDIARA	IY12233475	EDEIA	03/01/2020 06:15	03/01/2020 08:18	03/01/2020 06:15	03/01/2020 08:18	2,04	5	10,18	CHI
20200110595	OUIDOR	CT21266219	CATALAO S1	03/01/2020 06:19	03/01/2020 09:24	03/01/2020 06:19	03/01/2020 09:24	3,08	1	3,08	CHI
20200110596	BOM JARDIM DE GOIAS	BM12155682	BOM JARDIM	03/01/2020 06:19	03/01/2020 10:20	03/01/2020 06:19	03/01/2020 10:20	4,01	14	56,07	CHI
20200110596	PIRANHAS	BM12155682	BOM JARDIM	03/01/2020 06:19	03/01/2020 10:20	03/01/2020 06:19	03/01/2020 10:20	4,01	4	16,02	CHI
20200110597	PORTELANDIA	PW12302000	PARQUE DAS EMAS	03/01/2020 06:20	04/01/2020 10:52	03/01/2020 06:20	04/01/2020 10:52	28,53	3	85,58	CHI
20200110602	ABADIANIA	AA12333151	DAIA S2	03/01/2020 06:22	03/01/2020 13:07	03/01/2020 06:22	03/01/2020 13:07	6,74	19	128,14	CHI
20200110603	BONOPOLIS	BX12292422	SAO MIGUEL DO ARAGUAIA	03/01/2020 06:22	03/01/2020 14:58	03/01/2020 14:54	03/01/2020 14:58	0,08	30	2,27	CHI
20200110603	PORANGATU	BX12292422	SAO MIGUEL DO ARAGUAIA	03/01/2020 06:22	03/01/2020 14:58	03/01/2020 14:54	03/01/2020 14:58	0,08	1	0,08	CHI
20200110603	BONOPOLIS	BX12203505	SAO MIGUEL DO ARAGUAIA	03/01/2020 06:22	03/01/2020 14:58	03/01/2020 06:22	03/01/2020 14:58	8,61	2	17,22	CHI
20200110608	PARAUNA	PU21045213	ACREUNA	03/01/2020 06:23	03/01/2020 14:04	03/01/2020 06:23	03/01/2020 14:04	7,68	1	7,68	CHI
20200110609	PADRE BERNARDO	PB12060341RE	PADRE BERNARDO	03/01/2020 06:24	03/01/2020 09:06	03/01/2020 06:24	03/01/2020 09:06	2,69	13	35,01	CHI
20200110610	MINEIROS	MY12336395	PARQUE DAS EMAS	03/01/2020 06:24	05/01/2020 19:26	03/01/2020 06:24	05/01/2020 19:26	61,02	4	244,10	CHI
20200110613	PORANGATU	PO12321070	NOVO PLANALTO	03/01/2020 06:25	03/01/2020 10:18	03/01/2020 06:25	03/01/2020 10:18	3,88	21	81,46	CHI
20200110615	URUACU	640005585	URUACU	03/01/2020 06:26	03/01/2020 07:54	03/01/2020 06:26	03/01/2020 07:54	1,46	1	1,46	CHI
20200110617	NOVO BRASIL	NB12120651LD	MATRINCHA	03/01/2020 06:26	03/01/2020 10:25	03/01/2020 06:26	03/01/2020 10:25	3,97	22	87,31	CHI
20200110621	FORMOSA	FA21067988	ITIQUEIRA	03/01/2020 06:27	03/01/2020 09:34	03/01/2020 06:27	03/01/2020 09:34	3,10	1	3,10	CHI
20200110625	CAMPO ALEGRE DE GOIAS	CM12042353	CAMPO ALEGRE DE GOIAS	03/01/2020 06:28	03/01/2020 11:06	03/01/2020 06:28	03/01/2020 11:06	4,63	5	23,13	CHI
20200110626	FORMOSA	FA12404379	ITIQUEIRA	03/01/2020 06:28	03/01/2020 09:22	03/01/2020 06:28	03/01/2020 09:22	2,89	11	31,80	CHI
20200110630	DIVINOPOLIS DE GOIAS	GH12228817	SAO DOMINGOS	03/01/2020 06:29	03/01/2020 09:03	03/01/2020 06:29	03/01/2020 09:03	2,57	13	33,36	CHI
20200110631	TRINDADE	TR32027168	TRINDADE	03/01/2020 06:29	03/01/2020 08:39	03/01/2020 06:29	03/01/2020 08:39	2,16	41	88,67	CHI
20200110635	NOVA CRIXAS	MZ13055730	MOZARLANDIA	03/01/2020 15:39	05/01/2020 09:48	03/01/2020 22:47	04/01/2020 08:30	9,73	2	19,46	CHI
20200110635	MOZARLANDIA	MZ10400707	MOZARLANDIA	03/01/2020 15:39	05/01/2020 09:48	04/01/2020 08:31	04/01/2020 09:47	1,26	21	26,54	CHI
20200110635	MOZARLANDIA	MZ13055730	MOZARLANDIA	03/01/2020 15:39	05/01/2020 09:48	04/01/2020 08:31	04/01/2020 11:11	2,68	14	37,50	CHI
20200110635	NOVA CRIXAS	MZ13055730	MOZARLANDIA	03/01/2020 15:39	05/01/2020 09:48	04/01/2020 08:31	04/01/2020 11:11	2,68	37	99,11	CHI
20200110635	CRIXAS	MZ13055730	MOZARLANDIA	03/01/2020 15:39	05/01/2020 09:48	04/01/2020 09:36	04/01/2020 11:11	1,59	2	3,19	CHI
20200110635	NOVA CRIXAS	MZ13055730	MOZARLANDIA	03/01/2020 15:39	05/01/2020 09:48	04/01/2020 09:36	04/01/2020 11:11	1,59	53	84,53	CHI
20200110635	MOZARLANDIA	MZ10400707	MOZARLANDIA	03/01/2020 15:39	05/01/2020 09:48	04/01/2020 11:11	04/01/2020 11:50	0,64	21	13,46	CHI
20200110635	MOZARLANDIA	MZ13055730	MOZARLANDIA	03/01/2020 15:39	05/01/2020 09:48	04/01/2020 11:43	04/01/2020 13:19	1,61	14	22,61	CHI
20200110635	NOVA CRIXAS	MZ13055730	MOZARLANDIA	03/01/2020 15:39	05/01/2020 09:48	04/01/2020 11:43	04/01/2020 13:19	1,61	31	50,06	CHI
20200110635	NOVA CRIXAS	NA13073596	NOVA CRIXAS	03/01/2020 15:39	05/01/2020 09:48	03/01/2020 22:47	05/01/2020 00:51	26,08	3	78,23	CHI

20200110635	NOVA CRIXAS	NA13073595	MOZARLANDIA	03/01/2020 15:39	05/01/2020 09:48	04/01/2020 08:31	05/01/2020 01:34	17,05	8	136,37	CHI
20200110635	CRIXAS	NA12057420LD	MOZARLANDIA	03/01/2020 15:39	05/01/2020 09:48	04/01/2020 08:31	05/01/2020 02:02	17,53	1	17,53	CHI
20200110635	NOVA CRIXAS	NA12057420LD	MOZARLANDIA	03/01/2020 15:39	05/01/2020 09:48	04/01/2020 08:31	05/01/2020 02:02	17,53	37	648,45	CHI
20200110635	NOVA CRIXAS	NA12321769	MOZARLANDIA	03/01/2020 15:39	05/01/2020 09:48	04/01/2020 08:31	05/01/2020 09:06	24,59	10	245,92	CHI
20200110635	CRIXAS	NA13259652	MOZARLANDIA	03/01/2020 15:39	05/01/2020 09:48	04/01/2020 11:43	05/01/2020 09:48	22,10	2	44,20	CHI
20200110635	NOVA CRIXAS	NA13259652	MOZARLANDIA	03/01/2020 15:39	05/01/2020 09:48	04/01/2020 11:43	05/01/2020 09:48	22,10	61	1348,05	CHI
20200110645	PLANALTINA	10024618738	PLANALTINA	03/01/2020 06:34	03/01/2020 08:24	03/01/2020 06:34	03/01/2020 08:24	1,83	1	1,83	CHI
20200110646	URUACU	UR12278486	URUACU	03/01/2020 06:34	03/01/2020 09:27	03/01/2020 06:34	03/01/2020 09:27	2,88	9	25,90	CHI
20200110648	DAMIANOPOLIS	MB12180672	IACIARA S2	03/01/2020 06:35	03/01/2020 12:38	03/01/2020 06:35	03/01/2020 12:38	6,04	9	54,37	CHI
20200110655	GOIATUBA	10030550791	GOIATUBA S2	03/01/2020 06:36	03/01/2020 13:53	03/01/2020 06:36	03/01/2020 13:53	7,28	1	7,28	CHI
20200110663	NOVA VENEZA	NV12010101	INHUMAS S1	03/01/2020 06:37	03/01/2020 09:44	03/01/2020 06:37	03/01/2020 09:44	3,10	16	49,63	CHI
20200110671	MONTIVIDIU	MV21303370	MONTIVIDIU T	03/01/2020 06:39	03/01/2020 12:09	03/01/2020 06:39	03/01/2020 12:09	5,49	1	5,49	CHI
20200110673	MORRINHOS	MR12242419	GOIATUBA S1	03/01/2020 05:48	03/01/2020 11:30	03/01/2020 05:48	03/01/2020 11:30	5,69	12	68,32	CHI
20200110674	CATALAO	9580000572	CATALAO S1	03/01/2020 06:40	04/01/2020 06:45	03/01/2020 06:40	04/01/2020 06:45	24,09	1	24,09	CHI
20200110676	SANTA TEREZINHA DE GOIAS	SG12320672	SANTA TEREZINHA	03/01/2020 06:40	03/01/2020 15:32	03/01/2020 06:40	03/01/2020 15:32	8,87	6	53,20	CHI
20200110681	JATAI	DP12345408	PARQUE DAS EMAS	03/01/2020 06:42	03/01/2020 20:53	03/01/2020 06:42	03/01/2020 12:40	5,97	1	5,97	CHI
20200110681	MINEIROS	DP12345408	PARQUE DAS EMAS	03/01/2020 06:42	03/01/2020 20:53	03/01/2020 06:42	03/01/2020 12:40	5,97	1	5,97	CHI
20200110681	JATAI	JT12226497	PARQUE DAS EMAS	03/01/2020 06:42	03/01/2020 20:53	03/01/2020 13:54	03/01/2020 14:04	0,18	20	3,62	CHI
20200110681	PEROLANDIA	JT12226497	PARQUE DAS EMAS	03/01/2020 06:42	03/01/2020 20:53	03/01/2020 13:54	03/01/2020 14:04	0,18	18	3,26	CHI
20200110681	JATAI	DP12345408	PARQUE DAS EMAS	03/01/2020 06:42	03/01/2020 20:53	03/01/2020 06:42	03/01/2020 20:53	14,19	1	14,19	CHI
20200110681	JATAI	DP12345408	PARQUE DAS EMAS	03/01/2020 06:42	03/01/2020 20:53	03/01/2020 12:56	03/01/2020 20:53	7,94	1	7,94	CHI
20200110681	MINEIROS	DP12345408	PARQUE DAS EMAS	03/01/2020 06:42	03/01/2020 20:53	03/01/2020 12:56	03/01/2020 20:53	7,94	1	7,94	CHI
20200110684	VICENTINOPOLIS	VI12000023	VICENTINOPOLIS	03/01/2020 06:42	03/01/2020 14:12	03/01/2020 06:42	03/01/2020 14:12	7,49	4	29,96	CHI
20200110685	AURILANDIA	AI12073526	FIRMINOPOLIS S2	03/01/2020 06:43	03/01/2020 12:16	03/01/2020 06:43	03/01/2020 12:16	5,56	13	72,25	CHI
20200110685	CACHOEIRA DE GOIAS	AI12073526	FIRMINOPOLIS S2	03/01/2020 06:43	03/01/2020 12:16	03/01/2020 06:43	03/01/2020 12:16	5,56	3	16,67	CHI
20200110691	QUIRINOPOLIS	QI31052461	QUIRINOPOLIS	03/01/2020 06:43	03/01/2020 08:31	03/01/2020 06:43	03/01/2020 08:31	1,78	1	1,78	CHI
20200110692	NOVA IGUACU DE GOIAS	NH10400425	SANTA TEREZINHA	03/01/2020 05:57	05/01/2020 13:20	03/01/2020 05:57	03/01/2020 17:59	12,04	26	313,10	CHI
20200110692	PILAR DE GOIAS	NH10400425	SANTA TEREZINHA	03/01/2020 05:57	05/01/2020 13:20	03/01/2020 05:57	03/01/2020 17:59	12,04	127	1529,36	CHI
20200110692	PILAR DE GOIAS	NH10400425	SANTA TEREZINHA	03/01/2020 05:57	05/01/2020 13:20	03/01/2020 05:57	04/01/2020 15:53	33,93	14	475,00	CHI
20200110692	SANTA TEREZINHA DE GOIAS	NH10400425	SANTA TEREZINHA	03/01/2020 05:57	05/01/2020 13:20	03/01/2020 05:57	04/01/2020 15:53	33,93	15	508,93	CHI
20200110692	PILAR DE GOIAS	SG12149672LD	SANTA TEREZINHA	03/01/2020 05:57	05/01/2020 13:20	03/01/2020 05:57	05/01/2020 13:20	55,38	13	719,90	CHI
20200110692	SANTA TEREZINHA DE GOIAS	SG12149672LD	SANTA TEREZINHA	03/01/2020 05:57	05/01/2020 13:20	03/01/2020 05:57	05/01/2020 13:20	55,38	24	1329,05	CHI
20200110694	PETROLINA DE GOIAS	PG32086638	SAO FRANCISCO DE GOIAS	03/01/2020 06:36	03/01/2020 08:21	03/01/2020 06:36	03/01/2020 08:21	1,74	34	59,14	CHI

20200110702	ITUMBIARA	IT12316685	ITUMBIARA NOVA	03/01/2020 05:21	03/01/2020 09:10	03/01/2020 05:21	03/01/2020 09:10	3,81	41	156,18	CHI
20200110704	MINACU	IH12207743	MINACU	03/01/2020 06:46	03/01/2020 15:00	03/01/2020 06:46	03/01/2020 15:00	8,23	18	148,05	CHI
20200110706	HIDROLINA	HL21221617	ITAPACI	03/01/2020 06:47	03/01/2020 10:31	03/01/2020 06:47	03/01/2020 10:31	3,73	1	3,73	CHI
20200110711	ITAPIRAPUA	IU21142813	MATRINCHA	03/01/2020 05:12	03/01/2020 10:44	03/01/2020 05:12	03/01/2020 10:44	5,52	1	5,52	CHI
20200110713	CATALAO	CT12399870	CATALAO S1	03/01/2020 06:48	03/01/2020 11:03	03/01/2020 06:48	03/01/2020 11:03	4,24	1	4,24	CHI
20200110715	ITABERAI	IB12108138	ITABERAI S2	03/01/2020 06:49	03/01/2020 09:54	03/01/2020 06:49	03/01/2020 09:54	3,08	28	86,17	CHI
20200110720	ABADIANIA	AN11289006	ANAPOLIS UNIVERSITARIO S2	03/01/2020 06:51	03/01/2020 13:49	03/01/2020 06:51	03/01/2020 13:49	6,96	8	55,71	CHI
20200110730	PIRACANJUBA	PJ12000181	ROCHEDO	03/01/2020 06:42	03/01/2020 13:46	03/01/2020 06:42	03/01/2020 13:46	7,06	2	14,13	CHI
20200110730	PROFESSOR JAMIL SAFADY	PJ12000181	ROCHEDO	03/01/2020 06:42	03/01/2020 13:46	03/01/2020 06:42	03/01/2020 13:46	7,06	6	42,38	CHI
20200110733	GOIAS	GS12071232	GOIAS	03/01/2020 05:37	03/01/2020 08:20	03/01/2020 05:37	03/01/2020 08:20	2,70	39	105,46	CHI
20200110739	MONTES CLAROS DE GOIAS	ME12260033	IPORA	03/01/2020 06:55	03/01/2020 16:16	03/01/2020 06:55	03/01/2020 16:16	9,34	4	37,37	CHI
20200110743	PALMEIRAS DE GOIAS	590023330	PALMEIRAS	03/01/2020 06:55	03/01/2020 08:00	03/01/2020 06:55	03/01/2020 08:00	1,08	1	1,08	CHI
20200110750	BOM JARDIM DE GOIAS	BM12064234	BOM JARDIM	03/01/2020 06:57	03/01/2020 10:25	03/01/2020 06:57	03/01/2020 10:25	3,46	4	13,83	CHI
20200110753	JANDAIA	JD21008218	PALMEIRAS	03/01/2020 06:58	03/01/2020 08:33	03/01/2020 06:58	03/01/2020 08:33	1,58	2	3,16	CHI
20200110754	SAO MIGUEL DO ARAGUAIA	SM12235205	SAO MIGUEL DO ARAGUAIA	03/01/2020 06:58	04/01/2020 00:51	03/01/2020 06:58	04/01/2020 00:51	17,88	9	160,91	CHI
20200110755	GOIAS	8528819	GOIAS	03/01/2020 06:58	03/01/2020 10:24	03/01/2020 06:58	03/01/2020 10:24	3,42	13	44,46	CHI
20200110756	APARECIDA DE GOIANIA	10000390400	REAL S2	03/01/2020 06:59	03/01/2020 09:17	03/01/2020 06:59	03/01/2020 09:17	2,30	1	2,30	CHI
20200110760	MINACU	IH12307129	MINACU	03/01/2020 07:00	04/01/2020 16:30	03/01/2020 07:00	03/01/2020 08:54	1,90	12	22,79	CHI
20200110760	MINACU	IH12307129	MINACU	03/01/2020 07:00	04/01/2020 16:30	03/01/2020 08:55	03/01/2020 11:49	2,91	8	23,29	CHI
20200110760	MINACU	IH12220750LD	MINACU	03/01/2020 07:00	04/01/2020 16:30	03/01/2020 08:55	03/01/2020 16:27	7,54	1	7,54	CHI
20200110760	MINACU	IH12220750LD	MINACU	03/01/2020 07:00	04/01/2020 16:30	03/01/2020 17:22	03/01/2020 17:29	0,12	1	0,12	CHI
20200110760	MINACU	IH12220750LD	MINACU	03/01/2020 07:00	04/01/2020 16:30	04/01/2020 12:49	04/01/2020 16:10	3,35	1	3,35	CHI
20200110760	MINACU	IH12292243LD	MINACU	03/01/2020 07:00	04/01/2020 16:30	03/01/2020 08:55	04/01/2020 16:30	31,60	3	94,79	CHI
20200110763	BALIZA	BH12343730	BOM JARDIM	02/01/2020 20:05	03/01/2020 10:44	02/01/2020 20:05	03/01/2020 10:44	14,64	8	117,15	CHI
20200110764	ARAGARCAS	AG12234260	ARAGARCAS	03/01/2020 07:00	03/01/2020 10:31	03/01/2020 07:00	03/01/2020 10:31	3,51	7	24,58	CHI
20200110767	HIDROLINA	HL12216904	ITAPACI	03/01/2020 07:02	03/01/2020 09:05	03/01/2020 07:02	03/01/2020 09:05	2,05	5	10,25	CHI
20200110769	NOVA CRIXAS	NA12170971	NOVA CRIXAS	03/01/2020 07:02	03/01/2020 14:04	03/01/2020 07:02	03/01/2020 14:04	7,03	81	569,47	CHI
20200110775	SAO MIGUEL DO ARAGUAIA	SM12000063	SAO MIGUEL DO ARAGUAIA	03/01/2020 07:02	03/01/2020 12:40	03/01/2020 07:02	03/01/2020 12:40	5,62	35	196,80	CHI
20200110777	ANAPOLIS	AN12061954	ANAPOLIS UNIVERSITARIO S2	03/01/2020 07:03	03/01/2020 09:02	03/01/2020 07:03	03/01/2020 09:02	1,98	9	17,84	CHI
20200110778	VALPARAISO DE GOIAS	VA11332730	PACAEMBU S1	03/01/2020 07:03	03/01/2020 10:26	03/01/2020 07:03	03/01/2020 10:26	3,38	26	87,91	CHI
20200110780	PONTALINA	PK12390272	PONTALINA	03/01/2020 07:03	03/01/2020 09:29	03/01/2020 07:03	03/01/2020 09:29	2,42	4	9,69	CHI
20200110783	CATALAO	CT21127695	CATALAO S1	03/01/2020 07:03	03/01/2020 14:01	03/01/2020 07:03	03/01/2020 14:01	6,95	1	6,95	CHI
20200110784	GOIANIA	10932793	FERROVIARIO S2	03/01/2020 07:04	03/01/2020 08:26	03/01/2020 07:04	03/01/2020 08:26	1,36	1	1,36	CHI

20200110787	PALESTINA DE GOIAS	PY21023475	PALESTINA	03/01/2020 07:04	03/01/2020 08:15	03/01/2020 07:04	03/01/2020 08:15	1,18	2	2,35	CHI
20200110797	EDEIA	EA12237745	EDEIA	03/01/2020 06:37	03/01/2020 17:49	03/01/2020 06:37	03/01/2020 17:49	11,19	9	100,70	CHI
20200110798	ITAPIRAPUA	IU12259711	MATRINCHA	03/01/2020 07:07	03/01/2020 16:32	03/01/2020 16:00	03/01/2020 16:29	0,50	4	1,98	CHI
20200110798	ITAPIRAPUA	IU21089745	MATRINCHA	03/01/2020 07:07	03/01/2020 16:32	03/01/2020 07:07	03/01/2020 16:32	9,43	1	9,43	CHI
20200110801	PLANALTINA	PI12146090	SAO JOAO D ALIANCA	03/01/2020 07:07	03/01/2020 10:17	03/01/2020 07:07	03/01/2020 10:17	3,16	76	240,05	CHI
20200110802	GOIATUBA	GT12122292	BOM JESUS DE GOIAS	03/01/2020 07:07	03/01/2020 11:30	03/01/2020 07:07	03/01/2020 11:30	4,37	7	30,62	CHI
20200110811	BRITANIA	BT12060643	BRITANIA	03/01/2020 07:08	03/01/2020 08:47	03/01/2020 07:08	03/01/2020 08:47	1,63	11	17,97	CHI
20200110817	NOVA ROMA	ND12160040	IACIARA S2	03/01/2020 06:41	03/01/2020 11:38	03/01/2020 06:41	03/01/2020 11:38	4,94	120	593,33	CHI
20200110818	VICENTINOPOLIS	VI12071025	VICENTINOPOLIS	03/01/2020 05:02	03/01/2020 07:37	03/01/2020 05:02	03/01/2020 07:37	2,58	556	1432,32	CHI
20200110819	GOIANIA	GN12044467	GOYA S2	03/01/2020 07:10	03/01/2020 08:19	03/01/2020 07:10	03/01/2020 08:19	1,14	127	144,32	CHI
20200110820	FLORES DE GOIAS	FB21180698	FLORES DE GOIAS	03/01/2020 07:11	03/01/2020 08:54	03/01/2020 07:11	03/01/2020 08:54	1,72	1	1,72	CHI
20200110821	AGUA LIMPA	MG12120778	VILA CORUMBA	03/01/2020 07:11	03/01/2020 18:20	03/01/2020 07:11	03/01/2020 18:20	11,14	16	178,30	CHI
20200110821	MARZAGAO	MG12120778	VILA CORUMBA	03/01/2020 07:11	03/01/2020 18:20	03/01/2020 07:11	03/01/2020 18:20	11,14	2	22,29	CHI
20200110824	ADELANDIA	MD12304614	ANICUNS	03/01/2020 07:11	03/01/2020 12:15	03/01/2020 07:11	03/01/2020 12:15	5,06	2	10,12	CHI
20200110824	MOSSAMEDES	MD12304614	ANICUNS	03/01/2020 07:11	03/01/2020 12:15	03/01/2020 07:11	03/01/2020 12:15	5,06	7	35,42	CHI
20200110825	CABECEIRAS	CW21154402	ITIQUEIRA	03/01/2020 07:11	03/01/2020 10:12	03/01/2020 07:11	03/01/2020 10:12	3,01	1	3,01	CHI
20200110830	APARECIDA DE GOIANIA	AP11169170	INDEPENDENCIA S1	03/01/2020 07:12	03/01/2020 12:16	03/01/2020 07:12	03/01/2020 12:16	5,06	72	364,48	CHI
20200110831	SANTA RITA DO NOVO DESTINO	DF12256464	BARRO ALTO	03/01/2020 07:12	03/01/2020 13:20	03/01/2020 07:12	03/01/2020 13:20	6,13	16	98,04	CHI
20200110833	MINACU	IH12245140	MINACU	03/01/2020 07:12	03/01/2020 14:07	03/01/2020 07:12	03/01/2020 14:07	6,91	6	41,43	CHI
20200110835	TRINDADE	TR12015761	INHUMAS S1	03/01/2020 07:12	03/01/2020 11:34	03/01/2020 07:12	03/01/2020 11:34	4,35	16	69,60	CHI
20200110842	FORMOSA	FA12051379	ITIQUEIRA	03/01/2020 07:13	03/01/2020 08:24	03/01/2020 07:13	03/01/2020 08:24	1,17	27	31,52	CHI
20200110845	FAINA	FC12299983	ITAPURANGA	03/01/2020 07:14	03/01/2020 15:20	03/01/2020 07:14	03/01/2020 15:20	8,11	3	24,32	CHI
20200110848	CRISTALINA	KR21090212	CRISTALINA S1	03/01/2020 07:14	03/01/2020 12:32	03/01/2020 07:14	03/01/2020 12:32	5,29	1	5,29	CHI
20200110850	LUZIANIA	LZ12330544	MARAJOARA	03/01/2020 07:15	03/01/2020 11:27	03/01/2020 07:15	03/01/2020 11:27	4,20	8	33,60	CHI
20200110853	CAIAPONIA	CP12094701	MONTIVIDIU T	03/01/2020 07:15	03/01/2020 22:26	03/01/2020 07:15	03/01/2020 22:26	15,18	3	45,54	CHI
20200110860	MINACU	IH12392289	MINACU	03/01/2020 07:15	03/01/2020 11:00	03/01/2020 07:15	03/01/2020 11:00	3,75	11	41,20	CHI
20200110862	CRISTIANOPOLIS	BC32088376	CRISTIANOPOLIS	03/01/2020 07:15	03/01/2020 09:24	03/01/2020 07:15	03/01/2020 09:24	2,14	8	17,10	CHI
20200110862	SANTA CRUZ DE GOIAS	BC32088376	CRISTIANOPOLIS	03/01/2020 07:15	03/01/2020 09:24	03/01/2020 07:15	03/01/2020 09:24	2,14	15	32,05	CHI
20200110864	RIO VERDE	RV12237206	CABRIUVA S2	03/01/2020 07:15	03/01/2020 13:35	03/01/2020 07:15	03/01/2020 13:35	6,33	6	37,96	CHI
20200110871	ITAPIRAPUA	IU12089730	MATRINCHA	03/01/2020 07:17	03/01/2020 09:12	03/01/2020 07:17	03/01/2020 09:12	1,91	4	7,65	CHI
20200110874	AGUA FRIA DE GOIAS	TL121320630	SAO JOAO D ALIANCA	03/01/2020 07:18	03/01/2020 08:51	03/01/2020 07:18	03/01/2020 08:51	1,55	1	1,55	CHI
20200110881	GOIATUBA	JV12222502	VICENTINOPOLIS	03/01/2020 07:19	03/01/2020 16:53	03/01/2020 07:19	03/01/2020 16:53	9,55	5	47,77	CHI
20200110881	JOVIANIA	JV12222502	VICENTINOPOLIS	03/01/2020 07:19	03/01/2020 16:53	03/01/2020 07:19	03/01/2020 16:53	9,55	1	9,55	CHI

20200110881	VICENTINOPOLIS	JV12222502	VICENTINOPOLIS	03/01/2020 07:19	03/01/2020 16:53	03/01/2020 07:19	03/01/2020 16:53	9,55	2	19,11	CHI
20200110884	CATALAO	CT12246501	CATALAO S1	03/01/2020 07:06	03/01/2020 15:51	03/01/2020 07:06	03/01/2020 15:51	8,74	4	34,97	CHI
20200110886	RIO VERDE	RV12200084	MONTIVIDIU T	03/01/2020 07:20	03/01/2020 15:27	03/01/2020 07:20	03/01/2020 15:27	8,11	3	24,34	CHI
20200110888	CAIAPONIA	CP21123265	MONTIVIDIU T	03/01/2020 07:20	03/01/2020 12:37	03/01/2020 07:20	03/01/2020 12:37	5,28	1	5,28	CHI
20200110891	MUNDO NOVO DE GOIAS	MH11255526	NOVA CRIXAS	03/01/2020 07:21	03/01/2020 08:34	03/01/2020 07:21	03/01/2020 08:34	1,22	54	65,64	CHI
20200110898	HIDROLANDIA	HD12006204	INDEPENDENCIA S1	03/01/2020 07:22	03/01/2020 10:56	03/01/2020 07:22	03/01/2020 10:56	3,57	26	92,76	CHI
20200110899	GOIAS	GS21042308	ITABERAI S1	03/01/2020 07:22	03/01/2020 09:15	03/01/2020 07:22	03/01/2020 09:15	1,88	2	3,76	CHI
20200110903	CRISTALINA	KR12304816	CRISTALINA S2	03/01/2020 06:43	03/01/2020 10:20	03/01/2020 06:43	03/01/2020 10:20	3,61	15	54,21	CHI
20200110904	SANTA RITA DO NOVO DESTINO	DF12079365	BARRO ALTO	03/01/2020 07:23	04/01/2020 18:53	03/01/2020 07:23	04/01/2020 18:53	35,50	1	35,50	CHI
20200110908	SILVANIA	SV12072440	DAIA S1	03/01/2020 07:23	03/01/2020 13:14	03/01/2020 07:23	03/01/2020 13:14	5,84	8	46,70	CHI
20200110911	ITAGUARU	IC12336553	ITABERAI S1	03/01/2020 07:24	03/01/2020 12:12	03/01/2020 07:24	03/01/2020 12:12	4,81	3	14,43	CHI
20200110913	PALMEIRAS DE GOIAS	PL10404074	PALMEIRAS	03/01/2020 06:55	03/01/2020 10:47	03/01/2020 06:55	03/01/2020 10:47	3,87	115	445,40	CHI
20200110914	AMARALINA	LC12170975	MARA ROSA	03/01/2020 07:25	03/01/2020 12:46	03/01/2020 07:25	03/01/2020 12:46	5,35	11	58,81	CHI
20200110922	PIRACANJUBA	PJ12034125	PIRACANJUBA	03/01/2020 07:26	03/01/2020 10:33	03/01/2020 07:26	03/01/2020 10:33	3,11	4	12,43	CHI
20200110924	COCALZINHO DE GOIAS	ZN21194703	COCALZINHO	03/01/2020 07:26	03/01/2020 15:36	03/01/2020 07:26	03/01/2020 15:36	8,15	1	8,15	CHI
20200110927	QUIRINOPOLIS	QI32014920	QUIRINOPOLIS	03/01/2020 07:28	03/01/2020 10:53	03/01/2020 07:28	03/01/2020 10:53	3,43	4	13,72	CHI
20200110930	SAO MIGUEL DO ARAGUAIA	SM12252091	SAO MIGUEL DO ARAGUAIA	03/01/2020 07:28	03/01/2020 13:03	03/01/2020 07:28	03/01/2020 13:03	5,57	61	339,75	CHI
20200110939	ANAPOLIS	AN12026162	ANAPOLIS UNIVERSITARIO S2	03/01/2020 07:25	03/01/2020 09:34	03/01/2020 07:25	03/01/2020 09:34	2,15	6	12,89	CHI
20200110941	PLANALTINA	PI21125110	SAO JOAO D ALIANCA	03/01/2020 07:31	03/01/2020 12:26	03/01/2020 07:31	03/01/2020 12:26	4,91	1	4,91	CHI
20200110942	MONTE ALEGRE DE GOIAS	SD12322677	SAO DOMINGOS	03/01/2020 06:32	03/01/2020 09:02	03/01/2020 06:32	03/01/2020 09:02	2,49	2	4,98	CHI
20200110942	NOVA ROMA	SD12322677	SAO DOMINGOS	03/01/2020 06:32	03/01/2020 09:02	03/01/2020 06:32	03/01/2020 09:02	2,49	1	2,49	CHI
20200110942	SAO DOMINGOS	SD12322677	SAO DOMINGOS	03/01/2020 06:32	03/01/2020 09:02	03/01/2020 06:32	03/01/2020 09:02	2,49	35	87,17	CHI
20200110945	GUAPO	710000844	GUAPO S1	03/01/2020 07:31	03/01/2020 09:25	03/01/2020 07:31	03/01/2020 09:25	1,89	1	1,89	CHI
20200110949	CIDADE OCIDENTAL	LZ12041538	MARAJOARA	03/01/2020 07:32	03/01/2020 09:38	03/01/2020 07:32	03/01/2020 09:38	2,10	16	33,54	CHI
20200110950	INDIARA	IY12010924	PALMEIRAS	03/01/2020 07:32	03/01/2020 08:27	03/01/2020 07:32	03/01/2020 08:27	0,92	14	12,84	CHI
20200110950	JANDAIA	IY12010924	PALMEIRAS	03/01/2020 07:32	03/01/2020 08:27	03/01/2020 07:32	03/01/2020 08:27	0,92	1	0,92	CHI
20200110953	CALDAS NOVAS	CN12363765	CALDAS NOVAS S1	03/01/2020 07:33	03/01/2020 12:56	03/01/2020 07:33	03/01/2020 12:56	5,38	1	5,38	CHI
20200110955	BONOPOLIS	BX21128385	SAO MIGUEL DO ARAGUAIA	03/01/2020 07:33	03/01/2020 20:07	03/01/2020 07:33	03/01/2020 20:07	12,58	1	12,58	CHI
20200110961	CRISTALINA	KR21183734	CRISTALINA S2	03/01/2020 07:33	03/01/2020 16:59	03/01/2020 07:33	03/01/2020 16:59	9,42	2	18,83	CHI
20200110963	SANCLERLANDIA	SC21163974	FIRMINOPOLIS S2	03/01/2020 07:34	03/01/2020 10:24	03/01/2020 07:34	03/01/2020 10:24	2,83	2	5,66	CHI
20200110965	BOM JARDIM DE GOIAS	BM12103742LD	BOM JARDIM	03/01/2020 07:34	04/01/2020 16:00	04/01/2020 09:38	04/01/2020 15:13	5,58	8	44,68	CHI
20200110965	BOM JARDIM DE GOIAS	BM21184292	BOM JARDIM	03/01/2020 07:34	04/01/2020 16:00	03/01/2020 07:34	04/01/2020 16:00	32,44	1	32,44	CHI
20200110968	MORRINHOS	PK12293231	PONTALINA	03/01/2020 07:26	03/01/2020 09:30	03/01/2020 07:26	03/01/2020 09:30	2,06	1	2,06	CHI

20200110968	PONTALINA	PK12293231	PONTALINA	03/01/2020 07:26	03/01/2020 09:30	03/01/2020 07:26	03/01/2020 09:30	2,06	19	39,16	CHI
20200110970	ESTRELA DO NORTE	ET12372080	MARA ROSA	03/01/2020 07:34	03/01/2020 12:33	03/01/2020 07:34	03/01/2020 12:33	4,97	2	9,95	CHI
20200110977	OUVIDOR	OU21127573	CATALAO S1	03/01/2020 07:35	03/01/2020 09:28	03/01/2020 07:35	03/01/2020 09:28	1,88	2	3,75	CHI
20200110978	CALDAS NOVAS	CN12231992	CALDAS NOVAS S1	03/01/2020 07:35	03/01/2020 12:56	03/01/2020 07:35	03/01/2020 12:56	5,34	118	630,42	CHI
20200110981	OURO VERDE DE GOIAS	OV12319823	NEROPOLIS S1	03/01/2020 07:34	03/01/2020 09:46	03/01/2020 07:34	03/01/2020 09:46	2,19	23	50,43	CHI
20200110985	VIANOPOLIS	VN12052202	VIANOPOLIS	03/01/2020 07:20	03/01/2020 09:37	03/01/2020 07:20	03/01/2020 09:37	2,28	21	47,90	CHI
20200110986	CALDAS NOVAS	CN21100582	CALDAS NOVAS S2	03/01/2020 07:36	03/01/2020 10:40	03/01/2020 07:36	03/01/2020 10:40	3,06	1	3,06	CHI
20200110990	MORRO AGUDO DE GOIAS	RB12292120	RUBIATABA	03/01/2020 06:15	03/01/2020 10:17	03/01/2020 06:15	03/01/2020 10:17	4,04	4	16,17	CHI
20200110990	RUBIATABA	RB12292120	RUBIATABA	03/01/2020 06:15	03/01/2020 10:17	03/01/2020 06:15	03/01/2020 10:17	4,04	4	16,17	CHI
20200110991	BELA VISTA DE GOIAS	BV12291753	BELA VISTA S1	03/01/2020 07:36	03/01/2020 08:34	03/01/2020 07:36	03/01/2020 08:34	0,95	87	82,82	CHI
20200110996	LUZIANIA	LZ12390041	CRISTALINA S2	03/01/2020 07:21	03/01/2020 09:10	03/01/2020 07:21	03/01/2020 09:10	1,81	9	16,26	CHI
20200110999	PEROLANDIA	MY12348932	PARQUE DAS EMAS	03/01/2020 07:37	03/01/2020 12:30	03/01/2020 07:37	03/01/2020 12:30	4,87	3	14,60	CHI
20200111000	ARAGUAPAZ	AZ12042945LD	MOZARLANDIA	03/01/2020 07:37	03/01/2020 12:04	03/01/2020 07:37	03/01/2020 12:04	4,44	3	13,32	CHI
20200111007	SANTA TEREZA DE GOIAS	SE12181947	PORANGATU	03/01/2020 07:38	03/01/2020 10:16	03/01/2020 07:38	03/01/2020 10:16	2,62	2	5,24	CHI
20200111011	ITABERAI	IB12272618	ITABERAI S1	03/01/2020 07:39	03/01/2020 12:32	03/01/2020 07:39	03/01/2020 12:32	4,88	19	92,67	CHI
20200111014	PIRANHAS	PH12247806	ARENOPOLIS	03/01/2020 07:40	03/01/2020 11:00	03/01/2020 07:40	03/01/2020 11:00	3,33	8	26,62	CHI
20200111015	MARA ROSA	MQ21338156	MARA ROSA	03/01/2020 07:40	03/01/2020 10:40	03/01/2020 07:40	03/01/2020 10:40	3,01	1	3,01	CHI
20200111017	JUSSARA	JR12212887	IPORA	03/01/2020 05:35	03/01/2020 15:38	03/01/2020 05:35	03/01/2020 15:38	10,04	22	220,88	CHI
20200111017	MONTES CLAROS DE GOIAS	JR12212887	IPORA	03/01/2020 05:35	03/01/2020 15:38	03/01/2020 05:35	03/01/2020 15:38	10,04	7	70,28	CHI
20200111019	CATALAO	CT12042368	CATALAO S1	03/01/2020 07:41	03/01/2020 14:34	03/01/2020 07:41	03/01/2020 14:34	6,88	32	220,24	CHI
20200111019	DISTRITO FEDERAL	CT12042368	CATALAO S1	03/01/2020 07:41	03/01/2020 14:34	03/01/2020 07:41	03/01/2020 14:34	6,88	1	6,88	CHI
20200111022	ACREUNA	BZ21271621	ACREUNA	03/01/2020 07:41	04/01/2020 09:20	03/01/2020 07:41	04/01/2020 09:20	25,65	1	25,65	CHI
20200111037	GAMELEIRA DE GOIAS	SV12033468	DAIA S2	03/01/2020 07:34	03/01/2020 09:18	03/01/2020 07:34	03/01/2020 09:18	1,72	14	24,11	CHI
20200111037	SILVANIA	SV12033468	DAIA S2	03/01/2020 07:34	03/01/2020 09:18	03/01/2020 07:34	03/01/2020 09:18	1,72	133	229,02	CHI
20200111039	CAMPOS VERDES	VD12049799	SANTA TEREZINHA	03/01/2020 06:39	03/01/2020 18:25	03/01/2020 06:39	03/01/2020 18:25	11,78	21	247,41	CHI
20200111039	PILAR DE GOIAS	VD12049799	SANTA TEREZINHA	03/01/2020 06:39	03/01/2020 18:25	03/01/2020 06:39	03/01/2020 18:25	11,78	6	70,69	CHI
20200111039	SANTA TEREZINHA DE GOIAS	VD12049799	SANTA TEREZINHA	03/01/2020 06:39	03/01/2020 18:25	03/01/2020 06:39	03/01/2020 18:25	11,78	3	35,34	CHI
20200111040	CORUMBAIBA	CI1200093RE	VILA CORUMBA	03/01/2020 06:56	03/01/2020 16:47	03/01/2020 06:56	03/01/2020 16:47	9,84	141	1386,93	CHI
20200111042	TRINDADE	TR12016546	GOIANIRA	03/01/2020 07:44	03/01/2020 12:33	03/01/2020 07:44	03/01/2020 12:33	4,81	8	38,52	CHI
20200111043	URUACU	UR12317135	URUACU	03/01/2020 07:44	03/01/2020 09:30	03/01/2020 07:44	03/01/2020 09:30	1,76	11	19,36	CHI
20200111046	EDEALINA	ED21101155	VICENTINOPOLIS	03/01/2020 07:44	04/01/2020 10:34	03/01/2020 07:44	04/01/2020 10:34	26,82	1	26,82	CHI
20200111047	GOIANIA	AP12040086	INDEPENDENCIA S2	03/01/2020 07:44	03/01/2020 09:48	03/01/2020 07:44	03/01/2020 09:48	2,05	232	476,63	CHI
20200111048	PLANALTINA	PI12072312	PLANALTINA	03/01/2020 07:45	03/01/2020 10:35	03/01/2020 07:45	03/01/2020 10:35	2,83	52	147,30	CHI

20200111049	CRISTALINA	KR21304899	PAMPLONA	03/01/2020 07:45	03/01/2020 19:32	03/01/2020 07:45	03/01/2020 19:32	11,78	1	11,78	CHI
20200111057	JATAI	JT21153996	JATAI S1	03/01/2020 07:46	03/01/2020 09:33	03/01/2020 07:46	03/01/2020 09:33	1,77	4	7,09	CHI
20200111060	RIO VERDE	630577407	MONTIVIDIU T	03/01/2020 12:32	04/01/2020 16:59	03/01/2020 12:32	04/01/2020 16:59	28,46	1	28,46	CHI
20200111064	GOIATUBA	GT11309844	GOIATUBA S2	03/01/2020 06:53	03/01/2020 08:40	03/01/2020 06:53	03/01/2020 08:40	1,78	117	208,26	CHI
20200111065	PORANGATU	PO12022073	PORANGATU	03/01/2020 07:24	03/01/2020 13:03	03/01/2020 07:24	03/01/2020 13:03	5,66	19	107,52	CHI
20200111065	PORANGATU	PO12022073	PORANGATU	03/01/2020 07:24	03/01/2020 13:03	03/01/2020 07:24	03/01/2020 13:03	5,66	26	147,12	CHI
20200111070	CUMARI	CT21134379	CATALAO S2	03/01/2020 07:48	03/01/2020 10:37	03/01/2020 07:48	03/01/2020 10:37	2,81	1	2,81	CHI
20200111072	FLORES DE GOIAS	IA12361389	IACIARA S2	03/01/2020 06:55	03/01/2020 10:53	03/01/2020 06:55	03/01/2020 10:53	3,95	1	3,95	CHI
20200111072	IACIARA	IA12361389	IACIARA S2	03/01/2020 06:55	03/01/2020 10:53	03/01/2020 06:55	03/01/2020 10:53	3,95	41	162,14	CHI
20200111075	JANDAIA	JD21330015	PALMEIRAS	03/01/2020 07:49	03/01/2020 10:05	03/01/2020 07:49	03/01/2020 10:05	2,27	1	2,27	CHI
20200111081	NOVO PLANALTO	SM12245706	SAO MIGUEL DO ARAGUAIA	03/01/2020 07:49	04/01/2020 00:54	03/01/2020 07:49	04/01/2020 00:54	17,08	25	427,10	CHI
20200111081	SAO MIGUEL DO ARAGUAIA	SM12245706	SAO MIGUEL DO ARAGUAIA	03/01/2020 07:49	04/01/2020 00:54	03/01/2020 07:49	04/01/2020 00:54	17,08	10	170,84	CHI
20200111081	NOVO PLANALTO	SM12245706	SAO MIGUEL DO ARAGUAIA	03/01/2020 07:49	04/01/2020 00:54	04/01/2020 00:17	04/01/2020 00:54	0,63	1	0,63	CHI
20200111085	VILA PROPICIO	NP21298215	GOIANESIA S2	03/01/2020 07:49	04/01/2020 10:50	03/01/2020 07:49	04/01/2020 10:50	27,00	2	54,01	CHI
20200111091	VARJAO	VJ31066197	GUAPO S2	03/01/2020 07:51	03/01/2020 11:03	03/01/2020 07:51	03/01/2020 11:03	3,20	1	3,20	CHI
20200111093	PIRANHAS	PH12316430	PIRANHAS	03/01/2020 07:28	03/01/2020 10:35	03/01/2020 07:28	03/01/2020 10:35	3,11	4	12,44	CHI
20200111094	EDEALINA	VI21166492	VICENTINOPOLIS	03/01/2020 07:51	03/01/2020 18:50	03/01/2020 07:51	03/01/2020 18:50	10,99	2	21,98	CHI
20200111096	PIRENOPOLIS	AN21319828	ANAPOLIS UNIVERSITARIO S2	03/01/2020 07:52	03/01/2020 10:01	03/01/2020 07:52	03/01/2020 10:01	2,15	1	2,15	CHI
20200111100	BURITINOPOLIS	BQ12149627	IACIARA S2	03/01/2020 05:50	03/01/2020 09:22	03/01/2020 05:50	03/01/2020 09:22	3,53	118	416,57	CHI
20200111101	CATURAI	IN12376879	ARACU	03/01/2020 07:52	03/01/2020 15:15	03/01/2020 07:52	03/01/2020 15:15	7,38	8	59,01	CHI
20200111102	BONOPOLIS	PO12103385	NOVO PLANALTO	03/01/2020 07:52	03/01/2020 14:50	03/01/2020 07:52	03/01/2020 14:50	6,95	1	6,95	CHI
20200111107	CAIAPONIA	MV12340904	MONTIVIDIU T	03/01/2020 05:08	03/01/2020 10:09	03/01/2020 05:08	03/01/2020 10:09	5,01	1	5,01	CHI
20200111107	MONTIVIDIU	MV12340904	MONTIVIDIU T	03/01/2020 05:08	03/01/2020 10:09	03/01/2020 05:08	03/01/2020 10:09	5,01	18	90,17	CHI
20200111109	INDIARA	IY21159085	EDEIA	03/01/2020 07:53	03/01/2020 09:28	03/01/2020 07:53	03/01/2020 09:28	1,57	1	1,57	CHI
20200111111	SANTA BARBARA DE GOIAS	1030009986	TRINDADE	03/01/2020 07:53	03/01/2020 10:51	03/01/2020 07:53	03/01/2020 10:51	2,96	1	2,96	CHI
20200111112	ITAGUARI	IC12220187	ITABERAI S1	03/01/2020 07:53	03/01/2020 10:16	03/01/2020 07:53	03/01/2020 10:16	2,37	10	23,68	CHI
20200111114	PIRACANJUBA	PJ21078727	PIRACANJUBA	03/01/2020 07:54	03/01/2020 11:06	03/01/2020 07:54	03/01/2020 11:06	3,19	1	3,19	CHI
20200111122	ITARUMA	IM21382620	CACHOEIRA ALTA	03/01/2020 07:55	03/01/2020 16:08	03/01/2020 07:55	03/01/2020 16:08	8,20	2	16,41	CHI
20200111124	PARAUNA	PU12039209	PARAUNA	03/01/2020 07:56	03/01/2020 10:05	03/01/2020 07:56	03/01/2020 10:05	2,14	5	10,72	CHI
20200111127	GOUVELANDIA	GB12296587	QUIRINOPOLIS	03/01/2020 07:56	03/01/2020 14:02	03/01/2020 07:56	03/01/2020 14:02	6,09	6	36,53	CHI
20200111128	ACREUNA	EU12200726	ACREUNA	03/01/2020 07:56	03/01/2020 09:56	03/01/2020 07:56	03/01/2020 09:56	1,99	1	1,99	CHI
20200111128	TURVELANDIA	EU12200726	ACREUNA	03/01/2020 07:56	03/01/2020 09:56	03/01/2020 07:56	03/01/2020 09:56	1,99	3	5,96	CHI
20200111133	ALEXANIA	7850002415	ALEXANIA	03/01/2020 07:57	03/01/2020 18:02	03/01/2020 07:57	03/01/2020 18:02	10,08	1	10,08	CHI

20200111140	ITAPACI	IW12081353	ITAPACI	03/01/2020 07:57	03/01/2020 13:39	03/01/2020 07:57	03/01/2020 13:39	5,68	23	130,75	CHI
20200111146	ITABERAI	II12217217	ITABERAI S1	03/01/2020 07:58	03/01/2020 15:27	03/01/2020 07:58	03/01/2020 15:27	7,47	22	164,36	CHI
20200111146	ITAGUARI	II12217217	ITABERAI S1	03/01/2020 07:58	03/01/2020 15:27	03/01/2020 07:58	03/01/2020 15:27	7,47	43	321,26	CHI
20200111146	TAQUARAL DE GOIAS	II12217217	ITABERAI S1	03/01/2020 07:58	03/01/2020 15:27	03/01/2020 07:58	03/01/2020 15:27	7,47	47	351,14	CHI
20200111151	SAO MIGUEL DO ARAGUAIA	SM12239670	SAO MIGUEL DO ARAGUAIA	03/01/2020 08:00	03/01/2020 12:11	03/01/2020 08:00	03/01/2020 12:11	4,18	11	46,01	CHI
20200111152	COCALZINHO DE GOIAS	SN12246920	AGUAS LINDAS DE GOIAS S2	03/01/2020 07:43	03/01/2020 15:03	03/01/2020 07:43	03/01/2020 15:03	7,33	6	44,01	CHI
20200111152	SANTO ANTONIO DO DESCOBERTO	SN12246920	AGUAS LINDAS DE GOIAS S2	03/01/2020 07:43	03/01/2020 15:03	03/01/2020 07:43	03/01/2020 15:03	7,33	20	146,70	CHI
20200111153	BARRO ALTO	BA12185125	BARRO ALTO	03/01/2020 07:17	04/01/2020 14:08	03/01/2020 07:17	04/01/2020 14:08	30,84	42	1295,37	CHI
20200111154	ALTO PARAISO DE GOIAS	BF12159157	NIQUELANDIA SUBTRANSMISSAO	03/01/2020 08:00	03/01/2020 10:16	03/01/2020 08:00	03/01/2020 10:16	2,25	16	36,08	CHI
20200111155	GOIANESIA	GE11321374	GOIANESIA S2	03/01/2020 08:00	04/01/2020 12:06	03/01/2020 08:00	04/01/2020 12:06	28,09	1	28,09	CHI
20200111157	ITARUMA	IM12340824	CACHOEIRA ALTA	03/01/2020 08:01	03/01/2020 12:57	03/01/2020 08:01	03/01/2020 12:57	4,93	4	19,73	CHI
20200111169	GOUVELANDIA	GB21301506	QUIRINOPOLIS	03/01/2020 08:02	03/01/2020 11:51	03/01/2020 08:02	03/01/2020 11:51	3,81	1	3,81	CHI
20200111171	SANTO ANTONIO DO DESCOBERTO	SN12188742	ALEXANIA	03/01/2020 10:06	03/01/2020 12:20	03/01/2020 10:06	03/01/2020 12:20	2,23	22	48,98	CHI
20200111172	ITUMBIARA	IT21088625	PARANAIBA	03/01/2020 08:03	03/01/2020 17:35	03/01/2020 08:03	03/01/2020 17:35	9,54	1	9,54	CHI
20200111173	HIDROLANDIA	180022908	CEPAIGO S2	03/01/2020 08:03	03/01/2020 12:23	03/01/2020 08:03	03/01/2020 12:23	4,32	1	4,32	CHI
20200111175	CEZARINA	CZ12010374	CEZARINA	03/01/2020 07:52	03/01/2020 09:52	03/01/2020 07:52	03/01/2020 09:52	1,99	7	13,95	CHI
20200111180	PORANGATU	PO11254784	PORANGATU	03/01/2020 08:04	03/01/2020 11:42	03/01/2020 08:04	03/01/2020 11:42	3,62	3	10,86	CHI
20200111183	CACHOEIRA ALTA	CA12094277	CACHOEIRA ALTA	03/01/2020 08:04	05/01/2020 12:57	05/01/2020 09:26	05/01/2020 12:57	3,53	1	3,53	CHI
20200111183	CACHOEIRA ALTA	CA21094416	CACHOEIRA ALTA	03/01/2020 08:04	05/01/2020 12:57	03/01/2020 08:04	05/01/2020 12:57	52,88	2	105,77	CHI
20200111186	NOVA CRIXAS	NA12354849	NOVA CRIXAS	03/01/2020 08:05	03/01/2020 14:39	03/01/2020 08:05	03/01/2020 14:39	6,56	17	111,55	CHI
20200111187	GOIAS	GS12234099	GOIAS	03/01/2020 08:05	03/01/2020 09:55	03/01/2020 08:05	03/01/2020 09:55	1,83	3	5,48	CHI
20200111188	IPAMERI	IP12404737	IPAMERI	03/01/2020 08:05	03/01/2020 09:55	03/01/2020 08:05	03/01/2020 09:55	1,83	3	5,48	CHI
20200111191	MINEIROS	1390095992	PARQUE DAS EMAS	03/01/2020 08:05	03/01/2020 18:29	03/01/2020 08:05	03/01/2020 18:29	10,39	1	10,39	CHI
20200111192	NIQUELANDIA	NQ12086224	NIQUELANDIA SUBTRANSMISSAO	03/01/2020 08:05	03/01/2020 10:51	03/01/2020 08:05	03/01/2020 10:51	2,75	16	44,04	CHI
20200111195	ESTRELA DO NORTE	MQ21265835	MARA ROSA	03/01/2020 08:05	03/01/2020 12:02	03/01/2020 08:05	03/01/2020 12:02	3,93	1	3,93	CHI
20200111201	MOZARLANDIA	MZ12057162	MOZARLANDIA	03/01/2020 14:55	04/01/2020 20:35	03/01/2020 14:55	03/01/2020 20:27	5,52	3	16,57	CHI
20200111201	ARUANA	MZ12250762	MOZARLANDIA	03/01/2020 14:55	04/01/2020 20:35	03/01/2020 14:55	04/01/2020 20:35	29,66	4	118,64	CHI
20200111201	MOZARLANDIA	MZ12250762	MOZARLANDIA	03/01/2020 14:55	04/01/2020 20:35	03/01/2020 14:55	04/01/2020 20:35	29,66	1	29,66	CHI
20200111205	PARAUNA	PU21136889	PARAUNA	03/01/2020 08:06	03/01/2020 08:53	03/01/2020 08:06	03/01/2020 08:53	0,77	2	1,54	CHI
20200111212	CAIAPONIA	CP12244220	CAIAPONIA	03/01/2020 07:42	03/01/2020 12:55	03/01/2020 07:42	03/01/2020 12:55	5,21	10	52,07	CHI
20200111215	PORANGATU	PO12297101	MARA ROSA	03/01/2020 08:07	03/01/2020 16:51	03/01/2020 08:07	03/01/2020 16:51	8,73	7	61,11	CHI
20200111216	FORMOSA	10006520446	ITUIQUIRA	03/01/2020 08:07	03/01/2020 09:24	03/01/2020 08:07	03/01/2020 09:24	1,27	1	1,27	CHI
20200111218	AGUAS LINDAS DE GOIAS	LA12412179	AGUAS LINDAS DE GOIAS S1	03/01/2020 08:08	03/01/2020 11:08	03/01/2020 08:08	03/01/2020 11:08	2,99	1	2,99	CHI



20200111222	ABADIANIA	AA12382488	ANAPOLIS UNIVERSITARIO S1	03/01/2020 05:49	03/01/2020 09:55	03/01/2020 05:49	03/01/2020 09:55	4,10	5	20,48	CHI
20200111223	GOIANIA	16654778	GOIANIA LESTE S3	03/01/2020 08:08	03/01/2020 09:14	03/01/2020 08:08	03/01/2020 09:14	1,09	1	1,09	CHI
20200111224	SILVANIA	SV21265339	VIANOPOLIS	03/01/2020 08:09	03/01/2020 11:37	03/01/2020 08:09	03/01/2020 11:37	3,47	2	6,93	CHI
20200111227	MUNDO NOVO DE GOIAS	10018471305	NOVA CRIXAS	03/01/2020 08:09	03/01/2020 13:45	03/01/2020 08:09	03/01/2020 13:45	5,60	1	5,60	CHI
20200111233	CEZARINA	CZ21344876	CEZARINA	03/01/2020 08:10	03/01/2020 10:35	03/01/2020 08:10	03/01/2020 10:35	2,42	1	2,42	CHI
20200111234	ITUMBIARA	IT11166331	PARANAIBA	03/01/2020 08:10	03/01/2020 14:56	03/01/2020 08:10	03/01/2020 14:56	6,77	11	74,42	CHI
20200111235	DOVERLANDIA	DV21123977	CAIAPONIA	03/01/2020 08:10	03/01/2020 16:12	03/01/2020 08:10	03/01/2020 16:12	8,04	1	8,04	CHI
20200111243	SANTA RITA DO ARAGUAIA	2130006730	SANTA RITA DO ARAGUAIA	03/01/2020 08:10	03/01/2020 18:31	03/01/2020 08:10	03/01/2020 18:31	10,34	1	10,34	CHI
20200111244	INHUMAS	IX12326257	INHUMAS S1	03/01/2020 08:10	03/01/2020 13:19	03/01/2020 08:10	03/01/2020 13:19	5,14	19	97,61	CHI
20200111255	APARECIDA DE GOIANIA	200180230	INDEPENDENCIA S1	03/01/2020 08:12	03/01/2020 10:12	03/01/2020 08:12	03/01/2020 10:12	1,99	1	1,99	CHI
20200111256	NOVA ROMA	8720010049	IACIARA S2	03/01/2020 08:12	03/01/2020 15:16	03/01/2020 08:12	03/01/2020 15:16	7,06	1	7,06	CHI
20200111259	NIQUELANDIA	NQ12330279	NIQUELANDIA SUBTRANSMISSAO	03/01/2020 08:13	03/01/2020 12:00	03/01/2020 08:13	03/01/2020 12:00	3,78	4	15,12	CHI
20200111261	PIRENOPOLIS	PV21171449	CORUMBA	03/01/2020 08:13	03/01/2020 12:52	03/01/2020 08:13	03/01/2020 12:52	4,65	4	18,59	CHI
20200111266	CAMPOS BELOS	CH12338303	SAO DOMINGOS	03/01/2020 08:14	03/01/2020 12:36	03/01/2020 08:14	03/01/2020 12:36	4,37	7	30,56	CHI
20200111267	CALDAS NOVAS	CN12292950	CALDAS NOVAS S1	03/01/2020 08:14	03/01/2020 19:20	03/01/2020 08:14	03/01/2020 19:20	11,09	2	22,19	CHI
20200111270	CAMPOS VERDES	SG12202098	SANTA TEREZINHA	03/01/2020 08:14	03/01/2020 12:25	03/01/2020 08:14	03/01/2020 12:25	4,17	41	171,08	CHI
20200111270	SANTA TEREZINHA DE GOIAS	SG12202098	SANTA TEREZINHA	03/01/2020 08:14	03/01/2020 12:25	03/01/2020 08:14	03/01/2020 12:25	4,17	133	554,98	CHI
20200111270	UIRAPURU	SG12202098	SANTA TEREZINHA	03/01/2020 08:14	03/01/2020 12:25	03/01/2020 08:14	03/01/2020 12:25	4,17	55	229,50	CHI
20200111271	FORMOSA	610307253	ITUIQUIRA	03/01/2020 08:14	03/01/2020 10:35	03/01/2020 08:14	03/01/2020 10:35	2,34	1	2,34	CHI
20200111274	GOIANIA	15819978	FERROVIARIO S1	03/01/2020 08:15	03/01/2020 11:29	03/01/2020 08:15	03/01/2020 11:29	3,24	1	3,24	CHI
20200111275	GOIAS	GS12206945	ITABERAI S1	03/01/2020 08:15	03/01/2020 10:23	03/01/2020 08:15	03/01/2020 10:23	2,13	2	4,26	CHI
20200111277	ACREUNA	2440073526	ACREUNA	03/01/2020 08:15	03/01/2020 12:30	03/01/2020 08:15	03/01/2020 12:30	4,24	1	4,24	CHI
20200111278	CUMARI	CT21152871	CATALAO S2	03/01/2020 08:15	03/01/2020 11:06	03/01/2020 08:15	03/01/2020 11:06	2,84	1	2,84	CHI
20200111281	URUTAI	600013820	URUTAI	03/01/2020 08:16	03/01/2020 09:25	03/01/2020 08:16	03/01/2020 09:25	1,16	1	1,16	CHI
20200111284	MINEIROS	MY12153196	PARQUE DAS EMAS	03/01/2020 08:16	03/01/2020 15:50	03/01/2020 08:16	03/01/2020 15:50	7,55	5	37,77	CHI
20200111285	CAMPESTRE DE GOIAS	GC12000125	TRINDADE	03/01/2020 08:17	03/01/2020 11:52	03/01/2020 08:17	03/01/2020 11:52	3,58	6	21,50	CHI
20200111287	JATAI	JT12008872	JATAI S1	03/01/2020 08:17	03/01/2020 11:37	03/01/2020 08:17	03/01/2020 11:37	3,33	10	33,29	CHI
20200111289	ARUANA	AK12292820	BRITANIA	03/01/2020 08:17	03/01/2020 10:38	03/01/2020 08:17	03/01/2020 10:38	2,36	4	9,42	CHI
20200111299	HIDROLANDIA	180051064	CEPAIGO S2	03/01/2020 08:18	03/01/2020 11:53	03/01/2020 08:18	03/01/2020 11:53	3,57	1	3,57	CHI
20200111301	APARECIDA DE GOIANIA	AP12161884	CEPAIGO S1	03/01/2020 08:19	03/01/2020 13:22	03/01/2020 08:19	03/01/2020 13:22	5,05	1	5,05	CHI
20200111311	CAIAPONIA	CP21374803	PALESTINA	03/01/2020 08:19	03/01/2020 21:19	03/01/2020 08:19	03/01/2020 21:19	12,98	1	12,98	CHI
20200111312	GOIAS	GS21140299	MATRINCHA	03/01/2020 08:20	03/01/2020 16:45	03/01/2020 08:20	03/01/2020 16:45	8,41	1	8,41	CHI
20200111313	IACIARA	IA12257653	IACIARA S1	03/01/2020 07:11	03/01/2020 11:33	03/01/2020 07:11	03/01/2020 11:33	4,36	6	26,14	CHI

20200111314	PIRENOPOLIS	PV21171298	CORUMBA	03/01/2020 08:20	03/01/2020 10:34	03/01/2020 08:20	03/01/2020 10:34	2,23	1	2,23	CHI
20200111318	VILA PROPICIO	PV12073537	GOIANESIA S1	03/01/2020 07:46	04/01/2020 11:24	03/01/2020 07:46	04/01/2020 11:24	27,63	4	110,51	CHI
20200111319	CRIXAS	CX21342230	SERRA DO OURO	03/01/2020 08:21	03/01/2020 11:37	03/01/2020 08:21	03/01/2020 11:37	3,27	1	3,27	CHI
20200111323	MARA ROSA	MQ12220763	SANTA TEREZINHA	03/01/2020 08:22	03/01/2020 21:50	03/01/2020 08:22	03/01/2020 21:50	13,47	7	94,26	CHI
20200111329	COCALZINHO DE GOIAS	ZN12258524RE	COCALZINHO	03/01/2020 08:07	03/01/2020 15:12	03/01/2020 08:07	03/01/2020 15:12	7,07	55	388,91	CHI
20200111331	TRINDADE	GR12394656	GOIANIRA	03/01/2020 08:23	03/01/2020 13:45	03/01/2020 08:23	03/01/2020 13:45	5,36	2	10,72	CHI
20200111341	LUZIANIA	LZ21209485	RIO VERMELHO	03/01/2020 08:24	03/01/2020 12:24	03/01/2020 08:24	03/01/2020 12:24	3,99	1	3,99	CHI
20200111344	DOVERLANDIA	DV12204324	CAIAPONIA	03/01/2020 08:06	03/01/2020 16:00	03/01/2020 08:06	03/01/2020 16:00	7,91	11	87,00	CHI
20200111351	ORIZONA	OZ12113702	PIRES DO RIO S2	03/01/2020 08:26	03/01/2020 09:57	03/01/2020 08:26	03/01/2020 09:57	1,52	11	16,67	CHI
20200111353	ITUMBIARA	690178086	ITUMBIARA NOVA	03/01/2020 08:26	03/01/2020 13:50	03/01/2020 08:26	03/01/2020 13:50	5,40	1	5,40	CHI
20200111354	GOIAS	GS21061611	ITABERAI S1	03/01/2020 08:26	03/01/2020 10:55	03/01/2020 08:26	03/01/2020 10:55	2,47	1	2,47	CHI
20200111356	GOIANESIA	550126995	GOIANESIA S2	03/01/2020 08:26	04/01/2020 09:26	03/01/2020 08:26	04/01/2020 09:26	24,99	1	24,99	CHI
20200111369	QUIRINOPOLIS	QI12273812	QUIRINOPOLIS	03/01/2020 08:28	03/01/2020 12:50	03/01/2020 08:28	03/01/2020 12:50	4,36	7	30,49	CHI
20200111370	APARECIDA DE GOIANIA	AP11193732	INDEPENDENCIA S1	03/01/2020 08:19	03/01/2020 10:05	03/01/2020 08:19	03/01/2020 10:05	1,76	147	258,15	CHI
20200111379	CAVALCANTE	CJ21408551	MINACU	03/01/2020 08:29	03/01/2020 19:03	03/01/2020 08:29	03/01/2020 19:03	10,56	1	10,56	CHI
20200111383	LUZIANIA	LZ12109848	VIANOPOLIS	03/01/2020 04:09	03/01/2020 11:18	03/01/2020 04:09	03/01/2020 11:18	7,15	21	150,08	CHI
20200111396	CACHOEIRA DE GOIAS	CG12289761	FIRMINOPOLIS S2	03/01/2020 08:31	03/01/2020 16:06	03/01/2020 08:31	03/01/2020 16:06	7,58	18	136,49	CHI
20200111397	ITUMBIARA	10004177620	ITUMBIARA NOVA	03/01/2020 08:31	03/01/2020 12:50	03/01/2020 08:31	03/01/2020 12:50	4,30	1	4,30	CHI
20200111399	PIRENOPOLIS	220004250	CORUMBA	03/01/2020 08:32	03/01/2020 20:07	03/01/2020 08:32	03/01/2020 20:07	11,58	1	11,58	CHI
20200111400	RIO VERDE	630081153	RIO VERDE S2	03/01/2020 08:32	03/01/2020 15:58	03/01/2020 08:32	03/01/2020 15:58	7,43	1	7,43	CHI
20200111404	FORMOSA	610209887	ITUIQUIRA	03/01/2020 08:33	03/01/2020 10:38	03/01/2020 08:33	03/01/2020 10:38	2,08	1	2,08	CHI
20200111408	PONTALINA	PK21381130	PONTALINA	03/01/2020 08:33	03/01/2020 11:05	03/01/2020 08:33	03/01/2020 11:05	2,53	1	2,53	CHI
20200111416	EDEIA	ED21044481	PONTALINA	03/01/2020 08:34	03/01/2020 22:15	03/01/2020 08:34	03/01/2020 22:15	13,69	1	13,69	CHI
20200111419	PORANGATU	PO12170950	PORANGATU	03/01/2020 08:34	03/01/2020 14:25	03/01/2020 08:34	03/01/2020 14:25	5,83	2	11,67	CHI
20200111426	BURITINOPOLIS	10000853702	IACIARA S2	03/01/2020 08:36	04/01/2020 13:31	03/01/2020 08:36	04/01/2020 13:31	28,91	1	28,91	CHI
20200111431	GOIANESIA	GE12354272	GOIANESIA S1	03/01/2020 08:37	04/01/2020 14:06	03/01/2020 08:37	04/01/2020 14:06	29,48	6	176,85	CHI
20200111433	SANTO ANTONIO DO DESCOBERTO	SN21070946	MARAJOARA	03/01/2020 08:37	03/01/2020 18:02	03/01/2020 08:37	03/01/2020 17:20	8,71	1	8,71	CHI
20200111433	SANTO ANTONIO DO DESCOBERTO	SN12382951	MARAJOARA	03/01/2020 08:37	03/01/2020 18:02	03/01/2020 14:40	03/01/2020 18:02	3,36	54	181,29	CHI
20200111439	GOIANESIA	10024941016	GOIANESIA S2	03/01/2020 08:38	03/01/2020 21:13	03/01/2020 08:38	03/01/2020 21:13	12,57	1	12,57	CHI
20200111442	ORIZONA	OZ21082756	PIRES DO RIO S2	03/01/2020 08:39	03/01/2020 10:13	03/01/2020 08:39	03/01/2020 10:13	1,57	1	1,57	CHI
20200111447	CRISTALINA	KR21206622	CRISTALINA S1	03/01/2020 08:40	03/01/2020 11:47	03/01/2020 08:40	03/01/2020 11:47	3,12	2	6,23	CHI
20200111449	PONTALINA	PK21249783	PONTALINA	03/01/2020 08:40	03/01/2020 11:35	03/01/2020 08:40	03/01/2020 11:35	2,91	1	2,91	CHI
20200111452	GUARANI DE GOIAS	GY12160070	IACIARA S1	03/01/2020 08:24	03/01/2020 13:45	03/01/2020 08:24	03/01/2020 13:45	5,35	3	16,05	CHI

20200111452	IACIARA	GY12160070	IACIARA S1	03/01/2020 08:24	03/01/2020 13:45	03/01/2020 08:24	03/01/2020 13:45	5,35	2	10,70	CHI
20200111452	SAO DOMINGOS	GY12160070	IACIARA S1	03/01/2020 08:24	03/01/2020 13:45	03/01/2020 08:24	03/01/2020 13:45	5,35	1	5,35	CHI
20200111453	MORRO AGUDO DE GOIAS	MS12113258	ITAPURANGA	03/01/2020 08:38	03/01/2020 13:11	03/01/2020 08:38	03/01/2020 13:11	4,55	29	131,86	CHI
20200111453	RUBIATABA	MS12113258	ITAPURANGA	03/01/2020 08:38	03/01/2020 13:11	03/01/2020 08:38	03/01/2020 13:11	4,55	2	9,09	CHI
20200111456	FORMOSO	10006181609	PORANGATU	03/01/2020 08:41	03/01/2020 15:48	03/01/2020 08:41	03/01/2020 15:48	7,11	1	7,11	CHI
20200111458	VARJAO	VJ21243317	GUAPO S2	03/01/2020 08:41	03/01/2020 13:53	03/01/2020 08:41	03/01/2020 13:53	5,20	1	5,20	CHI
20200111462	BOM JESUS DE GOIAS	BJ21222336	BOM JESUS DE GOIAS	03/01/2020 08:42	03/01/2020 18:42	03/01/2020 08:42	03/01/2020 18:42	10,00	1	10,00	CHI
20200111467	JATAI	290068344	JATAI S3	03/01/2020 08:43	03/01/2020 11:25	03/01/2020 08:43	03/01/2020 11:25	2,70	1	2,70	CHI
20200111471	PIRACANJUBA	PJ21131287	PIRACANJUBA	03/01/2020 08:44	03/01/2020 18:55	03/01/2020 08:44	03/01/2020 18:55	10,18	1	10,18	CHI
20200111472	GOIATUBA	GT21352573	BOM JESUS DE GOIAS	03/01/2020 08:44	03/01/2020 18:53	03/01/2020 08:44	03/01/2020 18:53	10,14	2	20,29	CHI
20200111479	VILA PROPICIO	NP21239009	GOIANESIA S1	03/01/2020 08:45	05/01/2020 15:49	03/01/2020 08:45	05/01/2020 15:49	55,06	1	55,06	CHI
20200111480	GOIANIA	GN11002836	XAVANTES	03/01/2020 08:42	03/01/2020 13:11	03/01/2020 08:42	03/01/2020 13:11	4,47	33	147,62	CHI
20200111483	SANTO ANTONIO DO DESCOBERTO	SN12330527	MARAJOARA	03/01/2020 06:12	03/01/2020 11:02	03/01/2020 06:12	03/01/2020 11:02	4,83	15	72,43	CHI
20200111485	MINEIROS	MY21322108	PARQUE DAS EMAS	03/01/2020 08:45	03/01/2020 17:33	03/01/2020 08:45	03/01/2020 17:33	8,79	1	8,79	CHI
20200111487	RIO VERDE	RV12260714	RIO VERDE S1	03/01/2020 08:19	03/01/2020 10:55	03/01/2020 08:19	03/01/2020 10:55	2,59	2	5,18	CHI
20200111501	CORUMBAIBA	CI12377064	CATALAO S1	03/01/2020 03:00	03/01/2020 16:11	03/01/2020 03:00	03/01/2020 16:11	13,17	12	158,06	CHI
20200111509	GOIANIA	GN11070242	XAVANTES	03/01/2020 08:48	03/01/2020 10:38	03/01/2020 08:48	03/01/2020 10:38	1,82	59	107,28	CHI
20200111512	ALEXANIA	AX12353458	ALEXANIA	03/01/2020 08:04	03/01/2020 13:27	03/01/2020 08:04	03/01/2020 13:27	5,37	15	80,54	CHI
20200111513	CORUMBA DE GOIAS	CB21191457	COCALZINHO	03/01/2020 08:49	03/01/2020 17:17	03/01/2020 08:49	03/01/2020 17:17	8,46	1	8,46	CHI
20200111519	RIO VERDE	QI21306090	QUIRINOPOLIS	03/01/2020 08:51	03/01/2020 14:22	03/01/2020 08:51	03/01/2020 14:22	5,51	3	16,54	CHI
20200111522	FLORES DE GOIAS	FA12397044	ITUIQUIRA	03/01/2020 08:51	03/01/2020 12:35	03/01/2020 08:51	03/01/2020 12:35	3,72	1	3,72	CHI
20200111522	FORMOSA	FA12397044	ITUIQUIRA	03/01/2020 08:51	03/01/2020 12:35	03/01/2020 08:51	03/01/2020 12:35	3,72	5	18,62	CHI
20200111523	COCALZINHO DE GOIAS	CB12075828	COCALZINHO	03/01/2020 08:35	03/01/2020 10:51	03/01/2020 08:35	03/01/2020 10:51	2,25	11	24,77	CHI
20200111525	SERRANOPOLIS	SX12216731	JATAI S1	03/01/2020 06:26	03/01/2020 12:26	03/01/2020 06:26	03/01/2020 12:26	6,00	78	468,20	CHI
20200111527	ORIZONA	OZ11000131	PIRES DO RIO S2	03/01/2020 08:47	03/01/2020 12:03	03/01/2020 08:47	03/01/2020 12:03	3,25	143	464,91	CHI
20200111540	ANAPOLIS	AN12258789	ANAPOLIS UNIVERSITARIO S1	03/01/2020 08:47	03/01/2020 11:28	03/01/2020 08:47	03/01/2020 11:28	2,68	13	34,80	CHI
20200111550	JUSSARA	JR12027532	BRITANIA	03/01/2020 08:49	03/01/2020 11:53	03/01/2020 08:49	03/01/2020 11:53	3,05	36	109,91	CHI
20200111557	RIO VERDE	SH12301407	SANTA HELENA S1	03/01/2020 06:45	04/01/2020 07:49	03/01/2020 06:45	04/01/2020 07:49	25,05	3	75,16	CHI
20200111557	SANTA HELENA DE GOIAS	SH12301407	SANTA HELENA S1	03/01/2020 06:45	04/01/2020 07:49	03/01/2020 06:45	04/01/2020 07:49	25,05	10	250,54	CHI
20200111559	PORANGATU	PO21189536	PORANGATU	03/01/2020 08:58	03/01/2020 10:42	03/01/2020 08:58	03/01/2020 10:42	1,72	1	1,72	CHI
20200111564	TRINDADE	TR32032838	TRINDADE	03/01/2020 08:59	03/01/2020 15:00	03/01/2020 08:59	03/01/2020 15:00	6,03	14	84,42	CHI
20200111566	URUTAI	UT21075965	PIRES DO RIO S2	03/01/2020 08:59	03/01/2020 10:47	03/01/2020 08:59	03/01/2020 10:47	1,80	1	1,80	CHI
20200111575	VILA PROPICIO	NP12382314	GOIANESIA S1	03/01/2020 09:00	03/01/2020 20:01	03/01/2020 09:00	03/01/2020 20:01	11,01	11	121,13	CHI

20200111584	APARECIDA DE GOIANIA	10007278118	REAL S1	03/01/2020 09:01	03/01/2020 11:08	03/01/2020 09:01	03/01/2020 11:08	2,11	1	2,11	CHI
20200111585	SAO DOMINGOS	SD12317864	SAO DOMINGOS	03/01/2020 08:10	03/01/2020 10:54	03/01/2020 08:10	03/01/2020 10:54	2,73	34	92,80	CHI
20200111587	GOIANESIA	550098677	GOIANESIA S2	03/01/2020 09:02	03/01/2020 14:04	03/01/2020 09:02	03/01/2020 14:04	5,04	1	5,04	CHI
20200111590	PADRE BERNARDO	PB12382220	PADRE BERNARDO	03/01/2020 09:02	03/01/2020 12:01	03/01/2020 09:02	03/01/2020 12:01	2,98	45	133,91	CHI
20200111606	PANAMA	IT12000120	PARANAIBA	03/01/2020 07:04	03/01/2020 18:24	03/01/2020 07:04	03/01/2020 18:24	11,33	2	22,66	CHI
20200111609	GOIANIA	GN11001847	GOIANIA LESTE S1	03/01/2020 09:04	03/01/2020 16:54	03/01/2020 11:22	03/01/2020 16:54	5,53	115	636,33	CHI
20200111611	RIO VERDE	RV21062669	CABRIUVA S1	03/01/2020 09:06	03/01/2020 13:30	03/01/2020 09:06	03/01/2020 13:30	4,40	1	4,40	CHI
20200111612	INDIARA	IY12323655	EDEIA	03/01/2020 09:06	03/01/2020 13:06	03/01/2020 09:06	03/01/2020 13:06	4,00	12	48,01	CHI
20200111614	PALESTINA DE GOIAS	PY12396120	PALESTINA	03/01/2020 08:10	03/01/2020 17:43	03/01/2020 08:10	03/01/2020 17:43	9,54	12	114,51	CHI
20200111621	PIRENOPOLIS	PV21318103	CORUMBA	03/01/2020 09:07	03/01/2020 13:45	03/01/2020 09:07	03/01/2020 13:45	4,62	2	9,24	CHI
20200111622	FAINA	FC12299837	GOIAS	03/01/2020 06:32	04/01/2020 10:00	03/01/2020 06:32	03/01/2020 19:00	12,46	3	37,39	CHI
20200111622	FAINA	FC12299837	GOIAS	03/01/2020 06:32	04/01/2020 10:00	03/01/2020 06:32	04/01/2020 09:14	26,70	2	53,41	CHI
20200111622	FAINA	FC12299837	GOIAS	03/01/2020 06:32	04/01/2020 10:00	03/01/2020 06:32	04/01/2020 10:00	27,47	1	27,47	CHI
20200111624	AMARALINA	LC12270203	SAO MIGUEL DO ARAGUAIA	03/01/2020 09:07	03/01/2020 15:09	03/01/2020 09:07	03/01/2020 15:09	6,02	9	54,18	CHI
20200111625	CRIXAS	CX21134502	RUBIATABA	03/01/2020 09:07	03/01/2020 13:34	03/01/2020 12:32	03/01/2020 13:34	1,02	2	2,05	CHI
20200111628	APARECIDA DE GOIANIA	14018615	REAL S1	03/01/2020 09:09	03/01/2020 11:56	03/01/2020 09:09	03/01/2020 11:56	2,78	1	2,78	CHI
20200111631	GOIANIA	15456195	FERROVIARIO S1	03/01/2020 09:09	03/01/2020 10:18	03/01/2020 09:09	03/01/2020 10:18	1,14	1	1,14	CHI
20200111633	PIRACANJUBA	PJ21139505	PIRACANJUBA	03/01/2020 09:10	03/01/2020 20:12	03/01/2020 09:10	03/01/2020 20:12	11,02	2	22,03	CHI
20200111639	SAO JOAO DA PARAUNA	RP21008155	FIRMINOPOLIS S2	03/01/2020 09:13	03/01/2020 10:33	03/01/2020 09:13	03/01/2020 10:33	1,33	2	2,67	CHI
20200111640	PIRACANJUBA	PJ21030027	CRISTIANOPOLIS	03/01/2020 09:13	04/01/2020 14:06	03/01/2020 09:13	04/01/2020 14:06	28,88	1	28,88	CHI
20200111643	FORMOSA	610034686	ITUIQUIRA	03/01/2020 09:13	03/01/2020 12:01	03/01/2020 09:13	03/01/2020 12:01	2,78	1	2,78	CHI
20200111651	IACIARA	IA21149611	IACIARA S2	03/01/2020 09:14	04/01/2020 02:11	03/01/2020 09:14	04/01/2020 01:47	16,56	1	16,56	CHI
20200111651	FLORES DE GOIAS	IA12218804LD	IACIARA S2	03/01/2020 09:14	04/01/2020 02:11	03/01/2020 22:50	04/01/2020 02:11	3,36	1	3,36	CHI
20200111651	IACIARA	IA12218804LD	IACIARA S2	03/01/2020 09:14	04/01/2020 02:11	03/01/2020 22:50	04/01/2020 02:11	3,36	73	245,06	CHI
20200111653	VICENTINOPOLIS	VI21198652	VICENTINOPOLIS	03/01/2020 09:13	03/01/2020 17:00	03/01/2020 09:13	03/01/2020 17:00	7,78	1	7,78	CHI
20200111654	CATALAO	1990227822	CATALAO S2	03/01/2020 09:15	03/01/2020 10:27	03/01/2020 09:15	03/01/2020 10:27	1,19	1	1,19	CHI
20200111658	AMARALINA	LC12230319	NOVA CRIXAS	03/01/2020 09:16	03/01/2020 17:09	03/01/2020 09:16	03/01/2020 17:09	7,88	3	23,64	CHI
20200111659	ANAPOLIS	AN21328304	ANAPOLIS UNIVERSITARIO S2	03/01/2020 09:16	03/01/2020 15:30	03/01/2020 11:33	03/01/2020 15:30	3,95	1	3,95	CHI
20200111662	BALIZA	BH12331164	CAIAPONIA	03/01/2020 09:16	04/01/2020 14:54	03/01/2020 09:16	04/01/2020 14:04	28,79	5	143,97	CHI
20200111662	BALIZA	BH12331164	CAIAPONIA	03/01/2020 09:16	04/01/2020 14:54	03/01/2020 09:16	04/01/2020 14:54	29,63	4	118,51	CHI
20200111662	BALIZA	BH12331164	CAIAPONIA	03/01/2020 09:16	04/01/2020 14:54	04/01/2020 14:05	04/01/2020 14:54	0,82	5	4,08	CHI
20200111674	GOIANIA	GN11001402	REAL S1	03/01/2020 09:19	03/01/2020 11:00	03/01/2020 09:19	03/01/2020 11:00	1,67	69	115,27	CHI
20200111676	SAO LUIS DE MONTES BELOS	SL32233383	SAO LUIZ DOS MONTES BELOS	03/01/2020 09:20	03/01/2020 11:35	03/01/2020 09:20	03/01/2020 11:35	2,25	19	42,68	CHI

20200111677	CALDAS NOVAS	10030847700	CALDAS NOVAS S1	03/01/2020 09:20	03/01/2020 12:47	03/01/2020 09:20	03/01/2020 12:47	3,44	0	0,00	CHI
20200111678	GOIANIA	11604955	XAVANTES	03/01/2020 09:20	03/01/2020 10:33	03/01/2020 09:20	03/01/2020 10:33	1,20	1	1,20	CHI
20200111680	MOZARLANDIA	MZ21058547	MOZARLANDIA	03/01/2020 09:21	03/01/2020 15:41	03/01/2020 09:21	03/01/2020 15:41	6,33	1	6,33	CHI
20200111681	TURVELANDIA	10017054140	RIO DOS BOIS	03/01/2020 09:21	04/01/2020 19:11	03/01/2020 09:21	04/01/2020 19:11	33,84	1	33,84	CHI
20200111684	PADRE BERNARDO	PI12099216LD	PLANALTINA	03/01/2020 05:23	03/01/2020 11:30	03/01/2020 05:23	03/01/2020 11:30	6,11	16	97,68	CHI
20200111684	PLANALTINA	PI12099216LD	PLANALTINA	03/01/2020 05:23	03/01/2020 11:30	03/01/2020 05:23	03/01/2020 11:30	6,11	109	665,48	CHI
20200111693	COCALZINHO DE GOIAS	ZN21129456	COCALZINHO	03/01/2020 09:23	04/01/2020 08:10	03/01/2020 09:23	04/01/2020 08:10	22,80	1	22,80	CHI
20200111694	PIRENOPOLIS	PV21337694	CORUMBA	03/01/2020 09:23	03/01/2020 19:10	03/01/2020 09:23	03/01/2020 19:10	9,77	1	9,77	CHI
20200111695	GOIANIA	GN12058907	GOIANIA LESTE S3	03/01/2020 09:23	03/01/2020 10:15	03/01/2020 09:23	03/01/2020 10:15	0,86	75	64,25	CHI
20200111697	DAMIANOPOLIS	DA12256650	IACIARA S2	03/01/2020 08:32	03/01/2020 10:55	03/01/2020 08:32	03/01/2020 10:55	2,38	27	64,37	CHI
20200111701	ITAGUARU	JA21062953	ITABERAI S1	03/01/2020 09:24	03/01/2020 13:59	03/01/2020 09:24	03/01/2020 13:59	4,57	1	4,57	CHI
20200111718	CRISTALINA	KR21251302	CRISTALINA S2	03/01/2020 09:29	03/01/2020 14:03	03/01/2020 09:29	03/01/2020 14:03	4,58	1	4,58	CHI
20200111720	ALVORADA DO NORTE	AQ12062306	IACIARA S2	03/01/2020 06:30	03/01/2020 16:21	03/01/2020 06:30	03/01/2020 16:21	9,83	6	59,01	CHI
20200111723	ITARUMA	IM21000001	CACHOEIRA ALTA	03/01/2020 09:30	03/01/2020 11:11	03/01/2020 09:30	03/01/2020 11:11	1,68	1	1,68	CHI
20200111724	CAIAPONIA	PY12126840	PALESTINA	03/01/2020 08:33	03/01/2020 15:44	03/01/2020 08:33	03/01/2020 15:44	7,18	4	28,73	CHI
20200111724	PALESTINA DE GOIAS	PY12126840	PALESTINA	03/01/2020 08:33	03/01/2020 15:44	03/01/2020 08:33	03/01/2020 15:44	7,18	7	50,27	CHI
20200111728	PIRENOPOLIS	PV12290370	CORUMBA	03/01/2020 08:45	03/01/2020 12:05	03/01/2020 08:45	03/01/2020 12:05	3,33	7	23,30	CHI
20200111731	GOIANDIRA	GD12073552	CATALAO S1	03/01/2020 09:32	04/01/2020 12:30	03/01/2020 09:32	04/01/2020 12:30	26,95	2	53,90	CHI
20200111734	PONTALINA	Z10018276	PONTALINA	03/01/2020 09:33	03/01/2020 11:00	03/01/2020 09:33	03/01/2020 11:00	1,45	1	1,45	CHI
20200111735	JAUPACI	JP21281731	IPORA	03/01/2020 09:34	03/01/2020 22:10	03/01/2020 09:34	03/01/2020 22:10	12,59	1	12,59	CHI
20200111738	COCALZINHO DE GOIAS	ZN21172742	COCALZINHO	03/01/2020 09:35	03/01/2020 13:07	03/01/2020 09:35	03/01/2020 13:07	3,53	1	3,53	CHI
20200111742	INHUMAS	10009191753	INHUMAS S2	03/01/2020 09:36	03/01/2020 15:24	03/01/2020 09:36	03/01/2020 15:24	5,81	1	5,81	CHI
20200111744	GOIANIA	11700877	REAL S1	03/01/2020 09:36	03/01/2020 12:52	03/01/2020 09:36	03/01/2020 12:52	3,26	1	3,26	CHI
20200111748	CAMPO ALEGRE DE GOIAS	CM21250231	CAMPO ALEGRE DE GOIAS	03/01/2020 09:36	03/01/2020 21:19	03/01/2020 09:36	03/01/2020 21:19	11,70	1	11,70	CHI
20200111757	INHUMAS	IN21169831	INHUMAS S1	03/01/2020 09:38	03/01/2020 14:24	03/01/2020 09:38	03/01/2020 14:24	4,77	2	9,53	CHI
20200111758	ANAPOLIS	AN12258779	JUNDIAI S1	03/01/2020 08:34	03/01/2020 16:52	03/01/2020 08:34	03/01/2020 16:52	8,30	4	33,20	CHI
20200111761	ACREUNA	EU12026741	RIO DOS BOIS	03/01/2020 09:40	03/01/2020 21:29	03/01/2020 09:40	03/01/2020 21:29	11,83	2	23,65	CHI
20200111762	ANAPOLIS	AN12267912	NEROPOLIS S1	03/01/2020 09:40	03/01/2020 12:29	03/01/2020 09:40	03/01/2020 12:29	2,82	22	61,95	CHI
20200111762	CAMPO LIMPO	AN12267912	NEROPOLIS S1	03/01/2020 09:40	03/01/2020 12:29	03/01/2020 09:40	03/01/2020 12:29	2,82	1	2,82	CHI
20200111763	PIRACANJUBA	PJ12097877	BELA VISTA S1	03/01/2020 10:37	03/01/2020 11:00	03/01/2020 10:37	03/01/2020 11:00	0,39	4	1,56	CHI
20200111770	PIRENOPOLIS	PV21248866	CORUMBA	03/01/2020 09:41	04/01/2020 10:01	03/01/2020 09:41	04/01/2020 10:01	24,33	1	24,33	CHI
20200111776	ITAPIRAPUA	IU12008889	MATRINCHA	03/01/2020 08:54	03/01/2020 15:07	03/01/2020 08:54	03/01/2020 15:07	6,21	9	55,88	CHI
20200111777	ITAPACI	IW12267460	ITAPACI	03/01/2020 09:38	03/01/2020 23:28	03/01/2020 09:38	03/01/2020 23:28	13,83	8	110,66	CHI

20200111796	PALMEIRAS DE GOIAS	PL12349319	PALMEIRAS	03/01/2020 09:46	03/01/2020 12:50	03/01/2020 09:46	03/01/2020 12:50	3,07	2	6,14	CHI
20200111803	CACHOEIRA DOURADA	CD21222520	CACHOEIRA DOURADA	03/01/2020 09:46	03/01/2020 21:08	03/01/2020 09:46	03/01/2020 21:08	11,36	1	11,36	CHI
20200111808	IPORA	IR11325040	IPORA	03/01/2020 09:47	03/01/2020 15:30	03/01/2020 15:00	03/01/2020 15:30	0,50	71	35,50	CHI
20200111811	DOVERLANDIA	DV21139931	CAIAPONIA	03/01/2020 09:47	03/01/2020 16:38	03/01/2020 09:47	03/01/2020 16:38	6,84	1	6,84	CHI
20200111820	APARECIDA DE GOIANIA	AP11130699	ATLANTICO S2	03/01/2020 09:35	03/01/2020 10:46	03/01/2020 09:35	03/01/2020 10:46	1,17	12	14,08	CHI
20200111821	ANAPOLIS	AN21258388	DAIA S1	03/01/2020 09:49	03/01/2020 12:15	03/01/2020 09:49	03/01/2020 12:15	2,43	2	4,85	CHI
20200111823	CATALAO	CT12103631	CATALAO S1	03/01/2020 09:50	03/01/2020 12:02	03/01/2020 09:50	03/01/2020 12:02	2,20	8	17,62	CHI
20200111824	ITARUMA	IM21188950	CACHOEIRA ALTA	03/01/2020 09:50	03/01/2020 12:41	03/01/2020 09:50	03/01/2020 12:41	2,84	1	2,84	CHI
20200111828	APARECIDA DE GOIANIA	AP11254910	INDEPENDENCIA S1	03/01/2020 09:50	03/01/2020 12:43	03/01/2020 09:50	03/01/2020 12:43	2,88	83	238,67	CHI
20200111830	APARECIDA DE GOIANIA	AP11078317	CEPAIGO S1	03/01/2020 09:14	03/01/2020 11:26	03/01/2020 09:14	03/01/2020 11:26	2,21	162	358,06	CHI
20200111833	AGUA LIMPA	AL12075701	VILA CORUMBA	03/01/2020 09:43	03/01/2020 11:26	03/01/2020 09:43	03/01/2020 11:26	1,71	5	8,57	CHI
20200111836	QUIRINOPOLIS	10008972760	QUIRINOPOLIS	03/01/2020 09:53	03/01/2020 16:55	03/01/2020 09:53	03/01/2020 16:55	7,03	1	7,03	CHI
20200111838	APARECIDA DE GOIANIA	AP16403900	CARAJAS S1	03/01/2020 09:48	03/01/2020 09:51	03/01/2020 09:48	03/01/2020 09:51	0,06	1987	121,98	CHI
20200111852	GOIANIA	GN11035916	CAMPINAS S2	03/01/2020 09:50	03/01/2020 11:18	03/01/2020 09:50	03/01/2020 11:18	1,45	94	136,35	CHI
20200111855	CALDAZINHA	DE21323979	CEPAIGO S2	03/01/2020 09:56	03/01/2020 13:52	03/01/2020 09:56	03/01/2020 13:52	3,92	1	3,92	CHI
20200111860	BELA VISTA DE GOIAS	BV12011061	BELA VISTA S1	03/01/2020 09:57	03/01/2020 11:30	03/01/2020 09:57	03/01/2020 11:30	1,54	28	43,04	CHI
20200111865	MORRINHOS	MR21315858	GOIATUBA S2	03/01/2020 09:58	03/01/2020 12:00	03/01/2020 09:58	03/01/2020 12:00	2,02	1	2,02	CHI
20200111869	GOIANIA	10977077	CAMPINAS S3	03/01/2020 09:59	03/01/2020 12:13	03/01/2020 09:59	03/01/2020 12:13	2,23	1	2,23	CHI
20200111870	POSSE	PS12256102	IACIARA S2	03/01/2020 07:15	03/01/2020 11:10	03/01/2020 07:15	03/01/2020 11:10	3,91	6	23,45	CHI
20200111874	ALTO PARAISO DE GOIAS	3870022289	FLORES DE GOIAS	03/01/2020 09:59	03/01/2020 11:27	03/01/2020 09:59	03/01/2020 11:27	1,46	1	1,46	CHI
20200111876	GOIANIA	10002232721	REAL S2	03/01/2020 10:00	03/01/2020 12:06	03/01/2020 10:00	03/01/2020 12:06	2,11	1	2,11	CHI
20200111877	NOVA CRIXAS	NA12229631	NOVA CRIXAS	03/01/2020 09:58	03/01/2020 13:44	03/01/2020 09:58	03/01/2020 13:44	3,76	4	15,04	CHI
20200111879	MINACU	4020100574	MINACU	03/01/2020 10:00	03/01/2020 11:36	03/01/2020 10:00	03/01/2020 11:36	1,59	1	1,59	CHI
20200111880	CATALAO	1990115710	CATALAO S2	03/01/2020 10:01	03/01/2020 20:20	03/01/2020 10:01	03/01/2020 20:20	10,32	1	10,32	CHI
20200111881	ANAPOLIS	AN21258867	JUNDIAI S2	03/01/2020 10:01	03/01/2020 11:50	03/01/2020 10:01	03/01/2020 11:50	1,82	1	1,82	CHI
20200111882	SAO MIGUEL DO ARAGUAIA	SM21000014	SAO MIGUEL DO ARAGUAIA	03/01/2020 10:01	03/01/2020 13:35	03/01/2020 10:01	03/01/2020 13:35	3,57	1	3,57	CHI
20200111886	GOIANIA	10003706395	CARAJAS S1	03/01/2020 10:02	03/01/2020 11:56	03/01/2020 10:02	03/01/2020 11:56	1,90	1	1,90	CHI
20200111891	ITUMBIARA	CD21222294	CACHOEIRA DOURADA	03/01/2020 10:03	03/01/2020 19:33	03/01/2020 10:03	03/01/2020 19:33	9,49	1	9,49	CHI
20200111892	ORIZONA	2060052793	PIRES DO RIO S2	03/01/2020 10:03	03/01/2020 17:25	03/01/2020 10:03	03/01/2020 17:25	7,37	1	7,37	CHI
20200111895	GOIANIA	12217797	CAMPINAS S3	03/01/2020 10:04	03/01/2020 17:19	03/01/2020 10:04	03/01/2020 17:19	7,25	1	7,25	CHI
20200111899	IPAMERI	IP12266895	IPAMERI	03/01/2020 10:05	03/01/2020 17:02	03/01/2020 10:05	03/01/2020 17:02	6,94	2	13,88	CHI
20200111905	DAMIANOPOLIS	DA12257669	IACIARA S2	03/01/2020 08:24	03/01/2020 12:10	03/01/2020 08:24	03/01/2020 12:10	3,76	26	97,88	CHI
20200111914	VALPARAISO DE GOIAS	2860159168	PACAEMBU S1	03/01/2020 10:08	03/01/2020 13:01	03/01/2020 10:08	03/01/2020 13:01	2,87	1	2,87	CHI

20200111915	RIO VERDE	630459307	RIO VERDE S1	03/01/2020 10:08	03/01/2020 12:58	03/01/2020 10:08	03/01/2020 12:58	2,82	1	2,82	CHI
20200111918	SAO MIGUEL DO ARAGUAIA	SM12276195	SAO MIGUEL DO ARAGUAIA	03/01/2020 09:56	03/01/2020 17:13	03/01/2020 09:56	03/01/2020 17:13	7,27	7	50,92	CHI
20200111919	CATALAO	1990233159	CATALAO S2	03/01/2020 10:10	03/01/2020 12:38	03/01/2020 10:10	03/01/2020 12:38	2,46	1	2,46	CHI
20200111926	PORANGATU	PO12265821	PORANGATU	03/01/2020 10:11	03/01/2020 21:17	03/01/2020 10:11	03/01/2020 21:17	11,09	5	55,44	CHI
20200111927	SAO MIGUEL DO ARAGUAIA	SM12328039	SAO MIGUEL DO ARAGUAIA	03/01/2020 10:11	03/01/2020 18:40	03/01/2020 10:11	03/01/2020 18:40	8,49	1	8,49	CHI
20200111930	TURVELANDIA	TD12025685	RIO DOS BOIS	03/01/2020 10:11	04/01/2020 09:13	03/01/2020 10:11	04/01/2020 09:13	23,02	29	667,59	CHI
20200111936	ANAPOLIS	10003965439	ANAPOLIS UNIVERSITARIO S2	03/01/2020 10:13	03/01/2020 18:57	03/01/2020 10:13	03/01/2020 18:57	8,72	1	8,72	CHI
20200111941	APARECIDA DE GOIANIA	200546028	ANHANGUERA	03/01/2020 10:14	03/01/2020 11:59	03/01/2020 10:14	03/01/2020 11:59	1,74	1	1,74	CHI
20200111942	VILA PROPICIO	NP21317931	COCALZINHO	03/01/2020 10:14	05/01/2020 15:15	03/01/2020 10:14	05/01/2020 15:15	53,00	1	53,00	CHI
20200111947	PLANALTINA	PI12149010	PLANALTINA	03/01/2020 10:15	03/01/2020 12:03	03/01/2020 10:15	03/01/2020 12:03	1,79	171	305,76	CHI
20200111948	GOIANIA	12858626	GOIANIA LESTE S1	03/01/2020 10:15	03/01/2020 11:50	03/01/2020 10:15	03/01/2020 11:50	1,57	1	1,57	CHI
20200111949	GOIATUBA	10003385955	GOIATUBA S2	03/01/2020 10:15	03/01/2020 12:52	03/01/2020 10:15	03/01/2020 12:52	2,61	1	2,61	CHI
20200111950	COCALZINHO DE GOIAS	ZN12384877	COCALZINHO	03/01/2020 08:46	03/01/2020 13:45	03/01/2020 08:46	03/01/2020 13:45	4,97	6	29,84	CHI
20200111952	SAO DOMINGOS	SD11389271	SAO DOMINGOS	03/01/2020 10:16	03/01/2020 12:28	03/01/2020 10:16	03/01/2020 12:28	2,19	1	2,19	CHI
20200111953	ORIZONA	OZ21326453	PIRES DO RIO S2	03/01/2020 10:16	03/01/2020 12:40	03/01/2020 10:16	03/01/2020 12:40	2,39	1	2,39	CHI
20200111964	CALDAS NOVAS	760098098	CALDAS NOVAS S2	03/01/2020 10:19	03/01/2020 17:44	03/01/2020 10:19	03/01/2020 17:44	7,41	1	7,41	CHI
20200111965	SANTA RITA DO NOVO DESTINO	DF12382402	BARRO ALTO	03/01/2020 10:19	04/01/2020 20:34	03/01/2020 10:19	04/01/2020 20:34	34,24	2	68,47	CHI
20200111967	CRIXAS	CX12297040	SERRA DO OURO	03/01/2020 10:19	05/01/2020 19:15	03/01/2020 10:19	05/01/2020 19:15	56,92	1	56,92	CHI
20200111969	CRISTALINA	KR21290492	CRISTALINA S2	03/01/2020 10:20	03/01/2020 13:44	03/01/2020 10:20	03/01/2020 13:44	3,39	1	3,39	CHI
20200111972	PETROLINA DE GOIAS	PG21201316	PETROLINA	03/01/2020 10:20	03/01/2020 12:00	03/01/2020 10:20	03/01/2020 12:00	1,66	1	1,66	CHI
20200111976	GOIAS	GS12333781	GOIAS	03/01/2020 10:21	03/01/2020 12:33	03/01/2020 10:21	03/01/2020 12:33	2,19	2	4,39	CHI
20200111981	CRISTALINA	KR21248626	CRISTALINA S1	03/01/2020 10:22	03/01/2020 15:58	03/01/2020 10:22	03/01/2020 15:58	5,59	2	11,18	CHI
20200111982	CALDAS NOVAS	760417891	CALDAS NOVAS S2	03/01/2020 10:22	03/01/2020 16:46	03/01/2020 10:22	03/01/2020 16:46	6,40	1	6,40	CHI
20200111994	GOIANIA	GN11001156	GOIANIA LESTE S2	03/01/2020 10:31	03/01/2020 21:52	03/01/2020 17:21	03/01/2020 21:52	4,52	70	316,17	CHI
20200111996	TRINDADE	TR11005163	TRINDADE	03/01/2020 09:59	03/01/2020 13:55	03/01/2020 09:59	03/01/2020 13:55	3,94	129	508,33	CHI
20200112005	APARECIDA DE GOIANIA	10003796190	INDEPENDENCIA S1	03/01/2020 10:28	03/01/2020 13:32	03/01/2020 10:28	03/01/2020 13:32	3,06	1	3,06	CHI
20200112009	ALEXANIA	480083447	ALEXANIA	03/01/2020 10:29	03/01/2020 16:52	03/01/2020 10:29	03/01/2020 16:52	6,38	1	6,38	CHI
20200112012	ACREUNA	EU21189129	ACREUNA	03/01/2020 10:29	04/01/2020 05:22	03/01/2020 10:29	04/01/2020 05:22	18,88	1	18,88	CHI
20200112013	SAO MIGUEL DO ARAGUAIA	830049538	SAO MIGUEL DO ARAGUAIA	03/01/2020 10:29	03/01/2020 14:55	03/01/2020 10:29	03/01/2020 14:55	4,43	1	4,43	CHI
20200112014	QUIRINOPOLIS	10018829870	QUIRINOPOLIS	03/01/2020 10:29	03/01/2020 12:42	03/01/2020 10:29	03/01/2020 12:42	2,20	1	2,20	CHI
20200112019	RIO VERDE	RV12261043	ACREUNA	03/01/2020 10:30	03/01/2020 15:49	03/01/2020 10:30	03/01/2020 15:49	5,31	2	10,62	CHI
20200112022	PIRANHAS	1930022004	PIRANHAS	03/01/2020 10:30	03/01/2020 23:22	03/01/2020 10:30	03/01/2020 23:22	12,87	1	12,87	CHI
20200112025	FORMOSO	FO12328885	PORANGATU	03/01/2020 10:31	03/01/2020 16:47	03/01/2020 10:31	03/01/2020 16:47	6,26	4	25,05	CHI

20200112025	SANTA TEREZA DE GOIAS	FO12328885	PORANGATU	03/01/2020 10:31	03/01/2020 16:47	03/01/2020 10:31	03/01/2020 16:47	6,26	12	75,16	CHI
20200112028	SILVANIA	SV12072440	DAIA S1	03/01/2020 17:01	03/01/2020 19:09	03/01/2020 17:01	03/01/2020 19:09	2,13	8	17,05	CHI
20200112032	GOIANIA	10920330	GOIANIA LESTE S1	03/01/2020 10:32	03/01/2020 11:37	03/01/2020 10:32	03/01/2020 11:37	1,08	1	1,08	CHI
20200112033	MINEIROS	MY21308762	PARQUE DAS EMAS	03/01/2020 10:32	03/01/2020 18:35	03/01/2020 10:32	03/01/2020 18:35	8,04	1	8,04	CHI
20200112035	GOIANIA	11992244	FERROVIARIO S1	03/01/2020 10:32	03/01/2020 11:54	03/01/2020 10:32	03/01/2020 11:54	1,36	1	1,36	CHI
20200112040	PIRACANJUBA	PJ21182523	PIRACANJUBA	03/01/2020 10:33	03/01/2020 18:40	03/01/2020 10:33	03/01/2020 18:40	8,13	1	8,13	CHI
20200112041	GOIANIA	GN11000992	CAMPINAS S1	03/01/2020 10:33	03/01/2020 15:43	03/01/2020 10:33	03/01/2020 15:43	5,16	73	376,74	CHI
20200112055	APARECIDA DE GOIANIA	10008395126	INDEPENDENCIA S2	03/01/2020 10:45	03/01/2020 12:10	03/01/2020 10:45	03/01/2020 12:10	1,41	1	1,41	CHI
20200112059	ANICUNS	AC21104763	ANICUNS	03/01/2020 10:38	03/01/2020 14:15	03/01/2020 10:38	03/01/2020 14:15	3,63	3	10,89	CHI
20200112060	CATALAO	CT12104183	CATALAO S1	03/01/2020 09:37	03/01/2020 16:09	03/01/2020 09:37	03/01/2020 16:09	6,52	6	39,14	CHI
20200112062	FAINA	FC12063187	GOIAS	03/01/2020 10:38	03/01/2020 18:51	03/01/2020 10:38	03/01/2020 16:13	5,59	6	33,56	CHI
20200112062	FAINA	FC12314511LD	GOIAS	03/01/2020 10:38	03/01/2020 18:51	03/01/2020 16:44	03/01/2020 18:51	2,10	5	10,52	CHI
20200112065	NOVA AMERICA	RB12251987	RUBIATABA	03/01/2020 10:38	03/01/2020 16:00	03/01/2020 10:38	03/01/2020 16:00	5,35	3	16,06	CHI
20200112065	RUBIATABA	RB12251987	RUBIATABA	03/01/2020 10:38	03/01/2020 16:00	03/01/2020 10:38	03/01/2020 16:00	5,35	6	32,11	CHI
20200112070	ANICUNS	AC12404420	ANICUNS	03/01/2020 10:39	03/01/2020 12:05	03/01/2020 10:39	03/01/2020 12:05	1,44	25	36,03	CHI
20200112072	GOIAS	GS12220476	GOIAS	03/01/2020 10:39	03/01/2020 18:49	03/01/2020 10:39	03/01/2020 18:49	8,16	1	8,16	CHI
20200112074	CRISTALINA	KR21343800	CRISTALINA S2	03/01/2020 10:39	03/01/2020 13:26	03/01/2020 10:39	03/01/2020 13:26	2,78	1	2,78	CHI
20200112079	CRIXAS	3880000590	RUBIATABA	03/01/2020 10:40	03/01/2020 15:45	03/01/2020 10:40	03/01/2020 15:45	5,08	1	5,08	CHI
20200112083	VILA PROPICIO	NP12298239	GOIANESIA S1	03/01/2020 08:37	04/01/2020 17:47	03/01/2020 08:37	04/01/2020 17:47	33,16	7	232,13	CHI
20200112092	SANCLERLANDIA	SC12307534LD	FIRMINOPOLIS S2	03/01/2020 10:43	03/01/2020 18:35	03/01/2020 10:43	03/01/2020 18:35	7,86	1	7,86	CHI
20200112098	NOVA CRIXAS	NA12283851	MOZARLANDIA	03/01/2020 10:45	05/01/2020 00:20	04/01/2020 13:24	05/01/2020 00:20	10,93	1	10,93	CHI
20200112099	CATALAO	CT12327323	CATALAO S1	03/01/2020 10:27	03/01/2020 12:45	03/01/2020 10:27	03/01/2020 12:45	2,30	3	6,89	CHI
20200112100	BURITINOPOLIS	BQ12262077	IACIARA S2	03/01/2020 10:09	03/01/2020 13:05	03/01/2020 10:09	03/01/2020 13:05	2,92	51	149,08	CHI
20200112102	CORUMBA DE GOIAS	ZN21201322	COCALZINHO	03/01/2020 10:47	03/01/2020 18:30	03/01/2020 10:47	03/01/2020 18:30	7,71	1	7,71	CHI
20200112112	CRISTALINA	KR21163719	CRISTALINA S2	03/01/2020 10:49	03/01/2020 21:43	03/01/2020 10:49	03/01/2020 21:43	10,89	2	21,78	CHI
20200112119	GOIANIA	11388596	GOYA S2	03/01/2020 10:50	03/01/2020 14:49	03/01/2020 10:50	03/01/2020 14:49	3,97	1	3,97	CHI
20200112120	MOSSAMEDES	MD21020743	ITABERAI S2	03/01/2020 10:50	03/01/2020 15:13	03/01/2020 10:50	03/01/2020 15:13	4,37	1	4,37	CHI
20200112123	CABECEIRAS	CW21181842	ITUIQUIRA	03/01/2020 10:53	03/01/2020 14:51	03/01/2020 10:53	03/01/2020 14:51	3,95	1	3,95	CHI
20200112124	PLANALTINA	PI12143003	PLANALTINA	03/01/2020 10:15	03/01/2020 13:07	03/01/2020 10:15	03/01/2020 13:07	2,86	13	37,14	CHI
20200112129	NOVA ROMA	ND12216998	IACIARA S2	03/01/2020 10:55	03/01/2020 17:27	03/01/2020 10:55	03/01/2020 17:27	6,52	23	150,04	CHI
20200112144	TAQUARAL DE GOIAS	TQ12396156	INHUMAS S1	03/01/2020 10:58	03/01/2020 16:21	03/01/2020 10:58	03/01/2020 16:21	5,37	2	10,75	CHI
20200112145	COCALZINHO DE GOIAS	ZN21351444	AGUAS LINDAS DE GOIAS S2	03/01/2020 10:58	03/01/2020 15:09	03/01/2020 10:58	03/01/2020 15:09	4,17	4	16,69	CHI
20200112149	APARECIDA DE GOIANIA	AP11277453	INDEPENDENCIA S1	03/01/2020 10:56	03/01/2020 13:15	03/01/2020 10:56	03/01/2020 13:15	2,31	95	219,45	CHI



20200112156	ABADIANIA	AA21297629	ANAPOLIS UNIVERSITARIO S1	03/01/2020 11:00	03/01/2020 14:55	03/01/2020 11:00	03/01/2020 14:55	3,91	2	7,82	CHI
20200112160	PIRES DO RIO	PR12404787	PIRES DO RIO S1	03/01/2020 10:11	03/01/2020 20:29	03/01/2020 10:11	03/01/2020 20:29	10,29	4	41,15	CHI
20200112162	IVOLANDIA	PU12090442	MONTIVIDIU T	03/01/2020 10:26	03/01/2020 18:14	03/01/2020 10:26	03/01/2020 18:14	7,79	22	171,43	CHI
20200112162	PARAUNA	PU12090442	MONTIVIDIU T	03/01/2020 10:26	03/01/2020 18:14	03/01/2020 10:26	03/01/2020 18:14	7,79	49	381,82	CHI
20200112163	IACIARA	IA21218834	IACIARA S2	03/01/2020 11:02	03/01/2020 16:44	03/01/2020 11:02	03/01/2020 16:44	5,69	1	5,69	CHI
20200112166	PALMEIRAS DE GOIAS	PL12076497	PALMEIRAS	03/01/2020 10:26	03/01/2020 17:23	03/01/2020 13:00	03/01/2020 14:34	1,58	1	1,58	CHI
20200112166	PALMEIRAS DE GOIAS	PL11000011	PALMEIRAS	03/01/2020 10:26	03/01/2020 17:23	03/01/2020 10:26	03/01/2020 15:08	4,70	86	403,87	CHI
20200112166	PALMEIRAS DE GOIAS	PL11000011	PALMEIRAS	03/01/2020 10:26	03/01/2020 17:23	03/01/2020 15:12	03/01/2020 17:23	2,18	86	187,74	CHI
20200112167	POSSE	PS21124642	IACIARA S2	03/01/2020 11:13	03/01/2020 11:47	03/01/2020 11:13	03/01/2020 11:47	0,56	1	0,56	CHI
20200112170	SANTO ANTONIO DO DESCOBERTO	2210163797	AGUAS LINDAS DE GOIAS S2	03/01/2020 11:02	03/01/2020 13:15	03/01/2020 11:02	03/01/2020 13:15	2,20	1	2,20	CHI
20200112172	MINEIROS	MY21274103	PARQUE DAS EMAS	03/01/2020 11:03	03/01/2020 16:00	03/01/2020 11:03	03/01/2020 16:00	4,94	1	4,94	CHI
20200112174	CORUMBAIBA	CI21062839	VILA CORUMBA	03/01/2020 11:03	04/01/2020 09:38	03/01/2020 11:03	04/01/2020 09:38	22,57	1	22,57	CHI
20200112184	AGUAS LINDAS DE GOIAS	10017338253	AGUAS LINDAS DE GOIAS S1	03/01/2020 11:08	03/01/2020 13:56	03/01/2020 11:08	03/01/2020 13:56	2,80	1	2,80	CHI
20200112187	CRISTALINA	KR21089658	CRISTALINA S2	03/01/2020 11:10	03/01/2020 19:39	03/01/2020 11:10	03/01/2020 19:39	8,48	3	25,45	CHI
20200112194	MAMBAI	MB12269732	IACIARA S2	03/01/2020 08:19	03/01/2020 17:10	03/01/2020 08:19	03/01/2020 17:10	8,84	10	88,43	CHI
20200112196	APARECIDA DE GOIANIA	10003258007	INDEPENDENCIA S2	03/01/2020 11:10	03/01/2020 15:43	03/01/2020 11:10	03/01/2020 15:43	4,53	1	4,53	CHI
20200112199	VARJAO	VJ31066138	GUAPO S2	03/01/2020 11:11	03/01/2020 15:04	03/01/2020 11:11	03/01/2020 15:04	3,88	1	3,88	CHI
20200112206	PONTALINA	PK21352961	PONTALINA	03/01/2020 11:12	03/01/2020 15:38	03/01/2020 11:12	03/01/2020 15:38	4,43	1	4,43	CHI
20200112207	GOIANIA	GN12000621	CAMPINAS S2	03/01/2020 11:06	03/01/2020 14:40	03/01/2020 11:06	03/01/2020 14:40	3,57	128	457,17	CHI
20200112208	ITARUMA	IM21239503	CACHOEIRA ALTA	03/01/2020 11:13	03/01/2020 17:37	03/01/2020 11:13	03/01/2020 17:37	6,41	1	6,41	CHI
20200112214	JARAGUA	70101528	JARAGUA	03/01/2020 11:14	03/01/2020 14:29	03/01/2020 11:14	03/01/2020 14:29	3,26	1	3,26	CHI
20200112217	GOIAS	GS21124756	GOIAS	03/01/2020 11:15	03/01/2020 13:43	03/01/2020 11:15	03/01/2020 13:43	2,46	1	2,46	CHI
20200112222	MINACU	IH21052568	MINACU	03/01/2020 11:16	03/01/2020 14:29	03/01/2020 11:16	03/01/2020 14:29	3,22	1	3,22	CHI
20200112226	CAMPINORTE	2040020178	CAMPINORTE	03/01/2020 11:18	03/01/2020 14:30	03/01/2020 11:18	03/01/2020 14:30	3,20	1	3,20	CHI
20200112233	RIO VERDE	630317410	CABRIUVA S1	03/01/2020 11:19	05/01/2020 00:11	03/01/2020 11:19	05/01/2020 00:11	36,86	1	36,86	CHI
20200112241	ITAJA	IJ21351534	CACHOEIRA ALTA	03/01/2020 11:22	03/01/2020 17:17	03/01/2020 11:22	03/01/2020 17:17	5,90	1	5,90	CHI
20200112250	ACREUNA	EU12244193	ACREUNA	03/01/2020 11:25	03/01/2020 23:36	03/01/2020 11:25	03/01/2020 23:36	12,18	2	24,36	CHI
20200112254	GOIATUBA	GT21050345	GOIATUBA S1	03/01/2020 11:27	03/01/2020 18:39	03/01/2020 11:27	03/01/2020 18:39	7,20	1	7,20	CHI
20200112258	BARRO ALTO	10022976912	BARRO ALTO	03/01/2020 11:29	04/01/2020 14:36	03/01/2020 11:29	04/01/2020 14:36	27,13	1	27,13	CHI
20200112261	AGUA FRIA DE GOIAS	TL21388643	SAO JOAO D ALIANCA	03/01/2020 11:30	03/01/2020 19:15	03/01/2020 11:30	03/01/2020 19:15	7,76	1	7,76	CHI
20200112263	GOIANIA	12705561	GOYA S1	03/01/2020 11:30	03/01/2020 15:06	03/01/2020 11:30	03/01/2020 15:06	3,60	1	3,60	CHI
20200112265	PALESTINA DE GOIAS	PY12396170	PALESTINA	04/01/2020 10:39	04/01/2020 22:51	04/01/2020 10:39	04/01/2020 22:51	12,21	10	122,10	CHI
20200112270	MORRINHOS	MR12352539	MORRINHOS	03/01/2020 10:35	03/01/2020 13:34	03/01/2020 10:35	03/01/2020 13:34	2,98	5	14,91	CHI

20200112272	MAMBAI	MB11331672	IACIARA S2	03/01/2020 11:31	03/01/2020 13:48	03/01/2020 11:31	03/01/2020 13:48	2,27	3	6,82	CHI
20200112276	GOIANIA	15736374	ATLANTICO S2	03/01/2020 11:32	03/01/2020 21:56	03/01/2020 11:32	03/01/2020 21:56	10,39	1	10,39	CHI
20200112279	CABECEIRAS	CW21181824	ITIQUEIRA	03/01/2020 11:33	03/01/2020 15:19	03/01/2020 11:33	03/01/2020 15:19	3,75	1	3,75	CHI
20200112282	URUACU	UR21278504	URUACU	03/01/2020 11:34	03/01/2020 15:19	03/01/2020 11:34	03/01/2020 15:19	3,73	1	3,73	CHI
20200112287	RIO VERDE	630408853	RIO VERDE S1	03/01/2020 11:37	03/01/2020 16:50	03/01/2020 11:37	03/01/2020 16:50	5,21	1	5,21	CHI
20200112290	VILA PROPICIO	NP12312760	GOIANESIA S1	03/01/2020 11:39	06/01/2020 17:05	03/01/2020 11:39	06/01/2020 17:05	77,43	1	77,43	CHI
20200112292	TRINDADE	TR11291620	TRINDADE	03/01/2020 09:20	03/01/2020 15:50	03/01/2020 09:20	03/01/2020 15:50	6,49	50	324,57	CHI
20200112297	CHAPADAO DO CEU	DJ12241656	CHAPADAO DO CEU	03/01/2020 11:40	03/01/2020 16:13	03/01/2020 11:40	03/01/2020 16:13	4,54	2	9,08	CHI
20200112301	SAO MIGUEL DO ARAGUAIA	SM12334354	SAO MIGUEL DO ARAGUAIA	03/01/2020 11:41	03/01/2020 21:27	03/01/2020 11:41	03/01/2020 21:27	9,76	1	9,76	CHI
20200112302	NIQUELANDIA	10012068401	NIQUELANDIA SUBTRANSMISSAO	03/01/2020 11:41	03/01/2020 14:11	03/01/2020 11:41	03/01/2020 14:11	2,49	1	2,49	CHI
20200112312	VALPARAISO DE GOIAS	VA11192829	PACAEMBU S1	03/01/2020 11:11	03/01/2020 12:50	03/01/2020 11:11	03/01/2020 12:50	1,64	227	371,96	CHI
20200112315	CRIXAS	CX12392061	SANTA TEREZINHA	03/01/2020 13:14	03/01/2020 17:50	03/01/2020 13:14	03/01/2020 17:50	4,60	8	36,78	CHI
20200112322	JOVIANIA	570007847	GOIATUBA S1	03/01/2020 11:46	03/01/2020 20:24	03/01/2020 11:46	03/01/2020 20:24	8,63	1	8,63	CHI
20200112327	RIO VERDE	RV21260570	MONTIVIDIU T	03/01/2020 11:48	03/01/2020 15:12	03/01/2020 11:48	03/01/2020 15:12	3,40	1	3,40	CHI
20200112328	ORIZONA	OZ21113732	PIRES DO RIO S2	03/01/2020 11:48	03/01/2020 17:30	03/01/2020 11:48	03/01/2020 17:30	5,69	1	5,69	CHI
20200112329	PLANALTINA	10000181151	PLANALTINA	03/01/2020 11:48	03/01/2020 14:22	03/01/2020 11:48	03/01/2020 14:22	2,57	1	2,57	CHI
20200112332	CEZARINA	CZ12323632	CEZARINA	03/01/2020 11:49	03/01/2020 13:16	03/01/2020 11:49	03/01/2020 13:16	1,45	4	5,79	CHI
20200112332	INDIARA	CZ12323632	CEZARINA	03/01/2020 11:49	03/01/2020 13:16	03/01/2020 11:49	03/01/2020 13:16	1,45	3	4,34	CHI
20200112336	CRISTALINA	KR12400836	CRISTALINA S1	03/01/2020 11:49	03/01/2020 17:30	03/01/2020 11:49	03/01/2020 17:30	5,67	4	22,68	CHI
20200112339	JOVIANIA	JV12071645	GOIATUBA S1	03/01/2020 11:50	03/01/2020 21:09	03/01/2020 11:50	03/01/2020 21:09	9,30	1	9,30	CHI
20200112347	CRISTALINA	KR12276494	CRISTALINA S2	03/01/2020 05:40	03/01/2020 14:55	03/01/2020 05:40	03/01/2020 14:55	9,25	5	46,26	CHI
20200112349	MIMOSO DE GOIAS	NQ12371855	BARRO ALTO	03/01/2020 11:49	03/01/2020 16:38	03/01/2020 11:49	03/01/2020 16:38	4,81	4	19,23	CHI
20200112349	NIQUELANDIA	NQ12371855	BARRO ALTO	03/01/2020 11:49	03/01/2020 16:38	03/01/2020 11:49	03/01/2020 16:38	4,81	242	1163,62	CHI
20200112350	ITARUMA	IM11045801	CACHOEIRA ALTA	03/01/2020 11:53	03/01/2020 19:10	03/01/2020 11:53	03/01/2020 19:10	7,28	7	50,94	CHI
20200112352	ARAGOIANIA	10023528492	GUAPO S2	03/01/2020 11:53	03/01/2020 17:33	03/01/2020 11:53	03/01/2020 17:33	5,65	1	5,65	CHI
20200112354	CATALAO	1990068719	CATALAO S2	03/01/2020 11:54	03/01/2020 13:50	03/01/2020 11:54	03/01/2020 13:50	1,93	1	1,93	CHI
20200112363	CALDAS NOVAS	760287259	SERRA DE CALDAS	03/01/2020 11:56	03/01/2020 15:33	03/01/2020 11:56	03/01/2020 15:33	3,62	1	3,62	CHI
20200112365	INDIARA	2710024592	EDEIA	03/01/2020 11:57	03/01/2020 13:12	03/01/2020 11:57	03/01/2020 13:12	1,25	1	1,25	CHI
20200112367	AGUAS LINDAS DE GOIAS	10011520386	AGUAS LINDAS DE GOIAS S1	03/01/2020 11:57	03/01/2020 15:06	03/01/2020 11:57	03/01/2020 15:06	3,14	1	3,14	CHI
20200112369	NOVO PLANALTO	TA12293689	SAO MIGUEL DO ARAGUAIA	03/01/2020 11:52	03/01/2020 14:30	03/01/2020 11:52	03/01/2020 14:30	2,64	10	26,39	CHI
20200112370	SAO JOAO D ALIANCA	JL12383335	SAO JOAO D ALIANCA	03/01/2020 11:59	03/01/2020 14:27	03/01/2020 11:59	03/01/2020 14:27	2,46	12	29,49	CHI
20200112372	COCALZINHO DE GOIAS	ZN12216781	PADRE BERNARDO	03/01/2020 07:38	03/01/2020 15:23	03/01/2020 07:38	03/01/2020 15:23	7,75	10	77,48	CHI
20200112376	MARA ROSA	ET21208326	MARA ROSA	03/01/2020 12:00	03/01/2020 13:58	03/01/2020 12:00	03/01/2020 13:58	1,95	1	1,95	CHI

20200112378	MOSSAMEDES	MD21234250	ITABERAI S2	03/01/2020 12:00	03/01/2020 20:03	03/01/2020 12:00	03/01/2020 20:03	8,04	1	8,04	CHI
20200112381	JANDAIA	JD12199849	ACREUNA	03/01/2020 12:02	03/01/2020 16:26	03/01/2020 12:02	03/01/2020 16:26	4,39	5	21,93	CHI
20200112387	ALEXANIA	AX12000166	ALEXANIA	03/01/2020 11:30	03/01/2020 16:19	03/01/2020 11:30	03/01/2020 16:19	4,82	9	43,34	CHI
20200112388	BALIZA	BH12142110	BOM JARDIM	03/01/2020 11:31	05/01/2020 18:37	03/01/2020 11:31	04/01/2020 00:02	12,52	35	438,35	CHI
20200112388	BALIZA	BH12142110	BOM JARDIM	03/01/2020 11:31	05/01/2020 18:37	04/01/2020 00:04	04/01/2020 00:56	0,88	10	8,77	CHI
20200112388	BALIZA	BH12334536LD	BOM JARDIM	03/01/2020 11:31	05/01/2020 18:37	03/01/2020 11:31	04/01/2020 01:28	13,96	24	335,07	CHI
20200112388	BALIZA	BH12334541	BOM JARDIM	03/01/2020 11:31	05/01/2020 18:37	03/01/2020 11:31	04/01/2020 01:54	14,39	18	259,02	CHI
20200112388	BALIZA	BH12142110	BOM JARDIM	03/01/2020 11:31	05/01/2020 18:37	03/01/2020 11:31	04/01/2020 01:55	14,40	7	100,80	CHI
20200112388	BALIZA	7047440	BOM JARDIM	03/01/2020 11:31	05/01/2020 18:37	04/01/2020 00:04	04/01/2020 13:14	13,17	11	144,83	CHI
20200112388	BALIZA	BH12142110	BOM JARDIM	03/01/2020 11:31	05/01/2020 18:37	04/01/2020 13:15	05/01/2020 08:50	19,59	54	1057,86	CHI
20200112388	BALIZA	BH12142110	BOM JARDIM	03/01/2020 11:31	05/01/2020 18:37	04/01/2020 14:53	05/01/2020 08:50	17,95	1	17,95	CHI
20200112388	BALIZA	BH12142110	BOM JARDIM	03/01/2020 11:31	05/01/2020 18:37	04/01/2020 13:15	05/01/2020 09:30	20,26	4	81,03	CHI
20200112388	BALIZA	BH12142110	BOM JARDIM	03/01/2020 11:31	05/01/2020 18:37	04/01/2020 00:04	05/01/2020 18:37	42,55	14	595,77	CHI
20200112388	BALIZA	BH12142110	BOM JARDIM	03/01/2020 11:31	05/01/2020 18:37	04/01/2020 13:15	05/01/2020 18:37	29,37	11	323,09	CHI
20200112388	BALIZA	BH12142110	BOM JARDIM	03/01/2020 11:31	05/01/2020 18:37	05/01/2020 17:40	05/01/2020 18:37	0,94	59	55,71	CHI
20200112390	SAO MIGUEL DO ARAGUAIA	830059453	SAO MIGUEL DO ARAGUAIA	03/01/2020 12:06	03/01/2020 18:55	03/01/2020 12:06	03/01/2020 18:55	6,83	1	6,83	CHI
20200112397	SAO DOMINGOS	GY21333104	SAO DOMINGOS	03/01/2020 12:08	03/01/2020 16:41	03/01/2020 12:08	03/01/2020 16:41	4,55	2	9,09	CHI
20200112398	APARECIDA DE GOIANIA	10007390538	INDEPENDENCIA S2	03/01/2020 12:08	03/01/2020 15:10	03/01/2020 12:08	03/01/2020 15:10	3,03	1	3,03	CHI
20200112402	COCALZINHO DE GOIAS	ZN21197987	COCALZINHO	03/01/2020 08:15	04/01/2020 17:00	03/01/2020 08:15	04/01/2020 17:00	32,76	1	32,76	CHI
20200112403	FAZENDA NOVA	FN12250532	JUSSARA	03/01/2020 12:15	03/01/2020 23:02	03/01/2020 16:27	03/01/2020 23:01	6,58	9	59,25	CHI
20200112403	FAZENDA NOVA	FN21132371	JUSSARA	03/01/2020 12:15	03/01/2020 23:02	03/01/2020 12:15	03/01/2020 23:02	10,78	1	10,78	CHI
20200112408	AMARALINA	MU12391672	MARA ROSA	03/01/2020 05:51	03/01/2020 16:18	03/01/2020 05:51	03/01/2020 16:18	10,44	100	1044,06	CHI
20200112408	MUTUNOPOLIS	MU12391672	MARA ROSA	03/01/2020 05:51	03/01/2020 16:18	03/01/2020 05:51	03/01/2020 16:18	10,44	7	73,08	CHI
20200112506	MINEIROS	MY11359695	PARQUE DAS EMAS	03/01/2020 11:46	03/01/2020 17:20	03/01/2020 11:46	03/01/2020 17:20	5,57	27	150,28	CHI
20200112511	IACIARA	IA21195840	IACIARA S2	03/01/2020 12:14	03/01/2020 18:20	03/01/2020 12:14	03/01/2020 18:20	6,10	1	6,10	CHI
20200112512	JATAI	290292621	JATAI S2	03/01/2020 12:14	03/01/2020 16:09	03/01/2020 12:14	03/01/2020 16:09	3,91	1	3,91	CHI
20200112517	FORMOSA	FA21051052	ITQUIRA	03/01/2020 12:16	03/01/2020 19:40	03/01/2020 12:16	03/01/2020 19:40	7,40	1	7,40	CHI
20200112518	ORIZONA	OZ21300769	PIRES DO RIO S2	03/01/2020 12:16	03/01/2020 15:10	03/01/2020 12:16	03/01/2020 15:10	2,90	1	2,90	CHI
20200112524	ALEXANIA	AX21185102	CORUMBA	03/01/2020 12:18	03/01/2020 21:34	03/01/2020 12:18	03/01/2020 21:34	9,27	1	9,27	CHI
20200112530	GOIAS	GS21014703	MATRINCHA	03/01/2020 12:18	03/01/2020 15:27	03/01/2020 12:18	03/01/2020 15:27	3,14	2	6,28	CHI
20200112532	APARECIDA DE GOIANIA	200118341	INDEPENDENCIA S2	03/01/2020 12:19	03/01/2020 17:35	03/01/2020 12:19	03/01/2020 17:35	5,26	1	5,26	CHI
20200112534	RIO VERDE	RV21384366	MONTIVIDIU T	03/01/2020 12:19	03/01/2020 16:36	03/01/2020 12:19	03/01/2020 16:36	4,27	1	4,27	CHI
20200112543	PIRENOPOLIS	1640000220	SAO FRANCISCO DE GOIAS	03/01/2020 12:23	03/01/2020 21:53	03/01/2020 12:23	03/01/2020 21:53	9,50	1	9,50	CHI

20200112544	DISTRITO FEDERAL	SN12237830	MARAJOARA	03/01/2020 10:39	03/01/2020 16:31	03/01/2020 10:39	03/01/2020 16:31	5,85	3	17,56	CHI
20200112544	SANTO ANTONIO DO DESCOBERTO	SN12237830	MARAJOARA	03/01/2020 10:39	03/01/2020 16:31	03/01/2020 10:39	03/01/2020 16:31	5,85	24	140,44	CHI
20200112550	ABADIANIA	AA21388614	ANAPOLIS UNIVERSITARIO S2	03/01/2020 12:25	03/01/2020 16:38	03/01/2020 12:25	03/01/2020 16:38	4,20	2	8,41	CHI
20200112553	GOIANIA	10795121	CARAJAS S1	03/01/2020 12:25	03/01/2020 15:12	03/01/2020 12:25	03/01/2020 15:12	2,77	1	2,77	CHI
20200112554	BURITI ALEGRE	BG12048409	ITUMBIARA VELHA S2	02/01/2020 13:47	03/01/2020 15:17	02/01/2020 13:47	03/01/2020 15:17	25,49	4	101,96	CHI
20200112560	SILVANIA	SV21161973	VIANOPOLIS	03/01/2020 12:27	03/01/2020 17:43	03/01/2020 12:27	03/01/2020 17:43	5,26	2	10,51	CHI
20200112561	CUMARI	CY21149246	CATALAO S1	03/01/2020 12:27	03/01/2020 19:46	03/01/2020 12:27	03/01/2020 19:46	7,31	1	7,31	CHI
20200112562	VALPARAISO DE GOIAS	10011711343	PACAEMBU S1	03/01/2020 12:27	03/01/2020 15:55	03/01/2020 12:27	03/01/2020 15:55	3,45	1	3,45	CHI
20200112563	AMARALINA	MQ12197505	NOVA CRIXAS	03/01/2020 12:28	03/01/2020 23:17	03/01/2020 12:28	03/01/2020 23:17	10,82	6	64,90	CHI
20200112563	UIRAPURU	MQ12197505	NOVA CRIXAS	03/01/2020 12:28	03/01/2020 23:17	03/01/2020 12:28	03/01/2020 23:17	10,82	3	32,45	CHI
20200112564	GOIANIA	GN11001165	CAMPINAS S2	03/01/2020 11:21	03/01/2020 13:51	03/01/2020 11:21	03/01/2020 13:51	2,50	58	144,82	CHI
20200112568	GOIANIA	TR21001619	TRINDADE	03/01/2020 12:30	03/01/2020 18:13	03/01/2020 12:30	03/01/2020 18:13	5,72	1	5,72	CHI
20200112573	SERRANOPOLIS	3000013580	JATAI S1	03/01/2020 12:30	03/01/2020 16:25	03/01/2020 12:30	03/01/2020 16:25	3,91	1	3,91	CHI
20200112583	TURVELANDIA	TD21205421	RIO DOS BOIS	03/01/2020 12:33	04/01/2020 11:12	03/01/2020 12:33	04/01/2020 11:12	22,65	1	22,65	CHI
20200112586	FLORES DE GOIAS	FB21334129	FLORES DE GOIAS	03/01/2020 12:33	03/01/2020 14:22	03/01/2020 12:33	03/01/2020 14:22	1,80	1	1,80	CHI
20200112600	MINEIROS	MY21193785	PARQUE DAS EMAS	03/01/2020 12:37	04/01/2020 09:26	03/01/2020 12:37	04/01/2020 09:26	20,81	1	20,81	CHI
20200112616	EDEIA	TD12246729	ACREUNA	03/01/2020 12:41	04/01/2020 11:02	03/01/2020 12:41	04/01/2020 11:02	22,35	2	44,70	CHI
20200112616	TURVELANDIA	TD12246729	ACREUNA	03/01/2020 12:41	04/01/2020 11:02	03/01/2020 12:41	04/01/2020 11:02	22,35	7	156,44	CHI
20200112617	GOIANIA	10025401414	GOYA S2	03/01/2020 12:41	03/01/2020 17:58	03/01/2020 12:41	03/01/2020 17:58	5,27	1	5,27	CHI
20200112620	SANTA CRUZ DE GOIAS	BC12023183	CRISTIANOPOLIS	03/01/2020 12:35	03/01/2020 14:52	03/01/2020 12:35	03/01/2020 14:52	2,28	44	100,20	CHI
20200112627	CAMPO LIMPO	AN21258735	NEROPOLIS S1	03/01/2020 12:43	03/01/2020 15:22	03/01/2020 12:43	03/01/2020 15:22	2,64	1	2,64	CHI
20200112628	NEROPOLIS	NR12322425	NEROPOLIS S2	03/01/2020 12:44	03/01/2020 14:05	03/01/2020 12:44	03/01/2020 14:05	1,34	34	45,63	CHI
20200112628	SANTO ANTONIO DE GOIAS	NR12322425	NEROPOLIS S2	03/01/2020 12:44	03/01/2020 14:05	03/01/2020 12:44	03/01/2020 14:05	1,34	4	5,37	CHI
20200112630	MUNDO NOVO DE GOIAS	MH21168226	NOVA CRIXAS	03/01/2020 12:44	03/01/2020 14:50	03/01/2020 12:44	03/01/2020 14:50	2,09	1	2,09	CHI
20200112634	GOIANIA	17253986	CAMPINAS S2	03/01/2020 12:45	03/01/2020 15:31	03/01/2020 12:45	03/01/2020 15:31	2,77	1	2,77	CHI
20200112635	MONTIVIDIU DO NORTE	PO12370546	PORANGATU	03/01/2020 07:11	03/01/2020 20:43	03/01/2020 07:11	03/01/2020 20:43	13,52	5	67,62	CHI
20200112638	ANICUNS	AC12073802	ANICUNS	03/01/2020 12:46	03/01/2020 16:00	03/01/2020 12:46	03/01/2020 16:00	3,22	3	9,66	CHI
20200112641	CAIAPONIA	CP12235316	PIRANHAS	03/01/2020 12:47	03/01/2020 18:09	03/01/2020 12:47	03/01/2020 18:09	5,38	5	26,90	CHI
20200112645	PALMEIRAS DE GOIAS	590022775	PALMEIRAS	03/01/2020 12:48	03/01/2020 14:47	03/01/2020 12:48	03/01/2020 14:47	1,98	1	1,98	CHI
20200112649	SILVANIA	SV12310174	DAIA S2	03/01/2020 12:29	03/01/2020 14:54	03/01/2020 12:29	03/01/2020 14:54	2,42	14	33,81	CHI
20200112656	FLORES DE GOIAS	FB11314577	FLORES DE GOIAS	03/01/2020 12:50	04/01/2020 22:28	03/01/2020 12:50	04/01/2020 22:28	33,65	1	33,65	CHI
20200112656	FLORES DE GOIAS	FB12314591	FLORES DE GOIAS	03/01/2020 12:50	04/01/2020 22:28	03/01/2020 16:42	04/01/2020 22:28	29,78	11	327,60	CHI
20200112665	INHUMAS	IN21326241	INHUMAS S2	03/01/2020 12:52	03/01/2020 16:28	03/01/2020 12:52	03/01/2020 16:28	3,60	2	7,19	CHI

20200112670	INDIARA	IY12391437	EDEIA	03/01/2020 12:44	03/01/2020 14:34	03/01/2020 12:44	03/01/2020 14:34	1,84	3	5,51	CHI
20200112671	PORANGATU	PO12192280	PORANGATU	03/01/2020 12:54	03/01/2020 15:25	03/01/2020 12:54	03/01/2020 15:25	2,51	5	12,54	CHI
20200112673	GOIANIA	15324126	XAVANTES	03/01/2020 12:55	03/01/2020 16:15	03/01/2020 12:55	03/01/2020 16:15	3,33	1	3,33	CHI
20200112678	SAO LUIS DE MONTES BELOS	SL12003948	SAO LUIZ DOS MONTES BELOS	03/01/2020 12:57	03/01/2020 14:11	03/01/2020 12:57	03/01/2020 14:11	1,23	592	728,82	CHI
20200112684	BELA VISTA DE GOIAS	BV21280918	BELA VISTA S2	03/01/2020 12:57	03/01/2020 14:04	03/01/2020 12:57	03/01/2020 14:04	1,11	1	1,11	CHI
20200112687	MINEIROS	1390059562	PARQUE DAS EMAS	03/01/2020 12:58	04/01/2020 08:36	03/01/2020 12:58	04/01/2020 08:36	19,63	1	19,63	CHI
20200112692	BOM JARDIM DE GOIAS	BM11209245	BOM JARDIM	03/01/2020 13:44	03/01/2020 23:44	03/01/2020 13:44	03/01/2020 23:44	9,99	1	9,99	CHI
20200112694	PADRE BERNARDO	PB12375241	PADRE BERNARDO	03/01/2020 10:49	03/01/2020 17:17	03/01/2020 10:49	03/01/2020 17:17	6,45	25	161,36	CHI
20200112697	ITABERAI	IB21299536	ITABERAI S1	03/01/2020 13:01	03/01/2020 16:20	03/01/2020 13:01	03/01/2020 16:20	3,31	1	3,31	CHI
20200112698	GOIANIA	12575010	CAMPINAS S2	03/01/2020 13:01	03/01/2020 16:02	03/01/2020 13:01	03/01/2020 16:02	3,01	1	3,01	CHI
20200112700	AGUA FRIA DE GOIAS	JL12262352	SAO JOAO D ALIANCA	03/01/2020 13:01	03/01/2020 15:41	03/01/2020 13:01	03/01/2020 15:41	2,66	6	15,94	CHI
20200112700	SAO JOAO D ALIANCA	JL12262352	SAO JOAO D ALIANCA	03/01/2020 13:01	03/01/2020 15:41	03/01/2020 13:01	03/01/2020 15:41	2,66	108	286,95	CHI
20200112718	MINEIROS	10028287221	PARQUE DAS EMAS	03/01/2020 14:07	03/01/2020 15:32	03/01/2020 14:07	03/01/2020 15:32	1,41	1	1,41	CHI
20200112806	CATALAO	1990009521	CATALAO S2	03/01/2020 13:03	03/01/2020 19:03	03/01/2020 13:03	03/01/2020 19:03	5,99	1	5,99	CHI
20200112808	TRINDADE	TR11158283	GOYA S2	03/01/2020 12:52	03/01/2020 16:42	03/01/2020 12:52	03/01/2020 16:42	3,83	177	677,37	CHI
20200112811	HIDROLANDIA	180026999	CEPAIGO S2	03/01/2020 13:04	03/01/2020 16:51	03/01/2020 13:04	03/01/2020 16:51	3,77	1	3,77	CHI
20200112822	GOIANIA	10544744	ATLANTICO S3	03/01/2020 13:08	03/01/2020 15:26	03/01/2020 13:08	03/01/2020 15:26	2,30	1	2,30	CHI
20200112823	EDEIA	1120043387	EDEIA	03/01/2020 13:06	03/01/2020 20:18	03/01/2020 13:06	03/01/2020 20:18	7,20	1	7,20	CHI
20200112824	CRISTALINA	KR12352836	CRISTALINA S1	03/01/2020 12:49	03/01/2020 16:33	03/01/2020 12:49	03/01/2020 16:33	3,72	64	237,94	CHI
20200112826	GOIATUBA	GT12050351	GOIATUBA S1	03/01/2020 13:08	03/01/2020 17:32	03/01/2020 13:08	03/01/2020 17:32	4,39	3	13,16	CHI
20200112826	VICENTINOPOLIS	GT12050351	GOIATUBA S1	03/01/2020 13:08	03/01/2020 17:32	03/01/2020 13:08	03/01/2020 17:32	4,39	3	13,16	CHI
20200112829	CAMPO LIMPO	AN21017611	NEROPOLIS S1	03/01/2020 13:09	03/01/2020 16:35	03/01/2020 13:09	03/01/2020 16:35	3,43	1	3,43	CHI
20200112831	CATALAO	CT12077605	CATALAO S1	03/01/2020 12:36	03/01/2020 19:59	03/01/2020 12:36	03/01/2020 19:59	7,37	9	66,37	CHI
20200112833	URUACU	UR21201742	URUACU	03/01/2020 13:09	03/01/2020 17:02	03/01/2020 13:09	03/01/2020 17:02	3,87	1	3,87	CHI
20200112841	LUZIANIA	120243222	RIO VERMELHO	03/01/2020 13:11	03/01/2020 14:43	03/01/2020 13:11	03/01/2020 14:43	1,52	1	1,52	CHI
20200112844	FORMOSA	610083594	ITIQUEIRA	03/01/2020 13:13	03/01/2020 18:42	03/01/2020 13:13	03/01/2020 18:42	5,50	1	5,50	CHI
20200112846	NIQUELANDIA	NQ12398048	URUACU	03/01/2020 13:13	04/01/2020 02:20	03/01/2020 13:13	04/01/2020 02:20	13,13	102	1339,29	CHI
20200112853	CRISTALINA	1060051609	CRISTALINA S1	03/01/2020 13:15	03/01/2020 14:23	03/01/2020 13:15	03/01/2020 14:23	1,13	1	1,13	CHI
20200112855	PORTELANDIA	PW12303462	PARQUE DAS EMAS	03/01/2020 13:15	04/01/2020 12:44	03/01/2020 13:15	03/01/2020 21:54	8,65	3	25,94	CHI
20200112855	PORTELANDIA	PW12303462	PARQUE DAS EMAS	03/01/2020 13:15	04/01/2020 12:44	03/01/2020 13:15	04/01/2020 00:14	10,98	4	43,92	CHI
20200112855	PORTELANDIA	PW12303462	PARQUE DAS EMAS	03/01/2020 13:15	04/01/2020 12:44	03/01/2020 13:15	04/01/2020 11:59	22,73	1	22,73	CHI
20200112855	PORTELANDIA	PW12303462	PARQUE DAS EMAS	03/01/2020 13:15	04/01/2020 12:44	03/01/2020 13:15	04/01/2020 12:10	22,91	1	22,91	CHI
20200112855	PORTELANDIA	PW12303462	PARQUE DAS EMAS	03/01/2020 13:15	04/01/2020 12:44	03/01/2020 13:15	04/01/2020 12:44	23,48	1	23,48	CHI

20200112872	EDEIA	1120027278	EDEIA	03/01/2020 13:20	03/01/2020 19:40	03/01/2020 13:20	03/01/2020 19:40	6,33	1	6,33	CHI
20200112879	COCALZINHO DE GOIAS	ZN12394290	COCALZINHO	03/01/2020 13:22	04/01/2020 11:40	03/01/2020 13:22	04/01/2020 11:40	22,30	4	89,20	CHI
20200112886	SANTA HELENA DE GOIAS	10002847149	IPEGUARI	03/01/2020 13:23	04/01/2020 09:05	03/01/2020 13:23	04/01/2020 09:05	19,69	1	19,69	CHI
20200112897	POSSE	PS21237075	IACIARA S2	03/01/2020 13:25	03/01/2020 16:19	03/01/2020 13:25	03/01/2020 16:19	2,89	1	2,89	CHI
20200112898	PIRES DO RIO	PR12337189RE	PIRES DO RIO S1	03/01/2020 13:14	03/01/2020 17:18	03/01/2020 13:14	03/01/2020 17:18	4,06	36	146,15	CHI
20200112898	SANTA CRUZ DE GOIAS	PR12337189RE	PIRES DO RIO S1	03/01/2020 13:14	03/01/2020 17:18	03/01/2020 13:14	03/01/2020 17:18	4,06	1	4,06	CHI
20200112898	URUTAI	PR12337189RE	PIRES DO RIO S1	03/01/2020 13:14	03/01/2020 17:18	03/01/2020 13:14	03/01/2020 17:18	4,06	1	4,06	CHI
20200112900	GOIANIA	13427374	CAMPINAS S3	02/01/2020 13:38	02/01/2020 16:03	02/01/2020 13:38	02/01/2020 16:03	2,41	1	2,41	CHI
20200112901	PADRE BERNARDO	PB12330439	PADRE BERNARDO	03/01/2020 12:46	04/01/2020 15:33	03/01/2020 12:46	04/01/2020 15:33	26,78	27	723,15	CHI
20200112901	PADRE BERNARDO	PB12330439	PADRE BERNARDO	03/01/2020 12:46	04/01/2020 15:33	04/01/2020 12:09	04/01/2020 15:33	3,40	8	27,23	CHI
20200112902	PILAR DE GOIAS	GG21282451	ITAPACI	03/01/2020 13:26	03/01/2020 15:56	03/01/2020 13:26	03/01/2020 15:56	2,49	1	2,49	CHI
20200112912	CATALAO	CT21143497	CATALAO S1	03/01/2020 13:29	04/01/2020 07:08	03/01/2020 13:29	04/01/2020 07:08	17,65	1	17,65	CHI
20200112919	GOIAS	GS11259637	MATRINCHA	03/01/2020 13:30	03/01/2020 21:42	03/01/2020 13:30	03/01/2020 21:42	8,20	84	688,99	CHI
20200112922	CAMPOS VERDES	VD21065503	SANTA TEREZINHA	03/01/2020 13:30	03/01/2020 22:10	03/01/2020 13:30	03/01/2020 22:10	8,66	1	8,66	CHI
20200112925	PONTALINA	210053239	PONTALINA	03/01/2020 13:31	04/01/2020 19:31	03/01/2020 13:31	04/01/2020 19:31	30,00	1	30,00	CHI
20200112927	FORMOSA	FA12000130	ITIQUEIRA	03/01/2020 13:31	03/01/2020 14:44	03/01/2020 13:31	03/01/2020 14:44	1,21	14	16,89	CHI
20200112936	MINACU	IH12063612	MINACU	03/01/2020 12:24	03/01/2020 15:42	03/01/2020 12:24	03/01/2020 14:49	2,41	408	983,85	CHI
20200112936	MINACU	IH11063603	MINACU	03/01/2020 12:24	03/01/2020 15:42	03/01/2020 14:57	03/01/2020 15:42	0,76	139	105,33	CHI
20200112940	BALIZA	BH12227581	BOM JARDIM	03/01/2020 13:34	03/01/2020 21:07	03/01/2020 13:34	03/01/2020 21:07	7,54	2	15,09	CHI
20200112942	INHUMAS	10005587091	INHUMAS S2	03/01/2020 13:34	03/01/2020 19:10	03/01/2020 13:34	03/01/2020 19:10	5,60	1	5,60	CHI
20200112951	CORUMBAIBA	CI12392071	VILA CORUMBA	03/01/2020 07:37	04/01/2020 12:12	03/01/2020 07:37	04/01/2020 12:12	28,58	7	200,06	CHI
20200112963	MONTES CLAROS DE GOIAS	ME12038971	IPORA	03/01/2020 11:02	03/01/2020 19:43	03/01/2020 11:02	03/01/2020 19:43	8,67	21	182,12	CHI
20200112967	URUACU	UR12353573	URUACU	03/01/2020 13:38	03/01/2020 16:35	03/01/2020 13:38	03/01/2020 16:35	2,95	10	29,46	CHI
20200112970	TRINDADE	TR21322400	TRINDADE	03/01/2020 13:38	03/01/2020 17:34	03/01/2020 13:38	03/01/2020 17:34	3,92	1	3,92	CHI
20200112972	TRINDADE	TR21108976	GOIANIRA	03/01/2020 13:39	03/01/2020 21:12	03/01/2020 13:39	03/01/2020 21:12	7,55	1	7,55	CHI
20200112974	JATAI	JT11182019	JATAI S2	03/01/2020 13:39	03/01/2020 15:01	03/01/2020 13:39	03/01/2020 15:01	1,36	117	159,45	CHI
20200112979	NOVO GAMA	2460035531	PACAEMBU S1	03/01/2020 13:40	03/01/2020 18:09	03/01/2020 13:40	03/01/2020 18:09	4,48	1	4,48	CHI
20200112982	SANTA RITA DO ARAGUAIA	SU11050002	SANTA RITA DO ARAGUAIA	03/01/2020 12:53	03/01/2020 14:42	03/01/2020 12:53	03/01/2020 14:42	1,81	118	214,14	CHI
20200112993	ALEXANIA	10013404421	ALEXANIA	03/01/2020 13:42	03/01/2020 14:53	03/01/2020 13:42	03/01/2020 14:53	1,18	1	1,18	CHI
20200112994	AGUAS LINDAS DE GOIAS	4830192782	AGUAS LINDAS DE GOIAS S1	03/01/2020 13:42	03/01/2020 15:57	03/01/2020 13:42	03/01/2020 15:57	2,24	1	2,24	CHI
20200113005	CRISTALINA	KR21230268	CRISTALINA S2	03/01/2020 13:44	03/01/2020 18:16	03/01/2020 13:44	03/01/2020 18:16	4,53	1	4,53	CHI
20200113007	TRINDADE	TR21016548	GOIANIRA	03/01/2020 13:44	03/01/2020 18:52	03/01/2020 13:44	03/01/2020 18:52	5,13	1	5,13	CHI
20200113008	PIRES DO RIO	PR21195156	PIRES DO RIO S1	03/01/2020 13:44	03/01/2020 16:00	03/01/2020 13:44	03/01/2020 16:00	2,27	1	2,27	CHI

20200113029	NIQUELANDIA	NQ21274781	BARRO ALTO	03/01/2020 13:49	03/01/2020 16:11	03/01/2020 13:49	03/01/2020 16:11	2,37	1	2,37	CHI
20200113035	UIRAPURU	UP12262981	NOVA CRIXAS	03/01/2020 13:50	04/01/2020 12:17	03/01/2020 13:50	04/01/2020 12:17	22,44	2	44,89	CHI
20200113039	PORANGATU	PO21288221	MARA ROSA	03/01/2020 13:51	03/01/2020 18:40	03/01/2020 13:51	03/01/2020 18:40	4,81	1	4,81	CHI
20200113040	BELA VISTA DE GOIAS	10025954499	BELA VISTA S2	03/01/2020 13:51	04/01/2020 11:16	03/01/2020 13:51	04/01/2020 11:16	21,40	1	21,40	CHI
20200113042	APARECIDA DE GOIANIA	AP12087565	INDEPENDENCIA S1	03/01/2020 13:52	03/01/2020 14:50	03/01/2020 13:52	03/01/2020 14:50	0,96	618	591,56	CHI
20200113046	GOIANIA	13768323	FERROVIARIO S1	03/01/2020 13:53	03/01/2020 15:54	03/01/2020 13:53	03/01/2020 15:54	2,01	1	2,01	CHI
20200113047	GOIATUBA	GT21247818	BOM JESUS DE GOIAS	03/01/2020 13:53	04/01/2020 11:15	03/01/2020 13:53	04/01/2020 11:15	21,36	1	21,36	CHI
20200113048	AGUAS LINDAS DE GOIAS	10004219900	AGUAS LINDAS DE GOIAS S2	03/01/2020 13:53	03/01/2020 16:54	03/01/2020 13:53	03/01/2020 16:54	3,00	1	3,00	CHI
20200113057	VARJAO	VJ21255574	GUAPO S2	03/01/2020 13:55	03/01/2020 16:52	03/01/2020 13:55	03/01/2020 16:52	2,94	1	2,94	CHI
20200113059	MINEIROS	MY21287500	PARQUE DAS EMAS	03/01/2020 13:56	03/01/2020 14:26	03/01/2020 13:56	03/01/2020 14:26	0,50	1	0,50	CHI
20200113067	BOM JARDIM DE GOIAS	BM12297154	BOM JARDIM	03/01/2020 13:58	03/01/2020 17:01	03/01/2020 13:58	03/01/2020 17:01	3,05	2	6,09	CHI
20200113070	LUZIANIA	LZ11261250	RIO VERMELHO	03/01/2020 13:58	03/01/2020 17:27	03/01/2020 13:58	03/01/2020 17:27	3,48	96	333,84	CHI
20200113075	IPAMERI	IP12272806	IPAMERI	03/01/2020 14:00	03/01/2020 18:47	03/01/2020 14:00	03/01/2020 18:47	4,77	1	4,77	CHI
20200113077	CAVALCANTE	TI12162624	NIQUELANDIA SUBTRANSMISSAO	03/01/2020 14:01	03/01/2020 17:16	03/01/2020 14:01	03/01/2020 17:16	3,24	1	3,24	CHI
20200113077	COLINAS DO SUL	TI12162624	NIQUELANDIA SUBTRANSMISSAO	03/01/2020 14:01	03/01/2020 17:16	03/01/2020 14:01	03/01/2020 17:16	3,24	6	19,47	CHI
20200113078	PALMEIRAS DE GOIAS	10012117038	PALMEIRAS	03/01/2020 14:01	03/01/2020 20:35	03/01/2020 14:01	03/01/2020 20:35	6,56	1	6,56	CHI
20200113084	IPORA	IR21361942	IPORA	03/01/2020 14:03	03/01/2020 20:06	03/01/2020 14:03	03/01/2020 20:06	6,04	1	6,04	CHI
20200113086	TRINDADE	TR12242149	TRINDADE	03/01/2020 12:23	03/01/2020 17:37	03/01/2020 12:23	03/01/2020 16:20	3,95	149	588,47	CHI
20200113086	TRINDADE	TR11241344	TRINDADE	03/01/2020 12:23	03/01/2020 17:37	03/01/2020 12:23	03/01/2020 17:37	5,23	144	753,52	CHI
20200113089	SAO LUIZ DO NORTE	3090000979	ITAPACI	02/01/2020 14:28	03/01/2020 01:13	02/01/2020 14:28	03/01/2020 01:13	10,75	1	10,75	CHI
20200113092	ITAPACI	IW12251271	ITAPACI	03/01/2020 13:49	03/01/2020 20:27	03/01/2020 13:49	03/01/2020 20:27	6,62	3	19,87	CHI
20200113094	GOIANIA	GN16407219	REAL S2	03/01/2020 14:02	03/01/2020 14:54	03/01/2020 14:02	03/01/2020 14:54	0,86	997	857,97	CHI
20200113094	GOIANIA	GN16404302	REAL S2	03/01/2020 14:02	03/01/2020 14:54	03/01/2020 14:02	03/01/2020 14:54	0,87	897	778,15	CHI
20200113096	GOIANIA	16708246	GOIANIA LESTE S1	03/01/2020 14:05	03/01/2020 16:52	03/01/2020 14:05	03/01/2020 16:52	2,77	1	2,77	CHI
20200113101	CORUMBAIBA	CI12039772	VILA CORUMBA	03/01/2020 14:07	04/01/2020 12:24	03/01/2020 14:07	04/01/2020 12:24	22,28	7	155,96	CHI
20200113103	IACIARA	IA12218688	IACIARA S2	03/01/2020 14:07	03/01/2020 18:49	03/01/2020 14:07	03/01/2020 18:49	4,69	3	14,06	CHI
20200113104	NOVO GAMA	2900084605	MARAJOARA	03/01/2020 14:08	03/01/2020 19:20	03/01/2020 14:08	03/01/2020 19:20	5,20	1	5,20	CHI
20200113110	CATALAO	CT12333570	CATALAO S1	03/01/2020 13:16	03/01/2020 16:54	03/01/2020 13:16	03/01/2020 16:54	3,63	113	409,94	CHI
20200113114	NOVA CRIXAS	NA21078557	NOVA CRIXAS	03/01/2020 14:10	03/01/2020 22:38	03/01/2020 14:10	03/01/2020 22:38	8,46	1	8,46	CHI
20200113124	PLANALTINA	2960037607	PLANALTINA	03/01/2020 14:13	03/01/2020 16:35	03/01/2020 14:13	03/01/2020 16:35	2,37	1	2,37	CHI
20200113126	GOIANESIA	SZ12366599	GOIANESIA S1	03/01/2020 14:09	04/01/2020 01:21	03/01/2020 14:09	04/01/2020 01:21	11,20	10	111,96	CHI
20200113130	SILVANIA	SV21160589	VIANOPOLIS	03/01/2020 14:14	03/01/2020 21:10	03/01/2020 14:14	03/01/2020 21:10	6,92	1	6,92	CHI
20200113132	AGUAS LINDAS DE GOIAS	4830428868	AGUAS LINDAS DE GOIAS S2	03/01/2020 14:14	03/01/2020 17:21	03/01/2020 14:14	03/01/2020 17:21	3,10	1	3,10	CHI

20200113136	ITAPURANGA	IK21298864	ITAPURANGA	03/01/2020 14:15	03/01/2020 16:55	03/01/2020 14:15	03/01/2020 16:55	2,66	2	5,32	CHI
20200113141	ANAPOLIS	AN11004087	ANAPOLIS UNIVERSITARIO S2	03/01/2020 14:07	03/01/2020 15:50	03/01/2020 14:07	03/01/2020 15:50	1,70	130	221,61	CHI
20200113144	CALDAS NOVAS	CN12217031	SERRA DE CALDAS	03/01/2020 14:06	03/01/2020 17:50	03/01/2020 14:06	03/01/2020 17:50	3,73	20	74,63	CHI
20200113146	RIO VERDE	10030564253	RIO VERDE S1	03/01/2020 14:16	03/01/2020 16:50	03/01/2020 14:16	03/01/2020 16:50	2,56	1	2,56	CHI
20200113150	CAMPO LIMPO	AN12011924	NEROPOLIS S1	03/01/2020 14:17	03/01/2020 16:35	03/01/2020 14:17	03/01/2020 16:35	2,28	46	105,08	CHI
20200113154	LUZIANIA	120027306	RIO VERMELHO	03/01/2020 14:18	03/01/2020 19:18	03/01/2020 14:18	03/01/2020 19:18	4,99	1	4,99	CHI
20200113157	RIO VERDE	RV12051746	MONTIVIDIU T	03/01/2020 13:54	03/01/2020 20:20	03/01/2020 13:54	03/01/2020 20:20	6,42	76	488,11	CHI
20200113160	JUSSARA	1290030410	JUSSARA	03/01/2020 14:20	03/01/2020 16:33	03/01/2020 14:20	03/01/2020 16:33	2,21	1	2,21	CHI
20200113169	PORANGATU	PO12027986	PORANGATU	03/01/2020 09:36	03/01/2020 18:56	03/01/2020 09:36	03/01/2020 18:56	9,33	3	27,99	CHI
20200113173	JARAGUA	JA11054446	JARAGUA	03/01/2020 13:01	03/01/2020 15:20	03/01/2020 13:01	03/01/2020 15:20	2,31	15	34,64	CHI
20200113176	VALPARAISO DE GOIAS	VA11350328	PACAEMBU S1	03/01/2020 14:25	03/01/2020 16:13	03/01/2020 14:25	03/01/2020 16:13	1,81	29	52,36	CHI
20200113178	APARECIDA DE GOIANIA	10006109347	INDEPENDENCIA S2	03/01/2020 14:25	03/01/2020 19:48	03/01/2020 14:25	03/01/2020 19:48	5,37	1	5,37	CHI
20200113183	PIRANHAS	1930042647	PIRANHAS	03/01/2020 14:25	03/01/2020 18:17	03/01/2020 14:25	03/01/2020 18:17	3,86	1	3,86	CHI
20200113187	RIO VERDE	RV21028153	SANTA HELENA S1	03/01/2020 14:27	04/01/2020 16:58	03/01/2020 14:27	04/01/2020 16:58	26,52	1	26,52	CHI
20200113188	CRISTALINA	KR12183725	CRISTALINA S2	03/01/2020 14:27	03/01/2020 17:57	03/01/2020 14:27	03/01/2020 17:57	3,49	1	3,49	CHI
20200113190	BRITANIA	BT12274251	BRITANIA	03/01/2020 14:27	04/01/2020 20:08	03/01/2020 14:27	04/01/2020 20:08	29,67	10	296,69	CHI
20200113191	CAMPO ALEGRE DE GOIAS	CM12192738RE	CAMPO ALEGRE DE GOIAS	03/01/2020 14:00	03/01/2020 19:02	03/01/2020 14:00	03/01/2020 19:02	5,02	48	240,96	CHI
20200113193	HIDROLANDIA	HD21293308	PONTALINA	03/01/2020 14:29	03/01/2020 19:08	03/01/2020 14:29	03/01/2020 19:08	4,64	2	9,29	CHI
20200113200	CRISTALINA	KR21320121	CRISTALINA S2	03/01/2020 14:30	03/01/2020 17:50	03/01/2020 14:30	03/01/2020 17:50	3,33	2	6,65	CHI
20200113306	VARJAO	680039387	GUAPO S2	03/01/2020 14:31	03/01/2020 22:48	03/01/2020 14:31	03/01/2020 22:48	8,28	1	8,28	CHI
20200113314	APARECIDA DE GOIANIA	200240973	CEPAIGO S1	03/01/2020 14:32	03/01/2020 17:19	03/01/2020 14:32	03/01/2020 17:19	2,77	1	2,77	CHI
20200113317	MOZARLANDIA	MZ12051179	MOZARLANDIA	03/01/2020 12:49	03/01/2020 16:53	03/01/2020 12:49	03/01/2020 16:53	4,06	14	56,78	CHI
20200113319	GUARANI DE GOIAS	GY12215935	IACIARA S1	03/01/2020 13:16	03/01/2020 16:53	03/01/2020 13:16	03/01/2020 16:53	3,62	8	28,95	CHI
20200113324	SILVANIA	SV21381624	VIANOPOLIS	03/01/2020 14:35	03/01/2020 17:08	03/01/2020 14:35	03/01/2020 17:08	2,53	1	2,53	CHI
20200113325	CORUMBAIBA	CI21107557	VILA CORUMBA	03/01/2020 14:36	05/01/2020 12:01	03/01/2020 14:36	05/01/2020 12:01	45,41	1	45,41	CHI
20200113327	CORUMBA DE GOIAS	CB21111205	CORUMBA	03/01/2020 14:36	03/01/2020 18:10	03/01/2020 14:36	03/01/2020 18:10	3,55	1	3,55	CHI
20200113330	TAQUARAL DE GOIAS	TQ12074928	ITABERAI S1	03/01/2020 14:35	03/01/2020 17:05	03/01/2020 14:35	03/01/2020 17:05	2,49	24	59,73	CHI
20200113333	AGUA FRIA DE GOIAS	TL12204618	SAO JOAO D ALIANCA	03/01/2020 14:38	03/01/2020 18:51	03/01/2020 14:38	03/01/2020 18:51	4,21	6	25,24	CHI
20200113336	JATAI	JT21274171	JATAI S1	03/01/2020 14:39	03/01/2020 17:29	03/01/2020 14:39	03/01/2020 17:29	2,83	1	2,83	CHI
20200113341	IPORA	IR21089257	ARENOPOLIS	03/01/2020 14:40	03/01/2020 17:11	03/01/2020 14:40	03/01/2020 17:11	2,50	1	2,50	CHI
20200113344	SANTA RITA DO ARAGUAIA	SU21184155	SANTA RITA DO ARAGUAIA	03/01/2020 14:41	03/01/2020 19:32	03/01/2020 14:41	03/01/2020 19:32	4,84	1	4,84	CHI
20200113347	ANAPOLIS	20705219	DAIA S1	03/01/2020 14:42	03/01/2020 20:23	03/01/2020 14:42	03/01/2020 20:23	5,68	1	5,68	CHI
20200113351	IVOLANDIA	IV12223033	IPORA	03/01/2020 14:42	04/01/2020 08:03	03/01/2020 14:42	04/01/2020 08:03	17,34	2	34,69	CHI



20200113354	PIRENOPOLIS	PV21290396	CORUMBA	03/01/2020 14:42	03/01/2020 18:08	03/01/2020 14:42	03/01/2020 18:08	3,42	1	3,42	CHI
20200113355	MARA ROSA	MQ11265785	SANTA TEREZINHA	03/01/2020 14:42	04/01/2020 09:15	03/01/2020 14:42	04/01/2020 09:15	18,54	1	18,54	CHI
20200113361	COCALZINHO DE GOIAS	ZN21188641	AGUAS LINDAS DE GOIAS S1	03/01/2020 14:45	03/01/2020 16:34	03/01/2020 14:45	03/01/2020 16:34	1,81	1	1,81	CHI
20200113365	APARECIDA DE GOIANIA	AP11389490	INDEPENDENCIA S2	03/01/2020 14:45	04/01/2020 00:40	03/01/2020 14:45	03/01/2020 20:01	5,26	128	672,71	CHI
20200113365	APARECIDA DE GOIANIA	AP12391735	INDEPENDENCIA S2	03/01/2020 14:45	04/01/2020 00:40	03/01/2020 21:11	04/01/2020 00:40	3,49	128	447,08	CHI
20200113368	AURILANDIA	6625084	FIRMINOPOLIS S2	03/01/2020 14:46	03/01/2020 17:44	03/01/2020 14:46	03/01/2020 17:44	2,97	1	2,97	CHI
20200113370	PONTALINA	PK12380501	PONTALINA	03/01/2020 14:46	03/01/2020 16:10	03/01/2020 14:46	03/01/2020 16:10	1,39	163	226,30	CHI
20200113372	AGUAS LINDAS DE GOIAS	4830000467	AGUAS LINDAS DE GOIAS S1	03/01/2020 14:47	03/01/2020 17:23	03/01/2020 14:47	03/01/2020 17:23	2,59	1	2,59	CHI
20200113374	BOM JARDIM DE GOIAS	BM12155682	BOM JARDIM	03/01/2020 14:16	03/01/2020 17:24	03/01/2020 14:16	03/01/2020 17:24	3,13	14	43,84	CHI
20200113374	PIRANHAS	BM12155682	BOM JARDIM	03/01/2020 14:16	03/01/2020 17:24	03/01/2020 14:16	03/01/2020 17:24	3,13	4	12,52	CHI
20200113376	AGUAS LINDAS DE GOIAS	6830020320	AGUAS LINDAS DE GOIAS S2	03/01/2020 14:47	03/01/2020 17:20	03/01/2020 14:47	03/01/2020 17:20	2,54	1	2,54	CHI
20200113378	CRISTALINA	KR11032819	PAMPLONA	03/01/2020 14:30	03/01/2020 16:47	03/01/2020 14:30	03/01/2020 16:47	2,28	69	157,09	CHI
20200113391	JANDAIA	JD21054539	PALMEIRAS	03/01/2020 14:51	03/01/2020 18:17	03/01/2020 14:51	03/01/2020 18:17	3,42	1	3,42	CHI
20200113395	IACIARA	IA12211664	IACIARA S2	03/01/2020 14:52	03/01/2020 17:01	03/01/2020 14:52	03/01/2020 17:01	2,14	9	19,24	CHI
20200113396	VALPARAISO DE GOIAS	2860123850	MARAJOARA	03/01/2020 14:52	03/01/2020 17:47	03/01/2020 14:52	03/01/2020 17:47	2,90	1	2,90	CHI
20200113397	GOIANIA	14484195	GOYA S2	03/01/2020 14:52	03/01/2020 16:39	03/01/2020 14:52	03/01/2020 16:39	1,77	1	1,77	CHI
20200113404	RIO VERDE	RV10394844	CABRIUVA S2	03/01/2020 14:43	05/01/2020 10:08	03/01/2020 14:43	03/01/2020 17:57	3,24	2	6,49	CHI
20200113404	RIO VERDE	RV10394844	CABRIUVA S2	03/01/2020 14:43	05/01/2020 10:08	03/01/2020 14:48	03/01/2020 17:57	3,15	10	31,47	CHI
20200113404	RIO VERDE	RV10394844	CABRIUVA S2	03/01/2020 14:43	05/01/2020 10:08	03/01/2020 14:48	03/01/2020 18:20	3,52	10	35,17	CHI
20200113404	RIO VERDE	RV10394844	CABRIUVA S2	03/01/2020 14:43	05/01/2020 10:08	03/01/2020 20:03	03/01/2020 20:08	0,08	22	1,84	CHI
20200113404	RIO VERDE	01600404	CABRIUVA S2	03/01/2020 14:43	05/01/2020 10:08	04/01/2020 11:02	04/01/2020 11:07	0,09	22	1,89	CHI
20200113404	RIO VERDE	01600404	RIO VERDE S2	03/01/2020 14:43	05/01/2020 10:08	04/01/2020 11:02	04/01/2020 11:07	0,09	28	2,41	CHI
20200113404	RIO VERDE	RV13213415	CABRIUVA S2	03/01/2020 14:43	05/01/2020 10:08	03/01/2020 14:48	04/01/2020 14:25	23,61	42	991,69	CHI
20200113404	RIO VERDE	RV10394844	CABRIUVA S2	03/01/2020 14:43	05/01/2020 10:08	03/01/2020 14:48	04/01/2020 16:01	25,20	4	100,80	CHI
20200113404	RIO VERDE	RV12306377	CABRIUVA S2	03/01/2020 14:43	05/01/2020 10:08	03/01/2020 14:48	04/01/2020 16:56	26,12	21	548,54	CHI
20200113404	RIO VERDE	RV13268346	CABRIUVA S2	03/01/2020 14:43	05/01/2020 10:08	04/01/2020 14:26	05/01/2020 10:08	19,70	42	827,49	CHI
20200113511	LUZIANIA	10011495349	MARAJOARA	03/01/2020 14:55	03/01/2020 16:25	03/01/2020 14:55	03/01/2020 16:25	1,51	1	1,51	CHI
20200113512	MONTIVIDIU	MV12267612	MONTIVIDIU T	03/01/2020 14:55	03/01/2020 17:37	03/01/2020 14:55	03/01/2020 17:37	2,69	8	21,52	CHI
20200113517	GOIANIA	5580018350	TRINDADE	03/01/2020 14:57	03/01/2020 16:56	03/01/2020 14:57	03/01/2020 16:56	1,98	1	1,98	CHI
20200113521	SANTA HELENA DE GOIAS	400058789	IPEGUARI	03/01/2020 14:57	04/01/2020 10:09	03/01/2020 14:57	04/01/2020 10:09	19,19	1	19,19	CHI
20200113524	TERESINA DE GOIAS	TE12237604	FLORES DE GOIAS	03/01/2020 14:58	03/01/2020 18:13	03/01/2020 14:58	03/01/2020 18:13	3,25	49	159,11	CHI
20200113525	SAO MIGUEL DO ARAGUAIA	SM21170930	SAO MIGUEL DO ARAGUAIA	03/01/2020 14:34	05/01/2020 01:37	03/01/2020 14:34	05/01/2020 01:37	35,04	1	35,04	CHI
20200113530	CUMARI	CY21130922	CATALAO S1	03/01/2020 14:56	03/01/2020 18:09	03/01/2020 14:56	03/01/2020 18:09	3,21	1	3,21	CHI

20200113533	VILA BOA	VB11146246	IACIARA S2	03/01/2020 14:12	03/01/2020 15:33	03/01/2020 14:12	03/01/2020 15:33	1,34	212	285,08	CHI
20200113535	RIO VERDE	10018003301	RIO VERDE S2	03/01/2020 15:00	04/01/2020 14:52	03/01/2020 15:00	04/01/2020 14:52	23,88	1	23,88	CHI
20200113536	SANTA TEREZINHA DE GOIAS	SG12321938	SANTA TEREZINHA	03/01/2020 15:00	03/01/2020 22:05	03/01/2020 15:00	03/01/2020 22:05	7,08	22	155,74	CHI
20200113539	NOVA VENEZA	NV12010268	INHUMAS S1	03/01/2020 14:46	03/01/2020 16:47	03/01/2020 14:46	03/01/2020 16:47	2,01	11	22,14	CHI
20200113542	ITUMBIARA	IT11310078	ITUMBIARA NOVA	03/01/2020 14:55	03/01/2020 21:07	03/01/2020 14:55	03/01/2020 21:07	6,20	167	1034,98	CHI
20200113546	PALMELO	BC21114805	PIRES DO RIO S2	03/01/2020 15:02	03/01/2020 17:21	03/01/2020 15:02	03/01/2020 17:21	2,31	1	2,31	CHI
20200113547	MONTIVIDIU	MV21213426	MONTIVIDIU T	03/01/2020 15:02	03/01/2020 21:18	03/01/2020 15:02	03/01/2020 21:18	6,26	1	6,26	CHI
20200113550	DAVINOPOLIS	IO21215593	CATALAO S1	03/01/2020 15:03	03/01/2020 22:06	03/01/2020 15:03	03/01/2020 22:06	7,04	1	7,04	CHI
20200113560	MINACU	IH21382555	MINACU	03/01/2020 15:06	03/01/2020 18:49	03/01/2020 15:06	03/01/2020 18:49	3,72	1	3,72	CHI
20200113564	INHUMAS	IN21169831	INHUMAS S1	03/01/2020 15:07	03/01/2020 16:53	03/01/2020 15:07	03/01/2020 16:53	1,77	2	3,53	CHI
20200113565	CORUMBA DE GOIAS	CB21289637	CORUMBA	03/01/2020 15:07	04/01/2020 18:06	03/01/2020 15:07	04/01/2020 18:06	26,98	1	26,98	CHI
20200113567	ANAPOLIS	AN21385376	ANAPOLIS UNIVERSITARIO S1	03/01/2020 15:08	06/01/2020 00:19	03/01/2020 15:08	06/01/2020 00:02	56,92	1	56,92	CHI
20200113567	ANAPOLIS	AN12375930	ANAPOLIS UNIVERSITARIO S1	03/01/2020 15:08	06/01/2020 00:19	05/01/2020 20:25	06/01/2020 00:19	3,89	61	237,32	CHI
20200113568	PORANGATU	PO21289312	PORANGATU	03/01/2020 15:08	04/01/2020 01:05	03/01/2020 15:08	04/01/2020 01:05	9,96	1	9,96	CHI
20200113570	CRISTALINA	KR21355482	PAMPLONA	03/01/2020 15:08	03/01/2020 19:18	03/01/2020 15:08	03/01/2020 19:18	4,16	1	4,16	CHI
20200113571	MUTUNOPOLIS	MU12391658	MARA ROSA	03/01/2020 15:08	04/01/2020 10:17	03/01/2020 15:08	04/01/2020 10:17	19,15	2	38,30	CHI
20200113571	MUTUNOPOLIS	MU12391658	MARA ROSA	03/01/2020 15:08	04/01/2020 10:17	03/01/2020 15:08	04/01/2020 10:17	19,15	30	574,47	CHI
20200113572	GOIANIA	15343698	FERROVIARIO S3	03/01/2020 15:08	03/01/2020 16:35	03/01/2020 15:08	03/01/2020 16:35	1,44	1	1,44	CHI
20200113578	CORREGO DO OURO	CO21200891	SAO LUIZ DOS MONTES BELOS	03/01/2020 15:10	03/01/2020 19:22	03/01/2020 15:10	03/01/2020 19:22	4,19	1	4,19	CHI
20200113584	MINEIROS	MY12336249	PARQUE DAS EMAS	03/01/2020 15:11	03/01/2020 16:00	03/01/2020 15:11	03/01/2020 16:00	0,80	3	2,41	CHI
20200113585	PALMEIRAS DE GOIAS	PL12205911	PALMEIRAS	03/01/2020 15:11	03/01/2020 19:14	03/01/2020 15:11	03/01/2020 19:14	4,04	2	8,07	CHI
20200113590	ANAPOLIS	AN21311896	ANAPOLIS UNIVERSITARIO S2	03/01/2020 15:12	03/01/2020 19:36	03/01/2020 15:12	03/01/2020 19:36	4,39	1	4,39	CHI
20200113594	CRISTALINA	KR12025841	PAMPLONA	03/01/2020 15:13	03/01/2020 18:10	03/01/2020 15:13	03/01/2020 18:10	2,94	3	8,82	CHI
20200113596	PLANALTINA	PI21264701	PLANALTINA	03/01/2020 15:13	03/01/2020 16:25	03/01/2020 15:13	03/01/2020 16:25	1,19	4	4,75	CHI
20200113598	JANDAIA	JD12008614	PALMEIRAS	03/01/2020 15:07	03/01/2020 18:07	03/01/2020 15:07	03/01/2020 18:07	2,99	21	62,84	CHI
20200113598	PARAUNA	JD12008614	PALMEIRAS	03/01/2020 15:07	03/01/2020 18:07	03/01/2020 15:07	03/01/2020 18:07	2,99	6	17,95	CHI
20200113600	QUIRINOPOLIS	QI32053165	QUIRINOPOLIS	03/01/2020 15:14	03/01/2020 17:20	03/01/2020 15:14	03/01/2020 17:20	2,09	7	14,64	CHI
20200113607	NIQUELANDIA	NQ21274738	BARRO ALTO	03/01/2020 15:15	03/01/2020 17:13	03/01/2020 15:15	03/01/2020 17:13	1,96	1	1,96	CHI
20200113608	SAO LUIS DE MONTES BELOS	SL12003948	SAO LUIZ DOS MONTES BELOS	03/01/2020 14:41	03/01/2020 16:34	03/01/2020 14:41	03/01/2020 16:34	1,88	592	1110,82	CHI
20200113626	CATALAO	CT12149194	CATALAO S1	03/01/2020 15:16	03/01/2020 18:30	03/01/2020 15:16	03/01/2020 18:30	3,22	14	45,05	CHI
20200113633	MORRINHOS	MR12389874	MORRINHOS	03/01/2020 15:18	03/01/2020 16:38	03/01/2020 15:18	03/01/2020 16:38	1,33	4	5,31	CHI
20200113634	CATURAI	30070326	ARACU	03/01/2020 16:53	03/01/2020 17:34	03/01/2020 16:53	03/01/2020 17:34	0,68	1	0,68	CHI
20200113638	CRISTALINA	KR11276499	CRISTALINA S2	03/01/2020 15:19	04/01/2020 09:09	03/01/2020 15:19	04/01/2020 09:09	17,83	1	17,83	CHI

20200113641	CAIAPONIA	CP21287569	PALESTINA	03/01/2020 15:19	04/01/2020 08:55	03/01/2020 15:19	04/01/2020 08:55	17,59	1	17,59	CHI
20200113664	CORREGO DO OURO	CO21308348	FIRMINOPOLIS S2	03/01/2020 15:25	03/01/2020 21:11	03/01/2020 15:25	03/01/2020 21:11	5,76	1	5,76	CHI
20200113671	MONTES CLAROS DE GOIAS	ME12140084	IPORA	03/01/2020 15:27	03/01/2020 22:15	03/01/2020 15:27	03/01/2020 22:15	6,79	5	33,97	CHI
20200113681	BOM JESUS DE GOIAS	BJ12000042	BOM JESUS DE GOIAS	03/01/2020 15:28	03/01/2020 17:51	03/01/2020 15:28	03/01/2020 17:51	2,38	4	9,51	CHI
20200113684	ANAPOLIS	20830180	ANAPOLIS UNIVERSITARIO S1	03/01/2020 15:29	04/01/2020 01:06	03/01/2020 15:29	04/01/2020 01:06	9,62	1	9,62	CHI
20200113687	DISTRITO FEDERAL	05410226	MARAJOARA	03/01/2020 15:30	03/01/2020 16:30	03/01/2020 15:30	03/01/2020 16:30	1,01	49	49,61	CHI
20200113687	NOVO GAMA	05410226	MARAJOARA	03/01/2020 15:30	03/01/2020 16:30	03/01/2020 15:30	03/01/2020 16:30	1,01	9	9,11	CHI
20200113687	SANTO ANTONIO DO DESCOBERTO	05410226	MARAJOARA	03/01/2020 15:30	03/01/2020 16:30	03/01/2020 15:30	03/01/2020 16:30	1,01	771	780,64	CHI
20200113689	GOIAS	GS12071258	GOIAS	03/01/2020 15:30	03/01/2020 22:04	03/01/2020 15:30	03/01/2020 22:04	6,56	91	596,56	CHI
20200113692	ITAJA	IJ21154853	ITAJA S2	03/01/2020 15:30	03/01/2020 20:38	03/01/2020 15:30	03/01/2020 20:38	5,13	1	5,13	CHI
20200113694	GOIANESIA	6802086	GOIANESIA S1	03/01/2020 15:31	04/01/2020 01:15	03/01/2020 15:31	04/01/2020 01:15	9,73	2	19,46	CHI
20200113701	MARA ROSA	MQ12391677	MARA ROSA	03/01/2020 15:32	04/01/2020 00:19	03/01/2020 15:32	04/01/2020 00:19	8,77	2	17,55	CHI
20200113703	MORRINHOS	MR21405519	MORRINHOS	03/01/2020 15:32	03/01/2020 19:20	03/01/2020 15:32	03/01/2020 19:20	3,80	1	3,80	CHI
20200113710	NIQUELANDIA	NQ12266021	NIQUELANDIA SUBTRANSMISSAO	03/01/2020 15:35	03/01/2020 19:25	03/01/2020 15:35	03/01/2020 19:25	3,83	3	11,49	CHI
20200113712	ALTO PARAISO DE GOIAS	BF12244571	SAO JOAO D ALIANCA	03/01/2020 15:30	03/01/2020 17:16	03/01/2020 15:30	03/01/2020 17:16	1,76	25	44,05	CHI
20200113714	DIORAMA	DI12066071	ARENOPOLIS	04/01/2020 17:03	04/01/2020 18:57	04/01/2020 17:03	04/01/2020 18:57	1,88	27	50,89	CHI
20200113717	HIDROLINA	HL11253146	URUACU	03/01/2020 14:53	03/01/2020 19:11	03/01/2020 14:53	03/01/2020 19:11	4,29	37	158,73	CHI
20200113721	SANTO ANTONIO DO DESCOBERTO	SN21017764	ALEXANIA	03/01/2020 15:38	04/01/2020 12:04	03/01/2020 15:38	04/01/2020 12:04	20,42	1	20,42	CHI
20200113722	SAO LUIZ DO NORTE	DF21272180	BARRO ALTO	03/01/2020 15:39	04/01/2020 10:50	03/01/2020 15:39	04/01/2020 10:50	19,18	1	19,18	CHI
20200113723	GOIANIA	12155299	AEROPORTO S2	03/01/2020 15:39	03/01/2020 17:16	03/01/2020 15:39	03/01/2020 17:16	1,62	1	1,62	CHI
20200113724	ITABERAI	IB12310510	ITABERAI S2	03/01/2020 15:39	03/01/2020 19:06	03/01/2020 15:39	03/01/2020 19:06	3,45	1	3,45	CHI
20200113731	ITUMBIARA	IT12000353	ITUMBIARA NOVA	03/01/2020 15:27	03/01/2020 18:42	03/01/2020 15:27	03/01/2020 18:42	3,24	21	68,13	CHI
20200113736	FORMOSA	FA12000130	ITIQUEIRA	03/01/2020 15:41	03/01/2020 17:21	03/01/2020 15:41	03/01/2020 17:21	1,66	14	23,19	CHI
20200113737	ITUMBIARA	IT12304246	ITUMBIARA NOVA	03/01/2020 15:41	04/01/2020 13:49	03/01/2020 15:41	04/01/2020 13:49	22,12	2	44,24	CHI
20200113739	SANTA HELENA DE GOIAS	400125950	RIO VERDE S2	03/01/2020 15:47	03/01/2020 20:57	03/01/2020 15:47	03/01/2020 20:57	5,17	1	5,17	CHI
20200113749	NIQUELANDIA	NQ21221866	URUACU	03/01/2020 15:45	03/01/2020 22:05	03/01/2020 15:45	03/01/2020 22:05	6,33	1	6,33	CHI
20200113752	CATALAO	CT21338768	CATALAO S1	03/01/2020 15:45	04/01/2020 08:45	03/01/2020 15:45	04/01/2020 08:45	17,01	1	17,01	CHI
20200113757	MINEIROS	10000106567	PARQUE DAS EMAS	03/01/2020 15:45	03/01/2020 17:58	03/01/2020 15:45	03/01/2020 17:58	2,20	1	2,20	CHI
20200113764	COCALZINHO DE GOIAS	ZN21186009	PADRE BERNARDO	03/01/2020 15:48	03/01/2020 23:31	03/01/2020 15:48	03/01/2020 23:31	7,71	1	7,71	CHI
20200113767	GOIANIA	11670149	CAMPINAS S2	03/01/2020 15:48	03/01/2020 17:25	03/01/2020 15:48	03/01/2020 17:25	1,60	1	1,60	CHI
20200113769	SAO SIMAO	CC21216651	CACHOEIRA ALTA	03/01/2020 15:47	03/01/2020 21:37	03/01/2020 15:47	03/01/2020 21:37	5,83	1	5,83	CHI
20200113771	ITABERAI	IB21336445	ITABERAI S2	03/01/2020 15:49	03/01/2020 19:07	03/01/2020 15:49	03/01/2020 19:07	3,31	1	3,31	CHI
20200113772	QUIRINOPOLIS	QI12034381	QUIRINOPOLIS	03/01/2020 15:49	03/01/2020 18:22	03/01/2020 15:49	03/01/2020 18:22	2,54	473	1202,87	CHI

20200113775	PADRE BERNARDO	PB12060341RE	PADRE BERNARDO	03/01/2020 15:27	03/01/2020 18:18	03/01/2020 15:27	03/01/2020 18:18	2,84	13	36,93	CHI
20200113786	JUSSARA	JR12101970RE	BRITANIA	03/01/2020 15:51	03/01/2020 18:35	03/01/2020 15:51	03/01/2020 18:35	2,72	11	29,89	CHI
20200113796	PIRACANJUBA	PJ21142466	PIRACANJUBA	03/01/2020 15:56	03/01/2020 22:50	03/01/2020 15:56	03/01/2020 22:50	6,89	1	6,89	CHI
20200113798	MAURILANDIA	ML21151724	RIO DOS BOIS	03/01/2020 15:56	03/01/2020 19:03	03/01/2020 15:56	03/01/2020 19:03	3,11	3	9,32	CHI
20200113801	GOIAS	19637703	ITAPURANGA	03/01/2020 00:00	03/01/2020 22:30	03/01/2020 00:00	03/01/2020 22:30	22,49	1	22,49	CHI
20200113801	ITAPURANGA	19637703	ITAPURANGA	03/01/2020 00:00	03/01/2020 22:30	03/01/2020 00:00	03/01/2020 22:30	22,49	1	22,49	CHI
20200113804	ALVORADA DO NORTE	00010414	IACIARA S2	03/01/2020 15:55	03/01/2020 22:18	03/01/2020 15:56	03/01/2020 17:19	1,39	204	282,65	CHI
20200113804	IACIARA	00010414	IACIARA S2	03/01/2020 15:55	03/01/2020 22:18	03/01/2020 15:56	03/01/2020 17:19	1,39	1	1,39	CHI
20200113804	SIMOLANDIA	00010414	IACIARA S2	03/01/2020 15:55	03/01/2020 22:18	03/01/2020 15:56	03/01/2020 17:19	1,39	1	1,39	CHI
20200113804	FLORES DE GOIAS	AQ13344346	IACIARA S2	03/01/2020 15:55	03/01/2020 22:18	03/01/2020 15:56	03/01/2020 17:43	1,78	691	1230,17	CHI
20200113804	FORMOSA	AQ13344346	IACIARA S2	03/01/2020 15:55	03/01/2020 22:18	03/01/2020 15:56	03/01/2020 17:43	1,78	1	1,78	CHI
20200113804	SITIO D ABADIA	AQ13344346	IACIARA S2	03/01/2020 15:55	03/01/2020 22:18	03/01/2020 15:56	03/01/2020 17:43	1,78	116	206,51	CHI
20200113804	VILA BOA	AQ13344346	IACIARA S2	03/01/2020 15:55	03/01/2020 22:18	03/01/2020 15:56	03/01/2020 17:43	1,78	4	7,12	CHI
20200113804	SITIO D ABADIA	AQ13344346	IACIARA S2	03/01/2020 15:55	03/01/2020 22:18	03/01/2020 15:56	03/01/2020 18:07	2,18	15	32,77	CHI
20200113804	ALVORADA DO NORTE	AQ13344346	IACIARA S2	03/01/2020 15:55	03/01/2020 22:18	03/01/2020 15:56	03/01/2020 19:00	3,06	1	3,06	CHI
20200113804	SITIO D ABADIA	AQ13344346	IACIARA S2	03/01/2020 15:55	03/01/2020 22:18	03/01/2020 15:56	03/01/2020 19:00	3,06	4	12,24	CHI
20200113804	ALVORADA DO NORTE	AQ13344346	IACIARA S2	03/01/2020 15:55	03/01/2020 22:18	03/01/2020 15:56	03/01/2020 22:18	6,36	87	553,71	CHI
20200113804	FLORES DE GOIAS	AQ13344346	IACIARA S2	03/01/2020 15:55	03/01/2020 22:18	03/01/2020 15:56	03/01/2020 22:18	6,36	41	260,94	CHI
20200113804	SITIO D ABADIA	AQ13344346	IACIARA S2	03/01/2020 15:55	03/01/2020 22:18	03/01/2020 15:56	03/01/2020 22:18	6,36	7	44,55	CHI
20200113906	AVELINOPOLIS	AV21366449	TRINDADE	03/01/2020 15:57	03/01/2020 17:05	03/01/2020 15:57	03/01/2020 17:05	1,13	1	1,13	CHI
20200113910	SAO LUIS DE MONTES BELOS	10001847030	SAO LUIZ DOS MONTES BELOS	03/01/2020 15:58	03/01/2020 18:51	03/01/2020 15:58	03/01/2020 18:51	2,88	1	2,88	CHI
20200113913	LUZIANIA	120285903	RIO VERMELHO	03/01/2020 15:59	03/01/2020 22:44	03/01/2020 15:59	03/01/2020 22:44	6,76	1	6,76	CHI
20200113919	CALDAS NOVAS	760042767	CALDAS NOVAS S2	03/01/2020 16:00	04/01/2020 00:46	03/01/2020 16:00	04/01/2020 00:46	8,75	1	8,75	CHI
20200113925	ITUMBIARA	IT12232598	ITUMBIARA VELHA S1	03/01/2020 16:02	04/01/2020 10:46	03/01/2020 16:02	04/01/2020 10:46	18,74	2	37,48	CHI
20200113926	GOIAS	GS21241337	MATRINCHA	03/01/2020 16:02	03/01/2020 19:14	03/01/2020 16:02	03/01/2020 19:14	3,20	1	3,20	CHI
20200113931	CAVALCANTE	CJ21404461	MINACU	03/01/2020 16:03	03/01/2020 20:04	03/01/2020 16:03	03/01/2020 20:04	4,01	1	4,01	CHI
20200113939	SAO FRANCISCO DE GOIAS	PV21021304	SAO FRANCISCO DE GOIAS	03/01/2020 16:04	03/01/2020 23:12	03/01/2020 16:04	03/01/2020 23:12	7,12	1	7,12	CHI
20200113941	BALIZA	BH12187387LD	BOM JARDIM	03/01/2020 16:05	03/01/2020 18:14	03/01/2020 16:05	03/01/2020 18:14	2,14	694	1488,05	CHI
20200113944	IPAMERI	IP21288019	IPAMERI	03/01/2020 16:06	03/01/2020 17:21	03/01/2020 16:06	03/01/2020 17:21	1,24	1	1,24	CHI
20200113950	GOIANIA	10456673	AEROPORTO S1	03/01/2020 16:07	03/01/2020 18:24	03/01/2020 16:07	03/01/2020 18:24	2,27	1	2,27	CHI
20200113953	GOIANIA	10007878980	INDEPENDENCIA S2	03/01/2020 16:08	03/01/2020 17:59	03/01/2020 16:08	03/01/2020 17:59	1,83	1	1,83	CHI
20200113958	SAO DOMINGOS	SD21264674	SAO DOMINGOS	03/01/2020 16:09	03/01/2020 18:40	03/01/2020 16:09	03/01/2020 18:40	2,51	1	2,51	CHI
20200113970	NOVO GAMA	10014661002	PACAEMBU S1	03/01/2020 16:13	03/01/2020 18:00	03/01/2020 16:13	03/01/2020 18:00	1,78	1	1,78	CHI

20200113976	IPAMERI	IP12216237	IPAMERI	03/01/2020 16:13	03/01/2020 16:53	03/01/2020 16:13	03/01/2020 16:53	0,66	20	13,21	CHI
20200113982	MONTIVIDIU	MV12260893	MONTIVIDIU T	03/01/2020 15:33	03/01/2020 21:29	03/01/2020 15:33	03/01/2020 21:29	5,93	14	83,00	CHI
20200113983	RIO VERDE	RV12030057	MONTIVIDIU T	03/01/2020 16:17	03/01/2020 21:41	03/01/2020 16:17	03/01/2020 21:41	5,38	13	69,99	CHI
20200113990	ITAJA	IJ21154264	CACHOEIRA ALTA	03/01/2020 16:20	04/01/2020 13:26	03/01/2020 16:20	04/01/2020 13:26	21,09	1	21,09	CHI
20200113994	CORUMBA DE GOIAS	CB12297694	CORUMBA	03/01/2020 15:57	03/01/2020 19:45	03/01/2020 15:57	03/01/2020 19:45	3,79	35	132,61	CHI
20200113996	NOVO PLANALTO	TA12293689	SAO MIGUEL DO ARAGUAIA	03/01/2020 16:22	04/01/2020 16:02	03/01/2020 16:22	04/01/2020 16:02	23,66	10	236,59	CHI
20200114002	AGUA LIMPA	AL12263113	VILA CORUMBA	03/01/2020 15:56	03/01/2020 20:25	03/01/2020 15:56	03/01/2020 20:25	4,47	31	138,70	CHI
20200114002	CORUMBAIBA	AL12263113	VILA CORUMBA	03/01/2020 15:56	03/01/2020 20:25	03/01/2020 15:56	03/01/2020 20:25	4,47	1	4,47	CHI
20200114004	ANAPOLIS	AN12370346	ANAPOLIS UNIVERSITARIO S2	03/01/2020 15:59	03/01/2020 17:51	03/01/2020 15:59	03/01/2020 17:51	1,86	330	612,98	CHI
20200114005	ALTO HORIZONTE	AJ12405433	SANTA TEREZINHA	03/01/2020 16:24	03/01/2020 16:55	03/01/2020 16:24	03/01/2020 16:55	0,51	2	1,01	CHI
20200114008	CRISTALINA	KR12171525	PAMPLONA	03/01/2020 13:20	04/01/2020 13:07	03/01/2020 13:20	04/01/2020 00:00	10,66	13	138,63	CHI
20200114008	CRISTALINA	KR12171525	PAMPLONA	03/01/2020 13:20	04/01/2020 13:07	03/01/2020 13:20	04/01/2020 13:07	23,79	4	95,16	CHI
20200114014	QUIRINOPOLIS	6501566	QUIRINOPOLIS	03/01/2020 16:26	03/01/2020 18:08	03/01/2020 16:26	03/01/2020 18:08	1,69	1	1,69	CHI
20200114020	CABECEIRAS	CW12218489	ITUIQUIRA	03/01/2020 16:27	03/01/2020 19:57	03/01/2020 16:27	03/01/2020 19:57	3,49	10	34,91	CHI
20200114024	MONTIVIDIU	MV12267625	MONTIVIDIU T	03/01/2020 16:28	03/01/2020 23:02	03/01/2020 16:28	03/01/2020 23:02	6,56	3	19,69	CHI
20200114025	SANTA HELENA DE GOIAS	SH12301071	RIO DOS BOIS	03/01/2020 15:32	04/01/2020 01:10	03/01/2020 15:32	04/01/2020 01:10	9,63	8	77,06	CHI
20200114025	TURVELANDIA	SH12301071	RIO DOS BOIS	03/01/2020 15:32	04/01/2020 01:10	03/01/2020 15:32	04/01/2020 01:10	9,63	2	19,26	CHI
20200114027	JATAI	JT21244768	JATAI S1	03/01/2020 16:28	03/01/2020 20:03	03/01/2020 16:28	03/01/2020 20:03	3,57	1	3,57	CHI
20200114032	PARAUNA	PU21007970	PARAUNA	03/01/2020 16:30	03/01/2020 21:02	03/01/2020 16:30	03/01/2020 21:02	4,53	1	4,53	CHI
20200114038	FLORES DE GOIAS	FB11255024	FLORES DE GOIAS	03/01/2020 16:31	03/01/2020 23:09	03/01/2020 16:31	03/01/2020 23:09	6,63	16	106,11	CHI
20200114044	NEROPOLIS	NR12219043LD	NEROPOLIS S2	03/01/2020 15:12	03/01/2020 18:38	03/01/2020 15:12	03/01/2020 18:38	3,43	51	174,83	CHI
20200114044	SANTO ANTONIO DE GOIAS	NR12219043LD	NEROPOLIS S2	03/01/2020 15:12	03/01/2020 18:38	03/01/2020 15:12	03/01/2020 18:38	3,43	4	13,71	CHI
20200114051	ITUMBIARA	IT12305618	PARANAIBA	03/01/2020 16:34	03/01/2020 20:18	03/01/2020 16:34	03/01/2020 20:18	3,74	3	11,22	CHI
20200114054	RIO VERDE	RV12098479	RIO VERDE S1	03/01/2020 16:34	04/01/2020 09:09	03/01/2020 16:34	04/01/2020 09:09	16,57	7	115,99	CHI
20200114057	BONOPOLIS	BX11398138	SAO MIGUEL DO ARAGUAIA	03/01/2020 16:36	03/01/2020 19:40	03/01/2020 16:36	03/01/2020 19:40	3,07	1	3,07	CHI
20200114063	IPAMERI	IP12017029	IPAMERI	03/01/2020 16:39	04/01/2020 09:12	03/01/2020 16:39	04/01/2020 09:12	16,54	15	248,12	CHI
20200114067	SANTO ANTONIO DO DESCOBERTO	SN21248315	AGUAS LINDAS DE GOIAS S2	03/01/2020 16:40	03/01/2020 17:50	03/01/2020 16:40	03/01/2020 17:50	1,17	3	3,50	CHI
20200114076	GOIANIA	15018234	CAMPINAS S2	03/01/2020 16:41	03/01/2020 18:41	03/01/2020 16:41	03/01/2020 18:41	1,99	1	1,99	CHI
20200114077	GOIANIA	GN11269264	CARAJAS S2	03/01/2020 16:39	03/01/2020 17:31	03/01/2020 16:39	03/01/2020 17:31	0,86	130	112,23	CHI
20200114078	CAIAPONIA	CP12117693	PALESTINA	03/01/2020 16:41	04/01/2020 11:41	03/01/2020 16:41	04/01/2020 11:41	18,98	2	37,97	CHI
20200114078	PALESTINA DE GOIAS	CP12117693	PALESTINA	03/01/2020 16:41	04/01/2020 11:41	03/01/2020 16:41	04/01/2020 11:41	18,98	2	37,97	CHI
20200114079	NOVA CRIXAS	NA11391140	NOVA CRIXAS	03/01/2020 16:42	04/01/2020 18:00	03/01/2020 16:42	04/01/2020 18:00	25,30	13	328,86	CHI
20200114080	MONTIVIDIU	MV12230886	MONTIVIDIU T	03/01/2020 16:28	03/01/2020 18:30	03/01/2020 16:28	03/01/2020 18:30	2,02	9	18,16	CHI

20200114080	RIO VERDE	MV12230886	MONTIVIDIU T	03/01/2020 16:28	03/01/2020 18:30	03/01/2020 16:28	03/01/2020 18:30	2,02	39	78,68	CHI
20200114082	CALDAS NOVAS	10003788898	SERRA DE CALDAS	03/01/2020 16:42	04/01/2020 01:22	03/01/2020 16:42	04/01/2020 01:22	8,65	1	8,65	CHI
20200114086	URUACU	10005161132	URUACU	03/01/2020 16:44	03/01/2020 18:26	03/01/2020 16:44	03/01/2020 18:26	1,70	1	1,70	CHI
20200114091	MONTIVIDIU DO NORTE	MX12192265	PORANGATU	03/01/2020 16:44	03/01/2020 23:41	03/01/2020 16:44	03/01/2020 23:41	6,93	54	374,46	CHI
20200114095	GOIANIA	11352383	ATLANTICO S2	03/01/2020 16:45	03/01/2020 20:23	03/01/2020 16:45	03/01/2020 20:23	3,62	1	3,62	CHI
20200114097	GAMELEIRA DE GOIAS	SV12033468	DAIA S2	03/01/2020 16:45	03/01/2020 17:57	03/01/2020 16:45	03/01/2020 17:57	1,19	14	16,61	CHI
20200114097	SILVANIA	SV12033468	DAIA S2	03/01/2020 16:45	03/01/2020 17:57	03/01/2020 16:45	03/01/2020 17:57	1,19	134	158,98	CHI
20200114098	SANTO ANTONIO DO DESCOBERTO	SN21082875	MARAJOARA	03/01/2020 16:46	04/01/2020 11:03	03/01/2020 16:46	04/01/2020 11:03	18,28	3	54,83	CHI
20200114099	SAO LUIS DE MONTES BELOS	500065135	SAO LUIZ DOS MONTES BELOS	03/01/2020 16:46	03/01/2020 22:42	03/01/2020 16:46	03/01/2020 22:42	5,92	1	5,92	CHI
20200114215	PARAUNA	PU12067611	ACREUNA	03/01/2020 16:48	03/01/2020 22:44	03/01/2020 16:48	03/01/2020 22:44	5,92	2	11,85	CHI
20200114216	GOIANIA	15371025	REAL S1	03/01/2020 16:49	03/01/2020 19:01	03/01/2020 16:49	03/01/2020 19:01	2,20	1	2,20	CHI
20200114222	INDIARA	IY12266581	EDEIA	03/01/2020 16:49	03/01/2020 22:09	03/01/2020 16:49	03/01/2020 22:09	5,34	4	21,36	CHI
20200114223	PLANALTINA	PI11383261	PLANALTINA	03/01/2020 16:49	03/01/2020 17:58	03/01/2020 16:49	03/01/2020 17:58	1,15	45	51,54	CHI
20200114225	BURITI ALEGRE	BG12066333	ITUMBIARA VELHA S2	03/01/2020 15:01	03/01/2020 19:23	03/01/2020 15:01	03/01/2020 19:23	4,38	1	4,38	CHI
20200114225	ITUMBIARA	BG12066333	ITUMBIARA VELHA S2	03/01/2020 15:01	03/01/2020 19:23	03/01/2020 15:01	03/01/2020 19:23	4,38	6	26,29	CHI
20200114226	NOVA GLORIA	IW21245606	RUBIATABA	03/01/2020 16:49	04/01/2020 00:46	03/01/2020 16:49	04/01/2020 00:46	7,94	2	15,87	CHI
20200114238	SANTO ANTONIO DO DESCOBERTO	SN12078141	MARAJOARA	03/01/2020 16:31	03/01/2020 21:53	03/01/2020 16:31	03/01/2020 18:42	2,20	344	756,51	CHI
20200114238	SANTO ANTONIO DO DESCOBERTO	SN12162757LD	MARAJOARA	03/01/2020 16:31	03/01/2020 21:53	03/01/2020 16:31	03/01/2020 21:53	5,38	291	1565,58	CHI
20200114239	RIO VERDE	RV12260156	RIO VERDE S1	03/01/2020 16:52	03/01/2020 19:29	03/01/2020 16:52	03/01/2020 19:29	2,62	1	2,62	CHI
20200114244	PALMEIRAS DE GOIAS	PL12000082	PALMEIRAS	03/01/2020 16:52	03/01/2020 19:25	03/01/2020 16:52	03/01/2020 19:25	2,53	13	32,94	CHI
20200114246	MONTIVIDIU	MV12303520	MONTIVIDIU T	03/01/2020 16:53	03/01/2020 23:26	03/01/2020 16:53	03/01/2020 23:26	6,55	2	13,10	CHI
20200114246	RIO VERDE	MV12303520	MONTIVIDIU T	03/01/2020 16:53	03/01/2020 23:26	03/01/2020 16:53	03/01/2020 23:26	6,55	1	6,55	CHI
20200114253	GOIANESIA	550141984	GOIANESIA S2	03/01/2020 16:54	04/01/2020 01:40	03/01/2020 16:54	04/01/2020 01:40	8,78	1	8,78	CHI
20200114257	URUACU	6360000369	URUACU	03/01/2020 16:54	03/01/2020 18:53	03/01/2020 16:54	03/01/2020 18:53	1,97	1	1,97	CHI
20200114264	DIVINOPOLIS DE GOIAS	GH12248894	SAO DOMINGOS	03/01/2020 16:55	03/01/2020 19:31	03/01/2020 16:55	03/01/2020 19:31	2,59	4	10,36	CHI
20200114269	CAIAPONIA	930045970	CAIAPONIA	03/01/2020 16:56	04/01/2020 01:15	03/01/2020 16:56	04/01/2020 01:15	8,31	1	8,31	CHI
20200114273	ITAJA	IJ21360969	ITAJA S2	03/01/2020 16:57	03/01/2020 22:22	03/01/2020 16:57	03/01/2020 22:22	5,41	1	5,41	CHI
20200114278	ITABERAI	IJ2217217	ITABERAI S1	03/01/2020 16:58	03/01/2020 17:48	03/01/2020 16:58	03/01/2020 17:48	0,83	22	18,25	CHI
20200114278	ITAGUARI	IJ2217217	ITABERAI S1	03/01/2020 16:58	03/01/2020 17:48	03/01/2020 16:58	03/01/2020 17:48	0,83	43	35,68	CHI
20200114278	TAQUARAL DE GOIAS	IJ2217217	ITABERAI S1	03/01/2020 16:58	03/01/2020 17:48	03/01/2020 16:58	03/01/2020 17:48	0,83	47	39,00	CHI
20200114280	PIRES DO RIO	PR21399181	PIRES DO RIO S2	03/01/2020 16:58	03/01/2020 18:10	03/01/2020 16:58	03/01/2020 18:10	1,19	1	1,19	CHI
20200114284	BONOPOLIS	4350001816	SAO MIGUEL DO ARAGUAIA	03/01/2020 16:59	03/01/2020 19:00	03/01/2020 16:59	03/01/2020 19:00	2,01	1	2,01	CHI
20200114285	BURITINOPOLIS	BQ11208227	IACIARA S2	03/01/2020 13:53	03/01/2020 22:44	03/01/2020 13:53	03/01/2020 22:44	8,85	26	230,11	CHI

20200114291	SANTA RITA DO ARAGUAIA	SU12374325	SANTA RITA DO ARAGUAIA	03/01/2020 17:02	03/01/2020 21:36	03/01/2020 17:02	03/01/2020 21:36	4,56	28	127,80	CHI
20200114299	CORUMBA DE GOIAS	CB21292223	ALEXANIA	03/01/2020 17:03	04/01/2020 12:36	03/01/2020 17:03	04/01/2020 12:36	19,54	1	19,54	CHI
20200114300	NIQUELANDIA	2750023641	NIQUELANDIA SUBTRANSMISSAO	03/01/2020 17:03	03/01/2020 20:04	03/01/2020 17:03	03/01/2020 20:04	3,00	1	3,00	CHI
20200114302	MONTIVIDIU DO NORTE	MX12276725	PORANGATU	03/01/2020 17:04	04/01/2020 02:57	03/01/2020 17:04	04/01/2020 02:57	9,88	10	98,83	CHI
20200114305	GOIANIA	GN12378780	CARAJAS S2	03/01/2020 16:41	03/01/2020 17:58	03/01/2020 16:41	03/01/2020 17:58	1,28	426	543,74	CHI
20200114306	GOIANDIRA	GD12160911RE	CATALAO S1	03/01/2020 15:44	03/01/2020 20:50	03/01/2020 15:44	03/01/2020 20:50	5,09	44	224,13	CHI
20200114312	GOIANDIRA	GD12127593	CATALAO S1	03/01/2020 16:52	03/01/2020 21:27	03/01/2020 16:52	03/01/2020 21:27	4,57	21	95,94	CHI
20200114314	CRISTALINA	KR21165864	CRISTALINA S2	03/01/2020 17:08	03/01/2020 21:46	03/01/2020 17:08	03/01/2020 21:46	4,62	1	4,62	CHI
20200114317	APARECIDA DE GOIANIA	200431353	CEPAIGO S1	03/01/2020 17:09	03/01/2020 17:45	03/01/2020 17:09	03/01/2020 17:45	0,59	1	0,59	CHI
20200114323	GOIANIA	13480273	CARAJAS S2	03/01/2020 17:10	03/01/2020 19:13	03/01/2020 17:10	03/01/2020 19:13	2,04	1	2,04	CHI
20200114328	SANTO ANTONIO DO DESCOBERTO	SN21238175	MARAJOARA	03/01/2020 17:11	04/01/2020 11:58	03/01/2020 17:11	04/01/2020 11:58	18,78	2	37,56	CHI
20200114335	GOIANIA	14887393	GOYA S2	03/01/2020 17:13	03/01/2020 20:56	03/01/2020 17:13	03/01/2020 20:56	3,70	1	3,70	CHI
20200114343	MORRINHOS	7227046	MORRINHOS	03/01/2020 17:14	04/01/2020 02:15	03/01/2020 17:14	04/01/2020 02:15	9,01	18	162,17	CHI
20200114346	GOIANIA	GN12395188	GOYA S2	03/01/2020 17:15	03/01/2020 19:58	03/01/2020 17:15	03/01/2020 19:58	2,72	1	2,72	CHI
20200114347	FORMOSA	FA11046850	ITUIQUIRA	03/01/2020 16:58	03/01/2020 18:41	03/01/2020 16:58	03/01/2020 18:41	1,72	208	357,30	CHI
20200114348	SANTA CRUZ DE GOIAS	BC21212546	CRISTIANOPOLIS	03/01/2020 17:16	03/01/2020 18:51	03/01/2020 17:16	03/01/2020 18:51	1,58	1	1,58	CHI
20200114353	FORMOSA	610125140	ITUIQUIRA	03/01/2020 17:17	03/01/2020 19:36	03/01/2020 17:17	03/01/2020 19:36	2,32	1	2,32	CHI
20200114357	IPAMERI	IP12231489	IPAMERI	03/01/2020 17:07	03/01/2020 20:15	03/01/2020 17:07	03/01/2020 20:15	3,12	133	415,03	CHI
20200114362	PONTALINA	PK21028550	GOIATUBA S1	03/01/2020 17:20	03/01/2020 22:24	03/01/2020 17:20	03/01/2020 22:24	5,06	1	5,06	CHI
20200114365	CAIAPONIA	CP12184786	CAIAPONIA	03/01/2020 16:32	03/01/2020 20:26	03/01/2020 16:32	03/01/2020 20:26	3,90	36	140,29	CHI
20200114365	DOVERLANDIA	CP12184786	CAIAPONIA	03/01/2020 16:32	03/01/2020 20:26	03/01/2020 16:32	03/01/2020 20:26	3,90	1	3,90	CHI
20200114367	CATURAI	IN12376879	ARACU	03/01/2020 17:21	03/01/2020 19:44	03/01/2020 17:21	03/01/2020 19:44	2,37	2	4,75	CHI
20200114373	ANAPOLIS	20042541	JUNDIAI S2	03/01/2020 17:24	03/01/2020 19:33	03/01/2020 17:24	03/01/2020 19:33	2,15	1	2,15	CHI
20200114376	DAVINOPOLIS	IO12394013	CATALAO S1	03/01/2020 17:24	04/01/2020 12:01	03/01/2020 17:24	04/01/2020 12:01	18,61	9	167,52	CHI
20200114376	DISTRITO FEDERAL	IO12394013	CATALAO S1	03/01/2020 17:24	04/01/2020 12:01	03/01/2020 17:24	04/01/2020 12:01	18,61	2	37,23	CHI
20200114377	MUTUNOPOLIS	MU12220645	MARA ROSA	03/01/2020 17:24	04/01/2020 10:57	03/01/2020 17:24	04/01/2020 10:57	17,54	31	543,70	CHI
20200114377	PORANGATU	MU12220645	MARA ROSA	03/01/2020 17:24	04/01/2020 10:57	03/01/2020 17:24	04/01/2020 10:57	17,54	14	245,54	CHI
20200114380	IPAMERI	IP12042440	IPAMERI	03/01/2020 17:24	05/01/2020 01:55	03/01/2020 17:24	05/01/2020 01:55	32,50	1	32,50	CHI
20200114381	GOIANIA	14237910	GOYA S2	03/01/2020 17:25	03/01/2020 19:52	03/01/2020 17:25	03/01/2020 19:52	2,45	1	2,45	CHI
20200114383	IPAMERI	IP21000030	IPAMERI	03/01/2020 17:10	03/01/2020 19:42	03/01/2020 17:10	03/01/2020 19:25	2,26	2	4,52	CHI
20200114383	IPAMERI	IP12000014	IPAMERI	03/01/2020 17:10	03/01/2020 19:42	03/01/2020 17:10	03/01/2020 19:42	2,54	15	38,14	CHI
20200114383	IPAMERI	IP12000014	IPAMERI	03/01/2020 17:10	03/01/2020 19:42	03/01/2020 19:29	03/01/2020 19:42	0,23	2	0,46	CHI
20200114384	CUMARI	2000009135	CATALAO S1	03/01/2020 17:26	03/01/2020 18:40	03/01/2020 17:26	03/01/2020 18:40	1,22	1	1,22	CHI

20200114385	NOVA AMERICA	NM12363582	RUBIATABA	03/01/2020 17:28	03/01/2020 20:58	03/01/2020 17:28	03/01/2020 20:58	3,50	3	10,50	CHI
20200114386	MUTUNOPOLIS	MU21094057	MARA ROSA	03/01/2020 17:28	04/01/2020 11:37	03/01/2020 17:28	04/01/2020 11:37	18,15	1	18,15	CHI
20200114388	RIO VERDE	630054642	RIO VERDE S2	03/01/2020 17:28	04/01/2020 10:06	03/01/2020 17:28	04/01/2020 10:06	16,63	1	16,63	CHI
20200114392	CORUMBAIBA	CI21298647	VILA CORUMBA	03/01/2020 17:29	04/01/2020 19:47	03/01/2020 17:29	04/01/2020 19:47	26,30	1	26,30	CHI
20200114396	LUZIANIA	10009131610	RIO VERMELHO	03/01/2020 17:30	03/01/2020 19:51	03/01/2020 17:30	03/01/2020 19:51	2,34	1	2,34	CHI
20200114501	CORUMBAIBA	CI12064619	VILA CORUMBA	03/01/2020 17:03	04/01/2020 18:22	03/01/2020 17:03	04/01/2020 18:22	25,31	36	911,27	CHI
20200114506	CAIAPONIA	CP12334323	PIRANHAS	03/01/2020 17:32	03/01/2020 18:25	03/01/2020 17:32	03/01/2020 18:25	0,89	7	6,21	CHI
20200114507	ITABERAI	IB21235436	ITABERAI S1	03/01/2020 17:32	03/01/2020 20:35	03/01/2020 17:32	03/01/2020 20:35	3,03	2	6,07	CHI
20200114508	CATALAO	CT12238478	CATALAO S1	03/01/2020 17:33	04/01/2020 18:32	03/01/2020 17:33	04/01/2020 18:32	24,98	2	49,96	CHI
20200114509	AGUA LIMPA	430010345	VILA CORUMBA	03/01/2020 17:33	04/01/2020 10:55	03/01/2020 17:33	04/01/2020 10:55	17,36	1	17,36	CHI
20200114514	URUTAI	UT12080724RE	URUTAI	03/01/2020 17:30	03/01/2020 19:17	03/01/2020 17:30	03/01/2020 19:17	1,77	80	141,71	CHI
20200114519	GOIANDIRA	GD12131094	CATALAO S1	03/01/2020 17:24	04/01/2020 13:55	03/01/2020 17:24	04/01/2020 13:55	20,50	7	143,52	CHI
20200114519	NOVA AURORA	GD12131094	CATALAO S1	03/01/2020 17:24	04/01/2020 13:55	03/01/2020 17:24	04/01/2020 13:55	20,50	3	61,51	CHI
20200114523	CRISTALINA	KR21320048	CRISTALINA S1	03/01/2020 17:37	04/01/2020 12:11	03/01/2020 17:37	04/01/2020 12:11	18,57	1	18,57	CHI
20200114524	AGUAS LINDAS DE GOIAS	LA11183870	AGUAS LINDAS DE GOIAS S1	03/01/2020 17:37	03/01/2020 19:50	03/01/2020 17:37	03/01/2020 19:50	2,21	82	181,27	CHI
20200114525	URUACU	CR21221635	MARA ROSA	03/01/2020 17:37	03/01/2020 20:54	03/01/2020 17:37	03/01/2020 20:54	3,28	1	3,28	CHI
20200114526	TRINDADE	40146236	TRINDADE	03/01/2020 17:37	03/01/2020 20:34	03/01/2020 17:37	03/01/2020 20:34	2,94	1	2,94	CHI
20200114533	GOIANIA	GN11001260	CAMPINAS S1	03/01/2020 17:39	03/01/2020 21:59	03/01/2020 17:39	03/01/2020 21:59	4,33	141	609,90	CHI
20200114536	CATALAO	CT21286876	CATALAO S1	03/01/2020 17:40	04/01/2020 10:10	03/01/2020 17:40	04/01/2020 10:10	16,51	1	16,51	CHI
20200114546	SANTO ANTONIO DO DESCOBERTO	SN21078159	MARAJOARA	03/01/2020 17:42	03/01/2020 21:05	03/01/2020 17:42	03/01/2020 21:05	3,37	1	3,37	CHI
20200114555	MONTIVIDIU	MV21054399	MONTIVIDIU T	03/01/2020 17:44	04/01/2020 07:41	03/01/2020 17:44	04/01/2020 07:41	13,94	1	13,94	CHI
20200114556	IPAMERI	IP12095243	IPAMERI	03/01/2020 17:38	04/01/2020 07:23	03/01/2020 17:38	04/01/2020 07:23	13,74	7	96,16	CHI
20200114557	CARMO DO RIO VERDE	RB10400426	RUBIATABA	03/01/2020 17:44	03/01/2020 19:20	03/01/2020 17:44	03/01/2020 19:20	1,61	3	4,82	CHI
20200114557	CERES	RB10400426	RUBIATABA	03/01/2020 17:44	03/01/2020 19:20	03/01/2020 17:44	03/01/2020 19:20	1,61	28	44,96	CHI
20200114557	IPIRANGA DE GOIAS	RB10400426	RUBIATABA	03/01/2020 17:44	03/01/2020 19:20	03/01/2020 17:44	03/01/2020 19:20	1,61	3	4,82	CHI
20200114557	RUBIATABA	RB10400426	RUBIATABA	03/01/2020 17:44	03/01/2020 19:20	03/01/2020 17:44	03/01/2020 19:20	1,61	396	635,80	CHI
20200114557	SAO PATRICIO	RB10400426	RUBIATABA	03/01/2020 17:44	03/01/2020 19:20	03/01/2020 17:44	03/01/2020 19:20	1,61	20	32,11	CHI
20200114558	MINEIROS	MY12372566	PARQUE DAS EMAS	03/01/2020 17:45	03/01/2020 19:38	03/01/2020 17:45	03/01/2020 19:38	1,88	2	3,76	CHI
20200114559	SANTO ANTONIO DO DESCOBERTO	SN21219870	MARAJOARA	03/01/2020 17:45	03/01/2020 20:56	03/01/2020 17:45	03/01/2020 20:56	3,18	1	3,18	CHI
20200114561	RIO VERDE	630178872	RIO VERDE S2	03/01/2020 17:45	03/01/2020 21:40	03/01/2020 17:45	03/01/2020 21:40	3,91	1	3,91	CHI
20200114563	JATAI	JT12008872	JATAI S1	03/01/2020 17:45	04/01/2020 11:34	03/01/2020 17:45	04/01/2020 10:42	16,95	1	16,95	CHI
20200114563	JATAI	JT12008872	JATAI S1	03/01/2020 17:45	04/01/2020 11:34	03/01/2020 17:45	04/01/2020 10:56	17,18	6	103,10	CHI
20200114563	JATAI	JT12008872	JATAI S1	03/01/2020 17:45	04/01/2020 11:34	03/01/2020 17:45	04/01/2020 11:34	17,81	3	53,43	CHI



20200114567	RIO VERDE	RV12018095	SANTA HELENA S1	03/01/2020 17:46	04/01/2020 08:59	03/01/2020 17:46	04/01/2020 08:59	15,21	9	136,90	CHI
20200114574	PEROLANDIA	DP21209809	JATAI S1	03/01/2020 17:47	03/01/2020 18:50	03/01/2020 17:47	03/01/2020 18:50	1,04	1	1,04	CHI
20200114575	MINEIROS	MY21301881	PARQUE DAS EMAS	03/01/2020 17:47	04/01/2020 11:13	03/01/2020 17:47	04/01/2020 11:13	17,42	1	17,42	CHI
20200114577	LUZIANIA	LZ21013823	VIANOPOLIS	03/01/2020 17:48	03/01/2020 19:47	03/01/2020 17:48	03/01/2020 19:47	1,97	1	1,97	CHI
20200114589	CATALAO	9580002507	CATALAO S1	03/01/2020 17:52	04/01/2020 07:17	03/01/2020 17:52	04/01/2020 07:17	13,42	1	13,42	CHI
20200114591	SILVANIA	SV11241013	VIANOPOLIS	03/01/2020 17:50	03/01/2020 20:08	03/01/2020 17:50	03/01/2020 20:08	2,29	148	339,33	CHI
20200114602	CRIXAS	CX12202125	SERRA DO OURO	03/01/2020 17:51	03/01/2020 21:55	03/01/2020 17:51	03/01/2020 21:55	4,07	3	12,20	CHI
20200114604	SANTO ANTONIO DO DESCOBERTO	SN21386393	MARAJOARA	03/01/2020 17:57	04/01/2020 12:26	03/01/2020 17:57	04/01/2020 12:26	18,47	3	55,41	CHI
20200114605	SAO MIGUEL DO ARAGUAIA	10003693986	SAO MIGUEL DO ARAGUAIA	03/01/2020 17:57	03/01/2020 20:02	03/01/2020 17:57	03/01/2020 20:02	2,07	1	2,07	CHI
20200114609	ABADIANIA	AA21130269	DAIA S2	03/01/2020 17:59	03/01/2020 21:27	03/01/2020 17:59	03/01/2020 21:27	3,45	1	3,45	CHI
20200114614	GOIANIA	GN12390233	CARAJAS S1	03/01/2020 18:00	03/01/2020 20:28	03/01/2020 18:00	03/01/2020 20:28	2,47	359	888,13	CHI
20200114618	ACREUNA	EU12317027	ACREUNA	03/01/2020 18:01	04/01/2020 09:27	03/01/2020 18:01	04/01/2020 09:27	15,44	1	15,44	CHI
20200114633	SAO SIMAO	SO21000014	CACHOEIRA ALTA	03/01/2020 18:04	03/01/2020 22:53	03/01/2020 18:04	03/01/2020 22:53	4,81	1	4,81	CHI
20200114634	CORUMBA DE GOIAS	CB21227489	CORUMBA	03/01/2020 18:04	04/01/2020 16:57	03/01/2020 18:04	04/01/2020 16:57	22,87	1	22,87	CHI
20200114648	CALDAZINHA	DE21326168	CEPAIGO S2	03/01/2020 18:10	03/01/2020 20:14	03/01/2020 18:10	03/01/2020 20:14	2,06	2	4,13	CHI
20200114654	COLINAS DO SUL	TI12277661	MINACU	03/01/2020 18:10	03/01/2020 20:21	03/01/2020 18:10	03/01/2020 20:21	2,17	10	21,75	CHI
20200114655	CATALAO	CT12399850	CATALAO S1	03/01/2020 17:42	03/01/2020 20:08	03/01/2020 17:42	03/01/2020 20:08	2,43	53	128,63	CHI
20200114655	GOIANDIRA	CT12399850	CATALAO S1	03/01/2020 17:42	03/01/2020 20:08	03/01/2020 17:42	03/01/2020 20:08	2,43	41	99,50	CHI
20200114656	CALDAS NOVAS	MG10400583	VILA CORUMBA	03/01/2020 18:09	04/01/2020 11:29	03/01/2020 19:23	03/01/2020 20:57	1,58	37	58,28	CHI
20200114656	MARZAGAO	MG10400583	VILA CORUMBA	03/01/2020 18:09	04/01/2020 11:29	03/01/2020 19:23	03/01/2020 20:57	1,58	38	59,85	CHI
20200114656	AGUA LIMPA	CN10396194	VILA CORUMBA	03/01/2020 18:09	04/01/2020 11:29	03/01/2020 18:09	04/01/2020 11:29	17,33	16	277,28	CHI
20200114656	CALDAS NOVAS	CN10396194	VILA CORUMBA	03/01/2020 18:09	04/01/2020 11:29	03/01/2020 18:09	04/01/2020 11:29	17,33	25	433,26	CHI
20200114656	MORRINHOS	CN10396194	VILA CORUMBA	03/01/2020 18:09	04/01/2020 11:29	03/01/2020 18:09	04/01/2020 11:29	17,33	5	86,65	CHI
20200114656	RIO QUENTE	CN10396194	VILA CORUMBA	03/01/2020 18:09	04/01/2020 11:29	03/01/2020 18:09	04/01/2020 11:29	17,33	113	1958,32	CHI
20200114656	CALDAS NOVAS	CN10396194	VILA CORUMBA	03/01/2020 18:09	04/01/2020 11:29	03/01/2020 19:23	04/01/2020 11:29	16,09	11	177,02	CHI
20200114659	BONFINOPOLIS	LB21029118	GOIANIA LESTE S2	03/01/2020 18:11	04/01/2020 12:28	03/01/2020 18:11	04/01/2020 12:28	18,28	2	36,55	CHI
20200114663	MINEIROS	1390030043	PARQUE DAS EMAS	03/01/2020 18:13	04/01/2020 11:54	03/01/2020 18:13	04/01/2020 11:54	17,68	1	17,68	CHI
20200114669	GOIATUBA	GT21013086	GOIATUBA S2	03/01/2020 18:16	03/01/2020 22:50	03/01/2020 18:16	03/01/2020 22:50	4,56	1	4,56	CHI
20200114678	CATALAO	1990340109	CATALAO S2	03/01/2020 18:19	03/01/2020 21:25	03/01/2020 18:19	03/01/2020 21:25	3,09	1	3,09	CHI
20200114684	FORMOSA	10015065063	ITUIQUIRA	03/01/2020 18:22	03/01/2020 21:40	03/01/2020 18:22	03/01/2020 21:40	3,30	1	3,30	CHI
20200114689	CAVALCANTE	CJ11320544	FLORES DE GOIAS	03/01/2020 15:55	03/01/2020 20:30	03/01/2020 15:55	03/01/2020 20:30	4,58	44	201,59	CHI
20200114691	QUIRINOPOLIS	QI21296556	QUIRINOPOLIS	03/01/2020 18:25	03/01/2020 22:34	03/01/2020 18:25	03/01/2020 22:34	4,15	1	4,15	CHI
20200114692	PONTALINA	210034695	PONTALINA	03/01/2020 18:25	03/01/2020 21:09	03/01/2020 18:25	03/01/2020 21:09	2,75	1	2,75	CHI

20200114693	CATALAO	CT12130976	CATALAO S1	03/01/2020 13:24	03/01/2020 22:34	03/01/2020 13:24	03/01/2020 22:34	9,15	11	100,69	CHI
20200114696	CALDAZINHA	BV12033394	SENADOR CANEDO	03/01/2020 18:25	03/01/2020 21:06	03/01/2020 18:25	03/01/2020 21:06	2,67	20	53,46	CHI
20200114698	CAMPO LIMPO	AN21258735	NEROPOLIS S1	03/01/2020 18:27	04/01/2020 05:30	03/01/2020 18:27	04/01/2020 05:30	11,04	1	11,04	CHI
20200114699	BELA VISTA DE GOIAS	SW21093826	SENADOR CANEDO	03/01/2020 18:27	04/01/2020 00:58	03/01/2020 18:27	04/01/2020 00:58	6,50	1	6,50	CHI
20200114806	ACREUNA	EU11189157	ACREUNA	03/01/2020 17:44	03/01/2020 20:24	03/01/2020 17:44	03/01/2020 20:24	2,66	171	455,62	CHI
20200114807	CALDAZINHA	DE12244749	CEPAIGO S2	03/01/2020 18:26	03/01/2020 21:08	03/01/2020 18:26	03/01/2020 21:08	2,69	17	45,70	CHI
20200114809	FLORES DE GOIAS	FA12397044	ITIQUEIRA	03/01/2020 18:29	04/01/2020 07:55	03/01/2020 18:29	04/01/2020 07:55	13,42	1	13,42	CHI
20200114809	FORMOSA	FA12397044	ITIQUEIRA	03/01/2020 18:29	04/01/2020 07:55	03/01/2020 18:29	04/01/2020 07:55	13,42	5	67,11	CHI
20200114813	RIO VERDE	RV21060221	MONTIVIDIU T	03/01/2020 18:30	04/01/2020 10:05	03/01/2020 18:30	04/01/2020 10:05	15,58	1	15,58	CHI
20200114829	DOVERLANDIA	DV12187350	CAIAPONIA	03/01/2020 17:28	03/01/2020 22:25	03/01/2020 17:28	03/01/2020 22:25	4,94	17	83,97	CHI
20200114834	BELA VISTA DE GOIAS	BV12059729	SENADOR CANEDO	03/01/2020 18:25	03/01/2020 20:48	03/01/2020 18:25	03/01/2020 20:48	2,38	5	11,88	CHI
20200114834	CALDAZINHA	BV12059729	SENADOR CANEDO	03/01/2020 18:25	03/01/2020 20:48	03/01/2020 18:25	03/01/2020 20:48	2,38	20	47,52	CHI
20200114835	COLINAS DO SUL	TI12237374	MINACU	03/01/2020 18:34	03/01/2020 21:24	03/01/2020 18:34	03/01/2020 21:24	2,82	4	11,28	CHI
20200114836	GAMELEIRA DE GOIAS	SV12056396	DAIA S2	03/01/2020 18:29	03/01/2020 22:06	03/01/2020 18:29	03/01/2020 22:06	3,61	99	356,92	CHI
20200114836	SILVANIA	SV12056396	DAIA S2	03/01/2020 18:29	03/01/2020 22:06	03/01/2020 18:29	03/01/2020 22:06	3,61	1	3,61	CHI
20200114842	ANAPOLIS	20566463	ANAPOLIS UNIVERSITARIO S2	03/01/2020 18:36	04/01/2020 03:08	03/01/2020 18:36	04/01/2020 03:08	8,52	1	8,52	CHI
20200114848	CALDAS NOVAS	CN21217032	SERRA DE CALDAS	03/01/2020 18:37	04/01/2020 09:25	03/01/2020 18:37	04/01/2020 09:25	14,79	1	14,79	CHI
20200114849	ITUMBIARA	IT21134649	PARANAIBA	03/01/2020 18:37	03/01/2020 21:48	03/01/2020 18:37	03/01/2020 21:48	3,17	1	3,17	CHI
20200114853	EDEIA	EA12237745	EDEIA	03/01/2020 18:11	03/01/2020 22:02	03/01/2020 18:11	03/01/2020 22:02	3,85	9	34,65	CHI
20200114854	SAO MIGUEL DO ARAGUAIA	SM11217900	SAO MIGUEL DO ARAGUAIA	03/01/2020 18:35	04/01/2020 00:30	03/01/2020 18:35	04/01/2020 00:30	5,91	80	472,87	CHI
20200114857	CRISTALINA	KR12087952	CRISTALINA S2	03/01/2020 18:38	03/01/2020 22:32	03/01/2020 18:38	03/01/2020 22:32	3,89	25	97,31	CHI
20200114858	ANAPOLIS	AN11040774	ANAPOLIS UNIVERSITARIO S2	03/01/2020 18:28	03/01/2020 20:42	03/01/2020 18:28	03/01/2020 20:42	2,23	111	247,16	CHI
20200114862	PALESTINA DE GOIAS	PY12151495	PALESTINA	03/01/2020 19:33	04/01/2020 21:56	03/01/2020 19:33	04/01/2020 21:56	26,39	4	105,56	CHI
20200114881	PIRENOPOLIS	PV21290405	CORUMBA	03/01/2020 18:44	03/01/2020 21:55	03/01/2020 18:44	03/01/2020 21:55	3,17	1	3,17	CHI
20200114884	TRINDADE	TR11053498	TRINDADE	03/01/2020 18:43	03/01/2020 20:32	03/01/2020 18:43	03/01/2020 20:32	1,81	151	273,10	CHI
20200114885	ANAPOLIS	AN12261182	JUNDIAI S1	03/01/2020 18:34	03/01/2020 19:59	03/01/2020 18:34	03/01/2020 19:59	1,41	62	87,11	CHI
20200114885	GOIANAPOLIS	AN12261182	JUNDIAI S1	03/01/2020 18:34	03/01/2020 19:59	03/01/2020 18:34	03/01/2020 19:59	1,41	9	12,65	CHI
20200114885	LEOPOLDO DE BULHOES	AN12261182	JUNDIAI S1	03/01/2020 18:34	03/01/2020 19:59	03/01/2020 18:34	03/01/2020 19:59	1,41	5	7,03	CHI
20200114889	GOIANIA	12997390	MEIA PONTE	03/01/2020 18:46	03/01/2020 21:10	03/01/2020 18:46	03/01/2020 21:10	2,39	1	2,39	CHI
20200114898	IPAMERI	IP12300933	IPAMERI	03/01/2020 18:00	04/01/2020 09:39	03/01/2020 18:00	04/01/2020 09:39	15,65	52	813,70	CHI
20200114901	IPORA	IR12231116	ARENOPOLIS	03/01/2020 18:46	03/01/2020 19:06	03/01/2020 18:46	03/01/2020 19:06	0,32	2	0,65	CHI
20200114903	BRITANIA	03290424	MATRINCHA	03/01/2020 18:55	03/01/2020 21:48	03/01/2020 18:55	03/01/2020 20:08	1,23	6	7,35	CHI
20200114903	ITAPIRAPUA	03290424	MATRINCHA	03/01/2020 18:55	03/01/2020 21:48	03/01/2020 18:55	03/01/2020 20:08	1,23	427	523,19	CHI

20200114903	ITAPIRAPUA	03290424	MATRINCHA	03/01/2020 18:55	03/01/2020 21:48	03/01/2020 18:55	03/01/2020 20:08	1,23	90	110,28	CHI
20200114903	ITAPIRAPUA	03290424	MATRINCHA	03/01/2020 18:55	03/01/2020 21:48	03/01/2020 18:55	03/01/2020 20:08	1,23	1	1,23	CHI
20200114903	JUSSARA	03290424	MATRINCHA	03/01/2020 18:55	03/01/2020 21:48	03/01/2020 18:55	03/01/2020 20:08	1,23	4	4,90	CHI
20200114903	MATRINCHA	03290424	MATRINCHA	03/01/2020 18:55	03/01/2020 21:48	03/01/2020 18:55	03/01/2020 20:08	1,23	21	25,73	CHI
20200114903	SANTA FE DE GOIAS	03290424	MATRINCHA	03/01/2020 18:55	03/01/2020 21:48	03/01/2020 18:55	03/01/2020 20:08	1,23	11	13,48	CHI
20200114903	BRITANIA	03290424	MATRINCHA	03/01/2020 18:55	03/01/2020 21:48	03/01/2020 20:29	03/01/2020 21:48	1,31	6	7,87	CHI
20200114903	ITAPIRAPUA	03290424	MATRINCHA	03/01/2020 18:55	03/01/2020 21:48	03/01/2020 20:29	03/01/2020 21:48	1,31	431	565,09	CHI
20200114903	ITAPIRAPUA	03290424	MATRINCHA	03/01/2020 18:55	03/01/2020 21:48	03/01/2020 20:29	03/01/2020 21:48	1,31	92	120,62	CHI
20200114903	ITAPIRAPUA	03290424	MATRINCHA	03/01/2020 18:55	03/01/2020 21:48	03/01/2020 20:29	03/01/2020 21:48	1,31	1	1,31	CHI
20200114903	JUSSARA	03290424	MATRINCHA	03/01/2020 18:55	03/01/2020 21:48	03/01/2020 20:29	03/01/2020 21:48	1,31	4	5,24	CHI
20200114903	MATRINCHA	03290424	MATRINCHA	03/01/2020 18:55	03/01/2020 21:48	03/01/2020 20:29	03/01/2020 21:48	1,31	21	27,53	CHI
20200114903	SANTA FE DE GOIAS	03290424	MATRINCHA	03/01/2020 18:55	03/01/2020 21:48	03/01/2020 20:29	03/01/2020 21:48	1,31	12	15,73	CHI
20200115005	GOIANAPOLIS	GP12285356	DAIA S2	03/01/2020 18:50	03/01/2020 21:49	03/01/2020 18:50	03/01/2020 21:49	2,97	8	23,74	CHI
20200115006	IPAMERI	IP12404710	IPAMERI	03/01/2020 18:51	04/01/2020 11:57	03/01/2020 18:51	04/01/2020 11:57	17,10	4	68,39	CHI
20200115008	SANTA BARBARA DE GOIAS	1030003601	TRINDADE	03/01/2020 18:51	03/01/2020 22:22	03/01/2020 18:51	03/01/2020 22:22	3,51	1	3,51	CHI
20200115012	SANTO ANTONIO DO DESCOBERTO	SN21157003	AGUAS LINDAS DE GOIAS S2	03/01/2020 18:52	03/01/2020 21:51	03/01/2020 18:52	03/01/2020 21:51	2,97	1	2,97	CHI
20200115019	CAIAPONIA	CP12260986	MONTIVIDIU T	03/01/2020 18:54	04/01/2020 13:40	03/01/2020 18:54	04/01/2020 13:40	18,78	6	112,66	CHI
20200115020	MINEIROS	MY12043892	PARQUE DAS EMAS	03/01/2020 18:49	04/01/2020 10:19	03/01/2020 18:49	04/01/2020 10:19	15,49	14	216,85	CHI
20200115021	CAMPO LIMPO	AN12017553LD	NEROPOLIS S1	03/01/2020 18:54	04/01/2020 09:33	03/01/2020 18:54	04/01/2020 09:33	14,64	3	43,92	CHI
20200115025	CATALAO	CT21266240	CATALAO S2	03/01/2020 18:55	04/01/2020 14:52	03/01/2020 18:55	04/01/2020 14:52	19,95	1	19,95	CHI
20200115031	IPAMERI	IP12404728	IPAMERI	03/01/2020 17:16	04/01/2020 11:15	03/01/2020 17:16	04/01/2020 11:15	17,97	10	179,71	CHI
20200115036	INDIARA	IY21057342	EDEIA	03/01/2020 18:58	04/01/2020 04:49	03/01/2020 18:58	04/01/2020 04:49	9,84	1	9,84	CHI
20200115050	AMORINOPOLIS	IV12165613	IPORA	03/01/2020 19:01	04/01/2020 06:23	03/01/2020 19:01	04/01/2020 06:23	11,36	6	68,14	CHI
20200115050	IVOLANDIA	IV12165613	IPORA	03/01/2020 19:01	04/01/2020 06:23	03/01/2020 19:01	04/01/2020 06:23	11,36	6	68,14	CHI
20200115051	ITUMBIARA	IT21000179	ITUMBIARA NOVA	03/01/2020 19:01	04/01/2020 12:31	03/01/2020 19:01	04/01/2020 12:31	17,49	1	17,49	CHI
20200115068	CALDAZINHA	SW21093825	SENADOR CANEDO	03/01/2020 19:04	04/01/2020 03:21	03/01/2020 19:04	04/01/2020 03:21	8,28	1	8,28	CHI
20200115072	MINEIROS	MY12126392	PARQUE DAS EMAS	03/01/2020 18:50	04/01/2020 02:17	03/01/2020 18:50	04/01/2020 02:17	7,44	14	104,21	CHI
20200115074	SENADOR CANEDO	SW12391634	SENADOR CANEDO	04/01/2020 06:45	04/01/2020 10:56	04/01/2020 06:45	04/01/2020 10:56	4,17	4	16,69	CHI
20200115076	APARECIDA DE GOIANIA	AP11137117	INDEPENDENCIA S2	03/01/2020 18:51	03/01/2020 20:50	03/01/2020 18:51	03/01/2020 20:50	1,97	104	204,68	CHI
20200115083	BELA VISTA DE GOIAS	BV21093633	CEPAIGO S2	03/01/2020 19:16	04/01/2020 00:59	03/01/2020 19:16	04/01/2020 00:59	5,70	2	11,40	CHI
20200115087	PORANGATU	PO21262608	PORANGATU	03/01/2020 19:07	04/01/2020 17:21	03/01/2020 19:07	04/01/2020 17:21	22,23	1	22,23	CHI
20200115090	GOIANIA	13238450	XAVANTES	03/01/2020 19:07	03/01/2020 22:33	03/01/2020 19:07	03/01/2020 22:33	3,42	1	3,42	CHI
20200115092	NOVO BRASIL	NB21020234	JUSSARA	03/01/2020 19:08	04/01/2020 16:25	03/01/2020 19:08	04/01/2020 16:25	21,28	1	21,28	CHI

20200115102	SILVANIA	SV12282736	VIANOPOLIS	03/01/2020 19:09	03/01/2020 21:50	03/01/2020 19:09	03/01/2020 21:50	2,68	3	8,03	CHI
20200115103	ANAPOLIS	20951589	JUNDIAI S1	03/01/2020 19:09	03/01/2020 21:17	03/01/2020 19:09	03/01/2020 21:17	2,12	1	2,12	CHI
20200115106	MONTES CLAROS DE GOIAS	ME21094759	IPORA	03/01/2020 19:10	04/01/2020 01:35	03/01/2020 19:10	04/01/2020 01:35	6,40	1	6,40	CHI
20200115111	NIQUELANDIA	NQ12255072	BARRO ALTO	03/01/2020 19:11	03/01/2020 22:17	03/01/2020 19:11	03/01/2020 22:17	3,09	7	21,64	CHI
20200115118	LEOPOLDO DE BULHOES	XX16873661	DAIA S2	03/01/2020 19:13	04/01/2020 04:14	03/01/2020 19:13	04/01/2020 04:14	9,02	1	9,02	CHI
20200115121	AGUAS LINDAS DE GOIAS	4830027000	AGUAS LINDAS DE GOIAS S1	03/01/2020 19:13	03/01/2020 21:25	03/01/2020 19:13	03/01/2020 21:25	2,20	1	2,20	CHI
20200115122	ITABERAI	IB12183031	ITABERAI S2	03/01/2020 19:01	03/01/2020 21:39	03/01/2020 19:01	03/01/2020 21:39	2,62	68	177,97	CHI
20200115125	JATAI	290331821	JATAI S3	03/01/2020 19:13	03/01/2020 21:44	03/01/2020 19:13	03/01/2020 21:44	2,51	1	2,51	CHI
20200115138	PIRACANJUBA	PJ21085377	PIRACANJUBA	03/01/2020 19:15	04/01/2020 14:59	03/01/2020 19:15	04/01/2020 14:59	19,73	2	39,46	CHI
20200115149	SANTA CRUZ DE GOIAS	BC21300792	PIRES DO RIO S2	03/01/2020 19:16	03/01/2020 23:51	03/01/2020 19:16	03/01/2020 23:51	4,57	1	4,57	CHI
20200115150	TERESINA DE GOIAS	2650008083	FLORES DE GOIAS	03/01/2020 19:17	04/01/2020 13:39	03/01/2020 19:17	04/01/2020 13:39	18,36	1	18,36	CHI
20200115164	BELA VISTA DE GOIAS	BV12000073	BELA VISTA S1	03/01/2020 19:20	03/01/2020 22:10	03/01/2020 19:20	03/01/2020 22:10	2,83	6	16,99	CHI
20200115166	FORMOSA	FA11046850	ITIQUEIRA	03/01/2020 19:05	03/01/2020 23:10	03/01/2020 19:05	03/01/2020 23:10	4,09	208	850,03	CHI
20200115175	IPAMERI	IP12275956	URUTAI	03/01/2020 19:21	04/01/2020 10:55	03/01/2020 19:21	04/01/2020 10:55	15,55	2	31,10	CHI
20200115178	ABADIANIA	AA21130723	DAIA S2	03/01/2020 19:23	04/01/2020 09:20	03/01/2020 19:23	04/01/2020 09:20	13,95	3	41,84	CHI
20200115182	ALEXANIA	10026912730	ALEXANIA	03/01/2020 19:23	04/01/2020 11:36	03/01/2020 19:23	04/01/2020 11:36	16,20	1	16,20	CHI
20200115187	BONFINOPOLIS	BO12200287	CEPAIGO S2	03/01/2020 19:24	04/01/2020 00:31	03/01/2020 19:24	04/01/2020 00:31	5,11	155	791,75	CHI
20200115188	JATAI	JT12191107	JATAI S1	03/01/2020 19:24	04/01/2020 10:02	03/01/2020 19:24	04/01/2020 10:02	14,62	5	73,10	CHI
20200115196	GOIANIA	10027360235	GOYA S1	03/01/2020 19:26	03/01/2020 21:46	03/01/2020 19:26	03/01/2020 21:46	2,32	1	2,32	CHI
20200115197	NOVO GAMA	4990074969	PACAEMBU S1	03/01/2020 19:26	03/01/2020 22:38	03/01/2020 19:26	03/01/2020 22:38	3,19	1	3,19	CHI
20200115199	BELA VISTA DE GOIAS	BV21117065	BELA VISTA S1	03/01/2020 19:26	04/01/2020 13:39	03/01/2020 19:26	04/01/2020 13:39	18,20	2	36,41	CHI
20200115202	CORUMBA DE GOIAS	CB12311892	CORUMBA	03/01/2020 19:23	03/01/2020 20:27	03/01/2020 19:23	03/01/2020 20:27	1,05	3	3,16	CHI
20200115204	JUSSARA	JR12016858	BRITANIA	03/01/2020 19:35	04/01/2020 19:56	03/01/2020 23:45	04/01/2020 19:56	20,18	6	121,08	CHI
20200115305	IPAMERI	IP12017034	IPAMERI	04/01/2020 07:36	04/01/2020 10:13	04/01/2020 07:36	04/01/2020 10:13	2,60	47	122,23	CHI
20200115314	GOIATUBA	PX12304288	PARANAIBA	03/01/2020 19:29	03/01/2020 23:02	03/01/2020 19:29	03/01/2020 23:02	3,54	4	14,16	CHI
20200115314	PANAMA	PX12304288	PARANAIBA	03/01/2020 19:29	03/01/2020 23:02	03/01/2020 19:29	03/01/2020 23:02	3,54	3	10,62	CHI
20200115322	CATALAO	1990203751	CATALAO S2	03/01/2020 19:30	03/01/2020 23:59	03/01/2020 19:30	03/01/2020 23:59	4,48	1	4,48	CHI
20200115328	APARECIDA DE GOIANIA	12436070	ATLANTICO S2	03/01/2020 19:32	03/01/2020 21:09	03/01/2020 19:32	03/01/2020 21:09	1,61	1	1,61	CHI
20200115337	CACU	CC21229435	CACHOEIRA ALTA	03/01/2020 19:34	04/01/2020 10:06	03/01/2020 19:34	04/01/2020 10:06	14,53	1	14,53	CHI
20200115339	MINEIROS	MY12260337	PARQUE DAS EMAS	03/01/2020 18:57	03/01/2020 23:08	03/01/2020 18:57	03/01/2020 22:36	3,64	517	1883,17	CHI
20200115339	MINEIROS	MY12036636	PARQUE DAS EMAS	03/01/2020 18:57	03/01/2020 23:08	03/01/2020 18:57	03/01/2020 23:08	4,18	9	37,58	CHI
20200115343	GOIANIA	11459694	GOIANIA LESTE S2	03/01/2020 19:35	03/01/2020 22:55	03/01/2020 19:35	03/01/2020 22:55	3,33	1	3,33	CHI
20200115344	GOIATUBA	BG21190825	GOIATUBA S2	03/01/2020 19:35	04/01/2020 13:00	03/01/2020 19:35	04/01/2020 13:00	17,42	1	17,42	CHI

20200115347	MINACU	IH21220732	MINACU	03/01/2020 19:35	03/01/2020 20:47	03/01/2020 19:35	03/01/2020 20:47	1,19	1	1,19	CHI
20200115350	MINEIROS	MY21303859	PARQUE DAS EMAS	03/01/2020 19:35	04/01/2020 11:40	03/01/2020 19:35	04/01/2020 11:40	16,07	1	16,07	CHI
20200115353	GOIANIA	14596787	GOIANIA LESTE S3	03/01/2020 19:36	03/01/2020 23:51	03/01/2020 19:36	03/01/2020 23:51	4,25	1	4,25	CHI
20200115355	JUSSARA	1290092361	JUSSARA	03/01/2020 19:36	04/01/2020 01:20	03/01/2020 19:36	04/01/2020 01:20	5,74	1	5,74	CHI
20200115359	GOIANIA	16634305	XAVANTES	03/01/2020 19:37	03/01/2020 21:53	03/01/2020 19:37	03/01/2020 21:53	2,26	1	2,26	CHI
20200115362	JATAI	JT12264349	JATAI S1	03/01/2020 19:34	05/01/2020 22:16	03/01/2020 19:34	04/01/2020 08:03	12,48	20	249,66	CHI
20200115362	JATAI	JT12264349	JATAI S1	03/01/2020 19:34	05/01/2020 22:16	03/01/2020 19:34	04/01/2020 14:42	19,13	28	535,65	CHI
20200115362	JATAI	JT12264349	JATAI S1	03/01/2020 19:34	05/01/2020 22:16	03/01/2020 19:34	04/01/2020 19:04	23,49	7	164,44	CHI
20200115362	JATAI	JT12264349	JATAI S1	03/01/2020 19:34	05/01/2020 22:16	04/01/2020 19:39	04/01/2020 23:07	3,45	20	69,07	CHI
20200115362	JATAI	JT12264349	JATAI S1	03/01/2020 19:34	05/01/2020 22:16	04/01/2020 19:39	05/01/2020 14:01	18,36	14	257,08	CHI
20200115362	JATAI	JT12264349	JATAI S1	03/01/2020 19:34	05/01/2020 22:16	03/01/2020 19:34	05/01/2020 22:16	50,69	5	253,46	CHI
20200115362	JATAI	JT12264349	JATAI S1	03/01/2020 19:34	05/01/2020 22:16	04/01/2020 19:39	05/01/2020 22:16	26,61	21	558,76	CHI
20200115362	JATAI	JT13219247	JATAI S1	03/01/2020 19:34	05/01/2020 22:16	05/01/2020 18:11	05/01/2020 22:16	4,08	14	57,09	CHI
20200115364	LUZIANIA	10001339921	MARAJOARA	03/01/2020 19:37	03/01/2020 21:18	03/01/2020 19:37	03/01/2020 21:18	1,67	1	1,67	CHI
20200115376	CABECEIRAS	9590000015	ITUIQUIRA	03/01/2020 19:39	03/01/2020 21:33	03/01/2020 19:39	03/01/2020 21:33	1,90	1	1,90	CHI
20200115384	GOIANIA	GN11244873	CARAJAS S2	03/01/2020 19:40	04/01/2020 00:07	03/01/2020 19:40	03/01/2020 23:25	3,75	88	329,63	CHI
20200115384	GOIANIA	GN12072342	CARAJAS S2	03/01/2020 19:40	04/01/2020 00:07	03/01/2020 22:04	04/01/2020 00:07	2,05	110	225,38	CHI
20200115393	CRISTIANOPOLIS	10013426948	CRISTIANOPOLIS	03/01/2020 19:41	03/01/2020 22:00	03/01/2020 19:41	03/01/2020 22:00	2,31	1	2,31	CHI
20200115396	GOUVELANDIA	QI21301498	QUIRINOPOLIS	03/01/2020 19:41	04/01/2020 01:52	03/01/2020 19:41	04/01/2020 01:52	6,17	1	6,17	CHI
20200115401	CRISTALINA	KR21332528	CRISTALINA S1	03/01/2020 19:42	04/01/2020 10:50	03/01/2020 19:42	04/01/2020 10:50	15,13	1	15,13	CHI
20200115407	MAIRIPOTABA	MI21060683	PONTALINA	03/01/2020 19:43	04/01/2020 11:29	03/01/2020 19:43	04/01/2020 11:29	15,77	1	15,77	CHI
20200115412	MATRINCHA	MP12206480	MATRINCHA	03/01/2020 19:43	03/01/2020 22:35	03/01/2020 19:43	03/01/2020 22:35	2,85	16	45,66	CHI
20200115414	TRINDADE	40048536	TRINDADE	03/01/2020 19:43	03/01/2020 22:45	03/01/2020 19:43	03/01/2020 22:45	3,02	1	3,02	CHI
20200115415	ALVORADA DO NORTE	1510007882	IACIARA S2	03/01/2020 19:44	04/01/2020 11:26	03/01/2020 19:44	04/01/2020 11:26	15,70	1	15,70	CHI
20200115421	SENADOR CANEDO	SW12129050	SENADOR CANEDO	03/01/2020 19:45	03/01/2020 23:36	03/01/2020 19:45	03/01/2020 23:36	3,84	5	19,20	CHI
20200115425	PIRACANJUBA	PJ12268166	ROCHEDO	03/01/2020 19:28	03/01/2020 21:57	03/01/2020 19:28	03/01/2020 21:57	2,47	172	424,89	CHI
20200115434	SAO MIGUEL DO ARAGUAIA	SM11247086	SAO MIGUEL DO ARAGUAIA	03/01/2020 19:49	04/01/2020 16:53	03/01/2020 19:49	04/01/2020 16:53	21,06	1	21,06	CHI
20200115446	MORRINHOS	10024912849	MORRINHOS	03/01/2020 19:51	03/01/2020 22:23	03/01/2020 19:51	03/01/2020 22:23	2,53	1	2,53	CHI
20200115450	GOIANIA	GN11151970	MEIA PONTE	03/01/2020 19:52	03/01/2020 21:51	03/01/2020 19:52	03/01/2020 21:51	1,98	239	473,42	CHI
20200115451	ANICUNS	TV12304696	FIRMINOPOLIS S2	03/01/2020 19:52	03/01/2020 22:30	03/01/2020 19:52	03/01/2020 22:30	2,63	3	7,88	CHI
20200115451	TURVANIA	TV12304696	FIRMINOPOLIS S2	03/01/2020 19:52	03/01/2020 22:30	03/01/2020 19:52	03/01/2020 22:30	2,63	14	36,77	CHI
20200115471	INHUMAS	IN10400763	INHUMAS S2	03/01/2020 19:56	04/01/2020 03:44	03/01/2020 19:56	04/01/2020 03:44	7,81	64	499,68	CHI
20200115474	MINEIROS	MY12377570	PARQUE DAS EMAS	03/01/2020 19:57	03/01/2020 22:51	03/01/2020 19:57	03/01/2020 22:51	2,90	132	382,76	CHI

20200115477	APARECIDA DE GOIANIA	12225472	INDEPENDENCIA S2	03/01/2020 19:57	03/01/2020 21:31	03/01/2020 19:57	03/01/2020 21:31	1,56	1	1,56	CHI
20200115480	QUIRINOPOLIS	QI32058080	QUIRINOPOLIS	03/01/2020 19:58	04/01/2020 11:02	03/01/2020 19:58	04/01/2020 11:02	15,07	10	150,66	CHI
20200115482	CAIAPONIA	CP21408813	CAIAPONIA	03/01/2020 19:58	04/01/2020 07:52	03/01/2020 19:58	04/01/2020 07:52	11,90	1	11,90	CHI
20200115496	CRISTALINA	KR21214839	CRISTALINA S2	03/01/2020 20:00	03/01/2020 21:21	03/01/2020 20:00	03/01/2020 21:21	1,34	1	1,34	CHI
20200115498	CAVALCANTE	740000676	FLORES DE GOIAS	03/01/2020 20:00	04/01/2020 15:25	03/01/2020 20:00	04/01/2020 15:25	19,40	1	19,40	CHI
20200115503	CORUMBA DE GOIAS	CB12297694	CORUMBA	03/01/2020 20:01	04/01/2020 09:59	03/01/2020 20:01	04/01/2020 09:59	13,96	34	474,64	CHI
20200115504	VALPARAISO DE GOIAS	2860160353	MARAJOARA	03/01/2020 20:01	03/01/2020 22:51	03/01/2020 20:01	03/01/2020 22:51	2,82	1	2,82	CHI
20200115506	ITUMBIARA	IT12000308RE	PARANAIBA	03/01/2020 19:39	04/01/2020 00:30	03/01/2020 19:39	04/01/2020 00:30	4,86	91	442,16	CHI
20200115509	SANTA HELENA DE GOIAS	SH32160716	IPEGUARI	03/01/2020 20:02	04/01/2020 13:33	03/01/2020 20:02	04/01/2020 13:33	17,51	4	70,03	CHI
20200115512	BELA VISTA DE GOIAS	BV12000022	BELA VISTA S1	03/01/2020 19:09	04/01/2020 02:41	03/01/2020 19:09	04/01/2020 02:41	7,52	93	699,80	CHI
20200115513	GOIANDIRA	GD12195324	CATALAO S1	03/01/2020 19:21	04/01/2020 01:18	03/01/2020 23:32	04/01/2020 00:01	0,49	93	46,03	CHI
20200115513	CALDAS NOVAS	IP16407450	IPAMERI	03/01/2020 19:21	04/01/2020 01:18	03/01/2020 19:21	04/01/2020 01:18	5,95	10	59,49	CHI
20200115513	CATALAO	IP16407450	IPAMERI	03/01/2020 19:21	04/01/2020 01:18	03/01/2020 19:21	04/01/2020 01:18	5,95	6	35,69	CHI
20200115513	CORUMBAIBA	IP16407450	IPAMERI	03/01/2020 19:21	04/01/2020 01:18	03/01/2020 19:21	04/01/2020 01:18	5,95	3	17,85	CHI
20200115513	GOIANDIRA	IP16407450	IPAMERI	03/01/2020 19:21	04/01/2020 01:18	03/01/2020 19:21	04/01/2020 01:18	5,95	6	35,69	CHI
20200115513	IPAMERI	IP16407450	IPAMERI	03/01/2020 19:21	04/01/2020 01:18	03/01/2020 19:21	04/01/2020 01:18	5,95	1129	6715,98	CHI
20200115513	IPAMERI	IP16407450	IPAMERI	03/01/2020 19:21	04/01/2020 01:18	03/01/2020 20:20	04/01/2020 01:18	4,96	143	709,40	CHI
20200115513	CATALAO	IP16407450	IPAMERI	03/01/2020 19:21	04/01/2020 01:18	03/01/2020 21:51	04/01/2020 01:18	3,45	1	3,45	CHI
20200115513	GOIANDIRA	IP16407450	IPAMERI	03/01/2020 19:21	04/01/2020 01:18	03/01/2020 21:51	04/01/2020 01:18	3,45	9	31,01	CHI
20200115513	IPAMERI	IP16407450	IPAMERI	03/01/2020 19:21	04/01/2020 01:18	03/01/2020 21:51	04/01/2020 01:18	3,45	13	44,80	CHI
20200115513	CORUMBAIBA	IP12231733LD	IPAMERI	03/01/2020 19:21	04/01/2020 01:18	03/01/2020 19:21	04/01/2020 01:18	5,95	16	95,19	CHI
20200115513	IPAMERI	IP12231733LD	IPAMERI	03/01/2020 19:21	04/01/2020 01:18	03/01/2020 19:21	04/01/2020 01:18	5,95	151	898,32	CHI
20200115513	NOVA AURORA	IP12231733LD	IPAMERI	03/01/2020 19:21	04/01/2020 01:18	03/01/2020 19:21	04/01/2020 01:18	5,95	2	11,90	CHI
20200115514	BALIZA	BH12187387LD	BOM JARDIM	03/01/2020 20:04	03/01/2020 23:45	03/01/2020 20:04	03/01/2020 23:45	3,68	694	2556,04	CHI
20200115518	BELA VISTA DE GOIAS	BV12018394	BELA VISTA S1	03/01/2020 20:04	04/01/2020 09:19	03/01/2020 20:04	04/01/2020 09:19	13,24	3	39,71	CHI
20200115518	PIRACANJUBA	BV12018394	BELA VISTA S1	03/01/2020 20:04	04/01/2020 09:19	03/01/2020 20:04	04/01/2020 09:19	13,24	33	436,77	CHI
20200115522	CALDAS NOVAS	CN21182604	CALDAS NOVAS S1	03/01/2020 20:05	04/01/2020 13:00	03/01/2020 20:05	04/01/2020 13:00	16,91	1	16,91	CHI
20200115525	ITAUCU	IX12000067	INHUMAS S1	03/01/2020 20:05	04/01/2020 08:03	03/01/2020 20:05	04/01/2020 08:03	11,95	14	167,34	CHI
20200115528	IPAMERI	IP12311771	IPAMERI	03/01/2020 20:06	04/01/2020 00:48	03/01/2020 20:06	04/01/2020 00:48	4,69	4	18,75	CHI
20200115533	INHUMAS	IN32066288	INHUMAS S2	03/01/2020 19:53	04/01/2020 03:44	03/01/2020 19:53	04/01/2020 03:44	7,86	8	62,88	CHI
20200115536	AGUAS LINDAS DE GOIAS	4830207670	AGUAS LINDAS DE GOIAS S2	03/01/2020 20:08	03/01/2020 21:59	03/01/2020 20:08	03/01/2020 21:59	1,85	1	1,85	CHI
20200115539	PARAUNA	PU12336647	MONTIVIDIU T	03/01/2020 19:40	04/01/2020 00:58	03/01/2020 19:40	04/01/2020 00:58	5,29	2	10,58	CHI
20200115546	TRINDADE	10003498105	TRINDADE	03/01/2020 20:10	03/01/2020 23:02	03/01/2020 20:10	03/01/2020 23:02	2,85	1	2,85	CHI

20200115551	MINEIROS	MY12324492	PARQUE DAS EMAS	03/01/2020 20:11	04/01/2020 04:55	03/01/2020 20:11	04/01/2020 04:55	8,72	1	8,72	CHI
20200115556	GOIANIA	13943352	MEIA PONTE	03/01/2020 20:13	03/01/2020 22:49	03/01/2020 20:13	03/01/2020 22:49	2,59	1	2,59	CHI
20200115563	LUZIANIA	120276203	RIO VERMELHO	03/01/2020 20:14	03/01/2020 21:35	03/01/2020 20:14	03/01/2020 21:35	1,34	1	1,34	CHI
20200115566	BURITI DE GOIAS	BS21318824	FIRMINOPOLIS S2	03/01/2020 20:15	04/01/2020 07:31	03/01/2020 20:15	04/01/2020 07:31	11,26	1	11,26	CHI
20200115567	SAO MIGUEL DO ARAGUAIA	SM12074411	SAO MIGUEL DO ARAGUAIA	03/01/2020 17:03	04/01/2020 03:29	03/01/2020 17:03	04/01/2020 03:29	10,42	8	83,34	CHI
20200115571	QUIRINOPOLIS	80039108	QUIRINOPOLIS	03/01/2020 20:18	03/01/2020 22:41	03/01/2020 20:18	03/01/2020 22:41	2,38	1	2,38	CHI
20200115578	BELA VISTA DE GOIAS	BV12000037	BELA VISTA S1	03/01/2020 19:38	04/01/2020 05:11	03/01/2020 19:38	04/01/2020 05:11	9,54	16	152,68	CHI
20200115580	URUACU	640137088	URUACU	03/01/2020 20:20	03/01/2020 23:49	03/01/2020 20:20	03/01/2020 23:49	3,48	1	3,48	CHI
20200115590	CAVALCANTE	CJ21408546	MINACU	03/01/2020 20:23	04/01/2020 13:16	03/01/2020 20:23	04/01/2020 13:16	16,88	1	16,88	CHI
20200115593	TRINDADE	12596838	GOYA S2	03/01/2020 20:24	03/01/2020 23:07	03/01/2020 20:24	03/01/2020 23:07	2,72	1	2,72	CHI
20200115594	ANAPOLIS	AN11000338	ANAPOLIS UNIVERSITARIO S2	03/01/2020 19:45	03/01/2020 22:19	03/01/2020 19:45	03/01/2020 22:19	2,55	91	232,38	CHI
20200115600	GOIANIA	10008423847	ATLANTICO S1	03/01/2020 20:25	03/01/2020 21:39	03/01/2020 20:25	03/01/2020 21:39	1,22	1	1,22	CHI
20200115609	ANAPOLIS	00050274	ANAPOLIS UNIVERSITARIO S2	03/01/2020 20:26	04/01/2020 00:45	03/01/2020 20:26	03/01/2020 20:35	0,14	3	0,43	CHI
20200115609	ANAPOLIS	AN16407075	ANAPOLIS UNIVERSITARIO S2	03/01/2020 20:26	04/01/2020 00:45	03/01/2020 20:26	03/01/2020 20:37	0,19	3619	686,60	CHI
20200115609	ANAPOLIS	AN16413912	ANAPOLIS UNIVERSITARIO S2	03/01/2020 20:26	04/01/2020 00:45	03/01/2020 20:26	03/01/2020 21:51	1,42	6274	8888,17	CHI
20200115609	ANAPOLIS	AN16413912	ANAPOLIS UNIVERSITARIO S2	03/01/2020 20:26	04/01/2020 00:45	03/01/2020 20:26	04/01/2020 00:45	4,32	167	720,74	CHI
20200115609	ANAPOLIS	AN16413912	ANAPOLIS UNIVERSITARIO S2	03/01/2020 20:26	04/01/2020 00:45	03/01/2020 20:37	04/01/2020 00:45	4,14	50	206,90	CHI
20200115627	ALTO PARAISO DE GOIAS	BF11129977	FLORES DE GOIAS	03/01/2020 19:54	03/01/2020 20:59	03/01/2020 19:54	03/01/2020 20:59	1,08	148	159,26	CHI
20200115630	DIVINOPOLIS DE GOIAS	4620001492	SAO DOMINGOS	03/01/2020 20:28	04/01/2020 12:21	03/01/2020 20:28	04/01/2020 12:21	15,88	1	15,88	CHI
20200115641	CATALAO	CT21318684	CATALAO S1	03/01/2020 17:33	04/01/2020 19:19	03/01/2020 17:33	04/01/2020 19:19	25,76	1	25,76	CHI
20200115661	CRIXAS	CX21287157	SANTA TEREZINHA	03/01/2020 20:30	04/01/2020 00:54	03/01/2020 20:30	04/01/2020 00:54	4,39	1	4,39	CHI
20200115671	CALDAS NOVAS	CN11114789	SERRA DE CALDAS	03/01/2020 20:30	04/01/2020 09:02	03/01/2020 20:30	04/01/2020 09:02	12,53	77	965,05	CHI
20200115678	MONTES CLAROS DE GOIAS	ME12140008	IPORA	03/01/2020 20:31	05/01/2020 21:39	03/01/2020 20:31	04/01/2020 08:00	11,47	17	195,04	CHI
20200115678	ARENOPOLIS	03830406	IPORA	03/01/2020 20:31	05/01/2020 21:39	04/01/2020 13:49	04/01/2020 13:56	0,13	133	16,70	CHI
20200115678	BOM JARDIM DE GOIAS	ME10400382	IPORA	03/01/2020 20:31	05/01/2020 21:39	04/01/2020 13:49	04/01/2020 13:56	0,13	17	2,13	CHI
20200115678	MONTES CLAROS DE GOIAS	ME10400382	IPORA	03/01/2020 20:31	05/01/2020 21:39	04/01/2020 13:49	04/01/2020 13:56	0,13	28	3,51	CHI
20200115678	ARENOPOLIS	AY13204816	IPORA	03/01/2020 20:31	05/01/2020 21:39	04/01/2020 08:38	04/01/2020 17:08	8,50	101	858,47	CHI
20200115678	MONTES CLAROS DE GOIAS	AY13204816	IPORA	03/01/2020 20:31	05/01/2020 21:39	04/01/2020 08:38	04/01/2020 17:08	8,50	1	8,50	CHI
20200115678	PIRANHAS	AY13204816	IPORA	03/01/2020 20:31	05/01/2020 21:39	04/01/2020 08:38	04/01/2020 17:08	8,50	2	17,00	CHI
20200115678	ARENOPOLIS	AY13204816	IPORA	03/01/2020 20:31	05/01/2020 21:39	04/01/2020 15:51	04/01/2020 17:08	1,28	6	7,69	CHI
20200115678	MONTES CLAROS DE GOIAS	AY12223209LD	IPORA	03/01/2020 20:31	05/01/2020 21:39	04/01/2020 08:38	04/01/2020 17:31	8,90	21	186,87	CHI
20200115678	MONTES CLAROS DE GOIAS	AY12223209LD	IPORA	03/01/2020 20:31	05/01/2020 21:39	04/01/2020 10:19	04/01/2020 17:31	7,20	30	216,05	CHI
20200115678	MONTES CLAROS DE GOIAS	AY12223209LD	IPORA	03/01/2020 20:31	05/01/2020 21:39	04/01/2020 10:19	05/01/2020 02:47	16,45	6	98,71	CHI

20200115678	MONTES CLAROS DE GOIAS	ME12140008	IPORA	03/01/2020 20:31	05/01/2020 21:39	04/01/2020 08:38	05/01/2020 21:25	36,80	17	625,57	CHI
20200115678	MONTES CLAROS DE GOIAS	AY12094793LD	IPORA	03/01/2020 20:31	05/01/2020 21:39	04/01/2020 08:38	05/01/2020 21:39	37,02	3	111,06	CHI
20200115678	MONTES CLAROS DE GOIAS	AY12094793LD	IPORA	03/01/2020 20:31	05/01/2020 21:39	04/01/2020 15:51	05/01/2020 21:39	29,80	2	59,60	CHI
20200115681	IPAMERI	UT12027140	URUTAI	03/01/2020 20:29	04/01/2020 08:40	03/01/2020 20:29	04/01/2020 08:40	12,17	13	158,22	CHI
20200115681	URUTAI	UT12027140	URUTAI	03/01/2020 20:29	04/01/2020 08:40	03/01/2020 20:29	04/01/2020 08:40	12,17	1	12,17	CHI
20200115699	EDEIA	EA21025321	EDEIA	03/01/2020 20:33	03/01/2020 23:14	03/01/2020 20:33	03/01/2020 23:14	2,68	2	5,36	CHI
20200115706	FIRMINOPOLIS	900046570	FIRMINOPOLIS S1	03/01/2020 20:33	03/01/2020 23:36	03/01/2020 20:33	03/01/2020 23:36	3,04	1	3,04	CHI
20200115720	ITUMBIARA	IT21000267	ITUMBIARA NOVA	03/01/2020 20:35	04/01/2020 09:30	03/01/2020 20:35	04/01/2020 09:30	12,91	1	12,91	CHI
20200115729	MINEIROS	MY12156811	PARQUE DAS EMAS	03/01/2020 19:44	04/01/2020 01:20	03/01/2020 19:44	04/01/2020 01:20	5,59	17	94,99	CHI
20200115740	BELA VISTA DE GOIAS	BV12118838	BELA VISTA S1	03/01/2020 20:37	04/01/2020 12:48	03/01/2020 20:37	04/01/2020 12:48	16,18	10	161,83	CHI
20200115759	MONTIVIDIU	MV21030641	MONTIVIDIU T	03/01/2020 20:38	03/01/2020 23:50	03/01/2020 20:38	03/01/2020 23:50	3,18	1	3,18	CHI
20200115772	SANTO ANTONIO DA BARRA	2270015582	ACREUNA	03/01/2020 20:40	04/01/2020 08:00	03/01/2020 20:40	04/01/2020 08:00	11,32	1	11,32	CHI
20200115776	CACHOEIRA ALTA	CA21136014	CACHOEIRA ALTA	03/01/2020 20:40	04/01/2020 00:23	03/01/2020 20:40	04/01/2020 00:23	3,70	1	3,70	CHI
20200115783	AURILANDIA	AI11215428	FIRMINOPOLIS S2	03/01/2020 20:09	03/01/2020 23:02	03/01/2020 20:09	03/01/2020 23:02	2,88	55	158,23	CHI
20200115796	NIQUELANDIA	NQ21031441	BARRO ALTO	03/01/2020 20:44	04/01/2020 00:02	03/01/2020 20:44	04/01/2020 00:02	3,28	1	3,28	CHI
20200115904	NEROPOLIS	NR12043193	NEROPOLIS S2	03/01/2020 20:45	04/01/2020 08:16	03/01/2020 20:45	04/01/2020 08:16	11,50	18	207,02	CHI
20200115904	OURO VERDE DE GOIAS	NR12043193	NEROPOLIS S2	03/01/2020 20:45	04/01/2020 08:16	03/01/2020 20:45	04/01/2020 08:16	11,50	13	149,51	CHI
20200115910	RIO VERDE	10010434842	CABRIUVA S1	03/01/2020 20:49	03/01/2020 22:30	03/01/2020 20:49	03/01/2020 22:30	1,69	1	1,69	CHI
20200115917	ALTO PARAISO DE GOIAS	BF21280067	FLORES DE GOIAS	03/01/2020 19:06	03/01/2020 21:28	03/01/2020 19:06	03/01/2020 21:28	2,35	1	2,35	CHI
20200115918	FORMOSO	2410003194	PORANGATU	03/01/2020 20:54	04/01/2020 01:07	03/01/2020 20:54	04/01/2020 01:07	4,20	1	4,20	CHI
20200115926	ITUMBIARA	IT21198619	ITUMBIARA NOVA	03/01/2020 20:57	04/01/2020 13:46	03/01/2020 20:57	04/01/2020 13:46	16,82	1	16,82	CHI
20200115928	ANAPOLIS	AN11375933	JUNDIAI S1	03/01/2020 20:35	04/01/2020 00:29	03/01/2020 20:35	04/01/2020 00:29	3,90	61	237,76	CHI
20200115929	QUIRINOPOLIS	80028391	QUIRINOPOLIS	03/01/2020 20:59	04/01/2020 08:01	03/01/2020 20:59	04/01/2020 08:01	11,03	1	11,03	CHI
20200115931	CRISTALINA	KR21133543	CRISTALINA S1	03/01/2020 21:00	04/01/2020 11:38	03/01/2020 21:00	04/01/2020 11:38	14,62	1	14,62	CHI
20200115936	NOVO BRASIL	NB12020254	JUSSARA	03/01/2020 19:37	04/01/2020 21:34	03/01/2020 19:37	04/01/2020 12:42	17,10	19	324,82	CHI
20200115936	ITAPIRAPUA	NB12396088	JUSSARA	03/01/2020 19:37	04/01/2020 21:34	03/01/2020 19:37	04/01/2020 21:34	25,96	4	103,83	CHI
20200115936	NOVO BRASIL	NB12396088	JUSSARA	03/01/2020 19:37	04/01/2020 21:34	03/01/2020 19:37	04/01/2020 21:34	25,96	5	129,79	CHI
20200115943	CACHOEIRA DOURADA	3290003046	CACHOEIRA DOURADA	03/01/2020 21:04	04/01/2020 14:13	03/01/2020 21:04	04/01/2020 14:13	17,15	1	17,15	CHI
20200115956	FORMOSA	FA11131890	ITIQUEIRA	03/01/2020 21:05	04/01/2020 00:05	03/01/2020 21:05	04/01/2020 00:05	2,99	78	233,07	CHI
20200115958	JATAI	JT12303837	JATAI S1	03/01/2020 21:08	05/01/2020 15:04	03/01/2020 21:08	05/01/2020 12:25	39,29	22	864,47	CHI
20200115958	JATAI	JT12303837	JATAI S1	03/01/2020 21:08	05/01/2020 15:04	03/01/2020 21:08	05/01/2020 15:04	41,93	4	167,73	CHI
20200115967	CRISTALINA	KR21183707	CRISTALINA S2	03/01/2020 21:13	04/01/2020 08:48	03/01/2020 21:13	04/01/2020 08:48	11,57	1	11,57	CHI
20200115972	CALDAS NOVAS	CN12163530	CALDAS NOVAS S2	03/01/2020 21:15	03/01/2020 22:46	03/01/2020 21:15	03/01/2020 22:46	1,50	664	997,11	CHI



20200115973	CAIAPONIA	CP12354285	CAIAPONIA	03/01/2020 21:16	04/01/2020 10:53	03/01/2020 21:16	04/01/2020 10:53	13,62	12	163,40	CHI
20200115976	ORIZONA	OZ12085014RE	PIRES DO RIO S2	03/01/2020 21:18	03/01/2020 23:54	03/01/2020 21:18	03/01/2020 23:54	2,59	35	90,82	CHI
20200115976	VIANOPOLIS	OZ12085014RE	PIRES DO RIO S2	03/01/2020 21:18	03/01/2020 23:54	03/01/2020 21:18	03/01/2020 23:54	2,59	8	20,76	CHI
20200115978	IPAMERI	IP11203205	IPAMERI	03/01/2020 19:53	04/01/2020 07:57	03/01/2020 19:53	04/01/2020 07:57	12,06	102	1230,12	CHI
20200115979	BARRO ALTO	BA12342220	GOIANESIA S1	03/01/2020 21:19	04/01/2020 15:44	03/01/2020 21:19	04/01/2020 15:44	18,42	1	18,42	CHI
20200115981	CIDADE OCIDENTAL	10001439217	MARAJOARA	03/01/2020 21:21	03/01/2020 23:31	03/01/2020 21:21	03/01/2020 23:31	2,16	1	2,16	CHI
20200115985	GOIANAPOLIS	GP11180138	DAIA S2	03/01/2020 21:24	04/01/2020 00:34	03/01/2020 21:24	04/01/2020 00:34	3,16	80	252,84	CHI
20200115991	GOIAS	GS12140275	MATRINCHA	03/01/2020 21:24	04/01/2020 16:52	03/01/2020 21:24	04/01/2020 16:52	19,46	13	252,94	CHI
20200115993	CACHOEIRA DE GOIAS	PU21092419	FIRMINOPOLIS S2	03/01/2020 21:28	04/01/2020 08:30	03/01/2020 21:28	04/01/2020 08:30	11,03	1	11,03	CHI
20200115994	IPAMERI	IP12186704	IPAMERI	03/01/2020 21:30	04/01/2020 10:35	03/01/2020 21:30	04/01/2020 10:35	13,08	17	222,31	CHI
20200115995	GOIANIA	10655554	CAMPINAS S1	03/01/2020 21:30	03/01/2020 22:32	03/01/2020 21:30	03/01/2020 22:32	1,02	1	1,02	CHI
20200116105	FIRMINOPOLIS	FR12314921	FIRMINOPOLIS S1	03/01/2020 20:50	03/01/2020 22:38	03/01/2020 20:50	03/01/2020 22:38	1,79	350	626,50	CHI
20200116110	AGUA LIMPA	AL12392069	VILA CORUMBA	03/01/2020 21:43	05/01/2020 11:29	03/01/2020 21:43	05/01/2020 11:29	37,76	3	113,29	CHI
20200116110	CORUMBAIBA	AL12392069	VILA CORUMBA	03/01/2020 21:43	05/01/2020 11:29	03/01/2020 21:43	05/01/2020 11:29	37,76	1	37,76	CHI
20200116115	EDEALINA	VI21166494	VICENTINOPOLIS	03/01/2020 21:44	04/01/2020 11:31	03/01/2020 21:44	04/01/2020 11:31	13,77	2	27,54	CHI
20200116121	APARECIDA DE GOIANIA	13673154	ATLANTICO S2	03/01/2020 21:47	03/01/2020 23:14	03/01/2020 21:47	03/01/2020 23:14	1,44	1	1,44	CHI
20200116122	GOIANIA	14389617	XAVANTES	03/01/2020 21:48	03/01/2020 23:46	03/01/2020 21:48	03/01/2020 23:46	1,96	1	1,96	CHI
20200116135	FIRMINOPOLIS	900013758	FIRMINOPOLIS S1	03/01/2020 21:53	04/01/2020 01:03	03/01/2020 21:53	04/01/2020 01:03	3,16	1	3,16	CHI
20200116137	GOIAS	GS12188132	GOIAS	03/01/2020 21:08	04/01/2020 11:00	03/01/2020 21:08	04/01/2020 11:00	13,87	26	360,50	CHI
20200116138	ITUMBIARA	BG12000148	ITUMBIARA VELHA S2	03/01/2020 21:55	04/01/2020 08:48	03/01/2020 21:55	04/01/2020 08:48	10,88	4	43,50	CHI
20200116146	JATAI	JT12264399	JATAI S1	03/01/2020 21:59	04/01/2020 00:07	03/01/2020 21:59	04/01/2020 00:07	2,13	5	10,64	CHI
20200116147	CORREGO DO OURO	CO21308348	FIRMINOPOLIS S2	03/01/2020 22:00	04/01/2020 07:40	03/01/2020 22:00	04/01/2020 07:40	9,67	1	9,67	CHI
20200116148	ANAPOLIS	AN11346902	JUNDIAI S1	03/01/2020 18:29	04/01/2020 04:24	03/01/2020 18:29	04/01/2020 04:24	9,91	25	247,84	CHI
20200116156	GOIATUBA	GT21105052	GOIATUBA S2	03/01/2020 22:04	03/01/2020 23:44	03/01/2020 22:04	03/01/2020 23:44	1,65	1	1,65	CHI
20200116161	APARECIDA DE GOIANIA	200259428	INDEPENDENCIA S1	03/01/2020 22:10	03/01/2020 23:48	03/01/2020 22:10	03/01/2020 23:48	1,63	1	1,63	CHI
20200116183	GAMELEIRA DE GOIAS	AN12285354	ANAPOLIS UNIVERSITARIO S2	03/01/2020 22:05	04/01/2020 02:25	03/01/2020 22:05	04/01/2020 02:25	4,32	1	4,32	CHI
20200116183	SILVANIA	AN12285354	ANAPOLIS UNIVERSITARIO S2	03/01/2020 22:05	04/01/2020 02:25	03/01/2020 22:05	04/01/2020 02:25	4,32	2	8,64	CHI
20200116185	ITAPURANGA	170033582	ITAPURANGA	03/01/2020 22:30	04/01/2020 09:14	03/01/2020 22:30	04/01/2020 09:14	10,72	1	10,72	CHI
20200116186	BURITI ALEGRE	BG12263568RE	ITUMBIARA VELHA S2	03/01/2020 22:04	04/01/2020 05:39	03/01/2020 22:04	04/01/2020 05:39	7,57	15	113,54	CHI
20200116186	ITUMBIARA	BG12263568RE	ITUMBIARA VELHA S2	03/01/2020 22:04	04/01/2020 05:39	03/01/2020 22:04	04/01/2020 05:39	7,57	5	37,85	CHI
20200116187	SENADOR CANEDO	SW21094875	SENADOR CANEDO	03/01/2020 22:31	04/01/2020 07:45	03/01/2020 22:31	04/01/2020 07:45	9,23	2	18,45	CHI
20200116189	TRINDADE	TR11005172	TRINDADE	03/01/2020 20:35	03/01/2020 23:18	03/01/2020 20:35	03/01/2020 23:18	2,72	138	374,98	CHI
20200116193	CATALAO	CT12130955	CATALAO S1	03/01/2020 22:35	04/01/2020 15:48	03/01/2020 22:35	04/01/2020 15:48	17,20	2	34,41	CHI

20200116198	GOIANESIA	550148681	GOIANESIA S2	03/01/2020 22:41	04/01/2020 07:30	03/01/2020 22:41	04/01/2020 07:30	8,82	1	8,82	CHI
20200116204	CALDAS NOVAS	CN12213872LD	CALDAS NOVAS S2	04/01/2020 07:27	04/01/2020 11:36	04/01/2020 07:27	04/01/2020 11:36	4,14	13	53,77	CHI
20200116210	RIO VERDE	RV13350913	CABRIUVA S2	03/01/2020 23:25	04/01/2020 18:30	03/01/2020 23:25	04/01/2020 10:47	11,35	33	374,58	CHI
20200116210	RIO VERDE	RV12207053LD	CABRIUVA S2	03/01/2020 23:25	04/01/2020 18:30	03/01/2020 23:25	04/01/2020 17:40	18,23	1	18,23	CHI
20200116210	RIO VERDE	RV13402251	CABRIUVA S2	03/01/2020 23:25	04/01/2020 18:30	03/01/2020 23:25	04/01/2020 18:30	19,07	26	495,75	CHI
20200116302	APARECIDA DE GOIANIA	14114501	ATLANTICO S2	03/01/2020 22:46	04/01/2020 01:24	03/01/2020 22:46	04/01/2020 01:24	2,63	1	2,63	CHI
20200116305	APARECIDA DE GOIANIA	15543900	ATLANTICO S1	03/01/2020 22:49	04/01/2020 00:54	03/01/2020 22:49	04/01/2020 00:54	2,07	1	2,07	CHI
20200116310	CACU	CC12196048	CACHOEIRA ALTA	03/01/2020 22:52	04/01/2020 12:25	03/01/2020 22:52	04/01/2020 12:25	13,54	19	257,22	CHI
20200116311	VALPARAISO DE GOIAS	2860205166	MARAJOARA	03/01/2020 22:53	04/01/2020 00:17	03/01/2020 22:53	04/01/2020 00:17	1,39	1	1,39	CHI
20200116315	DISTRITO FEDERAL	05410226	MARAJOARA	03/01/2020 22:28	04/01/2020 02:05	03/01/2020 22:28	04/01/2020 02:05	3,60	49	176,56	CHI
20200116315	NOVO GAMA	05410226	MARAJOARA	03/01/2020 22:28	04/01/2020 02:05	03/01/2020 22:28	04/01/2020 02:05	3,60	1	3,60	CHI
20200116315	SANTO ANTONIO DO DESCOBERTO	05410226	MARAJOARA	03/01/2020 22:28	04/01/2020 02:05	03/01/2020 22:28	04/01/2020 02:05	3,60	795	2864,65	CHI
20200116318	GOIANIA	GN11328207	CAMPINAS S2	03/01/2020 23:02	04/01/2020 03:27	03/01/2020 23:02	04/01/2020 03:27	4,41	62	273,25	CHI
20200116329	GOIANIA	12606741	GOIANIA LESTE S2	03/01/2020 23:13	04/01/2020 01:08	03/01/2020 23:13	04/01/2020 01:08	1,91	1	1,91	CHI
20200116331	GOIAS	GS12234111	GOIAS	03/01/2020 23:14	04/01/2020 12:20	03/01/2020 23:14	04/01/2020 12:20	13,09	51	667,75	CHI
20200116332	SAO FRANCISCO DE GOIAS	SF12319829	SAO FRANCISCO DE GOIAS	03/01/2020 23:15	04/01/2020 00:47	03/01/2020 23:15	04/01/2020 00:47	1,52	20	30,39	CHI
20200116342	GOIANIA	11642075	CAMPINAS S1	03/01/2020 23:32	04/01/2020 00:39	03/01/2020 23:32	04/01/2020 00:39	1,11	1	1,11	CHI
20200116343	TAQUARAL DE GOIAS	TQ12035425	ITABERAI S1	03/01/2020 23:32	04/01/2020 07:49	03/01/2020 23:32	04/01/2020 07:49	8,28	1	8,28	CHI
20200116344	ITUMBIARA	IT12222527	PARANAIBA	03/01/2020 23:36	04/01/2020 11:00	03/01/2020 23:36	04/01/2020 11:00	11,40	14	159,61	CHI
20200116345	GOIANIRA	10026769393	MEIA PONTE	03/01/2020 23:39	04/01/2020 02:04	03/01/2020 23:39	04/01/2020 02:04	2,41	1	2,41	CHI
20200116350	GOIANIA	GN21381498	CAMPINAS S1	03/01/2020 23:44	04/01/2020 10:42	03/01/2020 23:44	04/01/2020 10:42	10,96	1	10,96	CHI
20200116351	BELA VISTA DE GOIAS	BV12079029	CEPAIGO S2	03/01/2020 19:29	04/01/2020 17:37	03/01/2020 19:29	04/01/2020 12:15	16,76	3	50,29	CHI
20200116351	BELA VISTA DE GOIAS	XX03390822	CEPAIGO S2	03/01/2020 19:29	04/01/2020 17:37	03/01/2020 19:29	04/01/2020 17:37	22,13	1	22,13	CHI
20200116358	ITAPIRAPUA	IU12018852	MATRINCHA	04/01/2020 07:27	05/01/2020 18:45	04/01/2020 07:27	04/01/2020 13:20	5,89	13	76,56	CHI
20200116358	ITAPIRAPUA	IU12035646	MATRINCHA	04/01/2020 07:27	05/01/2020 18:45	04/01/2020 07:27	04/01/2020 14:58	7,52	11	82,67	CHI
20200116358	ITAPIRAPUA	IU12030113	MATRINCHA	04/01/2020 07:27	05/01/2020 18:45	04/01/2020 07:27	04/01/2020 15:39	8,20	11	90,24	CHI
20200116358	ITAPIRAPUA	IU12030113	MATRINCHA	04/01/2020 07:27	05/01/2020 18:45	04/01/2020 15:40	05/01/2020 18:45	27,09	11	298,00	CHI
20200116359	BELA VISTA DE GOIAS	BV12080122	CEPAIGO S2	03/01/2020 23:58	04/01/2020 03:56	03/01/2020 23:58	04/01/2020 03:56	3,96	5	19,81	CHI
20200116362	CACHOEIRA DOURADA	CD11273796	CACHOEIRA DOURADA	03/01/2020 22:05	04/01/2020 04:36	03/01/2020 22:05	04/01/2020 04:36	6,52	166	1081,54	CHI
20200116369	GOIANESIA	BA12163310	GOIANESIA S1	03/01/2020 18:04	04/01/2020 01:55	03/01/2020 18:04	04/01/2020 01:55	7,85	2	15,70	CHI
20200116369	VILA PROPICIO	BA12163310	GOIANESIA S1	03/01/2020 18:04	04/01/2020 01:55	03/01/2020 18:04	04/01/2020 01:55	7,85	11	86,35	CHI
20200116372	GOIANIA	GN11193747	CAMPINAS S1	04/01/2020 00:23	04/01/2020 02:59	04/01/2020 00:23	04/01/2020 02:59	2,59	70	181,40	CHI
20200116373	ITUMBIARA	690131422	PARANAIBA	04/01/2020 00:27	04/01/2020 07:14	04/01/2020 00:27	04/01/2020 07:14	6,78	1	6,78	CHI

20200116374	ALEXANIA	AX12221403	ALEXANIA	04/01/2020 00:13	04/01/2020 07:54	04/01/2020 00:13	04/01/2020 07:54	7,68	122	936,76	CHI
20200116376	PARAUNA	PU12295855	ACREUNA	04/01/2020 00:44	04/01/2020 08:25	04/01/2020 00:44	04/01/2020 08:25	7,67	4	30,69	CHI
20200116379	CACU	CC12075913	CACHOEIRA ALTA	04/01/2020 00:50	04/01/2020 09:17	04/01/2020 00:50	04/01/2020 09:17	8,44	13	109,72	CHI
20200116379	ITARUMA	CC12075913	CACHOEIRA ALTA	04/01/2020 00:50	04/01/2020 09:17	04/01/2020 00:50	04/01/2020 09:17	8,44	31	261,65	CHI
20200116382	GOIANAPOLIS	GN12000928	GOIANIA LESTE S3	04/01/2020 00:59	04/01/2020 08:57	04/01/2020 00:59	04/01/2020 08:57	7,97	10	79,66	CHI
20200116382	GOIANIA	GN12000928	GOIANIA LESTE S3	04/01/2020 00:59	04/01/2020 08:57	04/01/2020 00:59	04/01/2020 08:57	7,97	3	23,90	CHI
20200116383	ALTO PARAISO DE GOIAS	BF21265759	FLORES DE GOIAS	04/01/2020 01:01	04/01/2020 11:28	04/01/2020 01:01	04/01/2020 11:28	10,44	1	10,44	CHI
20200116390	MORRINHOS	MR11349815	MORRINHOS	04/01/2020 01:23	04/01/2020 09:40	04/01/2020 01:23	04/01/2020 09:40	8,28	23	190,51	CHI
20200116394	SANTO ANTONIO DA BARRA	BZ12200724	ACREUNA	04/01/2020 01:28	05/01/2020 12:49	04/01/2020 22:20	04/01/2020 22:31	0,17	101	16,86	CHI
20200116394	SANTO ANTONIO DA BARRA	BZ12295804LD	ACREUNA	04/01/2020 01:28	05/01/2020 12:49	04/01/2020 23:22	05/01/2020 00:08	0,77	6	4,61	CHI
20200116394	SANTO ANTONIO DA BARRA	BZ12295784LD	ACREUNA	04/01/2020 01:28	05/01/2020 12:49	04/01/2020 01:28	05/01/2020 01:32	24,08	2	48,16	CHI
20200116394	RIO VERDE	BZ12295784LD	ACREUNA	04/01/2020 01:28	05/01/2020 12:49	04/01/2020 01:28	05/01/2020 12:49	35,36	24	848,62	CHI
20200116394	SANTA HELENA DE GOIAS	BZ12295784LD	ACREUNA	04/01/2020 01:28	05/01/2020 12:49	04/01/2020 01:28	05/01/2020 12:49	35,36	5	176,80	CHI
20200116394	SANTO ANTONIO DA BARRA	BZ12295784LD	ACREUNA	04/01/2020 01:28	05/01/2020 12:49	04/01/2020 01:28	05/01/2020 12:49	35,36	36	1272,93	CHI
20200116397	JARAGUA	JA12283464	JARAGUA	04/01/2020 01:40	04/01/2020 08:14	04/01/2020 01:40	04/01/2020 08:14	6,56	13	85,28	CHI
20200116400	GOIANIA	10333381	CAMPINAS S1	04/01/2020 01:53	04/01/2020 02:45	04/01/2020 01:53	04/01/2020 02:45	0,85	1	0,85	CHI
20200116401	PIRACANJUBA	PJ10396076	PIRACANJUBA	04/01/2020 00:16	04/01/2020 19:36	04/01/2020 00:16	04/01/2020 09:54	9,64	12	115,66	CHI
20200116401	CRISTIANOPOLIS	PJ12212190LD	PIRACANJUBA	04/01/2020 00:16	04/01/2020 19:36	04/01/2020 00:16	04/01/2020 13:07	12,85	9	115,66	CHI
20200116401	PIRACANJUBA	PJ12212190LD	PIRACANJUBA	04/01/2020 00:16	04/01/2020 19:36	04/01/2020 00:16	04/01/2020 13:07	12,85	92	1182,30	CHI
20200116401	SANTA CRUZ DE GOIAS	PJ12212190LD	PIRACANJUBA	04/01/2020 00:16	04/01/2020 19:36	04/01/2020 00:16	04/01/2020 13:07	12,85	106	1362,22	CHI
20200116401	PIRACANJUBA	PJ10396076	PIRACANJUBA	04/01/2020 00:16	04/01/2020 19:36	04/01/2020 00:16	04/01/2020 19:25	19,14	1	19,14	CHI
20200116401	PIRACANJUBA	PJ10396076	PIRACANJUBA	04/01/2020 00:16	04/01/2020 19:36	04/01/2020 00:16	04/01/2020 19:36	19,34	1	19,34	CHI
20200116403	JATAI	RV12038514	CABRIUVA S1	04/01/2020 06:59	04/01/2020 18:16	04/01/2020 06:59	04/01/2020 10:22	3,39	6	20,36	CHI
20200116403	RIO VERDE	RV12038514	CABRIUVA S1	04/01/2020 06:59	04/01/2020 18:16	04/01/2020 06:59	04/01/2020 10:22	3,39	45	152,66	CHI
20200116403	RIO VERDE	RV12038514	CABRIUVA S1	04/01/2020 06:59	04/01/2020 18:16	04/01/2020 10:23	04/01/2020 13:30	3,12	20	62,44	CHI
20200116403	RIO VERDE	RV13038519	CABRIUVA S1	04/01/2020 06:59	04/01/2020 18:16	04/01/2020 06:59	04/01/2020 18:16	11,28	2	22,57	CHI
20200116403	JATAI	RV13038519	CABRIUVA S1	04/01/2020 06:59	04/01/2020 18:16	04/01/2020 10:23	04/01/2020 18:16	7,89	6	47,34	CHI
20200116403	RIO VERDE	RV13038519	CABRIUVA S1	04/01/2020 06:59	04/01/2020 18:16	04/01/2020 10:23	04/01/2020 18:16	7,89	55	433,98	CHI
20200116412	BOM JESUS DE GOIAS	ID12130520LD	QUIRINOPOLIS	04/01/2020 01:48	05/01/2020 00:42	04/01/2020 01:48	04/01/2020 23:25	21,61	69	1490,97	CHI
20200116412	INACIOLANDIA	ID12130520LD	QUIRINOPOLIS	04/01/2020 01:48	05/01/2020 00:42	04/01/2020 01:48	04/01/2020 23:25	21,61	21	453,77	CHI
20200116412	INACIOLANDIA	ID10396083	QUIRINOPOLIS	04/01/2020 01:48	05/01/2020 00:42	04/01/2020 01:48	05/01/2020 00:42	22,90	30	686,89	CHI
20200116412	ITUMBIARA	ID10396083	QUIRINOPOLIS	04/01/2020 01:48	05/01/2020 00:42	04/01/2020 01:48	05/01/2020 00:42	22,90	5	114,48	CHI
20200116421	CALDAS NOVAS	00320254	CALDAS NOVAS S2	04/01/2020 02:54	04/01/2020 09:21	04/01/2020 02:54	04/01/2020 04:09	1,24	3898	4840,02	CHI

20200116421	CALDAS NOVAS	00320254	CALDAS NOVAS S2	04/01/2020 02:54	04/01/2020 09:21	04/01/2020 02:54	04/01/2020 05:51	2,95	1	2,95	CHI
20200116421	CALDAS NOVAS	00320254	CALDAS NOVAS S2	04/01/2020 02:54	04/01/2020 09:21	04/01/2020 02:54	04/01/2020 08:36	5,69	1574	8963,93	CHI
20200116421	CALDAS NOVAS	00320254	CALDAS NOVAS S2	04/01/2020 02:54	04/01/2020 09:21	04/01/2020 02:54	04/01/2020 09:21	6,44	114	734,60	CHI
20200116424	ANAPOLIS	02370269	JUNDIAI S2	04/01/2020 04:28	04/01/2020 08:15	04/01/2020 04:28	04/01/2020 04:35	0,12	2741	329,68	CHI
20200116424	ANAPOLIS	AN10384955	JUNDIAI S2	04/01/2020 04:28	04/01/2020 08:15	04/01/2020 04:28	04/01/2020 04:36	0,14	7176	1012,61	CHI
20200116424	ANAPOLIS	02370269	JUNDIAI S2	04/01/2020 04:28	04/01/2020 08:15	04/01/2020 04:28	04/01/2020 08:15	3,79	330	1251,43	CHI
20200116427	ITABERAI	00880404	ITABERAI S1	04/01/2020 05:06	04/01/2020 13:49	04/01/2020 05:06	04/01/2020 07:49	2,73	46	125,48	CHI
20200116427	ITABERAI	00880404	ITABERAI S1	04/01/2020 05:06	04/01/2020 13:49	04/01/2020 05:06	04/01/2020 09:46	4,67	50	233,43	CHI
20200116427	ITAUCU	00880404	ITABERAI S1	04/01/2020 05:06	04/01/2020 13:49	04/01/2020 05:06	04/01/2020 09:46	4,67	2	9,34	CHI
20200116427	ITABERAI	IB13250730	ITABERAI S1	04/01/2020 05:06	04/01/2020 13:49	04/01/2020 13:41	04/01/2020 13:49	0,13	50	6,31	CHI
20200116427	ITAUCU	IB13250730	ITABERAI S1	04/01/2020 05:06	04/01/2020 13:49	04/01/2020 13:41	04/01/2020 13:49	0,13	2	0,25	CHI
20200116433	RIO VERDE	RV12147889	RIO VERDE S1	03/01/2020 13:58	04/01/2020 11:51	03/01/2020 13:58	04/01/2020 11:51	21,88	2	43,75	CHI
20200116501	ITUMBIARA	IT12000100RE	PARANAIBA	03/01/2020 23:06	04/01/2020 08:24	03/01/2020 23:06	04/01/2020 08:24	9,31	32	297,86	CHI
20200116510	ISRAELANDIA	8651696	IPORA	04/01/2020 02:32	04/01/2020 09:55	04/01/2020 02:32	04/01/2020 09:55	7,38	4	29,51	CHI
20200116516	MINEIROS	MY10396070	PARQUE DAS EMAS	04/01/2020 02:54	04/01/2020 08:58	04/01/2020 02:54	04/01/2020 08:58	6,06	119	721,31	CHI
20200116516	SERRANOPOLIS	MY10396070	PARQUE DAS EMAS	04/01/2020 02:54	04/01/2020 08:58	04/01/2020 02:54	04/01/2020 08:58	6,06	7	42,43	CHI
20200116519	INDIARA	IY21057345	EDEIA	03/01/2020 18:17	04/01/2020 04:22	03/01/2020 18:17	04/01/2020 04:22	10,08	1	10,08	CHI
20200116520	DOVERLANDIA	DV12204324	CAIAPONIA	04/01/2020 03:04	04/01/2020 13:29	04/01/2020 03:04	04/01/2020 13:29	10,40	11	114,42	CHI
20200116521	CASTELANDIA	DM12000064	RIO DOS BOIS	04/01/2020 03:04	04/01/2020 09:10	04/01/2020 03:04	04/01/2020 09:10	6,09	10	60,86	CHI
20200116521	MAURILANDIA	DM12000064	RIO DOS BOIS	04/01/2020 03:04	04/01/2020 09:10	04/01/2020 03:04	04/01/2020 09:10	6,09	1	6,09	CHI
20200116529	AGUAS LINDAS DE GOIAS	10011072065	AGUAS LINDAS DE GOIAS S1	04/01/2020 03:23	04/01/2020 09:03	04/01/2020 03:23	04/01/2020 09:03	5,66	1	5,66	CHI
20200116530	GOIAS	GS12217234	MATRINCHA	04/01/2020 03:21	04/01/2020 11:25	04/01/2020 03:21	04/01/2020 11:25	8,07	84	677,83	CHI
20200116530	ITAPIRAPUA	GS12217234	MATRINCHA	04/01/2020 03:21	04/01/2020 11:25	04/01/2020 03:21	04/01/2020 11:25	8,07	1	8,07	CHI
20200116530	NOVO BRASIL	GS12217234	MATRINCHA	04/01/2020 03:21	04/01/2020 11:25	04/01/2020 03:21	04/01/2020 11:25	8,07	36	290,50	CHI
20200116531	PORANGATU	PO12192371	PORANGATU	04/01/2020 03:30	04/01/2020 15:17	04/01/2020 03:30	04/01/2020 15:17	11,78	12	141,37	CHI
20200116532	ARENOPOLIS	AY12040872	ARENOPOLIS	04/01/2020 03:30	04/01/2020 09:08	04/01/2020 03:30	04/01/2020 09:08	5,62	13	73,03	CHI
20200116534	FORMOSA	FA12261997	ITUIQUIRA	04/01/2020 03:32	04/01/2020 08:28	04/01/2020 03:32	04/01/2020 08:28	4,93	65	320,49	CHI
20200116534	VILA BOA	FA12261997	ITUIQUIRA	04/01/2020 03:32	04/01/2020 08:28	04/01/2020 03:32	04/01/2020 08:28	4,93	4	19,72	CHI
20200116544	MUTUNOPOLIS	PO12360454	PORANGATU	04/01/2020 03:42	04/01/2020 08:48	04/01/2020 03:42	04/01/2020 08:48	5,10	32	163,04	CHI
20200116544	PORANGATU	PO12360454	PORANGATU	04/01/2020 03:42	04/01/2020 08:48	04/01/2020 03:42	04/01/2020 08:48	5,10	44	224,18	CHI
20200116548	CORREGO DO OURO	CO12079990	SAO LUIZ DOS MONTES BELOS	04/01/2020 03:54	04/01/2020 08:58	04/01/2020 03:54	04/01/2020 08:58	5,08	35	177,73	CHI
20200116548	MOIPORA	CO12079990	SAO LUIZ DOS MONTES BELOS	04/01/2020 03:54	04/01/2020 08:58	04/01/2020 03:54	04/01/2020 08:58	5,08	2	10,16	CHI
20200116552	MORRINHOS	MR12125522	MORRINHOS	04/01/2020 04:00	04/01/2020 08:30	04/01/2020 04:00	04/01/2020 08:30	4,50	30	134,99	CHI

20200116553	AMERICANO DO BRASIL	KB12000021	ANICUNS	04/01/2020 04:03	04/01/2020 08:58	04/01/2020 04:03	04/01/2020 08:58	4,92	10	49,19	CHI
20200116553	ITABERAÍ	KB12000021	ANICUNS	04/01/2020 04:03	04/01/2020 08:58	04/01/2020 04:03	04/01/2020 08:58	4,92	100	491,92	CHI
20200116553	MOSSAMEDES	KB12000021	ANICUNS	04/01/2020 04:03	04/01/2020 08:58	04/01/2020 04:03	04/01/2020 08:58	4,92	14	68,87	CHI
20200116554	ITUMBIARA	IT12316685	ITUMBIARA NOVA	04/01/2020 03:58	04/01/2020 07:16	04/01/2020 03:58	04/01/2020 07:16	3,29	41	134,78	CHI
20200116556	IPORA	AM12402911	IPORA	04/01/2020 04:15	04/01/2020 10:47	04/01/2020 04:15	04/01/2020 10:47	6,52	45	293,32	CHI
20200116557	SANTO ANTONIO DA BARRA	BZ12200724	ACREUNA	04/01/2020 06:33	04/01/2020 11:03	04/01/2020 06:33	04/01/2020 11:03	4,49	100	449,22	CHI
20200116558	JUSSARA	JR12212887	IPORA	04/01/2020 04:22	04/01/2020 18:57	04/01/2020 04:22	04/01/2020 18:57	14,58	22	320,75	CHI
20200116558	MONTES CLAROS DE GOIAS	JR12212887	IPORA	04/01/2020 04:22	04/01/2020 18:57	04/01/2020 04:22	04/01/2020 18:57	14,58	7	102,06	CHI
20200116559	PETROLINA DE GOIAS	PG12216919	PETROLINA	04/01/2020 02:17	04/01/2020 07:16	04/01/2020 02:17	04/01/2020 07:16	4,97	8	39,75	CHI
20200116559	SAO FRANCISCO DE GOIAS	PG12216919	PETROLINA	04/01/2020 02:17	04/01/2020 07:16	04/01/2020 02:17	04/01/2020 07:16	4,97	1	4,97	CHI
20200116566	MINEIROS	SU12184133	SANTA RITA DO ARAGUAIA	04/01/2020 04:32	04/01/2020 10:20	04/01/2020 04:32	04/01/2020 10:20	5,79	11	63,68	CHI
20200116566	SANTA RITA DO ARAGUAIA	SU12184133	SANTA RITA DO ARAGUAIA	04/01/2020 04:32	04/01/2020 10:20	04/01/2020 04:32	04/01/2020 10:20	5,79	23	133,16	CHI
20200116573	CACHOEIRA DOURADA	IT12088560	CACHOEIRA DOURADA	04/01/2020 04:35	04/01/2020 10:12	04/01/2020 04:35	04/01/2020 10:12	5,62	1	5,62	CHI
20200116573	ITUMBIARA	IT12088560	CACHOEIRA DOURADA	04/01/2020 04:35	04/01/2020 10:12	04/01/2020 04:35	04/01/2020 10:12	5,62	4	22,47	CHI
20200116576	BALIZA	BM12390150	BOM JARDIM	04/01/2020 04:38	04/01/2020 10:36	04/01/2020 04:38	04/01/2020 10:36	5,96	50	297,94	CHI
20200116576	BOM JARDIM DE GOIAS	BM12390150	BOM JARDIM	04/01/2020 04:38	04/01/2020 10:36	04/01/2020 04:38	04/01/2020 10:36	5,96	9	53,63	CHI
20200116577	PONTALINA	PK12074321	VICENTINOPOLIS	04/01/2020 04:39	04/01/2020 21:05	04/01/2020 04:39	04/01/2020 21:05	16,43	1	16,43	CHI
20200116584	PALESTINA DE GOIAS	PY21223232	PALESTINA	04/01/2020 04:50	05/01/2020 10:02	04/01/2020 04:50	05/01/2020 10:02	29,19	1	29,19	CHI
20200116585	ITABERAÍ	IB12300320	ITABERAÍ S2	04/01/2020 04:50	04/01/2020 05:40	04/01/2020 04:50	04/01/2020 05:40	0,82	21	17,26	CHI
20200116586	AURILANDIA	SL12003813	SAO LUIZ DOS MONTES BELOS	04/01/2020 04:51	04/01/2020 08:41	04/01/2020 04:51	04/01/2020 08:41	3,83	6	22,98	CHI
20200116586	FIRMINOPOLIS	SL12003813	SAO LUIZ DOS MONTES BELOS	04/01/2020 04:51	04/01/2020 08:41	04/01/2020 04:51	04/01/2020 08:41	3,83	2	7,66	CHI
20200116586	SANCLERLANDIA	SL12003813	SAO LUIZ DOS MONTES BELOS	04/01/2020 04:51	04/01/2020 08:41	04/01/2020 04:51	04/01/2020 08:41	3,83	1	3,83	CHI
20200116586	SAO LUIS DE MONTES BELOS	SL12003813	SAO LUIZ DOS MONTES BELOS	04/01/2020 04:51	04/01/2020 08:41	04/01/2020 04:51	04/01/2020 08:41	3,83	20	76,59	CHI
20200116593	CAMPO ALEGRE DE GOIAS	CM10397305	CAMPO ALEGRE DE GOIAS	04/01/2020 05:00	04/01/2020 14:01	04/01/2020 05:00	04/01/2020 08:10	3,17	29	91,81	CHI
20200116593	CAMPO ALEGRE DE GOIAS	CM10397305	CAMPO ALEGRE DE GOIAS	04/01/2020 05:00	04/01/2020 14:01	04/01/2020 05:00	04/01/2020 08:55	3,92	103	403,56	CHI
20200116593	CATALAO	CM10397305	CAMPO ALEGRE DE GOIAS	04/01/2020 05:00	04/01/2020 14:01	04/01/2020 05:00	04/01/2020 08:55	3,92	21	82,28	CHI
20200116593	DISTRITO FEDERAL	CM10397305	CAMPO ALEGRE DE GOIAS	04/01/2020 05:00	04/01/2020 14:01	04/01/2020 05:00	04/01/2020 08:55	3,92	1	3,92	CHI
20200116593	IPAMERI	CM10397305	CAMPO ALEGRE DE GOIAS	04/01/2020 05:00	04/01/2020 14:01	04/01/2020 05:00	04/01/2020 08:55	3,92	11	43,10	CHI
20200116593	CAMPO ALEGRE DE GOIAS	CM10397305	CAMPO ALEGRE DE GOIAS	04/01/2020 05:00	04/01/2020 14:01	04/01/2020 08:11	04/01/2020 08:55	0,75	16	11,95	CHI
20200116593	CAMPO ALEGRE DE GOIAS	CM10397305	CAMPO ALEGRE DE GOIAS	04/01/2020 05:00	04/01/2020 14:01	04/01/2020 08:56	04/01/2020 10:29	1,56	8	12,48	CHI
20200116593	CAMPO ALEGRE DE GOIAS	CM13333480	CAMPO ALEGRE DE GOIAS	04/01/2020 05:00	04/01/2020 14:01	04/01/2020 08:11	04/01/2020 14:01	5,85	13	76,00	CHI
20200116593	CAMPO ALEGRE DE GOIAS	CM13333480	CAMPO ALEGRE DE GOIAS	04/01/2020 05:00	04/01/2020 14:01	04/01/2020 08:56	04/01/2020 14:01	5,09	111	565,30	CHI
20200116593	CATALAO	CM13333480	CAMPO ALEGRE DE GOIAS	04/01/2020 05:00	04/01/2020 14:01	04/01/2020 08:56	04/01/2020 14:01	5,09	21	106,95	CHI

20200116593	DISTRITO FEDERAL	CM13333480	CAMPO ALEGRE DE GOIAS	04/01/2020 05:00	04/01/2020 14:01	04/01/2020 08:56	04/01/2020 14:01	5,09	1	5,09	CHI
20200116593	IPAMERI	CM13333480	CAMPO ALEGRE DE GOIAS	04/01/2020 05:00	04/01/2020 14:01	04/01/2020 08:56	04/01/2020 14:01	5,09	11	56,02	CHI
20200116599	ANICUNS	AC12000089	ANICUNS	04/01/2020 05:16	04/01/2020 07:24	04/01/2020 05:16	04/01/2020 07:24	2,14	45	96,20	CHI
20200116599	TURVANIA	AC12000089	ANICUNS	04/01/2020 05:16	04/01/2020 07:24	04/01/2020 05:16	04/01/2020 07:24	2,14	8	17,10	CHI
20200116603	NAZARIO	NZ12003897	ANICUNS	04/01/2020 05:18	04/01/2020 07:46	04/01/2020 05:18	04/01/2020 07:46	2,46	18	44,23	CHI
20200116607	ALTO HORIZONTE	AJ12321035	SANTA TEREZINHA	03/01/2020 21:34	04/01/2020 10:38	03/01/2020 21:34	04/01/2020 10:38	13,07	15	196,07	CHI
20200116609	CRISTALINA	KR12087952	CRISTALINA S2	04/01/2020 05:22	04/01/2020 10:36	04/01/2020 05:22	04/01/2020 10:36	5,23	25	130,64	CHI
20200116612	MINEIROS	MY12303454	PARQUE DAS EMAS	03/01/2020 18:30	04/01/2020 18:26	03/01/2020 18:30	04/01/2020 18:26	23,92	11	263,14	CHI
20200116613	CROMINIA	CQ21009389	PONTALINA	04/01/2020 05:25	04/01/2020 09:40	04/01/2020 05:25	04/01/2020 09:40	4,25	1	4,25	CHI
20200116614	IPORA	IR12040189	IPORA	04/01/2020 05:25	04/01/2020 09:59	04/01/2020 05:25	04/01/2020 09:59	4,56	29	132,14	CHI
20200116616	CEZARINA	IY12220511	EDEIA	04/01/2020 05:27	04/01/2020 07:36	04/01/2020 05:27	04/01/2020 07:36	2,15	6	12,89	CHI
20200116616	INDIARA	IY12220511	EDEIA	04/01/2020 05:27	04/01/2020 07:36	04/01/2020 05:27	04/01/2020 07:36	2,15	6	12,89	CHI
20200116617	PETROLINA DE GOIAS	SF12273257RE	SAO FRANCISCO DE GOIAS	04/01/2020 05:29	04/01/2020 08:51	04/01/2020 05:29	04/01/2020 08:51	3,36	60	201,73	CHI
20200116617	PIRENOPOLIS	SF12273257RE	SAO FRANCISCO DE GOIAS	04/01/2020 05:29	04/01/2020 08:51	04/01/2020 05:29	04/01/2020 08:51	3,36	38	127,76	CHI
20200116617	SAO FRANCISCO DE GOIAS	SF12273257RE	SAO FRANCISCO DE GOIAS	04/01/2020 05:29	04/01/2020 08:51	04/01/2020 05:29	04/01/2020 08:51	3,36	42	141,21	CHI
20200116622	FIRMINOPOLIS	FR12096968	FIRMINOPOLIS S1	04/01/2020 04:34	04/01/2020 06:52	04/01/2020 04:34	04/01/2020 06:52	2,30	24	55,12	CHI
20200116627	RIO VERDE	RV12136174	CABRIUVA S2	04/01/2020 08:26	05/01/2020 08:25	04/01/2020 08:26	04/01/2020 12:59	4,56	14	63,79	CHI
20200116627	RIO VERDE	RV12136174	CABRIUVA S2	04/01/2020 08:26	05/01/2020 08:25	04/01/2020 13:00	05/01/2020 08:25	19,42	14	271,81	CHI
20200116628	CEZARINA	CZ21117013	CEZARINA	04/01/2020 05:39	04/01/2020 08:56	04/01/2020 05:39	04/01/2020 08:56	3,29	1	3,29	CHI
20200116630	CRIXAS	CX12319064	SERRA DO OURO	04/01/2020 05:39	05/01/2020 01:30	04/01/2020 05:39	05/01/2020 01:30	19,84	2	39,68	CHI
20200116631	JANDAIA	PP12307065	PALMEIRAS	04/01/2020 04:57	04/01/2020 07:08	04/01/2020 04:57	04/01/2020 07:08	2,18	15	32,63	CHI
20200116631	PALMINOPOLIS	PP12307065	PALMEIRAS	04/01/2020 04:57	04/01/2020 07:08	04/01/2020 04:57	04/01/2020 07:08	2,18	7	15,23	CHI
20200116633	TRINDADE	TR12393570	GOIANIRA	04/01/2020 05:40	04/01/2020 08:48	04/01/2020 05:40	04/01/2020 08:48	3,12	13	40,53	CHI
20200116634	GOIATUBA	GT12000228	GOIATUBA S2	04/01/2020 01:23	04/01/2020 08:09	04/01/2020 01:23	04/01/2020 08:09	6,76	158	1067,82	CHI
20200116637	BOM JESUS DE GOIAS	BJ21000057	BOM JESUS DE GOIAS	04/01/2020 05:41	04/01/2020 07:44	04/01/2020 05:41	04/01/2020 07:44	2,04	1	2,04	CHI
20200116640	BOM JARDIM DE GOIAS	BM12342013	BOM JARDIM	04/01/2020 05:29	04/01/2020 07:48	04/01/2020 05:29	04/01/2020 07:48	2,31	13	30,01	CHI
20200116642	MONTES CLAROS DE GOIAS	ME12074048	IPORA	04/01/2020 05:44	05/01/2020 01:54	04/01/2020 05:44	05/01/2020 01:54	20,16	1	20,16	CHI
20200116649	CACU	CC21078905	CACHOEIRA ALTA	04/01/2020 05:48	04/01/2020 23:37	04/01/2020 05:48	04/01/2020 23:37	17,82	1	17,82	CHI
20200116650	CALDAS NOVAS	CN12363792	SERRA DE CALDAS	04/01/2020 05:48	04/01/2020 07:56	04/01/2020 05:48	04/01/2020 07:56	2,12	126	266,81	CHI
20200116651	SILVANIA	SV12340735	VIANOPOLIS	04/01/2020 05:49	04/01/2020 09:32	04/01/2020 05:49	04/01/2020 09:32	3,71	46	170,70	CHI
20200116652	PADRE BERNARDO	PB12382236	PADRE BERNARDO	04/01/2020 05:50	04/01/2020 07:20	04/01/2020 05:50	04/01/2020 07:20	1,49	5	7,43	CHI
20200116653	ITAJA	IJ12321777	CACHOEIRA ALTA	04/01/2020 05:51	04/01/2020 11:11	04/01/2020 05:51	04/01/2020 11:11	5,32	25	133,01	CHI
20200116653	LAGOA SANTA	IJ12321777	CACHOEIRA ALTA	04/01/2020 05:51	04/01/2020 11:11	04/01/2020 05:51	04/01/2020 11:11	5,32	8	42,56	CHI

20200116656	FIRMINOPOLIS	FR12076441	FIRMINOPOLIS S1	04/01/2020 05:54	04/01/2020 07:32	04/01/2020 05:54	04/01/2020 07:32	1,63	1	1,63	CHI
20200116657	BOM JESUS DE GOIAS	BJ1200088RE	BOM JESUS DE GOIAS	04/01/2020 03:47	04/01/2020 08:55	04/01/2020 03:47	04/01/2020 08:55	5,13	10	51,25	CHI
20200116657	GOIATUBA	BJ1200088RE	BOM JESUS DE GOIAS	04/01/2020 03:47	04/01/2020 08:55	04/01/2020 03:47	04/01/2020 08:55	5,13	44	225,51	CHI
20200116659	PORANGATU	PO12141124	NOVO PLANALTO	04/01/2020 05:35	04/01/2020 11:50	04/01/2020 05:35	04/01/2020 11:50	6,24	20	124,76	CHI
20200116660	CACU	CC12028172	CACHOEIRA ALTA	04/01/2020 05:19	04/01/2020 14:53	04/01/2020 05:19	04/01/2020 14:53	9,55	5	47,77	CHI
20200116661	ARENOPOLIS	AY12000035	ARENOPOLIS	04/01/2020 05:57	04/01/2020 07:32	04/01/2020 05:57	04/01/2020 07:32	1,57	7	10,98	CHI
20200116662	PONTALINA	PK12092091	PONTALINA	04/01/2020 05:58	04/01/2020 11:12	04/01/2020 05:58	04/01/2020 11:12	5,23	14	73,17	CHI
20200116663	BARRO ALTO	BA12210748	BARRO ALTO	04/01/2020 05:58	04/01/2020 16:23	04/01/2020 05:58	04/01/2020 16:23	10,41	8	83,31	CHI
20200116666	CATALAO	CT12266142RE	CATALAO S1	04/01/2020 02:49	04/01/2020 08:07	04/01/2020 02:49	04/01/2020 08:07	5,29	108	571,32	CHI
20200116666	GOIANDIRA	CT12266142RE	CATALAO S1	04/01/2020 02:49	04/01/2020 08:07	04/01/2020 02:49	04/01/2020 08:07	5,29	43	227,47	CHI
20200116676	CACHOEIRA DOURADA	CD12000311	CACHOEIRA DOURADA	04/01/2020 06:04	04/01/2020 11:52	04/01/2020 06:04	04/01/2020 11:52	5,80	6	34,77	CHI
20200116679	ARENOPOLIS	AY12345509	ARENOPOLIS	04/01/2020 06:04	04/01/2020 10:21	04/01/2020 06:04	04/01/2020 10:21	4,27	9	38,40	CHI
20200116680	LUZIANIA	LZ12016676	RIO VERMELHO	04/01/2020 03:05	04/01/2020 07:08	04/01/2020 03:05	04/01/2020 07:08	4,04	27	109,03	CHI
20200116681	APORE	SX12264389	JATAI S1	04/01/2020 06:05	04/01/2020 10:08	04/01/2020 06:05	04/01/2020 10:08	4,05	7	28,37	CHI
20200116681	ITARUMA	SX12264389	JATAI S1	04/01/2020 06:05	04/01/2020 10:08	04/01/2020 06:05	04/01/2020 10:08	4,05	1	4,05	CHI
20200116681	SERRANOPOLIS	SX12264389	JATAI S1	04/01/2020 06:05	04/01/2020 10:08	04/01/2020 06:05	04/01/2020 10:08	4,05	53	214,81	CHI
20200116684	CAMPOS VERDES	VD12251082	SANTA TEREZINHA	04/01/2020 06:06	04/01/2020 08:48	04/01/2020 06:06	04/01/2020 08:48	2,70	4	10,79	CHI
20200116684	SANTA TEREZINHA DE GOIAS	VD12251082	SANTA TEREZINHA	04/01/2020 06:06	04/01/2020 08:48	04/01/2020 06:06	04/01/2020 08:48	2,70	17	45,87	CHI
20200116685	CACHOEIRA ALTA	CA21074170	CACHOEIRA ALTA	04/01/2020 06:06	04/01/2020 12:50	04/01/2020 06:06	04/01/2020 12:50	6,73	2	13,45	CHI
20200116688	FORMOSO	FO12185309	MARA ROSA	04/01/2020 06:07	04/01/2020 09:45	04/01/2020 06:07	04/01/2020 09:45	3,63	7	25,43	CHI
20200116690	PONTALINA	PK12388313	PONTALINA	04/01/2020 06:07	04/01/2020 11:30	04/01/2020 06:07	04/01/2020 11:30	5,38	6	32,26	CHI
20200116694	PORANGATU	TB12262770	PORANGATU	04/01/2020 06:08	04/01/2020 10:12	04/01/2020 06:08	04/01/2020 10:12	4,06	1	4,06	CHI
20200116694	SANTA TEREZA DE GOIAS	TB12262770	PORANGATU	04/01/2020 06:08	04/01/2020 10:12	04/01/2020 06:08	04/01/2020 10:12	4,06	5	20,28	CHI
20200116694	TROMBAS	TB12262770	PORANGATU	04/01/2020 06:08	04/01/2020 10:12	04/01/2020 06:08	04/01/2020 10:12	4,06	13	52,73	CHI
20200116695	MATRINCHA	MP12010442	MOZARLANDIA	04/01/2020 06:08	04/01/2020 16:59	04/01/2020 06:08	04/01/2020 16:59	10,84	4	43,36	CHI
20200116696	GOIANESIA	GE12357342	GOIANESIA S2	04/01/2020 06:09	04/01/2020 09:56	04/01/2020 06:09	04/01/2020 09:56	3,78	18	67,95	CHI
20200116696	VILA PROPICIO	GE12357342	GOIANESIA S2	04/01/2020 06:09	04/01/2020 09:56	04/01/2020 06:09	04/01/2020 09:56	3,78	9	33,98	CHI
20200116699	CAMPINORTE	MQ12390480	MARA ROSA	04/01/2020 04:35	04/01/2020 08:40	04/01/2020 04:35	04/01/2020 08:40	4,09	1	4,09	CHI
20200116699	MARA ROSA	MQ12390480	MARA ROSA	04/01/2020 04:35	04/01/2020 08:40	04/01/2020 04:35	04/01/2020 08:40	4,09	4	16,36	CHI
20200116701	ORIZONA	OZ12074417	VIANOPOLIS	04/01/2020 05:27	04/01/2020 08:15	04/01/2020 05:27	04/01/2020 08:15	2,80	3	8,39	CHI
20200116702	AURILANDIA	CG12018650	FIRMINOPOLIS S2	04/01/2020 06:11	04/01/2020 20:22	04/01/2020 06:11	04/01/2020 09:30	3,32	24	79,77	CHI
20200116702	CACHOEIRA DE GOIAS	CG12018650	FIRMINOPOLIS S2	04/01/2020 06:11	04/01/2020 20:22	04/01/2020 06:11	04/01/2020 09:30	3,32	31	103,03	CHI
20200116702	MOIPORA	CG12018650	FIRMINOPOLIS S2	04/01/2020 06:11	04/01/2020 20:22	04/01/2020 06:11	04/01/2020 09:30	3,32	1	3,32	CHI

20200116702	AURILANDIA	CG12018650	FIRMINOPOLIS S2	04/01/2020 06:11	04/01/2020 20:22	04/01/2020 09:31	04/01/2020 13:27	3,94	24	94,59	CHI
20200116702	CACHOEIRA DE GOIAS	CG12018650	FIRMINOPOLIS S2	04/01/2020 06:11	04/01/2020 20:22	04/01/2020 09:31	04/01/2020 13:27	3,94	29	114,29	CHI
20200116702	MOIPORA	CG12018650	FIRMINOPOLIS S2	04/01/2020 06:11	04/01/2020 20:22	04/01/2020 09:31	04/01/2020 13:27	3,94	1	3,94	CHI
20200116702	CACHOEIRA DE GOIAS	CG12018650	FIRMINOPOLIS S2	04/01/2020 06:11	04/01/2020 20:22	04/01/2020 09:31	04/01/2020 20:12	10,68	1	10,68	CHI
20200116702	CACHOEIRA DE GOIAS	CG12018650	FIRMINOPOLIS S2	04/01/2020 06:11	04/01/2020 20:22	04/01/2020 09:31	04/01/2020 20:22	10,85	1	10,85	CHI
20200116710	CACHOEIRA ALTA	CC12084267	CACHOEIRA ALTA	04/01/2020 06:13	04/01/2020 10:43	04/01/2020 06:13	04/01/2020 10:43	4,49	6	26,94	CHI
20200116712	CRIXAS	CX21319041	SERRA DO OURO	04/01/2020 06:13	05/01/2020 04:04	04/01/2020 06:13	05/01/2020 04:04	21,84	1	21,84	CHI
20200116714	ALTO HORIZONTE	MQ12181177	MARA ROSA	04/01/2020 03:05	05/01/2020 11:49	04/01/2020 03:05	04/01/2020 20:09	17,06	2	34,12	CHI
20200116714	MARA ROSA	MQ12181177	MARA ROSA	04/01/2020 03:05	05/01/2020 11:49	04/01/2020 03:05	04/01/2020 20:09	17,06	2	34,12	CHI
20200116714	ALTO HORIZONTE	MQ12181177	MARA ROSA	04/01/2020 03:05	05/01/2020 11:49	04/01/2020 12:02	04/01/2020 20:09	8,11	1	8,11	CHI
20200116714	MARA ROSA	MQ12181177	MARA ROSA	04/01/2020 03:05	05/01/2020 11:49	04/01/2020 12:02	04/01/2020 20:09	8,11	2	16,21	CHI
20200116714	MARA ROSA	MQ12181177	MARA ROSA	04/01/2020 03:05	05/01/2020 11:49	04/01/2020 03:05	04/01/2020 21:44	18,65	10	186,46	CHI
20200116714	MARA ROSA	MQ12146901LD	MARA ROSA	04/01/2020 03:05	05/01/2020 11:49	04/01/2020 12:02	04/01/2020 21:44	9,70	2	19,39	CHI
20200116714	MARA ROSA	MQ12181177	MARA ROSA	04/01/2020 03:05	05/01/2020 11:49	04/01/2020 03:05	05/01/2020 11:49	32,73	8	261,80	CHI
20200116714	MARA ROSA	MQ12192461	MARA ROSA	04/01/2020 03:05	05/01/2020 11:49	04/01/2020 12:02	05/01/2020 11:49	23,77	4	95,10	CHI
20200116714	URUACU	MQ12192461	MARA ROSA	04/01/2020 03:05	05/01/2020 11:49	04/01/2020 12:02	05/01/2020 11:49	23,77	1	23,77	CHI
20200116715	QUIRINOPOLIS	QI32011354	QUIRINOPOLIS	04/01/2020 06:14	04/01/2020 09:01	04/01/2020 06:14	04/01/2020 09:01	2,78	12	33,32	CHI
20200116716	APARECIDA DE GOIANIA	AP11193732	INDEPENDENCIA S1	04/01/2020 06:14	04/01/2020 10:02	04/01/2020 06:14	04/01/2020 10:02	3,79	147	557,21	CHI
20200116719	GOIATUBA	GT12044869	GOIATUBA S2	04/01/2020 06:16	04/01/2020 10:47	04/01/2020 06:16	04/01/2020 10:47	4,52	5	22,58	CHI
20200116720	GAMELEIRA DE GOIAS	SV12278872	DAIA S2	04/01/2020 06:16	04/01/2020 09:22	04/01/2020 06:16	04/01/2020 09:22	3,10	34	105,24	CHI
20200116721	CAIAPONIA	DP12296462	JATAI S1	04/01/2020 06:13	04/01/2020 08:10	04/01/2020 06:13	04/01/2020 08:10	1,94	38	73,66	CHI
20200116721	MINEIROS	DP12296462	JATAI S1	04/01/2020 06:13	04/01/2020 08:10	04/01/2020 06:13	04/01/2020 08:10	1,94	2	3,88	CHI
20200116721	PEROLANDIA	DP12296462	JATAI S1	04/01/2020 06:13	04/01/2020 08:10	04/01/2020 06:13	04/01/2020 08:10	1,94	10	19,38	CHI
20200116724	RIO VERDE	RV12360613	RIO VERDE S2	04/01/2020 06:17	04/01/2020 08:49	04/01/2020 06:17	04/01/2020 08:49	2,53	75	189,52	CHI
20200116726	CALDAS NOVAS	RQ12100189	RIO QUENTE	04/01/2020 06:18	04/01/2020 11:28	04/01/2020 06:18	04/01/2020 11:28	5,16	133	685,80	CHI
20200116726	MORRINHOS	RQ12100189	RIO QUENTE	04/01/2020 06:18	04/01/2020 11:28	04/01/2020 06:18	04/01/2020 11:28	5,16	8	41,25	CHI
20200116726	PIRACANJUBA	RQ12100189	RIO QUENTE	04/01/2020 06:18	04/01/2020 11:28	04/01/2020 06:18	04/01/2020 11:28	5,16	1	5,16	CHI
20200116726	RIO QUENTE	RQ12100189	RIO QUENTE	04/01/2020 06:18	04/01/2020 11:28	04/01/2020 06:18	04/01/2020 11:28	5,16	122	629,08	CHI
20200116729	ITAGUARU	IC12027950	ITABERAI S1	04/01/2020 06:19	04/01/2020 10:52	04/01/2020 06:19	04/01/2020 10:52	4,54	11	49,96	CHI
20200116729	JARAGUA	IC12027950	ITABERAI S1	04/01/2020 06:19	04/01/2020 10:52	04/01/2020 06:19	04/01/2020 10:52	4,54	15	68,13	CHI
20200116731	GOIANESIA	GE12215070	GOIANESIA S1	04/01/2020 06:20	04/01/2020 18:39	04/01/2020 06:20	04/01/2020 18:39	12,31	24	295,47	CHI
20200116733	BONOPOLIS	BX12013030	SAO MIGUEL DO ARAGUAIA	04/01/2020 06:21	04/01/2020 19:20	04/01/2020 06:21	04/01/2020 19:20	12,98	5	64,91	CHI
20200116737	ALTO HORIZONTE	AJ12143571	MARA ROSA	04/01/2020 04:26	04/01/2020 13:45	04/01/2020 04:26	04/01/2020 13:45	9,30	37	344,14	CHI



20200116737	MARA ROSA	AJ12143571	MARA ROSA	04/01/2020 04:26	04/01/2020 13:45	04/01/2020 04:26	04/01/2020 13:45	9,30	5	46,51	CHI
20200116737	NOVA IGUACU DE GOIAS	AJ12143571	MARA ROSA	04/01/2020 04:26	04/01/2020 13:45	04/01/2020 04:26	04/01/2020 13:45	9,30	12	111,61	CHI
20200116738	IPORA	IR12202000	ARENOPOLIS	04/01/2020 06:21	04/01/2020 09:19	04/01/2020 06:21	04/01/2020 09:19	2,95	8	23,61	CHI
20200116739	MORRINHOS	MR11275191	GOIATUBA S1	04/01/2020 06:22	04/01/2020 12:57	04/01/2020 06:22	04/01/2020 12:57	6,57	1	6,57	CHI
20200116740	APARECIDA DE GOIANIA	AP12000208	CEPAIGO S1	04/01/2020 06:23	04/01/2020 08:37	04/01/2020 06:23	04/01/2020 08:37	2,23	14	31,26	CHI
20200116740	GOIANIA	AP12000208	CEPAIGO S1	04/01/2020 06:23	04/01/2020 08:37	04/01/2020 06:23	04/01/2020 08:37	2,23	4	8,93	CHI
20200116743	MINEIROS	MY21296302	PARQUE DAS EMAS	04/01/2020 06:23	05/01/2020 05:00	04/01/2020 06:23	05/01/2020 05:00	22,61	1	22,61	CHI
20200116746	JARAGUA	JA12298032	JARAGUA	04/01/2020 02:17	04/01/2020 08:14	04/01/2020 02:17	04/01/2020 08:14	5,94	124	736,49	CHI
20200116750	TURVANIA	TV21259935	FIRMINOPOLIS S2	04/01/2020 06:24	04/01/2020 09:40	04/01/2020 06:24	04/01/2020 09:40	3,25	2	6,51	CHI
20200116751	CALDAS NOVAS	10024305454	SERRA DE CALDAS	04/01/2020 06:25	04/01/2020 17:41	04/01/2020 06:25	04/01/2020 17:41	11,26	1	11,26	CHI
20200116755	ALEXANIA	AX12061853	ALEXANIA	04/01/2020 05:52	04/01/2020 09:12	04/01/2020 05:52	04/01/2020 09:12	3,33	6	19,95	CHI
20200116759	MINEIROS	MY12126392	PARQUE DAS EMAS	04/01/2020 06:13	04/01/2020 10:11	04/01/2020 06:13	04/01/2020 10:11	3,96	14	55,49	CHI
20200116761	ITUMBIARA	IT12000050	ITUMBIARA VELHA S1	04/01/2020 06:26	04/01/2020 08:42	04/01/2020 06:26	04/01/2020 08:42	2,26	72	162,38	CHI
20200116776	ITAUCU	XX08606742	INHUMAS S1	04/01/2020 06:30	04/01/2020 09:40	04/01/2020 06:30	04/01/2020 09:40	3,16	1	3,16	CHI
20200116783	PORANGATU	PO12230420	NOVO PLANALTO	04/01/2020 06:31	04/01/2020 10:55	04/01/2020 06:31	04/01/2020 10:55	4,38	3	13,15	CHI
20200116784	ORIZONA	OZ12052340	PIRES DO RIO S2	04/01/2020 06:32	04/01/2020 19:30	04/01/2020 06:32	04/01/2020 19:30	12,96	11	142,56	CHI
20200116785	BOM JARDIM DE GOIAS	BM12155682	BOM JARDIM	04/01/2020 06:32	04/01/2020 11:18	04/01/2020 06:32	04/01/2020 11:18	4,76	14	66,63	CHI
20200116785	PIRANHAS	BM12155682	BOM JARDIM	04/01/2020 06:32	04/01/2020 11:18	04/01/2020 06:32	04/01/2020 11:18	4,76	4	19,04	CHI
20200116787	CATALAO	1990059457	CATALAO S2	04/01/2020 06:32	04/01/2020 08:47	04/01/2020 06:32	04/01/2020 08:47	2,23	1	2,23	CHI
20200116792	DISTRITO FEDERAL	SN12053556	MARAJOARA	04/01/2020 06:33	04/01/2020 10:32	04/01/2020 06:33	04/01/2020 10:32	3,97	48	190,55	CHI
20200116792	SANTO ANTONIO DO DESCOBERTO	SN12053556	MARAJOARA	04/01/2020 06:33	04/01/2020 10:32	04/01/2020 06:33	04/01/2020 10:32	3,97	21	83,36	CHI
20200116794	PIRACANJUBA	PJ21199385	BELA VISTA S1	04/01/2020 06:34	04/01/2020 17:52	04/01/2020 06:34	04/01/2020 17:52	11,30	1	11,30	CHI
20200116797	CACHOEIRA ALTA	CA12040332	CACHOEIRA ALTA	04/01/2020 06:34	04/01/2020 13:15	04/01/2020 06:34	04/01/2020 13:15	6,69	11	73,63	CHI
20200116798	PALMEIRAS DE GOIAS	PL12289855	ANICUNS	04/01/2020 06:34	04/01/2020 09:36	04/01/2020 06:34	04/01/2020 09:36	3,03	22	66,59	CHI
20200116813	CAIAPONIA	CP21207954	CAIAPONIA	04/01/2020 07:25	04/01/2020 08:27	04/01/2020 07:25	04/01/2020 08:27	1,02	1	1,02	CHI
20200116820	SAO MIGUEL DO ARAGUAIA	SM10388763	SAO MIGUEL DO ARAGUAIA	04/01/2020 07:30	05/01/2020 00:59	04/01/2020 07:30	04/01/2020 08:29	0,98	53	51,81	CHI
20200116820	SAO MIGUEL DO ARAGUAIA	SM10388763	SAO MIGUEL DO ARAGUAIA	04/01/2020 07:30	05/01/2020 00:59	04/01/2020 09:29	04/01/2020 09:46	0,29	53	15,41	CHI
20200116820	SAO MIGUEL DO ARAGUAIA	SM10388763	SAO MIGUEL DO ARAGUAIA	04/01/2020 07:30	05/01/2020 00:59	04/01/2020 11:46	04/01/2020 11:56	0,18	53	9,58	CHI
20200116820	SAO MIGUEL DO ARAGUAIA	SM10388763	SAO MIGUEL DO ARAGUAIA	04/01/2020 07:30	05/01/2020 00:59	04/01/2020 15:52	04/01/2020 16:19	0,45	53	23,88	CHI
20200116820	SAO MIGUEL DO ARAGUAIA	SM13182440	SAO MIGUEL DO ARAGUAIA	04/01/2020 07:30	05/01/2020 00:59	04/01/2020 07:30	04/01/2020 23:20	15,82	149	2357,14	CHI
20200116820	SAO MIGUEL DO ARAGUAIA	6633316	SAO MIGUEL DO ARAGUAIA	04/01/2020 07:30	05/01/2020 00:59	04/01/2020 07:30	05/01/2020 00:59	17,48	57	996,47	CHI
20200116820	SAO MIGUEL DO ARAGUAIA	SM13182440	SAO MIGUEL DO ARAGUAIA	04/01/2020 07:30	05/01/2020 00:59	04/01/2020 07:30	05/01/2020 00:59	17,48	53	926,54	CHI
20200116852	ACREUNA	EU12000002	ACREUNA	04/01/2020 08:52	04/01/2020 15:51	04/01/2020 08:52	04/01/2020 15:51	6,99	6	41,92	CHI

20200116860	FORMOSA	FA12242845	ITUIQUIRA	04/01/2020 08:11	04/01/2020 10:36	04/01/2020 08:11	04/01/2020 10:36	2,41	4	9,66	CHI
20200116901	ESTRELA DO NORTE	ET12390095	MARA ROSA	04/01/2020 06:09	04/01/2020 12:51	04/01/2020 06:09	04/01/2020 12:51	6,69	4	26,76	CHI
20200116902	PADRE BERNARDO	PB12290560	PADRE BERNARDO	04/01/2020 05:02	04/01/2020 08:16	04/01/2020 05:02	04/01/2020 08:16	3,22	29	93,43	CHI
20200116904	BALIZA	BH12187387LD	BOM JARDIM	04/01/2020 06:36	04/01/2020 09:34	04/01/2020 06:36	04/01/2020 09:34	2,96	694	2056,17	CHI
20200116905	BONFINOPOLIS	BO12379463LD	CEPAIGO S2	04/01/2020 06:36	04/01/2020 13:10	04/01/2020 06:36	04/01/2020 13:10	6,56	32	209,78	CHI
20200116905	BONFINOPOLIS	BO12379463LD	CEPAIGO S2	04/01/2020 06:36	04/01/2020 13:10	04/01/2020 08:20	04/01/2020 13:10	4,82	36	173,42	CHI
20200116908	GOIANESIA	GE12376533	GOIANESIA S1	04/01/2020 06:06	04/01/2020 16:20	04/01/2020 06:06	04/01/2020 16:20	10,22	86	879,09	CHI
20200116909	HIDROLANDIA	HD12000189	INDEPENDENCIA S1	04/01/2020 06:37	04/01/2020 09:49	04/01/2020 06:37	04/01/2020 09:49	3,19	9	28,73	CHI
20200116912	JATAI	JT12210073	JATAI S1	04/01/2020 06:38	04/01/2020 08:37	04/01/2020 06:38	04/01/2020 08:37	1,98	23	45,60	CHI
20200116914	PETROLINA DE GOIAS	PG12016096	PETROLINA	04/01/2020 06:38	04/01/2020 09:00	04/01/2020 06:38	04/01/2020 09:00	2,36	3	7,09	CHI
20200116918	BURITI ALEGRE	BG12048473	GOIATUBA S2	04/01/2020 06:39	04/01/2020 11:13	04/01/2020 06:39	04/01/2020 11:13	4,56	2	9,11	CHI
20200116918	MORRINHOS	BG12048473	GOIATUBA S2	04/01/2020 06:39	04/01/2020 11:13	04/01/2020 06:39	04/01/2020 11:13	4,56	4	18,22	CHI
20200116924	POSSE	PS12344418	IACIARA S1	04/01/2020 06:40	04/01/2020 12:54	04/01/2020 06:40	04/01/2020 12:54	6,22	41	255,17	CHI
20200116925	CACHOEIRA ALTA	PC12013610	CACHOEIRA ALTA	04/01/2020 06:40	04/01/2020 18:02	04/01/2020 06:40	04/01/2020 18:02	11,36	1	11,36	CHI
20200116925	PARANAIGUARA	PC12013610	CACHOEIRA ALTA	04/01/2020 06:40	04/01/2020 18:02	04/01/2020 06:40	04/01/2020 18:02	11,36	2	22,71	CHI
20200116931	CAIAPONIA	CP12252503	CAIAPONIA	04/01/2020 06:42	04/01/2020 19:22	04/01/2020 06:42	04/01/2020 19:22	12,66	6	75,95	CHI
20200116933	ITUMBIARA	IT12208124	PARANAIBA	04/01/2020 06:04	04/01/2020 07:07	04/01/2020 06:04	04/01/2020 07:07	1,04	143	149,36	CHI
20200116935	RUBIATABA	RB12170307	RUBIATABA	04/01/2020 05:08	05/01/2020 13:17	04/01/2020 05:08	04/01/2020 11:57	6,83	26	177,51	CHI
20200116935	CRIXAS	RB12170307	RUBIATABA	04/01/2020 05:08	05/01/2020 13:17	04/01/2020 05:08	05/01/2020 10:16	29,14	1	29,14	CHI
20200116935	NOVA AMERICA	RB12170307	RUBIATABA	04/01/2020 05:08	05/01/2020 13:17	04/01/2020 05:08	05/01/2020 10:16	29,14	4	116,56	CHI
20200116935	RUBIATABA	RB12170307	RUBIATABA	04/01/2020 05:08	05/01/2020 13:17	04/01/2020 05:08	05/01/2020 10:16	29,14	32	932,51	CHI
20200116935	NOVA AMERICA	RB12170307	RUBIATABA	04/01/2020 05:08	05/01/2020 13:17	04/01/2020 05:08	05/01/2020 13:17	32,16	15	482,37	CHI
20200116939	ITARUMA	IM21122620	CACHOEIRA ALTA	04/01/2020 06:44	05/01/2020 07:18	04/01/2020 06:44	05/01/2020 07:18	24,55	1	24,55	CHI
20200116941	VIANOPOLIS	VN21278870	VIANOPOLIS	04/01/2020 06:45	04/01/2020 09:40	04/01/2020 06:45	04/01/2020 09:40	2,91	1	2,91	CHI
20200116943	POSSE	PS12235404	IACIARA S2	04/01/2020 04:57	04/01/2020 10:59	04/01/2020 04:57	04/01/2020 10:59	6,03	32	192,88	CHI
20200116945	SAO MIGUEL DO ARAGUAIA	SM12128351	SAO MIGUEL DO ARAGUAIA	04/01/2020 06:46	04/01/2020 15:26	04/01/2020 06:46	04/01/2020 15:26	8,67	20	173,47	CHI
20200116951	APORE	AE12324797	ITAJA S1	04/01/2020 06:48	04/01/2020 09:12	04/01/2020 06:48	04/01/2020 09:12	2,40	11	26,40	CHI
20200116951	SERRANOPOLIS	AE12324797	ITAJA S1	04/01/2020 06:48	04/01/2020 09:12	04/01/2020 06:48	04/01/2020 09:12	2,40	8	19,20	CHI
20200116955	URUACU	UR12317135	URUACU	04/01/2020 06:48	04/01/2020 09:39	04/01/2020 06:48	04/01/2020 09:39	2,84	11	31,19	CHI
20200116956	CORUMBA DE GOIAS	CB21141603	CORUMBA	04/01/2020 06:48	04/01/2020 11:43	04/01/2020 06:48	04/01/2020 11:43	4,90	1	4,90	CHI
20200116960	MARA ROSA	MQ12170945	MARA ROSA	04/01/2020 06:50	04/01/2020 15:05	04/01/2020 06:50	04/01/2020 15:05	8,25	5	41,23	CHI
20200116961	GOIAS	IU12089755	MATRINCHA	04/01/2020 05:47	04/01/2020 21:55	04/01/2020 05:47	04/01/2020 21:55	16,13	1	16,13	CHI
20200116961	ITAPIRAPUA	IU12089755	MATRINCHA	04/01/2020 05:47	04/01/2020 21:55	04/01/2020 05:47	04/01/2020 21:55	16,13	56	903,39	CHI

20200116970	CRIXAS	2490020311	SERRA DO OURO	04/01/2020 06:52	04/01/2020 08:45	04/01/2020 06:52	04/01/2020 08:45	1,87	1	1,87	CHI
20200116972	CEZARINA	CZ12402797	GUAPO S2	04/01/2020 06:48	04/01/2020 08:55	04/01/2020 06:48	04/01/2020 08:55	2,11	11	23,22	CHI
20200116976	PALESTINA DE GOIAS	PY12223011	PALESTINA	04/01/2020 06:03	04/01/2020 21:56	04/01/2020 06:03	04/01/2020 21:56	15,89	110	1748,11	CHI
20200116987	PIRACANJUBA	PJ12293360	PIRACANJUBA	04/01/2020 06:56	04/01/2020 14:20	04/01/2020 06:56	04/01/2020 14:20	7,39	10	73,94	CHI
20200116998	AGUAS LINDAS DE GOIAS	LA11089677	AGUAS LINDAS DE GOIAS S1	04/01/2020 06:42	04/01/2020 08:22	04/01/2020 06:42	04/01/2020 08:22	1,66	185	307,41	CHI
20200116999	CATALAO	CT12011272	CATALAO S1	04/01/2020 04:46	04/01/2020 08:39	04/01/2020 04:46	04/01/2020 08:39	3,90	167	650,51	CHI
20200117002	PORANGATU	PO12020580	PORANGATU	04/01/2020 06:01	04/01/2020 09:48	04/01/2020 06:01	04/01/2020 09:48	3,77	67	252,70	CHI
20200117003	DIORAMA	DI21126777	ARENOPOLIS	04/01/2020 07:01	04/01/2020 20:27	04/01/2020 07:01	04/01/2020 20:27	13,43	1	13,43	CHI
20200117006	ITAPACI	IW12405202	ITAPACI	04/01/2020 07:01	04/01/2020 09:55	04/01/2020 07:01	04/01/2020 09:55	2,90	17	49,32	CHI
20200117006	NOVA GLORIA	IW12405202	ITAPACI	04/01/2020 07:01	04/01/2020 09:55	04/01/2020 07:01	04/01/2020 09:55	2,90	1	2,90	CHI
20200117008	ANAPOLIS	20622880	ANAPOLIS UNIVERSITARIO S1	04/01/2020 07:01	04/01/2020 14:45	04/01/2020 07:01	04/01/2020 14:45	7,72	1	7,72	CHI
20200117013	ITAPIRAPUA	IU12014779	MATRINCHA	04/01/2020 07:02	04/01/2020 23:04	04/01/2020 07:02	04/01/2020 23:04	16,03	12	192,31	CHI
20200117017	CROMINIA	CQ21252508	ROCHEDO	04/01/2020 07:03	04/01/2020 16:02	04/01/2020 07:03	04/01/2020 16:02	8,98	2	17,96	CHI
20200117029	CATALAO	CT12266191RE	CATALAO S1	04/01/2020 07:02	04/01/2020 09:35	04/01/2020 07:02	04/01/2020 09:35	2,54	28	70,99	CHI
20200117031	GUARAITA	IK12300242	ITAPURANGA	04/01/2020 06:41	04/01/2020 09:35	04/01/2020 06:41	04/01/2020 09:35	2,90	2	5,79	CHI
20200117031	ITAPURANGA	IK12300242	ITAPURANGA	04/01/2020 06:41	04/01/2020 09:35	04/01/2020 06:41	04/01/2020 09:35	2,90	48	139,04	CHI
20200117034	CUMARI	CY21131050	CATALAO S1	04/01/2020 07:05	04/01/2020 11:47	04/01/2020 07:05	04/01/2020 11:47	4,69	1	4,69	CHI
20200117037	BELA VISTA DE GOIAS	BV12031912	BELA VISTA S1	04/01/2020 07:05	04/01/2020 10:14	04/01/2020 07:05	04/01/2020 10:14	3,13	27	84,62	CHI
20200117045	ALTO PARAISO DE GOIAS	BF12159157	NIQUELANDIA SUBTRANSMISSAO	04/01/2020 07:07	04/01/2020 10:02	04/01/2020 07:07	04/01/2020 10:02	2,90	16	46,46	CHI
20200117046	QUIRINOPOLIS	QI12052515	QUIRINOPOLIS	04/01/2020 07:07	04/01/2020 10:39	04/01/2020 07:07	04/01/2020 10:39	3,52	2	7,03	CHI
20200117049	MINACU	IH12341446	MINACU	04/01/2020 07:08	04/01/2020 09:36	04/01/2020 07:08	04/01/2020 09:36	2,46	36	88,38	CHI
20200117053	CORUMBAIBA	CI12081002	VILA CORUMBA	04/01/2020 07:10	04/01/2020 09:44	04/01/2020 07:10	04/01/2020 09:44	2,56	5	12,79	CHI
20200117055	ANAPOLIS	AN12004481	NEROPOLIS S1	04/01/2020 05:32	04/01/2020 08:53	04/01/2020 05:32	04/01/2020 08:53	3,35	8	26,78	CHI
20200117056	CACHOEIRA ALTA	CA21384654	CACHOEIRA ALTA	04/01/2020 07:11	04/01/2020 11:00	04/01/2020 07:11	04/01/2020 11:00	3,81	1	3,81	CHI
20200117059	RIO QUENTE	RQ12100108	RIO QUENTE	04/01/2020 06:34	04/01/2020 17:10	04/01/2020 06:34	04/01/2020 17:10	10,60	8	84,79	CHI
20200117064	MINEIROS	MY12203399	PARQUE DAS EMAS	04/01/2020 07:12	04/01/2020 14:36	04/01/2020 07:12	04/01/2020 14:36	7,39	8	59,16	CHI
20200117067	BELA VISTA DE GOIAS	BV12006337	CEPAIGO S2	04/01/2020 06:28	04/01/2020 10:01	04/01/2020 06:28	04/01/2020 10:01	3,54	6	21,26	CHI
20200117070	CATALAO	CT12215621	CATALAO S1	04/01/2020 07:13	04/01/2020 11:00	04/01/2020 07:13	04/01/2020 11:00	3,77	9	33,91	CHI
20200117071	ITAPACI	IW12251271	ITAPACI	04/01/2020 07:14	04/01/2020 11:40	04/01/2020 07:14	04/01/2020 11:40	4,43	3	13,29	CHI
20200117075	FIRMINOPOLIS	TV12105311	FIRMINOPOLIS S1	04/01/2020 07:15	04/01/2020 09:22	04/01/2020 07:15	04/01/2020 09:22	2,11	6	12,69	CHI
20200117078	FIRMINOPOLIS	FR21076445	FIRMINOPOLIS S1	04/01/2020 06:34	04/01/2020 08:19	04/01/2020 06:34	04/01/2020 08:19	1,73	3	5,20	CHI
20200117082	INACIOLANDIA	ID12271587	CACHOEIRA DOURADA	04/01/2020 07:16	04/01/2020 12:25	04/01/2020 07:16	04/01/2020 12:25	5,14	12	61,68	CHI
20200117091	ARAGOIANIA	HD12000186	CEPAIGO S2	04/01/2020 07:17	04/01/2020 11:33	04/01/2020 07:17	04/01/2020 11:33	4,26	14	59,63	CHI

20200117091	HIDROLANDIA	HD12000186	CEPAIGO S2	04/01/2020 07:17	04/01/2020 11:33	04/01/2020 07:17	04/01/2020 11:33	4,26	11	46,85	CHI
20200117092	GOIANIA	14901638	XAVANTES	04/01/2020 07:17	04/01/2020 08:07	04/01/2020 07:17	04/01/2020 08:07	0,83	1	0,83	CHI
20200117093	CRISTALINA	KR11032674	CRISTALINA S1	04/01/2020 06:05	04/01/2020 12:34	04/01/2020 06:05	04/01/2020 12:34	6,47	64	414,08	CHI
20200117095	SENADOR CANEDO	SW11092178	SENADOR CANEDO	04/01/2020 07:11	04/01/2020 08:22	04/01/2020 07:11	04/01/2020 08:22	1,17	159	186,74	CHI
20200117097	AMORINOPOLIS	AM12091444	IPORA	04/01/2020 07:17	04/01/2020 12:07	04/01/2020 07:17	04/01/2020 12:07	4,82	16	77,08	CHI
20200117107	DAVINOPOLIS	CT21318675	CATALAO S1	04/01/2020 07:19	04/01/2020 13:39	04/01/2020 07:19	04/01/2020 13:39	6,34	1	6,34	CHI
20200117110	CAMPO ALEGRE DE GOIAS	CM12192738RE	CAMPO ALEGRE DE GOIAS	04/01/2020 07:17	04/01/2020 11:18	04/01/2020 07:17	04/01/2020 11:18	4,00	51	204,13	CHI
20200117112	URUACU	UR12213102	URUACU	04/01/2020 07:19	04/01/2020 11:49	04/01/2020 07:19	04/01/2020 11:49	4,49	9	40,40	CHI
20200117113	URUACU	UR12003395	URUACU	04/01/2020 07:20	04/01/2020 10:13	04/01/2020 07:20	04/01/2020 10:13	2,88	8	23,02	CHI
20200117114	ITAJA	03700234	CACHOEIRA ALTA	04/01/2020 05:20	04/01/2020 10:30	04/01/2020 05:20	04/01/2020 10:30	5,18	8	41,42	CHI
20200117114	ITARUMA	03700234	CACHOEIRA ALTA	04/01/2020 05:20	04/01/2020 10:30	04/01/2020 05:20	04/01/2020 10:30	5,18	78	403,80	CHI
20200117116	CALDAS NOVAS	10027385319	SERRA DE CALDAS	04/01/2020 07:20	04/01/2020 10:25	04/01/2020 07:20	04/01/2020 10:25	3,07	1	3,07	CHI
20200117120	URUACU	UR12003416	URUACU	04/01/2020 07:21	04/01/2020 10:58	04/01/2020 07:21	04/01/2020 10:58	3,61	1	3,61	CHI
20200117122	PARAUNA	PU12007902	PARAUNA	04/01/2020 07:21	04/01/2020 09:46	04/01/2020 07:21	04/01/2020 09:46	2,40	1	2,40	CHI
20200117127	GOIANESIA	BA12163310	GOIANESIA S1	04/01/2020 07:22	04/01/2020 09:58	04/01/2020 07:22	04/01/2020 09:58	2,58	2	5,17	CHI
20200117127	VILA PROPICIO	BA12163310	GOIANESIA S1	04/01/2020 07:22	04/01/2020 09:58	04/01/2020 07:22	04/01/2020 09:58	2,58	11	28,43	CHI
20200117131	SAO FRANCISCO DE GOIAS	SF12000177	SAO FRANCISCO DE GOIAS	04/01/2020 07:23	04/01/2020 09:51	04/01/2020 07:23	04/01/2020 09:51	2,46	4	9,82	CHI
20200117135	NOVA ROMA	ND12096857	IACIARA S2	04/01/2020 07:23	04/01/2020 12:49	04/01/2020 07:23	04/01/2020 12:49	5,42	2	10,84	CHI
20200117135	SAO DOMINGOS	ND12096857	IACIARA S2	04/01/2020 07:23	04/01/2020 12:49	04/01/2020 07:23	04/01/2020 12:49	5,42	3	16,26	CHI
20200117139	GOIAS	GS12029627	GOIAS	04/01/2020 07:24	04/01/2020 13:15	04/01/2020 07:24	04/01/2020 13:15	5,84	10	58,43	CHI
20200117147	CEZARINA	CZ12000015	CEZARINA	04/01/2020 06:55	04/01/2020 10:43	04/01/2020 06:55	04/01/2020 10:43	3,79	61	230,94	CHI
20200117147	INDIARA	CZ12000015	CEZARINA	04/01/2020 06:55	04/01/2020 10:43	04/01/2020 06:55	04/01/2020 10:43	3,79	37	140,08	CHI
20200117148	EDEIA	ED12000041	EDEIA	04/01/2020 06:38	04/01/2020 09:23	04/01/2020 06:38	04/01/2020 09:23	2,76	25	69,08	CHI
20200117149	PORANGATU	PO12137591	PORANGATU	04/01/2020 07:26	04/01/2020 16:07	04/01/2020 07:26	04/01/2020 16:07	8,68	3	26,04	CHI
20200117152	VALPARAISO DE GOIAS	10024659884	PACAEMBU S1	04/01/2020 07:27	04/01/2020 12:25	04/01/2020 07:27	04/01/2020 12:25	4,96	1	4,96	CHI
20200117153	SAO MIGUEL DO ARAGUAIA	830072287	SAO MIGUEL DO ARAGUAIA	04/01/2020 07:27	05/01/2020 03:57	04/01/2020 07:27	05/01/2020 03:57	20,50	1	20,50	CHI
20200117166	ANAPOLIS	20279360	ANAPOLIS UNIVERSITARIO S2	04/01/2020 07:27	04/01/2020 14:01	04/01/2020 07:27	04/01/2020 14:01	6,57	1	6,57	CHI
20200117168	RIO VERDE	10030839619	RIO VERDE S1	04/01/2020 07:28	04/01/2020 10:21	04/01/2020 07:28	04/01/2020 10:21	2,87	0	0,00	CHI
20200117175	NAZARIO	NZ12000021	ANICUNS	04/01/2020 06:53	04/01/2020 08:44	04/01/2020 06:53	04/01/2020 08:44	1,86	2	3,73	CHI
20200117175	PALMEIRAS DE GOIAS	NZ12000021	ANICUNS	04/01/2020 06:53	04/01/2020 08:44	04/01/2020 06:53	04/01/2020 08:44	1,86	19	35,41	CHI
20200117176	BURITINOPOLIS	MB12344322RE	IACIARA S2	04/01/2020 07:18	04/01/2020 09:44	04/01/2020 07:18	04/01/2020 09:44	2,42	30	72,61	CHI
20200117176	MAMBAI	MB12344322RE	IACIARA S2	04/01/2020 07:18	04/01/2020 09:44	04/01/2020 07:18	04/01/2020 09:44	2,42	125	302,53	CHI
20200117185	ANAPOLIS	AN11019594	ANAPOLIS UNIVERSITARIO S2	04/01/2020 06:31	04/01/2020 13:18	04/01/2020 06:31	04/01/2020 13:06	6,58	38	250,17	CHI

20200117185	ANAPOLIS	AN12204075LD	ANAPOLIS UNIVERSITARIO S2	04/01/2020 06:31	04/01/2020 13:18	04/01/2020 11:08	04/01/2020 13:18	2,17	108	234,24	CHI
20200117190	MINACU	IH12253865	MINACU	04/01/2020 07:32	04/01/2020 17:00	04/01/2020 07:32	04/01/2020 17:00	9,46	245	2318,58	CHI
20200117190	TROMBAS	IH12253865	MINACU	04/01/2020 07:32	04/01/2020 17:00	04/01/2020 07:32	04/01/2020 17:00	9,46	6	56,78	CHI
20200117195	CRIXAS	CX12276585	SERRA DO OURO	04/01/2020 07:32	05/01/2020 09:11	04/01/2020 07:32	05/01/2020 09:11	25,64	2	51,28	CHI
20200117198	EDEIA	ED12044478	PONTALINA	04/01/2020 07:32	04/01/2020 12:40	04/01/2020 07:32	04/01/2020 12:40	5,12	1	5,12	CHI
20200117199	CATALAO	CY12064048	CATALAO S2	04/01/2020 07:33	04/01/2020 13:05	04/01/2020 07:33	04/01/2020 13:05	5,53	3	16,60	CHI
20200117199	CUMARI	CY12064048	CATALAO S2	04/01/2020 07:33	04/01/2020 13:05	04/01/2020 07:33	04/01/2020 13:05	5,53	3	16,60	CHI
20200117201	PLANALTINA	2960098608	PLANALTINA	04/01/2020 07:33	04/01/2020 09:18	04/01/2020 07:33	04/01/2020 09:18	1,75	1	1,75	CHI
20200117206	ANAPOLIS	20382704	ANAPOLIS UNIVERSITARIO S2	04/01/2020 07:33	04/01/2020 15:04	04/01/2020 07:33	04/01/2020 15:04	7,51	1	7,51	CHI
20200117212	VILA PROPICIO	NP12235934	GOIANESIA S1	04/01/2020 07:33	04/01/2020 12:02	04/01/2020 07:33	04/01/2020 12:02	4,48	8	35,85	CHI
20200117215	VARJAO	VJ31061533	GUAPO S2	04/01/2020 07:35	04/01/2020 10:50	04/01/2020 07:35	04/01/2020 10:50	3,25	1	3,25	CHI
20200117218	RIO VERDE	RV21207007	RIO VERDE S2	04/01/2020 07:35	04/01/2020 10:46	04/01/2020 07:35	04/01/2020 10:46	3,18	3	9,53	CHI
20200117220	RIO VERDE	RV21213257	MONTIVIDIU T	04/01/2020 07:35	04/01/2020 11:17	04/01/2020 07:35	04/01/2020 11:17	3,70	1	3,70	CHI
20200117222	FAZENDA NOVA	NB12396253	JUSSARA	04/01/2020 06:04	04/01/2020 15:16	04/01/2020 06:04	04/01/2020 15:16	9,20	13	119,59	CHI
20200117222	JUSSARA	NB12396253	JUSSARA	04/01/2020 06:04	04/01/2020 15:16	04/01/2020 06:04	04/01/2020 15:16	9,20	1	9,20	CHI
20200117235	ITAPURANGA	IK12299453	ITAPURANGA	04/01/2020 05:13	04/01/2020 10:28	04/01/2020 05:13	04/01/2020 10:28	5,25	8	41,97	CHI
20200117237	BARRO ALTO	DF12194371	BARRO ALTO	04/01/2020 07:25	04/01/2020 13:09	04/01/2020 07:25	04/01/2020 13:09	5,73	67	383,87	CHI
20200117237	SANTA RITA DO NOVO DESTINO	DF12194371	BARRO ALTO	04/01/2020 07:25	04/01/2020 13:09	04/01/2020 07:25	04/01/2020 13:09	5,73	33	189,07	CHI
20200117238	MINEIROS	MY12260468	PARQUE DAS EMAS	04/01/2020 07:37	04/01/2020 14:17	04/01/2020 07:37	04/01/2020 14:17	6,65	5	33,26	CHI
20200117241	FORMOSA	FA12397866	ITUIQUIRA	04/01/2020 07:38	04/01/2020 09:44	04/01/2020 07:38	04/01/2020 09:44	2,10	140	293,65	CHI
20200117242	JATAI	JT12324674	JATAI S2	04/01/2020 02:37	04/01/2020 15:05	04/01/2020 02:37	04/01/2020 15:05	12,46	14	174,46	CHI
20200117243	CATALAO	CT12266322	CATALAO S1	04/01/2020 07:04	04/01/2020 11:10	04/01/2020 07:04	04/01/2020 11:10	4,09	39	159,32	CHI
20200117244	PORANGATU	PO12020947	PORANGATU	04/01/2020 07:11	04/01/2020 09:13	04/01/2020 07:11	04/01/2020 09:13	2,02	44	88,75	CHI
20200117245	BURITI ALEGRE	GT12000112	GOIATUBA S2	04/01/2020 07:39	04/01/2020 11:48	04/01/2020 07:39	04/01/2020 11:48	4,15	7	29,05	CHI
20200117247	NOVA IGUACU DE GOIAS	NH12202113	SANTA TEREZINHA	04/01/2020 07:39	04/01/2020 16:20	04/01/2020 07:39	04/01/2020 16:20	8,68	62	538,44	CHI
20200117248	IVOLANDIA	IV12108126	IPORA	04/01/2020 07:39	04/01/2020 21:49	04/01/2020 07:39	04/01/2020 21:49	14,16	16	226,63	CHI
20200117248	PALESTINA DE GOIAS	IV12108126	IPORA	04/01/2020 07:39	04/01/2020 21:49	04/01/2020 07:39	04/01/2020 21:49	14,16	33	467,42	CHI
20200117250	GOIAS	GS12336540	GOIAS	04/01/2020 07:23	04/01/2020 11:47	04/01/2020 07:23	04/01/2020 11:47	4,40	9	39,58	CHI
20200117255	PORANGATU	PO12139105	PORANGATU	04/01/2020 07:40	04/01/2020 16:47	04/01/2020 07:40	04/01/2020 16:47	9,12	3	27,37	CHI
20200117260	PIRENOPOLIS	PV12196920LD	SAO FRANCISCO DE GOIAS	04/01/2020 07:29	04/01/2020 12:04	04/01/2020 07:29	04/01/2020 12:04	4,57	3	13,71	CHI
20200117261	BARRO ALTO	GE12255886	GOIANESIA S1	04/01/2020 07:40	04/01/2020 15:39	04/01/2020 07:40	04/01/2020 15:39	7,98	1	7,98	CHI
20200117261	GOIANESIA	GE12255886	GOIANESIA S1	04/01/2020 07:40	04/01/2020 15:39	04/01/2020 07:40	04/01/2020 15:39	7,98	4	31,93	CHI
20200117265	VALPARAISO DE GOIAS	10001302173	PACAEMBU S1	04/01/2020 07:42	04/01/2020 09:53	04/01/2020 07:42	04/01/2020 09:53	2,17	1	2,17	CHI

20200117266	COCALZINHO DE GOIAS	ZN12216781	PADRE BERNARDO	04/01/2020 07:43	04/01/2020 12:48	04/01/2020 07:43	04/01/2020 12:48	5,08	3	15,25	CHI
20200117268	POSSE	SA21195799	IACIARA S2	04/01/2020 07:43	04/01/2020 19:04	04/01/2020 07:43	04/01/2020 19:04	11,35	2	22,69	CHI
20200117273	AGUA LIMPA	MG12120778	VILA CORUMBA	04/01/2020 07:43	04/01/2020 16:30	04/01/2020 07:43	04/01/2020 16:30	8,77	16	140,34	CHI
20200117273	MARZAGAO	MG12120778	VILA CORUMBA	04/01/2020 07:43	04/01/2020 16:30	04/01/2020 07:43	04/01/2020 16:30	8,77	2	17,54	CHI
20200117275	JATAI	290174491	JATAI S2	04/01/2020 07:43	04/01/2020 09:48	04/01/2020 07:43	04/01/2020 09:48	2,07	1	2,07	CHI
20200117276	RIO VERDE	RV21240540	MONTIVIDIU T	04/01/2020 07:43	04/01/2020 10:25	04/01/2020 07:43	04/01/2020 10:25	2,69	1	2,69	CHI
20200117278	NOVO PLANALTO	TA12369993	NOVO PLANALTO	04/01/2020 01:34	04/01/2020 14:29	04/01/2020 01:34	04/01/2020 14:29	12,91	8	103,26	CHI
20200117282	CATALAO	CY21061111	CATALAO S2	04/01/2020 07:45	04/01/2020 16:43	04/01/2020 07:45	04/01/2020 16:43	8,96	2	17,93	CHI
20200117283	BONOPOLIS	BX12168214	SAO MIGUEL DO ARAGUAIA	04/01/2020 07:15	04/01/2020 15:40	04/01/2020 07:15	04/01/2020 11:22	4,12	5	20,58	CHI
20200117283	BONOPOLIS	BX12168214	SAO MIGUEL DO ARAGUAIA	04/01/2020 07:15	04/01/2020 15:40	04/01/2020 07:15	04/01/2020 15:40	8,41	119	1001,35	CHI
20200117285	ITUMBIARA	IT12000308RE	PARANAIBA	04/01/2020 06:49	04/01/2020 09:10	04/01/2020 06:49	04/01/2020 09:10	2,35	91	213,95	CHI
20200117287	BELA VISTA DE GOIAS	BV12185857	CEPAIGO S2	04/01/2020 07:34	04/01/2020 16:13	04/01/2020 07:34	04/01/2020 16:13	8,65	3	25,95	CHI
20200117289	RIO VERDE	RV21260148	RIO VERDE S2	04/01/2020 07:46	04/01/2020 11:26	04/01/2020 07:46	04/01/2020 11:26	3,66	1	3,66	CHI
20200117292	URUACU	UR12210930	URUACU	04/01/2020 06:40	04/01/2020 10:03	04/01/2020 06:40	04/01/2020 10:03	3,38	11	37,23	CHI
20200117301	CRISTALINA	KR11376905	CRISTALINA S2	04/01/2020 07:48	04/01/2020 10:39	04/01/2020 07:48	04/01/2020 10:39	2,85	1	2,85	CHI
20200117304	RIO VERDE	10013599915	RIO VERDE S2	04/01/2020 07:48	04/01/2020 09:14	04/01/2020 07:48	04/01/2020 09:14	1,43	1	1,43	CHI
20200117308	ITUMBIARA	690279700	ITUMBIARA VELHA S1	04/01/2020 07:48	04/01/2020 10:11	04/01/2020 07:48	04/01/2020 10:11	2,38	1	2,38	CHI
20200117310	SAO LUIS DE MONTES BELOS	500018157	SAO LUIZ DOS MONTES BELOS	04/01/2020 07:49	04/01/2020 12:23	04/01/2020 07:49	04/01/2020 12:23	4,58	1	4,58	CHI
20200117315	CATALAO	CT21231565	CATALAO S1	04/01/2020 07:49	04/01/2020 12:06	04/01/2020 07:49	04/01/2020 12:06	4,28	1	4,28	CHI
20200117317	CRISTALINA	KR21237873	CRISTALINA S2	04/01/2020 07:50	05/01/2020 02:50	04/01/2020 07:50	04/01/2020 17:43	9,89	1	9,89	CHI
20200117317	CRISTALINA	KR21230150	CRISTALINA S2	04/01/2020 07:50	05/01/2020 02:50	04/01/2020 07:50	04/01/2020 18:02	10,20	1	10,20	CHI
20200117317	CRISTALINA	KR12230241	CRISTALINA S2	04/01/2020 07:50	05/01/2020 02:50	04/01/2020 07:50	04/01/2020 19:26	11,60	2	23,20	CHI
20200117317	CRISTALINA	KR21245992	CRISTALINA S2	04/01/2020 07:50	05/01/2020 02:50	04/01/2020 07:50	04/01/2020 23:29	15,66	1	15,66	CHI
20200117317	CRISTALINA	KR12230241	CRISTALINA S2	04/01/2020 07:50	05/01/2020 02:50	04/01/2020 23:15	05/01/2020 00:10	0,91	3	2,74	CHI
20200117317	CRISTALINA	KR21245993	CRISTALINA S2	04/01/2020 07:50	05/01/2020 02:50	04/01/2020 19:35	05/01/2020 02:50	7,25	1	7,25	CHI
20200117321	MINEIROS	MY21302939	PARQUE DAS EMAS	04/01/2020 08:02	05/01/2020 00:33	04/01/2020 08:02	05/01/2020 00:33	16,51	1	16,51	CHI
20200117322	AGUA LIMPA	AL12000251	VILA CORUMBA	04/01/2020 06:26	04/01/2020 10:40	04/01/2020 06:26	04/01/2020 10:40	4,23	52	219,82	CHI
20200117322	BURITI ALEGRE	AL12000251	VILA CORUMBA	04/01/2020 06:26	04/01/2020 10:40	04/01/2020 06:26	04/01/2020 10:40	4,23	3	12,68	CHI
20200117322	MORRINHOS	AL12000251	VILA CORUMBA	04/01/2020 06:26	04/01/2020 10:40	04/01/2020 06:26	04/01/2020 10:40	4,23	2	8,45	CHI
20200117323	GUAPO	GA12276638	GUAPO S2	04/01/2020 07:50	04/01/2020 10:47	04/01/2020 07:50	04/01/2020 10:47	2,94	6	17,65	CHI
20200117328	PILAR DE GOIAS	GG21172329	SANTA TEREZINHA	04/01/2020 07:51	04/01/2020 10:20	04/01/2020 07:51	04/01/2020 10:20	2,48	1	2,48	CHI
20200117331	GOIANESIA	GE12384180	GOIANESIA S2	04/01/2020 07:51	04/01/2020 14:39	04/01/2020 07:51	04/01/2020 14:39	6,79	4	27,17	CHI
20200117332	ANAPOLIS	AN12261182	JUNDIAI S1	04/01/2020 07:15	04/01/2020 09:28	04/01/2020 07:15	04/01/2020 09:28	2,20	149	328,54	CHI

20200117332	GOIANAPOLIS	AN12261182	JUNDIAI S1	04/01/2020 07:15	04/01/2020 09:28	04/01/2020 07:15	04/01/2020 09:28	2,20	9	19,84	CHI
20200117332	LEOPOLDO DE BULHOES	AN12261182	JUNDIAI S1	04/01/2020 07:15	04/01/2020 09:28	04/01/2020 07:15	04/01/2020 09:28	2,20	5	11,02	CHI
20200117333	PEROLANDIA	10007673718	JATAI S1	04/01/2020 07:51	04/01/2020 09:40	04/01/2020 07:51	04/01/2020 09:40	1,81	1	1,81	CHI
20200117335	APARECIDA DE GOIANIA	AP11034424	INDEPENDENCIA S1	04/01/2020 07:51	04/01/2020 11:12	04/01/2020 07:51	04/01/2020 11:12	3,34	225	750,75	CHI
20200117338	CRISTALINA	KR21037186	CRISTALINA S1	04/01/2020 07:52	05/01/2020 04:22	04/01/2020 07:52	05/01/2020 04:22	20,50	1	20,50	CHI
20200117339	APORE	AE21232116	ITAJA S1	04/01/2020 07:52	04/01/2020 10:20	04/01/2020 07:52	04/01/2020 10:20	2,46	1	2,46	CHI
20200117340	PADRE BERNARDO	PB12377203	PADRE BERNARDO	04/01/2020 07:35	04/01/2020 10:20	04/01/2020 07:35	04/01/2020 10:20	2,73	14	38,28	CHI
20200117342	JUSSARA	JR12124817	BRITANIA	03/01/2020 22:35	04/01/2020 21:57	03/01/2020 22:35	04/01/2020 21:57	23,36	11	256,95	CHI
20200117346	GOIANIA	GN11072665	GOIANIA LESTE S1	04/01/2020 07:52	04/01/2020 11:52	04/01/2020 10:00	04/01/2020 11:52	1,87	169	315,47	CHI
20200117349	NIQUELANDIA	NQ12292626	BARRO ALTO	04/01/2020 07:54	04/01/2020 10:44	04/01/2020 07:54	04/01/2020 10:44	2,82	6	16,95	CHI
20200117351	GOIANIA	11441811	ATLANTICO S3	04/01/2020 07:54	04/01/2020 09:19	04/01/2020 07:54	04/01/2020 09:19	1,41	1	1,41	CHI
20200117353	TURVANIA	TV21308876	ANICUNS	04/01/2020 07:54	04/01/2020 09:59	04/01/2020 07:54	04/01/2020 09:59	2,07	1	2,07	CHI
20200117354	GUARANI DE GOIAS	GY12465246	IACIARA S1	04/01/2020 07:54	04/01/2020 11:52	04/01/2020 07:54	04/01/2020 11:52	3,95	13	51,39	CHI
20200117354	IACIARA	GY12465246	IACIARA S1	04/01/2020 07:54	04/01/2020 11:52	04/01/2020 07:54	04/01/2020 11:52	3,95	3	11,86	CHI
20200117356	VILA PROPICIO	NP12188681	GOIANESIA S1	04/01/2020 07:55	04/01/2020 11:56	04/01/2020 07:55	04/01/2020 11:56	4,01	86	345,00	CHI
20200117358	CAMPOS VERDES	VD11055151	SANTA TEREZINHA	04/01/2020 07:55	04/01/2020 09:59	04/01/2020 07:55	04/01/2020 09:59	2,06	5	10,28	CHI
20200117359	PORANGATU	PO21220716	NOVO PLANALTO	04/01/2020 07:55	04/01/2020 18:09	04/01/2020 07:55	04/01/2020 18:09	10,22	1	10,22	CHI
20200117360	ANAPOLIS	AN12009330	NEROPOLIS S1	04/01/2020 07:55	04/01/2020 10:28	04/01/2020 07:55	04/01/2020 10:28	2,54	25	63,47	CHI
20200117360	PIRENOPOLIS	AN12009330	NEROPOLIS S1	04/01/2020 07:55	04/01/2020 10:28	04/01/2020 07:55	04/01/2020 10:28	2,54	20	50,77	CHI
20200117364	ESTRELA DO NORTE	ET12168852	MARA ROSA	04/01/2020 07:56	04/01/2020 11:24	04/01/2020 07:56	04/01/2020 11:24	3,46	4	13,86	CHI
20200117364	FORMOSO	ET12168852	MARA ROSA	04/01/2020 07:56	04/01/2020 11:24	04/01/2020 07:56	04/01/2020 11:24	3,46	2	6,93	CHI
20200117365	SANTA RITA DO ARAGUAIA	2130019475	SANTA RITA DO ARAGUAIA	04/01/2020 07:56	04/01/2020 22:36	04/01/2020 07:56	04/01/2020 22:36	14,66	1	14,66	CHI
20200117373	BONOPOLIS	BX21123177	SAO MIGUEL DO ARAGUAIA	04/01/2020 07:58	04/01/2020 21:42	04/01/2020 07:58	04/01/2020 21:42	13,73	2	27,46	CHI
20200117374	ANAPOLIS	AN11374432	JUNDIAI S1	04/01/2020 07:35	04/01/2020 10:59	04/01/2020 07:35	04/01/2020 10:59	3,39	46	156,09	CHI
20200117379	SILVANIA	SV21113602	VIANOPOLIS	04/01/2020 07:59	04/01/2020 10:06	04/01/2020 07:59	04/01/2020 10:06	2,12	1	2,12	CHI
20200117384	PIRENOPOLIS	PV12000461	SAO FRANCISCO DE GOIAS	04/01/2020 07:27	04/01/2020 10:31	04/01/2020 07:27	04/01/2020 10:31	3,07	64	196,21	CHI
20200117386	VILA PROPICIO	NQ12252378	BARRO ALTO	04/01/2020 06:12	04/01/2020 10:56	04/01/2020 06:12	04/01/2020 10:56	4,73	15	70,90	CHI
20200117390	COCALZINHO DE GOIAS	ZN12376728	AGUAS LINDAS DE GOIAS S2	04/01/2020 07:59	04/01/2020 09:59	04/01/2020 07:59	04/01/2020 09:59	1,99	16	31,76	CHI
20200117393	ITAPURANGA	IK12298441	ITAPURANGA	04/01/2020 08:00	04/01/2020 08:57	04/01/2020 08:00	04/01/2020 08:57	0,94	118	110,43	CHI
20200117396	GOIAS	GS12311035	GOIAS	04/01/2020 08:01	04/01/2020 12:27	04/01/2020 08:01	04/01/2020 12:27	4,42	3	13,26	CHI
20200117404	PARAUNA	PU12301143	ACREUNA	04/01/2020 08:02	04/01/2020 13:20	04/01/2020 08:02	04/01/2020 13:20	5,30	10	52,97	CHI
20200117405	PORANGATU	PO11252093	PORANGATU	04/01/2020 07:50	04/01/2020 11:52	04/01/2020 07:50	04/01/2020 11:20	3,50	142	497,36	CHI
20200117405	PORANGATU	PO12252126	PORANGATU	04/01/2020 07:50	04/01/2020 11:52	04/01/2020 07:50	04/01/2020 11:52	4,02	67	269,49	CHI

20200117406	CRISTALINA	KR21214839	CRISTALINA S2	04/01/2020 08:02	05/01/2020 08:12	04/01/2020 08:02	05/01/2020 08:12	24,17	1	24,17	CHI
20200117407	CIDADE OCIDENTAL	DH11350427	MARAJOARA	04/01/2020 08:02	04/01/2020 09:29	04/01/2020 08:02	04/01/2020 09:29	1,44	71	102,12	CHI
20200117410	MORRINHOS	MR12212245	MORRINHOS	04/01/2020 07:40	04/01/2020 11:28	04/01/2020 07:40	04/01/2020 11:28	3,81	6	22,85	CHI
20200117418	GOIANIA	10941411	FERROVIARIO S2	04/01/2020 08:03	04/01/2020 09:04	04/01/2020 08:03	04/01/2020 09:04	1,00	1	1,00	CHI
20200117425	LUZIANIA	10024855039	MARAJOARA	04/01/2020 08:04	04/01/2020 10:52	04/01/2020 08:04	04/01/2020 10:52	2,79	1	2,79	CHI
20200117426	GOIANIA	10019384821	CAMPINAS S1	04/01/2020 08:05	04/01/2020 09:52	04/01/2020 08:05	04/01/2020 09:52	1,78	1	1,78	CHI
20200117433	SAO MIGUEL DO ARAGUAIA	SM12282234	SAO MIGUEL DO ARAGUAIA	04/01/2020 08:02	04/01/2020 17:10	04/01/2020 08:02	04/01/2020 17:10	9,14	8	73,10	CHI
20200117436	OUVIDOR	CT12000105	CATALAO S1	04/01/2020 07:18	05/01/2020 13:10	04/01/2020 07:18	04/01/2020 16:40	9,36	3	28,09	CHI
20200117436	CATALAO	CT12000105	CATALAO S1	04/01/2020 07:18	05/01/2020 13:10	04/01/2020 07:18	04/01/2020 23:29	16,19	1	16,19	CHI
20200117436	OUVIDOR	CT12000105	CATALAO S1	04/01/2020 07:18	05/01/2020 13:10	04/01/2020 07:18	04/01/2020 23:29	16,19	6	97,11	CHI
20200117436	OUVIDOR	CT12000105	CATALAO S1	04/01/2020 07:18	05/01/2020 13:10	04/01/2020 22:13	04/01/2020 23:29	1,26	3	3,77	CHI
20200117436	OUVIDOR	CT12000105	CATALAO S1	04/01/2020 07:18	05/01/2020 13:10	04/01/2020 23:30	05/01/2020 13:02	13,53	8	108,27	CHI
20200117436	CATALAO	CT21377081	CATALAO S1	04/01/2020 07:18	05/01/2020 13:10	04/01/2020 23:30	05/01/2020 13:03	13,55	1	13,55	CHI
20200117436	CATALAO	CT21287036	CATALAO S1	04/01/2020 07:18	05/01/2020 13:10	04/01/2020 07:18	05/01/2020 13:10	29,86	1	29,86	CHI
20200117438	ORIZONA	OZ21203240	PIRES DO RIO S2	04/01/2020 07:19	04/01/2020 16:45	04/01/2020 07:19	04/01/2020 16:45	9,43	1	9,43	CHI
20200117439	ITAPIRAPUA	IU12206870	MATRINCHA	04/01/2020 06:27	04/01/2020 20:55	04/01/2020 06:27	04/01/2020 20:55	14,46	8	115,66	CHI
20200117442	ABADIANIA	SV12125412	DAIA S2	04/01/2020 07:59	04/01/2020 10:51	04/01/2020 07:59	04/01/2020 10:51	2,86	2	5,73	CHI
20200117442	GAMELEIRA DE GOIAS	SV12125412	DAIA S2	04/01/2020 07:59	04/01/2020 10:51	04/01/2020 07:59	04/01/2020 10:51	2,86	11	31,50	CHI
20200117446	GOIANIA	14860030	GOIANIA LESTE S1	04/01/2020 08:08	04/01/2020 09:36	04/01/2020 08:08	04/01/2020 09:36	1,46	1	1,46	CHI
20200117447	JARAGUA	JA12000214	JARAGUA	04/01/2020 05:07	04/01/2020 09:47	04/01/2020 05:07	04/01/2020 09:47	4,66	51	237,90	CHI
20200117451	LUZIANIA	LZ12254468	VIANOPOLIS	04/01/2020 08:08	04/01/2020 10:26	04/01/2020 08:08	04/01/2020 10:26	2,29	7	16,00	CHI
20200117453	LEOPOLDO DE BULHOES	LB12000624	DAIA S1	04/01/2020 08:05	04/01/2020 10:44	04/01/2020 08:05	04/01/2020 10:44	2,63	2	5,27	CHI
20200117453	LEOPOLDO DE BULHOES	LB12000624	DAIA S1	04/01/2020 08:05	04/01/2020 10:44	04/01/2020 08:05	04/01/2020 10:44	2,63	32	84,29	CHI
20200117455	BARRO ALTO	BA12035658	BARRO ALTO	04/01/2020 08:09	05/01/2020 23:15	04/01/2020 08:09	04/01/2020 17:08	8,97	1	8,97	CHI
20200117455	BARRO ALTO	BA12035658	BARRO ALTO	04/01/2020 08:09	05/01/2020 23:15	04/01/2020 08:09	05/01/2020 23:15	39,09	3	117,27	CHI
20200117455	NIQUELANDIA	BA12035658	BARRO ALTO	04/01/2020 08:09	05/01/2020 23:15	04/01/2020 08:09	05/01/2020 23:15	39,09	2	78,18	CHI
20200117458	NOVA CRIXAS	NA12092868	MOZARLANDIA	04/01/2020 08:09	05/01/2020 10:07	04/01/2020 08:09	05/01/2020 10:07	25,95	4	103,81	CHI
20200117464	BARRO ALTO	BA12382484	BARRO ALTO	04/01/2020 07:08	04/01/2020 14:28	04/01/2020 07:08	04/01/2020 14:28	7,33	17	124,55	CHI
20200117466	JUSSARA	JR12017175	JUSSARA	04/01/2020 08:11	04/01/2020 10:30	04/01/2020 08:11	04/01/2020 10:30	2,31	7	16,20	CHI
20200117469	SANTA RITA DO ARAGUAIA	2130004010	SANTA RITA DO ARAGUAIA	04/01/2020 08:11	05/01/2020 00:23	04/01/2020 08:11	05/01/2020 00:23	16,20	1	16,20	CHI
20200117470	CACU	CC21202727	CACHOEIRA ALTA	04/01/2020 08:11	05/01/2020 17:54	04/01/2020 08:11	05/01/2020 17:54	33,71	1	33,71	CHI
20200117475	ESTRELA DO NORTE	2420015533	MARA ROSA	04/01/2020 08:12	04/01/2020 14:36	04/01/2020 08:12	04/01/2020 14:36	6,41	1	6,41	CHI
20200117478	JATAI	JT12306444	JATAI S3	04/01/2020 08:12	04/01/2020 13:33	04/01/2020 08:12	04/01/2020 13:33	5,34	6	32,06	CHI



20200117479	PEROLANDIA	DP12324790	JATAI S1	04/01/2020 08:12	04/01/2020 11:50	04/01/2020 08:12	04/01/2020 11:50	3,63	3	10,88	CHI
20200117480	GUAPO	GA21134294	GUAPO S2	04/01/2020 08:12	04/01/2020 12:57	04/01/2020 08:12	04/01/2020 12:57	4,74	2	9,48	CHI
20200117486	CORUMBAIBA	CI21085841	VILA CORUMBA	04/01/2020 08:13	04/01/2020 20:00	04/01/2020 08:13	04/01/2020 20:00	11,79	1	11,79	CHI
20200117488	FLORES DE GOIAS	FB21252167	FLORES DE GOIAS	04/01/2020 08:13	04/01/2020 10:25	04/01/2020 08:13	04/01/2020 10:25	2,19	1	2,19	CHI
20200117494	CACU	CC12028258	CACHOEIRA ALTA	04/01/2020 08:14	04/01/2020 12:40	04/01/2020 08:14	04/01/2020 12:40	4,43	58	257,10	CHI
20200117494	QUIRINOPOLIS	CC12028258	CACHOEIRA ALTA	04/01/2020 08:14	04/01/2020 12:40	04/01/2020 08:14	04/01/2020 12:40	4,43	1	4,43	CHI
20200117500	MINEIROS	MY21301970	PARQUE DAS EMAS	04/01/2020 08:15	04/01/2020 14:03	04/01/2020 08:15	04/01/2020 14:03	5,80	1	5,80	CHI
20200117505	COCALZINHO DE GOIAS	ZN12394288	COCALZINHO	04/01/2020 08:10	04/01/2020 11:27	04/01/2020 08:10	04/01/2020 11:27	3,27	2	6,53	CHI
20200117505	CORUMBA DE GOIAS	ZN12394288	COCALZINHO	04/01/2020 08:10	04/01/2020 11:27	04/01/2020 08:10	04/01/2020 11:27	3,27	11	35,94	CHI
20200117511	TRINDADE	TR32011387	TRINDADE	04/01/2020 08:16	04/01/2020 11:40	04/01/2020 08:16	04/01/2020 11:40	3,39	1	3,39	CHI
20200117513	PORANGATU	PO12141123	NOVO PLANALTO	04/01/2020 08:16	04/01/2020 10:56	04/01/2020 08:16	04/01/2020 10:56	2,66	1	2,66	CHI
20200117525	MATRINCHA	MP12122364	MATRINCHA	04/01/2020 07:55	04/01/2020 14:12	04/01/2020 07:55	04/01/2020 14:12	6,27	10	62,72	CHI
20200117531	TURVANIA	TV12111578	FIRMINOPOLIS S1	04/01/2020 08:19	04/01/2020 11:02	04/01/2020 08:19	04/01/2020 11:02	2,70	4	10,82	CHI
20200117532	CUMARI	CY12287056	CATALAO S1	04/01/2020 08:06	04/01/2020 12:15	04/01/2020 08:06	04/01/2020 12:15	4,15	3	12,45	CHI
20200117533	JARAGUA	SF12050973	SAO FRANCISCO DE GOIAS	04/01/2020 07:12	04/01/2020 11:01	04/01/2020 07:12	04/01/2020 11:01	3,81	5	19,06	CHI
20200117533	SAO FRANCISCO DE GOIAS	SF12050973	SAO FRANCISCO DE GOIAS	04/01/2020 07:12	04/01/2020 11:01	04/01/2020 07:12	04/01/2020 11:01	3,81	33	125,82	CHI
20200117538	CAMPOS VERDES	VD12390493	SANTA TEREZINHA	04/01/2020 07:36	04/01/2020 15:01	04/01/2020 07:36	04/01/2020 15:01	7,41	11	81,56	CHI
20200117538	MARA ROSA	VD12390493	SANTA TEREZINHA	04/01/2020 07:36	04/01/2020 15:01	04/01/2020 07:36	04/01/2020 15:01	7,41	2	14,83	CHI
20200117542	PORANGATU	PO12391676	NOVO PLANALTO	04/01/2020 08:08	04/01/2020 15:39	04/01/2020 08:08	04/01/2020 15:39	7,51	5	37,54	CHI
20200117543	AGUA LIMPA	AL21150141	VILA CORUMBA	04/01/2020 08:20	04/01/2020 13:08	04/01/2020 08:20	04/01/2020 13:08	4,78	1	4,78	CHI
20200117545	CATALAO	1990169354	CATALAO S1	04/01/2020 08:07	04/01/2020 11:24	04/01/2020 08:07	04/01/2020 11:24	3,28	1	3,28	CHI
20200117546	ANAPOLIS	AN12210801	NEROPOLIS S1	04/01/2020 08:21	04/01/2020 12:30	04/01/2020 08:21	04/01/2020 12:30	4,15	15	62,20	CHI
20200117546	CAMPO LIMPO	AN12210801	NEROPOLIS S1	04/01/2020 08:21	04/01/2020 12:30	04/01/2020 08:21	04/01/2020 12:30	4,15	7	29,02	CHI
20200117546	OURO VERDE DE GOIAS	AN12210801	NEROPOLIS S1	04/01/2020 08:21	04/01/2020 12:30	04/01/2020 08:21	04/01/2020 12:30	4,15	2	8,29	CHI
20200117547	DAMOLANDIA	PG12297932	PETROLINA	04/01/2020 08:21	04/01/2020 10:00	04/01/2020 08:21	04/01/2020 10:00	1,65	1	1,65	CHI
20200117547	PETROLINA DE GOIAS	PG12297932	PETROLINA	04/01/2020 08:21	04/01/2020 10:00	04/01/2020 08:21	04/01/2020 10:00	1,65	12	19,75	CHI
20200117548	GUARANI DE GOIAS	GY12180835	IACIARA S1	04/01/2020 02:22	04/01/2020 09:30	04/01/2020 02:22	04/01/2020 09:30	7,12	314	2234,81	CHI
20200117548	IACIARA	GY12180835	IACIARA S1	04/01/2020 02:22	04/01/2020 09:30	04/01/2020 02:22	04/01/2020 09:30	7,12	2	14,23	CHI
20200117550	MARA ROSA	MQ12220617	MARA ROSA	04/01/2020 05:42	04/01/2020 14:07	04/01/2020 05:42	04/01/2020 14:07	8,41	7	58,87	CHI
20200117551	GOIAS	GS12250581	GOIAS	04/01/2020 05:23	04/01/2020 09:21	04/01/2020 05:23	04/01/2020 09:21	3,96	53	209,88	CHI
20200117553	ARENOPOLIS	10024687381	IPORA	04/01/2020 08:22	04/01/2020 12:29	04/01/2020 08:22	04/01/2020 12:29	4,11	1	4,11	CHI
20200117559	CAVALCANTE	TE12265878	FLORES DE GOIAS	04/01/2020 08:22	05/01/2020 11:17	04/01/2020 08:22	05/01/2020 11:17	26,91	4	107,64	CHI
20200117559	TERESINA DE GOIAS	TE12265878	FLORES DE GOIAS	04/01/2020 08:22	05/01/2020 11:17	04/01/2020 08:22	05/01/2020 11:17	26,91	1	26,91	CHI

20200117564	PADRE BERNARDO	PB12382939	PADRE BERNARDO	04/01/2020 08:03	04/01/2020 11:08	04/01/2020 08:03	04/01/2020 11:08	3,07	6	18,45	CHI
20200117565	ARUANA	MP12165389	MOZARLANDIA	04/01/2020 08:23	04/01/2020 18:28	04/01/2020 08:23	04/01/2020 18:28	10,08	1	10,08	CHI
20200117565	MATRINCHA	MP12165389	MOZARLANDIA	04/01/2020 08:23	04/01/2020 18:28	04/01/2020 08:23	04/01/2020 18:28	10,08	5	50,40	CHI
20200117570	CATALAO	CT21242335	CATALAO S1	04/01/2020 08:24	04/01/2020 11:14	04/01/2020 08:24	04/01/2020 11:14	2,83	1	2,83	CHI
20200117571	PORANGATU	PO12028196	PORANGATU	04/01/2020 08:24	04/01/2020 17:23	04/01/2020 08:24	04/01/2020 17:23	8,99	5	44,94	CHI
20200117577	MONTIVIDIU	MV12230886	MONTIVIDIU T	04/01/2020 08:24	05/01/2020 08:48	04/01/2020 08:24	05/01/2020 08:48	24,40	9	219,60	CHI
20200117577	RIO VERDE	MV12230886	MONTIVIDIU T	04/01/2020 08:24	05/01/2020 08:48	04/01/2020 08:24	05/01/2020 08:48	24,40	27	658,80	CHI
20200117578	BONOPOLIS	BX21329902	NOVO PLANALTO	04/01/2020 08:24	04/01/2020 22:21	04/01/2020 08:24	04/01/2020 22:21	13,94	1	13,94	CHI
20200117588	CRISTALINA	KR12332627	CRISTALINA S1	04/01/2020 08:26	04/01/2020 12:43	04/01/2020 08:26	04/01/2020 12:43	4,28	1	4,28	CHI
20200117589	CATALAO	1990241223	CATALAO S2	04/01/2020 08:26	04/01/2020 14:21	04/01/2020 08:26	04/01/2020 14:21	5,91	1	5,91	CHI
20200117592	DOVERLANDIA	DV12212826	CAIAPONIA	04/01/2020 08:26	04/01/2020 12:24	04/01/2020 08:26	04/01/2020 12:24	3,96	10	39,55	CHI
20200117593	GOIATUBA	GT12293085	GOIATUBA S2	04/01/2020 07:32	04/01/2020 10:04	04/01/2020 07:32	04/01/2020 10:04	2,55	3	7,64	CHI
20200117595	PORTEIRAO	CL21361128	RIO DOS BOIS	04/01/2020 08:28	04/01/2020 13:24	04/01/2020 08:28	04/01/2020 13:24	4,93	1	4,93	CHI
20200117596	NOVA CRIXAS	NA12334349	NOVA CRIXAS	04/01/2020 08:28	04/01/2020 15:32	04/01/2020 08:28	04/01/2020 15:32	7,06	86	607,16	CHI
20200117597	MARA ROSA	MQ21156019	MARA ROSA	04/01/2020 08:28	05/01/2020 12:49	04/01/2020 08:28	05/01/2020 12:49	28,34	1	28,34	CHI
20200117599	ARUANA	AK12016451	BRITANIA	04/01/2020 08:28	04/01/2020 16:12	04/01/2020 08:28	04/01/2020 16:12	7,72	2	15,44	CHI
20200117600	GOIANIA	10009763854	GOYA S1	04/01/2020 08:28	04/01/2020 09:16	04/01/2020 08:28	04/01/2020 09:16	0,78	1	0,78	CHI
20200117606	FAZENDA NOVA	1080005101	JUSSARA	04/01/2020 08:29	05/01/2020 08:39	04/01/2020 08:29	05/01/2020 08:39	24,15	1	24,15	CHI
20200117607	RIO VERDE	630402220	RIO VERDE S2	04/01/2020 08:30	04/01/2020 11:16	04/01/2020 08:30	04/01/2020 11:16	2,77	1	2,77	CHI
20200117609	ANICUNS	AC21021764	ANICUNS	04/01/2020 08:30	04/01/2020 12:10	04/01/2020 08:30	04/01/2020 12:10	3,66	1	3,66	CHI
20200117613	MONTES CLAROS DE GOIAS	ME21250636	IPORA	04/01/2020 08:30	05/01/2020 08:16	04/01/2020 08:30	05/01/2020 08:16	23,75	1	23,75	CHI
20200117620	RUBIATABA	RB12161677	RUBIATABA	04/01/2020 08:32	04/01/2020 09:48	04/01/2020 08:32	04/01/2020 09:48	1,28	12	15,33	CHI
20200117626	FORMOSA	FA12383252	ITIQUEIRA	04/01/2020 08:33	04/01/2020 10:54	04/01/2020 08:33	04/01/2020 10:54	2,35	1	2,35	CHI
20200117627	FAINA	FC12299850	GOIAS	04/01/2020 08:33	04/01/2020 11:49	04/01/2020 08:33	04/01/2020 11:49	3,26	1	3,26	CHI
20200117627	GOIAS	FC12299850	GOIAS	04/01/2020 08:33	04/01/2020 11:49	04/01/2020 08:33	04/01/2020 11:49	3,26	4	13,05	CHI
20200117629	CACHOEIRA DOURADA	CD21000033	CACHOEIRA DOURADA	04/01/2020 08:33	04/01/2020 19:05	04/01/2020 08:33	04/01/2020 19:05	10,52	1	10,52	CHI
20200117633	PIRENOPOLIS	PV21135421	JARAGUA	04/01/2020 08:34	04/01/2020 15:20	04/01/2020 08:34	04/01/2020 15:20	6,78	2	13,55	CHI
20200117634	MOSSAMEDES	MD21157127	FIRMINOPOLIS S2	04/01/2020 08:34	04/01/2020 10:13	04/01/2020 08:34	04/01/2020 10:13	1,65	1	1,65	CHI
20200117635	MIMOSO DE GOIAS	MJ12305277	PADRE BERNARDO	04/01/2020 06:55	04/01/2020 13:03	04/01/2020 06:55	04/01/2020 13:03	6,12	16	97,91	CHI
20200117636	ALTO PARAISO DE GOIAS	BF21385528	NIQUELANDIA SUBTRANSMISSAO	04/01/2020 08:34	04/01/2020 11:55	04/01/2020 08:34	04/01/2020 11:55	3,34	1	3,34	CHI
20200117637	GAMELEIRA DE GOIAS	SV12187064	DAIA S2	04/01/2020 08:34	04/01/2020 11:53	04/01/2020 08:34	04/01/2020 11:53	3,31	1	3,31	CHI
20200117642	CAMPINORTE	UR12231322	MARA ROSA	04/01/2020 08:35	05/01/2020 03:16	04/01/2020 08:35	05/01/2020 03:16	18,67	4	74,70	CHI
20200117644	MAMBAI	4560000221	IACIARA S2	04/01/2020 08:35	04/01/2020 12:07	04/01/2020 08:35	04/01/2020 12:07	3,52	1	3,52	CHI

20200117645	PIRANHAS	PH12343593	PIRANHAS	04/01/2020 08:35	05/01/2020 00:28	04/01/2020 08:35	05/01/2020 00:28	15,87	4	63,47	CHI
20200117647	VALPARAISO DE GOIAS	2860153208	MARAJOARA	04/01/2020 08:36	04/01/2020 12:22	04/01/2020 08:36	04/01/2020 12:22	3,76	1	3,76	CHI
20200117648	ANAPOLIS	AN12258127	ANAPOLIS UNIVERSITARIO S1	04/01/2020 07:58	04/01/2020 10:27	04/01/2020 07:58	04/01/2020 10:27	2,48	5	12,38	CHI
20200117648	GAMELEIRA DE GOIAS	AN12258127	ANAPOLIS UNIVERSITARIO S1	04/01/2020 07:58	04/01/2020 10:27	04/01/2020 07:58	04/01/2020 10:27	2,48	5	12,38	CHI
20200117649	ITUMBIARA	IT21000237	ITUMBIARA NOVA	04/01/2020 08:36	04/01/2020 14:10	04/01/2020 08:36	04/01/2020 14:10	5,56	1	5,56	CHI
20200117651	OUIDOR	CT21266219	CATALAO S1	04/01/2020 08:36	04/01/2020 12:10	04/01/2020 08:36	04/01/2020 12:10	3,57	1	3,57	CHI
20200117658	ALOANDIA	AD12293239	GOIATUBA S1	04/01/2020 05:43	04/01/2020 20:07	04/01/2020 05:43	04/01/2020 20:07	14,39	3	43,17	CHI
20200117658	PONTALINA	AD12293239	GOIATUBA S1	04/01/2020 05:43	04/01/2020 20:07	04/01/2020 05:43	04/01/2020 20:07	14,39	6	86,34	CHI
20200117660	CRIXAS	CX12158232	SERRA DO OURO	04/01/2020 08:38	05/01/2020 03:41	04/01/2020 08:38	05/01/2020 03:41	19,05	5	95,23	CHI
20200117661	ABADIANIA	AA21290057	DAIA S2	04/01/2020 08:38	04/01/2020 16:46	04/01/2020 08:38	04/01/2020 16:46	8,12	1	8,12	CHI
20200117667	SANTA TEREZINHA DE GOIAS	SG11181030	SANTA TEREZINHA	04/01/2020 08:39	04/01/2020 18:50	04/01/2020 17:58	04/01/2020 18:50	0,86	157	134,98	CHI
20200117669	NOVA IGUACU DE GOIAS	NH21051101	SANTA TEREZINHA	04/01/2020 08:40	04/01/2020 14:32	04/01/2020 08:40	04/01/2020 14:32	5,87	2	11,74	CHI
20200117671	SANTA FE DE GOIAS	RN12009765	BRITANIA	04/01/2020 07:21	04/01/2020 22:47	04/01/2020 07:21	04/01/2020 22:47	15,42	23	354,68	CHI
20200117673	COLINAS DO SUL	9700006213	NIQUELANDIA SUBTRANSMISSAO	04/01/2020 08:40	04/01/2020 09:26	04/01/2020 08:40	04/01/2020 09:26	0,75	1	0,75	CHI
20200117681	CAVALCANTE	MA12280212LD	SAO DOMINGOS	04/01/2020 08:41	04/01/2020 12:21	04/01/2020 08:41	04/01/2020 12:21	3,65	170	620,64	CHI
20200117681	MONTE ALEGRE DE GOIAS	MA12280212LD	SAO DOMINGOS	04/01/2020 08:41	04/01/2020 12:21	04/01/2020 08:41	04/01/2020 12:21	3,65	167	609,69	CHI
20200117684	CACU	CC12191712	CACHOEIRA ALTA	04/01/2020 08:42	05/01/2020 19:08	04/01/2020 08:42	05/01/2020 19:08	34,43	6	206,58	CHI
20200117685	FORMOSA	2870005125	ITUIQUIRA	04/01/2020 08:42	04/01/2020 14:25	04/01/2020 08:42	04/01/2020 14:25	5,72	1	5,72	CHI
20200117687	MONTIVIDIU DO NORTE	MX12270910	PORANGATU	04/01/2020 08:42	04/01/2020 12:28	04/01/2020 08:42	04/01/2020 12:28	3,76	7	26,30	CHI
20200117688	QUIRINOPOLIS	QI31207034	QUIRINOPOLIS	04/01/2020 08:42	04/01/2020 11:54	04/01/2020 08:42	04/01/2020 11:54	3,19	2	6,37	CHI
20200117689	CRIXAS	CX12392063	SANTA TEREZINHA	04/01/2020 08:42	05/01/2020 08:46	04/01/2020 08:42	05/01/2020 08:46	24,07	28	673,84	CHI
20200117689	ITAPACI	CX12392063	SANTA TEREZINHA	04/01/2020 08:42	05/01/2020 08:46	04/01/2020 08:42	05/01/2020 08:46	24,07	4	96,26	CHI
20200117690	CACHOEIRA DOURADA	CD12257146	CACHOEIRA DOURADA	04/01/2020 07:31	04/01/2020 13:10	04/01/2020 07:31	04/01/2020 13:10	5,64	229	1292,39	CHI
20200117691	GUARINOS	GG12237782	URUACU	04/01/2020 08:43	05/01/2020 03:42	04/01/2020 08:43	05/01/2020 03:42	18,98	4	75,92	CHI
20200117691	SANTA TEREZINHA DE GOIAS	GG12237782	URUACU	04/01/2020 08:43	05/01/2020 03:42	04/01/2020 08:43	05/01/2020 03:42	18,98	1	18,98	CHI
20200117697	ITAPURANGA	IK12299350	ITAPURANGA	04/01/2020 07:59	04/01/2020 10:19	04/01/2020 07:59	04/01/2020 10:19	2,32	13	30,17	CHI
20200117699	LUZIANIA	LZ12203332	VIANOPOLIS	04/01/2020 08:44	04/01/2020 11:26	04/01/2020 08:44	04/01/2020 11:26	2,70	16	43,17	CHI
20200117701	LUZIANIA	LZ12330880	PAMPLONA	04/01/2020 08:44	04/01/2020 17:50	04/01/2020 08:44	04/01/2020 17:50	9,10	5	45,49	CHI
20200117706	PONTALINA	PK12047209	PONTALINA	04/01/2020 08:05	04/01/2020 14:14	04/01/2020 08:05	04/01/2020 14:14	6,14	12	73,67	CHI
20200117709	JUSSARA	JR12092772	JUSSARA	04/01/2020 07:29	04/01/2020 19:10	04/01/2020 07:29	04/01/2020 19:10	11,68	13	151,84	CHI
20200117710	PORANGATU	PO12349234	MARA ROSA	04/01/2020 07:59	04/01/2020 22:58	04/01/2020 07:59	04/01/2020 22:58	14,99	16	239,85	CHI
20200117712	JATAI	JT12115871	JATAI S1	04/01/2020 08:45	04/01/2020 12:08	04/01/2020 08:45	04/01/2020 12:08	3,37	7	23,60	CHI
20200117714	NOVA VENEZA	NV11000021	INHUMAS S1	04/01/2020 08:46	04/01/2020 12:54	04/01/2020 08:46	04/01/2020 12:54	4,13	70	289,12	CHI

20200117716	ARAGUAPAZ	AZ12219983	GOIAS	04/01/2020 08:46	04/01/2020 13:51	04/01/2020 08:46	04/01/2020 13:51	5,07	2	10,15	CHI
20200117718	LEOPOLDO DE BULHOES	LB21150018	DAIA S2	04/01/2020 08:46	04/01/2020 11:26	04/01/2020 08:46	04/01/2020 11:26	2,66	1	2,66	CHI
20200117719	ABADIANIA	AA12297632	DAIA S2	04/01/2020 05:08	04/01/2020 12:54	04/01/2020 05:08	04/01/2020 12:54	7,76	2	15,51	CHI
20200117719	GAMELEIRA DE GOIAS	AA12297632	DAIA S2	04/01/2020 05:08	04/01/2020 12:54	04/01/2020 05:08	04/01/2020 12:54	7,76	1	7,76	CHI
20200117722	NIQUELANDIA	NQ12396795	URUACU	04/01/2020 08:47	05/01/2020 01:08	04/01/2020 08:47	05/01/2020 01:08	16,36	45	736,02	CHI
20200117722	NIQUELANDIA	NQ12396795	URUACU	04/01/2020 08:47	05/01/2020 01:08	04/01/2020 08:47	05/01/2020 01:08	16,36	257	4203,38	CHI
20200117723	SITIO D ABADIA	SI12211381	IACIARA S2	04/01/2020 08:47	04/01/2020 14:49	04/01/2020 08:47	04/01/2020 14:49	6,03	28	168,76	CHI
20200117734	VALPARAISO DE GOIAS	2860335451	MARAJOARA	04/01/2020 08:49	04/01/2020 12:45	04/01/2020 08:49	04/01/2020 12:45	3,92	1	3,92	CHI
20200117740	MATRINCHA	MP12362399	MATRINCHA	04/01/2020 08:10	04/01/2020 20:17	04/01/2020 08:10	04/01/2020 20:17	12,12	4	48,48	CHI
20200117741	NIQUELANDIA	NQ12135340	NIQUELANDIA SUBTRANSMISSAO	04/01/2020 08:44	04/01/2020 15:39	04/01/2020 08:44	04/01/2020 15:39	6,91	216	1493,40	CHI
20200117743	BELA VISTA DE GOIAS	BV12011703	BELA VISTA S1	04/01/2020 08:41	04/01/2020 12:11	04/01/2020 08:41	04/01/2020 12:11	3,49	8	27,95	CHI
20200117745	MARA ROSA	MQ12086247	MARA ROSA	04/01/2020 08:08	04/01/2020 13:03	04/01/2020 08:08	04/01/2020 13:03	4,91	7	34,35	CHI
20200117749	MARA ROSA	MQ12391677	MARA ROSA	04/01/2020 08:52	05/01/2020 13:04	04/01/2020 08:52	05/01/2020 13:04	28,18	2	56,37	CHI
20200117750	BURITINOPOLIS	BQ12149627	IACIARA S2	04/01/2020 06:09	04/01/2020 10:03	04/01/2020 06:09	04/01/2020 10:03	3,89	118	458,66	CHI
20200117751	CACHOEIRA DOURADA	CD21000071	CACHOEIRA DOURADA	04/01/2020 08:53	04/01/2020 18:21	04/01/2020 08:53	04/01/2020 18:21	9,45	1	9,45	CHI
20200117756	SANTA HELENA DE GOIAS	SH21296187	IPEGUARI	04/01/2020 08:54	04/01/2020 16:13	04/01/2020 08:54	04/01/2020 16:13	7,31	1	7,31	CHI
20200117757	ARAGARCAS	AG21320785	ARAGARCAS	04/01/2020 08:54	04/01/2020 13:44	04/01/2020 08:54	04/01/2020 13:44	4,82	1	4,82	CHI
20200117758	ANAPOLIS	21021480	JUNDIAI S2	04/01/2020 08:54	04/01/2020 14:05	04/01/2020 08:54	04/01/2020 14:05	5,17	1	5,17	CHI
20200117760	CAMPO ALEGRE DE GOIAS	1160022036	CAMPO ALEGRE DE GOIAS	04/01/2020 08:54	04/01/2020 14:13	04/01/2020 08:54	04/01/2020 14:13	5,30	1	5,30	CHI
20200117762	CRISTALINA	KR12025841	PAMPLONA	04/01/2020 08:44	04/01/2020 11:58	04/01/2020 08:44	04/01/2020 11:58	3,23	3	9,69	CHI
20200117764	MINEIROS	MY12195578	PARQUE DAS EMAS	04/01/2020 08:55	04/01/2020 13:24	04/01/2020 08:55	04/01/2020 13:24	4,47	10	44,75	CHI
20200117766	RUBIATABA	RB12070014	RUBIATABA	04/01/2020 08:55	04/01/2020 22:58	04/01/2020 08:55	04/01/2020 22:58	14,04	3	42,11	CHI
20200117767	PORANGATU	MU12266664	MARA ROSA	04/01/2020 08:55	04/01/2020 22:58	04/01/2020 08:55	04/01/2020 22:58	14,04	32	449,44	CHI
20200117769	PILAR DE GOIAS	GG21341634	SANTA TEREZINHA	04/01/2020 08:56	05/01/2020 10:23	04/01/2020 08:56	05/01/2020 10:23	25,45	1	25,45	CHI
20200117770	IPAMERI	10017859776	IPAMERI	04/01/2020 08:56	04/01/2020 09:20	04/01/2020 08:56	04/01/2020 09:20	0,41	1	0,41	CHI
20200117778	PETROLINA DE GOIAS	PG12025388	SAO FRANCISCO DE GOIAS	04/01/2020 08:57	04/01/2020 13:42	04/01/2020 08:57	04/01/2020 13:42	4,74	10	47,41	CHI
20200117778	PIRENOPOLIS	PG12025388	SAO FRANCISCO DE GOIAS	04/01/2020 08:57	04/01/2020 13:42	04/01/2020 08:57	04/01/2020 13:42	4,74	38	180,14	CHI
20200117785	PIRENOPOLIS	PV12377430	GOIANESIA S1	04/01/2020 07:55	04/01/2020 16:34	04/01/2020 07:55	04/01/2020 16:34	8,65	10	86,46	CHI
20200117787	IPAMERI	IP21233845	URUTAI	04/01/2020 08:58	04/01/2020 21:04	04/01/2020 08:58	04/01/2020 21:04	12,09	1	12,09	CHI
20200117793	MORRINHOS	MR21302597	GOIATUBA S1	04/01/2020 08:59	04/01/2020 17:32	04/01/2020 08:59	04/01/2020 17:32	8,55	1	8,55	CHI
20200117798	RIO VERDE	RV21260582	RIO VERDE S2	04/01/2020 08:59	04/01/2020 11:39	04/01/2020 08:59	04/01/2020 11:39	2,65	1	2,65	CHI
20200117799	RIO VERDE	630353414	RIO VERDE S2	04/01/2020 08:59	04/01/2020 10:44	04/01/2020 08:59	04/01/2020 10:44	1,74	0	0,00	CHI
20200117803	SILVANIA	SV21251293	VIANOPOLIS	04/01/2020 09:00	04/01/2020 11:23	04/01/2020 09:00	04/01/2020 11:23	2,37	1	2,37	CHI

20200117806	CROMINIA	CQ12079876	ROCHEDO	04/01/2020 09:01	04/01/2020 16:02	04/01/2020 09:01	04/01/2020 16:02	7,01	13	91,16	CHI
20200117808	MINEIROS	MY21296307	PARQUE DAS EMAS	04/01/2020 09:01	05/01/2020 14:01	04/01/2020 09:01	05/01/2020 14:01	28,99	1	28,99	CHI
20200117814	JATAI	JT12244770	JATAI S1	04/01/2020 08:26	04/01/2020 10:24	04/01/2020 08:26	04/01/2020 10:24	1,96	12	23,51	CHI
20200117815	ANAPOLIS	20574447	ANAPOLIS UNIVERSITARIO S1	04/01/2020 09:02	04/01/2020 13:15	04/01/2020 09:02	04/01/2020 13:15	4,21	1	4,21	CHI
20200117816	APARECIDA DE GOIANIA	10003258007	INDEPENDENCIA S2	04/01/2020 09:02	04/01/2020 10:36	04/01/2020 09:02	04/01/2020 10:36	1,57	1	1,57	CHI
20200117819	CATALAO	CT12333638RE	CATALAO S1	04/01/2020 09:02	04/01/2020 12:10	04/01/2020 09:02	04/01/2020 12:10	3,12	62	193,61	CHI
20200117822	CRISTALINA	KR12230276	CRISTALINA S2	04/01/2020 09:03	04/01/2020 18:34	04/01/2020 09:03	04/01/2020 18:34	9,51	12	114,14	CHI
20200117827	BRAZABRANTES	1110001440	INHUMAS S2	04/01/2020 09:03	04/01/2020 11:32	04/01/2020 09:03	04/01/2020 11:32	2,47	1	2,47	CHI
20200117830	CORREGO DO OURO	SC12034208	FIRMINOPOLIS S2	04/01/2020 09:04	04/01/2020 11:03	04/01/2020 09:04	04/01/2020 11:03	1,98	1	1,98	CHI
20200117830	SANCLERLANDIA	SC12034208	FIRMINOPOLIS S2	04/01/2020 09:04	04/01/2020 11:03	04/01/2020 09:04	04/01/2020 11:03	1,98	3	5,95	CHI
20200117832	RIO VERDE	RV12360702	MONTIVIDIU T	04/01/2020 08:03	05/01/2020 08:48	04/01/2020 08:03	05/01/2020 08:48	24,76	12	297,12	CHI
20200117838	PORANGATU	PO12182336	PORANGATU	04/01/2020 06:26	04/01/2020 19:29	04/01/2020 06:26	04/01/2020 19:29	13,04	5	65,19	CHI
20200117841	IPAMERI	IP21311704	CATALAO S1	04/01/2020 09:05	05/01/2020 08:49	04/01/2020 09:05	05/01/2020 08:49	23,73	1	23,73	CHI
20200117844	NIQUELANDIA	NQ21235463	NIQUELANDIA SUBTRANSMISSAO	04/01/2020 09:06	04/01/2020 13:21	04/01/2020 09:06	04/01/2020 10:34	1,46	1	1,46	CHI
20200117844	NIQUELANDIA	6308376	NIQUELANDIA SUBTRANSMISSAO	04/01/2020 09:06	04/01/2020 13:21	04/01/2020 09:06	04/01/2020 13:21	4,26	33	140,44	CHI
20200117844	URUACU	6308376	NIQUELANDIA SUBTRANSMISSAO	04/01/2020 09:06	04/01/2020 13:21	04/01/2020 09:06	04/01/2020 13:21	4,26	1	4,26	CHI
20200117846	CATALAO	9580006320	CATALAO S1	04/01/2020 09:06	04/01/2020 15:06	04/01/2020 09:06	04/01/2020 15:06	5,99	1	5,99	CHI
20200117847	BELA VISTA DE GOIAS	240018783	BELA VISTA S1	04/01/2020 09:07	04/01/2020 12:43	04/01/2020 09:07	04/01/2020 12:43	3,59	1	3,59	CHI
20200117848	PIRACANJUBA	PJ21139505	PIRACANJUBA	04/01/2020 09:07	04/01/2020 16:22	04/01/2020 09:07	04/01/2020 16:22	7,24	2	14,48	CHI
20200117851	GOIAS	GS21070331	GOIAS	04/01/2020 09:08	04/01/2020 17:45	04/01/2020 09:08	04/01/2020 17:45	8,61	1	8,61	CHI
20200117855	CATALAO	CT12292316	CATALAO S1	04/01/2020 08:41	04/01/2020 17:01	04/01/2020 08:41	04/01/2020 17:01	8,33	5	41,65	CHI
20200117856	ORIZONA	OZ21231492	PIRES DO RIO S2	04/01/2020 09:09	04/01/2020 13:26	04/01/2020 09:09	04/01/2020 13:26	4,27	1	4,27	CHI
20200117869	ITABERAI	IB21336445	ITABERAI S2	04/01/2020 09:11	04/01/2020 10:25	04/01/2020 09:11	04/01/2020 10:25	1,22	1	1,22	CHI
20200117871	AGUAS LINDAS DE GOIAS	LA12078090	AGUAS LINDAS DE GOIAS S1	04/01/2020 09:12	04/01/2020 11:58	04/01/2020 09:12	04/01/2020 11:58	2,76	4	11,06	CHI
20200117873	ITUMBIARA	CD12097345RE	CACHOEIRA DOURADA	04/01/2020 09:12	05/01/2020 08:56	04/01/2020 09:12	05/01/2020 08:56	23,73	9	213,54	CHI
20200117876	FLORES DE GOIAS	FB12361334	FLORES DE GOIAS	04/01/2020 09:12	04/01/2020 13:39	04/01/2020 09:12	04/01/2020 13:39	4,44	1	4,44	CHI
20200117879	APARECIDA DE GOIANIA	10007704230	REAL S1	04/01/2020 09:13	04/01/2020 10:41	04/01/2020 09:13	04/01/2020 10:41	1,46	1	1,46	CHI
20200117882	FIRMINOPOLIS	900026479	FIRMINOPOLIS S1	04/01/2020 09:15	04/01/2020 12:19	04/01/2020 09:15	04/01/2020 12:19	3,07	1	3,07	CHI
20200117884	ARAGUAPAZ	AZ12307359	MOZARLANDIA	04/01/2020 09:15	04/01/2020 19:03	04/01/2020 09:15	04/01/2020 19:03	9,81	2	19,61	CHI
20200117894	CAIAPONIA	930066996	CAIAPONIA	04/01/2020 09:16	05/01/2020 04:46	04/01/2020 09:16	05/01/2020 04:46	19,49	1	19,49	CHI
20200117895	RIO VERDE	630370904	RIO VERDE S2	04/01/2020 09:16	04/01/2020 11:08	04/01/2020 09:16	04/01/2020 11:08	1,85	1	1,85	CHI
20200117897	SILVANIA	SV12072440	DAIA S1	04/01/2020 08:37	04/01/2020 14:41	04/01/2020 08:37	04/01/2020 14:41	6,07	8	48,54	CHI
20200117901	SANTA CRUZ DE GOIAS	CN12409033	CALDAS NOVAS S1	04/01/2020 09:17	05/01/2020 10:36	04/01/2020 09:17	05/01/2020 10:36	25,31	11	278,39	CHI

20200117902	ITABERAÍ	IB21300096	ITABERAÍ S2	04/01/2020 09:17	04/01/2020 15:46	04/01/2020 09:17	04/01/2020 15:46	6,48	2	12,95	CHI
20200117909	TRINDADE	TR12393570	GOIANIRA	04/01/2020 09:18	04/01/2020 12:49	04/01/2020 09:18	04/01/2020 12:49	3,51	5	17,56	CHI
20200117912	ANAPOLIS	AN12384292	ANAPOLIS UNIVERSITARIO S2	04/01/2020 09:19	04/01/2020 10:50	04/01/2020 09:19	04/01/2020 10:50	1,51	17	25,74	CHI
20200117919	MATRINCHA	MP12299715LD	MATRINCHA	04/01/2020 09:19	04/01/2020 17:15	04/01/2020 09:19	04/01/2020 17:15	7,93	15	118,93	CHI
20200117920	QUIRINOPOLIS	QI12029093	QUIRINOPOLIS	04/01/2020 09:19	04/01/2020 16:24	04/01/2020 09:19	04/01/2020 16:24	7,07	18	127,26	CHI
20200117921	CAMPOS VERDES	3790006152	SANTA TEREZINHA	04/01/2020 09:20	04/01/2020 11:59	04/01/2020 09:20	04/01/2020 11:59	2,65	1	2,65	CHI
20200117926	BURITI ALEGRE	BG21263831	ALTO BURITI	04/01/2020 09:20	04/01/2020 11:00	04/01/2020 09:20	04/01/2020 11:00	1,65	1	1,65	CHI
20200117927	LEOPOLDO DE BULHOES	LB12353164	DAIA S2	04/01/2020 08:24	04/01/2020 11:30	04/01/2020 08:24	04/01/2020 11:30	3,09	8	24,73	CHI
20200117929	ITUMBIARA	IT12273866	ITUMBIARA VELHA S1	04/01/2020 09:22	04/01/2020 11:11	04/01/2020 09:22	04/01/2020 11:11	1,83	10	18,27	CHI
20200117933	JARAGUA	JA12000239	JARAGUA	04/01/2020 09:06	04/01/2020 11:21	04/01/2020 09:06	04/01/2020 11:21	2,25	13	29,21	CHI
20200117936	PORANGATU	PO12170950	PORANGATU	04/01/2020 09:22	04/01/2020 19:34	04/01/2020 09:22	04/01/2020 19:34	10,19	2	20,38	CHI
20200117941	FIRMINOPOLIS	FR21081392	FIRMINOPOLIS S1	04/01/2020 09:23	04/01/2020 10:04	04/01/2020 09:23	04/01/2020 10:04	0,67	2	1,35	CHI
20200117942	BURITI DE GOIAS	BS12387554	FIRMINOPOLIS S2	04/01/2020 09:23	04/01/2020 12:05	04/01/2020 09:23	04/01/2020 12:05	2,69	8	21,50	CHI
20200117943	SÃO MIGUEL DO ARAGUAIA	SM11292333	SÃO MIGUEL DO ARAGUAIA	04/01/2020 09:35	04/01/2020 14:55	04/01/2020 09:35	04/01/2020 14:55	5,33	31	165,14	CHI
20200117945	ITAPURANGA	IK12235803	ITAPURANGA	04/01/2020 09:24	04/01/2020 20:22	04/01/2020 09:24	04/01/2020 20:22	10,97	2	21,93	CHI
20200117951	RIO VERDE	RV12098479	RIO VERDE S1	04/01/2020 09:25	04/01/2020 11:34	04/01/2020 09:25	04/01/2020 11:34	2,15	7	15,05	CHI
20200117955	SERRANOPOLIS	SX12260467	JATAI S1	04/01/2020 07:17	04/01/2020 10:55	04/01/2020 07:17	04/01/2020 10:55	3,63	7	25,39	CHI
20200117958	PARAUNA	PU12067721	MONTIVIDIU T	04/01/2020 09:25	04/01/2020 23:23	04/01/2020 09:25	04/01/2020 23:23	13,95	16	223,26	CHI
20200117959	CEZARINA	CZ21041305	CEZARINA	04/01/2020 09:26	04/01/2020 11:13	04/01/2020 09:26	04/01/2020 11:13	1,78	1	1,78	CHI
20200117960	SILVANIA	SV21386890	DAIA S2	04/01/2020 09:26	04/01/2020 14:23	04/01/2020 09:26	04/01/2020 14:23	4,95	1	4,95	CHI
20200117961	PORANGATU	PO12239639	MARA ROSA	04/01/2020 05:01	04/01/2020 12:34	04/01/2020 05:01	04/01/2020 12:34	7,54	31	233,63	CHI
20200117966	MINEIROS	1390118700	PARQUE DAS EMAS	04/01/2020 09:26	05/01/2020 09:48	04/01/2020 09:26	05/01/2020 09:48	24,37	1	24,37	CHI
20200117977	JOVIANIA	570007847	GOIATUBA S1	04/01/2020 09:28	04/01/2020 18:44	04/01/2020 09:28	04/01/2020 18:44	9,26	1	9,26	CHI
20200117983	SANTA RITA DO ARAGUAIA	2130024793	SANTA RITA DO ARAGUAIA	04/01/2020 09:30	04/01/2020 23:24	04/01/2020 09:30	04/01/2020 23:24	13,89	1	13,89	CHI
20200117985	SANTO ANTONIO DA BARRA	01690214	ACREUNA	04/01/2020 08:48	05/01/2020 13:15	04/01/2020 08:48	04/01/2020 10:15	1,44	1334	1918,00	CHI
20200117985	SANTO ANTONIO DA BARRA	BZ10407792	ACREUNA	04/01/2020 08:48	05/01/2020 13:15	04/01/2020 08:48	04/01/2020 11:32	2,74	77	210,64	CHI
20200117985	SANTO ANTONIO DA BARRA	01690214	ACREUNA	04/01/2020 08:48	05/01/2020 13:15	04/01/2020 13:54	04/01/2020 14:40	0,75	1444	1083,80	CHI
20200117985	SANTO ANTONIO DA BARRA	BZ10407792	ACREUNA	04/01/2020 08:48	05/01/2020 13:15	04/01/2020 13:54	04/01/2020 14:58	1,06	102	107,78	CHI
20200117985	SANTO ANTONIO DA BARRA	BZ12000006LD	ACREUNA	04/01/2020 08:48	05/01/2020 13:15	04/01/2020 08:48	04/01/2020 19:22	10,56	6	63,35	CHI
20200117985	SANTO ANTONIO DA BARRA	BZ12000006LD	ACREUNA	04/01/2020 08:48	05/01/2020 13:15	04/01/2020 13:54	04/01/2020 19:22	5,45	21	114,55	CHI
20200117985	SANTO ANTONIO DA BARRA	01690214	ACREUNA	04/01/2020 08:48	05/01/2020 13:15	04/01/2020 21:51	04/01/2020 21:57	0,09	1444	129,96	CHI
20200117985	RIO VERDE	BZ12048964	ACREUNA	04/01/2020 08:48	05/01/2020 13:15	04/01/2020 08:48	05/01/2020 07:48	22,99	35	804,69	CHI
20200117985	SANTO ANTONIO DA BARRA	BZ12048964	ACREUNA	04/01/2020 08:48	05/01/2020 13:15	04/01/2020 08:48	05/01/2020 07:48	22,99	38	873,66	CHI

20200117985	SANTO ANTONIO DA BARRA	BZ1200006LD	ACREUNA	04/01/2020 08:48	05/01/2020 13:15	04/01/2020 08:48	05/01/2020 09:01	24,21	23	556,75	CHI
20200117985	SANTO ANTONIO DA BARRA	BZ13189086	ACREUNA	04/01/2020 08:48	05/01/2020 13:15	04/01/2020 13:54	05/01/2020 09:01	19,10	1	19,10	CHI
20200117985	PARAUNA	BZ1200006LD	ACREUNA	04/01/2020 08:48	05/01/2020 13:15	04/01/2020 08:48	05/01/2020 13:13	28,42	19	539,93	CHI
20200117985	SANTO ANTONIO DA BARRA	BZ1200006LD	ACREUNA	04/01/2020 08:48	05/01/2020 13:15	04/01/2020 08:48	05/01/2020 13:13	28,42	4	113,67	CHI
20200117985	PARAUNA	BZ1200006LD	ACREUNA	04/01/2020 08:48	05/01/2020 13:15	04/01/2020 08:48	05/01/2020 13:15	28,45	139	3954,94	CHI
20200117985	RIO VERDE	BZ1200006LD	ACREUNA	04/01/2020 08:48	05/01/2020 13:15	04/01/2020 08:48	05/01/2020 13:15	28,45	95	2703,01	CHI
20200117985	RIO VERDE	BZ13189087	ACREUNA	04/01/2020 08:48	05/01/2020 13:15	04/01/2020 13:54	05/01/2020 13:15	23,35	4	93,40	CHI
20200117986	SILVANIA	SV21072589	VIANOPOLIS	04/01/2020 09:30	04/01/2020 11:19	04/01/2020 09:30	04/01/2020 11:19	1,81	3	5,42	CHI
20200117987	VARJAO	VJ21247786	GUAPO S2	04/01/2020 09:31	04/01/2020 16:54	04/01/2020 09:31	04/01/2020 16:54	7,38	1	7,38	CHI
20200117992	LUZIANIA	LZ12261248	RIO VERMELHO	04/01/2020 09:31	04/01/2020 11:45	04/01/2020 09:31	04/01/2020 11:45	2,23	148	329,30	CHI
20200117994	ACREUNA	EA12257973	EDEIA	04/01/2020 08:04	04/01/2020 18:18	04/01/2020 08:04	04/01/2020 18:18	10,23	13	133,01	CHI
20200117994	EDEIA	EA12257973	EDEIA	04/01/2020 08:04	04/01/2020 18:18	04/01/2020 08:04	04/01/2020 18:18	10,23	25	255,78	CHI
20200117994	INDIARA	EA12257973	EDEIA	04/01/2020 08:04	04/01/2020 18:18	04/01/2020 08:04	04/01/2020 18:18	10,23	7	71,62	CHI
20200118001	RIO VERDE	RV12212559	CABRIUVA S2	04/01/2020 09:18	04/01/2020 11:46	04/01/2020 09:18	04/01/2020 11:46	2,46	9	22,12	CHI
20200118002	MINEIROS	MY12149315	PARQUE DAS EMAS	04/01/2020 08:32	04/01/2020 12:57	04/01/2020 08:32	04/01/2020 12:57	4,41	27	119,07	CHI
20200118005	PETROLINA DE GOIAS	PG12216919	PETROLINA	04/01/2020 09:33	04/01/2020 14:10	04/01/2020 09:33	04/01/2020 14:10	4,61	8	36,84	CHI
20200118005	SAO FRANCISCO DE GOIAS	PG12216919	PETROLINA	04/01/2020 09:33	04/01/2020 14:10	04/01/2020 09:33	04/01/2020 14:10	4,61	1	4,61	CHI
20200118009	PIRENOPOLIS	PV21236319	CORUMBA	04/01/2020 09:34	04/01/2020 17:12	04/01/2020 09:34	04/01/2020 17:12	7,63	1	7,63	CHI
20200118012	SERRANOPOLIS	3000028326	CHAPADAO DO CEU	04/01/2020 09:34	05/01/2020 10:25	04/01/2020 09:34	05/01/2020 10:25	24,85	1	24,85	CHI
20200118013	RIO VERDE	RV12240064	RIO VERDE S1	04/01/2020 09:34	04/01/2020 13:19	04/01/2020 09:34	04/01/2020 13:19	3,74	9	33,65	CHI
20200118015	IPAMERI	IP21333565	CAMPO ALEGRE DE GOIAS	04/01/2020 09:34	04/01/2020 18:32	04/01/2020 09:34	04/01/2020 18:32	8,95	1	8,95	CHI
20200118017	SILVANIA	SV21075006	VIANOPOLIS	04/01/2020 09:35	04/01/2020 12:10	04/01/2020 09:35	04/01/2020 12:10	2,58	1	2,58	CHI
20200118018	MAURILANDIA	ML21279453	RIO DOS BOIS	04/01/2020 09:35	04/01/2020 20:05	04/01/2020 09:35	04/01/2020 20:05	10,50	1	10,50	CHI
20200118019	GOIANESIA	GE21000083	GOIANESIA S1	04/01/2020 09:35	04/01/2020 14:50	04/01/2020 09:35	04/01/2020 14:50	5,26	1	5,26	CHI
20200118025	ITABERAI	IB12304486	ANICUNS	04/01/2020 09:35	04/01/2020 12:09	04/01/2020 09:35	04/01/2020 12:09	2,57	57	146,30	CHI
20200118025	MOSSAMEDES	IB12304486	ANICUNS	04/01/2020 09:35	04/01/2020 12:09	04/01/2020 09:35	04/01/2020 12:09	2,57	5	12,83	CHI
20200118026	CATALAO	CT21280756	CATALAO S1	04/01/2020 09:35	04/01/2020 11:21	04/01/2020 09:35	04/01/2020 11:21	1,75	1	1,75	CHI
20200118027	LUZIANIA	LZ12118949	MARAJOARA	04/01/2020 09:36	04/01/2020 10:30	04/01/2020 09:36	04/01/2020 10:30	0,89	11	9,81	CHI
20200118028	GAMELEIRA DE GOIAS	SV12382483	ANAPOLIS UNIVERSITARIO S1	04/01/2020 08:22	04/01/2020 11:33	04/01/2020 08:22	04/01/2020 11:33	3,18	17	54,07	CHI
20200118031	JATAI	JT12260433	JATAI S1	04/01/2020 09:36	04/01/2020 19:40	04/01/2020 09:36	04/01/2020 19:40	10,05	1	10,05	CHI
20200118031	PEROLANDIA	JT12260433	JATAI S1	04/01/2020 09:36	04/01/2020 19:40	04/01/2020 09:36	04/01/2020 19:40	10,05	6	60,31	CHI
20200118033	SANTA CRUZ DE GOIAS	CN21180305	CALDAS NOVAS S1	04/01/2020 09:37	04/01/2020 13:39	04/01/2020 09:37	04/01/2020 13:39	4,03	1	4,03	CHI
20200118036	ANAPOLIS	10012115884	ANAPOLIS UNIVERSITARIO S2	04/01/2020 09:36	04/01/2020 13:18	04/01/2020 09:36	04/01/2020 13:18	3,68	1	3,68	CHI

20200118039	DAMOLANDIA	DL31025234	INHUMAS S1	04/01/2020 09:37	04/01/2020 13:31	04/01/2020 09:37	04/01/2020 13:31	3,89	1	3,89	CHI
20200118042	IPAMERI	IP12404733	IPAMERI	04/01/2020 07:24	04/01/2020 14:10	04/01/2020 07:24	04/01/2020 14:10	6,75	8	54,00	CHI
20200118048	CALDAS NOVAS	CN12163530	CALDAS NOVAS S2	04/01/2020 08:41	04/01/2020 12:26	04/01/2020 08:41	04/01/2020 12:26	3,75	664	2487,42	CHI
20200118053	IPAMERI	10005900253	IPAMERI	04/01/2020 06:04	04/01/2020 08:15	04/01/2020 06:04	04/01/2020 08:15	2,18	1	2,18	CHI
20200118055	CATALAO	IP12157299RE	IPAMERI	04/01/2020 06:34	04/01/2020 13:42	04/01/2020 06:34	04/01/2020 13:42	7,13	7	49,93	CHI
20200118055	GOIANDIRA	IP12157299RE	IPAMERI	04/01/2020 06:34	04/01/2020 13:42	04/01/2020 06:34	04/01/2020 13:42	7,13	15	107,00	CHI
20200118055	IPAMERI	IP12157299RE	IPAMERI	04/01/2020 06:34	04/01/2020 13:42	04/01/2020 06:34	04/01/2020 13:42	7,13	55	392,33	CHI
20200118056	IPAMERI	10007763458	IPAMERI	04/01/2020 06:44	04/01/2020 09:51	04/01/2020 06:44	04/01/2020 09:51	3,11	1	3,11	CHI
20200118059	IPAMERI	10002945493	IPAMERI	04/01/2020 06:52	04/01/2020 08:52	04/01/2020 06:52	04/01/2020 08:52	1,99	1	1,99	CHI
20200118078	IPAMERI	10009218961	IPAMERI	04/01/2020 08:16	04/01/2020 10:40	04/01/2020 08:16	04/01/2020 10:40	2,39	1	2,39	CHI
20200118080	VARJAO	VJ21171886	GUAPO S2	04/01/2020 09:39	04/01/2020 15:16	04/01/2020 09:39	04/01/2020 15:16	5,61	1	5,61	CHI
20200118092	SANTA TEREZA DE GOIAS	TB12182394	PORANGATU	04/01/2020 07:48	04/01/2020 11:18	04/01/2020 07:48	04/01/2020 11:18	3,49	3	10,46	CHI
20200118092	TROMBAS	TB12182394	PORANGATU	04/01/2020 07:48	04/01/2020 11:18	04/01/2020 07:48	04/01/2020 11:18	3,49	117	407,75	CHI
20200118095	PIRACANJUBA	PJ21115911	BELA VISTA S1	04/01/2020 09:41	04/01/2020 18:51	04/01/2020 09:41	04/01/2020 18:51	9,16	1	9,16	CHI
20200118098	MORRINHOS	MR12384523	MORRINHOS	04/01/2020 09:42	04/01/2020 14:03	04/01/2020 09:42	04/01/2020 14:03	4,35	2	8,70	CHI
20200118099	ARAGOIANIA	AO11352064	GUAPO S2	04/01/2020 09:35	04/01/2020 20:15	04/01/2020 09:35	04/01/2020 20:15	10,66	111	1183,32	CHI
20200118100	JANDAIA	1180009499	PALMEIRAS	04/01/2020 09:42	04/01/2020 12:16	04/01/2020 09:42	04/01/2020 12:16	2,57	1	2,57	CHI
20200118101	MINEIROS	02430414	CHAPADAO DO CEU	04/01/2020 09:35	04/01/2020 19:32	04/01/2020 09:35	04/01/2020 11:10	1,57	20	31,48	CHI
20200118101	SERRANOPOLIS	02430414	CHAPADAO DO CEU	04/01/2020 09:35	04/01/2020 19:32	04/01/2020 09:35	04/01/2020 11:10	1,57	59	92,86	CHI
20200118101	CHAPADAO DO CEU	02430414	CHAPADAO DO CEU	04/01/2020 09:35	04/01/2020 19:32	04/01/2020 09:35	04/01/2020 11:50	2,24	11	24,67	CHI
20200118101	SERRANOPOLIS	02430414	CHAPADAO DO CEU	04/01/2020 09:35	04/01/2020 19:32	04/01/2020 09:35	04/01/2020 11:50	2,24	6	13,46	CHI
20200118101	SERRANOPOLIS	02430414	CHAPADAO DO CEU	04/01/2020 09:35	04/01/2020 19:32	04/01/2020 09:35	04/01/2020 13:12	3,61	5	18,07	CHI
20200118101	SERRANOPOLIS	02430414	CHAPADAO DO CEU	04/01/2020 09:35	04/01/2020 19:32	04/01/2020 09:35	04/01/2020 15:32	5,95	2	11,89	CHI
20200118101	CHAPADAO DO CEU	02430414	CHAPADAO DO CEU	04/01/2020 09:35	04/01/2020 19:32	04/01/2020 17:21	04/01/2020 17:34	0,22	11	2,37	CHI
20200118101	SERRANOPOLIS	02430414	CHAPADAO DO CEU	04/01/2020 09:35	04/01/2020 19:32	04/01/2020 17:21	04/01/2020 17:34	0,22	13	2,80	CHI
20200118101	SERRANOPOLIS	02430414	CHAPADAO DO CEU	04/01/2020 09:35	04/01/2020 19:32	04/01/2020 09:35	04/01/2020 19:00	9,40	3	28,21	CHI
20200118101	SERRANOPOLIS	02430414	CHAPADAO DO CEU	04/01/2020 09:35	04/01/2020 19:32	04/01/2020 09:35	04/01/2020 19:06	9,51	1	9,51	CHI
20200118101	SERRANOPOLIS	02430414	CHAPADAO DO CEU	04/01/2020 09:35	04/01/2020 19:32	04/01/2020 09:35	04/01/2020 19:19	9,72	3	29,15	CHI
20200118101	MINEIROS	02430414	CHAPADAO DO CEU	04/01/2020 09:35	04/01/2020 19:32	04/01/2020 09:35	04/01/2020 19:32	9,93	5	49,67	CHI
20200118101	SERRANOPOLIS	02430414	CHAPADAO DO CEU	04/01/2020 09:35	04/01/2020 19:32	04/01/2020 09:35	04/01/2020 19:32	9,93	3	29,80	CHI
20200118103	MINEIROS	MY10401436	PARQUE DAS EMAS	04/01/2020 09:40	04/01/2020 19:03	04/01/2020 09:40	04/01/2020 14:49	5,14	2	10,28	CHI
20200118103	MINEIROS	MY10401436	PARQUE DAS EMAS	04/01/2020 09:40	04/01/2020 19:03	04/01/2020 09:40	04/01/2020 18:18	8,63	6	51,76	CHI
20200118103	MINEIROS	MY13303915	PARQUE DAS EMAS	04/01/2020 09:40	04/01/2020 19:03	04/01/2020 09:40	04/01/2020 18:46	9,08	28	254,36	CHI



20200118103	MINEIROS	MY12360840	PARQUE DAS EMAS	04/01/2020 09:40	04/01/2020 19:03	04/01/2020 15:27	04/01/2020 19:03	3,60	20	71,98	CHI
20200118121	PALMINOPOLIS	PP10404110	PALMEIRAS	04/01/2020 10:17	04/01/2020 19:42	04/01/2020 10:17	04/01/2020 10:21	0,06	50	2,99	CHI
20200118121	JANDAIA	PP10404111	PALMEIRAS	04/01/2020 10:17	04/01/2020 19:42	04/01/2020 10:17	04/01/2020 19:42	9,41	50	470,57	CHI
20200118121	PALMINOPOLIS	PP10404111	PALMEIRAS	04/01/2020 10:17	04/01/2020 19:42	04/01/2020 10:17	04/01/2020 19:42	9,41	162	1524,65	CHI
20200118201	ABADIANIA	CB12382389	CORUMBA	04/01/2020 09:08	04/01/2020 16:34	04/01/2020 09:08	04/01/2020 16:34	7,42	9	66,81	CHI
20200118201	CORUMBA DE GOIAS	CB12382389	CORUMBA	04/01/2020 09:08	04/01/2020 16:34	04/01/2020 09:08	04/01/2020 16:34	7,42	4	29,69	CHI
20200118203	TAQUARAL DE GOIAS	340005762	ITABERAI S1	04/01/2020 09:42	04/01/2020 12:19	04/01/2020 09:42	04/01/2020 12:19	2,60	1	2,60	CHI
20200118218	VARJAO	3630001103	GUAPO S2	04/01/2020 09:44	04/01/2020 11:50	04/01/2020 09:44	04/01/2020 11:50	2,09	1	2,09	CHI
20200118224	AGUA LIMPA	AL21263207	VILA CORUMBA	04/01/2020 09:44	05/01/2020 08:31	04/01/2020 09:44	05/01/2020 08:31	22,77	1	22,77	CHI
20200118228	PALESTINA DE GOIAS	PY12023466	PALESTINA	04/01/2020 07:53	04/01/2020 23:15	04/01/2020 07:53	04/01/2020 23:15	15,35	4	61,40	CHI
20200118231	CRISTALINA	KR21304932	CRISTALINA S2	04/01/2020 09:45	05/01/2020 07:32	04/01/2020 09:45	05/01/2020 07:32	21,77	1	21,77	CHI
20200118242	IPAMERI	IP12114042	IPAMERI	04/01/2020 09:49	05/01/2020 08:38	04/01/2020 09:49	05/01/2020 08:38	22,81	3	68,42	CHI
20200118244	CALDAS NOVAS	CN21271744	SERRA DE CALDAS	04/01/2020 09:50	05/01/2020 08:57	04/01/2020 09:50	05/01/2020 08:57	23,12	1	23,12	CHI
20200118246	MORRINHOS	10029913975	MORRINHOS	04/01/2020 09:50	04/01/2020 11:20	04/01/2020 09:50	04/01/2020 11:20	1,50	1	1,50	CHI
20200118247	SANTA HELENA DE GOIAS	EU12026832	RIO DOS BOIS	04/01/2020 09:26	06/01/2020 19:37	04/01/2020 09:26	04/01/2020 14:00	4,56	1	4,56	CHI
20200118247	TURVELANDIA	EU12026832	RIO DOS BOIS	04/01/2020 09:26	06/01/2020 19:37	04/01/2020 09:26	04/01/2020 14:00	4,56	5	22,80	CHI
20200118247	SANTA HELENA DE GOIAS	EU12026832	RIO DOS BOIS	04/01/2020 09:26	06/01/2020 19:37	04/01/2020 09:26	04/01/2020 20:24	10,96	14	153,47	CHI
20200118247	TURVELANDIA	EU12026832	RIO DOS BOIS	04/01/2020 09:26	06/01/2020 19:37	04/01/2020 09:26	04/01/2020 20:24	10,96	1	10,96	CHI
20200118247	TURVELANDIA	EU12026832	RIO DOS BOIS	04/01/2020 09:26	06/01/2020 19:37	04/01/2020 09:26	06/01/2020 15:50	54,39	2	108,79	CHI
20200118247	SANTA HELENA DE GOIAS	EU12026832	RIO DOS BOIS	04/01/2020 09:26	06/01/2020 19:37	04/01/2020 09:26	06/01/2020 19:37	58,18	1	58,18	CHI
20200118247	TURVELANDIA	EU12026832	RIO DOS BOIS	04/01/2020 09:26	06/01/2020 19:37	04/01/2020 09:26	06/01/2020 19:37	58,18	1	58,18	CHI
20200118248	GOIAS	GS12217959	GOIAS	04/01/2020 09:50	04/01/2020 14:59	04/01/2020 09:50	04/01/2020 14:59	5,14	6	30,85	CHI
20200118260	ALEXANIA	480047273	ALEXANIA	04/01/2020 09:52	04/01/2020 15:57	04/01/2020 09:52	04/01/2020 15:57	6,08	1	6,08	CHI
20200118263	SAO MIGUEL DO ARAGUAIA	SM11220638	SAO MIGUEL DO ARAGUAIA	04/01/2020 17:39	05/01/2020 00:14	04/01/2020 17:39	05/01/2020 00:14	6,59	49	322,76	CHI
20200118271	MORRINHOS	MR21182916	MORRINHOS	04/01/2020 09:54	04/01/2020 12:00	04/01/2020 09:54	04/01/2020 12:00	2,09	1	2,09	CHI
20200118282	CALDAS NOVAS	IP10375985	IPAMERI	04/01/2020 11:16	04/01/2020 23:12	04/01/2020 11:16	04/01/2020 23:12	11,93	10	119,33	CHI
20200118282	CORUMBAIBA	IP10375985	IPAMERI	04/01/2020 11:16	04/01/2020 23:12	04/01/2020 11:16	04/01/2020 23:12	11,93	3	35,80	CHI
20200118282	IPAMERI	IP10375985	IPAMERI	04/01/2020 11:16	04/01/2020 23:12	04/01/2020 11:16	04/01/2020 23:12	11,93	308	3675,47	CHI
20200118282	IPAMERI	IP10375985	IPAMERI	04/01/2020 11:16	04/01/2020 23:12	04/01/2020 18:09	04/01/2020 23:12	5,04	57	287,36	CHI
20200118297	CORUMBAIBA	IP12404719	IPAMERI	04/01/2020 08:29	04/01/2020 23:12	04/01/2020 08:29	04/01/2020 23:12	14,71	16	235,33	CHI
20200118297	IPAMERI	IP12404719	IPAMERI	04/01/2020 08:29	04/01/2020 23:12	04/01/2020 08:29	04/01/2020 23:12	14,71	72	1058,98	CHI
20200118297	NOVA AURORA	IP12404719	IPAMERI	04/01/2020 08:29	04/01/2020 23:12	04/01/2020 08:29	04/01/2020 23:12	14,71	2	29,42	CHI
20200118302	CRISTALINA	KR11276350	CRISTALINA S2	04/01/2020 09:55	04/01/2020 13:09	04/01/2020 09:55	04/01/2020 13:09	3,22	1	3,22	CHI

20200118311	ITUMBIARA	IT12305607	ITUMBIARA NOVA	04/01/2020 08:55	04/01/2020 11:55	04/01/2020 08:55	04/01/2020 11:55	2,99	13	38,83	CHI
20200118325	BRAZABRANTES	DL31019845	INHUMAS S1	04/01/2020 09:59	04/01/2020 13:33	04/01/2020 09:59	04/01/2020 13:33	3,57	1	3,57	CHI
20200118328	MUNDO NOVO DE GOIAS	MH11269109	NOVA CRIXAS	04/01/2020 10:00	04/01/2020 23:24	04/01/2020 10:00	04/01/2020 23:24	13,40	1	13,40	CHI
20200118329	GOIATUBA	GT21041276	GOIATUBA S2	04/01/2020 10:00	04/01/2020 13:03	04/01/2020 10:00	04/01/2020 13:03	3,04	1	3,04	CHI
20200118335	CAMPINACU	UC12265668	PORANGATU	04/01/2020 10:01	04/01/2020 12:47	04/01/2020 10:01	04/01/2020 12:47	2,76	4	11,04	CHI
20200118337	LUZIANIA	8203801	VIANOPOLIS	04/01/2020 10:01	04/01/2020 13:28	04/01/2020 10:01	04/01/2020 12:40	2,64	2	5,29	CHI
20200118337	LUZIANIA	8203801	VIANOPOLIS	04/01/2020 10:01	04/01/2020 13:28	04/01/2020 10:01	04/01/2020 13:28	3,44	1	3,44	CHI
20200118341	PONTALINA	PK12080063	PONTALINA	03/01/2020 22:04	04/01/2020 14:59	03/01/2020 22:04	04/01/2020 14:59	16,91	38	642,70	CHI
20200118342	CATALAO	CT12077499	CATALAO S1	04/01/2020 08:19	04/01/2020 14:11	04/01/2020 08:19	04/01/2020 14:11	5,86	5	29,28	CHI
20200118344	GOIANIA	GN12002182	AEROPORTO S2	04/01/2020 10:02	04/01/2020 11:11	04/01/2020 10:02	04/01/2020 11:11	1,14	422	480,02	CHI
20200118346	MONTE ALEGRE DE GOIAS	10030852941	SAO DOMINGOS	04/01/2020 10:02	04/01/2020 14:03	04/01/2020 10:02	04/01/2020 14:03	4,00	1	4,00	CHI
20200118348	NOVA CRIXAS	NA21361525	NOVA CRIXAS	04/01/2020 10:03	04/01/2020 18:34	04/01/2020 10:03	04/01/2020 18:34	8,51	1	8,51	CHI
20200118354	CRISTALINA	KR11375055	CRISTALINA S2	03/01/2020 23:07	04/01/2020 10:53	03/01/2020 23:07	04/01/2020 10:53	11,76	1	11,76	CHI
20200118358	SANTA HELENA DE GOIAS	SH12246720	ACREUNA	04/01/2020 21:22	05/01/2020 01:42	04/01/2020 21:22	05/01/2020 01:42	4,32	32	138,31	CHI
20200118359	MONTIVIDIU	MV12214188	MONTIVIDIU T	04/01/2020 10:05	05/01/2020 11:19	04/01/2020 10:05	05/01/2020 11:19	25,22	2	50,45	CHI
20200118363	COLINAS DO SUL	TI12358161	NIQUELANDIA SUBTRANSMISSAO	04/01/2020 10:06	04/01/2020 11:11	04/01/2020 10:06	04/01/2020 11:11	1,08	333	358,07	CHI
20200118364	ITUMBIARA	IT21034341	CACHOEIRA DOURADA	04/01/2020 10:06	04/01/2020 17:43	04/01/2020 10:06	04/01/2020 17:43	7,61	1	7,61	CHI
20200118367	ITUMBIARA	690184785	ITUMBIARA NOVA	04/01/2020 10:07	04/01/2020 23:23	04/01/2020 10:07	04/01/2020 23:23	13,27	1	13,27	CHI
20200118368	INHUMAS	30101347	INHUMAS S2	04/01/2020 10:07	04/01/2020 11:37	04/01/2020 10:07	04/01/2020 11:37	1,49	1	1,49	CHI
20200118382	PORTEIRAO	CL21062947	RIO DOS BOIS	04/01/2020 10:09	04/01/2020 21:05	04/01/2020 10:09	04/01/2020 21:05	10,94	1	10,94	CHI
20200118386	INDIARA	2710006504	EDEIA	04/01/2020 10:10	04/01/2020 11:18	04/01/2020 10:10	04/01/2020 11:18	1,13	1	1,13	CHI
20200118389	PORANGATU	840098765	PORANGATU	04/01/2020 10:11	04/01/2020 17:39	04/01/2020 10:11	04/01/2020 17:39	7,47	1	7,47	CHI
20200118393	MINACU	IH11262530	MINACU	04/01/2020 10:11	04/01/2020 11:58	04/01/2020 10:11	04/01/2020 11:58	1,77	21	37,14	CHI
20200118405	DOVERLANDIA	DV12187350	CAIAPONIA	04/01/2020 09:43	04/01/2020 14:39	04/01/2020 09:43	04/01/2020 14:39	4,92	17	83,60	CHI
20200118411	MINACU	IH12334428LD	MINACU	04/01/2020 10:13	04/01/2020 10:55	04/01/2020 10:13	04/01/2020 10:55	0,70	79	55,12	CHI
20200118416	CIDADE OCIDENTAL	10019643096	MARAJOARA	04/01/2020 10:14	04/01/2020 11:50	04/01/2020 10:14	04/01/2020 11:50	1,60	1	1,60	CHI
20200118419	VARJAO	VJ12085702	CEZARINA	04/01/2020 10:14	04/01/2020 14:45	04/01/2020 10:14	04/01/2020 14:45	4,51	7	31,55	CHI
20200118423	ANAPOLIS	20020223	ANAPOLIS UNIVERSITARIO S1	04/01/2020 10:15	04/01/2020 12:29	04/01/2020 10:15	04/01/2020 12:29	2,23	1	2,23	CHI
20200118425	GOIANIA	17204392	CAMPINAS S1	04/01/2020 10:15	04/01/2020 10:44	04/01/2020 10:15	04/01/2020 10:44	0,47	1	0,47	CHI
20200118427	CABECEIRAS	CW12218489	ITUIQUIRA	04/01/2020 10:16	04/01/2020 11:42	04/01/2020 10:16	04/01/2020 11:42	1,43	10	14,33	CHI
20200118431	COCALZINHO DE GOIAS	9970007706	AGUAS LINDAS DE GOIAS S2	04/01/2020 10:17	04/01/2020 11:19	04/01/2020 10:17	04/01/2020 11:19	1,04	1	1,04	CHI
20200118432	NOVO GAMA	2460047363	PACAEMBU S1	04/01/2020 10:17	04/01/2020 11:26	04/01/2020 10:17	04/01/2020 11:26	1,16	1	1,16	CHI
20200118433	GOIANIA	10015112347	CARAJAS S2	04/01/2020 10:17	04/01/2020 12:36	04/01/2020 10:17	04/01/2020 12:36	2,31	1	2,31	CHI

20200118437	VALPARAISO DE GOIAS	10004124020	PACAEMBU S1	04/01/2020 10:18	04/01/2020 22:45	04/01/2020 10:18	04/01/2020 22:45	12,45	1	12,45	CHI
20200118462	HEITORAI	HE12019118	ITAPURANGA	04/01/2020 10:22	04/01/2020 11:43	04/01/2020 10:22	04/01/2020 11:43	1,34	1	1,34	CHI
20200118467	ANICUNS	AC2100038	ANICUNS	04/01/2020 10:23	04/01/2020 14:52	04/01/2020 10:23	04/01/2020 14:52	4,48	1	4,48	CHI
20200118476	IVOLANDIA	IV12206098	IPORA	04/01/2020 10:24	05/01/2020 00:06	04/01/2020 10:24	05/01/2020 00:06	13,69	2	27,39	CHI
20200118479	PALMEIRAS DE GOIAS	PL21025196	PALMEIRAS	04/01/2020 10:24	04/01/2020 13:26	04/01/2020 10:24	04/01/2020 13:26	3,02	1	3,02	CHI
20200118481	IPORA	IR21204817	IPORA	04/01/2020 10:25	04/01/2020 13:56	04/01/2020 10:25	04/01/2020 13:56	3,51	2	7,03	CHI
20200118485	PIRACANJUBA	MR12223456	MORRINHOS	04/01/2020 10:23	04/01/2020 11:04	04/01/2020 10:23	04/01/2020 11:04	0,67	8	5,35	CHI
20200118488	PADRE BERNARDO	PB12231532	PADRE BERNARDO	04/01/2020 10:26	04/01/2020 15:09	04/01/2020 10:26	04/01/2020 15:09	4,71	8	37,65	CHI
20200118494	ANAPOLIS	AN12261182	JUNDIAI S1	04/01/2020 09:55	04/01/2020 14:01	04/01/2020 09:55	04/01/2020 14:01	4,10	150	614,67	CHI
20200118494	GOIANAPOLIS	AN12261182	JUNDIAI S1	04/01/2020 09:55	04/01/2020 14:01	04/01/2020 09:55	04/01/2020 14:01	4,10	9	36,88	CHI
20200118494	LEOPOLDO DE BULHOES	AN12261182	JUNDIAI S1	04/01/2020 09:55	04/01/2020 14:01	04/01/2020 09:55	04/01/2020 14:01	4,10	5	20,49	CHI
20200118498	MINEIROS	MY21234368	PARQUE DAS EMAS	04/01/2020 10:28	05/01/2020 15:08	04/01/2020 10:28	05/01/2020 15:08	28,66	1	28,66	CHI
20200118499	JATAI	JT12336920	JATAI S1	04/01/2020 10:28	04/01/2020 16:28	04/01/2020 10:28	04/01/2020 16:28	5,99	10	59,88	CHI
20200118502	GAMELEIRA DE GOIAS	AN11264488	DAIA S1	04/01/2020 09:35	04/01/2020 16:25	04/01/2020 09:35	04/01/2020 16:25	6,82	18	122,79	CHI
20200118505	MUNDO NOVO DE GOIAS	MH12242017	NOVA CRIXAS	04/01/2020 10:30	04/01/2020 20:09	04/01/2020 10:30	04/01/2020 20:09	9,65	3	28,95	CHI
20200118516	ITUMBIARA	IT21134508	CACHOEIRA DOURADA	04/01/2020 10:32	04/01/2020 18:45	04/01/2020 10:32	04/01/2020 18:45	8,21	1	8,21	CHI
20200118523	TROMBAS	TB11240716	PORANGATU	04/01/2020 10:33	04/01/2020 14:43	04/01/2020 10:33	04/01/2020 14:26	3,89	3	11,67	CHI
20200118523	TROMBAS	TB12240756	PORANGATU	04/01/2020 10:33	04/01/2020 14:43	04/01/2020 14:27	04/01/2020 14:43	0,26	31	8,14	CHI
20200118525	SILVANIA	SV31017848	DAIA S1	04/01/2020 10:33	04/01/2020 20:00	04/01/2020 10:33	04/01/2020 20:00	9,44	1	9,44	CHI
20200118526	ITARUMA	IM12295758	CACHOEIRA ALTA	04/01/2020 09:00	04/01/2020 16:40	04/01/2020 09:00	04/01/2020 16:40	7,65	2	15,31	CHI
20200118529	CACU	CC12202706	CACHOEIRA ALTA	04/01/2020 10:33	04/01/2020 16:57	04/01/2020 10:33	04/01/2020 16:57	6,39	9	57,47	CHI
20200118534	PIRACANJUBA	PJ21080373	PIRACANJUBA	04/01/2020 10:35	04/01/2020 14:53	04/01/2020 10:35	04/01/2020 14:53	4,30	1	4,30	CHI
20200118536	INHUMAS	30146318	INHUMAS S2	04/01/2020 10:35	04/01/2020 14:57	04/01/2020 10:35	04/01/2020 14:57	4,36	1	4,36	CHI
20200118541	PIRANHAS	PH12204960	PIRANHAS	04/01/2020 10:36	05/01/2020 02:15	04/01/2020 10:36	05/01/2020 02:15	15,65	2	31,29	CHI
20200118546	GOIANIA	10001617654	GOYA S1	04/01/2020 10:38	04/01/2020 12:12	04/01/2020 10:38	04/01/2020 12:12	1,56	1	1,56	CHI
20200118554	BELA VISTA DE GOIAS	PJ12010877	BELA VISTA S1	04/01/2020 10:04	04/01/2020 15:04	04/01/2020 10:04	04/01/2020 15:04	4,99	2	9,97	CHI
20200118554	PIRACANJUBA	PJ12010877	BELA VISTA S1	04/01/2020 10:04	04/01/2020 15:04	04/01/2020 10:04	04/01/2020 15:04	4,99	12	59,83	CHI
20200118555	MINEIROS	MY12232687	PARQUE DAS EMAS	04/01/2020 10:39	04/01/2020 12:41	04/01/2020 10:39	04/01/2020 12:41	2,02	5	10,11	CHI
20200118556	GOIANIRA	10015785058	GOIANIRA	04/01/2020 10:40	04/01/2020 19:20	04/01/2020 10:40	04/01/2020 19:20	8,67	1	8,67	CHI
20200118558	BURITI ALEGRE	BG12283221	ALTO BURITI	04/01/2020 10:40	04/01/2020 13:00	04/01/2020 10:40	04/01/2020 13:00	2,34	4	9,36	CHI
20200118559	NOVA CRIXAS	NA12392031	NOVA CRIXAS	04/01/2020 10:40	04/01/2020 23:05	04/01/2020 10:40	04/01/2020 23:05	12,41	414	5138,31	CHI
20200118569	BOM JESUS DE GOIAS	BJ21000057	BOM JESUS DE GOIAS	04/01/2020 10:42	04/01/2020 18:11	04/01/2020 10:42	04/01/2020 18:11	7,48	1	7,48	CHI
20200118572	FORMOSA	FA11046850	ITIQUEIRA	04/01/2020 10:43	04/01/2020 15:35	04/01/2020 10:43	04/01/2020 15:35	4,87	208	1012,67	CHI

20200118573	ARENOPOLIS	AY12345509	ARENOPOLIS	04/01/2020 10:43	05/01/2020 07:56	04/01/2020 10:43	05/01/2020 07:56	21,21	9	190,86	CHI
20200118578	TURVELANDIA	TD12025685	RIO DOS BOIS	04/01/2020 09:59	04/01/2020 17:39	04/01/2020 09:59	04/01/2020 17:39	7,65	29	221,95	CHI
20200118586	MONTIVIDIU	2840011100	MONTIVIDIU T	04/01/2020 10:47	06/01/2020 09:38	04/01/2020 10:47	06/01/2020 09:38	46,84	1	46,84	CHI
20200118587	APARECIDA DE GOIANIA	AP12149479	INDEPENDENCIA S2	04/01/2020 10:12	04/01/2020 11:58	04/01/2020 10:12	04/01/2020 11:58	1,75	505	885,57	CHI
20200118589	CRIXAS	CX21318758	SANTA TEREZINHA	04/01/2020 10:48	04/01/2020 20:38	04/01/2020 10:48	04/01/2020 20:38	9,84	6	59,05	CHI
20200118590	NEROPOLIS	NR11104451	NEROPOLIS S2	04/01/2020 10:48	04/01/2020 15:05	04/01/2020 10:48	04/01/2020 15:05	4,27	18	76,94	CHI
20200118591	FLORES DE GOIAS	FB12245566	IACIARA S2	04/01/2020 09:36	04/01/2020 12:56	04/01/2020 09:36	04/01/2020 12:56	3,32	73	242,38	CHI
20200118591	SITIO D ABADIA	FB12245566	IACIARA S2	04/01/2020 09:36	04/01/2020 12:56	04/01/2020 09:36	04/01/2020 12:56	3,32	38	126,17	CHI
20200118593	FIRMINOPOLIS	900012493	FIRMINOPOLIS S1	04/01/2020 10:49	04/01/2020 13:11	04/01/2020 10:49	04/01/2020 13:11	2,36	1	2,36	CHI
20200118596	AVELINOPOLIS	AV21019686	ANICUNS	04/01/2020 10:50	04/01/2020 17:10	04/01/2020 10:50	04/01/2020 17:10	6,33	1	6,33	CHI
20200118601	NIQUELANDIA	10005077484	NIQUELANDIA SUBTRANSMISSAO	04/01/2020 10:51	04/01/2020 22:11	04/01/2020 10:51	04/01/2020 22:11	11,32	1	11,32	CHI
20200118604	PIRENOPOLIS	PV21337694	CORUMBA	04/01/2020 10:53	04/01/2020 12:55	04/01/2020 10:53	04/01/2020 12:55	2,03	1	2,03	CHI
20200118609	ITAPURANGA	GK21158263	ITAPURANGA	04/01/2020 10:53	04/01/2020 12:48	04/01/2020 10:53	04/01/2020 12:48	1,91	1	1,91	CHI
20200118612	BELA VISTA DE GOIAS	BV12031918	BELA VISTA S1	04/01/2020 10:54	04/01/2020 15:45	04/01/2020 10:54	04/01/2020 15:45	4,84	23	111,34	CHI
20200118615	CALDAZINHA	SW21093825	SENADOR CANEDO	04/01/2020 10:54	04/01/2020 14:53	04/01/2020 10:54	04/01/2020 14:53	3,97	1	3,97	CHI
20200118621	SILVANIA	SV12161953	VIANOPOLIS	04/01/2020 10:39	04/01/2020 11:57	04/01/2020 10:39	04/01/2020 11:57	1,30	3	3,89	CHI
20200118622	IPAMERI	10022044904	IPAMERI	04/01/2020 10:55	04/01/2020 11:30	04/01/2020 10:55	04/01/2020 11:30	0,58	1	0,58	CHI
20200118625	SAO JOAO D ALIANCA	JL11131720	SAO JOAO D ALIANCA	04/01/2020 10:55	04/01/2020 19:50	04/01/2020 10:55	04/01/2020 19:50	8,91	93	828,35	CHI
20200118627	GOIANIA	10024713587	CAMPINAS S1	04/01/2020 10:55	04/01/2020 15:53	04/01/2020 10:55	04/01/2020 15:53	4,95	1	4,95	CHI
20200118628	CORUMBAIBA	CI12392158	VILA CORUMBA	04/01/2020 07:17	04/01/2020 20:35	04/01/2020 07:17	04/01/2020 20:35	13,30	10	132,98	CHI
20200118632	MORRINHOS	MR21125533	MORRINHOS	04/01/2020 10:56	05/01/2020 08:03	04/01/2020 10:56	05/01/2020 08:03	21,11	1	21,11	CHI
20200118635	FIRMINOPOLIS	FR21149424	FIRMINOPOLIS S1	04/01/2020 10:57	04/01/2020 12:02	04/01/2020 10:57	04/01/2020 12:02	1,07	1	1,07	CHI
20200118639	VARJAO	VJ21113923	GUAPO S2	04/01/2020 10:58	04/01/2020 15:05	04/01/2020 10:58	04/01/2020 15:05	4,12	1	4,12	CHI
20200118645	MINEIROS	MY12325793	PARQUE DAS EMAS	04/01/2020 07:01	04/01/2020 17:30	04/01/2020 07:01	04/01/2020 17:30	10,47	3	31,41	CHI
20200118647	CRIXAS	IW12032522	RUBIATABA	04/01/2020 10:49	04/01/2020 15:48	04/01/2020 10:49	04/01/2020 15:48	4,97	12	59,65	CHI
20200118647	GUARINOS	IW12032522	RUBIATABA	04/01/2020 10:49	04/01/2020 15:48	04/01/2020 10:49	04/01/2020 15:48	4,97	11	54,68	CHI
20200118647	ITAPACI	IW12032522	RUBIATABA	04/01/2020 10:49	04/01/2020 15:48	04/01/2020 10:49	04/01/2020 15:48	4,97	33	164,05	CHI
20200118649	ITUMBIARA	690332233	ITUMBIARA VELHA S1	04/01/2020 11:01	04/01/2020 14:54	04/01/2020 11:01	04/01/2020 14:54	3,88	1	3,88	CHI
20200118653	APARECIDA DE GOIANIA	14212523	ATLANTICO S1	04/01/2020 11:01	04/01/2020 12:28	04/01/2020 11:01	04/01/2020 12:28	1,44	1	1,44	CHI
20200118654	PARAUNA	PU21007975	PARAUNA	04/01/2020 11:01	04/01/2020 12:17	04/01/2020 11:01	04/01/2020 12:17	1,27	1	1,27	CHI
20200118656	CRISTALINA	KR12087952	CRISTALINA S2	04/01/2020 10:41	05/01/2020 14:51	04/01/2020 10:41	05/01/2020 12:59	26,30	25	657,55	CHI
20200118656	CRISTALINA	KR12183710	CRISTALINA S2	04/01/2020 10:41	05/01/2020 14:51	04/01/2020 10:41	05/01/2020 14:08	27,45	1	27,45	CHI
20200118656	CRISTALINA	KR12381876LD	CRISTALINA S2	04/01/2020 10:41	05/01/2020 14:51	04/01/2020 10:41	05/01/2020 14:51	28,17	1	28,17	CHI

20200118657	CRISTALINA	KR11376975	CRISTALINA S2	04/01/2020 11:01	04/01/2020 11:17	04/01/2020 11:01	04/01/2020 11:17	0,26	1	0,26	CHI
20200118660	HIDROLANDIA	HD12000189	INDEPENDENCIA S1	04/01/2020 11:02	04/01/2020 13:19	04/01/2020 11:02	04/01/2020 13:19	2,27	9	20,47	CHI
20200118661	CAVALCANTE	TI12162624	NIQUELANDIA SUBTRANSMISSAO	04/01/2020 11:03	04/01/2020 14:34	04/01/2020 11:03	04/01/2020 14:34	3,52	49	172,26	CHI
20200118661	COLINAS DO SUL	TI12162624	NIQUELANDIA SUBTRANSMISSAO	04/01/2020 11:03	04/01/2020 14:34	04/01/2020 11:03	04/01/2020 14:34	3,52	6	21,09	CHI
20200118665	GOIANIA	13498149	REAL S1	04/01/2020 11:03	04/01/2020 12:21	04/01/2020 11:03	04/01/2020 12:21	1,29	1	1,29	CHI
20200118666	CAVALCANTE	CJ21389783	MINACU	04/01/2020 11:04	04/01/2020 16:28	04/01/2020 11:04	04/01/2020 16:28	5,40	1	5,40	CHI
20200118670	APARECIDA DE GOIANIA	200134772	INDEPENDENCIA S2	04/01/2020 11:05	04/01/2020 13:08	04/01/2020 11:05	04/01/2020 13:08	2,06	1	2,06	CHI
20200118673	URUACU	UR21066501	URUACU	04/01/2020 11:05	04/01/2020 18:22	04/01/2020 11:05	04/01/2020 18:22	7,28	2	14,55	CHI
20200118674	JATAI	JT12158077	JATAI S1	04/01/2020 11:05	04/01/2020 14:39	04/01/2020 11:05	04/01/2020 14:39	3,55	2	7,11	CHI
20200118677	NIQUELANDIA	NQ12239432	URUACU	04/01/2020 11:07	04/01/2020 13:15	04/01/2020 11:07	04/01/2020 13:15	2,13	19	40,46	CHI
20200118678	FLORES DE GOIAS	3480016684	FLORES DE GOIAS	04/01/2020 11:07	05/01/2020 20:17	04/01/2020 11:07	05/01/2020 20:17	33,17	1	33,17	CHI
20200118685	GOIATUBA	140047347	GOIATUBA S2	04/01/2020 11:09	05/01/2020 14:38	04/01/2020 11:09	05/01/2020 14:38	27,49	1	27,49	CHI
20200118688	ACREUNA	2440068579	ACREUNA	04/01/2020 11:09	04/01/2020 15:37	04/01/2020 11:09	04/01/2020 15:37	4,45	1	4,45	CHI
20200118691	ARAGARCAS	AG12259439	ARAGARCAS	04/01/2020 11:10	04/01/2020 19:14	04/01/2020 11:10	04/01/2020 19:14	8,06	6	48,37	CHI
20200118697	ITABERAI	IB21307595	ITABERAI S1	04/01/2020 11:12	04/01/2020 14:33	04/01/2020 11:12	04/01/2020 14:33	3,34	1	3,34	CHI
20200118699	GOIANIA	10005003405	CARAJAS S2	04/01/2020 11:13	04/01/2020 11:53	04/01/2020 11:13	04/01/2020 11:53	0,67	1	0,67	CHI
20200118707	VALPARAISO DE GOIAS	VA11192936	PACAEMBU S1	04/01/2020 11:15	04/01/2020 17:28	04/01/2020 11:15	04/01/2020 17:28	6,22	7	43,51	CHI
20200118708	GOIANESIA	GE12321396	GOIANESIA S2	04/01/2020 10:14	04/01/2020 12:22	04/01/2020 10:14	04/01/2020 12:22	2,13	47	100,21	CHI
20200118708	VILA PROPICIO	GE12321396	GOIANESIA S2	04/01/2020 10:14	04/01/2020 12:22	04/01/2020 10:14	04/01/2020 12:22	2,13	18	38,38	CHI
20200118714	NIQUELANDIA	NQ21147623	URUACU	04/01/2020 11:16	05/01/2020 10:25	04/01/2020 11:16	05/01/2020 10:25	23,14	1	23,14	CHI
20200118716	MUTUNOPOLIS	MU21357177	MARA ROSA	04/01/2020 11:17	05/01/2020 08:36	04/01/2020 11:17	05/01/2020 08:36	21,31	1	21,31	CHI
20200118718	DOVERLANDIA	MY12209127	PARQUE DAS EMAS	04/01/2020 11:17	05/01/2020 11:00	04/01/2020 11:17	05/01/2020 11:00	23,72	4	94,87	CHI
20200118721	RIO VERDE	10019884964	RIO VERDE S2	04/01/2020 11:18	04/01/2020 20:17	04/01/2020 11:18	04/01/2020 20:17	8,98	1	8,98	CHI
20200118722	PONTALINA	PK21074609	PONTALINA	04/01/2020 11:18	04/01/2020 21:31	04/01/2020 11:18	04/01/2020 21:31	10,21	1	10,21	CHI
20200118724	SANTA TEREZINHA DE GOIAS	2480030320	SANTA TEREZINHA	04/01/2020 11:18	04/01/2020 14:30	04/01/2020 11:18	04/01/2020 14:30	3,20	1	3,20	CHI
20200118727	URUACU	UR21181610	URUACU	04/01/2020 11:19	04/01/2020 19:12	04/01/2020 11:19	04/01/2020 19:12	7,88	1	7,88	CHI
20200118741	SAO MIGUEL DO ARAGUAIA	SM12020668	SAO MIGUEL DO ARAGUAIA	04/01/2020 11:23	04/01/2020 20:00	04/01/2020 11:23	04/01/2020 20:00	8,61	13	111,93	CHI
20200118743	PIRACANJUBA	PJ21403657	ROCHEDO	04/01/2020 11:24	05/01/2020 15:23	04/01/2020 11:24	05/01/2020 15:23	27,97	1	27,97	CHI
20200118747	SANCLERLANDIA	1210011958	FIRMINOPOLIS S2	04/01/2020 11:25	04/01/2020 12:33	04/01/2020 11:25	04/01/2020 12:33	1,13	1	1,13	CHI
20200118752	GOIATUBA	GT21293078	GOIATUBA S2	04/01/2020 11:26	04/01/2020 13:20	04/01/2020 11:26	04/01/2020 13:20	1,90	1	1,90	CHI
20200118753	BELA VISTA DE GOIAS	10003735115	BELA VISTA S2	04/01/2020 11:26	04/01/2020 19:02	04/01/2020 11:26	04/01/2020 19:02	7,60	1	7,60	CHI
20200118757	MONTIVIDIU	RV12100300	MONTIVIDIU T	04/01/2020 11:27	04/01/2020 15:22	04/01/2020 11:27	04/01/2020 15:22	3,91	3	11,74	CHI
20200118757	RIO VERDE	RV12100300	MONTIVIDIU T	04/01/2020 11:27	04/01/2020 15:22	04/01/2020 11:27	04/01/2020 15:22	3,91	1	3,91	CHI

20200118761	AGUAS LINDAS DE GOIAS	4830449707	AGUAS LINDAS DE GOIAS S1	04/01/2020 11:27	04/01/2020 13:01	04/01/2020 11:27	04/01/2020 13:01	1,55	1	1,55	CHI
20200118762	SANTA RITA DO ARAGUAIA	SU21301975	SANTA RITA DO ARAGUAIA	04/01/2020 11:28	04/01/2020 19:40	04/01/2020 11:28	04/01/2020 19:40	8,20	1	8,20	CHI
20200118763	ANAPOLIS	21302571	ANAPOLIS UNIVERSITARIO S2	04/01/2020 11:28	04/01/2020 15:55	04/01/2020 11:28	04/01/2020 15:55	4,45	1	4,45	CHI
20200118764	IVOLANDIA	PU12090442	MONTIVIDIU T	04/01/2020 11:28	05/01/2020 13:07	04/01/2020 11:28	05/01/2020 13:07	25,65	22	564,20	CHI
20200118764	PARAUNA	PU12090442	MONTIVIDIU T	04/01/2020 11:28	05/01/2020 13:07	04/01/2020 11:28	05/01/2020 13:07	25,65	49	1256,63	CHI
20200118766	TRINDADE	TR31089336	TRINDADE	04/01/2020 11:28	04/01/2020 15:03	04/01/2020 11:28	04/01/2020 15:03	3,57	1	3,57	CHI
20200118778	NOVO GAMA	NJ11277155	PACAEMBU S1	04/01/2020 11:30	04/01/2020 18:30	04/01/2020 11:30	04/01/2020 18:30	6,99	9	62,89	CHI
20200118784	IPORA	IR12212833	IPORA	04/01/2020 11:31	04/01/2020 15:12	04/01/2020 11:31	04/01/2020 15:12	3,68	4	14,71	CHI
20200118792	IPAMERI	IP12404744	IPAMERI	04/01/2020 10:18	04/01/2020 17:40	04/01/2020 10:18	04/01/2020 17:40	7,36	15	110,42	CHI
20200118796	ALTO PARAISO DE GOIAS	10025128629	NIQUELANDIA SUBTRANSMISSAO	04/01/2020 11:34	04/01/2020 12:55	04/01/2020 11:34	04/01/2020 12:55	1,34	1	1,34	CHI
20200118798	SANTO ANTONIO DO DESCOBERTO	SN12162757LD	MARAJOARA	04/01/2020 11:35	04/01/2020 15:47	04/01/2020 13:44	04/01/2020 15:47	2,05	291	595,74	CHI
20200118803	GOIANIA	16940751	GOIANIA LESTE S2	04/01/2020 11:35	05/01/2020 01:35	04/01/2020 11:35	05/01/2020 01:35	13,99	1	13,99	CHI
20200118805	PONTALINA	210017119	PONTALINA	04/01/2020 11:36	04/01/2020 19:00	04/01/2020 11:36	04/01/2020 19:00	7,40	1	7,40	CHI
20200118811	JAUPACI	JP12028023	IPORA	04/01/2020 08:49	04/01/2020 17:56	04/01/2020 08:49	04/01/2020 17:56	9,12	7	63,81	CHI
20200118813	CEZARINA	CZ12000015	CEZARINA	04/01/2020 11:38	04/01/2020 16:17	04/01/2020 11:38	04/01/2020 16:17	4,65	61	283,48	CHI
20200118813	INDIARA	CZ12000015	CEZARINA	04/01/2020 11:38	04/01/2020 16:17	04/01/2020 11:38	04/01/2020 16:17	4,65	37	171,95	CHI
20200118815	APORE	AE21107464	ITAJA S1	04/01/2020 11:38	04/01/2020 17:55	04/01/2020 11:38	04/01/2020 17:55	6,28	1	6,28	CHI
20200118818	ANAPOLIS	AN21048806	ANAPOLIS UNIVERSITARIO S2	04/01/2020 11:38	04/01/2020 14:00	04/01/2020 11:38	04/01/2020 14:00	2,36	2	4,71	CHI
20200118823	CRIXAS	NA12171143	NOVA CRIXAS	04/01/2020 10:13	05/01/2020 07:55	04/01/2020 10:13	05/01/2020 07:55	21,68	4	86,74	CHI
20200118835	POSSE	PS21264755	IACIARA S2	04/01/2020 11:42	04/01/2020 18:53	04/01/2020 11:42	04/01/2020 18:53	7,17	2	14,34	CHI
20200118836	SANTA CRUZ DE GOIAS	BC21117753	PIRES DO RIO S2	04/01/2020 11:42	04/01/2020 18:00	04/01/2020 11:42	04/01/2020 18:00	6,29	1	6,29	CHI
20200118841	MUNDO NOVO DE GOIAS	4240000507	NOVA CRIXAS	04/01/2020 11:43	04/01/2020 21:47	04/01/2020 11:43	04/01/2020 21:47	10,06	1	10,06	CHI
20200118844	CATALAO	CT12195398RE	CATALAO S1	04/01/2020 10:07	04/01/2020 14:26	04/01/2020 10:07	04/01/2020 14:26	4,31	103	443,44	CHI
20200118849	RIO VERDE	630075580	RIO VERDE S1	04/01/2020 11:45	04/01/2020 15:41	04/01/2020 11:45	04/01/2020 15:41	3,92	1	3,92	CHI
20200118852	APORE	SX12153265	JATAI S1	04/01/2020 12:41	04/01/2020 18:53	04/01/2020 12:41	04/01/2020 18:53	6,19	7	43,34	CHI
20200118852	ITARUMA	SX12153265	JATAI S1	04/01/2020 12:41	04/01/2020 18:53	04/01/2020 12:41	04/01/2020 18:53	6,19	1	6,19	CHI
20200118852	SERRANOPOLIS	SX12153265	JATAI S1	04/01/2020 12:41	04/01/2020 18:53	04/01/2020 12:41	04/01/2020 18:53	6,19	4	24,77	CHI
20200118861	APARECIDA DE GOIANIA	200170272	INDEPENDENCIA S1	04/01/2020 11:48	04/01/2020 13:35	04/01/2020 11:48	04/01/2020 13:35	1,77	1	1,77	CHI
20200118870	CATALAO	CT21266356	CATALAO S1	04/01/2020 11:51	04/01/2020 15:46	04/01/2020 11:51	04/01/2020 15:46	3,92	1	3,92	CHI
20200118872	HIDROLANDIA	PJ12000097	PIRACANJUBA	04/01/2020 11:44	04/01/2020 21:44	04/01/2020 11:44	04/01/2020 21:44	10,00	8	79,99	CHI
20200118872	PIRACANJUBA	PJ12000097	PIRACANJUBA	04/01/2020 11:44	04/01/2020 21:44	04/01/2020 11:44	04/01/2020 21:44	10,00	34	339,95	CHI
20200118873	RIO VERDE	RV21105896	RIO VERDE S1	04/01/2020 11:51	05/01/2020 08:00	04/01/2020 11:51	05/01/2020 08:00	20,14	2	40,28	CHI
20200118886	TAQUARAL DE GOIAS	TQ12074928	ITABERAI S1	04/01/2020 11:54	04/01/2020 13:26	04/01/2020 11:54	04/01/2020 13:26	1,52	27	41,03	CHI

20200118887	VALPARAISO DE GOIAS	10014488840	PACAEMBU S1	04/01/2020 11:54	04/01/2020 20:27	04/01/2020 11:54	04/01/2020 20:27	8,53	1	8,53	CHI
20200118904	CRISTALINA	KR10394624	CRISTALINA S1	04/01/2020 12:27	04/01/2020 19:50	04/01/2020 12:27	04/01/2020 15:27	3,00	16	47,94	CHI
20200118904	CRISTALINA	KR10394624	CRISTALINA S1	04/01/2020 12:27	04/01/2020 19:50	04/01/2020 15:28	04/01/2020 18:58	3,50	16	55,96	CHI
20200118904	CRISTALINA	KR12170192LD	CRISTALINA S1	04/01/2020 12:27	04/01/2020 19:50	04/01/2020 12:27	04/01/2020 19:50	7,39	56	413,96	CHI
20200118905	LUZIANIA	LZ10396182	VIANOPOLIS	04/01/2020 12:26	04/01/2020 18:31	04/01/2020 12:32	04/01/2020 14:55	2,39	84	200,64	CHI
20200118905	ORIZONA	LZ10396182	VIANOPOLIS	04/01/2020 12:26	04/01/2020 18:31	04/01/2020 12:32	04/01/2020 14:55	2,39	2	4,78	CHI
20200118905	LUZIANIA	LZ10396182	VIANOPOLIS	04/01/2020 12:26	04/01/2020 18:31	04/01/2020 12:32	04/01/2020 18:31	5,98	62	370,91	CHI
20200118905	ORIZONA	LZ10396182	VIANOPOLIS	04/01/2020 12:26	04/01/2020 18:31	04/01/2020 12:32	04/01/2020 18:31	5,98	91	544,41	CHI
20200118905	LUZIANIA	LZ13190481	VIANOPOLIS	04/01/2020 12:26	04/01/2020 18:31	04/01/2020 12:34	04/01/2020 18:31	5,95	1	5,95	CHI
20200118911	SAO MIGUEL DO ARAGUAIA	SM11218997	SAO MIGUEL DO ARAGUAIA	04/01/2020 10:11	04/01/2020 16:22	04/01/2020 10:11	04/01/2020 16:22	6,17	58	357,80	CHI
20200118912	ALTO PARAISO DE GOIAS	00520214	FLORES DE GOIAS	04/01/2020 12:58	04/01/2020 14:54	04/01/2020 12:58	04/01/2020 13:50	0,88	3152	2769,38	CHI
20200118912	ALTO PARAISO DE GOIAS	00520214	FLORES DE GOIAS	04/01/2020 12:58	04/01/2020 14:54	04/01/2020 12:58	04/01/2020 14:54	1,95	221	430,27	CHI
20200118912	SAO JOAO D ALIANCA	00520214	FLORES DE GOIAS	04/01/2020 12:58	04/01/2020 14:54	04/01/2020 12:58	04/01/2020 14:54	1,95	2	3,89	CHI
20200118912	ALTO PARAISO DE GOIAS	BF12102259LD	FLORES DE GOIAS	04/01/2020 12:58	04/01/2020 14:54	04/01/2020 12:59	04/01/2020 14:54	1,93	1	1,93	CHI
20200118923	GOUVELANDIA	01560414	QUIRINOPOLIS	04/01/2020 13:09	04/01/2020 16:08	04/01/2020 13:21	04/01/2020 14:55	1,57	13	20,37	CHI
20200118923	INACIOLANDIA	01560414	QUIRINOPOLIS	04/01/2020 13:09	04/01/2020 16:08	04/01/2020 13:21	04/01/2020 14:55	1,57	2	3,13	CHI
20200118923	QUIRINOPOLIS	01560414	QUIRINOPOLIS	04/01/2020 13:09	04/01/2020 16:08	04/01/2020 13:21	04/01/2020 14:55	1,57	23	36,03	CHI
20200118923	INACIOLANDIA	ID13000029	QUIRINOPOLIS	04/01/2020 13:09	04/01/2020 16:08	04/01/2020 13:21	04/01/2020 16:08	2,78	1	2,78	CHI
20200118948	PIRANHAS	PH21383563	PIRANHAS	04/01/2020 13:34	05/01/2020 01:08	04/01/2020 13:34	05/01/2020 01:08	11,56	2	23,12	CHI
20200118952	PALMEIRAS DE GOIAS	01382104	PALMEIRAS	04/01/2020 15:06	05/01/2020 13:03	04/01/2020 15:06	04/01/2020 16:06	1,01	291	294,56	CHI
20200118952	PALMEIRAS DE GOIAS	PL13000025	PALMEIRAS	04/01/2020 15:06	05/01/2020 13:03	04/01/2020 15:06	04/01/2020 17:17	2,18	49	106,87	CHI
20200118952	PALMEIRAS DE GOIAS	01382104	PALMEIRAS	04/01/2020 15:06	05/01/2020 13:03	04/01/2020 17:20	04/01/2020 18:12	0,86	292	251,69	CHI
20200118952	PALMEIRAS DE GOIAS	01382104	PALMEIRAS	04/01/2020 15:06	05/01/2020 13:03	04/01/2020 20:19	04/01/2020 20:40	0,36	292	103,98	CHI
20200118952	PALMEIRAS DE GOIAS	PL13000015	PALMEIRAS	04/01/2020 15:06	05/01/2020 13:03	04/01/2020 15:06	04/01/2020 21:54	6,81	168	1144,22	CHI
20200118952	PALMEIRAS DE GOIAS	PL13000025	PALMEIRAS	04/01/2020 15:06	05/01/2020 13:03	04/01/2020 17:20	05/01/2020 11:53	18,55	49	908,90	CHI
20200118952	PALMEIRAS DE GOIAS	PL13006138	PALMEIRAS	04/01/2020 15:06	05/01/2020 13:03	05/01/2020 12:55	05/01/2020 13:03	0,13	169	22,20	CHI
20200118955	GOIANESIA	GE11372619	GOIANESIA S1	04/01/2020 06:06	04/01/2020 22:15	04/01/2020 06:06	04/01/2020 22:15	16,15	2	32,31	CHI
20200118992	MORRINHOS	MR12000280	MORRINHOS	04/01/2020 11:41	04/01/2020 18:40	04/01/2020 11:41	04/01/2020 18:40	6,98	35	244,37	CHI
20200118994	MORRINHOS	MR32076974	MORRINHOS	04/01/2020 12:39	04/01/2020 19:53	04/01/2020 12:39	04/01/2020 19:53	7,22	9	65,02	CHI
20200119003	BURITINOPOLIS	BQ21386628	IACIARA S2	04/01/2020 11:57	04/01/2020 17:47	04/01/2020 11:57	04/01/2020 17:47	5,82	1	5,82	CHI
20200119012	MINACU	IH21171871	MINACU	04/01/2020 11:59	04/01/2020 14:36	04/01/2020 11:59	04/01/2020 14:36	2,60	1	2,60	CHI
20200119013	ITAPACI	IW21123085	ITAPACI	04/01/2020 12:00	04/01/2020 20:06	04/01/2020 12:00	04/01/2020 20:06	8,09	1	8,09	CHI
20200119015	QUIRINOPOLIS	QI21091036	QUIRINOPOLIS	04/01/2020 12:00	05/01/2020 11:30	04/01/2020 12:00	05/01/2020 11:30	23,49	1	23,49	CHI

20200119016	CATALAO	CT21165190	CATALAO S1	04/01/2020 12:00	04/01/2020 21:32	04/01/2020 12:00	04/01/2020 21:32	9,52	1	9,52	CHI
20200119017	PONTALINA	PK32047343RE	VICENTINOPOLIS	04/01/2020 08:39	04/01/2020 19:07	04/01/2020 08:39	04/01/2020 19:07	10,47	32	335,13	CHI
20200119020	JATAI	290297643	JATAI S2	04/01/2020 12:02	04/01/2020 15:23	04/01/2020 12:02	04/01/2020 15:23	3,34	1	3,34	CHI
20200119025	VILA PROPICIO	PV21144561	GOIANESIA S1	04/01/2020 12:03	04/01/2020 15:54	04/01/2020 12:03	04/01/2020 15:54	3,84	1	3,84	CHI
20200119038	NOVO GAMA	NJ11376146	PACAEMBU S1	04/01/2020 12:07	04/01/2020 22:00	04/01/2020 12:07	04/01/2020 22:00	9,88	95	939,02	CHI
20200119039	NOVO BRASIL	NB12396223	JUSSARA	04/01/2020 08:44	04/01/2020 17:05	04/01/2020 08:44	04/01/2020 17:05	8,35	4	33,40	CHI
20200119041	POSSE	PS21256282	IACIARA S2	04/01/2020 12:07	04/01/2020 17:53	04/01/2020 12:07	04/01/2020 17:53	5,75	2	11,51	CHI
20200119042	RIO VERDE	630533015	RIO VERDE S2	04/01/2020 12:07	04/01/2020 16:06	04/01/2020 12:07	04/01/2020 16:06	3,97	1	3,97	CHI
20200119044	NIQUELANDIA	NQ12035673	NIQUELANDIA SUBTRANSMISSAO	04/01/2020 11:49	04/01/2020 22:16	04/01/2020 11:49	04/01/2020 15:07	3,31	300	992,83	CHI
20200119044	NIQUELANDIA	NQ12035673	NIQUELANDIA SUBTRANSMISSAO	04/01/2020 11:49	04/01/2020 22:16	04/01/2020 11:49	04/01/2020 22:16	10,46	114	1192,31	CHI
20200119045	CALDAS NOVAS	CN21324649	SERRA DE CALDAS	04/01/2020 12:09	05/01/2020 12:30	04/01/2020 12:09	05/01/2020 12:30	24,35	1	24,35	CHI
20200119051	APORE	AE12214485	ITAJA S1	04/01/2020 12:10	04/01/2020 15:52	04/01/2020 12:10	04/01/2020 15:52	3,69	5	18,47	CHI
20200119059	ALTO PARAISO DE GOIAS	BF12180928	SAO JOAO D ALIANCA	04/01/2020 12:12	04/01/2020 20:26	04/01/2020 12:12	04/01/2020 20:26	8,23	1	8,23	CHI
20200119059	ALTO PARAISO DE GOIAS	BF12180928	SAO JOAO D ALIANCA	04/01/2020 12:12	04/01/2020 20:26	04/01/2020 12:12	04/01/2020 20:26	8,23	1	8,23	CHI
20200119065	CACHOEIRA DOURADA	CD21134594	CACHOEIRA DOURADA	04/01/2020 12:13	04/01/2020 17:22	04/01/2020 12:13	04/01/2020 17:22	5,15	2	10,30	CHI
20200119069	SENADOR CANEDO	10001412351	CEPAIGO S2	04/01/2020 12:13	04/01/2020 16:46	04/01/2020 12:13	04/01/2020 16:46	4,54	1	4,54	CHI
20200119073	CAIAPONIA	CP12158231	CAIAPONIA	04/01/2020 11:02	04/01/2020 18:39	04/01/2020 11:02	04/01/2020 18:39	7,61	5	38,07	CHI
20200119074	AGUA FRIA DE GOIAS	JL12117446	SAO JOAO D ALIANCA	04/01/2020 12:14	04/01/2020 14:13	04/01/2020 12:14	04/01/2020 14:13	1,98	19	37,53	CHI
20200119074	SAO JOAO D ALIANCA	JL12117446	SAO JOAO D ALIANCA	04/01/2020 12:14	04/01/2020 14:13	04/01/2020 12:14	04/01/2020 14:13	1,98	25	49,38	CHI
20200119092	APARECIDA DE GOIANIA	200633624	ANHANGUERA	04/01/2020 12:19	04/01/2020 14:45	04/01/2020 12:19	04/01/2020 14:45	2,42	1	2,42	CHI
20200119093	QUIRINOPOLIS	QI32094315	QUIRINOPOLIS	04/01/2020 12:20	05/01/2020 20:34	04/01/2020 12:20	05/01/2020 20:34	32,23	2	64,45	CHI
20200119109	PIRACANJUBA	PJ12056105	PIRACANJUBA	04/01/2020 12:21	04/01/2020 18:02	04/01/2020 12:21	04/01/2020 18:02	5,68	2	11,37	CHI
20200119113	IPORA	AM12402911	IPORA	04/01/2020 12:13	04/01/2020 16:26	04/01/2020 12:13	04/01/2020 16:26	4,21	45	189,34	CHI
20200119117	APARECIDA DE GOIANIA	10005251425	INDEPENDENCIA S1	04/01/2020 12:23	04/01/2020 13:50	04/01/2020 12:23	04/01/2020 13:50	1,44	1	1,44	CHI
20200119128	SAO LUIS DE MONTES BELOS	SL32145964	SAO LUIZ DOS MONTES BELOS	04/01/2020 12:26	04/01/2020 13:40	04/01/2020 12:26	04/01/2020 13:40	1,22	36	43,84	CHI
20200119129	GOIANIA	GN11000994	CAMPINAS S1	04/01/2020 11:52	04/01/2020 16:13	04/01/2020 11:52	04/01/2020 16:13	4,35	102	443,64	CHI
20200119131	GOIANIA	13451613	CAMPINAS S1	04/01/2020 12:27	04/01/2020 15:04	04/01/2020 12:27	04/01/2020 15:04	2,61	1	2,61	CHI
20200119132	SAO JOAO D ALIANCA	10011623053	SAO JOAO D ALIANCA	04/01/2020 12:27	04/01/2020 15:20	04/01/2020 12:27	04/01/2020 15:20	2,88	1	2,88	CHI
20200119133	SILVANIA	SV21317634	VIANOPOLIS	04/01/2020 12:28	04/01/2020 15:27	04/01/2020 12:28	04/01/2020 15:27	2,98	2	5,97	CHI
20200119136	GOIANIA	GN11180059	GOYA S1	04/01/2020 12:28	04/01/2020 14:42	04/01/2020 14:27	04/01/2020 14:42	0,24	69	16,69	CHI
20200119139	PONTALINA	PK21284869	VICENTINOPOLIS	04/01/2020 12:29	04/01/2020 19:42	04/01/2020 12:29	04/01/2020 19:42	7,21	1	7,21	CHI
20200119140	URUACU	UR21000029	CAMPINORTE	04/01/2020 12:29	04/01/2020 14:42	04/01/2020 12:29	04/01/2020 14:42	2,21	1	2,21	CHI
20200119141	MUTUNOPOLIS	MU12391658	MARA ROSA	04/01/2020 11:23	04/01/2020 15:37	04/01/2020 11:23	04/01/2020 15:37	4,22	34	143,49	CHI



20200119142	GOIANIA	10003861579	CAMPINAS S2	04/01/2020 12:29	04/01/2020 18:27	04/01/2020 12:29	04/01/2020 18:27	5,96	1	5,96	CHI
20200119143	SILVANIA	SV21227660	DAIA S2	04/01/2020 12:29	05/01/2020 11:52	04/01/2020 12:29	05/01/2020 11:52	23,39	1	23,39	CHI
20200119147	NIQUELANDIA	NQ21147097	URUACU	04/01/2020 12:29	05/01/2020 10:00	04/01/2020 12:29	05/01/2020 10:00	21,51	1	21,51	CHI
20200119148	ITABERAI	50040029	ITABERAI S2	04/01/2020 12:30	04/01/2020 16:17	04/01/2020 12:30	04/01/2020 16:17	3,78	1	3,78	CHI
20200119150	NIQUELANDIA	NQ11256407	NIQUELANDIA SUBTRANSMISSAO	04/01/2020 12:15	04/01/2020 22:30	04/01/2020 12:15	04/01/2020 22:30	10,24	74	757,55	CHI
20200119155	SAO DOMINGOS	SD12389179	SAO DOMINGOS	04/01/2020 12:30	04/01/2020 17:48	04/01/2020 12:30	04/01/2020 17:48	5,29	10	52,91	CHI
20200119160	CRISTALINA	KR12261471	CRISTALINA S2	04/01/2020 12:30	04/01/2020 16:17	04/01/2020 12:30	04/01/2020 16:17	3,78	10	37,78	CHI
20200119161	NIQUELANDIA	2750073632	NIQUELANDIA SUBTRANSMISSAO	04/01/2020 12:31	05/01/2020 04:56	04/01/2020 12:31	05/01/2020 04:56	16,40	1	16,40	CHI
20200119162	FLORES DE GOIAS	02590204	ITUIQUIRA	04/01/2020 12:32	04/01/2020 19:59	04/01/2020 12:32	04/01/2020 16:20	3,80	3	11,40	CHI
20200119162	FORMOSA	02590204	ITUIQUIRA	04/01/2020 12:32	04/01/2020 19:59	04/01/2020 12:32	04/01/2020 16:20	3,80	259	984,13	CHI
20200119162	SAO JOAO D ALIANCA	02590204	ITUIQUIRA	04/01/2020 12:32	04/01/2020 19:59	04/01/2020 12:32	04/01/2020 16:20	3,80	224	851,14	CHI
20200119162	VILA BOA	02590204	ITUIQUIRA	04/01/2020 12:32	04/01/2020 19:59	04/01/2020 12:32	04/01/2020 16:20	3,80	3	11,40	CHI
20200119162	FORMOSA	02590204	ITUIQUIRA	04/01/2020 12:32	04/01/2020 19:59	04/01/2020 12:32	04/01/2020 16:36	4,08	317	1293,98	CHI
20200119162	VILA BOA	02590204	ITUIQUIRA	04/01/2020 12:32	04/01/2020 19:59	04/01/2020 12:32	04/01/2020 16:36	4,08	2	8,16	CHI
20200119162	VILA BOA	02590204	ITUIQUIRA	04/01/2020 12:32	04/01/2020 19:59	04/01/2020 12:32	04/01/2020 19:59	7,45	1	7,45	CHI
20200119166	ANAPOLIS	21007639	ANAPOLIS UNIVERSITARIO S2	04/01/2020 12:32	04/01/2020 16:33	04/01/2020 12:32	04/01/2020 16:33	4,01	1	4,01	CHI
20200119169	GOIANIA	GN12001014	GOYA S2	04/01/2020 12:33	04/01/2020 14:23	04/01/2020 12:33	04/01/2020 14:23	1,83	6	10,96	CHI
20200119171	ITUMBIARA	IT12310076	ITUMBIARA VELHA S1	04/01/2020 12:12	04/01/2020 23:24	04/01/2020 12:12	04/01/2020 23:24	11,21	104	1165,84	CHI
20200119172	PIRACANJUBA	PJ21375783	MORRINHOS	04/01/2020 12:33	05/01/2020 16:40	04/01/2020 12:33	05/01/2020 16:40	28,10	1	28,10	CHI
20200119177	SAO JOAO D ALIANCA	5950000102	SAO JOAO D ALIANCA	04/01/2020 12:34	04/01/2020 16:36	04/01/2020 12:34	04/01/2020 16:36	4,03	1	4,03	CHI
20200119179	JATAI	JT21150153	JATAI S2	04/01/2020 12:34	04/01/2020 16:05	04/01/2020 12:34	04/01/2020 16:05	3,50	2	7,01	CHI
20200119182	ITAPURANGA	IK21259655	ITAPURANGA	04/01/2020 12:35	04/01/2020 18:32	04/01/2020 12:35	04/01/2020 18:32	5,94	1	5,94	CHI
20200119184	GOIANESIA	GE12291463LD	GOIANESIA S2	04/01/2020 12:31	04/01/2020 14:42	04/01/2020 12:31	04/01/2020 14:42	2,18	363	791,14	CHI
20200119188	PIRACANJUBA	PJ12212163	PIRACANJUBA	04/01/2020 11:57	04/01/2020 19:23	04/01/2020 11:57	04/01/2020 19:23	7,43	32	237,71	CHI
20200119195	CRISTALINA	KR12168277	PAMPLONA	04/01/2020 12:38	04/01/2020 17:57	04/01/2020 12:38	04/01/2020 17:57	5,32	5	26,58	CHI
20200119200	FLORES DE GOIAS	FB21344397	FLORES DE GOIAS	04/01/2020 12:39	05/01/2020 09:49	04/01/2020 12:39	05/01/2020 09:49	21,15	1	21,15	CHI
20200119212	CAMPOS BELOS	820016639	SAO DOMINGOS	04/01/2020 12:41	04/01/2020 17:47	04/01/2020 12:41	04/01/2020 17:47	5,08	1	5,08	CHI
20200119214	GOIANIA	11777590	REAL S1	04/01/2020 12:42	04/01/2020 15:46	04/01/2020 12:42	04/01/2020 15:46	3,06	1	3,06	CHI
20200119216	ITUMBIARA	IT12305607	ITUMBIARA NOVA	04/01/2020 12:42	04/01/2020 19:06	04/01/2020 12:42	04/01/2020 19:06	6,39	13	83,05	CHI
20200119229	RIO VERDE	RV21240416	MONTIVIDIU T	04/01/2020 12:44	05/01/2020 08:29	04/01/2020 12:44	05/01/2020 08:29	19,74	1	19,74	CHI
20200119230	GOIANIA	10158182	FERROVIARIO S3	04/01/2020 12:44	04/01/2020 15:15	04/01/2020 12:44	04/01/2020 15:15	2,51	1	2,51	CHI
20200119231	CRISTALINA	KR12412112	CRISTALINA S2	04/01/2020 06:26	05/01/2020 08:19	04/01/2020 06:26	05/01/2020 08:19	25,87	23	594,95	CHI
20200119240	JARAGUA	JA21000192	JARAGUA	04/01/2020 12:45	04/01/2020 15:32	04/01/2020 12:45	04/01/2020 15:32	2,77	1	2,77	CHI

20200119243	POSSE	PS21225392	IACIARA S2	04/01/2020 12:47	04/01/2020 17:02	04/01/2020 12:47	04/01/2020 17:02	4,25	1	4,25	CHI
20200119246	TRINDADE	10009760995	GOYA S1	04/01/2020 12:47	04/01/2020 18:38	04/01/2020 12:47	04/01/2020 18:38	5,84	1	5,84	CHI
20200119247	CATALAO	CT21358262	CATALAO S1	04/01/2020 12:47	04/01/2020 22:45	04/01/2020 12:47	04/01/2020 22:45	9,96	1	9,96	CHI
20200119253	FORMOSA	610109870	ITUIQUIRA	04/01/2020 12:48	04/01/2020 15:22	04/01/2020 12:48	04/01/2020 15:22	2,56	1	2,56	CHI
20200119254	LUZIANIA	LZ12000149	MARAJOARA	04/01/2020 12:48	04/01/2020 16:07	04/01/2020 12:48	04/01/2020 16:07	3,30	7	23,11	CHI
20200119256	CACHOEIRA DOURADA	CD11166433	CACHOEIRA DOURADA	04/01/2020 12:40	04/01/2020 20:40	04/01/2020 12:40	04/01/2020 20:40	8,00	131	1047,60	CHI
20200119261	TURVANIA	TV21299143	FIRMINOPOLIS S1	04/01/2020 12:50	04/01/2020 14:23	04/01/2020 12:50	04/01/2020 14:23	1,55	1	1,55	CHI
20200119272	NIQUELANDIA	NQ12235651	NIQUELANDIA SUBTRANSMISSAO	04/01/2020 11:51	04/01/2020 16:21	04/01/2020 11:51	04/01/2020 16:21	4,49	48	215,39	CHI
20200119273	JANDAIA	JD21412812	ACREUNA	04/01/2020 12:55	04/01/2020 15:08	04/01/2020 12:55	04/01/2020 15:08	2,22	1	2,22	CHI
20200119274	RIO VERDE	10013599915	RIO VERDE S2	04/01/2020 12:55	04/01/2020 15:16	04/01/2020 12:55	04/01/2020 15:16	2,34	1	2,34	CHI
20200119279	ITUMBIARA	CD12222514	ITUMBIARA NOVA	04/01/2020 08:50	04/01/2020 21:32	04/01/2020 08:50	04/01/2020 21:32	12,69	7	88,80	CHI
20200119291	PILAR DE GOIAS	IW21201603	ITAPACI	04/01/2020 13:00	04/01/2020 21:22	04/01/2020 13:00	04/01/2020 21:22	8,36	1	8,36	CHI
20200119295	ARAGARCAS	AG11231066	ARAGARCAS	04/01/2020 13:01	04/01/2020 14:48	04/01/2020 13:01	04/01/2020 14:48	1,77	79	139,59	CHI
20200119296	ANAPOLIS	20421321	JUNDIAI S2	04/01/2020 13:02	04/01/2020 17:05	04/01/2020 13:02	04/01/2020 17:05	4,04	1	4,04	CHI
20200119298	CALDAS NOVAS	CN12392073	VILA CORUMBA	04/01/2020 13:02	04/01/2020 19:13	04/01/2020 13:02	04/01/2020 19:13	6,18	2	12,36	CHI
20200119299	APARECIDA DE GOIANIA	14960011	REAL S1	04/01/2020 13:03	04/01/2020 14:49	04/01/2020 13:03	04/01/2020 14:49	1,76	1	1,76	CHI
20200119303	AGUAS LINDAS DE GOIAS	LA11206578	AGUAS LINDAS DE GOIAS S1	04/01/2020 13:04	04/01/2020 14:26	04/01/2020 13:04	04/01/2020 14:26	1,36	13	17,70	CHI
20200119305	IPORA	IR12065090	IPORA	04/01/2020 12:56	04/01/2020 20:28	04/01/2020 12:56	04/01/2020 20:28	7,52	29	218,11	CHI
20200119306	AGUA LIMPA	AL21000254	VILA CORUMBA	04/01/2020 13:05	04/01/2020 14:41	04/01/2020 13:05	04/01/2020 14:41	1,59	1	1,59	CHI
20200119309	SAO JOAO DA PARAUNA	RP21032212	FIRMINOPOLIS S2	04/01/2020 13:07	04/01/2020 14:14	04/01/2020 13:07	04/01/2020 14:14	1,12	1	1,12	CHI
20200119310	ITUMBIARA	IT21403358	CACHOEIRA DOURADA	04/01/2020 13:07	05/01/2020 09:11	04/01/2020 13:07	05/01/2020 09:11	20,06	1	20,06	CHI
20200119311	HIDROLANDIA	HD21000202	CEPAIGO S2	04/01/2020 13:07	04/01/2020 17:37	04/01/2020 13:07	04/01/2020 17:37	4,49	1	4,49	CHI
20200119315	SAO LUIS DE MONTES BELOS	SL21151317	SAO LUIZ DOS MONTES BELOS	04/01/2020 13:08	04/01/2020 14:11	04/01/2020 13:08	04/01/2020 14:11	1,05	2	2,10	CHI
20200119318	TURVELANDIA	TD12325947	ACREUNA	04/01/2020 13:08	05/01/2020 10:31	04/01/2020 13:08	05/01/2020 10:31	21,38	2	42,76	CHI
20200119321	ABADIANIA	AA12258349LD	DAIA S2	04/01/2020 09:02	04/01/2020 15:57	04/01/2020 09:02	04/01/2020 15:57	6,91	9	62,23	CHI
20200119328	VALPARAISO DE GOIAS	2860151017	MARAJOARA	04/01/2020 13:11	04/01/2020 17:13	04/01/2020 13:11	04/01/2020 17:13	4,03	1	4,03	CHI
20200119329	IPAMERI	IP12017029	IPAMERI	04/01/2020 13:11	05/01/2020 08:38	04/01/2020 13:11	05/01/2020 08:38	19,44	11	213,83	CHI
20200119337	PLANALTINA	PI12383393	PLANALTINA	04/01/2020 12:12	04/01/2020 14:06	04/01/2020 12:12	04/01/2020 14:06	1,89	28	52,92	CHI
20200119338	PARAUNA	PU12194223	FIRMINOPOLIS S2	04/01/2020 13:13	05/01/2020 14:38	04/01/2020 13:13	05/01/2020 14:38	25,40	1	25,40	CHI
20200119342	JUSSARA	RN12078427	BRITANIA	04/01/2020 08:30	04/01/2020 21:02	04/01/2020 08:30	04/01/2020 21:02	12,53	3	37,59	CHI
20200119342	SANTA FE DE GOIAS	RN12078427	BRITANIA	04/01/2020 08:30	04/01/2020 21:02	04/01/2020 08:30	04/01/2020 21:02	12,53	2	25,06	CHI
20200119361	PIRACANJUBA	PJ21142466	PIRACANJUBA	04/01/2020 13:17	04/01/2020 17:14	04/01/2020 13:17	04/01/2020 17:14	3,94	1	3,94	CHI
20200119364	PLANALTINA	PI12100880	PLANALTINA	04/01/2020 12:51	04/01/2020 14:26	04/01/2020 12:51	04/01/2020 14:26	1,57	99	155,15	CHI

20200119365	ITAPACI	IW12251271	ITAPACI	04/01/2020 13:18	05/01/2020 01:10	04/01/2020 13:18	05/01/2020 01:10	11,85	3	35,56	CHI
20200119367	SANTA HELENA DE GOIAS	RV12322172	RIO VERDE S1	04/01/2020 13:19	04/01/2020 16:10	04/01/2020 13:19	04/01/2020 16:10	2,85	2	5,70	CHI
20200119372	BONFINOPOLIS	10002103778	CEPAIGO S2	04/01/2020 13:20	05/01/2020 11:20	04/01/2020 13:20	05/01/2020 11:20	21,99	1	21,99	CHI
20200119373	SANTA TEREZA DE GOIAS	SE12060934	PORANGATU	04/01/2020 13:20	05/01/2020 10:55	04/01/2020 13:20	05/01/2020 10:55	21,57	6	129,45	CHI
20200119378	SAO LUIS DE MONTES BELOS	10021462648	SAO LUIZ DOS MONTES BELOS	04/01/2020 13:21	04/01/2020 19:50	04/01/2020 13:21	04/01/2020 19:50	6,47	1	6,47	CHI
20200119385	RUBIATABA	780057703	RUBIATABA	04/01/2020 13:22	05/01/2020 01:22	04/01/2020 13:22	05/01/2020 01:22	12,00	1	12,00	CHI
20200119388	SANCLERLANDIA	6856435	SAO LUIZ DOS MONTES BELOS	04/01/2020 13:23	04/01/2020 15:48	04/01/2020 13:23	04/01/2020 15:48	2,41	2	4,82	CHI
20200119391	CIDADE OCIDENTAL	10010946592	MARAJOARA	04/01/2020 13:24	04/01/2020 19:06	04/01/2020 13:24	04/01/2020 19:06	5,69	1	5,69	CHI
20200119392	CRIXAS	CX12297041	SERRA DO OURO	04/01/2020 13:24	05/01/2020 15:28	04/01/2020 13:24	05/01/2020 15:28	26,06	1	26,06	CHI
20200119396	PARAUNA	PU12194221	ACREUNA	04/01/2020 12:12	05/01/2020 19:17	04/01/2020 17:57	04/01/2020 18:40	0,70	28	19,68	CHI
20200119396	PARAUNA	PU12301178	ACREUNA	04/01/2020 12:12	05/01/2020 19:17	04/01/2020 12:12	05/01/2020 19:17	31,07	9	279,64	CHI
20200119399	CRISTALINA	KR12165873	CRISTALINA S2	04/01/2020 13:26	05/01/2020 11:51	04/01/2020 13:26	05/01/2020 11:51	22,41	19	425,76	CHI
20200119408	ABADIANIA	AA12335610	ANAPOLIS UNIVERSITARIO S1	04/01/2020 13:03	04/01/2020 15:02	04/01/2020 13:03	04/01/2020 15:02	1,97	9	17,76	CHI
20200119410	ARAGOIANIA	AO21027549	GUAPO S2	04/01/2020 13:29	04/01/2020 16:57	04/01/2020 13:29	04/01/2020 16:57	3,46	1	3,46	CHI
20200119413	BELA VISTA DE GOIAS	BV12075694	BELA VISTA S1	04/01/2020 13:30	04/01/2020 17:20	04/01/2020 13:30	04/01/2020 17:20	3,83	11	42,13	CHI
20200119418	ANAPOLIS	21216149	JUNDIAI S2	04/01/2020 13:31	04/01/2020 14:49	04/01/2020 13:31	04/01/2020 14:49	1,29	1	1,29	CHI
20200119419	PIRACANJUBA	PJ21019737	PIRACANJUBA	04/01/2020 13:31	04/01/2020 16:25	04/01/2020 13:31	04/01/2020 16:25	2,89	2	5,77	CHI
20200119424	FORMOSA	FA11257808	ITUIQUIRA	04/01/2020 13:32	04/01/2020 14:19	04/01/2020 13:32	04/01/2020 14:19	0,78	5	3,88	CHI
20200119430	CATALAO	1990118735	CATALAO S2	04/01/2020 13:33	04/01/2020 20:32	04/01/2020 13:33	04/01/2020 20:32	6,97	1	6,97	CHI
20200119435	PIRANHAS	PH12241286	PIRANHAS	04/01/2020 11:01	05/01/2020 07:39	04/01/2020 11:01	05/01/2020 07:39	20,63	4	82,51	CHI
20200119440	SILVANIA	10016928405	VIANOPOLIS	04/01/2020 13:35	04/01/2020 15:22	04/01/2020 13:35	04/01/2020 15:22	1,78	1	1,78	CHI
20200119441	BONFINOPOLIS	BO12200291	CEPAIGO S2	04/01/2020 13:36	04/01/2020 17:43	04/01/2020 13:36	04/01/2020 17:43	4,12	6	24,69	CHI
20200119444	PLANALTINA	PI11361426	PLANALTINA	04/01/2020 13:16	04/01/2020 16:46	04/01/2020 13:16	04/01/2020 16:46	3,50	179	626,00	CHI
20200119448	COCALZINHO DE GOIAS	10007369741	AGUAS LINDAS DE GOIAS S2	04/01/2020 13:38	04/01/2020 17:11	04/01/2020 13:38	04/01/2020 17:11	3,54	1	3,54	CHI
20200119452	ANAPOLIS	AN21302393	ANAPOLIS UNIVERSITARIO S1	04/01/2020 13:39	04/01/2020 16:30	04/01/2020 13:39	04/01/2020 16:30	2,85	1	2,85	CHI
20200119456	JARAGUA	JA21278912	JARAGUA	04/01/2020 13:39	04/01/2020 19:36	04/01/2020 13:39	04/01/2020 19:36	5,94	1	5,94	CHI
20200119459	ITAPURANGA	IK16408577	ITAPURANGA	04/01/2020 13:39	05/01/2020 00:27	04/01/2020 13:39	05/01/2020 00:27	10,80	231	2494,86	CHI
20200119459	GUARAITA	IK16408577	ITAPURANGA	04/01/2020 13:39	05/01/2020 00:27	05/01/2020 00:20	05/01/2020 00:27	0,12	7	0,86	CHI
20200119459	ITAPURANGA	IK16408577	ITAPURANGA	04/01/2020 13:39	05/01/2020 00:27	05/01/2020 00:20	05/01/2020 00:27	0,12	1532	187,67	CHI
20200119463	ARAGOIANIA	AO21031751	GUAPO S2	04/01/2020 13:40	04/01/2020 20:46	04/01/2020 13:40	04/01/2020 20:46	7,09	1	7,09	CHI
20200119465	LAGOA SANTA	IJ13110420	CACHOEIRA ALTA	04/01/2020 13:41	05/01/2020 14:41	05/01/2020 08:35	05/01/2020 09:33	0,97	22	21,27	CHI
20200119465	LAGOA SANTA	IJ13112761	CACHOEIRA ALTA	04/01/2020 13:41	05/01/2020 14:41	05/01/2020 10:23	05/01/2020 14:41	4,30	43	184,94	CHI
20200119472	ANAPOLIS	10009745775	ANAPOLIS UNIVERSITARIO S2	04/01/2020 13:43	04/01/2020 19:00	04/01/2020 13:43	04/01/2020 19:00	5,27	1	5,27	CHI

20200119474	INDIARA	JD12005508	PALMEIRAS	04/01/2020 13:39	04/01/2020 17:12	04/01/2020 13:39	04/01/2020 17:12	3,55	28	99,35	CHI
20200119474	JANDAIA	JD12005508	PALMEIRAS	04/01/2020 13:39	04/01/2020 17:12	04/01/2020 13:39	04/01/2020 17:12	3,55	7	24,84	CHI
20200119475	ITUMBIARA	IT11000155	PARANAIBA	04/01/2020 12:56	04/01/2020 16:26	04/01/2020 12:56	04/01/2020 16:26	3,49	74	258,01	CHI
20200119479	FORMOSA	FA11279194	ITUIQUIRA	04/01/2020 13:44	04/01/2020 14:46	04/01/2020 13:44	04/01/2020 14:46	1,02	70	71,26	CHI
20200119485	CUMARI	CY21149246	CATALAO S1	04/01/2020 13:46	05/01/2020 10:05	04/01/2020 13:46	05/01/2020 10:05	20,31	1	20,31	CHI
20200119491	VILA PROPICIO	PV12115143	GOIANESIA S1	04/01/2020 13:47	04/01/2020 16:43	04/01/2020 13:47	04/01/2020 16:43	2,93	4	11,71	CHI
20200119493	CORREGO DO OURO	CO12028902	SAO LUIZ DOS MONTES BELOS	04/01/2020 13:47	04/01/2020 15:52	04/01/2020 13:47	04/01/2020 15:52	2,07	54	112,02	CHI
20200119502	PALMEIRAS DE GOIAS	PL12398710	PALMEIRAS	04/01/2020 13:48	04/01/2020 17:06	04/01/2020 13:48	04/01/2020 17:06	3,31	22	72,73	CHI
20200119515	FAZENDA NOVA	FN12383508	FIRMINOPOLIS S2	04/01/2020 13:50	05/01/2020 07:18	04/01/2020 13:50	05/01/2020 07:18	17,46	3	52,37	CHI
20200119516	COLINAS DO SUL	TI12135666	NIQUELANDIA SUBTRANSMISSAO	04/01/2020 11:21	04/01/2020 14:58	04/01/2020 11:21	04/01/2020 14:58	3,62	33	119,32	CHI
20200119517	CAMPINACU	UC21393187	PORANGATU	04/01/2020 13:50	04/01/2020 16:20	04/01/2020 13:50	04/01/2020 16:20	2,48	1	2,48	CHI
20200119522	INDIARA	IY12194007	EDEIA	04/01/2020 13:52	04/01/2020 16:51	04/01/2020 13:52	04/01/2020 16:51	2,99	5	14,97	CHI
20200119523	AGUA FRIA DE GOIAS	PI12325588	SAO JOAO D ALIANCA	04/01/2020 13:52	05/01/2020 10:20	04/01/2020 13:52	04/01/2020 19:56	6,07	1	6,07	CHI
20200119523	PLANALTINA	PI12325588	SAO JOAO D ALIANCA	04/01/2020 13:52	05/01/2020 10:20	04/01/2020 13:52	04/01/2020 19:56	6,07	53	321,72	CHI
20200119523	PLANALTINA	PI13361361	SAO JOAO D ALIANCA	04/01/2020 13:52	05/01/2020 10:20	04/01/2020 13:52	05/01/2020 10:20	20,48	50	1023,83	CHI
20200119527	JANDAIA	JD12008614	PALMEIRAS	04/01/2020 13:34	04/01/2020 16:43	04/01/2020 13:34	04/01/2020 16:43	3,14	22	69,03	CHI
20200119527	PARAUNA	JD12008614	PALMEIRAS	04/01/2020 13:34	04/01/2020 16:43	04/01/2020 13:34	04/01/2020 16:43	3,14	6	18,83	CHI
20200119531	SAO MIGUEL DO PASSA QUATRO	SQ12111663	CRISTIANOPOLIS	04/01/2020 13:53	04/01/2020 16:34	04/01/2020 13:53	04/01/2020 16:34	2,68	14	37,48	CHI
20200119535	CATALAO	CT12077605	CATALAO S1	04/01/2020 09:14	04/01/2020 20:47	04/01/2020 09:14	04/01/2020 20:47	11,54	9	103,90	CHI
20200119538	GOIATUBA	GT12048500	GOIATUBA S2	04/01/2020 13:54	04/01/2020 19:34	04/01/2020 13:54	04/01/2020 19:34	5,67	7	39,67	CHI
20200119545	CACU	CC12260993	CACHOEIRA ALTA	04/01/2020 13:10	04/01/2020 21:59	04/01/2020 13:10	04/01/2020 21:59	8,82	7	61,71	CHI
20200119547	CRISTALINA	KR21133578	CRISTALINA S2	04/01/2020 13:55	04/01/2020 16:30	04/01/2020 13:55	04/01/2020 16:30	2,57	1	2,57	CHI
20200119554	PIRENOPOLIS	PV21000057	CORUMBA	04/01/2020 13:57	04/01/2020 20:00	04/01/2020 13:57	04/01/2020 20:00	6,04	2	12,08	CHI
20200119557	INDIARA	JD12005507	PALMEIRAS	04/01/2020 13:35	04/01/2020 17:34	04/01/2020 13:35	04/01/2020 17:34	3,98	96	382,05	CHI
20200119557	JANDAIA	JD12005507	PALMEIRAS	04/01/2020 13:35	04/01/2020 17:34	04/01/2020 13:35	04/01/2020 17:34	3,98	32	127,35	CHI
20200119557	PALMEIRAS DE GOIAS	JD12005507	PALMEIRAS	04/01/2020 13:35	04/01/2020 17:34	04/01/2020 13:35	04/01/2020 17:34	3,98	38	151,23	CHI
20200119561	GOIANIA	15444077	FERROVIARIO S1	04/01/2020 13:57	04/01/2020 15:50	04/01/2020 13:57	04/01/2020 15:50	1,87	1	1,87	CHI
20200119572	PILAR DE GOIAS	GG21131420	SANTA TEREZINHA	04/01/2020 13:59	05/01/2020 11:50	04/01/2020 13:59	05/01/2020 11:50	21,84	1	21,84	CHI
20200119574	ARAGOIANIA	AO31097615	GUAPO S2	04/01/2020 14:00	05/01/2020 08:33	04/01/2020 14:00	05/01/2020 08:33	18,55	1	18,55	CHI
20200119586	AGUAS LINDAS DE GOIAS	LA12044225	AGUAS LINDAS DE GOIAS S2	04/01/2020 14:02	04/01/2020 17:15	04/01/2020 14:02	04/01/2020 17:15	3,21	63	202,49	CHI
20200119588	GOIANESIA	550058746	GOIANESIA S2	04/01/2020 14:02	04/01/2020 20:57	04/01/2020 14:02	04/01/2020 20:57	6,91	1	6,91	CHI
20200119608	JATAI	JT12209819	JATAI S1	04/01/2020 14:02	04/01/2020 16:57	04/01/2020 14:02	04/01/2020 16:57	2,91	10	29,08	CHI
20200119610	CRISTIANOPOLIS	CF21107196	CRISTIANOPOLIS	04/01/2020 14:05	04/01/2020 14:49	04/01/2020 14:05	04/01/2020 14:49	0,73	1	0,73	CHI

20200119615	TRINDADE	TR13403525	TRINDADE	04/01/2020 11:01	04/01/2020 15:49	04/01/2020 11:01	04/01/2020 15:49	4,80	500	2399,03	CHI
20200119617	IPAMERI	IP12275536	CAMPO ALEGRE DE GOIAS	04/01/2020 10:57	04/01/2020 18:01	04/01/2020 10:57	04/01/2020 18:01	7,06	6	42,38	CHI
20200119620	CAMPINORTE	CR21321001	MARA ROSA	04/01/2020 14:06	05/01/2020 15:48	04/01/2020 14:06	05/01/2020 15:48	25,69	1	25,69	CHI
20200119622	VIANOPOLIS	VN12072139	VIANOPOLIS	04/01/2020 13:53	04/01/2020 22:32	04/01/2020 13:53	04/01/2020 22:32	8,64	11	95,00	CHI
20200119627	NIQUELANDIA	10000391113	NIQUELANDIA SUBTRANSMISSAO	04/01/2020 14:08	05/01/2020 03:53	04/01/2020 14:08	05/01/2020 03:53	13,75	1	13,75	CHI
20200119631	RIO VERDE	RV12153892	RIO VERDE S2	04/01/2020 14:04	04/01/2020 15:20	04/01/2020 14:04	04/01/2020 15:20	1,25	9	11,27	CHI
20200119632	FORMOSA	FA12376643	ITIQUEIRA	04/01/2020 13:30	04/01/2020 18:22	04/01/2020 13:30	04/01/2020 18:22	4,86	100	485,92	CHI
20200119636	ARAGOIANIA	AO21362871	GUAPO S2	04/01/2020 14:08	05/01/2020 09:06	04/01/2020 14:08	05/01/2020 09:06	18,96	2	37,91	CHI
20200119637	ITAPACI	IW11120478	ITAPACI	04/01/2020 13:00	04/01/2020 19:10	04/01/2020 13:00	04/01/2020 19:10	6,16	121	745,33	CHI
20200119642	BONOPOLIS	PO12090602	MARA ROSA	04/01/2020 12:28	05/01/2020 02:09	04/01/2020 12:28	05/01/2020 02:09	13,68	2	27,36	CHI
20200119642	PORANGATU	PO12090602	MARA ROSA	04/01/2020 12:28	05/01/2020 02:09	04/01/2020 12:28	05/01/2020 02:09	13,68	66	902,79	CHI
20200119645	CRISTALINA	KR12400531	CRISTALINA S1	04/01/2020 14:10	05/01/2020 14:01	04/01/2020 14:10	05/01/2020 11:54	21,74	51	1108,98	CHI
20200119645	CRISTALINA	KR12183809LD	CRISTALINA S1	04/01/2020 14:10	05/01/2020 14:01	04/01/2020 14:10	05/01/2020 14:01	23,85	28	667,84	CHI
20200119650	FAINA	FC12199793	GOIAS	04/01/2020 14:10	04/01/2020 19:21	04/01/2020 14:10	04/01/2020 19:21	5,17	17	87,88	CHI
20200119651	APARECIDA DE GOIANIA	200082577	INDEPENDENCIA S1	04/01/2020 14:11	04/01/2020 15:49	04/01/2020 14:11	04/01/2020 15:49	1,63	1	1,63	CHI
20200119652	SANTA TEREZINHA DE GOIAS	SG12371040	SANTA TEREZINHA	04/01/2020 14:11	04/01/2020 20:46	04/01/2020 14:11	04/01/2020 20:46	6,58	2	13,16	CHI
20200119654	PORANGATU	PO21115460	PORANGATU	04/01/2020 14:11	04/01/2020 18:16	04/01/2020 14:11	04/01/2020 18:16	4,08	1	4,08	CHI
20200119660	JANDAIA	JD12005438	PALMEIRAS	04/01/2020 14:11	05/01/2020 07:23	04/01/2020 14:11	05/01/2020 07:23	17,19	55	945,56	CHI
20200119660	PALMEIRAS DE GOIAS	JD12005438	PALMEIRAS	04/01/2020 14:11	05/01/2020 07:23	04/01/2020 14:11	05/01/2020 07:23	17,19	8	137,54	CHI
20200119660	PALMINOPOLIS	JD12005438	PALMEIRAS	04/01/2020 14:11	05/01/2020 07:23	04/01/2020 14:11	05/01/2020 07:23	17,19	14	240,69	CHI
20200119661	BELA VISTA DE GOIAS	BV21324930	CEPAIGO S2	04/01/2020 14:12	04/01/2020 18:13	04/01/2020 14:12	04/01/2020 18:13	4,02	2	8,03	CHI
20200119662	FORMOSA	FA12051134	ITIQUEIRA	04/01/2020 14:12	05/01/2020 08:10	04/01/2020 14:12	05/01/2020 08:10	17,96	22	395,09	CHI
20200119665	SILVANIA	SV21056826	VIANOPOLIS	04/01/2020 14:12	04/01/2020 16:37	04/01/2020 14:12	04/01/2020 16:37	2,41	1	2,41	CHI
20200119669	ALVORADA DO NORTE	AQ21068782	FLORES DE GOIAS	04/01/2020 14:13	05/01/2020 12:20	04/01/2020 14:13	05/01/2020 12:20	22,12	1	22,12	CHI
20200119671	CUMARI	CT21152871	CATALAO S2	04/01/2020 14:13	05/01/2020 07:50	04/01/2020 14:13	05/01/2020 07:50	17,61	1	17,61	CHI
20200119673	CRISTALINA	KR21345956	CRISTALINA S2	04/01/2020 14:13	05/01/2020 10:35	04/01/2020 14:13	05/01/2020 10:35	20,36	1	20,36	CHI
20200119676	CAIAPONIA	CP12380880	CAIAPONIA	04/01/2020 13:19	04/01/2020 17:19	04/01/2020 13:19	04/01/2020 17:19	3,99	10	39,92	CHI
20200119679	ITUMBIARA	IT11000096	ITUMBIARA NOVA	04/01/2020 14:10	04/01/2020 15:15	04/01/2020 14:10	04/01/2020 15:15	1,08	149	160,80	CHI
20200119680	NIQUELANDIA	NQ12375620	URUACU	04/01/2020 14:03	06/01/2020 00:12	04/01/2020 14:03	06/01/2020 00:12	34,16	3	102,47	CHI
20200119686	POSSE	PS12164555	IACIARA S2	04/01/2020 13:55	04/01/2020 15:26	04/01/2020 13:55	04/01/2020 15:26	1,50	85	127,62	CHI
20200119687	PADRE BERNARDO	PI12099216LD	PLANALTINA	04/01/2020 14:14	04/01/2020 16:02	04/01/2020 14:14	04/01/2020 16:02	1,79	16	28,64	CHI
20200119687	PLANALTINA	PI12099216LD	PLANALTINA	04/01/2020 14:14	04/01/2020 16:02	04/01/2020 14:14	04/01/2020 16:02	1,79	157	281,03	CHI
20200119692	CORUMBA DE GOIAS	CB21094722	ALEXANIA	04/01/2020 14:14	05/01/2020 22:12	04/01/2020 14:14	05/01/2020 22:12	31,95	2	63,90	CHI

20200119699	SIMOLANDIA	SA12180855	IACIARA S2	04/01/2020 14:13	04/01/2020 16:28	04/01/2020 14:13	04/01/2020 16:28	2,23	230	513,73	CHI
20200119707	HIDROLINA	HL12292474	URUACU	04/01/2020 11:14	05/01/2020 08:17	04/01/2020 11:14	05/01/2020 08:17	21,04	7	147,30	CHI
20200119711	CRIXAS	CX12380748	SERRA DO OURO	04/01/2020 12:12	04/01/2020 20:13	04/01/2020 12:12	04/01/2020 20:13	8,01	25	200,22	CHI
20200119720	GOIANIA	GN21197193	GOIANIA LESTE S2	04/01/2020 14:18	04/01/2020 18:52	04/01/2020 14:18	04/01/2020 18:52	4,56	1	4,56	CHI
20200119722	VILA PROPICIO	GE12243252	GOIANESIA S1	04/01/2020 13:59	04/01/2020 19:53	04/01/2020 13:59	04/01/2020 19:53	5,89	11	64,80	CHI
20200119727	ALEXANIA	AX12374685	CORUMBA	04/01/2020 14:19	04/01/2020 17:11	04/01/2020 14:19	04/01/2020 17:11	2,86	36	102,84	CHI
20200119728	FORMOSA	FA21257564	ITIQUEIRA	04/01/2020 14:20	04/01/2020 19:06	04/01/2020 14:20	04/01/2020 19:06	4,75	1	4,75	CHI
20200119731	TRINDADE	TR21207362	GOIANIRA	04/01/2020 14:21	04/01/2020 17:15	04/01/2020 14:21	04/01/2020 17:15	2,90	1	2,90	CHI
20200119734	HIDROLANDIA	HD12389450	INDEPENDENCIA S1	04/01/2020 14:22	04/01/2020 17:09	04/01/2020 14:22	04/01/2020 17:09	2,77	7	19,42	CHI
20200119735	CAMPO ALEGRE DE GOIAS	CM12077401	CAMPO ALEGRE DE GOIAS	04/01/2020 14:22	05/01/2020 09:00	04/01/2020 14:22	05/01/2020 09:00	18,62	2	37,25	CHI
20200119735	CATALAO	CM12077401	CAMPO ALEGRE DE GOIAS	04/01/2020 14:22	05/01/2020 09:00	04/01/2020 14:22	05/01/2020 09:00	18,62	1	18,62	CHI
20200119736	CATALAO	10017005513	CATALAO S2	04/01/2020 14:22	04/01/2020 19:01	04/01/2020 14:22	04/01/2020 19:01	4,64	1	4,64	CHI
20200119739	GOIANIA	13024681	ATLANTICO S1	04/01/2020 14:22	04/01/2020 16:44	04/01/2020 14:22	04/01/2020 16:44	2,35	1	2,35	CHI
20200119740	MORRINHOS	VN12060828	VIANOPOLIS	04/01/2020 13:27	05/01/2020 09:22	04/01/2020 13:27	05/01/2020 09:22	19,91	1	19,91	CHI
20200119740	ORIZONA	VN12060828	VIANOPOLIS	04/01/2020 13:27	05/01/2020 09:22	04/01/2020 13:27	05/01/2020 09:22	19,91	51	1015,17	CHI
20200119740	SILVANIA	VN12060828	VIANOPOLIS	04/01/2020 13:27	05/01/2020 09:22	04/01/2020 13:27	05/01/2020 09:22	19,91	5	99,53	CHI
20200119740	VIANOPOLIS	VN12060828	VIANOPOLIS	04/01/2020 13:27	05/01/2020 09:22	04/01/2020 13:27	05/01/2020 09:22	19,91	20	398,11	CHI
20200119745	IPAMERI	IP21321679	IPAMERI	04/01/2020 14:23	05/01/2020 07:39	04/01/2020 14:23	05/01/2020 07:39	17,25	1	17,25	CHI
20200119747	MORRINHOS	MR21158097	MORRINHOS	04/01/2020 14:24	05/01/2020 08:27	04/01/2020 14:24	05/01/2020 08:27	18,05	2	36,09	CHI
20200119753	GOIAS	GS11259637	MATRINCHA	04/01/2020 12:43	04/01/2020 23:33	04/01/2020 12:43	04/01/2020 23:33	10,83	84	910,02	CHI
20200119754	IPAMERI	IP21133652	CRISTALINA S2	04/01/2020 14:25	05/01/2020 11:30	04/01/2020 14:25	05/01/2020 11:30	21,08	1	21,08	CHI
20200119756	ARAGOIANIA	10005534680	GUAPO S2	04/01/2020 14:25	04/01/2020 16:33	04/01/2020 14:25	04/01/2020 16:33	2,12	1	2,12	CHI
20200119762	TRINDADE	TR21063627	GOIANIRA	04/01/2020 14:27	04/01/2020 18:08	04/01/2020 14:27	04/01/2020 18:08	3,69	2	7,37	CHI
20200119763	DAMIANOPOLIS	DA11195993	IACIARA S2	04/01/2020 13:38	04/01/2020 17:13	04/01/2020 13:38	04/01/2020 17:13	3,58	72	257,48	CHI
20200119764	GOIANIA	13993847	CARAJAS S1	04/01/2020 14:27	04/01/2020 16:43	04/01/2020 14:27	04/01/2020 16:43	2,26	1	2,26	CHI
20200119765	GOIANIA	GN11041972	FERROVIARIO S1	04/01/2020 13:51	04/01/2020 17:34	04/01/2020 13:51	04/01/2020 17:34	3,70	121	448,27	CHI
20200119767	PIRES DO RIO	PR21051300	PIRES DO RIO S1	04/01/2020 14:27	04/01/2020 15:10	04/01/2020 14:27	04/01/2020 15:10	0,70	1	0,70	CHI
20200119769	APORE	AE12168305	ITAJA S1	04/01/2020 14:28	04/01/2020 17:37	04/01/2020 14:28	04/01/2020 17:37	3,15	2	6,30	CHI
20200119773	PEROLANDIA	DP12260360	JATAI S1	04/01/2020 14:28	04/01/2020 20:50	04/01/2020 14:28	04/01/2020 20:50	6,36	2	12,71	CHI
20200119780	URUACU	UR12136315	CAMPINORTE	04/01/2020 14:29	04/01/2020 19:41	04/01/2020 14:29	04/01/2020 19:41	5,18	3	15,55	CHI
20200119784	ORIZONA	OZ21280181	PIRES DO RIO S2	04/01/2020 06:32	04/01/2020 20:29	04/01/2020 06:32	04/01/2020 20:29	13,95	1	13,95	CHI
20200119786	GOIANIA	15657607	GOYA S2	04/01/2020 14:31	04/01/2020 18:39	04/01/2020 14:31	04/01/2020 18:39	4,13	1	4,13	CHI
20200119797	CACHOEIRA ALTA	CA12209792	CACHOEIRA ALTA	04/01/2020 14:14	04/01/2020 19:10	04/01/2020 14:14	04/01/2020 19:10	4,93	6	29,58	CHI

20200119802	ANAPOLIS	AN12270323	ANAPOLIS UNIVERSITARIO S2	04/01/2020 14:22	04/01/2020 17:25	04/01/2020 14:22	04/01/2020 17:25	3,04	7	21,27	CHI
20200119802	PIRENOPOLIS	AN12270323	ANAPOLIS UNIVERSITARIO S2	04/01/2020 14:22	04/01/2020 17:25	04/01/2020 14:22	04/01/2020 17:25	3,04	41	124,61	CHI
20200119806	CRIXAS	2490029004	SERRA DO OURO	04/01/2020 14:34	04/01/2020 21:32	04/01/2020 14:34	04/01/2020 21:32	6,96	1	6,96	CHI
20200119810	ANAPOLIS	AN12259031	ANAPOLIS UNIVERSITARIO S2	04/01/2020 14:32	04/01/2020 19:13	04/01/2020 14:32	04/01/2020 19:13	4,68	11	51,46	CHI
20200119818	CAMPO ALEGRE DE GOIAS	CM21294594	CAMPO ALEGRE DE GOIAS	04/01/2020 14:35	04/01/2020 20:26	04/01/2020 14:35	04/01/2020 20:26	5,84	1	5,84	CHI
20200119821	HIDROLANDIA	HD31186089	INDEPENDENCIA S1	04/01/2020 14:36	04/01/2020 20:01	04/01/2020 14:36	04/01/2020 20:01	5,41	2	10,83	CHI
20200119824	ANICUNS	910006921	ANICUNS	04/01/2020 14:36	04/01/2020 16:49	04/01/2020 14:36	04/01/2020 16:49	2,21	1	2,21	CHI
20200119826	ANAPOLIS	AN12258710	JUNDIAI S1	04/01/2020 14:27	04/01/2020 17:53	04/01/2020 14:27	04/01/2020 17:53	3,42	3	10,25	CHI
20200119826	LEOPOLDO DE BULHOES	AN12258710	JUNDIAI S1	04/01/2020 14:27	04/01/2020 17:53	04/01/2020 14:27	04/01/2020 17:53	3,42	3	10,25	CHI
20200119828	ALTO PARAISO DE GOIAS	BF21403427	NIQUELANDIA SUBTRANSMISSAO	04/01/2020 14:37	04/01/2020 17:46	04/01/2020 14:37	04/01/2020 17:46	3,14	1	3,14	CHI
20200119835	ITABERAI	IB12206926	ITABERAI S2	04/01/2020 14:38	04/01/2020 16:44	04/01/2020 14:38	04/01/2020 16:44	2,10	21	44,04	CHI
20200119837	COCALZINHO DE GOIAS	ZN21114959	COCALZINHO	04/01/2020 14:38	04/01/2020 18:31	04/01/2020 14:38	04/01/2020 18:31	3,88	1	3,88	CHI
20200119840	ALEXANIA	AX12000154	CORUMBA	04/01/2020 14:14	04/01/2020 19:03	04/01/2020 14:14	04/01/2020 19:03	4,81	22	105,84	CHI
20200119840	CORUMBA DE GOIAS	AX12000154	CORUMBA	04/01/2020 14:14	04/01/2020 19:03	04/01/2020 14:14	04/01/2020 19:03	4,81	4	19,24	CHI
20200119843	GOIANIA	15797594	CAMPINAS S1	04/01/2020 14:38	04/01/2020 16:01	04/01/2020 14:38	04/01/2020 16:01	1,37	1	1,37	CHI
20200119845	CACU	CC12125875	CACHOEIRA ALTA	04/01/2020 06:38	06/01/2020 04:48	04/01/2020 06:38	06/01/2020 04:48	46,15	2	92,31	CHI
20200119851	SAO LUIS DE MONTES BELOS	SL12206347	FIRMINOPOLIS S2	04/01/2020 14:40	04/01/2020 16:47	04/01/2020 14:40	04/01/2020 16:47	2,11	1	2,11	CHI
20200119852	AGUAS LINDAS DE GOIAS	4830195588	AGUAS LINDAS DE GOIAS S1	04/01/2020 14:40	04/01/2020 17:00	04/01/2020 14:40	04/01/2020 17:00	2,33	1	2,33	CHI
20200119857	MONTIVIDIU DO NORTE	MX11139248	PORANGATU	04/01/2020 14:33	04/01/2020 17:32	04/01/2020 14:33	04/01/2020 17:32	2,97	156	464,01	CHI
20200119858	MORRINHOS	10008554852	MORRINHOS	04/01/2020 14:40	04/01/2020 16:26	04/01/2020 14:40	04/01/2020 16:26	1,76	1	1,76	CHI
20200119859	PIRANHAS	1930021905	PIRANHAS	04/01/2020 14:41	05/01/2020 14:56	04/01/2020 14:41	05/01/2020 14:56	24,25	1	24,25	CHI
20200119864	FAINA	FC12281058	GOIAS	04/01/2020 14:42	04/01/2020 20:21	04/01/2020 14:42	04/01/2020 20:21	5,64	5	28,22	CHI
20200119870	AGUAS LINDAS DE GOIAS	4830165500	AGUAS LINDAS DE GOIAS S2	04/01/2020 14:43	04/01/2020 15:52	04/01/2020 14:43	04/01/2020 15:52	1,16	1	1,16	CHI
20200119872	CACU	CC11153989	CACHOEIRA ALTA	04/01/2020 08:12	05/01/2020 02:31	04/01/2020 08:12	05/01/2020 02:31	18,32	17	311,40	CHI
20200119874	CRISTALINA	KR21211936	CRISTALINA S2	04/01/2020 14:43	05/01/2020 13:02	04/01/2020 14:43	05/01/2020 13:02	22,30	1	22,30	CHI
20200119877	PALMEIRAS DE GOIAS	PL32051821	PALMEIRAS	04/01/2020 14:44	05/01/2020 03:14	04/01/2020 14:44	05/01/2020 03:14	12,50	2	25,00	CHI
20200119885	GOIANIA	GN12036683	GOYA S2	04/01/2020 14:44	04/01/2020 15:50	04/01/2020 14:44	04/01/2020 15:50	1,08	46	49,91	CHI
20200119888	CALDAS NOVAS	CN21081171	VILA CORUMBA	04/01/2020 14:45	04/01/2020 19:36	04/01/2020 14:45	04/01/2020 19:36	4,84	1	4,84	CHI
20200119891	CRISTALINA	KR12320036	CRISTALINA S2	04/01/2020 11:05	04/01/2020 19:11	04/01/2020 11:05	04/01/2020 19:11	8,10	11	89,08	CHI
20200119901	JARAGUA	JA11339469	JARAGUA	04/01/2020 14:47	05/01/2020 14:20	04/01/2020 14:47	05/01/2020 14:20	23,55	20	470,97	CHI
20200119902	PEROLANDIA	DP11254580	JATAI S1	04/01/2020 14:48	04/01/2020 23:59	04/01/2020 14:48	04/01/2020 23:59	9,18	1	9,18	CHI
20200119905	RIO VERDE	RV12098479	RIO VERDE S1	04/01/2020 11:46	04/01/2020 17:54	04/01/2020 11:46	04/01/2020 17:54	6,13	7	42,92	CHI
20200119908	SANTA HELENA DE GOIAS	SH21000252	SANTA HELENA S1	04/01/2020 14:49	04/01/2020 22:49	04/01/2020 14:49	04/01/2020 22:49	7,98	1	7,98	CHI

20200119909	CAIAPONIA	930015939	CAIAPONIA	04/01/2020 14:50	05/01/2020 07:19	04/01/2020 14:50	05/01/2020 07:19	16,48	1	16,48	CHI
20200119910	URUACU	UR12295219	URUACU	04/01/2020 14:50	04/01/2020 23:55	04/01/2020 14:50	04/01/2020 23:55	9,08	5	45,41	CHI
20200119919	POSSE	SA11180532	IACIARA S2	04/01/2020 14:51	04/01/2020 19:56	04/01/2020 14:51	04/01/2020 19:56	5,08	4	20,31	CHI
20200119924	SENADOR CANEDO	190093419	SENADOR CANEDO	04/01/2020 14:52	04/01/2020 16:56	04/01/2020 14:52	04/01/2020 16:56	2,06	1	2,06	CHI
20200119926	PLANALTINA	PI12383393	PLANALTINA	04/01/2020 14:52	06/01/2020 08:16	04/01/2020 17:06	05/01/2020 18:56	25,83	11	284,10	CHI
20200119926	PLANALTINA	PI12103612	PLANALTINA	04/01/2020 14:52	06/01/2020 08:16	04/01/2020 17:06	06/01/2020 08:16	39,16	17	665,72	CHI
20200119930	JATAI	JT12000085	JATAI S3	04/01/2020 14:36	04/01/2020 16:05	04/01/2020 14:36	04/01/2020 16:05	1,48	1420	2100,81	CHI
20200119935	GOUVELANDIA	GB12303132	QUIRINOPOLIS	04/01/2020 14:03	04/01/2020 18:29	04/01/2020 14:03	04/01/2020 18:29	4,42	49	216,72	CHI
20200119936	TURVANIA	TV12394814	FIRMINOPOLIS S2	04/01/2020 14:54	04/01/2020 17:10	04/01/2020 14:54	04/01/2020 17:10	2,26	1	2,26	CHI
20200119937	PADRE BERNARDO	PB21310322	PADRE BERNARDO	04/01/2020 14:54	04/01/2020 16:07	04/01/2020 14:54	04/01/2020 16:07	1,21	1	1,21	CHI
20200119938	GOIANIA	14533443	CARAJAS S2	04/01/2020 14:54	04/01/2020 16:47	04/01/2020 14:54	04/01/2020 16:47	1,87	1	1,87	CHI
20200119940	JOVIANIA	JV12071645	GOIATUBA S1	04/01/2020 14:54	04/01/2020 18:14	04/01/2020 14:54	04/01/2020 18:14	3,32	1	3,32	CHI
20200119945	LUZIANIA	LZ12320207	CRISTALINA S2	04/01/2020 14:02	04/01/2020 19:39	04/01/2020 14:02	04/01/2020 19:39	5,61	2	11,22	CHI
20200119946	MONTES CLAROS DE GOIAS	ME12215841	IPORA	04/01/2020 09:28	04/01/2020 22:41	04/01/2020 09:28	04/01/2020 22:41	13,22	15	198,23	CHI
20200119947	CATALAO	CT12333638RE	CATALAO S1	04/01/2020 12:37	04/01/2020 19:15	04/01/2020 12:37	04/01/2020 19:15	6,63	62	410,91	CHI
20200119954	PLANALTINA	PI12355773	PLANALTINA	04/01/2020 14:23	04/01/2020 17:21	04/01/2020 14:23	04/01/2020 17:21	2,96	48	141,88	CHI
20200119956	PIRACANJUBA	PJ21078735	PIRACANJUBA	04/01/2020 14:57	04/01/2020 19:20	04/01/2020 14:57	04/01/2020 19:20	4,38	2	8,76	CHI
20200119957	HIDROLANDIA	HD21000201	CEPAIGO S2	04/01/2020 14:57	04/01/2020 18:36	04/01/2020 14:57	04/01/2020 18:36	3,64	1	3,64	CHI
20200119959	JATAI	JT12034816	JATAI S3	04/01/2020 14:35	04/01/2020 18:11	04/01/2020 14:35	04/01/2020 18:11	3,59	3	10,78	CHI
20200119962	PIRACANJUBA	PJ21019540	BELA VISTA S1	04/01/2020 14:58	05/01/2020 17:31	04/01/2020 14:58	05/01/2020 16:50	25,86	1	25,86	CHI
20200119962	BELA VISTA DE GOIAS	PJ13200203	BELA VISTA S1	04/01/2020 14:58	05/01/2020 17:31	05/01/2020 14:11	05/01/2020 17:31	3,34	2	6,68	CHI
20200119962	PIRACANJUBA	PJ13200203	BELA VISTA S1	04/01/2020 14:58	05/01/2020 17:31	05/01/2020 14:11	05/01/2020 17:31	3,34	30	100,18	CHI
20200119967	URUACU	UR21050043	URUACU	04/01/2020 14:59	04/01/2020 19:56	04/01/2020 14:59	04/01/2020 19:56	4,94	3	14,83	CHI
20200119968	ABADIANIA	AX12221526	ALEXANIA	04/01/2020 14:15	04/01/2020 17:36	04/01/2020 14:15	04/01/2020 17:36	3,35	7	23,43	CHI
20200119968	ALEXANIA	AX12221526	ALEXANIA	04/01/2020 14:15	04/01/2020 17:36	04/01/2020 14:15	04/01/2020 17:36	3,35	145	485,43	CHI
20200119970	CRISTALINA	KR12330533	CRISTALINA S1	04/01/2020 14:59	05/01/2020 05:46	04/01/2020 14:59	05/01/2020 05:46	14,77	34	502,25	CHI
20200119970	IPAMERI	KR12330533	CRISTALINA S1	04/01/2020 14:59	05/01/2020 05:46	04/01/2020 14:59	05/01/2020 05:46	14,77	1	14,77	CHI
20200119970	LUZIANIA	KR12330533	CRISTALINA S1	04/01/2020 14:59	05/01/2020 05:46	04/01/2020 14:59	05/01/2020 05:46	14,77	8	118,18	CHI
20200119972	VILA PROPICIO	PV12115031	GOIANESIA S1	04/01/2020 14:54	04/01/2020 23:13	04/01/2020 14:54	04/01/2020 23:13	8,30	25	207,53	CHI
20200119973	APARECIDA DE GOIANIA	AP11254436	INDEPENDENCIA S2	04/01/2020 15:00	04/01/2020 17:58	04/01/2020 15:00	04/01/2020 17:58	2,96	125	370,38	CHI
20200119974	ARAGOIANIA	AO32024098	GUAPO S2	04/01/2020 14:58	04/01/2020 19:25	04/01/2020 14:58	04/01/2020 19:25	4,44	3	13,31	CHI
20200119974	HIDROLANDIA	AO32024098	GUAPO S2	04/01/2020 14:58	04/01/2020 19:25	04/01/2020 14:58	04/01/2020 19:25	4,44	3	13,31	CHI
20200119985	PIRENOPOLIS	PV11210828	SAO FRANCISCO DE GOIAS	04/01/2020 14:25	04/01/2020 17:33	04/01/2020 14:25	04/01/2020 17:33	3,13	119	372,87	CHI



20200119986	SANTO ANTONIO DO DESCOBERTO	01680224	ALEXANIA	04/01/2020 14:53	04/01/2020 18:39	04/01/2020 14:53	04/01/2020 15:01	0,14	1277	175,94	CHI
20200119986	SANTO ANTONIO DO DESCOBERTO	01680224	ALEXANIA	04/01/2020 14:53	04/01/2020 18:39	04/01/2020 14:53	04/01/2020 15:02	0,16	2334	373,44	CHI
20200119986	SANTO ANTONIO DO DESCOBERTO	01680224	ALEXANIA	04/01/2020 14:53	04/01/2020 18:39	04/01/2020 14:53	04/01/2020 15:06	0,21	1802	380,92	CHI
20200119986	SANTO ANTONIO DO DESCOBERTO	01680224	ALEXANIA	04/01/2020 14:53	04/01/2020 18:39	04/01/2020 14:53	04/01/2020 17:30	2,63	4887	12836,52	CHI
20200119986	CORUMBA DE GOIAS	SN10395421	ALEXANIA	04/01/2020 14:53	04/01/2020 18:39	04/01/2020 14:53	04/01/2020 17:32	2,66	13	34,56	CHI
20200119986	SANTO ANTONIO DO DESCOBERTO	SN10395421	ALEXANIA	04/01/2020 14:53	04/01/2020 18:39	04/01/2020 14:53	04/01/2020 17:32	2,66	193	513,11	CHI
20200119986	SANTO ANTONIO DO DESCOBERTO	SN12375212	ALEXANIA	04/01/2020 14:53	04/01/2020 18:39	04/01/2020 15:48	04/01/2020 17:43	1,92	4679	8968,08	CHI
20200119986	DISTRITO FEDERAL	01680414	AGUAS LINDAS DE GOIAS S2	04/01/2020 14:53	04/01/2020 18:39	04/01/2020 17:54	04/01/2020 18:08	0,22	1	0,22	CHI
20200119986	SANTO ANTONIO DO DESCOBERTO	01680414	AGUAS LINDAS DE GOIAS S2	04/01/2020 14:53	04/01/2020 18:39	04/01/2020 17:54	04/01/2020 18:08	0,22	8291	1856,26	CHI
20200119986	SANTO ANTONIO DO DESCOBERTO	01680414	ALEXANIA	04/01/2020 14:53	04/01/2020 18:39	04/01/2020 17:54	04/01/2020 18:08	0,22	157	35,15	CHI
20200119986	SANTO ANTONIO DO DESCOBERTO	01680224	ALEXANIA	04/01/2020 14:53	04/01/2020 18:39	04/01/2020 14:53	04/01/2020 18:20	3,44	74	254,85	CHI
20200119986	SANTO ANTONIO DO DESCOBERTO	SN16410092	ALEXANIA	04/01/2020 14:53	04/01/2020 18:39	04/01/2020 17:54	04/01/2020 18:29	0,59	5413	3178,63	CHI
20200119986	SANTO ANTONIO DO DESCOBERTO	01680224	ALEXANIA	04/01/2020 14:53	04/01/2020 18:39	04/01/2020 14:53	04/01/2020 18:39	3,76	1769	6656,35	CHI
20200119988	PLANALTINA	PI11136679	PLANALTINA	04/01/2020 15:03	04/01/2020 17:34	04/01/2020 15:03	04/01/2020 17:34	2,52	83	208,81	CHI
20200119990	ALEXANIA	AX12066452	ALEXANIA	04/01/2020 15:03	04/01/2020 18:32	04/01/2020 15:03	04/01/2020 18:32	3,50	25	87,42	CHI
20200119993	ITARUMA	IM12084177	CACHOEIRA ALTA	04/01/2020 14:51	05/01/2020 14:58	04/01/2020 14:51	05/01/2020 14:58	24,11	5	120,57	CHI
20200119999	CORUMBA DE GOIAS	CB21111203	CORUMBA	04/01/2020 15:04	04/01/2020 20:36	04/01/2020 15:04	04/01/2020 20:36	5,52	1	5,52	CHI
20200120004	JATAI	JT21360632	CABRIUVA S2	04/01/2020 15:05	05/01/2020 12:03	04/01/2020 15:05	05/01/2020 12:03	20,96	1	20,96	CHI
20200120008	PLANALTINA	PI12100880	PLANALTINA	04/01/2020 14:38	04/01/2020 16:41	04/01/2020 14:38	04/01/2020 16:41	2,05	99	202,73	CHI
20200120012	TURVELANDIA	TD21040337	RIO DOS BOIS	04/01/2020 15:06	05/01/2020 12:36	04/01/2020 15:06	05/01/2020 12:36	21,49	2	42,99	CHI
20200120013	JATAI	JT12196245	JATAI S1	04/01/2020 15:02	04/01/2020 18:44	04/01/2020 15:02	04/01/2020 18:44	3,69	4	14,74	CHI
20200120018	FLORES DE GOIAS	FB12211535	IACIARA S2	04/01/2020 14:29	04/01/2020 17:40	04/01/2020 14:29	04/01/2020 17:40	3,18	53	168,35	CHI
20200120023	ARUANA	AK12292820	BRITANIA	04/01/2020 15:08	04/01/2020 16:59	04/01/2020 15:08	04/01/2020 16:59	1,84	3	5,52	CHI
20200120024	MOSSAMEDES	MD12020754	ITABERAI S2	04/01/2020 15:09	05/01/2020 07:56	04/01/2020 15:09	05/01/2020 07:56	16,78	7	117,44	CHI
20200120025	PIRENOPOLIS	10026988281	CORUMBA	04/01/2020 15:09	04/01/2020 18:06	04/01/2020 15:09	04/01/2020 18:06	2,94	1	2,94	CHI
20200120027	MOSSAMEDES	MD21299601	ITABERAI S2	04/01/2020 15:09	04/01/2020 21:45	04/01/2020 15:09	04/01/2020 21:45	6,58	1	6,58	CHI
20200120028	MUNDO NOVO DE GOIAS	4240013710	NOVA CRIXAS	04/01/2020 15:10	05/01/2020 01:33	04/01/2020 15:10	05/01/2020 01:33	10,38	1	10,38	CHI
20200120030	CORUMBA DE GOIAS	CB12215044	CORUMBA	04/01/2020 15:09	04/01/2020 17:07	04/01/2020 15:09	04/01/2020 17:07	1,95	24	46,83	CHI
20200120030	PIRENOPOLIS	CB12215044	CORUMBA	04/01/2020 15:09	04/01/2020 17:07	04/01/2020 15:09	04/01/2020 17:07	1,95	2	3,90	CHI
20200120031	RIO VERDE	RV21271243	CABRIUVA S2	04/01/2020 15:11	05/01/2020 08:59	04/01/2020 15:11	05/01/2020 08:59	17,80	1	17,80	CHI
20200120034	GOIANIA	10326108	CAMPINAS S1	04/01/2020 15:11	04/01/2020 16:16	04/01/2020 15:11	04/01/2020 16:16	1,08	1	1,08	CHI
20200120037	ITARUMA	IM12107438	CACHOEIRA ALTA	04/01/2020 15:11	04/01/2020 19:19	04/01/2020 15:11	04/01/2020 19:19	4,12	4	16,49	CHI
20200120038	ARAGOIANIA	HD12000076	INDEPENDENCIA S1	04/01/2020 14:44	04/01/2020 17:09	04/01/2020 14:44	04/01/2020 17:09	2,41	11	26,50	CHI

20200120038	HIDROLANDIA	HD12000076	INDEPENDENCIA S1	04/01/2020 14:44	04/01/2020 17:09	04/01/2020 14:44	04/01/2020 17:09	2,41	16	38,55	CHI
20200120039	JUSSARA	JR21235003	JUSSARA	04/01/2020 15:12	05/01/2020 03:21	04/01/2020 15:12	05/01/2020 03:21	12,15	1	12,15	CHI
20200120047	PLANALTINA	10012932564	PLANALTINA	04/01/2020 15:13	04/01/2020 19:57	04/01/2020 15:13	04/01/2020 19:57	4,73	1	4,73	CHI
20200120058	SILVANIA	SV12358037	BELA VISTA S2	04/01/2020 15:15	06/01/2020 10:30	04/01/2020 15:15	06/01/2020 10:30	43,24	3	129,71	CHI
20200120060	ANAPOLIS	AN12000193RE	ANAPOLIS UNIVERSITARIO S2	04/01/2020 14:30	04/01/2020 18:12	04/01/2020 14:30	04/01/2020 18:12	3,69	47	173,30	CHI
20200120060	PIRENOPOLIS	AN12000193RE	ANAPOLIS UNIVERSITARIO S2	04/01/2020 14:30	04/01/2020 18:12	04/01/2020 14:30	04/01/2020 18:12	3,69	16	59,00	CHI
20200120063	CRIXAS	CX12330135	SERRA DO OURO	04/01/2020 06:57	05/01/2020 07:25	04/01/2020 06:57	05/01/2020 07:25	24,47	7	171,32	CHI
20200120066	ABADIANIA	AA12167101	ANAPOLIS UNIVERSITARIO S2	04/01/2020 15:12	05/01/2020 13:32	04/01/2020 15:12	05/01/2020 13:32	22,32	6	133,92	CHI
20200120067	LUZIANIA	10019024892	RIO VERMELHO	04/01/2020 15:17	04/01/2020 18:37	04/01/2020 15:17	04/01/2020 18:37	3,32	1	3,32	CHI
20200120070	ALTO PARAISO DE GOIAS	BF11113687	FLORES DE GOIAS	04/01/2020 15:01	04/01/2020 16:01	04/01/2020 15:01	04/01/2020 16:01	1,00	63	62,70	CHI
20200120073	AURILANDIA	AI12032163	FIRMINOPOLIS S2	04/01/2020 15:19	04/01/2020 22:56	04/01/2020 15:19	04/01/2020 22:56	7,61	8	60,92	CHI
20200120079	GOIAS	GS11000003	GOIAS	04/01/2020 14:43	04/01/2020 19:26	04/01/2020 14:43	04/01/2020 19:26	4,72	79	372,55	CHI
20200120080	CIDADE OCIDENTAL	DH11370634	MARAJOARA	04/01/2020 15:20	04/01/2020 16:52	04/01/2020 15:20	04/01/2020 16:52	1,53	101	154,42	CHI
20200120081	SANTA HELENA DE GOIAS	SH13400230	IPEGUARI	04/01/2020 13:49	04/01/2020 17:33	04/01/2020 13:49	04/01/2020 17:33	3,72	1112	4141,89	CHI
20200120082	RIO VERDE	RV12049047	RIO VERDE S2	04/01/2020 14:19	04/01/2020 23:31	04/01/2020 14:19	04/01/2020 23:31	9,19	28	257,25	CHI
20200120083	SANTA HELENA DE GOIAS	SH12296117	IPEGUARI	04/01/2020 09:15	04/01/2020 17:49	04/01/2020 09:15	04/01/2020 17:49	8,55	5	42,77	CHI
20200120085	ITAGUARU	230004738	ITABERAI S1	04/01/2020 15:20	05/01/2020 09:34	04/01/2020 15:20	05/01/2020 09:34	18,22	1	18,22	CHI
20200120087	PIRACANJUBA	PJ11363803	ROCHEDO	04/01/2020 15:20	05/01/2020 17:03	04/01/2020 15:20	05/01/2020 17:03	25,70	14	359,85	CHI
20200120091	MOIPORA	MO12389847	IPORA	05/01/2020 08:11	05/01/2020 09:39	05/01/2020 08:11	05/01/2020 09:39	1,45	4	5,81	CHI
20200120096	COCALZINHO DE GOIAS	ZN12327436	GOIANESIA S1	04/01/2020 15:18	04/01/2020 20:59	04/01/2020 15:18	04/01/2020 20:59	5,68	14	79,56	CHI
20200120098	NIQUELANDIA	NQ21264164	BARRO ALTO	04/01/2020 15:22	05/01/2020 11:30	04/01/2020 15:22	05/01/2020 11:30	20,13	1	20,13	CHI
20200120102	GOIATUBA	10029043385	GOIATUBA S2	04/01/2020 15:22	04/01/2020 17:59	04/01/2020 15:22	04/01/2020 17:59	2,60	1	2,60	CHI
20200120105	CRISTALINA	KR12248700	CRISTALINA S2	04/01/2020 15:23	05/01/2020 12:07	04/01/2020 15:23	05/01/2020 12:07	20,72	5	103,60	CHI
20200120106	CRISTALINA	KR11375058	CRISTALINA S2	04/01/2020 15:23	05/01/2020 09:10	04/01/2020 15:23	05/01/2020 09:10	17,77	1	17,77	CHI
20200120109	EDEALINA	ED12201550	VICENTINOPOLIS	04/01/2020 15:24	05/01/2020 12:46	04/01/2020 15:24	05/01/2020 12:46	21,36	4	85,42	CHI
20200120113	MINACU	IH12052555	MINACU	04/01/2020 14:13	04/01/2020 16:22	04/01/2020 14:13	04/01/2020 16:22	2,14	278	594,07	CHI
20200120114	PONTALINA	PK12000456	PONTALINA	04/01/2020 15:25	04/01/2020 19:30	04/01/2020 15:25	04/01/2020 19:30	4,07	3	12,22	CHI
20200120117	VICENTINOPOLIS	VI21124452	VICENTINOPOLIS	04/01/2020 15:25	05/01/2020 08:25	04/01/2020 15:25	05/01/2020 08:25	16,99	1	16,99	CHI
20200120120	VIANOPOLIS	VN12051236	VIANOPOLIS	04/01/2020 15:25	04/01/2020 19:20	04/01/2020 15:25	04/01/2020 19:20	3,90	6	23,40	CHI
20200120125	CAIAPONIA	CP12395453	PALESTINA	04/01/2020 07:51	05/01/2020 15:39	04/01/2020 07:51	05/01/2020 15:39	31,80	6	190,81	CHI
20200120126	CALDAS NOVAS	CN12363765	CALDAS NOVAS S1	04/01/2020 15:15	04/01/2020 22:45	04/01/2020 15:15	04/01/2020 22:45	7,49	19	142,40	CHI
20200120127	ITAGUARI	IC12300154	ITABERAI S1	04/01/2020 13:27	04/01/2020 17:53	04/01/2020 13:27	04/01/2020 17:53	4,43	12	53,13	CHI
20200120130	ITAGUARI	IC21250525	ITABERAI S1	04/01/2020 15:27	05/01/2020 10:40	04/01/2020 15:27	05/01/2020 10:40	19,21	2	38,42	CHI

20200120132	SAO JOAO D ALIANCA	JL12324141	SAO JOAO D ALIANCA	04/01/2020 15:27	05/01/2020 09:54	04/01/2020 15:27	05/01/2020 09:54	18,44	4	73,76	CHI
20200120138	VALPARAISO DE GOIAS	2860119869	PACAEMBU S1	04/01/2020 15:29	04/01/2020 20:59	04/01/2020 15:29	04/01/2020 20:59	5,49	1	5,49	CHI
20200120140	ARAGOIANIA	AO21091703	GUAPO S2	04/01/2020 15:29	04/01/2020 21:52	04/01/2020 15:29	04/01/2020 21:52	6,37	1	6,37	CHI
20200120144	GOIANIA	16892598	CARAJAS S2	04/01/2020 15:30	04/01/2020 16:41	04/01/2020 15:30	04/01/2020 16:41	1,17	1	1,17	CHI
20200120149	JARAGUA	JA11054616	JARAGUA	04/01/2020 15:06	04/01/2020 21:36	04/01/2020 15:06	04/01/2020 21:36	6,49	127	824,72	CHI
20200120150	ABADIANIA	AA21318062	ANAPOLIS UNIVERSITARIO S1	04/01/2020 15:32	05/01/2020 14:59	04/01/2020 15:32	05/01/2020 14:59	23,44	1	23,44	CHI
20200120152	ALEXANIA	AX21094729	ALEXANIA	04/01/2020 15:32	05/01/2020 20:57	04/01/2020 15:32	05/01/2020 20:57	29,42	1	29,42	CHI
20200120153	MORRINHOS	150073227	MORRINHOS	04/01/2020 15:32	05/01/2020 11:14	04/01/2020 15:32	05/01/2020 11:14	19,69	1	19,69	CHI
20200120156	SANTO ANTONIO DO DESCOBERTO	SN12275480	MARAJOARA	04/01/2020 15:51	04/01/2020 20:17	04/01/2020 15:51	04/01/2020 20:17	4,42	13	57,49	CHI
20200120157	PORANGATU	PO12020618	PORANGATU	04/01/2020 08:34	04/01/2020 17:18	04/01/2020 08:34	04/01/2020 17:18	8,74	24	209,72	CHI
20200120158	PETROLINA DE GOIAS	PV12062894	SAO FRANCISCO DE GOIAS	04/01/2020 15:34	05/01/2020 10:20	04/01/2020 15:34	05/01/2020 10:20	18,76	3	56,28	CHI
20200120158	PIRENOPOLIS	PV12062894	SAO FRANCISCO DE GOIAS	04/01/2020 15:34	05/01/2020 10:20	04/01/2020 15:34	05/01/2020 10:20	18,76	21	393,93	CHI
20200120168	GOIANIA	GN11199192	ATLANTICO S3	04/01/2020 15:36	04/01/2020 16:25	04/01/2020 15:36	04/01/2020 16:25	0,82	121	98,62	CHI
20200120169	FORMOSA	FA21062287	ITUIQUIRA	04/01/2020 15:36	04/01/2020 18:10	04/01/2020 15:36	04/01/2020 18:10	2,56	2	5,12	CHI
20200120182	URUACU	UR21117941	URUACU	04/01/2020 15:39	04/01/2020 21:14	04/01/2020 15:39	04/01/2020 21:14	5,58	1	5,58	CHI
20200120184	GOIANIA	GN11193747	CAMPINAS S1	04/01/2020 15:39	04/01/2020 18:33	04/01/2020 15:39	04/01/2020 18:33	2,89	70	202,40	CHI
20200120187	JANDAIA	JD12377185	PALMEIRAS	04/01/2020 13:45	05/01/2020 07:22	04/01/2020 13:45	05/01/2020 07:22	17,62	28	493,36	CHI
20200120192	ITUMBIARA	690160306	PARANAIBA	04/01/2020 15:40	04/01/2020 17:27	04/01/2020 15:40	04/01/2020 17:27	1,77	1	1,77	CHI
20200120194	TROMBAS	TB11364155	PORANGATU	04/01/2020 15:41	04/01/2020 17:37	04/01/2020 15:41	04/01/2020 17:37	1,95	1	1,95	CHI
20200120198	IPAMERI	600005290	URUTAI	04/01/2020 15:42	04/01/2020 20:01	04/01/2020 15:42	04/01/2020 20:01	4,32	1	4,32	CHI
20200120199	PIRENOPOLIS	NP21311742	CORUMBA	04/01/2020 15:42	04/01/2020 20:17	04/01/2020 15:42	04/01/2020 20:17	4,58	1	4,58	CHI
20200120201	TURVANIA	1220016333	FIRMINOPOLIS S2	04/01/2020 15:42	04/01/2020 18:07	04/01/2020 15:42	04/01/2020 18:07	2,41	1	2,41	CHI
20200120202	NOVA CRIXAS	NA12262986	NOVA CRIXAS	04/01/2020 13:15	04/01/2020 16:46	04/01/2020 13:15	04/01/2020 16:46	3,50	289	1012,70	CHI
20200120203	PIRACANJUBA	PJ21406568	PIRACANJUBA	04/01/2020 15:42	04/01/2020 17:36	04/01/2020 15:42	04/01/2020 17:36	1,89	1	1,89	CHI
20200120206	DAVINOPOLIS	IO12266778	CATALAO S1	04/01/2020 15:14	04/01/2020 18:25	04/01/2020 15:14	04/01/2020 18:25	3,17	13	41,24	CHI
20200120206	DISTRITO FEDERAL	IO12266778	CATALAO S1	04/01/2020 15:14	04/01/2020 18:25	04/01/2020 15:14	04/01/2020 18:25	3,17	1	3,17	CHI
20200120208	SANTA HELENA DE GOIAS	400104090	IPEGUARI	04/01/2020 15:43	04/01/2020 18:56	04/01/2020 15:43	04/01/2020 18:56	3,21	1	3,21	CHI
20200120209	NOVA CRIXAS	NA12334349	NOVA CRIXAS	04/01/2020 15:43	04/01/2020 20:36	04/01/2020 15:43	04/01/2020 20:36	4,87	86	419,18	CHI
20200120211	MINEIROS	MY21358859	PARQUE DAS EMAS	04/01/2020 15:44	05/01/2020 10:33	04/01/2020 15:44	05/01/2020 10:33	18,82	1	18,82	CHI
20200120212	ITABERAI	IB21020482	ANICUNS	04/01/2020 15:44	04/01/2020 23:26	04/01/2020 15:44	04/01/2020 23:26	7,70	1	7,70	CHI
20200120213	PEROLANDIA	2370000254	JATAI S1	04/01/2020 15:44	04/01/2020 17:06	04/01/2020 15:44	04/01/2020 17:06	1,37	1	1,37	CHI
20200120222	CATALAO	CT12266116	CATALAO S1	04/01/2020 15:45	04/01/2020 20:33	04/01/2020 15:45	04/01/2020 20:33	4,79	3	14,36	CHI
20200120231	PADRE BERNARDO	9980023101	PADRE BERNARDO	04/01/2020 15:47	04/01/2020 18:22	04/01/2020 15:47	04/01/2020 18:22	2,58	1	2,58	CHI

20200120232	ITABERAI	50015436	ITABERAI S2	04/01/2020 15:47	04/01/2020 22:16	04/01/2020 15:47	04/01/2020 22:16	6,48	1	6,48	CHI
20200120239	CAMPOS VERDES	3790010970	SANTA TEREZINHA	04/01/2020 15:48	05/01/2020 00:50	04/01/2020 15:48	05/01/2020 00:50	9,03	1	9,03	CHI
20200120241	ALEXANIA	AX12312012	ALEXANIA	04/01/2020 14:20	04/01/2020 19:32	04/01/2020 14:20	04/01/2020 19:32	5,19	8	41,53	CHI
20200120242	ARENOPOLIS	PH12023602	PIRANHAS	04/01/2020 15:48	05/01/2020 11:02	04/01/2020 15:48	05/01/2020 11:02	19,22	6	115,31	CHI
20200120242	PIRANHAS	PH12023602	PIRANHAS	04/01/2020 15:48	05/01/2020 11:02	04/01/2020 15:48	05/01/2020 11:02	19,22	9	172,97	CHI
20200120246	VALPARAISO DE GOIAS	10008413051	PACAEMBU S1	04/01/2020 15:49	04/01/2020 19:52	04/01/2020 15:49	04/01/2020 19:52	4,04	1	4,04	CHI
20200120247	GUAPO	710028787	GUAPO S1	04/01/2020 15:50	04/01/2020 21:41	04/01/2020 15:50	04/01/2020 21:41	5,86	1	5,86	CHI
20200120248	ITAUCU	IX21313001	ARACU	04/01/2020 15:50	05/01/2020 07:57	04/01/2020 15:50	05/01/2020 07:57	16,11	1	16,11	CHI
20200120250	GOIANIA	16697108	MEIA PONTE	04/01/2020 15:51	04/01/2020 17:36	04/01/2020 15:51	04/01/2020 17:36	1,75	1	1,75	CHI
20200120255	LUZIANIA	LZ11000045	MARAJOARA	04/01/2020 15:51	04/01/2020 17:02	04/01/2020 15:51	04/01/2020 17:02	1,17	22	25,83	CHI
20200120261	NAZARIO	NZ12006961	ANICUNS	04/01/2020 15:52	04/01/2020 21:34	04/01/2020 15:52	04/01/2020 21:34	5,69	11	62,62	CHI
20200120265	GOIANAPOLIS	GP21283828	DAIA S2	04/01/2020 15:53	05/01/2020 11:57	04/01/2020 15:53	05/01/2020 11:57	20,06	1	20,06	CHI
20200120266	CATURAI	CK12032824	ARACU	04/01/2020 15:53	04/01/2020 19:54	04/01/2020 15:53	04/01/2020 19:54	4,02	13	52,20	CHI
20200120269	NIQUELANDIA	NQ12374766	URUACU	04/01/2020 15:53	05/01/2020 11:45	04/01/2020 15:53	05/01/2020 11:45	19,86	2	39,71	CHI
20200120274	ALEXANIA	AX12000097	CORUMBA	04/01/2020 15:51	05/01/2020 14:41	04/01/2020 15:51	05/01/2020 14:41	22,82	6	136,92	CHI
20200120277	CUMARI	CY21071479	CATALAO S1	04/01/2020 15:55	04/01/2020 18:40	04/01/2020 15:55	04/01/2020 18:40	2,74	1	2,74	CHI
20200120280	AGUAS LINDAS DE GOIAS	4830166047	AGUAS LINDAS DE GOIAS S1	04/01/2020 15:55	04/01/2020 23:21	04/01/2020 15:55	04/01/2020 23:21	7,42	1	7,42	CHI
20200120281	CATALAO	IP12234083	IPAMERI	04/01/2020 15:55	05/01/2020 11:29	04/01/2020 15:55	05/01/2020 11:29	19,55	2	39,11	CHI
20200120283	BOM JARDIM DE GOIAS	BM12395433	BOM JARDIM	04/01/2020 15:55	04/01/2020 22:53	04/01/2020 15:55	04/01/2020 22:53	6,95	7	48,68	CHI
20200120292	AGUA FRIA DE GOIAS	NQ12140182	SAO JOAO D ALIANCA	04/01/2020 15:57	04/01/2020 19:45	04/01/2020 15:57	04/01/2020 19:45	3,79	70	265,05	CHI
20200120292	NIQUELANDIA	NQ12140182	SAO JOAO D ALIANCA	04/01/2020 15:57	04/01/2020 19:45	04/01/2020 15:57	04/01/2020 19:45	3,79	6	22,72	CHI
20200120297	ANAPOLIS	AN11349042	JUNDIAI S1	04/01/2020 15:51	05/01/2020 04:25	04/01/2020 15:51	05/01/2020 04:25	12,56	19	238,63	CHI
20200120301	INHUMAS	IN21019843	ARACU	04/01/2020 15:58	04/01/2020 17:44	04/01/2020 15:58	04/01/2020 17:44	1,75	1	1,75	CHI
20200120305	RIO VERDE	RV21160795	RIO VERDE S1	04/01/2020 15:59	04/01/2020 20:10	04/01/2020 15:59	04/01/2020 20:10	4,18	1	4,18	CHI
20200120311	SAO MIGUEL DO ARAGUAIA	SM12282216	SAO MIGUEL DO ARAGUAIA	04/01/2020 16:00	05/01/2020 09:50	04/01/2020 16:00	05/01/2020 09:50	17,83	2	35,66	CHI
20200120312	PIRANHAS	PH12342187	PIRANHAS	04/01/2020 15:53	05/01/2020 09:46	04/01/2020 15:53	05/01/2020 09:46	17,88	2	35,75	CHI
20200120314	BOM JARDIM DE GOIAS	BM12065725	BOM JARDIM	04/01/2020 16:00	04/01/2020 17:48	04/01/2020 16:00	04/01/2020 17:48	1,78	102	182,04	CHI
20200120314	PIRANHAS	BM12065725	BOM JARDIM	04/01/2020 16:00	04/01/2020 17:48	04/01/2020 16:00	04/01/2020 17:48	1,78	9	16,06	CHI
20200120321	MOSSAMEDES	MD21194840	FIRMINOPOLIS S2	04/01/2020 16:03	05/01/2020 08:31	04/01/2020 16:03	05/01/2020 08:31	16,46	1	16,46	CHI
20200120326	ARAGOIANIA	AO12329577	GUAPO S2	04/01/2020 15:13	04/01/2020 18:33	04/01/2020 15:13	04/01/2020 18:33	3,33	85	283,10	CHI
20200120328	CORUMBA DE GOIAS	ZN21374429	COCALZINHO	04/01/2020 16:05	04/01/2020 17:34	04/01/2020 16:05	04/01/2020 17:34	1,48	1	1,48	CHI
20200120340	LUZIANIA	LZ12313611	VIANOPOLIS	04/01/2020 16:07	04/01/2020 18:20	04/01/2020 16:07	04/01/2020 18:20	2,22	12	26,65	CHI
20200120341	PIRENOPOLIS	PV12115149	GOIANESIA S1	04/01/2020 15:03	04/01/2020 19:23	04/01/2020 15:03	04/01/2020 19:23	4,32	3	12,97	CHI

20200120341	VILA PROPICIO	PV12115149	GOIANESIA S1	04/01/2020 15:03	04/01/2020 19:23	04/01/2020 15:03	04/01/2020 19:23	4,32	2	8,65	CHI
20200120344	CORREGO DO OURO	CO12003798	SAO LUIZ DOS MONTES BELOS	04/01/2020 16:07	04/01/2020 19:29	04/01/2020 16:07	04/01/2020 19:29	3,35	57	191,12	CHI
20200120347	ARAGARCAS	BM12155745	BOM JARDIM	04/01/2020 15:45	04/01/2020 20:34	04/01/2020 15:45	04/01/2020 20:34	4,82	61	293,75	CHI
20200120347	BOM JARDIM DE GOIAS	BM12155745	BOM JARDIM	04/01/2020 15:45	04/01/2020 20:34	04/01/2020 15:45	04/01/2020 20:34	4,82	47	226,33	CHI
20200120350	PORANGATU	TB12262770	PORANGATU	04/01/2020 16:08	04/01/2020 18:20	04/01/2020 16:08	04/01/2020 18:20	2,19	1	2,19	CHI
20200120350	SANTA TEREZA DE GOIAS	TB12262770	PORANGATU	04/01/2020 16:08	04/01/2020 18:20	04/01/2020 16:08	04/01/2020 18:20	2,19	5	10,96	CHI
20200120350	TROMBAS	TB12262770	PORANGATU	04/01/2020 16:08	04/01/2020 18:20	04/01/2020 16:08	04/01/2020 18:20	2,19	13	28,51	CHI
20200120351	MONTES CLAROS DE GOIAS	ME12050933	IPORA	04/01/2020 16:09	05/01/2020 02:47	04/01/2020 16:09	05/01/2020 02:47	10,63	1	10,63	CHI
20200120354	VIANOPOLIS	VN12067569	VIANOPOLIS	04/01/2020 16:09	05/01/2020 15:24	04/01/2020 16:09	05/01/2020 15:24	23,24	2	46,47	CHI
20200120355	BOM JARDIM DE GOIAS	BM12334832	BOM JARDIM	04/01/2020 16:04	04/01/2020 19:26	04/01/2020 16:04	04/01/2020 19:26	3,37	8	26,93	CHI
20200120358	PARAUNA	10003460833	PARAUNA	04/01/2020 16:10	04/01/2020 22:40	04/01/2020 16:10	04/01/2020 22:40	6,50	1	6,50	CHI
20200120360	CAMPESTRE DE GOIAS	TR12323218	TRINDADE	04/01/2020 16:11	04/01/2020 22:30	04/01/2020 16:11	04/01/2020 22:30	6,33	5	31,66	CHI
20200120360	SANTA BARBARA DE GOIAS	TR12323218	TRINDADE	04/01/2020 16:11	04/01/2020 22:30	04/01/2020 16:11	04/01/2020 22:30	6,33	11	69,65	CHI
20200120362	INHUMAS	DL21331988	INHUMAS S1	04/01/2020 16:11	05/01/2020 13:04	04/01/2020 16:11	05/01/2020 13:04	20,87	3	62,61	CHI
20200120373	HIDROLINA	HL12000009	URUACU	04/01/2020 16:13	04/01/2020 21:24	04/01/2020 16:13	04/01/2020 21:24	5,18	4	20,73	CHI
20200120382	SANTO ANTONIO DO DESCOBERTO	SN21198686	ALEXANIA	04/01/2020 16:14	04/01/2020 20:23	04/01/2020 16:14	04/01/2020 20:23	4,14	1	4,14	CHI
20200120383	URUACU	UR12237461	URUACU	04/01/2020 16:14	05/01/2020 00:59	04/01/2020 16:14	05/01/2020 00:59	8,73	1	8,73	CHI
20200120386	GOIANIA	10641300	AEROPORTO S2	04/01/2020 16:15	04/01/2020 17:47	04/01/2020 16:15	04/01/2020 17:47	1,53	1	1,53	CHI
20200120388	GOIANIA	16398919	CARAJAS S1	04/01/2020 16:16	04/01/2020 18:27	04/01/2020 16:16	04/01/2020 18:27	2,18	1	2,18	CHI
20200120390	TRINDADE	TR21232951	TRINDADE	04/01/2020 16:16	04/01/2020 20:53	04/01/2020 16:16	04/01/2020 20:53	4,61	1	4,61	CHI
20200120402	RIO VERDE	630357122	RIO VERDE S2	04/01/2020 16:17	05/01/2020 13:45	04/01/2020 16:17	05/01/2020 13:45	21,45	1	21,45	CHI
20200120407	CEZARINA	CZ12000022LD	CEZARINA	04/01/2020 16:03	04/01/2020 20:25	04/01/2020 16:03	04/01/2020 20:25	4,36	102	444,44	CHI
20200120407	INDIARA	CZ12000022LD	CEZARINA	04/01/2020 16:03	04/01/2020 20:25	04/01/2020 16:03	04/01/2020 20:25	4,36	9	39,22	CHI
20200120407	PALMEIRAS DE GOIAS	CZ12000022LD	CEZARINA	04/01/2020 16:03	04/01/2020 20:25	04/01/2020 16:03	04/01/2020 20:25	4,36	21	91,50	CHI
20200120414	APORE	AE21122786	ITAJA S2	04/01/2020 16:19	04/01/2020 23:18	04/01/2020 16:19	04/01/2020 23:18	6,98	1	6,98	CHI
20200120417	AGUAS LINDAS DE GOIAS	4830179376	AGUAS LINDAS DE GOIAS S2	04/01/2020 16:19	04/01/2020 19:00	04/01/2020 16:19	04/01/2020 19:00	2,67	1	2,67	CHI
20200120422	ANAPOLIS	AN12000433	ANAPOLIS UNIVERSITARIO S2	04/01/2020 14:31	04/01/2020 18:10	04/01/2020 14:31	04/01/2020 18:10	3,64	18	65,53	CHI
20200120422	PIRENOPOLIS	AN12000433	ANAPOLIS UNIVERSITARIO S2	04/01/2020 14:31	04/01/2020 18:10	04/01/2020 14:31	04/01/2020 18:10	3,64	12	43,69	CHI
20200120431	ITABERAI	IB12250751	ITABERAI S1	04/01/2020 15:27	05/01/2020 08:05	04/01/2020 15:27	05/01/2020 08:05	16,62	7	116,32	CHI
20200120433	IACIARA	10028420916	IACIARA S1	04/01/2020 16:21	04/01/2020 17:39	04/01/2020 16:21	04/01/2020 17:39	1,29	1	1,29	CHI
20200120437	TRINDADE	TR31045879	TRINDADE	04/01/2020 16:22	05/01/2020 10:08	04/01/2020 16:22	05/01/2020 10:08	17,76	1	17,76	CHI
20200120442	SAO DOMINGOS	SD12344106	SAO DOMINGOS	04/01/2020 16:23	04/01/2020 18:12	04/01/2020 16:23	04/01/2020 18:12	1,81	6	10,89	CHI
20200120444	JANDAIA	JD12008612	PALMEIRAS	04/01/2020 14:05	05/01/2020 08:46	04/01/2020 14:05	05/01/2020 08:46	18,68	10	186,79	CHI

20200120447	ITABERAI	IB21216469	ITABERAI S1	04/01/2020 16:23	04/01/2020 17:54	04/01/2020 16:23	04/01/2020 17:54	1,50	1	1,50	CHI
20200120453	SENADOR CANEDO	10023838815	SENADOR CANEDO	04/01/2020 16:24	04/01/2020 20:33	04/01/2020 16:24	04/01/2020 20:33	4,14	1	4,14	CHI
20200120455	PALMEIRAS DE GOIAS	PL12000268	PALMEIRAS	04/01/2020 16:24	05/01/2020 07:04	04/01/2020 16:24	05/01/2020 07:04	14,67	7	102,66	CHI
20200120473	AMORINOPOLIS	IR12060655	IPORA	04/01/2020 15:52	04/01/2020 19:24	04/01/2020 15:52	04/01/2020 19:24	3,53	8	28,22	CHI
20200120473	IPORA	IR12060655	IPORA	04/01/2020 15:52	04/01/2020 19:24	04/01/2020 15:52	04/01/2020 19:24	3,53	149	525,64	CHI
20200120473	IVOLANDIA	IR12060655	IPORA	04/01/2020 15:52	04/01/2020 19:24	04/01/2020 15:52	04/01/2020 19:24	3,53	55	194,03	CHI
20200120473	MOIPORA	IR12060655	IPORA	04/01/2020 15:52	04/01/2020 19:24	04/01/2020 15:52	04/01/2020 19:24	3,53	14	49,39	CHI
20200120474	TRINDADE	TR21323751	TRINDADE	04/01/2020 16:26	04/01/2020 22:40	04/01/2020 16:26	04/01/2020 22:40	6,22	1	6,22	CHI
20200120483	SAO JOAO D ALIANCA	JL12106845	SAO JOAO D ALIANCA	04/01/2020 16:28	04/01/2020 18:25	04/01/2020 16:28	04/01/2020 18:25	1,94	15	29,10	CHI
20200120485	BONFINOPOLIS	10010410846	CEPAIGO S2	04/01/2020 16:29	05/01/2020 11:04	04/01/2020 16:29	05/01/2020 11:04	18,58	1	18,58	CHI
20200120488	ANAPOLIS	AN12000092	ANAPOLIS UNIVERSITARIO S2	04/01/2020 16:12	04/01/2020 19:41	04/01/2020 16:12	04/01/2020 19:41	3,47	147	509,84	CHI
20200120492	ANICUNS	AC12020513	ANICUNS	04/01/2020 15:46	04/01/2020 22:23	04/01/2020 15:46	04/01/2020 22:23	6,60	14	92,41	CHI
20200120492	AVELINOPOLIS	AC12020513	ANICUNS	04/01/2020 15:46	04/01/2020 22:23	04/01/2020 15:46	04/01/2020 22:23	6,60	3	19,80	CHI
20200120492	ITABERAI	AC12020513	ANICUNS	04/01/2020 15:46	04/01/2020 22:23	04/01/2020 15:46	04/01/2020 22:23	6,60	10	66,01	CHI
20200120499	LUZIANIA	LZ21209569	CRISTALINA S2	04/01/2020 16:32	05/01/2020 19:50	04/01/2020 16:32	05/01/2020 19:24	26,88	1	26,88	CHI
20200120499	LUZIANIA	LZ12333210	CRISTALINA S2	04/01/2020 16:32	05/01/2020 19:50	05/01/2020 17:50	05/01/2020 19:50	1,99	15	29,82	CHI
20200120501	BELA VISTA DE GOIAS	BV12038126	BELA VISTA S1	04/01/2020 16:32	05/01/2020 11:01	04/01/2020 16:32	05/01/2020 11:01	18,48	3	55,43	CHI
20200120503	ARAGOIANIA	AO32000013	GUAPO S2	04/01/2020 16:33	05/01/2020 09:30	04/01/2020 16:33	04/01/2020 23:20	6,79	2	13,58	CHI
20200120503	ARAGOIANIA	AO32000013	GUAPO S2	04/01/2020 16:33	05/01/2020 09:30	04/01/2020 23:21	05/01/2020 09:30	10,15	2	20,30	CHI
20200120506	SERRANOPOLIS	SX12260467	JATAI S1	04/01/2020 16:33	04/01/2020 18:40	04/01/2020 16:33	04/01/2020 18:40	2,11	7	14,78	CHI
20200120508	ARACU	AV21019663	ANICUNS	04/01/2020 16:33	05/01/2020 06:44	04/01/2020 16:33	05/01/2020 06:44	14,19	1	14,19	CHI
20200120522	ORIZONA	OZ21309638	PIRES DO RIO S2	04/01/2020 16:35	04/01/2020 21:29	04/01/2020 16:35	04/01/2020 21:29	4,89	1	4,89	CHI
20200120528	ANAPOLIS	AN12000959	ANAPOLIS UNIVERSITARIO S2	04/01/2020 16:36	04/01/2020 20:52	04/01/2020 16:36	04/01/2020 20:52	4,26	20	85,12	CHI
20200120532	BOM JARDIM DE GOIAS	PH12193387	PIRANHAS	04/01/2020 16:34	04/01/2020 18:42	04/01/2020 16:34	04/01/2020 18:42	2,12	3	6,37	CHI
20200120532	PIRANHAS	PH12193387	PIRANHAS	04/01/2020 16:34	04/01/2020 18:42	04/01/2020 16:34	04/01/2020 18:42	2,12	5	10,62	CHI
20200120534	PONTALINA	PK21197126	VICENTINOPOLIS	04/01/2020 16:37	04/01/2020 21:31	04/01/2020 16:37	04/01/2020 21:31	4,89	1	4,89	CHI
20200120536	LUZIANIA	LZ11153074	MARAJOARA	04/01/2020 16:38	05/01/2020 00:55	04/01/2020 16:38	05/01/2020 00:55	8,29	171	1417,59	CHI
20200120540	LUZIANIA	LZ21195024	VIANOPOLIS	04/01/2020 16:38	05/01/2020 11:43	04/01/2020 16:38	05/01/2020 11:43	19,08	1	19,08	CHI
20200120545	SANTA BARBARA DE GOIAS	SB12233412	ANICUNS	04/01/2020 15:49	05/01/2020 08:18	04/01/2020 15:49	05/01/2020 08:18	16,48	19	313,17	CHI
20200120546	GOIANESIA	GE11321374	GOIANESIA S2	04/01/2020 16:40	05/01/2020 03:16	04/01/2020 16:40	05/01/2020 03:16	10,59	1	10,59	CHI
20200120554	SAO LUIS DE MONTES BELOS	SL12223177	SAO LUIZ DOS MONTES BELOS	04/01/2020 16:42	04/01/2020 17:56	04/01/2020 16:42	04/01/2020 17:56	1,23	2	2,47	CHI
20200120555	CATALAO	GD12063788	CATALAO S1	04/01/2020 16:42	05/01/2020 07:06	04/01/2020 16:42	05/01/2020 07:06	14,40	3	43,20	CHI
20200120556	POSSE	1480022217	IACIARA S2	04/01/2020 16:42	04/01/2020 17:43	04/01/2020 16:42	04/01/2020 17:43	1,01	1	1,01	CHI

20200120562	IVOLANDIA	IV12162964	IPORA	04/01/2020 16:43	04/01/2020 22:58	04/01/2020 16:43	04/01/2020 22:58	6,25	2	12,50	CHI
20200120572	ANAPOLIS	AN12210801	NEROPOLIS S1	04/01/2020 16:46	04/01/2020 18:48	04/01/2020 16:46	04/01/2020 18:48	2,04	15	30,56	CHI
20200120572	CAMPO LIMPO	AN12210801	NEROPOLIS S1	04/01/2020 16:46	04/01/2020 18:48	04/01/2020 16:46	04/01/2020 18:48	2,04	7	14,26	CHI
20200120572	OURO VERDE DE GOIAS	AN12210801	NEROPOLIS S1	04/01/2020 16:46	04/01/2020 18:48	04/01/2020 16:46	04/01/2020 18:48	2,04	2	4,07	CHI
20200120583	TRINDADE	40100042	TRINDADE	04/01/2020 16:47	05/01/2020 03:02	04/01/2020 16:47	05/01/2020 03:02	10,25	1	10,25	CHI
20200120591	CATALAO	CT21280756	CATALAO S1	04/01/2020 16:48	05/01/2020 11:47	04/01/2020 16:48	05/01/2020 11:47	18,99	1	18,99	CHI
20200120594	CAMPO LIMPO	AN21258746	NEROPOLIS S1	04/01/2020 16:48	04/01/2020 20:18	04/01/2020 16:48	04/01/2020 20:18	3,49	1	3,49	CHI
20200120596	SILVANIA	SV12282723	VIANOPOLIS	04/01/2020 16:49	05/01/2020 15:16	04/01/2020 16:49	05/01/2020 15:16	22,46	6	134,79	CHI
20200120599	URUACU	UR21090384	CAMPINORTE	04/01/2020 16:49	04/01/2020 21:28	04/01/2020 16:49	04/01/2020 21:28	4,64	2	9,29	CHI
20200120602	JATAI	JT12234308	JATAI S3	04/01/2020 16:49	04/01/2020 17:28	04/01/2020 16:49	04/01/2020 17:28	0,64	2	1,27	CHI
20200120605	TRINDADE	TR12382734	GOYA S1	04/01/2020 16:49	04/01/2020 23:33	04/01/2020 16:49	04/01/2020 23:33	6,72	27	181,37	CHI
20200120610	FORMOSA	FA11046850	ITIQUEIRA	04/01/2020 16:49	04/01/2020 19:35	04/01/2020 16:49	04/01/2020 19:35	2,76	208	573,44	CHI
20200120624	DOVERLANDIA	DV12212770	CAIAPONIA	04/01/2020 15:54	04/01/2020 22:25	04/01/2020 15:54	04/01/2020 22:25	6,51	5	32,53	CHI
20200120632	PIRANHAS	PH12041158LD	PIRANHAS	04/01/2020 15:37	04/01/2020 20:20	04/01/2020 15:37	04/01/2020 20:20	4,73	575	2717,35	CHI
20200120636	FLORES DE GOIAS	FB12204157	FLORES DE GOIAS	04/01/2020 14:37	04/01/2020 19:34	04/01/2020 14:37	04/01/2020 19:34	4,94	13	64,19	CHI
20200120642	PIRACANJUBA	PJ21291892	BELA VISTA S1	04/01/2020 16:55	05/01/2020 11:54	04/01/2020 16:55	05/01/2020 11:54	18,98	1	18,98	CHI
20200120656	APARECIDA DE GOIANIA	AP12000208	CEPAIGO S1	04/01/2020 16:56	04/01/2020 19:02	04/01/2020 16:56	04/01/2020 19:02	2,10	5	10,50	CHI
20200120656	GOIANIA	AP12000208	CEPAIGO S1	04/01/2020 16:56	04/01/2020 19:02	04/01/2020 16:56	04/01/2020 19:02	2,10	3	6,30	CHI
20200120660	COCALZINHO DE GOIAS	9970034760	AGUAS LINDAS DE GOIAS S2	04/01/2020 16:56	04/01/2020 18:16	04/01/2020 16:56	04/01/2020 18:16	1,32	1	1,32	CHI
20200120661	ITABERAI	AC12382721	ARACU	04/01/2020 16:56	05/01/2020 10:06	04/01/2020 16:56	05/01/2020 10:06	17,15	1	17,15	CHI
20200120666	CRISTALINA	KR12335919	PAMPLONA	04/01/2020 16:55	05/01/2020 08:44	04/01/2020 16:55	05/01/2020 08:44	15,81	2	31,61	CHI
20200120669	LUZIANIA	LZ11261573	RIO VERMELHO	04/01/2020 16:57	04/01/2020 19:51	04/01/2020 16:57	04/01/2020 19:51	2,89	99	286,36	CHI
20200120670	PALMEIRAS DE GOIAS	PL12087671	PALMEIRAS	04/01/2020 16:57	05/01/2020 00:40	04/01/2020 16:57	05/01/2020 00:40	7,71	1	7,71	CHI
20200120671	MONTES CLAROS DE GOIAS	ME12198229	IPORA	04/01/2020 08:14	05/01/2020 01:14	04/01/2020 08:14	05/01/2020 01:14	16,99	8	135,88	CHI
20200120677	MINEIROS	MY21375348	PARQUE DAS EMAS	04/01/2020 16:58	05/01/2020 14:13	04/01/2020 16:58	05/01/2020 14:13	21,24	1	21,24	CHI
20200120686	MONTES CLAROS DE GOIAS	ME12380972	IPORA	04/01/2020 14:15	05/01/2020 00:01	04/01/2020 14:15	05/01/2020 00:01	9,76	8	78,08	CHI
20200120690	GOIANIRA	10027275190	GOIANIRA	04/01/2020 16:59	05/01/2020 04:28	04/01/2020 16:59	05/01/2020 04:28	11,48	1	11,48	CHI
20200120693	MONTIVIDIU	MV21075459	MONTIVIDIU T	04/01/2020 16:59	05/01/2020 06:48	04/01/2020 16:59	05/01/2020 06:48	13,80	2	27,61	CHI
20200120694	ACREUNA	EU12219448	ACREUNA	04/01/2020 16:59	05/01/2020 16:27	04/01/2020 16:59	05/01/2020 15:52	22,87	4	91,47	CHI
20200120694	PARAUNA	EU12219448	ACREUNA	04/01/2020 16:59	05/01/2020 16:27	04/01/2020 16:59	05/01/2020 15:52	22,87	3	68,60	CHI
20200120694	ACREUNA	EU12296083LD	ACREUNA	04/01/2020 16:59	05/01/2020 16:27	05/01/2020 13:30	05/01/2020 16:27	2,95	6	17,69	CHI
20200120701	COLINAS DO SUL	9700006213	NIQUELANDIA SUBTRANSMISSAO	04/01/2020 17:01	04/01/2020 18:34	04/01/2020 17:01	04/01/2020 18:34	1,55	1	1,55	CHI
20200120708	CABECEIRAS	CW21184542	ITIQUEIRA	04/01/2020 17:01	04/01/2020 18:10	04/01/2020 17:01	04/01/2020 18:10	1,13	1	1,13	CHI

20200120712	AMARALINA	MU21315002	MARA ROSA	04/01/2020 17:02	05/01/2020 11:17	04/01/2020 17:02	05/01/2020 11:17	18,24	1	18,24	CHI
20200120715	APARECIDA DE GOIANIA	12307804	INDEPENDENCIA S2	04/01/2020 17:02	04/01/2020 21:55	04/01/2020 17:02	04/01/2020 21:55	4,87	1	4,87	CHI
20200120723	ITABERAI	IB21183132	ITABERAI S1	04/01/2020 17:04	04/01/2020 18:59	04/01/2020 17:04	04/01/2020 18:59	1,91	2	3,82	CHI
20200120726	CASTELANDIA	RV12370119	RIO DOS BOIS	04/01/2020 07:02	04/01/2020 22:43	04/01/2020 07:02	04/01/2020 22:43	15,68	8	125,45	CHI
20200120726	RIO VERDE	RV12370119	RIO DOS BOIS	04/01/2020 07:02	04/01/2020 22:43	04/01/2020 07:02	04/01/2020 22:43	15,68	4	62,73	CHI
20200120729	ESTRELA DO NORTE	MU12391986	MARA ROSA	04/01/2020 15:46	04/01/2020 19:35	04/01/2020 15:46	04/01/2020 19:35	3,81	1	3,81	CHI
20200120729	MUTUNOPOLIS	MU12391986	MARA ROSA	04/01/2020 15:46	04/01/2020 19:35	04/01/2020 15:46	04/01/2020 19:35	3,81	100	381,39	CHI
20200120731	PORTELANDIA	PW11000033	PARQUE DAS EMAS	04/01/2020 16:24	04/01/2020 23:00	04/01/2020 16:24	04/01/2020 23:00	6,58	80	526,69	CHI
20200120734	CIDADE OCIDENTAL	10005604590	MARAJOARA	04/01/2020 17:05	05/01/2020 09:27	04/01/2020 17:05	05/01/2020 09:27	16,36	1	16,36	CHI
20200120735	GOIANIA	8476459	GOYA S2	04/01/2020 17:05	05/01/2020 12:43	04/01/2020 17:05	05/01/2020 12:43	19,62	1	19,62	CHI
20200120741	VIANOPOLIS	VN21159781	VIANOPOLIS	04/01/2020 17:07	05/01/2020 19:00	04/01/2020 17:07	05/01/2020 19:00	25,88	1	25,88	CHI
20200120742	ALTO PARAISO DE GOIAS	BF12180923	FLORES DE GOIAS	04/01/2020 17:00	05/01/2020 18:16	04/01/2020 17:00	05/01/2020 18:16	25,27	7	176,92	CHI
20200120744	GOIANIA	13905181	CARAJAS S1	04/01/2020 17:06	04/01/2020 18:42	04/01/2020 17:06	04/01/2020 18:42	1,60	1	1,60	CHI
20200120745	FORMOSA	FA12234933	SAO JOAO D ALIANCA	04/01/2020 16:07	04/01/2020 21:01	04/01/2020 16:07	04/01/2020 21:01	4,89	32	156,61	CHI
20200120748	POSSE	PS12195974	IACIARA S2	04/01/2020 16:49	04/01/2020 18:06	04/01/2020 16:49	04/01/2020 18:06	1,28	277	353,87	CHI
20200120752	PALMEIRAS DE GOIAS	PL12046351	PALMEIRAS	04/01/2020 17:09	05/01/2020 07:55	04/01/2020 17:09	05/01/2020 07:55	14,76	4	59,03	CHI
20200120753	NEROPOLIS	160050406	NEROPOLIS S2	04/01/2020 17:09	04/01/2020 18:47	04/01/2020 17:09	04/01/2020 18:47	1,62	1	1,62	CHI
20200120762	LUZIANIA	LZ12000274	MARAJOARA	04/01/2020 17:11	04/01/2020 17:22	04/01/2020 17:11	04/01/2020 17:22	0,17	44	7,66	CHI
20200120764	CRISTALINA	KR12249948	PAMPLONA	04/01/2020 15:27	05/01/2020 11:09	04/01/2020 15:27	05/01/2020 11:09	19,68	15	295,27	CHI
20200120765	VILA PROPICIO	NP12188681	GOIANESIA S1	04/01/2020 12:40	05/01/2020 15:08	04/01/2020 12:40	05/01/2020 15:08	26,46	86	2275,66	CHI
20200120767	ANAPOLIS	10013554318	ANAPOLIS UNIVERSITARIO S1	04/01/2020 17:11	04/01/2020 21:00	04/01/2020 17:11	04/01/2020 21:00	3,82	1	3,82	CHI
20200120768	FORMOSA	610059038	ITUIQUIRA	04/01/2020 17:11	06/01/2020 11:19	04/01/2020 17:11	06/01/2020 11:19	42,13	1	42,13	CHI
20200120780	ITAGUARI	IC12045481	ITABERAI S1	04/01/2020 15:19	04/01/2020 18:27	04/01/2020 15:19	04/01/2020 18:27	3,13	5	15,64	CHI
20200120780	ITAGUARU	IC12045481	ITABERAI S1	04/01/2020 15:19	04/01/2020 18:27	04/01/2020 15:19	04/01/2020 18:27	3,13	1	3,13	CHI
20200120786	SANCLERLANDIA	SC21353086	FIRMINOPOLIS S2	04/01/2020 17:14	04/01/2020 19:04	04/01/2020 17:14	04/01/2020 19:04	1,83	1	1,83	CHI
20200120790	GUAPO	GA11347762	GUAPO S1	04/01/2020 16:59	04/01/2020 23:40	04/01/2020 16:59	04/01/2020 23:40	6,68	150	1001,58	CHI
20200120792	LEOPOLDO DE BULHOES	BO21270639	CEPAIGO S2	04/01/2020 17:14	05/01/2020 09:48	04/01/2020 17:14	05/01/2020 09:48	16,56	2	33,11	CHI
20200120794	LEOPOLDO DE BULHOES	DE12233204	CEPAIGO S2	04/01/2020 17:14	05/01/2020 12:43	04/01/2020 17:14	05/01/2020 12:43	19,47	7	136,28	CHI
20200120802	NIQUELANDIA	NQ12275490	NIQUELANDIA SUBTRANSMISSAO	04/01/2020 12:33	04/01/2020 19:02	04/01/2020 12:33	04/01/2020 19:02	6,48	194	1257,01	CHI
20200120808	CAVALCANTE	TI12162624	NIQUELANDIA SUBTRANSMISSAO	04/01/2020 17:16	05/01/2020 15:44	04/01/2020 17:16	05/01/2020 15:44	22,46	1	22,46	CHI
20200120808	COLINAS DO SUL	TI12162624	NIQUELANDIA SUBTRANSMISSAO	04/01/2020 17:16	05/01/2020 15:44	04/01/2020 17:16	05/01/2020 15:44	22,46	4	89,83	CHI
20200120810	NEROPOLIS	NR12000048	NEROPOLIS S2	04/01/2020 17:07	05/01/2020 12:16	04/01/2020 17:07	04/01/2020 21:45	4,63	8	37,07	CHI
20200120810	NEROPOLIS	NR12317385LD	NEROPOLIS S2	04/01/2020 17:07	05/01/2020 12:16	04/01/2020 17:07	05/01/2020 10:21	17,23	3	51,70	CHI



20200120810	NEROPOLIS	NR12010662LD	NEROPOLIS S2	04/01/2020 17:07	05/01/2020 12:16	04/01/2020 17:07	05/01/2020 12:16	19,15	5	95,75	CHI
20200120816	CACHOEIRA ALTA	CA12079001	CACHOEIRA ALTA	04/01/2020 14:07	05/01/2020 23:40	04/01/2020 14:07	05/01/2020 23:40	33,54	4	134,16	CHI
20200120817	NIQUELANDIA	NQ21137729	URUACU	04/01/2020 17:18	05/01/2020 12:05	04/01/2020 17:18	05/01/2020 12:05	18,79	1	18,79	CHI
20200120823	VALPARAISO DE GOIAS	3350066080	PACAEMBU S2	04/01/2020 17:19	04/01/2020 21:19	04/01/2020 17:19	04/01/2020 21:19	4,00	1	4,00	CHI
20200120825	NIQUELANDIA	NQ21256572	URUACU	04/01/2020 17:19	05/01/2020 21:07	04/01/2020 17:19	05/01/2020 21:07	27,80	1	27,80	CHI
20200120830	JANDAIA	JD12008614	PALMEIRAS	04/01/2020 17:13	05/01/2020 16:59	04/01/2020 17:13	04/01/2020 20:25	3,20	21	67,21	CHI
20200120830	JANDAIA	6780058	PALMEIRAS	04/01/2020 17:13	05/01/2020 16:59	04/01/2020 17:13	05/01/2020 16:59	23,76	1	23,76	CHI
20200120830	PARAUNA	6780058	PALMEIRAS	04/01/2020 17:13	05/01/2020 16:59	04/01/2020 17:13	05/01/2020 16:59	23,76	6	142,58	CHI
20200120833	FLORES DE GOIAS	FB21334129	FLORES DE GOIAS	04/01/2020 17:20	05/01/2020 10:14	04/01/2020 17:20	05/01/2020 10:14	16,90	1	16,90	CHI
20200120837	FORMOSA	FA12241131	ITIQUEIRA	04/01/2020 14:17	05/01/2020 01:27	04/01/2020 14:17	05/01/2020 01:27	11,16	17	189,65	CHI
20200120839	PADRE BERNARDO	PB12275452	PADRE BERNARDO	04/01/2020 17:20	04/01/2020 19:41	04/01/2020 17:20	04/01/2020 19:41	2,34	29	67,84	CHI
20200120842	BELA VISTA DE GOIAS	BV12045716	SENADOR CANEDO	04/01/2020 16:54	04/01/2020 19:05	04/01/2020 16:54	04/01/2020 19:05	2,17	6	13,01	CHI
20200120848	EDEIA	ED21254471	EDEIA	04/01/2020 17:22	05/01/2020 14:38	04/01/2020 17:22	05/01/2020 14:38	21,26	1	21,26	CHI
20200120851	CRISTALINA	KR12304801	CRISTALINA S2	04/01/2020 15:19	05/01/2020 08:30	04/01/2020 15:19	05/01/2020 08:30	17,17	2	34,34	CHI
20200120852	FLORES DE GOIAS	FB21106815	FLORES DE GOIAS	04/01/2020 17:24	05/01/2020 11:20	04/01/2020 17:24	05/01/2020 11:20	17,92	1	17,92	CHI
20200120856	FORMOSA	610236556	ITIQUEIRA	04/01/2020 17:25	04/01/2020 20:37	04/01/2020 17:25	04/01/2020 20:37	3,19	1	3,19	CHI
20200120866	APARECIDA DE GOIANIA	AP11163698	REAL S1	04/01/2020 17:13	04/01/2020 20:09	04/01/2020 17:13	04/01/2020 20:09	2,93	89	261,07	CHI
20200120873	GUAPO	GA12000164	GUAPO S1	04/01/2020 17:04	04/01/2020 21:04	04/01/2020 17:04	04/01/2020 21:04	3,98	9	35,86	CHI
20200120883	TRINDADE	TR32027168	TRINDADE	04/01/2020 16:32	04/01/2020 23:41	04/01/2020 16:32	04/01/2020 23:41	7,16	41	293,53	CHI
20200120895	BARRO ALTO	BA21326392	BARRO ALTO	04/01/2020 17:30	05/01/2020 08:32	04/01/2020 17:30	05/01/2020 08:32	15,02	1	15,02	CHI
20200120898	VIANOPOLIS	VN21014660	VIANOPOLIS	04/01/2020 17:31	05/01/2020 16:40	04/01/2020 17:31	05/01/2020 16:40	23,15	1	23,15	CHI
20200120909	ITARUMA	IM12041685	CACHOEIRA ALTA	04/01/2020 13:14	05/01/2020 11:41	04/01/2020 13:14	05/01/2020 11:41	22,46	4	89,84	CHI
20200120917	CACHOEIRA ALTA	CA12137736	CACHOEIRA ALTA	04/01/2020 05:41	05/01/2020 15:35	04/01/2020 05:41	05/01/2020 15:35	33,89	4	135,56	CHI
20200120922	QUIRINOPOLIS	QI10396886	QUIRINOPOLIS	04/01/2020 17:15	04/01/2020 22:16	04/01/2020 17:15	04/01/2020 19:11	1,94	1819	3527,34	CHI
20200120922	QUIRINOPOLIS	QI10396886	QUIRINOPOLIS	04/01/2020 17:15	04/01/2020 22:16	04/01/2020 17:15	04/01/2020 22:16	5,02	689	3459,55	CHI
20200120922	QUIRINOPOLIS	QI13355088	QUIRINOPOLIS	04/01/2020 17:15	04/01/2020 22:16	04/01/2020 17:15	04/01/2020 22:16	5,02	80	401,69	CHI
20200120925	PIRANHAS	1930022004	PIRANHAS	04/01/2020 10:23	04/01/2020 19:39	04/01/2020 10:23	04/01/2020 19:39	9,25	1	9,25	CHI
20200120927	MONTIVIDIU	05700414	MONTIVIDIU T	04/01/2020 18:13	05/01/2020 15:19	04/01/2020 18:13	04/01/2020 23:53	5,67	1	5,67	CHI
20200120927	RIO VERDE	05700414	MONTIVIDIU T	04/01/2020 18:13	05/01/2020 15:19	04/01/2020 18:13	04/01/2020 23:53	5,67	10	56,67	CHI
20200120927	RIO VERDE	RV13271658	MONTIVIDIU T	04/01/2020 18:13	05/01/2020 15:19	04/01/2020 18:13	04/01/2020 23:53	5,67	63	357,00	CHI
20200120927	MONTIVIDIU	05700414	MONTIVIDIU T	04/01/2020 18:13	05/01/2020 15:19	04/01/2020 18:13	05/01/2020 01:28	7,26	1	7,26	CHI
20200120927	MONTIVIDIU	05700414	MONTIVIDIU T	04/01/2020 18:13	05/01/2020 15:19	05/01/2020 11:59	05/01/2020 15:19	3,35	1	3,35	CHI
20200120930	FLORES DE GOIAS	FB21161681	FLORES DE GOIAS	04/01/2020 18:43	04/01/2020 18:55	04/01/2020 18:43	04/01/2020 18:55	0,19	1	0,19	CHI

20200120950	MINEIROS	MY12296343	PARQUE DAS EMAS	04/01/2020 11:39	04/01/2020 21:12	04/01/2020 11:39	04/01/2020 21:12	9,55	9	85,94	CHI
20200120956	MINACU	IH10400794	MINACU	04/01/2020 19:25	05/01/2020 23:47	04/01/2020 19:27	04/01/2020 21:49	2,38	46	109,62	CHI
20200120956	MINACU	IH10400794	MINACU	04/01/2020 19:25	05/01/2020 23:47	05/01/2020 02:11	05/01/2020 09:36	7,41	46	341,03	CHI
20200120956	MINACU	IH10400794	MINACU	04/01/2020 19:25	05/01/2020 23:47	05/01/2020 13:28	05/01/2020 14:32	1,07	46	49,25	CHI
20200120956	MINACU	IH13216335	MINACU	04/01/2020 19:25	05/01/2020 23:47	04/01/2020 19:27	05/01/2020 22:45	27,31	258	7045,55	CHI
20200120956	TROMBAS	IH13216335	MINACU	04/01/2020 19:25	05/01/2020 23:47	04/01/2020 19:27	05/01/2020 22:45	27,31	6	163,85	CHI
20200120956	MINACU	IH13216335	MINACU	04/01/2020 19:25	05/01/2020 23:47	04/01/2020 19:27	05/01/2020 23:47	28,34	354	10033,84	CHI
20200120956	MINACU	6815199	MINACU	04/01/2020 19:25	05/01/2020 23:47	05/01/2020 02:11	05/01/2020 23:47	21,60	2	43,21	CHI
20200120963	ITARUMA	IM12340999	CACHOEIRA ALTA	04/01/2020 16:02	05/01/2020 07:40	04/01/2020 16:02	05/01/2020 07:40	15,63	8	125,00	CHI
20200120967	ITARUMA	IM21148582	CACHOEIRA ALTA	04/01/2020 14:44	05/01/2020 01:12	04/01/2020 14:44	05/01/2020 01:12	10,46	1	10,46	CHI
20200120973	PONTALINA	PK12080054	PONTALINA	04/01/2020 18:23	05/01/2020 17:06	04/01/2020 18:23	05/01/2020 17:06	22,71	96	2180,00	CHI
20200120976	CAMPOS BELOS	CH12130297	SAO DOMINGOS	04/01/2020 21:36	04/01/2020 22:36	04/01/2020 21:36	04/01/2020 22:36	0,99	5	4,96	CHI
20200120979	MINEIROS	MY12347908	PARQUE DAS EMAS	04/01/2020 07:50	04/01/2020 23:23	04/01/2020 07:50	04/01/2020 23:23	15,54	4	62,18	CHI
20200120980	MINEIROS	1390168960	PARQUE DAS EMAS	04/01/2020 09:24	05/01/2020 10:20	04/01/2020 09:24	05/01/2020 10:20	24,93	1	24,93	CHI
20200120982	INACIOLANDIA	ID12128131	QUIRINOPOLIS	04/01/2020 13:09	05/01/2020 16:40	04/01/2020 13:21	05/01/2020 16:40	27,33	11	300,65	CHI
20200120989	CACU	CC21037333	CACHOEIRA ALTA	04/01/2020 22:07	05/01/2020 22:00	04/01/2020 22:07	05/01/2020 22:00	23,88	1	23,88	CHI
20200120990	MORRINHOS	MR21405516	MORRINHOS	04/01/2020 22:19	05/01/2020 04:09	04/01/2020 22:19	05/01/2020 04:09	5,82	1	5,82	CHI
20200120992	BELA VISTA DE GOIAS	BV21080363	CRISTIANOPOLIS	04/01/2020 22:30	05/01/2020 13:55	04/01/2020 22:30	05/01/2020 13:20	14,83	1	14,83	CHI
20200120992	BELA VISTA DE GOIAS	SQ12317631	CRISTIANOPOLIS	04/01/2020 22:30	05/01/2020 13:55	05/01/2020 12:30	05/01/2020 13:55	1,42	27	38,34	CHI
20200120993	ITUMBIARA	IT11316728	ITUMBIARA NOVA	04/01/2020 22:35	05/01/2020 01:30	04/01/2020 22:35	05/01/2020 01:30	2,93	84	245,72	CHI
20200121007	GOIANIA	12083938	GOYA S1	04/01/2020 17:33	04/01/2020 18:25	04/01/2020 17:33	04/01/2020 18:25	0,86	1	0,86	CHI
20200121009	SANTO ANTONIO DE GOIAS	BW21274494	NEROPOLIS S1	04/01/2020 17:33	04/01/2020 22:26	04/01/2020 17:33	04/01/2020 22:26	4,88	1	4,88	CHI
20200121018	LUZIANIA	LZ21264828	VIANOPOLIS	04/01/2020 17:33	05/01/2020 10:39	04/01/2020 17:33	05/01/2020 10:39	17,09	4	68,36	CHI
20200121026	GOIANIA	GN12000315	GOIANIA LESTE S1	04/01/2020 17:16	04/01/2020 23:08	04/01/2020 17:16	04/01/2020 19:25	2,15	239	514,71	CHI
20200121026	GOIANIA	GN11265241	GOIANIA LESTE S1	04/01/2020 17:16	04/01/2020 23:08	04/01/2020 17:16	04/01/2020 22:50	5,57	7	39,02	CHI
20200121026	GOIANIA	GN12000315	GOIANIA LESTE S1	04/01/2020 17:16	04/01/2020 23:08	04/01/2020 21:10	04/01/2020 23:08	1,97	239	471,03	CHI
20200121029	CAIAPONIA	PY12121107	PALESTINA	04/01/2020 16:08	04/01/2020 21:32	04/01/2020 16:08	04/01/2020 21:32	5,39	49	263,96	CHI
20200121029	PALESTINA DE GOIAS	PY12121107	PALESTINA	04/01/2020 16:08	04/01/2020 21:32	04/01/2020 16:08	04/01/2020 21:32	5,39	35	188,54	CHI
20200121032	VALPARAISO DE GOIAS	VA11212058	PACAEMBU S2	04/01/2020 17:27	04/01/2020 19:58	04/01/2020 17:27	04/01/2020 19:58	2,51	121	303,17	CHI
20200121033	ANAPOLIS	AN12003370	JUNDIAI S1	04/01/2020 17:17	04/01/2020 18:29	04/01/2020 17:17	04/01/2020 18:29	1,19	187	223,26	CHI
20200121036	JATAI	JT21068873	JATAI S1	04/01/2020 17:35	04/01/2020 20:53	04/01/2020 17:35	04/01/2020 20:53	3,28	2	6,57	CHI
20200121038	GUAPO	TR21071369	GUAPO S1	04/01/2020 17:36	05/01/2020 13:26	04/01/2020 17:36	05/01/2020 13:26	19,83	1	19,83	CHI
20200121040	QUIRINOPOLIS	QI12271537	QUIRINOPOLIS	04/01/2020 17:36	04/01/2020 19:55	04/01/2020 17:36	04/01/2020 19:55	2,31	90	207,60	CHI

20200121046	MINEIROS	MY12043893	PARQUE DAS EMAS	04/01/2020 13:19	04/01/2020 20:19	04/01/2020 13:19	04/01/2020 20:19	6,99	4	27,95	CHI
20200121047	AGUAS LINDAS DE GOIAS	10010128733	AGUAS LINDAS DE GOIAS S1	04/01/2020 17:38	04/01/2020 19:15	04/01/2020 17:38	04/01/2020 19:15	1,61	1	1,61	CHI
20200121050	NEROPOLIS	NV21251983	NEROPOLIS S1	04/01/2020 17:38	05/01/2020 05:39	04/01/2020 17:38	05/01/2020 05:39	12,00	3	36,01	CHI
20200121056	TAQUARAL DE GOIAS	TQ12074928	ITABERAI S1	04/01/2020 16:00	05/01/2020 08:28	04/01/2020 16:00	05/01/2020 08:28	16,45	27	444,22	CHI
20200121058	APARECIDA DE GOIANIA	200141855	INDEPENDENCIA S2	04/01/2020 17:40	04/01/2020 19:24	04/01/2020 17:40	04/01/2020 19:24	1,73	1	1,73	CHI
20200121070	BALIZA	BH12210020	BOM JARDIM	04/01/2020 17:41	04/01/2020 20:41	04/01/2020 17:41	04/01/2020 20:41	2,99	93	278,20	CHI
20200121071	AMARALINA	MU12060988	MARA ROSA	05/01/2020 01:33	05/01/2020 14:31	05/01/2020 01:33	05/01/2020 12:42	11,16	2	22,32	CHI
20200121071	MUTUNOPOLIS	MU12060988	MARA ROSA	05/01/2020 01:33	05/01/2020 14:31	05/01/2020 01:33	05/01/2020 12:42	11,16	9	100,45	CHI
20200121071	AMARALINA	MU12060988	MARA ROSA	05/01/2020 01:33	05/01/2020 14:31	05/01/2020 01:33	05/01/2020 14:31	12,97	139	1802,79	CHI
20200121071	MUTUNOPOLIS	MU12060988	MARA ROSA	05/01/2020 01:33	05/01/2020 14:31	05/01/2020 01:33	05/01/2020 14:31	12,97	22	285,33	CHI
20200121072	ARAGOIANA	AO21239783	INDEPENDENCIA S1	04/01/2020 17:41	05/01/2020 07:36	04/01/2020 17:41	05/01/2020 07:36	13,91	1	13,91	CHI
20200121074	AMARALINA	LC12270203	SAO MIGUEL DO ARAGUAIA	04/01/2020 07:40	04/01/2020 20:52	04/01/2020 07:40	04/01/2020 20:52	13,20	9	118,81	CHI
20200121083	JARAGUA	JA21000192	JARAGUA	04/01/2020 17:42	04/01/2020 21:25	04/01/2020 17:42	04/01/2020 21:25	3,71	1	3,71	CHI
20200121097	GOIANIA	GN12000509	FERROVIARIO S3	04/01/2020 17:44	04/01/2020 18:55	04/01/2020 17:44	04/01/2020 18:55	1,17	59	69,19	CHI
20200121098	PLANALTINA	2960104530	PLANALTINA	04/01/2020 17:44	04/01/2020 18:45	04/01/2020 17:44	04/01/2020 18:45	1,00	1	1,00	CHI
20200121099	FORMOSA	FA11062273	ITIQUIRA	04/01/2020 17:29	05/01/2020 00:39	04/01/2020 17:29	05/01/2020 00:39	7,16	85	608,20	CHI
20200121101	MONTIVIDIU	MV12267712	MONTIVIDIU T	04/01/2020 17:36	05/01/2020 15:25	04/01/2020 17:36	04/01/2020 20:24	2,79	27	75,30	CHI
20200121101	MONTIVIDIU	MV12267712	MONTIVIDIU T	04/01/2020 17:36	05/01/2020 15:25	04/01/2020 20:25	05/01/2020 15:25	19,01	27	513,24	CHI
20200121102	GOIANIA	11513690	CAMPINAS S3	04/01/2020 17:45	04/01/2020 18:50	04/01/2020 17:45	04/01/2020 18:50	1,08	1	1,08	CHI
20200121110	ABADIANIA	AA12388796	DAIA S2	04/01/2020 17:45	05/01/2020 09:46	04/01/2020 17:45	05/01/2020 09:46	16,01	32	512,19	CHI
20200121116	IPAMERI	IP21359965	PIRES DO RIO S2	04/01/2020 17:47	04/01/2020 23:34	04/01/2020 17:47	04/01/2020 23:34	5,78	1	5,78	CHI
20200121119	SENADOR CANEDO	AP12020276	CEPAIGO S1	04/01/2020 17:43	05/01/2020 19:10	04/01/2020 17:43	04/01/2020 23:35	5,88	319	1876,25	CHI
20200121119	SENADOR CANEDO	AP12020276	CEPAIGO S1	04/01/2020 17:43	05/01/2020 19:10	04/01/2020 23:36	05/01/2020 00:48	1,19	171	204,11	CHI
20200121119	SENADOR CANEDO	SW12291707LD	CEPAIGO S1	04/01/2020 17:43	05/01/2020 19:10	04/01/2020 23:36	05/01/2020 03:23	3,79	72	272,94	CHI
20200121119	SENADOR CANEDO	SW12085413LD	CEPAIGO S1	04/01/2020 17:43	05/01/2020 19:10	04/01/2020 23:36	05/01/2020 18:21	18,74	9	168,70	CHI
20200121119	SENADOR CANEDO	SW12363356LD	CEPAIGO S1	04/01/2020 17:43	05/01/2020 19:10	04/01/2020 23:36	05/01/2020 18:45	19,15	10	191,48	CHI
20200121119	SENADOR CANEDO	SW12291712LD	CEPAIGO S1	04/01/2020 17:43	05/01/2020 19:10	04/01/2020 23:36	05/01/2020 19:10	19,57	57	1115,24	CHI
20200121122	IVOLANDIA	IV12223012	IPORA	04/01/2020 07:42	04/01/2020 21:48	04/01/2020 07:42	04/01/2020 21:48	14,09	11	155,00	CHI
20200121123	MUTUNOPOLIS	MU12060992	MARA ROSA	04/01/2020 14:23	04/01/2020 20:01	04/01/2020 14:23	04/01/2020 20:01	5,62	3	16,85	CHI
20200121124	NIQUELANDIA	NQ11035688	NIQUELANDIA SUBTRANSMISSAO	04/01/2020 12:16	04/01/2020 20:17	04/01/2020 12:16	04/01/2020 20:17	8,02	109	873,70	CHI
20200121126	BELA VISTA DE GOIAS	SW12062064	CEPAIGO S2	04/01/2020 17:38	04/01/2020 22:01	04/01/2020 17:38	04/01/2020 22:01	4,37	3	13,12	CHI
20200121126	SENADOR CANEDO	SW12062064	CEPAIGO S2	04/01/2020 17:38	04/01/2020 22:01	04/01/2020 17:38	04/01/2020 22:01	4,37	254	1111,25	CHI
20200121127	GOIANIA	GN12000632	CAMPINAS S1	04/01/2020 17:48	04/01/2020 20:06	04/01/2020 17:48	04/01/2020 20:06	2,28	62	141,67	CHI

20200121128	DIORAMA	DI21335267	ARENOPOLIS	03/01/2020 15:36	04/01/2020 19:54	03/01/2020 15:36	04/01/2020 19:54	28,30	1	28,30	CHI
20200121132	MORRINHOS	MR12264053	MORRINHOS	04/01/2020 17:44	04/01/2020 18:41	04/01/2020 17:44	04/01/2020 18:41	0,95	9	8,54	CHI
20200121135	BOM JESUS DE GOIAS	BJ12305342	BOM JESUS DE GOIAS	04/01/2020 17:50	04/01/2020 21:48	04/01/2020 17:50	04/01/2020 21:48	3,97	1	3,97	CHI
20200121135	GOIATUBA	BJ12305342	BOM JESUS DE GOIAS	04/01/2020 17:50	04/01/2020 21:48	04/01/2020 17:50	04/01/2020 21:48	3,97	3	11,90	CHI
20200121138	ANICUNS	AC12304607	FIRMINOPOLIS S2	04/01/2020 16:33	05/01/2020 07:24	04/01/2020 16:33	05/01/2020 07:24	14,84	3	44,53	CHI
20200121139	FLORES DE GOIAS	FB12245566	IACIARA S2	04/01/2020 17:50	05/01/2020 10:24	04/01/2020 17:50	05/01/2020 10:24	16,56	73	1208,64	CHI
20200121139	SITIO D ABADIA	FB12245566	IACIARA S2	04/01/2020 17:50	05/01/2020 10:24	04/01/2020 17:50	05/01/2020 10:24	16,56	38	629,15	CHI
20200121141	SANTO ANTONIO DO DESCOBERTO	SN21290595	AGUAS LINDAS DE GOIAS S2	04/01/2020 17:51	05/01/2020 17:10	04/01/2020 17:51	05/01/2020 17:10	23,31	1	23,31	CHI
20200121144	CIDADE OCIDENTAL	DH12092833	MARAJOARA	04/01/2020 17:51	04/01/2020 22:46	04/01/2020 17:51	04/01/2020 22:46	4,91	25	122,63	CHI
20200121147	BALIZA	BH21207591	BOM JARDIM	04/01/2020 17:52	05/01/2020 09:21	04/01/2020 17:52	05/01/2020 09:21	15,48	1	15,48	CHI
20200121154	RIO VERDE	RV21015637	RIO VERDE S2	04/01/2020 17:52	04/01/2020 23:40	04/01/2020 17:52	04/01/2020 23:40	5,79	2	11,57	CHI
20200121155	GOIANIRA	10019201344	GOIANIRA	04/01/2020 17:52	04/01/2020 21:30	04/01/2020 17:52	04/01/2020 21:30	3,63	1	3,63	CHI
20200121158	GOIATUBA	GT11000042	GOIATUBA S2	04/01/2020 17:48	04/01/2020 20:02	04/01/2020 17:48	04/01/2020 20:02	2,24	93	207,88	CHI
20200121159	LUZIANIA	LZ12114519	PIRES DO RIO S2	04/01/2020 17:53	04/01/2020 22:37	04/01/2020 17:53	04/01/2020 22:37	4,72	23	108,66	CHI
20200121159	ORIZONA	LZ12114519	PIRES DO RIO S2	04/01/2020 17:53	04/01/2020 22:37	04/01/2020 17:53	04/01/2020 22:37	4,72	36	170,07	CHI
20200121163	ITAPIRAPUA	10029348470	MATRINCHA	04/01/2020 17:54	05/01/2020 04:50	04/01/2020 17:54	05/01/2020 04:50	10,93	1	10,93	CHI
20200121167	CAMPINORTE	CR12282384	MARA ROSA	04/01/2020 17:55	05/01/2020 17:27	04/01/2020 17:55	05/01/2020 17:27	23,53	1	23,53	CHI
20200121167	URUACU	CR12282384	MARA ROSA	04/01/2020 17:55	05/01/2020 17:27	04/01/2020 17:55	05/01/2020 17:27	23,53	3	70,59	CHI
20200121173	ALTO PARAISO DE GOIAS	BF11113687	FLORES DE GOIAS	04/01/2020 17:00	04/01/2020 18:30	04/01/2020 17:00	04/01/2020 18:30	1,49	63	94,15	CHI
20200121176	AGUAS LINDAS DE GOIAS	10006269123	AGUAS LINDAS DE GOIAS S1	04/01/2020 17:56	05/01/2020 11:36	04/01/2020 17:56	05/01/2020 11:36	17,67	1	17,67	CHI
20200121178	ITAPURANGA	IK12311015	ITAPURANGA	04/01/2020 17:50	05/01/2020 09:14	04/01/2020 17:50	05/01/2020 09:14	15,39	142	2184,67	CHI
20200121180	GUAPO	TR21364939	TRINDADE	04/01/2020 17:56	04/01/2020 22:38	04/01/2020 17:56	04/01/2020 22:38	4,69	1	4,69	CHI
20200121183	TRINDADE	TR1250473	TRINDADE	04/01/2020 16:56	05/01/2020 07:21	04/01/2020 16:56	05/01/2020 07:21	14,40	6	86,40	CHI
20200121189	AGUAS LINDAS DE GOIAS	4830023285	AGUAS LINDAS DE GOIAS S1	04/01/2020 17:57	04/01/2020 19:50	04/01/2020 17:57	04/01/2020 19:50	1,88	1	1,88	CHI
20200121191	ITUMBIARA	IT11316728	ITUMBIARA NOVA	04/01/2020 16:41	04/01/2020 20:36	04/01/2020 16:41	04/01/2020 20:36	3,92	84	329,61	CHI
20200121195	ANAPOLIS	20508736	JUNDIAI S1	04/01/2020 17:57	05/01/2020 07:30	04/01/2020 17:57	05/01/2020 07:30	13,54	1	13,54	CHI
20200121199	LUZIANIA	2860219669	RIO VERMELHO	04/01/2020 17:58	05/01/2020 08:58	04/01/2020 17:58	05/01/2020 08:58	15,00	1	15,00	CHI
20200121210	MINEIROS	1390082481	PARQUE DAS EMAS	04/01/2020 17:58	05/01/2020 12:42	04/01/2020 17:58	05/01/2020 12:42	18,72	1	18,72	CHI
20200121227	AMERICANO DO BRASIL	KB11377158	ANICUNS	04/01/2020 18:00	05/01/2020 16:30	05/01/2020 14:32	05/01/2020 16:30	1,97	5	9,87	CHI
20200121231	PIRACANJUBA	PJ21080373	PIRACANJUBA	04/01/2020 18:00	05/01/2020 15:29	04/01/2020 18:00	05/01/2020 15:29	21,47	1	21,47	CHI
20200121232	NIQUELANDIA	NQ12239432	URUACU	04/01/2020 14:17	05/01/2020 17:11	04/01/2020 14:17	05/01/2020 17:11	26,88	19	510,80	CHI
20200121233	CALDAS NOVAS	CN12409034	CALDAS NOVAS S1	04/01/2020 17:32	05/01/2020 12:26	04/01/2020 17:32	05/01/2020 12:26	18,88	1	18,88	CHI
20200121233	SANTA CRUZ DE GOIAS	CN12409034	CALDAS NOVAS S1	04/01/2020 17:32	05/01/2020 12:26	04/01/2020 17:32	05/01/2020 12:26	18,88	16	302,14	CHI

20200121239	PALESTINA DE GOIAS	CP12247810	PALESTINA	04/01/2020 17:42	05/01/2020 12:27	04/01/2020 17:42	05/01/2020 12:27	18,76	4	75,02	CHI
20200121243	ARAGOIANIA	A032097617	GUAPO S2	04/01/2020 18:01	05/01/2020 12:04	04/01/2020 18:01	05/01/2020 12:04	18,04	1	18,04	CHI
20200121252	GUAPO	TR12040839	GUAPO S1	04/01/2020 18:02	05/01/2020 12:07	04/01/2020 18:02	05/01/2020 12:07	18,07	6	108,42	CHI
20200121253	CALDAS NOVAS	03854116	VILA CORUMBA	04/01/2020 17:36	04/01/2020 19:35	04/01/2020 17:36	04/01/2020 19:35	1,98	2	3,97	CHI
20200121255	ITAPACI	IW12267460	ITAPACI	04/01/2020 14:52	05/01/2020 11:00	04/01/2020 14:52	05/01/2020 11:00	20,13	8	161,02	CHI
20200121256	NIQUELANDIA	BA12035658	BARRO ALTO	04/01/2020 09:14	05/01/2020 23:15	04/01/2020 09:14	05/01/2020 23:15	38,02	1	38,02	CHI
20200121262	SAO LUIS DE MONTES BELOS	SL12383600	SAO LUIZ DOS MONTES BELOS	04/01/2020 17:19	05/01/2020 11:01	04/01/2020 17:19	05/01/2020 11:01	17,70	9	159,26	CHI
20200121263	LUZIANIA	LZ12261566	VIANOPOLIS	04/01/2020 16:12	05/01/2020 08:48	04/01/2020 16:12	05/01/2020 08:48	16,60	29	481,30	CHI
20200121268	ITAJA	IJ21122571	ITAJA S2	04/01/2020 18:04	05/01/2020 16:20	04/01/2020 18:04	05/01/2020 16:20	22,26	1	22,26	CHI
20200121270	JUSSARA	JR12341198	JUSSARA	04/01/2020 13:44	05/01/2020 14:46	04/01/2020 13:44	05/01/2020 14:46	25,04	7	175,27	CHI
20200121273	VICENTINOPOLIS	VI21124437	VICENTINOPOLIS	04/01/2020 18:04	05/01/2020 09:57	04/01/2020 18:04	05/01/2020 09:57	15,87	1	15,87	CHI
20200121275	CORUMBA DE GOIAS	CB21171922	CORUMBA	04/01/2020 18:05	05/01/2020 11:18	04/01/2020 18:05	05/01/2020 11:18	17,22	1	17,22	CHI
20200121280	SAO MIGUEL DO ARAGUAIA	SM21013247	SAO MIGUEL DO ARAGUAIA	04/01/2020 07:30	05/01/2020 13:35	04/01/2020 07:30	05/01/2020 13:35	30,07	1	30,07	CHI
20200121283	BOM JARDIM DE GOIAS	BM12155682	BOM JARDIM	04/01/2020 18:00	04/01/2020 21:05	04/01/2020 18:00	04/01/2020 21:05	3,07	14	42,96	CHI
20200121283	PIRANHAS	BM12155682	BOM JARDIM	04/01/2020 18:00	04/01/2020 21:05	04/01/2020 18:00	04/01/2020 21:05	3,07	4	12,27	CHI
20200121284	CAIAPONIA	MV13123330	MONTIVIDIU T	04/01/2020 18:05	07/01/2020 19:29	07/01/2020 13:21	07/01/2020 13:44	0,38	17	6,49	CHI
20200121284	MONTIVIDIU	MV13123330	MONTIVIDIU T	04/01/2020 18:05	07/01/2020 19:29	07/01/2020 13:21	07/01/2020 13:44	0,38	52	19,85	CHI
20200121284	MONTIVIDIU	05700434	MONTIVIDIU T	04/01/2020 18:05	07/01/2020 19:29	07/01/2020 14:52	07/01/2020 15:35	0,71	90	64,10	CHI
20200121284	RIO VERDE	05700434	MONTIVIDIU T	04/01/2020 18:05	07/01/2020 19:29	07/01/2020 14:52	07/01/2020 15:35	0,71	1	0,71	CHI
20200121284	MONTIVIDIU	MV13080903	MONTIVIDIU T	04/01/2020 18:05	07/01/2020 19:29	07/01/2020 15:36	07/01/2020 17:06	1,51	16	24,23	CHI
20200121284	MONTIVIDIU	05700434	MONTIVIDIU T	04/01/2020 18:05	07/01/2020 19:29	07/01/2020 17:57	07/01/2020 18:54	0,95	74	70,28	CHI
20200121284	RIO VERDE	05700434	MONTIVIDIU T	04/01/2020 18:05	07/01/2020 19:29	07/01/2020 17:57	07/01/2020 18:54	0,95	1	0,95	CHI
20200121284	CAIAPONIA	RV10400629	MONTIVIDIU T	04/01/2020 18:05	07/01/2020 19:29	07/01/2020 17:57	07/01/2020 18:54	0,95	280	265,14	CHI
20200121284	CAIAPONIA	RV10400629	MONTIVIDIU T	04/01/2020 18:05	07/01/2020 19:29	07/01/2020 17:57	07/01/2020 18:54	0,95	38	35,98	CHI
20200121284	JATAI	RV10400629	MONTIVIDIU T	04/01/2020 18:05	07/01/2020 19:29	07/01/2020 17:57	07/01/2020 18:54	0,95	7	6,63	CHI
20200121284	MONTIVIDIU	RV10400629	MONTIVIDIU T	04/01/2020 18:05	07/01/2020 19:29	07/01/2020 17:57	07/01/2020 18:54	0,95	6	5,68	CHI
20200121284	MONTIVIDIU	RV10400629	MONTIVIDIU T	04/01/2020 18:05	07/01/2020 19:29	07/01/2020 17:57	07/01/2020 18:54	0,95	129	122,16	CHI
20200121284	RIO VERDE	RV10400629	MONTIVIDIU T	04/01/2020 18:05	07/01/2020 19:29	07/01/2020 17:57	07/01/2020 18:54	0,95	81	76,70	CHI
20200121284	RIO VERDE	RV10400629	MONTIVIDIU T	04/01/2020 18:05	07/01/2020 19:29	07/01/2020 17:57	07/01/2020 18:54	0,95	2	1,89	CHI
20200121284	MONTIVIDIU	MV12327001	MONTIVIDIU T	04/01/2020 18:05	07/01/2020 19:29	06/01/2020 12:08	07/01/2020 18:54	30,77	1	30,77	CHI
20200121284	MONTIVIDIU	MV12214245	MONTIVIDIU T	04/01/2020 18:05	07/01/2020 19:29	04/01/2020 18:05	07/01/2020 19:29	73,39	14	1027,49	CHI
20200121285	ALTO PARAISO DE GOIAS	BF12302848	FLORES DE GOIAS	04/01/2020 18:06	05/01/2020 18:16	04/01/2020 18:06	05/01/2020 18:16	24,18	2	48,35	CHI
20200121287	CAVALCANTE	10003618623	FLORES DE GOIAS	04/01/2020 18:06	05/01/2020 15:25	04/01/2020 18:06	05/01/2020 15:25	21,31	1	21,31	CHI

20200121291	GOIANIA	10004694420	GOYA S1	04/01/2020 18:07	04/01/2020 20:06	04/01/2020 18:07	04/01/2020 20:06	1,98	1	1,98	CHI
20200121293	TURVANIA	TV21399768	FIRMINOPOLIS S2	04/01/2020 18:07	05/01/2020 10:05	04/01/2020 18:07	05/01/2020 10:05	15,96	1	15,96	CHI
20200121294	GOIANIA	13280016	AEROPORTO S1	04/01/2020 18:07	04/01/2020 22:01	04/01/2020 18:07	04/01/2020 22:01	3,89	1	3,89	CHI
20200121295	GOIAS	GS21150089	GOIAS	04/01/2020 18:07	05/01/2020 09:27	04/01/2020 18:07	05/01/2020 09:27	15,33	1	15,33	CHI
20200121298	GAMELEIRA DE GOIAS	GL12265246	DAIA S2	04/01/2020 18:08	05/01/2020 16:10	04/01/2020 18:08	05/01/2020 16:10	22,02	6	132,15	CHI
20200121303	GOIANIA	10952603	FERROVIARIO S1	04/01/2020 18:09	04/01/2020 20:54	04/01/2020 18:09	04/01/2020 20:54	2,76	1	2,76	CHI
20200121311	JATAI	JT21375485	JATAI S1	04/01/2020 18:11	04/01/2020 20:24	04/01/2020 18:11	04/01/2020 20:24	2,22	1	2,22	CHI
20200121313	PIRENOPOLIS	PV21171287	CORUMBA	04/01/2020 18:11	05/01/2020 08:59	04/01/2020 18:11	05/01/2020 08:59	14,80	1	14,80	CHI
20200121316	BOM JESUS DE GOIAS	BJ21305368	BOM JESUS DE GOIAS	04/01/2020 18:11	04/01/2020 22:47	04/01/2020 18:11	04/01/2020 22:47	4,59	1	4,59	CHI
20200121320	CORREGO DO OURO	CO12237607	SAO LUIZ DOS MONTES BELOS	04/01/2020 18:12	05/01/2020 09:13	04/01/2020 18:12	05/01/2020 09:13	15,01	3	45,02	CHI
20200121322	PILAR DE GOIAS	UR12280291	SANTA TEREZINHA	04/01/2020 18:12	05/01/2020 12:12	04/01/2020 18:12	05/01/2020 12:12	17,99	1	17,99	CHI
20200121322	URUACU	UR12280291	SANTA TEREZINHA	04/01/2020 18:12	05/01/2020 12:12	04/01/2020 18:12	05/01/2020 12:12	17,99	2	35,97	CHI
20200121324	DOVERLANDIA	DV12187350	CAIAPONIA	04/01/2020 15:51	04/01/2020 23:21	04/01/2020 15:51	04/01/2020 23:21	7,48	17	127,23	CHI
20200121330	NOVO GAMA	2460199461	PACAEMBU S1	04/01/2020 18:14	04/01/2020 19:34	04/01/2020 18:14	04/01/2020 19:34	1,33	1	1,33	CHI
20200121331	BONOPOLIS	BX21128385	SAO MIGUEL DO ARAGUAIA	04/01/2020 18:14	05/01/2020 01:28	04/01/2020 18:14	05/01/2020 01:28	7,23	1	7,23	CHI
20200121332	ABADIA DE GOIAS	LG11362826	CARAJAS S1	04/01/2020 17:38	04/01/2020 22:29	04/01/2020 17:38	04/01/2020 22:29	4,83	48	232,03	CHI
20200121335	CEZARINA	CZ12000019	CEZARINA	04/01/2020 17:29	04/01/2020 21:02	04/01/2020 17:29	04/01/2020 21:02	3,55	9	31,92	CHI
20200121335	VARJAO	CZ12000019	CEZARINA	04/01/2020 17:29	04/01/2020 21:02	04/01/2020 17:29	04/01/2020 21:02	3,55	8	28,37	CHI
20200121337	SAO MIGUEL DO PASSA QUATRO	SQ21159816	VIANOPOLIS	04/01/2020 20:06	05/01/2020 09:38	04/01/2020 20:06	05/01/2020 09:38	13,52	1	13,52	CHI
20200121339	ARAGOIANIA	AO11265752	GUAPO S2	04/01/2020 18:15	05/01/2020 01:11	04/01/2020 18:15	05/01/2020 01:11	6,93	6	41,57	CHI
20200121341	GOIANIA	GN21130665	GOIANIA LESTE S1	04/01/2020 18:15	04/01/2020 20:28	04/01/2020 18:15	04/01/2020 20:28	2,21	1	2,21	CHI
20200121344	JARAGUA	JA12203641	JARAGUA	04/01/2020 16:19	05/01/2020 12:00	04/01/2020 16:19	05/01/2020 12:00	19,68	82	1613,94	CHI
20200121345	GOIANIA	10348773	CAMPINAS S1	04/01/2020 18:16	04/01/2020 19:17	04/01/2020 18:16	04/01/2020 19:17	1,01	1	1,01	CHI
20200121350	ARAGARCAS	AG12316281	ARAGARCAS	04/01/2020 18:16	04/01/2020 23:41	04/01/2020 18:16	04/01/2020 23:41	5,40	2	10,81	CHI
20200121351	VALPARAISO DE GOIAS	2860011463	PACAEMBU S1	04/01/2020 18:17	04/01/2020 21:35	04/01/2020 18:17	04/01/2020 21:35	3,30	1	3,30	CHI
20200121353	CAMPO ALEGRE DE GOIAS	CM12192738RE	CAMPO ALEGRE DE GOIAS	04/01/2020 18:00	04/01/2020 23:18	04/01/2020 18:00	04/01/2020 23:18	5,30	46	243,70	CHI
20200121360	MOIPORA	MO12072530	IPORA	04/01/2020 18:19	05/01/2020 08:28	04/01/2020 18:19	05/01/2020 08:28	14,14	3	42,41	CHI
20200121365	ALTO PARAISO DE GOIAS	NQ12234731	NIQUELANDIA SUBTRANSMISSAO	04/01/2020 18:20	05/01/2020 01:30	04/01/2020 18:20	05/01/2020 01:30	7,15	12	85,81	CHI
20200121365	NIQUELANDIA	NQ12234731	NIQUELANDIA SUBTRANSMISSAO	04/01/2020 18:20	05/01/2020 01:30	04/01/2020 18:20	05/01/2020 01:30	7,15	13	92,96	CHI
20200121365	SAO JOAO D ALIANCA	NQ12234731	NIQUELANDIA SUBTRANSMISSAO	04/01/2020 18:20	05/01/2020 01:30	04/01/2020 18:20	05/01/2020 01:30	7,15	1	7,15	CHI
20200121370	CUMARI	CT21161094	CATALAO S2	04/01/2020 18:21	05/01/2020 08:33	04/01/2020 18:21	05/01/2020 08:33	14,19	1	14,19	CHI
20200121371	APORE	AE21122778	ITAJA S1	04/01/2020 18:21	05/01/2020 07:21	04/01/2020 18:21	05/01/2020 07:21	12,99	2	25,97	CHI
20200121376	MOIPORA	MO12374844	IPORA	04/01/2020 17:41	05/01/2020 07:25	04/01/2020 17:41	05/01/2020 07:25	13,73	10	137,33	CHI

20200121382	AGUAS LINDAS DE GOIAS	4830288682	AGUAS LINDAS DE GOIAS S1	04/01/2020 18:23	04/01/2020 21:40	04/01/2020 18:23	04/01/2020 21:40	3,27	1	3,27	CHI
20200121387	AGUAS LINDAS DE GOIAS	LA21282555	AGUAS LINDAS DE GOIAS S2	04/01/2020 18:25	05/01/2020 12:09	04/01/2020 18:25	05/01/2020 12:09	17,73	2	35,46	CHI
20200121390	IACIARA	1550023886	IACIARA S1	04/01/2020 18:25	04/01/2020 19:36	04/01/2020 18:25	04/01/2020 19:36	1,18	1	1,18	CHI
20200121392	PIRANHAS	00160404	ARENOPOLIS	04/01/2020 17:05	05/01/2020 00:42	04/01/2020 17:05	05/01/2020 00:40	7,58	1	7,58	CHI
20200121392	ARENOPOLIS	00160404	ARENOPOLIS	04/01/2020 17:05	05/01/2020 00:42	04/01/2020 17:05	05/01/2020 00:42	7,61	19	144,63	CHI
20200121392	PALESTINA DE GOIAS	00160404	ARENOPOLIS	04/01/2020 17:05	05/01/2020 00:42	04/01/2020 17:05	05/01/2020 00:42	7,61	6	45,67	CHI
20200121392	PIRANHAS	00160404	ARENOPOLIS	04/01/2020 17:05	05/01/2020 00:42	04/01/2020 17:05	05/01/2020 00:42	7,61	66	502,41	CHI
20200121393	EDEALINA	ED12000006	PONTALINA	04/01/2020 18:18	05/01/2020 10:56	04/01/2020 18:18	05/01/2020 10:56	16,63	4	66,52	CHI
20200121393	PONTALINA	ED12000006	PONTALINA	04/01/2020 18:18	05/01/2020 10:56	04/01/2020 18:18	05/01/2020 10:56	16,63	19	315,98	CHI
20200121397	COLINAS DO SUL	TI21236625	MINACU	04/01/2020 18:26	04/01/2020 19:44	04/01/2020 18:26	04/01/2020 19:44	1,30	2	2,60	CHI
20200121399	ALEXANIA	AX12398552	ALEXANIA	04/01/2020 17:13	05/01/2020 18:01	04/01/2020 17:13	05/01/2020 18:01	24,79	7	173,52	CHI
20200121407	GOIANIA	14283293	ATLANTICO S1	04/01/2020 18:27	04/01/2020 20:31	04/01/2020 18:27	04/01/2020 20:31	2,05	1	2,05	CHI
20200121408	GOIANIA	GN12213543	XAVANTES	04/01/2020 17:16	04/01/2020 19:52	04/01/2020 17:16	04/01/2020 19:52	2,59	1150	2984,25	CHI
20200121411	GOIANIA	GN11030548	GOIANIA LESTE S1	04/01/2020 17:45	04/01/2020 21:27	04/01/2020 17:45	04/01/2020 21:27	3,69	128	472,64	CHI
20200121413	RUBIATABA	780026676	RUBIATABA	04/01/2020 18:28	05/01/2020 15:23	04/01/2020 18:28	05/01/2020 15:23	20,91	1	20,91	CHI
20200121419	ITABERAI	IB12093891	ITABERAI S2	04/01/2020 18:29	05/01/2020 10:36	04/01/2020 18:29	05/01/2020 10:36	16,11	3	48,33	CHI
20200121420	ARAGOIANIA	GA32098705	GUAPO S2	04/01/2020 17:52	04/01/2020 22:22	04/01/2020 17:52	04/01/2020 22:22	4,50	3	13,49	CHI
20200121420	GUAPO	GA32098705	GUAPO S2	04/01/2020 17:52	04/01/2020 22:22	04/01/2020 17:52	04/01/2020 22:22	4,50	1	4,50	CHI
20200121428	LUZIANIA	LZ21031681	CRISTALINA S2	04/01/2020 18:31	04/01/2020 22:11	04/01/2020 18:31	04/01/2020 22:11	3,67	1	3,67	CHI
20200121430	IPORA	IR12222975	IPORA	04/01/2020 17:11	05/01/2020 12:26	04/01/2020 17:11	05/01/2020 12:26	19,24	68	1308,49	CHI
20200121430	IVOLANDIA	IR12222975	IPORA	04/01/2020 17:11	05/01/2020 12:26	04/01/2020 17:11	05/01/2020 12:26	19,24	6	115,46	CHI
20200121430	MOIPORA	IR12222975	IPORA	04/01/2020 17:11	05/01/2020 12:26	04/01/2020 17:11	05/01/2020 12:26	19,24	20	384,85	CHI
20200121431	ALEXANIA	AX12258528	ALEXANIA	04/01/2020 18:31	05/01/2020 19:48	04/01/2020 18:31	05/01/2020 19:48	25,28	37	935,29	CHI
20200121438	GOIANIA	10004658	CAMPINAS S2	04/01/2020 18:33	04/01/2020 21:36	04/01/2020 18:33	04/01/2020 21:36	3,05	1	3,05	CHI
20200121446	URUTAI	UT12075970	PIRES DO RIO S2	04/01/2020 18:34	04/01/2020 21:40	04/01/2020 18:34	04/01/2020 21:40	3,10	2	6,19	CHI
20200121450	NOVO BRASIL	NB12396223	JUSSARA	04/01/2020 18:03	05/01/2020 10:23	04/01/2020 18:03	05/01/2020 10:23	16,33	4	65,31	CHI
20200121453	SILVANIA	SV21379011	VIANOPOLIS	04/01/2020 18:34	05/01/2020 16:52	04/01/2020 18:34	05/01/2020 16:52	22,30	1	22,30	CHI
20200121462	BALIZA	BH12187387LD	BOM JARDIM	04/01/2020 17:00	04/01/2020 22:41	04/01/2020 17:00	04/01/2020 22:41	5,68	662	3759,98	CHI
20200121466	GOIAS	GS11063136	GOIAS	04/01/2020 17:45	04/01/2020 23:37	04/01/2020 17:45	04/01/2020 23:37	5,86	75	439,58	CHI
20200121469	GOIAS	GS12234099	GOIAS	04/01/2020 18:38	05/01/2020 11:12	04/01/2020 18:38	05/01/2020 11:12	16,56	3	49,69	CHI
20200121470	BALIZA	BH12331164	CAIAPONIA	04/01/2020 18:27	05/01/2020 07:09	04/01/2020 18:27	05/01/2020 07:09	12,70	9	114,28	CHI
20200121471	ANAPOLIS	AN11130795	JUNDIAI S1	04/01/2020 18:38	05/01/2020 20:26	04/01/2020 18:38	05/01/2020 20:26	25,79	66	1701,94	CHI
20200121479	RIO VERDE	RV12394796	RIO VERDE S1	04/01/2020 18:19	04/01/2020 21:46	04/01/2020 18:19	04/01/2020 21:46	3,44	17	58,44	CHI

20200121488	CIDADE OCIDENTAL	DH11304735	MARAJOARA	04/01/2020 18:42	05/01/2020 08:15	04/01/2020 18:42	05/01/2020 08:15	13,54	1	13,54	CHI
20200121491	JUSSARA	JR12250934	BRITANIA	04/01/2020 17:12	05/01/2020 10:46	04/01/2020 17:12	05/01/2020 10:46	17,56	5	87,82	CHI
20200121493	NAZARIO	NZ12000054	ANICUNS	04/01/2020 16:27	04/01/2020 22:48	04/01/2020 16:27	04/01/2020 22:48	6,34	3	19,03	CHI
20200121493	PALMEIRAS DE GOIAS	NZ12000054	ANICUNS	04/01/2020 16:27	04/01/2020 22:48	04/01/2020 16:27	04/01/2020 22:48	6,34	19	120,53	CHI
20200121501	CAMPINORTE	CR12101039	CAMPINORTE	04/01/2020 14:40	05/01/2020 08:48	04/01/2020 14:40	05/01/2020 08:48	18,13	3	54,38	CHI
20200121504	BELA VISTA DE GOIAS	SQ12318950	CRISTIANOPOLIS	04/01/2020 16:37	04/01/2020 23:12	04/01/2020 16:37	04/01/2020 23:12	6,58	18	118,49	CHI
20200121504	CRISTIANOPOLIS	SQ12318950	CRISTIANOPOLIS	04/01/2020 16:37	04/01/2020 23:12	04/01/2020 16:37	04/01/2020 23:12	6,58	22	144,82	CHI
20200121504	SAO MIGUEL DO PASSA QUATRO	SQ12318950	CRISTIANOPOLIS	04/01/2020 16:37	04/01/2020 23:12	04/01/2020 16:37	04/01/2020 23:12	6,58	78	513,44	CHI
20200121504	VIANOPOLIS	SQ12318950	CRISTIANOPOLIS	04/01/2020 16:37	04/01/2020 23:12	04/01/2020 16:37	04/01/2020 23:12	6,58	3	19,75	CHI
20200121507	LEOPOLDO DE BULHOES	LB21203905	DAIA S2	04/01/2020 18:47	05/01/2020 12:26	04/01/2020 18:47	05/01/2020 12:26	17,66	2	35,31	CHI
20200121508	IPAMERI	MR13142429	MORRINHOS	04/01/2020 18:44	04/01/2020 22:38	04/01/2020 22:15	04/01/2020 22:38	0,38	1	0,38	CHI
20200121508	MORRINHOS	MR13142429	MORRINHOS	04/01/2020 18:44	04/01/2020 22:38	04/01/2020 22:15	04/01/2020 22:38	0,38	140	53,67	CHI
20200121516	ITABERAI	IB21336323	ITABERAI S2	04/01/2020 18:49	04/01/2020 21:50	04/01/2020 18:49	04/01/2020 21:50	3,01	1	3,01	CHI
20200121524	QUIRINOPOLIS	QI11380623	QUIRINOPOLIS	04/01/2020 17:41	04/01/2020 23:08	04/01/2020 17:41	04/01/2020 23:08	5,44	89	483,94	CHI
20200121525	SAO JOAO D ALIANCA	3840012488	SAO JOAO D ALIANCA	04/01/2020 18:51	04/01/2020 19:48	04/01/2020 18:51	04/01/2020 19:48	0,95	1	0,95	CHI
20200121527	CIDADE OCIDENTAL	DH11149726	MARAJOARA	04/01/2020 18:51	04/01/2020 21:48	04/01/2020 18:51	04/01/2020 21:48	2,93	149	437,23	CHI
20200121536	RUBIATABA	780011892	RUBIATABA	04/01/2020 18:53	05/01/2020 15:16	04/01/2020 18:53	05/01/2020 15:16	20,37	1	20,37	CHI
20200121540	ABADIANIA	AA21184558	ANAPOLIS UNIVERSITARIO S2	04/01/2020 18:54	05/01/2020 14:05	04/01/2020 18:54	05/01/2020 14:05	19,18	1	19,18	CHI
20200121547	GOUVELANDIA	QI12279492	QUIRINOPOLIS	04/01/2020 18:40	05/01/2020 15:02	04/01/2020 18:40	05/01/2020 15:02	20,38	2	40,76	CHI
20200121547	QUIRINOPOLIS	QI12279492	QUIRINOPOLIS	04/01/2020 18:40	05/01/2020 15:02	04/01/2020 18:40	05/01/2020 15:02	20,38	7	142,66	CHI
20200121550	NIQUELANDIA	NQ11151012	NIQUELANDIA SUBTRANSMISSAO	04/01/2020 18:02	05/01/2020 01:26	04/01/2020 18:02	05/01/2020 01:26	7,40	70	517,79	CHI
20200121551	ALTO PARAISO DE GOIAS	BF11048001	FLORES DE GOIAS	04/01/2020 18:55	04/01/2020 23:01	04/01/2020 18:55	04/01/2020 23:01	4,09	43	175,89	CHI
20200121554	JUSSARA	RN12057000	BRITANIA	04/01/2020 18:55	05/01/2020 09:38	04/01/2020 18:55	05/01/2020 09:38	14,70	4	58,81	CHI
20200121554	SANTA FE DE GOIAS	RN12057000	BRITANIA	04/01/2020 18:55	05/01/2020 09:38	04/01/2020 18:55	05/01/2020 09:38	14,70	1	14,70	CHI
20200121555	ITABERAI	IB21406509	ITABERAI S1	04/01/2020 18:55	05/01/2020 15:56	04/01/2020 18:55	05/01/2020 15:56	21,00	1	21,00	CHI
20200121556	CATALAO	1990219746	CATALAO S2	04/01/2020 18:55	05/01/2020 00:04	04/01/2020 18:55	05/01/2020 00:04	5,14	1	5,14	CHI
20200121560	BALIZA	BH12343730	BOM JARDIM	04/01/2020 18:08	05/01/2020 08:46	04/01/2020 18:08	05/01/2020 08:46	14,62	8	117,00	CHI
20200121561	GAMELEIRA DE GOIAS	SV12062620	DAIA S2	04/01/2020 18:23	06/01/2020 16:00	04/01/2020 18:23	06/01/2020 16:00	45,61	5	228,07	CHI
20200121563	SANTA HELENA DE GOIAS	SH11246705	RIO VERDE S1	04/01/2020 18:56	05/01/2020 09:14	04/01/2020 18:56	05/01/2020 09:14	14,29	1	14,29	CHI
20200121570	GOIANIA	14531987	CAMPINAS S1	04/01/2020 18:57	04/01/2020 20:59	04/01/2020 18:57	04/01/2020 20:59	2,02	1	2,02	CHI
20200121572	GOIANIA	GN12383185	XAVANTES	04/01/2020 18:58	04/01/2020 23:28	04/01/2020 18:58	04/01/2020 23:28	4,50	10	44,99	CHI
20200121572	SANTO ANTONIO DE GOIAS	GN12383185	XAVANTES	04/01/2020 18:58	04/01/2020 23:28	04/01/2020 18:58	04/01/2020 23:28	4,50	9	40,49	CHI
20200121575	NOVA VENEZA	NV21000156	INHUMAS S1	04/01/2020 18:58	05/01/2020 09:21	04/01/2020 18:58	05/01/2020 09:21	14,38	1	14,38	CHI



20200121576	CAIAPONIA	MV12030666	MONTIVIDIU T	04/01/2020 18:58	05/01/2020 20:44	04/01/2020 18:58	05/01/2020 20:44	25,77	5	128,84	CHI
20200121576	MONTIVIDIU	MV12030666	MONTIVIDIU T	04/01/2020 18:58	05/01/2020 20:44	04/01/2020 18:58	05/01/2020 20:44	25,77	14	360,75	CHI
20200121576	CAIAPONIA	MV12030666	MONTIVIDIU T	04/01/2020 18:58	05/01/2020 20:44	05/01/2020 13:00	05/01/2020 20:44	7,72	11	84,97	CHI
20200121576	MONTIVIDIU	MV12030666	MONTIVIDIU T	04/01/2020 18:58	05/01/2020 20:44	05/01/2020 13:00	05/01/2020 20:44	7,72	9	69,52	CHI
20200121578	BELA VISTA DE GOIAS	BV12126689LD	BELA VISTA S2	04/01/2020 18:58	06/01/2020 10:30	04/01/2020 18:58	06/01/2020 10:30	39,52	8	316,17	CHI
20200121583	CAMPINORTE	UR21147046	URUACU	04/01/2020 18:59	05/01/2020 02:05	04/01/2020 18:59	05/01/2020 02:05	7,09	1	7,09	CHI
20200121585	PILAR DE GOIAS	GG21244237	SANTA TEREZINHA	04/01/2020 18:59	05/01/2020 12:57	04/01/2020 18:59	05/01/2020 12:57	17,95	1	17,95	CHI
20200121588	NOVO GAMA	2900106900	MARAJOARA	04/01/2020 19:00	04/01/2020 20:28	04/01/2020 19:00	04/01/2020 20:28	1,46	1	1,46	CHI
20200121590	VALPARAISO DE GOIAS	2860018433	PACAEMBU S2	04/01/2020 19:00	04/01/2020 22:23	04/01/2020 19:00	04/01/2020 22:23	3,37	1	3,37	CHI
20200121592	EDEALINA	ED12063150	PONTALINA	04/01/2020 19:00	05/01/2020 10:40	04/01/2020 19:00	05/01/2020 10:40	15,67	10	156,67	CHI
20200121594	PIRENOPOLIS	PV12172907	CORUMBA	04/01/2020 19:01	04/01/2020 22:46	04/01/2020 19:01	04/01/2020 22:46	3,75	4	15,00	CHI
20200121596	GOIAS	GS21140294	MATRINCHA	04/01/2020 19:01	05/01/2020 11:12	04/01/2020 19:01	05/01/2020 11:12	16,18	3	48,54	CHI
20200121598	EDEALINA	ED12007552	PONTALINA	04/01/2020 18:30	05/01/2020 10:44	04/01/2020 18:30	05/01/2020 10:44	16,23	7	113,60	CHI
20200121598	EDEIA	ED12007552	PONTALINA	04/01/2020 18:30	05/01/2020 10:44	04/01/2020 18:30	05/01/2020 10:44	16,23	1	16,23	CHI
20200121600	EDEIA	EA12214462	EDEIA	04/01/2020 18:29	04/01/2020 22:32	04/01/2020 18:29	04/01/2020 22:32	4,05	5	20,23	CHI
20200121601	PADRE BERNARDO	10008419025	PADRE BERNARDO	04/01/2020 19:02	04/01/2020 22:36	04/01/2020 19:02	04/01/2020 22:36	3,56	1	3,56	CHI
20200121603	INHUMAS	30147359	INHUMAS S2	04/01/2020 19:02	05/01/2020 00:44	04/01/2020 19:02	05/01/2020 00:44	5,69	1	5,69	CHI
20200121604	ISRAELANDIA	IV12011798	IPORA	04/01/2020 17:41	04/01/2020 23:52	04/01/2020 17:41	04/01/2020 23:52	6,17	4	24,67	CHI
20200121604	IVOLANDIA	IV12011798	IPORA	04/01/2020 17:41	04/01/2020 23:52	04/01/2020 17:41	04/01/2020 23:52	6,17	22	135,69	CHI
20200121604	MOIPORA	IV12011798	IPORA	04/01/2020 17:41	04/01/2020 23:52	04/01/2020 17:41	04/01/2020 23:52	6,17	21	129,52	CHI
20200121606	SANTA BARBARA DE GOIAS	1030010216	TRINDADE	04/01/2020 19:03	05/01/2020 10:50	04/01/2020 19:03	05/01/2020 10:50	15,78	1	15,78	CHI
20200121607	ALVORADA DO NORTE	AQ12184658	FLORES DE GOIAS	04/01/2020 17:02	05/01/2020 00:19	04/01/2020 17:02	05/01/2020 00:19	7,28	18	130,96	CHI
20200121610	PETROLINA DE GOIAS	PG21087220	PETROLINA	04/01/2020 19:03	05/01/2020 19:10	04/01/2020 19:03	05/01/2020 19:10	24,11	3	72,33	CHI
20200121630	RIO VERDE	RV21329999	MONTIVIDIU T	04/01/2020 19:05	05/01/2020 13:20	04/01/2020 19:05	05/01/2020 13:20	18,25	1	18,25	CHI
20200121631	MORRINHOS	MR12264053	MORRINHOS	04/01/2020 19:05	05/01/2020 00:05	04/01/2020 19:05	05/01/2020 00:05	5,00	9	44,98	CHI
20200121633	APARECIDA DE GOIANIA	AP11251479	ATLANTICO S3	04/01/2020 19:06	04/01/2020 20:49	04/01/2020 19:06	04/01/2020 20:49	1,71	79	135,24	CHI
20200121639	FIRMINOPOLIS	FR12308490	FIRMINOPOLIS S1	04/01/2020 18:25	05/01/2020 07:38	04/01/2020 18:25	05/01/2020 07:38	13,22	13	171,85	CHI
20200121643	POSSE	1480017209	IACIARA S2	04/01/2020 19:08	04/01/2020 20:04	04/01/2020 19:08	04/01/2020 20:04	0,93	1	0,93	CHI
20200121650	GOIANIA	10029508043	GOIANIA LESTE S3	04/01/2020 19:09	04/01/2020 22:34	04/01/2020 19:09	04/01/2020 22:34	3,41	1	3,41	CHI
20200121658	SAO JOAO DA PARAUNA	RP12049414	FIRMINOPOLIS S2	04/01/2020 17:55	05/01/2020 06:24	04/01/2020 17:55	05/01/2020 06:24	12,48	32	399,29	CHI
20200121661	GOIANIA	10000423635	GOYA S2	04/01/2020 19:10	04/01/2020 22:39	04/01/2020 19:10	04/01/2020 22:39	3,47	1	3,47	CHI
20200121663	PONTALINA	PK21307948	PONTALINA	04/01/2020 19:11	05/01/2020 11:18	04/01/2020 19:11	05/01/2020 11:18	16,11	3	48,33	CHI
20200121668	LUZIANIA	3200080400	MARAJOARA	04/01/2020 19:12	04/01/2020 20:56	04/01/2020 19:12	04/01/2020 20:56	1,73	1	1,73	CHI

20200121673	PIRENOPOLIS	10026988281	CORUMBA	04/01/2020 19:13	04/01/2020 23:31	04/01/2020 19:13	04/01/2020 23:31	4,29	1	4,29	CHI
20200121679	BOM JARDIM DE GOIAS	BM12260019	BOM JARDIM	04/01/2020 19:09	05/01/2020 00:04	04/01/2020 19:09	05/01/2020 00:04	4,91	4	19,62	CHI
20200121683	CAIAPONIA	MV12214230	MONTIVIDIU T	04/01/2020 19:15	05/01/2020 17:13	04/01/2020 19:15	05/01/2020 17:13	21,95	1	21,95	CHI
20200121683	MONTIVIDIU	MV12214230	MONTIVIDIU T	04/01/2020 19:15	05/01/2020 17:13	04/01/2020 19:15	05/01/2020 17:13	21,95	10	219,54	CHI
20200121689	EDEALINA	ED12284469	PONTALINA	04/01/2020 18:40	05/01/2020 10:10	04/01/2020 18:40	05/01/2020 10:10	15,49	4	61,96	CHI
20200121691	RIO VERDE	RV12020006	CABRIUVA S1	04/01/2020 19:17	05/01/2020 14:59	04/01/2020 19:17	05/01/2020 14:59	19,69	5	98,45	CHI
20200121692	ITABERAI	10006724939	ITABERAI S2	04/01/2020 19:17	05/01/2020 11:19	04/01/2020 19:17	05/01/2020 11:19	16,02	1	16,02	CHI
20200121693	GOIANIRA	GR21191244	MEIA PONTE	04/01/2020 19:18	05/01/2020 01:08	04/01/2020 19:18	05/01/2020 01:08	5,83	2	11,67	CHI
20200121695	APARECIDA DE GOIANIA	10026920636	INDEPENDENCIA S2	04/01/2020 19:18	04/01/2020 20:19	04/01/2020 19:18	04/01/2020 20:19	1,01	1	1,01	CHI
20200121696	SANTA ROSA DE GOIAS	540002392	INHUMAS S1	04/01/2020 19:18	05/01/2020 14:19	04/01/2020 19:18	05/01/2020 14:19	19,02	1	19,02	CHI
20200121699	RIO VERDE	RV12260108	RIO VERDE S2	04/01/2020 19:19	05/01/2020 08:12	04/01/2020 19:19	05/01/2020 08:12	12,88	10	128,78	CHI
20200121700	CACHOEIRA ALTA	7176412	CACHOEIRA ALTA	04/01/2020 19:19	05/01/2020 08:20	04/01/2020 19:19	05/01/2020 08:20	13,01	5	65,05	CHI
20200121709	ALTO HORIZONTE	AJ11300507	SANTA TEREZINHA	04/01/2020 18:33	04/01/2020 23:02	04/01/2020 18:33	04/01/2020 23:02	4,47	80	357,87	CHI
20200121711	SANTA CRUZ DE GOIAS	BC12390405RE	PIRES DO RIO S2	04/01/2020 19:21	04/01/2020 21:39	04/01/2020 19:21	04/01/2020 21:39	2,30	12	27,55	CHI
20200121718	LEOPOLDO DE BULHOES	SV21011178	DAIA S2	04/01/2020 19:22	04/01/2020 22:50	04/01/2020 19:22	04/01/2020 22:50	3,46	1	3,46	CHI
20200121729	BOM JARDIM DE GOIAS	BM21102072	BOM JARDIM	04/01/2020 19:24	05/01/2020 07:46	04/01/2020 19:24	05/01/2020 07:46	12,36	1	12,36	CHI
20200121735	ITAPIRAPUA	IU21071448	MATRINCHA	04/01/2020 19:25	05/01/2020 14:00	04/01/2020 19:25	05/01/2020 14:00	18,59	1	18,59	CHI
20200121739	APARECIDA DE GOIANIA	AP11141264	ANHANGUERA	04/01/2020 19:25	05/01/2020 01:05	04/01/2020 22:38	05/01/2020 01:05	2,45	93	227,88	CHI
20200121752	AGUA LIMPA	AL12075702	VILA CORUMBA	04/01/2020 19:30	05/01/2020 12:37	04/01/2020 19:30	05/01/2020 12:37	17,12	2	34,23	CHI
20200121754	COCALZINHO DE GOIAS	10011384350	AGUAS LINDAS DE GOIAS S2	04/01/2020 19:30	05/01/2020 11:32	04/01/2020 19:30	05/01/2020 11:32	16,03	1	16,03	CHI
20200121758	ANAPOLIS	AN12297643	ANAPOLIS UNIVERSITARIO S2	04/01/2020 19:09	04/01/2020 21:55	04/01/2020 19:09	04/01/2020 21:55	2,77	19	52,64	CHI
20200121759	GOIANIA	13577256	FERROVIARIO S2	04/01/2020 19:30	04/01/2020 22:46	04/01/2020 19:30	04/01/2020 22:46	3,26	1	3,26	CHI
20200121775	ANAPOLIS	AN11163699	JUNDIAI S1	04/01/2020 19:30	05/01/2020 12:10	04/01/2020 19:30	05/01/2020 12:10	16,66	157	2615,84	CHI
20200121778	ITABERAI	IB12250660	ITABERAI S2	04/01/2020 19:29	05/01/2020 08:46	04/01/2020 19:29	05/01/2020 08:46	13,28	3	39,85	CHI
20200121780	PORANGATU	PO21208389	PORANGATU	04/01/2020 19:34	05/01/2020 09:28	04/01/2020 19:34	05/01/2020 09:28	13,89	2	27,79	CHI
20200121791	NEROPOLIS	NR21000087	NEROPOLIS S2	04/01/2020 19:36	05/01/2020 00:37	04/01/2020 19:36	05/01/2020 00:37	5,01	1	5,01	CHI
20200121792	PIRACANJUBA	PJ21316595	BELA VISTA S1	04/01/2020 19:37	05/01/2020 10:47	04/01/2020 19:37	05/01/2020 10:47	15,16	1	15,16	CHI
20200121793	UIRAPURU	UP21281708	SANTA TEREZINHA	04/01/2020 19:37	05/01/2020 12:33	04/01/2020 19:37	05/01/2020 12:33	16,93	1	16,93	CHI
20200121795	CRIXAS	2490050637	SERRA DO OURO	04/01/2020 19:37	05/01/2020 09:52	04/01/2020 19:37	05/01/2020 09:52	14,24	1	14,24	CHI
20200121797	GOIANIA	16989880	GOYA S2	04/01/2020 19:38	05/01/2020 00:31	04/01/2020 19:38	05/01/2020 00:31	4,88	1	4,88	CHI
20200121802	GOIANIA	10111104	XAVANTES	04/01/2020 19:38	05/01/2020 05:04	04/01/2020 19:38	05/01/2020 05:04	9,43	1	9,43	CHI
20200121803	ABADIANIA	AA21132551	ANAPOLIS UNIVERSITARIO S1	04/01/2020 19:38	05/01/2020 16:37	04/01/2020 19:38	05/01/2020 16:37	20,97	1	20,97	CHI
20200121804	PADRE BERNARDO	2800002287	PADRE BERNARDO	04/01/2020 19:38	04/01/2020 21:01	04/01/2020 19:38	04/01/2020 21:01	1,38	1	1,38	CHI

20200121808	ANAPOLIS	AN21144098	ANAPOLIS UNIVERSITARIO S2	04/01/2020 19:39	05/01/2020 11:11	04/01/2020 19:39	05/01/2020 11:11	15,53	2	31,05	CHI
20200121813	ALEXANIA	AX11388847	ALEXANIA	04/01/2020 19:09	05/01/2020 09:30	04/01/2020 19:09	05/01/2020 09:30	14,34	109	1562,79	CHI
20200121816	RIO VERDE	630036690	RIO VERDE S2	04/01/2020 19:40	05/01/2020 12:47	04/01/2020 19:40	05/01/2020 12:47	17,10	1	17,10	CHI
20200121817	GOIANIA	GN11295098	CARAJAS S1	04/01/2020 19:30	05/01/2020 00:19	04/01/2020 22:23	05/01/2020 00:19	1,93	185	357,41	CHI
20200121818	QUIRINOPOLIS	QI11402259	QUIRINOPOLIS	04/01/2020 17:34	04/01/2020 22:01	04/01/2020 17:34	04/01/2020 22:01	4,45	56	248,94	CHI
20200121821	ITABERAI	IB12310577	ITABERAI S2	04/01/2020 19:41	05/01/2020 12:34	04/01/2020 19:41	05/01/2020 12:34	16,87	3	50,61	CHI
20200121827	RIO VERDE	RV12260606	CABRIUVA S1	04/01/2020 19:43	05/01/2020 18:13	04/01/2020 19:43	05/01/2020 18:13	22,49	4	89,97	CHI
20200121835	ARAGOIANIA	AO11350689	INDEPENDENCIA S2	04/01/2020 19:45	05/01/2020 13:52	04/01/2020 19:45	05/01/2020 13:52	18,11	34	615,78	CHI
20200121836	CALDAS NOVAS	760051501	CALDAS NOVAS S1	04/01/2020 19:45	04/01/2020 23:52	04/01/2020 19:45	04/01/2020 23:52	4,11	1	4,11	CHI
20200121837	BOM JARDIM DE GOIAS	BM21065741	BOM JARDIM	04/01/2020 19:45	05/01/2020 07:10	04/01/2020 19:45	05/01/2020 07:10	11,41	1	11,41	CHI
20200121838	MONTIVIDIU	MV12010585	MONTIVIDIU T	04/01/2020 18:20	05/01/2020 08:55	04/01/2020 18:20	05/01/2020 08:55	14,57	26	378,79	CHI
20200121838	RIO VERDE	MV12010585	MONTIVIDIU T	04/01/2020 18:20	05/01/2020 08:55	04/01/2020 18:20	05/01/2020 08:55	14,57	20	291,38	CHI
20200121841	PETROLINA DE GOIAS	PG12017366	PETROLINA	04/01/2020 19:41	05/01/2020 00:40	04/01/2020 19:41	05/01/2020 00:40	4,97	34	168,90	CHI
20200121841	SAO FRANCISCO DE GOIAS	PG12017366	PETROLINA	04/01/2020 19:41	05/01/2020 00:40	04/01/2020 19:41	05/01/2020 00:40	4,97	8	39,74	CHI
20200121844	MUTUNOPOLIS	MU21187884	MARA ROSA	04/01/2020 19:46	05/01/2020 13:26	04/01/2020 19:46	05/01/2020 13:26	17,66	1	17,66	CHI
20200121854	RIO VERDE	RV12240290	MONTIVIDIU T	04/01/2020 19:47	05/01/2020 19:03	04/01/2020 19:47	05/01/2020 19:03	23,26	14	325,60	CHI
20200121856	ALEXANIA	AX21377767	CORUMBA	04/01/2020 19:47	05/01/2020 22:02	04/01/2020 19:47	05/01/2020 22:02	26,25	2	52,50	CHI
20200121858	GOIANIA	17379726	CARAJAS S1	04/01/2020 19:48	04/01/2020 23:20	04/01/2020 19:48	04/01/2020 23:20	3,53	1	3,53	CHI
20200121861	PALMINOPOLIS	PP21006730	PALMEIRAS	04/01/2020 19:48	05/01/2020 07:23	04/01/2020 19:48	05/01/2020 07:23	11,57	1	11,57	CHI
20200121863	PIRES DO RIO	460111360	PIRES DO RIO S1	04/01/2020 19:49	04/01/2020 22:32	04/01/2020 19:49	04/01/2020 22:32	2,71	1	2,71	CHI
20200121865	GOIANIA	10007210971	CARAJAS S2	04/01/2020 19:49	04/01/2020 21:50	04/01/2020 19:49	04/01/2020 21:50	2,00	1	2,00	CHI
20200121866	ITABERAI	IB21040785	ITABERAI S2	04/01/2020 19:50	05/01/2020 19:49	04/01/2020 19:50	05/01/2020 19:49	23,98	1	23,98	CHI
20200121871	CAMPO ALEGRE DE GOIAS	CM12152114	CAMPO ALEGRE DE GOIAS	04/01/2020 19:51	05/01/2020 07:08	04/01/2020 19:51	05/01/2020 07:08	11,27	17	191,66	CHI
20200121873	PIRENOPOLIS	PV12295641	SAO FRANCISCO DE GOIAS	04/01/2020 19:45	04/01/2020 22:04	04/01/2020 19:45	04/01/2020 22:04	2,32	184	427,14	CHI
20200121877	APARECIDA DE GOIANIA	200618726	INDEPENDENCIA S1	04/01/2020 19:52	04/01/2020 21:09	04/01/2020 19:52	04/01/2020 21:09	1,28	1	1,28	CHI
20200121879	ITAGUARI	770000964	ITABERAI S1	04/01/2020 19:52	05/01/2020 09:02	04/01/2020 19:52	05/01/2020 09:02	13,17	1	13,17	CHI
20200121885	FAZENDA NOVA	FN12383522	FIRMINOPOLIS S2	04/01/2020 14:47	05/01/2020 07:18	04/01/2020 14:47	05/01/2020 07:18	16,51	9	148,61	CHI
20200121887	BURITI DE GOIAS	CO12000058	FIRMINOPOLIS S2	04/01/2020 15:07	05/01/2020 07:18	04/01/2020 15:07	05/01/2020 07:18	16,18	31	501,52	CHI
20200121887	CORREGO DO OURO	CO12000058	FIRMINOPOLIS S2	04/01/2020 15:07	05/01/2020 07:18	04/01/2020 15:07	05/01/2020 07:18	16,18	141	2281,11	CHI
20200121887	FAZENDA NOVA	CO12000058	FIRMINOPOLIS S2	04/01/2020 15:07	05/01/2020 07:18	04/01/2020 15:07	05/01/2020 07:18	16,18	26	420,63	CHI
20200121897	MONTIVIDIU	RV12062709	MONTIVIDIU T	04/01/2020 17:55	05/01/2020 13:33	04/01/2020 17:55	05/01/2020 10:15	16,33	1	16,33	CHI
20200121897	MONTIVIDIU	MV12305751	MONTIVIDIU T	04/01/2020 17:55	05/01/2020 13:33	04/01/2020 17:55	05/01/2020 11:00	17,09	17	290,53	CHI
20200121897	MONTIVIDIU	MV12305751	MONTIVIDIU T	04/01/2020 17:55	05/01/2020 13:33	05/01/2020 11:01	05/01/2020 13:33	2,55	17	43,33	CHI

20200121902	APARECIDA DE GOIANIA	200146622	INDEPENDENCIA S1	04/01/2020 19:56	04/01/2020 21:08	04/01/2020 19:56	04/01/2020 21:08	1,20	1	1,20	CHI
20200121904	DISTRITO FEDERAL	SN12237830	MARAJOARA	04/01/2020 19:57	05/01/2020 08:42	04/01/2020 19:57	05/01/2020 08:42	12,75	3	38,24	CHI
20200121904	SANTO ANTONIO DO DESCOBERTO	SN12237830	MARAJOARA	04/01/2020 19:57	05/01/2020 08:42	04/01/2020 19:57	05/01/2020 08:42	12,75	24	305,89	CHI
20200121905	COCALZINHO DE GOIAS	9970030509	AGUAS LINDAS DE GOIAS S2	04/01/2020 19:57	05/01/2020 13:07	04/01/2020 19:57	05/01/2020 13:07	17,16	1	17,16	CHI
20200121912	CRISTALINA	03460414	CRISTALINA S2	04/01/2020 19:56	05/01/2020 14:38	05/01/2020 10:44	05/01/2020 10:55	0,19	3	0,57	CHI
20200121912	CRISTALINA	03460414	PAMPLONA	04/01/2020 19:56	05/01/2020 14:38	05/01/2020 10:44	05/01/2020 10:55	0,19	89	16,84	CHI
20200121912	LUZIANIA	03460414	PAMPLONA	04/01/2020 19:56	05/01/2020 14:38	05/01/2020 10:44	05/01/2020 10:55	0,19	1	0,19	CHI
20200121912	LUZIANIA	KR13095494	PAMPLONA	04/01/2020 19:56	05/01/2020 14:38	04/01/2020 19:56	05/01/2020 14:38	18,70	34	635,97	CHI
20200121912	CRISTALINA	KR13095494	PAMPLONA	04/01/2020 19:56	05/01/2020 14:38	05/01/2020 10:44	05/01/2020 14:38	3,91	4	15,66	CHI
20200121912	LUZIANIA	KR13095494	PAMPLONA	04/01/2020 19:56	05/01/2020 14:38	05/01/2020 10:44	05/01/2020 14:38	3,91	35	136,99	CHI
20200121913	GOIANIA	11458630	ATLANTICO S1	04/01/2020 19:58	04/01/2020 21:55	04/01/2020 19:58	04/01/2020 21:55	1,93	1	1,93	CHI
20200121921	JAUPACI	JP12349752	IPORA	04/01/2020 19:40	05/01/2020 07:31	04/01/2020 19:40	05/01/2020 07:31	11,84	41	485,51	CHI
20200121934	GOIAS	GS12217234	MATRINCHA	04/01/2020 19:59	05/01/2020 02:09	04/01/2020 19:59	05/01/2020 02:09	6,17	84	517,88	CHI
20200121934	ITAPIRAPUA	GS12217234	MATRINCHA	04/01/2020 19:59	05/01/2020 02:09	04/01/2020 19:59	05/01/2020 02:09	6,17	1	6,17	CHI
20200121934	NOVO BRASIL	GS12217234	MATRINCHA	04/01/2020 19:59	05/01/2020 02:09	04/01/2020 19:59	05/01/2020 02:09	6,17	36	221,95	CHI
20200121939	CATALAO	CT11045439	CATALAO S2	04/01/2020 19:54	04/01/2020 21:25	04/01/2020 19:54	04/01/2020 21:25	1,50	115	172,85	CHI
20200121946	CASTELANDIA	QI12296614	QUIRINOPOLIS	04/01/2020 20:02	04/01/2020 21:33	04/01/2020 20:02	04/01/2020 21:33	1,51	1	1,51	CHI
20200121946	QUIRINOPOLIS	QI12296614	QUIRINOPOLIS	04/01/2020 20:02	04/01/2020 21:33	04/01/2020 20:02	04/01/2020 21:33	1,51	11	16,60	CHI
20200121952	PIRACANJUBA	PJ21034050	MORRINHOS	04/01/2020 20:04	05/01/2020 16:25	04/01/2020 20:04	05/01/2020 16:25	20,34	1	20,34	CHI
20200121964	CORUMBAIBA	CI12263856	VILA CORUMBA	04/01/2020 19:46	05/01/2020 14:30	04/01/2020 19:46	05/01/2020 14:30	18,73	168	3146,36	CHI
20200121964	NOVA AURORA	CI12263856	VILA CORUMBA	04/01/2020 19:46	05/01/2020 14:30	04/01/2020 19:46	05/01/2020 14:30	18,73	7	131,10	CHI
20200121969	CAIAPONIA	CP21062847	IPORA	04/01/2020 20:08	05/01/2020 11:16	04/01/2020 20:08	05/01/2020 11:16	15,13	2	30,27	CHI
20200121974	NOVO GAMA	05410226	MARAJOARA	04/01/2020 20:10	06/01/2020 16:48	06/01/2020 11:26	06/01/2020 12:00	0,57	9	5,10	CHI
20200121974	SANTO ANTONIO DO DESCOBERTO	05410226	MARAJOARA	04/01/2020 20:10	06/01/2020 16:48	06/01/2020 11:26	06/01/2020 12:00	0,57	119	67,40	CHI
20200121974	SANTO ANTONIO DO DESCOBERTO	8206432	MARAJOARA	04/01/2020 20:10	06/01/2020 16:48	04/01/2020 20:10	06/01/2020 16:48	44,65	1	44,65	CHI
20200121981	NOVA CRIXAS	NA12087039	NOVA CRIXAS	04/01/2020 18:31	05/01/2020 08:05	04/01/2020 18:31	05/01/2020 08:05	13,55	4	54,22	CHI
20200121983	GOIAS	GS12029627	GOIAS	04/01/2020 18:15	05/01/2020 10:03	04/01/2020 18:15	05/01/2020 10:03	15,79	10	157,88	CHI
20200121984	SAO FRANCISCO DE GOIAS	SF12297998	SAO FRANCISCO DE GOIAS	04/01/2020 19:33	05/01/2020 11:06	04/01/2020 19:33	05/01/2020 11:06	15,55	45	699,76	CHI
20200121984	SAO FRANCISCO DE GOIAS	SF12297998	SAO FRANCISCO DE GOIAS	04/01/2020 19:33	05/01/2020 11:06	05/01/2020 03:00	05/01/2020 11:06	8,10	3	24,30	CHI
20200121987	LUZIANIA	120401230	RIO VERMELHO	04/01/2020 20:15	04/01/2020 21:49	04/01/2020 20:15	04/01/2020 21:49	1,57	1	1,57	CHI
20200121995	MINEIROS	1390097770	PARQUE DAS EMAS	04/01/2020 20:19	05/01/2020 11:41	04/01/2020 20:19	05/01/2020 11:41	15,36	1	15,36	CHI
20200121999	MINEIROS	MY21303456	PARQUE DAS EMAS	04/01/2020 20:20	05/01/2020 14:42	04/01/2020 20:20	05/01/2020 14:42	18,36	1	18,36	CHI
20200122003	MORRINHOS	MR12254399	MORRINHOS	04/01/2020 20:20	05/01/2020 12:45	04/01/2020 20:20	05/01/2020 12:45	16,41	3	49,24	CHI

20200122005	JATAI	290057670	JATAI S3	04/01/2020 20:20	04/01/2020 22:46	04/01/2020 20:20	04/01/2020 22:46	2,42	1	2,42	CHI
20200122007	PETROLINA DE GOIAS	PV12295527	SAO FRANCISCO DE GOIAS	04/01/2020 19:17	04/01/2020 23:03	04/01/2020 19:17	04/01/2020 23:03	3,77	3	11,30	CHI
20200122007	PIRENOPOLIS	PV12295527	SAO FRANCISCO DE GOIAS	04/01/2020 19:17	04/01/2020 23:03	04/01/2020 19:17	04/01/2020 23:03	3,77	6	22,59	CHI
20200122011	SANTA HELENA DE GOIAS	SH21000048	IPEGUARI	04/01/2020 20:22	04/01/2020 23:34	04/01/2020 20:22	04/01/2020 23:34	3,19	1	3,19	CHI
20200122015	ITUMBIARA	IT21000183	ITUMBIARA NOVA	04/01/2020 20:23	05/01/2020 00:33	04/01/2020 20:23	05/01/2020 00:33	4,15	1	4,15	CHI
20200122017	URUACU	UR21202153	URUACU	04/01/2020 20:24	05/01/2020 12:22	04/01/2020 20:24	05/01/2020 12:22	15,96	1	15,96	CHI
20200122018	JATAI	290106618	JATAI S2	04/01/2020 20:24	04/01/2020 21:28	04/01/2020 20:24	04/01/2020 21:28	1,06	1	1,06	CHI
20200122019	CAIAPONIA	CP12253788	CAIAPONIA	04/01/2020 20:24	05/01/2020 01:09	04/01/2020 20:24	05/01/2020 01:09	4,74	22	104,38	CHI
20200122027	BURITI ALEGRE	BG21285861	ITUMBIARA VELHA S2	04/01/2020 20:26	05/01/2020 10:25	04/01/2020 20:26	05/01/2020 10:25	13,98	1	13,98	CHI
20200122031	GOIANIA	13422250	GOIANIA LESTE S3	04/01/2020 20:27	04/01/2020 23:59	04/01/2020 20:27	04/01/2020 23:59	3,53	1	3,53	CHI
20200122034	PIRENOPOLIS	PV12273236	SAO FRANCISCO DE GOIAS	04/01/2020 20:27	04/01/2020 23:16	04/01/2020 20:27	04/01/2020 23:16	2,81	9	25,29	CHI
20200122034	SAO FRANCISCO DE GOIAS	PV12273236	SAO FRANCISCO DE GOIAS	04/01/2020 20:27	04/01/2020 23:16	04/01/2020 20:27	04/01/2020 23:16	2,81	2	5,62	CHI
20200122038	GUAPO	GA21000017	GUAPO S1	04/01/2020 20:28	05/01/2020 00:01	04/01/2020 20:28	05/01/2020 00:01	3,54	1	3,54	CHI
20200122039	SAO FRANCISCO DE GOIAS	SF12000173	SAO FRANCISCO DE GOIAS	04/01/2020 20:28	05/01/2020 01:05	04/01/2020 20:28	05/01/2020 01:05	4,61	11	50,74	CHI
20200122042	QUIRINOPOLIS	04150224	CABRIUVA S2	04/01/2020 17:49	05/01/2020 08:25	04/01/2020 17:49	05/01/2020 08:25	14,59	4	58,34	CHI
20200122042	RIO VERDE	04150224	CABRIUVA S2	04/01/2020 17:49	05/01/2020 08:25	04/01/2020 17:49	05/01/2020 08:25	14,59	200	2917,11	CHI
20200122045	ITABERAI	IB12401037	ITABERAI S1	04/01/2020 20:30	05/01/2020 15:56	04/01/2020 20:30	05/01/2020 15:56	19,43	1	19,43	CHI
20200122053	GOIANIA	GN11133952	AEROPORTO S3	04/01/2020 20:32	05/01/2020 01:14	05/01/2020 00:44	05/01/2020 01:14	0,49	53	26,01	CHI
20200122060	SAO FRANCISCO DE GOIAS	SF12039051	SAO FRANCISCO DE GOIAS	04/01/2020 20:34	05/01/2020 09:58	04/01/2020 20:34	05/01/2020 09:58	13,39	28	374,97	CHI
20200122062	ABADIANIA	AA21050408	ANAPOLIS UNIVERSITARIO S1	04/01/2020 20:36	05/01/2020 14:42	04/01/2020 20:36	05/01/2020 14:42	18,10	2	36,19	CHI
20200122068	SERRANOPOLIS	MY21214502	CHAPADAO DO CEU	04/01/2020 20:37	05/01/2020 11:52	04/01/2020 20:37	05/01/2020 11:52	15,24	1	15,24	CHI
20200122069	NOVA IGUACU DE GOIAS	10026055064	SANTA TEREZINHA	04/01/2020 20:38	05/01/2020 10:55	04/01/2020 20:38	05/01/2020 10:55	14,28	1	14,28	CHI
20200122071	SANTO ANTONIO DO DESCOBERTO	SN12082917	MARAJOARA	04/01/2020 20:38	05/01/2020 12:23	04/01/2020 20:38	05/01/2020 12:23	15,74	31	487,89	CHI
20200122073	JARAGUA	JA12273265	JARAGUA	04/01/2020 20:21	04/01/2020 22:47	04/01/2020 20:21	04/01/2020 22:47	2,42	16	38,78	CHI
20200122077	ALEXANIA	SN12382967	MARAJOARA	04/01/2020 20:33	05/01/2020 04:17	04/01/2020 20:33	05/01/2020 04:17	7,73	1	7,73	CHI
20200122077	SANTO ANTONIO DO DESCOBERTO	SN12382967	MARAJOARA	04/01/2020 20:33	05/01/2020 04:17	04/01/2020 20:33	05/01/2020 04:17	7,73	16	123,66	CHI
20200122078	GAMELEIRA DE GOIAS	SV12211132	VIANOPOLIS	04/01/2020 15:44	05/01/2020 03:39	04/01/2020 15:44	05/01/2020 03:39	11,90	20	238,06	CHI
20200122078	SILVANIA	SV12211132	VIANOPOLIS	04/01/2020 15:44	05/01/2020 03:39	04/01/2020 15:44	05/01/2020 03:39	11,90	44	523,73	CHI
20200122080	PORANGATU	PO21392639	PORANGATU	04/01/2020 20:42	05/01/2020 11:25	04/01/2020 20:42	05/01/2020 11:25	14,71	1	14,71	CHI
20200122081	FORMOSA	FA11131890	ITUIQUIRA	04/01/2020 20:42	04/01/2020 21:01	04/01/2020 20:42	04/01/2020 21:01	0,31	78	23,88	CHI
20200122093	PIRENOPOLIS	PV21000709	ANAPOLIS UNIVERSITARIO S2	04/01/2020 20:46	05/01/2020 20:57	04/01/2020 20:46	05/01/2020 20:57	24,18	1	24,18	CHI
20200122097	BRITANIA	BT12210256	BRITANIA	04/01/2020 21:17	05/01/2020 14:30	04/01/2020 21:17	05/01/2020 14:30	17,21	10	172,12	CHI
20200122098	PIRENOPOLIS	PV12171295	CORUMBA	04/01/2020 20:47	05/01/2020 09:59	04/01/2020 20:47	05/01/2020 09:59	13,19	3	39,58	CHI

20200122100	GOIANESIA	BA12163310	GOIANESIA S1	04/01/2020 17:33	05/01/2020 07:58	04/01/2020 17:33	05/01/2020 07:58	14,41	2	28,82	CHI
20200122100	VILA PROPICIO	BA12163310	GOIANESIA S1	04/01/2020 17:33	05/01/2020 07:58	04/01/2020 17:33	05/01/2020 07:58	14,41	11	158,50	CHI
20200122101	ANAPOLIS	AN12254173	JUNDIAI S1	04/01/2020 19:30	05/01/2020 02:59	04/01/2020 19:30	05/01/2020 02:59	7,49	258	1931,92	CHI
20200122105	GOIANIA	10288193	CAMPINAS S2	04/01/2020 20:51	05/01/2020 00:40	04/01/2020 20:51	05/01/2020 00:40	3,81	1	3,81	CHI
20200122109	SANTO ANTONIO DO DESCOBERTO	SN12314001	MARAJOARA	04/01/2020 19:28	05/01/2020 16:16	04/01/2020 19:28	05/01/2020 16:16	20,80	26	540,77	CHI
20200122109	SANTO ANTONIO DO DESCOBERTO	SN12314001	MARAJOARA	04/01/2020 19:28	05/01/2020 16:16	05/01/2020 14:24	05/01/2020 16:16	1,87	98	183,40	CHI
20200122123	ALTO PARAISO DE GOIAS	BF11113687	FLORES DE GOIAS	04/01/2020 20:23	04/01/2020 23:38	04/01/2020 20:23	04/01/2020 23:38	3,25	63	204,63	CHI
20200122125	CRISTALINA	KR21199527	PAMPLONA	04/01/2020 20:55	05/01/2020 09:43	04/01/2020 20:55	05/01/2020 09:43	12,79	1	12,79	CHI
20200122128	FORMOSA	FA12397866	ITUIQUIRA	04/01/2020 20:15	04/01/2020 22:25	04/01/2020 20:15	04/01/2020 22:25	2,16	140	302,75	CHI
20200122140	SILVANIA	SV21075301	VIANOPOLIS	04/01/2020 20:57	05/01/2020 18:23	04/01/2020 20:57	05/01/2020 18:23	21,42	1	21,42	CHI
20200122158	PILAR DE GOIAS	GG21318444	URUACU	04/01/2020 21:00	05/01/2020 16:31	04/01/2020 21:00	05/01/2020 16:31	19,51	6	117,08	CHI
20200122171	ANAPOLIS	05800244	ANAPOLIS UNIVERSITARIO S2	04/01/2020 21:03	05/01/2020 18:07	04/01/2020 21:03	04/01/2020 22:23	1,33	6153	8186,91	CHI
20200122171	ANAPOLIS	05800244	ANAPOLIS UNIVERSITARIO S2	04/01/2020 21:03	05/01/2020 18:07	04/01/2020 21:03	04/01/2020 23:35	2,53	1697	4285,87	CHI
20200122171	ANAPOLIS	05800244	ANAPOLIS UNIVERSITARIO S2	04/01/2020 21:03	05/01/2020 18:07	05/01/2020 12:53	05/01/2020 12:56	0,05	6153	329,87	CHI
20200122171	ANAPOLIS	AN13258122	ANAPOLIS UNIVERSITARIO S2	04/01/2020 21:03	05/01/2020 18:07	05/01/2020 12:53	05/01/2020 15:57	3,06	1697	5188,11	CHI
20200122171	ANAPOLIS	05800244	ANAPOLIS UNIVERSITARIO S2	04/01/2020 21:03	05/01/2020 18:07	04/01/2020 21:03	05/01/2020 16:02	18,98	12	227,77	CHI
20200122171	ANAPOLIS	05800244	ANAPOLIS UNIVERSITARIO S2	04/01/2020 21:03	05/01/2020 18:07	04/01/2020 21:03	05/01/2020 16:04	19,01	51	969,37	CHI
20200122171	ANAPOLIS	05800244	ANAPOLIS UNIVERSITARIO S2	04/01/2020 21:03	05/01/2020 18:07	04/01/2020 21:03	05/01/2020 18:07	21,06	225	4737,69	CHI
20200122171	GAMELEIRA DE GOIAS	05800244	ANAPOLIS UNIVERSITARIO S2	04/01/2020 21:03	05/01/2020 18:07	04/01/2020 21:03	05/01/2020 18:07	21,06	104	2189,86	CHI
20200122171	SILVANIA	05800244	ANAPOLIS UNIVERSITARIO S2	04/01/2020 21:03	05/01/2020 18:07	04/01/2020 21:03	05/01/2020 18:07	21,06	37	779,09	CHI
20200122171	ANAPOLIS	20605821	ANAPOLIS UNIVERSITARIO S2	04/01/2020 21:03	05/01/2020 18:07	04/01/2020 21:13	05/01/2020 18:07	20,89	2	41,79	CHI
20200122171	ANAPOLIS	20605821	ANAPOLIS UNIVERSITARIO S2	04/01/2020 21:03	05/01/2020 18:07	04/01/2020 21:22	05/01/2020 18:07	20,75	11	228,23	CHI
20200122174	ALEXANIA	AX21194514	ALEXANIA	04/01/2020 21:04	06/01/2020 07:37	04/01/2020 21:04	06/01/2020 07:37	34,55	1	34,55	CHI
20200122184	ITAPIRAPUA	IU12142807	MATRINCHA	04/01/2020 20:45	04/01/2020 23:44	04/01/2020 20:45	04/01/2020 23:44	2,97	12	35,68	CHI
20200122200	RIO VERDE	RV21032005	RIO VERDE S1	04/01/2020 21:09	05/01/2020 10:46	04/01/2020 21:09	05/01/2020 10:46	13,61	1	13,61	CHI
20200122206	MORRINHOS	MR21106049	MORRINHOS	04/01/2020 11:31	05/01/2020 09:28	04/01/2020 11:31	05/01/2020 09:28	21,94	1	21,94	CHI
20200122209	GOIANESIA	JA12313023	GOIANESIA S2	04/01/2020 21:11	05/01/2020 00:57	04/01/2020 21:11	05/01/2020 00:57	3,76	1	3,76	CHI
20200122209	JARAGUA	JA12313023	GOIANESIA S2	04/01/2020 21:11	05/01/2020 00:57	04/01/2020 21:11	05/01/2020 00:57	3,76	2	7,53	CHI
20200122212	RIO VERDE	RV12260596	CABRIUVA S2	04/01/2020 19:21	05/01/2020 00:32	04/01/2020 19:21	05/01/2020 00:32	5,18	2	10,37	CHI
20200122214	MOSSAMEDES	MD21121031	ITABERAI S2	04/01/2020 21:12	05/01/2020 10:21	04/01/2020 21:12	05/01/2020 10:21	13,15	1	13,15	CHI
20200122216	RIO VERDE	RV21028152	SANTA HELENA S1	04/01/2020 21:12	05/01/2020 10:15	04/01/2020 21:12	05/01/2020 10:15	13,04	1	13,04	CHI
20200122229	GUAPO	GA21216295	GUAPO S1	04/01/2020 21:16	04/01/2020 23:29	04/01/2020 21:16	04/01/2020 23:29	2,22	1	2,22	CHI
20200122232	GOIANIA	10019777858	CARAJAS S2	04/01/2020 21:16	04/01/2020 22:27	04/01/2020 21:16	04/01/2020 22:27	1,18	1	1,18	CHI

20200122233	FLORES DE GOIAS	FB12397955	FLORES DE GOIAS	04/01/2020 21:16	05/01/2020 10:44	04/01/2020 21:16	05/01/2020 10:44	13,46	9	121,13	CHI
20200122234	LUZIANIA	LZ21084531	MARAJOARA	04/01/2020 21:16	05/01/2020 13:15	04/01/2020 21:16	05/01/2020 11:35	14,31	1	14,31	CHI
20200122234	LUZIANIA	LZ12330544	MARAJOARA	04/01/2020 21:16	05/01/2020 13:15	05/01/2020 09:02	05/01/2020 13:15	4,22	7	29,52	CHI
20200122235	APARECIDA DO RIO DOCE	JT21033571	CACHOEIRA ALTA	04/01/2020 21:16	05/01/2020 08:00	04/01/2020 21:16	05/01/2020 08:00	10,72	1	10,72	CHI
20200122241	FAZENDA NOVA	FN12060710	IPORA	04/01/2020 21:07	05/01/2020 10:58	04/01/2020 21:07	05/01/2020 10:58	13,85	48	664,76	CHI
20200122252	ALEXANIA	AX21342868	ALEXANIA	04/01/2020 21:20	06/01/2020 01:03	04/01/2020 21:20	06/01/2020 01:03	27,70	16	443,22	CHI
20200122258	ANAPOLIS	20400421	JUNDIAI S1	04/01/2020 21:22	05/01/2020 08:28	04/01/2020 21:22	05/01/2020 08:28	11,09	1	11,09	CHI
20200122260	MOSSAMEDES	MD21144864	FIRMINOPOLIS S2	04/01/2020 21:23	05/01/2020 09:05	04/01/2020 21:23	05/01/2020 09:05	11,70	1	11,70	CHI
20200122261	GOIANIA	10411069	FERROVIARIO S3	04/01/2020 21:23	04/01/2020 23:38	04/01/2020 21:23	04/01/2020 23:38	2,25	1	2,25	CHI
20200122262	GOIANIA	GN11001417	CAMPINAS S2	04/01/2020 21:13	05/01/2020 01:04	04/01/2020 21:13	05/01/2020 01:04	3,84	86	330,31	CHI
20200122265	IPAMERI	IP12404713	IPAMERI	04/01/2020 20:49	05/01/2020 00:40	04/01/2020 20:49	05/01/2020 00:40	3,84	54	207,18	CHI
20200122274	BRAZABRANTES	380001706	NEROPOLIS S1	04/01/2020 21:28	05/01/2020 01:29	04/01/2020 21:28	05/01/2020 01:29	4,01	1	4,01	CHI
20200122281	NEROPOLIS	NR21268874	NEROPOLIS S2	04/01/2020 21:33	05/01/2020 16:54	04/01/2020 21:33	05/01/2020 16:54	19,34	2	38,69	CHI
20200122282	MAIRIPOTABA	MI12060664	PONTALINA	04/01/2020 18:48	05/01/2020 14:59	04/01/2020 18:48	05/01/2020 14:59	20,17	2	40,34	CHI
20200122285	PONTALINA	PK21131191	PONTALINA	04/01/2020 21:35	05/01/2020 08:28	04/01/2020 21:35	05/01/2020 08:28	10,87	1	10,87	CHI
20200122289	MONTIVIDIU	MV21213303	MONTIVIDIU T	04/01/2020 21:39	05/01/2020 07:30	04/01/2020 21:39	05/01/2020 07:30	9,85	1	9,85	CHI
20200122293	ANAPOLIS	10005830468	ANAPOLIS UNIVERSITARIO S2	04/01/2020 21:41	05/01/2020 14:21	04/01/2020 21:41	05/01/2020 14:21	16,65	1	16,65	CHI
20200122299	SAO SIMAO	SO11000024	CACHOEIRA ALTA	04/01/2020 21:45	05/01/2020 01:20	04/01/2020 21:45	05/01/2020 01:20	3,57	76	271,68	CHI
20200122308	GOIANIA	GN11199220	XAVANTES	04/01/2020 21:52	04/01/2020 23:43	04/01/2020 21:52	04/01/2020 23:43	1,85	43	79,62	CHI
20200122311	CRIXAS	2490033597	SERRA DO OURO	04/01/2020 21:54	05/01/2020 14:32	04/01/2020 21:54	05/01/2020 14:32	16,62	1	16,62	CHI
20200122312	CRISTALINA	IP21386743	CRISTALINA S1	04/01/2020 21:54	05/01/2020 09:38	04/01/2020 21:54	05/01/2020 09:38	11,72	1	11,72	CHI
20200122319	APARECIDA DO RIO DOCE	JT21033569	CACHOEIRA ALTA	04/01/2020 22:00	06/01/2020 11:16	04/01/2020 22:00	06/01/2020 11:16	37,26	1	37,26	CHI
20200122323	ACREUNA	EU21245954	ACREUNA	04/01/2020 22:04	05/01/2020 00:04	04/01/2020 22:04	05/01/2020 00:04	2,00	1	2,00	CHI
20200122326	MONTIVIDIU	MV12260799	MONTIVIDIU T	04/01/2020 18:14	05/01/2020 09:53	04/01/2020 18:14	05/01/2020 09:53	15,65	8	125,16	CHI
20200122333	INHUMAS	IN12012214	INHUMAS S2	04/01/2020 19:49	04/01/2020 22:25	04/01/2020 19:49	04/01/2020 22:25	2,59	181	469,09	CHI
20200122335	BALIZA	BH12381003	BOM JARDIM	04/01/2020 22:06	05/01/2020 08:19	04/01/2020 22:06	05/01/2020 08:19	10,21	23	234,80	CHI
20200122337	PARAUNA	PU12007910	PARAUNA	04/01/2020 22:09	05/01/2020 09:39	04/01/2020 22:09	05/01/2020 09:39	11,49	3	34,46	CHI
20200122340	MORRINHOS	MR21000153	MORRINHOS	04/01/2020 22:10	05/01/2020 10:28	04/01/2020 22:10	05/01/2020 10:28	12,29	2	24,58	CHI
20200122342	GOIANDIRA	GD12131094	CATALAO S1	04/01/2020 22:11	05/01/2020 12:06	04/01/2020 22:11	05/01/2020 12:06	13,90	7	97,33	CHI
20200122342	NOVA AURORA	GD12131094	CATALAO S1	04/01/2020 22:11	05/01/2020 12:06	04/01/2020 22:11	05/01/2020 12:06	13,90	3	41,71	CHI
20200122348	SANTO ANTONIO DO DESCOBERTO	10004850864	ALEXANIA	04/01/2020 22:15	04/01/2020 23:12	04/01/2020 22:15	04/01/2020 23:12	0,94	1	0,94	CHI
20200122349	MORRINHOS	MR21153556	MORRINHOS	04/01/2020 22:15	05/01/2020 07:40	04/01/2020 22:15	05/01/2020 07:40	9,42	2	18,83	CHI
20200122355	CALDAS NOVAS	CN21074893	RIO QUENTE	04/01/2020 22:20	05/01/2020 09:19	04/01/2020 22:20	05/01/2020 09:19	10,97	1	10,97	CHI

20200122359	NOVO GAMA	2460036559	PACAEMBU S1	04/01/2020 22:23	04/01/2020 23:42	04/01/2020 22:23	04/01/2020 23:42	1,30	1	1,30	CHI
20200122361	VILA BOA	FA12102763	ITIQUEIRA	04/01/2020 22:25	05/01/2020 14:39	04/01/2020 22:25	05/01/2020 14:39	16,23	1	16,23	CHI
20200122362	MINACU	IH12307129	MINACU	04/01/2020 22:26	05/01/2020 10:45	04/01/2020 22:26	05/01/2020 10:45	12,31	12	147,74	CHI
20200122363	ADELANDIA	DN21276751	FIRMINOPOLIS S2	04/01/2020 22:26	05/01/2020 09:31	04/01/2020 22:26	05/01/2020 09:31	11,08	1	11,08	CHI
20200122367	SILVANIA	SV12031948	DAIA S2	04/01/2020 15:53	05/01/2020 09:25	04/01/2020 15:53	05/01/2020 09:25	17,53	5	87,63	CHI
20200122370	MINEIROS	1390173139	PARQUE DAS EMAS	04/01/2020 22:32	05/01/2020 08:42	04/01/2020 22:32	05/01/2020 08:42	10,17	1	10,17	CHI
20200122371	AGUA LIMPA	MG12100096RE	VILA CORUMBA	04/01/2020 22:32	05/01/2020 14:53	04/01/2020 22:32	05/01/2020 14:53	16,35	16	261,52	CHI
20200122371	CALDAS NOVAS	MG12100096RE	VILA CORUMBA	04/01/2020 22:32	05/01/2020 14:53	04/01/2020 22:32	05/01/2020 14:53	16,35	2	32,69	CHI
20200122371	MARZAGAO	MG12100096RE	VILA CORUMBA	04/01/2020 22:32	05/01/2020 14:53	04/01/2020 22:32	05/01/2020 14:53	16,35	15	245,18	CHI
20200122371	RIO QUENTE	MG12100096RE	VILA CORUMBA	04/01/2020 22:32	05/01/2020 14:53	04/01/2020 22:32	05/01/2020 14:53	16,35	4	65,38	CHI
20200122381	GOIANIA	15482157	ATLANTICO S3	04/01/2020 22:42	04/01/2020 23:35	04/01/2020 22:42	04/01/2020 23:35	0,88	1	0,88	CHI
20200122382	AGUA FRIA DE GOIAS	MJ12040650	PADRE BERNARDO	04/01/2020 22:43	05/01/2020 03:53	04/01/2020 22:43	05/01/2020 03:53	5,16	9	46,41	CHI
20200122382	MIMOSO DE GOIAS	MJ12040650	PADRE BERNARDO	04/01/2020 22:43	05/01/2020 03:53	04/01/2020 22:43	05/01/2020 03:53	5,16	12	61,88	CHI
20200122386	ANAPOLIS	AN21221499	ANAPOLIS UNIVERSITARIO S2	04/01/2020 22:48	05/01/2020 07:21	04/01/2020 22:48	05/01/2020 07:21	8,55	1	8,55	CHI
20200122392	PIRES DO RIO	460050151	PIRES DO RIO S1	04/01/2020 22:52	05/01/2020 00:28	04/01/2020 22:52	05/01/2020 00:28	1,59	1	1,59	CHI
20200122393	BOM JESUS DE GOIAS	DM12345983	RIO DOS BOIS	04/01/2020 22:54	05/01/2020 09:28	04/01/2020 22:54	05/01/2020 09:28	10,56	10	105,57	CHI
20200122393	CASTELANDIA	DM12345983	RIO DOS BOIS	04/01/2020 22:54	05/01/2020 09:28	04/01/2020 22:54	05/01/2020 09:28	10,56	22	232,25	CHI
20200122399	CRISTALINA	KR12376278	PAMPLONA	04/01/2020 22:58	05/01/2020 13:05	04/01/2020 22:58	05/01/2020 13:05	14,10	10	141,02	CHI
20200122404	CAIAPONIA	930060003	CAIAPONIA	04/01/2020 23:09	05/01/2020 12:37	04/01/2020 23:09	05/01/2020 12:37	13,47	1	13,47	CHI
20200122409	PALMINOPOLIS	PP12077093	PALMEIRAS	04/01/2020 23:16	05/01/2020 07:52	04/01/2020 23:16	05/01/2020 07:52	8,59	2	17,19	CHI
20200122422	PIRACANJUBA	PJ21349844	PIRACANJUBA	04/01/2020 23:31	05/01/2020 22:02	04/01/2020 23:31	05/01/2020 22:02	22,50	2	45,01	CHI
20200122432	GUAPO	GA12082436	GUAPO S2	04/01/2020 23:12	05/01/2020 05:45	04/01/2020 23:12	05/01/2020 05:45	6,54	46	300,70	CHI
20200122432	VARJAO	GA12082436	GUAPO S2	04/01/2020 23:12	05/01/2020 05:45	04/01/2020 23:12	05/01/2020 05:45	6,54	24	156,89	CHI
20200122455	SENADOR CANEDO	190090364	SENADOR CANEDO	05/01/2020 00:13	05/01/2020 01:35	05/01/2020 00:13	05/01/2020 01:35	1,37	1	1,37	CHI
20200122458	GOIANIA	GN11229576	ATLANTICO S3	04/01/2020 23:42	05/01/2020 01:28	04/01/2020 23:42	05/01/2020 01:28	1,76	47	82,82	CHI
20200122470	PALESTINA DE GOIAS	PY12027944	PALESTINA	05/01/2020 00:45	05/01/2020 07:50	05/01/2020 00:45	05/01/2020 07:50	7,08	53	375,17	CHI
20200122475	JATAI	6405994	JATAI S1	05/01/2020 00:55	05/01/2020 09:40	05/01/2020 00:55	05/01/2020 09:40	8,73	5	43,67	CHI
20200122476	EDEIA	EA12263293	EDEIA	05/01/2020 00:48	05/01/2020 09:30	05/01/2020 00:48	05/01/2020 09:30	8,70	9	78,29	CHI
20200122478	GOIAS	IU12073717	MATRINCHA	05/01/2020 01:06	05/01/2020 12:12	05/01/2020 01:06	05/01/2020 12:12	11,11	21	233,21	CHI
20200122478	ITAPIRAPUA	IU12073717	MATRINCHA	05/01/2020 01:06	05/01/2020 12:12	05/01/2020 01:06	05/01/2020 12:12	11,11	26	288,74	CHI
20200122483	CALDAS NOVAS	CN12106304	CALDAS NOVAS S2	05/01/2020 00:49	05/01/2020 02:28	05/01/2020 00:49	05/01/2020 02:28	1,65	122	201,27	CHI
20200122500	FIRMINOPOLIS	FR12028946	FIRMINOPOLIS S1	04/01/2020 23:51	05/01/2020 08:40	04/01/2020 23:51	05/01/2020 08:40	8,81	21	185,02	CHI
20200122511	SAO MIGUEL DO ARAGUAIA	SM10391487	SAO MIGUEL DO ARAGUAIA	05/01/2020 01:59	07/01/2020 01:06	05/01/2020 01:59	05/01/2020 13:05	11,09	26	288,29	CHI



20200122511	SAO MIGUEL DO ARAGUAIA	SM10391487	SAO MIGUEL DO ARAGUAIA	05/01/2020 01:59	07/01/2020 01:06	05/01/2020 01:59	05/01/2020 13:26	11,45	12	137,40	CHI
20200122511	SAO MIGUEL DO ARAGUAIA	SM10388763	SAO MIGUEL DO ARAGUAIA	05/01/2020 01:59	07/01/2020 01:06	05/01/2020 18:06	05/01/2020 18:09	0,05	139	7,37	CHI
20200122511	SAO MIGUEL DO ARAGUAIA	SM10388763	SAO MIGUEL DO ARAGUAIA	05/01/2020 01:59	07/01/2020 01:06	05/01/2020 18:06	05/01/2020 18:10	0,08	126	9,48	CHI
20200122511	SAO MIGUEL DO ARAGUAIA	SM10388763	SAO MIGUEL DO ARAGUAIA	05/01/2020 01:59	07/01/2020 01:06	05/01/2020 18:06	05/01/2020 18:11	0,10	12	1,17	CHI
20200122511	SAO MIGUEL DO ARAGUAIA	SM10388763	SAO MIGUEL DO ARAGUAIA	05/01/2020 01:59	07/01/2020 01:06	05/01/2020 20:40	05/01/2020 20:43	0,06	298	16,64	CHI
20200122511	SAO MIGUEL DO ARAGUAIA	SM10388763	SAO MIGUEL DO ARAGUAIA	05/01/2020 01:59	07/01/2020 01:06	05/01/2020 20:44	06/01/2020 05:50	9,10	28	254,76	CHI
20200122511	SAO MIGUEL DO ARAGUAIA	SM10388763	SAO MIGUEL DO ARAGUAIA	05/01/2020 01:59	07/01/2020 01:06	06/01/2020 12:08	06/01/2020 12:20	0,20	28	5,61	CHI
20200122511	SAO MIGUEL DO ARAGUAIA	SM10388763	SAO MIGUEL DO ARAGUAIA	05/01/2020 01:59	07/01/2020 01:06	06/01/2020 13:26	06/01/2020 13:34	0,13	35	4,38	CHI
20200122511	SAO MIGUEL DO ARAGUAIA	SM10388763	SAO MIGUEL DO ARAGUAIA	05/01/2020 01:59	07/01/2020 01:06	05/01/2020 20:44	06/01/2020 19:04	22,34	12	268,11	CHI
20200122511	SAO MIGUEL DO ARAGUAIA	SM10391487	SAO MIGUEL DO ARAGUAIA	05/01/2020 01:59	07/01/2020 01:06	05/01/2020 01:59	07/01/2020 01:06	47,10	19	894,99	CHI
20200122511	SAO MIGUEL DO ARAGUAIA	SM13375314	SAO MIGUEL DO ARAGUAIA	05/01/2020 01:59	07/01/2020 01:06	05/01/2020 20:44	07/01/2020 01:06	28,37	12	340,43	CHI
20200122511	SAO MIGUEL DO ARAGUAIA	SM10388763	SAO MIGUEL DO ARAGUAIA	05/01/2020 01:59	07/01/2020 01:06	05/01/2020 20:44	07/01/2020 01:06	28,37	126	3574,38	CHI
20200122511	SAO MIGUEL DO ARAGUAIA	SM10388763	SAO MIGUEL DO ARAGUAIA	05/01/2020 01:59	07/01/2020 01:06	05/01/2020 20:44	07/01/2020 01:06	28,36	110	3120,06	CHI
20200122511	SAO MIGUEL DO ARAGUAIA	SM13375314	SAO MIGUEL DO ARAGUAIA	05/01/2020 01:59	07/01/2020 01:06	05/01/2020 22:32	07/01/2020 01:06	26,56	1	26,56	CHI
20200122511	SAO MIGUEL DO ARAGUAIA	SM12013063LD	SAO MIGUEL DO ARAGUAIA	05/01/2020 01:59	07/01/2020 01:06	05/01/2020 20:44	07/01/2020 01:06	28,36	10	283,65	CHI
20200122601	LEOPOLDO DE BULHOES	XX16873661	DAIA S2	05/01/2020 02:22	05/01/2020 11:26	05/01/2020 02:22	05/01/2020 11:26	9,07	1	9,07	CHI
20200122603	PORANGATU	PO12139169	PORANGATU	05/01/2020 02:39	05/01/2020 07:20	05/01/2020 02:39	05/01/2020 07:20	4,68	105	491,58	CHI
20200122604	IPORA	IR12014024	IPORA	05/01/2020 02:27	05/01/2020 06:01	05/01/2020 02:27	05/01/2020 06:01	3,55	17	60,43	CHI
20200122612	NIQUELANDIA	NQ12295506	NIQUELANDIA SUBTRANSMISSAO	05/01/2020 02:50	05/01/2020 09:49	05/01/2020 02:50	05/01/2020 09:49	6,98	19	132,59	CHI
20200122614	FIRMINOPOLIS	FR12299099	FIRMINOPOLIS S1	05/01/2020 03:02	05/01/2020 10:07	05/01/2020 03:02	05/01/2020 10:07	7,08	4	28,30	CHI
20200122618	PALMINOPOLIS	PP12233526	PALMEIRAS	05/01/2020 03:09	05/01/2020 09:18	05/01/2020 03:09	05/01/2020 09:18	6,14	30	184,09	CHI
20200122619	GOIANIA	13082115	GOYA S1	05/01/2020 03:10	05/01/2020 04:57	05/01/2020 03:10	05/01/2020 04:57	1,78	1	1,78	CHI
20200122620	EDEIA	EA12044472	EDEIA	05/01/2020 03:10	05/01/2020 10:00	05/01/2020 03:10	05/01/2020 10:00	6,82	12	81,88	CHI
20200122623	SANTA FE DE GOIAS	RN12009765	BRITANIA	05/01/2020 03:28	05/01/2020 08:16	05/01/2020 03:28	05/01/2020 08:16	4,80	23	110,36	CHI
20200122624	ITABERAI	50130754	ITABERAI S2	05/01/2020 03:32	05/01/2020 10:20	05/01/2020 03:32	05/01/2020 10:20	6,80	1	6,80	CHI
20200122625	IPAMERI	IP12000078RE	IPAMERI	05/01/2020 03:37	05/01/2020 07:34	05/01/2020 03:37	05/01/2020 07:34	3,95	76	300,05	CHI
20200122626	GOIANIA	11710822	GOIANIA LESTE S2	05/01/2020 03:38	05/01/2020 06:20	05/01/2020 03:38	05/01/2020 06:20	2,70	1	2,70	CHI
20200122628	GOIANIA	15935565	GOIANIA LESTE S2	05/01/2020 03:41	05/01/2020 06:33	05/01/2020 03:41	05/01/2020 06:33	2,86	1	2,86	CHI
20200122632	QUIRINOPOLIS	01560214	QUIRINOPOLIS	04/01/2020 23:39	05/01/2020 12:02	05/01/2020 05:00	05/01/2020 05:04	0,07	5938	437,10	CHI
20200122632	QUIRINOPOLIS	01560214	QUIRINOPOLIS	04/01/2020 23:39	05/01/2020 12:02	05/01/2020 05:00	05/01/2020 05:33	0,55	676	370,11	CHI
20200122632	QUIRINOPOLIS	01560214	QUIRINOPOLIS	04/01/2020 23:39	05/01/2020 12:02	05/01/2020 05:00	05/01/2020 07:09	2,16	1361	2934,85	CHI
20200122632	QUIRINOPOLIS	01560214	QUIRINOPOLIS	04/01/2020 23:39	05/01/2020 12:02	05/01/2020 05:02	05/01/2020 07:09	2,13	33	70,17	CHI
20200122632	QUIRINOPOLIS	Q12361059	QUIRINOPOLIS	04/01/2020 23:39	05/01/2020 12:02	04/01/2020 23:39	05/01/2020 08:55	9,26	388	3592,02	CHI

20200122632	QUIRINOPOLIS	QI12361059	QUIRINOPOLIS	04/01/2020 23:39	05/01/2020 12:02	04/01/2020 23:39	05/01/2020 09:30	9,84	141	1386,93	CHI
20200122632	QUIRINOPOLIS	01560214	QUIRINOPOLIS	04/01/2020 23:39	05/01/2020 12:02	05/01/2020 05:00	05/01/2020 12:02	7,04	309	2174,76	CHI
20200122634	IPAMERI	IP12404713	IPAMERI	05/01/2020 03:55	05/01/2020 06:00	05/01/2020 03:55	05/01/2020 05:40	1,75	49	85,65	CHI
20200122634	IPAMERI	IP11363722	IPAMERI	05/01/2020 03:55	05/01/2020 06:00	05/01/2020 03:55	05/01/2020 06:00	2,08	5	10,41	CHI
20200122635	BELA VISTA DE GOIAS	BV12321565	CEPAIGO S2	05/01/2020 03:58	05/01/2020 10:30	05/01/2020 03:58	05/01/2020 10:30	6,52	7	45,62	CHI
20200122641	ARENOPOLIS	AY12000021	ARENOPOLIS	05/01/2020 04:07	05/01/2020 11:52	05/01/2020 04:07	05/01/2020 11:52	7,74	19	147,15	CHI
20200122643	CAMPESTRE DE GOIAS	GC17399994	TRINDADE	05/01/2020 04:10	05/01/2020 08:34	05/01/2020 04:10	05/01/2020 08:34	4,38	163	714,71	CHI
20200122650	JUSSARA	JR12017175	JUSSARA	05/01/2020 04:19	05/01/2020 08:10	05/01/2020 04:19	05/01/2020 08:10	3,84	7	26,91	CHI
20200122654	RUBIATABA	RB12003316	RUBIATABA	05/01/2020 04:28	05/01/2020 16:10	05/01/2020 04:28	05/01/2020 16:10	11,70	45	526,41	CHI
20200122659	MORRINHOS	MR12000135RE	GOIATUBA S1	05/01/2020 04:42	05/01/2020 10:02	05/01/2020 04:42	05/01/2020 10:02	5,32	133	707,49	CHI
20200122661	MINACU	IH12088797	MINACU	05/01/2020 04:51	05/01/2020 09:28	05/01/2020 04:51	05/01/2020 09:28	4,61	165	761,11	CHI
20200122665	JANDAIA	JD12010996LD	PALMEIRAS	05/01/2020 03:44	05/01/2020 08:16	05/01/2020 03:44	05/01/2020 08:16	4,53	19	86,06	CHI
20200122666	MINEIROS	PW12219569	PARQUE DAS EMAS	05/01/2020 04:54	05/01/2020 19:26	05/01/2020 04:54	05/01/2020 19:26	14,52	90	1306,65	CHI
20200122666	PORTELANDIA	PW12219569	PARQUE DAS EMAS	05/01/2020 04:54	05/01/2020 19:26	05/01/2020 04:54	05/01/2020 19:26	14,52	5	72,59	CHI
20200122672	BONOPOLIS	TA12263013	NOVO PLANALTO	05/01/2020 05:04	05/01/2020 11:38	05/01/2020 05:04	05/01/2020 11:38	6,56	31	203,21	CHI
20200122676	COCALZINHO DE GOIAS	10014974043	AGUAS LINDAS DE GOIAS S2	05/01/2020 05:06	06/01/2020 12:28	05/01/2020 05:06	06/01/2020 12:28	31,36	1	31,36	CHI
20200122678	GOIANIA	10268972	CAMPINAS S2	05/01/2020 05:08	05/01/2020 08:37	05/01/2020 05:08	05/01/2020 08:37	3,48	1	3,48	CHI
20200122682	PADRE BERNARDO	PB12290560	PADRE BERNARDO	05/01/2020 04:07	05/01/2020 07:40	05/01/2020 04:07	05/01/2020 07:40	3,55	29	102,89	CHI
20200122684	GOIAS	GS12206865	MATRINCHA	04/01/2020 22:14	05/01/2020 11:29	04/01/2020 22:14	05/01/2020 11:29	13,24	68	900,51	CHI
20200122685	TRINDADE	TR11035134	GOYA S1	05/01/2020 05:14	05/01/2020 10:35	05/01/2020 05:14	05/01/2020 10:35	5,35	185	989,29	CHI
20200122688	ARUANA	MP12274498	MOZARLANDIA	05/01/2020 05:16	05/01/2020 07:50	05/01/2020 05:16	05/01/2020 07:50	2,57	5	12,83	CHI
20200122688	MATRINCHA	MP12274498	MOZARLANDIA	05/01/2020 05:16	05/01/2020 07:50	05/01/2020 05:16	05/01/2020 07:50	2,57	3	7,70	CHI
20200122689	CRIXAS	CX12181008	SERRA DO OURO	05/01/2020 05:15	05/01/2020 16:40	05/01/2020 05:15	05/01/2020 16:40	11,40	7	79,82	CHI
20200122693	CAIAPONIA	CP12200875	CAIAPONIA	05/01/2020 05:20	05/01/2020 13:14	05/01/2020 05:20	05/01/2020 13:14	7,89	9	71,02	CHI
20200122743	CORUMBAIBA	CI12092137	CATALAO S1	04/01/2020 10:21	06/01/2020 13:37	04/01/2020 10:21	06/01/2020 13:37	51,26	7	358,81	CHI
20200122745	LUZIANIA	LZ11172177	RIO VERMELHO	05/01/2020 07:18	05/01/2020 11:02	05/01/2020 08:20	05/01/2020 11:02	2,70	145	391,50	CHI
20200122763	PALESTINA DE GOIAS	PY12395461	PALESTINA	05/01/2020 08:33	05/01/2020 08:57	05/01/2020 08:33	05/01/2020 08:57	0,40	3	1,20	CHI
20200122764	SILVANIA	SV21334099	VIANOPOLIS	05/01/2020 07:41	05/01/2020 15:26	05/01/2020 07:41	05/01/2020 15:26	7,74	2	15,49	CHI
20200122780	ITABERAI	50083880	ITABERAI S2	04/01/2020 19:41	05/01/2020 20:24	04/01/2020 19:41	05/01/2020 20:24	24,71	1	24,71	CHI
20200122785	IPAMERI	00830204	IPAMERI	05/01/2020 10:16	05/01/2020 16:21	05/01/2020 10:16	05/01/2020 10:19	0,05	8450	445,97	CHI
20200122785	IPAMERI	00830204	IPAMERI	05/01/2020 10:16	05/01/2020 16:21	05/01/2020 11:51	05/01/2020 11:55	0,07	8399	573,93	CHI
20200122785	IPAMERI	IP13000002	IPAMERI	05/01/2020 10:16	05/01/2020 16:21	05/01/2020 11:51	05/01/2020 16:09	4,29	51	219,03	CHI
20200122785	CALDAS NOVAS	00830204	IPAMERI	05/01/2020 10:16	05/01/2020 16:21	05/01/2020 10:16	05/01/2020 16:21	6,08	10	60,80	CHI

20200122785	CATALAO	00830204	IPAMERI	05/01/2020 10:16	05/01/2020 16:21	05/01/2020 10:16	05/01/2020 16:21	6,08	6	36,48	CHI
20200122785	CORUMBAIBA	00830204	IPAMERI	05/01/2020 10:16	05/01/2020 16:21	05/01/2020 10:16	05/01/2020 16:21	6,08	16	97,28	CHI
20200122785	GOIANDIRA	00830204	IPAMERI	05/01/2020 10:16	05/01/2020 16:21	05/01/2020 10:16	05/01/2020 16:21	6,08	15	91,20	CHI
20200122785	IPAMERI	00830204	IPAMERI	05/01/2020 10:16	05/01/2020 16:21	05/01/2020 10:16	05/01/2020 16:21	6,08	1489	9053,12	CHI
20200122785	NOVA AURORA	00830204	IPAMERI	05/01/2020 10:16	05/01/2020 16:21	05/01/2020 10:16	05/01/2020 16:21	6,08	2	12,16	CHI
20200122802	MORRINHOS	MR32076974	MORRINHOS	05/01/2020 05:26	05/01/2020 10:37	05/01/2020 05:26	05/01/2020 10:37	5,17	9	46,55	CHI
20200122814	IPIRANGA DE GOIAS	RB12391473	RUBIATABA	05/01/2020 05:34	06/01/2020 01:10	05/01/2020 05:34	05/01/2020 16:08	10,56	3	31,69	CHI
20200122814	RUBIATABA	RB12391473	RUBIATABA	05/01/2020 05:34	06/01/2020 01:10	05/01/2020 05:34	05/01/2020 16:08	10,56	140	1478,83	CHI
20200122814	RUBIATABA	RB10400426	RUBIATABA	05/01/2020 05:34	06/01/2020 01:10	05/01/2020 06:59	05/01/2020 16:08	9,15	99	905,85	CHI
20200122814	CARMO DO RIO VERDE	RB12000045LD	RUBIATABA	05/01/2020 05:34	06/01/2020 01:10	05/01/2020 05:34	05/01/2020 16:08	10,58	3	31,73	CHI
20200122814	CERES	RB12000045LD	RUBIATABA	05/01/2020 05:34	06/01/2020 01:10	05/01/2020 05:34	05/01/2020 16:08	10,58	2	21,15	CHI
20200122814	RUBIATABA	RB12000045LD	RUBIATABA	05/01/2020 05:34	06/01/2020 01:10	05/01/2020 05:34	05/01/2020 16:08	10,58	106	1121,16	CHI
20200122814	SAO PATRICIO	RB12000045LD	RUBIATABA	05/01/2020 05:34	06/01/2020 01:10	05/01/2020 05:34	05/01/2020 16:08	10,58	20	211,54	CHI
20200122814	CERES	RB12000045LD	RUBIATABA	05/01/2020 05:34	06/01/2020 01:10	05/01/2020 05:34	06/01/2020 01:10	19,60	25	490,05	CHI
20200122814	RUBIATABA	RB12000045LD	RUBIATABA	05/01/2020 05:34	06/01/2020 01:10	05/01/2020 05:34	06/01/2020 01:10	19,60	20	392,04	CHI
20200122814	CERES	RB12392307	RUBIATABA	05/01/2020 05:34	06/01/2020 01:10	05/01/2020 16:08	06/01/2020 01:10	9,02	1	9,02	CHI
20200122814	RUBIATABA	RB12392307	RUBIATABA	05/01/2020 05:34	06/01/2020 01:10	05/01/2020 16:08	06/01/2020 01:10	9,02	2	18,05	CHI
20200122816	JARAGUA	JA12064317	JARAGUA	05/01/2020 03:09	05/01/2020 08:00	05/01/2020 03:09	05/01/2020 08:00	4,84	51	246,95	CHI
20200122817	MORRINHOS	MR12092130	MORRINHOS	05/01/2020 05:35	05/01/2020 11:51	05/01/2020 05:35	05/01/2020 11:51	6,26	13	81,39	CHI
20200122819	PARAUNA	PU12079039	PARAUNA	05/01/2020 05:36	05/01/2020 06:58	05/01/2020 05:36	05/01/2020 06:58	1,37	37	50,81	CHI
20200122822	MAIRIPOTABA	MI12000233	PONTALINA	05/01/2020 05:37	06/01/2020 12:00	05/01/2020 05:37	05/01/2020 22:40	17,03	9	153,31	CHI
20200122822	MAIRIPOTABA	MI12000233	PONTALINA	05/01/2020 05:37	06/01/2020 12:00	05/01/2020 05:37	06/01/2020 12:00	30,38	5	151,92	CHI
20200122824	GOIANIA	GN12001501	XAVANTES	05/01/2020 05:39	05/01/2020 10:22	05/01/2020 05:39	05/01/2020 10:22	4,71	210	989,22	CHI
20200122825	BELA VISTA DE GOIAS	BV12000021	BELA VISTA S1	05/01/2020 03:04	05/01/2020 07:04	05/01/2020 03:04	05/01/2020 07:04	3,99	51	203,52	CHI
20200122836	ALTO HORIZONTE	AJ12210309LD	MARA ROSA	05/01/2020 05:45	05/01/2020 18:49	05/01/2020 05:45	05/01/2020 18:49	13,06	19	248,05	CHI
20200122836	MARA ROSA	AJ12210309LD	MARA ROSA	05/01/2020 05:45	05/01/2020 18:49	05/01/2020 05:45	05/01/2020 18:49	13,06	3	39,17	CHI
20200122837	CORREGO DO OURO	CO12054528	FIRMINOPOLIS S2	05/01/2020 05:46	05/01/2020 19:28	05/01/2020 05:46	05/01/2020 19:28	13,70	8	109,63	CHI
20200122844	ANICUNS	AC21019290	ANICUNS	05/01/2020 05:48	05/01/2020 07:58	05/01/2020 05:48	05/01/2020 07:58	2,17	2	4,34	CHI
20200122849	COCALZINHO DE GOIAS	ZN21201252	PADRE BERNARDO	05/01/2020 05:49	05/01/2020 10:19	05/01/2020 05:49	05/01/2020 10:19	4,49	2	8,98	CHI
20200122851	GOIANIRA	00550224	GOIANIRA	05/01/2020 05:46	05/01/2020 12:18	05/01/2020 05:48	05/01/2020 06:53	1,10	5285	5803,22	CHI
20200122851	TRINDADE	00550224	GOIANIRA	05/01/2020 05:46	05/01/2020 12:18	05/01/2020 05:48	05/01/2020 06:53	1,10	187	205,34	CHI
20200122851	GOIANIRA	GR16401509	GOIANIRA	05/01/2020 05:46	05/01/2020 12:18	05/01/2020 05:48	05/01/2020 06:55	1,12	666	746,29	CHI
20200122851	GOIANIRA	00550224	GOIANIRA	05/01/2020 05:46	05/01/2020 12:18	05/01/2020 10:49	05/01/2020 10:56	0,11	5951	644,69	CHI

20200122851	TRINDADE	00550224	GOIANIRA	05/01/2020 05:46	05/01/2020 12:18	05/01/2020 10:49	05/01/2020 10:56	0,11	187	20,26	CHI
20200122851	GOIANIRA	GR12273553LD	GOIANIRA	05/01/2020 05:46	05/01/2020 12:18	05/01/2020 05:48	05/01/2020 12:18	6,51	155	1009,35	CHI
20200122853	GOIANIA	AP11048934	REAL S1	05/01/2020 05:50	05/01/2020 12:04	05/01/2020 05:50	05/01/2020 12:04	6,23	112	698,04	CHI
20200122854	PIRES DO RIO	PR12064876RE	PIRES DO RIO S1	05/01/2020 05:50	05/01/2020 08:21	05/01/2020 05:50	05/01/2020 08:21	2,50	33	82,62	CHI
20200122857	PIRACANJUBA	PJ12384538	MORRINHOS	05/01/2020 05:52	05/01/2020 18:07	05/01/2020 05:52	05/01/2020 18:07	12,25	21	257,16	CHI
20200122858	PORANGATU	PO12189561	PORANGATU	05/01/2020 05:52	06/01/2020 12:32	05/01/2020 05:52	05/01/2020 14:54	9,03	6	54,15	CHI
20200122858	PORANGATU	PO12189561	PORANGATU	05/01/2020 05:52	06/01/2020 12:32	05/01/2020 05:52	06/01/2020 12:32	30,65	1	30,65	CHI
20200122867	ARENOPOLIS	AY12123896	ARENOPOLIS	05/01/2020 04:14	05/01/2020 10:10	05/01/2020 04:14	05/01/2020 10:10	5,92	14	82,88	CHI
20200122867	DIORAMA	AY12123896	ARENOPOLIS	05/01/2020 04:14	05/01/2020 10:10	05/01/2020 04:14	05/01/2020 10:10	5,92	15	88,80	CHI
20200122870	ORIZONA	OZ21255836	PIRES DO RIO S2	05/01/2020 05:56	05/01/2020 08:40	05/01/2020 05:56	05/01/2020 08:40	2,72	1	2,72	CHI
20200122872	MAMBAI	MB11120560	IACIARA S2	05/01/2020 05:58	05/01/2020 07:31	05/01/2020 05:58	05/01/2020 07:31	1,55	5	7,73	CHI
20200122875	ITAPIRAPUA	IU12089733	MATRINCHA	04/01/2020 22:41	05/01/2020 09:00	04/01/2020 22:41	05/01/2020 09:00	10,30	24	247,30	CHI
20200122878	MOZARLANDIA	MZ12051179	MOZARLANDIA	04/01/2020 21:39	06/01/2020 16:39	04/01/2020 21:39	06/01/2020 16:39	42,98	15	644,76	CHI
20200122882	PIRACANJUBA	PJ12082177	MORRINHOS	04/01/2020 20:06	05/01/2020 19:01	04/01/2020 20:06	05/01/2020 19:01	22,91	13	297,77	CHI
20200122884	ITAPIRAPUA	IU12259711	MATRINCHA	05/01/2020 06:02	05/01/2020 11:55	05/01/2020 06:02	05/01/2020 11:55	5,89	5	29,43	CHI
20200122886	FORMOSA	FA12397866	ITUIQUIRA	05/01/2020 06:02	05/01/2020 11:16	05/01/2020 06:02	05/01/2020 11:16	5,23	140	732,36	CHI
20200122887	NIQUELANDIA	NQ21146081	URUACU	05/01/2020 06:03	05/01/2020 10:42	05/01/2020 06:03	05/01/2020 10:42	4,64	1	4,64	CHI
20200122895	MINACU	IH12315089	MINACU	05/01/2020 06:06	05/01/2020 11:41	05/01/2020 06:06	05/01/2020 11:41	5,59	2	11,18	CHI
20200122898	AURILANDIA	AI21194096	FIRMINOPOLIS S2	05/01/2020 06:07	05/01/2020 09:19	05/01/2020 06:07	05/01/2020 09:19	3,20	1	3,20	CHI
20200122899	AMARALINA	UP12294696	NOVA CRIXAS	05/01/2020 06:07	05/01/2020 16:26	05/01/2020 06:07	05/01/2020 16:26	10,31	54	556,56	CHI
20200122899	MARA ROSA	UP12294696	NOVA CRIXAS	05/01/2020 06:07	05/01/2020 16:26	05/01/2020 06:07	05/01/2020 16:26	10,31	43	443,19	CHI
20200122899	SANTA TEREZINHA DE GOIAS	UP12294696	NOVA CRIXAS	05/01/2020 06:07	05/01/2020 16:26	05/01/2020 06:07	05/01/2020 16:26	10,31	1	10,31	CHI
20200122899	UIRAPURU	UP12294696	NOVA CRIXAS	05/01/2020 06:07	05/01/2020 16:26	05/01/2020 06:07	05/01/2020 16:26	10,31	4	41,23	CHI
20200122901	ITUMBIARA	BG12363928	ITUMBIARA VELHA S2	05/01/2020 06:08	05/01/2020 10:20	05/01/2020 06:08	05/01/2020 10:20	4,19	5	20,97	CHI
20200122903	PALMEIRAS DE GOIAS	PL12333051	PALMEIRAS	05/01/2020 06:09	05/01/2020 09:20	05/01/2020 06:09	05/01/2020 09:20	3,18	1	3,18	CHI
20200122908	ORIZONA	OZ12084921RE	PIRES DO RIO S2	05/01/2020 05:43	05/01/2020 11:08	05/01/2020 05:43	05/01/2020 11:08	5,42	3	16,26	CHI
20200122909	SAO LUIS DE MONTES BELOS	SL12003916	SAO LUIZ DOS MONTES BELOS	05/01/2020 00:17	05/01/2020 10:46	05/01/2020 00:17	05/01/2020 10:46	10,48	19	199,18	CHI
20200122911	SANTA RITA DO NOVO DESTINO	DF12256464	BARRO ALTO	05/01/2020 03:21	05/01/2020 11:49	05/01/2020 03:21	05/01/2020 11:49	8,46	16	135,44	CHI
20200122914	BONOPOLIS	BX12391936	SAO MIGUEL DO ARAGUAIA	05/01/2020 06:11	05/01/2020 09:16	05/01/2020 06:11	05/01/2020 09:16	3,07	29	88,98	CHI
20200122916	NOVA CRIXAS	NA21243597	NOVA CRIXAS	05/01/2020 06:12	05/01/2020 12:11	05/01/2020 06:12	05/01/2020 12:11	5,97	1	5,97	CHI
20200122920	MORRINHOS	20266224	MORRINHOS	05/01/2020 06:13	05/01/2020 12:22	05/01/2020 06:13	05/01/2020 12:22	6,15	3	18,44	CHI
20200122921	PIRACANJUBA	PJ12326569	CRISTIANOPOLIS	05/01/2020 04:59	05/01/2020 07:50	05/01/2020 04:59	05/01/2020 07:50	2,84	29	82,46	CHI
20200122924	ITUMBIARA	IT11316728	ITUMBIARA NOVA	05/01/2020 06:13	05/01/2020 13:15	05/01/2020 12:30	05/01/2020 13:15	0,75	84	63,02	CHI

20200122927	CALDAS NOVAS	CN12298642	CALDAS NOVAS S2	05/01/2020 06:14	05/01/2020 08:35	05/01/2020 06:14	05/01/2020 08:35	2,34	14	32,80	CHI
20200122928	VILA PROPICIO	GE12243252	GOIANESIA S1	05/01/2020 06:11	05/01/2020 09:10	05/01/2020 06:11	05/01/2020 09:10	2,97	11	32,67	CHI
20200122930	BARRO ALTO	DF12194371	BARRO ALTO	05/01/2020 04:52	05/01/2020 10:59	05/01/2020 04:52	05/01/2020 10:59	6,10	66	402,91	CHI
20200122930	SANTA RITA DO NOVO DESTINO	DF12194371	BARRO ALTO	05/01/2020 04:52	05/01/2020 10:59	05/01/2020 04:52	05/01/2020 10:59	6,10	33	201,46	CHI
20200122931	URUACU	UR12339041	URUACU	05/01/2020 06:15	05/01/2020 10:24	05/01/2020 06:15	05/01/2020 10:24	4,13	35	144,69	CHI
20200122935	AGUAS LINDAS DE GOIAS	LA12096115	AGUAS LINDAS DE GOIAS S1	05/01/2020 06:16	05/01/2020 11:26	05/01/2020 06:16	05/01/2020 11:26	5,16	62	320,04	CHI
20200122943	SAO FRANCISCO DE GOIAS	SF12377527	SAO FRANCISCO DE GOIAS	05/01/2020 06:18	05/01/2020 16:00	05/01/2020 06:18	05/01/2020 16:00	9,69	2	19,38	CHI
20200122944	ALEXANIA	AX12379446	ALEXANIA	04/01/2020 20:45	05/01/2020 12:06	04/01/2020 20:45	05/01/2020 12:06	15,35	35	537,13	CHI
20200122946	JATAI	JT12303012	JATAI S1	05/01/2020 06:19	05/01/2020 14:01	05/01/2020 06:19	05/01/2020 14:01	7,69	3	23,06	CHI
20200122948	PIRENOPOLIS	NP21311742	CORUMBA	05/01/2020 06:21	05/01/2020 15:09	05/01/2020 06:21	05/01/2020 15:09	8,79	1	8,79	CHI
20200122950	SILVANIA	SV12205367	VIANOPOLIS	05/01/2020 06:21	05/01/2020 16:53	05/01/2020 06:21	05/01/2020 16:53	10,53	16	168,48	CHI
20200122951	BOM JARDIM DE GOIAS	BM12205305	BOM JARDIM	05/01/2020 06:22	05/01/2020 14:20	05/01/2020 06:22	05/01/2020 14:20	7,96	7	55,74	CHI
20200122953	COCALZINHO DE GOIAS	ZN12327436	GOIANESIA S1	05/01/2020 06:22	05/01/2020 12:53	05/01/2020 06:22	05/01/2020 12:53	6,50	14	91,05	CHI
20200122954	CRIXAS	CX12319064	SERRA DO OURO	05/01/2020 06:23	05/01/2020 09:20	05/01/2020 06:23	05/01/2020 09:20	2,94	3	8,82	CHI
20200122955	PORANGATU	PO12088782	PORANGATU	05/01/2020 06:23	05/01/2020 08:08	05/01/2020 06:23	05/01/2020 08:08	1,73	5	8,67	CHI
20200122956	IACIARA	IA21160075	IACIARA S1	05/01/2020 06:24	05/01/2020 09:02	05/01/2020 06:24	05/01/2020 09:02	2,63	1	2,63	CHI
20200122957	CRIXAS	CX12171173	RUBIATABA	05/01/2020 06:24	06/01/2020 12:39	05/01/2020 06:24	06/01/2020 12:39	30,24	4	120,96	CHI
20200122958	GUARAITA	IK12064427	ITAPURANGA	05/01/2020 06:24	05/01/2020 10:16	05/01/2020 06:24	05/01/2020 10:16	3,86	1	3,86	CHI
20200122958	ITAPURANGA	IK12064427	ITAPURANGA	05/01/2020 06:24	05/01/2020 10:16	05/01/2020 06:24	05/01/2020 10:16	3,86	15	57,88	CHI
20200122963	GOIANIA	14079318	GOIANIA LESTE S2	05/01/2020 06:26	05/01/2020 07:10	05/01/2020 06:26	05/01/2020 07:10	0,73	1	0,73	CHI
20200122965	GOIANIA	GN11000768	GOIANIA LESTE S2	05/01/2020 08:51	05/01/2020 12:08	05/01/2020 08:51	05/01/2020 11:55	3,07	38	116,54	CHI
20200122965	GOIANIA	GN12000269	GOIANIA LESTE S2	05/01/2020 08:51	05/01/2020 12:08	05/01/2020 08:51	05/01/2020 12:08	3,29	167	549,80	CHI
20200122966	BURITI ALEGRE	BG12000110	ITUMBIARA VELHA S2	05/01/2020 06:28	05/01/2020 09:52	05/01/2020 06:28	05/01/2020 09:52	3,39	7	23,75	CHI
20200122967	FAZENDA NOVA	JR12250545	BRITANIA	05/01/2020 05:44	05/01/2020 17:00	05/01/2020 05:44	05/01/2020 17:00	11,26	1	11,26	CHI
20200122967	JUSSARA	JR12250545	BRITANIA	05/01/2020 05:44	05/01/2020 17:00	05/01/2020 05:44	05/01/2020 17:00	11,26	58	653,24	CHI
20200122968	CORUMBAIBA	CI12000463RE	VILA CORUMBA	05/01/2020 04:03	05/01/2020 10:37	05/01/2020 04:03	05/01/2020 10:37	6,56	129	846,13	CHI
20200122969	CORUMBA DE GOIAS	CB12382340	CORUMBA	04/01/2020 22:05	05/01/2020 09:13	04/01/2020 22:05	05/01/2020 09:13	11,12	6	66,72	CHI
20200122970	PIRACANJUBA	PJ121228173	MORRINHOS	05/01/2020 06:29	05/01/2020 11:04	05/01/2020 06:29	05/01/2020 11:04	4,57	1	4,57	CHI
20200122973	SAO FRANCISCO DE GOIAS	PV31084552	SAO FRANCISCO DE GOIAS	05/01/2020 06:31	05/01/2020 10:40	05/01/2020 06:31	05/01/2020 10:40	4,14	1	4,14	CHI
20200122975	BOM JARDIM DE GOIAS	BM21228035	BOM JARDIM	05/01/2020 06:33	05/01/2020 17:47	05/01/2020 06:33	05/01/2020 17:47	11,23	1	11,23	CHI
20200122978	JANDAIA	EU12000110	ACREUNA	05/01/2020 06:33	05/01/2020 08:34	05/01/2020 06:33	05/01/2020 08:34	2,01	1	2,01	CHI
20200122978	PARAUNA	EU12000110	ACREUNA	05/01/2020 06:33	05/01/2020 08:34	05/01/2020 06:33	05/01/2020 08:34	2,01	11	22,13	CHI
20200122979	PANAMA	PX12057616	GOIATUBA S1	05/01/2020 06:34	05/01/2020 10:01	05/01/2020 06:34	05/01/2020 10:01	3,44	45	154,91	CHI

20200122981	GOIAS	GS12061061	ITAPURANGA	05/01/2020 06:36	05/01/2020 15:21	05/01/2020 06:36	05/01/2020 15:21	8,75	36	314,97	CHI
20200122987	SANCLERLANDIA	SC12376362	FIRMINOPOLIS S2	05/01/2020 06:38	05/01/2020 09:44	05/01/2020 06:38	05/01/2020 09:44	3,10	10	30,98	CHI
20200122991	SAO MIGUEL DO ARAGUAIA	SM12151000	SAO MIGUEL DO ARAGUAIA	05/01/2020 06:16	05/01/2020 23:00	05/01/2020 06:16	05/01/2020 12:38	6,36	11	69,97	CHI
20200122991	SAO MIGUEL DO ARAGUAIA	SM12151000	SAO MIGUEL DO ARAGUAIA	05/01/2020 06:16	05/01/2020 23:00	05/01/2020 06:16	05/01/2020 23:00	16,72	8	133,77	CHI
20200122992	PARANAIGUARA	QI12279808	QUIRINOPOLIS	05/01/2020 05:42	05/01/2020 17:39	05/01/2020 05:42	05/01/2020 17:39	11,95	44	525,59	CHI
20200122992	QUIRINOPOLIS	QI12279808	QUIRINOPOLIS	05/01/2020 05:42	05/01/2020 17:39	05/01/2020 05:42	05/01/2020 17:39	11,95	64	764,50	CHI
20200122994	SAO LUIS DE MONTES BELOS	SL12006949	SAO LUIZ DOS MONTES BELOS	05/01/2020 06:39	05/01/2020 09:31	05/01/2020 06:39	05/01/2020 09:31	2,85	41	116,95	CHI
20200122995	ARUANA	AK12404527	MOZARLANDIA	05/01/2020 06:39	05/01/2020 08:40	05/01/2020 06:39	05/01/2020 08:40	2,00	34	68,04	CHI
20200122997	CATALAO	CT12130960RE	CATALAO S2	05/01/2020 06:40	05/01/2020 12:02	05/01/2020 06:40	05/01/2020 12:02	5,36	49	262,56	CHI
20200122997	CUMARI	CT12130960RE	CATALAO S2	05/01/2020 06:40	05/01/2020 12:02	05/01/2020 06:40	05/01/2020 12:02	5,36	153	819,83	CHI
20200122997	GOIANDIRA	CT12130960RE	CATALAO S2	05/01/2020 06:40	05/01/2020 12:02	05/01/2020 06:40	05/01/2020 12:02	5,36	6	32,15	CHI
20200123006	FLORES DE GOIAS	FA12038556	SAO JOAO D ALIANCA	05/01/2020 06:41	05/01/2020 11:57	05/01/2020 06:41	05/01/2020 11:57	5,25	6	31,51	CHI
20200123006	FORMOSA	FA12038556	SAO JOAO D ALIANCA	05/01/2020 06:41	05/01/2020 11:57	05/01/2020 06:41	05/01/2020 11:57	5,25	99	519,86	CHI
20200123007	ARAGUAPAZ	AZ12404560	GOIAS	05/01/2020 06:38	05/01/2020 14:50	05/01/2020 06:38	05/01/2020 14:50	8,19	4	32,76	CHI
20200123009	RIO VERDE	RV12327013	CABRIUVA S1	05/01/2020 06:42	05/01/2020 16:29	05/01/2020 06:42	05/01/2020 16:29	9,77	10	97,75	CHI
20200123011	APARECIDA DE GOIANIA	10021884887	ANHANGUERA	05/01/2020 06:42	05/01/2020 18:58	05/01/2020 06:42	05/01/2020 18:58	12,25	1	12,25	CHI
20200123013	PIRENOPOLIS	GE12185195	GOIANESIA S1	05/01/2020 06:43	05/01/2020 13:45	05/01/2020 06:43	05/01/2020 13:45	7,03	30	210,95	CHI
20200123016	QUIRINOPOLIS	QI32017987	QUIRINOPOLIS	05/01/2020 06:36	05/01/2020 17:47	05/01/2020 06:36	05/01/2020 17:47	11,17	11	122,92	CHI
20200123017	VARJAO	VJ12085702	CEZARINA	04/01/2020 22:33	05/01/2020 08:40	04/01/2020 22:33	05/01/2020 08:40	10,10	7	70,72	CHI
20200123018	JARAGUA	JA21000192	JARAGUA	05/01/2020 06:44	05/01/2020 09:26	05/01/2020 06:44	05/01/2020 09:26	2,69	1	2,69	CHI
20200123025	ALEXANIA	AX21000120	CORUMBA	05/01/2020 06:47	05/01/2020 23:05	05/01/2020 06:47	05/01/2020 23:05	16,29	1	16,29	CHI
20200123026	GOIATUBA	GT31056497	GOIATUBA S1	05/01/2020 06:48	05/01/2020 11:25	05/01/2020 06:48	05/01/2020 11:25	4,61	1	4,61	CHI
20200123027	ABADIANIA	AA12377766	ANAPOLIS UNIVERSITARIO S1	05/01/2020 06:47	05/01/2020 12:55	05/01/2020 06:47	05/01/2020 12:55	6,12	9	55,09	CHI
20200123029	ARAGUAPAZ	AZ12404547	MOZARLANDIA	05/01/2020 06:51	05/01/2020 12:05	05/01/2020 06:51	05/01/2020 12:05	5,23	4	20,92	CHI
20200123030	SANTA CRUZ DE GOIAS	BC21086022	CRISTIANOPOLIS	05/01/2020 06:51	05/01/2020 10:16	05/01/2020 06:51	05/01/2020 10:16	3,41	1	3,41	CHI
20200123031	ITUMBIARA	690300335	ITUMBIARA VELHA S1	05/01/2020 06:51	05/01/2020 08:27	05/01/2020 06:51	05/01/2020 08:27	1,61	1	1,61	CHI
20200123037	CORUMBAIBA	CI12392158	VILA CORUMBA	05/01/2020 06:52	05/01/2020 13:38	05/01/2020 06:52	05/01/2020 13:38	6,76	10	67,56	CHI
20200123039	ALEXANIA	AX12319851	ALEXANIA	04/01/2020 20:27	05/01/2020 13:54	04/01/2020 20:27	05/01/2020 13:54	17,45	21	366,35	CHI
20200123046	CRIXAS	CX21253000	SERRA DO OURO	05/01/2020 06:55	05/01/2020 12:00	05/01/2020 06:55	05/01/2020 12:00	5,07	1	5,07	CHI
20200123048	GOIANDIRA	GD12078359	CATALAO S1	05/01/2020 06:56	05/01/2020 09:08	05/01/2020 06:56	05/01/2020 09:08	2,20	27	59,37	CHI
20200123052	IVOLANDIA	IV12037918	IPORA	05/01/2020 06:57	05/01/2020 10:47	05/01/2020 06:57	05/01/2020 10:47	3,82	10	38,24	CHI
20200123060	SANTA TEREZINHA DE GOIAS	GG12171180	SANTA TEREZINHA	05/01/2020 07:00	05/01/2020 14:22	05/01/2020 07:00	05/01/2020 14:22	7,36	45	331,29	CHI
20200123063	CAMPINACU	IH12192447	MINACU	05/01/2020 05:42	05/01/2020 10:10	05/01/2020 05:42	05/01/2020 10:10	4,46	5	22,28	CHI

20200123063	MINACU	IH12192447	MINACU	05/01/2020 05:42	05/01/2020 10:10	05/01/2020 05:42	05/01/2020 10:10	4,46	24	106,96	CHI
20200123069	MINEIROS	MY12324340	PARQUE DAS EMAS	05/01/2020 07:01	05/01/2020 09:09	05/01/2020 07:01	05/01/2020 09:09	2,12	13	27,57	CHI
20200123070	CACHOEIRA ALTA	CC12013147RE	CACHOEIRA ALTA	04/01/2020 22:56	06/01/2020 00:26	04/01/2020 22:56	06/01/2020 00:26	25,50	49	1249,31	CHI
20200123070	QUIRINOPOLIS	CC12013147RE	CACHOEIRA ALTA	04/01/2020 22:56	06/01/2020 00:26	04/01/2020 22:56	06/01/2020 00:26	25,50	28	713,89	CHI
20200123073	MORRINHOS	10001846424	MORRINHOS	05/01/2020 09:49	05/01/2020 13:53	05/01/2020 09:49	05/01/2020 13:53	4,08	1	4,08	CHI
20200123074	DAMOLANDIA	DL12014166	INHUMAS S1	05/01/2020 07:02	05/01/2020 10:43	05/01/2020 07:02	05/01/2020 10:43	3,68	2	7,36	CHI
20200123074	NOVA VENEZA	DL12014166	INHUMAS S1	05/01/2020 07:02	05/01/2020 10:43	05/01/2020 07:02	05/01/2020 10:43	3,68	26	95,66	CHI
20200123077	BOM JESUS DE GOIAS	BJ11000010	BOM JESUS DE GOIAS	05/01/2020 07:02	05/01/2020 11:49	05/01/2020 07:02	05/01/2020 11:49	4,78	99	473,03	CHI
20200123081	CATURAI	CK21246885	ARACU	05/01/2020 07:04	05/01/2020 19:15	05/01/2020 07:04	05/01/2020 19:15	12,18	1	12,18	CHI
20200123081	CATURAI	CK12246477	ARACU	05/01/2020 07:04	05/01/2020 19:15	05/01/2020 16:40	05/01/2020 19:15	2,58	2	5,17	CHI
20200123082	PETROLINA DE GOIAS	PG12017366	PETROLINA	05/01/2020 05:34	05/01/2020 11:51	05/01/2020 05:34	05/01/2020 11:51	6,28	34	213,44	CHI
20200123082	SAO FRANCISCO DE GOIAS	PG12017366	PETROLINA	05/01/2020 05:34	05/01/2020 11:51	05/01/2020 05:34	05/01/2020 11:51	6,28	8	50,22	CHI
20200123085	ITAPURANGA	IK21286235	ITAPURANGA	05/01/2020 07:05	05/01/2020 10:47	05/01/2020 07:05	05/01/2020 10:47	3,69	1	3,69	CHI
20200123088	POSSE	PS12180860	IACIARA S2	05/01/2020 07:06	05/01/2020 10:43	05/01/2020 07:06	05/01/2020 10:43	3,61	24	86,65	CHI
20200123090	PONTALINA	PK12111981	PONTALINA	05/01/2020 07:07	05/01/2020 11:06	05/01/2020 07:07	05/01/2020 11:06	3,97	3	11,92	CHI
20200123093	ITABERAI	IB21216436	ANICUNS	05/01/2020 07:08	05/01/2020 17:57	05/01/2020 07:08	05/01/2020 17:57	10,81	1	10,81	CHI
20200123094	SANTO ANTONIO DO DESCOBERTO	SN12188742	ALEXANIA	05/01/2020 05:58	05/01/2020 13:57	05/01/2020 05:58	05/01/2020 13:57	7,97	22	175,39	CHI
20200123100	SAO MIGUEL DO ARAGUAIA	SM12096096	SAO MIGUEL DO ARAGUAIA	05/01/2020 06:59	05/01/2020 16:59	05/01/2020 06:59	05/01/2020 16:59	9,98	13	129,79	CHI
20200123102	BALIZA	BH11334507	BOM JARDIM	05/01/2020 07:11	05/01/2020 09:34	05/01/2020 07:11	05/01/2020 09:34	2,38	1	2,38	CHI
20200123106	ANAPOLIS	AN21075815	NEROPOLIS S1	05/01/2020 07:11	05/01/2020 12:56	05/01/2020 07:11	05/01/2020 12:56	5,74	1	5,74	CHI
20200123117	CRISTALINA	KR12248743	CRISTALINA S2	05/01/2020 07:15	05/01/2020 10:59	05/01/2020 07:15	05/01/2020 10:59	3,73	8	29,85	CHI
20200123118	ORIZONA	OZ13288380	PIRES DO RIO S2	05/01/2020 07:14	05/01/2020 11:08	05/01/2020 07:58	05/01/2020 11:08	3,17	108	342,12	CHI
20200123118	VIANOPOLIS	OZ13288380	PIRES DO RIO S2	05/01/2020 07:14	05/01/2020 11:08	05/01/2020 07:58	05/01/2020 11:08	3,17	129	408,64	CHI
20200123121	QUIRINOPOLIS	QI12305704	QUIRINOPOLIS	05/01/2020 05:37	05/01/2020 19:29	05/01/2020 05:37	05/01/2020 19:29	13,86	38	526,57	CHI
20200123123	JATAI	RV12038514	CABRIUVA S1	04/01/2020 23:38	05/01/2020 16:05	04/01/2020 23:38	05/01/2020 16:05	16,46	6	98,77	CHI
20200123123	RIO VERDE	RV12038514	CABRIUVA S1	04/01/2020 23:38	05/01/2020 16:05	04/01/2020 23:38	05/01/2020 16:05	16,46	77	1267,51	CHI
20200123131	CAMPO ALEGRE DE GOIAS	CM12042353	CAMPO ALEGRE DE GOIAS	05/01/2020 07:16	05/01/2020 10:50	05/01/2020 07:16	05/01/2020 10:50	3,55	5	17,76	CHI
20200123134	DISTRITO FEDERAL	FA12146118	ITIQUEIRA	05/01/2020 07:17	05/01/2020 10:18	05/01/2020 07:17	05/01/2020 10:18	3,01	1	3,01	CHI
20200123134	FORMOSA	FA12146118	ITIQUEIRA	05/01/2020 07:17	05/01/2020 10:18	05/01/2020 07:17	05/01/2020 10:18	3,01	29	87,31	CHI
20200123137	JARAGUA	JA11054446	JARAGUA	05/01/2020 07:18	05/01/2020 09:12	05/01/2020 07:18	05/01/2020 09:12	1,90	15	28,47	CHI
20200123140	GOIAS	GS12234111	GOIAS	05/01/2020 07:07	05/01/2020 10:45	05/01/2020 07:07	05/01/2020 10:45	3,62	51	184,62	CHI
20200123144	CORUMBAIBA	IP12152359	IPAMERI	05/01/2020 07:17	05/01/2020 08:44	05/01/2020 07:17	05/01/2020 08:44	1,44	7	10,10	CHI
20200123144	IPAMERI	IP12152359	IPAMERI	05/01/2020 07:17	05/01/2020 08:44	05/01/2020 07:17	05/01/2020 08:44	1,44	8	11,55	CHI

20200123145	PONTALINA	PK12045970	PONTALINA	05/01/2020 07:19	05/01/2020 13:21	05/01/2020 07:19	05/01/2020 13:21	6,03	1	6,03	CHI
20200123147	GOIAS	90059116	GOIAS	05/01/2020 07:19	06/01/2020 10:02	05/01/2020 07:19	06/01/2020 10:02	26,72	1	26,72	CHI
20200123150	GOIATUBA	GT12000264	GOIATUBA S1	05/01/2020 07:20	05/01/2020 11:25	05/01/2020 07:20	05/01/2020 11:25	4,08	15	61,20	CHI
20200123150	PANAMA	GT12000264	GOIATUBA S1	05/01/2020 07:20	05/01/2020 11:25	05/01/2020 07:20	05/01/2020 11:25	4,08	1	4,08	CHI
20200123150	RUBIATABA	GT12000264	GOIATUBA S1	05/01/2020 07:20	05/01/2020 11:25	05/01/2020 07:20	05/01/2020 11:25	4,08	1	4,08	CHI
20200123151	PIRACANJUBA	PJ21286225	PIRACANJUBA	05/01/2020 07:21	05/01/2020 12:54	05/01/2020 07:21	05/01/2020 12:54	5,55	1	5,55	CHI
20200123155	NOVA CRIXAS	NA12380421	NOVA CRIXAS	05/01/2020 07:21	05/01/2020 10:56	05/01/2020 07:21	05/01/2020 10:56	3,57	48	171,28	CHI
20200123156	CAMPINORTE	CR10404187	MARA ROSA	05/01/2020 03:54	05/01/2020 11:23	05/01/2020 03:54	05/01/2020 11:23	7,48	88	658,66	CHI
20200123156	URUACU	CR10404187	MARA ROSA	05/01/2020 03:54	05/01/2020 11:23	05/01/2020 03:54	05/01/2020 11:23	7,48	121	905,65	CHI
20200123157	ALEXANIA	AX31114995	ALEXANIA	05/01/2020 07:21	06/01/2020 08:33	05/01/2020 07:21	06/01/2020 08:33	25,18	1	25,18	CHI
20200123159	FLORES DE GOIAS	FB21071380	FLORES DE GOIAS	05/01/2020 07:22	05/01/2020 11:25	05/01/2020 07:22	05/01/2020 11:25	4,05	1	4,05	CHI
20200123162	CEZARINA	CZ12000019	CEZARINA	05/01/2020 07:22	05/01/2020 08:40	05/01/2020 07:22	05/01/2020 08:40	1,29	9	11,61	CHI
20200123162	VARJAO	CZ12000019	CEZARINA	05/01/2020 07:22	05/01/2020 08:40	05/01/2020 07:22	05/01/2020 08:40	1,29	1	1,29	CHI
20200123165	PLANALTINA	2960198445	PLANALTINA	05/01/2020 07:23	05/01/2020 08:54	05/01/2020 07:23	05/01/2020 08:54	1,52	1	1,52	CHI
20200123168	URUACU	UR21247222	MARA ROSA	05/01/2020 07:23	06/01/2020 21:05	05/01/2020 07:23	06/01/2020 21:05	37,69	1	37,69	CHI
20200123172	CRISTALINA	KR12304800	CRISTALINA S2	05/01/2020 07:14	05/01/2020 10:12	05/01/2020 07:14	05/01/2020 10:12	2,95	66	195,03	CHI
20200123176	PALMEIRAS DE GOIAS	PL12034684	PALMEIRAS	05/01/2020 06:20	05/01/2020 10:50	05/01/2020 06:20	05/01/2020 10:50	4,49	13	58,39	CHI
20200123179	VALPARAISO DE GOIAS	2860067560	MARAJOARA	05/01/2020 07:25	05/01/2020 09:38	05/01/2020 07:25	05/01/2020 09:38	2,21	1	2,21	CHI
20200123182	CAIAPONIA	930051403	PALESTINA	05/01/2020 07:25	05/01/2020 14:52	05/01/2020 07:25	05/01/2020 14:52	7,45	1	7,45	CHI
20200123187	BONOPOLIS	BX21168219	SAO MIGUEL DO ARAGUAIA	05/01/2020 07:26	05/01/2020 11:23	05/01/2020 07:26	05/01/2020 11:23	3,95	1	3,95	CHI
20200123188	INHUMAS	30189007	INHUMAS S2	05/01/2020 07:26	05/01/2020 10:42	05/01/2020 07:26	05/01/2020 10:42	3,26	1	3,26	CHI
20200123192	APARECIDA DE GOIANIA	11046399	REAL S2	05/01/2020 07:27	05/01/2020 11:23	05/01/2020 07:27	05/01/2020 11:23	3,93	1	3,93	CHI
20200123193	JARAGUA	JA12297444	JARAGUA	05/01/2020 07:27	05/01/2020 18:25	05/01/2020 07:27	05/01/2020 18:25	10,96	8	87,67	CHI
20200123194	INHUMAS	IN12012230	INHUMAS S2	05/01/2020 07:28	05/01/2020 08:57	05/01/2020 07:28	05/01/2020 08:57	1,48	364	538,42	CHI
20200123202	CRISTALINA	KR21304966	CRISTALINA S2	05/01/2020 07:29	05/01/2020 12:06	05/01/2020 07:29	05/01/2020 12:06	4,61	1	4,61	CHI
20200123204	ITAUCU	IX12317263	INHUMAS S1	05/01/2020 07:30	05/01/2020 09:18	05/01/2020 07:30	05/01/2020 09:18	1,80	1	1,80	CHI
20200123206	APARECIDA DE GOIANIA	AP11226781	REAL S1	05/01/2020 07:30	05/01/2020 12:37	05/01/2020 07:30	05/01/2020 12:37	5,11	25	127,75	CHI
20200123207	RIO VERDE	RV21276678	CABRIUVA S2	05/01/2020 07:30	05/01/2020 10:39	05/01/2020 07:30	05/01/2020 10:39	3,14	1	3,14	CHI
20200123210	GOIAS	IB12210550	ITABERAI S1	05/01/2020 07:21	05/01/2020 10:00	05/01/2020 07:21	05/01/2020 10:00	2,64	3	7,91	CHI
20200123210	ITABERAI	IB12210550	ITABERAI S1	05/01/2020 07:21	05/01/2020 10:00	05/01/2020 07:21	05/01/2020 10:00	2,64	36	94,92	CHI
20200123211	MUTUNOPOLIS	MU12263034	MARA ROSA	05/01/2020 04:34	05/01/2020 13:26	05/01/2020 04:34	05/01/2020 13:26	8,85	4	35,41	CHI
20200123215	GUARANI DE GOIAS	GY12267998	IACIARA S1	05/01/2020 07:31	05/01/2020 09:51	05/01/2020 07:31	05/01/2020 09:51	2,32	16	37,20	CHI
20200123216	GOIANIA	16080087	GOIANIA LESTE S2	05/01/2020 07:31	05/01/2020 09:54	05/01/2020 07:31	05/01/2020 09:54	2,37	1	2,37	CHI



20200123222	HIDROLANDIA	HD12058749	CEPAIGO S2	05/01/2020 07:33	05/01/2020 12:21	05/01/2020 07:33	05/01/2020 12:21	4,80	10	47,97	CHI
20200123224	ALEXANIA	AX12402036	ALEXANIA	04/01/2020 19:55	05/01/2020 12:23	04/01/2020 19:55	05/01/2020 12:23	16,47	46	757,42	CHI
20200123224	SANTO ANTONIO DO DESCOBERTO	AX12402036	ALEXANIA	04/01/2020 19:55	05/01/2020 12:23	04/01/2020 19:55	05/01/2020 12:23	16,47	1	16,47	CHI
20200123227	SAO MIGUEL DO ARAGUAIA	SM12100371	SAO MIGUEL DO ARAGUAIA	05/01/2020 07:33	05/01/2020 13:43	05/01/2020 07:33	05/01/2020 13:43	6,16	73	449,82	CHI
20200123229	BOM JESUS DE GOIAS	BJ12000040	BOM JESUS DE GOIAS	05/01/2020 07:33	05/01/2020 10:28	05/01/2020 07:33	05/01/2020 10:28	2,90	4	11,61	CHI
20200123232	GOIANIRA	TR12017110	INHUMAS S1	05/01/2020 07:34	05/01/2020 13:18	05/01/2020 07:34	05/01/2020 13:18	5,73	1	5,73	CHI
20200123232	TRINDADE	TR12017110	INHUMAS S1	05/01/2020 07:34	05/01/2020 13:18	05/01/2020 07:34	05/01/2020 13:18	5,73	2	11,45	CHI
20200123233	GOIAS	GS12087829	ITABERAI S1	05/01/2020 07:34	05/01/2020 11:45	05/01/2020 07:34	05/01/2020 11:45	4,17	4	16,70	CHI
20200123234	GOIANIA	13958630	MEIA PONTE	05/01/2020 07:34	05/01/2020 10:21	05/01/2020 07:34	05/01/2020 10:21	2,77	1	2,77	CHI
20200123238	INACIOLANDIA	ID21128180	QUIRINOPOLIS	05/01/2020 07:35	05/01/2020 18:12	05/01/2020 07:35	05/01/2020 18:12	10,62	2	21,23	CHI
20200123239	ITUMBIARA	690292211	ITUMBIARA VELHA S1	05/01/2020 07:35	05/01/2020 15:21	05/01/2020 07:35	05/01/2020 15:21	7,78	1	7,78	CHI
20200123240	PANAMA	IT21000195	PARANAIBA	05/01/2020 07:35	05/01/2020 10:00	05/01/2020 07:35	05/01/2020 10:00	2,41	1	2,41	CHI
20200123245	APARECIDA DE GOIANIA	13918552	ATLANTICO S1	05/01/2020 07:36	05/01/2020 09:59	05/01/2020 07:36	05/01/2020 09:59	2,37	1	2,37	CHI
20200123246	PARANAIGUARA	PC21000119	CACHOEIRA ALTA	05/01/2020 07:36	05/01/2020 18:57	05/01/2020 07:36	05/01/2020 18:57	11,34	1	11,34	CHI
20200123249	CACU	CC21078905	CACHOEIRA ALTA	05/01/2020 07:37	06/01/2020 17:30	05/01/2020 07:37	06/01/2020 17:30	33,88	1	33,88	CHI
20200123250	CRIXAS	20078745	RUBIATABA	05/01/2020 07:37	06/01/2020 10:01	05/01/2020 07:37	06/01/2020 10:01	26,40	5	131,99	CHI
20200123252	INACIOLANDIA	ID21128152	QUIRINOPOLIS	05/01/2020 07:37	06/01/2020 00:22	05/01/2020 07:37	06/01/2020 00:22	16,75	1	16,75	CHI
20200123254	GOIANIRA	GR21073551	MEIA PONTE	05/01/2020 07:37	05/01/2020 11:13	05/01/2020 07:37	05/01/2020 11:13	3,59	1	3,59	CHI
20200123260	MIMOSO DE GOIAS	PB12333289	PADRE BERNARDO	05/01/2020 06:26	05/01/2020 09:35	05/01/2020 06:26	05/01/2020 09:35	3,14	47	147,59	CHI
20200123260	PADRE BERNARDO	PB12333289	PADRE BERNARDO	05/01/2020 06:26	05/01/2020 09:35	05/01/2020 06:26	05/01/2020 09:35	3,14	6	18,84	CHI
20200123263	MONTIVIDIU	MV12267621	MONTIVIDIU T	05/01/2020 07:38	05/01/2020 15:08	05/01/2020 07:38	05/01/2020 15:08	7,49	3	22,46	CHI
20200123265	IVOLANDIA	IV12213610	IPORA	05/01/2020 07:38	05/01/2020 14:02	05/01/2020 07:38	05/01/2020 14:02	6,39	3	19,16	CHI
20200123273	FLORES DE GOIAS	FB12164628	IACIARA S2	05/01/2020 07:39	05/01/2020 12:13	05/01/2020 07:39	05/01/2020 12:13	4,55	41	186,62	CHI
20200123275	GOIANIRA	GR12310231	MEIA PONTE	05/01/2020 07:40	05/01/2020 13:05	05/01/2020 07:40	05/01/2020 13:05	5,42	2	10,83	CHI
20200123279	PIRACANJUBA	PJ12032540	PIRACANJUBA	05/01/2020 07:39	05/01/2020 16:44	05/01/2020 07:39	05/01/2020 16:44	9,08	6	54,49	CHI
20200123282	MOIPORA	SL21180376	SAO LUIZ DOS MONTES BELOS	05/01/2020 07:41	05/01/2020 12:12	05/01/2020 07:41	05/01/2020 12:12	4,53	1	4,53	CHI
20200123284	SILVANIA	SV12093612	VIANOPOLIS	04/01/2020 21:50	05/01/2020 10:30	04/01/2020 21:50	05/01/2020 10:30	12,67	17	215,31	CHI
20200123287	ALTO PARAISO DE GOIAS	BF12096495	SAO JOAO D ALIANCA	05/01/2020 05:41	05/01/2020 14:36	05/01/2020 05:41	05/01/2020 14:36	8,90	7	62,33	CHI
20200123290	ESTRELA DO NORTE	ET21037048	MARA ROSA	05/01/2020 07:42	05/01/2020 14:48	05/01/2020 07:42	05/01/2020 14:48	7,10	1	7,10	CHI
20200123292	PORANGATU	PO21100765	PORANGATU	05/01/2020 07:42	05/01/2020 09:19	05/01/2020 07:42	05/01/2020 09:19	1,62	1	1,62	CHI
20200123293	CORREGO DO OURO	CO21194073	SAO LUIZ DOS MONTES BELOS	05/01/2020 07:42	05/01/2020 18:38	05/01/2020 07:42	05/01/2020 18:38	10,93	1	10,93	CHI
20200123294	CRISTALINA	KR12230276	CRISTALINA S2	05/01/2020 07:42	05/01/2020 13:29	05/01/2020 07:42	05/01/2020 13:29	5,77	12	69,29	CHI
20200123295	RIO VERDE	630436447	RIO VERDE S2	05/01/2020 07:42	05/01/2020 17:10	05/01/2020 07:42	05/01/2020 17:10	9,46	1	9,46	CHI

20200123297	AMARALINA	MU12394938	MARA ROSA	05/01/2020 06:27	05/01/2020 12:07	05/01/2020 06:27	05/01/2020 12:07	5,66	7	39,63	CHI
20200123297	BONOPOLIS	MU12394938	MARA ROSA	05/01/2020 06:27	05/01/2020 12:07	05/01/2020 06:27	05/01/2020 12:07	5,66	2	11,32	CHI
20200123297	MUTUNOPOLIS	MU12394938	MARA ROSA	05/01/2020 06:27	05/01/2020 12:07	05/01/2020 06:27	05/01/2020 12:07	5,66	14	79,25	CHI
20200123297	PORANGATU	MU12394938	MARA ROSA	05/01/2020 06:27	05/01/2020 12:07	05/01/2020 06:27	05/01/2020 12:07	5,66	75	424,56	CHI
20200123305	JATAI	JT12209699	JATAI S1	05/01/2020 07:43	05/01/2020 15:17	05/01/2020 07:43	05/01/2020 15:17	7,55	20	151,07	CHI
20200123306	PARANAIGUARA	CA21081286	CACHOEIRA ALTA	05/01/2020 07:43	06/01/2020 14:51	05/01/2020 07:43	06/01/2020 14:51	31,14	1	31,14	CHI
20200123307	PORANGATU	PO21143679	PORANGATU	05/01/2020 07:44	05/01/2020 11:04	05/01/2020 07:44	05/01/2020 11:04	3,33	1	3,33	CHI
20200123309	INDIARA	IY12312492	CEZARINA	05/01/2020 07:44	05/01/2020 10:18	05/01/2020 07:44	05/01/2020 10:18	2,56	1	2,56	CHI
20200123315	PIRENOPOLIS	PV21098128	SAO FRANCISCO DE GOIAS	05/01/2020 07:45	05/01/2020 22:15	05/01/2020 07:45	05/01/2020 22:15	14,49	1	14,49	CHI
20200123317	CRISTALINA	KR12348546	PAMPLONA	05/01/2020 07:45	05/01/2020 11:51	05/01/2020 07:45	05/01/2020 11:51	4,10	19	77,89	CHI
20200123322	EDEIA	EA12029830	EDEIA	05/01/2020 07:46	05/01/2020 17:55	05/01/2020 07:46	05/01/2020 17:55	10,14	3	30,43	CHI
20200123323	ESTRELA DO NORTE	MU12391986	MARA ROSA	05/01/2020 07:46	05/01/2020 13:26	05/01/2020 07:46	05/01/2020 13:26	5,66	1	5,66	CHI
20200123323	MUTUNOPOLIS	MU12391986	MARA ROSA	05/01/2020 07:46	05/01/2020 13:26	05/01/2020 07:46	05/01/2020 13:26	5,66	95	537,57	CHI
20200123326	MOZARLANDIA	MZ12066086	MOZARLANDIA	05/01/2020 07:46	06/01/2020 04:31	05/01/2020 07:46	06/01/2020 04:31	20,74	5	103,68	CHI
20200123329	RIO VERDE	RV12207197	MONTIVIDIU T	05/01/2020 07:47	05/01/2020 15:14	05/01/2020 07:47	05/01/2020 15:14	7,45	18	134,04	CHI
20200123334	LUZIANIA	LZ21209581	MARAJOARA	05/01/2020 07:48	05/01/2020 10:46	05/01/2020 07:48	05/01/2020 10:46	2,97	1	2,97	CHI
20200123338	LUZIANIA	LZ12041471	RIO VERMELHO	05/01/2020 07:48	05/01/2020 12:59	05/01/2020 07:48	05/01/2020 12:59	5,17	9	46,55	CHI
20200123344	BOM JARDIM DE GOIAS	BM12231130	BOM JARDIM	05/01/2020 07:48	05/01/2020 16:55	05/01/2020 07:48	05/01/2020 16:55	9,10	10	91,00	CHI
20200123347	GUAPO	GA12000016	GUAPO S1	05/01/2020 06:35	05/01/2020 10:36	05/01/2020 06:35	05/01/2020 10:36	4,02	5	20,08	CHI
20200123348	ITABERAI	IB21000125	ITABERAI S2	05/01/2020 07:49	05/01/2020 11:29	05/01/2020 07:49	05/01/2020 11:29	3,66	1	3,66	CHI
20200123356	GOIANIA	10991761	FERROVIARIO S1	05/01/2020 07:49	05/01/2020 09:04	05/01/2020 07:49	05/01/2020 09:04	1,23	1	1,23	CHI
20200123359	PARAUNA	PU12273594	PARAUNA	05/01/2020 07:50	05/01/2020 12:18	05/01/2020 07:50	05/01/2020 12:18	4,46	9	40,16	CHI
20200123361	PADRE BERNARDO	PB12376752	PADRE BERNARDO	05/01/2020 07:31	05/01/2020 08:58	05/01/2020 07:31	05/01/2020 08:58	1,44	6	8,66	CHI
20200123362	RIO VERDE	RV12018095	SANTA HELENA S1	05/01/2020 07:50	05/01/2020 12:22	05/01/2020 07:50	05/01/2020 12:22	4,53	9	40,80	CHI
20200123365	SAO MIGUEL DO PASSA QUATRO	SQ12355286	CRISTIANOPOLIS	05/01/2020 07:51	05/01/2020 12:00	05/01/2020 07:51	05/01/2020 12:00	4,14	1	4,14	CHI
20200123373	LUZIANIA	LZ12061391	MARAJOARA	05/01/2020 07:52	05/01/2020 12:23	05/01/2020 07:52	05/01/2020 12:23	4,52	68	307,04	CHI
20200123376	ITAPACI	IW21251272	ITAPACI	05/01/2020 07:52	05/01/2020 14:02	05/01/2020 07:52	05/01/2020 14:02	6,16	1	6,16	CHI
20200123382	BURITI ALEGRE	BG12263567	ITUMBIARA VELHA S2	05/01/2020 07:53	05/01/2020 12:52	05/01/2020 07:53	05/01/2020 12:52	4,98	3	14,93	CHI
20200123382	ITUMBIARA	BG12263567	ITUMBIARA VELHA S2	05/01/2020 07:53	05/01/2020 12:52	05/01/2020 07:53	05/01/2020 12:52	4,98	18	89,59	CHI
20200123385	MUTUNOPOLIS	MU12354547	MARA ROSA	05/01/2020 07:33	05/01/2020 10:32	05/01/2020 07:33	05/01/2020 10:32	2,98	13	38,74	CHI
20200123388	BALIZA	BM12343637	BOM JARDIM	05/01/2020 07:54	05/01/2020 11:17	05/01/2020 07:54	05/01/2020 11:17	3,38	2	6,76	CHI
20200123389	ABADIANIA	AA12258347	ANAPOLIS UNIVERSITARIO S1	05/01/2020 07:43	05/01/2020 11:01	05/01/2020 07:43	05/01/2020 11:01	3,29	12	39,47	CHI
20200123392	SANTO ANTONIO DO DESCOBERTO	SN21068714	ALEXANIA	05/01/2020 07:55	06/01/2020 13:21	05/01/2020 07:55	06/01/2020 13:21	29,43	2	58,86	CHI

20200123397	JUSSARA	JR12331712	JUSSARA	05/01/2020 07:56	05/01/2020 18:39	05/01/2020 07:56	05/01/2020 18:39	10,71	2	21,42	CHI
20200123407	SILVANIA	SV21013800	VIANOPOLIS	05/01/2020 07:57	05/01/2020 11:02	05/01/2020 07:57	05/01/2020 11:02	3,08	1	3,08	CHI
20200123409	HIDROLANDIA	180040133	CEPAIGO S2	05/01/2020 07:57	05/01/2020 11:15	05/01/2020 07:57	05/01/2020 11:15	3,30	1	3,30	CHI
20200123415	VIANOPOLIS	VN12060844	VIANOPOLIS	05/01/2020 04:41	05/01/2020 12:05	05/01/2020 04:41	05/01/2020 12:05	7,40	13	96,20	CHI
20200123416	CRIXAS	CX11394454	SERRA DO OURO	05/01/2020 07:58	06/01/2020 11:24	05/01/2020 07:58	06/01/2020 11:24	27,43	1	27,43	CHI
20200123419	CATALAO	CT12231643	CATALAO S1	05/01/2020 07:56	05/01/2020 09:58	05/01/2020 07:56	05/01/2020 09:58	2,02	13	26,26	CHI
20200123420	CAMPOS BELOS	CH12130297	SAO DOMINGOS	05/01/2020 07:59	05/01/2020 08:41	05/01/2020 07:59	05/01/2020 08:41	0,70	5	3,49	CHI
20200123421	TRINDADE	TR21119159	TRINDADE	05/01/2020 07:59	05/01/2020 16:17	05/01/2020 07:59	05/01/2020 16:17	8,30	1	8,30	CHI
20200123422	GOIANESIA	GE12358979	GOIANESIA S2	05/01/2020 07:57	05/01/2020 09:30	05/01/2020 07:57	05/01/2020 09:30	1,53	4	6,14	CHI
20200123422	VILA PROPICIO	GE12358979	GOIANESIA S2	05/01/2020 07:57	05/01/2020 09:30	05/01/2020 07:57	05/01/2020 09:30	1,53	8	12,27	CHI
20200123423	SITIO D ABADIA	AQ12344369	IACIARA S2	05/01/2020 07:59	05/01/2020 13:20	05/01/2020 07:59	05/01/2020 13:20	5,35	2	10,69	CHI
20200123428	GOIANIA	GN11044650	FERROVIARIO S1	05/01/2020 07:59	05/01/2020 14:45	05/01/2020 07:59	05/01/2020 14:45	6,76	103	696,28	CHI
20200123429	CRIXAS	CX12226949	SANTA TEREZINHA	05/01/2020 07:59	05/01/2020 20:56	05/01/2020 07:59	05/01/2020 20:56	12,94	11	142,37	CHI
20200123430	MUTUNOPOLIS	PO12372640	PORANGATU	05/01/2020 07:59	05/01/2020 09:44	05/01/2020 07:59	05/01/2020 09:44	1,74	2	3,48	CHI
20200123430	PORANGATU	PO12372640	PORANGATU	05/01/2020 07:59	05/01/2020 09:44	05/01/2020 07:59	05/01/2020 09:44	1,74	1	1,74	CHI
20200123432	GOIATUBA	BJ12030830	RIO DOS BOIS	05/01/2020 07:59	05/01/2020 13:05	05/01/2020 07:59	05/01/2020 13:05	5,10	1	5,10	CHI
20200123432	PORTEIRAO	BJ12030830	RIO DOS BOIS	05/01/2020 07:59	05/01/2020 13:05	05/01/2020 07:59	05/01/2020 13:05	5,10	2	10,20	CHI
20200123437	TURVELANDIA	EU21057485	RIO DOS BOIS	05/01/2020 08:00	05/01/2020 12:58	05/01/2020 08:00	05/01/2020 12:58	4,96	1	4,96	CHI
20200123442	MOSSAMEDES	MD21185374	ITABERAI S2	05/01/2020 08:00	05/01/2020 14:44	05/01/2020 08:00	05/01/2020 14:44	6,73	1	6,73	CHI
20200123453	CATALAO	CT12000055	CATALAO S1	05/01/2020 08:02	05/01/2020 11:34	05/01/2020 08:02	05/01/2020 11:34	3,54	5	17,70	CHI
20200123454	PORANGATU	PO12391667	PORANGATU	05/01/2020 08:02	05/01/2020 10:39	05/01/2020 08:02	05/01/2020 10:39	2,61	2	5,22	CHI
20200123459	MORRINHOS	MR12060428	MORRINHOS	05/01/2020 08:03	05/01/2020 13:10	05/01/2020 08:03	05/01/2020 13:10	5,11	3	15,34	CHI
20200123460	ANAPOLIS	AN12258127	ANAPOLIS UNIVERSITARIO S1	05/01/2020 07:23	05/01/2020 10:54	05/01/2020 07:23	05/01/2020 10:54	3,50	5	17,51	CHI
20200123460	GAMELEIRA DE GOIAS	AN12258127	ANAPOLIS UNIVERSITARIO S1	05/01/2020 07:23	05/01/2020 10:54	05/01/2020 07:23	05/01/2020 10:54	3,50	5	17,51	CHI
20200123466	FAZENDA NOVA	FN21159071	FIRMINOPOLIS S2	05/01/2020 08:04	05/01/2020 12:16	05/01/2020 08:04	05/01/2020 12:16	4,19	1	4,19	CHI
20200123468	VIANOPOLIS	VN21060166	VIANOPOLIS	05/01/2020 08:04	05/01/2020 15:46	05/01/2020 08:04	05/01/2020 15:46	7,69	1	7,69	CHI
20200123469	COCALZINHO DE GOIAS	ZN12154765	AGUAS LINDAS DE GOIAS S2	05/01/2020 08:04	05/01/2020 17:31	05/01/2020 08:04	05/01/2020 17:31	9,44	3	28,31	CHI
20200123470	SANTO ANTONIO DO DESCOBERTO	SN12037170	MARAJOARA	04/01/2020 21:10	05/01/2020 13:06	04/01/2020 21:10	05/01/2020 13:06	15,93	38	605,52	CHI
20200123471	MARA ROSA	MQ12338220	MARA ROSA	05/01/2020 08:04	05/01/2020 17:57	05/01/2020 08:04	05/01/2020 17:57	9,87	2	19,74	CHI
20200123473	PIRACANJUBA	CF21140448	CRISTIANOPOLIS	05/01/2020 08:05	05/01/2020 11:38	05/01/2020 08:05	05/01/2020 11:38	3,55	1	3,55	CHI
20200123475	LUZIANIA	LZ21031681	CRISTALINA S2	05/01/2020 08:05	05/01/2020 17:24	05/01/2020 08:05	05/01/2020 17:24	9,31	1	9,31	CHI
20200123476	BELA VISTA DE GOIAS	BV21077155	BELA VISTA S2	05/01/2020 08:05	05/01/2020 17:26	05/01/2020 08:05	05/01/2020 17:26	9,35	1	9,35	CHI
20200123477	CALDAS NOVAS	CN12354038	CALDAS NOVAS S1	05/01/2020 08:05	05/01/2020 14:59	05/01/2020 08:05	05/01/2020 14:59	6,89	14	96,51	CHI

20200123478	ALEXANIA	AX21319856	ALEXANIA	05/01/2020 08:05	05/01/2020 20:08	05/01/2020 08:05	05/01/2020 20:08	12,05	2	24,10	CHI
20200123479	JARAGUA	01020224	JARAGUA	05/01/2020 07:53	05/01/2020 08:05	05/01/2020 07:53	05/01/2020 07:57	0,07	5133	343,63	CHI
20200123479	JARAGUA	01020224	JARAGUA	05/01/2020 07:53	05/01/2020 08:05	05/01/2020 07:53	05/01/2020 07:57	0,07	2883	213,02	CHI
20200123479	JARAGUA	01020224	JARAGUA	05/01/2020 07:53	05/01/2020 08:05	05/01/2020 07:53	05/01/2020 08:02	0,15	315	46,46	CHI
20200123479	JARAGUA	01020224	JARAGUA	05/01/2020 07:53	05/01/2020 08:05	05/01/2020 07:53	05/01/2020 08:02	0,16	768	121,81	CHI
20200123479	JARAGUA	01020224	JARAGUA	05/01/2020 07:53	05/01/2020 08:05	05/01/2020 07:53	05/01/2020 08:05	0,20	375	76,15	CHI
20200123479	PIRENOPOLIS	01020224	JARAGUA	05/01/2020 07:53	05/01/2020 08:05	05/01/2020 07:53	05/01/2020 08:05	0,20	54	10,96	CHI
20200123479	JARAGUA	JA10394589	JARAGUA	05/01/2020 07:53	05/01/2020 08:05	05/01/2020 07:55	05/01/2020 08:05	0,17	1	0,17	CHI
20200123490	ANAPOLIS	AN12270373	ANAPOLIS UNIVERSITARIO S2	05/01/2020 08:06	05/01/2020 15:51	05/01/2020 08:06	05/01/2020 15:51	7,75	16	123,96	CHI
20200123491	ITABERAI	IB12000071	ITABERAI S2	05/01/2020 07:36	05/01/2020 10:52	05/01/2020 07:36	05/01/2020 10:52	3,26	40	130,37	CHI
20200123495	MINEIROS	MY21126176	PARQUE DAS EMAS	05/01/2020 08:06	05/01/2020 15:44	05/01/2020 08:06	05/01/2020 15:44	7,62	1	7,62	CHI
20200123502	IPORA	IR12172534	IPORA	05/01/2020 08:07	05/01/2020 18:09	05/01/2020 08:07	05/01/2020 18:09	10,03	9	90,25	CHI
20200123502	IVOLANDIA	IR12172534	IPORA	05/01/2020 08:07	05/01/2020 18:09	05/01/2020 08:07	05/01/2020 18:09	10,03	1	10,03	CHI
20200123505	SANCLERLANDIA	SC12005463	SAO LUIZ DOS MONTES BELOS	05/01/2020 08:07	05/01/2020 11:43	05/01/2020 08:07	05/01/2020 11:43	3,59	13	46,64	CHI
20200123505	SAO LUIS DE MONTES BELOS	SC12005463	SAO LUIZ DOS MONTES BELOS	05/01/2020 08:07	05/01/2020 11:43	05/01/2020 08:07	05/01/2020 11:43	3,59	19	68,17	CHI
20200123506	IPAMERI	IP12266894	IPAMERI	05/01/2020 07:24	05/01/2020 10:00	05/01/2020 07:24	05/01/2020 10:00	2,59	13	33,71	CHI
20200123507	MAURILANDIA	DM21306310	RIO DOS BOIS	05/01/2020 08:08	05/01/2020 14:58	05/01/2020 08:08	05/01/2020 14:58	6,83	1	6,83	CHI
20200123508	POSSE	6259212	IACIARA S2	05/01/2020 08:08	05/01/2020 09:48	05/01/2020 08:08	05/01/2020 09:48	1,66	52	86,49	CHI
20200123510	GOIANIA	13426175	AEROPORTO S1	05/01/2020 08:08	05/01/2020 10:50	05/01/2020 08:08	05/01/2020 10:50	2,69	1	2,69	CHI
20200123511	FORMOSA	FA12404372	ITUIQUIRA	05/01/2020 06:00	05/01/2020 11:53	05/01/2020 06:00	05/01/2020 11:53	5,87	170	997,90	CHI
20200123514	SANTO ANTONIO DO DESCOBERTO	SN21068735	ALEXANIA	05/01/2020 08:08	06/01/2020 14:28	05/01/2020 08:08	06/01/2020 14:28	30,32	2	60,64	CHI
20200123515	SANTA HELENA DE GOIAS	SH21295793	ACREUNA	05/01/2020 08:08	05/01/2020 15:44	05/01/2020 08:08	05/01/2020 15:44	7,59	1	7,59	CHI
20200123517	TRINDADE	TR21028728	TRINDADE	05/01/2020 08:09	05/01/2020 16:34	05/01/2020 08:09	05/01/2020 16:34	8,41	1	8,41	CHI
20200123523	IPAMERI	IP12000086	IPAMERI	05/01/2020 08:10	05/01/2020 10:00	05/01/2020 08:10	05/01/2020 10:00	1,83	4	7,31	CHI
20200123524	NIQUELANDIA	NQ12262808	BARRO ALTO	05/01/2020 07:16	05/01/2020 12:48	05/01/2020 07:16	05/01/2020 12:48	5,53	26	143,85	CHI
20200123528	SANTA HELENA DE GOIAS	SH12279544	IPEGUARI	05/01/2020 08:10	05/01/2020 13:22	05/01/2020 08:10	05/01/2020 13:22	5,19	2	10,37	CHI
20200123531	GOIANIA	GN11000367	GOIANIA LESTE S1	05/01/2020 08:10	05/01/2020 10:45	05/01/2020 08:10	05/01/2020 10:45	2,57	41	105,29	CHI
20200123532	CACU	CC11153989	CACHOEIRA ALTA	05/01/2020 08:11	05/01/2020 23:10	05/01/2020 08:11	05/01/2020 23:10	14,98	17	254,71	CHI
20200123540	MINACU	IH21230376	MINACU	05/01/2020 08:11	05/01/2020 13:45	05/01/2020 08:11	05/01/2020 13:45	5,55	2	11,11	CHI
20200123541	ARAGOIANIA	AO31034842	GUAPO S2	05/01/2020 08:12	05/01/2020 14:48	05/01/2020 08:12	05/01/2020 14:48	6,60	5	33,00	CHI
20200123542	CRISTALINA	KR12000042	CRISTALINA S2	05/01/2020 08:12	05/01/2020 16:35	05/01/2020 08:12	05/01/2020 16:35	8,38	1	8,38	CHI
20200123556	FAZENDA NOVA	JR12362437	BRITANIA	05/01/2020 06:48	05/01/2020 13:30	05/01/2020 06:48	05/01/2020 13:30	6,70	3	20,09	CHI
20200123556	JUSSARA	JR12362437	BRITANIA	05/01/2020 06:48	05/01/2020 13:30	05/01/2020 06:48	05/01/2020 13:30	6,70	7	46,87	CHI

20200123557	PIRENOPOLIS	PV21172932	CORUMBA	05/01/2020 08:13	06/01/2020 14:13	05/01/2020 08:13	06/01/2020 14:13	29,99	1	29,99	CHI
20200123560	PIRENOPOLIS	PV12273035	SAO FRANCISCO DE GOIAS	05/01/2020 04:15	05/01/2020 11:05	05/01/2020 04:15	05/01/2020 11:05	6,82	12	81,81	CHI
20200123562	PIRES DO RIO	PR12251174	PIRES DO RIO S1	05/01/2020 08:11	05/01/2020 10:16	05/01/2020 08:11	05/01/2020 10:16	2,08	4	8,33	CHI
20200123563	LUZIANIA	LZ21086000	MARAJOARA	05/01/2020 08:13	05/01/2020 10:14	05/01/2020 08:13	05/01/2020 10:14	2,02	1	2,02	CHI
20200123564	IPORA	IR21112667	IPORA	05/01/2020 08:13	05/01/2020 18:40	05/01/2020 08:13	05/01/2020 18:40	10,45	1	10,45	CHI
20200123567	JARAGUA	JA11244742	JARAGUA	05/01/2020 08:14	05/01/2020 11:15	05/01/2020 08:14	05/01/2020 11:15	3,01	88	264,83	CHI
20200123570	SANTA RITA DO ARAGUAIA	SU12184139	SANTA RITA DO ARAGUAIA	05/01/2020 08:14	05/01/2020 09:55	05/01/2020 08:14	05/01/2020 09:55	1,67	1	1,67	CHI
20200123572	GOIANIRA	390018480	GOIANIRA	05/01/2020 08:14	05/01/2020 16:30	05/01/2020 08:14	05/01/2020 16:30	8,25	1	8,25	CHI
20200123573	SAO LUIS DE MONTES BELOS	SC21019470	SAO LUIZ DOS MONTES BELOS	05/01/2020 08:14	05/01/2020 11:38	05/01/2020 08:14	05/01/2020 11:38	3,39	2	6,77	CHI
20200123574	GOIAS	GS12076722	GOIAS	05/01/2020 07:56	05/01/2020 15:15	05/01/2020 07:56	05/01/2020 15:15	7,30	14	102,23	CHI
20200123579	ALTO PARAISO DE GOIAS	BF12245433	FLORES DE GOIAS	05/01/2020 07:23	05/01/2020 10:34	05/01/2020 07:23	05/01/2020 10:34	3,17	9	28,56	CHI
20200123585	IACIARA	IA12160059	IACIARA S1	05/01/2020 08:13	05/01/2020 09:25	05/01/2020 08:13	05/01/2020 09:25	1,20	22	26,33	CHI
20200123586	NOVA ROMA	ND12051336	IACIARA S2	05/01/2020 08:16	05/01/2020 10:50	05/01/2020 08:16	05/01/2020 10:50	2,56	5	12,81	CHI
20200123587	FORMOSA	FA12376669	ITUIQUIRA	05/01/2020 08:16	05/01/2020 13:02	05/01/2020 08:16	05/01/2020 13:02	4,76	56	266,44	CHI
20200123587	VILA BOA	FA12376669	ITUIQUIRA	05/01/2020 08:16	05/01/2020 13:02	05/01/2020 08:16	05/01/2020 13:02	4,76	6	28,55	CHI
20200123593	QUIRINOPOLIS	80023484	QUIRINOPOLIS	05/01/2020 08:17	06/01/2020 00:31	05/01/2020 08:17	06/01/2020 00:31	16,23	1	16,23	CHI
20200123594	MORRINHOS	MR12000355	MORRINHOS	05/01/2020 08:17	05/01/2020 16:50	05/01/2020 08:17	05/01/2020 16:50	8,55	2	17,09	CHI
20200123596	RIO VERDE	630474771	RIO VERDE S1	05/01/2020 08:17	05/01/2020 10:38	05/01/2020 08:17	05/01/2020 10:38	2,34	1	2,34	CHI
20200123598	BELA VISTA DE GOIAS	BV12000030	BELA VISTA S1	05/01/2020 08:17	05/01/2020 09:49	05/01/2020 08:17	05/01/2020 09:49	1,52	13	19,82	CHI
20200123598	HIDROLANDIA	BV12000030	BELA VISTA S1	05/01/2020 08:17	05/01/2020 09:49	05/01/2020 08:17	05/01/2020 09:49	1,52	1	1,52	CHI
20200123598	PIRACANJUBA	BV12000030	BELA VISTA S1	05/01/2020 08:17	05/01/2020 09:49	05/01/2020 08:17	05/01/2020 09:49	1,52	2	3,05	CHI
20200123599	NOVA CRIXAS	NA12158761	NOVA CRIXAS	05/01/2020 08:07	05/01/2020 14:23	05/01/2020 08:07	05/01/2020 14:23	6,26	6	37,58	CHI
20200123616	PLANALTINA	PI12072312	PLANALTINA	05/01/2020 07:46	05/01/2020 11:09	05/01/2020 07:46	05/01/2020 11:09	3,37	52	175,41	CHI
20200123617	URUACU	UR12256445	URUACU	05/01/2020 08:19	05/01/2020 15:28	05/01/2020 08:19	05/01/2020 15:28	7,14	11	78,50	CHI
20200123618	AGUA FRIA DE GOIAS	TL12381390	SAO JOAO D ALIANCA	05/01/2020 08:19	05/01/2020 11:29	05/01/2020 08:19	05/01/2020 11:29	3,15	3	9,46	CHI
20200123618	PLANALTINA	TL12381390	SAO JOAO D ALIANCA	05/01/2020 08:19	05/01/2020 11:29	05/01/2020 08:19	05/01/2020 11:29	3,15	20	63,03	CHI
20200123619	ITABERAI	50084320	ITABERAI S2	05/01/2020 08:20	05/01/2020 09:47	05/01/2020 08:20	05/01/2020 09:47	1,45	1	1,45	CHI
20200123620	ARAGOIANIA	AO32097647	GUAPO S2	05/01/2020 06:41	05/01/2020 09:03	05/01/2020 06:41	05/01/2020 09:03	2,37	10	23,65	CHI
20200123620	HIDROLANDIA	AO32097647	GUAPO S2	05/01/2020 06:41	05/01/2020 09:03	05/01/2020 06:41	05/01/2020 09:03	2,37	17	40,21	CHI
20200123620	MAIRIPOTABA	AO32097647	GUAPO S2	05/01/2020 06:41	05/01/2020 09:03	05/01/2020 06:41	05/01/2020 09:03	2,37	2	4,73	CHI
20200123620	VARJAO	AO32097647	GUAPO S2	05/01/2020 06:41	05/01/2020 09:03	05/01/2020 06:41	05/01/2020 09:03	2,37	70	165,57	CHI
20200123626	IVOLANDIA	IV12334659	IPORA	05/01/2020 08:14	05/01/2020 17:50	05/01/2020 08:14	05/01/2020 17:50	9,59	2	19,18	CHI
20200123634	GOIANAPOLIS	TJ12353408	DAIA S2	05/01/2020 08:21	05/01/2020 13:57	05/01/2020 08:21	05/01/2020 13:57	5,59	3	16,76	CHI

20200123634	TEREZOPOLIS DE GOIAS	TJ12353408	DAIA S2	05/01/2020 08:21	05/01/2020 13:57	05/01/2020 08:21	05/01/2020 13:57	5,59	1	5,59	CHI
20200123635	POSSE	PS12375542	IACIARA S2	05/01/2020 08:21	05/01/2020 09:33	05/01/2020 08:21	05/01/2020 09:33	1,18	4	4,74	CHI
20200123637	POSSE	SA12195795	IACIARA S2	05/01/2020 08:22	05/01/2020 11:21	05/01/2020 08:22	05/01/2020 11:21	2,97	5	14,87	CHI
20200123647	CORREGO DO OURO	CO21005023	FIRMINOPOLIS S2	05/01/2020 08:24	05/01/2020 17:59	05/01/2020 08:24	05/01/2020 17:59	9,58	1	9,58	CHI
20200123651	GOIANIA	13993847	CARAJAS S1	05/01/2020 08:24	05/01/2020 09:41	05/01/2020 08:24	05/01/2020 09:41	1,27	1	1,27	CHI
20200123652	MOSSAMEDES	MD21294185	FIRMINOPOLIS S2	05/01/2020 08:24	05/01/2020 12:27	05/01/2020 08:24	05/01/2020 12:27	4,04	1	4,04	CHI
20200123653	CACHOEIRA DOURADA	CD12000188	CACHOEIRA DOURADA	05/01/2020 08:25	05/01/2020 12:14	05/01/2020 08:25	05/01/2020 12:14	3,81	8	30,52	CHI
20200123653	ITUMBIARA	CD12000188	CACHOEIRA DOURADA	05/01/2020 08:25	05/01/2020 12:14	05/01/2020 08:25	05/01/2020 12:14	3,81	2	7,63	CHI
20200123662	ARAGOIANIA	680033634	INDEPENDENCIA S1	05/01/2020 08:26	05/01/2020 21:05	05/01/2020 08:26	05/01/2020 21:05	12,64	1	12,64	CHI
20200123665	GOIAS	GS11037752	GOIAS	05/01/2020 08:26	05/01/2020 11:23	05/01/2020 08:26	05/01/2020 11:23	2,94	69	202,57	CHI
20200123670	COCALZINHO DE GOIAS	ZN12330813	PADRE BERNARDO	05/01/2020 07:25	05/01/2020 16:55	05/01/2020 07:25	05/01/2020 16:55	9,49	3	28,46	CHI
20200123675	CEZARINA	CZ12323632	CEZARINA	05/01/2020 08:28	05/01/2020 09:43	05/01/2020 08:28	05/01/2020 09:43	1,25	4	4,99	CHI
20200123675	INDIARA	CZ12323632	CEZARINA	05/01/2020 08:28	05/01/2020 09:43	05/01/2020 08:28	05/01/2020 09:43	1,25	3	3,74	CHI
20200123676	UIRAPURU	CX21082544	SANTA TEREZINHA	05/01/2020 08:28	06/01/2020 02:36	05/01/2020 08:28	06/01/2020 02:36	18,13	1	18,13	CHI
20200123677	PIRANHAS	PH12038102	PIRANHAS	05/01/2020 08:28	05/01/2020 21:20	05/01/2020 08:28	05/01/2020 21:20	12,86	3	38,58	CHI
20200123679	CRISTALINA	KR12404434	CRISTALINA S1	05/01/2020 06:39	05/01/2020 13:24	05/01/2020 06:39	05/01/2020 13:24	6,76	7	47,29	CHI
20200123686	ALEXANIA	AX12362305	ALEXANIA	05/01/2020 13:02	06/01/2020 09:06	05/01/2020 13:02	06/01/2020 09:06	20,06	31	621,96	CHI
20200123687	SANTA HELENA DE GOIAS	SH21380641	SANTA HELENA S1	05/01/2020 08:30	05/01/2020 17:12	05/01/2020 08:30	05/01/2020 17:12	8,69	1	8,69	CHI
20200123689	MORRINHOS	MR12075101	MORRINHOS	05/01/2020 08:27	05/01/2020 17:35	05/01/2020 08:27	05/01/2020 17:35	9,12	43	392,08	CHI
20200123690	CASTELANDIA	RV12370119	RIO DOS BOIS	05/01/2020 08:31	05/01/2020 13:59	05/01/2020 08:31	05/01/2020 13:59	5,47	8	43,77	CHI
20200123690	RIO VERDE	RV12370119	RIO DOS BOIS	05/01/2020 08:31	05/01/2020 13:59	05/01/2020 08:31	05/01/2020 13:59	5,47	4	21,89	CHI
20200123691	JANDAIA	JD21048726	PALMEIRAS	05/01/2020 08:31	05/01/2020 09:24	05/01/2020 08:31	05/01/2020 09:24	0,88	1	0,88	CHI
20200123694	RUBIATABA	RB12194747	RUBIATABA	05/01/2020 08:30	05/01/2020 17:23	05/01/2020 08:30	05/01/2020 17:23	8,87	11	97,55	CHI
20200123695	GOIANIA	10023759192	MEIA PONTE	05/01/2020 08:31	05/01/2020 11:18	05/01/2020 08:31	05/01/2020 11:18	2,77	1	2,77	CHI
20200123696	NOVO GAMA	NJ11376146	PACAEMBU S1	05/01/2020 08:31	05/01/2020 14:26	05/01/2020 08:31	05/01/2020 14:26	5,91	95	561,58	CHI
20200123699	SILVANIA	SV12202392	DAIA S2	04/01/2020 16:20	05/01/2020 10:13	04/01/2020 16:20	05/01/2020 10:13	17,88	12	214,58	CHI
20200123703	CASTELANDIA	QI12296614	QUIRINOPOLIS	05/01/2020 07:13	06/01/2020 16:55	05/01/2020 07:13	06/01/2020 16:55	33,70	1	33,70	CHI
20200123703	QUIRINOPOLIS	QI12296614	QUIRINOPOLIS	05/01/2020 07:13	06/01/2020 16:55	05/01/2020 07:13	06/01/2020 16:55	33,70	11	370,72	CHI
20200123704	SAO LUIS DE MONTES BELOS	SL12206347	FIRMINOPOLIS S2	05/01/2020 08:32	05/01/2020 11:42	05/01/2020 08:32	05/01/2020 11:42	3,16	1	3,16	CHI
20200123705	ITABERAI	50027086	ITABERAI S2	05/01/2020 08:32	05/01/2020 10:41	05/01/2020 08:32	05/01/2020 10:41	2,14	1	2,14	CHI
20200123708	APARECIDA DE GOIANIA	10015757330	ATLANTICO S3	05/01/2020 08:33	05/01/2020 09:24	05/01/2020 08:33	05/01/2020 09:24	0,84	1	0,84	CHI
20200123709	SANTA TEREZINHA DE GOIAS	SG12314437	SANTA TEREZINHA	05/01/2020 08:33	05/01/2020 19:25	05/01/2020 08:33	05/01/2020 19:25	10,87	6	65,25	CHI
20200123718	MORRINHOS	MR12040536	MORRINHOS	05/01/2020 08:26	05/01/2020 21:46	05/01/2020 08:26	05/01/2020 21:46	13,33	8	106,66	CHI

20200123720	CALDAS NOVAS	CN12204409	CALDAS NOVAS S1	05/01/2020 07:29	05/01/2020 13:51	05/01/2020 07:29	05/01/2020 13:51	6,35	107	679,60	CHI
20200123721	MONTES CLAROS DE GOIAS	ME12097811	IPORA	05/01/2020 08:35	05/01/2020 21:33	05/01/2020 08:35	05/01/2020 21:33	12,95	1	12,95	CHI
20200123723	MINACU	IH12252364	MINACU	05/01/2020 08:36	05/01/2020 14:31	05/01/2020 08:36	05/01/2020 14:31	5,93	9	53,34	CHI
20200123729	GUARINOS	GG12318446	URUACU	05/01/2020 08:12	05/01/2020 10:26	05/01/2020 08:12	05/01/2020 10:26	2,23	1	2,23	CHI
20200123729	PILAR DE GOIAS	GG12318446	URUACU	05/01/2020 08:12	05/01/2020 10:26	05/01/2020 08:12	05/01/2020 10:26	2,23	113	252,02	CHI
20200123729	SANTA TEREZINHA DE GOIAS	GG12318446	URUACU	05/01/2020 08:12	05/01/2020 10:26	05/01/2020 08:12	05/01/2020 10:26	2,23	4	8,92	CHI
20200123730	JATAI	290090106	JATAI S3	05/01/2020 08:37	05/01/2020 10:47	05/01/2020 08:37	05/01/2020 10:47	2,16	1	2,16	CHI
20200123731	QUIRINOPOLIS	QI32011354	QUIRINOPOLIS	05/01/2020 08:13	05/01/2020 14:01	05/01/2020 08:13	05/01/2020 14:01	5,80	12	69,57	CHI
20200123732	ALEXANIA	AX12211852	ALEXANIA	05/01/2020 06:55	05/01/2020 15:22	05/01/2020 06:55	05/01/2020 15:22	8,44	15	126,67	CHI
20200123734	ANAPOLIS	20027930	ANAPOLIS UNIVERSITARIO S2	05/01/2020 08:37	05/01/2020 14:07	05/01/2020 08:37	05/01/2020 14:07	5,49	1	5,49	CHI
20200123738	CATALAO	CT21077466	CATALAO S1	05/01/2020 08:38	05/01/2020 15:09	05/01/2020 08:38	05/01/2020 15:09	6,52	1	6,52	CHI
20200123739	ITAPURANGA	IK12299453	ITAPURANGA	05/01/2020 08:21	05/01/2020 13:55	05/01/2020 08:21	05/01/2020 13:55	5,56	7	38,93	CHI
20200123740	VIANOPOLIS	VN21109899	VIANOPOLIS	05/01/2020 08:38	05/01/2020 21:16	05/01/2020 08:38	05/01/2020 21:16	12,63	1	12,63	CHI
20200123742	APARECIDA DE GOIANIA	16774334	ANHANGUERA	05/01/2020 08:38	05/01/2020 12:45	05/01/2020 08:38	05/01/2020 12:45	4,10	1	4,10	CHI
20200123743	ARENOPOLIS	AY12000029	ARENOPOLIS	05/01/2020 07:05	05/01/2020 15:30	05/01/2020 07:05	05/01/2020 15:30	8,40	7	58,83	CHI
20200123746	RUBIATABA	780057703	RUBIATABA	05/01/2020 08:39	06/01/2020 10:25	05/01/2020 08:39	06/01/2020 10:25	25,76	1	25,76	CHI
20200123747	UIRAPURU	UP12396313	NOVA CRIXAS	05/01/2020 08:39	05/01/2020 23:30	05/01/2020 08:39	05/01/2020 23:30	14,85	33	489,97	CHI
20200123748	MONTE ALEGRE DE GOIAS	MA11273523	SAO DOMINGOS	05/01/2020 08:40	05/01/2020 11:05	05/01/2020 08:40	05/01/2020 11:05	2,42	1	2,42	CHI
20200123752	ITABERAI	IB21373127	ITABERAI S1	05/01/2020 08:40	05/01/2020 11:50	05/01/2020 08:40	05/01/2020 11:50	3,16	1	3,16	CHI
20200123753	CIDADE OCIDENTAL	DH11128724	MARAJOARA	05/01/2020 08:40	05/01/2020 13:14	05/01/2020 08:40	05/01/2020 13:14	4,55	14	63,77	CHI
20200123755	APORE	IJ12202625	ITAJA S2	05/01/2020 15:29	05/01/2020 21:24	05/01/2020 15:29	05/01/2020 21:24	5,91	4	23,64	CHI
20200123755	ITAJA	IJ12202625	ITAJA S2	05/01/2020 15:29	05/01/2020 21:24	05/01/2020 15:29	05/01/2020 21:24	5,91	24	141,85	CHI
20200123756	CAMPOS VERDES	VD12257334	SANTA TEREZINHA	05/01/2020 08:41	05/01/2020 20:34	05/01/2020 08:41	05/01/2020 20:34	11,88	6	71,28	CHI
20200123760	IPAMERI	IP12041051	IPAMERI	05/01/2020 07:33	05/01/2020 10:03	05/01/2020 07:33	05/01/2020 10:03	2,49	7	17,43	CHI
20200123761	GOIANIA	13616808	CARAJAS S1	05/01/2020 08:42	05/01/2020 10:47	05/01/2020 08:42	05/01/2020 10:47	2,07	1	2,07	CHI
20200123762	CORUMBAIBA	IP21233842	IPAMERI	05/01/2020 08:42	05/01/2020 11:07	05/01/2020 08:42	05/01/2020 11:07	2,41	1	2,41	CHI
20200123765	IPAMERI	IP12000095	IPAMERI	05/01/2020 08:43	05/01/2020 13:02	05/01/2020 08:43	05/01/2020 13:02	4,30	15	64,55	CHI
20200123767	MONTIVIDIU DO NORTE	MX12270910	PORANGATU	05/01/2020 08:43	05/01/2020 15:50	05/01/2020 08:43	05/01/2020 15:50	7,10	7	49,73	CHI
20200123768	CORUMBA DE GOIAS	ZN12382309	COCALZINHO	05/01/2020 08:43	05/01/2020 13:00	05/01/2020 08:43	05/01/2020 13:00	4,27	62	264,98	CHI
20200123772	URUACU	UR12190194	URUACU	05/01/2020 08:44	05/01/2020 17:21	05/01/2020 08:44	05/01/2020 17:21	8,61	7	60,25	CHI
20200123773	ANAPOLIS	AN21267869	ANAPOLIS UNIVERSITARIO S2	05/01/2020 08:44	05/01/2020 15:34	05/01/2020 08:44	05/01/2020 15:34	6,82	1	6,82	CHI
20200123774	SANTO ANTONIO DE GOIAS	BW12406479	NEROPOLIS S1	05/01/2020 08:44	05/01/2020 18:19	05/01/2020 08:44	05/01/2020 18:19	9,57	6	57,41	CHI
20200123776	SAO JOAO D ALIANCA	JL12383338	SAO JOAO D ALIANCA	05/01/2020 08:45	05/01/2020 10:41	05/01/2020 08:45	05/01/2020 10:41	1,93	39	75,39	CHI

20200123779	CAMPINORTE	UR21147046	URUACU	05/01/2020 08:45	05/01/2020 11:56	05/01/2020 08:45	05/01/2020 11:56	3,17	1	3,17	CHI
20200123783	APARECIDA DE GOIANIA	AP11162111	ATLANTICO S2	05/01/2020 08:46	05/01/2020 11:27	05/01/2020 08:46	05/01/2020 11:27	2,68	120	321,77	CHI
20200123784	COLINAS DO SUL	TI12237626	MINACU	05/01/2020 08:46	05/01/2020 13:43	05/01/2020 08:46	05/01/2020 13:43	4,94	53	262,08	CHI
20200123784	NIQUELANDIA	TI12237626	MINACU	05/01/2020 08:46	05/01/2020 13:43	05/01/2020 08:46	05/01/2020 13:43	4,94	1	4,94	CHI
20200123784	URUACU	TI12237626	MINACU	05/01/2020 08:46	05/01/2020 13:43	05/01/2020 08:46	05/01/2020 13:43	4,94	1	4,94	CHI
20200123788	GOIANIA	GN11251494	REAL S1	05/01/2020 08:47	05/01/2020 12:39	05/01/2020 08:47	05/01/2020 12:39	3,86	84	324,43	CHI
20200123795	PIRENOPOLIS	PV12381257	CORUMBA	05/01/2020 06:53	05/01/2020 11:49	05/01/2020 06:53	05/01/2020 11:49	4,93	124	611,60	CHI
20200123801	URUACU	CR12410914	MARA ROSA	05/01/2020 08:48	06/01/2020 14:07	05/01/2020 08:48	06/01/2020 14:07	29,31	15	439,67	CHI
20200123802	LUZIANIA	LZ21131421	MARAJOARA	05/01/2020 08:48	05/01/2020 11:40	05/01/2020 08:48	05/01/2020 11:40	2,85	1	2,85	CHI
20200123803	PIRENOPOLIS	SF12017628	SAO FRANCISCO DE GOIAS	05/01/2020 08:18	05/01/2020 11:35	05/01/2020 08:18	05/01/2020 11:35	3,28	4	13,11	CHI
20200123803	SAO FRANCISCO DE GOIAS	SF12017628	SAO FRANCISCO DE GOIAS	05/01/2020 08:18	05/01/2020 11:35	05/01/2020 08:18	05/01/2020 11:35	3,28	8	26,23	CHI
20200123805	SAO FRANCISCO DE GOIAS	SF12377537	SAO FRANCISCO DE GOIAS	05/01/2020 08:49	05/01/2020 16:53	05/01/2020 08:49	05/01/2020 16:53	8,06	2	16,12	CHI
20200123806	TRINDADE	40278244	TRINDADE	05/01/2020 08:49	05/01/2020 13:42	05/01/2020 08:49	05/01/2020 13:42	4,89	1	4,89	CHI
20200123808	ABADIANIA	AA12261204	ANAPOLIS UNIVERSITARIO S1	05/01/2020 08:26	05/01/2020 12:08	05/01/2020 08:26	05/01/2020 12:08	3,69	21	77,46	CHI
20200123810	QUIRINOPOLIS	QI31036473	QUIRINOPOLIS	05/01/2020 08:49	06/01/2020 21:53	05/01/2020 08:49	06/01/2020 21:53	37,05	1	37,05	CHI
20200123813	SANTA BARBARA DE GOIAS	1030016528	TRINDADE	05/01/2020 08:50	05/01/2020 15:21	05/01/2020 08:50	05/01/2020 15:21	6,53	1	6,53	CHI
20200123819	ABADIANIA	AN21339489	ANAPOLIS UNIVERSITARIO S2	05/01/2020 08:50	05/01/2020 13:49	05/01/2020 08:50	05/01/2020 13:49	4,97	1	4,97	CHI
20200123821	PIRENOPOLIS	10015645760	CORUMBA	05/01/2020 08:50	06/01/2020 16:24	05/01/2020 08:50	06/01/2020 16:24	31,55	1	31,55	CHI
20200123825	GOIANIA	GN11000677	GOIANIA LESTE S2	05/01/2020 08:01	05/01/2020 11:43	05/01/2020 08:01	05/01/2020 11:43	3,69	102	376,55	CHI
20200123835	GOIAS	GS12198785	GOIAS	05/01/2020 08:02	05/01/2020 13:16	05/01/2020 08:02	05/01/2020 13:16	5,22	8	41,77	CHI
20200123835	GUARAITA	GS12198785	GOIAS	05/01/2020 08:02	05/01/2020 13:16	05/01/2020 08:02	05/01/2020 13:16	5,22	2	10,44	CHI
20200123835	ITAPURANGA	GS12198785	GOIAS	05/01/2020 08:02	05/01/2020 13:16	05/01/2020 08:02	05/01/2020 13:16	5,22	2	10,44	CHI
20200123836	BOM JESUS DE GOIAS	BJ21305368	BOM JESUS DE GOIAS	05/01/2020 08:52	05/01/2020 11:54	05/01/2020 08:52	05/01/2020 11:54	3,02	1	3,02	CHI
20200123844	PARAUNA	PU21103308	FIRMINOPOLIS S2	05/01/2020 08:54	05/01/2020 15:59	05/01/2020 08:54	05/01/2020 15:59	7,08	1	7,08	CHI
20200123848	EDEIA	EA12223551RE	EDEIA	05/01/2020 06:33	05/01/2020 15:03	05/01/2020 06:33	05/01/2020 15:03	8,49	63	534,61	CHI
20200123848	INDIARA	EA12223551RE	EDEIA	05/01/2020 06:33	05/01/2020 15:03	05/01/2020 06:33	05/01/2020 15:03	8,49	4	33,94	CHI
20200123848	PONTALINA	EA12223551RE	EDEIA	05/01/2020 06:33	05/01/2020 15:03	05/01/2020 06:33	05/01/2020 15:03	8,49	1	8,49	CHI
20200123852	DIORAMA	DI12354638	IPORA	05/01/2020 08:55	06/01/2020 07:58	05/01/2020 08:55	05/01/2020 23:14	14,33	3	42,98	CHI
20200123852	DIORAMA	DI12354638	IPORA	05/01/2020 08:55	06/01/2020 07:58	05/01/2020 08:55	06/01/2020 02:53	17,97	1	17,97	CHI
20200123852	DIORAMA	DI12354638	IPORA	05/01/2020 08:55	06/01/2020 07:58	05/01/2020 08:55	06/01/2020 07:58	23,06	0	0,00	CHI
20200123853	PETROLINA DE GOIAS	PG32086638	SAO FRANCISCO DE GOIAS	05/01/2020 05:30	05/01/2020 12:39	05/01/2020 05:30	05/01/2020 12:39	7,14	40	285,78	CHI
20200123854	CRIXAS	CX12262895	SERRA DO OURO	05/01/2020 07:57	05/01/2020 10:47	05/01/2020 07:57	05/01/2020 10:47	2,83	10	28,29	CHI
20200123857	SANTA HELENA DE GOIAS	SH11000005	IPEGUARI	05/01/2020 07:36	05/01/2020 11:07	05/01/2020 07:36	05/01/2020 11:07	3,51	138	485,07	CHI



20200123859	TRINDADE	TR21119154	TRINDADE	05/01/2020 08:56	05/01/2020 15:56	05/01/2020 08:56	05/01/2020 15:56	7,01	1	7,01	CHI
20200123860	GOIANIA	12411371	GOIANIA LESTE S1	05/01/2020 08:56	05/01/2020 15:07	05/01/2020 08:56	05/01/2020 15:07	6,18	1	6,18	CHI
20200123862	ALEXANIA	AX12412641	ALEXANIA	05/01/2020 08:56	06/01/2020 18:18	05/01/2020 08:56	06/01/2020 18:18	33,36	1	33,36	CHI
20200123864	PORANGATU	PO12391933	MARA ROSA	05/01/2020 08:56	06/01/2020 12:20	05/01/2020 08:56	05/01/2020 16:46	7,83	2	15,66	CHI
20200123864	PORANGATU	PO12391933	MARA ROSA	05/01/2020 08:56	06/01/2020 12:20	05/01/2020 08:56	06/01/2020 12:20	27,40	3	82,21	CHI
20200123864	PORANGATU	PO12391933	MARA ROSA	05/01/2020 08:56	06/01/2020 12:20	06/01/2020 11:07	06/01/2020 12:20	1,21	2	2,43	CHI
20200123866	CAMPO ALEGRE DE GOIAS	CM12192738RE	CAMPO ALEGRE DE GOIAS	05/01/2020 08:33	05/01/2020 17:04	05/01/2020 08:33	05/01/2020 17:04	8,51	51	434,05	CHI
20200123869	CATURAI	CK21065632	ARACU	05/01/2020 08:57	05/01/2020 22:57	05/01/2020 08:57	05/01/2020 22:57	13,99	1	13,99	CHI
20200123872	PARAUNA	EU21296113	ACREUNA	05/01/2020 08:58	05/01/2020 17:35	05/01/2020 08:58	05/01/2020 17:35	8,60	1	8,60	CHI
20200123874	URUACU	CR21221635	MARA ROSA	05/01/2020 08:59	06/01/2020 20:30	05/01/2020 08:59	06/01/2020 20:30	35,51	1	35,51	CHI
20200123881	TURVANIA	TV12289727	FIRMINOPOLIS S2	05/01/2020 09:00	05/01/2020 10:56	05/01/2020 09:00	05/01/2020 10:56	1,94	3	5,81	CHI
20200123890	GOIANIRA	10004933891	MEIA PONTE	05/01/2020 09:01	05/01/2020 18:01	05/01/2020 09:01	05/01/2020 18:01	9,01	1	9,01	CHI
20200123894	ANAPOLIS	21141137	JUNDIAI S2	05/01/2020 09:02	05/01/2020 10:32	05/01/2020 09:02	05/01/2020 10:32	1,50	1	1,50	CHI
20200123896	SAO MIGUEL DO PASSA QUATRO	BV21019780	CRISTIANOPOLIS	05/01/2020 09:02	05/01/2020 15:45	05/01/2020 09:02	05/01/2020 15:45	6,71	2	13,42	CHI
20200123897	MINEIROS	MY12348107	PARQUE DAS EMAS	05/01/2020 07:55	05/01/2020 12:38	05/01/2020 07:55	05/01/2020 12:38	4,70	11	51,75	CHI
20200123899	CORUMBAIBA	CI21280625	VILA CORUMBA	05/01/2020 09:02	05/01/2020 16:27	05/01/2020 09:02	05/01/2020 16:27	7,40	1	7,40	CHI
20200123900	NOVA ROMA	ND21132174	IACIARA S2	05/01/2020 09:02	05/01/2020 16:17	05/01/2020 09:02	05/01/2020 16:17	7,23	1	7,23	CHI
20200123908	COLINAS DO SUL	TI12355503	MINACU	05/01/2020 09:04	05/01/2020 14:49	05/01/2020 09:04	05/01/2020 14:49	5,75	9	51,75	CHI
20200123917	SAO JOAO D ALIANCA	JL21261867	SAO JOAO D ALIANCA	05/01/2020 09:04	05/01/2020 10:56	05/01/2020 09:04	05/01/2020 10:56	1,86	2	3,71	CHI
20200123928	NOVA CRIXAS	NA21273492	NOVA CRIXAS	05/01/2020 09:05	06/01/2020 11:27	05/01/2020 09:05	06/01/2020 11:27	26,35	1	26,35	CHI
20200123930	MORRINHOS	MR12071594	MORRINHOS	05/01/2020 09:05	05/01/2020 15:50	05/01/2020 09:05	05/01/2020 15:50	6,74	2	13,47	CHI
20200123933	INHUMAS	IN11365566	INHUMAS S2	05/01/2020 09:06	05/01/2020 10:10	05/01/2020 09:06	05/01/2020 10:10	1,06	48	50,92	CHI
20200123938	SAO DOMINGOS	SD21139017	SAO DOMINGOS	05/01/2020 09:06	05/01/2020 11:34	05/01/2020 09:06	05/01/2020 11:34	2,45	1	2,45	CHI
20200123939	AGUAS LINDAS DE GOIAS	6830015104	AGUAS LINDAS DE GOIAS S2	05/01/2020 09:06	05/01/2020 14:37	05/01/2020 09:06	05/01/2020 14:37	5,50	1	5,50	CHI
20200123940	CRISTALINA	KR21171601	CRISTALINA S2	05/01/2020 09:06	05/01/2020 13:18	05/01/2020 09:06	05/01/2020 13:18	4,18	2	8,37	CHI
20200123949	GOIANIA	GN10400557	GOIANIA LESTE S3	05/01/2020 09:03	05/01/2020 12:27	05/01/2020 09:07	05/01/2020 09:35	0,48	1240	598,30	CHI
20200123949	GOIANIA	GN12395884LD	GOIANIA LESTE S3	05/01/2020 09:03	05/01/2020 12:27	05/01/2020 09:07	05/01/2020 12:27	3,35	118	394,74	CHI
20200123954	MUTUNOPOLIS	MU12086730	MARA ROSA	05/01/2020 09:08	05/01/2020 12:15	05/01/2020 09:08	05/01/2020 12:15	3,10	31	96,25	CHI
20200123956	TAQUARAL DE GOIAS	TQ12074928	ITABERAI S1	05/01/2020 09:09	05/01/2020 15:15	05/01/2020 09:09	05/01/2020 15:15	6,11	27	165,04	CHI
20200123957	GOIANIA	13516772	CARAJAS S1	05/01/2020 09:09	05/01/2020 11:58	05/01/2020 09:09	05/01/2020 11:58	2,82	1	2,82	CHI
20200123958	BONOPOLIS	BX12115527	SAO MIGUEL DO ARAGUAIA	05/01/2020 09:09	05/01/2020 14:00	05/01/2020 09:09	05/01/2020 14:00	4,86	4	19,42	CHI
20200123965	GUARANI DE GOIAS	GY21215923	IACIARA S1	05/01/2020 09:10	05/01/2020 10:46	05/01/2020 09:10	05/01/2020 10:46	1,59	1	1,59	CHI
20200123966	GOIANIA	11074115	GOYA S1	05/01/2020 09:11	05/01/2020 11:29	05/01/2020 09:11	05/01/2020 11:29	2,29	1	2,29	CHI

20200123977	PIRACANJUBA	PJ21247814	PIRACANJUBA	05/01/2020 09:12	05/01/2020 21:04	05/01/2020 09:12	05/01/2020 21:04	11,86	1	11,86	CHI
20200123980	AMARALINA	LC12220898	MARA ROSA	05/01/2020 09:12	05/01/2020 17:40	05/01/2020 09:12	05/01/2020 17:40	8,46	2	16,91	CHI
20200123981	PIRACANJUBA	PJ12000214	PIRACANJUBA	05/01/2020 09:12	05/01/2020 22:02	05/01/2020 09:12	05/01/2020 22:02	12,82	4	51,29	CHI
20200123982	APARECIDA DE GOIANIA	AP12043971	INDEPENDENCIA S2	05/01/2020 09:12	05/01/2020 12:11	05/01/2020 09:12	05/01/2020 11:54	2,69	146	393,19	CHI
20200123982	APARECIDA DE GOIANIA	AP11043247	INDEPENDENCIA S2	05/01/2020 09:12	05/01/2020 12:11	05/01/2020 09:12	05/01/2020 12:11	2,98	102	303,70	CHI
20200123993	SANTO ANTONIO DO DESCOBERTO	SN21248353	MARAJOARA	05/01/2020 09:13	05/01/2020 19:32	05/01/2020 09:13	05/01/2020 19:32	10,31	2	20,61	CHI
20200124005	ADELANDIA	SC12323567	FIRMINOPOLIS S2	05/01/2020 08:55	05/01/2020 09:46	05/01/2020 08:55	05/01/2020 09:46	0,84	10	8,41	CHI
20200124005	SANCLERLANDIA	SC12323567	FIRMINOPOLIS S2	05/01/2020 08:55	05/01/2020 09:46	05/01/2020 08:55	05/01/2020 09:46	0,84	1	0,84	CHI
20200124008	GOIANIRA	10008000890	GOIANIRA	05/01/2020 09:15	05/01/2020 15:56	05/01/2020 09:15	05/01/2020 15:56	6,68	1	6,68	CHI
20200124013	CACU	CC12196047	CACHOEIRA ALTA	05/01/2020 03:43	06/01/2020 01:05	05/01/2020 03:43	06/01/2020 01:05	21,36	11	234,92	CHI
20200124014	GOIANESIA	550087011	GOIANESIA S2	05/01/2020 09:15	05/01/2020 15:17	05/01/2020 09:15	05/01/2020 15:17	6,02	1	6,02	CHI
20200124017	ANICUNS	AC12065201	ANICUNS	05/01/2020 09:16	05/01/2020 18:40	05/01/2020 09:16	05/01/2020 18:40	9,40	6	56,39	CHI
20200124020	COCALZINHO DE GOIAS	10022975410	COCALZINHO	05/01/2020 09:16	05/01/2020 12:42	05/01/2020 09:16	05/01/2020 12:42	3,43	1	3,43	CHI
20200124031	CATALAO	CT12333388	CATALAO S1	05/01/2020 09:17	05/01/2020 18:31	05/01/2020 09:17	05/01/2020 18:31	9,23	1	9,23	CHI
20200124036	SANTA TEREZINHA DE GOIAS	SG12197603	SANTA TEREZINHA	05/01/2020 09:18	05/01/2020 15:52	05/01/2020 09:18	05/01/2020 15:52	6,56	2	13,13	CHI
20200124047	APARECIDA DE GOIANIA	10021507226	INDEPENDENCIA S2	05/01/2020 09:19	05/01/2020 11:32	05/01/2020 09:19	05/01/2020 11:32	2,21	1	2,21	CHI
20200124049	BARRO ALTO	BA12382485	BARRO ALTO	05/01/2020 07:44	05/01/2020 12:47	05/01/2020 07:44	05/01/2020 12:47	5,04	9	45,38	CHI
20200124050	CAIAPONIA	CP12248981	CAIAPONIA	05/01/2020 09:19	05/01/2020 18:31	05/01/2020 09:19	05/01/2020 18:31	9,19	8	73,49	CHI
20200124051	PORANGATU	PO12000021	PORANGATU	05/01/2020 07:25	05/01/2020 11:25	05/01/2020 07:25	05/01/2020 11:25	3,99	187	746,23	CHI
20200124052	CRIXAS	CX12318400	MOZARLANDIA	05/01/2020 09:19	06/01/2020 17:26	05/01/2020 09:19	05/01/2020 11:38	2,30	2	4,61	CHI
20200124052	CRIXAS	CX13307449	MOZARLANDIA	05/01/2020 09:19	06/01/2020 17:26	05/01/2020 09:19	05/01/2020 15:17	5,96	4	23,83	CHI
20200124052	CRIXAS	CX12240192LD	MOZARLANDIA	05/01/2020 09:19	06/01/2020 17:26	05/01/2020 09:19	05/01/2020 18:16	8,94	3	26,82	CHI
20200124052	CRIXAS	CX12318400	MOZARLANDIA	05/01/2020 09:19	06/01/2020 17:26	05/01/2020 09:19	06/01/2020 15:22	30,05	1	30,05	CHI
20200124052	CRIXAS	CX12318400	MOZARLANDIA	05/01/2020 09:19	06/01/2020 17:26	06/01/2020 15:13	06/01/2020 15:22	0,17	9	1,49	CHI
20200124052	CRIXAS	CX12342282LD	MOZARLANDIA	05/01/2020 09:19	06/01/2020 17:26	05/01/2020 09:19	06/01/2020 17:26	32,12	1	32,12	CHI
20200124055	ESTRELA DO NORTE	2420014255	MARA ROSA	05/01/2020 09:20	05/01/2020 15:43	05/01/2020 09:20	05/01/2020 15:43	6,38	1	6,38	CHI
20200124058	SANTO ANTONIO DO DESCOBERTO	SN21313987	ALEXANIA	05/01/2020 09:21	06/01/2020 13:57	05/01/2020 09:21	06/01/2020 13:57	28,60	1	28,60	CHI
20200124063	GUARINOS	GF12202065	SANTA TEREZINHA	05/01/2020 13:58	05/01/2020 21:25	05/01/2020 13:58	05/01/2020 21:25	7,45	8	59,57	CHI
20200124066	GOIANIA	GN11001287	GOIANIA LESTE S2	05/01/2020 09:12	05/01/2020 14:09	05/01/2020 09:12	05/01/2020 14:09	4,94	67	331,26	CHI
20200124069	MOSSAMEDES	MD12277723	FIRMINOPOLIS S2	05/01/2020 09:22	05/01/2020 12:45	05/01/2020 09:22	05/01/2020 12:45	3,37	4	13,48	CHI
20200124071	GOIANIA	GN11189921	GOYA S2	05/01/2020 09:22	05/01/2020 10:24	05/01/2020 09:22	05/01/2020 10:24	1,02	84	85,66	CHI
20200124073	ARUANA	2380003434	ARUANA	05/01/2020 09:23	05/01/2020 11:33	05/01/2020 09:23	05/01/2020 11:33	2,17	1	2,17	CHI
20200124079	ORIZONA	OZ12036983	PIRES DO RIO S2	05/01/2020 09:23	05/01/2020 14:55	05/01/2020 09:23	05/01/2020 14:55	5,52	1	5,52	CHI

20200124079	VIANOPOLIS	OZ12036983	PIRES DO RIO S2	05/01/2020 09:23	05/01/2020 14:55	05/01/2020 09:23	05/01/2020 14:55	5,52	10	55,23	CHI
20200124083	GOIANIA	GN11001688	XAVANTES	05/01/2020 09:23	05/01/2020 18:24	05/01/2020 09:23	05/01/2020 18:24	9,00	30	270,06	CHI
20200124089	JARAGUA	JA21016190	GOIANESIA S2	05/01/2020 09:24	06/01/2020 07:48	05/01/2020 09:24	06/01/2020 07:48	22,39	1	22,39	CHI
20200124092	RIO VERDE	RV21205437	MONTIVIDIU T	05/01/2020 09:25	05/01/2020 19:12	05/01/2020 09:25	05/01/2020 19:12	9,78	13	127,18	CHI
20200124095	BOM JESUS DE GOIAS	BJ12305342	BOM JESUS DE GOIAS	05/01/2020 09:25	05/01/2020 15:40	05/01/2020 09:25	05/01/2020 15:40	6,24	1	6,24	CHI
20200124095	GOIATUBA	BJ12305342	BOM JESUS DE GOIAS	05/01/2020 09:25	05/01/2020 15:40	05/01/2020 09:25	05/01/2020 15:40	6,24	3	18,72	CHI
20200124096	MINEIROS	SU12157170	SANTA RITA DO ARAGUAIA	05/01/2020 09:25	05/01/2020 12:38	05/01/2020 09:25	05/01/2020 12:38	3,20	5	16,02	CHI
20200124097	CAIAPONIA	CP21260082	MONTIVIDIU T	05/01/2020 09:25	06/01/2020 18:15	05/01/2020 09:25	06/01/2020 18:15	32,83	1	32,83	CHI
20200124106	CALDAS NOVAS	760416618	SERRA DE CALDAS	05/01/2020 09:27	05/01/2020 14:40	05/01/2020 09:27	05/01/2020 14:40	5,21	1	5,21	CHI
20200124108	GOIAS	4390000811	MATRINCHA	05/01/2020 09:27	05/01/2020 14:24	05/01/2020 09:27	05/01/2020 14:24	4,94	1	4,94	CHI
20200124110	LEOPOLDO DE BULHOES	LB21203907	DAIA S2	05/01/2020 09:27	05/01/2020 13:13	05/01/2020 09:27	05/01/2020 13:13	3,75	2	7,50	CHI
20200124114	FORMOSA	610057066	ITUIQUIRA	05/01/2020 09:28	05/01/2020 13:02	05/01/2020 09:28	05/01/2020 13:02	3,55	1	3,55	CHI
20200124123	INDIARA	IY12312446	CEZARINA	05/01/2020 07:52	05/01/2020 11:20	05/01/2020 07:52	05/01/2020 11:20	3,46	7	24,25	CHI
20200124124	BARRO ALTO	BA21165593	BARRO ALTO	04/01/2020 17:45	05/01/2020 21:50	04/01/2020 17:45	05/01/2020 21:50	28,08	1	28,08	CHI
20200124126	NOVA ROMA	ND12392237	IACIARA S2	05/01/2020 09:30	05/01/2020 12:24	05/01/2020 09:30	05/01/2020 12:24	2,89	10	28,88	CHI
20200124129	NOVA VENEZA	NV12200061	INHUMAS S1	05/01/2020 09:26	05/01/2020 12:30	05/01/2020 09:26	05/01/2020 12:30	3,07	271	830,77	CHI
20200124139	JARAGUA	70122120	JARAGUA	05/01/2020 09:33	06/01/2020 08:18	05/01/2020 09:33	06/01/2020 08:18	22,74	1	22,74	CHI
20200124143	IVOLANDIA	MO12165608	IPORA	05/01/2020 06:31	05/01/2020 19:25	05/01/2020 06:31	05/01/2020 19:25	12,89	17	219,15	CHI
20200124143	MOIPORA	MO12165608	IPORA	05/01/2020 06:31	05/01/2020 19:25	05/01/2020 06:31	05/01/2020 19:25	12,89	1	12,89	CHI
20200124149	ABADIA DE GOIAS	TR12310248	GUAPO S1	05/01/2020 08:54	05/01/2020 13:21	05/01/2020 08:54	05/01/2020 13:21	4,44	1	4,44	CHI
20200124149	GUAPO	TR12310248	GUAPO S1	05/01/2020 08:54	05/01/2020 13:21	05/01/2020 08:54	05/01/2020 13:21	4,44	3	13,31	CHI
20200124151	JANDAIA	JD21307063	PALMEIRAS	05/01/2020 09:35	05/01/2020 10:48	05/01/2020 09:35	05/01/2020 10:48	1,21	1	1,21	CHI
20200124152	MONTIVIDIU	MV12260779	MONTIVIDIU T	05/01/2020 09:35	05/01/2020 21:36	05/01/2020 09:35	05/01/2020 21:36	12,00	5	60,00	CHI
20200124153	BALIZA	BH12360382	BOM JARDIM	05/01/2020 09:36	06/01/2020 09:20	05/01/2020 09:36	06/01/2020 09:20	23,73	3	71,20	CHI
20200124154	PIRANHAS	1930050139	PIRANHAS	05/01/2020 09:36	05/01/2020 20:15	05/01/2020 09:36	05/01/2020 20:15	10,64	1	10,64	CHI
20200124156	PALMINOPOLIS	PP21233483	PALMEIRAS	05/01/2020 09:36	05/01/2020 11:02	05/01/2020 09:36	05/01/2020 11:02	1,43	1	1,43	CHI
20200124159	AGUAS LINDAS DE GOIAS	10001160476	AGUAS LINDAS DE GOIAS S1	05/01/2020 09:36	05/01/2020 16:01	05/01/2020 09:36	05/01/2020 16:01	6,40	1	6,40	CHI
20200124161	CAMPO LIMPO	AN12297667	NEROPOLIS S1	05/01/2020 09:37	05/01/2020 11:54	05/01/2020 09:37	05/01/2020 11:54	2,28	10	22,80	CHI
20200124161	OURO VERDE DE GOIAS	AN12297667	NEROPOLIS S1	05/01/2020 09:37	05/01/2020 11:54	05/01/2020 09:37	05/01/2020 11:54	2,28	1	2,28	CHI
20200124164	CRISTALINA	KR21237942	CRISTALINA S1	05/01/2020 09:37	05/01/2020 14:32	05/01/2020 09:37	05/01/2020 14:32	4,90	1	4,90	CHI
20200124167	AGUAS LINDAS DE GOIAS	4830395401	AGUAS LINDAS DE GOIAS S1	05/01/2020 09:38	05/01/2020 13:01	05/01/2020 09:38	05/01/2020 13:01	3,37	1	3,37	CHI
20200124173	INHUMAS	30001687	INHUMAS S2	05/01/2020 09:40	05/01/2020 15:08	05/01/2020 09:40	05/01/2020 15:08	5,46	1	5,46	CHI
20200124176	CORREGO DO OURO	CO21307212	FIRMINOPOLIS S2	05/01/2020 09:40	05/01/2020 17:59	05/01/2020 09:40	05/01/2020 17:59	8,30	1	8,30	CHI

20200124178	PALMINOPOLIS	PP21013321	PALMEIRAS	05/01/2020 09:41	05/01/2020 15:45	05/01/2020 09:41	05/01/2020 15:45	6,08	3	18,23	CHI
20200124184	PONTALINA	PK21090553	VICENTINOPOLIS	05/01/2020 09:43	05/01/2020 16:01	05/01/2020 09:43	05/01/2020 16:01	6,30	1	6,30	CHI
20200124186	GOIAS	GS11352490	GOIAS	05/01/2020 09:43	05/01/2020 13:43	05/01/2020 09:43	05/01/2020 13:43	3,99	48	191,33	CHI
20200124188	ALEXANIA	AX12312012	ALEXANIA	05/01/2020 09:08	05/01/2020 15:29	05/01/2020 09:08	05/01/2020 15:29	6,35	7	44,43	CHI
20200124190	AGUA FRIA DE GOIAS	TL12279981	SAO JOAO D ALIANCA	05/01/2020 09:44	05/01/2020 12:30	05/01/2020 09:44	05/01/2020 12:30	2,75	41	112,91	CHI
20200124194	RIO VERDE	RV21076186	CABRIUVA S2	05/01/2020 09:45	06/01/2020 16:00	05/01/2020 09:45	06/01/2020 16:00	30,25	1	30,25	CHI
20200124197	MONTES CLAROS DE GOIAS	ME12132529	IPORA	05/01/2020 08:01	05/01/2020 12:16	05/01/2020 08:01	05/01/2020 12:16	4,25	31	131,66	CHI
20200124199	GOIAS	GS12172048	GOIAS	05/01/2020 08:15	05/01/2020 10:35	05/01/2020 08:15	05/01/2020 10:35	2,33	13	30,28	CHI
20200124201	SANTA HELENA DE GOIAS	SH12271341	ACREUNA	05/01/2020 09:47	05/01/2020 14:16	05/01/2020 09:47	05/01/2020 14:16	4,48	9	40,34	CHI
20200124203	ARUANA	MP12099916	MATRINCHA	05/01/2020 09:47	06/01/2020 01:23	05/01/2020 09:47	06/01/2020 01:23	15,60	5	77,98	CHI
20200124203	MATRINCHA	MP12099916	MATRINCHA	05/01/2020 09:47	06/01/2020 01:23	05/01/2020 09:47	06/01/2020 01:23	15,60	2	31,19	CHI
20200124204	MINEIROS	MY21413103	PARQUE DAS EMAS	05/01/2020 09:47	06/01/2020 09:55	05/01/2020 09:47	06/01/2020 09:55	24,14	1	24,14	CHI
20200124205	MUNDO NOVO DE GOIAS	4240002735	NOVA CRIXAS	05/01/2020 09:47	05/01/2020 16:58	05/01/2020 09:47	05/01/2020 16:58	7,19	1	7,19	CHI
20200124207	PIRACANJUBA	PJ12000042RE	PIRACANJUBA	05/01/2020 09:09	05/01/2020 17:51	05/01/2020 09:09	05/01/2020 17:51	8,69	10	86,90	CHI
20200124217	ITABERAI	IB11000041	ITABERAI S2	04/01/2020 19:25	05/01/2020 16:55	04/01/2020 19:25	05/01/2020 16:55	21,50	110	2364,57	CHI
20200124218	CRIXAS	CX21238338	SERRA DO OURO	05/01/2020 09:49	06/01/2020 09:35	05/01/2020 09:49	06/01/2020 09:35	23,77	1	23,77	CHI
20200124226	HIDROLANDIA	HD21200010	CEPAIGO S2	05/01/2020 07:33	05/01/2020 15:23	05/01/2020 07:33	05/01/2020 15:23	7,83	1	7,83	CHI
20200124228	CACHOEIRA DE GOIAS	CG21388886	FIRMINOPOLIS S2	05/01/2020 09:50	05/01/2020 18:50	05/01/2020 09:50	05/01/2020 18:50	8,98	1	8,98	CHI
20200124235	PORTELANDIA	PW12303462	PARQUE DAS EMAS	05/01/2020 09:51	05/01/2020 15:14	05/01/2020 09:51	05/01/2020 15:14	5,37	8	42,98	CHI
20200124238	ABADIANIA	AA12382488	ANAPOLIS UNIVERSITARIO S1	05/01/2020 09:52	05/01/2020 13:47	05/01/2020 09:52	05/01/2020 13:47	3,91	3	11,74	CHI
20200124246	EDEIA	EA12043986	EDEIA	05/01/2020 09:53	06/01/2020 13:50	05/01/2020 09:53	06/01/2020 13:50	27,94	2	55,88	CHI
20200124249	GOIANIA	10001418430	CAMPINAS S2	05/01/2020 09:54	05/01/2020 11:37	05/01/2020 09:54	05/01/2020 11:37	1,71	1	1,71	CHI
20200124251	ITUMBIARA	CD12222334	CACHOEIRA DOURADA	05/01/2020 09:54	05/01/2020 16:11	05/01/2020 09:54	05/01/2020 16:11	6,27	3	18,81	CHI
20200124252	PLANALTINA	2960061269	PLANALTINA	05/01/2020 09:55	05/01/2020 13:08	05/01/2020 09:55	05/01/2020 13:08	3,21	1	3,21	CHI
20200124253	MORRINHOS	MR21000089	GOIATUBA S1	05/01/2020 09:55	05/01/2020 12:38	05/01/2020 09:55	05/01/2020 12:38	2,71	1	2,71	CHI
20200124257	ITUMBIARA	IT21293318	CACHOEIRA DOURADA	05/01/2020 09:56	05/01/2020 14:50	05/01/2020 09:56	05/01/2020 14:50	4,90	1	4,90	CHI
20200124261	CAMPO ALEGRE DE GOIAS	CT12306674RE	CATALAO S1	05/01/2020 09:56	05/01/2020 13:19	05/01/2020 09:56	05/01/2020 13:19	3,37	1	3,37	CHI
20200124261	CATALAO	CT12306674RE	CATALAO S1	05/01/2020 09:56	05/01/2020 13:19	05/01/2020 09:56	05/01/2020 13:19	3,37	336	1132,51	CHI
20200124262	AGUAS LINDAS DE GOIAS	4830151056	AGUAS LINDAS DE GOIAS S1	05/01/2020 09:56	05/01/2020 15:50	05/01/2020 09:56	05/01/2020 15:50	5,89	1	5,89	CHI
20200124266	MINACU	IH12236142	MINACU	05/01/2020 09:57	05/01/2020 15:40	05/01/2020 09:57	05/01/2020 15:40	5,71	28	160,01	CHI
20200124267	CRISTALINA	KR12332627	CRISTALINA S1	05/01/2020 09:57	05/01/2020 14:23	05/01/2020 09:57	05/01/2020 14:23	4,43	1	4,43	CHI
20200124268	ITAUCU	IX31195664	INHUMAS S1	05/01/2020 09:57	05/01/2020 18:23	05/01/2020 09:57	05/01/2020 18:23	8,43	2	16,85	CHI
20200124274	PIRENOPOLIS	PV21294272	CORUMBA	05/01/2020 09:58	05/01/2020 15:46	05/01/2020 09:58	05/01/2020 15:46	5,79	2	11,59	CHI

20200124276	FAZENDA NOVA	FN12031321	JUSSARA	05/01/2020 09:58	05/01/2020 19:00	05/01/2020 09:58	05/01/2020 19:00	9,02	2	18,05	CHI
20200124276	NOVO BRASIL	FN12031321	JUSSARA	05/01/2020 09:58	05/01/2020 19:00	05/01/2020 09:58	05/01/2020 19:00	9,02	1	9,02	CHI
20200124278	GOIAS	GS21206990	ITABERAI S1	05/01/2020 09:58	05/01/2020 16:42	05/01/2020 09:58	05/01/2020 16:42	6,72	1	6,72	CHI
20200124279	ANAPOLIS	AN12000433	ANAPOLIS UNIVERSITARIO S2	05/01/2020 09:50	05/01/2020 15:51	05/01/2020 09:50	05/01/2020 15:51	6,01	1	6,01	CHI
20200124279	PIRENOPOLIS	AN12000433	ANAPOLIS UNIVERSITARIO S2	05/01/2020 09:50	05/01/2020 15:51	05/01/2020 09:50	05/01/2020 15:51	6,01	7	42,09	CHI
20200124281	SANTA ROSA DE GOIAS	10002686137	INHUMAS S1	05/01/2020 09:59	05/01/2020 16:00	05/01/2020 09:59	05/01/2020 16:00	6,03	1	6,03	CHI
20200124283	PONTALINA	PK12033342	VICENTINOPOLIS	05/01/2020 04:04	05/01/2020 19:34	05/01/2020 04:04	05/01/2020 19:34	15,49	23	356,30	CHI
20200124285	ITUMBIARA	IT21115849	ITUMBIARA NOVA	05/01/2020 09:59	05/01/2020 12:35	05/01/2020 09:59	05/01/2020 12:35	2,59	1	2,59	CHI
20200124286	MONTE ALEGRE DE GOIAS	MA12236748	SAO DOMINGOS	05/01/2020 08:35	05/01/2020 15:13	05/01/2020 08:35	05/01/2020 15:13	6,63	2	13,27	CHI
20200124286	NOVA ROMA	MA12236748	SAO DOMINGOS	05/01/2020 08:35	05/01/2020 15:13	05/01/2020 08:35	05/01/2020 15:13	6,63	57	378,05	CHI
20200124292	APARECIDA DE GOIANIA	12817521	ATLANTICO S1	05/01/2020 10:01	05/01/2020 12:33	05/01/2020 10:01	05/01/2020 12:33	2,53	1	2,53	CHI
20200124294	SAO MIGUEL DO ARAGUAIA	SM12371801B	SAO MIGUEL DO ARAGUAIA	05/01/2020 10:01	05/01/2020 14:00	05/01/2020 10:01	05/01/2020 14:00	3,97	226	897,16	CHI
20200124295	TROMBAS	TB12240756	PORANGATU	05/01/2020 07:26	05/01/2020 14:35	05/01/2020 07:26	05/01/2020 14:35	7,14	45	321,31	CHI
20200124298	SANTA CRUZ DE GOIAS	BC12263232	PIRACANJUBA	05/01/2020 10:02	05/01/2020 17:29	05/01/2020 10:02	05/01/2020 17:29	7,44	9	66,93	CHI
20200124299	SANTA RITA DO ARAGUAIA	SU12188579	PARQUE DAS EMAS	05/01/2020 09:32	05/01/2020 20:02	05/01/2020 09:32	05/01/2020 20:02	10,49	5	52,45	CHI
20200124305	SILVANIA	SV21327842	DAIA S2	05/01/2020 10:04	05/01/2020 14:46	05/01/2020 10:04	05/01/2020 14:46	4,69	1	4,69	CHI
20200124307	ARUANA	AK12396237	BRITANIA	05/01/2020 10:04	05/01/2020 19:20	05/01/2020 10:04	05/01/2020 19:20	9,25	4	37,02	CHI
20200124309	CALDAZINHA	SW12317421	SENADOR CANEDO	05/01/2020 08:47	05/01/2020 13:38	05/01/2020 08:47	05/01/2020 13:38	4,84	26	125,81	CHI
20200124309	SENADOR CANEDO	SW12317421	SENADOR CANEDO	05/01/2020 08:47	05/01/2020 13:38	05/01/2020 08:47	05/01/2020 13:38	4,84	5	24,19	CHI
20200124310	SENADOR CANEDO	10027211000	SENADOR CANEDO	05/01/2020 10:05	05/01/2020 13:28	05/01/2020 10:05	05/01/2020 13:28	3,37	1	3,37	CHI
20200124313	INHUMAS	IN11012237	INHUMAS S2	05/01/2020 09:06	05/01/2020 12:40	05/01/2020 09:06	05/01/2020 12:40	3,56	78	277,77	CHI
20200124314	GOIANIA	13549108	CARAJAS S2	05/01/2020 10:06	05/01/2020 14:00	05/01/2020 10:06	05/01/2020 14:00	3,90	1	3,90	CHI
20200124316	IPAMERI	IP12071429	PIRES DO RIO S2	05/01/2020 10:06	05/01/2020 20:52	05/01/2020 10:06	05/01/2020 20:52	10,76	2	21,52	CHI
20200124318	CEZARINA	CZ12010355	CEZARINA	05/01/2020 10:06	05/01/2020 11:01	05/01/2020 10:06	05/01/2020 11:01	0,90	6	5,43	CHI
20200124320	JATAI	290197960	JATAI S3	05/01/2020 10:07	05/01/2020 11:47	05/01/2020 10:07	05/01/2020 11:47	1,66	1	1,66	CHI
20200124325	CEZARINA	CZ12314866	CEZARINA	05/01/2020 10:08	05/01/2020 14:07	05/01/2020 10:08	05/01/2020 14:07	4,00	3	11,99	CHI
20200124327	CRISTALINA	KR21025857	PAMPLONA	05/01/2020 10:08	05/01/2020 13:44	05/01/2020 10:08	05/01/2020 13:44	3,59	1	3,59	CHI
20200124332	CAMPOS VERDES	VD12251082	SANTA TEREZINHA	05/01/2020 06:36	05/01/2020 18:28	05/01/2020 06:36	05/01/2020 18:28	11,87	4	47,48	CHI
20200124332	SANTA TEREZINHA DE GOIAS	VD12251082	SANTA TEREZINHA	05/01/2020 06:36	05/01/2020 18:28	05/01/2020 06:36	05/01/2020 18:28	11,87	17	201,80	CHI
20200124333	TRINDADE	TR12390003	GOYA S2	05/01/2020 09:16	05/01/2020 14:31	05/01/2020 09:16	05/01/2020 14:31	5,25	227	1192,13	CHI
20200124337	PETROLINA DE GOIAS	PV21155043	SAO FRANCISCO DE GOIAS	05/01/2020 10:11	06/01/2020 08:23	05/01/2020 10:11	06/01/2020 08:23	22,19	2	44,38	CHI
20200124338	CAMPINACU	UC12237456	MARA ROSA	05/01/2020 09:03	06/01/2020 00:40	05/01/2020 09:03	06/01/2020 00:40	15,61	6	93,65	CHI
20200124338	URUACU	UC12237456	MARA ROSA	05/01/2020 09:03	06/01/2020 00:40	05/01/2020 09:03	06/01/2020 00:40	15,61	5	78,04	CHI

20200124341	GOIATUBA	GT21008265	BOM JESUS DE GOIAS	05/01/2020 10:12	05/01/2020 17:52	05/01/2020 10:12	05/01/2020 17:52	7,66	1	7,66	CHI
20200124349	ARAGOIANIA	10018397482	GUAPO S2	05/01/2020 10:13	05/01/2020 15:35	05/01/2020 10:13	05/01/2020 15:35	5,35	1	5,35	CHI
20200124351	CRIXAS	CX12392063	SANTA TEREZINHA	05/01/2020 10:14	06/01/2020 09:57	05/01/2020 10:14	06/01/2020 09:57	23,71	28	663,83	CHI
20200124351	ITAPACI	CX12392063	SANTA TEREZINHA	05/01/2020 10:14	06/01/2020 09:57	05/01/2020 10:14	06/01/2020 09:57	23,71	4	94,83	CHI
20200124354	NIQUELANDIA	NQ11151012	NIQUELANDIA SUBTRANSMISSAO	05/01/2020 06:48	05/01/2020 16:00	05/01/2020 06:48	05/01/2020 16:00	9,20	70	643,65	CHI
20200124356	MARA ROSA	MQ12146955	MARA ROSA	05/01/2020 09:16	05/01/2020 15:03	05/01/2020 09:16	05/01/2020 15:03	5,78	12	69,40	CHI
20200124361	CACU	CC12360934	CACHOEIRA ALTA	05/01/2020 04:24	05/01/2020 15:57	05/01/2020 04:24	05/01/2020 15:57	11,54	9	103,86	CHI
20200124361	ITARUMA	CC12360934	CACHOEIRA ALTA	05/01/2020 04:24	05/01/2020 15:57	05/01/2020 04:24	05/01/2020 15:57	11,54	3	34,62	CHI
20200124363	SENADOR CANEDO	SW12395816	GOIANIA LESTE S1	05/01/2020 10:17	05/01/2020 16:40	05/01/2020 10:17	05/01/2020 16:40	6,38	2	12,77	CHI
20200124367	TRINDADE	10008636743	TRINDADE	05/01/2020 10:18	05/01/2020 17:29	05/01/2020 10:18	05/01/2020 17:29	7,18	1	7,18	CHI
20200124369	NOVO GAMA	2900052628	MARAJOARA	05/01/2020 10:18	06/01/2020 12:03	05/01/2020 10:18	06/01/2020 12:03	25,75	1	25,75	CHI
20200124373	ITAPIRAPUA	1420016109	MATRINCHA	05/01/2020 10:19	05/01/2020 11:40	05/01/2020 10:19	05/01/2020 11:40	1,35	1	1,35	CHI
20200124378	PIRES DO RIO	PR21248989	PIRES DO RIO S2	05/01/2020 10:19	05/01/2020 12:18	05/01/2020 10:19	05/01/2020 12:18	1,97	1	1,97	CHI
20200124379	ITABERAI	IB21021868	ITABERAI S2	05/01/2020 08:02	05/01/2020 19:46	05/01/2020 08:02	05/01/2020 17:58	9,94	1	9,94	CHI
20200124379	ITABERAI	IB21021861	ITABERAI S2	05/01/2020 08:02	05/01/2020 19:46	05/01/2020 08:02	05/01/2020 19:43	11,68	1	11,68	CHI
20200124379	ITABERAI	IB21000126	ITABERAI S2	05/01/2020 08:02	05/01/2020 19:46	05/01/2020 08:02	05/01/2020 19:44	11,69	1	11,69	CHI
20200124379	ITABERAI	IB21310631	ITABERAI S2	05/01/2020 08:02	05/01/2020 19:46	05/01/2020 08:02	05/01/2020 19:45	11,71	1	11,71	CHI
20200124379	ITABERAI	IB12078577	ITABERAI S2	05/01/2020 08:02	05/01/2020 19:46	05/01/2020 08:02	05/01/2020 19:46	11,73	9	105,55	CHI
20200124380	SENADOR CANEDO	SW21032482	SENADOR CANEDO	05/01/2020 10:20	05/01/2020 14:14	05/01/2020 10:20	05/01/2020 14:14	3,90	1	3,90	CHI
20200124384	GOIANIA	16266213	GOYA S2	05/01/2020 10:20	05/01/2020 11:44	05/01/2020 10:20	05/01/2020 11:44	1,39	1	1,39	CHI
20200124386	GOIANIA	17352058	GOIANIA LESTE S2	05/01/2020 10:20	05/01/2020 18:46	05/01/2020 10:20	05/01/2020 18:46	8,42	1	8,42	CHI
20200124387	PALESTINA DE GOIAS	PY12396170	PALESTINA	05/01/2020 10:21	06/01/2020 23:19	05/01/2020 10:21	06/01/2020 23:08	36,78	6	220,71	CHI
20200124387	PALESTINA DE GOIAS	7715924	PALESTINA	05/01/2020 10:21	06/01/2020 23:19	05/01/2020 10:21	06/01/2020 23:19	36,97	4	147,89	CHI
20200124392	COLINAS DO SUL	TI12357757	NIQUELANDIA SUBTRANSMISSAO	05/01/2020 10:21	05/01/2020 20:06	05/01/2020 10:21	05/01/2020 20:06	9,74	7	68,16	CHI
20200124394	PIRACANJUBA	PJ21040399	MORRINHOS	05/01/2020 10:21	05/01/2020 12:15	05/01/2020 10:21	05/01/2020 12:15	1,88	1	1,88	CHI
20200124397	TRINDADE	40119385	TRINDADE	05/01/2020 10:22	05/01/2020 17:13	05/01/2020 10:22	05/01/2020 17:13	6,84	1	6,84	CHI
20200124406	PIRENOPOLIS	PV21289879	CORUMBA	05/01/2020 10:23	05/01/2020 16:23	05/01/2020 10:23	05/01/2020 16:23	5,99	1	5,99	CHI
20200124413	NOVO GAMA	2900005377	MARAJOARA	05/01/2020 10:24	05/01/2020 16:30	05/01/2020 10:24	05/01/2020 16:30	6,09	1	6,09	CHI
20200124419	NEROPOLIS	NR12353500	DAIA S2	05/01/2020 08:21	05/01/2020 14:57	05/01/2020 08:21	05/01/2020 14:57	6,59	7	46,16	CHI
20200124423	SILVANIA	SV12112101	VIANOPOLIS	05/01/2020 07:59	05/01/2020 11:32	05/01/2020 07:59	05/01/2020 11:32	3,54	8	28,32	CHI
20200124428	CROMINIA	MI12000411	PONTALINA	05/01/2020 08:38	05/01/2020 20:31	05/01/2020 08:38	05/01/2020 20:31	11,87	4	47,49	CHI
20200124428	MAIRIPOTABA	MI12000411	PONTALINA	05/01/2020 08:38	05/01/2020 20:31	05/01/2020 08:38	05/01/2020 20:31	11,87	11	130,61	CHI
20200124430	PIRENOPOLIS	PV12297602	CORUMBA	05/01/2020 08:59	05/01/2020 15:48	05/01/2020 08:59	05/01/2020 15:48	6,81	14	95,32	CHI

20200124434	TURVANIA	TV12394814	FIRMINOPOLIS S2	05/01/2020 10:29	05/01/2020 19:00	05/01/2020 10:29	05/01/2020 12:24	1,90	1	1,90	CHI
20200124434	TURVANIA	TV12394814	FIRMINOPOLIS S2	05/01/2020 10:29	05/01/2020 19:00	05/01/2020 13:01	05/01/2020 19:00	5,98	1	5,98	CHI
20200124439	FORMOSA	10001080600	ITIQUEIRA	05/01/2020 10:30	05/01/2020 11:40	05/01/2020 10:30	05/01/2020 11:40	1,16	1	1,16	CHI
20200124443	CABECEIRAS	CW21154402	ITIQUEIRA	05/01/2020 10:30	05/01/2020 18:42	05/01/2020 10:30	05/01/2020 18:42	8,19	1	8,19	CHI
20200124445	LUZIANIA	LZ12092906	MARAJOARA	05/01/2020 10:31	05/01/2020 15:45	05/01/2020 10:31	05/01/2020 15:45	5,23	21	109,75	CHI
20200124448	BELA VISTA DE GOIAS	BV12118838	BELA VISTA S1	05/01/2020 10:31	05/01/2020 15:26	05/01/2020 10:31	05/01/2020 15:26	4,91	9	44,15	CHI
20200124450	CATALAO	10024602084	CATALAO S1	05/01/2020 10:33	05/01/2020 16:47	05/01/2020 10:33	05/01/2020 16:47	6,23	1	6,23	CHI
20200124452	IPAMERI	IP21153080	IPAMERI	05/01/2020 10:34	05/01/2020 17:34	05/01/2020 10:34	05/01/2020 17:34	7,00	1	7,00	CHI
20200124453	MORRINHOS	MR12000356	MORRINHOS	05/01/2020 10:02	05/01/2020 15:00	05/01/2020 10:02	05/01/2020 15:00	4,96	2	9,92	CHI
20200124457	EDEIA	EA12084053	EDEIA	05/01/2020 07:56	05/01/2020 17:06	05/01/2020 07:56	05/01/2020 17:06	9,16	6	54,94	CHI
20200124459	ITUMBIARA	IT12257047	PARANAIBA	05/01/2020 10:35	05/01/2020 14:33	05/01/2020 10:35	05/01/2020 14:33	3,95	3	11,86	CHI
20200124462	CRIXAS	NA12171143	NOVA CRIXAS	05/01/2020 10:24	06/01/2020 11:24	05/01/2020 10:24	06/01/2020 11:24	24,99	4	99,94	CHI
20200124473	CUMARI	CY21071479	CATALAO S1	05/01/2020 10:38	05/01/2020 16:20	05/01/2020 10:38	05/01/2020 16:20	5,69	1	5,69	CHI
20200124479	FORMOSA	FA21325712	ITIQUEIRA	05/01/2020 10:39	05/01/2020 16:32	05/01/2020 10:39	05/01/2020 16:32	5,87	1	5,87	CHI
20200124481	ALTO PARAISO DE GOIAS	BF12128334	SAO JOAO D ALIANCA	05/01/2020 10:40	05/01/2020 20:11	05/01/2020 10:40	05/01/2020 20:11	9,51	2	19,02	CHI
20200124492	ITAPURANGA	IK12311015	ITAPURANGA	05/01/2020 10:27	05/01/2020 12:09	05/01/2020 10:27	05/01/2020 12:09	1,69	142	240,65	CHI
20200124494	GAMELEIRA DE GOIAS	SV21180488	DAIA S2	05/01/2020 10:42	05/01/2020 18:51	05/01/2020 10:42	05/01/2020 18:51	8,14	1	8,14	CHI
20200124495	LUZIANIA	3200144140	MARAJOARA	05/01/2020 10:42	05/01/2020 19:20	05/01/2020 10:42	05/01/2020 19:20	8,62	1	8,62	CHI
20200124502	JOVIANIA	JV21263673	GOIATUBA S1	05/01/2020 10:44	05/01/2020 20:30	05/01/2020 10:44	05/01/2020 20:30	9,76	1	9,76	CHI
20200124505	PETROLINA DE GOIAS	PV12295527	SAO FRANCISCO DE GOIAS	05/01/2020 07:32	05/01/2020 12:49	05/01/2020 07:32	05/01/2020 12:49	5,27	3	15,82	CHI
20200124505	PIRENOPOLIS	PV12295527	SAO FRANCISCO DE GOIAS	05/01/2020 07:32	05/01/2020 12:49	05/01/2020 07:32	05/01/2020 12:49	5,27	6	31,63	CHI
20200124507	EDEIA	EA12398648	VICENTINOPOLIS	05/01/2020 09:13	05/01/2020 19:17	05/01/2020 09:13	05/01/2020 19:17	10,06	5	50,30	CHI
20200124508	MOSSAMEDES	MD21343841	ITABERAI S2	05/01/2020 10:45	05/01/2020 13:12	05/01/2020 10:45	05/01/2020 13:12	2,45	1	2,45	CHI
20200124510	SILVANIA	SV21078662	VIANOPOLIS	05/01/2020 10:45	06/01/2020 09:44	05/01/2020 10:45	06/01/2020 09:44	22,98	1	22,98	CHI
20200124511	MINEIROS	MY12193782	PARQUE DAS EMAS	05/01/2020 06:16	05/01/2020 22:18	05/01/2020 06:16	05/01/2020 22:18	16,02	5	80,10	CHI
20200124512	SENADOR CANEDO	10017969237	SENADOR CANEDO	05/01/2020 10:45	05/01/2020 15:12	05/01/2020 10:45	05/01/2020 15:12	4,44	1	4,44	CHI
20200124513	BARRO ALTO	BA21194373	BARRO ALTO	05/01/2020 10:45	06/01/2020 02:26	05/01/2020 10:45	06/01/2020 02:26	15,67	1	15,67	CHI
20200124516	NIQUELANDIA	NQ21268906	URUACU	05/01/2020 10:46	05/01/2020 16:10	05/01/2020 10:46	05/01/2020 16:10	5,39	1	5,39	CHI
20200124519	PADRE BERNARDO	PB12375241	PADRE BERNARDO	05/01/2020 10:46	05/01/2020 12:37	05/01/2020 10:46	05/01/2020 12:37	1,84	25	45,88	CHI
20200124524	PLANALTINA	PI11355782	PLANALTINA	05/01/2020 10:48	05/01/2020 15:12	05/01/2020 10:48	05/01/2020 15:12	4,39	1	4,39	CHI
20200124525	CORREGO DO OURO	CO12299163	FIRMINOPOLIS S2	05/01/2020 09:36	05/01/2020 17:59	05/01/2020 09:36	05/01/2020 14:00	4,38	11	48,22	CHI
20200124525	CORREGO DO OURO	CO12299163	FIRMINOPOLIS S2	05/01/2020 09:36	05/01/2020 17:59	05/01/2020 09:36	05/01/2020 17:59	8,37	2	16,73	CHI
20200124527	SANTA BARBARA DE GOIAS	SB21118371	TRINDADE	05/01/2020 10:49	05/01/2020 16:15	05/01/2020 10:49	05/01/2020 16:15	5,43	1	5,43	CHI

20200124532	ITAPURANGA	IK21210461	ITAPURANGA	05/01/2020 10:49	05/01/2020 18:56	05/01/2020 10:49	05/01/2020 18:56	8,11	1	8,11	CHI
20200124533	ANAPOLIS	AN12258779	JUNDIAI S1	05/01/2020 10:19	05/01/2020 13:22	05/01/2020 10:19	05/01/2020 13:22	3,05	4	12,18	CHI
20200124534	APARECIDA DE GOIANIA	10013620752	INDEPENDENCIA S2	05/01/2020 10:50	05/01/2020 14:32	05/01/2020 10:50	05/01/2020 14:32	3,69	1	3,69	CHI
20200124537	ITUMBIARA	IT12000188	ITUMBIARA NOVA	05/01/2020 10:50	05/01/2020 17:22	05/01/2020 10:50	05/01/2020 17:22	6,52	1	6,52	CHI
20200124538	BOM JARDIM DE GOIAS	BM12065721	BOM JARDIM	05/01/2020 08:49	05/01/2020 20:15	05/01/2020 08:49	05/01/2020 20:15	11,43	6	68,59	CHI
20200124542	PIRENOPOLIS	PV12382304	SAO FRANCISCO DE GOIAS	05/01/2020 10:51	05/01/2020 13:45	05/01/2020 10:51	05/01/2020 13:45	2,90	7	20,28	CHI
20200124544	JANDAIA	10022337073	PALMEIRAS	05/01/2020 10:52	05/01/2020 12:10	05/01/2020 10:52	05/01/2020 12:10	1,30	1	1,30	CHI
20200124545	AGUAS LINDAS DE GOIAS	4830094012	AGUAS LINDAS DE GOIAS S2	05/01/2020 10:52	05/01/2020 18:28	05/01/2020 10:52	05/01/2020 18:28	7,59	1	7,59	CHI
20200124551	GOIANIA	GN11275643	CARAJAS S2	05/01/2020 09:39	05/01/2020 12:05	05/01/2020 09:39	05/01/2020 12:05	2,43	109	264,39	CHI
20200124555	AGUAS LINDAS DE GOIAS	10009577384	AGUAS LINDAS DE GOIAS S1	05/01/2020 10:54	05/01/2020 15:53	05/01/2020 10:54	05/01/2020 15:53	4,97	1	4,97	CHI
20200124556	GOIANIA	GN12000915	XAVANTES	05/01/2020 10:37	05/01/2020 20:01	05/01/2020 10:37	05/01/2020 20:01	9,40	141	1325,40	CHI
20200124557	PIRES DO RIO	PR12000071	PIRES DO RIO S1	05/01/2020 10:54	05/01/2020 14:05	05/01/2020 10:54	05/01/2020 14:05	3,17	73	231,49	CHI
20200124559	ITAPIRAPUA	IU12336387	MATRINCHA	05/01/2020 10:54	05/01/2020 20:05	05/01/2020 10:54	05/01/2020 20:05	9,18	2	18,36	CHI
20200124565	BALIZA	BH12381003	BOM JARDIM	05/01/2020 10:06	05/01/2020 23:05	05/01/2020 10:06	05/01/2020 23:05	12,98	23	298,46	CHI
20200124570	CORUMBA DE GOIAS	CB31132575	CORUMBA	05/01/2020 10:58	06/01/2020 17:25	05/01/2020 10:58	06/01/2020 17:25	30,45	1	30,45	CHI
20200124572	ITUMBIARA	BJ12389714	BOM JESUS DE GOIAS	05/01/2020 08:39	05/01/2020 13:44	05/01/2020 08:39	05/01/2020 13:44	5,07	7	35,50	CHI
20200124589	VILA PROPICIO	PV21144561	GOIANESIA S1	05/01/2020 11:01	06/01/2020 02:49	05/01/2020 11:01	06/01/2020 02:49	15,79	1	15,79	CHI
20200124591	ANAPOLIS	21279317	JUNDIAI S2	05/01/2020 11:01	05/01/2020 14:00	05/01/2020 11:01	05/01/2020 14:00	2,97	1	2,97	CHI
20200124593	JANDAIA	1180017149	PALMEIRAS	05/01/2020 11:02	05/01/2020 13:07	05/01/2020 11:02	05/01/2020 13:07	2,08	1	2,08	CHI
20200124598	MORRINHOS	MR21000054	MORRINHOS	05/01/2020 11:03	05/01/2020 14:16	05/01/2020 11:03	05/01/2020 14:16	3,22	1	3,22	CHI
20200124600	PORANGATU	PO12228609	PORANGATU	05/01/2020 11:03	05/01/2020 19:51	05/01/2020 11:03	05/01/2020 19:51	8,80	16	140,72	CHI
20200124601	ITAJA	IJ21000009	ITAJA S2	05/01/2020 11:03	05/01/2020 17:27	05/01/2020 11:03	05/01/2020 17:27	6,39	1	6,39	CHI
20200124603	SILVANIA	SV21143232	DAIA S2	05/01/2020 11:03	05/01/2020 13:00	05/01/2020 11:03	05/01/2020 13:00	1,94	3	5,81	CHI
20200124605	FORMOSA	FA12085474	ITUIQUIRA	05/01/2020 10:47	05/01/2020 15:21	05/01/2020 10:47	05/01/2020 15:21	4,56	27	123,25	CHI
20200124608	MINEIROS	MY21274160	PARQUE DAS EMAS	05/01/2020 11:04	06/01/2020 10:42	05/01/2020 11:04	06/01/2020 10:42	23,63	1	23,63	CHI
20200124609	CATALAO	CT21131482	CATALAO S1	05/01/2020 11:04	05/01/2020 16:11	05/01/2020 11:04	05/01/2020 16:11	5,11	3	15,32	CHI
20200124611	VILA PROPICIO	PV12115031	GOIANESIA S1	05/01/2020 11:02	06/01/2020 09:15	05/01/2020 11:02	06/01/2020 09:15	22,21	25	555,19	CHI
20200124615	ANAPOLIS	10015943389	ANAPOLIS UNIVERSITARIO S2	05/01/2020 11:05	05/01/2020 13:30	05/01/2020 11:05	05/01/2020 13:30	2,41	1	2,41	CHI
20200124620	ITAPURANGA	IK12084437	ITAPURANGA	05/01/2020 11:06	05/01/2020 16:59	05/01/2020 11:06	05/01/2020 16:59	5,88	14	82,28	CHI
20200124624	MONTIVIDIU DO NORTE	PO12370546	PORANGATU	05/01/2020 10:43	05/01/2020 16:39	05/01/2020 10:43	05/01/2020 16:39	5,93	5	29,64	CHI
20200124628	GOIANIA	16780528	GOYA S1	05/01/2020 11:08	05/01/2020 13:28	05/01/2020 11:08	05/01/2020 13:28	2,32	1	2,32	CHI
20200124631	CRISTIANOPOLIS	CF12363982	CRISTIANOPOLIS	05/01/2020 11:09	05/01/2020 14:21	05/01/2020 11:09	05/01/2020 14:21	3,20	8	25,57	CHI
20200124633	RIO VERDE	RV21016733	RIO VERDE S1	05/01/2020 11:09	05/01/2020 19:56	05/01/2020 11:09	05/01/2020 19:56	8,77	1	8,77	CHI



20200124635	SANTA BARBARA DE GOIAS	1030016590	TRINDADE	05/01/2020 11:10	05/01/2020 17:05	05/01/2020 11:10	05/01/2020 17:05	5,91	1	5,91	CHI
20200124636	GOIANIA	14360081	CARAJAS S1	05/01/2020 11:11	05/01/2020 13:41	05/01/2020 11:11	05/01/2020 13:41	2,50	1	2,50	CHI
20200124637	SANTO ANTONIO DO DESCOBERTO	SN12345926	MARAJOARA	05/01/2020 11:11	05/01/2020 21:04	05/01/2020 11:11	05/01/2020 21:04	9,88	2	19,76	CHI
20200124643	CRISTALINA	03470474	CRISTALINA S2	05/01/2020 11:04	05/01/2020 16:46	05/01/2020 13:13	05/01/2020 13:18	0,09	1	0,09	CHI
20200124643	CRISTALINA	KR13313627	CRISTALINA S2	05/01/2020 11:04	05/01/2020 16:46	05/01/2020 13:13	05/01/2020 16:46	3,55	1	3,55	CHI
20200124643	LUZIANIA	KR13313627	CRISTALINA S2	05/01/2020 11:04	05/01/2020 16:46	05/01/2020 13:13	05/01/2020 16:46	3,55	4	14,20	CHI
20200124645	SAO FRANCISCO DE GOIAS	SF12000173	SAO FRANCISCO DE GOIAS	05/01/2020 10:17	05/01/2020 12:35	05/01/2020 10:17	05/01/2020 12:35	2,29	12	27,47	CHI
20200124647	CRIXAS	NA12252970	MOZARLANDIA	05/01/2020 11:12	07/01/2020 12:53	05/01/2020 11:12	07/01/2020 12:53	49,67	4	198,67	CHI
20200124648	GUARINOS	GG12318452	URUACU	05/01/2020 11:02	05/01/2020 15:54	05/01/2020 11:02	05/01/2020 15:54	4,88	1	4,88	CHI
20200124648	PILAR DE GOIAS	GG12318452	URUACU	05/01/2020 11:02	05/01/2020 15:54	05/01/2020 11:02	05/01/2020 15:54	4,88	84	409,99	CHI
20200124648	SANTA TEREZINHA DE GOIAS	GG12318452	URUACU	05/01/2020 11:02	05/01/2020 15:54	05/01/2020 11:02	05/01/2020 15:54	4,88	4	19,52	CHI
20200124652	GOIANIA	16698058	GOIANIA LESTE S1	05/01/2020 11:13	05/01/2020 17:47	05/01/2020 11:13	05/01/2020 17:47	6,56	1	6,56	CHI
20200124654	APARECIDA DE GOIANIA	10009536408	INDEPENDENCIA S2	05/01/2020 11:13	05/01/2020 13:39	05/01/2020 11:13	05/01/2020 13:39	2,43	1	2,43	CHI
20200124663	ALEXANIA	AX11345812	ALEXANIA	05/01/2020 08:30	06/01/2020 08:37	05/01/2020 08:30	06/01/2020 08:37	24,11	18	434,05	CHI
20200124665	PADRE BERNARDO	10005482060	PADRE BERNARDO	05/01/2020 11:15	05/01/2020 19:53	05/01/2020 11:15	05/01/2020 19:53	8,63	1	8,63	CHI
20200124669	JARAGUA	JA12360274	GOIANESIA S2	05/01/2020 10:57	05/01/2020 21:33	05/01/2020 10:57	05/01/2020 21:33	10,60	8	84,80	CHI
20200124671	ITABERAI	50129569	ITABERAI S2	05/01/2020 11:16	06/01/2020 04:41	05/01/2020 11:16	06/01/2020 04:41	17,42	1	17,42	CHI
20200124675	JARAGUA	70112484	JARAGUA	05/01/2020 11:16	05/01/2020 15:04	05/01/2020 11:16	05/01/2020 15:04	3,79	1	3,79	CHI
20200124676	CAMPINORTE	2040024755	CAMPINORTE	05/01/2020 11:16	05/01/2020 14:04	05/01/2020 11:16	05/01/2020 14:04	2,80	1	2,80	CHI
20200124677	FORMOSA	FA32042714	SAO JOAO D ALIANCA	05/01/2020 10:39	05/01/2020 13:47	05/01/2020 10:39	05/01/2020 13:47	3,13	8	25,05	CHI
20200124678	ANAPOLIS	AN12026162	ANAPOLIS UNIVERSITARIO S2	05/01/2020 11:02	05/01/2020 16:34	05/01/2020 11:02	05/01/2020 16:34	5,53	6	33,17	CHI
20200124680	URUTAI	UT12075970	PIRES DO RIO S2	05/01/2020 11:17	05/01/2020 20:50	05/01/2020 11:17	05/01/2020 20:50	9,54	2	19,09	CHI
20200124682	ARAGOIANIA	AO31064812	GUAPO S2	05/01/2020 11:17	05/01/2020 22:53	05/01/2020 11:17	05/01/2020 22:53	11,59	1	11,59	CHI
20200124683	INACIOLANDIA	CD12000137	CACHOEIRA DOURADA	05/01/2020 07:15	05/01/2020 17:11	05/01/2020 07:15	05/01/2020 17:11	9,93	17	168,73	CHI
20200124685	GOIANIA	10542620	REAL S2	05/01/2020 11:18	05/01/2020 13:18	05/01/2020 11:18	05/01/2020 13:18	2,00	1	2,00	CHI
20200124695	ORIZONA	OZ12022880RE	PIRES DO RIO S2	05/01/2020 11:04	05/01/2020 13:15	05/01/2020 11:04	05/01/2020 13:15	2,18	59	128,57	CHI
20200124697	PALMINOPOLIS	PP21077086	PALMEIRAS	05/01/2020 11:21	05/01/2020 18:20	05/01/2020 11:21	05/01/2020 18:20	6,98	1	6,98	CHI
20200124801	MONTE ALEGRE DE GOIAS	1620006859	SAO DOMINGOS	05/01/2020 11:22	05/01/2020 16:43	05/01/2020 11:22	05/01/2020 16:43	5,35	1	5,35	CHI
20200124802	SAO JOAO D ALIANCA	3840007419	SAO JOAO D ALIANCA	05/01/2020 11:22	05/01/2020 14:49	05/01/2020 11:22	05/01/2020 14:49	3,45	1	3,45	CHI
20200124812	SANTA HELENA DE GOIAS	SH21315680	RIO DOS BOIS	05/01/2020 11:23	05/01/2020 23:42	05/01/2020 11:23	05/01/2020 23:42	12,30	2	24,60	CHI
20200124817	VALPARAISO DE GOIAS	2860335451	MARAJOARA	05/01/2020 11:24	05/01/2020 12:39	05/01/2020 11:24	05/01/2020 12:39	1,24	1	1,24	CHI
20200124818	AGUAS LINDAS DE GOIAS	4830300414	AGUAS LINDAS DE GOIAS S1	05/01/2020 11:24	05/01/2020 16:32	05/01/2020 11:24	05/01/2020 16:32	5,12	1	5,12	CHI
20200124819	PIRACANJUBA	MR12000241	MORRINHOS	05/01/2020 11:25	05/01/2020 17:47	05/01/2020 11:25	05/01/2020 17:47	6,36	6	38,19	CHI

20200124825	NOVO GAMA	10017424109	PACAEMBU S1	05/01/2020 11:27	05/01/2020 18:30	05/01/2020 11:27	05/01/2020 18:30	7,04	1	7,04	CHI
20200124837	APARECIDA DE GOIANIA	17037440	ATLANTICO S3	05/01/2020 11:32	05/01/2020 14:05	05/01/2020 11:32	05/01/2020 14:05	2,55	1	2,55	CHI
20200124841	HEITORAI	HE12336326	ITAPURANGA	05/01/2020 11:32	05/01/2020 18:05	05/01/2020 11:32	05/01/2020 18:05	6,54	2	13,08	CHI
20200124843	RIO VERDE	10006335622	RIO VERDE S1	05/01/2020 11:32	05/01/2020 22:21	05/01/2020 11:32	05/01/2020 22:21	10,81	1	10,81	CHI
20200124846	JUSSARA	JR12212887	IPORA	05/01/2020 11:33	05/01/2020 21:44	05/01/2020 11:33	05/01/2020 21:44	10,19	22	224,14	CHI
20200124846	MONTES CLAROS DE GOIAS	JR12212887	IPORA	05/01/2020 11:33	05/01/2020 21:44	05/01/2020 11:33	05/01/2020 21:44	10,19	7	71,32	CHI
20200124847	MINACU	4020075063	MINACU	05/01/2020 11:33	06/01/2020 08:36	05/01/2020 11:33	06/01/2020 08:36	21,04	1	21,04	CHI
20200124848	INACIOLANDIA	ID12088523	QUIRINOPOLIS	05/01/2020 09:06	05/01/2020 15:23	05/01/2020 09:06	05/01/2020 15:23	6,27	137	859,03	CHI
20200124849	CALDAS NOVAS	760358990	CALDAS NOVAS S1	05/01/2020 11:34	05/01/2020 16:04	05/01/2020 11:34	05/01/2020 16:04	4,49	1	4,49	CHI
20200124850	BELA VISTA DE GOIAS	BV12066103	CEPAIGO S2	05/01/2020 11:34	05/01/2020 17:54	05/01/2020 11:34	05/01/2020 17:54	6,32	39	246,62	CHI
20200124851	COCALZINHO DE GOIAS	10000573270	AGUAS LINDAS DE GOIAS S2	05/01/2020 11:34	05/01/2020 16:12	05/01/2020 11:34	05/01/2020 16:12	4,62	1	4,62	CHI
20200124854	ADELANDIA	2330000802	FIRMINOPOLIS S2	05/01/2020 11:35	05/01/2020 16:05	05/01/2020 11:35	05/01/2020 16:05	4,51	1	4,51	CHI
20200124856	PANAMA	PX12057616	GOIATUBA S1	05/01/2020 11:35	05/01/2020 16:20	05/01/2020 11:35	05/01/2020 16:20	4,76	45	214,08	CHI
20200124857	PIRES DO RIO	10010627594	PIRES DO RIO S1	05/01/2020 11:35	05/01/2020 15:25	05/01/2020 11:35	05/01/2020 15:25	3,82	1	3,82	CHI
20200124860	GOIANIA	14182609	ATLANTICO S3	05/01/2020 11:36	05/01/2020 15:03	05/01/2020 11:36	05/01/2020 15:03	3,44	1	3,44	CHI
20200124861	JATAI	290029417	JATAI S2	05/01/2020 11:36	05/01/2020 17:07	05/01/2020 11:36	05/01/2020 17:07	5,50	1	5,50	CHI
20200124868	CAIAPONIA	PY12011439	PALESTINA	05/01/2020 08:45	05/01/2020 15:39	05/01/2020 08:45	05/01/2020 15:39	6,89	115	792,83	CHI
20200124868	PALESTINA DE GOIAS	PY12011439	PALESTINA	05/01/2020 08:45	05/01/2020 15:39	05/01/2020 08:45	05/01/2020 15:39	6,89	25	172,35	CHI
20200124869	SAO MIGUEL DO ARAGUAIA	SM21020632	SAO MIGUEL DO ARAGUAIA	05/01/2020 07:38	05/01/2020 16:50	05/01/2020 07:38	05/01/2020 16:50	9,19	1	9,19	CHI
20200124871	CORUMBA DE GOIAS	ZN11327775	COCALZINHO	05/01/2020 11:39	05/01/2020 14:54	05/01/2020 11:39	05/01/2020 14:54	3,24	5	16,22	CHI
20200124874	RIO VERDE	RV11240310	RIO VERDE S1	05/01/2020 11:40	05/01/2020 20:43	05/01/2020 11:40	05/01/2020 20:43	9,04	117	1057,94	CHI
20200124875	CAIAPONIA	CP21378444	CAIAPONIA	05/01/2020 11:40	06/01/2020 13:28	05/01/2020 11:40	06/01/2020 13:28	25,80	1	25,80	CHI
20200124876	BOM JARDIM DE GOIAS	BM21102072	BOM JARDIM	05/01/2020 11:40	05/01/2020 21:33	05/01/2020 11:40	05/01/2020 21:33	9,87	1	9,87	CHI
20200124877	SANTO ANTONIO DO DESCOBERTO	2210170479	AGUAS LINDAS DE GOIAS S2	05/01/2020 11:41	05/01/2020 19:00	05/01/2020 11:41	05/01/2020 19:00	7,32	1	7,32	CHI
20200124878	CORREGO DO OURO	CO12000058	FIRMINOPOLIS S2	05/01/2020 09:48	05/01/2020 17:59	05/01/2020 09:48	05/01/2020 17:59	8,17	80	653,44	CHI
20200124878	FAZENDA NOVA	CO12000058	FIRMINOPOLIS S2	05/01/2020 09:48	05/01/2020 17:59	05/01/2020 09:48	05/01/2020 17:59	8,17	14	114,35	CHI
20200124880	LUZIANIA	3200091809	MARAJOARA	05/01/2020 11:41	05/01/2020 12:59	05/01/2020 11:41	05/01/2020 12:59	1,29	1	1,29	CHI
20200124882	SENADOR CANEDO	SW11329404	SENADOR CANEDO	05/01/2020 11:22	05/01/2020 14:00	05/01/2020 11:22	05/01/2020 14:00	2,64	90	237,38	CHI
20200124885	MORRINHOS	MR21036226	GOIATUBA S2	05/01/2020 11:43	05/01/2020 16:32	05/01/2020 11:43	05/01/2020 16:32	4,80	1	4,80	CHI
20200124892	ITAPURANGA	IK12300173	ITAPURANGA	05/01/2020 11:46	05/01/2020 14:47	05/01/2020 11:46	05/01/2020 14:47	3,02	2	6,03	CHI
20200124895	APARECIDA DE GOIANIA	200256415	CEPAIGO S1	05/01/2020 11:47	05/01/2020 15:43	05/01/2020 11:47	05/01/2020 15:43	3,93	1	3,93	CHI
20200124902	SILVANIA	SV21105201	VIANOPOLIS	05/01/2020 11:49	05/01/2020 17:14	05/01/2020 11:49	05/01/2020 17:14	5,42	1	5,42	CHI
20200124904	QUIRINOPOLIS	80094314	QUIRINOPOLIS	05/01/2020 11:49	06/01/2020 08:17	05/01/2020 11:49	06/01/2020 08:17	20,46	1	20,46	CHI

20200124912	AGUAS LINDAS DE GOIAS	4830108229	AGUAS LINDAS DE GOIAS S1	05/01/2020 11:52	05/01/2020 13:25	05/01/2020 11:52	05/01/2020 13:25	1,54	1	1,54	CHI
20200124914	IACIARA	IA21251103	IACIARA S1	05/01/2020 11:53	05/01/2020 13:40	05/01/2020 11:53	05/01/2020 13:40	1,77	1	1,77	CHI
20200124916	SAO MIGUEL DO ARAGUAIA	830031054	SAO MIGUEL DO ARAGUAIA	05/01/2020 11:54	05/01/2020 15:40	05/01/2020 11:54	05/01/2020 15:40	3,77	1	3,77	CHI
20200124917	GOIANIA	16377758	CARAJAS S1	05/01/2020 11:54	05/01/2020 13:49	05/01/2020 11:54	05/01/2020 13:49	1,91	1	1,91	CHI
20200124918	ITUMBIARA	IT12386202	ITUMBIARA VELHA S1	05/01/2020 11:54	05/01/2020 18:00	05/01/2020 11:54	05/01/2020 18:00	6,09	7	42,63	CHI
20200124920	GOIANAPOLIS	LB21029189	GOIANIA LESTE S2	05/01/2020 11:55	05/01/2020 20:27	05/01/2020 11:55	05/01/2020 20:27	8,53	1	8,53	CHI
20200124922	TRINDADE	TR12347398	TRINDADE	05/01/2020 11:55	05/01/2020 19:21	05/01/2020 11:55	05/01/2020 19:21	7,43	2	14,85	CHI
20200124924	FORMOSA	FA12071048	ITUIQUIRA	05/01/2020 11:48	05/01/2020 14:18	05/01/2020 11:48	05/01/2020 14:18	2,50	14	34,95	CHI
20200124929	NOVA AURORA	NE12384411	CATALAO S1	05/01/2020 11:57	05/01/2020 15:07	05/01/2020 11:57	05/01/2020 15:05	3,12	95	296,29	CHI
20200124929	CORUMBAIBA	NE10397343	CATALAO S1	05/01/2020 11:57	05/01/2020 15:07	05/01/2020 11:57	05/01/2020 15:07	3,15	114	359,35	CHI
20200124929	IPAMERI	NE10397343	CATALAO S1	05/01/2020 11:57	05/01/2020 15:07	05/01/2020 11:57	05/01/2020 15:07	3,15	15	47,28	CHI
20200124929	MORRINHOS	NE10397343	CATALAO S1	05/01/2020 11:57	05/01/2020 15:07	05/01/2020 11:57	05/01/2020 15:07	3,15	1	3,15	CHI
20200124929	NOVA AURORA	NE10397343	CATALAO S1	05/01/2020 11:57	05/01/2020 15:07	05/01/2020 11:57	05/01/2020 15:07	3,15	114	359,35	CHI
20200124931	JATAI	JT12390597	JATAI S1	05/01/2020 10:59	05/01/2020 16:30	05/01/2020 10:59	05/01/2020 16:30	5,51	13	71,68	CHI
20200124931	PEROLANDIA	JT12390597	JATAI S1	05/01/2020 10:59	05/01/2020 16:30	05/01/2020 10:59	05/01/2020 16:30	5,51	6	33,08	CHI
20200124934	CRISTALINA	KR12168475	CRISTALINA S1	05/01/2020 11:59	05/01/2020 17:40	05/01/2020 11:59	05/01/2020 17:40	5,68	1	5,68	CHI
20200124936	GOIANIA	15278943	ATLANTICO S2	05/01/2020 11:59	05/01/2020 13:04	05/01/2020 11:59	05/01/2020 13:04	1,07	1	1,07	CHI
20200124939	SENADOR CANEDO	14967509	GOIANIA LESTE S1	05/01/2020 12:00	05/01/2020 21:11	05/01/2020 12:00	05/01/2020 21:11	9,17	1	9,17	CHI
20200124941	CAMPO ALEGRE DE GOIAS	10010611299	CAMPO ALEGRE DE GOIAS	05/01/2020 12:01	05/01/2020 13:46	05/01/2020 12:01	05/01/2020 13:46	1,75	1	1,75	CHI
20200124944	JARAGUA	JA11054424	GOIANESIA S2	05/01/2020 12:02	06/01/2020 11:46	06/01/2020 11:18	06/01/2020 11:46	0,46	93	42,62	CHI
20200124945	CATURAI	250016965	INHUMAS S1	05/01/2020 12:02	06/01/2020 01:25	05/01/2020 12:02	06/01/2020 01:25	13,38	1	13,38	CHI
20200124946	SAO FRANCISCO DE GOIAS	SF12026053	SAO FRANCISCO DE GOIAS	05/01/2020 11:25	05/01/2020 19:11	05/01/2020 11:25	05/01/2020 19:11	7,76	10	77,63	CHI
20200124950	CATALAO	CT21274680	CATALAO S1	05/01/2020 12:04	05/01/2020 19:26	05/01/2020 12:04	05/01/2020 19:26	7,36	1	7,36	CHI
20200124951	LEOPOLDO DE BULHOES	LB21078539	DAIA S2	05/01/2020 12:04	05/01/2020 18:19	05/01/2020 12:04	05/01/2020 18:19	6,24	1	6,24	CHI
20200124957	GOIANIA	16276887	GOIANIA LESTE S2	05/01/2020 12:06	05/01/2020 17:53	05/01/2020 12:06	05/01/2020 17:53	5,77	1	5,77	CHI
20200124961	GOIANIA	GN11210898	AEROPORTO S3	05/01/2020 12:07	05/01/2020 15:15	05/01/2020 12:07	05/01/2020 15:15	3,13	12	37,51	CHI
20200124965	QUIRINOPOLIS	QI21134269	QUIRINOPOLIS	05/01/2020 12:08	06/01/2020 08:40	05/01/2020 12:08	06/01/2020 08:40	20,53	6	123,17	CHI
20200124969	JATAI	JT12360636	CABRIUVA S2	05/01/2020 12:09	05/01/2020 19:20	05/01/2020 12:09	05/01/2020 19:20	7,17	5	35,84	CHI
20200124975	FORMOSA	FA12270556	ITUIQUIRA	05/01/2020 11:57	05/01/2020 14:14	05/01/2020 11:57	05/01/2020 14:14	2,28	17	38,73	CHI
20200124977	DISTRITO FEDERAL	PB12163215	PADRE BERNARDO	05/01/2020 12:11	05/01/2020 16:30	05/01/2020 12:11	05/01/2020 16:30	4,31	3	12,92	CHI
20200124977	PADRE BERNARDO	PB12163215	PADRE BERNARDO	05/01/2020 12:11	05/01/2020 16:30	05/01/2020 12:11	05/01/2020 16:30	4,31	238	1025,32	CHI
20200124979	SANTO ANTONIO DO DESCOBERTO	10005078332	ALEXANIA	05/01/2020 12:11	05/01/2020 20:40	05/01/2020 12:11	05/01/2020 20:40	8,47	1	8,47	CHI
20200124980	RIO QUENTE	RQ21196411	VILA CORUMBA	05/01/2020 12:12	05/01/2020 21:16	05/01/2020 12:12	05/01/2020 21:16	9,07	1	9,07	CHI

20200124985	PORANGATU	840107511	PORANGATU	05/01/2020 12:12	05/01/2020 15:27	05/01/2020 12:12	05/01/2020 15:27	3,24	1	3,24	CHI
20200124991	CALDAS NOVAS	CN11103220	SERRA DE CALDAS	05/01/2020 11:39	05/01/2020 14:08	05/01/2020 11:39	05/01/2020 14:08	2,48	106	262,41	CHI
20200124997	TRINDADE	40054500	TRINDADE	05/01/2020 12:15	05/01/2020 20:22	05/01/2020 12:15	05/01/2020 20:22	8,10	1	8,10	CHI
20200124998	SAO FRANCISCO DE GOIAS	SF21017615	SAO FRANCISCO DE GOIAS	05/01/2020 12:16	05/01/2020 20:19	05/01/2020 12:16	05/01/2020 20:19	8,04	1	8,04	CHI
20200125106	AMARALINA	LC12168861	MARA ROSA	05/01/2020 12:17	05/01/2020 14:41	05/01/2020 12:17	05/01/2020 14:41	2,39	4	9,56	CHI
20200125107	FORMOSA	FA11397823	ITIQUEIRA	05/01/2020 12:17	05/01/2020 18:08	05/01/2020 12:17	05/01/2020 18:08	5,84	1	5,84	CHI
20200125121	OUIDOR	CT21266161	CATALAO S1	05/01/2020 12:20	05/01/2020 21:33	05/01/2020 12:20	05/01/2020 21:33	9,20	1	9,20	CHI
20200125123	QUIRINOPOLIS	10006974340	QUIRINOPOLIS	05/01/2020 12:21	06/01/2020 07:29	05/01/2020 12:21	06/01/2020 07:29	19,13	1	19,13	CHI
20200125126	ITABERAI	IB21000133	ITABERAI S2	05/01/2020 12:22	06/01/2020 08:52	05/01/2020 12:22	06/01/2020 08:52	20,50	2	40,99	CHI
20200125134	ISRAELANDIA	IS12101895	IPORA	05/01/2020 12:24	06/01/2020 07:29	05/01/2020 12:24	06/01/2020 07:29	19,08	6	114,49	CHI
20200125136	PLANALTINA	PI11164572	PLANALTINA	05/01/2020 12:15	05/01/2020 13:18	05/01/2020 12:15	05/01/2020 13:18	1,04	81	84,24	CHI
20200125147	ABADIANIA	GL12376845	DAIA S2	05/01/2020 12:26	05/01/2020 23:12	05/01/2020 22:31	05/01/2020 23:12	0,69	4	2,75	CHI
20200125152	MONTIVIDIU	MV21260808	MONTIVIDIU T	05/01/2020 12:27	06/01/2020 10:50	05/01/2020 12:27	06/01/2020 10:50	22,38	1	22,38	CHI
20200125153	MONTIVIDIU	MV21075459	MONTIVIDIU T	05/01/2020 12:27	05/01/2020 16:20	05/01/2020 12:27	05/01/2020 16:20	3,87	2	7,74	CHI
20200125159	NOVO GAMA	4990080544	PACAEMBU S1	05/01/2020 12:29	05/01/2020 15:43	05/01/2020 12:29	05/01/2020 15:43	3,23	1	3,23	CHI
20200125160	NOVA AMERICA	NM21184685	RUBIATABA	05/01/2020 12:29	06/01/2020 09:58	05/01/2020 12:29	06/01/2020 09:58	21,48	1	21,48	CHI
20200125166	LUZIANIA	120125390	RIO VERMELHO	05/01/2020 12:31	05/01/2020 14:16	05/01/2020 12:31	05/01/2020 14:16	1,74	1	1,74	CHI
20200125167	FORMOSA	7194593	ITIQUEIRA	05/01/2020 12:32	05/01/2020 16:15	05/01/2020 12:32	05/01/2020 16:15	3,71	41	152,29	CHI
20200125168	ITAPIRAPUA	IU12089737	MATRINCHA	05/01/2020 11:15	06/01/2020 02:54	05/01/2020 11:15	06/01/2020 02:54	15,65	7	109,52	CHI
20200125169	NIQUELANDIA	NQ12281633	BARRO ALTO	05/01/2020 12:32	06/01/2020 13:52	05/01/2020 12:32	06/01/2020 13:52	25,32	4	101,29	CHI
20200125183	GOIANIA	GN10394599	XAVANTES	05/01/2020 12:27	05/01/2020 16:22	05/01/2020 12:27	05/01/2020 13:47	1,34	259	346,63	CHI
20200125183	GOIANIA	GN10394599	XAVANTES	05/01/2020 12:27	05/01/2020 16:22	05/01/2020 12:27	05/01/2020 16:22	3,91	124	484,29	CHI
20200125183	GOIANIA	GN10394599	XAVANTES	05/01/2020 12:27	05/01/2020 16:22	05/01/2020 13:48	05/01/2020 16:22	2,56	259	663,33	CHI
20200125184	PALMEIRAS DE GOIAS	PL12333051	PALMEIRAS	05/01/2020 12:35	05/01/2020 14:17	05/01/2020 12:35	05/01/2020 14:17	1,70	1	1,70	CHI
20200125187	MINEIROS	MY21324354	PARQUE DAS EMAS	05/01/2020 12:35	06/01/2020 10:25	05/01/2020 12:35	06/01/2020 10:25	21,84	1	21,84	CHI
20200125188	NEROPOLIS	NR21353496	DAIA S2	05/01/2020 12:35	05/01/2020 21:02	05/01/2020 12:35	05/01/2020 21:02	8,45	1	8,45	CHI
20200125191	MORRINHOS	OZ12064707	VIANOPOLIS	05/01/2020 12:34	05/01/2020 15:16	05/01/2020 12:34	05/01/2020 15:16	2,70	1	2,70	CHI
20200125191	ORIZONA	OZ12064707	VIANOPOLIS	05/01/2020 12:34	05/01/2020 15:16	05/01/2020 12:34	05/01/2020 15:16	2,70	29	78,27	CHI
20200125191	SILVANIA	OZ12064707	VIANOPOLIS	05/01/2020 12:34	05/01/2020 15:16	05/01/2020 12:34	05/01/2020 15:16	2,70	4	10,80	CHI
20200125196	RIO VERDE	RV12018224	CABRIUVA S2	05/01/2020 12:09	05/01/2020 14:12	05/01/2020 12:09	05/01/2020 14:12	2,04	4	8,15	CHI
20200125197	PIRENOPOLIS	PV21194686	CORUMBA	05/01/2020 12:37	06/01/2020 10:14	05/01/2020 12:37	06/01/2020 10:14	21,62	3	64,85	CHI
20200125198	AGUAS LINDAS DE GOIAS	10007752693	AGUAS LINDAS DE GOIAS S1	05/01/2020 12:36	05/01/2020 21:40	05/01/2020 12:36	05/01/2020 21:40	9,06	1	9,06	CHI
20200125199	CATALAO	1990079420	CATALAO S2	05/01/2020 12:37	05/01/2020 14:06	05/01/2020 12:37	05/01/2020 14:06	1,48	1	1,48	CHI

20200125200	GOIANIA	15608293	GOIANIA LESTE S3	05/01/2020 12:37	05/01/2020 23:49	05/01/2020 12:37	05/01/2020 23:49	11,19	1	11,19	CHI
20200125205	CACHOEIRA ALTA	PC12078919	CACHOEIRA ALTA	04/01/2020 16:26	05/01/2020 16:00	04/01/2020 16:26	05/01/2020 16:00	23,57	1	23,57	CHI
20200125205	PARANAIGUARA	PC12078919	CACHOEIRA ALTA	04/01/2020 16:26	05/01/2020 16:00	04/01/2020 16:26	05/01/2020 16:00	23,57	2	47,15	CHI
20200125209	PARANAIGUARA	PC11389650	CACHOEIRA ALTA	05/01/2020 11:06	06/01/2020 11:50	05/01/2020 11:06	06/01/2020 11:50	24,74	2	49,47	CHI
20200125212	MAURILANDIA	1040011473	RIO DOS BOIS	05/01/2020 12:39	05/01/2020 17:20	05/01/2020 12:39	05/01/2020 17:20	4,68	1	4,68	CHI
20200125213	GOIAS	GS12220489	ITABERAI S1	05/01/2020 12:39	06/01/2020 08:35	05/01/2020 12:39	06/01/2020 08:35	19,93	3	59,78	CHI
20200125214	AVELINOPOLIS	AC12075670	ANICUNS	05/01/2020 12:17	05/01/2020 17:22	05/01/2020 12:17	05/01/2020 17:22	5,07	2	10,14	CHI
20200125214	ITABERAI	AC12075670	ANICUNS	05/01/2020 12:17	05/01/2020 17:22	05/01/2020 12:17	05/01/2020 17:22	5,07	3	15,21	CHI
20200125217	SAO LUIS DE MONTES BELOS	SL12067900	SAO LUIZ DOS MONTES BELOS	05/01/2020 12:42	05/01/2020 14:40	05/01/2020 12:42	05/01/2020 14:40	1,96	2	3,92	CHI
20200125218	JARAGUA	JA21284673	SAO FRANCISCO DE GOIAS	05/01/2020 12:42	05/01/2020 21:23	05/01/2020 12:42	05/01/2020 21:23	8,67	1	8,67	CHI
20200125219	FLORES DE GOIAS	FB12277896	IACIARA S2	05/01/2020 12:43	05/01/2020 19:13	05/01/2020 12:43	05/01/2020 19:13	6,50	3	19,50	CHI
20200125219	SITIO D ABADIA	FB12277896	IACIARA S2	05/01/2020 12:43	05/01/2020 19:13	05/01/2020 12:43	05/01/2020 19:13	6,50	19	123,47	CHI
20200125221	TRINDADE	10043032	GOYA S1	05/01/2020 12:43	05/01/2020 15:10	05/01/2020 12:43	05/01/2020 15:10	2,43	1	2,43	CHI
20200125222	PIRENOPOLIS	JA21250474	CORUMBA	05/01/2020 14:04	06/01/2020 11:54	05/01/2020 14:04	06/01/2020 11:54	21,83	1	21,83	CHI
20200125226	VALPARAISO DE GOIAS	10028641777	PACAEMBU S1	05/01/2020 12:44	05/01/2020 17:50	05/01/2020 12:44	05/01/2020 17:50	5,09	1	5,09	CHI
20200125227	PIRENOPOLIS	PV21054507	SAO FRANCISCO DE GOIAS	05/01/2020 12:45	06/01/2020 08:27	05/01/2020 12:45	06/01/2020 08:27	19,70	1	19,70	CHI
20200125229	LUZIANIA	LZ12376188	RIO VERMELHO	05/01/2020 12:45	05/01/2020 17:51	05/01/2020 12:45	05/01/2020 17:51	5,09	10	50,86	CHI
20200125231	CALDAZINHA	DE21087809	CEPAIGO S2	05/01/2020 12:46	05/01/2020 16:50	05/01/2020 12:46	05/01/2020 16:50	4,06	1	4,06	CHI
20200125233	GOIANIA	10472083	GOIANIA LESTE S1	05/01/2020 12:46	05/01/2020 22:12	05/01/2020 12:46	05/01/2020 22:12	9,42	1	9,42	CHI
20200125236	CRISTALINA	KR12305252	PAMPLONA	05/01/2020 12:48	05/01/2020 18:30	05/01/2020 12:48	05/01/2020 18:30	5,70	6	34,18	CHI
20200125238	QUIRINOPOLIS	QI31007547	QUIRINOPOLIS	05/01/2020 07:49	05/01/2020 15:17	05/01/2020 07:49	05/01/2020 15:17	7,45	1	7,45	CHI
20200125239	JATAI	JT12080857	JATAI S1	05/01/2020 12:49	06/01/2020 12:24	05/01/2020 12:49	06/01/2020 12:24	23,57	3	70,71	CHI
20200125242	GOIANIA	13298070	GOIANIA LESTE S1	05/01/2020 12:49	05/01/2020 15:10	05/01/2020 12:49	05/01/2020 15:10	2,35	1	2,35	CHI
20200125250	GOIANIA	10794827	CARAJAS S1	05/01/2020 12:52	05/01/2020 19:36	05/01/2020 12:52	05/01/2020 19:36	6,73	1	6,73	CHI
20200125255	GOIANIA	AP11048934	REAL S1	05/01/2020 12:10	05/01/2020 16:33	05/01/2020 12:10	05/01/2020 16:33	4,38	112	490,50	CHI
20200125256	GOUVELANDIA	GB21296586	QUIRINOPOLIS	05/01/2020 12:53	06/01/2020 08:41	05/01/2020 12:53	06/01/2020 08:41	19,80	1	19,80	CHI
20200125258	AGUAS LINDAS DE GOIAS	LA12370896	AGUAS LINDAS DE GOIAS S1	05/01/2020 12:54	05/01/2020 15:32	05/01/2020 12:54	05/01/2020 15:32	2,63	389	1023,18	CHI
20200125263	GOUVELANDIA	GB21296592	QUIRINOPOLIS	05/01/2020 12:55	06/01/2020 08:16	05/01/2020 12:55	06/01/2020 08:16	19,35	1	19,35	CHI
20200125265	HIDROLINA	1020001930	URUACU	05/01/2020 12:55	05/01/2020 21:39	05/01/2020 12:55	05/01/2020 21:39	8,73	1	8,73	CHI
20200125276	CORUMBAIBA	CI12107484	VILA CORUMBA	05/01/2020 12:56	05/01/2020 17:16	05/01/2020 12:56	05/01/2020 17:16	4,32	3	12,97	CHI
20200125281	CALDAS NOVAS	CN21103285	CALDAS NOVAS S1	05/01/2020 12:58	05/01/2020 17:15	05/01/2020 12:58	05/01/2020 17:15	4,28	1	4,28	CHI
20200125287	GOIANIA	11114848	CAMPINAS S2	05/01/2020 12:59	05/01/2020 14:46	05/01/2020 12:59	05/01/2020 14:46	1,78	1	1,78	CHI
20200125288	GOIANIA	11647700	CAMPINAS S1	05/01/2020 12:59	05/01/2020 15:25	05/01/2020 12:59	05/01/2020 15:25	2,43	1	2,43	CHI

20200125289	NOVA CRIXAS	NA12092868	MOZARLANDIA	05/01/2020 11:20	06/01/2020 15:21	05/01/2020 11:20	06/01/2020 15:21	28,02	4	112,06	CHI
20200125293	ALEXANIA	AX12066452	ALEXANIA	05/01/2020 12:33	05/01/2020 16:15	05/01/2020 12:33	05/01/2020 16:15	3,69	25	92,19	CHI
20200125294	BELA VISTA DE GOIAS	BV21154770	BELA VISTA S1	05/01/2020 13:00	05/01/2020 18:30	05/01/2020 13:00	05/01/2020 18:30	5,50	1	5,50	CHI
20200125295	PLANALTINA	PI11194814	PLANALTINA	05/01/2020 12:55	05/01/2020 14:11	05/01/2020 12:55	05/01/2020 14:11	1,26	113	142,47	CHI
20200125296	POSSE	10013084290	IACIARA S2	05/01/2020 13:01	05/01/2020 14:34	05/01/2020 13:01	05/01/2020 14:34	1,54	1	1,54	CHI
20200125297	PADRE BERNARDO	PB12097184	PADRE BERNARDO	05/01/2020 13:02	05/01/2020 21:08	05/01/2020 13:02	05/01/2020 21:08	8,09	5	40,46	CHI
20200125300	CAIAPONIA	PH12390191	CAIAPONIA	05/01/2020 12:06	06/01/2020 09:06	05/01/2020 12:06	06/01/2020 09:06	20,99	2	41,99	CHI
20200125300	PIRANHAS	PH12390191	CAIAPONIA	05/01/2020 12:06	06/01/2020 09:06	05/01/2020 12:06	06/01/2020 09:06	20,99	7	146,95	CHI
20200125301	INHUMAS	10021713047	INHUMAS S2	05/01/2020 13:03	05/01/2020 14:40	05/01/2020 13:03	05/01/2020 14:40	1,61	1	1,61	CHI
20200125304	MOSSAMEDES	MD12364733	FIRMINOPOLIS S2	05/01/2020 13:03	05/01/2020 16:20	05/01/2020 13:03	05/01/2020 16:20	3,29	18	59,16	CHI
20200125314	NEROPOLIS	NR21315532	NEROPOLIS S2	05/01/2020 13:06	05/01/2020 21:36	05/01/2020 13:06	05/01/2020 21:36	8,50	1	8,50	CHI
20200125315	MOIPIORA	1450006386	IPORA	05/01/2020 13:06	05/01/2020 20:47	05/01/2020 13:06	05/01/2020 20:47	7,69	1	7,69	CHI
20200125317	EDEIA	ED21254381	EDEIA	05/01/2020 13:07	05/01/2020 23:02	05/01/2020 13:07	05/01/2020 23:02	9,92	1	9,92	CHI
20200125320	GOIAS	GS12220495	ITABERAI S1	05/01/2020 13:00	05/01/2020 19:00	05/01/2020 13:00	05/01/2020 19:00	6,00	2	11,99	CHI
20200125324	GOIANIA	12731754	MEIA PONTE	05/01/2020 13:09	05/01/2020 17:09	05/01/2020 13:09	05/01/2020 17:09	3,99	1	3,99	CHI
20200125325	ITABERAI	IB12250660	ITABERAI S2	05/01/2020 12:50	05/01/2020 22:08	05/01/2020 12:50	05/01/2020 22:08	9,30	2	18,59	CHI
20200125326	JATAI	JT21364421	JATAI S1	05/01/2020 13:09	05/01/2020 16:10	05/01/2020 13:09	05/01/2020 16:10	3,00	1	3,00	CHI
20200125330	AGUAS LINDAS DE GOIAS	10000491860	AGUAS LINDAS DE GOIAS S2	05/01/2020 13:11	05/01/2020 21:56	05/01/2020 13:11	05/01/2020 21:56	8,74	1	8,74	CHI
20200125331	SANTO ANTONIO DO DESCOBERTO	SN12305157	MARAJOARA	05/01/2020 13:11	06/01/2020 09:23	05/01/2020 13:11	06/01/2020 09:23	20,19	14	282,68	CHI
20200125332	CORUMBA DE GOIAS	10023850432	CORUMBA	05/01/2020 13:11	06/01/2020 09:54	05/01/2020 13:11	06/01/2020 09:54	20,71	1	20,71	CHI
20200125333	GOIANIA	10007880047	GOYA S1	05/01/2020 13:12	05/01/2020 15:18	05/01/2020 13:12	05/01/2020 15:18	2,09	1	2,09	CHI
20200125341	NIQUELANDIA	NQ12197661	BARRO ALTO	05/01/2020 13:13	05/01/2020 17:58	05/01/2020 13:13	05/01/2020 17:58	4,75	11	52,25	CHI
20200125344	GOIAS	GS21311051	ITABERAI S1	05/01/2020 13:14	06/01/2020 09:40	05/01/2020 13:14	06/01/2020 09:40	20,43	1	20,43	CHI
20200125358	RIO VERDE	RV21074160	MONTIVIDIU T	05/01/2020 13:18	05/01/2020 22:05	05/01/2020 13:18	05/01/2020 22:05	8,78	2	17,55	CHI
20200125362	RIO VERDE	RV21301222	SANTA HELENA S1	05/01/2020 13:19	05/01/2020 20:02	05/01/2020 13:19	05/01/2020 20:02	6,72	1	6,72	CHI
20200125365	PLANALTINA	2960164447	PLANALTINA	05/01/2020 13:19	05/01/2020 16:53	05/01/2020 13:19	05/01/2020 16:53	3,55	1	3,55	CHI
20200125367	NOVA VENEZA	NV21211025	INHUMAS S1	05/01/2020 13:21	05/01/2020 23:16	05/01/2020 13:21	05/01/2020 23:16	9,92	1	9,92	CHI
20200125374	GOIAS	GS12061668	ITABERAI S1	05/01/2020 13:11	05/01/2020 18:34	05/01/2020 13:11	05/01/2020 18:34	5,38	5	26,90	CHI
20200125377	GOIAS	GS12259678	ITABERAI S2	05/01/2020 12:52	06/01/2020 08:19	05/01/2020 12:52	06/01/2020 08:19	19,44	49	952,52	CHI
20200125380	GOIANIA	10006983217	CARAJAS S1	05/01/2020 13:24	05/01/2020 16:34	05/01/2020 13:24	05/01/2020 16:34	3,16	1	3,16	CHI
20200125381	ITABERAI	IB12250719	ITABERAI S2	05/01/2020 13:24	06/01/2020 01:41	05/01/2020 13:24	06/01/2020 01:41	12,27	5	61,34	CHI
20200125382	PONTALINA	AD12060078	GOIATUBA S1	05/01/2020 09:21	05/01/2020 17:08	05/01/2020 09:21	05/01/2020 17:08	7,77	12	93,28	CHI
20200125384	GOIANIA	GN11001284	FERROVIARIO S3	05/01/2020 09:24	05/01/2020 14:52	05/01/2020 09:24	05/01/2020 14:52	5,45	87	474,46	CHI

20200125390	CATALAO	1990070635	CATALAO S2	05/01/2020 13:27	05/01/2020 14:51	05/01/2020 13:27	05/01/2020 14:51	1,39	1	1,39	CHI
20200125392	IPAMERI	IP12041051	IPAMERI	05/01/2020 13:25	05/01/2020 16:14	05/01/2020 13:25	05/01/2020 16:14	2,82	7	19,71	CHI
20200125396	MONTES CLAROS DE GOIAS	ME12095618	IPORA	05/01/2020 13:28	05/01/2020 18:51	05/01/2020 13:28	05/01/2020 18:51	5,38	176	947,17	CHI
20200125400	MONTES CLAROS DE GOIAS	ME21215837	IPORA	05/01/2020 13:28	05/01/2020 20:39	05/01/2020 13:28	05/01/2020 20:39	7,17	2	14,34	CHI
20200125410	RIO VERDE	RV12260108	RIO VERDE S2	05/01/2020 13:29	06/01/2020 07:23	05/01/2020 13:29	06/01/2020 07:23	17,89	10	178,89	CHI
20200125414	PIRENOPOLIS	PV12381257	CORUMBA	05/01/2020 12:07	06/01/2020 10:33	05/01/2020 12:07	05/01/2020 23:22	11,26	40	450,44	CHI
20200125414	PIRENOPOLIS	PV12381257	CORUMBA	05/01/2020 12:07	06/01/2020 10:33	05/01/2020 12:07	06/01/2020 01:07	13,00	50	650,22	CHI
20200125414	PIRENOPOLIS	PV12381257	CORUMBA	05/01/2020 12:07	06/01/2020 10:33	05/01/2020 12:07	06/01/2020 08:29	20,38	1	20,38	CHI
20200125414	PIRENOPOLIS	PV12381257	CORUMBA	05/01/2020 12:07	06/01/2020 10:33	05/01/2020 12:07	06/01/2020 09:22	21,25	24	510,06	CHI
20200125414	PIRENOPOLIS	PV12381257	CORUMBA	05/01/2020 12:07	06/01/2020 10:33	05/01/2020 12:07	06/01/2020 10:33	22,43	9	201,89	CHI
20200125415	FORMOSA	610297065	ITUIQUIRA	05/01/2020 13:31	05/01/2020 16:06	05/01/2020 13:31	05/01/2020 16:06	2,60	1	2,60	CHI
20200125416	ITAPURANGA	IK11299480	ITAPURANGA	05/01/2020 13:31	06/01/2020 10:15	05/01/2020 13:31	06/01/2020 10:15	20,73	110	2280,57	CHI
20200125417	SAO LUIS DE MONTES BELOS	SL12006949	SAO LUIZ DOS MONTES BELOS	05/01/2020 13:31	05/01/2020 16:32	05/01/2020 13:31	05/01/2020 16:32	3,01	41	123,38	CHI
20200125420	RIO VERDE	630604447	RIO VERDE S1	05/01/2020 13:31	06/01/2020 07:34	05/01/2020 13:31	06/01/2020 07:34	18,03	1	18,03	CHI
20200125421	QUIRINOPOLIS	10004995609	QUIRINOPOLIS	05/01/2020 13:32	05/01/2020 15:00	05/01/2020 13:32	05/01/2020 15:00	1,47	1	1,47	CHI
20200125425	URUTAI	UT21064888	URUTAI	05/01/2020 13:32	05/01/2020 16:05	05/01/2020 13:32	05/01/2020 16:05	2,54	1	2,54	CHI
20200125427	ALEXANIA	AX31061865	ALEXANIA	05/01/2020 13:33	06/01/2020 13:01	05/01/2020 13:33	06/01/2020 13:01	23,46	1	23,46	CHI
20200125428	PIRENOPOLIS	PV21119809	CORUMBA	05/01/2020 13:33	06/01/2020 20:36	05/01/2020 13:33	06/01/2020 20:36	31,05	1	31,05	CHI
20200125431	PIRACANJUBA	PJ21291892	BELA VISTA S1	05/01/2020 13:34	06/01/2020 07:23	05/01/2020 13:34	06/01/2020 07:23	17,81	1	17,81	CHI
20200125436	ITAPURANGA	IK12299287	ITAPURANGA	05/01/2020 12:33	06/01/2020 19:18	05/01/2020 12:33	06/01/2020 19:18	30,76	13	399,84	CHI
20200125437	ACREUNA	2440075122	ACREUNA	05/01/2020 13:36	05/01/2020 20:14	05/01/2020 13:36	05/01/2020 20:14	6,62	1	6,62	CHI
20200125438	BARRO ALTO	BA21326392	BARRO ALTO	05/01/2020 13:36	06/01/2020 01:40	05/01/2020 13:36	06/01/2020 01:40	12,06	1	12,06	CHI
20200125439	ALTO PARAISO DE GOIAS	BF12155974	SAO JOAO D ALIANCA	05/01/2020 13:28	05/01/2020 16:11	05/01/2020 13:28	05/01/2020 16:11	2,71	153	413,95	CHI
20200125441	ARACU	AR12104723	ARACU	05/01/2020 12:55	05/01/2020 16:39	05/01/2020 12:55	05/01/2020 16:39	3,72	20	74,39	CHI
20200125441	ITAUCU	AR12104723	ARACU	05/01/2020 12:55	05/01/2020 16:39	05/01/2020 12:55	05/01/2020 16:39	3,72	10	37,20	CHI
20200125443	CALDAS NOVAS	CN21100582	CALDAS NOVAS S2	05/01/2020 13:38	05/01/2020 17:57	05/01/2020 13:38	05/01/2020 17:57	4,32	1	4,32	CHI
20200125447	GOIATUBA	GT21048451	GOIATUBA S1	05/01/2020 13:39	05/01/2020 19:37	05/01/2020 13:39	05/01/2020 19:37	5,96	1	5,96	CHI
20200125449	IPORA	IR12014557	IPORA	05/01/2020 13:40	05/01/2020 17:05	05/01/2020 13:40	05/01/2020 17:05	3,40	22	74,85	CHI
20200125450	ITAUCU	IX21045655	INHUMAS S1	05/01/2020 13:41	05/01/2020 18:20	05/01/2020 13:41	05/01/2020 18:20	4,65	1	4,65	CHI
20200125451	CACHOEIRA DE GOIAS	CG12165601	FIRMINOPOLIS S2	05/01/2020 07:37	05/01/2020 17:20	05/01/2020 07:37	05/01/2020 17:20	9,70	2	19,40	CHI
20200125457	HIDROLANDIA	10021596717	ANHANGUERA	05/01/2020 13:43	05/01/2020 17:28	05/01/2020 13:43	05/01/2020 17:28	3,75	1	3,75	CHI
20200125464	APARECIDA DE GOIANIA	AP11162141	INDEPENDENCIA S2	05/01/2020 12:46	05/01/2020 16:10	05/01/2020 12:46	05/01/2020 16:10	3,40	87	295,56	CHI
20200125465	TRINDADE	10027566860	GOYA S1	05/01/2020 13:45	05/01/2020 20:37	05/01/2020 13:45	05/01/2020 20:37	6,86	1	6,86	CHI

20200125469	ARACU	AV12083933	ANICUNS	05/01/2020 13:27	05/01/2020 16:57	05/01/2020 13:27	05/01/2020 16:57	3,50	2	6,99	CHI
20200125469	AVELINOPOLIS	AV12083933	ANICUNS	05/01/2020 13:27	05/01/2020 16:57	05/01/2020 13:27	05/01/2020 16:57	3,50	11	38,47	CHI
20200125474	BOM JESUS DE GOIAS	1250047587	BOM JESUS DE GOIAS	05/01/2020 13:48	05/01/2020 17:59	05/01/2020 13:48	05/01/2020 17:59	4,17	1	4,17	CHI
20200125480	GOIANIA	10021272377	GOYA S1	05/01/2020 13:50	05/01/2020 16:21	05/01/2020 13:50	05/01/2020 16:21	2,52	1	2,52	CHI
20200125481	VIANOPOLIS	VN21327152	VIANOPOLIS	05/01/2020 13:50	05/01/2020 18:01	05/01/2020 13:50	05/01/2020 18:01	4,19	1	4,19	CHI
20200125483	RIO VERDE	RV12322324	CABRIUVA S2	05/01/2020 13:50	05/01/2020 16:18	05/01/2020 13:50	05/01/2020 16:18	2,46	2	4,92	CHI
20200125487	LEOPOLDO DE BULHOES	870028145	DAIA S2	05/01/2020 13:51	05/01/2020 18:24	05/01/2020 13:51	05/01/2020 18:24	4,54	1	4,54	CHI
20200125489	FORMOSA	FA21387139	ITUIQUIRA	05/01/2020 13:51	05/01/2020 19:22	05/01/2020 13:51	05/01/2020 19:22	5,50	1	5,50	CHI
20200125494	BOM JESUS DE GOIAS	1250064974	BOM JESUS DE GOIAS	05/01/2020 13:52	05/01/2020 19:00	05/01/2020 13:52	05/01/2020 19:00	5,12	1	5,12	CHI
20200125501	PALESTINA DE GOIAS	PY12207804	IPORA	05/01/2020 08:56	06/01/2020 06:31	05/01/2020 08:56	06/01/2020 06:31	21,58	6	129,47	CHI
20200125601	CRISTALINA	KR21339727	PAMPLONA	04/01/2020 17:08	05/01/2020 16:26	04/01/2020 17:08	05/01/2020 16:26	23,30	1	23,30	CHI
20200125607	BARRO ALTO	DF12194371	BARRO ALTO	05/01/2020 13:48	05/01/2020 15:28	05/01/2020 13:48	05/01/2020 15:28	1,66	66	109,49	CHI
20200125607	SANTA RITA DO NOVO DESTINO	DF12194371	BARRO ALTO	05/01/2020 13:48	05/01/2020 15:28	05/01/2020 13:48	05/01/2020 15:28	1,66	33	54,74	CHI
20200125609	NOVO PLANALTO	TA12271828	NOVO PLANALTO	05/01/2020 13:55	06/01/2020 09:58	05/01/2020 13:55	06/01/2020 09:58	20,04	14	280,57	CHI
20200125611	CALDAZINHA	DE21239239	SENADOR CANEDO	05/01/2020 13:55	05/01/2020 16:15	05/01/2020 13:55	05/01/2020 16:15	2,32	4	9,27	CHI
20200125612	VIANOPOLIS	VN21151143	VIANOPOLIS	05/01/2020 13:56	05/01/2020 19:30	05/01/2020 13:56	05/01/2020 19:30	5,56	5	27,81	CHI
20200125614	AVELINOPOLIS	AV21306998	ANICUNS	05/01/2020 13:56	05/01/2020 16:38	05/01/2020 13:56	05/01/2020 16:38	2,69	1	2,69	CHI
20200125618	FORMOSA	FA21038895	ITUIQUIRA	05/01/2020 13:57	06/01/2020 08:37	05/01/2020 13:57	06/01/2020 08:37	18,66	1	18,66	CHI
20200125619	AGUAS LINDAS DE GOIAS	4830163332	AGUAS LINDAS DE GOIAS S1	05/01/2020 13:58	06/01/2020 10:08	05/01/2020 13:58	06/01/2020 10:08	20,16	1	20,16	CHI
20200125626	QUIRINOPOLIS	QI12035342	QUIRINOPOLIS	05/01/2020 08:36	06/01/2020 07:33	05/01/2020 08:36	06/01/2020 07:33	22,94	5	114,72	CHI
20200125630	GOIATUBA	GT21102747	GOIATUBA S2	05/01/2020 14:00	05/01/2020 17:48	05/01/2020 14:00	05/01/2020 17:48	3,80	1	3,80	CHI
20200125632	CALDAS NOVAS	CN12056763	CALDAS NOVAS S1	05/01/2020 13:57	05/01/2020 17:29	05/01/2020 13:57	05/01/2020 17:29	3,53	2	7,06	CHI
20200125649	GOUVELANDIA	GB12402307	QUIRINOPOLIS	05/01/2020 11:56	05/01/2020 22:27	05/01/2020 11:56	05/01/2020 22:27	10,52	3	31,55	CHI
20200125650	BELA VISTA DE GOIAS	BV21218951	SENADOR CANEDO	05/01/2020 14:04	05/01/2020 17:01	05/01/2020 14:04	05/01/2020 17:01	2,93	3	8,80	CHI
20200125652	SAO FRANCISCO DE GOIAS	SF12008967	SAO FRANCISCO DE GOIAS	05/01/2020 12:47	05/01/2020 19:30	05/01/2020 12:47	05/01/2020 19:30	6,71	18	120,75	CHI
20200125653	JOVIANIA	JV21123850	GOIATUBA S1	05/01/2020 14:05	05/01/2020 21:44	05/01/2020 14:05	05/01/2020 21:44	7,64	1	7,64	CHI
20200125657	SITIO D ABADIA	AQ12240882	IACIARA S2	05/01/2020 14:07	05/01/2020 21:41	05/01/2020 14:07	05/01/2020 21:41	7,56	2	15,13	CHI
20200125658	AGUAS LINDAS DE GOIAS	4830268841	AGUAS LINDAS DE GOIAS S1	05/01/2020 14:08	05/01/2020 16:36	05/01/2020 14:08	05/01/2020 16:36	2,46	1	2,46	CHI
20200125659	AGUA FRIA DE GOIAS	NQ12270128RE	SAO JOAO D ALIANCA	05/01/2020 13:57	06/01/2020 18:32	05/01/2020 13:57	06/01/2020 18:32	28,58	70	2000,76	CHI
20200125659	NIQUELANDIA	NQ12270128RE	SAO JOAO D ALIANCA	05/01/2020 13:57	06/01/2020 18:32	05/01/2020 13:57	06/01/2020 18:32	28,58	18	514,48	CHI
20200125664	ALEXANIA	480032956	ALEXANIA	05/01/2020 14:11	05/01/2020 15:22	05/01/2020 14:11	05/01/2020 15:22	1,18	1	1,18	CHI
20200125666	GOIANIA	10792650	CARAJAS S1	05/01/2020 14:11	05/01/2020 17:20	05/01/2020 14:11	05/01/2020 17:20	3,14	1	3,14	CHI
20200125671	CRIXAS	CX12266385	SERRA DO OURO	05/01/2020 14:12	05/01/2020 17:11	05/01/2020 14:12	05/01/2020 17:11	2,97	14	41,64	CHI



20200125676	MORRINHOS	MR21056677	MORRINHOS	05/01/2020 14:13	05/01/2020 16:30	05/01/2020 14:13	05/01/2020 16:30	2,28	1	2,28	CHI
20200125683	PIRENOPOLIS	PV21273400	SAO FRANCISCO DE GOIAS	05/01/2020 14:15	05/01/2020 18:34	05/01/2020 14:15	05/01/2020 18:34	4,30	2	8,61	CHI
20200125685	COCALZINHO DE GOIAS	ZN12389400	AGUAS LINDAS DE GOIAS S2	05/01/2020 12:56	05/01/2020 16:12	05/01/2020 12:56	05/01/2020 16:12	3,25	104	338,06	CHI
20200125685	PADRE BERNARDO	ZN12389400	AGUAS LINDAS DE GOIAS S2	05/01/2020 12:56	05/01/2020 16:12	05/01/2020 12:56	05/01/2020 16:12	3,25	4	13,00	CHI
20200125692	RIO VERDE	630041106	RIO VERDE S1	05/01/2020 14:21	05/01/2020 15:47	05/01/2020 14:21	05/01/2020 15:47	1,42	1	1,42	CHI
20200125696	GOIANIRA	GR12310231	MEIA PONTE	05/01/2020 14:24	06/01/2020 07:07	05/01/2020 14:24	06/01/2020 07:07	16,71	2	33,42	CHI
20200125702	MINACU	IH11244068	MINACU	05/01/2020 12:23	05/01/2020 16:29	05/01/2020 12:23	05/01/2020 16:29	4,09	79	323,24	CHI
20200125706	SERRANOPOLIS	SX12390581	JATAI S1	05/01/2020 14:25	05/01/2020 21:47	05/01/2020 14:25	05/01/2020 21:47	7,35	5	36,76	CHI
20200125712	MUTUNOPOLIS	MU12391658	MARA ROSA	05/01/2020 13:51	05/01/2020 15:47	05/01/2020 13:51	05/01/2020 15:47	1,92	34	65,37	CHI
20200125715	APARECIDA DE GOIANIA	200156846	INDEPENDENCIA S2	05/01/2020 14:28	05/01/2020 16:50	05/01/2020 14:28	05/01/2020 16:50	2,36	1	2,36	CHI
20200125716	MUTUNOPOLIS	MU12263047	MARA ROSA	05/01/2020 14:28	05/01/2020 15:06	05/01/2020 14:28	05/01/2020 15:06	0,63	1	0,63	CHI
20200125718	LUZIANIA	3200050522	MARAJOARA	05/01/2020 14:28	05/01/2020 17:34	05/01/2020 14:28	05/01/2020 17:34	3,08	1	3,08	CHI
20200125722	GOIANIA	15367095	CARAJAS S2	05/01/2020 14:31	05/01/2020 17:12	05/01/2020 14:31	05/01/2020 17:12	2,68	1	2,68	CHI
20200125723	GOIANIA	10015737304	XAVANTES	05/01/2020 14:31	05/01/2020 19:43	05/01/2020 14:31	05/01/2020 19:43	5,19	1	5,19	CHI
20200125725	GOIANIA	14387244	MEIA PONTE	05/01/2020 14:32	05/01/2020 15:49	05/01/2020 14:32	05/01/2020 15:49	1,27	1	1,27	CHI
20200125726	BARRO ALTO	GE12000092	GOIANESIA S1	05/01/2020 14:32	06/01/2020 01:05	05/01/2020 14:32	06/01/2020 01:05	10,54	2	21,07	CHI
20200125726	GOIANESIA	GE12000092	GOIANESIA S1	05/01/2020 14:32	06/01/2020 01:05	05/01/2020 14:32	06/01/2020 01:05	10,54	19	200,17	CHI
20200125739	LUZIANIA	120142934	RIO VERMELHO	05/01/2020 14:35	05/01/2020 17:31	05/01/2020 14:35	05/01/2020 17:31	2,92	1	2,92	CHI
20200125740	GUARAITA	IK12064427	ITAPURANGA	05/01/2020 14:14	05/01/2020 20:52	05/01/2020 14:14	05/01/2020 20:52	6,63	1	6,63	CHI
20200125740	ITAPURANGA	IK12064427	ITAPURANGA	05/01/2020 14:14	05/01/2020 20:52	05/01/2020 14:14	05/01/2020 20:52	6,63	15	99,40	CHI
20200125750	LEOPOLDO DE BULHOES	AN21319628	DAIA S1	05/01/2020 14:38	05/01/2020 16:38	05/01/2020 14:38	05/01/2020 16:38	2,00	1	2,00	CHI
20200125754	LUZIANIA	LZ12417538	MARAJOARA	05/01/2020 14:40	05/01/2020 16:56	05/01/2020 14:40	05/01/2020 16:56	2,26	26	58,75	CHI
20200125758	TRINDADE	TR21143128	TRINDADE	05/01/2020 14:41	05/01/2020 23:15	05/01/2020 14:41	05/01/2020 23:15	8,55	1	8,55	CHI
20200125760	MARA ROSA	MQ12246483	MARA ROSA	05/01/2020 14:42	05/01/2020 18:55	05/01/2020 14:42	05/01/2020 18:55	4,21	4	16,83	CHI
20200125763	JATAI	JT12303012	JATAI S1	05/01/2020 14:43	05/01/2020 22:06	05/01/2020 14:43	05/01/2020 22:06	7,38	3	22,14	CHI
20200125765	GOIAS	GS12217051	GOIAS	05/01/2020 14:22	05/01/2020 18:10	05/01/2020 14:22	05/01/2020 18:10	3,80	235	892,87	CHI
20200125768	MORRINHOS	MR12000077RE	MORRINHOS	05/01/2020 06:01	05/01/2020 15:22	05/01/2020 06:01	05/01/2020 15:22	9,36	101	945,14	CHI
20200125769	AMORINOPOLIS	1240017082	IPORA	05/01/2020 14:44	06/01/2020 09:00	05/01/2020 14:44	06/01/2020 09:00	18,26	1	18,26	CHI
20200125774	AMORINOPOLIS	AM12193255	IPORA	05/01/2020 14:45	06/01/2020 08:00	05/01/2020 14:45	06/01/2020 08:00	17,24	1	17,24	CHI
20200125776	GOIANIA	GN11001786	AEROPORTO S3	05/01/2020 14:46	05/01/2020 18:09	05/01/2020 14:46	05/01/2020 18:09	3,37	39	131,57	CHI
20200125777	ITABERAI	IB12307680	ITABERAI S1	05/01/2020 14:47	05/01/2020 19:50	05/01/2020 14:47	05/01/2020 19:50	5,06	4	20,23	CHI
20200125783	DISTRITO FEDERAL	6365373	PADRE BERNARDO	05/01/2020 14:48	05/01/2020 21:57	05/01/2020 14:48	05/01/2020 21:57	7,14	6	42,83	CHI
20200125783	ITARUMA	6365373	PADRE BERNARDO	05/01/2020 14:48	05/01/2020 21:57	05/01/2020 14:48	05/01/2020 21:57	7,14	1	7,14	CHI

20200125783	PADRE BERNARDO	6365373	PADRE BERNARDO	05/01/2020 14:48	05/01/2020 21:57	05/01/2020 14:48	05/01/2020 21:57	7,14	7	49,97	CHI
20200125783	PLANALTINA	6365373	PADRE BERNARDO	05/01/2020 14:48	05/01/2020 21:57	05/01/2020 14:48	05/01/2020 21:57	7,14	13	92,81	CHI
20200125784	COCALZINHO DE GOIAS	ZN12302461	COCALZINHO	05/01/2020 13:17	05/01/2020 19:58	05/01/2020 13:17	05/01/2020 19:58	6,68	13	86,85	CHI
20200125784	PADRE BERNARDO	ZN12302461	COCALZINHO	05/01/2020 13:17	05/01/2020 19:58	05/01/2020 13:17	05/01/2020 19:58	6,68	1	6,68	CHI
20200125786	TURVANIA	TV12029567	FIRMINOPOLIS S2	05/01/2020 14:48	05/01/2020 21:38	05/01/2020 14:48	05/01/2020 21:38	6,82	10	68,21	CHI
20200125789	JOVIANIA	JV12050204	VICENTINOPOLIS	05/01/2020 12:33	05/01/2020 19:34	05/01/2020 12:33	05/01/2020 19:34	7,01	2	14,01	CHI
20200125789	PONTALINA	JV12050204	VICENTINOPOLIS	05/01/2020 12:33	05/01/2020 19:34	05/01/2020 12:33	05/01/2020 19:34	7,01	1	7,01	CHI
20200125791	ARUANA	AK12353719	BRITANIA	05/01/2020 14:50	05/01/2020 16:29	05/01/2020 14:50	05/01/2020 16:29	1,64	1	1,64	CHI
20200125792	MARA ROSA	MQ12391677	MARA ROSA	05/01/2020 14:50	05/01/2020 21:30	05/01/2020 14:50	05/01/2020 21:30	6,66	2	13,33	CHI
20200125793	ALTO PARAISO DE GOIAS	BF11113687	FLORES DE GOIAS	05/01/2020 14:32	05/01/2020 18:04	05/01/2020 14:32	05/01/2020 18:04	3,53	63	222,25	CHI
20200126001	GOIANIA	10013721265	CARAJAS S1	05/01/2020 14:54	05/01/2020 18:11	05/01/2020 14:54	05/01/2020 18:11	3,27	1	3,27	CHI
20200126005	NIQUELANDIA	NQ12221620	URUACU	05/01/2020 14:55	05/01/2020 18:29	05/01/2020 14:55	05/01/2020 18:29	3,55	147	522,18	CHI
20200126006	PALESTINA DE GOIAS	AY12390161	ARENOPOLIS	05/01/2020 14:56	06/01/2020 12:24	05/01/2020 14:56	06/01/2020 12:24	21,46	6	128,77	CHI
20200126007	APARECIDA DE GOIANIA	10022667502	INDEPENDENCIA S1	05/01/2020 14:56	05/01/2020 16:50	05/01/2020 14:56	05/01/2020 16:50	1,89	1	1,89	CHI
20200126008	PIRENOPOLIS	PV12382304	SAO FRANCISCO DE GOIAS	05/01/2020 14:57	05/01/2020 18:51	05/01/2020 14:57	05/01/2020 18:51	3,89	7	27,25	CHI
20200126009	GOIANIA	15481281	CAMPINAS S2	05/01/2020 14:57	05/01/2020 16:43	05/01/2020 14:57	05/01/2020 16:43	1,76	1	1,76	CHI
20200126010	GOIATUBA	GT21074955	GOIATUBA S2	05/01/2020 14:58	05/01/2020 17:14	05/01/2020 14:58	05/01/2020 17:14	2,27	2	4,53	CHI
20200126012	APARECIDA DE GOIANIA	10028363157	INDEPENDENCIA S2	05/01/2020 14:58	05/01/2020 17:45	05/01/2020 14:58	05/01/2020 17:45	2,78	1	2,78	CHI
20200126018	GAMELEIRA DE GOIAS	SV12219193	DAIA S2	05/01/2020 15:00	06/01/2020 10:10	05/01/2020 15:00	06/01/2020 10:10	19,16	2	38,33	CHI
20200126020	URUACU	UR21146989	URUACU	05/01/2020 15:00	05/01/2020 20:10	05/01/2020 15:00	05/01/2020 20:10	5,16	2	10,31	CHI
20200126023	ITARUMA	2910004783	CACHOEIRA ALTA	05/01/2020 15:00	06/01/2020 15:00	05/01/2020 15:00	06/01/2020 15:00	23,99	1	23,99	CHI
20200126029	COLINAS DO SUL	TI12344613	MINACU	05/01/2020 15:02	05/01/2020 18:54	05/01/2020 15:02	05/01/2020 18:54	3,85	13	50,10	CHI
20200126029	URUACU	TI12344613	MINACU	05/01/2020 15:02	05/01/2020 18:54	05/01/2020 15:02	05/01/2020 18:54	3,85	1	3,85	CHI
20200126030	GOIANIA	11370397	AEROPORTO S2	05/01/2020 15:03	05/01/2020 20:58	05/01/2020 15:03	05/01/2020 20:58	5,91	1	5,91	CHI
20200126034	RIO VERDE	RV12062716	ACREUNA	05/01/2020 15:05	05/01/2020 22:47	05/01/2020 15:05	05/01/2020 22:47	7,69	2	15,38	CHI
20200126035	PORTEIRAO	BJ11309792	RIO DOS BOIS	05/01/2020 15:05	05/01/2020 21:43	05/01/2020 15:05	05/01/2020 21:43	6,62	1	6,62	CHI
20200126036	ABADIANIA	AA21000003	ANAPOLIS UNIVERSITARIO S1	05/01/2020 15:05	05/01/2020 18:35	05/01/2020 15:05	05/01/2020 18:35	3,49	1	3,49	CHI
20200126037	GOIANIA	11250665	GOIANIA LESTE S1	05/01/2020 15:06	06/01/2020 00:31	05/01/2020 15:06	06/01/2020 00:31	9,41	1	9,41	CHI
20200126044	IVOLANDIA	MO12336568	IPORA	05/01/2020 14:00	05/01/2020 18:22	05/01/2020 14:00	05/01/2020 18:22	4,37	6	26,21	CHI
20200126044	MOIPORA	MO12336568	IPORA	05/01/2020 14:00	05/01/2020 18:22	05/01/2020 14:00	05/01/2020 18:22	4,37	6	26,21	CHI
20200126046	GOIANESIA	NP12240132	GOIANESIA S1	05/01/2020 14:44	06/01/2020 01:40	05/01/2020 14:44	06/01/2020 01:40	10,93	1	10,93	CHI
20200126046	VILA PROPICIO	NP12240132	GOIANESIA S1	05/01/2020 14:44	06/01/2020 01:40	05/01/2020 14:44	06/01/2020 01:40	10,93	9	98,34	CHI
20200126048	GOIANIRA	GR11038274	GOIANIRA	05/01/2020 15:04	05/01/2020 21:20	05/01/2020 15:04	05/01/2020 21:20	6,26	174	1089,97	CHI

20200126052	JUSSARA	JR12023506	IPORA	05/01/2020 14:22	05/01/2020 18:24	05/01/2020 14:22	05/01/2020 18:24	4,02	7	28,14	CHI
20200126057	GUAPO	710021045	GUAPO S1	05/01/2020 15:11	05/01/2020 19:42	05/01/2020 15:11	05/01/2020 19:42	4,50	1	4,50	CHI
20200126063	VILA BOA	FA12102763	ITUIQUIRA	05/01/2020 15:14	06/01/2020 11:14	05/01/2020 15:14	06/01/2020 11:14	20,01	1	20,01	CHI
20200126067	JATAI	290212900	JATAI S2	05/01/2020 15:16	05/01/2020 19:30	05/01/2020 15:16	05/01/2020 19:30	4,23	1	4,23	CHI
20200126077	JARAGUA	SF12000122	SAO FRANCISCO DE GOIAS	05/01/2020 15:12	05/01/2020 17:59	05/01/2020 15:12	05/01/2020 17:59	2,77	106	293,83	CHI
20200126077	SAO FRANCISCO DE GOIAS	SF12000122	SAO FRANCISCO DE GOIAS	05/01/2020 15:12	05/01/2020 17:59	05/01/2020 15:12	05/01/2020 17:59	2,77	6	16,63	CHI
20200126078	GOIANIA	GN12395829	XAVANTES	05/01/2020 15:18	05/01/2020 20:01	05/01/2020 15:18	05/01/2020 20:01	4,71	2	9,41	CHI
20200126081	ANAPOLIS	AN21258391	JUNDIAI S1	05/01/2020 15:19	05/01/2020 16:16	05/01/2020 15:19	05/01/2020 16:16	0,95	2	1,90	CHI
20200126084	ARAGARCAS	ME12193486	IPORA	05/01/2020 15:19	07/01/2020 18:16	05/01/2020 15:19	07/01/2020 18:16	50,95	1	50,95	CHI
20200126084	MONTES CLAROS DE GOIAS	ME12193486	IPORA	05/01/2020 15:19	07/01/2020 18:16	05/01/2020 15:19	07/01/2020 18:16	50,95	3	152,85	CHI
20200126095	BRITANIA	BT11281024	BRITANIA	05/01/2020 15:21	05/01/2020 20:46	05/01/2020 15:21	05/01/2020 20:46	5,41	96	519,12	CHI
20200126098	CAMPINORTE	UR12243278	MARA ROSA	05/01/2020 11:38	06/01/2020 01:41	05/01/2020 11:38	06/01/2020 01:41	14,05	7	98,32	CHI
20200126098	URUACU	UR12243278	MARA ROSA	05/01/2020 11:38	06/01/2020 01:41	05/01/2020 11:38	06/01/2020 01:41	14,05	15	210,68	CHI
20200126100	SILVANIA	SV12239452	DAIA S2	05/01/2020 14:55	05/01/2020 17:21	05/01/2020 14:55	05/01/2020 17:21	2,43	7	16,99	CHI
20200126101	ORIZONA	OZ21189455	PIRES DO RIO S2	05/01/2020 15:23	05/01/2020 17:08	05/01/2020 15:23	05/01/2020 17:08	1,74	1	1,74	CHI
20200126102	COCALZINHO DE GOIAS	ZN12084617	AGUAS LINDAS DE GOIAS S2	05/01/2020 14:59	05/01/2020 20:06	05/01/2020 14:59	05/01/2020 20:06	5,12	27	138,20	CHI
20200126104	NOVA CRIXAS	NA12229631	NOVA CRIXAS	05/01/2020 15:24	06/01/2020 08:54	05/01/2020 15:24	06/01/2020 08:54	17,49	4	69,98	CHI
20200126106	ANAPOLIS	AN12258710	JUNDIAI S1	05/01/2020 15:17	05/01/2020 16:57	05/01/2020 15:17	05/01/2020 16:57	1,66	3	4,97	CHI
20200126106	LEOPOLDO DE BULHOES	AN12258710	JUNDIAI S1	05/01/2020 15:17	05/01/2020 16:57	05/01/2020 15:17	05/01/2020 16:57	1,66	3	4,97	CHI
20200126108	PADRE BERNARDO	PB12275695	PADRE BERNARDO	05/01/2020 15:25	05/01/2020 22:21	05/01/2020 15:25	05/01/2020 22:21	6,92	5	34,60	CHI
20200126111	GOIANIA	10014036531	MEIA PONTE	05/01/2020 15:26	05/01/2020 17:27	05/01/2020 15:26	05/01/2020 17:27	2,00	1	2,00	CHI
20200126120	MARA ROSA	MQ12146955	MARA ROSA	05/01/2020 15:20	06/01/2020 07:28	05/01/2020 15:20	06/01/2020 07:28	16,12	12	193,44	CHI
20200126122	NEROPOLIS	NR11271853	NEROPOLIS S2	05/01/2020 13:49	05/01/2020 18:37	05/01/2020 13:49	05/01/2020 18:37	4,79	154	738,26	CHI
20200126123	FIRMINOPOLIS	FR21158924	FIRMINOPOLIS S1	05/01/2020 15:31	05/01/2020 22:59	05/01/2020 15:31	05/01/2020 22:59	7,46	1	7,46	CHI
20200126124	VILA PROPICIO	PV12073537	GOIANESIA S1	05/01/2020 12:33	06/01/2020 00:20	05/01/2020 12:33	06/01/2020 00:20	11,77	7	82,42	CHI
20200126126	SANTA CRUZ DE GOIAS	BC21114896	PIRACANJUBA	05/01/2020 15:32	05/01/2020 17:54	05/01/2020 15:32	05/01/2020 17:54	2,36	2	4,71	CHI
20200126141	RIO VERDE	RV12018095	SANTA HELENA S1	05/01/2020 15:34	06/01/2020 01:19	05/01/2020 15:34	06/01/2020 01:19	9,74	9	87,69	CHI
20200126149	ITAPACI	IW12379430	ITAPACI	05/01/2020 15:38	06/01/2020 09:15	05/01/2020 15:38	06/01/2020 09:15	17,62	2	35,23	CHI
20200126153	RIO VERDE	RV12301462	ACREUNA	05/01/2020 15:39	05/01/2020 22:01	05/01/2020 15:39	05/01/2020 22:01	6,36	3	19,09	CHI
20200126153	SANTO ANTONIO DA BARRA	RV12301462	ACREUNA	05/01/2020 15:39	05/01/2020 22:01	05/01/2020 15:39	05/01/2020 22:01	6,36	1	6,36	CHI
20200126156	GOIANIA	GN12383185	XAVANTES	05/01/2020 13:04	06/01/2020 00:42	05/01/2020 13:04	06/01/2020 00:42	11,63	9	104,68	CHI
20200126156	SANTO ANTONIO DE GOIAS	GN12383185	XAVANTES	05/01/2020 13:04	06/01/2020 00:42	05/01/2020 13:04	06/01/2020 00:42	11,63	4	46,52	CHI
20200126162	APARECIDA DE GOIANIA	200275410	INDEPENDENCIA S1	05/01/2020 15:40	05/01/2020 20:17	05/01/2020 15:40	05/01/2020 20:17	4,61	1	4,61	CHI

20200126169	SANTA HELENA DE GOIAS	400056744	IPEGUARI	05/01/2020 15:42	05/01/2020 17:53	05/01/2020 15:42	05/01/2020 17:53	2,18	1	2,18	CHI
20200126170	FAZENDA NOVA	FN21146339	BRITANIA	05/01/2020 15:42	06/01/2020 12:10	05/01/2020 15:42	06/01/2020 12:10	20,46	1	20,46	CHI
20200126171	RIO VERDE	630537720	RIO VERDE S2	05/01/2020 15:43	05/01/2020 19:15	05/01/2020 15:43	05/01/2020 19:15	3,54	1	3,54	CHI
20200126175	CRISTALINA	KR12330533	CRISTALINA S1	05/01/2020 15:44	05/01/2020 18:50	05/01/2020 15:44	05/01/2020 18:50	3,09	34	105,04	CHI
20200126175	IPAMERI	KR12330533	CRISTALINA S1	05/01/2020 15:44	05/01/2020 18:50	05/01/2020 15:44	05/01/2020 18:50	3,09	1	3,09	CHI
20200126175	LUZIANIA	KR12330533	CRISTALINA S1	05/01/2020 15:44	05/01/2020 18:50	05/01/2020 15:44	05/01/2020 18:50	3,09	8	24,72	CHI
20200126181	CIDADE OCIDENTAL	2680050727	MARAJOARA	05/01/2020 15:45	05/01/2020 17:33	05/01/2020 15:45	05/01/2020 17:33	1,80	1	1,80	CHI
20200126188	NOVA AURORA	2220006329	CATALAO S1	05/01/2020 15:46	05/01/2020 18:00	05/01/2020 15:46	05/01/2020 18:00	2,22	1	2,22	CHI
20200126191	FLORES DE GOIAS	FB21051035	FLORES DE GOIAS	05/01/2020 15:47	05/01/2020 22:31	05/01/2020 15:47	05/01/2020 22:31	6,72	1	6,72	CHI
20200126195	ANAPOLIS	AN12061954	ANAPOLIS UNIVERSITARIO S2	05/01/2020 12:51	05/01/2020 20:10	05/01/2020 12:51	05/01/2020 20:10	7,31	5	36,53	CHI
20200126199	LUZIANIA	120307844	RIO VERMELHO	05/01/2020 15:50	05/01/2020 16:46	05/01/2020 15:50	05/01/2020 16:46	0,92	1	0,92	CHI
20200126401	SENADOR CANEDO	190071862	SENADOR CANEDO	05/01/2020 15:50	05/01/2020 18:59	05/01/2020 15:50	05/01/2020 18:59	3,14	1	3,14	CHI
20200126406	NIQUELANDIA	NQ12328652	NIQUELANDIA SUBTRANSMISSAO	05/01/2020 10:01	06/01/2020 11:50	05/01/2020 10:01	06/01/2020 11:50	25,81	8	206,49	CHI
20200126412	ITAPACI	IW12040081	ITAPACI	05/01/2020 15:53	06/01/2020 00:05	05/01/2020 15:53	06/01/2020 00:05	8,19	32	262,20	CHI
20200126414	CORUMBAIBA	CI12110198	VILA CORUMBA	05/01/2020 15:53	06/01/2020 15:06	05/01/2020 15:53	06/01/2020 15:06	23,21	8	185,66	CHI
20200126417	BARRO ALTO	10000383170	BARRO ALTO	05/01/2020 15:54	06/01/2020 11:00	05/01/2020 15:54	06/01/2020 11:00	19,10	1	19,10	CHI
20200126419	ITAJA	IJ21154804	ITAJA S2	05/01/2020 15:54	06/01/2020 13:43	05/01/2020 15:54	06/01/2020 13:43	21,81	1	21,81	CHI
20200126425	ANAPOLIS	10017457660	ANAPOLIS UNIVERSITARIO S2	05/01/2020 15:55	05/01/2020 20:58	05/01/2020 15:55	05/01/2020 20:58	5,04	1	5,04	CHI
20200126433	NIQUELANDIA	NQ11280412	NIQUELANDIA SUBTRANSMISSAO	05/01/2020 15:57	06/01/2020 01:20	05/01/2020 15:57	06/01/2020 01:20	9,38	1	9,38	CHI
20200126436	GOIANIA	12809810	MEIA PONTE	05/01/2020 15:57	05/01/2020 16:58	05/01/2020 15:57	05/01/2020 16:58	1,01	1	1,01	CHI
20200126437	ANAPOLIS	AN12297708	ANAPOLIS UNIVERSITARIO S2	05/01/2020 15:57	06/01/2020 02:56	05/01/2020 15:57	06/01/2020 02:56	10,97	10	109,73	CHI
20200126441	APARECIDA DE GOIANIA	200452162	INDEPENDENCIA S2	05/01/2020 15:58	05/01/2020 17:44	05/01/2020 15:58	05/01/2020 17:44	1,76	1	1,76	CHI
20200126442	APARECIDA DE GOIANIA	200080131	INDEPENDENCIA S1	05/01/2020 15:58	05/01/2020 18:09	05/01/2020 15:58	05/01/2020 18:09	2,18	1	2,18	CHI
20200126447	SILVANIA	SV12400026	VIANOPOLIS	05/01/2020 16:00	05/01/2020 19:01	05/01/2020 16:00	05/01/2020 18:30	2,50	15	37,50	CHI
20200126447	SILVANIA	SV21100426	VIANOPOLIS	05/01/2020 16:00	05/01/2020 19:01	05/01/2020 16:00	05/01/2020 19:01	3,01	2	6,02	CHI
20200126454	GOIANIA	13339576	INDEPENDENCIA S2	05/01/2020 16:01	05/01/2020 20:01	05/01/2020 16:01	05/01/2020 20:01	3,99	1	3,99	CHI
20200126456	JATAI	10019848925	JATAI S2	05/01/2020 16:02	05/01/2020 22:10	05/01/2020 16:02	05/01/2020 22:10	6,13	1	6,13	CHI
20200126458	FAZENDA NOVA	NB12117282	JUSSARA	05/01/2020 16:02	05/01/2020 23:30	05/01/2020 16:02	05/01/2020 23:30	7,46	1	7,46	CHI
20200126458	JUSSARA	NB12117282	JUSSARA	05/01/2020 16:02	05/01/2020 23:30	05/01/2020 16:02	05/01/2020 23:30	7,46	1	7,46	CHI
20200126458	NOVO BRASIL	NB12117282	JUSSARA	05/01/2020 16:02	05/01/2020 23:30	05/01/2020 16:02	05/01/2020 23:30	7,46	12	89,58	CHI
20200126462	OUIDOR	CT21266163	CATALAO S1	04/01/2020 07:18	05/01/2020 20:18	04/01/2020 23:30	05/01/2020 20:18	20,80	1	20,80	CHI
20200126464	GOIANIA	13006423	GOIANIA LESTE S1	05/01/2020 16:04	06/01/2020 02:32	05/01/2020 16:04	06/01/2020 02:32	10,46	1	10,46	CHI
20200126470	LEOPOLDO DE BULHOES	LB12057538	DAIA S1	05/01/2020 15:01	05/01/2020 17:04	05/01/2020 15:01	05/01/2020 17:04	2,05	11	22,51	CHI

20200126470	SILVANIA	LB12057538	DAIA S1	05/01/2020 15:01	05/01/2020 17:04	05/01/2020 15:01	05/01/2020 17:04	2,05	24	49,11	CHI
20200126474	JUSSARA	JR12341198	JUSSARA	05/01/2020 16:06	06/01/2020 07:42	05/01/2020 16:06	06/01/2020 07:42	15,59	7	109,13	CHI
20200126479	BARRO ALTO	BA12066363	BARRO ALTO	05/01/2020 07:52	06/01/2020 00:15	05/01/2020 07:52	06/01/2020 00:15	16,37	7	114,60	CHI
20200126481	FAZENDA NOVA	FN12183426	IPORA	05/01/2020 16:05	06/01/2020 09:02	05/01/2020 16:05	06/01/2020 09:02	16,95	9	152,54	CHI
20200126482	PIRACANJUBA	MR12223456	MORRINHOS	05/01/2020 16:04	05/01/2020 20:15	05/01/2020 16:04	05/01/2020 20:15	4,17	8	33,38	CHI
20200126488	SANTA TEREZA DE GOIAS	TB12182394	PORANGATU	05/01/2020 16:10	05/01/2020 22:48	05/01/2020 16:10	05/01/2020 22:48	6,62	3	19,86	CHI
20200126488	TROMBAS	TB12182394	PORANGATU	05/01/2020 16:10	05/01/2020 22:48	05/01/2020 16:10	05/01/2020 22:48	6,62	117	774,70	CHI
20200126489	ANICUNS	AC12304607	FIRMINOPOLIS S2	05/01/2020 13:54	05/01/2020 18:16	05/01/2020 13:54	05/01/2020 18:16	4,36	3	13,07	CHI
20200126496	NOVA CRIXAS	NA12334349	NOVA CRIXAS	05/01/2020 16:12	05/01/2020 17:56	05/01/2020 16:12	05/01/2020 17:56	1,74	86	149,97	CHI
20200126498	ITAPURANGA	IK12071744	ITAPURANGA	05/01/2020 15:57	05/01/2020 23:07	05/01/2020 15:57	05/01/2020 23:07	7,15	10	71,52	CHI
20200126500	VALPARAISO DE GOIAS	VA11350342	PACAEMBU S2	05/01/2020 15:20	05/01/2020 17:20	05/01/2020 15:20	05/01/2020 17:20	1,99	73	144,95	CHI
20200126601	SANTA HELENA DE GOIAS	SH21136761	ACREUNA	05/01/2020 16:14	05/01/2020 18:00	05/01/2020 16:14	05/01/2020 18:00	1,77	1	1,77	CHI
20200126602	SENADOR CANEDO	SW21265032	SENADOR CANEDO	05/01/2020 16:14	05/01/2020 17:16	05/01/2020 16:14	05/01/2020 17:16	1,02	2	2,05	CHI
20200126604	SANTA RITA DO NOVO DESTINO	BA11374465	GOIANESIA S1	05/01/2020 16:14	06/01/2020 08:20	05/01/2020 16:14	06/01/2020 08:20	16,08	83	1335,01	CHI
20200126606	FAZENDA NOVA	FN12237035	JUSSARA	05/01/2020 15:43	05/01/2020 20:09	05/01/2020 15:43	05/01/2020 20:09	4,43	7	31,01	CHI
20200126609	RIO VERDE	RV12098479	RIO VERDE S1	05/01/2020 12:44	05/01/2020 19:31	05/01/2020 12:44	05/01/2020 19:31	6,78	7	47,45	CHI
20200126610	NOVO GAMA	NJ12245533LD	MARAJOARA	05/01/2020 15:27	05/01/2020 18:25	05/01/2020 15:27	05/01/2020 17:35	2,12	695	1473,21	CHI
20200126610	DISTRITO FEDERAL	01350214	MARAJOARA	05/01/2020 15:27	05/01/2020 18:25	05/01/2020 18:22	05/01/2020 18:25	0,05	742	39,16	CHI
20200126610	NOVO GAMA	01350214	MARAJOARA	05/01/2020 15:27	05/01/2020 18:25	05/01/2020 18:22	05/01/2020 18:25	0,05	3346	176,59	CHI
20200126610	SANTO ANTONIO DO DESCOBERTO	01350214	MARAJOARA	05/01/2020 15:27	05/01/2020 18:25	05/01/2020 18:22	05/01/2020 18:25	0,05	166	8,76	CHI
20200126613	MORRINHOS	150051943	MORRINHOS	05/01/2020 16:17	05/01/2020 17:40	05/01/2020 16:17	05/01/2020 17:40	1,39	1	1,39	CHI
20200126615	ANAPOLIS	21007639	ANAPOLIS UNIVERSITARIO S2	05/01/2020 16:17	05/01/2020 17:18	05/01/2020 16:17	05/01/2020 17:18	1,01	1	1,01	CHI
20200126618	NIQUELANDIA	NQ21371153	NIQUELANDIA SUBTRANSMISSAO	05/01/2020 16:17	05/01/2020 19:58	05/01/2020 16:17	05/01/2020 19:58	3,68	2	7,35	CHI
20200126625	TRINDADE	10023762088	TRINDADE	05/01/2020 16:19	05/01/2020 20:53	05/01/2020 16:19	05/01/2020 20:53	4,55	1	4,55	CHI
20200126626	PLANALTINA	PI12262312	PLANALTINA	05/01/2020 11:08	05/01/2020 17:59	05/01/2020 11:08	05/01/2020 17:59	6,85	10	68,47	CHI
20200126639	ITAPURANGA	IK12310861	ITAPURANGA	05/01/2020 16:21	06/01/2020 12:41	05/01/2020 16:21	06/01/2020 12:41	20,32	1	20,32	CHI
20200126641	LUZIANIA	LZ12330544	MARAJOARA	05/01/2020 15:50	05/01/2020 18:32	05/01/2020 15:50	05/01/2020 18:32	2,70	8	21,59	CHI
20200126645	SANTO ANTONIO DO DESCOBERTO	2210099773	ALEXANIA	05/01/2020 16:23	05/01/2020 21:47	05/01/2020 16:23	05/01/2020 21:47	5,40	1	5,40	CHI
20200126649	ITAPIRAPUA	IU12061602	JUSSARA	05/01/2020 16:24	06/01/2020 08:33	05/01/2020 16:24	06/01/2020 08:33	16,15	1	16,15	CHI
20200126649	NOVO BRASIL	IU12061602	JUSSARA	05/01/2020 16:24	06/01/2020 08:33	05/01/2020 16:24	06/01/2020 08:33	16,15	15	242,22	CHI
20200126657	CORUMBAIBA	CI12090583	VILA CORUMBA	05/01/2020 16:26	06/01/2020 13:40	05/01/2020 16:26	06/01/2020 13:40	21,23	4	84,91	CHI
20200126661	SILVANIA	SV12282723	VIANOPOLIS	05/01/2020 16:27	06/01/2020 11:43	05/01/2020 16:27	06/01/2020 11:43	19,25	6	115,52	CHI
20200126667	GAMELEIRA DE GOIAS	SV21197259	DAIA S2	05/01/2020 16:28	06/01/2020 12:51	05/01/2020 16:29	06/01/2020 12:40	20,19	1	20,19	CHI

20200126667	GAMELEIRA DE GOIAS	SV21197260	DAIA S2	05/01/2020 16:28	06/01/2020 12:51	06/01/2020 11:30	06/01/2020 12:51	1,35	1	1,35	CHI
20200126674	MORRINHOS	MR12000077RE	MORRINHOS	05/01/2020 16:15	07/01/2020 13:55	05/01/2020 18:15	05/01/2020 21:40	3,42	58	198,15	CHI
20200126674	MORRINHOS	MR12028754	MORRINHOS	05/01/2020 16:15	07/01/2020 13:55	05/01/2020 16:15	05/01/2020 22:59	6,74	27	182,08	CHI
20200126674	MORRINHOS	MR12028754	MORRINHOS	05/01/2020 16:15	07/01/2020 13:55	05/01/2020 23:00	06/01/2020 10:44	11,74	27	317,04	CHI
20200126674	MORRINHOS	MR12028754	MORRINHOS	05/01/2020 16:15	07/01/2020 13:55	05/01/2020 16:15	06/01/2020 12:52	20,62	15	309,33	CHI
20200126674	MORRINHOS	MR12028754	MORRINHOS	05/01/2020 16:15	07/01/2020 13:55	06/01/2020 10:51	06/01/2020 12:52	2,02	22	44,51	CHI
20200126674	MORRINHOS	MR12028754	MORRINHOS	05/01/2020 16:15	07/01/2020 13:55	06/01/2020 18:40	07/01/2020 08:15	13,58	28	380,33	CHI
20200126674	MORRINHOS	MR21028755	MORRINHOS	05/01/2020 16:15	07/01/2020 13:55	06/01/2020 10:51	07/01/2020 12:40	25,82	1	25,82	CHI
20200126674	MORRINHOS	MR12000077RE	MORRINHOS	05/01/2020 16:15	07/01/2020 13:55	06/01/2020 10:51	07/01/2020 13:55	27,07	4	108,30	CHI
20200126674	MORRINHOS	MR12028754	MORRINHOS	05/01/2020 16:15	07/01/2020 13:55	07/01/2020 11:15	07/01/2020 13:55	2,68	38	101,67	CHI
20200126674	MORRINHOS	MR12000077RE	MORRINHOS	05/01/2020 16:15	07/01/2020 13:55	07/01/2020 11:15	07/01/2020 13:55	2,68	58	155,17	CHI
20200126675	ITUMBIARA	IT12304246	ITUMBIARA NOVA	05/01/2020 16:30	05/01/2020 18:40	05/01/2020 16:30	05/01/2020 18:40	2,16	3	6,49	CHI
20200126679	APARECIDA DE GOIANIA	13621592	INDEPENDENCIA S1	05/01/2020 16:31	05/01/2020 18:29	05/01/2020 16:31	05/01/2020 18:29	1,97	1	1,97	CHI
20200126680	CARMO DO RIO VERDE	IK12310871	ITAPURANGA	05/01/2020 12:34	05/01/2020 19:12	05/01/2020 12:34	05/01/2020 19:12	6,63	8	53,04	CHI
20200126680	ITAPURANGA	IK12310871	ITAPURANGA	05/01/2020 12:34	05/01/2020 19:12	05/01/2020 12:34	05/01/2020 19:12	6,63	223	1478,49	CHI
20200126688	LUZIANIA	LZ11168140	RIO VERMELHO	05/01/2020 16:26	05/01/2020 18:03	05/01/2020 16:26	05/01/2020 18:03	1,60	79	126,79	CHI
20200126697	IPAMERI	IP12300933	IPAMERI	05/01/2020 16:35	05/01/2020 19:43	05/01/2020 16:35	05/01/2020 19:43	3,13	52	162,53	CHI
20200126699	PIRES DO RIO	PR12000071	PIRES DO RIO S1	05/01/2020 16:36	05/01/2020 18:50	05/01/2020 16:36	05/01/2020 18:50	2,23	72	160,54	CHI
20200126700	GOIANIA	GN11170372	GOIANIA LESTE S1	05/01/2020 16:36	05/01/2020 19:02	05/01/2020 16:36	05/01/2020 19:02	2,43	21	51,03	CHI
20200126701	PIRACANJUBA	PJ21053212	PIRACANJUBA	05/01/2020 05:43	05/01/2020 17:23	05/01/2020 05:43	05/01/2020 17:23	11,66	1	11,66	CHI
20200126809	CABECEIRAS	CW21181820	ITUIQUIRA	05/01/2020 16:38	05/01/2020 20:01	05/01/2020 16:38	05/01/2020 20:01	3,39	1	3,39	CHI
20200126810	MOSSAMEDES	1310002402	FIRMINOPOLIS S2	05/01/2020 16:38	06/01/2020 07:32	05/01/2020 16:38	06/01/2020 07:32	14,89	1	14,89	CHI
20200126812	CORUMBA DE GOIAS	CB12155979	CORUMBA	05/01/2020 16:39	05/01/2020 21:19	05/01/2020 16:39	05/01/2020 21:19	4,65	14	65,16	CHI
20200126813	CORUMBAIBA	CI21328932	CATALAO S1	05/01/2020 16:39	06/01/2020 11:30	05/01/2020 16:39	06/01/2020 11:30	18,83	1	18,83	CHI
20200126819	ANAPOLIS	AN12004481	NEROPOLIS S1	05/01/2020 16:33	05/01/2020 17:54	05/01/2020 16:33	05/01/2020 17:54	1,34	8	10,68	CHI
20200126821	SANTO ANTONIO DO DESCOBERTO	SN11162758	MARAJOARA	05/01/2020 16:41	05/01/2020 18:38	05/01/2020 16:41	05/01/2020 18:38	1,94	100	193,56	CHI
20200126823	AGUAS LINDAS DE GOIAS	10009667936	AGUAS LINDAS DE GOIAS S1	05/01/2020 16:41	05/01/2020 17:59	05/01/2020 16:41	05/01/2020 17:59	1,29	1	1,29	CHI
20200126824	IPAMERI	IP12195235	IPAMERI	05/01/2020 14:28	05/01/2020 19:19	05/01/2020 14:28	05/01/2020 19:19	4,85	13	63,03	CHI
20200126828	MONTIVIDIU	MV21147824	MONTIVIDIU T	05/01/2020 16:43	06/01/2020 12:13	05/01/2020 16:43	06/01/2020 12:13	19,50	1	19,50	CHI
20200126831	MONTES CLAROS DE GOIAS	ME12204928	IPORA	05/01/2020 16:43	05/01/2020 23:24	05/01/2020 16:43	05/01/2020 23:24	6,67	3	20,01	CHI
20200126833	MIMOSO DE GOIAS	MJ12183873	PADRE BERNARDO	05/01/2020 16:44	05/01/2020 19:27	05/01/2020 16:44	05/01/2020 19:27	2,70	8	21,61	CHI
20200126835	GOIANIRA	GR11094599	GOIANIRA	05/01/2020 16:36	05/01/2020 21:11	05/01/2020 16:36	05/01/2020 21:11	4,57	102	466,57	CHI
20200126839	ITAPACI	10017989939	ITAPACI	05/01/2020 16:46	06/01/2020 08:37	05/01/2020 16:46	06/01/2020 08:37	15,84	1	15,84	CHI

20200126841	GOIANIA	11760989	XAVANTES	05/01/2020 16:47	06/01/2020 00:02	05/01/2020 16:47	06/01/2020 00:02	7,25	1	7,25	CHI
20200126842	HIDROLINA	10004798633	URUACU	05/01/2020 16:47	05/01/2020 19:47	05/01/2020 16:47	05/01/2020 19:47	3,00	1	3,00	CHI
20200126849	ITAPACI	IW21123083	ITAPACI	05/01/2020 16:49	06/01/2020 10:28	05/01/2020 16:49	06/01/2020 10:28	17,64	2	35,28	CHI
20200126856	PIRENOPOLIS	PV12000067	CORUMBA	05/01/2020 15:40	06/01/2020 07:40	05/01/2020 15:40	06/01/2020 07:40	16,00	18	287,96	CHI
20200126858	IPAMERI	IP12017029	IPAMERI	05/01/2020 16:51	05/01/2020 18:44	05/01/2020 16:51	05/01/2020 18:44	1,87	15	28,06	CHI
20200126862	LEOPOLDO DE BULHOES	LB21000002	DAIA S2	05/01/2020 16:52	05/01/2020 18:36	05/01/2020 16:52	05/01/2020 18:36	1,73	1	1,73	CHI
20200126864	BOM JARDIM DE GOIAS	BM21065741	BOM JARDIM	05/01/2020 16:53	05/01/2020 22:13	05/01/2020 16:53	05/01/2020 22:13	5,33	1	5,33	CHI
20200126865	ANAPOLIS	AN12000235	ANAPOLIS UNIVERSITARIO S2	05/01/2020 16:29	05/01/2020 17:31	05/01/2020 16:29	05/01/2020 17:31	1,03	61	62,75	CHI
20200126868	SAO FRANCISCO DE GOIAS	PV12058914	SAO FRANCISCO DE GOIAS	05/01/2020 11:48	05/01/2020 19:42	05/01/2020 11:48	05/01/2020 19:42	7,90	3	23,70	CHI
20200126876	FORMOSA	FA21085592	SAO JOAO D ALIANCA	05/01/2020 16:55	05/01/2020 21:53	05/01/2020 16:55	05/01/2020 21:53	4,97	1	4,97	CHI
20200126878	GOIAS	GS21020994	ITABERAI S1	05/01/2020 16:56	06/01/2020 09:31	05/01/2020 16:56	06/01/2020 09:31	16,58	1	16,58	CHI
20200126880	AGUAS LINDAS DE GOIAS	4830030903	AGUAS LINDAS DE GOIAS S2	05/01/2020 16:56	06/01/2020 08:30	05/01/2020 16:56	06/01/2020 08:30	15,56	1	15,56	CHI
20200126882	MONTIVIDIU	MV21214100	MONTIVIDIU T	05/01/2020 16:56	05/01/2020 22:17	05/01/2020 16:56	05/01/2020 22:17	5,33	1	5,33	CHI
20200126883	BELA VISTA DE GOIAS	BV12079678	BELA VISTA S1	05/01/2020 16:18	05/01/2020 21:06	05/01/2020 16:18	05/01/2020 21:06	4,80	126	604,49	CHI
20200126883	HIDROLANDIA	BV12079678	BELA VISTA S1	05/01/2020 16:18	05/01/2020 21:06	05/01/2020 16:18	05/01/2020 21:06	4,80	1	4,80	CHI
20200126885	ANAPOLIS	AN21357853	ANAPOLIS UNIVERSITARIO S2	05/01/2020 16:57	06/01/2020 00:13	05/01/2020 16:57	06/01/2020 00:13	7,26	2	14,53	CHI
20200126888	ACREUNA	TD12025737	RIO DOS BOIS	05/01/2020 14:58	05/01/2020 20:13	05/01/2020 14:58	05/01/2020 20:13	5,24	24	125,83	CHI
20200126888	SANTA HELENA DE GOIAS	TD12025737	RIO DOS BOIS	05/01/2020 14:58	05/01/2020 20:13	05/01/2020 14:58	05/01/2020 20:13	5,24	17	89,13	CHI
20200126888	TURVELANDIA	TD12025737	RIO DOS BOIS	05/01/2020 14:58	05/01/2020 20:13	05/01/2020 14:58	05/01/2020 20:13	5,24	63	330,31	CHI
20200126890	ITAPURANGA	IK12310867	ITAPURANGA	05/01/2020 16:14	06/01/2020 15:04	05/01/2020 16:14	06/01/2020 15:04	22,82	11	251,04	CHI
20200126895	CORUMBAIBA	CI12027244	VILA CORUMBA	05/01/2020 16:59	05/01/2020 20:21	05/01/2020 16:59	05/01/2020 20:21	3,36	3	10,07	CHI
20200126895	NOVA AURORA	CI12027244	VILA CORUMBA	05/01/2020 16:59	05/01/2020 20:21	05/01/2020 16:59	05/01/2020 20:21	3,36	1	3,36	CHI
20200126899	ITABERAI	IB21210539	ITABERAI S2	05/01/2020 17:00	06/01/2020 10:12	05/01/2020 17:00	06/01/2020 10:12	17,19	1	17,19	CHI
20200127006	ABADIANIA	AA12057569	ANAPOLIS UNIVERSITARIO S1	05/01/2020 17:01	06/01/2020 03:34	05/01/2020 17:01	06/01/2020 03:34	10,54	7	73,79	CHI
20200127009	GOIANIA	12057319	CAMPINAS S2	05/01/2020 17:02	05/01/2020 21:29	05/01/2020 17:02	05/01/2020 21:29	4,45	1	4,45	CHI
20200127010	ABADIANIA	AN12001083	ANAPOLIS UNIVERSITARIO S2	05/01/2020 15:56	05/01/2020 18:59	05/01/2020 15:56	05/01/2020 18:59	3,04	30	91,29	CHI
20200127014	GUARINOS	GF21181197	SANTA TEREZINHA	05/01/2020 17:03	06/01/2020 08:45	05/01/2020 17:03	06/01/2020 08:45	15,70	1	15,70	CHI
20200127017	AGUA FRIA DE GOIAS	TL12279981	SAO JOAO D ALIANCA	05/01/2020 17:03	05/01/2020 18:36	05/01/2020 17:03	05/01/2020 18:36	1,54	41	63,15	CHI
20200127023	PIRES DO RIO	PR21399738	PIRES DO RIO S1	05/01/2020 16:36	05/01/2020 19:28	05/01/2020 16:36	05/01/2020 19:28	2,88	1	2,88	CHI
20200127028	PANAMA	PX21115856	GOIATUBA S1	05/01/2020 17:05	05/01/2020 20:42	05/01/2020 17:05	05/01/2020 20:42	3,61	1	3,61	CHI
20200127030	SANTA FE DE GOIAS	RN21399427	BRITANIA	05/01/2020 17:06	06/01/2020 08:19	05/01/2020 17:06	06/01/2020 08:19	15,22	1	15,22	CHI
20200127036	BURITI DE GOIAS	BS12008822	FIRMINOPOLIS S2	05/01/2020 17:07	05/01/2020 21:31	05/01/2020 17:07	05/01/2020 21:31	4,39	33	144,79	CHI
20200127037	ABADIANIA	AX13061969	ALEXANIA	05/01/2020 08:23	05/01/2020 18:56	05/01/2020 16:54	05/01/2020 18:56	2,03	4	8,12	CHI

20200127037	ALEXANIA	AX13061969	ALEXANIA	05/01/2020 08:23	05/01/2020 18:56	05/01/2020 16:54	05/01/2020 18:56	2,03	3984	8086,41	CHI
20200127037	CORUMBA DE GOIAS	AX13061969	ALEXANIA	05/01/2020 08:23	05/01/2020 18:56	05/01/2020 16:54	05/01/2020 18:56	2,03	121	245,60	CHI
20200127037	JARAGUA	AX13061969	ALEXANIA	05/01/2020 08:23	05/01/2020 18:56	05/01/2020 16:54	05/01/2020 18:56	2,03	74	150,20	CHI
20200127037	ABADIANIA	AX13061969	ALEXANIA	05/01/2020 08:23	05/01/2020 18:56	05/01/2020 18:52	05/01/2020 18:56	0,05	13	0,71	CHI
20200127037	ALEXANIA	AX13061969	ALEXANIA	05/01/2020 08:23	05/01/2020 18:56	05/01/2020 18:52	05/01/2020 18:56	0,05	187	10,18	CHI
20200127040	ORIZONA	OZ21382042	PIRES DO RIO S2	05/01/2020 17:08	05/01/2020 17:52	05/01/2020 17:08	05/01/2020 17:52	0,73	1	0,73	CHI
20200127042	JATAI	290079378	JATAI S3	05/01/2020 17:09	06/01/2020 01:40	05/01/2020 17:09	06/01/2020 01:40	8,52	1	8,52	CHI
20200127043	ANAPOLIS	10007789686	JUNDIAI S2	05/01/2020 17:09	06/01/2020 08:02	05/01/2020 17:09	06/01/2020 08:02	14,88	1	14,88	CHI
20200127044	AGUAS LINDAS DE GOIAS	4830317578	AGUAS LINDAS DE GOIAS S1	05/01/2020 17:09	05/01/2020 19:42	05/01/2020 17:09	05/01/2020 19:42	2,55	1	2,55	CHI
20200127045	ORIZONA	OZ21172815	VIANOPOLIS	05/01/2020 17:09	05/01/2020 18:18	05/01/2020 17:09	05/01/2020 18:18	1,15	1	1,15	CHI
20200127050	GOIANIRA	390010900	GOIANIRA	05/01/2020 17:10	05/01/2020 21:23	05/01/2020 17:10	05/01/2020 21:23	4,21	1	4,21	CHI
20200127052	SILVANIA	SV12319704	DAIA S2	05/01/2020 17:11	06/01/2020 10:11	05/01/2020 17:11	06/01/2020 10:11	16,99	4	67,98	CHI
20200127056	JARAGUA	JA21027417	SAO FRANCISCO DE GOIAS	05/01/2020 17:12	06/01/2020 09:46	05/01/2020 17:12	06/01/2020 09:46	16,56	7	115,92	CHI
20200127059	GAMELEIRA DE GOIAS	SV12265414	DAIA S2	05/01/2020 17:12	06/01/2020 10:55	05/01/2020 17:12	06/01/2020 10:55	17,70	1	17,70	CHI
20200127065	FORMOSA	10024161851	ITUIQUIRA	05/01/2020 17:14	05/01/2020 19:22	05/01/2020 17:14	05/01/2020 19:22	2,12	1	2,12	CHI
20200127070	NIQUELANDIA	NQ12264564	BARRO ALTO	05/01/2020 15:17	06/01/2020 12:19	05/01/2020 15:17	06/01/2020 12:19	21,02	12	252,21	CHI
20200127071	BALIZA	BH11331464	CAIAPONIA	05/01/2020 17:15	05/01/2020 23:02	05/01/2020 17:15	05/01/2020 23:02	5,78	1	5,78	CHI
20200127078	CAIAPONIA	CP12260986	MONTIVIDIU T	05/01/2020 15:21	06/01/2020 17:18	05/01/2020 15:21	06/01/2020 17:18	25,95	14	363,28	CHI
20200127079	AGUAS LINDAS DE GOIAS	LA12389383	AGUAS LINDAS DE GOIAS S2	05/01/2020 17:16	05/01/2020 17:38	05/01/2020 17:16	05/01/2020 17:38	0,35	16	5,61	CHI
20200127080	GOIANIA	15970073	GOYA S1	05/01/2020 17:16	05/01/2020 19:53	05/01/2020 17:16	05/01/2020 19:53	2,60	1	2,60	CHI
20200127082	SILVANIA	SV21227083	VIANOPOLIS	05/01/2020 17:17	05/01/2020 18:38	05/01/2020 17:17	05/01/2020 18:38	1,35	1	1,35	CHI
20200127095	JUSSARA	JR12364553	BRITANIA	05/01/2020 17:14	06/01/2020 04:38	05/01/2020 17:14	06/01/2020 04:38	11,40	18	205,11	CHI
20200127305	PLANALTINA	PI12131795	PLANALTINA	05/01/2020 17:24	05/01/2020 19:36	05/01/2020 17:24	05/01/2020 19:36	2,20	7	15,39	CHI
20200127316	JATAI	RV12040452	CABRIUVA S1	05/01/2020 20:08	06/01/2020 00:24	05/01/2020 20:08	06/01/2020 00:24	4,25	2	8,50	CHI
20200127316	RIO VERDE	RV12040452	CABRIUVA S1	05/01/2020 20:08	06/01/2020 00:24	05/01/2020 20:08	06/01/2020 00:24	4,25	6	25,51	CHI
20200127320	ITUMBIARA	690238903	PARANAIBA	05/01/2020 17:26	05/01/2020 20:09	05/01/2020 17:26	05/01/2020 20:09	2,72	1	2,72	CHI
20200127322	ESTRELA DO NORTE	ET12168852	MARA ROSA	05/01/2020 17:19	06/01/2020 00:08	05/01/2020 17:19	06/01/2020 00:08	6,81	4	27,24	CHI
20200127322	FORMOSO	ET12168852	MARA ROSA	05/01/2020 17:19	06/01/2020 00:08	05/01/2020 17:19	06/01/2020 00:08	6,81	2	13,62	CHI
20200127330	RIO VERDE	RV21279520	CABRIUVA S2	05/01/2020 17:28	06/01/2020 10:14	05/01/2020 17:28	06/01/2020 10:14	16,76	1	16,76	CHI
20200127331	PIRACANJUBA	PJ12097877	BELA VISTA S1	05/01/2020 17:28	06/01/2020 00:44	05/01/2020 17:28	06/01/2020 00:44	7,25	4	29,00	CHI
20200127333	ABADIANIA	350006003	ANAPOLIS UNIVERSITARIO S1	05/01/2020 13:51	06/01/2020 13:59	05/01/2020 13:51	06/01/2020 13:59	24,13	1	24,13	CHI
20200127336	QUIRINOPOLIS	QI11402259	QUIRINOPOLIS	05/01/2020 16:36	05/01/2020 19:11	05/01/2020 16:36	05/01/2020 19:11	2,57	56	144,08	CHI
20200127338	ITAPURANGA	IK21289427	ITAPURANGA	05/01/2020 17:30	06/01/2020 15:41	05/01/2020 17:30	06/01/2020 15:41	22,18	2	44,35	CHI



20200127340	PALMEIRAS DE GOIAS	10001169775	PALMEIRAS	05/01/2020 17:31	06/01/2020 08:24	05/01/2020 17:31	06/01/2020 08:24	14,88	1	14,88	CHI
20200127343	ORIZONA	OZ21080394	VIANOPOLIS	05/01/2020 17:32	06/01/2020 10:12	05/01/2020 17:32	06/01/2020 10:12	16,66	1	16,66	CHI
20200127346	NOVO BRASIL	1460005275	JUSSARA	05/01/2020 17:33	06/01/2020 02:12	05/01/2020 17:33	06/01/2020 02:12	8,65	1	8,65	CHI
20200127351	HIDROLANDIA	180012216	ANHANGUERA	05/01/2020 17:34	05/01/2020 18:48	05/01/2020 17:34	05/01/2020 18:48	1,22	1	1,22	CHI
20200127354	CAMPOS VERDES	VD21017239	SANTA TEREZINHA	05/01/2020 17:35	05/01/2020 21:55	05/01/2020 17:35	05/01/2020 21:55	4,33	1	4,33	CHI
20200127357	NOVA AURORA	NE21157544	CATALAO S1	05/01/2020 17:35	06/01/2020 01:30	05/01/2020 17:35	06/01/2020 01:30	7,90	2	15,81	CHI
20200127359	PILAR DE GOIAS	GG12341538	SANTA TEREZINHA	05/01/2020 16:50	05/01/2020 23:50	05/01/2020 16:50	05/01/2020 23:50	6,99	13	90,88	CHI
20200127360	VIANOPOLIS	VN21221253	PIRES DO RIO S2	05/01/2020 17:36	06/01/2020 10:20	05/01/2020 17:36	06/01/2020 10:20	16,74	1	16,74	CHI
20200127364	GOIANESIA	550195166	GOIANESIA S2	05/01/2020 17:36	05/01/2020 22:49	05/01/2020 17:36	05/01/2020 22:49	5,20	1	5,20	CHI
20200127366	IPAMERI	IP21309707	IPAMERI	05/01/2020 17:37	06/01/2020 07:37	05/01/2020 17:37	06/01/2020 07:37	14,00	1	14,00	CHI
20200127368	IPAMERI	IP21031362	IPAMERI	05/01/2020 17:37	05/01/2020 21:22	05/01/2020 17:37	05/01/2020 21:22	3,74	1	3,74	CHI
20200127369	VICENTINOPOLIS	EA21263317	VICENTINOPOLIS	05/01/2020 17:37	05/01/2020 20:47	05/01/2020 17:37	05/01/2020 20:47	3,16	1	3,16	CHI
20200127370	SAO LUIS DE MONTES BELOS	SL12006949	SAO LUIZ DOS MONTES BELOS	05/01/2020 17:37	05/01/2020 19:09	05/01/2020 17:37	05/01/2020 19:09	1,53	41	62,63	CHI
20200127371	ESTRELA DO NORTE	ET12088710	MARA ROSA	05/01/2020 17:37	06/01/2020 10:18	05/01/2020 17:37	06/01/2020 10:18	16,67	3	50,00	CHI
20200127372	BOM JARDIM DE GOIAS	BM21184497	BOM JARDIM	05/01/2020 17:38	05/01/2020 18:36	05/01/2020 17:38	05/01/2020 18:36	0,96	1	0,96	CHI
20200127376	EDEIA	EA21143725	VICENTINOPOLIS	05/01/2020 17:40	05/01/2020 20:10	05/01/2020 17:40	05/01/2020 20:10	2,50	1	2,50	CHI
20200127378	SAO JOAO D ALIANCA	JL11130014	SAO JOAO D ALIANCA	05/01/2020 17:42	06/01/2020 01:23	05/01/2020 17:42	06/01/2020 01:23	7,67	4	30,70	CHI
20200127383	CRIXAS	CX12230553	RUBIATABA	05/01/2020 08:16	06/01/2020 09:26	05/01/2020 08:16	06/01/2020 09:26	25,17	15	377,49	CHI
20200127383	NOVA CRIXAS	CX12230553	RUBIATABA	05/01/2020 08:16	06/01/2020 09:26	05/01/2020 08:16	06/01/2020 09:26	25,17	1	25,17	CHI
20200127384	PILAR DE GOIAS	GG21118351	SANTA TEREZINHA	05/01/2020 17:43	06/01/2020 10:57	05/01/2020 17:43	06/01/2020 10:57	17,22	1	17,22	CHI
20200127385	GOIANIA	14337824	XAVANTES	05/01/2020 17:43	05/01/2020 21:10	05/01/2020 17:43	05/01/2020 21:10	3,43	1	3,43	CHI
20200127401	GOIATUBA	GT12318190	BOM JESUS DE GOIAS	05/01/2020 06:01	05/01/2020 22:53	05/01/2020 06:01	05/01/2020 22:53	16,86	6	101,15	CHI
20200127503	IVOLANDIA	IV12323715	IPORA	05/01/2020 17:47	06/01/2020 11:39	05/01/2020 17:47	06/01/2020 11:39	17,85	1	17,85	CHI
20200127507	FORMOSA	FA11140425	ITUIQUIRA	05/01/2020 17:48	05/01/2020 20:29	05/01/2020 17:48	05/01/2020 20:29	2,67	61	163,09	CHI
20200127513	ANICUNS	910043486	ANICUNS	05/01/2020 17:49	05/01/2020 20:20	05/01/2020 17:49	05/01/2020 20:20	2,51	1	2,51	CHI
20200127514	ANAPOLIS	AN11335100	ANAPOLIS UNIVERSITARIO S2	05/01/2020 17:50	05/01/2020 18:12	05/01/2020 17:50	05/01/2020 18:12	0,36	22	7,95	CHI
20200127520	NOVO BRASIL	NB12020253	JUSSARA	05/01/2020 17:25	05/01/2020 21:57	05/01/2020 17:25	05/01/2020 21:57	4,53	7	31,69	CHI
20200127524	TRES RANCHOS	TH11165256	CATALAO S1	05/01/2020 17:51	05/01/2020 19:18	05/01/2020 17:51	05/01/2020 19:18	1,44	173	248,69	CHI
20200127525	SANTA TEREZINHA DE GOIAS	SG21242351	SANTA TEREZINHA	05/01/2020 17:51	06/01/2020 10:20	05/01/2020 17:51	06/01/2020 10:20	16,47	1	16,47	CHI
20200127528	GOIANIA	GN11380212	GOIANIA LESTE S3	05/01/2020 16:40	05/01/2020 19:35	05/01/2020 16:40	05/01/2020 19:35	2,90	85	246,90	CHI
20200127529	GOIANIA	14314113	GOYA S2	05/01/2020 17:53	05/01/2020 19:56	05/01/2020 17:53	05/01/2020 19:56	2,05	1	2,05	CHI
20200127533	INACIOLANDIA	ID21315396	QUIRINOPOLIS	05/01/2020 17:53	05/01/2020 23:31	05/01/2020 17:53	05/01/2020 23:31	5,63	1	5,63	CHI
20200127538	CRISTALINA	KR11304752	CRISTALINA S1	05/01/2020 17:53	05/01/2020 18:52	05/01/2020 17:53	05/01/2020 18:52	0,97	2	1,94	CHI

20200127543	GOIANIA	14646274	INDEPENDENCIA S2	05/01/2020 17:54	05/01/2020 19:38	05/01/2020 17:54	05/01/2020 19:38	1,73	1	1,73	CHI
20200127544	GOIANIA	11565949	CAMPINAS S2	05/01/2020 17:54	05/01/2020 22:26	05/01/2020 17:54	05/01/2020 22:26	4,52	1	4,52	CHI
20200127551	MORRINHOS	MR12076889	MORRINHOS	05/01/2020 14:37	05/01/2020 19:45	05/01/2020 14:37	05/01/2020 19:45	5,13	6	30,79	CHI
20200127554	BELA VISTA DE GOIAS	BV21381616	BELA VISTA S1	05/01/2020 17:57	06/01/2020 08:52	05/01/2020 17:57	06/01/2020 08:52	14,91	1	14,91	CHI
20200127557	RIO QUENTE	RQ12050875	VILA CORUMBA	05/01/2020 16:48	05/01/2020 19:33	05/01/2020 16:48	05/01/2020 19:33	2,76	12	33,09	CHI
20200127575	GOIAS	GS21059821	ITABERAI S1	05/01/2020 18:01	06/01/2020 10:21	05/01/2020 18:01	06/01/2020 10:21	16,32	1	16,32	CHI
20200127576	BURITINOPOLIS	BQ12320638	IACIARA S2	05/01/2020 17:44	05/01/2020 19:18	05/01/2020 17:44	05/01/2020 19:18	1,56	50	77,86	CHI
20200127578	SAO JOAO D ALIANCA	JL11130016	SAO JOAO D ALIANCA	05/01/2020 18:02	06/01/2020 01:10	05/01/2020 18:02	06/01/2020 01:10	7,12	8	57,00	CHI
20200127582	ITAPIRAPUA	IU12264118	MATRINCHA	05/01/2020 17:33	06/01/2020 05:43	05/01/2020 17:33	06/01/2020 05:43	12,16	8	97,24	CHI
20200127588	URUTAI	UT12080724RE	URUTAI	05/01/2020 17:58	05/01/2020 22:41	05/01/2020 17:58	05/01/2020 22:41	4,70	72	338,42	CHI
20200127591	IPAMERI	IP21195210	IPAMERI	05/01/2020 18:04	05/01/2020 19:57	05/01/2020 18:04	05/01/2020 19:57	1,88	1	1,88	CHI
20200127592	ANAPOLIS	AN12270373	ANAPOLIS UNIVERSITARIO S2	05/01/2020 16:54	05/01/2020 23:28	05/01/2020 16:54	05/01/2020 23:28	6,56	16	104,95	CHI
20200127593	CALDAS NOVAS	IP12195206	IPAMERI	05/01/2020 17:53	05/01/2020 19:33	05/01/2020 17:53	05/01/2020 19:33	1,67	3	5,00	CHI
20200127593	IPAMERI	IP12195206	IPAMERI	05/01/2020 17:53	05/01/2020 19:33	05/01/2020 17:53	05/01/2020 19:33	1,67	11	18,32	CHI
20200127595	SAO MIGUEL DO ARAGUAIA	SM12000065	SAO MIGUEL DO ARAGUAIA	05/01/2020 18:04	06/01/2020 15:13	05/01/2020 18:04	06/01/2020 08:50	14,76	15	221,44	CHI
20200127595	SAO MIGUEL DO ARAGUAIA	SM12000065	SAO MIGUEL DO ARAGUAIA	05/01/2020 18:04	06/01/2020 15:13	05/01/2020 18:04	06/01/2020 10:27	16,39	3	49,16	CHI
20200127595	SAO MIGUEL DO ARAGUAIA	SM12000065	SAO MIGUEL DO ARAGUAIA	05/01/2020 18:04	06/01/2020 15:13	05/01/2020 18:04	06/01/2020 15:13	21,15	6	126,91	CHI
20200127595	SAO MIGUEL DO ARAGUAIA	SM13253733	SAO MIGUEL DO ARAGUAIA	05/01/2020 18:04	06/01/2020 15:13	06/01/2020 14:23	06/01/2020 15:13	0,83	3	2,49	CHI
20200127605	TRINDADE	TR12071529	TRINDADE	05/01/2020 17:53	05/01/2020 20:33	05/01/2020 17:53	05/01/2020 20:33	2,66	100	266,08	CHI
20200127608	NOVA CRIXAS	NA12096364	NOVA CRIXAS	05/01/2020 11:55	05/01/2020 19:22	05/01/2020 11:55	05/01/2020 19:22	7,44	5	37,22	CHI
20200127703	UIRAPURU	UP11088744	SANTA TEREZINHA	05/01/2020 13:49	05/01/2020 21:07	05/01/2020 13:49	05/01/2020 21:07	7,30	136	992,23	CHI
20200127706	PONTALINA	PK12293240	GOIATUBA S1	05/01/2020 18:06	06/01/2020 08:30	05/01/2020 18:06	06/01/2020 08:30	14,38	7	100,69	CHI
20200127709	NOVA CRIXAS	NA21266401	NOVA CRIXAS	05/01/2020 18:07	06/01/2020 13:08	05/01/2020 18:07	06/01/2020 13:08	19,01	1	19,01	CHI
20200127720	PIRENOPOLIS	PV21318034	JARAGUA	05/01/2020 18:12	06/01/2020 21:10	05/01/2020 18:12	06/01/2020 21:10	26,97	1	26,97	CHI
20200127721	ALVORADA DO NORTE	AQ12184985	IACIARA S2	05/01/2020 18:12	05/01/2020 20:12	05/01/2020 18:12	05/01/2020 20:12	1,99	11	21,89	CHI
20200127722	BARRO ALTO	PV12069121	GOIANESIA S1	05/01/2020 17:28	05/01/2020 21:36	05/01/2020 17:28	05/01/2020 21:36	4,13	1	4,13	CHI
20200127722	VILA PROPICIO	PV12069121	GOIANESIA S1	05/01/2020 17:28	05/01/2020 21:36	05/01/2020 17:28	05/01/2020 21:36	4,13	6	24,78	CHI
20200127725	BELA VISTA DE GOIAS	SQ12317631	CRISTIANOPOLIS	05/01/2020 16:43	05/01/2020 20:02	05/01/2020 16:43	05/01/2020 20:02	3,31	28	92,80	CHI
20200127726	JARAGUA	JA12000153	JARAGUA	05/01/2020 18:13	06/01/2020 00:02	05/01/2020 18:13	06/01/2020 00:02	5,81	2	11,61	CHI
20200127733	APARECIDA DE GOIANIA	12844275	ATLANTICO S3	05/01/2020 18:14	05/01/2020 20:23	05/01/2020 18:14	05/01/2020 20:23	2,13	1	2,13	CHI
20200127738	MINEIROS	MY21195529	PARQUE DAS EMAS	05/01/2020 18:15	05/01/2020 21:28	05/01/2020 18:15	05/01/2020 21:28	3,21	1	3,21	CHI
20200127739	CRISTALINA	KR21165864	CRISTALINA S2	05/01/2020 18:16	05/01/2020 20:56	05/01/2020 18:16	05/01/2020 20:56	2,66	1	2,66	CHI
20200127740	FORMOSA	FA11270008	ITIQUEIRA	05/01/2020 18:17	06/01/2020 09:24	05/01/2020 18:17	06/01/2020 09:24	15,11	1	15,11	CHI

20200127748	ANICUNS	AC21278671	FIRMINOPOLIS S2	05/01/2020 18:20	05/01/2020 19:07	05/01/2020 18:20	05/01/2020 19:07	0,78	1	0,78	CHI
20200127751	LUZIANIA	10027251916	MARAJOARA	05/01/2020 18:20	05/01/2020 20:09	05/01/2020 18:20	05/01/2020 20:09	1,81	1	1,81	CHI
20200127752	SANTA RITA DO NOVO DESTINO	1330000186	GOIANESIA S1	05/01/2020 18:21	06/01/2020 22:13	05/01/2020 18:21	06/01/2020 22:13	27,88	1	27,88	CHI
20200127766	CRIXAS	CX12054992	SANTA TEREZINHA	06/01/2020 08:08	06/01/2020 16:57	06/01/2020 08:08	06/01/2020 16:57	8,83	97	856,21	CHI
20200127769	ABADIANIA	AA12322447	CORUMBA	05/01/2020 14:25	05/01/2020 19:47	05/01/2020 14:25	05/01/2020 19:47	5,36	25	134,00	CHI
20200127772	SENADOR CANEDO	10014161140	SENADOR CANEDO	05/01/2020 18:24	05/01/2020 21:58	05/01/2020 18:24	05/01/2020 21:58	3,56	1	3,56	CHI
20200127773	CATALAO	CT12399870	CATALAO S1	05/01/2020 18:24	05/01/2020 21:37	05/01/2020 18:24	05/01/2020 21:37	3,20	11	35,24	CHI
20200127782	SILVANIA	SV12012810	VIANOPOLIS	05/01/2020 17:19	06/01/2020 13:44	05/01/2020 17:19	06/01/2020 13:44	20,41	19	387,73	CHI
20200127786	ESTRELA DO NORTE	MU12075219	MARA ROSA	05/01/2020 18:24	05/01/2020 22:50	05/01/2020 18:24	05/01/2020 22:50	4,43	1	4,43	CHI
20200127786	MUTUNOPOLIS	MU12075219	MARA ROSA	05/01/2020 18:24	05/01/2020 22:50	05/01/2020 18:24	05/01/2020 22:50	4,43	8	35,43	CHI
20200127791	AURILANDIA	RP12076381	FIRMINOPOLIS S2	05/01/2020 18:27	05/01/2020 21:59	05/01/2020 18:27	05/01/2020 21:59	3,52	4	14,08	CHI
20200127791	SAO JOAO DA PARAUNA	RP12076381	FIRMINOPOLIS S2	05/01/2020 18:27	05/01/2020 21:59	05/01/2020 18:27	05/01/2020 21:59	3,52	33	116,12	CHI
20200127797	BALIZA	BH11331348	CAIAPONIA	05/01/2020 18:28	06/01/2020 01:22	05/01/2020 18:28	06/01/2020 01:22	6,89	1	6,89	CHI
20200127799	GOIANESIA	GE21376590	GOIANESIA S1	05/01/2020 18:29	06/01/2020 15:35	05/01/2020 18:29	06/01/2020 15:35	21,10	1	21,10	CHI
20200127800	PADRE BERNARDO	PB12283897	PADRE BERNARDO	05/01/2020 18:29	06/01/2020 12:07	05/01/2020 18:29	06/01/2020 12:07	17,63	7	123,40	CHI
20200127801	ITARUMA	00950224	CACHOEIRA ALTA	05/01/2020 18:15	06/01/2020 09:23	05/01/2020 18:15	06/01/2020 01:56	7,68	39	299,59	CHI
20200127801	ITAJA	00950224	CACHOEIRA ALTA	05/01/2020 18:15	06/01/2020 09:23	05/01/2020 18:15	06/01/2020 08:12	13,96	19	265,29	CHI
20200127801	ITARUMA	00950224	CACHOEIRA ALTA	05/01/2020 18:15	06/01/2020 09:23	05/01/2020 18:15	06/01/2020 08:12	13,96	73	1019,28	CHI
20200127801	ITARUMA	00950224	CACHOEIRA ALTA	05/01/2020 18:15	06/01/2020 09:23	06/01/2020 08:13	06/01/2020 09:23	1,17	39	45,45	CHI
20200127908	ABADIANIA	AA21000002	ANAPOLIS UNIVERSITARIO S1	05/01/2020 18:30	06/01/2020 14:58	05/01/2020 18:30	06/01/2020 14:58	20,46	1	20,46	CHI
20200127909	ANAPOLIS	10003987734	ANAPOLIS UNIVERSITARIO S2	05/01/2020 18:30	05/01/2020 23:29	05/01/2020 18:30	05/01/2020 23:29	4,97	1	4,97	CHI
20200127914	SAO LUIS DE MONTES BELOS	SL16404022	SAO LUIZ DOS MONTES BELOS	05/01/2020 18:31	05/01/2020 22:09	05/01/2020 18:57	05/01/2020 19:57	1,00	3499	3493,17	CHI
20200127914	SAO LUIS DE MONTES BELOS	SL11107199	SAO LUIZ DOS MONTES BELOS	05/01/2020 18:31	05/01/2020 22:09	05/01/2020 18:31	05/01/2020 22:09	3,63	115	417,90	CHI
20200127921	SANTO ANTONIO DA BARRA	BZ12316322	ACREUNA	05/01/2020 18:33	05/01/2020 20:55	05/01/2020 18:33	05/01/2020 20:55	2,36	3	7,09	CHI
20200127924	ALEXANIA	AX12000097	CORUMBA	05/01/2020 15:25	05/01/2020 21:15	05/01/2020 15:25	05/01/2020 21:15	5,83	6	34,95	CHI
20200127929	ALEXANIA	AX12211852	ALEXANIA	05/01/2020 15:54	05/01/2020 22:07	05/01/2020 15:54	05/01/2020 22:07	6,20	15	93,02	CHI
20200127935	APARECIDA DE GOIANIA	13490497	CARAJAS S1	05/01/2020 18:36	05/01/2020 20:12	05/01/2020 18:36	05/01/2020 20:12	1,60	1	1,60	CHI
20200127936	CAMPINORTE	03260224	CAMPINORTE	05/01/2020 18:18	05/01/2020 19:35	05/01/2020 18:18	05/01/2020 19:35	1,28	2357	3015,65	CHI
20200127936	CAMPINORTE	03260224	CAMPINORTE	05/01/2020 18:18	05/01/2020 19:35	05/01/2020 18:18	05/01/2020 19:35	1,28	2262	2894,10	CHI
20200127936	NOVA IGUACU DE GOIAS	03260224	CAMPINORTE	05/01/2020 18:18	05/01/2020 19:35	05/01/2020 18:18	05/01/2020 19:35	1,28	21	26,87	CHI
20200127936	NOVA IGUACU DE GOIAS	03260224	CAMPINORTE	05/01/2020 18:18	05/01/2020 19:35	05/01/2020 18:18	05/01/2020 19:35	1,28	116	148,42	CHI
20200127936	URUACU	03260224	CAMPINORTE	05/01/2020 18:18	05/01/2020 19:35	05/01/2020 18:18	05/01/2020 19:35	1,28	532	680,66	CHI
20200127937	RIO VERDE	RV12200084	MONTIVIDIU T	05/01/2020 18:36	06/01/2020 12:30	05/01/2020 18:36	06/01/2020 12:30	17,89	1	17,89	CHI

20200127939	ITABERAI	IB21300317	ITABERAI S2	05/01/2020 18:36	06/01/2020 14:07	05/01/2020 18:36	06/01/2020 14:07	19,51	1	19,51	CHI
20200127943	GOIANIA	10890816	GOIANIA LESTE S1	05/01/2020 18:37	06/01/2020 00:00	05/01/2020 18:37	06/01/2020 00:00	5,38	1	5,38	CHI
20200127949	VILA PROPICIO	NP21249470	GOIANESIA S1	05/01/2020 18:38	07/01/2020 02:40	05/01/2020 18:38	07/01/2020 02:40	32,04	1	32,04	CHI
20200127956	AMARALINA	LC12230337	NOVA CRIXAS	05/01/2020 18:38	06/01/2020 10:41	05/01/2020 18:38	06/01/2020 10:41	16,04	3	48,12	CHI
20200127957	QUIRINOPOLIS	QI21100942	QUIRINOPOLIS	05/01/2020 18:39	06/01/2020 09:01	05/01/2020 18:39	06/01/2020 09:01	14,36	1	14,36	CHI
20200127963	MAIRIPOTABA	MI21060560	PONTALINA	05/01/2020 18:40	06/01/2020 07:50	05/01/2020 18:40	06/01/2020 07:50	13,16	1	13,16	CHI
20200127978	MONTIVIDIU DO NORTE	MX12243327	PORANGATU	05/01/2020 18:43	06/01/2020 11:11	05/01/2020 18:43	06/01/2020 11:11	16,46	7	115,24	CHI
20200127985	ITABERAI	IB21198928	ITABERAI S1	05/01/2020 18:43	06/01/2020 14:56	05/01/2020 18:43	06/01/2020 14:56	20,20	1	20,20	CHI
20200127986	TROMBAS	TB12156640	PORANGATU	05/01/2020 18:44	05/01/2020 21:26	05/01/2020 18:44	05/01/2020 21:26	2,70	9	24,30	CHI
20200127987	IPAMERI	IP21071410	IPAMERI	05/01/2020 18:44	06/01/2020 10:54	05/01/2020 18:44	06/01/2020 10:54	16,17	1	16,17	CHI
20200127988	NOVA CRIXAS	NA12334349	NOVA CRIXAS	05/01/2020 18:28	05/01/2020 22:31	05/01/2020 18:28	05/01/2020 22:31	4,05	86	348,18	CHI
20200127992	VIANOPOLIS	510024210	VIANOPOLIS	05/01/2020 18:44	06/01/2020 11:02	05/01/2020 18:44	06/01/2020 11:02	16,30	1	16,30	CHI
20200127998	ARAGUAPAZ	AZ12290380	MOZARLANDIA	05/01/2020 18:45	06/01/2020 09:05	05/01/2020 18:45	06/01/2020 09:05	14,33	7	100,28	CHI
20200127998	MOZARLANDIA	AZ12290380	MOZARLANDIA	05/01/2020 18:45	06/01/2020 09:05	05/01/2020 18:45	06/01/2020 09:05	14,33	2	28,65	CHI
20200128000	ANAPOLIS	AN21258368	ANAPOLIS UNIVERSITARIO S2	05/01/2020 18:46	05/01/2020 23:30	05/01/2020 18:46	05/01/2020 23:30	4,73	1	4,73	CHI
20200128001	SAO MIGUEL DO ARAGUAIA	SM13377685	SAO MIGUEL DO ARAGUAIA	05/01/2020 14:52	06/01/2020 12:08	05/01/2020 14:52	06/01/2020 12:08	21,26	7	148,79	CHI
20200128104	QUIRINOPOLIS	QI12295719	QUIRINOPOLIS	05/01/2020 18:34	06/01/2020 10:39	05/01/2020 18:34	06/01/2020 10:39	16,08	4	64,33	CHI
20200128105	ITABERAI	IB12406510	ITABERAI S1	05/01/2020 18:46	06/01/2020 09:52	05/01/2020 18:46	06/01/2020 09:52	15,09	1	15,09	CHI
20200128108	FORMOSA	FA11085463	ITUIQUIRA	05/01/2020 18:47	05/01/2020 22:24	05/01/2020 18:47	05/01/2020 22:24	3,61	2	7,22	CHI
20200128113	ANAPOLIS	AN12166243	ANAPOLIS UNIVERSITARIO S2	05/01/2020 18:40	05/01/2020 19:24	05/01/2020 18:40	05/01/2020 19:24	0,72	195	139,80	CHI
20200128115	SANTO ANTONIO DO DESCOBERTO	SN12037174	MARAJOARA	05/01/2020 13:26	05/01/2020 21:14	05/01/2020 13:26	05/01/2020 21:14	7,79	7	54,55	CHI
20200128116	AGUA FRIA DE GOIAS	TL21204695	SAO JOAO D ALIANCA	05/01/2020 18:48	05/01/2020 23:25	05/01/2020 18:48	05/01/2020 23:25	4,60	2	9,21	CHI
20200128124	MARZAGAO	MG21246556	VILA CORUMBA	05/01/2020 18:49	05/01/2020 22:47	05/01/2020 18:49	05/01/2020 22:47	3,95	1	3,95	CHI
20200128126	GOIANIA	GN12035915	GOYA S1	05/01/2020 17:42	05/01/2020 21:19	05/01/2020 17:42	05/01/2020 21:19	3,60	127	457,34	CHI
20200128127	APARECIDA DE GOIANIA	200535961	ANHANGUERA	05/01/2020 18:50	05/01/2020 23:33	05/01/2020 18:50	05/01/2020 23:33	4,71	1	4,71	CHI
20200128131	CATALAO	1990309152	CATALAO S2	05/01/2020 18:50	05/01/2020 19:51	05/01/2020 18:50	05/01/2020 19:51	1,00	1	1,00	CHI
20200128132	JATAI	290044029	JATAI S3	05/01/2020 18:51	06/01/2020 00:18	05/01/2020 18:51	06/01/2020 00:18	5,44	1	5,44	CHI
20200128133	PORANGATU	PO12170950	PORANGATU	05/01/2020 18:51	06/01/2020 11:47	05/01/2020 18:51	06/01/2020 11:47	16,93	2	33,85	CHI
20200128134	MORRINHOS	MR21000208	MORRINHOS	05/01/2020 18:51	05/01/2020 21:25	05/01/2020 18:51	05/01/2020 21:25	2,55	1	2,55	CHI
20200128141	ALTO HORIZONTE	AJ12204148	SANTA TEREZINHA	05/01/2020 17:51	05/01/2020 21:48	05/01/2020 17:51	05/01/2020 21:48	3,94	14	55,19	CHI
20200128142	CRISTALINA	KR21339710	CRISTALINA S2	05/01/2020 18:53	06/01/2020 07:55	05/01/2020 18:53	06/01/2020 07:55	13,02	1	13,02	CHI
20200128143	ORIZONA	PR12000068RE	PIRES DO RIO S1	05/01/2020 18:40	06/01/2020 15:36	05/01/2020 18:40	06/01/2020 01:10	6,51	27	175,67	CHI
20200128143	PIRES DO RIO	PR12000068RE	PIRES DO RIO S1	05/01/2020 18:40	06/01/2020 15:36	05/01/2020 18:40	06/01/2020 01:10	6,51	12	78,08	CHI

20200128143	PIRES DO RIO	PR12000068RE	PIRES DO RIO S1	05/01/2020 18:40	06/01/2020 15:36	05/01/2020 20:49	06/01/2020 01:10	4,35	2	8,70	CHI
20200128143	ORIZONA	PR12000068RE	PIRES DO RIO S1	05/01/2020 18:40	06/01/2020 15:36	05/01/2020 18:40	06/01/2020 15:36	20,95	51	1068,25	CHI
20200128143	PIRES DO RIO	PR12000068RE	PIRES DO RIO S1	05/01/2020 18:40	06/01/2020 15:36	05/01/2020 18:40	06/01/2020 15:36	20,95	7	146,62	CHI
20200128143	URUTAI	PR12000068RE	PIRES DO RIO S1	05/01/2020 18:40	06/01/2020 15:36	05/01/2020 18:40	06/01/2020 15:36	20,95	1	20,95	CHI
20200128148	PONTALINA	PK12109416	PONTALINA	05/01/2020 17:58	06/01/2020 09:29	05/01/2020 17:58	06/01/2020 07:44	13,76	13	178,92	CHI
20200128148	PONTALINA	PK12109416	PONTALINA	05/01/2020 17:58	06/01/2020 09:29	06/01/2020 07:49	06/01/2020 09:29	1,67	13	21,75	CHI
20200128159	RIO VERDE	10002573103	RIO VERDE S1	05/01/2020 18:57	06/01/2020 00:25	05/01/2020 18:57	06/01/2020 00:25	5,46	1	5,46	CHI
20200128183	ISRAELANDIA	IS12228356	IPORA	05/01/2020 19:01	06/01/2020 13:17	05/01/2020 19:01	06/01/2020 13:17	18,27	2	36,54	CHI
20200128189	PADRE BERNARDO	PB11231530	PADRE BERNARDO	05/01/2020 19:02	05/01/2020 22:57	05/01/2020 19:02	05/01/2020 22:57	3,91	8	31,26	CHI
20200128195	AVELINOPOLIS	AV21278408	ANICUNS	05/01/2020 19:03	05/01/2020 20:21	05/01/2020 19:03	05/01/2020 20:21	1,29	1	1,29	CHI
20200128197	URUACU	6732161	URUACU	05/01/2020 19:03	05/01/2020 21:26	05/01/2020 19:03	05/01/2020 21:26	2,37	11	26,09	CHI
20200128200	PIRANHAS	PH12381051	PIRANHAS	05/01/2020 14:27	06/01/2020 07:58	05/01/2020 14:27	06/01/2020 07:58	17,51	10	175,08	CHI
20200128301	MINACU	4020034796	MINACU	05/01/2020 19:04	06/01/2020 02:05	05/01/2020 19:04	06/01/2020 02:05	7,01	1	7,01	CHI
20200128302	AGUA FRIA DE GOIAS	TL12279981	SAO JOAO D ALIANCA	05/01/2020 19:04	05/01/2020 23:14	05/01/2020 19:04	05/01/2020 23:14	4,16	41	170,56	CHI
20200128307	ARUANA	AK12310723	BRITANIA	05/01/2020 19:05	05/01/2020 20:04	05/01/2020 19:05	05/01/2020 20:04	0,98	4	3,91	CHI
20200128313	GOIANDIRA	GD12000011RE	CATALAO S1	05/01/2020 17:37	05/01/2020 21:51	05/01/2020 17:37	05/01/2020 21:51	4,23	8	33,83	CHI
20200128314	LEOPOLDO DE BULHOES	LB12053626	DAIA S2	05/01/2020 18:59	06/01/2020 03:39	05/01/2020 18:59	06/01/2020 03:39	8,65	8	69,22	CHI
20200128318	CACHOEIRA ALTA	QI12119881	QUIRINOPOLIS	05/01/2020 19:06	06/01/2020 10:34	05/01/2020 19:06	06/01/2020 10:34	15,45	6	92,71	CHI
20200128318	QUIRINOPOLIS	QI12119881	QUIRINOPOLIS	05/01/2020 19:06	06/01/2020 10:34	05/01/2020 19:06	06/01/2020 10:34	15,45	17	262,69	CHI
20200128318	CACHOEIRA ALTA	QI12119881	QUIRINOPOLIS	05/01/2020 19:06	06/01/2020 10:34	05/01/2020 19:06	06/01/2020 10:34	15,45	7	108,17	CHI
20200128318	QUIRINOPOLIS	QI12119881	QUIRINOPOLIS	05/01/2020 19:06	06/01/2020 10:34	05/01/2020 19:06	06/01/2020 10:34	15,45	1	15,45	CHI
20200128318	RIO VERDE	QI12119881	QUIRINOPOLIS	05/01/2020 19:06	06/01/2020 10:34	05/01/2020 19:06	06/01/2020 10:34	15,45	5	77,26	CHI
20200128320	DOVERLANDIA	DV12187350	CAIAPONIA	05/01/2020 14:06	06/01/2020 03:08	05/01/2020 14:06	06/01/2020 03:08	13,03	17	221,49	CHI
20200128336	ITAPURANGA	IK12250509	ITAPURANGA	05/01/2020 17:12	06/01/2020 11:32	05/01/2020 17:12	06/01/2020 11:32	18,33	7	128,30	CHI
20200128351	ALTO PARAISO DE GOIAS	BF12384754	FLORES DE GOIAS	05/01/2020 18:19	06/01/2020 11:50	05/01/2020 18:19	06/01/2020 11:50	17,50	113	1977,85	CHI
20200128361	PIRES DO RIO	PR12000028	PIRES DO RIO S1	05/01/2020 19:12	05/01/2020 21:02	05/01/2020 19:12	05/01/2020 21:02	1,82	4	7,27	CHI
20200128366	SANTO ANTONIO DO DESCOBERTO	SN12261733	MARAJOARA	05/01/2020 19:13	06/01/2020 12:19	05/01/2020 19:13	06/01/2020 12:19	17,08	10	170,84	CHI
20200128376	AGUAS LINDAS DE GOIAS	4830090110	AGUAS LINDAS DE GOIAS S1	05/01/2020 19:17	06/01/2020 16:29	05/01/2020 19:17	06/01/2020 16:29	21,19	1	21,19	CHI
20200128382	CATALAO	10005359145	CATALAO S2	05/01/2020 19:17	05/01/2020 20:37	05/01/2020 19:17	05/01/2020 20:37	1,32	1	1,32	CHI
20200128387	ITUMBIARA	IT11091623	ITUMBIARA NOVA	05/01/2020 19:11	05/01/2020 19:59	05/01/2020 19:11	05/01/2020 19:59	0,79	191	150,04	CHI
20200128393	CAMPOS BELOS	CH12261981	SAO DOMINGOS	05/01/2020 19:16	05/01/2020 22:14	05/01/2020 19:16	05/01/2020 22:14	2,96	74	219,31	CHI
20200128501	GOIANESIA	GE16404355	GOIANESIA S2	05/01/2020 19:10	05/01/2020 20:19	05/01/2020 19:22	05/01/2020 19:39	0,28	3478	977,70	CHI
20200128501	GOIANESIA	GE16401578	GOIANESIA S2	05/01/2020 19:10	05/01/2020 20:19	05/01/2020 19:22	05/01/2020 19:44	0,38	2515	948,02	CHI

20200128501	VILA PROPICIO	GE16401578	GOIANESIA S2	05/01/2020 19:10	05/01/2020 20:19	05/01/2020 19:22	05/01/2020 19:44	0,38	12	4,52	CHI
20200128501	GOIANESIA	GE10394587	GOIANESIA S2	05/01/2020 19:10	05/01/2020 20:19	05/01/2020 19:22	05/01/2020 19:47	0,42	254	106,33	CHI
20200128501	JARAGUA	GE10394587	GOIANESIA S2	05/01/2020 19:10	05/01/2020 20:19	05/01/2020 19:22	05/01/2020 19:47	0,42	473	198,00	CHI
20200128501	PIRENOPOLIS	GE10394587	GOIANESIA S2	05/01/2020 19:10	05/01/2020 20:19	05/01/2020 19:22	05/01/2020 19:47	0,42	1	0,42	CHI
20200128501	GOIANESIA	00560224	GOIANESIA S2	05/01/2020 19:10	05/01/2020 20:19	05/01/2020 19:48	05/01/2020 19:52	0,06	11467	652,98	CHI
20200128501	SANTA ISABEL	00560224	GOIANESIA S2	05/01/2020 19:10	05/01/2020 20:19	05/01/2020 19:48	05/01/2020 19:52	0,06	1	0,06	CHI
20200128501	GOIANESIA	GE16404355	GOIANESIA S2	05/01/2020 19:10	05/01/2020 20:19	05/01/2020 19:48	05/01/2020 19:53	0,07	3565	252,52	CHI
20200128501	GOIANESIA	00560224	GOIANESIA S2	05/01/2020 19:10	05/01/2020 20:19	05/01/2020 19:48	05/01/2020 20:19	0,50	2887	1455,53	CHI
20200128501	JARAGUA	00560224	GOIANESIA S2	05/01/2020 19:10	05/01/2020 20:19	05/01/2020 19:48	05/01/2020 20:19	0,50	473	238,47	CHI
20200128501	PIRENOPOLIS	00560224	GOIANESIA S2	05/01/2020 19:10	05/01/2020 20:19	05/01/2020 19:48	05/01/2020 20:19	0,50	1	0,50	CHI
20200128501	VILA PROPICIO	00560224	GOIANESIA S2	05/01/2020 19:10	05/01/2020 20:19	05/01/2020 19:48	05/01/2020 20:19	0,50	18	9,07	CHI
20200128618	TRINDADE	TR11144365	TRINDADE	05/01/2020 18:54	05/01/2020 22:52	05/01/2020 18:54	05/01/2020 22:52	3,96	149	589,63	CHI
20200128619	CAIAPONIA	CP12395438	PALESTINA	05/01/2020 13:29	05/01/2020 22:02	05/01/2020 13:29	05/01/2020 22:02	8,55	5	42,75	CHI
20200128619	PALESTINA DE GOIAS	CP12395438	PALESTINA	05/01/2020 13:29	05/01/2020 22:02	05/01/2020 13:29	05/01/2020 22:02	8,55	1	8,55	CHI
20200128622	RIO VERDE	10017058781	CABRIUVA S1	05/01/2020 19:26	06/01/2020 09:09	05/01/2020 19:26	06/01/2020 09:09	13,72	1	13,72	CHI
20200128625	CRISTALINA	KR11170182	CRISTALINA S2	05/01/2020 19:27	05/01/2020 20:47	05/01/2020 19:27	05/01/2020 20:47	1,32	10	13,23	CHI
20200128629	JAUPACI	JP12006114	IPORA	05/01/2020 10:41	06/01/2020 06:19	05/01/2020 10:41	06/01/2020 06:19	19,63	29	569,19	CHI
20200128662	NOVA ROMA	ND21117705	IACIARA S2	05/01/2020 19:38	05/01/2020 20:58	05/01/2020 19:38	05/01/2020 20:58	1,33	1	1,33	CHI
20200128665	OUVIDOR	10002752547	CATALAO S1	05/01/2020 19:39	05/01/2020 21:22	05/01/2020 19:39	05/01/2020 21:22	1,71	1	1,71	CHI
20200128667	ALEXANIA	AX21144175	ALEXANIA	05/01/2020 19:39	06/01/2020 14:40	05/01/2020 19:39	06/01/2020 14:40	19,01	1	19,01	CHI
20200128670	PORTEIRAO	CL21301099	RIO DOS BOIS	05/01/2020 19:39	05/01/2020 22:54	05/01/2020 19:39	05/01/2020 22:54	3,24	1	3,24	CHI
20200128679	SANTA HELENA DE GOIAS	SH32160716	IPEGUARI	05/01/2020 16:06	05/01/2020 23:41	05/01/2020 16:06	05/01/2020 23:41	7,57	4	30,29	CHI
20200128683	GOIAS	GS12162479	GOIAS	05/01/2020 18:52	06/01/2020 14:32	05/01/2020 18:52	06/01/2020 14:32	19,66	3	58,99	CHI
20200128691	RIO VERDE	630284696	RIO VERDE S1	05/01/2020 19:44	06/01/2020 09:51	05/01/2020 19:44	06/01/2020 09:51	14,11	1	14,11	CHI
20200128697	SANTA HELENA DE GOIAS	SH12271563	IPEGUARI	05/01/2020 19:36	05/01/2020 22:11	05/01/2020 19:36	05/01/2020 22:11	2,58	28	72,12	CHI
20200128697	TURVELANDIA	SH12271563	IPEGUARI	05/01/2020 19:36	05/01/2020 22:11	05/01/2020 19:36	05/01/2020 22:11	2,58	12	30,91	CHI
20200128698	GOIAS	GS12073702	MATRINCHA	05/01/2020 15:10	06/01/2020 08:36	05/01/2020 15:10	06/01/2020 08:36	17,42	2	34,85	CHI
20200128700	VICENTINOPOLIS	VI12218225	VICENTINOPOLIS	05/01/2020 19:47	06/01/2020 17:35	05/01/2020 19:47	06/01/2020 17:35	21,80	2	43,59	CHI
20200128705	QUIRINOPOLIS	QI21230973	QUIRINOPOLIS	05/01/2020 19:48	06/01/2020 08:03	05/01/2020 19:48	06/01/2020 08:03	12,24	1	12,24	CHI
20200128707	CORUMBA DE GOIAS	ZN21251869	COCALZINHO	05/01/2020 19:49	06/01/2020 08:52	05/01/2020 19:49	06/01/2020 08:52	13,05	1	13,05	CHI
20200128708	PIRACANJUBA	PJ21182629	PIRACANJUBA	05/01/2020 19:49	06/01/2020 08:27	05/01/2020 19:49	06/01/2020 08:27	12,63	2	25,26	CHI
20200128714	CAMPINORTE	03260224	CAMPINORTE	05/01/2020 19:51	06/01/2020 11:20	05/01/2020 19:51	05/01/2020 20:42	0,85	1456	1231,13	CHI
20200128714	CAMPINORTE	03260224	CAMPINORTE	05/01/2020 19:51	06/01/2020 11:20	05/01/2020 19:51	05/01/2020 20:42	0,85	2214	1872,06	CHI

20200128714	NOVA IGUACU DE GOIAS	03260224	CAMPINORTE	05/01/2020 19:51	06/01/2020 11:20	05/01/2020 19:51	05/01/2020 20:42	0,85	116	98,08	CHI
20200128714	URUACU	03260224	CAMPINORTE	05/01/2020 19:51	06/01/2020 11:20	05/01/2020 19:51	05/01/2020 20:42	0,85	102	86,25	CHI
20200128714	CAMPINORTE	03260224	CAMPINORTE	05/01/2020 19:51	06/01/2020 11:20	05/01/2020 19:51	05/01/2020 20:48	0,95	48	45,48	CHI
20200128714	URUACU	03260224	CAMPINORTE	05/01/2020 19:51	06/01/2020 11:20	05/01/2020 19:51	05/01/2020 20:48	0,95	430	407,42	CHI
20200128714	CAMPINORTE	03260224	CAMPINORTE	05/01/2020 19:51	06/01/2020 11:20	05/01/2020 19:51	05/01/2020 21:54	2,06	605	1245,46	CHI
20200128714	CAMPINORTE	03260224	CAMPINORTE	05/01/2020 19:51	06/01/2020 11:20	05/01/2020 19:51	06/01/2020 11:20	15,48	294	4551,20	CHI
20200128714	NOVA IGUACU DE GOIAS	03260224	CAMPINORTE	05/01/2020 19:51	06/01/2020 11:20	05/01/2020 19:51	06/01/2020 11:20	15,48	21	325,09	CHI
20200128715	FAINA	IK12300247	ITAPURANGA	05/01/2020 17:07	05/01/2020 22:36	05/01/2020 17:07	05/01/2020 22:36	5,47	24	131,31	CHI
20200128715	ITAPURANGA	IK12300247	ITAPURANGA	05/01/2020 17:07	05/01/2020 22:36	05/01/2020 17:07	05/01/2020 22:36	5,47	7	38,30	CHI
20200128725	BALIZA	BH21355350	BOM JARDIM	05/01/2020 19:55	06/01/2020 10:37	05/01/2020 19:55	06/01/2020 10:37	14,69	1	14,69	CHI
20200128729	MINACU	IH12220680	MINACU	05/01/2020 18:02	06/01/2020 05:33	05/01/2020 18:02	06/01/2020 05:33	11,50	13	149,55	CHI
20200128732	PALMEIRAS DE GOIAS	PP21168184	PALMEIRAS	05/01/2020 19:56	05/01/2020 22:08	05/01/2020 19:56	05/01/2020 22:08	2,19	1	2,19	CHI
20200128734	ITABERAI	50026422	ITABERAI S2	05/01/2020 19:57	06/01/2020 16:19	05/01/2020 19:57	06/01/2020 16:19	20,37	1	20,37	CHI
20200128735	PIRENOPOLIS	PV21096782	ANAPOLIS UNIVERSITARIO S2	05/01/2020 19:57	05/01/2020 21:21	05/01/2020 19:57	05/01/2020 21:21	1,39	1	1,39	CHI
20200128741	ALEXANIA	480018110	ALEXANIA	05/01/2020 19:58	06/01/2020 13:39	05/01/2020 19:58	06/01/2020 13:39	17,67	1	17,67	CHI
20200128745	CATALAO	1990060307	CATALAO S2	05/01/2020 19:59	06/01/2020 01:40	05/01/2020 19:59	06/01/2020 01:40	5,67	1	5,67	CHI
20200128752	JATAI	JT21000191	JATAI S2	05/01/2020 20:01	06/01/2020 08:26	05/01/2020 20:01	06/01/2020 08:26	12,40	1	12,40	CHI
20200128756	PALMEIRAS DE GOIAS	PL21089279	PALMEIRAS	05/01/2020 20:02	05/01/2020 23:00	05/01/2020 20:02	05/01/2020 23:00	2,95	1	2,95	CHI
20200128762	HIDROLINA	HL21293461	URUACU	05/01/2020 20:05	06/01/2020 14:01	05/01/2020 20:05	06/01/2020 14:01	17,92	1	17,92	CHI
20200128767	JATAI	JT12260433	JATAI S1	05/01/2020 20:07	06/01/2020 10:46	05/01/2020 20:07	06/01/2020 10:46	14,65	1	14,65	CHI
20200128767	PEROLANDIA	JT12260433	JATAI S1	05/01/2020 20:07	06/01/2020 10:46	05/01/2020 20:07	06/01/2020 10:46	14,65	6	87,87	CHI
20200128785	TRINDADE	TR12234174	TRINDADE	05/01/2020 18:31	05/01/2020 21:37	05/01/2020 18:31	05/01/2020 21:37	3,10	156	483,34	CHI
20200128791	QUIRINOPOLIS	QI21116484	QUIRINOPOLIS	05/01/2020 20:15	06/01/2020 09:14	05/01/2020 20:15	06/01/2020 09:14	12,98	1	12,98	CHI
20200128793	ABADIANIA	AA21297769	ANAPOLIS UNIVERSITARIO S1	05/01/2020 20:16	06/01/2020 16:54	05/01/2020 20:16	06/01/2020 16:54	20,63	1	20,63	CHI
20200128798	CAIAPONIA	CP12119577	CAIAPONIA	05/01/2020 06:53	06/01/2020 01:26	05/01/2020 06:53	06/01/2020 01:26	18,54	66	1223,46	CHI
20200128798	DOVERLANDIA	CP12119577	CAIAPONIA	05/01/2020 06:53	06/01/2020 01:26	05/01/2020 06:53	06/01/2020 01:26	18,54	7	129,76	CHI
20200129027	COCALZINHO DE GOIAS	CB12089828	AGUAS LINDAS DE GOIAS S2	05/01/2020 20:20	05/01/2020 21:41	05/01/2020 20:20	05/01/2020 21:41	1,34	6	8,02	CHI
20200129036	GOIAS	90076606	GOIAS	05/01/2020 20:24	06/01/2020 18:02	05/01/2020 20:24	06/01/2020 18:02	21,63	1	21,63	CHI
20200129037	MONTIVIDIU	MV12267720	MONTIVIDIU T	05/01/2020 09:38	05/01/2020 23:40	05/01/2020 09:38	05/01/2020 23:40	14,02	3	42,06	CHI
20200129038	FORMOSA	610127524	ITUIQUIRA	05/01/2020 20:25	05/01/2020 21:41	05/01/2020 20:25	05/01/2020 21:41	1,27	1	1,27	CHI
20200129041	EDEIA	EA12086939	EDEIA	05/01/2020 18:17	05/01/2020 22:00	05/01/2020 18:17	05/01/2020 22:00	3,70	9	33,33	CHI
20200129044	IPAMERI	IP21041048	IPAMERI	05/01/2020 20:26	05/01/2020 22:30	05/01/2020 20:26	05/01/2020 22:30	2,07	1	2,07	CHI
20200129045	ITAPURANGA	IK12274575	ITAPURANGA	05/01/2020 20:26	06/01/2020 12:04	05/01/2020 20:26	06/01/2020 12:04	15,63	1	15,63	CHI

20200129046	ANICUNS	AC21278671	FIRMINOPOLIS S2	05/01/2020 20:27	05/01/2020 22:53	05/01/2020 20:27	05/01/2020 22:53	2,43	1	2,43	CHI
20200129048	POSSE	PS12318325	IACIARA S2	05/01/2020 20:27	05/01/2020 21:12	05/01/2020 20:27	05/01/2020 21:12	0,75	2	1,49	CHI
20200129052	PLANALTINA	2960115643	PLANALTINA	05/01/2020 20:27	05/01/2020 22:12	05/01/2020 20:27	05/01/2020 22:12	1,73	1	1,73	CHI
20200129060	SANTO ANTONIO DO DESCOBERTO	2210202596	AGUAS LINDAS DE GOIAS S2	05/01/2020 20:31	06/01/2020 01:29	05/01/2020 20:31	06/01/2020 01:29	4,96	1	4,96	CHI
20200129061	ANAPOLIS	20911361	JUNDIAI S2	05/01/2020 20:32	06/01/2020 02:58	05/01/2020 20:32	06/01/2020 02:58	6,43	1	6,43	CHI
20200129062	CORUMBAIBA	CI12363786	VILA CORUMBA	05/01/2020 20:32	06/01/2020 14:26	05/01/2020 20:32	06/01/2020 14:26	17,90	18	322,17	CHI
20200129064	PETROLINA DE GOIAS	PG21150848	PETROLINA	05/01/2020 17:27	06/01/2020 14:24	05/01/2020 17:27	06/01/2020 14:24	20,94	1	20,94	CHI
20200129068	ANAPOLIS	21059597	JUNDIAI S1	05/01/2020 20:36	06/01/2020 02:10	05/01/2020 20:36	06/01/2020 02:10	5,55	1	5,55	CHI
20200129069	ANAPOLIS	10023705335	JUNDIAI S2	05/01/2020 20:37	06/01/2020 07:02	05/01/2020 20:37	06/01/2020 07:02	10,41	1	10,41	CHI
20200129076	RUBIATABA	RB12003320	RUBIATABA	05/01/2020 18:29	06/01/2020 04:17	05/01/2020 18:29	06/01/2020 04:17	9,79	88	861,69	CHI
20200129101	CABECEIRAS	CW12181812	ITUIQUIRA	05/01/2020 20:55	05/01/2020 21:05	05/01/2020 20:55	05/01/2020 21:05	0,18	2	0,35	CHI
20200129104	ANAPOLIS	20538807	ANAPOLIS UNIVERSITARIO S2	05/01/2020 20:55	06/01/2020 12:36	05/01/2020 20:55	06/01/2020 12:36	15,67	1	15,67	CHI
20200129109	ITUMBIARA	130009088	CACHOEIRA DOURADA	05/01/2020 20:58	06/01/2020 11:39	05/01/2020 20:58	06/01/2020 11:39	14,69	1	14,69	CHI
20200129112	CEZARINA	CZ21138563	CEZARINA	05/01/2020 21:00	06/01/2020 07:39	05/01/2020 21:00	06/01/2020 07:39	10,64	2	21,29	CHI
20200129114	CRISTALINA	KR21000013	CRISTALINA S2	05/01/2020 21:03	06/01/2020 00:11	05/01/2020 21:03	06/01/2020 00:11	3,12	1	3,12	CHI
20200129116	FAZENDA NOVA	FN12013300	FIRMINOPOLIS S2	05/01/2020 21:06	06/01/2020 12:34	05/01/2020 21:06	06/01/2020 12:34	15,46	8	123,66	CHI
20200129121	BALIZA	BH12187387LD	BOM JARDIM	05/01/2020 18:50	05/01/2020 22:20	05/01/2020 18:50	05/01/2020 22:20	3,49	689	2405,95	CHI
20200129124	ANAPOLIS	AN21050441	ANAPOLIS UNIVERSITARIO S2	05/01/2020 21:13	05/01/2020 23:14	05/01/2020 21:13	05/01/2020 23:14	2,02	2	4,03	CHI
20200129126	BALIZA	BH21135456	BOM JARDIM	05/01/2020 21:15	05/01/2020 22:26	05/01/2020 21:15	05/01/2020 22:26	1,18	1	1,18	CHI
20200129128	SANTO ANTONIO DO DESCOBERTO	10014709188	ALEXANIA	05/01/2020 21:16	06/01/2020 07:19	05/01/2020 21:16	06/01/2020 07:19	10,06	1	10,06	CHI
20200129129	ANAPOLIS	10018354279	JUNDIAI S2	05/01/2020 21:16	06/01/2020 11:18	05/01/2020 21:16	06/01/2020 11:18	14,03	1	14,03	CHI
20200129131	VALPARAISO DE GOIAS	10000625378	PACAEMBU S1	05/01/2020 21:17	05/01/2020 22:47	05/01/2020 21:17	05/01/2020 22:47	1,50	1	1,50	CHI
20200129158	AGUAS LINDAS DE GOIAS	10003383600	AGUAS LINDAS DE GOIAS S1	05/01/2020 21:34	06/01/2020 18:16	05/01/2020 21:34	06/01/2020 18:16	20,70	1	20,70	CHI
20200129168	MARA ROSA	MQ12192427	MARA ROSA	05/01/2020 21:41	06/01/2020 10:07	05/01/2020 21:41	06/01/2020 10:07	12,42	3	37,26	CHI
20200129182	IPAMERI	IP21026522	IPAMERI	05/01/2020 21:52	06/01/2020 11:04	05/01/2020 21:52	06/01/2020 11:04	13,20	1	13,20	CHI
20200129306	RIO VERDE	RV11326786	RIO VERDE S1	05/01/2020 22:11	06/01/2020 01:39	05/01/2020 22:11	06/01/2020 01:39	3,46	67	232,01	CHI
20200129308	GOIANESIA	550134475	GOIANESIA S2	05/01/2020 22:22	06/01/2020 22:25	05/01/2020 22:22	06/01/2020 22:25	24,05	1	24,05	CHI
20200129310	NOVA ROMA	SD12067690	IACIARA S2	05/01/2020 22:25	06/01/2020 09:30	05/01/2020 22:25	06/01/2020 09:30	11,08	1	11,08	CHI
20200129310	SAO DOMINGOS	SD12067690	IACIARA S2	05/01/2020 22:25	06/01/2020 09:30	05/01/2020 22:25	06/01/2020 09:30	11,08	2	22,16	CHI
20200129311	ANAPOLIS	AN21258225	ANAPOLIS UNIVERSITARIO S2	05/01/2020 22:26	06/01/2020 03:49	05/01/2020 22:26	06/01/2020 03:49	5,39	1	5,39	CHI
20200129312	EDEIA	EA12394167	EDEIA	05/01/2020 18:00	06/01/2020 12:32	05/01/2020 18:00	06/01/2020 12:32	18,52	6	111,15	CHI
20200129326	URUTAI	UT21190492	URUTAI	05/01/2020 22:31	06/01/2020 07:03	05/01/2020 22:31	06/01/2020 07:03	8,53	2	17,06	CHI
20200129342	AGUAS LINDAS DE GOIAS	4830401309	AGUAS LINDAS DE GOIAS S2	05/01/2020 22:39	05/01/2020 23:30	05/01/2020 22:39	05/01/2020 23:30	0,84	1	0,84	CHI



20200129346	ANICUNS	AC12000051	ANICUNS	05/01/2020 22:44	06/01/2020 03:45	05/01/2020 22:44	06/01/2020 03:45	5,01	50	250,44	CHI
20200129346	AVELINOPOLIS	AC12000051	ANICUNS	05/01/2020 22:44	06/01/2020 03:45	05/01/2020 22:44	06/01/2020 03:45	5,01	1	5,01	CHI
20200129348	GOIAS	GS12061617	ITABERAI S1	05/01/2020 20:18	06/01/2020 08:48	05/01/2020 20:18	06/01/2020 08:48	12,48	10	124,84	CHI
20200129349	SAO LUIZ DO NORTE	3090009806	ITAPACI	05/01/2020 22:48	06/01/2020 08:49	05/01/2020 22:48	06/01/2020 08:49	10,00	1	10,00	CHI
20200129355	FORMOSA	FA12062257	ITUIQUIRA	05/01/2020 22:55	05/01/2020 23:55	05/01/2020 22:55	05/01/2020 23:55	1,00	168	167,63	CHI
20200129364	CORUMBAIBA	IP12199861	IPAMERI	05/01/2020 20:31	06/01/2020 08:12	05/01/2020 20:31	06/01/2020 08:12	11,68	2	23,37	CHI
20200129364	IPAMERI	IP12199861	IPAMERI	05/01/2020 20:31	06/01/2020 08:12	05/01/2020 20:31	06/01/2020 08:12	11,68	2	23,37	CHI
20200129366	ABADIANIA	AA21200969	ANAPOLIS UNIVERSITARIO S1	05/01/2020 23:23	06/01/2020 14:23	05/01/2020 23:23	06/01/2020 14:23	14,99	1	14,99	CHI
20200129368	QUIRINOPOLIS	QI31191869	QUIRINOPOLIS	04/01/2020 22:01	06/01/2020 09:31	05/01/2020 23:17	06/01/2020 09:31	10,22	1	10,22	CHI
20200129369	RIO VERDE	630258016	RIO VERDE S2	05/01/2020 23:27	06/01/2020 09:48	05/01/2020 23:27	06/01/2020 09:48	10,35	1	10,35	CHI
20200129379	MONTIVIDIU	MV21104893	MONTIVIDIU T	05/01/2020 23:41	06/01/2020 12:37	05/01/2020 23:41	06/01/2020 12:37	12,93	1	12,93	CHI
20200129396	QUIRINOPOLIS	QI13000038	QUIRINOPOLIS	05/01/2020 15:19	06/01/2020 07:16	05/01/2020 15:19	06/01/2020 07:16	15,95	3	47,84	CHI
20200129401	GOIANIRA	10022930912	GOIANIRA	05/01/2020 17:05	05/01/2020 23:06	05/01/2020 17:05	05/01/2020 23:06	6,02	1	6,02	CHI
20200129804	MINACU	IH21220706	MINACU	04/01/2020 19:25	06/01/2020 13:58	04/01/2020 19:27	05/01/2020 23:48	28,36	1	28,36	CHI
20200129804	MINACU	IH21220706	MINACU	04/01/2020 19:25	06/01/2020 13:58	06/01/2020 12:20	06/01/2020 13:38	1,29	1	1,29	CHI
20200129804	MINACU	IH12236116	MINACU	04/01/2020 19:25	06/01/2020 13:58	04/01/2020 19:27	06/01/2020 13:58	42,52	2	85,04	CHI
20200129819	CRIXAS	05630224	MOZARLANDIA	06/01/2020 05:53	06/01/2020 12:51	06/01/2020 05:53	06/01/2020 08:13	2,34	3	7,02	CHI
20200129819	NOVA CRIXAS	05630224	MOZARLANDIA	06/01/2020 05:53	06/01/2020 12:51	06/01/2020 05:53	06/01/2020 08:13	2,34	119	278,26	CHI
20200129819	NOVA CRIXAS	05630224	NOVA CRIXAS	06/01/2020 05:53	06/01/2020 12:51	06/01/2020 05:53	06/01/2020 09:01	3,13	24	75,15	CHI
20200129819	CRIXAS	05630224	NOVA CRIXAS	06/01/2020 05:53	06/01/2020 12:51	06/01/2020 05:53	06/01/2020 12:51	6,97	3	20,92	CHI
20200129819	NOVA CRIXAS	05630224	NOVA CRIXAS	06/01/2020 05:53	06/01/2020 12:51	06/01/2020 05:53	06/01/2020 12:51	6,97	40	278,91	CHI
20200129869	SERRANOPOLIS	SX21156860	JATAI S1	06/01/2020 09:19	06/01/2020 12:09	06/01/2020 09:19	06/01/2020 12:09	2,82	1	2,82	CHI
20200129881	PLANALTINA	PI12100881LD	PLANALTINA	06/01/2020 09:34	06/01/2020 11:15	06/01/2020 09:34	06/01/2020 11:15	1,68	15	25,23	CHI
20200129889	MONTIVIDIU	MV21103170	MONTIVIDIU T	05/01/2020 16:51	06/01/2020 13:06	05/01/2020 16:51	06/01/2020 13:06	20,24	1	20,24	CHI
20200129898	ITABERAI	IB12029603	ITABERAI S2	06/01/2020 07:51	06/01/2020 12:17	06/01/2020 07:51	06/01/2020 12:17	4,42	1	4,42	CHI
20200129901	BALIZA	BH12356956	BOM JARDIM	06/01/2020 01:46	06/01/2020 11:58	06/01/2020 01:46	06/01/2020 11:58	10,19	2	20,39	CHI
20200129905	AGUAS LINDAS DE GOIAS	10006063681	AGUAS LINDAS DE GOIAS S1	06/01/2020 02:18	06/01/2020 11:50	06/01/2020 02:18	06/01/2020 11:50	9,52	1	9,52	CHI
20200129910	DOVERLANDIA	DV12235070	PARQUE DAS EMAS	06/01/2020 03:06	06/01/2020 09:43	06/01/2020 03:06	06/01/2020 09:43	6,63	5	33,14	CHI
20200129913	DOVERLANDIA	DV12123974	CAIAPONIA	06/01/2020 03:08	06/01/2020 08:59	06/01/2020 03:08	06/01/2020 08:59	5,84	12	70,09	CHI
20200129914	VILA PROPICIO	PV21119844	GOIANESIA S1	06/01/2020 03:15	06/01/2020 07:28	06/01/2020 03:15	06/01/2020 07:28	4,21	1	4,21	CHI
20200129915	GOIAS	IU12073717	MATRINCHA	06/01/2020 03:15	06/01/2020 07:27	06/01/2020 03:15	06/01/2020 07:27	4,19	21	88,01	CHI
20200129915	ITAPIRAPUA	IU12073717	MATRINCHA	06/01/2020 03:15	06/01/2020 07:27	06/01/2020 03:15	06/01/2020 07:27	4,19	26	108,96	CHI
20200129916	MORRINHOS	MR12263657	GOIATUBA S1	06/01/2020 03:16	06/01/2020 10:10	06/01/2020 03:16	06/01/2020 10:10	6,89	13	89,56	CHI

20200129921	VALPARAISO DE GOIAS	VA11170133	PACAEMBU S1	06/01/2020 03:26	06/01/2020 07:24	06/01/2020 03:26	06/01/2020 07:24	3,96	155	614,27	CHI
20200129924	JATAI	JT12191724	JATAI S2	06/01/2020 03:25	06/01/2020 07:32	06/01/2020 03:25	06/01/2020 07:32	4,12	118	486,32	CHI
20200129926	ARAGUAPAZ	AZ12042908	MOZARLANDIA	06/01/2020 03:41	06/01/2020 07:40	06/01/2020 03:41	06/01/2020 07:40	3,97	46	182,61	CHI
20200129928	GOIAS	GS12217234	MATRINCHA	06/01/2020 02:35	06/01/2020 10:37	06/01/2020 02:35	06/01/2020 10:37	8,02	84	673,98	CHI
20200129928	ITAPIRAPUA	GS12217234	MATRINCHA	06/01/2020 02:35	06/01/2020 10:37	06/01/2020 02:35	06/01/2020 10:37	8,02	1	8,02	CHI
20200129928	NOVO BRASIL	GS12217234	MATRINCHA	06/01/2020 02:35	06/01/2020 10:37	06/01/2020 02:35	06/01/2020 10:37	8,02	36	288,85	CHI
20200129932	FAZENDA NOVA	FN12054011	BRITANIA	06/01/2020 04:04	06/01/2020 10:50	06/01/2020 04:04	06/01/2020 10:50	6,77	6	40,60	CHI
20200129934	PORANGATU	PO12239639	MARA ROSA	06/01/2020 04:09	06/01/2020 09:28	06/01/2020 04:09	06/01/2020 09:28	5,31	31	164,54	CHI
20200129935	RIO VERDE	RV12123344	RIO VERDE S1	06/01/2020 04:13	08/01/2020 13:05	06/01/2020 04:13	08/01/2020 13:05	56,86	3	170,59	CHI
20200129943	MINEIROS	SU12184133	SANTA RITA DO ARAGUAIA	06/01/2020 04:38	06/01/2020 12:30	06/01/2020 04:38	06/01/2020 12:30	7,85	2	15,71	CHI
20200129946	AMORINOPOLIS	AM12000032	IPORA	06/01/2020 04:43	06/01/2020 11:52	06/01/2020 04:43	06/01/2020 11:52	7,14	6	42,85	CHI
20200129946	IVOLANDIA	AM12000032	IPORA	06/01/2020 04:43	06/01/2020 11:52	06/01/2020 04:43	06/01/2020 11:52	7,14	11	78,55	CHI
20200129948	AGUAS LINDAS DE GOIAS	LA12119081	AGUAS LINDAS DE GOIAS S1	06/01/2020 04:47	06/01/2020 07:55	06/01/2020 04:47	06/01/2020 07:55	3,13	654	2044,11	CHI
20200129954	ORIZONA	OZ12105272	PIRES DO RIO S2	06/01/2020 04:54	06/01/2020 07:50	06/01/2020 04:54	06/01/2020 07:50	2,94	32	94,06	CHI
20200129954	VIANOPOLIS	OZ12105272	PIRES DO RIO S2	06/01/2020 04:54	06/01/2020 07:50	06/01/2020 04:54	06/01/2020 07:50	2,94	4	11,76	CHI
20200129955	MOSSAMEDES	MD12024152	FIRMINOPOLIS S2	06/01/2020 03:07	06/01/2020 07:10	06/01/2020 03:07	06/01/2020 07:10	4,05	108	437,25	CHI
20200129955	SANCLERLANDIA	MD12024152	FIRMINOPOLIS S2	06/01/2020 03:07	06/01/2020 07:10	06/01/2020 03:07	06/01/2020 07:10	4,05	9	36,44	CHI
20200129958	IPAMERI	IP12337216	IPAMERI	06/01/2020 04:58	06/01/2020 09:36	06/01/2020 04:58	06/01/2020 09:36	4,63	4	18,51	CHI
20200129958	NOVA AURORA	IP12337216	IPAMERI	06/01/2020 04:58	06/01/2020 09:36	06/01/2020 04:58	06/01/2020 09:36	4,63	2	9,25	CHI
20200129962	PIRES DO RIO	PR12051693	PIRES DO RIO S2	06/01/2020 05:00	06/01/2020 08:29	06/01/2020 05:00	06/01/2020 08:29	3,48	13	45,21	CHI
20200129962	SANTA CRUZ DE GOIAS	PR12051693	PIRES DO RIO S2	06/01/2020 05:00	06/01/2020 08:29	06/01/2020 05:00	06/01/2020 08:29	3,48	2	6,96	CHI
20200129963	APORE	AE21214467	JATAI S1	06/01/2020 05:04	06/01/2020 10:57	06/01/2020 05:04	06/01/2020 10:57	5,88	1	5,88	CHI
20200129964	CAMPINORTE	MQ12051944	MARA ROSA	06/01/2020 05:04	06/01/2020 10:22	06/01/2020 05:04	06/01/2020 10:22	5,29	8	42,29	CHI
20200129964	MARA ROSA	MQ12051944	MARA ROSA	06/01/2020 05:04	06/01/2020 10:22	06/01/2020 05:04	06/01/2020 10:22	5,29	1	5,29	CHI
20200129966	CAMPINORTE	CR12202139	MARA ROSA	06/01/2020 04:43	06/01/2020 08:53	06/01/2020 04:43	06/01/2020 08:53	4,15	32	132,92	CHI
20200129966	URUACU	CR12202139	MARA ROSA	06/01/2020 04:43	06/01/2020 08:53	06/01/2020 04:43	06/01/2020 08:53	4,15	106	440,31	CHI
20200129967	CORREGO DO OURO	CO12080000	SAO LUIZ DOS MONTES BELOS	06/01/2020 05:06	06/01/2020 09:30	06/01/2020 05:06	06/01/2020 09:30	4,40	49	215,45	CHI
20200129967	MOIPORA	CO12080000	SAO LUIZ DOS MONTES BELOS	06/01/2020 05:06	06/01/2020 09:30	06/01/2020 05:06	06/01/2020 09:30	4,40	2	8,79	CHI
20200129972	IVOLANDIA	IV12062833	IPORA	06/01/2020 05:11	06/01/2020 11:42	06/01/2020 05:11	06/01/2020 11:42	6,50	19	123,55	CHI
20200129973	ORIZONA	OZ12113013	PIRES DO RIO S2	06/01/2020 04:16	06/01/2020 07:04	06/01/2020 04:16	06/01/2020 07:04	2,79	11	30,65	CHI
20200129975	AMORINOPOLIS	AM21000004	IPORA	06/01/2020 05:17	06/01/2020 12:02	06/01/2020 05:17	06/01/2020 12:02	6,75	1	6,75	CHI
20200129976	ANAPOLIS	AN12258960	ANAPOLIS UNIVERSITARIO S1	06/01/2020 05:17	06/01/2020 14:59	06/01/2020 05:17	06/01/2020 14:59	9,69	7	67,83	CHI
20200129979	CAIAPONIA	CP12207858	PALESTINA	06/01/2020 05:21	06/01/2020 10:45	06/01/2020 05:21	06/01/2020 10:45	5,39	18	97,09	CHI

20200129979	PALESTINA DE GOIAS	CP12207858	PALESTINA	06/01/2020 05:21	06/01/2020 10:45	06/01/2020 05:21	06/01/2020 10:45	5,39	1	5,39	CHI
20200129986	PARAUNA	PU21154409	PARAUNA	06/01/2020 05:36	06/01/2020 07:54	06/01/2020 05:36	06/01/2020 07:54	2,29	1	2,29	CHI
20200129987	AMERICANO DO BRASIL	KB12065192	ANICUNS	06/01/2020 05:36	06/01/2020 07:22	06/01/2020 05:36	06/01/2020 07:22	1,75	11	19,28	CHI
20200129993	FAINA	IK12300247	ITAPURANGA	06/01/2020 05:05	09/01/2020 09:31	06/01/2020 05:05	07/01/2020 00:25	19,34	1	19,34	CHI
20200129993	ITAPURANGA	IK12300247	ITAPURANGA	06/01/2020 05:05	09/01/2020 09:31	06/01/2020 05:05	07/01/2020 00:25	19,34	7	135,40	CHI
20200129993	FAINA	IK12300247	ITAPURANGA	06/01/2020 05:05	09/01/2020 09:31	06/01/2020 05:05	09/01/2020 09:31	76,44	23	1758,10	CHI
20200129993	FAINA	IK12300247	ITAPURANGA	06/01/2020 05:05	09/01/2020 09:31	09/01/2020 07:57	09/01/2020 09:31	1,56	1	1,56	CHI
20200129993	ITAPURANGA	IK12300247	ITAPURANGA	06/01/2020 05:05	09/01/2020 09:31	09/01/2020 07:57	09/01/2020 09:31	1,56	7	10,94	CHI
20200129994	GOIAS	GS12124232	GOIAS	06/01/2020 05:42	06/01/2020 10:04	06/01/2020 05:42	06/01/2020 10:04	4,36	10	43,61	CHI
20200129996	PIRES DO RIO	PR12075960	PIRES DO RIO S1	06/01/2020 05:44	06/01/2020 20:11	06/01/2020 05:44	06/01/2020 20:11	14,45	5	72,24	CHI
20200129997	CALDAS NOVAS	CN12110097	SERRA DE CALDAS	06/01/2020 05:44	06/01/2020 10:27	06/01/2020 05:44	06/01/2020 10:27	4,71	5	23,56	CHI
20200129998	SANTA HELENA DE GOIAS	SH12271563	IPEGUARI	05/01/2020 22:56	06/01/2020 10:15	05/01/2020 22:56	06/01/2020 10:15	11,31	28	316,72	CHI
20200129998	TURVELANDIA	SH12271563	IPEGUARI	05/01/2020 22:56	06/01/2020 10:15	05/01/2020 22:56	06/01/2020 10:15	11,31	12	135,74	CHI
20200130000	TURVANIA	TV12289727	FIRMINOPOLIS S2	06/01/2020 05:46	06/01/2020 08:12	06/01/2020 05:46	06/01/2020 08:12	2,44	3	7,32	CHI
20200130001	CAIAPONIA	DV12332038	CAIAPONIA	06/01/2020 05:47	06/01/2020 10:01	06/01/2020 05:47	06/01/2020 10:01	4,24	22	93,31	CHI
20200130001	DOVERLANDIA	DV12332038	CAIAPONIA	06/01/2020 05:47	06/01/2020 10:01	06/01/2020 05:47	06/01/2020 10:01	4,24	28	118,76	CHI
20200130002	SAO FRANCISCO DE GOIAS	SF21245354	SAO FRANCISCO DE GOIAS	06/01/2020 05:47	06/01/2020 18:42	06/01/2020 05:47	06/01/2020 18:42	12,91	1	12,91	CHI
20200130004	ARUANA	AK12404527	MOZARLANDIA	06/01/2020 05:48	06/01/2020 07:34	06/01/2020 05:48	06/01/2020 07:34	1,75	34	59,56	CHI
20200130005	CACU	CA12196122	CACHOEIRA ALTA	06/01/2020 05:48	06/01/2020 12:16	06/01/2020 05:48	06/01/2020 12:16	6,45	39	251,59	CHI
20200130007	PORTELANDIA	PW12302000	PARQUE DAS EMAS	06/01/2020 05:49	08/01/2020 17:21	06/01/2020 05:49	08/01/2020 17:21	59,53	3	178,60	CHI
20200130009	DOVERLANDIA	DV12380977	CAIAPONIA	06/01/2020 05:49	06/01/2020 14:34	06/01/2020 05:49	06/01/2020 14:07	8,31	68	564,74	CHI
20200130009	DOVERLANDIA	DV12221004LD	CAIAPONIA	06/01/2020 05:49	06/01/2020 14:34	06/01/2020 05:49	06/01/2020 14:34	8,76	25	219,04	CHI
20200130011	ANICUNS	AC12228150LD	ANICUNS	06/01/2020 05:50	06/01/2020 06:56	06/01/2020 05:50	06/01/2020 06:56	1,10	109	119,39	CHI
20200130011	AVELINOPOLIS	AC12228150LD	ANICUNS	06/01/2020 05:50	06/01/2020 06:56	06/01/2020 05:50	06/01/2020 06:56	1,10	1	1,10	CHI
20200130012	FORMOSA	FB21242938	FLORES DE GOIAS	06/01/2020 05:50	06/01/2020 07:34	06/01/2020 05:50	06/01/2020 07:34	1,72	1	1,72	CHI
20200130013	BOM JESUS DE GOIAS	BJ12030804	RIO DOS BOIS	06/01/2020 05:51	06/01/2020 08:36	06/01/2020 05:51	06/01/2020 08:36	2,75	4	10,98	CHI
20200130013	GOIATUBA	BJ12030804	RIO DOS BOIS	06/01/2020 05:51	06/01/2020 08:36	06/01/2020 05:51	06/01/2020 08:36	2,75	1	2,75	CHI
20200130015	PORTELANDIA	PW12303462	PARQUE DAS EMAS	06/01/2020 05:51	08/01/2020 23:55	06/01/2020 05:51	07/01/2020 10:32	28,67	3	86,02	CHI
20200130015	PORTELANDIA	PW12303462	PARQUE DAS EMAS	06/01/2020 05:51	08/01/2020 23:55	07/01/2020 10:33	07/01/2020 23:40	13,10	1	13,10	CHI
20200130015	PORTELANDIA	PW12303462	PARQUE DAS EMAS	06/01/2020 05:51	08/01/2020 23:55	07/01/2020 10:33	08/01/2020 12:26	25,87	1	25,87	CHI
20200130015	PORTELANDIA	PW12303462	PARQUE DAS EMAS	06/01/2020 05:51	08/01/2020 23:55	07/01/2020 10:33	08/01/2020 15:12	28,64	1	28,64	CHI
20200130015	PORTELANDIA	PW21318133	PARQUE DAS EMAS	06/01/2020 05:51	08/01/2020 23:55	08/01/2020 11:16	08/01/2020 15:17	4,01	1	4,01	CHI
20200130015	PORTELANDIA	PW12303420	PARQUE DAS EMAS	06/01/2020 05:51	08/01/2020 23:55	08/01/2020 17:29	08/01/2020 22:20	4,85	14	67,90	CHI

20200130015	PORTELANDIA	PW12303462	PARQUE DAS EMAS	06/01/2020 05:51	08/01/2020 23:55	08/01/2020 12:27	08/01/2020 22:20	9,88	1	9,88	CHI
20200130015	PORTELANDIA	PW12303462	PARQUE DAS EMAS	06/01/2020 05:51	08/01/2020 23:55	06/01/2020 05:51	08/01/2020 23:55	66,07	7	462,50	CHI
20200130019	CROMINIA	CQ12033164	PONTALINA	06/01/2020 05:54	06/01/2020 11:11	06/01/2020 05:54	06/01/2020 11:11	5,29	10	52,88	CHI
20200130023	MAIRIPOTABA	MI12051347	PONTALINA	06/01/2020 05:54	06/01/2020 09:28	06/01/2020 05:54	06/01/2020 09:28	3,55	7	24,86	CHI
20200130023	PONTALINA	MI12051347	PONTALINA	06/01/2020 05:54	06/01/2020 09:28	06/01/2020 05:54	06/01/2020 09:28	3,55	3	10,65	CHI
20200130028	BARRO ALTO	BA12035658	BARRO ALTO	06/01/2020 04:53	06/01/2020 12:03	06/01/2020 04:53	06/01/2020 12:03	7,15	4	28,60	CHI
20200130028	NIQUELANDIA	BA12035658	BARRO ALTO	06/01/2020 04:53	06/01/2020 12:03	06/01/2020 04:53	06/01/2020 12:03	7,15	2	14,30	CHI
20200130032	IPAMERI	UT12016932RE	URUTAI	06/01/2020 05:57	06/01/2020 09:58	06/01/2020 05:57	06/01/2020 09:58	4,01	3	12,04	CHI
20200130032	URUTAI	UT12016932RE	URUTAI	06/01/2020 05:57	06/01/2020 09:58	06/01/2020 05:57	06/01/2020 09:58	4,01	5	20,06	CHI
20200130038	PIRANHAS	PH12343726	PIRANHAS	06/01/2020 05:59	06/01/2020 11:45	06/01/2020 05:59	06/01/2020 11:45	5,76	4	23,03	CHI
20200130039	IPORA	IR12069053	IPORA	06/01/2020 05:59	06/01/2020 13:11	06/01/2020 05:59	06/01/2020 13:11	7,19	14	100,63	CHI
20200130043	AGUA FRIA DE GOIAS	MJ12305238	PADRE BERNARDO	06/01/2020 06:00	06/01/2020 07:41	06/01/2020 06:00	06/01/2020 07:41	1,68	2	3,35	CHI
20200130043	MIMOSO DE GOIAS	MJ12305238	PADRE BERNARDO	06/01/2020 06:00	06/01/2020 07:41	06/01/2020 06:00	06/01/2020 07:41	1,68	3	5,03	CHI
20200130051	JARAGUA	JA12297448	JARAGUA	06/01/2020 06:02	06/01/2020 09:58	06/01/2020 06:02	06/01/2020 09:58	3,93	158	621,03	CHI
20200130051	PIRENOPOLIS	JA12297448	JARAGUA	06/01/2020 06:02	06/01/2020 09:58	06/01/2020 06:02	06/01/2020 09:58	3,93	47	184,74	CHI
20200130052	MORRINHOS	MR12223453	GOIATUBA S1	06/01/2020 05:58	06/01/2020 08:10	06/01/2020 05:58	06/01/2020 08:10	2,19	35	76,82	CHI
20200130054	DOVERLANDIA	DV21207891	CAIAPONIA	06/01/2020 06:03	06/01/2020 14:32	06/01/2020 06:03	06/01/2020 14:32	8,48	1	8,48	CHI
20200130055	BELA VISTA DE GOIAS	CF12300739	CRISTIANOPOLIS	06/01/2020 06:03	06/01/2020 09:09	06/01/2020 06:03	06/01/2020 09:09	3,10	40	123,93	CHI
20200130055	CRISTIANOPOLIS	CF12300739	CRISTIANOPOLIS	06/01/2020 06:03	06/01/2020 09:09	06/01/2020 06:03	06/01/2020 09:09	3,10	25	77,46	CHI
20200130055	SAO MIGUEL DO PASSA QUATRO	CF12300739	CRISTIANOPOLIS	06/01/2020 06:03	06/01/2020 09:09	06/01/2020 06:03	06/01/2020 09:09	3,10	5	15,49	CHI
20200130057	DOVERLANDIA	DV12204324	CAIAPONIA	06/01/2020 06:03	06/01/2020 10:03	06/01/2020 06:03	06/01/2020 10:03	3,99	11	43,94	CHI
20200130059	FIRMINOPOLIS	FR12096977	FIRMINOPOLIS S1	06/01/2020 03:57	06/01/2020 07:20	06/01/2020 03:57	06/01/2020 07:20	3,38	80	270,33	CHI
20200130062	IPAMERI	IP12404721	IPAMERI	06/01/2020 06:06	06/01/2020 10:24	06/01/2020 06:06	06/01/2020 10:24	4,29	4	17,16	CHI
20200130065	BOM JARDIM DE GOIAS	BM12190379	BOM JARDIM	06/01/2020 06:07	06/01/2020 10:16	06/01/2020 06:07	06/01/2020 10:16	4,14	3	12,41	CHI
20200130066	ITAJA	IJ12202625	ITAJA S2	06/01/2020 06:07	10/01/2020 01:01	06/01/2020 06:07	07/01/2020 11:01	28,89	5	144,45	CHI
20200130066	ITAJA	IJ12202625	ITAJA S2	06/01/2020 06:07	10/01/2020 01:01	06/01/2020 06:07	07/01/2020 14:26	32,32	8	258,53	CHI
20200130066	ITAJA	IJ12202625	ITAJA S2	06/01/2020 06:07	10/01/2020 01:01	06/01/2020 06:07	07/01/2020 16:03	33,93	10	339,26	CHI
20200130066	ITAJA	IJ12202625	ITAJA S2	06/01/2020 06:07	10/01/2020 01:01	06/01/2020 06:07	08/01/2020 12:11	54,06	1	54,06	CHI
20200130066	ITAJA	IJ12202625	ITAJA S2	06/01/2020 06:07	10/01/2020 01:01	08/01/2020 12:21	08/01/2020 18:46	6,42	24	154,10	CHI
20200130066	APORE	IJ12202625	ITAJA S2	06/01/2020 06:07	10/01/2020 01:01	06/01/2020 06:07	10/01/2020 01:01	90,90	4	363,60	CHI
20200130070	BONOPOLIS	BX21123196	SAO MIGUEL DO ARAGUAIA	06/01/2020 06:09	06/01/2020 07:01	06/01/2020 06:09	06/01/2020 07:01	0,86	1	0,86	CHI
20200130077	BONFINOPOLIS	TA12247490	NOVO PLANALTO	06/01/2020 06:11	06/01/2020 08:44	06/01/2020 06:11	06/01/2020 08:44	2,54	1	2,54	CHI
20200130077	BONOPOLIS	TA12247490	NOVO PLANALTO	06/01/2020 06:11	06/01/2020 08:44	06/01/2020 06:11	06/01/2020 08:44	2,54	11	27,96	CHI

20200130077	PORANGATU	TA12247490	NOVO PLANALTO	06/01/2020 06:11	06/01/2020 08:44	06/01/2020 06:11	06/01/2020 08:44	2,54	2	5,08	CHI
20200130080	ORIZONA	OZ12114502	PIRES DO RIO S2	06/01/2020 04:57	06/01/2020 07:34	06/01/2020 04:57	06/01/2020 07:34	2,60	15	39,02	CHI
20200130083	NOVA CRIXAS	NA12334349	NOVA CRIXAS	06/01/2020 06:13	06/01/2020 09:32	06/01/2020 06:13	06/01/2020 09:32	3,31	86	285,02	CHI
20200130085	BALIZA	BH12380942	BOM JARDIM	06/01/2020 06:13	06/01/2020 06:48	06/01/2020 06:13	06/01/2020 06:48	0,58	7	4,06	CHI
20200130087	GOUVELANDIA	QI12295738	QUIRINOPOLIS	06/01/2020 06:13	06/01/2020 09:20	06/01/2020 06:13	06/01/2020 09:20	3,11	2	6,21	CHI
20200130088	CAMPOS VERDES	VD12181194	SANTA TEREZINHA	06/01/2020 06:14	06/01/2020 09:00	06/01/2020 06:14	06/01/2020 09:00	2,77	14	38,79	CHI
20200130090	MOSSAMEDES	MD21204374	FIRMINOPOLIS S2	06/01/2020 06:14	06/01/2020 07:29	06/01/2020 06:14	06/01/2020 07:29	1,24	1	1,24	CHI
20200130091	ALTO HORIZONTE	AJ12202017	SANTA TEREZINHA	06/01/2020 06:14	06/01/2020 13:36	06/01/2020 06:14	06/01/2020 13:36	7,36	11	80,94	CHI
20200130093	CACU	CC12384080	CACHOEIRA ALTA	06/01/2020 06:15	06/01/2020 10:19	06/01/2020 06:15	06/01/2020 10:19	4,06	4	16,23	CHI
20200130093	ITARUMA	CC12384080	CACHOEIRA ALTA	06/01/2020 06:15	06/01/2020 10:19	06/01/2020 06:15	06/01/2020 10:19	4,06	2	8,11	CHI
20200130094	FORMOSA	FA12245453	ITIQUEIRA	06/01/2020 06:16	06/01/2020 11:24	06/01/2020 06:16	06/01/2020 11:24	5,13	3	15,39	CHI
20200130098	ACREUNA	EU12030223	ACREUNA	06/01/2020 06:18	06/01/2020 08:47	06/01/2020 06:18	06/01/2020 08:47	2,48	3	7,44	CHI
20200130103	MORRINHOS	MR12000194	MORRINHOS	06/01/2020 06:19	06/01/2020 10:53	06/01/2020 06:19	06/01/2020 10:53	4,57	36	164,43	CHI
20200130108	SANTO ANTONIO DO DESCOBERTO	SN12330527	MARAJOARA	06/01/2020 06:20	06/01/2020 18:41	06/01/2020 06:20	06/01/2020 18:41	12,33	13	160,34	CHI
20200130110	FORMOSA	FA12085474	ITIQUEIRA	06/01/2020 06:21	06/01/2020 07:42	06/01/2020 06:21	06/01/2020 07:42	1,34	27	36,17	CHI
20200130117	PORANGATU	PO12020580	PORANGATU	06/01/2020 04:21	06/01/2020 09:19	06/01/2020 04:21	06/01/2020 09:19	4,96	67	332,49	CHI
20200130121	JATAI	JT21306510	JATAI S1	06/01/2020 06:26	06/01/2020 11:57	06/01/2020 06:26	06/01/2020 11:57	5,50	1	5,50	CHI
20200130123	ARAGARCAS	AG12188251	ARAGARCAS	06/01/2020 02:12	06/01/2020 09:16	06/01/2020 02:12	06/01/2020 09:16	7,05	55	387,84	CHI
20200130126	SERRANOPOLIS	SX12296514	JATAI S1	06/01/2020 06:10	06/01/2020 09:21	06/01/2020 06:10	06/01/2020 09:21	3,19	23	73,31	CHI
20200130128	ESTRELA DO NORTE	ET21037048	MARA ROSA	06/01/2020 06:28	06/01/2020 14:41	06/01/2020 06:28	06/01/2020 14:41	8,21	1	8,21	CHI
20200130129	ITUMBIARA	690340825	PARANAIBA	06/01/2020 06:28	06/01/2020 08:31	06/01/2020 06:28	06/01/2020 08:31	2,05	1	2,05	CHI
20200130130	MORRINHOS	MR12212264RE	GOIATUBA S1	06/01/2020 06:28	06/01/2020 10:15	06/01/2020 06:28	06/01/2020 10:15	3,78	59	222,95	CHI
20200130132	RIO VERDE	RV21131629	CABRIUVA S1	06/01/2020 06:29	06/01/2020 11:15	06/01/2020 06:29	06/01/2020 11:15	4,77	1	4,77	CHI
20200130133	MORRINHOS	MR12000350	GOIATUBA S1	06/01/2020 06:29	06/01/2020 09:07	06/01/2020 06:29	06/01/2020 09:07	2,63	3	7,90	CHI
20200130134	CAMPOS VERDES	VD21017239	SANTA TEREZINHA	06/01/2020 06:29	06/01/2020 08:05	06/01/2020 06:29	06/01/2020 08:05	1,61	1	1,61	CHI
20200130135	FORMOSO	ET12143681	MARA ROSA	06/01/2020 04:40	06/01/2020 11:15	06/01/2020 04:40	06/01/2020 11:15	6,58	13	85,50	CHI
20200130136	ITAPURANGA	IK12310785	ITAPURANGA	06/01/2020 06:29	06/01/2020 15:29	06/01/2020 06:29	06/01/2020 15:29	8,99	21	188,76	CHI
20200130137	GOIAS	90006367	GOIAS	06/01/2020 06:29	06/01/2020 17:10	06/01/2020 06:29	06/01/2020 17:10	10,67	1	10,67	CHI
20200130145	ACREUNA	SH12301267	ACREUNA	06/01/2020 06:31	06/01/2020 10:08	06/01/2020 06:31	06/01/2020 10:08	3,60	5	18,02	CHI
20200130145	SANTA HELENA DE GOIAS	SH12301267	ACREUNA	06/01/2020 06:31	06/01/2020 10:08	06/01/2020 06:31	06/01/2020 10:08	3,60	1	3,60	CHI
20200130145	SANTO ANTONIO DA BARRA	SH12301267	ACREUNA	06/01/2020 06:31	06/01/2020 10:08	06/01/2020 06:31	06/01/2020 10:08	3,60	16	57,68	CHI
20200130147	CACHOEIRA DOURADA	CD12000044	CACHOEIRA DOURADA	06/01/2020 06:32	06/01/2020 08:00	06/01/2020 06:32	06/01/2020 08:00	1,46	11	16,04	CHI
20200130157	IPAMERI	10006712990	IPAMERI	06/01/2020 06:34	06/01/2020 10:07	06/01/2020 06:34	06/01/2020 10:07	3,55	1	3,55	CHI

20200130160	GOIANESIA	GE12357342	GOIANESIA S2	06/01/2020 06:35	06/01/2020 20:13	06/01/2020 06:35	06/01/2020 20:13	13,62	18	245,20	CHI
20200130160	VILA PROPICIO	GE12357342	GOIANESIA S2	06/01/2020 06:35	06/01/2020 20:13	06/01/2020 06:35	06/01/2020 20:13	13,62	9	122,60	CHI
20200130164	MORRO AGUDO DE GOIAS	MS12136795	ITAPURANGA	06/01/2020 06:36	06/01/2020 10:10	06/01/2020 06:36	06/01/2020 10:10	3,56	35	124,61	CHI
20200130171	BURITI ALEGRE	BG12046640	ITUMBIARA VELHA S2	06/01/2020 06:38	06/01/2020 08:33	06/01/2020 06:38	06/01/2020 08:33	1,91	3	5,74	CHI
20200130175	JATAI	290240803	JATAI S3	06/01/2020 06:38	06/01/2020 08:58	06/01/2020 06:38	06/01/2020 08:58	2,33	1	2,33	CHI
20200130176	VALPARAISO DE GOIAS	VA12247720	MARAJOARA	06/01/2020 06:38	06/01/2020 07:56	06/01/2020 06:38	06/01/2020 07:56	1,29	219	282,81	CHI
20200130177	PALMEIRAS DE GOIAS	PL12380964	ANICUNS	06/01/2020 06:38	06/01/2020 07:38	06/01/2020 06:38	06/01/2020 07:38	1,00	6	6,03	CHI
20200130180	ITARUMA	IM12087819	CACHOEIRA ALTA	06/01/2020 06:37	07/01/2020 11:19	06/01/2020 06:37	06/01/2020 14:00	7,37	6	44,22	CHI
20200130180	ITARUMA	IM12296690LD	CACHOEIRA ALTA	06/01/2020 06:37	07/01/2020 11:19	06/01/2020 06:37	06/01/2020 15:52	9,24	1	9,24	CHI
20200130180	ITARUMA	IM12087819	CACHOEIRA ALTA	06/01/2020 06:37	07/01/2020 11:19	07/01/2020 07:09	07/01/2020 10:10	3,01	6	18,08	CHI
20200130180	ITARUMA	IM12296690LD	CACHOEIRA ALTA	06/01/2020 06:37	07/01/2020 11:19	07/01/2020 07:09	07/01/2020 10:50	3,68	1	3,68	CHI
20200130180	ITARUMA	IM12092329LD	CACHOEIRA ALTA	06/01/2020 06:37	07/01/2020 11:19	06/01/2020 06:37	07/01/2020 11:19	28,69	8	229,54	CHI
20200130185	MARA ROSA	MQ12295258	MARA ROSA	06/01/2020 06:40	06/01/2020 12:04	06/01/2020 06:40	06/01/2020 12:04	5,39	2	10,77	CHI
20200130196	NOVA IGUACU DE GOIAS	NH21148297	SANTA TEREZINHA	06/01/2020 06:42	06/01/2020 11:13	06/01/2020 06:42	06/01/2020 11:13	4,51	1	4,51	CHI
20200130210	ORIZONA	OZ21231421	PIRES DO RIO S2	06/01/2020 06:46	06/01/2020 08:15	06/01/2020 06:46	06/01/2020 08:15	1,49	1	1,49	CHI
20200130213	ARENOPOLIS	AY21000037	ARENOPOLIS	06/01/2020 06:47	06/01/2020 12:53	06/01/2020 06:47	06/01/2020 12:53	6,10	1	6,10	CHI
20200130214	PARAUNA	PU12034828	ACREUNA	06/01/2020 06:47	06/01/2020 10:45	06/01/2020 06:47	06/01/2020 10:45	3,96	14	55,50	CHI
20200130217	JATAI	JT12219503	JATAI S3	06/01/2020 06:48	06/01/2020 09:30	06/01/2020 06:48	06/01/2020 09:30	2,69	5	13,47	CHI
20200130228	IPAMERI	IP12272804	IPAMERI	06/01/2020 06:51	06/01/2020 14:59	06/01/2020 06:51	06/01/2020 14:59	8,12	2	16,24	CHI
20200130230	IPORA	IR12222997	ARENOPOLIS	06/01/2020 06:51	06/01/2020 12:37	06/01/2020 06:51	06/01/2020 12:37	5,76	11	63,33	CHI
20200130230	IVOLANDIA	IR12222997	ARENOPOLIS	06/01/2020 06:51	06/01/2020 12:37	06/01/2020 06:51	06/01/2020 12:37	5,76	35	201,51	CHI
20200130230	PALESTINA DE GOIAS	IR12222997	ARENOPOLIS	06/01/2020 06:51	06/01/2020 12:37	06/01/2020 06:51	06/01/2020 12:37	5,76	37	213,03	CHI
20200130231	SANTA RITA DO NOVO DESTINO	DF21287222	BARRO ALTO	06/01/2020 06:52	06/01/2020 14:51	06/01/2020 06:52	06/01/2020 14:51	7,99	1	7,99	CHI
20200130235	RUBIATABA	RB12303953	RUBIATABA	06/01/2020 02:07	06/01/2020 07:48	06/01/2020 02:07	06/01/2020 07:48	5,67	3	17,01	CHI
20200130237	GOIAS	GS21234116	GOIAS	06/01/2020 06:54	06/01/2020 10:37	06/01/2020 06:54	06/01/2020 10:37	3,72	1	3,72	CHI
20200130238	ITABERAI	II12217217	ITABERAI S1	06/01/2020 02:25	06/01/2020 08:43	06/01/2020 02:25	06/01/2020 08:43	6,29	22	138,42	CHI
20200130238	ITAGUARI	II12217217	ITABERAI S1	06/01/2020 02:25	06/01/2020 08:43	06/01/2020 02:25	06/01/2020 08:43	6,29	43	270,55	CHI
20200130238	TAQUARAL DE GOIAS	II12217217	ITABERAI S1	06/01/2020 02:25	06/01/2020 08:43	06/01/2020 02:25	06/01/2020 08:43	6,29	47	295,72	CHI
20200130245	PIRENOPOLIS	PV21144043	CORUMBA	06/01/2020 06:56	07/01/2020 12:29	06/01/2020 06:56	07/01/2020 12:29	29,55	1	29,55	CHI
20200130246	GOIANESIA	GE12255999	GOIANESIA S2	05/01/2020 22:34	06/01/2020 11:38	05/01/2020 22:34	06/01/2020 11:38	13,05	34	443,84	CHI
20200130250	MUNDO NOVO DE GOIAS	NA12035650	NOVA CRIXAS	06/01/2020 05:09	06/01/2020 09:02	06/01/2020 05:09	06/01/2020 09:02	3,87	8	30,98	CHI
20200130250	NOVA CRIXAS	NA12035650	NOVA CRIXAS	06/01/2020 05:09	06/01/2020 09:02	06/01/2020 05:09	06/01/2020 09:02	3,87	24	92,94	CHI
20200130251	GOIAS	GS12274373	GOIAS	06/01/2020 06:57	06/01/2020 10:30	06/01/2020 06:57	06/01/2020 10:30	3,54	12	42,54	CHI

20200130260	CRISTIANOPOLIS	BC32088376	CRISTIANOPOLIS	06/01/2020 06:59	06/01/2020 07:57	06/01/2020 06:59	06/01/2020 07:57	0,96	8	7,64	CHI
20200130260	SANTA CRUZ DE GOIAS	BC32088376	CRISTIANOPOLIS	06/01/2020 06:59	06/01/2020 07:57	06/01/2020 06:59	06/01/2020 07:57	0,96	15	14,33	CHI
20200130261	PIRACANJUBA	PJ12000117	PIRACANJUBA	06/01/2020 06:59	06/01/2020 11:25	06/01/2020 06:59	06/01/2020 11:25	4,42	7	30,93	CHI
20200130261	PROFESSOR JAMIL SAFADY	PJ12000117	PIRACANJUBA	06/01/2020 06:59	06/01/2020 11:25	06/01/2020 06:59	06/01/2020 11:25	4,42	5	22,09	CHI
20200130263	CATALAO	CT21231565	CATALAO S1	06/01/2020 06:59	06/01/2020 09:06	06/01/2020 06:59	06/01/2020 09:06	2,11	1	2,11	CHI
20200130264	TEREZOPOLIS DE GOIAS	GP21095990	DAIA S2	06/01/2020 07:00	06/01/2020 16:17	06/01/2020 07:00	06/01/2020 16:17	9,28	1	9,28	CHI
20200130267	RIO VERDE	RV12360956	RIO VERDE S1	06/01/2020 07:00	06/01/2020 10:25	06/01/2020 07:00	06/01/2020 10:25	3,41	11	37,47	CHI
20200130268	JUSSARA	JR12212887	IPORA	06/01/2020 07:00	06/01/2020 17:10	06/01/2020 07:00	06/01/2020 17:10	10,16	22	223,50	CHI
20200130268	MONTES CLAROS DE GOIAS	JR12212887	IPORA	06/01/2020 07:00	06/01/2020 17:10	06/01/2020 07:00	06/01/2020 17:10	10,16	7	71,11	CHI
20200130272	EDEIA	EA21033181	EDEIA	06/01/2020 07:01	06/01/2020 08:21	06/01/2020 07:01	06/01/2020 08:21	1,33	1	1,33	CHI
20200130274	MINACU	IH21252348	MINACU	06/01/2020 07:01	06/01/2020 14:35	06/01/2020 07:01	06/01/2020 14:35	7,56	1	7,56	CHI
20200130281	CACHOEIRA ALTA	CA12024254	CACHOEIRA ALTA	06/01/2020 07:00	06/01/2020 14:51	06/01/2020 07:00	06/01/2020 14:51	7,85	21	164,87	CHI
20200130281	QUIRINOPOLIS	CA12024254	CACHOEIRA ALTA	06/01/2020 07:00	06/01/2020 14:51	06/01/2020 07:00	06/01/2020 14:51	7,85	7	54,96	CHI
20200130282	AURILANDIA	AI11000009	FIRMINOPOLIS S2	06/01/2020 07:03	06/01/2020 12:25	06/01/2020 07:03	06/01/2020 12:25	5,37	94	504,34	CHI
20200130283	ABADIANIA	AA12146399	ANAPOLIS UNIVERSITARIO S1	06/01/2020 06:32	06/01/2020 09:35	06/01/2020 06:32	06/01/2020 09:35	3,05	13	39,62	CHI
20200130283	GAMELEIRA DE GOIAS	AA12146399	ANAPOLIS UNIVERSITARIO S1	06/01/2020 06:32	06/01/2020 09:35	06/01/2020 06:32	06/01/2020 09:35	3,05	2	6,10	CHI
20200130285	QUIRINOPOLIS	QI21126474	QUIRINOPOLIS	06/01/2020 07:03	06/01/2020 09:20	06/01/2020 07:03	06/01/2020 09:20	2,27	1	2,27	CHI
20200130289	PADRE BERNARDO	PB12377211	PADRE BERNARDO	06/01/2020 07:04	06/01/2020 09:12	06/01/2020 07:04	06/01/2020 09:12	2,12	12	25,50	CHI
20200130290	URUACU	UR21400307	URUACU	06/01/2020 07:04	06/01/2020 11:25	06/01/2020 07:04	06/01/2020 11:25	4,34	1	4,34	CHI
20200130291	ITAPACI	IW11120478	ITAPACI	06/01/2020 04:58	06/01/2020 10:06	06/01/2020 04:58	06/01/2020 10:06	5,12	121	619,82	CHI
20200130295	CORUMBAIBA	CI21110137	VILA CORUMBA	06/01/2020 07:05	06/01/2020 10:15	06/01/2020 07:05	06/01/2020 10:15	3,16	1	3,16	CHI
20200130297	AMARALINA	LC12308828	MARA ROSA	06/01/2020 07:05	06/01/2020 12:30	06/01/2020 07:05	06/01/2020 12:30	5,41	2	10,81	CHI
20200130297	MARA ROSA	LC12308828	MARA ROSA	06/01/2020 07:05	06/01/2020 12:30	06/01/2020 07:05	06/01/2020 12:30	5,41	1	5,41	CHI
20200130298	SAO MIGUEL DO ARAGUAIA	SM12128351	SAO MIGUEL DO ARAGUAIA	06/01/2020 07:02	06/01/2020 13:09	06/01/2020 07:02	06/01/2020 13:09	6,11	20	122,26	CHI
20200130299	PLANALTINA	PI12081001	PLANALTINA	06/01/2020 07:05	06/01/2020 10:25	06/01/2020 07:05	06/01/2020 10:25	3,32	2	6,64	CHI
20200130302	LUZIANIA	20462936	RIO VERMELHO	06/01/2020 07:06	06/01/2020 13:59	06/01/2020 07:06	06/01/2020 13:59	6,87	99	680,49	CHI
20200130304	MINEIROS	10016040943	PARQUE DAS EMAS	06/01/2020 07:06	06/01/2020 11:32	06/01/2020 07:06	06/01/2020 11:32	4,42	1	4,42	CHI
20200130305	LUZIANIA	LZ12290683	MARAJOARA	06/01/2020 07:06	06/01/2020 09:14	06/01/2020 07:06	06/01/2020 09:14	2,12	16	33,88	CHI
20200130307	JUSSARA	JR12076133	BRITANIA	06/01/2020 07:07	06/01/2020 09:40	06/01/2020 07:07	06/01/2020 09:40	2,55	3	7,64	CHI
20200130313	FORMOSO	TB10396085	PORANGATU	06/01/2020 07:08	06/01/2020 17:49	06/01/2020 12:08	06/01/2020 12:47	0,66	2	1,32	CHI
20200130313	MONTIVIDIU DO NORTE	TB10396085	PORANGATU	06/01/2020 07:08	06/01/2020 17:49	06/01/2020 12:08	06/01/2020 12:47	0,66	1638	1079,72	CHI
20200130313	TROMBAS	TB10396085	PORANGATU	06/01/2020 07:08	06/01/2020 17:49	06/01/2020 12:08	06/01/2020 12:47	0,66	172	113,38	CHI
20200130313	TROMBAS	TB21156721	PORANGATU	06/01/2020 07:08	06/01/2020 17:49	06/01/2020 07:08	06/01/2020 17:01	9,87	1	9,87	CHI

20200130313	MONTIVIDIU DO NORTE	TB12156640	PORANGATU	06/01/2020 07:08	06/01/2020 17:49	06/01/2020 12:08	06/01/2020 17:49	5,69	1	5,69	CHI
20200130313	TROMBAS	TB12156640	PORANGATU	06/01/2020 07:08	06/01/2020 17:49	06/01/2020 12:08	06/01/2020 17:49	5,69	94	534,96	CHI
20200130315	PORANGATU	PO12208396	PORANGATU	06/01/2020 07:09	06/01/2020 12:26	06/01/2020 07:09	06/01/2020 12:26	5,28	1	5,28	CHI
20200130318	QUIRINOPOLIS	QI21370184	QUIRINOPOLIS	06/01/2020 07:09	06/01/2020 09:38	06/01/2020 07:09	06/01/2020 09:38	2,48	1	2,48	CHI
20200130319	JARAGUA	JA21272998	JARAGUA	06/01/2020 07:09	06/01/2020 12:20	06/01/2020 07:09	06/01/2020 12:20	5,17	1	5,17	CHI
20200130321	PARAUNA	RV12206011	ACREUNA	06/01/2020 07:09	06/01/2020 08:58	06/01/2020 07:09	06/01/2020 08:58	1,80	98	176,56	CHI
20200130324	MONTIVIDIU DO NORTE	MX12168971	PORANGATU	06/01/2020 07:10	06/01/2020 13:04	06/01/2020 07:10	06/01/2020 13:04	5,89	43	253,27	CHI
20200130325	DOVERLANDIA	MY12036563	PARQUE DAS EMAS	06/01/2020 04:47	06/01/2020 12:24	06/01/2020 04:47	06/01/2020 12:24	7,60	72	547,48	CHI
20200130328	RIO VERDE	RV12076338	RIO VERDE S1	06/01/2020 05:56	06/01/2020 11:00	06/01/2020 05:56	06/01/2020 11:00	5,06	8	40,49	CHI
20200130330	CAMPINACU	UC12237456	MARA ROSA	06/01/2020 06:58	06/01/2020 22:23	06/01/2020 06:58	06/01/2020 22:23	15,41	7	107,89	CHI
20200130330	URUACU	UC12237456	MARA ROSA	06/01/2020 06:58	06/01/2020 22:23	06/01/2020 06:58	06/01/2020 22:23	15,41	5	77,07	CHI
20200130333	MINACU	IH12337406	MINACU	06/01/2020 07:11	06/01/2020 16:01	06/01/2020 07:11	06/01/2020 16:01	8,83	41	361,87	CHI
20200130334	CAMPO ALEGRE DE GOIAS	CM12042353	CAMPO ALEGRE DE GOIAS	06/01/2020 07:11	06/01/2020 10:30	06/01/2020 07:11	06/01/2020 10:30	3,30	5	16,50	CHI
20200130336	PIRENOPOLIS	CB21130159	CORUMBA	06/01/2020 07:12	06/01/2020 16:50	06/01/2020 07:12	06/01/2020 16:50	9,63	1	9,63	CHI
20200130343	NOVA AMERICA	NM12052447	RUBIATABA	06/01/2020 06:08	06/01/2020 09:00	06/01/2020 06:08	06/01/2020 09:00	2,86	14	40,07	CHI
20200130352	MARA ROSA	MQ12125574	MARA ROSA	06/01/2020 07:13	06/01/2020 08:30	06/01/2020 07:13	06/01/2020 08:30	1,27	13	16,48	CHI
20200130359	GOIAS	GS12058298	MATRINCHA	06/01/2020 06:33	06/01/2020 11:40	06/01/2020 06:33	06/01/2020 11:40	5,11	26	132,97	CHI
20200130360	ITABERAI	IB12250696	ITABERAI S1	06/01/2020 06:33	06/01/2020 11:06	06/01/2020 06:33	06/01/2020 11:06	4,55	42	190,97	CHI
20200130361	IPAMERI	IP12041047LD	IPAMERI	06/01/2020 07:15	06/01/2020 11:13	06/01/2020 07:15	06/01/2020 11:13	3,96	8	31,65	CHI
20200130367	PLANALTINA	2960231734	PLANALTINA	06/01/2020 07:16	06/01/2020 08:10	06/01/2020 07:16	06/01/2020 08:10	0,91	1	0,91	CHI
20200130371	EDEALINA	ED21249752	PONTALINA	06/01/2020 07:17	06/01/2020 10:09	06/01/2020 07:17	06/01/2020 10:09	2,86	1	2,86	CHI
20200130372	ORIZONA	OZ12084921RE	PIRES DO RIO S2	06/01/2020 06:44	06/01/2020 09:01	06/01/2020 06:44	06/01/2020 09:01	2,27	110	249,49	CHI
20200130372	VIANOPOLIS	OZ12084921RE	PIRES DO RIO S2	06/01/2020 06:44	06/01/2020 09:01	06/01/2020 06:44	06/01/2020 09:01	2,27	17	38,56	CHI
20200130373	CORUMBAIBA	CI12298710	VILA CORUMBA	06/01/2020 06:41	06/01/2020 16:25	06/01/2020 06:41	06/01/2020 16:25	9,72	14	136,08	CHI
20200130374	ESTRELA DO NORTE	ET21256315	MARA ROSA	06/01/2020 07:17	06/01/2020 12:29	06/01/2020 07:17	06/01/2020 12:29	5,19	1	5,19	CHI
20200130376	GOIAS	GS12028005	GOIAS	06/01/2020 06:01	06/01/2020 08:57	06/01/2020 06:01	06/01/2020 08:57	2,92	4	11,68	CHI
20200130385	LUZIANIA	LZ12051365	CRISTALINA S2	06/01/2020 07:19	06/01/2020 10:42	06/01/2020 07:19	06/01/2020 10:42	3,38	3	10,13	CHI
20200130396	ORIZONA	OZ12052340	PIRES DO RIO S2	06/01/2020 07:20	06/01/2020 10:51	06/01/2020 07:20	06/01/2020 10:51	3,51	12	42,17	CHI
20200130401	TURVANIA	TV21399768	FIRMINOPOLIS S2	06/01/2020 07:21	06/01/2020 14:20	06/01/2020 07:21	06/01/2020 14:20	6,98	1	6,98	CHI
20200130402	NAZARIO	PL12308590	ANICUNS	06/01/2020 07:21	06/01/2020 08:41	06/01/2020 07:21	06/01/2020 08:41	1,33	3	3,98	CHI
20200130402	PALMEIRAS DE GOIAS	PL12308590	ANICUNS	06/01/2020 07:21	06/01/2020 08:41	06/01/2020 07:21	06/01/2020 08:41	1,33	2	2,65	CHI
20200130405	BOM JESUS DE GOIAS	BJ21257012	BOM JESUS DE GOIAS	06/01/2020 07:21	06/01/2020 10:02	06/01/2020 07:21	06/01/2020 10:02	2,67	1	2,67	CHI
20200130407	HEITORAI	10011552750	ITAPURANGA	06/01/2020 07:21	07/01/2020 08:13	06/01/2020 07:21	07/01/2020 08:13	24,86	1	24,86	CHI



20200130411	ARENOPOLIS	AY21331915	ARENOPOLIS	06/01/2020 07:22	06/01/2020 14:55	06/01/2020 07:22	06/01/2020 14:55	7,56	1	7,56	CHI
20200130412	ALEXANIA	AX12211852	ALEXANIA	06/01/2020 06:32	06/01/2020 10:24	06/01/2020 06:32	06/01/2020 10:24	3,85	15	57,77	CHI
20200130414	GOIAS	GS12336540	GOIAS	06/01/2020 01:04	06/01/2020 09:55	06/01/2020 01:04	06/01/2020 09:55	8,83	9	79,50	CHI
20200130421	URUTAI	UT21107821	URUTAI	06/01/2020 07:23	06/01/2020 09:30	06/01/2020 07:23	06/01/2020 09:30	2,11	1	2,11	CHI
20200130423	VALPARAISO DE GOIAS	2860094630	PACAEMBU S2	06/01/2020 07:23	06/01/2020 10:04	06/01/2020 07:23	06/01/2020 10:04	2,67	1	2,67	CHI
20200130425	VALPARAISO DE GOIAS	VA12206670	PACAEMBU S2	06/01/2020 07:24	06/01/2020 11:00	06/01/2020 07:24	06/01/2020 11:00	3,60	246	885,19	CHI
20200130426	ITAPURANGA	IK12220544	ITAPURANGA	06/01/2020 07:16	06/01/2020 14:59	06/01/2020 07:16	06/01/2020 14:59	7,72	27	208,34	CHI
20200130428	MOIPORA	MO12015679	IPORA	06/01/2020 06:50	06/01/2020 14:30	06/01/2020 06:50	06/01/2020 14:30	7,67	5	38,33	CHI
20200130431	SAO MIGUEL DO ARAGUAIA	SM12240639	SAO MIGUEL DO ARAGUAIA	06/01/2020 07:25	06/01/2020 18:11	06/01/2020 07:25	06/01/2020 18:11	10,77	3	32,30	CHI
20200130441	CAIAPONIA	MV12340904	MONTIVIDIU T	06/01/2020 06:16	06/01/2020 14:42	06/01/2020 06:16	06/01/2020 14:42	8,42	1	8,42	CHI
20200130441	MONTIVIDIU	MV12340904	MONTIVIDIU T	06/01/2020 06:16	06/01/2020 14:42	06/01/2020 06:16	06/01/2020 14:42	8,42	14	117,86	CHI
20200130449	BALIZA	BH12061407	BOM JARDIM	06/01/2020 07:28	06/01/2020 11:59	06/01/2020 07:28	06/01/2020 11:59	4,50	30	135,11	CHI
20200130451	PONTALINA	VI12047300	VICENTINOPOLIS	06/01/2020 07:27	06/01/2020 10:49	06/01/2020 07:27	06/01/2020 10:49	3,36	2	6,72	CHI
20200130451	VICENTINOPOLIS	VI12047300	VICENTINOPOLIS	06/01/2020 07:27	06/01/2020 10:49	06/01/2020 07:27	06/01/2020 10:49	3,36	3	10,07	CHI
20200130453	ANICUNS	AC12299011	FIRMINOPOLIS S2	06/01/2020 07:29	06/01/2020 08:34	06/01/2020 07:29	06/01/2020 08:34	1,08	10	10,76	CHI
20200130457	CAMPOS BELOS	CH21262240	SAO DOMINGOS	06/01/2020 07:30	06/01/2020 08:23	06/01/2020 07:30	06/01/2020 08:23	0,87	1	0,87	CHI
20200130458	SAO LUIS DE MONTES BELOS	SL12206033	SAO LUIZ DOS MONTES BELOS	06/01/2020 07:03	06/01/2020 08:38	06/01/2020 07:03	06/01/2020 08:38	1,58	13	20,53	CHI
20200130460	QUIRINOPOLIS	80033143	QUIRINOPOLIS	06/01/2020 07:30	06/01/2020 11:11	06/01/2020 07:30	06/01/2020 11:11	3,67	1	3,67	CHI
20200130463	RIO VERDE	RV21306312	RIO VERDE S2	06/01/2020 07:31	06/01/2020 09:22	06/01/2020 07:31	06/01/2020 09:22	1,85	1	1,85	CHI
20200130469	PONTALINA	PK21204455	PONTALINA	06/01/2020 07:31	06/01/2020 11:17	06/01/2020 07:31	06/01/2020 11:17	3,75	1	3,75	CHI
20200130470	FAZENDA NOVA	FN21259498	IPORA	06/01/2020 07:31	06/01/2020 17:46	06/01/2020 07:31	06/01/2020 17:46	10,24	1	10,24	CHI
20200130473	GOIANAPOLIS	TJ12402041	DAIA S2	06/01/2020 07:32	06/01/2020 13:54	06/01/2020 07:32	06/01/2020 13:54	6,37	15	95,48	CHI
20200130473	TEREZOPOLIS DE GOIAS	TJ12402041	DAIA S2	06/01/2020 07:32	06/01/2020 13:54	06/01/2020 07:32	06/01/2020 13:54	6,37	3	19,10	CHI
20200130484	MINACU	IH21230307	MINACU	06/01/2020 07:35	06/01/2020 10:35	06/01/2020 07:35	06/01/2020 10:35	3,01	1	3,01	CHI
20200130487	MINACU	IH21262677	MINACU	06/01/2020 07:35	06/01/2020 09:11	06/01/2020 07:35	06/01/2020 09:11	1,59	2	3,19	CHI
20200130491	LUZIANIA	LZ21282129	MARAJOARA	06/01/2020 07:35	06/01/2020 11:45	06/01/2020 07:35	06/01/2020 11:45	4,15	1	4,15	CHI
20200130492	VILA PROPICIO	GE21376598	GOIANESIA S2	06/01/2020 07:36	07/01/2020 15:05	06/01/2020 07:36	07/01/2020 15:05	31,49	1	31,49	CHI
20200130493	IPAMERI	IP21112309	IPAMERI	06/01/2020 07:36	06/01/2020 17:59	06/01/2020 07:36	06/01/2020 17:59	10,38	1	10,38	CHI
20200130498	ANAPOLIS	AN21130420	ANAPOLIS UNIVERSITARIO S2	06/01/2020 07:37	06/01/2020 10:55	06/01/2020 07:37	06/01/2020 10:55	3,31	2	6,62	CHI
20200130499	ABADIANIA	350039835	ANAPOLIS UNIVERSITARIO S1	06/01/2020 07:37	06/01/2020 16:02	06/01/2020 07:37	06/01/2020 16:02	8,41	1	8,41	CHI
20200130504	URUTAI	UT21231343	URUTAI	06/01/2020 07:37	06/01/2020 13:15	06/01/2020 07:37	06/01/2020 13:15	5,62	1	5,62	CHI
20200130507	GOIANESIA	10020303015	GOIANESIA S2	06/01/2020 07:38	07/01/2020 03:53	06/01/2020 07:38	07/01/2020 03:53	20,24	1	20,24	CHI
20200130514	COLINAS DO SUL	TI12357757	NIQUELANDIA SUBTRANSMISSAO	06/01/2020 07:39	06/01/2020 09:03	06/01/2020 07:39	06/01/2020 09:03	1,39	7	9,70	CHI

20200130521	PORANGATU	PO12391671	PORANGATU	06/01/2020 07:40	06/01/2020 16:40	06/01/2020 07:40	06/01/2020 16:40	8,99	24	215,80	CHI
20200130525	PONTALINA	MR12249782	PONTALINA	06/01/2020 07:41	06/01/2020 14:10	06/01/2020 07:41	06/01/2020 14:10	6,48	6	38,88	CHI
20200130532	PLANALTINA	PI21379176	PLANALTINA	06/01/2020 07:42	06/01/2020 11:49	06/01/2020 07:42	06/01/2020 11:49	4,11	1	4,11	CHI
20200130535	CATALAO	IP12000097	IPAMERI	06/01/2020 06:26	06/01/2020 12:02	06/01/2020 06:26	06/01/2020 12:02	5,59	19	106,21	CHI
20200130535	IPAMERI	IP12000097	IPAMERI	06/01/2020 06:26	06/01/2020 12:02	06/01/2020 06:26	06/01/2020 12:02	5,59	5	27,95	CHI
20200130537	SANTA HELENA DE GOIAS	SH11000012	IPEGUARI	06/01/2020 07:42	06/01/2020 11:50	06/01/2020 07:42	06/01/2020 11:50	4,12	52	214,11	CHI
20200130539	SAO JOAO D ALIANCA	JL12383338	SAO JOAO D ALIANCA	06/01/2020 07:43	06/01/2020 11:16	06/01/2020 07:43	06/01/2020 11:16	3,55	39	138,26	CHI
20200130542	RIO VERDE	RV12305757	MONTIVIDIU T	06/01/2020 07:43	06/01/2020 15:40	06/01/2020 07:43	06/01/2020 15:40	7,94	5	39,69	CHI
20200130543	VICENTINOPOLIS	VI21263279	VICENTINOPOLIS	06/01/2020 07:43	06/01/2020 13:34	06/01/2020 07:43	06/01/2020 13:34	5,83	1	5,83	CHI
20200130544	MORRINHOS	MR21265903	MORRINHOS	06/01/2020 07:44	06/01/2020 11:12	06/01/2020 07:44	06/01/2020 11:12	3,47	2	6,93	CHI
20200130552	FORMOSA	FA31042761	SAO JOAO D ALIANCA	06/01/2020 07:45	06/01/2020 16:46	06/01/2020 07:45	06/01/2020 16:46	9,01	1	9,01	CHI
20200130556	ANAPOLIS	AN11198739	ANAPOLIS UNIVERSITARIO S2	06/01/2020 07:02	06/01/2020 09:17	06/01/2020 07:02	06/01/2020 09:17	2,24	88	197,12	CHI
20200130557	ITUMBIARA	690296290	ITUMBIARA NOVA	06/01/2020 07:46	06/01/2020 08:56	06/01/2020 07:46	06/01/2020 08:56	1,15	1	1,15	CHI
20200130558	CRISTALINA	KR12305009	PAMPLONA	06/01/2020 07:46	06/01/2020 16:55	06/01/2020 07:46	06/01/2020 16:55	9,14	6	54,82	CHI
20200130559	VILA PROPICIO	PV21074934	GOIANESIA S1	06/01/2020 07:46	06/01/2020 12:52	06/01/2020 07:46	06/01/2020 12:52	5,09	1	5,09	CHI
20200130560	MONTES CLAROS DE GOIAS	ME21354606	BRITANIA	06/01/2020 07:46	06/01/2020 17:41	06/01/2020 07:46	06/01/2020 17:41	9,90	1	9,90	CHI
20200130562	COCALZINHO DE GOIAS	9970029647	AGUAS LINDAS DE GOIAS S2	06/01/2020 07:47	06/01/2020 12:48	06/01/2020 07:47	06/01/2020 12:48	5,01	1	5,01	CHI
20200130565	MATRINCHA	MP12122364	MATRINCHA	06/01/2020 07:47	06/01/2020 16:12	06/01/2020 07:47	06/01/2020 16:12	8,41	10	84,12	CHI
20200130566	RIO VERDE	RV12261010LD	RIO VERDE S2	06/01/2020 07:47	06/01/2020 12:42	06/01/2020 07:47	06/01/2020 12:42	4,91	4	19,64	CHI
20200130568	IPAMERI	IP21151170	IPAMERI	06/01/2020 07:47	06/01/2020 13:04	06/01/2020 07:47	06/01/2020 13:04	5,28	1	5,28	CHI
20200130579	MAMBAI	MB12140432	IACIARA S2	06/01/2020 07:48	06/01/2020 09:40	06/01/2020 07:48	06/01/2020 09:40	1,85	17	31,51	CHI
20200130582	CAIAPONIA	PY12040163	PALESTINA	06/01/2020 02:42	06/01/2020 09:50	06/01/2020 02:42	06/01/2020 09:50	7,13	44	313,73	CHI
20200130582	PALESTINA DE GOIAS	PY12040163	PALESTINA	06/01/2020 02:42	06/01/2020 09:50	06/01/2020 02:42	06/01/2020 09:50	7,13	92	655,99	CHI
20200130588	CACHOEIRA ALTA	CA21094407	CACHOEIRA ALTA	06/01/2020 07:50	06/01/2020 09:30	06/01/2020 07:50	06/01/2020 09:30	1,67	1	1,67	CHI
20200130590	ITAPIRAPUA	IU12259711	MATRINCHA	06/01/2020 07:50	06/01/2020 10:25	06/01/2020 07:50	06/01/2020 10:25	2,57	5	12,83	CHI
20200130591	VICENTINOPOLIS	VI12263322	VICENTINOPOLIS	06/01/2020 07:51	06/01/2020 12:22	06/01/2020 07:51	06/01/2020 12:22	4,51	8	36,10	CHI
20200130606	QUIRINOPOLIS	QI32107559	QUIRINOPOLIS	06/01/2020 07:52	06/01/2020 10:02	06/01/2020 07:52	06/01/2020 10:02	2,15	1	2,15	CHI
20200130614	MOZARLANDIA	AZ12326097	MOZARLANDIA	06/01/2020 07:54	06/01/2020 14:55	06/01/2020 07:54	06/01/2020 14:55	7,01	1	7,01	CHI
20200130615	NOVA CRIXAS	NA21295443	NOVA CRIXAS	06/01/2020 07:54	06/01/2020 16:00	06/01/2020 07:54	06/01/2020 16:00	8,09	2	16,18	CHI
20200130616	SERRANOPOLIS	SX12298330	JATAI S1	06/01/2020 07:40	06/01/2020 09:30	06/01/2020 07:40	06/01/2020 09:30	1,83	7	12,78	CHI
20200130621	SAO MIGUEL DO ARAGUAIA	SM21020632	SAO MIGUEL DO ARAGUAIA	06/01/2020 07:54	06/01/2020 12:27	06/01/2020 07:54	06/01/2020 12:27	4,54	1	4,54	CHI
20200130623	JARAGUA	JA12297901	JARAGUA	06/01/2020 06:51	06/01/2020 11:35	06/01/2020 06:51	06/01/2020 11:35	4,72	5	23,61	CHI
20200130630	NIQUELANDIA	NQ12208518	NIQUELANDIA SUBTRANSMISSAO	06/01/2020 07:55	06/01/2020 11:26	06/01/2020 07:55	06/01/2020 11:26	3,50	96	336,05	CHI

20200130632	ESTRELA DO NORTE	ET12143710	MARA ROSA	06/01/2020 07:56	06/01/2020 22:40	06/01/2020 07:56	06/01/2020 22:40	14,73	4	58,93	CHI
20200130632	SANTA TEREZA DE GOIAS	ET12143710	MARA ROSA	06/01/2020 07:56	06/01/2020 22:40	06/01/2020 07:56	06/01/2020 22:40	14,73	4	58,93	CHI
20200130636	GOIANESIA	SZ12171895	ITAPACI	06/01/2020 07:56	06/01/2020 11:34	06/01/2020 07:56	06/01/2020 11:34	3,63	2	7,26	CHI
20200130643	GOIATUBA	GT21197910	GOIATUBA S2	06/01/2020 07:56	06/01/2020 09:35	06/01/2020 07:56	06/01/2020 09:35	1,64	1	1,64	CHI
20200130644	ABADIANIA	AN11289006	ANAPOLIS UNIVERSITARIO S2	06/01/2020 07:57	07/01/2020 02:24	06/01/2020 07:57	07/01/2020 02:24	18,46	8	147,67	CHI
20200130652	GAMELEIRA DE GOIAS	SV12033468	DAIA S2	06/01/2020 07:40	06/01/2020 09:19	06/01/2020 07:40	06/01/2020 09:19	1,64	14	22,99	CHI
20200130652	SILVANIA	SV12033468	DAIA S2	06/01/2020 07:40	06/01/2020 09:19	06/01/2020 07:40	06/01/2020 09:19	1,64	134	220,06	CHI
20200130654	FORMOSA	610026124	ITUIQUIRA	06/01/2020 07:58	06/01/2020 11:06	06/01/2020 07:58	06/01/2020 11:06	3,13	1	3,13	CHI
20200130657	PLANALTINA	PI21243063	PLANALTINA	06/01/2020 07:58	06/01/2020 09:41	06/01/2020 07:58	06/01/2020 09:41	1,71	1	1,71	CHI
20200130660	RIO VERDE	630129587	RIO VERDE S1	06/01/2020 07:58	06/01/2020 10:10	06/01/2020 07:58	06/01/2020 10:10	2,20	1	2,20	CHI
20200130662	GOIAS	IK12299970	GOIAS	06/01/2020 06:12	06/01/2020 14:04	06/01/2020 06:12	06/01/2020 14:04	7,85	24	188,45	CHI
20200130662	HEITORAI	IK12299970	GOIAS	06/01/2020 06:12	06/01/2020 14:04	06/01/2020 06:12	06/01/2020 14:04	7,85	32	251,27	CHI
20200130662	ITABERAI	IK12299970	GOIAS	06/01/2020 06:12	06/01/2020 14:04	06/01/2020 06:12	06/01/2020 14:04	7,85	2	15,70	CHI
20200130662	ITAPURANGA	IK12299970	GOIAS	06/01/2020 06:12	06/01/2020 14:04	06/01/2020 06:12	06/01/2020 14:04	7,85	3	23,56	CHI
20200130666	PADRE BERNARDO	10026815026	PADRE BERNARDO	06/01/2020 07:59	06/01/2020 11:15	06/01/2020 07:59	06/01/2020 11:15	3,27	1	3,27	CHI
20200130672	MORRINHOS	MR12242419	GOIATUBA S1	06/01/2020 07:04	06/01/2020 11:35	06/01/2020 07:04	06/01/2020 11:35	4,52	12	54,28	CHI
20200130674	ITAPACI	IW12267460	ITAPACI	06/01/2020 08:00	06/01/2020 19:04	06/01/2020 08:00	06/01/2020 19:04	11,06	8	88,52	CHI
20200130675	CACHOEIRA ALTA	CA12200034	CACHOEIRA ALTA	06/01/2020 08:00	06/01/2020 15:18	06/01/2020 08:00	06/01/2020 15:18	7,30	3	21,89	CHI
20200130678	PIRES DO RIO	PR13202866	PIRES DO RIO S1	06/01/2020 08:00	06/01/2020 14:24	06/01/2020 08:00	06/01/2020 14:24	6,40	73	467,36	CHI
20200130678	PALMELO	PR13202866	PIRES DO RIO S1	06/01/2020 08:00	06/01/2020 14:24	06/01/2020 11:12	06/01/2020 14:24	3,20	9	28,76	CHI
20200130678	PIRES DO RIO	PR13202866	PIRES DO RIO S1	06/01/2020 08:00	06/01/2020 14:24	06/01/2020 11:12	06/01/2020 14:24	3,20	171	546,44	CHI
20200130678	SANTA CRUZ DE GOIAS	PR13202866	PIRES DO RIO S1	06/01/2020 08:00	06/01/2020 14:24	06/01/2020 11:12	06/01/2020 14:24	3,20	1	3,20	CHI
20200130678	URUTAI	PR13202866	PIRES DO RIO S1	06/01/2020 08:00	06/01/2020 14:24	06/01/2020 11:12	06/01/2020 14:24	3,20	1	3,20	CHI
20200130680	TAQUARAL DE GOIAS	TQ12073428LD	ITABERAI S1	06/01/2020 04:35	06/01/2020 09:56	06/01/2020 04:35	06/01/2020 09:56	5,34	35	186,82	CHI
20200130688	ABADIANIA	AA12295623	ANAPOLIS UNIVERSITARIO S1	06/01/2020 08:00	06/01/2020 12:40	06/01/2020 08:00	06/01/2020 12:40	4,66	7	32,63	CHI
20200130688	GAMELEIRA DE GOIAS	AA12295623	ANAPOLIS UNIVERSITARIO S1	06/01/2020 08:00	06/01/2020 12:40	06/01/2020 08:00	06/01/2020 12:40	4,66	27	125,87	CHI
20200130693	CAMPINACU	IH12250126	MINACU	06/01/2020 08:01	06/01/2020 14:20	06/01/2020 08:01	06/01/2020 14:20	6,30	9	56,71	CHI
20200130694	FORMOSA	FA12242845	ITUIQUIRA	06/01/2020 08:01	06/01/2020 11:37	06/01/2020 08:01	06/01/2020 11:37	3,58	4	14,34	CHI
20200130700	SANTO ANTONIO DA BARRA	RV21135929	ACREUNA	06/01/2020 08:03	06/01/2020 09:27	06/01/2020 08:03	06/01/2020 09:27	1,40	1	1,40	CHI
20200130702	PIRACANJUBA	PJ12000119	PIRACANJUBA	06/01/2020 08:03	06/01/2020 21:48	06/01/2020 08:03	06/01/2020 21:48	13,75	1	13,75	CHI
20200130702	PIRACANJUBA	PJ12000119	PIRACANJUBA	06/01/2020 08:03	06/01/2020 21:48	06/01/2020 18:24	06/01/2020 21:48	3,39	5	16,97	CHI
20200130706	ACREUNA	EU12230897	ACREUNA	06/01/2020 08:03	06/01/2020 11:50	06/01/2020 08:03	06/01/2020 11:50	3,77	1	3,77	CHI
20200130708	INDIARA	IY21152598	CEZARINA	06/01/2020 08:03	06/01/2020 09:54	06/01/2020 08:03	06/01/2020 09:54	1,85	1	1,85	CHI

20200130709	ITABERAÍ	IB21019977	ITABERAÍ S2	06/01/2020 08:04	06/01/2020 10:57	06/01/2020 08:04	06/01/2020 10:57	2,88	2	5,75	CHI
20200130711	QUIRINÓPOLIS	QI31232891	QUIRINÓPOLIS	06/01/2020 08:04	06/01/2020 10:00	06/01/2020 08:04	06/01/2020 10:00	1,92	1	1,92	CHI
20200130713	CACU	CC21125900	CACHOEIRA ALTA	06/01/2020 08:04	06/01/2020 15:33	06/01/2020 08:04	06/01/2020 15:33	7,47	1	7,47	CHI
20200130715	CRIXAS	MZ12055628	MOZARLANDIA	06/01/2020 07:19	06/01/2020 13:11	06/01/2020 07:19	06/01/2020 13:11	5,85	24	140,51	CHI
20200130715	MOZARLANDIA	MZ12055628	MOZARLANDIA	06/01/2020 07:19	06/01/2020 13:11	06/01/2020 07:19	06/01/2020 13:11	5,85	38	222,48	CHI
20200130720	SANTO ANTONIO DO DESCOBERTO	8205071	MARAJÓARA	06/01/2020 08:05	06/01/2020 12:19	06/01/2020 08:05	06/01/2020 12:19	4,22	7	29,54	CHI
20200130727	PORANGATU	PO12363572	PORANGATU	06/01/2020 08:06	06/01/2020 17:04	06/01/2020 08:06	06/01/2020 17:04	8,95	9	80,57	CHI
20200130732	BARRO ALTO	PV12069121	GOIANESIA S1	06/01/2020 07:05	06/01/2020 13:21	06/01/2020 07:05	06/01/2020 13:21	6,26	1	6,26	CHI
20200130732	VILA PROPÍCIO	PV12069121	GOIANESIA S1	06/01/2020 07:05	06/01/2020 13:21	06/01/2020 07:05	06/01/2020 13:21	6,26	7	43,84	CHI
20200130735	ANAPÓLIS	AN11107750	ANAPÓLIS UNIVERSITÁRIO S2	06/01/2020 07:14	06/01/2020 14:19	06/01/2020 07:14	06/01/2020 14:19	7,08	106	750,42	CHI
20200130742	SANTA HELENA DE GOIAS	SH21315680	RIO DOS BOIS	06/01/2020 08:08	06/01/2020 14:50	06/01/2020 08:08	06/01/2020 14:50	6,70	2	13,40	CHI
20200130743	CORREGO DO OURO	CO21406121	SÃO LUIZ DOS MONTES BELOS	06/01/2020 08:08	06/01/2020 10:31	06/01/2020 08:08	06/01/2020 10:31	2,38	2	4,76	CHI
20200130747	NAZÁRIO	440016101	ANICUNS	06/01/2020 08:08	06/01/2020 09:44	06/01/2020 08:08	06/01/2020 09:44	1,60	1	1,60	CHI
20200130750	MARA ROSA	MQ21192412	MARA ROSA	06/01/2020 08:08	06/01/2020 12:36	06/01/2020 08:08	06/01/2020 12:36	4,45	1	4,45	CHI
20200130770	ABADIANIA	AA12221505LD	DAIA S2	06/01/2020 07:13	06/01/2020 11:43	06/01/2020 07:13	06/01/2020 11:43	4,49	16	71,84	CHI
20200130771	ANAPÓLIS	AN21287805	ANAPÓLIS UNIVERSITÁRIO S2	06/01/2020 08:11	06/01/2020 23:20	06/01/2020 08:11	06/01/2020 23:20	15,15	1	15,15	CHI
20200130772	LUZIANIA	LZ11199599	RIO VERMELHO	06/01/2020 08:11	06/01/2020 09:35	06/01/2020 08:11	06/01/2020 09:35	1,40	89	124,30	CHI
20200130774	MUTUNÓPOLIS	PO12242427	PORANGATU	06/01/2020 03:40	06/01/2020 12:58	06/01/2020 03:40	06/01/2020 12:58	9,29	8	74,30	CHI
20200130774	PORANGATU	PO12242427	PORANGATU	06/01/2020 03:40	06/01/2020 12:58	06/01/2020 03:40	06/01/2020 12:58	9,29	1	9,29	CHI
20200130780	HIDROLINA	GE12382134	BARRO ALTO	06/01/2020 07:23	06/01/2020 10:43	06/01/2020 07:23	06/01/2020 10:43	3,33	1	3,33	CHI
20200130780	SÃO LUIZ DO NORTE	GE12382134	BARRO ALTO	06/01/2020 07:23	06/01/2020 10:43	06/01/2020 07:23	06/01/2020 10:43	3,33	5	16,66	CHI
20200130793	IPAMERI	GD21157519	IPAMERI	06/01/2020 08:12	06/01/2020 17:09	06/01/2020 08:12	06/01/2020 17:09	8,93	1	8,93	CHI
20200130797	ACREUNA	EU21189129	ACREUNA	06/01/2020 08:13	06/01/2020 10:35	06/01/2020 08:13	06/01/2020 10:35	2,36	1	2,36	CHI
20200130799	PIRENÓPOLIS	SF12017628	SÃO FRANCISCO DE GOIAS	06/01/2020 06:08	06/01/2020 10:41	06/01/2020 06:08	06/01/2020 10:41	4,54	4	18,14	CHI
20200130799	SÃO FRANCISCO DE GOIAS	SF12017628	SÃO FRANCISCO DE GOIAS	06/01/2020 06:08	06/01/2020 10:41	06/01/2020 06:08	06/01/2020 10:41	4,54	8	36,28	CHI
20200130800	VALPARAISO DE GOIAS	VA11247721	MARAJÓARA	06/01/2020 08:14	06/01/2020 11:01	06/01/2020 08:14	06/01/2020 11:01	2,77	189	523,32	CHI
20200130802	URUACU	UR21136432	MARA ROSA	06/01/2020 08:14	06/01/2020 15:42	06/01/2020 08:14	06/01/2020 15:42	7,47	1	7,47	CHI
20200130803	URUACU	UR12190084LD	URUACU	06/01/2020 08:14	06/01/2020 15:40	06/01/2020 08:14	06/01/2020 15:40	7,43	1	7,43	CHI
20200130804	MORRINHOS	MR21119776	GOIATUBA S1	06/01/2020 08:14	06/01/2020 13:30	06/01/2020 08:14	06/01/2020 13:30	5,26	2	10,53	CHI
20200130807	ITUMBIAIRA	IT12305498	ITUMBIAIRA NOVA	06/01/2020 08:14	06/01/2020 09:20	06/01/2020 08:14	06/01/2020 09:20	1,10	2	2,20	CHI
20200130811	IPAMERI	IP21137526	PIRES DO RIO S2	06/01/2020 08:15	06/01/2020 13:11	06/01/2020 08:15	06/01/2020 13:11	4,93	1	4,93	CHI
20200130812	CRISTALINA	KR21034740	PAMPLONA	06/01/2020 08:15	06/01/2020 19:55	06/01/2020 08:15	06/01/2020 19:55	11,66	1	11,66	CHI
20200130815	VALPARAISO DE GOIAS	2860116030	PACAEMBU S1	06/01/2020 08:15	06/01/2020 12:07	06/01/2020 08:15	06/01/2020 12:07	3,86	1	3,86	CHI

20200130816	PADRE BERNARDO	2760012895	PADRE BERNARDO	06/01/2020 08:15	06/01/2020 09:29	06/01/2020 08:15	06/01/2020 09:29	1,22	1	1,22	CHI
20200130817	FORMOSA	FA21218758	ITUIQUIRA	06/01/2020 08:15	06/01/2020 11:30	06/01/2020 08:15	06/01/2020 11:30	3,24	1	3,24	CHI
20200130819	FIRMINOPOLIS	FR12028946	FIRMINOPOLIS S1	06/01/2020 08:16	06/01/2020 12:15	06/01/2020 08:16	06/01/2020 12:15	3,99	21	83,83	CHI
20200130822	CATALAO	CT12130955	CATALAO S1	06/01/2020 08:16	07/01/2020 13:36	06/01/2020 08:16	07/01/2020 13:36	29,32	3	87,96	CHI
20200130822	DISTRITO FEDERAL	CT12130955	CATALAO S1	06/01/2020 08:16	07/01/2020 13:36	06/01/2020 08:16	07/01/2020 13:36	29,32	1	29,32	CHI
20200130822	CATALAO	CT12130955	CATALAO S1	06/01/2020 08:16	07/01/2020 13:36	07/01/2020 11:40	07/01/2020 13:36	1,93	1	1,93	CHI
20200130827	JATAI	290173401	JATAI S2	06/01/2020 08:17	06/01/2020 10:14	06/01/2020 08:17	06/01/2020 10:14	1,95	1	1,95	CHI
20200130835	PORTEIRAO	TD21213458	RIO DOS BOIS	06/01/2020 08:17	07/01/2020 10:12	06/01/2020 08:17	07/01/2020 10:12	25,91	1	25,91	CHI
20200130840	ITAPACI	10018131377	ITAPACI	06/01/2020 08:18	06/01/2020 13:45	06/01/2020 08:18	06/01/2020 13:45	5,45	1	5,45	CHI
20200130849	MINEIROS	MY12195578	PARQUE DAS EMAS	06/01/2020 08:19	06/01/2020 16:58	06/01/2020 08:19	06/01/2020 16:58	8,65	10	86,49	CHI
20200130850	GOUVELANDIA	QI21326630	QUIRINOPOLIS	06/01/2020 08:19	06/01/2020 11:50	06/01/2020 08:19	06/01/2020 11:50	3,51	1	3,51	CHI
20200130851	RIO VERDE	630005230	RIO VERDE S1	06/01/2020 08:19	06/01/2020 12:27	06/01/2020 08:19	06/01/2020 12:27	4,13	1	4,13	CHI
20200130853	CRISTALINA	KR10400355	PAMPLONA	06/01/2020 08:19	06/01/2020 16:12	06/01/2020 12:11	06/01/2020 12:34	0,38	108	41,01	CHI
20200130853	CRISTALINA	KR13060737	PAMPLONA	06/01/2020 08:19	06/01/2020 16:12	06/01/2020 12:11	06/01/2020 16:12	4,02	3	12,05	CHI
20200130853	CRISTALINA	KR21096915	PAMPLONA	06/01/2020 08:19	06/01/2020 16:12	06/01/2020 08:19	06/01/2020 16:12	7,88	2	15,76	CHI
20200130860	FORMOSA	FA12207282	ITUIQUIRA	06/01/2020 06:26	06/01/2020 11:17	06/01/2020 06:26	06/01/2020 11:17	4,84	14	67,79	CHI
20200130864	AGUAS LINDAS DE GOIAS	LA12209578	AGUAS LINDAS DE GOIAS S2	06/01/2020 08:21	06/01/2020 09:42	06/01/2020 08:21	06/01/2020 09:42	1,35	204	275,00	CHI
20200130868	IPAMERI	IP12404715	IPAMERI	06/01/2020 08:21	06/01/2020 21:15	06/01/2020 08:21	06/01/2020 21:15	12,89	2	25,79	CHI
20200130870	DOVERLANDIA	PW10341001	PARQUE DAS EMAS	06/01/2020 13:11	08/01/2020 19:47	07/01/2020 04:18	07/01/2020 11:35	7,29	104	758,45	CHI
20200130870	MINEIROS	PW10341001	PARQUE DAS EMAS	06/01/2020 13:11	08/01/2020 19:47	07/01/2020 04:18	07/01/2020 11:35	7,29	190	1385,63	CHI
20200130870	PORTELANDIA	PW10341001	PARQUE DAS EMAS	06/01/2020 13:11	08/01/2020 19:47	07/01/2020 04:18	07/01/2020 11:35	7,29	135	984,52	CHI
20200130870	PORTELANDIA	PW10341001	PARQUE DAS EMAS	06/01/2020 13:11	08/01/2020 19:47	07/01/2020 11:26	07/01/2020 11:35	0,16	2	0,32	CHI
20200130870	MINEIROS	PW10341001	PARQUE DAS EMAS	06/01/2020 13:11	08/01/2020 19:47	07/01/2020 11:36	07/01/2020 14:04	2,47	7	17,30	CHI
20200130870	PORTELANDIA	PW10341001	PARQUE DAS EMAS	06/01/2020 13:11	08/01/2020 19:47	07/01/2020 11:36	07/01/2020 14:04	2,47	107	264,38	CHI
20200130870	MINEIROS	PW10341001	PARQUE DAS EMAS	06/01/2020 13:11	08/01/2020 19:47	07/01/2020 14:06	07/01/2020 15:20	1,23	7	8,61	CHI
20200130870	PORTELANDIA	PW10341001	PARQUE DAS EMAS	06/01/2020 13:11	08/01/2020 19:47	07/01/2020 14:06	07/01/2020 15:20	1,23	107	131,67	CHI
20200130870	MINEIROS	PW10341001	PARQUE DAS EMAS	06/01/2020 13:11	08/01/2020 19:47	07/01/2020 11:36	07/01/2020 22:02	10,45	37	386,58	CHI
20200130870	PORTELANDIA	PW10341001	PARQUE DAS EMAS	06/01/2020 13:11	08/01/2020 19:47	07/01/2020 11:36	07/01/2020 22:02	10,45	26	271,65	CHI
20200130870	MINEIROS	PW10341001	PARQUE DAS EMAS	06/01/2020 13:11	08/01/2020 19:47	07/01/2020 18:39	07/01/2020 22:02	3,40	7	23,80	CHI
20200130870	PORTELANDIA	PW10341001	PARQUE DAS EMAS	06/01/2020 13:11	08/01/2020 19:47	07/01/2020 18:39	07/01/2020 22:02	3,40	107	363,74	CHI
20200130870	MINEIROS	PW10341001	PARQUE DAS EMAS	06/01/2020 13:11	08/01/2020 19:47	07/01/2020 22:53	07/01/2020 23:15	0,35	44	15,53	CHI
20200130870	PORTELANDIA	PW10341001	PARQUE DAS EMAS	06/01/2020 13:11	08/01/2020 19:47	07/01/2020 22:53	07/01/2020 23:15	0,35	133	46,96	CHI
20200130870	MINEIROS	PW10341001	PARQUE DAS EMAS	06/01/2020 13:11	08/01/2020 19:47	08/01/2020 00:23	08/01/2020 01:08	0,75	44	32,98	CHI

20200130870	PORTELANDIA	PW10341001	PARQUE DAS EMAS	06/01/2020 13:11	08/01/2020 19:47	08/01/2020 00:23	08/01/2020 01:08	0,75	133	99,68	CHI
20200130870	MINEIROS	PW10341001	PARQUE DAS EMAS	06/01/2020 13:11	08/01/2020 19:47	07/01/2020 04:18	08/01/2020 01:30	21,20	109	2310,32	CHI
20200130870	MINEIROS	PW10341001	PARQUE DAS EMAS	06/01/2020 13:11	08/01/2020 19:47	07/01/2020 11:36	08/01/2020 01:30	13,90	1	13,90	CHI
20200130870	MINEIROS	RT00410215	PARQUE DAS EMAS	06/01/2020 13:11	08/01/2020 19:47	07/01/2020 19:32	08/01/2020 01:30	5,96	48	286,11	CHI
20200130870	MINEIROS	MY12159188	PARQUE DAS EMAS	06/01/2020 13:11	08/01/2020 19:47	06/01/2020 23:56	08/01/2020 01:31	25,58	7	179,06	CHI
20200130870	SANTA RITA DO ARAGUAIA	MY12159188	PARQUE DAS EMAS	06/01/2020 13:11	08/01/2020 19:47	06/01/2020 23:56	08/01/2020 01:31	25,58	2	51,16	CHI
20200130870	DOVERLANDIA	PW10341001	PARQUE DAS EMAS	06/01/2020 13:11	08/01/2020 19:47	07/01/2020 11:36	08/01/2020 01:31	13,92	15	208,74	CHI
20200130870	MINEIROS	PW10341001	PARQUE DAS EMAS	06/01/2020 13:11	08/01/2020 19:47	07/01/2020 11:36	08/01/2020 01:31	13,92	10	139,16	CHI
20200130870	MINEIROS	PW10341001	PARQUE DAS EMAS	06/01/2020 13:11	08/01/2020 19:47	07/01/2020 11:36	08/01/2020 11:47	24,19	20	483,82	CHI
20200130870	MINEIROS	PW12219569	PARQUE DAS EMAS	06/01/2020 13:11	08/01/2020 19:47	07/01/2020 11:36	08/01/2020 15:03	27,45	86	2360,84	CHI
20200130870	PORTELANDIA	PW12219569	PARQUE DAS EMAS	06/01/2020 13:11	08/01/2020 19:47	07/01/2020 11:36	08/01/2020 15:03	27,45	5	137,26	CHI
20200130870	MINEIROS	PW12219569	PARQUE DAS EMAS	06/01/2020 13:11	08/01/2020 19:47	07/01/2020 11:36	08/01/2020 16:56	29,34	9	264,05	CHI
20200130870	DOVERLANDIA	PW10341001	PARQUE DAS EMAS	06/01/2020 13:11	08/01/2020 19:47	07/01/2020 11:36	08/01/2020 19:47	32,19	11	354,09	CHI
20200130870	MINEIROS	PW10341001	PARQUE DAS EMAS	06/01/2020 13:11	08/01/2020 19:47	07/01/2020 11:36	08/01/2020 19:47	32,19	1	32,19	CHI
20200130872	JATAI	JT21214409	JATAI S1	06/01/2020 08:21	06/01/2020 13:20	06/01/2020 08:21	06/01/2020 13:20	4,97	1	4,97	CHI
20200130873	ANAPOLIS	AN12259031	ANAPOLIS UNIVERSITARIO S2	06/01/2020 08:22	06/01/2020 12:40	06/01/2020 08:22	06/01/2020 12:40	4,31	11	47,44	CHI
20200130875	COCALZINHO DE GOIAS	ZN12089830	COCALZINHO	06/01/2020 06:54	07/01/2020 21:42	06/01/2020 06:54	07/01/2020 09:35	26,67	10	266,74	CHI
20200130875	PADRE BERNARDO	ZN12089830	COCALZINHO	06/01/2020 06:54	07/01/2020 21:42	06/01/2020 06:54	07/01/2020 09:35	26,67	1	26,67	CHI
20200130875	COCALZINHO DE GOIAS	ZN12089830	COCALZINHO	06/01/2020 06:54	07/01/2020 21:42	07/01/2020 09:36	07/01/2020 21:42	12,10	10	120,98	CHI
20200130875	PADRE BERNARDO	ZN12089830	COCALZINHO	06/01/2020 06:54	07/01/2020 21:42	07/01/2020 09:36	07/01/2020 21:42	12,10	1	12,10	CHI
20200130876	ANAPOLIS	AN12258630	ANAPOLIS UNIVERSITARIO S2	06/01/2020 06:01	06/01/2020 10:02	06/01/2020 06:01	06/01/2020 10:02	4,01	5	20,05	CHI
20200130877	ALEXANIA	480035581	ALEXANIA	06/01/2020 08:22	06/01/2020 15:29	06/01/2020 08:22	06/01/2020 15:29	7,11	1	7,11	CHI
20200130878	VILA PROPICIO	PV21073538	GOIANESIA S1	06/01/2020 08:22	06/01/2020 12:27	06/01/2020 08:22	06/01/2020 12:27	4,07	1	4,07	CHI
20200130883	CAIAPONIA	CP12395453	PALESTINA	06/01/2020 08:23	06/01/2020 12:59	06/01/2020 08:23	06/01/2020 12:59	4,61	6	27,63	CHI
20200130892	PALMEIRAS DE GOIAS	PL12289855	ANICUNS	06/01/2020 08:24	06/01/2020 13:41	06/01/2020 08:24	06/01/2020 13:41	5,27	22	116,01	CHI
20200130896	RIO VERDE	630052232	RIO VERDE S2	06/01/2020 08:25	06/01/2020 11:45	06/01/2020 08:25	06/01/2020 11:45	3,33	1	3,33	CHI
20200130900	MINACU	4020041296	MINACU	06/01/2020 08:25	06/01/2020 10:56	06/01/2020 08:25	06/01/2020 10:56	2,51	1	2,51	CHI
20200130901	COCALZINHO DE GOIAS	ZN21138795	AGUAS LINDAS DE GOIAS S2	06/01/2020 08:25	07/01/2020 11:41	06/01/2020 08:25	07/01/2020 11:41	27,26	1	27,26	CHI
20200130902	GOIANESIA	GE11000041	GOIANESIA S2	06/01/2020 08:25	06/01/2020 11:00	06/01/2020 08:25	06/01/2020 11:00	2,58	57	146,85	CHI
20200130906	POSSE	PS12257701	IACIARA S2	06/01/2020 08:26	06/01/2020 09:39	06/01/2020 08:26	06/01/2020 09:39	1,21	30	36,38	CHI
20200130907	MINEIROS	MY11387729	PARQUE DAS EMAS	06/01/2020 08:26	06/01/2020 15:04	06/01/2020 08:26	06/01/2020 15:04	6,63	1	6,63	CHI
20200130909	IPAMERI	IP21275748	IPAMERI	06/01/2020 08:26	06/01/2020 11:31	06/01/2020 08:26	06/01/2020 11:31	3,07	1	3,07	CHI
20200130912	ANICUNS	10000867614	ANICUNS	06/01/2020 08:26	06/01/2020 09:27	06/01/2020 08:26	06/01/2020 09:27	1,01	1	1,01	CHI

20200130913	LUZIANIA	120403201	RIO VERMELHO	06/01/2020 08:26	06/01/2020 10:46	06/01/2020 08:26	06/01/2020 10:46	2,32	1	2,32	CHI
20200130916	ITABERAI	IB21216436	ANICUNS	06/01/2020 08:26	06/01/2020 10:11	06/01/2020 08:26	06/01/2020 10:11	1,74	1	1,74	CHI
20200130920	CABECEIRAS	FA21146209	ITIQUEIRA	06/01/2020 08:27	06/01/2020 10:27	06/01/2020 08:27	06/01/2020 10:27	2,00	1	2,00	CHI
20200130921	MINACU	IH12192297	MINACU	06/01/2020 08:27	07/01/2020 00:50	06/01/2020 08:27	07/01/2020 00:50	16,38	7	114,64	CHI
20200130930	SANTA TEREZA DE GOIAS	SE12094686	MARA ROSA	06/01/2020 08:01	06/01/2020 17:52	06/01/2020 08:01	06/01/2020 17:52	9,86	6	59,17	CHI
20200130935	IPORA	IR12223035	IPORA	06/01/2020 08:28	06/01/2020 10:08	06/01/2020 08:28	06/01/2020 10:08	1,66	3	4,97	CHI
20200130953	FORMOSO	FO21359154	MARA ROSA	06/01/2020 08:31	06/01/2020 15:18	06/01/2020 08:31	06/01/2020 15:18	6,78	1	6,78	CHI
20200130956	PIRACANJUBA	6416931	PIRACANJUBA	06/01/2020 08:31	06/01/2020 11:53	06/01/2020 08:31	06/01/2020 11:53	3,36	1	3,36	CHI
20200130962	LEOPOLDO DE BULHOES	LB21000006	DAIA S2	06/01/2020 08:31	06/01/2020 14:40	06/01/2020 08:31	06/01/2020 14:40	6,14	1	6,14	CHI
20200130964	INACIOLANDIA	ID12128107	QUIRINOPOLIS	06/01/2020 08:31	06/01/2020 09:25	06/01/2020 08:31	06/01/2020 09:25	0,89	17	15,07	CHI
20200130970	RIO VERDE	BZ12296270LD	ACREUNA	06/01/2020 08:31	07/01/2020 00:33	06/01/2020 19:56	06/01/2020 23:59	4,04	7	28,31	CHI
20200130970	SANTO ANTONIO DA BARRA	BZ12296270LD	ACREUNA	06/01/2020 08:31	07/01/2020 00:33	06/01/2020 19:56	06/01/2020 23:59	4,04	23	93,01	CHI
20200130970	SANTO ANTONIO DA BARRA	BZ12296271	ACREUNA	06/01/2020 08:31	07/01/2020 00:33	06/01/2020 08:31	07/01/2020 00:33	16,03	1	16,03	CHI
20200130975	PONTALINA	210060955	PONTALINA	06/01/2020 08:32	06/01/2020 19:12	06/01/2020 08:32	06/01/2020 19:12	10,66	1	10,66	CHI
20200130976	FORMOSO	FO21137204	MARA ROSA	06/01/2020 08:32	06/01/2020 16:35	06/01/2020 08:32	06/01/2020 16:35	8,04	1	8,04	CHI
20200130979	ITABERAI	IB12022008	ITABERAI S2	06/01/2020 08:33	06/01/2020 10:30	06/01/2020 08:33	06/01/2020 10:30	1,95	29	56,46	CHI
20200130984	AGUA FRIA DE GOIAS	4140007292	SAO JOAO D ALIANCA	06/01/2020 08:33	06/01/2020 11:30	06/01/2020 08:33	06/01/2020 11:30	2,94	1	2,94	CHI
20200130985	LEOPOLDO DE BULHOES	10029861304	DAIA S2	06/01/2020 08:33	06/01/2020 15:56	06/01/2020 08:33	06/01/2020 15:56	7,37	1	7,37	CHI
20200130993	SANTA HELENA DE GOIAS	SH21296187	IPEGUARI	06/01/2020 08:34	06/01/2020 18:35	06/01/2020 08:34	06/01/2020 18:35	10,01	1	10,01	CHI
20200130994	CRISTALINA	KR21171596	CRISTALINA S1	06/01/2020 08:34	06/01/2020 11:29	06/01/2020 08:34	06/01/2020 11:29	2,90	1	2,90	CHI
20200131000	ALVORADA DO NORTE	1510031550	IACIARA S2	06/01/2020 08:35	06/01/2020 09:56	06/01/2020 08:35	06/01/2020 09:56	1,35	1	1,35	CHI
20200131003	LUZIANIA	LZ11183515	RIO VERMELHO	06/01/2020 08:35	06/01/2020 09:42	06/01/2020 08:35	06/01/2020 09:42	1,10	79	87,01	CHI
20200131006	JANDAIA	1180009384	PALMEIRAS	06/01/2020 08:36	06/01/2020 11:00	06/01/2020 08:36	06/01/2020 11:00	2,40	1	2,40	CHI
20200131013	GAMELEIRA DE GOIAS	SV21166972	DAIA S2	06/01/2020 08:37	06/01/2020 13:57	06/01/2020 08:37	06/01/2020 13:57	5,33	1	5,33	CHI
20200131016	CAMPOS VERDES	VD12251082	SANTA TEREZINHA	06/01/2020 06:07	06/01/2020 11:17	06/01/2020 06:07	06/01/2020 11:17	5,16	4	20,64	CHI
20200131016	SANTA TEREZINHA DE GOIAS	VD12251082	SANTA TEREZINHA	06/01/2020 06:07	06/01/2020 11:17	06/01/2020 06:07	06/01/2020 11:17	5,16	17	87,70	CHI
20200131023	QUIRINOPOLIS	80064504	QUIRINOPOLIS	06/01/2020 08:38	06/01/2020 10:00	06/01/2020 08:38	06/01/2020 10:00	1,36	1	1,36	CHI
20200131025	CATALAO	1990045963	CATALAO S2	06/01/2020 08:38	06/01/2020 10:39	06/01/2020 08:38	06/01/2020 10:39	2,01	1	2,01	CHI
20200131028	VALPARAISO DE GOIAS	VA11376102	MARAJOARA	06/01/2020 08:38	06/01/2020 16:17	06/01/2020 08:38	06/01/2020 16:17	7,64	13	99,31	CHI
20200131031	PIRENOPOLIS	PV21298810	GOIANESIA S1	06/01/2020 08:39	07/01/2020 16:16	06/01/2020 08:39	07/01/2020 16:16	31,62	1	31,62	CHI
20200131034	LUZIANIA	3200129928	PACAEMBU S1	06/01/2020 08:39	06/01/2020 15:13	06/01/2020 08:39	06/01/2020 15:13	6,56	1	6,56	CHI
20200131038	GOUVELANDIA	GB21303123	QUIRINOPOLIS	06/01/2020 08:39	06/01/2020 10:35	06/01/2020 08:39	06/01/2020 10:35	1,92	3	5,77	CHI
20200131045	CORUMBA DE GOIAS	CB12312010	CORUMBA	06/01/2020 08:03	06/01/2020 19:48	06/01/2020 08:03	06/01/2020 19:48	11,75	24	281,94	CHI

20200131048	TURVANIA	AC21016429	ANICUNS	06/01/2020 08:40	06/01/2020 10:22	06/01/2020 08:40	06/01/2020 10:22	1,69	1	1,69	CHI
20200131049	ITUMBIARA	IT12037085	CACHOEIRA DOURADA	06/01/2020 08:40	06/01/2020 16:05	06/01/2020 08:40	06/01/2020 16:05	7,40	12	88,83	CHI
20200131049	PANAMA	IT12037085	CACHOEIRA DOURADA	06/01/2020 08:40	06/01/2020 16:05	06/01/2020 08:40	06/01/2020 16:05	7,40	12	88,83	CHI
20200131051	ITABERAI	IB11171749	ITABERAI S2	06/01/2020 08:40	06/01/2020 15:05	06/01/2020 08:40	06/01/2020 15:05	6,40	13	83,20	CHI
20200131066	VARJAO	VJ21312466	CEZARINA	06/01/2020 08:42	06/01/2020 10:31	06/01/2020 08:42	06/01/2020 10:31	1,80	1	1,80	CHI
20200131069	HEITORAI	HE21019128	ITAPURANGA	06/01/2020 08:43	07/01/2020 11:49	06/01/2020 08:43	07/01/2020 11:49	27,10	1	27,10	CHI
20200131071	PARAUNA	PU21237780	PALMEIRAS	06/01/2020 08:43	06/01/2020 11:30	06/01/2020 08:43	06/01/2020 11:30	2,79	1	2,79	CHI
20200131077	ANAPOLIS	10005989432	ANAPOLIS UNIVERSITARIO S2	06/01/2020 08:44	06/01/2020 11:46	06/01/2020 08:44	06/01/2020 11:46	3,02	1	3,02	CHI
20200131080	BURITI DE GOIAS	BS12076542	FIRMINOPOLIS S2	06/01/2020 08:42	06/01/2020 09:46	06/01/2020 08:42	06/01/2020 09:46	1,05	38	40,07	CHI
20200131082	MARA ROSA	MQ21295306	MARA ROSA	06/01/2020 08:45	06/01/2020 15:03	06/01/2020 08:45	06/01/2020 15:03	6,30	1	6,30	CHI
20200131096	UIRAPURU	CX21082544	SANTA TEREZINHA	06/01/2020 08:46	06/01/2020 15:44	06/01/2020 08:46	06/01/2020 15:44	6,95	1	6,95	CHI
20200131109	PALMINOPOLIS	PP12077093	PALMEIRAS	06/01/2020 08:47	06/01/2020 10:54	06/01/2020 08:47	06/01/2020 10:54	2,11	2	4,22	CHI
20200131111	CRISTIANOPOLIS	SQ21283994	CRISTIANOPOLIS	06/01/2020 08:47	06/01/2020 10:30	06/01/2020 08:47	06/01/2020 10:30	1,71	1	1,71	CHI
20200131112	ITAJA	IJ12264408	CACHOEIRA ALTA	06/01/2020 08:47	07/01/2020 20:00	06/01/2020 08:47	07/01/2020 20:00	35,22	4	140,87	CHI
20200131113	IPORA	IR12207942	ARENOPOLIS	06/01/2020 08:47	06/01/2020 10:53	06/01/2020 08:47	06/01/2020 10:53	2,09	1	2,09	CHI
20200131115	CRISTALINA	KR21349075	PAMPLONA	06/01/2020 08:48	07/01/2020 00:39	06/01/2020 08:48	07/01/2020 00:39	15,84	1	15,84	CHI
20200131119	ARAGARCAS	1820011190	ARAGARCAS	06/01/2020 08:48	06/01/2020 11:07	06/01/2020 08:48	06/01/2020 11:07	2,31	1	2,31	CHI
20200131128	ANAPOLIS	AN21000287	JUNDIAI S2	06/01/2020 08:49	06/01/2020 16:35	06/01/2020 08:49	06/01/2020 16:35	7,76	1	7,76	CHI
20200131133	SANTO ANTONIO DO DESCOBERTO	SN21082937	MARAJOARA	06/01/2020 08:50	06/01/2020 17:21	06/01/2020 08:50	06/01/2020 17:21	8,51	1	8,51	CHI
20200131134	GOIANDIRA	GD21157528	CATALAO S1	06/01/2020 08:50	06/01/2020 17:59	06/01/2020 08:50	06/01/2020 17:59	9,15	1	9,15	CHI
20200131137	VALPARAISO DE GOIAS	2860151017	MARAJOARA	06/01/2020 08:50	06/01/2020 10:47	06/01/2020 08:50	06/01/2020 10:47	1,94	1	1,94	CHI
20200131139	FORMOSA	FA31039570	ITIQUEIRA	06/01/2020 08:50	06/01/2020 15:02	06/01/2020 08:50	06/01/2020 15:02	6,19	1	6,19	CHI
20200131141	DISTRITO FEDERAL	FA12383392	ITIQUEIRA	06/01/2020 08:50	06/01/2020 10:50	06/01/2020 08:50	06/01/2020 10:50	1,99	2	3,98	CHI
20200131141	FORMOSA	FA12383392	ITIQUEIRA	06/01/2020 08:50	06/01/2020 10:50	06/01/2020 08:50	06/01/2020 10:50	1,99	1	1,99	CHI
20200131143	VALPARAISO DE GOIAS	VA11096866	PACAEMBU S1	06/01/2020 08:50	06/01/2020 13:14	06/01/2020 08:50	06/01/2020 13:14	4,39	93	407,88	CHI
20200131144	COCALZINHO DE GOIAS	ZN12295711	COCALZINHO	06/01/2020 08:50	06/01/2020 21:41	06/01/2020 08:50	06/01/2020 21:41	12,84	1	12,84	CHI
20200131150	PORANGATU	840147946	PORANGATU	06/01/2020 08:51	06/01/2020 11:44	06/01/2020 08:51	06/01/2020 11:44	2,89	1	2,89	CHI
20200131154	CAIAPONIA	CP12374978	PALESTINA	06/01/2020 08:51	06/01/2020 16:05	06/01/2020 08:51	06/01/2020 16:05	7,22	4	28,89	CHI
20200131158	IPAMERI	IP12241882	IPAMERI	06/01/2020 08:39	06/01/2020 10:57	06/01/2020 08:39	06/01/2020 10:57	2,29	3	6,87	CHI
20200131162	NIQUELANDIA	NQ12374583	URUACU	06/01/2020 08:53	06/01/2020 15:59	06/01/2020 08:53	06/01/2020 15:59	7,10	38	269,72	CHI
20200131164	FORMOSA	610260728	ITIQUEIRA	06/01/2020 08:53	06/01/2020 09:55	06/01/2020 08:53	06/01/2020 09:55	1,02	1	1,02	CHI
20200131167	LUZIANIA	10011188128	MARAJOARA	06/01/2020 08:53	06/01/2020 12:08	06/01/2020 08:53	06/01/2020 12:08	3,25	1	3,25	CHI
20200131168	CACHOEIRA DOURADA	CD21000068	CACHOEIRA DOURADA	06/01/2020 08:54	06/01/2020 11:50	06/01/2020 08:54	06/01/2020 11:50	2,94	1	2,94	CHI



20200131171	TAQUARAL DE GOIAS	I121217069	ITABERAI S1	06/01/2020 08:54	06/01/2020 12:16	06/01/2020 08:54	06/01/2020 12:16	3,36	2	6,73	CHI
20200131173	SAO MIGUEL DO ARAGUAIA	SM21147707	SAO MIGUEL DO ARAGUAIA	06/01/2020 08:54	06/01/2020 19:45	06/01/2020 08:54	06/01/2020 19:45	10,85	1	10,85	CHI
20200131174	CATALAO	CT21333727	CATALAO S1	06/01/2020 08:54	06/01/2020 20:06	06/01/2020 08:54	06/01/2020 20:06	11,19	1	11,19	CHI
20200131176	CAVALCANTE	CJ21412401	MINACU	06/01/2020 08:54	06/01/2020 17:42	06/01/2020 08:54	06/01/2020 17:42	8,79	1	8,79	CHI
20200131181	PIRENOPOLIS	PV21008483	CORUMBA	06/01/2020 08:55	06/01/2020 15:40	06/01/2020 08:55	06/01/2020 15:40	6,74	1	6,74	CHI
20200131183	BONOPOLIS	BX12398148	SAO MIGUEL DO ARAGUAIA	06/01/2020 08:55	06/01/2020 12:00	06/01/2020 08:55	06/01/2020 12:00	3,07	16	49,16	CHI
20200131185	JATAI	JT12182089	JATAI S1	06/01/2020 08:55	06/01/2020 13:18	06/01/2020 08:55	06/01/2020 13:18	4,37	9	39,33	CHI
20200131186	FLORES DE GOIAS	FB11278012	IACIARA S2	06/01/2020 08:56	06/01/2020 13:48	06/01/2020 08:56	06/01/2020 13:48	4,87	1	4,87	CHI
20200131188	CACHOEIRA DOURADA	CD12051386	CACHOEIRA DOURADA	06/01/2020 08:51	08/01/2020 08:02	06/01/2020 08:51	08/01/2020 08:02	47,19	5	235,93	CHI
20200131191	DIORAMA	DI12380801	IPORA	06/01/2020 08:56	06/01/2020 11:10	06/01/2020 08:56	06/01/2020 11:10	2,23	8	17,80	CHI
20200131192	ORIZONA	OZ12188739	PIRES DO RIO S2	06/01/2020 08:56	06/01/2020 16:17	06/01/2020 08:56	06/01/2020 16:17	7,35	13	95,51	CHI
20200131202	MORRINHOS	MR11255626	GOIATUBA S1	06/01/2020 08:58	06/01/2020 12:30	06/01/2020 08:58	06/01/2020 12:30	3,53	1	3,53	CHI
20200131205	BURITI ALEGRE	BG21000181	ITUMBIARA VELHA S2	06/01/2020 08:58	06/01/2020 10:23	06/01/2020 08:58	06/01/2020 10:23	1,41	1	1,41	CHI
20200131211	TAQUARAL DE GOIAS	I121217073	ITABERAI S1	06/01/2020 08:59	06/01/2020 12:40	06/01/2020 08:59	06/01/2020 12:40	3,69	2	7,38	CHI
20200131213	NAZARIO	NZ12233489	ANICUNS	06/01/2020 08:59	06/01/2020 10:54	06/01/2020 08:59	06/01/2020 10:54	1,91	39	74,68	CHI
20200131213	PALMEIRAS DE GOIAS	NZ12233489	ANICUNS	06/01/2020 08:59	06/01/2020 10:54	06/01/2020 08:59	06/01/2020 10:54	1,91	3	5,74	CHI
20200131216	CRISTALINA	KR21212126	CRISTALINA S2	06/01/2020 09:00	06/01/2020 09:38	06/01/2020 09:00	06/01/2020 09:38	0,63	4	2,52	CHI
20200131217	PIRACANJUBA	JS21249898	ROCHEDO	06/01/2020 09:00	06/01/2020 17:55	06/01/2020 09:00	06/01/2020 17:55	8,91	4	35,64	CHI
20200131219	ANAPOLIS	Z1157420	ANAPOLIS UNIVERSITARIO S2	06/01/2020 09:00	06/01/2020 11:35	06/01/2020 09:00	06/01/2020 11:35	2,57	1	2,57	CHI
20200131220	ITAPURANGA	IK12310823	ITAPURANGA	06/01/2020 09:00	06/01/2020 12:06	06/01/2020 09:00	06/01/2020 12:06	3,08	3	9,25	CHI
20200131227	NOVO PLANALTO	TA12084367	SAO MIGUEL DO ARAGUAIA	06/01/2020 09:02	06/01/2020 11:10	06/01/2020 09:02	06/01/2020 11:10	2,12	1	2,12	CHI
20200131228	POSSE	PS12235239	IACIARA S2	06/01/2020 09:02	06/01/2020 10:47	06/01/2020 09:02	06/01/2020 10:47	1,74	2	3,47	CHI
20200131232	PALESTINA DE GOIAS	PY12395457	PALESTINA	06/01/2020 05:49	06/01/2020 18:28	06/01/2020 05:49	06/01/2020 18:28	12,66	4	50,63	CHI
20200131235	QUIRINOPOLIS	QI21014938	QUIRINOPOLIS	06/01/2020 09:03	06/01/2020 10:05	06/01/2020 09:03	06/01/2020 10:05	1,03	1	1,03	CHI
20200131241	RIO VERDE	10006735663	RIO VERDE S1	06/01/2020 09:04	06/01/2020 15:01	06/01/2020 09:04	06/01/2020 15:01	5,94	1	5,94	CHI
20200131247	NIQUELANDIA	NQ21256571	URUACU	06/01/2020 09:05	06/01/2020 21:06	06/01/2020 09:05	06/01/2020 21:06	12,01	1	12,01	CHI
20200131249	CORUMBA DE GOIAS	CB21121732	CORUMBA	06/01/2020 09:05	06/01/2020 15:44	06/01/2020 09:05	06/01/2020 15:44	6,64	1	6,64	CHI
20200131253	ORIZONA	OZ12306688	PIRES DO RIO S2	06/01/2020 09:05	06/01/2020 14:45	06/01/2020 09:05	06/01/2020 14:45	5,67	5	28,33	CHI
20200131255	UIRAPURU	UP12181266	SANTA TEREZINHA	06/01/2020 09:05	06/01/2020 13:00	06/01/2020 09:05	06/01/2020 13:00	3,90	8	31,22	CHI
20200131267	ITAPIRAPUA	IU11072495	MATRINCHA	06/01/2020 09:07	06/01/2020 13:44	06/01/2020 09:07	06/01/2020 13:44	4,62	48	221,73	CHI
20200131275	JARAGUA	JA12000239	JARAGUA	06/01/2020 07:39	06/01/2020 10:22	06/01/2020 07:39	06/01/2020 10:22	2,71	13	35,28	CHI
20200131279	ANAPOLIS	AN11040774	ANAPOLIS UNIVERSITARIO S2	06/01/2020 09:04	06/01/2020 14:39	06/01/2020 09:04	06/01/2020 14:39	5,57	111	618,67	CHI
20200131280	PETROLINA DE GOIAS	PG21117028	SAO FRANCISCO DE GOIAS	06/01/2020 09:08	06/01/2020 13:00	06/01/2020 09:08	06/01/2020 13:00	3,85	2	7,71	CHI

20200131282	PIRANHAS	1930033579	PIRANHAS	06/01/2020 09:08	06/01/2020 11:19	06/01/2020 09:08	06/01/2020 11:19	2,18	1	2,18	CHI
20200131287	SITIO D ABADIA	FB11277907	IACIARA S2	06/01/2020 09:10	06/01/2020 13:27	06/01/2020 09:10	06/01/2020 13:27	4,28	1	4,28	CHI
20200131289	CIDADE OCIDENTAL	DH12370632	MARAJOARA	06/01/2020 08:51	06/01/2020 10:47	06/01/2020 08:51	06/01/2020 10:47	1,93	101	195,01	CHI
20200131292	MINEIROS	MY21209752	PARQUE DAS EMAS	06/01/2020 09:12	06/01/2020 15:00	06/01/2020 09:12	06/01/2020 15:00	5,80	1	5,80	CHI
20200131295	FORMOSA	VB12164674	ITUIQUIRA	06/01/2020 07:22	06/01/2020 13:42	06/01/2020 07:22	06/01/2020 13:42	6,32	44	278,03	CHI
20200131295	VILA BOA	VB12164674	ITUIQUIRA	06/01/2020 07:22	06/01/2020 13:42	06/01/2020 07:22	06/01/2020 13:42	6,32	6	37,91	CHI
20200131297	MUTUNOPOLIS	MU12302569	MARA ROSA	06/01/2020 09:12	06/01/2020 18:08	06/01/2020 09:12	06/01/2020 18:08	8,92	2	17,84	CHI
20200131298	FORMOSO	TB12372648	PORANGATU	06/01/2020 07:02	06/01/2020 10:08	06/01/2020 07:02	06/01/2020 10:08	3,10	1	3,10	CHI
20200131298	TROMBAS	TB12372648	PORANGATU	06/01/2020 07:02	06/01/2020 10:08	06/01/2020 07:02	06/01/2020 10:08	3,10	66	204,29	CHI
20200131304	MORRINHOS	MR12074752	MORRINHOS	06/01/2020 09:12	06/01/2020 13:55	06/01/2020 09:12	06/01/2020 13:55	4,70	2	9,41	CHI
20200131311	ANAPOLIS	AN11086501	JUNDIAI S2	06/01/2020 09:13	06/01/2020 12:16	06/01/2020 09:13	06/01/2020 12:16	3,03	147	446,02	CHI
20200131313	VICENTINOPOLIS	VI12050320	GOIATUBA S1	06/01/2020 09:14	06/01/2020 17:11	06/01/2020 09:14	06/01/2020 17:11	7,95	1	7,95	CHI
20200131316	INDIARA	IY11206043	EDEIA	06/01/2020 09:14	06/01/2020 10:26	06/01/2020 09:14	06/01/2020 10:26	1,20	132	158,44	CHI
20200131325	TERESINA DE GOIAS	TE12328359	FLORES DE GOIAS	06/01/2020 09:15	06/01/2020 12:34	06/01/2020 09:15	06/01/2020 12:34	3,31	2	6,61	CHI
20200131328	CORUMBA DE GOIAS	CB21146682	CORUMBA	06/01/2020 09:14	06/01/2020 11:17	06/01/2020 09:14	06/01/2020 11:17	2,04	1	2,04	CHI
20200131329	ACREUNA	2440052158	ACREUNA	06/01/2020 09:15	06/01/2020 14:44	06/01/2020 09:15	06/01/2020 14:44	5,48	1	5,48	CHI
20200131336	ALEXANIA	AX21351216	ALEXANIA	06/01/2020 09:16	07/01/2020 12:39	06/01/2020 09:16	07/01/2020 12:39	27,37	6	164,20	CHI
20200131337	ANAPOLIS	21080008	ANAPOLIS UNIVERSITARIO S2	06/01/2020 09:17	06/01/2020 19:51	06/01/2020 09:17	06/01/2020 19:51	10,57	1	10,57	CHI
20200131339	ALTO PARAISO DE GOIAS	BF21218637	FLORES DE GOIAS	06/01/2020 09:17	06/01/2020 10:02	06/01/2020 09:17	06/01/2020 10:02	0,74	1	0,74	CHI
20200131345	SILVANIA	SV12202392	DAIA S2	06/01/2020 07:26	06/01/2020 12:05	06/01/2020 07:26	06/01/2020 12:05	4,65	12	55,78	CHI
20200131348	PIRES DO RIO	PR12272817	PIRES DO RIO S1	06/01/2020 09:19	06/01/2020 10:50	06/01/2020 09:19	06/01/2020 10:50	1,52	4	6,09	CHI
20200131355	SAO FRANCISCO DE GOIAS	SF12008967	SAO FRANCISCO DE GOIAS	06/01/2020 09:19	07/01/2020 01:32	06/01/2020 09:19	07/01/2020 01:32	16,21	18	291,72	CHI
20200131363	INACIOLANDIA	ID12271587	CACHOEIRA DOURADA	06/01/2020 09:20	06/01/2020 12:37	06/01/2020 09:20	06/01/2020 12:37	3,28	12	39,35	CHI
20200131366	TURVANIA	TV12391015	FIRMINOPOLIS S2	06/01/2020 09:21	06/01/2020 15:19	06/01/2020 09:21	06/01/2020 15:19	5,97	1	5,97	CHI
20200131369	CATALAO	GD21203020	CATALAO S1	06/01/2020 09:22	06/01/2020 10:39	06/01/2020 09:22	06/01/2020 10:39	1,28	1	1,28	CHI
20200131370	AGUA LIMPA	02660216	VILA CORUMBA	06/01/2020 08:02	06/01/2020 13:47	06/01/2020 08:02	06/01/2020 11:18	3,26	16	52,17	CHI
20200131370	CALDAS NOVAS	02660216	VILA CORUMBA	06/01/2020 08:02	06/01/2020 13:47	06/01/2020 08:02	06/01/2020 11:18	3,26	2	6,52	CHI
20200131370	MARZAGAO	02660216	VILA CORUMBA	06/01/2020 08:02	06/01/2020 13:47	06/01/2020 08:02	06/01/2020 11:18	3,26	232	756,45	CHI
20200131370	RIO QUENTE	02660216	VILA CORUMBA	06/01/2020 08:02	06/01/2020 13:47	06/01/2020 08:02	06/01/2020 11:18	3,26	4	13,04	CHI
20200131370	CALDAS NOVAS	MG13078813	VILA CORUMBA	06/01/2020 08:02	06/01/2020 13:47	06/01/2020 08:02	06/01/2020 13:16	5,23	18	94,13	CHI
20200131370	CORUMBAIBA	MG13078813	VILA CORUMBA	06/01/2020 08:02	06/01/2020 13:47	06/01/2020 08:02	06/01/2020 13:16	5,23	39	203,94	CHI
20200131370	MARZAGAO	MG13078813	VILA CORUMBA	06/01/2020 08:02	06/01/2020 13:47	06/01/2020 08:02	06/01/2020 13:16	5,23	777	4063,06	CHI
20200131370	AGUA LIMPA	MG13078813	VILA CORUMBA	06/01/2020 08:02	06/01/2020 13:47	06/01/2020 12:05	06/01/2020 13:16	1,19	16	18,97	CHI

20200131370	CALDAS NOVAS	MG13078813	VILA CORUMBA	06/01/2020 08:02	06/01/2020 13:47	06/01/2020 12:05	06/01/2020 13:16	1,19	2	2,37	CHI
20200131370	MARZAGAO	MG13078813	VILA CORUMBA	06/01/2020 08:02	06/01/2020 13:47	06/01/2020 12:05	06/01/2020 13:16	1,19	233	276,23	CHI
20200131370	RIO QUENTE	MG13078813	VILA CORUMBA	06/01/2020 08:02	06/01/2020 13:47	06/01/2020 12:05	06/01/2020 13:16	1,19	4	4,74	CHI
20200131370	AGUA LIMPA	CN10396194	VILA CORUMBA	06/01/2020 08:02	06/01/2020 13:47	06/01/2020 13:42	06/01/2020 13:47	0,08	16	1,24	CHI
20200131370	CALDAS NOVAS	CN10396194	VILA CORUMBA	06/01/2020 08:02	06/01/2020 13:47	06/01/2020 13:42	06/01/2020 13:47	0,08	36	2,80	CHI
20200131370	MORRINHOS	CN10396194	VILA CORUMBA	06/01/2020 08:02	06/01/2020 13:47	06/01/2020 13:42	06/01/2020 13:47	0,08	5	0,39	CHI
20200131370	RIO QUENTE	CN10396194	VILA CORUMBA	06/01/2020 08:02	06/01/2020 13:47	06/01/2020 13:42	06/01/2020 13:47	0,08	113	8,79	CHI
20200131370	CALDAS NOVAS	CN10396194	VILA CORUMBA	06/01/2020 08:02	06/01/2020 13:47	06/01/2020 13:43	06/01/2020 13:47	0,07	37	2,59	CHI
20200131370	MARZAGAO	CN10396194	VILA CORUMBA	06/01/2020 08:02	06/01/2020 13:47	06/01/2020 13:43	06/01/2020 13:47	0,07	38	2,66	CHI
20200131373	IPAMERI	IP12233856	URUTAI	06/01/2020 09:23	07/01/2020 11:35	06/01/2020 09:23	07/01/2020 11:35	26,20	1	26,20	CHI
20200131380	LUZIANIA	10005760230	MARAJOARA	06/01/2020 09:23	06/01/2020 19:46	06/01/2020 09:23	06/01/2020 19:46	10,37	1	10,37	CHI
20200131388	LUZIANIA	LZ11162827	RIO VERMELHO	06/01/2020 09:25	06/01/2020 23:07	06/01/2020 09:25	06/01/2020 23:07	13,71	19	260,53	CHI
20200131390	IPAMERI	IP21204177	IPAMERI	06/01/2020 09:26	06/01/2020 22:31	06/01/2020 09:26	06/01/2020 22:31	13,08	1	13,08	CHI
20200131392	GOIANDIRA	GD21127633	CATALAO S1	06/01/2020 09:26	06/01/2020 16:32	06/01/2020 09:26	06/01/2020 16:32	7,11	1	7,11	CHI
20200131404	SILVANIA	SV21011692	DAIA S2	06/01/2020 09:28	06/01/2020 16:12	06/01/2020 09:28	06/01/2020 16:12	6,72	1	6,72	CHI
20200131409	AGUAS LINDAS DE GOIAS	6830020100	AGUAS LINDAS DE GOIAS S2	06/01/2020 09:28	06/01/2020 15:57	06/01/2020 09:28	06/01/2020 15:57	6,47	1	6,47	CHI
20200131410	COCALZINHO DE GOIAS	ZN21168637	GOIANESIA S1	06/01/2020 09:29	06/01/2020 17:03	06/01/2020 09:29	06/01/2020 17:03	7,57	1	7,57	CHI
20200131415	UIRAPURU	4200001860	SANTA TEREZINHA	06/01/2020 09:29	06/01/2020 12:21	06/01/2020 09:29	06/01/2020 12:21	2,86	1	2,86	CHI
20200131417	ANAPOLIS	21285287	JUNDIAI S2	06/01/2020 09:29	06/01/2020 22:39	06/01/2020 09:29	06/01/2020 22:39	13,16	1	13,16	CHI
20200131435	RUBIATABA	RB12392304	RUBIATABA	06/01/2020 07:26	06/01/2020 10:35	06/01/2020 07:26	06/01/2020 10:35	3,14	4	12,57	CHI
20200131438	FORMOSA	FA11278163	ITUIQUIRA	06/01/2020 09:32	06/01/2020 12:39	06/01/2020 09:32	06/01/2020 12:39	3,11	1	3,11	CHI
20200131440	GOIAS	GS21062867	ITABERAI S1	06/01/2020 09:32	06/01/2020 11:43	06/01/2020 09:32	06/01/2020 11:43	2,17	2	4,34	CHI
20200131442	ANAPOLIS	21177594	ANAPOLIS UNIVERSITARIO S2	06/01/2020 09:33	06/01/2020 20:42	06/01/2020 09:33	06/01/2020 20:42	11,15	1	11,15	CHI
20200131444	MINEIROS	MY21303800	PARQUE DAS EMAS	06/01/2020 09:33	06/01/2020 19:00	06/01/2020 09:33	06/01/2020 19:00	9,45	1	9,45	CHI
20200131445	SANTA HELENA DE GOIAS	SH21134862	IPEGUARI	06/01/2020 09:33	06/01/2020 15:40	06/01/2020 09:33	06/01/2020 15:40	6,11	1	6,11	CHI
20200131451	LUZIANIA	LZ21136620	MARAJOARA	06/01/2020 09:33	06/01/2020 18:53	06/01/2020 09:33	06/01/2020 18:53	9,32	1	9,32	CHI
20200131452	IPAMERI	580083433	IPAMERI	06/01/2020 09:34	06/01/2020 11:59	06/01/2020 09:34	06/01/2020 11:59	2,42	1	2,42	CHI
20200131457	JARAGUA	JA12283464	JARAGUA	06/01/2020 09:31	06/01/2020 14:31	06/01/2020 09:31	06/01/2020 14:31	4,99	13	64,90	CHI
20200131458	JAUPACI	JP12028023	IPORA	06/01/2020 08:07	06/01/2020 13:18	06/01/2020 08:07	06/01/2020 13:18	5,19	7	36,30	CHI
20200131463	CRISTALINA	KR21391163	CRISTALINA S2	06/01/2020 09:35	06/01/2020 10:46	06/01/2020 09:35	06/01/2020 10:46	1,17	2	2,35	CHI
20200131467	CAMPOS VERDES	VD21049807	SANTA TEREZINHA	06/01/2020 09:36	06/01/2020 11:55	06/01/2020 09:36	06/01/2020 11:55	2,32	2	4,64	CHI
20200131478	ANAPOLIS	AN12288618	JUNDIAI S2	06/01/2020 09:35	06/01/2020 14:11	06/01/2020 09:35	06/01/2020 14:11	4,60	90	413,77	CHI
20200131481	LEOPOLDO DE BULHOES	LB21239288	DAIA S2	06/01/2020 09:38	06/01/2020 15:35	06/01/2020 09:38	06/01/2020 15:35	5,93	1	5,93	CHI

20200131482	CRIXAS	CX12319094	SERRA DO OURO	06/01/2020 09:39	06/01/2020 14:14	06/01/2020 09:39	06/01/2020 14:14	4,58	5	22,92	CHI
20200131483	CACHOEIRA ALTA	CA21078874	CACHOEIRA ALTA	06/01/2020 09:39	06/01/2020 18:17	06/01/2020 09:39	06/01/2020 18:17	8,63	1	8,63	CHI
20200131486	ABADIANIA	AA12377404	ANAPOLIS UNIVERSITARIO S1	06/01/2020 08:36	06/01/2020 14:23	06/01/2020 08:36	06/01/2020 14:23	5,77	58	334,66	CHI
20200131487	ANAPOLIS	21269841	JUNDIAI S2	06/01/2020 09:39	06/01/2020 14:19	06/01/2020 09:39	06/01/2020 14:19	4,66	1	4,66	CHI
20200131493	PILAR DE GOIAS	GG12320964	URUACU	06/01/2020 09:05	06/01/2020 22:01	06/01/2020 09:05	06/01/2020 22:01	12,93	7	90,50	CHI
20200131495	CABECEIRAS	860007704	ITIQUEIRA	06/01/2020 09:39	06/01/2020 13:07	06/01/2020 09:39	06/01/2020 13:07	3,45	1	3,45	CHI
20200131503	NOVA AURORA	NE12337562	CATALAO S1	06/01/2020 09:41	06/01/2020 23:02	06/01/2020 09:41	06/01/2020 23:02	13,34	4	53,35	CHI
20200131514	IACIARA	IA11039967	IACIARA S1	06/01/2020 12:40	06/01/2020 14:09	06/01/2020 12:40	06/01/2020 14:09	1,47	130	191,68	CHI
20200131524	MINACU	4020038625	MINACU	06/01/2020 09:44	06/01/2020 19:49	06/01/2020 09:44	06/01/2020 19:49	10,08	1	10,08	CHI
20200131532	FORMOSA	FA12000130	ITIQUEIRA	06/01/2020 09:45	06/01/2020 12:08	06/01/2020 09:45	06/01/2020 12:08	2,37	14	33,24	CHI
20200131536	GOIATUBA	JV12208118	GOIATUBA S1	06/01/2020 08:31	06/01/2020 13:35	06/01/2020 08:31	06/01/2020 13:35	5,06	4	20,25	CHI
20200131536	JOVIANIA	JV12208118	GOIATUBA S1	06/01/2020 08:31	06/01/2020 13:35	06/01/2020 08:31	06/01/2020 13:35	5,06	15	75,92	CHI
20200131544	QUIRINOPOLIS	QI21134433	QUIRINOPOLIS	06/01/2020 09:46	06/01/2020 12:50	06/01/2020 09:46	06/01/2020 12:50	3,05	2	6,10	CHI
20200131546	GOIATUBA	GT12000265	GOIATUBA S2	06/01/2020 09:46	06/01/2020 12:13	06/01/2020 09:46	06/01/2020 12:13	2,44	8	19,51	CHI
20200131547	PORANGATU	PO12228609	PORANGATU	06/01/2020 07:12	06/01/2020 17:47	06/01/2020 07:12	06/01/2020 17:47	10,57	16	169,10	CHI
20200131551	AGUA LIMPA	AL21246559	VILA CORUMBA	06/01/2020 09:47	06/01/2020 14:34	06/01/2020 09:47	06/01/2020 14:34	4,77	1	4,77	CHI
20200131552	FORMOSA	FA12042584	ITIQUEIRA	06/01/2020 09:47	06/01/2020 17:30	06/01/2020 09:47	06/01/2020 17:30	7,70	1	7,70	CHI
20200131559	PLANALTINA	PI11048030	PLANALTINA	06/01/2020 09:38	06/01/2020 10:14	06/01/2020 09:38	06/01/2020 10:14	0,59	66	38,96	CHI
20200131563	PIRACANJUBA	PJ12000214	PIRACANJUBA	06/01/2020 09:49	06/01/2020 17:10	06/01/2020 09:49	06/01/2020 17:10	7,34	6	44,06	CHI
20200131564	CRIXAS	CX12391679	SANTA TEREZINHA	06/01/2020 09:49	07/01/2020 17:28	06/01/2020 09:49	07/01/2020 17:28	31,65	8	253,22	CHI
20200131569	FORMOSA	PI12208713	PLANALTINA	06/01/2020 09:43	06/01/2020 11:21	06/01/2020 09:43	06/01/2020 11:21	1,62	1	1,62	CHI
20200131569	PLANALTINA	PI12208713	PLANALTINA	06/01/2020 09:43	06/01/2020 11:21	06/01/2020 09:43	06/01/2020 11:21	1,62	251	406,62	CHI
20200131571	ORIZONA	OZ21027134	PIRES DO RIO S2	06/01/2020 09:50	06/01/2020 12:12	06/01/2020 09:50	06/01/2020 12:12	2,35	1	2,35	CHI
20200131572	FORMOSA	FA21180826	SAO JOAO D ALIANCA	06/01/2020 09:50	06/01/2020 12:05	06/01/2020 09:50	06/01/2020 12:05	2,24	1	2,24	CHI
20200131575	JARAGUA	JA21006454	JARAGUA	06/01/2020 09:51	07/01/2020 10:00	06/01/2020 09:51	07/01/2020 10:00	24,14	2	48,29	CHI
20200131578	PIRACANJUBA	PJ21199391	CALDAS NOVAS S1	06/01/2020 09:51	06/01/2020 15:20	06/01/2020 09:51	06/01/2020 15:20	5,48	1	5,48	CHI
20200131583	CRISTALINA	KR21247880	CRISTALINA S2	06/01/2020 09:52	06/01/2020 12:40	06/01/2020 09:52	06/01/2020 12:40	2,79	2	5,59	CHI
20200131584	CAIAPONIA	CP21357594	PALESTINA	06/01/2020 09:52	06/01/2020 14:15	06/01/2020 09:52	06/01/2020 14:15	4,38	1	4,38	CHI
20200131587	CRISTALINA	KR21118414	PAMPLONA	06/01/2020 09:52	06/01/2020 14:12	06/01/2020 09:52	06/01/2020 14:12	4,33	1	4,33	CHI
20200131590	MINACU	IH21255537	MINACU	06/01/2020 09:52	06/01/2020 16:54	06/01/2020 09:52	06/01/2020 16:54	7,02	1	7,02	CHI
20200131593	ALEXANIA	AX12313240	ALEXANIA	06/01/2020 09:47	06/01/2020 11:32	06/01/2020 09:47	06/01/2020 11:32	1,74	17	29,66	CHI
20200131596	ANAPOLIS	20048853	JUNDIAI S1	06/01/2020 09:53	06/01/2020 17:43	06/01/2020 09:53	06/01/2020 17:43	7,83	1	7,83	CHI
20200131597	PIRES DO RIO	10012938708	PIRES DO RIO S1	06/01/2020 09:53	06/01/2020 11:28	06/01/2020 09:53	06/01/2020 11:28	1,58	1	1,58	CHI

20200131599	ITABERAÍ	IB21235761	ITABERAÍ S2	06/01/2020 09:53	06/01/2020 17:10	06/01/2020 09:53	06/01/2020 17:10	7,27	1	7,27	CHI
20200131604	LUZIANIA	10025165079	RIO VERMELHO	06/01/2020 09:53	06/01/2020 12:33	06/01/2020 09:53	06/01/2020 12:33	2,65	1	2,65	CHI
20200131606	QUIRINOPOLIS	Q111191797	QUIRINOPOLIS	06/01/2020 09:54	06/01/2020 17:50	06/01/2020 09:54	06/01/2020 17:50	7,93	4	31,73	CHI
20200131609	RIO VERDE	RV12260654	MONTIVÍDIU T	06/01/2020 09:54	06/01/2020 14:47	06/01/2020 09:54	06/01/2020 14:47	4,87	3	14,62	CHI
20200131610	CATALAO	CT21130165	CATALAO S1	06/01/2020 09:54	06/01/2020 13:40	06/01/2020 09:54	06/01/2020 13:40	3,76	1	3,76	CHI
20200131613	CRIXAS	4610002943	SERRA DO OURO	06/01/2020 09:54	06/01/2020 11:27	06/01/2020 09:54	06/01/2020 11:27	1,54	1	1,54	CHI
20200131630	ITAPACI	100016420	ITAPACI	06/01/2020 09:57	06/01/2020 16:52	06/01/2020 09:57	06/01/2020 16:52	6,92	1	6,92	CHI
20200131636	CAMPO ALEGRE DE GOIAS	CM12084693	CAMPO ALEGRE DE GOIAS	06/01/2020 09:58	06/01/2020 12:21	06/01/2020 09:58	06/01/2020 12:21	2,38	1	2,38	CHI
20200131639	PORANGATU	PO12000021	PORANGATU	06/01/2020 09:58	06/01/2020 12:25	06/01/2020 09:58	06/01/2020 12:25	2,44	187	457,01	CHI
20200131640	SAO FRANCISCO DE GOIAS	SF21381360	SAO FRANCISCO DE GOIAS	06/01/2020 09:58	07/01/2020 02:24	06/01/2020 09:58	07/01/2020 02:24	16,43	1	16,43	CHI
20200131644	SAO MIGUEL DO ARAGUAIA	SM12277403	SAO MIGUEL DO ARAGUAIA	06/01/2020 09:58	06/01/2020 19:02	06/01/2020 09:58	06/01/2020 19:02	9,07	1	9,07	CHI
20200131648	GOIANAPOLIS	GP12357383	DAIA S2	06/01/2020 09:41	06/01/2020 12:25	06/01/2020 09:41	06/01/2020 12:25	2,73	16	43,67	CHI
20200131648	GOIANIA	GP12357383	DAIA S2	06/01/2020 09:41	06/01/2020 12:25	06/01/2020 09:41	06/01/2020 12:25	2,73	1	2,73	CHI
20200131650	JATAI	290261077	JATAI S3	06/01/2020 09:59	06/01/2020 12:10	06/01/2020 09:59	06/01/2020 12:10	2,19	1	2,19	CHI
20200131654	COCALZINHO DE GOIAS	ZN11388041	GOIANESIA S1	06/01/2020 09:59	06/01/2020 16:01	06/01/2020 09:59	06/01/2020 16:01	6,03	1	6,03	CHI
20200131657	ITARUMA	03700234	CACHOEIRA ALTA	06/01/2020 09:37	07/01/2020 03:50	06/01/2020 09:37	06/01/2020 17:04	7,45	33	245,69	CHI
20200131657	ITAJA	03700234	CACHOEIRA ALTA	06/01/2020 09:37	07/01/2020 03:50	06/01/2020 15:30	06/01/2020 17:04	1,57	8	12,53	CHI
20200131657	ITARUMA	03700234	CACHOEIRA ALTA	06/01/2020 09:37	07/01/2020 03:50	06/01/2020 15:30	06/01/2020 17:04	1,57	9	14,10	CHI
20200131657	ITARUMA	03700234	CACHOEIRA ALTA	06/01/2020 09:37	07/01/2020 03:50	06/01/2020 09:37	07/01/2020 03:29	17,87	9	160,83	CHI
20200131657	ITARUMA	03700234	CACHOEIRA ALTA	06/01/2020 09:37	07/01/2020 03:50	06/01/2020 09:37	07/01/2020 03:50	18,22	25	455,44	CHI
20200131660	LUZIANIA	LZ12330544	MARAJOARA	06/01/2020 10:00	06/01/2020 13:08	06/01/2020 10:00	06/01/2020 13:08	3,13	8	25,05	CHI
20200131669	GOIANDIRA	GD12281470	CATALAO S1	06/01/2020 10:01	06/01/2020 13:37	06/01/2020 10:01	06/01/2020 13:37	3,60	5	17,98	CHI
20200131685	FLORES DE GOIAS	FB12277844	IACIARA S2	06/01/2020 10:03	06/01/2020 14:23	06/01/2020 10:03	06/01/2020 14:23	4,33	2	8,65	CHI
20200131685	SITIO D ABADIA	FB12277844	IACIARA S2	06/01/2020 10:03	06/01/2020 14:23	06/01/2020 10:03	06/01/2020 14:23	4,33	5	21,63	CHI
20200131691	ANAPOLIS	AN31088317	ANAPOLIS UNIVERSITARIO S2	06/01/2020 10:04	06/01/2020 10:41	06/01/2020 10:04	06/01/2020 10:41	0,61	1	0,61	CHI
20200131692	EDEIA	1120045311	EDEIA	06/01/2020 10:03	06/01/2020 12:58	06/01/2020 10:03	06/01/2020 12:58	2,90	1	2,90	CHI
20200131714	ITAPIRAPUA	IU11292785	MATRINCHA	06/01/2020 10:06	06/01/2020 18:45	06/01/2020 10:06	06/01/2020 18:45	8,65	67	579,46	CHI
20200131721	PLANALTINA	2960219369	PLANALTINA	06/01/2020 10:07	06/01/2020 11:04	06/01/2020 10:07	06/01/2020 11:04	0,95	1	0,95	CHI
20200131722	RIO VERDE	630398264	RIO VERDE S1	06/01/2020 10:07	06/01/2020 11:33	06/01/2020 10:07	06/01/2020 11:33	1,44	1	1,44	CHI
20200131726	MINACU	IH21230434	MINACU	06/01/2020 10:08	06/01/2020 12:31	06/01/2020 10:08	06/01/2020 12:31	2,38	1	2,38	CHI
20200131727	JARAGUA	JA21354202	JARAGUA	06/01/2020 10:08	07/01/2020 13:16	06/01/2020 10:08	07/01/2020 13:16	27,12	1	27,12	CHI
20200131732	ITAPACI	IW12167983	ITAPACI	06/01/2020 09:55	06/01/2020 16:39	06/01/2020 09:55	06/01/2020 16:39	6,72	29	194,86	CHI
20200131736	INACIOLANDIA	ID21128112	QUIRINOPOLIS	06/01/2020 10:09	06/01/2020 13:58	06/01/2020 10:09	06/01/2020 13:58	3,81	1	3,81	CHI

20200131740	FIRMINOPOLIS	AI21092597	FIRMINOPOLIS S2	06/01/2020 10:10	06/01/2020 11:15	06/01/2020 10:10	06/01/2020 11:15	1,10	1	1,10	CHI
20200131741	MINEIROS	01030404	CHAPADAO DO CEU	06/01/2020 09:44	06/01/2020 15:19	06/01/2020 15:15	06/01/2020 15:19	0,07	20	1,39	CHI
20200131741	SERRANOPOLIS	01030404	CHAPADAO DO CEU	06/01/2020 09:44	06/01/2020 15:19	06/01/2020 15:15	06/01/2020 15:19	0,07	58	4,03	CHI
20200131741	CAIAPONIA	01030404	JATAI S1	06/01/2020 09:44	06/01/2020 15:19	06/01/2020 15:15	06/01/2020 15:19	0,07	20	1,39	CHI
20200131741	CAIAPONIA	01030404	JATAI S1	06/01/2020 09:44	06/01/2020 15:19	06/01/2020 15:15	06/01/2020 15:19	0,07	38	2,64	CHI
20200131741	JATAI	01030404	JATAI S1	06/01/2020 09:44	06/01/2020 15:19	06/01/2020 15:15	06/01/2020 15:19	0,07	301	20,90	CHI
20200131741	JATAI	01030404	JATAI S1	06/01/2020 09:44	06/01/2020 15:19	06/01/2020 15:15	06/01/2020 15:19	0,07	408	28,33	CHI
20200131741	MINEIROS	01030404	JATAI S1	06/01/2020 09:44	06/01/2020 15:19	06/01/2020 15:15	06/01/2020 15:19	0,07	2	0,14	CHI
20200131741	MINEIROS	01030404	JATAI S1	06/01/2020 09:44	06/01/2020 15:19	06/01/2020 15:15	06/01/2020 15:19	0,07	3	0,21	CHI
20200131741	PEROLANDIA	01030404	JATAI S1	06/01/2020 09:44	06/01/2020 15:19	06/01/2020 15:15	06/01/2020 15:19	0,07	1032	71,67	CHI
20200131741	PEROLANDIA	01030404	JATAI S1	06/01/2020 09:44	06/01/2020 15:19	06/01/2020 15:15	06/01/2020 15:19	0,07	41	2,85	CHI
20200131741	PEROLANDIA	01030404	JATAI S1	06/01/2020 09:44	06/01/2020 15:19	06/01/2020 15:15	06/01/2020 15:19	0,07	136	9,44	CHI
20200131741	PEROLANDIA	01030404	JATAI S1	06/01/2020 09:44	06/01/2020 15:19	06/01/2020 15:15	06/01/2020 15:19	0,07	46	3,19	CHI
20200131741	SERRANOPOLIS	01030404	JATAI S1	06/01/2020 09:44	06/01/2020 15:19	06/01/2020 15:15	06/01/2020 15:19	0,07	38	2,64	CHI
20200131742	CRISTALINA	KR21214838	CRISTALINA S2	06/01/2020 10:10	06/01/2020 16:42	06/01/2020 10:10	06/01/2020 16:42	6,53	1	6,53	CHI
20200131743	NIQUELANDIA	NQ12245210	NIQUELANDIA SUBTRANSMISSAO	06/01/2020 08:14	06/01/2020 15:20	06/01/2020 08:14	06/01/2020 15:20	7,10	68	482,74	CHI
20200131745	ITABERAI	IB21188776	ITABERAI S2	06/01/2020 10:10	06/01/2020 18:31	06/01/2020 10:10	06/01/2020 18:31	8,34	1	8,34	CHI
20200131747	BOM JARDIM DE GOIAS	BM12297154	BOM JARDIM	06/01/2020 10:12	06/01/2020 16:45	06/01/2020 10:12	06/01/2020 16:45	6,55	2	13,09	CHI
20200131748	GOIAS	90067230	GOIAS	06/01/2020 10:10	06/01/2020 16:43	06/01/2020 10:10	06/01/2020 16:43	6,54	1	6,54	CHI
20200131752	HIDROLANDIA	PJ12000097	PIRACANJUBA	06/01/2020 10:11	06/01/2020 17:40	06/01/2020 10:11	06/01/2020 17:40	7,48	8	59,83	CHI
20200131752	PIRACANJUBA	PJ12000097	PIRACANJUBA	06/01/2020 10:11	06/01/2020 17:40	06/01/2020 10:11	06/01/2020 17:40	7,48	34	254,29	CHI
20200131759	PADRE BERNARDO	PB12237990	PADRE BERNARDO	06/01/2020 10:12	06/01/2020 16:38	06/01/2020 10:12	06/01/2020 16:38	6,43	1	6,43	CHI
20200131763	BOM JARDIM DE GOIAS	BM12394990	BOM JARDIM	06/01/2020 10:14	06/01/2020 16:21	06/01/2020 10:14	06/01/2020 16:21	6,10	6	36,62	CHI
20200131764	AGUA FRIA DE GOIAS	TL12048061	SAO JOAO D ALIANCA	06/01/2020 09:41	06/01/2020 13:23	06/01/2020 09:41	06/01/2020 13:23	3,70	53	195,92	CHI
20200131772	GOIANAPOLIS	TJ12353408	DAIA S2	06/01/2020 10:13	07/01/2020 00:25	06/01/2020 10:13	07/01/2020 00:25	14,19	3	42,57	CHI
20200131772	TEREZOPOLIS DE GOIAS	TJ12353408	DAIA S2	06/01/2020 10:13	07/01/2020 00:25	06/01/2020 10:13	07/01/2020 00:25	14,19	1	14,19	CHI
20200131774	LUZIANIA	120047470	RIO VERMELHO	06/01/2020 10:14	06/01/2020 20:56	06/01/2020 10:14	06/01/2020 20:56	10,69	1	10,69	CHI
20200131777	EDEALINA	ED21088855	PONTALINA	06/01/2020 10:15	06/01/2020 15:36	06/01/2020 10:15	06/01/2020 15:36	5,35	2	10,70	CHI
20200131778	JARAGUA	JA12273331	JARAGUA	06/01/2020 10:15	06/01/2020 17:37	06/01/2020 10:15	06/01/2020 17:37	7,36	15	110,42	CHI
20200131778	PIRENOPOLIS	JA12273331	JARAGUA	06/01/2020 10:15	06/01/2020 17:37	06/01/2020 10:15	06/01/2020 17:37	7,36	28	206,12	CHI
20200131779	ANICUNS	AC21000044	ANICUNS	06/01/2020 10:15	06/01/2020 11:15	06/01/2020 10:15	06/01/2020 11:15	0,99	1	0,99	CHI
20200131784	ISRAELANDIA	IS21101657	IPORA	06/01/2020 10:16	07/01/2020 06:43	06/01/2020 10:16	07/01/2020 06:43	20,45	1	20,45	CHI
20200131789	GOIAS	GS21079309	MATRINCHA	06/01/2020 10:16	06/01/2020 19:00	06/01/2020 10:16	06/01/2020 19:00	8,72	1	8,72	CHI

20200131790	INDIARA	IY21206040	EDEIA	06/01/2020 10:17	06/01/2020 12:28	06/01/2020 10:17	06/01/2020 12:28	2,20	1	2,20	CHI
20200131791	IVOLANDIA	PU12090442	MONTIVIDIU T	06/01/2020 10:09	06/01/2020 17:41	06/01/2020 10:09	06/01/2020 17:41	7,52	22	165,43	CHI
20200131791	PARAUNA	PU12090442	MONTIVIDIU T	06/01/2020 10:09	06/01/2020 17:41	06/01/2020 10:09	06/01/2020 17:41	7,52	49	368,45	CHI
20200131792	ITAPURANGA	IK11061593	ITAPURANGA	06/01/2020 09:29	06/01/2020 14:59	06/01/2020 09:29	06/01/2020 14:59	5,51	120	660,77	CHI
20200131795	PADRE BERNARDO	9980014999	PADRE BERNARDO	06/01/2020 10:18	06/01/2020 13:34	06/01/2020 10:18	06/01/2020 13:34	3,27	1	3,27	CHI
20200131799	FAINA	FC12232835	GOIAS	06/01/2020 10:14	06/01/2020 14:28	06/01/2020 10:14	06/01/2020 14:28	4,22	10	42,21	CHI
20200131801	COCALZINHO DE GOIAS	ZN12297574	COCALZINHO	06/01/2020 08:27	06/01/2020 12:33	06/01/2020 08:27	06/01/2020 12:33	4,10	1	4,10	CHI
20200131801	CORUMBA DE GOIAS	ZN12297574	COCALZINHO	06/01/2020 08:27	06/01/2020 12:33	06/01/2020 08:27	06/01/2020 12:33	4,10	2	8,20	CHI
20200131804	JUSSARA	1290001320	JUSSARA	06/01/2020 10:18	06/01/2020 18:36	06/01/2020 10:18	06/01/2020 18:36	8,29	1	8,29	CHI
20200131805	PONTALINA	PK12033340	PONTALINA	06/01/2020 10:18	06/01/2020 18:37	06/01/2020 10:18	06/01/2020 18:37	8,30	1	8,30	CHI
20200131809	BALIZA	BH12187387LD	BOM JARDIM	06/01/2020 09:37	06/01/2020 10:59	06/01/2020 09:37	06/01/2020 10:59	1,37	632	862,86	CHI
20200131814	AMARALINA	LC21200480	SAO MIGUEL DO ARAGUAIA	06/01/2020 10:19	06/01/2020 15:15	06/01/2020 10:19	06/01/2020 15:15	4,92	1	4,92	CHI
20200131816	ITUMBIARA	IT12305607	ITUMBIARA NOVA	06/01/2020 10:13	06/01/2020 13:00	06/01/2020 10:13	06/01/2020 13:00	2,77	13	36,05	CHI
20200131817	ANAPOLIS	20575762	JUNDIAI S2	06/01/2020 10:20	06/01/2020 16:48	06/01/2020 10:20	06/01/2020 16:48	6,46	1	6,46	CHI
20200131818	ALVORADA DO NORTE	AQ11347076	IACIARA S2	06/01/2020 10:20	06/01/2020 14:11	06/01/2020 10:20	06/01/2020 14:11	3,84	2	7,68	CHI
20200131822	CALDAS NOVAS	10010234398	SERRA DE CALDAS	06/01/2020 10:21	06/01/2020 12:34	06/01/2020 10:21	06/01/2020 12:34	2,22	1	2,22	CHI
20200131824	FORMOSA	FA11085495	ITUIQUIRA	06/01/2020 10:21	06/01/2020 12:14	06/01/2020 10:21	06/01/2020 12:14	1,88	2	3,76	CHI
20200131825	MINEIROS	1390049428	PARQUE DAS EMAS	06/01/2020 10:21	06/01/2020 17:20	06/01/2020 10:21	06/01/2020 17:20	6,98	1	6,98	CHI
20200131827	CRIXAS	CX11399949	RUBIATABA	06/01/2020 10:22	06/01/2020 16:50	06/01/2020 10:22	06/01/2020 16:50	6,46	1	6,46	CHI
20200131830	PALMEIRAS DE GOIAS	PL12000012	PALMEIRAS	06/01/2020 10:22	06/01/2020 11:15	06/01/2020 10:22	06/01/2020 11:15	0,88	92	80,60	CHI
20200131831	HIDROLINA	HL12372465	SANTA TEREZINHA	06/01/2020 10:22	06/01/2020 15:19	06/01/2020 10:22	06/01/2020 15:19	4,94	1	4,94	CHI
20200131847	ALVORADA DO NORTE	AQ21146158	IACIARA S2	06/01/2020 10:24	06/01/2020 11:25	06/01/2020 10:24	06/01/2020 11:25	1,01	2	2,02	CHI
20200131851	PIRENOPOLIS	PV21298812	GOIANESIA S1	06/01/2020 10:24	07/01/2020 15:37	06/01/2020 10:24	07/01/2020 15:37	29,20	1	29,20	CHI
20200131859	ALTO PARAISO DE GOIAS	BF12155974	SAO JOAO D ALIANCA	06/01/2020 10:07	07/01/2020 12:04	06/01/2020 10:07	06/01/2020 12:42	2,57	93	239,11	CHI
20200131859	ALTO PARAISO DE GOIAS	BF12244628LD	SAO JOAO D ALIANCA	06/01/2020 10:07	07/01/2020 12:04	06/01/2020 10:07	06/01/2020 15:27	5,34	33	176,10	CHI
20200131859	ALTO PARAISO DE GOIAS	BF12155974	SAO JOAO D ALIANCA	06/01/2020 10:07	07/01/2020 12:04	06/01/2020 15:30	06/01/2020 16:43	1,20	99	119,29	CHI
20200131859	ALTO PARAISO DE GOIAS	BF12244628LD	SAO JOAO D ALIANCA	06/01/2020 10:07	07/01/2020 12:04	06/01/2020 15:30	06/01/2020 18:01	2,52	21	53,00	CHI
20200131859	ALTO PARAISO DE GOIAS	BF12365360LD	SAO JOAO D ALIANCA	06/01/2020 10:07	07/01/2020 12:04	06/01/2020 10:07	06/01/2020 18:38	8,52	31	264,09	CHI
20200131859	ALTO PARAISO DE GOIAS	BF12365266	SAO JOAO D ALIANCA	06/01/2020 10:07	07/01/2020 12:04	06/01/2020 15:30	07/01/2020 12:04	20,57	12	246,82	CHI
20200131862	GOIATUBA	140102437	GOIATUBA S2	06/01/2020 10:26	06/01/2020 13:08	06/01/2020 10:26	06/01/2020 13:08	2,70	1	2,70	CHI
20200131863	ALEXANIA	480023128	ALEXANIA	06/01/2020 10:26	06/01/2020 16:16	06/01/2020 10:26	06/01/2020 16:16	5,83	1	5,83	CHI
20200131865	ANAPOLIS	10000179203	ANAPOLIS UNIVERSITARIO S2	06/01/2020 10:27	06/01/2020 20:55	06/01/2020 10:27	06/01/2020 20:55	10,47	1	10,47	CHI
20200131866	CRISTALINA	KR12133610	CRISTALINA S2	06/01/2020 10:27	06/01/2020 12:18	06/01/2020 10:27	06/01/2020 12:18	1,84	12	22,13	CHI

20200131867	ANICUNS	AC21101202	FIRMINOPOLIS S2	06/01/2020 10:27	06/01/2020 12:21	06/01/2020 10:27	06/01/2020 12:21	1,88	1	1,88	CHI
20200131868	JATAI	290165570	JATAI S2	06/01/2020 10:27	06/01/2020 13:26	06/01/2020 10:27	06/01/2020 13:26	2,97	1	2,97	CHI
20200131872	IVOLANDIA	IV12323743	IPORA	06/01/2020 10:29	06/01/2020 18:14	06/01/2020 10:29	06/01/2020 18:14	7,75	6	46,52	CHI
20200131879	NOVO GAMA	2900006886	MARAJOARA	06/01/2020 10:29	06/01/2020 14:41	06/01/2020 10:29	06/01/2020 14:41	4,19	1	4,19	CHI
20200131891	CROMINIA	CQ12079865	ROCHEDO	06/01/2020 08:49	06/01/2020 15:08	06/01/2020 08:49	06/01/2020 15:08	6,32	3	18,95	CHI
20200131892	CATALAO	1990110700	CATALAO S2	06/01/2020 10:32	06/01/2020 18:48	06/01/2020 10:32	06/01/2020 18:48	8,26	1	8,26	CHI
20200131898	MUNDO NOVO DE GOIAS	MH21035586	NOVA CRIXAS	06/01/2020 10:32	06/01/2020 18:49	06/01/2020 10:32	06/01/2020 18:49	8,28	1	8,28	CHI
20200131946	QUIRINOPOLIS	10005490683	QUIRINOPOLIS	06/01/2020 12:04	06/01/2020 14:00	06/01/2020 12:04	06/01/2020 14:00	1,92	1	1,92	CHI
20200132001	SAO DOMINGOS	SD21264724	SAO DOMINGOS	06/01/2020 10:33	06/01/2020 11:33	06/01/2020 10:33	06/01/2020 11:33	0,99	1	0,99	CHI
20200132004	JATAI	JT21205252	JATAI S1	06/01/2020 10:33	06/01/2020 13:18	06/01/2020 10:33	06/01/2020 13:18	2,74	1	2,74	CHI
20200132008	LEOPOLDO DE BULHOES	LB12032416	CEPAIGO S2	06/01/2020 09:32	06/01/2020 15:47	06/01/2020 09:32	06/01/2020 15:47	6,24	1	6,24	CHI
20200132008	LEOPOLDO DE BULHOES	LB12032416	DAIA S2	06/01/2020 09:32	06/01/2020 15:47	06/01/2020 09:32	06/01/2020 15:47	6,24	51	318,10	CHI
20200132021	URUTAI	UT21404790	URUTAI	06/01/2020 10:35	06/01/2020 13:55	06/01/2020 10:35	06/01/2020 13:55	3,34	1	3,34	CHI
20200132023	CABECEIRAS	CW21257768	ITUIQUIRA	06/01/2020 10:35	06/01/2020 11:48	06/01/2020 10:35	06/01/2020 11:48	1,20	1	1,20	CHI
20200132025	SANTA HELENA DE GOIAS	400078429	IPEGUARI	06/01/2020 10:36	06/01/2020 17:10	06/01/2020 10:36	06/01/2020 17:10	6,56	1	6,56	CHI
20200132035	PORANGATU	840146334	PORANGATU	06/01/2020 10:37	06/01/2020 16:22	06/01/2020 10:37	06/01/2020 16:22	5,74	1	5,74	CHI
20200132041	URUTAI	UT21207644	URUTAI	06/01/2020 10:37	06/01/2020 14:20	06/01/2020 10:37	06/01/2020 14:20	3,71	2	7,41	CHI
20200132043	ALEXANIA	10006725226	ALEXANIA	05/01/2020 08:23	05/01/2020 16:54	05/01/2020 08:23	05/01/2020 16:54	8,52	1	8,52	CHI
20200132044	MORRO AGUDO DE GOIAS	MS21331560	ITAPURANGA	06/01/2020 10:34	06/01/2020 20:06	06/01/2020 10:34	06/01/2020 20:06	9,52	1	9,52	CHI
20200132052	VALPARAISO DE GOIAS	VA12083678	MARAJOARA	06/01/2020 08:24	06/01/2020 13:00	06/01/2020 08:24	06/01/2020 13:00	4,60	633	2910,92	CHI
20200132053	ALEXANIA	AX12381241	ALEXANIA	06/01/2020 09:30	06/01/2020 13:54	06/01/2020 09:30	06/01/2020 13:54	4,40	3	13,19	CHI
20200132084	ANAPOLIS	20188092	JUNDIAI S2	06/01/2020 08:08	06/01/2020 14:10	06/01/2020 08:08	06/01/2020 14:10	6,02	1	6,02	CHI
20200132087	SAO LUIS DE MONTES BELOS	SL21206336	FIRMINOPOLIS S2	06/01/2020 10:42	06/01/2020 13:56	06/01/2020 10:42	06/01/2020 13:56	3,22	1	3,22	CHI
20200132097	CAIAPONIA	CP12252503	CAIAPONIA	06/01/2020 10:43	06/01/2020 15:42	06/01/2020 10:43	06/01/2020 15:42	4,97	6	29,84	CHI
20200132101	SAO LUIS DE MONTES BELOS	SL12006949	SAO LUIZ DOS MONTES BELOS	06/01/2020 10:43	06/01/2020 21:15	06/01/2020 10:43	06/01/2020 18:16	7,54	11	82,89	CHI
20200132101	SAO LUIS DE MONTES BELOS	SL12006949	SAO LUIZ DOS MONTES BELOS	06/01/2020 10:43	06/01/2020 21:15	06/01/2020 10:43	06/01/2020 18:43	7,99	11	87,84	CHI
20200132101	SAO LUIS DE MONTES BELOS	SL12006949	SAO LUIZ DOS MONTES BELOS	06/01/2020 10:43	06/01/2020 21:15	06/01/2020 10:43	06/01/2020 19:05	8,35	11	91,87	CHI
20200132101	SAO LUIS DE MONTES BELOS	SL12006949	SAO LUIZ DOS MONTES BELOS	06/01/2020 10:43	06/01/2020 21:15	06/01/2020 10:43	06/01/2020 21:15	10,53	8	84,20	CHI
20200132133	NOVA CRIXAS	NA12090020	NOVA CRIXAS	06/01/2020 10:45	06/01/2020 12:39	06/01/2020 10:45	06/01/2020 12:39	1,89	11	20,82	CHI
20200132135	BONOPOLIS	BX21265986	NOVO PLANALTO	06/01/2020 10:45	06/01/2020 14:12	06/01/2020 10:45	06/01/2020 14:12	3,44	1	3,44	CHI
20200132138	QUIRINOPOLIS	QI21298323	QUIRINOPOLIS	06/01/2020 10:45	06/01/2020 15:50	06/01/2020 10:45	06/01/2020 15:50	5,07	2	10,14	CHI
20200132145	SANTA HELENA DE GOIAS	10018565067	IPEGUARI	06/01/2020 10:45	06/01/2020 14:58	06/01/2020 10:45	06/01/2020 14:58	4,20	1	4,20	CHI
20200132152	NIQUELANDIA	NQ21295162	NIQUELANDIA SUBTRANSMISSAO	06/01/2020 10:46	06/01/2020 20:17	06/01/2020 10:46	06/01/2020 20:17	9,51	1	9,51	CHI



20200132159	COLINAS DO SUL	TI12357757	NIQUELANDIA SUBTRANSMISSAO	06/01/2020 10:46	06/01/2020 14:59	06/01/2020 10:46	06/01/2020 14:59	4,21	7	29,45	CHI
20200132174	LUZIANIA	10029254491	RIO VERMELHO	06/01/2020 10:47	06/01/2020 16:36	06/01/2020 10:47	06/01/2020 16:36	5,81	1	5,81	CHI
20200132185	ALEXANIA	480091468	ALEXANIA	06/01/2020 10:48	06/01/2020 14:35	06/01/2020 10:48	06/01/2020 14:35	3,78	1	3,78	CHI
20200132188	CRISTALINA	KR11381393	PAMPLONA	06/01/2020 10:48	06/01/2020 19:00	06/01/2020 18:30	06/01/2020 19:00	0,50	42	21,00	CHI
20200132191	PLANALTINA	2960153097	PLANALTINA	06/01/2020 10:48	06/01/2020 12:25	06/01/2020 10:48	06/01/2020 12:25	1,61	1	1,61	CHI
20200132197	LEOPOLDO DE BULHOES	LB12351258	DAIA S2	06/01/2020 09:00	06/01/2020 14:52	06/01/2020 09:00	06/01/2020 14:52	5,87	10	58,66	CHI
20200132209	ALTO PARAISO DE GOIAS	BF21047995	FLORES DE GOIAS	06/01/2020 10:50	06/01/2020 15:20	06/01/2020 10:50	06/01/2020 15:20	4,49	2	8,98	CHI
20200132210	JOVIANIA	JV12071645	GOIATUBA S1	06/01/2020 10:50	06/01/2020 19:04	06/01/2020 10:50	06/01/2020 19:04	8,22	1	8,22	CHI
20200132212	MORRO AGUDO DE GOIAS	MS12246463	ITAPURANGA	06/01/2020 09:45	06/01/2020 16:18	06/01/2020 09:45	06/01/2020 16:18	6,55	3	19,65	CHI
20200132214	CORUMBA DE GOIAS	AX12000153	CORUMBA	06/01/2020 10:49	06/01/2020 14:30	06/01/2020 10:49	06/01/2020 14:30	3,67	10	36,68	CHI
20200132222	NOVA ROMA	5600000010	IACIARA S2	06/01/2020 10:52	06/01/2020 13:02	06/01/2020 10:52	06/01/2020 13:02	2,16	1	2,16	CHI
20200132242	SANTO ANTONIO DO DESCOBERTO	2210002388	AGUAS LINDAS DE GOIAS S2	06/01/2020 10:54	06/01/2020 17:06	06/01/2020 10:54	06/01/2020 17:06	6,19	1	6,19	CHI
20200132244	LUZIANIA	10009428915	RIO VERMELHO	06/01/2020 10:54	06/01/2020 16:30	06/01/2020 10:54	06/01/2020 16:30	5,60	1	5,60	CHI
20200132264	ESTRELA DO NORTE	ET21143706	MARA ROSA	06/01/2020 10:57	06/01/2020 15:34	06/01/2020 10:57	06/01/2020 15:34	4,61	1	4,61	CHI
20200132265	NOVO GAMA	NJ11245529	MARAJOARA	06/01/2020 10:57	06/01/2020 19:08	06/01/2020 10:57	06/01/2020 19:08	8,17	113	923,62	CHI
20200132266	JARAGUA	JA11348280	JARAGUA	06/01/2020 10:57	06/01/2020 13:01	06/01/2020 10:57	06/01/2020 13:01	2,05	30	61,61	CHI
20200132268	LUZIANIA	LZ12041474	RIO VERMELHO	06/01/2020 10:58	06/01/2020 15:23	06/01/2020 10:58	06/01/2020 15:23	4,41	11	48,56	CHI
20200132276	JARAGUA	JA12360274	GOIANESIA S2	06/01/2020 06:33	06/01/2020 18:38	06/01/2020 06:33	06/01/2020 18:38	12,08	8	96,62	CHI
20200132280	PONTALINA	210007874	PONTALINA	06/01/2020 10:58	06/01/2020 19:44	06/01/2020 10:58	06/01/2020 19:44	8,75	1	8,75	CHI
20200132282	RIO VERDE	RV12111096	RIO VERDE S1	06/01/2020 10:58	06/01/2020 14:40	06/01/2020 10:58	06/01/2020 14:40	3,69	9	33,23	CHI
20200132283	RIO VERDE	RV21111084	MONTIVIDIU T	06/01/2020 10:59	06/01/2020 16:05	06/01/2020 10:59	06/01/2020 16:05	5,10	1	5,10	CHI
20200132285	CIDADE OCIDENTAL	10020224131	MARAJOARA	06/01/2020 10:59	06/01/2020 17:54	06/01/2020 10:59	06/01/2020 17:54	6,91	1	6,91	CHI
20200132288	NIQUELANDIA	NQ12391958	NIQUELANDIA SUBTRANSMISSAO	06/01/2020 10:59	06/01/2020 16:06	06/01/2020 10:59	06/01/2020 16:06	5,11	20	102,21	CHI
20200132290	VILA PROPICIO	NP12228399	GOIANESIA S1	06/01/2020 06:45	06/01/2020 16:02	06/01/2020 06:45	06/01/2020 16:02	9,28	10	92,76	CHI
20200132294	GOIAS	GS12248147	ITABERAI S1	06/01/2020 11:00	06/01/2020 12:31	06/01/2020 11:00	06/01/2020 12:31	1,51	5	7,55	CHI
20200132296	CIDADE OCIDENTAL	LZ11261071	MARAJOARA	06/01/2020 11:00	06/01/2020 20:10	06/01/2020 11:00	06/01/2020 20:10	9,15	9	82,37	CHI
20200132297	FAZENDA NOVA	FN12019390	JUSSARA	06/01/2020 09:22	06/01/2020 17:11	06/01/2020 09:22	06/01/2020 17:11	7,80	57	444,87	CHI
20200132300	RIO VERDE	630345284	RIO VERDE S1	06/01/2020 11:01	06/01/2020 13:06	06/01/2020 11:01	06/01/2020 13:06	2,08	1	2,08	CHI
20200132304	GOIAS	GS11162333	GOIAS	06/01/2020 11:02	06/01/2020 18:33	06/01/2020 11:02	06/01/2020 18:33	7,51	2	15,03	CHI
20200132305	JARAGUA	JA21031515	JARAGUA	06/01/2020 11:02	06/01/2020 12:17	06/01/2020 11:02	06/01/2020 12:17	1,24	1	1,24	CHI
20200132308	ARAGUAPAZ	1780004944	MOZARLANDIA	06/01/2020 11:02	06/01/2020 14:31	06/01/2020 11:02	06/01/2020 14:31	3,47	1	3,47	CHI
20200132309	JARAGUA	JA21336699	JARAGUA	06/01/2020 11:02	06/01/2020 16:40	06/01/2020 11:02	06/01/2020 16:40	5,64	1	5,64	CHI
20200132310	ANAPOLIS	21270466	ANAPOLIS UNIVERSITARIO S2	06/01/2020 11:02	06/01/2020 15:43	06/01/2020 11:02	06/01/2020 15:43	4,67	1	4,67	CHI

20200132318	CRISTALINA	KR21183755	PAMPLONA	06/01/2020 11:04	06/01/2020 18:15	06/01/2020 11:04	06/01/2020 18:15	7,17	1	7,17	CHI
20200132319	FORMOSA	610316175	ITIQUEIRA	06/01/2020 11:04	06/01/2020 21:26	06/01/2020 11:04	06/01/2020 21:26	10,36	1	10,36	CHI
20200132323	FORMOSA	FA12383234	ITIQUEIRA	06/01/2020 11:03	06/01/2020 14:05	06/01/2020 11:03	06/01/2020 14:05	3,02	15	45,34	CHI
20200132325	SILVANIA	GL21331571	DAIA S1	06/01/2020 11:05	06/01/2020 22:33	06/01/2020 11:05	06/01/2020 22:33	11,46	1	11,46	CHI
20200132326	CIDADE OCIDENTAL	LZ11000566	MARAJOARA	06/01/2020 11:05	06/01/2020 12:30	06/01/2020 11:05	06/01/2020 12:30	1,41	12	16,93	CHI
20200132329	CIDADE OCIDENTAL	LZ12041538	MARAJOARA	06/01/2020 11:05	07/01/2020 12:53	06/01/2020 11:05	07/01/2020 12:53	25,79	16	412,58	CHI
20200132339	MUNDO NOVO DE GOIAS	MH12170092	NOVA CRIXAS	06/01/2020 11:06	06/01/2020 19:55	06/01/2020 11:06	06/01/2020 19:55	8,81	15	132,09	CHI
20200132344	SAO LUIS DE MONTES BELOS	500045100	SAO LUIZ DOS MONTES BELOS	06/01/2020 11:07	06/01/2020 15:57	06/01/2020 11:07	06/01/2020 15:57	4,82	1	4,82	CHI
20200132345	FORMOSA	610289925	ITIQUEIRA	06/01/2020 11:08	06/01/2020 13:12	06/01/2020 11:08	06/01/2020 13:12	2,06	1	2,06	CHI
20200132352	AGUA FRIA DE GOIAS	TL21204695	SAO JOAO D ALIANCA	06/01/2020 11:09	06/01/2020 13:11	06/01/2020 11:09	06/01/2020 13:11	2,03	2	4,06	CHI
20200132356	FORMOSA	610071774	ITIQUEIRA	06/01/2020 11:09	06/01/2020 14:22	06/01/2020 11:09	06/01/2020 14:22	3,21	1	3,21	CHI
20200132360	ANAPOLIS	20598841	ANAPOLIS UNIVERSITARIO S2	06/01/2020 11:10	06/01/2020 16:38	06/01/2020 11:10	06/01/2020 16:38	5,46	1	5,46	CHI
20200132362	SILVANIA	SV21098103	DAIA S2	06/01/2020 11:10	06/01/2020 15:18	06/01/2020 11:10	06/01/2020 15:18	4,12	1	4,12	CHI
20200132369	PARAUNA	PU12344873	PARAUNA	06/01/2020 11:11	07/01/2020 04:18	06/01/2020 11:11	07/01/2020 04:18	17,11	2	34,23	CHI
20200132376	LEOPOLDO DE BULHOES	LB11217016	DAIA S2	06/01/2020 11:11	07/01/2020 13:06	06/01/2020 11:11	07/01/2020 13:06	25,90	120	3108,50	CHI
20200132381	FAZENDA NOVA	NB12396238	JUSSARA	06/01/2020 11:12	06/01/2020 20:18	06/01/2020 11:12	06/01/2020 20:18	9,09	1	9,09	CHI
20200132381	NOVO BRASIL	NB12396238	JUSSARA	06/01/2020 11:12	06/01/2020 20:18	06/01/2020 11:12	06/01/2020 20:18	9,09	4	36,35	CHI
20200132386	ITABERAI	50074350	ITABERAI S2	06/01/2020 11:14	06/01/2020 18:16	06/01/2020 11:14	06/01/2020 18:16	7,03	1	7,03	CHI
20200132388	CAIAPONIA	CP12374977	PALESTINA	06/01/2020 11:12	06/01/2020 16:46	06/01/2020 11:12	06/01/2020 16:46	5,57	31	172,56	CHI
20200132389	NOVO PLANALTO	TA21146556	NOVO PLANALTO	06/01/2020 11:14	07/01/2020 02:59	06/01/2020 11:14	07/01/2020 02:59	15,74	1	15,74	CHI
20200132394	COCALZINHO DE GOIAS	ZN21236644	GOIANESIA S1	06/01/2020 11:15	06/01/2020 16:24	06/01/2020 11:15	06/01/2020 16:24	5,15	1	5,15	CHI
20200132406	VICENTINOPOLIS	VI21164306	VICENTINOPOLIS	06/01/2020 11:17	06/01/2020 21:55	06/01/2020 11:17	06/01/2020 21:55	10,63	1	10,63	CHI
20200132408	NIQUELANDIA	NQ11378060	NIQUELANDIA SUBTRANSMISSAO	06/01/2020 11:17	06/01/2020 16:49	06/01/2020 11:17	06/01/2020 16:49	5,52	1	5,52	CHI
20200132431	RUBIATABA	RB21110489	RUBIATABA	06/01/2020 11:23	06/01/2020 13:42	06/01/2020 11:23	06/01/2020 13:42	2,31	2	4,62	CHI
20200132433	ANAPOLIS	20063672	ANAPOLIS UNIVERSITARIO S2	06/01/2020 11:23	06/01/2020 13:55	06/01/2020 11:23	06/01/2020 13:55	2,52	1	2,52	CHI
20200132449	ALEXANIA	AX31196597	ALEXANIA	06/01/2020 11:26	07/01/2020 02:08	06/01/2020 11:26	07/01/2020 02:08	14,69	2	29,38	CHI
20200132453	QUIRINOPOLIS	QI21054855	QUIRINOPOLIS	06/01/2020 11:26	06/01/2020 14:26	06/01/2020 11:26	06/01/2020 14:26	2,99	1	2,99	CHI
20200132459	PIRENOPOLIS	220058131	CORUMBA	06/01/2020 11:27	06/01/2020 20:38	06/01/2020 11:27	06/01/2020 20:38	9,17	1	9,17	CHI
20200132465	SANTO ANTONIO DO DESCOBERTO	SN12078187	MARAJOARA	06/01/2020 10:46	06/01/2020 15:00	06/01/2020 10:46	06/01/2020 15:00	4,23	33	139,59	CHI
20200132467	ITUMBARA	690234843	PARANAIBA	06/01/2020 11:28	06/01/2020 14:07	06/01/2020 11:28	06/01/2020 14:07	2,65	1	2,65	CHI
20200132478	CUMARI	CY21315067	CATALAO S1	06/01/2020 11:29	06/01/2020 16:06	06/01/2020 11:29	06/01/2020 16:06	4,61	2	9,22	CHI
20200132483	ITABERAI	IB12000047	ITABERAI S2	06/01/2020 11:30	06/01/2020 18:39	06/01/2020 11:30	06/01/2020 18:39	7,14	9	64,26	CHI
20200132484	RUBIATABA	10017486520	RUBIATABA	06/01/2020 11:30	06/01/2020 14:54	06/01/2020 11:30	06/01/2020 14:54	3,39	1	3,39	CHI

20200132488	JARAGUA	JA11121790	SAO FRANCISCO DE GOIAS	06/01/2020 11:31	06/01/2020 20:25	06/01/2020 11:31	06/01/2020 20:25	8,89	14	124,44	CHI
20200132491	ORIZONA	OZ12402559	PIRES DO RIO S2	06/01/2020 11:31	06/01/2020 15:41	06/01/2020 11:31	06/01/2020 15:41	4,15	3	12,46	CHI
20200132491	PIRES DO RIO	OZ12402559	PIRES DO RIO S2	06/01/2020 11:31	06/01/2020 15:41	06/01/2020 11:31	06/01/2020 15:41	4,15	2	8,30	CHI
20200132497	ANAPOLIS	20101417	JUNDIAI S2	06/01/2020 11:33	06/01/2020 20:21	06/01/2020 11:33	06/01/2020 20:21	8,80	1	8,80	CHI
20200132498	COCALZINHO DE GOIAS	ZN11141458	AGUAS LINDAS DE GOIAS S2	06/01/2020 06:00	06/01/2020 17:39	06/01/2020 06:00	06/01/2020 17:39	11,65	17	198,01	CHI
20200132502	CAIAPONIA	DV12332038	CAIAPONIA	06/01/2020 11:34	06/01/2020 17:14	06/01/2020 11:34	06/01/2020 17:14	5,67	22	124,67	CHI
20200132502	DOVERLANDIA	DV12332038	CAIAPONIA	06/01/2020 11:34	06/01/2020 17:14	06/01/2020 11:34	06/01/2020 17:14	5,67	28	158,67	CHI
20200132503	JANDAIA	JD12289833	PALMEIRAS	06/01/2020 10:37	06/01/2020 12:41	06/01/2020 10:37	06/01/2020 12:41	2,06	59	121,69	CHI
20200132503	PARAUNA	JD12289833	PALMEIRAS	06/01/2020 10:37	06/01/2020 12:41	06/01/2020 10:37	06/01/2020 12:41	2,06	36	74,25	CHI
20200132506	SAO LUIS DE MONTES BELOS	SL11158901	SAO LUIZ DOS MONTES BELOS	06/01/2020 10:23	06/01/2020 14:31	06/01/2020 10:23	06/01/2020 14:31	4,12	196	807,36	CHI
20200132513	VALPARAISO DE GOIAS	2860047380	MARAJOARA	06/01/2020 11:35	06/01/2020 15:53	06/01/2020 11:35	06/01/2020 15:53	4,29	1	4,29	CHI
20200132517	CACU	1140027338	CACHOEIRA ALTA	06/01/2020 11:36	06/01/2020 17:13	06/01/2020 11:36	06/01/2020 17:13	5,62	1	5,62	CHI
20200132520	ALOANDIA	AD12293139	GOIATUBA S1	06/01/2020 10:03	06/01/2020 16:59	06/01/2020 10:03	06/01/2020 16:59	6,94	7	48,56	CHI
20200132520	PONTALINA	AD12293139	GOIATUBA S1	06/01/2020 10:03	06/01/2020 16:59	06/01/2020 10:03	06/01/2020 16:59	6,94	1	6,94	CHI
20200132525	NOVA IGUACU DE GOIAS	NH21034953	SANTA TEREZINHA	06/01/2020 11:38	06/01/2020 16:10	06/01/2020 11:38	06/01/2020 16:10	4,53	1	4,53	CHI
20200132528	BURITINOPOLIS	MB12026276	IACIARA S2	06/01/2020 11:38	06/01/2020 16:45	06/01/2020 11:38	06/01/2020 16:45	5,11	2	10,21	CHI
20200132530	IPAMERI	IP21071395	PIRES DO RIO S2	06/01/2020 11:38	06/01/2020 13:46	06/01/2020 11:38	06/01/2020 13:46	2,12	1	2,12	CHI
20200132545	LUZIANIA	LZ12313692	CRISTALINA S2	06/01/2020 11:40	06/01/2020 19:04	06/01/2020 11:40	06/01/2020 19:04	7,39	10	73,88	CHI
20200132551	FAZENDA NOVA	FN12371907	IPORA	06/01/2020 11:37	06/01/2020 17:41	06/01/2020 11:37	06/01/2020 17:41	6,06	4	24,25	CHI
20200132555	TURVANIA	TV12009083	FIRMINOPOLIS S2	06/01/2020 11:43	06/01/2020 18:03	06/01/2020 11:43	06/01/2020 18:03	6,33	3	19,00	CHI
20200132557	BARRO ALTO	1150016349	BARRO ALTO	06/01/2020 11:43	06/01/2020 13:49	06/01/2020 11:43	06/01/2020 13:49	2,11	1	2,11	CHI
20200132558	MONTIVIDIU DO NORTE	MX12276731	PORANGATU	06/01/2020 11:41	07/01/2020 10:52	06/01/2020 11:41	07/01/2020 10:52	23,18	16	370,91	CHI
20200132564	PADRE BERNARDO	PB12313564	PADRE BERNARDO	06/01/2020 11:44	07/01/2020 12:51	06/01/2020 11:44	07/01/2020 12:51	25,10	1	25,10	CHI
20200132567	ANAPOLIS	AN12258555LD	ANAPOLIS UNIVERSITARIO S2	06/01/2020 11:46	07/01/2020 12:06	06/01/2020 11:46	07/01/2020 12:06	24,33	1	24,33	CHI
20200132568	NOVA CRIXAS	NA21321948	NOVA CRIXAS	06/01/2020 11:46	06/01/2020 23:22	06/01/2020 11:46	06/01/2020 23:22	11,59	1	11,59	CHI
20200132573	PADRE BERNARDO	PB13383679B	PADRE BERNARDO	06/01/2020 14:11	07/01/2020 00:18	06/01/2020 14:11	06/01/2020 19:43	5,53	85	469,72	CHI
20200132573	COCALZINHO DE GOIAS	PB13383679B	PADRE BERNARDO	06/01/2020 14:11	07/01/2020 00:18	06/01/2020 14:11	06/01/2020 20:05	5,91	1	5,91	CHI
20200132573	DISTRITO FEDERAL	PB13383679B	PADRE BERNARDO	06/01/2020 14:11	07/01/2020 00:18	06/01/2020 14:11	06/01/2020 20:05	5,91	3	17,72	CHI
20200132573	PADRE BERNARDO	PB13383679B	PADRE BERNARDO	06/01/2020 14:11	07/01/2020 00:18	06/01/2020 14:11	06/01/2020 20:05	5,91	358	2115,08	CHI
20200132573	COCALZINHO DE GOIAS	PB10400401	PADRE BERNARDO	06/01/2020 14:11	07/01/2020 00:18	06/01/2020 20:06	06/01/2020 20:10	0,08	7	0,53	CHI
20200132573	DISTRITO FEDERAL	PB10400401	PADRE BERNARDO	06/01/2020 14:11	07/01/2020 00:18	06/01/2020 20:06	06/01/2020 20:10	0,08	7	0,53	CHI
20200132573	ITARUMA	PB10400401	PADRE BERNARDO	06/01/2020 14:11	07/01/2020 00:18	06/01/2020 20:06	06/01/2020 20:10	0,08	2	0,15	CHI
20200132573	PADRE BERNARDO	PB10400401	PADRE BERNARDO	06/01/2020 14:11	07/01/2020 00:18	06/01/2020 20:06	06/01/2020 20:10	0,08	3612	270,90	CHI

20200132573	PADRE BERNARDO	PB10400401	PADRE BERNARDO	06/01/2020 14:11	07/01/2020 00:18	06/01/2020 20:06	06/01/2020 20:10	0,08	590	44,25	CHI
20200132573	PLANALTINA	PB10400401	PADRE BERNARDO	06/01/2020 14:11	07/01/2020 00:18	06/01/2020 20:06	06/01/2020 20:10	0,08	12	0,90	CHI
20200132573	PADRE BERNARDO	PB13375238	PADRE BERNARDO	06/01/2020 14:11	07/01/2020 00:18	06/01/2020 20:06	06/01/2020 22:42	2,60	12	31,26	CHI
20200132573	PADRE BERNARDO	PB12163212	PADRE BERNARDO	06/01/2020 14:11	07/01/2020 00:18	06/01/2020 20:06	06/01/2020 23:13	3,12	31	96,84	CHI
20200132573	COCALZINHO DE GOIAS	PB13163198	PADRE BERNARDO	06/01/2020 14:11	07/01/2020 00:18	06/01/2020 20:06	06/01/2020 23:22	3,27	1	3,27	CHI
20200132573	DISTRITO FEDERAL	PB13163198	PADRE BERNARDO	06/01/2020 14:11	07/01/2020 00:18	06/01/2020 20:06	06/01/2020 23:22	3,27	3	9,81	CHI
20200132573	PADRE BERNARDO	PB13163198	PADRE BERNARDO	06/01/2020 14:11	07/01/2020 00:18	06/01/2020 20:06	06/01/2020 23:22	3,27	309	1009,92	CHI
20200132573	COCALZINHO DE GOIAS	PB13383679B	PADRE BERNARDO	06/01/2020 14:11	07/01/2020 00:18	06/01/2020 14:11	07/01/2020 00:09	9,97	22	219,34	CHI
20200132573	PADRE BERNARDO	PB13376766	PADRE BERNARDO	06/01/2020 14:11	07/01/2020 00:18	06/01/2020 14:11	07/01/2020 00:09	9,97	7	69,79	CHI
20200132573	PADRE BERNARDO	PB13383679B	PADRE BERNARDO	06/01/2020 14:11	07/01/2020 00:18	06/01/2020 14:11	07/01/2020 00:09	9,97	221	2203,37	CHI
20200132573	PADRE BERNARDO	PB13376766	PADRE BERNARDO	06/01/2020 14:11	07/01/2020 00:18	06/01/2020 16:47	07/01/2020 00:09	7,38	2	14,75	CHI
20200132573	PADRE BERNARDO	PB12313846LD	PADRE BERNARDO	06/01/2020 14:11	07/01/2020 00:18	06/01/2020 20:06	07/01/2020 00:18	4,20	6	25,20	CHI
20200132577	FORMOSA	FA21106836	SAO JOAO D ALIANCA	06/01/2020 11:48	06/01/2020 22:20	06/01/2020 11:48	06/01/2020 22:20	10,53	1	10,53	CHI
20200132580	RIO VERDE	10030795913	RIO VERDE S1	06/01/2020 11:48	06/01/2020 15:04	06/01/2020 11:48	06/01/2020 15:04	3,27	1	3,27	CHI
20200132581	CRISTALINA	KR21171596	CRISTALINA S1	06/01/2020 11:48	06/01/2020 13:31	06/01/2020 11:48	06/01/2020 13:31	1,70	1	1,70	CHI
20200132584	ABADIANIA	AA21297631	ANAPOLIS UNIVERSITARIO S1	06/01/2020 11:49	06/01/2020 15:32	06/01/2020 11:49	06/01/2020 15:32	3,71	2	7,42	CHI
20200132586	GOIAS	GS12220496	MATRINCHA	06/01/2020 11:49	06/01/2020 17:11	06/01/2020 11:49	06/01/2020 17:11	5,35	5	26,77	CHI
20200132593	SANTA RITA DO ARAGUAIA	SU12374325	SANTA RITA DO ARAGUAIA	06/01/2020 11:50	07/01/2020 17:44	06/01/2020 11:50	07/01/2020 17:44	29,89	28	836,90	CHI
20200132601	IACIARA	IA12062299	IACIARA S2	06/01/2020 11:52	06/01/2020 13:49	06/01/2020 11:52	06/01/2020 13:49	1,95	1	1,95	CHI
20200132604	RIO VERDE	630516110	RIO VERDE S1	06/01/2020 11:52	06/01/2020 16:38	06/01/2020 11:52	06/01/2020 16:38	4,76	1	4,76	CHI
20200132616	LUZIANIA	3200105250	MARAJOARA	06/01/2020 11:54	06/01/2020 14:35	06/01/2020 11:54	06/01/2020 14:35	2,67	1	2,67	CHI
20200132626	PARAUNA	980006764	PARAUNA	06/01/2020 11:55	06/01/2020 14:53	06/01/2020 11:55	06/01/2020 14:53	2,95	1	2,95	CHI
20200132628	GOIANESIA	GE12354152	GOIANESIA S2	06/01/2020 10:59	08/01/2020 00:11	06/01/2020 10:59	08/01/2020 00:11	37,19	1	37,19	CHI
20200132628	JARAGUA	GE12354152	GOIANESIA S2	06/01/2020 10:59	08/01/2020 00:11	06/01/2020 10:59	08/01/2020 00:11	37,19	1	37,19	CHI
20200132630	FORMOSA	FA21316957	ITUIQUIRA	06/01/2020 11:56	06/01/2020 18:02	06/01/2020 11:56	06/01/2020 18:02	6,09	1	6,09	CHI
20200132631	VALPARAISO DE GOIAS	2860237854	PACAEMBU S1	06/01/2020 11:56	06/01/2020 16:22	06/01/2020 11:56	06/01/2020 16:22	4,43	1	4,43	CHI
20200132642	VALPARAISO DE GOIAS	VA11170118	PACAEMBU S1	06/01/2020 10:48	06/01/2020 13:58	06/01/2020 10:48	06/01/2020 13:58	3,17	184	582,46	CHI
20200132645	GOIAS	GS11220484	GOIAS	06/01/2020 11:57	06/01/2020 17:40	06/01/2020 16:20	06/01/2020 17:40	1,33	46	61,35	CHI
20200132647	CRISTALINA	KR21025851	PAMPLONA	06/01/2020 11:57	06/01/2020 16:25	06/01/2020 11:57	06/01/2020 16:25	4,45	1	4,45	CHI
20200132657	IPAMERI	IP21399604	IPAMERI	06/01/2020 11:58	07/01/2020 18:39	06/01/2020 11:58	07/01/2020 18:39	30,67	2	61,34	CHI
20200132670	MINEIROS	MY21133294	PARQUE DAS EMAS	06/01/2020 12:00	08/01/2020 17:30	06/01/2020 12:00	08/01/2020 17:30	53,50	1	53,50	CHI
20200132677	DISTRITO FEDERAL	SN12053556	MARAJOARA	06/01/2020 10:30	06/01/2020 13:02	06/01/2020 10:30	06/01/2020 13:02	2,52	48	121,00	CHI
20200132677	SANTO ANTONIO DO DESCOBERTO	SN12053556	MARAJOARA	06/01/2020 10:30	06/01/2020 13:02	06/01/2020 10:30	06/01/2020 13:02	2,52	21	52,94	CHI

20200132691	ALEXANIA	AX21342868	ALEXANIA	06/01/2020 12:02	06/01/2020 22:34	06/01/2020 12:02	06/01/2020 22:34	10,52	16	168,39	CHI
20200132707	CROMINIA	CQ21161596	PONTALINA	06/01/2020 12:04	06/01/2020 14:26	06/01/2020 12:04	06/01/2020 14:26	2,38	1	2,38	CHI
20200132709	CALDAS NOVAS	760052049	CALDAS NOVAS S1	06/01/2020 12:04	06/01/2020 17:24	06/01/2020 12:04	06/01/2020 17:24	5,33	1	5,33	CHI
20200132740	ALEXANIA	AX12000074	ALEXANIA	06/01/2020 10:41	06/01/2020 15:28	06/01/2020 10:41	06/01/2020 15:28	4,78	9	42,98	CHI
20200132741	URUTAI	UT12080724RE	URUTAI	06/01/2020 12:03	06/01/2020 17:21	06/01/2020 12:03	06/01/2020 17:21	5,29	79	418,24	CHI
20200132743	AVELINOPOLIS	AV21030090	ANICUNS	06/01/2020 12:07	06/01/2020 13:59	06/01/2020 12:07	06/01/2020 13:59	1,86	2	3,72	CHI
20200132744	NIQUELANDIA	NQ21197720	NIQUELANDIA SUBTRANSMISSAO	06/01/2020 12:08	07/01/2020 00:00	06/01/2020 12:08	07/01/2020 00:00	11,85	1	11,85	CHI
20200132748	ABADIANIA	AA12167101	ANAPOLIS UNIVERSITARIO S2	06/01/2020 06:48	06/01/2020 17:54	06/01/2020 06:48	06/01/2020 17:54	11,09	6	66,53	CHI
20200132749	PADRE BERNARDO	PB21377280	PADRE BERNARDO	06/01/2020 12:09	07/01/2020 11:37	06/01/2020 12:09	07/01/2020 11:37	23,45	2	46,90	CHI
20200132751	FORMOSA	610297065	ITUIQUIRA	06/01/2020 12:10	06/01/2020 18:27	06/01/2020 12:10	06/01/2020 18:27	6,27	1	6,27	CHI
20200132752	CIDADE OCIDENTAL	DH11370634	MARAJOARA	06/01/2020 11:08	06/01/2020 14:38	06/01/2020 11:08	06/01/2020 14:38	3,49	101	351,99	CHI
20200132756	MAIRIPOTABA	MI21000420	PONTALINA	06/01/2020 12:11	06/01/2020 16:34	06/01/2020 12:11	06/01/2020 16:34	4,38	1	4,38	CHI
20200132757	CRISTALINA	KR21246122	PAMPLONA	06/01/2020 12:11	07/01/2020 09:27	06/01/2020 12:11	07/01/2020 09:27	21,26	4	85,03	CHI
20200132759	CERES	RB12110429	RUBIATABA	06/01/2020 12:12	06/01/2020 17:17	06/01/2020 12:12	06/01/2020 17:17	5,08	1	5,08	CHI
20200132763	GOIANESIA	GE21000118	GOIANESIA S1	06/01/2020 12:11	06/01/2020 17:05	06/01/2020 12:11	06/01/2020 17:05	4,89	1	4,89	CHI
20200132767	BOM JARDIM DE GOIAS	BM12208982	ARAGARCAS	06/01/2020 11:27	06/01/2020 18:27	06/01/2020 11:27	06/01/2020 18:27	7,00	3	20,99	CHI
20200132768	CACHOEIRA DE GOIAS	CG21153738	FIRMINOPOLIS S2	06/01/2020 12:13	06/01/2020 15:40	06/01/2020 12:13	06/01/2020 15:40	3,44	1	3,44	CHI
20200132770	PLANALTINA	10022616797	PLANALTINA	06/01/2020 12:14	06/01/2020 14:08	06/01/2020 12:14	06/01/2020 14:08	1,90	1	1,90	CHI
20200132772	AMARALINA	MQ21208310	MARA ROSA	06/01/2020 12:14	06/01/2020 18:16	06/01/2020 12:14	06/01/2020 18:16	6,02	1	6,02	CHI
20200132794	CAMPINORTE	CR11213202	CAMPINORTE	05/01/2020 19:51	06/01/2020 20:16	05/01/2020 19:51	06/01/2020 20:16	24,42	2	48,85	CHI
20200132800	PLANALTINA	PI11383217	PLANALTINA	06/01/2020 12:19	06/01/2020 13:29	06/01/2020 12:19	06/01/2020 13:29	1,16	14	16,20	CHI
20200132803	ANAPOLIS	20840720	JUNDIAI S2	06/01/2020 12:20	06/01/2020 15:56	06/01/2020 12:20	06/01/2020 15:56	3,59	1	3,59	CHI
20200132805	JATAI	JT21219521	JATAI S1	06/01/2020 12:20	06/01/2020 14:17	06/01/2020 12:20	06/01/2020 14:17	1,94	1	1,94	CHI
20200132811	PIRENOPOLIS	PV21302207	CORUMBA	06/01/2020 12:21	06/01/2020 16:58	06/01/2020 12:21	06/01/2020 16:58	4,60	1	4,60	CHI
20200132822	ITUMBIARA	IT12062955	PARANAIBA	06/01/2020 12:25	06/01/2020 16:27	06/01/2020 12:25	06/01/2020 16:27	4,03	3	12,10	CHI
20200132828	NOVO GAMA	4990007427	PACAEMBU S1	06/01/2020 12:26	06/01/2020 22:25	06/01/2020 12:26	06/01/2020 22:25	9,98	1	9,98	CHI
20200132849	ANAPOLIS	20026316	JUNDIAI S2	06/01/2020 12:30	06/01/2020 14:51	06/01/2020 12:30	06/01/2020 14:51	2,35	1	2,35	CHI
20200132850	MARZAGAO	MG12000366	VILA CORUMBA	06/01/2020 11:32	06/01/2020 16:23	06/01/2020 11:32	06/01/2020 16:23	4,84	8	38,73	CHI
20200132851	GOIATUBA	BJ21273967	BOM JESUS DE GOIAS	06/01/2020 12:30	06/01/2020 18:39	06/01/2020 12:30	06/01/2020 18:39	6,14	1	6,14	CHI
20200132854	CAIAPONIA	CP12260986	MONTIVIDIU T	06/01/2020 10:00	06/01/2020 17:18	06/01/2020 10:00	06/01/2020 17:18	7,29	9	65,59	CHI
20200132866	PADRE BERNARDO	PB11375258	PADRE BERNARDO	06/01/2020 12:34	06/01/2020 21:01	06/01/2020 12:34	06/01/2020 21:01	8,44	1	8,44	CHI
20200132871	ITAPACI	CX21359378	SANTA TEREZINHA	06/01/2020 12:35	07/01/2020 02:55	06/01/2020 12:35	07/01/2020 02:55	14,32	1	14,32	CHI
20200132873	HIDROLANDIA	180009680	ROCHEDO	06/01/2020 12:35	06/01/2020 21:43	06/01/2020 12:35	06/01/2020 21:43	9,13	1	9,13	CHI

20200132875	MATRINCHA	MP11224128	MATRINCHA	06/01/2020 12:36	06/01/2020 17:52	06/01/2020 12:36	06/01/2020 17:52	5,27	1	5,27	CHI
20200132879	GOIAS	GS21201041	MATRINCHA	06/01/2020 12:36	06/01/2020 15:32	06/01/2020 12:36	06/01/2020 15:32	2,93	1	2,93	CHI
20200132880	PADRE BERNARDO	10015345228	PADRE BERNARDO	06/01/2020 12:37	06/01/2020 18:06	06/01/2020 12:37	06/01/2020 18:06	5,48	1	5,48	CHI
20200132884	SANTA TEREZINHA DE GOIAS	SG11034167	SANTA TEREZINHA	06/01/2020 12:29	06/01/2020 18:28	06/01/2020 12:29	06/01/2020 18:28	5,98	122	729,97	CHI
20200132891	GOIAS	GS12061617	ITABERAI S1	06/01/2020 11:11	06/01/2020 14:01	06/01/2020 11:11	06/01/2020 14:01	2,83	10	28,31	CHI
20200132892	PONTALINA	PK12109416	PONTALINA	06/01/2020 10:54	06/01/2020 14:54	06/01/2020 10:54	06/01/2020 14:54	4,01	13	52,09	CHI
20200132894	ARAGUAPAZ	1780013090	MOZARLANDIA	06/01/2020 12:39	06/01/2020 15:32	06/01/2020 12:39	06/01/2020 15:32	2,87	1	2,87	CHI
20200132906	AGUAS LINDAS DE GOIAS	4830454053	AGUAS LINDAS DE GOIAS S2	06/01/2020 12:41	06/01/2020 16:39	06/01/2020 12:41	06/01/2020 16:39	3,95	1	3,95	CHI
20200132911	PONTALINA	PK21307948	PONTALINA	06/01/2020 12:42	06/01/2020 15:59	06/01/2020 12:42	06/01/2020 15:59	3,27	3	9,81	CHI
20200132912	CIDADE OCIDENTAL	10011980670	MARAJOARA	06/01/2020 12:42	06/01/2020 17:10	06/01/2020 12:42	06/01/2020 17:10	4,45	1	4,45	CHI
20200132917	ARUANA	AK12157845	MOZARLANDIA	06/01/2020 12:45	06/01/2020 16:26	06/01/2020 12:45	06/01/2020 16:26	3,68	61	224,50	CHI
20200132923	JARAGUA	JA21062943	ITABERAI S1	06/01/2020 12:46	07/01/2020 15:01	06/01/2020 12:46	07/01/2020 15:01	26,24	1	26,24	CHI
20200132926	RIO VERDE	10004014551	RIO VERDE S1	06/01/2020 12:47	06/01/2020 15:30	06/01/2020 12:47	06/01/2020 15:30	2,72	1	2,72	CHI
20200132927	PIRENOPOLIS	PV21354791	CORUMBA	06/01/2020 12:47	06/01/2020 18:31	06/01/2020 12:47	06/01/2020 18:31	5,73	2	11,46	CHI
20200132930	PALMEIRAS DE GOIAS	PL11377101	PALMEIRAS	06/01/2020 12:47	06/01/2020 15:51	06/01/2020 12:47	06/01/2020 15:51	3,06	198	606,21	CHI
20200132934	INDIARA	IY12057279	EDEIA	06/01/2020 11:44	06/01/2020 14:09	06/01/2020 11:44	06/01/2020 14:09	2,43	6	14,58	CHI
20200132947	PIRES DO RIO	460074015	PIRES DO RIO S1	06/01/2020 12:51	07/01/2020 01:03	06/01/2020 12:51	07/01/2020 01:03	12,20	1	12,20	CHI
20200132960	VALPARAISO DE GOIAS	3350114451	PACAEMBU S1	06/01/2020 12:54	06/01/2020 20:17	06/01/2020 12:54	06/01/2020 20:17	7,38	1	7,38	CHI
20200132977	SANTO ANTONIO DO DESCOBERTO	SN12313924	MARAJOARA	06/01/2020 12:57	06/01/2020 13:08	06/01/2020 12:57	06/01/2020 13:08	0,18	5	0,91	CHI
20200132986	ANAPOLIS	10000109701	JUNDIAI S1	06/01/2020 12:58	07/01/2020 00:39	06/01/2020 12:58	07/01/2020 00:39	11,67	1	11,67	CHI
20200132989	NOVA IGUACU DE GOIAS	MQ12034723	CAMPINORTE	06/01/2020 12:59	06/01/2020 21:49	06/01/2020 12:59	06/01/2020 21:49	8,83	7	61,83	CHI
20200132992	ACREUNA	EU21101953	ACREUNA	06/01/2020 13:00	06/01/2020 14:58	06/01/2020 13:00	06/01/2020 14:58	1,97	1	1,97	CHI
20200133007	MONTIVIDIU	MV11301192	MONTIVIDIU T	06/01/2020 13:01	06/01/2020 18:56	06/01/2020 13:01	06/01/2020 18:56	5,90	65	383,66	CHI
20200133023	BALIZA	BH12187387LD	BOM JARDIM	06/01/2020 13:04	06/01/2020 13:51	06/01/2020 13:04	06/01/2020 13:51	0,77	694	536,31	CHI
20200133027	ANICUNS	AC12304607	FIRMINOPOLIS S2	06/01/2020 13:05	06/01/2020 14:18	06/01/2020 13:05	06/01/2020 14:18	1,21	3	3,63	CHI
20200133036	ITABERAI	IB11335255	ITABERAI S2	06/01/2020 13:07	06/01/2020 18:49	06/01/2020 13:07	06/01/2020 18:49	5,69	22	125,28	CHI
20200133039	JATAI	JT11377852	JATAI S1	06/01/2020 13:08	06/01/2020 17:53	06/01/2020 13:08	06/01/2020 17:53	4,75	1	4,75	CHI
20200133040	NOVA CRIXAS	8570042737	NOVA CRIXAS	06/01/2020 13:08	06/01/2020 14:54	06/01/2020 13:08	06/01/2020 14:54	1,77	1	1,77	CHI
20200133042	VILA BOA	VB12235758	IACIARA S2	06/01/2020 13:08	06/01/2020 14:12	06/01/2020 13:08	06/01/2020 14:12	1,06	3	3,19	CHI
20200133046	CAIAPONIA	CP12380880	CAIAPONIA	06/01/2020 13:08	06/01/2020 17:51	06/01/2020 13:08	06/01/2020 17:51	4,70	10	47,04	CHI
20200133053	JATAI	290216837	JATAI S3	06/01/2020 13:09	06/01/2020 17:00	06/01/2020 13:09	06/01/2020 17:00	3,85	1	3,85	CHI
20200133054	MOZARLANDIA	MZ12066086	MOZARLANDIA	06/01/2020 13:10	07/01/2020 12:13	06/01/2020 13:10	07/01/2020 12:13	23,04	5	115,22	CHI
20200133059	GOIATUBA	CL12295982	RIO DOS BOIS	06/01/2020 09:05	06/01/2020 18:03	06/01/2020 09:05	06/01/2020 18:03	8,95	18	161,14	CHI

20200133059	PORTEIRAO	CL12295982	RIO DOS BOIS	06/01/2020 09:05	06/01/2020 18:03	06/01/2020 09:05	06/01/2020 18:03	8,95	13	116,38	CHI
20200133060	AGUAS LINDAS DE GOIAS	4830394159	AGUAS LINDAS DE GOIAS S1	06/01/2020 13:11	06/01/2020 19:40	06/01/2020 13:11	06/01/2020 19:40	6,47	1	6,47	CHI
20200133063	PLANALTINA	2960129459	PLANALTINA	06/01/2020 13:12	06/01/2020 14:15	06/01/2020 13:12	06/01/2020 14:15	1,05	1	1,05	CHI
20200133066	LUZIANIA	LZ12313691	CRISTALINA S2	06/01/2020 13:12	06/01/2020 17:14	06/01/2020 13:12	06/01/2020 17:14	4,02	20	80,34	CHI
20200133067	LEOPOLDO DE BULHOES	LB21180113	DAIA S2	06/01/2020 13:13	06/01/2020 17:05	06/01/2020 13:13	06/01/2020 17:05	3,87	1	3,87	CHI
20200133068	FORMOSA	FA21204699	ITUIQUIRA	06/01/2020 13:13	06/01/2020 17:29	06/01/2020 13:13	06/01/2020 17:29	4,26	1	4,26	CHI
20200133070	BONOPOLIS	BX12202590	SAO MIGUEL DO ARAGUAIA	06/01/2020 13:13	07/01/2020 18:31	06/01/2020 13:13	07/01/2020 16:29	27,26	10	272,59	CHI
20200133070	BONOPOLIS	BX12244250LD	SAO MIGUEL DO ARAGUAIA	06/01/2020 13:13	07/01/2020 18:31	06/01/2020 13:13	07/01/2020 18:31	29,30	1	29,30	CHI
20200133073	VILA PROPICIO	NP11228733	GOIANESIA S1	06/01/2020 13:14	07/01/2020 10:40	06/01/2020 13:14	07/01/2020 10:40	21,43	1	21,43	CHI
20200133096	URUACU	UR12310334	URUACU	06/01/2020 13:19	07/01/2020 03:28	06/01/2020 13:19	07/01/2020 03:28	14,14	3	42,43	CHI
20200133206	PARAUNA	PU12301614	PARAUNA	06/01/2020 13:22	06/01/2020 16:58	06/01/2020 13:22	06/01/2020 16:58	3,60	2	7,19	CHI
20200133207	SITIO D ABADIA	FB11285682	IACIARA S2	06/01/2020 13:22	06/01/2020 21:35	06/01/2020 13:22	06/01/2020 21:35	8,21	2	16,41	CHI
20200133208	FORMOSO	FO21243341	MARA ROSA	06/01/2020 13:22	06/01/2020 15:51	06/01/2020 13:22	06/01/2020 15:51	2,47	1	2,47	CHI
20200133210	ABADIANIA	AA21146387	DAIA S2	06/01/2020 13:23	06/01/2020 21:30	06/01/2020 13:23	06/01/2020 21:30	8,12	1	8,12	CHI
20200133215	LEOPOLDO DE BULHOES	LB21037888	DAIA S1	06/01/2020 13:25	07/01/2020 11:01	06/01/2020 13:25	07/01/2020 11:01	21,59	2	43,18	CHI
20200133228	AGUAS LINDAS DE GOIAS	4830100796	AGUAS LINDAS DE GOIAS S1	06/01/2020 13:27	06/01/2020 16:46	06/01/2020 13:27	06/01/2020 16:46	3,30	1	3,30	CHI
20200133237	FORMOSO	FO21115459	MARA ROSA	06/01/2020 13:28	06/01/2020 21:03	06/01/2020 13:28	06/01/2020 21:03	7,57	2	15,15	CHI
20200133244	GOIANESIA	10008522888	GOIANESIA S2	06/01/2020 13:30	06/01/2020 14:12	06/01/2020 13:30	06/01/2020 14:12	0,70	1	0,70	CHI
20200133246	JATAI	290319687	JATAI S3	06/01/2020 13:30	06/01/2020 15:54	06/01/2020 13:30	06/01/2020 15:54	2,40	1	2,40	CHI
20200133251	CORUMBAIBA	CI12263856	VILA CORUMBA	06/01/2020 12:52	06/01/2020 16:47	06/01/2020 12:52	06/01/2020 16:47	3,91	35	137,02	CHI
20200133253	MINEIROS	1390047183	PARQUE DAS EMAS	06/01/2020 13:31	06/01/2020 18:00	06/01/2020 13:31	06/01/2020 18:00	4,47	1	4,47	CHI
20200133255	AGUAS LINDAS DE GOIAS	10008616556	AGUAS LINDAS DE GOIAS S1	06/01/2020 13:32	06/01/2020 16:08	06/01/2020 13:32	06/01/2020 16:08	2,60	1	2,60	CHI
20200133257	GOIANESIA	GE21401025	GOIANESIA S1	06/01/2020 13:32	06/01/2020 14:55	06/01/2020 13:32	06/01/2020 14:55	1,38	1	1,38	CHI
20200133271	JATAI	JT12150958	JATAI S1	06/01/2020 13:23	06/01/2020 20:20	06/01/2020 13:23	06/01/2020 20:20	6,95	33	229,24	CHI
20200133280	FORMOSA	FA11279194	ITUIQUIRA	06/01/2020 13:38	06/01/2020 15:13	06/01/2020 13:38	06/01/2020 15:13	1,57	70	109,92	CHI
20200133289	PALMEIRAS DE GOIAS	590020717	PALMEIRAS	06/01/2020 13:40	06/01/2020 18:27	06/01/2020 13:40	06/01/2020 18:27	4,77	1	4,77	CHI
20200133293	ANAPOLIS	20025816	ANAPOLIS UNIVERSITARIO S2	06/01/2020 13:41	07/01/2020 01:39	06/01/2020 13:41	07/01/2020 01:39	11,96	1	11,96	CHI
20200133295	CORUMBAIBA	CI12027816	VILA CORUMBA	06/01/2020 13:42	06/01/2020 17:56	06/01/2020 13:42	06/01/2020 17:56	4,23	23	97,18	CHI
20200133309	MUTUNOPOLIS	MU12060992	MARA ROSA	06/01/2020 13:45	06/01/2020 14:57	06/01/2020 13:45	06/01/2020 14:57	1,19	3	3,58	CHI
20200133312	PLANALTINA	2960234966	PLANALTINA	06/01/2020 13:45	06/01/2020 17:25	06/01/2020 13:45	06/01/2020 17:25	3,66	1	3,66	CHI
20200133315	PIRACANJUBA	PJ21045930	MORRINHOS	06/01/2020 13:46	07/01/2020 03:32	06/01/2020 13:46	07/01/2020 03:32	13,76	1	13,76	CHI
20200133324	JATAI	JT12334233	JATAI S1	06/01/2020 13:47	07/01/2020 14:10	06/01/2020 13:47	07/01/2020 14:10	24,38	1	24,38	CHI
20200133334	CATALAO	CT21236824	CATALAO S1	06/01/2020 13:49	06/01/2020 17:47	06/01/2020 13:49	06/01/2020 17:47	3,96	1	3,96	CHI

20200133336	PLANALTINA	PI12242877	PLANALTINA	06/01/2020 13:49	06/01/2020 14:00	06/01/2020 13:49	06/01/2020 14:00	0,17	82	13,92	CHI
20200133338	BARRO ALTO	1150018954	BARRO ALTO	06/01/2020 13:50	07/01/2020 11:50	06/01/2020 13:50	07/01/2020 11:50	22,00	1	22,00	CHI
20200133339	ALEXANIA	AX12211846	ALEXANIA	06/01/2020 12:58	06/01/2020 19:40	06/01/2020 12:58	06/01/2020 19:00	6,03	49	295,54	CHI
20200133339	ALEXANIA	AX11370351	ALEXANIA	06/01/2020 12:58	06/01/2020 19:40	06/01/2020 12:58	06/01/2020 19:10	6,20	6	37,19	CHI
20200133339	ALEXANIA	AX11055171	ALEXANIA	06/01/2020 12:58	06/01/2020 19:40	06/01/2020 12:58	06/01/2020 19:15	6,28	94	590,45	CHI
20200133339	ALEXANIA	AX11326435	ALEXANIA	06/01/2020 12:58	06/01/2020 19:40	06/01/2020 12:58	06/01/2020 19:30	6,53	30	195,93	CHI
20200133339	ALEXANIA	AX11285390	ALEXANIA	06/01/2020 12:58	06/01/2020 19:40	06/01/2020 12:58	06/01/2020 19:35	6,61	7	46,30	CHI
20200133339	ALEXANIA	AX11146816	ALEXANIA	06/01/2020 12:58	06/01/2020 19:40	06/01/2020 12:58	06/01/2020 19:40	6,70	28	187,54	CHI
20200133340	NOVA IGUACU DE GOIAS	NH12270877	CAMPINORTE	06/01/2020 13:46	06/01/2020 17:51	06/01/2020 13:46	06/01/2020 17:51	4,07	5	20,37	CHI
20200133343	FLORES DE GOIAS	FB21051035	FLORES DE GOIAS	06/01/2020 13:50	06/01/2020 17:23	06/01/2020 13:50	06/01/2020 17:23	3,54	1	3,54	CHI
20200133344	JATAI	290067364	JATAI S2	06/01/2020 13:50	06/01/2020 16:47	06/01/2020 13:50	06/01/2020 16:47	2,95	1	2,95	CHI
20200133345	FLORES DE GOIAS	FB12044974RE	IACIARA S2	06/01/2020 11:11	07/01/2020 01:43	06/01/2020 11:11	07/01/2020 01:43	14,53	22	319,73	CHI
20200133360	VALPARAISO DE GOIAS	VA12199729	MARAJOARA	06/01/2020 10:35	06/01/2020 16:17	06/01/2020 10:35	06/01/2020 16:17	5,70	35	199,46	CHI
20200133363	JATAI	JT12347255	JATAI S1	06/01/2020 13:56	06/01/2020 18:41	06/01/2020 13:56	06/01/2020 18:41	4,74	1	4,74	CHI
20200133364	MUNDO NOVO DE GOIAS	MH12291176	NOVA CRIXAS	06/01/2020 13:25	06/01/2020 19:08	06/01/2020 13:25	06/01/2020 19:08	5,71	8	45,65	CHI
20200133365	AGUAS LINDAS DE GOIAS	10008408732	AGUAS LINDAS DE GOIAS S1	06/01/2020 13:56	06/01/2020 18:52	06/01/2020 13:56	06/01/2020 18:52	4,92	1	4,92	CHI
20200133371	SANTA HELENA DE GOIAS	400087091	IPEGUARI	06/01/2020 13:58	06/01/2020 17:54	06/01/2020 13:58	06/01/2020 17:54	3,93	1	3,93	CHI
20200133372	RIO VERDE	RV11217558	JATAI S2	06/01/2020 13:58	06/01/2020 16:59	06/01/2020 13:58	06/01/2020 16:59	3,02	1	3,02	CHI
20200133378	FIRMINOPOLIS	900041791	FIRMINOPOLIS S1	06/01/2020 14:00	06/01/2020 17:06	06/01/2020 14:00	06/01/2020 17:06	3,10	1	3,10	CHI
20200133379	CATALAO	CT21270766	CATALAO S2	06/01/2020 14:00	06/01/2020 16:53	06/01/2020 14:00	06/01/2020 16:53	2,89	1	2,89	CHI
20200133381	MINACU	IH12208347	MINACU	06/01/2020 12:53	06/01/2020 21:10	06/01/2020 12:53	06/01/2020 21:10	8,27	23	190,15	CHI
20200133382	AGUAS LINDAS DE GOIAS	LA11183868	AGUAS LINDAS DE GOIAS S1	06/01/2020 13:34	06/01/2020 15:48	06/01/2020 13:34	06/01/2020 15:48	2,23	146	325,34	CHI
20200133388	JATAI	JT12264349	JATAI S1	06/01/2020 14:02	06/01/2020 16:03	06/01/2020 14:02	06/01/2020 16:03	2,00	60	120,18	CHI
20200133392	COCALZINHO DE GOIAS	ZN21215030	COCALZINHO	06/01/2020 14:03	07/01/2020 10:15	06/01/2020 14:03	07/01/2020 10:15	20,20	1	20,20	CHI
20200133399	IPAMERI	IP21275916	URUTAI	06/01/2020 14:05	07/01/2020 13:47	06/01/2020 14:05	07/01/2020 13:06	23,02	1	23,02	CHI
20200133399	IPAMERI	IP21275915	URUTAI	06/01/2020 14:05	07/01/2020 13:47	06/01/2020 14:05	07/01/2020 13:47	23,69	1	23,69	CHI
20200133400	RIO VERDE	10018918300	RIO VERDE S1	05/01/2020 17:24	05/01/2020 22:54	05/01/2020 17:24	05/01/2020 22:54	5,50	1	5,50	CHI
20200133404	AGUAS LINDAS DE GOIAS	10020220659	AGUAS LINDAS DE GOIAS S1	06/01/2020 14:06	06/01/2020 17:16	06/01/2020 14:06	06/01/2020 17:16	3,16	1	3,16	CHI
20200133413	ESTRELA DO NORTE	ET12208647	MARA ROSA	06/01/2020 14:08	06/01/2020 23:50	06/01/2020 14:08	06/01/2020 23:50	9,70	1	9,70	CHI
20200133416	IPAMERI	580081187	IPAMERI	06/01/2020 14:08	07/01/2020 02:20	06/01/2020 14:08	07/01/2020 02:20	12,20	1	12,20	CHI
20200133419	NOVA IGUACU DE GOIAS	NH12371949	SANTA TEREZINHA	06/01/2020 14:09	06/01/2020 18:12	06/01/2020 14:09	06/01/2020 18:12	4,04	1	4,04	CHI
20200133419	PILAR DE GOIAS	NH12371949	SANTA TEREZINHA	06/01/2020 14:09	06/01/2020 18:12	06/01/2020 14:09	06/01/2020 18:12	4,04	2	8,07	CHI
20200133424	MUTUNOPOLIS	MU12086727	MARA ROSA	06/01/2020 14:10	06/01/2020 18:23	06/01/2020 14:10	06/01/2020 18:23	4,20	1	4,20	CHI



20200133438	ACREUNA	10018322873	ACREUNA	06/01/2020 14:11	06/01/2020 17:16	06/01/2020 14:11	06/01/2020 17:16	3,08	1	3,08	CHI
20200133440	JAUPACI	JP21156170	IPORA	06/01/2020 14:12	06/01/2020 22:38	06/01/2020 14:12	06/01/2020 22:38	8,43	1	8,43	CHI
20200133444	NOVA CRIXAS	NA21091700	NOVA CRIXAS	06/01/2020 14:13	06/01/2020 19:37	06/01/2020 14:13	06/01/2020 19:37	5,40	1	5,40	CHI
20200133449	DOVERLANDIA	4220013351	CAIAPONIA	06/01/2020 14:12	06/01/2020 21:11	06/01/2020 14:12	06/01/2020 21:11	6,97	1	6,97	CHI
20200133450	LUZIANIA	3200168466	MARAJOARA	06/01/2020 14:13	06/01/2020 17:04	06/01/2020 14:13	06/01/2020 17:04	2,84	1	2,84	CHI
20200133455	PETROLINA DE GOIAS	PG12297866	PETROLINA	06/01/2020 14:14	06/01/2020 22:24	06/01/2020 14:14	06/01/2020 22:24	8,16	4	32,62	CHI
20200133457	GOIANDIRA	CY21081493	CATALAO S1	06/01/2020 14:14	06/01/2020 20:02	06/01/2020 14:14	06/01/2020 20:02	5,79	1	5,79	CHI
20200133462	UIRAPURU	UP21257305	SANTA TEREZINHA	06/01/2020 14:15	06/01/2020 16:56	06/01/2020 14:15	06/01/2020 16:56	2,67	1	2,67	CHI
20200133472	SANTO ANTONIO DO DESCOBERTO	2210126200	AGUAS LINDAS DE GOIAS S2	06/01/2020 14:16	06/01/2020 18:57	06/01/2020 14:16	06/01/2020 18:57	4,67	1	4,67	CHI
20200133475	RIO VERDE	RV12260699	CABRIUVA S1	06/01/2020 14:11	06/01/2020 17:27	06/01/2020 14:11	06/01/2020 17:27	3,25	19	61,78	CHI
20200133477	IPAMERI	IP21157328	IPAMERI	06/01/2020 14:17	06/01/2020 21:16	06/01/2020 14:17	06/01/2020 21:16	6,97	1	6,97	CHI
20200133483	GOIAS	GS12249339	MATRINCHA	06/01/2020 14:18	06/01/2020 21:23	06/01/2020 14:18	06/01/2020 21:23	7,08	10	70,77	CHI
20200133486	MINACU	CR12234940	PORANGATU	06/01/2020 14:18	07/01/2020 11:27	06/01/2020 14:18	07/01/2020 11:27	21,14	9	190,29	CHI
20200133494	NOVO BRASIL	NB21292779	JUSSARA	06/01/2020 14:20	06/01/2020 21:49	06/01/2020 14:20	06/01/2020 21:49	7,47	1	7,47	CHI
20200133498	CAIAPONIA	CP12248274	IPORA	06/01/2020 13:38	06/01/2020 19:28	06/01/2020 13:38	06/01/2020 19:28	5,83	3	17,50	CHI
20200133500	PORANGATU	PO21288190	MARA ROSA	06/01/2020 14:22	06/01/2020 19:42	06/01/2020 14:22	06/01/2020 19:42	5,33	1	5,33	CHI
20200133606	UIRAPURU	UP11396283	NOVA CRIXAS	06/01/2020 14:23	07/01/2020 11:13	06/01/2020 14:23	07/01/2020 11:13	20,83	1	20,83	CHI
20200133610	PLANALTINA	PI12326717	SAO JOAO D ALIANCA	06/01/2020 14:23	06/01/2020 18:28	06/01/2020 14:23	06/01/2020 18:28	4,07	1	4,07	CHI
20200133611	CHAPADAO DO CEU	02430524	CHAPADAO DO CEU	06/01/2020 14:19	06/01/2020 16:05	06/01/2020 14:19	06/01/2020 14:56	0,63	83	52,01	CHI
20200133611	CHAPADAO DO CEU	02430524	CHAPADAO DO CEU	06/01/2020 14:19	06/01/2020 16:05	06/01/2020 14:19	06/01/2020 14:56	0,63	11	6,91	CHI
20200133611	MINEIROS	02430524	CHAPADAO DO CEU	06/01/2020 14:19	06/01/2020 16:05	06/01/2020 14:19	06/01/2020 14:56	0,63	5	3,14	CHI
20200133611	SERRANOPOLIS	02430524	CHAPADAO DO CEU	06/01/2020 14:19	06/01/2020 16:05	06/01/2020 14:19	06/01/2020 14:56	0,63	23	14,45	CHI
20200133611	CHAPADAO DO CEU	02430524	CHAPADAO DO CEU	06/01/2020 14:19	06/01/2020 16:05	06/01/2020 14:19	06/01/2020 14:57	0,63	2348	1487,72	CHI
20200133611	CHAPADAO DO CEU	02430524	CHAPADAO DO CEU	06/01/2020 14:19	06/01/2020 16:05	06/01/2020 14:19	06/01/2020 14:57	0,64	2000	1270,00	CHI
20200133611	MINEIROS	02430524	CHAPADAO DO CEU	06/01/2020 14:19	06/01/2020 16:05	06/01/2020 14:19	06/01/2020 14:57	0,64	9	5,72	CHI
20200133611	MINEIROS	DJ13164070	CHAPADAO DO CEU	06/01/2020 14:19	06/01/2020 16:05	06/01/2020 15:30	06/01/2020 16:05	0,57	20	11,34	CHI
20200133611	SERRANOPOLIS	DJ13164070	CHAPADAO DO CEU	06/01/2020 14:19	06/01/2020 16:05	06/01/2020 15:30	06/01/2020 16:05	0,57	58	32,90	CHI
20200133612	JUSSARA	JR21073944	IPORA	06/01/2020 14:24	06/01/2020 16:29	06/01/2020 14:24	06/01/2020 16:29	2,08	1	2,08	CHI
20200133614	AGUAS LINDAS DE GOIAS	LA11351442	AGUAS LINDAS DE GOIAS S1	06/01/2020 14:12	06/01/2020 16:04	06/01/2020 14:12	06/01/2020 16:04	1,86	237	439,70	CHI
20200133621	FORMOSA	610315500	ITUIQUIRA	06/01/2020 14:25	06/01/2020 18:25	06/01/2020 14:25	06/01/2020 18:25	4,01	1	4,01	CHI
20200133635	LUZIANIA	LZ11061747	MARAJOARA	06/01/2020 10:21	06/01/2020 22:09	06/01/2020 10:21	06/01/2020 22:09	11,80	17	200,57	CHI
20200133637	MUTUNOPOLIS	MU11240599	MARA ROSA	06/01/2020 14:29	06/01/2020 19:27	06/01/2020 14:29	06/01/2020 19:27	4,97	1	4,97	CHI
20200133649	NOVA ROMA	ND11314144	IACIARA S2	06/01/2020 14:32	06/01/2020 17:22	06/01/2020 14:32	06/01/2020 17:22	2,83	6	17,00	CHI

20200133650	APORE	AE12209682	ITAJA S2	06/01/2020 14:32	07/01/2020 07:39	06/01/2020 14:32	07/01/2020 07:39	17,12	11	188,27	CHI
20200133657	PALMINOPOLIS	PP12053922	PALMEIRAS	06/01/2020 14:33	06/01/2020 17:25	06/01/2020 14:33	06/01/2020 17:25	2,88	3	8,63	CHI
20200133660	BALIZA	BM12390150	BOM JARDIM	06/01/2020 14:14	06/01/2020 17:28	06/01/2020 14:14	06/01/2020 17:28	3,23	50	161,64	CHI
20200133660	BOM JARDIM DE GOIAS	BM12390150	BOM JARDIM	06/01/2020 14:14	06/01/2020 17:28	06/01/2020 14:14	06/01/2020 17:28	3,23	9	29,09	CHI
20200133669	FORMOSA	FA12000130	ITUIQUIRA	06/01/2020 14:36	06/01/2020 17:30	06/01/2020 14:36	06/01/2020 17:30	2,90	14	40,59	CHI
20200133671	SILVANIA	LB21164101	DAIA S2	06/01/2020 14:36	06/01/2020 22:52	06/01/2020 14:36	06/01/2020 22:52	8,25	2	16,51	CHI
20200133673	LUZIANIA	LZ21149730	RIO VERMELHO	06/01/2020 14:36	06/01/2020 17:42	06/01/2020 14:36	06/01/2020 17:42	3,09	1	3,09	CHI
20200133687	IPORA	730156102	IPORA	06/01/2020 14:39	07/01/2020 10:54	06/01/2020 14:39	07/01/2020 10:54	20,24	1	20,24	CHI
20200133690	AGUAS LINDAS DE GOIAS	4830437055	AGUAS LINDAS DE GOIAS S1	06/01/2020 14:39	06/01/2020 17:56	06/01/2020 14:39	06/01/2020 17:56	3,27	1	3,27	CHI
20200133696	AGUAS LINDAS DE GOIAS	4830043831	AGUAS LINDAS DE GOIAS S1	06/01/2020 14:41	06/01/2020 17:10	06/01/2020 14:41	06/01/2020 17:10	2,48	1	2,48	CHI
20200133801	JAUPACI	JP12349721	IPORA	06/01/2020 12:54	06/01/2020 19:26	06/01/2020 12:54	06/01/2020 19:26	6,53	7	45,70	CHI
20200133803	ABADIANIA	AA21284933	DAIA S2	06/01/2020 14:42	07/01/2020 10:59	06/01/2020 14:42	07/01/2020 10:59	20,28	3	60,85	CHI
20200133808	AGUAS LINDAS DE GOIAS	10020874640	AGUAS LINDAS DE GOIAS S1	06/01/2020 14:42	06/01/2020 17:51	06/01/2020 14:42	06/01/2020 17:51	3,14	1	3,14	CHI
20200133816	PIRANHAS	1930029552	PIRANHAS	06/01/2020 14:42	06/01/2020 19:36	06/01/2020 14:42	06/01/2020 19:36	4,89	1	4,89	CHI
20200133819	CABECEIRAS	CW21218332	ITUIQUIRA	06/01/2020 14:43	06/01/2020 18:28	06/01/2020 14:43	06/01/2020 18:28	3,74	2	7,48	CHI
20200133821	RIO VERDE	RV11226991	JATAI S2	06/01/2020 14:43	06/01/2020 19:58	06/01/2020 14:43	06/01/2020 19:58	5,24	1	5,24	CHI
20200133832	CATALAO	CT12000060	CATALAO S1	06/01/2020 14:45	06/01/2020 17:53	06/01/2020 14:45	06/01/2020 17:53	3,12	1	3,12	CHI
20200133834	SANCLERLANDIA	SC21235853	FIRMINOPOLIS S2	06/01/2020 14:46	06/01/2020 16:22	06/01/2020 14:46	06/01/2020 16:22	1,60	1	1,60	CHI
20200133848	IPAMERI	IP12112780	IPAMERI	06/01/2020 14:47	06/01/2020 17:29	06/01/2020 14:47	06/01/2020 17:29	2,69	11	29,58	CHI
20200133850	VALPARAISO DE GOIAS	10000783003	PACAEMBU S2	06/01/2020 14:48	06/01/2020 18:05	06/01/2020 14:48	06/01/2020 18:05	3,28	1	3,28	CHI
20200133852	ANICUNS	AC21229763	FIRMINOPOLIS S2	06/01/2020 14:48	06/01/2020 16:22	06/01/2020 14:48	06/01/2020 16:22	1,56	1	1,56	CHI
20200133857	QUIRINOPOLIS	QI21129193	QUIRINOPOLIS	06/01/2020 14:48	06/01/2020 18:52	06/01/2020 14:48	06/01/2020 18:52	4,05	1	4,05	CHI
20200133873	PIRES DO RIO	PR21186608	PIRES DO RIO S1	06/01/2020 14:51	06/01/2020 18:21	06/01/2020 14:51	06/01/2020 18:21	3,50	1	3,50	CHI
20200133890	ANAPOLIS	AN12261182	JUNDIAI S1	06/01/2020 14:35	06/01/2020 16:59	06/01/2020 14:35	06/01/2020 16:59	2,38	150	357,58	CHI
20200133890	GOIANAPOLIS	AN12261182	JUNDIAI S1	06/01/2020 14:35	06/01/2020 16:59	06/01/2020 14:35	06/01/2020 16:59	2,38	9	21,46	CHI
20200133890	LEOPOLDO DE BULHOES	AN12261182	JUNDIAI S1	06/01/2020 14:35	06/01/2020 16:59	06/01/2020 14:35	06/01/2020 16:59	2,38	5	11,92	CHI
20200133892	ANAPOLIS	10014183461	ANAPOLIS UNIVERSITARIO S2	06/01/2020 14:54	07/01/2020 14:13	06/01/2020 14:54	07/01/2020 14:13	23,30	1	23,30	CHI
20200133893	FORMOSA	FA21218523	ITUIQUIRA	06/01/2020 14:55	06/01/2020 19:33	06/01/2020 14:55	06/01/2020 19:33	4,63	1	4,63	CHI
20200133894	AGUAS LINDAS DE GOIAS	10015523193	AGUAS LINDAS DE GOIAS S1	06/01/2020 14:55	07/01/2020 00:20	06/01/2020 14:55	07/01/2020 00:20	9,41	1	9,41	CHI
20200133898	CAMPO ALEGRE DE GOIAS	CM12042353	CAMPO ALEGRE DE GOIAS	06/01/2020 14:56	06/01/2020 17:54	06/01/2020 14:56	06/01/2020 17:54	2,95	5	14,77	CHI
20200134005	AGUAS LINDAS DE GOIAS	4830169541	AGUAS LINDAS DE GOIAS S2	06/01/2020 14:57	06/01/2020 20:16	06/01/2020 14:57	06/01/2020 20:16	5,31	1	5,31	CHI
20200134008	IPORA	IR21014050	IPORA	06/01/2020 14:57	07/01/2020 07:34	06/01/2020 14:57	07/01/2020 07:34	16,60	1	16,60	CHI
20200134009	CAIAPONIA	PY12396111LD	PALESTINA	06/01/2020 14:19	06/01/2020 23:34	06/01/2020 14:19	06/01/2020 23:34	9,25	18	166,43	CHI

20200134009	PALESTINA DE GOIAS	PY12396111LD	PALESTINA	06/01/2020 14:19	06/01/2020 23:34	06/01/2020 14:19	06/01/2020 23:34	9,25	12	110,96	CHI
20200134010	DOVERLANDIA	DV12207926	CAIAPONIA	06/01/2020 14:39	06/01/2020 18:29	06/01/2020 14:39	06/01/2020 18:29	3,82	58	221,72	CHI
20200134023	RIO QUENTE	RQ12100108	RIO QUENTE	06/01/2020 14:55	06/01/2020 16:28	06/01/2020 14:55	06/01/2020 16:28	1,54	8	12,28	CHI
20200134030	ABADIANIA	AA12377404	ANAPOLIS UNIVERSITARIO S1	06/01/2020 14:47	06/01/2020 18:04	06/01/2020 14:47	06/01/2020 18:04	3,28	58	190,45	CHI
20200134037	ABADIANIA	AA21264159	ANAPOLIS UNIVERSITARIO S1	06/01/2020 15:04	07/01/2020 15:28	06/01/2020 15:04	07/01/2020 15:28	24,39	2	48,79	CHI
20200134045	CAMPOS VERDES	3790008422	SANTA TEREZINHA	06/01/2020 15:05	07/01/2020 00:53	06/01/2020 15:05	07/01/2020 00:53	9,80	1	9,80	CHI
20200134052	RIO VERDE	10009950875	RIO VERDE S2	06/01/2020 15:07	06/01/2020 16:26	06/01/2020 15:07	06/01/2020 16:26	1,33	1	1,33	CHI
20200134059	JAUPACI	JP21193317	IPORA	06/01/2020 15:07	06/01/2020 22:04	06/01/2020 15:07	06/01/2020 22:04	6,93	1	6,93	CHI
20200134061	PIRANHAS	PH12281564	PIRANHAS	06/01/2020 15:08	07/01/2020 07:05	06/01/2020 15:08	07/01/2020 07:05	15,94	1	15,94	CHI
20200134062	FORMOSA	PI12208713	PLANALTINA	06/01/2020 14:19	06/01/2020 18:18	06/01/2020 14:19	06/01/2020 18:18	3,98	1	3,98	CHI
20200134062	PLANALTINA	PI12208713	PLANALTINA	06/01/2020 14:19	06/01/2020 18:18	06/01/2020 14:19	06/01/2020 18:18	3,98	229	911,87	CHI
20200134063	RIO VERDE	630602827	RIO VERDE S1	06/01/2020 15:09	06/01/2020 16:53	06/01/2020 15:09	06/01/2020 16:53	1,74	1	1,74	CHI
20200134074	PLANALTINA	PI12383393	PLANALTINA	06/01/2020 15:10	06/01/2020 18:47	06/01/2020 15:10	06/01/2020 18:47	3,60	28	100,90	CHI
20200134075	LUZIANIA	LZ12000519	RIO VERMELHO	06/01/2020 14:40	06/01/2020 18:27	06/01/2020 14:40	06/01/2020 18:27	3,78	32	121,01	CHI
20200134086	AGUAS LINDAS DE GOIAS	10016616896	AGUAS LINDAS DE GOIAS S1	06/01/2020 15:12	06/01/2020 18:28	06/01/2020 15:12	06/01/2020 18:28	3,26	1	3,26	CHI
20200134092	RIO VERDE	RV12098479	RIO VERDE S1	06/01/2020 11:59	06/01/2020 16:12	06/01/2020 11:59	06/01/2020 16:12	4,22	7	29,53	CHI
20200134096	COLINAS DO SUL	TI21196544	MINACU	06/01/2020 15:15	07/01/2020 00:32	06/01/2020 15:15	07/01/2020 00:32	9,28	1	9,28	CHI
20200134097	LAGOA SANTA	IJ12219243	CACHOEIRA ALTA	06/01/2020 15:15	06/01/2020 23:51	06/01/2020 15:15	06/01/2020 23:51	8,59	3	25,76	CHI
20200134207	NOVO BRASIL	NB21165501	JUSSARA	06/01/2020 15:17	06/01/2020 19:44	06/01/2020 15:17	06/01/2020 19:44	4,44	1	4,44	CHI
20200134211	NIQUELANDIA	NQ12256599	NIQUELANDIA SUBTRANSMISSAO	06/01/2020 11:01	06/01/2020 17:15	06/01/2020 11:01	06/01/2020 17:15	6,22	4	24,88	CHI
20200134213	CATALAO	CT12103631	CATALAO S1	06/01/2020 15:18	06/01/2020 19:09	06/01/2020 15:18	06/01/2020 19:09	3,84	8	30,72	CHI
20200134218	ITAJA	IJ12162692	ITAJA S2	06/01/2020 15:19	07/01/2020 09:28	06/01/2020 15:19	07/01/2020 09:28	18,14	6	108,86	CHI
20200134221	BELA VISTA DE GOIAS	CF21107176	CRISTIANOPOLIS	06/01/2020 15:19	06/01/2020 16:55	06/01/2020 15:19	06/01/2020 16:55	1,59	2	3,17	CHI
20200134226	BALIZA	BH12061407	BOM JARDIM	06/01/2020 15:20	06/01/2020 17:23	06/01/2020 15:20	06/01/2020 17:23	2,04	30	61,09	CHI
20200134227	CRIXAS	CX12285665	SERRA DO OURO	06/01/2020 15:21	06/01/2020 18:33	06/01/2020 15:21	06/01/2020 18:33	3,20	2	6,40	CHI
20200134234	FORMOSA	FA21322671	ITIQUEIRA	06/01/2020 15:23	06/01/2020 18:01	06/01/2020 15:23	06/01/2020 18:01	2,63	1	2,63	CHI
20200134237	JARAGUA	70018650	JARAGUA	06/01/2020 15:23	07/01/2020 11:31	06/01/2020 15:23	07/01/2020 11:31	20,12	1	20,12	CHI
20200134240	NIQUELANDIA	NQ21330291	NIQUELANDIA SUBTRANSMISSAO	06/01/2020 15:23	07/01/2020 01:31	06/01/2020 15:23	07/01/2020 01:31	10,12	1	10,12	CHI
20200134243	GOIAS	GS12035930	GOIAS	06/01/2020 15:24	06/01/2020 21:46	06/01/2020 15:24	06/01/2020 21:46	6,36	40	254,40	CHI
20200134243	HEITORAI	GS12035930	GOIAS	06/01/2020 15:24	06/01/2020 21:46	06/01/2020 15:24	06/01/2020 21:46	6,36	32	203,52	CHI
20200134243	ITABERAI	GS12035930	GOIAS	06/01/2020 15:24	06/01/2020 21:46	06/01/2020 15:24	06/01/2020 21:46	6,36	2	12,72	CHI
20200134243	ITAPURANGA	GS12035930	GOIAS	06/01/2020 15:24	06/01/2020 21:46	06/01/2020 15:24	06/01/2020 21:46	6,36	3	19,08	CHI
20200134248	DOVERLANDIA	DV11253420	CAIAPONIA	06/01/2020 15:24	07/01/2020 02:12	06/01/2020 15:24	07/01/2020 02:12	10,79	1	10,79	CHI

20200134250	RIO VERDE	RV21040457	CABRIUVA S1	06/01/2020 15:25	06/01/2020 19:00	06/01/2020 15:25	06/01/2020 19:00	3,58	1	3,58	CHI
20200134251	CAMPINACU	UC21325355	PORANGATU	06/01/2020 15:23	07/01/2020 10:30	06/01/2020 15:23	07/01/2020 10:30	19,10	1	19,10	CHI
20200134258	NOVO GAMA	4990045258	PACAEMBU S1	06/01/2020 15:26	06/01/2020 21:42	06/01/2020 15:26	06/01/2020 21:42	6,25	1	6,25	CHI
20200134260	MINEIROS	MY11387729	PARQUE DAS EMAS	06/01/2020 15:26	06/01/2020 16:00	06/01/2020 15:26	06/01/2020 16:00	0,55	1	0,55	CHI
20200134263	SAO JOAO DA PARAUNA	RP12390964	FIRMINOPOLIS S2	06/01/2020 15:27	06/01/2020 17:14	06/01/2020 15:27	06/01/2020 17:14	1,77	2	3,54	CHI
20200134268	MINACU	IH21182308	MINACU	06/01/2020 15:28	06/01/2020 22:10	06/01/2020 15:28	06/01/2020 22:10	6,69	4	26,78	CHI
20200134272	PIRENOPOLIS	PV21024448	CORUMBA	06/01/2020 15:28	07/01/2020 11:05	06/01/2020 15:28	07/01/2020 11:05	19,60	1	19,60	CHI
20200134273	CAMPINACU	UC12064847	PORANGATU	06/01/2020 15:28	07/01/2020 16:08	06/01/2020 15:28	07/01/2020 16:08	24,65	1	24,65	CHI
20200134275	URUACU	UR11202046	URUACU	06/01/2020 15:17	06/01/2020 20:10	06/01/2020 18:24	06/01/2020 20:10	1,76	133	234,41	CHI
20200134276	JATAI	290307545	JATAI S2	06/01/2020 15:29	06/01/2020 18:37	06/01/2020 15:29	06/01/2020 18:37	3,13	1	3,13	CHI
20200134278	ALTO PARAISO DE GOIAS	3870000439	FLORES DE GOIAS	06/01/2020 15:29	06/01/2020 17:38	06/01/2020 15:29	06/01/2020 17:38	2,14	1	2,14	CHI
20200134286	CATALAO	CT12134367	CATALAO S1	06/01/2020 15:30	07/01/2020 16:47	06/01/2020 15:30	07/01/2020 16:47	25,29	11	278,16	CHI
20200134300	JATAI	JT21324902	JATAI S1	06/01/2020 15:34	08/01/2020 10:39	06/01/2020 21:50	07/01/2020 15:02	17,20	1	17,20	CHI
20200134300	JATAI	JT12303012	JATAI S1	06/01/2020 15:34	08/01/2020 10:39	06/01/2020 15:34	07/01/2020 15:35	24,02	1	24,02	CHI
20200134300	JATAI	JT12303012	JATAI S1	06/01/2020 15:34	08/01/2020 10:39	06/01/2020 15:34	08/01/2020 10:39	43,09	1	43,09	CHI
20200134408	NIQUELANDIA	2750002698	NIQUELANDIA SUBTRANSMISSAO	06/01/2020 15:35	06/01/2020 22:39	06/01/2020 15:35	06/01/2020 22:39	7,06	1	7,06	CHI
20200134410	BALIZA	BH12331465	CAIAPONIA	06/01/2020 15:23	06/01/2020 19:35	06/01/2020 15:23	06/01/2020 19:35	4,19	26	108,93	CHI
20200134419	FORMOSA	FA21116856	ITUIQUIRA	06/01/2020 15:37	06/01/2020 23:30	06/01/2020 15:37	06/01/2020 23:30	7,88	2	15,76	CHI
20200134422	AGUAS LINDAS DE GOIAS	4830033825	AGUAS LINDAS DE GOIAS S2	06/01/2020 15:38	06/01/2020 15:59	06/01/2020 15:38	06/01/2020 15:59	0,34	1	0,34	CHI
20200134429	ITAPACI	IW21040080	ITAPACI	06/01/2020 15:39	06/01/2020 18:56	06/01/2020 15:39	06/01/2020 18:56	3,28	1	3,28	CHI
20200134431	MAURILANDIA	RV12315683	SANTA HELENA S1	06/01/2020 15:28	07/01/2020 00:07	06/01/2020 15:28	07/01/2020 00:07	8,64	4	34,56	CHI
20200134431	RIO VERDE	RV12315683	SANTA HELENA S1	06/01/2020 15:28	07/01/2020 00:07	06/01/2020 15:28	07/01/2020 00:07	8,64	7	60,47	CHI
20200134437	ARAGARCAS	10017439688	ARAGARCAS	06/01/2020 15:40	06/01/2020 23:00	06/01/2020 15:40	06/01/2020 23:00	7,32	1	7,32	CHI
20200134438	LUZIANIA	3200120068	RIO VERMELHO	06/01/2020 15:40	06/01/2020 21:38	06/01/2020 15:40	06/01/2020 21:38	5,96	1	5,96	CHI
20200134440	IPORA	IR12014557	IPORA	06/01/2020 15:40	07/01/2020 07:12	06/01/2020 15:40	07/01/2020 07:12	15,52	22	341,38	CHI
20200134449	AGUAS LINDAS DE GOIAS	4830044082	AGUAS LINDAS DE GOIAS S1	06/01/2020 15:41	07/01/2020 09:59	06/01/2020 15:41	07/01/2020 09:59	18,29	1	18,29	CHI
20200134453	SANTO ANTONIO DO DESCOBERTO	10028222324	AGUAS LINDAS DE GOIAS S2	06/01/2020 15:42	06/01/2020 20:06	06/01/2020 15:42	06/01/2020 20:06	4,39	1	4,39	CHI
20200134458	BONOPOLIS	BX12377680LD	SAO MIGUEL DO ARAGUAIA	06/01/2020 15:43	07/01/2020 15:42	06/01/2020 15:43	07/01/2020 15:42	23,99	95	2278,97	CHI
20200134458	SAO MIGUEL DO ARAGUAIA	BX12377680LD	SAO MIGUEL DO ARAGUAIA	06/01/2020 15:43	07/01/2020 15:42	06/01/2020 15:43	07/01/2020 15:42	23,99	0	0,00	CHI
20200134458	BONOPOLIS	BX12377680LD	SAO MIGUEL DO ARAGUAIA	06/01/2020 15:43	07/01/2020 15:42	07/01/2020 12:34	07/01/2020 15:42	3,14	5	15,70	CHI
20200134461	SAO MIGUEL DO ARAGUAIA	SM12074411	SAO MIGUEL DO ARAGUAIA	06/01/2020 11:23	07/01/2020 00:15	06/01/2020 11:23	07/01/2020 00:15	12,86	10	128,61	CHI
20200134463	QUIRINOPOLIS	QI21112204	QUIRINOPOLIS	06/01/2020 15:44	06/01/2020 17:57	06/01/2020 15:44	06/01/2020 17:57	2,22	1	2,22	CHI
20200134470	NOVO BRASIL	1460005019	JUSSARA	06/01/2020 15:44	06/01/2020 18:20	06/01/2020 15:44	06/01/2020 18:20	2,59	1	2,59	CHI

20200134474	RUBIATABA	RB21312134	RUBIATABA	06/01/2020 15:47	06/01/2020 17:26	06/01/2020 15:47	06/01/2020 17:26	1,64	1	1,64	CHI
20200134475	VALPARAISO DE GOIAS	2860074527	MARAJOARA	06/01/2020 15:47	06/01/2020 16:46	06/01/2020 15:47	06/01/2020 16:46	0,98	1	0,98	CHI
20200134477	CRISTIANOPOLIS	SQ21283994	CRISTIANOPOLIS	06/01/2020 15:47	07/01/2020 10:01	06/01/2020 15:47	07/01/2020 10:01	18,22	1	18,22	CHI
20200134480	CAMPO ALEGRE DE GOIAS	CM12338755	CAMPO ALEGRE DE GOIAS	06/01/2020 15:48	06/01/2020 19:44	06/01/2020 15:48	06/01/2020 19:44	3,93	3	11,79	CHI
20200134497	LUZIANIA	10012649722	RIO VERMELHO	06/01/2020 15:52	06/01/2020 20:47	06/01/2020 15:52	06/01/2020 20:47	4,90	1	4,90	CHI
20200134503	NOVA AURORA	NE12306653	CATALAO S1	06/01/2020 15:40	06/01/2020 21:55	06/01/2020 18:04	06/01/2020 21:55	3,85	2	7,71	CHI
20200134601	ITAPIRAPUA	IU12054520	JUSSARA	06/01/2020 15:50	06/01/2020 17:26	06/01/2020 15:50	06/01/2020 17:26	1,58	1	1,58	CHI
20200134703	FORMOSA	FA21072536	ITUIQUIRA	06/01/2020 15:54	06/01/2020 22:36	06/01/2020 15:54	06/01/2020 22:36	6,69	1	6,69	CHI
20200134712	CEZARINA	CZ12228898	CEZARINA	06/01/2020 15:57	06/01/2020 19:53	06/01/2020 15:57	06/01/2020 19:53	3,93	9	35,33	CHI
20200134718	MARZAGAO	MG21182884	VILA CORUMBA	06/01/2020 15:59	07/01/2020 11:10	06/01/2020 15:59	07/01/2020 11:10	19,18	2	38,36	CHI
20200134719	VALPARAISO DE GOIAS	VA12370668	PACAEMBU S2	06/01/2020 15:01	06/01/2020 18:14	06/01/2020 15:01	06/01/2020 18:14	3,21	185	594,31	CHI
20200134720	LUZIANIA	LZ12389566	PACAEMBU S1	06/01/2020 12:02	06/01/2020 18:44	06/01/2020 12:02	06/01/2020 18:44	6,70	18	120,57	CHI
20200134720	NOVO GAMA	LZ12389566	PACAEMBU S1	06/01/2020 12:02	06/01/2020 18:44	06/01/2020 12:02	06/01/2020 18:44	6,70	3	20,09	CHI
20200134721	AGUAS LINDAS DE GOIAS	10019713140	AGUAS LINDAS DE GOIAS S1	06/01/2020 15:59	06/01/2020 19:00	06/01/2020 15:59	06/01/2020 19:00	3,00	1	3,00	CHI
20200134723	ANAPOLIS	AN12258789	ANAPOLIS UNIVERSITARIO S1	06/01/2020 12:20	06/01/2020 19:10	06/01/2020 12:20	06/01/2020 19:10	6,83	13	88,83	CHI
20200134724	CRISTALINA	KR21313720	PAMPLONA	06/01/2020 15:59	07/01/2020 10:18	06/01/2020 15:59	07/01/2020 10:18	18,30	1	18,30	CHI
20200134725	AGUAS LINDAS DE GOIAS	4830146164	AGUAS LINDAS DE GOIAS S1	06/01/2020 15:59	06/01/2020 17:12	06/01/2020 15:59	06/01/2020 17:12	1,20	1	1,20	CHI
20200134732	JARAGUA	JA21049593	JARAGUA	06/01/2020 16:02	07/01/2020 10:18	06/01/2020 16:02	07/01/2020 10:18	18,26	1	18,26	CHI
20200134742	LUZIANIA	120295015	RIO VERMELHO	06/01/2020 16:04	06/01/2020 20:49	06/01/2020 16:04	06/01/2020 20:49	4,75	1	4,75	CHI
20200134743	PORANGATU	PO12390257	PORANGATU	06/01/2020 16:04	07/01/2020 11:17	06/01/2020 16:04	07/01/2020 11:17	19,21	4	76,84	CHI
20200134746	DOVERLANDIA	DV12155481	CAIAPONIA	06/01/2020 16:04	06/01/2020 22:58	06/01/2020 16:04	06/01/2020 22:58	6,89	5	34,43	CHI
20200134763	VALPARAISO DE GOIAS	VA11170112	MARAJOARA	06/01/2020 14:57	06/01/2020 17:31	06/01/2020 14:57	06/01/2020 17:31	2,55	89	227,37	CHI
20200134764	CIDADE OCIDENTAL	LZ12086008	MARAJOARA	06/01/2020 12:16	06/01/2020 17:26	06/01/2020 12:16	06/01/2020 17:26	5,16	7	36,14	CHI
20200134787	CORUMBA DE GOIAS	10003143820	CORUMBA	06/01/2020 16:15	06/01/2020 22:28	06/01/2020 16:15	06/01/2020 22:28	6,21	1	6,21	CHI
20200134789	ITABERAI	10009359930	ITABERAI S2	06/01/2020 16:15	06/01/2020 21:01	06/01/2020 16:15	06/01/2020 21:01	4,75	1	4,75	CHI
20200134790	TROMBAS	TB12324048	PORANGATU	06/01/2020 16:15	07/01/2020 13:06	06/01/2020 16:15	07/01/2020 13:06	20,85	1	20,85	CHI
20200134793	DAMIANOPOLIS	DA21262343	IACIARA S2	06/01/2020 16:16	06/01/2020 17:51	06/01/2020 16:16	06/01/2020 17:51	1,58	1	1,58	CHI
20200135028	RIO VERDE	RV12207197	MONTIVIDIU T	06/01/2020 18:06	06/01/2020 20:23	06/01/2020 18:06	06/01/2020 20:23	2,28	1	2,28	CHI
20200135040	RIO VERDE	RV12245473	CABRIUVA S2	06/01/2020 16:23	06/01/2020 21:48	06/01/2020 16:23	06/01/2020 21:48	5,42	8	43,34	CHI
20200135042	JARAGUA	70107099	JARAGUA	06/01/2020 16:23	06/01/2020 18:00	06/01/2020 16:23	06/01/2020 18:00	1,62	1	1,62	CHI
20200135045	NIQUELANDIA	NQ11243420	NIQUELANDIA SUBTRANSMISSAO	06/01/2020 16:24	07/01/2020 00:44	06/01/2020 16:24	07/01/2020 00:44	8,33	16	133,34	CHI
20200135049	APORE	AE21209707	ITAJA S1	06/01/2020 16:24	07/01/2020 15:12	06/01/2020 16:24	07/01/2020 15:12	22,79	1	22,79	CHI
20200135066	AMARALINA	LC12230319	NOVA CRIXAS	06/01/2020 15:44	06/01/2020 21:58	06/01/2020 15:44	06/01/2020 21:58	6,23	3	18,68	CHI

20200135068	FORMOSA	610246021	ITIQUEIRA	06/01/2020 16:26	06/01/2020 17:24	06/01/2020 16:26	06/01/2020 17:24	0,95	1	0,95	CHI
20200135070	MONTES CLAROS DE GOIAS	ME21070940	BRITANIA	06/01/2020 09:13	06/01/2020 17:15	06/01/2020 09:13	06/01/2020 17:15	8,03	3	24,09	CHI
20200135078	VALPARAISO DE GOIAS	VA11376102	MARAJOARA	06/01/2020 16:27	06/01/2020 17:53	06/01/2020 16:27	06/01/2020 17:53	1,42	13	18,45	CHI
20200135088	GOIANDIRA	GD21203144	CATALAO S1	06/01/2020 16:29	07/01/2020 10:11	06/01/2020 16:29	07/01/2020 10:11	17,69	1	17,69	CHI
20200135093	MORRINHOS	MR31092100	MORRINHOS	06/01/2020 16:30	07/01/2020 01:32	06/01/2020 16:30	07/01/2020 01:32	9,02	1	9,02	CHI
20200135096	JATAI	290214683	JATAI S2	06/01/2020 16:34	07/01/2020 12:37	06/01/2020 16:34	07/01/2020 12:37	20,05	1	20,05	CHI
20200135302	LUZIANIA	LZ21000395	PACAEMBU S1	06/01/2020 16:42	06/01/2020 23:13	06/01/2020 16:42	06/01/2020 23:13	6,52	1	6,52	CHI
20200135304	JARAGUA	70050480	JARAGUA	06/01/2020 16:43	07/01/2020 00:12	06/01/2020 16:43	07/01/2020 00:12	7,48	1	7,48	CHI
20200135311	RIO VERDE	RV10400561	CABRIUVA S2	06/01/2020 16:45	06/01/2020 18:30	06/01/2020 16:45	06/01/2020 18:30	1,74	90	156,93	CHI
20200135311	RIO VERDE	RV10400561	MONTIVIDIU T	06/01/2020 16:45	06/01/2020 18:30	06/01/2020 16:45	06/01/2020 18:30	1,74	10	17,44	CHI
20200135312	ITUMBIARA	IT12304246	ITUMBIARA NOVA	06/01/2020 16:45	06/01/2020 20:10	06/01/2020 16:45	06/01/2020 20:10	3,41	3	10,23	CHI
20200135315	MOSSAMEDES	MD21299587	ITABERAI S2	06/01/2020 16:45	06/01/2020 19:16	06/01/2020 16:45	06/01/2020 19:16	2,51	1	2,51	CHI
20200135319	JARAGUA	JA12000124	JARAGUA	06/01/2020 12:23	06/01/2020 21:15	06/01/2020 12:23	06/01/2020 21:15	8,86	16	141,73	CHI
20200135327	JATAI	JT21065817	JATAI S1	06/01/2020 16:59	06/01/2020 20:34	06/01/2020 16:59	06/01/2020 20:34	3,58	1	3,58	CHI
20200135331	JATAI	JT11361756	JATAI S2	06/01/2020 17:03	06/01/2020 22:06	06/01/2020 17:03	06/01/2020 22:06	5,04	3	15,13	CHI
20200135334	GOIATUBA	GT21000017	GOIATUBA S2	06/01/2020 17:04	06/01/2020 19:12	06/01/2020 17:04	06/01/2020 19:12	2,12	2	4,24	CHI
20200135335	AGUAS LINDAS DE GOIAS	4830219143	AGUAS LINDAS DE GOIAS S1	06/01/2020 17:05	06/01/2020 18:11	06/01/2020 17:05	06/01/2020 18:11	1,09	1	1,09	CHI
20200135337	ARENOPOLIS	AY13349761	ARENOPOLIS	06/01/2020 17:08	07/01/2020 22:28	06/01/2020 17:08	06/01/2020 17:18	0,17	245	40,97	CHI
20200135337	DIORAMA	AY13349761	ARENOPOLIS	06/01/2020 17:08	07/01/2020 22:28	06/01/2020 17:08	06/01/2020 17:18	0,17	12	2,01	CHI
20200135337	MONTES CLAROS DE GOIAS	AY13349761	ARENOPOLIS	06/01/2020 17:08	07/01/2020 22:28	06/01/2020 17:08	06/01/2020 17:18	0,17	25	4,18	CHI
20200135337	PALESTINA DE GOIAS	AY13349761	ARENOPOLIS	06/01/2020 17:08	07/01/2020 22:28	06/01/2020 17:08	06/01/2020 17:18	0,17	3	0,50	CHI
20200135337	PIRANHAS	AY13349761	ARENOPOLIS	06/01/2020 17:08	07/01/2020 22:28	06/01/2020 17:08	06/01/2020 17:18	0,17	25	4,18	CHI
20200135337	ARENOPOLIS	AY13349761	ARENOPOLIS	06/01/2020 17:08	07/01/2020 22:28	06/01/2020 20:45	07/01/2020 22:00	25,25	207	5226,98	CHI
20200135337	DIORAMA	AY13349761	ARENOPOLIS	06/01/2020 17:08	07/01/2020 22:28	06/01/2020 20:45	07/01/2020 22:00	25,25	12	303,01	CHI
20200135337	MONTES CLAROS DE GOIAS	AY13349761	ARENOPOLIS	06/01/2020 17:08	07/01/2020 22:28	06/01/2020 20:45	07/01/2020 22:00	25,25	25	631,28	CHI
20200135337	PALESTINA DE GOIAS	AY13349761	ARENOPOLIS	06/01/2020 17:08	07/01/2020 22:28	06/01/2020 20:45	07/01/2020 22:00	25,25	3	75,75	CHI
20200135337	PIRANHAS	AY13349761	ARENOPOLIS	06/01/2020 17:08	07/01/2020 22:28	06/01/2020 20:45	07/01/2020 22:00	25,25	21	530,27	CHI
20200135337	ARENOPOLIS	AY12000027	ARENOPOLIS	06/01/2020 17:08	07/01/2020 22:28	06/01/2020 20:45	07/01/2020 22:28	25,72	36	925,77	CHI
20200135337	PIRANHAS	AY12000027	ARENOPOLIS	06/01/2020 17:08	07/01/2020 22:28	06/01/2020 20:45	07/01/2020 22:28	25,72	4	102,86	CHI
20200135338	PEROLANDIA	DP11272268	JATAI S1	06/01/2020 17:05	07/01/2020 14:20	06/01/2020 17:05	07/01/2020 14:20	21,23	1	21,23	CHI
20200135344	NOVO GAMA	4990009242	PACAEMBU S1	06/01/2020 17:11	06/01/2020 22:41	06/01/2020 17:11	06/01/2020 22:41	5,49	1	5,49	CHI
20200135346	CUMARI	CT12042313	CATALAO S2	06/01/2020 17:13	06/01/2020 20:09	06/01/2020 17:13	06/01/2020 20:09	2,92	8	23,36	CHI
20200135346	GOIANDIRA	CT12042313	CATALAO S2	06/01/2020 17:13	06/01/2020 20:09	06/01/2020 17:13	06/01/2020 20:09	2,92	3	8,76	CHI

20200135354	VICENTINOPOLIS	VI12047297	VICENTINOPOLIS	06/01/2020 16:12	06/01/2020 17:52	06/01/2020 16:12	06/01/2020 17:52	1,66	5	8,29	CHI
20200135358	MUTUNOPOLIS	MU21147229	MARA ROSA	06/01/2020 17:21	07/01/2020 10:26	06/01/2020 17:21	07/01/2020 10:26	17,08	1	17,08	CHI
20200135362	ANAPOLIS	AN12000524	ANAPOLIS UNIVERSITARIO S2	06/01/2020 09:12	06/01/2020 19:38	06/01/2020 09:12	06/01/2020 19:38	10,43	6	62,56	CHI
20200135376	ANAPOLIS	AN12189910	ANAPOLIS UNIVERSITARIO S2	06/01/2020 17:33	06/01/2020 20:01	06/01/2020 17:33	06/01/2020 20:01	2,46	247	607,48	CHI
20200135378	CATALAO	10016021094	CATALAO S2	06/01/2020 17:34	06/01/2020 22:27	06/01/2020 17:34	06/01/2020 22:27	4,87	1	4,87	CHI
20200135380	CAIAPONIA	CP12075059	CAIAPONIA	06/01/2020 16:23	07/01/2020 01:25	06/01/2020 16:23	07/01/2020 01:25	9,02	84	757,63	CHI
20200135501	ITAGUARI	II21385177	ITABERAI S1	06/01/2020 17:17	06/01/2020 19:38	06/01/2020 17:17	06/01/2020 19:38	2,35	1	2,35	CHI
20200135906	MINEIROS	SU13191740	SANTA RITA DO ARAGUAIA	06/01/2020 17:50	07/01/2020 19:50	06/01/2020 17:50	06/01/2020 20:35	2,74	31	84,86	CHI
20200135906	SANTA RITA DO ARAGUAIA	SU13191740	SANTA RITA DO ARAGUAIA	06/01/2020 17:50	07/01/2020 19:50	06/01/2020 17:50	06/01/2020 20:35	2,74	1983	5428,46	CHI
20200135906	BURITINOPOLIS	SU13273995	SANTA RITA DO ARAGUAIA	06/01/2020 17:50	07/01/2020 19:50	06/01/2020 17:50	06/01/2020 20:54	3,05	1	3,05	CHI
20200135906	MINEIROS	SU13273995	SANTA RITA DO ARAGUAIA	06/01/2020 17:50	07/01/2020 19:50	06/01/2020 17:50	06/01/2020 20:54	3,05	3	9,16	CHI
20200135906	SANTA RITA DO ARAGUAIA	SU13273995	SANTA RITA DO ARAGUAIA	06/01/2020 17:50	07/01/2020 19:50	06/01/2020 17:50	06/01/2020 20:54	3,05	1166	3561,16	CHI
20200135906	MINEIROS	02610424	PARQUE DAS EMAS	06/01/2020 17:50	07/01/2020 19:50	06/01/2020 17:50	06/01/2020 21:35	3,75	15	56,23	CHI
20200135906	PORTELANDIA	02610424	PARQUE DAS EMAS	06/01/2020 17:50	07/01/2020 19:50	06/01/2020 17:50	06/01/2020 21:35	3,75	2	7,50	CHI
20200135906	MINEIROS	PW13130288	PARQUE DAS EMAS	06/01/2020 17:50	07/01/2020 19:50	06/01/2020 17:50	06/01/2020 23:38	5,79	10	57,93	CHI
20200135906	MONTIVIDIU	PW13130288	PARQUE DAS EMAS	06/01/2020 17:50	07/01/2020 19:50	06/01/2020 17:50	06/01/2020 23:38	5,79	1	5,79	CHI
20200135906	PORTELANDIA	PW13130288	PARQUE DAS EMAS	06/01/2020 17:50	07/01/2020 19:50	06/01/2020 17:50	06/01/2020 23:38	5,79	8	46,34	CHI
20200135906	MINEIROS	MY13301880	PARQUE DAS EMAS	06/01/2020 17:50	07/01/2020 19:50	06/01/2020 17:50	07/01/2020 10:35	16,75	10	167,48	CHI
20200135906	MINEIROS	02610424	PARQUE DAS EMAS	06/01/2020 17:50	07/01/2020 19:50	07/01/2020 17:20	07/01/2020 17:25	0,08	35	2,83	CHI
20200135906	MONTIVIDIU	02610424	PARQUE DAS EMAS	06/01/2020 17:50	07/01/2020 19:50	07/01/2020 17:20	07/01/2020 17:25	0,08	1	0,08	CHI
20200135906	PORTELANDIA	02610424	PARQUE DAS EMAS	06/01/2020 17:50	07/01/2020 19:50	07/01/2020 17:20	07/01/2020 17:25	0,08	10	0,81	CHI
20200135906	MINEIROS	MY13151591	PARQUE DAS EMAS	06/01/2020 17:50	07/01/2020 19:50	06/01/2020 17:50	07/01/2020 18:37	24,78	13	322,14	CHI
20200135906	PORTELANDIA	MY13151591	PARQUE DAS EMAS	06/01/2020 17:50	07/01/2020 19:50	06/01/2020 17:50	07/01/2020 18:37	24,78	2	49,56	CHI
20200135906	MINEIROS	MY13374435	PARQUE DAS EMAS	06/01/2020 17:50	07/01/2020 19:50	06/01/2020 17:50	07/01/2020 18:51	25,02	10	250,15	CHI
20200135906	MINEIROS	MY13151591	PARQUE DAS EMAS	06/01/2020 17:50	07/01/2020 19:50	06/01/2020 17:50	07/01/2020 19:05	25,24	11	277,69	CHI
20200135906	MINEIROS	SU13377949	SANTA RITA DO ARAGUAIA	06/01/2020 17:50	07/01/2020 19:50	07/01/2020 19:30	07/01/2020 19:45	0,25	31	7,75	CHI
20200135906	SANTA RITA DO ARAGUAIA	SU13377949	SANTA RITA DO ARAGUAIA	06/01/2020 17:50	07/01/2020 19:50	07/01/2020 19:30	07/01/2020 19:45	0,25	2011	502,75	CHI
20200135906	BURITINOPOLIS	SU13377948	SANTA RITA DO ARAGUAIA	06/01/2020 17:50	07/01/2020 19:50	07/01/2020 19:25	07/01/2020 19:50	0,42	1	0,42	CHI
20200135906	SANTA RITA DO ARAGUAIA	SU13377948	SANTA RITA DO ARAGUAIA	06/01/2020 17:50	07/01/2020 19:50	07/01/2020 19:25	07/01/2020 19:50	0,42	1162	484,81	CHI
20200136008	SANTA HELENA DE GOIAS	SH12363860	IPEGUARI	06/01/2020 17:56	07/01/2020 12:00	06/01/2020 17:56	06/01/2020 22:25	4,48	208	931,72	CHI
20200136008	SANTA HELENA DE GOIAS	05770264	IPEGUARI	06/01/2020 17:56	07/01/2020 12:00	06/01/2020 19:04	07/01/2020 12:00	16,94	106	1795,99	CHI
20200136014	PIRACANJUBA	PJ12040285	MORRINHOS	06/01/2020 17:57	09/01/2020 21:05	06/01/2020 17:57	09/01/2020 21:05	75,12	2	150,24	CHI
20200136015	MATRINCHA	MP12122364	MATRINCHA	06/01/2020 17:58	06/01/2020 21:32	06/01/2020 17:58	06/01/2020 21:32	3,56	10	35,63	CHI

20200136020	RIO VERDE	RV21306312	RIO VERDE S2	06/01/2020 17:58	07/01/2020 12:32	06/01/2020 17:58	07/01/2020 12:32	18,56	1	18,56	CHI
20200136021	LUZIANIA	LZ12000232	RIO VERMELHO	06/01/2020 17:58	06/01/2020 23:07	06/01/2020 17:58	06/01/2020 23:07	5,15	83	427,66	CHI
20200136023	AGUA FRIA DE GOIAS	TL21322494	SAO JOAO D ALIANCA	06/01/2020 17:58	06/01/2020 20:02	06/01/2020 17:58	06/01/2020 20:02	2,06	3	6,17	CHI
20200136024	JATAI	JT21241677	JATAI S1	06/01/2020 17:58	07/01/2020 10:00	06/01/2020 17:58	07/01/2020 10:00	16,02	1	16,02	CHI
20200136029	GAMELEIRA DE GOIAS	SV12033468	DAIA S2	06/01/2020 16:18	06/01/2020 21:25	06/01/2020 16:18	06/01/2020 21:25	5,10	14	71,42	CHI
20200136029	SILVANIA	SV12033468	DAIA S2	06/01/2020 16:18	06/01/2020 21:25	06/01/2020 16:18	06/01/2020 21:25	5,10	134	683,59	CHI
20200136036	CRISTALINA	KR21159928	CRISTALINA S2	06/01/2020 18:00	07/01/2020 09:45	06/01/2020 18:00	07/01/2020 09:45	15,75	1	15,75	CHI
20200136038	GOIAS	MD12062634	ITABERAI S1	06/01/2020 18:00	06/01/2020 20:32	06/01/2020 18:00	06/01/2020 20:32	2,53	1	2,53	CHI
20200136038	ITABERAI	MD12062634	ITABERAI S1	06/01/2020 18:00	06/01/2020 20:32	06/01/2020 18:00	06/01/2020 20:32	2,53	2	5,06	CHI
20200136038	MOSSAMEDES	MD12062634	ITABERAI S1	06/01/2020 18:00	06/01/2020 20:32	06/01/2020 18:00	06/01/2020 20:32	2,53	86	217,65	CHI
20200136041	VALPARAISO DE GOIAS	10020176463	MARAJOARA	06/01/2020 18:00	06/01/2020 19:41	06/01/2020 18:00	06/01/2020 19:41	1,68	1	1,68	CHI
20200136044	RIO VERDE	630128996	RIO VERDE S1	06/01/2020 18:00	07/01/2020 00:41	06/01/2020 18:00	07/01/2020 00:41	6,67	1	6,67	CHI
20200136051	SANTA TEREZINHA DE GOIAS	VD21327219	SANTA TEREZINHA	06/01/2020 18:01	06/01/2020 22:36	06/01/2020 18:01	06/01/2020 22:36	4,58	1	4,58	CHI
20200136061	ARUANA	AK12353719	BRITANIA	06/01/2020 18:01	06/01/2020 18:40	06/01/2020 18:01	06/01/2020 18:40	0,63	1	0,63	CHI
20200136064	MINEIROS	MY12360840	PARQUE DAS EMAS	06/01/2020 17:58	07/01/2020 11:00	06/01/2020 17:58	07/01/2020 11:00	17,03	20	340,62	CHI
20200136065	PIRANHAS	PH12201915	ARENOPOLIS	06/01/2020 17:27	07/01/2020 12:30	06/01/2020 17:27	07/01/2020 12:30	19,05	6	114,31	CHI
20200136067	ACREUNA	TD12213318	RIO DOS BOIS	06/01/2020 16:21	06/01/2020 19:37	06/01/2020 16:21	06/01/2020 19:37	3,25	24	78,10	CHI
20200136067	SANTA HELENA DE GOIAS	TD12213318	RIO DOS BOIS	06/01/2020 16:21	06/01/2020 19:37	06/01/2020 16:21	06/01/2020 19:37	3,25	17	55,32	CHI
20200136067	TURVELANDIA	TD12213318	RIO DOS BOIS	06/01/2020 16:21	06/01/2020 19:37	06/01/2020 16:21	06/01/2020 19:37	3,25	83	270,10	CHI
20200136070	JARAGUA	JA12374473LD	JARAGUA	06/01/2020 06:27	06/01/2020 19:23	06/01/2020 06:27	06/01/2020 19:23	12,93	289	3736,37	CHI
20200136074	CRISTALINA	KR21323381	PAMPLONA	06/01/2020 18:03	07/01/2020 11:04	06/01/2020 18:03	07/01/2020 11:04	17,01	1	17,01	CHI
20200136077	LUZIANIA	LZ21041455	RIO VERMELHO	06/01/2020 18:03	06/01/2020 22:07	06/01/2020 18:03	06/01/2020 22:07	4,05	1	4,05	CHI
20200136079	IPAMERI	IP21383857	IPAMERI	06/01/2020 18:04	06/01/2020 21:00	06/01/2020 18:04	06/01/2020 21:00	2,93	1	2,93	CHI
20200136081	ESTRELA DO NORTE	ET21143706	MARA ROSA	06/01/2020 18:04	07/01/2020 02:42	06/01/2020 18:04	07/01/2020 02:42	8,63	1	8,63	CHI
20200136087	VILA PROPICIO	NP11229031	GOIANESIA S1	06/01/2020 18:04	07/01/2020 10:43	06/01/2020 18:04	07/01/2020 10:43	16,64	1	16,64	CHI
20200136088	CAMPO ALEGRE DE GOIAS	CM12084693	CAMPO ALEGRE DE GOIAS	06/01/2020 18:04	06/01/2020 23:39	06/01/2020 18:04	06/01/2020 23:39	5,57	1	5,57	CHI
20200136090	PIRES DO RIO	PR21407522	PIRES DO RIO S2	06/01/2020 18:05	06/01/2020 22:47	06/01/2020 18:05	06/01/2020 22:47	4,70	1	4,70	CHI
20200136091	MINEIROS	MY12274100	PARQUE DAS EMAS	06/01/2020 18:03	07/01/2020 11:27	06/01/2020 18:03	07/01/2020 11:27	17,40	16	278,36	CHI
20200136096	CABECEIRAS	860010314	ITUIQUIRA	06/01/2020 18:05	06/01/2020 19:52	06/01/2020 18:05	06/01/2020 19:52	1,77	1	1,77	CHI
20200136097	VICENTINOPOLIS	VI21122097	VICENTINOPOLIS	06/01/2020 18:05	06/01/2020 20:20	06/01/2020 18:05	06/01/2020 20:20	2,24	2	4,47	CHI
20200136104	ORIZONA	OZ12402559	PIRES DO RIO S2	06/01/2020 18:06	06/01/2020 20:40	06/01/2020 18:06	06/01/2020 20:40	2,56	3	7,67	CHI
20200136104	PIRES DO RIO	OZ12402559	PIRES DO RIO S2	06/01/2020 18:06	06/01/2020 20:40	06/01/2020 18:06	06/01/2020 20:40	2,56	2	5,11	CHI
20200136106	EDEIA	ED21254471	EDEIA	06/01/2020 18:06	06/01/2020 20:38	06/01/2020 18:06	06/01/2020 20:38	2,52	1	2,52	CHI



20200136108	CALDAS NOVAS	760437440	CALDAS NOVAS S1	06/01/2020 18:06	07/01/2020 03:27	06/01/2020 18:06	07/01/2020 03:27	9,34	1	9,34	CHI
20200136116	MATRINCHA	MP21171757	MATRINCHA	06/01/2020 18:08	06/01/2020 23:05	06/01/2020 18:08	06/01/2020 23:05	4,95	1	4,95	CHI
20200136118	CACHOEIRA DOURADA	IT12088560	CACHOEIRA DOURADA	06/01/2020 18:08	07/01/2020 02:00	06/01/2020 18:08	07/01/2020 02:00	7,86	1	7,86	CHI
20200136118	ITUMBIARA	IT12088560	CACHOEIRA DOURADA	06/01/2020 18:08	07/01/2020 02:00	06/01/2020 18:08	07/01/2020 02:00	7,86	4	31,46	CHI
20200136131	CAMPOS VERDES	VD12251079	SANTA TEREZINHA	06/01/2020 16:20	06/01/2020 20:33	06/01/2020 16:20	06/01/2020 19:51	3,51	3	10,54	CHI
20200136131	SANTA TEREZINHA DE GOIAS	VD12251079	SANTA TEREZINHA	06/01/2020 16:20	06/01/2020 20:33	06/01/2020 16:20	06/01/2020 19:51	3,51	3	10,54	CHI
20200136131	CAMPOS VERDES	VD12251082	SANTA TEREZINHA	06/01/2020 16:20	06/01/2020 20:33	06/01/2020 20:24	06/01/2020 20:33	0,14	4	0,55	CHI
20200136131	SANTA TEREZINHA DE GOIAS	VD12251082	SANTA TEREZINHA	06/01/2020 16:20	06/01/2020 20:33	06/01/2020 20:24	06/01/2020 20:33	0,14	16	2,19	CHI
20200136133	BOM JESUS DE GOIAS	BJ12000202	CACHOEIRA DOURADA	06/01/2020 18:10	06/01/2020 20:42	06/01/2020 18:10	06/01/2020 20:42	2,53	23	58,16	CHI
20200136133	GOIATUBA	BJ12000202	CACHOEIRA DOURADA	06/01/2020 18:10	06/01/2020 20:42	06/01/2020 18:10	06/01/2020 20:42	2,53	7	17,70	CHI
20200136133	PANAMA	BJ12000202	CACHOEIRA DOURADA	06/01/2020 18:10	06/01/2020 20:42	06/01/2020 18:10	06/01/2020 20:42	2,53	2	5,06	CHI
20200136136	VALPARAISO DE GOIAS	10012353211	PACAEMBU S2	06/01/2020 18:10	06/01/2020 18:53	06/01/2020 18:10	06/01/2020 18:53	0,70	1	0,70	CHI
20200136138	NIQUELANDIA	NQ12141164	NIQUELANDIA SUBTRANSMISSAO	06/01/2020 18:11	06/01/2020 23:10	06/01/2020 18:11	06/01/2020 23:10	4,98	3	14,95	CHI
20200136140	CRISTALINA	KR12133610	CRISTALINA S2	06/01/2020 18:11	06/01/2020 19:29	06/01/2020 18:11	06/01/2020 19:29	1,29	12	15,50	CHI
20200136147	FORMOSA	610321225	ITUIQUIRA	06/01/2020 18:12	06/01/2020 19:52	06/01/2020 18:12	06/01/2020 19:52	1,66	1	1,66	CHI
20200136154	RIO VERDE	RV31159367	ACREUNA	06/01/2020 18:13	07/01/2020 11:41	06/01/2020 18:13	07/01/2020 11:41	17,45	1	17,45	CHI
20200136156	PIRENOPOLIS	PV21318039	CORUMBA	06/01/2020 18:14	07/01/2020 11:28	06/01/2020 18:14	07/01/2020 11:28	17,23	1	17,23	CHI
20200136158	PORANGATU	PO12236178	PORANGATU	06/01/2020 18:14	07/01/2020 13:14	06/01/2020 18:14	07/01/2020 13:14	19,00	3	56,99	CHI
20200136171	JATAI	RV12104996	JATAI S2	06/01/2020 18:15	07/01/2020 11:46	06/01/2020 18:15	07/01/2020 11:46	17,51	13	227,65	CHI
20200136171	RIO VERDE	RV12104996	JATAI S2	06/01/2020 18:15	07/01/2020 11:46	06/01/2020 18:15	07/01/2020 11:46	17,51	7	122,58	CHI
20200136173	ITUMBIARA	BJ21000257	CACHOEIRA DOURADA	06/01/2020 18:15	06/01/2020 22:11	06/01/2020 18:15	06/01/2020 22:11	3,92	1	3,92	CHI
20200136174	GOIAS	GS21103887	MATRINCHA	06/01/2020 18:15	07/01/2020 05:59	06/01/2020 18:15	07/01/2020 05:59	11,72	1	11,72	CHI
20200136182	RIO VERDE	RV12260247	RIO VERDE S2	06/01/2020 18:01	06/01/2020 21:21	06/01/2020 18:01	06/01/2020 21:21	3,33	5	16,65	CHI
20200136188	MINEIROS	MY12197173	PARQUE DAS EMAS	06/01/2020 18:04	07/01/2020 20:29	06/01/2020 18:04	07/01/2020 20:29	26,41	21	554,57	CHI
20200136193	RIO VERDE	RV12000092	CABRIUVA S1	06/01/2020 17:31	06/01/2020 22:10	06/01/2020 17:31	06/01/2020 22:10	4,65	39	181,26	CHI
20200136196	CAIAPONIA	CP12207864	CAIAPONIA	06/01/2020 18:06	06/01/2020 21:42	06/01/2020 18:06	06/01/2020 21:42	3,60	43	154,67	CHI
20200136198	RIO VERDE	RV12054354	MONTIVIDIU T	06/01/2020 18:20	07/01/2020 08:54	06/01/2020 18:20	07/01/2020 08:54	14,57	2	29,13	CHI
20200136204	FORMOSA	FA11046850	ITUIQUIRA	06/01/2020 18:13	06/01/2020 19:21	06/01/2020 18:13	06/01/2020 19:21	1,13	208	234,29	CHI
20200136209	RIO VERDE	RV12296245	CABRIUVA S1	06/01/2020 18:21	07/01/2020 09:19	06/01/2020 18:21	07/01/2020 09:19	14,96	10	149,56	CHI
20200136210	CUMARI	CT21152871	CATALAO S2	06/01/2020 18:21	06/01/2020 21:26	06/01/2020 18:21	06/01/2020 21:26	3,07	1	3,07	CHI
20200136211	APORE	AE12219323	ITAJA S1	06/01/2020 18:21	07/01/2020 08:48	06/01/2020 18:21	07/01/2020 08:48	14,44	1	14,44	CHI
20200136212	JARAGUA	JA21273027	JARAGUA	06/01/2020 18:21	07/01/2020 02:32	06/01/2020 18:21	07/01/2020 02:32	8,17	2	16,34	CHI
20200136218	MONTES CLAROS DE GOIAS	ME21118708	IPORA	06/01/2020 18:23	07/01/2020 14:34	06/01/2020 18:23	07/01/2020 14:34	20,18	1	20,18	CHI

20200136219	PLANALTINA	PI11383217	PLANALTINA	06/01/2020 18:23	06/01/2020 22:10	06/01/2020 18:23	06/01/2020 22:10	3,78	14	52,87	CHI
20200136221	MINEIROS	MY12048095	PARQUE DAS EMAS	06/01/2020 18:23	07/01/2020 14:32	06/01/2020 18:23	07/01/2020 14:32	20,14	22	443,04	CHI
20200136222	ALEXANIA	480102107	ALEXANIA	06/01/2020 18:23	06/01/2020 19:46	06/01/2020 18:23	06/01/2020 19:46	1,37	1	1,37	CHI
20200136228	NOVO GAMA	2900014019	MARAJOARA	06/01/2020 18:25	07/01/2020 13:20	06/01/2020 18:25	07/01/2020 13:20	18,91	1	18,91	CHI
20200136231	JARAGUA	JA21216793	JARAGUA	06/01/2020 18:26	07/01/2020 19:15	06/01/2020 18:26	07/01/2020 19:15	24,83	1	24,83	CHI
20200136234	MOSSAMEDES	MD21141462	FIRMINOPOLIS S2	06/01/2020 18:26	06/01/2020 19:47	06/01/2020 18:26	06/01/2020 19:47	1,34	1	1,34	CHI
20200136235	ANAPOLIS	AN12000025	ANAPOLIS UNIVERSITARIO S2	06/01/2020 18:26	06/01/2020 20:22	06/01/2020 18:26	06/01/2020 20:22	1,92	212	407,57	CHI
20200136242	PIRACANJUBA	PJ12000114	CALDAS NOVAS S1	06/01/2020 15:54	06/01/2020 20:49	06/01/2020 15:54	06/01/2020 20:49	4,91	12	58,96	CHI
20200136257	CRISTALINA	10015038716	PAMPLONA	06/01/2020 18:30	07/01/2020 12:30	06/01/2020 18:30	07/01/2020 12:30	18,00	1	18,00	CHI
20200136258	ANAPOLIS	21058659	JUNDIAI S1	06/01/2020 18:30	07/01/2020 11:28	06/01/2020 18:30	07/01/2020 11:28	16,96	1	16,96	CHI
20200136264	APORE	AE12000050	ITAJA S1	06/01/2020 18:30	07/01/2020 13:55	06/01/2020 18:30	07/01/2020 13:55	19,40	3	58,20	CHI
20200136271	CAVALCANTE	BF21264703	FLORES DE GOIAS	06/01/2020 18:31	06/01/2020 20:03	06/01/2020 18:31	06/01/2020 20:03	1,52	1	1,52	CHI
20200136278	IVOLANDIA	IV12231245	ARENOPOLIS	06/01/2020 18:02	07/01/2020 01:19	06/01/2020 18:02	07/01/2020 01:19	7,28	13	94,61	CHI
20200136278	PALESTINA DE GOIAS	IV12231245	ARENOPOLIS	06/01/2020 18:02	07/01/2020 01:19	06/01/2020 18:02	07/01/2020 01:19	7,28	4	29,11	CHI
20200136288	RIO VERDE	RV21098505	CABRIUVA S1	06/01/2020 18:35	07/01/2020 10:32	06/01/2020 18:35	07/01/2020 10:32	15,94	1	15,94	CHI
20200136300	RIO VERDE	RV21028151	SANTA HELENA S1	06/01/2020 18:37	07/01/2020 17:18	06/01/2020 18:37	07/01/2020 17:18	22,68	1	22,68	CHI
20200136401	PIRES DO RIO	OZ12372381	PIRES DO RIO S2	06/01/2020 18:37	06/01/2020 21:00	06/01/2020 18:37	06/01/2020 21:00	2,38	10	23,75	CHI
20200136401	VIANOPOLIS	OZ12372381	PIRES DO RIO S2	06/01/2020 18:37	06/01/2020 21:00	06/01/2020 18:37	06/01/2020 21:00	2,38	19	45,13	CHI
20200136409	AGUAS LINDAS DE GOIAS	LA11313758	AGUAS LINDAS DE GOIAS S1	06/01/2020 14:06	06/01/2020 23:47	06/01/2020 14:06	06/01/2020 23:47	9,67	13	125,71	CHI
20200136412	MINEIROS	MY21332658	PARQUE DAS EMAS	06/01/2020 18:38	07/01/2020 18:56	06/01/2020 18:38	07/01/2020 18:56	24,30	1	24,30	CHI
20200136418	QUIRINOPOLIS	80039571	QUIRINOPOLIS	06/01/2020 18:38	06/01/2020 20:01	06/01/2020 18:38	06/01/2020 20:01	1,37	1	1,37	CHI
20200136423	RIO VERDE	RV21136205	CABRIUVA S2	06/01/2020 18:40	07/01/2020 01:04	06/01/2020 18:40	07/01/2020 01:04	6,40	2	12,80	CHI
20200136436	CATALAO	CT12061200	CATALAO S1	06/01/2020 18:19	06/01/2020 22:08	06/01/2020 18:19	06/01/2020 22:08	3,80	4	15,22	CHI
20200136437	SANTO ANTONIO DO DESCOBERTO	2210123556	AGUAS LINDAS DE GOIAS S2	06/01/2020 18:42	06/01/2020 19:06	06/01/2020 18:42	06/01/2020 19:06	0,39	1	0,39	CHI
20200136440	AGUAS LINDAS DE GOIAS	4830246377	AGUAS LINDAS DE GOIAS S1	06/01/2020 18:42	06/01/2020 21:54	06/01/2020 18:42	06/01/2020 21:54	3,19	1	3,19	CHI
20200136442	ACREUNA	EU12301577	ACREUNA	06/01/2020 18:43	06/01/2020 23:48	06/01/2020 18:43	06/01/2020 23:48	5,08	1	5,08	CHI
20200136444	CACU	CC21191607	CACHOEIRA ALTA	06/01/2020 18:43	07/01/2020 10:05	06/01/2020 18:43	07/01/2020 10:05	15,36	1	15,36	CHI
20200136445	CAMPINACU	FO10328897	PORANGATU	06/01/2020 18:43	07/01/2020 03:05	06/01/2020 18:43	06/01/2020 19:31	0,81	60	48,52	CHI
20200136445	CAMPINORTE	FO10328897	PORANGATU	06/01/2020 18:43	07/01/2020 03:05	06/01/2020 18:43	06/01/2020 19:31	0,81	146	118,06	CHI
20200136445	FORMOSO	FO10328897	PORANGATU	06/01/2020 18:43	07/01/2020 03:05	06/01/2020 18:43	06/01/2020 19:31	0,81	45	36,39	CHI
20200136445	MINACU	FO10328897	PORANGATU	06/01/2020 18:43	07/01/2020 03:05	06/01/2020 18:43	06/01/2020 19:31	0,81	34	27,49	CHI
20200136445	CAMPINORTE	FO10328897	PORANGATU	06/01/2020 18:43	07/01/2020 03:05	06/01/2020 19:32	06/01/2020 20:58	1,44	114	163,88	CHI
20200136445	FORMOSO	FO10328897	PORANGATU	06/01/2020 18:43	07/01/2020 03:05	06/01/2020 19:32	06/01/2020 20:58	1,44	42	60,38	CHI

20200136445	MINACU	FO10328897	PORANGATU	06/01/2020 18:43	07/01/2020 03:05	06/01/2020 19:32	06/01/2020 20:58	1,44	33	47,44	CHI
20200136445	CAMPINACU	UC13182499	PORANGATU	06/01/2020 18:43	07/01/2020 03:05	06/01/2020 19:32	06/01/2020 22:52	3,35	45	150,66	CHI
20200136445	CAMPINORTE	UC13182499	PORANGATU	06/01/2020 18:43	07/01/2020 03:05	06/01/2020 19:32	06/01/2020 22:52	3,35	32	107,14	CHI
20200136445	FORMOSO	UC13182499	PORANGATU	06/01/2020 18:43	07/01/2020 03:05	06/01/2020 19:32	06/01/2020 22:52	3,35	3	10,04	CHI
20200136445	CAMPINACU	FO10328897	PORANGATU	06/01/2020 18:43	07/01/2020 03:05	06/01/2020 18:43	07/01/2020 01:53	7,17	1453	10416,40	CHI
20200136445	PORANGATU	FO10328897	PORANGATU	06/01/2020 18:43	07/01/2020 03:05	06/01/2020 18:43	07/01/2020 01:53	7,17	1	7,17	CHI
20200136445	CAMPINACU	UC12197170	PORANGATU	06/01/2020 18:43	07/01/2020 03:05	06/01/2020 19:32	07/01/2020 02:40	7,15	13	92,94	CHI
20200136445	MINACU	UC12197170	PORANGATU	06/01/2020 18:43	07/01/2020 03:05	06/01/2020 19:32	07/01/2020 02:40	7,15	1	7,15	CHI
20200136445	CAMPINACU	UC21378345	PORANGATU	06/01/2020 18:43	07/01/2020 03:05	06/01/2020 19:32	07/01/2020 02:44	7,21	1	7,21	CHI
20200136445	CAMPINACU	UC21276749	PORANGATU	06/01/2020 18:43	07/01/2020 03:05	06/01/2020 19:32	07/01/2020 03:05	7,57	1	7,57	CHI
20200136448	MONTIVIDIU	MV12267712	MONTIVIDIU T	06/01/2020 18:43	07/01/2020 01:04	06/01/2020 18:43	07/01/2020 01:04	6,34	27	171,06	CHI
20200136449	CAIAPONIA	7252073	CAIAPONIA	06/01/2020 18:00	07/01/2020 00:30	06/01/2020 18:00	07/01/2020 00:30	6,48	5	32,42	CHI
20200136450	ACREUNA	BZ21207115	ACREUNA	06/01/2020 18:44	07/01/2020 02:04	06/01/2020 18:44	07/01/2020 02:04	7,33	1	7,33	CHI
20200136451	MONTIVIDIU	MV21191794	MONTIVIDIU T	06/01/2020 18:44	06/01/2020 21:42	06/01/2020 18:44	06/01/2020 21:42	2,95	1	2,95	CHI
20200136455	TAQUARAL DE GOIAS	TQ21016625	ITABERAI S1	06/01/2020 18:45	07/01/2020 00:18	06/01/2020 18:45	07/01/2020 00:18	5,55	1	5,55	CHI
20200136461	VALPARAISO DE GOIAS	10012064805	MARAJOARA	06/01/2020 18:46	06/01/2020 21:17	06/01/2020 18:46	06/01/2020 21:17	2,52	1	2,52	CHI
20200136464	PARAUNA	PU21336639	ACREUNA	06/01/2020 18:46	06/01/2020 21:57	06/01/2020 18:46	06/01/2020 21:57	3,18	1	3,18	CHI
20200136469	CIDADE OCIDENTAL	2680019770	MARAJOARA	06/01/2020 18:46	06/01/2020 22:33	06/01/2020 18:46	06/01/2020 22:33	3,77	1	3,77	CHI
20200136470	JATAI	JT21150949	JATAI S1	06/01/2020 18:47	07/01/2020 11:15	06/01/2020 18:47	07/01/2020 11:15	16,47	1	16,47	CHI
20200136471	MORRINHOS	MR12239051	MORRINHOS	06/01/2020 13:42	06/01/2020 20:52	06/01/2020 13:42	06/01/2020 20:52	7,15	10	71,55	CHI
20200136476	JUSSARA	JR12212887	IPORA	06/01/2020 18:47	07/01/2020 17:01	06/01/2020 18:47	07/01/2020 10:30	15,71	22	345,56	CHI
20200136476	MONTES CLAROS DE GOIAS	JR12212887	IPORA	06/01/2020 18:47	07/01/2020 17:01	06/01/2020 18:47	07/01/2020 10:30	15,71	5	78,54	CHI
20200136476	MONTES CLAROS DE GOIAS	JR12212881LD	IPORA	06/01/2020 18:47	07/01/2020 17:01	06/01/2020 18:47	07/01/2020 17:01	22,23	2	44,46	CHI
20200136479	PEROLANDIA	DP21378186	PARQUE DAS EMAS	06/01/2020 18:47	07/01/2020 18:49	06/01/2020 18:47	07/01/2020 18:49	24,02	1	24,02	CHI
20200136483	AGUAS LINDAS DE GOIAS	10005975318	AGUAS LINDAS DE GOIAS S1	06/01/2020 18:47	06/01/2020 19:27	06/01/2020 18:47	06/01/2020 19:27	0,65	1	0,65	CHI
20200136488	SANTA HELENA DE GOIAS	SH12301062	RIO DOS BOIS	06/01/2020 18:48	07/01/2020 15:50	06/01/2020 18:48	07/01/2020 15:50	21,03	3	63,09	CHI
20200136488	TURVELANDIA	SH12301062	RIO DOS BOIS	06/01/2020 18:48	07/01/2020 15:50	06/01/2020 18:48	07/01/2020 15:50	21,03	3	63,09	CHI
20200136489	GOIAS	GS21251984	MATRINCHA	06/01/2020 18:48	07/01/2020 11:48	06/01/2020 18:48	07/01/2020 11:48	17,00	1	17,00	CHI
20200136499	PORANGATU	PO12228609	PORANGATU	06/01/2020 18:38	07/01/2020 00:14	06/01/2020 18:38	07/01/2020 00:14	5,60	16	89,54	CHI
20200136612	MATRINCHA	MP21165371	MATRINCHA	06/01/2020 18:51	06/01/2020 22:38	06/01/2020 18:51	06/01/2020 22:38	3,77	1	3,77	CHI
20200136616	VALPARAISO DE GOIAS	10027886369	MARAJOARA	06/01/2020 18:51	06/01/2020 20:17	06/01/2020 18:51	06/01/2020 20:17	1,42	1	1,42	CHI
20200136618	AMORINOPOLIS	IR12188430	IPORA	06/01/2020 18:13	06/01/2020 21:02	06/01/2020 18:13	06/01/2020 21:02	2,81	42	117,90	CHI
20200136618	IPORA	IR12188430	IPORA	06/01/2020 18:13	06/01/2020 21:02	06/01/2020 18:13	06/01/2020 21:02	2,81	22	61,76	CHI

20200136618	IVOLANDIA	IR12188430	IPORA	06/01/2020 18:13	06/01/2020 21:02	06/01/2020 18:13	06/01/2020 21:02	2,81	104	291,95	CHI
20200136618	PALESTINA DE GOIAS	IR12188430	IPORA	06/01/2020 18:13	06/01/2020 21:02	06/01/2020 18:13	06/01/2020 21:02	2,81	12	33,69	CHI
20200136638	CAIAPONIA	MV12030666	MONTIVIDIU T	06/01/2020 18:54	07/01/2020 08:16	06/01/2020 18:54	07/01/2020 08:16	13,36	16	213,83	CHI
20200136638	MONTIVIDIU	MV12030666	MONTIVIDIU T	06/01/2020 18:54	07/01/2020 08:16	06/01/2020 18:54	07/01/2020 08:16	13,36	23	307,38	CHI
20200136647	ESTRELA DO NORTE	MU12391986	MARA ROSA	06/01/2020 18:08	06/01/2020 21:29	06/01/2020 18:08	06/01/2020 21:29	3,35	1	3,35	CHI
20200136647	MUTUNOPOLIS	MU12391986	MARA ROSA	06/01/2020 18:08	06/01/2020 21:29	06/01/2020 18:08	06/01/2020 21:29	3,35	80	268,02	CHI
20200136656	QUIRINOPOLIS	80164201	QUIRINOPOLIS	06/01/2020 18:55	06/01/2020 22:00	06/01/2020 18:55	06/01/2020 22:00	3,07	1	3,07	CHI
20200136659	GOIANESIA	550123600	GOIANESIA S2	06/01/2020 18:55	07/01/2020 15:30	06/01/2020 18:55	07/01/2020 15:30	20,57	1	20,57	CHI
20200136680	JUSSARA	1290027903	JUSSARA	06/01/2020 18:58	07/01/2020 03:40	06/01/2020 18:58	07/01/2020 03:40	8,70	1	8,70	CHI
20200136681	ITUMBIARA	690211399	ITUMBIARA NOVA	06/01/2020 18:58	06/01/2020 22:03	06/01/2020 18:58	06/01/2020 22:03	3,07	1	3,07	CHI
20200136682	ANAPOLIS	21297058	JUNDIAI S2	06/01/2020 18:59	07/01/2020 17:34	06/01/2020 18:59	07/01/2020 17:34	22,58	1	22,58	CHI
20200136695	PLANALTINA	2960143766	PLANALTINA	06/01/2020 19:00	06/01/2020 22:52	06/01/2020 19:00	06/01/2020 22:52	3,86	1	3,86	CHI
20200136707	CALDAS NOVAS	CN12311549	CALDAS NOVAS S1	06/01/2020 19:02	06/01/2020 22:25	06/01/2020 19:02	06/01/2020 22:25	3,37	26	87,70	CHI
20200136710	NOVO GAMA	NJ11209637	PACAEMBU S1	06/01/2020 19:01	06/01/2020 21:53	06/01/2020 19:01	06/01/2020 21:53	2,86	152	435,40	CHI
20200136711	AGUAS LINDAS DE GOIAS	10027725977	AGUAS LINDAS DE GOIAS S1	06/01/2020 19:02	06/01/2020 21:26	06/01/2020 19:02	06/01/2020 21:26	2,39	1	2,39	CHI
20200136714	CATALAO	CT12013670	CATALAO S1	06/01/2020 18:07	07/01/2020 14:53	06/01/2020 18:07	07/01/2020 14:53	20,77	5	103,83	CHI
20200136715	COCALZINHO DE GOIAS	ZN21154346	COCALZINHO	06/01/2020 19:03	07/01/2020 18:59	06/01/2020 19:03	07/01/2020 18:59	23,93	1	23,93	CHI
20200136726	FORMOSA	610006010	ITUIQUIRA	06/01/2020 19:04	06/01/2020 21:23	06/01/2020 19:04	06/01/2020 21:23	2,31	1	2,31	CHI
20200136727	CHAPADAO DO CEU	DJ21160245	CHAPADAO DO CEU	06/01/2020 19:04	06/01/2020 20:19	06/01/2020 19:04	06/01/2020 20:19	1,24	1	1,24	CHI
20200136728	TURVELANDIA	TD12025764	RIO DOS BOIS	06/01/2020 06:43	07/01/2020 15:52	06/01/2020 06:43	07/01/2020 15:52	33,14	3	99,42	CHI
20200136748	SAO MIGUEL DO ARAGUAIA	SM12371801B	SAO MIGUEL DO ARAGUAIA	06/01/2020 19:06	06/01/2020 23:20	06/01/2020 19:06	06/01/2020 23:20	4,23	246	1039,97	CHI
20200136760	FAZENDA NOVA	FN12354616LD	BRITANIA	06/01/2020 19:07	07/01/2020 10:10	06/01/2020 19:07	07/01/2020 10:10	15,04	44	661,94	CHI
20200136760	JUSSARA	FN12354616LD	BRITANIA	06/01/2020 19:07	07/01/2020 10:10	06/01/2020 19:07	07/01/2020 10:10	15,04	11	165,49	CHI
20200136761	NOVA CRIXAS	NA12334349	NOVA CRIXAS	06/01/2020 19:01	06/01/2020 21:18	06/01/2020 19:01	06/01/2020 21:18	2,28	86	195,82	CHI
20200136821	MINEIROS	01140434	PARQUE DAS EMAS	06/01/2020 19:07	06/01/2020 19:36	06/01/2020 19:07	06/01/2020 19:36	0,48	95	45,97	CHI
20200136907	SANTO ANTONIO DO DESCOBERTO	SN21102067	MARAJOARA	06/01/2020 19:10	06/01/2020 23:52	06/01/2020 19:10	06/01/2020 23:50	4,67	1	4,67	CHI
20200136907	SANTO ANTONIO DO DESCOBERTO	AX12070929LD	MARAJOARA	06/01/2020 19:10	06/01/2020 23:52	06/01/2020 22:04	06/01/2020 23:52	1,80	4	7,22	CHI
20200136921	DAMIANOPOLIS	DA11180579	IACIARA S2	06/01/2020 19:13	06/01/2020 20:12	06/01/2020 19:13	06/01/2020 20:12	0,97	20	19,34	CHI
20200136922	GOIANDIRA	GD21136828	CATALAO S1	06/01/2020 19:14	07/01/2020 11:55	06/01/2020 19:14	07/01/2020 11:55	16,68	1	16,68	CHI
20200136926	PIRENOPOLIS	PV11210828	SAO FRANCISCO DE GOIAS	06/01/2020 19:09	06/01/2020 22:12	06/01/2020 19:09	06/01/2020 22:12	3,04	119	361,79	CHI
20200136928	TROMBAS	TB21212845	PORANGATU	06/01/2020 19:14	07/01/2020 15:25	06/01/2020 19:14	07/01/2020 15:25	20,19	1	20,19	CHI
20200136930	SANTA HELENA DE GOIAS	SH12279544	IPEGUARI	06/01/2020 18:41	07/01/2020 00:25	06/01/2020 18:41	07/01/2020 00:25	5,73	2	11,46	CHI
20200136934	IPORA	IR12060703	IPORA	06/01/2020 19:15	07/01/2020 08:46	06/01/2020 19:15	07/01/2020 08:46	13,51	6	81,03	CHI

20200136939	RIO VERDE	RV21301461	ACREUNA	06/01/2020 19:16	07/01/2020 09:31	06/01/2020 19:16	07/01/2020 09:31	14,25	1	14,25	CHI
20200136941	JATAI	290203466	JATAI S3	06/01/2020 19:16	06/01/2020 23:28	06/01/2020 19:16	06/01/2020 23:28	4,19	1	4,19	CHI
20200136949	COCALZINHO DE GOIAS	CB12090420	COCALZINHO	06/01/2020 19:17	07/01/2020 11:41	06/01/2020 19:17	07/01/2020 11:41	16,40	14	229,59	CHI
20200136969	ORIZONA	OZ12085010	PIRES DO RIO S2	06/01/2020 19:19	06/01/2020 22:29	06/01/2020 19:19	06/01/2020 22:29	3,16	3	9,49	CHI
20200136976	ANAPOLIS	AN12258779	JUNDIAI S1	06/01/2020 18:09	07/01/2020 04:51	06/01/2020 18:09	07/01/2020 04:51	10,70	4	42,80	CHI
20200136978	SANTA TEREZA DE GOIAS	SE12143626	PORANGATU	06/01/2020 19:20	07/01/2020 14:30	06/01/2020 19:20	07/01/2020 14:30	19,16	5	95,82	CHI
20200136979	ANAPOLIS	10004209565	JUNDIAI S2	06/01/2020 19:21	07/01/2020 10:00	06/01/2020 19:21	07/01/2020 10:00	14,65	1	14,65	CHI
20200136981	RIO VERDE	RV21322157	CABRIUVA S2	06/01/2020 19:21	06/01/2020 23:57	06/01/2020 19:21	06/01/2020 23:57	4,60	1	4,60	CHI
20200136984	LUZIANIA	120288485	RIO VERMELHO	06/01/2020 19:21	06/01/2020 21:34	06/01/2020 19:21	06/01/2020 21:34	2,20	1	2,20	CHI
20200136985	ANAPOLIS	AN21255907	ANAPOLIS UNIVERSITARIO S1	06/01/2020 19:22	07/01/2020 12:11	06/01/2020 19:22	07/01/2020 12:11	16,81	1	16,81	CHI
20200136990	ITUMBIARA	10007894684	ITUMBIARA VELHA S1	06/01/2020 19:22	06/01/2020 21:03	06/01/2020 19:22	06/01/2020 21:03	1,67	1	1,67	CHI
20200136996	CRIXAS	CX12166640	SANTA TEREZINHA	06/01/2020 19:23	06/01/2020 23:43	06/01/2020 19:23	06/01/2020 23:43	4,32	25	108,07	CHI
20200136997	RIO VERDE	RV21200702	CABRIUVA S2	06/01/2020 19:23	07/01/2020 01:55	06/01/2020 19:23	07/01/2020 01:55	6,52	1	6,52	CHI
20200137006	RIO VERDE	630557755	RIO VERDE S1	06/01/2020 19:24	06/01/2020 22:56	06/01/2020 19:24	06/01/2020 22:56	3,53	1	3,53	CHI
20200137027	CORUMBAIBA	CI12090583	VILA CORUMBA	06/01/2020 19:27	07/01/2020 14:10	06/01/2020 19:27	07/01/2020 14:10	18,70	4	74,82	CHI
20200137028	URUACU	640039947	URUACU	06/01/2020 19:27	06/01/2020 23:30	06/01/2020 19:27	06/01/2020 23:30	4,04	1	4,04	CHI
20200137035	MINEIROS	MY12402495	PARQUE DAS EMAS	06/01/2020 19:09	06/01/2020 20:39	06/01/2020 19:09	06/01/2020 20:39	1,50	1431	2146,50	CHI
20200137040	TEREZOPOLIS DE GOIAS	AN21258081	JUNDIAI S1	06/01/2020 19:29	07/01/2020 10:35	06/01/2020 19:29	07/01/2020 10:35	15,10	1	15,10	CHI
20200137041	PLANALTINA	PI11146248	PLANALTINA	06/01/2020 19:26	06/01/2020 21:02	06/01/2020 19:26	06/01/2020 21:02	1,59	409	650,20	CHI
20200137045	CRISTALINA	KR11170149	CRISTALINA S1	06/01/2020 18:52	06/01/2020 20:10	06/01/2020 18:52	06/01/2020 20:10	1,32	122	160,57	CHI
20200137050	DIVINOPOLIS DE GOIAS	2570006860	SAO DOMINGOS	06/01/2020 19:30	06/01/2020 23:04	06/01/2020 19:30	06/01/2020 23:04	3,56	1	3,56	CHI
20200137053	MONTIVIDIU	MV12267717	MONTIVIDIU T	06/01/2020 19:31	06/01/2020 22:00	06/01/2020 19:31	06/01/2020 22:00	2,49	3	7,48	CHI
20200137053	RIO VERDE	MV12267717	MONTIVIDIU T	06/01/2020 19:31	06/01/2020 22:00	06/01/2020 19:31	06/01/2020 22:00	2,49	2	4,98	CHI
20200137054	AGUAS LINDAS DE GOIAS	LA11089677	AGUAS LINDAS DE GOIAS S1	06/01/2020 19:28	06/01/2020 21:17	06/01/2020 19:28	06/01/2020 21:17	1,80	185	333,46	CHI
20200137060	PORTELANDIA	PW12248465	PARQUE DAS EMAS	06/01/2020 18:56	08/01/2020 09:50	06/01/2020 18:56	08/01/2020 09:50	38,90	11	427,87	CHI
20200137066	NOVA CRIXAS	NA21127355	NOVA CRIXAS	06/01/2020 19:33	07/01/2020 00:37	06/01/2020 19:33	07/01/2020 00:37	5,06	1	5,06	CHI
20200137072	CORUMBA DE GOIAS	CB21059902	CORUMBA	06/01/2020 19:33	07/01/2020 19:03	06/01/2020 19:33	07/01/2020 19:03	23,49	1	23,49	CHI
20200137081	FORMOSA	610041551	ITUIQUIRA	06/01/2020 19:34	06/01/2020 23:01	06/01/2020 19:34	06/01/2020 23:01	3,44	1	3,44	CHI
20200137083	QUIRINOPOLIS	QI12013481	QUIRINOPOLIS	06/01/2020 18:01	06/01/2020 22:32	06/01/2020 18:01	06/01/2020 22:32	4,51	6	27,04	CHI
20200137085	LUZIANIA	LZ11149779	MARAJOARA	06/01/2020 19:19	06/01/2020 20:40	06/01/2020 19:19	06/01/2020 20:40	1,35	175	235,72	CHI
20200137115	ANAPOLIS	2100000579	JUNDIAI S1	06/01/2020 19:41	07/01/2020 09:51	06/01/2020 19:41	07/01/2020 09:51	14,16	1	14,16	CHI
20200137116	ANAPOLIS	AN12258789	ANAPOLIS UNIVERSITARIO S1	06/01/2020 19:40	07/01/2020 04:00	06/01/2020 19:40	07/01/2020 04:00	8,33	13	108,31	CHI
20200137119	ITAPURANGA	IK21283424	ITAPURANGA	06/01/2020 16:22	07/01/2020 00:49	06/01/2020 16:22	07/01/2020 00:49	8,45	1	8,45	CHI

20200137120	ITAPURANGA	IK21161859	ITAPURANGA	06/01/2020 18:05	06/01/2020 23:16	06/01/2020 18:05	06/01/2020 23:16	5,19	3	15,57	CHI
20200137129	IACIARA	IA21000007	IACIARA S1	06/01/2020 19:44	06/01/2020 21:29	06/01/2020 19:44	06/01/2020 21:29	1,75	1	1,75	CHI
20200137138	RIO VERDE	630590310	RIO VERDE S2	06/01/2020 19:45	07/01/2020 00:13	06/01/2020 19:45	07/01/2020 00:13	4,45	1	4,45	CHI
20200137141	QUIRINOPOLIS	QI21321906	QUIRINOPOLIS	06/01/2020 19:47	07/01/2020 02:22	06/01/2020 19:47	07/01/2020 02:22	6,58	2	13,17	CHI
20200137143	IACIARA	10000657652	IACIARA S1	06/01/2020 19:47	06/01/2020 22:12	06/01/2020 19:47	06/01/2020 22:12	2,41	1	2,41	CHI
20200137152	GOUVELANDIA	GB12303167	QUIRINOPOLIS	06/01/2020 19:48	07/01/2020 11:38	06/01/2020 19:48	07/01/2020 11:38	15,82	1	15,82	CHI
20200137155	SAO MIGUEL DO ARAGUAIA	SM21192305	SAO MIGUEL DO ARAGUAIA	06/01/2020 19:49	07/01/2020 10:25	06/01/2020 19:49	07/01/2020 10:25	14,59	1	14,59	CHI
20200137160	CHAPADAO DO CEU	9880017115	CHAPADAO DO CEU	06/01/2020 19:50	07/01/2020 08:21	06/01/2020 19:50	07/01/2020 08:21	12,53	1	12,53	CHI
20200137165	NOVO GAMA	10011304500	PACAEMBU S1	06/01/2020 19:50	06/01/2020 23:40	06/01/2020 19:50	06/01/2020 23:40	3,82	1	3,82	CHI
20200137176	MONTES CLAROS DE GOIAS	ME12204934	IPORA	06/01/2020 19:33	06/01/2020 22:17	06/01/2020 19:33	06/01/2020 22:17	2,72	13	35,36	CHI
20200137177	MARA ROSA	2260040129	MARA ROSA	06/01/2020 19:53	07/01/2020 02:07	06/01/2020 19:53	07/01/2020 02:07	6,22	1	6,22	CHI
20200137179	RIO VERDE	RV11217557	JATAI S2	06/01/2020 14:46	07/01/2020 08:56	06/01/2020 14:46	07/01/2020 08:56	18,15	1	18,15	CHI
20200137186	SANTO ANTONIO DO DESCOBERTO	SN21141631	MARAJOARA	06/01/2020 19:55	07/01/2020 18:09	06/01/2020 19:55	07/01/2020 18:09	22,23	2	44,46	CHI
20200137189	SAO JOAO D ALIANCA	3840025550	SAO JOAO D ALIANCA	06/01/2020 19:55	06/01/2020 20:48	06/01/2020 19:55	06/01/2020 20:48	0,87	1	0,87	CHI
20200137191	NOVA AMERICA	RB12320982	RUBIATABA	06/01/2020 19:56	06/01/2020 22:54	06/01/2020 19:56	06/01/2020 22:54	2,96	3	8,88	CHI
20200137191	RUBIATABA	RB12320982	RUBIATABA	06/01/2020 19:56	06/01/2020 22:54	06/01/2020 19:56	06/01/2020 22:54	2,96	23	68,09	CHI
20200137196	ABADIANIA	AN12001083	ANAPOLIS UNIVERSITARIO S2	06/01/2020 18:00	07/01/2020 02:24	06/01/2020 18:00	07/01/2020 02:24	8,41	22	185,01	CHI
20200137200	GOIANDIRA	GD21143396	CATALAO S1	06/01/2020 19:57	07/01/2020 14:42	06/01/2020 19:57	07/01/2020 14:42	18,74	1	18,74	CHI
20200137201	MINEIROS	MY10396070	PARQUE DAS EMAS	06/01/2020 19:38	09/01/2020 21:56	06/01/2020 19:38	07/01/2020 03:32	7,90	36	284,47	CHI
20200137201	MINEIROS	MY12341117LD	PARQUE DAS EMAS	06/01/2020 19:38	09/01/2020 21:56	06/01/2020 19:38	07/01/2020 05:04	9,43	13	122,61	CHI
20200137201	MINEIROS	MY10396070	PARQUE DAS EMAS	06/01/2020 19:38	09/01/2020 21:56	06/01/2020 19:38	07/01/2020 13:53	18,25	27	492,84	CHI
20200137201	MINEIROS	MY10396070	PARQUE DAS EMAS	06/01/2020 19:38	09/01/2020 21:56	06/01/2020 19:38	07/01/2020 18:21	22,72	21	477,03	CHI
20200137201	MINEIROS	MY10396070	PARQUE DAS EMAS	06/01/2020 19:38	09/01/2020 21:56	06/01/2020 19:38	07/01/2020 18:56	23,29	30	698,75	CHI
20200137201	SERRANOPOLIS	MY10396070	PARQUE DAS EMAS	06/01/2020 19:38	09/01/2020 21:56	06/01/2020 19:38	07/01/2020 18:56	23,29	7	163,04	CHI
20200137201	MINEIROS	MY10396070	PARQUE DAS EMAS	06/01/2020 19:38	09/01/2020 21:56	07/01/2020 19:00	07/01/2020 19:14	0,24	97	23,60	CHI
20200137201	MINEIROS	MY13324497	PARQUE DAS EMAS	06/01/2020 19:38	09/01/2020 21:56	07/01/2020 19:00	08/01/2020 11:29	16,50	17	280,42	CHI
20200137201	SERRANOPOLIS	MY13324497	PARQUE DAS EMAS	06/01/2020 19:38	09/01/2020 21:56	07/01/2020 19:00	08/01/2020 11:29	16,50	7	115,47	CHI
20200137201	MINEIROS	MY13324361	PARQUE DAS EMAS	06/01/2020 19:38	09/01/2020 21:56	07/01/2020 19:00	08/01/2020 13:30	18,50	1	18,50	CHI
20200137201	MINEIROS	MY13337099	PARQUE DAS EMAS	06/01/2020 19:38	09/01/2020 21:56	07/01/2020 19:00	09/01/2020 15:30	44,50	5	222,50	CHI
20200137201	MINEIROS	MY13324414	PARQUE DAS EMAS	06/01/2020 19:38	09/01/2020 21:56	07/01/2020 19:00	09/01/2020 21:56	50,94	7	356,56	CHI
20200137301	ITABERAI	IB21156278	ITABERAI S1	06/01/2020 19:57	06/01/2020 23:16	06/01/2020 19:57	06/01/2020 23:16	3,30	1	3,30	CHI
20200137304	QUIRINOPOLIS	QI11000016	QUIRINOPOLIS	06/01/2020 19:55	06/01/2020 23:17	06/01/2020 19:55	06/01/2020 23:17	3,36	133	446,40	CHI
20200137320	LUZIANIA	10023466195	MARAJOARA	06/01/2020 20:01	06/01/2020 21:27	06/01/2020 20:01	06/01/2020 21:27	1,43	1	1,43	CHI

20200137321	CRISTALINA	10008751879	CRISTALINA S1	06/01/2020 20:01	06/01/2020 23:00	06/01/2020 20:01	06/01/2020 23:00	2,98	1	2,98	CHI
20200137323	PIRES DO RIO	460040091	PIRES DO RIO S1	06/01/2020 20:01	06/01/2020 22:00	06/01/2020 20:01	06/01/2020 22:00	1,98	1	1,98	CHI
20200137325	CATALAO	CT11045439	CATALAO S2	06/01/2020 19:46	06/01/2020 21:09	06/01/2020 19:46	06/01/2020 21:09	1,38	115	158,76	CHI
20200137334	MINEIROS	MY12303391	PARQUE DAS EMAS	06/01/2020 19:36	06/01/2020 21:53	06/01/2020 19:36	06/01/2020 21:53	2,28	138	315,10	CHI
20200137335	CAMPOS BELOS	820039330	SAO DOMINGOS	06/01/2020 20:04	06/01/2020 21:55	06/01/2020 20:04	06/01/2020 21:55	1,84	1	1,84	CHI
20200137341	SILVANIA	SV21143105	DAIA S2	06/01/2020 20:05	07/01/2020 11:37	06/01/2020 20:05	07/01/2020 11:37	15,53	1	15,53	CHI
20200137348	VALPARAISO DE GOIAS	VA11170133	PACAEMBU S1	06/01/2020 20:02	06/01/2020 21:13	06/01/2020 20:02	06/01/2020 21:13	1,18	155	182,30	CHI
20200137361	SAO LUIS DE MONTES BELOS	500085961	SAO LUIZ DOS MONTES BELOS	06/01/2020 20:07	06/01/2020 23:01	06/01/2020 20:07	06/01/2020 23:01	2,90	1	2,90	CHI
20200137370	MATRINCHA	MP21253812	MATRINCHA	06/01/2020 20:09	07/01/2020 11:20	06/01/2020 20:09	07/01/2020 11:20	15,18	1	15,18	CHI
20200137402	RIO VERDE	RV21260585	RIO VERDE S2	06/01/2020 18:14	07/01/2020 10:18	06/01/2020 18:14	07/01/2020 10:18	16,06	3	48,19	CHI
20200137602	JARAGUA	70042172	JARAGUA	06/01/2020 20:12	07/01/2020 10:29	06/01/2020 20:12	07/01/2020 10:29	14,28	1	14,28	CHI
20200137611	BALIZA	BH11331444	CAIAPONIA	06/01/2020 20:14	07/01/2020 13:28	06/01/2020 20:14	07/01/2020 13:28	17,22	1	17,22	CHI
20200137613	MINEIROS	MY21264436	PARQUE DAS EMAS	06/01/2020 20:16	07/01/2020 12:10	06/01/2020 20:16	07/01/2020 12:10	15,89	1	15,89	CHI
20200137614	OUVIDOR	IO12037572	CATALAO S1	06/01/2020 20:16	07/01/2020 16:20	06/01/2020 20:16	07/01/2020 16:20	20,06	3	60,17	CHI
20200137614	TRES RANCHOS	IO12037572	CATALAO S1	06/01/2020 20:16	07/01/2020 16:20	06/01/2020 20:16	07/01/2020 16:20	20,06	1	20,06	CHI
20200137617	PLANALTINA	PI21359019	PLANALTINA	06/01/2020 20:17	07/01/2020 10:20	06/01/2020 20:17	07/01/2020 10:20	14,05	2	28,09	CHI
20200137619	ALEXANIA	AX12211846	ALEXANIA	06/01/2020 20:06	06/01/2020 21:02	06/01/2020 20:06	06/01/2020 21:02	0,93	120	111,83	CHI
20200137623	ITABERAI	IB11269299	ITABERAI S2	06/01/2020 20:18	06/01/2020 22:34	06/01/2020 20:18	06/01/2020 22:34	2,26	1	2,26	CHI
20200137624	RIO VERDE	630229545	CABRIUVA S1	06/01/2020 20:18	06/01/2020 23:10	06/01/2020 20:18	06/01/2020 23:10	2,86	1	2,86	CHI
20200137652	CATALAO	CT11032138	CATALAO S2	06/01/2020 20:11	06/01/2020 21:35	06/01/2020 20:11	06/01/2020 21:35	1,40	180	251,15	CHI
20200137656	GOIATUBA	GT11309844	GOIATUBA S2	06/01/2020 20:18	06/01/2020 21:45	06/01/2020 20:18	06/01/2020 21:45	1,44	117	169,03	CHI
20200137659	QUIRINOPOLIS	80151437	QUIRINOPOLIS	06/01/2020 20:25	07/01/2020 00:19	06/01/2020 20:25	07/01/2020 00:19	3,90	1	3,90	CHI
20200137665	RIO VERDE	RV12249076	CABRIUVA S2	06/01/2020 20:26	07/01/2020 00:25	06/01/2020 20:26	07/01/2020 00:25	3,97	1	3,97	CHI
20200137668	PLANALTINA	PI12208713	PLANALTINA	06/01/2020 20:13	06/01/2020 22:10	06/01/2020 20:13	06/01/2020 22:10	1,93	147	284,24	CHI
20200137673	PALMEIRAS DE GOIAS	590057777	PALMEIRAS	06/01/2020 20:30	06/01/2020 23:45	06/01/2020 20:30	06/01/2020 23:45	3,24	1	3,24	CHI
20200137675	MINEIROS	MY12203397	PARQUE DAS EMAS	06/01/2020 20:30	07/01/2020 14:00	06/01/2020 20:30	07/01/2020 14:00	17,49	1	17,49	CHI
20200137678	JANDAIA	JD12083934	PALMEIRAS	06/01/2020 19:54	06/01/2020 22:22	06/01/2020 19:54	06/01/2020 22:22	2,45	13	31,88	CHI
20200137683	GOIAS	GS12028005	GOIAS	06/01/2020 17:32	06/01/2020 22:10	06/01/2020 17:32	06/01/2020 22:10	4,62	4	18,48	CHI
20200137695	JARAGUA	JA12254078	JARAGUA	06/01/2020 20:46	07/01/2020 15:23	06/01/2020 20:46	07/01/2020 15:23	18,62	24	446,79	CHI
20200137701	AGUAS LINDAS DE GOIAS	LA11104728	AGUAS LINDAS DE GOIAS S1	06/01/2020 19:40	06/01/2020 21:43	06/01/2020 19:40	06/01/2020 21:43	2,03	198	402,71	CHI
20200137710	SAO LUIS DE MONTES BELOS	2930000564	FIRMINOPOLIS S2	06/01/2020 20:38	07/01/2020 00:12	06/01/2020 20:38	07/01/2020 00:12	3,56	1	3,56	CHI
20200137714	SANTO ANTONIO DA BARRA	2270015582	ACREUNA	06/01/2020 20:38	06/01/2020 22:55	06/01/2020 20:38	06/01/2020 22:55	2,27	1	2,27	CHI
20200137735	JATAI	DP12345408	PARQUE DAS EMAS	06/01/2020 20:39	07/01/2020 11:01	06/01/2020 20:39	07/01/2020 11:01	14,35	3	43,06	CHI

20200137735	MINEIROS	DP12345408	PARQUE DAS EMAS	06/01/2020 20:39	07/01/2020 11:01	06/01/2020 20:39	07/01/2020 11:01	14,35	1	14,35	CHI
20200137736	RIO VERDE	RV12018092	SANTA HELENA S1	06/01/2020 14:37	07/01/2020 13:22	06/01/2020 14:37	07/01/2020 13:22	22,74	13	295,64	CHI
20200137747	JATAI	290088513	JATAI S2	06/01/2020 20:44	06/01/2020 23:41	06/01/2020 20:44	06/01/2020 23:41	2,94	1	2,94	CHI
20200137748	CAVALCANTE	740015047	FLORES DE GOIAS	06/01/2020 20:44	07/01/2020 11:24	06/01/2020 20:44	07/01/2020 11:24	14,66	1	14,66	CHI
20200137762	SITIO D ABADIA	SI12010205	IACIARA S2	06/01/2020 20:47	07/01/2020 09:30	06/01/2020 20:47	07/01/2020 09:30	12,70	65	825,68	CHI
20200137764	ITAGUARI	770015670	ITABERAI S1	06/01/2020 20:48	07/01/2020 00:58	06/01/2020 20:48	07/01/2020 00:58	4,16	1	4,16	CHI
20200137772	AGUAS LINDAS DE GOIAS	LA11382905	AGUAS LINDAS DE GOIAS S2	06/01/2020 20:35	06/01/2020 21:16	06/01/2020 20:35	06/01/2020 21:16	0,67	263	176,43	CHI
20200137776	CRIXAS	CX12171173	RUBIATABA	06/01/2020 20:53	07/01/2020 21:49	06/01/2020 20:53	07/01/2020 21:49	24,93	4	99,71	CHI
20200137777	DOVERLANDIA	DV12342581	CAIAPONIA	06/01/2020 20:53	07/01/2020 14:11	06/01/2020 20:53	07/01/2020 14:11	17,29	7	121,03	CHI
20200137781	MINEIROS	MY11095199	PARQUE DAS EMAS	06/01/2020 20:46	07/01/2020 11:55	06/01/2020 20:46	07/01/2020 11:55	15,14	194	2937,97	CHI
20200137784	GOIANESIA	550104525	GOIANESIA S2	06/01/2020 20:56	07/01/2020 11:15	06/01/2020 20:56	07/01/2020 11:15	14,32	1	14,32	CHI
20200137785	AGUAS LINDAS DE GOIAS	LA11382968	AGUAS LINDAS DE GOIAS S2	06/01/2020 20:52	06/01/2020 21:39	06/01/2020 20:52	06/01/2020 21:39	0,77	80	61,84	CHI
20200137790	PORTELANDIA	PW12303420	PARQUE DAS EMAS	06/01/2020 20:46	07/01/2020 14:02	06/01/2020 20:46	07/01/2020 14:02	17,26	14	241,61	CHI
20200137792	FAZENDA NOVA	FN12390152	IPORA	06/01/2020 20:03	06/01/2020 22:29	06/01/2020 20:03	06/01/2020 22:29	2,42	12	29,04	CHI
20200137792	ISRAELANDIA	FN12390152	IPORA	06/01/2020 20:03	06/01/2020 22:29	06/01/2020 20:03	06/01/2020 22:29	2,42	2	4,84	CHI
20200137802	PIRENOPOLIS	PV11285245	CORUMBA	06/01/2020 18:03	06/01/2020 21:58	06/01/2020 18:03	06/01/2020 21:58	3,91	84	328,23	CHI
20200137803	SANTA HELENA DE GOIAS	SH11048624	IPEGUARI	06/01/2020 20:33	07/01/2020 00:45	06/01/2020 20:33	07/01/2020 00:45	4,20	100	419,61	CHI
20200137811	BURITI DE GOIAS	BS21209325	FIRMINOPOLIS S2	06/01/2020 21:07	06/01/2020 22:43	06/01/2020 21:07	06/01/2020 22:43	1,59	1	1,59	CHI
20200137819	CORUMBAIBA	7288826	CATALAO S1	06/01/2020 21:11	08/01/2020 10:35	06/01/2020 21:11	08/01/2020 10:35	37,39	1	37,39	CHI
20200137825	ANAPOLIS	AN11130759	ANAPOLIS UNIVERSITARIO S2	06/01/2020 20:22	06/01/2020 21:59	06/01/2020 20:22	06/01/2020 21:59	1,60	130	208,25	CHI
20200137829	CALDAS NOVAS	10022273415	SERRA DE CALDAS	06/01/2020 21:15	07/01/2020 00:36	06/01/2020 21:15	07/01/2020 00:36	3,34	1	3,34	CHI
20200137830	MINEIROS	MY21035008	PARQUE DAS EMAS	06/01/2020 21:16	07/01/2020 16:01	06/01/2020 21:16	07/01/2020 16:01	18,75	1	18,75	CHI
20200137831	QUIRINOPOLIS	80131128	QUIRINOPOLIS	06/01/2020 21:16	06/01/2020 22:36	06/01/2020 21:16	06/01/2020 22:36	1,32	1	1,32	CHI
20200137844	ANAPOLIS	20317761	JUNDIAI S1	06/01/2020 21:22	07/01/2020 12:31	06/01/2020 21:22	07/01/2020 12:31	15,14	1	15,14	CHI
20200137849	ITUMBIARA	10022014215	ITUMBIARA VELHA S1	06/01/2020 21:26	08/01/2020 11:03	06/01/2020 21:26	08/01/2020 11:03	37,60	1	37,60	CHI
20200137855	EDEALINA	10014821620	PONTALINA	06/01/2020 21:30	06/01/2020 23:08	06/01/2020 21:30	06/01/2020 23:08	1,63	1	1,63	CHI
20200137860	SILVANIA	SV21205376	DAIA S2	06/01/2020 21:34	06/01/2020 22:42	06/01/2020 21:34	06/01/2020 22:42	1,12	2	2,24	CHI
20200137870	PLANALTINA	PI11146248	PLANALTINA	06/01/2020 21:20	06/01/2020 22:04	06/01/2020 21:20	06/01/2020 22:04	0,72	409	294,71	CHI
20200137872	GOIAS	GS21062867	ITABERAI S1	06/01/2020 21:42	07/01/2020 10:04	06/01/2020 21:42	07/01/2020 10:04	12,36	2	24,73	CHI
20200137882	SANTO ANTONIO DO DESCOBERTO	10004560556	ALEXANIA	06/01/2020 21:46	06/01/2020 23:03	06/01/2020 21:46	06/01/2020 23:03	1,28	1	1,28	CHI
20200137883	ITAPURANGA	170088637	ITAPURANGA	06/01/2020 21:47	07/01/2020 17:40	06/01/2020 21:47	07/01/2020 17:40	19,87	1	19,87	CHI
20200137892	DAVINOPOLIS	IO21149261	CATALAO S1	06/01/2020 21:56	07/01/2020 12:52	06/01/2020 21:56	07/01/2020 12:52	14,92	1	14,92	CHI
20200137904	AGUAS LINDAS DE GOIAS	LA11382968	AGUAS LINDAS DE GOIAS S2	06/01/2020 21:50	06/01/2020 23:40	06/01/2020 21:50	06/01/2020 23:40	1,83	80	146,04	CHI



20200137913	ITUMBIARA	IT11091623	ITUMBIARA NOVA	06/01/2020 22:02	06/01/2020 22:50	06/01/2020 22:02	06/01/2020 22:50	0,80	191	153,28	CHI
20200137917	RIO VERDE	10009884805	RIO VERDE S2	06/01/2020 22:15	07/01/2020 10:51	06/01/2020 22:15	07/01/2020 10:51	12,59	1	12,59	CHI
20200137926	GAMELEIRA DE GOIAS	SV12167943	DAIA S2	06/01/2020 22:22	07/01/2020 09:39	06/01/2020 22:22	07/01/2020 09:39	11,28	203	2289,11	CHI
20200137929	LUZIANIA	120412214	RIO VERMELHO	06/01/2020 22:25	06/01/2020 23:04	06/01/2020 22:25	06/01/2020 23:04	0,64	1	0,64	CHI
20200137960	MINACU	IH11135606	MINACU	06/01/2020 22:47	07/01/2020 15:10	07/01/2020 14:40	07/01/2020 15:10	0,50	78	39,00	CHI
20200137964	BALIZA	BH12331164	CAIAPONIA	06/01/2020 22:51	07/01/2020 12:08	06/01/2020 22:51	07/01/2020 12:08	13,28	9	119,50	CHI
20200137969	SAO LUIS DE MONTES BELOS	SL11000059	SAO LUIZ DOS MONTES BELOS	06/01/2020 22:55	07/01/2020 08:10	06/01/2020 22:55	07/01/2020 08:10	9,25	185	1711,82	CHI
20200137971	CORUMBAIBA	CI12100089	VILA CORUMBA	06/01/2020 22:57	07/01/2020 13:21	06/01/2020 22:57	07/01/2020 13:21	14,41	5	72,03	CHI
20200137976	MINEIROS	MY12377363	PARQUE DAS EMAS	06/01/2020 23:07	07/01/2020 02:55	06/01/2020 23:07	07/01/2020 02:55	3,80	1	3,80	CHI
20200137988	PORTEIRAO	2470004348	RIO DOS BOIS	06/01/2020 23:24	07/01/2020 13:03	06/01/2020 23:24	07/01/2020 13:03	13,66	1	13,66	CHI
20200137991	RIO VERDE	10019386743	RIO VERDE S2	06/01/2020 23:35	07/01/2020 03:43	06/01/2020 23:35	07/01/2020 03:43	4,13	1	4,13	CHI
20200137994	VALPARAISO DE GOIAS	2860273550	MARAJOARA	06/01/2020 23:39	07/01/2020 09:25	06/01/2020 23:39	07/01/2020 09:25	9,75	1	9,75	CHI
20200137996	ITAPURANGA	IK12310867	ITAPURANGA	06/01/2020 20:34	07/01/2020 09:50	06/01/2020 20:34	07/01/2020 09:50	13,26	11	145,85	CHI
20200137999	ITAGUARI	II12250788	ITABERAI S1	06/01/2020 23:53	07/01/2020 11:21	06/01/2020 23:53	07/01/2020 10:08	10,25	2	20,49	CHI
20200137999	JARAGUA	II12250788	ITABERAI S1	06/01/2020 23:53	07/01/2020 11:21	06/01/2020 23:53	07/01/2020 10:08	10,25	7	71,73	CHI
20200137999	ITAGUARI	JA12075992LD	ITABERAI S1	06/01/2020 23:53	07/01/2020 11:21	06/01/2020 23:53	07/01/2020 11:21	11,47	1	11,47	CHI
20200137999	JARAGUA	JA12075992LD	ITABERAI S1	06/01/2020 23:53	07/01/2020 11:21	06/01/2020 23:53	07/01/2020 11:21	11,47	3	34,40	CHI
20200138202	RIO VERDE	10009859290	RIO VERDE S2	07/01/2020 00:00	07/01/2020 10:00	07/01/2020 00:00	07/01/2020 10:00	9,99	1	9,99	CHI
20200138205	MARA ROSA	MQ12028228	MARA ROSA	07/01/2020 00:07	07/01/2020 11:46	07/01/2020 00:07	07/01/2020 11:46	11,64	14	162,97	CHI
20200138214	CRISTALINA	KR21385519	CRISTALINA S2	07/01/2020 00:57	07/01/2020 10:07	07/01/2020 00:57	07/01/2020 10:07	9,16	2	18,32	CHI
20200138216	QUIRINOPOLIS	PC21247828	QUIRINOPOLIS	07/01/2020 00:57	07/01/2020 07:31	07/01/2020 00:57	07/01/2020 07:31	6,56	1	6,56	CHI
20200138223	ITABERAI	IB12300320	ITABERAI S2	07/01/2020 01:53	07/01/2020 09:44	07/01/2020 01:53	07/01/2020 09:44	7,84	2	15,67	CHI
20200138228	PLANALTINA	10003739161	PLANALTINA	07/01/2020 03:00	07/01/2020 13:05	07/01/2020 03:00	07/01/2020 13:05	10,08	1	10,08	CHI
20200138229	FIRMINOPOLIS	TV12005554	FIRMINOPOLIS S1	07/01/2020 02:58	07/01/2020 08:40	07/01/2020 02:58	07/01/2020 08:40	5,70	2	11,41	CHI
20200138229	TURVANIA	TV12005554	FIRMINOPOLIS S1	07/01/2020 02:58	07/01/2020 08:40	07/01/2020 02:58	07/01/2020 08:40	5,70	46	262,39	CHI
20200138234	GOIAS	NB12064413LD	MATRINCHA	07/01/2020 05:58	07/01/2020 21:46	07/01/2020 05:58	07/01/2020 21:46	15,79	1	15,79	CHI
20200138234	NOVO BRASIL	NB12064413LD	MATRINCHA	07/01/2020 05:58	07/01/2020 21:46	07/01/2020 05:58	07/01/2020 21:46	15,79	28	442,22	CHI
20200138242	PORANGATU	PO12192371	PORANGATU	07/01/2020 03:44	07/01/2020 14:53	07/01/2020 03:44	07/01/2020 14:53	11,14	12	133,63	CHI
20200138250	LUZIANIA	LZ21330606	RIO VERMELHO	07/01/2020 04:20	07/01/2020 13:50	07/01/2020 04:20	07/01/2020 13:50	9,49	1	9,49	CHI
20200138258	GOIAS	IK12250721	GOIAS	06/01/2020 23:07	07/01/2020 10:27	06/01/2020 23:07	07/01/2020 10:27	11,32	14	158,52	CHI
20200138258	ITABERAI	IK12250721	GOIAS	06/01/2020 23:07	07/01/2020 10:27	06/01/2020 23:07	07/01/2020 10:27	11,32	2	22,65	CHI
20200138258	ITAPURANGA	IK12250721	GOIAS	06/01/2020 23:07	07/01/2020 10:27	06/01/2020 23:07	07/01/2020 10:27	11,32	3	33,97	CHI
20200138261	NOVO PLANALTO	TA21146556	NOVO PLANALTO	07/01/2020 04:44	07/01/2020 12:05	07/01/2020 04:44	07/01/2020 12:05	7,34	1	7,34	CHI

20200138263	CAIAPONIA	DV12357631	CAIAPONIA	07/01/2020 04:44	07/01/2020 18:36	07/01/2020 04:44	07/01/2020 18:36	13,85	3	41,56	CHI
20200138264	MARA ROSA	MQ21254074	SANTA TEREZINHA	07/01/2020 04:49	07/01/2020 11:47	07/01/2020 04:49	07/01/2020 11:47	6,97	1	6,97	CHI
20200138265	COCALZINHO DE GOIAS	ZN21344992	COCALZINHO	07/01/2020 04:52	07/01/2020 08:36	07/01/2020 04:52	07/01/2020 08:36	3,73	1	3,73	CHI
20200138268	ITAGUARI	IC12035368	ITABERAI S1	07/01/2020 01:37	07/01/2020 14:14	07/01/2020 01:37	07/01/2020 14:14	12,60	27	340,21	CHI
20200138268	JARAGUA	IC12035368	ITABERAI S1	07/01/2020 01:37	07/01/2020 14:14	07/01/2020 01:37	07/01/2020 14:14	12,60	9	113,40	CHI
20200138269	BOM JARDIM DE GOIAS	BM12064260	BOM JARDIM	07/01/2020 04:55	07/01/2020 09:06	07/01/2020 04:55	07/01/2020 09:06	4,17	17	70,91	CHI
20200138272	LUZIANIA	OZ12402562RE	PIRES DO RIO S2	07/01/2020 05:03	07/01/2020 08:37	07/01/2020 05:03	07/01/2020 08:37	3,55	133	472,37	CHI
20200138272	ORIZONA	OZ12402562RE	PIRES DO RIO S2	07/01/2020 05:03	07/01/2020 08:37	07/01/2020 05:03	07/01/2020 08:37	3,55	7	24,86	CHI
20200138276	IVOLANDIA	IV12015643	IPORA	07/01/2020 05:17	07/01/2020 08:42	07/01/2020 05:17	07/01/2020 08:42	3,42	65	221,99	CHI
20200138278	QUIRINOPOLIS	QI12064733	QUIRINOPOLIS	07/01/2020 05:22	07/01/2020 11:05	07/01/2020 05:22	07/01/2020 11:05	5,70	7	39,93	CHI
20200138282	ALEXANIA	AX31061865	ALEXANIA	07/01/2020 05:26	07/01/2020 17:53	07/01/2020 05:26	07/01/2020 17:53	12,45	1	12,45	CHI
20200138283	PORANGATU	PO12027986	PORANGATU	07/01/2020 05:27	07/01/2020 12:58	07/01/2020 05:27	07/01/2020 12:58	7,51	7	52,59	CHI
20200138284	PARAUNA	AI12008084	FIRMINOPOLIS S2	07/01/2020 05:28	07/01/2020 09:45	07/01/2020 05:28	07/01/2020 09:45	4,28	6	25,70	CHI
20200138287	PALMINOPOLIS	PP12006641	PALMEIRAS	07/01/2020 05:33	07/01/2020 09:34	07/01/2020 05:33	07/01/2020 09:34	4,00	13	52,03	CHI
20200138288	MINEIROS	MY12325793	PARQUE DAS EMAS	07/01/2020 05:34	08/01/2020 11:11	07/01/2020 05:34	08/01/2020 11:11	29,60	3	88,80	CHI
20200138289	JANDAIA	JD12102347	ACREUNA	07/01/2020 05:35	07/01/2020 07:38	07/01/2020 05:35	07/01/2020 07:38	2,05	1	2,05	CHI
20200138291	ANAPOLIS	AN12347854RE	ANAPOLIS UNIVERSITARIO S2	07/01/2020 05:36	07/01/2020 12:50	07/01/2020 05:36	07/01/2020 12:50	7,23	24	173,56	CHI
20200138292	DAVINOPOLIS	IO12000011RE	CATALAO S1	07/01/2020 04:02	07/01/2020 11:46	07/01/2020 04:02	07/01/2020 11:46	7,73	33	255,09	CHI
20200138292	DISTRITO FEDERAL	IO12000011RE	CATALAO S1	07/01/2020 04:02	07/01/2020 11:46	07/01/2020 04:02	07/01/2020 11:46	7,73	3	23,19	CHI
20200138292	OUVIDOR	IO12000011RE	CATALAO S1	07/01/2020 04:02	07/01/2020 11:46	07/01/2020 04:02	07/01/2020 11:46	7,73	12	92,76	CHI
20200138292	TRES RANCHOS	IO12000011RE	CATALAO S1	07/01/2020 04:02	07/01/2020 11:46	07/01/2020 04:02	07/01/2020 11:46	7,73	4	30,92	CHI
20200138295	CATALAO	CT21192627	CATALAO S1	07/01/2020 05:39	07/01/2020 18:19	07/01/2020 05:39	07/01/2020 18:19	12,66	1	12,66	CHI
20200138300	CACU	CC12063074	CACHOEIRA ALTA	07/01/2020 05:44	08/01/2020 00:42	07/01/2020 05:44	08/01/2020 00:42	18,95	3	56,85	CHI
20200138300	ITARUMA	CC12063074	CACHOEIRA ALTA	07/01/2020 05:44	08/01/2020 00:42	07/01/2020 05:44	08/01/2020 00:42	18,95	14	265,30	CHI
20200138300	JATAI	CC12063074	CACHOEIRA ALTA	07/01/2020 05:44	08/01/2020 00:42	07/01/2020 05:44	08/01/2020 00:42	18,95	19	360,06	CHI
20200138305	SAO MIGUEL DO ARAGUAIA	SM12309562	SAO MIGUEL DO ARAGUAIA	07/01/2020 01:06	07/01/2020 10:24	07/01/2020 02:08	07/01/2020 10:24	8,25	2	16,51	CHI
20200138306	SAO MIGUEL DO ARAGUAIA	SM12013063LD	SAO MIGUEL DO ARAGUAIA	07/01/2020 01:06	07/01/2020 13:20	07/01/2020 02:11	07/01/2020 13:20	11,15	11	122,64	CHI
20200138309	SANTA HELENA DE GOIAS	SH10404081	IPEGUARI	07/01/2020 04:01	07/01/2020 17:20	07/01/2020 04:04	07/01/2020 08:18	4,24	115	487,66	CHI
20200138309	SANTA HELENA DE GOIAS	SH12271576	IPEGUARI	07/01/2020 04:01	07/01/2020 17:20	07/01/2020 09:25	07/01/2020 09:50	0,41	3	1,23	CHI
20200138309	SANTA HELENA DE GOIAS	SH12271563	IPEGUARI	07/01/2020 04:01	07/01/2020 17:20	07/01/2020 04:04	07/01/2020 10:29	6,42	8	51,32	CHI
20200138309	SANTA HELENA DE GOIAS	SH12301284	IPEGUARI	07/01/2020 04:01	07/01/2020 17:20	07/01/2020 09:25	07/01/2020 10:30	1,07	8	8,55	CHI
20200138309	SANTA HELENA DE GOIAS	SH12394803	IPEGUARI	07/01/2020 04:01	07/01/2020 17:20	07/01/2020 10:31	07/01/2020 13:26	2,90	103	299,04	CHI
20200138309	SANTA HELENA DE GOIAS	SH12271576	IPEGUARI	07/01/2020 04:01	07/01/2020 17:20	07/01/2020 10:31	07/01/2020 16:30	5,97	19	113,43	CHI

20200138309	SANTA HELENA DE GOIAS	SH12271562	IPEGUARI	07/01/2020 04:01	07/01/2020 17:20	07/01/2020 04:04	07/01/2020 17:00	12,93	18	232,72	CHI
20200138309	TURVELANDIA	SH12271562	IPEGUARI	07/01/2020 04:01	07/01/2020 17:20	07/01/2020 04:04	07/01/2020 17:00	12,93	3	38,79	CHI
20200138309	SANTA HELENA DE GOIAS	SH12000123	IPEGUARI	07/01/2020 04:01	07/01/2020 17:20	07/01/2020 04:04	07/01/2020 17:20	13,26	2	26,53	CHI
20200138309	TURVELANDIA	SH12000123	IPEGUARI	07/01/2020 04:01	07/01/2020 17:20	07/01/2020 04:04	07/01/2020 17:20	13,26	9	119,36	CHI
20200138317	CACHOEIRA ALTA	CC10400649	CACHOEIRA ALTA	07/01/2020 06:23	07/01/2020 07:28	07/01/2020 06:23	07/01/2020 07:28	1,08	258	278,71	CHI
20200138317	CACU	CC10400649	CACHOEIRA ALTA	07/01/2020 06:23	07/01/2020 07:28	07/01/2020 06:23	07/01/2020 07:28	1,08	1	1,08	CHI
20200138317	QUIRINOPOLIS	CC10400649	CACHOEIRA ALTA	07/01/2020 06:23	07/01/2020 07:28	07/01/2020 06:23	07/01/2020 07:28	1,08	28	30,25	CHI
20200138337	LUZIANIA	10015920770	RIO VERMELHO	07/01/2020 08:04	07/01/2020 09:57	07/01/2020 08:04	07/01/2020 09:57	1,89	1	1,89	CHI
20200138359	JARAGUA	JA21352328	JARAGUA	06/01/2020 20:34	07/01/2020 19:04	06/01/2020 20:34	07/01/2020 19:04	22,48	2	44,97	CHI
20200138361	JARAGUA	JA21297912	JARAGUA	06/01/2020 20:46	07/01/2020 19:52	06/01/2020 20:46	07/01/2020 19:52	23,09	1	23,09	CHI
20200138363	JARAGUA	JA12374473LD	JARAGUA	07/01/2020 06:19	07/01/2020 15:23	07/01/2020 06:19	07/01/2020 15:23	9,06	276	2501,63	CHI
20200138402	ITUMBIARA	BG12363928	ITUMBIARA VELHA S2	07/01/2020 05:48	07/01/2020 07:59	07/01/2020 05:48	07/01/2020 07:59	2,18	5	10,89	CHI
20200138404	ITABERAI	IB12253438	ITABERAI S1	07/01/2020 05:49	07/01/2020 13:07	07/01/2020 05:49	07/01/2020 13:07	7,30	5	36,48	CHI
20200138407	GOIANESIA	10014930801	GOIANESIA S2	07/01/2020 05:50	08/01/2020 03:13	07/01/2020 05:50	08/01/2020 03:13	21,38	1	21,38	CHI
20200138410	EDEIA	EA12378410	EDEIA	07/01/2020 05:52	07/01/2020 09:58	07/01/2020 05:52	07/01/2020 09:58	4,10	5	20,49	CHI
20200138413	CATALAO	CT12011272	CATALAO S1	07/01/2020 04:54	08/01/2020 23:24	08/01/2020 12:54	08/01/2020 14:14	1,34	28	37,62	CHI
20200138413	CATALAO	CT12011272	CATALAO S1	07/01/2020 04:54	08/01/2020 23:24	08/01/2020 13:19	08/01/2020 14:14	0,93	108	100,20	CHI
20200138413	CATALAO	CT12215619	CATALAO S1	07/01/2020 04:54	08/01/2020 23:24	07/01/2020 04:54	08/01/2020 15:09	34,24	15	513,65	CHI
20200138413	CATALAO	CT12215619	CATALAO S1	07/01/2020 04:54	08/01/2020 23:24	07/01/2020 04:54	08/01/2020 20:16	39,36	3	118,07	CHI
20200138413	CATALAO	CT12215619	CATALAO S1	07/01/2020 04:54	08/01/2020 23:24	07/01/2020 04:54	08/01/2020 22:01	41,10	4	164,41	CHI
20200138413	CATALAO	CT12215619	CATALAO S1	07/01/2020 04:54	08/01/2020 23:24	07/01/2020 04:54	08/01/2020 22:02	41,12	1	41,12	CHI
20200138413	CATALAO	CT12215619	CATALAO S1	07/01/2020 04:54	08/01/2020 23:24	07/01/2020 04:54	08/01/2020 23:24	42,49	11	467,36	CHI
20200138415	FORMOSA	FA12270001	ITIQUEIRA	07/01/2020 05:54	07/01/2020 11:26	07/01/2020 05:54	07/01/2020 11:26	5,53	5	27,64	CHI
20200138417	URUTAI	UT21016960	URUTAI	07/01/2020 05:54	07/01/2020 10:10	07/01/2020 05:54	07/01/2020 10:10	4,26	1	4,26	CHI
20200138418	SAO MIGUEL DO ARAGUAIA	SM12192361	SAO MIGUEL DO ARAGUAIA	07/01/2020 05:25	07/01/2020 10:20	07/01/2020 05:25	07/01/2020 10:20	4,91	169	829,51	CHI
20200138419	ALOANDIA	AD12013446	GOIATUBA S1	07/01/2020 04:12	07/01/2020 08:52	07/01/2020 04:12	07/01/2020 08:52	4,67	9	42,06	CHI
20200138419	PONTALINA	AD12013446	GOIATUBA S1	07/01/2020 04:12	07/01/2020 08:52	07/01/2020 04:12	07/01/2020 08:52	4,67	13	60,76	CHI
20200138424	ALTO HORIZONTE	NH12396799	SANTA TEREZINHA	07/01/2020 05:59	07/01/2020 09:19	07/01/2020 05:59	07/01/2020 09:19	3,34	58	193,74	CHI
20200138424	CAMPOS VERDES	NH12396799	SANTA TEREZINHA	07/01/2020 05:59	07/01/2020 09:19	07/01/2020 05:59	07/01/2020 09:19	3,34	7	23,38	CHI
20200138424	PILAR DE GOIAS	NH12396799	SANTA TEREZINHA	07/01/2020 05:59	07/01/2020 09:19	07/01/2020 05:59	07/01/2020 09:19	3,34	1	3,34	CHI
20200138425	CACHOEIRA DE GOIAS	IV12253637	IPORA	07/01/2020 06:00	07/01/2020 10:08	07/01/2020 06:00	07/01/2020 10:08	4,13	5	20,63	CHI
20200138425	IVOLANDIA	IV12253637	IPORA	07/01/2020 06:00	07/01/2020 10:08	07/01/2020 06:00	07/01/2020 10:08	4,13	37	152,64	CHI
20200138425	PARAUNA	IV12253637	IPORA	07/01/2020 06:00	07/01/2020 10:08	07/01/2020 06:00	07/01/2020 10:08	4,13	7	28,88	CHI

20200138426	QUIRINOPOLIS	QI32007538	QUIRINOPOLIS	07/01/2020 05:52	07/01/2020 09:17	07/01/2020 05:52	07/01/2020 09:17	3,42	40	136,84	CHI
20200138427	JUSSARA	JR21223171	JUSSARA	07/01/2020 06:00	07/01/2020 16:25	07/01/2020 06:00	07/01/2020 16:25	10,40	2	20,81	CHI
20200138429	ABADIANIA	AN11289006	ANAPOLIS UNIVERSITARIO S2	07/01/2020 06:01	07/01/2020 18:01	07/01/2020 06:01	07/01/2020 18:01	11,99	8	95,96	CHI
20200138430	BRITANIA	BT12183055	BRITANIA	07/01/2020 06:02	07/01/2020 16:50	07/01/2020 06:02	07/01/2020 16:50	10,80	21	226,79	CHI
20200138430	ITAPIRAPUA	BT12183055	BRITANIA	07/01/2020 06:02	07/01/2020 16:50	07/01/2020 06:02	07/01/2020 16:50	10,80	2	21,60	CHI
20200138436	ARAGUAPAZ	AZ12042965	MOZARLANDIA	07/01/2020 06:03	08/01/2020 14:30	07/01/2020 06:03	07/01/2020 19:20	13,28	10	132,82	CHI
20200138436	ARAGUAPAZ	AZ10404194	MOZARLANDIA	07/01/2020 06:03	08/01/2020 14:30	07/01/2020 14:05	07/01/2020 19:20	5,25	55	288,67	CHI
20200138436	ARAGUAPAZ	AZ10404194	MOZARLANDIA	07/01/2020 06:03	08/01/2020 14:30	07/01/2020 19:51	07/01/2020 20:15	0,39	65	25,30	CHI
20200138436	ARUANA	AZ12042965	MOZARLANDIA	07/01/2020 06:03	08/01/2020 14:30	07/01/2020 06:03	07/01/2020 20:18	14,25	4	57,00	CHI
20200138436	ARUANA	MP12010436LD	MOZARLANDIA	07/01/2020 06:03	08/01/2020 14:30	07/01/2020 14:05	07/01/2020 20:18	6,22	57	354,38	CHI
20200138436	MATRINCHA	MP12010436LD	MOZARLANDIA	07/01/2020 06:03	08/01/2020 14:30	07/01/2020 14:05	07/01/2020 20:18	6,22	1	6,22	CHI
20200138436	MATRINCHA	AZ12042965	MOZARLANDIA	07/01/2020 06:03	08/01/2020 14:30	07/01/2020 06:03	07/01/2020 20:25	14,36	1	14,36	CHI
20200138436	MATRINCHA	MP12010442	MOZARLANDIA	07/01/2020 06:03	08/01/2020 14:30	07/01/2020 14:05	07/01/2020 20:25	6,32	3	18,97	CHI
20200138436	ARAGUAPAZ	AZ10404194	MOZARLANDIA	07/01/2020 06:03	08/01/2020 14:30	08/01/2020 09:04	08/01/2020 09:43	0,65	65	42,16	CHI
20200138436	ARUANA	AZ10404194	MOZARLANDIA	07/01/2020 06:03	08/01/2020 14:30	08/01/2020 09:04	08/01/2020 09:43	0,65	61	39,57	CHI
20200138436	MATRINCHA	AZ10404194	MOZARLANDIA	07/01/2020 06:03	08/01/2020 14:30	08/01/2020 09:04	08/01/2020 09:43	0,65	5	3,24	CHI
20200138436	ARUANA	AZ12042965	MOZARLANDIA	07/01/2020 06:03	08/01/2020 14:30	07/01/2020 06:03	08/01/2020 13:30	31,45	4	125,80	CHI
20200138436	MATRINCHA	AZ12042965	MOZARLANDIA	07/01/2020 06:03	08/01/2020 14:30	07/01/2020 06:03	08/01/2020 13:30	31,45	8	251,60	CHI
20200138436	ARUANA	MP13042875	MOZARLANDIA	07/01/2020 06:03	08/01/2020 14:30	07/01/2020 14:05	08/01/2020 13:30	23,42	8	187,33	CHI
20200138436	MATRINCHA	MP13042875	MOZARLANDIA	07/01/2020 06:03	08/01/2020 14:30	07/01/2020 14:05	08/01/2020 13:30	23,42	28	655,67	CHI
20200138436	ARAGUAPAZ	AZ10404194	MOZARLANDIA	07/01/2020 06:03	08/01/2020 14:30	08/01/2020 13:33	08/01/2020 14:30	0,95	65	61,82	CHI
20200138436	ARUANA	AZ10404194	MOZARLANDIA	07/01/2020 06:03	08/01/2020 14:30	08/01/2020 13:33	08/01/2020 14:30	0,95	73	69,43	CHI
20200138436	MATRINCHA	AZ10404194	MOZARLANDIA	07/01/2020 06:03	08/01/2020 14:30	08/01/2020 13:33	08/01/2020 14:30	0,95	41	39,00	CHI
20200138441	GOIANESIA	GE12353391	GOIANESIA S2	07/01/2020 06:04	07/01/2020 19:37	07/01/2020 06:04	07/01/2020 19:37	13,54	1	13,54	CHI
20200138441	JARAGUA	GE12353391	GOIANESIA S2	07/01/2020 06:04	07/01/2020 19:37	07/01/2020 06:04	07/01/2020 19:37	13,54	8	108,29	CHI
20200138445	IACIARA	IA12164539	IACIARA S2	07/01/2020 06:06	07/01/2020 09:57	07/01/2020 06:06	07/01/2020 09:57	3,85	25	96,13	CHI
20200138446	ITARUMA	IM21084423	CACHOEIRA ALTA	07/01/2020 06:06	07/01/2020 12:01	07/01/2020 06:06	07/01/2020 12:01	5,91	2	11,82	CHI
20200138449	JATAI	JT12191107	JATAI S1	07/01/2020 06:10	07/01/2020 16:45	07/01/2020 06:10	07/01/2020 16:45	10,58	5	52,92	CHI
20200138452	PONTALINA	PK12182928	PONTALINA	07/01/2020 06:11	07/01/2020 09:50	07/01/2020 06:11	07/01/2020 09:50	3,66	15	54,83	CHI
20200138453	CALDAS NOVAS	CN12223697	CALDAS NOVAS S1	07/01/2020 06:12	07/01/2020 11:10	07/01/2020 06:12	07/01/2020 11:10	4,96	3	14,88	CHI
20200138460	MIMOSO DE GOIAS	NQ12213063	BARRO ALTO	07/01/2020 06:15	07/01/2020 13:47	07/01/2020 06:15	07/01/2020 13:47	7,52	9	67,71	CHI
20200138460	NIQUELANDIA	NQ12213063	BARRO ALTO	07/01/2020 06:15	07/01/2020 13:47	07/01/2020 06:15	07/01/2020 13:47	7,52	1	7,52	CHI
20200138460	VILA PROPICIO	NQ12213063	BARRO ALTO	07/01/2020 06:15	07/01/2020 13:47	07/01/2020 06:15	07/01/2020 13:47	7,52	12	90,29	CHI

20200138461	PIRES DO RIO	PR21288055	PIRES DO RIO S1	07/01/2020 06:16	07/01/2020 09:36	07/01/2020 06:16	07/01/2020 09:36	3,33	1	3,33	CHI
20200138462	BONOPOLIS	BX12292422	SAO MIGUEL DO ARAGUAIA	07/01/2020 06:17	07/01/2020 11:42	07/01/2020 06:17	07/01/2020 11:42	5,42	33	178,75	CHI
20200138462	PORANGATU	BX12292422	SAO MIGUEL DO ARAGUAIA	07/01/2020 06:17	07/01/2020 11:42	07/01/2020 06:17	07/01/2020 11:42	5,42	1	5,42	CHI
20200138465	CACU	CC21238998	CACHOEIRA ALTA	07/01/2020 06:17	07/01/2020 17:32	07/01/2020 06:17	07/01/2020 17:32	11,23	1	11,23	CHI
20200138466	JATAI	JT21065817	JATAI S1	07/01/2020 06:18	07/01/2020 10:00	07/01/2020 06:18	07/01/2020 10:00	3,70	1	3,70	CHI
20200138467	BARRO ALTO	GE12000092	GOIANESIA S1	07/01/2020 06:18	08/01/2020 22:29	07/01/2020 06:18	07/01/2020 21:37	15,32	1	15,32	CHI
20200138467	GOIANESIA	GE12000092	GOIANESIA S1	07/01/2020 06:18	08/01/2020 22:29	07/01/2020 06:18	07/01/2020 21:37	15,32	4	61,30	CHI
20200138467	BARRO ALTO	GE12000092	GOIANESIA S1	07/01/2020 06:18	08/01/2020 22:29	07/01/2020 06:18	08/01/2020 22:29	40,19	1	40,19	CHI
20200138467	GOIANESIA	GE12000092	GOIANESIA S1	07/01/2020 06:18	08/01/2020 22:29	07/01/2020 06:18	08/01/2020 22:29	40,19	15	602,78	CHI
20200138467	BARRO ALTO	GE12000092	GOIANESIA S1	07/01/2020 06:18	08/01/2020 22:29	07/01/2020 21:38	08/01/2020 22:29	24,85	1	24,85	CHI
20200138467	GOIANESIA	GE12000092	GOIANESIA S1	07/01/2020 06:18	08/01/2020 22:29	07/01/2020 21:38	08/01/2020 22:29	24,85	4	99,41	CHI
20200138473	IPAMERI	IP12300933	IPAMERI	07/01/2020 06:19	07/01/2020 08:39	07/01/2020 06:19	07/01/2020 08:39	2,33	52	121,16	CHI
20200138475	SAO MIGUEL DO PASSA QUATRO	SQ12355286	CRISTIANOPOLIS	07/01/2020 06:20	07/01/2020 13:08	07/01/2020 06:20	07/01/2020 13:08	6,79	1	6,79	CHI
20200138480	MINACU	IH12236222	MINACU	07/01/2020 06:22	07/01/2020 10:50	07/01/2020 06:22	07/01/2020 10:50	4,47	19	84,86	CHI
20200138482	MUTUNOPOLIS	SE12000015	MARA ROSA	07/01/2020 05:10	07/01/2020 09:27	07/01/2020 05:10	07/01/2020 09:27	4,27	2	8,55	CHI
20200138482	PORANGATU	SE12000015	MARA ROSA	07/01/2020 05:10	07/01/2020 09:27	07/01/2020 05:10	07/01/2020 09:27	4,27	3	12,82	CHI
20200138482	SANTA TEREZA DE GOIAS	SE12000015	MARA ROSA	07/01/2020 05:10	07/01/2020 09:27	07/01/2020 05:10	07/01/2020 09:27	4,27	97	414,62	CHI
20200138485	POSSE	PS12143770	IACIARA S2	07/01/2020 06:23	07/01/2020 09:20	07/01/2020 06:23	07/01/2020 09:20	2,95	109	321,43	CHI
20200138488	ITAPIRAPUA	IU12250533	MATRINCHA	07/01/2020 06:24	07/01/2020 12:48	07/01/2020 06:24	07/01/2020 12:48	6,40	1	6,40	CHI
20200138497	FAZENDA NOVA	NB12396238	JUSSARA	07/01/2020 06:26	07/01/2020 12:59	07/01/2020 06:26	07/01/2020 12:59	6,53	1	6,53	CHI
20200138497	NOVO BRASIL	NB12396238	JUSSARA	07/01/2020 06:26	07/01/2020 12:59	07/01/2020 06:26	07/01/2020 12:59	6,53	4	26,14	CHI
20200138501	BALIZA	BH12358780	BOM JARDIM	07/01/2020 06:27	07/01/2020 15:26	07/01/2020 06:27	07/01/2020 15:26	8,97	19	170,42	CHI
20200138502	CRIXAS	CX12166640	SANTA TEREZINHA	07/01/2020 06:24	08/01/2020 18:43	07/01/2020 06:24	07/01/2020 23:06	16,71	13	217,22	CHI
20200138502	CRIXAS	6673538	SANTA TEREZINHA	07/01/2020 06:24	08/01/2020 18:43	07/01/2020 06:24	08/01/2020 12:15	29,86	2	59,71	CHI
20200138502	CRIXAS	CX21135535	SANTA TEREZINHA	07/01/2020 06:24	08/01/2020 18:43	08/01/2020 12:16	08/01/2020 18:00	5,73	1	5,73	CHI
20200138502	CRIXAS	CX11397644	SANTA TEREZINHA	07/01/2020 06:24	08/01/2020 18:43	08/01/2020 12:17	08/01/2020 18:15	5,95	1	5,95	CHI
20200138502	CRIXAS	CX12166640	SANTA TEREZINHA	07/01/2020 06:24	08/01/2020 18:43	07/01/2020 06:24	08/01/2020 18:43	36,31	11	399,41	CHI
20200138502	CRIXAS	CX12166640	SANTA TEREZINHA	07/01/2020 06:24	08/01/2020 18:43	08/01/2020 15:25	08/01/2020 18:43	3,30	13	42,90	CHI
20200138504	MORRO AGUDO DE GOIAS	MS12335823	ITAPURANGA	07/01/2020 06:29	07/01/2020 14:40	07/01/2020 06:29	07/01/2020 14:40	8,19	2	16,37	CHI
20200138505	ITABERAI	IB12000038	ITABERAI S2	07/01/2020 05:25	07/01/2020 14:35	07/01/2020 05:25	07/01/2020 14:35	9,17	33	302,71	CHI
20200138509	CATALAO	1990024133	CATALAO S2	07/01/2020 06:32	07/01/2020 19:59	07/01/2020 06:32	07/01/2020 19:59	13,45	1	13,45	CHI
20200138510	CAMPO ALEGRE DE GOIAS	CM12042353	CAMPO ALEGRE DE GOIAS	07/01/2020 06:32	07/01/2020 12:58	07/01/2020 06:32	07/01/2020 12:58	6,43	5	32,14	CHI
20200138511	MONTES CLAROS DE GOIAS	ME21152625	IPORA	07/01/2020 06:32	07/01/2020 10:01	07/01/2020 06:32	07/01/2020 10:01	3,48	1	3,48	CHI

20200138512	JATAI	SX12013892	JATAI S1	07/01/2020 04:41	07/01/2020 08:52	07/01/2020 04:41	07/01/2020 08:52	4,17	13	54,23	CHI
20200138512	SERRANOPOLIS	SX12013892	JATAI S1	07/01/2020 04:41	07/01/2020 08:52	07/01/2020 04:41	07/01/2020 08:52	4,17	141	588,20	CHI
20200138513	FLORES DE GOIAS	FB12253535	IACIARA S2	07/01/2020 06:33	07/01/2020 10:42	07/01/2020 06:33	07/01/2020 10:42	4,15	68	282,12	CHI
20200138516	EDEIA	EA12044006	EDEIA	07/01/2020 01:41	07/01/2020 10:46	07/01/2020 01:41	07/01/2020 10:46	9,08	12	108,96	CHI
20200138518	FORMOSA	FA12394724	ITUIQUIRA	07/01/2020 06:34	07/01/2020 10:32	07/01/2020 06:34	07/01/2020 10:32	3,96	28	111,02	CHI
20200138523	MONTES CLAROS DE GOIAS	ME12380882	IPORA	07/01/2020 06:36	07/01/2020 11:53	07/01/2020 06:36	07/01/2020 11:53	5,28	2	10,56	CHI
20200138524	CRIXAS	CX12390328	SANTA TEREZINHA	07/01/2020 06:36	07/01/2020 21:34	07/01/2020 06:36	07/01/2020 21:34	14,97	31	463,94	CHI
20200138526	EDEALINA	ED12257974	PONTALINA	07/01/2020 06:36	07/01/2020 13:13	07/01/2020 06:36	07/01/2020 13:13	6,60	4	26,42	CHI
20200138527	ITAPURANGA	IK21300022	ITAPURANGA	07/01/2020 06:36	07/01/2020 11:09	07/01/2020 06:36	07/01/2020 11:09	4,54	1	4,54	CHI
20200138529	ORIZONA	OZ12081168	PIRES DO RIO S2	07/01/2020 06:37	07/01/2020 09:35	07/01/2020 06:37	07/01/2020 09:35	2,97	1	2,97	CHI
20200138529	VIANOPOLIS	OZ12081168	PIRES DO RIO S2	07/01/2020 06:37	07/01/2020 09:35	07/01/2020 06:37	07/01/2020 09:35	2,97	11	32,62	CHI
20200138530	PONTALINA	PK12263503	PONTALINA	07/01/2020 06:37	07/01/2020 08:59	07/01/2020 06:37	07/01/2020 08:59	2,36	15	35,44	CHI
20200138531	PALMINOPOLIS	PP12053927	PALMEIRAS	07/01/2020 06:37	07/01/2020 11:41	07/01/2020 06:37	07/01/2020 11:41	5,07	3	15,20	CHI
20200138534	CRIXAS	CX12318400	MOZARLANDIA	07/01/2020 01:18	07/01/2020 16:45	07/01/2020 01:18	07/01/2020 16:45	15,44	11	169,79	CHI
20200138540	JATAI	JT12209699	JATAI S1	07/01/2020 06:40	07/01/2020 10:12	07/01/2020 06:40	07/01/2020 10:12	3,52	20	70,47	CHI
20200138544	GOIANESIA	GE12376533	GOIANESIA S1	07/01/2020 05:50	07/01/2020 09:18	07/01/2020 05:50	07/01/2020 09:18	3,47	88	304,94	CHI
20200138545	CAMPINACU	UC21300540	PORANGATU	07/01/2020 06:41	07/01/2020 10:59	07/01/2020 06:41	07/01/2020 10:59	4,29	1	4,29	CHI
20200138548	MINEIROS	1390051850	PARQUE DAS EMAS	07/01/2020 06:41	07/01/2020 17:00	07/01/2020 06:41	07/01/2020 17:00	10,30	1	10,30	CHI
20200138551	PETROLINA DE GOIAS	PG12377584	PETROLINA	07/01/2020 06:42	07/01/2020 09:40	07/01/2020 06:42	07/01/2020 09:40	2,96	4	11,83	CHI
20200138551	SAO FRANCISCO DE GOIAS	PG12377584	PETROLINA	07/01/2020 06:42	07/01/2020 09:40	07/01/2020 06:42	07/01/2020 09:40	2,96	12	35,49	CHI
20200138553	ANAPOLIS	AN12285315	ANAPOLIS UNIVERSITARIO S2	06/01/2020 22:48	07/01/2020 18:25	06/01/2020 22:48	07/01/2020 18:25	19,60	21	411,67	CHI
20200138558	PONTALINA	PK12390272	PONTALINA	07/01/2020 06:43	07/01/2020 11:17	07/01/2020 06:43	07/01/2020 11:17	4,55	4	18,22	CHI
20200138565	PEROLANDIA	DP12013860	JATAI S1	07/01/2020 06:45	07/01/2020 13:07	07/01/2020 06:45	07/01/2020 13:07	6,36	8	50,86	CHI
20200138572	RUBIATABA	RB12066220	RUBIATABA	07/01/2020 06:47	07/01/2020 09:38	07/01/2020 06:47	07/01/2020 09:38	2,84	5	14,22	CHI
20200138575	BOM JARDIM DE GOIAS	BM12155682	BOM JARDIM	07/01/2020 05:51	07/01/2020 11:43	07/01/2020 05:51	07/01/2020 11:43	5,86	14	82,11	CHI
20200138575	PIRANHAS	BM12155682	BOM JARDIM	07/01/2020 05:51	07/01/2020 11:43	07/01/2020 05:51	07/01/2020 11:43	5,86	4	23,46	CHI
20200138580	ITAJA	IM12303245	CACHOEIRA ALTA	07/01/2020 06:49	08/01/2020 14:10	07/01/2020 06:49	08/01/2020 14:10	31,35	8	250,77	CHI
20200138580	ITARUMA	IM12303245	CACHOEIRA ALTA	07/01/2020 06:49	08/01/2020 14:10	07/01/2020 06:49	08/01/2020 14:10	31,35	9	282,11	CHI
20200138583	GOIATUBA	GT21102746	GOIATUBA S2	07/01/2020 06:49	07/01/2020 08:04	07/01/2020 06:49	07/01/2020 08:04	1,24	1	1,24	CHI
20200138587	QUIRINOPOLIS	QI12054921	QUIRINOPOLIS	07/01/2020 06:50	07/01/2020 14:30	07/01/2020 06:50	07/01/2020 14:30	7,65	3	22,96	CHI
20200138591	ANAPOLIS	20215526	ANAPOLIS UNIVERSITARIO S2	07/01/2020 06:51	07/01/2020 14:57	07/01/2020 06:51	07/01/2020 14:57	8,08	1	8,08	CHI
20200138595	MONTIVIDIU	MV12267718	MONTIVIDIU T	07/01/2020 06:52	07/01/2020 08:40	07/01/2020 06:52	07/01/2020 08:40	1,79	13	23,27	CHI
20200138595	RIO VERDE	MV12267718	MONTIVIDIU T	07/01/2020 06:52	07/01/2020 08:40	07/01/2020 06:52	07/01/2020 08:40	1,79	1	1,79	CHI

20200138597	ORIZONA	OZ21110774	PIRES DO RIO S2	07/01/2020 06:52	07/01/2020 09:35	07/01/2020 06:52	07/01/2020 09:35	2,70	1	2,70	CHI
20200138599	RIO VERDE	RV12327004	RIO VERDE S2	07/01/2020 06:53	07/01/2020 12:32	07/01/2020 06:53	07/01/2020 12:32	5,65	2	11,29	CHI
20200138603	SAO MIGUEL DO ARAGUAIA	SM12032000	SAO MIGUEL DO ARAGUAIA	07/01/2020 06:54	07/01/2020 14:01	07/01/2020 06:54	07/01/2020 14:01	7,12	5	35,61	CHI
20200138604	CAMPO ALEGRE DE GOIAS	CT12306674RE	CATALAO S1	07/01/2020 03:34	07/01/2020 11:31	07/01/2020 03:34	07/01/2020 11:31	7,94	1	7,94	CHI
20200138604	CATALAO	CT12306674RE	CATALAO S1	07/01/2020 03:34	07/01/2020 11:31	07/01/2020 03:34	07/01/2020 11:31	7,94	336	2666,63	CHI
20200138607	SAO JOAO D ALIANCA	JL21361376	FLORES DE GOIAS	07/01/2020 06:54	07/01/2020 11:09	07/01/2020 06:54	07/01/2020 11:09	4,24	1	4,24	CHI
20200138608	CAIAPONIA	930044204	CAIAPONIA	07/01/2020 06:54	07/01/2020 12:01	07/01/2020 06:54	07/01/2020 12:01	5,10	1	5,10	CHI
20200138609	ANAPOLIS	AN12285251	ANAPOLIS UNIVERSITARIO S2	07/01/2020 06:55	07/01/2020 16:37	07/01/2020 06:55	07/01/2020 14:25	7,50	3	22,50	CHI
20200138609	ABADIANIA	AN12285251	ANAPOLIS UNIVERSITARIO S2	07/01/2020 06:55	07/01/2020 16:37	07/01/2020 06:55	07/01/2020 16:37	9,70	4	38,80	CHI
20200138609	ANAPOLIS	AN12285251	ANAPOLIS UNIVERSITARIO S2	07/01/2020 06:55	07/01/2020 16:37	07/01/2020 06:55	07/01/2020 16:37	9,70	2	19,40	CHI
20200138609	PIRENOPOLIS	AN12285251	ANAPOLIS UNIVERSITARIO S2	07/01/2020 06:55	07/01/2020 16:37	07/01/2020 06:55	07/01/2020 16:37	9,70	6	58,20	CHI
20200138610	CAMPO LIMPO	AN12384149	ANAPOLIS UNIVERSITARIO S2	07/01/2020 06:55	07/01/2020 10:52	07/01/2020 06:55	07/01/2020 10:52	3,95	1	3,95	CHI
20200138617	PLANALTINA	PI12242877	PLANALTINA	07/01/2020 06:56	07/01/2020 11:18	07/01/2020 06:56	07/01/2020 11:18	4,36	82	357,59	CHI
20200138630	IACIARA	IA12394108	IACIARA S1	07/01/2020 06:58	07/01/2020 09:38	07/01/2020 06:58	07/01/2020 09:38	2,66	7	18,64	CHI
20200138631	NIQUELANDIA	NQ12254342	NIQUELANDIA SUBTRANSMISSAO	07/01/2020 06:58	07/01/2020 09:28	07/01/2020 06:58	07/01/2020 09:28	2,49	1	2,49	CHI
20200138638	CAMPINORTE	CR12291233	MARA ROSA	07/01/2020 07:00	07/01/2020 16:06	07/01/2020 07:00	07/01/2020 16:06	9,09	3	27,27	CHI
20200138641	RIO VERDE	RV21022574	MONTIVIDIU T	07/01/2020 07:01	07/01/2020 10:40	07/01/2020 07:01	07/01/2020 10:40	3,65	1	3,65	CHI
20200138653	COCALZINHO DE GOIAS	CB21101926	COCALZINHO	07/01/2020 07:04	08/01/2020 08:50	07/01/2020 07:04	08/01/2020 08:50	25,76	1	25,76	CHI
20200138660	ABADIANIA	AA12258346	ANAPOLIS UNIVERSITARIO S1	07/01/2020 07:05	07/01/2020 09:18	07/01/2020 07:05	07/01/2020 09:18	2,22	21	46,54	CHI
20200138660	CORUMBA DE GOIAS	AA12258346	ANAPOLIS UNIVERSITARIO S1	07/01/2020 07:05	07/01/2020 09:18	07/01/2020 07:05	07/01/2020 09:18	2,22	2	4,43	CHI
20200138666	GOIATUBA	GT12247742	BOM JESUS DE GOIAS	07/01/2020 05:05	07/01/2020 12:46	07/01/2020 05:05	07/01/2020 12:46	7,68	4	30,70	CHI
20200138670	DISTRITO FEDERAL	PB12313905	PADRE BERNARDO	07/01/2020 04:12	07/01/2020 10:24	07/01/2020 04:12	07/01/2020 10:24	6,20	6	37,18	CHI
20200138670	ITARUMA	PB12313905	PADRE BERNARDO	07/01/2020 04:12	07/01/2020 10:24	07/01/2020 04:12	07/01/2020 10:24	6,20	1	6,20	CHI
20200138670	PADRE BERNARDO	PB12313905	PADRE BERNARDO	07/01/2020 04:12	07/01/2020 10:24	07/01/2020 04:12	07/01/2020 10:24	6,20	1	6,20	CHI
20200138670	PLANALTINA	PB12313905	PADRE BERNARDO	07/01/2020 04:12	07/01/2020 10:24	07/01/2020 04:12	07/01/2020 10:24	6,20	10	61,97	CHI
20200138672	NOVO GAMA	NJ11333225	PACAEMBU S1	07/01/2020 07:08	07/01/2020 12:18	07/01/2020 07:08	07/01/2020 12:18	5,16	1	5,16	CHI
20200138674	MOZARLANDIA	MZ32057109	MOZARLANDIA	07/01/2020 07:08	07/01/2020 16:54	07/01/2020 07:08	07/01/2020 16:54	9,75	1	9,75	CHI
20200138677	CAMPINORTE	CR12101042	CAMPINORTE	07/01/2020 07:09	07/01/2020 10:57	07/01/2020 07:09	07/01/2020 10:57	3,79	7	26,56	CHI
20200138679	GUARANI DE GOIAS	02090424	SAO DOMINGOS	07/01/2020 06:41	07/01/2020 08:39	07/01/2020 06:41	07/01/2020 08:39	1,96	148	289,63	CHI
20200138679	MONTE ALEGRE DE GOIAS	02090424	SAO DOMINGOS	07/01/2020 06:41	07/01/2020 08:39	07/01/2020 06:41	07/01/2020 08:39	1,96	2	3,91	CHI
20200138679	NOVA ROMA	02090424	SAO DOMINGOS	07/01/2020 06:41	07/01/2020 08:39	07/01/2020 06:41	07/01/2020 08:39	1,96	3	5,87	CHI
20200138679	SAO DOMINGOS	02090424	SAO DOMINGOS	07/01/2020 06:41	07/01/2020 08:39	07/01/2020 06:41	07/01/2020 08:39	1,96	1159	2268,10	CHI
20200138681	PADRE BERNARDO	PB12290529	PADRE BERNARDO	07/01/2020 07:09	07/01/2020 12:04	07/01/2020 07:09	07/01/2020 12:04	4,90	16	78,44	CHI

20200138684	IPAMERI	IP12017029	IPAMERI	07/01/2020 06:59	07/01/2020 09:13	07/01/2020 06:59	07/01/2020 09:13	2,23	13	29,03	CHI
20200138685	NOVA CRIXAS	NA12380421	NOVA CRIXAS	07/01/2020 06:04	07/01/2020 13:47	07/01/2020 06:04	07/01/2020 13:47	7,70	48	369,83	CHI
20200138686	ACREUNA	BZ12240318	ACREUNA	07/01/2020 02:25	07/01/2020 09:32	07/01/2020 02:25	07/01/2020 09:32	7,11	2	14,22	CHI
20200138686	RIO VERDE	BZ12240318	ACREUNA	07/01/2020 02:25	07/01/2020 09:32	07/01/2020 02:25	07/01/2020 09:32	7,11	1	7,11	CHI
20200138686	SANTO ANTONIO DA BARRA	BZ12240318	ACREUNA	07/01/2020 02:25	07/01/2020 09:32	07/01/2020 02:25	07/01/2020 09:32	7,11	22	156,46	CHI
20200138689	NOVA AURORA	NE12143243	CATALAO S1	07/01/2020 04:42	07/01/2020 10:42	07/01/2020 04:42	07/01/2020 10:42	5,99	5	29,93	CHI
20200138693	ANAPOLIS	20731152	JUNDIAI S2	07/01/2020 07:11	07/01/2020 15:18	07/01/2020 07:11	07/01/2020 15:18	8,11	1	8,11	CHI
20200138696	PORANGATU	PO12390255	PORANGATU	07/01/2020 07:12	07/01/2020 11:55	07/01/2020 07:12	07/01/2020 11:55	4,71	4	18,86	CHI
20200138697	CRIXAS	CX12380748	SERRA DO OURO	07/01/2020 07:12	07/01/2020 12:18	07/01/2020 07:12	07/01/2020 12:18	5,09	25	127,33	CHI
20200138699	CRISTALINA	KR12330533	CRISTALINA S1	07/01/2020 06:11	07/01/2020 18:57	07/01/2020 06:11	07/01/2020 15:08	8,95	1	8,95	CHI
20200138699	CRISTALINA	KR12330533	CRISTALINA S1	07/01/2020 06:11	07/01/2020 18:57	07/01/2020 06:11	07/01/2020 15:24	9,22	1	9,22	CHI
20200138699	CRISTALINA	KR12330533	CRISTALINA S1	07/01/2020 06:11	07/01/2020 18:57	07/01/2020 06:11	07/01/2020 18:57	12,78	33	421,60	CHI
20200138699	IPAMERI	KR12330533	CRISTALINA S1	07/01/2020 06:11	07/01/2020 18:57	07/01/2020 06:11	07/01/2020 18:57	12,78	1	12,78	CHI
20200138699	LUZIANIA	KR12330533	CRISTALINA S1	07/01/2020 06:11	07/01/2020 18:57	07/01/2020 06:11	07/01/2020 18:57	12,78	8	102,21	CHI
20200138702	ITUMBIARA	IT12385751	ITUMBIARA NOVA	07/01/2020 07:12	07/01/2020 09:09	07/01/2020 07:12	07/01/2020 09:09	1,94	403	780,14	CHI
20200138704	JATAI	JT11083521	JATAI S2	07/01/2020 07:13	07/01/2020 11:27	07/01/2020 07:13	07/01/2020 11:27	4,23	1	4,23	CHI
20200138710	IPORA	730033806	IPORA	07/01/2020 07:15	07/01/2020 08:59	07/01/2020 07:15	07/01/2020 08:59	1,73	1	1,73	CHI
20200138711	BOM JARDIM DE GOIAS	BM12335409	BOM JARDIM	07/01/2020 07:15	07/01/2020 09:46	07/01/2020 07:15	07/01/2020 09:46	2,51	6	15,04	CHI
20200138712	NOVA CRIXAS	NA12334349	NOVA CRIXAS	07/01/2020 00:50	08/01/2020 10:38	07/01/2020 00:50	07/01/2020 15:45	14,92	18	268,64	CHI
20200138712	NOVA CRIXAS	NA12334349	NOVA CRIXAS	07/01/2020 00:50	08/01/2020 10:38	07/01/2020 00:50	07/01/2020 16:18	15,47	61	943,75	CHI
20200138712	NOVA CRIXAS	NA12334349	NOVA CRIXAS	07/01/2020 00:50	08/01/2020 10:38	07/01/2020 00:50	07/01/2020 16:45	15,91	7	111,39	CHI
20200138712	NOVA CRIXAS	NA12334349	NOVA CRIXAS	07/01/2020 00:50	08/01/2020 10:38	07/01/2020 16:50	07/01/2020 18:04	1,24	25	30,94	CHI
20200138712	NOVA CRIXAS	NA12202054LD	NOVA CRIXAS	07/01/2020 00:50	08/01/2020 10:38	07/01/2020 16:50	07/01/2020 20:07	3,29	10	32,90	CHI
20200138712	NOVA CRIXAS	NA12095931LD	NOVA CRIXAS	07/01/2020 00:50	08/01/2020 10:38	07/01/2020 16:50	08/01/2020 00:27	7,62	23	175,22	CHI
20200138712	NOVA CRIXAS	NA12354877LD	NOVA CRIXAS	07/01/2020 00:50	08/01/2020 10:38	07/01/2020 16:50	08/01/2020 03:50	11,00	13	142,97	CHI
20200138712	NOVA CRIXAS	NA12354847LD	NOVA CRIXAS	07/01/2020 00:50	08/01/2020 10:38	07/01/2020 16:50	08/01/2020 08:10	15,34	8	122,70	CHI
20200138712	NOVA CRIXAS	NA12354855LD	NOVA CRIXAS	07/01/2020 00:50	08/01/2020 10:38	07/01/2020 16:50	08/01/2020 10:38	17,81	7	124,64	CHI
20200138712	NOVA CRIXAS	NA12334349	NOVA CRIXAS	07/01/2020 00:50	08/01/2020 10:38	08/01/2020 08:38	08/01/2020 10:38	2,01	79	158,70	CHI
20200138718	QUIRINOPOLIS	QI12101220	QUIRINOPOLIS	07/01/2020 07:15	07/01/2020 10:35	07/01/2020 07:15	07/01/2020 10:35	3,32	4	13,27	CHI
20200138720	CACHOEIRA ALTA	CA21384088	CACHOEIRA ALTA	07/01/2020 07:16	07/01/2020 08:30	07/01/2020 07:16	07/01/2020 08:30	1,23	1	1,23	CHI
20200138721	CAMPO ALEGRE DE GOIAS	CM21073555	CAMPO ALEGRE DE GOIAS	07/01/2020 07:16	07/01/2020 09:19	07/01/2020 07:16	07/01/2020 09:19	2,05	1	2,05	CHI
20200138722	MARA ROSA	MQ12313418	MARA ROSA	07/01/2020 06:02	07/01/2020 18:32	07/01/2020 06:02	07/01/2020 18:32	12,50	6	74,99	CHI
20200138725	NIQUELANDIA	2750068326	NIQUELANDIA SUBTRANSMISSAO	07/01/2020 07:16	07/01/2020 10:54	07/01/2020 07:16	07/01/2020 10:54	3,62	1	3,62	CHI



20200138727	ANICUNS	AC12104779	ANICUNS	07/01/2020 06:02	07/01/2020 08:45	07/01/2020 06:02	07/01/2020 08:45	2,72	12	32,66	CHI
20200138738	ISRAELANDIA	IS21358924	IPORA	07/01/2020 07:19	07/01/2020 14:25	07/01/2020 07:19	07/01/2020 14:25	7,10	1	7,10	CHI
20200138742	CAIAPONIA	CP12251344	CAIAPONIA	07/01/2020 07:20	07/01/2020 13:55	07/01/2020 07:20	07/01/2020 13:55	6,58	1	6,58	CHI
20200138743	PIRACANJUBA	PJ12412508	CRISTIANOPOLIS	07/01/2020 07:15	07/01/2020 09:56	07/01/2020 07:15	07/01/2020 09:56	2,67	12	32,05	CHI
20200138750	BURITINOPOLIS	BQ12262077	IACIARA S2	07/01/2020 07:20	07/01/2020 10:47	07/01/2020 07:20	07/01/2020 10:47	3,44	51	175,51	CHI
20200138751	PIRENOPOLIS	PV12285301	CORUMBA	07/01/2020 04:34	07/01/2020 10:07	07/01/2020 04:34	07/01/2020 10:07	5,54	54	299,33	CHI
20200138756	QUIRINOPOLIS	QI31249039	QUIRINOPOLIS	07/01/2020 07:22	07/01/2020 11:00	07/01/2020 07:22	07/01/2020 11:00	3,63	1	3,63	CHI
20200138758	AVELINOPOLIS	AV12020477	ANICUNS	07/01/2020 06:27	07/01/2020 10:25	07/01/2020 06:27	07/01/2020 10:25	3,98	6	23,86	CHI
20200138758	ITABERAI	AV12020477	ANICUNS	07/01/2020 06:27	07/01/2020 10:25	07/01/2020 06:27	07/01/2020 10:25	3,98	28	111,35	CHI
20200138760	TAQUARAL DE GOIAS	TQ12025614	ITABERAI S1	07/01/2020 04:24	07/01/2020 10:09	07/01/2020 04:24	07/01/2020 10:09	5,74	52	298,71	CHI
20200138763	CAMPINORTE	CR12190203	MARA ROSA	07/01/2020 07:23	07/01/2020 12:02	07/01/2020 07:23	07/01/2020 12:02	4,65	2	9,30	CHI
20200138764	RIO VERDE	RV12260701	CABRIUVA S1	07/01/2020 06:04	07/01/2020 10:56	07/01/2020 06:04	07/01/2020 10:56	4,86	2	9,73	CHI
20200138777	ITABERAI	IB12000076	ITABERAI S2	07/01/2020 07:25	07/01/2020 11:06	07/01/2020 07:25	07/01/2020 11:06	3,67	4	14,69	CHI
20200138780	DIORAMA	DI12060554	IPORA	07/01/2020 07:26	08/01/2020 01:39	07/01/2020 07:26	08/01/2020 01:39	18,22	7	127,51	CHI
20200138781	PALESTINA DE GOIAS	PY12138375	PALESTINA	07/01/2020 07:26	07/01/2020 13:02	07/01/2020 07:26	07/01/2020 13:02	5,59	24	134,19	CHI
20200138783	MORRO AGUDO DE GOIAS	MS12136795	ITAPURANGA	07/01/2020 06:56	07/01/2020 10:37	07/01/2020 06:56	07/01/2020 10:37	3,67	35	128,41	CHI
20200138785	GOIANDIRA	GD21143392	CATALAO S1	07/01/2020 07:27	07/01/2020 09:20	07/01/2020 07:27	07/01/2020 09:20	1,88	1	1,88	CHI
20200138786	GOIATUBA	GT11257180	GOIATUBA S2	07/01/2020 07:27	07/01/2020 10:16	07/01/2020 07:27	07/01/2020 10:16	2,81	54	151,49	CHI
20200138788	CACHOEIRA ALTA	CA12040843	CACHOEIRA ALTA	07/01/2020 07:27	07/01/2020 13:30	07/01/2020 07:27	07/01/2020 13:30	6,04	1	6,04	CHI
20200138791	PLANALTINA	PI21167022	PLANALTINA	07/01/2020 07:28	07/01/2020 13:43	07/01/2020 07:28	07/01/2020 13:43	6,25	1	6,25	CHI
20200138792	ITABERAI	IB12300069	ITABERAI S2	07/01/2020 07:28	07/01/2020 11:40	07/01/2020 07:28	07/01/2020 11:40	4,19	8	33,53	CHI
20200138796	MONTES CLAROS DE GOIAS	ME21354606	BRITANIA	07/01/2020 07:29	07/01/2020 13:13	07/01/2020 07:29	07/01/2020 13:13	5,73	1	5,73	CHI
20200138803	CATALAO	CT21344510	CATALAO S1	07/01/2020 07:29	07/01/2020 09:49	07/01/2020 07:29	07/01/2020 09:49	2,32	1	2,32	CHI
20200138804	PIRES DO RIO	460102930	PIRES DO RIO S1	07/01/2020 07:29	07/01/2020 11:13	07/01/2020 07:29	07/01/2020 11:13	3,72	1	3,72	CHI
20200138810	CAIAPONIA	CP12252503	CAIAPONIA	07/01/2020 07:30	07/01/2020 10:27	07/01/2020 07:30	07/01/2020 10:27	2,95	6	17,68	CHI
20200138811	ITAGUARI	II12172706	ITABERAI S1	07/01/2020 06:41	07/01/2020 13:21	07/01/2020 06:41	07/01/2020 13:21	6,65	14	93,15	CHI
20200138812	GOIANDIRA	GD21294347	CATALAO S1	07/01/2020 07:30	07/01/2020 13:01	07/01/2020 07:30	07/01/2020 13:01	5,51	1	5,51	CHI
20200138813	JUSSARA	JR21025083	BRITANIA	07/01/2020 07:30	07/01/2020 21:52	07/01/2020 07:30	07/01/2020 21:52	14,35	1	14,35	CHI
20200138816	MUNDO NOVO DE GOIAS	MH12394971	NOVA CRIXAS	07/01/2020 07:31	08/01/2020 16:46	07/01/2020 07:31	07/01/2020 15:50	8,31	5	41,57	CHI
20200138816	MUNDO NOVO DE GOIAS	6522612	NOVA CRIXAS	07/01/2020 07:31	08/01/2020 16:46	07/01/2020 07:31	08/01/2020 16:46	33,25	1	33,25	CHI
20200138817	GOIAS	GS11333809	GOIAS	07/01/2020 07:31	07/01/2020 12:27	07/01/2020 07:31	07/01/2020 12:27	4,93	1	4,93	CHI
20200138820	ITUMBIARA	CD12222343	CACHOEIRA DOURADA	07/01/2020 07:31	07/01/2020 17:33	07/01/2020 07:31	07/01/2020 17:33	10,04	6	60,22	CHI
20200138830	JUSSARA	JR21073372	BRITANIA	07/01/2020 07:33	07/01/2020 21:17	07/01/2020 07:33	07/01/2020 21:17	13,73	1	13,73	CHI

20200138837	SANTA CRUZ DE GOIAS	BC12231405	PIRES DO RIO S2	07/01/2020 07:34	07/01/2020 10:32	07/01/2020 07:34	07/01/2020 10:32	2,96	24	71,02	CHI
20200138838	ITAPACI	100000022	ITAPACI	07/01/2020 07:34	07/01/2020 09:34	07/01/2020 07:34	07/01/2020 09:34	1,99	1	1,99	CHI
20200138839	SAO MIGUEL DO ARAGUAIA	SM21104525	SAO MIGUEL DO ARAGUAIA	07/01/2020 07:34	07/01/2020 12:14	07/01/2020 07:34	07/01/2020 12:14	4,65	1	4,65	CHI
20200138840	RIO VERDE	RV21076164	CABRIUVA S2	07/01/2020 07:34	07/01/2020 09:20	07/01/2020 07:34	07/01/2020 09:20	1,75	1	1,75	CHI
20200138850	MONTIVIDIU	MV12267717	MONTIVIDIU T	07/01/2020 07:37	07/01/2020 23:22	07/01/2020 07:37	07/01/2020 23:22	15,75	2	31,50	CHI
20200138850	RIO VERDE	MV12267717	MONTIVIDIU T	07/01/2020 07:37	07/01/2020 23:22	07/01/2020 07:37	07/01/2020 23:22	15,75	2	31,50	CHI
20200138851	MOSSAMEDES	MD12206378	FIRMINOPOLIS S2	07/01/2020 07:23	07/01/2020 10:08	07/01/2020 07:23	07/01/2020 10:08	2,75	15	41,24	CHI
20200138853	CRISTALINA	KR21034740	PAMPLONA	07/01/2020 07:37	07/01/2020 12:00	07/01/2020 07:37	07/01/2020 12:00	4,37	1	4,37	CHI
20200138855	CIDADE OCIDENTAL	10030356383	MARAJOARA	07/01/2020 07:38	07/01/2020 11:29	07/01/2020 07:38	07/01/2020 11:29	3,85	1	3,85	CHI
20200138856	ANICUNS	AC12259100	ANICUNS	07/01/2020 07:38	07/01/2020 09:18	07/01/2020 07:38	07/01/2020 09:18	1,66	14	23,28	CHI
20200138859	JARAGUA	JA12112525	JARAGUA	07/01/2020 07:00	07/01/2020 16:19	07/01/2020 07:00	07/01/2020 16:19	9,31	12	111,69	CHI
20200138860	ARAGARCAS	1820049120	ARAGARCAS	07/01/2020 07:39	07/01/2020 10:29	07/01/2020 07:39	07/01/2020 10:29	2,83	1	2,83	CHI
20200138862	IVOLANDIA	IV12231193	ARENOPOLIS	07/01/2020 07:03	07/01/2020 10:10	07/01/2020 07:03	07/01/2020 10:10	3,10	10	31,01	CHI
20200138862	PALESTINA DE GOIAS	IV12231193	ARENOPOLIS	07/01/2020 07:03	07/01/2020 10:10	07/01/2020 07:03	07/01/2020 10:10	3,10	12	37,21	CHI
20200138863	PIRES DO RIO	460012642	PIRES DO RIO S1	07/01/2020 07:39	07/01/2020 09:44	07/01/2020 07:39	07/01/2020 09:44	2,08	1	2,08	CHI
20200138865	MORRO AGUDO DE GOIAS	MS12017328	ITAPURANGA	07/01/2020 07:39	07/01/2020 11:34	07/01/2020 07:39	07/01/2020 11:34	3,91	10	39,06	CHI
20200138866	CAMPOS VERDES	VD12251082	SANTA TEREZINHA	07/01/2020 05:54	07/01/2020 11:33	07/01/2020 05:54	07/01/2020 11:33	5,65	4	22,58	CHI
20200138866	SANTA TEREZINHA DE GOIAS	VD12251082	SANTA TEREZINHA	07/01/2020 05:54	07/01/2020 11:33	07/01/2020 05:54	07/01/2020 11:33	5,65	17	95,97	CHI
20200138868	NOVA IGUACU DE GOIAS	NH12181620	CAMPINORTE	07/01/2020 07:40	07/01/2020 14:10	07/01/2020 07:40	07/01/2020 14:10	6,50	6	38,97	CHI
20200138871	GUARINOS	GF12164881	SANTA TEREZINHA	07/01/2020 07:40	07/01/2020 11:35	07/01/2020 07:40	07/01/2020 11:35	3,91	36	140,59	CHI
20200138873	IPAMERI	IP11089951	IPAMERI	07/01/2020 06:01	07/01/2020 08:50	07/01/2020 06:01	07/01/2020 08:50	2,83	217	613,27	CHI
20200138876	ARUANA	AK12310740	ARUANA	07/01/2020 05:56	07/01/2020 10:52	07/01/2020 05:56	07/01/2020 10:52	4,92	12	59,04	CHI
20200138878	SAO JOAO D ALIANCA	JL21268109	FLORES DE GOIAS	07/01/2020 07:41	07/01/2020 11:22	07/01/2020 07:41	07/01/2020 11:22	3,67	1	3,67	CHI
20200138884	BURITI ALEGRE	420028559	ALTO BURITI	07/01/2020 07:42	07/01/2020 10:06	07/01/2020 07:42	07/01/2020 10:06	2,39	1	2,39	CHI
20200138885	NAZARIO	NZ21113765	ANICUNS	07/01/2020 07:42	07/01/2020 11:05	07/01/2020 07:42	07/01/2020 11:05	3,37	1	3,37	CHI
20200138887	JARAGUA	70037073	JARAGUA	07/01/2020 07:42	07/01/2020 13:53	07/01/2020 07:42	07/01/2020 13:53	6,17	1	6,17	CHI
20200138890	COLINAS DO SUL	TI12239194	MINACU	07/01/2020 07:43	07/01/2020 10:57	07/01/2020 07:43	07/01/2020 10:57	3,23	1	3,23	CHI
20200138893	GOIATUBA	GT21048514	GOIATUBA S2	07/01/2020 07:43	07/01/2020 12:07	07/01/2020 07:43	07/01/2020 12:07	4,39	1	4,39	CHI
20200138908	MINEIROS	MY21102165	PARQUE DAS EMAS	07/01/2020 07:45	07/01/2020 12:28	07/01/2020 07:45	07/01/2020 12:28	4,71	1	4,71	CHI
20200138909	MINEIROS	MY21252484	PARQUE DAS EMAS	07/01/2020 07:45	07/01/2020 15:09	07/01/2020 07:45	07/01/2020 15:09	7,39	3	22,17	CHI
20200138913	CRISTALINA	KR21096915	PAMPLONA	07/01/2020 07:45	07/01/2020 12:54	07/01/2020 07:45	07/01/2020 12:54	5,14	2	10,27	CHI
20200138919	EDEIA	EA12086939	EDEIA	07/01/2020 06:15	07/01/2020 09:02	07/01/2020 06:15	07/01/2020 09:02	2,78	9	25,01	CHI
20200138923	POSSE	PS12235293	IACIARA S2	07/01/2020 07:47	07/01/2020 11:33	07/01/2020 07:47	07/01/2020 11:33	3,76	23	86,38	CHI

20200138924	TROMBAS	TB12185404	PORANGATU	06/01/2020 20:08	07/01/2020 12:43	06/01/2020 20:08	07/01/2020 12:43	16,57	3	49,71	CHI
20200138925	URUACU	UR12003395	URUACU	07/01/2020 07:47	07/01/2020 11:12	07/01/2020 07:47	07/01/2020 11:12	3,40	8	27,20	CHI
20200138932	PORANGATU	PO12365598	PORANGATU	07/01/2020 06:57	07/01/2020 14:35	07/01/2020 06:57	07/01/2020 14:35	7,62	8	60,99	CHI
20200138937	PALMEIRAS DE GOIAS	PL21034687	PALMEIRAS	07/01/2020 07:51	07/01/2020 08:50	07/01/2020 07:51	07/01/2020 08:50	0,97	2	1,95	CHI
20200138938	ALEXANIA	480012271	ALEXANIA	07/01/2020 07:51	07/01/2020 14:36	07/01/2020 07:51	07/01/2020 14:36	6,74	1	6,74	CHI
20200138940	ACREUNA	2440006033	ACREUNA	07/01/2020 07:51	07/01/2020 11:56	07/01/2020 07:51	07/01/2020 11:56	4,07	1	4,07	CHI
20200138942	JARAGUA	JA12284958	JARAGUA	07/01/2020 07:17	07/01/2020 10:21	07/01/2020 07:17	07/01/2020 10:21	3,06	4	12,23	CHI
20200138951	ITABERAI	IB11282419	ITABERAI S2	07/01/2020 07:54	07/01/2020 09:03	07/01/2020 07:54	07/01/2020 09:03	1,14	82	93,64	CHI
20200138952	ITUMBIARA	IT21352730	ITUMBIARA VELHA S1	07/01/2020 07:54	07/01/2020 08:43	07/01/2020 07:54	07/01/2020 08:43	0,81	2	1,62	CHI
20200138959	TRES RANCHOS	TH12149128	CATALAO S1	07/01/2020 07:55	07/01/2020 09:25	07/01/2020 07:55	07/01/2020 09:25	1,49	137	204,66	CHI
20200138961	SILVANIA	LB21164101	DAIA S2	07/01/2020 07:55	07/01/2020 10:53	07/01/2020 07:55	07/01/2020 10:53	2,96	2	5,92	CHI
20200138962	MAIRIPOTABA	MI12000233	PONTALINA	07/01/2020 07:55	07/01/2020 10:46	07/01/2020 07:55	07/01/2020 10:46	2,84	14	39,76	CHI
20200138964	MOSSAMEDES	MD21121031	ITABERAI S2	07/01/2020 07:55	07/01/2020 18:43	07/01/2020 07:55	07/01/2020 18:43	10,79	1	10,79	CHI
20200138969	MARZAGAO	MG12391590	VILA CORUMBA	07/01/2020 07:56	07/01/2020 10:46	07/01/2020 07:56	07/01/2020 10:46	2,82	2	5,63	CHI
20200138970	RUBIATABA	RB21062090	RUBIATABA	07/01/2020 07:57	07/01/2020 11:34	07/01/2020 07:57	07/01/2020 11:34	3,60	1	3,60	CHI
20200138972	CAMPINORTE	CR12078290	MARA ROSA	07/01/2020 07:58	07/01/2020 12:06	07/01/2020 07:58	07/01/2020 12:06	4,13	5	20,66	CHI
20200138975	JATAI	JT12378137	JATAI S2	07/01/2020 07:58	07/01/2020 09:56	07/01/2020 07:58	07/01/2020 09:56	1,95	8	15,61	CHI
20200138978	ALEXANIA	AX11049456	ALEXANIA	07/01/2020 06:55	07/01/2020 17:40	07/01/2020 16:10	07/01/2020 17:40	1,50	147	220,54	CHI
20200138979	PIRACANJUBA	PJ12039733	PIRACANJUBA	07/01/2020 07:59	07/01/2020 11:22	07/01/2020 07:59	07/01/2020 11:22	3,37	25	84,27	CHI
20200138980	ANAPOLIS	10004654089	ANAPOLIS UNIVERSITARIO S2	07/01/2020 08:00	07/01/2020 11:19	07/01/2020 08:00	07/01/2020 11:19	3,31	1	3,31	CHI
20200138985	NOVA GLORIA	IW12181408	RUBIATABA	07/01/2020 08:01	07/01/2020 10:04	07/01/2020 08:01	07/01/2020 10:04	2,05	10	20,49	CHI
20200138985	NOVA GLORIA	NG12181391	RUBIATABA	07/01/2020 08:01	07/01/2020 10:04	07/01/2020 08:01	07/01/2020 10:04	2,05	11	22,53	CHI
20200138988	APORE	AE12343398	ITAJA S1	07/01/2020 08:01	07/01/2020 11:54	07/01/2020 08:01	07/01/2020 11:54	3,87	2	7,74	CHI
20200138995	BOM JARDIM DE GOIAS	BM12155744	BOM JARDIM	07/01/2020 07:05	07/01/2020 14:25	07/01/2020 07:05	07/01/2020 14:25	7,32	4	29,30	CHI
20200138997	SAO MIGUEL DO ARAGUAIA	SM12170986	SAO MIGUEL DO ARAGUAIA	07/01/2020 08:03	07/01/2020 11:45	07/01/2020 08:03	07/01/2020 11:45	3,71	2	7,41	CHI
20200138998	BALIZA	BH21239202	BOM JARDIM	07/01/2020 08:03	07/01/2020 10:28	07/01/2020 08:03	07/01/2020 10:28	2,40	1	2,40	CHI
20200139000	RIO VERDE	630058416	RIO VERDE S2	07/01/2020 08:04	07/01/2020 12:29	07/01/2020 08:04	07/01/2020 12:29	4,41	1	4,41	CHI
20200139008	FAZENDA NOVA	FN21019383	JUSSARA	07/01/2020 08:04	08/01/2020 08:42	07/01/2020 08:04	08/01/2020 08:42	24,62	1	24,62	CHI
20200139009	ITUMBIARA	IT12352760	PARANAIBA	07/01/2020 08:04	07/01/2020 11:44	07/01/2020 08:04	07/01/2020 11:44	3,65	4	14,60	CHI
20200139011	JARAGUA	JA12000124	JARAGUA	07/01/2020 08:05	07/01/2020 11:38	07/01/2020 08:05	07/01/2020 11:38	3,55	15	53,18	CHI
20200139015	ACREUNA	2440052158	ACREUNA	07/01/2020 08:03	07/01/2020 15:48	07/01/2020 08:03	07/01/2020 15:48	7,73	1	7,73	CHI
20200139018	PIRENOPOLIS	PV11090372	SAO FRANCISCO DE GOIAS	07/01/2020 08:05	07/01/2020 14:40	07/01/2020 08:05	07/01/2020 14:40	6,57	77	505,89	CHI
20200139022	LEOPOLDO DE BULHOES	LB12100600	DAIA S2	07/01/2020 08:06	07/01/2020 10:22	07/01/2020 08:06	07/01/2020 10:22	2,26	50	113,01	CHI

20200139023	ARAGUAPAZ	AZ21042920	MOZARLANDIA	07/01/2020 08:06	07/01/2020 13:57	07/01/2020 08:06	07/01/2020 13:57	5,84	1	5,84	CHI
20200139028	EDEALINA	PK13263479	PONTALINA	07/01/2020 05:50	08/01/2020 12:16	07/01/2020 22:10	08/01/2020 12:16	14,10	28	394,81	CHI
20200139028	PONTALINA	PK13263479	PONTALINA	07/01/2020 05:50	08/01/2020 12:16	07/01/2020 22:10	08/01/2020 12:16	14,10	59	831,92	CHI
20200139035	PIRACANJUBA	PJ12212220	PIRACANJUBA	07/01/2020 08:08	07/01/2020 12:42	07/01/2020 08:08	07/01/2020 12:42	4,56	16	73,00	CHI
20200139047	RIO VERDE	RV12024714	RIO VERDE S1	07/01/2020 07:45	07/01/2020 10:46	07/01/2020 07:45	07/01/2020 10:46	3,00	5	15,02	CHI
20200139048	HIDROLINA	UR12374713	URUACU	07/01/2020 05:44	07/01/2020 09:35	07/01/2020 05:44	07/01/2020 09:35	3,84	4	15,34	CHI
20200139048	URUACU	UR12374713	URUACU	07/01/2020 05:44	07/01/2020 09:35	07/01/2020 05:44	07/01/2020 09:35	3,84	3	11,51	CHI
20200139051	PIRENOPOLIS	PV12366314	CORUMBA	07/01/2020 08:10	07/01/2020 09:43	07/01/2020 08:10	07/01/2020 09:43	1,53	3	4,60	CHI
20200139052	RIO VERDE	RV21054357	MONTIVIDIU T	07/01/2020 08:10	07/01/2020 12:20	07/01/2020 08:10	07/01/2020 12:20	4,15	1	4,15	CHI
20200139055	SERRANOPOLIS	SX12172839	CHAPADAO DO CEU	07/01/2020 07:32	08/01/2020 09:02	07/01/2020 07:32	08/01/2020 09:02	25,49	25	637,24	CHI
20200139056	SANTO ANTONIO DO DESCOBERTO	SN12379433	ALEXANIA	07/01/2020 07:54	07/01/2020 10:16	07/01/2020 07:54	07/01/2020 10:16	2,36	24	56,75	CHI
20200139060	NOVA CRIXAS	8570006319	NOVA CRIXAS	07/01/2020 08:11	07/01/2020 11:04	07/01/2020 08:11	07/01/2020 11:04	2,87	1	2,87	CHI
20200139065	JUSSARA	JR12076133	BRITANIA	07/01/2020 08:12	07/01/2020 15:14	07/01/2020 08:12	07/01/2020 15:14	7,03	3	21,08	CHI
20200139066	PILAR DE GOIAS	HL12238601	SANTA TEREZINHA	07/01/2020 08:12	07/01/2020 14:20	07/01/2020 08:12	07/01/2020 14:20	6,13	8	49,00	CHI
20200139068	QUIRINOPOLIS	QI21279792	QUIRINOPOLIS	07/01/2020 08:12	07/01/2020 15:54	07/01/2020 08:12	07/01/2020 15:54	7,69	1	7,69	CHI
20200139072	BOM JARDIM DE GOIAS	BM12231130	BOM JARDIM	07/01/2020 08:13	07/01/2020 10:03	07/01/2020 08:13	07/01/2020 10:03	1,83	10	18,31	CHI
20200139073	SERRANOPOLIS	SX12296496	JATAI S1	07/01/2020 07:33	07/01/2020 10:16	07/01/2020 07:33	07/01/2020 10:16	2,70	143	386,46	CHI
20200139075	BOM JESUS DE GOIAS	BJ12205369	BOM JESUS DE GOIAS	07/01/2020 08:13	07/01/2020 10:55	07/01/2020 08:13	07/01/2020 10:55	2,70	2	5,39	CHI
20200139079	MINEIROS	MY12305765	PARQUE DAS EMAS	07/01/2020 08:14	07/01/2020 14:26	07/01/2020 08:14	07/01/2020 14:26	6,20	6	37,17	CHI
20200139084	MINEIROS	MY12233970	PARQUE DAS EMAS	07/01/2020 08:15	07/01/2020 16:47	07/01/2020 08:15	07/01/2020 16:47	8,53	1	8,53	CHI
20200139085	ABADIANIA	AN12221398	ANAPOLIS UNIVERSITARIO S2	07/01/2020 08:15	07/01/2020 16:37	07/01/2020 08:15	07/01/2020 16:37	8,36	13	108,74	CHI
20200139085	PIRENOPOLIS	AN12221398	ANAPOLIS UNIVERSITARIO S2	07/01/2020 08:15	07/01/2020 16:37	07/01/2020 08:15	07/01/2020 16:37	8,36	7	58,55	CHI
20200139086	ANAPOLIS	AN12258789	ANAPOLIS UNIVERSITARIO S1	07/01/2020 08:14	07/01/2020 10:39	07/01/2020 08:14	07/01/2020 10:39	2,40	13	31,24	CHI
20200139088	FORMOSA	10014303513	ITUIQUIRA	07/01/2020 08:15	07/01/2020 10:16	07/01/2020 08:15	07/01/2020 10:16	2,01	1	2,01	CHI
20200139090	LUZIANIA	LZ21000395	PACAEMBU S1	07/01/2020 08:15	07/01/2020 15:50	07/01/2020 08:15	07/01/2020 15:50	7,59	1	7,59	CHI
20200139092	URUACU	5940001020	URUACU	07/01/2020 08:16	07/01/2020 12:09	07/01/2020 08:16	07/01/2020 12:09	3,88	1	3,88	CHI
20200139093	CRISTALINA	7506329	PAMPLONA	07/01/2020 08:16	07/01/2020 14:26	07/01/2020 08:16	07/01/2020 14:26	6,16	2	12,33	CHI
20200139096	JATAI	JT21150349	CACHOEIRA ALTA	07/01/2020 08:16	07/01/2020 15:30	07/01/2020 08:16	07/01/2020 15:30	7,22	1	7,22	CHI
20200139101	AGUAS LINDAS DE GOIAS	4830187233	AGUAS LINDAS DE GOIAS S1	07/01/2020 08:17	07/01/2020 10:46	07/01/2020 08:17	07/01/2020 10:46	2,47	1	2,47	CHI
20200139102	APORE	AE21000007	ITAJA S1	07/01/2020 08:17	07/01/2020 09:58	07/01/2020 08:17	07/01/2020 09:58	1,67	1	1,67	CHI
20200139110	ANAPOLIS	10013080774	JUNDIAI S1	07/01/2020 08:18	07/01/2020 11:18	07/01/2020 08:18	07/01/2020 11:18	2,99	1	2,99	CHI
20200139112	CATALAO	1990055191	CATALAO S2	07/01/2020 08:19	07/01/2020 09:42	07/01/2020 08:19	07/01/2020 09:42	1,38	1	1,38	CHI
20200139117	LEOPOLDO DE BULHOES	LB12353166	DAIA S2	07/01/2020 07:29	07/01/2020 14:37	07/01/2020 07:29	07/01/2020 14:37	7,13	3	21,40	CHI

20200139130	MONTIVIDIU	2840024968	MONTIVIDIU T	07/01/2020 08:21	07/01/2020 12:25	07/01/2020 08:21	07/01/2020 12:25	4,06	1	4,06	CHI
20200139137	AGUAS LINDAS DE GOIAS	10012526515	AGUAS LINDAS DE GOIAS S1	07/01/2020 08:22	07/01/2020 11:21	07/01/2020 08:22	07/01/2020 11:21	2,98	1	2,98	CHI
20200139141	CRISTALINA	1060115016	CRISTALINA S1	07/01/2020 08:22	07/01/2020 16:40	07/01/2020 08:22	07/01/2020 16:40	8,30	1	8,30	CHI
20200139143	ANAPOLIS	AN12351048	ANAPOLIS UNIVERSITARIO S2	07/01/2020 08:23	07/01/2020 12:25	07/01/2020 08:23	07/01/2020 12:25	4,03	17	68,52	CHI
20200139145	GOIANESIA	GE12000129	GOIANESIA S1	07/01/2020 07:20	07/01/2020 12:39	07/01/2020 07:20	07/01/2020 12:39	5,33	3	15,99	CHI
20200139155	PONTALINA	PK32046032	PONTALINA	07/01/2020 08:25	07/01/2020 10:24	07/01/2020 08:25	07/01/2020 10:24	1,97	15	29,57	CHI
20200139157	NIQUELANDIA	NQ12262921	BARRO ALTO	07/01/2020 08:26	07/01/2020 20:47	07/01/2020 08:26	07/01/2020 20:47	12,34	6	74,06	CHI
20200139158	LUZIANIA	10024555574	RIO VERMELHO	07/01/2020 08:26	07/01/2020 11:27	07/01/2020 08:26	07/01/2020 11:27	3,01	1	3,01	CHI
20200139159	NAZARIO	440003507	ANICUNS	07/01/2020 08:26	07/01/2020 12:25	07/01/2020 08:26	07/01/2020 12:25	3,97	1	3,97	CHI
20200139164	GOIANESIA	GE21292273	GOIANESIA S1	07/01/2020 08:26	07/01/2020 11:04	07/01/2020 08:26	07/01/2020 11:04	2,62	1	2,62	CHI
20200139166	RIO VERDE	630290623	RIO VERDE S2	07/01/2020 08:28	07/01/2020 11:12	07/01/2020 08:28	07/01/2020 11:12	2,73	1	2,73	CHI
20200139168	PARAUNA	PU21030318	ACREUNA	07/01/2020 08:27	08/01/2020 11:26	07/01/2020 08:27	08/01/2020 11:26	26,97	1	26,97	CHI
20200139171	SANTO ANTONIO DO DESCOBERTO	2210030013	AGUAS LINDAS DE GOIAS S2	07/01/2020 08:28	07/01/2020 14:49	07/01/2020 08:28	07/01/2020 14:49	6,33	1	6,33	CHI
20200139175	LAGOA SANTA	IJ21148243	CACHOEIRA ALTA	07/01/2020 08:29	07/01/2020 21:00	07/01/2020 08:29	07/01/2020 21:00	12,52	1	12,52	CHI
20200139178	ANAPOLIS	20538285	JUNDIAI S1	07/01/2020 08:29	07/01/2020 15:00	07/01/2020 08:29	07/01/2020 15:00	6,51	1	6,51	CHI
20200139181	PALMEIRAS DE GOIAS	PL21129778	PALMEIRAS	07/01/2020 08:30	07/01/2020 09:51	07/01/2020 08:30	07/01/2020 09:51	1,34	2	2,67	CHI
20200139189	FAZENDA NOVA	1080003852	JUSSARA	07/01/2020 08:31	07/01/2020 13:14	07/01/2020 08:31	07/01/2020 13:14	4,70	1	4,70	CHI
20200139190	JUSSARA	1290028312	JUSSARA	07/01/2020 08:31	07/01/2020 18:32	07/01/2020 08:31	07/01/2020 18:32	10,01	1	10,01	CHI
20200139193	AURILANDIA	AI12215430	FIRMINOPOLIS S2	07/01/2020 08:31	07/01/2020 10:30	07/01/2020 08:31	07/01/2020 10:30	1,97	9	17,77	CHI
20200139193	FIRMINOPOLIS	AI12215430	FIRMINOPOLIS S2	07/01/2020 08:31	07/01/2020 10:30	07/01/2020 08:31	07/01/2020 10:30	1,97	7	13,82	CHI
20200139195	URUTAI	UT21336153	URUTAI	07/01/2020 08:32	07/01/2020 15:07	07/01/2020 08:32	07/01/2020 15:07	6,58	1	6,58	CHI
20200139205	ANAPOLIS	AN12258779	JUNDIAI S1	07/01/2020 08:35	07/01/2020 12:00	07/01/2020 08:35	07/01/2020 12:00	3,40	4	13,62	CHI
20200139206	NIQUELANDIA	NQ12371149	SAO JOAO D ALIANCA	07/01/2020 08:35	07/01/2020 11:37	07/01/2020 08:35	07/01/2020 11:37	3,03	35	106,14	CHI
20200139210	JAUPACI	JP12349752	IPORA	07/01/2020 08:36	07/01/2020 15:51	07/01/2020 08:36	07/01/2020 15:51	7,25	41	297,34	CHI
20200139214	ABADIANIA	AA12057569	ANAPOLIS UNIVERSITARIO S1	07/01/2020 08:36	07/01/2020 17:14	07/01/2020 08:36	07/01/2020 17:14	8,62	9	77,58	CHI
20200139218	JARAGUA	70066085	JARAGUA	07/01/2020 08:37	07/01/2020 15:08	07/01/2020 08:37	07/01/2020 15:08	6,52	1	6,52	CHI
20200139219	CATALAO	CT21152870	CATALAO S1	07/01/2020 08:37	07/01/2020 16:35	07/01/2020 08:37	07/01/2020 16:35	7,96	1	7,96	CHI
20200139224	PANAMA	PX12057616	GOIATUBA S1	07/01/2020 07:43	07/01/2020 11:46	07/01/2020 07:43	07/01/2020 11:46	4,03	45	181,53	CHI
20200139226	ITAPIRAPUA	IU12067919	MATRINCHA	07/01/2020 08:38	07/01/2020 15:02	07/01/2020 08:38	07/01/2020 15:02	6,39	8	51,08	CHI
20200139232	AGUA LIMPA	AL12193151	VILA CORUMBA	07/01/2020 08:39	07/01/2020 18:51	07/01/2020 14:08	07/01/2020 18:51	4,72	9	42,46	CHI
20200139238	URUTAI	UT21075965	PIRES DO RIO S2	07/01/2020 08:42	07/01/2020 13:42	07/01/2020 08:42	07/01/2020 13:42	5,00	1	5,00	CHI
20200139244	SAO LUIS DE MONTES BELOS	SL21019520	SAO LUIZ DOS MONTES BELOS	07/01/2020 08:43	07/01/2020 09:16	07/01/2020 08:43	07/01/2020 09:16	0,55	1	0,55	CHI
20200139251	CIDADE OCIDENTAL	2680059755	MARAJOARA	07/01/2020 08:44	07/01/2020 12:19	07/01/2020 08:44	07/01/2020 12:19	3,57	1	3,57	CHI

20200139255	NIQUELANDIA	2750133860	NIQUELANDIA SUBTRANSMISSAO	07/01/2020 08:45	07/01/2020 21:20	07/01/2020 08:45	07/01/2020 21:20	12,59	1	12,59	CHI
20200139257	RIO VERDE	RV21267675	CABRIUVA S2	07/01/2020 08:45	07/01/2020 11:28	07/01/2020 08:45	07/01/2020 11:28	2,70	1	2,70	CHI
20200139260	MAIRIPOTABA	MI12060664	PONTALINA	07/01/2020 08:46	07/01/2020 16:08	07/01/2020 08:46	07/01/2020 16:08	7,36	2	14,72	CHI
20200139263	LUZIANIA	LZ12065471LD	MARAJOARA	07/01/2020 08:47	07/01/2020 16:40	07/01/2020 11:16	07/01/2020 16:40	5,40	1	5,40	CHI
20200139264	CRISTALINA	KR21183840	PAMPLONA	07/01/2020 08:44	07/01/2020 15:37	07/01/2020 08:44	07/01/2020 15:37	6,88	1	6,88	CHI
20200139266	BURITI ALEGRE	BG12222481	ALTO BURITI	07/01/2020 08:47	07/01/2020 10:21	07/01/2020 08:47	07/01/2020 10:21	1,56	17	26,57	CHI
20200139272	GOIAS	GS12093357	MATRINCHA	07/01/2020 08:37	07/01/2020 15:37	07/01/2020 08:37	07/01/2020 15:37	6,99	7	48,92	CHI
20200139274	SAO MIGUEL DO ARAGUAIA	SM12334354	SAO MIGUEL DO ARAGUAIA	07/01/2020 08:47	07/01/2020 22:59	07/01/2020 08:47	07/01/2020 22:59	14,18	1	14,18	CHI
20200139275	SANTA RITA DO NOVO DESTINO	BA21154649	BARRO ALTO	07/01/2020 08:48	08/01/2020 01:06	07/01/2020 08:48	08/01/2020 01:06	16,30	1	16,30	CHI
20200139276	DOVERLANDIA	DV11251413	CAIAPONIA	07/01/2020 08:48	07/01/2020 11:34	07/01/2020 08:48	07/01/2020 11:34	2,76	118	325,84	CHI
20200139280	ARAGUAPAZ	AZ12329923	MOZARLANDIA	07/01/2020 08:48	07/01/2020 15:31	07/01/2020 08:48	07/01/2020 15:31	6,70	3	20,11	CHI
20200139286	ABADIANIA	AA21127335	DAIA S2	07/01/2020 08:49	07/01/2020 12:16	07/01/2020 08:49	07/01/2020 12:16	3,44	3	10,32	CHI
20200139288	ANAPOLIS	10000109701	JUNDIAI S1	07/01/2020 08:49	07/01/2020 13:19	07/01/2020 08:49	07/01/2020 13:19	4,49	1	4,49	CHI
20200139291	ITAPURANGA	IK21287003	ITAPURANGA	07/01/2020 08:49	07/01/2020 12:49	07/01/2020 08:49	07/01/2020 12:49	3,98	1	3,98	CHI
20200139294	MINEIROS	MY21260444	PARQUE DAS EMAS	07/01/2020 08:50	07/01/2020 13:04	07/01/2020 08:50	07/01/2020 13:04	4,23	1	4,23	CHI
20200139299	BOM JARDIM DE GOIAS	BM21184313	BOM JARDIM	07/01/2020 08:51	07/01/2020 10:56	07/01/2020 08:51	07/01/2020 10:56	2,07	1	2,07	CHI
20200139300	PONTALINA	PK12181924	VICENTINOPOLIS	07/01/2020 08:52	07/01/2020 11:40	07/01/2020 08:52	07/01/2020 11:40	2,79	21	58,65	CHI
20200139314	GOIANDIRA	CT21152875	CATALAO S1	07/01/2020 08:55	08/01/2020 00:18	07/01/2020 08:55	08/01/2020 00:18	15,37	1	15,37	CHI
20200139316	CATALAO	CT21130165	CATALAO S1	07/01/2020 08:55	07/01/2020 22:27	07/01/2020 08:55	07/01/2020 22:27	13,52	1	13,52	CHI
20200139331	FORMOSA	610217150	ITUIQUIRA	07/01/2020 08:58	07/01/2020 12:02	07/01/2020 08:58	07/01/2020 12:02	3,06	1	3,06	CHI
20200139332	QUIRINOPOLIS	QI12279796	QUIRINOPOLIS	07/01/2020 08:58	07/01/2020 15:19	07/01/2020 08:58	07/01/2020 15:19	6,35	11	69,81	CHI
20200139351	LEOPOLDO DE BULHOES	LB21353177	DAIA S2	07/01/2020 07:29	07/01/2020 18:53	07/01/2020 07:29	07/01/2020 18:53	11,40	1	11,40	CHI
20200139354	JUSSARA	JR12250544	BRITANIA	07/01/2020 07:49	07/01/2020 14:58	07/01/2020 07:49	07/01/2020 14:58	7,14	30	214,12	CHI
20200139368	ANAPOLIS	AN12196926	DAIA S1	07/01/2020 08:22	07/01/2020 11:07	07/01/2020 08:22	07/01/2020 11:07	2,75	5	13,73	CHI
20200139380	CACHOEIRA ALTA	CA12014743RE	CACHOEIRA ALTA	07/01/2020 07:33	07/01/2020 14:00	07/01/2020 07:33	07/01/2020 14:00	6,44	63	405,74	CHI
20200139516	AURILANDIA	AI12071814	FIRMINOPOLIS S2	07/01/2020 05:01	07/01/2020 16:50	07/01/2020 05:01	07/01/2020 16:50	11,81	11	129,91	CHI
20200139517	JARAGUA	JA12353232	GOIANESIA S2	07/01/2020 06:38	07/01/2020 18:01	07/01/2020 06:38	07/01/2020 18:01	11,37	31	352,42	CHI
20200139558	DAMIANOPOLIS	SI12099838	IACIARA S2	07/01/2020 07:24	07/01/2020 12:18	07/01/2020 07:24	07/01/2020 12:18	4,91	36	176,92	CHI
20200139558	SITIO D ABADIA	SI12099838	IACIARA S2	07/01/2020 07:24	07/01/2020 12:18	07/01/2020 07:24	07/01/2020 12:18	4,91	231	1135,24	CHI
20200139569	PIRES DO RIO	OZ12372381	PIRES DO RIO S2	07/01/2020 08:17	08/01/2020 12:49	07/01/2020 08:17	07/01/2020 18:47	10,49	5	52,46	CHI
20200139569	PIRES DO RIO	OZ12372381	PIRES DO RIO S2	07/01/2020 08:17	08/01/2020 12:49	07/01/2020 08:17	07/01/2020 20:35	12,29	2	24,58	CHI
20200139569	PIRES DO RIO	OZ12372381	PIRES DO RIO S2	07/01/2020 08:17	08/01/2020 12:49	07/01/2020 19:00	07/01/2020 20:35	1,58	5	7,89	CHI
20200139569	PIRES DO RIO	OZ12372381	PIRES DO RIO S2	07/01/2020 08:17	08/01/2020 12:49	08/01/2020 09:35	08/01/2020 12:08	2,55	7	17,86	CHI

20200139569	PIRES DO RIO	VN12159654LD	PIRES DO RIO S2	07/01/2020 08:17	08/01/2020 12:49	07/01/2020 08:17	08/01/2020 12:49	28,52	3	85,57	CHI
20200139569	VIANOPOLIS	VN12159654LD	PIRES DO RIO S2	07/01/2020 08:17	08/01/2020 12:49	07/01/2020 08:17	08/01/2020 12:49	28,52	19	541,97	CHI
20200139603	MOZARLANDIA	MZ21141956	MOZARLANDIA	06/01/2020 19:24	07/01/2020 15:25	06/01/2020 19:24	07/01/2020 15:25	20,02	1	20,02	CHI
20200139630	GOIANESIA	GE21229845	GOIANESIA S1	07/01/2020 08:28	08/01/2020 08:30	08/01/2020 08:03	08/01/2020 08:30	0,45	1	0,45	CHI
20200139663	RIO VERDE	RV21240540	MONTIVIDIU T	06/01/2020 17:51	07/01/2020 15:31	06/01/2020 17:51	07/01/2020 15:31	21,66	1	21,66	CHI
20200139729	SERRANOPOLIS	SX12226484	JATAI S1	07/01/2020 08:30	07/01/2020 19:57	07/01/2020 08:30	07/01/2020 19:57	11,45	14	160,25	CHI
20200139739	APARECIDA DO RIO DOCE	AW12189038	CACHOEIRA ALTA	07/01/2020 08:49	09/01/2020 12:31	07/01/2020 08:49	07/01/2020 16:46	7,95	5	39,74	CHI
20200139739	APARECIDA DO RIO DOCE	AW12189038	CACHOEIRA ALTA	07/01/2020 08:49	09/01/2020 12:31	07/01/2020 08:49	09/01/2020 12:31	51,70	20	1033,92	CHI
20200139792	LUZIANIA	LZ21329605	PIRES DO RIO S2	07/01/2020 08:47	07/01/2020 14:54	07/01/2020 08:47	07/01/2020 14:54	6,11	1	6,11	CHI
20200139889	BARRO ALTO	SJ12006466	GOIANESIA S1	07/01/2020 07:29	07/01/2020 19:24	07/01/2020 07:29	07/01/2020 19:24	11,91	1	11,91	CHI
20200139889	GOIANESIA	SJ12006466	GOIANESIA S1	07/01/2020 07:29	07/01/2020 19:24	07/01/2020 07:29	07/01/2020 19:24	11,91	7	83,40	CHI
20200139889	VILA PROPICIO	SJ12006466	GOIANESIA S1	07/01/2020 07:29	07/01/2020 19:24	07/01/2020 07:29	07/01/2020 19:24	11,91	1	11,91	CHI
20200139910	JARAGUA	JA12273177	JARAGUA	07/01/2020 06:19	07/01/2020 17:50	07/01/2020 06:19	07/01/2020 17:50	11,52	7	80,61	CHI
20200140004	CAIAPONIA	CP12193263	MONTIVIDIU T	07/01/2020 08:41	08/01/2020 09:37	07/01/2020 08:41	08/01/2020 09:37	24,93	8	199,44	CHI
20200140046	GOIANESIA	BA12163310	GOIANESIA S1	07/01/2020 06:31	07/01/2020 21:16	07/01/2020 06:31	07/01/2020 21:16	14,74	2	29,48	CHI
20200140046	VILA PROPICIO	BA12163310	GOIANESIA S1	07/01/2020 06:31	07/01/2020 21:16	07/01/2020 06:31	07/01/2020 21:16	14,74	11	162,12	CHI
20200140134	PORANGATU	PO12391918	PORANGATU	07/01/2020 08:49	07/01/2020 14:26	07/01/2020 08:49	07/01/2020 14:26	5,61	11	61,67	CHI
20200140158	PADRE BERNARDO	PB12333235	PADRE BERNARDO	07/01/2020 06:34	07/01/2020 14:04	07/01/2020 06:34	07/01/2020 14:04	7,49	25	187,24	CHI
20200140453	ALEXANIA	AX12095963	ALEXANIA	07/01/2020 08:46	07/01/2020 16:21	07/01/2020 08:46	07/01/2020 16:21	7,58	3	22,74	CHI
20200141111	MIMOSO DE GOIAS	MJ12377239	PADRE BERNARDO	07/01/2020 06:33	07/01/2020 19:15	07/01/2020 06:33	07/01/2020 19:15	12,70	5	63,50	CHI
20200141302	TURVELANDIA	TD12213301	RIO DOS BOIS	07/01/2020 08:28	08/01/2020 15:14	07/01/2020 08:28	08/01/2020 11:22	26,91	3	80,72	CHI
20200141302	TURVELANDIA	TD12213301	RIO DOS BOIS	07/01/2020 08:28	08/01/2020 15:14	07/01/2020 08:28	08/01/2020 15:14	30,77	2	61,54	CHI
20200143218	DOVERLANDIA	MY12210052LD	PARQUE DAS EMAS	06/01/2020 13:11	10/01/2020 16:10	07/01/2020 11:36	08/01/2020 16:25	28,82	71	2046,36	CHI
20200143218	MINEIROS	MY12210052LD	PARQUE DAS EMAS	06/01/2020 13:11	10/01/2020 16:10	07/01/2020 11:36	08/01/2020 16:25	28,82	25	720,55	CHI
20200143218	DOVERLANDIA	MY12217015	PARQUE DAS EMAS	06/01/2020 13:11	10/01/2020 16:10	07/01/2020 11:36	08/01/2020 17:54	30,31	7	212,15	CHI
20200143218	DOVERLANDIA	PW10341001	PARQUE DAS EMAS	06/01/2020 13:11	10/01/2020 16:10	08/01/2020 19:47	08/01/2020 20:08	0,35	73	25,49	CHI
20200143218	MINEIROS	PW10341001	PARQUE DAS EMAS	06/01/2020 13:11	10/01/2020 16:10	08/01/2020 19:47	08/01/2020 20:08	0,35	345	120,46	CHI
20200143218	PORTELANDIA	PW10341001	PARQUE DAS EMAS	06/01/2020 13:11	10/01/2020 16:10	08/01/2020 19:47	08/01/2020 20:08	0,35	148	51,68	CHI
20200143218	SANTA RITA DO ARAGUAIA	PW10341001	PARQUE DAS EMAS	06/01/2020 13:11	10/01/2020 16:10	08/01/2020 19:47	08/01/2020 20:08	0,35	3	1,05	CHI
20200143218	DOVERLANDIA	MY12217015	PARQUE DAS EMAS	06/01/2020 13:11	10/01/2020 16:10	08/01/2020 19:47	08/01/2020 21:29	1,70	20	33,99	CHI
20200143218	MINEIROS	MY12217015	PARQUE DAS EMAS	06/01/2020 13:11	10/01/2020 16:10	08/01/2020 19:47	08/01/2020 21:29	1,70	7	11,90	CHI
20200143218	DOVERLANDIA	MY13374305	PARQUE DAS EMAS	06/01/2020 13:11	10/01/2020 16:10	08/01/2020 23:49	10/01/2020 16:10	40,35	1	40,35	CHI
20200143218	MINEIROS	MY13374305	PARQUE DAS EMAS	06/01/2020 13:11	10/01/2020 16:10	08/01/2020 23:49	10/01/2020 16:10	40,35	2	80,69	CHI

202001141548	DIORAMA	030902214	IPORA	04/01/2020 11:48	04/01/2020 16:12	04/01/2020 11:48	04/01/2020 16:12	4,39	12	52,64	CHI
202001141548	FAZENDA NOVA	030902214	IPORA	04/01/2020 11:48	04/01/2020 16:12	04/01/2020 11:48	04/01/2020 16:12	4,39	22	96,51	CHI
202001141548	JAUPACI	030902214	IPORA	04/01/2020 11:48	04/01/2020 16:12	04/01/2020 11:48	04/01/2020 16:12	4,39	1388	6089,08	CHI
202001141887	CAIAPONIA	CP12193263	MONTIVIDIU T	04/01/2020 13:38	05/01/2020 15:10	04/01/2020 13:38	05/01/2020 15:10	25,53	8	204,25	CHI
202001146609	FORMOSA	FA12218264	ITIQUEIRA	03/01/2020 15:05	03/01/2020 16:34	03/01/2020 15:05	03/01/2020 16:34	1,47	96	141,12	CHI
202001146609	VILA BOA	FA12218264	ITIQUEIRA	03/01/2020 15:05	03/01/2020 16:34	03/01/2020 15:05	03/01/2020 16:34	1,47	4	5,88	CHI
202001147729	JARAGUA	JA12194298	JARAGUA	05/01/2020 10:35	05/01/2020 19:37	05/01/2020 16:31	05/01/2020 19:37	3,10	3	9,30	CHI
202001147756	JARAGUA	70045409	JARAGUA	05/01/2020 10:35	05/01/2020 16:31	05/01/2020 10:35	05/01/2020 16:31	5,92	1	5,92	CHI
202001162804	VICENTINOPOLIS	VI12218225	VICENTINOPOLIS	02/01/2020 11:34	02/01/2020 22:02	02/01/2020 11:34	02/01/2020 22:02	10,46	2	20,91	CHI
202001162892	PLANALTINA	PI12383393	PLANALTINA	02/01/2020 12:33	02/01/2020 18:57	02/01/2020 12:33	02/01/2020 18:57	6,39	28	178,98	CHI
202001162918	FAZENDA NOVA	FN12228496	IPORA	03/01/2020 07:15	03/01/2020 14:09	03/01/2020 07:15	03/01/2020 14:09	6,90	3	20,69	CHI
202001163383	FORMOSA	VB12164674	ITIQUEIRA	02/01/2020 16:09	02/01/2020 19:06	02/01/2020 16:09	02/01/2020 19:06	2,95	44	129,74	CHI
202001163383	VILA BOA	VB12164674	ITIQUEIRA	02/01/2020 16:09	02/01/2020 19:06	02/01/2020 16:09	02/01/2020 19:06	2,95	6	17,69	CHI
202001163827	PLANALTINA	PI12100881LD	PLANALTINA	02/01/2020 17:42	02/01/2020 19:59	02/01/2020 17:42	02/01/2020 19:59	2,28	15	34,19	CHI
202001163907	GAMELEIRA DE GOIAS	AN12390619	DAIA S1	02/01/2020 18:36	02/01/2020 20:37	02/01/2020 18:36	02/01/2020 20:37	2,00	33	66,06	CHI
202001164403	IVOLANDIA	IV12374885	IPORA	02/01/2020 21:04	03/01/2020 11:40	02/01/2020 21:04	03/01/2020 11:40	14,60	1	14,60	CHI
202001164403	MOIPORA	IV12374885	IPORA	02/01/2020 21:04	03/01/2020 11:40	02/01/2020 21:04	03/01/2020 11:40	14,60	1	14,60	CHI
202001164605	PIRACANJUBA	PJ12249778	MORRINHOS	03/01/2020 09:14	03/01/2020 18:20	03/01/2020 09:14	03/01/2020 18:20	9,10	10	90,97	CHI
202001180847	PARANAIGUARA	PC12093843	QUIRINOPOLIS	04/01/2020 09:10	04/01/2020 18:13	04/01/2020 09:10	04/01/2020 18:13	9,05	2	18,10	CHI
202001182822	GOIANESIA	GE12357342	GOIANESIA S2	04/01/2020 12:32	05/01/2020 19:44	04/01/2020 12:32	04/01/2020 16:02	3,50	13	45,45	CHI
202001182822	VILA PROPICIO	GE12357342	GOIANESIA S2	04/01/2020 12:32	05/01/2020 19:44	04/01/2020 12:32	04/01/2020 16:02	3,50	9	31,46	CHI
202001182822	GOIANESIA	GE12357342	GOIANESIA S2	04/01/2020 12:32	05/01/2020 19:44	04/01/2020 16:06	05/01/2020 17:40	25,57	13	332,37	CHI
202001182822	VILA PROPICIO	GE12357342	GOIANESIA S2	04/01/2020 12:32	05/01/2020 19:44	04/01/2020 16:06	05/01/2020 17:40	25,57	3	76,70	CHI
202001182822	GOIANESIA	GE12321405LD	GOIANESIA S2	04/01/2020 12:32	05/01/2020 19:44	04/01/2020 12:32	05/01/2020 18:18	29,76	5	148,81	CHI
202001182822	VILA PROPICIO	GE12372190LD	GOIANESIA S2	04/01/2020 12:32	05/01/2020 19:44	04/01/2020 16:06	05/01/2020 19:44	27,65	6	165,89	CHI
202001184305	QUIRINOPOLIS	QI12065224	CACHOEIRA ALTA	04/01/2020 13:26	05/01/2020 19:50	04/01/2020 13:26	05/01/2020 19:50	30,39	8	243,10	CHI
202001193410	BRAZABRANTES	NV10383766	NEROPOLIS S1	04/01/2020 17:29	04/01/2020 17:35	04/01/2020 17:29	04/01/2020 17:35	0,11	9	1,03	CHI
202001193410	NOVA VENEZA	NV10383766	NEROPOLIS S1	04/01/2020 17:29	04/01/2020 17:35	04/01/2020 17:29	04/01/2020 17:35	0,11	83	9,50	CHI
202001193410	SANTO ANTONIO DE GOIAS	NV10383766	NEROPOLIS S1	04/01/2020 17:29	04/01/2020 17:35	04/01/2020 17:29	04/01/2020 17:35	0,11	167	19,11	CHI
202001211757	HEITORAI	HE12099418	ITAPURANGA	05/01/2020 14:33	05/01/2020 15:35	05/01/2020 14:33	05/01/2020 15:35	1,02	38	38,68	CHI
202001213503	SANTO ANTONIO DA BARRA	BZ12301710	ACREUNA	05/01/2020 14:53	05/01/2020 22:44	05/01/2020 14:53	05/01/2020 22:44	7,84	5	39,22	CHI
202001216805	HEITORAI	HE12099418	ITAPURANGA	05/01/2020 15:35	05/01/2020 15:46	05/01/2020 15:43	05/01/2020 15:46	0,05	38	2,01	CHI
202001217604	MINACU	IH12247493	MINACU	04/01/2020 02:41	04/01/2020 05:16	04/01/2020 02:41	04/01/2020 05:16	2,58	98	252,62	CHI



202001218907	SILVANIA	SV12072440	DAIA S1	05/01/2020 19:02	06/01/2020 09:38	05/01/2020 19:02	06/01/2020 09:38	14,59	8	116,69	CHI
202001221888	COCALZINHO DE GOIAS	ZN12216781	PADRE BERNARDO	06/01/2020 07:22	07/01/2020 00:09	06/01/2020 07:22	07/01/2020 00:09	16,78	11	184,61	CHI
202001222367	ITABERAI	IB12000047	ITABERAI S2	07/01/2020 01:38	07/01/2020 04:22	07/01/2020 01:38	07/01/2020 04:22	2,72	9	24,51	CHI
202001224244	MUTUNOPOLIS	MU12214691	MARA ROSA	06/01/2020 05:52	06/01/2020 21:29	06/01/2020 05:52	06/01/2020 21:29	15,60	20	312,09	CHI
202001225102	RIO VERDE	RV12062719	CABRIUVA S2	06/01/2020 08:18	06/01/2020 11:47	06/01/2020 08:18	06/01/2020 11:47	3,48	7	24,33	CHI
202001225827	ARENOPOLIS	AY12259522	ARENOPOLIS	06/01/2020 15:11	07/01/2020 23:26	06/01/2020 15:11	07/01/2020 23:26	32,23	1	32,23	CHI
202001233024	SILVANIA	SV12072440	DAIA S1	07/01/2020 08:44	07/01/2020 10:16	07/01/2020 08:44	07/01/2020 10:16	1,52	8	12,14	CHI
202001235604	RIO VERDE	RV12226317	MONTIVIDIU T	06/01/2020 21:57	07/01/2020 10:39	06/01/2020 21:57	07/01/2020 10:39	12,70	2	25,40	CHI
202001237097	MINEIROS	MY12358901	PARQUE DAS EMAS	06/01/2020 07:53	07/01/2020 13:39	06/01/2020 07:53	07/01/2020 13:39	29,76	53	1577,49	CHI
202001237097	SANTA RITA DO ARAGUAIA	MY12358901	PARQUE DAS EMAS	06/01/2020 07:53	07/01/2020 13:39	06/01/2020 07:53	07/01/2020 13:39	29,76	2	59,53	CHI
202001237247	PLANALTINA	PI11164618	PLANALTINA	06/01/2020 08:50	06/01/2020 11:40	06/01/2020 08:50	06/01/2020 11:40	2,82	78	219,94	CHI
202001237250	CALDAS NOVAS	CN13000018	CALDAS NOVAS S2	02/01/2020 11:41	02/01/2020 16:50	02/01/2020 11:41	02/01/2020 16:50	5,14	650	3340,10	CHI
202001237259	MAIRIPOTABA	MR16405523	MORRINHOS	04/01/2020 11:31	04/01/2020 22:48	04/01/2020 11:31	04/01/2020 21:49	10,29	13	133,74	CHI
202001237259	MORRINHOS	MR16405523	MORRINHOS	04/01/2020 11:31	04/01/2020 22:48	04/01/2020 11:31	04/01/2020 21:49	10,29	191	1965,02	CHI
202001237259	MORRINHOS	MR16405523	MORRINHOS	04/01/2020 11:31	04/01/2020 22:48	04/01/2020 11:31	04/01/2020 21:49	10,29	13	133,74	CHI
202001237259	PIRACANJUBA	MR16405523	MORRINHOS	04/01/2020 11:31	04/01/2020 22:48	04/01/2020 11:31	04/01/2020 21:49	10,29	79	812,76	CHI
202001237259	PONTALINA	MR16405523	MORRINHOS	04/01/2020 11:31	04/01/2020 22:48	04/01/2020 11:31	04/01/2020 21:49	10,29	15	154,32	CHI
202001237259	MORRINHOS	MR12000278	MORRINHOS	04/01/2020 11:31	04/01/2020 22:48	04/01/2020 11:31	04/01/2020 22:17	10,76	2	21,53	CHI
202001237259	MORRINHOS	MR11000045	MORRINHOS	04/01/2020 11:31	04/01/2020 22:48	04/01/2020 11:31	04/01/2020 22:38	11,11	49	544,43	CHI
202001237259	MORRINHOS	MR11041910	MORRINHOS	04/01/2020 11:31	04/01/2020 22:48	04/01/2020 11:31	04/01/2020 22:48	11,28	25	281,96	CHI
202001237276	CACHOEIRA ALTA	01560404	QUIRINOPOLIS	04/01/2020 21:54	06/01/2020 19:53	04/01/2020 21:54	04/01/2020 23:48	1,90	3	5,70	CHI
202001237276	QUIRINOPOLIS	01560404	QUIRINOPOLIS	04/01/2020 21:54	06/01/2020 19:53	04/01/2020 21:54	04/01/2020 23:48	1,90	86	163,45	CHI
202001237276	QUIRINOPOLIS	01560404	QUIRINOPOLIS	04/01/2020 21:54	06/01/2020 19:53	04/01/2020 21:54	04/01/2020 23:48	1,90	1	1,90	CHI
202001237276	RIO VERDE	01560404	QUIRINOPOLIS	04/01/2020 21:54	06/01/2020 19:53	04/01/2020 21:54	04/01/2020 23:48	1,90	43	81,72	CHI
202001237276	CACHOEIRA ALTA	01560404	QUIRINOPOLIS	04/01/2020 21:54	06/01/2020 19:53	04/01/2020 22:01	04/01/2020 23:48	1,77	37	65,58	CHI
202001237276	QUIRINOPOLIS	01560404	QUIRINOPOLIS	04/01/2020 21:54	06/01/2020 19:53	04/01/2020 22:01	04/01/2020 23:48	1,77	86	152,43	CHI
202001237276	QUIRINOPOLIS	01560404	QUIRINOPOLIS	04/01/2020 21:54	06/01/2020 19:53	04/01/2020 22:01	04/01/2020 23:48	1,77	201	356,27	CHI
202001237276	QUIRINOPOLIS	01560404	QUIRINOPOLIS	04/01/2020 21:54	06/01/2020 19:53	04/01/2020 22:01	04/01/2020 23:48	1,77	279	494,53	CHI
202001237276	RIO VERDE	01560404	QUIRINOPOLIS	04/01/2020 21:54	06/01/2020 19:53	04/01/2020 22:01	04/01/2020 23:48	1,77	112	198,52	CHI
202001237276	QUIRINOPOLIS	QI13000034	QUIRINOPOLIS	04/01/2020 21:54	06/01/2020 19:53	04/01/2020 21:54	05/01/2020 02:53	4,98	31	154,51	CHI
202001237276	PARANAIGUARA	PC10400581	QUIRINOPOLIS	04/01/2020 21:54	06/01/2020 19:53	04/01/2020 21:54	05/01/2020 02:56	5,04	208	1049,13	CHI
202001237276	QUIRINOPOLIS	PC10400581	QUIRINOPOLIS	04/01/2020 21:54	06/01/2020 19:53	04/01/2020 21:54	05/01/2020 02:56	5,04	106	534,65	CHI
202001237276	BOM JESUS DE GOIAS	01562128	QUIRINOPOLIS	04/01/2020 21:54	06/01/2020 19:53	05/01/2020 05:00	05/01/2020 05:29	0,48	69	33,33	CHI

202001237276	CACHOEIRA ALTA	01562128	QUIRINOPOLIS	04/01/2020 21:54	06/01/2020 19:53	05/01/2020 05:00	05/01/2020 05:29	0,48	37	17,87	CHI
202001237276	CACHOEIRA ALTA	01562128	QUIRINOPOLIS	04/01/2020 21:54	06/01/2020 19:53	05/01/2020 05:00	05/01/2020 05:29	0,48	3	1,45	CHI
202001237276	GOUVELANDIA	01562128	QUIRINOPOLIS	04/01/2020 21:54	06/01/2020 19:53	05/01/2020 05:00	05/01/2020 05:29	0,48	2011	971,42	CHI
202001237276	GOUVELANDIA	01562128	QUIRINOPOLIS	04/01/2020 21:54	06/01/2020 19:53	05/01/2020 05:00	05/01/2020 05:29	0,48	13	6,28	CHI
202001237276	INACIOLANDIA	01562128	QUIRINOPOLIS	04/01/2020 21:54	06/01/2020 19:53	05/01/2020 05:00	05/01/2020 05:29	0,48	2673	1291,21	CHI
202001237276	INACIOLANDIA	01562128	QUIRINOPOLIS	04/01/2020 21:54	06/01/2020 19:53	05/01/2020 05:00	05/01/2020 05:29	0,48	3	1,45	CHI
202001237276	ITUMBIARA	01562128	QUIRINOPOLIS	04/01/2020 21:54	06/01/2020 19:53	05/01/2020 05:00	05/01/2020 05:29	0,48	9	4,35	CHI
202001237276	QUIRINOPOLIS	01562128	QUIRINOPOLIS	04/01/2020 21:54	06/01/2020 19:53	05/01/2020 05:00	05/01/2020 05:29	0,48	89	42,99	CHI
202001237276	QUIRINOPOLIS	01562128	QUIRINOPOLIS	04/01/2020 21:54	06/01/2020 19:53	05/01/2020 05:00	05/01/2020 05:29	0,48	86	41,54	CHI
202001237276	QUIRINOPOLIS	01562128	QUIRINOPOLIS	04/01/2020 21:54	06/01/2020 19:53	05/01/2020 05:00	05/01/2020 05:29	0,48	287	138,64	CHI
202001237276	QUIRINOPOLIS	01562128	QUIRINOPOLIS	04/01/2020 21:54	06/01/2020 19:53	05/01/2020 05:00	05/01/2020 05:29	0,48	279	134,77	CHI
202001237276	QUIRINOPOLIS	01562128	QUIRINOPOLIS	04/01/2020 21:54	06/01/2020 19:53	05/01/2020 05:00	05/01/2020 05:29	0,48	23	11,11	CHI
202001237276	RIO VERDE	01562128	QUIRINOPOLIS	04/01/2020 21:54	06/01/2020 19:53	05/01/2020 05:00	05/01/2020 05:29	0,48	112	54,10	CHI
202001237276	RIO VERDE	01562128	QUIRINOPOLIS	04/01/2020 21:54	06/01/2020 19:53	05/01/2020 05:00	05/01/2020 05:29	0,48	43	20,77	CHI
202001237276	CACHOEIRA ALTA	01560404	QUIRINOPOLIS	04/01/2020 21:54	06/01/2020 19:53	05/01/2020 08:21	05/01/2020 09:13	0,86	37	31,76	CHI
202001237276	QUIRINOPOLIS	01560404	QUIRINOPOLIS	04/01/2020 21:54	06/01/2020 19:53	05/01/2020 08:21	05/01/2020 09:13	0,86	86	73,82	CHI
202001237276	QUIRINOPOLIS	01560404	QUIRINOPOLIS	04/01/2020 21:54	06/01/2020 19:53	05/01/2020 08:21	05/01/2020 09:13	0,86	201	172,53	CHI
202001237276	QUIRINOPOLIS	01560404	QUIRINOPOLIS	04/01/2020 21:54	06/01/2020 19:53	05/01/2020 08:21	05/01/2020 09:13	0,86	279	239,48	CHI
202001237276	RIO VERDE	01560404	QUIRINOPOLIS	04/01/2020 21:54	06/01/2020 19:53	05/01/2020 08:21	05/01/2020 09:13	0,86	112	96,13	CHI
202001237276	PARANAIGUARA	Q113000034	QUIRINOPOLIS	04/01/2020 21:54	06/01/2020 19:53	04/01/2020 21:54	05/01/2020 11:25	13,52	2	27,05	CHI
202001237276	QUIRINOPOLIS	Q113000034	QUIRINOPOLIS	04/01/2020 21:54	06/01/2020 19:53	04/01/2020 21:54	05/01/2020 11:25	13,52	40	540,96	CHI
202001237276	QUIRINOPOLIS	01560404	QUIRINOPOLIS	04/01/2020 21:54	06/01/2020 19:53	04/01/2020 22:01	05/01/2020 11:25	13,40	61	817,15	CHI
202001237276	QUIRINOPOLIS	Q113000034	QUIRINOPOLIS	04/01/2020 21:54	06/01/2020 19:53	05/01/2020 08:21	05/01/2020 16:53	8,54	31	264,70	CHI
202001237276	PARANAIGUARA	Q113000034	QUIRINOPOLIS	04/01/2020 21:54	06/01/2020 19:53	04/01/2020 21:54	05/01/2020 22:05	24,19	11	266,04	CHI
202001237276	QUIRINOPOLIS	Q113000034	QUIRINOPOLIS	04/01/2020 21:54	06/01/2020 19:53	04/01/2020 21:54	05/01/2020 22:05	24,19	85	2055,73	CHI
202001237276	CACHOEIRA ALTA	01560404	QUIRINOPOLIS	04/01/2020 21:54	06/01/2020 19:53	05/01/2020 23:17	05/01/2020 23:55	0,63	24	15,01	CHI
202001237276	CACHOEIRA ALTA	01560404	QUIRINOPOLIS	04/01/2020 21:54	06/01/2020 19:53	05/01/2020 23:17	05/01/2020 23:55	0,63	3	1,88	CHI
202001237276	PARANAIGUARA	01560404	QUIRINOPOLIS	04/01/2020 21:54	06/01/2020 19:53	05/01/2020 23:17	05/01/2020 23:55	0,63	11	6,88	CHI
202001237276	QUIRINOPOLIS	01560404	QUIRINOPOLIS	04/01/2020 21:54	06/01/2020 19:53	05/01/2020 23:17	05/01/2020 23:55	0,63	66	41,27	CHI
202001237276	QUIRINOPOLIS	01560404	QUIRINOPOLIS	04/01/2020 21:54	06/01/2020 19:53	05/01/2020 23:17	05/01/2020 23:55	0,63	287	179,45	CHI
202001237276	QUIRINOPOLIS	01560404	QUIRINOPOLIS	04/01/2020 21:54	06/01/2020 19:53	05/01/2020 23:17	05/01/2020 23:55	0,63	397	248,24	CHI
202001237276	RIO VERDE	01560404	QUIRINOPOLIS	04/01/2020 21:54	06/01/2020 19:53	05/01/2020 23:17	05/01/2020 23:55	0,63	107	66,90	CHI
202001237276	RIO VERDE	01560404	QUIRINOPOLIS	04/01/2020 21:54	06/01/2020 19:53	05/01/2020 23:17	05/01/2020 23:55	0,63	43	26,89	CHI

202001237276	CACHOEIRA ALTA	QI13349535	QUIRINOPOLIS	04/01/2020 21:54	06/01/2020 19:53	06/01/2020 02:04	06/01/2020 02:15	0,18	24	4,23	CHI
202001237276	CACHOEIRA ALTA	QI13349535	QUIRINOPOLIS	04/01/2020 21:54	06/01/2020 19:53	06/01/2020 02:04	06/01/2020 02:15	0,18	3	0,53	CHI
202001237276	PARANAIGUARA	QI13349535	QUIRINOPOLIS	04/01/2020 21:54	06/01/2020 19:53	06/01/2020 02:04	06/01/2020 02:15	0,18	11	1,94	CHI
202001237276	QUIRINOPOLIS	QI13349535	QUIRINOPOLIS	04/01/2020 21:54	06/01/2020 19:53	06/01/2020 02:04	06/01/2020 02:15	0,18	66	11,62	CHI
202001237276	QUIRINOPOLIS	QI13349535	QUIRINOPOLIS	04/01/2020 21:54	06/01/2020 19:53	06/01/2020 02:04	06/01/2020 02:15	0,18	287	50,54	CHI
202001237276	QUIRINOPOLIS	QI13349535	QUIRINOPOLIS	04/01/2020 21:54	06/01/2020 19:53	06/01/2020 02:04	06/01/2020 02:15	0,18	397	69,92	CHI
202001237276	RIO VERDE	QI13349535	QUIRINOPOLIS	04/01/2020 21:54	06/01/2020 19:53	06/01/2020 02:04	06/01/2020 02:15	0,18	107	18,84	CHI
202001237276	RIO VERDE	QI13349535	QUIRINOPOLIS	04/01/2020 21:54	06/01/2020 19:53	06/01/2020 02:04	06/01/2020 02:15	0,18	43	7,57	CHI
202001237276	QUIRINOPOLIS	PC10400581	QUIRINOPOLIS	04/01/2020 21:54	06/01/2020 19:53	05/01/2020 22:30	06/01/2020 03:31	5,01	51	255,75	CHI
202001237276	QUIRINOPOLIS	QI13082105	QUIRINOPOLIS	04/01/2020 21:54	06/01/2020 19:53	05/01/2020 22:30	06/01/2020 03:31	5,01	34	170,50	CHI
202001237276	PARANAIGUARA	QI13082105	QUIRINOPOLIS	04/01/2020 21:54	06/01/2020 19:53	05/01/2020 22:30	06/01/2020 06:02	7,53	208	1566,01	CHI
202001237276	QUIRINOPOLIS	QI13082105	QUIRINOPOLIS	04/01/2020 21:54	06/01/2020 19:53	05/01/2020 22:30	06/01/2020 06:02	7,53	105	790,53	CHI
202001237276	PARANAIGUARA	PC10400581	QUIRINOPOLIS	04/01/2020 21:54	06/01/2020 19:53	06/01/2020 15:22	06/01/2020 17:50	2,46	208	512,08	CHI
202001237276	QUIRINOPOLIS	PC10400581	QUIRINOPOLIS	04/01/2020 21:54	06/01/2020 19:53	06/01/2020 15:22	06/01/2020 17:50	2,46	106	260,97	CHI
202001237276	PARANAIGUARA	QI13082105	QUIRINOPOLIS	04/01/2020 21:54	06/01/2020 19:53	05/01/2020 22:30	06/01/2020 19:11	20,68	2	41,36	CHI
202001237276	QUIRINOPOLIS	QI13082105	QUIRINOPOLIS	04/01/2020 21:54	06/01/2020 19:53	05/01/2020 22:30	06/01/2020 19:11	20,68	6	124,09	CHI
202001237276	PARANAIGUARA	QI13340800	QUIRINOPOLIS	04/01/2020 21:54	06/01/2020 19:53	06/01/2020 19:38	06/01/2020 19:53	0,24	210	50,93	CHI
202001237276	QUIRINOPOLIS	QI13340800	QUIRINOPOLIS	04/01/2020 21:54	06/01/2020 19:53	06/01/2020 19:38	06/01/2020 19:53	0,24	112	27,16	CHI
202001237331	SANCLERLANDIA	SL13003678	FIRMINOPOLIS S2	07/01/2020 06:09	08/01/2020 19:24	07/01/2020 06:09	07/01/2020 13:00	6,85	16	109,63	CHI
202001237331	SAO LUIS DE MONTES BELOS	SL13003678	FIRMINOPOLIS S2	07/01/2020 06:09	08/01/2020 19:24	07/01/2020 06:09	07/01/2020 13:00	6,85	54	370,01	CHI
202001237331	BURITI DE GOIAS	SL12377184	FIRMINOPOLIS S2	07/01/2020 06:09	08/01/2020 19:24	07/01/2020 06:09	07/01/2020 14:08	7,99	60	479,20	CHI
202001237331	CORREGO DO OURO	SL12377184	FIRMINOPOLIS S2	07/01/2020 06:09	08/01/2020 19:24	07/01/2020 06:09	07/01/2020 14:08	7,99	130	1038,27	CHI
202001237331	CORREGO DO OURO	SL12377184	FIRMINOPOLIS S2	07/01/2020 06:09	08/01/2020 19:24	07/01/2020 06:09	07/01/2020 14:08	7,99	6	47,92	CHI
202001237331	NOVO BRASIL	SL12377184	FIRMINOPOLIS S2	07/01/2020 06:09	08/01/2020 19:24	07/01/2020 06:09	07/01/2020 14:08	7,99	16	127,79	CHI
202001237331	SANCLERLANDIA	SL12377184	FIRMINOPOLIS S2	07/01/2020 06:09	08/01/2020 19:24	07/01/2020 06:09	07/01/2020 14:08	7,99	231	1844,92	CHI
202001237331	SAO LUIS DE MONTES BELOS	SL12377184	FIRMINOPOLIS S2	07/01/2020 06:09	08/01/2020 19:24	07/01/2020 06:09	07/01/2020 14:08	7,99	9	71,88	CHI
202001237331	BURITI DE GOIAS	CO13024053	FIRMINOPOLIS S2	07/01/2020 06:09	08/01/2020 19:24	07/01/2020 06:09	07/01/2020 14:08	7,99	31	247,60	CHI
202001237331	CORREGO DO OURO	CO13024053	FIRMINOPOLIS S2	07/01/2020 06:09	08/01/2020 19:24	07/01/2020 06:09	07/01/2020 14:08	7,99	1014	8099,04	CHI
202001237331	FAZENDA NOVA	CO13024053	FIRMINOPOLIS S2	07/01/2020 06:09	08/01/2020 19:24	07/01/2020 06:09	07/01/2020 14:08	7,99	38	303,51	CHI
202001237331	CORREGO DO OURO	CO13131324	FIRMINOPOLIS S2	07/01/2020 06:09	08/01/2020 19:24	07/01/2020 06:09	07/01/2020 23:42	17,55	2	35,10	CHI
202001237331	BURITI DE GOIAS	CO13024053	FIRMINOPOLIS S2	07/01/2020 06:09	08/01/2020 19:24	08/01/2020 00:15	08/01/2020 00:32	0,28	31	8,78	CHI
202001237331	CORREGO DO OURO	CO13024053	FIRMINOPOLIS S2	07/01/2020 06:09	08/01/2020 19:24	08/01/2020 00:15	08/01/2020 00:32	0,28	1014	287,30	CHI
202001237331	FAZENDA NOVA	CO13024053	FIRMINOPOLIS S2	07/01/2020 06:09	08/01/2020 19:24	08/01/2020 00:15	08/01/2020 00:32	0,28	38	10,77	CHI

202001237331	BURITI DE GOIAS	SL10406690	FIRMINOPOLIS S2	07/01/2020 06:09	08/01/2020 19:24	08/01/2020 00:43	08/01/2020 01:39	0,92	60	55,30	CHI
202001237331	CORREGO DO OURO	SL10406690	FIRMINOPOLIS S2	07/01/2020 06:09	08/01/2020 19:24	08/01/2020 00:43	08/01/2020 01:39	0,92	130	119,82	CHI
202001237331	CORREGO DO OURO	SL10406690	FIRMINOPOLIS S2	07/01/2020 06:09	08/01/2020 19:24	08/01/2020 00:43	08/01/2020 01:39	0,92	6	5,53	CHI
202001237331	NOVO BRASIL	SL10406690	FIRMINOPOLIS S2	07/01/2020 06:09	08/01/2020 19:24	08/01/2020 00:43	08/01/2020 01:39	0,92	16	14,75	CHI
202001237331	SANCLERLANDIA	SL10406690	FIRMINOPOLIS S2	07/01/2020 06:09	08/01/2020 19:24	08/01/2020 00:43	08/01/2020 01:39	0,92	247	227,65	CHI
202001237331	SAO LUIS DE MONTES BELOS	SL10406690	FIRMINOPOLIS S2	07/01/2020 06:09	08/01/2020 19:24	08/01/2020 00:43	08/01/2020 01:39	0,92	63	58,06	CHI
202001237331	CORREGO DO OURO	CO12036131	FIRMINOPOLIS S2	07/01/2020 06:09	08/01/2020 19:24	07/01/2020 06:09	08/01/2020 19:24	37,25	1	37,25	CHI
202001237360	PLANALTINA	2960129034	PLANALTINA	04/01/2020 14:52	04/01/2020 17:06	04/01/2020 14:52	04/01/2020 17:06	2,23	1	2,23	CHI
202001237365	ANAPOLIS	00050234	ANAPOLIS UNIVERSITARIO S2	04/01/2020 20:49	05/01/2020 00:30	04/01/2020 20:49	04/01/2020 20:55	0,11	1198	130,45	CHI
202001237365	ANAPOLIS	00050234	ANAPOLIS UNIVERSITARIO S2	04/01/2020 20:49	05/01/2020 00:30	04/01/2020 20:49	04/01/2020 22:12	1,38	2915	4016,22	CHI
202001237365	ANAPOLIS	00050234	ANAPOLIS UNIVERSITARIO S2	04/01/2020 20:49	05/01/2020 00:30	04/01/2020 20:49	04/01/2020 22:12	1,39	3548	4922,85	CHI
202001237365	ANAPOLIS	00050234	ANAPOLIS UNIVERSITARIO S2	04/01/2020 20:49	05/01/2020 00:30	04/01/2020 20:49	04/01/2020 22:12	1,39	5907	8195,96	CHI
202001237365	ANAPOLIS	00050234	ANAPOLIS UNIVERSITARIO S2	04/01/2020 20:49	05/01/2020 00:30	04/01/2020 20:49	04/01/2020 23:17	2,47	958	2365,46	CHI
202001237365	ANAPOLIS	00050234	ANAPOLIS UNIVERSITARIO S2	04/01/2020 20:49	05/01/2020 00:30	04/01/2020 20:49	05/01/2020 00:30	3,69	1	3,69	CHI
202001237389	CAMPOS VERDES	VD12390493	SANTA TEREZINHA	03/01/2020 13:24	03/01/2020 17:48	03/01/2020 13:24	03/01/2020 17:48	4,39	6	26,34	CHI
202001237389	CAMPOS VERDES	VD12390493	SANTA TEREZINHA	03/01/2020 13:24	03/01/2020 17:48	03/01/2020 14:19	03/01/2020 17:48	3,47	4	13,89	CHI
202001237389	MARA ROSA	VD12390493	SANTA TEREZINHA	03/01/2020 13:24	03/01/2020 17:48	03/01/2020 14:19	03/01/2020 17:48	3,47	2	6,95	CHI
202001237390	ORIZONA	OZ12022855	PIRES DO RIO S2	04/01/2020 07:19	04/01/2020 13:58	04/01/2020 07:19	04/01/2020 13:58	6,64	7	46,50	CHI
202001237392	IPAMERI	IP11203205	IPAMERI	04/01/2020 08:02	04/01/2020 10:01	04/01/2020 08:02	04/01/2020 10:01	1,98	102	202,13	CHI
202001237406	APARECIDA DE GOIANIA	AP11050802	REAL S1	05/01/2020 08:59	05/01/2020 19:35	05/01/2020 08:59	05/01/2020 19:35	10,59	39	413,00	CHI
2020010200042	ITAPIRAPUA	01050224	JUSSARA	02/01/2020 09:58	02/01/2020 10:01	02/01/2020 09:58	02/01/2020 10:01	0,05	168	8,40	CHI
2020010200042	JUSSARA	01050214	JUSSARA	02/01/2020 09:58	02/01/2020 10:01	02/01/2020 09:58	02/01/2020 10:01	0,05	6033	301,65	CHI
2020010200042	JUSSARA	01050224	JUSSARA	02/01/2020 09:58	02/01/2020 10:01	02/01/2020 09:58	02/01/2020 10:01	0,05	2347	117,35	CHI
2020010200042	NOVO BRASIL	01050224	JUSSARA	02/01/2020 09:58	02/01/2020 10:01	02/01/2020 09:58	02/01/2020 10:01	0,05	12	0,60	CHI
2020010300053	ITAGUARU	01020214	JARAGUA	03/01/2020 10:42	03/01/2020 10:45	03/01/2020 10:42	03/01/2020 10:45	0,05	26	1,30	CHI
2020010300053	JARAGUA	01020214	JARAGUA	03/01/2020 10:42	03/01/2020 10:45	03/01/2020 10:42	03/01/2020 10:45	0,05	8897	444,85	CHI
2020010300053	PIRENOPOLIS	01020214	JARAGUA	03/01/2020 10:42	03/01/2020 10:45	03/01/2020 10:42	03/01/2020 10:45	0,05	95	4,75	CHI
2020010300053	URUJANA	01020214	JARAGUA	03/01/2020 10:42	03/01/2020 10:45	03/01/2020 10:42	03/01/2020 10:45	0,05	8	0,40	CHI
2020010400054	IPAMERI	02940214	MORRINHOS	04/01/2020 04:22	04/01/2020 05:06	04/01/2020 04:22	04/01/2020 05:06	0,73	1	0,73	CHI
2020010400054	MORRINHOS	02940214	MORRINHOS	04/01/2020 04:22	04/01/2020 05:06	04/01/2020 04:22	04/01/2020 05:06	0,73	336	246,40	CHI
2020010400055	CEZARINA	35802	PONTALINA	04/01/2020 04:22	04/01/2020 05:02	04/01/2020 04:22	04/01/2020 05:02	0,67	40	26,67	CHI
2020010400055	CROMINIA	31101	PONTALINA	04/01/2020 04:22	04/01/2020 05:02	04/01/2020 04:22	04/01/2020 05:02	0,67	1788	1192,00	CHI
2020010400055	CROMINIA	35801	PONTALINA	04/01/2020 04:22	04/01/2020 05:02	04/01/2020 04:22	04/01/2020 05:02	0,67	20	13,33	CHI

2020010400055	CROMINIA	36601	PONTALINA	04/01/2020 04:22	04/01/2020 05:02	04/01/2020 04:22	04/01/2020 05:02	0,67	2	1,33	CHI
2020010400055	CROMINIA	35802	PONTALINA	04/01/2020 04:22	04/01/2020 05:02	04/01/2020 04:22	04/01/2020 05:02	0,67	18	12,00	CHI
2020010400055	CROMINIA	01515114	PONTALINA	04/01/2020 04:22	04/01/2020 05:02	04/01/2020 04:22	04/01/2020 05:02	0,67	43	28,67	CHI
2020010400055	CROMINIA	31132	PONTALINA	04/01/2020 04:22	04/01/2020 05:02	04/01/2020 04:22	04/01/2020 05:02	0,67	12	8,00	CHI
2020010400055	CROMINIA	31133	PONTALINA	04/01/2020 04:22	04/01/2020 05:02	04/01/2020 04:22	04/01/2020 05:02	0,67	9	6,00	CHI
2020010400055	EDEALINA	01515114	PONTALINA	04/01/2020 04:22	04/01/2020 05:02	04/01/2020 04:22	04/01/2020 05:02	0,67	28	18,67	CHI
2020010400055	HIDROLANDIA	36601	PONTALINA	04/01/2020 04:22	04/01/2020 05:02	04/01/2020 04:22	04/01/2020 05:02	0,67	183	122,00	CHI
2020010400055	HIDROLANDIA	36602	PONTALINA	04/01/2020 04:22	04/01/2020 05:02	04/01/2020 04:22	04/01/2020 05:02	0,67	75	50,00	CHI
2020010400055	HIDROLANDIA	31133	PONTALINA	04/01/2020 04:22	04/01/2020 05:02	04/01/2020 04:22	04/01/2020 05:02	0,67	4	2,67	CHI
2020010400055	MAIRIPOTABA	01515114	PONTALINA	04/01/2020 04:22	04/01/2020 05:02	04/01/2020 04:22	04/01/2020 05:02	0,67	101	67,33	CHI
2020010400055	MAIRIPOTABA	31101	PONTALINA	04/01/2020 04:22	04/01/2020 05:02	04/01/2020 04:22	04/01/2020 05:02	0,67	68	45,33	CHI
2020010400055	MAIRIPOTABA	35801	PONTALINA	04/01/2020 04:22	04/01/2020 05:02	04/01/2020 04:22	04/01/2020 05:02	0,67	777	518,00	CHI
2020010400055	MAIRIPOTABA	36601	PONTALINA	04/01/2020 04:22	04/01/2020 05:02	04/01/2020 04:22	04/01/2020 05:02	0,67	10	6,67	CHI
2020010400055	MAIRIPOTABA	35802	PONTALINA	04/01/2020 04:22	04/01/2020 05:02	04/01/2020 04:22	04/01/2020 05:02	0,67	356	237,33	CHI
2020010400055	MAIRIPOTABA	01515114	PONTALINA	04/01/2020 04:22	04/01/2020 05:02	04/01/2020 04:22	04/01/2020 05:02	0,67	155	103,33	CHI
2020010400055	MAIRIPOTABA	31132	PONTALINA	04/01/2020 04:22	04/01/2020 05:02	04/01/2020 04:22	04/01/2020 05:02	0,67	2	1,33	CHI
2020010400055	MAIRIPOTABA	31133	PONTALINA	04/01/2020 04:22	04/01/2020 05:02	04/01/2020 04:22	04/01/2020 05:02	0,67	3	2,00	CHI
2020010400055	MORRINHOS	01515114	PONTALINA	04/01/2020 04:22	04/01/2020 05:02	04/01/2020 04:22	04/01/2020 05:02	0,67	1	0,67	CHI
2020010400055	MORRINHOS	01515114	PONTALINA	04/01/2020 04:22	04/01/2020 05:02	04/01/2020 04:22	04/01/2020 05:02	0,67	4	2,67	CHI
2020010400055	PIRACANJUBA	01515114	PONTALINA	04/01/2020 04:22	04/01/2020 05:02	04/01/2020 04:22	04/01/2020 05:02	0,67	1	0,67	CHI
2020010400055	PONTALINA	01515114	PONTALINA	04/01/2020 04:22	04/01/2020 05:02	04/01/2020 04:22	04/01/2020 05:02	0,67	4183	2788,67	CHI
2020010400055	PONTALINA	31101	PONTALINA	04/01/2020 04:22	04/01/2020 05:02	04/01/2020 04:22	04/01/2020 05:02	0,67	34	22,67	CHI
2020010400055	PONTALINA	35801	PONTALINA	04/01/2020 04:22	04/01/2020 05:02	04/01/2020 04:22	04/01/2020 05:02	0,67	3	2,00	CHI
2020010400055	PONTALINA	01515114	PONTALINA	04/01/2020 04:22	04/01/2020 05:02	04/01/2020 04:22	04/01/2020 05:02	0,67	3850	2566,67	CHI
2020010400055	PONTALINA	35802	PONTALINA	04/01/2020 04:22	04/01/2020 05:02	04/01/2020 04:22	04/01/2020 05:02	0,67	61	40,67	CHI
2020010400055	PONTALINA	01515114	PONTALINA	04/01/2020 04:22	04/01/2020 05:02	04/01/2020 04:22	04/01/2020 05:02	0,67	49	32,67	CHI
2020010400055	PONTALINA	01515114	PONTALINA	04/01/2020 04:22	04/01/2020 05:02	04/01/2020 04:22	04/01/2020 05:02	0,67	270	180,00	CHI
2020010400055	PROFESSOR JAMIL SAFADY	01515114	PONTALINA	04/01/2020 04:22	04/01/2020 05:02	04/01/2020 04:22	04/01/2020 05:02	0,67	15	10,00	CHI
2020010400055	PROFESSOR JAMIL SAFADY	31101	PONTALINA	04/01/2020 04:22	04/01/2020 05:02	04/01/2020 04:22	04/01/2020 05:02	0,67	14	9,33	CHI
2020010400055	PROFESSOR JAMIL SAFADY	01515114	PONTALINA	04/01/2020 04:22	04/01/2020 05:02	04/01/2020 04:22	04/01/2020 05:02	0,67	52	34,67	CHI
2020010400055	VARJAO	36601	PONTALINA	04/01/2020 04:22	04/01/2020 05:02	04/01/2020 04:22	04/01/2020 05:02	0,67	1	0,67	CHI
2020010400091	CACHOEIRA ALTA	48602	QUIRINOPOLIS	04/01/2020 13:52	04/01/2020 13:57	04/01/2020 13:52	04/01/2020 13:57	0,08	3	0,25	CHI
2020010400091	GOUVELANDIA	23101	QUIRINOPOLIS	04/01/2020 13:52	04/01/2020 13:57	04/01/2020 13:52	04/01/2020 13:57	0,08	2011	167,58	CHI

2020010400091	INACIOLANDIA	22201	QUIRINOPOLIS	04/01/2020 13:52	04/01/2020 13:57	04/01/2020 13:52	04/01/2020 13:57	0,08	2622	218,50	CHI
2020010400091	ITUMBIARA	22201	QUIRINOPOLIS	04/01/2020 13:52	04/01/2020 13:57	04/01/2020 13:52	04/01/2020 13:57	0,08	4	0,33	CHI
2020010400091	PARANAIGUARA	01560404	QUIRINOPOLIS	04/01/2020 13:52	04/01/2020 13:57	04/01/2020 13:52	04/01/2020 13:57	0,08	220	18,33	CHI
2020010400091	QUIRINOPOLIS	23101	QUIRINOPOLIS	04/01/2020 13:52	04/01/2020 13:57	04/01/2020 13:52	04/01/2020 13:57	0,08	89	7,42	CHI
2020010400091	QUIRINOPOLIS	48602	QUIRINOPOLIS	04/01/2020 13:52	04/01/2020 13:57	04/01/2020 13:52	04/01/2020 13:57	0,08	287	23,92	CHI
2020010400091	QUIRINOPOLIS	01560404	QUIRINOPOLIS	04/01/2020 13:52	04/01/2020 13:57	04/01/2020 13:52	04/01/2020 13:57	0,08	263	21,92	CHI
2020010400091	RIO VERDE	48602	QUIRINOPOLIS	04/01/2020 13:52	04/01/2020 13:57	04/01/2020 13:52	04/01/2020 13:57	0,08	43	3,58	CHI
2020010400106	CACHOEIRA ALTA	48602	QUIRINOPOLIS	04/01/2020 17:09	04/01/2020 17:35	04/01/2020 17:09	04/01/2020 17:35	0,43	3	1,30	CHI
2020010400106	GOUVELANDIA	23101	QUIRINOPOLIS	04/01/2020 17:09	04/01/2020 17:35	04/01/2020 17:09	04/01/2020 17:35	0,43	2011	871,43	CHI
2020010400106	GOUVELANDIA	01560414	QUIRINOPOLIS	04/01/2020 17:09	04/01/2020 17:35	04/01/2020 17:09	04/01/2020 17:35	0,43	13	5,63	CHI
2020010400106	INACIOLANDIA	22201	QUIRINOPOLIS	04/01/2020 17:09	04/01/2020 17:35	04/01/2020 17:09	04/01/2020 17:35	0,43	2622	1136,20	CHI
2020010400106	INACIOLANDIA	01560414	QUIRINOPOLIS	04/01/2020 17:09	04/01/2020 17:35	04/01/2020 17:09	04/01/2020 17:35	0,43	3	1,30	CHI
2020010400106	ITUMBIARA	22201	QUIRINOPOLIS	04/01/2020 17:09	04/01/2020 17:35	04/01/2020 17:09	04/01/2020 17:35	0,43	4	1,73	CHI
2020010400106	PARANAIGUARA	01560404	QUIRINOPOLIS	04/01/2020 17:09	04/01/2020 17:35	04/01/2020 17:09	04/01/2020 17:35	0,43	219	94,90	CHI
2020010400106	QUIRINOPOLIS	23101	QUIRINOPOLIS	04/01/2020 17:09	04/01/2020 17:35	04/01/2020 17:09	04/01/2020 17:35	0,43	89	38,57	CHI
2020010400106	QUIRINOPOLIS	48602	QUIRINOPOLIS	04/01/2020 17:09	04/01/2020 17:35	04/01/2020 17:09	04/01/2020 17:35	0,43	86	37,27	CHI
2020010400106	QUIRINOPOLIS	01560404	QUIRINOPOLIS	04/01/2020 17:09	04/01/2020 17:35	04/01/2020 17:09	04/01/2020 17:35	0,43	263	113,97	CHI
2020010400106	QUIRINOPOLIS	01560414	QUIRINOPOLIS	04/01/2020 17:09	04/01/2020 17:35	04/01/2020 17:09	04/01/2020 17:35	0,43	23	9,97	CHI
2020010400106	RIO VERDE	48602	QUIRINOPOLIS	04/01/2020 17:09	04/01/2020 17:35	04/01/2020 17:09	04/01/2020 17:35	0,43	43	18,63	CHI
2020010500011	CACHOEIRA ALTA	48602	QUIRINOPOLIS	05/01/2020 08:21	05/01/2020 09:15	05/01/2020 08:21	05/01/2020 09:15	0,90	3	2,70	CHI
2020010500011	PARANAIGUARA	01560404	QUIRINOPOLIS	05/01/2020 08:21	05/01/2020 09:15	05/01/2020 08:21	05/01/2020 09:15	0,90	163	146,70	CHI
2020010500011	QUIRINOPOLIS	48602	QUIRINOPOLIS	05/01/2020 08:21	05/01/2020 09:15	05/01/2020 08:21	05/01/2020 09:15	0,90	86	77,40	CHI
2020010500011	QUIRINOPOLIS	01560404	QUIRINOPOLIS	05/01/2020 08:21	05/01/2020 09:15	05/01/2020 08:21	05/01/2020 09:15	0,90	43	38,70	CHI
2020010500011	RIO VERDE	48602	QUIRINOPOLIS	05/01/2020 08:21	05/01/2020 09:15	05/01/2020 08:21	05/01/2020 09:15	0,90	43	38,70	CHI
2020010500039	PETROLINA DE GOIAS	03160214	SAO FRANCISCO DE GOIAS	04/01/2020 19:33	05/01/2020 03:00	04/01/2020 19:33	05/01/2020 03:00	7,45	60	447,00	CHI
2020010500039	PIRENOPOLIS	03160214	SAO FRANCISCO DE GOIAS	04/01/2020 19:33	05/01/2020 03:00	04/01/2020 19:33	05/01/2020 03:00	7,45	43	320,35	CHI
2020010500039	SAO FRANCISCO DE GOIAS	03160214	SAO FRANCISCO DE GOIAS	04/01/2020 19:33	05/01/2020 03:00	04/01/2020 19:33	05/01/2020 03:00	7,45	1782	13275,90	CHI
2020010500043	PARANAIGUARA	01560404	QUIRINOPOLIS	05/01/2020 05:00	05/01/2020 05:29	05/01/2020 05:00	05/01/2020 05:29	0,48	208	100,53	CHI
2020010500043	QUIRINOPOLIS	01560404	QUIRINOPOLIS	05/01/2020 05:00	05/01/2020 05:29	05/01/2020 05:00	05/01/2020 05:29	0,48	138	66,70	CHI



# Plotagem das Ocorrências conforme a Espacialização das Chuvas

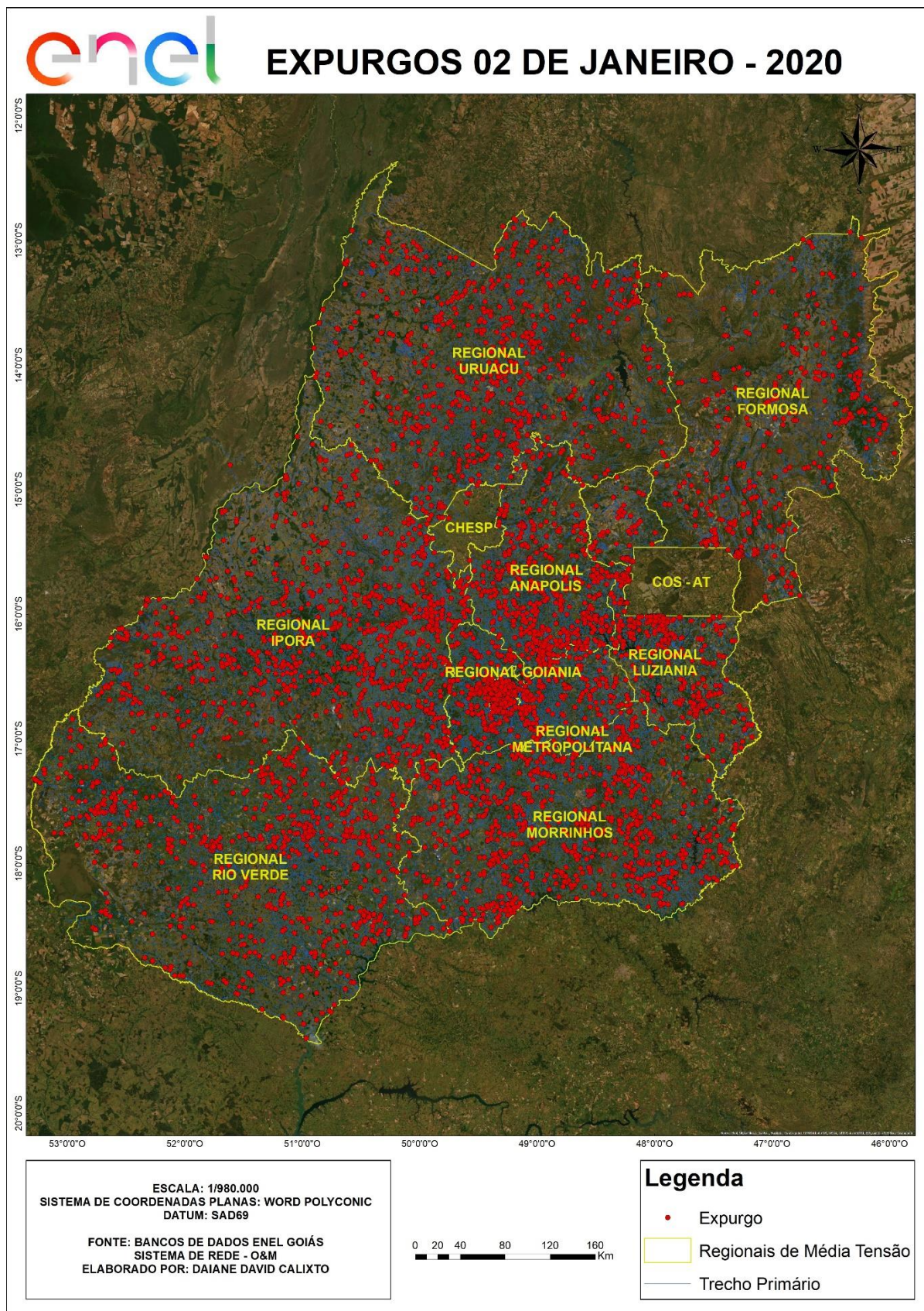

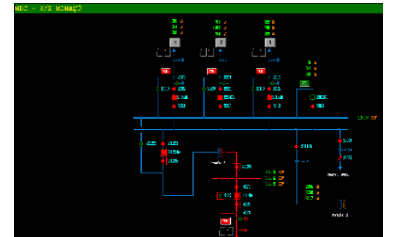
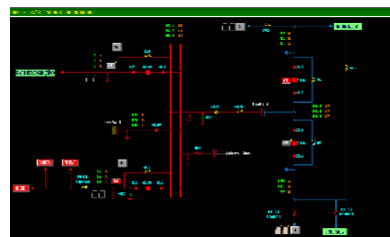
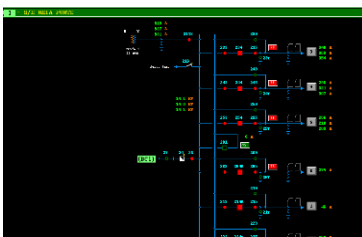
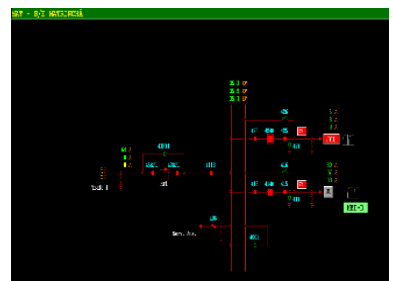
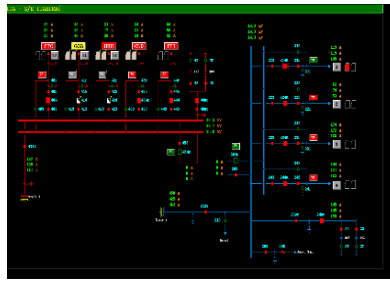
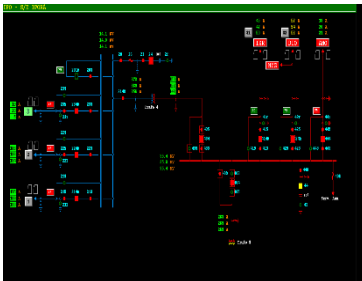
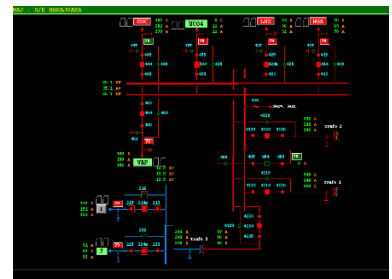
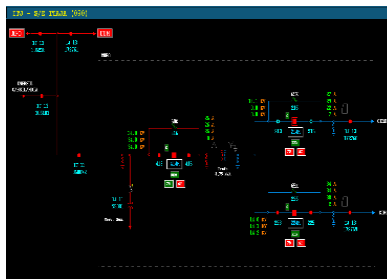
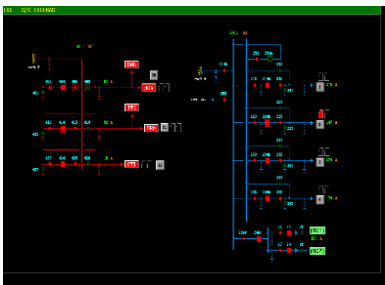
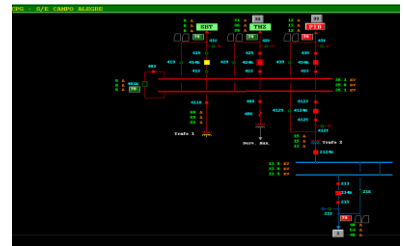
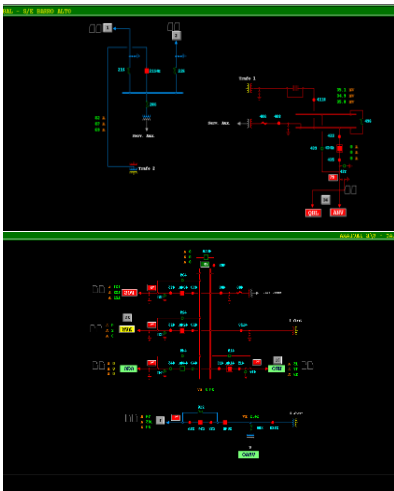
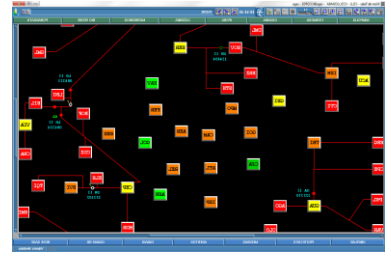
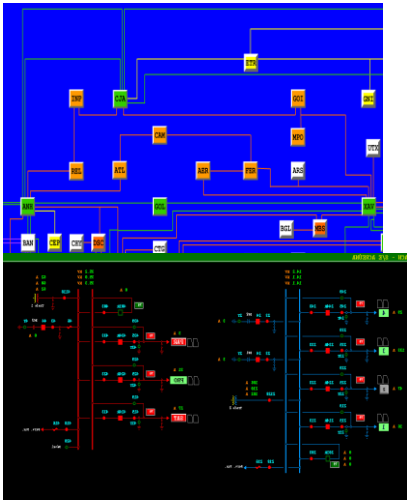



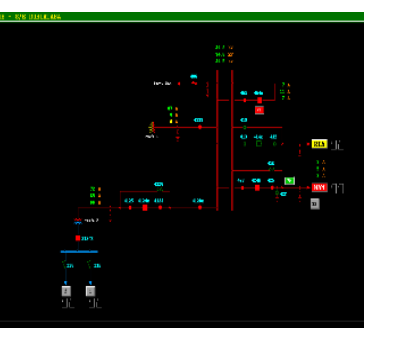
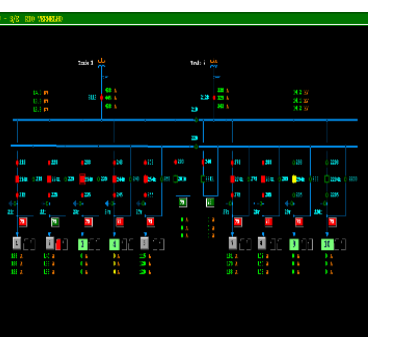
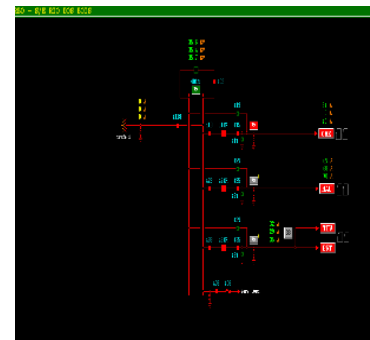
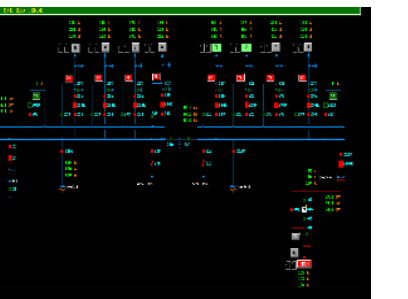
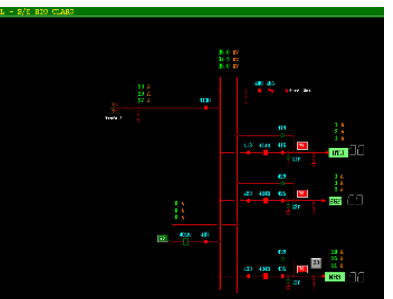
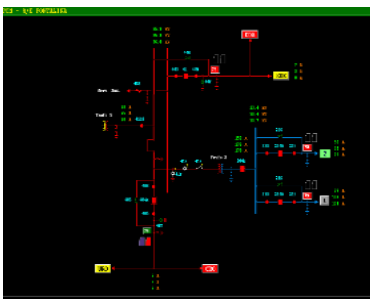
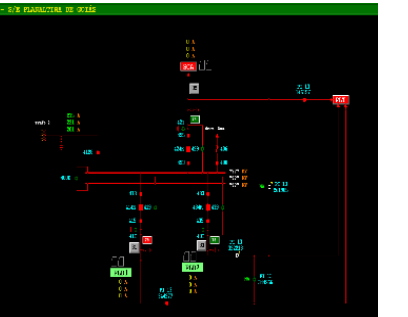
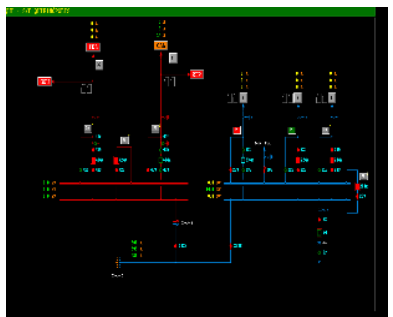
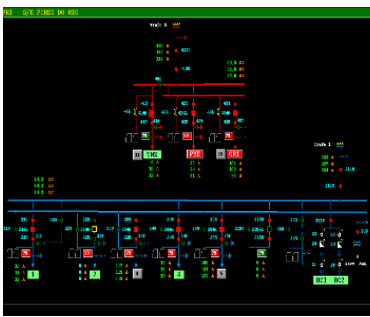
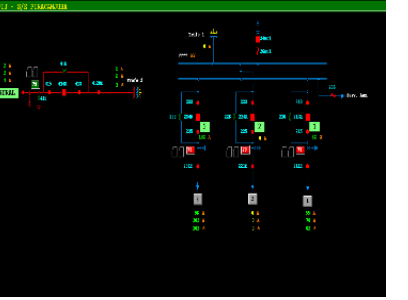
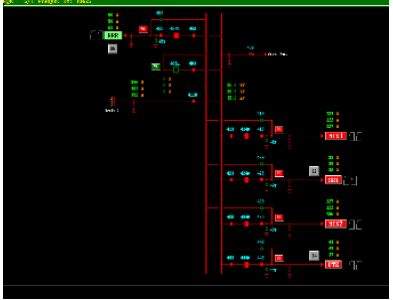
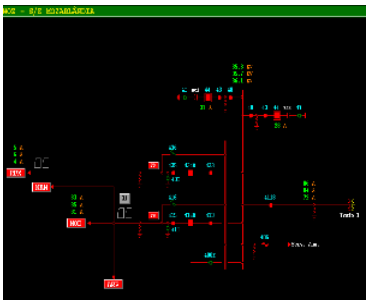
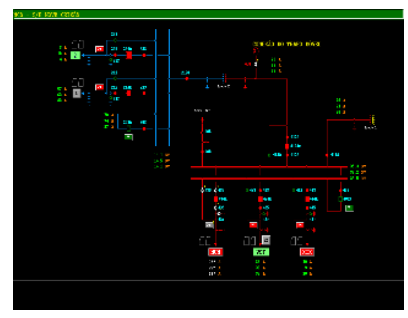
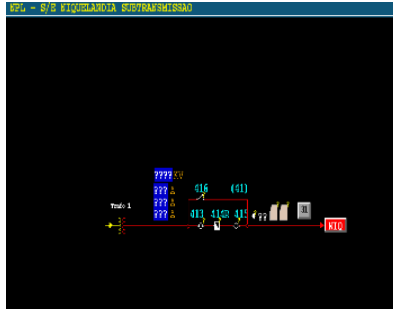

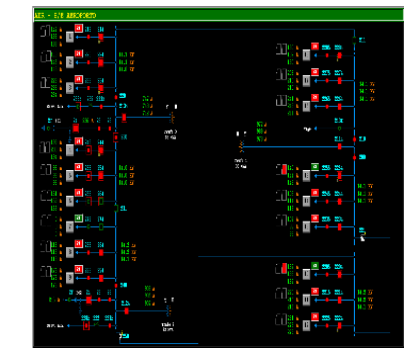
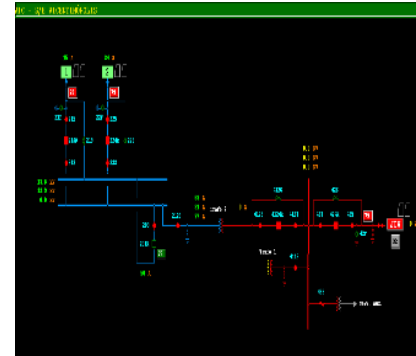
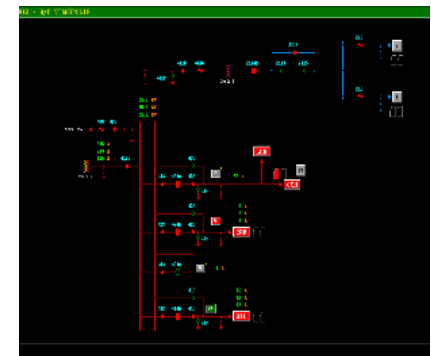
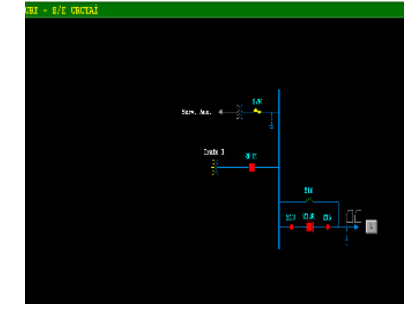
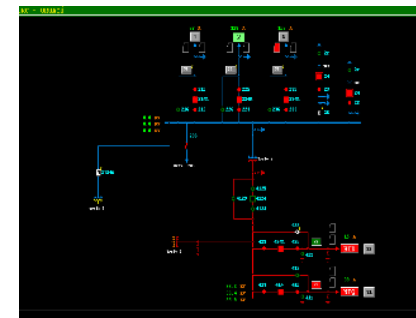
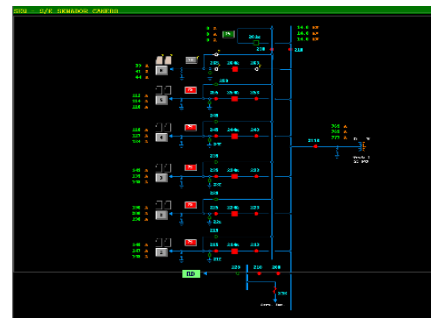
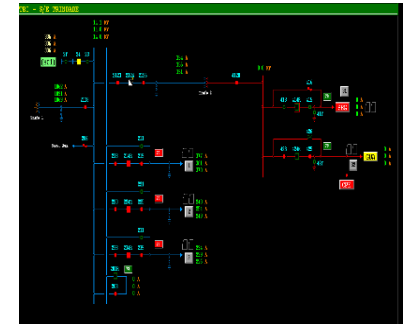
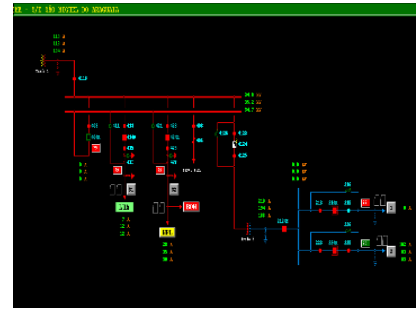
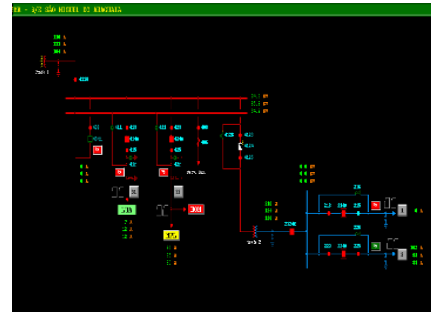
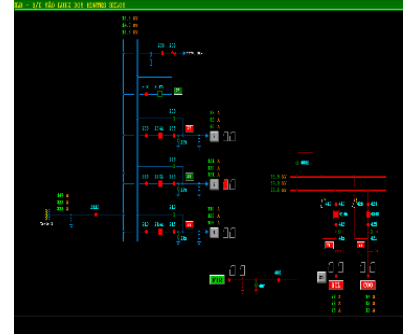
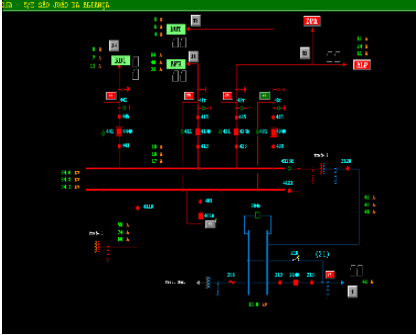
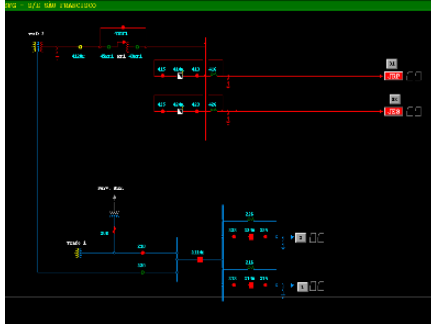
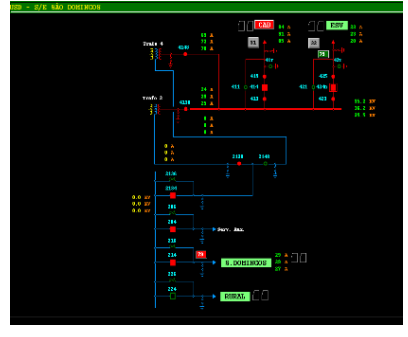
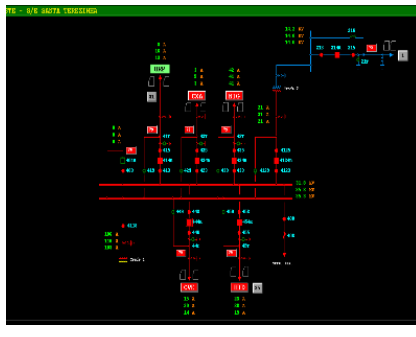
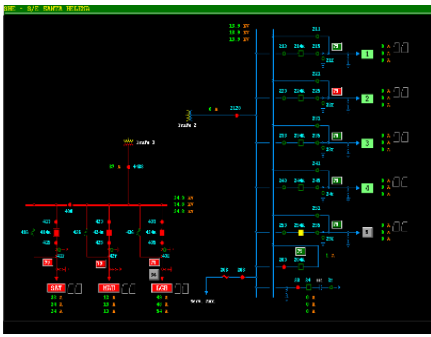

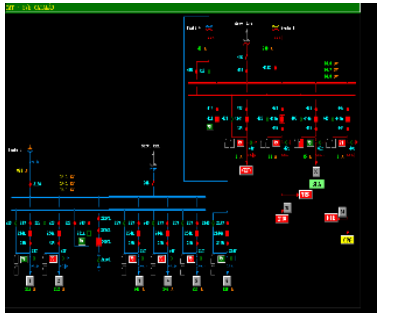
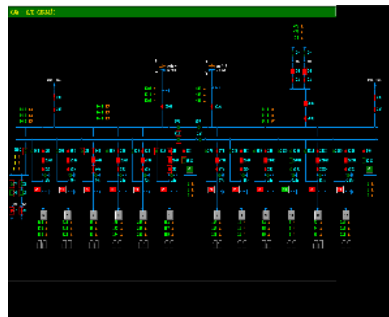
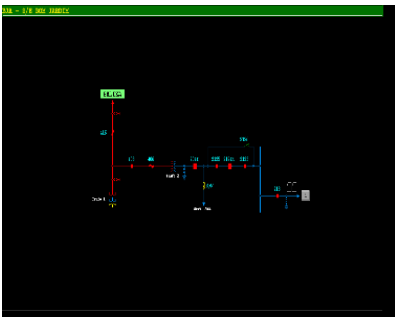
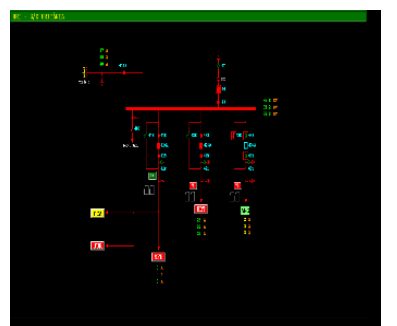
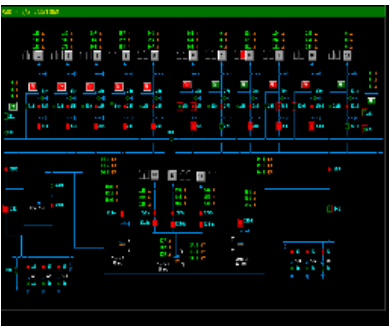
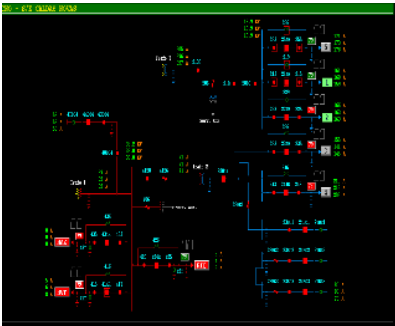
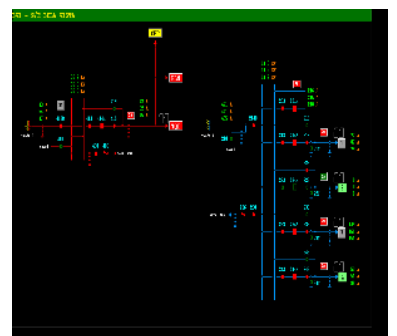
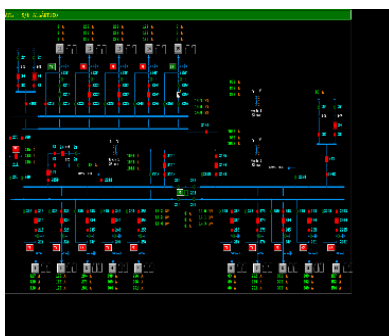
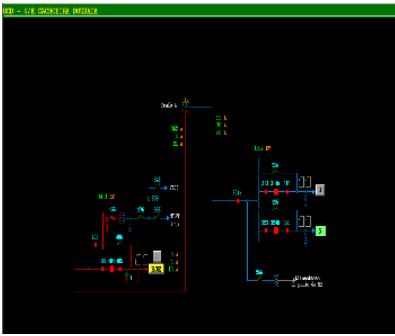
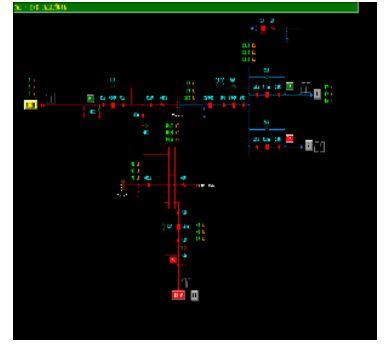
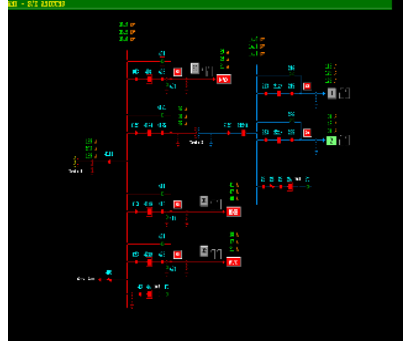
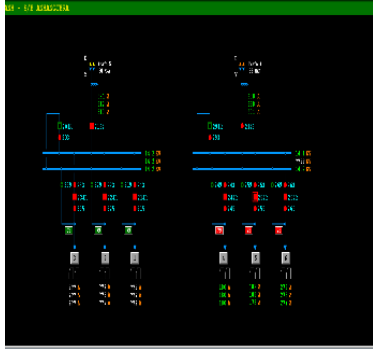
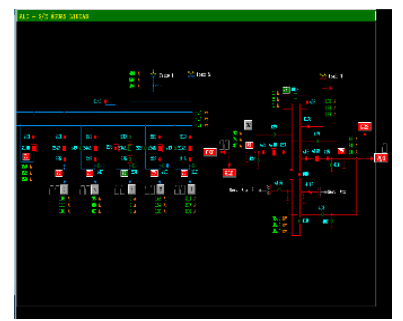
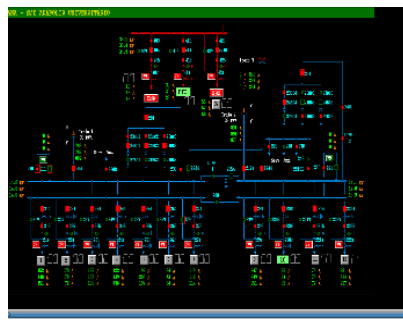
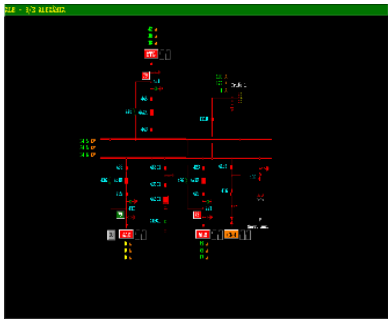

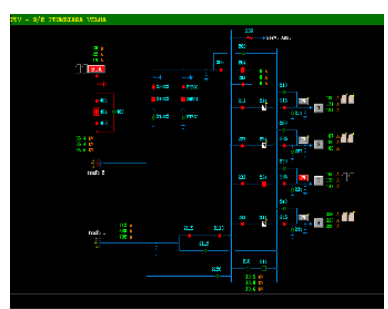
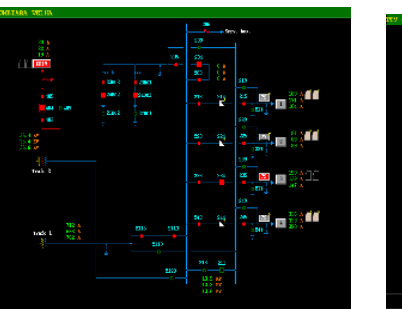
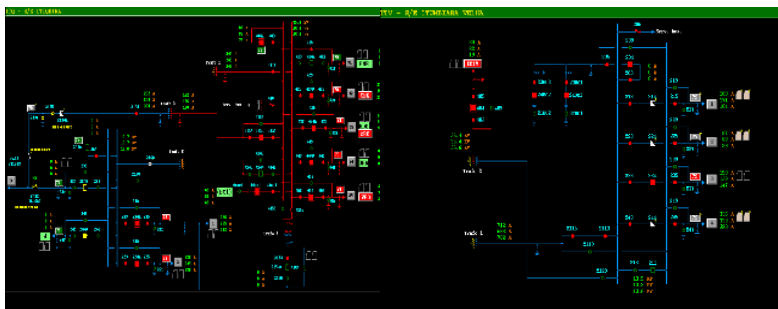
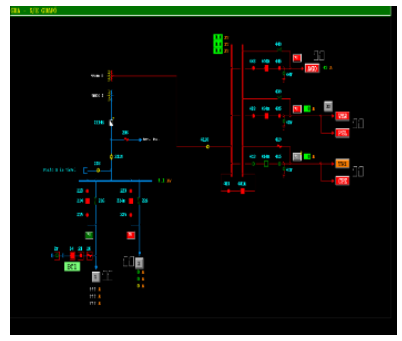
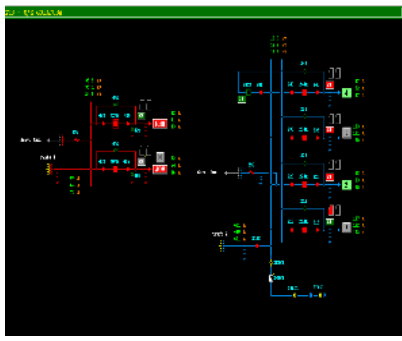
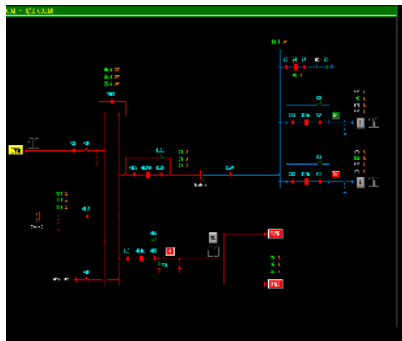
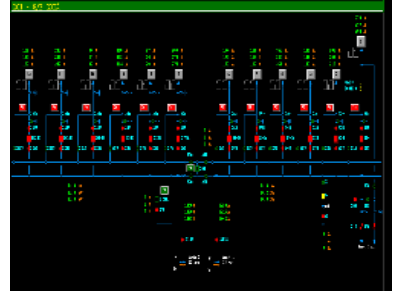
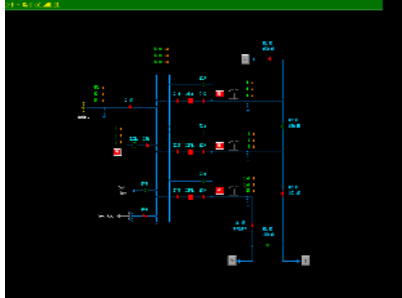
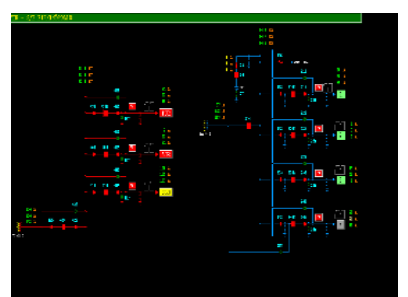
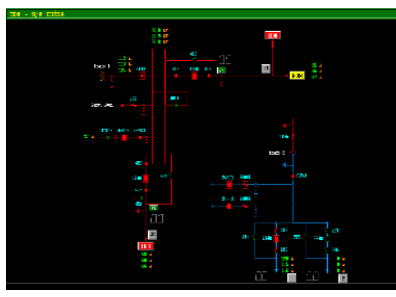
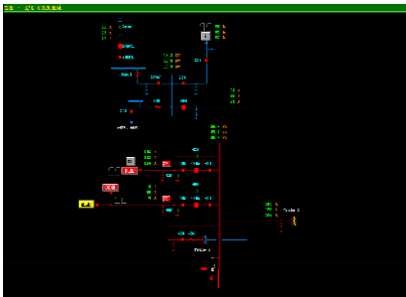
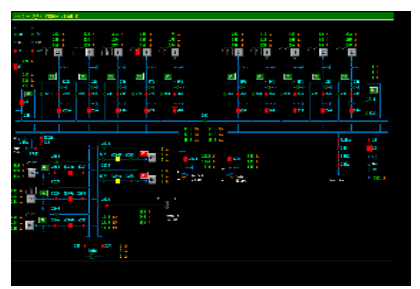
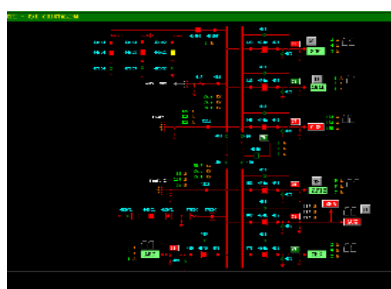
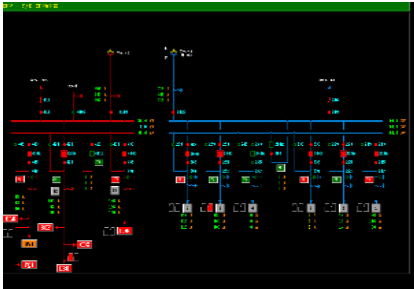
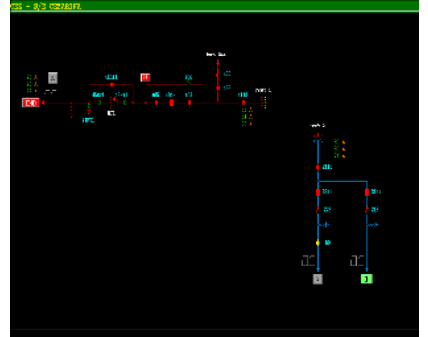
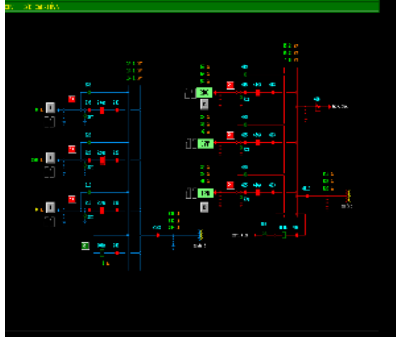
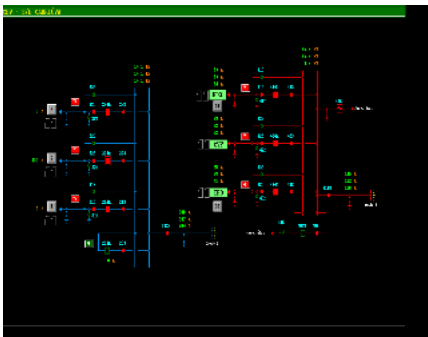

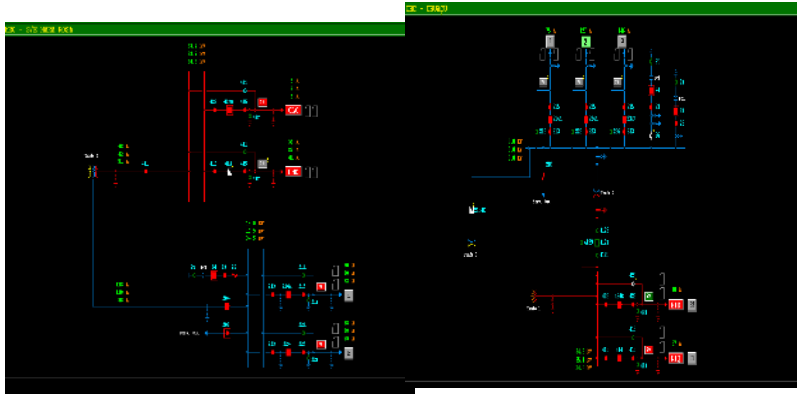
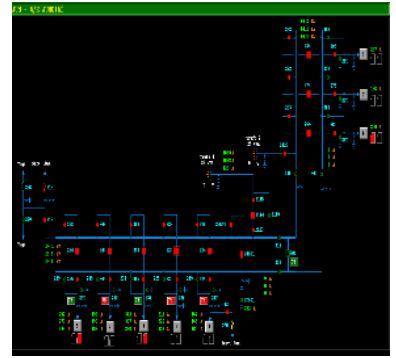
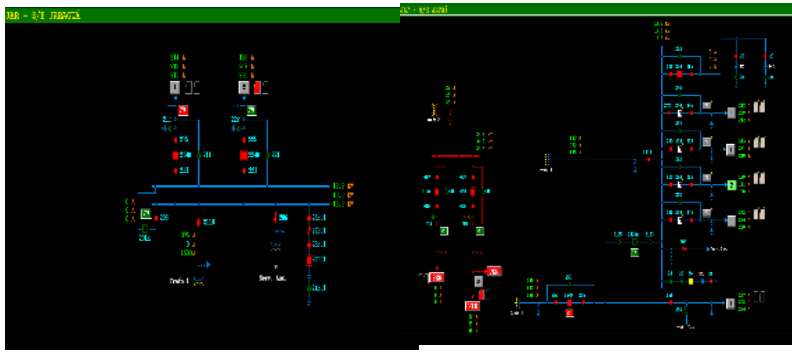

# DEMAIS EVIDÊNCIAS

## DADOS TÉCNICO - OPERACIONAIS ENEL GO

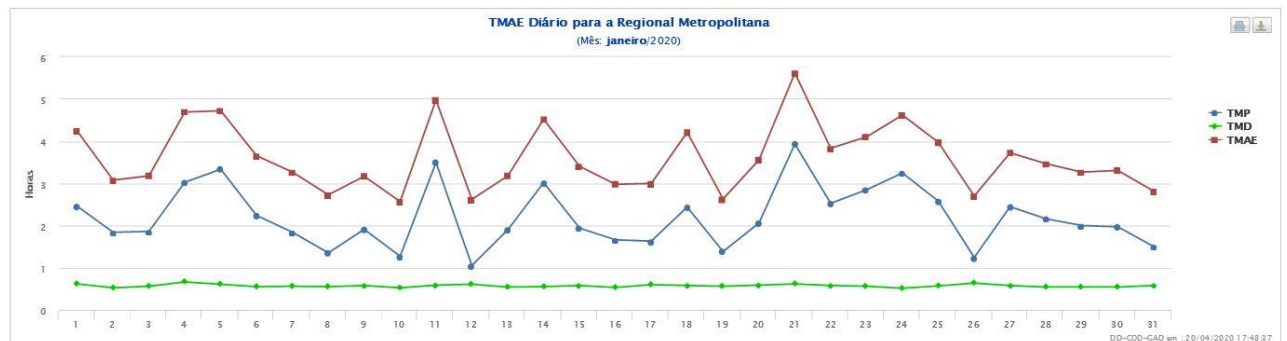
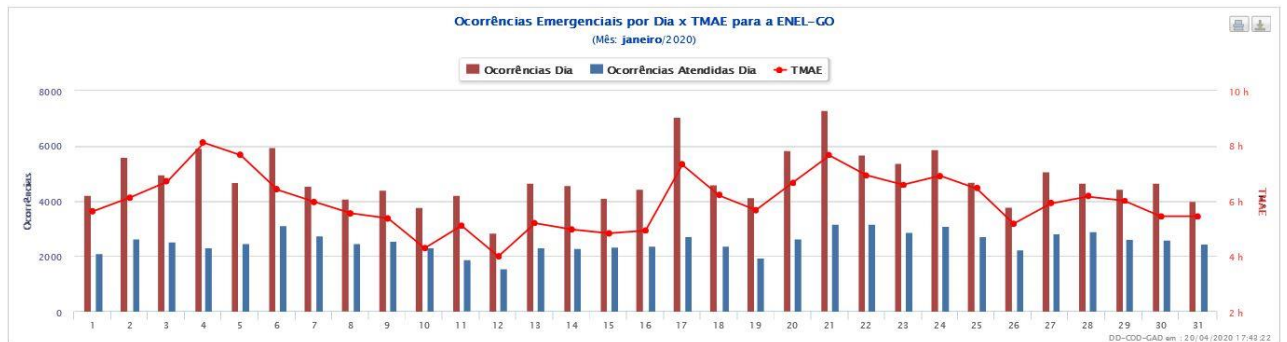

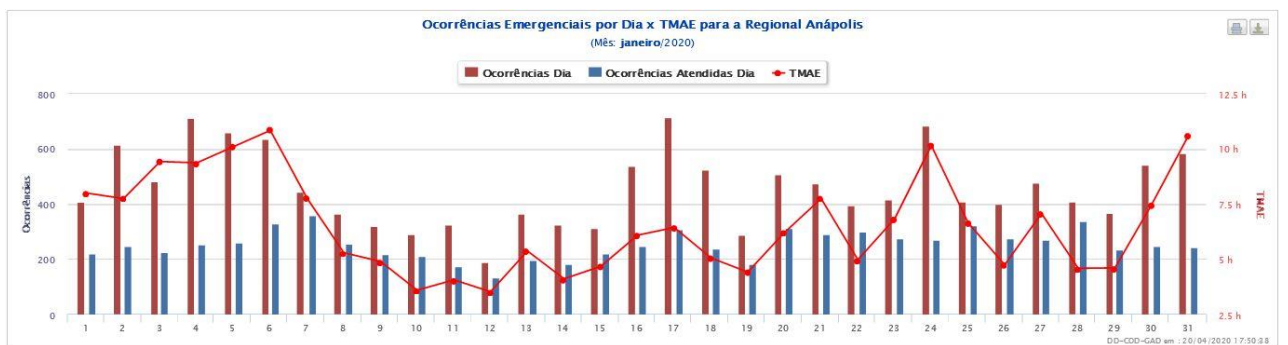
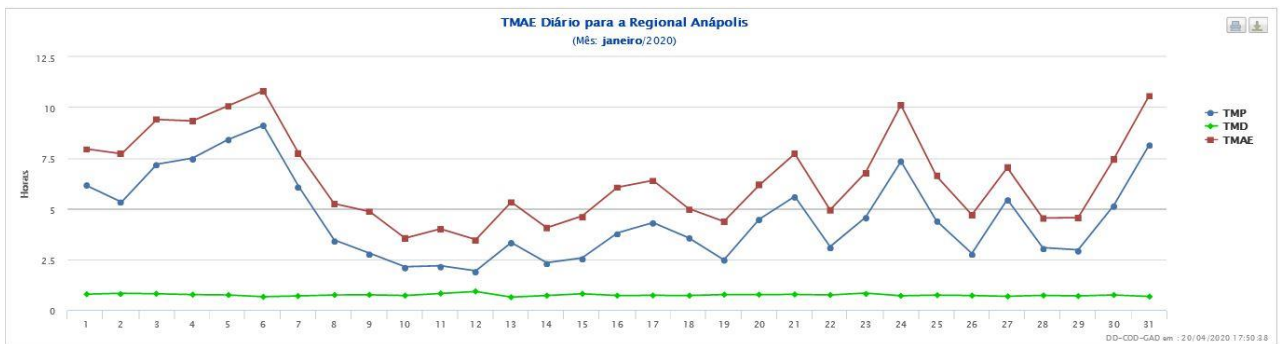
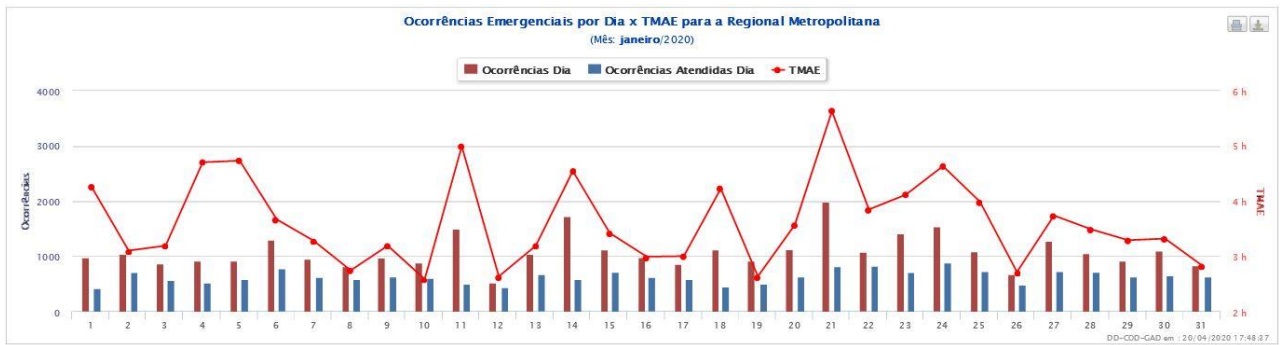



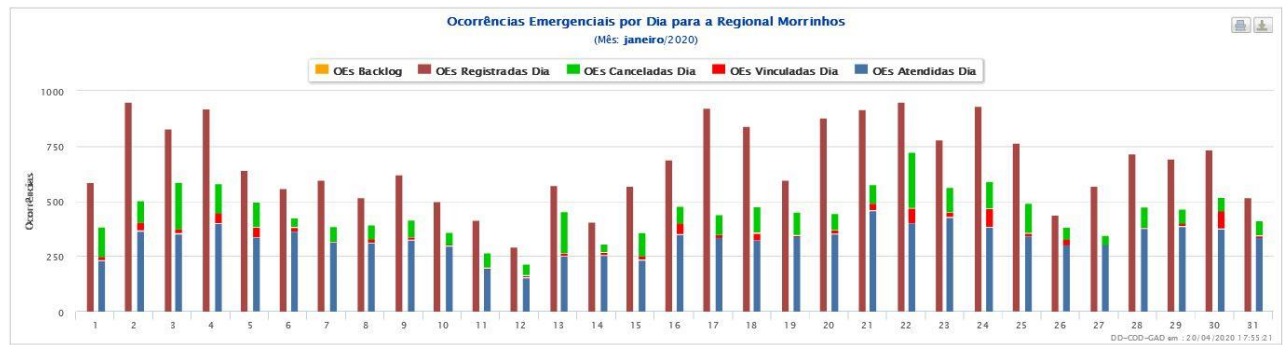
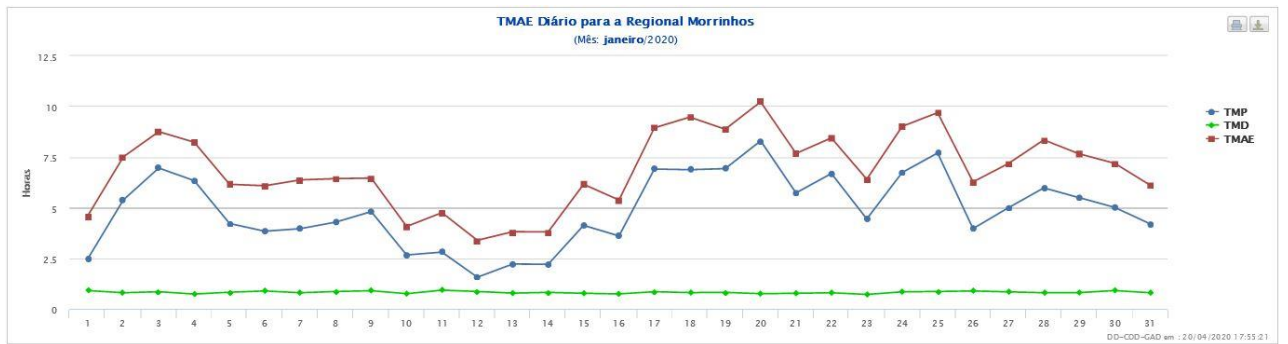
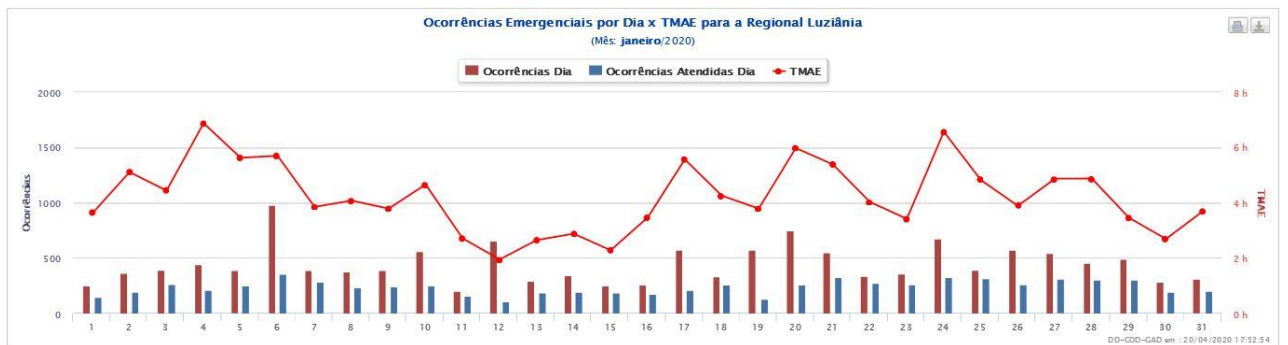
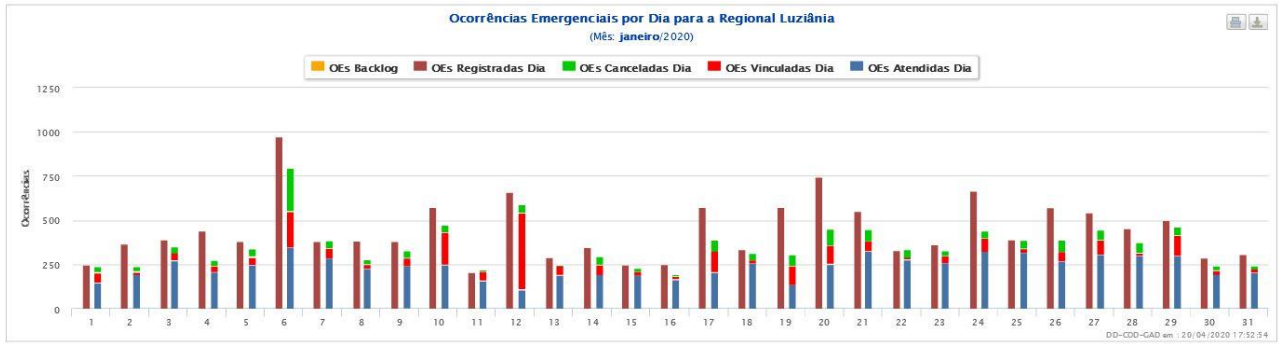
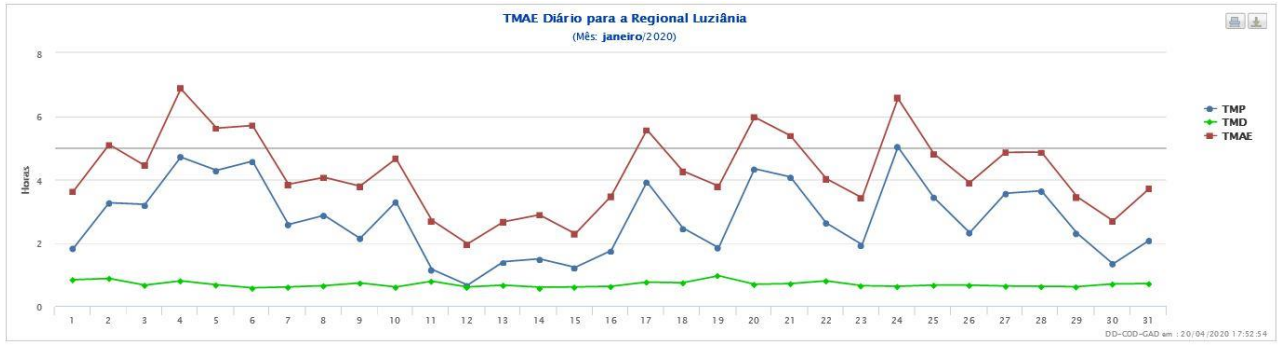



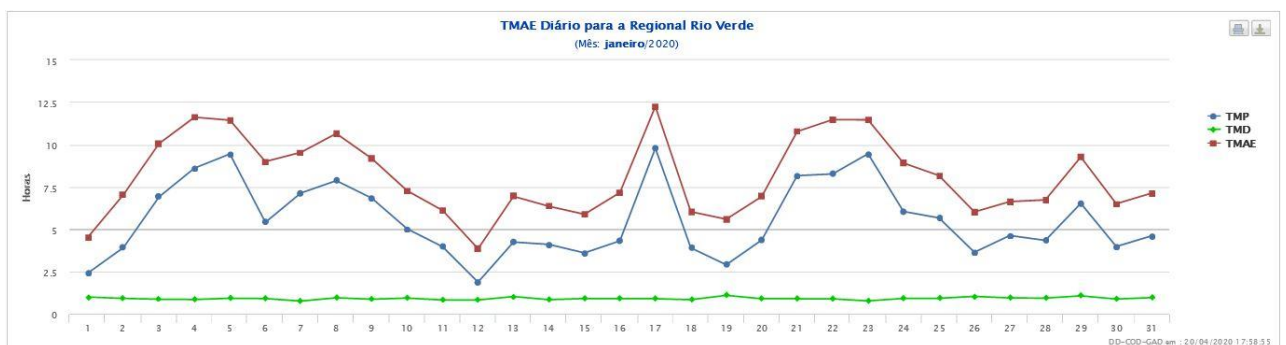
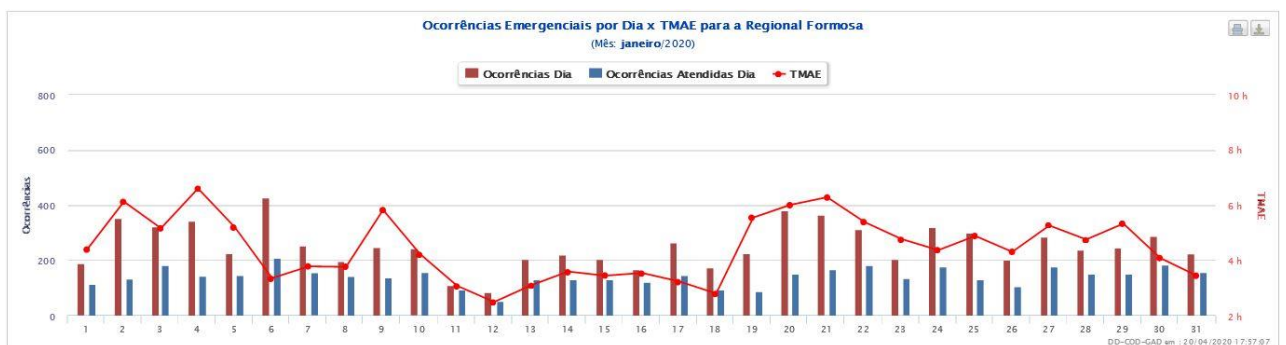
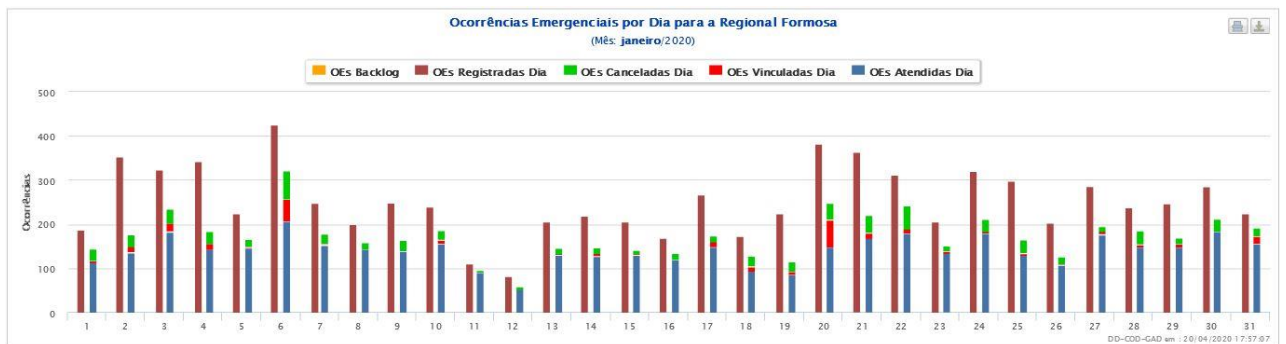
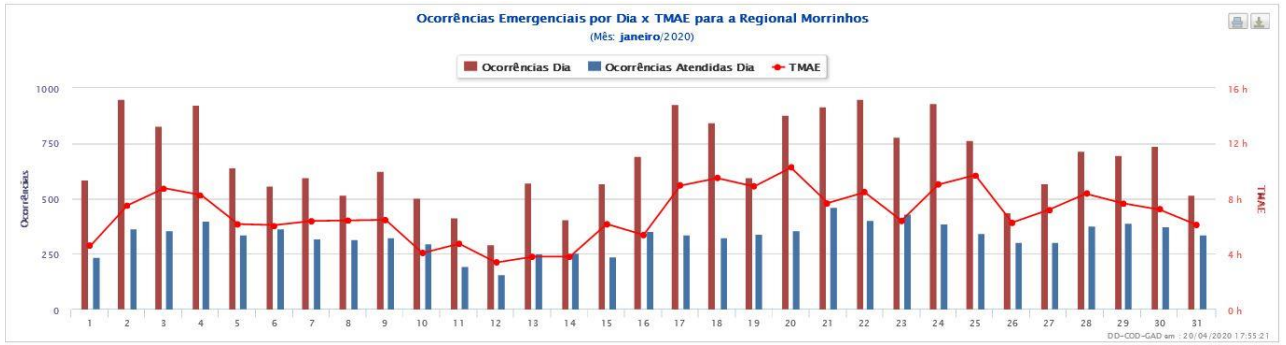

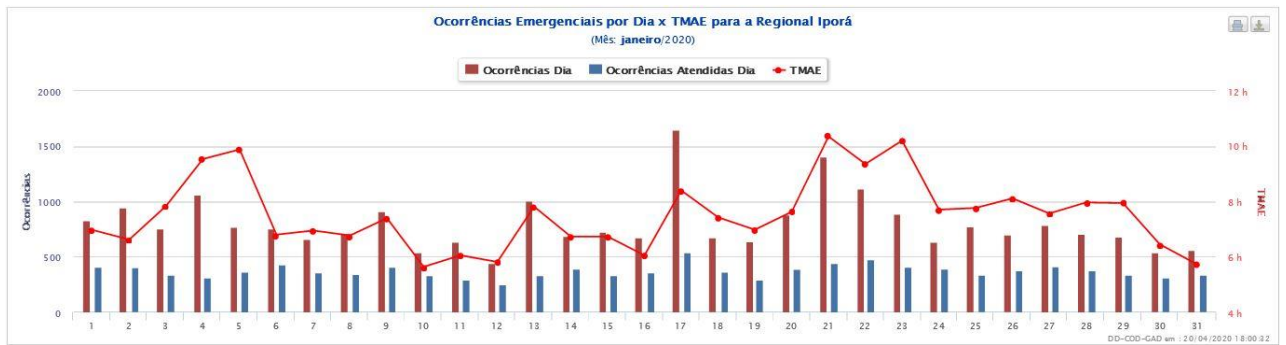
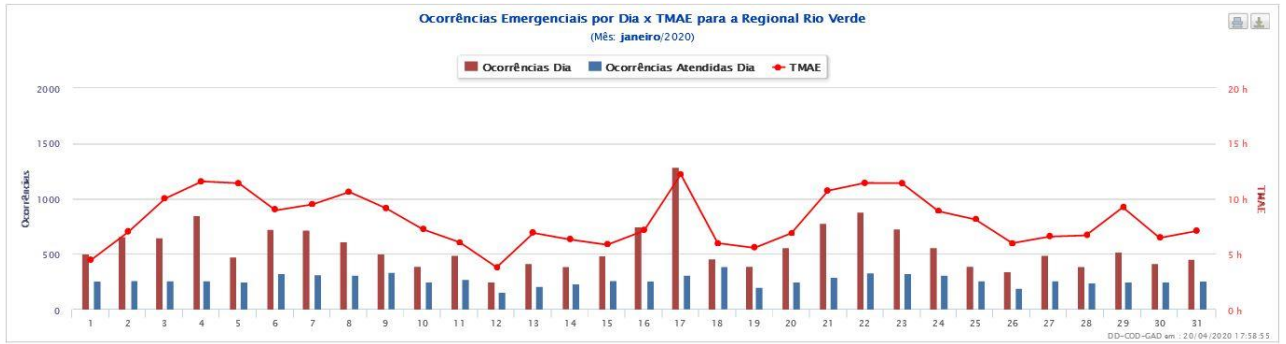

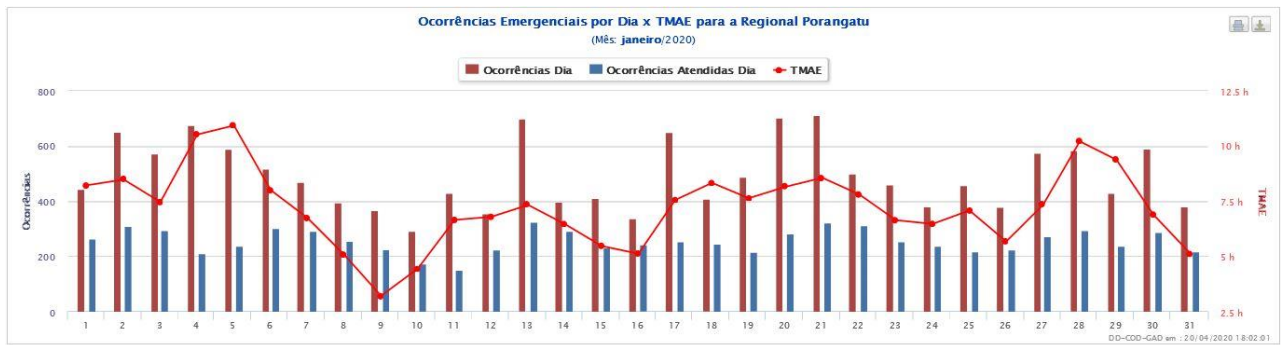
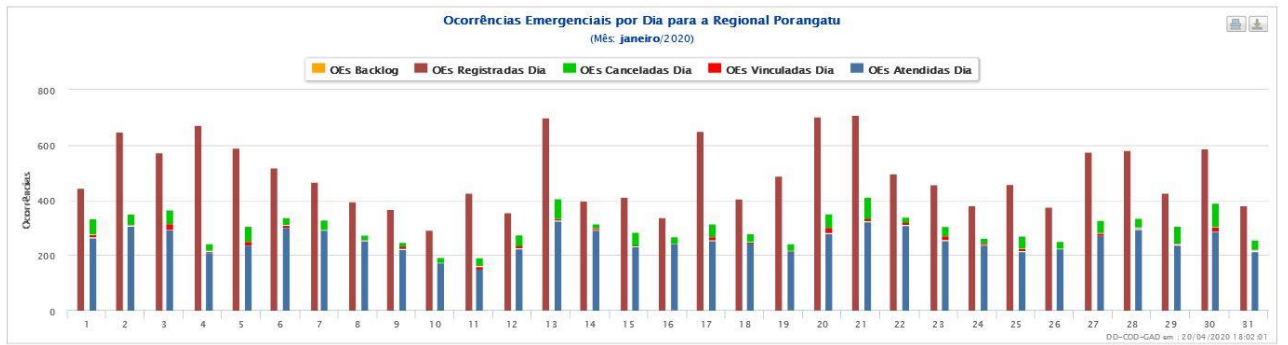
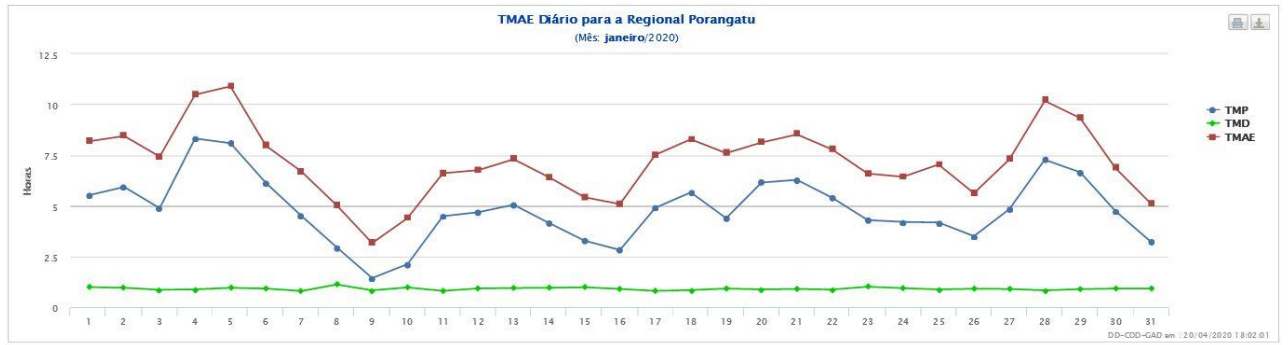

CLIMATEMPO

**Laudo Meteorológico de Evento Climático -  
ENEL Goiás - 02 de janeiro de 2020**

São Paulo, SP, Brasil Fevereiro de 2020

# Sumário

<b>1</b>	<b>ANÁLISE DE EVENTO METEOROLÓGICO .....</b>	<b>2</b>
<b>1.1</b>	<b>Descrição do Evento.....</b>	<b>2</b>
<b>1.2</b>	<b>Abrangência do Evento .....</b>	<b>7</b>
<b>2</b>	<b>CLASSIFICAÇÃO COBRADE .....</b>	<b>22</b>
<b>3</b>	<b>RESUMO DO EVENTO .....</b>	<b>23</b>
<b>4</b>	<b>REFERÊNCIAS.....</b>	<b>27</b>

# 1 Análise de Evento Meteorológico

## 1.1 Descrição do Evento

Na figura a seguir é apresentada a área de concessão da ENEL Goiás, dividida em regiões, a serem analisadas neste relatório.



Figura 1 – Regiões atendidas pela ENEL Goiás.

A organização de um canal de umidade sobre o Brasil manteve as condições meteorológicas favoráveis à formação de nuvens de tempestade sobre o estado de Goiás entre os dias 02 e 07 de janeiro de 2020.

Nas Figuras 2 e 3 são apresentadas as descargas atmosféricas nuvem-solo (raios) e nuvem-nuvem detectadas pelo sistema Earth Networks. Entre as 09h30 do dia 02 e 08h00 do dia 07 de janeiro de 2020 foram registrados 27057 raios nuvem-solo e 51812 descargas nuvem-nuvem sobre a área da CELG Distribuição em Goiás.

Na tabela 1 são apresentadas as rajadas de vento maiores ou iguais a 50 km/h registradas pelo Instituto Nacional de Meteorologia (INMET) representativas da área de concessão da ENEL Goiás. Como é possível observar, o maior valor registrado foi de 69,1 km/h na estação de Monte Alegre de Goiás entre as 11h00 e 12h00 do dia 04 de janeiro

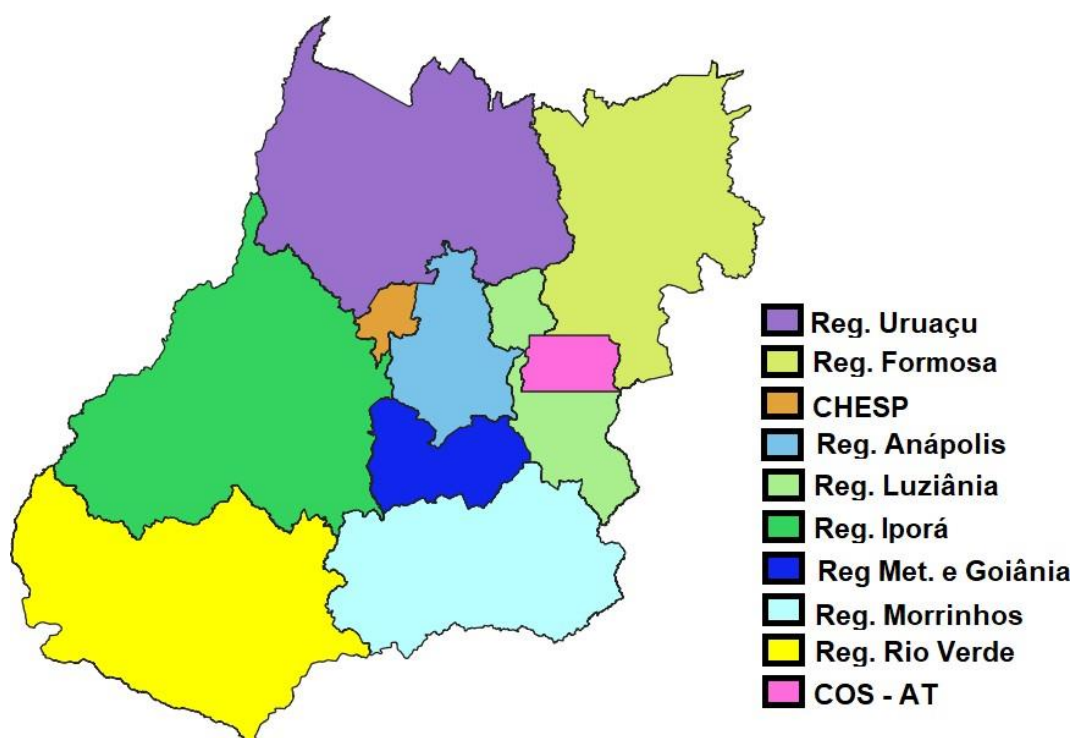

de 2020. Segundo a escala Beaufort, ventos entre 62 e 74 km/h são classificados como ventania.

Nas tabelas de 2 a 6 são apresentados os acumulados diários, também registrados pelo INMET, entre os dias 02 e 07 de janeiro de 2020. O maior volume diário registrado foi na estação de Cristalina entre as 09h00 do dia 04 e as 09h00 do dia 05 de janeiro, com 93,2 mm acumulados, o que corresponde a aproximadamente 37% da média climatológica para o mês de janeiro na região.



Figura 2 – Descargas atmosféricas nuvem-solo (em preto) detectadas pelo sistema Earth Networks entre 09h30 do dia 02 e 08h00 do dia 07 de janeiro de 2020 sobre a área de concessão da CELG Distribuição.



Figura 3 – Descargas atmosféricas nuvem-nuvem (em vermelho) detectadas pelo sistema Earth Networks entre 09h30 do dia 02 e 08h00 do dia 07 de janeiro de 2020 sobre a área de concessão da CELG Distribuição.

Tabela 1 – Rajadas de vento maiores ou iguais a 50 km/h registradas pelo INMET. Segundo a escala Beaufort, ventos entre 50 e 61 km/h são classificados como vento forte e entre 62 e 74 km/h como ventania.

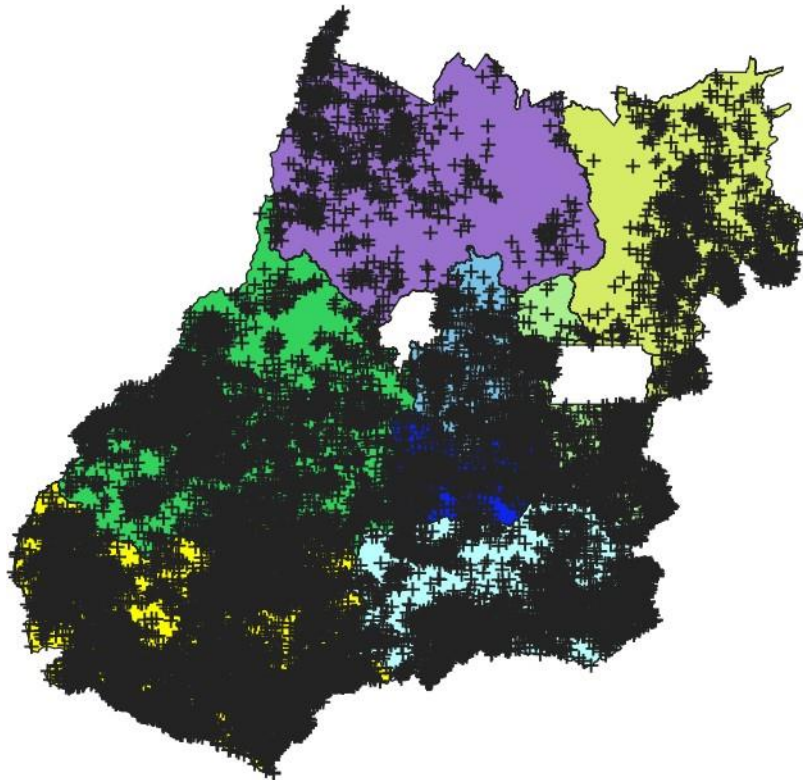
Estação	Horário	Rajada (km/h)
Alto Paraíso de Goiás	Entre 14h e 15h do dia 4/1/2020	55.1
Alto Paraíso de Goiás	Entre 15h e 16h do dia 4/1/2020	55.1
Alto Paraíso de Goiás	Entre 16h e 17h do dia 4/1/2020	57.2
Goianésia	Entre 12h e 13h do dia 4/1/2020	63.4
Goianésia	Entre 5h e 6h do dia 6/1/2020	58.0
Monte Alegre de Goiás	Entre 10h e 11h do dia 4/1/2020	59
Monte Alegre de Goiás	Entre 11h e 12h do dia 4/1/2020	69.1
Monte Alegre de Goiás	Entre 12h e 13h do dia 4/1/2020	52.2
Monte Alegre de Goiás	Entre 14h e 15h do dia 4/1/2020	51.1
São Simão	Entre 14h e 15h do dia 2/1/2020	54.4

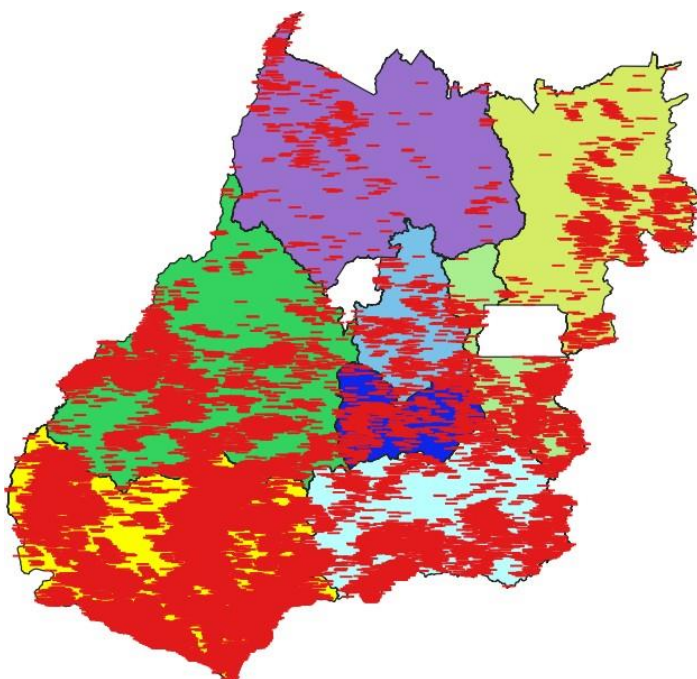

Tabela 2 – Precipitação acumulada entre 09h do dia 02 e 09h do dia 03 de janeiro de 2020. FONTE: INMET

Estação	Precipitação Acumulada(mm)
ITUMBIARA	33,0

Tabela 3 – Precipitação acumulada entre 09h do dia 03 e 09h do dia 04 de janeiro de 2020. FONTE: INMET

Estação	Precipitação Acumulada(mm)
CATALÃO	65,2
IPAMERI	61,1
ARAGARCAS	47,0
ITUMBIARA	46,6
CATALAO	42,4
ARAGARÇAS	42,4
MORRINHOS	31,6
MINEIROS	30,2

Tabela 4 – Precipitação acumulada entre 09h do dia 04 e 09h do dia 05 de janeiro de 2020. FONTE: INMET

Estação	Precipitação Acumulada(mm)
CRISTALINA (FAZENDA SANTA MÔNICA)	93,2
LUZIANIA	80,2
EDEIA	78,4
RIO VERDE	62,6
GOIANIA	49,6
GOIÁS	45,4
SILVANIA	45,0
CRISTALINA	44,0
PIRENOPOLIS	36,1
SÃO SIMÃO	33,6
PIRES DO RIO	30,2

Tabela 5 – Precipitação acumulada entre 09h do dia 05 e 09h do dia 06 de janeiro de 2020. FONTE: INMET

Estação	Precipitação Acumulada(mm)
ITAPACI	74,2
GOIÁS	71,6
GOIANESIA	65,6
PIRENOPOLIS	58,9
FORMOSA	46,9
CAIAPÔNIA	30,6

Tabela 6 – Precipitação acumulada entre 09h do dia 06 e 09h do dia 07 de janeiro de 2020. FONTE: INMET

Estação	Precipitação Acumulada(mm)
PARAUNA	36,2
CAIAPÔNIA	30,6

## 1.2 Abrangência do Evento

A seguir são apresentadas as imagens realçadas do satélite GOES-16 entre as 11h00 do dia 02 e 07h00 do dia 07 de janeiro de 2020. Os tons em vermelho e preto indicam a presença de nuvens de grande desenvolvimento vertical, geralmente associadas à ocorrência de tempo severo.

**11h00 - 02 de janeiro de 2020**



Figura 4 – Imagens realçadas do satélite GOES-16 das 11h00 do dia 02 de janeiro de 2020.  
FONTE: Cptec/INPE.

**15h00 - 02 de janeiro de 2020**

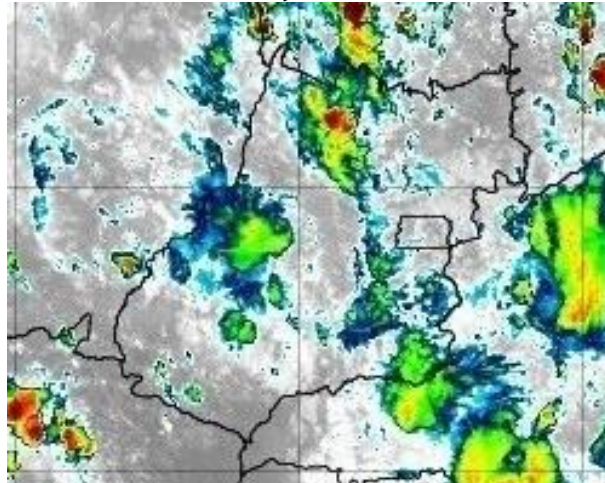

Figura 5 – Imagens realçadas do satélite GOES-16 das 15h00 do dia 02 de janeiro de 2020.  
FONTE: Cptec/INPE.

**21h00 - 02 de janeiro de 2020**

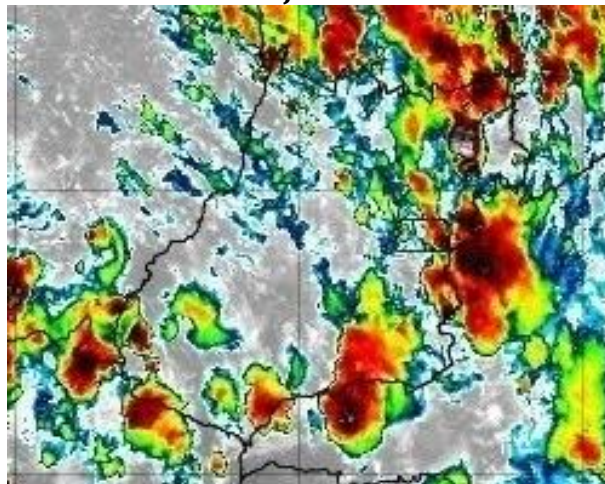

Figura 6 – Imagens realçadas do satélite GOES-16 das 21h00 do dia 02 de janeiro de 2020.  
FONTE: Cptec/INPE.

**01h00 - 03 de janeiro de 2020**

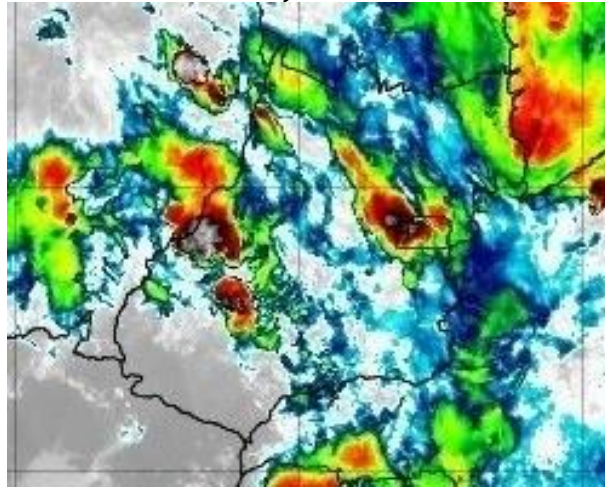

Figura 7 – Imagens realçadas do satélite GOES-16 das 01h00 do dia 03 de janeiro de 2020.  
FONTE: Cptec/INPE.

**05h00 - 03 de janeiro de 2020**

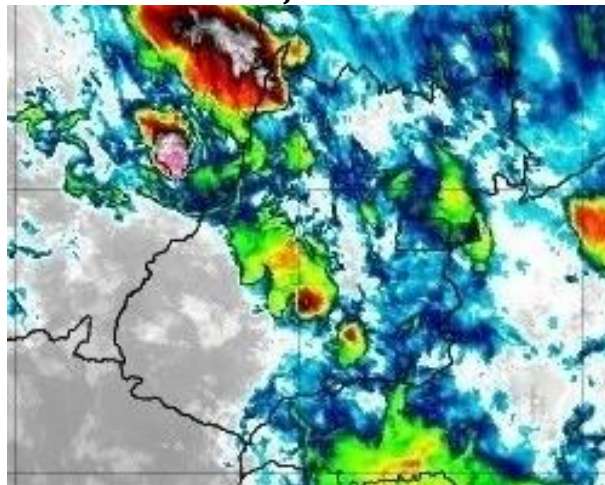

Figura 8 – Imagens realçadas do satélite GOES-16 das 05h00 do dia 03 de janeiro de 2020.  
FONTE: Cptec/INPE.

**09h00 - 03 de janeiro de 2020**



Figura 9 – Imagens realçadas do satélite GOES-16 das 09h00 do dia 03 de janeiro de 2020.  
FONTE: Cptec/INPE.

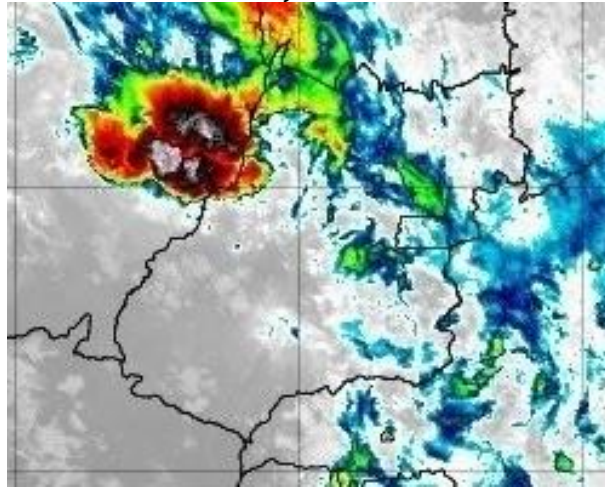

**13h00 - 03 de janeiro de 2020**

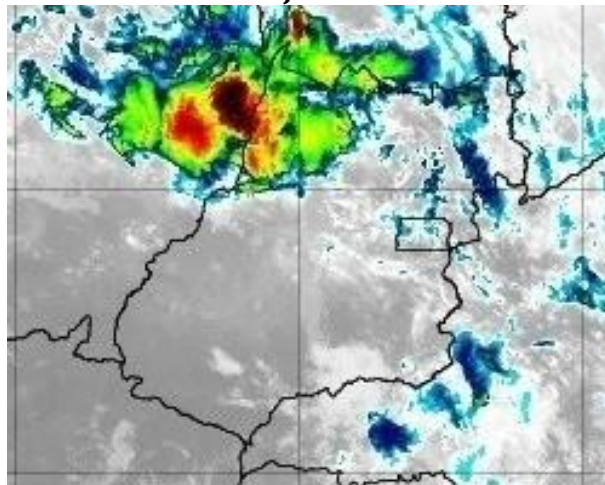

Figura 10 – Imagens realçadas do satélite GOES-16 das 13h00 do dia 03 de janeiro de 2020. FONTE: Cptec/INPE.

**17h00 - 03 de janeiro de 2020**

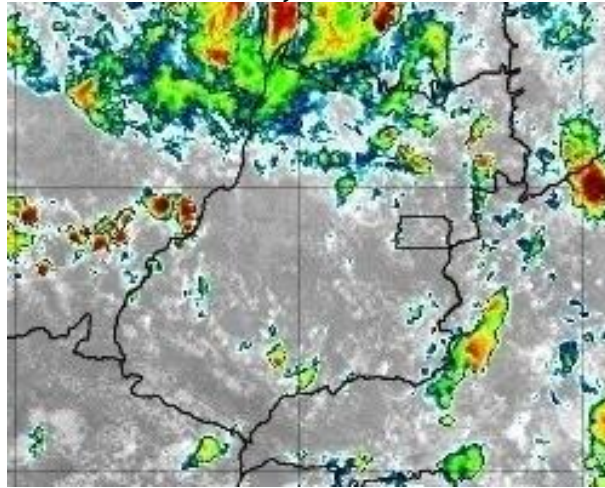

Figura 11 – Imagens realçadas do satélite GOES-16 das 17h00 do dia 03 de janeiro de 2020. FONTE: Cptec/INPE.

**21h00 - 03 de janeiro de 2020**

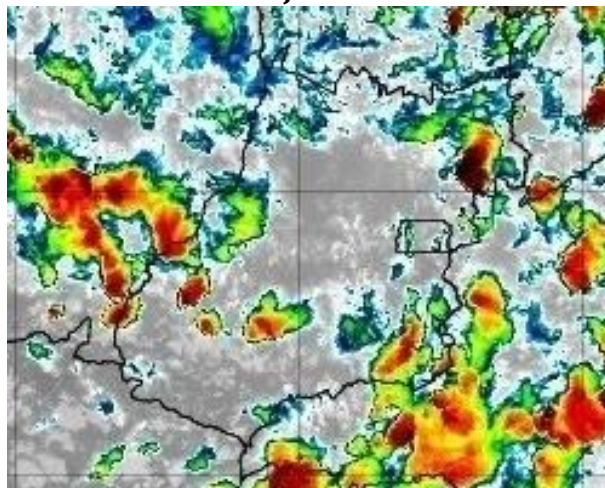

Figura 12 – Imagens realçadas do satélite GOES-16 das 21h00 do dia 03 de janeiro de 2020. FONTE: Cptec/INPE.

**01h00 - 04 de janeiro de 2020**

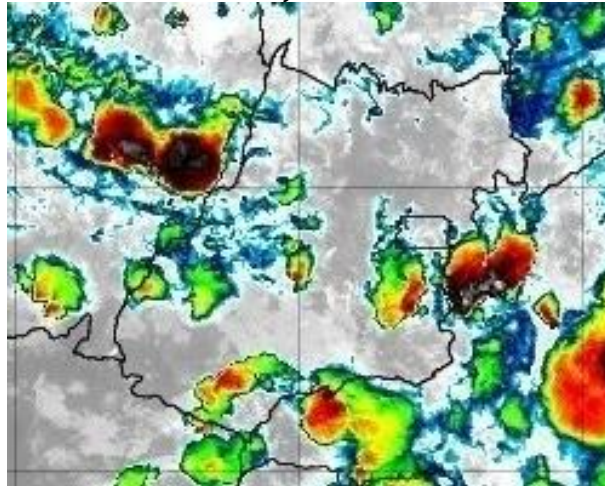

Figura 13 – Imagens realçadas do satélite GOES-16 das 01h00 do dia 04 de janeiro de 2020. FONTE: Cptec/INPE.

**05h00 - 04 de janeiro de 2020**

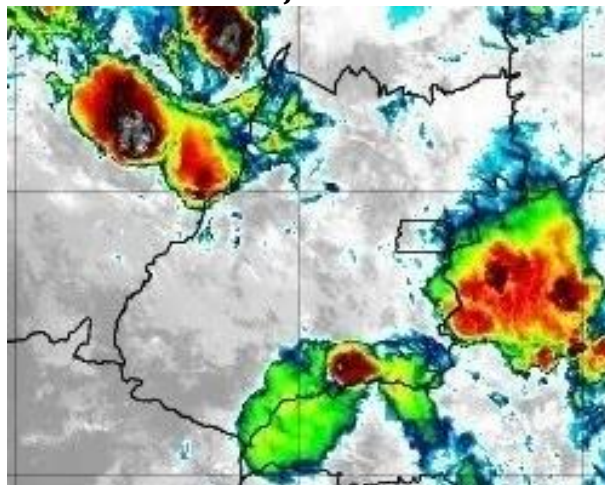

Figura 14 – Imagens realçadas do satélite GOES-16 das 05h00 do dia 04 de janeiro de 2020. FONTE: Cptec/INPE.

**09h00 - 04 de janeiro de 2020**



Figura 15 – Imagens realçadas do satélite GOES-16 das 09h00 do dia 04 de janeiro de 2020. FONTE: Cptec/INPE.

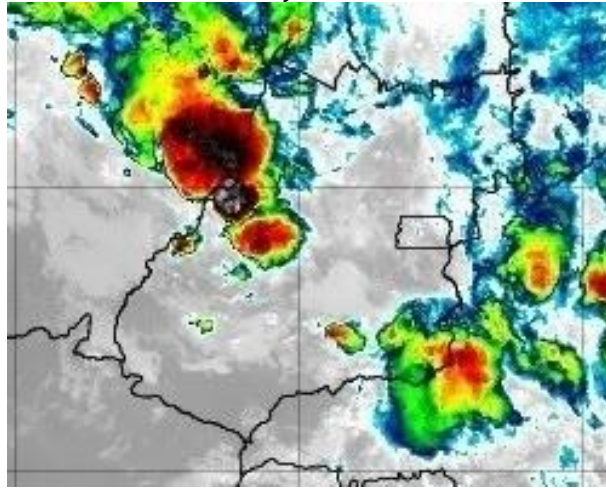

**13h00 - 04 de janeiro de 2020**

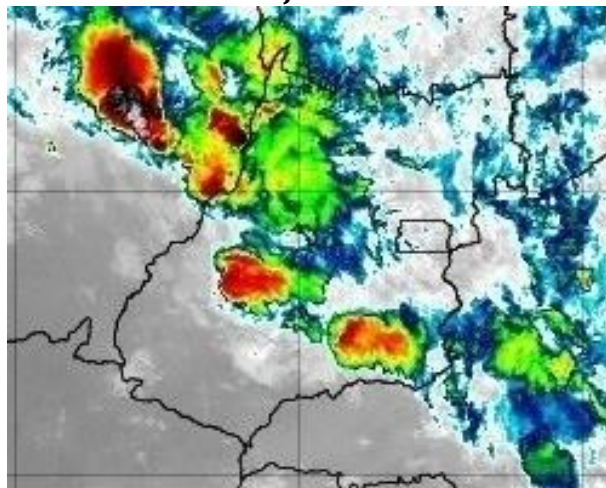

Figura 16 – Imagens realçadas do satélite GOES-16 das 13h00 do dia 04 de janeiro de 2020. FONTE: Cptec/INPE.

**17h00 - 04 de janeiro de 2020**

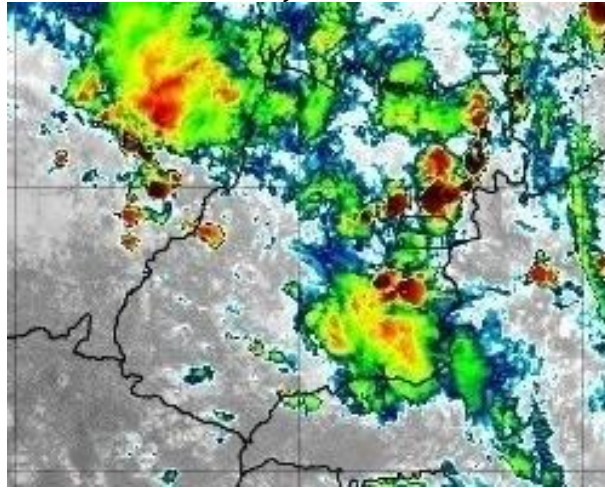

Figura 17 – Imagens realçadas do satélite GOES-16 das 17h00 do dia 04 de janeiro de 2020. FONTE: Cptec/INPE.

**21h00 - 04 de janeiro de 2020**

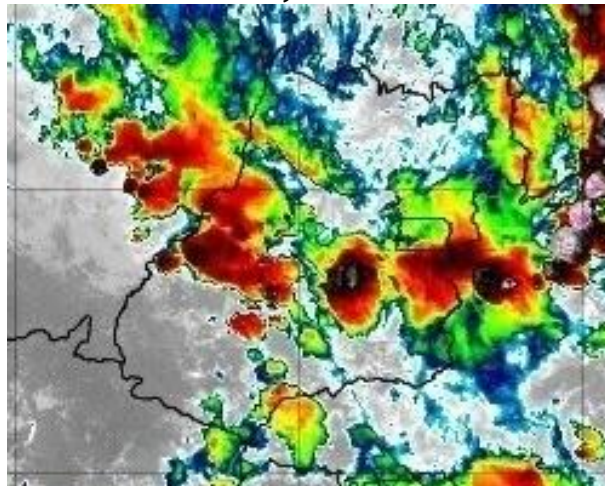

Figura 18 – Imagens realçadas do satélite GOES-16 das 21h00 do dia 04 de janeiro de 2020. FONTE: Cptec/INPE.

**01h00 - 05 de janeiro de 2020**

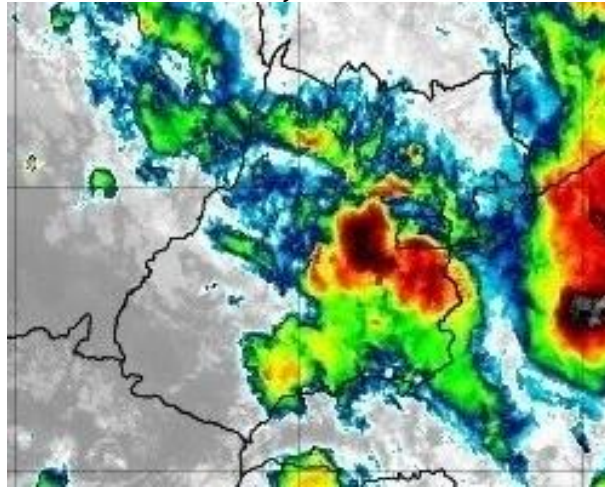

Figura 19 – Imagens realçadas do satélite GOES-16 das 01h00 do dia 05 de janeiro de 2020. FONTE: Cptec/INPE.

**05h00 - 05 de janeiro de 2020**



Figura 20 – Imagens realçadas do satélite GOES-16 das 05h00 do dia 05 de janeiro de 2020. FONTE: Cptec/INPE.

**09h00 - 05 de janeiro de 2020**



Figura 21 – Imagens realçadas do satélite GOES-16 das 09h00 do dia 05 de janeiro de 2020. FONTE: Cptec/INPE.

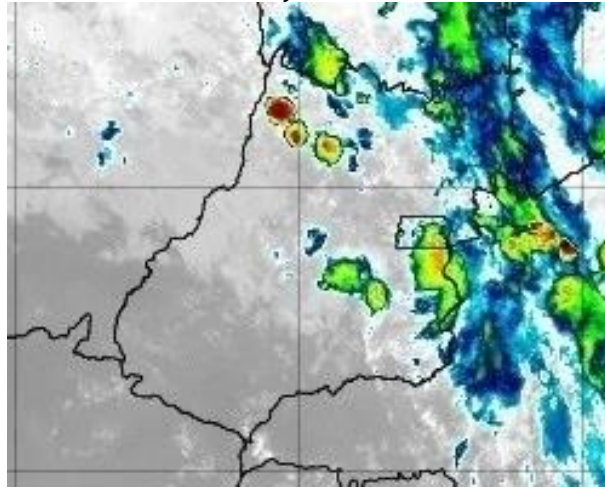

**13h00 - 05 de janeiro de 2020**



Figura 22 – Imagens realçadas do satélite GOES-16 das 13h00 do dia 05 de janeiro de 2020. FONTE: Cptec/INPE.

**17h00 - 05 de janeiro de 2020**

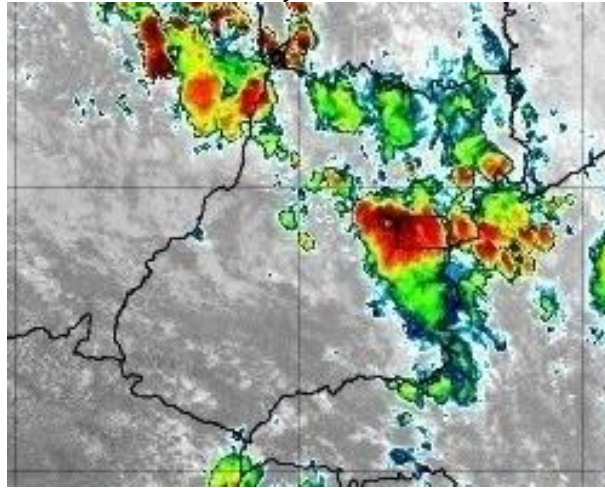

Figura 23 – Imagens realçadas do satélite GOES-16 das 17h00 do dia 05 de janeiro de 2020. FONTE: Cptec/INPE.

**21h00 - 05 de janeiro de 2020**



Figura 24 – Imagens realçadas do satélite GOES-16 das 21h00 do dia 05 de janeiro de 2020. FONTE: Cptec/INPE.

**01h00 - 06 de janeiro de 2020**



Figura 25 – Imagens realçadas do satélite GOES-16 das 01h00 do dia 06 de janeiro de 2020. FONTE: Cptec/INPE.

**05h00 - 06 de janeiro de 2020**

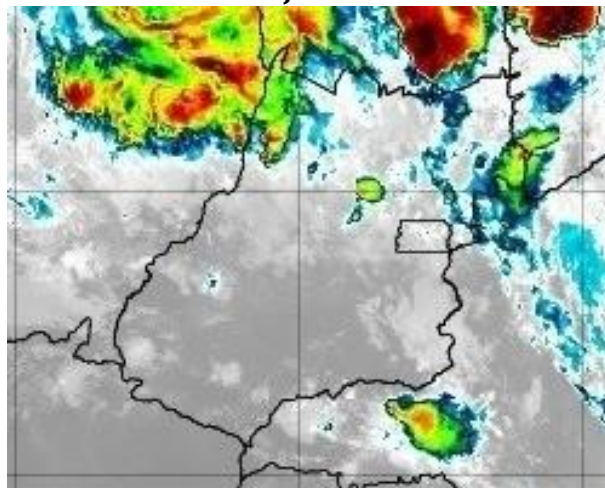

Figura 26 – Imagens realçadas do satélite GOES-16 das 05h00 do dia 06 de janeiro de 2020. FONTE: Cptec/INPE.

**09h00 - 06 de janeiro de 2020**

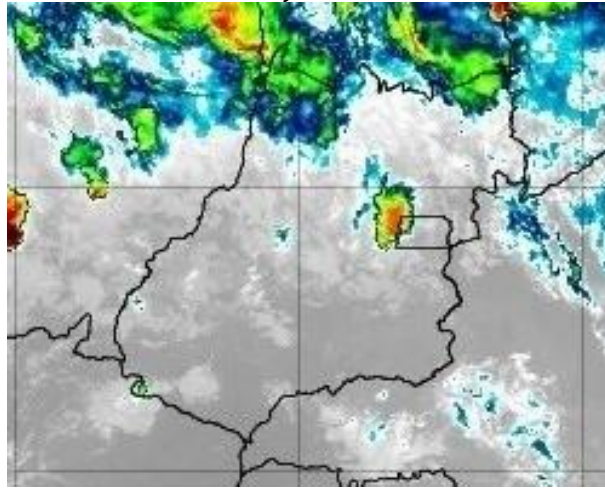

Figura 27 – Imagens realçadas do satélite GOES-16 das 09h00 do dia 06 de janeiro de 2020. FONTE: Cptec/INPE.

**13h00 - 06 de janeiro de 2020**

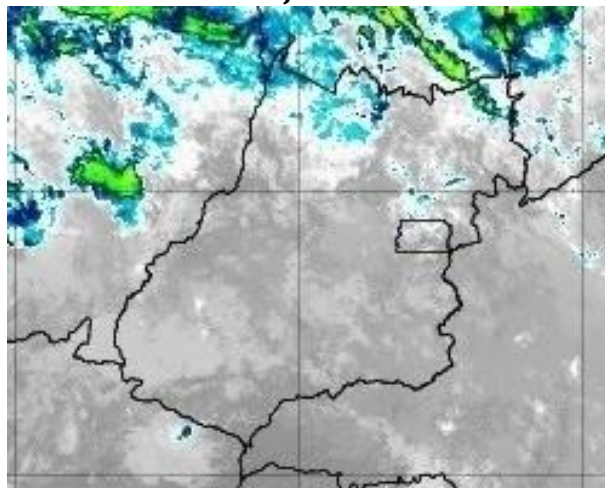

Figura 28 – Imagens realçadas do satélite GOES-16 das 13h00 do dia 06 de janeiro de 2020. FONTE: Cptec/INPE.

**17h00 - 06 de janeiro de 2020**



Figura 29 – Imagens realçadas do satélite GOES-16 das 17h00 do dia 06 de janeiro de 2020. FONTE: Cptec/INPE.

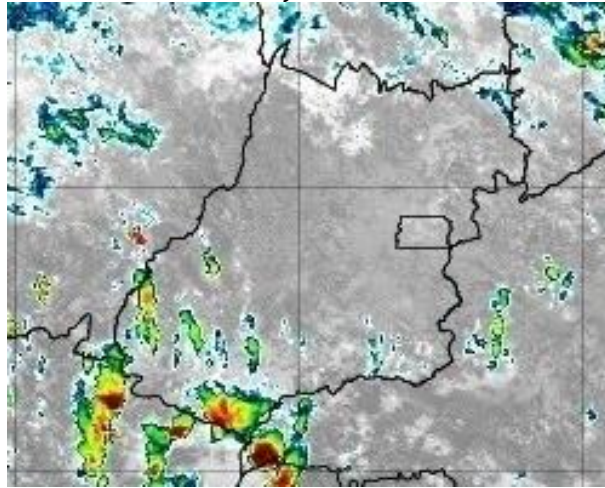

**23h00 - 06 de janeiro de 2020**

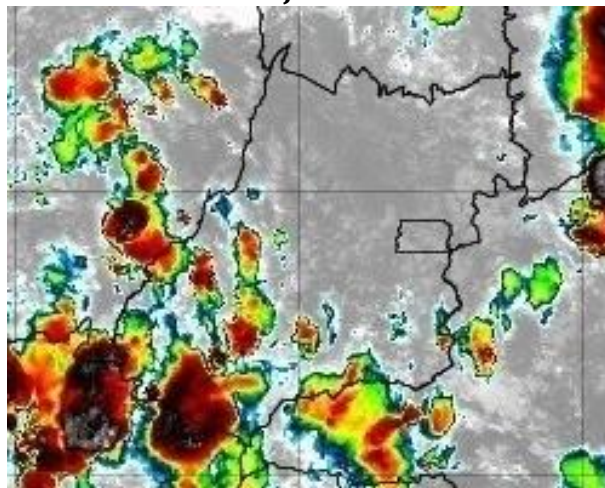

Figura 30 – Imagens realçadas do satélite GOES-16 das 23h00 do dia 06 de janeiro de 2020. FONTE: Cptec/INPE.

**03h00 - 07 de janeiro de 2020**



Figura 31 – Imagens realçadas do satélite GOES-16 das 03h00 do dia 07 de janeiro de 2020. FONTE: Cptec/INPE.



**07h00 - 07 de janeiro de 2020**

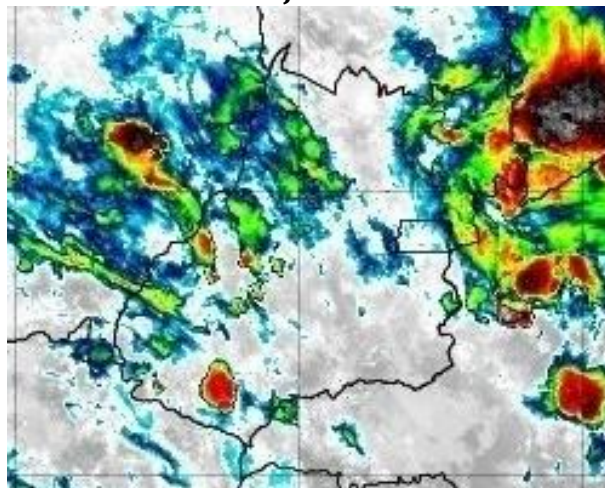

Figura 32 – Imagens realçadas do satélite GOES-16 das 07h00 do dia 07 de janeiro de 2020. FONTE: Cptec/INPE.

## 2 Classificação COBRADE

O COBRADE (Classificação e Codificação Brasileira de Desastres) foi criado com o intuito de adequar a classificação brasileira à classificação utilizada pela ONU na classificação de desastres e nivelar o país aos demais organismos de gestão de desastres do mundo.

Baseados nos dados analisados nos itens anteriores, podemos classificar o evento ocorrido na ENEL em Goiás como Zona de Convergência (Código COBRADE 1.3.1.2.0).

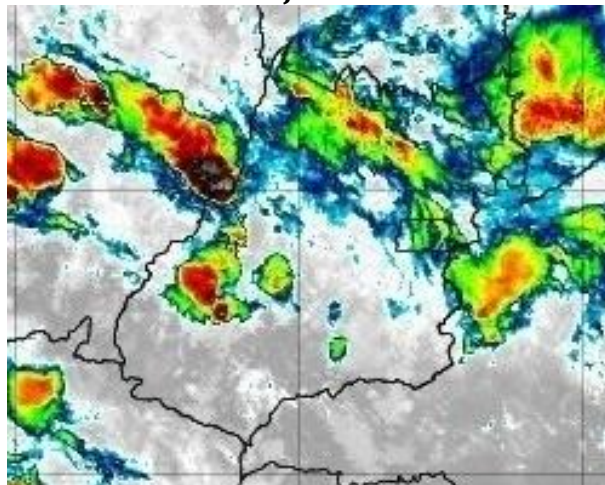
### 3 Resumo do Evento

Áreas de instabilidade formadas pela presença de uma zona de convergência de umidade atuaram sobre o estado de Goiás entre a manhã do dia 02 e a manhã do dia 07 de janeiro de 2020.

O sistema de detecção da EarthNetworks registrou 78869 descargas atmosféricas sobre a área de concessão da ENEL em Goiás entre as 09h30 do dia 02 e 08h00 do dia 07 de janeiro de 2020.

Rajadas de vento forte e ventania foram registradas pelo INMET durante o evento. A rajada máxima registrada foi de 69,1 km/h na estação de Monte Alegre de Goiás entre as 11h00 e 12h00 do dia 04 de janeiro de 2020.

Na estação de Cristalina entre as 09h00 do dia 04 e as 09h00 do dia 05 de janeiro foram acumulados 93,2 mm, valor que corresponde a aproximadamente 37% da média climatológica para o mês de janeiro na região.

Tabela 7 – Resumo do evento Regional Rio Verde

Número/Código do Evento	
Número/Código do Relatório	
Descrição	Região ligada à tempestade causada por uma zona de baixa pressão atmosférica, provocando forte deslocamento de massas de ar, vendavais, chuvas intensa e possível queda de granizo.
Código COBRADE	1.3.1.2.0 – Zona de Convergência
Hora início do evento	09h30 do dia 02 de janeiro de 2020
Hora de fim do evento	06h00 do dia 07 de janeiro de 2020
Abrangência	Regional Rio Verde

Tabela 8 – Resumo do evento Regional Morrinhos

Número/Código do Evento	
Número/Código do Relatório	
Descrição	Região ligada à tempestade causada por uma zona de baixa pressão atmosférica, provocando forte deslocamento de massas de ar, vendavais, chuvas intensa e possível queda de granizo.
Código COBRADE	1.3.1.2.0 – Zona de Convergência
Hora início do evento	10h30 do dia 02 de janeiro de 2020
Hora de fim do evento	07h00 do dia 07 de janeiro de 2020
Abrangência	Regional Morrinhos

Tabela 9 – Resumo do evento Regional Metropolitana e Goiânia

Número/Código do Evento	
Número/Código do Relatório	
Descrição	Região ligada à tempestade causada por uma zona de baixa pressão atmosférica, provocando forte deslocamento de massas de ar, vendavais, chuvas intensa e possível queda de granizo.
Código COBRADE	1.3.1.2.0 – Zona de Convergência
Hora início do evento	12h00 do dia 02 de janeiro de 2020
Hora de fim do evento	19h00 do dia 05 de janeiro de 2020
Abrangência	Regional Metropolitana e Goiânia

Tabela 10 – Resumo do evento Regional Iporá

Número/Código do Evento	
Número/Código do Relatório	
Descrição	Região ligada à tempestade causada por uma zona de baixa pressão atmosférica, provocando forte deslocamento de massas de ar, vendavais, chuvas intensa e possível queda de granizo.
Código COBRADE	1.3.1.2.0 – Zona de Convergência
Hora início do evento	09h30 do dia 02 de janeiro de 2020
Hora de fim do evento	06h30 do dia 07 de janeiro de 2020
Abrangência	Regional Iporá

Tabela 11 – Resumo do evento Regional Luziânia

Número/Código do Evento	
Número/Código do Relatório	
Descrição	Região ligada à tempestade causada por uma zona de baixa pressão atmosférica, provocando forte deslocamento de massas de ar, vendavais, chuvas intensa e possível queda de granizo.
Código COBRADE	1.3.1.2.0 – Zona de Convergência
Hora início do evento	11h00 do dia 02 de janeiro de 2020
Hora de fim do evento	03h30 do dia 07 de janeiro de 2020
Abrangência	Regional Luziânia

Tabela 12 – Resumo do evento Regional Anápolis

Número/Código do Evento	
Número/Código do Relatório	
Descrição	Região ligada à tempestade causada por uma zona de baixa pressão atmosférica, provocando forte deslocamento de massas de ar, vendavais, chuvas intensa e possível queda de granizo.
Código COBRADE	1.3.1.2.0 – Zona de Convergência
Hora início do evento	12h30 do dia 02 de janeiro de 2020
Hora de fim do evento	01h00 do dia 07 de janeiro de 2020
Abrangência	Regional Anápolis

Tabela 13 – Resumo do evento Regional Uruaçu

Número/Código do Evento	
Número/Código do Relatório	
Descrição	Região ligada à tempestade causada por uma zona de baixa pressão atmosférica, provocando forte deslocamento de massas de ar, vendavais, chuvas intensa e possível queda de granizo.
Código COBRADE	1.3.1.2.0 – Zona de Convergência
Hora início do evento	09h30 do dia 02 de janeiro de 2020
Hora de fim do evento	07h00 do dia 07 de janeiro de 2020
Abrangência	Regional Uruaçu

Tabela 14 – Resumo do evento Regional Formosa

Número/Código do Evento	
Número/Código do Relatório	
Descrição	Região ligada à tempestade causada por uma zona de baixa pressão atmosférica, provocando forte deslocamento de massas de ar, vendavais, chuvas intensa e possível queda de granizo.
Código COBRADE	1.3.1.2.0 – Zona de Convergência
Hora início do evento	10h30 do dia 02 de janeiro de 2020
Hora de fim do evento	07h30 do dia 07 de janeiro de 2020
Abrangência	Regional Formosa

## 4 Referências

- RMets Royal Meteorological Society – Beaufort Scale - <https://www.rmets.org/weather-and-climate/observing/beaufort-scale>
- Instituto Nacional de Meteorologia (INMET) - <http://www.inmet.gov.br>
- Cptec/INPE- <https://www.cptec.inpe.br/>
- Centro de Hidrografia da Marinha do Brasil - <https://www.marinha.mil.br/chm/>
- Meteorology Glossary - American Meteorological Society - <http://glossary.ametsoc.org/>

# Anexos

## A.1 Carta Sinótica



Figura A1 - Carta sinótica para as 1200Z do dia 02 de janeiro de 2020 (0900 do dia 02 de janeiro de 2020 hora local. FONTE: Marinha do Brasil).



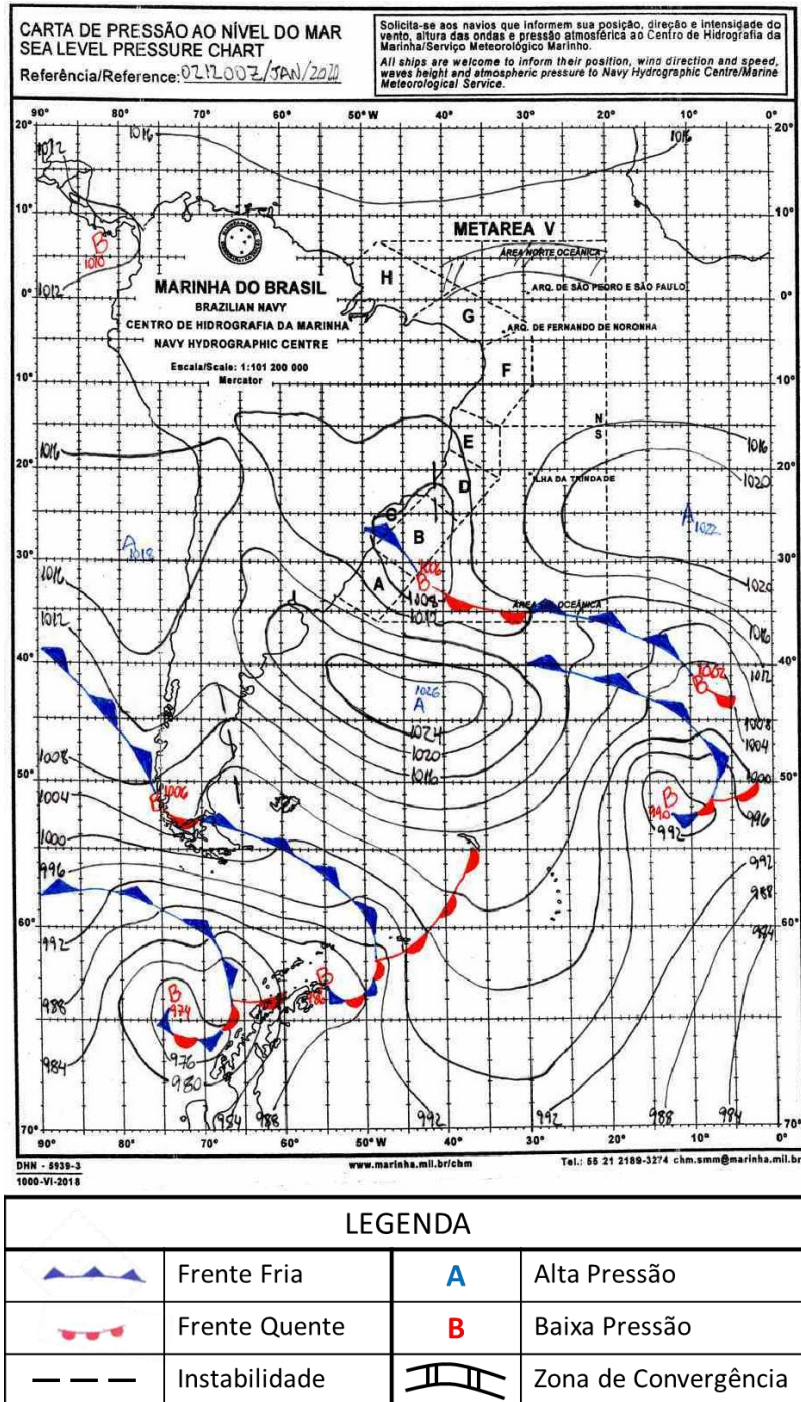
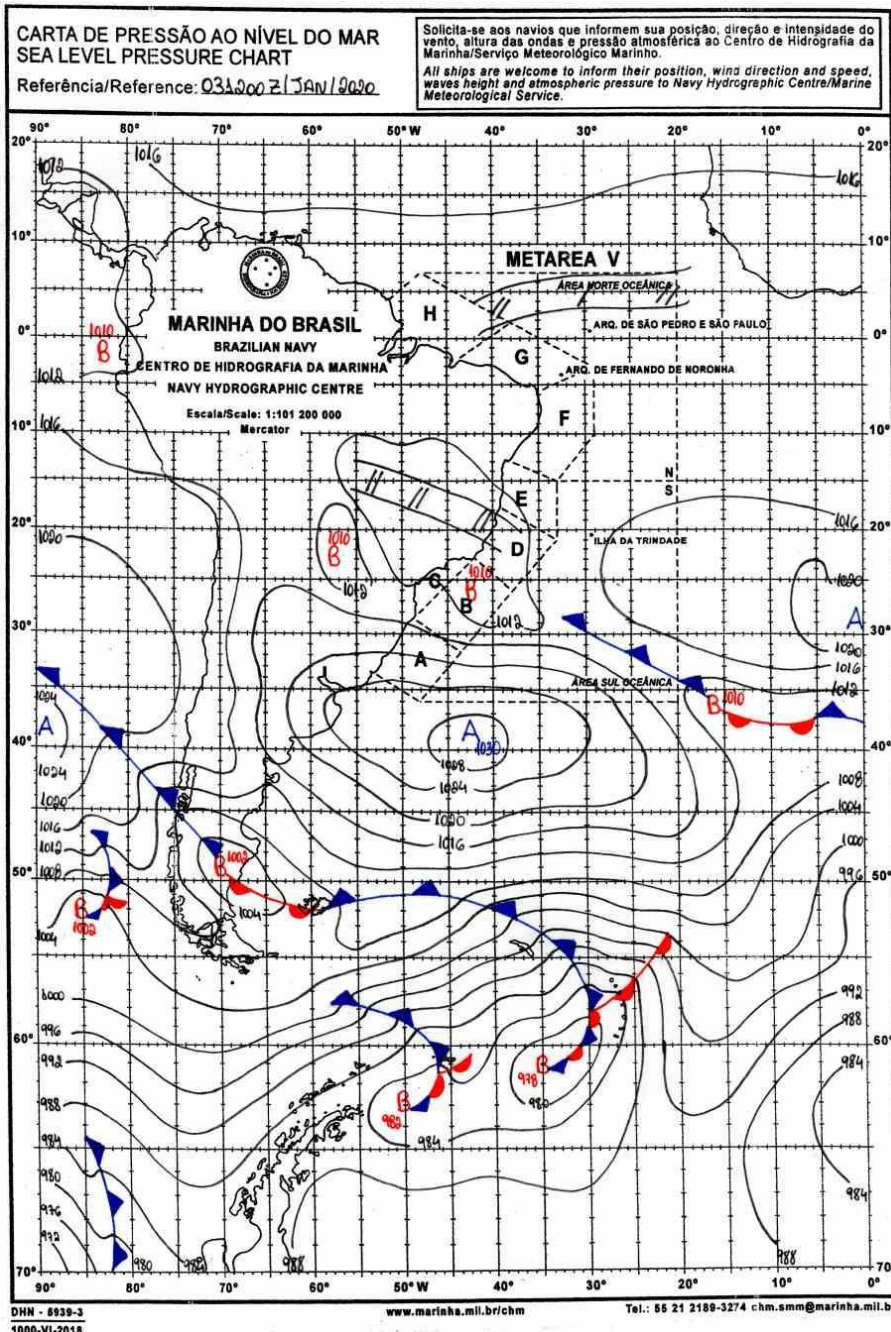

LEGENDA			
	Frente Fria	<b>A</b>	Alta Pressão
	Frente Quente	<b>B</b>	Baixa Pressão
	Instabilidade		Zona de Convergência

Figura A2 - Carta sinótica para as 1200Z do dia 03 de janeiro de 2020 (09h00 do dia 03 de janeiro de 2020 hora local. FONTE: Marinha do Brasil).

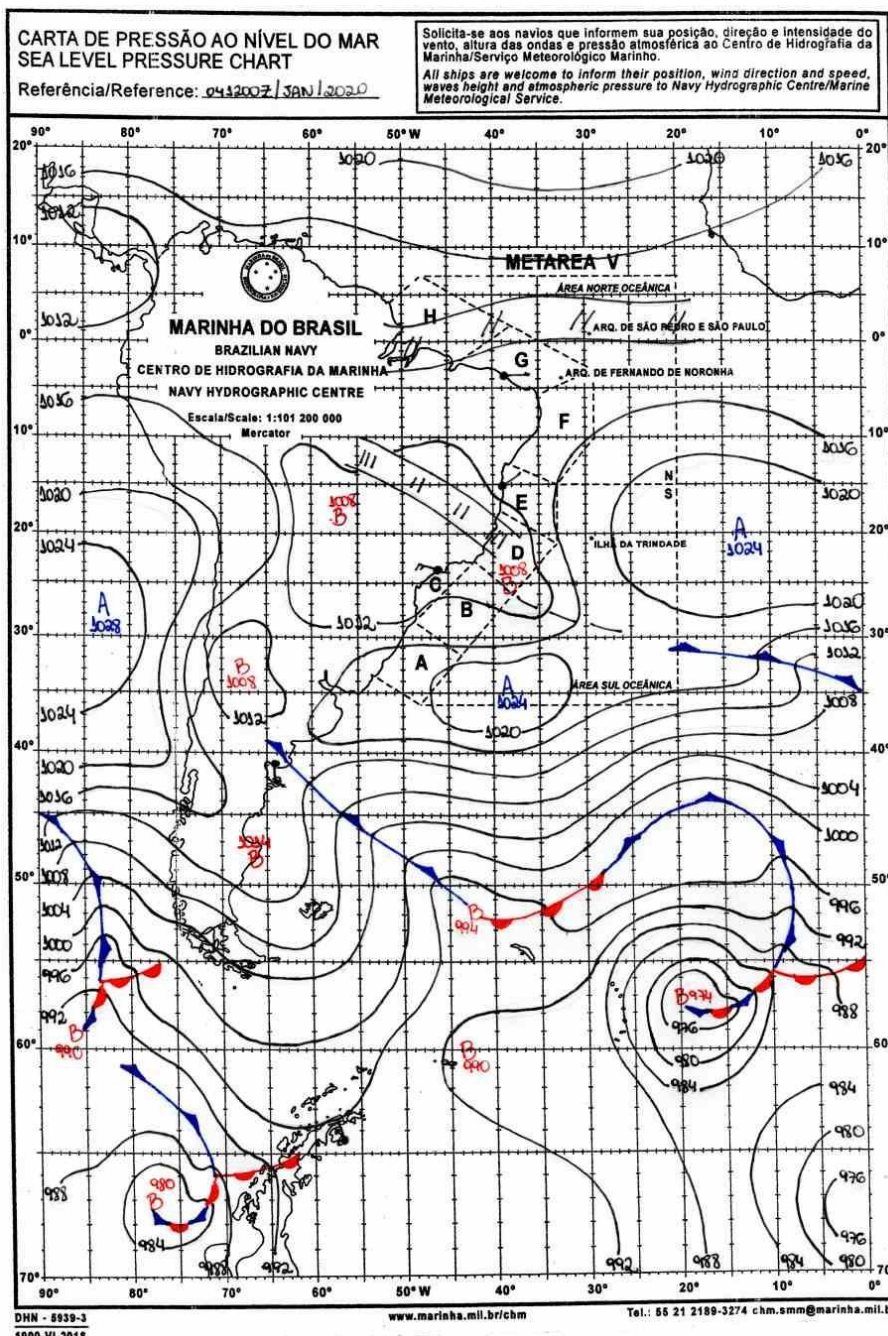

LEGENDA			
	Frente Fria	<b>A</b>	Alta Pressão
	Frente Quente	<b>B</b>	Baixa Pressão
	Instabilidade		Zona de Convergência

Figura A3 - Carta sinótica para as 1200Z do dia 04 de janeiro de 2020 (09h00 do dia 04 de janeiro de 2020 hora local. FONTE: Marinha do Brasil).



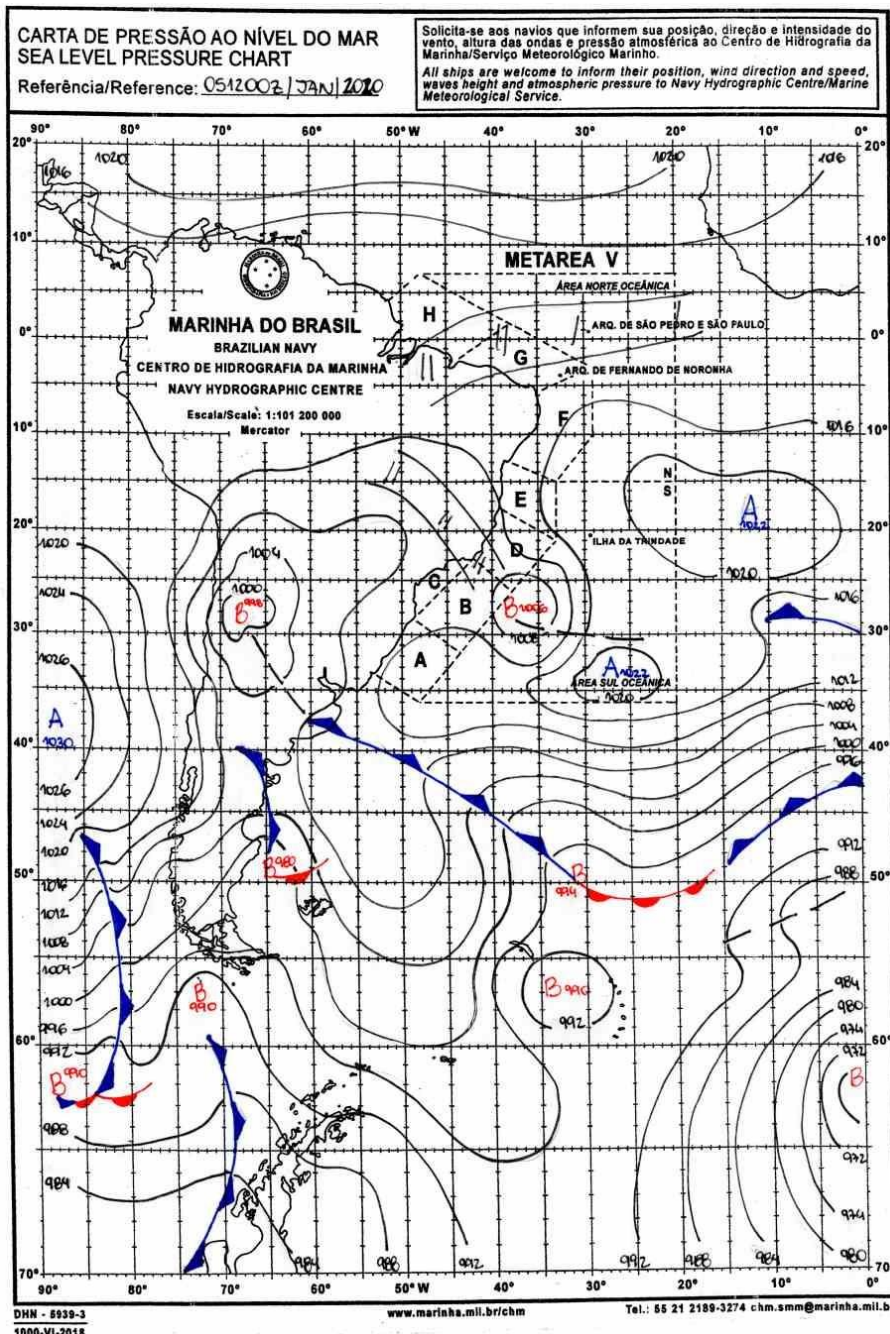

LEGENDA			
	Frente Fria	<b>A</b>	Alta Pressão
	Frente Quente	<b>B</b>	Baixa Pressão
	Instabilidade		Zona de Convergência

Figura A4 - Carta sinótica para as 1200Z do dia 05 de janeiro de 2020 (09h00 do dia 05 de janeiro de 2020 hora local. FONTE: Marinha do Brasil).

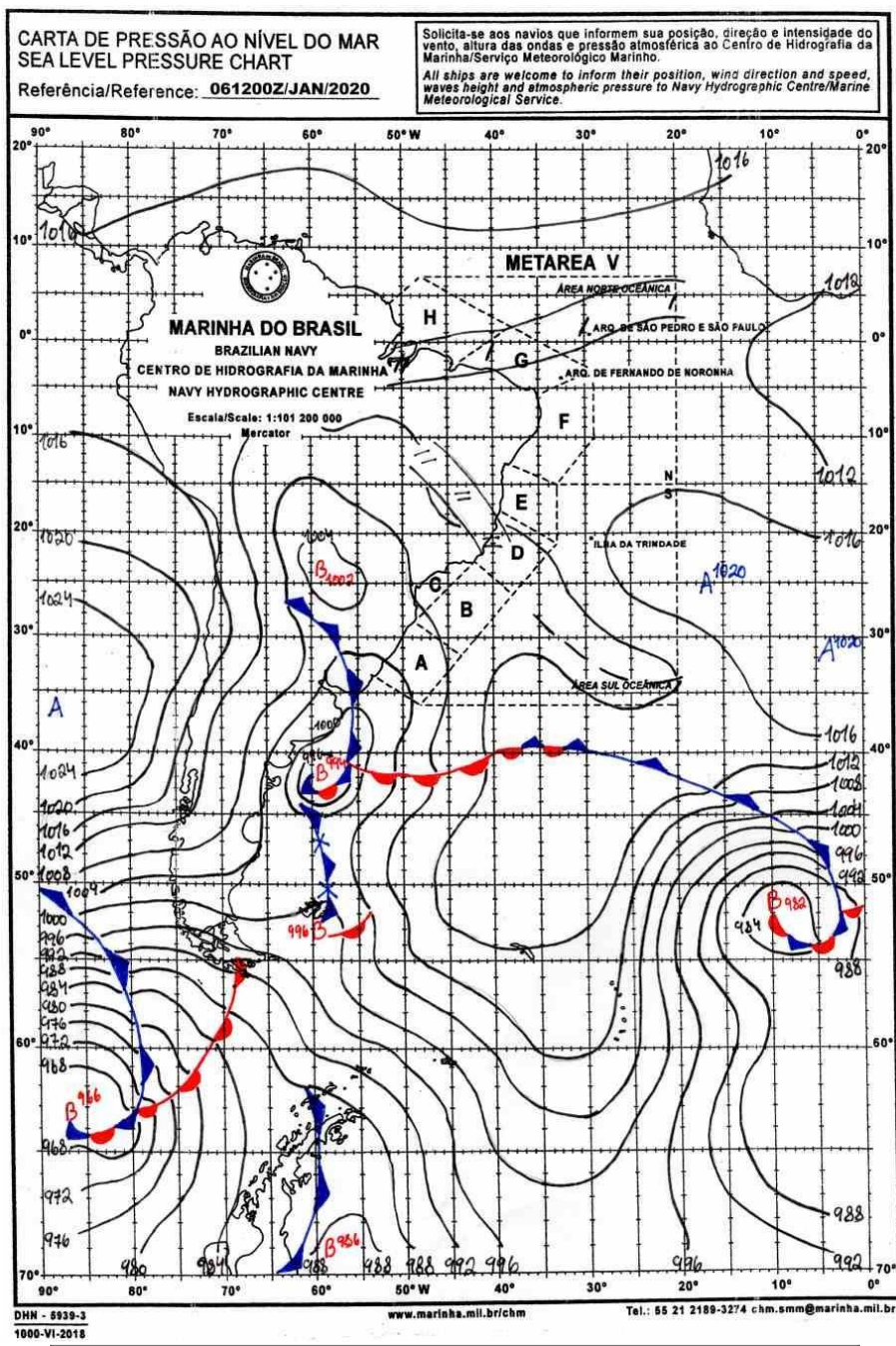

LEGENDA			
	Frente Fria	<b>A</b>	Alta Pressão
	Frente Quente	<b>B</b>	Baixa Pressão
	Instabilidade		Zona de Convergência

Figura A5 - Carta sinótica para as 1200Z do dia 06 de janeiro de 2020 (09h00 do dia 06 de janeiro de 2020 hora local. FONTE: Marinha do Brasil).

## A.2 Média climatológica de precipitação acumulada para janeiro (1981-2010)



Figura A6 - Média climatológica de precipitação acumulada para o mês de janeiro. Fonte: INMET.



---

## A.3 Notícias associadas

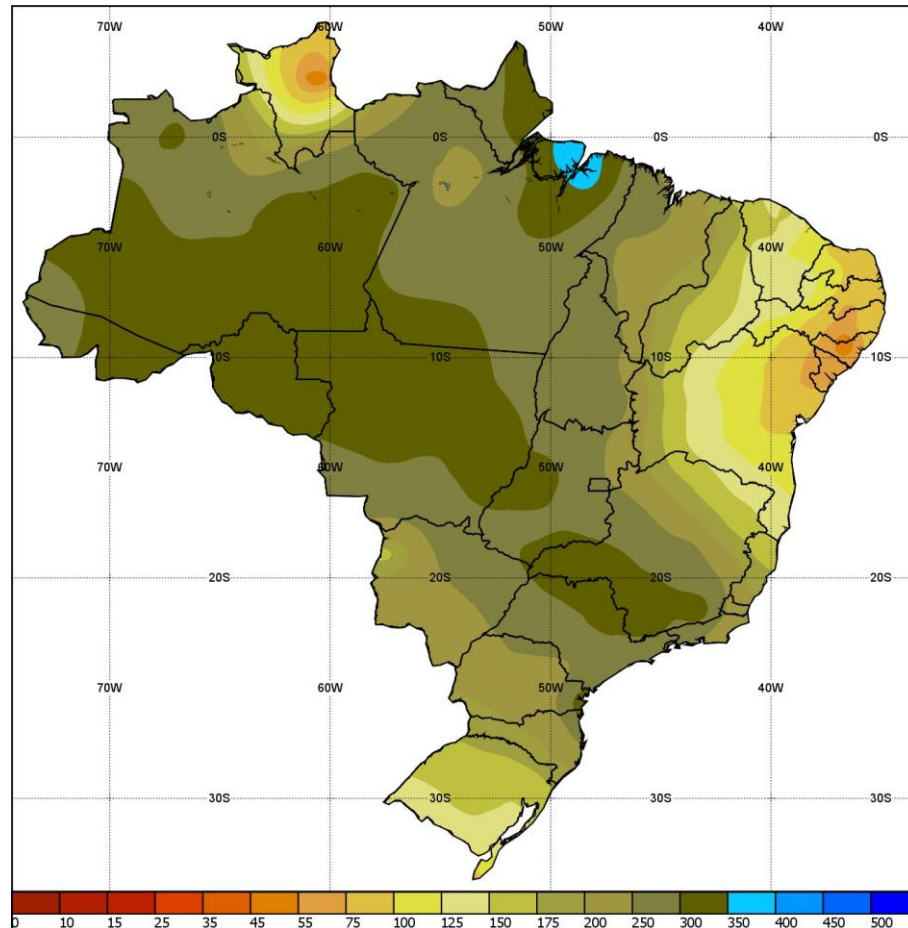
- Muita chuva em GO e no DF

<https://www.climatempo.com.br/noticia/2020/01/06/muita-chuva-em-go-e-no-df-1135>

- Comerciantes e moradores contam prejuízos após forte chuva e rompimento de represa em Pontalina

<https://g1.globo.com/go/goias/noticia/2020/01/06/comerciantes-e-moradores-contam-prejuizos-apos-forte-chuva-e-rompimento-de-represa-em-pontalina.ghtml>

- Suspeita é que chuva causou rompimento de barragem em Goiás

<https://www.metropoles.com/brasil/suspeita-e-que-chuva-causou-rompimento-de-barragem-em-goias>

- Barragem se rompe e inunda parte de cidade após chuvas em GO

<https://www1.folha.uol.com.br/cotidiano/2020/01/barragem-se-rompe-e-inunda-parte-de-cidade-apos-chuvas-em-go.shtml>

Bianca Lobo Silva

Meteorologista

CREA 5063840461

### Instituto Nacional de Meteorologia - INMET

Umidade Relativa do Ar 00h UTC  
Estação: ARAGARCAS (GO) - 01/2020

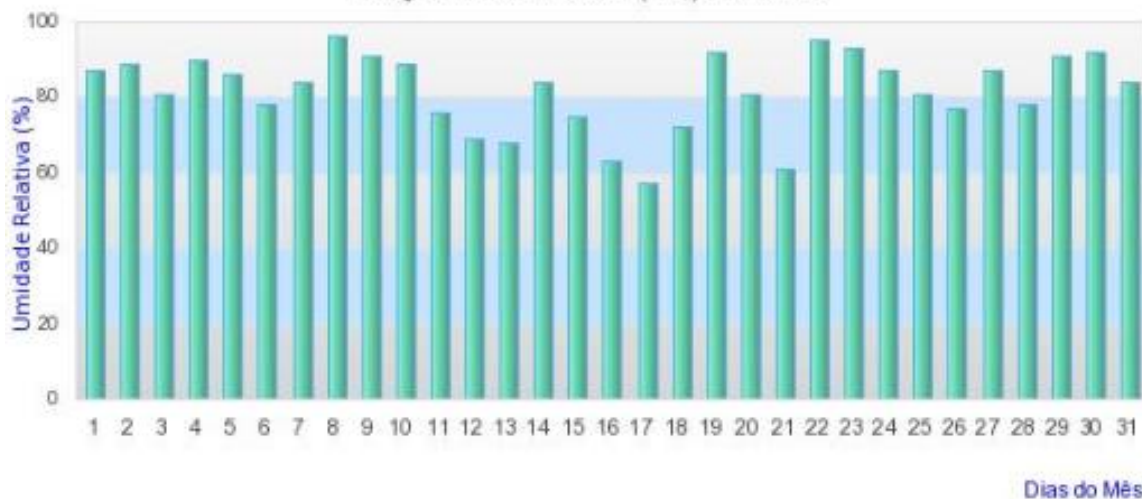

### Instituto Nacional de Meteorologia - INMET

Chuva Acumulada 24h  
Estação: ARAGARCAS - 01/2020



### Instituto Nacional de Meteorologia - INMET

Umidade Relativa do Ar 00h UTC  
Estação: CATALAO (GO) - 01/2020

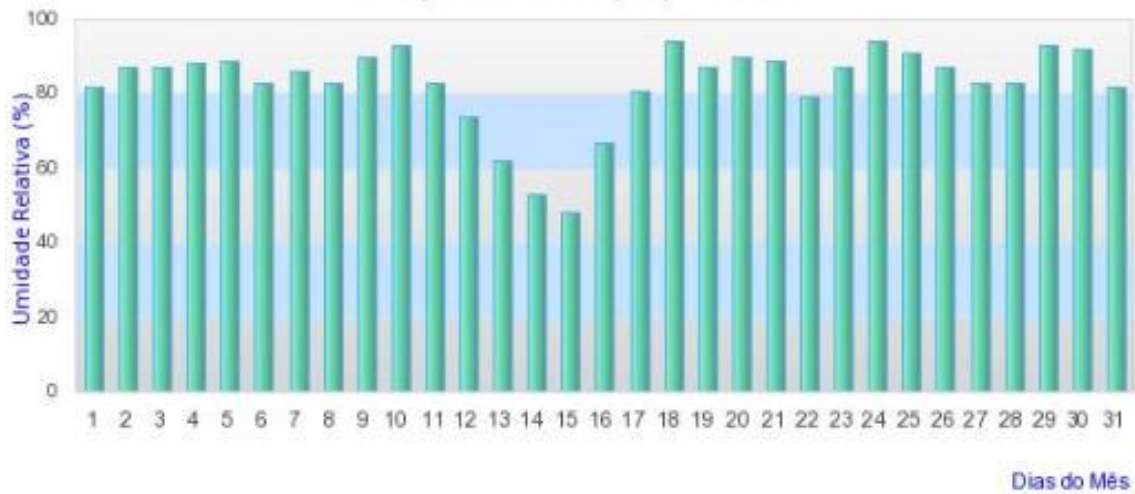

### Instituto Nacional de Meteorologia - INMET

Chuva Acumulada 24h  
Estação: CATALAO - 01/2020





### Instituto Nacional de Meteorologia - INMET

Umidade Relativa do Ar 00h UTC  
Estação: FORMOSA (GO) - 01/2020

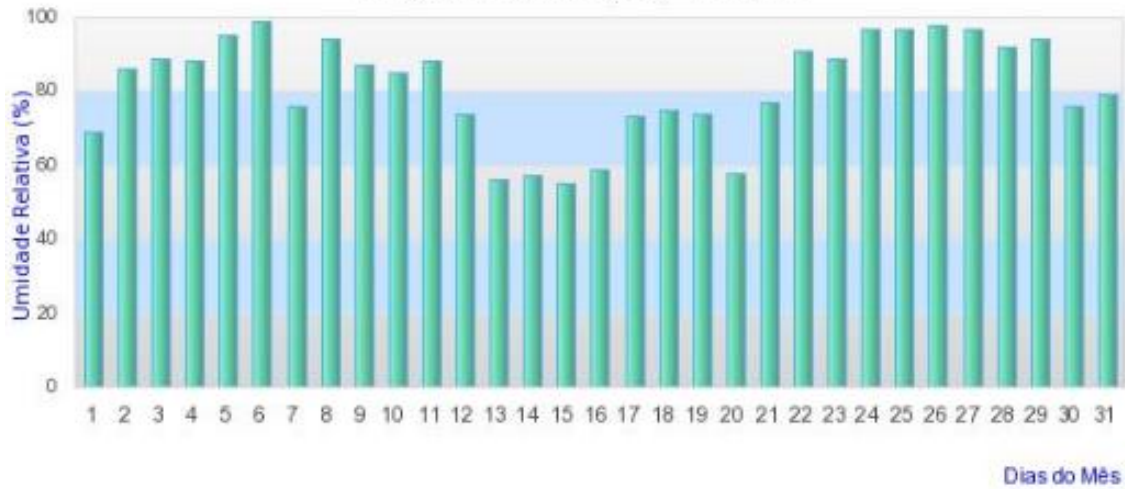

### Instituto Nacional de Meteorologia - INMET

Chuva Acumulada 24h  
Estação: FORMOSA - 01/2020

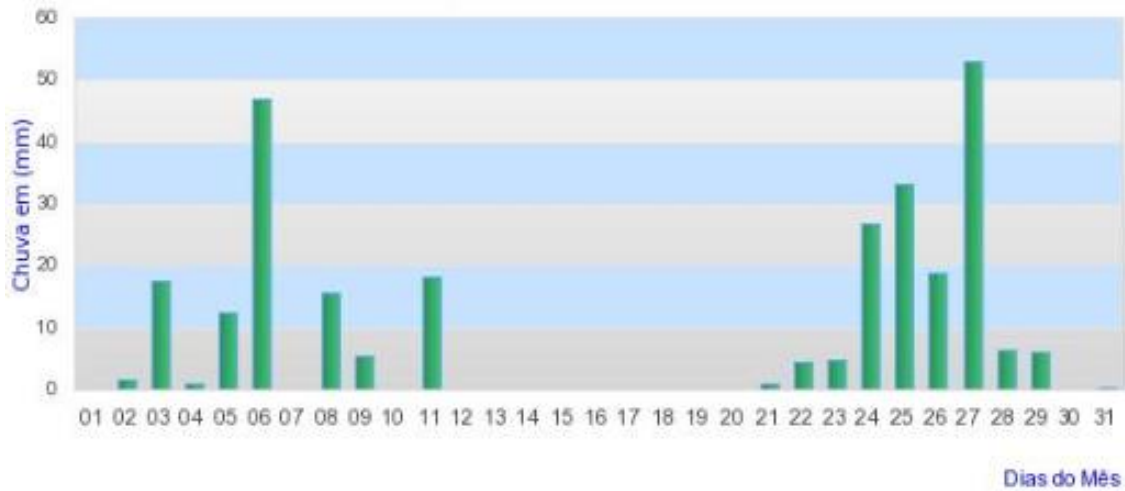

### Instituto Nacional de Meteorologia - INMET

Umidade Relativa do Ar 00h UTC  
Estação: GOIANIA (GO) - 01/2020

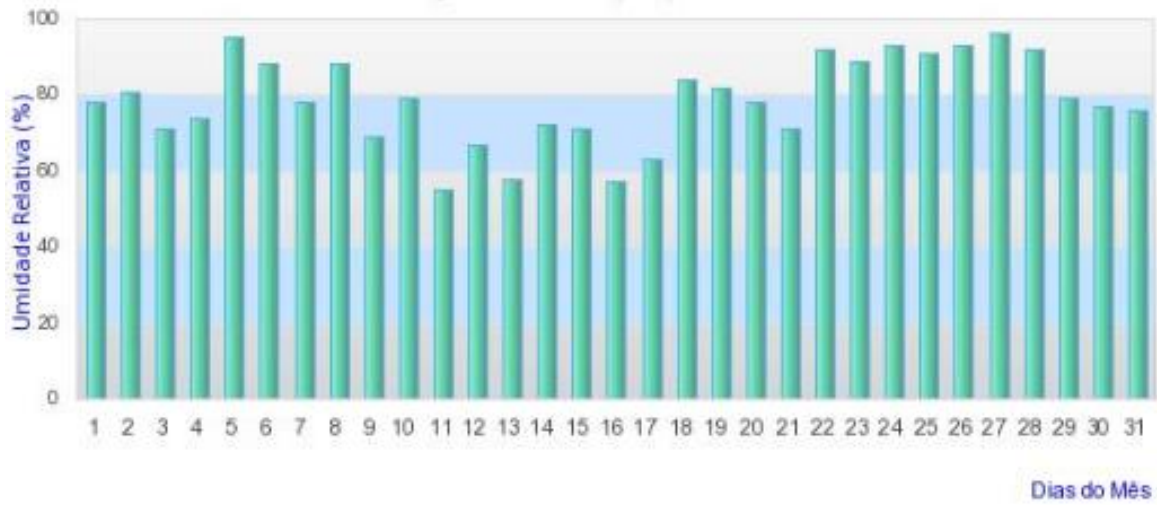

### Instituto Nacional de Meteorologia - INMET

Chuva Acumulada 24h  
Estação: GOIANIA - 01/2020

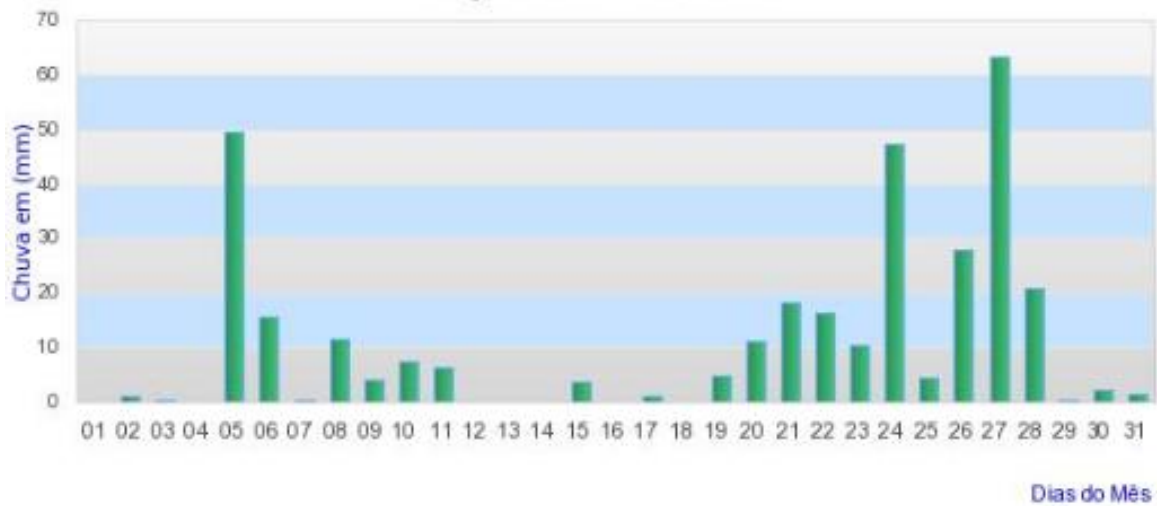

### Instituto Nacional de Meteorologia - INMET

Umidade Relativa do Ar 00h UTC  
Estação: IPAMERI (GO) - 01/2020

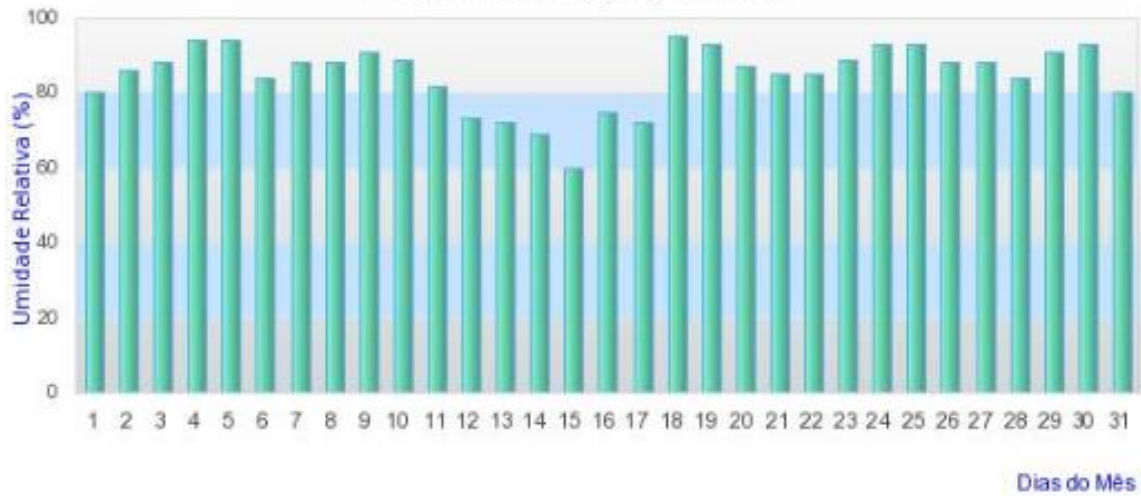

### Instituto Nacional de Meteorologia - INMET

Chuva Acumulada 24h  
Estação: IPAMERI - 01/2020

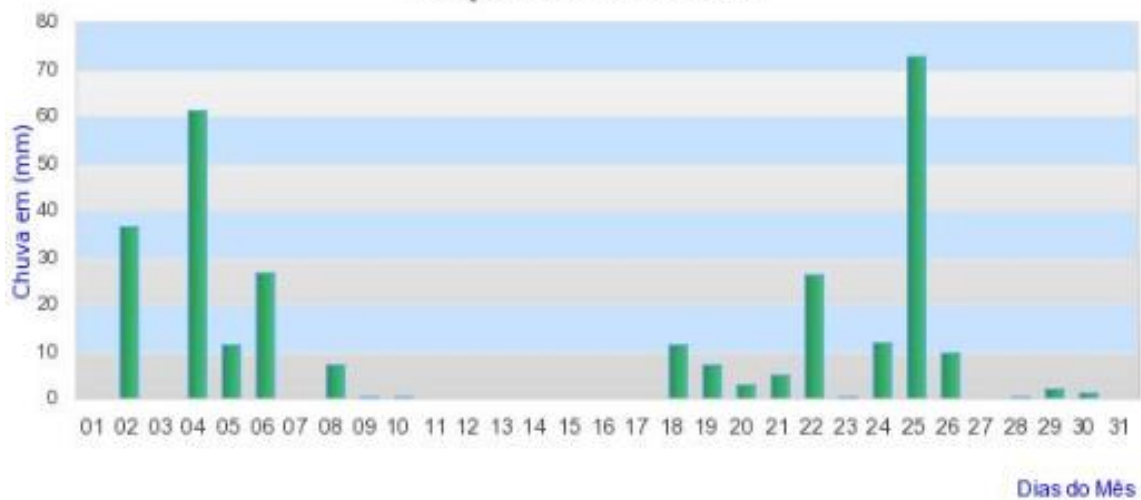

### Instituto Nacional de Meteorologia - INMET

Umidade Relativa do Ar 00h UTC  
Estação: JATAI (GO) - 01/2020

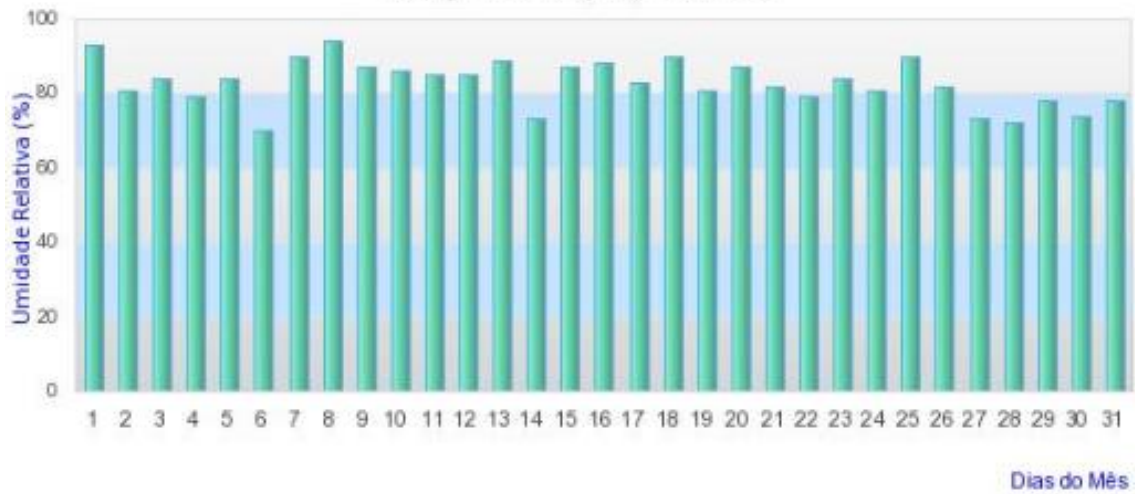

### Instituto Nacional de Meteorologia - INMET

Chuva Acumulada 24h  
Estação: JATAI - 01/2020

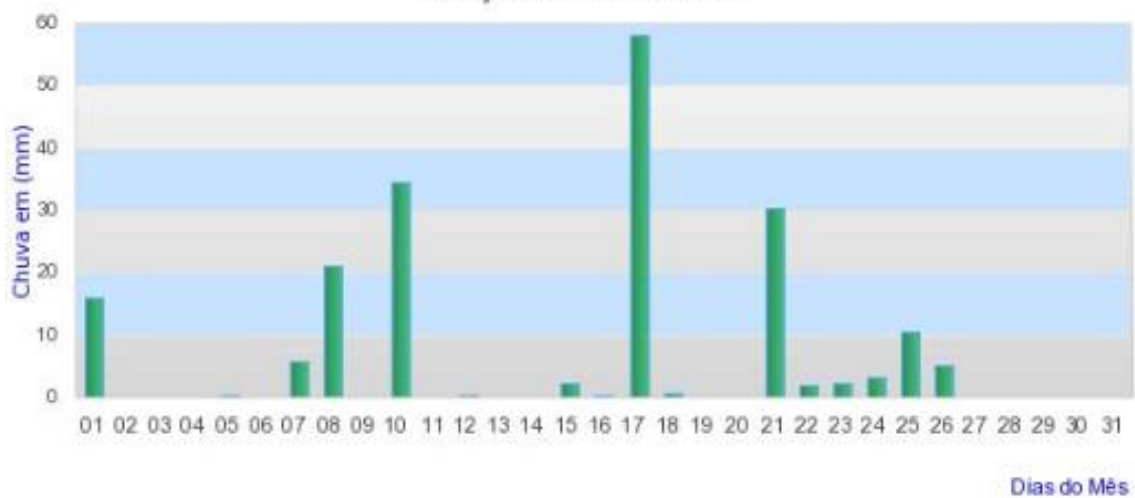

### Instituto Nacional de Meteorologia - INMET

Umidade Relativa do Ar 00h UTC  
Estação: PIRENOPOLIS (GO) - 01/2020

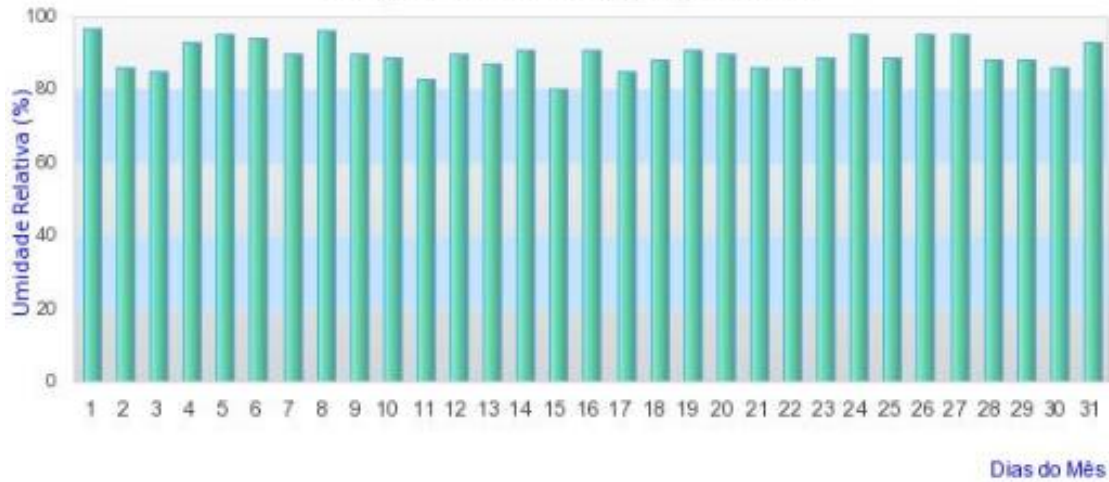

### Instituto Nacional de Meteorologia - INMET

Chuva Acumulada 24h  
Estação: PIRENOPOLIS - 01/2020

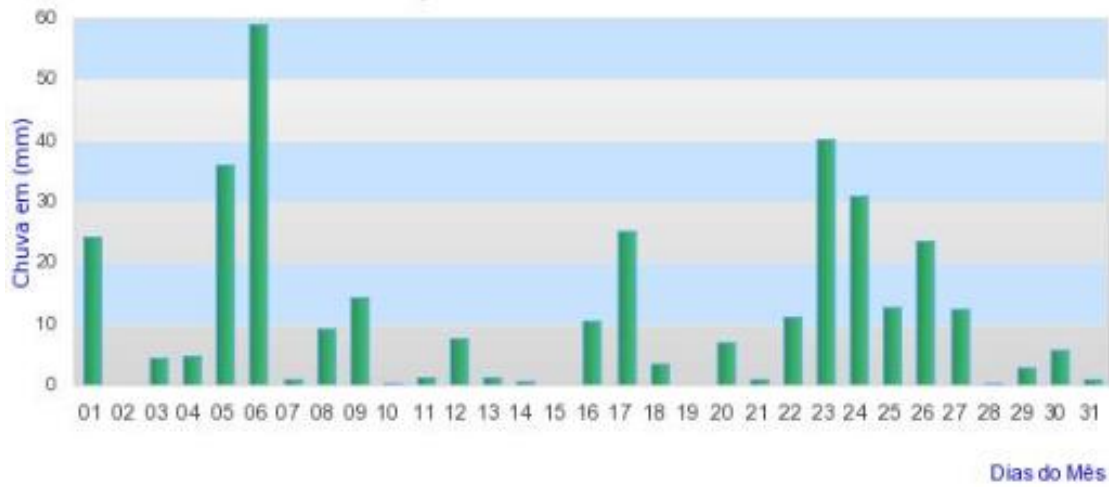



### Instituto Nacional de Meteorologia - INMET

Umidade Relativa do Ar 00h UTC  
Estação: POSSE (GO) - 01/2020

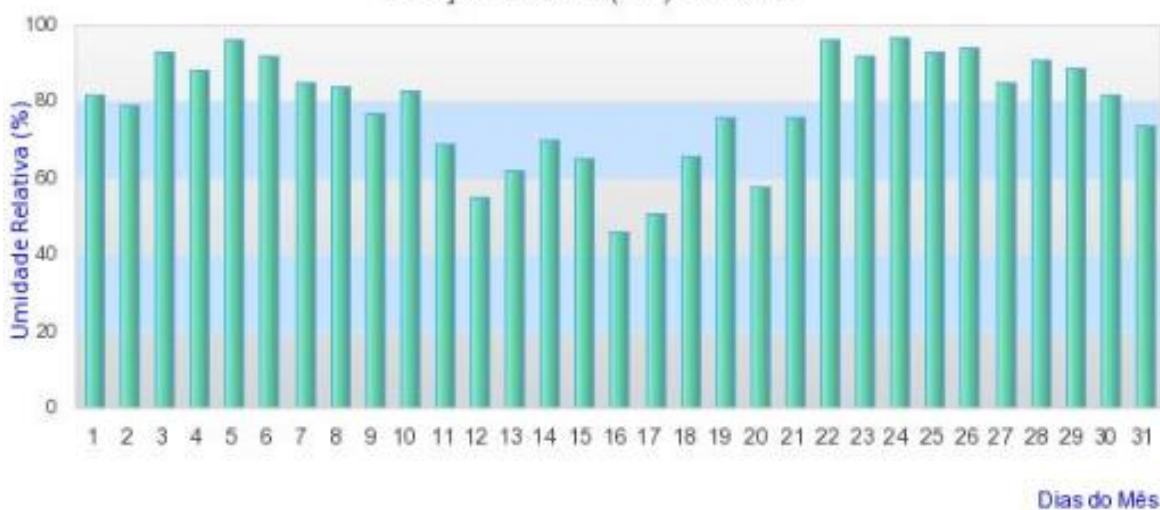

### Instituto Nacional de Meteorologia - INMET

Chuva Acumulada 24h  
Estação: POSSE - 01/2020

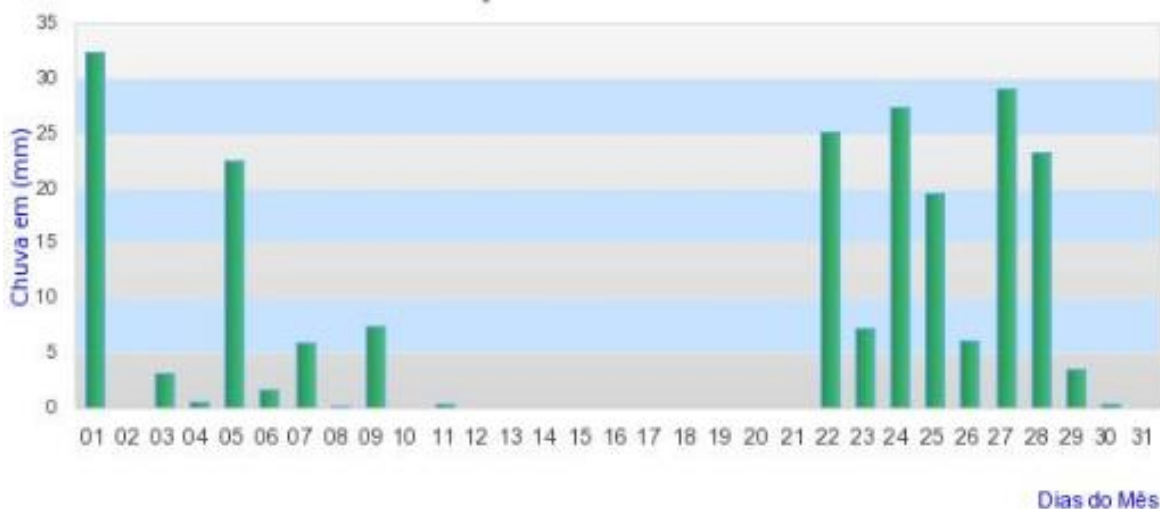

### Instituto Nacional de Meteorologia - INMET

Umidade Relativa do Ar 00h UTC  
Estação: RIO VERDE (GO) - 01/2020

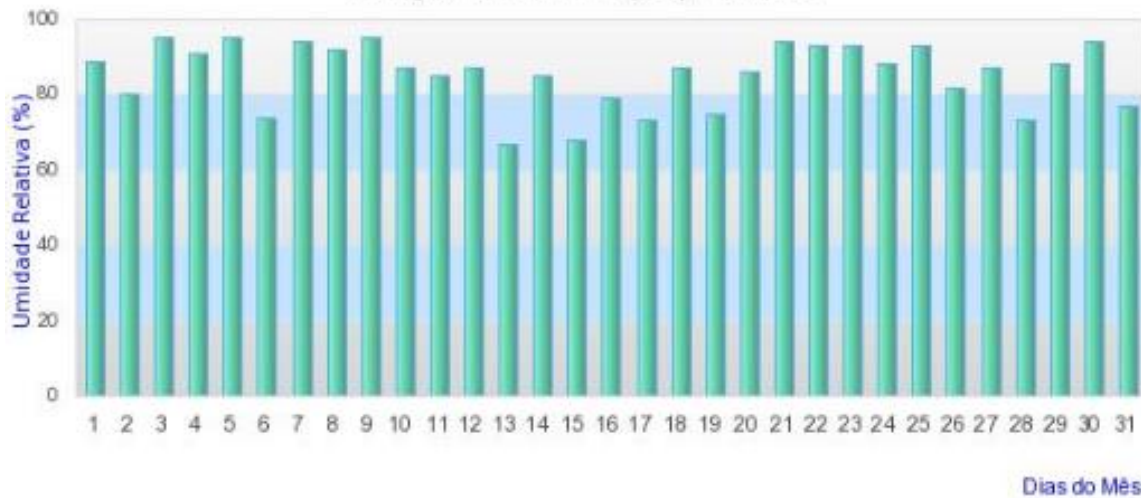

### Instituto Nacional de Meteorologia - INMET

Chuva Acumulada 24h  
Estação: RIO VERDE - 01/2020

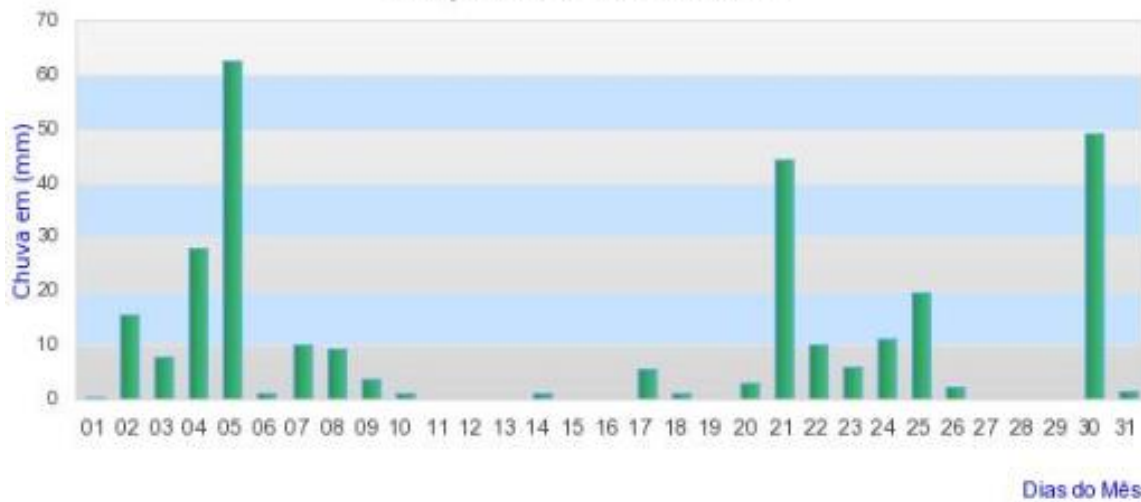

## NOTÍCIAS RELACIONADAS

<https://www.climatempo.com.br/noticia/2020/01/06/muita-chuva-em-go-e-no-df-1135>

<https://www.climatempo.com.br/noticia/2020/01/06/muita-chuva-em-go-e-no-df-1135>

**CLIMATEMPO**

☰ **Previsão do tempo** ▾ **Chuva** ▾ **Satélite** **Vídeos** **Notícias** ▾ S

### Muita chuva em GO e no DF

06/01/2020 às 00:08  
por Josélia Pegorim

compartilhar 

 **Curtir**  **Compartilhar** 1,6 mi pessoas curtiram isso. Cadastre-se para ver do que

---

Oferecimento

---

O estado de Goiás e a região do Distrito Federal ficaram entre as áreas mais chuvosas do país no primeiro fim de semana de 2020. As áreas de instabilidade começam a enfraquecer nesta segunda-feira, 6, mas as pancadas de chuva vão continuar ocorrendo no decorrer da semana.

Com o enfraquecimento das áreas de instabilidade, a nebulosidade diminui um pouco, o que vai permitir períodos com sol especialmente pela manhã. As pancadas de chuva com raios ficam concentradas nos períodos da tarde e noite e ainda podem ser moderadas a fortes em vários locais, incluindo as capitais **Goiânia** e **Brasília**.

<https://g1.globo.com/go/goias/noticia/2020/01/06/comerciantes-e-moradores-contam-prejuizos-apos-forte-chuva-e-rompimento-de-represa-em-pontalina.ghtml>



# Comerciantes e moradores contam prejuízos após forte chuva e rompimento de represa em Pontalina

Vídeos mostram ruas, casas e lojas completamente alagadas. Moradores de quatro casas precisam sair dos imóveis, que foram interditados.

Por Honório Jacometto, Emerson Ferreira e Vanessa Martins, TV Anhanguera e G1 GO

06/01/2020 08h35 - Atualizado há 3 meses



<https://www.metropoles.com/brasil/suspeita-e-que-chuva-causou-rompimento-de-barragem-em-goias>

→ ↻ 🔒 <https://www.metropoles.com/brasil/suspeita-e-que-chuva-causou-rompimento-de-barragem-em-goias>



BRASIL 

## Suspeita é que chuva causou rompimento de barragem em Goiás

Barragem que se rompeu em cidade goiana estava irregular, segundo Secretaria Estadual de Meio Ambiente

FOTO: REPRODUÇÃO



<https://www1.folha.uol.com.br/cotidiano/2020/01/barragem-se-rompe-e-inunda-parte-de-cidade-apos-chuvas-em-go.shtml>

# Barragem se rompe e inunda parte de cidade após chuvas em GO

Entre sexta (3) e sábado, choveu 191 milímetros, o equivalente a 76% do volume de chuva esperado para todo o mês



Dia: 04/01/2020  
Cidade: Pontalina

Relato: Fortes chuvas fazem represa do município de Pontalina se romper.





Dia:02/01/2020

Cidade: Luziânia

Relato: após receber informação e vídeo de cabo partido, foi aberto o alimentador 7 da SE rio vermelho em caráter emergencial através da chave LZ 16 410100, 1090 clientes interrompidos.



Dia:02/01/2020

Cidade: Cristalina

Relato: Bloqueio do alimentador Pamplona – Alphaville manobras sem sucesso de energização Equipe informou jump partido e poste quebrado sérvios atrasou se devido chuva na região



Relato: chuvas intensas nos dias 08 e 09/01/2020 em todo entorno do DF estas imagens foram gravadas na cidade de Valparaiso de Goiás

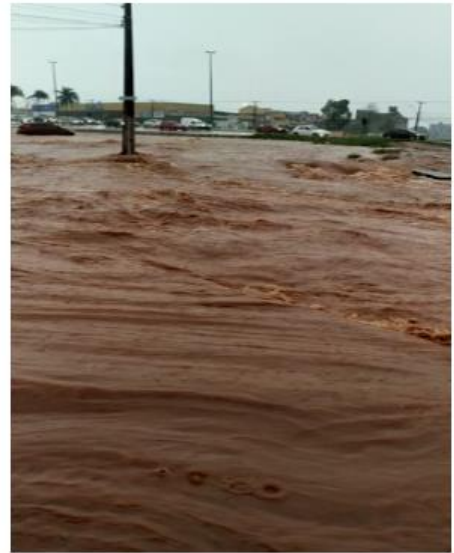

Dia:09/01/2020  
Cidade: Valparaiso



Dia:09/01/2020  
Cidade: Aguas Lindas

Relato: chuvas intensas nos dias 08 e 09/01/2020 em todo entorno do DF estas imagens foram gravadas na cidade de Aguas Lindas de Goiás



**CIDADE:** PALESTINA - GO

**DIA:** 03-01-2020

**RELATO:** ÁRVORE CAIU NA RODOVIA GO – 221 DEVIDO AO VENDAVAL, EQUIPE EM ATENDIMENTO EMERGENCIAL TEVE UM RETARDAMENTO ATÉ A CHEGADA DO CORPO DE BOMBEIRO PARA FAZER A RETIRADA DA MESMA.



**CIDADE:** PALESTINA - GO

**DIA:** 03-01-2020

**RELATO:** ÁRVORE CAIU NA RODOVIA GO – 221 DEVIDO AO VENDAVAL, EQUIPE EM ATENDIMENTO EMERGENCIAL TEVE UM RETARDAMENTO ATÉ A CHEGADA DO CORPO DE BOMBEIRO PARA FAZER A RETIRADA DA MESMA.



**CIDADE:** SÃO LUIZ MONTES BELO

**DIA:** 04-01-2020

**RELATO:** FORTE CHUVA NA REGIÃO OCASIONOU ROMPIMENTO DO BUEIRO E TODA A ESTRADA FOI LEVADA PELA FORÇA DA AGUA, ATRAPALHANDO O ATENDIMENTO DE EMERGÊNCIA.



**CIDADE:** ITAPIRAPUA - GO

**DIA:** 05-01-2020

**RELATO:** RIO TRANSBORDOU DEVIDO FORTES CHUVA NA REGIÃO DE BOM JARDIM E BALIZA DIFICULTANDO ATENDIMENTO DE EMERGÊNCIA.





**CIDADE:** BRITANIA - GO

**DIA:** 06-01-2020

**RELATO:** DEVIDO ÀS CHUVAS INTENSAS, EQUIPE TEVE GRANDES DIFICULDADES PARA ATENDER OCORRÊNCIAS DEVIDO A CÔRREGOS QUE TRANSBORDARAM ATRAPALHANDO O ACESSO.

**CIDADE:** JUSSARA - GO

**DIA:** 07-01-2020

**RELATO:** FORTES VENDAÍAS NA REGIÃO DE JUSSARA OCASIONOU DANOS A REDE DE ENERGIA, ÁRVORES CAIDA SOBRE A REDE E IMPEDINDO O ACESSO A PONTO DE DEFEITO.



Dia:02/01/2020  
Cidade: Goiânia

**Relato:** Chuva com vendaval



Dia:02/01/2020  
Cidade: Goiânia

**Relato:** Grande chuva com fortes ventos diversas arvores quebradas





Dia: 05/01/2020  
Cidade: Goiânia

**Relato:** Grande chuva com fortes ventos diversas arvores quebradas, e outdoors caídos

Dia: 04/01/2020  
Cidade: Anápolis

**Relato:** Forte chuva atingiu Anápolis no sábado (04/01) que fizeram estragos em ruas e avenidas, como também deixaram várias famílias desabrigadas. Houve quedas de energia em várias regiões da cidade.



Prefeitura de Anápolis cria força-tarefa para evitar transtornos devido às fortes chuvas

domingo 05 janeiro 2020 11:55 — Por Livia Barbosa —

Foram disponibilizados alojamentos no Ginásio Internacional Newton de Faria para as pessoas e famílias que estiverem desabrigadas